

ANC



POPULAR MECHANICS

MAGAZINE

WRITTEN SO YOU CAN UNDERSTAND

REG. TRADE MARK GREAT BRITAIN NO. 410426



BUILD YOUR OWN URANIUM DETECTOR - Page 238

Imagine
Dad
 selling me
 on a
 Whizzer!



SAY, EDDIE, YOUR FRIEND BOB TELLS ME HE'S HAD A WHIZZER MOTOR PUT ON HIS BIKE



YEAH, NOT A BAD IDEA

NOT A BAD IDEA! LISTEN — HE GETS 125 MILES ON A GALLON OF GAS!



THAT'S GOOD, ISN'T IT?

DO YOU THINK I CAN PAY FOR ONE OUT OF MY ALLOWANCE?



SURE YOU CAN — A WHIZZER IS EASY TO OWN AND IT COSTS ONLY \$10 A YEAR TO RUN. BETTER TRY A WHIZZER, EDDIE

SEE, JUST LIKE I SAID — DAD TALKED ME INTO IT



FOR FUN, FOR THRIFT, FOR WORK, IT'S WISE TO GO WHIZZER!

COMPLETE WITH ALL NECESSARY ATTACHMENTS

\$109⁹⁷

Federal Tax Included. F. O. B. Pontiac, Mich.

Fits any man's balloon-tire bike

Twist-Grip Controls

Steel Cable Core Notched V-belt Drive

Rugged 2½ h.p. 4-cycle engine

Over 4000 Whizzer Dealers coast to coast

For free literature, write WHIZZER MOTOR COMPANY, Pontiac, Michigan

Research keeps

B.F. Goodrich

FIRST IN RUBBER



1 "...NEVER RECEIVED better service from any tire," says H. L. Smith, Unicori, Tenn. His B. F. G. tires have gone 30,595 miles, half of it over rocky roads.



2 "THESE TIRES had gone 49,723 miles when the picture was taken and I believe are good for another 10,000," writes P. U. Alexander, Goose Creek, Texas.



3 WRITES E. B. PALMER of Denver: "I drive . . . at comparatively high speeds. This B. F. Goodrich tire has been driven 36,664 miles. It still has a good tread."

*...That's why users
get more miles with
B.F. Goodrich tires!*

PREMIUM SILVERTOWN
Highest quality

B. F. G. EXTRA-CUSHION
Easiest riding

B. F. G. SILVERTOWN
Lowest cost per mile

B. F. G. DEFIANCE
Lowest price



GET A JOB IN AVIATION

No Experience Needed . . .

Good Pay While Learning

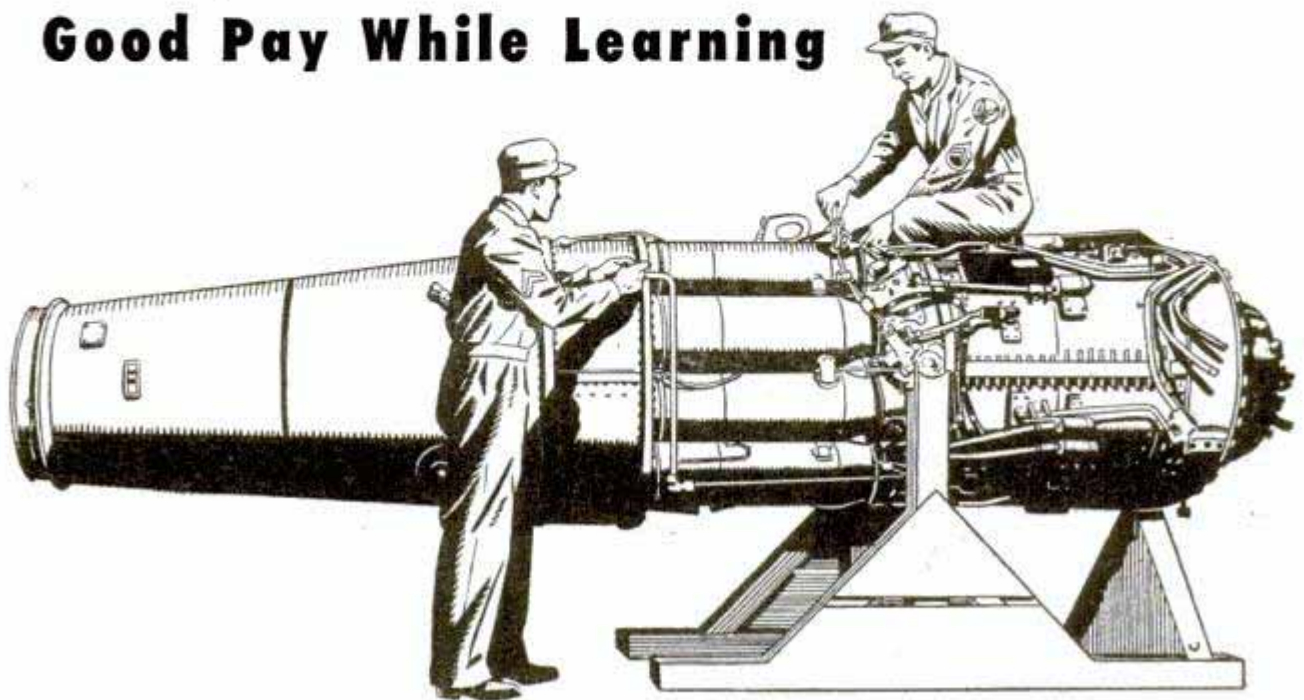

If you are looking for a job with a *real* future, get into aviation . . . NOW. Today's *best* deal for the aviation beginner is in the United States Air Force. Look into the opportunities it offers and see for yourself.

EARN WHILE LEARNING. You get good pay *right from the start* in the Air Force . . . \$75 a month in cash . . . *free* room and board . . . *free* clothing and equipment . . . *free* medical and dental care . . . *free* retirement plan. Air Force beginner's pay is equal to at least \$3,000 a year in civilian life. Where can you match that?

BEST OF TRAINING. Two kinds of training are open to men in the Air Force. You can learn on the job, under the world's most skilled experts. Or, if you qualify, you can go to the finest

Air Force technical schools while vacancies exist. It would cost hundreds of dollars to get such training elsewhere.

PROMOTIONS. Advancement in the Air Force is based on merit. Better jobs . . . non-commissioned ratings . . . go to the qualified men next in line. Right now skilled men are needed.

This is your *big* opportunity. Look into it *today*. You can get full details, without obligation, at your nearest Recruiting Station, Air Force Base, or by writing: Chief of Staff, U. S. Air Force, Att.: PMP-3A, Washington 25, D. C.

**VOLUNTEER
TODAY**



**FOR THE
U. S. AIR FORCE**

U. S. ARMY and U. S. AIR FORCE RECRUITING SERVICE

Popular Mechanics Magazine

Registered in U. S. Patent Office and Canada

H. H. WINDSOR, Founder

H. H. WINDSOR, Jr., Editor and Publisher



Posies for "Vittles" Pilot

GRATEFUL for food and coal delivered by the air lift, a German girl presents a bouquet to an American pilot.

"Life Line to Berlin," page 114, is the story of this great air operation by Associate Editor Cookman, who flew from Chicago to Berlin. Wrapped in fog of arm's-length visibility he wrote home this lamentation from Frankfurt:

"Dear Boss: Got a crying towel handy? For the umpteenth time fog has me tied down tighter than a drum. On the heels of the 96-hour session the papers call the longest in Europe's history, another fog moved in last night and socked this place (Rhein-Main) and Wiesbaden in for the day. A C-54 attempting to push through at Fassberg this morning crashed and killed all its occupants. I sat up last night from Strasbourg here, and what with border authorities, etc., took 5½ hours to go 150 miles. They are letting nothing up this morning. I was told to go back to the hotel and sit close to a phone, in case the weather improved . . ."

Editor's note: He got there, as always—to Bikini in '46, to Alaska in '48. In fact, having spent several days in Berlin, he beat the above air-mailed letter to his office by a day.

Volume 91 FEBRUARY 1949 Number 2

Managing Editor..... Roderick M. Grant
 Assistant Managing Editor..... Wayne Whittaker
 Shop Notes and Crafts Editor..... James R. Ward
 Radio-Television, Electronics Editor..... Frank L. Brittin
 Associate Editor, Aviation..... Aubrey O. Cookman, Jr.
 Associate Editor..... Clifford B. Hicks
 Eastern Editor..... Bill Reiche
 Western Editor..... Thomas E. Stimson, Jr.
 Art Director..... Frank Beatty

Assistant Editors
 Donald R. Brooks Dorothy E. Hoffmann Arthur R. Railton

Assistant Editors, Shop Notes and Crafts
 W. Clyde Lammey Wayne C. Leckey Frank N. Stephany A. E. Youngquist

In This Issue

'49 Uranium Rush - - - - -	89
Uncle Sam's Stamp Factory - - - - -	100
Hell's Canyon Mailman - - - - -	104
Life Line to Berlin - - - - -	114
Debut for the '49 Chevrolet - - - - -	130
<u>The Power Line Comes to Yellowknife</u>	<u>134</u>
<u>King of the Mushers - - - - -</u>	<u>141</u>
<u>Television Mountain - - - - -</u>	<u>152</u>
<u>Armed With a Camera - - - - -</u>	<u>158</u>
<u>Mining a Marble Mountain - - - - -</u>	<u>168</u>
<u>Engineering Better Meat - - - - -</u>	<u>174</u>

For the Craftsman

<u>Projects in Plastic - - - - -</u>	<u>182</u>
<u>Furniture for Your Bedroom—Part I</u>	<u>190</u>
<u>11½-Ft. Plywood Rowboat - - - - -</u>	<u>202</u>
<u>Five Kwikie Projects - - - - -</u>	<u>209</u>
<u>Build Your Own Tool-Post Turret</u>	<u>221</u>
<u>Broadcast Seeder Mounts on Tractor</u>	<u>226</u>
<u>Bandsaw Know-How - - - - -</u>	<u>230</u>
<u>Radio-Television, Electronics - - - - -</u>	<u>237</u>
<u>Clinic for Homemakers - - - - -</u>	<u>248</u>

Other items, and manufacturers of available products described, are listed on pages 8 and 10

Published monthly by POPULAR MECHANICS COMPANY, 200 East Ontario Street, Chicago 11, Ill. H. H. Windsor, Jr., president; Paul H. Dunakin, vice president and general manager; D. F. Windsor, vice president and secretary-treasurer; William Harrison Petridge, vice president and assistant to the publisher; Clover L. Perkins, advertising manager; Alan M. Deyoe, circulation manager. Single copy in the United States and Canada, 35 cents; subscription rates in United States and possessions, Canada, Philippines and countries of the Pan-American Postal Union, 1 year, \$3.50; 2 years, \$6.00; 3 years, \$8.00. To all other countries add \$1.00 a year over United States prices for overseas postage. If you plan to move, notify us at least 30 days in advance so you will not miss an issue. Give both old and new addresses. Entered as Second Class Matter, September 15, 1903, at the Post Office at Chicago, Illinois, under Act of March 3, 1879. Entered as Second Class Matter at Post Office Dept., Canada. Copyright 1949 by Popular Mechanics Company. Copyright under International Copyright Union. Copyright in France. All rights reserved under Pan-American Copyright Union. Printed in the United States of America

What's Your choice?...

of these sturdy, dependable
Low-Cost
Marlin .22's

TUBULAR MAGAZINE
 18-25 shots on one loading
\$26.95*
**Price slightly higher west of the Rockies.*

MARLIN MODEL 81-DL

Shooting efficiency, with *least* fuss and bother! Magazine holds a load for a full day's hunting. Patented non-jamming feed. Shoots .22 short, long and long rifle cartridges—regular and high speed without adjustment. Quick-release trigger—self-cocking action—side ejection—Off and On safety—American walnut stock. Available with peep sight or open sights; sling strap swivels.



Unbeatable for pests and vermin...owls; rats, hawks and crows, the 81-DL carries up to 25 shots.

BOYS!

Be a ranger. Write Sportsmen's Service Bureau, 343 Lexington Avenue, New York, for FREE booklet.

NEW Marlin Catalog, with complete specifications, now available. Send 10 cents to Dept. 61, Marlin.

CLIP MAGAZINE
 for rapid fire

\$22.90*
**Price slightly higher west of the Rockies.*

MARLIN MODEL 80-DL

Whale of a value—this man-sized .22 repeater! Ready for instant action on vermin or small game. 8 rapid-fire shots to get 'em, no matter how fast they run. Quick-release trigger—self-cocking action—side ejection—Off and On safety—American walnut stock. Available with peep sight or open sights; sling strap swivels. More sport for your money with Marlin's 80-DL!



Marlin's 80-DL is a sure getter of woodchuck, raccoons, rabbits and other fur-bearing game.

THE MARLIN FIREARMS CO. • NEW HAVEN, CONN.

SPORTSMEN'S SET—collar and tie clasp—real jewelry, richly gold-plated. Yours for only 50¢ with box top of Marlin Blades; 25¢ with 3 box tops. Address Dept. 62, MARLIN, New Haven, Conn.



Inseparable

GOOD CRAFTSMANSHIP...GOOD TOOLS

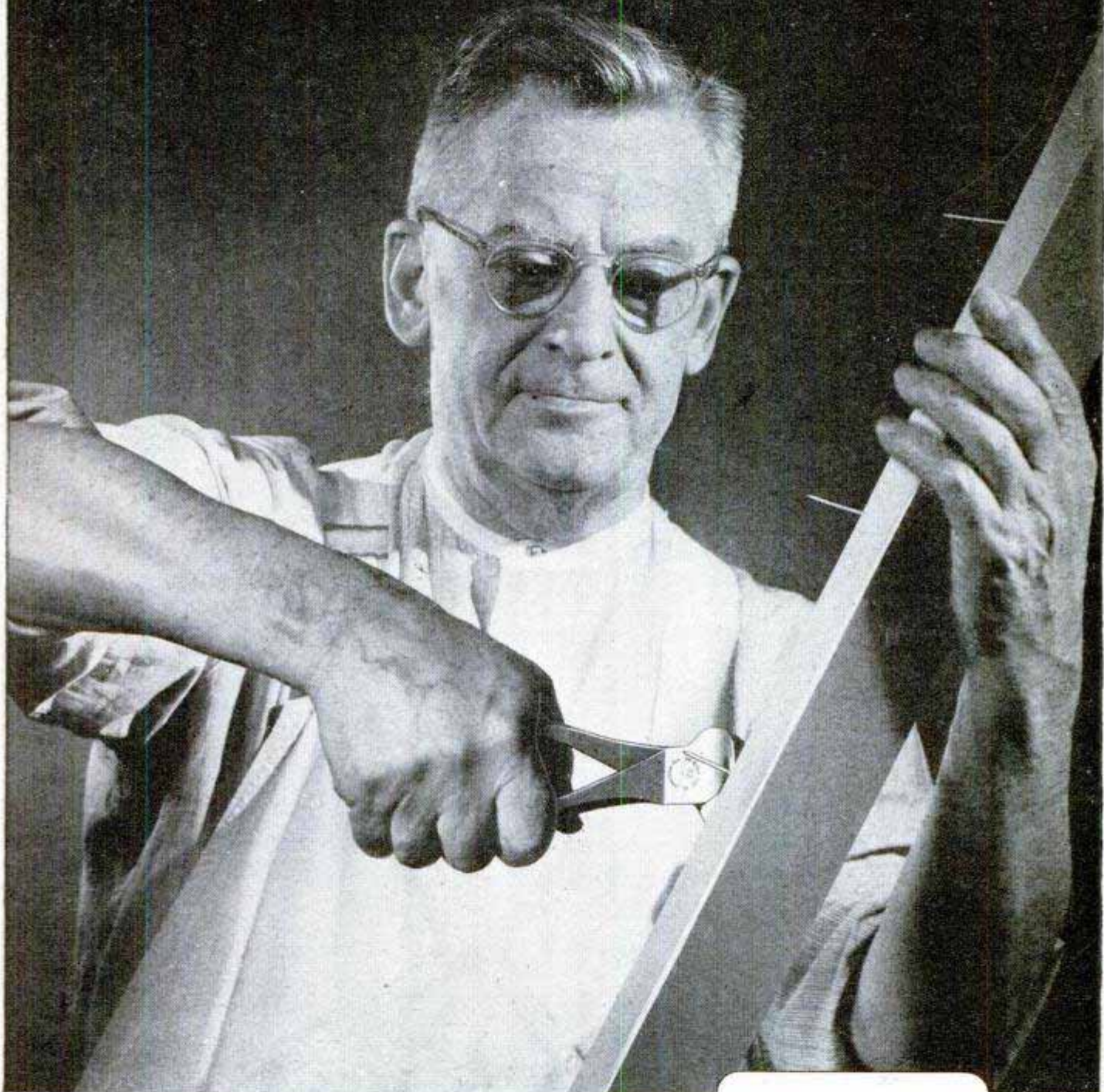

"CRESCENT" is our trade-mark registered in the United States and foreign countries for wrenches and other tools. "Crescent" tools are made only by Crescent Tool Company of Jamestown, N. Y., and are sold by leading distributors everywhere.

CRESCENT TOOL COMPANY,
Jamestown, N. Y.

CRESCENT TOOLS

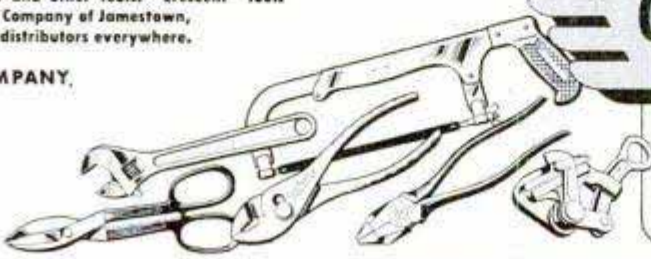

*Sign of the Artisan
Symbol of Excellence*





**KNOWLEDGE
THAT HAS
ENDURED WITH THE
PYRAMIDS**

A SECRET METHOD FOR THE MASTERY OF LIFE

WHENCE came the knowledge that built the Pyramids and the mighty Temples of the Pharaohs? Civilization began in the Nile Valley centuries ago. Where did its first builders acquire their astounding wisdom that started man on his upward climb? Beginning with naught they overcame nature's forces and gave the world its first sciences and arts. Did their knowledge come from a race now submerged beneath the sea, or were they touched with Infinite inspiration? From what concealed source came the wisdom that produced such characters as Amenhotep IV, Leonardo da Vinci, Isaac Newton, and a host of others? Today it is known that they discovered and learned to interpret certain *Secret Methods* for the development of their inner power of mind. They learned to command the inner forces within their own beings, and to master life. This secret art of living has been preserved and handed down throughout the ages. Today it is extended to those who dare to use its profound principles to meet and solve the problems of life in these complex times.

This Sealed Book—FREE

Has life brought you that personal satisfaction, the sense of achievement and happiness that you desire? If not, it is your duty to yourself to learn about this rational method of applying natural laws for the mastery of life. To the thoughtful person it is obvious that everyone cannot be entrusted with an intimate knowledge of the mysteries of life, for everyone is not capable of properly using it. But if you are one of those possessed of a true desire to forge ahead and wish to make use of the subtle influences of life, the Rosicrucians (not a religious organization) will send you A Sealed Book of explanation without obligation. This Sealed Book tells how you, in the privacy of your own home, without interference with your personal affairs or manner of living, may receive these secret teachings. Not weird or strange practices, but a rational application of the basic laws of life. Use the coupon, and obtain your complimentary copy.

The ROSICRUCIANS

SAN JOSE (AMORC) CALIFORNIA



AMENHOTEP IV
Founder of Egypt's
Mystery Schools

Use this
coupon for
FREE
copy of book

SCRIBE J. D. D.
The Rosicrucians (AMORC)
San Jose, California

Please send free copy of Sealed Book,
which I shall read as directed.

NAME.....
ADDRESS.....
CITY.....

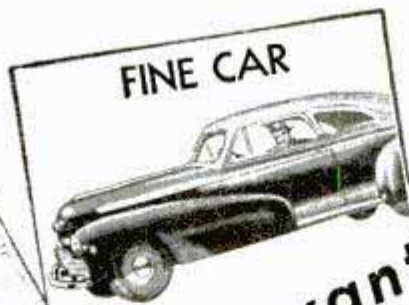

To the man who wants to enjoy
an **ACCOUNTANT'S** CAREER



IF you're that man, here's something that will interest you.

Not a magic formula—not a get-rich-quick scheme—but something more substantial, more practical.

Of course, you need something more than just the desire to be an accountant. You've got to pay the price—be willing to study earnestly, thoroughly.

Still, wouldn't it be worth your while to sacrifice some of your leisure in favor of interesting home study—over a comparatively brief period? Always provided that the rewards were good—a salary of \$3,000 to \$10,000?

An accountant's duties are interesting, varied and of real worth to his employers. He has *standing!*

Do you feel that such things aren't for you? Well, don't be too sure. Very possibly they *can* be!

Why not, like so many before you, investigate LaSalle's modern Problem Method of training for an accountancy position?

Just suppose you were permitted to work in a large accounting house under the personal supervision of an expert accountant. Suppose, with his aid, you studied accounting principles and solved problems day by day—easy ones at first—then more difficult ones. If you could do this—and could turn to him for advice as the problems became complex—soon you'd master them all.

That's the training you follow in principle under the LaSalle Problem Method.

You cover accountancy from the basic Principles right up through Accountancy Systems and Income Tax Procedure. Then you add C. P. A. Training and prepare for the C. P. A. examinations.

As you go along, you absorb the principles of Auditing, Cost Accounting, Business Law, Statistical Control, Organization, Management and Finance.

Your progress is as speedy as you care to make it—depending on your own eagerness to learn and the time you spend in study.

Will recognition come? The only answer, as you know, is that success *does* come to the man who is really *trained*. It's possible your employers will notice your improvement in a very few weeks or months. Indeed, many LaSalle graduates have paid for their training—with increased earnings—before they have completed it! For accountants, who are trained in organization and management, are the executives of the future.

Write For This Free Book

For your own good, don't put off investigation of *all* the facts. Write for our free 48-page book, "Accountancy, The Profession That Pays." It'll prove that accountancy offers brilliant futures to those who aren't afraid of serious home study. We'll also include "Ten Years' Promotion in One"—a book which has helped many men. Send us the coupon *now*.

**LASALLE EXTENSION
CHICAGO 5, ILL.**

Over 2800 Certified
Public Accountants among
LaSalle alumni

Other LaSalle Opportunities

- Higher Accountancy
- C.P.A. Coaching
- Bookkeeping
- Law: LL.B. Degree
- Business Management
- Salesmanship
- Traffic Management
- Foremanship
- Industr'l Management
- Stenotypy
(Machine Shorthand)

LASALLE EXTENSION UNIVERSITY A CORRESPONDENCE INSTITUTION

417 S. Dearborn St. Dept. 264-HR Chicago 5, Ill.

I want to be an accountant. Send me without obligation, "Accountancy, the Profession that Pays" training program—also "Ten Years' Promotion in One."

Name.....Age.....

Address.....

City, Zone & State.....



Wintertime is Time for PYROIL

* The viscosity of lubricating oil increases as temperature is lowered. Winter oil is a low viscosity oil to help you start your car in cold weather. But after starting, the running temperature of the engine is the same as summer, and the low viscosity oil needs PYROIL more than ever. PYROIL permits oil rings and piston rings to work freely, without "pumping" due to gum and sludge. PYROIL gives oil the property of clinging to cylinder walls, protecting them from corrosion and wearing "dry starts." If you haven't PYROIL in your car now—drive in to the next gas station. Add PYROIL—and add miles to your car.

Pyroil for Aircraft Engines

Use Aircraft Pyroil B for lubricating oil, Aircraft Pyroil A for gasoline.

GIVEN!! An attractive Pyroil metal savings bank — takes coins up to 50c pieces — is yours for the asking—sent postage paid.



Manufactured and Guaranteed by Pyroil Company, 88 Pyroil Bldg., La Crosse, Wisconsin.

Canadian Distributors:
Central Purchasing Agencies, Ltd.,
Toronto, Ontario

PYROIL COMPANY
88 Pyroil Bldg., La Crosse, Wisconsin

I want my car to last and run properly. Please tell me more about Pyroil and how it can accomplish this for me.

Name _____

Address _____

City or Town _____ State _____



WHERE-TO-BUY-IT INDEX

Source of supply appears after items commercially available

AUTOMOTIVE	
Lightweight cars for Europeans.....	122
Pickup truck used as semitrailer tractor (Texas Sheet Metal & Mfg. Co., 6130 Forest Park Road, Dallas Tex.).....	123
Electric heater for car motor (Phillips Manufacturing Co., 2816 Aldrich Ave. South, Minneapolis 8, Minn.).....	137
Rear-engine car looks like bus (Mustang Engineering Corp., c/o Ralph B. Potts, 1702 Hige Bldg., Seattle 4, Wash.).....	137
Lightweight vehicle.....	178
Motorcar for handicapped.....	179
Garment bag (Miner Corp., 4493 N. Logan St., Denver, Colo.).....	180
AVIATION	
Radio is test pilot for "flying stovepipe".....	95
Shipboard jet fighter.....	98
Overpass for aircraft.....	112
Supersonic parachute.....	133
Carrier-deck polisher.....	146
Air-tow rescue.....	151
"Sea water" used to make plane.....	163
Shipboard bomber faster and bigger.....	163
FARM	
Windrow turner (Twin-Draulic, Inc., Laurens, Iowa).....	94
Automatic egg-collector on nest (Russell M.g. Co., 488 Wells St., Caro, Mich.).....	94
Rocks ballast fence.....	139
HOUSE AND HOME	
Housebuilding with a "howitzer".....	96
Lead-free paint (Pittsburgh Plate Glass Co., Paint Division, 632 Duquesne Way, Pittsburgh 22, Pa.).....	98
Furnace burns either coal or oil (Diesel Oil Burner Corp., 105-20 N. Y. Blvd., Jamaica, N. Y.).....	122
Infrared cooker (Dorby Co., 2501 West 24th St., Chicago).....	124
Stove from unexploded bomb.....	124
Pull-out kitchenette (Jefferson Industries, Inc., 309 W. Jackson Blvd., Chicago 6).....	125
Sub-zero housing project.....	126
Gasket-repair kit (Zimmerman Packing Co., Norwood, Ohio).....	129
Lawn edger uses razor blades (Commercial Mfg. Co., 1330 N. Halsted St., Chicago 22).....	150
Wax paper seals itself (The Munising Paper Co., 135 South La Salle St., Chicago 3).....	157
Bathroom hanger (Rochow Swirl Mixer Co., Box 781, Rochester 3, N. Y.).....	164
Screw-cap wrench (Simplex Manufacturing Co., 418 East Ninth St., Kansas City 6, Mo.).....	164
Spring-type hanger for trousers and skirts (Perfect Products Co., Box 411, Beloit, Wis.).....	164
Self-emptying vacuum cleaned (Hydroway, Inc., 201 N. Broad St., Philadelphia, Pa.).....	164
Dispensing tray for bar soap (Richard C. Kisselburg, 466 Addison St., Elgin, Ill.).....	165
Waterless radiator (Henry J. Morton Associates, 518 Jefferson Ave., Toledo 4, Ohio).....	165
Serving cart has removable tray (American Central Div., Avco Manufacturing Corp., Connersville, Ind.).....	165
Food shaver (Work Savers Industries, Box 330, Route 4, Farmington, Mich.).....	165
Oil-level gauge (Krueger, Inc., Green Bay, Wis.).....	173
INDUSTRY	
Typewriter-size hand loom (Mooreville Mills, Empire State Bldg., New York City 1).....	124
X-ray microscope opens new field in living-tissue research.....	140
Heat-resistant plastic (Koppers Co., Inc., Pittsburgh 19, Pa.).....	157
Land-load hauler (R. G. LeTourneau, Inc., Longview, Texas).....	161
Rock-screening tank for gravel pumps.....	161
Hydraulic rams "uproot" telephone poles.....	166
OUTDOOR RECREATION	
Lever-action rifle has round bolt (The Marlin Firearms Co., 17 East 42nd St., New York City 17).....	150
Boat trailer becomes tent.....	167
Spotting scope for marksmen (Bausch & Lomb Optical Co., 635 St. Paul St., Rochester 2, N. Y.).....	179
Coaching by radio.....	180
TOOLS	
Master tool performs score of jobs (Musgrave Manufacturing Co., 2915 Columbus Ave., Springfield, Ohio).....	125
Self-contained paint sprayer (Selico Corp., 815 Andrus Bldg., Minneapolis 2, Minn.).....	133
Gun sprays liquid or abrasive (Engineered Products Inc., 1224 Spear Blvd., Denver, Colo.).....	139
Micrometer measures crankshaft journal (The Central Tool Company, Cranston 10, R. I.).....	146
Electric paint remover (Heating Equipment Co., Box 318, Rochester 1, N. Y.).....	179
MISCELLANEOUS	
Four-passenger stroller.....	94
Rhythm in roots.....	99
Bicycle motor (Retlaw Corp., 221 N. La Salle St., Chicago).....	111
Medical mold found on photo.....	111
"Cake icer" trims ceramics.....	111
Naval gun tests ton bombs.....	112
Endless plastic belt records dictation (Dictaphone Corp., 420 Lexington Ave., New York City 17).....	113
Flexible template (C. H. Clark & W. E. Poggenburg, 4900 Wynnefield Ave., Philadelphia 31, Pa.).....	113
Jet-powered bicycle (Areomarine Co., Dayton Municipal Airport, Vandalia, Ohio).....	113
Road surfaced with synthetic-rubber mixture.....	123
Solar motor.....	128
Self-feeding paint roller (Schaefer Self-Feeding Paint Roller Co., 107 North Freeman Blvd., Inglewood, Calif.).....	128
Picture-frame kit (Arthur H. Cutler Associated Enterprises, Box 829, Iowa City, Iowa).....	129
Motorcycle cover (Cycle Weather Pack Co., 36-19 Bowne St., Flushing, N. Y.).....	137
Blood-pressure indicator.....	138
Lettering scribe (Keuffel & Esser Co., Adams & Third Sts., Hoboken, N. J.).....	146

(Continued to page 10)

are you suffering from *HIDDEN TALENTS?*



Locked in your mind may be the germ of a valuable idea . . . an undeveloped aptitude . . . a hidden talent. And the key that can help unlock those capabilities of yours is *training*—sound, practical, down-to-earth training!

Helping men and women bring out the best that's in them has been the job of I. C. S. for more than 57 years. In every field of industry, you'll find leaders whose skills were developed through study with I. C. S.

They are the ones who sensed a latent ability within themselves—and *who proceeded to do something about it*. While others (equally gifted, perhaps) plodded along in routine jobs, they mastered I. C. S. courses . . . qualified themselves for rich rewards.

You can develop your hidden talents the same way they did. Start *today* and be ready for tomorrow's opportunities. Here's the coupon to mail:

INTERNATIONAL CORRESPONDENCE SCHOOLS



BOX 5645-K, SCRANTON 9, PENNA.

Without cost or obligation, please send me full particulars about the course BEFORE which I have marked X:

- | | | | |
|---|--|---|--|
| <p>Business and Academic Courses</p> <ul style="list-style-type: none"> <input type="checkbox"/> Accounting <input type="checkbox"/> Advertising <input type="checkbox"/> Bookkeeping <input type="checkbox"/> Business Administration <input type="checkbox"/> Business Correspondence <input type="checkbox"/> Certified Public Accounting <input type="checkbox"/> Commercial <input type="checkbox"/> Commercial Art <input type="checkbox"/> Cost Accounting <input type="checkbox"/> Federal Tax <input type="checkbox"/> First Year College <input type="checkbox"/> Foremanship <input type="checkbox"/> Good English <input type="checkbox"/> High School <input type="checkbox"/> Higher Mathematics <input type="checkbox"/> Motor Traffic <input type="checkbox"/> Postal Civil Service <input type="checkbox"/> Retailing <input type="checkbox"/> Retail Store Management <input type="checkbox"/> Salesmanship <input type="checkbox"/> Secretarial <input type="checkbox"/> Sign Lettering <input type="checkbox"/> Spanish <input type="checkbox"/> Stenography <input type="checkbox"/> Traffic Management <p>Air Conditioning and Plumbing Courses</p> <ul style="list-style-type: none"> <input type="checkbox"/> Air Conditioning <input type="checkbox"/> Heating <input type="checkbox"/> Plumbing <input type="checkbox"/> Refrigeration <input type="checkbox"/> Steam Fitting | <p>Chemistry Courses</p> <ul style="list-style-type: none"> <input type="checkbox"/> Chemical Engineering <input type="checkbox"/> Chemistry, Analytical <input type="checkbox"/> Chemistry, Industrial <input type="checkbox"/> Chemistry, Mfg. Iron & Steel <input type="checkbox"/> Petroleum Refining <input type="checkbox"/> Plastics <input type="checkbox"/> Pulp and Paper Making <p>Civil Engineering, Architectural and Mining Courses</p> <ul style="list-style-type: none"> <input type="checkbox"/> Architecture <input type="checkbox"/> Architectural Drafting <input type="checkbox"/> Building Estimating <input type="checkbox"/> Civil Engineering <input type="checkbox"/> Coal Mining <input type="checkbox"/> Contracting and Building <input type="checkbox"/> Highway Engineering <input type="checkbox"/> Lumber Dealer <input type="checkbox"/> Reading Structural Blueprints <input type="checkbox"/> Sanitary Engineering <input type="checkbox"/> Structural Drafting <input type="checkbox"/> Structural Engineering <input type="checkbox"/> Surveying and Mapping <p>Communications Courses</p> <ul style="list-style-type: none"> <input type="checkbox"/> Electronics <input type="checkbox"/> Practical Telephony <input type="checkbox"/> Radio, General <input type="checkbox"/> Radio Operating <input type="checkbox"/> Radio Servicing | <ul style="list-style-type: none"> <input type="checkbox"/> Telegraph Engineering <p>Electrical Courses</p> <ul style="list-style-type: none"> <input type="checkbox"/> Electrical Drafting <input type="checkbox"/> Electrical Engineering <input type="checkbox"/> Electric Light and Power <input type="checkbox"/> Lighting Technician <input type="checkbox"/> Practical Electrician <input type="checkbox"/> Power House Electric <input type="checkbox"/> Ship Electrician <p>Internal Combustion Engines Courses</p> <ul style="list-style-type: none"> <input type="checkbox"/> Auto Technician <input type="checkbox"/> Aviation <input type="checkbox"/> Diesel-Electric <input type="checkbox"/> Diesel Engines <input type="checkbox"/> Gas Engines <p>Mechanical Courses</p> <ul style="list-style-type: none"> <input type="checkbox"/> Aeronautical Engineer's, Jr. <input type="checkbox"/> Aircraft Drafting <input type="checkbox"/> Flight Engineer <input type="checkbox"/> Forging <input type="checkbox"/> Foundry Work <input type="checkbox"/> Heat Treatment of Metals <input type="checkbox"/> Industrial Engineering <input type="checkbox"/> Industrial Metallurgy <input type="checkbox"/> Machine Shop <input type="checkbox"/> Machine Shop Inspection <input type="checkbox"/> Mechanical Drafting <input type="checkbox"/> Mechanical Engineering | <ul style="list-style-type: none"> <input type="checkbox"/> Mold-Loft Work <input type="checkbox"/> Patternmaking—Wood, Metal <input type="checkbox"/> Reading Shop Blueprints <input type="checkbox"/> Sheet-Metal Drafting <input type="checkbox"/> Sheet-Metal Worker <input type="checkbox"/> Ship Drafting <input type="checkbox"/> Ship Fitting <input type="checkbox"/> Tool Designing <input type="checkbox"/> Toolmaking <input type="checkbox"/> Welding—Gas and Electric <input type="checkbox"/> Welding Engineering <p>Railroad Courses</p> <ul style="list-style-type: none"> <input type="checkbox"/> Air Brake <input type="checkbox"/> Car Inspector <input type="checkbox"/> Diesel Locomotive <input type="checkbox"/> Locomotive Engineer <input type="checkbox"/> Locomotive Fireman <input type="checkbox"/> Locomotive Machinist <input type="checkbox"/> Railroad Section Foreman <p>Steam Engineering Courses</p> <ul style="list-style-type: none"> <input type="checkbox"/> Boilermaking <input type="checkbox"/> Combustion Engineering <input type="checkbox"/> Engine Running <input type="checkbox"/> Marine Engineering <input type="checkbox"/> Steam Electric <input type="checkbox"/> Steam Engineer <p>Textile Courses</p> <ul style="list-style-type: none"> <input type="checkbox"/> Cotton Manufacturing <input type="checkbox"/> Loom Fixing <input type="checkbox"/> Rayon Weaving <input type="checkbox"/> Textile Designing <input type="checkbox"/> Woolen Manufacturing |
|---|--|---|--|

Name _____ Age _____ Home Address _____
 City _____ State _____ Working Hours _____ A.M. to _____ P.M.
 Present Position _____ Employed by _____

Special tuition rates to members of the Armed Forces. Enrollment under G.I. Bill and P.L. 16 approved for World War II Veterans.
 Canadian residents send coupon to International Correspondence Schools Canadian, Ltd., Montreal, Canada.

4 Keys to SUCCESS IN AVIATION

Through **Embry Riddle** Training

1 AIRCRAFT & ENGINE MECHANICS



We have hundreds of urgent requests for A. & E. Mechanics -- key men in Aviation -- from airlines, oil companies, fixed base operators, etc., both U. S. and Overseas. Training in a C. A. A. approved school is the quickest way to get ahead. Embry-Riddle students learn fast with modern equipment... working on live aircraft in airline-size hangars.

2 COMMERCIAL PILOTS

Flying holds a real future for Embry-Riddle trained pilots. A quarter-century of experience with 30,000 students... the best instructors, up-to-date aircraft, superb year-round flying weather... qualifications unexcelled anywhere. Multi-engine, instrument and horsepower ratings are also available.

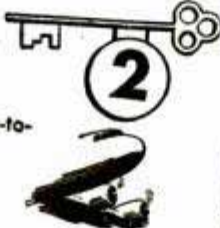

3 ENGINEERING

Embry-Riddle's Design Engineering and Maintenance course offers you eligibility for A. & E. certification plus necessary basic engineering knowledge required to fill positions such as Maintenance Foreman or Field Service, Project or Sales Engineer. If your aim is high, take this course.



4 A.&E. COMBINED WITH COMMERCIAL

Pilot Mechanics who can test fly the ships they repair... executive pilots able to service their own aircraft -- airmen with dual ability are needed by aviation companies and operators. Embry-Riddle combination training offers you the most in your aviation career.

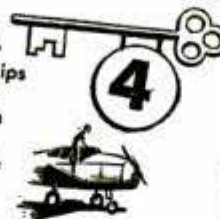

Aviation needs you now! Never has there been such opportunity for you in Aviation. Start your career now at Embry-Riddle -- living facilities directly on the Airport. Write today for full information and proof of job opportunities.

Authorized G. I. Training

Dean of Enrollments -- Dept. 99
Embry-Riddle School of Aviation
MIAMI 30, FLORIDA
Please Print

NAME _____

ADDRESS _____

City _____

State _____ Age _____

I am interested in...

- A.&E. Mechanic
 Commercial Pilot
 Engineering
 A.&E. Combined with Commercial Pilot
 Flying Mechanic

Check One Veteran Non-Veteran

TRAIN IN MIAMI--AIR CAPITAL OF THE WORLD

(Continued from page 8)

Surgery for a destroyer.....	147
The atom bomb—two conceptions.....	148
Electric machine takes footprints.....	150
Sprayer subdues criminals.....	150
Matchstick stories.....	157
Railroad sleep hanger.....	157
Rebuilding an old-time pumper.....	162
Weight-lifting rig for paralytics.....	163
Japanese brush-writer.....	166
Molded parts for model planes (Thomas Associates, 4607 Alger St., Los Angeles 26, Calif.).....	173
Memorial for Columbus.....	178

Craftsman and Shop Notes Index

AUTOMOTIVE	
Glove holds small tools in car compartment.....	195
Auto tips.....	213
Rejuvenate your battery.....	214
Inside lock for garage door.....	216
FARM	
Guard rails for hayloft door fold against wall.....	227
Harrow disk in feed kettle aids cooking mash.....	229
Hinged section of barnyard fence lowers to form manger.....	236
HOUSE AND HOME	
Fireplace rails are assembled with door-hinge parts.....	184
Solving home problems.....	186
Doors fitted with modern swinging bookcases.....	188
Shelf light.....	189
Basement partitions elevated on concrete blocks.....	195
Don't be caught napping.....	198
Cookstove heats upper rooms.....	200
Wire ring takes up end play of agitator drive shaft.....	206
Cardboard box forms bed table for convalescent child.....	208
Vibrating light blinks warning at bottom of stairway.....	211
Furnace cement kept from crumbling with steel wool.....	212
Wallpapering around window sill.....	212
Guard on sewing machine prevents injured fingers.....	216
NOVELTIES	
Unusual cigarette box looks like armchair.....	197
Flower clock.....	207
Miniature gateway contains twin bud vases.....	212
PHOTOGRAPHY	
Temporary lens mountings.....	217
Filing envelopes for negatives sectioned with staples.....	218
Cards aid loading film tank.....	218
Mounting photofloods overhead.....	218
Drying rack from coat hanger.....	218
Flasher times enlargements.....	218
Tripod adapter supports booster flash gun.....	219
Switch mounted on door casing operates safelights.....	219
Sprayer for ferrotype solution.....	219
Easy method of filtering photo solutions.....	220
Empty cut-film packs provide convenient filing cases.....	220
Cloth sleeve cleans lenses.....	220
Ash tray forms camera stand.....	220
RADIO-TELEVISION, ELECTRONICS	
Utility volt-ohm checker.....	237
How to build a Geiger-Mueller uranium survey meter.....	238
Radio-electronics hints.....	240
SHOP AND TOOLS	
Wooden coat hanger provides short rails for workbench.....	184
Grinding-wheel dresser from old hacksaw blade.....	184
Adjustable marking gauge.....	188
Sanding tool for small work.....	188
C-clamp used to drive pegs does not damage point.....	196
Jig locates wood-turning centers.....	196
Polished tool surfaces rustproofed with paste wax.....	197
Simple rack for small tools made from corner beading.....	200
Carriage bolt caps chisel handle.....	200
Cam-action clamps.....	201
C-clamp provides vise for child's workbench.....	206
Safety cover over machine switch.....	208
C-clamps form wheel puller.....	216
Faceplate converted to lathe chuck.....	224
Plate glass faced with emery cloth provides lapping plate.....	224
Scale scribed on triangle aids setting dividers.....	225
Eyebolt to lift machinery parts has three thread sizes.....	228
Drilling holes through rod stock.....	228
Rubber cover keeps lathe chuck dust-free.....	229
Automatic starting switch for drill press.....	236
Gear teeth from bolts.....	236
Lard oil aids tapping blind holes.....	236
WOODWORKING	
Wastebaskets.....	185
Cellulose tape masks glue joints.....	200
Wide miter box held steady by workbench stops.....	200
MISCELLANEOUS	
Shading aids pattern tracing.....	195
Paint swatch on piece of glass aids matching colors.....	196
Cardboard tie rack for suitcase.....	196
Rubber seal repairs split in frozen water pipe.....	206
Screw hook on stepladder shelf prevents tipping.....	206
Skis held to car-top carrier with screen-door catches.....	208
Wastebasket serves as plumb bob when setting fence posts.....	208
Funnel holds two balls of yarn.....	212
Moleskin over holster fastener protects pistol finish.....	212
Heating lacquer improves spraying.....	216
Servicing your cigarette lighter.....	216
Hip boots hung by tongs are kept from cracking.....	216
Brush holder for paste paint.....	224
Submersible element heats water quickly.....	225
Guide strip for knife speeds skinning pork sides.....	228
Repairing air-hose leak.....	228
Cardboard cartons held open by garden-hose sections.....	236

IMPORTANT NOTICE—It is the intention of this magazine to provide its readers with information regarding the latest developments in the mechanical arts. We take no responsibility as to whether the disclosures contained in our articles are covered by patents and advise readers to investigate this subject before making, using, or selling any of the products, machines, or processes described in order to avoid possible liability for patent infringements.

AUDELS CARPENTERS & BUILDERS GUIDES—(4 Book Set).....\$6

A practical illustrated trade assistant on modern construction for carpenters, joiners, builders, mechanics and all woodworkers. 4 vols., 1600 pages, 3700 illustrations. Fully indexed, flexible covers. Each volume sold separately \$1.50 a vol.

AUDELS PLUMBERS & STEAMFITTERS GUIDES—(4 Book Set).....\$6

A Practical Trade Assistant & Ready Reference. Explains in plain language & by clear illustrations, diagrams, charts, graphs, pictures principles of modern plumbing practice including Marine Pipe Fitting and Air Conditioning. 4 Vols.—1670 Pages—3642 Diagrams & Illustrations. Each Vol. Sold Separately \$1.50 a Vol.

AUDELS OIL BURNER GUIDE.....\$1

384 Pages Covering Installation, Servicing & Repairs All Types Domestic & Industrial Burners. Illustrated. Highly Endorsed.

AUDELS HOUSE HEATING GUIDE..\$4

1000 Pages Covering Working Principles, Installation, Service of All Modern House Heating, Ventilating & Air Conditioning Systems. Explains New Radiant Heating. Fully Illustrated & Indexed.

AUDELS REFRIGERATION & AIR CONDITIONING GUIDE.....\$4

New from Cover to Cover—1280 Pages, Fully Illus. Covering basic principles, servicing, operation & repair of household, commercial & industrial refrigeration & air conditioning. A gold mine of essential important facts for engineers, servicemen, users.

AUDELS SHEETMETAL WORKERS HANDY BOOK.....\$1

Practical inside information. Fundamentals of Sheet Metal Work. 388 pages, illustrated. 11 sections. Clearly written. Essential & important facts, figures, pointers in everyday language. Ref. Index.

AUDELS SHEETMETAL PATTERN LAYOUTS.....\$4

Developed by Experts for Sheet Metal Workers, Layout Men & Mechanics. A Practical Encyclopedia in 10 Sections, size 7 x 10 x 2—1125 Pages—350 Layouts—1600 Illustrations. 1001 Key Facts. Fully indexed for ready reference in answering your layout problems. Covers all phases of sheet metal work including Pattern Cutting, Pattern Development & Shop Procedure.

AUDELS BLUE PRINT READING.....\$2

For Mechanics & Builders. Covers all types of blue print reading including ship & airplane. 416 pages, fully illustrated.

AUDELS MATHEMATICS & CALCULATIONS FOR MECHANICS \$2

Mathematics for home study or reference. 700 pages, 550 illus. Practical mathematics from beginning. How to figure correctly. Easy, correct methods covering complete review. Illus. & Indexed.

AUDELS AUTOMOBILE GUIDE.....\$4

A practical quick ready reference book for auto mechanics, service men, operators & owners. Explains theory, construction & servicing of modern motor cars, trucks, buses & auto type Diesel engines. 1700 pages, fully illustrated. 55 chapters. Indexed. A standard book for mechanics. New Hydraulic drive covered.

AUDELS DIESEL ENGINE MANUAL....\$2

A practical, concise treatise with questions and answers on the theory, operation and maintenance of modern diesel engines. Over 400 pages, fully illus. All details plainly brought out, this book is of extreme value to engineers, operators & students.

AUDELS WELDERS GUIDE.....\$1

A concise, practical text on operation & maintenance of all welding machines for all mechanics. Over 400 pages, illustrated. Covers all methods of electric and acetylene welding including airplane work.

AUDELS MACHINIST & TOOLMAKERS HANDY BOOK.....\$4

Covers modern machine shop practice in all its branches. Tells how to set up & operate lathes, screw and milling machines, shapers, drill presses & all other machine & hand tools. 1600 pages, fully illustrated. Indexed. 5 sections. 1—Modern Machine Shop Practice. 2—Blue Print Reading & How to Draw. 3—Calculations & Mathematics for Machinists. 4—Shop Physics. 5—How to Use the Slide Rule. 60 chapters. Easy to read and understand. A shop companion that answers your questions.

AUDELS ELECTRIC MOTOR GUIDE \$4

Practical Information Covering Construction, Control, Maintenance & Wiring Hookups of All Types Electric Motors also Armature Winding. 1000 Pages Fully Illustrated & Indexed.

AUDELS ELEC. WIRING DIAGRAMS \$1

210 Pages, Illustrated. Gives practical facts on wiring of electrical apparatus. It shows clearly how to wire apparatus for practically all fields of electricity. Each diagram is complete & self-explanatory. Highly Endorsed Pocket Companion.

AUDELS PRACTICAL ELECTRICITY \$4

A key to a practical understanding of Electricity. For maintenance engineers, electricians & all electrical workers. 1440 Pages, 2600 Illus. Covers important electrical information in handy form—including wiring for Light & Power. Indexed.

AUDELS RADIOMANS GUIDE.....\$4

A key to the practical understanding of radio including Frequency Modulation, Television, etc., Aircraft & Marine Radio. For radio engineers, servicemen, amateurs, 914 Pages, 633 Illustrations & Diagrams. Photos. Review Questions & Answers, Reference Index.

AUDELS, Publishers, 49 W. 23 St., N.Y. 10

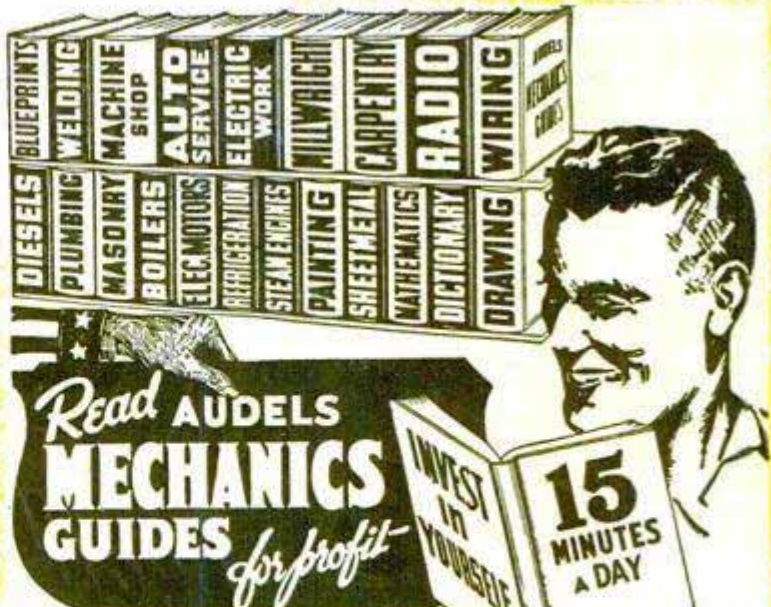

Read AUDELS MECHANICS GUIDES for profit

AN AUDEL GUIDE IS A GOOD FRIEND!

Step Up Your Own Skill with the Practical Facts and Figures of Your Trade. Save time and money with right methods, short cuts, labor saving ideas. CHECK NOW! You can look over any Audel Guide in your home. Start the Easy Payments if satisfied.

— CUT HERE — MAIL ORDER

AUDEL, Publishers, 49 W. 23 St., New York 10, N. Y.

Please mail me for 7 days' free examination the books marked (X) below. I agree to mail \$1 in 7 days on each book or set ordered, and to further mail \$1 a month on each book or set ordered until I have paid the purchase price. If I am not satisfied with Guides I will return them.

- AUTOMOBILE GUIDE, 1700 Pages \$4
- DIESEL ENGINE MANUAL, 400 Pages 2
- WELDERS GUIDE, 400 Pages 1
- CARPENTERS & Builders Guides (4 Book Set) 6
- PLUMBERS & Steamfitters Guides (4 Book Set) 6
- MASONS and Builders Guides (4 Book Set) 6
- BLUE PRINT READING, 416 Pages 2
- MASTER PAINTER & Decorator, 320 Pages 2
- GARDENERS & GROWERS GUIDES (4 Book Set) 6
- OIL BURNER GUIDE, 384 Pages 1
- HOUSE HEATING GUIDE, 1000 Pages 4
- REFRIGERATION & Air Conditioning Guide, 1280 Pages 4
- SHEET METAL WORKERS Handy Book, 388 Pages 1
- SHEET METAL PATTERN LAYOUTS, 1100 Pages 4
- AIRCRAFT WORKER, 240 Pages 1
- MECHANICAL DRAWING GUIDE, 160 Pages 1
- MECHANICAL DRAWING & DESIGN, 480 Pages 2
- MATHEMATICS and CALCULATIONS, 700 Pages 2
- MECHANICAL DICTIONARY, 968 Pages 4
- MACHINISTS & Toolmakers Handy Book, 1600 Pages 4
- MILLWRIGHTS & Mechanics Guide, 1200 Pages 4
- POWER PLANT ENGINEERS GUIDE, 1500 Pages 4
- ENGINEERS & FIREMANS EXAMINATIONS, 528 Pages 1
- PUMPS, HYDRAULICS & Air Compressors, 1658 Pages 4
- MARINE ENGINEERS Handy Book, 1280 Pages 4
- ENGINEERS and Mechanics Guides (8 Book Set) 12
- Answers on Practical ENGINEERING, 254 Pages 1
- ELECTRIC WIRING DIAGRAMS, 210 Pages 1
- ELECTRICIANS EXAMINATIONS, 250 Pages 1
- ELECTRIC DICTIONARY, 9000 Terms 2
- ELECTRIC MOTOR GUIDE, 1000 Pages 4
- PRACTICAL ELECTRICITY Handy Book, 1440 Pages 4
- ELECTRICAL POWER CALCULATIONS, 425 Pages 2
- RADIOMANS GUIDE, 914 Pages 4
- ELECTRONIC DEVICES, 216 Pages 2
- NEW ELECTRIC LIBRARY, 7000 Pages (12 Book Set). 18 Vols. I, II, III, IV, V, VI, VII, VIII, IX, X, XI, XII—\$1.50 Each

Name _____
 Address _____
 Occupation _____
 Employed by _____



MAKE EXTRA MONEY WHILE LEARNING
 Early in my Course I show you how to earn cash by fixing neighbors' Radios in spare time.

Be a RADIO Learn by Practicing

**MY
 COURSE INCLUDES
 TELEVISION**

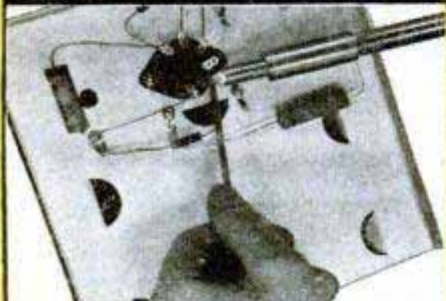

YOU PRACTICE Radio Soldering with Soldering Equipment and Radio Parts I send you. Get practical experience mounting and connecting parts.

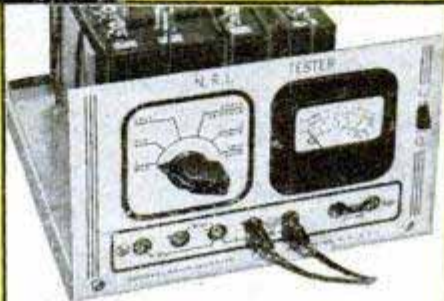

YOU BUILD this Tester with parts N. R. I. sends early in course. Soon helps you fix neighbors' Radios and **EARN EXTRA MONEY** in spare time.

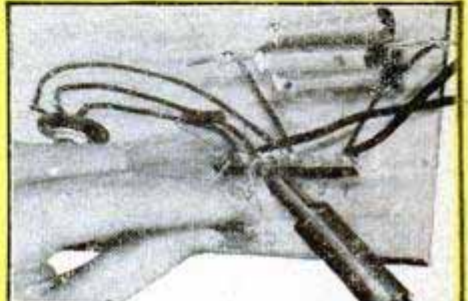

YOU TEST Radio Circuits like this built with parts I send. Build special circuits; learn how to locate and repair circuit defects.

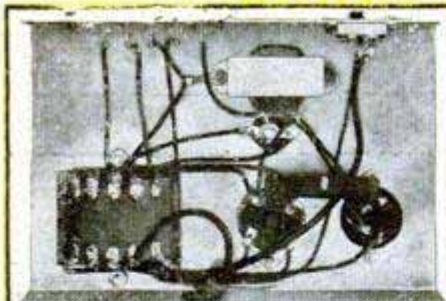

YOU BUILD Vacuum Tube Power Pack; make changes which give you experience with packs of many kinds. Learn how to correct Power Pack troubles.

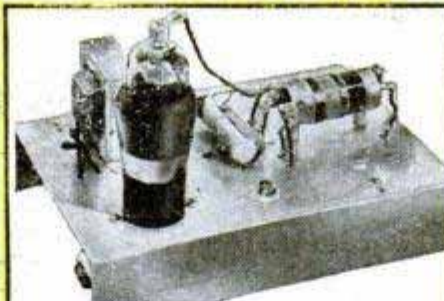

YOU BUILD this A. M. Signal Generator for more valuable experience. It provides amplitude-modulated signals for many tests and experiments.

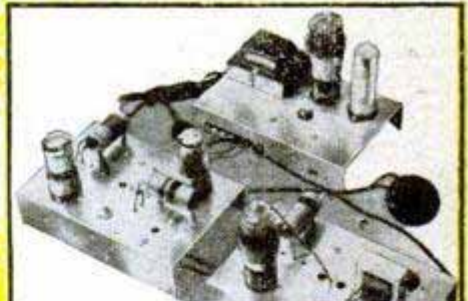

YOU PRACTICE FM (Frequency Modulation) experiments, get more experience with this Superheterodyne Receiver Circuit you build with parts I send.

I TRAINED THESE MEN FOR GOOD PAY JOBS

Now My Own Boss
 "N. R. I. trained my brother and me. We now have our own shop and more business than we can handle."—**JERRY McCARTHY**, Washington, D. C.

Extra Cash in Spare Time
 "For the past five years I have averaged \$15 and up a week in my spare time."—**STANLEY GENTON**, Cincinnati, Ohio.

Radio Station Pays
 "As Broadcast Engineer for Station KROP. Fundamentals of Radio learned in N. R. I. training invaluable."—**JERRY G. COLLETT**, Brawley, Cal.

Makes Extra Cash
 "Service Radios three or four hours an evening and my monthly average is \$75."—**R. E. HAMRICK**, Houston, Texas.

Good Job in Radio Station
 "Am Chief Engineer of Station WORD, in charge of four men. Owe all I know about Radio to N. R. I."—**CLYDE J. BURDETTE**, Spartanburg, S. C.

Has Own Radio Business
 "After finishing course, opened my own Radio shop. Can't praise your training too high. It's the best!"—**ERNEST T. SLATE**, Corsicana, Texas.

VETERANS You Can Get This Training Under G. I. Bill

TECHNICIAN

at Home in Spare Time

I Send You
BIG KITS
of Parts



**You Build This
MODERN RADIO**

As part of your training . . . to give you practical experience . . . N. R. I. sends you the speaker, tubes, chassis, transformer, sockets, loop antenna, etc., to build this powerful receiver.

KNOW RADIO-Win Success I Train You at Home

**ACTUAL
LESSON
FREE**



J. E. SMITH, President
National Radio Institute

Want a good-pay job in the fast-growing RADIO - TELEVISION Industry? Want a money-making Radio-Television shop of your own? I've trained hundreds of men to be Radio Technicians . . . MEN WITH NO PREVIOUS EXPERIENCE.

My tested and proved train-at-home method makes learning easy. You learn Radio-Television principles from illustrated lessons. You get practical experience with MANY KITS OF PARTS I send. All equipment yours to keep.

Make EXTRA MONEY in Spare Time

The day you enroll, I start sending SPECIAL BOOKLETS that show you how to make EXTRA MONEY fixing neighbors' Radios in spare time. From here it's a short step to your own shop, or a good-pay Radio-Television servicing job. Or get into Police, Aviation, Marine Radio, Broadcasting, Public Address work, etc. And think of opportunities in the booming Television Industry.

See What N. R. I. Can Do For You

Act now! Send for my **DOUBLE FREE OFFER**. Coupon entitles you to actual lesson, absolutely free. You also get my 64-page book, "HOW TO BE A SUCCESS IN RADIO AND TELEVISION-ELECTRONICS." Tells how quickly, easily you can get started. Send coupon in envelope or paste on penny postal. J. E. Smith, President, Dept. 9BP, National Radio Institute, Pioneer Home Study Radio School, Washington 9, D. C.

Tells Radio repair shortcuts. Same coupon also entitles you to my 64-page book, "HOW TO BE A SUCCESS IN RADIO-TELEVISION - ELECTRONICS." Send NOW!

Get Both FREE

MR. J. E. SMITH, Pres., Dept. 9BP
National Radio Institute, Washington 9, D. C.

Mail me FREE Sample Lesson and 64-page book about how to win success in Radio and Television—Electronics. (No salesman will call. Please write plainly.)

Name..... Age.....

Address.....

City..... Zone..... State.....

Check If Veteran Approved For Training Under G. I. Bill

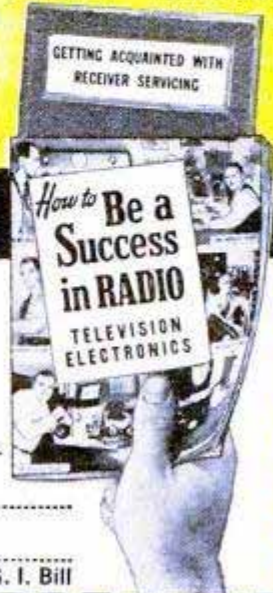

Mail Coupon

Everything in Radio at Lowest Prices!

FREE

Send for
ALLIED'S
180 Page
Catalog



**BUILDER'S KITS
TELEVISION SETS
HI-FIDELITY SOUND
AMATEUR GEAR
THOUSANDS OF PARTS
TUBES, TOOLS, TESTERS
BOOKS & DIAGRAMS**

Everything for
**Servicemen, Engineers,
Experimenters, Builders,
Soundmen, Amateurs**



Radio's Leading Buying Guide

Get ALLIED'S 1949 Catalog—biggest and most complete in Radio. Get *everything* you need from the world's largest stocks of top-quality equipment—at down-to-earth money-saving prices. Have the advantages of speedy reliable shipment, expert personal help, and complete satisfaction on every purchase. Get more for your money at ALLIED—Radio's Largest Supply House. Send today for your **FREE ALLIED Catalog**—the preferred Buying Guide to *everything* in radio and electronic equipment.

ALLIED RADIO

ALLIED RADIO CORP.,
833 W. Jackson Blvd., Dept. 5-B-9
Chicago 7, Illinois

FREE

Send **FREE** 1949 ALLIED Catalog.

Name.....

Address.....

City.....Zone.....State.....

Hollywood GOOSE HORN

FOR BICYCLES • TRICYCLES
SCOOTERS



RIDE SAFELY
Many accidents have
been caused by a warning
signal for bicycles.

\$1
POSTPAID

Be safe! Ride a fully equipped bike. Put the new, smart looking Hollywood Goose Horn on your bike today. A precision built, bulb-type bicycle horn. Overall length 9 inches with 2 1/2 inch flared bell. Black live-rubber bulb. Clamp fits securely to front of handle bar near the steering post in PROTECTED position. Only \$1.00 Postage Paid. Send cash, check or M. O. Order direct today, if your dealer can't supply you. No COD's please.

YODER MANUFACTURING COMPANY

2403 21-T E. 103rd Street, Los Angeles 2, California

Only \$16.95 **DUAL PURPOSE SPRAY GUN**

Complete

USES ONLY 25 LBS. AIR PRESSURE
FLOCKS AND SANDBLASTS



AT HOME: You can refinish Lamps, Radios, Book Ends, Statues and hundreds of things with lovely colorful flocking. **ETCH GLASS:** Many designs and initials can be sandblasted on shower doors, ash trays, glassware. **AUTO INTERIORS:** Transform ugly dirty auto interiors to "new car beauty" with a **BLASTO DUAL PURPOSE SPRAY GUN**. Merely spray flock similar to Velvet, Plush, Suede and Mohair inside your car. **ANTIQUÉ WOOD . . . REMOVE PAINT. MAKE EXTRA MONEY** by doing any or all the above for profit. **BLASTO** is highest quality and carries a 5 day money-back guarantee. Operates on small air compressor. Send \$16.95 cash, check or money order for postpaid delivery. Write for free information. Full line of Flocking Supplies.

BLASTO SPRAY GUN MFG. Dept. PM-2, 7007 Haas Avenue
Los Angeles 44, California

STAMMER ?

This new 128-page book, "Stammering, Its Cause and Correction," describes the Bogue Unit Method for scientific correction of stammering and stuttering—successful for 48 years. **Benj. N. Bogue, Dept. 4914, Circle Tower, Indianapolis 4, Ind.**

GET THIS
FREE
BOOK!

CORRESPONDENCE COURSES IN RADIO and ELECTRICAL ENGINEERING

ELECTRICAL ENGINEERING. Get good grasp of wide electrical field. Modern. Very understandable. Theory made easy. **RADIO ENGINEERING.** Extra fine course in radio, public address, photo-electric work. Trains you to be super-service man, real vacuum tube technician. Tuition **ONLY \$25**, either course. Deferred payment plan. Servicemen needed badly. **FREE** Write for free copies of school catalogs, student magazines, etc. **LINCOLN ENGINEERING SCHOOL, Box 931-P122, Lincoln, Nebr.**

Tuition
\$25



HAMSTERS!

Get the unique Golden Hamster today. Profitable, Prolific, Educational, friendly. 1000's needed by labs and pet shops. Raised anywhere. No experience required. Send 10c for literature or \$5 for pair and literature.

Azalea City Hamstery, 1412 East Linwood Dr., Dept. F, Mobile 18, Alabama

BE A NOTARY PUBLIC

Be a Notary Public. Largest legal supply house. 22 cities. guarantees your appointment by governor if you qualify, equips you completely for \$16.97. Respected public office. You certify legal papers, use official seal made with your name, collect fees. Easy. Notaries needed everywhere. Be one. Write—

STATIONERS EXCHANGE — BOERNE 32, TEXAS

SAY YOU SAW IT IN POPULAR MECHANICS

10 SHELF PLANS

NEW FULL SIZE

New, full size, easily built, beautiful wall shelf plans ready to trace on lumber, cut out and assemble. Corner and wall racks with 1 to 3 shelves. Stores charge about \$75.00 for these shelves. Make money selling them. Finest selection available. **PLUS BONUS** of 48 other novel cut-outs, Dutch Boys, Girls, Toys, etc., etc. **PLUS FREE** new 1949 Handicraft Catalog. Send only \$1 to

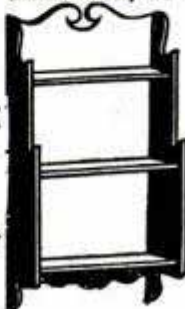

JACKSON, Dept. 65

5440 N. Shoreland Ave.
Milwaukee 11, Wis.

\$1





INVENTORS



Learn how to protect your invention. The U. S. Patent Laws provide that any new and useful art, machine, article of manufacture, or composition of matter, or any new and useful improvement thereof, may be patented if the act of invention is involved. Therefore, every inventor with a valuable invention should take advantage of the Patent Laws and proceed for patent protection in order to safeguard his rights.

A patent gives the inventor the exclusive right to prevent others from making, using, or selling the invention claimed in the patent for a period of seventeen years.

The Patent Laws were enacted for the benefit of the inventor to give him protection for the features of his invention which are patentable. These features must be properly and concisely set forth and claimed in a formal application for patent, in order to comply with the requirements of the Patent Laws. For that reason, unless the inventor is familiar with patent matters, he should engage a competent registered patent attorney or agent to represent him. We are registered to practice before the U. S. Patent Office and are prepared to serve you in the handling of your patent matters.

A specially prepared booklet entitled "Patent Guide for the Inventor", containing detailed information with respect to patent protection and procedure, together with a "Record of Invention" form will be promptly forwarded to you without obligation upon request.

CLARENCE A. O'BRIEN & HARVEY JACOBSON

Registered Patent Attorneys

91-B DISTRICT NATIONAL BUILDING • WASHINGTON 5, D. C.

Patents
Trademarks
Copyrights

CLARENCE A. O'BRIEN & HARVEY JACOBSON
Registered Patent Attorneys

91-B District National Bldg., Washington 5, D. C.
Please send me copy of "Patent Guide for the Inventor" and also
"Record of Invention" form. This request does not obligate me.

Name _____

Address _____

City _____ State _____
(Please write or print plainly.)



**I Put You to Work with Your Hands to LEARN RADIO!
You Build Receivers! You Make Typical Defects Occur
and Make Tests to Prove the Theory!**

**YOU GET
8 BIG KITS OF RADIO
PARTS & EQUIPMENT
including**

**2-BAND SUPER
RECEIVER!**

**and 16 RANGE METER
FOR TESTING**

F. L. SPRAYBERRY, PRES-
IDENT of the SPRAYBERRY
ACADEMY OF RADIO. This
is the man who directs
your study. His years of
experience and Radio
"know-how" assure you of
the finest in home Radio
Training!

**LEARN RADIO
to MAKE MONEY!**

LOW COST TRAINING — EASY PAYMENT PLAN!

**You Learn at Home How to
Build and Test Dozens and
Dozens of Circuits — Simple
and Complex!**

**YOU DO
OVER 175
INSTRUCTIVE
EXPERIMENTS**



**YOU BUILD
ALL THESE TESTERS
..... AND MORE!**

I give you a fine,
moving-coil type
Meter Instrument
on Jewel Bearings
— with parts for a
complete Analyzer
Circuit Continuity
Tester. You learn
how to check and
correct Receiver

defects with professional speed and
accuracy.

You'll get
valuable ex-
perience and
practice
building this
Signal Gen-
erator and
multi-
purpose
Tester.
Makes a
breeze out of fixing Radios and you
don't have to spend money on ready-
made Equipment.

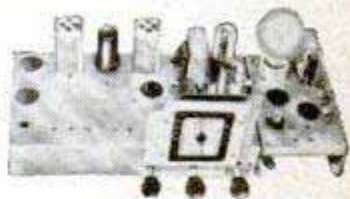

Soldering, wiring, connecting Radio
parts . . . building circuits with your
own hands — you can't beat this
method of learning. When you con-
struct this Rectifier and Filter,
Resistor and Condenser Tester, etc., you
get a really practical slant on Radio
that leads to a money-making future.

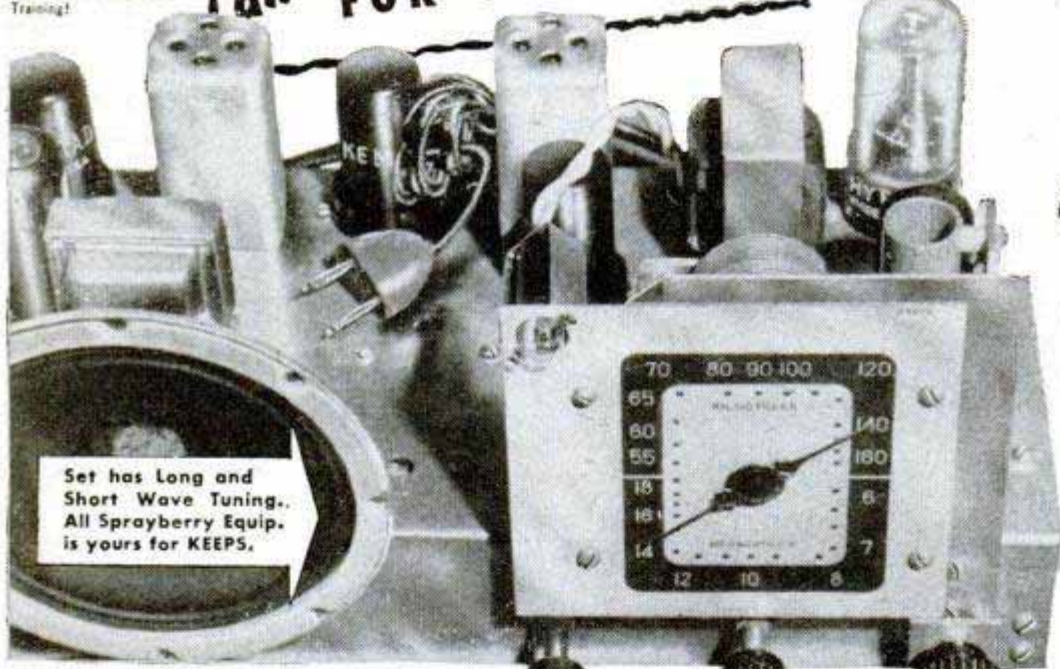

Set has Long and
Short Wave Tuning.
All Sprayberry Equip.
is yours for KEEPS.

SPRAYBERRY HOME TRAINING is PLANNED to MAKE MONEY for you FAST!

I train you with regular professional Radio Equip-
ment. I tell you exactly what to do . . . how to do
it. You handle Radio Parts, see them operate,
learn what they're for. With the fine Kits I supply,
you learn how to build Radio Circuits, construct
your own Test Equipment. I'll show you how to
cause typical Radio defects so you can watch and
see how they act. You learn the latest methods for
trouble-shooting and repair. All this adds up to

the finest kind of "bench" experience. And you get
it right in your own home. In no time at all, you'll
be ready for a business of your own or a good job
in Radio, FM, Television,
Radar, Industrial Elec-
tronics, etc. Now's
the time to get
started!

VETERANS!

Approved for
G. I. Training
Under Public
Laws 16 and
346

**SEND FOR MY
VALUABLE
FREE BOOKS!**

**NOW! Two Locations
To Serve You Better!
Mail Coupon to Location
Nearest Your Home**

**SPRAYBERRY ACADEMY of RADIO, Dept. 10-O,
SPRAYBERRY BUILDING, PUEBLO, COLORADO, or
20 NORTH WACKER DRIVE, CHICAGO 6, ILLINOIS**

Please rush my FREE copies of "How to MAKE MONEY in RADIO, ELEC-
TRONICS and TELEVISION" and "How to READ RADIO DIAGRAMS and
SYMBOLS."

Name _____ Age _____
Address _____
City and Zone _____ State _____

(Mail in envelope or paste on penny postcard)

INVENTORS

Patent laws encourage the development of inventions.

We recommend that an inventor employ a registered Patent Attorney or agent, if the inventor is not familiar with patent matters. This is because the value of a patent depends largely upon the skillful preparation of the specification and claims in the patent application.

The firm of McMorrow, Berman and Davidson is registered to practice before the United States Patent Office. Additionally it engages patent attorneys able to readily understand inventors' disclosures, to advise concerning patentability, and to prepare appropriate specifications and claims.

If an inventor believes he has an invention, a search of the most pertinent prior U. S. patents should be made and a report obtained relative to its patentability. Where such report indicates that the invention appears patentable, in order to secure protection, diligence should be exercised in making application for a patent.

Send for a copy of Patent Booklet entitled "How To Protect Your Invention." This booklet contains information on patent protection and procedure. You will also receive an "Invention Record" blank. This will be promptly forwarded to you upon request—no obligation.

McMORROW, BERMAN & DAVIDSON

Registered Patent Attorneys

PATENTS • TRADE MARKS • COPYRIGHTS

135-W VICTOR BUILDING, WASHINGTON 1, D. C.

McMORROW, BERMAN & DAVIDSON

Registered Patent Attorneys

135-W Victor Building, Washington 1, D. C.

Send me your Patent Booklet, "How To Protect Your Invention", and also "Invention Record" form at once. I understand this request does not obligate me.

Name.....

Address.....

City.....

(WRITE OR PRINT NAME CLEARLY)

And to think they used to call me SKINNY!

Give Me 15 Minutes a Day and I'll Give You a NEW BODY

PEOPLE used to laugh at my skinny 97 lb. body. I was ashamed to strip for sports or for a swim. Girls made fun of me behind my back. THEN I discovered my muscle-building system—"Dynamic Tension." It turned me into such a complete specimen of MANHOOD that today I hold the title "THE WORLD'S MOST PERFECTLY DEVELOPED MAN."

That's how I traded in my "bag of bones" for a barrel of muscle! And I felt so much on top of the world in my big new, husky body that I decided to devote my life to helping other fellows change themselves into "perfectly developed men."

What's My Secret?

When you look in the mirror and see a healthy, husky, strapping fellow smiling back at you—then you'll be astonished at how short a time it takes "Dynamic Tension" to GET RESULTS! "Dynamic Tension" is the easy, NATURAL method you can practice in the privacy of your own room—JUST 15 MINUTES EACH DAY—while your scrawny shoulder muscles begin to swell . . . those spindly arms and legs of yours bulge . . . and your whole body starts to feel "alive," full of zip and go!

Thousands are becoming marvelous physical specimens—my way. I give you no gadgets or contraptions to fool with. With "Dynamic Tension" you simply utilize the dormant muscle-power in your own body—watch it increase and multiply into real, solid LIVE MUSCLE.

FREE Book

Mail coupon right now for my illustrated book, "Everlasting Health and Strength." Tells all about my "Dynamic Tension" method. Shows actual photos of men I've made into Atlas Champions. It's a valuable book—and it's FREE. Mail coupon to me personally. CHARLES ATLAS, Dept. 8P, 115 East 23rd St., New York 10, N. Y.



CHARLES ATLAS, DEPT. 8P,
115 East 23rd Street, New York 10, N. Y.

I want the proof that "Dynamic Tension" will help make a new man of me—give me a healthy, husky body and big muscle development. Send me your free book, "Everlasting Health and Strength."

Name _____ Age _____
(Please print or write plainly)

Address _____

City _____ State _____

SAY YOU SAW IT IN POPULAR MECHANICS

Command Bigger Money! STUDY LAW

STUDY AT HOME for BUSINESS SUCCESS and LARGER PERSONAL EARNINGS. 40 years expert instruction—over 114,000 students enrolled. LL.B. Degree awarded. All text material furnished. Easy payment plan. Send now for FREE BOOK—"Law and Executive Guidance." It explains the course—how you may enroll and the many ways you can profit from Law Study. Write TODAY to:

AMERICAN EXTENSION SCHOOL OF LAW
Dept. 11 - PM, 646 N. Michigan Ave., Chicago 11, Ill.



RAISE HAMSTERS

The new wonder animals from Syria. Often called Toy Bears. Delightful pets. Everyone wants them. Laboratories need thousands. Clean, odorless. Raise anywhere. A profitable and interesting hobby or business. We furnish breeding stock with manual of instructions.

Write today for free illustrated literature.
GULF HAMSTERY, 1536 BASIL, MOBILE, ALA.

How to Make Money with Simple Cartoons



A book everyone who likes to draw should have. It is free; no obligation. Simply address

FREE BOOK

CARTOONISTS' EXCHANGE
Dept. 92-D Pleasant Hill, Ohio

SADDLE HORSES

LEARN HORSE TRAINING AND MANAGEMENT
SUBSCRIBE FOR The "EXPERT HORSEMAN"
FREE BOOK—You will also receive a booklet that tells how you can learn to Break Colts, Gait Show Horses, Train Rodeo, Stock, and Race Horses, Break Bad Habits, Handle any horse, Train Circus Trick Horses.
ANIMAL LOVERS ASSOCIATION
BOX KA-111 TARZANA, CALIFORNIA

ONLY \$1.00 YEAR
10 COPY MAILED AT ONCE

AIR RIFLES BENJAMIN AIR PISTOLS

PIONEERS - LEADERS
SEND FOR FREE FOLDER OF LATEST MODELS TODAY
If you want a REAL GUN for PRACTICAL USE inside or outdoors get a SAFE - CLEAN - ECONOMICAL - BENJAMIN with Adjustable Power and Amazing Accuracy. For BEST RESULTS use BENJAMIN H-C PELLETS. WRITE AT ONCE. BENJAMIN AIR RIFLE CO., 812 MARION ST., ST. LOUIS 4, MO.

Photography for



PLEASURE or PROFIT

Learn at home. Spare time. Practical basic training. Long-established school. Many have earned while learning. Send coupon below for free booklet, "Opportunities in Modern Photography" and full particulars.

AMERICAN SCHOOL OF PHOTOGRAPHY
1315 Michigan Avenue Dept. 1352 Chicago 5, Illinois
Send booklet, "Opportunities in Modern Photography," full particulars and requirements. No salesman will call.
Name _____
Address _____
City _____ Zone _____ State _____

POPULAR MECHANICS

The gI's have it!



GOOD NEWS for Veterans! I. C. S. Courses—all 400 of them—are now available under the G.I. Bill of Rights and Public Law 16.

Here's your chance to learn while you earn . . . to master a trade or profession and qualify for promotions and pay raises *on the job*.

The coupon brings full details of the course you check—and complete instructions on how to enroll. Mail it today!

INTERNATIONAL CORRESPONDENCE SCHOOLS



BOX 5646-K, SCRANTON 9, PENNA.

Without cost or obligation, please send me full particulars about the course BEFORE which I have marked X:

- | | | | |
|--|--|--|---|
| <p>Air Conditioning and Plumbing Courses</p> <p><input type="checkbox"/> Air Conditioning
<input type="checkbox"/> Heating
<input type="checkbox"/> Refrigeration</p> <p><input type="checkbox"/> Plumbing
<input type="checkbox"/> Steam Fitting</p> <p>Chemistry Courses</p> <p><input type="checkbox"/> Chemical Engineering
<input type="checkbox"/> Chemistry, Analytical
<input type="checkbox"/> Chemistry, Industrial
<input type="checkbox"/> Chemistry, Mfg. Iron & Steel
<input type="checkbox"/> Petroleum Refining
<input type="checkbox"/> Pulp and Paper Making</p> <p><input type="checkbox"/> Plastics</p> <p>Civil Engineering, Architectural and Mining Courses</p> <p><input type="checkbox"/> Architecture
<input type="checkbox"/> Architectural Drafting
<input type="checkbox"/> Bridge and Building Foreman
<input type="checkbox"/> Building Estimating
<input type="checkbox"/> Civil Engineering
<input type="checkbox"/> Coal Mining
<input type="checkbox"/> Contracting and Building
<input type="checkbox"/> Highway Engineering
<input type="checkbox"/> Lumber Dealer
<input type="checkbox"/> Reading Structural Blueprints
<input type="checkbox"/> Sanitary Engineering
<input type="checkbox"/> Structural Drafting</p> | <p><input type="checkbox"/> Structural Engineering
<input type="checkbox"/> Surveying and Mapping</p> <p>Communications Courses</p> <p><input type="checkbox"/> Electronics
<input type="checkbox"/> Practical Telephony
<input type="checkbox"/> Radio, General
<input type="checkbox"/> Radio Operating
<input type="checkbox"/> Radio Servicing
<input type="checkbox"/> Telegraph Engineering</p> <p>Electrical Courses</p> <p><input type="checkbox"/> Electrical Drafting
<input type="checkbox"/> Electrical Engineering
<input type="checkbox"/> Electric Light and Power
<input type="checkbox"/> Lighting Technician
<input type="checkbox"/> Practical Electrician</p> <p>Internal Combustion Engines Courses</p> <p><input type="checkbox"/> Auto Technician
<input type="checkbox"/> Diesel-Electric
<input type="checkbox"/> Diesel Engines
<input type="checkbox"/> Gas Engines</p> <p><input type="checkbox"/> Aviation</p> <p>Mechanical Courses</p> <p><input type="checkbox"/> Aeronautical Engineer's, Jr.
<input type="checkbox"/> Aircraft Drafting
<input type="checkbox"/> Forging
<input type="checkbox"/> Heat Treatment of Metals
<input type="checkbox"/> Industrial Engineering</p> | <p><input type="checkbox"/> Industrial Metallurgy
<input type="checkbox"/> Machine Shop
<input type="checkbox"/> Mechanical Drafting
<input type="checkbox"/> Mechanical Engineering
<input type="checkbox"/> Mold-Loft Work
<input type="checkbox"/> Patternmaking—Wood, Metal
<input type="checkbox"/> Reading Shop Blueprints
<input type="checkbox"/> Sheet-Metal Drafting
<input type="checkbox"/> Sheet-Metal Worker
<input type="checkbox"/> Ship Drafting
<input type="checkbox"/> Tool Designing
<input type="checkbox"/> Welding Engineering
<input type="checkbox"/> Welding—Gas and Electric</p> <p>Railroad Courses</p> <p><input type="checkbox"/> Air Brake
<input type="checkbox"/> Diesel Locomotive
<input type="checkbox"/> Locomotive Engineer
<input type="checkbox"/> Locomotive Fireman
<input type="checkbox"/> Locomotive Machinist
<input type="checkbox"/> Railroad Section Foreman</p> <p>Steam Engineering Courses</p> <p><input type="checkbox"/> Boilermaking
<input type="checkbox"/> Combustion Engineering
<input type="checkbox"/> Engine Running
<input type="checkbox"/> Marine Engineering
<input type="checkbox"/> Steam Electric</p> | <p>Textile Courses</p> <p><input type="checkbox"/> Cotton Manufacturing
<input type="checkbox"/> Loom Fixing
<input type="checkbox"/> Textile Designing
<input type="checkbox"/> Woolen Manufacturing</p> <p><input type="checkbox"/> Rayon Weaving</p> <p>Business and Academic Courses</p> <p><input type="checkbox"/> Accounting
<input type="checkbox"/> Bookkeeping
<input type="checkbox"/> Business Administration
<input type="checkbox"/> Business Correspondence
<input type="checkbox"/> Certified Public Accounting
<input type="checkbox"/> Commercial
<input type="checkbox"/> Cost Accounting
<input type="checkbox"/> Federal Tax
<input type="checkbox"/> Foremanship
<input type="checkbox"/> Good English
<input type="checkbox"/> Higher Mathematics
<input type="checkbox"/> Motor Traffic
<input type="checkbox"/> Retailing
<input type="checkbox"/> Retail Store Management
<input type="checkbox"/> Salesmanship
<input type="checkbox"/> Sign Lettering
<input type="checkbox"/> Spanish
<input type="checkbox"/> Traffic Management</p> <p><input type="checkbox"/> Advertising
<input type="checkbox"/> Commercial Art
<input type="checkbox"/> Commercial Art
<input type="checkbox"/> First Year College
<input type="checkbox"/> French
<input type="checkbox"/> High School
<input type="checkbox"/> Postal Civil Service
<input type="checkbox"/> Secretarial
<input type="checkbox"/> Stenography</p> |
|--|--|--|---|

Name _____ Age _____ Home Address _____

City _____ State _____ Working Hours _____ A.M. to _____ P.M.

Present Position _____ Employed by _____

Special tuition rates to members of the Armed Forces. Enrollment under G.I. Bill and P.L. 16 approved for World War II Veterans.
Canadian residents send coupon to International Correspondence Schools Canadian, Ltd., Montreal, Canada.

I N V E N T O R S

A patent is a valuable right. On the basis of a constitutional provision Congress has established a system under which inventors may secure the exclusive right to prevent the unauthorized use, manufacture and sale of their inventions for periods of seventeen years. The inventor secures this protection by obtaining a patent.

Unless an inventor is thoroughly familiar with such matters, he is advised to employ a competent registered patent attorney, as the value of patents depends largely upon the skillful preparation of the specification and claims.

We recommend that you authorize us to conduct a search through the United States patents pertinent to your invention and to submit a report setting forth our opinion with respect to its patentability.

This firm is registered to practice before the U. S. Patent Office and is available to assist inventors in the preparation and prosecution of their cases. Detailed information and the preliminary steps to take to obtain patent protection will be furnished upon request. *Form below for mailing convenience.*

VICTOR J. EVANS & CO. • *Merlin M. Evans*
REGISTERED PATENT ATTORNEY
430-B MERLIN BUILDING, WASHINGTON 6, D. C.

VICTOR J. EVANS & CO. • Merlin M. Evans
Registered Patent Attorney
430-B Merlin Building, Washington 6, D. C.

Please send me without obligation a copy of your booklet "Patent Protection For Inventors" together with your convenient "Evidence of Invention" form.

Name.....

Address.....

City and State.....

PATENTS

TRADEMARKS

COPYRIGHTS

These Men are Learning

ELECTRICITY

in the Great SHOPS of COYNE



ESTABLISHED 1899
Oldest, Largest, Best
Equipped School of
Its Kind in U. S.

Why Spend Years Preparing for a Good Job?
Train Quickly at COYNE—Be Making Real
Money While Others are Still Puttering Along!

Learn on Real Equipment

Do as these fellows are doing! Get ready for Good Pay—a Big Future in ELECTRICITY—by training in the Great Shops of COYNE. Here you work on real motors, armatures, switchboards; do actual wiring and trouble shooting; get "all-around" training for dozens of well-paid job opportunities. Mail coupon today!

Not a "Home-Study" Course

We do not teach by mail. All training plus necessary theory is given in our Great Shops. Expert instructors guide you. No advanced education or previous experience needed.

EARN WHILE LEARNING

If you need part-time work to help out with living expenses while at Coyne, we'll help you get it. Don't be held back by lack of money.

GI Approved—Finance Plan for Non-Vets

COYNE is authorized to train men under the G. I. Bill. Non-veterans may enroll now, pay most of tuition after graduation. Coupon brings details of our special plan for MEN OF DRAFT AGE.

Electrical Refrigeration Included

Added training now included in great new field of Electric Refrigeration—also Industrial Electronics. Both mean added opportunities for you.

B. W. COOKE, President

COYNE ELECTRICAL AND RADIO SCHOOL

500 S. Paulina St., Dept. 29-72
CHICAGO 12, ILLINOIS

PREPARE
AT COYNE
FOR REAL
FUTURE

in Jobs
Like These

Switchboards
House Wiring
Power Wiring
Maintenance
Electric Mfg.
Refrigeration
Signal Work

Motor Testing
Armature Work
Industrial
Electronics
Power Plants
Substations
Your Own Shop

FREE Lifetime Job Service to
COYNE Graduates.



Get This
Free Book!

See what COYNE offers in quick, pay-raising training. Send coupon for Big FREE BOOK, filled with pictures of our great shops and all the facts to help you. No obligation. No salesman will call. Rush coupon now!



B. W. COOKE, Pres.
COYNE ELECTRICAL AND RADIO
SCHOOL, 500 S. Paulina
St., Dept. 29-72, Chicago 12.

Send me your big FREE BOOK on ELECTRICITY and special plan for men of draft age. This does not obligate me in any way and no salesman will call on me.

NAME.....

ADDRESS.....

CITY.....STATE.....

MAIL NOW!

BE A WINNER AT ANYTHING YOU TACKLE WITH **PROGRESSIVE POWER** Now **ALL 5 FAMOUS JOWETT COURSES** in 1 Volume For only **25¢**

WHAM! DARLING, THAT BULLY WON'T PICK ON YOU AGAIN.

JOE YOUR NEW ENERGY AND APPEARANCE SURE DO A GOOD JOB YOU EARNED YOUR PROMOTION.



George F. Jowett
Whom experts call "Champion of Champions"

- World's wrestling and weight lifting champ at 17 and 19.
- World's Strongest Arms. • 4 times World's Perfect Body — plus other records.

Let's Go, Pal! I'll prove I can make YOU an **"ALL-AROUND" HE-MAN**
FAST — OR NO COST!
says George F. Jowett
World's Greatest Body Builder

Enjoy My "Progressive Power" Strength Secrets! Give Me 10 Easy Minutes a Day — Without Strain! I'll teach you the "Progressive Power Method" through which I rebuilt myself from a physical wreck the doctors condemned to die at 15, to the holder of more strength records than any other living athlete or teacher! "Progressive Power" has proven its ability to build the strongest, handsomest men in the world. And I stand ready to show you on a money back basis—that no matter how flabby or puny you are I can do the same for you right in your own home. Let me prove I can add inches to your arms, broaden your shoulders, give you a man-sized chest, powerful legs and a Rock-like back—in fact, power pack your whole body so quickly it will amaze you! Yes, I'll jam you with power and confidence to master any situation—to win popularity—and to get ahead on the job! Through my proven secrets I bring to life new power in you inside and out, until YOU are fully satisfied you are the man you want to be.

PROVE IT TO YOURSELF IN ONE NIGHT.
Send only 25c for my 5 easy-to-follow, picture-packed courses now in 1 complete volume "How to Become a Muscular He-Man." Try it for one night! Experience the thrilling strength that surges through your muscles.

I am making a drive for thousands of new friends fast—REGARD-
LESS OF COST!
SO GET NOW MY 5 Muscle Building COURSES
(Valued at \$5 each)
All in 1 Great Complete Volume Packed With How-To-Do-It Pictures!
Now, this "get-acquainted," extremely low price of only **25c** is your chance to build a body you'll be proud of! Follow Jowett's easy method of muscle building NOW!
For Only 25c

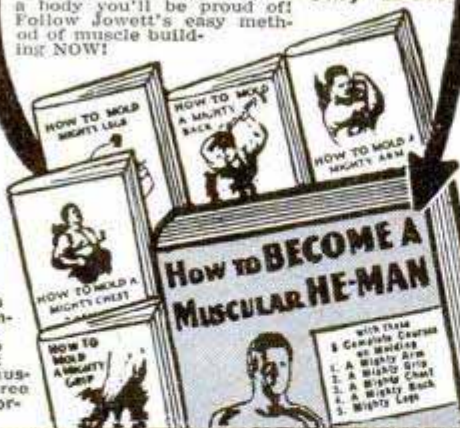

10 DAY TRIAL!
Think of it—all five of these famous courses now in one picture-packed muscle-building volume for only 25c. If you don't actually FEEL results within ONE WEEK, send it back and your money will be promptly refunded!
Photo Book Of Famous Strong Men!

FREE!
Photos that inspire you to might and muscle. Free with order.

FREE GIFT COUPON!

Jowett Institute of Physical Culture DEPT. PM-92
230 Fifth Avenue, New York 1, N. Y.

Dear George:—Please send by return mail, pre-paid, **FREE** Jowett's Photo Book of Strong Men, along with all 5 Muscle Building Courses, 1. Molding a Mighty Chest. 2. Molding a Mighty Arm. 3. Molding a Mighty Grip. 4. Molding a Mighty Back. 5. Molding Mighty Legs—Now all in One Volume "How to Become a Muscular He-Man." Enclosed find 25c. NO C.O.D.'S.

NAME _____ AGE _____
(Please Print Plainly, Include Zone Number)

ADDRESS _____

MAKE MORE MONEY THROUGH AUDIOMETRY

in spare time at home

Free literature tells how you can become expert in fitting of hearing aids in short time. Get into this well-paying uncrowded professional field. Complete course consists of General Physics, Anatomy, Physiology of the Human Ear, Psychology of Hearing, etc. together with Audiometry. Degree of Doctor of Audiometry conferred.

Write today for free literature.

ONLY SCHOOL OF ITS KIND
NATIONAL COLLEGE OF AUDIOMETRY
DEPT. PM-2 ANTIOCH, ILLINOIS

CHINCHILLA

CLEAN • GENTLE • HARDY
RAISE THEM FOR PROFIT—FREE INFORMATION—
BREEDERS FOR SALE—SUPPLY & FEED CATALOG FREE...
HISTORY & HANDBOOK—PRICE \$2.50.

NEED LITTLE SPACE | ALLIED DISTRIBUTORS
Write for facts to | GARDENA, CALIFORNIA

NEW! LOW COST! RESPIRATOR

Wear when sanding, grinding, paint spraying, sweeping, dusting, furnace cleaning, etc. Handy as a pair of glasses. Just keep mouth closed and breathe through nose is all you do to operate. Protects against nuisance dusts, lint, coal, cement, grain dust, hay fever pollen. Has 9 sq. in. filter. For EYE protection against paint spray, dusts, gases, fumes, smoke, order our Fog-Proof Rubber GOGGLES \$2.00 p.p.

JERRY BRYANT, Dept. PM
919 N. Michigan Ave. Chicago 11, Ill.



Learn to Write at Home in Spare Time

Why write a poor hand? Be a Good Penman—Win Prestige, Success. Right in your own home, regardless of how you Now write, you can learn Expert Penmanship during your spare moments by my Simplified Method, that will enable you to attract attention and amaze your friends, and for your Social and Business Advancement. Investigate NOW! Write for Complete Information and my FREE BOOK, "How to Become an Expert Penman," which shows what others have accomplished by taking my Courses. If you wish, enclose 10c for Special Penpoint and your name with a flourished bird written on a card. Write TODAY.

T. M. TEVIS, BOX 25K, CHILLICOTHE, MO.

TOOL AND DIE DESIGN

FREE COPY of our catalog explains comprehensive 12 month course in tool or die design. Expertly planned curriculum. Highly individualized instruction. Housing, employment problems aided.

Write today for complete information.

TECHNICAL EDUCATION, INC. (Acme School)
Dept. PM, 2804 Belmont Chicago

LABORATORY TECHNICIAN

BE A LABORATORY SPECIALIST; complete course. Big demand from hospitals, doctors, clinics. We teach all branches of medical laboratory work, including **Medical and Dental X-Ray**.

Approved by American College of Medical Technologists
Co-educational Free Placement Bureau
Free Catalog
Accredited for "veteran" training

CHICAGO COLLEGE OF LABORATORY TECHNIQUE
Dept. P.M., 431 S. Wabash Ave. Chicago 5, Illinois

Thrilling Work COLORING PHOTOS

Fascinating vocation learned at home by those with aptitude. Thrilling pastime. National method brings out life-like colors. Free booklet.

NATIONAL PHOTO COLORING SCHOOL
1315 S. Michigan, Dept. 1352, Chicago 5

EASY TO LEARN

WHICH OF THESE *Opportunities* INTERESTS *You* MOST?

Accounting
Air Conditioning
Architecture & Building
Automotive Engineering
Aviation—Practical
Aviation Drafting & Design
Better Foremanship
Bookkeeping
Business Management

Contracting
Diesel Engineering
Drafting & Design
Electrical Engineering
Electricity—Practical
Electronics, Industrial
High School Courses
Machine Shop Operations
Mechanical Engineering

Plastics Engineering
Plumbing—Practical
Private Secretary
Radio Operating & Servicing
Railway Training
Refrigeration
Sheet Metal Pattern Drafting
Shop Management
Tool Making

THINK! LOOK FORWARD!

Business is making big, new plans

Men and Women are preparing for the future

WHAT ARE YOU DOING ABOUT YOUR TOMORROWS?

● *Today*, choose the job you want—and prepare for it. Or if you are already engaged in the work you like best, start training *now* for quicker promotion. Acquire the knowledge that will help you to get ahead faster, make more money and have greater security.

Invest part of your spare time in more rapid progress. Start training now, in spare time in your own home. Be ready to grasp your opportunity and step out ahead of those who lack the ability you have attained.

American School, founded in 1897 as an educational institution *not for profit*, can help you to reach your goal just as it has helped others during the past fifty-two years. Give serious thought to the list above. Pick one or more subjects that interest you. Then check the coupon at right, add your name and address and mail it at once. The school will send you details on its training plan and outline of study prepared by specialists. There is no charge, no obligation, so send the coupon immediately.

PRACTICAL, EFFECTIVE HOME • STUDY TRAINING SINCE 1897

Take This First Easy Step

CHECK, CLIP AND MAIL COUPON NOW

AMERICAN SCHOOL, Dept. G-245, Drexel at 58th, Chicago 37, Ill.
Without obligation, Please send FREE and postpaid, bulletin and details of the Subject checked.

- | | | |
|--|--|--|
| <input type="checkbox"/> PLASTICS ENGR' R | <input type="checkbox"/> Accounting | <input type="checkbox"/> Drafting and Design for Men and Women |
| <input type="checkbox"/> Refrigeration | <input type="checkbox"/> Electrical Engr. | <input type="checkbox"/> Radio |
| <input type="checkbox"/> Architecture and Building | <input type="checkbox"/> Electricity-Pract. | <input type="checkbox"/> High School |
| <input type="checkbox"/> Contracting | <input type="checkbox"/> Electronics, Industr. | <input type="checkbox"/> Air Conditioning |
| <input type="checkbox"/> Practical Plumbing | <input type="checkbox"/> Bookkeeping | <input type="checkbox"/> Mechanical Eng. |
| <input type="checkbox"/> Automotive Engineering | <input type="checkbox"/> Private Secretary | <input type="checkbox"/> Shop Management |
| <input type="checkbox"/> Aviation Drafting | <input type="checkbox"/> Diesel Engineering | <input type="checkbox"/> Tool Making |
| <input type="checkbox"/> Aviation | <input type="checkbox"/> Sheet Metal | <input type="checkbox"/> Better Foremanship |
| <input type="checkbox"/> Business Mgmt | <input type="checkbox"/> Pattern Drafting | <input type="checkbox"/> Machine Shop Operations |
| <input type="checkbox"/> Railway Training | | |

Name..... Occupation.....
Address..... Age.....
City..... State.....

AMERICAN SCHOOL

Dept. G-245, Drexel at 58th Street, Chicago 37

ART FOR PLEASURE AND PROFIT



DRAW YOUR WAY TO HAPPINESS! LEARN AT HOME IN YOUR SPARE TIME
TWO BIG ART OUTFITS GIVEN

As soon as you enroll, we send you the first of the TWO complete Artists' Outfits, including all the material you need to start the course. Later in the course you receive the second, advanced outfit. All at no extra cost.

Read What These Graduates Say:
FREE LANCE ARTIST — R. H. Woodruff of Cleveland, Ohio, has more than paid for his WSA training by doing sign and poster work. (4-46)
STAFF ARTIST AND CARTOONIST — G. W. Thomas, Los Angeles newspaper artist, says: "WSA is Number One school in U. S. A." (1-46)

WRITE FOR FREE BOOK
"ART FOR PLEASURE & PROFIT"

Tells about our method of instruction and commercial opportunities for you . . . also about WSA students, what they say, and reproductions of their artwork.

G.I. APPROVED

EST. 1914

WASHINGTON SCHOOL OF ART

AUDELS Carpenters and Builders Guides 4 vols. \$6

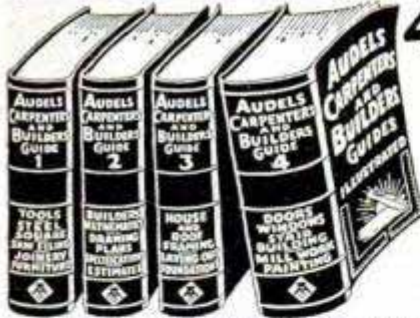

Inside Trade Information for Carpenters, Builders, Joiners, Building Mechanics and all Woodworkers. These Guides give you the short-cut instructions that you want—including new methods, ideas, solutions, plans, systems and money saving suggestions. An easy progressive course for the apprentice and student. A practical daily helper and Quick Reference for the master worker. Carpenters everywhere are using these Guides as a Helping Hand to Easier Work, Better Work and Better Pay. To get this assistance for yourself, simply fill in and mail the FREE COUPON below.

How to use the steel square—How to file and set saws—How to build furniture—How to use a mitre box—How to use the chalk line—How to use rules and scales—How to make joints—Carpenters arithmetic—Solving mensuration problems—Estimating strength of timbers—How to set girders and sills—How to frame houses and roofs—How to estimate costs—How to build houses, barns, garages, bungalows, etc.—How to read and draw plans—Drawing up specifications—How to excavate—How to use settings 12, 13 and 17 on the steel square—How to build hoists and scaffolds—skylights—How to build stairs—How to put on interior trim—How to hang doors—How to lath—lay floors—How to paint



AUDELS, Publishers, 49 W. 23rd St., New York 10, N. Y.
 Mail Audels Carpenters and Builders Guides, 4 vols., on 7 days free trial. If OK I will remit \$1 in 7 days and \$1 monthly until \$6 is paid. Otherwise I will return them. No obligation unless I am satisfied.

Name _____
 Address _____
 Occupation _____
 Employed by _____ PM

TRAINED ARTISTS ARE CAPABLE OF EARNING \$65, \$85 and More a Week

Prepare yourself for a pleasant, profitable Art career. **COMMERCIAL ART, DESIGNING, CARTOONING**—all in one complete modern home study course. Many pleasant art positions available in this great field. You can become your own boss. Work at home on your own time. Many students earn extra money while learning by designing posters, rendering signs, lettering, etc. W. S. A. is now in its 35th successful year of training men and women. No previous art experience necessary, we teach you step-by-step for professional Art jobs in advertising, newspaper and magazine publishing, department stores, printers, engravers, art studios, etc. Get the facts now. Low tuition — easy terms.

FREE BOOK gives details

WASHINGTON SCHOOL OF ART, Studio 122R
 1115—15th St., N. W., Washington 5, D. C.

Please send me full information and your Free Book, "Art for Pleasure and Profit."

Name _____ Age _____

Street _____

City _____ Zone _____ State _____

I am entitled to training under the GI Bill.



WATCH REPAIRING

Be a Master Watchmaker! Graduates earn big money — many in business for themselves. The famous Swezey System of Instruction teaches you quickly and easily. Our 41st year.

Write today for free information.

CHICAGO SCHOOL OF WATCHMAKING
 Dept. 129, 1608 Milwaukee Ave. Chicago 47, Ill.

make MONEY CASTING AT HOME

Make your own rubber molds quickly, cheaply with X.L. RUBBER. Cast thousands of perfect figurines, book ends, plaques, ornaments, ash trays, etc. **GREAT PROFITS!**

Write for **NEW Catalog**.
 X.L. Rubber, Pts. \$2.00; Qts. \$3.50; Gallons \$8.95; Models and enough rubber for 3 molds \$1.00 plus postage.

PLASTIC ARTS STUDIO Route 2 • Dept. 2 • Muncie Ind.

THIS GOOD PAYING TRADE NEEDS TRAINED MEN . . .

MECHANICAL REFRIGERATION and AIR CONDITIONING

Get into this well-established trade, alive with new opportunities. Air Conditioning and Refrigeration have become a necessary part of modern living—at home and in businesses. Trained installation and servicemen needed. Now you can prepare for profitable future experience by practical training at home plus short shop practice at famous U.E.I. Send coupon for interesting facts FREE.

UTILITIES ENGINEERING INSTITUTE (Founded 1927)
 2525 SHEFFIELD AVE., DEPT. 129, CHICAGO 14, ILLINOIS
 Send FREE facts about opportunities in Refrigeration and Air Conditioning.

NAME _____ AGE _____
 ADDRESS _____

NOW!

Amazing new equipment helps you learn

TELEVISION RADIO-ELECTRONICS

... faster-easier

BUILD AND KEEP THIS EQUIPMENT

- 6-TUBE RADIO RECEIVER • OSCILLOSCOPE
- SIGNAL GENERATOR • MULTI-METER

**OUR
GREATEST
OFFER
IN 17
YEARS**



Here's good news . . . big news . . . our **BIGGEST NEWS** in 17 years. The equipment at right gives a partial idea of D.T.I.'s remarkable, new combination of shop-method training aids . . . to prepare you **AT HOME** for your start in Television-Radio-Electronics.

GET **FREE** BOOKLET

Mail coupon today for D.T.I.'s big, new 48-page **OPPORTUNITY GUIDE BOOK**. See how this amazing newer method helps you get started toward a **GOOD JOB** or your **OWN BUSINESS** in one of America's most promising fields . . . Television . . . F.M., Train, 2-Way Taxi, Aviation, and Broadcast Radio . . . Industrial Electronics . . . and other fascinating branches.

In addition to well-illustrated lessons, you work over 300 instructive projects from 16 shipments of Radio-Electronic parts — including (1) a commercial-type **CATHODE RAY OSCILLOSCOPE** that helps you get practical Television circuit training, (2) a double range **RF SIGNAL GENERATOR**, (3) a jewel-bearing **MULTI-METER**, and (4) a quality 6-tube **SUPERHET RADIO**. You keep all of this equipment.

**WORK OVER
300 HOME
EXPERIMENTS**

MODERN CHICAGO LABORATORIES

If you prefer, make **ALL** your preparation in our new, Chicago training laboratory . . . one of the finest of its kind. Ample instructors . . . modern equipment. Write for details!

EFFECTIVE EMPLOYMENT SERVICE

When you complete your training, our effective Employment Service is available to you without extra cost to help you get started.



USE MODERN HOME MOVIES . . . A D.T.I. EXCLUSIVE

D.T.I. alone includes the use of modern, visual training aids — **MOVIES** — to help you learn faster at home. You see electrons on the march and other fascinating "hidden action" . . . a remarkable home-training advantage that speeds your progress.

MAIL COUPON TODAY!

DeForest's Training, Inc.
2533 N. Ashland Ave., Dept. PM-F2
Chicago 14, Illinois

Send me **FREE** your 48-page **OPPORTUNITY GUIDE BOOK** showing how I may make my start in Television-Radio-Electronics.

Name _____ Age _____
 Street _____ Apt. _____
 City _____ Zone _____ State _____

DeForest's Training, Inc.

CHICAGO, ILLINOIS
 Affiliated with the DeVry Corporation,
 Builders of Electronic and Movie Equipment

Be a **RADIO TECHNICIAN!** **TELEVISION** - F.M. - **ELECTRONICS** INCLUDED



Get **PRACTICAL** Training
in the

Great Shops of **COYNE**

BIG opportunities are waiting for men who know the *practical* and *technical* end of Radio and Television. That's what you get at COYNE—besides practical Shop training in F.M., Electronics and other branches of this giant field.

COYNE offers both a Practical Course and a Practical Technicians Course in the field of **Radio** and **TELEVISION SERVICE**. Coupon brings details on both courses. Mail it today.

**NOT A
CORRESPONDENCE
COURSE!**



OLDEST, LARGEST, BEST EQUIPPED SCHOOL OF ITS KIND IN AMERICA



Established 1899—50th ANNI-VERSARY YEAR. The better your training, the brighter your future. At Coyne you train on a vast outlay of real Radio and Television equipment. We don't teach by mail.

G.I. APPROVED... FINANCE PLAN FOR NON-VETERANS

Don't be held back by lack of cash. Start now, pay most of tuition later. Coupon brings special plan for men of draft age.

Send for BIG FREE BOOK

Dozens of big pictures, all the facts about COYNE Practical Course and Practical Technicians Course in Radio-Television. No obligation. No salesman will call. Rush coupon now!

COYNE B.W. COOKE, Pres.
**ELECTRICAL &
RADIO SCHOOL**

500 S. Paulina, Dept. 29-3H, Chicago 12



FREE BOOK COUPON

B.W. COOKE, Pres.,
COYNE Electrical & Radio School
500 S. Paulina St., Dept. 29-3H, Chicago 12, Ill.

Send me **FREE BOOK** and information about your Practical Course and Practical Technicians Course in **RADIO-TELEVISION**. Also details of special plan for men of draft age.

NAME.....
ADDRESS.....
CITY..... STATE.....

Have an **OFFICE of YOUR OWN!**

LEARN NEW PROFITABLE PROFESSION
At Home in 60 Days, Men & Women, 18 to 70!

Be Your Own Boss and the Boss of Others. Be Respected. Meet Interesting People.

Earnings of men and women in this profession run as high as \$5,000-\$15,000 yearly. Others make good money in spare time. Little money needed to start. A business where your earnings begin sooner. Easy to learn. No selling or goods to buy. No experience necessary. A depression-proof business. A course of action to guide you step by step as you earn. All 53 lessons sent at once to use as operating manuals. Easy terms. Diploma. Money-back agreement. Write for **FREE BULLETIN**.



FRANKLIN CREDIT SCHOOL
Dept. 75-B ROANOKE 7, VIRGINIA

**BY MAIL in
Easy Lessons**



Sensational Tetra SNAPDRAGONS

New SCIENTIFIC INTRODUCTION

Chemically treated. Produces the largest flowered Snapdragons, many attractively ruffled. Sturdy spikes 2½ feet high. Combination of gorgeous rich colors. Bloom all summer. Send only 10c for 300 seeds and my **FREE**

Big Seed and Nursery Catalog. **Box 700**
R. H. SHUMWAY SEEDSMAN Rockford, ILL.

YOUR SUCCESS POULTRY PROFITS WITH

Berry's Rugged Year Around Layers. Feed Economizers. Quick growing and Fast Feathering Broilers. Originators and Largest Producers of Austra-White. The New Wonder Chicken of Today "**Berigold**". Improved White Rocks, New Hampshire-bred for the Middle West, South-West. **Specializing in 5 Rugged cross breeds, 10 Pure breeds. Day Old, 4-6 Week Old Chicks.** Write Today for New Catalog Telling about how More Profits can be made.

BERRY'S CHICKS, Box 52 NEWTON, KANSAS



LEARN LANDSCAPING

Profitable career—absorbing hobby for men and women! Thorough home-study course in landscaping, garden design. 45 lessons beautifully printed and illustrated. Learn in spare time 8-12 months. Hundreds of successful graduates all over the world. 33rd year. Write for Free Catalog.

AMERICAN LANDSCAPE SCHOOL
6531 Grand Ave., Des Moines 12, Ia.

LAW FREE BOOK



Your **FREE** copy of "The Law-Trained Man" shows how to gain prestige and greater earnings through Blackstone home law study. All instruction material furnished including 18-volume Law Library written by 65 well-known law authorities. Lawyers, judges among our graduates. LL.B. degree. Low cost; easy terms. Write today. 225 N. Michigan Ave. Dept. 52, Chicago 1, Ill.

BLACKSTONE COLLEGE OF LAW
A Correspondence Institution Founded in 1890

LEARN MONEY- MAKING CARTOONING

IN SPARE TIME — by Easy Picture Chart Method

Same Simplified Method that has helped train creators of "Terry & Pirates," "Freckles," "Out Our Way," "Winnie Winkle," "Reg'lar Fellars," "Strange As It Seems," "The Neighbors," and many others. Earn while learning. Send 10c for Picture Chart (to test your ability), and full details. (State age.)



THE LONDON SCHOOL, 4902 Cleve. Transit Bldg., Cleveland, O.

Be an INVESTIGATOR

JAMES S. BOLAN, FORMER POLICE COMMISSIONER OF NEW YORK CITY offers **MEN & WOMEN** an attractive opportunity to prepare for a future in **Investigation & Criminology** by comprehensive Home Study Course. Free placement service assists graduates to obtain jobs. **APPROVED UNDER G. I. BILL OF RIGHTS.**

Write for Free Booklet PM.

THE BOLAN ACADEMY, INC.
EMPIRE STATE BLDG., NEW YORK 1, N. Y.

THOUSANDS NOW PLAY

who never thought they could!



After Ten Months Plays in Band

I had no idea I would accomplish so much musically. After only ten months I was playing in bands. I now am employed in a music store as an instructor. This I owe to your marvelously simple lessons.
*R. C., Paterson, New Jersey



Wouldn't Take \$1000 for Course

The lessons are so simple that anyone can understand them. I have learned to play by note in a little more than a month. I wouldn't take a thousand dollars for my course.
*S. E. A., Kansas City, Mo.



Shares Course With Sister

The teaching is so interesting and the pieces so beautiful I couldn't ask for anything better. I recommend your course highly. My sister shares it with me and feels the same way.
*D. E. G., Wausau, Wis.

You, too, can play any instrument By this EASY A-B-C Method

YOU think it's difficult to learn music? That's what thousands of others have thought! Just like you, they long to play some instrument—the piano, violin, guitar, saxophone or other favorites. But they denied themselves the pleasure—because they thought it took months and years of tedious study to learn.

Learn in Spare Time at Home

And then they made an amazing discovery! They learned about a wonderful way to learn music at home—without a private teacher—without tedious study—and in a surprisingly short time. They wrote to the U. S. School of Music for the facts about this remarkable short-cut method. And the facts opened their eyes! They were amazed to find how easy it was to learn.

The result? Over 850,000 men and women have studied music at home this simple, A-B-C way. Now, all over the world, enthusiastic music-lovers are enjoying the thrilling satisfaction of creating their own music. They have found the key to good time, popularity and profit.

Costs Only Few Cents a Day

And that's what you can do, right now. Get the proof that you, too, can learn to play your favorite instrument—quickly, easily, in spare

time at home for only a few cents a day. Never mind if you have no musical knowledge, training or talent. Just read the fascinating booklet and Print and Picture sample that fully explain all about the famous U. S. School method. Instruments supplied when needed, cash or credit. If interested tear out the coupon now, before you turn the page. U. S. School of Music, 72 Brunswick Bldg., New York 10, N. Y. (51st year)

FREE!

Print and Picture Sample



NOTICE

Prices of our courses have not gone up. Music lessons still cost only a few cents a day. Remember, we don't teach music "by ear" or by numbers. We teach you to play by standard notes.



Lots of Fun

The progress I have made is thrilling. I'm on Lesson Seven and tossing off "Little Buttercup" like a maestro. The course is easy and what is most important—lots of fun.
*B. B., Jr., Hartford, Connecticut



Plays After 2 Months

I hesitated before sending for your course because of an earlier experience I had with a course by ear from another company. I am playing pieces now I never dreamed I would play after only two months.
*E. T., Prichard, Ala.

*Actual pupils' names on request. Pictures by professional models.

U. S. SCHOOL OF MUSIC,
72 Brunswick Bldg., New York 10, N. Y.

I am interested in music study, particularly in the instrument checked below. Please send me your free illustrated booklet "How to Learn Music at Home," and your free Print and Picture Sample. (Instrument supplied when needed, cash or credit.)

Piano	Saxophone	Clarinet	Practical
Guitar	Trumpet, Cornet	Trombone	Finger
Hawaiian	Reed Organ	Flute	Control
Guitar	Tenor Banjo	Modern	Piccolo
Violin	Ukulele	Elementary	Mandolin
Piano Accordion		Harmony	

Mr. _____ Have you _____
Mrs. _____ Instrument? _____
Miss _____ (Please print)

Address _____

City _____ State _____

NOTE: If you are under 16 years of age, parent must sign coupon.

SAVE 2c — STICK COUPON ON PENNY POSTCARD



Satisfied with my JOB and PAY? NOT ME!!

"Some day I'll really get a break and go right on to the top." That's wishful thinking.

You know that the "breaks" go to the man or woman who is prepared to take advantage of them—to the person who can fill the better job and is worth more money. He makes the "breaks" instead of waiting for them.

You can influence your own future by preparing now for the step forward—so that openings come because you are equipped for them—not as the result of luck.

Why not take the road that thousands of ambitious men and women have taken to help them to better jobs and more money.

Prepare now. Send the coupon below—check the business field of your choice and we'll send you without obligation our FREE 48-page book describing the opportunities and complete information on that field—plus "Ten Years' Promotion in One"—a book which has helped many men.

Send the coupon Now. It may be the turning point in your life to that better job and more money.

LASALLE Extension University
A Correspondence Institution
Dept. 264-R Chicago 5, Ill.

LASALLE Extension University
A Correspondence Institution

417 S. Dearborn St., Dept. 264-R, Chicago 5, Ill.

I want to make my own "breaks" by preparing for a better job. Send free 48-page book on the subject I have checked.

- | | |
|--|--|
| <input type="checkbox"/> Higher Accountancy | <input type="checkbox"/> Salesmanship |
| <input type="checkbox"/> C.P.A. Coaching | <input type="checkbox"/> Traffic Management |
| <input type="checkbox"/> Bookkeeping | <input type="checkbox"/> Foremanship |
| <input type="checkbox"/> Law: LL.B. Degree | <input type="checkbox"/> Industrial Management |
| <input type="checkbox"/> Business Management | <input type="checkbox"/> Stenotypy (Machine Shorthand) |

Name Age

Address

City Zone State

MIRACLE TOMATO Yields 2 BUSHELS To a Vine



Now—You can grow the world's most amazing Tomato right in your own garden and get from 2 to 3 bushels of delicious, ripe tomatoes from every vine.

BURGESS CLIMBING TRIP-L-CROP

TOMATO grows 16 to 20 feet high. Huge, meaty, solid fruit, wonderful flavor. Some weigh as much as 2 pounds each. Unsurpassed for canning and slicing. Blight free—drought and disease-resistant. Grows in any garden. Outyields all other varieties.

**TRIAL PACKET OF PELLETED
BETTER GROWING SEEDS ONLY**
10c—3 FOR 25c POSTPAID.
ORDER TODAY.

Write for FREE complete
Catalog listing many unusual
Seeds, Plants and Bulbs.

BURGESS SEED & PLANT CO.
217 T. Galesburg, Mich.

AVIATION TRAINING

AERONAUTICAL ENGINEERING AIRCRAFT and ENGINE MECHANICS (A & E)

Train on famous Northrop Field—New classes starting soon.
Write for illustrated catalog.

Northrop Aeronautical Institute

1527 E. BROADWAY Division of Northrop Aircraft, Inc. LOS ANGELES COUNTY
HAWTHORNE CALIFORNIA

APPROVED FOR VETERANS

NEW YORK SCHOOL of MECHANICAL DENTISTRY

SINCE 1920—The outstanding Training Center for all phases of Dental Laboratory Technology.
Licensed by New York and New Jersey States
Approved for Veterans G.I. BILL & P.L. 16
Visitors Welcome. Ask for Free Bulletin "P."
NEW YORK SCHOOL OF MECHANICAL DENTISTRY
America's Oldest School of Dental Technology
138 Washington St. NEWARK 2, NEW JERSEY
Also: 125 W. 31 Street NEW YORK 1, N. Y.
Immediate Enrollment—Day and Evening



RAISE Money Making CHINCHILLAS

Several females and a male start a large herd which will furnish you an income for years. Just a few feet of space are required. No experience needed. We furnish all instructions. Write world's largest breeder today for free details.

WILLOW BROOK FARM, R-36, Sellersville, Pa.

APTITUDE TESTS

discover the kind of work or studies best for your success! You get a personal report—a guide for life—more happiness—more prosperity. For men, women, boys and girls. Write for complete facts.
VOCATIONAL COUNSELING INSTITUTE
956 Maccabees Bldg., Detroit 2, Michigan

PLAY THE ACCORDION IN FEW WEEKS

Thru Startling New "SEE—HEAR—and LEARN" method



Makes learning to play the accordion SURE... FASTER... EASIER... and it's great fun while learning.

Get all the thrilling details.
Write to

O. PAGANI & BRO.
289 Bleecker St., New York 14, N. Y.

Now Any AUTO REPAIR JOB Can Be a "Push-Over" for You!

**IN LESS TIME —
WITH LESS WORK —
AND MORE PROFITS!**

MoToR's new AUTO REPAIR MANUAL shows you how to service and repair ANY part of ANY car! Now you can lick even the toughest jobs when you have this amazing Manual to make your work easier!

Every job on every car built since 1935 is explained as simply as A-B-C. Clear, illustrated instructions lead you step by step. NOW you can tackle ANY job from carburetor to rear end—and do it quick, easy, right, the FIRST time! Just look up make, model, and the job in the quick index of MoToR's AUTO REPAIR MANUAL—and go to it!

ONLY Manual of Its Kind

No wonder this manual is used by the U. S. Army, Navy, trade and technical schools everywhere, and thousands of successful auto servicemen!

To make this great book possible, the engineer-editors of MoToR Magazine condensed all the meat from over 150 official factory manuals for you. They dug out all the information you need; made sure every word is crystal-clear; and put "the whole works" into this one great, handy book!

MoToR's AUTO REPAIR MANUAL is a big book: over 700 large pages, 8½x11 inches, bound in sturdy covers. Nearly 200,000

service, repair, adjustment, replacement, tune-up facts on every car built from 1935 to 1948!

Over 1700 Pictures!

More than 1700 cutaway photos, diagrams, drawings, charts, SHOW you what the clear text TELLS you! No wonder thousands of men call this amazing book their Auto Repair "Bible"! No wonder it will save YOU countless hours of work—and help you make MORE MONEY from auto repairs!

See for yourself—without cost!—what a work-saver, time-saver, and "life-saver" MoToR's AUTO REPAIR MANUAL will be for you! TRY it FREE—for 7 days. Learn first-hand how it can pay for itself the first few times you use it!



Clear, Pictured Facts on Every Job on Every Car Built Since 1935!

Nearly 200,000 service and repair facts on all these makes:

American	Crosley	Lafayette	Pierce
Bantam	De Soto	La Salle	Arrow
Auburn	Dodge	Lincoln	Plymouth
Austin	Ford	Lincoln	Pontiac
Buick	Frazer	Zephyr	Reo
Cadillac	Graham	Mercury	Studebaker
Chevrolet	Hudson	Nash	Terraplane
Chrysler	Hupmobile	Oldsmobile	Willys
Cord	Kaiser	Packard	

Over 700 big pages; including 70 pages of carburetor text, charts, illustrations covering all models. Over 200 charts, tables; Tune-up Chart; Valve Measurements; Torque Wrench Reading; Starting Motor; Engine Clearances; Generator; Body Service; Dash Gauges; Brake Specifications; Front End Measurements, etc.; Engines; Electric, Fuel, Cooling, Lubricating Systems; Transmissions; Universals; Front Ends; Wheels; Rear Ends, etc.



Just mail coupon below—without money! When the postman brings your book, examine it thoroughly. Make it show you what it's got! Unless you agree this is the greatest time-saver and work-saver you've ever seen—return book in 7 days and pay nothing. Mail coupon today! Address: MoToR Book Department, Desk 12, 250 West 55th Street, New York 19, New York.



Same FREE 7-Day Offer Applies on MoToR's Truck Repair Manual

For mechanics, truck specialists, service stations, fleet owners. Covers EVERY job on EVERY truck made since 1936! 1400 pictures, 952 pages, 300,000 facts. Used by Armed Forces. Warranted to contain every essential fact you need to know. Strong binding, size 8½x11.

Covers all types Gasoline Engines; Diesels and Hesselmanns. Fuel Systems, Governors, Lubrication Systems, Ignition Systems, Starters, Generators, Clutches, Transmissions, Axles, Torque Dividers, Transfer Cases,

Brakes, Steering, etc., etc. Also services buses, farm and industrial tractors, contractor and road building equipment, stationary power machinery, etc. (on all parts described in Manual.)

Offered on same FREE 7-Day examination as Auto Repair Manual. Check box in coupon at right.



Published by MoToR, The Leading Automotive Business Magazine. MoToR's manuals assure high standards of repair work.

MoToR Book Dept., Desk 12, 250 West 55th Street, N. Y. 19

Rush to me at once: (Check box opposite book you want)

MoToR's AUTO REPAIR MANUAL. If O.K. I will remit \$1 in 7 days, plus 35c delivery charges; \$2 monthly for 2 months and a final payment of 95c a month later. Otherwise I will return book postpaid in 7 days. (Foreign price, remit \$8 cash with order.)

MoToR's TRUCK REPAIR MANUAL. (Described at left.) If O.K. I will remit \$2 in 7 days, and \$2 monthly for 3 months, plus 35c delivery charge with final payment. Otherwise I will return book postpaid in 7 days. (Foreign price, remit \$10 cash with order.)

Print Name _____ Age _____

Print Address _____ Zone No. _____

City _____ (if any) _____

State _____ Occupation _____

Check box and SAVE 35c delivery charge by enclosing WITH COUPON entire payment of \$5.95 for Auto Repair Manual (or \$8.00 for Truck Repair Manual). Same 7-day return-refund privilege applies.

BIG MONEY IN WATCH REPAIRING



**LEARN
AT
HOME**

Get into this top-pay, easy-to-learn, uncrowded field thru our unique 10-lesson home study course. Watch makers in big demand. You train step-by-step under experts. We furnish all tools and new 15 jeweled watch. No interference with present job. Get out of the rut—turn spare time into money. More jobs than men to fill them. We have students from 18 to 65 who have profited by our training. Low cost.

Write today for all the facts — NO OBLIGATION.

ILLINOIS SCHOOL OF WATCH REPAIRING Dept. PM-2
2870 Eiston Ave.
Chicago 18, Ill.



AUTO BOOKS ON APPROVAL



SEND NO MONEY. Just mail the coupon for a complete set of 4 Big, Thick Auto Books. 20th Edition. Over 2700 Pages! Whether you are a mechanic or helper, expert or apprentice, auto owner or driver, take immediate advantage of this FREE EXAMINATION OFFER.

**MAKE GOOD MONEY NOW
HOLD A PERMANENT JOB**

America wants its automobiles kept in good repair. Men with "know how" are in demand, at big pay. These books will help you get and hold an important job, or give you a chance to go into business for yourself now or later. Any man who half tries to improve himself can learn auto servicing and repairing by this quick reference method. Use the JIFFY INDEX to find easily understood answer to any auto problem. These wonder books prepared by eleven of America's great automobile engineers. Many hundreds of valuable illustrations. Send the coupon TODAY.

A year's consulting privileges with our engineers now given with these books without extra charge.

Publishers Since 1898

AMERICAN TECHNICAL SOCIETY, Dept. A219
Drexel Ave. at 58th St., Chicago 37, Ill.

I would like to examine your 4-Volume Set of Auto Books. I will pay the delivery charges only, but if I choose I may return them express collect. If after 10 days' use I prefer to keep them, I will send you \$2 and pay the balance at the rate of only \$3 a month until \$24.80 has been paid. Include consulting service as offered above.

Name _____
Address _____
City _____ State _____

Please attach letter stating age, occupation, employer's name and address and name and address of at least one business man as reference. Men in service, also please give home address.

BECOME AN EXPERT DRAFTSMAN

You can qualify easily for splendid openings in Industry. The Triangle School, established 1943, is approved for Veterans and offers the training you need. (High School education required for entrance). Living quarters arranged.

Send for
information.

TRIANGLE SCHOOL OF DRAFTING

DEPT. M—347 FIFTH AVE., PITTSBURGH, PA.

EASY TO LEARN CODE

Learn or increase speed with an Instructograph—the Code Teacher that takes the place of an operator-instructor and enables anyone to master code without further assistance. Available tapes from beginners alphabet to typical messages on all subjects. Speed range 5 to 40 WPM. Always ready—no QRM. Thousands have "acquired the code" with the Instructograph System. Write today for convenient rental and purchase plans.

INSTRUCTOGRAPH COMPANY

4701-V Sheridan Road, Chicago 40, Illinois

THERE'S MONEY IN CARTOONS!

RAYE BURNS will teach you HOW to CREATE ORIGINAL CARTOONS at home that you may SELL! Course contains 26 lessons and over 600 illustrations. All for **\$2.85**

Send name and address for free details.

RAYE BURNS SCHOOL, Dept. M, Box 3583, Cleveland, Ohio

Get this Great Catalog of MAGIC



Amazing tricks, mystifying and spooky stage and party illusions. Easy to do—no skill—perfect instructions. Fool your friends. Loads of fun. Add "life" to any party. 350 pages. 600 illustrations. Mail \$1.00 for catalog, credited on your first order for \$5.00 or more.

NATIONAL MAGIC COMPANY
119 S. State St., Dept. P-2
Chicago 3, Ill.

BE A DETECTIVE

WORK HOME or TRAVEL. Experience unnecessary. DETECTIVE Particulars FREE. Write NOW to **GEO. P. M. WAGNER, 125 W. 86th St., N. Y.**

FIBRE ARMS AND LEGS!
Light, correctly fitted, strong and comfortable. Natural appearance. Braces for all deformities. Scientific design. Fair Terms.
BUCHSTEIN-MEDCALF 223 S. 6th St., Minneapolis, Minn.

"LEARN-BY-DOING"
ELECTRICITY
PRACTICAL TRAINING
NOT "HOME STUDY"

G.I. APPROVED Get actual experience in great shops of M.T.I. Learn all phases Practical Electricity; Housewiring, Motors, Const., Maintenance, etc. Living arrangements, Part-time jobs, etc.

Send coupon TODAY.

MICHIGAN TECHNICAL INSTITUTE Veteran
2281 W. Fort St., Detroit, Mich., Dept. PM-2

Name _____
Street _____
City _____ State _____

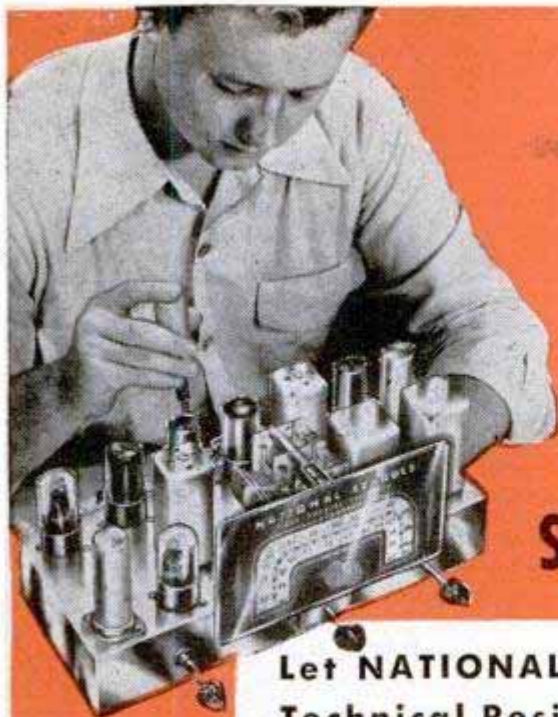

You receive all parts, including tubes, for building this fine, modern Superheterodyne Receiver. This and other valuable standard equipment becomes your property.

Learn RADIO

TELEVISION, ELECTRONICS

by

SHOP METHOD HOME TRAINING

Let NATIONAL SCHOOLS, of Los Angeles, a practical Technical Resident Trade School for almost 50 years, train you for today's unlimited opportunities in Radio

these two **FREE** books will tell you how



Good Jobs Await the Trained Radio Technician

You are needed in the great, modern Radio, Television and Electronics industry! Trained Radio technicians are in constant and growing demand at excellent pay—in Broadcasting, Communications, Television, Radar, Research Laboratories, Home Radio Service, etc. National Schools Master Shop Method Home Study Course, with newly added lessons and equipment, can train you in your spare time, right in your own home, for these exciting opportunities. Our method has been proved by the remarkable success of National Schools-trained men all over the world.

You Learn by Building Equipment with Standard Radio Parts We Send You

Your National Schools Course includes not only basic theory, but practical training as well—you learn by doing. We send you complete standard equipment of professional quality for building various experimental and test units. You advance step by step until you are able to build the modern superheterodyne receiver shown above, which is yours to keep and enjoy. You perform more than 100 experiments—build many types of circuits, signal generator, low power radio transmitter, audio oscillator, and other units. The Free Books shown above tell you more about it—send for them today!



NOW! NEW PROFESSIONAL MULTITESTER INCLUDED



This versatile testing instrument is portable and complete with test leads and batteries. Simple to operate, accurate and dependable. You will be able to quickly locate trouble and adjust the most delicate circuits. You can use the Multitester at home or on service calls. It is designed to measure AC and DC volts, current, resistance and decibels. You will be proud to own and use this valuable professional instrument.

GET THE DETAILS—SEND THE COUPON

LESSONS AND INSTRUCTION MATERIAL ARE UP-TO-DATE, PRACTICAL, INTERESTING

National Schools Master Shop Method Home Training gives you basic and advanced instruction in all phases of Radio, Television and Electronics. Each lesson is made easy to understand by numerous illustrations and diagrams. All instruction material has been developed and tested in our own shops and laboratories, under the supervision of our own engineers and instructors. A free sample lesson is yours upon request—use the coupon below.

You Get This and Other Valuable Information in the Free Sample Lesson:

1. Basic Receiver Circuits and How They are Used.
2. Construction of the Antenna Circuit.
3. How Energy is Picked Up by the Aerial.
4. How Signal Currents are Converted into Sound.
5. How the Tuning Condenser Operates.
6. How the R-F Transformer Handles the signal, and other data, with diagrams and illustrations.

Both Resident and Home Study Courses Offered

APPROVED FOR VETERANS
CHECK COUPON

NATIONAL SCHOOLS

LOS ANGELES 37, CALIF. • EST. 1905

MAIL OPPORTUNITY COUPON FOR QUICK ACTION

National Schools, Dept. PM-2
4000 South Figueroa Street
Los Angeles 37, California

(Mail in envelope or paste on penny postcard.)

Mail me FREE the book "Your Future in Radio" and a sample lesson of your course. I understand no salesman will call on me.

NAME _____ AGE _____

ADDRESS _____

CITY _____ ZONE _____ STATE _____

Check here if veteran of World War II

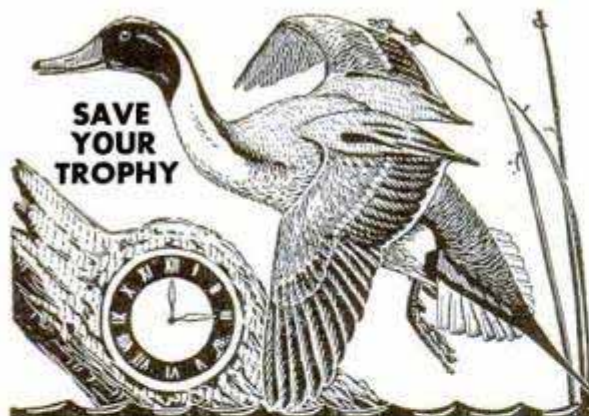

SAVE
YOUR
TROPHY

MOUNT your
own
Hunting Trophies

WHAT A HOBBY

Save and MOUNT your WILD-GAME
Be Your Own Taxidermist!

Hunters, anglers, nature-lovers, you will be **AMAZED** to learn and know the pleasures of Taxidermy. Your home-museum of beautiful **TROPHIES** will delight you and your family and friends.

LEARN AT HOME BY MAIL

We can teach you with fine success. More than **350,000** students have learned from this reliable school, **EASILY AND QUICKLY**. Here is the greatest **HOBBY** you ever dreamed of.

Mount Ducks, Quail, Deer, Fish
Save these beautiful trophies. **TAN** skins and furs. Decorate your **HOME AND DEN**. Become widely known and **FAMOUS** as a Taxidermist.

MEN AND BOYS Double your interest in hunting and outdoor-life. Have a magnificent **hobby** that will **enthral** you all your lifetime. **WRITE TODAY**.

Ask for FREE BOOK

MAIL THE COUPON—TODAY
Tells how **YOU** can learn Taxidermy at home. 48 pages, 100 pictures of wild-game. A wonderful book, strange, unique. You never saw the like before. This book is **PRICELESS** to hunters, trappers and nature-lovers. **ABSOLUTELY FREE** if you **WRITE AT ONCE**, this minute! Use the **COUPON** or a **POSTAL** will do. **PLEASE STATE YOUR AGE**.

FREE BOOK

Northwestern School of Taxidermy,
2502 Elwood Bldg., Omaha, Neb.

Send me your free illustrated book, "How to Mount Game". Also tell me how I may learn this fascinating art easily and quickly by mail. No obligation. State your age.

Name _____

Age _____

Address _____



CHEMISTRY

LEARN AT HOME... Chemical knowledge is essential for thousands of good jobs in industry, business, science. IPC enables you to master practical chemistry. It's the **ONLY** home study chemistry course which enables you to learn by performing actual experiments—using chemicals and apparatus supplied with the course—in addition to your IPC textbook studies. Compares with recognized college courses in General Chemistry. Write today for free descriptive booklet.

INSTITUTE OF PRACTICAL CHEMISTRY
3 PROSPECT AVENUE, HAGERSTOWN, MD.

Be Sure To Send For Free Book Now!



I HAVE SOME-
THING VALUABLE
TO GIVE YOU

I would like to send you my **PICTURE TOUR BOOK** absolutely **FREE** about one of America's largest and oldest Poultry Farm and Hatchery organizations.

My book is very complete and full of interesting and instructive color pictures. I know you'll enjoy and profit by reading it.

AMAZING POULTRY SECRETS

This book reveals many secrets you should know about profitable chicken raising, and especially **HYBRIDS** and **PURE BREDS**. It is **ABSOLUTELY FREE**. A postcard will bring it.

If you are interested in raising good chickens that make better profits and more pleasure write me **TODAY**.

MRS. HARRY HAM
ROUTE 56 ATCHISON, KANSAS

ANALYZE Handwriting

Uncrowded, fascinating field. Gratifying earnings reported by graduates in Employment, Credit, Social Service, Police and Entertainment fields. Others have developed profitable private practice, full or spare time, as Personal Problem and Vocational Counselors. Send for 3000 word **TEST LESSON** and Grapho Analyst **FREE**.

FREE
BOOK
and
LESSON

A.I.G.A. Inc.

Witholt Bldg., Dept. 120 Springfield, Mo.

EXPERT PHOTOGRAPHY MADE EASY

LEARN PHOTOGRAPHY NOW

—for both a sound and secure future and immediate opportunities. Ever-increasing demand for trained men and women. Excellent earnings. Resident or home study. 39th year. Write for full details.

NEW YORK INSTITUTE OF PHOTOGRAPHY
Dept. "49," 10 West 33 Street New York 1, New York

STRENGTHEN Your VOICE!

YES—you can now build yourself a powerful speaking and singing voice with this amazing new scientifically sound tested method. Self-training . . . no music or piano required. Results **GUARANTEED**. Just send your name for the sensational details. **FREE** chart of your vocal mechanism included!

PERFECT VOICE STUDIOS, Studio B-10, Kimball Hall Building, Chicago 4, Ill.

Become a Doctor of PSYCHOLOGY

Win the degree of **Ps.D.** Teach the secret of contentment, happiness. Solve mental worries. Experience the revelation of truth. Chartered college. Individual help. Write for **FREE** book. **COLLEGE OF UNIVERSAL TRUTH, 5153-B North Clark St., Chicago.**

BAKING

— a Sound Trade
or Business



Baking is one of America's high industries in wages. Not seasonal, but year 'round good field for trained experienced men. Thorough basic spare time home study course lays solid foundation. If you have aptitude for this type of work, send coupon below for **FREE** Booklet, "Opportunities in the Baking Industry."

NATIONAL BAKING SCHOOL
1315 S. Michigan Ave., Dept. 1352, Chicago 5, Ill.
Send free booklet "Opportunities in the Baking Industry" and full particulars.

Name _____

Address _____

City _____ State _____

Want to be in
BUSINESS
for **YOURSELF**

or Get a Good Pay Job?

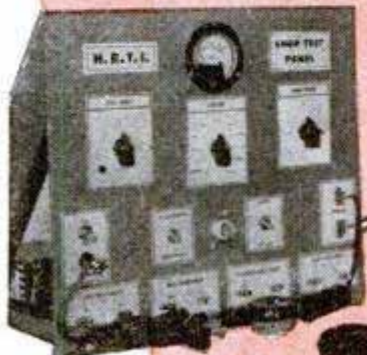

You Construct the Multi-purpose Shop Test Panel Shown at Left and Build **SCORES** of Radio Circuits Like Those Shown Below With the Parts I Send You.



Since 1929 I have been training men **ALL OVER THE WORLD** for success in radio. Find out how easy it is to learn right in your home through my two-way method - lessons plus actual practice. Send for big **FREE** book, **TODAY**.

H.R.T.I. Trained Men Win in Big Contest

FIRST, SECOND and FOURTH prizes in open contest for best Radio Technicians in Cuba **WERE WON BY HRTI** students and graduates! In fact, **SEVEN** of the first ten prizes were won by HRTI trained men! Over 250, graduates from many schools, as well as professional radio technicians, competed! Convincing proof of the quality of HRTI training. Get the facts about this amazing contest in my big **FREE** book. Don't gamble with your future success—choose the training of **PROVEN** quality... HRTI training!

BIG BOOK FREE

Sending for this book has marked the turning point in the lives of many men. You owe it to your future to find out about H.R.T.I. Training. Mail the coupon **TODAY**.



LEARN
Radio

Make Money in Spare Time While Learning at Home

Want to make more money? Want to be your own boss - have your own money-making business - with your future assured? Then learn Radio & Television with my proven 2-Way Method that can help you get into this great and growing business **QUICKER**.

Many of my students make money, some even start their own business in spare time - while learning.

Take the first step toward a successful career - **NOW** - send for my big 56-page illustrated book that tells how my home training can help prepare you to cash in on Radio and Television's opportunities. It's free, but it may mean your future success!

You Learn by Doing!

YOU GET 10 KITS OF RADIO PARTS!

YOU DO OVER 300 FASCINATING TESTS



You Build This 3 Tube Experimental Receiver (above) and This A-C Power Supply (right)

During your training you get 10 big kits of radio parts with which you perform hundreds of tests and experiments, build scores of circuits and testers, to help you learn faster, more thoroughly.

You learn first hand, by doing.

You Also Construct This Powerful, Four-Band, Six-Tube, A-C or D-C Superheterodyne Receiver

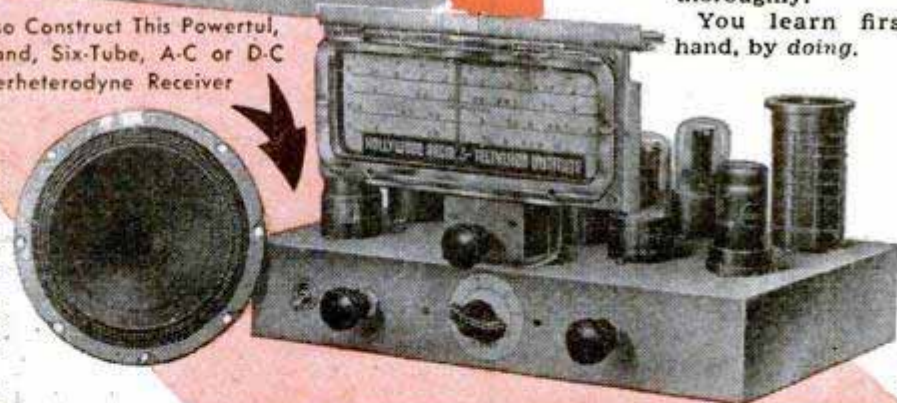

MAIL COUPON NOW

C. H. MANSFIELD, Pres., Dept. A 14
Hollywood Radio and Television Institute
810 West Sixth St., Los Angeles 14, California, U.S.A.

Send me your **FREE** book, "Your Opportunities in Radio, Television and Electronics," which explains your 2-way home study training method.
No salesman will call.

NAME _____

ADDRESS _____

CITY _____ STATE _____

If a veteran of World War II, check here

HOLLYWOOD RADIO & TELEVISION INSTITUTE
810 West 6th St., Los Angeles 14, California, U.S.A.

DIESEL

IS GOING PLACES ARE YOU?



Look around—you will see Diesel Power in action all about you! In tractors, trucks, buses, trains, boats, power and lighting plants, farm and road equipment. Diesel's the Field of the Future! Low cost dependable power—new uses are constantly developing—and every Diesel engine increases the need for Diesel-trained men!

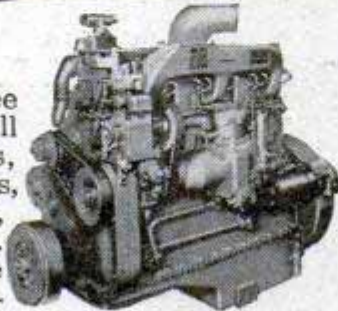

ON LAND



ON WATER



IN INDUSTRY



LEARN DIESEL AT HOME IN SPARE TIME!

If you are over 17, under 60, and mechanically inclined, you can get thorough Diesel instruction right at home. With U.E.I. balanced training, you learn fundamentals first, through home study. Practical, easy-to-understand lessons explain DIESEL operation... fuel systems... how to make repairs... auxiliary equipment, etc.

ACTUAL SHOP PRACTICE



START AT HOME FINISH IN OUR SHOP

Then, you finish your training on actual engines in our Shop. You work on costly equipment under expert Diesel men who know latest techniques. On graduation, you get job-placement assistance. U.E.I. has 20 years of successful experience in fitting thousands for employment in new opportunity fields.

GET THE FACTS It costs you nothing to get full information on Diesel opportunities and how they can apply to you! FULL FACTS SUPPLIED FREE. Simply mail the coupon below now!

UTILITIES ENGINEERING INSTITUTE
DIESEL DIVISION

FOUNDED 1927



MAIL THIS COUPON TODAY!

UTILITIES ENGINEERING INSTITUTE, Diesel Division, Dept. 129-D, 2521 SHEFFIELD AVE., CHICAGO 14, ILLINOIS

Please send me FREE FACTS about U.E.I. Training Opportunities. I am interested in:

- DIESEL REFRIGERATION AUTO BODY & FENDER REPAIR AIR CONDITIONING

NAME _____

ADDRESS _____

CITY _____ ZONE or COUNTY _____ STATE _____

Check here for special information if you are under 17.

CORTINAPHONE Makes It EASY! Learn to SPEAK SPANISH FRENCH • GERMAN • ITALIAN



Count Cortina

BIG OPPORTUNITIES await Americans who speak SPANISH. Learn as a child learns—"by listening" to these new CORTINA recordings. The CORTINAPHONE METHOD, famous for 65 years, teaches you to speak SPANISH as a NATIVE speaks! Right at home, relaxed and at ease.



Listen to this Record!

Sent on 5 Days' Approval

Write today for our amazing free book. "The Cortina Short-Cut." State language interested in.

VETS
Spanish course available under G. I. Bill State if Veteran

FREE BOOK

CORTINA ACADEMY
Dept. 642, 105 West 40th Street
New York 18, N. Y.

MONEY for MEN ALL DATA FREE

THE PLASTEX Industry needs manufacturers on small scale and for big production of Lamp and Clock Stands, Art Goods and Novelties in Plastex and Marble imitation. Experience unnecessary. 1/2c material makes regular 10c store sellers. Rubber moulds furnished for speed production. Small investment brings good returns. Big chain store orders now being placed. Ambitious men have chance for real prosperity. Our Free booklet will interest and benefit you.

PLASTEX INDUSTRIES, Dept. A
3400 Third Ave. New York 56, N. Y.

REAL ESTATE BE A BROKER

PAYS BIG! SEND FOR FREE, BIG, ILLUSTRATED CATALOG NOW! No obligation. Graduates report making substantial incomes. Start and run your own business quickly. Men, women of all ages, learn easily. Course covers Sales, Property Management, Appraising, Loans, Mortgages, and related subjects. **STUDY AT HOME** or in our classrooms in big cities. Diploma awarded. G.I. approved. Nationally known.

FREE BOOK TELLS HOW

WEAVER SCHOOL OF REAL ESTATE (Est. 1936)
15 E. Pershing Road Dept. PM-2 Kansas City, Mo.

HYDROPONICS

Grow out-of-season vegetables, rare flowers or house plants by hydroponics—WITHOUT SOIL— Start a fascinating hobby or a profitable business in your own home. No experience needed for top results. Only small space gets big returns. Easy, clean, pleasant way to grow any plant indoors or out every day in the year. Fast growth, increased yields, unlimited profit opportunities. Send today for FREE 16 page picture book showing how others from every state are succeeding in this wide open field. Send postcard for complete facts.

CHAPMAN-GILBERT, 824 W. IVY, SAN DIEGO, CALIF.

PROTECT YOUR LOVED ONES!

Genuine Legal Reserve
LIFE INSURANCE

Only 3¢ A DAY!



Now, you can provide the life protection you've always wanted for your family. Here it is, issued by mail, at a price anyone can afford. Liberal amounts of old-line, legal reserve life insurance with cash values, loan values and other valuable protection features including **DOUBLE** and **TRIPLE BENEFIT** provisions, for only 3¢-a-day, the amount depending on your age... for example, \$666 worth at age 35. Let us send you the policy for 10 Days Free Examination. No cost. No obligation. No agent will call. Just send us your name, address, age and name of beneficiary.

SERVICE LIFE INS. CO., Dept. 143, Omaha 2, Nebr.

House Wiring

Vol. VII TELLS HOW!

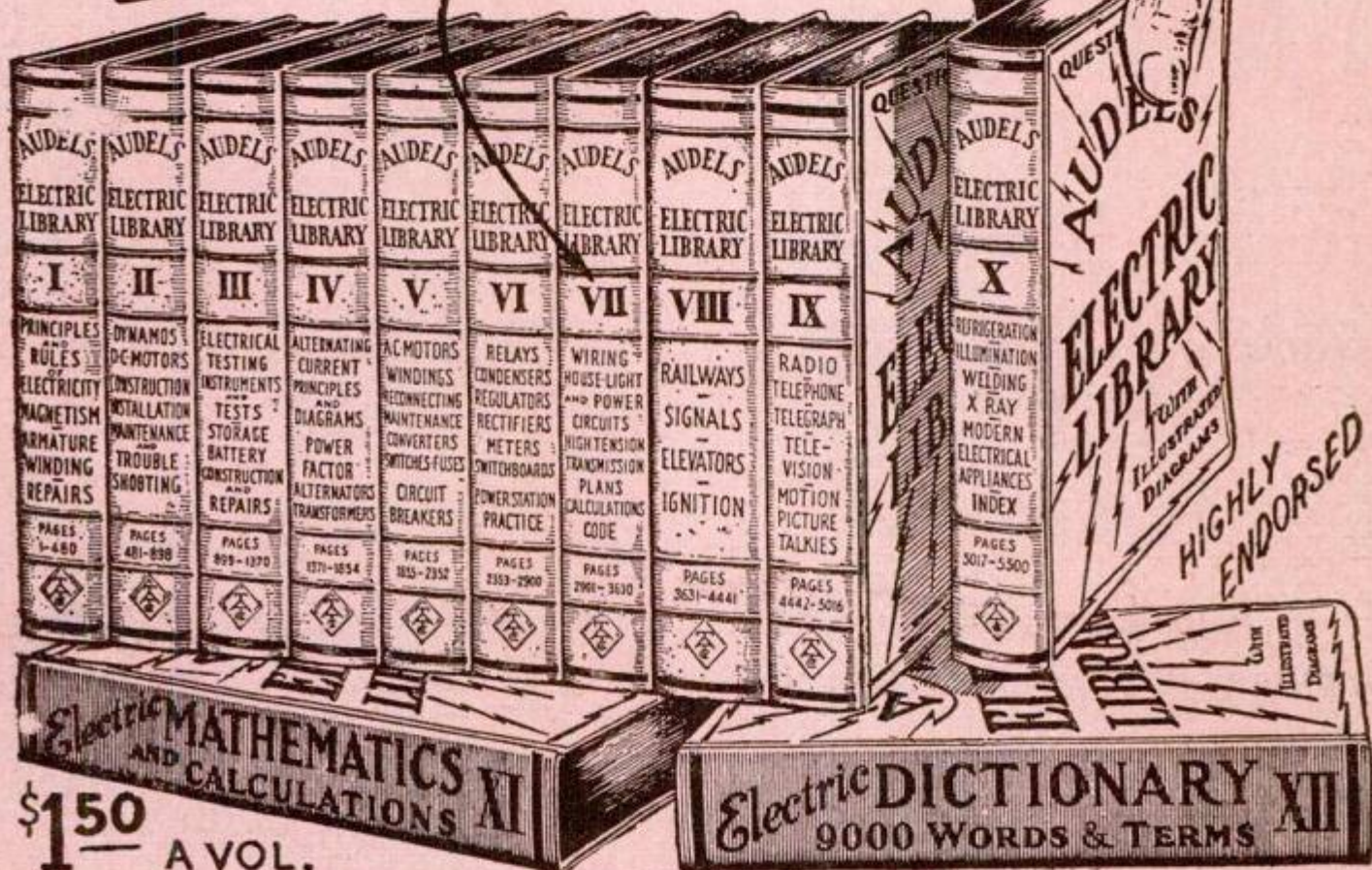
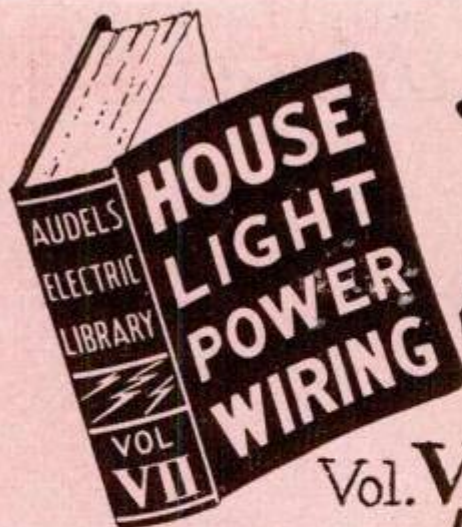

\$1.50
A VOL.

HERE ARE THE ANSWERS

MAIL THIS COUPON TODAY

Audels Electric Library gives thousands of answers to your electrical problems. Every Electrician, Engineer, Mechanic, Maintenance Man and Student should know about these very helpful books.

The 12 volumes contain 9500 clear, simplified illustrations of the Theories and Applications of Electricity, and 7200 interesting pages of Practical Trade Information relating to Construction, Operation and Maintenance. Valuable for Ready Reference or Home Study. Price only \$1.50 a volume, sold separately.

Audels Electric Library is truly a progressive home study course in Practical Electricity. Devote 15 to 30 minutes a day to its easy reading—acquire a practical working knowledge of Electricity in all its branches. Written in plain language.

AS A REFERENCE LIBRARY it is valuable. The Quick Finder Index helps you locate the desired information quickly. These books have helped thousands of men by giving them a broader knowledge of the whole field of Electricity. Take this opportunity to use our Book-A-Month Plan; mail the coupon today. No obligation unless satisfied.

AUDELS BOOK-A-MONTH PLAN
You will receive your first book for 7 days' Free Trial and Examination. If you are satisfied, send us only \$1.50. If not O.K., return the book to us and you owe us nothing. When we receive your payment for the first book, we send you the second book.

REMEMBER: You can Start Your Subscription with Any Number you choose or Stop at Any Time. Not a cent to pay until you get the books. No obligation to buy unless satisfied.

AUDELS PUBLISHERS
49 West 23rd St., New York 10, N.Y.

Please enter my subscription for AUDELS ELECTRIC LIBRARY, price \$1.50 a volume. Mail one volume each month, for which I will remit \$1.50 promptly.

Start with Volume Number _____
Name _____
Address _____
Occupation _____
Employed by _____

AUDELS PUBLISHERS, 49 WEST 23rd ST., NEW YORK 10, N. Y.

PM

HIGHLY ENDORSED

MEN-IF YOU VALUE Your Future- read this FREE BOOK

SEND
FOR IT
Today!



**Tells You How to Win
Bigger Pay and Real Security**

This book is yours without a penny of cost. "Your Future in Refrigeration and Air Conditioning" tells you what's in store for you in this fast moving, big pay field. No obligation. We want you to have this big, fascinating book. We want you to have the opportunity to read it—and to decide for yourself whether this is the field for you. You'll see pages of interesting pictures showing men on-the-job in Refrigeration and Air Conditioning. You'll read all about the fine opportunities in this amazing industry. This can easily be the most important book you'll ever receive and read—because it concerns your own future! Refrigeration and Air Conditioning has plenty of room for trained men—to handle good paying jobs in the many branches of this great industry. Almost unlimited future for men who know this work. Now you may learn Refrigeration and Air Conditioning at home in spare time. No need to give up present job or income while preparing to step into a better job. Act now! Simply write your name and address on the coupon below and mail today. Get your free copy at once . . .

INDUSTRIAL TRAINING INSTITUTE

2150 Lawrence Avenue, Dept. P-1, Chicago 25, Ill.

MAIL COUPON NOW No Cost
No Obligation

Mr. C. H. Smith, President,
Industrial Training Institute, Dept. P-1
2150 Lawrence Avenue, Chicago 25, Illinois

Please send me a FREE COPY of "Your Opportunity in Refrigeration and Air Conditioning" by return mail.

Name _____
Address _____
City and Zone _____ State _____



LEARN MEAT CUTTING

through actual practice. Profitable Meat Cutting and Successful Meat Merchandising taught easily, quickly in large cutting rooms and big modern retail meat department in just six short weeks.

LEARN BY DOING AT TOLEDO

Training given under actual meat market conditions. For beginners or men with experience. Thousands of successful graduates throughout the United States.

COMPLETE TRAINING IN 6 WEEKS

All related subjects taught thoroughly and completely. Diploma given upon graduation. Job help. Get a money-making store of your own. Assured future. PEOPLE MUST EAT. School in operation for over 25 years.

APPROVED FOR GI TRAINING

Send today for FREE 52-page illustrated catalog. No obligation. No salesman will call.

NATIONAL SCHOOL OF MEAT CUTTING
Dept. 50-J Toledo 4, Ohio

Save On CIGARETTES

All Popular Brands \$1.57 Carton!

We pay all postage and insurance on 5 cartons or more to any point in the U. S. Add 5c per carton on less than 5 cartons. Send Remittance with Order.

SIDNEY SMITH, INC.

BOX 1025 — DEPT. PM2 — JOPLIN, MO.

PRACTICAL MATHEMATICS 4 BOOKS IN ONE! SAVE HALF PRICE!

Easy self-instruction in 25 branches by college experts—all in one volume! Helps you qualify for a better job. 1280 pages, 600 illustrations. Sent for free trial. Only \$1.00 down, \$1.00 a month; total \$4.00 plus postage. (Cash price \$5.00 postpaid) 100-page logarithm book free with order. National Educational Alliance, Inc., Dept. 562, 37 West 47th St., New York 19, N. Y.

SHORTHAND in 6 Weeks at Home

Famous Speedwriting system. No signs; no symbols; no machines; uses ABC's. Easy to learn; easy to write and transcribe. Fast preparation for a job. Surprisingly low cost. 100,000 taught by mail. Used in leading offices and Civil Service. Write for free booklet. **SPEEDWRITING, Dept. 1502-9, 55 W. 42 St., New York 18**



AJAX LIGHT BRAHMAS

WONDERLAY STRAIN Egg-show winners. Gigantic size. Quick growing. Heavy layers. Exceptional eggs. Illinois-U. S. Approved-Pullorum Controlled. Thousands hatching weekly. Low farm prices. Catalog FREE. Write TODAY. **AJAX HATCHERY, BOX 434, QUINCY, ILLINOIS**



Learn to DRAW FUNNY FACES

In 5 Evenings—It's loads of fun—grand hooley—develop your talent, train yourself, improve your drawing ability—be popular—wow your friends—Earn EXTRA MONEY, too. Write for FREE literature. **FUNNY FACES, MODESTO 8, CALIFORNIA**



POUR GORGEOUS BOOKENDS with Magic Liquid Plastic

"Pours like honey...
Sets like glass"

It's easy to create exquisite bookends like the one shown . . . cast duplicates of hundreds of art objects with Castolite—the "magic" liquid plastic that pours cold, sets without pressure or high temperatures. Cast figurines, candlesticks, plaques . . .

embed photos, real flowers, butterflies, etc. Use only home utensils. No artistic ability required. Follow simple step-by-step method. New pleasure, fine profits are possible. Send 25c for exciting new Home Project Manual showing how to get started. Write today! **The Castolite Company, Dept. TB-1, Box 391, Woodstock, Illinois.**

MANUAL
25¢

SPECIALIZE • BUILD YOUR CAREER WITH PRACTICAL TECHNICAL TRAINING

SPECIALIZE • BUILD YOUR CAREER WITH PRACTICAL TECHNICAL TRAINING

Drafting

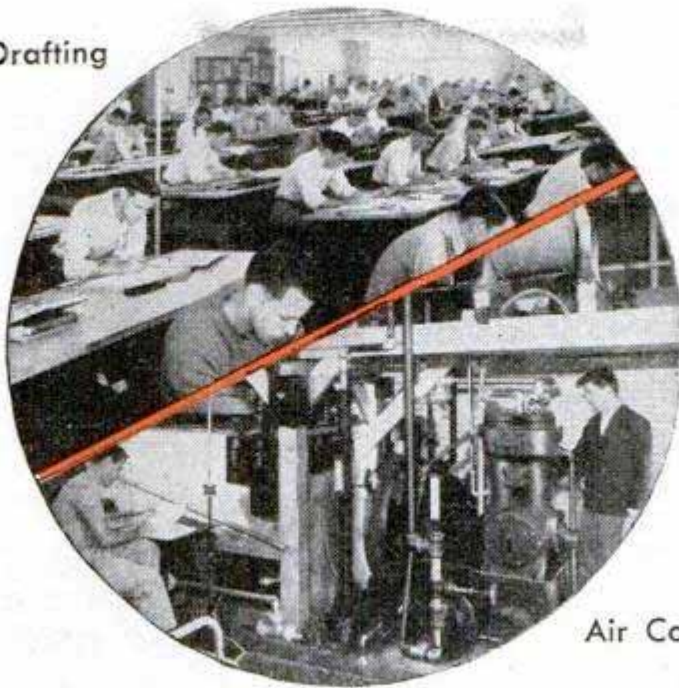

Air Conditioning

35,000 Careers Started Here!

Since its founding in 1903 over 35,000 students have received practical technical training at the Milwaukee School of Engineering. Our time-tested concentric curriculum enables you to build your career step by step in 6 to 36 months at service, technical and professional level. Each course unit is complete in itself. It prepares you for specific occupational objectives or advanced training. You select the course in which you are most interested. More than 1,500 students now enrolled from 48 states and 18 overseas countries. Faculty of 85 specialists. Alumni counselors everywhere.

Industry Needs Technically Trained Men

Select the Course That Interests You Most

SERVICE — 6 to 12 months

- Practical Electricity
- Practical Welding
- Refrigeration Service
- Heating Service

TECHNICIAN — 1 to 2 years

- Electrotechnics (Power)
- Radio and Television Technician
- Electronics Technician
- Refrigeration, Heating and Air Conditioning Technician

PROFESSIONAL — 3 years

- Electrical Engineering
- Bachelor of Science Degree
- Major in Electronics or Power



MILWAUKEE SCHOOL OF ENGINEERING



A Technical Institute
Founded 1903 by
Oscar Werwath

MILWAUKEE SCHOOL OF ENGINEERING
Dept. PM-249, N. Broadway and E. State,
Milwaukee, Wis.

Without obligation send me free booklet "Career Building" and more details on course in

.....
Name Age
Address
City State

Terms start April, July, September, January. SEND COUPON TODAY

Complete blueprints of this RICHARDSON refreshment stand available for construction.



Go in Business

WITH THIS REAL MONEY MAKER

Open your own roadside stand! It's a profitable enterprise requiring little investment. And your investment is protected by the exclusive RICHARDSON Root Beer franchise. Many veterans and other progressive business men are making hundreds of dollars a week with the RICHARDSON refreshment stand... and they are having fun, too.

SEND FOR FREE BOOKLET

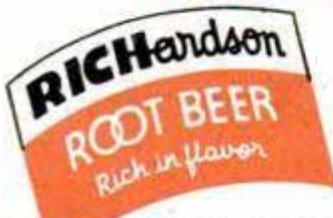

Free booklet shows layout drawings and gives full details on basic stand and plans for later expansion into a larger stand. Write for your copy today.

RICHARDSON Corporation
Dept. P-2, Rochester 3, N. Y.

INVENTORS

When you are satisfied that you have invented a matter of value—write me, without obligation, for full information as to what steps you should take to secure a Patent.

The usual first step is to have a search of the prior U. S. Patents conducted, so that I can report to you on the question of Patentability.

PATRICK D. BEAVERS

(Formerly RANDOLPH & BEAVERS)

Registered Patent Attorney

934 Columbian Building Washington 1, D. C.

PATRICK D. BEAVERS, Registered Patent Atty.
934 Columbian Bldg., Washington 1, D. C.

Please send me full information on how to secure Patent Protection and Trademark Registration.

Name _____
Street _____
City _____ State _____

Get This Now!

SPRAY PAINTING

New Book Makes Money Saves Money



COMPLETE INSTRUCTION FOR PROFESSIONAL USE AND 'ROUND-THE-HOUSE JOBS — INCLUDES AUTO PAINTING AND REFINISHING

Get this new 1948 spray painting book to help you on the job or for better and time-saving paint work around the home and car. Thoroughly practical—covers every phase of spray painting technique. Tells what paint or other finish to use, how to mix colors, how to make perfect jobs, easy, quick.

New edition has over 160 pages. Cloth binding, illustrated. Send \$2.00 for postpaid delivery or we will send C.O.D. Money back if not satisfied.

FREDERICK J. DRAKE & CO.

117 GREEN BAY ROAD

DEPT. 12

WILMETTE, ILL.

LEARN WATCHMAKING JEWELRY REPAIRING

Start your training now for a better paying job or your own profitable business. Intensive practical training by experienced craftsman. Write for free catalog.

SCIENTIFIC SCHOOL OF WATCHMAKING, DEPT. PM-2
3923 SAN FERNANDO ROAD GLENDALE 4, CALIFORNIA

PATENTS AND TRADE MARKS

C. A. SNOW & CO.

REGISTERED PATENT ATTORNEYS

"WRITE FOR INFORMATION TO"

428 SNOW BUILDING, WASHINGTON 1, D. C.

INVENTORS

Whether an invention is patentable can be substantially determined by a search of the U. S. Patent records. Without obligation, write for information explaining the steps you should take to secure a patent.

JOHN N. RANDOLPH

Registered Patent Attorney

201 Columbian Building, Washington 1, D. C.

INVENTING

—FOR PROFIT! If you have an inventive turn of mind, write for free 28-page booklet explaining how the Institute of American Inventors is helping inventors pre-test the profit possibilities of proposed devices to fill today's unprecedented demand for useful new inventions.

INSTITUTE of AMERICAN INVENTORS

Dept. 4, 1926 Eye St., NW, Washington 6, D. C.

PATENTS

"Proof of Invention" Folder mailed without obligation.

E. E. VROOMAN, Registered Patent Atty.

505 McKim Building, Washington 5, D. C.

SAY YOU SAW IT IN POPULAR MECHANICS

INVENTORS

IF YOU WISH TO PROTECT YOUR INVENTION, You should take steps to protect it by a U. S. Patent. Write me for "Record of Invention" form.

CARL MILLER REGISTERED PATENT ATTORNEY

Woolworth Bldg., 35th Floor, Dept. 29-A, New York City
Please send me "Record of Invention" form.

NAME _____
ADDRESS _____

Draw Me!



COPY THIS GIRL AND TRY FOR A

FREE \$240.00 ART COURSE!

5 PRIZES! 5 complete art courses . . . including Drawing Outfits! Each course valued at \$240

EXTRA! Whether you win or not, our instruction staff will grade your drawing and write you . . . if they feel that you have enough talent to develop profitably.

If you *do* have a worth while talent, Art Instruction, Inc. can bring you *individual* teaching and criticism, no matter where you live. Our famous home study course makes your own

room an extension of one of the world's largest art schools. Art Instruction has been turning out successful, money-making graduates for 34 years.

Splendid opportunities available for *trained* Commercial Artists, Illustrators, Cartoonists, Designers. Look ahead! Find out how much ability you really have. Take this Drawing Test **FREE**.

ART INSTRUCTION, INC.

500 South Fourth Street, Minneapolis 15, Minn.

CONTEST RULES:

Contestants must be amateurs. Make copy of girl 5 inches high on paper 7 inches high. (Omit lettering.) Use only pencil or pen. No drawings returned. All drawings must be received by February 28, 1949. Winners notified by mail. Names of all winners available on request . . . send stamped, self-addressed envelope.

MAIL THIS COUPON WITH YOUR DRAWING

ART INSTRUCTION, INC., Dept. 2139-C, 500 S. 4th St., Minneapolis 15.

Please enter my drawing (attached) in your **FREE \$240 ART COURSE CONTEST.** (Please Print)

Name

Address

City Zone State

Age Occupation



LINGUAPHONE



is your *Passport*
to the World

In your own home, alone or in a group, you can now learn to speak

**SPANISH • PORTUGUESE
FRENCH • RUSSIAN
ITALIAN • GERMAN**

or any of 23 other languages by the world-famous

LINGUAPHONE Conversational METHOD

You learn the new language by listening to voices of native teachers. It is amazingly simple; thousands have succeeded. Educators hail Linguaphone as a notable advance in simplifying the mastery of languages. That is why so many Linguaphone Sets are used in schools, colleges, universities, as an aid to fluent speaking.

**Available to Veterans under
G I BILL OF RIGHTS**

SEND FOR FREE BOOK
LINGUAPHONE INSTITUTE
98 RCA BUILDING, NEW YORK 20, N.Y.

LINGUAPHONE INSTITUTE
98 RCA Bldg., New York 20, N.Y.

Send me the FREE Linguaphone Book.

I am , am not a World War II Veteran

I want to learn.....language.

Name

Address..... City.....

**FREE
BOOK**

TELLS HOW
TO BE AN...

*Accountant
Salesman
Secretary
Stenographer*

SECURED FUTURE... FREE EMPLOYMENT SERVICE

Enter one of the "substantial earnings" fields through Hill's "Success Plan" training. A lifetime opportunity to join thousands of successful graduates in positions secured through our nation-wide employment service. No matter where you live, what you are doing now, Hill's can train you by study at home or in the resident school. Big Free book shows you the way to substantial earnings and an assured future. G. I. Approved.

Hill's Extension School & Business University
Dept. PM-29, 619 W. Main St., Oklahoma City 2, Okla.
Please send your free book, "Through Hill's to Success."

NAME _____
ADDRESS _____
CITY _____ STATE _____

Check here if eligible under G.I. Bill.

Please check course and training plan preferred.

Course _____ Resident Home Study

EASY-TO-USE COUPON TODAY



Learn WOOD PRODUCTION ENGINEERING

GET THIS FREE BOOK
Today

It tells you how you can learn to become a successful **WOOD PRODUCTION ENGINEER**... by the Klok Home Study Correspondence Method... or by studying here in Grand Rapids in our Resident School... Training in WOOD PRODUCTION ENGINEERING offers you great opportunities... either to get a top position or to operate your own plant successfully.

The Klok Course teaches you SKETCHING, ROD-MAKING, DETAILING, STOCK BILLING, TIME STUDY, COST and MANAGEMENT.

WRITE FOR FREE BOOK TODAY! State preference whether Home Study or Resident course, with name, age, occupation and if veteran.

KLOK INSTITUTE
LOUIS ST., N.W.
GRAND RAPIDS, MICHIGAN



MAGIC TRICKS

It's FUN to do MAGIC

Be popular! Amaze—mystify—entertain! For 30 years Douglas has satisfied customers all over the world. Now, you can enjoy this fascinating hobby. Only 10c brings our new 1949 Catalog 500 Tricks, containing brand new tricks for pocket, parlor, stage. Join in the fun—send 10c today!

Douglas Magicland, Dept. C, Dallas, Texas

MAKE A WILL - \$1.00

Find out the proper way by referring to the new simplified book, "HOW TO MAKE A WILL" by P. Callahan, Lawyer. 96 pages — covers law in 48 states. Mail \$1.00 today for book postpaid.

OCEANA PUB., 461 W. 18th Street, Dept. 393, New York 11

ENGINEERING DEGREE IN 27 MONTHS

**INDIANA
TECHNICAL
COLLEGE**

Aeronautical, Chemical, Civil, Electrical, Mechanical, and Radio Engineering (Inc. television); Drafting, 1-yr. Gov't approved for G.I.'s. Low rate. Earn board. Large industrial center. Students from 48 states, 18 countries. Demand for graduates. Enter March, June, September, December. Catalog.

529 E. Washington Blvd., Ft. Wayne 2, Ind.

FREE MRS. BERRY'S POULTRY BOOK

BABY CHICKS or STARTED. Champion-Mated, Licensed-Inspected, B.W.D. TESTED. 52 BREEDS, 6 HYBRIDS. Send or straight. Mature fow, Hatching Eggs and Bantams. **LOW PRICES.** The ORIGINAL Berry's Farm—over 50 years' service. **LARGE BEAUTIFUL BOOK FREE.** Stamps appreciated.
BERRY POULTRY FARM, Ex. 29, CLARINDA, IOWA



BE AN ARTIST

Send for interesting picture book "BUILDING A FUTURE"

Explains the unique position of the professional artist in American life. Gives examples of huge professional income. Tells definitely how YOU can acquire PROFESSIONAL skill—AND PROFESSIONAL INCOME—within one year—in spare time at home. No obligation. Book is free. Write name, address and age on penny postcard and mail TODAY to:

GRANT SCHOOL OF ART
Dept. 12, 53 W. Jackson Blvd., Chicago 4, Ill.

SAY YOU SAW IT IN POPULAR MECHANICS

**CLEANS WINDOWS
WITHOUT WATER**

NEW CHEMICAL MITT
Sensational! DRY Window Cleaner! Uses no water, no messy liquids. Chemically Treated. Simply glide over windows; leaves glass sparkling clear. No heating water, no heavy buckets to carry. No rags, powders, sponges, cloths. No mess or fuss. No red chapped hands. Dust, dirt, grime, fog disappear like magic. Wonderful for auto windows, windshields!

SAMPLES FOR AGENTS Sample offer sent immediately to all who send name at once. A penny postal will do. **SEND NO MONEY—just your name.** KRISTEE CO., 674 Bar Street, AKRON, OHIO.



Learn ELECTRIC APPLIANCE

Service & Repair

AT HOME IN YOUR SPARE TIME

We teach you this interesting, good-paying business from A to Z—at home. Our practical, thorough, shop-method course qualifies you to take a job at once, or start in for yourself. A grade school education is all you need. This is an ideal time for men of all ages (up to 60) to get into this active, constantly expanding field, for every year sees millions of new homes wired for electricity . . . and multiple millions of new electric appliances produced. Everyone, literally, is a customer for the man who knows how to service and repair electric devices.

This business is particularly suited to the man who is handy with tools, and likes to keep busy with his hands . . . the men who are the makers, builders, and servicers of life. If you are not completely happy in your present work, there is a WIDE-OPEN OPPORTUNITY for you in this field . . . which is getting bigger and better every day.

YOU LEARN

How To Repair
Washing Machines
Vacuum Cleaners
Electric Ranges
Lamps, Motors,
Irons, etc.
REFRIGERATION
and
House Wiring

This
ELECTRICAL
APPLIANCE
TESTER

and a
BIG KIT OF TOOLS
INCLUDED
at No Extra Cost!

Earn While You Learn

You can actually start earning before your course is finished with the Kit of Tools and Tester we send you. With your first set of lessons, I show you easy jobs that can be done in your spare time, at home. And remember—just one good repair job can pay for the complete cost of the course. A business can be started in your garage or basement—expanding from there, as you grow. Let's talk it over by mail.

Make it a point to get posted about our course by sending TODAY—without obligation—for our free booklet telling the entire story.

OPEN YOUR OWN SHOP Be Independent and Secure

No new-fangled machine can ever take your place in this work . . . as it calls for trained hands to service appliances—so your job is safe, even in a depression. If you open your own shop, you not only enjoy security and independence . . . and can have others work for you . . . it's just a step to a prosperous appliance business where the **BIG PROFITS LIE**. There's no satisfaction like being your own boss, and here's a real opportunity to make that a reality. Or, of course, you can take a well paid job in this active line, as trained men are needed. Remember, this is AN ELECTRICAL AGE. Getting into this field now is to ride the tide of progress.



Send
for this
FREE
BOOKLET



No Salesman Will Call

MAIL COUPON TODAY

PACIFIC TRAINING SCHOOL—Dept. P-92
7217 So. Broadway, Los Angeles 3, Calif.

Please send me your FREE BOOKLET:
"Today's Big Opportunity—Appliance Servicing"

NAME _____ AGE _____

ADDRESS _____ ZONE _____

CITY _____ STATE _____

Please print plainly

MAKE BIG MONEY FAST WITH STEVINSON TRAINING



**STEVINSON TRAINED
AUTO, ELECTRICAL, and
REFRIGERATION EXPERTS
GET TOP MONEY**

Our 26 years of Successful Training of men in chosen careers in automotive, air-conditioning, refrigeration, and electrical appliance industries, has perfected the famous **Stevinson classroom-shop system** of instruction... a technical, plus practical experience method... which speeds your progress... assures quick qualification for top incomes.

APPROVED FOR CIVILIAN AND VETERANS TRAINING

The steady work, backed by proved time-saving methods of Stevinson training and experience has won approval from civilians and veterans alike. If you are a qualified G I, don't delay a day. Write today. Approved under laws 346 and 16.

EARN WHILE YOU LEARN

No wasted time. Be an expert in latest modern methods... you work with most advanced new equipment. We help you arrange part-time work... help you get best jobs or set up your own business on graduating. Don't limit yourself. Get on the quick road to success with a solid Stevinson foundation.

GET FULL FACTS FREE. MAIL COUPON NOW!

Stevinson Auto & Electrical School,
Dept. PMF 2008 Main St., Kansas City 8, Mo.

Common sense tells me the practical 26 years success of Stevinson classroom-shop training means faster earning of big money for me. Send me full facts on the training courses I have checked, at no cost or obligation:

- | | |
|--|---|
| <input type="checkbox"/> Auto | <input type="checkbox"/> Air Conditioning |
| <input type="checkbox"/> Refrigeration | <input type="checkbox"/> Electrical Appliance |
| <input type="checkbox"/> Auto Body & Fender Rebuilding | |

Name _____

Street _____

Town _____ State _____



CODE-RECEIVING SPEED

Learn to send and receive Radio Code with greater speed. Stop nervous tension. Have confidence. Be proficient. Same system used by radiotelegraph specialists. Thousands of operators needed. Rush name for FREE book.

CANDLER SYSTEM CO.

Dept. 5-B, Box 928, Denver 1, Colo., U. S. A.

SAY YOU SAW IT IN POPULAR MECHANICS

Learn FINGERPRINTING AND IDENTIFICATION

**IN YOUR OWN HOME
IN YOUR SPARE TIME**

Specially prepared correspondence courses make it easy to learn this fascinating study essential in the field of CRIME DETECTION.

Under the Private Correspondence School Law of Pennsylvania, Licensed by the Dept. of Public Instruction.



**PENNA. INSTITUTE
OF CRIMINOLOGY**

Dr. W. Nisson Brenner, Director
DEPT. NO. 17
Extension Division
135 So. 2nd Street
Philadelphia 6, Pa.

**FREE
Booklet**

On Request

STUDY AT HOME

With An Educational Institution

Men with specialized training win higher positions, insure larger earnings, and are bigger successes in business and public life. Opportunities NOW greater than ever before. Send for our Catalog.

ARTS and SCIENCES

Courses in Philosophy; Education; Letters; Public Health; Medical Jurisprudence; Psychology; Sociology; Physics; Chemistry; Plastics; Geology; Political Science; Theology; Business and Commerce; Accounting; Mathematics; Statistics; Agriculture.

ENGINEERING

Courses in Electrical, Civil Mechanical, Drafting, Architectural, Steam, Aeronautical, Radio, Structural, Mining, Industrial, Petroleum, Marine, Chemical, Diesel, Automobile, Refrigeration, and Air Conditioning Engineering.

LAW

Complete Professional Law Course includes 18 Hornbook Series college grade textbooks. Courses also in Commercial Law, Patent Law and Medical Jurisprudence.

McKinley-Roosevelt Incorporated, 4610-K, Sheridan Rd., Chicago 40, Ill.

Learn ORNAMENTAL HORTICULTURE

A thorough, constructive home training for employment or advancement in Nursery Operations, Park Supervision or maintenance, Landscape Designing or Landscape Gardening. My 3 way Plan shows you how to start your own business, get a better job, or earn extra money in spare time. Send for Free Book. APPROVED FOR VETERANS.

NATIONAL LANDSCAPE INSTITUTE

Dept. P-2, 310 So. Robertson Los Angeles 36, California

NEW! FOR PROFIT & PLEASURE

IN COPPER TOOLING & ETCHING
No Experience needed - start at once. BIG MONEY waiting in COPPER ART field. Plaques, Bowls, Trays, Gifts, Souvenirs of all kinds. Start on the road to success NOW! Here is an opportunity to get started in your own Big Paying Business - FREE DETAILS don't wait - WRITE NOW!
HOLLYWOOD COPPER ART - Dept. PM-2
7266 Sunset Blvd., Hollywood 46, Calif.

LEARN MOVIE PROJECTION THEATRE MANAGEMENT

The Motion Picture Theatre Business offers big opportunities for trained men. Get into a fascinating field with a promising future. Train at home in spare time. Free Catalog. Established 20 years.
THEATRE SCHOOL, 370 Washington St., Elmira, New York

AJAX AUSTRALORPS

Sensational WORLD CHAMPION LAYERS.
Mature fast. Excellent rosters-capons. Massive size. Illinois-U.S. Approved-Pullorum controlled. Low farm prices. PROFIT SHARING PLAN. Catalog FREE. Write TODAY.
AJAX HATCHERY, BOX 432, QUINCY, ILLINOIS

YOU can draw!

AMAZING NEW HOLLYWOOD PLAN
Yes, YOU can draw GIRLS, CARS, FRIENDS and even MAGAZINE COVERS. It's so simple, no matter what your age. Many artists make more than \$150.00 per week in advertising and cartoons. Be your own boss, draw for money anywhere. Our Commercial Artists will teach you the secrets from HOLLYWOOD. Drawing materials furnished. Be a success. Write NOW for free details

HOLLYWOOD SCHOOL OF ART
DIVISION OF NELSON STUDIOS

6533 Hollywood Blvd.
Hollywood 28, Calif.

Name _____
Address _____
City _____ Zone _____ State _____

THESE 5 TRADES ASSURE YOU

HIGH PAY • Future Security

- **PLUMBING** Every phase of plumbing: Pipe-Cutting and Threading, Lead-Wiping, Rough-in Projects on Installations, Completed Installations of entire plumbing systems, Blueprint reading, Estimating.
- **DRAFTING** College-level courses in General Machine and Architectural Drafting, with fundamentals in Drafting Mathematics—all under graduate engineers.
- **SHOE REPAIRING** From simplest repairs on boots and shoes to the finest details of reconditioning and rebuilding, under expert craftsmen.
- **ELECTRICAL** Technical and shop training include Basic Electricity, Residential Wiring, Industrial Wiring, General Testing and Trouble Shooting, and Appliance Repair.
- **AUTOMOTIVE & TRACTOR** Applied training on latest model automobiles and tractors, including engine overhaul, transmission and differentials, carburetion, generator and ignition systems, engine tune up, Hydramatic and Vacumatic Transmissions, and general service.

Choose One of these 5 Essential Trades

Our complete courses of thorough training prepare you to go right into the field as a Qualified Tradesman at High Pay in only 34 weeks (39 in Shoe Repair). All courses under especially trained instructors with practical experience. 6 Hour Classes 5 Days a Week. Our Employment Department helps you.

VETERANS "Approved for veterans' training by the State Department of Education under Public Law 346."
"Approved for veterans' training by the Veterans' Administration under Law 16."

Send Coupon for Free Information Now

"There's Always a Demand for the Man who KNOWS!"

CHOOSE ONE OF THESE 5 LEADING TRADES

Get Out of that Rut... Be a Skilled Tradesman! Have a Lifetime Career... Own Your Own Business and Be Secure in Your Old Age.

NOW while Enrollment is still open, send for FREE information.

THE 5 DIVISIONS OF

NATIONAL TRADE SCHOOL

2610 Grand Ave., Kansas City 8, Mo.

- Plumbing
- Drafting
- Shoe Repairing
- Electrical
- Automotive & Tractor

NAME _____

ADDRESS _____

CITY _____ STATE _____

VETERAN _____ OCCUPATION _____

SHOE REPAIR OFFERS BIG INCOME

LEARN IN 12 WEEKS TIME

You can own your own shop or earn big income as skilled shoe repairman. Growing demand everywhere at top wages for men who know how. We teach you quickly by actually working on shoes and modern machines. School open to all from 18 to 60 years of age. FREE BIG 20 PAGE BOOK explains everything. Send for your copy today.

MODERN SHOE REBUILDING SCHOOL

Approved for Vets. Established 1927 Dept. PM
2937 Belmont Ave., Chicago, Ill. Rush Postcard Today
806 So. Figueroa St., Los Angeles 14, Calif.



LEARN MODERN WATCH AND CLOCK REPAIRING

Complete Course - Only \$4.95

At home, spare time. Good field now... security and contentment in future. Start part-time business and EARN while you learn. Horology is precision instrument work... a great and growing field, sensational opportunities. Easy self-instruction course. Full price, only \$4.95. SEND NO MONEY. Just pay postman, plus C.O.D. postage. Or send \$4.95 with order, we'll ship postpaid. Satisfaction guaranteed or refund. NELSON-HALL CO., 1139 S. Wabash Ave., Dept. 2B2, Chicago 5, Ill.

CREI Prepares Young Men for Professional Careers with Industry-Recognized training in a minimum of time

RADIO-ELECTRONICS-TELEVISION ENGINEERING

GRADUATES of the Capitol Radio Engineering Institute residence school are preferred by industry because of their training and ability. This recognition is the reason that CREI men quickly find good jobs in radio-electronics-television engineering and technical fields.

With 22 years of practical teaching experience in these highly technical fields, CREI offers an outstanding faculty, modern and complete laboratories, shops and equipment.

New students are accepted twice monthly and each may advance as rapidly as he is capable. The basic

course with one specialized course requires an average of 20 months to complete, depending on the ability of the individual student.

CREI is recognized as one of the country's leading technical institutes. Its work is of college level. It prepares the young man for a good job in industry in a minimum of time.

Approved for Veterans' Training



CAPITOL RADIO ENGINEERING INSTITUTE

An Accredited Technical Institute Founded in 1927
Dept. 172A, 16th and Park Rd., N.W., Washington 10, D.C.

FEBRUARY 1949

MAIL COUPON FOR FREE CATALOG

Capitol Radio Engineering Institute, Dept. 172A
16th and Park Rd., N.W., Washington 10, D.C.

Please send me your illustrated catalog and complete details.

Name _____ Age _____

Street _____

City _____ Zone _____ State _____

Don't Envy The PLUMBER—Be One

Make \$15 to \$50 a Day

Every skilled workman will tell you Plumbers have the best of it. WINTER and SUMMER the Plumber is busy at top wages. No skilled Plumber is ever out of a job. Compare his opportunities with any trade. To the man with know how, Plumbing means profit. Investigate Universal Plumbing School. Not a "war born School," but a plumbing school developed and operated by plumbers since 1923.



Own Your Own BUSINESS

Have your own business and big profits with little other than training and a kit of tools.

JOURNEYMAN Gets Good Salary

Master Plumbers own their own shop. A Journeyman works for a Master. With this training journeymen can depend on high wages.

G. I. Approved. Established 1923

UNIVERSAL PLUMBING SCHOOL

877 Holmes Street

Kansas City, Mo.

BE A PLUMBER IN JUST 32 WEEKS

Learn With Tools—Not Books

No need ever serve an apprenticeship. Don't envy the plumbers big profits—enjoy them. Learn every trick of the trade—Leadwork—Blueprint for plan reading, etc. under Licensed Master Plumbers.

Over 7,000 Successful Plumbers Recommend This School

This system has made more than 7,000 plumbers. Investigate our past performance. If you like to work with tools this is your opportunity. Become a Plumber in America's largest and only school devoted exclusively to plumbing. Write today for FREE information.

PRACTICAL AUTO INFORMATION

Keeps Cars Rolling by Making Repairs and Adjustments Easy!

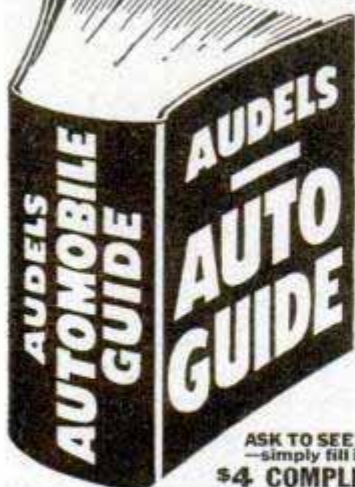

AUDELS AUTO GUIDE
For Every Mechanic, Driver, Owner and Repair Shop.

Sent on 7 Days Approval
Shows How to Tune Up—Keep Brakes Safe—Batteries Powerful—Tire Mileage Up—Save Gas—Lubricate Correctly.

ANSWERS YOUR QUESTIONS
Contains all you need to know about 1—Construction, 2—Operation, 3—Service, 4—Repair of Modern Motor Cars, Trucks, Buses & Diesel Engines in every detail.

NEW FLUID DRIVE TREATED
Easy to understand—1540 Pages, 1540 Illustrations. Gives definite directions on How to handle service jobs.

ASK TO SEE IT—Get this information for yourself—simply fill in and mail coupon today.

\$4 COMPLETE • PAY ONLY \$1 A MO.

AUDEL, Publishers, 49 West 23rd St., New York
Mail AUDELS AUTOMOBILE GUIDE (\$4) for free examination. If O. K., I will send you \$1 in 7 days; then remit \$1 monthly until \$4 is paid. Otherwise, I will return book promptly.

Name _____
Address _____
Occupation _____
Employed by _____ PM

Famous BAILEY TECHNICAL SCHOOLS

OFFER THE FOLLOWING COURSES:
PRACTICAL DIESEL ENGINEERING
REFRIGERATION - AIR CONDITIONING
COMMERCIAL ELECTRICITY
RADIO - TELEVISION MECHANICS

Your future success depends largely on the reputation of the school you attend. Don't take chances! Train at America's foremost school of mechanical specialization. Bailey is recognized and approved by industry. Bailey graduates get the top pay jobs! G.I. Approved. Send for FREE Catalog.

BAILEY TECHNICAL SCHOOLS

1655 So. Grand Blvd., St. Louis, Mo.



Become An Artist!

CASH IN ON BIG ART MARKET!
LEARN Cartooning, Commercial Art, Lettering, Showcard Writing, Photo Coloring, etc. QUICKLY with our NEW, EASY METHODS.

Interesting Catalog FREE

NATIONAL ARTISTS BUREAU
P. O. Box 4248 Dallas 8, Texas

LEARN WATCH REPAIRING



AT HOME. By our modern and original system of instruction you can learn every part of the **WATCH REPAIRING TRADE AT HOME.** Prepare yourself for a well-paying position or start in business after completing our course of instruction. Good watch repairers are in demand and generally earn very good salaries. For particulars apply to the Wisconsin School of Watch Repairing 759 North Milwaukee St., Milwaukee 2, Wis.

CHICKS ON 30 Days Trial

guarantee. Money refunded on any chicks not true to breed. No need to take chances. You get 30 days to make sure chicks are as represented. Male or pullet chicks furnished. Low prices. All varieties. Mo. Approved. Blood Tested. Easy buying plan. Bargain Prices and Chick Manual Free. MISSOURI STATE HATCHERY, Box 289, BUTLER, MO.

TRI-STATE COLLEGE

B. S. Degree in 27 months in Civil, Electrical, Mechanical, Chemical, Aeronautical, Radio Engineering; Bus. Admin., Ace't and Sec. Science. Graduates successful. 65th year. Enter March, June, Sept., Jan. Catalog. 429 College Ave., Angola, Ind.

Sand Casting—Forging—Heat Treating—Case Hardening BRONZE FOUNDRY



In your own workshop allows you to design and build your own GASOLINE ENGINES, STEAM ENGINES, STATUARY, ART OBJECTS, SPECIAL TOOLS, NEW INVENTIONS, ETC. You can also make forgings and case harden steel. Your shop is not complete without a FOUNDRYETTE. Three sizes are available capable of making bronze castings of 1½, 3 and 6 pounds weight, aluminum, copper, brass, etc., \$22.50, \$29.50, \$42.00 f.o.b. Kansas City. Domestic gas supply and 110 volt AC or DC energy required for operation. Write for circular.

KANSAS CITY SPECIALTIES CO.
Box 6022, Dept. P-12 Kansas City, Mo.

Learn Public Speaking

Learn theory and fundamentals at home—in spare time. Then acquire actual experience and practice. Send for FREE booklet "Power of Effective Speech."

NORTH AMERICAN SCHOOL, Dept. 1352
1315 S. Michigan Ave., Chicago 5, Illinois

**LOW
FACTORY
PRICES!**

... on the Sensationally **NEW 1949**

MIDWEST RADIOS

NOW Available with New Automatic
DUAL-SPEED RECORD PLAYER

For Playing Both Standard and LP (Long Playing) Records

30 DAYS TRIAL

NEW

SERIES 16

**SUPER DE LUXE
AM-FM
CHASSIS**

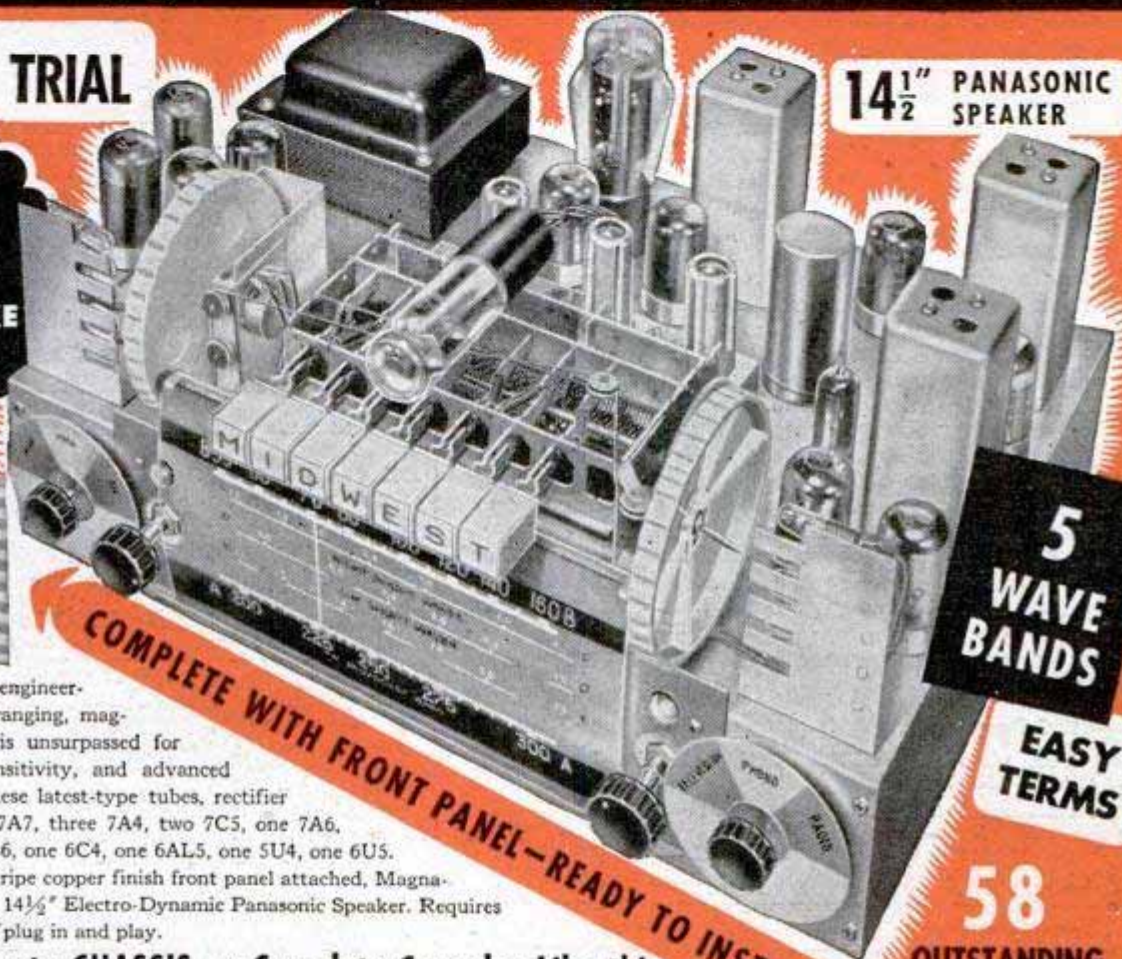

**14 1/2" PANASONIC
SPEAKER**

**5
WAVE
BANDS**

**EASY
TERMS**

58

**OUTSTANDING
FEATURES**

Including the
Exclusive Midwest
FLASH-O-MATIC
Volume and Band Indication
TELEVISION
Audio Switch-Over
HIDE-A-STAT
Color-Ray Tone Selection
TRI-MAGNADYNE
Coil System
... Plus **NO-DRIFT FM**
and many other features

Here is the last word in radio engineering . . . a powerful, world-ranging, magnificently-toned radio that is unsurpassed for performance, selectivity, sensitivity, and advanced engineering features. Uses these latest-type tubes, rectifier and tuning indicator: three 7A7, three 7A4, two 7C5, one 7A6, one 7Q7, one 6BA6, one 6BE6, one 6C4, one 6AL5, one 5U4, one 6U5. Comes complete with satin stripe copper finish front panel attached, Magna-Tenna Loop Aerial and giant 14 1/2" Electro-Dynamic Panasonic Speaker. Requires only a few minutes to install, plug in and play.

AVAILABLE in Separate CHASSIS or Complete Consoles Like this



Beautiful **SYMPHONY GRAND
AM-FM RADIO PHONOGRAPH**

with **NEW DUAL-SPEED
Automatic RECORD PLAYER**

For Both **STANDARD and LP RECORDS**

A Magnificent musical instrument and a masterpiece of cabinet design. Uses Series 16 Super DeLuxe AM-FM Chassis. Giant 14 1/2" Panasonic Speaker; Tri-Magnadyne Coil System; Built-in Loop Antenna. Other luxurious console and table model cabinets available with Series 16, 12 and 8 chassis—on Easy Terms and 30 Days Free Trial.

Rush for Free Catalog!

Send This Coupon Today—Write In Name and Address (Please Print) on Coupon or 1c Postcard

MIDWEST RADIO & TELEVISION CORP.
Dept. 257, 909 Broadway, Cincinnati 2, Ohio
Please send me your new FREE 1949 Catalog.

NAME _____
ADDRESS _____
CITY _____ ZONE _____ STATE _____

**BUY DIRECT FROM FACTORY and SAVE!
MIDWEST RADIO & TELEVISION CORP.**

Dept. 257 909 Broadway, CINCINNATI 2, OHIO

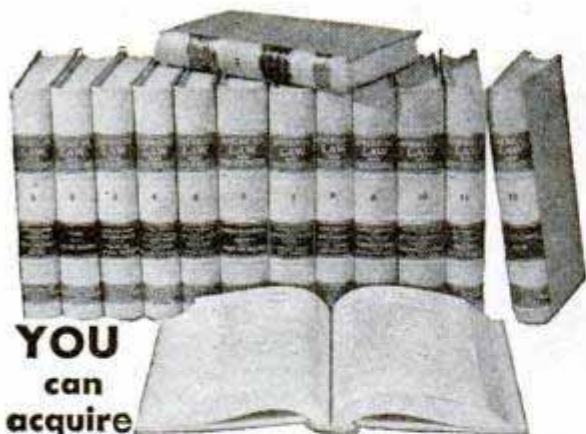

YOU
can
acquire

LAW NIGHTS AT HOME! L. B. DEGREE

LaSalle's famous Law Library—used as reference in many Law libraries and Law offices—has enabled thousands to master Law surprisingly fast, in spare hours at home, for business and professional advancement.

These 14 remarkable volumes, compiled by leading professors and lawyers, cover the whole basic field of Law in condensed, orderly, simplified manner.

You advance rapidly with this great library, plus special lectures furnished. We guide you step-by-step with personalized Problem Method of instruction . . . you learn by doing—handling legal problems—not by memorizing rules.

Send for two FREE 48-page booklets, "Law Training for Leadership," and "Evidence," answering questions about Law and its value to you, and telling how LaSalle Law graduates are winning rapid advancement in business and public life. Mail coupon below. No obligation.

LA SALLE EXTENSION UNIVERSITY

A Correspondence Institution

417 S. Dearborn St. Dept. 264-L Chicago 5, ILL.

Send me your two FREE booklets described above, without obligation.

Name _____ Age _____

Street _____

City, Zone & State _____

BE A SUPERVISOR



Franklin Technical Institute
Helps Young People Get Ahead

• The door to well-paid supervisory jobs in industry is wide open—to the man or woman with specialized technical training. 50,000 graduates of this Boston school have gone out to good jobs in engineering and technical fields.

Practical two-year day courses in industrial electricity and electronics, industrial chemistry, mechanical and machine design, structural and architectural design, automotive service and management, electric wiring and maintenance. Also preparatory and evening classes. G.I.-approved. 40th year.

FRANKLIN TECHNICAL INSTITUTE
43 Berkeley St. Boston, Mass.

Please send free information on all courses.

Name _____ Age _____

Address _____

City _____ State _____

New
Advertising
Machine



Prints & Illustrates 1¢ Post Cards

FREE Learn how thousands of business men, in every line, are boosting sales in spite of conditions—with 1¢ messages—printed and illustrated in a few minutes on gov't post cards—with amazing new patented **CARDMASTER**. Your "today's" ideas, read by your prospects next morning. Not a toy, but a sturdy advertising machine, built to last for years. Low price, sold direct. Guaranteed for five years. Send name today.

SEND NAME We'll send **FREE** illustrated book of money-making **IDEAS** for your business and complete, unique advertising plans. **RUSH YOUR NAME TODAY.**

CARDMASTER COMPANY
4546 RAVENSWOOD, Dept. 132, CHICAGO 40, ILL.

Learn RADIO-TELEVISION In Your Own HOME WORKSHOP

Build interesting Radio Circuits, acquire real experience, do scores of practical experiments—all through RTA's complete balanced training plus 10 BIG KITS of parts which RTA GIVES YOU! Get finest instruction direct from Hollywood, nerve-center of broadcasting, television and radio activities.

FREE BOOK
Send postal for complete details plus **FREE BOOK** "How to Make Good in Radio-Television."

RADIO TRAINING ASSOCIATION OF AMERICA
5620 Hollywood Blvd. Dept. 2-PM Hollywood 28, Calif.

LEARN TO WRITE a Good Hand!

FOR BUSINESS AND SOCIAL SUCCESS!

Easy to improve your handwriting at home quickly with my new instruction books just off the press. Master all the secrets of better penmanship. Simple and easy, fully illustrated, highly endorsed. Begin today. Write for: New Free Book, "How to Become a Good Penman," or check books wanted, \$1.00 each. Business Writing Artistic Writing Card Writing Engraving Alphabets Bird and Design Flourishing Complete Set \$4.00 Enclose 10¢ for your name beautifully written and special penpoint for shaded writing. S. A. Ziller, President, **TAMBLYN SCHOOL OF PENMANSHIP** 441 Ridge Bldg. In Business Over 52 Years Kansas City, Mo., U.S.A.

ELECTRICAL TRAINING

Intensive 32 weeks' residence courses in fundamentals of industrial electrical engineering, including radio, electronics. Prepares for technician, engineering aides. Approved for veteran training. 56th year. Enter April 4, September 6. Catalog.

BLISS ELECTRICAL SCHOOL
7626 YAKOMA AVENUE
WASHINGTON 12, D. C.



Learn CARTOONING

HAVE FUN! MAKE MONEY! Cash in on your sense of humor at HOME—BY MAIL. No experience needed to start. Write today for **FREE TRIAL LESSON** and full particulars.

MooN Gag Cartoon School, Dept. M, Fall Creek, Wis.



There's No "Mystery" in Watchmaking! YOU CAN LEARN THIS PROFITABLE SKILL!



For 300 years, watchmakers' skills have been closely-guarded secrets. Now, you can learn skilled watchmaking in scenic, mile-high Denver. I'll give you everything in practical benchwork from hair-spring manipulation to position adjustment. Nationally accredited, veteran approved. Write Orville R. Hagans for information, no obligation. No salesman will call. **FREE BOOKLET.**

AMERICAN ACADEMY INC.
SCHOOL OF HOROLOGY
1549 Lawrence St., Dept. F, Denver 2, Colo.

**\$200 GROSS IN MY
FIRST WEEK!**



**Some Make More, Some
Less... Start This Busi-
ness for YOUR OWN**

Would YOU like to own a permanent, year-round business in which it is possible to take in as much as \$200 gross the first week, as did L. A. Eagles? R. E. Traynor says, "I made \$62 gross in one day." R. R. Newlin reports, "I have averaged \$173 gross per week." Others report gross from \$100 per week to \$12,000 per year.

Surely YOU will want to investigate a golden opportunity like that. You need not have any special skill or experience, but if you are ambitious, honest and courteous, we will help you to start and succeed in YOUR OWN money-making business where net profits are high.

No Shop Necessary

Our Electric Rug Washer cleans rugs and carpets like new right on the customer's floor. This quick, thorough and highly efficient method removes dirt and grime, thus restoring the natural, fresh beauty of floor coverings. Anyone can run it. Rugs and carpets are not harmed.

There are hundreds of possible customers in YOUR vicinity. Most of them have several rugs needing regular cleaning. To get a quick start,

FREE BOOK! MAIL COUPON

VON SCHRADER MFG. CO.
A291, Racine, Wis.

Send at once (no obligation) your FREE booklet containing information about your Electric Rug Washer and how I can own my own permanent, profitable business.

Name _____

Address _____

City _____ (Zone) _____ State _____

shampoo a few rugs or carpets. These customers tell their friends and soon you should have an independent, prosperous business, and you should be able to keep it growing. Send the coupon RIGHT NOW for booklet that explains everything.

**Every Machine Guaranteed
and Easy to Own**

You take no risk. These wonderful, fully guaranteed machines have been used and endorsed by largest hotels, railroads—also used by U. S. Government. Many individuals have built up successful businesses that made big profits. Mail the coupon TODAY and we will send complete information, including how to start and succeed in YOUR business without a large investment. Don't delay your BIG opportunity. Send the coupon AT ONCE.



MAIL COUPON TO

VON SCHRADER MFG. CO., A291, RACINE, WIS.



GET INTO

DRAFTING

**The Draftsman Plays a most
Important Part in INDUSTRY**

**DRAWING OUTFIT INCLUDED
with Drafting courses**

All the tools you need including folding drawing table. With them you can put your ideas on paper quickly and with accuracy. With training you are all set to master Drafting in months, — not years — at home.

**Learn in Spare Time—At Home!
(or at the College in Chicago)**

A few hours of pleasant home study every week — that's all. With Chicago Tech's help, you train yourself step by step. This tested method — developed over 44 years of C.T.C. progress — prepares men for good positions in industry.



Practically everything that's built or manufactured these days is constructed from blue print drawings prepared by the draftsman. He is the KEY man in industry. No new machines can be built, no bridges erected, no buildings constructed until the draftsman has completed his work.

Drafting is clean, interesting, professional-type work. The draftsman is paid well to start. And he has real opportunities for advancement to high-pay jobs in Engineering. The tremendous production programs ahead in industry will require more draftsmen than ever before.

Send today for free information. See what this training has done for others, what it can do for you. Simply MAIL COUPON TODAY in an envelope or use a penny postcard.

MAIL COUPON NOW

Chicago Technical College
B-212 Tech Bldg., 2000 So. Michigan Ave.
Chicago 16, Illinois

Mail me FREE Drafting Lesson with information about big opportunities in DRAFTING and how I can train at home.

- Architectural Drafting
- Machine Drafting
- Electrical Drafting
- Structural Drafting
- Builders' Course

Name _____ Age _____

Address _____

City _____ Zone _____ State _____

**CHICAGO
TECHNICAL COLLEGE**
B-212 Tech Building, 2000 South Michigan Ave.
Chicago 16, Illinois

WILL YOU SPEND

to **3** MONTHS...
BUILD A New BODY?

Will you work three months for a stronger, more handsome physique? If you have that much ambition, **PARAMOUNT BAR BELLS** are your sure, fast way to physical development. In no time at all you'll actually see your neck, chest, arms, shoulders and thighs growing to new, shapely proportions. Thru the use of Paramount Bar Bells you will be providing these sets of muscles with the right kind of resistance for fast development.



WRITE FOR

Free ILLUSTRATED CATALOGUE

895
UP

See **PARAMOUNT'S** complete catalogue of barbells, dumbbells and home gyms. You can save 20 to 30% on body building equipment. **ACT NOW! WRITE TODAY!**

FACTORY PRICES

INDEPENDENT IRON WORKS

2416 East 23rd St., Dept. 21, Los Angeles 11, California

Learn this Profitable Profession



IN 90 DAYS AT HOME

Money-Making Career Open to Men and Women, 18 to 50

Hundreds of men and women between 18 and 50 make \$10 to \$20 in a single day giving scientific Swedish Massage and Hydro-Therapy treatments. There is big demand from doctors, hospitals, sanatoriums and clubs. Graduates earn large full time incomes from these or in private practice in their own offices. Others make good money from home treatments given in spare time. Learn this interesting, money-making profession in your own home, through our home study course. Same instructors as in our nationally known resident school. You can win independence and prepare for future security by qualifying for your Diploma. Course can be completed in 3 to 4 months. Many earn while they learn. Begin your training at once.

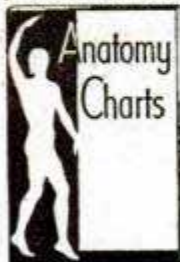

Anatomy Charts & Booklet FREE

Enroll now and we will include, at no extra cost, many needed supplies. Fit yourself to help meet growing demand for Scientific Swedish Massage. Send the coupon at once for complete details. Anatomy Charts and 32-Page Illustrated Booklet, **FREE**, postpaid.

THE COLLEGE OF SWEDISH MASSAGE
Dept. 964-B, 41 E. Pearson, Chicago 11, Illinois

Please send me **FREE** and postpaid, Anatomy Charts, 32-page Booklet and complete details on Home Training.

Name _____ Age _____
Address _____
City _____ State _____

DON'T BE A JOB SLAVE!
LEARN WATCH REPAIRING AT HOME



WITH OUR SELF TRAINING KIT

Get started **NOW** in this uncrowded field! **EASY** to learn! **BIG MONEY! SECURE FUTURE!** Earn while you learn! Even as a sideline you can make \$50 and up each week.—Our new **PRACTICAL SELF-TRAINING KIT** is all you need. Contains set of **PROFESSIONAL TOOLS:** (Loupe, 3-4 power; Complete Set of 6 Special Screw Drivers—finest tempered steel blades; Tweezer AA; Plastic Material Tray) and **COMPLETE BOOK** on Modern Watch Repairing. Fully illustrated, easy to understand, shows every step in repair, adjustment and use of tools. Only **\$6.25** Post Paid (If C.O.D., plus charges.) Money Back Guarantee. If ordered separately; book \$3.25; set of tools, \$3.50. Special **WATCH REPAIR DEPT** for advanced jobs. Lowest prices. Send watch for free estimate.

MODERN TECHNICAL SUPPLY CO.

Dept. MMC, 55 W. 42nd Street, New York 18, N. Y.

Complete Precision Tool, Material & Book Catalog for Watch-Clockmakers, Jewelers, Tool-Instrument Makers, Handcrafters. Over 600 **ILLUSTRATIONS.** SEND 25c for catalog—**FREE** with order.

MUFFLERS

STEELS and ALUMINUMS
with a motorboat tone



SINGLES, Chev., V-8, Plymouth, Steels \$5.50, Aluminum \$7.00. Chry., Olds., Buicks, etc., Steels \$7.50, Aluminum \$9.00. V-8 and MERCURY DUALS, Steel \$17.50, Aluminum \$21.00, '49 FORD DUALS, \$2.50 extra. Split Manifold Sets, Steels \$35.00, Aluminum \$45.00. Aluminums are guaranteed for life of your car.

DEALERS WANTED

SANDEE MUFFLER CO.

BOX 296 LA TIJ., LOS ANGELES 43, CALIF
2624 W. SLAUSON AVE., LOS ANGELES, CALIF.



BUILD YOUR OWN ENLARGER

Enjoy Photography's most fascinating hobby at a fraction of usual cost. With simple step-by-step instructions and diagrams plus a screwdriver and pliers you assemble your own Enlarger and Save! Get all features of more expensive Enlargers: precision machined aluminum alloy castings, 90° tilt for wall projection of prints, spherical aluminum lamphouse, helical rack and pinion focusing, with extra large knobs, unconditional guarantee. For 35mm to 2 1/4 x 3 1/4 negatives. Time payment plan.

Write Today for Free Illustrated Folder

CALIFORNIA TECHNICAL PRODUCTS CO.

448 S. Hill, Dept. M-2, Los Angeles 13, Calif.

RADIO ENGINEERING, Broadcasting, Television, FM, Servicing, Electronics, Aviation, Marine & Police Radio taught thoroughly.

Engineering course equivalent to 3 years' college radio work. Approved Veteran Training. Catalog free. **VALPARAISO TECHNICAL INSTITUTE**, Dept. D. Valparaiso, Ind.

SAY YOU SAW IT IN POPULAR MECHANICS

ALL ABOARD FOR ADVENTURE



Every month the **WIDEWORLD MAGAZINE** sets forth on a voyage of adventure to many colourful lands. This famous British monthly is unique in its presentation of the world's most thrilling true-life stories. All narratives actual happenings, usually told by those who experienced them. Vivid illustrations. Packed with adventure, excitement, romance! Send coupon below **NOW.**

CLIP AND MAIL

Send only \$3 (reduced rate) with this coupon completed to **George Newnes Ltd., U.S. Subscription Office (WW 22), 342 Madison Avenue, New York 17, N.Y.** for 12 monthly issues sent direct to your address from London.

Name _____
Address _____
City _____ State _____

HOW TO BECOME A POPULAR DANCER OVERNIGHT

"The New Arthur Murray Way"

Makes learning to dance easier . . . faster

THINK back to the last dancing party you went to . . . Who had the best time? The good dancers, of course. Were you one? Or, did timidity and lack of skill keep you on the sidelines? Arthur Murray has helped thousands conquer shyness and develop self-confidence through dance lessons. And, he can help you, too. You see he has discovered a new, short cut to expert dancing,

"The First Step To Popularity", that makes learning faster and easier than ever before. Once you master this key step the secret of the Rumba, Fox Trot, Waltz, Samba, will be yours. So visit an Arthur Murray Studio now and have a free 15-minute dance analysis. And, send today for Arthur Murray's entertaining dance book "Murray-Go-Round." Use coupon below.



What's wrong with your dancing?

1. Poor posture?
2. Weak lead?
3. Old-fashioned style?
4. No confidence?
5. Lack of grace?
6. No variety?

You'll be amazed and thrilled how quickly these common dancing errors can be corrected. With "The New Arthur Murray Way" you learn the right way.

Learning to dance is fun when you put yourself in the hands of an Arthur Murray expert



"Many think the Rumba's only for experts. The steps seem so tricky," says Betty Jordan. "But, you can learn the secret to this gay dance in just 5 minutes at Arthur Murray's."



"The New Arthur Murray Way' is such an easy way to learn, that everyone understands the first time you show them," says Lisa Derney.

Copyright, 1949—Arthur Murray Inc.

ONLY 25¢

ARTHUR MURRAY STUDIOS, Dept. 9C (Consult telephone directory for address of nearest studio, or write Arthur Murray Studios, 11 East 43rd Street, New York 17, N.Y.) Please send me your magazine, "Murray-Go-Round", 44 pages of pictures, dance news, instructions. I enclose 25c.

NAME _____

ADDRESS _____

CITY _____ ZONE _____ STATE _____

Pop. Mech.—Feb.

ARTHUR MURRAY

Studios From Coast to Coast

Visit the one nearest you for a FREE dance analysis

Learn A Trade NOW! PRACTICAL SHOP TRAINING!

In Our Chicago Shops

- | | |
|---|--|
| <input type="checkbox"/> AUTO MECHANICS | <input type="checkbox"/> WELDING—ARC and GAS |
| <input type="checkbox"/> DIESEL MECHANICS | <input type="checkbox"/> MACHINIST |
| <input type="checkbox"/> REFRIGERATION | <input type="checkbox"/> PIANO TUNING |
| <input type="checkbox"/> BODY-FENDER | |

Above Approved For G. I.'s and Civilians

One of America's Leading Practical Schools
7 Floors of Fully Equipped Shops
Over 48,000 Successful Graduates
Expert Individual Instruction
Learn by Doing—Low Living Expense
Established 1902—Day and Evening Classes

Also the following Home Study Courses

- | | | |
|----------------------------------|--|---------------------------------|
| <input type="checkbox"/> PLASTIC | <input type="checkbox"/> REFRIGERATION | <input type="checkbox"/> DIESEL |
|----------------------------------|--|---------------------------------|

—CALL IN PERSON OR MAIL THIS AD TO—
GREER SHOP TRAINING

(Dept. PM-29) 460 South State St., Chicago 5, Ill.

Please send without obligation free information regarding trade checked above. (Specify whether you are a Veteran or Civilian)

Name _____ Age _____
Address _____
City _____ State _____

9 BIG BUILDING BOOKS

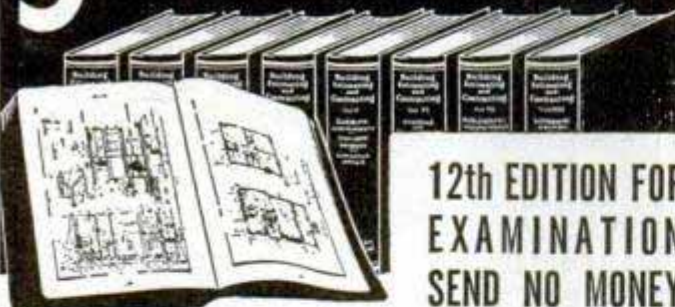

12th EDITION FOR
EXAMINATION
SEND NO MONEY

Learn to draw plans, estimate, be a live-wire builder, do remodeling, contracting. These 9 practical, profusely illustrated books cover subjects that will help you to get more work and make more money. Masonry, concrete forms, carpentry, steel square, roof framing, construction, plumbing, heating, painting, decorating and many other subjects. More than 4000 pages—2750 illustrations.

BETTER JOBS — BETTER PAY UP-TO-DATE EDITION

A nationwide building boom is in full swing and trained men are needed. Big opportunities are always for MEN WHO KNOW HOW. These books supply quick, easily understood training and handy, permanent reference information that helps solve building problems.

These books are the most up-to-date and complete we have ever published on these many subjects.

Coupon Brings Nine Big Books for Examination

AMERICAN TECHNICAL SOCIETY—Publishers since 1898
Dept. G219 Drexel at 58th Street Chicago 37, Ill.

You may ship me the Up-to-Date edition of your nine big books, "Building, Estimating and Contracting," without any obligation to buy. I will pay the delivery charges only, and if fully satisfied in ten days, I will send you \$2.00, and after that only \$3.00 a month, until the total price of only \$34.80 is paid. I am not obligated in any way unless I keep the books.

Name _____
Address _____
City _____ State _____

Please attach a letter stating your age, occupation, employer's name and address, and name and address of at least one business man as a reference. Men in service, also please give home address.

Drafting PAYS BIG

Learn in Spare Time — At Home
or at Allied School in Chicago

KEY POSITIONS OPEN IN INDUSTRY

- Mechanical Drafting
- Structural Drafting
- Aircraft Drafting
- Tool and Die Making
- Tool and Die Designing
- Machinist Trade
- Product Designing
- Product Illustrating

Train Now!

In
Nationally Known,
Fully Approved
School and
Endorsed by
Industry . . .

Established
in 1928

FREE
EMPLOYMENT
SERVICE

Approved for Civilians
and Veterans . . .

• • • Write For Catalog — A 1c Postcard will do

ALLIED SCHOOL OF MECHANICAL TRADES

1338-1340-1342 So. Michigan Ave.
422 Allied Bldg. CHICAGO 5, ILL.

An ASSURED FUTURE for You Learn Profitable WATCH REPAIRING

BIG MONEY WHILE LEARNING
Study at Home — or at Our Accredited School
Complete Home Correspondence Course or G. I. Approved
Residence School Plan. Also, Post-Graduate Plan at school
for correspondence students.

Write Today for COMPLETE DETAILS to
American Institute of Specialized Watch Repair
Dept. No. 100 270-76 East Building Grand Rapids, Michigan

MIRACLE WALL CLEANER

Saves Costly Redecorating!
AMAZING INVENTION. Banishes old-style housecleaning mess and mud. No rags—no sticky "dough"—no red, swollen hands. No more dangerous stepladders. Literally erases dirt like magic from walls, ceilings, window shades, upholstered furniture, etc. **Endorsed by SAVES REDECORATING!**

SAMPLES FOR AGENTS Sample offer sent immediately to all who send name at once. A penny postal will do. **SEND NO MONEY—just your name, KRISTEE CO., 673 Bar Street, AKRON, OHIO.**

IF I Send YOU THIS FINE SUIT—

Will You Wear It and Show It to Friends?
I need a reliable man in your town to get a fine, made-to-measure, all-wool suit without paying cash, but by taking a few orders from friends. Wear it—show it—to help you take more orders with my line of nearly 100 guaranteed quality fabrics. You can make up to \$12 in a day without experience or investment. I supply everything required FREE. Write for FREE outfit. **John Grant, STONE-FIELD Corp., 532 S. Throop St., Dept. P-816, Chicago 7, Ill.**

SUCCEED IN THE POULTRY BUSINESS!

Poultry is providing many trained men and women with a good, comfortable living, either part or full time. You, too, can enjoy country life, home-grown food, increased income, if you have the specialized knowledge that is so important.

For 28 years our Home Study Course has been helping thousands to greater success. Proper knowledge and "Know How" mean extra income from the start. Don't delay—write today for prospectus describing courses, methods, opportunities, service.

NATIONAL POULTRY INSTITUTE
DEPT. 50 — ADAMS CENTER, N. Y.

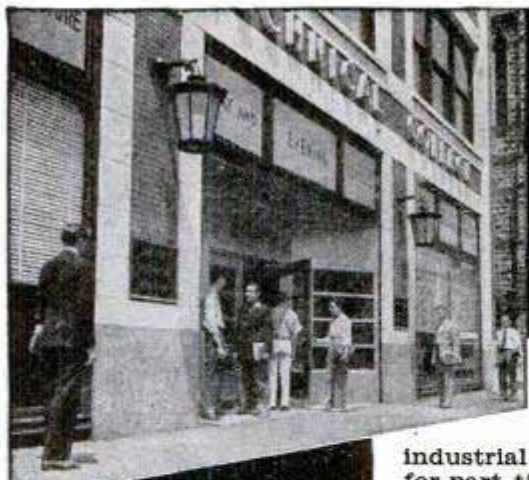

Learn ENGINEERING DRAFTING...BUILDING in Chicago, Industrial Hub

Approved for
G.I. Training

Time-Saving
Courses

Day & Evening
Classes

Get your training at **Chicago Tech** in the Nation's industrial center. Chicago provides unequaled opportunities for part-time employment while training and for permanent positions upon graduation. Many other cultural and recreational advantages described in Catalog—sent Free!

Chicago Tech, founded 45 years ago, has trained thousands of men now occupying important places in industry the world over. Training combines theory and practice in 1 year, 2 year, and 3 year (Degree) courses. Saving in time means earlier graduation — and consequently earlier employment.

Terms start January, April, July and October. Get information now to arrange for early admission and accommodations.

CHICAGO TECHNICAL COLLEGE

B-83 Tech Bldg.
2000 So. Michigan Ave.
Chicago 16, Ill.



**1 YEAR • 2 YEAR
3 YEAR COURSES**

**BUILDING
DRAFTING
ENGINEERING
AIR CONDITIONING
REFRIGERATION
ELECTRICITY
RADIO**

MAIL COUPON TODAY

CHICAGO TECHNICAL COLLEGE
B-83 Tech Bldg., 2000 So. Michigan Ave.
Chicago 16, Ill.

Please send me without obligation free booklet on Time-Saving Technical Training.

Name _____ Age _____

Address _____

City _____ Zone _____ State _____

HIGH INCOME TRAVEL ABROAD

LEARN EXPORT

Tired of humdrum, low-paid, overcrowded vocations? U. S. A. Export-Import volume was over \$19 Billion during the year ending last July. Compare the few listings of World Traders in your phone book against the hundreds in struggle-to-live lines. Men and women have room to prosper and opportunities to travel abroad in World Trade.

EXPORT MANAGERS MAKE UP TO \$12,000 A YEAR... and even more. But the sky's the limit in your own business. Commissions of \$10,000 to \$20,000 or more a year are possible. Customers in other lands tell you what they want. You buy FOR them—ship at their expense at handsome profits. Big profits in Imports too.

PAST EXPERIENCE UNIMPORTANT. No previous experience or special education is necessary when you learn by simple methods based on my 25 years' practical experience.

I TEACH YOU AT HOME. I have trained others in as little time as one month because my methods are direct, free of non-essentials and red tape. You can start your own mail order Export business at home on practically no investment — **FULL OR SPARE TIME!**

Write for **FREE BOOK**

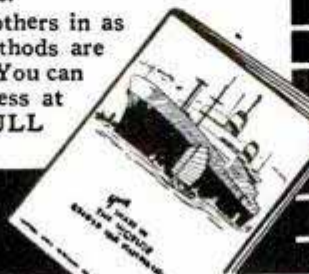

PRACTICAL—NO THEORY. Twenty clear, fascinating lessons, full year's consultation service included, also full year membership in International Traders' Guild which puts you in contact with traders the World over. **WORLD TRADE CERTIFICATE AWARDED.** Money-Back Agreement.

START TODAY—GET FREE BOOK!

Rush coupon today for illustrated **FREE** book. No obligation. No salesman will call. Airmail reaches us overnight.

B. L. Mellinger, Director, The Mellinger Co.
1422-EG Westwood Blvd., Los Angeles 24, Calif.

MAIL COUPON NOW

B. L. Mellinger, Director, The Mellinger Co.
1422-EG Westwood Blvd., Los Angeles 24, Calif.

Please send **FREE BOOK** showing how I may enter the profitable career of World Trade.

Name _____

Address _____

City _____ State _____

Veteran? _____ Occupation? _____ Age? _____

Location preferred? _____

NOW EASY TO START A Big Business ON A SMALL INVESTMENT



WARNER SUCCESS PLAN Gives exact instructions showing you

- How to start in spare time
- How to use home as headquarters
- How to bring in the business
- How to do real METALIZING in genuine GOLD, SILVER, or BRONZE, by the easy Warner Method
- How to start without risking your job
- How to pyramid your profits
- How to be sure of steady, big income.

Don't turn this page until you've given serious thought to your future. In the uncertain years ahead, the men who own their businesses are the ones who will be happiest. A small start now easily can lead you to complete independence, freedom from time clocks, freedom from fear of lay-offs, freedom from the limits of a pay check.

Now, while you can do it without risk—now is the time to investigate the exceptional opportunity offered you by the Warner Success Plan. Looking into the market, checking up on the possibilities for big sales and big profits will not cost you anything. Isn't this the time to lay the foundation for a future of complete independence—a life of happiness—a steady, dependable income?

METALIZING BABY SHOES AND OTHER KEEPSAKES

offers an exciting new opportunity to men or couples who want personal independence

If you'd like the feeling of being boss instead of being bossed—the Baby Shoe business is made to order for you. Just think of the appeal. A mother's love for her child—her desire to preserve forever the tiny shoes in which her baby took its first toddling steps. No wonder orders come easy and fast. No wonder profits are big. Then think of the Future. Fifteen Million babies in the last five years—three million last year—millions more next year. As long as babies are born, this business will prosper—in good times or bad. Think of the fun. Every job is different, interesting. And when you deliver a job and collect the money, you get a tremendous glow of satisfaction out of the mother's happy exclamations over your work. There's not another business I know of that offers you such big rewards in cash, in security, in a future, in independence that can be started on such a shoestring. You'll be glad you saw this ad—IF YOU SEND THE FREE COUPON.



READ THE ENTIRE PLAN

7 DAYS AT MY RISK

DON'T SEND A PENNY . . . Just Send Your Name

This is one of the most fascinating businesses you can imagine. There are 15 MILLION pair of baby shoes waiting right now to be METALIZED. The opportunities are unlimited. The future is very big. And it's a business in which the whole family can have fun helping. A perfect business for man and wife to start—or for two partners. And I want you to read the whole Plan at my risk. Don't spend a cent unless you go ahead.

I want every serious minded man to let me show what I've done in our own shops here in Chicago—reveal the exact facts about the profits to be made and the way to make them. I don't want you to spend a cent for supplies until you've studied the facts, talked them over with the family, and satisfied yourself that this is the ONE BIG OPPORTUNITY FOR YOU. That's why I allow you to read all trade secrets contained in the Warner Success Plan at My Risk. If you don't go ahead, you don't pay a cent.



You Have Nothing to Lose

ALL FACTS FREE! MAIL!

Raymond E. Brandell, Mgr., Warner Electric Co.,
1512 Jarvis Ave., Dept. 32, Chicago 26, Ill.

As long as it doesn't cost me a cent, I'm willing to read the facts, investigate, and then give you my decision. Send the facts by next mail. No cost to me now or at any other time.

NAME _____
ADDRESS _____
CITY _____ Zone _____ STATE _____



\$5.00 AN HOUR

Yes, it's possible for one man to turn out enough work to make \$5.00 an hour for his time. Think of how that pyramids when a partner or the whole family works.

Old Established Firm Backs You Up

The Warner Electric Company just celebrated its 26th year of success. You get a *Real Start* when you "join up with Warner"—you get real *Guidance to Success*.

Warner Electric Co., Dept. 32
1512 Jarvis Ave., CHICAGO 26, ILL.

WE SUPPLY EVERYTHING

You don't have to go "hunting" when Warner is behind you. We supply all materials, all mounts, chemicals, and metals. And you get the low prices made possible by our big quantity purchases and our own manufacture. You send for just what you need—and never have any big investment tied up in stock.

**WORLD'S
BEST
WANT AD
MEDIUM**

CLASSIFIED Advertisements



Advertisements in this section 75 cents per word, each insertion, minimum 10 words, payable in advance
To be inserted under proper classification, copy must be in our office the 22nd of the
second month preceding date of issue

F. W. Johnson, Manager, Classified Advertising
Popular Mechanics Magazine, 200 East Ontario Street, Chicago 11, Illinois

1100

CLASSIFIED ADVERTISEMENTS

1100

OPPORTUNITIES FOR YOU

AUTOMOBILES, MIDGET CARS

"SPEED And Power" Handbook—Very latest methods! Construct your own superchargers, "water injectors," hi-compression heads, fuel saving devices, dual manifolds—easily. Save many dollars! Get racing speed, acceleration, dynamic power increases from any automobile! Build fast stock cars! California roadsters! Hotrods! Get ingenious formulas! Speed secrets! Illustrations! Conversion ideas! Also "Economy Information"—mileage tricks! Tuning techniques! Instructions! Picture catalogues, including "California Restyling Ideas"—glossy photographs! Drawings! Model revising! Customizing! Streamlining! Leatherlike bound—\$1.98 complete. Newhouse Automotive Industries, 5941-B2 Hereford, Los Angeles 22.

FORD Fuel pumps can't fail with my spacers. \$1.00 postpaid. Fully guaranteed. Details free. Hooper System, 13191 Gridley, San Fernando, Calif.

SEE Our ad under motorscooters for midget car bargains. Midget Motors Directory, Athens, Ohio.

"SPEED & Mileage" Manual—Easily obtain greater speed, mileage, racing performance from any automobile! Famous (original) book shows soup up methods; speed tuning; mileage secrets; racing tricks; "customizing ideas!" Photographs! Complete instructions on building inexpensive speed equipment! Economizers! Superchargers! "Water injectors!" Mufflers! "Hot-rods!" Speedsters! Fast conversions! Engines! All about "economy tuning," compression, manifolds, ignition, lubricants, cams, fuels! Latest "Hollywood stylizing;" streamlining; sports car conversions! Plans; "fascinating pictorial supplement;" speed catalogues; charts; parts lists! Deluxe enlarged edition, \$1.98. (Guaranteed). Almqvist Engineering, Milford 55, Pennsylvania.

CLYMER'S Test reports on post-war Kaiser-Frazer, Studebaker, 1949 Ford, 1949 Mercury, gives impartial, uncensored report 3000-mile economy, speed, record tests. Part-by-part equipment analysis. 3000 owner tabulations in each book. 200 owner letters. Good, bad comments about each make, no punches pulled. Learn the truth. Specify make car interested in. \$1.50 postpaid. Clymer, Dept. A-TR, 1268 So. Alvarado, Los Angeles 6, Calif.

"SUPERCHARGER" Needle valve—Increases speed, power, pep! Starting! 10% more mileage guaranteed! Free trial! Quickly replaces idling jet. Specify car. \$1.50 (Eight's take 2, six's 1). Almqvist Engineering, Milford 55, Pennsylvania.

FUMES! Keep them out of your car or truck. Easy to make. Instructions \$1.00. Auto Tips, Box 93, Crab Orchard, Ky.

"1949" CUSTOMIZING Manual—Shows how to easily make your car look beautifully custom! Latest restyling, streamlining, customizing methods! Hollywood sport changes! Fast model conversions! Scores of photographs, illustrations, drawings! "Hop-up" specifications. Complete restyling information. (Including custom car catalog and amateurs "Idea Starter" kit). Everything \$2. Almqvist Engineering, Milford 55, Pennsylvania.

CALIFORNIA Speed equipment. Doll'em up chrome accessories. Dual, single. Mufflers, skirts. Konverti-Kovers, lowering kits (a step ahead in the automotive field) 1949 catalog 25c. Von Esser's, 2840 North Kedzie, Chicago 18, Illinois.

MODEL "A" and "T" Ford book. 572 pages, complete information repairing, maintenance, servicing both models and Fordson tractor. \$3.50. Model "A" book only \$1.00 postpaid. Clymer, Dept. A-ATA, 1268 So Alvarado, Los Angeles 6, Calif.

"VAPO-STEAMATIC" Water injection. Build your own—easily (about \$1.00 cost). Finest "Moist-Humidity" system, completely automatic! Engineering triumph; many more miles per gallon! Increases horsepower! Speed! Acceleration! Eliminates knocking, carbon, overheating. Reduces wear! Engines last longer! Copyrighted "Installation Handbook" (illustrated), detailed diagrams, parts lists, automobile equipment catalogues including "Mileage Information." \$1.00 complete. Newhouse Automotive Industries, 5941-B1 Hereford, Los Angeles 22.

FAMOUS Car catalog reprints. Duesenberg, Italian Maserati racing and new sport car, Mercedes-Benz, new rear-engined Isotta-Fraschini V-8, Rolls-Royce "Silver Wraith," Miller race cars, Cord, Rayfield Cyclecar, V-8 Chevrolet, Stanley Steamer, Doble Steamer. Specify catalog desired. \$1.00 each postpaid. Clymer, Dept. A-2X, 1268 So. Alvarado, Los Angeles 6, Calif.

SPEED Equipment bargains! Dual manifolds \$12.95, racing heads \$29.00, California mufflers \$4.50, duals \$17.50, water injectors \$4.95, chrome echo cans \$1.65, lowering bars \$2.95, supercharger stacks \$3.50, others! Beautiful "Handbook-Catalog" 25c. Almqvist Engineering, Milford 55, Pennsylvania.

HOW To build racing car book. New revised, complete mechanical data, big cars, midgets, hotrods. 50 photos, drawings, charts. \$2.00 postpaid. Clymer, Dept. A-NRB, 1268 So. Alvarado, Los Angeles 6, Calif.

CARBURETION For car owners. New simplified illustrated pamphlet shows the way to better mileage, performance. Stop stalling, flooding with simple home adjustments. \$1.00. Carburetor Specialist, 501 N. Parramoro St., Orlando, Fla.

AUTOMOBILE Spray painting. Complete instructions 25c. Mohan, 942 Moss St., Reading, Penna.

CALIFORNIA Custom styling headquarters. Buy direct from original designers and save. Solid hood sides, lowering kits, grille panels, fender skirts, dual pipes, speed equipment, chrome motor accessories. 24 page picture catalogue with scores of beautifying accessories; 25c. Eastern Auto Supply, 3319S South Grand, Los Angeles 7, California.

"MIDGET Car" book—Complete plans for easily building inexpensive midget racers, two passenger highway runabouts, "streamlined roadsters." 3-wheel cars, scooters, etc. Motor data, supply sources, 75 photographs, blueprints! Instruction kit! \$1.98. Almqvist Engineering, Milford 55, Pennsylvania.

NEW Hot-rod book. Revised 1946-47-48 cars. 125 photographs, descriptions. California Dry Lake speed records. \$1.50 postpaid. Clymer, Dept. A-2NV, 1268 So. Alvarado, Los Angeles 6, Calif.

OIL Cooler: Liquid cooled engines. Better lubrication, longer life. Complete \$15.00. Free illustrated folder. Gilbert Brass Foundry Company, St. Louis 15, Mo.

MAKE Your Ford fast! Complete details, photographs. How to construct 120 m.p.h. Hotrod. \$1 postpaid. California Bill, Box L-1 Eaglerock, Los Angeles 41, Calif.

R & R Mfg. Co., Robert M. Roof, Box 546, Anderson, Indiana, U.S.A. We sell direct to our customers over 200 speed equipment parts mfg. by us. Complete racing engines for cars and boats for Fords A, B, V8—6-4-40 Studebaker Champion, Willys, Chevrolets. Dual intake manifolds, cylinder heads, Lynite flywheels, oversize valves, camshafts new or yours reground, compound springs and other supplies. \$1.00 to cover cost of literature and mailing.

CHEVROLET Speed manual now available to discriminating Chevrolet owners who desire real "hotrod" performance from their 1937 to 1948 Chevrolets. Filled with photographs, complete information, proven methods showing you how to make your road car into a genuine 110 m.p.h. job, or how to build 134.52 m.p.h. Chevrolet hotrod. Every page worth the purchase price of only \$2.00 postpaid. California Bill, Box L-1, Eaglerock, Los Angeles 41, Calif.

DUALTONE Crystalline packed California mufflers for all automobiles. Large chrome tailpipe extensions. Chromed carburetors, fuel pumps, long shackles, dual manifolds, hi-compression heads, flywheels, camshafts, fender skirts, plexitops. Send 20c illustrated catalogue, deduct from first order. Streamlining Manual \$2.00. Dualtone Mufflers, 2636C India Street, San Diego 1, Calif.

MAKE Your Model "A" do 100 m.p.h. Lightning acceleration, breath-taking top speed. Complete details, photographs. \$1 postpaid. Four Barrel, Box L-1, Eaglerock, Los Angeles 41, Calif.

PHOTOGRAPHS, World's finest automobiles. List, sample, 10c. Box 1028, Minneapolis, Minnesota.

FROM Speedway to roadway! Track-proved hi-speed heads and manifolds now available for your passenger car! No special tools needed! Increase horsepower 25%! Astounding getaway! Free illustrated catalog. Speedsport, 6215AA Diversey, Chicago 39.

AUTOMOBILE Racing book, fifth edition, well illustrated. Instructions on building bodies, frames, engines. Ford A and B conversions. Plans. AAA rules, specifications. Roadster racing. Indianapolis cars. \$1.00 postpaid, \$1.30 C.O.D. Ray Kuns, Dept. 47, Madisonville, Cincinnati 27, Ohio.

INSTALL V-8 engine in your Model A for extreme acceleration, more top speed, smoother performance. Complete details, photographs. \$1 postpaid. A-V-8, Box L-1, Eaglerock, Los Angeles 41, Calif.

NEW Sensational seat cover. Mono, \$545 Santa Monica Blvd., Hollywood, California.

AUTOMOBILE Racing, Sixth Edition. 100 illustrations. Working drawings with building instructions for Ford-60 midget, California roadster, Offenhauser racer. Details on racer parts. Sample entrance blank. World's record 158.5 m.p.h. rear engine four-wheel drive car. Interesting information for fans, drivers, mechanics. \$2.00 postpaid; \$2.25 c.o.d. Ray Kuns, Department 63, Cincinnati 27, Ohio.

CUSTOMIZE Your car! Authentic California restyling plans galore! Working sketches, specific model changes. Comprehensive; complete! 130 photographs! Largest, finest, or refund! \$2 postpaid. Post Publications, Box 723-BE, Arcadia, California.

AUTO SUPPLIES AND EQUIPMENT

CHEVROLET Parts. Scarce motor, body, sheet metal parts. Grossman Chevrolet, Minneapolis, Minnesota.

GOVERNMENT Surplus. Low voltage circuit tester in steel box. Brand new. Our price \$27.50. Will test batteries, starters, generators, voltage regulators, grounds, short circuits. Middle West Products Co., 500 W. 79th Street, Chicago 20, Ill.

CARS Start instantly, even draggy starters. Anyone can install with my instructions, only \$1.00. Guaranteed. Ted Hoskinson, P.O. Box 165, Louisville, Ky.

CHEVROLET Owners. Start instantly without choking with sure start vaporizer. Save gasoline, fast acceleration. Easy to install. Complete \$2.95 prepaid. Sure Start Mfg. Co., 8217 La Mesa Blvd., La Mesa, Calif.

"AIRFLOW Needles." Save gasoline. Write for free trial! Give make car and carburetor. Neher Industries, La Verne, Calif.

CONVERTIBLE Tops—Completely sewn. Easily installed. Reasonable prices. Free literature. Rio Top Company, 1370 Roanoke, Newport News 24, Virginia.

WELDING Bodies, blocks, repairing fenders adds profits. Easy with Hobart Welders. Low cost. Free catalog. Write Hobart Weld, Box M-292, Troy, Ohio.

KAISER-FRAZER Genuine factory parts mailed c.o.d. Special discount to dealers. All orders shipped same day. Write, wire Albany Park Motors, Inc., Parts Division, 2747 Lawrence Ave., Chicago 25, Ill.

SMITHYS Mufflers for Fords and other cars. Bucks Auto Parts, Box 1296H, Merced 5, Calif.

ELECTRIC Pencil—Writes, engraves all metals. 110 volts. \$2.95 postpaid. Reb Industries 265-DP, Elmhurst, Illinois.

1949 SUPERIGNITIONITER: Starting mileage, pep, \$4.85. Dealers. EG Mfg., Elmsford, N. Y.

MOTORISTS Save gasoline by Vacuumating overrich mixtures. Fits all cars. For free particulars write Vacuumatic, Dept. 1469, Wauwatosa, Wis.

SALE. Latest type engine for Stanley steam car—perfect shape, 4x5. Beale Garage, R.D., Long Branch, N. J.

VAPOR Injector, now available, only \$8.00 complete. It gives high test performance with regular gas and cooler operation. Saves oil, gas, engine wear and money. Installation easy. Warranted. Thomas Engineering and Novelty Co., Branch Office, Washington 16, D. C., Box 5528. No c.o.d. orders. Send make and year of car with order.

SOLID-Brass auto bells. Two tones, no wiring. \$8.50. Details free. Bermuda Auto Bells, Dept. 12, 16 Concord St., West Hartford 7, Conn.

CHEVROLET Owners—Lock your car from driver's seat. Can't be pushed or towed. Sent post paid \$1.00 Motor Industries, Quincy, Illinois.

SAVE Gas! Quick winter starting. "Lektron" spark intensifier. Easily installed. \$2.00. Money-back guarantee. Specify car. Electronic Industries, Cleveland 11, Ohio.

"SMOKO" Generates fantastic smoke screens! Free information! Smoko Engineering Company, Huntington 1, Indiana.

AUTOMOTIVE Surplus bargains! Welding outfits, hones, bearing pullers, sockets, wrenches, also large stock of industrial tools. Catalog free. Glenco Supply, 75-19 Myrtle Ave., Glendale 27, N. Y.

AUTO Parts—New, used or rebuilt. Anything for engine or body. Any model car or truck. Reasonable prices. Immediate shipments. What do you need? Write: Brown & Baker Motors (Parts Division), 5254 West Pico Blvd., Los Angeles 35, Calif.

HARD-TO-GET Auto body parts. We supply. Miller Auto Parts Service, 192 N. Clark Street, Chicago.

TIRE Mileage boosted. All pressures. Engineered economy. Free literature. Alto, 2319 Walnut, Texarkana, Texas.

CIG-STICK Parks your cigarette safely on dashboard or other metal surface. handy. \$1.00 pair. Edwards Industries, 4268 Shendoan, St. Louis 10, Mo.

PISTONS—American and foreign makes. M. Merryman Co., Lawndale, Calif.

NEW Grilles for all cars. Wagner Grille Co., Route 2, Bernville, Penna.

BUICK Parts. We stock a complete line of new Buick parts and engines. Same day service on orders and inquiries. We ship anywhere. Write today. Robertson Buick Co., 1001 S. Wabash, Chicago 5, Ill.

REPAIR Your car. Motor parts for all engines, chassis parts, ignition and carburetor parts, etc.; new replacement parts. Genuine and highest quality at manufacturers' retail prices. Orders receive priority over inquiries. Briggs Automotive Engineering, Box 3454, Merchandise Mart, P.O. Chicago 54, Ill.

AIR Horns—"Strombos" most powerful of all signals: Complete passenger car kits; all cars. Models available for boats, trucks, buses, and diesel locomotives. For the "right of way" right away! Buy Strombos. Illustrated bulletins on request. Strombos Company, 4525 Twelfth, Detroit 8, Michigan.

NEW And used automobile and truck parts. Lowest prices. Complete stock. Prompt reply. Babbitt Auto Parts, 2833 W. Chicago Ave., Chicago 22.

BRUSH Plating outfits connect to a battery. No tanks or shop required. Free particulars. Gunmetal Co., Avenue J, Decatur, Illinois.

CAR Trouble? Million new, used parts. Describe needs. Automotive, 2928A North Western, Chicago 18.

AUTO Parts. Buy direct. Get dealers' prices. Represent us in your territory. Write requirements. Specify car make. Mechanics Auto Parts, Factory Warehouse, 3807-PM N. Ashland, Chicago 13.

AUTO Parts for all cars, transmissions, motors, differentials, fenders, carburetors. Security Auto Parts, 1923-PM Grace, Chicago 13.

AUTO TRAILERS

PLANS, 10 Ft. trailerhouse, wt. 750. Send 50c Tweten, Box 541, Portland, Ore.

BUILD Your own trailer! Save money! Have every feature you want! Plans for house, sport, camp and utility trailers. Catalog describing 9 models 10c. 15c in Canada and overseas. Jim Dandy, Box 125-A, Wausau, Wisconsin.

MOTORCYCLES, BICYCLES, MOTORSCOOTERS AND SUPPLIES

WHIZZER Bike-motor \$25.00; Cushman motorscooter \$15.00; midget racer \$40.00; Shaw bicycle-motor \$15.00; Harley-Davidson motorcycle \$15.00; Smith motor-wheel \$25.00; Good motorscooter (twist grip) \$22.50. Rush 25c for new catalog #13 listing many other amazing bargains in motorscooters, used motors, midget cars, parts, wheels, etc. Gail, 538 Erie, Toledo, Ohio.

CUSHMAN Motorscooters \$8, midget car \$25, motorbike \$10 less motors; motors \$3 up; Harley engine \$5; motorbike conversions \$5; midget racer and parts \$40. Winter special: Four balloon tires for motorscooters or midget cars \$3. Mailorder only. Over 6000 tires in stock. Plenty brand new Regal motorscooters less motors \$37.50, plenty new midget cars, engines, automatic clutches, transmissions etc., in stock at factory prices. Send 25c for Big War-Bargain Catalogue Number 29 just out listing these and almost 400 other bargains. (35c by first class mail). Midget Motors Directory, Athens, Ohio.

INDIAN And Harley parts catalog 25c. Pistons, motor parts, batteries, tires, chrome accessories. Bootz, 1700 East University, Des Moines 16, Iowa.

MOTORBIKE Outfit \$5.00; midget car (complete) \$35.00; Indian motorcycle \$30.00; Cushman motorscooter (complete with extra tire) \$20.00; 1946 Whizzer \$35.00; other motorscooters \$10.00 up; motors \$3.00 up. Send 25c for new catalog #942 listing many other sensational bargains in used motors, motorscooters, motorcycles, parts, etc. Associated, Box 1764-CS, Toledo, Ohio.

FACTORY Built scooter \$75.00, midget cars, Briggs motor \$15.00, Maytag motor \$15.00. Race cars, motorbikes, scooters and many more bargains. Send 25c or 35c first class mail. Behnke's, Dept. B, 5721 Leland, Chicago 30, Ill.

AIRCOOLED Engines, new or used, bought and sold. Kenny's, Annandale, Minn.

MOTORCYCLE Bags by Allen. Allen Streamlined Bag Co., 106 Brook St., Elgin, Ill.

JET Propelled bicycle. Assemble your own. Photo and instructions \$1.00. Rush order. Maupin, Tipp City 5, Ohio.

BICYCLE Supplies. Wholesale, retail list 10c. Universal, 4713 Virginia, St. Louis, Missouri.

MOTOR Scooters, bicycle engines. 120 miles gallon. Dime for catalog. Clymer, Desk A-25, 1268 So. Alvarado, Los Angeles 6, Calif.

MOTORSCOOTERS, New design, 6 big features. Literature 10c. Rollaway Motors, Lancaster, N. H.

MOTORCYCLE News, monthly. Yearly subscription \$1.00. Latest worldwide information. Sample 15c. Motorcycle News, 5424-A Sawyer, Chicago 25.

MODERN Motorcycle Mechanics Manual—Latest third edition 600 pages 275 illustrations, covers all British and American motorcycles, most complete motorcycle book available; \$4.00 postpaid. Nicholson Bros., Saskatoon, Canada.

RECONDITIONED Motorcycles and motors. Chromium accessories. Complete stock Indian parts. Expert rebuilding. Fast service. Indian Motorcycle Sales, Kansas City 1, Mo.

COMPLETE One Stop Harley Davidson Sales Service, 813 Ohio Street, Wichita Falls, Texas.

HARLEY-DAVIDSON Parts, accessories, oil, expert service. Tires all sizes. Rebuilt 45" motors. Send \$2.25 for Army 45 Motorcycle Manual. 25c for accessory catalog and bulletins. Knuth's (Harley-Davidson Dealers), 2491 Fondulac, Milwaukee, Wis.

WHEELS! Build wagons, scooters, mowers, trailers, wheelbarrows, grocery carts, baby carts, play pens, baby carriages. 4" to 18". Free list. Trulsen Mfg. Co., 811 E. 31, Kansas City, Mo.

TIRES And industrial wheels, suitable for scooters, wheelbarrows, farm equipment, etc. All sizes. Bicycles and accessories. Largest assortment in America. Send dime for list. Cycle Transport Company, 1241 So. Michigan Ave., Chicago 5, Illinois.

AVIATION

FAMOUS "Zweng Texts" include: mechanic's rating \$3.00; flight engineer \$4.00; surplus sextants \$12.50. (Free Catalog). Pan American Navigation Service, 12021-6 Ventura Blvd., North Hollywood, Calif.

PROPELLERS, Plans for ice-snow sleds, air boats. Catalog 10c. Banks-Maxwell, Ft. Worth, Texas.

PROPELLERS—2-3 Blade for sleds, air-drive boats. Catalog. Standard Aero Craft, Box 387, Ft. Worth, Texas.

BATTERIES, GENERATORS

EDISON Non-Acid lifetime storage batteries for home lighting, motors, industrial uses, radios, etc. Free interesting literature. Hawley Smith Co., Croton Falls 1, N. Y.

ELECTRICAL SUPPLIES

WATTHOUR Meters, reconditioned, calibrated, guaranteed, complete stock, all types and sizes, \$2.75 up, write for list. Maspenock Electric Light Co., 44 Starr Lane, Jamaica Plain, Mass.

BUY Lamp parts wholesale. Parts you need for building, repairing, or assembling. Save money on large or small orders. New catalog for 10c. Gearon Company, Dept. 300-B, 27 South Desplaines, Chicago, Illinois.

MAGNETS, Two Alnico (V) rods, booklet, circulars—25c. Terry Sales Company, Box 1014, Toledo 1, Ohio.

ELECTRIC Pencil—Writes, engraves all metals. 110 volts. \$2.95 postpaid. Battery model \$1.00. Reb Industries, 265-DL, Elmhurst, Illinois.

LAMPS—Build own originals. Parts wholesale, any amounts. Catalogue 10c. Brown Lamp Co., Box 501, Wellston, St. Louis 12, Mo.

ELECTRIC Pencil: Engraves all metals \$1.25. Beyer Mfg., 10511-H Springfield, Chicago 43.

FREE Catalog—Motors, welders, welding supplies, generators, home freezers, rotary snow plows, many other electrical bargains. LeJay Company, Minneapolis, Minnesota.

NEW, New—Amazing simple kit for single, two or three phase motor group connections. Complete \$3.00. Motor Winding Calculator Service, Box 124, Hasbrouck Heights, N. J.

MOTORS, New General Electric 1/3 horsepower \$12.50. Free literature. Plenge, 114 Elliot Place, Bronx 52, New York.

RECONDITIONED G.E., Westinghouse, watthour meters. Ideal for cabins, trailers, shops. \$2.95. T. Price, 310-14th, Raymond, Washington.

LAMPS—If you build or repair, send 10c for 36 page, illustrated catalog showing every part necessary. If dealer send business card for quantity discount. Gyro Lamps, 5402P Clark, Chicago 40.

WELDING, SOLDERING, PLATING

"BUILD-UR-OWN" Welder. Portable. Hobart Welder plus auto engine saves \$350. Free instruction book. Write Hobartweld, Box M-293, Troy, Ohio.

WE Repair all kinds of welding gauges, torches, etc. Big stock new and rebuilt equipment for gas or electric. Also wire, hose, cable, holder, hoods, etc. Welding Headquarters, 2425 Milwaukee Ave., Chicago 47, Ill.

WELDERS For all requirements. Free catalog. Write Hobartweld, Box M-294, Troy, Ohio.

GASOLINE Soldering torch, auto radiator repair supplies and equipment. Write for circular. Curfman Mfg. Co., Maryville, Mo.

WELDING School pays. G.I. approved. Finest equipped in U.S. Free catalog. Write Hobart Welding School, Box M-295, Troy, Ohio.

MOST Amazing 110 volt electric arc welder. Build your own with very little time and expense. Will use 5/32 rod and will weld boiler plate. Send \$1.00 for full information. H. E. Younger, R.R. #8, North Kansas City 16, Mo.

OXY-ACETYLENE "Demurrage-free" Linde cylinders, Purox apparatus, Oxweld supplies, Metalmaster outfits, Miller electric hobby welders, approved fire extinguishers. Free literature. A-A Welding Supply Company, Dept. A, 9228 So. Ada St., Chicago 20, Ill.

RADIATOR Repairing, cleaning, re-coring. Our instructions tell how, how to equip a small shop at low cost, where to buy. Radiator Book, McBain, Michigan.

WELDER! New portable Champion Special transformer welder; 110/120 volts a.c. develops to 75 amps.; 9 heat stages. Welds, brazes, solders, cuts all metals. Easy to use. Simple instructions. Special flame weld torch free. Splendid for shop, farm, home repairs. Saves hundreds of dollars yearly. Only \$27.50. Also heavier models. 10 day free trial. Magic Welder Co., 239 MP Canal St., New York, N. Y.

WELDERS 110v. Welds 1/2" steel \$32.50. Morris Welding Service, 1850A State, Schenectady 4, N. Y.

BUY Direct from factory. Welding outfit, \$48.36. Soldering outfits \$7.76 to \$10.16 complete prepaid. Box 331, Hamilton, Ohio.

OWN Mirror shop. Resilver mirrors. Glass sign making. Electroplating. Supply prices. John Sprinkle, V55, Marion, Indiana.

RECTIFIERS: Ramyr Selenium platers, 10, 30, 50, 100 amp. sizes. Immediate shipment. Complete line of bronze baby shoe mounts. Write for list. Hollywood Bronze Supply, 1770 N. Vermont, Hollywood 27, Calif.

MACHINERY, TOOLS, SUPPLIES

WORK Shop table. 14 gage steel. Strong. Top 23" x 44". 3' high. Metal back with tool clip. \$35 delivered. Money-back guarantee. Balantire, Cheyenne, Wyoming.

YOUR Own machine shop will save time and money on your repairs. Your neighbors work will pay you \$2-\$4 per hour. Our surplus machines are accurate, low-prices and delivered at once. Screw-cutting engine lathes \$150 and up. Powerful upright drill press from \$110. Milling machines \$150 some higher. Shaper, welders, band saws, grinders. Our guarantee; satisfaction or your money back. Conversion Parts Co., 278 Adams St., Boston 22, Mass., U.S.A.

16" AND 26" Size jigsaws. Ten dollars and fourteen dollars. Mail money order. Shellington Machinery, 2055 W. Hunting Park Ave., Philadelphia 40, Penna.

"BUILD-UR-OWN"—Welder, plus a.c. power generator for tools, lights. Your engine plus Hobart generator saves \$350. Free instruction book. Write Hobartweld, Box M-296, Troy, Ohio.

FOOT Switch—Operates all power tools. Guaranteed \$3.95—2 for \$6.50 postpaid. Reb Industries, 265-DT, Elmhurst, Illinois.

BENCH Power tools, motors, supplies. Wholesale prices. Homecrafters Co-operative, Grand Rapids 6, Mich.

CIRCULAR Saw sharpener. Complete \$6.95. Sure-Sharp, Box 24-D, Santa Ana, Calif.

CONCRETE Block machines from \$39.50. Catalog free. Concrete Machine Company, 5466 Gravois, St. Louis 16, Missouri.

HYDRAULIC Transmission, Vickers, \$14.00. Other big bargains in war surplus geared speed reducers, motors, switches, etc. Delta Sales, P.O. Box 968, Shreveport, Louisiana.

FIRE Extinguishers. C-O-2, \$6.45, \$9.95 seller; agents wanted. Domonkos, 98 Vermont, Newark 6, New Jersey.

BACK Geared metal and wood cutting 12" band saw. 6" jointer, ball bearing. 47" long. Ball bearing spindle shaper, 15" x 20" table. 8" tilting table ball bearing bench saw. Lowest priced line of high grade tools on market. Free catalog. Dealers wanted. Backus Machine Co., Boyd, Wisconsin.

DRILL Grinder for twist drills, \$2.95. See ad on page 298.

VARIABLE Speed attachment, fits almost all drill presses, \$27.50. Also bench model for lathes and other machinery. \$21.00. When ordering specify make and model of your machine. Era Meter Co., 3934 N. Kilpatrick Ave., Chicago 41, Ill.

BALL Bearings one-fourth list price. Free list. Burgess, Box 168, Ferguson, Mo.

PRECISION Tools, used micrometers, verniers, height gages, etc., bought, sold, exchanged. Precision Exchange, 30 Church Street, New York 7, N. Y.

HOME Lathe owners—Build your own attachments. Send for picture, sample of work and list of blueprints. Cut gears, ratchets, etc. Make neat screws easy way. The Home Shop, 415 Raymond Ave., Glendale 1, Calif.

CHUCKS. (Genuine Westcott) Independent, Universal, threaded 1 1/2"-8 for South Bend, Atlas, Logan, Clausing, Craftsman lathes. Also other chucks to 16". Top value. Free literature. Westcott Chuck Co., 3600 Walnut, Oneida, N. Y.

BOATS, OUTBOARD MOTORS

BUILD Better boats from better plans. Send for free design selection form. Westlawn Associates, Montville 5, N. J.

BOAT Plans: Wood; steel. Book, "Modern Designs for Boats and Yachts," \$1.00. John B. Clark, Yacht Designer, 329 Kenmore Drive, Bay Village, Ohio.

KNOCK Down boat kits, outboards, inboards, sail, racing, molded shapes. Easy to build, enjoyable, minimum cost. Illustrated catalog 25c. Brooks Boat Company, Carrollton P2, Michigan.

OUTBOARD Motor parts, new and used, all makes. We can save you money. Write for price quotation. Cylinders rebored. Oversize pistons and rings for all makes, regardless of age. Outboard Motor Mart, Inc., 309-B Atlantic Ave., Boston 10, Mass.

STEERING Wheels, windshield brackets, from \$6.95. Modern fittings, lowest prices, also complete pre-cut plywood boats. Bargains galore. Folder 10c. Marine, Box 681, Mendota, Minnesota.

BARGAIN \$20. Make your own boat now with readymade streamlined laminated one piece hull as developed for Navy. Light, sturdy, leakproof. Anyone can convert into dinghy, outboard scooter, cartopper, other craft. 9'x4'. Write Warwood, 480 Lexington, New York 17.

KAYAK Construction kits. Lightweight! Strong! Seaworthy! Speedy! Economical! Literature. Dedham Kayaks, Dedham, Mass.

OUTBOARD Motorboating handbook. 252 pages, 89 charts, drawings. Complete service information every make outboard. Greatest outboard book ever. Just published. \$3.50 postpaid. Clymer, Dept. A-OM, 1268 So. Alvarado, Los Angeles 6, Calif.

BUILD Marine motors, Ford or Jeep. Federal Marine Motors, 9011 Cottage Grove, Chicago 19, Ill.

P-38 BELLY Tank speed boat. Complete plans and instructions. Twintank Boat Co., 1032 62nd Street, Oakland, Calif.

BOAT Covers made by Norwegian sail-makers. Send for copyrighted chart. You measure, we make it. All types of craft. Jenkins Technical Service, 366 Madison, New York 17, N. Y.

P-38 BELLY Tanks, New, steel. 10 foot or 6 foot size, \$9.95. Anzio Boat Company, 89H, Merced 9, Calif.

TWENTY Plywood boat plans \$1.00. Catalog boat building plans 10c. The Rudder, 15 Murray Street, New York 7.

NEW, Used, rebuilt marine motors. Marine conversions, fittings. Free catalog. Stokes Marine Supply, Dept. 24, Coldwater, Michigan.

BOATS And all about them. How to select, build, repair and operate. For 40 years the leading practical boating magazine. Half price trial subscription. 12 issues for \$1.00. Motor Boat, 62 Gold Street, New York 7.

NEPTUNE Outboard motors. Wholesale prices all sizes. Outboard Sales, 820 Dryades St., New Orleans, Louisiana.

BUILD Your own boat by the Welch System, ready cut parts. No experience necessary. Save 2/3 cost. Rowboats to cruisers. Illustrated catalog 25c. Midwest Boat Company, Menomonee Falls, Wis.

OUTBOARD Motors—Good values, used motors. Also used parts for most makes and models. Crandall-Hicks Co., 911 Commonwealth, Boston, Mass.

MARINE Conversions for Ford and Jeep engines. Catalog 10c. Lehman Manufacturing Company, Department D, Newark 2, New Jersey.

COMPLETE Constructional details on seventeen low-cost boats—power, sail, row. Designed for home builder with limited tools, no experience and little money to spend \$1.25. Popular Mechanics Press, (C-43), 200 E. Ontario, Chicago.

ENGINES, MOTORS, DYNAMOS

WELDING Generators, 150 ampere \$47.50. 1/2 horse, 1750 r.p.m. motors \$19.75. 3/4 horse, 3450 r.p.m. \$22.50. 1 horse \$28.50. Compressors \$17.50. Butler, 1885 Milwaukee, Chicago.

MOTORS! 1/2 H.P. D.C. converted to A.C. All new. High speed 110 volt, 25 or 60 cycle, ball bearing motors. Actual value about \$75.00. Now \$15.00 each or 3 for \$40.00. Countless uses for home mechanics. Can be used in any position. Order today! Immediate delivery! No c.o.d. orders. "Amazing Bachman's," 27 Herman Street, Rochester 5, New York.

WINDING Data, listing 225 motors, single and three phase, \$1.00. Motor Data Co., Box 7631, Kansas City 3, Mo.

ATHLETIC EQUIPMENT, BODY BUILDING COURSES

BIG Bargains, 12 courses \$1.00. News 10c. Sid's System, Southgate, California.

BARBELLS, Exercise equipment. Courses. Free booklet. Good Barbell Co., Reading, Penna.

DEADLY Judo—Fiercest fighting technique. Trick knockouts. (200 photographs, plus illustrations.) Expert instructions, three volumes. Complete \$2.25. Variety House, Box 46-B, Wall Station, New York 5.

SPORTING GOODS, GUNS, FISHING TACKLE, ARCHERY, TRAPPING

BUYING Guns, every kind, modern, antique. Describe fully with lowest price wanted first letter. (25c brings big bargain sporting goods lists). Numrich Arms, Dept. A, Mamaroneck, N. Y.

SEND 10c For list 100 used guns. Frayseth's, Willmar, Minn.

PISTOLS, Revolvers, rifles, shotguns, ammunition. List 25c. Frank Parish, Vicksburg, Mississippi.

SLINGSHOTS. Accurate, balanced, sturdy die cast aluminum crotch. Heavy rubber pulls and leather sling. For boys. For sportsmen. For target. For hunting small game. \$2.00 postage prepaid. Send cash or money order to Roget Industries, P.O. Box 631, Trenton, Michigan.

SPORTSMEN, Get our new 1949 catalog. 32 pages packed with sporting goods. Send 25c, which we refund on \$1.00 order. Midwest Sporting Goods, Palace Building, Minneapolis, Minn.

WRITE For introductory offer "Clark's Wobbling Baits." Sample simulated pork rind free. R. K. Clark, Greenville, Ohio.

\$1.00 BRINGS You Usher's 1949 fishing calendar. Reveals very best fishing days. 85% correct. Reuben Usher, 726 N. Hampton, Dallas, Texas.

SURPLUS Camping supplies. Bargains. Free catalog. R. McManus, Cuttingsville 4, Vt.

BOAT Seat. Really relax while fishing. Postpaid \$3.95 or build it yourself, drawings complete 25c. Comfyseat, Box 350, Kenosha, Wis.

SHOTGUNS, Rifles, revolvers, over 500 modern, obsolete. Also cartridges. List 10c coin. Ed Howe, 52 Main, Coopers Mills, Maine.

MOLDS For fishermen's sinkers, squids, and jigs. Sweet's Molds, Tonawanda, N. Y.

SPECIAL For fly tiers. Complete kits \$1.00, \$1.95, \$6.95 and \$9.95. Tully's, 6104 Roscoe Street, Chicago 34, Illinois.

BINOCULARS, TELESCOPES, MICROSCOPES, MAGNIFIERS

BINOCULARS. Unused navy 6 x 30 Universal, leather case, \$50. Arco, 430 Lexington Ave., New York 17.

POWERFUL Astronomical telescope, equatorial mounting, two eyepieces, \$16.50. Bluhm Optical Lab., 4213 Gifford Ave., Cleveland 9, Ohio.

BINOCULARS, Telescopes, watches, guns, sell, trade. Schweer's, Donnellson, Iowa.

REFLECTING Telescopes, 60X, completely assembled \$25.00. Guaranteed observatory clearness. Free information. Skyscope, 475 Fifth Avenue, New York 17.

POWERFUL Astronomical telescopes easily made. Perfect lenses and instructions; 100X \$3.00, 100X and 200X \$4.00, 100X, 200X and 400X \$6.00. Clear vision, full power guaranteed. Instructions alone 10c. Suffolk Science Service, Manorville, N. Y.

ASTRONOMICAL Telescopes, binoculars, microscopes; bought, sold, repaired. Books. Lists 10c. Rasmussen-Reece, Amsterdam, N. Y.

TELESCOPES, Binoculars, microscopes, big bargain catalog free. Brownscope Company, 24 West 45th Street, New York.

GIANT Astronomical telescope 100 diameters magnification, with tripod. Full power, clear vision, \$15.00. Suffolk Science Service, Manorville, N. Y.

DOGS, PETS, BIRDS, RABBITS

RAISE Guinea pigs. Make money at home. Big demand. Booklet free. Taylor, Box 426A, Hapeville, Georgia.

\$300.00 MONTHLY Raising Angoras for our market. Particulars free. Associated Breeders, 610 Marshall, St. Paul, Minn.

BEAUTIFUL Pure white pedigreed police puppies. Ansonia Kennels, Mose, N. Dak.

DIRECTORY Breeders, buyers, rabbits, cavies, etc., quarter. Hartman, New City, New York.

BOXER Puppies. Schwarzwald Hof Kennels, 5136 Cascade Road, Grand Rapids 6, Mich.

ZOOLOGICAL And pet animals for sale. Illustrated catalogue, literature, 25c. Trails End Zoo-5, St. Stephen, S. C.

\$3000 YEARLY Raising Angoras. Circular free. Vaughn's Rabbitry, Otley, Iowa.

SEE Gulf Hamstery ad on page 18. Shows picture of Hamster.

MINKS, Raccoons, bred females. Baby skunks. Catalog, 25c. Shady Fur Farm, Springfield, Minnesota.

ANGORAS, Giant Chinchillas, White Giants. World's most profitable rabbits. Finest pedigreed, heavy-producing, prize-winners. Literature free. Grinsteeds, Edwardsville, Illinois.

RAISING Rabbits, Cavies, Hamsters, Chinchillas is profitable. Big demand. Instruction book and magazine 25c. Book and magazine (monthly) one year, \$1. Small Stock Farmer, Fairlawn 2, New Jersey.

MINK Raising information free. Complete. Lake Superior Mink Farm, Superior, Eel, Wisconsin.

RAISE Chinchilla rabbits. Year-round money-makers from furs, meat, breeders. Experience unnecessary. Folder 25c. Willow Farm, Sellersville 15, Penna.

\$250.00 MONTHLY Raising angora rabbits. Particulars free. White's Rabbitry, Newark, Ohio.

MINK Raising amazingly profitable. Free folder gives inside "secrets" on feed; care. Lawrence Molgard, Brigham City 12, Utah.

INCREASE Your income by raising domestic rabbits. Small space needed. Ready market for delicious meat, fur and wool. Largest magazine in the industry tells you how. \$1.50 per year. Sample 15 cents. No stamps. Small Stock Magazine, Lamoni 20, Iowa.

\$3000 YEARLY Raising Angora rabbits. We buy your output. Contract particulars free. Kise's Enterprises, St. Paul 8, Minn.

PLANTS, SEEDS, NURSERY AND GARDEN SUPPLIES

GROW Newest marvels of science. Mid-get vegetables, prize-taking flowers, hybrid hullless popcorn. See latest garden gadgets in big free Seed and Nursery Annual, Write Farmer Seed & Nursery Company, 34 East 32 St., Faribault, Minnesota.

RAISE Your own trees and shrubs from seed for shade, windbreak, erosion control, etc. Write for free planting guide and price list. Woodlot Seed Co., Norway 4, Michigan.

RAPE Seed, White Dutch and Alsike clover. North Idaho grown. Cheap prices, samples on request. Stellys Seed Cleaning, Gifford, Idaho.

WE Sell on the installment plan. Best varieties peach and apple trees, low as 12c; grapevines 4c; shrubs 13c; evergreens 15c. Berries and plants. Catalog free. Benton County Nursery, Box 542, Rogers, Arkansas.

GLADIOLUS—New varieties, novelties, list. Robinson, Box 31, Sebastopol, Calif.

FARMS, FARM LANDS, REAL ESTATE

BIG Free spring catalog of farm bargains, many states, some equipped, many illustrated! Write today! United Farm Agency, 1408-PM Consumers Bldg., Chicago 4, Ill.

GOVERNMENT Lands \$1.00 acre up. Information all states 25 cents. National Tax Service Bureau, 834A Majestic Building, Detroit.

WEST'S New 1949 catalogue, 1000 farm and business bargains. Free. West's Farm Agency, HE-20, Pittsburgh 17, Penna.

INVEST in pine timber. Multiply your money in few years. 10 to 1,000 acres at \$10 per acre. Also Ozark Mt. farms. Hunt, fish and trap. All near proven lead and zinc deposits. All rights goes. Brasel, Jasper, Arkansas.

CALIFORNIA, Land, homes and groves, (avocado, orange, lemon). World famous climate. Free list. Dale E. Wood, P.O. Box 555, Vista, California.

BIG Lists farms, ranches, water frontage properties. Free descriptive folders, prices. Splendid opportunities, Washington, Idaho, Montana, Dakotas, Upper Michigan, Wisconsin, Central Corn Belt. Information regarding Columbia and Missouri River Basin irrigation projects. L. H. Robbins, Milwaukee Railroad, 736K Union Station, Chicago 6, Illinois.

STROUT'S Fall-Winter farm catalog—free! Red cover. Check-full of bargains coast-to-coast. Eqpd. and uneqpd. farms, groves, retirement places, etc., etc. Write today for your free copy. Strout Realty, 255P 4th Ave., New York 10, N. Y. 20 W. 9th St., Kansas City 6, Mo. 453 S. Spring, Los Angeles 13, Calif.

GOOD Farms—Ranches, Washington, Minnesota, Montana, Idaho, Oregon, North Dakota. Dependable crops, favorable climate. Write for literature, lists describing typical farm opportunities. Specify which state. J. W. Haw, 119 Northern Pacific Railway, St. Paul 1, Minn.

\$5.00 MONTHLY Buys 40 acres. Near town; price \$200.00. Free list; Box 425-P, Carthage, Mo.

OZARK Magazine, Eureka Springs 11, Arkansas. For homeseekers, tourists. Year, \$1.50.

SOLD For taxes, Calif., Oregon, Washington timber, grazing, ranch and mining lands. 25c to \$3 acre min. bid. 10c (coin) brings circulars, photos, maps. Pacific Lands, Box 2350-PM, Hollywood, Calif.

LOTS \$300—Convenient payments. California's finest garden section. On Morro Bay's scenic shores. Wonderful fishing, hunting, boating, bathing. Fertile soil, softest water, temperate climate, congenial community. Free literature. Richard Otto, Department M, San Luis Obispo, California.

OZARK Lands for all purposes. Actual river frontages. 5 acres \$90.00 and upwards. Free list and literature. Hubbard, 424-I Minnesota Ave., Kansas City 4, Kansas.

POULTRY, FARM SUPPLIES

RAISE Fryers new easy way. One man home plant earns \$500 monthly. Farm proven methods. Circular 10 free. Poultrymen Institute, 1046 So. Olive, Los Angeles 15, Calif.

BABY Chicks, champion mated. 52 varieties, 6 hybrids, licensed inspected, bloodtested. Rush postal, large colored book free, low prices. Berry's Farm, Route 12, Clarinda, Iowa.

FREE Information on how you can make up to \$5,000.00 raising broilers and fryers the newest way in your backyard or in your farm buildings. Write National Broiler Institute, Dept. 3, Versailles, Missouri.

YOU Can make money from poultry this year! Future outlook excellent. Our experimental farm advice will help you. Subscribe today! \$1.00, two years. Poultry Tribune, Dept. 16, Mount Morris, Illinois.

EARN \$4 To \$12 hourly. Chick sexing, culling and caponizing. G.I. approved. Pilch's School, Box PM, Thompsonville, Connecticut.

KNOW How to raise poultry for profit. Read Northeastern Poultryman. Every issue packed with helpful hints and practical suggestions. Latest articles on breeding, feeding and management. Subscribe now. 1 year 65c. 2 years one dollar, foreign subscriptions \$1.00 a year. Northeastern Poultryman, Dept. P.M., 376 Boylston St., Boston 16, Mass.

RAISE Turkeys the new way. Write for free information explaining how to make up to \$3000.00 in your own backyard. Address National Turkey Institute, Dept. 3, Columbus, Kansas.

PROFITABLE OCCUPATIONS

START Your own business on our capital. Always your own boss. Hundreds average \$6,000 to \$25,000 annual sales year after year. We supply stocks, equipment on credit. 200 home necessities. Selling experience unnecessary to start. Wonderful opportunity to own pleasant, profitable business backed by world-wide industry. Write Rawleigh's, Dept. B-U-PPM, Freeport, Ill.

"EVERYBODY Likes candy." Learn to make in a professional manner. (Our 39th year.) Ragsdale Candies, D6, East Orange, New Jersey.

TYPISTS—Profitable business at home. Complete copyrighted information, 50c. Gaunt, 3521-A Broadway, Chicago 13, Ill.

SENSATIONAL! It's easy to earn big money with your own profitable business. Earn \$10.00 to \$50.00 a day. Make lamps at home. General illustrated course teaches you quickly. Course and wholesale supply catalog only \$2.00. Gearon Company, Dept. 200-B, 27 South Desplains, Chicago, Illinois.

FOREIGN Employment? Application forms, overseas directory and Bulletin 42-A-\$1.00 (c.o.d.-\$.128). Foreign Service Institute, Box 3934, Miami, Fla.

FREE Book "372 Unusual Worldwide Business Adventures!" Pictures! True! Successful! Australia, Africa, South America, New Zealand! Work delightful, "different" plans home. Publishers-J. Carlsbad, Calif.

MUSHROOMS Grown. Boxes, barrels. Instructions 50c. Spawn \$1.00. Manureless process \$2.00. Gordons, 553 William, Winnipeg, Manitoba.

MECHANICALLY Inclined men. Electrical technicians command big wages. Own profitable lifetime business. Charge \$5.00-\$6.00 hour! Service factory, household equipment, wiring, motor winding, etc. Illustrated course plus home training kits give you practical experience. Liberal terms. Free illustrated booklet. Write Christy Trades School, 2835 N. Central, Dept. C-102, Chicago 34.

YOU Can make real money raising Golden Hamsters. New tiny animal. Easily raised at home. Write for details. Hudson Hamstery, RFD #1, Newfoundland 1, N. J.

WE Offer interesting proposition as associate manufacturer filling orders for high class outstanding, copyrighted wall plaques. Instruction and orders furnished. Reasonable investment—interesting, profitable business. Plastex Products, 711 Laguna, San Francisco.

SHARPEN Circular saws. Complete outfit \$8.95. Sure-Sharp, Box 24-A, Santa Ana, Calif.

CONSTRUCTION Report—Send \$1.00 for world wide job project listings. Up-to-minute facts for construction men. Global Reports, P.O. Box 883-DX, Hollywood 28, Calif.

MAKE Flexible molds! Cast plaques, novelties, bookends! Free sample! H. Tooker, Hamilton 9, Ohio.

MAKE Liquid marble, artificial marble flooring, flexible molds, statuary, art goods, novelties. Literature free, Kemico, Park Ridge 50, Ill.

EXCELLENT Profits. Make, sell holiday flowers, novelties. Literature free. Velya Artcrafts, 324-M East 14, New York 3, N. Y.

EARN \$50.00 Or more weekly operating nut and gum vending machines in your spare time. Details free. Danco Coin Machine Co., Dept. PM, 1304 E. Baltimore St., Baltimore 31, Maryland.

"FROG-RAISING"—New book explains everything! Marlboro, 1035 Marlborough, Detroit 15, Michigan.

BE The Popular Mechanics representative in your neighborhood and earn big profits in your spare time. Write Popular Mechanics Magazine, Room 408M, 200 E. Ontario St., Chicago, Ill.

\$46 FROM Square foot plywood; jigsaw necessary. Write, Woodarts, P-38, Bridgewater, Mass.

LOCKSMITHING Secrets—Key fitting, lock opening, repairing, prices to charge, supply sources. Illustrated book only \$1.00. Wechsler Supply, 7 W. 36, New York City.

OWN Mirror shop. Resilver mirrors. Glass sign making. Electroplating. Supply prices. John Sprinkle, V50, Marion, Ind.

\$40.00 WEEKLY Made growing mushrooms, fresh, dried. Dominion patent 331583. Free spawn. North American, 169P Yonge, Toronto, Canada.

INTERESTED In Latin American and foreign employment? \$1.00 brings Foreign Service Directory listing exporters and importers, oil, construction, mining, aviation companies. Hot tips for applications. Global Reports, Box 883-M, Hollywood 28, Calif.

ALASKA—The Last Frontier offers unlimited opportunities, \$1 brings government map and directory listing firms in fishing, construction, mining, aviation, fish and game rules, homestead data. Alaska Opportunist, Box 883-M, Hollywood 28, Calif.

BOOKS, PERIODICALS, PICTURES, POSTCARDS

EASY Profits taking magazine subscriptions, handling greeting cards and boxed stationery. Cassell Publishers, Westfield, New Jersey.

SEND Five books (good condition) and \$1.00. Receive five postpaid. Fiction or non-fiction. Bookman, 107 Brentwood, Macon, Georgia.

WILL Pay up to \$5,000.00 for certain old books! Catalogue 10c. Ohio Historical Publishing Company, PMF, Columbus 1, Ohio.

EXCITING, Strange, unusual books. Send \$2.00 for sample book plus 25 page catalog and private collectors list. Rare Book Company, Dept. C, 1219 1/2 North LaBrea Ave., Hollywood 38, California.

HOME Craft course series, 26 books step by step, simple, easy to follow instructions—Profusely illustrated—many designs—some in full color. Write, Mrs. C. Naaman Keyser, Plymouth Meeting, Penna.

BACK Number magazines, used books. Reasonable. Reedmore, 240 East 9th, New York, N. Y.

THANKSGIVING Day parade, New York. Decorated floats, girls in fancy costumes, drum majorettes. 22 different glossy snapshots \$2.00. Frederick Forman, 868 Lorimer, Brooklyn 22, N. Y.

"MAKING Money at home." 68 pages, 63 projects, fully illustrated. What to do, how to do it, where and how to sell it. \$1.00 postpaid; 5-day return privilege. Earl B. Shields, Publisher, 107-A West Wacker Drive, Chicago 1.

PLEASURE Profit book list free. Johnson, Box 49, Astoria Station, Long Island City, N. Y.

300 HOME Addresses top movie stars. Send \$1.00. Pacific Enterprises, Stevenson Bldg., Pasadena, California.

BOOKFINDERS! (Scarce, out-of-print, unusual books). Quickly supplied. Send wants. Clifton, Box 1377-PM, Beverly Hills, Calif.

SELF-EXPLAINING Bible: Illustrated circular free. Box 446-P, Minneapolis, Minn.

BOOKHUNTERS! All subjects. Send wants! Jaher Book Service, 620-P East 178 Street, New York 57.

GAMES, ENTERTAINMENT

MYSTIFY Your friends. 10 mind reading secrets \$1.00. R & E Magic Co., Box 1021, Worcester 1, Mass.

HOURS Of baffling fun. Send 35 cents, coin for giant puzzle sheet. Bobbe, Midlothian, Ill.

MAGIC TRICKS, PUZZLES, JOKER NOVELTIES

BE A magician. Large professional magic catalog of latest tricks, 35c. Ireland, C-109 North Dearborn, Chicago 2.

CHINESE Mechanical ring puzzle \$1.00 postpaid, Box 85, Cambridge, Ohio.

SEND 35c For famous magical coin. Receive illustrated literature free. Rone's, Box 97, Katonah, N. Y.

BE A memory whiz! To introduce my remarkable system I will send my \$1.00 "Modern Memorizer" free (no strings attached). Simply send your name and address to H. Burkhardt, 2041 East 64th St., Brooklyn 10, N. Y.

MAGIC List free. "Marean" Magic Shop, Box 551-R, Hopewell, Virginia.

CONJURORS' Magazine, most widely read magazine of magic, is not for public sale. If sincerely interested in magic, send \$1.00 for three sample copies. The ultimate in professional and magic news. Don't delay. Mail a dollar bill today. Conjurers' Press, Inc., Maplewood, N. J.

LARGE 160 Page catalog, just published, 35c. We have supplied the best tricks to beginners and professionals for 38 years. Chicago Magic Company, 2300-B No. Mason Avenue, Chicago 39.

"MAGIC Is Fun" magazine, catalog. 500 marvelous tricks, both for 50c. Robbins Co., 152-S West 42nd St., New York.

LARGE Catalogue of the best magic for professionals and amateurs. Send 35c. Mazda Magic Co., 1135 Westgate Ave., Oak Park, Ill.

16 CARD Tricks and catalog 25c. Sterling Magic, Royal Oak, Mich.

MYSTIFYING "Magic Library." Free folio. Lynch, 402-10 Hazlett, Baltimore 29, Md.

ENTERTAIN. Mystify! 96 page catalog magic, joke and party goods, 25c. Riley-Borin, P-7909 Rhodes, Chicago 19.

500 TRICKS, New 1949 edition. Send 10c for Douglas famous catalog showing best in good magic, lowest prices, fastest same-day service. 30 years in business. Douglas Magician, Dept. 1, Dallas, Texas.

400-PAGE Catalogue of 2000 tricks, pocket, parlor, stage. World's finest magic. Send \$1.00 for catalogue (refundable first \$5.00 order). Kanter's, M-1311 Walnut, Philadelphia 7.

DOLLAR Magic set free with mammoth catalog 25c. "Mysto," 4462-PM Germantown, Philadelphia.

"VENTRILLO." Professional voice throwing instrument and "unusual" catalog 25c. POB-971, Philadelphia.

SNEEZING, Itching, powders. Eighteen other tricks free with joker's catalog 25c. 2404-N Fifteenth, Philadelphia.

PROFESSIONAL Catalog. 124 pages, 25c. Williams, 900 Plymouth, Ellwood City, Penna.

VENTRILLOQUISM Taught. 3c stamp bring particulars. Smith, 801 Bigelow, Peoria 5, Ill.

WORLD'S Largest professional magic shop, keeps you in touch with latest tricks. To receive mailings, send 50c for new catalog. Holden's, M220 West 42nd St., New York.

MAGIC Tricks, puzzles, books, cards, punch boards. Catalog 10c. Specialty, Box 671, St. Louis 1, Mo.

LEARN Magic, ventriloquism, mind-reading. Write for particulars. Quackenbush, Big Flats, N. Y.

200 ELECTRIC Stunts, 110 volts, \$1.00. Kutting Sons, Campbell, Calif.

COINS, TOKENS, CURRENCY

OLD Money wanted. Do you know that coin collectors pay up to \$100.00 for certain U. S. cents? And high premiums for all rare coins? We buy all kinds. Send 4c for large coin folder. May mean much profit to you. Numismatic Co., Dept. 20, Fort Worth, Texas.

4 WHITMAN Folders \$1.00. complete stock. Foreign coin included with bargain price list, 10c. Little, 337 North Menard, Chicago 44.

FOREIGN Coin and banknote free with huge price list 10c. 4 Whitman coin albums only \$1.00 postpaid. Tousseau Coin Company, 109 So. Mathilda Ave., Sunnyvale, Calif.

VALUABLE Coins now in circulation. List dime. Myatts, Pittsboro, N. C.

COINS Bought, sold, list. Globe, 3238 Orange, Chicago 34, Illinois.

LARGE \$1.00 Bill \$1.60, large \$2.00 bill \$3.40, 4 copper-nickel cents \$1.00, 4-2c pieces \$1.00, 4-3c nickels \$1.00, 4 Whitman coin folders \$1.00, type folder \$1.00, hand-book 75c, 254 page guidebook \$1.50. Big bargain catalogue 15c. Bebee Coin Company, 1180 East 63rd, Chicago 37, Illinois.

BARGAIN! 40 Different dates large cents, 90 to 145 years old \$10.00, 25 different Indian cents \$1.00, 40-44.00, 5 different types commemorative half dollars \$5.00, 1862 Maryland \$1.00 bill \$1.50. Know the true value of old money. Our complete buying-selling catalogue 25c. Worthycoin Corporation, 294 Washington, Boston, Mass.

25 COINS And bills, 25c. Oddehon, Box 482, St. Louis, Mo.

43 MIXED Indian cents \$1.00, 33 different foreign coins \$1.00. Chelsea, 40 West 18, New York City 11.

HELP A worthy cause—Buy rare Booker T. Washington half dollar sets (PDS mints): 1946 \$4.50, 1947 \$6.00, 1948 \$7.50, 1949 \$8.50. Bebee Coin Company, 1180 East 63rd, Chicago 37, Illinois.

35 WORLD Coins \$1.00. List free. Harry Elsholz, Box 9014, Pittsburgh 24, Penna.

GET Profit and pleasure in collecting old coins. Send 10c for 56 page illustrated coin catalog. You'll be delighted with it. Send for it now. B. Max Mehl, 370 Mehl Bldg., Fort Worth, Texas. Largest rare coin establishment in U. S. Established 49 years.

FREE! Foreign coin, banknote and coin collectors illustrated catalog to approval service applicants. Send 3c postage. Tatham Coinco, Springfield 30, Mass.

4-IN-1 Special \$1.00 bargain offer: (1) United States 1893 Columbian world's fair half dollar; (2) album for holding coins; (3) large 56 page coin catalog; (4) genuine wooden nickel. Yes! All four items for only \$1.00. Order today. Money back if not pleased. Ben's Coin Company, 72 W. Washington, Chicago 2, Illinois.

SEND Dime for sales list No. 16. Acorn Stamp & Coin Co., Box 53, So. Norwalk, Conn.

COINS Wanted, will pay up to \$2000 for certain coins, send 25c for catalogue. Burton's, 111 So. Third, Columbus, Ohio.

COMMEMORATIVE 1/2, Oregon, Texas, Kentucky, Cleveland, Long Island, \$2.00 ea. Illustrated catalogue 25c. Norman Shultz, Salt Lake 9, Utah.

STAMP COLLECTING

TREMENDOUS Bargains! 2,000 stamps from all over world \$1.00, 5,000, \$2.00, 2,000 United States \$1.00, 5,000, \$2.00. Standard Products Company, 2001 Atlantic Building, Washington 4, D. C.

20 ASSORTED U. S. Commemorative stamps 15c. Five U. S. Air Mail 10c. Ideal Stamp, Box 179, Park Ridge, Ill.

FREE—Famous Americans set, plus Flag Set, plus the National Parks Set, plus the Presidential Set to the \$5. A total of 90 stamps absolutely free to customers for our unsurpassed U. S. or foreign selections. Send 3c postage for 15 of the above mentioned stamps and full particulars. Triboro Stamp Company, 145 Nassau St., Dept. 102, New York.

VICTORY Packet free—Includes stamps from Tanganyika, British Cayman Islands, animal, scarce babyhead, Coronation, early Victorian, airmail, map stamps. Including big illustrated catalogue. Send 5c for postage. Gray Stamp Company, Dept. PM, Toronto, Canada.

UNITED States bargain. It sounds unbelievable, but it's true! 50 different United States ranging in age as far back as over 60 years and in face value as high as one dollar. Only postage, commemorative, and air mails included. Nothing else. Extra 2 Jap Occupation of Philippines, all for only 10c to approval applicants. Please state whether approvals shall consist of U. S. or foreign stamps or both. Globus Stamp Company, 268 Fourth Avenue, New York 10, N. Y., Dept. 211.

10c SPECIAL; Worth four times the price; stamps from Canada, Ceylon, Colombia, Peru, British Guiana, Australia, Jamaica, Italy, Finland, New Zealand, Argentine, Chile, Newfoundland; to introduce approvals to serious collectors only. Leslie J. Vaughn, P.O. Box 222, Coconut Grove, Florida.

ZEPPELIN, German U Boat, Cyprus, Trinidad, Tobago, Uganda. All sent upon receipt of 10c. Approvals included. Thirco, 101 3rd Ave., Newark 4, N. J.

FREE U. S. foreign price lists. Schneider, Jr., Route 3, McHenry, Illinois.

66 DIFFERENT Stamps, including U. S. battleships 6c. World wide approvals. Telic-Arts, Devon, Conn.

AIRMAILS 100 Different, stamp magazine \$1.00. Scanlon, 1122 High, Des Moines, Iowa.

ILLUSTRATED Stamp magazine, 26 weeks 25c. Stamp Journal, Kalamazoo, Michigan.

500 UNITED States, good mixture, 25c. "Stamps," Van Buren, Indiana.

BEAUTIFUL Nude Alva duchess, China airs, others 10c with approvals. Aztec, Tornillo, Texas.

GIFT Six Roosevelts San Marino to approval applicants. Deane Stamps, Box 87, Miami 35, Florida.

1862 PRINCE Edward Islands—just 3c with approvals. Viking, 130-Z Clinton St., Brooklyn, N. Y.

BIGGER, Better, lower priced United States approvals. Box 488, Minneapolis.

GIVEAWAY! 155 Different 10c. Approvals. Brooks, 2352 East 23rd Street, Brooklyn 29, New York.

WORLDWIDE Approvals—1c up. Dept. PM, 1267 Tutwiler, Memphis 7, Tenn.

SEND 125 Different clean stamps for 125 all different. Job-Oyd's, 476 Metairie Road, New Orleans 20, La.

FREE San Marino Roosevelt set to approval applicants. R. Hagemann, 6139 Ridge Ave., Cincinnati 13, Ohio.

FREE—100 Old issues! Approvals. National, Box 42A, Passaic, N. J.

FREE Pony Express or 5c Olympics with U. S. approvals. Manning, 3259 Decatur, New York 67.

FREE With approvals. British, Spanish, French Colonies, Vatican, Hitler heads, and airmail packet. Pan-American Stamp Co., Box 145, New York 33, N. Y.

LATIN America, British Guiana, West Indies. 70 different 25c. Dr. Rowell, Star Route, Lawton, Okla.

STAMP Buyers' Guide plus 50 different Italy for 10c. Stampguide, Box 1649P, Oakland 4, California.

WORTHWHILE 30 U. S. commemoratives 25c; 50 airmails 50c; 50 Persia 50c; 100 Switzerland 60c; 100 Norway 75c; all different or all for \$2.00. Stuart, Box 72, Bowling Green Station, New York 4, N. Y.

UNITED States commemorative collection. Thirty-three different unused, Columbians to 1943 commemoratives only. Price \$1.00. Request approvals. "Stamps," Albany 1, New York.

FREE! Liberia triangle airmail set, with approvals. Martin, Box 1128, Miami Beach, Florida.

ELECTRIC Pencil—Writes, engraves all metals. 110 volts. \$2.95 postpaid. Reb Industries, 265-DQ, Elmhurst, Illinois.

FREE! Fifty different worldwide with approvals. Jack Dudak, 150-B-2, Streator, Illinois.

COLLECTORS! World's most attractive stamps, illustrated folder free. Nations Stamps, 3338 Monterey, Detroit 6, Mich.

HI-IQ Hinges. New safety feature. Thousand 35c. Three boxes \$1. Stampade, 1219 Huron, Cleveland 15, Ohio.

UNUSUAL Penny stamps or keep entire packet. 200 different for one dollar just half price. Other bargains. H. Codwise, Box 5, Melrose Highlands, Mass.

500 DIFFERENT China \$2.00 with approvals. Henry Bardsley, Roslyn, Penna.

FREE! U. S. monthly lists, fine stamps! Cole, 43-A Rinewalt, Buffalo 21, N. Y.

UNITED States stamps—Approvals. Bargain prices. Metropolitan, 140-B Nassau, New York City 7.

ATTRACTIVE United States approvals, low priced. Wakonda, 140-G Nassau, New York City 7.

\$4,550.00 FACE China p.o. set. Ivory Coast girl set, plus biggest U. S. single postage stamp only 20c to approval applicants. Marshall's, Box 5152, Denver, Colo.

PICTORIAL Set. Six 10c. Ten other sets free. Newstamps, Alexandria, Ont.

25 DIFF. 19th Century given to approval applicants. Rossom, 218 West 59th St., Chicago 21, Ill.

SELECTED U. S. mint Roosevelt and flag sets. Both only \$1.00. Approvals. Quinn, 570, Madison 1, Wis.

15 AIRMAIL Stamps from 15 different countries 5 cents with general or airmail approvals. Elmhurst Stamp Company, P. O. B. 44M, Elmhurst, N. Y.

\$1.00, \$2.00, \$5.00 U. S. Free. Approval applicants. Flamingo, Box 4038, Miami 38, Florida.

FREE, 12 Different U. S., approvals accompanying. Village Stamps, 90-39P 214th St., Queens Village 8, N. Y.

1/2c UP U. S. or foreign approvals by countries. Free lists. Hurt & Fosse, Box 102, Blue Ridge, Virginia.

GENUINE "Goya Nude" set complete 50c. Approvals. Royal Stamp Company, Tamaqua, Penna.

AROUND The world—30 different countries; Basutoland, Nyassaland, Tangier, Cyprus, St. Helena, 10c with approvals. Excello Stamps, P. O. Box #95, Hackensack, N. J.

EXCELLENT U. S. approvals, upon request. Panther Stamp Co., Dorchester Center, Mass.

FREE Catalogue of U. S. stamps, albums, supplies. Stone, Box 52, Dorchester 24, Mass.

PICTORIALS, Airmails, new issues are plentiful in our penny approvals. Tilbury, Box 862, Newark 1, New Jersey.

BRITISH Colonials on approval; mostly half catalog. Ostrow, Box 121-B, Elizabeth, N. J.

GERMANY "War packet," assaultboats, warplanes, Hitlers; free to sincere approval customers. William Deems, Ravenswood, W. Va.

YOU'LL Like my approvals and gift. Walter Kotowski, 5864 Staubin, Detroit 11, Mich.

SEALED Sacks containing 500 British Colonials from Empire Missions—\$1.00. Catalogue free. Price Company, Killogrange, Dublin, Ireland.

STAMPS You need, 1/2c up approvals. Free premiums with purchases. Holmes, 628 Connally Drive, East Point, Ga.

GORGEOUS Illustrated Russia list free. Finley, 671 West 193rd, New York 33.

REQUEST Sample copy interesting stamp newspaper. Southern Philatelist, Miami 42, Florida.

STAMP Magazine! Copy free! "Stamp Post," Station A, Pasadena, Calif.

TANNAU Tauva "Wrestler" triangle 30 others all different only 5c with approvals. Ed Vidal, 3396 Altavista, Cincinnati 11, Ohio.

STAMPS For collectors. G. D. Ridings, Dept. D, Melvin Hill, N. C.

U. S. and foreign on approval. Wyandotte Stamp Co., Box 62P, Packers Station, Kansas City, Kansas.

SENSATIONAL! \$5,000.00 stamp, triangles, airmails, Grenada, over 100 different others. Everything 10c with approvals. Hart, 2430 W. Washington, Phoenix, Arizona.

FREE Canada with approvals that satisfy. Rheume, 8949 Routhier, Montreal 12, Canada.

FREE! 25 Different Switzerland, with swell approvals. Eric Kardell, 1175-M Clay, San Francisco 8, California.

FREE! Asia, Africa, Europe packet. Approvals. Standard, Box 43, West Farms, New York 60, New York.

AUSTRALIAN, 300 Mixed \$1.00. Robertson, 17 Poath Road, Bentleigh East S.E. 15, Victoria, Australia.

THESE Are them! Unusual penny approval. Roscoe Stamp, 1321 Roscoe, Chicago 13.

154 U.S. Commemoratives, etc. 10c. Approvals. Dorenbusch, 501 Ridgeway, Cincinnati 29, Ohio.

ROOSEVELT Commemoratives. 18 different 25c! Approvals. Robert Wilks, Beverly, Massachusetts.

\$3.00 CATALOGUE Value—Airmails, etc. 10c when requesting approvals. Florida Stamp Company, Box 807, Miami 5, Fla.

SALE! 200,000 Stamps 1c each, approvals. Greenwood, 263 Meridian, Miami Beach, Fla.

USED Famous Americans complete \$1.50, flags 80c, 100 diff. comms. 80c. Approvals. Valerga, 2374 29 St., Astoria 5, New York.

BRAZIL Diamond shaped set, 10c with approvals. Vargo Stamps, 6044 South Fairfield, Chicago 29, Illinois.

RECEIVE Without cost, 1000 mixed United States! Send 25c (deductible from first order) for bargain lists. Halay, 132N West 63rd, New York 23.

CARLINS Approval Service, Box 307, Fresno, California. 50 different stamps 5c to new customers.

PENNY Postcard brings you approvals. Stampmart, Box 29, Beaumont, Texas.

BEAUTIFUL New issues on approval, reasonably priced. Portnoy, 137 No. Oxford, Ventnor, N. J.

1c UP Foreign approvals by countries. Price list. Raymond Schwarting, Box 69P, Marengo, Iowa.

FREE! Volcano pictorial! Mozambique! Burmese! Nigeria! Approvals. Keating, 637-P Bergen, Jersey City, New Jersey.

PERU—100 All different \$1.00. U. S. mixture 60c pound. Nichols, 746 River, Mattapan 26, Mass.

ONLY 1c—Romania school issue with foreign approvals. Modern Stampco, Box 12, Wakefield Station, N. Y.

SPECIAL—25 Union South Africa only 10c with approvals. Lists free. Douglas, Hawkesbury, Ontario.

"MAN Size" United States approvals! Illustrated catalog! Sullivan, Endicott Arcade, St. Paul 1, Minn.

U. S. Price list. Send postage. Stanley Gibbons, 38-P Park Row, New York.

ILLUSTRATED Album with spaces for 2000 stamps, plus stamps cataloging over \$1, hinges, gauge, 10c with approvals. Moulblow, 740 Hegnay, Bronx 56.

STAMPS Of the United States, Canada, Newfoundland, worldwide upon request. Dan Hayden, Box 703, Bloomington, Ill.

FRENCH Colonies, 50 colorful, large pictorials, 10c only with approvals. Fields, 1939 E. 85, Cleveland 6, Ohio.

FLAG Stamp free with U. S. approvals. Wenigman, 1933 Patterson, Chicago.

FREE Lists—Albums, packets, sets. H. Favill, Box 2005, Madison 5, Wis.

AMAZING "Queer Countries" packet—Free with approvals! Saxon, Walden, N. Y.

50 DIFFERENT United States 10c. Price-list free. Seidenberg, Eustis, Fla.

NEWFOUNDLAND 75 Unsorted 25c. Real value. Mayfair, Regal Rd., Toronto 10, Canada.

TRIANGLES! Diamonds! Octagons! Midgets! Giants! Roosevelts! Hitlers! U. S. \$2.00-\$5.00! Stamp magazine. Everything 5c with approvals! Thrifty Stamps, Silver Spring, Maryland.

POSITIVELY Greatest free offer—Rare octagonal (eight sided) stamp, gorgeous diamond, giant triangle, also mammoth and midget stamps, total value \$2.00, all free to foreign approval buyers. Plus free, Scott's International \$6.00 album and latest Scott stamp catalogues. Odd Stamps, Santa Ana, California.

UNITED STATES Unused. Complete set 13 flag stamps plus 5c China commemorative only \$1.00. Fine approvals. Willett Stamps, Box 507, Port Chester, N. Y.

PENNY Approvals. Premiums each selection. Ruches, 941 Enfield, Thompsonville, Conn.

FREE Illustrated list. Elbe dealer, "Treasure Hunt" penny approvals on request. Reed Company, Box 980, Chicago 90, Illinois.

FREE! United States commemorative price list. Historical Stamp Co., 1280 Ocean Ave., Brooklyn 30, N. Y.

25 DIFFERENT Stamps 10c. Approvals on request. J. W. Reilly, P.O. Box 787, Ocala, Florida.

50,000 STAMP Grabbags 25c each. Anderson, 630 Bingaman 1, Reading, Penna.

WORLDWIDE Different. 200, 25c; 500, 50c; 1000, \$1.25; 2000, \$3.00, 5000, \$15.00. Beacon Sales, Maynard 2, Mass.

15,000 DIFFERENT Stamps 2c each! Gordon Davison, Box 1019B, Manchester, N. H.

U. S. Price list. Send postage. State Stamp Service, 1225 Park Building, Pittsburgh 22, Penna.

200 DIFFERENT Including Roosevelt triangle, 5c to approval applicants. M. Avalon Stamp Company, Springfield, Mass.

50 DIFFERENT Stamps, triangle, airmails, etc., 5c with approvals. Carlton's, 10243 Silverton, Tujunga, California.

GIANT Bicolored royal visits, Malta pictorials, gorgeous Guianas, Goose airmail, Scandinavian packet and illustrated stamp publication, 10 cents with approvals. Crown Stamps, Box 331, Toronto, Canada.

307 ALL Different 10c. You will find scores of new varieties here for your collection! Big and little stamps, bisected stamp, commemoratives, triangles, high values! Bicolored beauties! Strange countries! Every stamp is different. All for only 10c to approval applicants. Write today and receive special Ionian Island stamp extra. Garcelon Stamp Company, Box 400, Calais, Maine.

300 DIFFERENT Given free with approvals. Postage 3c. Windsor Stamps, 1435 East 67th Place, Chicago 37.

128-PAGE United States catalog—1000 illustrations, 10c. Harris & Co., 202 Transit Bldg., Boston.

FREE! Crystal-mount samples! Har-risco, 202 Transit Bldg., Boston.

GREAT "\$5.00 Catalog price for 10c" offer! (1) Big collection of 112 all different genuine stamps from Africa, South America, South Sea Islands, etc. Includes airmails, triangle and animal stamps; many others. (2) Four scarce unused United States, catalog price 40c. (3) Fine packet 25 different British Colonies—Burma, Hong Kong, Solomon Islands, etc. (4) U. S. \$5.00 high value. Total catalog price over \$5.00! Everything for only 10c to approval applicants! Big lists of other bargains given. Crystal Stamp Co., Littleton 16, N. H.

BINGO! Jackpot collection! Triangles, maps, animals, midgets. All for 5c to approval applicants only. Southwest Stamps, Box 117, Long Beach 1, California.

200 BRITISH Empire stamps; only 3c. Kenmore Stamp Co., Arlington 74c, Massachusetts.

FREE—Illustrated catalog! Kenmore Stamp Co., Arlington 74c, Massachusetts.

YOU'LL Like our American and British Colonial approvals. Write now. Chesapeake Stamps, 748 Overbrook, Baltimore 12, Maryland.

FREE. Irish commemorative collection, including rebellion issue with approvals. Raymax, 123-Z William St., New York City 7.

FREE U. S. price list, postage 3c. Mark Hanna, 335 5th Ave., Pittsburgh 22, Penna.

WORLD—500 Diff. 50c, 1000 \$1.25, 75 Canada 25c, approvals, lists. Victoria Stamp Co., London 4, Canada.

WORLD'S Largest stamp (7½x14 inches). A real curiosity! Retail for 50c, only 3c to approval applicants. Tatham Stamp Co., Springfield 30, Mass.

25 ALL Different stamps 10c. Tunis, Wakeman Ave., Newark 4, New Jersey.

ZOWIE-E! A barrel of fun for only a dime. 500 United States stamps—absolutely unpicked and unsorted—just as received from church missions. Many varieties, including large commemoratives, airmails, dome denominations up to \$5.00! Stampdom's biggest package of fun—and you might find something really valuable! Price only 10c to serious approval service applicants. Money back if not delighted. Illustrated bargain lists with each order. Mystic Stamp Company, Dept. 80, Camden, New York.

WOW! \$10.00 Worth of fun. Only 10c! What a treasure hunt! Big package 500 foreign stamps from foreign missions, other sources. Includes stamps from Africa, South America, Free French, Somali, Palestine, etc. Includes airmails, commemoratives and stamps worth up to 50c. This offer sent for 10c to approval applicants only. Jamestown Stamp Co., Dept. 22, Jamestown, N. Y.

FREE! 100 Worldwide different stamps to approval buyers. Big U.S. and illustrated bargain lists sent with approvals. Bookman, Maplewood, N. J.

STAMP Collections wanted. Complete collections, duplicate lots, surplus stock, mint and used. Prefer trade for printing or other items, buy outright if priced right. What have you, what's wanted? Vanroy Shirk, Lebanon, Penna.

DEALERS—Wholesale list. Postage 3c. Frank, 5031 Queensberry, Baltimore 15, Md.

OLD Scarce U. S. seconds on approval. Slightly defective, bargain prices. Her-nfeld, Clintonhill Station, Newark 8, N. J.

POUND Stamps containing thousands \$1.00. Longacre Shop, 108 West 42nd, New York 18.

BERLIN Bears, complete set of eight and 100 different stamps only 10c to approval applicants. Reich Stamp Co., 4647 Kenmore, Chicago 40, Ill., Dept. M11.

NICARAGUA "Tin Pan Alley" diamond, Ecuador showing George Washington, and American flag in natural colors. Fezzan, Trieste. "American Army" stamp, first U. S. commemorative, \$100.00 Shanghai, Corsica, Anzac, Antique, others. All 5c. Approvals, Capital Stamp Co., Dept. 2, Little Rock, Ark.

ANTIQUES, RELICS, INDIAN GOODS, CURIOS

10 ANCIENT Indian arrowheads \$1.00.

PRECIOUS STONES, MINERALS

ZIRCONS, Loose, Genuine Siam imports. Pure white. Special: 3 genuine zircons, from ½ kts. to 1½ kts., \$6.00 tax included. We can supply zircons in all sizes and mountings of all types. Send order or write for details today. B. Lowe, Holland Bldg., Dept. PM, St. Louis, Mo.

"GENUINE" Deep red Arizona rubies (garnets). Send quarter for packet. Bit-ner's, Box 2651, Phoenix, Arizona.

CASSITERITE 25c, Bixbyite 50c, fool's gold 25c. Prospector, Box 114, Winston, New Mexico.

GEMSTONES, Rough, polished. Crystallized specimens. Every variety, lowest prices. List free. Plummer's, 5068 Brighton, San Diego 7, California.

METAL Detectors. The very latest circuit. Free literature. Hedden Metal Detectors, 3329 Liberty Avenue, Pittsburgh 1, Penna.

HOBBIES AND COLLECTIONS

WANTED Old cigarette cards. Write Charles Bray, East Bangor, Penna.

SHELL Collection \$1.00. Free catalog. Shell House, Box 1685A, Miami 35, Fla.

HANDY Small parts cabinet. Free folder. Metalart Co., Box 261, Lawndale, California.

POSTCARDS Your hobby? Samples, lists, dime. Wilkins, 417 Hill, London 13, Canada.

HOBBY News-letter presents latest information of lesser-known hobbies. Official organ of Hobby Enterprise Program, new and different world-wide hobby club. Sample copy, full details, twenty cents. Hep, Box 369, GPO, Brooklyn, New York.

NEW—15 Different match covers 10c. Box 202, Rochester 1, N. Y.

UNPAINTED Figurines. Illustrated list free. Oman, 642 Broadway, St. Paul 1, Minn.

UNUSED Matchbook covers; 100 different \$1.00; free catalog. Charles Edelman, 1311C East 84, Cleveland 3, Ohio.

INVENTING Can be an interesting and profitable hobby. Write for complete particulars. Institute of American Inventors, Dept. 40-E, 1926-Eye St. N. W., Washington 6, D. C.

50 DIFFERENT Army embroidered patches \$1. Other bargains. Insignia Mart, 703A Broadway, New York 3, N. Y.

MAKE Your own "Rustic Furniture." Our "Easy to Understand" plans tell how. You can make chairs, benches, tables, lamps, bird houses, summer house, and scores of other things. Our complete plan booklet only 25c. (Worth dollars.) Ask for Booklet No. 18. Popular Mechanics Press, 200 East Ontario St., Chicago 11, Illinois.

CAMERAS, PHOTO SUPPLIES

BELLOWS—127, \$2.75; 120, \$3. All sizes in stock. Guaranteed service on American and foreign cameras. Most work 48 hour service. Reasonable prices. Willman Camera Service, 3223 North 21 Place, Phoenix, Arizona.

BASS Says: Bargaingram 257 ready and waiting for you. The book which tells all. The finest in new and used camera equipment, a veritable encyclopedia. Write, phone or call the sign of the old "Horse Trader." 39th year of satisfaction or your money back dealing. Bass buys, sells and trades. Bass Camera Company, Dept. AG, 179 W. Madison St., Chicago 2.

HYDROJET. Amazing washer for all size prints, \$3.95 postpaid. Postcard brings literature and bargain list of unusual photographic items. Post Sales Company, 169 Clinton Avenue, Jersey City, 4, N. J.

FREE! 116-Page illustrated photographic catalog, send 3c stamp. Bloom's Camera Center, Inc., 1657-PM Main, Springfield, Mass.

BARGAINS—Roll film all popular sizes, 19c each. Surplus contact paper, all sizes, 50c gross. G. I. developer, same as D76 and D72, gallon size, 28c, 6 for \$1.39. All types photo equipment, films, lenses, cameras, tripods, at bargain prices. Trades accepted. Equipment bought, ask for lists. Mogull's, 68 W. 48th St., New York 19, N. Y.

YOUR Prized negatives make prize winning photo enlargements with new Precise enlarger, only \$22.20 complete. Write Tam Products CM2, 3814 Wrightwood, Chicago 47, Ill.

OPERATE Your own photographic business. Details free! Peace Products Co., Dept. 800, 152 West 42nd St., New York

PHOTOGRAPHY For pleasure or profit. Learn at home. Practical basic training. Long established school. Write for booklet. American School of Photography, 1315 Michigan, Dept. 3431, Chicago 5.

PHOTOCOPY Anything—Papers, books. No darkroom. \$6.95 complete. Fotoflek, 4801 Yarmouth, Cincinnati 29, Ohio.

OIL Coloring photographs can be a fascinating hobby or profitable sideline for those with artistic talent. Learn at home. Easy simplified method. Send for free booklet. National Photo Coloring School, 1315 Michigan, Dept. 3431, Chicago 5, Ill.

200X TELEPHOTO Camera easily made. Trifling cost. Telephoto lens and instructions \$3.00. Instructions alone 10c. Suffolk Science Service, Box 208, Manorville, N. Y.

PHOTO FINISHING

8 HOUR Service, Box 468, San Francisco. Your 8 exposure roll printed jumbo or regular size 30c; 12 exposures 35c; 16 exposures 50c; 36 exposures \$1.00. Reprints, jumbo or regular 3c. Regular prints deckled. Fine grain developing. Send for free mailers. Quality Photo Service, Box 468, San Francisco 1, Calif.

35MM. Rolls developed—enlarged 3½x5" size, 36 exposures \$1.00, 20 exposures 65c. Plus-X reloads, 20 exposures 30c, 36 exposures 45c. MacDonald's Photos, Box 228-K, Congress Park, Illinois.

THIS Ad plus 35c gives you 16 jumbo, oversize, enlarged prints from any 8 exposure roll developed. Enlargement coupon free. Quality and quick service for 19 years. Skrudland, 6444-P Diversey, Chicago.

SNAPSHOTS Enlarged on postcards. Sample 10c. Robert Wilkinson, 247 Cabot St., Beverly, Massachusetts.

LIFETIME Prints, free samples. Swift Photo, Box 23, Springfield 2, Missouri.

PHOTOGRAPHY For pleasure or profit. Learn at home. Practical basic training. Long established school. Write for booklet. American School of Photography, 1315 Michigan, Dept. 3452, Chicago 5.

BEAUTIFUL Enlargement from each picture on roll 30c. Cut Rate Photos, Dept. B4, Janesville, Wis.

FREE Price list on quality developing, printing, enlarging. Write for it today. Bryan's Photo Shop, Dept. M, Panama City, Florida.

WALLET Photos, cards sealed in plastic 25c each. Quick service. Dura-Seal Laminating Dept., Box 1384, Baltimore 3, Md.

FILMS Developed and enlarged double size, 8 exposures only 30 cents, 12 exposures 45 cents, 16 exposures 60 cents. Prompt service. Mailing envelopes on request. Real Fotos, P.O. Box 172, Station B, Brooklyn, N. Y.

EXPERT Finishing. Roll developed and 8 prints 30c. Rancho Photo, Dept. P, Ontario, Calif.

TWO Beautiful prints from each picture on roll 30c. Twenty-seven years of satisfied customers. Quick service. Lens Photos, Dept. J4, Janesville, Wis.

8 BEAUTIFUL Double size pictures and roll developed 30c. 8 hour service. Free mailers. Pacific Photo Service, Box 666, San Francisco, Calif.

2 BEAUTIFUL Hi-Gloss prints each good negative and enlarging coupon with each 8 exposure roll developed 28c. Free mailers. Owlphoto Co., Weatherford, Oklahoma.

OVERSIZE Prints; overnight service; 35c. Films developed and 8 prints near postcard, only 35c. Electronic process, non-fade, glossy pictures. Write for free mailers. Peachtree Photo Finishers, Dept. PM, P.O. Box 4324, Atlanta, Georgia.

8 PRINTS All enlarged to nearly postcard size from your roll or negatives 25c; 16-50c. (Trial offer). Willard Studios, Box 3535A, Cleveland, Ohio.

MOTION PICTURES AND SOUND EQUIPMENT

BRAND New 16mm. sound projectors \$129.50. Send 10c for photographic catalog. Sterling's, 679 Northampton, Easton, Pennsylvania.

NEW 16MM. sound projectors. Free lists. Cine Service, Box 582, Ithaca, N. Y.

PROCESS Your own movie film. Free literature. Duro, 1519 Eggert, Buffalo 21, N. Y.

HOUDINI In "Man From Beyond", 6 reels 8mm. \$27.50. Film Classic, Fredonia, N. Y.

LOWEST Prices, raw film 8mm.-16mm. Free list. MK Photo, 451 Continental, Detroit 14, Michigan.

BASS Says: 39 years of leadership guarantees satisfaction. Finest cine equipment, 8mm., 16mm., and 35mm., silent and sound. Write the old "Horse Trader." Satisfaction or your money back always! Bass Camera Company, Dept. A, 179 W. Madison St., Chicago 2.

BARGAINS! 16MM. sound films and supplies. Free lists! Waverly, 5707 South Christiana, Chicago 29.

16 35MM. Silent sound films. Bedner, 5300 So. Talman, Chicago.

16MM. Sound projectors. Robert Salmon, 3558 So. 11th East, Salt Lake City, Utah.

BARGAINS In good used 16mm. sound films. Complete one reel subjects often available at \$2.95. List for stamp. Blackhawk Films, Davenport, Iowa.

BARGAINS—16MM. sound and silent film, miscellaneous, as is 1c per foot. Bargains in sound and silent features, shorts. Reels, cans, belts, lenses, screens, at low prices. Huge selection of projectors and cameras. Trades accepted, films and equipment bought. Ask for lists. Mogull's, 68 W. 48th St., New York 19, N. Y.

BARGAINS—16MM. sound projectors from \$112.50, 35mm. sound projectors from \$125.00. Huge selection of screens, cans, amplifiers, speakers, microphones, splicers, processing equipment. Films and equipment bought and traded. Ask for lists. Mogull's, 68 W. 48th St., New York 19, N. Y.

MOVIE Film at tremendous savings! Kodak Super-X govt. stock—tested, guaranteed. 16mm., 100-ft. \$2.95; 50-ft. magazine \$2.50; double 8mm., 25-ft. \$1.65; Super XX—50c add. each roll. Free processing. Photo Surplus Sales, Box 11, 12 Duane St., New York City.

KODACHROME Duplicating. 35mm slides; 20c each. 3 or more same slide 15c each. Glass-mounted 10c each. Minimum \$1.00. Color slides and film strips from original art work; 35mm. reductions from larger transparencies. Movie film duplicating—black-and-white or color. Fast service—write for prices! Photoshop, Room 19, 18 East 42nd St., New York City.

FREE, Movie catalog; samples 10c. Projectors, cameras, supplies. Goodwill Company, Jackson, Tennessee.

EXCLUSIVE Movies—Sports, select films. Projectors, screens. Free catalog. Home Pix, 1674 Broadway, New York 19.

WE Buy, sell, rent, exchange home movies. Details for dime. Midland, Box 429, Oak Park 4, Ill.

RENT 16mm. sound films 50c reel. Large selection, free catalog. Film Service, 128 Chestnut St., Roselle Park, N. J.

FEATURE Films—Brand new optical reduction 16mm. sound prints. Rin-Tin-Tin's \$100.00. Tom Tyler, Bob Custer, Jack Perrin westerns \$85.00. Dick Talmage actions \$100.00. Trades accepted. Ask for lists. Mogull's, 68 W. 48th St., New York 19, N. Y.

GUARANTEED Fresh anti-halo outdoor movie film! Weston 12! Daylight loading! Processing free! Three spools double 8 mm. \$3.45! Six single 8 mm. for Univex, \$4.60! Postpaid! Catalog. Eso-S, 47th Holly, Kansas City 2, Missouri.

8-16MM. Silent-sound films. Complete rental library. All latest subjects. Free catalogue, (sample film 10c). Garden Film, 317 West 50th, New York 19.

LEARN Professional motion picture technique at home. Approved for veteran training under G.I. Bill. Free catalog. Motion Picture Institute, Birmingham 4, Mich.

LEARN Movie projection, management. Free catalog. Theatre Institute, Elmira, N. Y.

MOVIE Film processing. Finest automatic machine processing. 8mm.-16mm. Also duplicating, editing, titling, other lab services. Fast service. Price list on request. Photoshop, Room 20, 18 East 42nd St., New York City.

MUSIC AND MUSICAL INSTRUMENTS

SONGWRITERS! Outstanding, ethical offer. Hibbler, C5, 2157 N. Avers, Chicago.

GUITARISTS: Sensational diagram chart shows names, readings, symbols, fingerings, 180 chords; \$1.00. Free catalogue. Caroli, Box 21, Lefferts, Brooklyn 25, N. Y.

SENSATIONAL Composing offer. Terry, 709 1/2 North Broadway, Oklahoma City, Okla.

PHONOGRAPH Records cheap. Catalogue. Paramount, BM-313 East Market, Wilkes-Barre, Penna.

POEMS Set to music. Splendid offer. Free sample melody, Rush poems. Radio Composers, WDP, Clinton, N. C.

SONGWRITERS—Publication collaboration. Newart Publishers, G.P.O. Box 1226, Syracuse, N. Y.

MUSIC Arranged, songs printed. Frank Wildt, Music Publisher, Lancaster, Penna.

SWISS Music movements. Assorted tunes \$1.90. Direct from manufacturers agent. Helax Company, 233 West 72 Street, New York.

RECORDS: New hillbilly, popular, spirituals—39c. Free catalog. Mailorc, Room 6, 570 N. Gay St., Baltimore-2, Md.

POEMS Wanted for musical setting. Send poems for free examination. Five Star Music Masters, 630 Beacon Bldg., Boston, Mass.

YOUR Poems set to music, recorded by professional artists. Free booklet, attractive offer. Write. Song Service, 331-C West 46th, New York.

STREAMLINE Accordions below wholesale. Circular. Metro, 44 North Albany, Chicago.

SONGWRITERS Attention! The amazing demand for phonograph records, accelerated by countless juke-boxes, warrants your immediate investigation. We are offering new writers the rare opportunity of having celebrated "hit" composer furnish music on reduced percentage basis for any likely poems received this month. The Petrillo ban does not affect us. Recola Records, Hollywood 28, Calif.

POEMS Wanted for musical setting. Send poems for free examination. Hamann Service, 614 Manhattan Building, Milwaukee, Wisconsin.

AMPLIFY Your accordion with our new mike \$22.50. Sounds like organ. Installed in minute. Use any amplifier. Amplifier and mike \$72.50. Write Del Principe, 307 So. Wabash Ave., Chicago.

POEMS Wanted to be set to music. Free examination. Send poems. McNeil, Master of Music, 510-PM S. Alexandria, Los Angeles, California.

SONGWRITERS: Send poems for free examination and outstanding offer. United Music Service, 150, Salem, Indiana.

WRITE Songs. Big money and reputation. Write for information. J. Gordon Pub. Co., 201 N. Hoyne Ave., Chicago.

ACCORDIONS—Guitars, trumpets and all musical instruments, new and used. Direct from national distributors, cash and terms. Save money. Del Principe, 307 So. Wabash Ave., Chicago.

RADIOS, SUPPLIES, INSTRUCTION

BUY Everything at wholesale prices! Radio parts, equipment for the amateur, service man and experimenter. Lowest prices anywhere. Write Mid America, Dept. B-21, 2412 S. Michigan, Chicago 16, Ill.

FREE Morse code lesson. Complete course \$1.00. Dept. M, Otto Luther, New Preston, Conn.

BUILD "Loudest" crystal radio. Instructions, loudest crystal, catalog: 25c. Amorose, Route Four, Richmond, Virginia.

JOIN Xtal-X Crystal Set Club: Year's membership, literature, diagrams, 25c. Box 608, Torrance, Calif.

"TELEVISION Simplified," \$5.88 postpaid. Catalog free. Communications, 110-L University, Seattle 1, Wash.

BEST Experimenter's guide is "Radio-builder," 3 issues 25c. Catalog. Laboratories, Eye-c, San Carlos, California.

FIX Any radio. Amazing new instrument locates radio troubles double quick. Simple instructions show you how. Thousands now in use. Write today for free 28-page illustrated technical manual. "The Inside Story," Feiler Engineering Company, Dept. 1PM9, 945 George St., Chicago, Illinois.

YOU Can have 26 years radio experience at your fingertips. I've repaired over 45,000 radios. Have perfected simple, easy system anyone can follow step by step. No calculations, no formulas. Total price \$2.00 postpaid or c.o.d. Money-back guarantee. Ross Radio, 14615-M Grandriver, Detroit 27, Michigan.

MAKE Simple, tubeless, batteryless, distance-getting crystal radios. Crystal and illustrated instructions 25c postpaid. Allen,

BUSINESS OPPORTUNITIES

START Your own business on our capital. Always your own boss. Hundreds average \$6,000 to \$25,000 annual sales year after year. We supply stocks, equipment on credit. 300 home necessities. Selling experience unnecessary to start. Wonderful opportunity to own pleasant, profitable business backed by world-wide industry. Write Rawleigh's, Dept. B-U-PPM, Freeport, Ill.

TRADE And class magazines. Keep posted. Latest single copies. Over 1000 covering every trade, business and interest. List of publications with prices free. Commercial Engraving Publishing Co., 34C North Ritter, Indianapolis 19, Ind.

AMAZING Invention! Screw-holding drivers; remove, insert screws difficult places! Factories, garages, mechanics buy quantities. Exclusive distributor. Toolco, 709 Wentworth Bldg., Boston, Mass.

MAKE Tough plastic 1c pound. Makes durable floors, walls, mantels, roofs, 101 uses. Build attractive home yourself. Material cost \$150 room. Bays Laboratories, Oklahoma City 9.

FOOT-PAL, Sales-dealers', large repeat commissions, \$1.00 sample and information. Brown Co., Box 126, Salt Lake City 8, Utah.

FREE Booklet "How to Sell by Mail." Raymond Rigor, Box 125, Columbus, Ind.

START Profitable ming tree business. Complete kit supplied. \$4.95 each. P.O. Box 329, Sparks, Nevada.

NEW Mail order item under your name—Assures you all repeats. Large profits. Everything furnished. Wave Products, 900 Taylor, Kokomo 2, Indiana.

LIQUID Rubber, make flexible molds. Free sample. Chaney, 1130 E. 16th St., Jacksonville 6, Fla.

"WATERLESS Hand Cleaner." Make, sell. No machinery. Build profitable business. Complete formula \$1.00. Ideal Service, Park Ridge 2, Illinois.

MAKE Money at home like I do! Free details. Dueffy, Covington, Ky.

SELECTED Money making plans-formulas. Particulars free. Flasco Sales, 2505VF 150 St., Flushing, New York.

EARN Money by mail, like I do. Literature free. Satterfield, 101 Pine, Abbott, Ark.

MAKE Rubber stamps, metalize baby shoes, repair dolls, silver mirrors, make plaster novelties. Catalogue of "30 ideas" free! Universal, Box 1076-A, Peoria, Ill.

YOUR Own profitable business. New simple press, puts permanent, hard plastic covering on drivers licenses, credit cards, photos, etc. Small investment. Write Studebaker Machine Company, 1232 S. 9th Avenue, Maywood, Illinois.

REPRODUCE Statuary, etc., with rubber molds. Free sample. Major Chemical Co., 131 Inman St., Cambridge 39, Mass.

BRONZING Baby shoes is big business. Start your own business for \$4.95. Price includes all materials and instructions. No equipment required. Particulars free. Metaloids, Box 2095, Wichita, Kans.

MAKE Hollywood style marble glazed cement pottery, birdbaths; without molds. Home-shop. Benches, mantels, fountains, stucco—rock walls, garden ornaments. Dime brings chemically colored sample, amazing pictures. Hollywood Cementcraft, 8527-R Wonderland, Hollywood 46, California.

METAL, Plastic, onyx, mountings for bronzed baby shoes. 20 styles. Hardening solution. Wholesale. Box 2095, Wichita, Kans.

EARTHWORM Breeding. Valuable bulletins on successful methods mailed free. Earthmaster Publications, Dept. 14, Sun Valley, Calif.

BABY Shoe mountings. Metal bronze ash trays, bookends, picture frames, etc. Onyx mountings also supplied. Write for catalog. St. Albans Plating and Casting Ind. Corp., 135-17 135 Ave., So Ozone Park 20, N. Y.

WHERE To buy 800,000 articles wholesale. Radios, refrigerators, etc. Details free! Schibani, Box 1576, Birmingham 1, Alabama.

MAKE Money from own home by mail selling office supplies. Tremendous demand. Snyder, 5-B Spring, Beachwood, New Jersey.

MAKE Over \$100 week at home, renewing certain small auto part for wholesale trade. No competition. Exclusive territory. Car and \$300 capital needed. Free instructions. Standard Parts, 3033 Main, Kansas

LEARN Piano tuning at home. Unlimited income. Sound recordings, electric record player, tools and instructions furnished. Write Capitol City Tuning School, Department PM, 211 East Michigan, Lansing, Michigan.

FREE! "How to Make Money by Mail at Home." Boyer, 65 Uptown, Hoboken, N.J.

"WATERLESS Hand Cleaner," make it yourself. No special equipment necessary. All chemicals can be bought locally. Used by auto mechanics, machinists, service men, etc. Send one dollar for formula. Alfred Iobbi, Post Office Box 157, Treose, Penna.

PACKAGED Offer gives all help needed to start you in mail order. Details free. Terwilliger, 303 PS Chestnut Street, E. Bound Brook, New Jersey.

PERFUME—Make it yourself. Learn how free. Profitable sparetime home business. Men and women. Write "International," 6347 Parnell, PM2, Chicago 21, Illinois.

YOUR Own sound, exclusive mail order business—engineered by dean of creative specialists. The proved, tested way to success. Moderate capital. Free program, bulletins, evidence. Erol Slater, 707 South Hill, Los Angeles 14.

INCOME From local information. Interesting. Sparetime. Neher Company, La Verne, Calif.

EXCEPTIONAL Money making opportunity for live-wire distributor. Dealer's county franchise now available for fast selling low-priced fire extinguisher and alarm. Made of glass, modern as tomorrow. Tremendous market. Big profit. Write for full information. Autofyrstop Co., Dept. E-2, 2035 Washington Avenue, Philadelphia 46, Penna.

LOOK! Be your own boss! Sell pop corn! 8c profit out of 10c sale. The Excel Electric Popper counter model with complete supplies puts you in business for \$113.00. Act now! Write us. Indiana Pop Corn Co., Dept. A, Muncie, Indiana.

START Big paying mail order business in your own home. 36 pages professional advice 25c. Satisfaction guaranteed. Publishers', 3006-P2 Williams, Detroit 16.

HALF Million articles wholesale. Directory 25c. Printers, Box 1302-P2, Detroit 31.

PAYING Mail order business, at home. Write, Dean, 2319-H Thomas, Fresno, Calif.

GAMBLE A penny. Send for tops in home mail business plan. Circulars free. Arvee Company, Box 125, Sta. A, Flushing, N. Y.

SAWDUST. Turn it into cash. Six methods. Instructions 25c. Charles, 12-BS, Norwood, Ohio.

ELECTROPLATING Instructions and formulas for brass, copper, cadmium, chromium, nickel, gold and silver plating. All for 25c. M. Hyde, Box 2099, Station V, Los Angeles 3, California.

HOUSE Paint—Wholesale \$2.70 gallon. Agents wanted. Free advertising offer. Certified Products, 812E 38th, Louisville, Ky.

"START A Candy Kitchen," a complete, clear, concise course in book form. How to make, package and sell. Start small and grow big. \$1.00 postpaid. Raymond Schenck, West Penn Street, Butler, Penna.

ORCHIDS. Real flowers preserved in natural colors! Plastic! Tints! Pearl! Metal! New field. Details free. Write, R. O. Morgan, 6230 Myrtle Ave., Long Beach 5, Calif.

START Profitable mail order business. Literature free. Paul Kelch, Box 133, Bloomfield, N. J.

FREE Book "372 Unusual Worldwide Business Adventures!" "Different!" Pictures! Australia, Africa, South America, New Zealand! Up to \$800 month reported (exceptional). Work delightful enterprises—home. Prepare for surprise! Publishers-L. Carlsbad, Calif.

RAISE Earthworms. Easy, profitable. Send for free literature or send dollar bill for illustrated book. Money back guarantee. Earthworm Culturists, Dept. P, Box 83, Station C, Atlanta 5, Ga.

ROADSIDE Inn management and operation—Greatly increased travel opening fine opportunities. Free information to men and women interested in establishing successful business or obtaining good job. Write today to Home Study Institute, Dept. PM-2, 209 Vine Avenue, Park Ridge, Ill.

PROFITABLE Mail merchandising plan features useful auto specialty. Sample 15c. Plan free. Flinson, Box 4333B, Kansas City 1, Mo.

WE Need more live-wire Rototiller dealers to handle the well known, nationally advertised Rototiller. This machine is a leader in its field. A demonstration usually means a sale. Occupies small floor space. Many owners say Rototiller pays for itself in one season. Big dealer profits on every machine plus profits on attachments. Small investment puts you into the Rototiller business. Why don't you, too, make big profits in '49 with Rototiller. Write or wire Frazer Farm Equipment Corp., York, Pennsylvania. A division of Graham-Paige Motors Corp.

PROVEN Profitable! Clean venetian blinds in own cellar. Then expand! Know-how means money! Write for details. "Regional," P.O. Box 1086, New Brunswick, N. J.

OPERATE Profitable mail order business. Splendid opportunity. For details write Kurt Service, 3325-P West 52 Street, Cleveland 2, Ohio.

GET Into this fascinating toy powered business—right in your own home. We furnish the parts, you assemble. Simple to do, no special tools required. To get started send \$1.00 for 2 complete assembled demonstrators. Use these to take orders. Make 100% profit on each one you sell. Every child wants one. Be first in your vicinity or town. It's brand new. Powered Toy Co., 1906-08 N. Cicero Ave, Chicago 39, Ill.

VENDING Machines earn big money! An investment as low as \$10.50 will start you in this fascinating, profitable business that can lead you to the road of success and independence. Routes can be established and operated in either full or spare time with no experience needed. Write for full details and our free catalog illustrating our nut, candy, gum and stamp vendors; also pin ball machines, music boxes, etc. Write immediately to Parkway Machine Corporation, Dept. 7, 623 W. North Avenue, Baltimore 17, Maryland.

MAKE Money this easy way at home. Make your own costume jewelry. Pleasant, interesting. No experience needed. We supply settings and sparkling rhinestones at wholesale prices. Steady profits. Write for details now. Sparkle Mart, Dept. B, 475 Fifth Ave., New York.

\$300 MONTHLY Selling metallized baby shoes through local papers. Free samples. Baggie Sales Company, Route 3, Box 459-A, Fresno, California.

LOCKSMITHING And keymaking—Learn at home. Excellent full or part time earning opportunities. Professional outfit includes supplies, tools, key making machine—everything needed to start your own business. Get practical training from master locksmiths on house locks, auto locks, padlocks. Booklet of information free. Write today. United Supply & Service, Dept. PM-2, 3327 Madison Street, Chicago, Illinois.

MAKE Money—Easier! \$3-\$10 hourly operating exceptionally profitable, lifetime service business. Big demand everywhere. Little capital. Puraclean, 17-B East 42nd, New York 17.

ADVERTISING—Publishing business anywhere in United States. Proven field. Requires: \$500 equipment investment; knowledge of selling. Ivory Tower Press, Buchanan, Michigan.

MAKE Up to \$500 weekly. Amazing opportunity. New product. Big demand from industrial plants, department stores, hotels, clubs, and those wishing to start own business. Excellent leads furnished. State or territory representation for live salesman who travels. Write giving full background and references of responsibility and experience. Studebaker Machine Co., 1230 S. 9th Avenue, Maywood, Illinois.

REUPHOLSTER Your own car or operate upholstery shop. Complete auto upholstery instruction manual \$2.00 Money Order. C.O.D. First Upholstery Service, 3439 Michigan Ave., Chicago, Ill.

START Home manufacturing business making Cleaning Compounds, Soaps, Insecticides, Cosmetics, Polishes, Food Flavors. No machinery. Literature free. Kemix, Park Ridge, Ill.

MAKE Money spare or full time, casting metal toys and novelties. Latest scale model autos, original ashtrays, savings banks, water pistols, etc. Enormous wholesale and chain store demand keeps manufacturers busy. No experience or special place necessary. Write for details and illustrations of patterns needed. Metal Cast Products Co., Dept. A, 1696 Boston Road, New York 60, N. Y.

"THIS Is it!"—Learn sewing machine repairing, plus profitable installing our motor kits, etc. Write Taylor Service Co., Hamilton 3A, Ohio.

COLLECT And Grow Rich is a booklet that is yours for ten cents. Learn of this opportunity for a life-time, spare or full-time office business of your own, where you can make a profit on the work of hundreds of others. T. J. Surface, Pres., Dept. 236-B, Roanoke 4, Va.

MAIL Order dealers wanted for specialty used daily by 30,000,000 people. Mail order plan. Sales letter and sample free. Get in on the ground floor. Write today. Syndicated D. Service, 25 Read, Pawtucket, R. I.

PROFITABLE Home business. Six plans 25c. Levine's, 15-PM Boulevard Station, New York 59, N. Y.

MAKE Cement paint 3c pound. Sell contractors, dealers. Operate lucrative cement painting business. Bryan, Box 702-M, Cincinnati 1.

BRONZED Baby shoe mountings. Reasonable prices. Write for price list. Standard Bronze Co., 311 N. Desplaines, Chicago 6, Ill.

FIGURINES, Gift ornaments. Unpainted, many to choose from. Start a profitable business-hobby. Free catalog and information. Sulter Art Industries, 314 Westport, Kansas City, Mo.

BE Independent—Operate America's lowest price penny vending machine. Big profits. Immediate shipments. Write for bulletin and prices. Fielding Mfg. Co., Desk 29, Jackson, Mich.

BIG Profits operating automatic shoe shine machines. Vassar, Cleveland 5, Ohio.

SPECIAL—Regular one dollar copy trade directory, chemicals, supplies, bulk and packaged private brand products. Price list for dime. Farrand Chemical, Tyrone, Penna.

GO in business for \$6.95. Sharpen circular saws. Sure-Sharp, Box 24-B, Santa Ana, Calif.

CHEMIST'S Formulas for sale. List free. Lab., P. O. Box 501, Chicago 90, Ill.

OWN—Operate ball gum, nut, cigarette vending machines. Amazing profits, no selling. Write for free details. Cameo Vending, Dept. P, 432 West 42nd, New York.

YOU Too can earn \$150.00 weekly, installing Glaze-O wall tile. Applied easily. Tile your own kitchen, bathroom. Free literature. Glaze-O Tile Co., 1419-B High St., Hamilton, Ohio.

MECHANICALLY Inclined men. Electrical technicians command big wages. Own profitable lifetime business. Charge \$5.00-\$6.00 hour! Service factory, household equipment, wiring, motor winding, etc. Illustrated course plus home training kits give you practical experience. Liberal terms. Free illustrated booklet. Write Christy Trades School, 2835 N. Central, Dept. C-101, Chicago 34.

OWN A saw filing business. The new machine sharpens all types of saws. Nu-Art, 607 47th St., Brooklyn 20, N. Y.

OPERATE Your own photographic business. Sales terrific! Cameras, projectors, enlargers, darkroom equipment, accessories, etc. Free details. Peace Products Co., Dept. 700, 152 West 42nd St., New York City.

YOUR Home or garage has space needed for mfg. new mechanics hand cleaner. Each \$1.00 invested brings \$4.00. No machinery needed. Exclusive territory. Trademark and formulae free. Tiffany Products, 289 E. 6th, St. Paul, Minn.

METALLIZE Baby shoes. Excellent profits. New system assures success. Free details. Treasures Forever, 89 Henry Ave., Lynn, Mass.

OPERATE Profitable mail-order business. Splendid opportunity. Write Sak Supply, 1421 St. Vincent St., Philadelphia 11, Penna.

STEP Into successful "business man's" class. Be independent. Operate money-making mailorder business with unlimited opportunity. Insure success with professional guidance. Free particulars. Melvin P. Hawkins, Drawer 1140-A, Wilson, N. C.

NEW Patented item for business, home, industry. Excellent side line. Ready for delivery. Sample and list of twenty investors \$1.00. Better Products Company, Madison, Wis.

80% PROFIT Needle threaders. Sample free. Delanos, 1117 Madison Ave., Covington, Ky.

MAIL Order success even for beginners. Details free. Condello, Box 443, Fords, N. J.

NICE Income. Learn designing, modeling and molding from plastics, plasters, compositions. Simplified, inexpensive methods. Write *Plastics Digest*, 2925-B Michigan, Kansas City 3, Mo.

BLUEPRINTING—Thousands of small manufacturers, inventors, and sales organizations need local blueprint facilities. New direct process requires only inexpensive, easy-to-make equipment. Establish full or part time business in your community. Complete instructions \$1.00. Macy of Illinois, Distributors, 30 W. Washington, Chicago, Illinois.

IMMEDIATE Cash profits by mail. I'll show you how. Write me today. B. C. Fryer, Department A-2, Box 1895, Atlanta, Georgia.

SELL By mail! Ideas galore! Join Mail Selling Opportunities Club! Details free! H. Wehner, Box 142-A, Roxbury 19, Mass.

FREE Literature—How to have profitable home mail business supplying popular self-help books to millions. Big demand! Good earnings! Everything furnished! Rush name. National, Box 88-G, Dorchester, Mass.

RED Hot home mail manufacturing business opportunity. Everything furnished. 300% profit! Facts free. Bridges, 286-A Third Avenue, New York 10, N. Y.

MAIL Business opportunities—New plans; proven propositions, "what to sell" service. Different! Profitable! Write: Smith, Box 2592-J, Hines, Illinois.

BABY Shoe plating for the trade only. 5 day service. Beautiful samples always available. Thoro Plate Co., 6260 Romaine St., Hollywood 38, Calif.

HERE It is, your opportunity! If you have mail order experience, fine. But if inexperienced, we teach you how at no cost. Send name, address, age, and sales experience if any, include three cent stamp for reply—Better hurry. Houston Mail Order House, Employment Dept., 5306 Pease, Houston 3, Texas.

GIGANTIC Mail, magazines, listing three times 25c, twelve times 50c. Waddell's Directory, 341 East 76th, New York 21.

SAVE Money. Get all bronze baby shoe supplies from one source. Prompt deliveries. Low costs. All types of mountings—book ends, ash trays, pen sets; plating compounds, equipment. Also complete course in electroplating baby shoes that shows easy way to start profitable business in spare time at home. Read details page 82 this magazine. Send name for free facts. Warner Electric Company, 1512 Jarvis Ave., Dept. C-32, Chicago 26, Ill.

BIG Money. Spare or full time in your home. No selling! Spray new miracle finishes, plush and suede on signs, radios, automobiles, figurines, lamps, toys, etc. Our business is booming—new easy Flok-Kraft methods—material costs few pennies, you get dollars. Free samples, complete powerful money making plan free. Write now! Coast, 1505-A West Manchester, Los Angeles 44.

\$250.00 MONTHLY. Raise Angora rabbits backyard easy way. Wool \$9.00 pound. Details free. White's Rabbitry, Newark, Ohio.

SCIENCE Of memory simplified. Free booklet "Memory Development." Memorology Club, 2016 Sunnyside Ave., Chicago 25, Ill.

MAKE Flexible molds! Cast plaques, novelties, bookends! Free sample! H. Tooker, Hamilton 44, Ohio.

NEW Industrial hand cleaner. Free manufacturing-distributing plans. Unusual money-making proposition. "Acro-Sol-Ex," 623 West 14th Ave., Denver 4, Colorado.

GLASY-CAST: New and finest liquid plastic on the market. Cold set. 15 to 30 minutes for finished product. Free instructions. Easy to make novelties, toys, jewelry, machinery parts, etc. \$2.50 per quart. Elasto-Mold: Flexible, transparent, permanent production molds made in 20 minutes. Free details and samples on request. Also quality rubber latex. Wholesale prices. Plastic Service, 294 Washington St., Room 813, Boston 5, Mass.

NOW Available! 1949 edition of Official Concessionaire's Guidebook. Jam-packed with money-making ideas, games, formulas, equipment for concessions, roadside stands, carnivals, medicine business, etc. Buyers guide. Send \$1.00 today for copy. Concessionaire's Guidebook, Box 133B Sta. B., Toledo 6, Ohio.

BECOME A finance man. Particulars free. George Lenhoff, Lincoln 8, Nebr.

YOUR Own profitable home business. Preserve live flowers to last forever. New simple discovery. Enormous demand all year 'round. Tremendous profits! Light fascinating work. Send \$2.00 for working equipment, instructions, and valuable sales plans. Satisfaction guaranteed or money promptly refunded. Alfred Hermansen, 210 Fifth Ave., Suite 1102A, New York 10, N. Y.

BUY Nationally advertised merchandise for others; radios, appliances, etc. Low wholesale prices. Make commission each purchase. Up to \$5,000 year possible. Easy, fascinating new business. Free information. Cox, Saugus 10, Massachusetts.

AUTO Body mechanic's tools that sell on sight. No demonstrating. Big profit. Douglass, 3615A South Grand, St. Louis 18, Missouri.

USE Your home as magazine subscription station. Represent all magazines. Liberal commissions. No experience—no capital needed. Catalog, full details, free. Write McGregor Magazine Agency, Dept. 22, Mount Morris, Ill.

POPCORN Equipment, potato chip outfits. Long Eakins Company, 4960 Hi Street, Springfield 99, Ohio.

PROFITABLE Mail order plans. Details free. Alfred Haseman, Beecher, Ill.

BABY Shoe metallizing. Secrets never before revealed. Amazing offer. Schoettle, Friendship, Ohio.

WAX-O-GLASS: Cleans glass; polishes metals amazingly quick. Make it yourself. Formula \$1.00. Ideal Service, Park Ridge 3, Ill.

NO Selling, operate vendors, amazing profits, details free. Silver-King, Suite B, 622 Diversey, Chicago 14, Ill.

HOME Business making statuettes, plaques, artificial marble, rubber molds. Metallizing baby shoes. Silvering mirrors. Formulas. Polder free. Creative, 236-L, Winnetka, Illinois.

IT'S Easy to convert hand mowers to power mowers with Handy-Dandy Lawn Mower Conversion Kits. Installed on any mower in 3 hours. Used with any small gasoline or electric motor. (Lauson engines and Pennsylvania mowers in stock. Immediate delivery.) Kits can be purchased with or without engines. Fits 16 to 20 inch mower. Dealers wanted. LeClaire Manufacturing Co., LeClaire, Iowa, Dept. PM.

START Profitable air conditioning business. Don Nelson, Warner Robins 2, Georgia.

RUBBER Molds! Genuine latex! Low cost! Catalog free! Castcraft Studios, 2027-P Fulton St., Brooklyn 33, N. Y.

RAISE Ginseng. Roots bring \$10.00 pound. Circular free. Fezler Seed Co., Patchogue, N. Y.

ANNOUNCING Home study course in commercial baking. Practical basic training. Good field for those with aptitude. Nearly depression proof. Send for free booklet, "Opportunities in Baking Industry." National Baking School, 1315 Michigan Ave., Dept. 3438, Chicago 5, Ill.

MAKE Money addressing envelopes. Our instructions reveal how. Glen Glenway, 5713 Euclid, Cleveland 3, Ohio.

I MAKE Big money in the mail-order business. You can do the same at home with copyrighted system. Write me. I'll tell you how. F. Little, R.D. #1, Glenshaw, Penna.

ENVELOPES Addressed accurately, reasonably. Fast service. We have capable addressers in your city. Glenway System, 5713-Y Euclid, Cleveland 3, Ohio.

READ "Advance"—The voice of mail order. Offers money-making opportunities, sources of supply, personal guidance, etc. Issued monthly. Sample copy 25c. Yearly subscription \$2.00. Advance Publishing Company, 313 East 21st Street, Suite 450, New York 10, N. Y.

A BUSINESS In your own home! Our chemicals, plus free water and cheap "grocery store" materials can bring you over \$500 monthly earnings. Plans and formulas free. Chemica Division, 1269 S. Norton, Los Angeles 6.

A FACTORY In your home garage! Mfg. and sales rights, mechanics' waterless hand cleaner. \$500-\$800 monthly. No special equipment necessary. Formula free. Western Aircraft Mfg., Dept. D, Los Angeles 6, Calif.

BUY The new Concession popcorn machine. Biggest low priced popper on market. \$100 puts you in business, complete. Also caramel corn, candy floss, candy pullers, kettles, heating equipment. Write for new catalog. Concession, Dept. A, Toledo 6, Ohio.

HOME Workers wanted to hand-spin Angora wool. Either sex. House of Angora, Springfield, Ill.

WHOLESALE Supply sources and money making plans offer security, success, in your own business. Details free. Reynard Publications, Smithfield 3, Ohio.

MAKE Money by mail. Howard, 1778A Hamburg St., Schenectady 4, N. Y.

LEARN Piano tuning, repairing, at home. Tremendous field! Piano parts, tools furnished. Established 1935. Empire School of Piano Tuning, 606-B East University Ave., Champaign, Ill.

UNPAINTED Bookends, plaques, statues, figurines. List. Haverly Products, 1219 8th Ave., Altoona, Penna.

NATURAL Molding Latex. Extra thick. Free sample. W. Wooley, 115-A Donald, Peoria, Ill.

MAKE Money sharpening saws at home on electric machine. No experience necessary. Hardware dealers act as your agents to secure work. Send for free book "Independence After 40" shows complete plan for starting in spare time. Foley Mfg. Co., 47 Foley Bldg., Minneapolis 18, Minn.

RUBBER! White liquid rubber! America's finest flexible moulding rubber! New! Extra heavy viscosity! Quick drying! Ideal for home, classroom, or industry. Only \$7.95 per gallon, \$2.95 per quart, and \$1.00 per half-pint sample. Parcel post prepaid! Plastercraft Supply Company, 3051 St. Clair Avenue, Cleveland 14, Ohio.

CASH For your idea, 280 manufacturers need inventions, patented or unpatented. List free. Invention Bureau, 208M Clinton, Oak Park, Illinois.

SPECIAL Rubber for making molds. Literature and sample free. Universal, Box 1076-A, Peoria, Ill.

HOW And where to obtain capital. Small and large loans. Free particulars. Star Service, Wapakoneta, Ohio.

OWN Mirror shop. Resilver mirrors. Glass sign making. Electroplating. Supply prices. John Sprinkle, V60, Marion, Indiana.

Bronzed Baby shoe mountings and supplies. All metal bronze bookends, picture frames, ash trays, etc. Onyx ash trays, desk sets, plaques. Hardening solution, 30-amp. plating rectifiers with powerstat control, \$85.00. Geared motors for agitation \$20.00. Lead lined tanks. Write for list. Hollywood Bronze Supply, 1770 N. Vermont, Hollywood 27, Calif.

QUICK Money. "Repairing car batteries." At home! Easy too! Batteryman, Grand Junction, Colorado.

\$46 FROM Square foot plywood. Jigsaw necessary. Write, Woodarts, X-38, Bridgewater, Mass.

OPERATE Profitable mail order business. Write Walter Service, 4159-A East 112th, Cleveland 5, Ohio.

COLORGLAZED Concrete pottery made without molds. Patented method. Cemetery products, novelties, tiles. Basement leak-sealing. Money-making projects. Booklet, details free. Men only. National Potteries Company, Grand Rapids, Minnesota.

SPECIALTY Manufacturing, the big money business that can be operated anywhere, start on a very small capital; we supply dependable formulas and complete instructions; get interesting free booklet, "Money-making Opportunities in Specialty Manufacturing." Howard Robinson, Ph.G., 1300-A South Ohio Street, Sedalia, Mo.

START Mailorder bookshop—Everything furnished. 25c brings booklet, samples, exciting ideas. General Publications, Ossining, N. Y.

\$25 WEEKLY Working two hours daily. No canvassing. No manufacturing. Lycke, Box 2471, Cleveland 12, Ohio.

137 WAYS To make money, in home or office, business of your own. Full particulars free. Elite Co., 220 Grand St., New York 13.

BRUSH Plating outfits connect to a battery. No tanks necessary. Good paying business at home plating autoparts, bathroom fixtures, bicycles, reflectors, silvering mirrors. No shop or experience required. Outfits furnished. Free booklet, Gunmetal Co., Ave. H, Decatur, Ill.

MAILING Postcards selling repeat merchandise is profitable. Everything supplied. Details free. Gordan Publishers, Box 23, Pawtucket, R. I.

RUBBER Molds, natural liquid rubber, flock filler (for making sectional molds), statuary plasters, felt finishes for novelties. Catalog and "Plastercraft" course free. Blue Rapids Supply, Blue Rapids, Kansas.

CO-PUBLISH And advertise in The Central Mail Advertiser. Sample copy for stamp. Low rates. Large circulation. Bagby Printing Co., Georgetown, Ohio.

MAIL Order opportunities. Full or spare time. Hundreds of chances. No charge. Postal brings copy. Blackstone Press, Somerville, New Jersey.

START Home plaster novelty business. Amazing course tells how. Literature free. Kemo-Courses, Dept. A, 4862 Catalpa, Chicago 30, Ill.

EARN \$200 Weekly installing new amazing "Styron" plastic wall tile in homes, offices. Easily applied. Tile your own kitchen, bathroom, too. Instructions, everything furnished. Literature free. U. S. Tile Co., 30 W. Washington St., Chicago 2, Ill.

COPUBLISH Leading m.o. paper. Latest copy Mail Sale Advertiser and proposition, dime. Vanroy W. Shirk, Lebanon, Penna.

MONEYMAKING OPPORTUNITIES

MEN—Women — "Most everybody likes candy." Learn to make in a professional manner. (Our 39th year.) Ragsdale Candies, D4, East Orange, New Jersey.

EASY Profits taking magazine subscriptions, handling greeting cards and boxed stationery. Cassell Publishers, Westfield, New Jersey.

BABY Shoes preserved. Formulas, instructions \$1.00. Supplies and bases. Novelty Bronzing, Box 56, Hyde Park 36, Mass.

HOME Workers—Handle our mail business your territory. Lynn, 5710 Bankfield, Culver City, California.

THOUSANDS Articles wholesale. "Supply Source Directory" 10c. Ideal Service, Park Ridge 40, Illinois.

BUYING Guns, every kind, modern, antique. Describe fully with lowest price wanted first letter. (25c brings big bargain sporting goods lists.) Numrich Arms, Dept. Z, Mamaroneck, N. Y.

UNPAINTED Plaster ornaments, easily decorated. Firestone's thick, white, natural-latex Loxite for rubber molds. Midwest Novelty Manufacturers, 524-A East Park, Anaconda, Montana.

15 MINUTES Masters sign and advertising lettering; sign-painters secrets; cartooning book. All three \$1. Free circular. Abenterprizes, Box 875-M, Peoria, Illinois.

START Profitable mailorder business at home. Everything furnished. Complete information 10c. Suproco, Ogema, Wisconsin.

WIN Cash, cars in prize contests! Write for copy filled with current contests, winning hints and tips. Send only 25c. Wright Contest Digest, Dept. 17-B, P.O. Box 2266, St. Louis 9, Missouri.

METALLIZING Baby shoes makes you money! Write today for your free copy of my new "Guide to the Baby Shoe Metallizing Business." Joseph B. Kushner, Metal Finishing Engineer, Stroudsburg 40, Penna.

TIN Cans. Turn them into cash. Nine methods. Instructions 50c. Charles, 12-BT, Norwood, Ohio.

FREE Book "372 Unusual Worldwide Business Adventures"! Pictures! True! Successful! Australia, Africa, South America, New Zealand! Not hokum! Work home. "Different" plans. Prepare for surprise! Publishers-K, Carlsbad, Calif.

BIG Profits and steady business metallizing baby shoes and other non-metallic objects. Home hobby or full time business. We show you simple process with limited equipment. Write Shuplate, Dept. A, Lawton, Okla.

TIRE Of working for someone else. Start your own mail order business and watch the money roll in. Small investment. Write T. Ryan, 1218 E. 21st, Oakland, Calif.

FREE Literature on money making ideas. Write: Lighthouse, 1023-F Hamilton Street, Lockport, Illinois.

EXTRA Money at home? Gold, silver, aluminum. Ring casting instructions 25c. Lauckner, 624-2A SW., Great Falls, Mont.

I MADE \$1000 From 1000 tomato plants. Instructions, \$1.00 (refundable). Alfred Dinsmore, Marlborough, Mass.

MAKE \$5.65 On every direct sale until you appoint a dealer. Then earn commissions on reorders. A proven necessity for all cars to save gas, oil and prolong motor life. Simple to install. Write for sales ammunition. Dept. M-1, Motor Economy, 1133 Broadway, New York 10.

EARN Money evenings, copying and duplicating comic cartoons for advertisers. Adservice, Argyle 1, Wisconsin.

METALLIZE Baby shoes. Further information 3c stamp. Metal Crafts, Box 125-R5, Tampa 4, Florida.

FOR Sound, sensible, proven successful mail order methods, send 10c for details to C. A. Griffith, 132 Water St., Fredonia, N. Y.

READ Progressive Mailtrade, the magazine that tells how to make money by mail. Dime brings sample and special offer. Progressive Mailtrade, Box 357, Sheboygan, Wisconsin.

FREE Offer. Cash income for life. Succeed, 317 American Bank Building, Portland 5, Oregon.

PROFIT With Larson Leathercraft, Belts, purses, 100 other ideas. Largest supply in U. S. Catalog 10c. Larson, Dept. C, 824 S. Tripp, Chicago 24.

CANDY Manufacturing and marketing, complete course \$6.00, literature 10c. Philip Pate, Kissimmee 1, Florida.

INCREASE Your earnings: Local business opportunities; mail order information; wholesale supply sources; valuable money-making tips; information, free details, rush name. Wilkin Company, Hillsboro, Ohio.

WIN Contest money. General Contest Bulletin gives hundreds of tips. Lists current contests and rules. Sample 25c. General Contests, 1609½ East 5th, Duluth, Minn.

ANALYZE Handwriting for profit! Complete outfit \$1.00. Graphologists, POB-971, Philadelphia.

UNPAINTED Figurines. Illustrated list free. Oman, 642 Broadway, St. Paul 1, Minn.

EARN Money at home! Thousands do! "Home Worker Magazine" tells how. Sample, 25c. Sizemore, Box 7, 4917 Kostner, Chicago 30, Ill.

RESILVER Mirrors at home. Formula 25c. Ideal Service, Park Ridge 6, Illinois.

PRIZE Contest bulletin gives various contests now operating, and valuable hints. 3c stamp. National Contest Bulletin, Box 2685P, Miami, Florida.

PUBLISH Your own magazine. Handsome 52 page format, well edited, illustrated. Cost low as \$1.00 month. Brings you prestige, profits. 25c brings sample, details. National, Ord, Nebr.

FORMULAS, PLANS, ETC.

10,000 FORMULAS And trade secrets. Free literature. Stillman, 555 Kingston Ave., Brooklyn 3, N. Y.

ANY Formula or process, \$1.00. Satisfaction guaranteed. Meldrum's, Stillwater, Oklahoma.

YOU Name it! We'll airmail formula \$1.00. Satisfaction or refund. Brown, 9111-K Hoyne, Chicago 20.

FORMULAS, Processes, analysis. Free literature. Pricopoulos, 761 Worthington, Springfield 5, Massachusetts.

PLANS—New patent sewage disposal system. Requires less drainage, build it yourself. Specifications and drawings by registered professional engineer. \$2.00. De Haviland, Mundelein, Illinois.

FORMULAS For nearly everything. Catalog free. Write Creative, Winnetka, Ill.

PRODUCTS Analyzed. Duplicated. Improved. Formulas. Consulting Scientific Company, Swarthmore, Pennsylvania.

MAKE—Sell cleaners, soaps, polishes, flavors, cosmetics. No machinery. Formula literature free. Kemico, Park Ridge 16, Illinois.

\$1.00 GETS You 21 money-making popcorn, candy apple formulas. We supply equipment. Concession Supply Company, Dept. A, Station "B," Toledo, Ohio.

TESTED Formulas. Interesting descriptive booklet free. Pont, Box 635-PM, Terre Haute, Indiana.

REAL Manufacturing formulas. Lists free. Cummings, Chemist, Gordon Ave., Syracuse 4, N. Y.

PLASTICS

LUCITE Cutoffs to 1½" thick. Suitable internal carving. 50c lb. plus postage. C & C Enterprises, 132 Rumsey Road, Yonkers, N. Y.

NORCELL—Magic plastic. Carves like soap, casts like lead, bounces like rubber. Send two dollars for liberal sample order, including free mold. Norrell, Incorporated, 2545 Summer Avenue, Memphis 12, Tenn.

PLASTIC—Sheets, rods, tubes, etc. Free list. Plastic Supply Co., 2901 No. Grand Blvd., St. Louis 6, Mo.

MOLDS Made for Plasticor C-2, lowest prices. Fleming Giddings, 2544 Clarkson, Denver, Colo.

INEXPENSIVE Injection molding press. Bulletins, sample, 3c. Technicraft, 1156 Commonwealth, Boston 34, Mass.

ELECTRIC Pencil—Writes; engraves all metals. 110 volts. \$2.95 postpaid. Reb Industries, 265-DS Elmhurst, Illinois.

LUCITE, Plexiglas. All size sheets. Cost square foot (12" x 12") 1/16" 96c; 1/8" \$1.25; 3/16" \$1.52; 1/4" \$1.80; colors add 10%. Include 10% postage. Almac Plastics, 230 Fifth Ave., New York 1, N. Y.

AMAZING Liquid plastic pours cold, hardens in half hour. Clear, colors. Expensive equipment unnecessary. Embed photographs, coins, flowers, seashells. Complete kit only \$3.25. Kristalon Plastics, Dept. A-12, Box 29, Wilmette, Illinois.

NEW Low prices on Plexiglas, jewelry findings, initials, sequins, tools, etc. Free catalog. G. Baker Company, River Edge, New Jersey.

INTERNAL Carved roses, orchids, swans, goldfish, butterflies, etc. Jewelry and gifts. Crystal Floral Novelty Co., Bound Brook, New Jersey.

PLASTICS—Supplies, findings, shells. Illustrated fabricating manual, bargain catalog, 10c. Gem-O-Lite, Box 686P, North Hollywood, Calif.

PLEXIGLAS—12" x 12" Masked sheets. 1/16"-\$1.00, 1/8"-\$1.25, 3/16"-\$1.55, 1/4"-\$1.85. Include 10% postage. Dyes, rods, tubes, luminous powders, carving blanks, drills, jewelry findings. Free catalogue. Craft Plastics, Somerville, New Jersey.

BARGAINS In plastics. Lucite, Plexiglas, Catalin. Many colors and sizes. Details free. George Plastics, 6938A George St., Chicago 34, Ill.

CHEMISTRY

FREE Catalog: Chemistry, mineralogy, physics, biology. Tracey Laboratories, Evanston, Illinois.

COMPLETE Supply catalog. 10c. Pilgrim Chemical, 348 Edith, Salt Lake City 4, Utah.

NEW Idea chemical and apparatus outfits for home experimenting. Photo-Scales, semi-professional microscopes and biological supplies. Specializing in chemicals and laboratory supplies in small quantities. Send 15c for catalog. Established 1931. John H. Winn, 124A West 23 St., New York, N. Y.

NEW Laboratory supply catalog of chemicals and apparatus. Contains many thousands of items with illustrations. Send 25c. Standard Science Supply Company, 1232 N. Paulina St., Chicago 22.

CHEMICALS And apparatus at low prices. Catalog 15c. Microscopic stain catalog, 20c. Both 25c. National Scientific Co., 2204 W. North Avenue, Chicago 47, Ill.

CHEMICALS And apparatus for industrial, analytical, and private laboratories. Catalog 15c. Dept. M-26. Biological Supply Co., 1176 Mt. Hope Ave., Rochester, 7, N. Y.

UNIVERSITY Professor teaches chemistry by mail. Details free. Box 1295, Toledo, Ohio.

HANDBOOK For chemical experimenters, illustrated, hundreds of experiments, 50c. Experiment booklet 15c. Supply catalog 5c. Reading Scientific Company, Reading, Penna.

AGENTS WANTED

WANT Pleasant outdoor work in a business of your own? Good profits selling over 200 widely advertised Rawleigh home/farm necessities. Pays better than most occupations. Hundreds in business 5 to 20 years or more! Products-equipment on credit. No experience needed to start—we help you. Write today for full particulars. Rawleigh's, Dept. B-145-PPM, Freeport, Ill.

MAKE More money quick! Sell new 1949 greeting cards, stationery. Tops in beauty, quality, value. Amazing variety. Plastic cards, deluxe gift wrappings, animated books, suede-tone initial stationery. Profits to 100%. Bonus. Special money-saving offers. Write today for feature all occasion samples on approval and free name imprinted, floral stationery sample portfolios. Elmira Greeting Card Co., M-9, Elmira, N. Y.

AGENTS To sell a fast moving item. Acclaimed by users throughout the country. Exclusive territories open for honest proven salesmen. Big profits to aggressive agents. If you can sell, then this is your opportunity. Write today. Speed Waxer Company, Dept. PM-2, 4451 Elston Ave., Chicago 30, Illinois.

DOUBLE Duty shopping bag. Zips open. Instantly changes from small to large size. Lightning seller. Samples sent on trial. Kristee 116, Akron, Ohio.

MAKE Money calling on friends. Show greeting card assortments—Birthday, get-well, others. Floral stationery. Gift wrappings. Experience unnecessary. Samples on approval. Wallace Brown, 225 Fifth Ave., Dept. E-4, New York 10.

FREE Water and our concentrates, makes flavors, lotions, shampoos, 72 products, labels, bottles furnished. Qualco, E-20030 Russell, Detroit.

ABSOLUTELY Free! Big package actual sample fabrics and style presentation of dresses, lingerie, hosiery, etc. Take orders. Commissions big. Send no money. Melville Co., Dept. 4775, Cincinnati, Ohio.

A DRESS For you with every 3 you order for yourself and family. Amazing new plan. Everything free. Harford Frocks, Dept. A-9128, Cincinnati, Ohio.

PLASTIC Tablecloth covers, curtains, drapes, baby pants, bowl covers and other plastic articles selling like wildfire! Make big money now! Free details. Write L & M Co., Dept. 58-B, 510 St. Charles, St. Louis, Mo.

EARN Big money. 21 Sunshine everyday cards with six lined envelopes \$1. 48 Sunshine notes for \$1. Sensational values. Costs 50c. Sells \$1. Also 1949 21 card Easter asst. Birthday, get well, napkins, gift wraps, stationery. Write today. Samples on approval. Sunshine Art Studios, 115 Fulton St., Dept. PM-2, New York 8, N.Y.

LOOK Here! Wanted—Men and women to start in business on credit. Sell some 200 farm-home products. Thousands our dealers now make quick sales, big profits. For particulars write Rawleigh's, Dept. B-192-PPM, Freeport, Ill.

EARN Big money year 'round. Be a one-person-department-store. Take orders for shirts, ties, hosiery, lingerie. Household linens, etc. For information. Corporate Merchandisers, Dept. PM-11, 547 Broadway, New York City 12.

STRANGE "Dry" window cleaner. Sells like wild. Replaces messy rags, liquids. Simply glide over glass. Samples sent on trial. Kristee, 115, Akron, Ohio.

EXTRA Cash income. Sell friends new, different greeting card assortments, exclusive stationery unobtainable elsewhere. Profits to 100%. Bonus. Request free samples exclusive personalized stationery and all-occasion samples on approval. Regal Greetings, PM-5, Hazel Park, Mich.

PARACHUTE (Nylon). Three amazing toys in one. Dollar value. Sells 50c. Costs 30c. BK Jobbers, 728 Cherry, Toledo, Ohio.

MUSIC Greeting cards. All occasions. Dorby Music Cards, P.O. Box 738, Morristown, New Jersey.

SELL Ultra-blue stock signs to stores. 1000 slogans, comedy, general, religious. "7x11" cost 6c, sells 35c. Make money. 15 samples ultra-blue signs "7x11" \$1.00 postpaid. Lowy, 8 West Broadway, Dept. 445, New York City 70.

AMAZING Offer—\$50 is yours for selling only 100 boxes entirely different, new deluxe all-occasion cards. Patented feature television card included. Each box sells for \$1.00, your profit 50c. Surprise items. It costs nothing to try. Write today for samples. Cheerful Card Co., 542, White Plains, N. Y.

BUY Thousands of nationally advertised products direct from manufacturers. Write for "buy direct and save." Consumers Assn., 218-F Investment Bldg., Pittsburgh 22, Penna.

NEW "Sponge" wall cleaner. Erases dirt like magic. Wallpaper, painted walls, ceilings. Saves redecorating. Lightning seller. Samples sent on trial. Kristee, 114, Akron, Ohio.

SCHOOL Seniors! Your postal will bring our wonder. Kwick-Sell Cardalog of popular graduation name cards. Biggest profits! Only firm giving free souvenir chest and card case. Don't miss out! Hurry that postal! Craftcards, Box 235(L), Pittsburgh 30, Pennsylvania.

400% PROFITS Selling genuine, guaranteed, "NuSilver Polish and Plating Liquid." Apply with cloth. Stores, offices, homes. NuProcess Products, Aurora, Ill.

LOOK! Special money-making opportunity! Profits to 100%. Bonus. Sell irresistible all occasion greeting card assortments, new style gift wrappings, plastic cards, exclusive stationery. Special offers. Request free name imprinted and floral stationery samples and all occasion boxes on approval. New England Art Publishers, North Abington 79, Mass.

UNUSUAL Profits—Agents say our best deal since 1927. Postcard brings particulars. Masion Marivonne, Dept. F, Troy, Missouri.

AT Last! Something new and sensational in everyday cards. Gorgeous satin and velour designs. Get orders fast. Big profits. Imprinted stationery. Floral charmettes, napkins. 25 assortments for all occasions, retail 60c to \$1. Samples on approval. Puro Co., 2801 Locust, Dept. 940-B, St. Louis 3, Mo.

COULD You use more money? Make up to 100% cash profit selling friends greeting cards. Novel all-occasion, birthday assortments. Gift wrappings, stationery. Bonus. Free samples name imprinted, floral stationery and new all-occasion samples on approval. Special offers. Write Pilgrim Greetings, 111 Summer, Dept. AN-1, Boston, Mass.

AGENTS: Stamping names on pocket-key protectors. Sample check with your name, address, 25c. Stamping outfits. Emblem checks, check-fobs, name plates. Hart Mfg. Co., 303 Degraw St., Brooklyn, N. Y.

DO You want \$25? Sell 55 boxes, lovely greeting cards, to friends, co-workers, neighbors. Free literature shows you easy way to make money. Send \$1 for beautiful sample box and receive one box free. Torres Co., 373 Fulton St., Brooklyn 1, N. Y.

GUARANTEED Swiss watches, jewelry; \$2.00 commission each \$7.50 sale; balance c.o.d. Brooklins, B-1975AB, Little Rock, Ark.

EASY Dollar plan—quick success. Sell advertising pencils, key cases, calendars to all businesses. 2000 fast sellers. Highest commissions. Free sample kit. Lederer Adv. Gifts, 125 West 33rd, Dept. 15, New York.

POCKET Pal: Replaces pocket knives, new, safe, beautiful. Always razor sharp. 50c seller. 321% profit. \$15.00 or more daily. Agents, salesmen, distributors. Sample 10c. Nelson Mfg. Co., 222 W. Kellogg, St. Paul 2, Minn.

NEWEST Money making sensation. Sell hand painted ties with personal initial. 100% profit. Experience unnecessary. Special offers. Write for free 20 page catalog complete line ties, mufflers. Philip's Neckwear, 20 West 22nd St., Dept. K-32, New York 10.

EARN Many dollars now with Thomas Terry's amazing new springtime and year 'round plans. Send today for two unusual assortments on approval and new free display folders. Write Thomas Terry Studios, 200 Union Ave., Westfield, Mass.

MAKE Sensational profits! New, sell-on-sight plastic line: Tablecloths, aprons; many other splendid fast-selling items, novelties. Postal brings free details, special deals. Hurry! Royalty, Box 748-H, Passaic, N. J.

MAKE Big money with the wonderful new, "Pink Satin" cream shampoo! Sells fast! Sales repeat! Splendid money-maker for you! Rush name for interesting free details, today. Demo Laboratories, Bogota, N. J.

25c NECESSITY 5c And self addressed envelope. Adjustrite, 35P 9th St., Columbus, Ohio.

PHOTO-Salesmen-agents. Sell beautiful hand-colored plastic enlargements. Collect deposit, we deliver. Profitable sideline. Send card, for free sample kit. Novel Portrait Co., 3343 North Ave., Chicago, Ill.

BETTER Plastics at lower prices! Proven hits in plastic tablecloths, aprons, garment bags, utility covers. Free catalogue M92. Acclaim Products, 25 Hillside Ave., New York 34, N. Y.

AGENTS Make big money selling "Ear-Buds," the perfume earrings with a place for mi-ladies own perfume. Every woman a prospect. Real jewelry, smartly packaged. 24k. gold plated. Sample \$1.68, tax included. Particulars free. Minot Inc., Box 77, 22 Minot Street, Dorchester 22, Massachusetts.

SELL Shoes. \$100.00 weekly selling 6 pair Miracle Cushion shoes daily. No investment. Experience unnecessary. Free outfit. Samples. Advance commissions, bonus. Paragon Shoes, 739 Columbus, Boston.

FREE Nylons given if Kendex hosiery runs or snags! World's only women's hosiery sold with written guarantee amazing everybody. Mere words could not express unbelievable money-making opportunity. Fantastic earnings become reality. Armstrong earned \$202 in 9 days. Watkins sent 92 orders in one day. Imagine replacing hosiery free regardless of cause—whether you or abuse! Truly sales dynamite for terrific profits. Even if you never sold before, three magic words: "Guaranteed Against Everything" will open doors for you—make women listen and pour money in your pocket. Complete line from sheerest to service (15-20-30-40-60 denier) all lengths 28 to 35 inches—latest colors—seamed full fashioned and seamless. No competition because Kendex guaranteed nylons not sold in stores. Also complete line men's hosiery actually guaranteed for one full year! Nothing like this anywhere. Includes rayon, nylon, lisle, wool, cotton, mixtures, etc. All styles, patterns, colors, prices to please everybody. Thousands shipped daily. 100,000 pairs constantly in stock for fast delivery. Over 30 years in business. You need no money or experience. Nothing to pay now or later. Show free outfits. Write orders. We deliver and collect. Big advance cash plus huge bonus. Earn money spare or full time—exclusively or side line. No restrictions. Become manager—appoint others to sell for you—earn steady income on their sales. Complete money-making outfits including salesbooks in color, samples of hosiery materials, etc. furnished free and prepaid. Simply mail name and address to: Kendex Company, Babylon 23, N. Y.

SELL Beautiful Forcolor playing cards—Plastic coated, endorsed by experts. Sample deck 65c. Frank Sunshine Sales, Loudonville, Ohio.

SENSATIONAL Sales everywhere. New "Ace Hi," adult game. Demonstrating sample \$1.00. Retail \$2.00. Leitner Co., 4031 N. Paulina St., Chicago, Ill.

AMAZING New non-electrical burglar alarm for windows or doors of homes, stores, offices, etc. Millions of prospects. Sells on sight. 100% profit. Easy sales. Tremendous opportunity. Retail at \$2.25. Write immediately. Robertson Company, 228 N. LaSalle St., Chicago 1, Ill.

SHOES. Entirely new, different specialized men's line. Custom made quality—popular prices. Immediate commissions. Bonuses. Free selling kit. Concordian Shoes, 5 West Concord, Mass.

GLOW In the dark bunnies, chickens. Samples 50c. Dozen assorted \$2.10. Matsonian, No. Grafton, Mass.

BEST Sellers only! Plastic lifetime playing cards; folding umbrellas; walking dolls; other items. Send for exciting circular. Atlanta, Inc., 5 Columbus Circle, New York 19.

MAKE More money selling personal initialed individualized belts, buckles, cap badges, tie holders, name plates, 2,000 emblems to choose. Big profits, whole or part time. Write today; special outfit offer. Hookfast Specialties, Box 1425, Dept. 6, Providence, Rhode Island.

FREE Samples. Big profits showing amazing glow-in-the-dark specialties. House numbers, pictures, plastic novelties, religious and nursery objects, etc. Large manufacturer. Madison Mills, 303 Fourth Ave., New York, N. Y.

PROFITS. Big demand and repeat orders selling rubber mats for home or auto. Free sales plan. Mitchell, 2140A San Fernando Road, Los Angeles 41.

HOTTEST Seller of all time. Details free. C & C Sales, Box 1046P, Chicago 90, Ill.

INFORMATION — Wholesale supply sources. Moneymaking plans. Increase your income! Write Reynard Service, Smithfield 3, Ohio.

FAST Money! Take orders for new sensationally different picture enlargements. No competition. Everybody buys. Gotham Products, Box 5427 M, Philadelphia 43, Penna.

SELL Books by mail. Mammoth sales and huge profits. Everything furnished. Send 3c stamp for complete details. Business Plans Foundation, Box 56, Madison Square Station, New York 10, N. Y.

SELL By mail books, novelties, bargains! Ready made circular service! Large profits! Catalog free! Elfco, 432 North Wells, Chicago 10.

SCHOOL Seniors—Earn 40% commission selling classmates America's most beautiful graduation name cards. Largest selection. Outsells all others. Free sample kit. Printcraft, Dept. M, 1425 E. Elm St., Scranton 5, Penna.

BIG Money selling cast iron and aluminum cooking utensils direct to consumer, exclusive designs. Free illustrations. Jones Machine & Foundry Co., Chattanooga 2, Tenn.

GUARANTEED Product in protected territory, if you are now selling or intend to sell house-to-house. For full 1 qt. sample amazing High Shine Windsor No Rubbing Wax, send only 25c covering handling and postage. (Sells for \$1.25.) Windsor Wax Co., Inc., Dept. P.M.-2, Hoboken, N. J.

MAGIC Cleaner — Laundry soap deal. Hotter than a firecracker. Big profits. Sample free. Bestco, 4642 No. Central, Chicago.

GOLD Lacquered window sign letters. Large sizes penny each. New foils. Absolutely beautiful. Free samples. Atlas, 544 W. 79th, Chicago 20.

EXCELLENT Sideline for printing and advertising salesmen. Decalcomania name plates in small quantities. Great demand. Also, make money with our line of automobile initials and sign letters. Free samples. "Ralco" XL-Roxbury, Boston 19, Mass.

AGENTS—300% Profit selling genuine gold window letters; stores and offices. Free samples. Metallic Letter Co., 438-B North Clark, Chicago.

HELP WANTED

BOYS Wanted. Over \$2.00 hour! Sell name plates for front doors. Free sample. Write Dept. 45, National Engravers, 214 Summer, Boston, Mass.

BOYS—Valuable prizes free for one hour's work. Write, Nichols, 4716 N. Winthrop, Chicago.

HIGH-GRADE SALESMEN

BRUSH And mop salespeople—Sell our improved 1949 model cellulose sponge mop with rubber window wiper, direct to homes. Earnings up to \$25.00 daily. No stock to carry. No delivering. We ship direct to customers, c.o.d. Write National Brush & Broom Co., Dept. PM-2, Valparaiso, Indiana.

SALESMEN. Earn \$100.00 weekly, selling only six pair shoes daily. Commission and bonus. Wide variety for men, women, children. No investment. Experience unnecessary. Tanners Shoes, 410, Boston, Mass.

AMAZING Invention! Screw-holding drivers; remove, insert screws difficult places! Factories, garages, mechanics buy quantities. Exclusive distributor, Toolco, 715 Wentworth Bldg., Boston, Mass.

UP TO \$50.00 in a week and tailored suit for yourself without paying one cent. Write for plan. Stonefield Corp., Dept. P-817, 1300 W. Harrison St., Chicago 7, Ill.

ADVERTISING Book matches—Cash in on big demand; sell union label matches. Cuts for all businesses and political parties. Free powerhouse selling kit, low prices, protection guaranteed on repeat orders. Cash commissions. Superior Match Co., Dept. M-29, 7530 Greenwood, Chicago.

ADVERTISING Decals and specialties sell easy. Big commissions. Samples, catalog 25c. Novelty Service, Dept. PM2, Reading, Penna.

MANUFACTURERS Agents-dealers. Rotacut-Farmco power lawn-sickle bar mowers. Open account. Write fully. Farm Products, M-2002, Excelsior Springs, Mo.

FIRE Control men who want top profits and top automatic extinguishers write Red Ball Inc., Box 1552, Salt Lake City, Utah. The home of the Automatic Aristocrat; beauty and dependability.

80c PROFIT On every dollar. Scientifically engineered automotive carburetor item. 3 minute sales easy. Details 1st class for stamp. Box 94, Englewood, Colorado.

SELL Refrigerator electric motor oil. Good profits. Free details. Warco, 2689-M Coolidge, Oakland 1, Calif.

SELL Merchants, doctors, etc., gummed collection reminders. 400% profit. Samples, plans, 25c postpaid. Slocumb's, 215-S Clisby, Macon, Ga.

RAY-PRUF Sunglasses—High quality line. Fast sellers, large profits. Write Sterling Optical Co., 150 South St., Newark, N. J.

BIG Money quickly and easily taking orders for complete line personalized initialed buckles, belts, cap badges, 2,000 emblems. Fast repeats. Write today, Hook-Fast Company, Box 480-PM, Roanoke, Virginia.

SALESMEN: Is your income getting smaller? Here is the opportunity of a lifetime, selling our article at 100 percent profit. Send \$1.00 for sample to J. Carcano, 63 Tracey Ave., Torrington, Conn.

SALESMEN—Put yourself in line for big money and real future. Keep stores supplied with 5c-10c counter goods. Nationally advertised merchandise. Top profits for you and merchants. Liberal deals boost sales. Sideline or full time. World's Products, Dept. 10-M, Spencer, Ind.

POPCORN Machines, all electric units, peanut roasters, carameltcorn, heating appliances. Northside Sales, Indianola, Iowa.

NEW Jobs open in selling! Send name, address for five free issues of Opportunity Magazine's money-making guide, listing hundreds of companies who'll pay you well, full or part-time. No experience needed. Opportunity, 28 E. Jackson, Dept. 17, Chicago 4, Ill.

QUICK Sure money. Selling Annie Blain flavors. Highland Park 1, New Jersey.

BIG Money selling tooth powder. Write today. James Walker, 633 Plymouth Ct., Chicago, Ill., Dept. 3.

BIG Money taking orders. Shirts, ties, Sox, pants, jackets, sweaters, shoes, uniforms, etc. Sales equipment free. Experience unnecessary. Nimrod, 4922-AN Lincoln, Chicago.

EDUCATIONAL AND INSTRUCTION

IF You'd like a profitable office business, operate a collection agency. Our inexpensive short course quickly qualifies you. Write Cole & Associates, Syracuse 2, New York.

LEARN Mechanical dentistry: World-wide opportunities. Start own business. Resident school gives practical instruction at the bench. G.I.-approved. Housing available. Write for folder PM. Franklin Schools, 719 Liberty, Pittsburgh 22, Penna.

SPANISH The easy way—with Speed-O-Way phonograph records. Complete course \$7.95. Free folder. Speed-O-Way, Dept. 111, Box 2301, Houston, Texas.

MAKE Up to \$30-\$40 week as a trained practical nurse! Learn quickly at home. Booklet free. Chicago School of Nursing, Dept. M-2, Chicago.

"HOW To Break and Train Horses"—A book every farmer and horseman should have. It is free, no obligation. Simply address, Beery School of Horsemanship, Dept. 1102, Pleasant Hill, Ohio.

NOW You can have an office. Learn credit-collection business by new home study course. Many earn up to \$5,000-\$15,000 annually. Free bulletin. Franklin Credit School, Dept. 202B, Roanoke 7, Virginia.

EXPORT! Learn at home from established world trader. Big paying positions. Your own profitable world-wide business by mail order without capital; or travel abroad. Experience unnecessary. Free booklet. Mellinger, 102W, Los Angeles 24, Calif.

WORK For U. S. government! Many openings expected. Men—women earn more. Qualify now for next exams. Free 40-page book, details. Write Franklin Institute, Dept. L24, Rochester, N. Y.

LEARN Auctioneering by mail. Sample lesson free. Nelson Auction School, Renville, Minnesota.

STAMMERING Corrected. Booklet gives full information. Write: William Dennison, 543-A Jarvis St., Toronto, Ont.

LEARN Photo negative retouching for a profitable trade and an exciting hobby! Easy 5 week home study course will show you how. Write for free illustrated brochure and complete details today. Marshall Photographers, Inc., Dept. PM2, 162 N. State Street, Chicago 2, Illinois.

USED Correspondence courses and educational books bought, sold, rented, catalog free. Educational Exchange, Summer-ville, Ga.

WELDING School pays. G.I. approved. Finest equipped in U. S. Free catalog. Write Hobart Welding School, Box M-297, Troy, Ohio.

PHOTOGRAPHIC Mind! Amaze, earn, learn! Facts, figures, names stick like burrs with Supermemory. Write Thor Books, M2, Box 1210, Chicago.

BE A mathematical wizard. Add columns instantly. Free details. Vanderdrift, 517 Lincoln Place, Orange 2, New Jersey.

STUTTERING Corrected at home. Free literature. Athenium, PM-21, 1714 Chestnut, St. Louis 3, Mo.

PIANO Tuning pays. Learn this profitable profession at home. Our Tonometer and mechanical aids make learning easy. No knowledge music necessary. Diploma granted. Largest and oldest school—50th year. G.I. approved. Write for booklet. Niles Bryant School, 78 Bryant Bldg., Washington 16, D.C.

WIN A well-paid job in travel—step into a new world of glamorous opportunity! Today more Americans are "going places" than ever before in history. As a result—the hotel and institutional field is surging ahead to new prosperity. Successful Lewis graduates are "making good" everywhere in luxurious hotels, fashionable resorts, smart restaurants, and clubs. Free book explains how to qualify at home for a well-paid position in this ever-growing business where you are not dropped because you are over 40—shows how you are registered free of extra cost in the Lewis National Placement Service. Course approved for veterans training. Write today. Room PB-395, Lewis Hotel Training School, Washington 7, D. C. (Now in its 33rd year.)

3800 LATEST Used correspondence courses 50c cat. EG, Elmsford, N. Y.

ENTER Used car business without capital stock investment. Copyrighted proven plan now available at low cost. Free particulars. Maradel, Waukegan, Illinois, Rte. 2-136-A.

LEARN Oil painting: Simplified course. Prickett, Studio PM, Portsmouth, N. H.

INVESTIGATOR Training. Phillips Secret Service, 1917B North Kenneth, Chicago 39, Illinois.

BOOKKEEPERS! Increase your earnings! Operate your own simplified "Dollar-A-Week" bookkeeping and tax service. Full or spare time. Details free. No obligation. Ellis, Box 200, Cedar Grove, North Carolina.

SCIENCE Of memory simplified. Free booklet "Memory Development." Memorology Club, 2016 Sunnyside Ave., Chicago 25, Ill.

HOME Study courses. Over 500 subjects. Courses include text, lessons, examinations, etc. Complete, only \$9.95. Write DeVoto Schools, 35 Vicente, San Francisco 16, Calif.

BOOKKEEPING Easily learned! Rapid, simplified instruction. Introductory lesson 35c—15 lesson course, \$5.00. B. Buchalter, 1280 Ocean Ave., Brooklyn 30, N. Y.

DENTAL Technician's practice kit. Artificial teeth, plastic, etc. Free instructions with kit. Grant Laboratory, S-219 W. 7th, Los Angeles, Calif.

MEDICAL Laboratory technicians in great demand. We train you in your own home, in your spare time. Also home study course in general chemistry. Free catalogue. Imperial Technical Institute, Box 973-J, Austin, Texas.

USED Correspondence courses and books bought, sold, rented and exchanged. Catalog free. Lee Mountain, Pisgah, Alabama.

LEARN Photo-engraving at home or in oldest, largest school in America. Work for newspaper or establish own profitable business. New Tasope' Photo-Engraving equipment available soon. Write for information. Veterans ask about G.I. training. The Aurora School of Photo-Engraving, Tasope' Bldg., Aurora, Mo.

LINGUAPHONE Makes languages easy. At home learn to speak Spanish, Portuguese, Italian, French, German, Russian, by quick, easy Linguaphone Conversational Method. Save time, work, money. Linguaphone correspondence courses are available to veterans under G.I. bill of rights. Send for free book. State if G.I. Linguaphone Institute, 83 RCA Bldg., New York 20, N. Y.

SECRET Investigation. Experience unnecessary. Investigators particulars free. George Wagner, M 125 West 86th, New York.

PLAYS, STORIES, MANUSCRIPTS

I WANT New writers to cash hundreds of checks for \$1 to \$100, offered each month. The easiest way to write for pay. No previous experience necessary. Send for free details. No obligation. Saunders M. Cummings, 468-M Independence Bldg., Colorado Springs, Colo.

BUSINESS SERVICE

WE Receive, remail letters; \$3.00 monthly or 25c each. "Hawkins," 1300 Tailor, Washington 11, D. C.

SPECIAL SERVICES

ELECTRIC Refrigerator problems analyzed. Send complete details, make, year to Tegner, 2689-N Coolidge, Oakland 1, Calif. If I help you send dollar.

INFORMATION

CALIFORNIA. Dependable facts and figures on jobs and housing, \$1.00. M. Pomeroy, 11926-PM Wilshire, Los Angeles 25.

FOREIGN Employment for you. Excellent permanent job opportunities for U. S. citizens. Wages at least 20% higher, less taxation, lower living costs. Improved social position. Transportation and housing furnished. Choice of climate and location. South and Central America, Far East, China, Alaska, Africa. Send \$1.00 for copyrighted Digest showing oil, shipping construction, mining, etc. Companies working and hiring. Includes sample application letter, advice on wages, tips, etc. World Wide Company, Dept. PM-2, Madison 1, Wisconsin.

CARTOONING, COMMERCIAL ART, SHOWCARD WRITING, SIGN PAINTING

"HOW To Make Money With Simple Cartoons"—a book everyone who likes to draw should have. It is free; no obligation. Simply address Cartoonists' Exchange, Dept. 92-C, Pleasant Hill, Ohio.

LEARN Sign painting. Wonderful trade. Big money. New method for teaching beginners. Price \$5.00. Free particulars. Haines System, Sabina, Ohio.

SIGN Painting made easy. Complete instructions 25c. Mohan, 942 Moss St., Reading, Penna.

LEARN Showcard writing at home in spare time. Fascinating, profitable. Free information. Sherwood Publishing Co., Irvington, 11-3, N. J.

9 ALPHABET 3 Numeral pattern sets and catalog, \$1.00. Sign Letter Distributors, P.O. Box 101, Mineola, N. Y.

BE A showcard writer. Learn at home in three weeks. Uncrowded. Big money field. Make sales very first week. Write: R. J. Meisner, 1539 Wisconsin Avenue, Dept. 12, Flint 6, Mich.

SIGN Painting taught at home. Test lesson free. Ben Kerns Studios, Box 812, Greenville, S. C.

BOYS. All ages. Comic pen and ink sketch made from photograph. Picture returned unharmed. State hobby or pastime. Send photo and \$1.00. Edward Hickley Studios, 313 N. Union Ave., Los Angeles 26, California.

BECOME Professional lettering artist the easy way. New amazing lettering kits \$8.50. Major-Art System, 3510-B Palmer, Chicago 47.

NEW Style home study course in advertising art now ready. Free portfolio "Your Career in Art." Applied Art Studio, 1662 Lincoln Avenue, Cleveland 7, Ohio.

CARTOONIST'S Magazine, 25c. Lessons, hints. Cartoonist Hartman, 2776 California Ct., Lincoln 8, Nebraska.

CHALK Talks. Laugh producing program, \$1.00. Catalog 10c. Balda The Cartoonist, Oshkosh, Wisconsin.

ADVERTISING AGENCIES, LETTER WRITERS, FOR ADVERTISERS

AVOID Costly advertising mistakes. Get enlightening Ad-Guide and Ratebook leading newspapers, magazines, mailing lists, 10c. Chicago Advertising Agency, (Established 1900), Chicago 4.

FREE! 1949 Advertisers Rate and Data Directory, 52 pages! E. H. Brown Advertising Agency, 20 N. Wacker, Chicago 6.

ADVERTISE In "Hobby-Sports," 15,000 readers. Inch \$2.65, word 5c. Paul Hollingsworth, Preston, Idaho.

MAILING Lists: \$2.00-1000. Homeworkers, agents, buyers. Fresh names "guaranteed." Louis Siegel, Box 183, New York 2.

ADVERTISE! 24 Words, 40 newspapers \$3.50. Lists free. Advertising Bureau, 10511-C Springfield, Chicago 43.

MAILORDER Advertising! Complete planning, writing, placing service. Quarter-century reputation. Les Finkle-Advertising, 257 South Spring, Los Angeles 12, California.

SALES Letter writing our specialty! Production facilities. Particulars on request. Commercial Record, Saugatuck, Michigan.

ADVERTISERS! Reach nearly 18,000,000 readers. 25 Sunday national key newspapers, 18 words, \$49.75. "Terrific pullers." 20 popular newspapers, \$10.00. "Free booklet." Special—One inch display 2,-821,198 circulation, \$48.30. Newmark's Advertising Agency, (Established 1893), 217-7th Ave., New York 11.

24 WORDS In 50 weeklies, \$4.96. J. Darnell, 730 Hays, Jackson, Tennessee.

ADS Placed in out of town newspapers and magazines. Low rates. Catalogue free. Ideas that pay. Baker Advertising Agency, Successors Ankrum Agency, 189 W. Madison, Chicago 2.

MAILING Lists, certified, productive, inexpensive, \$5.00 1000. Homeworkers, agents, buyers, etc. Write Dixie Service, King, N. C.

RUBBER STAMPS AND OFFICE SUPPLIES

3 LINES, 50c. 125 Letterheads, 125 envelopes printed, \$1.98. 1949 catalogue. Johnson Press, Box 6-A, New York City 26.

RUBBER Stamps. Send for catalog. Excello, Box 500, Shreveport, Louisiana.

3 LINES 45c; cushioned, indexed 55c; pads 35c. Stampright, Wauwatosa, Wis.

LINE 20c; 2-35c; 3-50c. Stamp Works, Auburn, Nebraska.

TYPEWRITERS, DUPLICATORS, OFFICE DEVICES

"PRINT-O-PRESS" DeLuxe automatic duplicators. Legal size, \$29.50; postal model \$9.95. Starting supplies furnished. Fred Schmaus, 895R East 241st Street, New York 66.

NEW Portable typewriters. Big discounts, send stamp. Dupligrath, River Grove, Illinois.

BOOM Your Business with postcard stencil duplicator, \$4.75. Guaranteed performance. Postagraph, Box 181, Cincinnati 1, Ohio.

PRINT-O-MATIC Mimeographing post card typeless stencil duplicator printer \$13.50. Office duplicators—Hilcos, Speedo-prints. Typewriters, portable adding machines, addressettes, automatic envelope sealers. All office machines. Duplicator supplies. Literature free. Pittsburgh Typewriter Supply, 336-4 Fourth Avenue, Pittsburgh 22, Penna.

RECONDITIONED Typewriters, mimeograph, multigraph printing devices, appliances, supplies. Catalog. Dixigraph Service, King, N. Carolina.

PRINTING, MULTIGRAPHING, MIMEOGRAPHING, GUMMED LABELS

50 8 1/2 x 11 HAMMERMILL Letterheads with 50 envelopes \$1.00 postpaid. Benneville Printing, Box 1931, Pittsburgh 30, Penna.

5000 6 x 9 CIRCULARS \$16.00 Postpaid. Samples free. Journal Printing Co., Newark, Ark.

HIGH Grade business stationery. Lowest prices. Samples. Crow, 533 18th St., Huntington 3, West Virginia.

100 8 1/2 x 11 HAMMERMILL Letterheads, 100 envelopes, (5 lines) \$2.00. R. Cook (Dept. 229), 730 West Gift, Peoria 5, Illinois.

100 8 1/2 x 11 HAMMERMILL Letterheads and 100 envelopes \$1.98. Herbert Hudson, 261 Woonasquatucket, Centredale, R. I.

400 8 1/2 x 5 1/2 LETTERHEADS \$1.35. Mango, 555A South 20th, Newark 3, N. J.

SHIPPING Labels—Gummed, (5x3) printed attractive 2 colors, \$5.50 prepaid. Certified Press, 400 Lafayette St., New York.

MIMEOGRAPHING Specialists—Any copy. Reasonable. Mailers Service, Box 606-K, Chicago 90, Ill.

1,000 BLOTTER Cards \$2.50 postpaid. Samples. Box 174, Niagara Falls, N. Y.

500 LETTERHEADS And envelopes, \$9.00, prepaid. Sumar Press, 81 W. Van Buren, Chicago, Ill.

IF You purchase 5,000 or more printed forms—mail your copy for savings and estimates to Courier Digest, Charleroi, Penna.

GLO-BRITE Letterheads "increase" business. Beautiful combination colors. Samples free. Rienzi Press, 24 North 7th Street, Newark 7, New Jersey.

100 ENVELOPES Printed, 2-colors \$1.00. Samples. Box 523, Rochester 2, N. Y.

BUSINESS, Personal stationery. State requirements. Samples. Mero Products, 100 Morrison, Punxsutawney, Penna.

BETTER Grade printing reasonable. Estimates on anything. Economic Press, Leonia, N. J.

1000 BUSINESS Cards, \$2.50 prepaid. Samples free. Reliable Print Shop, 905 East Jefferson, Louisville 6, Ky.

SAVE Money on your printing. Write today for new, low price list and offset ordering chart PM-1 free. We photograph your copy and reproduce it on white or colored paper. Advertisers Service Litho, 161 W. Harrison, Chicago 5, Illinois.

SEND 10c Now, for our 48 page 1949 price list—refunded first order. McCall Press, 1326 South 27th, Omaha, Nebraska.

1000 BUSINESS Cards (embossed) \$2.95 postpaid. Zephyr Printing, Box 312ppm, Venice, California.

500 3/4x2 1/4 FOUR Line gummed stickers 35c; red border 50c. Moritz Printery, Saginaw, Mich.

QUALITY Printing—Reasonable prices. Fast service on catalogs, folders, publications. Write for prices. Bagby Printing Co., Georgetown, Ohio.

MIMEOGRAPHING—Letters, pricelists, formulas, instructions. Lowest prices. Lem's Letter Shop, 5710 Stanton, Detroit 8.

PRINTING OUTFITS AND SUPPLIES

REBUILT Presses, bought, sold. List 3c. Exchange, 212 Curtis, Meriden, Conn.

BARGAINS—Hand presses, supplies. Catalogs 10c. Customprint, 211-P, Springfield, Missouri.

MAKE Your own plastic printing cuts. New Plexiplate process. Plexiservice, Argyle 1, Wisconsin.

BARGAINS. Presses, type, supplies. Send stamp. 8 Walden, Cambridge 40, Mass.

HEMOCRAFT Presses, supplies. Catalog 10c, refundable. Riegel, 1111 Harrison, Philadelphia 24, Penna.

PRINTING Presses, type, supplies. Lists 3c. Turnbaugh Service, Loysville, Penna.

PRINTING Presses, type, supplies. Send dime for complete illustrated printer's supply book, details and press samples. Kelsey, Inc., A-11, Meriden, Connecticut.

INEXPENSIVE Home-made printing press. Details free. Novelty Shop, Downsville, Louisiana.

PATENT ATTORNEYS

INVENTORS—Patent laws encourage the development of inventions. The Rules of Practice of the U. S. Patent Office advises—unless an inventor is familiar with such matters—that he employ a competent registered attorney or registered agent, as the value of patents depends largely upon the skilful preparation of the specifications and claims. Write for further particulars as to patent protection and procedure and "Invention Record" form at once. No obligation. Mc Morrow; Berman & Davidson, Registered Patent Attorneys, 1341 Victor Building, Washington 1, D. C.

PATENT Protection—Unless an inventor is thoroughly familiar with such matters, he is advised to employ a competent registered Patent Attorney as the value of a patent depends largely upon the skilful preparation of the specification and claims. Send for booklet, "Patent Protection for Inventors," outlining preliminary steps to take to obtain patent protection. Victor J. Evans & Co., 431-B Merlin Building, Washington 6, D. C.

PATENTS. Trade marks. Sanders, 6430 Evans, Chicago. Registered U. S. Patent Office.

INVENTORS: When you are satisfied that you have invented something of value write me, without obligation, for information as to what steps you should take to secure a patent. Write Patrick D. Beavers (Formerly Randolph & Beavers) Registered Patent Atty., 935 Columbian Bldg., Washington 1, D. C.

PATENTS. "Proof of Invention" folder mailed without obligation. E. E. Vrooman, Registered Patent Attorney, 505 McKim Building, Washington 5, D. C.

C. A. SNOW & Co.—M-427, Snow Building, Washington 1, D. C. Registered Patent Attorneys. Write for information.

PATENTS—Trade marks. Irving L. McCathran, 315 McLachlen Bldg., Washington 1, D. C. Registered Patent Attorney.

INVENTORS: Learn how to protect your invention. Unless the inventor is familiar with patent matters, he should engage a competent registered patent attorney or agent to represent him. We are registered to practise before the U.S. Patent Office and prepared to serve you in handling your patent matters. "Patent Guide for the Inventor" containing detailed information concerning patent protection and procedure with "Record of Invention" form will be forwarded to you upon request—without obligation. Clarence O. O'Brien & Harvey Jacobson, Registered Patent Attorneys, 91B-A District National Building, Washington, D. C.

INVENTORS. For "Record of Invention" form, contact Carl Miller, Registered Patent Attorney, Woolworth Building, New York.

INVENTORS: Without obligation, write for information explaining the steps you should take to secure a patent. John N. Randolph, Registered Patent Attorney, 203 Columbian Bldg., Washington 1, D. C.

"INVENTOR'S Guide" free on request. Frank Ledermann, Registered Patent Attorney, 154 Nassau St., New York 7, N. Y.

INVENTORS: Write for free brochure "Evidence of Invention." Labiner, World Building, New York 7.

PATENT Practice before U. S. Patent Office. Validity and infringement investigations and opinions. Booklet and form "Evidence of Conception" forwarded upon request. Lancaster, Allwine & Rommel, Registered Patent Attorneys, Suite 411, 815-15th Street, N.W., Washington 5, D. C.

FOR INVENTORS

INVENTORS—If you consider your invention to be something of importance, you may take steps to protect it with a U. S. Patent which gives you the right to exclude others from making, using and selling your invention as claimed. "Patent Protection for Inventors" booklet outlining steps to take to secure patent protection will be mailed promptly without obligation. Victor J. Evans & Co., Merlin M. Evans, Registered Patent Attorney, 432-B Merlin Building, Washington 6, D. C.

PATENT Searches \$5.00. Reports air-mailed in 4 days. Invention protection forms free. Write Miss Ann Hastings, Patent Searcher, P.O. Box 176, Washington 4, D. C.

INVENTORS—Patent laws encourage the development of inventions. The Rules of Practice of the U. S. Patent Office advises—unless an inventor is familiar with such matters—that he employ a competent registered attorney or registered agent, as the value of patents depends largely upon the skillful preparation of the specifications and claims. Write for further particulars as to patent protection and procedure and "Invention Record" form at once. No obligation. McMorrow, Berman & Davidson, Registered Patent Attorneys, 134-Z Victor Building, Washington 1, D. C.

INVENTORS—Possibly I can help you. Many years experience. Charles A. Scott, 773PM Garson Avenue, Rochester 9, N. Y.

DEVELOP Your ideas now. Free booklet. Elo Development Company, Long Island City 1.

PATENT Searches \$5.00. Reports air-mailed in 4 days. Invention protection forms free. Write Raymond L. Smith, Patent Searcher, 410 Bond Building, Washington 5, D. C.

BUY Patents. Cash. Wm. H. Evans Agency, 4016 East 15th Street, Oakland 1, California.

PATENTED. Unpatented inventions promoted. M. Joyce Humphries, 1424 Landtitle, Philadelphia 10, Penna.

PATENT Searches \$5.00. Reports air-mailed within 4 days. Invention protection forms free. Write Patent Research Service, 703M Albee Bldg., Washington 5, D. C.

INVENTORS: The usual first step is to have a search of the U. S. Patents conducted, so I can report on patentability. Write, without obligation, Patrick D. Beavers (Formerly Randolph & Beavers), Registered Patent Atty., 936 Columbian Bldg., Washington 1, D. C.

PATENT Searches \$5.00. Reports air-mailed in 4 days. Invention protection forms free. Write Patent Research Engineering, 318 Evans Building, Washington 5, D. C.

INVENTORS: If you have an invention for sale, patented or unpatented, write Institute of American Inventors, Dept. 40A, 1926 Eye St. N.W., Washington 6, D. C.

INVENTORS: Learn how to protect your invention. Unless the inventor is familiar with patent matters, he should engage a competent registered patent attorney or agent to represent him. We are registered to practise before the U.S. Patent Office and prepared to serve you in handling your patent matters. "Patent Guide for the Inventor" containing detailed information concerning patent protection and procedure with "Record of Invention" form will be forwarded to you upon request—without obligation. Clarence A. O'Brien & Harvey Jacobson, Registered Patent Attorneys, 91A-A District National Building, Washington, D. C.

INVENTORS' Financial assistance. Investment Development Company, Box 1462, Amarillo, Texas.

"INVENTOR'S Guide" free on request. Frank Ledermann, Registered Patent Attorney, 154 Nassau St., New York 7, N. Y.

INVENTORS: Without obligation, write for information explaining the steps you should take to secure a patent on your invention. John N. Randolph, Registered Patent Attorney, 203 Columbian Bldg., Washington 1, D. C.

CASH For your idea. 280 manufacturers need inventions, patented or unpatented. List free. Invention Bureau, 208M Clinton, Oak Park, Illinois.

INVENTIONS WANTED

MANUFACTURER Needs new automotive, truck or railroad hand tools to complete present line. Will buy your manufacturing and sales rights on such tools either outright or on a royalty basis. Old firm, financially sound. Howry-Berg Steel and Iron Works, Inc., 2949 N. Speer Blvd., Denver 11, Colo.

INVENTIONS Wanted. Patented or pending only. Inventors' Exchange-B, Hartford 1, Conn.

PATENT Wanted. Royalty basis. Rm. 3-C, 2100 Walnut, Philadelphia 3, Penna.

WE Sell patents. Submit full details. Universal Guaranty Co., Lakewood, N. Y.

HIGHEST Royalties—Cash. Official U. S. I. R. C. certification. Request free Booklet "M". Universal Marketing Co., 354 South Spring St., Los Angeles 13, Calif.

CASH For your idea. 280 manufacturers need inventions, patented or unpatented. List free. Invention Bureau, 208M Clinton, Oak Park, Illinois.

INVENTORS: Hundreds of manufacturers have requested our assistance in locating marketable new products. Complete information, free. Institute of American Inventors, Dept. 40-D, 1926-Eye St. N.W., Washington 6, D. C.

BOOKS—All Kinds—Homecraft, Radio, Plastics, Boat Building, Photography, Model Building. Catalog free. Popular Mechanics Press, 200 E. Ontario St., Chicago 11, Ill.

PATENTS FOR SALE

PATENTS Pending. Simple. For sale. Dr. Roberts, Cross City, Fla.

INVENTORS: Test the commercial value of your patented or unpatented inventions, quickly and inexpensively. Write for free information. Institute of American Inventors, Dept. 40-B, 1926-Eye St. N.W., Washington 6, D. C.

MANUFACTURING

SMALL Lot production wanted. Aluminum castings; stampings; screw machine; plastics. J and M Company, Burlington, Kentucky.

MODELS. Experimental work; designing; manufacturing. Henry, Engineer, 2815 Hudson Blvd., Jersey City 6, N. J.

MODELS—Small lot manufacturing. Metals, plastics, etc. Milburn, Burlington, Kentucky.

MODELS, Tools, dies, experimental work; large and small lot manufacturing. Van-Ess Specialties Company, 212 W. 14th Street, Covington, Ky.

MODELS, MODEL SUPPLIES

COVER Your flying models properly with Grafiglu cement. Contains plasticizer. Also an excellent adhesive for cloth, metal, and their combinations. Economy jar (4 oz.); \$1.00 prepaid parcel post. Cumer Laboratories, 4053 Lindell Blvd., St. Louis 8, Mo.

SHIP Models—Kits, fittings, plans, books, engines. Illustrated catalog 25c. James Bliss & Co., Inc., 220 State Street, Boston, Mass.

SHIP Model kits. Send 15c for 1949 catalog. Model Shipways, Folio 60, 476 Main Street, Fort Lee, New Jersey.

SHIP And yacht model fittings; blueprints. Send 25c for illustrated catalog No. 21—listing hundreds of items. A. J. Fisher, 1002-1 Etowah Ave., Royal Oak, Mich.

RAILROADERS—50c Gets new 1949 catalog reference manual. State O or HO gauge. Walthers, 247 Erie, Milwaukee 2, Wis.

LARGE Illustrated catalog Lionel trains and accessories, 10c. Bens Hobby Shop, 72 West Washington, Chicago 2.

MINIATURE Steam locomotives, 1/4", 1/2", 3/4" scales. Castings, parts, rail, steam fittings! Thorough drawings with instructions. Catalog 25c. Little Engines, Wilmington, Calif.

SHIP Models and yacht supplies complete. Large 64 page catalogue 30c. Bill Wild's, 510 East 11 St., New York City 9.

LANDLOCKED Sailors! Here's a beautiful, richly illustrated, fully descriptive catalogue of famous model ships—whalers, slavers, corvettes, etc., authentic in every detail. Send for it today. Only 25c. Halesite Yacht Service, Inc., Halesite, Huntington, N. Y.

BUILD Historic ship models, complete kits 39c to \$8.50; send 10c for catalog. Ideal Models, 19 West 18th Street, New York 11, N. Y.

KEEP In touch with the activities of the British modelmaking fraternity. Send a dollar bill for year's subscription (4 issues) Modelcraft Magazine and list. 77 Grosvenor Road, London, S. W. 1.

HOME CRAFTSMEN

LAWN Chairs, garden figures, furniture, novelties, toys, etc., 69 popular plans with full size patterns, \$1.00. Mastercraft 2M, 7041 Olcott, Chicago 31, Ill.

LEATHERCRAFTERS—Get your new second 1948 edition of "The Leatherworkers' Bible"! Completely illustrated catalogue and textbook; instructions, descriptions and actual leather samples—\$1.65 postpaid. Guaranteed to exceed any expectation or your money refunded. Artcraft Leather, 271 12th St., Dept. PM-2, Oakland 7, Calif.

NEW 1949 Illustrated catalogue. 84 pages showing thousands of items for the leather crafter. Leathers, copper, tools, supplies, designs, patterns, books, and ready cut projects. Send 10c today to cover handling charges. Russo Handicraft Supplies, 239 South Spring Street, Dept. PM2, Los Angeles, California.

FREE Price list. Flocking kit containing 6 packages different colored flock, brush, adhesive, designs, instructions, \$1.00 postpaid. 2 packages flock 25c. A and M Crafts, 672-C East 91 Street, Brooklyn 12, New York.

SHELLS. Plastics, findings. Lowest prices. Free catalog. Frances Jones, Box 251, Sarasota, Fla.

HUNDREDS Show-how plans, patterns, descriptions various workshop projects: woodworking, metal, plastics, leathercraft, home repairs. Read Popular Homecraft, published bimonthly. Sample copy 35c; \$2 year. 814-M North Tower Court, Chicago.

SCRAP Leather, assorted colors. Six pounds for \$1.00 prepaid. Box 397, Tulsa, Oklahoma.

TOOLS, Machinery for home craftsmen, hobbyists, mechanics. Make your shop pay profits. Details free. Precision Tool Service, 55 E. Washington, Chicago 2, Illinois.

SAVE Thousands building your own home. Practical 47-lesson home-study course explains home-building A to Z. Includes plans and specifications for 6-room house. Others using with great success. Big 22-page book sent free. Commercial Trades Institute, Dept. DC2-2, 1400 Greenleaf Ave., Chicago 26, Ill.

SHARPEN Circular saws at home. Complete outfit \$6.95. Sure-Sharp, Box 24-C, Santa Ana, Calif.

FLOCKING Kits \$5.00. Plaster casting supplies. Kalamazoo Mail Order, 705 Barney Road, Kalamazoo 84, Michigan.

BOOKLET. Helpful hobbycraft hints and catalog 10c. Leisure Hour Products, 416-20 Rose, West Hazleton, Penna.

UNPAINTED Figurines. Wholesale and retail. Free list. K. & H., 334 E. 22nd St., Minneapolis, Minn.

LEATHERCRAFT Lacing, bargains! Francis Byrd, 3406 Montrose Ave., Richmond, Virginia.

"KLONDIKE" Jewelry findings—bracelets, pins, earrings, chains, rings, stones, clips and other jewelry parts. Easy to assemble. Sample pound \$2.00, five pounds \$7.50. Imported cut stones. For rings, jewelry, novelties, etc. All shapes, colors, sizes. Sample 100 stones assorted, \$1.50 lot. Thousand lots, \$5.00. Imported beads, all colors, sizes, sample pound \$1.00, five-pound lots, \$4.00. Prepaid only. Merchandise Distributing, Dept. 1, 19 E. 16th Street, New York 3.

MYRTLEWOOD Now available. World's most beautiful wood. Found only in Oregon and Holyland. Make your own novelties. Information furnished. Dillard Myrtlewood Products, Dillard, Ore.

TURN Your workshop into cash. Send postcard for catalog of modern saleable projects. Craftplans, 7241-P Madison, Kansas City 5, Mo.

WINTER Shop project deals. Designs and materials for lamps, tables, etc. Veneers, Sedlo Company, P.O. Box 7161, New Orleans, La.

LEATHERCRAFTERS: Belt kits, projects, leather, supplies. Free catalog. Art Leather, 411 Joseph Ave., Rochester 5, N.Y.

TORTOISE Shell makes beautiful costume jewelry. Bracelet, earring, and pin blanks. Polished. All four \$1.00. Earring blanks free for stamp. Sam Patchett, 5053, Cristobal, Canal Zone.

TEXAS Ebony, America's most beautiful lathe turning wood. Large piece \$1.00, prepaid. Sample 10c. Information on southern woods, stamp. StarCraft (1), Edinburg, Texas.

BANDSAW, Jigsaw owners, let your machine bring extra profits, fun. Free details. Nu-Art, 33 Rosemont, Weymouth 91, Massachusetts.

MAKE Your own jewelry! All types of findings, metal and plastic; cameos, beads, shell kits, illustrated catalog, 20c. Hobby Art, P.O.B. 276, Dept. 7, New York 18, N. Y.

50 PATTERNS Toy furniture, action toys, etc., \$1.00. Continental Homecrafters, 907 Birch, Eau Claire 3, Wisconsin.

CATALOG: Patterns plywood novelty furniture, lawn ornaments, letters, numerals, plaques, frames, silhouettes, weathervanes, toys. Decal transfers. Over 100 other items. 200 articles illustrated. 25c, refunded first order. (No stamps please). Wo-Met Shop, Box 167, Ashburn, Georgia.

LEATHER, Retail, mail orders, catalog, tools, lacing, supplies. National Handicraft Co., 30 Frankfort St., New York City 7.

PLASTIC Jewelry supplies. Free catalog. J & M Novelties, Box 464P, Griffith, Indiana.

KNOCKDOWN Cedar chests. Lumber and veneers. Free price list. Giles & Kendall Company, Huntsville, Ala.

LEATHERCRAFT! Complete stocks of leathers, tools, supplies. Immediate shipment. Free catalog. Kit Kraft, 3203 W. Washington Blvd., Los Angeles 16, California.

CERAMIC Jewelry supplies, bar pins, ear screws, for ceramic and woodworkers; also glass and seashell assemblers. Free catalog. Philadelphia Badge Co., Dept. B-1, 1007 Filbert St., Philadelphia, Penna.

COPPER And brass materials. Complete line for craftsmen and workshops. Catalog A free. Groundmaster Company, Boulder, Colorado.

SPECIAL Offer: 80 full size toy, novelty, and lawn ornament patterns only \$1.00 postpaid. Lynds, Box 193D, Medway, Mass.

START Plating business at home. Amazing profits. Make own outfit. Inexpensive. Illustrated instruction booklet 25c. Popular Mechanics Press, (C-43), 200 E. Ontario, Chicago.

MAKE IT YOURSELF

PIPE Smokers blend your own mixtures. The why and how. Formulas. Sauces. Tobacco Blenders Handbook \$1.00 post paid. Refundable. Blair House, Dept. P, Montclair, N. J.

BUILD Concrete blockmaker. Inexpensive. Practical. Vibrator or hand. Write. Clyde Lee, Mountain View—A, Oklahoma.

TINKERING With and building things catalog handbook 25c. Details free. Agents wanted. Edman, 307J, Radio City Station, New York 19.

BALL Bearing arbors, pillow blocks, other tools. Free catalog, return mail. Hawthorne Tool Co., Otsego, Mich.

PLASTIC Paint made at home. Formula 25c. Ingredients can be bought local hardware. T. Zimmerman, 38 North 6th Street, Reading, Penna.

"CONCRETE Block Homes." 32 page booklet on how to build. \$1.00. Other home building booklets, \$1.00. H. C. Lightfoot, Civil Engineer, Richboro 1, Penna.

STREAMLINED, Built-in kitchen cabinets to fit any kitchen. Complete, easy to understand detailed plans and specifications showing "professional" construction methods. All for \$1.00. Thombert Co., Box 447 M, Newton, Iowa.

MAKE It yourself book of handicrafts \$1.00. Free catalogue, interesting books. A. Faller Company, 201 Dewey Street, Newark 8, New Jersey.

GRANDFATHER Clock easily built. Big savings. See ad page 298.

BUILD Your own light or heavy duty garden tractor. Send postcard for free information on plans, easy instructions. Elsworth Tractor Co., Dept. A, Camp-tonville, California.

SAVE Up to half on hot water bills. Average tank poorly insulated, if at all. Use \$5 worth locally obtained material. Complete illustrated instructions 50c. Satisfaction guaranteed, long experience. Economic Enterprises, 65 Saville Row, Quincy, Massachusetts.

SUPERVISE My self-prefabricated houses. 182 drawings. Instructions \$1.00. Nelson Frissell, Civil Engineer, Gardner 101, Massachusetts.

MAKE Your own handy lightweight concrete blocks quickly with new block-maker. Circular stamp. Manual 25c. Peerless, New Lenox, Illinois.

SOLAR Water heater systems efficient any locality. Standard materials, low cost and easily built. Free facts. Solar Water Company, Box 175, Coral Gables, Florida.

ELECTRIC Operator, for overhead garage doors up to 7½ feet lift, sectional or one piece, simple to install. Open or close and lock door, also switch garage light from drivers' seat of your automobile. Choice of electronic or key control. Automatic clutch permits manual operation of door from within, in case of power failure. Key controlled model, complete including 110 v. 60 cy. motor \$187.50. Electronic dash control model \$222.50. Prices f.o.b. factory. Sales Incorporated, 3934 North Kilpatrick Avenue, Chicago 41, Ill.

PLANS AND BLUEPRINTS

MANUFACTURE Toys, full size patterns, over 100 easy to make all purpose toys \$1.00 postpaid. Free catalog. Variety Print Service, 307 White Bldg., Buffalo 2, N. Y.

WATCHES, OLD GOLD, JEWELRY

WATCHMAKERS' Tools, supplies, sold—bought. Catalogue! Bengal Company, Culver City, California.

GOLD \$35.00 Ounce—Mail old gold teeth, jewelry, watches, diamonds—receive cash by return mail. Satisfaction guaranteed. Free information. Dr. Weisberg's Gold Refining Company, 1500-Q Hennepin, Minneapolis, Minn.

HIGHEST Prices paid for old gold, silver, platinum, diamonds, watches, gold teeth, old jewelry. Send now. Cash immediately. Goods returned if offer is not satisfactory. United Smelting Works, (The Old Reliable), 39-B South State, Chicago 3.

HIGHEST Cash for old, broken jewelry. Mail gold teeth, watches, rings, silverware, diamonds, spectacles. Satisfaction guaranteed. Free information. Rose Smelting Co., 29-A East Madison, Chicago.

GEMS, Precious and semi-precious, all genuine, from world wide sources. Deal direct, no overhead, save money. Catalog 10c. Hill Co., Route 7, Salem, Oregon.

TOBACCO, SMOKERS' SUPPLIES

SECONDS \$5.00 Pipes 65c. Briar block, bit 75c. Silver bands, carnauba wax. Free literature. Carvapipe, 2829-G Dixie, Hamilton, Ohio.

PIPE Repairs. Mouthpieces (bits) for any make, size or shape briar pipe replaced. Only 75c. Send pipe and money. Repaired pipe returned postpaid. Dept. PM-1, Benbow Briar Pipe Co., 49 E. First Street, New York 5, N. Y.

CIGARETTES—Popular brands; minimum 3 cartons. Price \$1.50 per carton; postpaid. Add 3c per carton for west of the Mississippi. Send check or money order. King Co., Box 569-D, Dover, Delaware.

SMOKING Pipes repaired: Stems \$1.00, silver bands \$1.00, renovate 75c. Meer-schaum repairs appraised. Prepay and save c.o.d. charges. The Humidor, 8129 Euclid, Cleveland 3, Ohio.

FREE—Booklet telling how to blend pipe tobacco to fit your taste at low cost. Pete Moberly, Box 963, Owensboro, Ky.

SECONDS \$5.00 Pipes, 2 for \$1.00. Briar blocks, bits, silver bands, screw connectors. Free literature. Carvapipe, 2829-G Dixie, Hamilton, Ohio.

SURVEYING INSTRUMENTS

GUARANTEED Factory rebuilt transits and levels, sale, or rent, with purchase option. We will repair, trade or buy old instruments. Write for list M-49. Warren-Knight Co. (Manufacturers of Surveying Instruments), 136 North 12th St., Philadelphia 7, Penna.

RAZORS, BLADES, SHARPENING

100 SURGICAL Steel blades for Gillette razors, \$1. Tomkins Brothers, 105 Fulton Street, New York 7, New York.

WHOLESALE—8 Million DuPont nylon hose, 3 pairs \$2.00. Ready Sibert Associates, Box 1242, Chattanooga, Tennessee.

FOR THE HOME

SEWING Machine motor kit complete, one year guarantee \$13.95. Sewlites \$1.95. Prepaid if cash accompanies order. Clark's, 244 North Main, Wichita, Kansas.

FOR SALE—MISCELLANEOUS

FREE List of surplus bargains. Marsden, 1010 Wyoming, Dayton 10, Ohio.

ARMY 2 Way combat phones. No batteries needed! New! 2 sets \$2.50. Akron Army Navy, 4379 Sunset, Los Angeles 27, Calif.

WARSHIP Photos. Glossy, 5 x 7, actual Navy pictures. Suitable for framing, 17 different 50c. Prints, Box 312, Westport, Conn.

WAR Surplus bargains: Send for our free illustrated circular of hundreds of hard to get items. Surplus Distributors, 701 W. Mitchell St., Milwaukee, Wisconsin.

WAR Surplus tents all sizes, clothing, paints, camping equipment, cots, canvas covers. Morsan, 10-17C 50th Ave., Long Island City 1, New York.

WAR Surplus, aircraft items, shop equipment, machinery and a million other items. Free catalog. Atlas Equipment, 229 Southwest Blvd., Kansas City 8, Mo.

WANTED—MISCELLANEOUS

SWAP, Sell, buy anything. Free lists. Swappers' Guide, Box 415, Evansville, Indiana.

CASH For Singer sewing machines—\$40.00 Model 66, \$20.00 Model 27, \$25.00 White Rotary. Ship head only. Clark's, 244 North Main, Wichita, Kansas.

WANTED—New, worth while mail order items to add to our line. Full details your proposition invited. The Universal Line, Orange, Massachusetts.

ANYTHING Of value. Robert, 207 North 5th Street, Springfield, Illinois.

QUICKSILVER (Mercury) urgently needed! Immediate payment. Wholesale Terminal, Norwood, Massachusetts.

PERSONAL

SECRETLY Stop that radio robbing your sleep late at night. Simple, private, harmless electric device. Send \$1 money order. H. R. Villarreal, Cerrada Vallarta 1, Mexico, D. F. Mexico.

BORROW By mail. Loans \$50.00 to \$300.00 to employed men and women. Easy, quick. Completely private, confidential. No endorsers. Repay in convenient monthly payments. Details free in plain envelope. Write State Finance Co., 216 Savings & Loan Bldg., Dept. P-14K, Des Moines 8, Iowa.

STUTTERING Corrected at home. Lesson technique successful with adults and children for many years. Send for free literature. The Athenium, PM-22, 1714 Chestnut, St. Louis 3, Mo.

FOOT Sufferers get instant relief with a pair of soft sponge rubber arch supports. Send \$1.00 to Cadwallader, 311 Crosby Bldg., Buffalo 2, N. Y.

RUPTURED? Positive comfort, no understraps, no steel, no elastic. Write Smith Manufacturing Company, Preston, Ontario.

TI-TRADE. Send 6 ties and \$1.00. Receive 6 equal quality, cleaned. Color preferences. Box 6065, Washington 5, D. C.

RECEIVE "Interesting Mails"—25c keeps your name on mailing list for six months. Bentz, Jr., Chatawa 44, Mississippi.

HOW You can find out! Information discreetly developed, any matter, person, problem, anywhere. Personal-business assignments, representations undertaken. Nation-wide. Officially licensed, bonded service established 1922. Reasonable. Confidential. William Herman, 170 Broadway, New York.

HAIR Falling? Dandruff? Write Trichologist, 137 Lewis St., Phillipsburg, N. J.

MISCELLANEOUS

AIR Tanks: 400 lb. pressure, 104 cu. inches, \$1.00. C-O-Two tanks: 1800 lb. pressure, \$1.49. Postpaid anywhere. United Surplus Sales, 233 Broadway, Oakland, Calif.

STOP Hoarding unwanted neckties. Send seven ties and \$1.00. We guarantee to mail you seven nice ties all freshly dry-cleaned. Ideal Tie Exchange, Dept. H, 3439 Michigan Ave., Chicago 16, Ill.

"RECEIVE Mail," Money-making offers, opportunities, catalogs. Name listed 10c. Ideal Service, Park Ridge 10, Ill.

TATTOOING Outfits, supplies. Illustrated list free. Zels, 728 Lesley, Rockford, Illinois.

AIR-FOAM Rubber. All sizes available. Write for prices. United Air-Foam, 233 Broadway, Oakland, Calif.

BUY Wholesale. One of America's largest distributors offers sensational savings on refrigerators, freezers, small appliances, bicycles, tricycles, pen and pencil sets, housewares and sporting goods. Orders filled for 1 or more. Send for free catalog today! P. M. Mands Distributors, Charleston, West Virginia.

AMAZING Non-metallic magnetic discs float in air. Set of 3-35c. 3 sets \$1.00 postpaid. Discs, 3104 West Vliet, Milwaukee 8, Wis.

WE Purchase Indianhead pennies. Complete all coin catalogue 10c. Fairview, 277 Broadway, New York 7.

RECEIVE Mails, magazines, samples. Your name in numerous mailing lists 10c. Greenwood, 273 Broadway, New York 7.

"THIS Is It!" Learn sewing machine repairing, plus profitable installing our motor kits, etc. Write, Taylor Service Co., Hamilton 6A, Ohio.

SILVER Tint plating polish for tarnished or copper articles. It's new, \$2.50. Introductory value \$1.25; refund guaranteed. Mazza's Chemical Service, 398A Columbia Street, Cambridge, Mass.

ELECTRIC Pencil—Writes, engraves all metals. 110 volts. \$2.95 postpaid. Reb Industries, 265-DR, Elmhurst, Illinois.

"INTERESTING Mails." (Free gift), 25c. Scott, 521 North Memorial, Rockford, Illinois.

INSTRUCTIONS For building Radio Treasure Finder, \$1.00. Wyss, 104 1/2 Francis, St. Joseph, Mo.

HOT Water anytime, anywhere with this new heavy duty electric water heater, plugs into light socket. \$5.95 postpaid. Money back guarantee. Elden Products Company, 41 Burroughs, Detroit 2, Mich.

PANNING Gold—Free instruction booklet. Catalogue mining books; supplies. Old Prospector, B-220, Dutch Flat, Calif.

ORANGES, Red grapefruit. Tree-ripened, my orchard. McCants, Weslaco, Tex.

NECKTIE Exchange Inc. Send six neckties you're tired of wearing and \$1.00 cash, check, m.o., receive six beautifully reconditioned different neckties, and coupons for valuable gift absolutely free. 159 North Wabash, Department C, Chicago 1, Illinois.

OUT Of print books found quickly. Send wants, no obligation, free catalog. Coast Bookfinders, Box 8686, Los Angeles 46, California.

STOP Counterfeiting. Positively analyzing counterfeit money. \$1.00 prepaid. Metro, 44 N. Albany, Chicago.

UNUSUAL Shell novelties. Free catalog. Shell House, Box 1685-B, Miami 35, Fla.

SQUARE Dance instructions. Calls. 25 sets. \$1.00. Rayburne, Eureka Springs, Arkansas.

SMASH Your worries and weakness. Enjoy the feeling of success and good health. Our home-study self-discovery plan may be the very thing you need right now. Write today for free lecture and details. No obligation. Personal Psychology School, 1008-9 Washington Bldg., Louisville 2, Kentucky.

YOUR Name engraved on beautiful brass plate 1 1/2"x9". Postpaid \$1.00. H. V. Ackerman, Malden on Hudson, N. Y.

25c SAVES You dollars. Amazing bargain catalog. Watches, clothing, etc. Save to 50% (25c refunded first order). Tip Top Sales, Box 9083PM, Dallas, Texas.

\$10,000 OFFERED By U. S. government for each usable uranium find. Goldak now offers an all-purpose Geiger Counter to prospectors of radioactive ore. For free bulletin, write The Goldak Co., Dept. M, 1542 W. Glenoaks, Glendale 1, Calif.

GEIGER Counters for finding uranium ores. Simple operation. Low prices. Interesting literature free. Fisher Research Laboratory, Inc., Palo Alto, California.

BIG Mail. Everlast ball pen 25c, 4 for dollar. Capener, 849 Almaden, San Jose, Calif.

LUMINOUS Powdered pigments. Trial offer and listing. \$1.00 prepaid. Glowelico, 475-MP Fifth Ave., New York 17.

THE Capper—New work glove. Outwears ordinary gloves up to seven times. Material contains thousands of tiny loops which form natural insulation against heat. Same principle makes it resist cutting and abrasion. Beats leather for handling rough or sharp materials. Safety cuff for easy removal. Washable. Ideal for open hearth, blast furnace, hot mill, foundry, recapping, kiln work. \$1.19 a pair. Three pairs \$3.50. Postpaid. Send check, money order, or postal note. Sorry, no c.o.d.'s. Please print address plainly. Practical Glove Co., Box 515, Johnstown, Penna.

TREASURE Locators. New electronic lightweight M-Scope mineral and metal finders are now available for immediate shipment. Built for arctic-tropic use. Revolutionizes locating of minerals, gold, silver, metal objects. Unsurpassed efficiency, factory guaranteed. Low prices, time payment plan available. Send for free 16-page illustrated booklet. Fisher Research Laboratory, Inc., Palo Alto, California.

THE Lord's coming! Get free proofs. International Evangelism, Box 263-X, Duluth, Minnesota.

TREASURE Finders! Goldak's new 11 pound lightweight, gold, silver and mineral locator, money-back guaranteed superior any other device. Free information. The Goldak Co., 1542 West Glenoaks Blvd., Glendale 1, Calif.

TATTOOING Machines, outfits. Free catalogue. Jensen, 120 West 83rd Street, Los Angeles 3.

MEDICAL Laboratory technicians in great demand. We train you in your own home, in your spare time. Also home study course in general Chemistry. Free catalogue. Imperial Technical Institute, Box 973-J, Austin, Texas.

NOW Ready: New, amazing Classified Advertising Record Book—prepared especially for classified advertisers. Here is a book that tells you instantly whether or not your advertising in any publication is paying you real results. You can tell immediately how many inquiries each publication produced—how much cash received from every ad. Spaces are provided for the name and address of the publication, date of issue, space used, rate, cost of ad, key number, etc. You have a complete record of each publication right before your eyes. Plenty of space to keep accurate record of 28 separate publications. You can have a copy by sending only 10c to cover postage and handling. Send for your copy now. W. F. Johnson, Classified Adv. Mgr., Popular Mechanics Magazine, 200 E. Ontario Street, Chicago 11, Illinois.

LEARN MEAT CUTTING EASILY-QUICKLY At Home-In Spare Time



The steady, dependable trade of Meat Cutting taught easily, quickly by improved HOME METHOD. National School, established over 25 years, has organized its famous "Learn By Doing" Classroom, Cutting room and Retail Market training system into sound, practical HOME STUDY form.

Now, by the miracle of this EXTENSION TRAINING you can prepare in Your Spare Time At Home, for a better job, bigger responsibilities or success and security in a store of your own. Remember, PEOPLE MUST EAT!

Buying, cutting, percentage, pricing, advertising, selling—a complete meat education. For beginner or men with ex-

perience. Thousands of successful graduates. Send coupon for FREE Bulletin NOW!

MAIL THIS COUPON TODAY FOR FREE BULLETIN

National School of Meat Cutting Div. U-102, Toledo 4, Ohio

Send me your FREE Bulletin on Meat Cutting and Meat Merchandising. No obligation. No Salesman will call.

Name _____

Street _____

City _____ State _____

Learn JEWELRY MAKING WATCHMAKING ENGRAVING

TRADES WITH
GREATER SECURITY



Above Average Pay. Trained Men Always in Demand.
Day and Night Classes. Enroll any Time. Write Today
for Free Catalog and Information.

Approved for G.I. Training

KANSAS CITY SCHOOL OF WATCHMAKING

America's Most Progressive Horological School
617-621 Wyandotte St. Kansas City 6, Mo.

Do you want

- ..to go to College?
- ..or to enter a Profession?

(Such as Accounting, Architecture, Nursing, Dentistry,
Teaching, Social Work, Osteopathy, Beauty Culture,
Optometry, Embalming, Chiropody, Law, Medicine, etc.)

- ..or get an Office Position?

To get anywhere, you practically MUST finish High School FIRST. You can complete our simplified High School Course in SPARE time at home, as FAST as your time and abilities permit. Equivalent to resident school work—prepares you for college, pre-professional examinations, business, industry. Standard texts furnished. Diploma. Credit for H. S. subjects already completed. Single subjects if desired. Low tuition, easy terms. American School, Chicago, est. 1897—endorsed by educators. Finish your high school education NOW. Write TODAY!

High School Course at Home

Many Finish in 2 Years

American School, Dept. H245, Drexel Ave. at 58th St., Chicago 37, Ill.
Gentlemen: Send me FREE information covering special training in subjects checked below. No obligation on my part.

- | | |
|--|--|
| <input type="checkbox"/> High School Course | <input type="checkbox"/> Diesel Engineering |
| <input type="checkbox"/> Architecture and Building | <input type="checkbox"/> Drafting and Design for Men & Women |
| <input type="checkbox"/> Automotive Engineering | <input type="checkbox"/> Plastics |
| <input type="checkbox"/> Business Management | <input type="checkbox"/> Private Secretary |
| <input type="checkbox"/> Electrical Engineering | <input type="checkbox"/> Mechanical Engineering |
| <input type="checkbox"/> Elec. and Gas Refrigeration | <input type="checkbox"/> Aviation |
| <input type="checkbox"/> Air Conditioning | <input type="checkbox"/> Salesmanship |
| <input type="checkbox"/> Railway Training | <input type="checkbox"/> Radio |
| <input type="checkbox"/> Electronics, Industrial | |

Name.....

Address.....

A Thousand and One
Ideas You Can
Use on the Farm!



POPULAR MECHANICS FARM MANUAL

Use it to Step up Farm
Efficiency — Increase
Production — Improve
Farm Appearance —
Save Time, Labor,
Money!

A Must for Every Farm
Family! Saves Money for
City Homeowners Too!

Here is the experience of hundreds of successful farm operators brought together in one handy, easy-to-read, easy-to-use, working handbook by the editors of Popular Mechanics. It is brimful of short cuts, labor-saving ideas, ingenious apparatus and methods that will simplify the day's work and lighten some of the more tedious chores, make money and save money for you.



HELPS IN THE FIELD — IN THE
BARN — IN THE HOME

Every department of the farm is covered in the Farm Manual. Every member of the family will find in it something that he or she can use to tremendous advantage in farm operation, maintenance and improvement, from the building and care of equipment to painting the farm home and fast freezing fruits and vegetables. It covers farm buildings, the farmhouse and other homes and is of interest equally to the woman looking for home improvement, beauty and convenience and the man striving for easier and more profitable operation.

ORDER TODAY — FOR YOUR-
SELF — FOR A GIFT

Use the coupon below. Mail it today. Book will be sent at once, postpaid if you include payment with your order. If you don't think the Farm Manual is worth even more than you paid for it after five days' use, send it back by mail and your money will be refunded. This may be the best investment you ever made. Rush coupon today.

284

FACT-PACKED PAGES

Hundreds of
Illustrations

Popular Mechanics Farm Manual is packed with practical ideas and usable information that can easily be worth hundreds of dollars to farm families and homeowners everywhere.

Farm Machinery and Implements
How to make and get the most out of farm implements.

Farm Workshop Equipment and Repairs
Ideas that can save hundreds of dollars.

Poultry and Livestock
How to build equipment, gadgets. Care of farm animals and poultry.

Vegetable Storage—Processing
Winter storage, home freezing tips, make your own freezer.

Farm Home Improvement
Fencing, repairing electrical appliances, plumbing, electrical wiring, saving coal, painting, curing leaky basements, hanging wall paper, making garden tools, garages, working with concrete, painting, etc.

Farm Hints and Kinks
Forty pages of illustrated, practical ideas, short cuts, etc. that will save time, labor and money.

MAIL COUPON • Money Back if Not Satisfied

POPULAR MECHANICS PRESS, Dept. 665
200 East Ontario St., Chicago 11, Ill.

Send.....copies of the Farm Manual at once.
 Remittance (\$3.00 each) enclosed. Send postpaid. Add 15% if outside U.S.A.
 Send C.O.D. (\$3.00 each) plus delivery charges. U.S.A. only.
 If sent as a gift to another, send name and address on separate sheet.

Name.....

Address.....

City..... Zone or Route..... State.....

DO ANY JOB.. EASIER.. QUICKER
MAKE MORE MONEY *in the*
BIG OPPORTUNITY
FIELDS

SEND NO MONEY
 Select the Books
YOU Need Now!
 We Ship C.O.D.
 Anywhere in U. S.
 and Will Refund
 Amount Paid if
 Not Satisfactory.

Here's the Help You Need
For Best Paying Jobs
Right NOW!

FREE TRIAL
IN YOUR OWN HOME

Used by Army, Navy, Other Government
Depts., 200 Schools and Industrial Firms.

Do it now! Get the better pay that goes to men with specialized knowledge. Get into one of these big opportunity fields. Big money and many other advantages await you if you prepare now. Here is the help you need—EASY—QUICK—AT LOW COST. Thousands of men have already used these famous books. Beginners and experienced men alike have doubled and tripled their earnings with this help. You too, can now get the special knowledge you need for top pay, better jobs, or a business of your own. This is your **GOLDEN OPPORTUNITY.**

AIR CONDITIONING

Big air conditioning boom is Nation-wide and bigger than ever. Alive with new opportunities! Get this non-technical book by international authority and be ready for your share of millions to be spent. Covers whole field. 450 pages. Illustrated. \$4.00.

SHEET METAL LAYOUT

Makes sheet metal layout work so simple that anyone can learn. Get this new instructor and get into the easiest, cleanest and best paying part of all sheet metal work. 143 jobs worked out in drawings and carefully explained. Gives standard for all sheet metal fittings. \$3.50.

BAILEY'S HANDBOOK

World famous handbook of universal questions and answers for Stationary, Marine and DIESEL engineers and firemen. Prepares for any license examination in installation, maintenance and operation of Diesel and steam plants. Pocket size. \$2.00.

MODERN WELDING

Newest book on all types of welding and heat treatment of metals. Written by recognized specialists in training men for production jobs. 430 Pages, 277 illus. Practical and Non-Technical. Covers everything you need to know. \$4.00.

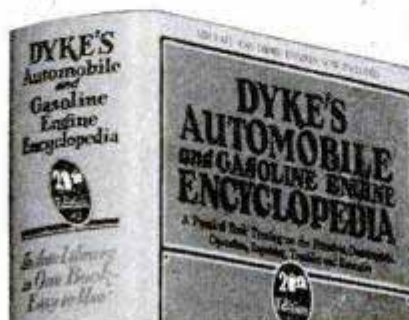

1948
21st
 EDITION
 Leading
 Auto
 Book
 for Over
 32 Years

World's Greatest AUTO BOOK

New Material, Specifications,
1947 Cars, 1948 Trucks, Busses,
Tractors, Diesels

Now with millions of cars needing repairs and thousands of men needed to do the work, you need the famous DYKE Auto Book more than ever before. New 21st Edition covers all principles, construction, repair, adjustments, testing, troubles and remedies. Over a half million copies of 20 editions of Dyke's have been sold. Buick Dynaflo, Farm and Outboard Motors and new electrical systems now covered. World's biggest book value. Only \$7.00.

This big book, a complete auto library in one volume, has 1483 pages—4600 illustrations and diagrams—weighs 6 lbs.—equal to 4 ordinary books.



The Easy Way to a
Profitable Business
Of Your Own!

Owners will spend big money to keep their good older cars looking like the new ones coming out. This is a practical money-making guide, ideal for shop owners and every man who wants a share of the millions to be spent in keeping old cars looking new. Tells how to get a good job or start business of your own with small capital. Covers everything including tools, methods and materials. Only book of its kind. 325 pages, 232 illustrations. \$3.50.

HOUSE WIRING — NEW EDITION

Get this new sixth edition of this standard and practical electrical wiring book. It gives complete practical instruction on every phase of house wiring in one handy volume. Goes further than most books on subject. Handbook style. Gives National Electric Code. 400 pages. 669 illustrations. Electrical work will reach a new high with millions of new homes to be built. Get started now. \$3.00.

CARBURETORS — Dyke

The standard guide in the best paying auto work for a generation. It has helped thousands of men make money. New edition covers engine tune-up, compression, ignition, carburetion, fuel pump valves, etc. Use this book to specialize in this big field. 244 pages, 549 illustrations. \$3.50.

Mail Coupon to **GOODHEART-WILCOX CO., Dept. 12, 1321 S. Michigan Ave., Chicago**

20 Million Refrigerators
Need Service and
Repairs

SEND NO MONEY! Mail Coupon

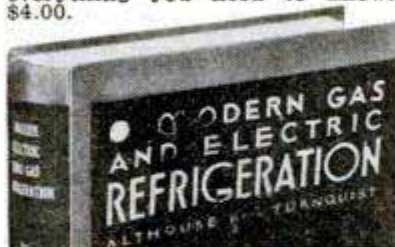

REFRIGERATION—Book of the Hour!

Biggest Opportunity in Many Years!
LATEST PRINTING — ALMOST 1000 PAGES

408 Pictures—17 Diagrams in Colors Makes All Refrigerator Service Maintenance, Repairs Simple as A. B. C.

Thousands of Refrigerators need repairs! Owners will pay big for competent service which will be needed more and more. Get **MODERN GAS AND ELECTRIC REFRIGERATION**, the non-technical guide to all types of refrigerators and get your share of this new profit. Get a job or start your own service business. This book will help you make money anywhere. It is the recognized standard book on the subject. Price \$5.00.

GOODHEART-WILCOX CO.

1321 S. Michigan Ave., Dept. 12, Chicago 5, Ill.

Send books checked, C.O.D. I will pay postman, plus few cents charges. If not satisfactory I will return books in 5 days and you will refund money paid. (Outside U.S. or possessions remit with order.)

- | | |
|--|--|
| <input type="checkbox"/> Gas & Electric Refrigeration \$5.00 | <input type="checkbox"/> Air Conditioning \$4.00 |
| <input type="checkbox"/> Dyke's Auto Book \$7.00 | <input type="checkbox"/> Engineers Handbook \$2.00 |
| <input type="checkbox"/> Dyke's Carburetor Book . \$3.50 | <input type="checkbox"/> Body and Fender Repair . \$3.50 |
| <input type="checkbox"/> Modern Welding \$4.00 | <input type="checkbox"/> Shop Math. (2 vols.) . . . \$3.00 |
| <input type="checkbox"/> Airplane Welding \$3.50 | <input type="checkbox"/> House Wiring \$3.00 |
| <input type="checkbox"/> Sheet Metal Layout . . . \$3.50 | <input type="checkbox"/> A.C. Power Wiring \$4.00 |
| | <input type="checkbox"/> D.C. Power Wiring \$4.00 |

If remittance accompanies order we will pay all postage charges under same return privilege.

Name _____
 Address _____
 City _____ State _____



Doesn't it seem more sensible?

ALL-VEGETABLE LAXATIVE

NATURE'S REMEDY (NR) TABLETS
—A purely vegetable laxative to relieve constipation without the usual griping, sickening, perturbing sensations, and does not cause a rash. Try NR—you will see the difference. Uncoated or candy coated—their action is dependable, thorough, yet gentle as millions of NR's have proved. Get a 25c box and use as directed.



FUSSY STOMACH?

RELIEF FOR ACID
INDIGESTION,
GAS AND
HEARTBURN



AVIATION

Aeronautical University Approved Training meets exacting standards of aviation industry, prepares for key positions, big opportunities.

Courses in:

- AERONAUTICAL ENGINEERING**, B.S. degree.
- AERONAUTICAL ENGINEERING DRAFTING**
- CERTIFIED AIRPLANE AND ENGINE MECHANICS ADMINISTRATION**—including sales.
- PRE-ENGINEERING**: Special course for high school graduates and veterans needing math and science.

Also refresher courses for Gov't Airplane and Engine Mechanics Licenses for those with aviation experience.

Oldest fully approved aviation school. Outstanding faculty, modern equipment, outside employment, placement service. Day, evening. Approved for Veterans. Send today for FREE catalog "Opportunities in Aviation."

AERONAUTICAL UNIVERSITY

Dept. 79, 116 S. Michigan Ave., Chicago 3, Ill.

FOUNDED
BY
CURTISS-
WRIGHT

LARGEST—PROOF OF THE BEST! WORLD'S LARGEST WATCHMAKING SCHOOL

Your lifetime career in watchmaking warrants the best of training . . . individual instruction by horological specialists, aided by giant working models, motion pictures and the greatest collection of watchmaker's tools and equipment ever assembled for teaching purposes. You get all this at Western Pennsylvania Horological Institute, largest among watchmaking schools and best-known among jewelers everywhere.

Enjoy the distinction of graduating from the largest school of its kind . . . know that you have had the best! Fully accredited and approved for veteran training.

WESTERN PENNSYLVANIA HOROLOGICAL INSTITUTE
Desk 40 Ridge Avenue Pittsburgh 12, Pa.

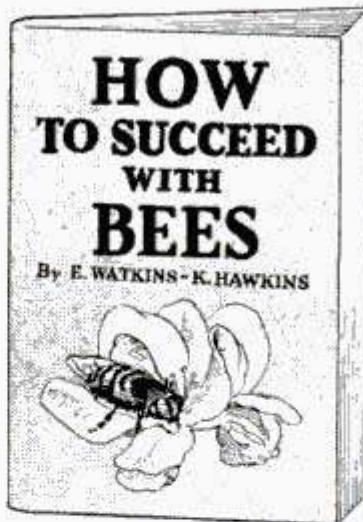

RAISE BEES SELL HONEY MAKE MONEY!

Get How to Succeed with Bees, written by two experts, which tells you all you need to know. Contains 190 tested successful plans to produce big crops of honey. Easy work and little capital required. There is always a ready market for honey and working with bees is fascinating. This 96-page well-illustrated book is only \$1.00 and is absolutely guaranteed to satisfy you or we shall refund your money. Send for your copy today!

POPULAR MECHANICS PRESS
200 E. ONTARIO STREET
CHICAGO 11, ILLINOIS



Row Boat—12 Foot
Dinghy—8 Foot
Dinghy—14 Foot Sailing
Training 5 1/2—6 Foot
Sea Sled—9 Foot
Outboard—12 Foot
Cruiser—18 Foot
Bicycle Boat—Kayak
Row Boat—Sectional
Dinghy—Sailing
Canoes—16 Foot
Sailing—12 Foot
Outboard—12 Foot
Outboard—Runabout
Pontoon Ice Yacht

FOR PLEASURE OR PROFIT DESCRIBES 17 LOW COST BOATS
Get this outstanding book and build a boat at home for your own use or to sell at a profit. You can do it. Just the boat you've always wanted—power, sail or row boat—17 different kinds and sizes.
Order **BUILD A BOAT** on postal card and pay only \$1.50 plus postage on delivery. Return in 5 days if not pleased and get money back. Or send \$1.50 with order and we'll pay postage. (Outside U. S. \$1.70 with order.) Order today.

POPULAR MECHANICS PRESS
Dept. 598, 200 E. Ontario, Chicago 11



Boy! What a Picture!

And boy, what a book is Popular Mechanics new **PHOTO HANDBOOK**. Gives you the big three of superior photography:

1. The secret of taking better shots.
2. The technique of clearer developing.
3. The way to build better photo equipment.

Be an expert! Have fun! Save money!

Paper covered edition on all newsstands . . . 60c

Order colorfully bound library volume from
POPULAR MECHANICS PRESS . . . \$2.00
200 E. ONTARIO ST. CHICAGO 11

FREE

TO VICTIMS OF DANDRUFF, DRY THINNING HAIR, OR DRY SCALP
16-page illustrated Booklet packed with helpful information bringing prompt relief and vital, lustrous hair.
REGIME COUNSELORS, Dept. T-1
9 S. Clinton St., Chicago 6, Illinois

★ Your training at W. P. H. I. prepares you to work in the finest jewelry stores in America. Working with precision instruments and jeweled movements is fascinating . . . exciting!

★ Become your town's most respected merchant with a profitable jewelry business of your own. Watchmaking is your big step to lifetime prosperity.

★ Your skill is your security as long as you live. You can begin your watchmaking career at home in your spare time.



"I WAS ASHAMED OF MY FACE

until Viderm helped make my skin clearer in one short week"

(FROM A LETTER BY E. S. JORDAN, DETROIT, MICH.)

If your face is broken-out, if bad skin is making you miserable, here is how to stop worrying about pimples, blackheads and other externally-caused skin troubles.

JUST FOLLOW SKIN DOCTOR'S SIMPLE DIRECTIONS



IT DOESN'T PAY to put up with a broken-out face. Your very success in business, love and social life may depend upon your looks. *Handsome and a good appearance usually start with the condition of your skin.* Nobody likes to look at a face that is blemished by blackheads or pimples. **WOMEN ARE ATTRACTED TO MEN WHO HAVE SMOOTH, CLEAR, HEALTHY-LOOKING SKIN.** Business executives don't choose men whose complexions are against them. Don't take chances with your success in life when this inexpensive Viderm formula may help you

Good-looking Skin Is Not for Women Only

You—yes, you—can have the same handsome complexion, free from externally caused skin troubles, simply by giving your face the special care that screen stars give theirs. There's almost nothing to it—it is just about as easy as washing your face. *The whole secret consists of washing your face in a way that thoroughly purges the pores of every last speck of dirt and grime—something that ordinary cleansing seldom does.* In fact, examination after examination shows that, usually, it is not a case of "bad skin" so much as a case of faulty cleansing. What you should use is a highly concentrated soap like Viderm Skin Cleanser. This penetrates the pores and acts as an anti-septic. Specks of irritating dirt and grime are quickly washed out. They dissolve and disappear, leaving your skin



DON'T DO THIS!

Don't murder your skin by squeezing it. Skin is delicate. When you break it, you leave yourself open to miseries. It's far easier, far safer, to let the Double Viderm Treatment help you enjoy a handsome, clearer, blemish-free complexion

entirely free of the dirt particles that usually bring out pimples, blackheads and other externally-caused skin troubles.

Squeezing pimples or blackheads to get rid of them is a nasty, messy business—but that isn't the worst of it. Doing so may also be injurious and leave your face with unsightly, embarrassing blemishes. There is, now, a much easier, safer, cleaner way to help you rid your face of ugly, offensive, externally-caused skin troubles. *You merely follow a doctor's simple directions*

Don't murder your skin! Here's all you have to do to get it smoother and clearer and to keep it that way. Use Viderm Skin Cleanser when you wash your face. Rub the rich lather of this highly-concentrated medicated soap on your face for just a few seconds and then rinse it off. Then apply a little Viderm Medicated Skin Cream and that's all there is to it. Viderm Medicated Skin Cream quickly disappears, leaving your skin nice and smooth. This simple treatment, used after shaving, helps heal tiny nicks and cuts, relieves razor-burn and smarting, besides conditioning your skin.

Give Your Face This Treat for 7 Days

Stop worrying and being embarrassed over what may happen

to your skin. Just send for your Viderm Double Treatment this minute, and be confident of a smoother and clearer complexion. Follow the simple directions, written by a doctor, that you will get with your Viderm Double Treatment. Then look in your mirror and listen to your friends admire your smoother, clearer skin—the kind that women go for

Just mail your name and address to The New York Skin Laboratory, 206 Division Street, Dept. 53, New York City 2, N. Y. By return mail you will receive both of the Viderm formulas, complete with full directions, and mailed in a plain wrapper. On delivery, pay two dollars plus postage. If you wish, you can save the postage fee by mailing the two dollars with your letter. Then, if you aren't thrilled with results, your money will be cheerfully refunded. Remember that both of the formulas you use have been fully tested and proven, and are reliable for you. *If they don't help you, your treatments cost you nothing.* After you have received your Viderm, if you have any questions to ask concerning abused skin, just send them in



GET INTO DIESEL-AUTO MECHANICS MASTER ALL PHASES

SHOP METHOD

HOME TRAINING

by an Established Resident School prepares you for **Many Good Jobs!**

Get Complete Training

Diesel-Automotive Industry needs trained men, to install, maintain and repair all types Diesel and Automotive engines — AND allied equipment. Now, National Schools offers you practical, proved home study training cover-

ing **ALL** phases. Basic instruction and specialization in field of your choice. All-embracing instruction. Valuable, large

engine manual — **TOOLS and EQUIPMENT** included. Earn while you learn. **INVESTIGATE**—get full information.

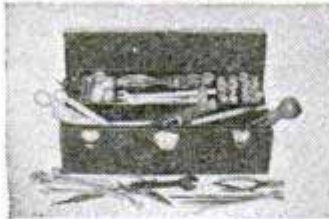

You Receive Tools and Equipment as Part of Your Course.

Big Book and Sample Lesson FREE

APPROVED FOR VETERANS

NATIONAL SCHOOLS

LOS ANGELES 37, CALIF. • EST. 1905



FIND OUT NOW... MAIL COUPON TODAY

NATIONAL SCHOOLS, Dept. PMD-2
4000 South Figueroa Street
Los Angeles 37, California

(Mail in envelope or paste on penny postcard)

Mail me **FREE** the book, **YOUR FUTURE IN DIESEL**, together with the Sample Lesson. I understand I may keep and use the information with no obligation.

Name _____ Age _____

Address _____

City _____ Zone _____ State _____

Check here if Veteran of World War II

HIGH PAY JOBS

FOR MEN WHO QUALIFY IN DIESEL



ASSURE YOUR FUTURE. Steady, big pay jobs await men qualified in Diesel, Tractor and Heavy Equipment. Can you take advantage of Diesel job and advancement opportunities in this fast-growing field?

COMPLETE DIESEL COURSE AVAILABLE.

If you are ambitious and want to get ahead in this lucrative field, you'll want to know about the complete training in Diesel provided by Interstate. Trains you at home in spare time. Does not interfere with your present job. Covers all phases of operation. Up to the minute. Revised regularly to cover new developments. Free placement advisory service.

YOU OWE IT TO YOURSELF

to investigate I.T.S. home Diesel training. Thousands of students agree it has helped them to better jobs... better pay. It can do the same for you!

SEND FOR FREE BOOK TODAY!

We'll gladly send you our big 24-page book "Getting Ahead In Diesel" **FREE!** Paste coupon on penny card and mail to



INTERSTATE TRAINING SERVICE
4035 N. E. Sandy, Portland 13, Oregon

Please see that I receive **FREE BOOK** "Getting Ahead In Diesel":

Name _____ Age _____

Address _____

City _____ Zone _____ State _____ (3)

BUILD THIS HOUSE Yourself



The Famous Popular Mechanics House

The picture below is from an actual photograph of the Build-It-Yourself House with breezeway and garage, as built by Jack Brownson, 23-year-old veteran, in Aurora, Illinois.

Designed by Popular Mechanics and Famous Architects. Every Detail Simplified and Explained. No Previous Experience Needed!

Can you use everyday tools as well as the average Popular Mechanics reader? Then you, too, can easily build this modern house in any of its five designs, doing every part of the job yourself. The new Popular Mechanics Book, "Your Home—How to Build It Yourself" will show you how.

Space for Living and Family Growth

This beautiful, modern house is 1½ stories, with basement, living room, kitchen, dining nook, two bedrooms, bath, plenty of closets and space for two additional bedrooms on second floor. The house itself is 35' 9"x28' 11"; breezeway 20' 10"x8'; garage 20' 10"x12'.

The House That Has Everything

Designed for easy construction and the most living space for the least cost, the Build-It-Yourself House is also most attractive and suitable for any community and most income groups. The basic plan is adaptable to four other exterior designs.

Get Book and Plans Now—Build When You Can

You may never have thought about actually building a house yourself, but now that building restrictions have been lifted, it is easier than you think. So order book and plans today. Even if you engage a contractor to build for you, you will need the plans. And you certainly will want the book which can easily save you hundreds of dollars, whether you build this or any other house.

Mail Coupon for New Book and Plans!

Build It Yourself or Have It Built — Save Hundreds of Dollars!

PLANS YOU CAN READ AND FOLLOW

Plans consist of ten working-size blueprints — floor plans, elevations, construction notes, framing, joints, lumber and mill list, specifications, plumbing and wiring diagrams. Every measurement is marked — every detail made clear as ABC. Book has 100 pages — three-fifths are photographs and drawings. Some sections in colors, showing just how your house will look when finished.

BIG BOOK
8½x11 inches



MAIL COUPON FOR BOOK AND PLANS

POPULAR MECHANICS PRESS

200 E. Ontario St., Chicago 11

I enclose \$_____. Send me the items checked at once.

- Your Home and How to Build It Yourself.....\$ 3.00
- Complete set of plans for Popular Mechanics Home... 12.50
- Book and plans at reduced price..... 14.00
- Duplicate sets of plans..... 5.00

Name _____

Address _____

City _____ Zone _____ State _____

Only 10c Brings this GIANT 500-Page Catalog to Thrill and Amuse YOU with its 7000 Unusual Articles!

Send TODAY for YOUR COPY of this MAMMOTH
NEW CATALOG OF 7000 NOVELTIES

500 Pages! ROTOGRAVURE SECTION **3500 Illustrations!**
 6 COLOR COVER

**BETTER
 BIGGER**

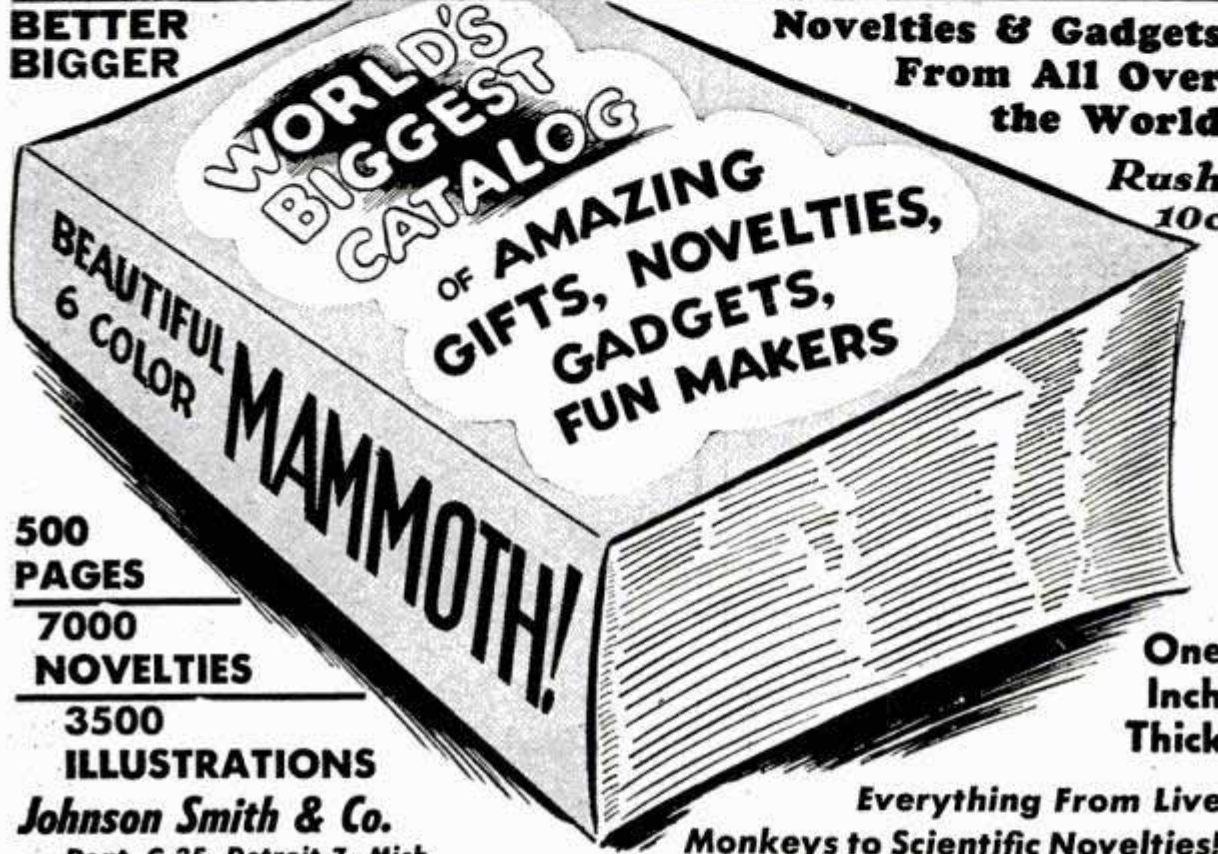

**Novelties & Gadgets
 From All Over
 the World**

Partial Contents

- Kits
- Wigs
- Pipes
- Locks
- Banks
- Boats
- Stamps
- Puzzles
- Hobbies
- Gadgets
- Turtles
- Jewelry
- Vendors
- Watches
- Disguises
- Alligators
- Telescopes
- Timesavers
- Funmakers
- Exercisers
- Air Pistols
- Slide Ruler
- Barometers
- Chameleons
- Novel Rings
- Microscopes
- Electric Eye
- Magic Tricks
- Archery Sets
- Money Savers
- Transmitters
- Indoor Games
- Field Glasses
- Curious Seeds
- Make Up Goods
- Jig Saw Puzzles
- Banks & Vaults
- Sporting Goods
- Cigarette Cases
- Fortune Tellers
- Electro Platers
- Fencing Supplies
- Fishing Supplies
- Lucky Novelities
- Games of Chance
- Indian Novelities
- Hula Skirts
- Occult Novelities
- Projectors & Films
- Sweater Emblems
- Radios & Supplies
- Live Animals & Pets
- Religious Novelities
- Smokers Articles
- Musical Instruments
- Auto & Bike Accessories
- 1000 Fascinating Books
- Winning Bets & Contests
- Guns
- Rings
- Games
- Models
- Billfolds
- Scientific Supplies
- Cameras
- Airplanes
- Magnifiers
- Artist Supplies
- Electric Shocker
- Imported Goods
- Western Novelities
- Shrunken Heads
- Sports Trophies
- Hand Carved Pipes
- Bull Whips
- Gazing Crystal
- Kissing Movies
- Bracelet
- Knives
- Midget Racers
- Atomic Science
- Midget Cameras & Radios
- Life Like Rubber Masks
- Printing Supplies
- Surprise Packages
- Engines & Motors
- Home Experiment Items
- Home & Shop Tools
- Jokes
- Team Supplies
- Office Supplies

**Rush
 10c**

**One
 Inch
 Thick**

**Everything From Live
 Monkeys to Scientific Novelities!**

**500
 PAGES**

**7000
 NOVELTIES**

**3500
 ILLUSTRATIONS**

Nothing else quite like it! More interesting than carnival, circus, world's fair and science exhibit rolled into one. 500 pages packed full of pictures, descriptions of odd items from all over the world. Many not sold in stores; hard-to-get things like monkeys. Covers all hobbies, useful gadgets, fun-makers, timesavers, etc. **WORLD'S GREATEST COLLECTION.** Weird things like shrunken skulls. Guns, rifles. Get some of the funmakers and fool your friends. Electric shocking handshakers for 50c, etc. See amazing hobby and scientific items, the money-makers and the money-savers. You'll be amazed and greatly pleased!

Colliers, Tide, Coronet, New Yorker Magazines Write About It!

Call it "MOST UNUSUAL CATALOG IN WORLD" in their stories about it. 25,000,000 orders in 35 years—our record. It's a catalog, but it is also the most wonderful book you've ever seen. Most articles are less than 50c! We charge small amount because of tremendous demand. Every copy costs us nearly 75c. No obligation—we want each person to have one copy.

**Jewelry, Hobbies, Books, Radios, Sporting Goods,
 Office and Household Novelities**

Useful supplies of every type for home, school, office, factory, shop. This GIANT CATALOG is bigger, better and flashier than ever before.

Beautiful 6-Color Cover; Roto Picture Section; 7000 Articles

Wonderful book to have. Send for your copy today—don't wait until this limited edition is gone. Unused U. S. Postage Stamps accepted in payment of orders.

De Luxe Hard Bound Library Edition Available

Regular paper covered catalog is only 10c, but many people like permanent, hard-bound library edition which costs only 25c and lasts for years. (Sent Air Mail for \$1.00.)

RUSH THIS COUPON TODAY!!!

RUSH ME MY NEW CATALOG!

10c Paper Cover Edition De Luxe Hard Bound Library Edition 25c

Name _____

Address _____

Johnson Smith & Co., Dept. C-35, Detroit 7, Mich.

OWN a GROWING Lifetime Business

BUILT on VOLUNTARY and REPEAT ORDERS



If you are capable . . . cooperative . . . willing to work to enjoy success, we'll establish you in YOUR OWN business. The nation-wide chain of Duraclean dealerships is now expanding.

The business is *easy to learn . . . and quickly established*. You use the proven methods of successful dealers. Your service is recommended nationally by America's foremost furniture and department stores.

Shop Optional

No overhead expense. Service is rendered in homes, offices, hotels, institutions, etc. by your service men. You can operate from a shop . . . an office . . . or your home.

Carpets and Upholstery Safely

Duracleaned . . . Use Again Same Day

Duracleaning ends need for harsh machine scrubbing and soaking. It does away with harmful solvents and strong soaps. Instead of floating surface soil into upholstery or rug pile, this improved process REMOVES it.

Cleans by ABSORPTION . . . No Scrubbing

Aerated foam is created by the *patented* electric Foamovator. Dirt, grease and many unsightly spots vanish. Fabrics and floor coverings are cleaned with a *new consideration for their life and beauty*.

Fiber Life Restored

The fiber lubrication of wool and other animal fabrics is restored. Resiliency returns to the pile. It rises again. Its life is prolonged. Brilliant colors revive. Results are often almost unbelievable.

Duraproof Immunizes Against Moths . . . Carpet-Beetles . . . Mildew

You give your customers a 4-year warranty. This year-round service is rendered without removing furnishings.

A Moderate Payment

establishes *your own* business. We furnish electric machines, folders, store-cards, introduction slips, sales portfolio, demonstrators and enough materials to return your TOTAL investment. If you are dependable, we want to hear from you. *Free 16 page booklet* explains everything. Write today while dealerships are available.

DURACLEAN CO., 16-2PI., Deerfield, Illinois

LOCKSMITHING & Key Making

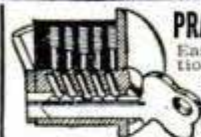

PRACTICAL UP-TO-DATE COURSE—ONLY \$3.95

Easy-to-learn modern information for self-instruction. How to work on locks, de-code, make master-keys, repair, install, service, etc. For every handyman, home owner, carpenter, mechanic, service station operator, fix-it shop, hardware dealer, gunsmith. 53 plain illustrated lessons. **FULL PRICE ONLY \$3.95. SEND NO MONEY.**

Just pay postman plus C.O.D. postage. Or send \$3.95 with order, we'll ship postpaid. Satisfaction guaranteed or refund. **NELSON-HALL CO., 1139 S. Wabash Ave., Dept. B-2, Chicago 5, Ill.**



**Cape Cod Chairs
Trellises - Arbors
Dutch Windmills**

Chairs, Style B-C-A 50c Ea. all 3 only \$1.00. 12 different Trellis designs. Plan of all 12 only 50c. Beautiful 31-Family Mt. Vernon

Martin House. Large fully detailed plan only \$1.00. Authentic 40' high Dutch Windmill detailed plan 75c. Five fine Lawn Figure patterns: Dutch Boy, Tulip Girl, Holland Pair, Sunbonnet Girl and Overall Boy all 5 patterns only \$1.00. Send 10c for illustrated catalog of many fine projects.

CRAFTSMAN'S MODEL COMPANY Dept. P1, 2030 N. 41st St. Milwaukee 8, Wis.

"SEA CRAFT" BLUEPRINTS READY NOW!

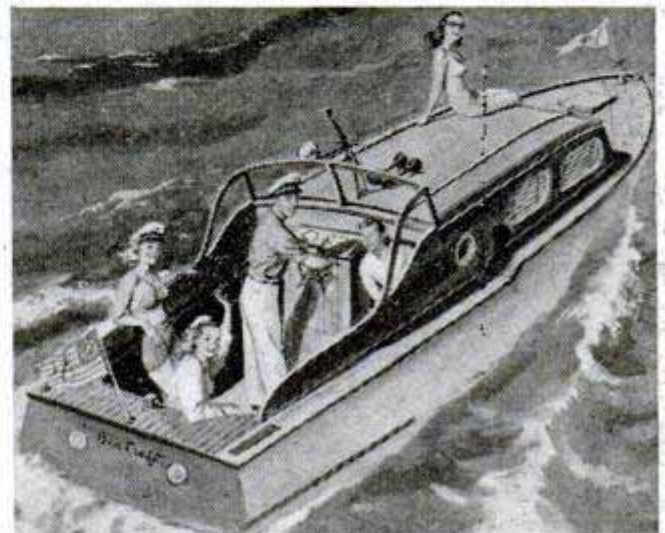

Build this luxurious cabin cruiser yourself and save money. What a beauty it is! A 25-foot boat readily adaptable as a sport fisher, express cruiser, or utility boat. Cruises effortlessly at 15 knots with a marine engine or converted auto motor. Its spacious cabin sleeps four and has a galley complete with fresh-water tank, sink, and cook stove. Has open cockpit large enough for fishing, lounging, etc.

During war the Coast Guard used "Sea Craft" for ship-to-shore travel. Order today your complete set of seven large-size blueprints scaled 1 inch to the foot. These, plus a 40-page two-color illustrated booklet giving step-by-step instructions, only \$10.00.

POPULAR MECHANICS PRESS

200 EAST ONTARIO ST.

CHICAGO 11, ILL.

HELPFUL BOOKS

Send post card asking for **FREE** catalog

Popular Mechanics Press, 200 E. Ontario, Dept. 601, Chicago 11

MAKE BIG MONEY in REFRIGERATION WE TEACH YOU

NOW IS THE TIME TO JOIN

Here is your one big opportunity to train in a field that is expanding tremendously . . . In the few months that it takes . . . you are a skilled craftsman, that means money . . . **BIG MONEY** and security for the future . . . Old Refrigerators: Millions of them! . . . New Homes . . . R.E.A. Farm Requirements . . . Frozen Foods Demand, etc., etc.

WONDERFUL OPPORTUNITY—HEAT BY REFRIGERATION

FOR VETERANS AND NON-VETERANS

Learn about new system of heating without fuel. (Reverse cycle of refrigeration.) Machines that draw warmth from Air, Water and Earth . . . Wonderful opportunity to be miles ahead of others . . . If you **ACT NOW** . . . Get the **FACTS** . . . They Are **FREE** . . . No obligation.

FREE

Employment Service

MAIL THIS COUPON TODAY

PRACTICAL TRADES INSTITUTE, INC.

25 University Ave. S.E., Dept. P-2, Minneapolis 14, Minn.

BE INDEPENDENT IN

YOUR OWN BUSINESS

BIG FUTURE

— HOW

• **INSTALLATION**

• **MAINTENANCE**

• **SERVICE**

—PART TIME EMPLOYMENT WHILE LEARNING AVAILABLE—

• **MAIL THIS COUPON TODAY** •

PRACTICAL TRADES INSTITUTE, INC.
25 UNIVERSITY AVE. S.E., DEPT. P-2
MINNEAPOLIS 14, MINN.

**NO OBLIGATION
FREE PARTICULARS**

I am interested—mail information at once.

NAME _____ AGE _____

STREET _____

CITY _____ ZONE _____ STATE _____

EXPERIENCE IS THE BEST TEACHER. OUR MANY YEARS PROVES—
You Can't GET More — Why PAY More?
→ VETS TAKE 10% DISCOUNT. YOU CERTAINLY DESERVE IT ←

		Goodrich Firestone Original High Tread	GOODYEAR TIRES	United States & Others Worn Just Slightly			
GOLDEN RULE 14 MONTH GUAR. BOND FREE BUTYL TUBE With All These AA1 Tires							
475-19	\$5.25	600-16	\$3.94	600-20	\$8.24	32x6 (8)	\$9.74
525-18	5.25	650-16	4.04	650-20	7.94	32x6 (10)	11.74
550-17	5.25	650-15	4.04	700-20	9.44	825-20	11.84
750-16	6.25	700-15	4.14	34 x 7	10.24	900-20	12.24
		700-16	4.74	1100-20	14.24	1000-20	13.24

WORLD'S BEST "ALL PURPOSE" TIRES "TRIPLE-A" TOP GRADE
 24 MONTH GOLDEN RULE GUARANTEE BOND
 You've Never Seen Tires Like These Factory Adjusted Tires

600-16	\$5.50	650-15	\$5.10	550-17	\$7.95	750-16	\$8.50
650-16	5.50	700-15	5.50	700-16	6.50	525-18	6.95

"TRIPLE A" TOP GRADE TRUCK TIRES ONCE-A-YEAR WHOLESALE
 8-10-12-14 PLY TIRES, GUAR. 24 MONTHS. "BRUTES FOR WEAR"
 600-20 \$9.75 32x6 (8) \$10.25 750-16 \$11.50 1000-20 \$16.75
 650-20 9.85 32x6 (10) 12.05 825-20 15.60 1100-20 17.00
 700-20 10.65 34x7 11.35 900-20 15.95 750-18 11.50

We've Shipped Tires to Canada, Italy, Czechoslovakia, Alaska, Puerto Rico, Germany, and South America.
 Our Tires Used on School Bus.

750-20 MILITARY MUD TREAD
 Fits 32 x 6 700-20 650-20 34 x 7
 8-ply Top Grade (Were \$9.75) \$9 Guar. 12 Mos.
 Premium Grade (Were \$18) \$13 Guar. 26 Mos.
 900-16 "A" \$7.50 900-16 "AA" \$9.50

Send check or money order & this ad for rush shipment. We won't ship a tire that we wouldn't use. Blatt Bros. have personally pinpoint-inspected 1/2 million tires.
BLATT GIRARD TO LANCASTER AVE. DEPT. P.M. BLATT BLDG., PHILADELPHIA 31, PA.



For a Shipshape Shop!

Popular Mechanics SHOP NOTES 1949 is the book you need. 240 interest-packed pages for mechanic, painter, carpenter, auto-worker, electrician, welder, farmer, plumber and home craftsman. Whether it's ball bearings or shotgun ganges, painting a car or mounting motors, the best and latest methods are here.

Hundreds of articles. Hundreds of ideas! See your news dealer or order direct from **POPULAR MECHANICS PRESS. . . . \$1.00**
 200 E. ONTARIO ST. CHICAGO 11

Your stepping-stone to a **BETTER-PAYING MACHINIST'S JOB**

Master shop work quickly with these books
 This big home study and reference course gives you the practical facts on machines and methods you need to advance in machine shop work. Take advantage of the other man's experience as found in books, to solve your problems, increase your efficiency with



Revised and Enlarged
 These 6 volumes give you not only accepted methods and practices, but latest developments in machine shop work, enabling you to meet today's shop requirements and needs.

6 volumes, 2645 pages
 2747 illustrations

THE AMERICAN MACHINISTS' LIBRARY

This library of machine shop practice was written for practical men. It gives you the best methods for every kind of machine shop work. It fully explains lathes, drills, and other machine tools and their operation, automatic screw machines, speeds and feeds, gear design and production, jigs and fixtures, punch and die work, metal surfacing, etc., etc. All plainly written and fully illustrated.

NO MONEY DOWN—Easy payments

EXAMINATION COUPON

McGraw-Hill Book Co., Inc., 330 W. 42 St., N. Y. C. 18, N. Y.
 Send me for ten days' free examination the AMERICAN MACHINISTS' LIBRARY. If satisfactory I will send you \$3.75 and \$4.00 monthly until the price of \$23.75 is paid. If not wanted I will return books postpaid.

Name _____
 Address _____
 City _____ Zone _____ State _____
 Company _____
 Position _____ PM-2-49

NOW! you can LEARN ELECTRIC MOTOR REPAIR

... A good-paying, modern profession
 ... for only \$5
FOR THE COMPLETE TRAINING
 (while the present low-cost supply lasts)

Based on what you can learn quickly at home from this big **ELECTRIC MOTOR REPAIR** book, you can train for profitable installation, service, repair and complete rewinding of practically any electric motor. Every subject is clearly explained by text AND ALSO by more than 900 clear-cut illustrations. You not only read what to do. You actually SEE how to do it! Quick reference guides show how to handle specific jobs. When certain motors come in for repairs, just look them up. **ELECTRIC MOTOR REPAIR** tells what to do—and exactly how to do it.

TRAIN FOR GOOD PAY IN A FIELD THAT ISN'T CROWDED

Every day, more and more electric motors and control systems are being used in industry and home appliances. The expert who can install them and keep them working properly is a valuable man in this Electrical Age! **ELECTRIC MOTOR REPAIR** teaches you every step of the work—quickly and easily—at home—in spare time. Ideal for beginners or for bench use in busy shops. Thousands already in use in vocational schools, shops and, most important of all, for home study.



560 pages
 900 special illustrations

JUST OUT!

The Book That Answers
1,001 ELECTRICAL QUESTIONS
 ... only \$2.50

THE ELECTRICIANS' POCKET COMPANION handbook gives you a comprehensive selection of the important facts, figures and data modern electrical workers need to know about all sorts of jobs. It gives needed information based on the National Electrical Code and Underwriters' requirements. It covers the entire range of subjects from motors, meters and transformers to lighting, wiring, tools and equipment and literally hundreds of others. Contains hundreds of illustrations, charts, diagrams and data tables. The ideal book for easier, better and more profitable work on down-to-earth electrical jobs! Four different indexes give quick access to any needed fact. 357 pages, 4 1/2 x 7. Use coupon for trial examination of **ELECTRICIANS' POCKET COMPANION**.

SHOWS YOU HOW every step of the way

ELECTRIC MOTOR REPAIR is designed for use right at the bench. Unique Duo-Spiral Binding divides book into two sections so that both text and related pictures can be viewed together. An instructor standing by your side could hardly do better! It covers the entire motor field—including alternating—and direct-current motors and generators, etc., as well as mechanical, electrical and electronic control systems. Right down the line, it explains every detail of trouble diagnosing, repair, rewinding and maintenance in a way you can easily understand.

Send coupon today! See for yourself that really good home training doesn't have to cost you a lot of money.

PRACTICE FROM IT FOR 10 DAYS at our risk!

10-DAY TRIAL COUPON

Dept. PM-29, MURRAY HILL BOOKS, INC.,
 232 Madison Ave., New York 16, N. Y.

Send me the books checked below for 10 days' examination on approval. In 10 days, I will pay for books plus a few cents postage, or return them postpaid. (Postage paid on cash orders; same return privilege. Books sent on approval in U.S.A. only.)

- ELECTRIC MOTOR REPAIR, \$5 (\$5.50 outside U.S.A.)
- ELECTRICIANS' POCKET COMPANION, \$2.50 (\$2.75 outside U.S.A.)

Name _____
 Address _____
 City, Zone, State _____

BE AN AUTO MACHINIST

Get Ready for
**GOOD PAY,
STEADY JOB**
Quickly

FREE BOOK
Tells Why Now's The
Time to get Your
**PRACTICAL
TRAINING**

Make more money in AutoMechanics when you specialize. Free Booklet tells how specialized training helps you get ahead.



AUTO MACHINIST
Student in engine rebuilding learning to operate a crankshaft grinder. Specialized training puts you in line for better jobs and higher pay.

ENGINE REBUILDING or GENERAL AUTO MECHANICS

Get ready for a good paying job in either of these big fields. Get PRACTICAL EXPERIENCE while you learn. See pictures of modern shops and up-to-date equipment in Free Booklet. Learn machine shop, auto electricity, carburetion, troubleshooting, motor tune-up, transmissions, many other jobs. Send for booklet today.

VETERANS American Trade School is G. I. Approved. Please state if veteran.

**WRITE TODAY FOR
FREE BOOKLET**
AMERICAN TRADE SCHOOL
2417 McGee, Kansas City, Mo.





"GET ON," Uncle Sam's PAYROLL

**START
as high as
\$3,351 Year**

**Prepare NOW For
Next Examinations**

20,000 appointments
each month

**VETERANS GET
SPECIAL PREFERENCE**
Many examinations
expected soon
**City Mail Carriers
City Postoffice Clerks
Stenographers-Typists
Messengers, Etc.
Liquor Inspectors—
and many others**
**40-Page Book
on Civil Service.**
**FREE
Mail
Coupon
today—
SURE**

FRANKLIN INSTITUTE

(Not Government
Controlled)
Dept. L-86
Rochester 4, N. Y.

Rush to me, entirely free of charge, 40 page book with: (1) A full description of U. S. Government jobs; (2) A list of U. S. Government jobs; (3) Tell me how to qualify for a job.

Name _____

Address _____

Vet? _____

Get This Fascinating New Popular Mechanics Book

WHAT to MAKE for Children



**175 Things
Dad and Mother
can Make for
Young Folks
at Home!**

This is a book by the editors of Popular Mechanics. It will show you how to make, at little or no cost, many of the

things so dear to the hearts of younger children — things that money won't buy, such as playroom and nursery toys and trappings, dolls and dollhouses, gymnasium equipment, things to ride on, toys that "work" and go.

A BOOK FOR THE ENTIRE FAMILY
Mother and Dad and Big Sister and Brother can save many dollars and have worlds of fun too, making all these things for the little tots. Only discarded materials or inexpensive new materials and only simple tools are needed, with **WHAT TO MAKE FOR CHILDREN** as a guide.

SIMPLIFIED INSTRUCTIONS — ANYONE CAN FOLLOW

The book contains 175 different projects with detailed "how-to-do-it" instructions, dimensions and more than 250 sketches, drawings, plans and photographs covering every detail of construction.

Order **WHAT TO MAKE FOR CHILDREN** today. Mail coupon below for immediate delivery. Money back if not satisfied.

**175 PROJECTS
250 ILLUSTRATIONS**

Action Toys—Dolls—Pull

Toys—Play Houses—
Games



Swings—Furniture—

Sleds—Playground Equip-
ment—Desks—Sandboxes



Wagons—Coasters—

Merry-go-round—Animals

—Cribs—Dozens of Others



POPULAR MECHANICS PRESS, Dept. 49C
200 East Ontario St., Chicago 11, Ill.

Send at once _____ copies of **WHAT TO MAKE FOR CHILDREN** at \$2.00 each. Remittance enclosed. I understand I may return the book in 5 days if not satisfactory and you will refund my money.

Name _____

Address _____

City _____ State _____



HERE'S A NEW AND VITAL BUSINESS!

LEARN ELECTRICAL EQUIPMENT SERVICING

OFFERS BIG MONEY — INDEPENDENCE

Learn in spare time at home. **NEW Shop Method Training System.** Work as many hours as you wish — the Electrical Equipment Technician is his own boss. It is not unusual for a technician to charge on the basis of \$5.00 to \$6.00 an hour! Command big wages.

NO PREVIOUS EXPERIENCE NEEDED

We furnish everything! Tool kits, training kits, including the famous Christy trouble-detecting **ELECTRONIC KIT.** Plus illustrated instructions written in simple, easy-to-understand language, check full of photographs and drawings. Shows you how to repair factory and household electrical units. Power machinery, refrigerators, washing machines, vacuum cleaners, irons, etc. Gives you a working knowledge of electricity, house wiring, motor winding, welding, nickel plating, etc. Shows how to build power tools you need, how to solicit business and what to charge. Many report paying for their entire course, tools, etc. on earnings made at home while learning!

FREE BOOK SENT TO YOU

Send your name for **FREE** booklet on Electrical Equipment Servicing and instructions for paying us later from your **EARNINGS WHILE LEARNING!**

CHRISTY TRADES SCHOOL

DEPT. D-6603 2835 N. CENTRAL AVE., CHICAGO 34, ILL.

Grow MUSHROOMS

EASILY RIGHT IN YOUR BASEMENT!

Prepared odorless "mushroom beds" in wooden flats, ready to place in any cool basement or storage room.



MAGIC MUSHROOM TRAYS

Water them as directed and pick mushrooms in 3 weeks — a bushel or more from 4 trays! **WRITE FOR ILLUSTRATED CIRCULAR** or send \$2.75 for 2 trays; \$5.00 for 4 trays; \$10.00 for 10 trays. Shipped 2nd class express charges collect from Ashtabula, Ohio. Each tray weighs 25 lbs. measures 14" x 18".

LOHRMAN SEED CO., 411 Macomb St. DETROIT 26, MICH. Our 56th Year!

PLOWS CLEAN THROUGH 3 DAYS' BEARD!



ONLY \$12.95

WhiskER ELECTRIC SHAVER
... the Shaver That Shaves Any Beard

Here's a precision made, close-cutting electric shaver at a pleasing price. The *WhiskER*, utilizing a long tested hair-clipper principle, shaves *any* beard . . . even 3 days' growth . . . effortlessly, quickly and cleanly. It's built to last . . . has no gears, brushes, bearings. Powerful, magnetic-type motor for 110 v., 60 cycle AC, is quiet operating. No radio interference. If your Barber, Beautician, or Dealer does not yet have the *WhiskER*, use coupon to order. Money back if not delighted.

ELECTRO TOOL CORP., DEPT. 529-B, RACINE, WISCONSIN

If Your Dealer Cannot Supply You MAIL THIS COUPON

ELECTRO TOOL CORP. Dept. 529-B, Racine, Wis.

I enclose (check, money order) for \$12.95, for which please send me a *WhiskER* Shaver postpaid on 5 day trial.

Name _____

Address _____

City _____ State _____

BURN WATER IN YOUR CAR!

The new **OCTA-GANE** Water Injector is designed to give your car premium performance from low grade fuels. In addition it will measurably increase power and mileage completely eliminate engine "ping" or "knock", and keep your engine internally clean.

The **OCTA-GANE** is a well constructed unit, engineered to last for the life of your car. It comes complete with a stainless steel tank and all necessary fittings and brackets for mounting. Installation is a simple matter of a few minutes. A one year guarantee comes with each **OCTA-GANE**.

The **OCTA-GANE** is priced at only \$24.95 delivered and we urge you to take advantage of the special coupon at right to give your car a new lease on life.

We will be pleased to send you full descriptive literature at your request.

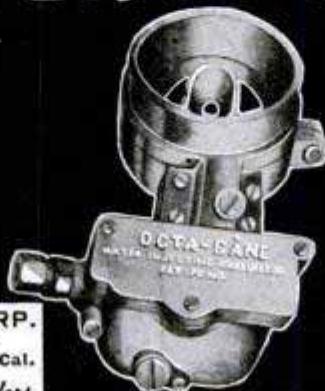

COMMONWEALTH CARBURETOR CORP. Div. 14-B, 1478 University Avenue, Berkeley, Cal.

SIRS: PLEASE SHIP TO ME IMMEDIATELY ONE COMPLETE **OCTA-GANE** WATER INJECTOR UNDER THE PLAN CHECKED BELOW

- \$1.00 ENCLOSED. PAY POSTMAN BALANCE C.O.D.
- \$24.95 ENCLOSED. SHIP FULLY PREPAID.

(PLEASE PRINT PLAINLY)

NAME: _____

STREET: _____

CITY: _____ STATE: _____

MAKE & YEAR OF CAR: _____

MODEL: _____ NUMBER OF CYLINDERS: _____

COMMONWEALTH CARBURETOR CORP. SUCCESSORS TO CONTINENTAL CARBURETION CO. Div. 14-B, 1478 University Avenue, Berkeley, Cal.

Inquiries invited from established automotive dealers.

This Coupon Will Bring You
FREE SUCCESS FACTS
Mail It Now!

UTILITIES ENGINEERING INSTITUTE (Autocrafts Div.)
 Dept. 129X, 2523 Sheffield Ave., Chicago 14, Ill.
 YES! I want to qualify for BIG PAY and great opportunities
 in Auto Body and Fender Work. Rush FREE FACTS about
 U.E.I. training.

NAME _____ AGE _____
 ADDRESS _____ ZONE _____ STATE _____
 CITY _____
 Check here for special information if you are under 17

Train For
Big Pay Opportunities in
AUTO BODY & FENDER WORK



Are you looking for a field which pays big money now and is growing rapidly? Then look to **AUTO BODY & FENDER REPAIRING**. Millions of cars badly need appearance reconditioning. Many more cars rolling off production lines will soon require the same service. Demand for trained, experienced men who can handle these repairs is big — and growing bigger! **AUTO BODY & FENDER REPAIRING** offers the mechanically-minded man with ambition a lifetime opportunity at dependable, well-paying jobs or a profitable business of his own.

TRAIN IN SPARE TIME—You can keep your present job and learn Auto Body and Fender Work at home with U.E.I. training. High school diploma not required. Easy lessons with crystal-clear examples, photos, diagrams help you learn quickly and easily.

The course includes Metalwork, Spray Painting, Welding Alignment, etc. You can also get practical training in our shops. Many have started their own business or used our placement service.

GET FREE FACTS TODAY!—Fill out coupon at top and mail it for FREE FACTS about U.E.I. training and opportunities in Auto Body and Fender Work. This may be your ticket to success... use it NOW!

UTILITIES ENGINEERING INSTITUTE *Founded 1927*
Autocrafts Division
 2523 Sheffield Ave., Dept. 129X
 CHICAGO 14, ILL.



LIQUID MARBLE
 Mold, Brush, Trowel, Spray It!
COMPOSITION FLOORS
 FLEXIBLE MOLDS
 MOLD Novelties, Statuary, Art Goods in Flexible Plastic Molds; 5¢ material makes \$1 seller. Make Marbleized floors, Tile Walls. Colorful, glossy, amazing! Easily learned; start in garage or basement. Particulars free.
MARBLEIZING SERVICE, Dept. 10-F, Edwardsville, Ill.

"MOWER POWER"

COMPLETE ATTACHMENT. For Either Electric Motor or Gasoline Engine. Fits Any Make or Size of Lawn Mower. **POSITIVE CHAIN DRIVE** and **FREE WHEELING.** Easy to Install, in Less Than an Hour. **IMMEDIATE DELIVERY** Sold Direct to You at Factory Price, **\$27.80** ATTACHMENT....

OUR 2 H.P. 4 Cycle Gasoline Engine is Designed for Rugged Work. No Vibration. Quick Easy Starting. Best **\$55.50** Engine Ever Made....

ALL PRICES F.O.B. ROYAL OAK MICHIGAN

Thousands Sold ALL Over the UNITED STATES. You'll Be Delighted. Complete Satisfaction or Your Money Back. Prompt Delivery.

ROYAL OAK LAWN MOWER SHOP
 P. O. BOX 48 **ROYAL OAK 1, MICHIGAN**



Requires No Welding

Free Folder

PRECISION BUILT To Last a Lifetime

CARBURETOR TOO RICH MAKES MOTORIST TOO POOR



Car owners who are wasting money and not getting proper gas mileage due to over-rich mixtures will be pleased to learn how to save gasoline by **VACU-MATING** over-rich mixtures. **VACU-MATIC** fits all cars, trucks and tractors. It is automatic and operates on the supercharge principle. Easily installed in a few minutes.

SALESMEN WANTED! Big Profits! Send name, address on penny postcard for free particulars and how to get yours for introducing.

VACU-MATIC CO., 7617-1468 W. State St., WAUWATOSA, WIS.



THIS BOOK SHOWS HOW TO DO IT

STEEL SQUARE POCKET BOOK

Completely Revised

This concise and handy little book illustrates and describes the best methods of using the carpenter's steel square in laying out all kinds of carpentry work — it is easy to understand as a picture of the square laying directly on the work shows exactly how the various cuts are made. Its compact and handy size makes it convenient to carry in the pocket for quick reference.

Price \$1.25 Postpaid

POPULAR MECHANICS PRESS
 DEPT. 627 200 E. ONTARIO, CHICAGO 11, ILL.

Say You Saw It in POPULAR MECHANICS

WHAT TO MAKE SERIES

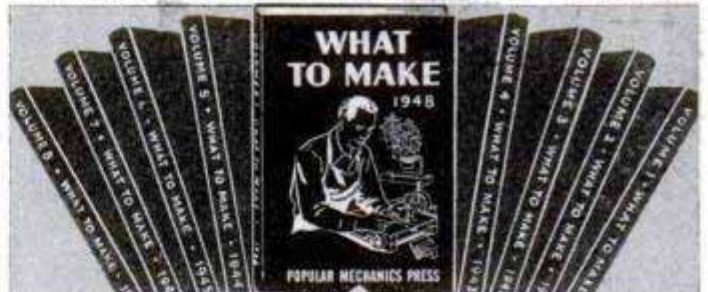

Send for your copy of the new 1948 clothbound edition now! Keep your set up to date. This is the 9th in this famous series of Home Workshop and Hobby Guides. If you do not have the earlier volumes you are missing a wonderful source of inspiration for making fascinating things at home. Every book is different... contains material not in the other volumes.

POPULAR MECHANICS 1948 EDITION

Partial contents: Birdhouses, sideboards, benches, furniture, book ends, chairs, toys, games, photo equipment, Dutch windmill, leathercraft, bookbinding, ship and yacht models, recaning chairs, fruit baskets, bob-sled, hamper, garden furniture, log cabins, porch furniture, tables, hostess trays, footstools, desks, lamps, fireplace screens, bookcases, wall cabinets.

PACKED WITH FUN AND PROFIT FOR EVERY HOME CRAFTSMAN

Nine big books.....1900 pages, 4000 pictures
\$1.75 a volume.....\$14.00 for set of nine

POPULAR MECHANICS PRESS, 200 E. Ontario St., Chicago 11, Ill.

Please send What to Make books as checked below. I will pay postman price and few cents postage. It is understood my money will be refunded if I'm not satisfied.

What to Make Vol. 9.....\$1.75
 What to Make Library (9 vols.).....\$14.00
 Postage paid if remittance accompanies order.
 Outside U.S.A. 15% additional.

Name _____
 Street and No. _____
 City _____ Zone _____ State _____

FREE BOOK Tells How to Build Own Home and SAVE

Big 22-page book, tells how you can get in on America's gigantic building boom, as a well paid building tradesman or by going into the building business for yourself. Book explains all about unusual practical course in home building methods; how to build your own home at savings of thousands of dollars; how to build for others. No experience needed. Course includes complete PLANS and SPECIFICATIONS for modern six-room Dutch Colonial house. Available to veterans under G.I. Bill. Nominal cost to others on easy monthly payments. House plans alone worth twice price of complete course. Send card for Free illustrated book, "Your Future in the Building Business." Write today:



COMMERCIAL TRADES INSTITUTE, Dept. D2-2
1400 Greenleaf Avenue Chicago 26, Illinois

BE A GOVERNMENT LICENSED AIRPLANE AND ENGINE MECHANIC

Train Now at LINCOLN



EARN BIG PAY IN AVIATION

Our new enlarged school now offers these courses: MASTER AVIATION MECHANICS, CAA Approved 1 Yr. Airplane & Engine Mechanics Course, REFRESHER AIRPLANE & ENGINE MECHANICS. Designed for veterans with aviation mechanics experience. Either course is available to veterans under the G. I. Bill of Rights. Write today for complete information.

LINCOLN AVIATION INSTITUTE

UNION AIR TERMINAL DEPT. P-2 LINCOLN, NEBRASKA

PROFIT AND PLEASURE IN LEATHER CARVING

NEW DEVICE found only in Baird home study course helps you improve overnight. BIG PROFITS, year round business, new method makes it EASY. Up to \$50 per week spare time. \$500 or more monthly full time. The Baird Course is COMPLETE. Full instructions—Tools, includes new device that makes learning easy. Full details sent FREE. WRITE NOW.



BAIRD SCHOOL OF LEATHER CARVING • Dept. PM-2
221 Manitou Ave. • Manitou Springs, Colorado

5 BRAND NEW NOVELTIES FOR \$1

Now you can preview the latest novelty creations months in advance. One dollar brings you FIVE new novel gifts—one each month for five whole months! Get the most fascinating and interesting novelties long before they are available locally! Send \$1.00 today to: THE NOVELTY OF THE MONTH CLUB
131-W West 42nd St. New York City 18



Happy Highways Ahead!

With Popular Mechanics new MOTORIST'S HANDBOOK, 160 pages of authoritative advice to keep your car rolling smartly—longer. Brakes, body, spark plugs, battery, starter—every automotive part is covered in this up-to-the-minute manual of year 'round driving pleasure.

Your news dealer has the 60c paper edition. Order the clothbound \$2.00 volume from

POPULAR MECHANICS PRESS
200 E. ONTARIO ST. CHICAGO 11



VOLUME 10 IS HERE!

Another great Popular Mechanics WHAT TO MAKE! This new 1949 edition has hundreds of practical ideas you can use around the home. Pictures and plans bring the words to life. Easy to understand. Easy on your budget.

Your news dealer has the gleaming \$1.00 Lamcote covered volume.....

Order the clothbound from
POPULAR MECHANICS PRESS... \$1.75
200 E. ONTARIO ST. CHICAGO 11

RAILWAY POSTAL CLERK

GOVERNMENT CLERK

MAIL CARRIER

POSTOFFICE CLERK

Start As High As \$3,351 a Year

Get Ready Now for 1949 Examinations In Your Locality

Veterans Get Preference

City Mail Carriers, Post Office Clerks

Clerks and Carriers now get \$2,550 the first year on regular and automatically increase \$100 a year to \$3,550. Open to men, women 18 to 50.



Railway Postal Clerks

Railway Postal Clerks get \$2,750 the first year regular, being paid on the first and fifteenth of each month. (\$114.60 each pay day.) Their pay is automatically increased yearly to \$3,850. Advance may be had to Chief Clerk at \$5,850 a year. (\$243.75 each pay day.) Male veterans only.

3 Days On—3 Days Off—Full Pay

Railway Postal Clerks on long runs usually work 3 days and have 3 days off duty or in the same proportion. During this off duty their pay continues just as though they were working. They travel on a pass when on business. When they grow old, they are retired with a pension.



Many Other Positions

Many other positions are obtainable. Rural Carriers—Stenographers—Typists—Assistant Statistical Clerks—Customs Inspectors—Liquor Inspectors—etc. Those wishing these positions should qualify at once.

Get Free List of Positions

Fill out the following coupon. Tear it off and mail it today—NOW, at once.

Although not government sponsored this investment can result in your getting a big paid government job.

FRANKLIN INSTITUTE, Dept. L-85, Rochester 4, N. Y.

Rush to me, entirely free of charge (1) a full description of U. S. Government Jobs; (2) Free copy of illustrated 40-page book, "How To Get A U. S. Government Job"; (3) List of U. S. Government Jobs; (4) Tell me what to do to qualify for one of these jobs.

Name _____

Address _____ Vet? _____

Use This Coupon Before You Mistake It. Write or Print Plainly.

LEARN

AVIATION

AN ESSENTIAL INDUSTRY IN PEACE OR WAR
MAXIMUM TRAINING IN MINIMUM TIME
 for 19 years Cal-Aero Technical Institute has specialized in...

✓ **AERONAUTICAL ENGINEERING**

2 year course - kept abreast of new research and scientific development.

✓ **MASTER AVIATION MECHANICS**

1 year course - C. A. A. approved for Airplane and Engine License.

Modern "live" training equipment, including helicopters, jets, rockets, wind tunnel
 ...Classes start monthly - Room and board available on our airport... Cal-Aero
 Tech Training is carefully designed for just one thing - **TO MAKE MORE
 MONEY FOR YOU.** More than 7000 successful graduates in addition to
 26,000 pilots and 7500 mechanics trained for Army & Navy Air Forces, prove
 that our career training is unsurpassed. **APPROVED FOR VETERANS**



MAIL THIS COUPON TODAY!

Please send full information on Aviation Training FREE - without obligation.

Name _____ Birth Date _____

Street _____ Zone _____

City _____ State _____

CHECK ONE VETERAN NON-VETERAN PM-2

Learn to Use the SLIDE RULE

SLIDE RULE and Famous **EASY! QUICK!**
 Book Both for Only \$2.98

Helps to Better Jobs - Bigger Pay for Everyone Who Uses Figures

Get this new 208 page simplified edition of the "Slide Rule and How to Use It" with full size, 10 inch Mannheim Type Slide Rule included. No other book like it. Contains complete instruction and removable work sheets that make the slide rule simple as A.B.C. Also five place logarithm tables and review of mathematics with complete answers to check yourself on every problem. It can easily be worth hundreds of dollars to you in promotions, better pay, saving time and error. It's a book for students, mechanics, business men - everyone should learn to use the slide rule, now that it is so easy.

Learn in Few Hours to Do Many Calculations

There is nothing mysterious about the slide rule when you read this book. You'll be amazed at the problems you can solve in just a few hours. Mail the coupon now. Book and slide rule will be sent at once. Use the coupon. See money refund guarantee. Mail now.

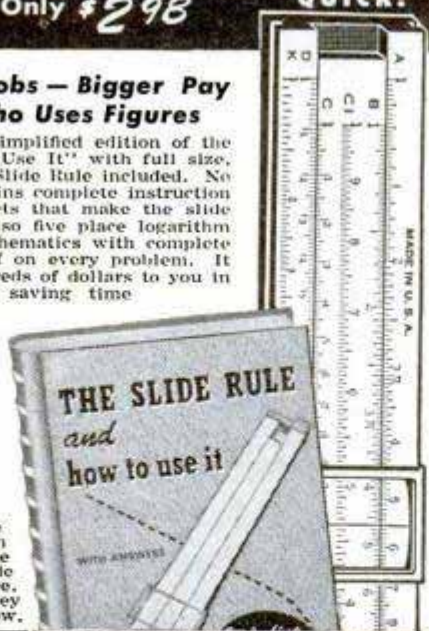

AUSTIN PUBLISHING CO., Dept. 12
 165 N. Pine Ave., Chicago 44, Ill.

Send me "The Slide Rule and How to Use It" and 10" full size Mannheim Type Slide Rule. Total cost for both \$2.98. I understand you will refund amount paid you if I return them in 5 days.

Remittance Enclosed. C.O.D. Plus Postage.

Name _____

Address _____

City _____ State _____

thinking of building a home?

Then you need...

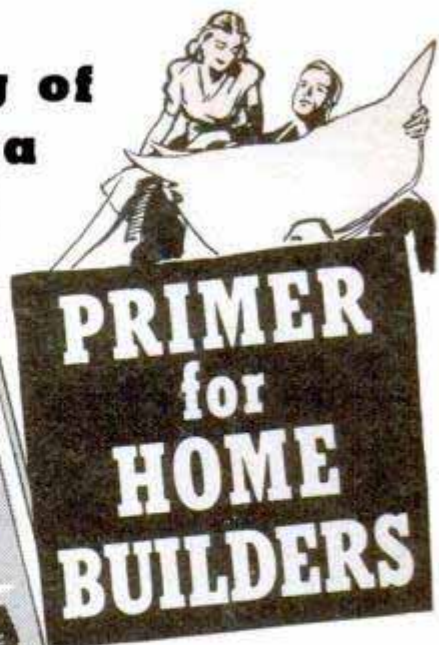

The New Book by 12 Leading Home Building Authorities That can so Easily Save You Hundreds of Dollars!

Answers These and Other Perplexing Questions



- Can I Afford to Build a Home?
- What Should I Know About Financing?
- What to Look for When Buying a Lot.
- What Community is Most Suitable for My Family?
- How to Go About Definite Planning.
- What is Most Suitable Inside Arrangement of Working and Living Space?
- Should I Employ an Architect?
- What Should Be My Guide When Buying an Older House?
- Legal Rights and How to Protect Them.
- How to Work with Contractors and Builders.

Whether you are actually planning to build a home or just hoping that some day you can. Primer for Home Builders is the most important book you can own. It's the combined work of twelve leading authorities and contains real down-to-earth facts on every phase of planning, contracting, building and financing a home, plus typical legal documents used in all real estate transactions. You can read it in a few hours but it can save you hundreds of dollars and a lot of time, trouble and tears.

A Book for Beginners - That Makes You Feel Experienced!

You'll like the way this book goes right into the business of building a new home, or buying an old one. Right from the start of "just dreaming," through whether or not to employ an architect and how to select an architect and work with him and contractors, how to plan the house, how to finance it, how to avoid legal difficulties, up to the time you take possession. You'll learn a hundred things you ought to know and probably don't know now.

Price \$2.50

Get Primer for Home Builders Now!

Don't wait until you are ready to start building. Before you do another day of thinking or planning or dreaming, get this most practical 171-page book to help you save time, worry and money.

MAIL COUPON TODAY

WINDSOR PRESS
 A Division of Popular Mechanics Co.
 200 E. Ontario St., Chicago

Rush _____ copies of Primer for Home Builders at \$2.50 each. Remittance enclosed.

Name _____

Address _____

City _____ Zone _____ State _____

START A BUSINESS at HOME... others make BIG MONEY

DOES THE WORK OF 6 TOOLS IN 1
Holds 20 times its weight in water



Hands Never Touch The Water .. Can Be Put In Boiling Water

"Enclosed find 56 orders representing 9 1/2 hours work on Monday and Tuesday." "Enclosed are 12 orders secured after supper this p.m."

Housewives Pleased
Everyone that sees this outstanding CELL-U-MOP immediately want one... That's the reason our distributors are so successful... For MOPPING, WAXING, WALLS, WINDOWS, AUTOS and CLEANING RUGS. Sells quick to Taverns, Clubs, Hotels, Hospitals, Stores, Restaurants, Homes, etc. Drain Bracket squeezes out water thoroughly. Write for FREE particulars

CLOSED CELL-U-MOP CO., Dept. P-2 FREEPORT, ILL.

AMAZING NEW

WOOD-TURNING TOOLS

SHARPEN ONCE IN 12-YEARS! (UNDER NORMAL USE)

These remarkable tools tipped with TUNGSTEN CARBIDE will astound you with their performance. They work FREE HAND equally well in wood, plastic or soft metals—and at the same time hold their razor-like edge almost indefinitely. Tests show that they will turn wood or plastic for days and days CONTINUOUSLY without showing any signs of dulling. They are the finest tools available at any price. Beautifully finished 5" blade—flush ground, polished tip—finest brass tube ferrule—9" hardwood handle—over all length 14"—10 tools to choose from: round and square nose from 1/2" to 1 1/2"—1 1/8" cut off; and 1/2"x30° skew. Amazingly Low Prices! Write at once for free literature. **JOHNS CARBIDE MFG. CO., Dept. PM2, Dunellen, N. J.**

Sources of HOME-BUILDING INFORMATION FREE

List of hundreds of sources of home-building books, folders, leaflets, plans, ideas—most of which are free or cost only few cents. Worth real money to you—and! You may copy it all down if you wish and return it for your money back! How can you lose? Send \$2 now to **WESTPORT PUBLISHING CO., Westport 3, Conn.**

Handy Mail Order List

Little Library of Useful INFORMATION

5 for \$1.00
12 for \$2.00
25¢ Each

Here at amazingly low cost is the practical help and information you have always wanted. Articles in previous issues of Popular Mechanics have been classified according to subject and are now available in these handy reprint booklets.

- How to Use Measuring Tools—Micrometers, Calipers, etc.—106.
- Power Driven Saws—74.
- Drill Presses, Grinders, Etc.—79.
- Wood, Metal Turning—Lathes—81.
- Filing Machine, Hack Saw, Cutoff Wheel, Shaper—82.
- Lathe Tools You Can Make—101.
- Workbenches—Tool Cabinets—47.
- Spray Painting—94.
- From Pattern to Casting—91.
- Tool and Saw Sharpening—92.
- Sharpening Drills, Wood Bits—90.
- Successful Wood Turning—32.
- How to Read Blueprint—71.
- Metal Turning Lathe Kinks—99.
- Operating a Metal Lathe—100.
- Heat Treating, Hardening—102.
- Working With Glass—103.
- Servicing Elec. Motors—75.
- Electromagnets & Solenoids—44.
- Transformer Construction—41.
- The Boy Electrician—43.
- Soldering and Brazing—17.
- Arc and Spot Welding—5.
- Electroplating With Nickel, Chromium, Cadmium, Etc.—86.
- Plating Leather, Wood, etc.—87.
- Lower Your Fuel Costs—31.
- Curing Leaky Basements—45.
- Fitting Home Game Room—55.
- Indoor & Outdoor Fireplaces—88.
- Backyard Gardening—39.
- Lawn and Garden Novelties—72.
- Trellises, Pergolas, Fences—76.
- Lawn and Garden Furniture—77.
- Playground Equipment—73.
- How to Use Your Drill Press—125.
- Making Serving Trays—53.
- Knots and Rope-work—105.
- Sanders—80.
- House Wiring—89.
- Hanging Wallpaper—38.
- Built-in Fixtures—78.
- Bird Houses—7.
- Magazine Racks—49.
- Clock Cases—50.
- Book Ends—52.
- Small Tables—54.
- Smoking Stands—56.
- Desks—58.
- Book Cases—59.
- Action Toys—66.
- High Flying Kites—67.
- Telescopes—20.
- Metal Craft—28.
- Small Looms—37.
- Gem Cutting—42.
- Photo Enlargers—1.
- Photo Kinks—98.
- Cleaning Formulas—11.
- Taxidermy—9.
- Photo Lighting—119.
- Training Dogs—35.
- Small Furnaces—36.
- Working With Plastics—61.
- Simple Home Improvements—104.
- Ridding Home of Insect Pests—107.
- Children's Room Furniture—61.
- Jigsawed Novelties—57.
- Doll House & Doll Furniture—60.
- 25 Sneaky You Can Make—64.
- Novelties Turned on Lathe—62.
- Inlay Pictures—Veneering—63.
- Wood, Soap Carving—65.
- Windmills & Weather-vanes—68.
- Lamps from Wood, Metal—69.
- Rustic Furniture—18.
- Wood Finishing—40.
- How to Fix Electrical Appliances—111.
- Painting Your House—117.
- Build Your Own Relays—123.
- Rowboats, Small Dinghy—83.
- Small Sail Boats—84.
- Two Outboard Runabouts—85.
- Build Own Canoe, Kayak—30.
- Build Class-E Ice Yacht—22.
- Auto Kinks, Shortcuts—10.
- Lawn and Garden Equipment—124.
- Motor-Driven Midget Cars—34.
- Stop Auto Elect. Troubles—95.
- Photo Printers and Dryers—25.
- Photo Darkroom Equipment—96.
- Trick and Table Top Photos—97.
- Home Movie Equipment—118.
- Poultry Houses—108.
- Guns and Decoys—109.
- Re-Silvering Mirrors—70.
- Chemical Experiments—93.
- Log Cabins, Tourist Houses—14.
- Using Basic Tools—120.
- Farm and Garden Tractors—8.
- Building Extra Attic Rooms—23.
- Attractive Basement Rooms—24.

POPULAR MECHANICS PRESS, Dept. 635, 200 E. Ontario, Chicago 11

Pay Is Good

for Trained mechanics in these Big Industries

LEARN IN A FEW WEEKS IN OUR BIG MODERN TRAINING SHOPS—

AUTOMOTIVE MECHANICS

NOW IS THE TIME TO PREPARE FOR YOUR PLACE IN A GIANT INDUSTRY

DIESEL MECHANICS

OR BEGIN TRAINING AT HOME AND COME TO SHOPS LATER.

BODY & FENDER REBUILDING

Automobile and Diesel industries making up for lost time! There may never again be such opportunities for men who want better jobs or business of their own to get in on ground floor and go up fast! Yes—FOR MEN WHO ACT FAST, THINGS CAN HAPPEN FAST!

AUTO MECHANICS needed to keep millions of cars, busses, trucks rolling. Efficient auto mechanics get fine pay. Can service, install, repair all mechanical and electrical parts of autos. Learn to overhaul and repair engines, transmissions, differentials and other assemblies.

DIESEL MECHANICS needed. Diesel engines are used in locomotives, ships, trucks, busses, power plants, tractors, farm equipment. Trained men needed to repair, rebuild, install, maintain, operate, equipment. A big field that promises even bigger things in the years right ahead.

BODY AND FENDER REBUILDING one of best paid branches of automobile industry. Trained men make good profits in garages, service stations. Practical, all around training—welding, aligning, mixing and matching colors, spray painting, power and hand tools.

A NATIONALLY KNOWN INSTITUTION

C. T. I. was only civilian school selected by Army to train service men for refrigeration. C. T. I. executives were active in training Auto Mechanics for U. S. Army. Same quality training available to you now. The method that has made rapid progress possible.

VETERANS—Just mail coupon, we will handle all details.

NON-VETERANS—Don't let the lack of ready cash prevent you from taking this training now. Investigate our Low Easy-Payment Plan and our Pay-After-Graduation Plan.

COMMERCIAL TRADES INSTITUTE
Dept. E2-2, 1400 W. Greenleaf Ave., Chicago 26, Ill.



FREE—Important Information Telling How To Get Started

CUT COUPON ALONG THIS LINE

Fill Out, Cut Out, Mail Today

FREE—IMPORTANT INFORMATION TELLING HOW TO GET STARTED IN ONE OF THESE GREAT FIELDS

COMMERCIAL TRADES INSTITUTE, Dept. E2-2
1400 W. Greenleaf, Chicago 26, Ill.

Send free illustrated Brochures and other information about the field I have checked below.

- Body & Fender Repairing
- Automotive Mechanics
- Diesel Mechanics
- Radio
- Television
- Electricity
- Building
- Drafting
- Refrigeration and Air Conditioning

Name _____

Address _____

City _____ State _____

Veteran Non-Veteran

Make Use of
**POPULAR
MECHANICS
BOOKS**

STREAMLINED HELP



**BETTER JOBS
HOBBIES
AND PASTIMES
HOME AND FARM
WORKSHOPS
HOME REPAIRS-
IMPROVEMENTS**

THE INEXPENSIVE PRACTICAL BOOKS WITH A MILLION READERS!

Want help on your job—extra knowledge that brings extra pay? Want to save money on home repairs? Want practical information to better enjoy hobbies and home and farm workshop projects? Then get a Popular Mechanics Book. These easy-to-use books, written in plain, everyday how-to-do-it English, and extravagant with pictures, plans, diagrams, etc., will give you the practical help you need. Full library size, cloth bound book unless otherwise described. Rush order on coupon today. Money back if not satisfied.



FORTY POWER TOOLS YOU CAN MAKE

Have your own powered workshop at low cost. Tells how to make forty different machines such as lathes, drill press, jig saw, band saw, circular saw, sanders, from pipe fittings, old auto parts, wood, etc. New 1948 edition. \$1.50

POPULAR MECHANICS PHOTO HANDBOOK

An entirely new and different book from our popular Photo Guide. It's a complete guide to better pictures and darkroom technique, and features dozens of handy gadgets you can make yourself. \$2.00

BUILD A BOAT FOR PLEASURE OR PROFIT

How to build 17 low-cost boats at home—power, sail or row boat. Prepared especially for the home builder with limited tools, no experience and little money to spend. Plans, diagrams and illustrations. \$1.50

WHAT TO MAKE FOR CHILDREN

A Popular Mechanics book for Dad, Mother and the whole family. Shows how to make toys, dolls, doll houses, slides, see-saws, rocking horses, furniture. 175 projects to make from discarded or inexpensive materials. \$2.00

THE GARDEN BOOK

How to build your own trellises, fences, lawn furniture, outdoor fireplace, attractive ornaments and other things for your yard and garden. Beautify your grounds—enjoy attractive equipment—at low cost. \$1.00.

OUTDOOR SPORTS MANUAL

220 helpful articles and hints for fishermen, hunters, campers, trappers, archers and boatmen. If you love the outdoors, double your enjoyment with the help of this new book. Contains 334 illustrations. \$2.00

WHAT TO MAKE. 10 Volumes



The famous annual craftsman's guide. Shows what to make and how to make hundreds of things in spare time for fun or profit. Novelties, gifts, toys, games, furniture, etc. Cloth bound and filled with instructive pictures. Single volumes, each \$1.75. Save money on 10 volume set, complete, only \$15.00.

POPULAR MECHANICS SHOP NOTES

New 1949 volume. Latest in series of practical and helpful year books for every man who uses tools. Contains 240 pages and 750 illustrations. This book will make money for you and make your job easier. Soil-proof paper cover. \$1.00

POPULAR MECHANICS MOTORIST'S HANDBOOK

For every man who drives a car and wants to do his own servicing and simple repairs. A money-maker for the professional auto repairman. Hundreds of ideas, helps, and kinks you can use every day. \$2.00.

CONCRETE HANDBOOK

How to do all types of concrete work and make ornamental things of cement—walks, driveways, foundations, steps, vases, benches, etc. Ideal book for home owner, handyman and construction men. \$1.50

WELDING, BRAZING AND SOLDERING

How to construct welding equipment and use it effectively—small arc welder, spot welder, arc torch. Best approved methods, tricks and kinks to use in soldering, brazing, heat treating iron and steel. \$1.25



YOUR HOME and HOW TO BUILD IT YOURSELF

Step by step instruction by which anyone with ordinary knowledge of use of hand tools can build a five-room house complete. Every detail is shown in pictures with amazing clarity. Will save hundreds of dollars building any house. Spiral bound. \$3.00. Complete set regular builders plans \$12.50. Book and plans \$14.00.

FARM MANUAL

Hundreds of articles on making farm implements and equipment, maintaining the home, farm workshop, live stock and poultry, many farm hints and kinks. A book for every member of every farm family. 284 pages. Hundreds of illustrations. \$3.00



THE BOY MECHANIC

One of the most popular and best known Popular Mechanics publications. Describes hundreds of things for boys to do and make. Develops natural talents and industry. Crammed with how-to-do-it illustrations. The perfect gift for every boy. \$2.00

PAINTING, FURNITURE FINISHING AND REPAIRING

A book for craftsmen, home owners, shop workers and furniture repairmen and finishers. Covers repairs and finishing, restoring antiques, spray and brush painting of all kinds. An all 'round book for everyone. \$1.50

USE THIS HANDY COUPON • Mail Today

POPULAR MECHANICS PRESS, Dept. 128, 200 E. Ontario St., Chicago 11

Send Popular Mechanics books checked. I will pay postman, plus charges (U.S.A. only). Remittance enclosed—send fully prepaid. I will return books in five days for return of money if not satisfactory. Outside U.S.A. please add 15% for postage and wrapping.

Forty Power Tools . . . \$1.50	What to Make (Children) . . . \$ 2.00	Boy Mechanic . . . \$ 2.00
Painting, Finishing, etc. 1.50	Garden Book . . . 1.00	Concrete Handbook . . 1.50
Motorist's Handbook . . 2.00	What to Make (1 Vol.) 1.75	Welding, Brazing . . . 1.25
Photo Handbook . . . 2.00	10 Volumes . . . 15.00	Your Home 3.00
Build a Boat 1.50	Shop Notes 1.00	Book with Plans . . . 14.00
Sports Manual 2.00		Farm Manual 3.00

Name _____

Address _____

City _____ State _____

Check
for
FREE
Cata-
log



Everybody Deduct 10%
OUR GUARANTEE
OUR TIRES must make good
or WE WILL
NEEDLESS TO PAY MORE
RISKY TO PAY LESS
Send this ad with order
TUBE GIVEN WITH EVERY TIRE

You get what we advertise
Highest Quality Lowest Prices

High Original Treads Slightly Used
BUY IN CONFIDENCE safe dependable selected POPULAR
BRANDS—Guaranteed to give A-1 SERVICE. Do not confuse
these tires with re-caps or re-treads.

SELECTED O.K. for TOUGHEST JOBS
Not just good... THE BEST
These are genuine Values!

One Trial will CONVINCE YOU		World's Best Truck Tire Values Top Service Minimum Prices		
600-16....	\$5.42	750-20 (10) \$11.42	600-20....	\$7.92
650-15....	4.92	825-20....	650-20 (6)	8.42
650-16....	5.52	900-20....	700-20 (8)	9.92
700-15....	\$5.52	1000-20....	32 x 6 (8)	10.52
700-16....	5.82	1100-20....	32 x 6 (10)	12.42
750-16....	6.82	1100-22....	750-20 (8)	10.52

750-20 MILITARY 8 PLY \$11.98

900-16 MILITARY 8 PLY \$7.92

ONE QUALITY THE BEST AVAILABLE

Thousands of tires shipped to satisfied customers. We've made thousands of friends. MAIL ORDERS given personal Attention. Send money order or check. Dep't 2

STANDARD 834 N. Broad St., Phila. 30, Pa.

Elegant WOOD FIBRE CARVINGS

for Mantels, Cabinets and Architectural Trim... Beautiful

Reproductions of hand carved patterns. Executed in the most artistic manner. Carvings furnished with brad holes can be bradged or glued to the woodwork. We have thousands of patterns in stock.



#13323—
10 1/4" x 4" x 1/2"

ONLY \$1.00 ea.

Here is an exquisite design for elaborate beauty to any cornice.

#13324
3" x 5" x 1/4" 4 for \$1.40

This is a popular design to blend in perfect harmony with any cornice.



This Basket of Fruit design is a real favorite in any home. You will like it.

ONLY \$1.00 pair

ARCHITECTS, BUILDERS and DEALERS. Write for Catalog.

#13334—5 1/2" x 6 3/8"

DECORATORS SUPPLY CORPORATION Remit with order
2601 SO. PEORIA ST. DEPT. P-2 CHICAGO 8 We pay postage.

Pick up DOLLARS off the floor!



Start your own floor finishing business... big profits—no overhead—small investment



Yes, YOU can make real money—and put the profits in your own pocket! Now's the time to cash in on new housing and construction. No experience needed. Our booklet instructs you completely in setting up, operating and selling your services. Get started now!



HOLT MANUFACTURING CO.
651 20th Street, Oakland 12, Calif.

Gentlemen: I enclose 25¢ in coin or stamps for your complete booklet: "How to Make Money in the Floor Business." I understand there is no further obligation.

NAME _____

ADDRESS _____

CITY _____ STATE _____

PLAN YOUR FUTURE NOW!



Permanently Metalized Baby Shoes

YOU CAN START YOUR OWN BUSINESS

AT HOME • SPARE TIME • FULL TIME

LARGEST NUMBER OF SUCCESSFUL BUSINESS MEN

Our course has the largest number of successful business men in this field today. All are men and women who acted and are making money.

THIS COURSE IS GUARANTEED.

- Money-Back Guarantee
- Most Successful Name in Metallizing
- Big Income
- Huge Demand
- Sales Plans
- Future Security
- Your Own Business

Now is the time to cash in on this big-paying, easy-to-operate, year-round business and you need no experience. MATERIALS COST YOU ONLY 5c—YOU GET \$6.00! With actual illustrations and step-by-step instructions, YOU can start earning money in *only one week*—up to \$50 to \$75 per week spare time—up to \$1000 per month full time—\$5.00 and more per hour possible. Working only a few hours you can make more money than most people make working an entire week.

IMMEDIATE RESULTS—This tested and proved method shows you complete details so that you may start at once metallizing baby shoes with real Gold, Silver, Bronze, Pearl and Glass. They will last for ever and ever retaining every priceless detail of natural shoes. Five million new customers waiting to buy every year.

BEGIN AT HOME—Don't pass up this golden opportunity to start your own business on a shoe string. **ACT NOW!** We will send you full details *absolutely free*.

USE THIS COUPON



FREE!!

KIKTAVI

Company Dept. P-2
2111 W Manchester
Los Angeles 44, California

Rush me FREE full particulars at once

NAME _____

ADDRESS _____

CITY _____ Zone _____ STATE _____

Course includes FREE—2 actual metalized baby shoes guaranteed most attractive on market or PAIR OF YOUR OWN baby shoes metalized if you prefer.

**FIND OUT
FREE!**

**HAVE YOU
GOT WHAT
IT TAKES?**

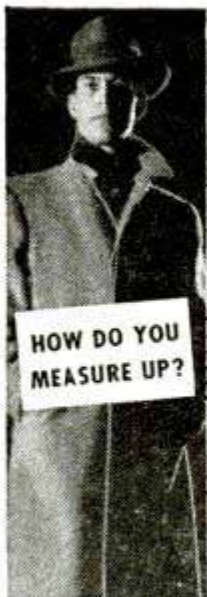

SUCCESS
HOME STUDY
WILL TO WIN
CHARACTER
HEALTH

to be a
**FINGER PRINT EXPERT or
TRAINED INVESTIGATOR?**
Send for free IAS
Qualification Question-
naire. In our opinion
your answers indicate
that you "have what it
takes," then you will
receive absolutely free
the famous "Blue Book
of Crime" . . . plus full
details on how to train
at home in Crime De-
tection and Finger
Printing! IAS gradu-
ates are key men in
over 800 Police Bu-
reaus. See if YOU can
train for this exciting,
steady, "good pay"
work! No obligation.
No salesman will call.
Write today, stating age.

INSTITUTE OF APPLIED SCIENCE
1920 Sunnyside Ave., Dept. 1352, Chicago 40, Ill.
INSTITUTE OF APPLIED SCIENCE
1920 Sunnyside Ave., Dept. 1352, Chicago 40, Ill. *
Gentlemen: Without obligation or expense on my part, send me
your qualification questionnaire. I understand that upon receipt
of my answers you will immediately advise me if you think they
indicate that I have a chance to succeed in criminal investigation
or finger print work. Then I will receive FREE the "Blue Book
of Crime," and information on your course and the 800 American
Identification Bureaus employing your students or graduates.
Name _____
Address _____ RFD or Zone _____
City _____ State _____ Age _____

SAY YOU SAW IT IN POPULAR MECHANICS

REAL ESTATE
BE A BROKER

**PAYS BIG! SEND FOR FREE, BIG, ILLUSTRATED
CATALOG NOW!** No obligation. Graduates report making
substantial incomes. Start and run your own business
quickly. Men, women of all ages, learn easily. Course covers
Sales, Property Management, Appraising, Loans, Mortgages,
and related subjects. **STUDY AT HOME** or in our classrooms in
big cities. Diploma awarded. G.I. approved. Nationally known.

WEAVER SCHOOL OF REAL ESTATE (Est. 1936)
15 E. Pershing Road Dept. NT-2 Kansas City, Mo.

**FREE
BOOK
TELLS
HOW**

NEON SIGN SCHOOL
BIG PAY—JOBS COAST TO COAST

MEN—You have the chance of your life for really big
money—\$100, \$150 a week and UP—by getting into Neon,
fastest-growing, most interesting branch of advertising.
Come to Acme and let us make you a real Neon Expert.
Interesting, 500 hour job-practice, **LEARN-BY-DOING**
Course. We teach you and train you in Glass Blowing,
Letter Bending, Color Gassing, Bombarding, other im-
portant branches. No text books. No home study. No
mathematics. Demand for Acme Graduates far greater
than we can supply. Day and Night Classes. Enrollments
accepted daily.

FREE FOLDER. Send today for FREE Fact folder, "Your Big
Opportunity." Gives you complete facts about jobs open, our training
facilities, your chances for SUCCESS. Write today.

VET. APPROVED

Acme Training approved under G.I. Bill of Rights. Acme is also
approved as registered school by Board of Education, State of Illinois.
Our Instructors are all top grade experts. Our Facilities are best
obtainable. We furnish all supplies, equipment.

ACME NEON INSTITUTE

Dept. BB3, 330 South Paulina St. Chicago 12, Ill.

WORLD'S FOREMOST NEON SCHOOL

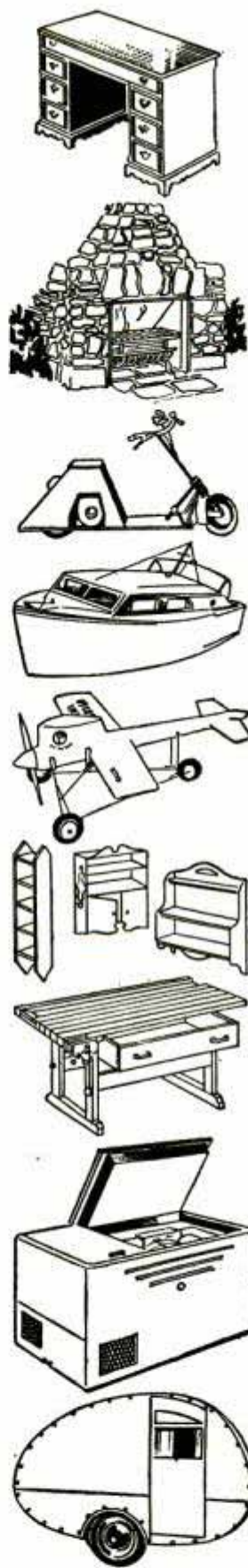

**YOU CAN MAKE THESE WITH
POPULAR MECHANICS
PLANS AND BLUEPRINTS**

- 501—Colonial Grandfather's Clock. 25c
- 507-508—Doll-House, 5 Rooms, Open staircase, fireplace. . . . 50c
- 526—Queen Anne Coffee Table: True replica of antique. . . . 25c
- 528—Duncan Phyfe Console Table: 30 in. high. . . . 25c
- 529—Lawn Chair: Southern style. 75c
- 593—Three Attractive Corner Shelves: Scroll-sawed. . . . 25c
- 59C—Three Hanging Type Shelves: Hold books, china, etc. . . . 25c
- 661—Rocking Horse: Scroll-sawed from plywood. . . . 25c
- 707—12 Ft. Rowboat: Flat-bottom, four seats. . . . 25c
- 795—Two Handsome Cedar Chests. 25c
- 811-812—16 Ft. Canoe: Canadian type, cedar planking. . . . 50c
- 813-814—Pops Outboard Racers: 10 ft. long, stepped bottom. . . 50c
- 828-835—Sovereign of the Seas: English warship model. . . \$2.00
- Sovereign of the Seas: Instruction Book. . . . \$1.00
- 836—12 in. Bandsaw: Uses ply-wood, cuts two in. stock. . . . 25c
- 839—Melrose Corner Cabinet: Old Colonial design. . . . 25c
- 846-848—Governor Winthrop Desk: True copy of original. . . 75c
- 896-897—Three Easily Made Workbenches—Simplified construction. 25c
- 906-909—Midget Auto: 58 in. wheelbase, 1/2 to 3/4 h.p. . . . \$1.00
- 910—Circular Saw Table: Hard-wood, 24" x 36", Stationary. . . 25c
- 917—Outdoor Fireplaces: Several simple but practical. . . . 25c
- 920-922—Lawn and Garden Furniture: Swings, arbors, tree seat. . 75c
- 923—Indoor Fireplaces: Standard Sizes. . . . 25c
- 926-927—Venetian Blinds: Three different styles. . . . 50c
- 930—Hooked Rug Frame—Quilting Frame. . . . 25c
- 931—Cape Cod Cupboard: 4 ft. wide, 5 ft. 8 in. high. . . . 25c
- 935—Knee-Hole Desk: 40 in. long, 30 in. high, 3 1/2 in. wide. . . 25c
- 936—Modern Coffee Table: 24 in. long, 15 in. wide. . . . 25c
- 952—Child's Crib in Maple. . . . 25c
- 958—Colonial Corner Cupboard: 6 ft. 8 in. high. . . . 25c
- 961—Hanging China Cabinet: 38 in. long, 40 in. high. . . . 25c
- 960—Combined Chest and Writing Desk: 35 1/4 in. high. . . . 25c
- 970—Modern Clothes Chest: Built of Plywood. . . . 25c
- 977—Bookcase in Chippendale Style: 47 in. high, 10 in. wide. 25c
- 978—Lawn Chair on Wheels: Lightweight, easy to wheel. . . 25c
- 981—Colonial Wall-Shelf: 30 in. high, 19 in. wide. . . . 25c
- 98—Duncan-Phyfe Drop-Leaf Table: Reproduction of historic piece. 25c
- 986-987—Utility Trailers: Built of old auto parts. . . . 50c
- 989-990—Speedy Motor Scooter: Gas engine, 40 to 60 miles on gal. of gas. . . . 50c
- 991—Gun Cabinet: Handy cabinet includes rack for rifles. . . . 25c
- 993—Twin-Deck Beds: 6 ft. 4 in. long, 3 1/2 ft. wide. . . . 25c
- 1106-1112—SEACRAFT—25 FT. CABIN CRUISER: Adaptable as sport fisher, express cruiser, or utility boat. Cruises at 15 knots with marine engine or converted auto engine. Cabin sleeps four. Galley has fresh-water tank, sink, and cook stove. Set of seven large-sized blueprints scaled 1 in. per ft. plus 40-page two-color illustrated booklet, only. . . . \$10.00
- 1011—Fireplace Fittings: Andirons, log rack, etc. . . . 25c
- 1080-1081—Banta: 12 Ft. Ply-wood Runabout: Vee-Bottom, 3-passenger. . . . 50c
- 1086—Black Forest Corner Shelf: Scroll-sawed. . . . 25c
- 1089-1090—Home-Constructed Freezing Unit: reaches 30 degree temp. . . . 50c
- 1091-1096—17 ft. trailer, 7 ft. wide. Steel chassis. . . . \$1.50
- 1102-1105—Midget Trailer: "Tear-drop" body. Sleeping quarters for two. . . . \$1.00
- 1113-1114—Gold Rush of '47: The A.M.A. Open Class B Record Holder Plane Model. . . . \$1.00

FILL OUT AND MAIL THIS COUPON NOW

POPULAR MECHANICS CO.
200 E. Ontario St., Chicago 11

Please send the following plans _____
I am enclosing \$ _____
Name _____
Address _____

SMOOTH is the word for
the man with **P.A.***



P. means **P**ipe **A**ppeal
A.* means **P**rince **A**lbert

Pipe Appeal is that extra attraction of the man who smokes a pipe. And when that pipe is packed with Prince Albert — you have really smooth smoking!

● Get Prince Albert today — and see for yourself why it's known as the National Joy Smoke. P. A. is really rich tasting — mild, and tongue-easy. That choice crimp cut tobacco is specially treated to insure against tongue bite. Get Prince Albert for real smoking joy and comfort!

R. J. Reynolds Tobacco Company, Winston-Salem, North Carolina



*"P.A. ROLLS UP SO SMOOTH — MAKES
A GRAND-TASTING CIGARETTE!"*

THE NATIONAL JOY SMOKE

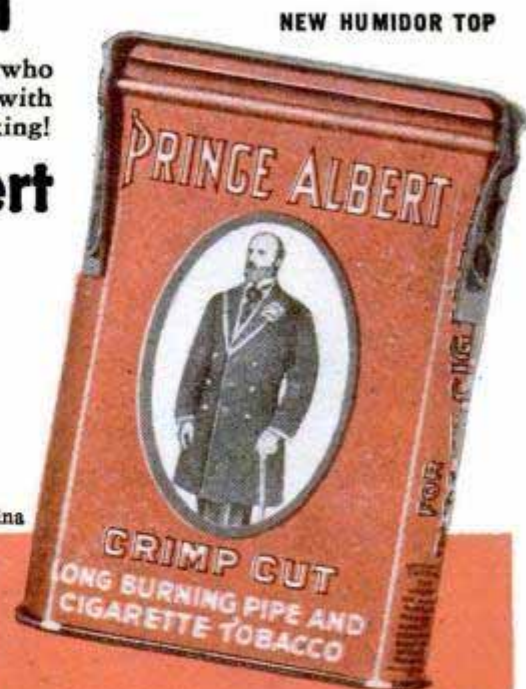

NEW HUMIDOR TOP



49 uranium rush

PROFESSIONAL and amateur prospectors by the thousands are literally leaving no stone unturned in the great uranium rush of '49. The ores which yield atomic energy are being sought in every part of North America.

Excited by reports of government rewards, many of the prospectors are wasting their time in localities where uranium of worthwhile quality can hardly be expected to be found, though there is always a chance that someone may upset the convictions of mining engineers by making a "strike" in a new region.

The Atomic Energy Commission wants to see samples of any ores suspected of containing valuable amounts of radioactive materials, but prospectors are urged to make reasonable tests of their samples before submitting them. Misinformed or overly enthusiastic people have submitted hundreds of samples of worthless rocks, including ordinary concrete, to the commission.

A woman in Alaska sent in a piece of wood from a birch tree which had shown traces of fluorescence. A Texas rancher sent in samples of earth from his ranch because he stated that when his cows walked in the area from which the earth came they invariably collapsed. Another citizen reported that he had seen a ball of



This 20th-century '49er is looking for uranium—not gold. He carries a radiation counter which reveals radioactivity in rock. Here he has lifted counter tube from unit to test ledge

fire rolling in the valley and that this was evidence of uranium. He was asked to provide a sample. One recent sample was carefully packed in a hot-water bottle, probably to shield the public from radioactivity which it failed to possess.

The latest important discovery was made by a smart Canadian prospector, Robert Campbell, who did his preliminary exploration work in a Toronto library. Poring over reports of prospectors who had sought copper ore a century ago, Campbell found that some of the reports mentioned deposits of uranium about 70 miles north of Sault Ste. Marie. Uranium was worthless 100 years ago and no one bothered to work the mineral or even to describe exactly its location.

Equipped with a Geiger-Mueller radiation meter, Campbell spent most of last summer in the region covered by the reports, probing the rocky shore of Lake Superior and climbing 1000-foot cliffs in his search. Week after week his earphones gave out only the normal background response, then while exploring a place called Alona Bay the earphones began to buzz wildly. He was standing within a few feet of a two-inch seam of black pitchblende. Ore that runs 10 percent uranium is considered very valuable; Campbell's discovery has a 60 percent radioactive content. Today, 500 claims or more have been staked out surrounding his find.

From now on the United States and the whole world can hardly find enough uranium and thorium to satisfy their needs. As producers of energy and for military uses, rich radioactive minerals are far more precious than gold. Canada, Belgian Congo and Czechoslovakia contain the principal known deposits. In the United States, uranium-bearing ores have come mainly from an area on the Colorado-Utah border. A recent pitchblende strike was made near Boulder, Colo. Deposits of low-grade materials so poor that they are not worth working with present techniques occur in many parts of the country.

Nevertheless the Atomic Energy Commission desires desperately to uncover any new sources of worthwhile ore and the commission has announced that a \$10,000 prize or bonus will be paid for the delivery of 20 tons of ore or concentrates that assay 20 percent or more in uranium oxide, provided that the material comes from a new, previously unworked deposit. In addition the commission will pay for the ore at the ordinary price. The offer applies to any discoveries inside the United States, its territories, possessions and the Canal Zone. The offer does not apply to carnotite-type ores of the Colorado plateau, neither is the reward paid simply for discovery or report of a new ore body. Twenty tons of good material must be delivered before the prospector can collect.

In the field—prospector holds "probe" containing counter tube to rock sample as he listens for "clicks." In the assay office—the heated sample will fluoresce after it is cooled and exposed to ultraviolet light



The guaranteed minimum AEC price for uranium ores is at the rate of \$3.50 per pound of uranium oxide that is recoverable from the ore, less refining costs, plus allowances for other valuable minerals that may be contained in the ore. Carnotite ores are priced on a different schedule at rates that vary from 30 cents to \$1.50 per pound of contained uranium oxide, plus certain bonuses, plus allowances for other valuable constituents. Carnotite purchases are made in minimum lots of 10 tons. Ores that assay less than 0.10 percent uranium oxide or that contain excessive quantities of lime are not purchased.

In all there are more than 100 recognized uranium ores, of which only a few are rich in radioactivity. The so-called primary ores are the most valuable, these being massive pitchblende that runs from 50 to 80 percent uranium and from which radium is also extracted, and crystalline uraninite, 65 to 80 percent uranium. Each is apt to occur in veins or dikes scattered through quartz formations. Each is dark, heavy, brittle and metallic or submetallic in appearance. Pitchblende may be associated with silver, nickel, or other metals, while uraninite often occurs in or near a deposit of black mica. Any dark, heavy mineral that is discovered in a pegmatite formation should be tested for possible uranium content. Black tourmaline and hornblende, often mistaken for uranium, are of a lighter weight with translucent splinters.

The secondary group of uranium compounds includes carnotite and autunite, or tobernite.



Above, final test of uranium ore is made with a \$7000 Geiger-Mueller counter X-ray spectrometer that records all elements contained in sample

Right, prospector's chart shows counts made at corners of 20-foot squares. He then can tell size and shape of subsurface ore so he can judge extent of strike

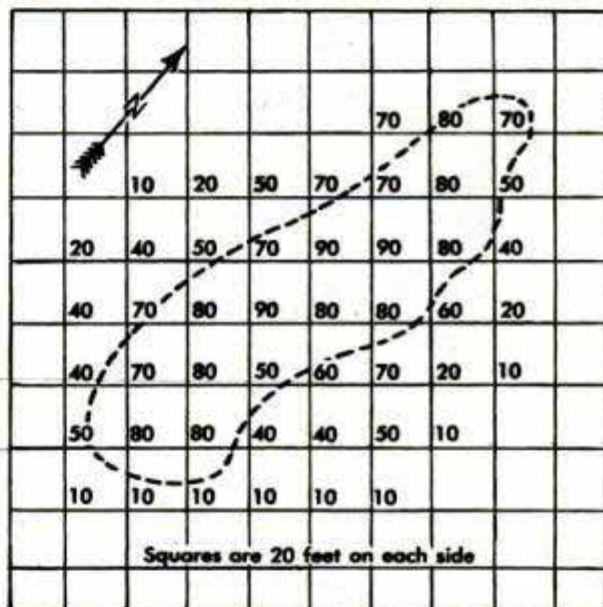

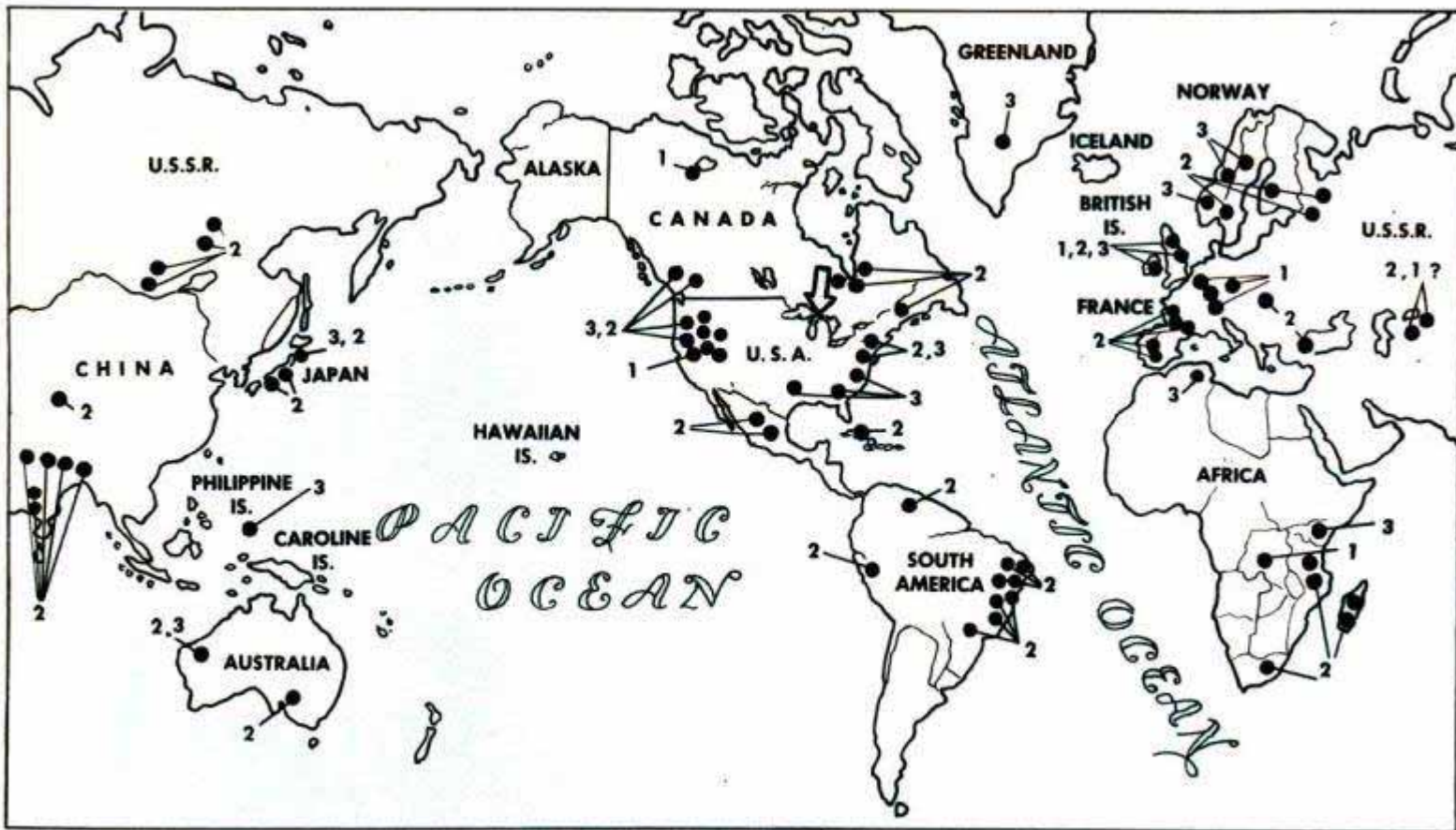

Copyright by Jack DeMent and H. C. Dake, Handbook of Uranium Minerals

World map shows location of known uranium areas. 1. Important producers. 2. Known deposits of radioactive minerals which have been worked in the past and are potential source. 3. Other known uranium localities

Some are rich enough to be valuable, some are simply impurities in the basic material. They may be found chemically united with lead, copper, or vanadium, among other elements, or they may occur as precipitated material in sedimentary formations. The secondary minerals are characteristically brilliant yellow, orange, or green, depending on associated elements, and they are apt to be found in the form of powdery crusts. Long exposure destroys their brilliant coloring. Colored crusts or veins near the surface, however, may be an indication of much richer ore below or nearby.

The group of thorium minerals, also sought after because of their radioactivity,

is often found in association with uranium. Different kinds of thorium may occur as cubes or other crystals and may be dark red, brown, or yellowish in color. Beach sands sometimes contain monazite crystals, one of the thorium minerals, just as they sometimes contain heavy black grains of primary uranium materials.

The United States has very few known deposits of primary uranium and few, if any, of these are very extensive. Deposits of secondary compounds are found from Maine to California, along both coasts, and in many parts of the West. Some are high-grade, most are worthless; all are being sought and evaluated today. Principal center of prospecting activity ranges roughly from Holbrook, Ariz., to Grand Junction, Colo.

Prospecting for uranium can be hard work but detecting the material is easy. This is because of the uranium prospector's newest tool, the Geiger-Mueller radiation meter that gives an immediate response when it is brought close to any radioactive material. Commercial portable models made especially for prospecting cost from \$125 to \$250 and thousands of

Exposed to ultraviolet lamp, uranium ore may fluoresce but this is not a sure test as reaction may indicate other minerals





them have been sold in the last few years. In this issue of *Popular Mechanics* (page 238) a lightweight portable model that you can build yourself for prospecting and for other uses is described in detail.

Simply stated, the heart of a Geiger-Mueller radiation meter, often shortened to "Geiger counter," is a glass tube filled with some nonconductive gas such as argon and containing two electrodes. A potential of 800 volts, higher for some models, is placed across the two electrodes, the voltage being just under the amount required to cause a discharge across the gap. When a gamma ray from any source happens to enter the tube, it is attracted to the central positive electrode and the ray's ionized path through the gas permits a momentary discharge from one electrode to the other. This discharge, amplified, is registered in the earphones as a click, or it may be indicated on a microammeter or even by the flashing of a small neon lamp. Current for the high potential and for amplification is furnished by batteries contained in the instrument's case.

The Geiger-Mueller radiation meters are used for the detection of lost amounts of

(Continued to page 266)

Scene of Canada's latest uranium find is this rocky shoreline along the eastern coast of Lake Superior, 70 miles north of Sault Ste. Marie, Ont. The discovery was made by Robert Campbell (below), Toronto mining man who spent weeks combing area with a radiation counter. He is shown beside his claim stakes





Four-Passenger Stroller

Although they have three children and a dog in their family, a Sunday stroll is a well-organized operation for Mr. and Mrs. Wayne Hetsler of Chicago. They just load the youngsters and dog into a four-seated stroller Hetsler built and they're ready for the walk. Collapsible, the stroller fits easily in the family car. The fourth seat also serves as a package rack when necessary.

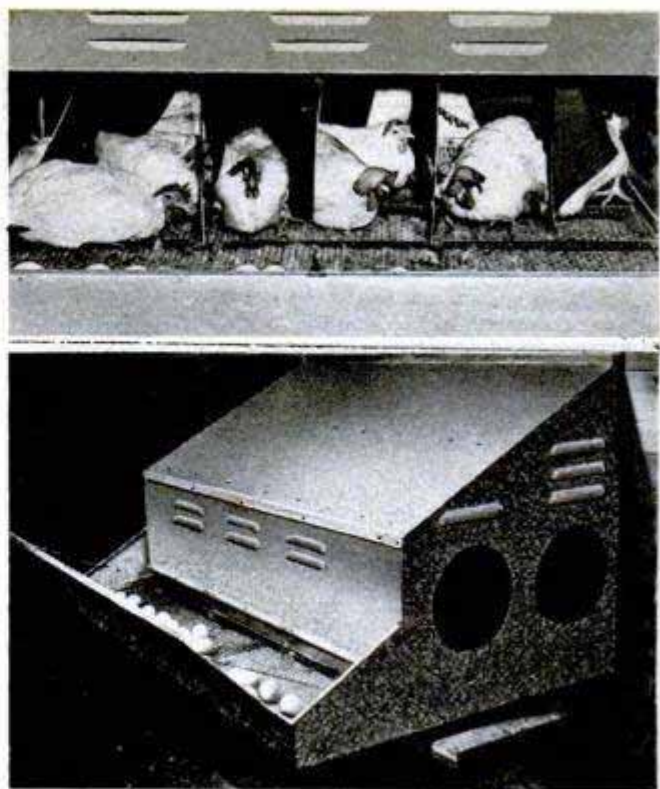

Top, a door swings up, revealing the sectional interior of the community-type nest. Above, the eggs roll down a metal screen to a collecting trough

Automatic Egg Collector on Nest

Eggs are automatically removed from under the hens when they are laid in a community-type nest. The eggs roll down a sloping screen into a collecting compartment where metal walls aid in dissipating the heat. The nest is easily cleaned with a removable tray beneath the screen. Each nest accommodates 70 to 80 hens and has four entrances covered by flaps. The interior is divided into sections and the front of the nest is hinged and swings back.

Spring-Pronged Wheel Turns Windrows for Quick Drying

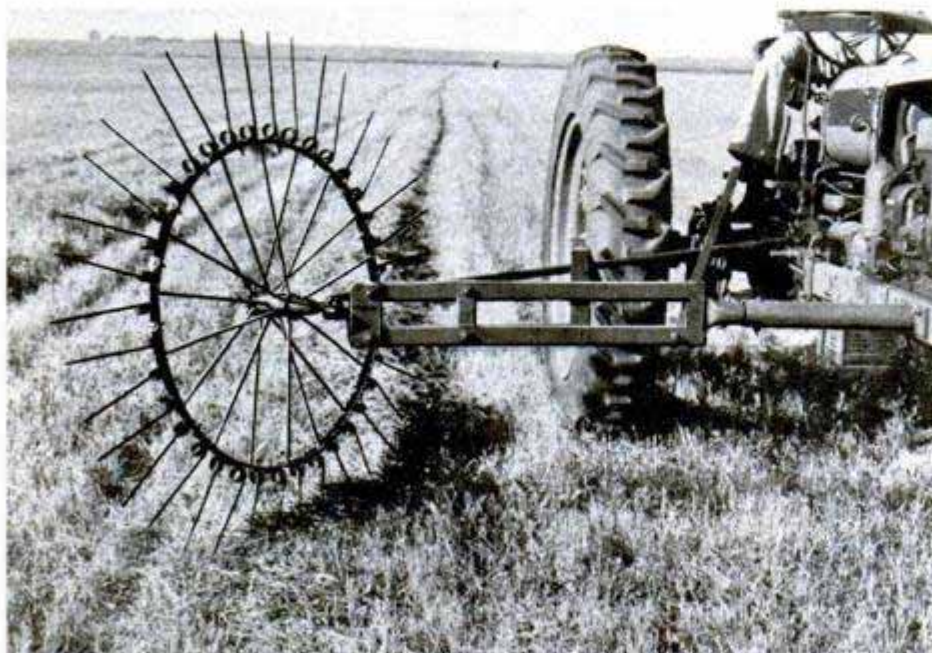

Windrowed crops are turned for quick drying without shelling or loss of leaves by a spring-pronged turner that can be attached to any tractor in a few minutes. Ground-driven, the turner has few parts to wear out. The wheel angle can be adjusted to three positions and also can be set for various sizes and weights of windrows.

☐ There are well over seven million acres of woodland being maintained by farmers of the United States.



RADIO IS TEST PILOT OF "FLYING STOVEPIPE"

Radio waves act as test pilot for the Navy when ramjet engines are put through their paces over the Pacific Ocean. Mounted on a tiny plane that looks very similar to the buzz bombs used by the Nazis, the ramjets are piloted on 10-minute flights by the radio-operated remote-control system. Data is transmitted back to the observers by a complex telemetering device. Since ramjets have no static thrust, they can't take off by themselves. A specially modified Black Widow fighter (top) carries the tiny plane aloft by means of a hanger under its right wing, upper right. Once over the test area, the ramjet is released and from then on it flies by radio control, right. Its flight is followed by radar. When its fuel supply is exhausted, the tiny plane automatically releases a large parachute which brings it down without damage (below), enabling the technicians to examine the engine for any faults that might have developed in flight



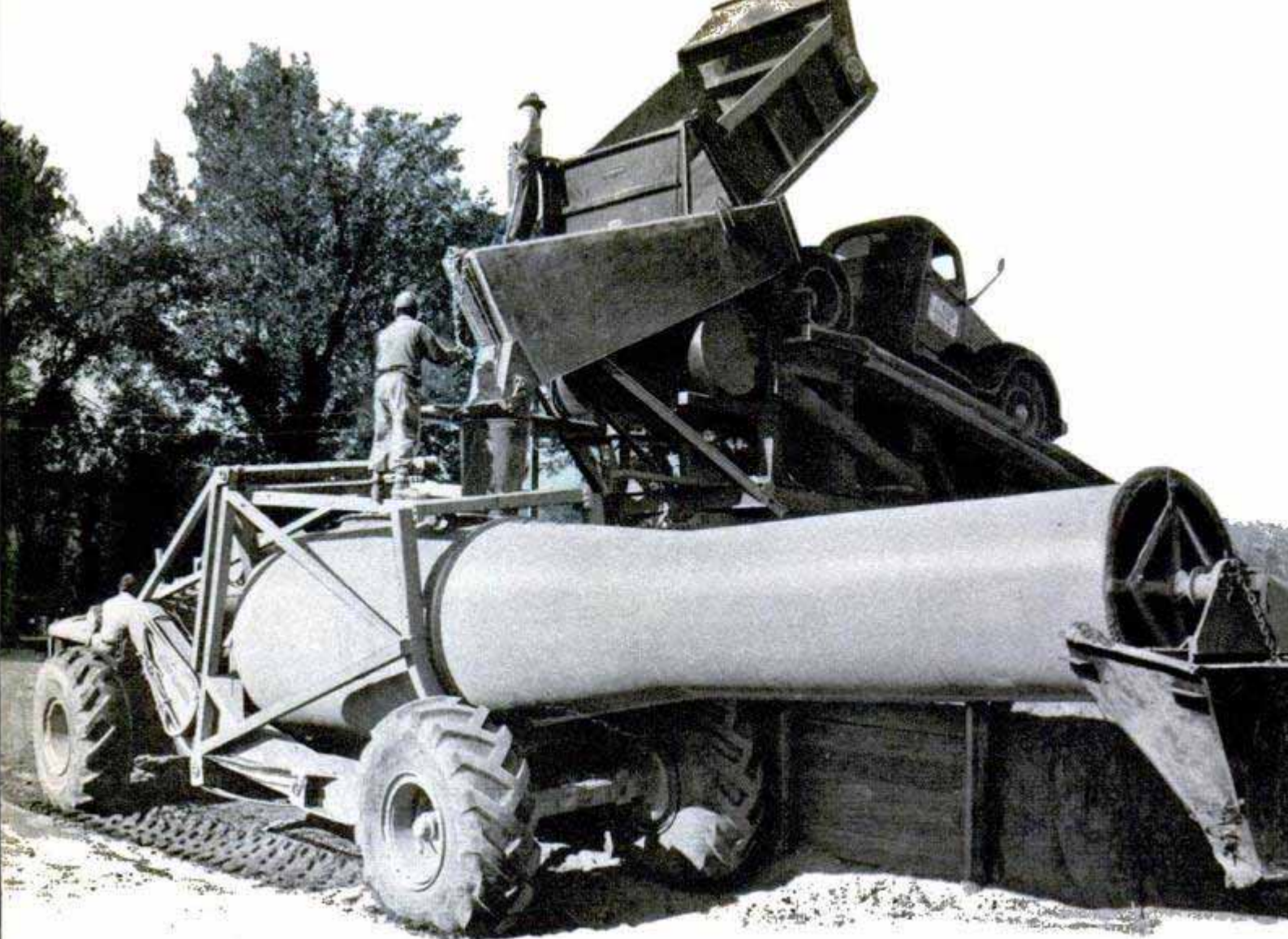

Concrete mixer with military profile takes on load of mix from truck which has backed onto the loading ramp

HOUSEBUILDING with a "HOWITZER"

A rear-wall form is lowered into proper position on footing

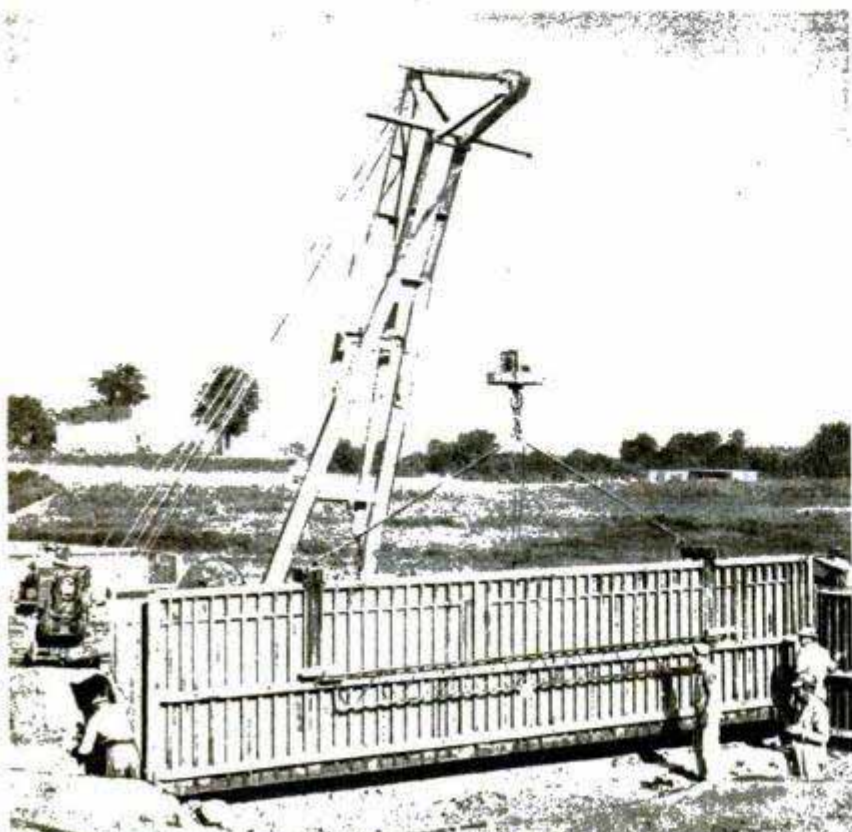

FOUR CONCRETE home foundations a day are being turned out by a new technique developed by Clarence T. Wilson, St. Louis contractor. Wilson, who is now working on a 400-home subdivision, has put foundation construction on a mass-production basis. He uses a special set of four portable steel forms and a mobile LeTourneau concrete mixer that pokes its mouth over the forms and pours a whole foundation with four fillings.

Each form consists of only eight major pieces, each seven feet eight inches tall. The eight sections, when bolted together into a hollow rectangle, take the place of the handmade wooden forms commonly used. Small steel outlines fastened temporarily between the inner and outer walls of the form leave necessary openings for basement windows and a coal chute.

The steel is coated with used motor oil before pouring so that the forms may be unbolted and easily slipped off after the concrete has set. Holes left by bolts holding the inner and outer walls together are plugged with cement to leave the walls watertight.

The mixer, with its 34-foot drum, resembles a giant howitzer. It is powered and moved about by a two-wheel, 110-horsepower prime mover which also tilts the mixer to raise or lower the muzzle for pouring. The mixer can pour at heights up to 20 feet.

On the inner surface of the drum are helical blades. As the drum revolves counterclockwise, the blades mix the six to seven cubic yards of ingredients while the mixer moves from a nearby loading ramp to the homesite. When the muzzle is in position over the form, the drum is reversed and the blades eject the mix through a swinging funnel into the form.

The mixer, one of four in the country, cost \$20,000, and the steel forms \$36,000. Wilson plans to use the outfit also in laying subdivision streets and basement floors.



Workman helps guide flow of concrete into a wall form. Cut-away section of drum shows helical blades inside. A swinging funnel is attached to mixer.



After 24 hours the bolts are removed and a crane lifts the frame from the hardened concrete. Bolt holes are plugged to make wall watertight.

Below left, 400 foundations are being poured in one subdivision with the "howitzer" equipment. Right, the finished product—a five-room house.



Jet Flying Wing for Carriers Travels Over 600 Miles Per Hour



For shipboard operations the Navy has a new jet fighter which hurtles through the air at speeds over 600 miles per hour. Designated the Chance-Vought XF7U-1, the jet fighter recently completed its initial flight tests. The plane is a flying wing of the swept-back type, and has two turbojet engines. Two vertical stabilizers and rudders are located on the trailing edge of the wing, but longitudinal and lateral control are obtained through a pair of "ailevators"—combined ailerons and elevators. The plane can be brought down to shipboard landing speed by extending two slats in the leading edge of the wing.

Lead-Free Paint Stays White Longer

Entirely lead-free, a new outside paint for homes stays white longer even in industrial areas where sulphurous gases darken white-lead paint by chemical action. Lead paints turn dark when sulphurous gases react with the lead to form lead sulphide which is black. In various places throughout the country, comparison tests of the lead-free paint and white-lead paints were made under adverse conditions. The lead-free paint remained white long after the other paints had darkened. The paint, available in white and colors, can be used on wood, brick and masonry.

These pictures, taken 14 months after the houses were painted, illustrate how the new type of paint resists darkening. First-quality lead-and-oil paint was used on house in upper picture. The lead-free paint was used on lower house. Panels at extreme right are close-ups of sidewalls





rhythm in roots

Nature is a fine sculptor, according to W. G. Hodgson of Dorothy, Alta., Can., who says he merely puts the finishing touches on Nature's artistry. Collectors on this continent, in England and Australia would dispute his word, though, for they claim the figurines he carves from juniper roots show the hand of a craftsman who has a fine imagination. Hodgson selects the twisted roots for grain and coloring, then lets the shape decide the nature of the finished figurine. His homemade tools produce weird but rhythmical effects. Hodgson finishes the figurines with "linseed oil and elbow grease—plenty of the latter."

Above left, wood sculptor selects a gnarled juniper root for a carving. Above, finished figure follows the lines of the root, giving a weird but rhythmical effect



Left, Hodgson makes his tools from bits of well-tempered steel. Ordinary tools wouldn't last long because the wood is so hard. Below, coloring and grain give the root graceful lines. Right, the sections of root are seasoned before they are shaped roughly for a carving



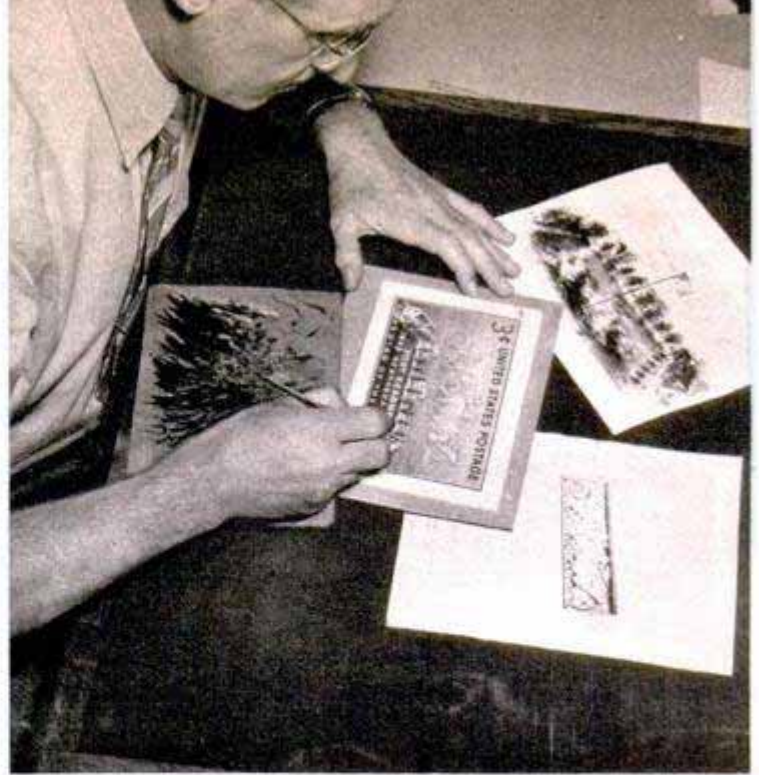
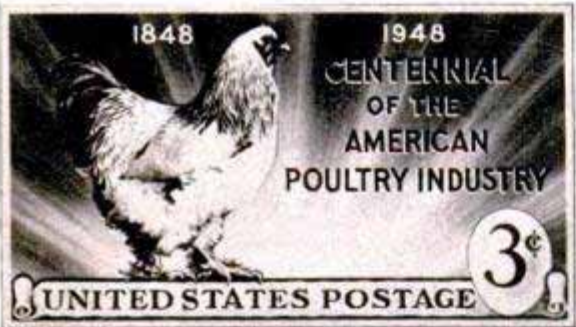
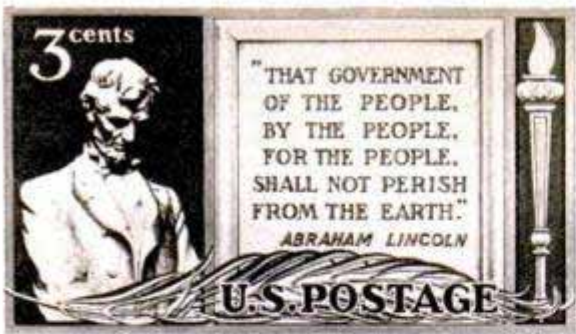

Carl T. Arlt, veteran stamp maker, puts finishing touches on his engraving of the Fort Kearny stamp

Uncle Sam's Stamp Factory

By Wayne Whittaker

THE THIN FELLOW you saw in the post office the other day with that worried look might well have been one of the millions of stamp collectors in this country. He has had a harrowing year—1948—trying to keep track of the special stamps that have rolled from the presses in the U. S. Treasury's Bureau of Engraving and Printing, Washington, D. C.

The last Congress may go down in history as the "Stamp Act" Congress. By congressional authorization, its members sponsored a new stamp on the average of every other week in 1948. Stamp dealers





Winding machine cuts the stamp rolls into strips to fit stamp machines. Big single coil has 3000 stamps

groaned. Stamp collectors groaned. Officials of the bureau groaned loudest of all, but Congress went happily on its way paying tribute to everything from the poultry industry to the Gettysburg Address.

The bureau has the big job of turning out some 20 billion postage stamps a year, (stamped envelopes are subcontracted) and billions of federal tax stamps such as are found on packages of cigarettes, playing cards and many other items.

The special postage stamps are called "commemoratives." In years past, the commemoratives have been issued by the authority of the Postmaster General who also is empowered by law to revise postage-stamp designs. Much fanfare accompanies the issuing of a commemorative and the stamp goes on sale the first day at a significantly located post office. For example, the U. S.-Canada Friendship stamp had a first-day sale at Niagara Falls, N. Y.; the Will Rogers stamp at Claremore, Okla., and the William Allen White stamp at Emporia, Kans. First-day covers, coveted by

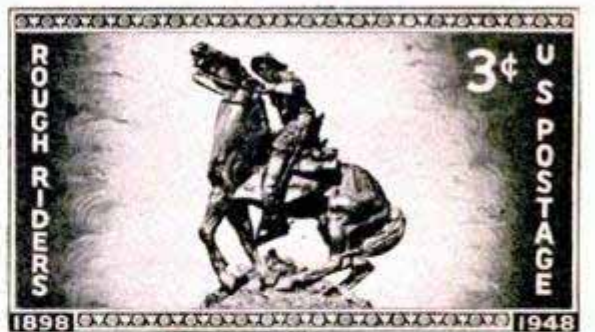
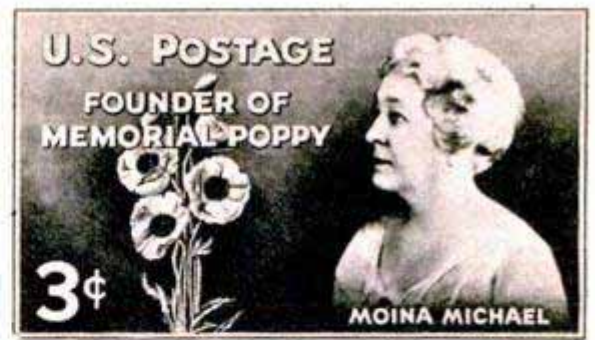

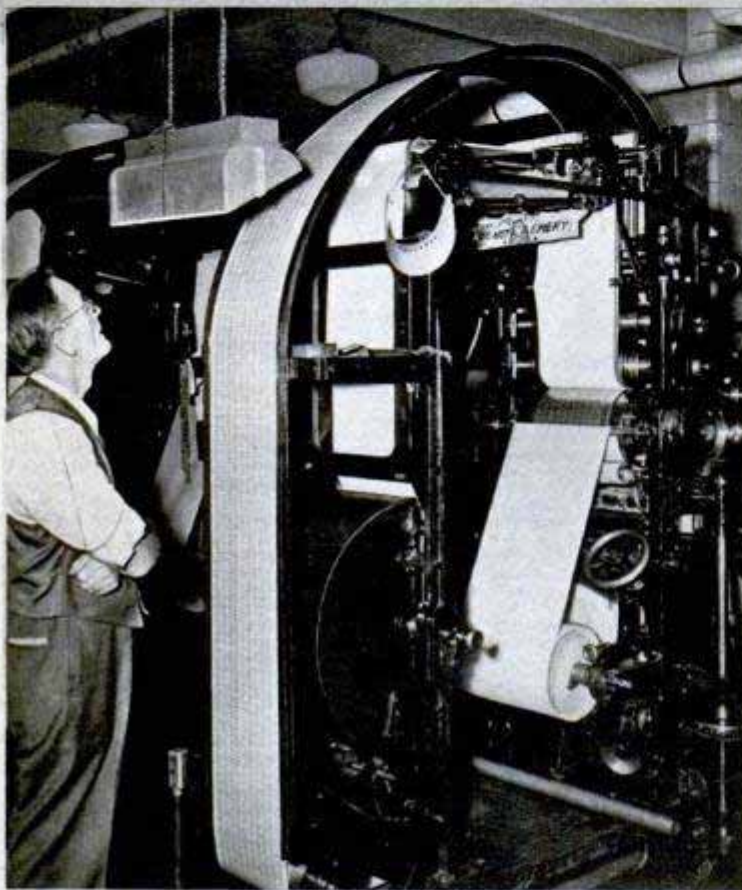
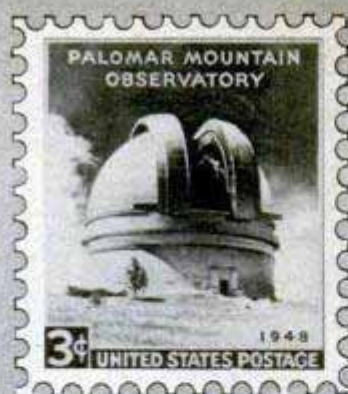

Most stamps are printed on specially designed rotary presses like this one. Below, hardening plate in cyanide bath. Right, reproducing stamp engraving on steel plate which will be bent to fit press
Photos by John Drew Atkin

stamp collectors, mailed from these post offices usually number about 450,000. This often means the organization of a special staff and weeks of preparation for the big day. The initial printing order for commemoratives is usually 50 or 60 million.

Sometimes sales of a special stamp are boomed by an unpredictable idiosyncrasy. When the three-cent Pony Express commemorative came out in 1940, somebody discovered the pony on the stamp looked like Seabiscuit, the famous race horse. This caused a furor among collectors and a rush to acquire the stamp. Then there was the two-cent Grand Canyon stamp back in 1934. A newspaper carried the story that if the stamp were held sidewise one could see a perfect profile of Mussolini. The rush was on.

If anyone thinks that getting out a commemorative, or any other kind of stamp, is a simple operation he is dead wrong. The procedure on the commemoratives ordered by Congress goes like this: The congressional authorization is sent to Jesse M. Donaldson, postmaster general; he sends it along to Alvin W. Hall, director of the Bureau of Engraving and Printing, who relays the order into the proper chan-

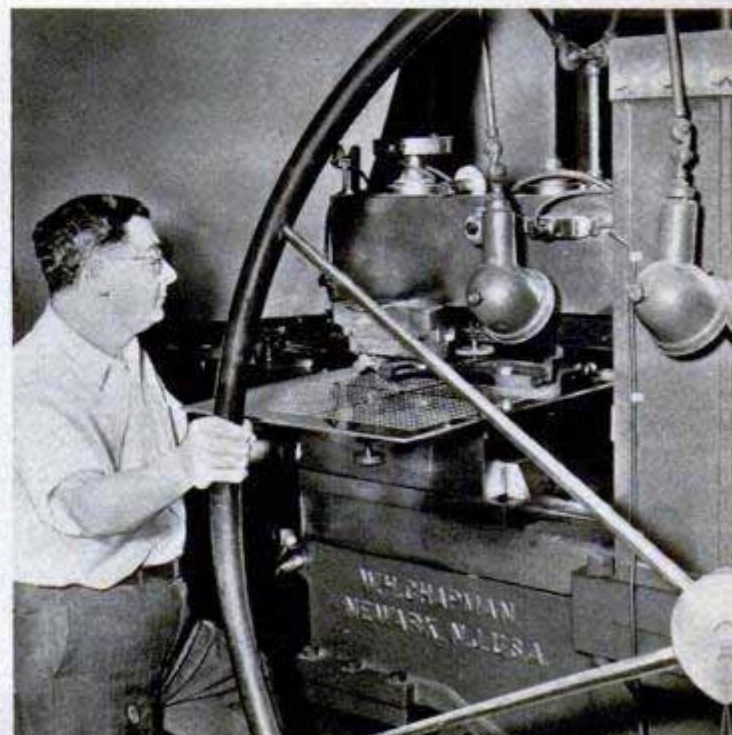



Right, fitting bent plate to the rotary cylinder is an exacting job. Plate holds 200 big-size stamps

nels for processing in the postage-stamp division and engraving department.

One of four designers in the bureau (who also design all remakes of paper currency such as the new \$20 bill with the Truman back porch on the White House) makes the layout for the new stamp. This is simplified if the Post Office Department has sent along subject material for the design. In the case of the Volunteer Firemen's stamp, which came out last October, a portrait of Peter Stuyvesant, founder of the organization, was submitted. All the designer had to do was secure a picture of one of the earliest fire engines in this country from the Library of Congress to use on the stamp with the portrait.

The designers get much of their material from the Library of Congress, but even this institution occasionally fails them. When William K. Schrage was working on the Fort Kearny stamp he was surprised to discover there was apparently no photograph of the early Nebraska fort anywhere to be found. After days of searching, the Army War College Library came to the rescue with an old photograph of an original sketch. This saved the day and the stamp was drawn up with the fort and a reproduction of a covered-wagon scene from a sculptor's group over the doorway of the capitol in Lincoln, Neb.

After the design has been scrutinized by Donald R. McLeod, superintendent of the engraving division, or his assistant, James T. Vail, it is then reduced to stamp size by photographing. This photo is submitted to the Postmaster General for an O.K. When the design has been approved, the original drawing is sent along to Carl T. Arlt, veteran foreman of the picture-engraving department. It takes about 120 to 130 hours to make the steel engraving which, of course, is the actual size of the stamp and is known as the master die. The

(Continued to page 262)

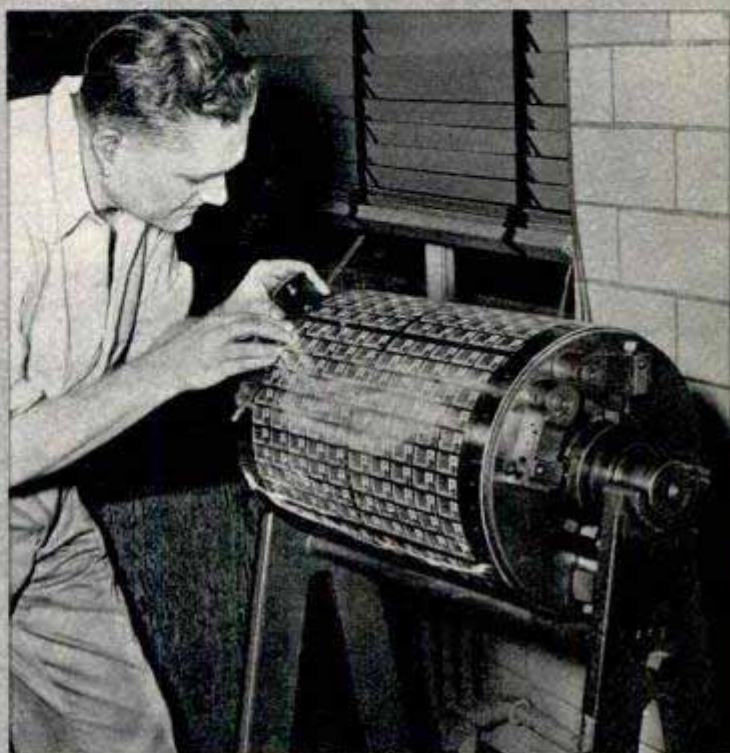

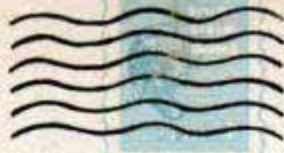

By Thomas E. Stimson, Jr.

the swift turbulence of the river, but today McGrady carries mail, passengers and cargo 100 miles upstream from Lewiston, Idaho, twice a week on schedule.

Sheep and cattle ranchers along the river depend on McGrady to bring them provisions and other necessities. Trappers and prospectors use the boat to reach country that is virtually untouched. Tourists who pay \$17.50 to ride upstream, returning the next

day, get a spectacular trip that they never forget. McGrady lost one boat when learning the river—now he knows just how to handle the Florence on every stretch of white water.

The riverman needs his pigeons because the Snake foams and tumbles through Hell's Canyon, the deepest abyss in the United States and possibly in the world. Broadcasts from a powerful radio station 80 miles away don't raise a whisper in a

Hell's Canyon Mailman

KYLE McGRADY figures that pigeons can deliver messages to places that radio waves can't reach and so this spring he will carry half a dozen homing pigeons on his boat, the Florence, every voyage.

McGrady is known as the "Mail Carrier of Hell's Canyon," the man who licked the Snake River and turned an adventurous boat ride into a routine run. Early explorers and the first settlers who ventured into what is now western Idaho were balked by

Burro-mounted tourist waves goodbye to the Florence and crew on return trip to Lewiston. On opposite page a dismantled wagon is being loaded on Florence for delivery to a ranch up the river while tourists look on

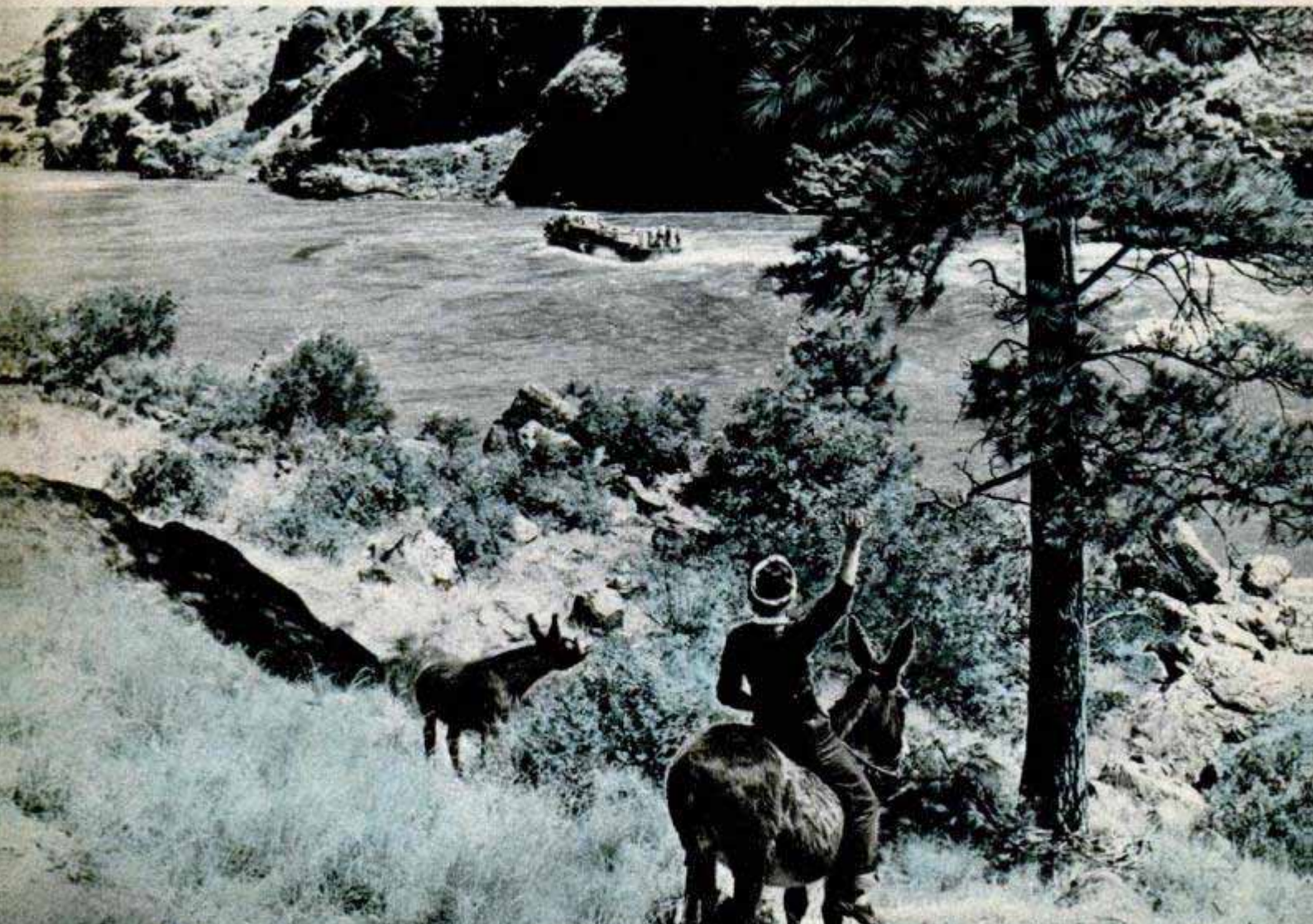



receiver at the bottom of the tremendous rift.

For 40 spectacular miles, the great V-shaped gash has an average depth of 5510 feet. Though it doesn't have walls as precipitous as those of the Grand Canyon of the Colorado, it is 7900 feet deep at one point as compared to a maximum depth of 6100 feet in the Grand Canyon. The Catskill Mountains could be put down intact in Hell's Canyon and their tops would still be 1500 feet below the rim.

McGrady doesn't traverse the length of Hell's Canyon, but he enters well into it. If he put a transmitter on his boat, the signals would fade out within a few miles. Yet occasionally he wants to send some routine message and he never knows when an emergency will occur and he will need to call for help, quick. That's why he is trying pigeons this year. If the canyon hawks don't get the birds, he'll be able to communicate with the outside for the first time. There's even a chance that he can train some of the birds to seek and land on the moving boat. Then he'll have two-way communication.

The Snake is one of the great rivers of the United States and carries more water than does the Rio Grande. It is part of the Columbia River system. The Snake has its beginning in Wyoming, winds across southern Idaho, turns north to form part of the Idaho-Oregon border, is joined by the Salmon, then moves west again to enter the Columbia.

Through southern Idaho the river is mild and tractable, but when it turns north into the mountainous Seven Devils region it becomes an "eighth devil." The gradient becomes steeper and the river picks up speed. A few adventurous rivermen, including McGrady, have run the Snake all the way down through Hell's Canyon in small boats. McGrady did it twice but once has been enough for the others. The Florence goes up into Hell's Canyon only as far as Johnson Bar. This is the present head of navigation.



Kyle McGrady is training pigeons to carry messages from Florence because radio waves do not penetrate to the depths of Hell's Canyon route

Lower left, Skipper McGrady shows big sturgeon to tourists on Snake River trip. Stream abounds in sturgeon caught by tying bait to end of rope

In addition to his skill as river navigator, McGrady pans gold during long waits along the river route. Here he is demonstrating to passenger

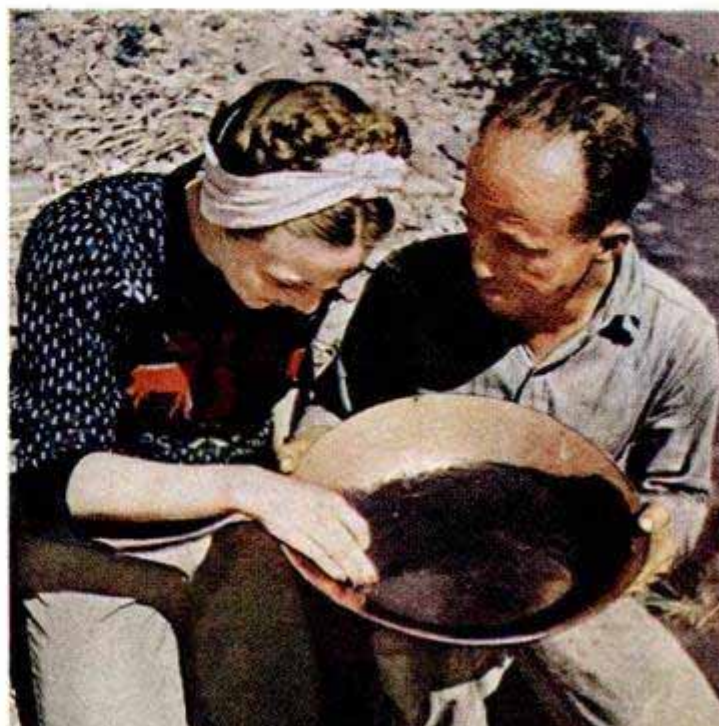



McGrady's specially built flat-bottomed Florence is 60 feet long, 12 feet wide and has a draft of 3½ feet. The steel hull has twin rudders and a sharp underwater bow. It is powered by two 165-horsepower diesels.

That's a lot of power and yet the pilot needs every bit of it to fight his way upstream against the 8 to 10-knot currents and to climb the 510 feet that the river rises en route to Johnson Bar. He needs the sharp nose and the twin rudders for holding the craft steady in the rapids, some of which have waves that stand five and six feet high.

There are more than 100 rapids in all, of which Pleasant Valley Rapids is the worst. Here the river drops 27 feet in 3000 yards of white cascade. Wild Goose and Zigzag are almost as bad and each must be run in different fashion. Not only does the riverman have to know the idiosyncrasies of each stretch of water but he has to handle the boat differently at various water stages, and the depth of water varies with the season.

It takes a long day to go from Lewiston to McGrady's camp at the head of navigation but next morning, after an overnight sleep and a big breakfast, it's only a four or five-hour run back to Lewiston. The Snake is a huge "shoot

Busy scene at stop along the river where ranchers pick up cargo ordered weeks ago. Goods for ranchers vary from a paper of pins and toys to tools and machinery

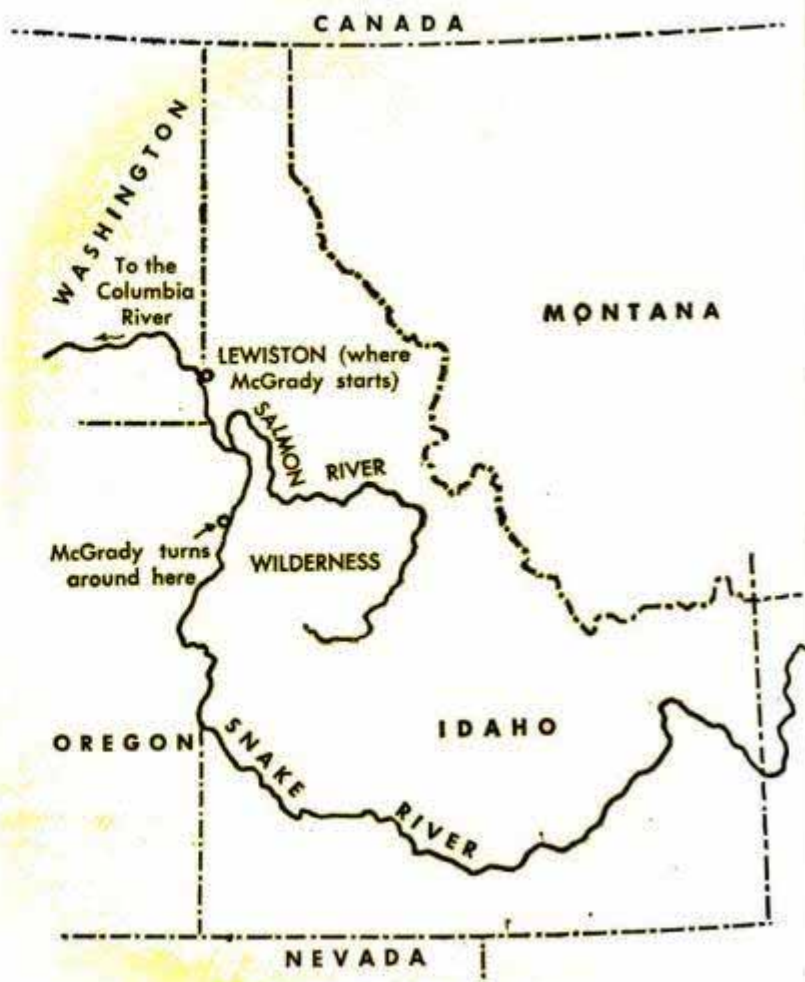



Cameras are much in evidence among tourists on Snake River trip; one passenger is taking notes on typewriter

the chutes" for a boat going downstream. Passengers hang onto the rail as the vessel slides over the rapids and around the bends at 20 to 30 miles per hour.

The Florence has a capacity of 10 tons of cargo or can carry 50 passengers plus some freight. Several dozen families live up the river and all of them depend on McGrady and his boat for the necessities and incidentals of life. McGrady brings them their mail, pays their bills, delivers their gold dust to the buyers, collects regular pension checks for some of them, and delivers their groceries.

Food is the most important item of cargo on the upriver trip and most of the food is made up into packages of the correct size for tying to the backs of pack animals. Usually, a rancher who expects a shipment meets the boat at the riverbank with a string of horses or mules. Otherwise McGrady leaves the packages on the bank. No one will disturb them.

Sacks of grain and other stock feed go upriver to the ranches; cookstoves, machinery, children's toys and building materials are other common pieces of cargo. Over a number of trips the riverman has delivered all the materials for three houses including lumber, bricks and cement. He

transported upstream all the equipment for his own camp, including sleeping tents, a dining room and kitchen, a lighting plant and saddle horses. The river is the sole highway into the region and the only other ways to get in or out are by airplane, by horse or on foot.

On the downstream trip, McGrady picks up some ranch produce for market, most of this being wool during the shearing season. He makes one trip a week during the winter, then with the coming of spring he goes upriver every Wednesday and Saturday. He hauls as many as 2000 passengers a year, most of whom are sightseers. Low water forces him to tie up during August and part of September, but this year he hopes to put a 15-passenger boat in operation that can make the trip at any time. Eventually, five of the worst parts of the river are to be blasted out and improved by constructing wing dams so that the boats can travel upstream more easily during low water.

Some of the tourists go along for the ride and they all get their money's worth; others go for the hunting and fishing. During the hunting season no one has any trouble in getting a deer. The hunter simply picks the side of the river for which he holds a license

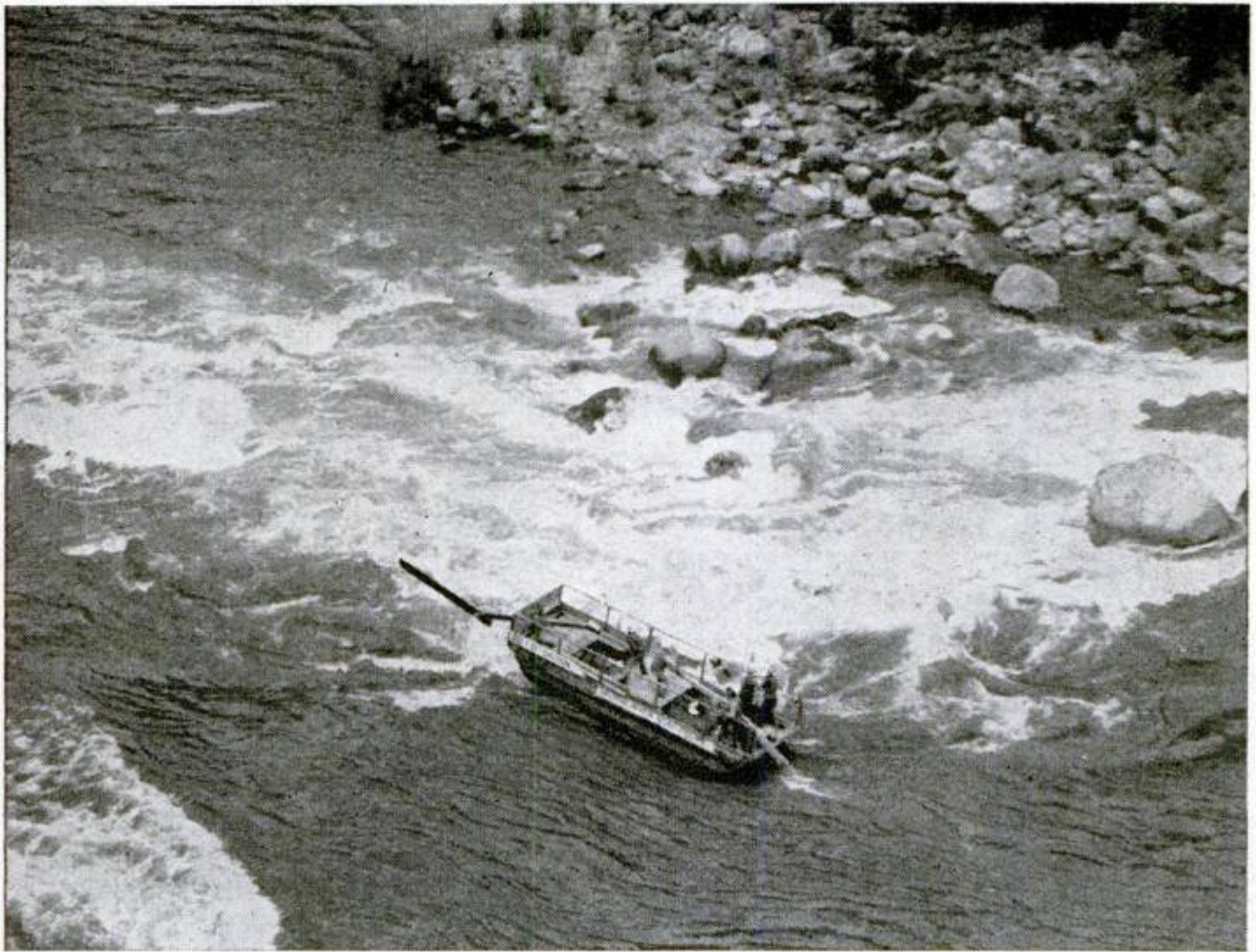

—the east side for an Idaho license, the west side for an Oregon license. Bear, cougar and small game abound and the river is a fisherman's paradise.

Those who want really big fish tie bait to a six or eight-inch hook and secure the hook to a heavy rope. Equipment like this, thrown out into the stream in the afternoon, can be expected to catch a Snake River sturgeon by morning, a fish that is apt to run six or seven feet long and weigh 150 pounds. A few specimens of this boneless fish have measured 12 feet in length and have run as high as 300 pounds. Once sturgeon eggs were shipped to New York as caviar, now the fish may not be taken for commercial purposes.

On both sides of Hell's Canyon are primitive areas, unspoiled as yet by civilization. Even more rugged and untouched is the wilderness country of the Salmon River in central Idaho. The Salmon is one of the principal tributaries of the Snake and joins the Snake a short distance above Lewiston. Its name comes from

Sportsmen on Salmon River use big steering sweeps to guide a scow through the dangerous rapids. Below is drawing of highest dam in world proposed for plugging Hell's Canyon. The dam will create a 4,400,000-acre-foot lake and will be 740 feet high

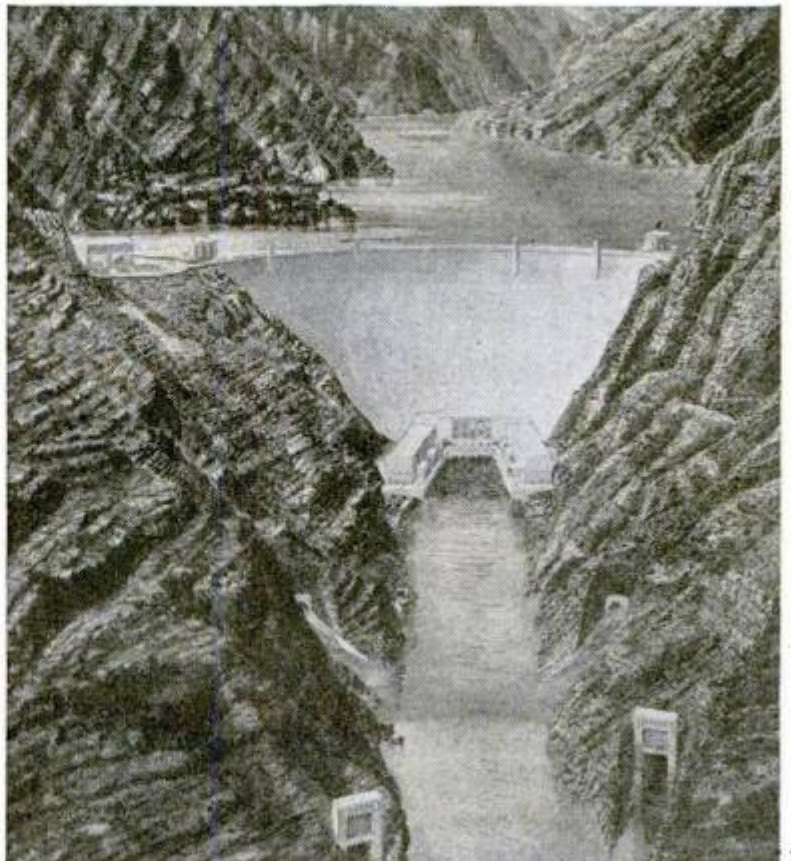



In upper Hell's Canyon, Snake River runs wild and can be ridden only in small boats. Note life jacket

the fact that Pacific Ocean salmon fight their way upstream from tidewater some 800 river miles away to spawn in its upper reaches. The Salmon is the famous "river of no return" down which adventurous rivermen and sportsmen have traveled by flatboat or skiff, but it is too swift and turbulent for returning upstream.

The Salmon River wilderness is larger than Massachusetts, Connecticut and Rhode Island combined. Elk, moose, mountain

sheep and deer abound. A few trails and dirt roads penetrate into the wilderness but no road crosses it. The "river of no return" is the only thoroughfare.

Several groups of sportsmen make the trip every summer on the City of Salmon, a 30-foot flat-bottom barge that is propelled through quiet stretches of water by a large outboard motor. The barge is guided by two tremendous sweeps, one at the bow and one at the stern. Don and Clyde Smith, who have lived along the river for 16 years, operate the vessel. They tie up at some convenient spot at night, then carefully guide the scow down through more white water and rapids to the next camp. Fishing and taking it easy along the way, each party spends a week on the river, moving down to the Snake and following that river as far as Lewiston.

The Salmon River country has been dedicated as a permanent wilderness area and both it and the river are to be left untouched. The Snake, however, eventually is to be tamed by a huge concrete dam that will be built about half-way down Hell's Canyon.



Two 165-hp. diesels power the twin screws of the Florence. The oversize twin rudders aid steering in rapids

"Cake Icer" Trims Ceramics With Colored Glazes

Almost like icing a cake, a method of applying various colored glazes to ceramic tile uses rubber bulbs from which coloring is squeezed to form the pattern. Each bulb contains a different color. After the design is completed, the tiles are baked and then assembled for decorating bathroom and kitchen walls.



Mold Discovered on Photo Combats Influenza Virus

Mold that formed on a photograph in the tropics has been found effective in combating the swine-influenza virus—a virus that is almost identical to the influenza-A virus which affects humans. While in the Navy on Guam in 1945, Commander Richard E. Shope noticed mold growing on a

photograph. Doctor Shope brought the mold strain back to the United States and developed it in broth. Experiments on rats showed it to be effective against the virus.

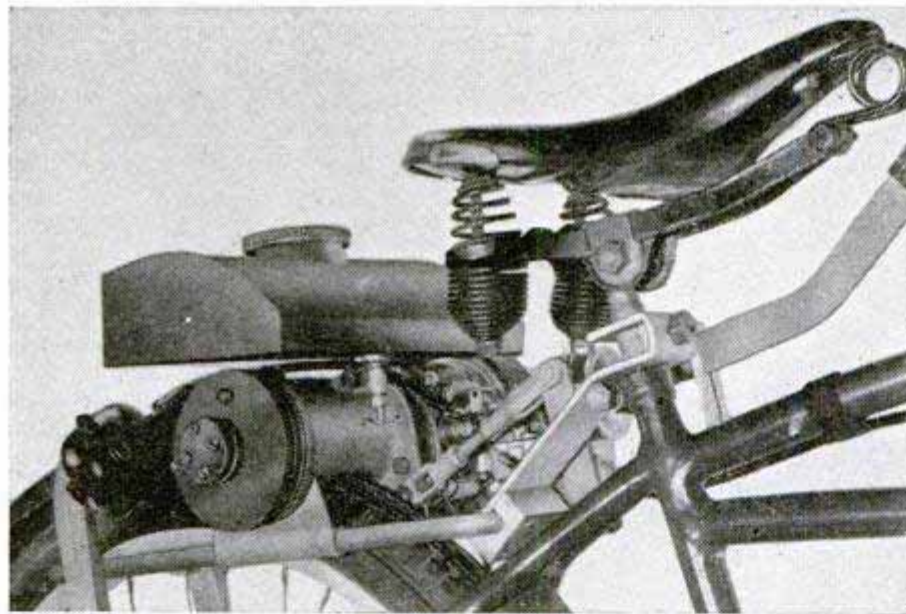

Rear Bicycle Motor Eliminates Fumes

Mounted above the rear wheel, a streamlined bicycle motor can't throw heat and fumes into the rider's face. The new motor is easily fitted on any standard bike. It is made of aluminum and weighs less than 15 pounds. Operating on a magneto, it provides speeds up to 29 miles an hour. Only two controls are required, the gas control on the handle bar and the clutch on the frame. The mechanism is enclosed in a streamlined hood mounted on a frame just behind the bicycle seat. The motor powers the bicycle through a roller mechanism and a free-running clutch which eliminate most of the tire wear.

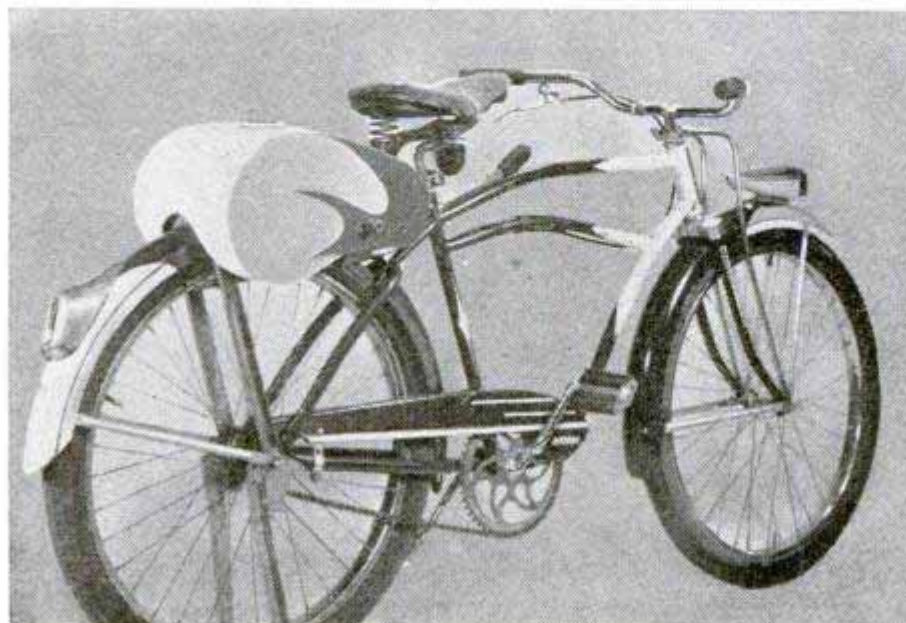

Multi-engine airliners can be made to descend 10,000 feet a minute by reversing the thrust of the propellers in flight, thus providing a means of making fast emergency landings from the high altitudes at which these planes fly.

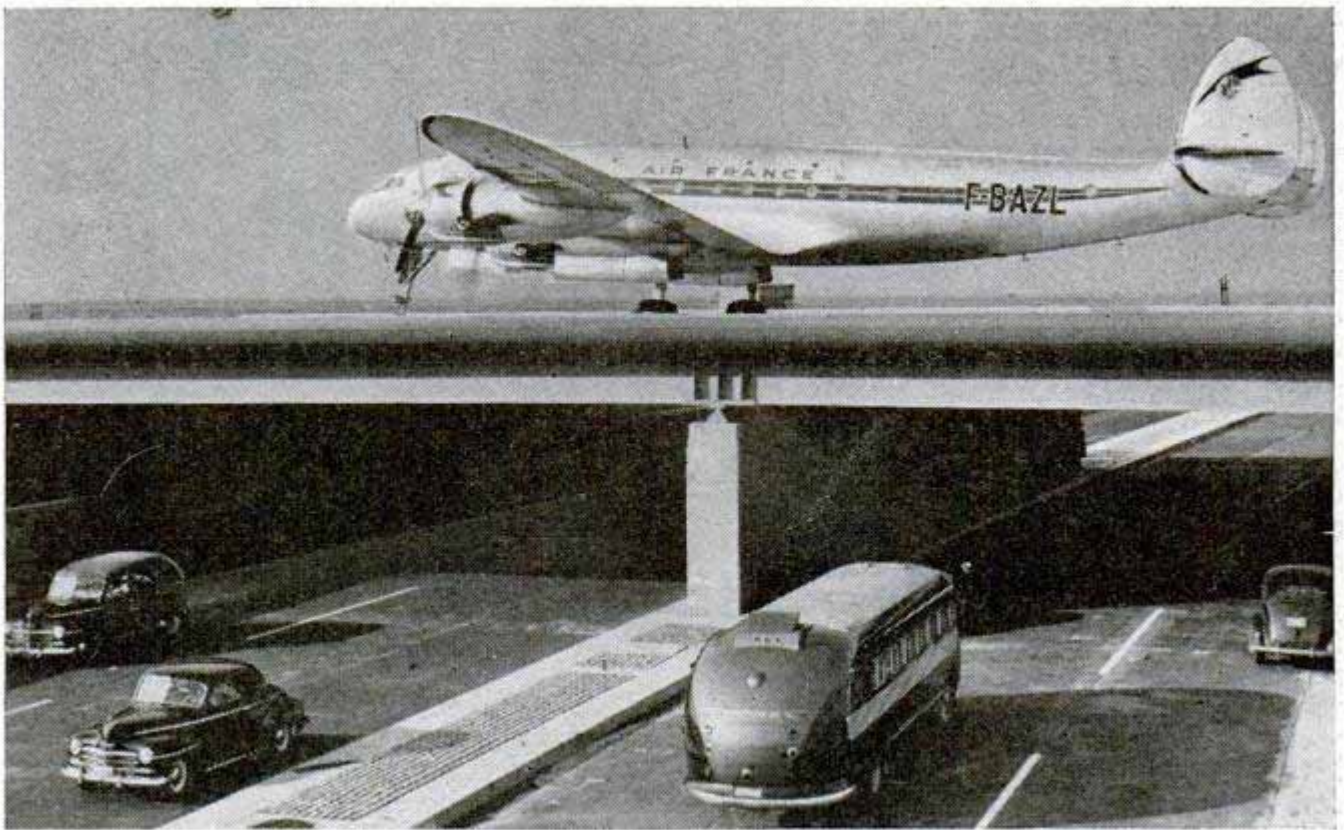

Overpass for Aircraft

Airplanes and automobiles are kept safely apart even though their paths intersect at New York International Airport by means of a two-level intersection,

said to be the first ever built for aircraft. Two bridges span the roadway, each capable of supporting a 300,000-pound plane. The overpass permits the uninterrupted flow of vehicles into the airport while planes taxi to and from the loading ramps.

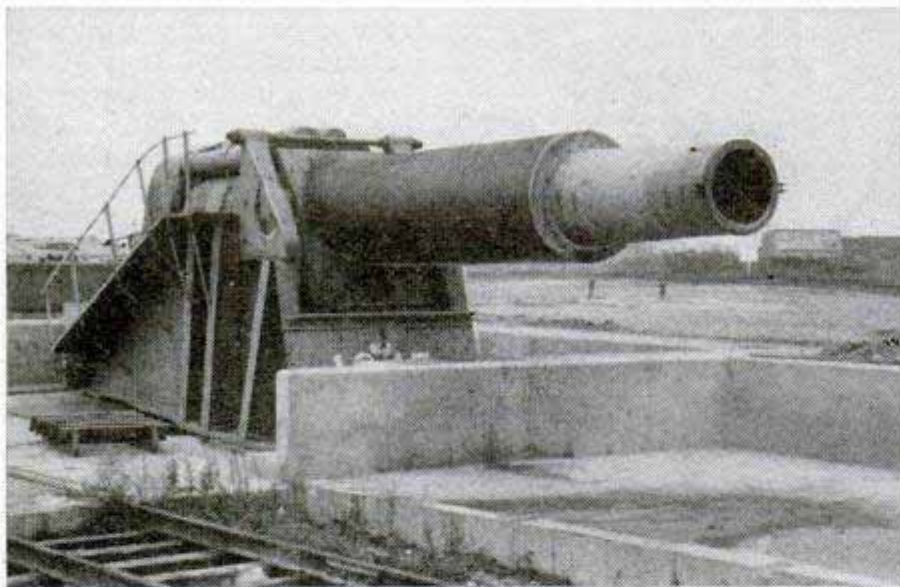

Rebuilt Naval Gun Tests Ton Bombs

Largest known weapon of its type, a 24-inch test gun hurls bombs and warheads weighing up to 2000 pounds against armor plate and concrete targets. The new gun permits ballistics experts to analyze the impact of a new missile on its target and on the missile itself. The gun is basically the sawed-off barrel of a standard 16-inch naval gun, damaged in combat.

Plane Servicing Speeded by Single-Point Refueling System

Greater flying safety and servicing speed result from a continuous-flow fuel system for planes developed at Wright-Patterson Air Force Base. The system provides automatic flow from all tanks to all engines instead of requiring pilots to switch tanks in flight. In case of failure or damage, an engine or part can be shut off manually from the rest of the system. The new single-point refueling feature makes

it possible for one man and a truck to fill a B-29 in 30 minutes. Now it takes 13 men with four trucks 45 minutes to do the job. The system, devised by Capt. David Samiran, who has contributed over 34 inventions to the government, is currently being put in B-36, B-45, B-40 and XB-52 planes.

□ National forests in this country now cover 179 million acres.

Jet-Powered Bike Travels 70 M.P.H.

Burning ordinary automotive gasoline, a jet engine for commercial use has been installed experimentally on a motorbike which scooted along at more than 70 miles an hour. The miniature jet develops a static thrust of 30 pounds, yet weighs only $8\frac{3}{4}$ pounds. It is a little over six inches in diameter and 51 inches long. No fuel pump is required as the intake air velocity performs the pumping function. The engine is started with a vibrator coil and air from a small compressed-air tank. It will be used initially for experiments in helicopter and airplane-engine laboratories

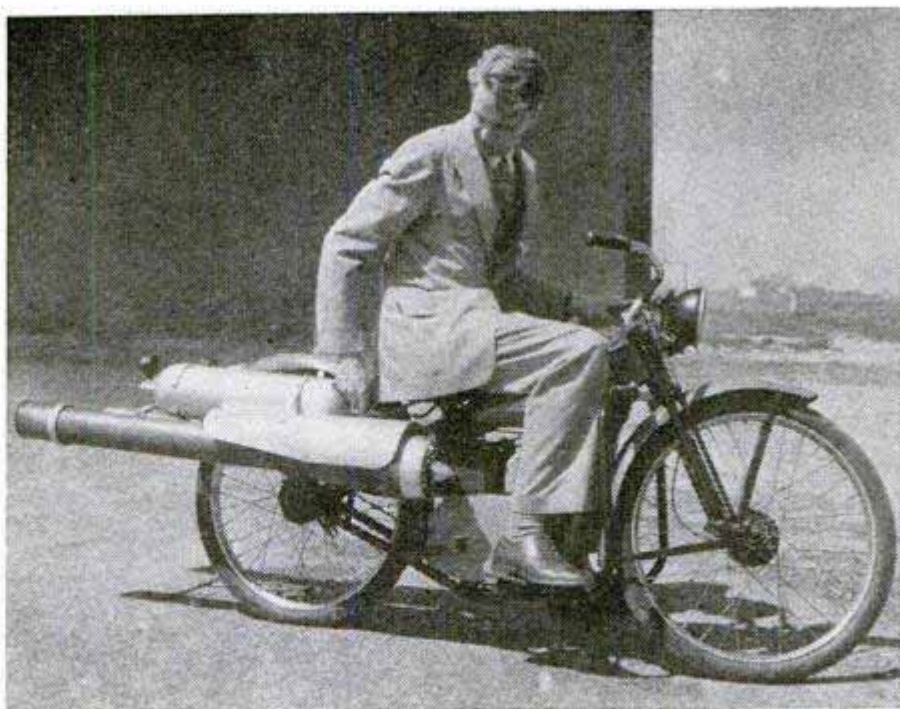

but later may be installed as a stand-by power plant for gliders and as a power source for racing cars and boats.

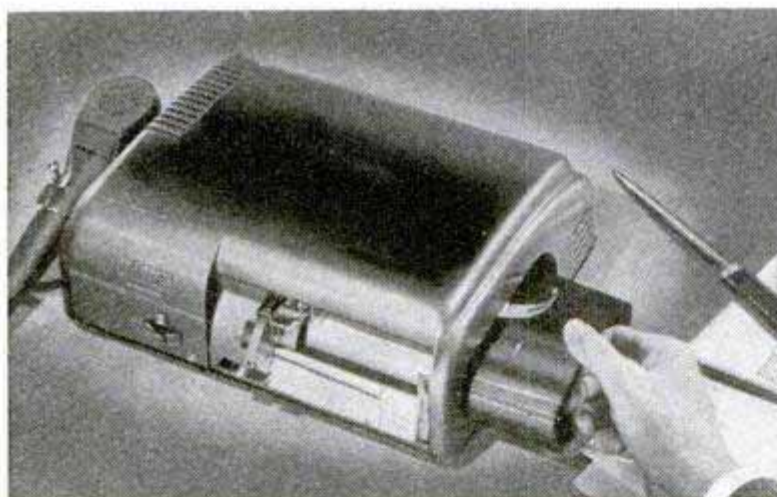

Endless Plastic Belt Records Dictation

Up to 15 minutes of dictation can be recorded on a new plastic record made in the shape of an endless belt. The recording is permanent and can be played back or filed for future use. Five of the endless belts, one nested within another, can be mailed in a small business envelope. The dictating machine is slightly larger than a standard letterhead and weighs only 20 pounds.

Flexible Template

Complex curves in construction materials can be duplicated in a few seconds with a flexible template that eliminates curve-plotting, drawing and template-making. The layout tool is a strip of spring steel with sliding arms and wing nuts on one side. Curves can be copied directly from blueprints or from existing installations that must be duplicated. The steel strip is bent to conform to the curve and locked into place with the wing nuts. It then may be moved anywhere to duplicate the curve. When the nuts are loos-

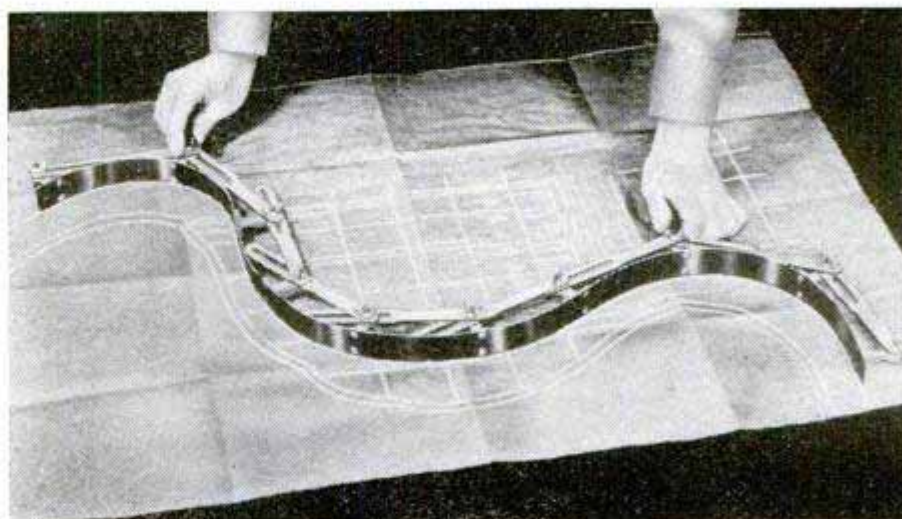

ened, the template springs back to its original shape. The tool is useful for bending pipe, curving conduit, inlaying linoleum and copying glass curves.

Life Line to Berlin

A first-hand report on our
blockade-hopping pilots, who
do business under the slogan:
"Anything, any time, anywhere"



THIS HAD BETTER **By Aubrey O. Cookman, Jr.** be it!"

Lt. Kyle E. McMichael of Houston, Tex., was in no mood for further delays as he gunned our Berlin-bound C-54 down the runway at Rhein-Main Air Force Base at Frankfurt, Germany.

It was past noon as the big plane finally

nosed upward—and the fifth time we'd been poised since eight o'clock that morning, waiting to pierce the thick winter fog hanging 150 feet above ground. Each time, with four powerful engines roaring impatiently at the delay, Operations had held us off, explaining either that our weather or Berlin's had closed down below safe minimums.

At the clearest you could see not more than a quarter of a mile ahead. My jeep driver got hopelessly lost on the taxi strip, just trying to find the plane. Occasionally a light drizzle fell.

But this time, racing against fickle weather that might close our door to Berlin at any moment, we pushed up through the murky ceiling. Our plane was the first of a long line to take off. Our pilot instantly called Operations: "Hit the top at 1500 feet. OK here."

We had climbed above the fog blanket to clear skies overhead. Only 270 miles lay between us,

Editor Cookman, just arrived by plane from Chicago, talks over Vittles' problems with lift's commander, Maj. Gen. W. H. Tunner

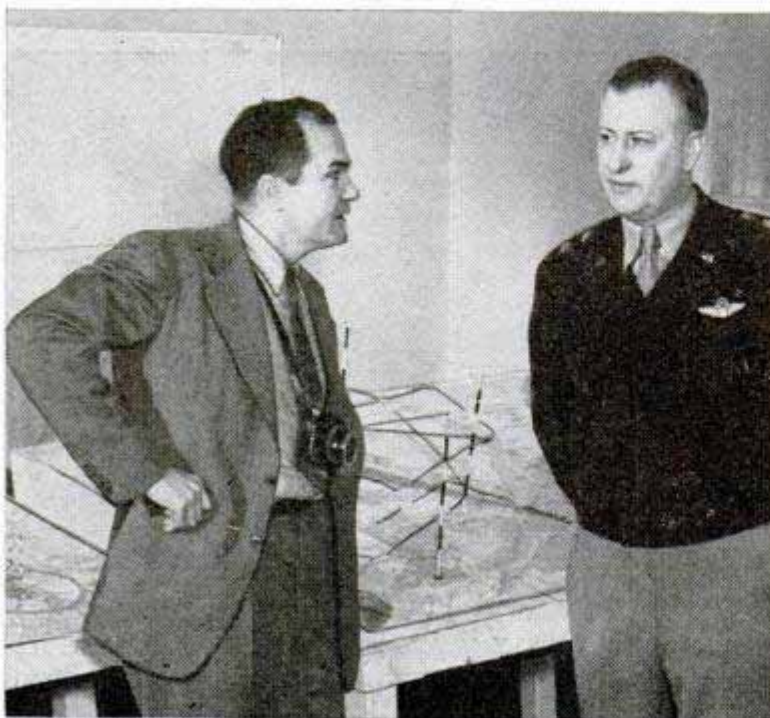

U. S. Air Force photo

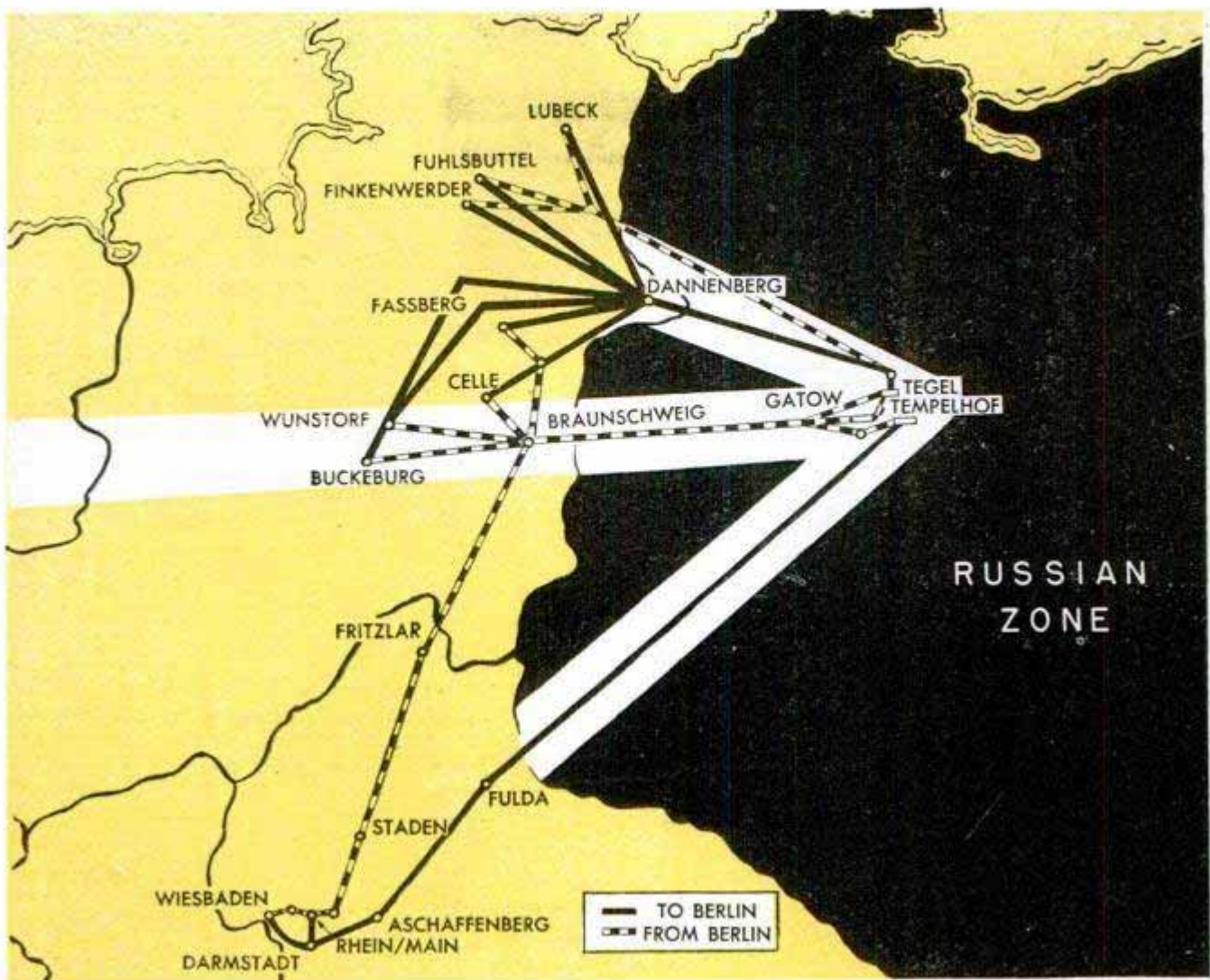

our 10-ton cargo of flour and potatoes, and Tempelhof airfield in Berlin.

Everything but the weather had cooperated smoothly to bring me in 10 days from my desk in Chicago to the heart of the greatest air-freight operation the world has ever known—Operation Vittles. An invitation from the U. S. Air Force to fly on the lift; cabled permission to enter the area from Gen. Lucius D. Clay, military governor of the American zone in Germany; a day in Washington for briefing and picking up my passport, and I was on my way.

Tail winds and a fast-flying airline Constellation moved us in 13 flying hours from New York, through Gander, Newfoundland, and Shannon, Ireland, to London. The ride was exceptionally smooth. Reading, eating

In arrowlike pattern pointed at Berlin, lift flows in and out of blockaded city along three air corridors. Traffic from the British zone uses the upper one, while U. S. craft fly lower two. Below, rows of high-intensity approach lights, like the one on tower at left, mark path into Tempelhof





Barges heaped with coal dumped from trucks above prepare to set out for ports in Berlin area. Left, below, a German frau gets part of her coal ration from air lift's stockpile. Right, unloading fresh milk from Denmark



and napping proved more exciting than flying the ocean to 1949 model passengers, so the "worry" of getting our craft across the big pond was left completely to the crew.

Bad weather that was soon to be a constant companion made its first appearance at London, blotting out all air traffic to the continent for three days. The "Great Fog," as a London newspaper labeled it, was gaining stature as the longest lasting and most widespread in Europe's recent history. There were disputes as to whether pedestrians could see ten or only five feet ahead. Flying was out of the question.

Finally, after a train trip north to an RAF base on the fourth day, I was able to catch a flight on an American courier C-47 returning to U. S. Air Force's European headquarters at Wiesbaden, Germany. More important to my mission, Wiesbaden is also the operational nerve center of the Air Lift Task Force.

At 5000 feet, moving away from fog-covered Rhein-Main at a comfortable 170 miles an hour, we quickly passed over the Darmstadt and Aschaffenburg radio beacons. A short way on, at the Fulda radio range station, we veered to the right and headed straight down the 20-mile-wide air corridor



Gen. Lucius D. Clay, center, military governor of American zone, inspects model of plane-truck-rail operation at Fassberg. Clay ordered lift's start when Russia halted surface access to Berlin



Placing and tying down of loads, like coal sacks above, is done by experienced air-cargo handlers. Below, flour sacks "chuted" down from belly hatch of giant C-74, are hoisted on trucks at Tempelhof





Loaded trucks at Fassberg await signal over loudspeaker to move forward with cargo for Berlin-bound planes

over 190 miles of Russian-held territory for Berlin.

As the only passenger, I sat up front with the crew, listening on an extra set of headphones to the instructions and banter passing back and forth between flyers and ground stations. Most of the pilots jokingly refer to themselves as "drivers" and to the operation as the Rhein-Main, Wiesbaden or Fassberg "Coal and Feed Co." Once in a while we'd hear recorded music broadcast from American stations in Germany.

Morale is generally good. It got a boost

when the first relief crews began arriving in December, replacing the originals who often worked stretches of 20 hours and more when the lift began. Now, it has leveled off to where each man flies a maximum of 90 to 110 hours a month. That doesn't include time devoted to ground duties. Crews flying out of Wiesbaden and Rhein-Main get in two round trips a day. On the shorter Fassberg Corridor they can make three.

Through low-hanging clouds we caught occasional glimpses of Soviet airfields.

Chart illustrating how Operation Vittles flying would be simplified if big cargo planes, such as Douglas C-74, were available in sufficient numbers. A C-74 has carried more than 170,000 pounds, but there are only 12, eight of which are being modified. Both the C-47 and 54 were designed in mid-1930s for passenger use

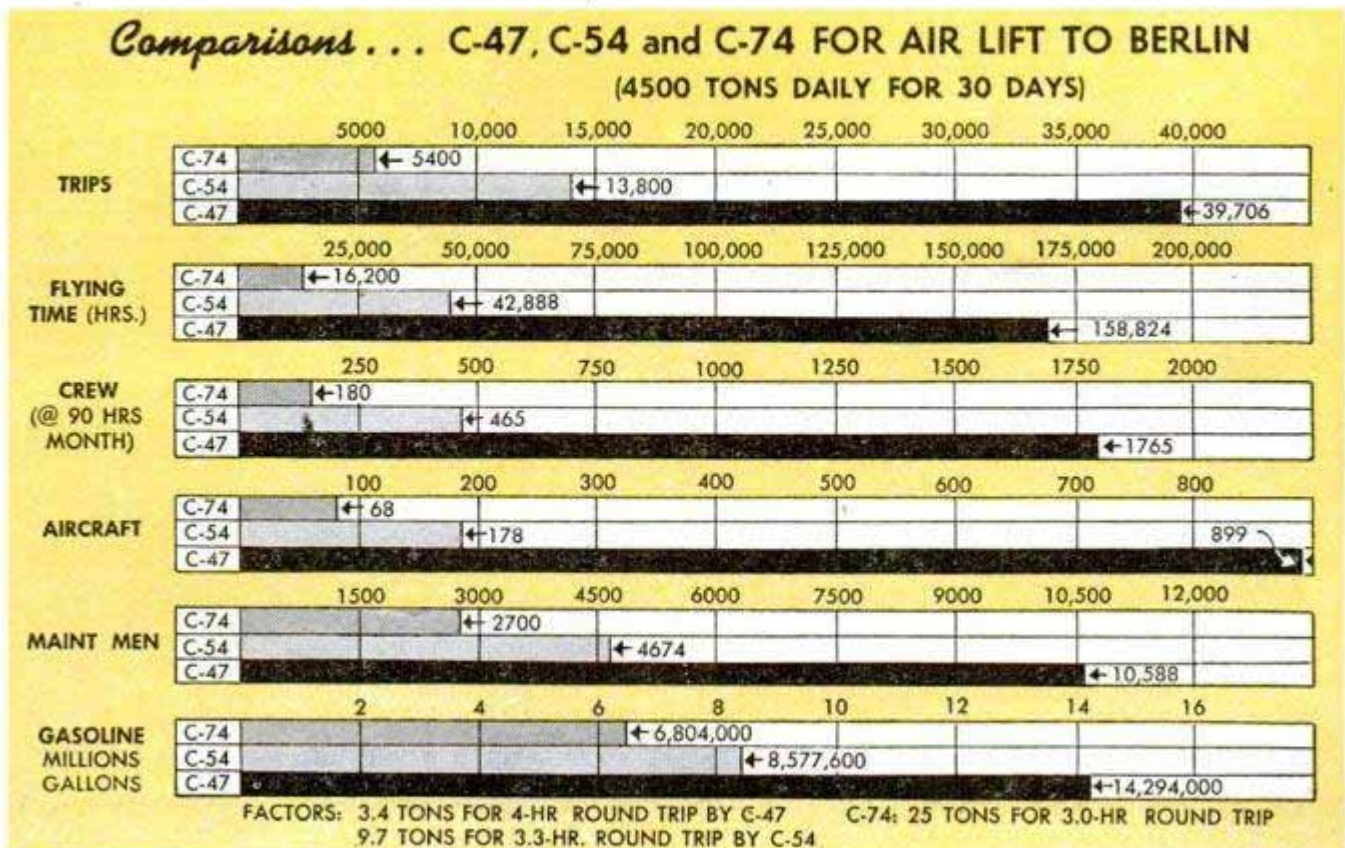



Most of its wartime bomb damage repaired, Tempelhof is the hub of U. S.-lift operations in German capital

Only a few parked planes dotted the landscape and there was no sign of activity. Apparently the second C-54, a few minutes to the rear in the lift parade we had just resumed, was the only thing flying within 15 miles of us. By the time Germany's war-shattered capital loomed below, the weather had cleared enough for us to follow visually Tempelhof's precise landing pattern. Our wheels touched just one hour and forty minutes after take-off.

A jeep with a large yellow and maroon "Follow Me" sign on the rear popped into view and we obediently followed. Lieutenant McMichael pulled up at the end of a nose-to-tail line of five inbound planes from the British lift base at Fassberg and cut the engines. Before the propellers had stopped whirling, our crew chief-engineer, Staff Sgt. Roy Farris of Weatherford, Tex., opened the cargo doors and a 10-ton truck

began backing up to receive our offering.

Before McMichael, copilot Lt. Dean Adams of Mt. Pleasant, Mich., and I were out of the plane, a crew of German laborers began undoing cargo tie-downs and loading flour and potato sacks into their truck. Two more jeeps pulled up outside. One carried a maintenance crew, ready to iron out minor mechanical ills, and in the other was a meteorologist bearing a full weather report for the trip back to Rhein-Main. It was service and efficiency that would make stateside airmen pinch themselves in wonder.

A final touch was a mobile canteen serving hot foods and drinks not more than 20 yards away. It was the logical supplement to an order that lift crews can't leave the orbit of their aircraft. Tempelhof's assembly-line mode of operation, like that at other Vittles fields, can't afford to be thrown

Like coaches of aerial trains, inbound planes fly at two levels, separated vertically by as little as three minutes in good weather. Their airspeed indicators are regularly calibrated to insure a universal 170-mile-an-hour pace. During instrument weather, interval between planes is lengthened to avoid traffic jams over Berlin

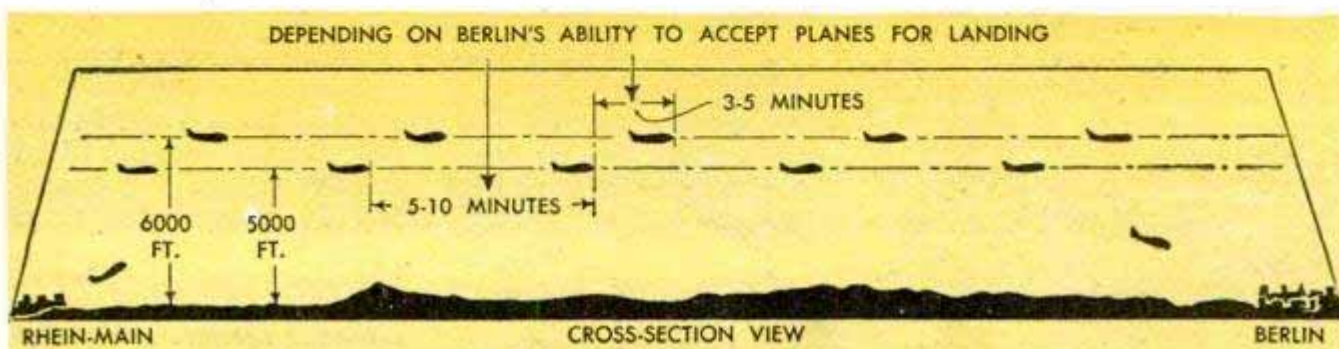



Children seated on brick rubble look on curiously as bulldozers and trucks work on new lift strip at Tegel

out of gear by wandering flyers, even hungry ones. When a plane is unloaded and ready to fly it goes, or else . . .

From small beginnings the Berlin air lift has snowballed into a tremendous and complex operation. It started June 26, 1948, after Russia closed off all rail and highway access to Berlin from the west. General Clay quickly responded by giving to the Air Force what was then thought to be a temporary assignment of flying in sufficient supplies for 2½ million Berliners and occupation personnel.

Hurriedly assembling at Wiesbaden all the planes and crews they had available in Europe, the Air Force moved 80 tons into Berlin the first day. Most of that was milk for children, flour and medicine. It seemed like a lot, then.

To supplement the original force of 110

Douglas C-47s, dependable but small planes designed in the early thirties for passenger use, emergency cables went all over the world for bigger aircraft and more crews. Missions were figuratively halted in midair and rerouted to Berlin. A pilot parked his brand new Hudson at an airfield near Austin, Tex., and hopped into a lift-bound plane. The keys still jingled in his pocket as he flew in and out of Berlin.

Vittles quickly grew from a sub-activity to a separate task force. Heading it now is Maj. Gen. William H. Tunner, a specialist in air transport who directed wartime freight flying over the Hump in China. Partners in the work are the British and the French. They are committed to lifting about one fourth of the 4500 tons required daily, using the shorter northern corridor from Fassberg to Gatow. The French are responsible for unloading and loading at Tegel.

The first day's 80 tons have skyrocketed to a 24-hour period high of almost 8000 tons, brought in on 895 flights. In the first six months 717,962 tons of supplies went into Berlin. During good-flying periods authorities have been able to stockpile some items against possible future shortages.

Successors to the pioneer 110 small planes are 335 aircraft, most of them four-engine C-54s carrying 10 tons, more than

Not even hunger is allowed to slow Operation Vittles. Mobile snack bar operates near planes



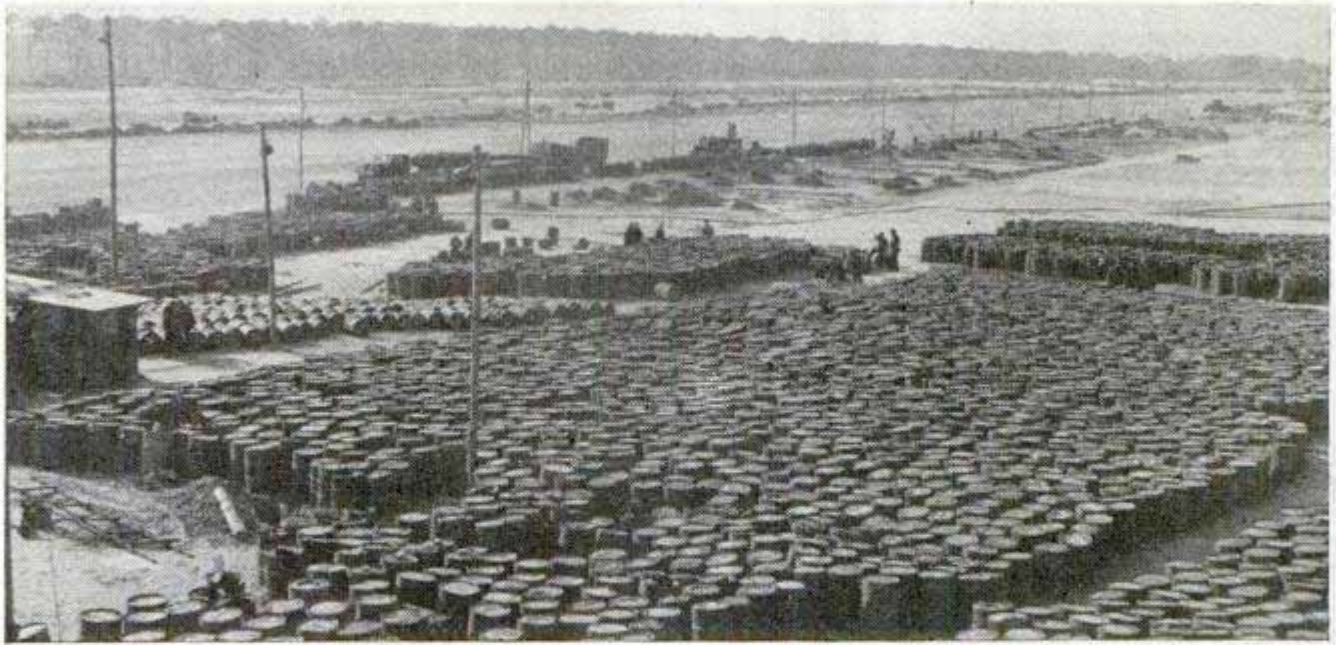

Part of 10,000 barrels of asphalt flown in to complete runway at Tegel, in the French sector. Bulky construction equipment was cut in two by blowtorches, shipped in on C-82s, and welded back together on arrival

treble the C-47's full load. Flight procedures and schedules have been reduced to as near precision standards as conditions permit.

Inbound traffic moves 170 miles an hour at assigned levels of 5000 or 6000 feet. Outbound craft fly 180 miles an hour at 6500 and 7500-foot altitudes. Airspeed indicators are constantly being calibrated to keep them all within a mile an hour of each other. Greater differences could mean fatal air collisions in bad weather.

In addition to careful initial coaching at the scene, pilots slated for the lift are now put through a three-week refresher course at Great Falls, Mont., Air Force Base, where most of the special Berlin procedures are rehearsed.

With ceiling and visibility unlimited, planes can be set down every three minutes at Tempelhof and Gatow. The same pace will eventually be duplicated at the third and newest field, Tegel, in the French sector. Even in the worst weather, the latest GCA radar units and experienced operators are expected to bring aircraft in at an average of one every six minutes. Airlines, under less pressure, take nearly three

(Continued to page 286)

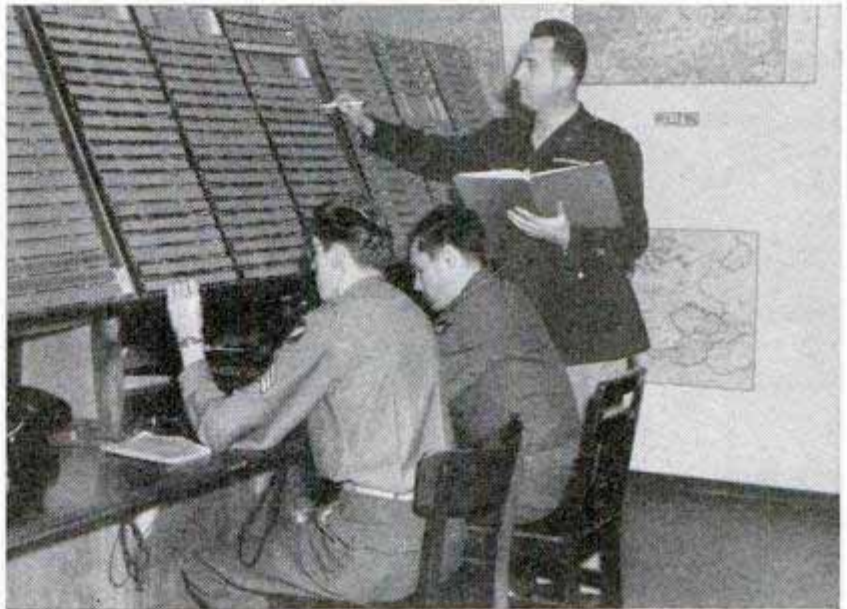

In contrast to busy Americans, above, keeping track of all U. S. aircraft in area, Soviet representative at Berlin Air Safety Center, below, has lone entry on flight control board, plenty of time to read

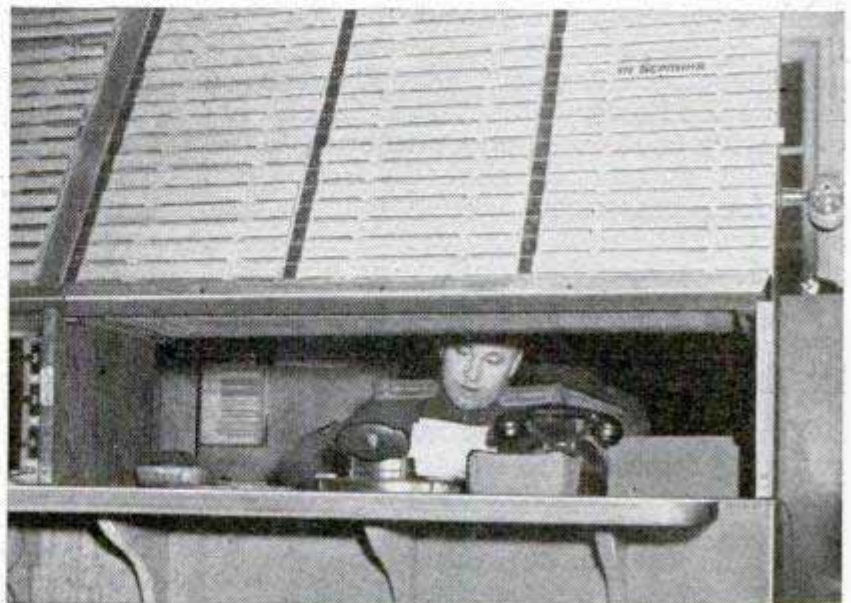

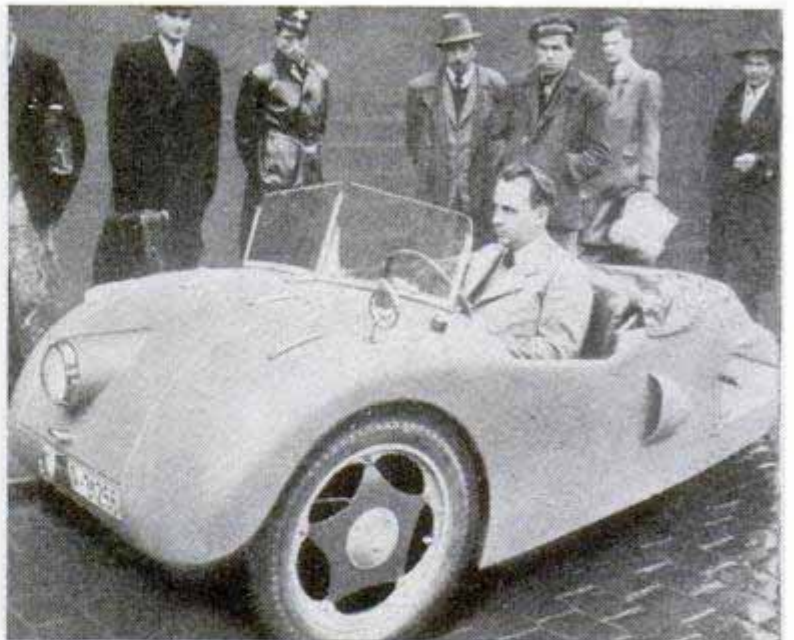
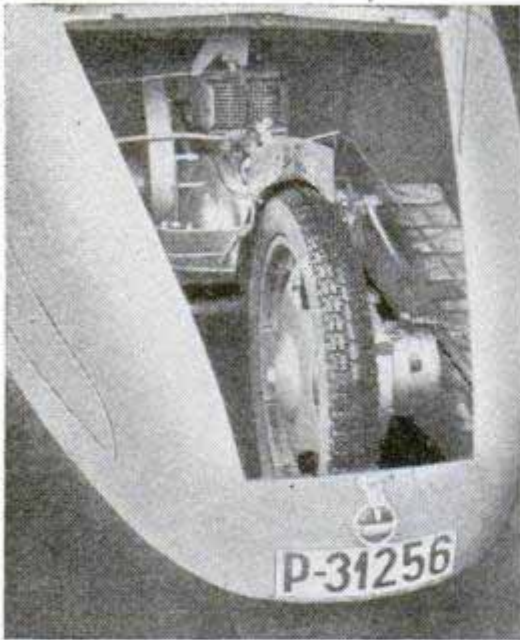

Three-wheeled Czech roadster has engine (left) just forward of rear wheel; note single headlight at right. The four-door French Citroen (left) is known as the "Ford" of France; right, another French car, the sporty Dynavia has excellent visibility. In background is the first jet aircraft built in France, the SO-6000

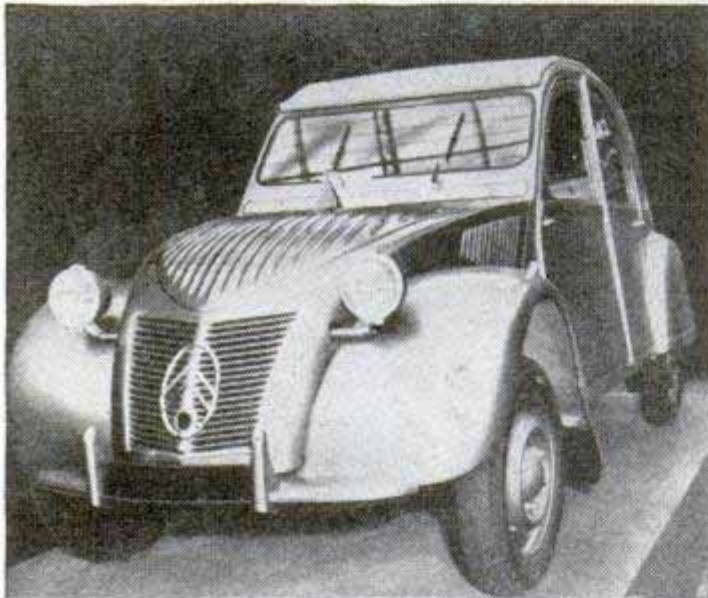

Three New Lightweight Automobiles for Europeans

More evidence that Europeans will continue to drive small, economical cars is evidenced by three new models. Czechs in Prague are holding a contest to find an inexpensive car that is cheap to operate. At a recent automobile show in Paris, two new four-passenger French models that attracted attention are the Dynavia, a streamlined sports car affording excellent visibility, and the 1949 Citroen. The two-

door Dynavia has three shifts and overdrive, the engine is air-cooled and the car is said to have a top speed of 90 m.p.h. "with some effort." At normal speeds it travels 42 miles on a gallon of gasoline. The four-door Citroen has front-wheel drive. One lightweight Czech car has a two-cylinder engine in the rear and attains a speed of 50 m.p.h. It is said to run 63 miles on one gallon of gasoline.

Double-Duty Furnace Can Be Used With Either Coal or Oil

You have only half as much chance of suffering from a fuel shortage when your home is heated by a combination furnace that burns either coal or oil. To convert from one fuel to the other you merely throw a switch on the side of the boiler.

Two separate combustion chambers are built into the furnace and automatic controls prevent both from being used simultaneously. Another advantage of the unit is that the coal chamber serves as an incinerator while the oil burner is operating.

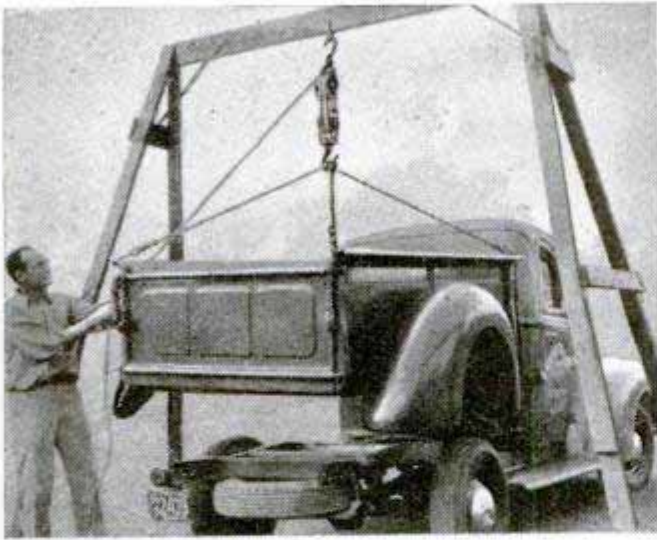

Conversion Kit Adapts Pickup Truck For Use as Semitrailer Tractor

Pickup trucks and jeeps can be converted into tractors for hauling semitrailers when larger trucking capacity is needed. The conversion kit consists of an aluminum semitrailer, available in 6000 to 10,000-pound capacities, and an easily installed fifth-wheel coupler that is attached to the truck or jeep chassis with four bolts. The changeover can be completed by one man in a short time. The trailer has heavy-duty hydraulic brakes actuated by a vacuum booster. Brake and electrical lines and controls are provided with the unit. Interchangeable sides and nose adapt the trailer for various loads. An enclosed-van model is being produced.

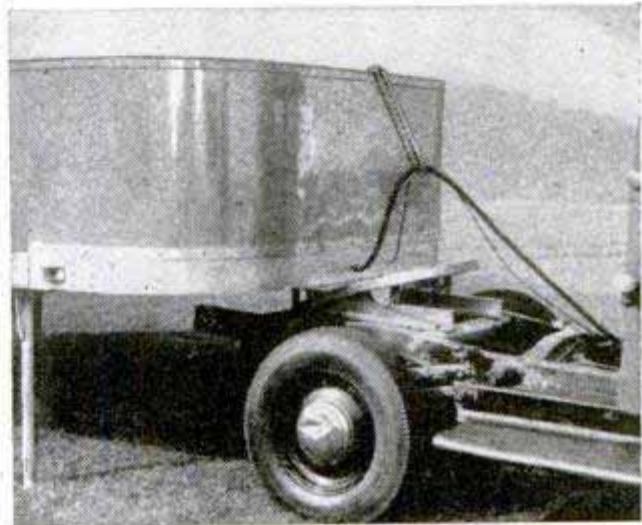

Top left, pickup body is removed from the chassis and (right) the fifth-wheel coupler bolted in place. Above, backing the tractor under the trailer body

Synthetic Rubber in Asphalt Makes Road Surface Wear Longer

There's a street in Akron, Ohio, that is paved with a synthetic-rubber mixture—not to make it softer to ride on, but to make it last longer under heavy usage. Finely powdered rubber is mixed with conventional asphalt black top at a tem-

perature of around 300 degrees. More nearly waterproof than regular black top, the new mixture is expected to be longer wearing and more resistant to cracking in cold weather. The mixture has been used successfully in England and Holland.



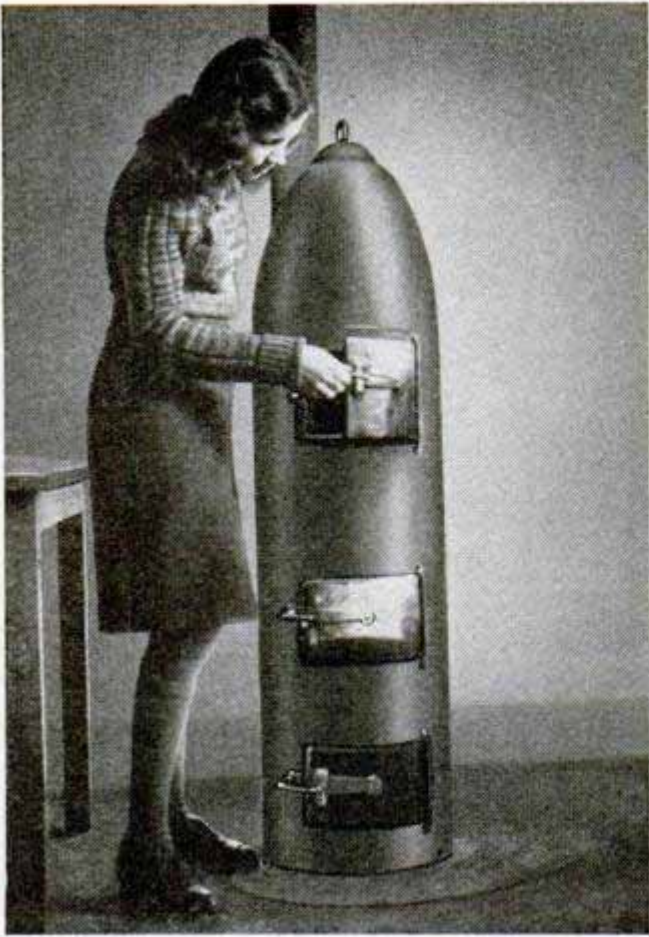

Stove From Unexploded Bomb

Even unexploded bombs are being used in Germany for commercial products because of the shortage of materials. A Hamburg firm is removing the explosive from 1000-pound dud bombs and rebuilding the shells into stoves. Hinged doors permit fuel to be added and ashes to be taken out.



Typewriter-Size Hand Loom Weaves Samples of New Designs

Sample swatches of new cloth patterns are woven in two hours on a small hand loom not much larger than a typewriter. If woven at a full-size mill, the sample would require several weeks' production time. The miniature loom is of the four-harness variety with a capacity of 240 ends of warp yarn. More than 200 new patterns of rayon for shirts and blouses have been woven on the loom. The sample swatches are 3½ inches wide and 14 inches long.

"Heatless" Oven Cooks Foods Quickly With Infrared Rays

Cooking can be done with the food wrapped in Cellophane to save dishwashing in a new infrared cooker that cuts cooking time 30 to 60 percent. The wrapped food is placed in a clear, heat-resistant glass dish and inserted in the cook-

er. Two infrared lamps, one above the wire shelf and the other below it, direct their heat rays into the food without heating the surrounding air and container. The cooker broils, fries or bakes and does all these without cooking odors. Roasts are cooked in less than 15 minutes, hamburgers in four minutes. You don't have to turn the food over because it is cooked on both sides. Frozen foods can be cooked without previous thawing.

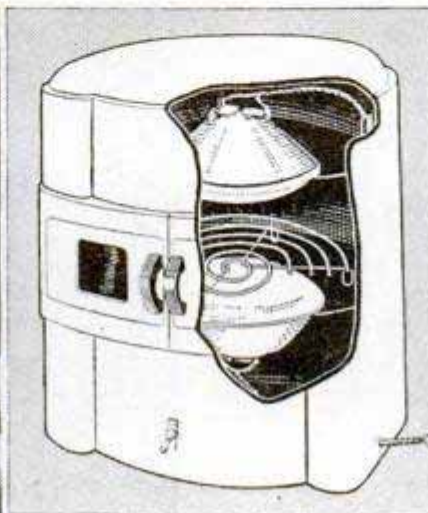
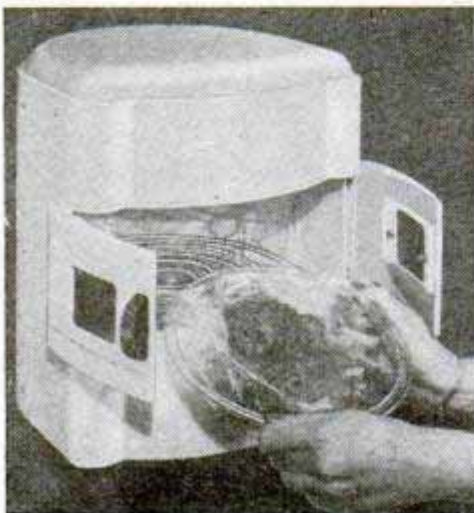

Flags recently developed by the Army's Quartermaster Corps are made of 75 percent nylon and 25 percent wool, a combination which gives a service life three times as long as all-wool flags.



Above, one of many attachments for handy power unit cuts weeds and thick brush. Other attachments at left from top to bottom are rotary hoe (hopper holds weights), buzz saw, power lawn mower

Master Tool Performs Score of Jobs

More than a score of attachments are available for a power unit which performs many jobs. It can be used to cut weeds and brush, as a power lawn mower, saw, garden cultivator, power sprayer, paint gun or snow sweeper. The power is supplied by either a two or four-horsepower engine mounted on a sturdy steel-tube frame with 20-inch wheels. When used as a weed cutter or in similar capacities, the machine travels on its own power. The saw attachment can be used horizontally for cutting small trees or in vertical position. Spray pump and tank convert the unit into a power sprayer which sprays trees up to 25 feet high.

Pull-Out Kitchenette With Refrigerator Fits in Small Cabinet

Most of the requirements of a kitchen are neatly fitted into a cabinet that resembles a piece of living-room furniture. The cabinet is 45 inches high, 37 inches wide and 20 inches deep. Inside are a pull-out sandwich board, a 2.2-cubic-foot refrigerator with two ice-cube trays, a cutlery drawer, and storage sections for dishes, glassware and foodstuffs. Designed as a snack bar for the home, office or boat, the cabinet has convenient electrical outlets for appliances.



Production of penicillin now is 125,000 times larger than it was in the first six months of 1943, and the price of 100,000 units has dropped from twenty dollars to less than one dollar.

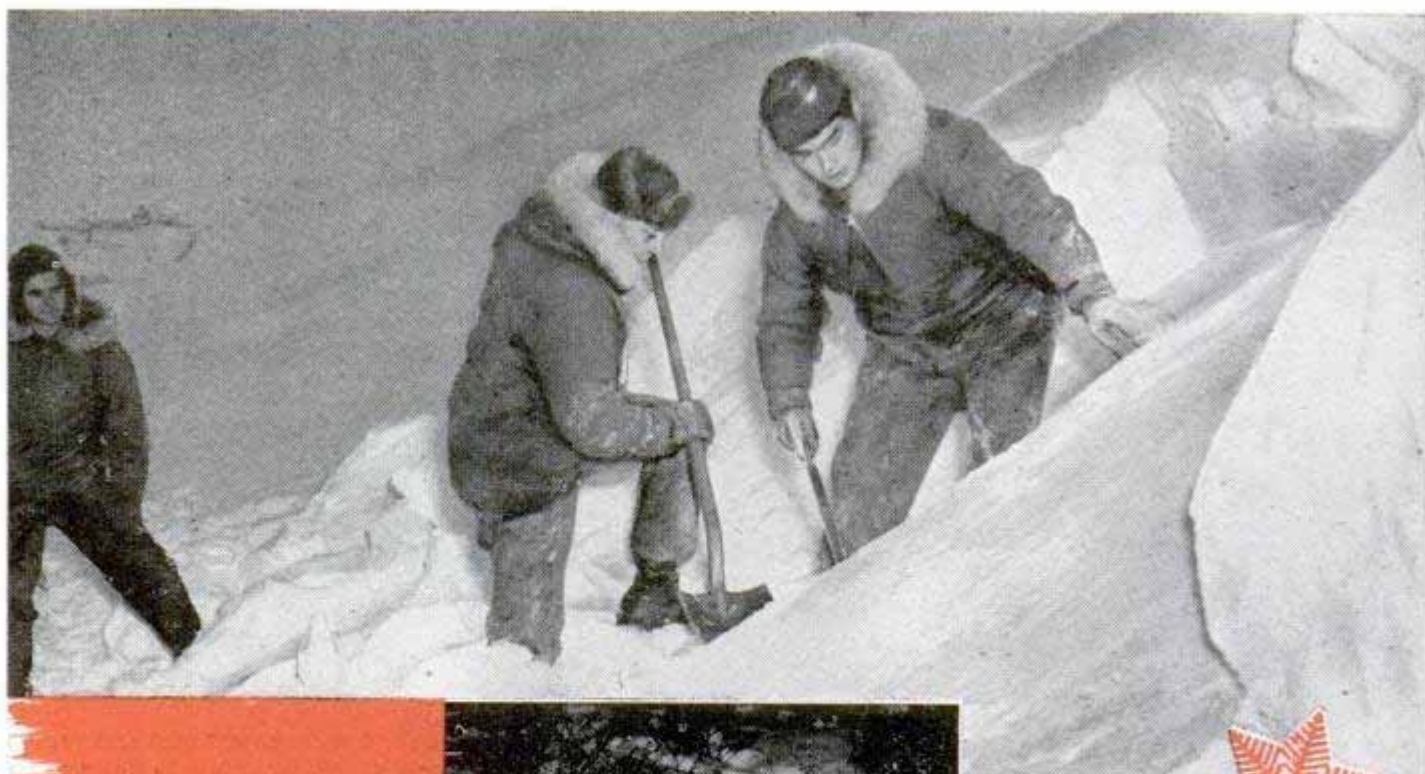

Air Force photo

At the Air Force's Arctic survival school, short saws prove best tool for cutting out blocks for snowhouses

For brief stops on frozen tundra, men learn to make shelters from scrub willow and scraps of chute cloth

As part of their training, students make trek across country wearing snowshoes, carrying a 50-pound pack

Sub-Zero Housing Project

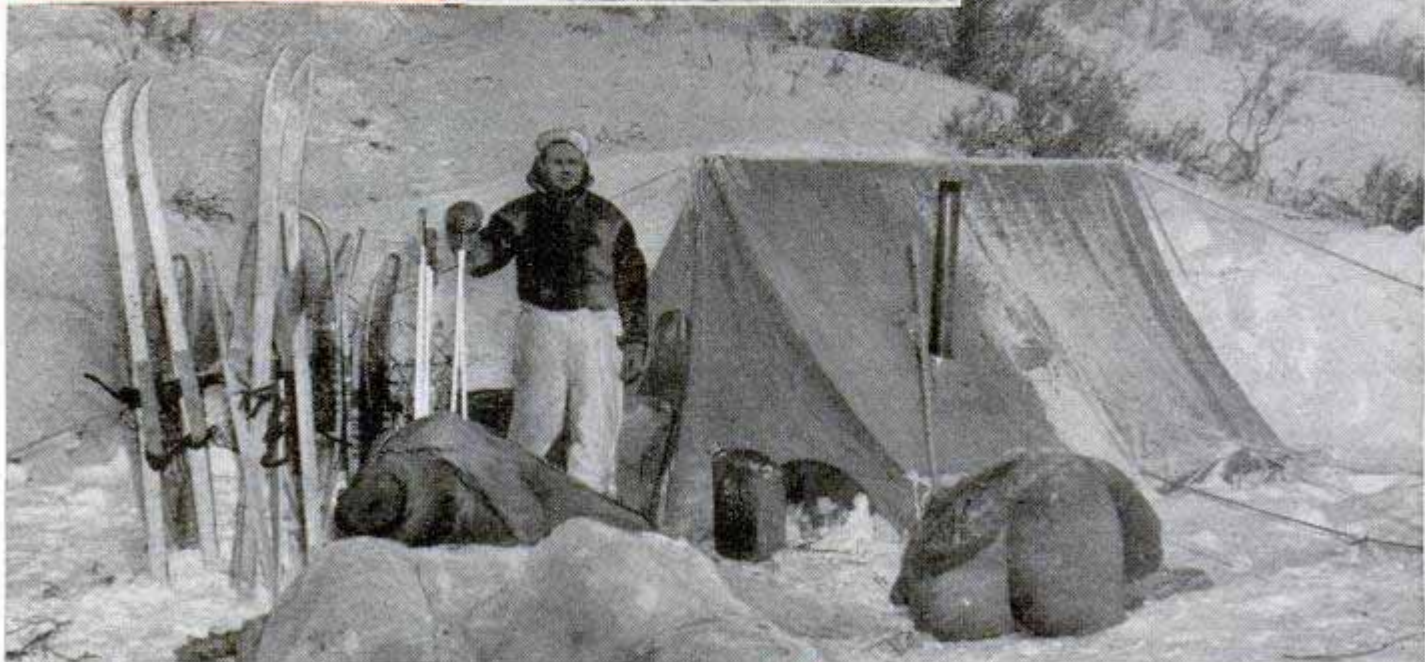

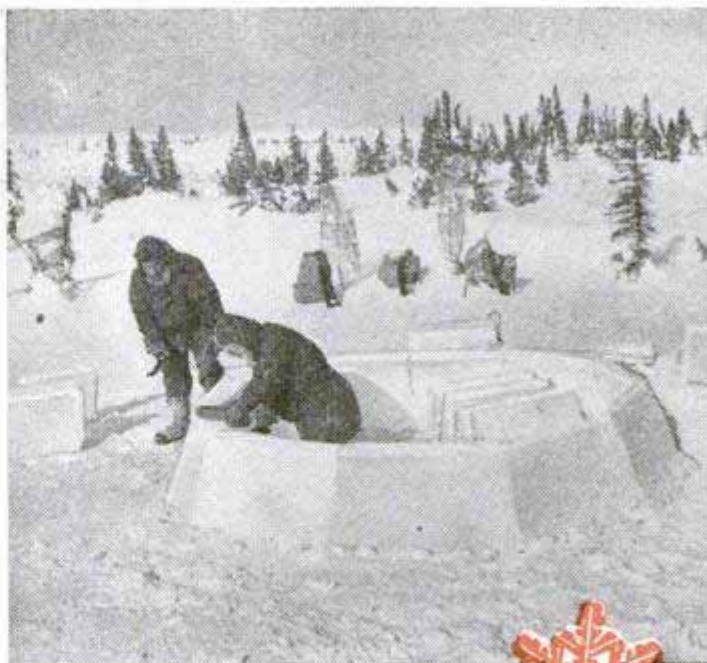

U. S. Army photos



Entrance to snow cave, above, is made as small as possible to prevent heat loss. The central room is high enough to permit occupants to sit erect at meals. Branching out on either side are smaller rooms for sleeping, each one just a trifle longer than the student's sleeping bag

From top to bottom at right, U. S. infantrymen in north-country maneuvers find packed snow in open drifts best for building igloos. With base circle complete, they chink loose snow on seams and shave surface rim at angle to start second row of blocks slanting inward. Best way is to start with big blocks and use smaller ones as wall rises. Structure is completed when worker pulls final block into remaining gap at peak and slices it into position. Finished in less than three hours, this weather-tight house will hold five and stand up to 500 pounds weight at top

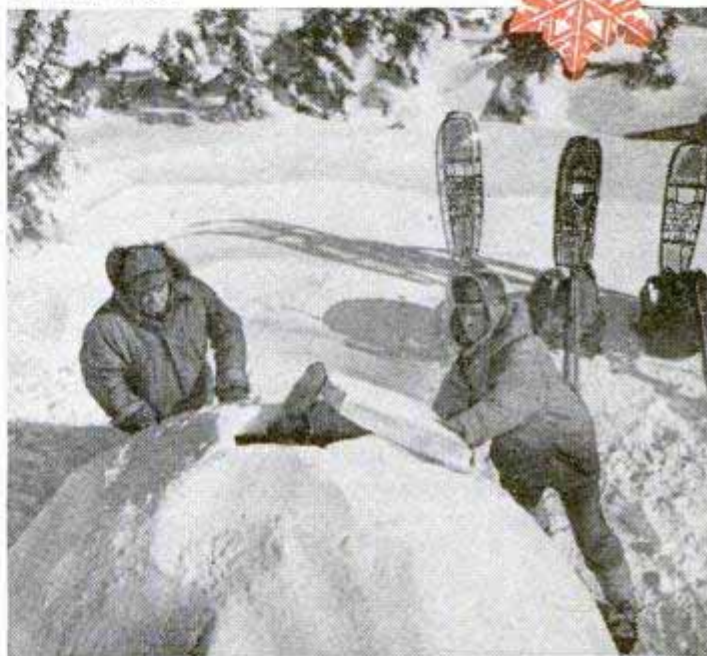

Full-length shelter, below, was built with too high an opening, permitting loss of precious heat. Pieces of wire and string are used to bind together branches forming skeleton for shelter. It can be erected in a few minutes



You Don't Have to Dip This Paint Roller—It's Fed By Air Pressure

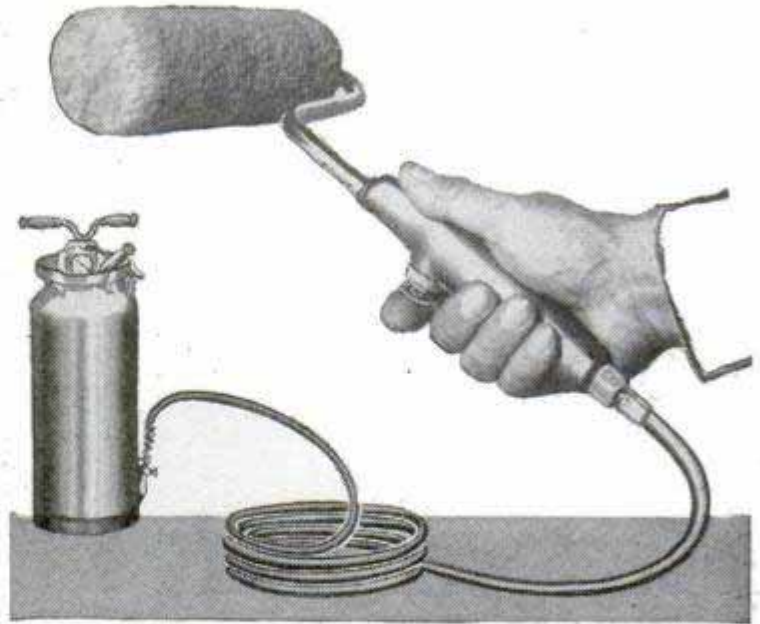
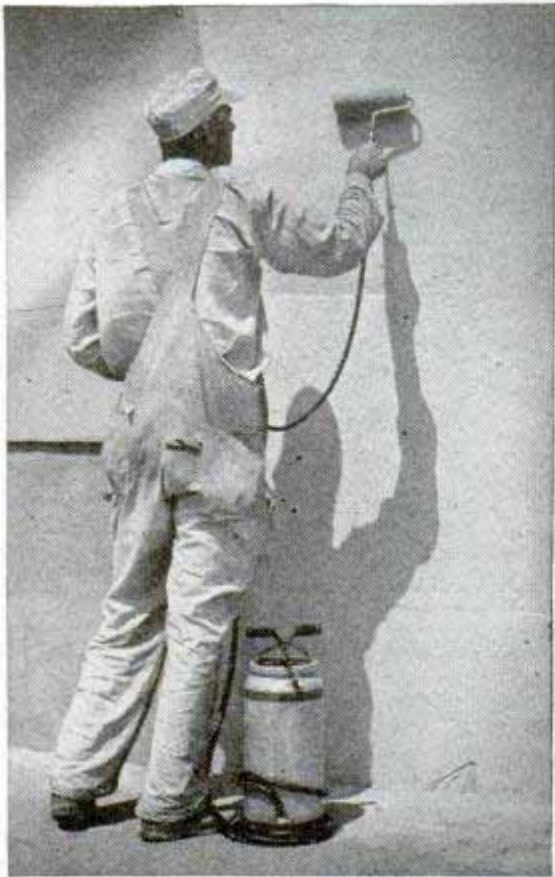

Left, painter doesn't have to stop to dip the roller. Top right, close-up shows the air-and-paint tank. Control valve is on handle of roller which consists of perforated plastic cylinder and sheepskin cover, below

Paint goes on any surface evenly without waste with a self-feeding roller that eliminates the brush and speeds paint application. Paint is forced by air pressure into a perforated plastic cylinder covered

with wool fleece. A hand pump built into the tank provides the pressure. Smaller rollers are provided for painting wood trim and for getting into corners. The roller can be used with almost any type of paint.

Sun's Rays Converted to Electrical Energy That Runs a Midget Motor

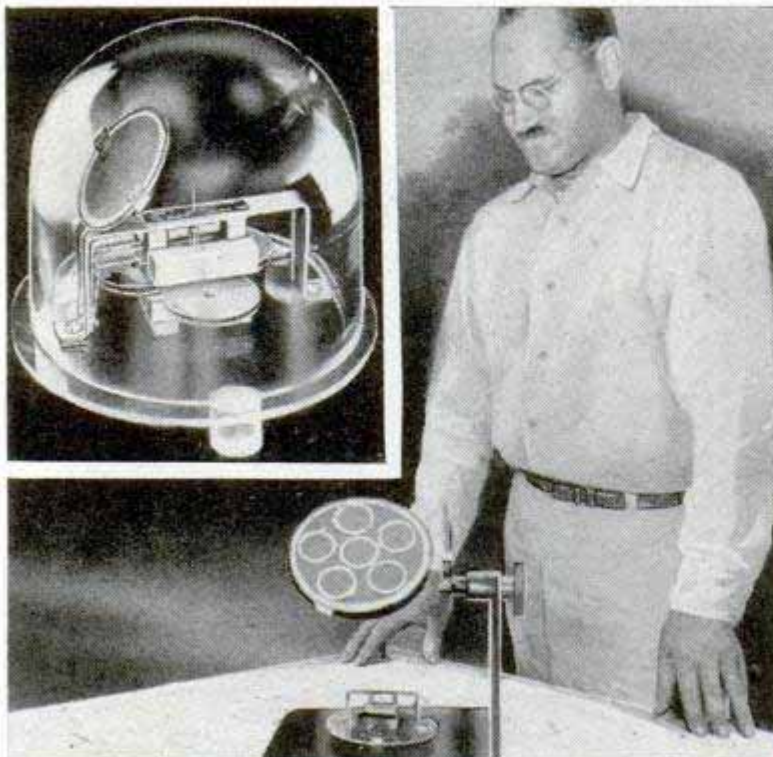

Sunshine can be used as a source of electric power, according to J. Thomas Rhamstine of Harlingen, Tex., who is building "solar motors" to prove his theory. When the sunrays strike a special metal disk they are converted into electrical energy, according to Rhamstine. In the models, the output is measured in microwatts and is used to turn a tiny motor.

Crepe Tape Made of Wood Is More Durable Than Paper

Colored decorative tape made of wood cut in very thin slices is being produced in Japan as a substitute for crepe-paper tape. It is described as more durable and less expensive than the paper variety sold in that country. Less inflammable than crepe paper, the wooden tape is also moisture resistant.

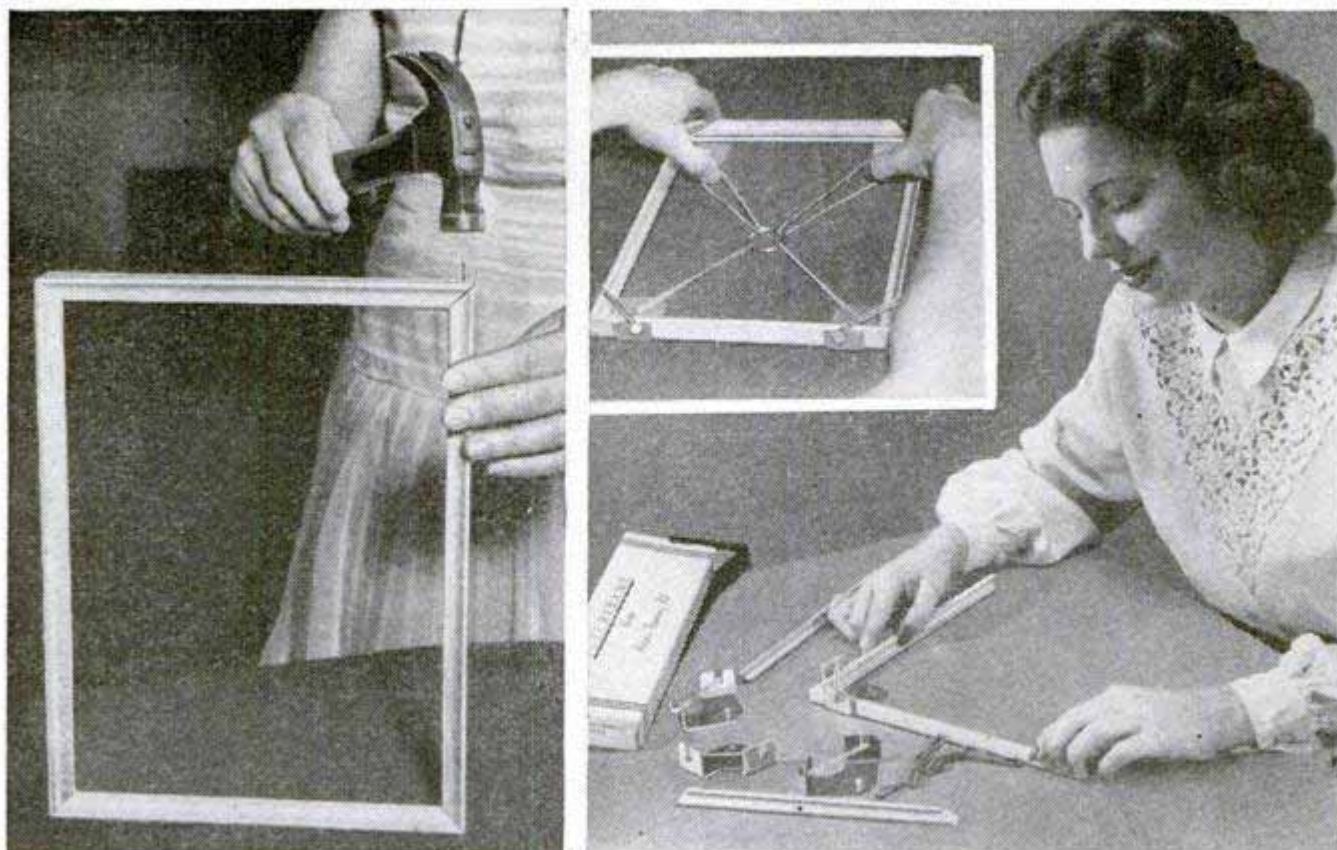

Picture-Framing Kit Includes Precision-Cut Molding

Amateur decorators can frame their own pictures of various sizes with a kit which holds all the necessary parts except the glass. Parts include the molding, aluminum corner supports to hold the frame pieces in position while "setting" and a ring with

rubber bands for drawing the frame together. The molding is precision mitered and the ends are coated with adhesive. Top and bottom pieces are drilled to accommodate small brads. The frames are available in sizes up to 16 by 20 inches.

Gasket Repair Kit

Materials for repairing worn gaskets of almost any type are included in a kit designed for home use. Homeowners can repair leaking faucets, valves, pipes, motors and pumps by cutting gaskets from the material. The kit contains a sheet of asbestos to repair steam, heat, acid and ammonia leaks; a sheet of fiber for oil, gas, air and gasoline leaks; a sheet of rubber for water leaks and a 24-foot length of fiber cord for stopping faucet leaks. Gaskets of any shape can be cut from the material with a pair of scissors.

☞ The amount of sugar in apples goes up with the amount of sunshine they have during the growing season.



Debut for the '49 Chevrolet



This Styleline De Luxe four-door sedan is roomier and wider and has a visibility increase of 30 percent

CHEVROLET—one of America's Big Three in popularity—is getting off to a flying start in 1949 with a complete line of new models that have a distinct "General Motors Look." The Chevrolet Division's first real postwar car is conservative in design compared with some of its competitors, but is a new automobile from the wheels up—with the exception of the engine which is basically the same as the '48.

Two of the major changes are a redistribution of weight which dictated the design of the new body and a new steering system. The combination of these two factors with direct-action shock absorbers and low-pressure tires on wide five-inch rims gives the driver a feeling of handling a much bigger car. Passenger comfort also hits a new high for Chevrolet in the roomy '49 models. The car is wider and lower and visibility has been increased 30 percent.

In the weight shift, the engine was moved four inches forward with corresponding changes in the passenger compartment. Rear-seat passengers no longer ride over the rear axle, but are cradled more comfortably between the front and rear axles. A lower center of gravity helps the car hold the road on curves and at high speeds. Also, the low floor, together with wider doors, makes it easier to get in and out.

The new center-point steering system is

so called because the master arm is located in the center of the chassis front end, equalizing the effort of right and left turns. This "big car" type of steering control is designed to check any tendency of the automobile to wander and is said to be easier on tires.

The 90-horsepower engine is a 216.5-cubic-inch valve-in-head six. Among engine improvements is a fuel-lubricated accelerator pump in the carburetor. The pump is submerged in gasoline, making it impossible for air to reach or pass by the pump seal. This assures consistent power delivery under all conditions, according to Chevrolet engineers.

The '49's gearshift is new—something which comes as a surprise to many Chevrolet drivers. A switch has been made from the former vacuum-assisted mechanism to the manual shift. This change was decreed after some recent improvements in shift linkage. The new shift has a light positive action and lends itself to fast shifting and easier maintenance.

Another innovation for the '49 is in the starter switch, which has been lifted from the floor to the instrument panel. This is a solenoid-type switch. The starting mechanism incorporates the time-tested overrunning clutch, which allows the flywheel to turn faster than the starting motor while

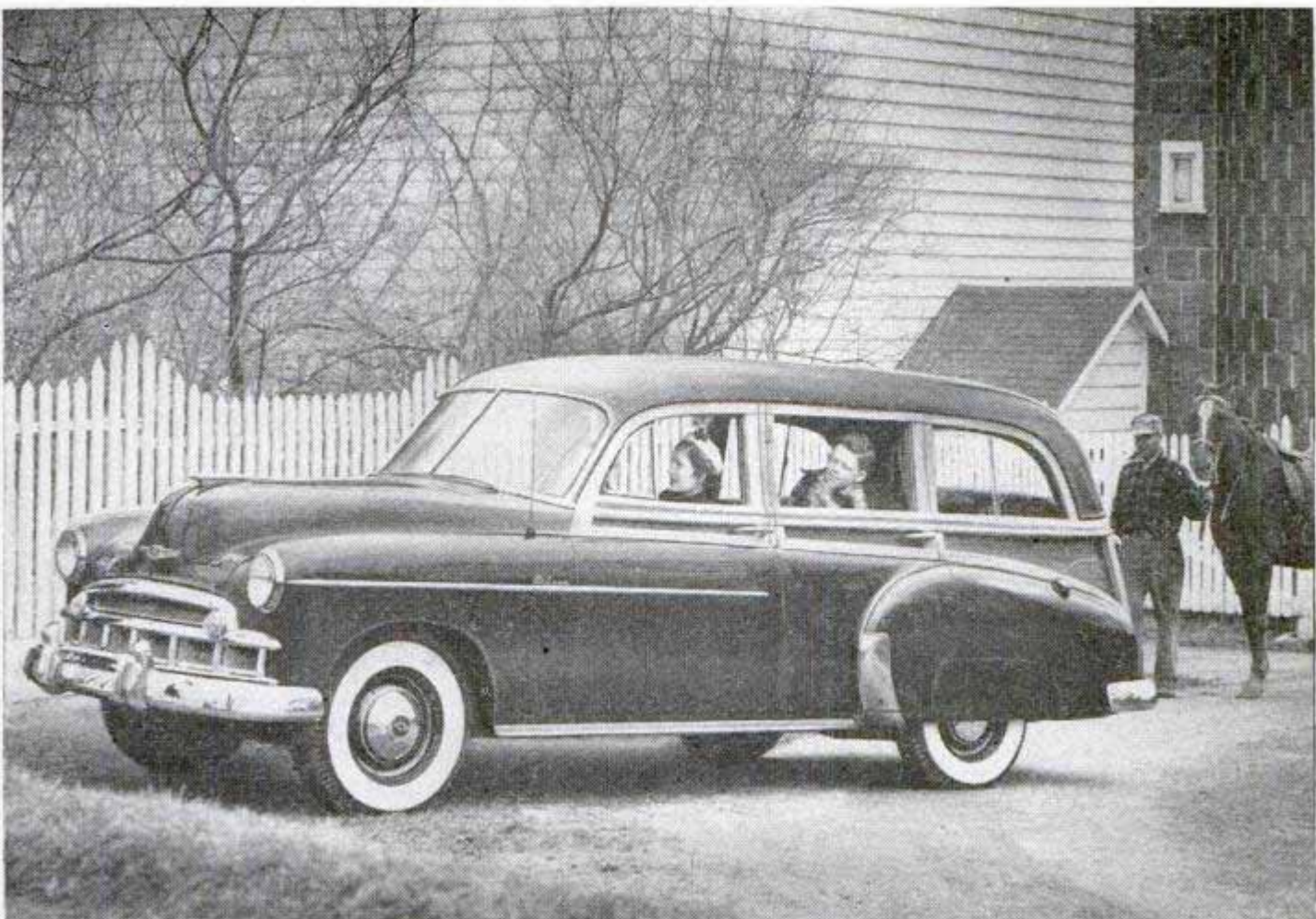

The 1949 Chevrolet station wagons are available in either wood or all-steel bodies. Above, wood-body type

the driving pinion remains engaged with the flywheel. This type of starter saves the driver the bother of having to release the starter button if the engine sputters and dies during the starting. The starter may be operated regardless of the position of the ignition switch.

Other new features for the driver include instrument dials grouped in a circular cluster on the face of a "jumbo" speedometer, push-pull window wings which eliminate the former "ventipane" handles, a thinner and lower steering wheel, and an entirely new ventilation system. The cowl

vent is omitted in the new Chevrolet and fresh air is drawn into the passenger compartment through ducts located between the front fenders and the radiator. These ducts lead to tubes ending behind the instrument panel. Air is metered by butterfly valves controlled by manually operated knobs on the instrument panel.

The new suspension system has helped reduce the car's weight. The old parallel-type shock absorbers, both at the front and rear, have been replaced with the airplane type. Those at the front are located inside the coil springs and are removable for

Here's Chevrolet's answer to: "Is it a new car?" Note how the car has been lowered and the engine and passenger compartment moved forward. Redistribution of weight with new low center of gravity dictated changes

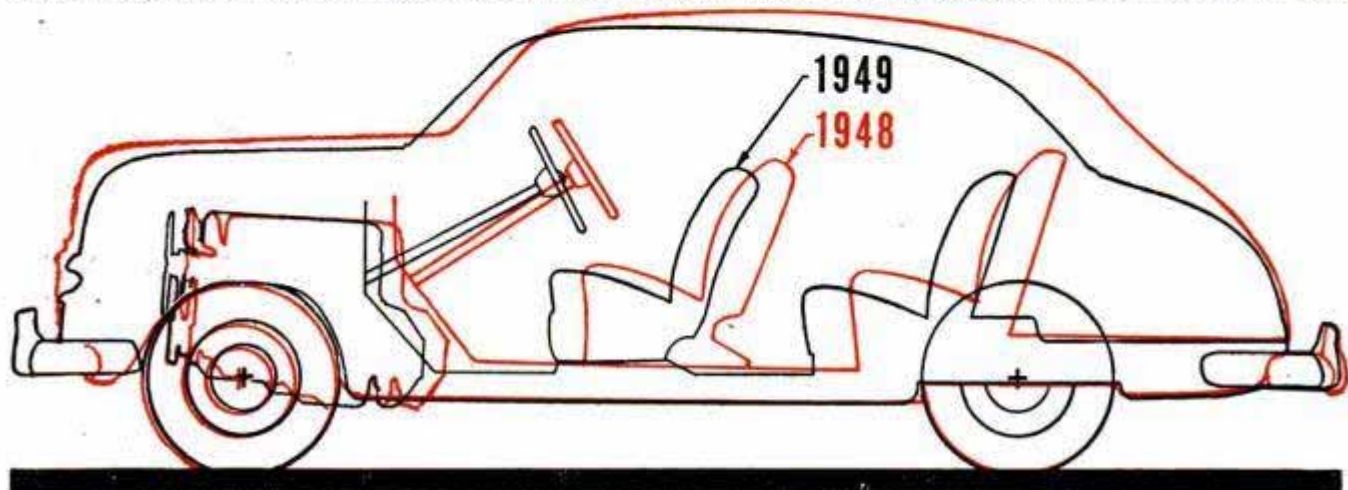

'49 Chevrolet ...

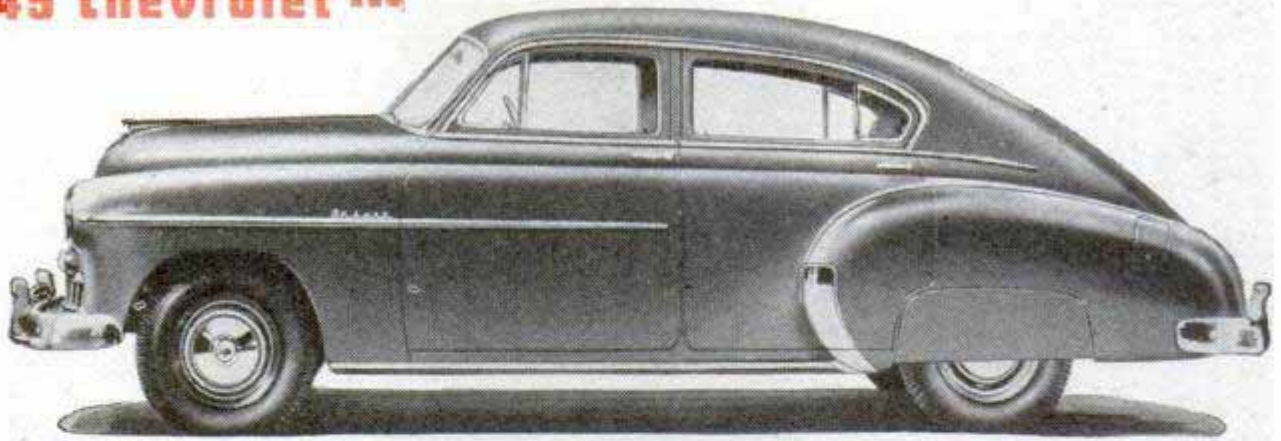

Fleetline four-door sedan retains popular roofline called "fast back." Model is also available as two-door

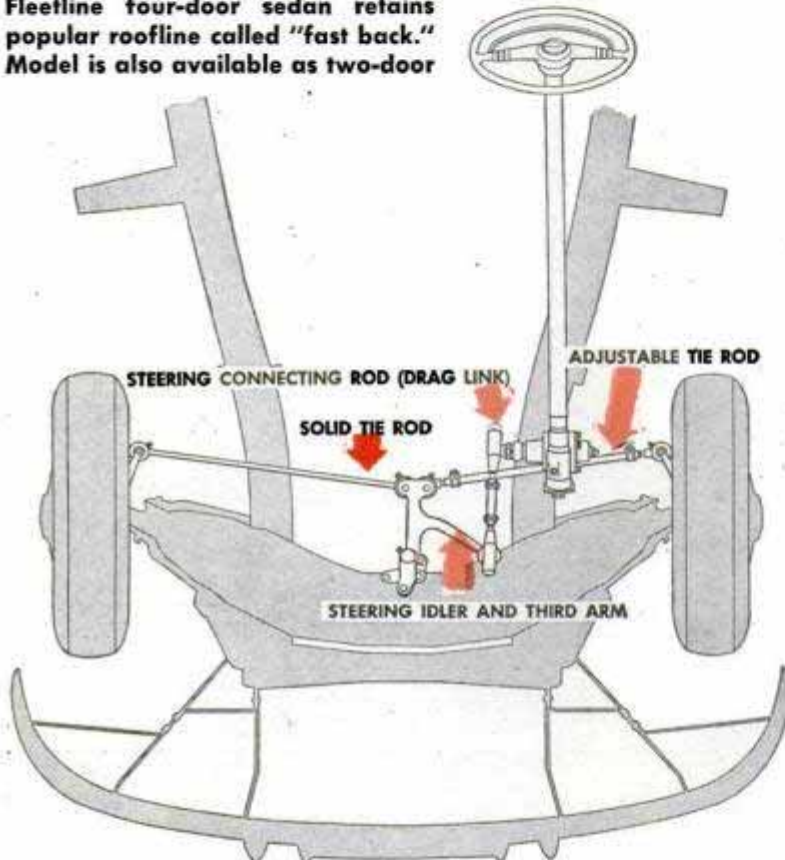

New center-point steering system reduces tendency of a car to wander. Below, arrows show new ventilation and heater system. Also, note new steering wheel and instrument dial cluster

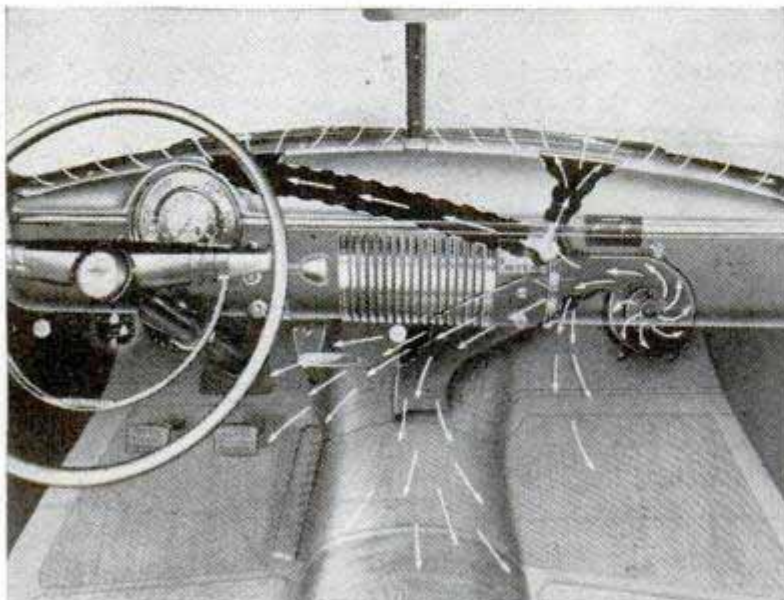

maintenance through a hole in the lower control arm of the knee-action unit. The entire suspension assembly, including the front cross member, is 12 percent lighter and has greater strength than that of previous models.

Other minor improvements on the new models include larger trunks equipped with automatic locks, rear-compartment dome light doubled in candlepower, a concealed gasoline filler pipe on the left side of the car, parking lamps built into the grille, a chromium body speedline for the protection of doors and a ball-bearing-mounted adjustment for the front seat.

The '49s are being built in both the Fleetline and Styleline series. Fleetline models consist of two and four-door sedans. The Styleline offers, in addition to the sedans, two coupes, a convertible and two station wagons.

CHEVROLET SPECIFICATIONS

Engine—Valve-in-head, 90 horsepower, 6 cylinders
 Compression ratio—6.6:1
 Fuel system—Single-adjustment balanced downdraft carburetor with accelerating pump
 Wheelbase—115 inches
 Over-all length (including bumpers)—197 inches
 Station-wagon length—198 inches
 Height—63 $\frac{3}{8}$ inches
 Width (widest part)—73-15/16 inches
 Ground clearance, rear axle—7-13/16 inches
 Weight (4-door sedan)—3225 pounds
 Gearshift—Mechanical
 Front suspension—Unitized knee action with double-action hydraulic shock absorbers, ride stabilizer
 Rear springs—Semielliptic springs and shackles of tension type, direct double-action hydraulic shock absorbers
 Drive—Torque tube
 Brakes—4-wheel hydraulic
 Tires—6.70-15 on 5-inch rims

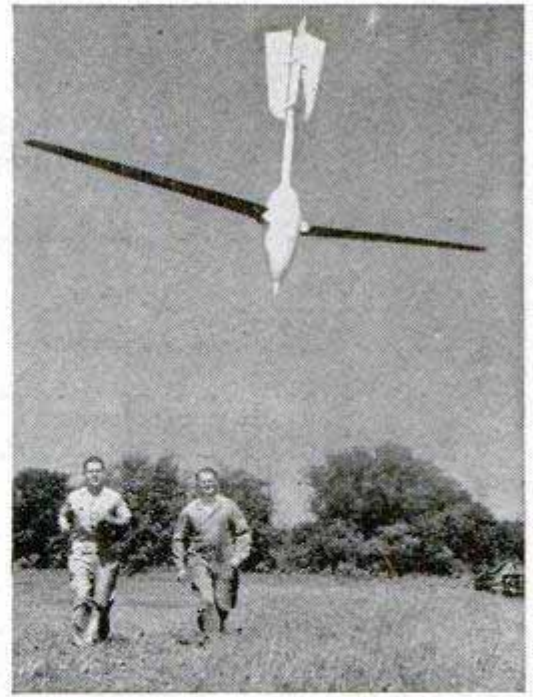
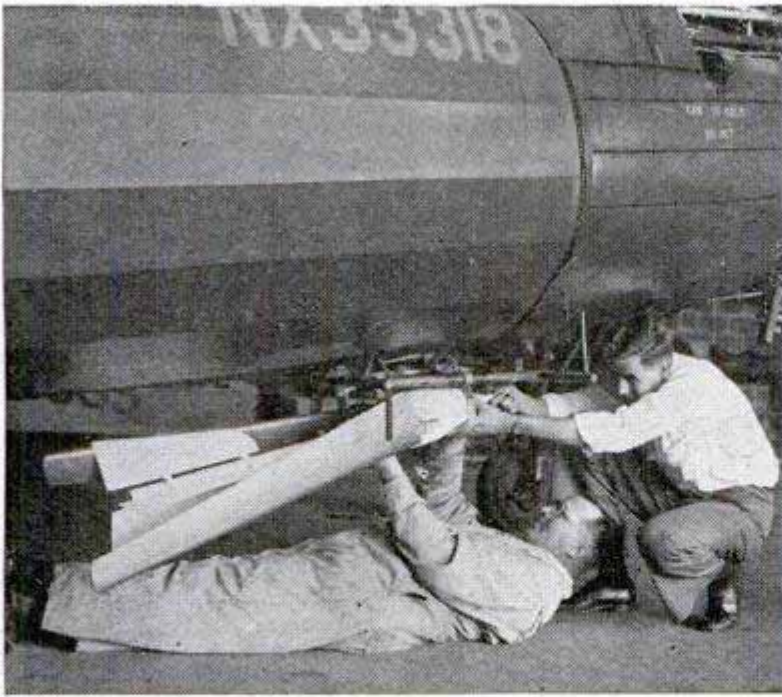

Supersonic "Chute" Has Propeller To Slow Down Rate of Descent

Resembling a giant dart with a whirling propeller near the tip, a rotochute gently lowers research instruments from rockets shot into the upper atmosphere. The rotochute may be used in the future to help supersonic pilots escape from disabled planes at high altitudes, where ordinary parachutes would be useless, according to General Electric engineers who developed the device. When it is released from a rocket or plane, the vanes begin to whirl and fold out at right angles to the bullet-shaped container. They act as brakes, slowing the rotochute from supersonic speeds to about 27 miles an hour when the container strikes the ground. Of those developed and tested, the most successful model is about four feet long, eight inches in diameter and has vanes which extend out about eight feet. It can carry a 20 to 30-pound load of instruments.



Top left, attaching the rotochute to helicopter for tests. Right, the "chute" falls at 27 miles an hour as it nears ground. Above, one of 23 models tested



Self-Contained Paint Sprayer Has Built-In Motor and Compressor

Complete with a built-in electric motor and compressor, a one-unit paint sprayer eliminates the need for cumbersome air hoses and extra equipment. You just fill the unbreakable paint container, plug in the power cord and the sprayer is ready for use. It is made of aluminum and weighs only four pounds. Operating at 50 pounds' pressure, the sprayer provides thorough atomization of paint.

☐ In two years the number of self-propelled combines on American farms increased 183 percent, from 3539 in 1945 to about 10,000 in 1947.

The Power Line Comes to Yellowknife

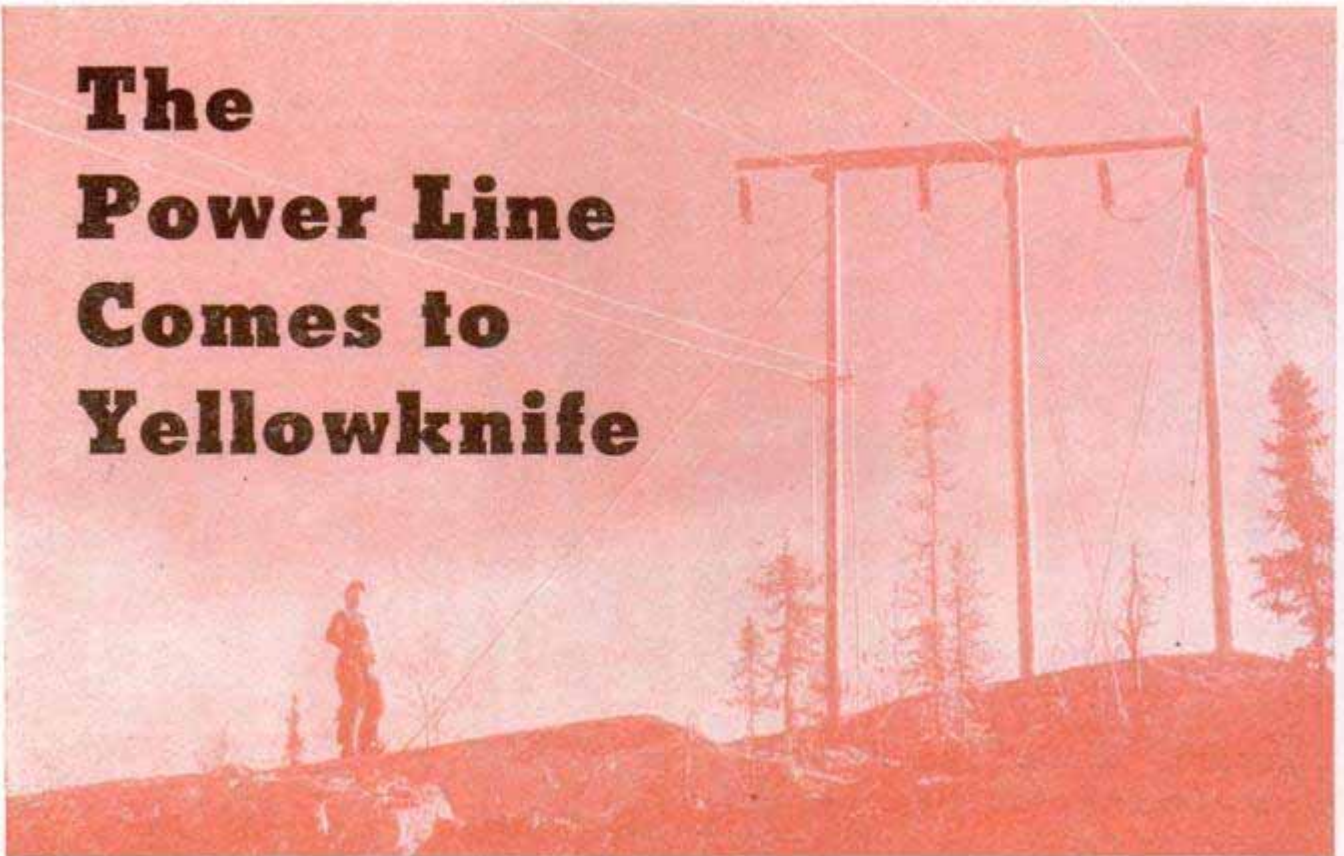

IN THE lonesome vastness of Canada's sub-Arctic region, a streamlined hydroelectric plant, less than 300 miles from the Arctic Sea, marks the advance of industrial progress in the northland. Straddling Snare River near its mouth on Great Slave Lake, the dam and power station provide continuous electric power for the fabulous and fast-growing community of Yellowknife, where gold mining and its related trades have attracted 4000 persons.

This newest northland installation augments by almost 200 percent an older

By Harry Chapin Plummer

generating station of 4700-horsepower capacity which for several years has been in operation at Blue Fish Lake, about 25 miles north of Yellowknife. The Snare River development, with its peak output of 9500 horsepower, will, in aiding the growth of the area's mining industry, help to bring about a need for even greater power facilities as industry spreads over the stretches of stunted woodland that separate the dam from its "market," Yellowknife.

That mining center is undergoing a metamorphosis from a primitive, "hell roar-

Tractor-train pulls into Yellowknife after snaking its way across the frozen surface of Great Slave Lake. The trip took more than a week

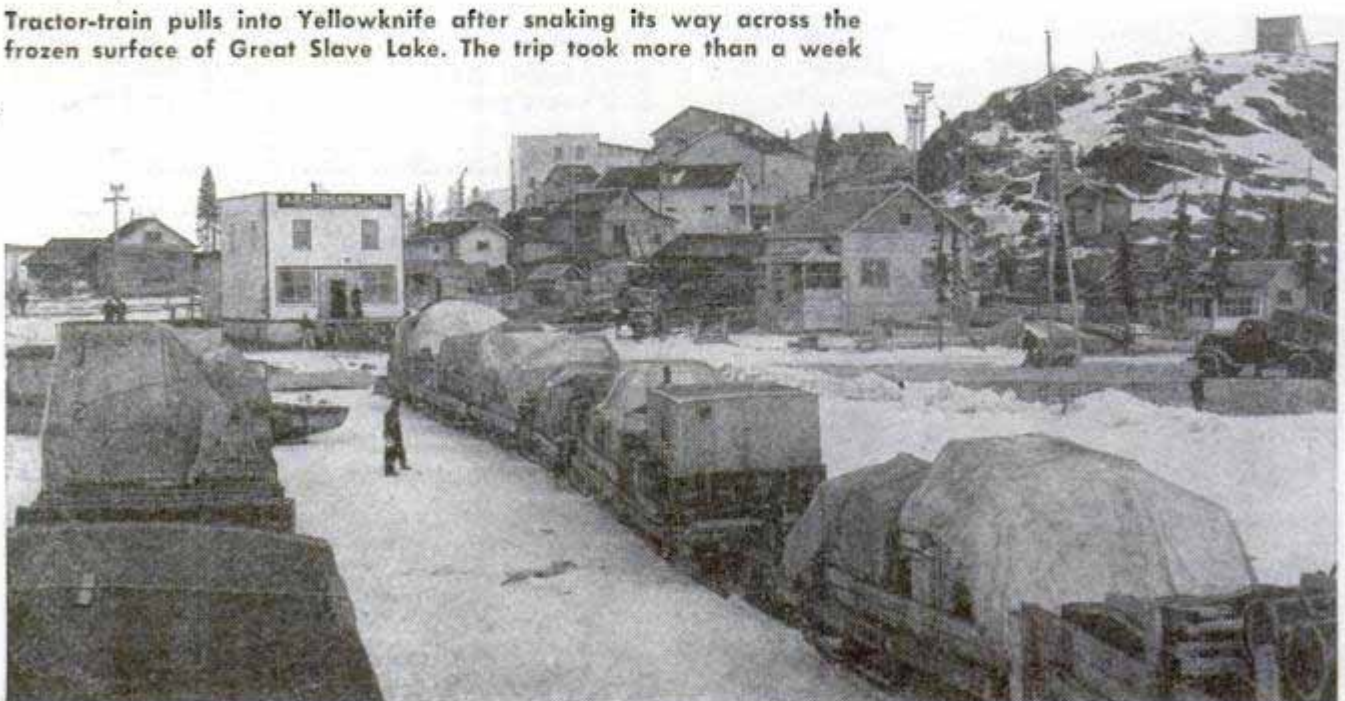



Marking the frontier of industrialization in Canada's northland is this dam and power station at Snare River

ing" pioneer settlement to a modern, planned town. Old frame dwellings and business structures that stood or leaned drunkenly askew for years are fast giving way to up-to-date construction.

Primarily, the Snare River development will serve the basic industry at Yellowknife, gold mining. At the same time it will serve other industries that have grown up around the community. Among these is a fish-canning and storage plant at Blue Fish Lake which annually ships upward of one million pounds of lake fish to Canadian and U. S. markets.

The staff at the power project has to be content with infrequent trips to the "big" city of Yellowknife. Such trips involve a plane ride equivalent to a flight from New York to Philadelphia. For a shopping junket, a trip for emergency supplies or a session at the movies, airplanes are the only means of transit. There is nothing that resembles a highway and no automobiles. If there's no hurry, the trip can be made in summer by canoes with portages or in winter by dog sled.

The equipment at the power project is the best available. Here a technician services the big generator and turbine

Construction of the Snare River power development by the Canadian Department of Mines and Resources was a difficult job made infinitely more difficult by the weather. The permanently frozen soil, permafrost, its surface turned into a sticky, slippery mud by the Arctic sun's intensive rays, was but one of the problems. Transport of incoming construction and installation equipment presented the supreme obstacle that had to be hurdled months and years

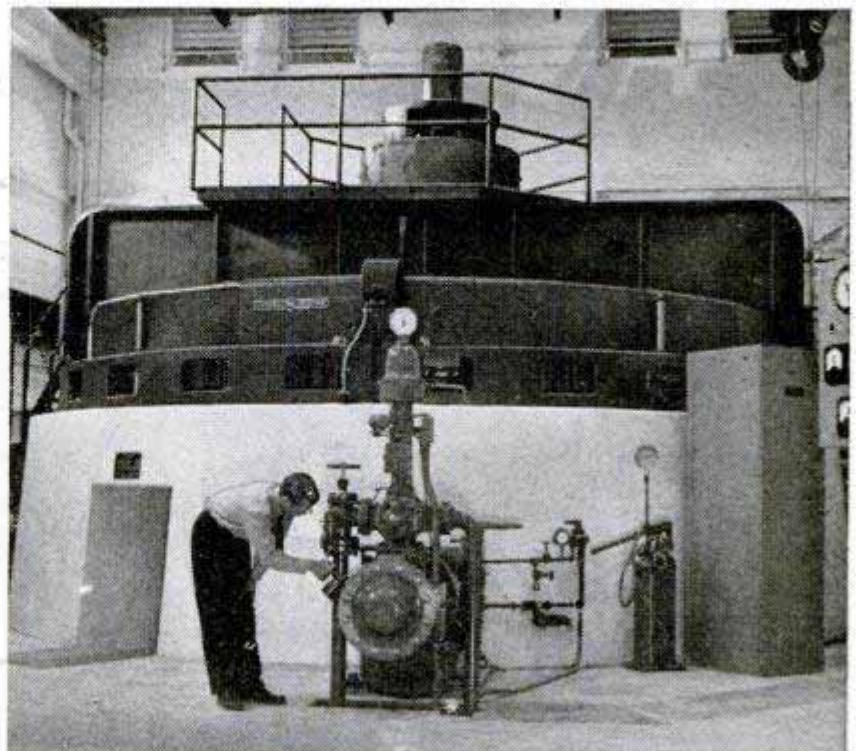

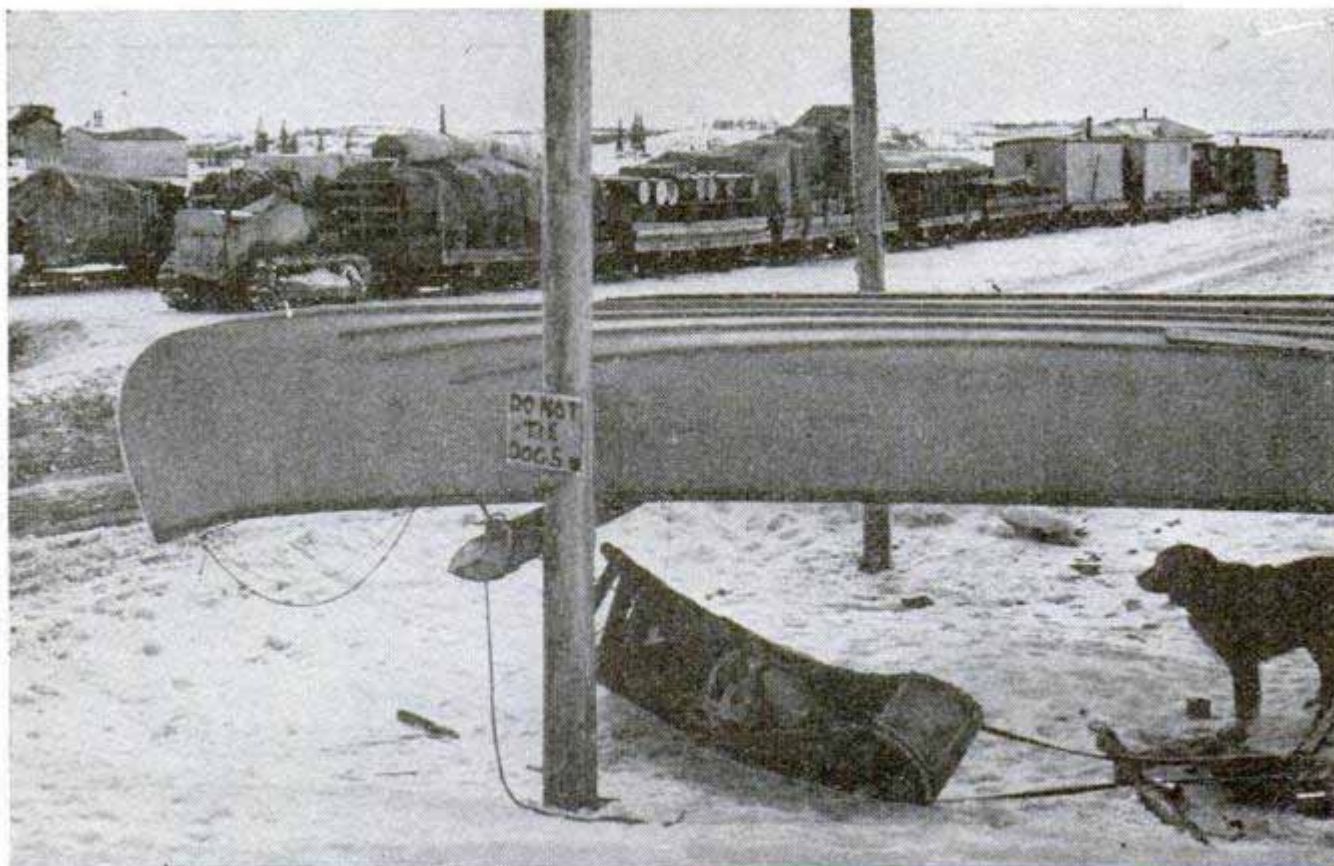

Another photo of the tractor-train at Yellowknife. Canoe in foreground has been stored for the winter

before the power could be turned on. There was the problem of gauging the correct tension on the three-wire transmission line in a land where the year's extremes of temperature range from 60 degrees below zero to 90 degrees above. Almost \$5,000,000 were spent on the new plant with no hope or expectation of an early return.

(Continued to page 284)

The home of the Snare River project's superintendent is complete with radio and other electrical servants

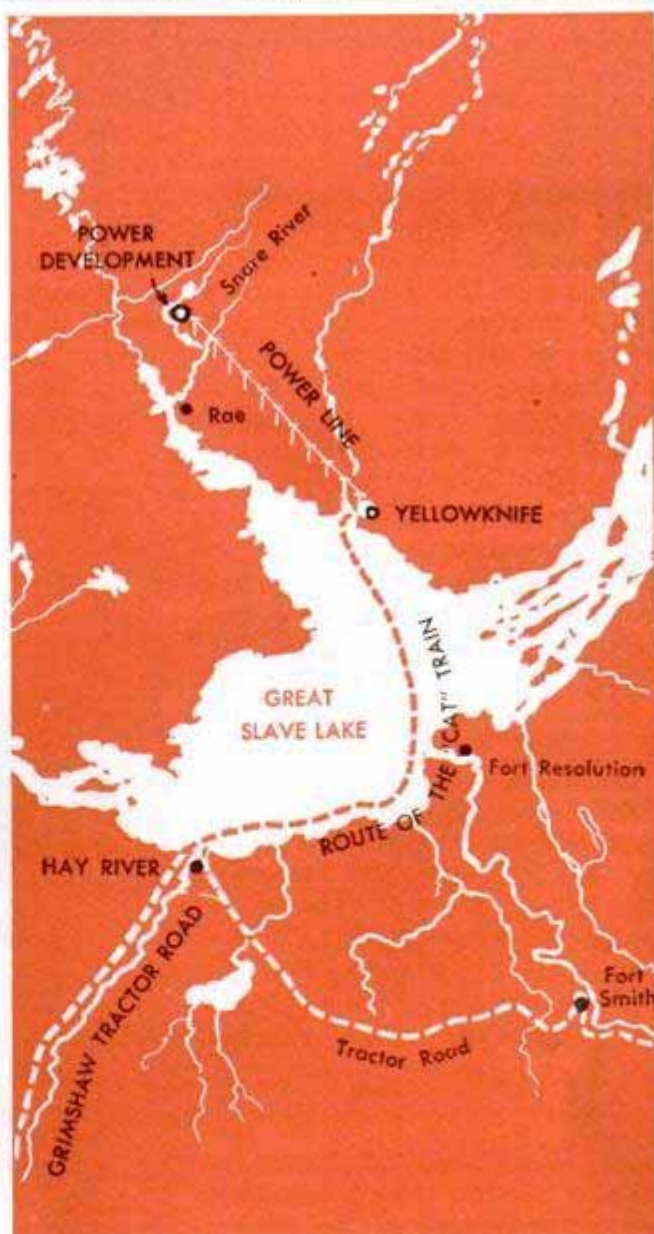

Rear-Engine Car Looks Like Bus

Assembled entirely from standard parts and sub-assemblies, a rear-engine automobile called the Mustang has been introduced in Seattle as the newest entry in the low-price field. The car, which seats six, two in front and four in back, is designed to sell for \$1235. It has a four-cylinder, 59-horsepower Hercules engine. The power unit, consisting of engine, transmission and rear axle, slides out for repair when the body is raised. A door in the body just ahead of the rear wheel provides access to the engine for servicing. There is a large luggage compartment in the rear. The buslike front end provides excellent visibility for front-seat occupants.

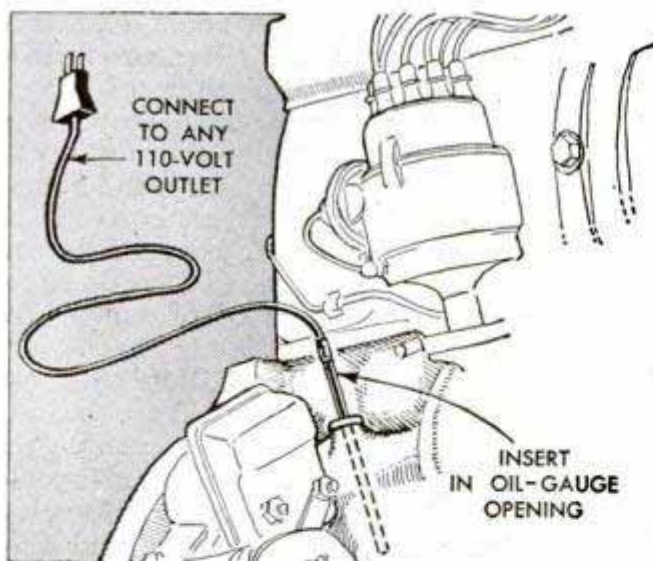
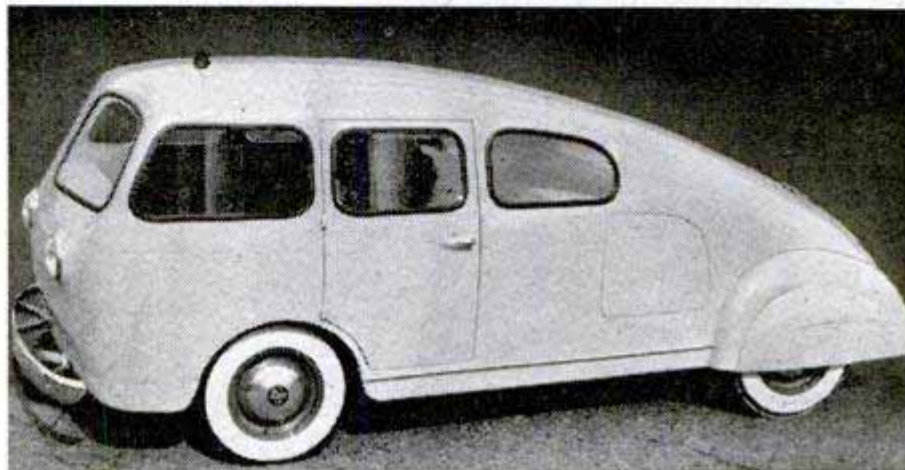
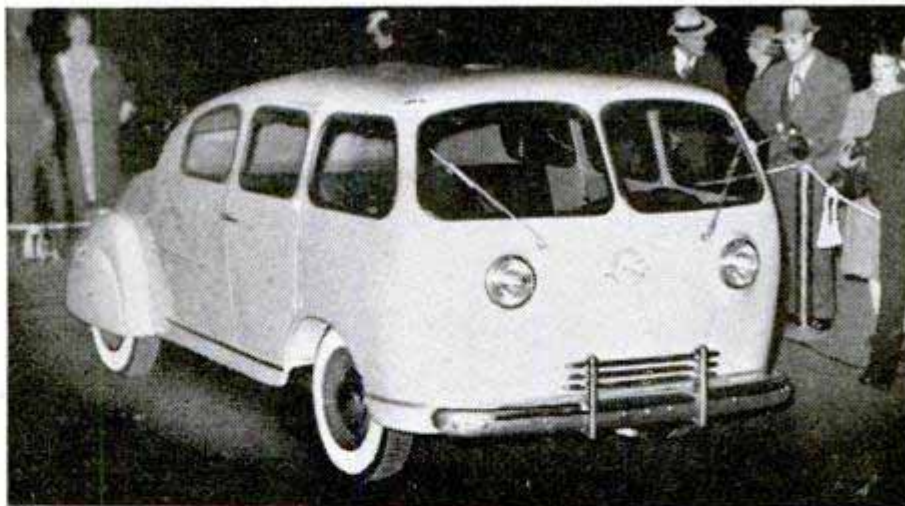

Electric Heater for Car Motor Fits in Dip-Stick Opening

Instant starting of a car in the coldest weather is assured with a motor heater that fits any auto and may be left in the motor any length of time. The heater is a rod that is inserted in the oil-gauge opening after removal of the dip stick. It plugs directly into a 110-volt a.c. or d.c. outlet, and is rated at 100 watts. Heat from the rod keeps the oil, motor block and all moving parts warm, reducing battery wear. The heater is available in two models, one with a 3-foot cord and the other with a 12-foot cord to eliminate the need for an extension.

Waterproof Cover of Nylon Straps Over Motorcycle

Motorcycles are protected from rain and snow by a waterproof cover made of nylon. The cover fits snugly over the motorcycle and is fastened at the bottom with straps. When not in use, it can be folded into a two-pound package measuring only 2 by 6 by 10 inches. The cover is available in two colors, and in models that are cut to fit motorcycles with or without windshields.

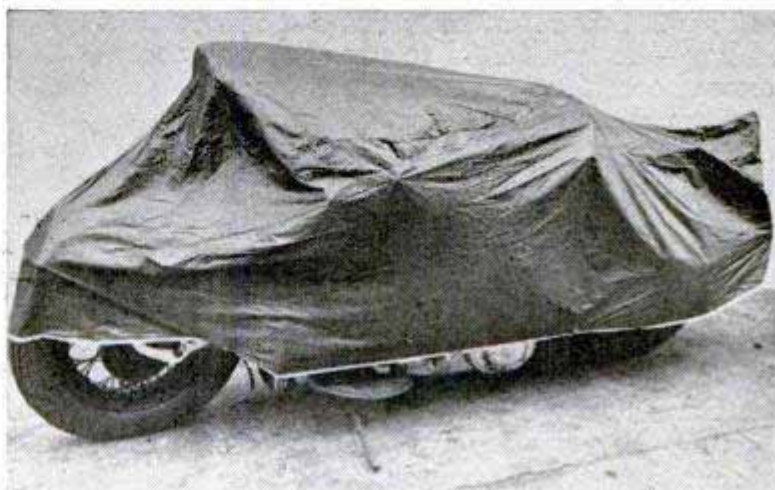

Automatic Recorder Takes Continual Reading

By Irvin A. Weinman

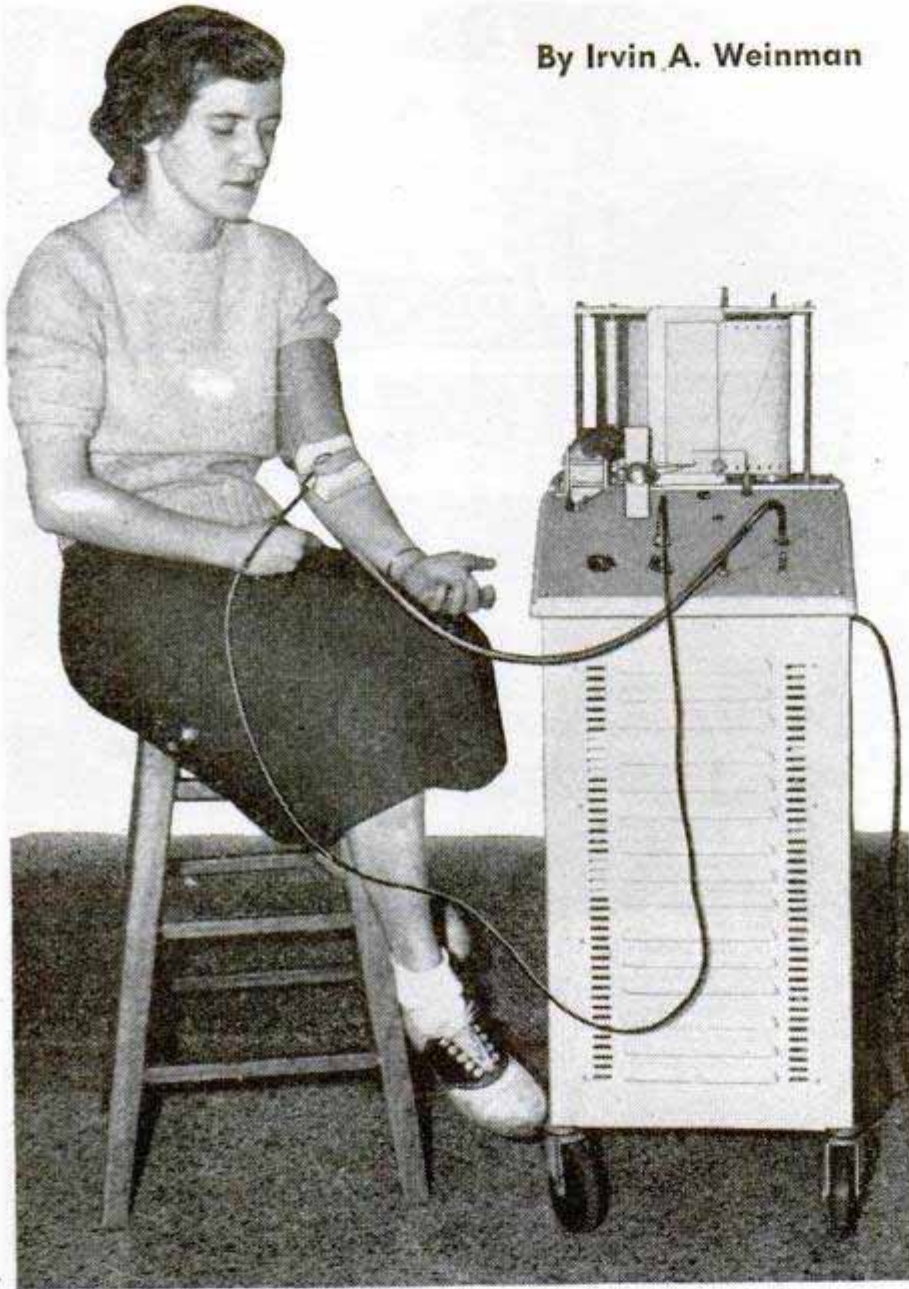

Nervous patient can be left alone with machine. When patient relaxes, the blood pressure drops and the instrument records the normal pressure

A HUSKY 20-year-old boy recently walked into a Navy recruiting office to enlist. A few minutes later he emerged in a daze—he had failed to pass the physical exam because of high blood pressure.

After considerable worry about his condition, he visited his family physician for treatment. A thorough recheck failed to indicate that his pressure was at all above normal. Had the Navy doctor made an error? Probably not.

What may have occurred is a phenomenon called "the psychic pressor effect"—boosting of the blood pressure by nervous tension. Grateful that he was in good health, the young man applied again. This time he passed with flying colors.

Because of this psychic effect, determining the real blood pressure is a dilemma to the doctor. He knows pressures can spiral upward at the slightest provocation. People can cleverly conceal their emotions, sometimes even from themselves. Consequently, it is a difficult task for the doctor to tell by casual observation whether or not his patient is tense.

Dr. W. E. Gilson, head of electronics research at the University of Wisconsin medical school, has developed a machine designed to lick this psychic pressor effect. It is called the automatic blood-pressure recorder. After a few simple adjustments have been made, the examining physician can leave the room and the machine will record faithfully variations of blood pressure on a moving strip of paper. Reclining on a cot if necessary, the high-strung patient is given an opportunity to calm down. As a result, accurate readings of pressure are possible.

Doctor Gilson's automatic machine operates on the same principle as conventional hand-operated equipment. A rubber cuff is automatically inflated and deflated by an electronic control which activates a built-in air compressor. Sounds of the blood flow in the arm are picked up by a tiny microphone called a stethophone, amplified thousands of times and recorded on the lower part of a moving chart by an electronically controlled pen. Another pen, controlled by the equivalent of the rising and falling mercury column, records the variations in blood pressure higher up on the chart. The actual pressures can be observed by matching the heart-sound lines with those made by the pressure indicator.

In his research Doctor Gilson also found that the recorder can be used in the operating room. The usual procedure during

of Patient's Blood Pressure

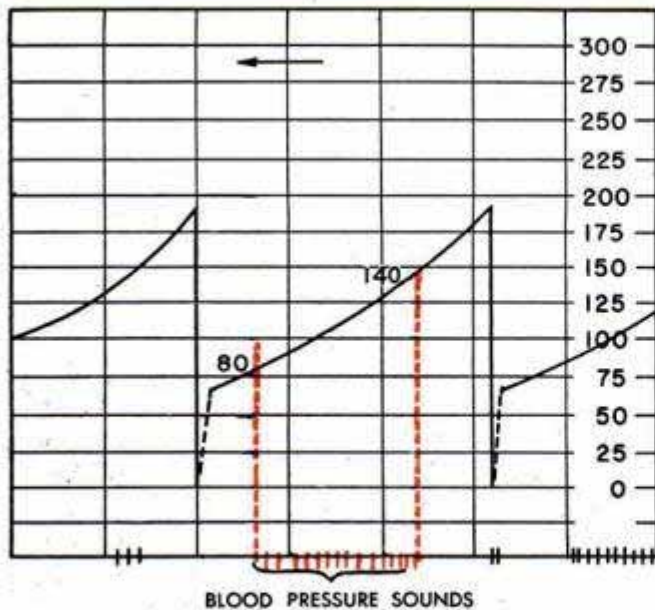

Patient's blood pressure, as recorded on this graph which rolls out of instrument, is about 140 over 80

surgery is for the anesthetist to take the patient's blood pressure periodically in addition to his regular duties. Sometimes, especially during long brain operations, it is difficult for him to do this. With the automatic recorder in use, movements of the recording pen, which is activated by the heart sounds, can be heard across the room. This allows the anesthetist to take blood pressures by ear, meanwhile attending to his other duties. An occasional glance at the pressure indicator will tell him whether blood pressure is rising or falling.

The automatic blood-pressure recorder, Doctor Gilson says, may also be used as a lie detector. Another pen, activated by respiration rate, can be attached to the machine. The three most important components of lie detection are pulse rate, blood pressure and respiration rate. The recorder can measure all three.

Doctor Gilson, recorder's inventor, also has used it as a lie detector by recording respiration rate, too

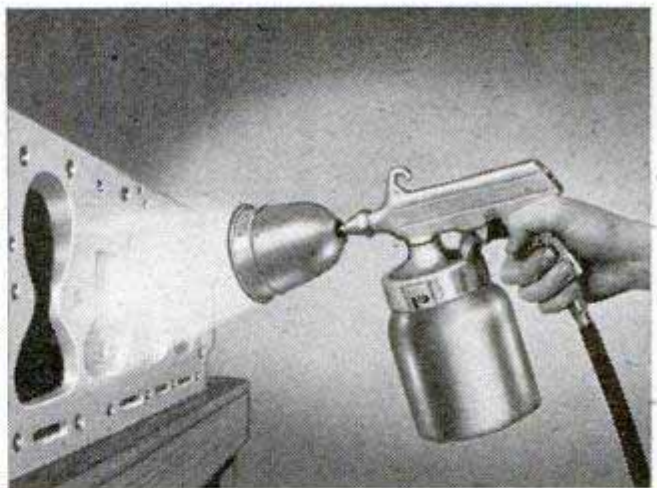

Gun Sprays Liquid or Abrasive

Sandblasting or liquid spraying reaches inaccessible places with a combination blast gun that can be connected to any air line. This blast gun, designed for automotive and industrial work, is handy when working on wheels, drip moldings, grillwork, steam radiators, fins and other parts. It is used to remove paint, rust and scale. Solvents are used to flush out grease, gum and tar. One retaining nut holds interchangeable nozzles—one for use in "blast" operations; the other for spraying oils or chemicals. A turbulence shield stops and retains most of the spent abrasive ricocheting from surfaces being worked. The solvents or abrasives are drawn up from a three-pint container that locks below the barrel with a quarter turn.

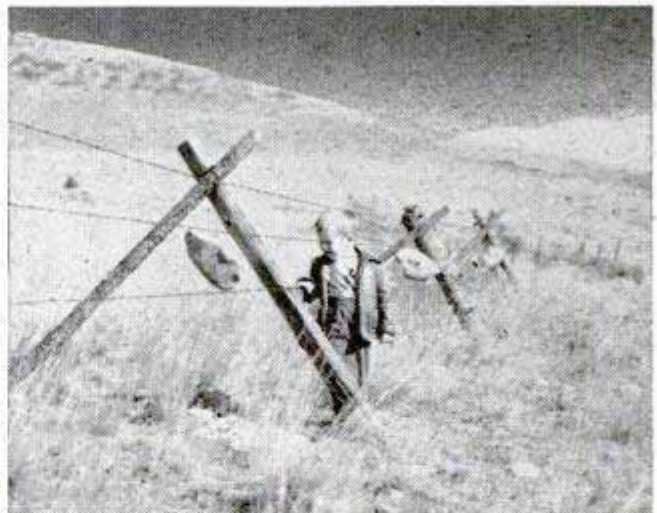

Rocks Ballast Fence

Because much of the terrain in the northern Rocky Mountains is so filled with stone that the digging of post holes is virtually impossible, ranchers have been forced to invent a new type of fence. They fasten two posts together and stand them on top of the ground in an inverted vee. Rocks are tied to lengths of heavy wire and suspended between each pair of crossed posts to give the fence stability.

X-Ray Microscope Opens New Fields in Living-Tissue Research

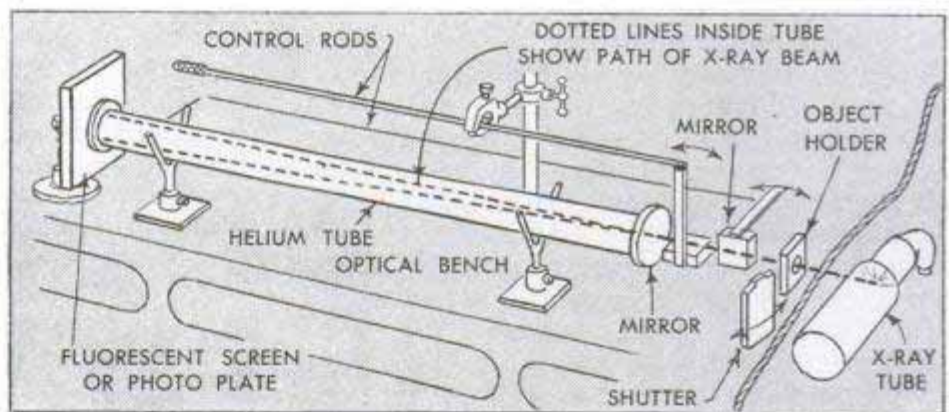
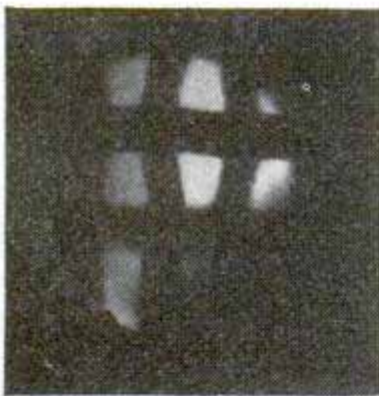
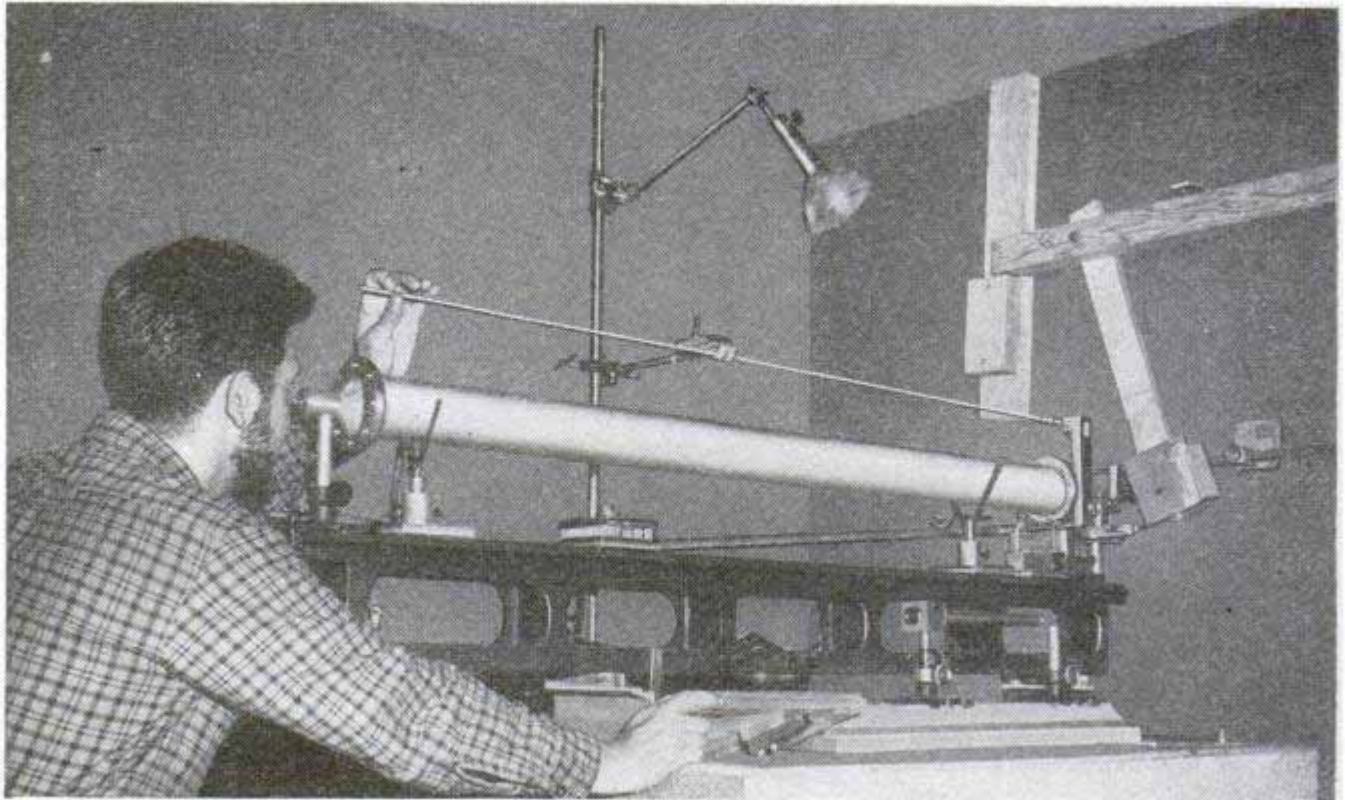

Top, long control rod is used to adjust microscope mirrors while examining X-ray image through eyepiece. Left, X-ray microscope photo of wire gauze with 250 meshes to inch; right, sketch shows how instrument works

An X-ray microscope developed at Stanford University eventually may allow examination of objects less than a millionth of an inch in size and will permit microscopic studies of living tissues.

Such a microscope long has been considered an impossibility because X-rays don't follow most optical laws. They may be reflected at very low angles from some surfaces, similar to the way a stone may be skipped across water, and this principle was utilized in the new microscope. Essentially, the device employs a beam of soft X-rays that after passing through an object is slanted off a small horizontal concave mirror with a metallic surface and is then slanted off a similar reflector placed in a vertical position. Each mirror balances out the distortion produced by the other and spreads the rays to produce magnification in the manner of a movie projector. The X-ray image is projected

through a long helium-filled tube to prevent absorption of the rays and the image may be examined by eye or photographed. Although research is not complete, successful X-ray photographs with a magnification of close to 100 times have been made of fine wires invisible to the naked eye in ordinary light, as well as magnified pictures of fine gauze screens. The investigation is being carried on by Dr. Paul H. Kirkpatrick and by Dr. Albert V. Baez. The new principle opens the way to examining interiors of living biological specimens, the interiors of metals and the simplification of X-ray spectroscopy. Another possibility is a high-intensity type of X-ray gun that would condense a broad beam of X-rays down to a pin point. The research, at some time in the future, may lead to the use of other particles, such as beams of neutrons that would be employed in neutron spectroscopy.

They're off! Work-trained dogs lunge forward in the harness at the beginning of the national title race



By Andrew Hamilton

ASHTON, IDAHO, is to dog-team racing what Madison Square Garden is to boxing, what Wimbledon is to tennis, what the Rose Bowl is to football.

On February 22, the shivering citizenry of the little potato-growing, wheat-raising community in eastern Idaho will literally "go to the dogs." It will take with it, however, some 10,000 spectators from all parts of the country who have gathered for the 31st annual running of the American Dog Derby.

A score or more dog teams will be entered in the speed race for the national title and a \$1000 first prize. Driver of the second gang of hounds to puff across the finish line will receive \$750; third place winner will get \$500.

The American Dog Derby was born during a conversation in Jay Ball's barbershop in Ashton one cold, wintry day in 1917. Jay had been reading about dog teams and the famous Scotty Allen, winner of many arctic races. George Zarn and "Tud" Kent were in the barbershop when Ball said:

"I see where runnin' dawgs over in Canada and Alaska have made a young fortune for Scotty Allen."

That touched off a discussion among the three men that continued long after the

last hair had been snipped and the last squirt of bay rum had been slapped on. It finally reached the point where the trio was beginning to ask: "Why not a dog derby for Ashton?"

So barber Jay Ball and his two customers, plus Gus Isenberg who ran the drug-store across the street, organized the first Ashton dog-team races in the early spring of 1917. The race was run over a 55-mile route from West Yellowstone, Mont., across the continental divide and down through some of the most beautiful scenery of the Rocky Mountains. "Tud" Kent won that year with a time of 29 hours and 23 minutes.

In 1938 the rough-and-tumble route across the continental divide, where snow sometimes drifted to depths of 12 to 15 feet, was abandoned. Instead, a speed race

Lloyd Van Sickle, last year's winner, and his lead setter "Red" delivered mail each day by sledge for years

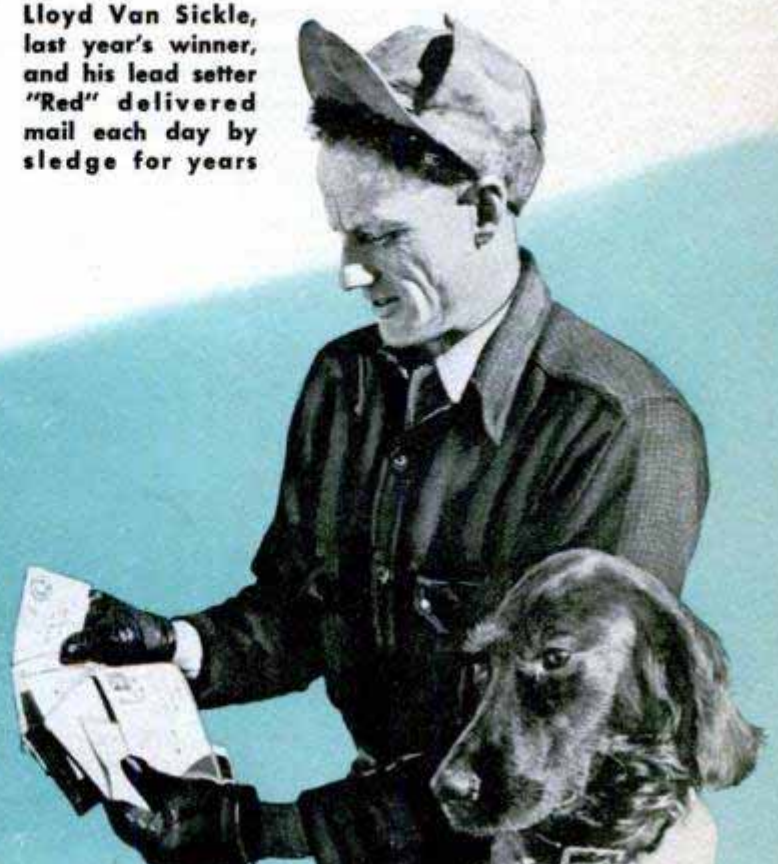

King of the mushers

was adopted—five laps around a two-mile circle, with teams in sight at all times.

This year's American Dog Derby will be directed by the newly organized Dog Musher's Club. Its members are local ranchers and dog breeders. Idaho has the largest primitive area of any state in the Union, and dog teams are used throughout the winter to transport mail and supplies to snowbound areas. In addition to these practical aspects, the three-decade existence of the dog derby has stimulated the breeding, training and racing of "runnin' dawgs" in this part of the country.

Last year's race was won by Lloyd Van Sickle with a "mixed" team (several different breeds). At that time Van Sickle was a U. S. mailman who carried from 50 to 200 pounds of letters and packages daily by dog sled to the little village of Drummond, 12 miles from Ashton. He's been running dog teams for 20 years now, having won the derby also in 1936 and 1937 at the age of 16 and 17. He's tabbed the favorite again in 1949.

The American Kennel Club recognizes four distinct breeds of sled dogs. They are: (1) the Alaskan Malamute, a heavy, powerful animal with a distinct, caplike marking over the head; (2) the Eskimo, developed in eastern Canada and Greenland; (3) the Siberian Husky, a medium-sized animal which is the fastest of the four breeds and which holds most of the racing records; and (4) the Samoyede, a slightly smaller sled dog, developed in Russia.

It is a rarity, however, to see a full-blooded team of any one particular breed. Many other so-called "domestic" breeds are trained as sled dogs and raced in the Ashton Dog Derby: German and Belgian shepherds, St. Bernards, collies, Irish setters, Doberman pinschers, Airedales and greyhounds. The most unusual dogs that will be entered in this year's race will be a team of Afghan hounds—strange-looking animals with wide paws and silky hair that were once royal watchdogs of Egyptian pharaohs 3000 years ago.

Over the years, a wide variety of sledges, sleds or sleighs—take your choice—has been developed for dog-team work. The four best-known types are: (1) the Nansen double-end freight sledge; (2) the Antarctic freight sledge; (3) the basket-type sledge; and (4) the Kematik, a Greenland development. In the Ashton races, the basket-type sledge in several variations is preferred.

Sledge runners are made of close-grained hickory with upper parts of ash or oak. The Nansen and Antarctic types, which have no handles, are fitted with "gee poles" to aid in starting and stopping. The basket-type is equipped with a foot brake which claws into the snow.

Experienced mother helps as pups get their first training by learning to pull a log

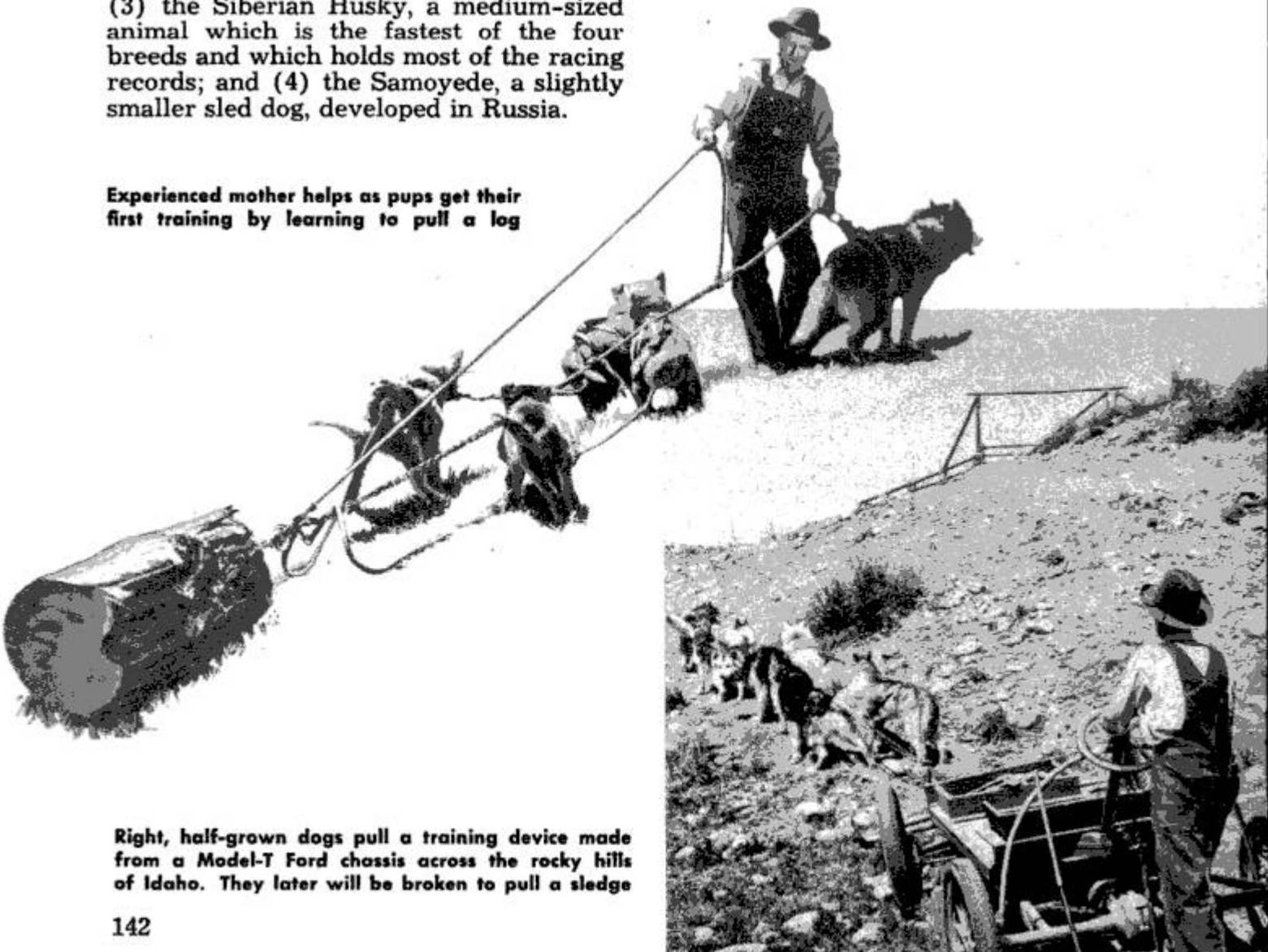

Right, half-grown dogs pull a training device made from a Model-T Ford chassis across the rocky hills of Idaho. They later will be broken to pull a sledge



Dog-team racing and skiing, both growing in popularity, here are combined into one thrilling winter sport

The harness used on dog teams is an important part of sledging equipment. If it is ill-fitting or an improper type, it will impair a dog's pulling power and may injure him. Proper harness puts the pulling strain on a dog's shoulders and chest. Materials used for harness are leather, webbing or lampwick. Most mushers prefer webbing because it is cheap, strong, easy to sew and doesn't become stiff in cold weather as leather does. Besides, dogs don't chew it as they sometimes do leather.

Drivers use a wide variety of commands, and dogs will respond readily to any word they hear regularly. The starting command

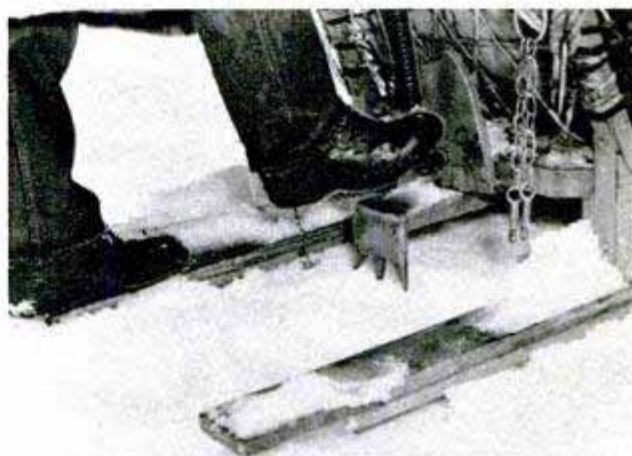

Above right, toothed brake plows through snow to slow sledge. Below, two racing teams near the halfway point



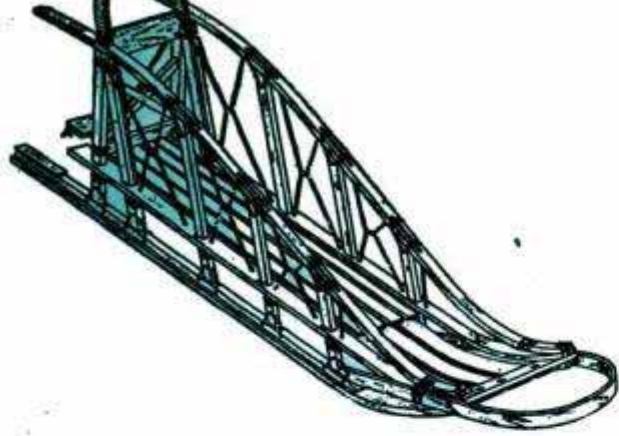

Basket-type sledge

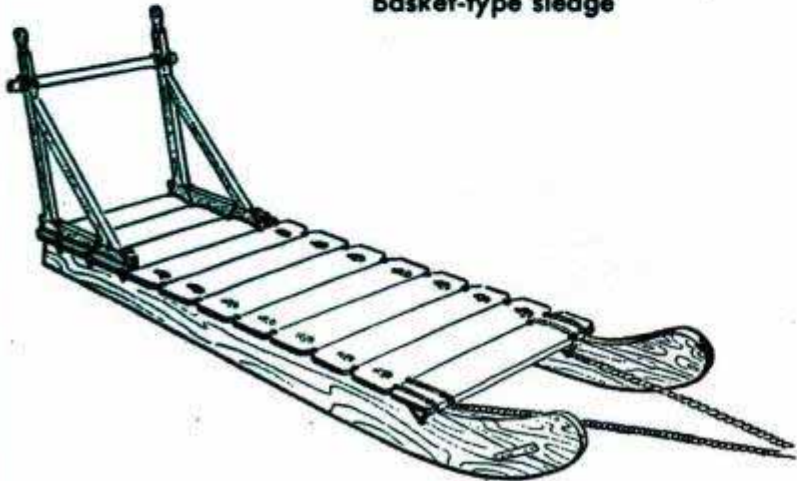

Kematik sledge

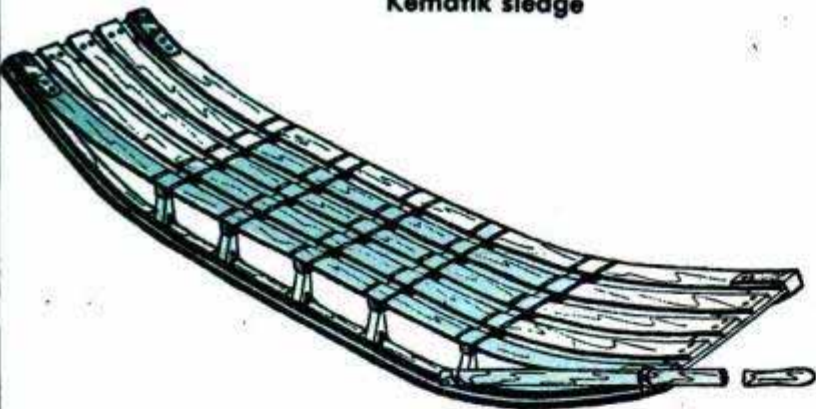

Nansen double-end freight sledge

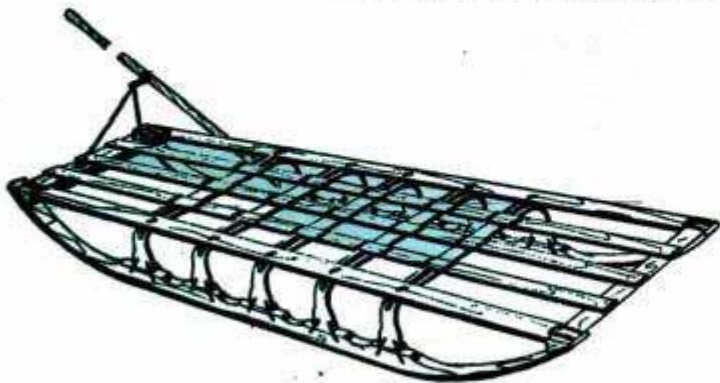

Antarctic freight sledge



Drawings on this and opposite page reproduced from Field Manual 25-6 by permission of the Department of the Army

† Most drivers make their own harnesses from leather, webbing or lampwick. Left, these are the most popular sledges as they appear in an Army training manual

"mush" is a corruption of the French word "marche" and it has been used for many years in Alaska and Canada. In recent years, however, the command "yake," first used in the Antarctic, has come into favor. "Hike" and "all right" have also been found effective as starting commands. A dog team should be trained to sit down or lie down in the traces at the command "down."

The following are U. S. Army commands which are fast becoming standard dog-team lingo:

- (1) "Yake" or "all right" for starting.
- (2) "Gee" for a right turn.
- (3) "Haw" for a left turn.
- (4) "Whoa" for stopping.
- (5) "Haw, come in" for a turn around.
- (6) "Down" for sit down or lie down.

The training of a sled dog begins early. At Sun Valley, Idaho, the famous dog and horse trainer, Morgan Heap, begins to school his puppies at the age of three months. The pups run loose with a team for a few trips. Then they are placed in light harness and pull a log. Most sled dogs are eager to pull—once they get the idea of what is expected.

When a pup is strong enough, it is hitched into a regular team—either alongside another half-grown dog or its mother.

For the first-summer education of young dogs, Heap has developed a training device from a Model-T Ford chassis. It consists of a short-wheelbase frame, four light wheels, a steering wheel and a platform at the rear for the trainer. During the first summer, half-grown dogs pull this contraption over



† Team of Samoyedes gets under way at the start of the Ashton Dog Derby. Right, Army teaches these hitches. Each has its good points and limitations

fields and trails to get the feel of a sledge. During the second winter, they are hitched with a regular team.

Heap believes that a good lead dog is of primary importance to a team. Much care and attention should be given to the selection and training of this animal. "Time spent," Heap says, "will be rewarded by the tremendous amount of work and trouble a good leader saves the driver."

Some mushers claim that a bitch makes the best leader, but this is much disputed. Leadership is a natural gift and a dog must have certain definite qualities to be a leader. Obedience is one of them, for without it commands are useless. In addition, the lead dog must possess intelligence, speed and a considerable amount of natural authority. Some drivers declare, "You can tell a good lead dog just by looking at him."

In the American Dog Derby last year, Van Sickle gave much of the credit for his victory to his lead dog "Red," a powerful and intelligent Irish setter. Another lead dog that has almost become a legend of the Ashton races is the plucky little bulldog of "Windriver" Smith's team in the 1917 race. When his other dogs refused to buck huge snowdrifts, Smith put the bulldog in the lead. The pug-nosed, short-legged little fellow often disappeared from sight in the snowbanks, but he guided his team to the finish line.

The personality of the driver is as important to the winning of a dog derby as the dogs he drives, the sledges or the training. Some men are "naturals" when it

(Continued to page 256)



Double tandem hitch



Single tandem hitch

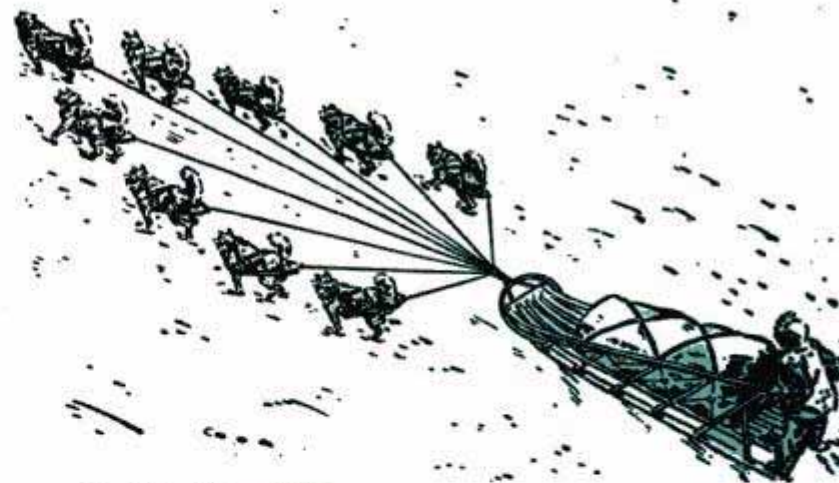

Modified fan hitch

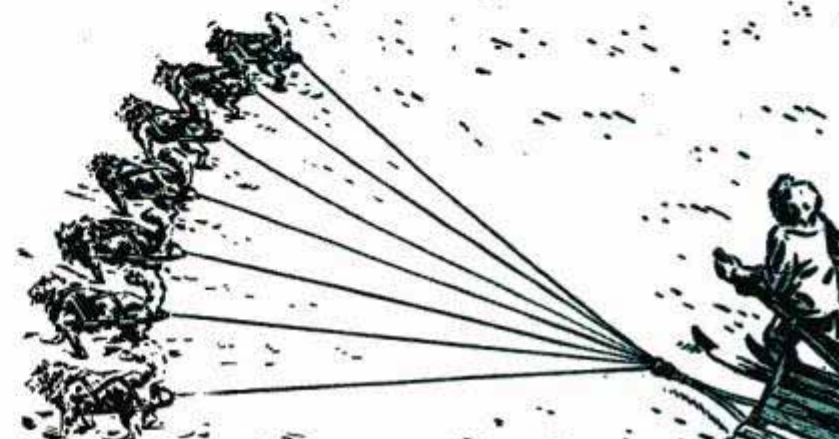

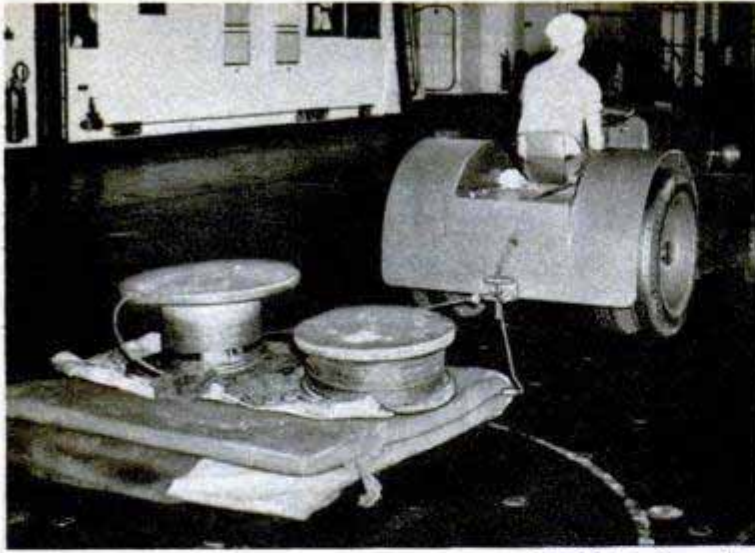

Official U. S. Navy photo

Carrier-Deck Polisher

Ingenuity saved the day when conventional polishing devices proved inadequate for the 700-foot-long hangar deck of the carrier USS Valley Forge. A canvas mat weighted with heavy wire spools was hitched to an airplane tractor and now the metal deck gets its daily burnishing with powdered graphite in less than an hour.

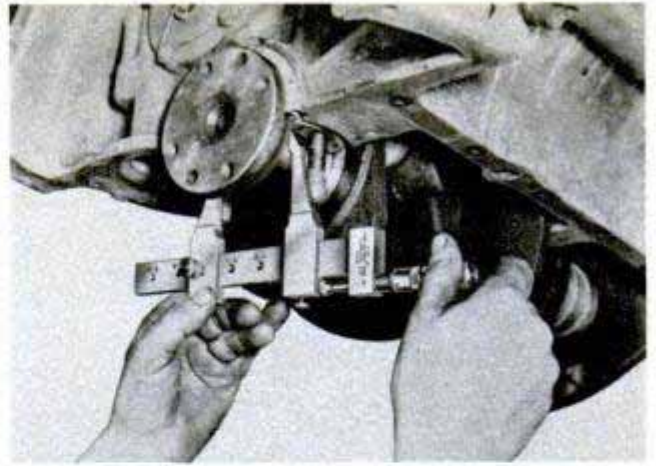

Micrometer Measures Journal With Crankshaft in Engine

Because it measures the diameter of any crankshaft journal up to five inches while the crankshaft is still in place, a special micrometer saves time in engine repairs. Diameters are read directly in thousandths of an inch over the entire range from zero to five inches. With the micrometer you can measure the exact size of main-bearing inserts, eliminating the trial-and-error method of fitting.

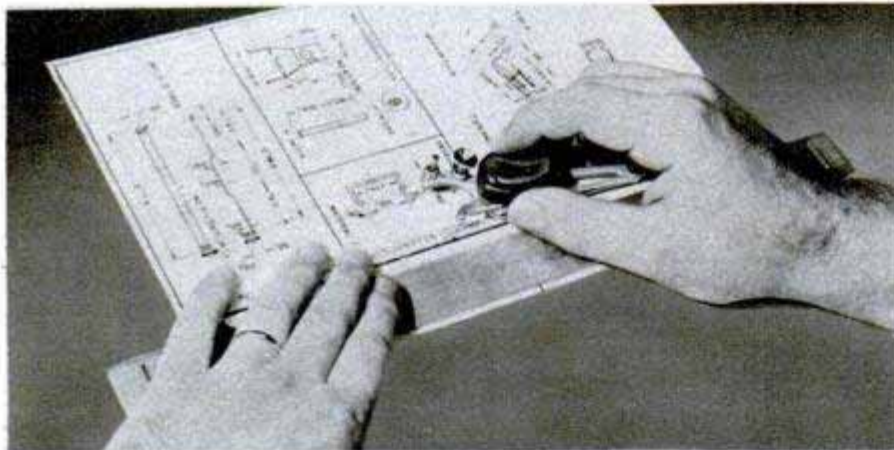

Neat lettering is easy with the template set shown in use above. A scriber, left, follows grooves in ruler-type template forming exact letters. Variety of templates is available

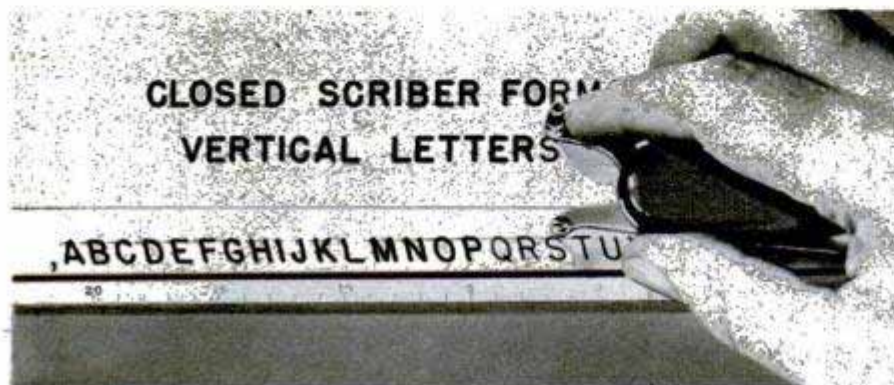

Lettering Scriber

Persons without drafting experience can letter drawings with neat, even characters with the aid of a scriber that copies from templates. The templates are deeply grooved with letters of the alphabet, numbers or symbols. The operator traces desired letters on the template with the scriber's stylus. A pen copies the letters as he traces. Several different types of letters are available in sizes from .08 to 2 inches high. Additional templates have map and welding symbols. For draftsmen working on radio and electrical-circuit diagrams, a template containing standard symbols is available.

Studies by the U. S. Bureau of Standards show that the average car goes 21 miles per gallon at 20 miles an hour, 16 at 40 miles an hour, 11 at 60 miles an hour and 8 at 80 miles an hour.

Surgery for a destroyer

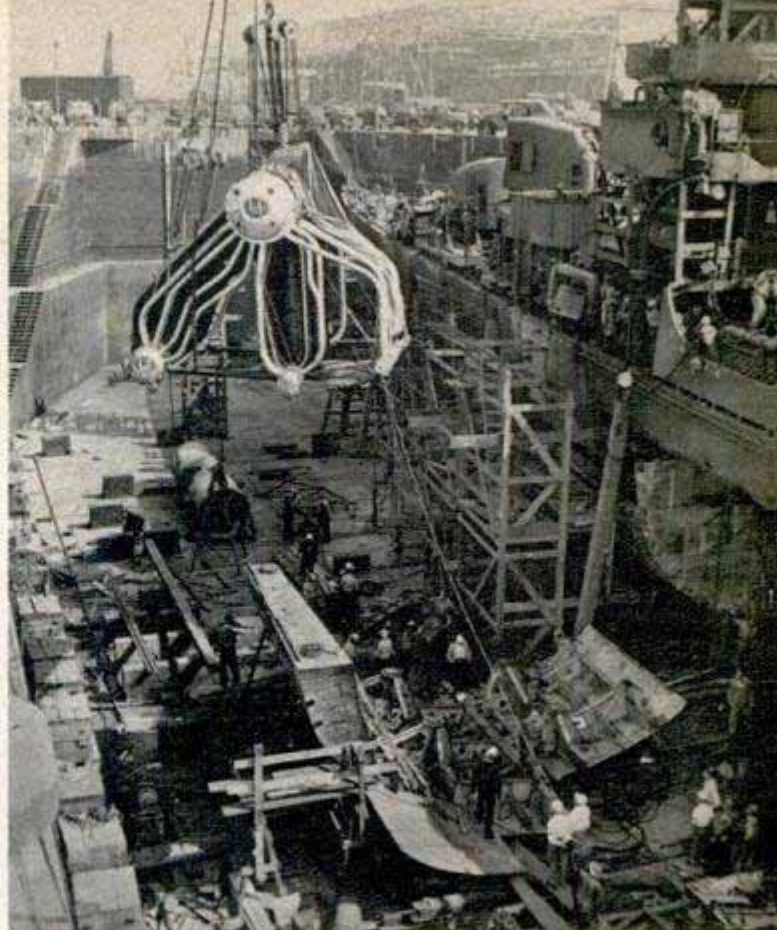
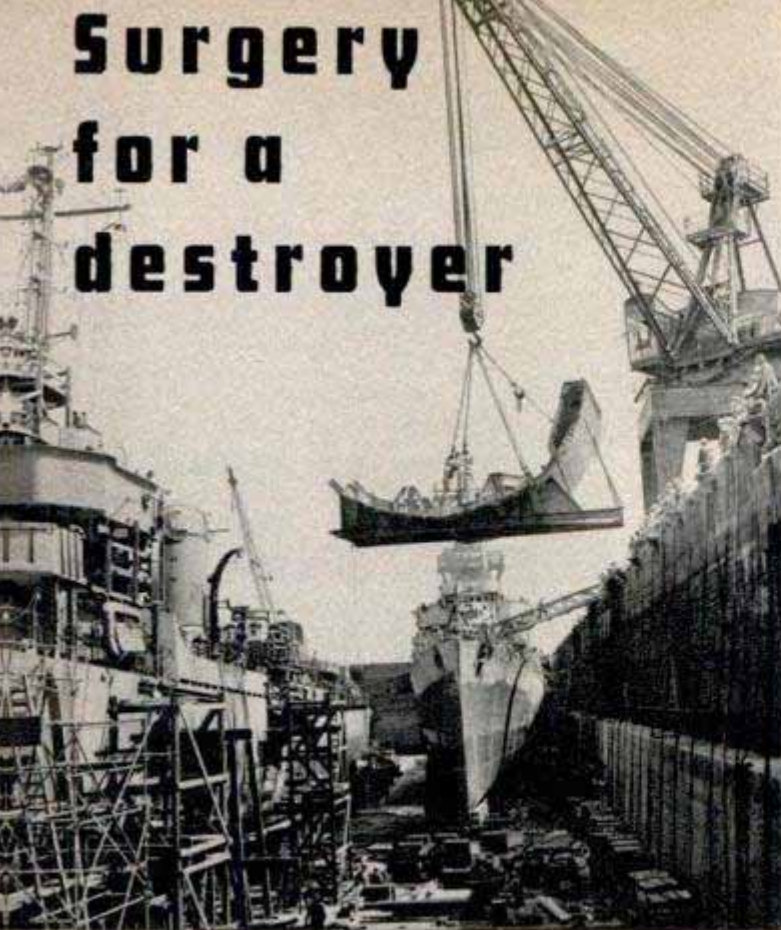

Fastest technique for replacing a destroyer's boiler is to operate on the hull. Former method was to disassemble the old boiler, remove it, bring the new parts aboard and build the boiler inside the ship. The top left photo shows how a large hull section is prefabricated before the ship even enters the drydock. Top right, the new boiler is assembled complete and lowered into the proper position on the hull section. Below, when the ship arrives, a section of the hull is cut out and the new section is slipped into its place. When all the boiler connections have been made, the hull section is welded and riveted and the ship is ready for sea

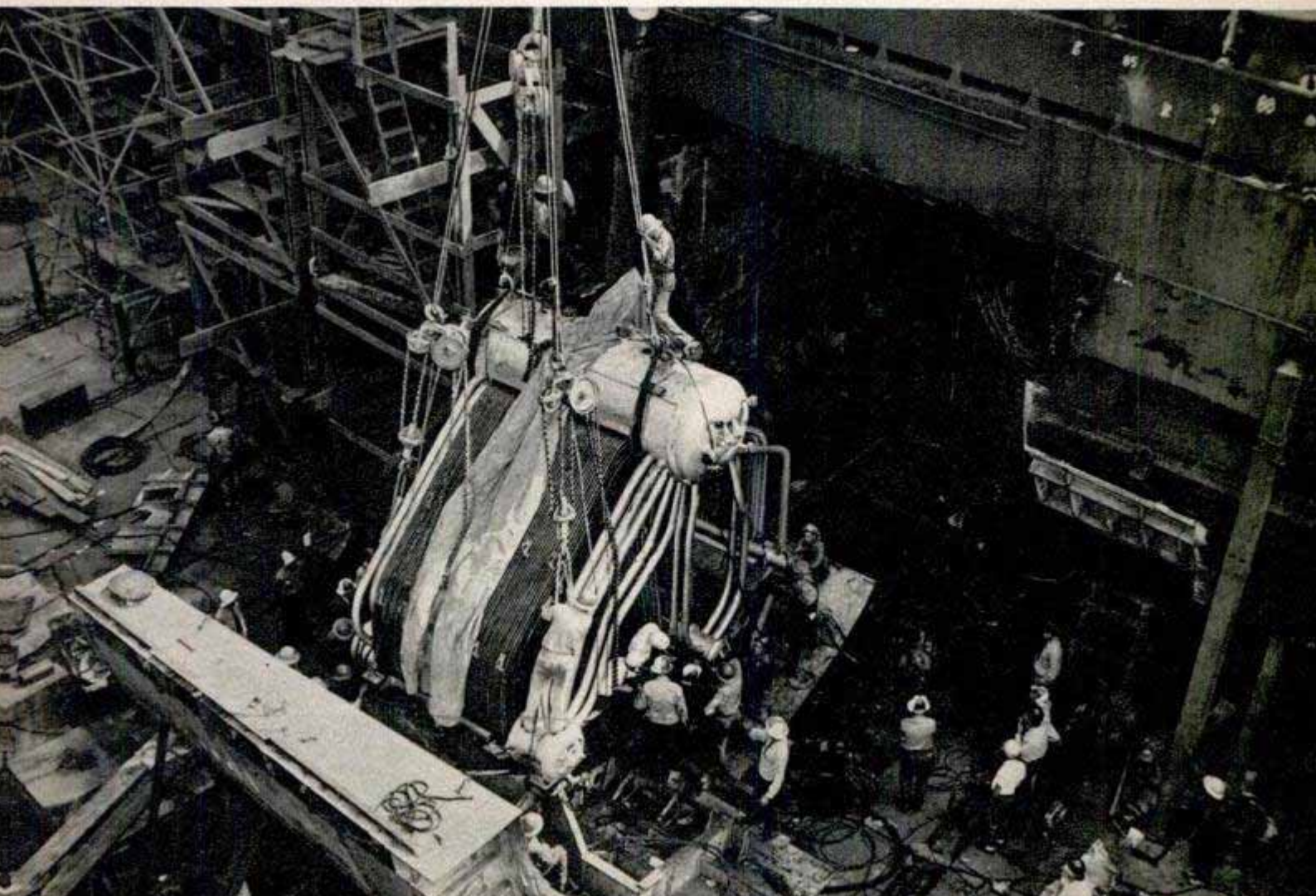

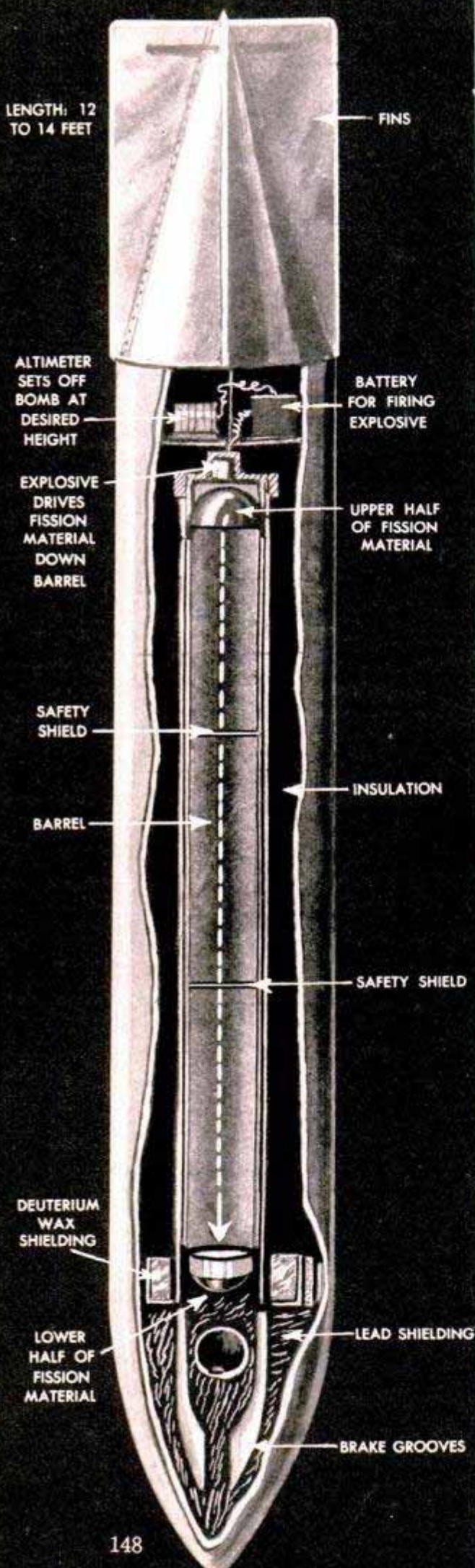

The Atom Bomb—

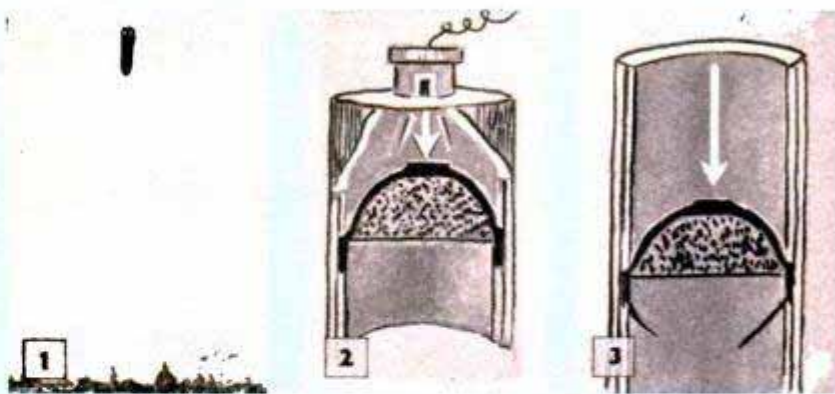

1. When the atom bomb reaches the desired height from the target, the altimeter fires a charge, driving the upper half of the fission material down the barrel. 2. The fission material, probably U-235 or plutonium, starts downward toward the nose of the bomb, traveling at a tremendous speed. 3. On its way down, the material bursts through two safety shields designed to prevent fission from occurring accidentally during handling

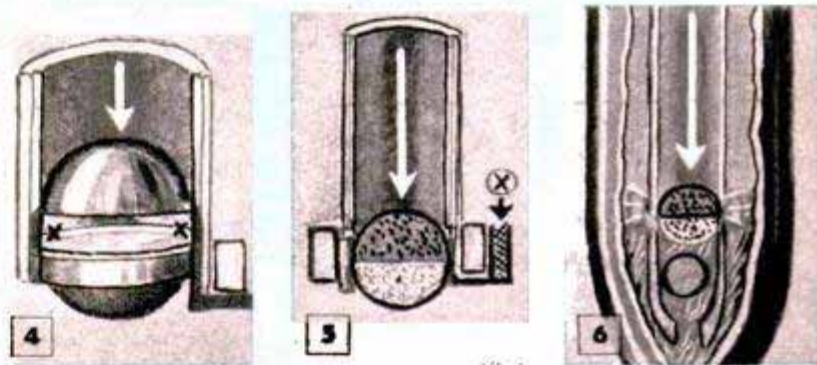

4. Two lugs, marked "X", sliding in grooves in the barrel, hit casing around lower fission material, knocking it away. Casing stops premature radiation. 5. Another shield, marked "X", is pushed aside as the upper half approaches the lower section. 6. Upper and lower halves come together to form the critical mass. Neutrons emitted from source of radiation go through a wax shield that adjusts their speed to induce chain reaction

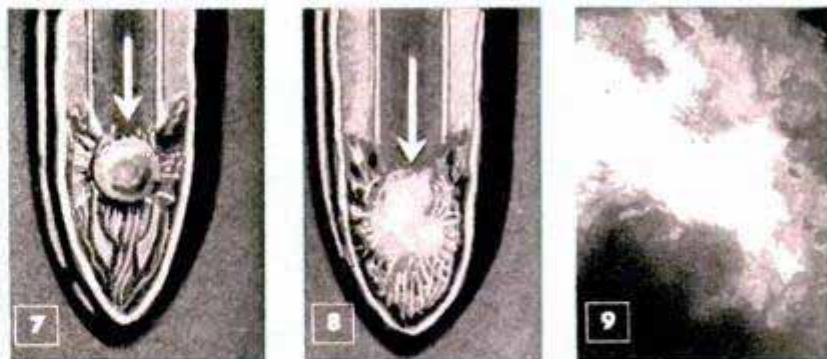

7. Thrust together, the two sections of fission material are driven as a unit into the lead shielding in the nose of the bomb, compressing the grooves to make room for itself. 8. The lead shielding allows only a few neutrons to escape and holds the material together until fission is completed. 9. Because the bomb goes off in air, the blast is spread over wide areas

Left, drawing by G. H. Davis explains the atom bomb as it is conceived by A. R. Weyl, prominent British scientist. Details of the operation of the bomb are shown in the drawings above

Two Conceptions

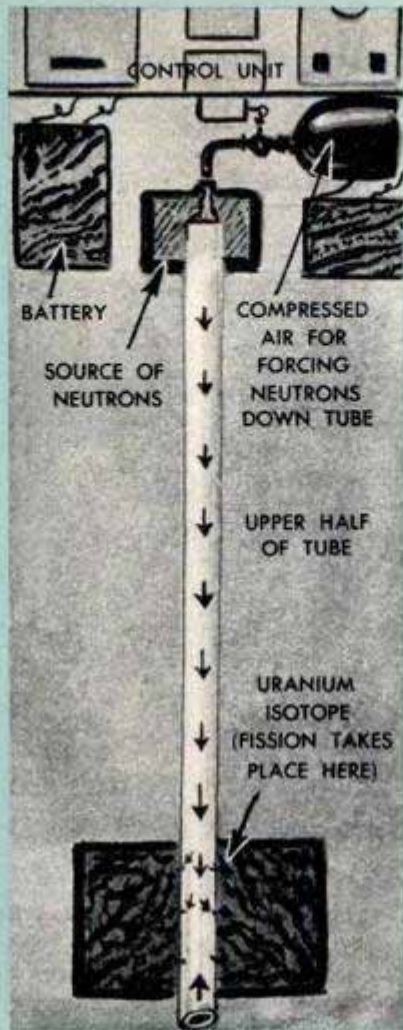
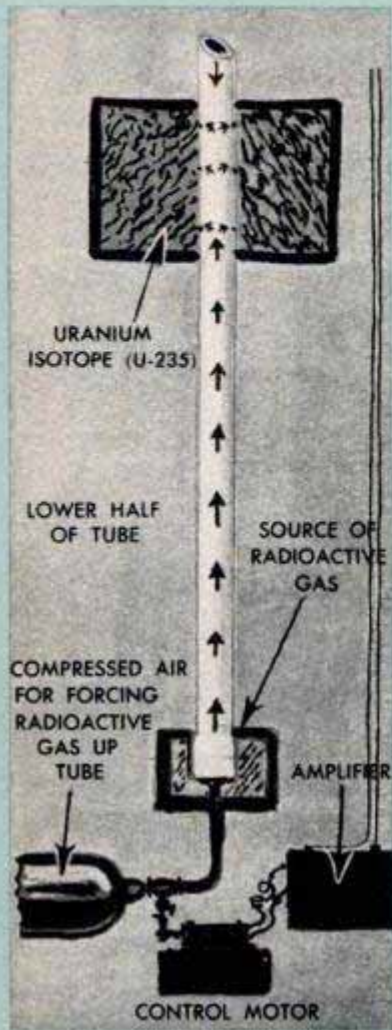

The Russian conception differs considerably from that of the British scientist. Above left, radioactive gas is forced up from the nose of the bomb by compressed air. Simultaneously, right, more radioactive gas is forced down from the tail and these two constituents are blown through tiny holes into the fissionable mass (U-235), which is enclosed in deuterium wax

EXPLODING AN ATOM BOMB BY MEANS OF A PILOT BOMB

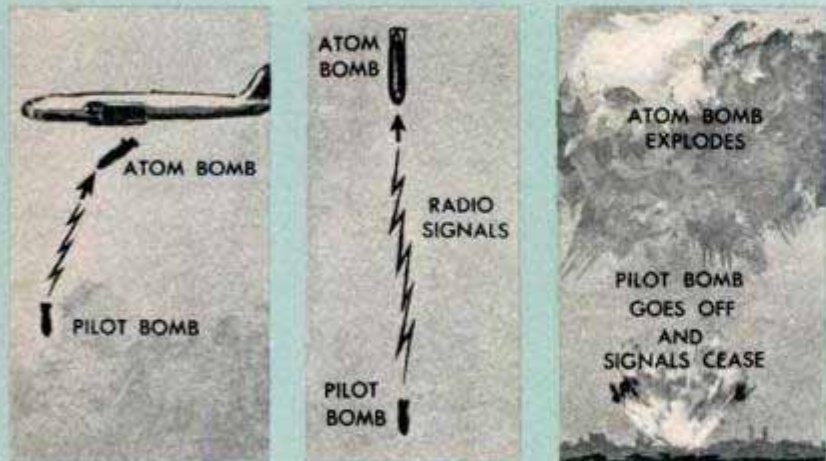

The A-bomb can be exploded by radio. A pilot bomb is released first and it sends radio signals to the atom bomb. When this pilot bomb hits the earth, signals cease, exploding the A-bomb

Right, the Russian conception of the atom bomb is based on an article published in the Russian zone of Germany. It could be controlled by radio signals (above) or by the altimeter method

RUSSIAN CONCEPTION

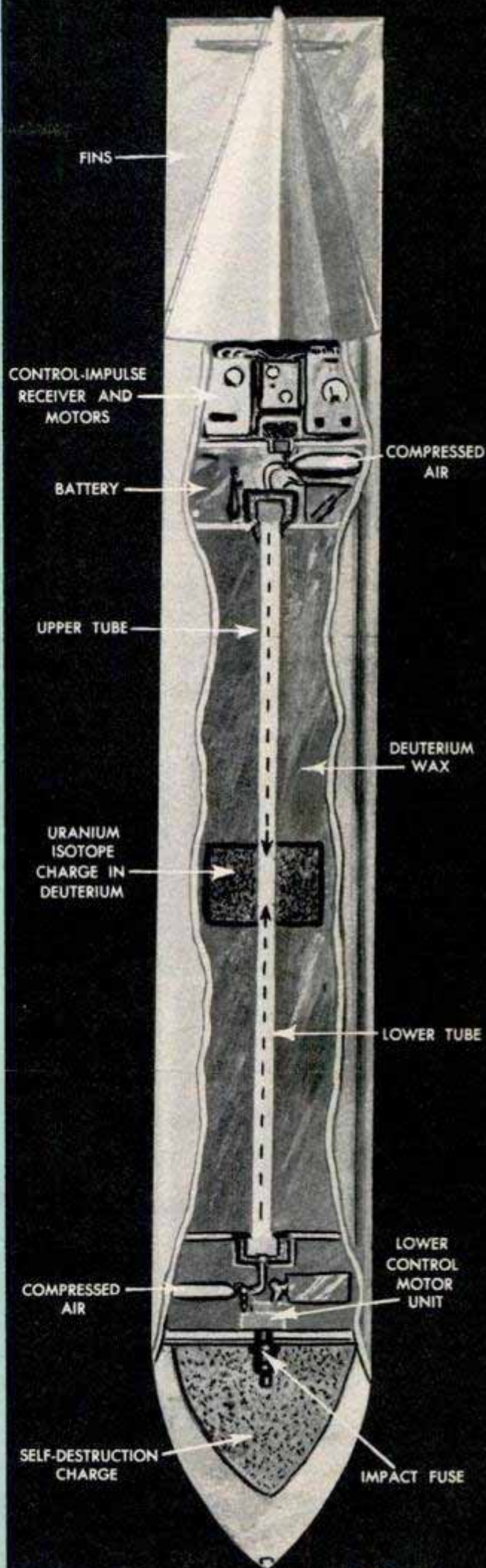



Sprayer Subdues Criminals

Anesthetic combined with an eye solution squirts in a fine stream from a "bomb" designed to subdue criminals. The "thug repellent" was invented by Charles L. Gebauer of Cleveland, executive of a chemical company. The Indianapolis police force is using the subduing fluid on an experimental basis.

Lawn Edger Uses Razor Blades

Razor blades are used to cut grass in a new lawn edger for trimming along sidewalks. Two single-edge blades are held at opposing 45-degree angles, making it possible to either push or pull the edger. A horizontal plate engages the edge of the sidewalk to guide in trimming the grass. When the blades become dull they can be removed and new blades installed.

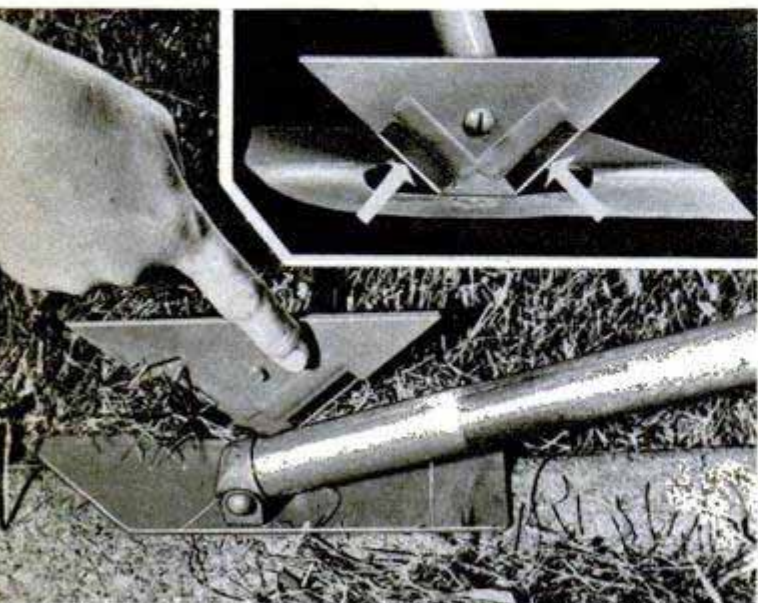

Lever-Action Hunting Rifle Has Round Breech Bolt

Featuring a round breech bolt enclosed by a solid steel receiver, a new high-power lever-action rifle promises improved shooting performance. The round-bolt construction assures smoother functioning. The guns also have a redesigned carrier for positive feeding and a matte surface on the receiver for glare elimination.

Electric Machine Takes Footprints

Measuring pressures on various parts of the feet as you walk and stand still, an electrical footprint machine will tell you whether or not you walk normally and, if not, where the fault lies. Small disks are attached to the shoe or the bare foot and connected by cable to an oscillograph. The pressures are measured and recorded as curves on a continuous film.

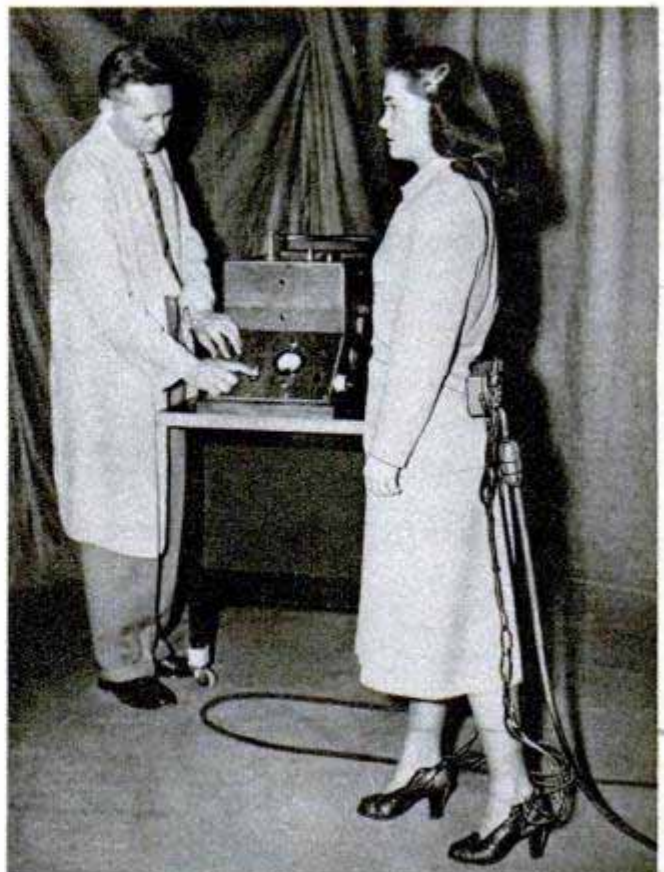



Combining virtues of each type aircraft, long-distance plane tows a short-range helicopter (1) to remote site of air crash. At the scene (2), helicopter's engine is restarted, the tow is unhitched and a landing is made

AIR-TOW RESCUE

Landing at remote, inaccessible places, air rescue's chief problem may be solved by a combination of helicopter and plane being tested by the U. S. Air Force. Both take off under their own power, keeping a 300-foot towline slack during that critical period. The plane tows the helicopter, too short-ranged to do the job alone, to the rescue site. There the helicopter's engine is restarted, the tow unhooked and descent made. With the rescued aboard, the helicopter rises, makes a mid-air pickup of the towline and is pulled to an air base.

Plasecki Helicopter Corp. illustrations



After rescued are loaded aboard (3), helicopter takes off and makes a midair pickup of trailing line (4) for tow to the nearest air base

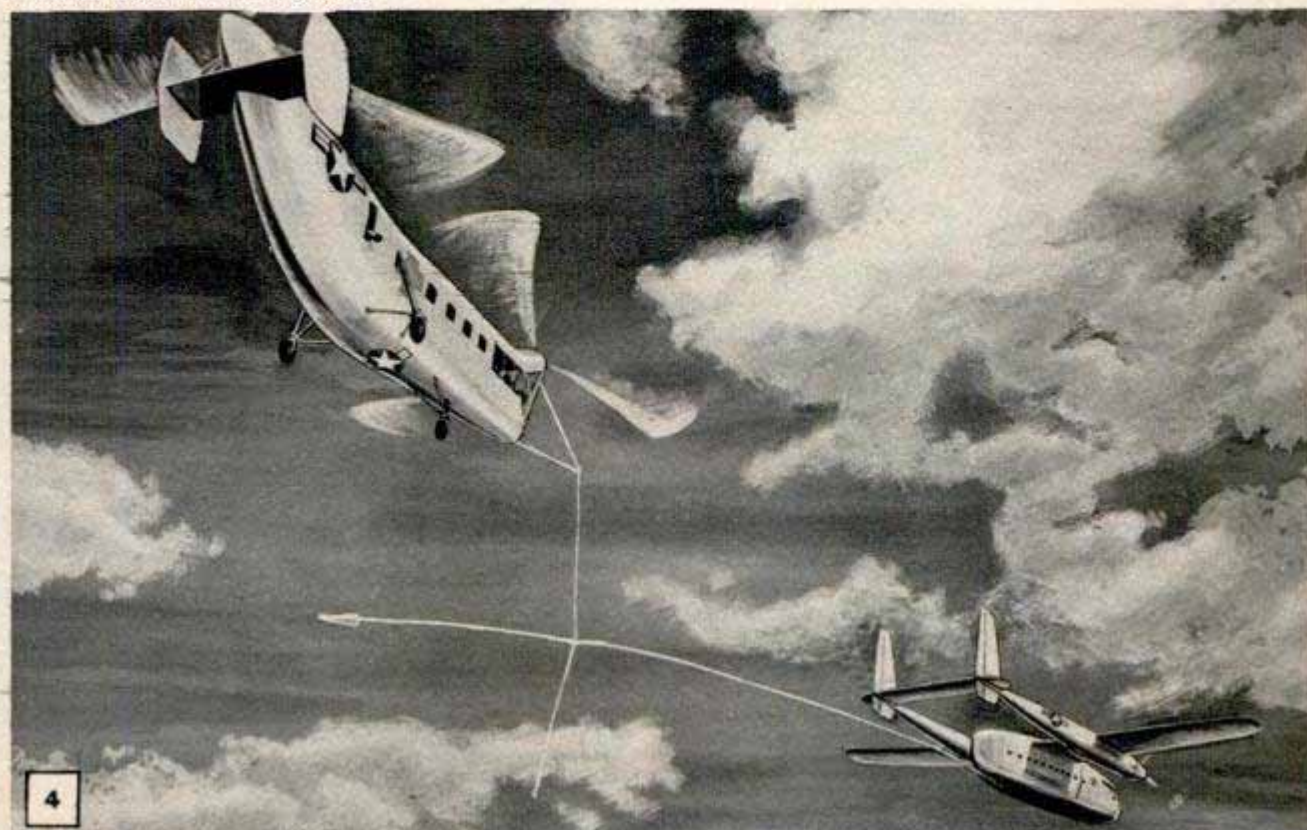

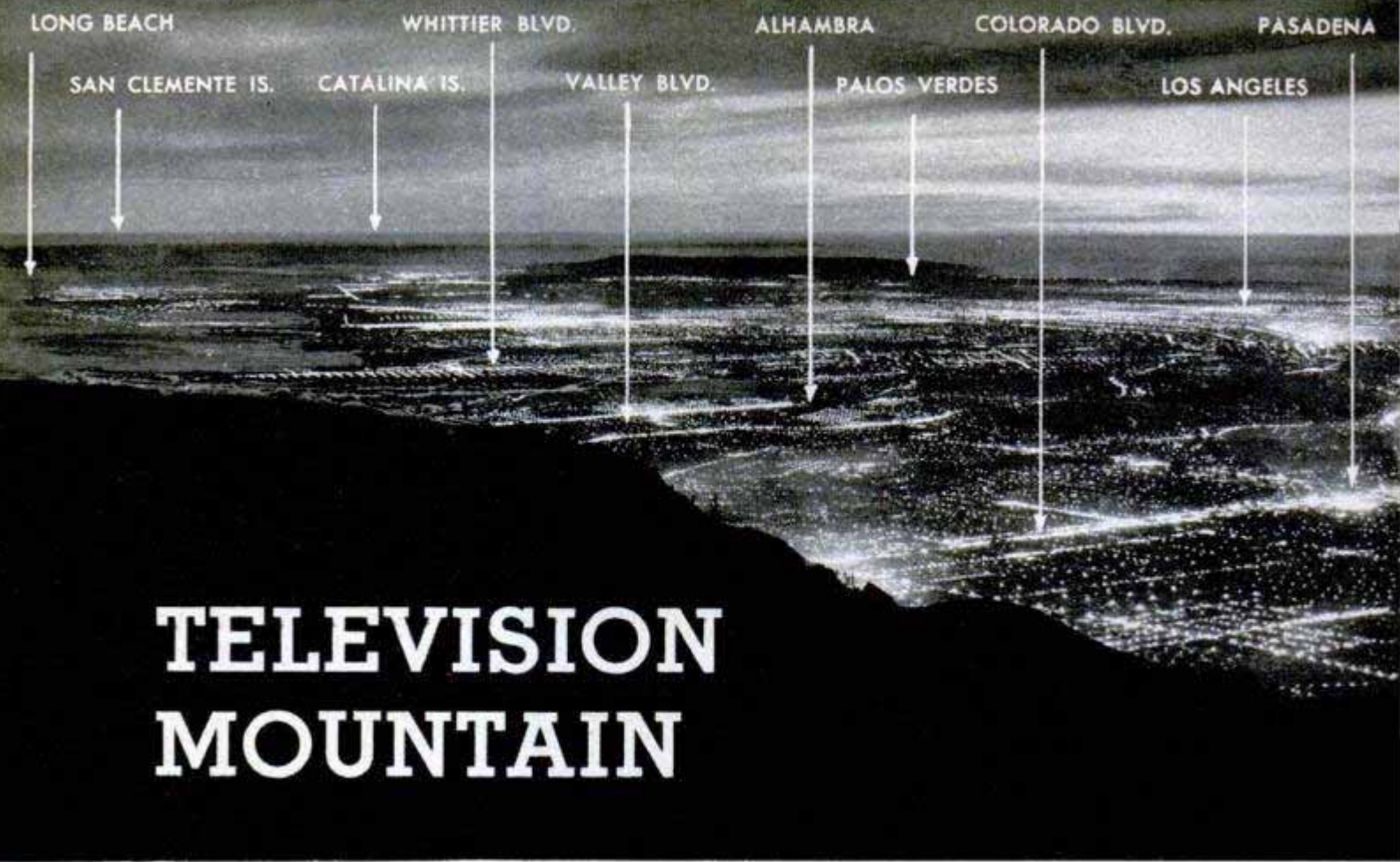

TELEVISION MOUNTAIN

THE DEER and bushy-tailed squirrels that live on Mount Wilson have been watching a strange new forest of "batwing" radiators and pylon antennas replace the trees that formerly grew on the mountain top.

Seven new television stations and five new FM stations are grouped together on top of a small ridge not far from the famed Mount Wilson Observatory where the 100-inch Hooker telescope is located. Except for one transmitter that is a short distance from the others, all the stations are within an area about half a mile long and a couple of hundred yards wide.

This unique crowding together of transmitters has occurred because, from the 6000-foot peak of Mount Wilson, there is a wide horizon for TV and FM, providing a service area that extends from Mexico and San Diego on the south to Bakersfield and Santa Barbara on the north. The sta-

tions directly overlook the entire Los Angeles metropolitan area in which are located most of the 60,000 television receivers of the region. The mountain top is no more than an hour and a half by road from the Hollywood television studios.

Seven of the stations are operating now and the others are almost ready to transmit their first test patterns and sound programs. As many as 19 different picture, sound and separate FM frequencies will be in use at the same time when all the stations are on the air. This is bound to lead to some confusion at first, but engineers are confident that within a few weeks after each new station comes on the air it will be possible to correct any interference. The differences between frequencies in the short waves, they explain, are about the same as standard broadcast stations operating on their regular frequencies while spaced 10 miles apart.

Exaggerated sketch shows how pictures are beamed from saucer-shaped reflectors in Hollywood to a tower atop Mount Wilson, rebroadcast to sets in Los Angeles area

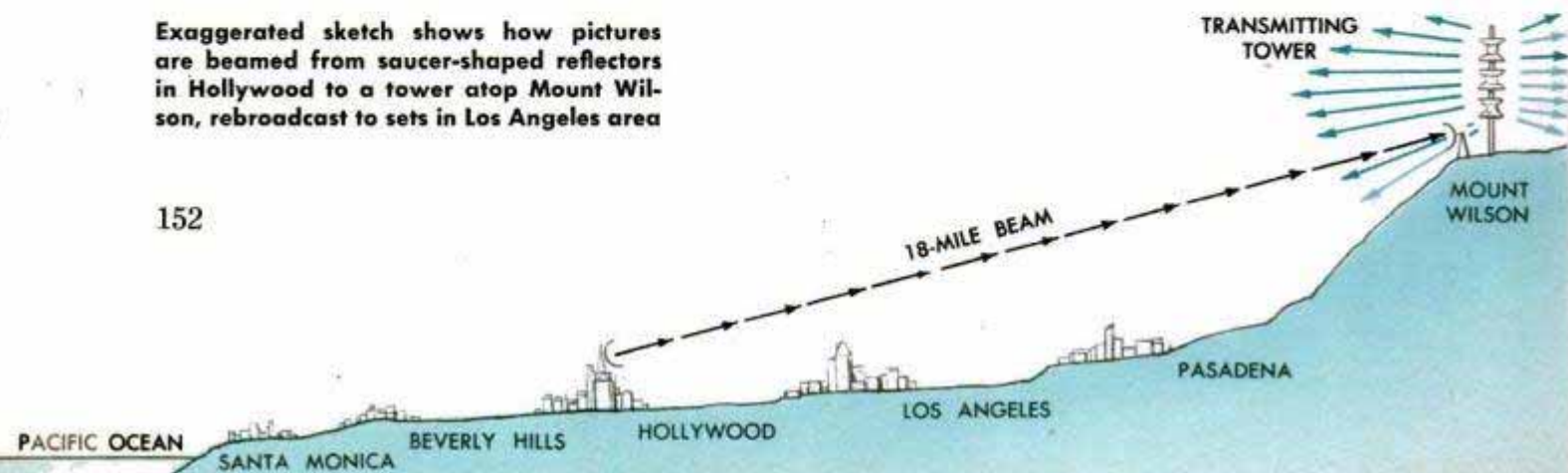

CULVER CITY

SANTA MONICA

HOLLYWOOD

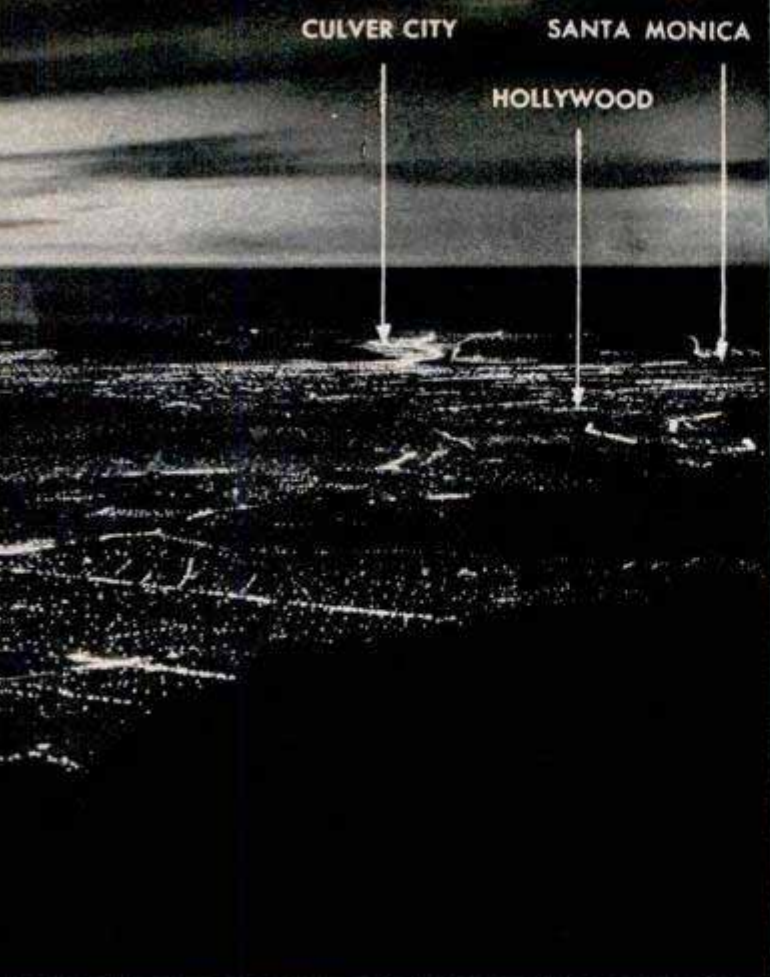

Copyright by J. O. Hickox

† Lights of Los Angeles and suburbs spread out like carpet when viewed from Mount Wilson. This is the area TV mountain serves

Oil country? No, these are just a few of the transmitting towers crowded on a few acres of earth atop the mountain. In foreground is a "dishpan" antenna

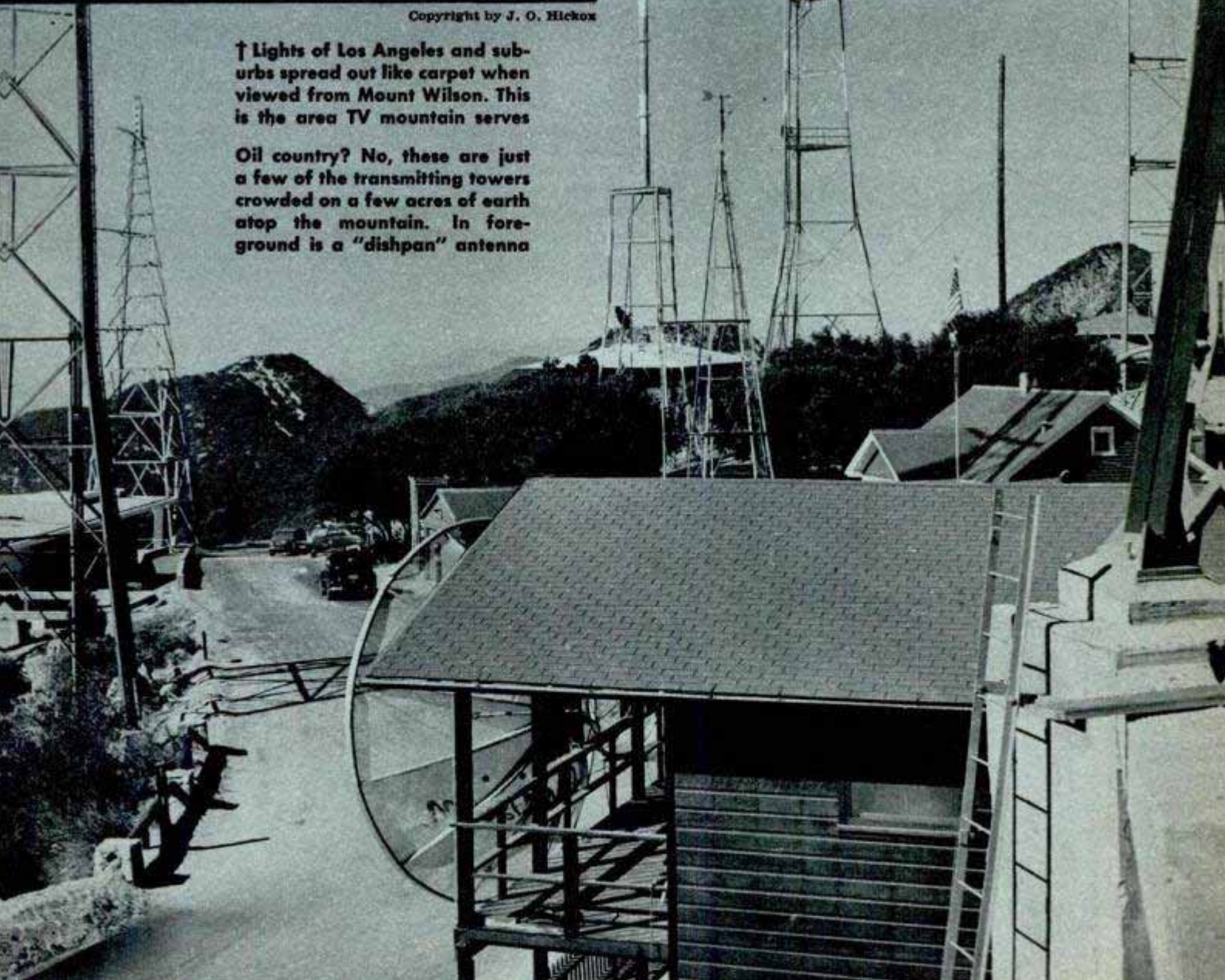

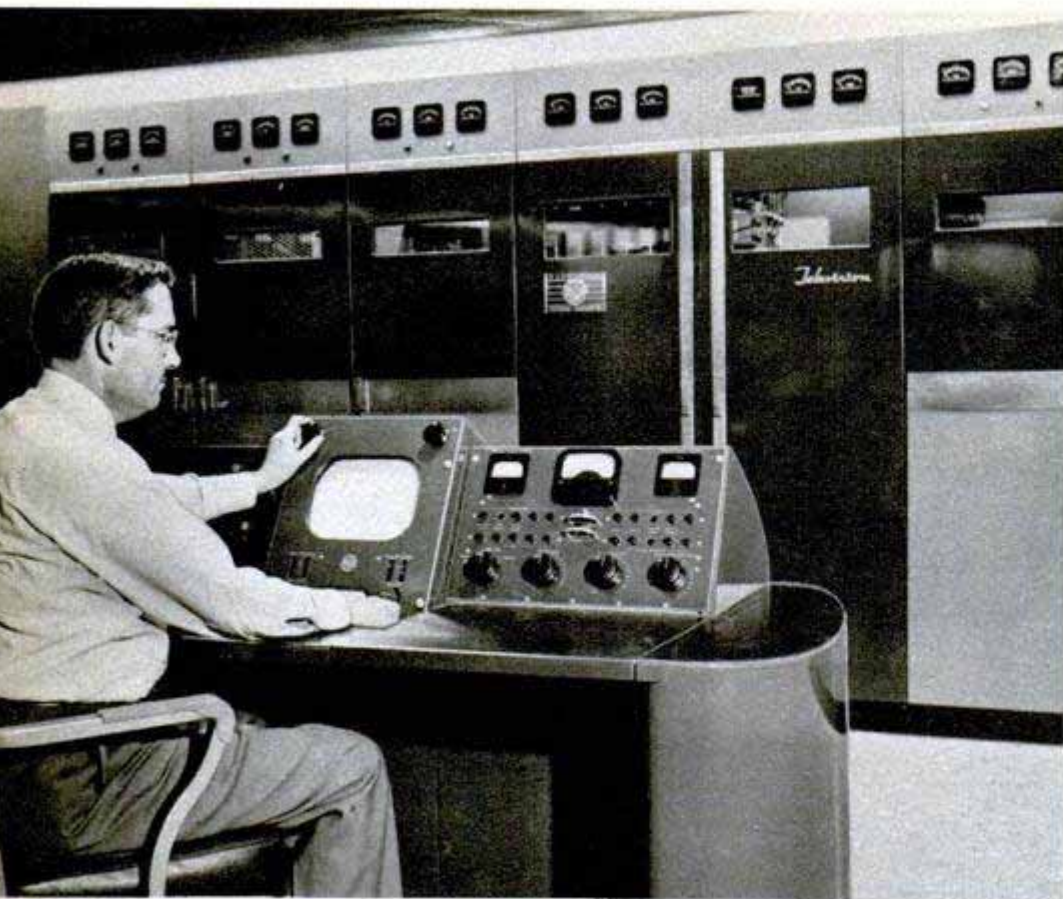

Console-type controls and monitoring screen are used in new NBC station

An advantage of concentrating all the stations is that a television-receiving antenna down in the lowlands will pick up all of the stations equally well and may be pointed permanently toward the mountain. It won't be necessary to rotate the antenna for best reception when switching from one station to another.

Each station is simply a big transmitter.

From a mobile truck-station technicians beam TV program to Mount Wilson



All the programs originate in Hollywood or Los Angeles or at other points and are relayed to the mountain for broadcasting. FM goes up the hill by telephone cable, as do some of the TV sound programs. All video and, in some cases, the accompanying sound as well is transmitted to the mountain by microwave radio beam. KTLA, for instance, has big parabolic reflectors on top of its Hollywood studio and other reflectors at its Mount Wilson station 18 miles away, in line of sight. Pictures and sound are beamed from the studio to the transmitter and are radiated back over Hollywood and the surrounding country. When KTLA is televising a remote program, such as a baseball game, it sends a mobile beam transmitter

out to the location and either beams the program direct to Mount Wilson or else back to Hollywood, from which point it is relayed by radio to the mountain.

Some of the television stations have installed their own beams, while others are using a radio link provided by Pacific Telephone and Telegraph Company. The phone company has erected its own building on the mountain for receiving the beamed programs that it handles, and for relaying them to the adjacent transmitters by coaxial cables. The microwave receiving antennas are mounted side by side in a large room inside the building instead of on the roof, where they would be exposed to the weather. The exterior wall of the room, in front of the antennas, consists of one large window of transparent plastic sheeting that offers no resistance to the incoming high-frequency energy.

The building also serves as one of the radio receiving and transmitting points for the phone company's mobile urban and mobile highway ra-

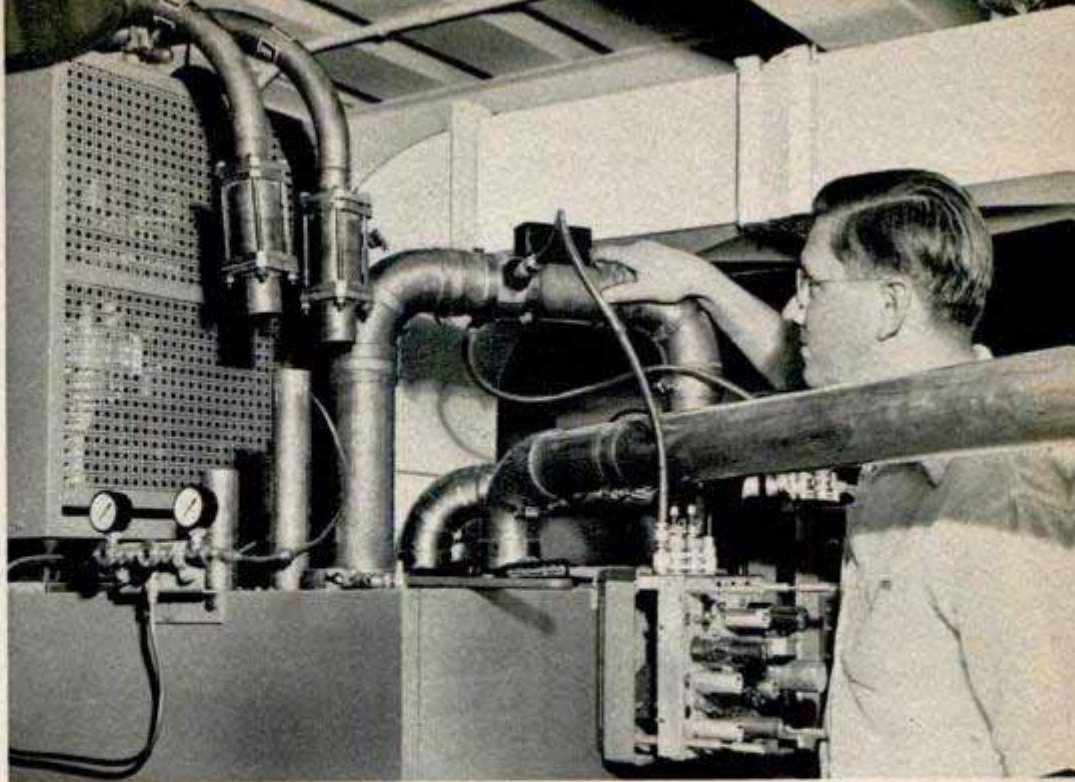
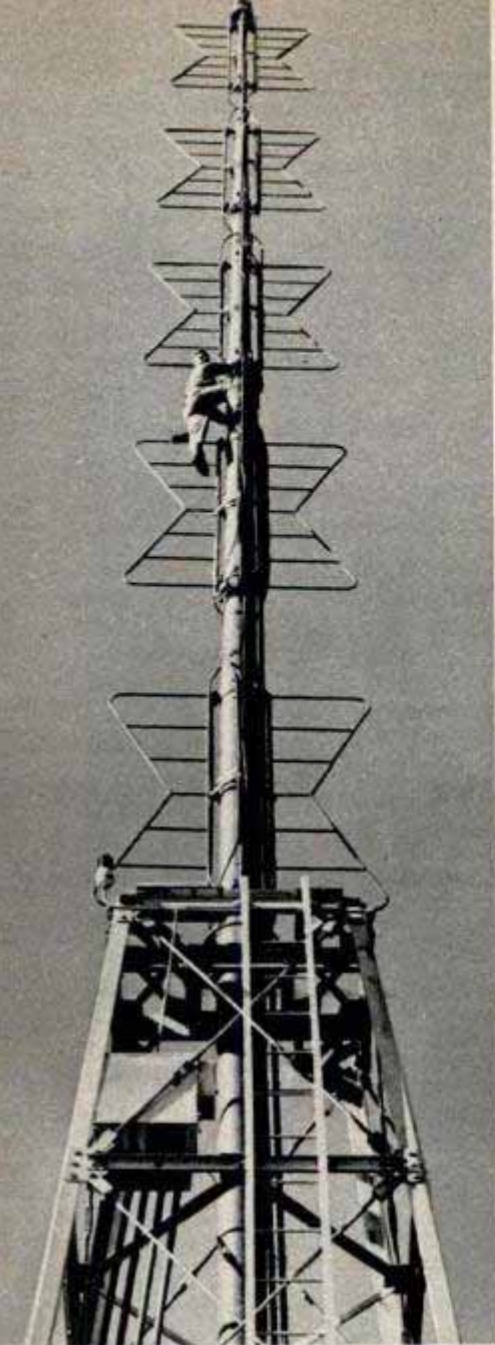

Wave guides—hollow copper tubes—conduct the high-frequency television energy from the station's transmitter to its tallest antenna

radio services which together have about 150 subscribers, mostly public utilities, doctors and trucking concerns. Also in the building is a small switchboard that handles the phone calls of the new radio community.

Typical of the television stations on Mount Wilson is the new NBC transmitter, KNBH, built at a cost of half a million dollars. It is equipped with a standard RCA TT-5A transmitter that puts an effective radiated power of 27.5 kilowatts (for picture) on its five-element superturnstile antenna. Three picture chains and two sound chains are available in the transmitting room. If any one circuit develops trouble, the operator can switch to another chain at once. Nine hundred different tubes are in use when the station is on the air. The main picture

Above, turnstile tower has 20 "batwing" elements (half at right angles). Below, left to right, four dishpan antennas pick up incoming sound beams, studio picture beams and pictures from two mobile transmitters



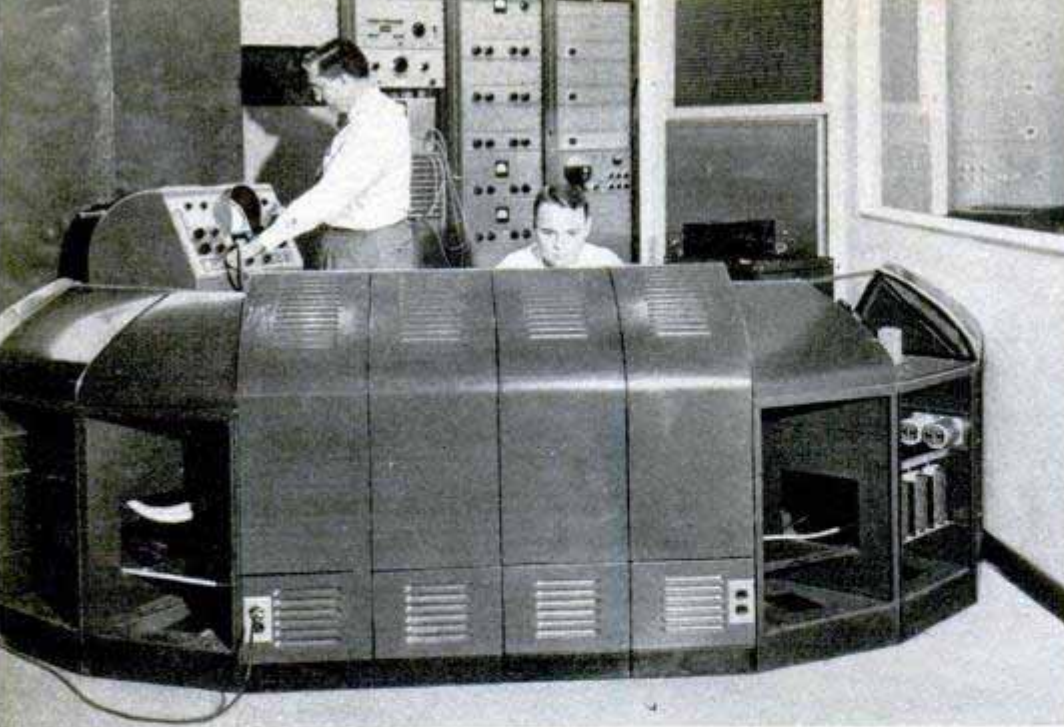

Control console at NBC station has four screens for monitoring pictures

and sound-transmitting tubes are air-cooled by means of blowers and are water-cooled by means of internal piping. The station has its own distilling plant for creating pure water for cooling tubes.

The station building also contains a three-room apartment for its caretaker; for emergencies it has a bunkroom in which four operators may sleep, and an electric kitchen equipped with a freezing unit and stocked with enough food, frozen and canned, for three months.

their antennas. Winds as strong as 85 miles an hour have been recorded, with gusts estimated at 100 miles per hour. All antenna towers have been designed with this condition in mind.

Icing conditions occur during the winter months and rime ice may build up to 10 times the diameter of the member on which it collects. To avoid any possible detuning of an antenna because of the ice load, most of them have been provided with internal electrical strip heaters to keep them warm. One 500-watt heater is placed inside each lobe of each batwing, a total of 20 heaters for a five-element superturnstile.

All the TV, FM and combination antennas are grounded direct to the earth, this being permissible because short-wave radiation is a matter of resonance tuning rather than insulation. Normally, a grounded antenna would dissipate the energy of any lightning bolts, but on Mount Wilson the thin layer of topsoil overlies a rock formation that is not an ideal conductor. At the Don Lee TV and FM stations more than half a mile of copper

(Continued to page 254)

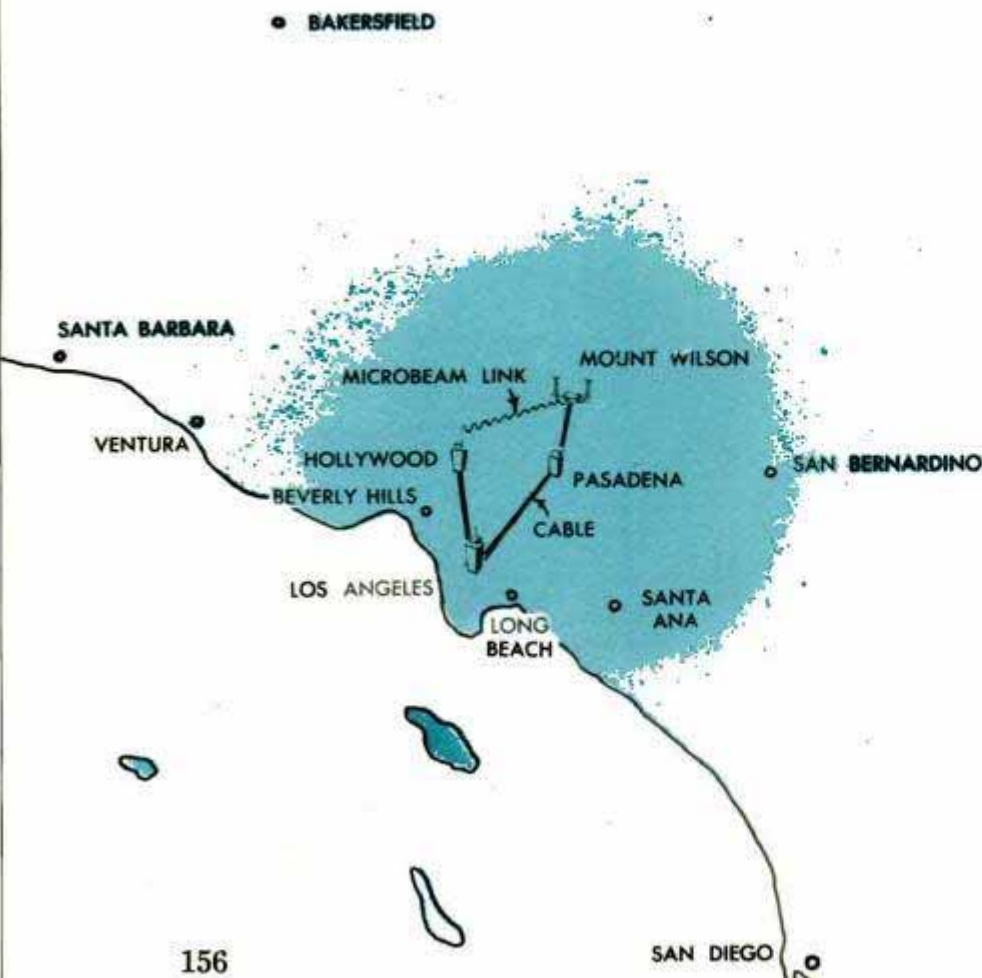

Map shows location of Mount Wilson and the area it blankets with television and FM broadcasts. The limits of the range are Santa Barbara, San Diego

Railroad Sleep Hanger

For railroad travelers, Dr. Igo Seeger of Vienna has come up with a sleep hanger that holds the passenger in a comfortable sleeping posture while sitting upright. The hanger is supported from overhead by an adjustable strap. A shelf holds the folded arms of the traveler, while another shelf has a pillow to support the head.



Wax Paper Seals Itself To Keep Food Fresh

Sandwiches and other foods stay fresh longer when wrapped in an adhesive wax paper that is self sealing. One side of the wax paper is coated with a sanitary adhesive that will seal itself, but will not adhere to anything else. You merely wrap the paper around the food and press the edges together for a complete seal.

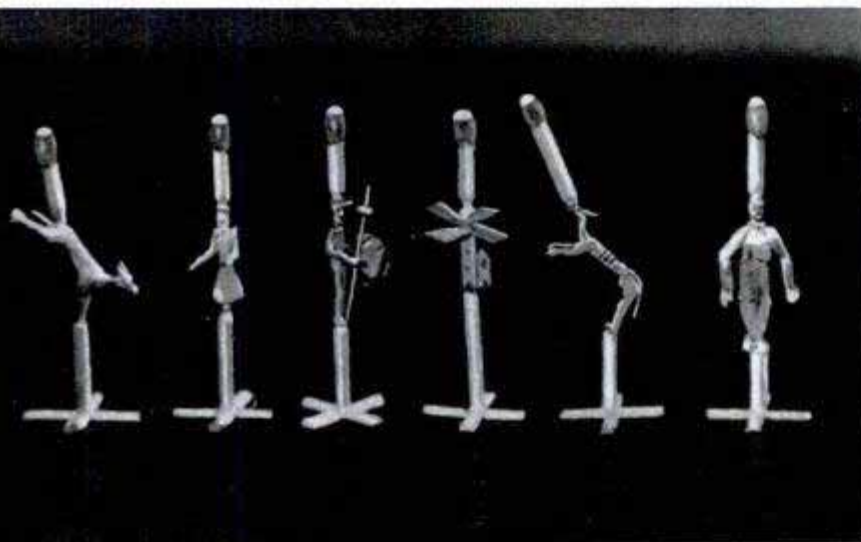

Matchstick Stories

Telling stories with matches is the hobby of Martin Saldana C. of Mexico. He carves common matchsticks to form the figures of the story. One of his groups includes Don Quixote, his horse, squire, the squire's donkey, a woman of the story and the famous windmill. Another set depicts the episodes in a popular Mexican cowboy song. The tools used are a razor, pin with a small head and the hair from an art brush stuck to a toothpick. All the figures are painted with water colors.

Heat-Resistant Plastic

Plastic of the polystyrene type now can be molded into products that must resist heat without shrinking or fading in color. In the past, plastics of this type had little resistance to heat. The new plastic, which can be left in boiling water for 15 minutes with little change, can be molded into tea strainers, knife and fork handles and radio cabinets which may develop hot spots from the tubes. A change in the molecular arrangement gives the plastic its heat-resistant properties. The material can be molded into transparent products or it can be colored uniformly.

Both of these radio cabinets were made from polystyrene, but the ivory one was made from the new type. It has resisted a boiling-water bath for 10 minutes



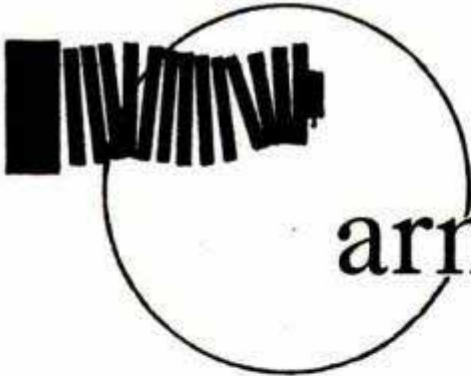

armed with a camera ...

A Mississippi professor does battle with insect adversaries, snakes and birds. His masterpiece is a "still life" study done by the light of the firefly

By Stuart Covington

Professor Hutchins gets ready to photograph the rhinoceros beetle in the museum at Mississippi State College. He is using the field camera here. Below, photograph of the harvester ant shows the extreme clarity of the pictures made by Hutchins

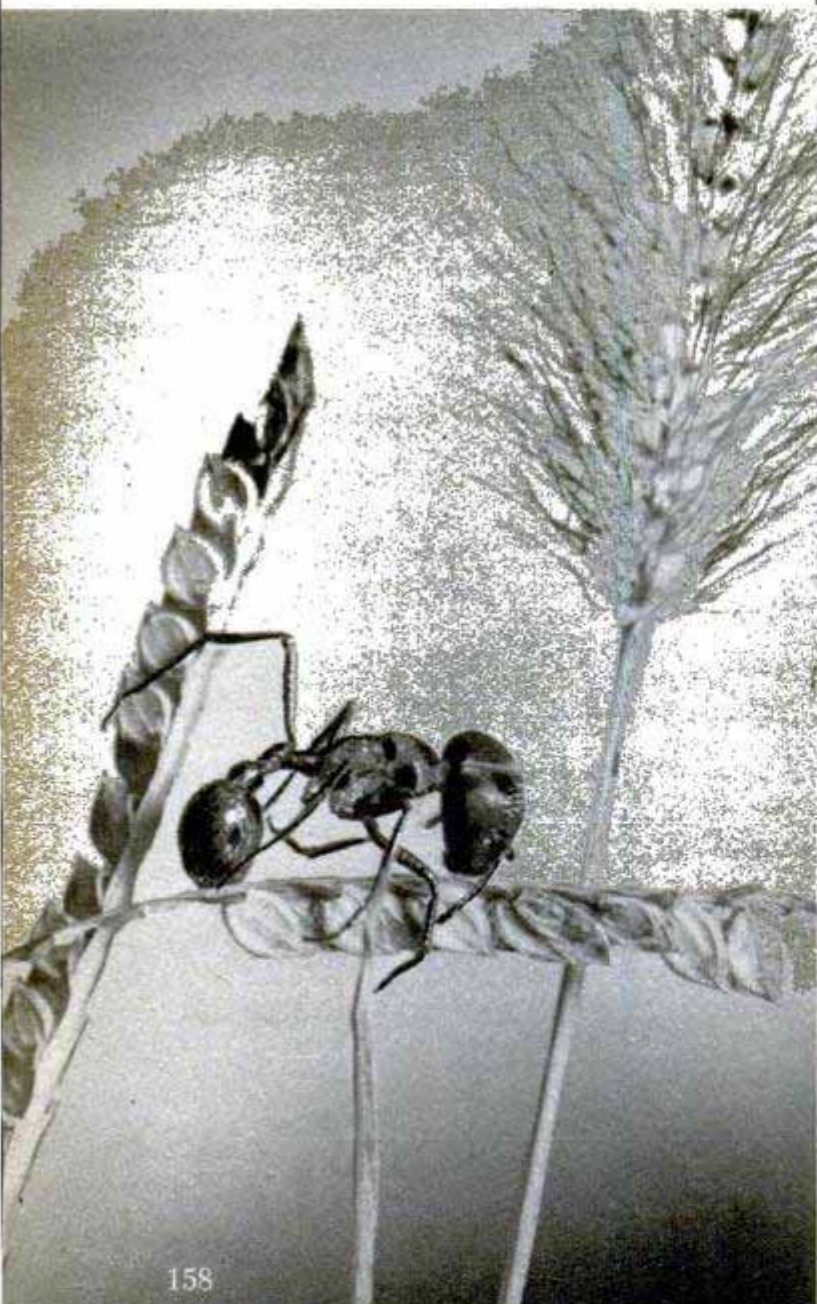

DID YOU ever look the *Camponotus* (*Colobopsis*) *mississippiensis* in the eye? Prof. Ross Hutchins of Mississippi State College has—with a camera, and the experience resulted in some of the weirdest photographs ever recorded on film. In his laboratory, the professor has accomplished feats which no other man has duplicated. The frolic with the *Colobopsis* was only one of them.

"Some of Nature's strangest works can be found right under your nose, if you only take the trouble to look for them," claims the professor of entomology, but he has roamed thousands of miles through every state in the union in search of targets for his camera. The result has been thousands of invaluable close-ups of American fauna, ranging from parasol ants to vicious chicken hawks and deadly copperhead moccasins.

Professor Hutchins uses two cameras: one in the field and another in the laboratory. His field camera, a view type with a long extension, is used for snapping subjects that cannot be captured and for the action shots in which the professor excels.

The laboratory model is Hutchins' personal brain child and required a month of spare time to create. As far as Professor Hutchins knows, there is no other like it. Originally a 4 by 5 view camera, it is now equipped with a solid plywood extension approximately three feet long. Captured insects are placed on an adjustable stage, controlled by the rack and pinion from a

discarded microscope. The stage is illuminated by a 500-watt spotlight and a photo-flood lamp. A microscope mirror deflects light to the subject. Because of the long extension, subjects may be placed almost in contact with the lens and a clear image obtained. This permits photographing of various sections of an insect's anatomy. Due to the camera's unusual length, three seconds' exposure is standard, though Hutchins has obtained photos in less time.

Hutchins and his cameras are fighting a battle which is beginning to pay dividends for the farmers of Mississippi. The professor has identified photographically every crop-damaging insect besieging the farmers of his state. His photographs have been reproduced in booklets issued by the Agricultural Experiment Station of Mississippi State College and are distributed free to farmers and used as texts by agricultural students. Armed with these unmistakable descriptions of their adversaries, farmers, county agents and agricultural extension workers are able to put the finger on the crop killers as soon as they invade new fields, often averting thousands of dollars of damage to plants.

One of Professor Hutchins' rarest subjects was the aforementioned *Colobopsis* ant. An industrious and highly destructive creature, it sets up living quarters in a hollowed-out white-ash twig. Warriors of the tribe have plug-shaped heads with which they block the nest's entrance to intruders. Other ants are admitted only after they signal by tapping on their kinsmen's plugs. With much patience, the professor was able to photograph this procedure.

Another oddity was the rhinoceros beetle, so called because of a peculiar horn-like projection jutting from its forehead. A third was the parasol ant, which carries leaves atop its body as though they were huge umbrellas. Once Hutchins made a vivid set of color prints of a single termite. Another session with the camera produced an unusual portrait of a louse. A third tiny subject was a microscopic aphid.

The Hutchins camera has been trained on over 100 varieties of fish, hundreds of butterflies, moths, birds, animals and snakes. Reptiles are perhaps his favorite subjects, though they have brought him some uneasy moments.

A less deadly adversary was the bomber

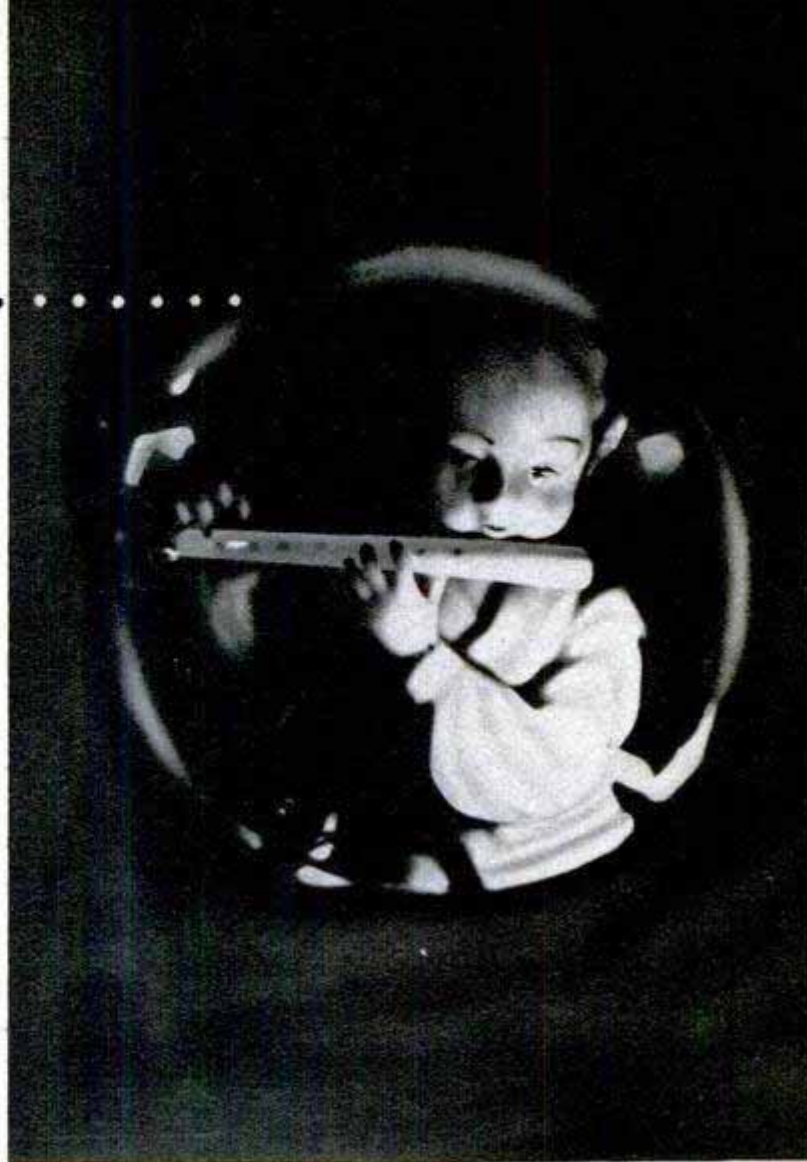

No photoflash bulbs were used for this picture. It was taken with the light from a group of fireflies.

Below, with his laboratory camera, Hutchins takes such enlarged photographs as this one of a housefly

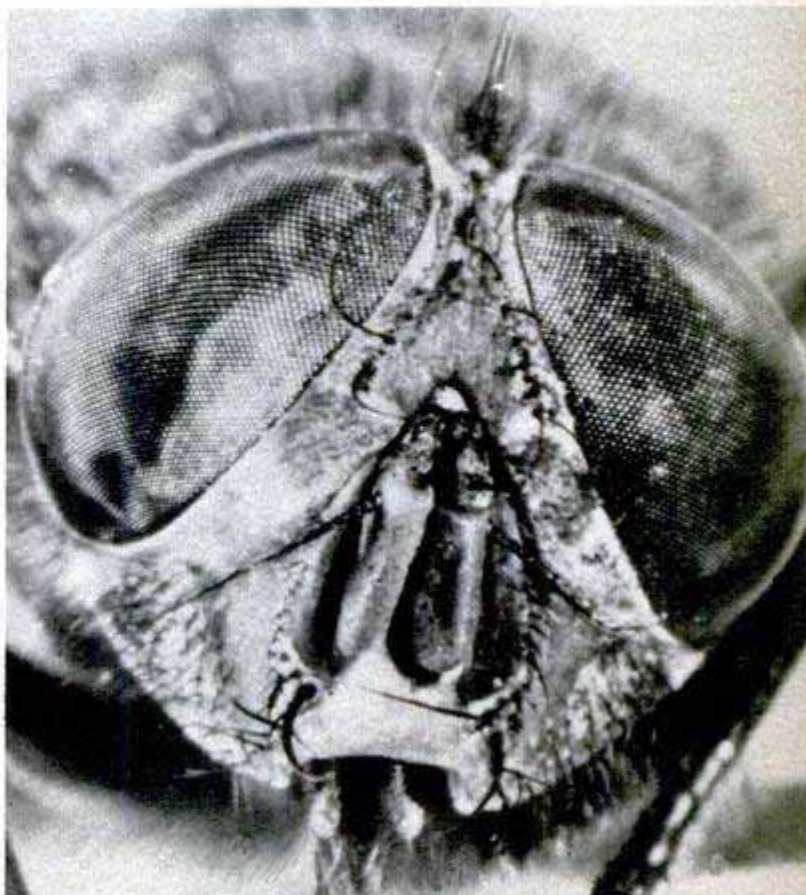

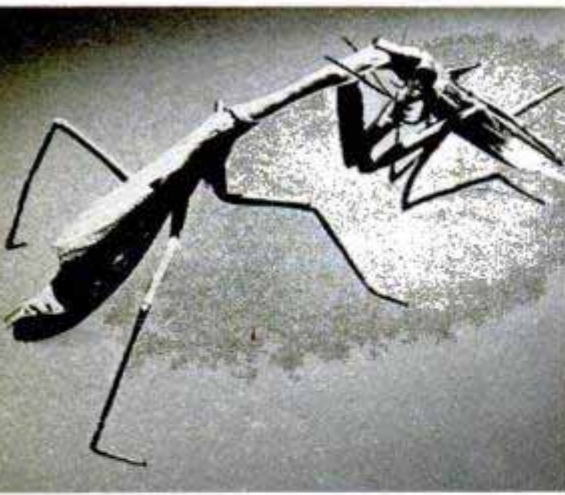

Above, the camera catches the praying mantis in the middle of a meal. He holds a grasshopper with his forelegs as he eats it

Right, a dentist's view of the copperhead moccasin! Its mouth is held open by a large paper clip. Reptiles are a favorite subject for Hutchins' cameras

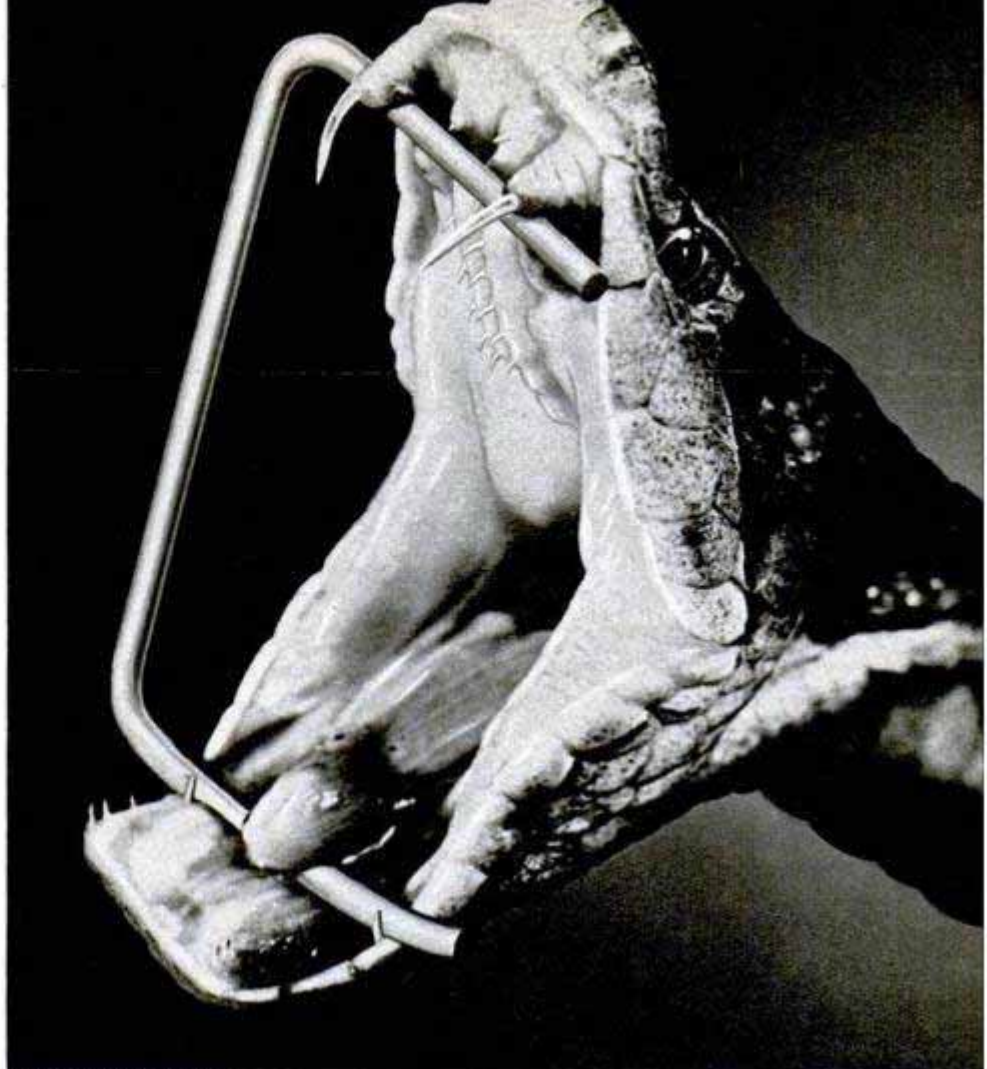

Below, this enlarged view of a rhinoceros beetle clearly shows the curved tusk on its forehead that gives the insect its name



beetle, an entomological specimen which Professor Hutchins dubbed the "gas bomb of the insect world." When captured, the inch-long beetle ejects a tiny cloud of thick, choking gas which, on a small scale, has the same effect as tear gas.

Hutchins' rarest accomplishment has been a photograph illuminated entirely by the light of fireflies. A group of glowworms was placed in a rough semicircle about the edge of a tiny statuette and, using the insects' feeble radiance as a substitute for a floodlight, Professor Hutchins took several dozen photographs, all of which are sharp in detail. The fireflies provided an eerie glow, which created a startling effect of delicate indirect lighting.

For relaxation, Professor Hutchins occasionally attaches a piece of chicken entrails to a long string leading to the shutter of his camera, which he conceals in a clump of underbrush in a remote section of some convenient woods. Illumination is provided by a flash attachment. The setup has yielded some excellent night action shots of 'possums, foxes and coons as they pounce upon the inviting food scraps.

Fighting farm foes with film has proved fascinating as well as profitable for Professor Hutchins. He has followed his unusual profession for almost two decades and is looking forward to many more exciting years of happy hunting with his camera.

Homemade Rock-Screening Tank Doubles Output of Floating Gravel Pump

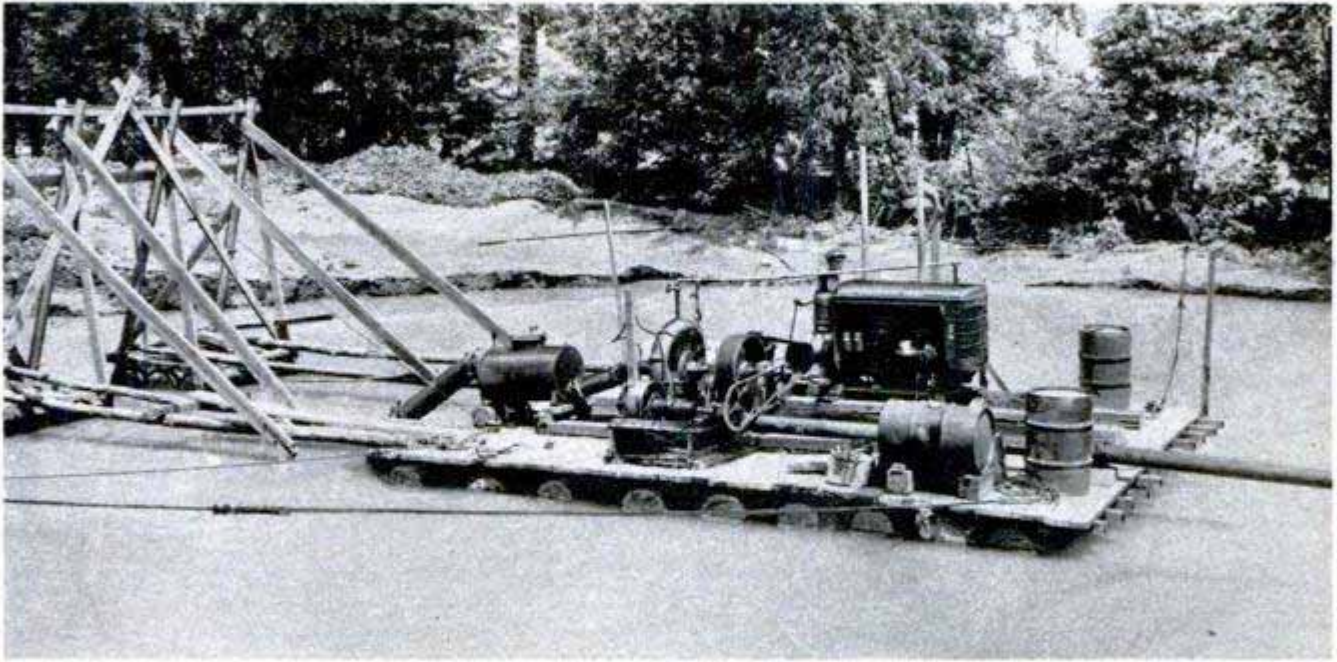

Protecting the pump from damage by large rocks, a homemade rock screen doubled the pump's production by permitting the hose to work close to the gravel bed. The screen, built into a tank near the pump, eliminates the screen nozzle that reduces effective suction. Waterborne material is drawn from the pit into the top of the tank. A grille of welded bars allows gravel to pass, but holds back large rocks and roots that would damage the pump. The gravel is then sucked from the bottom of the tank through the pump to the screening plant. A gasketed cover on the tank permits the operator to remove the large rocks.

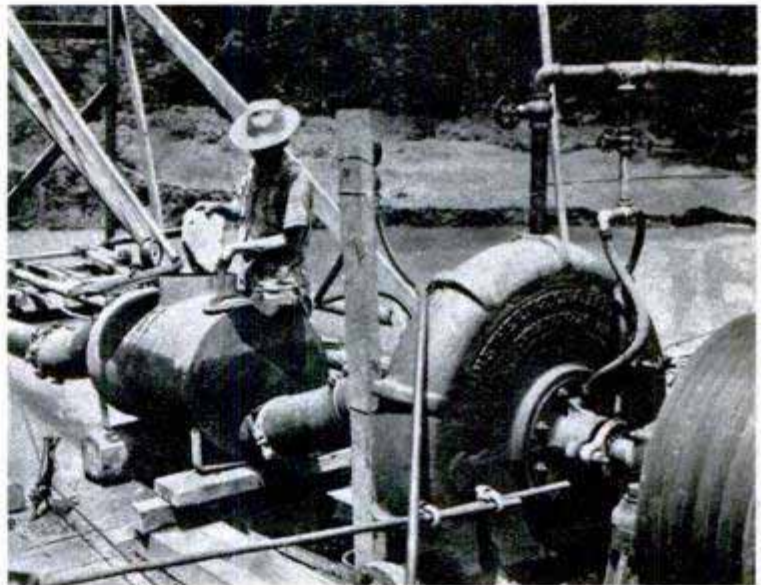

Powerful Semitrailer Vehicle Hauls Long Loads Over Rough Terrain



Heavy loads of great length are carried by a hauler designed to operate both in soft earth and on the highway. Pipe, timber and steel can be loaded on the hauler and carried through mud and up steep grades to the construction job. The vehicle features electric power steering and the elimination of springs and other parts under the frame which would drag when traveling through soft ground. Large, low-pressure tires prevent the vehicle from sinking into mud.

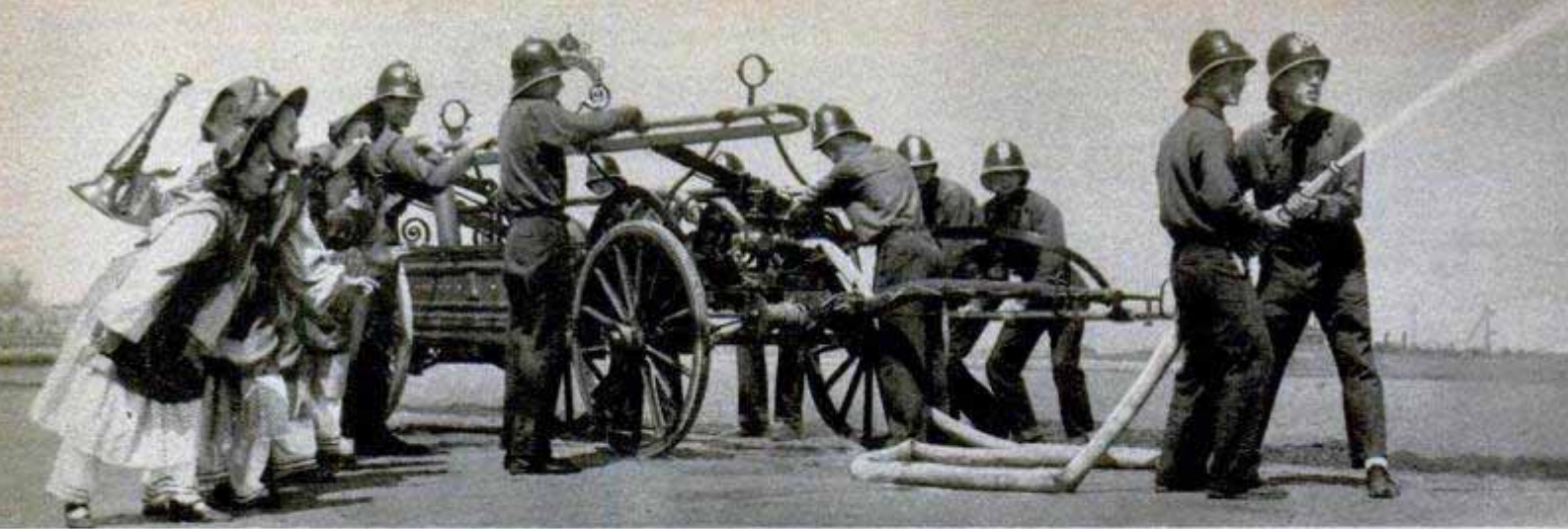

It really works! Used in the pageant at the Chicago Railroad Fair, the pumper threw a steady stream of water. In the old days the tank held water for priming the pump, which drew water from a well or river

Old-Time Pumper Rebuilt

When Carlos A. Whitney, a worker at Chicago's Museum of Science and Industry, rebuilt an ancient fire engine he first cleaned away the grime and dust of a century. Beneath it he found a tank made of inlaid wood and a name plate showing that the pumper was built in 1855. Whitney rebuilt the body, turned new brass parts for the pump and made new leather washers for the cylinders. The completed pumper, shined and ready for a fire, really throws water

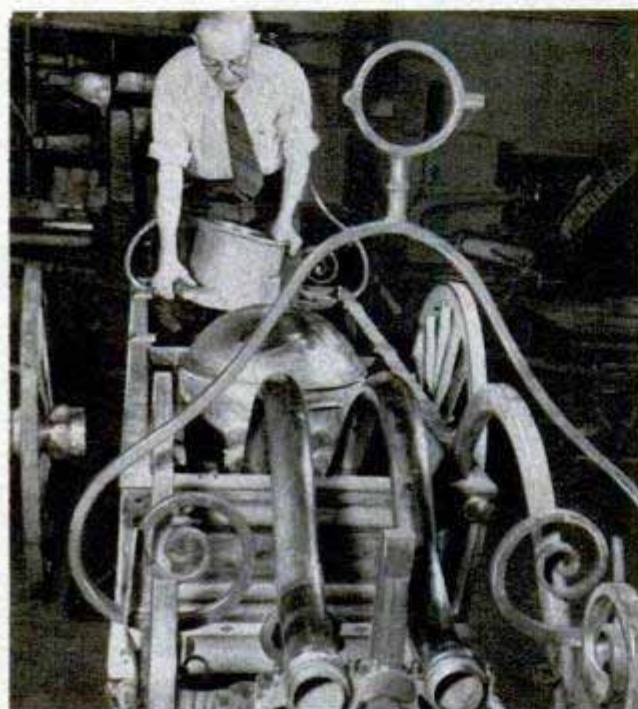

Piston and other old parts had to be recut. A brass strainer prevented debris from entering the mechanism when water was pumped from a river. Below, most parts were usable, few were remade by hand



Old name plate shows that the pumper was built in 1855. Below, the inlaid body was completely refinished. Note length of pump handle used by crew members, undoubtedly proud of their inlaid wagon

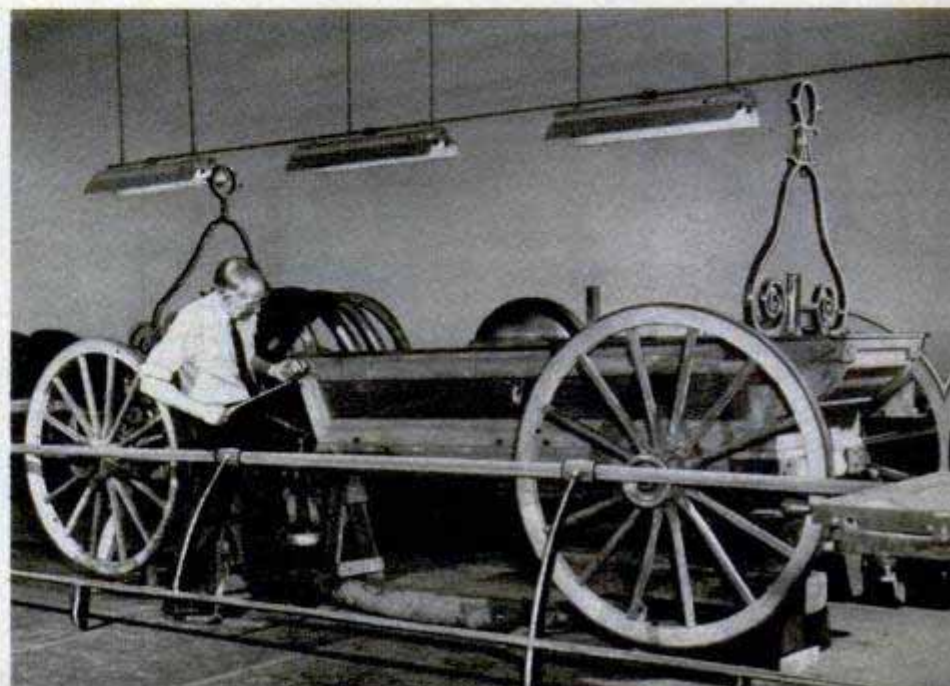

Weight-Lifting Rig May Aid Paralytics

Based on the principle of weight-lifting, an exerciser for polio victims may increase the size and strength of muscles that are partially paralyzed. The weight-lifting apparatus was designed by three doctors, using funds advanced by the National Foundation for Infantile Paralysis. The limb to be exercised is placed in a harness and the patient tries to move the paralyzed muscles enough to overcome the pull of the weights. Instruments record the strength of the muscles. In experiments, more than 20 polio patients who had been making little progress under other treatments increased

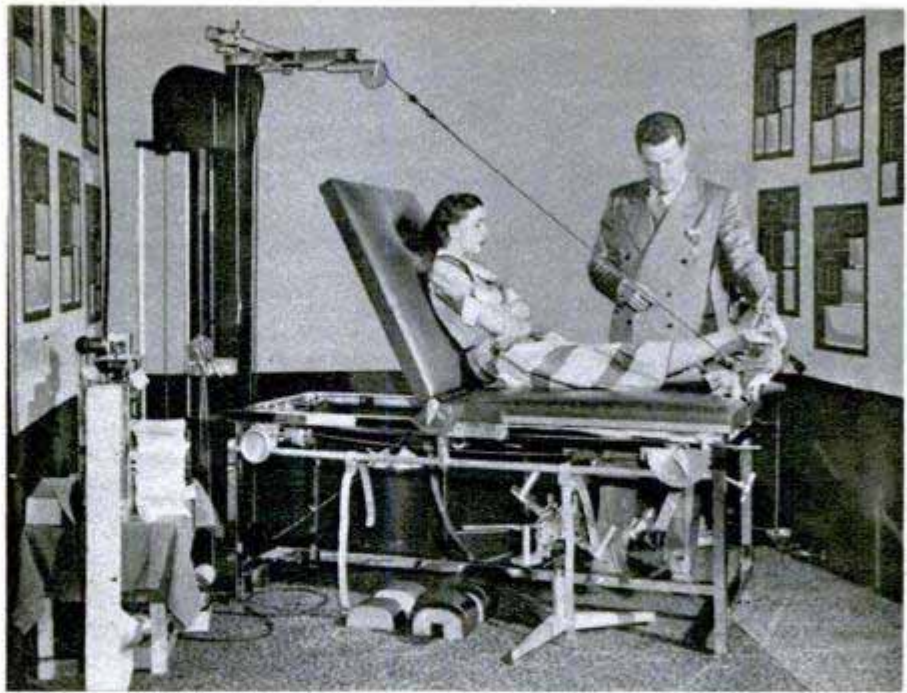

the size and strength of paralyzed limbs. The exerciser is designed only for muscles which still retain some of their power.



Official U. S. Navy photo

"Sea Water" Metal Used to Make Plane

Sea and air combine in a five-seater British personal plane made of magnesium alloy, an element extracted from sea water. Though the metal weighs less than the lightest aluminum, the wings in bending tests have withstood deflection five times greater than is required. Expected to fly over 200 m.p.h., the unorthodox craft was designed by an "amateur" who had never before worked around airplanes.



Shipboard Bomber Faster and Bigger

More speed, weight and bomb-carrying capacity give the Navy's North American-built XAJ-1 an edge over present carrier planes. A turbojet engine cuts in with the two piston engines to provide added power during combat and emergencies. For easier shipboard handling, the outer wing panels fold inboard and the vertical tail folds down.



SELF-EMPTYING VACUUM CLEANER mixes the dust and dirt with water from the tap and flushes them down the drain. An accordionlike rubber hose stretches five times its original length of eight feet, giving the equivalent of 40 feet of flexible hose. A nylon screen catches hairpins, paper clips and other objects that might stop up the sink drain



BATHROOM HANGER, below left, has three grips on each of eight arms so you can hang 24 items in a small space and they won't fall to the floor. The arms swing into the plastic shell when not in use

SCREW-CAP WRENCH, center, loosens jar covers like magic. Two adjustable prongs grip the jar lid when you pull on a trigger. The long bar provides plenty of leverage for removing the tightest cover

SPRING-TYPE HANGER for trousers and skirts can be put on with one hand, right. You squeeze it and it opens, release it and it grips the garment. All metal, it will hold up to 15 pounds of clothes

WHAT'S NEW *For Your Home*

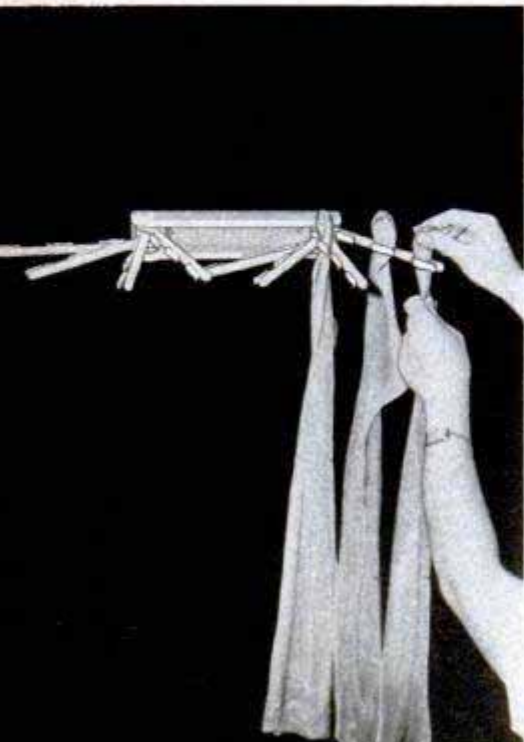

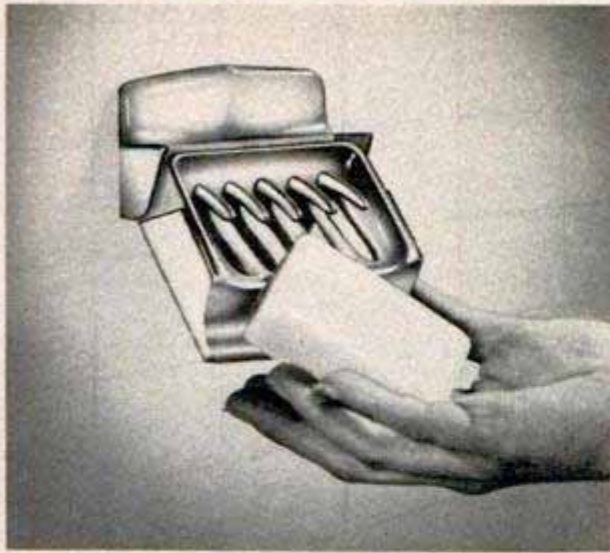

DISPENSING TRAY for bar soap keeps the soap from getting soggy. Water drains through slotted base. Press down on edge of the trap and the soap slides forward

WATERLESS RADIATOR, below, plugs into any electric outlet. Using no water or steam, it comes in two sizes. Portable, its handle swings down for use as a rack



SERVING CART has a removable tray as its top, making it convenient to pass the food around after you've wheeled it in from the kitchen. The two rear wheels pivot for easy maneuvering around furniture. Made entirely of aluminum for long life, the wagon has two fixed shelves in addition to the top tray

FOOD SHAVER speeds the preparation of salads, sandwiches, potato chips and other dishes. It uses two interchangeable blades, one for cutting the thin slices such as used in making potato chips and the other for thicker slices. Made of cast aluminum, the stainproof shaver is nickel plated for easy cleaning

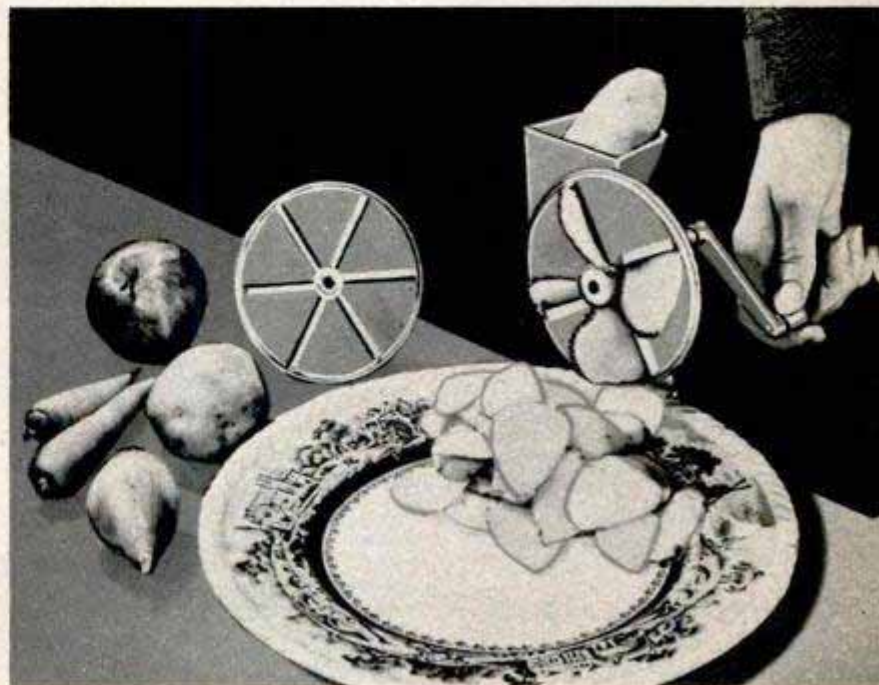

No Job Is Too Large or Too Small for Japanese Brush-Writer



POPULAR MECHANICS



Top left, speed-writing in giant size. Right, writing brush used at left. Bottom, that's no spike! It's a common pin that shows the amount of enlargement needed to bring tiny letters above it up to a readable size

From one extreme to the other, Tendo Ohbayashi of Odawara, Japan, is an expert in penmanship. Using a Japanese writing brush, not a sharp-pointed pen as is generally used for microscopic writing, he prints 10,000 Japanese characters on a paper one inch square. He has printed the words *Popular Mechanics* in such tiny let-

ters that they can be read only under a strong reading glass. At the opposite extreme, he prints Japanese characters with a giant brush that weighs 50 pounds. In a recent demonstration, he printed two complicated Japanese characters, requiring five gallons of India ink, on a sheet of paper 20 by 50 feet in less than one minute.

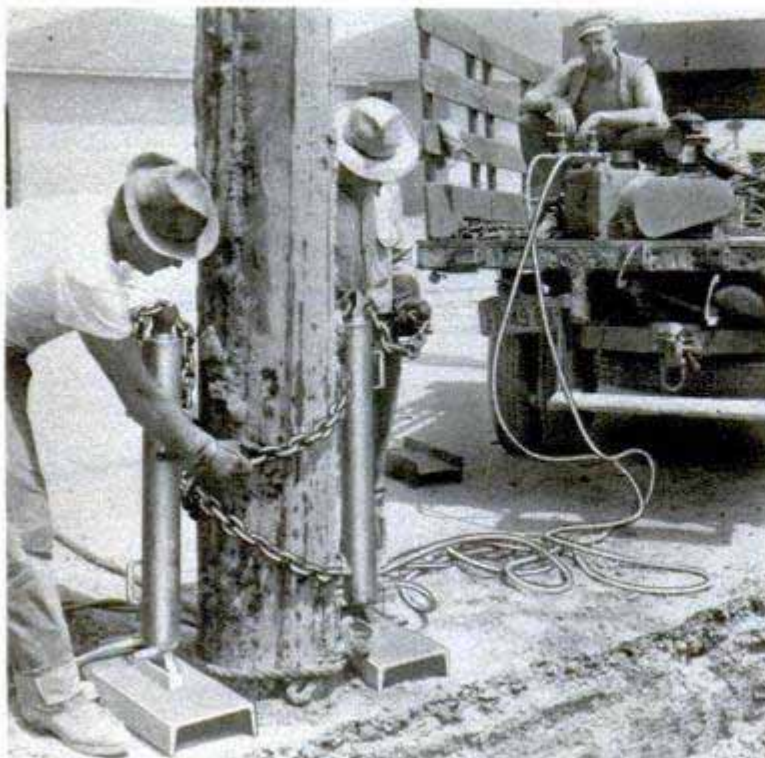

Powerful Hydraulic Rams "Uproot" Telephone Poles

Even the largest telephone pole is pulled out of the ground in less than five minutes by a hydraulic-ram device used by a western utilities company. Two 50-ton hydraulic rams, with strokes of 22 inches, are connected to heavy chains that wrap around the pole. A small gasoline-driven compressor on the truck provides the hydraulic power. Hand-operated jacks, formerly used for this purpose, required at least two hours to raise a large telephone pole.

¶ Fifty million persons, which is 49 percent of the population of the United States over 16 years of age, are motor-vehicle drivers, according to the Automobile Manufacturers Association.



Collapsible camp is concealed in the car trunk and beneath the boat when Hardy shoves off on a fishing trip

BOAT TRAILER BECOMES CAMP TENT

Fisherman Vessie E. Hardy, Jr., of Dallas, Tex., can roam anywhere in search of good angling spots without worrying about accommodations for the night. Hardy carries a complete camp, including tent and boat, behind his car. When he wants to camp for the night he pulls a tent and two cots from the car trunk. Then he lifts the boat off the trailer, exposing a tent platform. Two extensions of the platform fold out over the trailer wheels, where they are supported by chains. Hardy converts the two boards that held the boat on the trailer into end poles for the tent, and runs a ridgepole between them. He then erects the tent and pegs it to the ground. Two camp cots fit into the tent, with four feet of space between them. Hardy can erect the camp in 15 minutes without help and repack it in the same length of time.

Top right, hinged sections of platform fold out over trailer wheels and are held with chains. Right, the poles fit into framework. Below, camp is erected in 15 minutes. It sleeps two, with space between cots



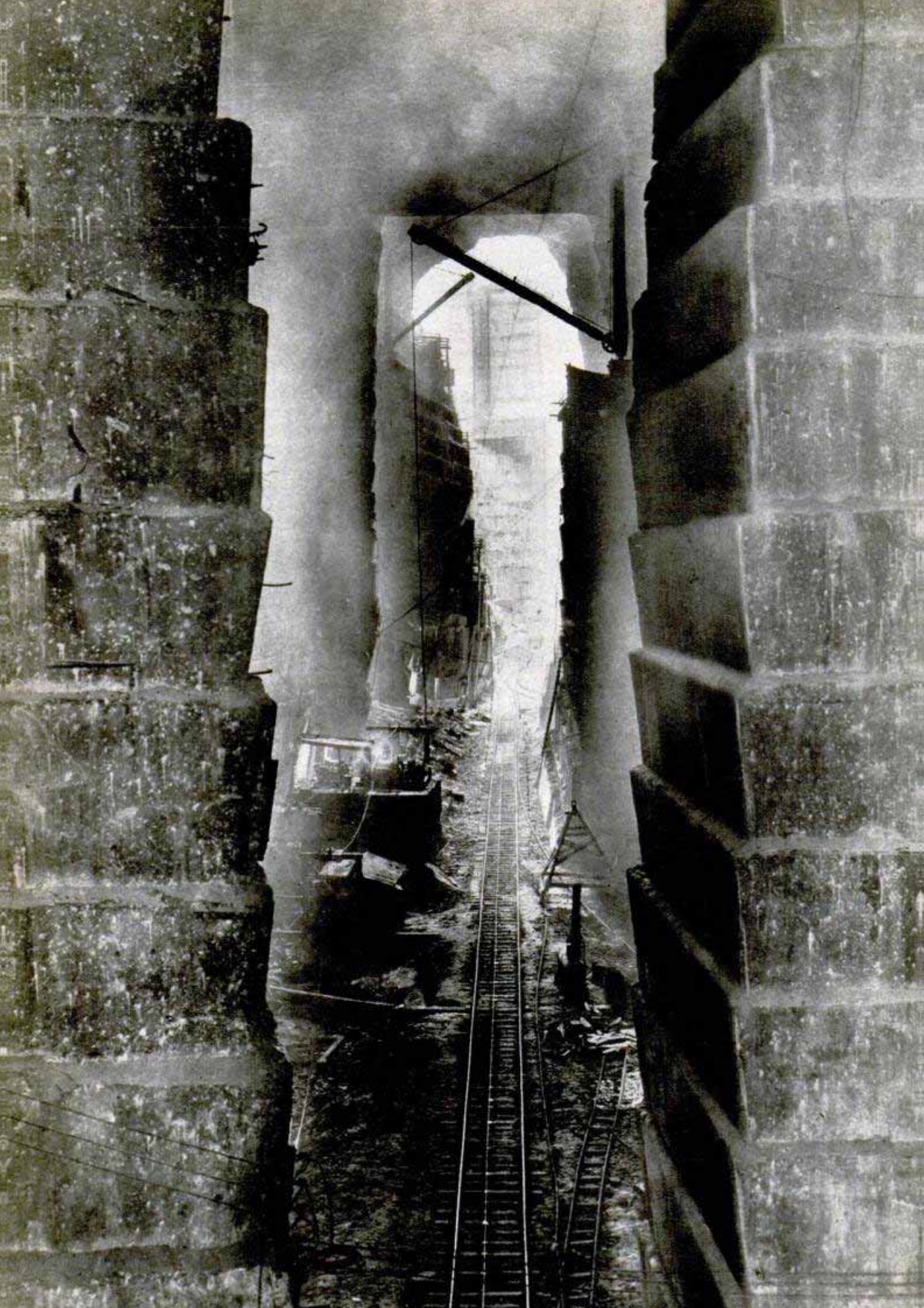

IT'S A FAR CRY from a scraggy mountainside in Vermont to the formal beauty of Washington, D.C., but without that New England peak, the nation's capital wouldn't look the same. That mountain at Danby, Vt., has provided the white marble for such beautiful buildings as the Jefferson Memorial, the Senate Office Building, the Supreme Court Building and the nearby Arlington Amphitheater.

Even the sharpest-eyed tourist would have difficulty spotting the quarry out of which so many of the nation's beautiful buildings have come. Only a ragged white scar on the forested slope marks the site. That scar, high up on the hillside, is the entrance to a vast marble mine that extends hundreds of feet inside the mountain.

Since 1840, Vermont quarrymen have been cutting giant blocks of white Danby marble and starting them on their way to fame. For the Supreme Court Building alone, more than 1000 carloads of marble were quarried at Danby.

Only one of many marble mountains in the country, the Danby mine has grown in size as blocks were removed until today the mammoth cavity covers more than 13 acres. Inside this marble hall, the temperature remains at a constant 45 degrees, winter and summer. Even on the hottest day of the year, the quarrymen wear warm jackets as they work.

Mining marble underground is about as different from mining coal as the black dust of the coal mine differs from the white dust of the quarry. Miners can get rough with coal and no

mining a marble mountain

By
Arthur R. Railton

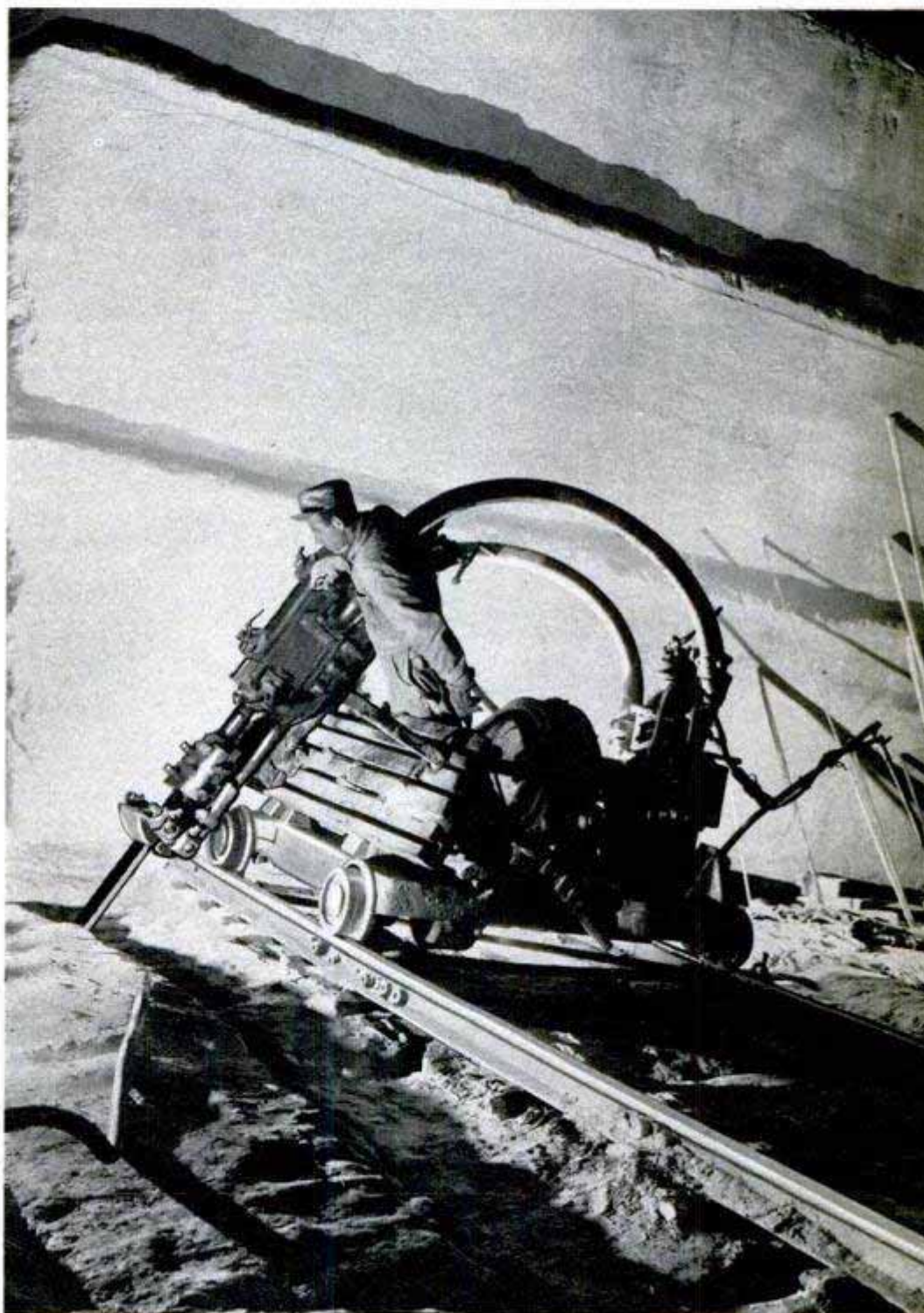

Three Lions photo

Channeler cuts deep grooves in the quarry floor as it runs back and forth on its track. It works like an air hammer. Photo on opposite page shows a quarry, looking toward the entrance. Ledges on the pillars were left when layers of marble were removed. The pillars support the roof of the quarry

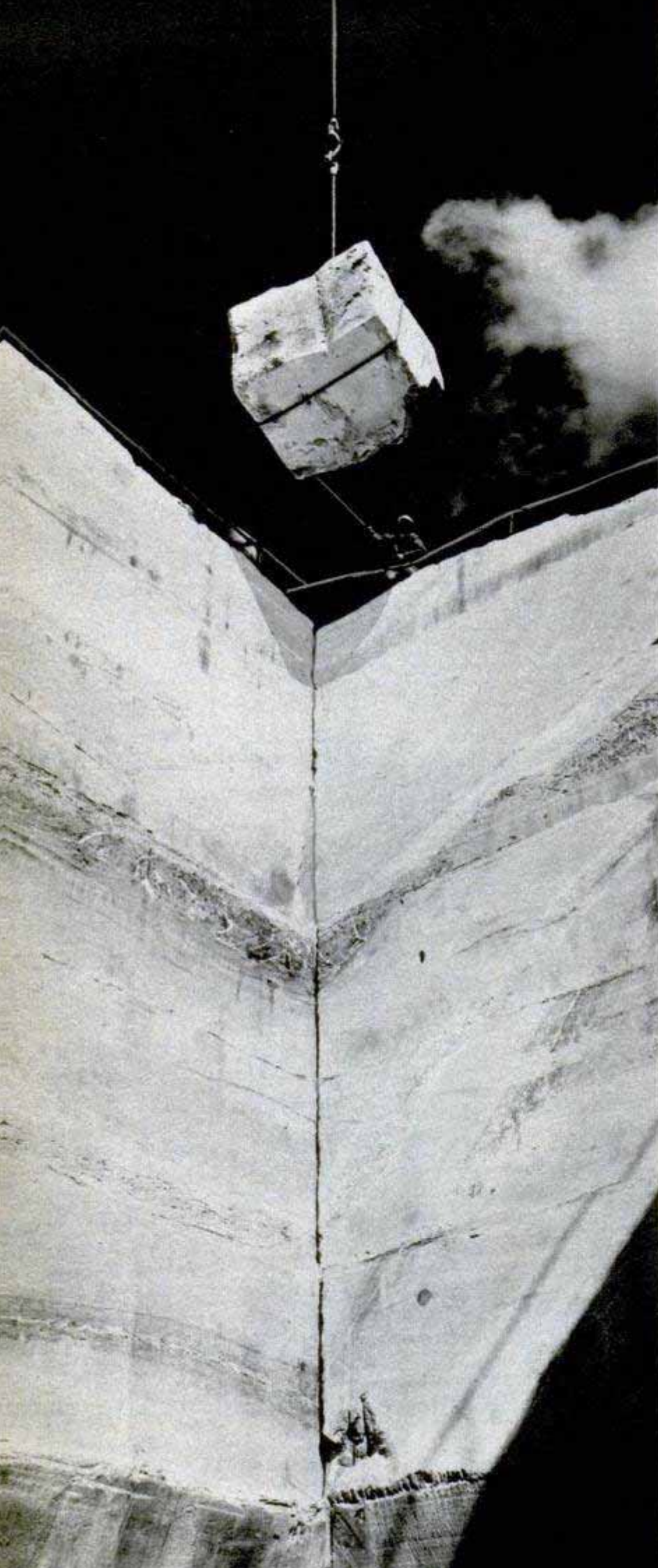

Above, quarrymen pound wedges into holes in the marble to loosen the layer of waste rock on top. Left, big block of marble leaves quarry on its way to the mill

damage is done, but marble has to be treated gently. Sudden shocks must be avoided. Blasting is never done in marble, although it is frequently used to clear away the waste rock around the deposit. Whenever blasting is done in the waste rock (the quarrymen call it country rock), an insulating channel is cut between the rock and the marble to prevent the blast from spreading and shattering the fine stone.

At the Danby quarry, the marble deposit comes almost to the surface on one side of the slope and then travels horizontally into the hill. It was much easier and more economical to tunnel into the rock above the marble deposit than to remove about 200 feet of waste-rock overlay to uncover the valuable stone.

This tunnel has grown until

Marble can be worked like wood or metal. Below, workman is turning a column on a lathe. A stream of water cools the tool





the quarrymen are now working more than 700 feet in the heart of the mountain. The underground mine is more than 700 feet square and more than 90 feet high. At regular intervals inside the quarry, thick pillars of marble are left to support the top of the mountain, else the mountain might cave in the quarry roof. The pillars are from 20 to 30 feet square at the base and about 75 feet apart. This marble is, of course, wasted and can never be removed safely.

In a project such as the Supreme Court Building, the exact location of each block in the building is known before any cutting in the quarry begins. The quarryman has to know the exact size of the piece before he can lay out the block for the channeling machines.

These channeling machines, operated by air pressure they produce themselves with an electric motor and compressor, cut long crevices in the marble floor.

Mirrorlike finishes are put on marble with this machine. The various polishing heads are shown at extreme left of photo

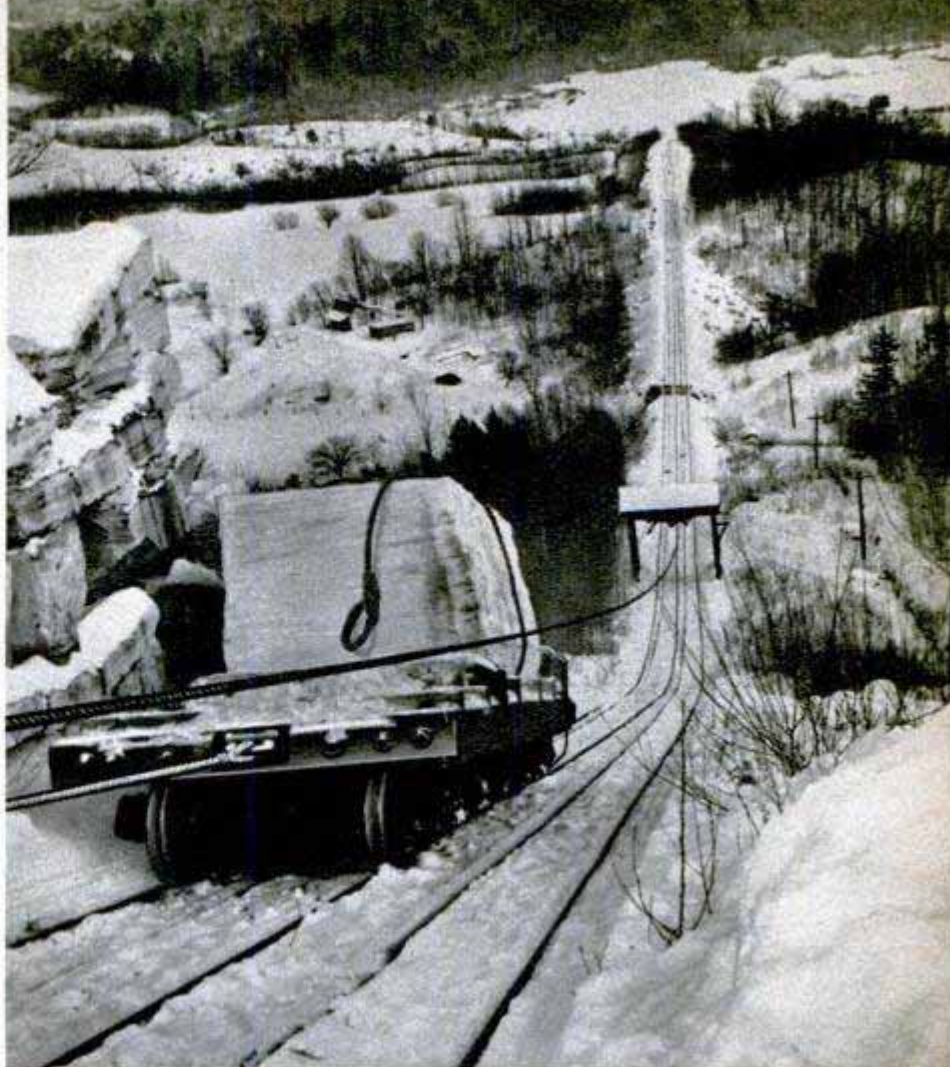

Marble blocks are carried down into the valley, 900 feet below Danby quarry, on this cable car. The track is almost a mile long

In the finishing mill, the marble is rubbed down to the exact size on huge cast-iron wheels. Sand and water are the abrasives



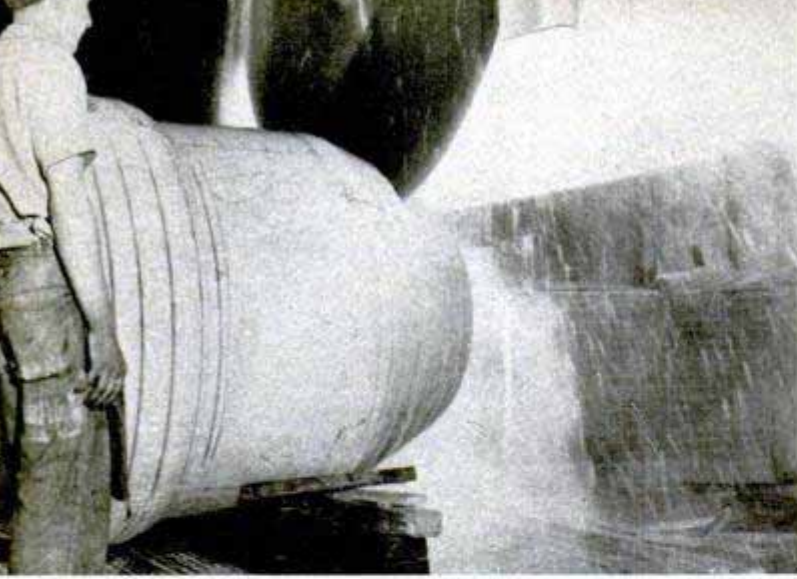

They run on steel tracks like pint-size locomotives moving back and forth, their chisel blades pounding into the marble. There are five different blades in each chisel and they pulverize the marble with a pile-driver action of 300 strokes a minute. The machines weigh more than four tons each and can cut a channel to a depth of 20 feet. Water is added, as the cut deepens, to keep the marble chips in suspension. At intervals during the cutting, the machine operator bails out the crevice-like cut with a slender scoop.

After the longitudinal channels have been cut, the operator moves the track for the crosscuts which divide the long strips into blocks of the desired sizes. When the cutting is completed, the quarry floor looks like a giant checkerboard with cuts running at right angles to each other.

Removing the key block (the first block in each level) is the step that "unlocks" the floor so the other pieces can be removed easily. A powerful derrick pulls on the block as one side is wedged or pried until the block breaks free at the bottom. After this operation, the quarrymen can work at the lower level, cutting the bottoms of the blocks with pneumatic drills and wedges.

The shape of each block is carefully marked in the marble and the cuts follow this marking exactly so that the block will

(Continued to page 258)



Top, diamond-toothed saw cuts the base of a marble urn. Center, carving a soldier memorial from solid block of marble. Plaster model is at left. Lower right, artisan uses pneumatic chisel to cut design of 25-foot White Chapel Memorial shown at the left

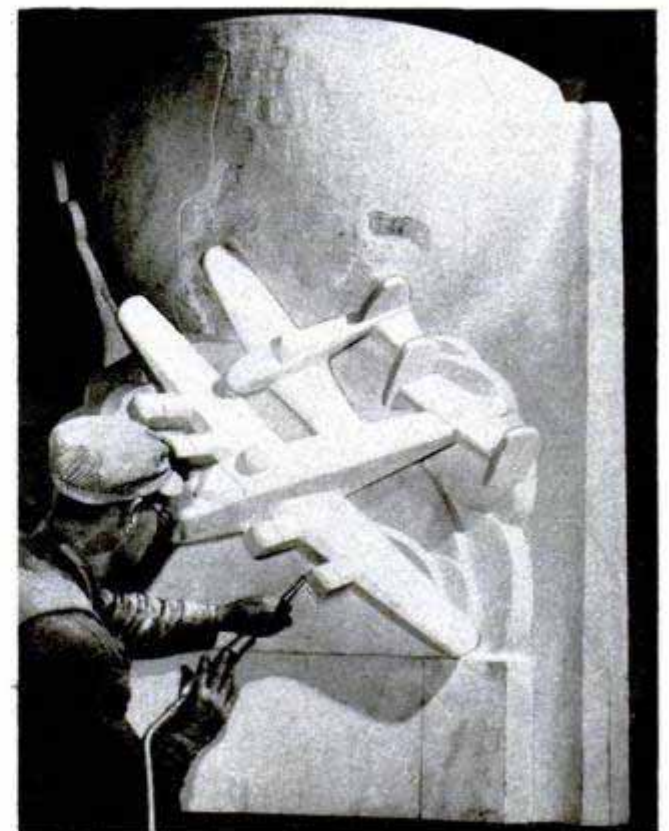

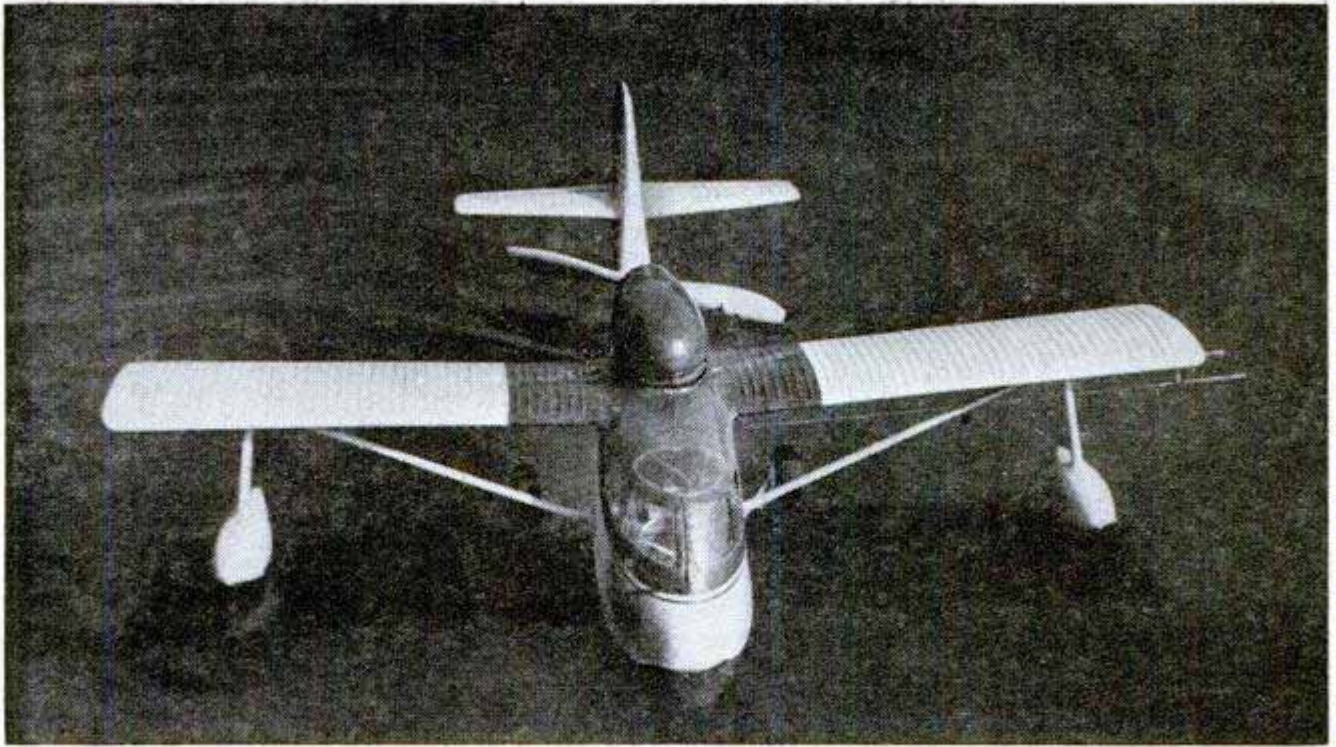

Molded Parts for Model Planes Give Accuracy With Strength

Skin parts molded of cloth and paper give model-airplane builders a perfection in scale that is impossible to attain except by professional modelmakers. The contour parts are laminated into a thin, rigid skin by combining paper and cloth under heat and pressure. The resulting parts are exact replicas of corresponding parts in the real plane, and are much stronger than wood frames covered with paper. The assembly time of the kit is reduced. Waterproof and highly resistant to fuel and oil, the preformed parts withstand crack-ups that would demolish other model planes.



Top, model of Republic Seabee shows the accuracy of detail possible with the molded skin parts. Above, plane assembled by gluing preformed parts to frame



Oil-Level Gauge Is Easy to Read

Oil-storage tanks need never run dry when a gauge which tells the oil level at a glance is used. All the visible parts of the gauge are made of plastics. The indicator is mounted on top of the tank through a steel coupling and can be read from all directions. The gauge withstands a filling pressure of more than 70 pounds per square inch.

There are approximately 9000 airplanes used by United States farmers now as compared with only about 100 in 1941.

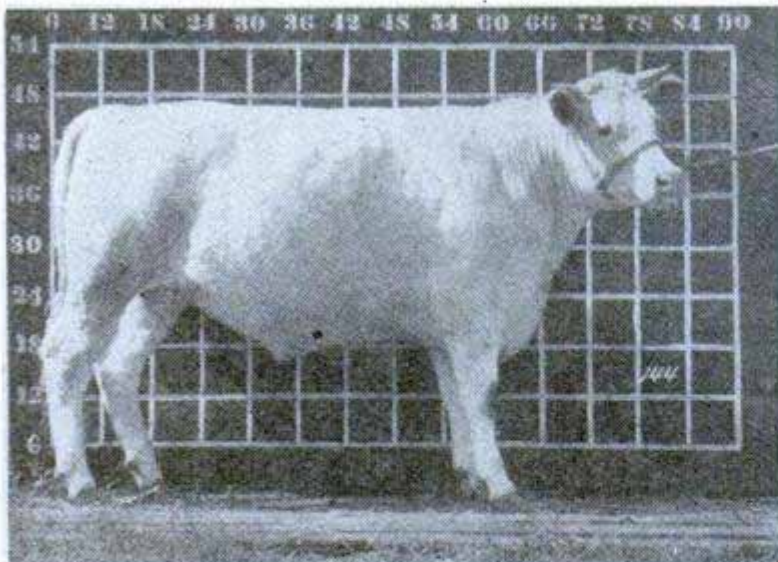

This 900-pound baby steer is a preview of the "streamlined" model that will provide you with choice cuts of meat in a few years. Note its square lines, low frame and short "wheelbase"

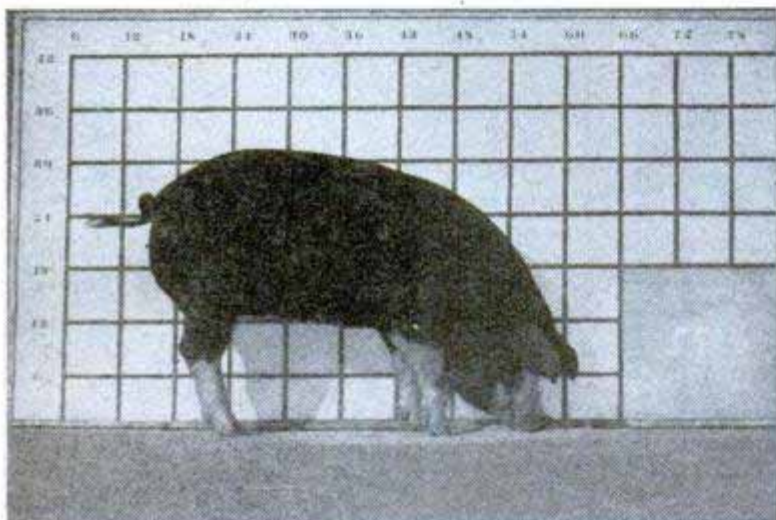

Compare this new-model Poland China pig with the scrawny hogs on the opposite page. Below, sheep at left, much bigger than pure Navajo at right, is a crossbreed of a Romney and Navajo



Nature needs help as a hungry world calls for food. "Blueprints" drawn up by animal engineers promise to give us more meals from each animal

Engineering

PLANS for the 1950-model beef critter already are on the drafting boards of the nation's animal engineers—and never did you see such a streamlined creation!

Built with square lines, low to the ground and with shorter "wheelbase," this advanced model will carry more T-bones and tenderloins for its weight than any animal yet to appear on American ranges.

The animal engineers have other new designs on the drafting board for release soon — specifications for ultra-efficient pigs, sheep, chickens and turkeys. Here are some of the new models:

An air-conditioned cow for hot climates.

Beautified sheep, without ugly neck wrinkles and dental defects.

Streamlined hogs with more pork chops, fewer spareribs.

Hens that lay firmer, better, poaching eggs—and more plentifully.

"Early bird" turkeys that beat the season to be ready for the roaster before Thanksgiving.

Home-grown sheep clothed in valuable Karakul coats.

"Piney woods rooster" with three little pigs that will grow into razorback hogs just as thin and scrawny as their mother. Animal engineers are developing more efficient breeds of swine to provide better meat for you

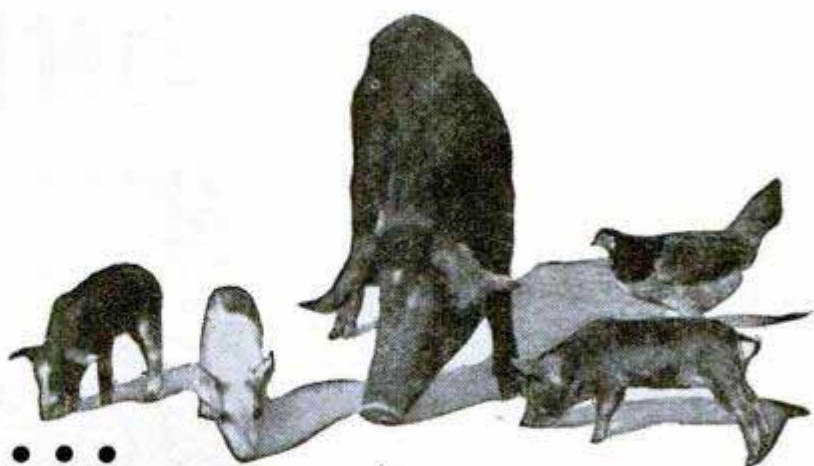

Better Meat

By Maxwell Reid Grant

And if 1950's steaks are juicier and more tender, you can thank such inventive geniuses as those who invented a mechanical chewing device to set new standards for meat quality. Don't laugh—a scientist *has* to be exact—and two government research men, testing meat in a project aimed at improving beef quality, needed an accurate way of rating the tenderness of steaks and roasts.

Their first effort was a set of jaws with teeth to imitate actual chewing. This didn't work too well, so they evolved a mechanical "biter" which cuts out a circular core sample much as a cook cores an apple. This tidbit of meat is put into a triangular hole in a large steel blade. A motor, pulling against a strong spring, draws the blade through the sample, just as a carpenter pulls a saw through a piece of wood in a

Veterinaries of the Department of Agriculture risk their lives while working with sleeping-sickness virus. This protective clothing reduces the risk of infection as they prepare a vaccine against the dread disease





Scale, held against a photomicrograph of fleece that is magnified 500 times, shows quality of wool hairs

miter box. As the meat is sheared in two, its tenderness is read on a scale.

Tender steaks are only one of the things the animal engineers are demanding of the improved beef critter. They also expect top performance—sturdy animals that are healthy, fast-growing and don't eat their heads off. By sea and air, animals from many parts of the world are being brought

to U. S. laboratories so their good qualities can be drafted for American agriculture.

For instance, there's the air-conditioned cow. Two years ago a ship docked at an eastern port, bringing two young bulls and two heifers on the last lap of a 12,000-mile sea-and-air journey from India. Government scientists, combing the earth's dairy population, had selected these animals for their ability to withstand hot weather.

Cows have no sweat glands—they keep cool by breathing hard and evaporating moisture from their lungs. In humid summers of the southern states, ordinary cows such as Guernseys and Jerseys pant listlessly and milk production falls off as much as 40 percent. But the Indian cows have loose skins with more cooling surface and their thick, hairy hides are good insulators. Their weakness is stingy milk production—only about 2000 pounds of milk yearly compared with a U. S. average of 4500 pounds.

Now the animal designers are well along toward combining the good qualities of the two types to get an air-conditioned cow that faces southern summers without a murmur, yet yields milk plentifully. It can mean new prosperity to southern farmers.

Another "model" is being air-conditioned by crossing the Aberdeen Angus cow with the Afrikaner, which is similar to the humpbacked zebu and whose tropical an-

Eggshells are tested for strength and porosity and only those of top quality are placed in the incubator



cestry promises to assure hot-weather efficiency.

Face lifting for sheep is a typical job by which the animal designers want to correct nature's mistakes, paving the way for production-line efficiency. Not that they are worried particularly about Mrs. Sheep's glamour—they want to do away with skin wrinkles that make shearing difficult and lower the value of the fleece. Too much wool about the eyes nearly blinds some sheep, so they can't even follow the leader—thus a relatively barefaced sheep is worth more. Occasionally, too, sheep have overshot jaws so that the front teeth don't meet, making chewing so difficult that the animal actually is underfed. These defects are avoided by not using such animals in breeding flocks. Research men at the Western Sheep Breeding Laboratory in Idaho already have cut down skin wrinkling of Rambouillet sheep and many lambs raised there are born free of the troublesome skin folds.

The animal engineer uses three main tools: (1) "selection," or picking out superior animals to be

(Continued to page 246)

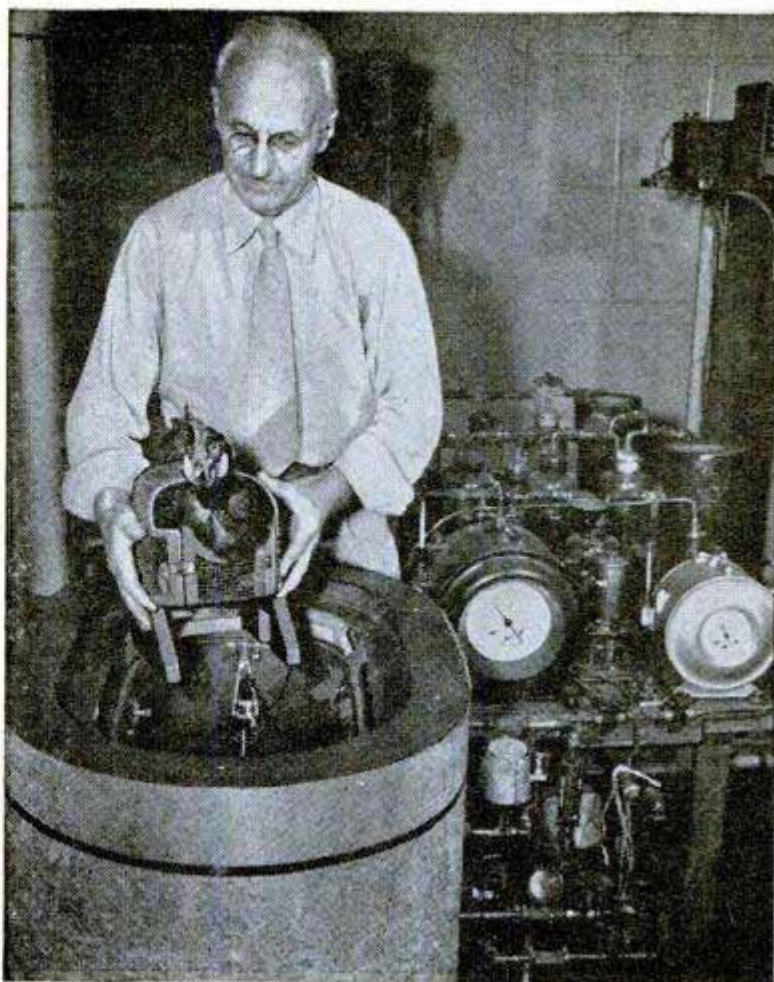

Hen being placed in test chamber will have her efficiency determined by measuring the intake of oxygen and output of heat and carbon dioxide. Below, weighing chicks that were fed same diet except one on left received a concentrate of cow manure

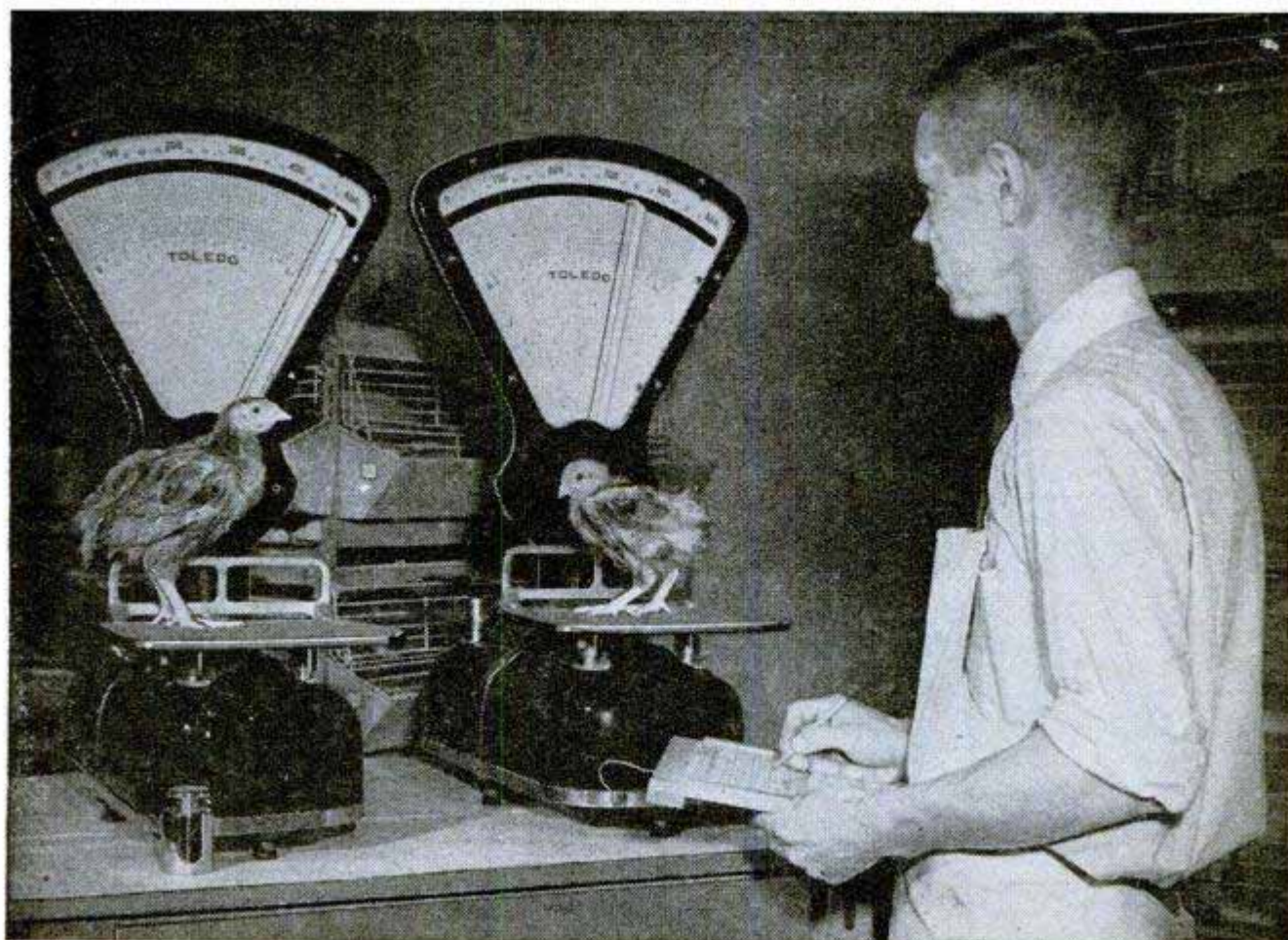



Scooter Scoots 75 Miles Per Gallon

Two passengers or a payload of 400 pounds are carried by a four-wheel vehicle that scoots along at speeds up to 30 miles an hour. The 160-pound vehicle travels 75 miles on a gallon of gas. A 2½-horsepower engine delivers thrust to only one of the wheels. The brake, clutch and shift lever have been replaced by a control stick. The lever operates a torque converter consisting of a drive unit for a bomber turret, providing a variable gear ratio. The driver pushes the stick forward

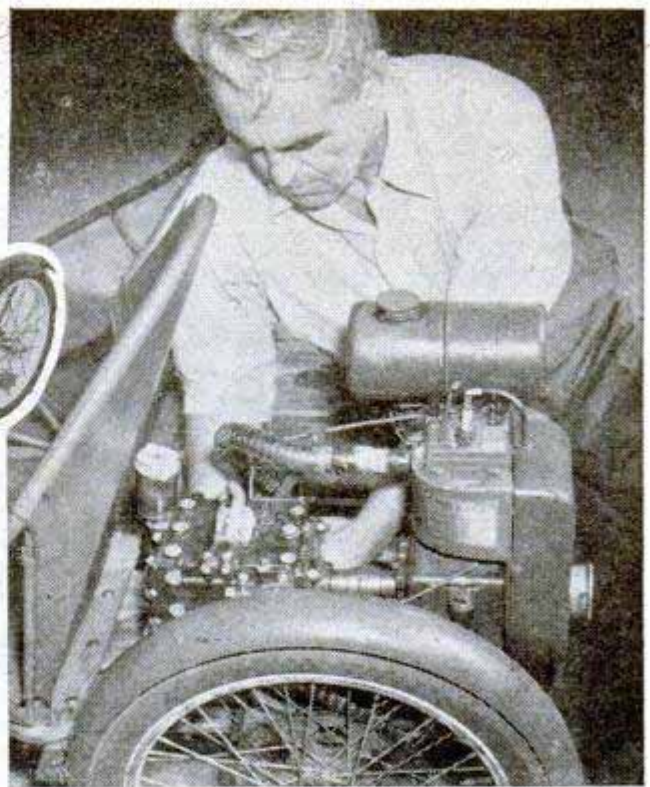

to move ahead and pulls on it to back up or brake. On the floorboard are a foot throttle and emergency brake. Oak slats that form the floor give the vehicle a spring action that eliminates the need for springs. The scooter is being used by disabled veterans, and guests at several resorts.

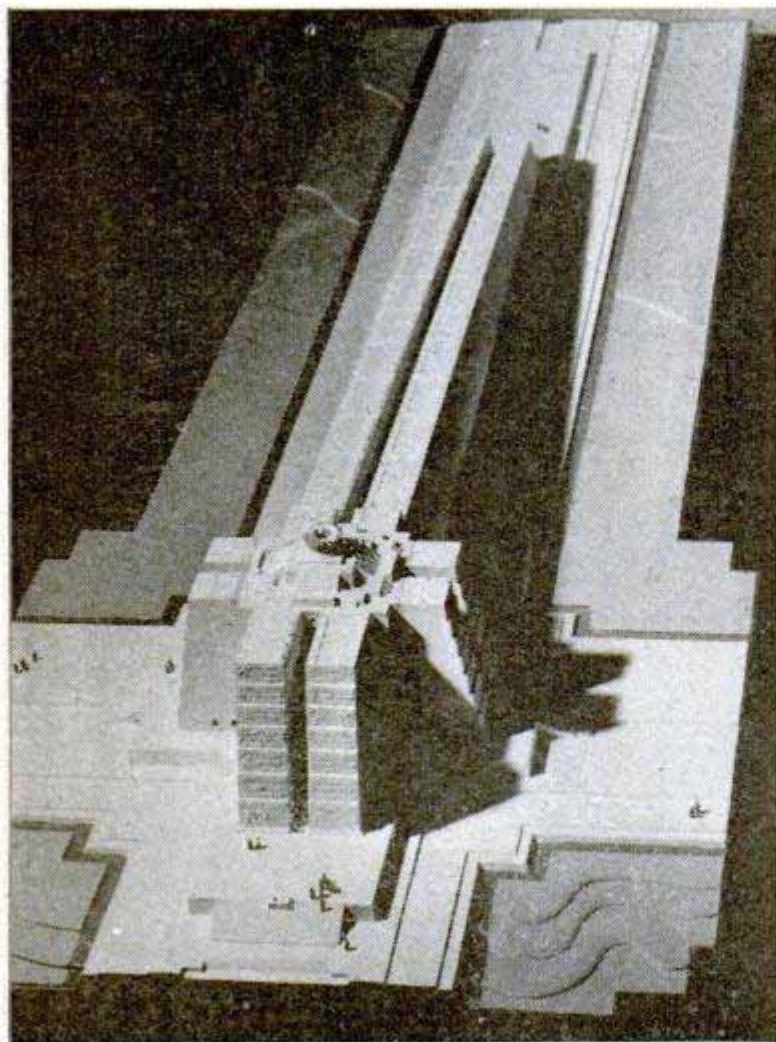

Memorial for Columbus To Be Giant Lighthouse

Ground recently was broken in a ceremony that marked the beginning of construction of a massive lighthouse memorial to Christopher Columbus on the south coast of the Dominican Republic. When completed, the memorial will form a recumbent cross measuring three quarters of a mile from end to end and 120 feet high. A powerful beacon at the junction of the crossarms will project a vertical beam to guide aircraft as well as ships. The body of Columbus will be moved to the memorial and 21 American nations will provide material for a museum and library. The memorial lighthouse will cost \$5,000,000. A large part of the money will be raised by special stamp issues of the 21 nations comprising the Pan American Union.

☐ A single 277-ton power generator, completed recently by Westinghouse, will turn out the equivalent of 134,000 horsepower — as much as produced by 20 of the largest railroad locomotives.

Electric Paint Remover Does Not Char Wood

Paint and putty are removed from buildings and windows safely with a small, electric tool that develops 1000 degrees of heat and has four scraping edges. The wood is not charred by the tool which blisters the paint, making it possible to scrape it away quickly and without danger. Its four edges can be sharpened when dulled by long use and are easily replaced when worn out. The tool operates on standard house current at a cost of about three cents an hour.

Right, there's no danger of setting your house on fire when you get rid of the old paint with an electrically heated scraper

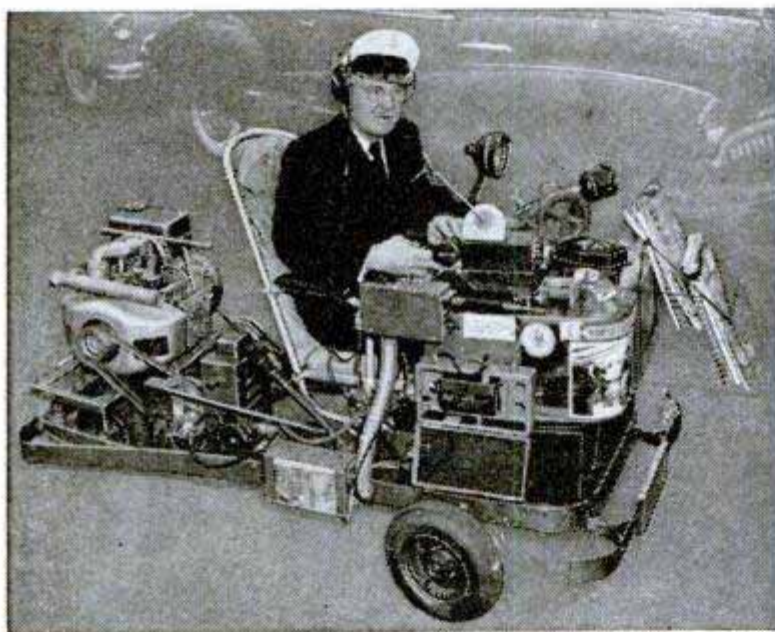
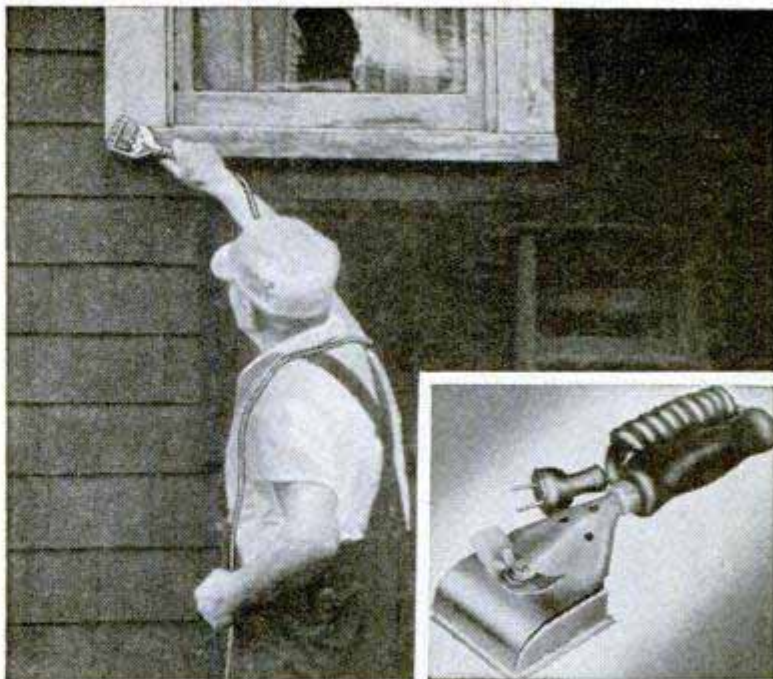

Motorcar for Handicapped Operates Like Plane

Many of the control features of an airplane have been built into a motor vehicle designed for handicapped veterans. Constructed by Edward T. Adkins of Palo Alto, Calif., the little car runs three miles an hour on electricity supplied by a self-charging battery or 20 miles an hour on a gasoline engine. The tires are from the tail wheels of fighter planes and the controls for operating the vehicle are grouped just as they are in multi-engine planes. A built-in spray for extinguishing fires operates automatically.

Spotting Scope For Marksmen

Banging the eyepiece with shooting glasses is unnecessary with a new 60-mm. spotting scope that gives a brilliant image from an eye distance of nearly one inch. This also eliminates squinting and makes target spotting quicker and easier for the marksman. The 20-power scope has coarse and fine focusing adjustments. It is about 14 inches long and fits any shooting kit. Lens caps screw over the eyepiece and objective, eliminating the need for a special case.



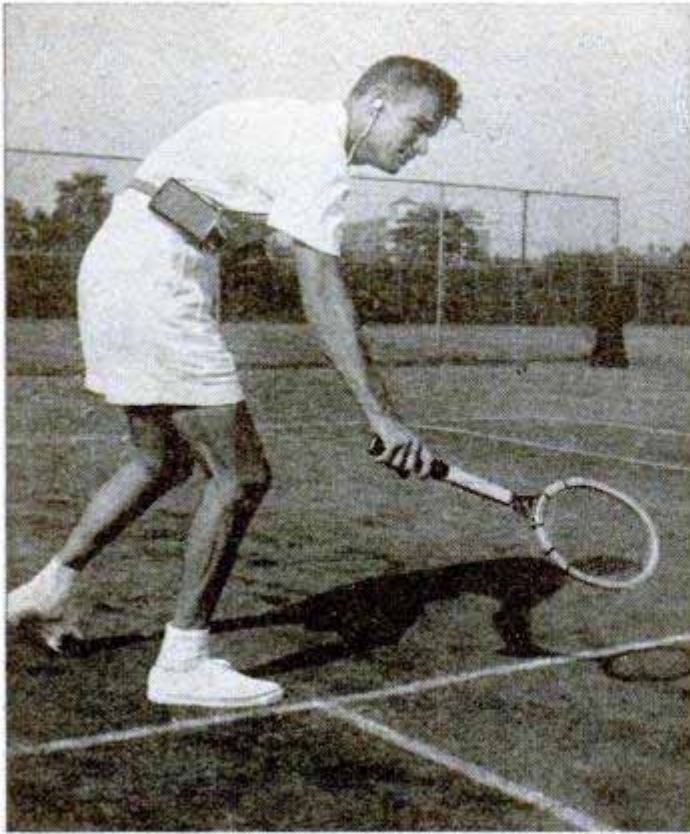

Coach Beams Instructions to Players By Short-Wave Radio

Coaches can instruct players by short wave with a miniature transmitter and receiver that has a headset about the size of a hearing aid. One of the tiny broadcasting stations has been assigned an FCC license and was used by coach Mercer Beasley at the Forest Hills tennis courts. The coach speaks into a microphone and his words are

picked up by an antenna in a belt worn by the player. Attached to the belt is a small box which holds the batteries for the transformer. Beasley conceived the idea for the coaching aid and Charles Lundgren, a sports enthusiast, developed the equipment. The men say that it can also be used to coach other sports.



Suits Travel Without Wrinkling In Automobile Garment Bag

Three suits are held without wrinkling in a waterproof garment bag designed for use in automobiles. Made of plastic-coated fabric, the bag has a full-length slide fastener. The material is said to be long-lasting because weather and rough treatment will not harm it.

Secret Chemicals of Head-Hunters May Aid Fight Against Cancer

Secret chemicals, said to have been used by the head-hunting tribes of South America, may provide a weapon in the fight against cancer. Because cancer is a condition in which the cellular tissue multiplies rapidly, the chemicals, used by the savages to shrink the heads of their victims, are thought by Dr. Wilburn H. Ferguson of Ecuador to be a means of returning the cells to normalcy. The chemicals are held in secrecy by the tribes and it was only after years of friendship that Ferguson was given a small jarful of the formula.



BUILD YOUR OWN FURNITURE

The CRAFTSMAN

★ In answer to many requests for good furniture design, the Craftsman editors feel especially proud in presenting the beautiful modern bedroom suite pictured in full color on page 190. Designed and constructed exclusively for Popular Mechanics, it was built in a home workshop with the tools pictured in the story to prove that it can be duplicated easily by the average craftsman. Patterned after the popular functional style, the group features a novel bed which incorporates storage space in the headboard. A special feature of the design is the inset or "hopper" front which gives a pleasing shadow line. Stock plywood reduces cost.

★ Ordinarily, craftsmen think of a bandsaw only as a tool designed primarily for making outside curved cuts in stock of varying thicknesses. But, properly set up and fitted with simple fixtures, this common shop tool can handle a wide variety of work difficult to do by any other means. A comprehensive shop article on page 230 explains in detail how to run a bandsaw.

★ An excellent two-man boat for fishing small lakes, this little plywood job is light enough to be transported on a car-top luggage carrier. Its construction, described on page 202, is simplicity itself, requiring no complicated patterns to be followed.



HOW TO RUN A BANDSAW

11½-FT. PLYWOOD ROWBOAT

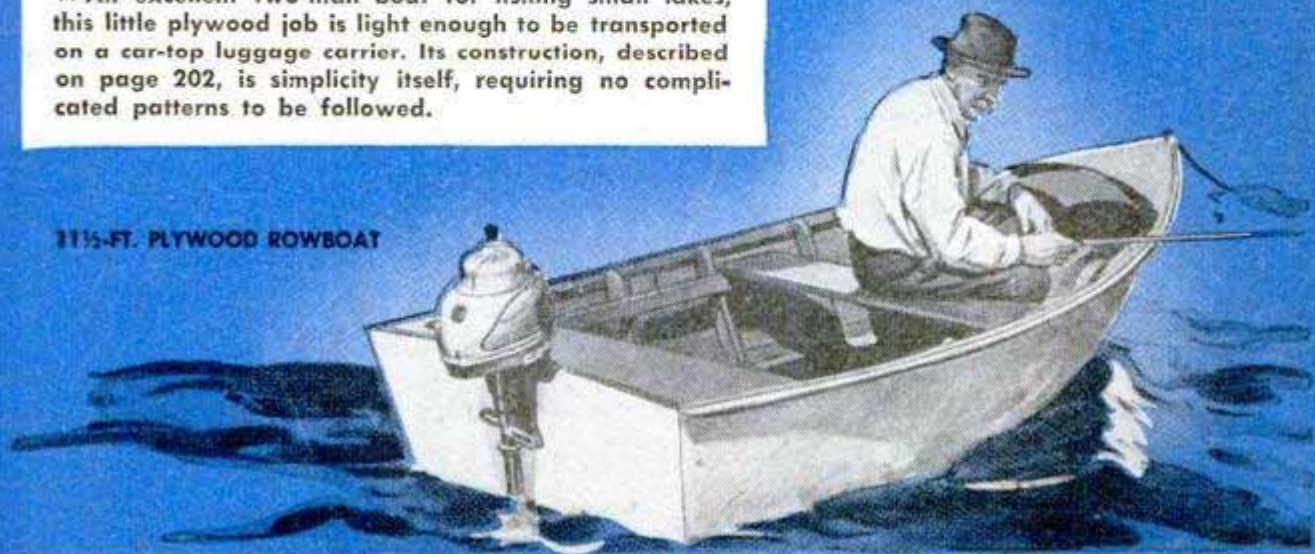

humidor-and-pipe rack

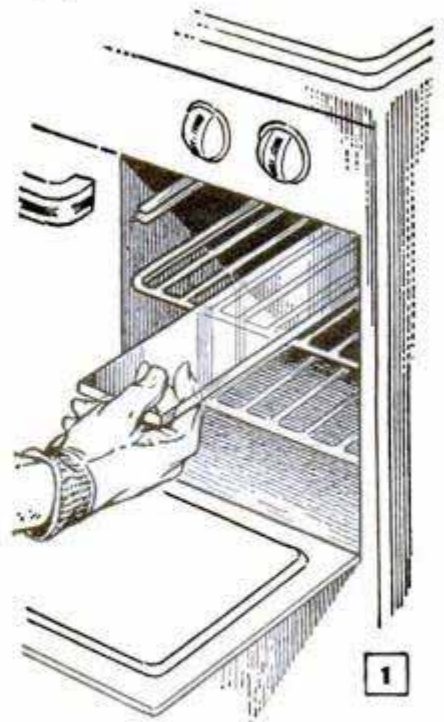

The plastic is made pliable by placing it in an oven set at 250 deg. F. When pliable, the plastic is handled carefully with gloves

Humidor-and-pipe rack: The humidor, Fig. 2, is a cylinder formed from a sheet of heat-forming crystal plastic, $\frac{3}{16}$ x $4\frac{1}{2}$ x $13\frac{1}{4}$ in. Forming is done by heating the sheet until it is pliable, Fig. 1, and then rolling and placing it in a forming jig to cool. The jig consists of a piece of sheet metal held in cylindrical form by two pieces of plywood cut out to slip over each end, Fig. 3. When the plastic has cooled, it is removed from the jig, the two

By R. Barsamian

PROJECTS

ends are coated with cement (ethylene dichloride) and held together a few moments until the cement sets. Then the plastic is again placed in the jig and wrapped with cord until thoroughly hardened.

The cylinder is cemented between two flat pieces of plastic. The top one is drilled for pipestems and an opening is turned in its center to suit the

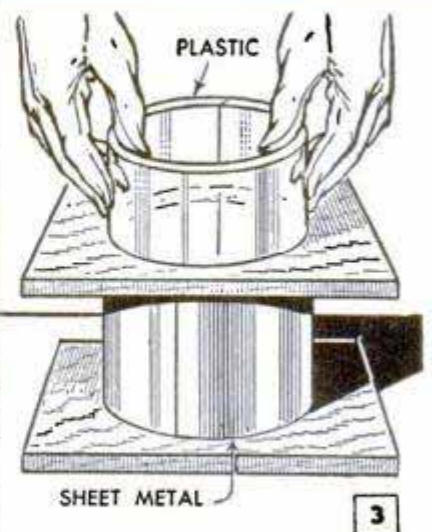
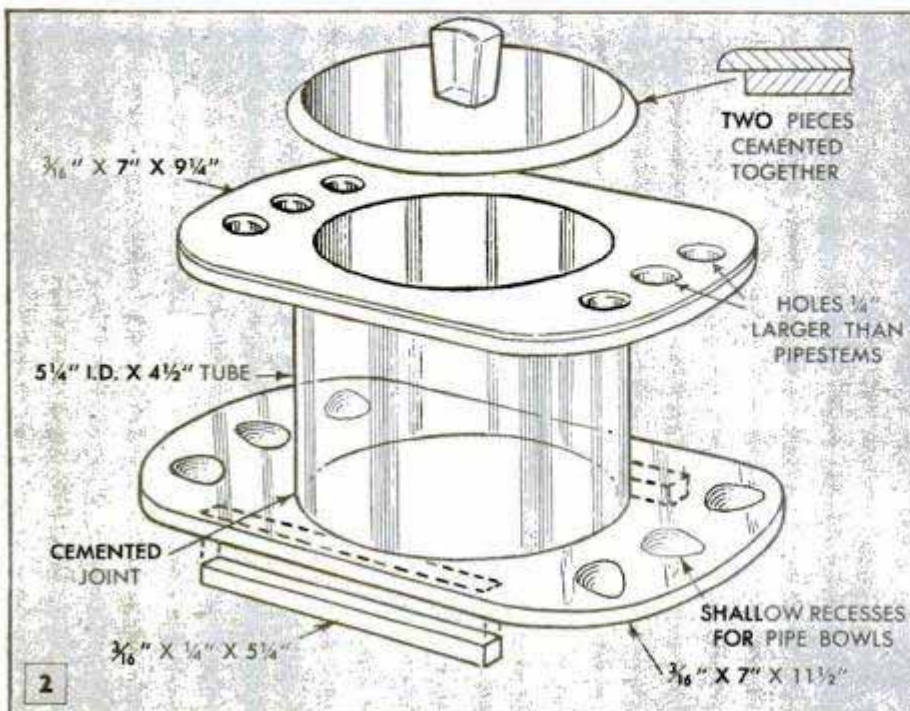

The pliable plastic is rolled to a cylindrical shape and placed in a sheet-metal mold to cool. As it cools, the plastic sheet will expand and conform to mold



4

Internal edges of the plastic are polished with a felt spindle-type buffer attached to polishing head. The buffer is charged with rouge

chip-and-card holder



in PLASTIC

inside diameter of the humidor cylinder. The edges of the holes are polished as in Fig. 4, and shallow depressions for the pipe bowls are formed and polished in the top surface of the bottom piece with a hand grinder. Two strips are cemented to the bottom of the base to provide feet.

Chip-and-card holder: Wells for the chips are cut from standard tubular stock

of the proper size. A groove is cut across the back of each tube near the top to receive the handle, and a finger slot is cut in the front of each tube. The wells are cemented to two separate pieces which are spaced apart and, in turn, cemented to a base piece to form a track for two playing-card containers. Note, Fig. 5, that shallow depressions are first filed in the edges of these pieces under the chip wells. These provide finger grips for removing the chips.

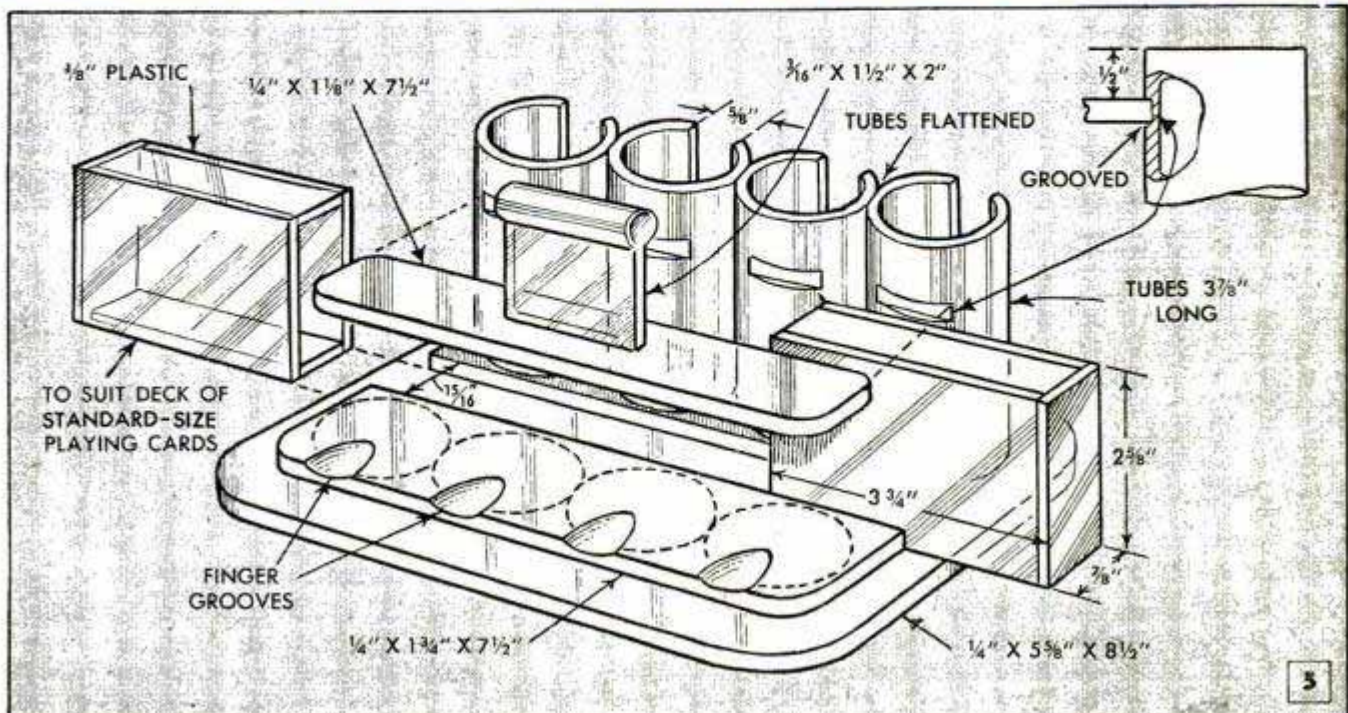

5

Furniture You Can Build p. 83.

w m - 91

Fireplace Rails of Polished Brass Pipe Are Assembled With Door-Hinge Parts

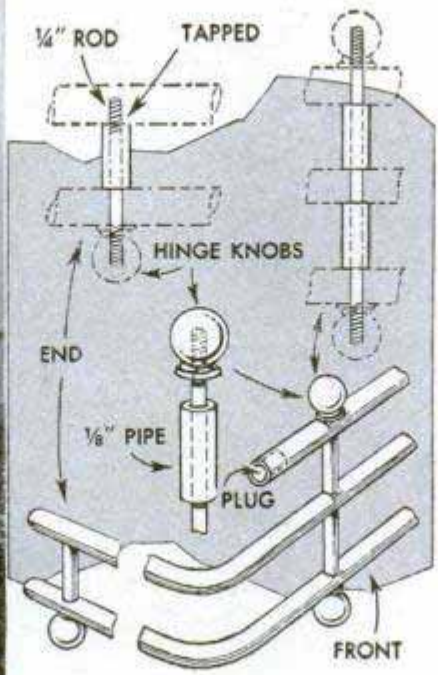

One homeowner added a decorative touch to the hearth of his fireplace by setting these modernistic brass rails in front of the andirons. The rails, cut and bent from lengths of 1/2-in. brass pipe, are held together with several ball tips taken from loose-pin door hinges. Spacers of 1/8-in. brass pipe are placed between the rails and the tips, after being tapped, are screwed onto the threaded ends of 1/4-in. rod. To give the appearance of rod stock, the open ends of the short top rail are plugged with pieces of brass stock, pressed in place and filed flush. All parts are buffed and lacquered. — Carl J. Terjung, Brooklyn, N. Y.

Wooden Coat Hanger Provides Short Rails for Workbench or Table Top

Arms of a wooden coat hanger are already shaped to provide short rails for the top of a workbench or table. It's just a matter of cutting them from the hanger, as shown, and fastening them in place. A wooden backing strip should be nailed to the edge of the bench top before attaching the rails.—Roland Cueva, New York City.

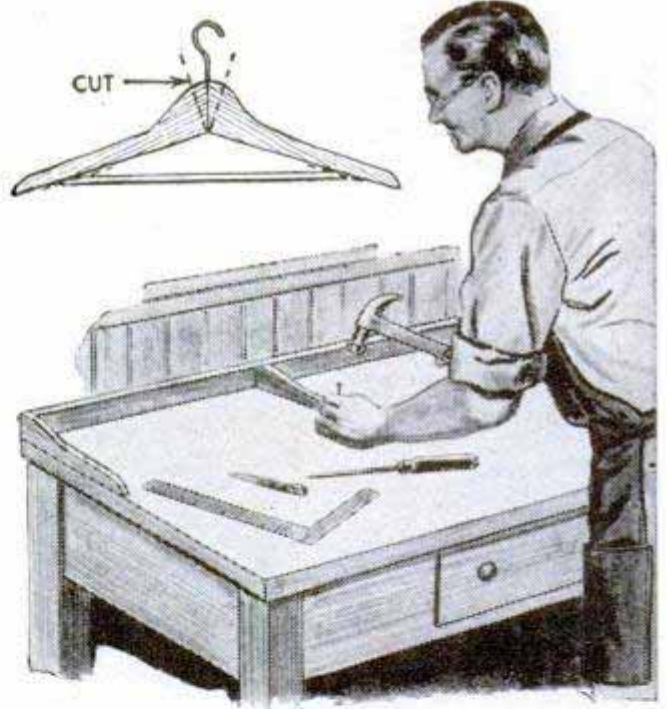

Improved Grinding-Wheel Dresser From Old Hacksaw Blade

If a wheel dresser is not available, a grinding wheel can be trued with a discarded hacksaw blade. First set the tool rest about 3/4 in. from the wheel. Then lay the saw blade flat on the rest and at a 45-deg. angle to the edge of the wheel. Holding the blade firmly, feed it slowly back and forth with light pressure. After a little experimenting to find the proper technique, the wheel can be dressed quickly.—C. R. Van Druff, McLouth, Kans.

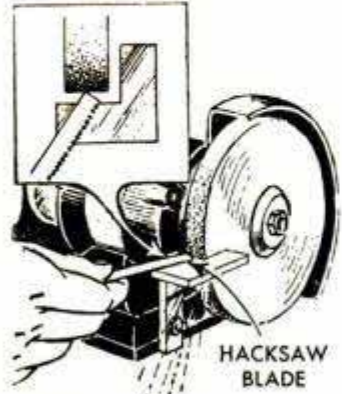

Power Handsaw Run Through Joint Aids Fitting Plywood Panels

Rather than take the time to plane the edges of plywood panels before abutting them, I obtain a perfectly matched joint in just a few minutes by laying the panels edge-to-edge on a flat surface and running a power handsaw through the joint. The panels, of course, must be temporarily tacked in place. A straightedge tacked to one of the panels is used as a saw guide.

Glue spots can be removed from fabric by soaking the spots with hot water and soap and then wiping dry with a clean cloth. Repeat this operation as often as necessary to remove the glue spot from the fabric.

C. E. Barker, Calgary, Alta., Can.

WASTEBASKETS

This basket was made from thin plywood salvaged from a shipping carton, although hardboard can be used. The bottom consists of a 10½-in. disk of ¾-in. wood around which the plywood is wrapped and fastened with small nails. The abutting edges of the plywood at the seam are faced on both sides with a plywood batten and nailed with escutcheon pins. Then the rim and bottom edge of the basket are covered with plywood hoops which are held with roundheaded gimp nails. The exposed ends of the hoops are tapered and lap about 4 in. The gimp nails at the top are clinched on the inside. Two strap handles complete the basket

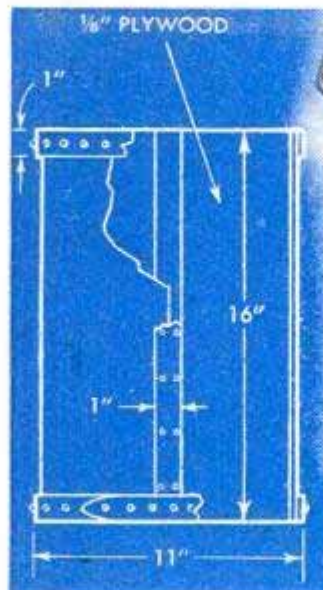

The utter simplicity of this five-piece basket will appeal to the beginner having few tools. The sides, being exactly alike, can all be sawed and drilled at one time from either plywood or hardboard. The edges are beveled 45 deg., and the bottom of the basket is a square piece of ¾-in. solid wood. Other than the screws which are used to attach the sides to the bottom, no metal fastenings are used, as the corners are laced together with a ¼-in. leather thong or a shoelace. Lacing is done in a manner similar to lacing a shoe, starting at the bottom and ending at the top with a knot on the inside

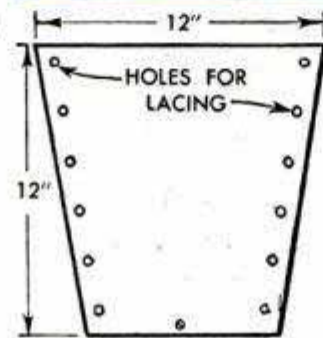

SIDE, 4 REQD.

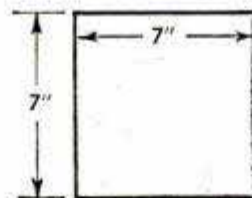

¾" BOTTOM



Consisting of eight tapered staves screwed to a solid-wood bottom and laced together at the top, this basket is somewhat more difficult to make than the one described above. Here the edges of each stave are beveled 22 deg. to produce mitered joints when the staves are assembled. The edges can be sawed on an angle if a power saw is available, but if the beveling must be done by hand, the staves are cut out and then beveled with a plane. With the latter method, uniformity of the bevel can be assured by using a jig to support the stave at the proper angle and the plane horizontally. Sash cord or clothesline is used to lace the staves. The ends can be knotted on the inside or tied in a bow on outside. Finish all parts before assembling





GILT PICTURE FRAMES are cleaned easily with a brush dipped in a mild solution of washing soda. After the frame has dried, brush it thoroughly with clean water

SOLVING

STEAMING WALLPAPER to remove it from a hall or other small room can be done quickly with your household iron, especially when so small a job does not justify renting a steamer. Dampen a cloth and fold it into a pad. Then hold the iron against the pad to steam the paper loose. Keep wetting the pad

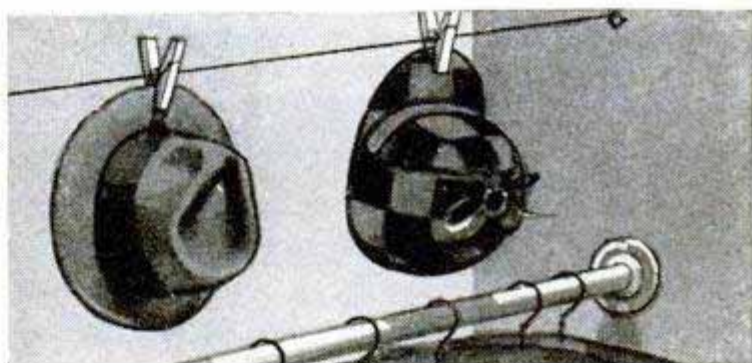

HATS, CAPS AND GLOVES will take less space in crowded clothes closet when they are hung on a wire strung above the clothes pole. Spring clothespins are threaded on the wire which is attached to screw eyes



LENGTHS OF LIGHTWEIGHT CHAIN held across the front of a bookcase with snap fasteners, left, prevent small children from taking books from the shelves

WINDOW-SHADE WEAR due to the irregular tracking of the shade when raised or lowered, is eliminated by attaching two auto-window antirattlers at the top of the shade roller and near its ends, below

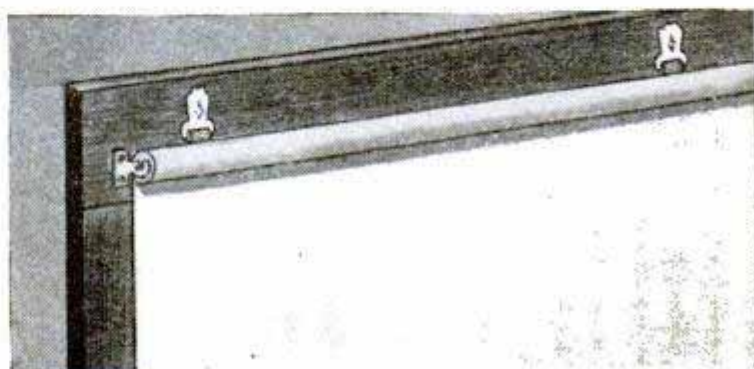

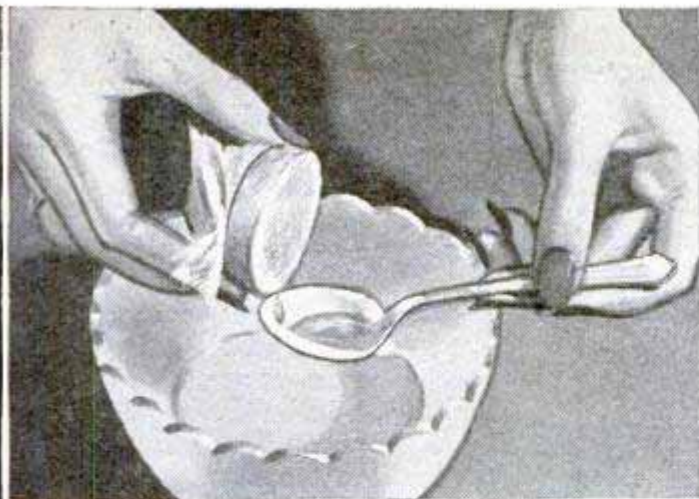

SQUEEZING A LEMON through cheesecloth is an easy way to obtain a small quantity of strained juice. The cloth is moistened with water so it will not absorb the fruit juice and then fastened over the end of the lemon with a rubber band

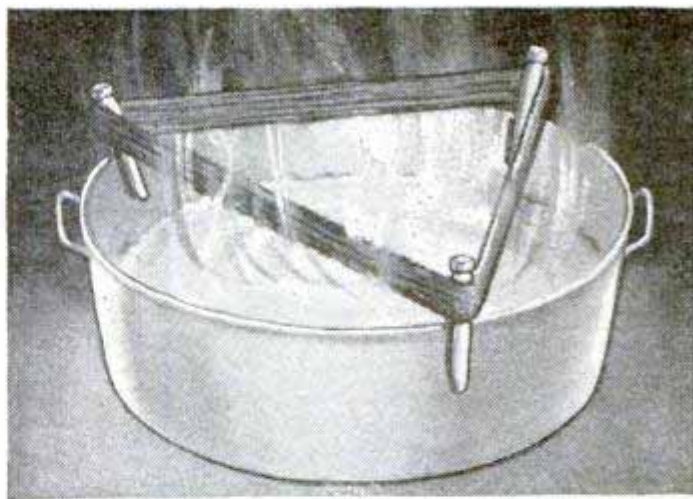

YARN FROM OLD SWEATERS or dresses can be reused if the kinks are removed by steaming over a pan of water. To do this, slip three clothespins over the rim of the pan and wind the yarn around them. It takes only a few minutes of steaming to straighten the yarn for reuse

HOME PROBLEMS

HAND-LOTION DISPENSER fastened to the wall above a bathinette provides a convenient dispenser for baby oil, right. With the oil bottle turned into the dispenser, the oil can be obtained with one hand while baby is held with the other

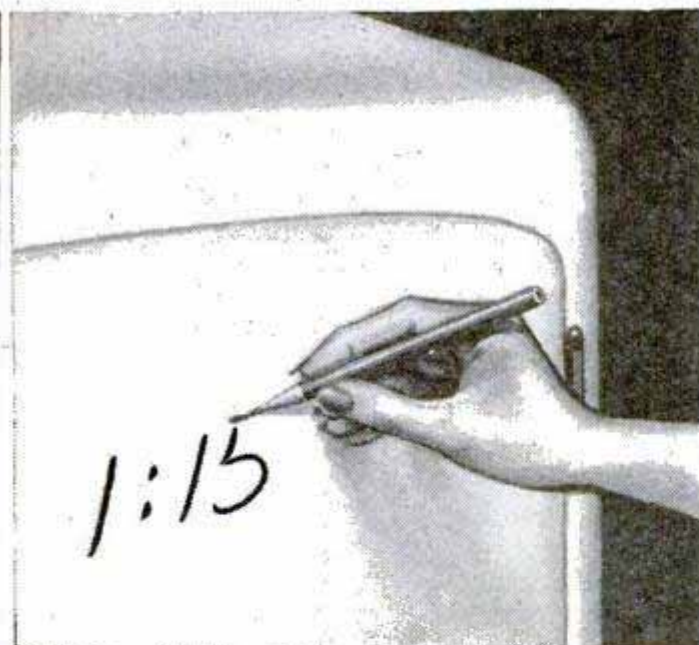
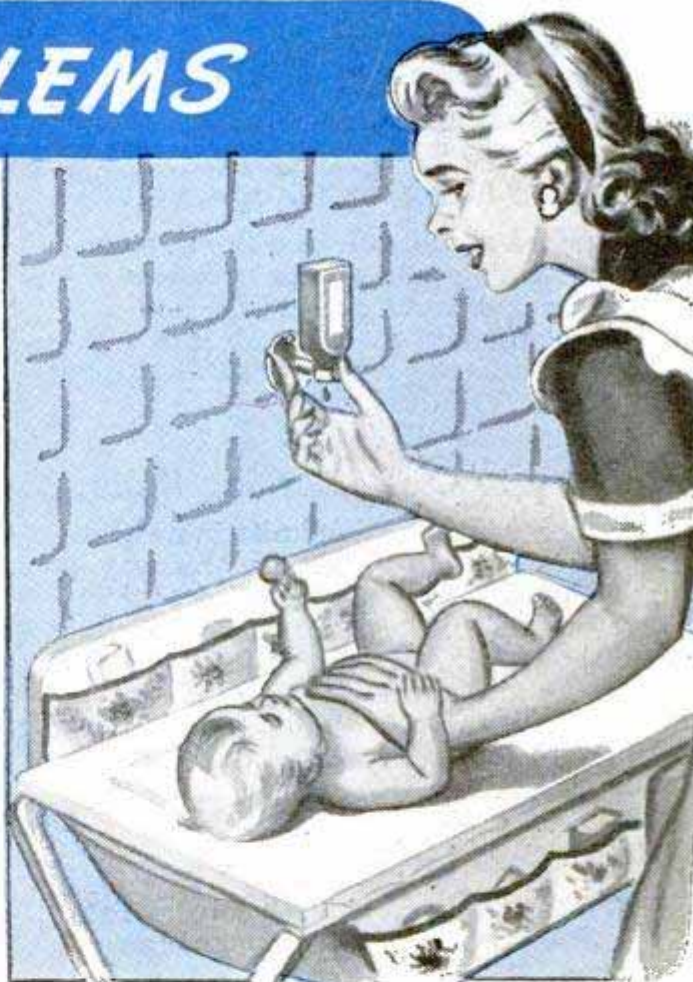

IF SHERBET OR ICE CREAM must be removed from the refrigerator at a definite time, write the hour on the refrigerator door with a grease pencil, above. Then, when in the kitchen, you are sure to notice the reminder. Marking is wiped off

STORING BUTTONS in a plastic egg container keeps them separated and makes selection easy. The depressions which hold the eggs in the container are about 1 in. deep and provide space for storing twelve types and colors of buttons



Furniture You Can Build p. 123

Doors Between Living and Dining Rooms Fitted With Modern Swinging Bookcases

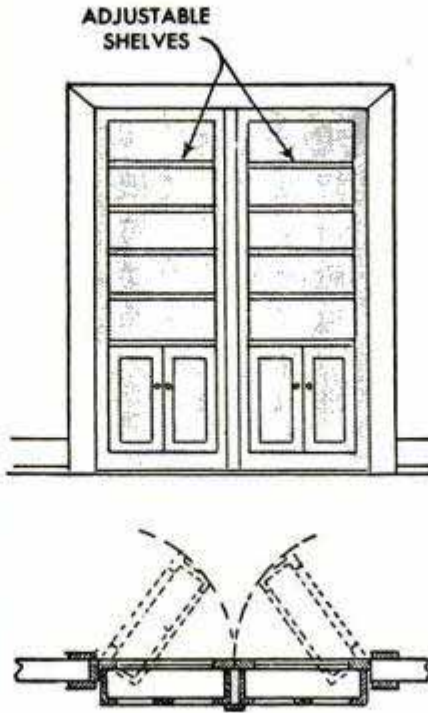
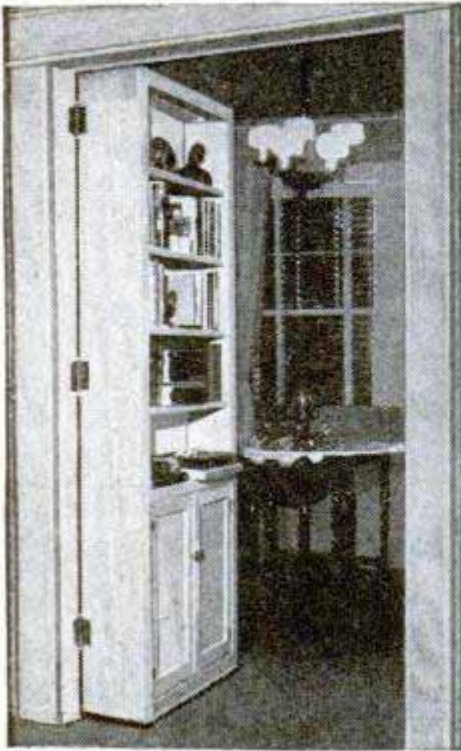

Our home is one of the older types which originally had large sliding doors between the dining and living rooms. To avoid a major remodeling job, we hit upon the idea of modernizing the opening by fitting it with two doors in the form of bookcases. Viewed from the living room, the doors appear to be a built-in bookcase. A large mural on the dining-room side adds an unusual decorative treatment to that room. Three heavy hinges fasten each door to the jamb. Note that space is allowed between abutting edges of the doors to permit them to close. A facing strip nailed to one of the doors covers the gap.—Nan Thomas Issett, Burlington, Vt.

Adjustable Marking Gauge

A standard zigzag rule doubles as a convenient marking gauge with sufficient accuracy for most work around the home. It is readily adjusted to the desired dimension and the folded portion serves as a guide along the edge of the work.

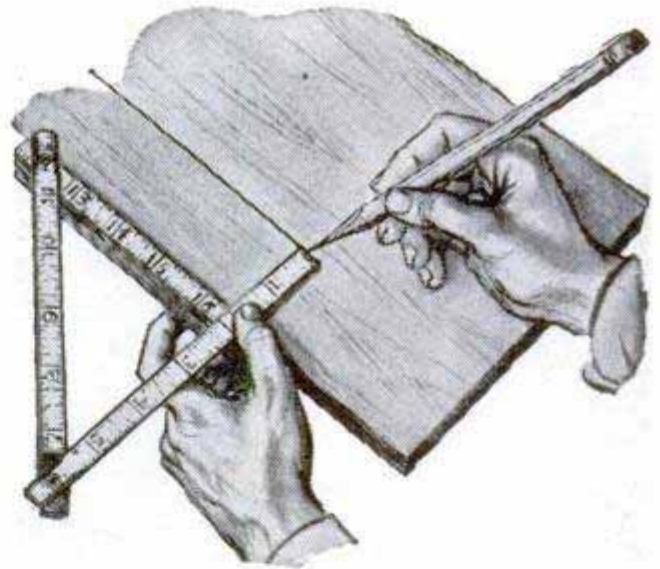

Safe Way to Carry Hunting Knife

Always carry a hunting knife in a sheath strapped over a hip pocket. In this way, a stumble or fall will not result in injury. It is also a good idea to reinforce the edge of the sheath with extra copper rivets. If there is no strap to hold the knife, run a leather thong through the belt slits in the sheath and tie it around the knife handle.
R. A. Jenkins, St. Louis, Mo.

Sanding Tool for Small Work

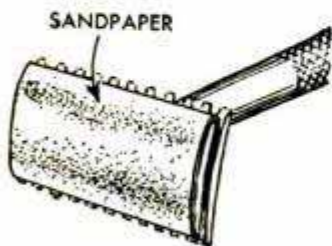

An old safety razor makes an excellent tool for sanding small jobs, especially curved surfaces. A piece of sandpaper is held in place by

tucking the ends between the head and comb of the razor and tightening the handle in the usual way. If very fine sandpaper is used, several pieces can be mounted on the razor and the top one removed when it becomes worn.

Jeff Sterns, New Bedford, Mass.

Key Ring Holds Bus Ticket

One commuter saves the embarrassment of fumbling for his bus ticket by inserting it in a large spring-type key ring. In this way, even though carried in the change pocket, the ticket can be located quickly.

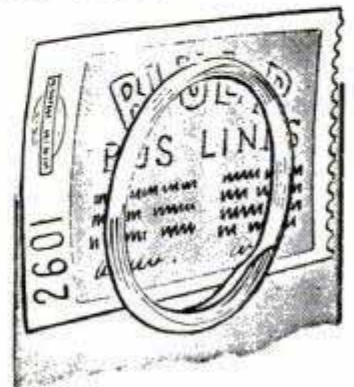

When baby begins to outgrow his high chair, an ordinary kitchen chair with a doorstop screwed into each leg to add height makes a handy youth chair.

SHELF LIGHT

By Don Mohler

Mounted above a kitchen range, this handy shelf light houses a fluorescent lamp and an oilcloth shade which can be lowered to protect the wall from grease spots. The unit is also a step-saver because its flat top provides an excellent shelf for a canister set.

The lamp parts, which can be purchased at most electrical-supply stores, consist of a 40-watt fluorescent lamp, one lamp holder, one combination lamp holder and starter socket, one automatic or manual-type starting switch and a proper ballast. These parts are wired as shown in Fig. 1. As fluorescent lamps radiate considerably less heat than filament lamps, an all-wood fixture, Fig. 3, can be used. The design of the fixture lends itself to the installation of the roller and the oilcloth shade.

No dimensions are given for the shelf and valance as these can best be determined from the length of the window-shade roller and the tube. The lamp holder must be drilled for a mounting screw, as shown in Fig. 2. The shade roller is held in place with inside brackets and the interior of the fixture is painted white. The exterior is decorated to harmonize with the kitchen.



This combination fluorescent light and window-shade backdrop for the range protects the wall from grease spots and provides extra shelf space and additional illumination to make cooking easier

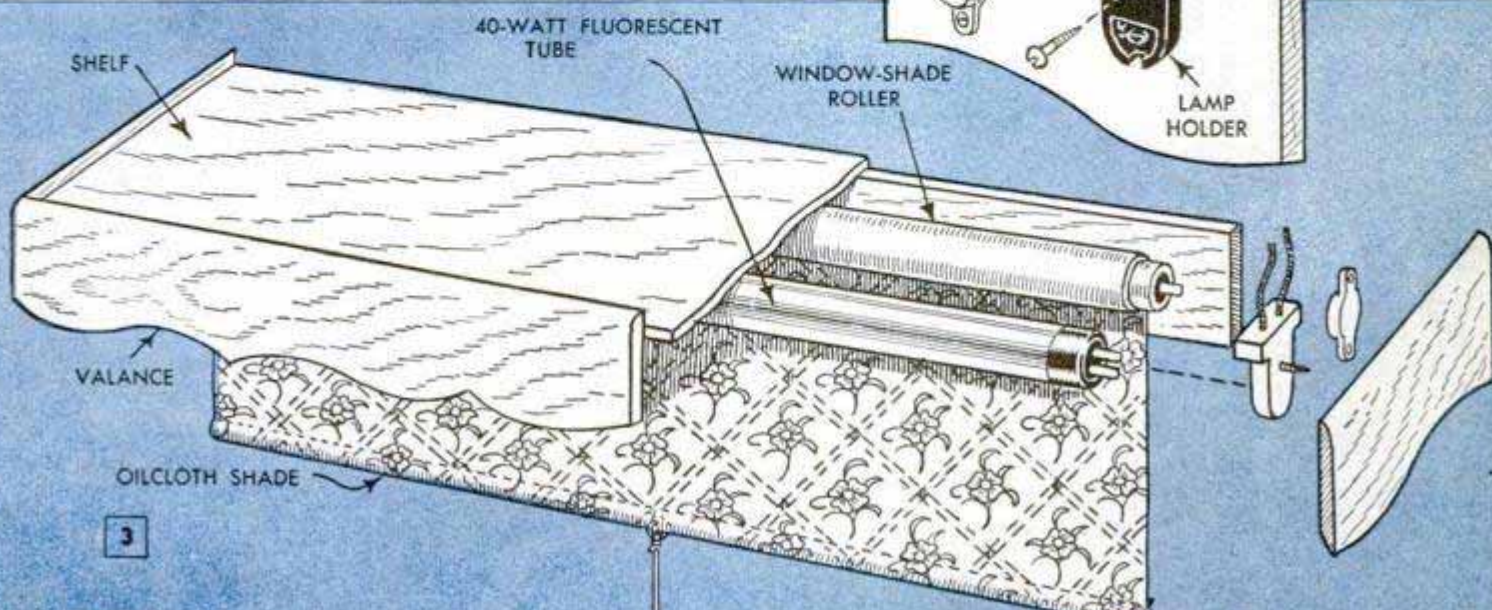
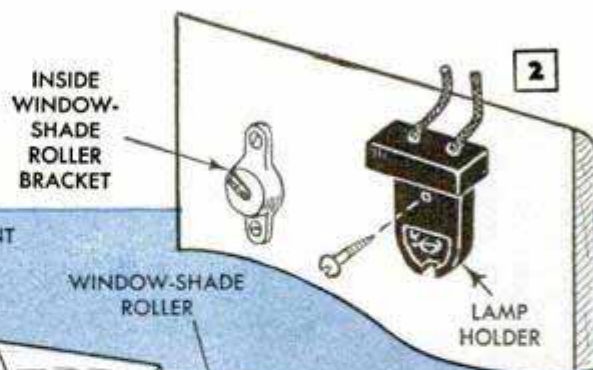
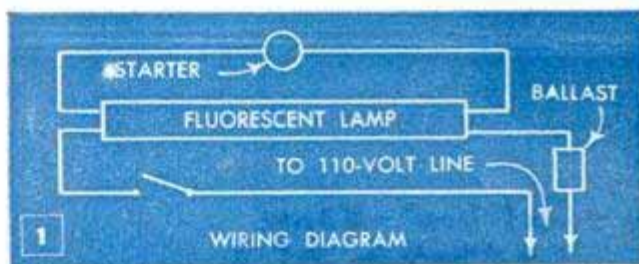



Furniture You Can Build P. 40

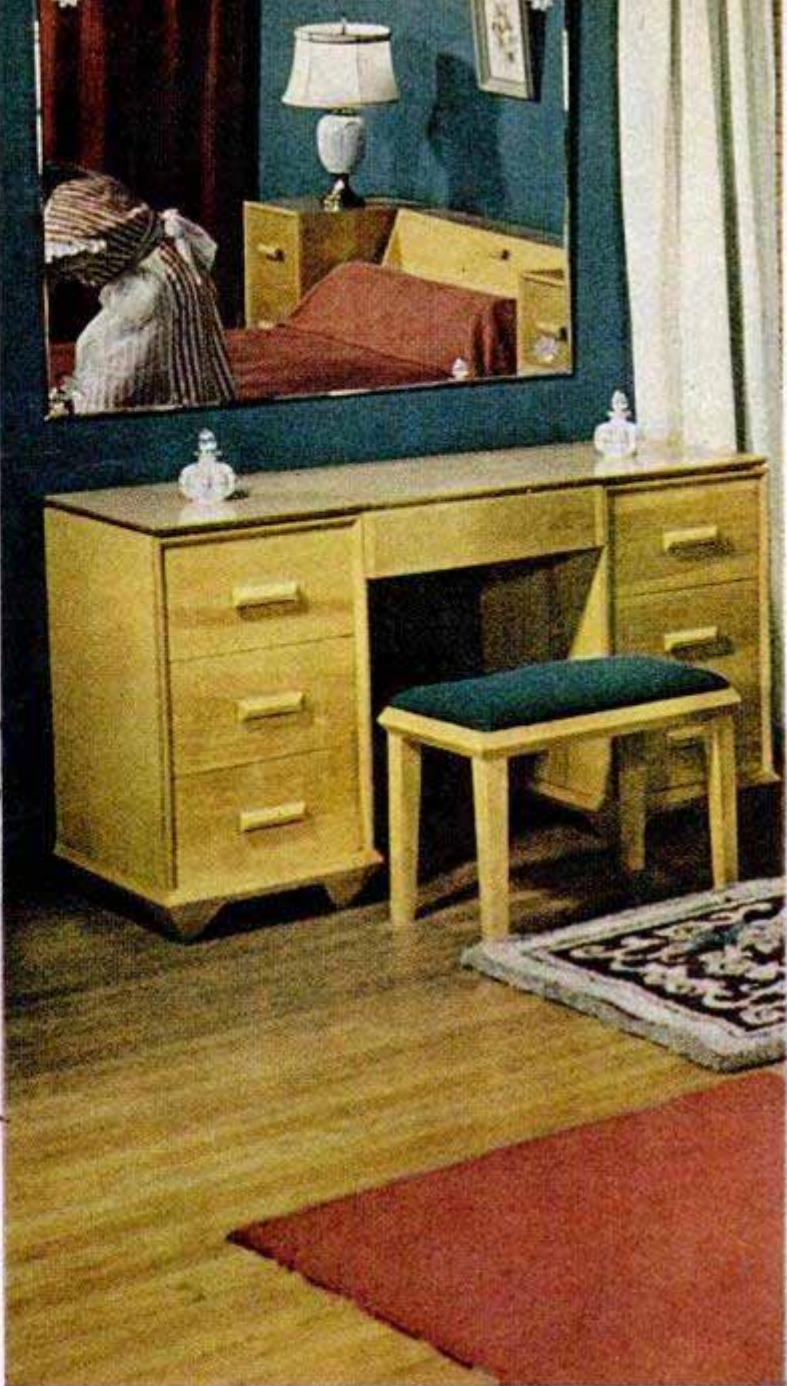

Popular Mechanics presents here a bedroom suite whose beauty lies in simple, modern lines matched by simplified construction appealing to any home craftsman. If you'd like this type of furniture extended to other rooms, write to—

The Craftsman Editor

Blueprints - Set 11145 - \$2.00
(4 prints in set)



Furniture for

Part I

PICTURE in your home this beautiful bedroom ensemble in honey maple, limed oak or rich walnut and then try to talk your way out of building it. Mom will want it by tomorrow, and if there is a teen-age daughter in your home she will say, "It's simply out of this world." Designed for flexibility, the pieces are functional and can be arranged, rearranged and interchanged to her heart's content.

All pieces are coordinated in size to fit together in sectional groups — chest, night stands and bed are all the same height. The group features a most practical bed which incorporates built-in storage space in the headboard. The front of it opens wide to reveal a spacious compartment for extra bedding and a roomy drawer pulls out at



Your Bedroom

each end of the headboard to provide storage for shoes. The chest-on-chest unit can be stacked to serve as a five-drawer highboy, or a pair of base units can be built and placed end-to-end under a large mirror to obtain the popular Mr. and Mrs. dresser. A novel three-piece vanity consists of two twin end units bridged with a separate top unit which opens to expose a cosmetic compartment and make-up mirror.

A product of a basement shop, the original furniture was built with the power tools shown. Only two tools, a saw and a jointer, actually are required as the construction involves just simple,

Right, edges of the plywood are mitered with the saw table tilted at a 45-deg. angle and planed accurately on the jointer to obtain a perfect fit





HIGHBOY CHEST

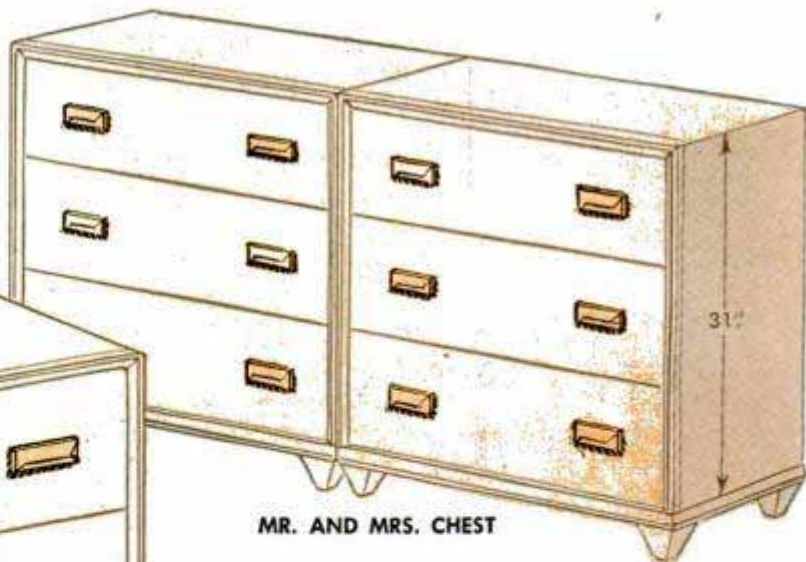

MR. AND MRS. CHEST

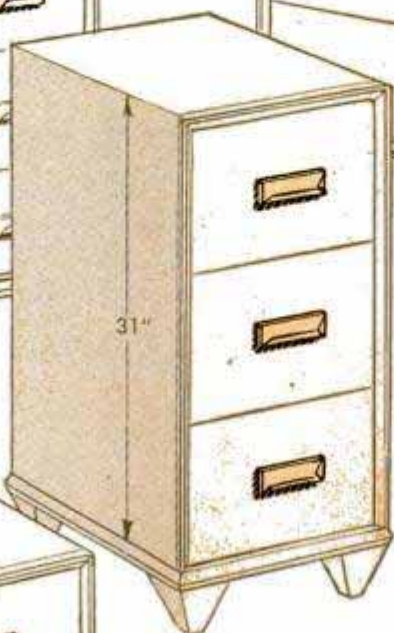

NIGHT STAND

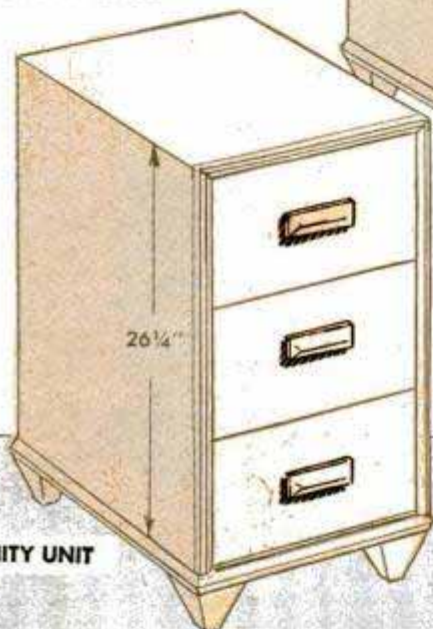

VANITY UNIT

Basic units are highly functional. Place two lowboy chests side by side to obtain the popular Mr. and Mrs. chest ensemble. The two-drawer unit stacked on top of a lowboy makes a highboy. Two vanity units spanned by a separate top unit (to be detailed in Part II) form a vanity or desk.

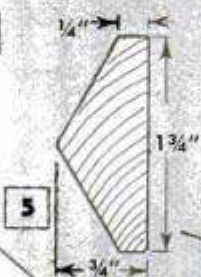
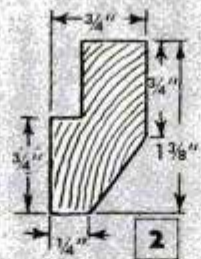
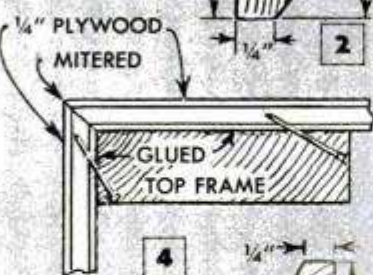
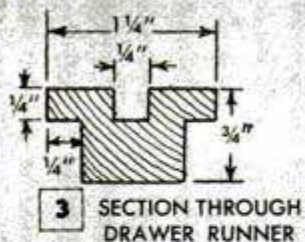

CORRUGATED FASTENER

ALL FRAMES 18 1/4" DEEP

3/4" X 2" STOCK

3/4" X 4" STOCK (SAME AT BACK)

NIGHT STAND AND VANITY UNIT 15 1/4"

CHEST 39 1/2"

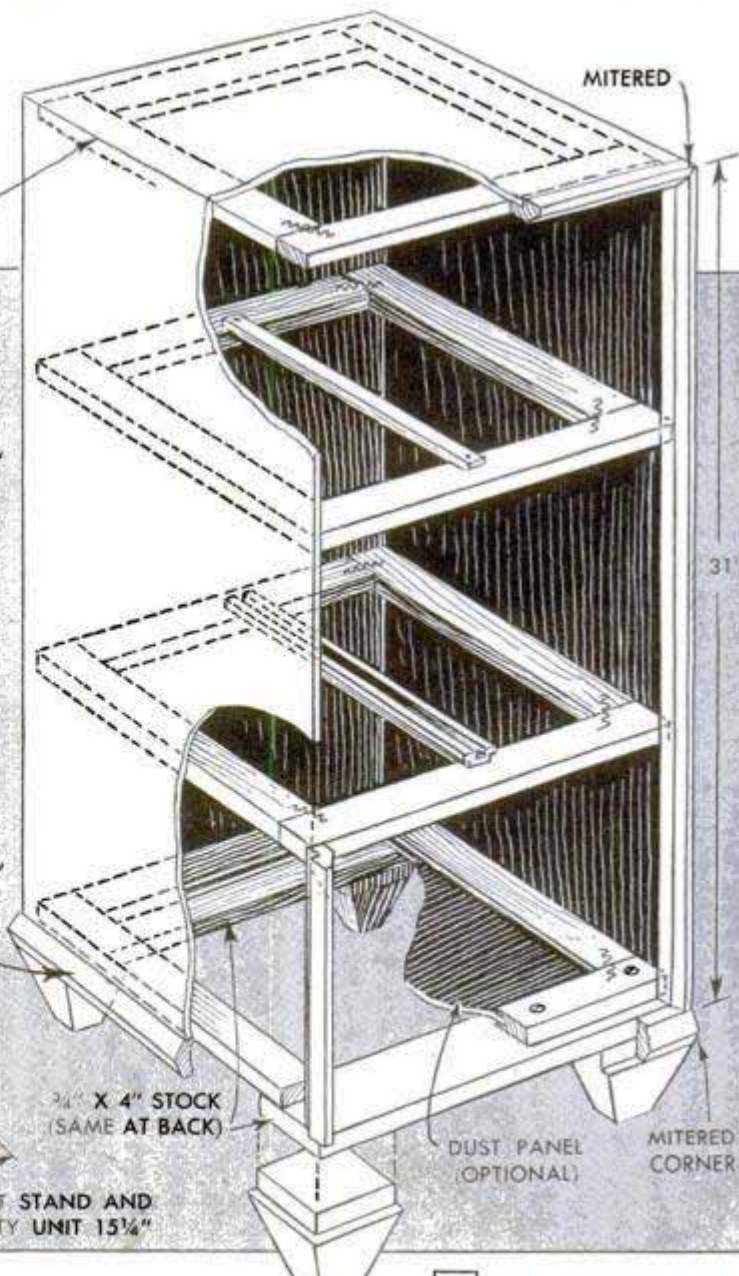

6 FRAME CONSTRUCTION

straight cuts in dimensional stock and incorporates the use of plywood to simplify the work. While the feet are shown being cut with a bandsaw, this can be done with a handsaw. Part I describes construction of the vanity units, chests and night stands. Assembly of the bed, vanity top and stool will be explained next month in Part II.

Basic construction of the night stands, chests and vanity units is exactly the same. It's merely a case of increasing the over-all height and width as given for each respective cabinet. Fig. 1 shows the extreme simplicity of construction. Each unit, with the exception of the two-drawer chest, requires three drawer frames and a top frame, four in all, which are made exactly alike as detailed in Fig. 6. Pine or other softwood will do for the frames, although the front rail of each frame can be of hardwood, if you wish. The top frame is of $\frac{1}{2}$ -in. stock while the others are $\frac{3}{4}$ -in., and if the bottom frame is to be fitted with a dust panel, a groove is centered in the edge of the members to take a $\frac{1}{4}$ -in. plywood panel. Otherwise, the frame pieces are merely butted, glued and nailed together with corrugated fasteners.

The next step is to glue and screw the bottom frame to two $\frac{3}{4}$ x 4-in. base pieces. These pieces, which are placed across the front and back, are made the same length as the frame. Note that at the front the

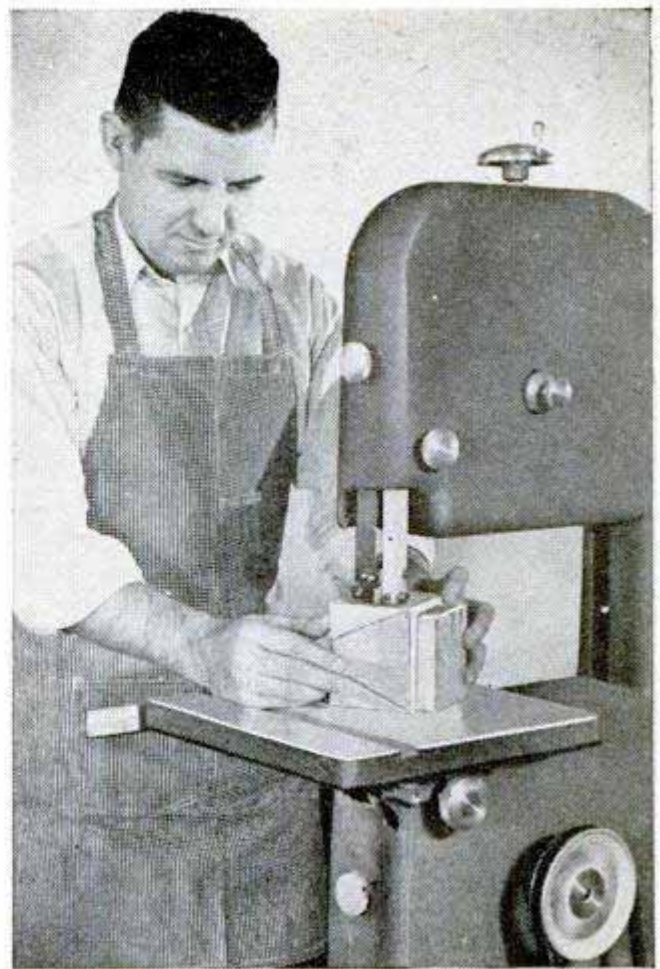

A bandsaw will speed the work of sawing the tapered feet. After two cuts are made, the waste pieces are tacked back on with cardboard between the joint to provide a flat surface for making the other two cuts

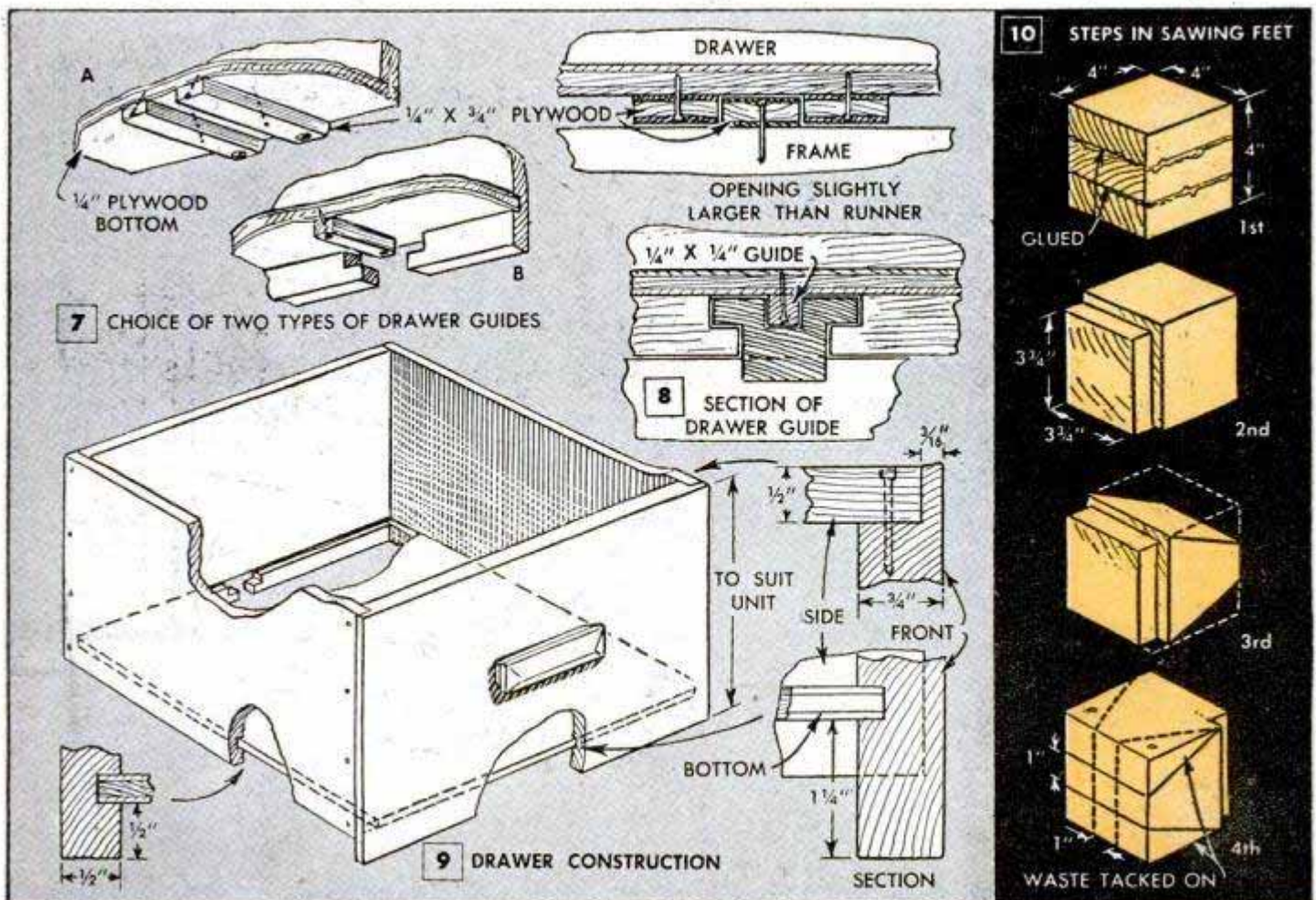

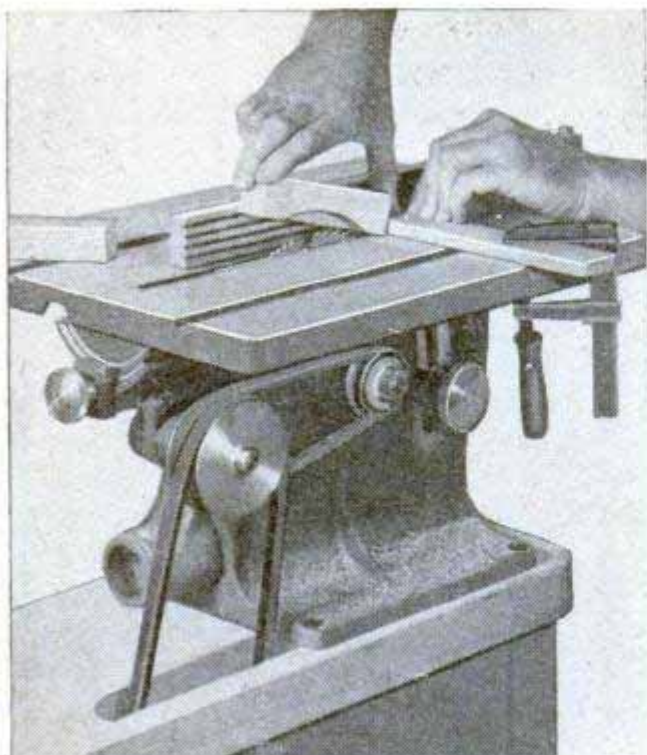

Finger grips in the drawer handles are formed by bringing the work down over the saw blade repeatedly. A block clamped to the table serves as a stop

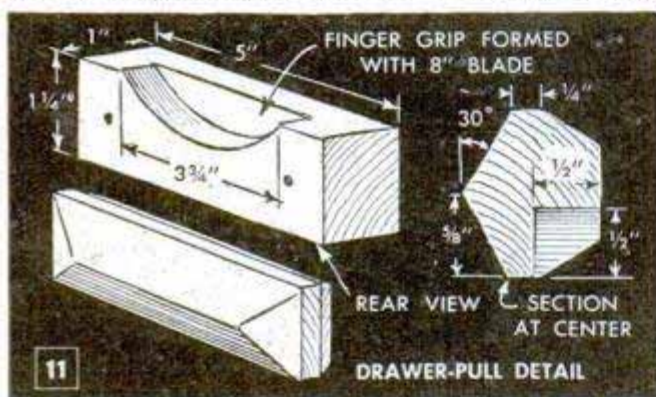

frame is placed $1\frac{1}{8}$ in. in from the edge, while at the back the frame is glued flush with the edge of the base piece. Now, a $1\frac{3}{4}$ -in. molding, Fig. 5, is mitered and glued to the edges of the base pieces so that it is flush with their top surfaces. The molding along the sides is cut $\frac{1}{4}$ in. longer than the depth of the base to allow for a $\frac{1}{4}$ -in. plywood back. Glue blocks along the sides, plus screws driven at an angle through the edges of the base pieces from the inside, are used to anchor the molding.

The edging which conceals the laminated edges of the plywood at the front is ripped from $\frac{3}{4}$ -in. stock according to Fig. 2. This is mitered and glued together as a separate assembly. The top piece of the edging is cut $\frac{1}{2}$ in. longer than the width of the frame to allow for the side panels. Glue the pieces together on a flat surface and place a temporary brace across the bottom. Next, the top frame is glued to the edging. The frame is kept flush with the rabbeted edge and is fastened with long screws driven through the edge of the frame from the inside. Now, you are ready to attach the edging-and-frame assembly to the base, but first the back panel should be made ready as this is installed at the same time. The plywood back panel is made the same width as the frames and is cut $\frac{1}{4}$ in. less than the length of the edging. Nail the panel to the back edges of the top and bottom frames and then coat the ends of the edging strips with glue and clamp to the base with bar clamps. After the glue has dried, drill a pilot hole

12 CONSTRUCTION OF HIGHBOY-CHEST UNIT

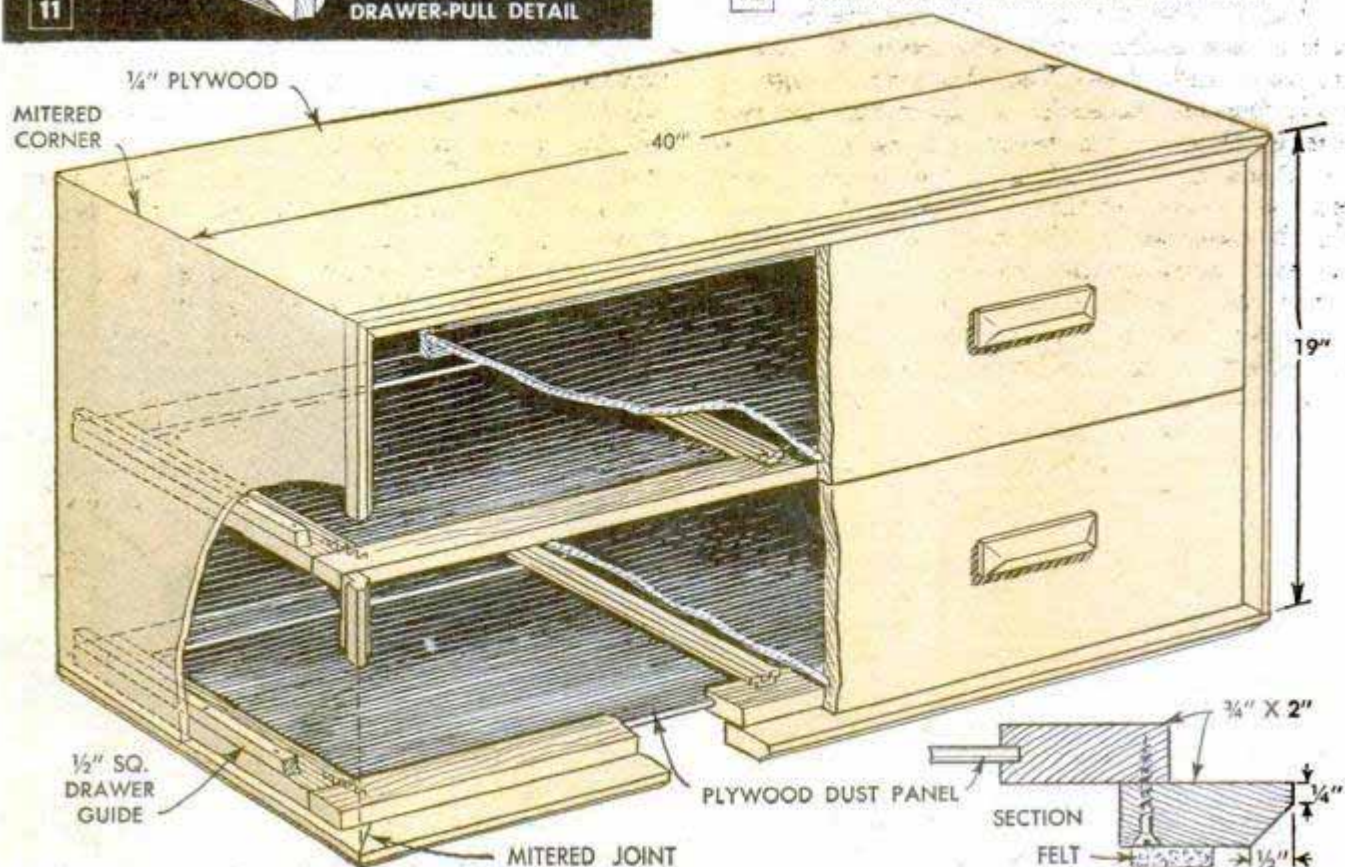

up into the end of each strip and drive a No. 9 1½-in. flat-headed screw. The remaining two frames are spaced equally between the top and bottom ones. These are fastened to the inside of the edging strips with small screws. Pockets are formed for the screws by drilling and counterboring holes through the frame at an angle.

Now, the framework is ready to be covered with ¼-in. plywood. Fit and install the top piece first. In addition to obtaining a well-fitting mitered joint, it also is important to get a tight fit where the plywood abuts the rabbet of the front edging. Use bar clamps to draw this joint tightly and C-clamps to clamp the plywood firmly to the frame. Brads can be used here, as indicated in Fig. 4, although a good resin-type glue will hold sufficiently. Like the top piece, the sides fit flush with the outer face of the edging and the molding at the bottom. Clamps should be used to draw the mitered joint together and, if you do not object to surface nailing, brads can be used to reinforce the joint and to nail the plywood to the edge of the frames.

Steps in sawing the feet are given in Fig. 10. In most cases, the blocks for these will have to be glued up using three or more pieces. The front feet require a ¼ x 1-in. rabbet on two adjacent edges, while the rear ones need a rabbet only along one side. The feet taper to 1 in. square at the bottom. After sawing two sides, the waste is replaced and held with either brads or cellulose tape so that a flat surface will be had to complete the sawing.

Typical drawer construction is detailed in Fig. 9. The method of fitting the bottom differs somewhat with the type of drawer runner used. Note that the lower edge of each drawer extends to cover the drawer frame. Drawer handles are detailed in Fig. 11. A choice of two types of drawer guides is given. One features a T-shaped runner, Fig. 3, over which the back of the drawer hooks to prevent the drawer from dropping down when all the way open. The runner is grooved for a ¼-in.-square guide, which is nailed to the underside of the drawer bottom as shown in Fig. 7, detail B. Note that the T-slot in the drawer, Fig. 8, is made slightly larger than the cross-section of the runner. A more simple guide is pictured in Fig. 7, detail A. This is formed merely by nailing two strips of plywood to the drawer bottom to form a track for a plywood runner nailed to the frame. Fig. 1 shows both types of runners in place.

Construction of the highboy (two-drawer) chest unit, Fig. 12, differs from the other units in one respect; the bottom drawer frame is screwed to a mitered base frame which is beveled to match the edging.

(To be continued)

Glove Holds Small Tools In Car Compartment

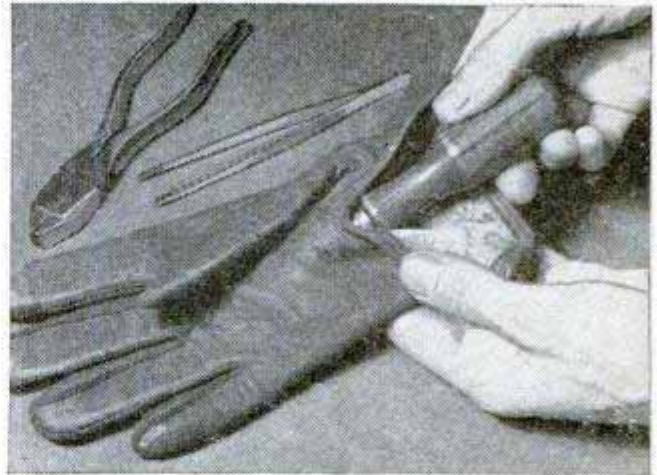

To prevent the rattling of small tools carried in the dashboard compartment of a car, insert them in the fingers of an old leather glove. This keeps the tools together but eliminates annoying metal-to-metal contact.—William Swallow, Brooklyn, N. Y.

Basement Partitions Elevated On Concrete Blocks

Because the lower portion of his coalbin wall was beginning to decay due to dampness, one man made a foundation for the wall from concrete blocks. He cut off the partition and installed a new sill at the correct height to permit the blocks to fit under it. Bolts anchored in the concrete floor with molten lead pass through the blocks and sill, as shown. Holes in the blocks then are filled with concrete. This method also prevents the walls from spreading when the bin is filled with coal.—Ernest M. Woerner, Eureka, Ill.

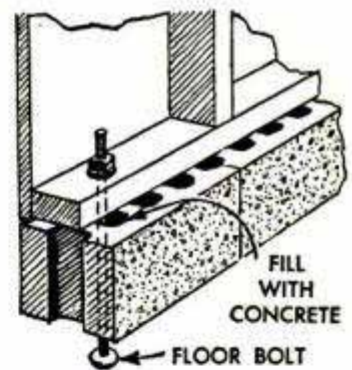

Shading Aids Pattern Tracing

Transferring drawings from one squared pattern to another is simplified and possibility of error reduced by shading alternate squares of both patterns with a pencil. This permits noting at a glance through which square the line is passing. As a further aid, the squares can be numbered correspondingly.

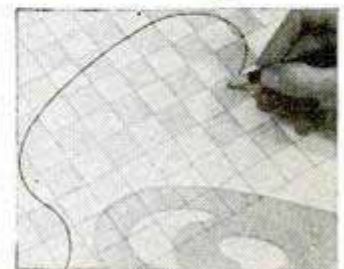

Paint Swatch on Piece of Glass Aids Matching Colors

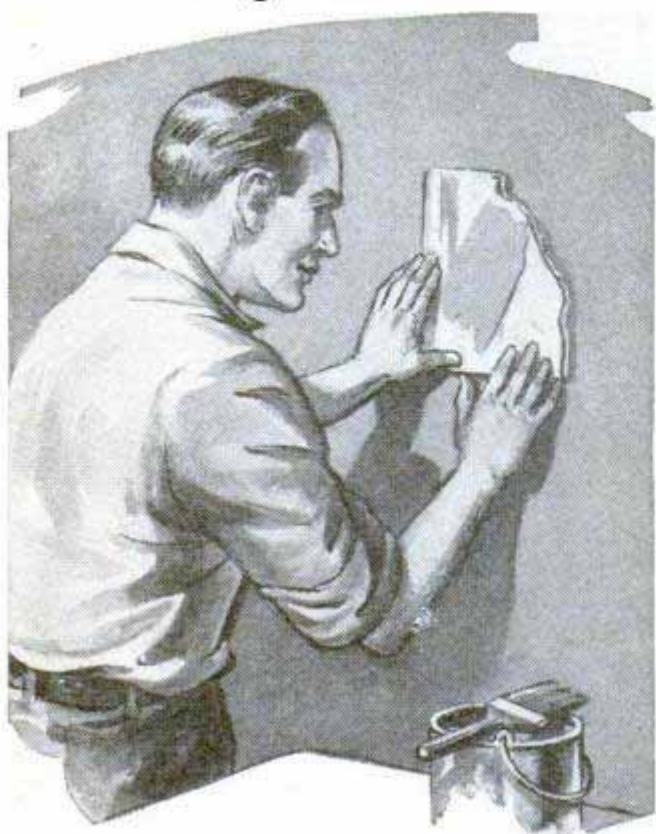

To simplify mixing paint to match work already done, smear a little of the mixed paint on a piece of window glass. Then hold the glass against the surface to be matched and compare the colors. If the swatch doesn't match, wipe it from the glass before applying another sample.

G. E. Hendrickson, Argyle, Wis.

C-Clamp Used to Drive Pegs Does Not Damage Point

Here's a trick, which I learned while making a ringtoss game, that can be applied to similar projects where pegs are used. I wanted the pegs to fit in undersize holes but the fact that the ends of the pegs were pointed created the problem of how to drive them without damaging the turned ends. I solved the problem by padding the ends of the pegs with a piece of thick felt

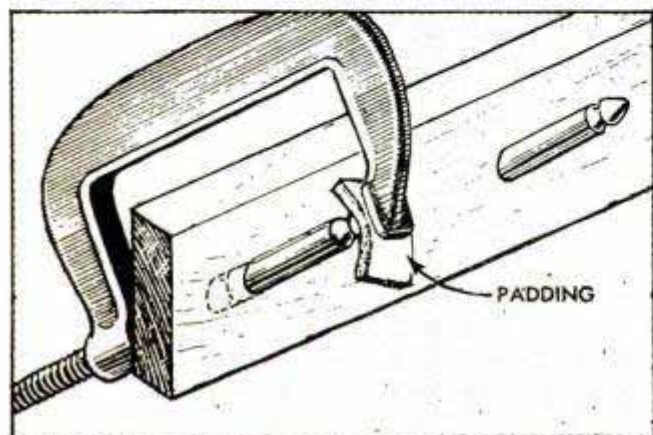

and using a C-clamp, in the manner shown in the drawing, to force the pegs into the holes.—H. Klein, Pittsburgh, Pa.

Jig Locates Wood-Turning Centers

Centering wood turnings is done quickly with this simple jig. It is made from four pieces of hardwood ($\frac{1}{4}$ -in. stock was used in the original). Two pieces are mitered at a 45-deg. angle and nailed to a cross-piece to form a 90-deg. angle at the center of the jig. A fourth piece, used as a straight-edge, is nailed to the top of the jig so one edge bisects the 90-deg. angle. To use the jig, place it over the end of the turning and draw a line along the straightedge. Then, rotate the turning a quarter turn and draw another line. The intersection of the two lines is the center of the turning.

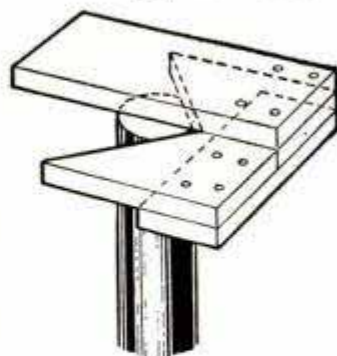

Herbert E. Fey, New Braunfels, Tex.

Calking Compound Patches Plaster

One man who found that ordinary patching plaster would not stick to his walls because of vibration filled the cracks with calking compound. Before painting, he applied the calking with his finger to the cracks and around the top of the base molding. The result was a neat, inexpensive job of patching. The calking compound should be allowed to set before paint is applied.—G. W. Marker, Tucker, Ga.

Cardboard Tie Rack for Suitcase

For the traveler who opens his suitcase only to find his ties wrinkled, this simple rack, cut from a piece of stiff cardboard, will keep ties neatly pressed. The size of the rack and the number of slots depends, of course, on the number of ties to be carried. If a more permanent rack is desired, use plywood or plastic instead of cardboard.

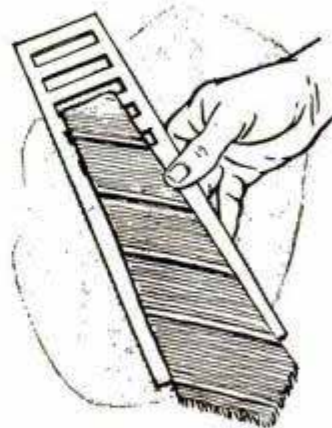

J. Harley Hosack, Hartford, Conn.

☐ Prevent damage by closing slide fasteners before washing outdoor garments.

Unusual Cigarette Box Looks Like Armchair

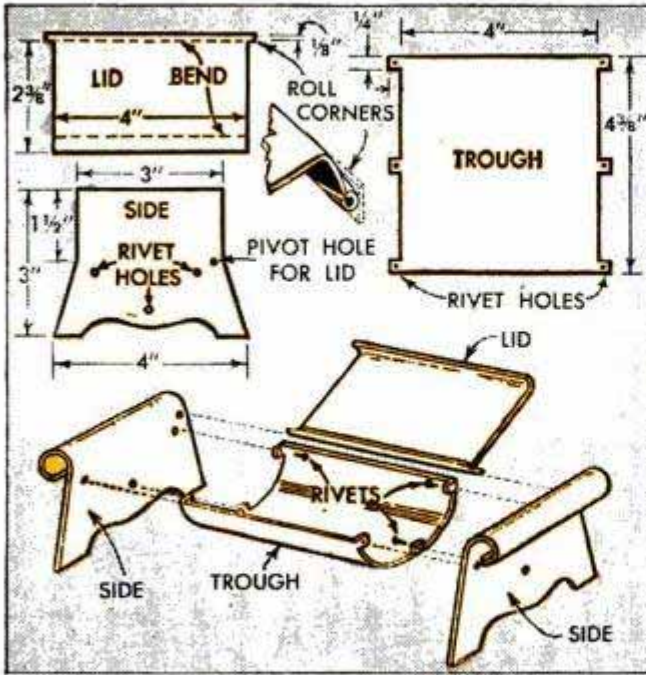

Made of sheet aluminum or copper, this novel cigarette box resembles a miniature chair when open. It consists of four pieces: two sides, a semicylindrical trough, and a pivoted lid. Although the box illustrated was designed for extra-long cigarettes, it can be made smaller for standard-length cigarettes by changing the 4-in. dimension of the lid and trough to 3 in. First, lay out the pieces on 16 or 18-ga. sheet metal and cut them to size with tinner's snips. Round the sharp edges with a file or emery cloth and drill rivet holes through the six tabs on the trough. The trough and sides are formed around a wooden dowel or a piece of pipe wrapped with heavy paper. To

avoid hammer marks when bending, use a wooden or rawhide mallet. Bend the tabs on the trough at right angles and use the trough as a template for drilling the rivet holes in the sides of the box. Two additional holes, one in each of the sidepieces, must be located and drilled for the hinge prongs of the lid. When assembling, insert the prongs in these holes before riveting the sides to the trough. The box is finished by buffing to a high luster or rubbing with fine emery cloth to a satin finish. The buffing can be done with a soft wheel charged with polishing rouge. A coat of clear lacquer will prevent the metal from tarnishing and thus eliminate frequent polishing.

Polished Tool Surfaces Rustproofed by Coating With Paste Wax

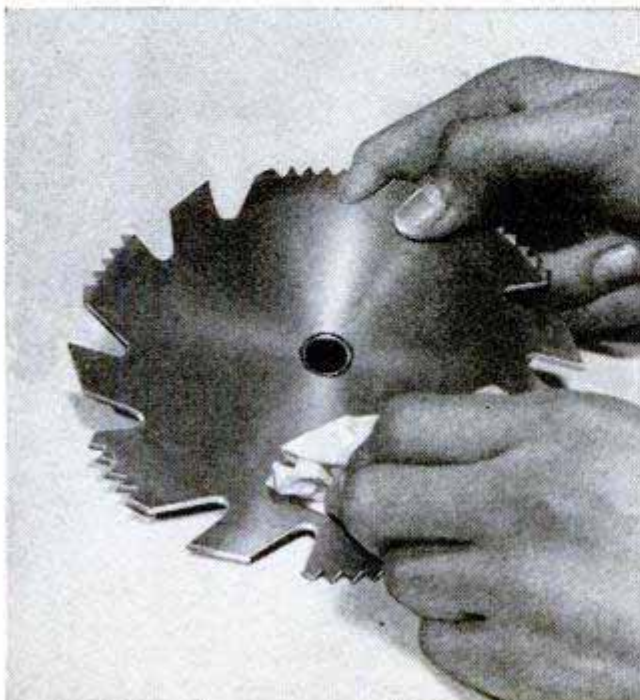

A coat of paste wax applied to the polished surfaces of saw blades, squares, etc., before storing them, affords adequate rust protection and does not necessitate removing before using the tool. The wax melts when the saw blade is in use and acts as a lubricant. The tools also are cleaner to handle than if coated with grease.

Refilling Lipstick Containers

It's easy to refill a lipstick container if both the refill and case are chilled. When both are thoroughly chilled, the old lipstick will slip out of the container easily and the refill can be inserted without breaking.—Alice Guiles, Syracuse, N. Y.

☞ You will get better light radiation from luminous paint that is to be applied over an old painted surface if you first apply a base coat of white lead to the particular spot.

DON'T BE CAUGHT

Wiring sensitive switches on doors and windows of your home and garage may not keep intruders out but it will give warning and permit you to summon help when someone attempts to force an entrance during the night

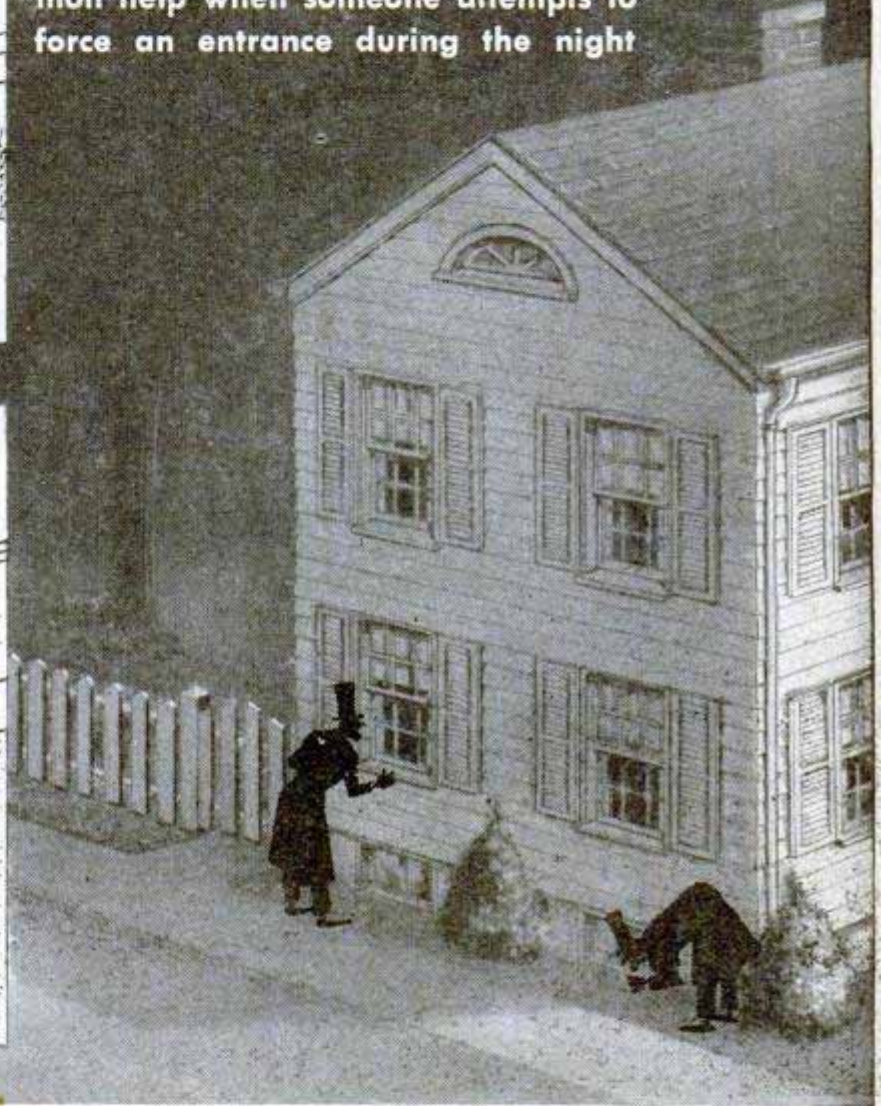
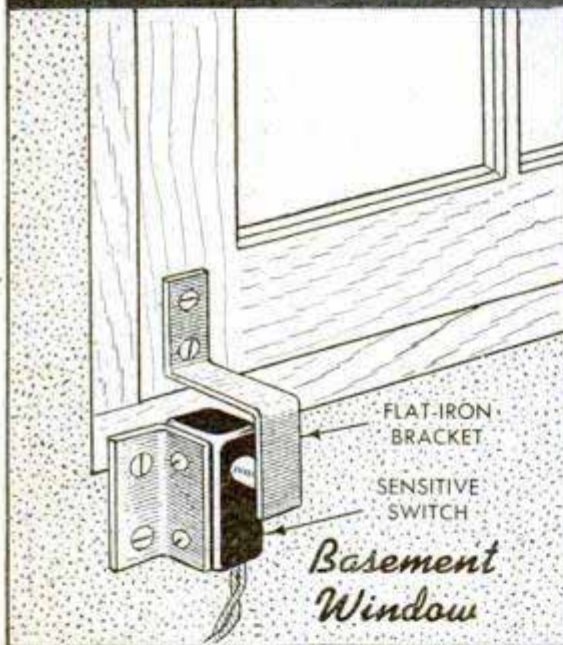
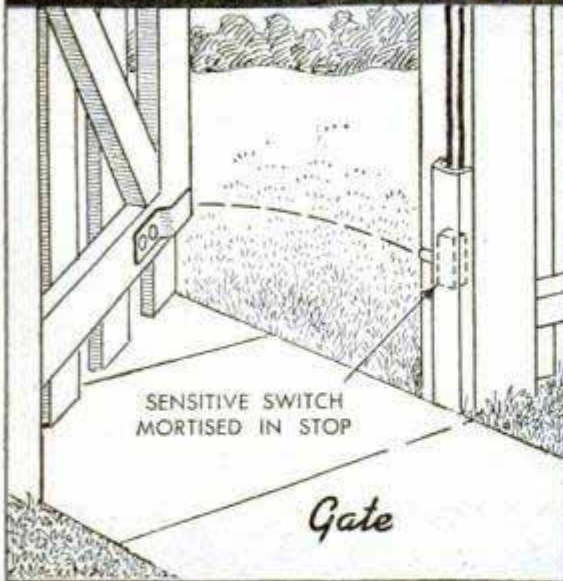

By Thomas E. Stimson, Jr.

YOU'LL get the jump on prowlers before they break in if electrical "night watchmen" are installed on doors and windows to tip you off. When a window or door is opened, pressure on tiny switches is relieved, causing a circuit to close and sound a buzzer in the bedroom. By wiring small lamps into separate circuits for the front and rear of the house, they will glow when the circuit is closed to indicate at a glance the part of the house being invaded. The system also can be wired to automatically turn on exterior floodlights and scare away intruders.

Each circuit consists of a master switch, a 6-volt buzzer, a 1.5-volt lamp and as many sensitive switches as required. These are wired as shown in the diagram to operate either off the doorbell transformer or four dry cells, and are

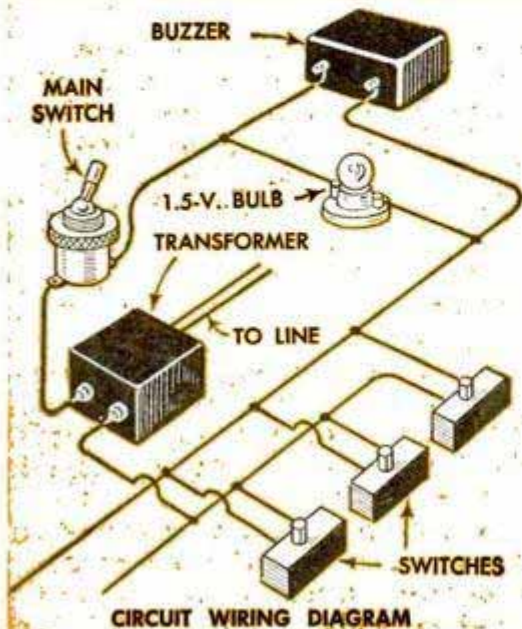

CIRCUIT WIRING DIAGRAM

NAPPING

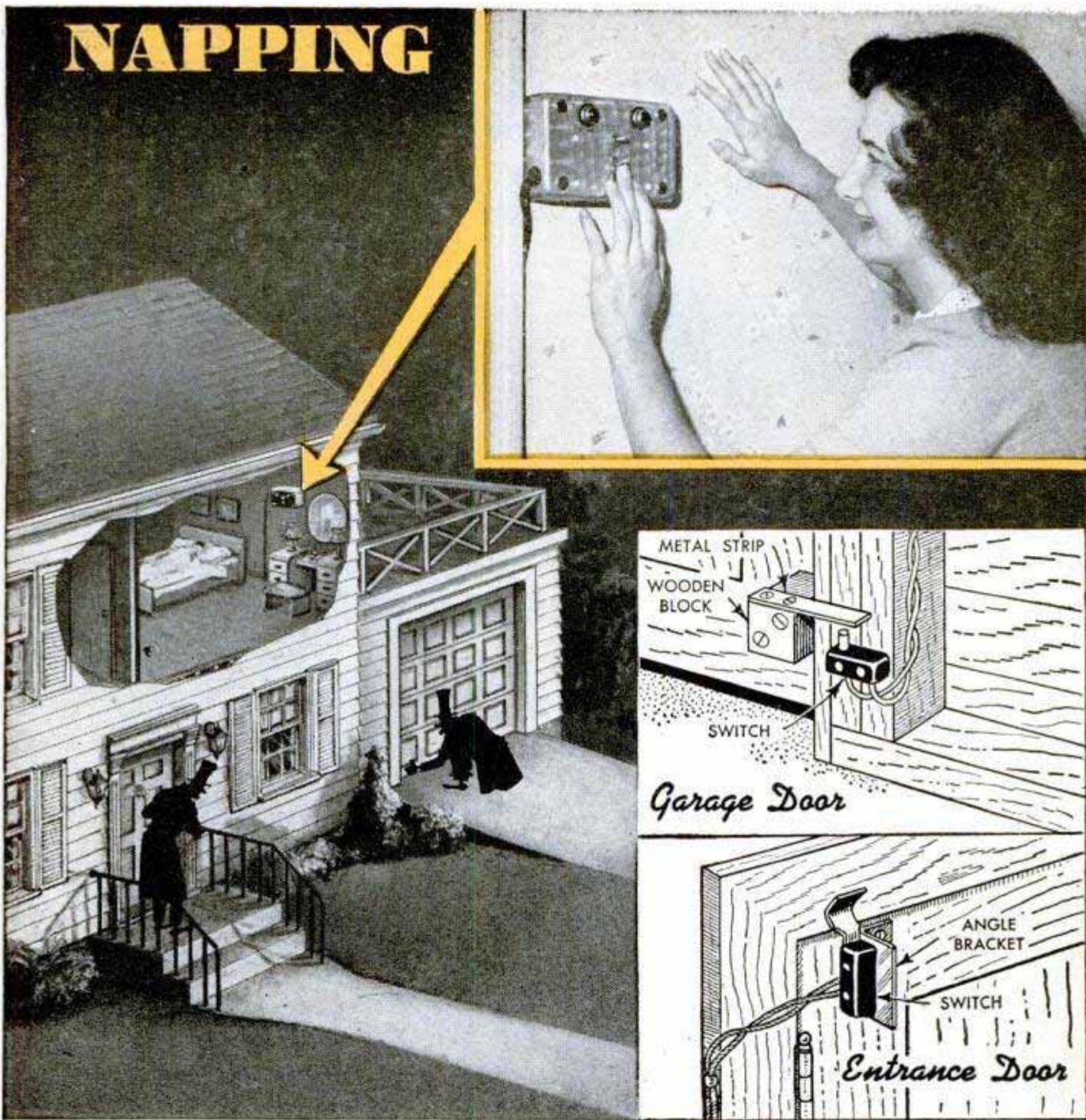

placed in a little box which is mounted on a wall where it can be seen readily. The sensitive switches are wired in parallel in an open circuit, using bell wire for the installation. The easiest way to install the wiring is to merely run it along the woodwork, fastening the wire with small insulated staples. However, if your home is a one-story dwelling, the wiring can be concealed in the walls by drilling up from the basement. Closing of any one sensitive switch completes the circuit and sounds the buzzer. Normally, the master switch in each circuit is left open during the day and closed when retiring. Sensitive switches are available at most electrical stores and sometimes as war surplus. They should be of the type that remain open when depressed. The accompanying drawings sug-

gest methods for mounting the switches on gates, basement windows and doors. Mounting a switch on a standard double-hung sash is done similarly to the method shown for an overhead garage door. With a little ingenuity the switches may be adapted to fit any door or window. Switches also can be arranged to work on window screens and screen doors during the summer months.

Heat switches may be used in connection with the sensitive switches to warn the family of fire. These are set to close at 180 deg. F. and are mounted near the ceiling of a room. A chicken-brooder control switch is ideal for this purpose or an automobile thermostat may be mounted on a suitable bracket to operate a sensitive switch when the thermostat expands.

Simple Rack for Small Tools Made From Corner Beading

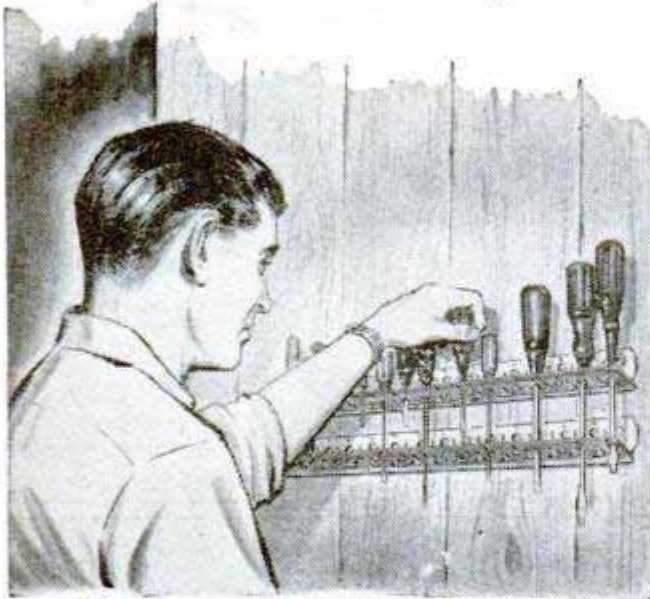

Two lengths of metal corner beading nailed to a wall, one above the other, provide an excellent rack for small files, screwdrivers and chisels. Make the rack long enough to store all your tools of this type, and grind off the sharp corners of the beading before nailing it to the wall.

Will Stoll, Elmhurst, Ill.

Cellulose Tape Masks Glue Joints



Scraping excess glue from wood joints is eliminated if the parts are masked close to the joint with cellulose tape. This makes it easy to strip off the hardened glue by removing the tape.

Cookstove Heats Upper Rooms

In one home, an upstairs bedroom is heated by jacketing the stove pipe of the kitchen range to retain waste heat. The heat then is piped into the bedroom through a ceiling register. The sheet-metal jacket, about 4 in. larger in diameter than the smoke pipe, is closed at the top except for an opening from which a length of small-diameter pipe runs to the ceiling register. A

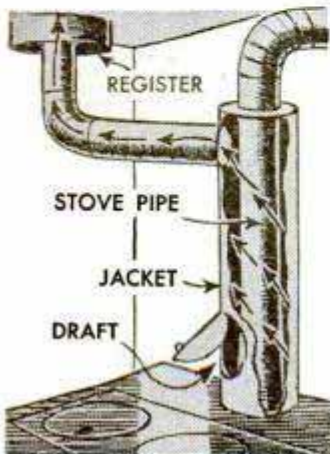

hole near the bottom of the jacket serves as an air intake and the amount of air is controlled by a hinged cover over the hole.

Carriage Bolt Caps Chisel Handle

An ordinary carriage bolt makes an excellent replacement for a broken metal cap on a plastic chisel handle. First, the stub of the broken cap is drilled out and a carriage bolt is selected to fit tightly into the hole. Then the bolt is cut to length and the squared section ground or filed round. Before the bolt is pressed into the handle, a narrow flat is filed along one side of the bolt to permit the air in the handle hole to escape as the bolt is inserted.

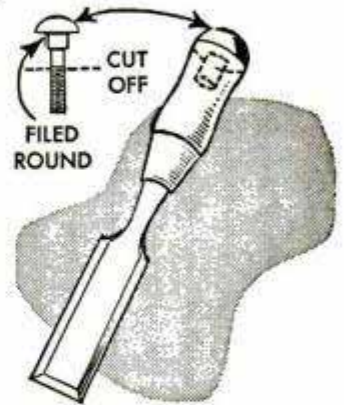

Paul L. Kauffman, Orrville, Ohio.

Wide Miter Box Held Steady By Workbench Stops

One craftsman who uses a homemade miter box that is too wide to be gripped in a vise, holds the box steady by means of a pair of screen-door handles and the stops on his workbench. He screwed the handles to one side of the box so they would fit over a pair of stops but would not interfere with the saw blade when making angle cuts.

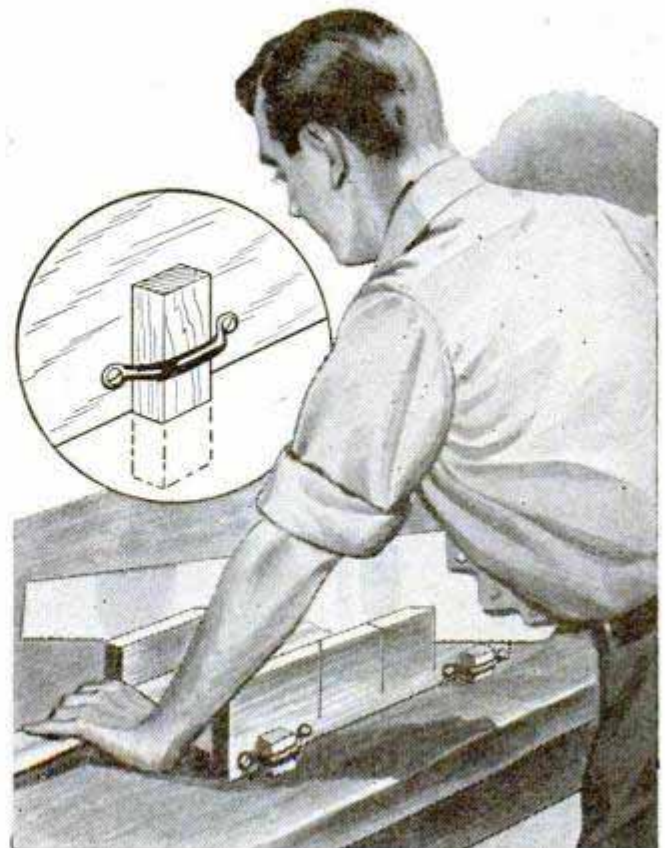

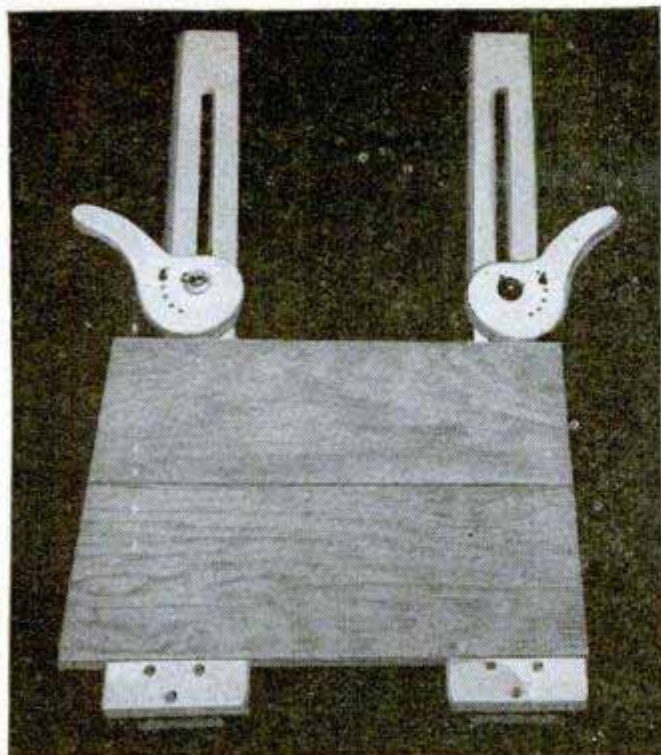

CAM-ACTION CLAMPS

If an occasional gluing job does not warrant investing in expensive bar clamps, excellent cam-action ones of hardwood can be made at very little cost. These clamps are adjustable and withstand considerable pressure. First, make the frame, slotting it for the cam assembly and fitting it with a stop block as in Fig. 2. Next, cut out the cam, Fig. 1, and drill it for a pivot bolt. After this, assemble the cam to the frame by inserting the pivot bolt through an anchor block, two bushings and a piece of flat iron. The latter clamps the assembly to the frame and the lower bushing facilitates moving the cam in the slot. Note that a series of holes for a locking pin is drilled near one edge of the cam. To use the clamp, set the work against the stop block, tighten the cam about $\frac{1}{4}$ in. from the edge of the work and then adjust the cam to exert pressure on the joint. Finally, lock the cam by slipping a locking pin (a screw eye will do) through one of the holes and against the edge of the frame.

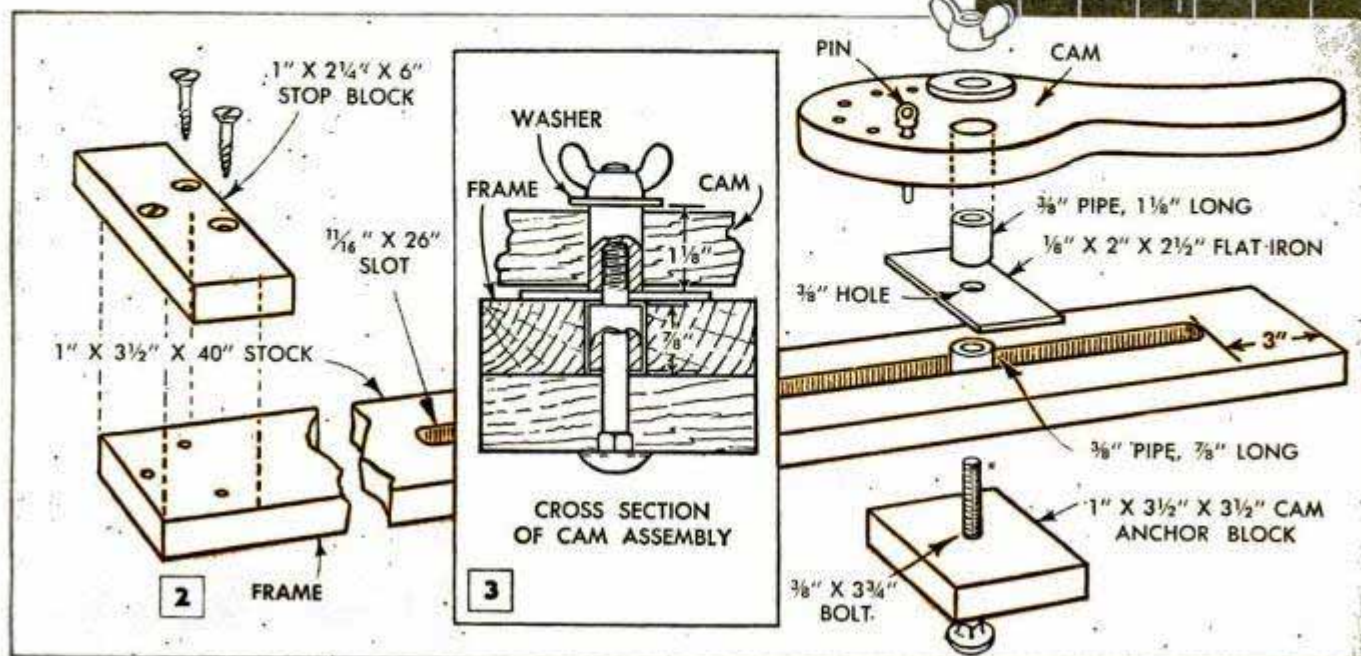
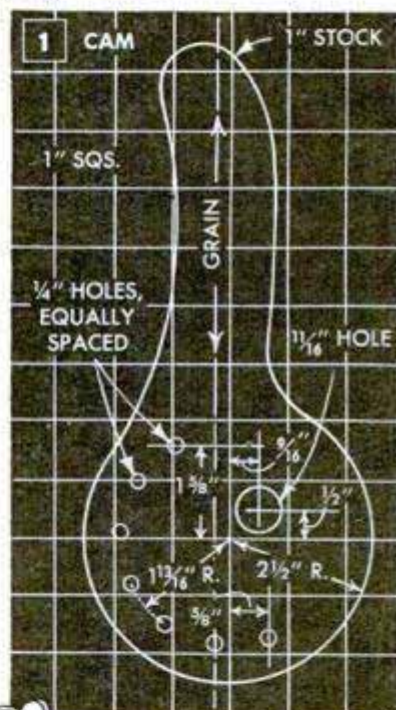

11½-Ft. PLYWOOD

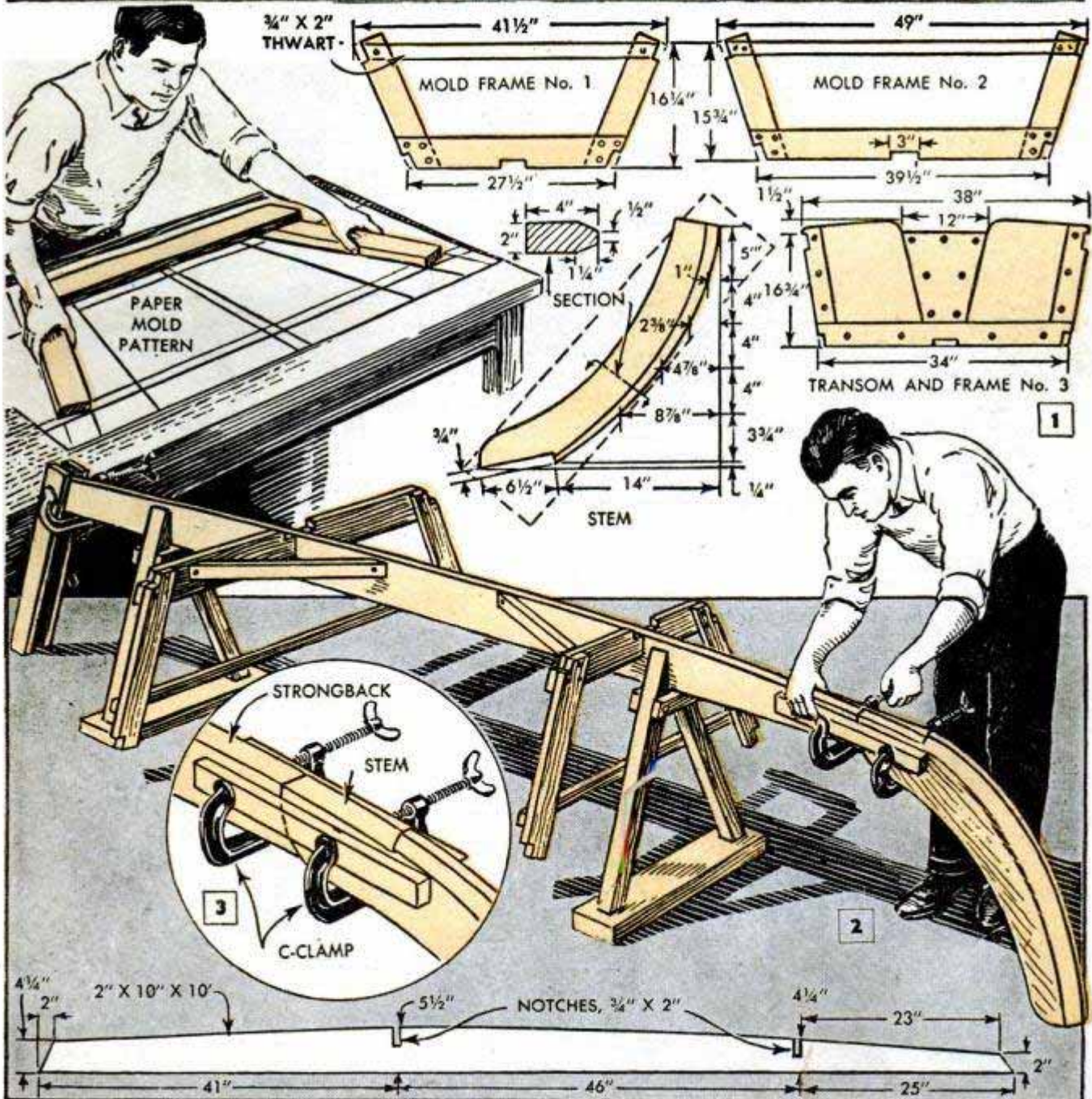
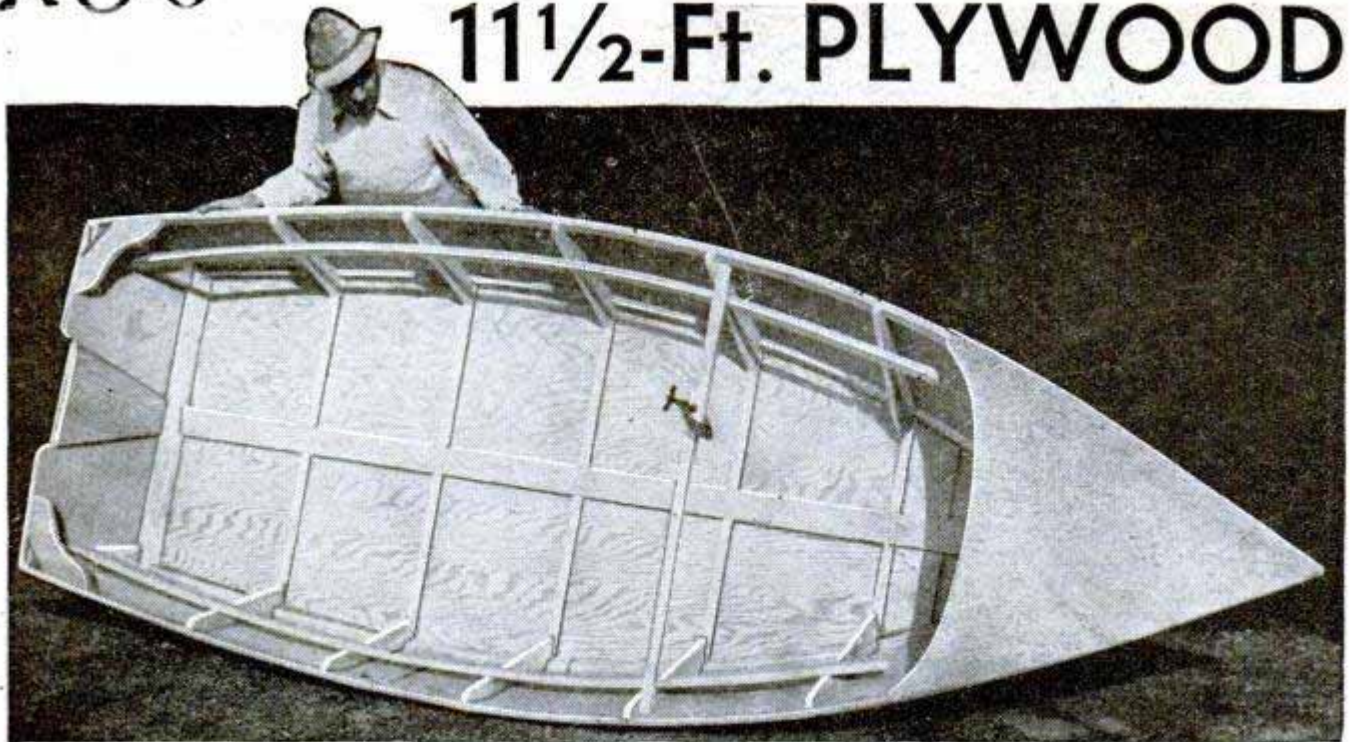

ROWBOAT Carried on Car Top

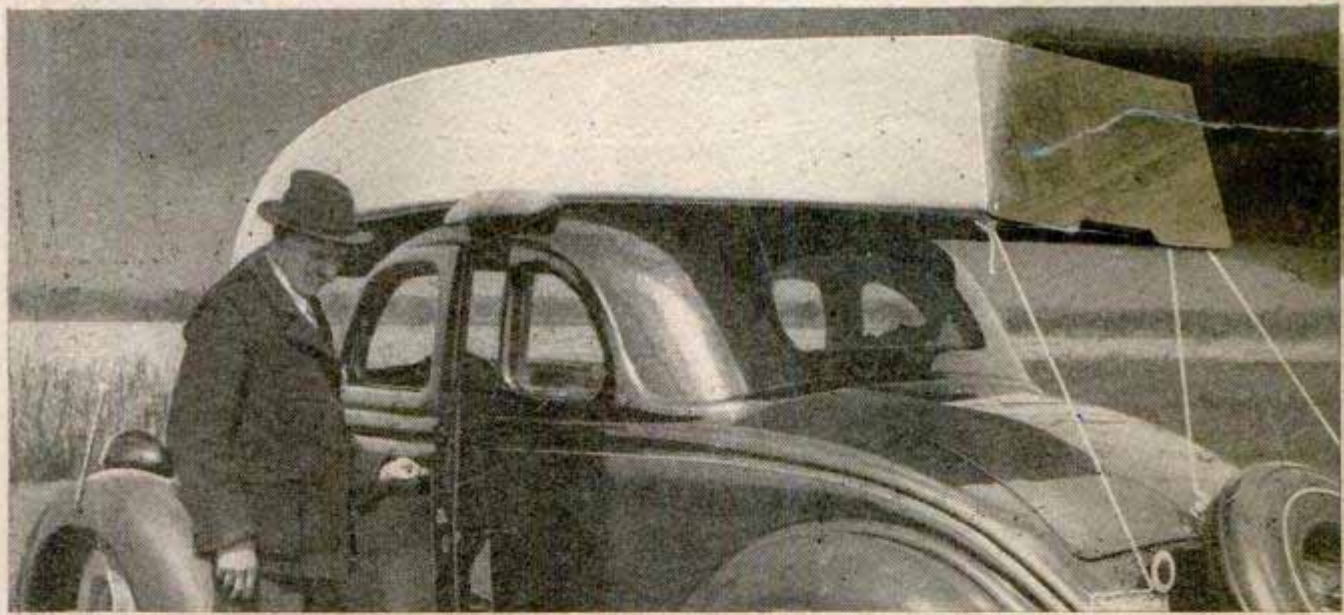

IF YOU CAN use a saw, hammer and plane, you can easily master the construction of this simple car-top rowboat. There are no tricky planks to fit and no difficult rabbet to cut in the stem. Not counting the transom, only two mold frames are required, Fig. 1, and as the molds are only temporary, their assembly is not too important other than seeing that they are put together squarely. To assure this, make a full-size paper pattern of each mold and assemble the pieces directly on the patterns. The transom is $\frac{3}{4}$ -in. plywood to which a notched frame is glued and screwed permanently to the inside face.

By William D. Jackson

This is cut from a plank, as indicated, and is supported in the manner shown in Fig. 2. The stem is clamped to the strongback as in Fig. 3 and the transom is clamped to two scrap boards which are clamped at an angle to the opposite end of the strongback, Fig. 11. The molds are leveled laterally and braced at right angles to the strongback.

Fig. 5 gives a general idea of how the keelson, chines and sheer battens are fitted. These parts simply rest in the notches of the molds and are fastened only to the stem and transom. The keelson and chines are fastened to the stem as in Fig. 6, using $1\frac{3}{4}$ -in. No. 8 flat-headed brass screws. One screw is used to fasten each aft end of the chines and sheer battens to the transom.

Next, the transom, molds and stem are fastened to a strongback or building board.

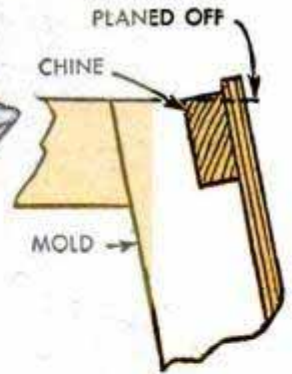
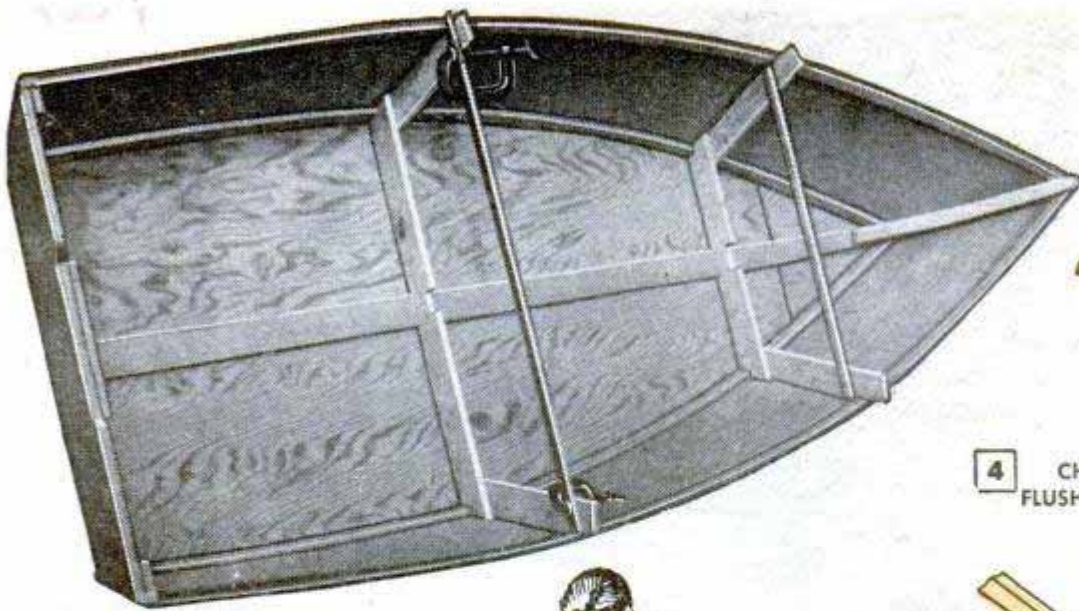

4 CHINE AND SIDE FAIRED FLUSH WITH FRAME BOTTOM

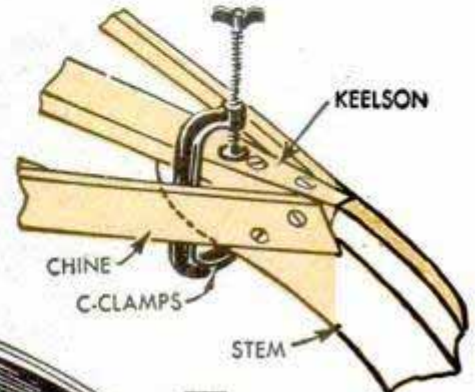
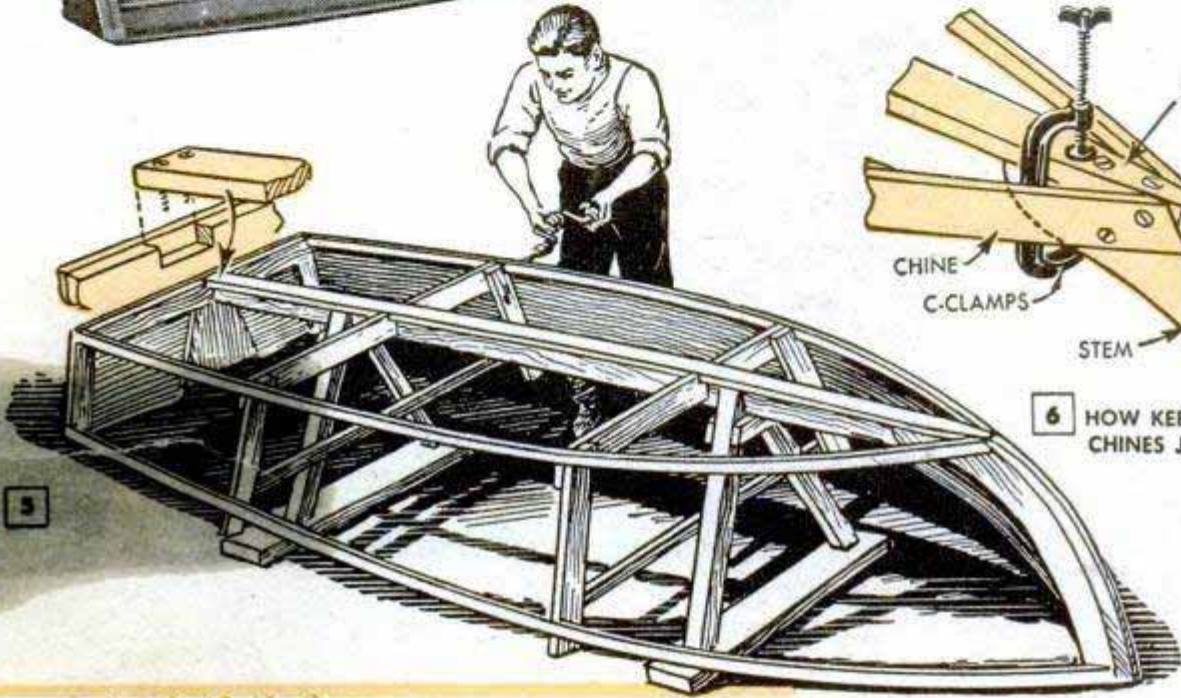

6 HOW KEELSON AND CHINES JOIN STEM

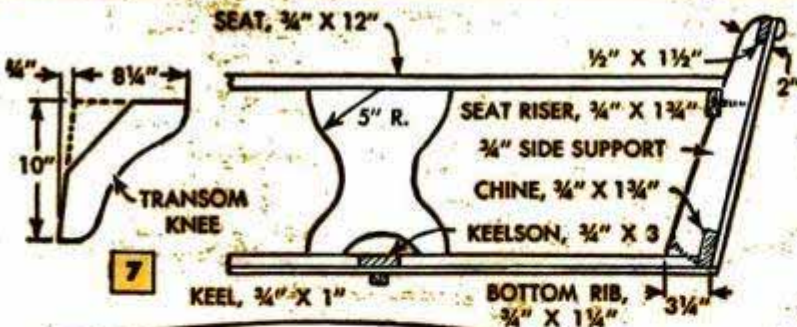

7

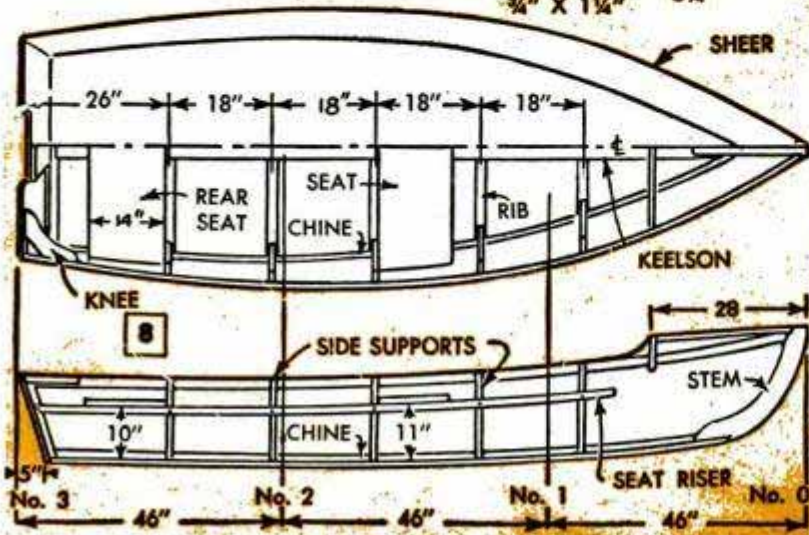

8

The framework is now ready to be covered with marine plywood. Apply the sides first by clamping the plywood temporarily in place and marking it a little oversize for sawing. To make a watertight joint along the chine, coat it with marine glue and lay muslin tape in the glue. Then apply a second coat to the tape and attach the plywood with 1-in. No. 8 flat-headed screws, spaced 2 in. apart. When dry, plane off the chine and plywood flush with the bottom of the molds as in Fig. 4. For the sake of economy, the plywood bottom can be applied in two or more pieces, Fig. 12, using copper clinch nails along a cleat-backed joint. The exposed edges of the plywood at the stem are faired into the curve of the stem, then coated with marine glue and covered with a strip of half-

MATERIAL LIST

Lumber:

- Waterproof plywood
- 1 pc. $\frac{1}{4}$ x 48 in. x 10 ft.—Bottom
 1 pc. $\frac{1}{4}$ x 48 in. x 12 ft.—Sides
 1 pc. $\frac{1}{4}$ x 36 x 36 in.—Deck
 1 pc. $\frac{3}{4}$ x 18 x 48 in.—Transom
- Spruce, fir, cypress or yellow pine
- 1 pc. $\frac{3}{4}$ x 6 x 30 in.—Deck beam
 1 pc. $\frac{3}{4}$ x 3 in. x 10 ft.—Keelson
 1 pc. $\frac{3}{4}$ x 1 in. x 10 ft.—Keel
 2 pcs. $\frac{3}{4}$ x $1\frac{3}{4}$ in. x 12 ft.—Chines
 2 pcs. $\frac{1}{2}$ x $1\frac{1}{2}$ in. x 12 ft.—Sheer battens
 1 pc. $\frac{3}{4}$ x 3 in. x 6 ft.—Transom frame
 2 pcs. $\frac{3}{4}$ x $3\frac{1}{4}$ in. x 8 ft.—Side supports
 2 pcs. $\frac{3}{4}$ x $1\frac{3}{8}$ in. x 10 ft.—Bottom ribs
 2 pcs. $\frac{3}{4}$ x 1 in. x 12 ft.—Molding
- Redwood, spruce
- 1 pc. $\frac{3}{4}$ x 14 x 48 in.—Rear seat
 1 pc. $\frac{3}{4}$ x 12 x 48 in.—Forward seat
- Oak, ash or yellow pine
- 1 pc. 2 x 8 x 30 in.—Stem
 1 pc. $\frac{1}{2}$ x 1 x 24 in.—Stem molding
 1 pc. 1 x 10 x 18 in.—Transom knees
 1 pc. $1\frac{3}{4}$ x $5\frac{3}{4}$ in. x 10 ft.—Building board
 2 pcs. $\frac{3}{4}$ x $3\frac{3}{4}$ in. x 8 ft.—Scrap stock frames
- Hardware:
- 4 gross 1-in. No. 8 flat-head brass screws
 1 gross $1\frac{1}{4}$ -in. No. 8 flat-head screws
 3 doz. $1\frac{3}{4}$ -in. No. 8 flat-head screws
 1 lb. $1\frac{1}{4}$ -in. galvanized shingle nails
 1 pr. oarlocks
 3 brass lifting handles
 1 mooring eyebolt
 $\frac{1}{2}$ pt. marine or phenol-resin glue
 Muslin tape
 Paint and varnish

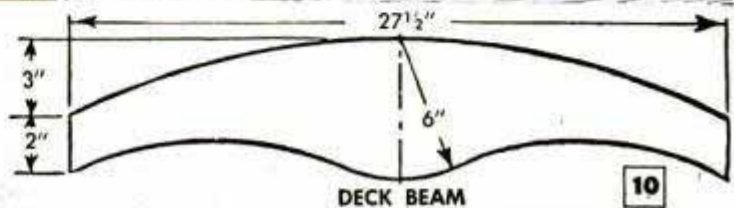
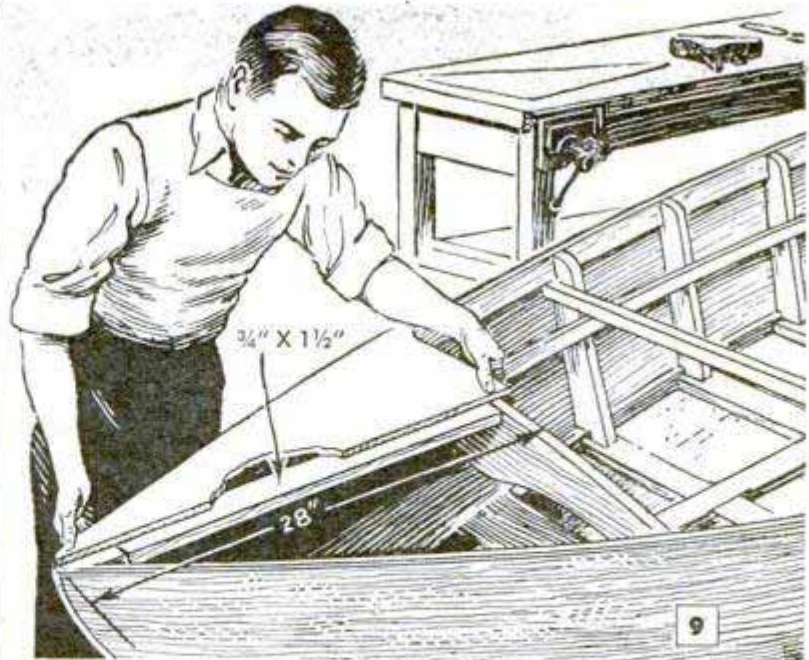

round molding to meet the keel.

Now, lift the boat from the strongback, but before removing the molds, place a temporary cross brace between the sheer battens to maintain shape until the seats are installed. Complete the deck as shown in Fig. 9, fitting a deck beam, Fig. 10, 28 in. from the stem. Five supports are fitted to each side of the boat on the inside at points indicated in Fig. 8. These are notched to fit over the chines and sheer battens as shown in the sectional view, Fig. 7. This step is followed by installing the ribs which are notched to straddle the side supports and simply butt against the keelson and chines. Copper or other rust-resistant nails are used to fasten the ribs to the plywood, the nails being clinched on the inside. Complete the boat by adding the transom knees, seat risers, seats, keel and the half-round sheer molding.

Use a copper bottom paint on the bottom of the boat and coat the rest of the wood above the water line with a lead-and-oil primer paint. Then finish with two full-bodied coats of deck enamel. A mooring eyebolt and three brass sash lifts screwed to the top edge of the transom provide convenient hooks for lashing the boat securely with rope to the car bumpers.

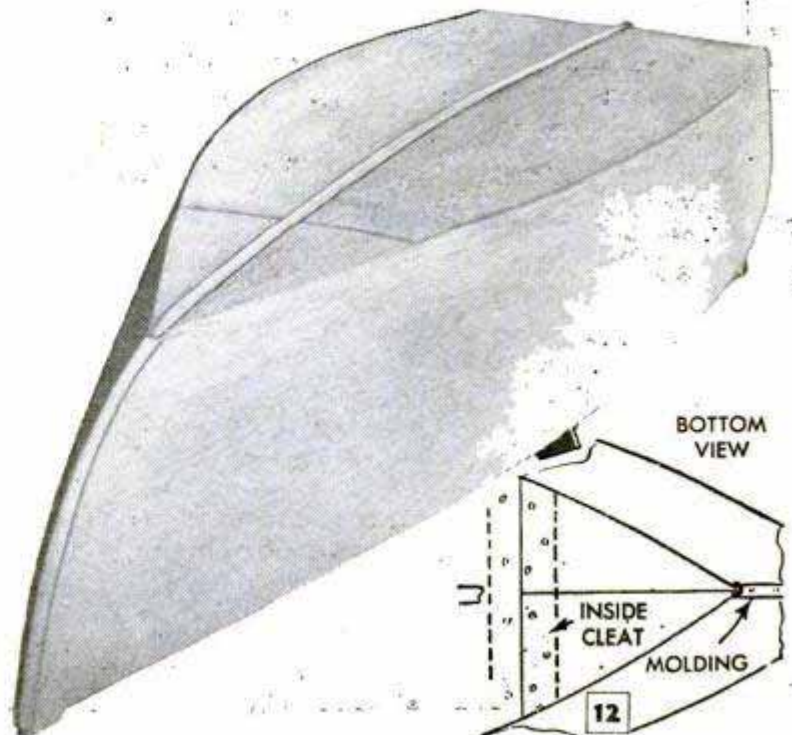
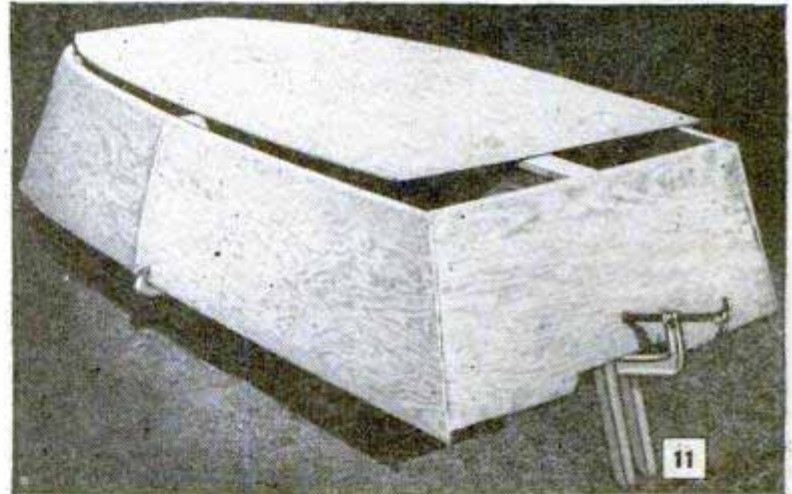

Rubber Seal Repairs Split In Frozen Water Pipe

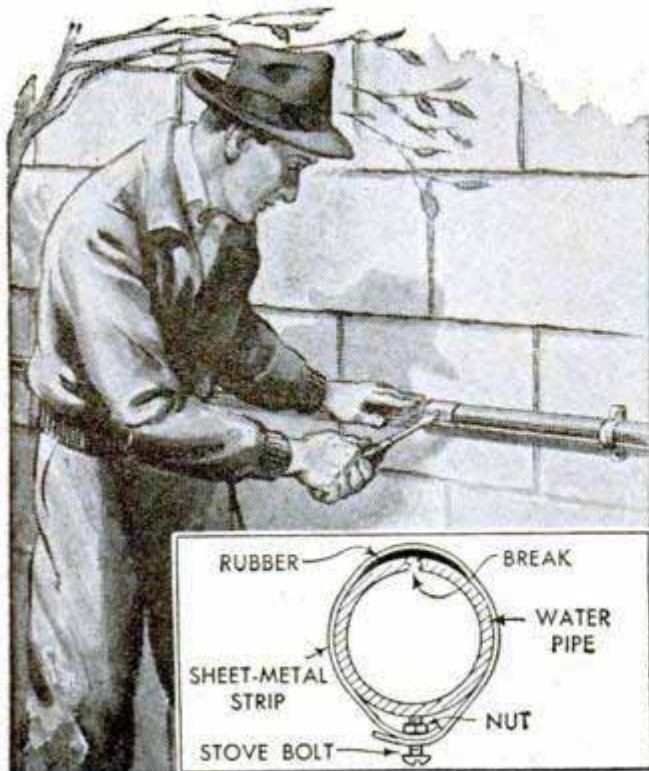

Breaks in exposed water pipes caused by a sudden freeze are repaired in a jiffy by sealing the crack with a piece of inner tube held by a sheet-metal clamp. The metal is cut into a strip slightly wider than the length of the break and long enough to overlap an inch or so when bent around the pipe. A hole for a stove bolt is punched or drilled through the overlapping parts of the metal. With the inner tube and clamp in place, the stove bolt is inserted through the holes and turned into a nut. The end of the bolt bears against the pipe and the nut draws the sheet metal outward, tightening it against the rubber on the opposite side of the pipe. If the break is more than 1 in. long, two bolts probably will be required to hold the clamp.

Wire Ring Takes Up End Play Of Agitator Drive Shaft

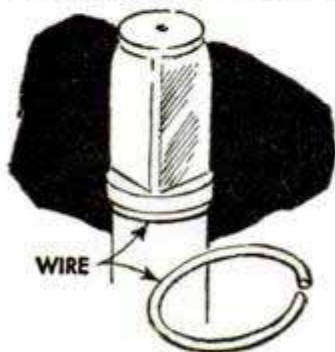

Scraping of the agitator on the bottom of a washing-machine tub often is due to wear at the top of the drive-shaft housing which allows the agitator to ride too low. One or more turns of copper wire between the top of the drive shaft and the housing usually will raise the driving shaft and, in turn, the agitator enough to clear

the bottom of the tub. Remove the agitator and pull up on the drive shaft to separate the top of the shaft from the housing enough to permit inserting the wire.

R. G. Hearn, Monticello, Iowa.

Screw Hook on Stepladder Shelf Prevents Accidental Tipping

The locking leg spreaders on a stepladder usually will prevent the folding pail shelf from accidentally tilting when moving the ladder from place to place. However, as a precaution against the spreaders unlocking and collapsing the legs when a pail or can of paint is on the shelf, attach a screw hook to the inner side of one of the shelf arms. Then turn a screw eye into the corresponding ladder leg so that when the hook is inserted in the eye the shelf arm will be held securely.



Victor H. Lamoy, Upper Jay, N. Y.

C-Clamp Provides Inexpensive Vise For Child's Workbench

A small-boy's workbench is fitted with a serviceable vise at low cost by screwing a C-clamp to one end of the bench top. Position the clamp so that the handle will clear the top when the clamp is fully closed.

John Krill, North Lima, Ohio.



FLOWER CLOCK

By Richard Hanscom

JIGSAWED from plywood and fitted with an inexpensive pocket watch, this unusual flower clockcase is an attractive novelty for the children's room. First, cut out the flower and pot according to the squared pattern, making the center hole to suit the diameter of the watch crystal. If desired, each flower petal can be scooped slightly concave with a burr chucked in an electric hand grinder. The leaves are veined with a knife or razor blade, and a thin strip of veneer is added to the rim of the pot to give depth to the design. The cutout is mounted on an oval-shaped base by gluing the tenon at the bottom of the flowerpot in a slot in the center of the base. To permit easy removal of the watch for winding, it is held in place with a piece of clock spring, one end of which is inserted in a saw cut made in a wooden block glued to the back of the cutout. The entire unit is finished in bright colors, artist's oils being excellent for this purpose. Paint the leaves green and the pot brick red, using any appropriate color combination for the flower and base.



1

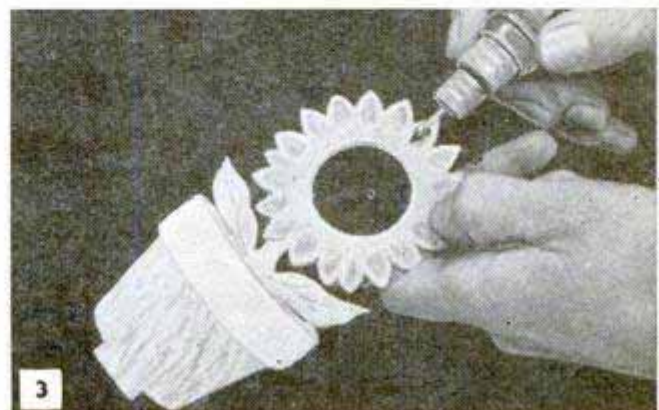
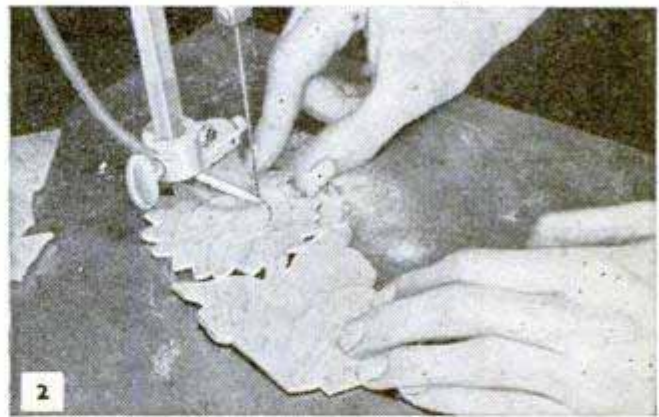
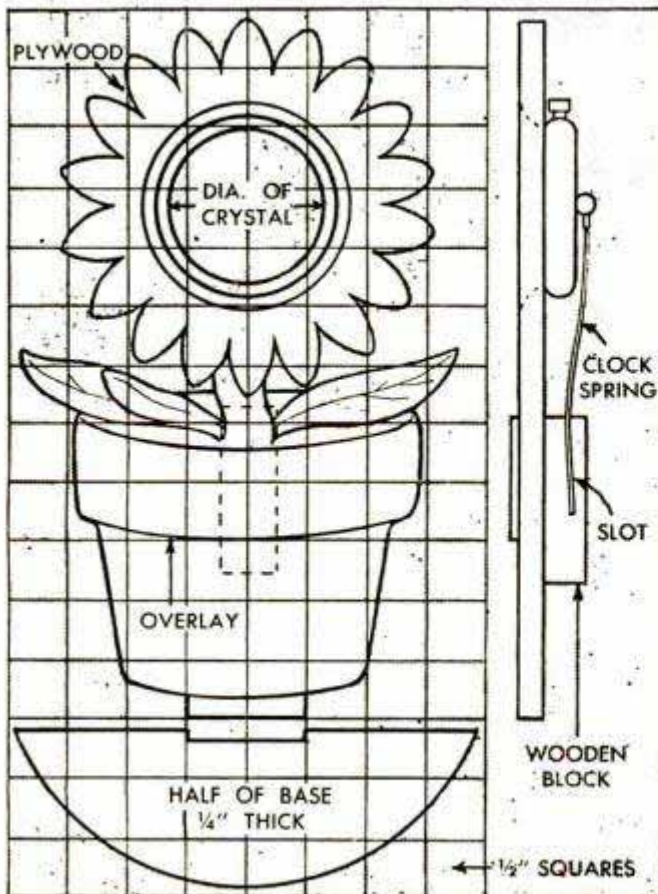

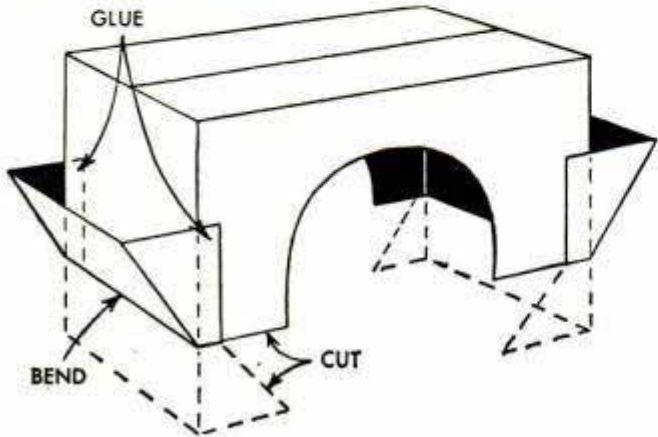

Cardboard Box Forms Bed Table For Convalescent Child

A small child confined to a sickbed for a few days will appreciate a play table made from a cardboard box. The bottom of the box forms the table top and the sides are arched so the box will fit over the child's legs. If the box is deep enough, the ends can be cut and bent upward, as shown, to provide pockets for toys and books. The table can be brightened by painting it and adding a rope handle to each end. The handles are both useful and decorative.

Mrs. Michael Fey, New York City.

Safety Cover Over Machine Switch

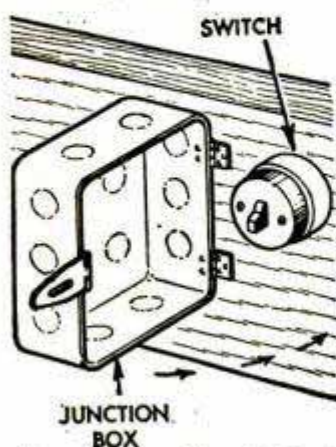

If you worry about the children turning on the power tools when you are not in the shop, cover the switch with a hinged junction box. Bolt or weld two hinges to one side of the box and fasten so it swings over the switch. Then fit a hasp to

the other side of the box to permit locking it with a padlock. Socket-head wood screws can be used to make removal of the cover more difficult.

S. S. Palestrant, Bronx, N. Y.

Wastebasket Serves as Plumb Bob When Setting Fence Posts

An old wastebasket, inverted and pivoted on a pointed stove bolt, substitutes for a plumb bob when setting fence posts. The bottom of the basket is drilled in the center for the bolt, which is fastened with a nut on each side. To use, place the basket over the top of the post, centering the pivot as nearly as possible. The post will be vertical when the rim of the basket is the same distance from the center of the post in all directions. This can be noted by eye with sufficient accuracy.

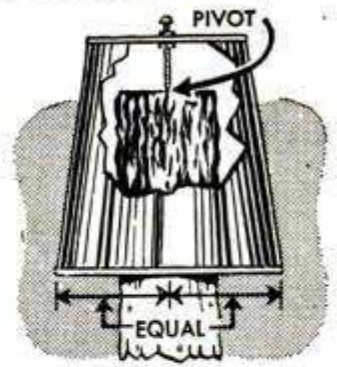

Skis Held to Car-Top Carrier With Screen-Door Catches

Using screen-door catches to clamp skis and toboggans to car-top carriers permits loading and unloading in a fraction of the time ordinarily required to do the job. The equipment is held tightly on the carrier by the springs of the catches while rubber rollers protect it from being scratched or marred. The catches are fastened to the carrier units with screws. If they are positioned as shown, two pairs of skis and a toboggan may be carried but, of course, the arrangement can be varied to suit your particular needs.

Howard W. Squires, Virginia City, Nev.

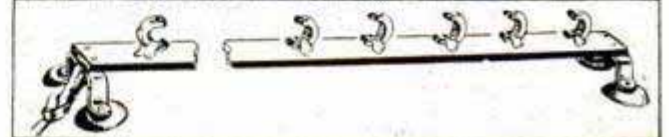

5

KWIKIE PROJECTS

By R. J. DeCristoforo

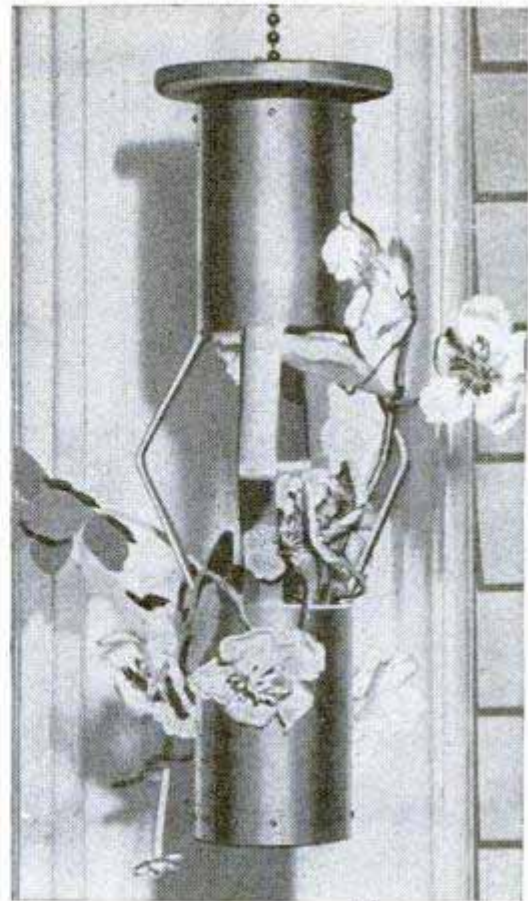
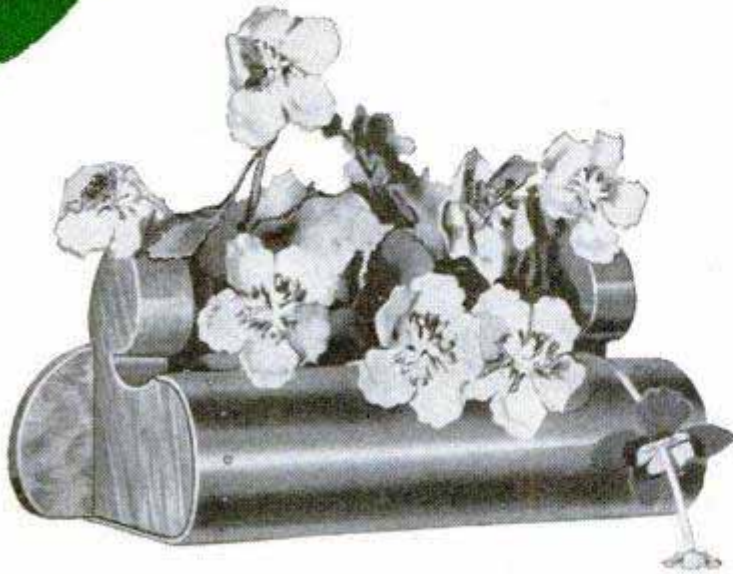

ALUMINUM tubing is an excellent medium for quickly made, attractive projects. It is easy to work, readily available and inexpensive. Any one of these eye-catching items can be made in an evening.

An important thing to remember when working with aluminum tubing is to cut the end of the tubing perfectly square. This can be done by using a hose clamp as a marking guide, Fig. 4, cutting the tubing with a hacksaw and filing it to the guide line. If the aluminum is free from scratches, fine steel wool lubricated with a light oil will result in a good finish. Otherwise, use emery paper first and then finish with the steel wool. A fine "chrome" finish is obtained by buffing, and a satin finish may be put on

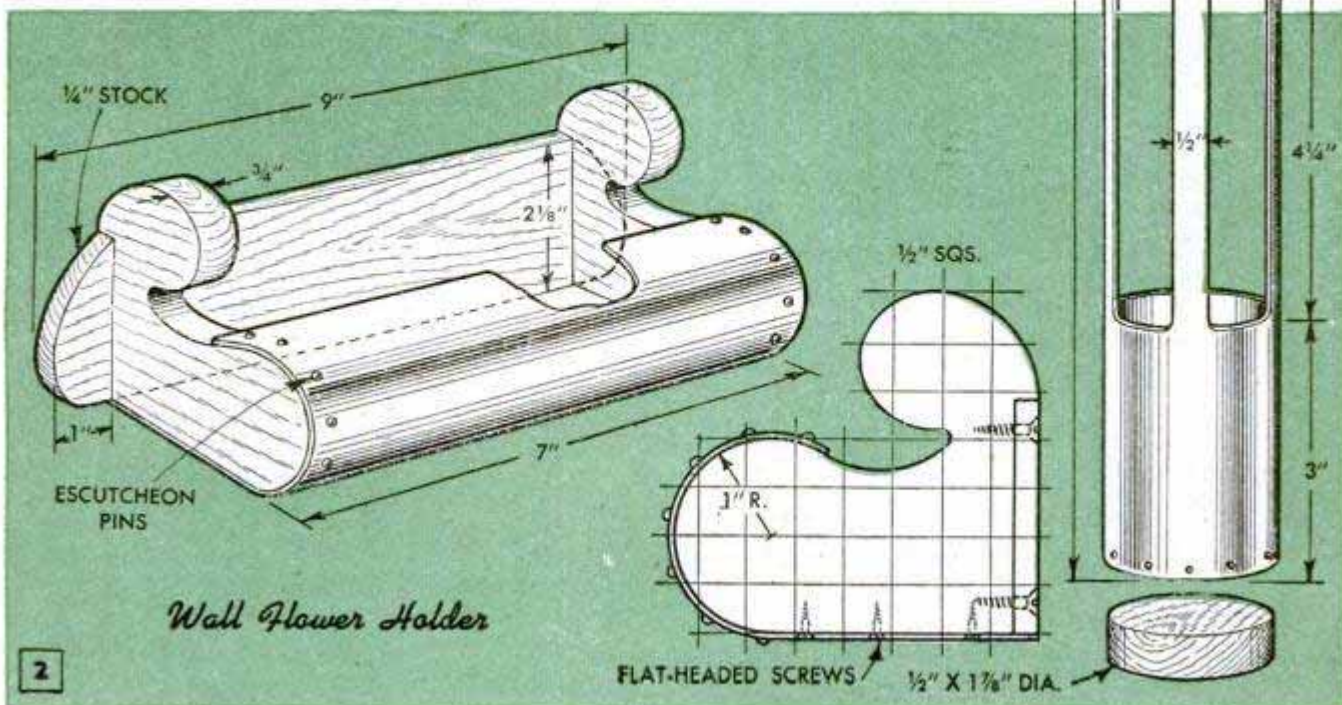
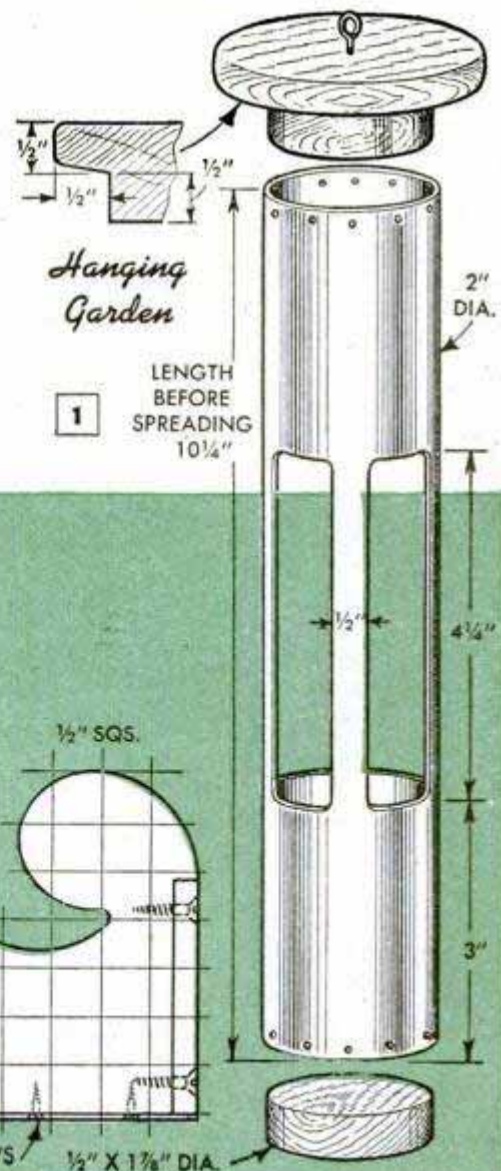

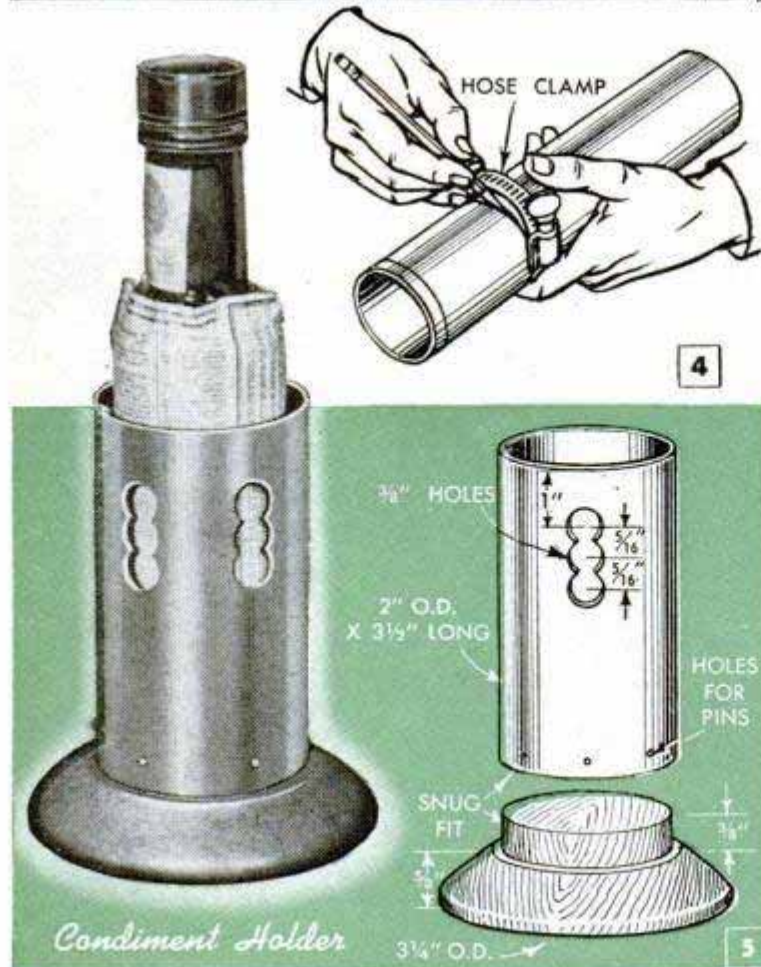
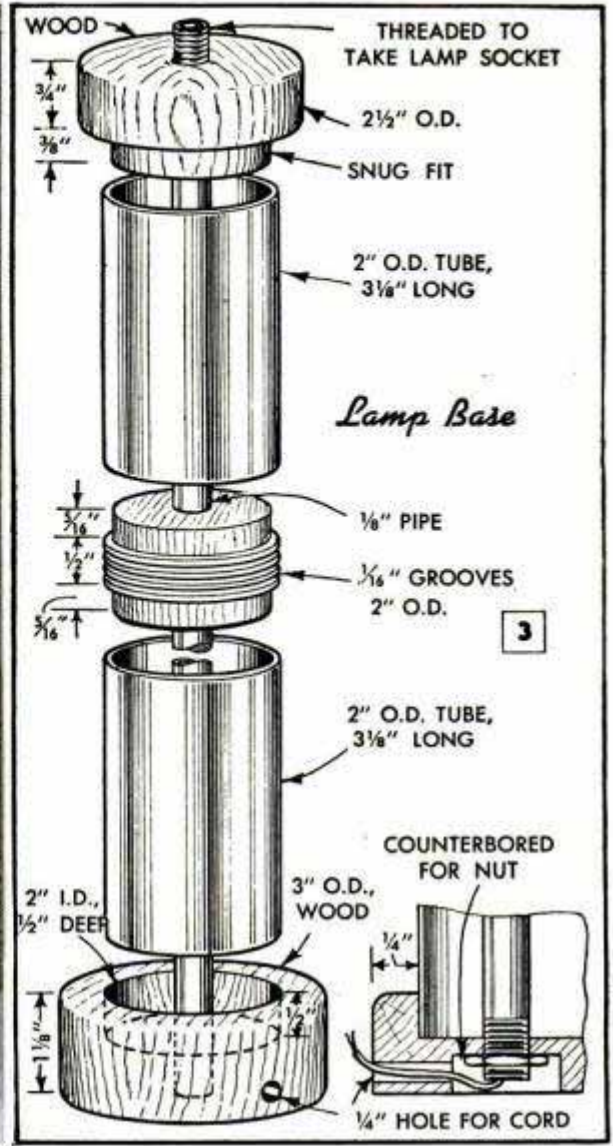
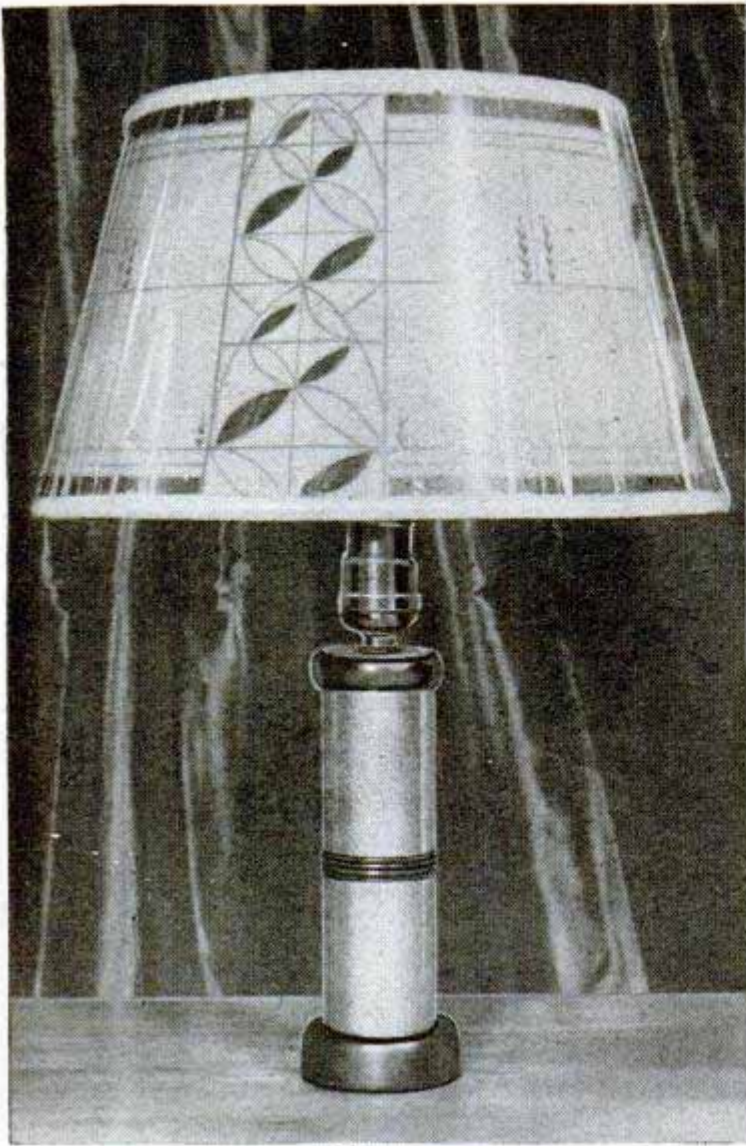

the tubing by using a wire brush.

Hanging garden: The tubing is cut to length and then cut out at the center as in Fig. 1. This can be done by drilling a hole in each corner of the cutout and sawing the tubing with a narrow hacksaw blade. Another way of cutting the openings is to slide the tubing over a piece of pipe and cut along the scribed lines with a small cold chisel. After this, the edges are smoothed with a fine file and the ribs in the cutout portion bent outward as shown in the photo. The wooden parts are turned, finished and attached to the tubing with escutcheon pins.

Wall flower holder: In this case, the tubing is slit lengthwise with a hacksaw. Then, approximately half the circumference is flattened by prying open the slit and hammering with a mallet. After the wooden parts are cut out and finished, the unit is assembled as shown in Fig. 2.

Lamp base: Construction of the lamp base is detailed in Fig. 3. Before assembly, the two pieces of tubing are slipped over a length of

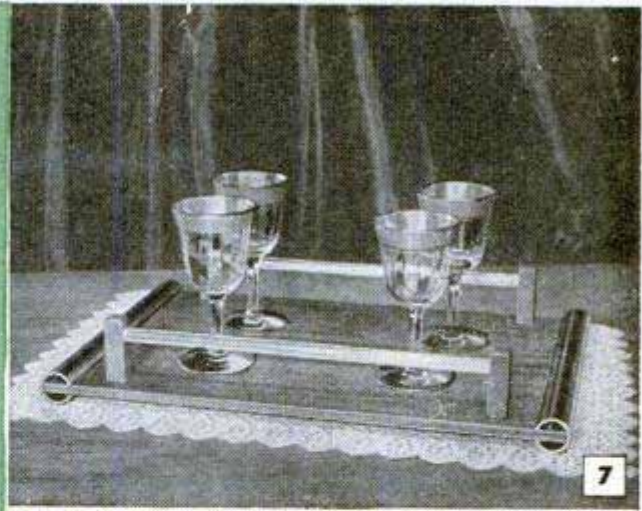
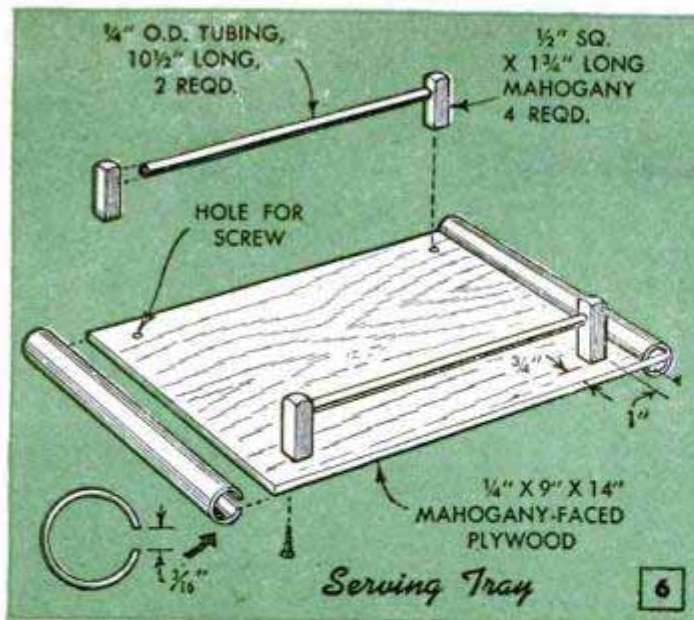

Attractive serving tray combines aluminum tubing with mahogany. Tubing is used to raise ends of tray and to provide decorative guardrails

bar stock or a piece of pipe and hammered with the rounded end of a ball-peen hammer. Wooden parts are turned carefully to size so the tubes fit them tightly. Note that the upper end of the $\frac{1}{8}$ -in. pipe is threaded for the lamp socket, and that the lower end is threaded for a nut which holds the assembly to the base. If desired, the diameter of the bottom wood turning can be made larger, or it can be weighted with lead.

Condiment holder: The decorative holes in the sides of the tubing, Fig. 5, are drilled with a $\frac{3}{8}$ -in. bit and the wooden base is attached with escutcheon pins. The top edge of the tubing may be scalloped, if preferred.

Serving tray: The tray, pictured in Fig. 7, is made as shown in Fig. 6. The lengths of

1-in. tubing used as endpieces are slotted to take the ends of the tray. This can be done by slitting the tubing and prying it apart $\frac{3}{16}$ in. to fit tightly over the $\frac{1}{4}$ -in. plywood. An easy way to slit the tubing is to break off the ends of a hacksaw blade and mount it in a block of wood. The tubing is held against a wooden strip which guides the block and the blade is run back and forth along the top of the tubing. A brad driven at each end of the tubing will serve as a stop to keep it from sliding and the fingers are used to keep it from rolling. Four posts are drilled to take the rails. They are fastened to the tray with countersunk flat-headed screws. The wooden parts should be varnished to protect them from spillage and to permit easy cleaning.

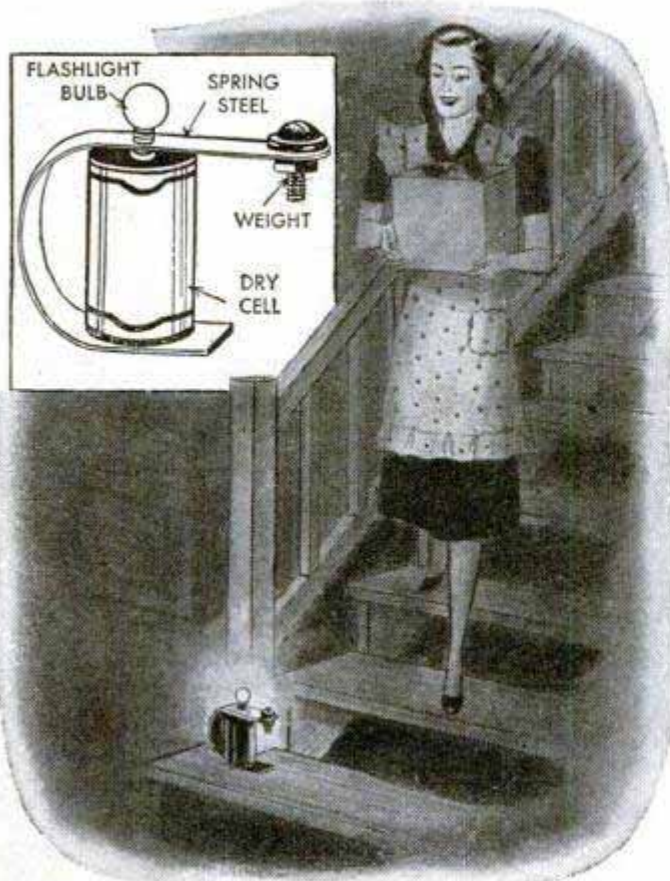

Vibrating Light Blinks Warning At Bottom of Dark Stairway

In homes where there is no electricity and a flight of stairs must be descended in darkness, this blinker will help prevent accidents if placed on the bottom step of the staircase. It serves as a warning light which, if critically adjusted, will blink at the slightest vibration, such as that caused by walking down the steps. To make the light, you will need a piece of spring steel, a small machine screw, a dry cell and a flashlight bulb. Bend the spring steel to a U-shape so that one leg is longer than the other and the distance between the legs is slightly greater than the length of the dry cell. Drill two holes in the long leg, one slightly undersize for a pen-type flashlight bulb (1.1-volt) and the other for a small machine screw which serves as a weight. Next, solder the short leg to the bottom of the dry cell, centering the hole for the bulb over the battery electrode. Some experimenting will be necessary to obtain a sensitive adjustment so the light will blink readily under the particular conditions.

Miniature Gateway Contains Twin Bud Vases

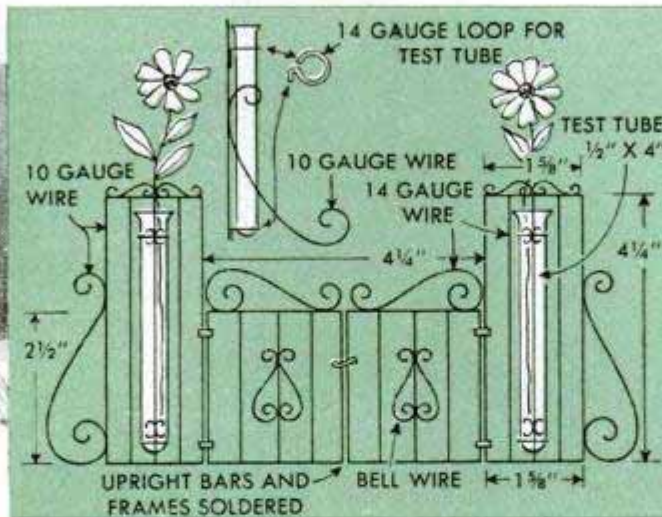

Made of wire and painted black to simulate wrought iron, this bud-vase holder is an attractive ornament for a mantel. Each gate and post frame is formed from one piece of wire soldered at a corner, and the other wire parts are soldered to the frames. Note that a large scroll at each end holds the unit upright. Test tubes serve as bud vases, and false gate hinges are made from strips of tin or copper.

Furnace Cement Kept From Crumbling by Reinforcing It With Steel Wool

When filling cracks with furnace cement, you can keep the cement from crumbling after it hardens by reinforcing it with coarse steel wool. Form the wool to the approximate size and shape of the crack and thoroughly work the cement into it. Then force the cement and wool into the crack with a screwdriver or putty knife.



Funnels Hold Two Balls of Yarn

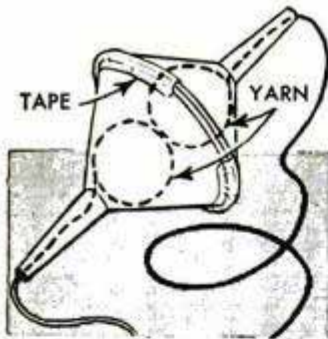

Two funnels taped together provide an excellent holder which is especially useful when crocheting or knitting with yarn of two different colors as it keeps both balls of yarn running

smoothly. After placing a ball of yarn in each funnel and slipping the end through the spout, tape the funnels together.

Violet Brown Shay, New Orleans, La.

Moleskin Over Holster Fastener Protects Pistol Finish



If the snap fastener on a holster mars a pistol, stick a circular piece of moleskin adhesive over the back of the snap on the inside of the holster. The moleskin should be cut slightly larger than the snap.

Wallpapering Around Window Sill

To do a neater job and save time when wallpapering around window sills, use a hacksaw blade to make a saw cut between the projecting portions of the sill and the wall. Then the paper can be slipped behind the sill instead of being cut to fit around it. Be sure to hold the saw blade tightly against the wall while cutting.

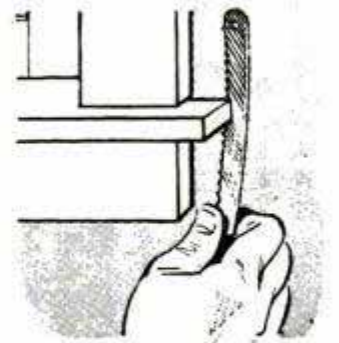

Richard I. Salzer, Baldwin, N. Y.

☞ Glass tumblers can be separated by putting the bottom one in warm water and pouring cold water in the top one.



AUTO TIPS



Checking the fuel line with a vacuum gauge may save unnecessary replacement of the fuel pump. Disconnect the fuel line at the pump and, with the engine idling, attach the vacuum gauge to the pump. Then, reconnect the fuel line and idle the engine to replace the gasoline in both pump and carburetor. Now, with the engine still idling, disconnect the fuel line at the gas tank and take a vacuum reading at this end of the line. If the latter reading is lower than the former, a defective fuel line is the cause of the trouble.



Sealing wax does an excellent job of repairing cracked or burned distributor caps. Hold the wax so it will drip into the area to be patched and melt it with a lighted match. When repairing charred spots, scrape burned surface clean before applying the wax.

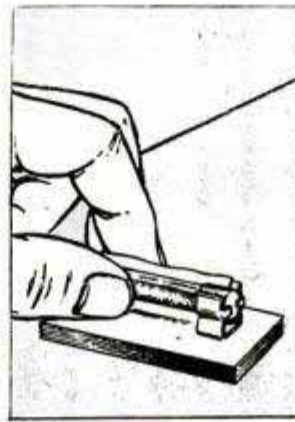

If fuses blow mysteriously in your car, the trouble may be due to loose and corroded fuse clips. To correct this, wrap a piece of fine sandpaper around a fuse and rotate it gently in the clips. Then bend the clips inward in order to increase their tension.

A spark-plug rack protects cleaned and regapped plugs from possible damage or upsetting of the gap. It consists of a series of holes drilled slightly oversize in a wooden block to take the threaded ends of the plugs. When the plugs are to be returned to the same cylinders, they can be kept in order by numbering the holes to correspond with the cylinders. If desired, the holes may be drilled undersize and tapped with the threads of an old spark plug.

Worn insulation on generator terminals is likely to result in their touching the housing. If the main terminal touches, the generator will stop charging and, if the field terminal touches, the generator may charge at such a high rate that it burns out. An easy way to remedy this is to fit two fiber bushings to each terminal, as shown. The shoulders of the bushings are the same diameter as the terminal hole and slightly less than half the thickness of the housing.

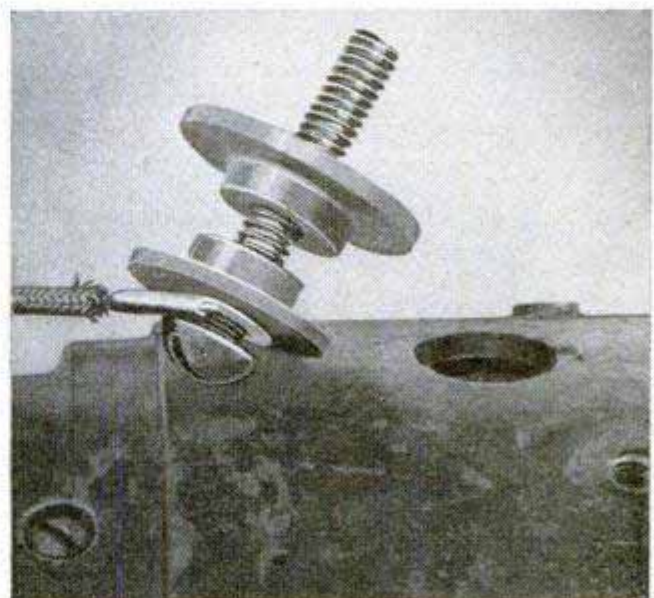
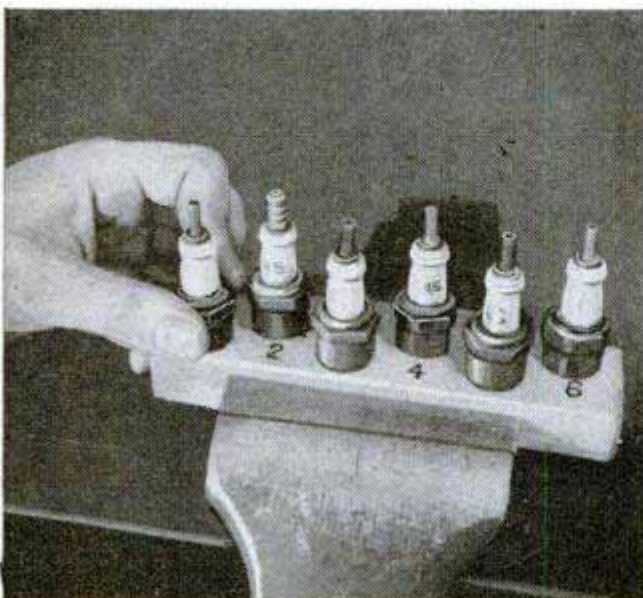

REJUVENATE YOUR BATTERY

By Ed Packer

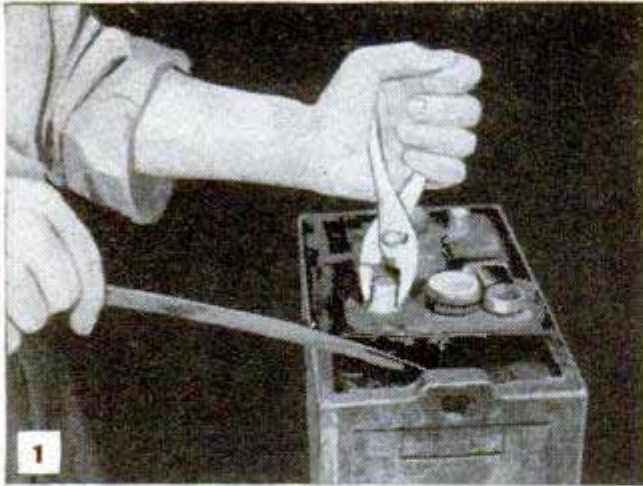

Softening sealing compound with a heated screwdriver will free the cell so that it is easily removed. Be careful not to spill acid solution in the case

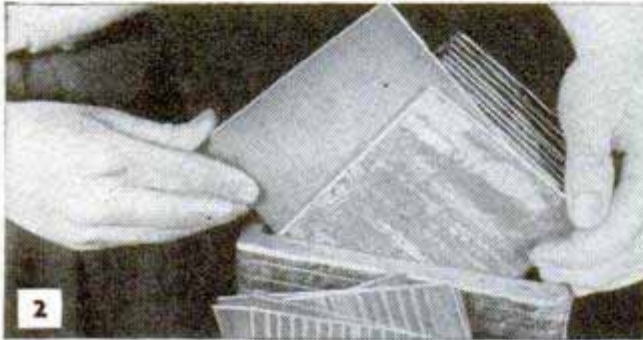

Replacing cracked or warped separators with new ones restores defective battery cell to continued use. Support the cell at an angle in the case as shown

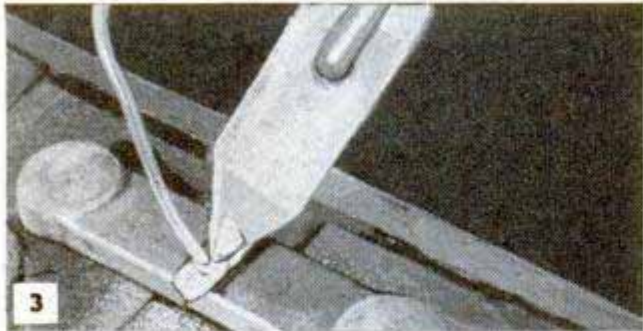

Above, soldering the cell-connector strap after cutting to remove a cell. Below, sealing a repaired cell into the battery case with a hot soldering iron



DIFFICULT starting, more use of lights and accessories plus the tendency of a battery to lose its charge during cold weather make it difficult for an old battery to function satisfactorily during winter months. If you are having "cold weather" trouble with your battery, the most satisfactory solution to the problem is to replace it, but if you feel that you must get additional service from it, possibly a major operation on one or more of the cells will keep it out of the junk pile for a few more months.

The usual sign of impending failure is a low gravity reading in one cell. Prompt repair often will save a battery in this condition, unless the plates have become "mushy" due to fast and frequent charging. To repair the battery, the faulty cell must be removed from the case and opened. If an end cell is at fault, it will be necessary to cut only one connector in order to remove it, but if the center cell is the faulty one, both connectors must be cut. Do this with a hacksaw as in Fig. 6. Then, heat the blade of a screwdriver and use it to melt the sealing compound around the top of the cell cover as in Fig. 1. Grip the terminal post with pliers and lift the element carefully, tipping it at an angle as it is raised and resting it on the battery case as in Fig. 2. The most common cause of a low cell is one or more cracked, broken or rotted separators which allow the positive and negative plates to touch, thus short-circuiting the cell and discharging it. Other possible causes are the "bridging" of sediment across the plates and over the tops of the separators, and also sediment built up in the bottom of the cell to such a height that it connects the plates. If separators

Battered or worn terminal posts are built up with molten lead, using a form made of sheet aluminum. Photo shows post rebuilt and metal form removed

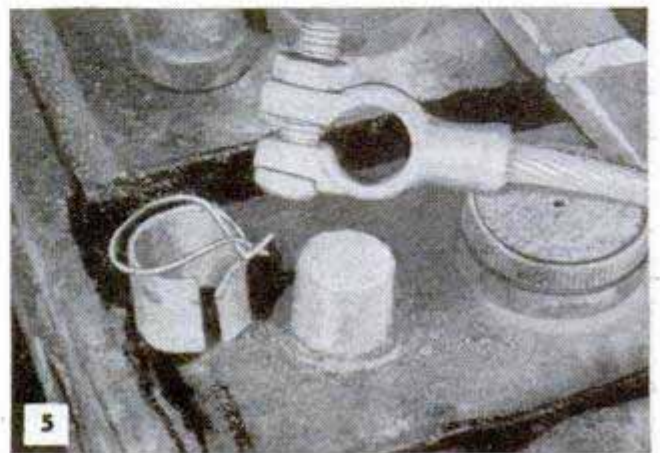

Regular gravity checks with a hydrometer, renewal of electrolyte and prompt repair of a low cell will add many months to the useful life of an old battery

are broken or otherwise damaged, simply replace them with new separators of the proper size and material. Scrape excess sediment from the plates with a softwood stick and remove sediment from the bottom of the cell with a wooden spoon. Then, lower the plate assembly, or element, back into the case, making sure that the element seats properly.

The meeting ends of the connector are filed to an angle of 45 deg. and the resulting vee is filled with lead melted into the joint with a hot soldering iron, Fig. 3. Reseal the cell cover by melting and running sealing compound into the joint with a soldering iron as in Fig. 4. *Caution:* Do not use an open flame to melt the sealing compound.

If the terminal posts of an old battery are battered or excessively worn, they should be built up to their original size and shape. Wrap the post with tape until its original diameter and taper are attained. Fit an aluminum collar, shown in Fig. 5, over the tape, binding it tightly with a piece of twisted wire. Then lift off the collar and strip off the tape. Replace the collar, centering it over the defective post where it serves as a form for retaining the molten lead, Fig. 7.

In a battery being repaired as described, there is an unknown amount of acid in the plates of the faulty cell. To equalize the solution, charge the battery until all cells are gassing freely and occasional checks with a hydrometer, used as in Fig. 8, show no rise in gravity over a period of four hours. This procedure assures that all the

To rebuild a worn post, wrap with tape to bring it to original size. Fit metal form over the tape and fasten with wire. Then remove form and the tape

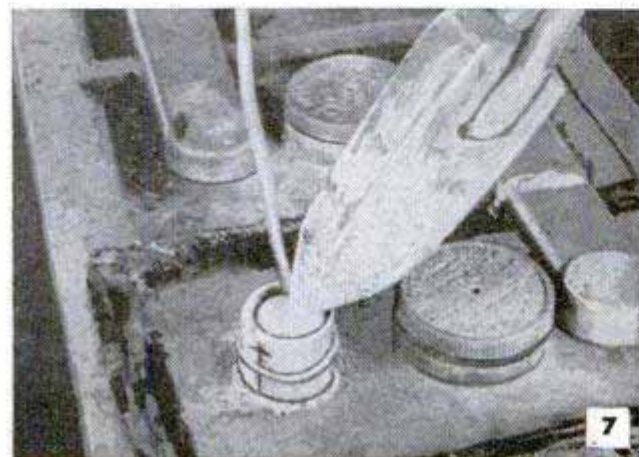

acid is once more in solution. To balance the solution in the low cell, withdraw liquid with the hydrometer until the tops of the plates are exposed. Then add acid of 1.400 gravity to bring the level of the liquid to the proper height above the plates. Should it happen that the solution in the defective cell was at a low level to begin with and the subsequent hydrometer check shows the gravity to be high, add distilled water instead. After this adjustment of the solution, charging should be continued for at least 30 minutes to mix the new acid or water with the liquid already in the cell. The gravity is again read and adjusting continued until the reading is 1.280 or 1.300.

Keep a regular check on the battery solution with a hydrometer. In cold weather add water just before driving car so that water will mix with solution

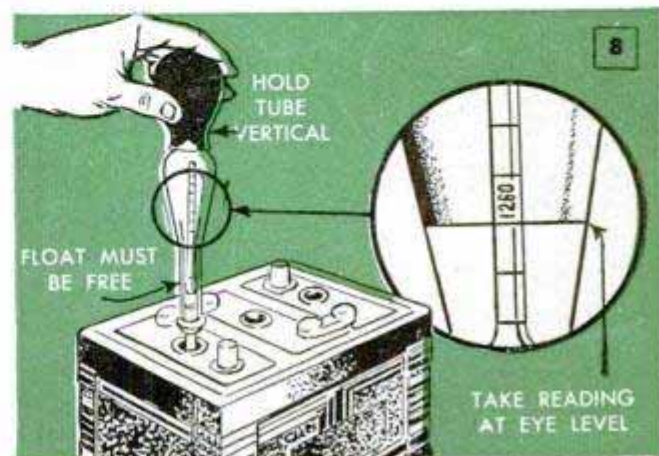

Guard on Sewing Machine Prevents Injured Fingers



If your sewing machine has a spoked handwheel, facing the wheel with a cardboard guard will reduce the possibility of the children injuring their fingers. This also makes the machine safer for the operator. Just cut a cardboard disk to fit the wheel and tie it to the spokes with pieces of string or strong thread.

A. E. Fenn, Chicago.

HK-51 Servicing Your Cigarette Lighter

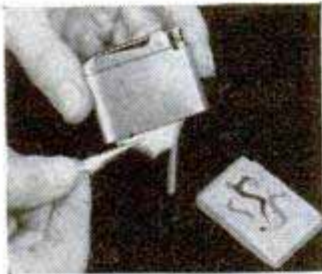

When a cigarette lighter fails to ignite or burns with a low flame, try removing the cotton from the fluid container and fluffing it before replacing. This increases the fluid capacity of

the cotton and speeds up the rate of absorption by the wick, resulting in fast lighting and a steady flame.

C-Clamps Form Wheel Puller

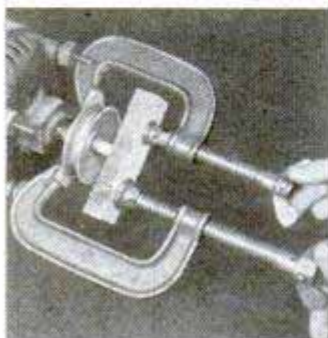

Finding that a wheel puller was needed to force a pulley frozen on a motor shaft, I improvised one from two C-clamps, a piece of dowel and a small block of hardwood. After the parts are arranged as shown,

tightening both clamps simultaneously will remove the pulley without damaging the motor or shaft. Using two clamps of dif-

ferent sizes keeps the handles from interfering with each other.

Willard Allphin, Danvers, Mass.

Heating Lacquer Improves Spraying

You will do a better job of lacquering if the lacquer in the spray gun is kept thin by warming it occasionally during the operation. Do this by immersing the spray-gun jar in a pan of hot water for a few minutes. Because of the inflammable nature of lacquer, be sure that the pan of water is not over an open flame while warming the gun.



Richard Hanscom, Elmhurst, Ill.

Inside Lock for Garage Door

As double protection for his car in case someone should gain entrance to the garage through the side door, one man padlocks the overhead door from the inside. He drilled a hole through the portion of the locking bar which projects through the track, and fastened a padlock at this point. This prevents the locking bar from being released.—Adolph Sprengel, Chicago.

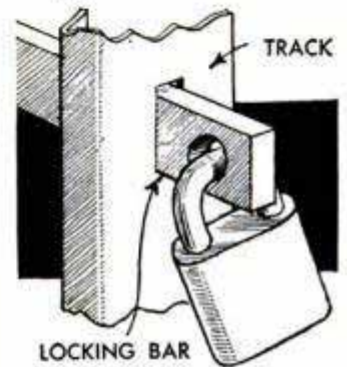

Hip Boots Hung by Tongues Are Kept From Cracking

To store rubber hip boots without danger of their becoming cracked at the knees, suspend them from the ceiling with these wooden tongs. The tongs are notched at one end to grip the sole of the boot, and joined at the center with a machine bolt. A length of cord is fastened between the ends opposite the notches so that when it is looped over a nail the weight of the boot causes the tongs to grip tightly.—Thomas E. Stimson, Jr., Los Angeles, Calif.

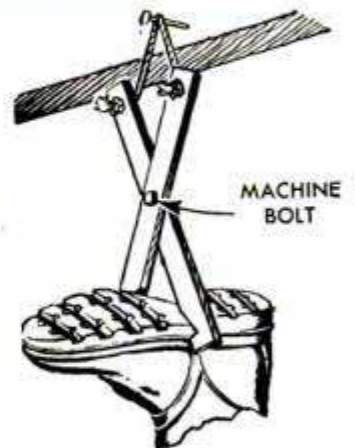

TEMPORARY LENS MOUNTINGS

By W. S. Kals

Upper right, a quick, easy way of mounting a lens for experimental work. Two cardboard tubes are selected, one with an inside diameter equal to that of the lens, the other of a size which will telescope firmly inside the first tube. Rings A and B are cut from the smaller and forced into the larger tube with the lens between. Right, a simple semipermanent mounting in a metal tube, making use of a split-wire retainer

Lenses subjected to heat from a nearby light source should be spring-mounted in such a way that the glass is free to expand without danger of cracking. One of the simplest ways to do this is to support the lens in metal holders, or brackets, attached to the end of the tube with screws. In making this mounting, care should be taken to shape the holders in duplicate so that the lens will be held firmly

This mounting is similar to the cardboard mounting described above except that the metal tube is machined with a shoulder to provide a back support for the lens. The friction ring is machined to a press fit, and its inner edge is carefully beveled to fit the curve of the lens. The lens should fit in the shouldered portion of the tube with a slight amount of play to allow for possible expansion of the glass

This is a variation of the friction-ring mounting employing a flat, split ring as a retainer. The ring is machined to an outside diameter slightly greater than the inner diameter of the shouldered section of the tube. The ring is then split and a short section removed so that when compressed it is an easy fit in the shouldered end of the lens tube. Note also that the inner edge of the ring is beveled to fit lens

Another variation of the split-wire retainer especially suitable for holding lenses of large diameter. Three equally spaced bosses are formed in the wire ring with long-nosed pliers. The ring snaps into a semicircular groove machined in the shouldered portion of the tube. Special care must be taken when machining to locate this groove the correct distance from the shoulder so that, with the lens in position in the tube, the ring will bear against it lightly when it is snapped into place in the groove

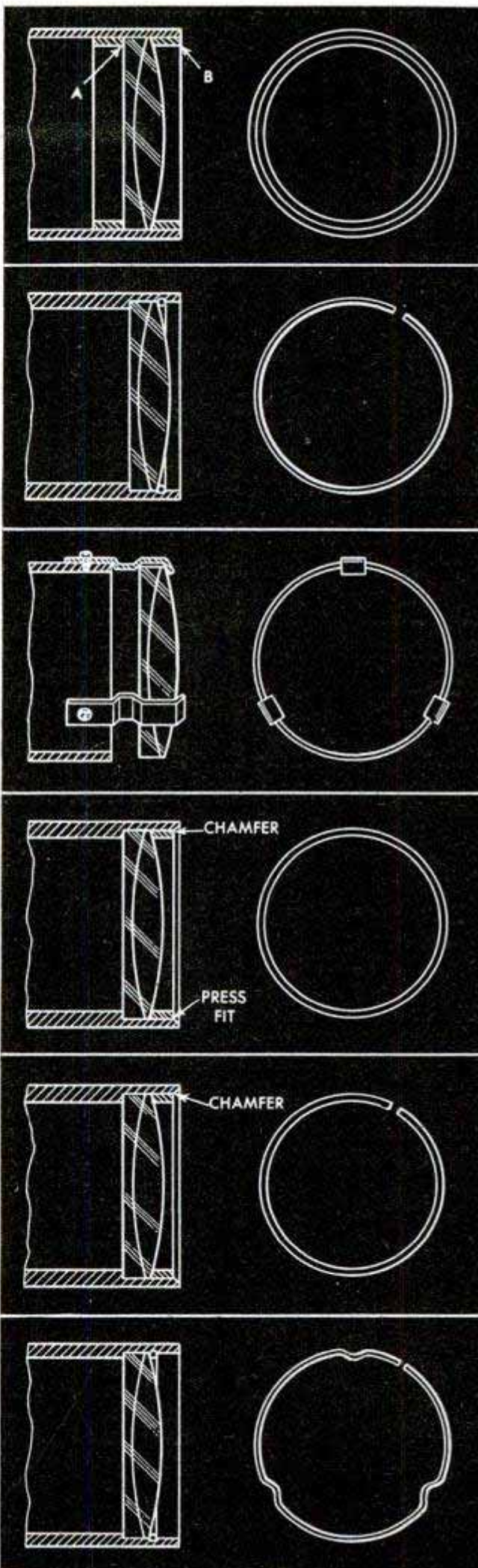



Filing Envelopes for Negatives Are Sectioned With Staples

Two sheets of paper stapled together form a handy envelope for filing negatives either in a standard filing cabinet or in a Manila folder kept in a drawer. Arranging the staples to divide the envelope into a section for each negative keeps the negatives separated and permits writing pertinent information about each shot.

C. S. Matthews, Berkeley, Calif.

On-the-Spot Movie Titles Describe Travel Scenes

It is not necessary to spend time titling travel films after a trip if you shoot the title right through the car window as you begin taking the movies. Just write the title and other information on the window with lipstick and shoot it from the inside of the car. Then continue to shoot while someone rolls down the window achieving a fadeaway effect disclosing the scene. If you wish, shoot the scene first and then have someone roll up the window with the title.

Cards Aid Loading Film Tank



When loading a cut-film tank in the darkroom, the annoyance of trying to work the end of the film into the proper slot is eliminated by inserting small filing cards in the reel before the lights

are turned off. The ends of the cards should project slightly so they will guide the film into the slots.

Mounting Photofloods Overhead

Instead of turning a reflector photoflood directly into a ceiling outlet for overhead lighting, you can fit the outlet with a swivel joint simply by turning two double sockets into it before inserting the lamp. This permits the light to be focused at a variety of angles, allowing the shot to be taken in any part of the room rather than only under the outlet. Additional variation of angles can be had by loosening the sockets slightly.

Wallace H. McClay, Pasadena, Calif.

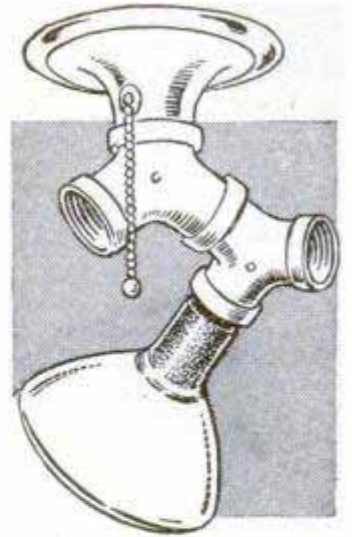

Drying Rack From Coat Hanger

An ordinary wire coat hanger provides a handy rack for drying roll film. The hook part of the hanger is bent to fit over the top of a door and the arms are bent outward as shown. When the film is hung at the ends of the arms, it is held several inches away from the door so that it is not likely to be damaged.

Harry Radzinsky, Great Neck, L. I.

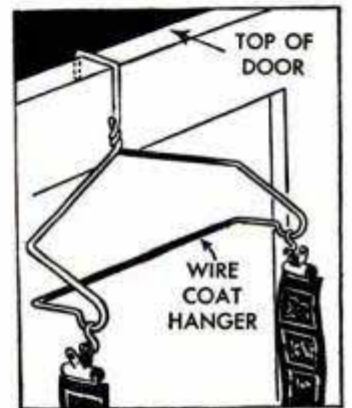

Flasher Times Enlargements

Timing enlargements is simply a matter of counting the flashes of the enlarger lamp if an ordinary flasher button is inserted in the lamp socket. Count the number of flashes required to produce a satisfactory test strip and then repeat this number for subsequent prints.

Another advantage is that the negative remains cooler during long exposures. Be sure that the capacity of the flasher is sufficient to handle the bulb to be used.

R. F. Donovan, Jersey City, N. J.



Tripod Adapter Supports Booster Flash

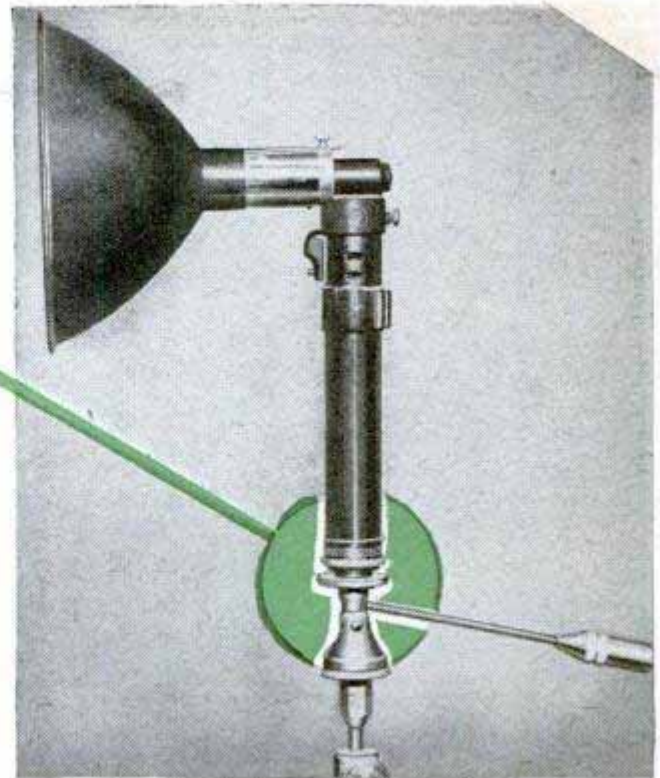
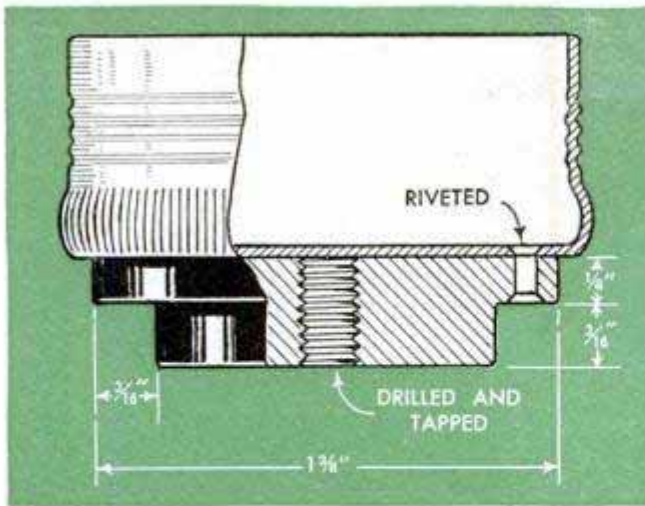

One three-cell flash gun may be too weak to flash several auxiliary lights placed a considerable distance from the camera. In such cases, it is not always satisfactory to clamp a second flash gun, used as a booster, to a tripod or light stand by means of the bracket furnished. This is due to the fact that the gun frequently tends to tilt forward, making it difficult to keep the light directed where desired. However, this little adapter will solve the problem in a jiffy. It's nothing more than a turned flange, drilled and tapped for the tripod screw and riveted to the end cap of the battery case.

Equipped in this way, a flash gun can be screwed on any standard tripod with or without a pan head or tilt top. In addition, it can be mounted on an ordinary light stand by turning it on a stud having a threaded tip.—Ed Mogridge, Omaha, Neb.

Switch Mounted on Door Casing Operates Safelights in Darkroom

If the safelights in your darkroom have been left burning all night, resulting in the overheating and ruining of their gelatin screen, you will appreciate this safelight

switch. It turns on the lights when the darkroom door is closed and turns them off when the door is open. An ordinary doorbell switch is wired into the safelight circuit and fastened to a flat-iron bracket. The bracket is screwed to the casing to hold the switch in front of the door. It should, of course, be located near the top of the door and out of the way. Then a long wood screw is driven into the door so that it will depress the switch button when the door is closed.

Arthur Trauffer, Council Bluffs, Iowa.

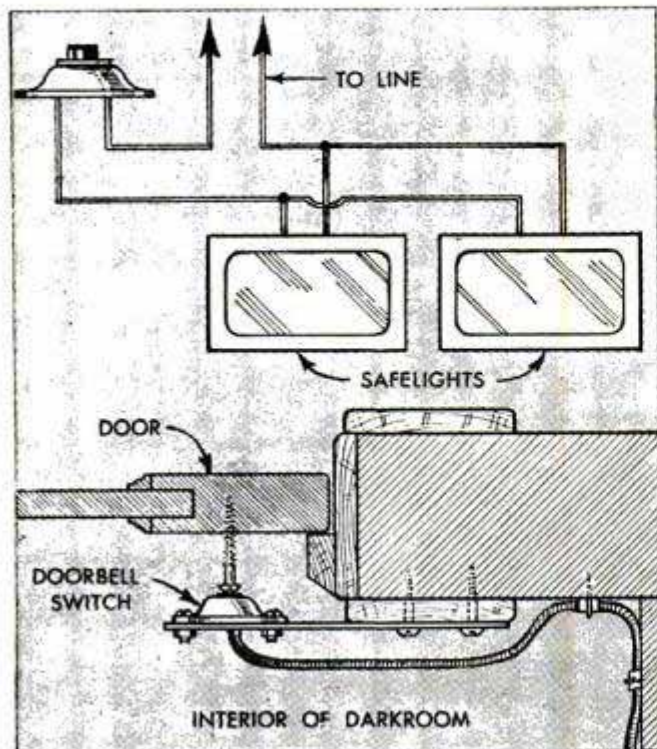

Sprayer for Ferrotyp Solution

An even coat of ferrotyp solution is easily applied to plates if sprayed on with an atomizer from a bottle of window cleaner. Window-cleaner bottle cap and atomizer will fit most ferrotyp solution bottles.



Easy Method of Filtering Photo Solutions Works Automatically and Helps Save Time

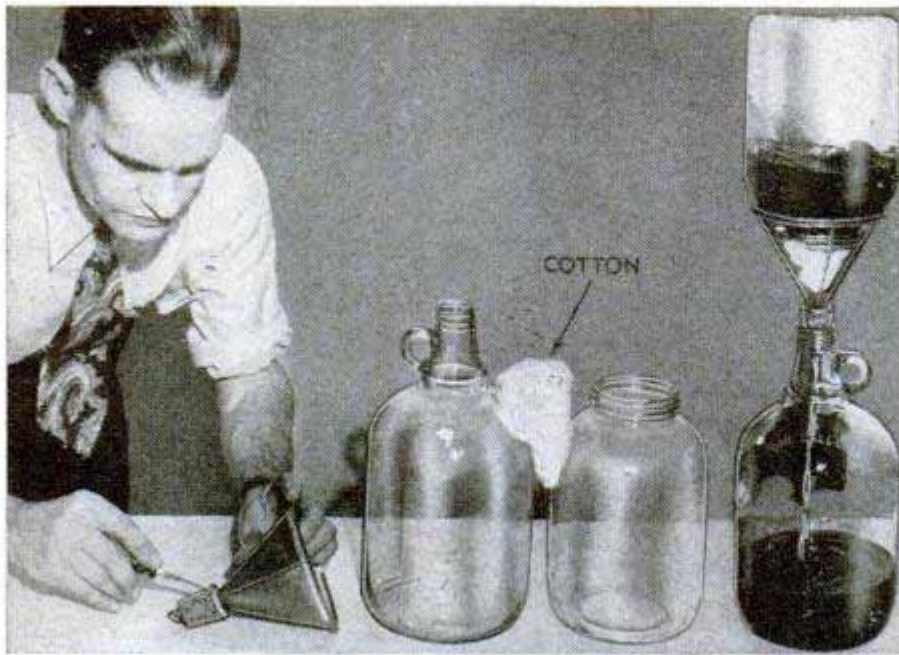

The following method saves time and eliminates spillage when filtering large quantities of photo solution. Select a cork to fit a gallon bottle, drill a hole through it to take the spout of a funnel, and slit one side for a breather. Then pour the solution into a widemouthed jar. Insert the cork and funnel in the neck of the bottle and place a large wad of cotton in the funnel. Turn the funnel and bottle upside down over the jar and, finally, invert the whole assembly. It will stand upright and the filtering process will continue without requiring further attention.

Empty Cut-Film Packs Provide Convenient Filing Cases for Negatives

Empty film-pack containers, that are usually discarded, make ideal dustproof filing cases for negatives. A paper separator is inserted between the negatives to protect the film and also to provide space to record pertinent data for each negative. A label on the pack lists the contents.

Norman Sklarewitz, Bloomington, Ind.

Novel Silhouettes From Negatives

Fairly thin negatives can be made into interesting pictures having a silhouette appearance. To do this, soak the negative in a solution of bichloride of mercury. This will turn the black portion of the negative a metallic white. After washing and drying the negative, coat the emulsion side with black paint and mount in a suitable frame. *Caution:* Bichloride of mercury is poisonous. It should be handled carefully.

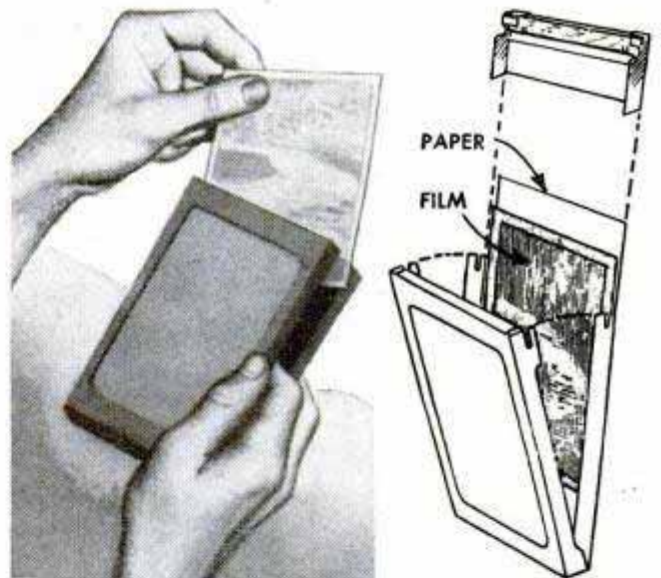

Cloth Sleeve Cleans Lenses

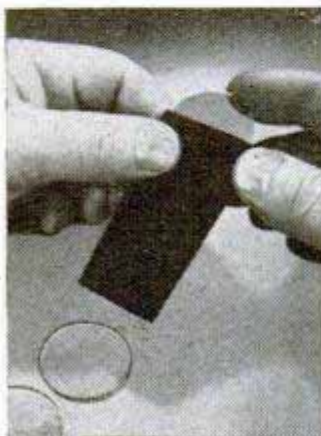

Passing a lens or filter through a flat sleeve of heavy, soft cloth cleans both sides of the disk at one time. The edges of the cloth are sewed or cemented together to form the sleeve which can be stored in a corner of the auxiliary-lens case.

Ash Tray Forms Camera Stand

If your camera is the type that cannot be set upright when the flash synchronizer is attached, bolt a small metal ash tray upside-down to the underside of the synchronizer bracket. This will keep the camera from tipping over and possibly bending the cable release or other attachments. A nickel or chrome-plated tray will add to the appearance of the camera. — Kenneth Murray, Colon, Mich.



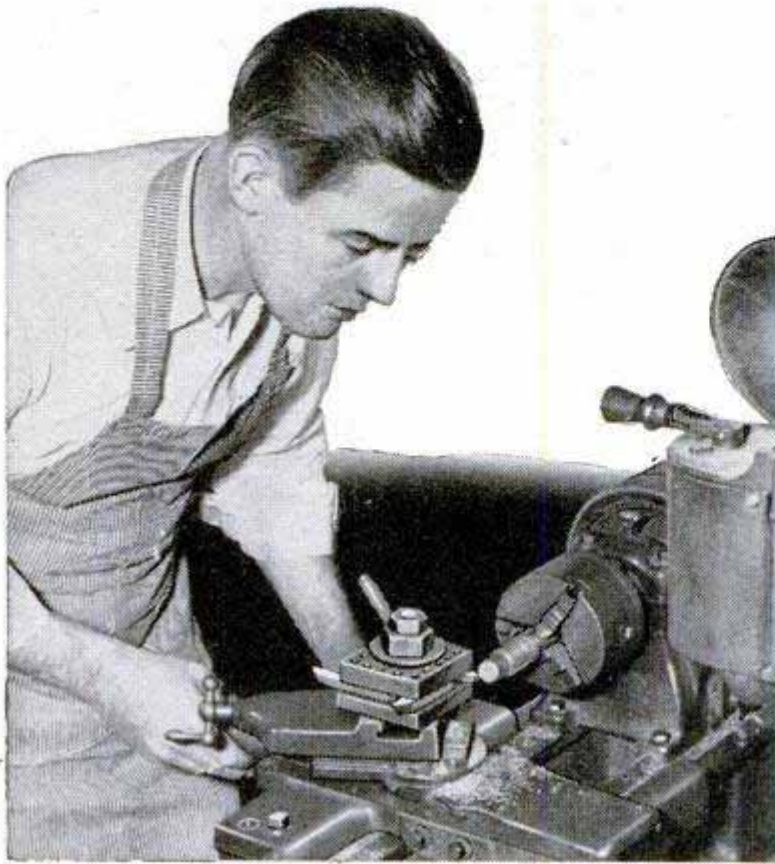

Build your own TOOL-POST TURRET

By E. M. HANSON

DESIGNED for lathes of the 9 and 10-in. swing sizes, this tool-post turret makes four different cutting tools instantly available without changing cutting bits or toolholders. The only power tools needed to make the turret are the lathe on which the turret is to be used and a drill press.

For the turret body, use a 2 x 3 x 3-in. block of cold-rolled steel. First, find the center of a 3 x 3-in. side by scribing diagonal lines as in Fig. 1. Then, center-punch the intersection of the lines and center the block in a four-jaw chuck by aligning the punch mark with the lathe tailstock center as in Fig. 2. Face off the end of the block and, referring to the dimensions given in Fig. 5, drill and bore a hole through the center and counterbore to the tolerances indicated. Then rechuck the work end-for-end to turn the other side. Put the block aside at this stage and chuck a piece of $2\frac{5}{8}$ -in.-dia. stock, $3\frac{5}{8}$ in. long, for the center post, Fig. 4. First, face off the end and turn down the stock to 1-in. dia. for a

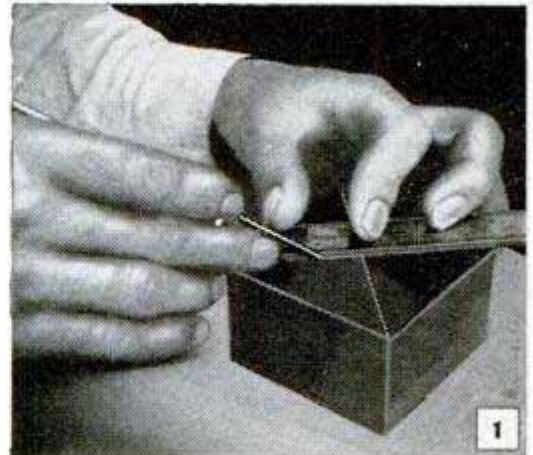

Scribing diagonal lines across corners of the tool-post turret block to locate center

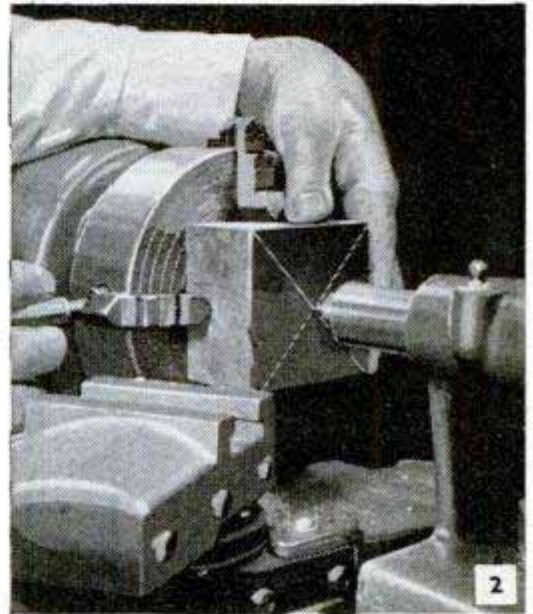

Block is centered in chuck by aligning center-punch mark with tailstock center



Drilling hole through center post. Drill chuck is held in ram of tailstock center

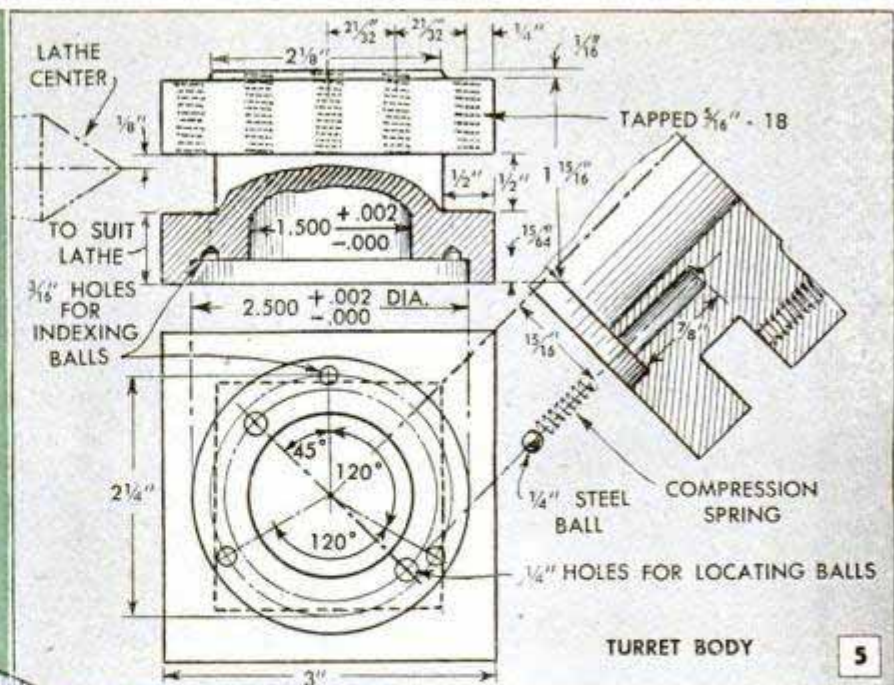
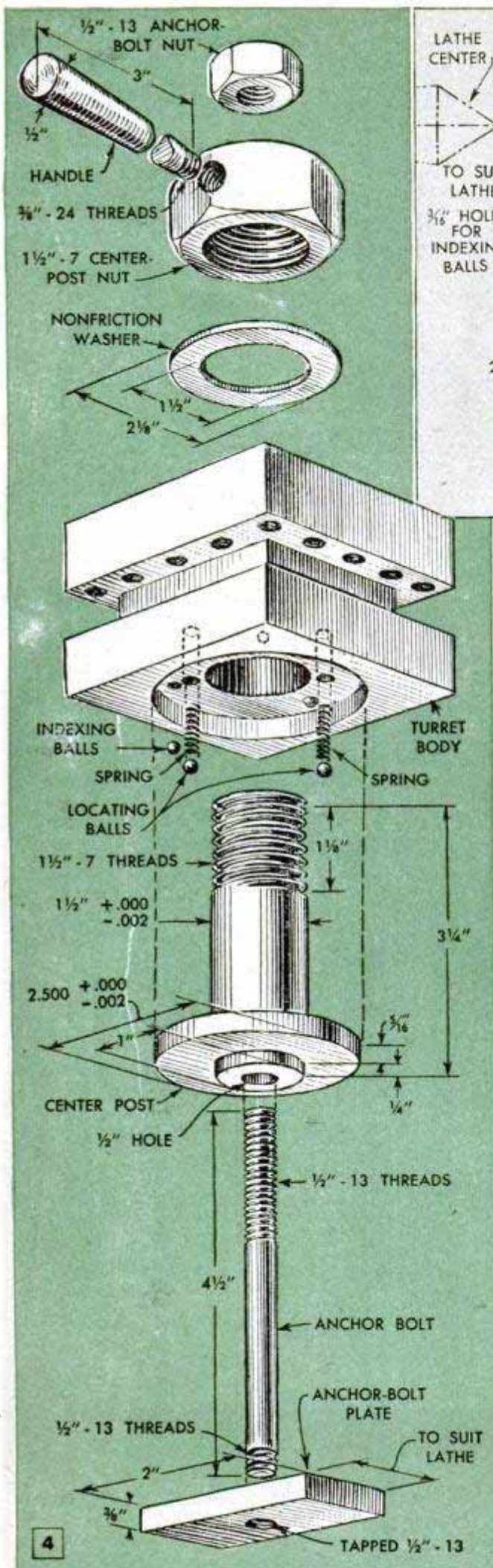

distance of $\frac{1}{2}$ in. from the end. Then remove the piece, chuck the turned portion, and face off the other end to a distance of 3 in. from the shouldered edge. This end should be center-drilled so the tailstock center can be used when turning down the piece to $1\frac{1}{2}$ in. in dia., $\frac{5}{16}$ in. from the shouldered edge. The piece is then threaded for a $1\frac{1}{2}$ -7 hexagon nut. Before removing the work from the lathe chuck, release the tailstock center and try the turret body and nut for fit. Now drill a $\frac{1}{2}$ -in. hole through the center as shown in Fig. 3. To finish the center post, again rechunk it end-for-end and face off the 1-in.-dia. portion to $\frac{1}{4}$ in. from the shouldered edge.

The center-post nut, Fig. 4, is drilled and tapped to take a handle. To start the drill, file a flat on one of the six corners of the nut. Center-punch and drill and tap at about a 15-deg. angle so the handle will tilt upwards as shown in Fig. 9. The handle is made of $\frac{1}{2}$ -in.-dia. cold-rolled steel taper-turned to $\frac{3}{8}$ in. at one end and threaded as indicated in Fig. 4. The non-friction washer, Fig. 4, is cut from sheet brass with a circle cutter as shown in Fig. 6. A $\frac{1}{2}$ -in. steel rod for an anchor bolt is threaded on both ends to take a standard $\frac{1}{2}$ -in. nut and anchor-bolt plate which fits into the T-slot of the lathe compound rest as in Fig. 7.

The turret body, which was previously set aside, must be drilled for the two $\frac{1}{4}$ -in. locating balls and three indexing balls, Fig. 4. Referring to Fig. 5, drill two holes 180 deg. apart for the $\frac{1}{4}$ -in. locating balls and springs. Use a drill one size larger than the balls to permit them to move freely in the holes. Then, 45 deg. from one of the $\frac{1}{4}$ -in. holes and on a $2\frac{1}{4}$ -in. circle, drill another hole $\frac{3}{32}$ in. deep with a No.

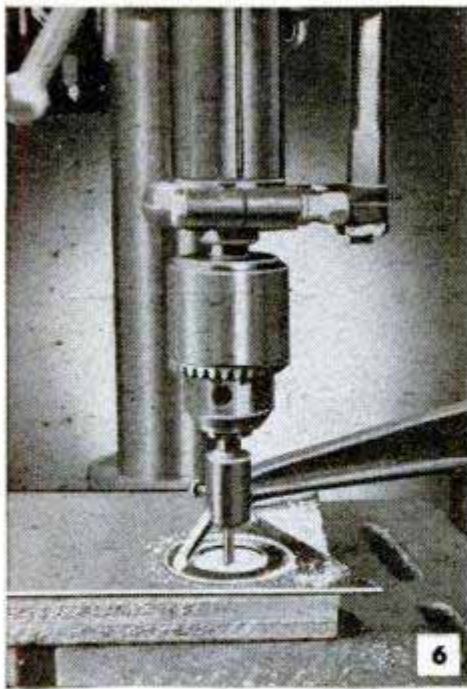

6

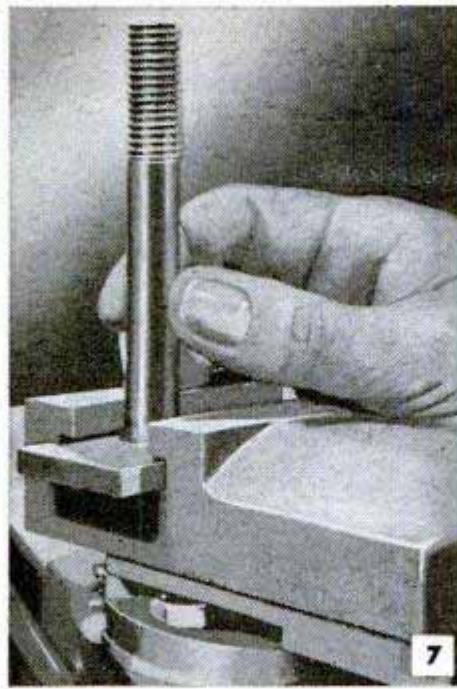

7

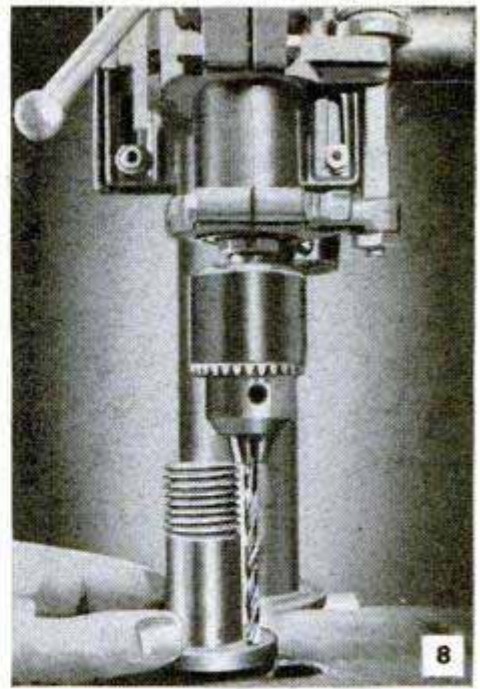

8

13 drill. Lay out the positions for the other two holes 120 deg. from the first hole. When drilling, have the drill-press gauge at exactly the same setting as for drilling the first hole. As these holes are slightly smaller than the $\frac{3}{16}$ -in. balls, use a piece of brass to avoid making a flat spot on the balls when driving them in place. With the five balls in their respective holes, coat with light grease the surface of the center-post base that will contact the balls when it is assembled with the turret body. When assembled, rotate the center post one complete revolution. This will leave a circular line on the base that can be easily seen when it is removed. Lay out and center-punch four equally spaced positions on the line made by the $\frac{1}{4}$ -in. balls, and drill four holes $\frac{1}{32}$ in. deep with a $\frac{1}{4}$ -in. drill as in Fig. 8. These holes are used for locating and retaining the turret body. Accurate indexing, to virtually zero percentage of error, is accomplished by making impressions on the base of the center post for the

$\frac{3}{16}$ -in. balls. To achieve this accuracy, re-assemble the turret body and center post, aligning the $\frac{1}{4}$ -in. balls with two of the holes in the base, and tighten the center-post nut. Then, with the center post resting on a solid base, tap the four corners of the turret body with a brass or lead hammer so the $\frac{3}{16}$ -in. balls will make an impression on the center-post base. Repeat this process at each quarter turn of the turret body.

To support the cutting tools, a $\frac{1}{2}$ -in. groove is milled all around the turret body with an end mill as in Fig. 9. Note in Fig. 5 that the top surface of the groove is $\frac{1}{8}$ in. above the lathe center. The top of the turret body is then drilled and tapped for 16 setscrews as indicated in Fig. 5. The cutting bits are placed at the desired height by use of shims and are held firmly in place with socket-head setscrews as in Fig. 10.

In use, to switch from one tool to another, loosen the center-post nut about a quarter turn, rotate the turret to the desired position, and tighten the nut.

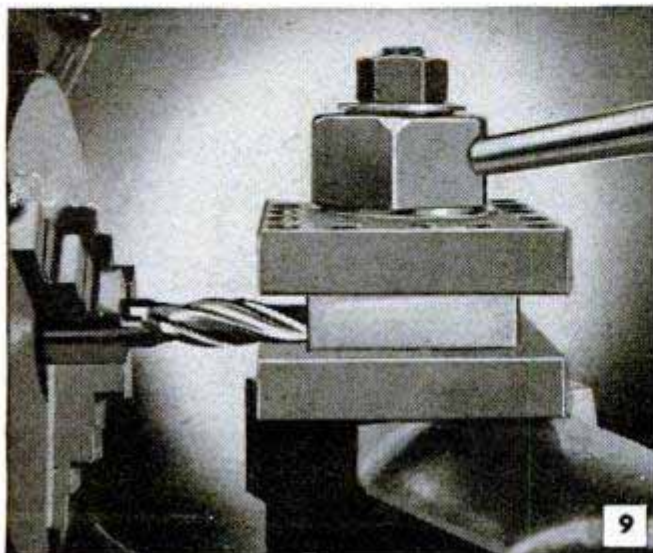

9

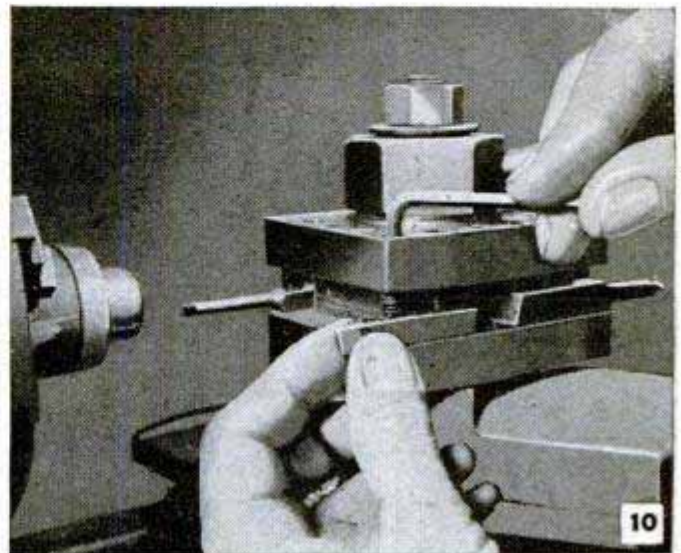

10

Faceplate Converted to Lathe Chuck By Addition of Jaws and Guide Lines

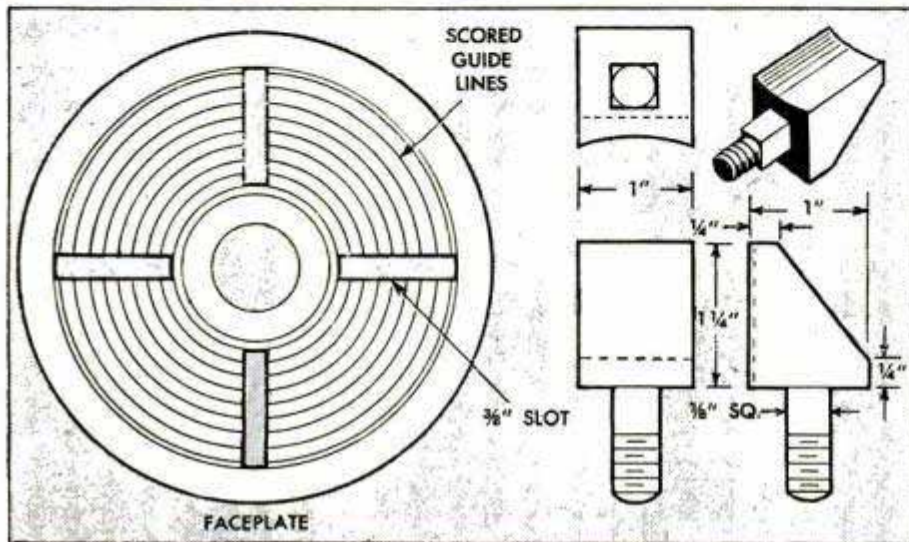
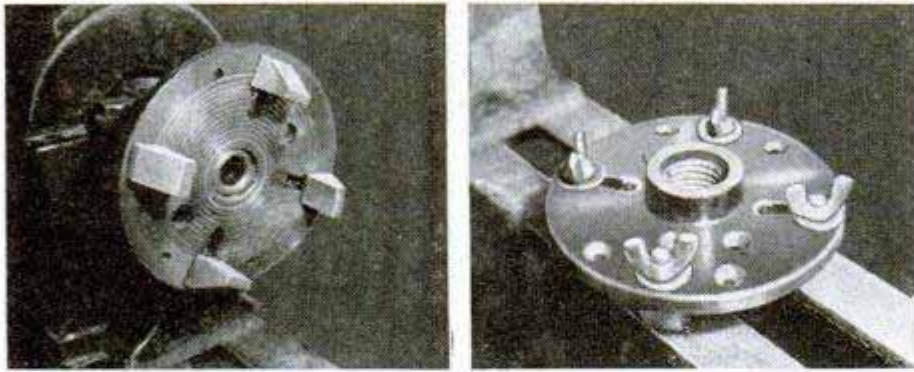

By converting a wood-lathe faceplate to a four-jaw chuck, it is no longer necessary to make a wooden chuck for each special turning job. In addition, the jaws can be removed when they are not needed. Slots for the jaws are formed in the faceplate at right angles to each other by drilling rows of holes and filing out the waste stock. To aid in centering the work, concentric guide lines are scored on the plate at 1/8-in. intervals. The jaws, made as shown in the detail, are of cold-rolled steel and are held in the slots with wing nuts. Note that the faces of the jaws are concave. As the concave is not critical, this can be done on a tool grinder. In order to protect the work, the face of each jaw is padded with a piece of rubber cemented in place.—D. C. Marshall, Manhattan, Kans.

Plate Glass Faced With Emery Cloth Provides Inexpensive Lapping Plate

Faced with emery cloth, a piece of heavy plate glass serves as an inexpensive lapping plate. Although it cannot be used for extreme accuracy, it does a good job where a reasonably smooth, flat surface is required. Use water glass (sodium silicate) to cement the cloth to the plate as this permits the cloth to be removed with warm water when it becomes worn. Spread the water glass on the back of the cloth with a spatula or putty knife. Then smooth the

cloth to the glass with a photoprint roller and allow to dry for 20 minutes. To use, lay the plate on a flat surface about waist high. Holding the work firmly, slide it back and forth or in a circular motion, applying very light pressure. The trick is to change the direction of motion continually in order to attain a matte finish as well as a flat surface. If the new abrasive cuts too rapidly, rub chalk over the grit. When the abrasive begins to wear smooth, flood it with lard oil. The most positive action is reached when the abrasive appears to be gone and the work is sliding in an oily slush.—Alexander Maxwell, Chicago.

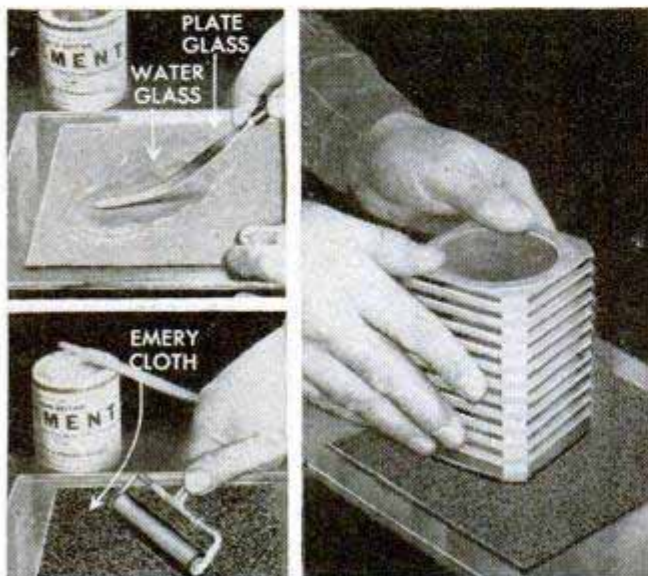

Brush Holder for Paste Pail

Made from a length of stiff wire pivoted to lie across a paste pail, this brush holder swings out of the way to permit mixing the paste. Drill a hole for the wire through the side of the pail just under the rim.

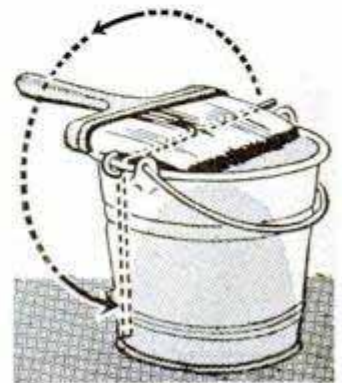

Submersible Element Heats Water Quickly

In either a home or shop where a constant supply of hot water is not available, a submersible heating element is just the thing to heat a pan or bucket of water in a jiffy. It consists fundamentally of a 500-watt, cone-type heating element enclosed in a watertight container. To make one, obtain a screw-top can having an inside diameter larger than the diameter of the heating element. Be sure that the element does not touch the sides of the can. Allow $\frac{1}{4}$ -in. clearance all around. Then, solder two pieces of wire to the bottom of the can to hold a metal weight necessary to keep the heater submerged. The heating element is turned into a porcelain socket bolted to the cap of the can. An extension cord from the socket runs through a short length of tubing threaded at one end and fastened to the cap with two nuts. The extension cord is tightly wrapped with asbestos paper for several inches back from the socket in order to minimize heat damage to the insulation of the cord. Note that two heatproof gaskets are inserted in the underside of the cap before the parts are assembled. A shallow groove is made

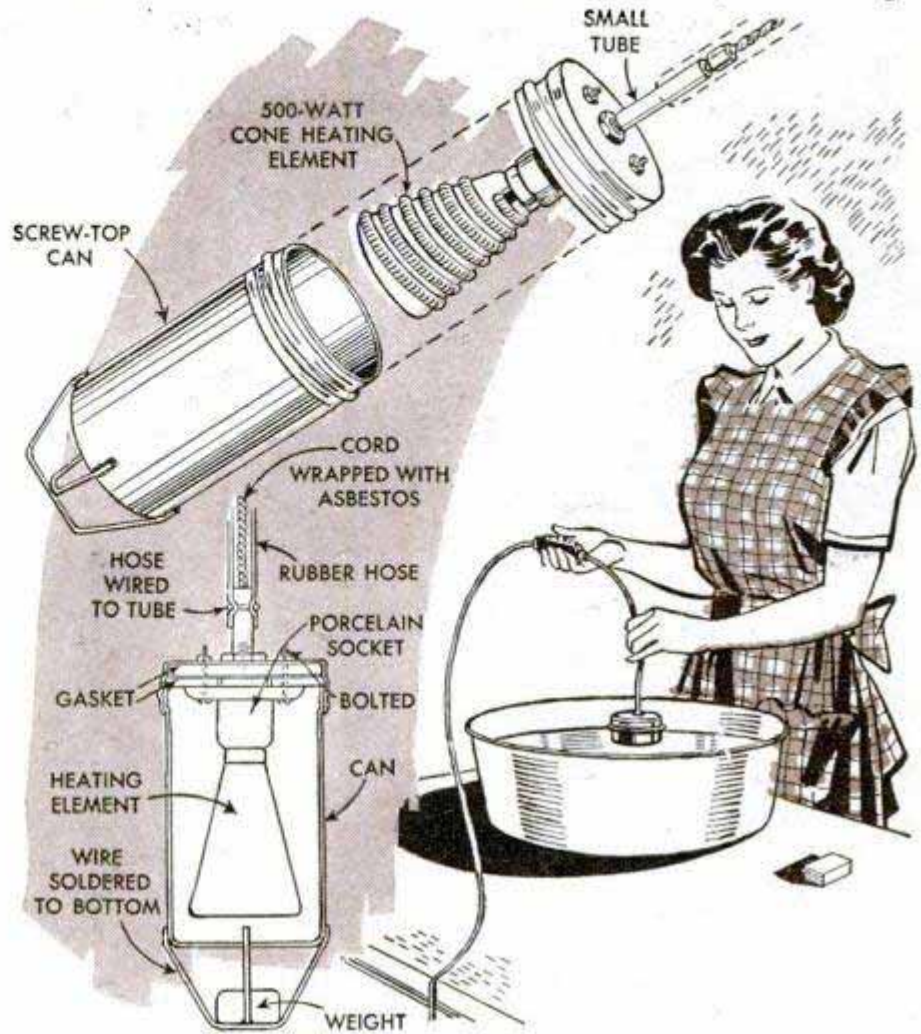

around the tubing near its upper end and a length of rubber hose is clamped to the tube by twisting a piece of wire around it at this point. The hose should extend well above the water level. When the assembly has been completed, test it for leaks before turning on the current.

C. L. Meehan, Lakeview, Ont., Can.



Scale Scribed on Triangle Aids Setting Dividers

Dividers can be quickly set from .01 in. to 1 in. by means of this 1-in. square scribed on the face of a triangle. Carefully lay out the square and divide it into ten equal parts vertically and horizontally. Then scribe a diagonal from one lower corner to the first vertical tenth line at the top of the square. The proper dimension is obtained by positioning the dividers between the tenth lines and the diagonal.

Iver Johnsen, Jr., Michigan City, Ind.

☞ To be sure that a gear cutter is centered directly over the dividing-head centers, mount a piece of scrap stock on an arbor between centers. Take a trial cut and then turn the stock end-for-end. If the cutter is centered, it will fit in the slot.

BROADCAST SEEDER MOUNTS

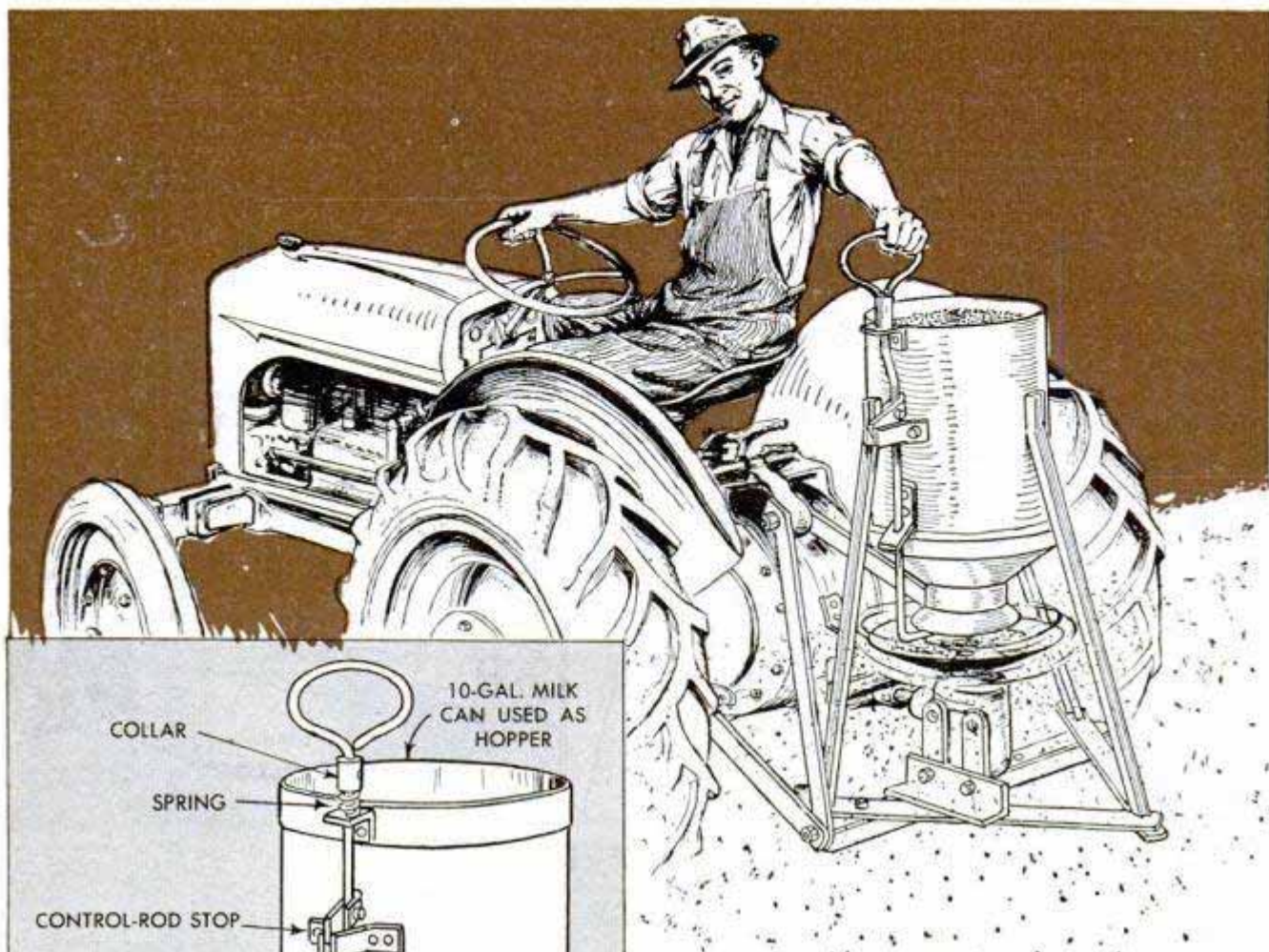

By Simon M. Schwartz

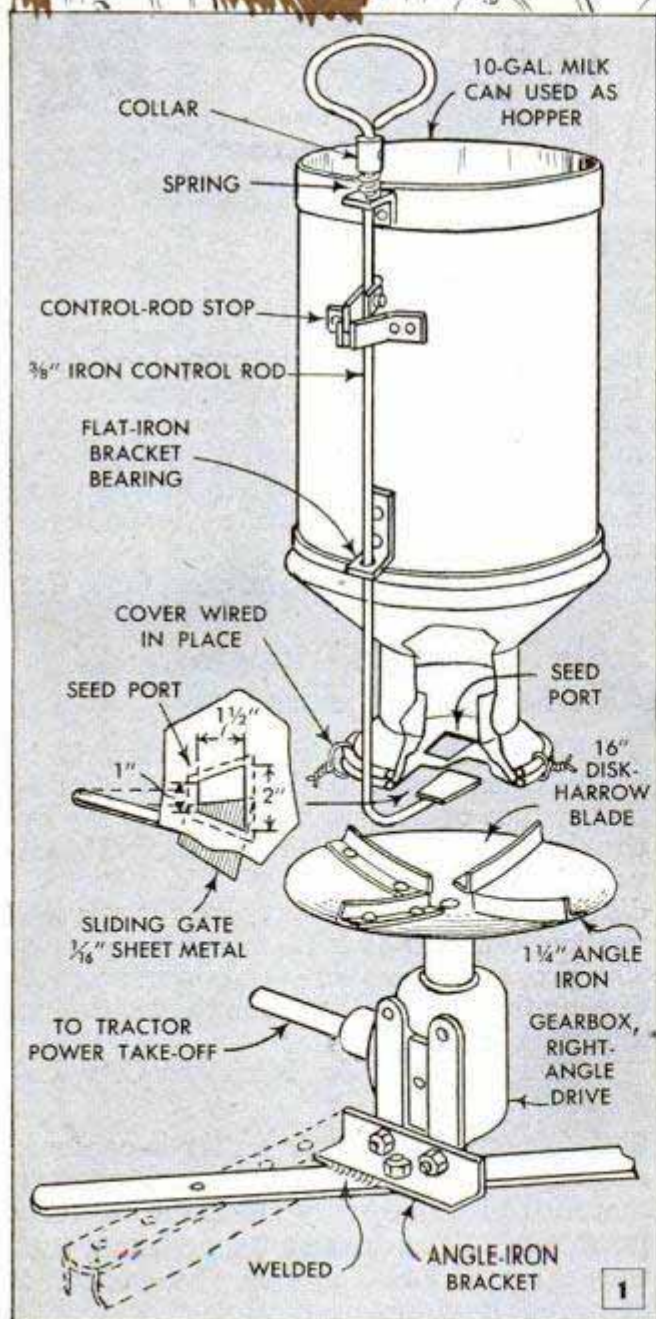

THIS EFFICIENT broadcast seeder was built by Frank Signs of Indiana for the special purpose of seeding a cover crop in growing corn at the time of the last cultivation. The seeder handles any of the common clover seed as well as rye, wheat and oats. When seeding in corn, a width of nine corn rows is covered on each trip across the field. The seeding rate is adjusted by means of a movable gate which slides across a seed port. An adjustable stop on the control rod permits the gate to be set to sow any amount of seed up to the full capacity of the seed-port opening. The stop also assures that the gate will be returned to the same position when the seed port is opened after the tractor is turned at the ends of the field.

A 10-gal. milk can, inverted and supported on a triangular frame, serves as a hopper, Fig. 1. Note that the frame is bolted to the tractor drawbar. The seed spreader, or slinger, consists of a disk-harrow blade fitted with angle-iron vanes and welded to one shaft of a right-angle gearbox such as that used on a combine. This drive unit is mounted inside the tri-

ON TRACTOR

angular frame in an inverted position and directly below the cover of the milk-can hopper. It is important when mounting the unit to place it off center with relation to the seed port so that the greater amount of seed will be thrown to the rear when the seeder is in operation. For example, if the disk rotates counterclockwise, the seed port should be located to the left of the center of the disk so that the seed will be distributed uniformly by the vanes. The driving shaft of the gearbox is connected to the tractor power take-off through a universal joint and whatever length of shaft extension is necessary to assure a positive drive. Fig. 2 shows the frame which supports the hopper and the drive unit. Some changes may have to be made in order to accommodate other types of gearboxes and variations in tractor drawbars. For this reason, the frame is not fully dimensioned, and dimensions given are only average. For sowing under some conditions, it may be necessary to set the spreader disk at a greater height above the ground. To do this, it would only be necessary to build a higher mounting for the gearbox and lengthen the vertical hopper supports. All parts of the frame which support the hopper are welded together for extra strength and rigidity. In addition to being bolted to the tractor drawbar, the frame is also braced to the tractor transmission at some point where it is convenient to attach a brace. This will prevent the hopper from rocking forward or backward

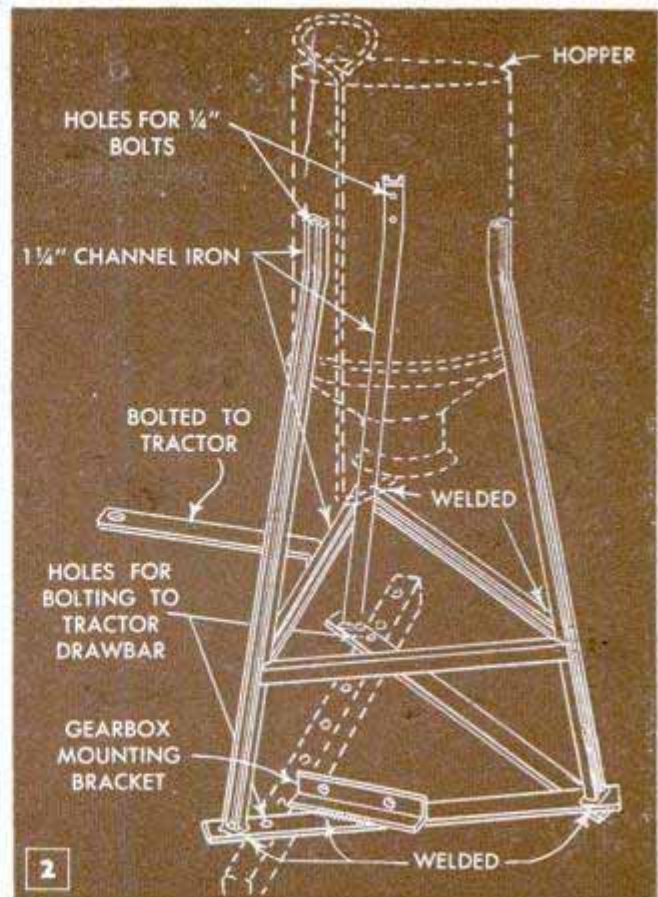

when traveling over rough ground. In using a broadcast seeder of this type it is best to sow only on quiet days, especially when sowing clover or light, chaffy, grass seed. Sowing on windy days may result in an irregular distribution of the seed. If the spreader disk and vanes are discarded parts and are rough or rusty when installed, they are easily polished by feeding a quantity of sand through the mechanism.

Guardrails for Hayloft Door Fold Against Wall When Not in Use

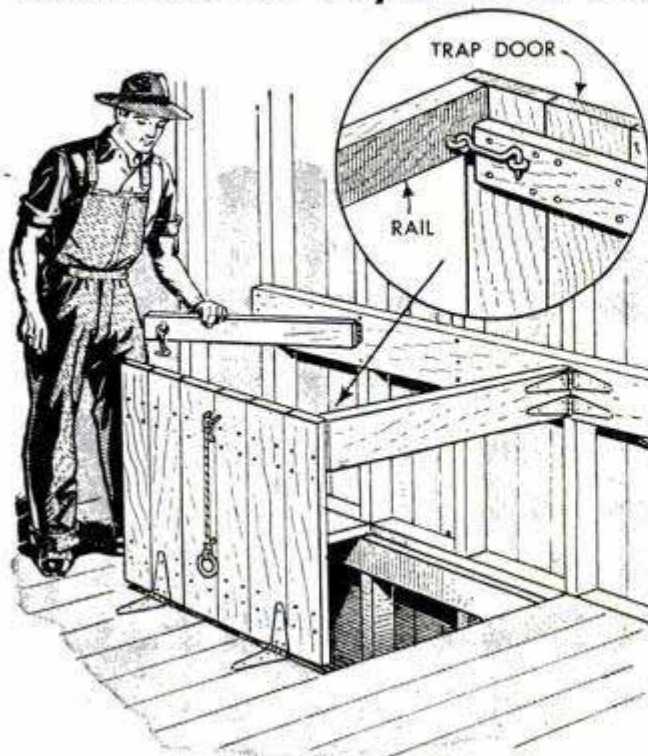

There will be no danger of falling through the trap door of the barn loft, even at night, if the door is fitted with guardrails. The rails, which are hinged to the barn wall, swing outward and are hooked to the trap door when it is in the upright position. When the door is closed, the rails are folded flush against the wall.

Improving Ticket-Window Counter

It is easier to pick up tickets from a wooden counter of a ticket window if several rows of furniture nails are driven into its surface. The nails raise the tickets so they can be grasped with finger tips.

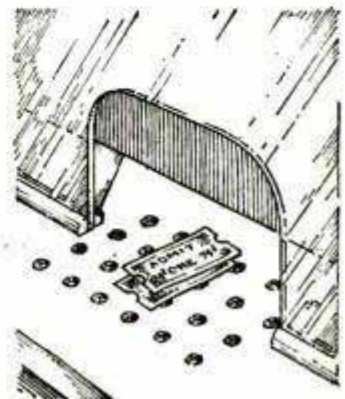
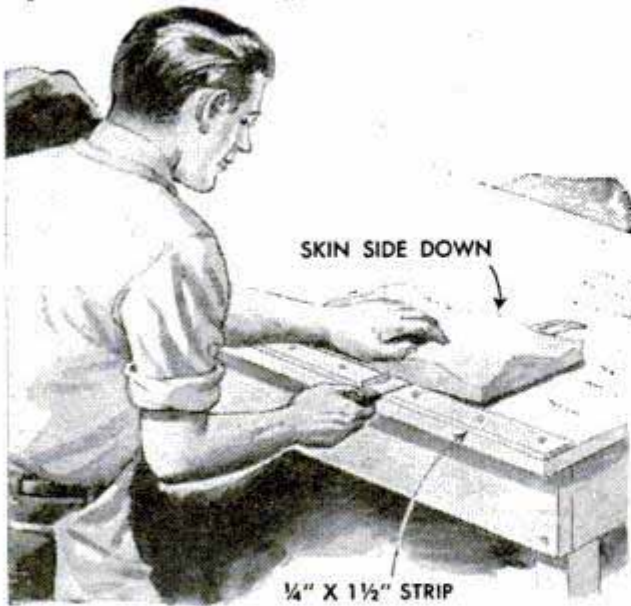

Table-Top Guide Strip for Knife Speeds Skinning Pork Sides



One farmer reduces the time required for skinning pork sides by nailing a thin strip of wood along the front edge of his worktable. When the meat is laid on the table, skin side down, the strip serves as a guide for the knife, permitting a uniform depth of cut which removes the skin without cutting into the fat. The knife, of course, is held parallel with the table top.

Eyebolt to Lift Machinery Parts Has Three Thread Sizes

The number of eyebolts necessary to lift various machinery parts with a shop crane can be reduced by using eyebolts having three thread sizes. These are made by welding three threaded studs to a ring at equidistant points. In some shops, one of these eyebolts is sufficient while in others

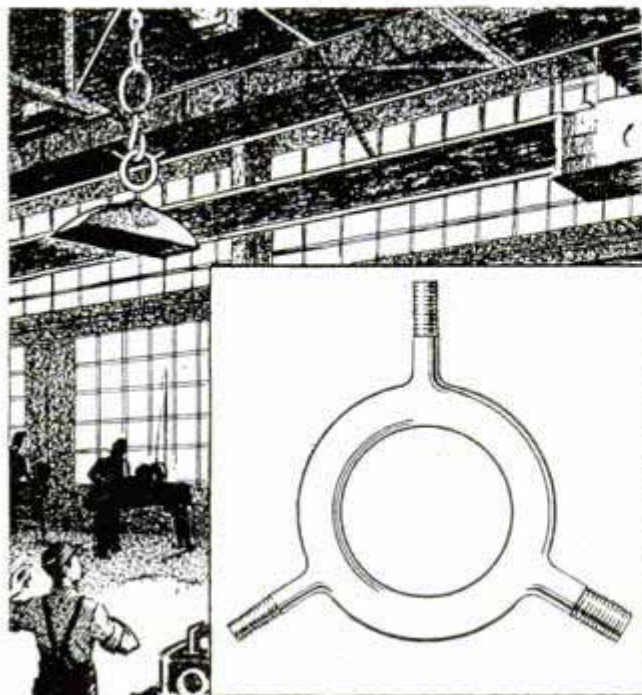

several are required to provide a wider range of thread sizes.

Fred A. Walters, Battle Creek, Mich.

Drilling Holes Through Rod Stock

When a hole is to be centered through a rod, the rod to be drilled is placed in a V-block and two additional rods, each of the same diameter, are placed one on each side of the first. All three are then clamped in position as shown. The diameter of the clamping rods must be such that, when clamped in place, the distance between them exactly equals the diameter of the hole to be drilled. In this position, they serve as an accurate guide for centering the drill.

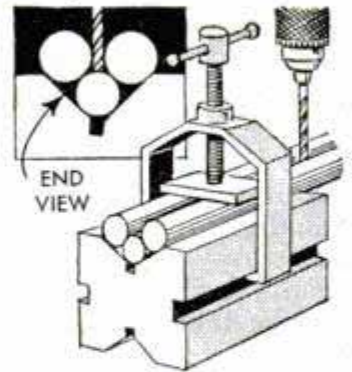

H. Moore, Leeds, England.

Finding Amount of Water in Well

To determine the number of gallons of water in a well or vertical, cylindrical tank, multiply the depth of water in inches by 34 and move the decimal point four places to the left. Then multiply the result by the square of the diameter of the tank or well (also in inches). The resulting figure is the quantity of water in gallons.

Repairing Air-Hose Leak

If an air hose develops a leak and no rubber tape is available to repair it, you can make a temporary repair by wrapping the hose with masking and friction tape. First wrap the hose with three or four layers of masking tape, overlapping each turn, and then wrap an equal number of layers of friction tape over the masking tape. The masking tape is used because it is airtight and the friction tape gives the necessary strength to the repair.

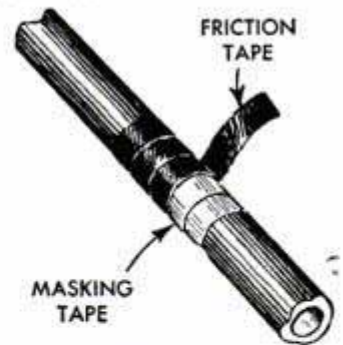

John Stankiewicz, Charlestown, Ind.

Typewriter Case Stores Paper

Placed in a large Manila envelope, a good supply of stationery can be carried inside the lid of a portable-typewriter case. Select an envelope that fits tightly in the lid.—Pat Fey, New York City.

Rubber Cover Keeps Lathe Chuck Dust-Free

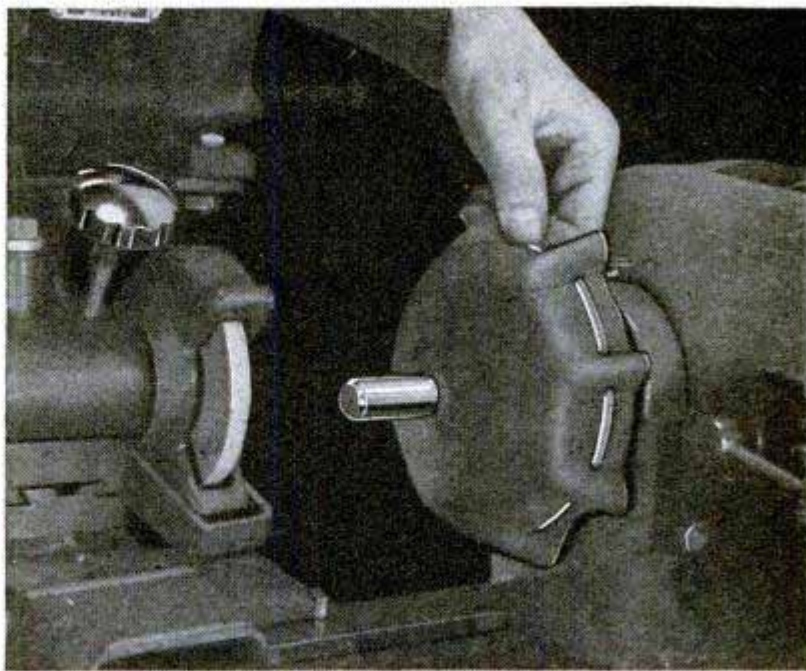
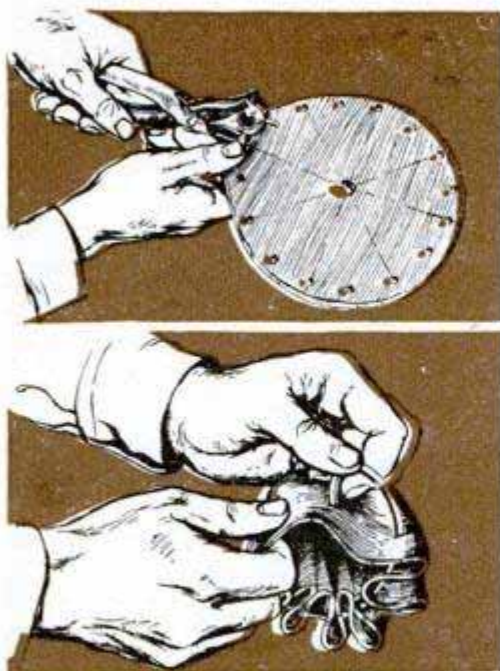

Abrasive dust from grinding operations causes most of the wear in a lathe chuck. Small work, where the grinding wheel must be operated close to the chuck, results in the greatest accumulation of dust. To protect either a three or four-jaw chuck from dust, make a rubber cover with a drawstring closure. The cover can be made from a discarded inner tube, and will not interfere with the normal use of the chuck. First, cut a disk from heavy paper and fold it over the chuck, trimming the edge of the paper flush with the back edge of the chuck body. Then, place the paper pattern on a piece of inner tube and cut a disk the same

size as the pattern. Punch 16 small, equally spaced holes around the edge and also cut or punch a hole at the center of the disk somewhat smaller than the diameter of the work. Thread a leather shoelace through the holes to serve as a drawstring. If desired, the spaced holes may be omitted and the closure made by snapping a strong rubber band over the cover after it is placed on the chuck. To use, place the work in the chuck and tighten the jaws. Slip the cover in place against the face of the chuck with the work projecting through the center hole, and then tighten the drawstring and knot it to hold the cover securely in place.

Harrow Disk in Feed Kettle Aids Cooking Mash

When cooking mash in a large feed kettle, you can eliminate much of the stirring by laying a harrow disk in the bottom of the kettle before dumping the grain into the water. The disk helps prevent scorching of the grain by keeping it from coming in contact with the hottest part of the kettle, and the water beneath the disk bubbles up through the center hole, agitating the mash for more thorough cooking. Note that the harrow disk must be placed in the kettle with its concave side downward.

Mirror on Combine Grain Bin

By using a rear-view mirror, fastened to the back of the grain bin of a combine, the amount of grain in the bin can be noted at any time without getting down from the tractor. The mirror is attached to the top of the bin and adjusted so the grain can be seen from the tractor seat.



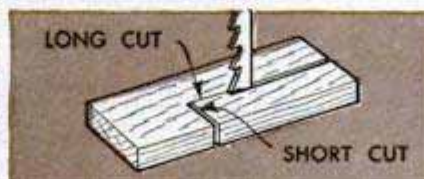
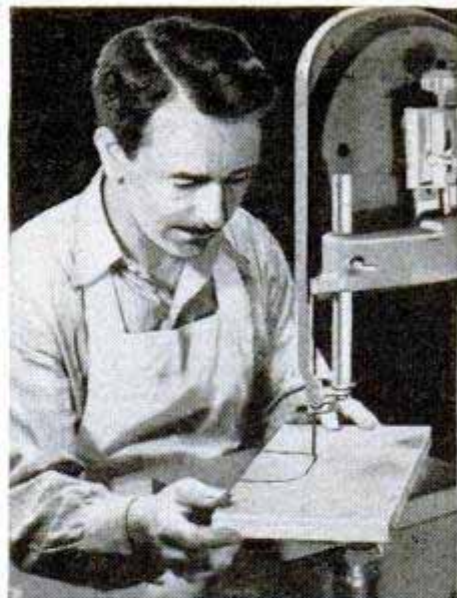
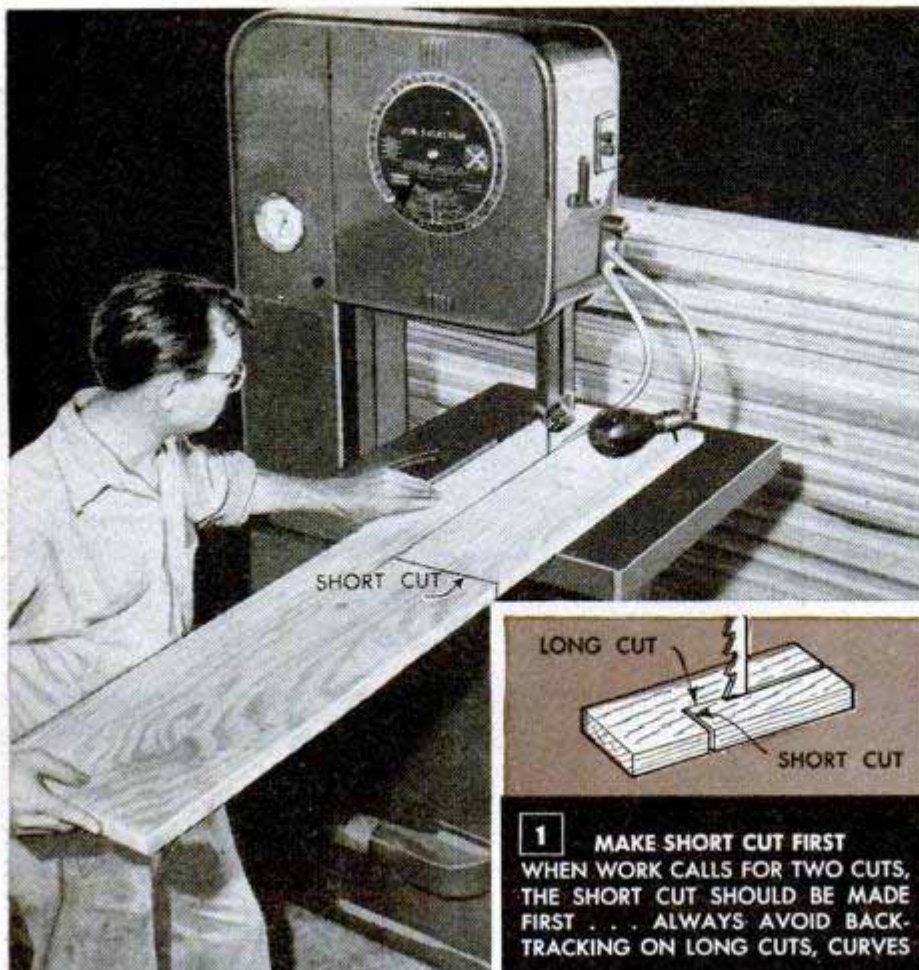

1 MAKE SHORT CUT FIRST WHEN WORK CALLS FOR TWO CUTS, THE SHORT CUT SHOULD BE MADE FIRST . . . ALWAYS AVOID BACK-TRACKING ON LONG CUTS, CURVES

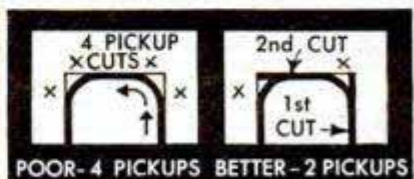

POOR - 4 PICKUPS BETTER - 2 PICKUPS

2 BACKTRACK ON U-TURNS CUT TO THE CORNER AND THEN BACKTRACK ENOUGH TO LEAD THE BLADE INTO THE 2nd CUT. AVOID PICKUP CUTS WHEN POSSIBLE

OPERATING a bandsaw is not difficult and anyone can do it with a little practice, but the difference between merely operating a saw and really doing expert work with it lies in the ability of the operator to do intricate cutting without running into numerous "booby traps." This article is intended to acquaint the beginner with the "tricks of the trade" and help him produce expert work.

Adjustments: After the blade is put on the bandsaw, it must be tensioned. Although some saws have a scale to simplify tensioning, it is merely a matter of drawing up the blade until it "feels" about right, Fig. 10. Note that the blade should not be set too tightly. A 1/4-in. blade should have about 1/4-in. side play. By means of the

BANDSAW

By Sam Brown

tilting screw, the blade is tracked to run in the center of the wheels, left-hand detail, Fig. 7. Turn the drive pulley by hand, as in Fig. 6, to check the adjustment. Then, the guides, which have been completely backed off up to this point, are adjusted. The blade support should be slightly clear of the blade, Fig. 7, right-hand detail, and the guide pins set to align with the bottom of the teeth, Figs. 8 and 9. If the pins are set forward of this point, they will cause the teeth to wear. The guides must also be ad-



6 TRACKING SHOULD PUT BLADE IN CENTER OF WHEELS

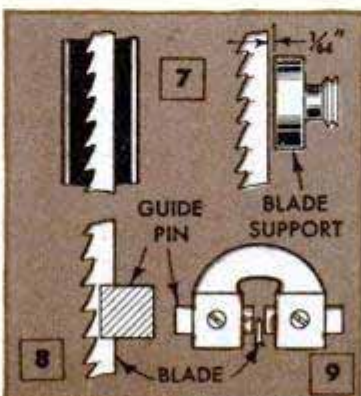

7 ADJUSTMENTS



10 BLADE TENSION MUST BE SET BY FEEL. BLADE SHOULDN'T BE TOO TIGHT

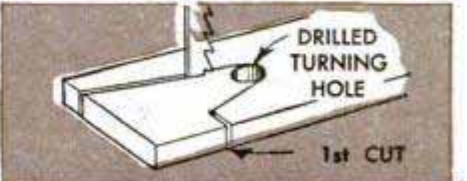
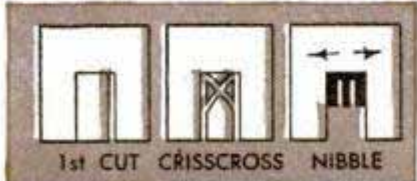
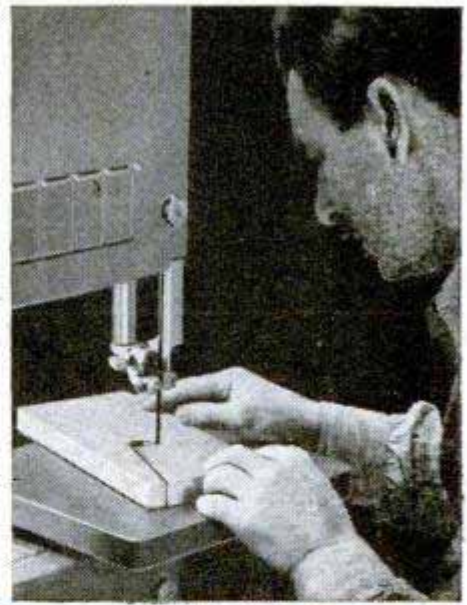
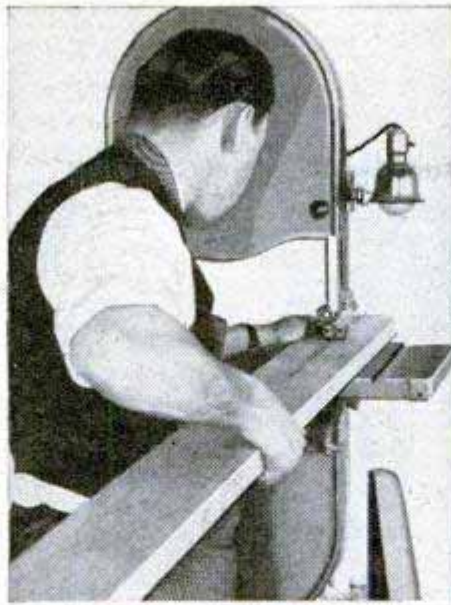

3 "NIBBLE" NARROW CUTS
SHORT SIDE OF NARROW GROOVES MUST BE NIBBLED. TECHNIQUE IS USEFUL ON MANY JOBS. IT WORKS BEST WITH A HEAVILY SET BLADE

4 "PIVOT" RIPPING CUTS
ON STRAIGHT RIPPING CUTS, THE LEFT HAND IS HELD ALONGSIDE THE WORK AND ACTS AS A PIVOT. RIGHT HAND SWINGS THE WORK TO FOLLOW LINE

5 USE TURNING HOLES
BACKTRACKING AND PICKUP CUTS OFTEN CAN BE AVOIDED BY BORING HOLES IN THE WORK TO ALLOW FOR SHIFTING OF THE BLADE POSITION

KNOW-HOW

justed close enough to the blade to keep it from twisting, but they should not come in actual contact with it. They can be set properly by placing a strip of paper between each pin and the blade and pressing the pins together. However, when doing this, be careful not to push the blade out of the vertical position.

Cutting technique: Fundamental band-sawing techniques are described in Figs. 1 to 5 inclusive. The general idea is to do the job with a minimum number of backtracking and pickup cuts. The left-hand diagram in Fig. 2 shows a U-cut made without

backtracking, but this method leaves four pickup cuts. When a pickup cut is made in this manner, the result is never quite as smooth as a cut made in one pass. Therefore, the method shown in the right-hand diagram is better as a little backtracking eliminates two of the pickup cuts.

The blade: For use on smaller bandsaws, blades range from 1/8 to 3/4 in. wide. The best practice, of course, is to use a narrow blade for light sawing, such as cutouts, and a heavier blade for other work. However, to avoid constantly changing blades, the 1/4-in. blade will be found best for all-purpose use. Important considerations in blade selection are the type of tooth and the amount of set. Fig. 13 pictures the standard blade; Fig. 14 shows the buttress

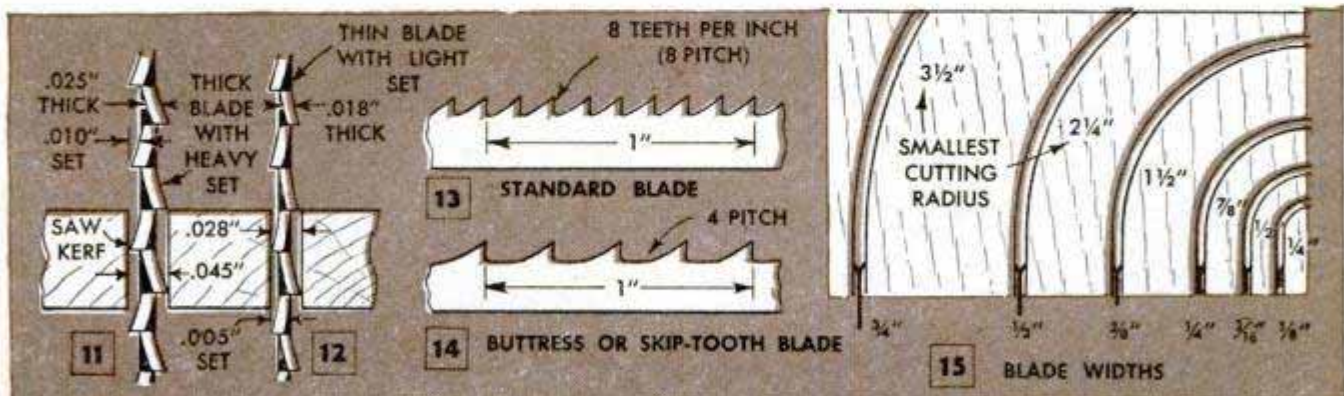

THE BLADE USE A SAW BLADE TO SUIT THE JOB. A 1/8" BLADE IS EXCELLENT FOR CUTOUTS BUT USELESS FOR RESAWING. A 1/4" WIDTH IS BEST ONE-BLADE CHOICE



17

THE BANDSAW CUT ALWAYS SHOWS SOME WASHBOARDING, DEPENDING ON SAW SET. LEAD IS USUALLY TO OUTER EDGE OF THE TABLE

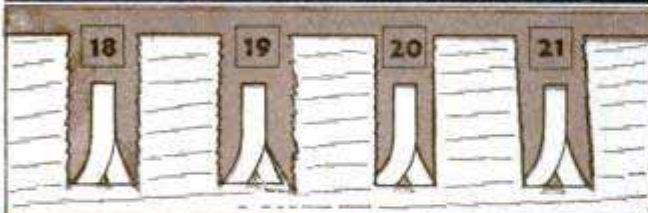

NORMAL WASHBOARDING CAUSED BY TEETH	ONE LONG TOOTH CAN DO A LOT OF DAMAGE	HONED TEETH CUT SMOOTHER BUT WORK HARDER	BLADE LEADS TOWARD SHARP SIDE
-------------------------------------	---------------------------------------	--	-------------------------------

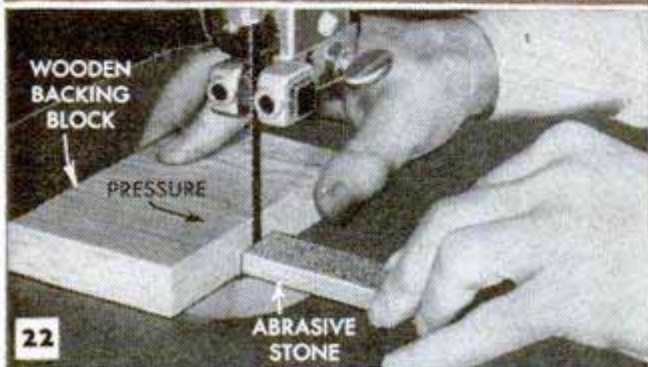

22

SMOOTHER CUTS CAN BE OBTAINED WITH HONED TEETH

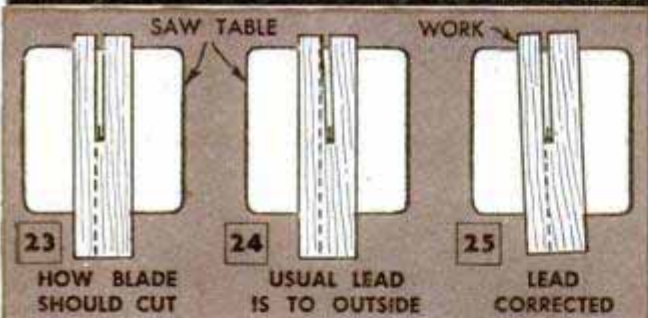

23 HOW BLADE SHOULD CUT

24 USUAL LEAD IS TO OUTSIDE

25 LEAD CORRECTED

or skip-tooth type blade. The latter is preferred by many craftsmen for sawing wood and plastics. Standard blades are available in a number of thicknesses from 20 to 28 ga., but a thin blade with a light set, Fig. 12, is commonly used on small bandsaws. The buttress blade in Fig. 11 is thicker and carries more set. Although the teeth of this blade are usually hardened and cannot be filed, the extra hardness retains both sharpness and set about twice as long as a blade of filing temper. The radius limitations of the various blade widths, Fig. 15, must also be considered when choosing a saw blade.

The bandsaw cut: Every tool makes a mark on the work, and the marks of a bandsaw blade resemble a washboard, Figs. 17 and 18. A blade having a heavy set "washboards" more than one with a light set, and a poorly made blade with a few long, snaggle teeth, as in Fig. 19, makes an exceptionally rough cut. Smoother cutting is attained by honing the teeth lightly as shown in Figs. 20 and 22. However, if the honing is overdone, it dulls the blade. If one side of the blade is dull and the other side sharp, the blade leads off toward the sharp side, Fig. 21. A perfect blade cuts straight, as in Fig. 23. Because the inside surface of the blade is in constant contact with the wheels, it dulls faster than the other side, and the blade tends to lead to the outside, Fig. 24. This lead is corrected by feeding the work at a slight angle as shown in Fig. 25.

Resawing: The job of making thin boards out of thick ones, or resawing, is the kind of work the bandsaw does better than any other type of saw. The simple resawing setup shown in Figs. 26 and 28 functions

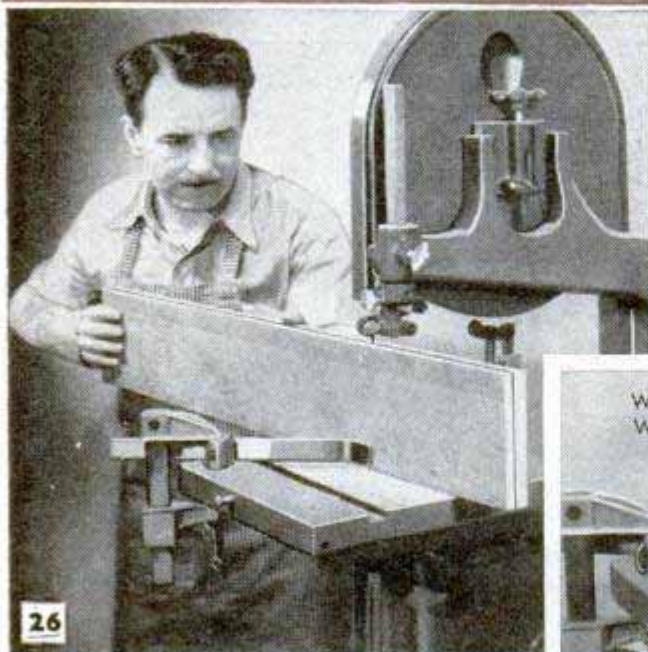

26

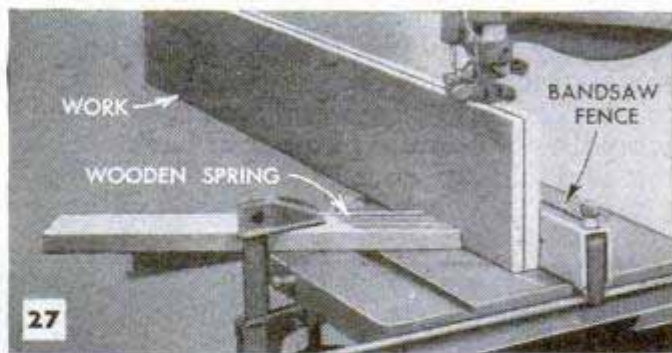

27

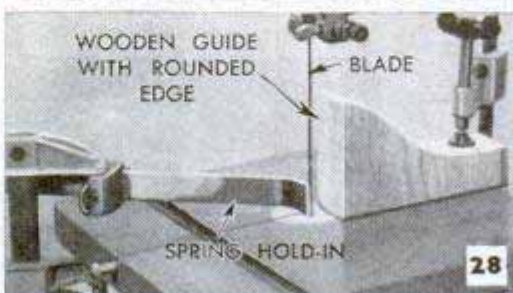

28

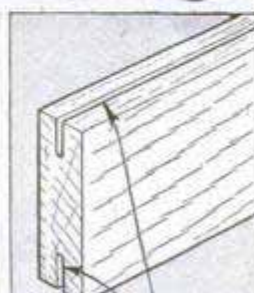

29 CUTS MADE ON CIRCULAR SAW

RESAWING IS A JOB BANDSAW DOES BETTER THAN ANY OTHER SAW. WORK UP TO 6" THICK CAN BE CUT WITH 1/3-HP. MOTOR.

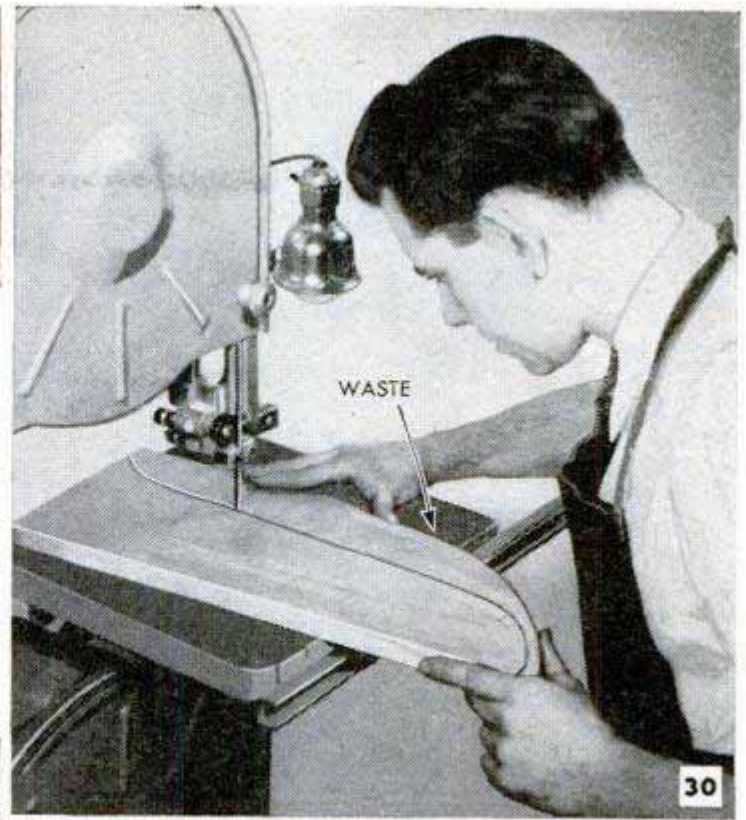
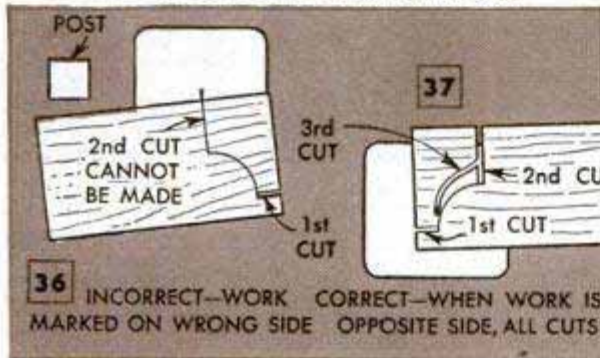
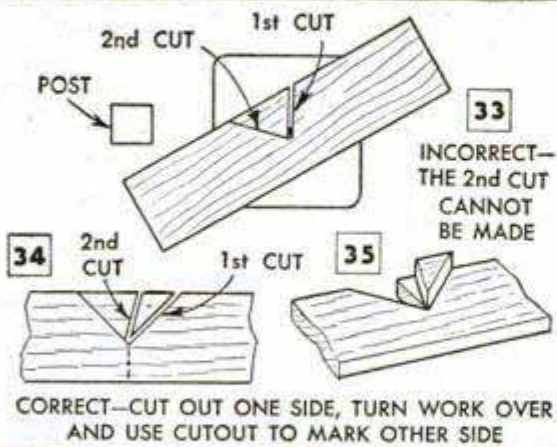
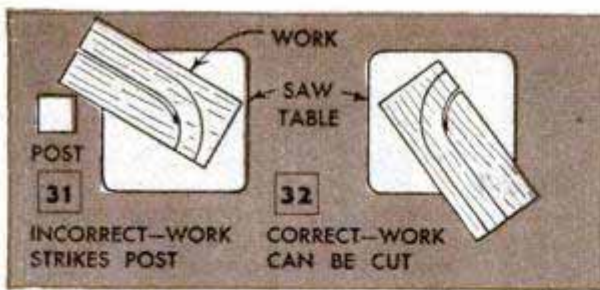

WATCH YOUR STEP
 DIAGRAMS SHOW THREE TYPES OF BOOBY TRAPS WHICH OFTEN FOOL EVEN EXPERIENCED SAWYERS

just as well as more elaborate fences. Fig. 27 shows the same job being done with a standard bandsaw fence and a wooden spring. Sometimes it is advisable to make circular-saw cuts on both edges of the work, as in Fig. 29, to serve as guidelines and also to reduce the cutting load. The blade used for resawing should be as wide as the bandsaw will carry, although good work can be done with the 1/4-in. blade. The buttress blade, with its hard temper and heavy set, is ideal for this work and does not clog with sawdust.

Booby traps: Certain bandsaw jobs can be cut in only one way, which is peculiar to that particular job. An example is shown in Fig. 30. Note that if the cut is made as in Fig. 31, the swing at the end of the cut will cause the work to strike the bandsaw frame and the cut cannot be completed. The right way to do this is to begin sawing at the opposite end as in Fig. 32. Most center cuts in long work must be completed by turning over the work as in Figs. 33 to 35.

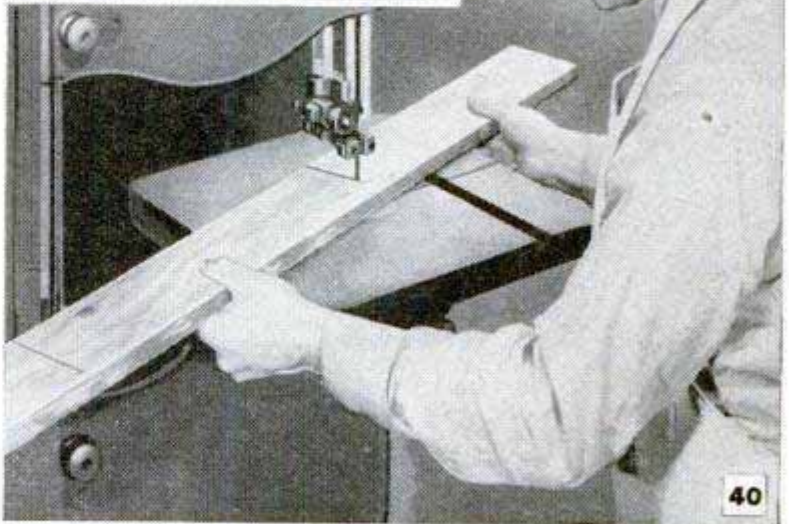
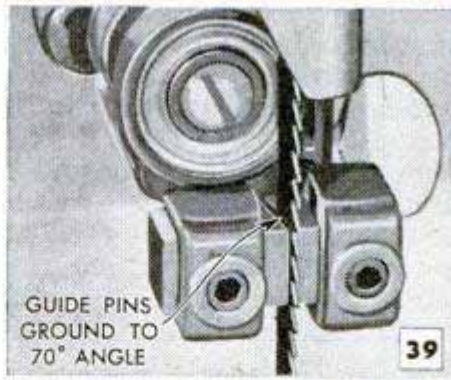

ANGLE GUIDES ARE USEFUL FOR INTRICATE SAWING AND SQUARE CUTOFFS IN LONG WORK

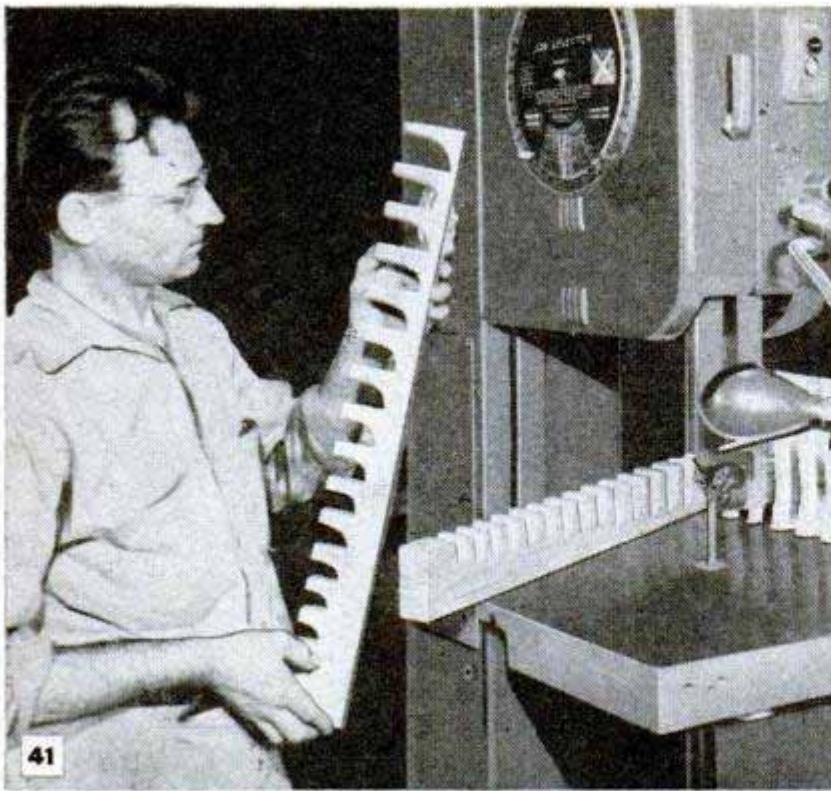

STACK SAWING

IS USEFUL IN MAKING DUPLICATE PARTS. SIX LAYERS OF $\frac{3}{4}$ " STOCK OR 15 LAYERS OF $\frac{1}{4}$ " PLYWOOD ARE EASILY CUT IN ONE OPERATION

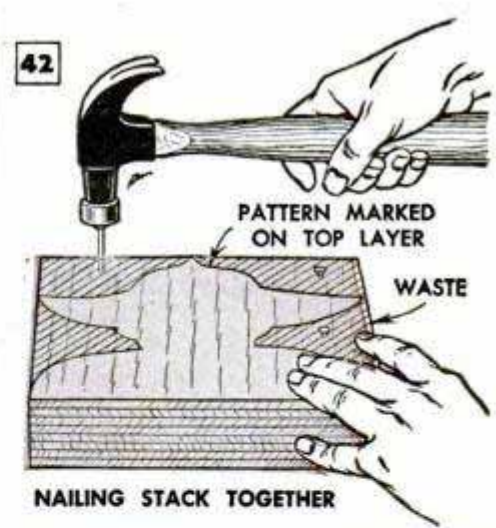

It also will be found that many booby traps are due to marking the work on the wrong side. The job shown in Fig. 36 cannot be continued, but if the work is marked on the other side, all cuts are easily made, Figs. 37 and 38. As bandsawing experience is acquired, each job is automatically visualized before it is started, thus eliminating "blind alleys" and excessive backtracking.

Angle guides: If the outer ends of the guide pins are ground to a 70-deg. angle and inserted end-for-end as in Fig. 39, long work can be cut off squarely as shown in Fig. 40. This setting also will be found useful for intricate cutting jobs. If the angle guides are used only occasionally for such a special job, it is not necessary to

grind the lower guide pins at an angle. Merely back them off until the blade is again set square.

Stack sawing: The tremendous cutting capacity of the bandsaw makes it practical for sawing several pieces in one operation, Fig. 41. Usually, the work is nailed together as in Fig. 42, but it may be held by a form similar to that shown in Fig. 43. The pattern, of course, is marked on the top layer and the stack is sawed just about as easily as a single piece of work.

Pattern sawing: A typical setup for using a master pattern as a guide to bandsaw duplicate parts is explained in Figs. 44 and 45. Although work of this kind is easy to do and accurate, a blade with a fairly heavy

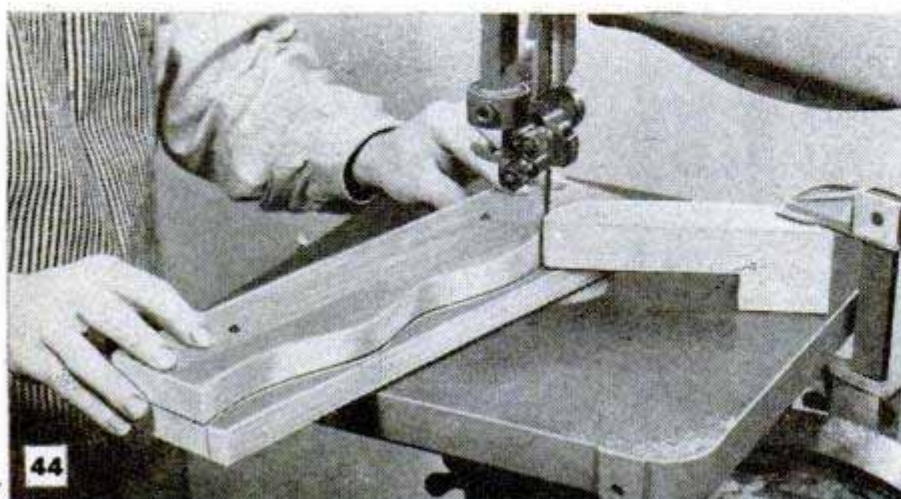

PATTERN SAWING

IS A SIMPLE METHOD OF CUTTING DUPLICATE PARTS WITH A PATTERN AND GUIDE

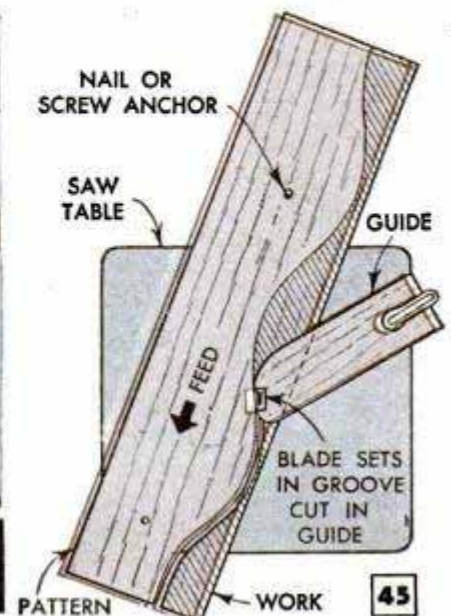

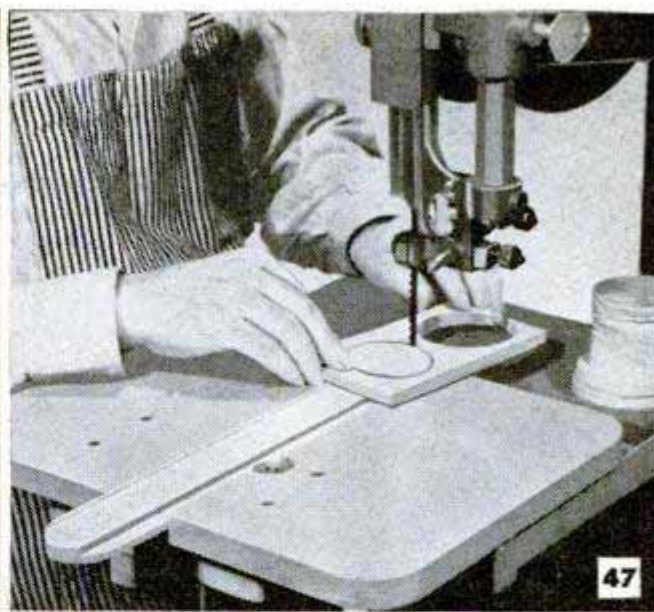
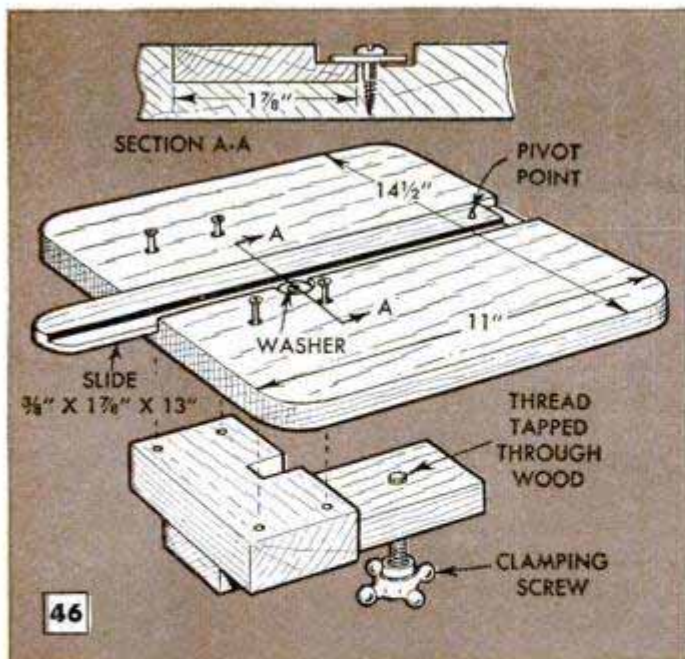

CIRCLE-CUTTING JIG DOES PERFECT WORK, ANY DIAMETER

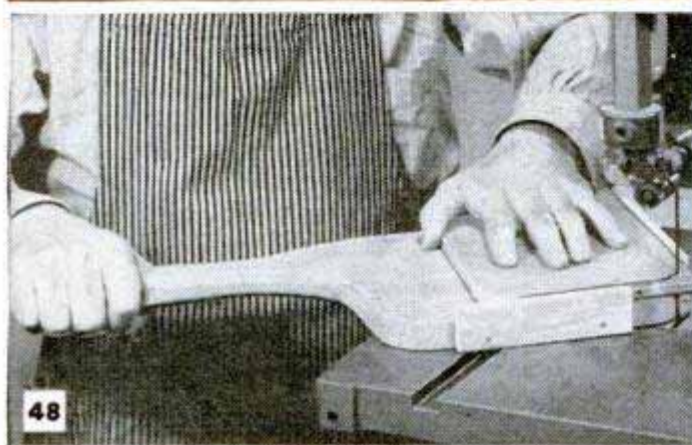

CORNER-ROUNDING JIG IS FAST . . . CUTS ONE SIZE ONLY

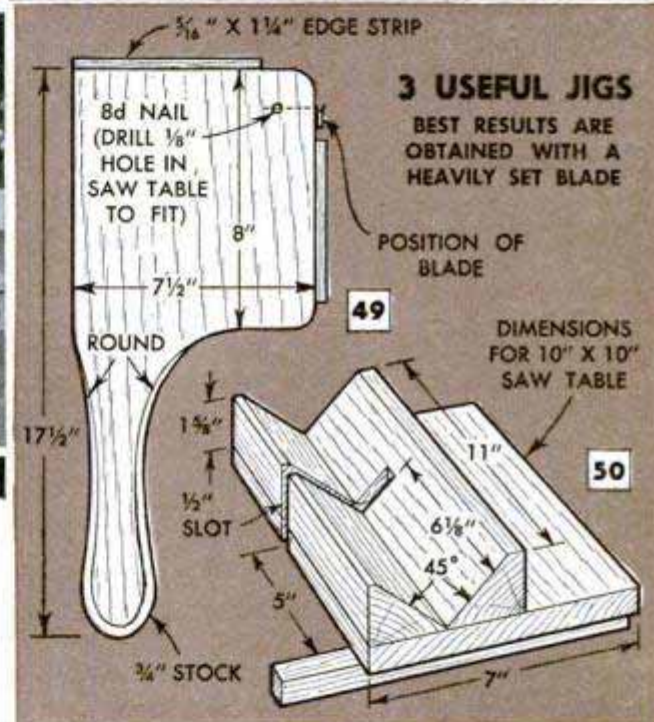

3 USEFUL JIGS

BEST RESULTS ARE OBTAINED WITH A HEAVILY SET BLADE

POSITION OF BLADE

DIMENSIONS FOR 10" X 10" SAW TABLE

set must be used in order to get the freedom of manipulation required to follow the contour of the pattern.

Useful jigs: Other than the standard fence and miter gauge, the most useful bandsaw jig is the one for circle cutting, Figs. 46 and 47. It also can be used for corner-rounding, but this work is done faster with a special corner-rounding jig, Figs. 48 and 49. However, this jig permits cutting one size only, usually about a 1 3/8-in. radius. The pivot fits into a small hole drilled in the bandsaw table in line with the blade teeth. Another handy device is the V-block jig shown in Fig. 50. It is used for cutting 45-deg. bevels as in Fig. 51 and also can be used as a cutoff guide for round stock. In the latter case, the guide bar rides along the edge of the bandsaw table as in Fig. 52. It is not practical to use any kind of a fence or jig with a thin blade having a very light set as some blade leading is inevitable and the light-set blade does not cut a kerf wide enough to permit freeing itself. A hardened blade having a fairly heavy set will make a true cut for a long time and do perfect work with any type of jig involving a fixed line-of-feed direction.



V-BLOCK . . . IS USED FOR BEVELS AND CUTOFFS

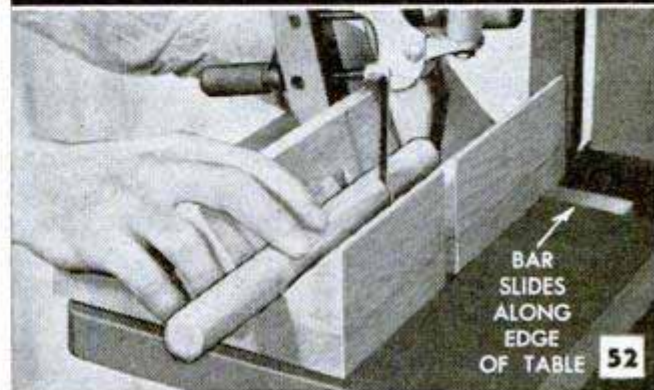

BAR SLIDES ALONG EDGE OF TABLE

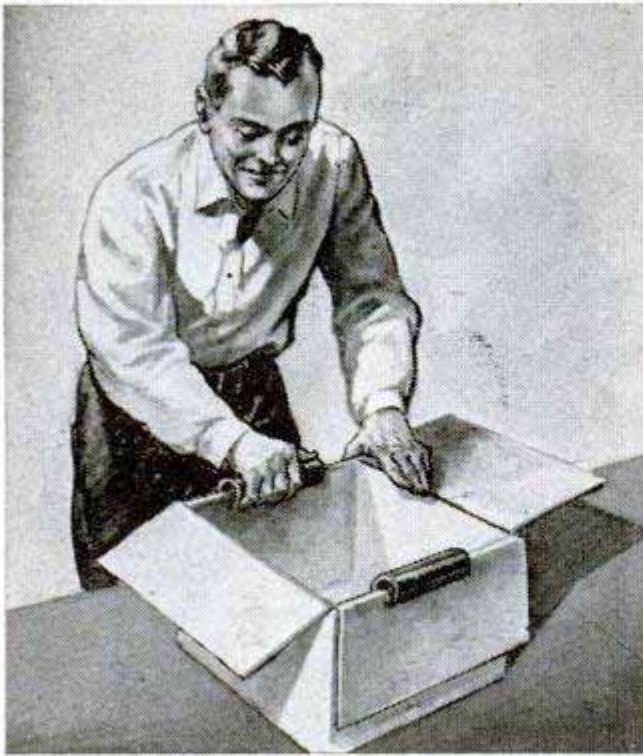

Cardboard Cartons Held Open By Garden-Hose Sections

Packing cardboard cartons is done faster if the flaps are held open by split sections of garden hose. It takes just a moment to slip them in place and to remove them when the carton is packed. Cut the sections several inches long and slit one side.

Automatic Starting Switch For Drill Press

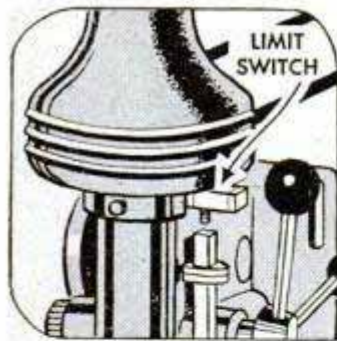

Mounting a limit (sensitive) switch on a drill press so it is operated by the depth-stop rod, automatically starts and stops the machine. When the spindle returns to the "up" position, the switch is opened and the machine is turned off. Then, when the spindle is lowered, the switch is closed, turning on the drill press.

Asher M. Wolfe, Bloomsburg, Pa.

Lard Oil Aids Tapping Blind Holes



When a bottoming tap is used in a blind hole, chips tend to collect in the hole and block the progress of the tap. To prevent this, fill the hole with thick lard oil before inserting

the tap. Then, as the tap enters, it forces the oil from the hole and the chips are carried away in the process.

Henry Hanscom, Elmhurst, Ill.

Gear Teeth From Bolts

One man who wished to salvage a gear having broken teeth found that teeth fashioned from bolts made satisfactory replacements for the broken ones. To do this, the remaining portion of a damaged tooth is filed away, and a

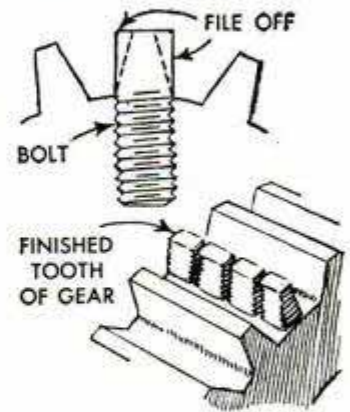

center line for the new tooth is scribed on the gear. Several bolts are selected so that when placed in a row they equal the width of the original tooth. Then, holes are drilled and tapped for these bolts along the scribed line. After the bolts are turned into the holes, the heads are cut off and the bolts are brazed in place and filed to shape.

Ralph Steider, Aurora, Neb.

Cutting Case-Hardened Rods

To cut case-hardened rods without the proper tools, first grind through the outer case. Then cut the rod with a hacksaw and grind the ends smooth.

John W. White, Ware, Mass.

Hinged Section of Barnyard Fence Lowers to Form Manger

Hinged at the bottom and held in position by chains, a reinforced section of fence is lowered to form a manger and raised, when not in use, to become again part of the fence. Stanchions can be made by setting heavy posts along the length of the manger, spacing them the desired distance apart. This idea is suitable for both high and low fences and, if used for the latter, the cattle are able to feed from either side.

Marion L. Rhodes, Knightstown, Ind.

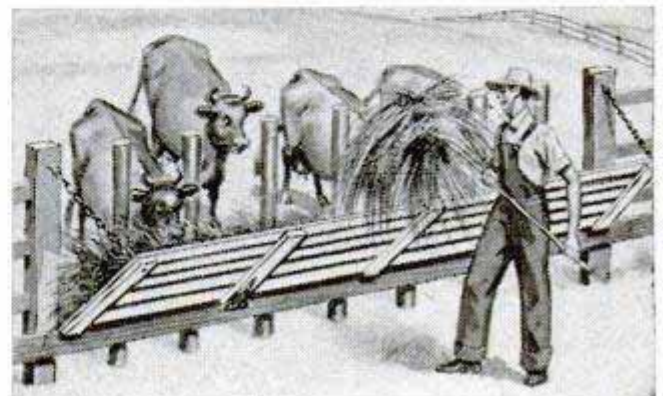

UTILITY VOLT-OHM CHECKER

THE MOST useful test instrument for the student and experimenter is a volt-ohm checker. While all values are given in a schematic circuit diagram the student should check and verify each specification and in so doing gain more knowledge of Ohm's law and how to apply it. The instrument in photos A and B was built by students as a class project.

A two-deck 12-point rotary-type switch is used for selecting the various positions. A small Bakelite plate, $1\frac{3}{4} \times 2$ in., with the fixed resistors attached is mounted on the back of the rotary switch, and the wiring is quite simple. All parts values are identified in the diagrams; the fixed resistors are all $\frac{1}{2}$ -watt carbon types except the special resistors .505-ohm and .05-ohm marked by stars in Fig. 1. These special resistors were assembled by using two $1\frac{1}{2}$ -megohm resistors for the forms; Nichrome resistance wire was wound on these forms and measured on a bridge to obtain .05 and .505 ohm. About 2 in. of No. 16 resistance wire was used for .05 and about 2 in. of No. 26 for .505. The wire was then soldered to the resistor leads, actually placing the two resistances in multiple, but due to their high value no difference would be observed in the smaller values. The 5.55-ohm resistor was made by connecting two 11-ohm carbon resistors in parallel; the 5000-ohm variable resistor is a midget linear-taper type. Two pointer-type dial knobs, a set of test prods and a 0-1 milliammeter complete the assembly which is made in a metal case $3\frac{1}{2} \times 4 \times 5$ in. deep. The meter is

(Continued to page 242)

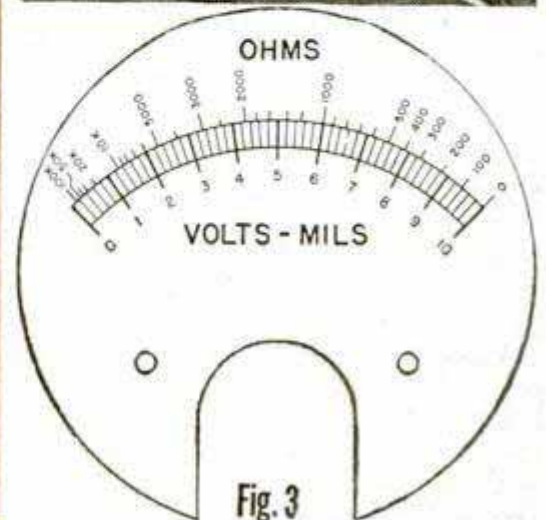
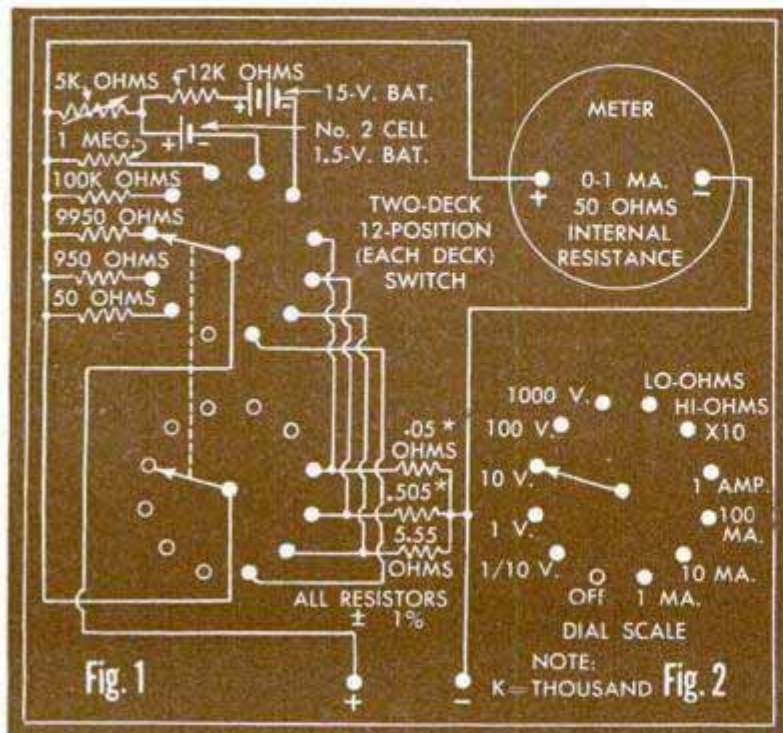
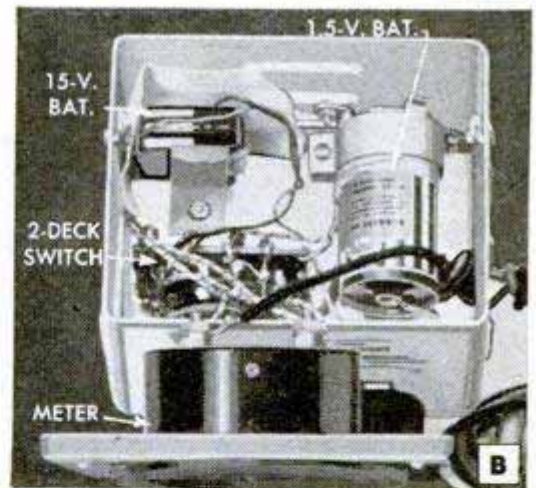
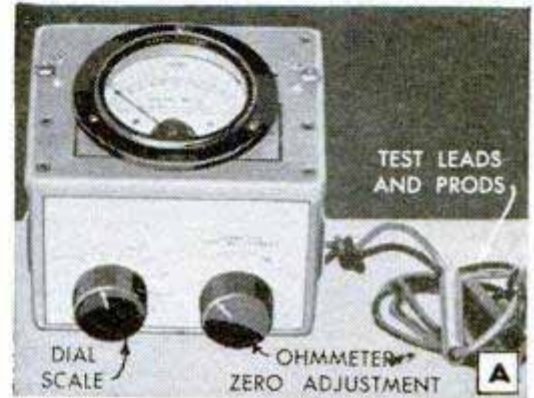

HOW TO BUILD A GEIGER-MUELLER

By F. L. Brittin, S.M., I.R.E.

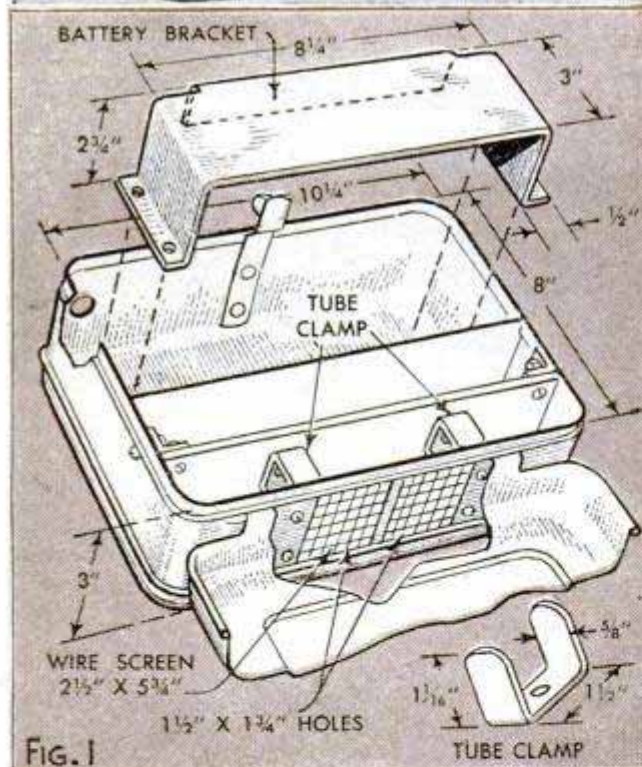
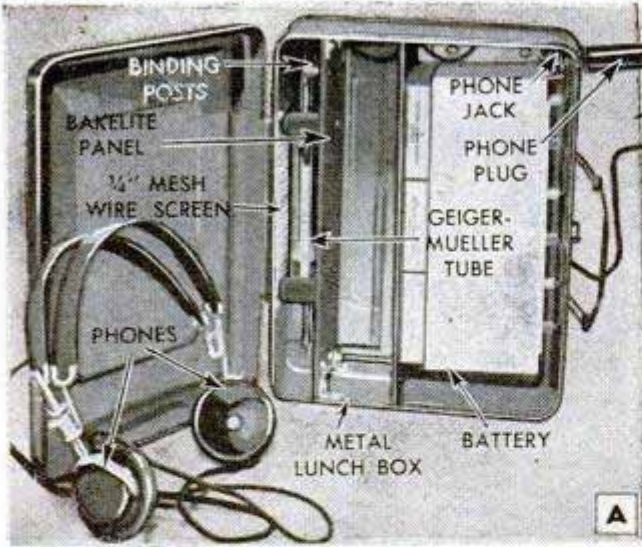

FIG. 1

ANYONE can build and operate this simplified Geiger-Mueller survey meter, which is an instrument for detecting the presence of radiations emanating from radioactive substances such as valuable uranium and radium. Specifically, the Geiger-Mueller tube, which is the most important component of the instrument, detects X-rays, cosmic rays and gamma rays. Beta rays can also be detected by Geiger tubes with very thin cathode walls.

When any one of the four types of radiations referred to above enters the Geiger tube, the gaseous mixture within the tube is ionized and the tube will deliver a definite pulse that can be used to actuate a meter, or a set of headphones. The uranium survey meter illustrated and described is a "Geiger counter" similar to those used in all of the recent sensational "strikes" and incorporates a set of high-impedance headphones as the indicating device for radioactivity detection. The exceptionally high sensitivity of this particular instrument to stray radiation is exemplified by infrequent clicking sounds heard in the headphones, caused by cosmic rays when the instrument is not in a field in which other radiation is present.

An ordinary metal lunch box of the type designed to include a small Thermos bottle is employed to house the instrument. It

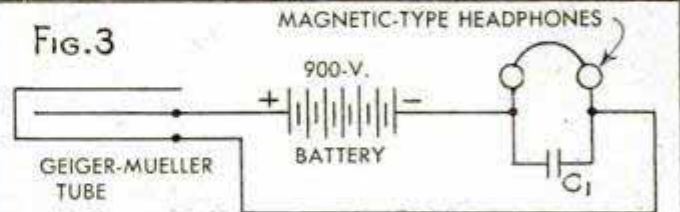

FIG. 3

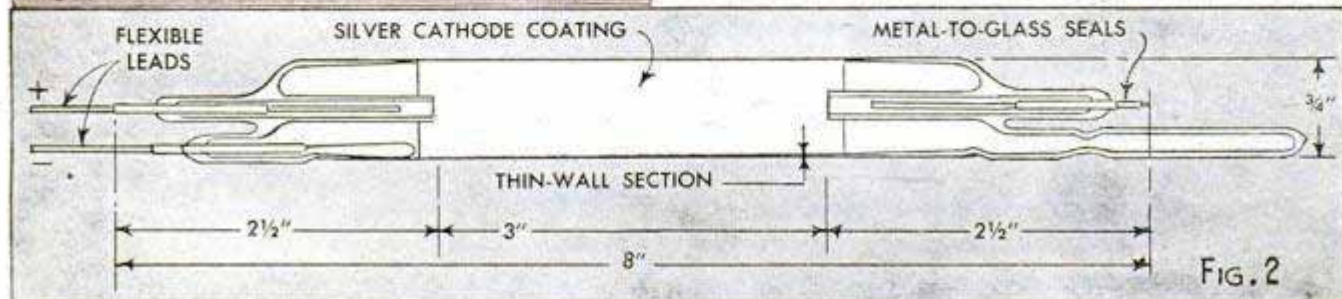

FIG. 2

URANIUM SURVEY METER



provides a rugged case 10¼ in. long, 8 in. wide and 3 in. deep. This case is easily portable and only a few minor alterations are necessary, as will be noted in Fig. 1. The two openings, cut to provide screened windows, are backed with a strip of ¼-in.-mesh wire screen, 2½ in. wide and 5¾ in. long. This wire screen is held in position by four short 6-32 machine screws, washers and hex nuts. A ⅜-in. hole is drilled for mounting the open-circuit phone jack.

The Geiger-Mueller tube is mounted on a ⅛-in. Bakelite panel by means of two rubber-covered clamps. These clamps are made as detailed in Fig. 1, or, ¾-in. fuse clips may be used. They are mounted 4½ in. apart and 2¾ in. from each end, by means of short 6-32 machine screws and hex nuts. A 1⅛-in. length of rubber tubing is slipped over the ends of each clamp where it contacts the Geiger-Mueller tube to hold it in position. This Bakelite panel is mounted in the case, 1⅜ in. above the screened openings, by means of four ⅝ x

(Continued to page 242)

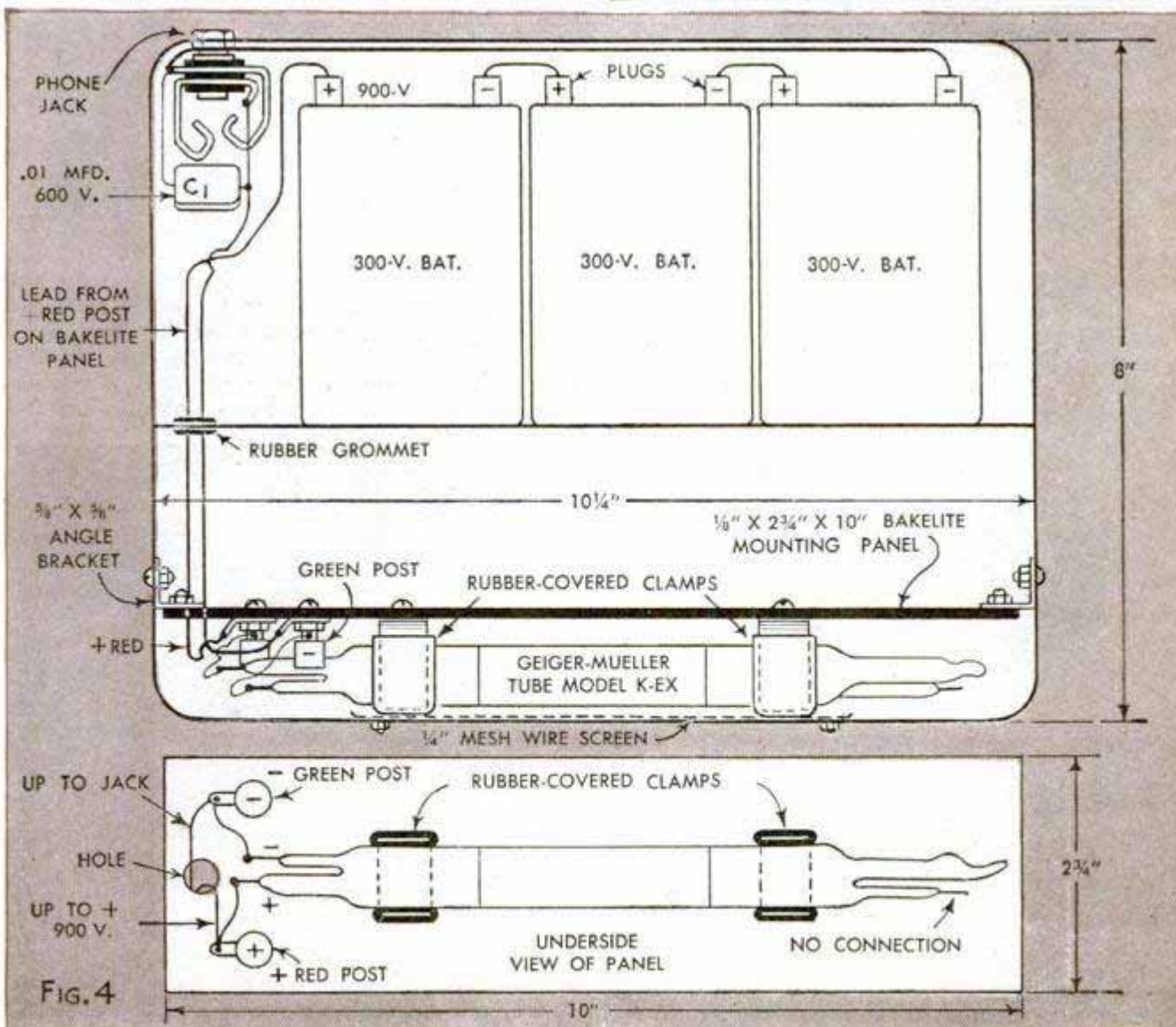

RADIO-ELECTRONICS HINTS



A—Portable Miro-Pix mirror enables TV serviceman to view the screen pattern of a television receiver while adjusting the rear controls and ion trap

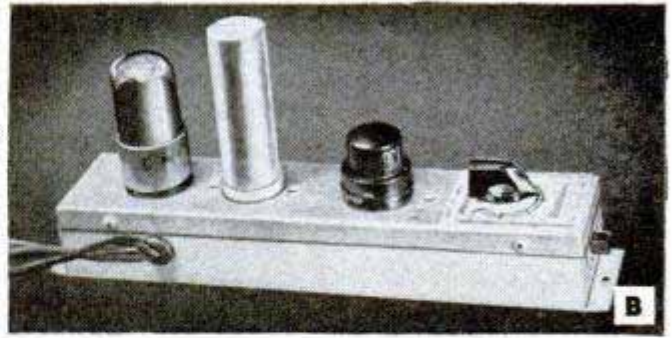

B—Compact Electro-Voice speech clipper operates directly from any high-impedance microphone into the microphone input of a conventional speech amplifier. It is a specially designed peak-limiting preamplifier that clips the tops and bottoms from speech frequencies which rise above a preset amplitude, thus providing higher articulation and intelligibility in radiophone and similar services

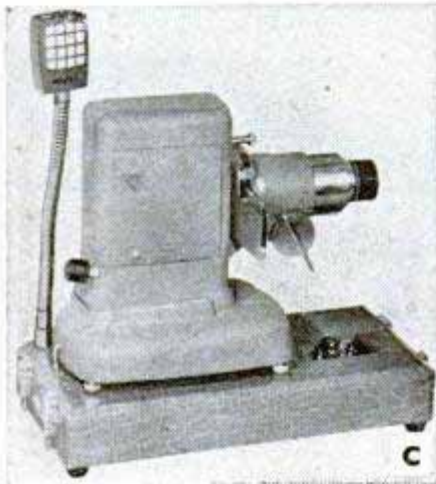

C—Slide-projector owners can add sound to silent slides by means of this Audio-Slide unit consisting of a 4-watt amplifier, microphone and 6-in. PM speaker. Flat case acts as projector stand

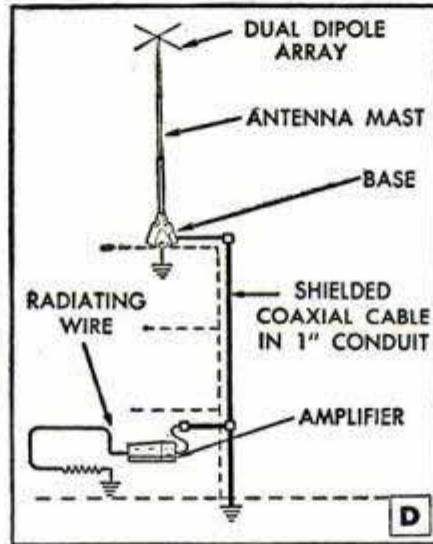

D—Puratone signal-booster system for demonstrating sets in stores located in noisy city areas. Unit covers AM, FM, short-wave bands



E—Automatic radio silencer called Radi-Off shuts off the radio as soon as the telephone receiver is lifted for conversation. It also turns the radio on again when telephone communication is ended



F—Wireless Microgroove record player for long-playing records; it works through your radio receiver. **G**—Funnel-shaped device called a Signal-Soc is claimed to improve reception in auto-radio receivers



H—Imagine the luxury of reading under an efficient bed lamp while listening to your favorite radio orchestra playing softly in your ears. This 5-tube Lullaby a.c.-d.c. radio clamps to the head of a bed

Magnificent Enlarging **PLUS**

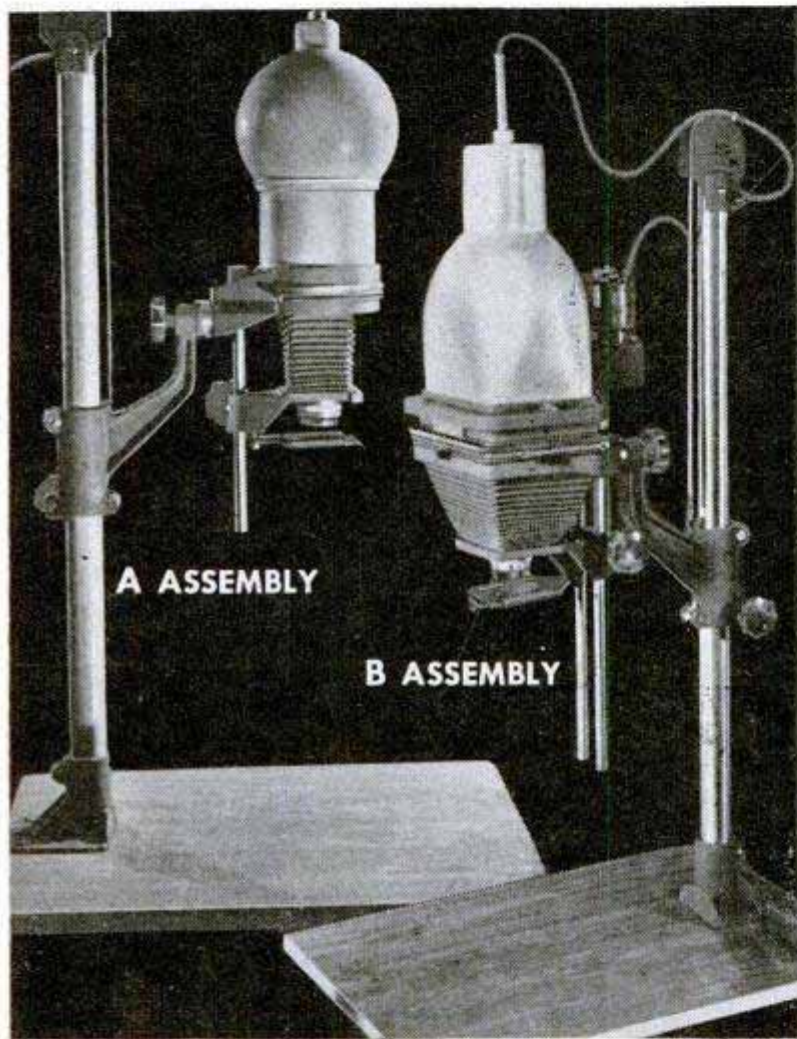

KODAK PRECISION ENLARGER (Showing A and B Assemblies)

Stand assembly takes either the A or B enlarger head. A assembly accepts negatives up to 2¼ x 3¼ inches . . . has friction-wheel drive for exact focusing. B assembly takes negatives up to 4 x 5 or 3¼ x 5½ inches . . . cooling system includes motor-driven fan. Wide selection of Kodak Ektar and Ektanon Lumenized lenses results in superb projection prints. At your dealer's.

**Eastman Kodak Company
Rochester 4, N. Y.**

Kodak



COPYING AND SLIDE-MAKING—

Camera back adapter, bellows assembly, and lens make a fine camera. For copying, use stand assembly and copying lights.



AN INDEPENDENT CAMERA

—For indoor and outdoor work, camera back adapter, bellows assembly, and tripod adapter make a "view-type" camera.



CLOSE-UP PHOTOGRAPHY—

By assembling as a camera and utilizing the lengthy extension of the bellows.



PHOTO- MICROGRAPHY—

The microscope attachment makes light-tight connection with the microscope. Exposure controlled by microscope lamp.

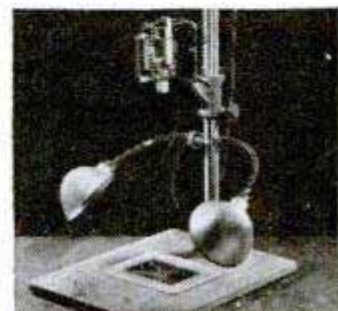

CINE-TITLING—

The inclined arm of the stand assembly supports a Cine-Kodak camera for making titles.

"Kodak" is a trade-mark

Utility Volt-Ohm Checker

(Continued from page 237)

mounted in the lid. If the builder prefers to make a wooden case, it can be built of 1/4-in. plywood, with the same inside dimensions given above.

The case is large enough to house the 1 1/2-volt flashlight cell and a Burgess type U-10-E, or similar, 15-volt battery. Dial scale for the switching points, Fig. 2, and the zero adjustment arrow may be made on a strip of paper and pasted on the case as indicated in photo A. The meter-dial scale, to replace the original scale on the 0-1 milliammeter, may be the one shown in Fig. 3 if you are using a 2-in. meter. If your meter is larger, merely make a photostat enlargement to the required size. If the resistor values are as specified, no alterations in the scale will be necessary.

How to Build a Geiger-Mueller Uranium Survey Meter

(Continued from page 239)

5/8-in. angle brackets. The battery clamp is made from 1/16-in. sheet metal and holds the three batteries in position.

Photos A, B, D and F show various views of the completed instrument. Fig. 2 is a

sectional drawing of the highly efficient "Keleket" model K-EX Geiger-Mueller Gem tube used in this instrument; the actual tube is shown in photo C. It should always be handled by the ends; do not touch the fragile center. The schematic circuit diagram is given in Fig. 3, and the pictorial wiring and assembly diagram appears in Fig. 4. The underside view of the panel shows the method of mounting and connecting the tube. Note that the center positive and the outside negative leads are brought out to two binding posts mounted on the Bakelite panel; keep these flexible leads well separated. The center positive, or "hot," lead goes directly to the positive 900-volt battery terminal and should never be touched when unit is "on;" always keep case dry. The open-circuit phone jack is in the negative battery lead. A .01-mfd. 600-volt fixed condenser is connected across the phone jack. Banana-type battery plugs with black for negative and red for positive, plastic insulated ends are used to connect the batteries in series. The phone plug is inserted only when the instrument is in use. There is practically no drain on the batteries; their life is estimated to be from six months to one year. These batteries list at \$11.00 each; the model K-EX Geiger-Mueller tube costs

(Continued to page 244)

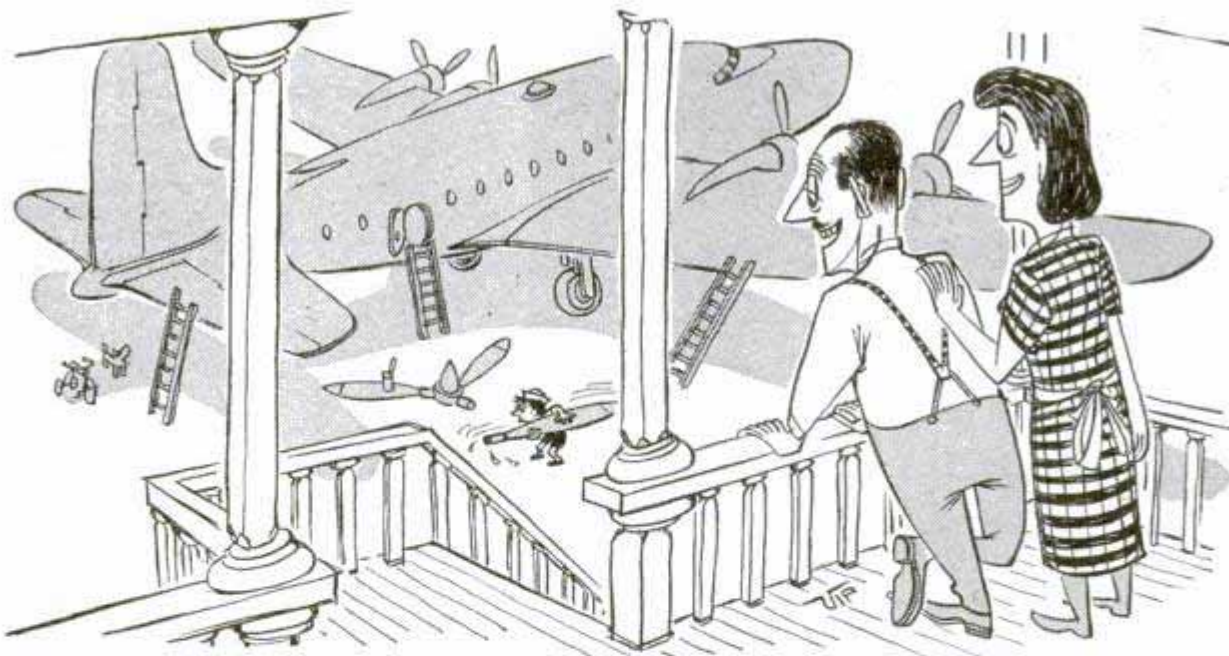

"And to think how we laughed when Junior asked for a can of Weldwood Glue to build a model plane"

When you want a wood-to-wood bond that will really hold... remember Weldwood Glue. It's quick to mix... easy to use... tremendously strong... stain-free... rot-proof... and permanent. At hardware stores, lumber yards, chain stores, in 15¢, 35¢, 65¢, 95¢ and larger sizes.



WELDWOOD
PLASTIC RESIN GLUE

United States Plywood Corporation, New York 18, N. Y.

"EVEREADY" the battery with "NINE LIVES"!



Just as an active cat...

...takes a cat nap  and ...



bounces back with new pep... so "Eveready" batteries bounce back for extra life!



BOUNCE BACK gives

"EVEREADY" BATTERIES LONGER LIFE!



"Eveready" brand batteries give you fresh power when you use them; naturally, they use up some power when your flashlight is turned on ... but—



When your "Eveready" batteries cat nap between uses, the chemical elements in the cell develop fresh energy — recover power — so that ...



When you snap on your flashlight again, the batteries *bounce back* with renewed power. That *bounce back* gives "Eveready" batteries *longer life!*

● Next time you buy batteries for your flashlight, be sure you get "Eveready"—the largest-selling brand in the world. Then you'll see what *bounce back* means ... why "Eveready" batteries are *the batteries with "Nine Lives"!*

"EVEREADY" FLASHLIGHT BATTERIES

The registered trade-mark "Eveready" distinguishes products of
NATIONAL CARBON COMPANY, INC.
30 East 42nd Street, New York 17, N. Y.
Unit of Union Carbide and Carbon Corporation





THE
NEW
JOHNSON
QD
GEAR SHIFT
OUTBOARD
MOTOR

**Neutral
Forward
Reverse**
-and MILE-MASTER Fuel Tank



Mile-Master Fuel Tank (16 lbs.) goes anywhere in boat!

And many other features—40 in all!

NOW IN PRODUCTION! Look for your Johnson dealer's name under "Outboard Motors" in your classified telephone directory. See him soon!

*10.0 O.B.C. Certified brake H.P. at 4000 r.p.m.!



FREE HANDY CHART

Write for new 1949 Sea-Horse Handy Chart. Illustrates, charts the QD and the 4 other great Johnsons for '49. All features are fully described—and what features!

JOHNSON MOTORS

400 Pershing Road, Waukegan, Illinois
Johnson Motors of Canada, Peterboro, Canada

JOHNSON
SEA-HORSES
for **DEPENDability**

\$20.00 and it will give approximately 15,000 hours service in constant use. Before the survey meter is taken into the field for use, a quick test may be made to determine if it is functioning by merely holding it over the dial of a radium-illuminated watch as illustrated in photo E. If there is an increase in the number of "clicks," it will indicate that the unit is working satisfactorily. Before making a survey, a background count should be noted in an area free from radioactivity. A pair of 4000-ohm phones should be plugged into the instrument and the number of clicks heard in the phones counted for a period of one minute. Ordinarily, the background count will vary between 10 and 50 per minute.

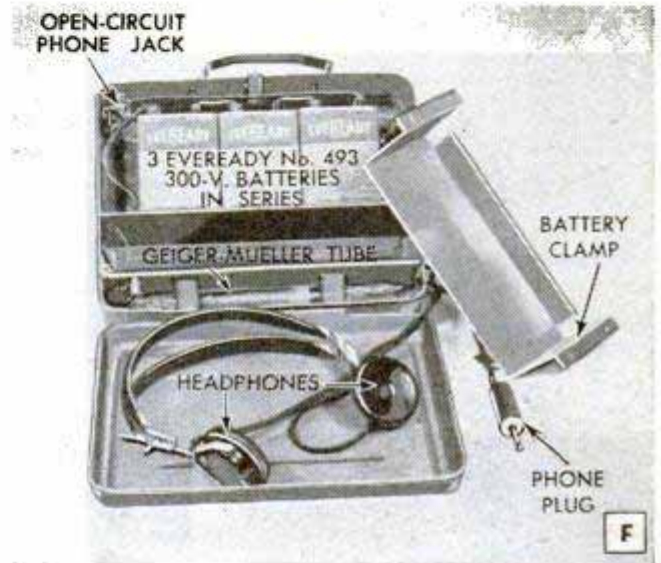

A topographic map of the area to be surveyed should be completed by the prospector before entering the field. Furthermore, familiarity with the various types of ores associated with uranium, thorium, radium and other radioactive material should be obtained. It should always be remembered that many precious metals such as vanadium, cobalt, nickel, gold, etc., are sometimes found in proximity to the radioactive ores, and subsequent analysis may indicate a lode of considerable value composed of nonradioactive metals. As successive counts are recorded at different stations on the area being surveyed, differences in background count should be noted and plotted on the topographic sketch. The instrument will effectively direct a prospector to an area where the radioactive background is higher. When digging is started, samples of the ore or rock formation should be tested with the instrument to determine if the digging is proceeding in the right direction.

Drive a FORD and Feel the DIFFERENCE



First time you drive the great '49 Ford, you sense immediately the new Ford "feel"—a feeling of handling ease and true control that's a revelation! It goes all the way through the car—brakes, engine, springs, frame, body, steering—to give you driving ease in three big elements of motoring pleasure.

First

... there's the feeling of positive, effortless control that comes from Ford's new finger-tip steering with symmetrical linkage and large worm and roller gear. Steering ratio has been increased nearly 10% to reduce steering effort.



Second

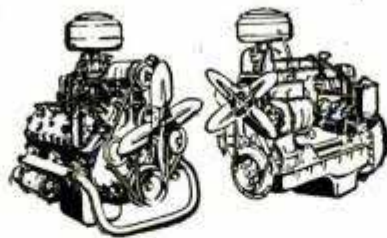

... these new Fords have a feeling of *responsiveness* that's outstanding—satin-smooth acceleration, power to spare in both the new 100 h.p. V-8 and 95 h.p. Six. Only Ford in its field gives this power choice!

Third

... the feeling of *safety* and *sureness* that comes from such Ford features as "Lifeguard" Body of heavy gauge steel ... body and frame combination 59% stronger ... "Magic Action" King-Size Brakes 35% easier-acting.



There's a ^{NEW} Ford in your future

Why not see for yourself ... take a ride in the new Ford and feel the difference!

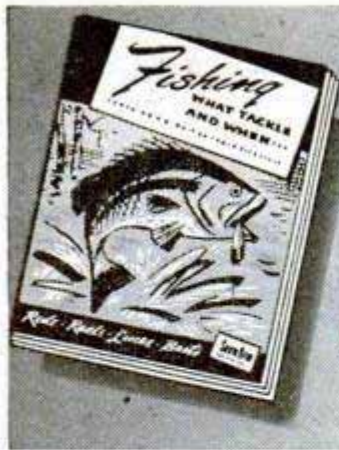

FREE! NEW BOOK ON FISHING

Every Fisherman Needs It!

This new 1949 edition of "Fishing — What Tackle and When" is packed full of fishing information...the kind you want. There are hours of profitable reading in its seventy-six pages, such as:

- Bait Casting Instructions • Fly Casting Instructions • Official World-record Fish Catches • Skish Instructions • 33 New Action Fish Pictures in Color (see below)
- Fishing Hints, etc. • South Bend Tackle



You won't want to be without it. Write today — a postal gets it. Free!

SOUTH BEND BAIT CO., 891 High St., South Bend 23, Ind.

Lines YOU CAN TRUST

EXCEL-ORENO — The finest of fly lines. Nylon level sizes G to C, \$1.85 to \$2.80 a coil; double tapers HEH, HDH, HCH, \$9; bug tapers GAF, GBF, GCG, \$9. Also in silk at slightly higher prices.

BLACK-ORENO — World-famed bait casting line. Hard braided, smooth finish. Guaranteed. Nylon \$1.20 to \$2.25 per 50 yards. Silk slightly higher.



SOUTH BEND

A NAME FAMOUS IN FISHING

Engineering Better Meat

(Continued from page 177)

the parents of the next generation; (2) "inbreeding," or mating members of the same animal family together, so as to reveal hereditary weaknesses and to concentrate strong points; and (3) "crossbreeding," or combining the desirable qualities of different breeds.

When the model animal begins to measure up to specifications, it is ready for "mass production." The new model is put on loan for breeding purposes. Universities and state farms cooperate in introducing it.

Step into the Department of Agriculture's 12,000-acre experimental farm at Beltsville, Md., and you can preview some of these remarkable creations, soon to be readied for the production line. Animal experts will point out husky young steers in the laboratory's Shorthorn herd that have grown 14 percent fatter than average and have reached market weight six weeks sooner. The latest-model milch goat produces milk for a period 145 percent longer than did her ancestors. The streamlined Holstein cow, which in 1918 was yielding 678 pounds of butterfat a year, has been improved so that today's model averages 814 pounds, a 20-percent improvement.

The animal designers will show you how they made hens lay nearly 50 more eggs each year. They'll explain their plans for building up the flocks of the Karakul sheep in this country to make possible the production of Persian lambskin.

This year enough of such blueprinted knowledge will move out of the laboratory to the nation's farms to save thousands of dollars' worth of grain. For instance, a hog ready for market means an investment of ½ ton of feed—and with corn prices at a high level, every pound counts. The highly efficient, 1949-model pig is lower to the ground, heavier in the loin and eats far less for its weight than older models. Here are the latest specifications:

Legs short, body not too long, bones small; weight medium, preferably about 200 to 225 pounds; an even layer of fat along the back, 1½ to 1¾ inches thick; and at least half the weight to be made up of ham, loin, bacon, butt and picnic shoulder.

Right now, only about one in fifty U. S. hogs reaches these ideal proportions—but the scientists are beginning to get uniformity among the experimental-farm animals now undergoing the streamlining process. These ultra-efficient porkers give fewer spareribs and pigs' knuckles, but more bacon and ham for the amount of feed consumed. Recently, "performance tests"

(Continued to page 252)

**NOW PRECISION Metalworking
For Your Shop — at LOW COST!**

Atlas
"QUICK-CHANGE"
10" LATHE

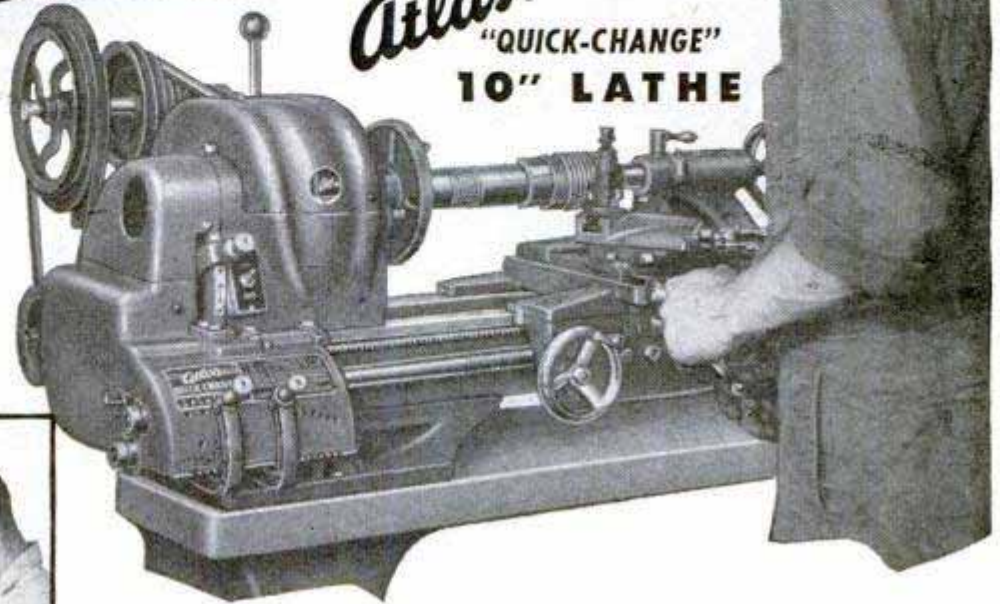

Prices quoted are F.O.B. Kalamazoo less motors. Atlas motors can be supplied at low cost.

**With the *Atlas* Tools That
Industry Uses**

Precision work in metals is the goal of many a home shop owner. It gives you the opportunity to develop your own ideas and inventions — save money on household equipment and repairs — make money in your spare time — or become independent with a business of your own. Low cost precision Atlas tools are ideal for such purposes.

The Atlas 10" "Quick-Change" lathe, for example, has 16 speeds — wide thread cutting range — precision ground bed — Timken tapered roller bearings — back gears for extra power — V-belt drive — instantly reversible power cross and longitudinal feeds — plus many other features for only..... **\$272.00**
Standard 10" lathes start at **\$212.00** — 6" lathes, **\$113.50**.

Atlas bearing construction — Timken — on every lathe, plus higher speed range, enables you to handle all turning operations in metals, plastics, and woods. Ask your Atlas distributor for complete information and term payment plans.

Send a Postcard for FREE Catalog

ATLAS PRESS CO.

243 N. Pitcher Street • Kalamazoo, Mich.

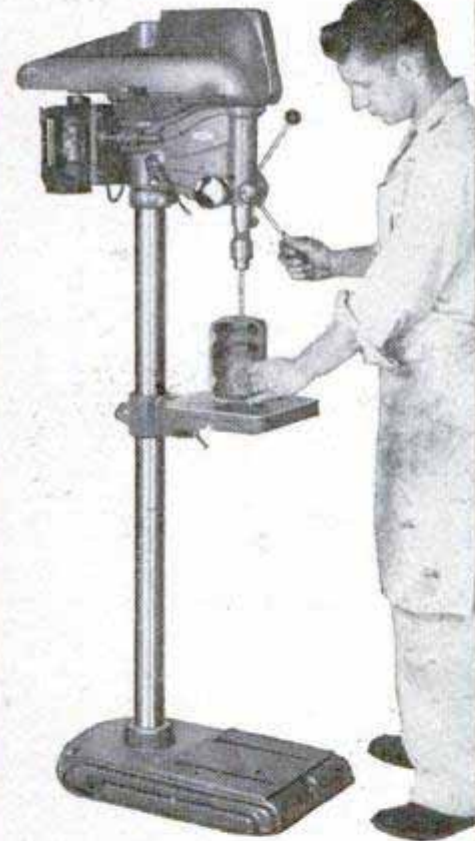

***Atlas* 15" Floor Drill**

Here's the work horse of thousands of shops. It drills or taps metals and plastics — up to 1/2" diameter holes — and with low-cost accessories and tools handles many woodworking operations — sands, carves, routs, mortises, shapes, inlays, etc. Has "floating-drive" spindle — 4 ball bearings — and **\$84.50** unusual value at.....



**MATCHED PRECISION TOOLS FOR
MACHINING AND WOODWORKING**

EASIER

reading

in any position!

New STANLEY VERTICAL READING PULL-PUSH RULES

Up, down, inside, outside . . . in any position this new rule saves time, irritation and mistakes. The numbers are always straight ahead . . . no head-twisting. Easy reading even in poor light. Broken blades replaced in a few minutes at small cost. Available with white blade or nickel plated blade—6 ft. or 8 ft. lengths. Useful more places, more years . . . one of the ways Stanley gives you so much more tool for the money.

Let this coupon bring you these two books
One is FREE! The other, the latest edition of a famous textbook for the home workshop, clothbound, fully illustrated, just \$1.00.

THE TOOL BOX OF THE WORLD

NO. 346W

STANLEY

Reg. U.S. Pat. Off.

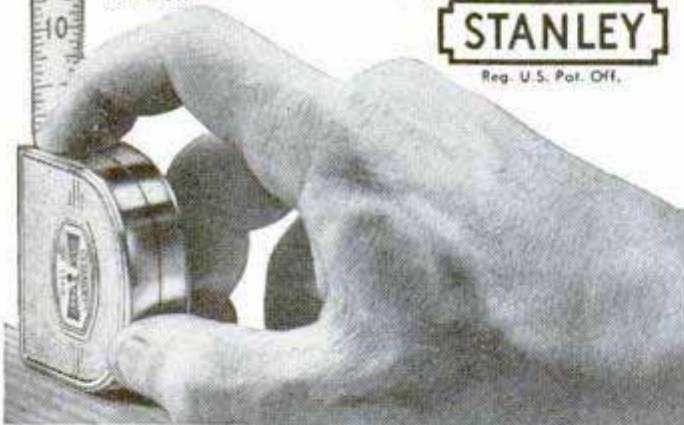

HARDWARE, HAND TOOLS, ELECTRIC TOOLS, STEEL STRAPPING

Stanley Tools, 129 Elm St.
New Britain, Conn.

Please send by return mail:

- FREE: "The Joy of Accomplishment".
- 188-page book: "How to Work with Tools and Wood". \$1.00 enclosed.

(In Canada: Send order to Stanley Tool Co. of Canada, Ltd., Roxton Pond, Quebec.)

Name.....

Address.....

City.....State.....

Clinic



for Homemakers

As a service to our readers in solving the hundreds of problems pertaining to a home—inside or out—the editors of *Popular Mechanics* invite you to present your problems to The Clinic Editor for help and advice. Address your questions to The Clinic Editor, *Popular Mechanics Magazine*, 200 East Ontario Street, Chicago 11, Ill.

Insulating a Warm-Air Pipe

Q—One warm-air pipe from my furnace extends under an unexcavated portion of the house for a distance of about 6 ft. to heat a small bedroom. Although the pipe rises directly from the furnace to the register, we do not get any heat in this room even in moderately cold weather. There is no cold-air return from this room and leaving the door open seems to make no difference. Floor joists are about 18 in. from the ground and there are screened air vents in the foundation. Will insulating this pipe help, and how do I do this?

G.B.—Topeka, Kan.

A—Of course, variations in temperature will tend to prevent passage of warm air through the pipe. Probably cooled air from the "cold" portion of the pipe extending under the floor of the room is finding its way back to the furnace. Insulating the pipe would undoubtedly help but we doubt if heat would be delivered to the room in the amount desired. A better plan perhaps would be to shorten the pipe and reinstall the register on the wall of the room nearest the furnace, if this is possible. Whether it would be advisable to rearrange the cold-air returns after making this change would depend on the way in which the heating plant is installed. If it is comparatively easy to get at the pipe to install a blanket-type insulation, it very likely would be worth a trial as the cost of the material would be negligible.

Removing Coating On Chimney

Q—I have an inside chimney extending up from the basement. A white crystal-like coating forms repeatedly from about 3 ft. above the floor up to where the smoke pipe enters the chimney. What is this and how can I eliminate it?

C.E.—Flint, Mich.

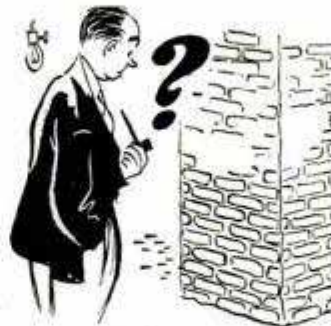

A—This is commonly known as efflorescence and is caused by the presence of soluble salts in the masonry materials. Moisture dissolves the salts, which are then drawn to the surface by a slow evaporation. In your case, it seems likely that moisture condenses in the lower portion of the chimney during the summer months and is absorbed by the bricks and mortar. Heat from the furnace causes the moisture to evaporate slowly. It may be that there is an accumulation of soot bridging the flue at a point just below the opening where the smoke

(Continued to page 250)

now screening
that will

NEVER RUST

at an amazing low price!



**NEVER NEEDS
PAINTING**

**AMAZINGLY
STRONGER**

**CAN'T STAIN
THE HOUSE**

Facts for Architects and Builders

Effects of Acids, Alkalies and Solvents—Essentially none.

Non-inflammable—Will not support flame.

Softening Point—240°-280°.

Tensile Strength, Ultimate (of filament)
—Up to 50,000 lbs. per square inch.

Impact Strength—Greater than conventional screening.

Installation—Cut with ordinary scissors. Fold cut edges under one-half inch. Tack every 1½ inches through two thicknesses.

It's true. You can now get rustproof screening and save money, too! LUMITE, the new miracle plastic, actually costs only 11½-12¢ per square foot—much less than any other quality screening.

And LUMITE is lifetime screening—never rusts or corrodes—never stains paint under windows—never needs painting in any climate, anywhere. Cleans bright with a swish of a damp cloth.

If you like, you can easily frame it yourself. And when properly framed it will never sag or bulge.

Order LUMITE from your hardware, lumber or building supply dealer. Write for free sample to Dept. PM-1, LUMITE DIVISION, Chicopee Manufacturing Corp., 47 Worth Street, New York 13, N. Y.

**SCREEN ONCE AND
FOR ALL WITH**

LUMITE*

Woven of saran

REPLACEMENT OR REFUND OF MONEY
Guaranteed by
Good Housekeeping
* AS ADVERTISED THEREIN

*®

Repair Storm Windows and Screens with **PLASTIC WOOD**

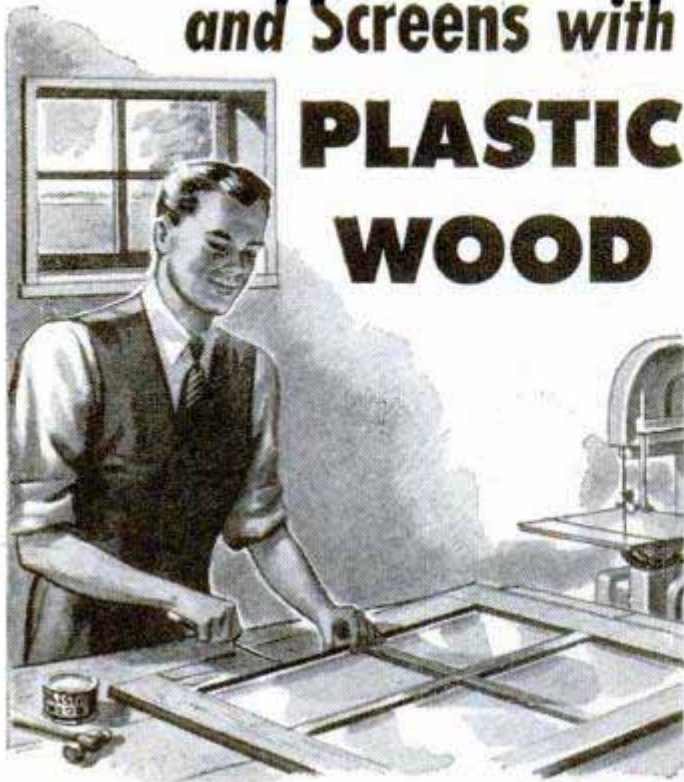

When making new screens, or replacing old rusted screen, apply thin layer of **PLASTIC WOOD** around frame after tacking down screen. This gives greater strength to the frame. **PLASTIC WOOD** can be easily shaped to match broken molding. Valuable in replacing rotted wood in storm windows.

... dozens of other uses

FOR FILLING ...

- Cracks in floors
- Countersunk screws
- Chipped furniture
- Nail and screw holes

FOR REPAIRING ...

- Loose tiles
- Loose casters
- Broken balusters
- Broken furniture

- **PLASTIC WOOD SOLVENT** is indispensable to the home workshop hobbyist for controlling the consistency of Plastic Wood and removing dried Plastic Wood from hands and tools.

T.M. Reg. U. S. Pat. Off.

At all Hardware,
Paint and 10c Stores



PLASTIC WOOD

Tube or Can

A CELLULOSE FIBRE FILLER

pipe enters the chimney. Be sure that the flue is clear of soot at this point. If there is no cleanout, it's a good idea to install one. Coating the affected surfaces with zinc sulphate or white asphaltum generally will prevent a recurrence of the trouble. Go over the whole affected surface thoroughly with a wire brush to remove all the crystal coating and also any loose sand in the mortar joints before applying either of these materials.

Cleaning Sink Drain

Q—I recently purchased a small home in which the kitchen sink is installed on the side opposite the bathroom, making a long drain from the sink to the soil pipe. This drain is clogged, allowing only a trickle of water to pass through. How can I clean this long drain?
J.D.—Seattle, Wash.

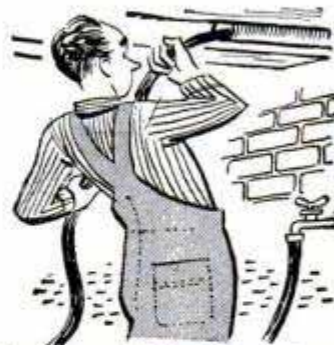

A—One easy and effective way of clearing such a drain is first to remove the cleanout plug from the lower section only and then attach the garden hose to the laundry-tub faucet and adjust the hose nozzle to give a medium-wide fan spray. With the water shut off, force the hose into the opened end of the drain and as far back as it will go. Then turn on the water full pressure and withdraw the hose slowly, a few inches at a time. After clearing the lower section and withdrawing the hose, close the cleanout plug tightly and treat the upper section in the same manner, allowing the water to run at full pressure until it is certain that all the soapy material has been washed away. Flushing out the drain occasionally in this way will keep it clear. Incidentally, before screwing the cleanout plugs back in place, coat the threads quite liberally with pipe-joint compound. This will prevent leakage and also will make the plugs easier to remove.

Moisture Collects in Low Attic

Q—My home is only two years old and is built with a low-pitched roof. The attic floor is insulated with a fill-type insulation poured to a 3-in. depth between the joists. In winter, moisture collects on the underside of the roof boards just above the point where the rafters join the plates. The boards have warped quite badly due to the presence of moisture. What can I do to correct this condition?
B.W.—Kansas City, Mo.

A—Lack of adequate ventilation is probably the cause of your trouble. It is likely that the louvers in the gables are too small to admit sufficient air for proper circulation. The louvers may also be filled with leaves, and cobwebs or dust on the screen coverings may restrict the passage of air as much as 50 percent. Inspect the area where the moisture collects to see that the insulating material is not banked up against the roof boards at any point. Although you did not state the size of the louvers in your attic, it is a fair rule to allow at least 25 sq. in. (12½ sq. in. of each louver) per 100 sq. ft. of attic floor area.

Removal of Ashes From Furnace

Q—Is there a method of removing ashes from the furnace ash-pit without creating a cloud of fine dust which settles over everything? Can you suggest a way of doing this disagreeable job without the necessity of building some mechanical device?
R.M.—Portland, Me.



A—After shaking the grates at the regular interval, level the bed of ashes and then add sufficient water to dampen them thoroughly. Should the ashes accumulate to a depth of several inches after shaking the grates, it will be necessary to wait a few minutes after adding the water to allow it to penetrate to the bottom of the ash bed.

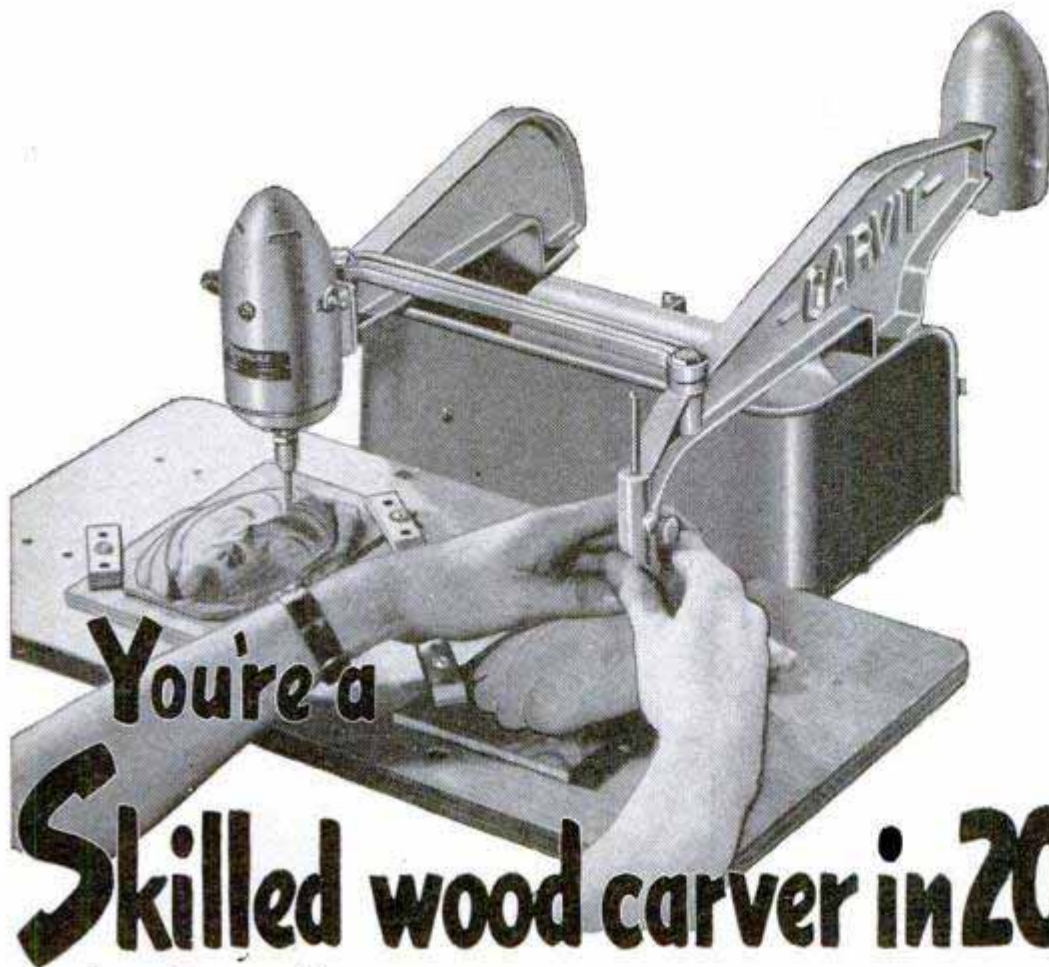

You're a Skilled wood carver in 20 minutes

... with a Dumore Carvit

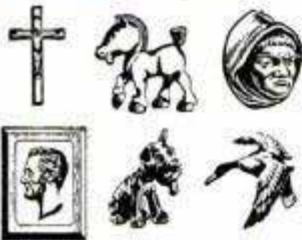

Woodcarving is great fun with the Carvit, a delightful hobby complete in one tool! It's simple, too. Even a child can make fine carvings with a Carvit. And experienced craftsmen say it's just the thing to give their wood-working projects a professional touch with carved ornamentation. With a Carvit, you make beautiful copies

of low-cost objects. You can find dozens of models in any dime store or gift shop. Reproduce them in mahogany, walnut, and other fine woods on your Carvit. Your carvings are many times more beautiful and valuable than the originals. And it's so easy! Your friends are amazed at the perfection of your first carving. Try it and see!

New!

Attachment makes your Carvit a Flexible-Shaft Machine.

No skill or training needed

Hundreds of Carvit owners find hours of happiness and profit in wood carving. They carve useful ornaments for the home, distinctive gifts, fine carvings that sell.

You can do the same. Here's how the Carvit works: You clamp a model below the tracer pin, and a block of wood below the cutter. Then you trace the model. The

Carvit makes an exact duplicate for you. With an index attachment, you can carve statuettes and busts the same way. Simple, isn't it?

The Carvit is an ideal gift for every hobby fan — and for anyone with an artistic flair. See the Carvit at your local hardware store today — or mail the coupon below.



Flexible-Shaft Chucks Right into Carvit Motor
— converting it to a tool of 1001 uses for work in wood, metal and plastic: sanding, filing, grinding, cleaning, polishing, routing, etc. \$6.25.

Tear out this coupon and mail it today!

The Dumore Company, Dept. B-51, Racine, Wis.

- Please send complete information on the Carvit.
- Please send one Carvit. \$48.50 enclosed.
- Please send one Carvit with Index Attachment. \$58.25 enclosed.
- Please send Flexible-Shaft attachment for Carvit. \$6.25 enclosed. Shipping charges C.O.D.

H-21

Name.....

Address.....

City..... (.....) State.....

Satisfaction guaranteed or your money back in 10 days!

when you
think of pliers...

think of
CHANNELLOCK

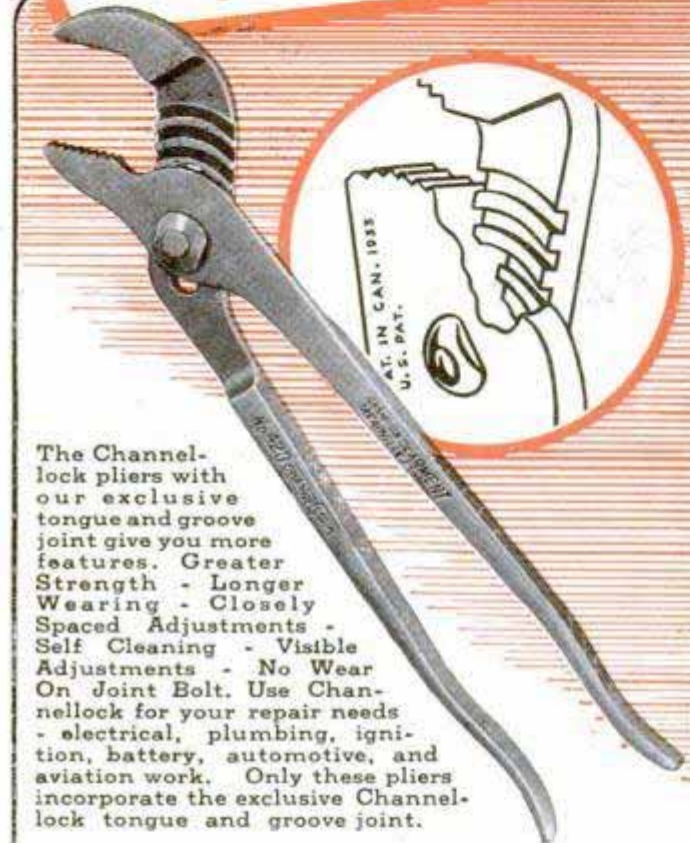

The Channellock pliers with our exclusive tongue and groove joint give you more features. Greater Strength - Longer Wearing - Closely Spaced Adjustments - Self Cleaning - Visible Adjustments - No Wear On Joint Bolt. Use Channellock for your repair needs - electrical, plumbing, ignition, battery, automotive, and aviation work. Only these pliers incorporate the exclusive Channellock tongue and groove joint.



There is a line of standard pattern pliers, too, with Channellock quality construction . . . including diagonal cutters, needle-nose pliers, linemen's and electricians' pliers, battery and standard slip-joint pliers.

Choose the pliers that fit your needs . . . Choose Channellock.

CHAMPION DEARMENT TOOL CO.
MEADVILLE, PA.

Only Champion DeArment makes

CHANNEL LOCK

showed the new-model pigs at the age of six months weigh 100 pounds more per litter than their common cousins, yet ate no more feed.

By juggling the laws of heredity, the animal engineers can speed up nature's slow processes a little, but many of the new designs are the result of experiments started long ago. For instance, while Germany was just beginning to cave in under Allied attacks, U. S. experts foresaw that Europe faced postwar famine unless her farm-animal population could be quickly rebuilt.

One of the quickest sources of meat is poultry. In the breeding pens at the government's Beltsville research center, experimenters were working to design a small, efficient turkey that would grow fast on an economical diet and would lay more eggs, with few that failed to hatch. They had already culled out inefficient, stingy layers in a new breed of turkeys. Just before V-J Day, they put a trial shipment of eggs from the "Beltsville Small White" flock on a plane bound for Europe.

Good heredity proved out, for 87.5 percent of the eggs hatched. The new design laid the foundation for a "high speed" turkey to help restock Europe's farms.

A small turkey recently designed by animal engineers is slanted for the U. S. market. Juggling the seasons, they have persuaded Madame Turkey to lay more eggs and to start laying them sooner. This is a long step toward better turkeys for Thanksgiving dinners, more fresh turkey meat throughout the year.

The animal engineers now are copying the revolutionary process that transformed yesterday's tall, top-heavy automobile into a long, low car with built-in running boards and smoothly streamlined body. Tall, long-legged steers mean more soupbones, when Americans want more T-bones. Farmers can profit by turning out a beef critter with shorter legs and a heavier build. Standardized animals mean fewer scrawny, cull cattle that are expensive boarders for the farmer, yet bring third-rate prices and yield tough, stringy steaks.

"No use feeding scrub animals!" the modern farmer says, for at today's feed prices, it doesn't pay to feed runts. By gradually breeding out the inefficient animals and replacing them with tomorrow's standard, up-to-date models, the nation's biggest industry is boosting its output to create more food for all. That's why tomorrow's farmer would no more want to turn out a runty, rawboned pig or a scrawny, thin-wooled sheep than a Detroit motor manufacturer would let an automobile leave his production line minus radiator grille or steering wheel.

Motorcycling

**WORLD'S
GREATEST SPORT**



Ever zip over a hill with the fresh morning air in your face, a companion clinging tight and happy laughter ringing in your ears? Ever feel the thrill of swinging down a beautiful country road on a swift, sleek Harley-Davidson that seems alive with power and anxious to go places? Ever hear the roar of races, hillclimbs and other spine-tingling events that only motorcycling provides? Ever join a jolly caravan of riders on a sight-seeing tour of scenic wonderlands, out-of-way places, distant cities? If you haven't, you're missing the world's greatest sport — motorcycling! And it's so *easy* to enjoy . . . easier to own a Harley-Davidson than you think. See your dealer, mail coupon.

HARLEY-DAVIDSON
with the new **HYDRA-GLIDE FORK**

HARLEY-DAVIDSON MOTOR COMPANY
Dept. P, Milwaukee 1, Wisconsin

Send free copy of ENTHUSIAST magazine, filled with motorcycle action pictures and stories; also literature on latest models.

Name.....

Street or R. F. D.....

City..... Zone..... State.....

DON'T YOU BELIEVE IT!

... THAT THE BEST PISTON RINGS COST MORE



● Some people think the best piston rings are more expensive. Burd "Graf-Flox" Piston Rings, proved superior performers on highway and speedway, cost no more than ordinary rings . . . actually cost less because they give longer service. Burd Piston Rings *out-perform* in rebuilt engines because they are cast of *electric furnace iron* . . . each type has its own special metal formula which imparts the right degree of hardness, flexibility, tension and long life for its specific use. The exclusive "Graf-Flox" process insures faster seating . . . without danger of rings scoring, seizing, or sticking in piston grooves. Burd "Graf-Flox" Piston Rings *stop* fuel and oil losses . . . *restore* pep and power. The coupon will bring you more information in two FREE booklets.



MAIL THIS COUPON FOR THESE FREE BOOKLETS
 BURD PISTON RING CO., DEPT. 119-B
 Rockford, Illinois

I'd like copies of your "Servicemen's Handy Handbook" which tells how to keep my car in good working order, and the booklet "No Job For a Dub."

Name.....
 Address.....
 City..... State.....



Television Mountain

(Continued from page 156)

strip has been buried underground to connect the two towers with a water tank, various water pipes and other objects in an effort to help dissipate the discharges of lightning. Similar precautions have been taken by the other stations. Some of them have connected their ground systems together to obtain additional coverage. Most of the transmitting equipment is further protected by automatic relays that open instantaneously when overloaded, and by lightning gaps in the circuits.

The stations are served by a commercial power cable. In anticipation of power failures each station has installed stand-by motor generators, gasoline or diesel-driven, that start automatically and take over the load any time the commercial power supply fails. The little community of technicians is prepared to dig in no matter how they are cut off from the rest of the world and to keep their transmitters operating just as long as the beamed programs come up to them from Hollywood.

Here is the status of the Mount Wilson stations:

- KECA-TV (ABC) To begin operation in 1949.
- KECA-FM (ABC) Operating now from Culver City, moving to Mount Wilson this year.
- KFI-TV Now in operation.
- KFI-FM Now in operation.
- KFMV FM only, now operating.
- KHJ-FM (Don Lee-Mutual) FM station under construction.
- KLAC-TV Now in operation.
- KNBH (NBC) Television only, programs began early in 1949.
- KNX-FM 10-watt transmitter to be increased to 50 watts.
- KTLA Television station only, now in operation.
- KTSL (Don Lee-Mutual) Television station under construction, now operating from Mount Lee, Hollywood.
- KTTV (CBS-L.A. Times) Television programs began early in 1949.

That's the list of stations on the mountain at present. Half a dozen other FM stations have applied for construction permits and expect to obtain locations on Mount Wilson or close by. There are no additional open television channels allocated to the Los Angeles area, but if additional channels are opened for picture radio, still more TV transmitters probably will join the tight cluster of stations and tall towers on Mount Wilson.

Snap-on
BLUE-POINT

Midget 1/4" Electric Drill

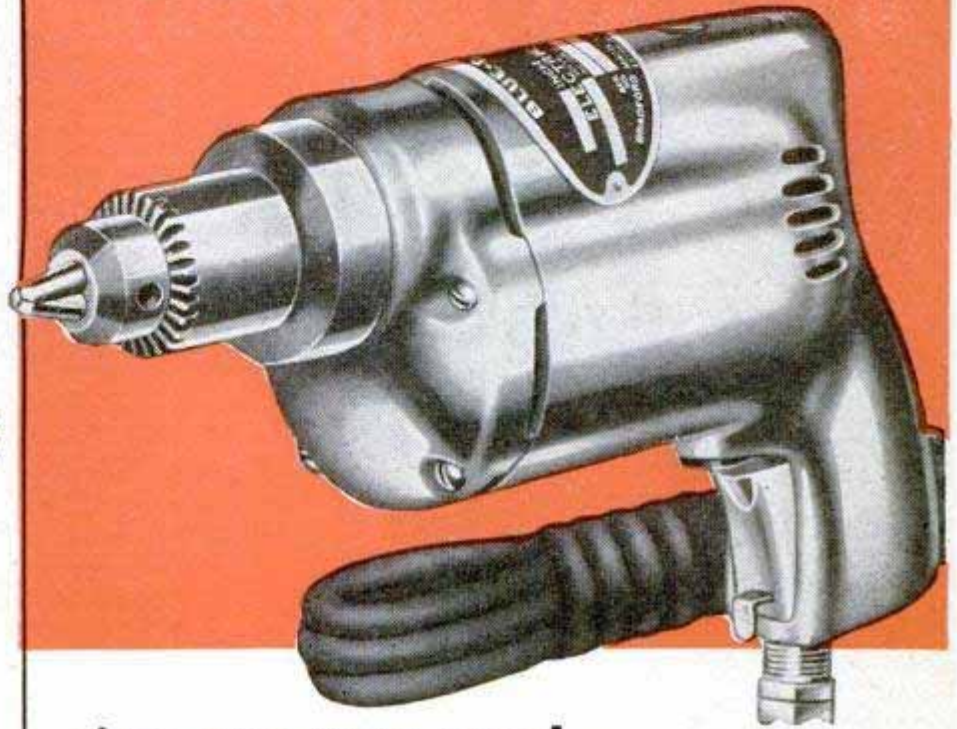

**gives you more speed...
more drilling power in close places!**

Here's a sturdy, dependable electric drill that packs a lot of power, yet is so compact that you can hold it in the palm of your hand. It's a great favorite with mechanics because it gives them drilling speed and power in close places... it gets in wherever your fist will fit. Comes complete with 1/4" Jacobs Chuck, key, and 15 feet of 3-conductor cable and plug. Mail the coupon for complete information.

SNAP-ON TOOLS CORPORATION

8062-B 28th AVENUE • KENOSHA, WISCONSIN

International Division: Kenosha, Wis., U. S. A.



CARBON BRUSH

Made of tightly twisted spirals of steel wire. Removes hard carbon deposits.



ARBOR ADAPTOR

Has 1/2" dia. arbor for use with brushes and grinding wheels up to 4" dia.



CIRCULAR HOLE SAWS

Has 1/4" pilot drill. Saw sizes range from 5/8" to 2". Shank fits 1/2" drill chuck.



CARBON BRUSH

Made of crimped bright music wire. Cleans carbon from cylinder heads and blocks.



WIRE CUP BRUSH

For use with disc Sanders. Fitted with

5/8" x 11-thread bushing. Removes scale, rust, etc.

Snap-on Tools
THE CHOICE OF BETTER MECHANICS

SNAP-ON TOOLS CORPORATION

8062-B 28th Ave., Kenosha, Wisconsin

Please send me more details about Electric Drill and accessories.

Name.....

Position.....

Company.....

Address.....

City..... (.....) State.....

PERFORMANCE GOES UP IN SMOKE . . .

*"It isn't a Volcano,
MAX-*

IT'S A CAR THAT NEEDS
**FEDERAL-MOGUL
ENGINE BEARINGS"**



REPLACE WORN CONNECTING ROD BEARINGS TO RESTORE PERFORMANCE!

Your car's performance goes on the skids when worn connecting rod and crankshaft bearings let excess oil escape and reach the combustion chambers. It burns to carbon, coating spark plugs, valves, pistons and piston rings, stealing power, pick-up and economy. To restore power, pep and performance replace with Federal-Mogul Oil-Control Bearings. *Ask your mechanic!*

FEDERAL-MOGUL SERVICE

(DIVISION OF FEDERAL-MOGUL CORPORATION)
COLDWATER, MICHIGAN

Replace in Sets with Genuine

FEDERAL-MOGUL

Oil-Control Bearings
in your car



King of the Mushers

(Continued from page 145)

comes to handling animals; others are not—and the dogs know it. Morgan Heap says that he once hired a sullen, morose driver to handle the Sun Valley dogs. From the very start, the animals didn't like this driver. At their first opportunity, they ganged up on him and tore his clothes off before he could be rescued.

A driver should be brisk and business-like when a team is working. Affection should be saved for later when the dogs are in their kennels. Even then, too much affection is not desirable. Punishment should be used sparingly—and only immediately after a dog has disobeyed a command. Most effective punishment is to grasp a dog's head between your knees, hold the head with your left hand and smack his nose smartly with your right hand. A whip should be used only by experts and only then to break up a fight between the dogs.

Often when traveling long distances across country, dogs become disinterested and ease up on their pulling. This necessitates "pepping them up." Snapping a whip, calling individual dogs by name or talking to them produces renewed alertness and energy. Often a bell on the lead dog will relieve the monotony. Some drivers also find that blowing a whistle helps.

Because of hard work and cold weather, sled dogs usually have a shorter span of life than other domesticated dogs. There are exceptions to this rule, however. A dog is at his best during the ages three to six years, and is retired around 10 years. Heap had one old blind dog that would still pull his weight when he was 14 years old.

Good sled-dog puppies cost from \$35 to \$50 apiece, while full-grown animals may vary from \$100 to \$150. A top-notch lead dog may cost \$250 or more. A sledge sells for \$350 or \$400, but many drivers prefer to build their own. Harness costs from \$50 to \$100 a set; but here again, many drivers have their own ideas and prefer to construct their own.

On the trail a dog usually can pull a load equal to his own weight. This may average around 100 pounds. On a packed slope with a down grade, a team can travel up to 30 miles an hour. On the trail, however, the average speed may be from three to five miles per hour—with a 20 to 25-mile day considered normal.

The world's record for speed and endurance among sled dogs was the famous dash from Nenana to Nome, Alaska, in 1925 to carry serum to that stricken community.

(Continued to page 258)



Genuine
HIDE GLUE
is best for all
WOOD
WORK

NO ODOR
NO MIXING
NO HEATING
NO CHILLED JOINTS

at most hardware stores

15c
extra-large
TUBE

Used by furniture mfgs.,
craftsmen, schools. If
dealer cannot supply, send 20c
(postage and wrapping) to THE
FRANKLIN GLUE CO., Columbus 15, O.

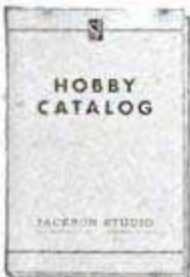

CRAFT CATALOG

NEW 1949 edition, 84 pages crammed with big selection of tools and materials for plastics, ceramics, hand power tools, plans, etc., etc. A gold mine of hard-to-find items such as foam rubber, kits, books and "How To" information. Every craftsman should have a copy. Send 25c now to

JACKSON, Dept. 75
5440 N. Shoreland Ave., Milwaukee 11, Wis.

OTTAWA TRACTOR SAW



350 Cuts Per Minute--cuts them down, saws them up, one man operates. Thousands in use, stiff heavy blade, built to last, safety clutch control, uses power take-off any tractor. Low price, **OTTAWA MFG. CO., 2-927 Forest Avenue, OTTAWA, KANSAS**

BIG 3 1/2" POWER BINOCULARS ⁹⁸/₂₉₈

Quality plus--yet priced to beat all competition. All metal with adjustable focusing wheel and shoulder strap. Tubes extend for sharp, instant view of distant objects. **SEND NO MONEY!** Clip ad and mail. We'll ship C.O.D. Check here to get handsome Carry Case only 50c extra. **Illinois Merchandise Mart, Dept. 2227-B, 1227 Loyola Ave., Chicago 26, Ill.**



BUILD YOUR OWN POWER LAWN MOWER

WHY BREAK YOUR BACK MOWING FIELD OR LAWN?

FREE
Write for
Building
Instructions
The Rite-Way
Mower
Attachment
Ball Bearing



SAVE MONEY
SAVE TIME

Now anyone can save time and effort mowing field or lawn by building their own whirl type power mower. Build according to your own ideas and needs at small cost. Cut close to fences, walks, buildings, etc. Build in short time with parts and instructions we furnish. Save hours of time and back breaking labor. Write today for **FREE** information.

T & H MFG. Co., Dept. MP-2
811 E. 31, Kan. City 3, Mo.

IT'S FUN TO BUILD

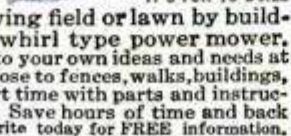

BIGGER, BETTER

100% more power!



Disc Sander-Polisher



101 USES . . . No other machine of the same type compares with the Guild Disc Sander-Polisher! It's much more than just a hobby tool. It's a precision-built machine, designed for those who want professional quality.

MORE VALUE for your money

The Guild Disc Sander-Polisher lasts longer . . . does better work . . . because--(1) the extra powerful motor avoids stalling; (2) the high-load thrust bearing takes the overstresses and strains of heavy drilling, sanding and cutting--the kind of work that quickly damages ordinary tools.

The heavy 5/8" ball bearing spindle is super rigid for sustained true running. Takes screw-on attachments and a chuck for drills and stub-shaft accessories.

The big 6" disc is one full inch larger than usual disc tools . . . covers 53% more working surface.

Made of highly polished die cast aluminum. A beauty to see, a beauty to use.

HANDLES ALL THESE TOOLS . . . AND MORE!

Wool buffer, sanding disc, grinding disc, cutting wheel, fabric pad, wire brush, cup grinder, drills, hole saw, mixer rotary file.

ONLY \$44.50 Sold by leading Hardware, Mill Supply and Lumber Dealers. Write today for name of your nearest dealer and detailed literature.

ALL GUILD TOOLS--Sander-Polisher, Saw, Belt Sander and Hedshear are precision built and guaranteed by Porter-Cable, makers of fine industrial and construction tools for more than 42 years.

PORTER-CABLE MACHINE CO.
1982 N. Salina St., Syracuse 8, N. Y.

SAY YOU SAW IT IN POPULAR MECHANICS

WOODWORKERS—CRAFTSMEN
Here is the Greatest
MASTER MANUAL
I have ever offered



ALBERT
 CONSTANTINE, JR.

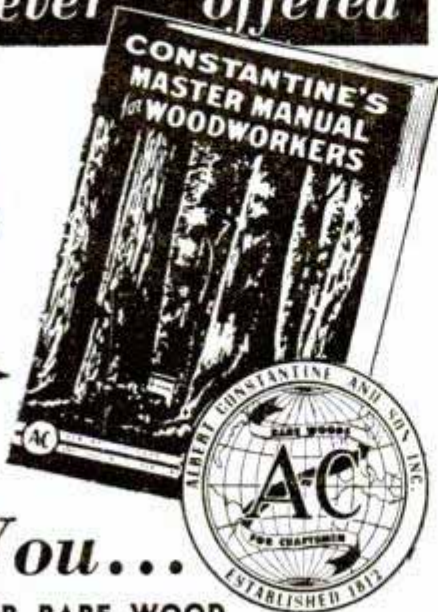

Gives You...

NATURAL COLOR RARE WOOD IDENTIFICATION CHART featuring 60 different woods, (suitable for framing). **8 PAGES IN FULL COLOR OF INLAYS AND BORDERS, 7 PAGES ON HOW TO MAKE INLAY PICTURES. COMPLETE STORY OF RARE WOODS AND OTHER INTERESTING, HELPFUL ARTICLES PLUS**

A MULTITUDE OF MATERIALS

- | | |
|------------------------|---------------------------|
| Rare and Fancy Veneers | Plastics and Supplies |
| Lumber and Plywood | Period Furniture Hardware |
| Inlays and Borders | Casters and Gliders |
| Inlay Pictures | Hinges and Locks |
| Finishing Materials | Musical Movements |
| Tools, Hand and Power | Bed Hardware |
| Veneer Press | Moulded Wood Carvings |
| Instruction Articles | Jewelry Findings |

GREATEST SOURCE OF SUPPLY FOR

... woodworking needs. Materials, hand and power tools, hard-to-get furniture hardware, fittings, locks, hinges, etc., etc. Dozens of plans from simple pipe racks to complete furniture sets. Acclaimed the greatest book of its kind ever offered. Send only 25c today and I will include free with each copy of my **MASTER MANUAL** a full year's subscription to "Chips and Chats", an interesting and newsy publication of craftsmen projects, activities and current bargains in tools.



SEND THIS COUPON NOW

Albert Constantine and Son, Inc.
 791-N 135th St., New York 54, New York.
 Enclosed is 25c for a copy of your "MASTER MANUAL" with which I get FREE one Year's subscription to "Chips and Chats".

NAME
 ADDRESS
 CITY..... ZONE..... STATE.....

By relays of teams and drivers, the 665-mile distance was covered in 5½ days, an average of 125 miles per day under adverse weather conditions.

Aided by the zooming popularity of skiing during the last decade, dog-team racing is taking its place as a popular winter sport—both for the participant and the spectator. "Runnin' dawg" races are held during the winter months in Brighton, Utah; McCall, Idaho; Ketchum, Idaho; Aspen, Colo., and West Yellowstone, Mont. But the title meet for the whole country is the Ashton Dog Derby. The winner of that race rightly wears the crown of King of the Musers.

Mining a Marble Mountain

(Continued from page 172)

be the proper size for that particular spot in the building.

When the block has been freed from its place in the quarry floor, it is hoisted onto a flatcar by derrick. The car runs along an underground railway to the quarry entrance. There it is hoisted out of the quarry by another derrick. At this point the block is washed to remove the marble chips and shavings. Its dimensions and identification numbers are painted on one face.

Because the Danby quarry is high up on a mountainside, the blocks have to be transported down into the valley where the railroad will take them to the mills. A cable-operated car takes the block down the mountain—a descent of 900 feet.

The block, still rough from the quarry-cutting operation, is hauled to the mill for trimming. The railroad runs right into the mill, alongside the giant gang saws. Still on a wheeled car, the block is rolled into a stall under horizontal saw blades. These blades have no teeth, but rather are smooth strips of steel locked under tension in the frame to cut the block to the proper size. When the block is to be cut into veneer, as many as 50 blades are locked in the frame at one time. These frames move back and forth in long, smooth strokes, rubbing the blades against the marble block. Cutting action results from the abrasion of sand and water ground into the marble by the steel blades. A pumping system pours the sand and water over the blocks. As the abrasive mixture runs down into the cuts, it wears away the marble slowly but smoothly. The saws run continuously, 24 hours a day, cutting two to three inches in eight hours. It requires about two weeks to cut through an average block.

The trimmed block or, in the case of veneer, the thin panel, is taken to a finishing mill, where revolving rubbing beds

(Continued to page 260)

GENIUS at WORK



12" DRILL PRESS



12" BAND SAW



SHOPMASTER TOOLS

gives ease of operation with professional results

Whatever it is you make, a simple stool or an elaborate cabinet, it will contain that indefinable extra craft touch only you can put into it.

Most Americans have this ability to design and make things. They like to work with their hands. They know and take pride in good tools.

Shopmaster Tools have been designed to meet the needs of American craftsmen, both amateur and professional. Expertly engineered to give precise results with ease of operation, they have the rugged construction necessary for long years of service. And, best of all, they are priced within the reach of all.

See Shopmaster Tools at your dealer, or for free catalog, illustrated in full color, write to:

SHOPMASTER, INC.

1214 Third St. South, Minneapolis 15, Minn.

LATHE



8" TILTING ARBOR SAW



15" JIG SAW



SABER SAW



8" TABLE SAW



6" JOINTER-PLANER

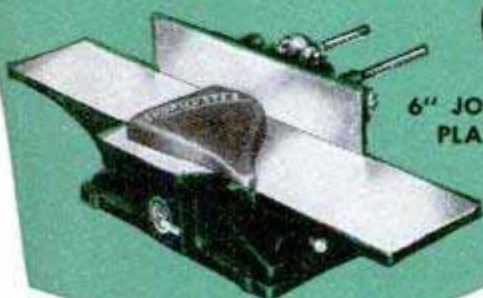

P.S. Simple, well-designed furniture and articles of wood regularly described in POPULAR MECHANICS are easy to build with Shopmaster tools.

**It's DANDY
HANDY.**

**A workshop
by itself!
Works wonders
around the house!**

**Every Home Craftsman Wants the
New BRADFORD TRIPLE TOOL**



**It's a SANDER!
It's a POLISHER!
It's a DRILL!
only \$48⁷⁵
complete**

Including 3 sanding discs, lamb's wool bonnet, backing pad, 7B Jacobs chuck with key and patented holder.

Here's the handiest portable electric tool yet made. In seconds you can change it from a 5" polisher, to a 5" disc sander, to a powerful 1/4" drill! Drills 1/4" in steel, 1/2" in hardwood. Drives numerous accessories. Polishes your car, woodwork, furniture, linoleum in a jiffy. Does all kinds of sanding, light grinding, wire brushing.

Precision-built of finest materials. 100% ball bearing. Powerful AC/DC motor. Helical cut hardened gears. Aluminum housing. Weighs only 6 lbs. Get it at your nearest Bradford dealer, or order now by coupon below. Write for illustrated bulletin.

Dealers: Write for our sales proposition.

Bradford Machine Tool Company
671 Evans St., Cincinnati, Ohio

Send me the Bradford Triple Tool complete with accessories. Money order for \$48.75 enclosed.
 Money order for \$12.35 enclosed, balance COD.

NAME _____

ADDRESS _____

CITY _____ ZONE _____ STATE _____

THE BRADFORD MACHINE TOOL CO.
671 Evans St., Cincinnati 4, Ohio

grind the marble down to the precise size desired. These rubbing beds are huge cast-iron wheels revolving horizontally. From 12 to 14 feet in diameter, the wheels weigh 10 tons when new. Continuous grinding of the marble wears away these five-inch-thick wheels in about six years.

Again sand and water do the work. The abrasive mixture is fed onto the surface of the wheel as it spins. The marble is held by a giant clamp and is slowly ground down to size. When the rubbing operation is completed, the marble has smooth, square sides and can be used without further processing for exterior blocks.

But the interior marble, such as the thin panels, have another finishing process to go through. They are placed on racks under a polishing head. By using a variety of abrasive heads, the workman produces a mirrorlike finish on the stone. No sand is used here, only water and fine abrasive.

Colored marbles, some of which are quarried in the Lake Champlain region of Vermont, take a brilliant polish and come out of the finishing mill shining like a new car. These colored marbles are used today more than ever in buildings. It's a pretty good bet that the front on your home town's newest department store or theater is colored Vermont marble.

Another method of cutting marble, used in the finishing mills for final cuts in small blocks, is with the diamond saw. These saws are six feet in diameter and contain replaceable teeth studded with industrial diamonds.

Cornices and moldings are produced on a planer very similar to the type used in metalworking shops. Lathes are used for cutting circular columns and decorative pieces such as urns.

But not all the marble can be cut by machine. Much of the marble used today is in the form of statuary and other delicately carved shapes. Skilled artisans turn the inanimate stone into beautiful statues with their chisels.

Years ago, the marble cutter fashioned his delicate carvings with a chisel and mallet. Today the pneumatic chisel does the job quicker and more precisely. The cutter can't afford to make a mistake, because there's no way to cover up a missing piece of stone.

Marble has been a favorite building material for centuries. Some methods used in mining and finishing the sparkling stone are the same as those used in ancient Greece and Rome. There are modern innovations, such as the use of electric power and pneumatic drills, but basically the techniques are unchanged.

PRESTO! MASTER GLAZE

ANYONE CAN



LEAVES HARD GLASS-LIKE FINISH
EASY TO APPLY
PROTECTS THE SURFACE
NO SMEAR OR STREAKS AS WITH WAX
LASTS SIX MONTHS TO A YEAR

SEALS THE PORES OF THE SURFACE
WILL NOT FINGER-MARK
NO OILY FILM AS WITH POLISH
EASY TO HELP CLEAN

SAVES YOU MONEY

Car Owners! Meet Master Glaze—the sensationally different luster for new and used cars! Not a wax—not an oil polish—not a paint!—nothing that “smears” over the surface.

MASTER GLAZE is a unique discovery—a creamy liquid—quick and easy to apply! Gives a hard, glass-like surface. Even gasoline cannot dull it! Lasts six months to a year! Amazing luster—beautiful, sparkling clean and brilliant! Doesn't finger-mark—doesn't smear! A match box full glazes an entire car. Seals the pores—protects! **NOTHING LIKE IT!**

AGENTS
An unusual opportunity! Quick, flashy demonstrator, Big profits, Good territory. Write today!

FREE SAMPLE

Just send your name and address to

MASTER GLAZE CO., 7720-660 W. Harwood Ave., Milwaukee, Wis.



NOW! FILE YOUR OWN SAWS

Do expert saw filing at home. Precision filing—easy without experience. Two simple adjustments. Keeps any hand saw extra sharp and true-cutting. Complete with file. Money back guarantee. Cash with order, prepaid. (COD postage extra.) Order today.

THE SPEED CORP., Dept. PM1
2025 N. E. Sandy, Portland 12, Oregon

LUMBER

A BOARD OR A CARLOAD

Harold Hunt wants to send you big, new No. 15-B Catalog. Over 148 pages of woodworking ideas. 12 pages of rare woods in colors. **UNEQUALLED BARGAINS** in imported and American woods, supplies, hard-to-find hardware. Send only 15c to cover postage and handling.

CRAFTSMAN WOOD SERVICE CO.
2729 S. Mary St. Dept. A-2 Chicago 8, Ill.

TOP GRADE KILN-DRIED
WALNUT
MAHOG
CHERRY
WHITE
HARD
MAPLE
POPLAR
OAK
AROMATIC
RED CEDAR

FOR LOWER COST HOME MOVIES BUY DIRECT AND SAVE WITH SOLAR

8mm-16mm MOVIE FILM
FAVORITE OF FANS SINCE 1937
24-HR. FREE PROCESSING
Send for Free Illustrated Book Describes all types of SOLAR FILM. Hundreds of rental subjects. Rates as low as 3 feature length films for only \$1. **SEND TODAY.** Buy Direct & Save
SOLAR CINE PRODUCTS, Inc. PM2
4247 S. Kedzie Ave. Chicago 32 Ill.

REAL DIESEL ENGINE

\$2.95

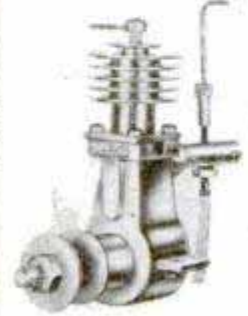

WE'RE CRAZY, they tell us, giving away a real diesel engine, complete with cylinder and piston, carburetor, crankshaft and connecting rod. All parts completely machined, ready for easy assembly. **ONLY \$2.95.** How do we do it? We're selling thousands of **DEEZILS**. So production's up; costs tumble down. **DEEZIL** is a precision engine. Actually runs at 7500 RPM. Produces 1/7 HP. Ideal for planes, boats, midget cars. Send \$2.95 plus 25c postage today.

GOTHAM HOBBY CORP.

107 East 126th Street New York 35, N. Y. Dept. "P"

YOU'RE NEVER OUT OF WORK
when you have a **sideline business to fall back on**

- STEADY, PROFITABLE INCOME
- NO EXPERIENCE REQUIRED
- BE YOUR OWN BOSS

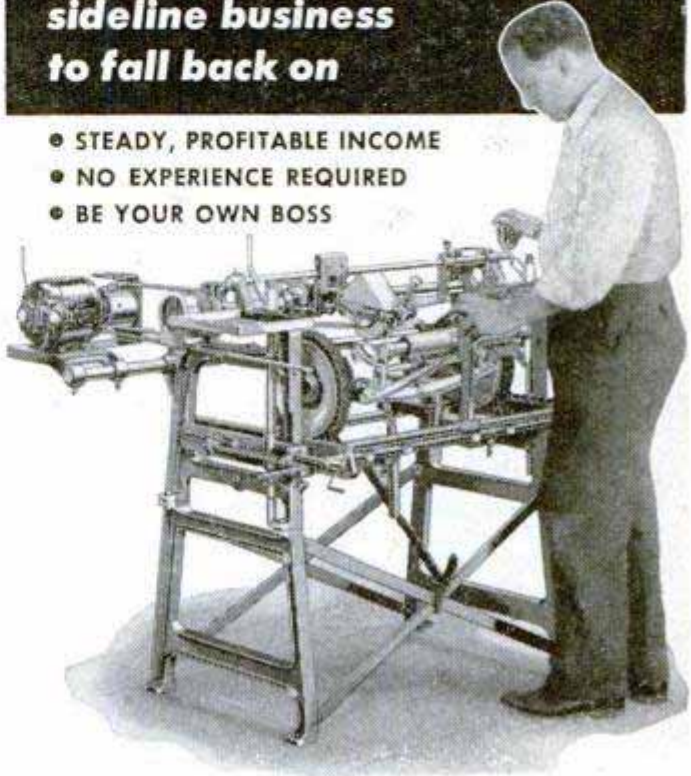

IN YOUR SPARE TIME—AT HOME SHARPEN LAWNMOWERS on the IDEAL SHARPENER

YOU can put one of our IDEAL Lawnmower Sharpeners in your cellar or garage and start a good paying business of your own—on the side—sharpening lawnmowers. In a short time your earnings will pay for the machine. From then on, everything you take in is “gravy.”

Get started now! Early this spring and all summer, people in your neighborhood will keep bringing you mowers to sharpen. Just place the lawnmower in the IDEAL, make a few simple adjustments! The IDEAL does the rest. You collect the cash! Get the facts! Be first in your neighborhood!

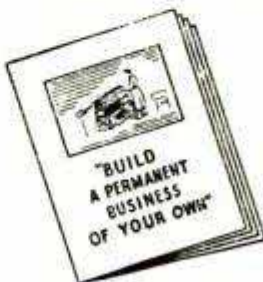

Send for FREE booklet today!

THE FATE-ROOT-HEATH CO.
DEPT. D-3, PLYMOUTH, OHIO

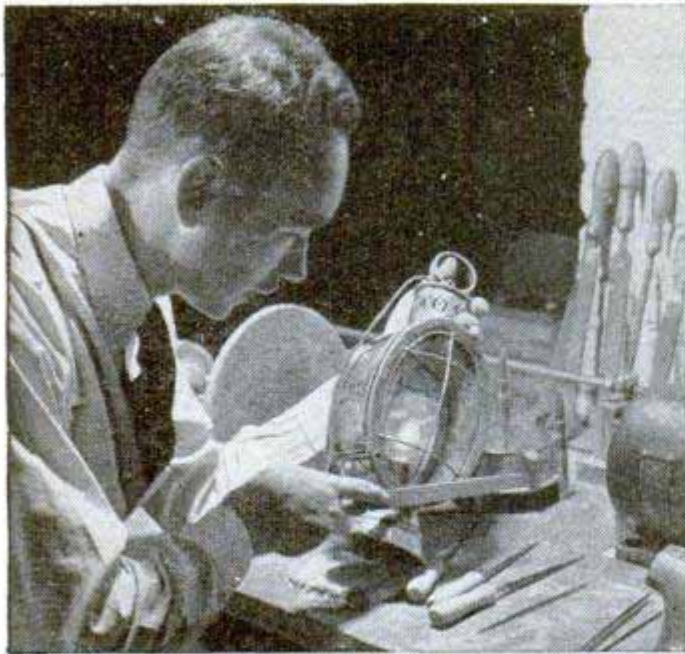

the FINISHING touch

It's the finished appearance of the job that counts. So, for those few final touches, you'll want the best in finishing tools.

In finishing files, that means Nicholson or Black Diamond. Here are a few of them, with the cuts and sizes recommended for home-workshop use:

Mill File—2nd or Smooth cuts in 6- to 10-inch lengths.

Hand Finishing File—2nd or Smooth cuts, 12-inch length.

Brass File—8- or 10-inch length.

Swiss Pattern Files—in a variety of shapes, sizes and cuts for extra-delicate work. Ideal for the model maker; Round Handle Needle files in boxed sets.

A popular, work-bench assortment of Nicholson or Black Diamond files will prove a prized possession. Your hardware dealer can supply you.

• Write for "FILE PHILOSOPHY"—a free book on the kinds, care and uses of files.

NICHOLSON FILE COMPANY

22 Acorn Street
Providence 1, R. I.

(In Canada, Port Hope, Ont.)

NICHOLSON
U.S.A.
MADE IN U.S.A.

NICHOLSON FILES

FOR EVERY PURPOSE

Uncle Sam's Stamp Factory

(Continued from page 103)

cutting is done in soft steel and the design appears in reverse.

The next step is to decide on color. A call goes out to Herbert C. Tucker, superintendent of the ink-making division, for "pull out" proofs (actually dabs of color) in several dozen shades. All of the stamp inks are especially made for steel-engraving work and Tucker keeps approximately 150 colors on hand. The bureau buys pigments under very rigid specifications, operating its own testing laboratory and production lines of mixing, grinding and blending machines. All samples are matched against standard samples for color and consistency. The ink-making department, a complete factory in itself, produces 3,000,000 pounds of ink a year for both currency and stamps. All formulas are secret.

Working with the various samples of ink, proofs of the new stamp are made from the master die. These proofs, known as die proofs, are submitted to the Postmaster General who selects the desired color. Then the master die is hardened. This is done by heating the die in a cyanide solution to a cherry red at 1400 degrees Fahrenheit and then quickly cooling it in a brine bath. The hardened master die then goes to the transfer department where it is placed in a transfer press. Under heavy pressure this press transfers the cutting on the die to the outer rim of a soft-steel roll. After hardening, this roll is used to transfer the design to the steel plates from which the stamps are printed. The plates are also hardened and if they are to be used on rotary presses they are bent to fit the cylinders.

Generally, only four plates are made for the special commemorative stamps. The ordinary three-cent stamp has about 60 plates while only 30 plates are required for the other ordinary stamps. The bureau has eight sets of plates available for the five-cent airmail stamp.

The men working in the transfer department, whose business it is to reproduce engravings on steel, are known as siderographers. There are only 55 siderographers in the United States and nine of them work in the bureau.

Printing of the stamps is under the close supervision of Jack M. Smith, superintendent of the postage-stamp division. Any tour of inspection through this department is under the watchful eye of the Secret Service. Every sheet or roll of paper

(Continued to page 264)

The "New Look" in Masonry is **STREAMLINED**



37' x 24' 936 Sq. Feet
Authentic Ranch Type
Especially Designed
for Dunstone

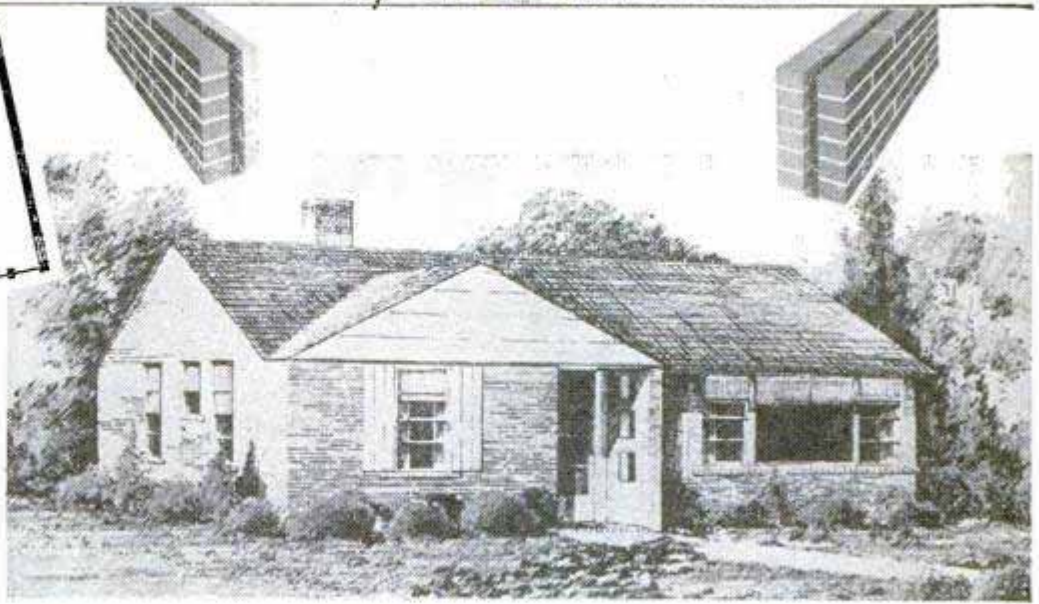

*National Average. May vary according to locality.

\$336³⁴*

Buys ALL the Dunstone for the "AMERICANA"

Outstanding Low-Cost Masonry Home

Dunstone is $2\frac{1}{4}'' \times 3\frac{3}{4}'' \times 16\frac{1}{2}''$ —twice the length of ordinary brick.

Exterior with laid flat, interior on edge, forms 8" cavity wall including 2" air space.

Both exterior and interior laid flat form 10" cavity wall with 2" air space.

Supplied in reds, buffs, tan, etc. for exterior. Natural grey for back-up when plastering is intended. Also supplied in pastel shades to form a self-contained interior finish.

Every Dunstone is absolutely square, straight and symmetrical. No warping, no distortion. Makes for easier laying and cleaner "streamlining."

The manufacture of Dunstone is an outstanding manufacturing opportunity. If interested in establishing a local plant write for informative book "Blueprints for Profit."

Here's a Dunstone message for those intending home builders who are masonry-minded but cost-cautious. Who want walls built of brick but refuse to pay the customary price penalty.

Dunstone is America's finest masonry. But costs less than lumber. It is brick brought up to date—streamlined and styled to fit today's needs.

You don't have to build according to the plan shown in order to use Dunstone, because Dunstone gears with any plan and with any kind of construction—residential, commercial and industrial. But the "Americana" does give you an idea of Dunstone economy, beauty, modernity and adaptability.

Dunstone is made in a chain of local plants, each using local materials and labor. Therefore, the two biggest cost items in the price of ordinary brick—freight and distribution—are practically eliminated, and the saving is split two ways: improving the quality and lowering the price.

Contact your local Dunbrik-Dunstone plant. See the product and get an estimate on Dunstone for the home you are planning to build. You can also get—if you want them—a set of blueprints on the "Americana", (Price \$15.00). If your city has no Dunstone plant at present, write us direct for descriptive literature.

W. E. DUNN MFG. CO., 610 W. 24th St., Holland, Mich.

DUNSTONE

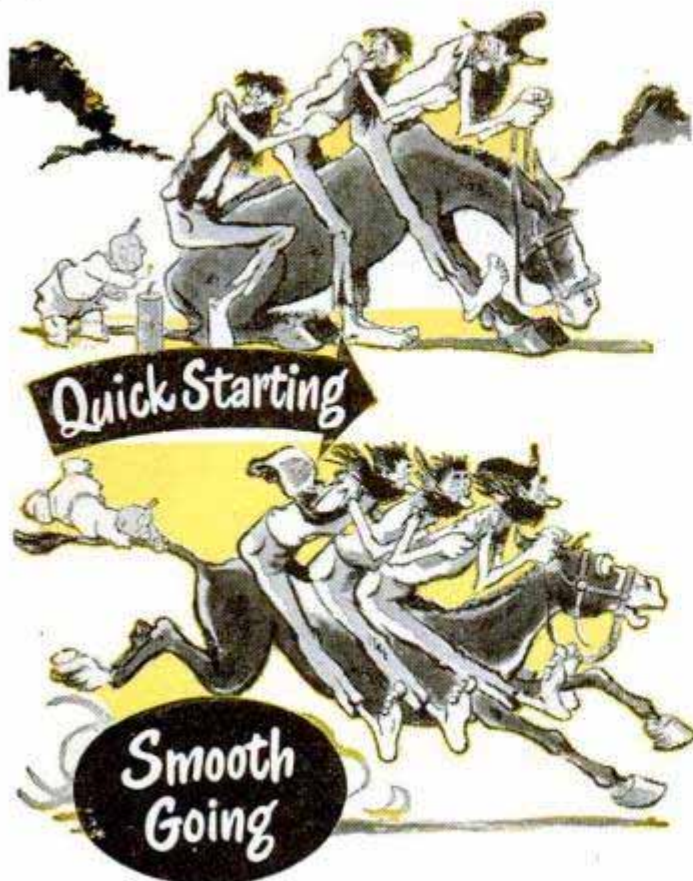

With **CASITE** in
your car

● Just press the starter—and whoosh—your car will go on coldest winter mornings.

Just relax—you'll keep going briskly, steadily—you'll get that smoother, sweeter performance you've been looking for.

And thousands of miles from now, you'll still have plenty of power. Casite cuts engine wear because it improves lubrication. No matter what kind of motor oil is used, Casite gets it around quickly and into the tight spots. Get Casite and go!

THE CASITE CORPORATION, Hastings, Michigan
CASITE DIVISION, Hastings Ltd., Toronto

75¢ a pint

95¢ in
Canada



used in the printing or proofing must be accounted for later, either in the form of finished stamps or scrap which is sent to an agency of the Treasury Department for verification and destruction by burning. There is no wastepaper to be thrown away here where any scrap might be a priceless collector's item.

Most of the stamps are printed on the nineteen large and nine small rotary presses. These presses were designed by a former employee, especially for the job. Each press can turn out about 7800 sheets a day. If the sheets are for the ordinary variety of stamps they will contain 400 stamps each; if for coil stamps (used in coin machines), only 170, and if for the book stamps, 360. The majority of the commemoratives are printed 200 to a sheet. The approximate number of stamps turned

1948 COMMEMORATIVE STAMPS

George Washington Carver	Palomar Mountain Observatory
Discovery of Gold	Poultry Industry
Mississippi Territory	Gold Star Mothers
Four Chaplains	Fort Kearny
Wisconsin Centennial	Volunteer Firemen
Swedish Pioneers	Indian Centennial
Progress of Women	Rough Riders
New York Golden Anniversary	Will Rogers
William Allen White	Fort Bliss
U.S.-Canada Friendship	Moina Michael
Francis Scott Key	Juliette Low
Salute to Youth	Gettysburg Address
Oregon Territory	American Turners Society
Harlan Fiske Stone	Joel Chandler Harris
Clara Barton	

out by a single press in one day is 3,120,000. The total value of stamps turned out in a day varies, but on many days the figure runs close to \$4,000,000.

Printing is also done on flat-bed presses for stamps of limited demand. Examples are the Canal Zone stamp and stamps of high denominations such as \$1, \$2 and \$5.

As the long web of stamps rolls from the rotary presses it passes through a gumming machine and an electric drying chamber. Here the gum is hardened in 30 seconds. This vegetable gum is not to be confused with glue and—stamp lickers please note—is said to be as pure and edible as the best food. At the end of the drier the sheets are wound into big rolls.

The rolls are moved along to machines which perforate the stamps in both directions and cut the rolls into sheets of 400 or 200 stamps each, depending on the size of the stamps. These perforating machines are electronically controlled. Register marks are engraved on the printing plates and appear on the sheets of stamps in the form of dashes. These dashes are scanned by an electric eye to hold the

(Continued to page 266)

The Amazing **ELECTRIC FAUCET HEATER** that gives

Now! HOT WATER from your COLD WATER FAUCET!

-in a *Jiffy!*

24 HOURS A DAY!

Think of it! **THE HOT WATER YOU WANT—the moment you want it**—from any sink cold-water faucet . . . just by plugging Kem's amazing new Faucet Heater into the nearest electrical outlet. No boiler or tank needed! No fussing with fires. Attached in a jiffy—takes seconds to attach or remove.

You merely turn faucet to regulate temperature.

- For **SHAVING** early in the morning and late at night
- For **BABY'S BOTTLES**
- For use in **SICKROOM**
- For quick **LAUNDERING**
- For use in **FACTORY, SHOP AND STORE**
- For **GARAGE, BASEMENT, etc.**
- For **FARMS, BUNGALOWS and COTTAGES** that do not have regular hot water supply or where not readily available
- When **HEATING PLANT BREAKDOWN** stops hot water supply

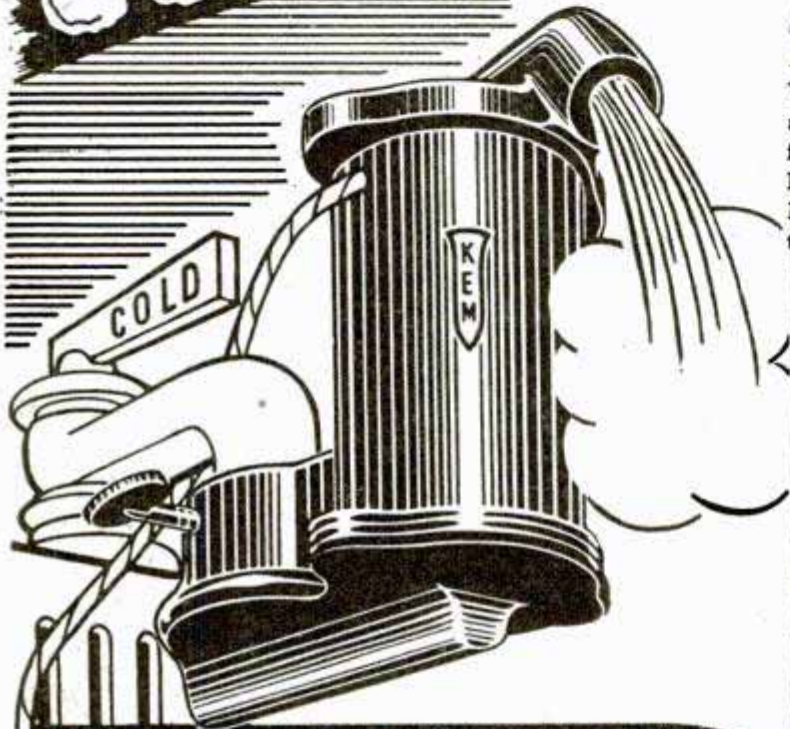

Worth many times its special
low price
of only

ADDITIONAL FEATURES

- Operates on AC or DC current
- No moving parts to wear away or get out of order
- Constructed of handsomely finished aluminum
- Weighs less than 1 pound (size 2¾ inches x 3¾ inches)
- Underwriter Approved 6-foot extension cord
- Costs little to operate a day

\$3.98

FULLY GUARANTEED!

The Kem Electric Faucet Heater is skillfully made and guaranteed against any and all defects in material and workmanship. With ordinary care it will give years of satisfactory service.

You're never without hot water when you own a Kem Electric Faucet Heater. Get one now at the amazingly low cost of only \$3.98. Mail coupon TODAY!

KEM COMPANY

18 East 41st Street, Dept. 3-Z, New York 17, N. Y.
WRITE, COME IN OR CALL LE 2-4181—8th FLOOR

KEM COMPANY, 18 East 41st Street, Dept. 3-Z, New York 17, N. Y.

- Rush KEM HOT WATER HEATER C.O.D., I'll pay postman \$3.98 plus postage.
- Enclosed find \$3.98. Send POSTPAID.

NAME.....

STREET.....

CITY.....ZONE.....STATE.....

(PLEASE PRINT)

MAIL COUPON TODAY!



FOR FAST, ACCURATE WORKMANSHIP

GREENLEE 22 is a name it will pay you well to remember whenever you buy Auger Bits. For it assures you sharp cutting edges, accurate sizing, bright, high finish, and that smooth, easy action so necessary in fine craftsmanship. You can be certain, too, that every GREENLEE 22 Solid-Center Auger Bit is "factory sharp" when it reaches you. For each is "Plastic-Sealed" with a special protective coating to keep it in perfect condition for you. To buy top quality, buy GREENLEE.



SPECIAL OFFER... ONLY 10¢ FOR HANDY WOODWORKING CALCULATOR

Quick solutions to countless woodworking problems. Just set dial: convert linear feet to board feet; compare characteristics and workability of various woods. Also shows bit



sizes; nail specifications; tool sharpening hints; etc. Heavily varnished cardboard, 6" diameter. Send 10c to Greenlee Tool Co., 2102 Columbia Avenue, Rockford, Illinois, U. S. A.

paper in proper position. Formerly, this adjustment was made manually which resulted in many mutilated stamps.

Every sheet is examined once and counted twice. Where flaws occur it is possible to salvage as little as a quarter of a sheet, the defective portions going to the furnaces after being checked by the section of mutilated paper. The inspected stamps form units of 100 sheets each. The 100-sheet units are stapled in four places on the margins and then cut into quarter sheets, the size for delivery. These big "books" hold 10,000 stamps of the ordinary size and 20 books make a large package of 200,000 stamps. One of these packages, which is about a cubic foot in size, is worth \$6000 if the stamps are of the three-cent denomination. Armored trucks carry the packaged stamps daily from the bureau to the Washington, D. C., Post Office.

Stamps sold in post offices in book form go through a slightly different procedure. They are stitched in booklets containing 12 or 24 stamps. The stamps for dispensing machines are wound into coils of 500, 1000 and 3000 stamps.

There are almost as many regulations in regard to the printing of any matter pertaining to stamps as there are to currency. It is illegal to reproduce a stamp (to illustrate an article such as this) unless the stamp is less than three fourths of actual size or more than 1½ times actual size. One company recently decided to send out in an advertising brochure a full-color reproduction of all the 1948 commemorative stamps. The Secret Service, which guards the Post Office Department, went into immediate action. The brochures were confiscated and so were the plates from which they were printed and action in the federal courts was threatened. That company learned the hard way that Uncle Sam is mighty particular about anything concerning his stamp factory.

'49 Uranium Rush

(Continued from page 93)

radium, for counting cosmic rays, for making measurements to safeguard public health in places where radioactive materials are used, and for prospecting, among other uses. Usually, the meters are designed for one special use and may be adjusted to various degrees of sensitivity.

Untrained prospectors have been wildly excited when first trying out their meters because the instruments immediately start to indicate radioactivity. This is due to the reception of cosmic rays and the

(Continued to page 268)

Mows and Trims Lawns



In One Simple
Easy Operation
8¼ Lbs.

Save Time
and Labor with a

MONTAMOWER

New model. New type metal handle has special device to adjust cutting height. Drive shaft now mounted on free rolling, factory lubricated, sealed ball bearings. No tired backs or aching arms. 8¼ lbs. live precision made mechanism that first gathers, then cuts smoothly a clean 16" swath through grass, dandelions, spike grass, lawn weeds. No noise or clatter. As modern and efficient as your electric razor. Cuts right up to walls, fences, trees or posts; leaves no fringes to be trimmed by hand. Cutters self-sharpening. Built to last many years. Many thousands in use. Sold direct from factory for 26 years. Costs little. Write at once for trial on your own lawn "approval offer," guarantee information and literature.

MONTAMOWER DISTRIBUTING CO.

92 Keeler Bldg. GRAND RAPIDS 2, MICHIGAN

GIVES YOU 2 DRILLS IN 1

Converts any ¼ inch Electric Drill to ½ inch capacity. Reduction gears reduce speed 5 to 1, the average speed of ½ inch Drill thereby increasing power.

Jobbers write Price \$1195
for proposition

M.O. or check with order

G. M. CO. MANUFACTURING, INC.

1308 43rd Avenue
Long Island City 1, New York



You're a Better Driver With a HULL AUTOMOBILE COMPASS

When you're sure of directions, every second, you're relaxed, undistracted, a better driver. Beaconlite illuminated \$5.95, Streamline standard \$3.95. At your dealer's. Write for literature.

HULL MFG. CO., P. O. Box 246-D2, Warren, Ohio



WORK GLOVES

Riegel
WORK
GLOVES

Riegel makes the
right glove for
every job.

Riegel Textile Corp.
342 Madison Avenue
New York 17, N. Y.



"THIS TRADE MARK IS YOUR GUARANTEE OF VALUE"

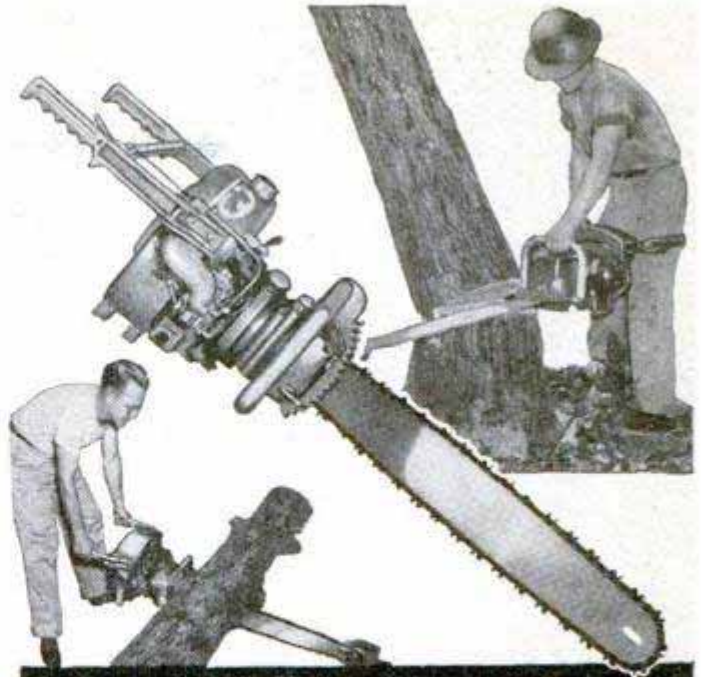

The Best Cutting Lightweight Chain Saw on the Market!

MODEL 10

Mall CHAIN SAW

FOR ONE OR TWO MAN USE

Saves time and Effort Felling, Bucking, and Limbing
Trees; Cutting Fence Posts, Cordwood, Crass Ties
and Firewood.

The Mall Tool Company - pioneers in designing, engineering and manufacturing Gasoline Engine, Electric and Pneumatic Chain Saw - climaxes its years of experience with this powerful, new lightweight gasoline engine Chain saw that incorporates important money-saving features not available in other makes of chain saws.

Easily handled by one man on horizontal, vertical or any angle cut • Indexed to any desired angle for felling or bucking • Lightweight die-cast magnesium construction makes it easy to carry • Powerful 2-cycle Gasoline Engine • Interchangeable Gear Ratios - slow speed for big trees, high speed for small ones • Round Nose Bucking Bar makes it possible to start cut with tip of round end; also permits felling and bucking trees twice the bar's length • Foolproof float-type carburetor keeps engine running for angle cuts • Speed Control by Throttle on right handle and on handle cross-bar (for one-man operation) • Quick detachable tailstock furnished with round nose bucking bar at no extra cost.



MALL Model 10 CHAIN SAW

Capacity	Weight	Price
18 inches	52 lbs.	\$380.00
24 inches	56 lbs.	385.00
36 inches	61 lbs.	395.00
48 inches	67 lbs.	405.00

F.O.B. Chicago

Write for free literature, demonstration and name of nearest dealer. Sales and Service Stations throughout the United States.

MALL TOOL COMPANY

ESTABLISHED 1921

7805 S. Chicago Avenue

Chicago 19, Ill.

normal radioactivity of the earth. A meter is apt to register from 5 to 50 random clicks a minutes and this so-called background must be disregarded when seeking radioactive materials. Before starting out it is best to count the clicks for 10 minutes and divide by 10 to establish the actual background count for any locality.

For normal prospecting the meter is simply carried across country or past likely formations at a slow walk while the operator listens or watches for any unusual change in the gamma-ray count. Variations in the count are apt to occur during a prospecting tour and the operator soon becomes familiar with these. Spurious counts, for instance, may be noticed at the approach of a thunderstorm. The normal background count is apt to fall off sharply when a gulley is entered. Contamination of the clothes by radioactive materials also can cause a count that has no significance as far as prospecting is concerned. When in a known radioactive locality it is best to walk very slowly to watch for any unusual changes in the count. Three feet of earth overburden or rock capping can almost completely shield a vein of material that would give out a very rich count, if it were exposed.

Careful prospectors who pick up an indication of radioactive ore use their meters

for surveying the extent of the deposit, exposed or unexposed. They mark the area off into 20-foot squares and post a stake or pile of rocks at each intersection. At each corner they then take a one-minute stop-watch count and mark the count on a grid map. If a vein of radioactive material lies below, the completed grid map immediately reveals its length, breadth and direction.

The Geiger counter is a dependable detector of radioactive materials but it is useless or virtually useless for estimating the richness of an ore. Even common country rock may cause an increase in the count if a sample is held close to the tube, due to the trace of radioactivity that the rock contains. The only sure way of learning the uranium or thorium content of a specimen is by spectroscopic analysis.

The Geiger-Mueller radiation meter is the most popular tool for uranium prospecting but it is not the only one. Unexposed photographic film left for a day or two in a light-tight container on a possible body of uranium material will be found to be fogged when developed if the deposit was truly radioactive. Various types of electroscopes give an indication of radioactivity when such an ore is examined

(Continued to page 270)

GROBAN'S - WAR SURPLUS BARGAINS

SHOP BY MAIL and SAVE
Better buys • Satisfaction guaranteed

SCOOP!

Brand New

High

Volume

CENTRIFUGAL PUMP

FOR FIRE PROTECTION, IRRIGATION, DE-WATERING, INDUSTRIAL USES, FARM USES, ETC.

PUMPS RATED 500 GALLONS PER MINUTE AT 275 FT. HEAD PRESSURE

Equipped with 1½" diameter straight splined shaft for direct coupling drive; 4½" threaded suction intake; two—2½" threaded discharge outlets; Hale Pump Co. Model CF volute type; requires 37 H.P.; dimensions: 21" x 24" x 28". Complete with full accessory kit including suction and pressure gauges, priming equipment, and instruction book. Ship. wt. 415 lbs.

Gov't. acquisition cost \$425.00

NOW

\$149.50

F.O.B. Chicago

WRITE FOR OUR FREE CATALOG!

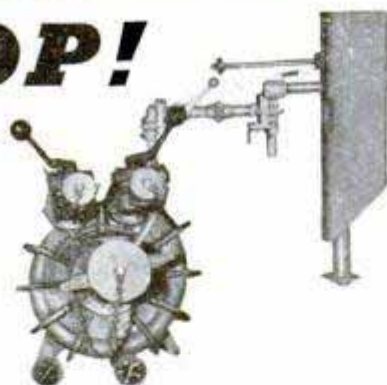

ALL-PURPOSE WATER PUMP

Mfd. by PACKARD MOTOR CAR CO.

Ready for use on any pumping need

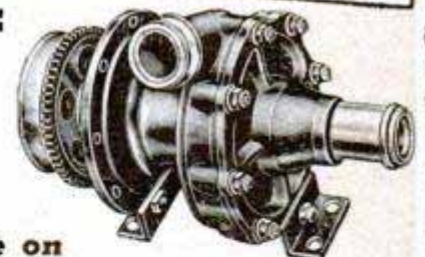

Brand New

Belt Driven — Centrifugal Pump

An extraordinary value for all types of intermittent or continuous pumping in the home . . . farm . . . factory. Built to exact specifications of Packard Motor Car Co. for use in Rolls-Royce Merlin Aircraft Engines. May be run with electric motor, gas engine or power take-off on tractor. Delivers up to 25 gallons a minute with ¼ H.P. motor; 80 gal. a min. with one H.P. motor. Will deliver up to 44 ft. head or 25 ft. suction. Use 1" outlet hose; 1" or 1½" inlet hose (recommended).

COMPLETE ENGINEERING REPORTS AND OPERATING INSTRUCTIONS FREE WITH PUMP

Has cast aluminum housing, accurately machined 5" bronze impeller; 3½" V belt pulley and mounting brackets. Shaft rotates on ball bearing; has grease gun fitting.

Original cost approx. \$88.00. Shipping weight 10 lbs. A REAL BUY.

\$21.50

F.O.B. Chicago

- Use it for:
- DRAINING BASEMENTS
- HOME WATER SYSTEMS
- FIRE PROTECTION
- PRESSURE BOOSTER
- IRRIGATION
- DRAINING PONDS, TANKS, etc.
- SPRINKLING SYSTEMS
- STOCK WATERING
- INDUSTRIAL PUMPING

Complete with pulley and mounting brackets, ready for use.

ORDER DIRECT FROM AD SATISFACTION GUARANTEED
Send payment or purchase order today

GROBAN SUPPLY CO.
1507 S. MICHIGAN AVE., Chicago 5, Dept. PM-2

GROBAN'S—WAR SURPLUS BARGAINS

SHOP BY MAIL and SAVE
Better buys • Satisfaction guaranteed

BRAND NEW

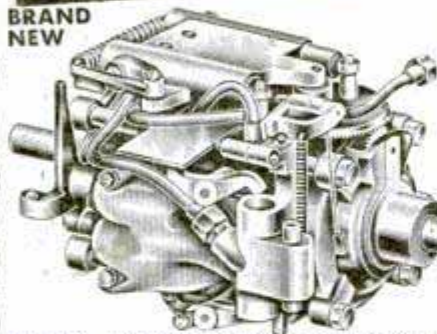

WESTINGHOUSE HYDRAULIC TRANSMISSION

Gov't. Acquisition cost.....\$300.00

Use it on chain saws, midget autos, lathes, drills, power machinery, chucking machines, farm machinery, potters' wheels, tractors, trucks, etc. Ideal as hydraulic torque converter.

Contains hydraulic pump and hydraulic motor; has reversing

controls. Designed for use on 2 ton 40 mm anti-aircraft guns; contains 10 ball bearings and high quality precision workmanship, made to exacting specifications of ordnance department. Overall dimensions: 12" long x 5 1/2" wide x 6 1/2" high. Ship. wt. 19 lbs. Complete engineering report included. **NOW ONLY**.....**\$18.95** F.O.B. Chicago



Vickers MF9 Hydraulic PUMP or MOTOR

Compact, powerful, rated 1,000 P.S.I., .507 cu. in. per revolution, 8 gal. per min. at 3750 r.p.m. Change rotation by reversing flow. Delivers up to 6 H.P. BRAND NEW. Requires 1/2 to 1 H.P. to drive directly or by pulley. Wt. 4 1/2 lbs., \$60.00 value for

\$14.95 Postpaid
Brand New CHECK and RELIEF VALVE. Adjustable for any pressure... **\$2.95** postpaid

FREE: New, 20-page illustrated Hydraulic Manual featuring diagrams, photographs and instructions—FREE with each hydraulic order.

Self-Priming ELECTRIC PUMP

APPLICATIONS: oil burners, aquariums, fluid metering, fuel pump, tool post grinder, coolant pump, pressure lubricating pump, general industrial, etc.

MOTOR MFD. BY BLACK & DECKER: double ball bearing series wound, continuous duty, 1/30 H.P. electric motor, rated 12,000 R.P.M. Transformer included for use on 110 VAC current. Also applicable for 24-32 VDC.

PUMP MFD. BY WELDON TOOL CO. with standard 1/4" tubing ports; rated 2 G.P.M.; remove pump and use motor as high speed grinder.

OVERALL DIMENSIONS: 7 3/4" long x 3 1/4" high x 3 1/4" wide. Approx. wt. 5 lbs. \$51.00 value.



Compact — BRAND NEW

\$12.95

postpaid

Self-Priming BRONZE PUMP

Positive Pumping Pressure

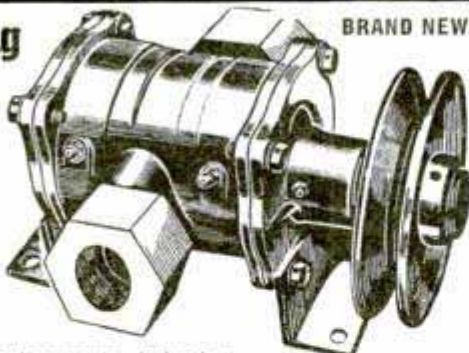

BRAND NEW

Perfect for draining basements, irrigation, fire fighting, sprinkling, pressure booster, insecticide and other spraying, fuel transfer, stock watering, industrial pumping, deep well jet pumping and home water systems. Rated 25 ft. suction and 150 ft. head pressure at 80 gallons. Use from 1/3 to 5 H.P. motor.

Complete engineering report and instructions FREE with pump

Supplied with mounting brackets and 5" V belt pulley, ready for instant use. Standard 1 1/2" pipe thread inlet and outlet. Dimensions: 6 1/2" x 7 1/4" x 4 1/4". Ship. wt. 18 lbs. A \$142.00 value.....**\$32.50** F.O.B. Chicago

WRITE FOR OUR FREE CATALOG!

BRAND NEW

Air or Oil HYDRAULICS

Use hydraulics on arbor presses, hydraulic presses, hay lifts, manure loaders, lift trucks—push or pull, lift or turn, press or squeeze, open or close, lift or lower—and other hydraulic and industrial applications. Use with either air or oil... of finest precision workmanship.



- Double action, 1 1/2" bore, 5" stroke, will lift 1760 lbs. in one second with Vickers MF9 Pump. Wt. 3 lbs. A \$35.00 value.....**\$8.95** postpaid
- Double action, 1 1/2" bore, 9" stroke, will lift 1760 lbs. in one second with Vickers MF9 Pump. Wt. 4 lbs. A \$45.00 value.....**\$10.95** postpaid
- Use these cylinders on farm trucks, bulldozers, hay lifts, manure loaders, etc. Double action, 1 1/2" bore, 27" stroke. Will lift 1760 lbs. in 2 seconds with Vickers Pump. Wt. 8 lbs. A \$55.00 hydraulic cylinder value for only...**\$12.95** postpaid
- Double action, 2 3/8" bore, 5" stroke. (Will lift 4400 lbs. in one second with Vickers Pump.) Will withstand 1500 P.S.I. against wall. Wt. 7 lbs. A \$65.00 value.....**\$14.50** postpaid
- Double action, 3" bore, 10 1/2" stroke. All steel hydraulic cylinder, will lift up to 12,000 lbs. (7000 lbs. in 3 seconds with Vickers Pump.) Complete with fittings. Wt. 12 lbs. A \$78.00 value.....**\$19.50** postpaid
- Double action, 3 1/2" bore, 11" stroke. (Will lift 9600 lbs. in 7 seconds using Vickers MF9 Pump.) Complete with fittings. Wt. 15 lbs. A \$92.00 value.....**\$22.50** postpaid

Hydraulic Control Valves Brand New



- Four-way control valve with built-in relief valve, for use with double action hydraulic cylinder, may be used with 1500 P.S.I. hydraulic system to open and close hydraulic cylinders. Brand new. Ship. wt. 4 lbs. A \$38.00 value.....**\$7.95** postpaid
- Four-way control valve for use with two hydraulic double action cylinders. Each cylinder may be operated independently of the other or in conjunction with the other. Oil may be locked in any of the cylinders to hold the piston at any required position. Brand New. Ship. wt. 6 lbs. A \$60.00 value...**\$10.95** postpaid
- A two cylinder double action valve with a unique arrangement, allowing the operator to raise both cylinders simultaneously, to lower them simultaneously or to raise one and lower the other at any predetermined rate and speed. Brand New. Ship. wt. 8 lbs. A \$75.00 value.....**\$14.95** postpaid

BRAND NEW

Vickers Heavy Duty HYDRAULIC PUMP



For tractors, bull-dozers, construction machinery, lift trucks, industrial applications, etc. Used on Ross carriers. Delivers 18 gal. per minute at 1000 P.S.I. at 1200 R.P.M. using 10 H.P. Has 1 1/2" intake; 1 1/2" outlet; threaded and keyed 3/4" shaft for direct or pulley drive. Wt. 40 lbs. Dimensions: 5 3/4" diameter, 7 1/2" high. Original value \$148.00. NOW.....**\$39.50** F.O.B. Chicago

Brand New Vickers Heavy Duty HYDRAULIC CONTROL VALVE

This Vickers heavy duty 4-way control valve, Part C-2330, is ideal for use with the Vickers Heavy Duty Pump for double action cylinders. Has built-in relief valve with 50 to 1000 lbs. per sq. in. overload adjustment; max. capacity 24 GPM; pressure inlet connection from pump 3/4" pipe thread; cylinder connections 3/4" pipe thread; discharge connection to tank 1 1/2" pipe thread; Over. dimen.: 2 3/4" W. x 10 1/2" L. x 7 3/4" H. Ship. wt. 54 lbs. **\$24.95** ORIGINAL COST MANY TIMES MORE.....NOW F.O.B. Chicago

ORDER DIRECT FROM AD
Send payment or purchase order today
SATISFACTION GUARANTEED

GROBAN SUPPLY CO.
1507 SOUTH MICHIGAN AVE.
Chicago 5, Ill. Dept. PM-2

WHAT A SCREEN!

and only ~~5~~ **4/35** *



DURALL

ALUMINUM TENSION SCREEN A FULL-LENGTH SCREEN FOR DOUBLE-HUNG WINDOWS

What a money-saver this Durall! You're ahead up to dollars per screen on the price alone . . . and you'll never pay for painting or costly repairs.

And what a trouble-saver! Just buy the size you need, install brackets and snap screen into place . . . from *inside*! It's flexible . . . no side frames to cut and fit, no ladder climbing. Simply release screen at bottom for window washing . . . roll it up for storage.

Beauty? Yes, indeed! Durall is neat, trim—it will not rust, stain, sag or bulge.

See Durall at your dealer's today or send coupon for attractive folder.

*for popular 28"x54" size

NEW YORK WIRE CLOTH CO., 445 Park Ave., New York 22, N. Y.

Please send me your DURALL folder PM- 2

Name _____

Street address _____

City _____ State _____

with one of the instruments. Ordinary old-fashioned panning, wet or dry, the same method used for detecting gold, is a useful field method of concentrating a mineral sample from the rock that contains it. Any dark, heavy concentrate that remains is likely to be valuable and might well be tested for a possible uranium content. Ultraviolet lamps whose rays cause numerous minerals to fluoresce in characteristic colors is a valuable aid in detecting some of the secondary uranium minerals.

Recent reports that there is not enough uranium available for a long-term atomic energy program have been branded as false by David E. Lilienthal, chairman of the AEC.

"The present search for uranium and the sources we have our hands upon provide an adequate supply and in the future will be sufficient," says Lilienthal.

Inquiries concerning worthwhile ores should be addressed to the Division of Raw Materials, U. S. Atomic Energy Commission, P.O. Box 30, Ansonia Station, New York 23, N. Y.

Oscillating Sander Has Double Motion

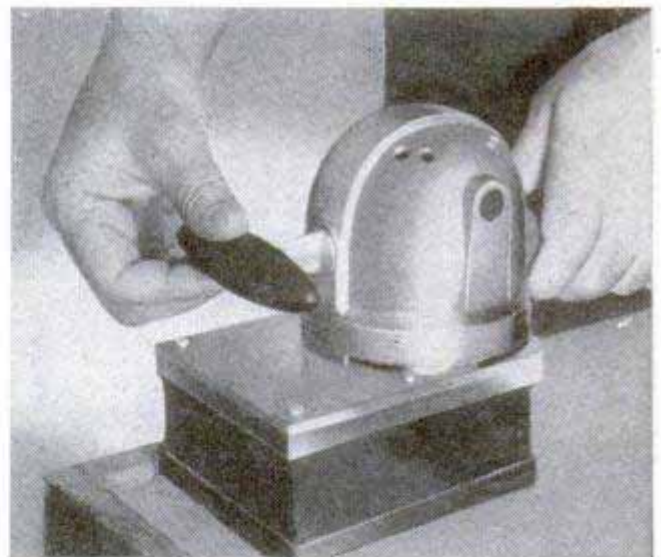

Compound motion of the pad on an oscillating sander speeds work in finishing and rubbing operations. The leading edge of the pad has a circular movement for fast cutting across the grain, while the trailing edge has a reciprocating motion that sands with the grain for a smooth finish. Abrasive sheets, cut to fit the synthetic-rubber sanding pad, come with adhesive on the back to simplify replacement. The rectangular shape of the pad permits the operator to sand right into the corners in recessed door panels or other work. The sander can also be used for sheet-metal work such as automobile-body repair.

THOUSANDS OF SUFFERERS USE
BREATHSEASY
 FOR
ASTHMA
 CARRY IT WITH YOU
 USE IT ANYWHERE
*Sold on Money-Back
 Guarantee*

Write To Dept. PM
 BREATHSEASY DISTRIBUTORS, INC.
 65 CEDAR STREET
 SEATTLE 1 WASHINGTON

DUAL TAIL PIPE EXTENSION
Fits all cars — chrome plated
DEEP TONE
 produced by 2½ inch outlets **\$2.95**
 Postage free on prepaid orders
 TRADE INQUIRIES INVITED
 LYONS PRODUCTS COMPANY
 PAT. PEND. 2426 So. LaBrea Ave., Dept. PM-2, Los Angeles 16, Calif.

NEWEST OTTAWA LOG SAW
SELF-PROPELLED — MOVES ANYWHERE on OWN POWER
 World's fastest Log Saw. Powerful 6 H-P air-cooled motor. Attachments for sawing down trees, buzzing limbs, post hole digging and pulley for belt jobs. Big demand for wood, pulp, posts. Make big money sawing wood this easy way. Low factory-to-user prices. Nothing like it. FREE details.
OTTAWA MFG. CO., 7-927 Pine St., Ottawa, Kansas

CURIOUS?
 ABOUT A
SHIP-IN-A-BOTTLE
 Here is the secret plus all of the material less bottle. See your dealer first. Catalog 10c.
 BRAUN-CRAFT, 1232 Etowah, Dept. PM-2A, Royal Oak, Mich.

Thompson BEATS the World on BOATS
Better Built Lower Prices
 Safe Boats With Full Length Spray Rails
 Keep passengers perfectly dry—even at high speeds. Catalog also shows two new models of "Take-Along" Boats. Two big factories—save you freight.
CATALOG FREE
 Write for your copy. State kind of boat in which you are interested.
THOMPSON BROS. BOAT MFG. CO. (161)
 213 Ann St. (Write to either place) PESHIGO, Wis.
 Light Boat for Auto
 113 Elm St. CORTLAND, N.Y.

Talk about Versatility..
THIS HANDY DRILL
is in a CLASS by ITSELF!



Home-Utility
 ¼" Drill
\$18.95



- Drilling for Cabinet Work
- Sanding Curves, Corners, Flats
- Grinding Off Burrs
- Sharpening Tools and Knives
- Polishing Hardware
- Removing Rust and Old Paint
- Drilling Out Broken Rivets

"I used to think a Drill was only for drilling—but my Home-Utility ¼" Drill has enough power and speed for sanding, light grinding, buffing and wire brushing, too! And for better, faster workshop drilling, it's a world-beater. Just when you think you've exhausted its uses, you'll find new ones for this handy Home-Utility Drill. To top it off, it's built by BLACK & DECKER, the people who've been making quality electric tools for 38 years. That means a powerful motor, husky housings, full-size gears and bearings. At only \$18.95, you won't find a bigger value!" Order Home-Utility Tools from your hardware, electrical or implement dealer.

ELECTRIC HOME-UTILITY TOOLS

Products of THE BLACK & DECKER MFG. CO.
 Dept. H2M, Towson 4, Maryland

SAY YOU SAW IT IN POPULAR MECHANICS
Save Time and Money with this Press
 Ten-ton press, ideal for all kinds of pressing, separating, straightening, and bending jobs. Ample capacity for home shops. Easily adjustable table takes work up to 18 inches wide and 11½ inches high. Roller-bearing ram for long life. Send for free bulletin showing press and wide variety of accessories.
 UT-10A Press f.o.b. factory \$31.00
DAKE ENGINE COMPANY
 624 Seventh Street, Grand Haven, Michigan



Made
\$900
IN SPARE TIME

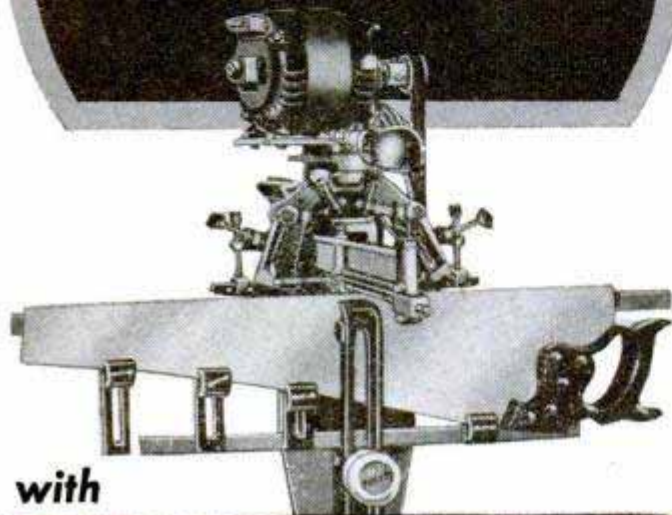

with

FOLEY* automatic **SAW FILER**

*Trade Mark Reg. U. S. Pat. Off.

"I did very well last year with my Foley equipment, about 950 saws and 240 lawn mowers, in my spare time. About \$900 for me." L.H.M., New York. A.G.W. in Mass. says: "I have filed over 5000 saws in 8 years and find the Foley Automatic Saw Filer very satisfactory."

Make up to \$2 or \$3 an hour in Spare Time. With the high prices of food, clothing and everything else, just think what you could do with extra money every week! With a Foley Automatic Saw Filer you can file hand, band and circular saws better than the most expert hand filer. "The first saw I sharpened with my Foley Filer came out 100%"—writes C.E.P. Every saw you sharpen with the machine accuracy of the Foley Saw Filer is an ad that brings you more customers. Cash business, no canvassing. No eyestrain, no experience needed.

FREE BOOK

INDEPENDENCE AFTER 40!

Shows just how you can start at home in spare time in your basement or garage. Just think—with a small investment, no overhead, no stock of goods to carry, you can get right into a cash business—and later on develop into a full-time repair shop. Send coupon today for this practical plan.



Send Coupon for FREE BOOK

FOLEY MFG. CO., 216-9 Foley Bldg., Minneapolis 18, Minn.
Send FREE BOOK—"Independence After 40."

Name _____

Address _____

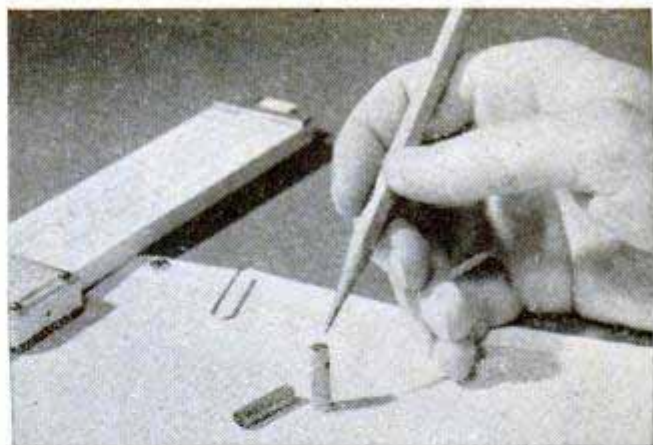

"Cat Whisker" Radio Tube

Nearly all the functions of a vacuum tube are performed by an extremely small and simple tube that requires no vacuum, glass envelope, grid, plate, cathode or warm-up period. The simple tube, developed by Bell Laboratories, is not much larger than a shoelace tip. It operates similarly to a "cat whisker" crystal set, except that the tube will amplify at least 100 times. The tube consists of two hair-thin wires touching a minute quantity of germanium, a rare metal by-product of zinc. Germanium is a semiconductor of electricity. When power is delivered to one contact it is amplified 100 times by the crystal and delivered to the output circuit. The tube may be used in telephone communication as well as radio, television and public-address systems.

Mist Wipes Out Odors By Chemical Reaction

Odors can be eliminated by changing them chemically to an odorless substance with a new deodorant called Metazene, rather than by the usual method of masking them with a more pleasant odor. Metazene mist combines with unsaturated sulphur and nitrogen compounds, which cause many disagreeable odors, and removes them from the air within five seconds. The exact chemical nature of the deodorant has not been announced and it is not yet commercially available.

Safety Car-Door Lock

Children can't fall out of a car equipped with door locks which slip into place whenever the motor is running. A vacuum tube from the engine pulls the strikers into locked position as soon as the starter is pushed. The doors remain locked until the driver presses a button on the instrument panel to break the vacuum, or until after the motor is stopped.

LAFAYETTE CONCORD

KIT-QUARTERS FOR 500,000
BEGINNERS AND HAMS AND PROFESSIONALS

It pays to do business with the top organization. You get what you want. You get it right away. You get it for less. That's why hundreds of thousands of radio men have been getting all their stuff from Lafayette-Concord for 29 years. It's the "super-market" . . . the biggest radio-electronics supply organization in the world! Shop by mail from our catalog, or in person at any of the outlets listed below. You save plenty either way!



**lowest price in years
for a 5-tube**

SUPERHET KIT!

Lafayette brings back the "good old days" with a spectacular kit value! Looks and plays like a million. Costs you pin money, and you have the fun of putting it together yourself! Smart 2-tone plastic case. Powerful 5-tube AC-DC superhet circuit. Complete with tubes and fool-proof instructions for easy assembling. Send for your kit while the supply holds out! Order now No. 32N24548P shpg. wt. 9 lbs. **\$11.95**

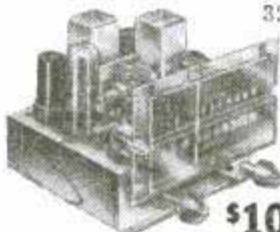

**for your
hi-fidelity combo!**

SUPER BROADCAST TUNER KIT

If you're looking for a really fine AM Tuner Kit to round out your high-fidelity combination, this is it! Also recommended by our engineers for use with PA systems. Unusually compact and efficient 4-tube superhet circuit. Complete with all necessary parts, including Cro-Flex dial assembly, cadmium plated punched chassis and instructions. Use the coupon to order this amazing Lafayette kit today. No. 32N24532P (less tubes) shpg. wt. 8 lbs. **\$10.95**

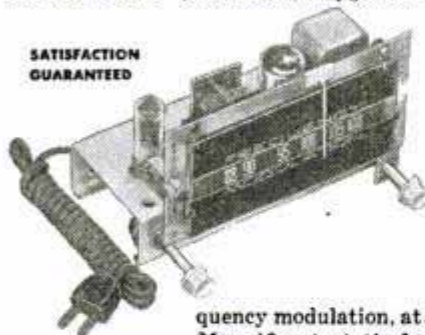

**unbelievable
value!
FM TUNER KIT**

Now — Lafayette makes it possible for you to enjoy FM frequency modulation, at a phenomenal low price! Magnificent static-free reception on the 88-108mc band. Hook it up to your present AM receiver. You can build it in a single evening with the easy-to-follow instructions! With tubes No. 32N24534P. Shpg. wt. 3 lbs. **\$14.39**

To speed delivery . . . please use numbers when ordering

LAFAYETTE-CONCORD

world's largest radio supply organization

100 SIXTH AVE., NEW YORK 13

901 W. JACKSON BLVD., CHICAGO 7 • 24 CENTRAL AVE., NEWARK 2
229 W. MADISON ST., CHICAGO 6 • 265 PEACHTREE ST., ATLANTA 3
110 FEDERAL ST., BOSTON 10 • 542 E. FORDHAM RD., BRONX 58

The First TV Kit You Can Assemble without Technical Knowledge LAFAYETTE'S famous RCA-type 10" TV KIT

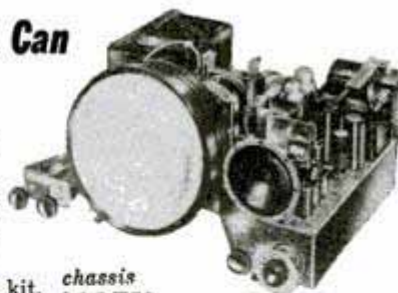

chassis
\$195⁵⁰



ALL CHASSIS
COMPONENTS
ALREADY
FACTORY ASSEMBLED
•
IDEAL FOR
CUSTOM JOBS

cabinet
(optional)
\$42⁵⁰

One day after you receive this kit, you can be enjoying the world's finest television reception — and for much less than you'd otherwise pay! All chassis components are already factory-assembled for you. All you do is wire and adjust! It's the RCA 630TS type chassis—generally rated as the best-engineered set on the market. Big RCA 10" picture tube, 30 tubes, everyone in its socket. Instruction manual supplied with six, 47" x 22" step-by-step wiring diagrams. The circuits are all in color. Each step is clearly outlined. It's a cinch for anybody who can follow a schematic and handle a soldering iron. Save by using a little ingenuity! Chassis No. 32N24544P, Cabinet No. 32N24543P.

THIS SOLDER IRON LISTS FOR \$6.75!

\$2⁶⁹

100 watts heavy duty



Here's your chance to pick up a fine 100-watt Belden iron, at nearly two-thirds off! Mfd. by Drake, and Underwriters Listed. Ideal for radios, switchboards and other "close quarter" work. Recommended for wiring any kit on this page! Complete with 6-ft. cord, stand. 3/8" tip. Terrific Lafayette bargain! 99N8000P—wt. 2 lbs. **\$2.69**

*It's easy to
build your own*

HIGH-FIDELITY AUDIO AMPLIFIER

This 4-tube amplifier kit brings you real hi-fi record enjoyment on a "shoestring"! Also good for FM and AM. Includes built-in equalization network and pre-amp. You can hook it up with the outstanding new G.E. reluctance pick-up, without having to spend money for a separate pre-amp! This combination will give you the finest type of musical reproduction. Push-pull type. Audio output of over 4 watts. Frequency response over 12,000 cps. Complete instructions. Nothing left to chance! Less tubes. 32N24535P, wt. 5 lbs. **\$13.95**

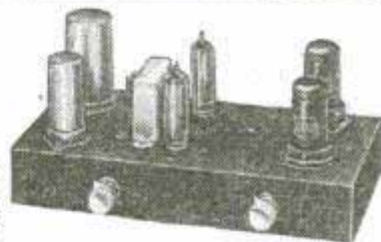

Tube kit **\$4.10**

THIS BIG CATALOG YOURS, FREE!

This world-famous catalog saves you anywhere from a few pennies to a couple of bucks on almost every order! (Figure it out: that means \$5 to \$100 extra in your bankbook at the end of the year!) It's practically a radio-electronics encyclopedia: 180 big pages crammed with every part and tool you need to build television, high-fidelity radio, ham gear, public address, testing equipment. Tens of thousands of sensational buys, made possible by the purchasing power of the biggest radio supply organization in the world.



RUSH THIS COUPON AT ONCE

Send your mail order to:
LAFAYETTE-CONCORD, Dep't LB-9
100 Sixth Avenue, New York 13
901 W. Jackson Blvd., Chicago 7
265 Peachtree Street, Atlanta 3
 Please send me Free Catalog No. 89.
 Please fill attached order. I enclose \$_____ in postal note, money order or check. Will remit few cents postage when order is received.

MAIL NOW

NAME _____
ADDRESS _____
CITY _____ ZONE _____ STATE _____

SHOPSMITH

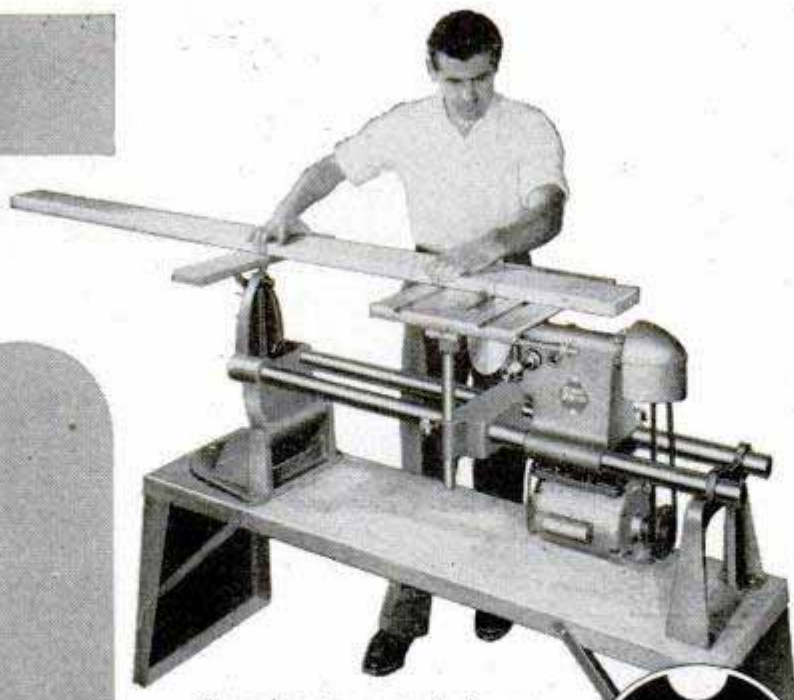

Shown here in use as circular saw, **SHOPSMITH** quickly converts to vertical drill press, lathe, sander and horizontal drill press



BIG-CAPACITY

POWER TOOLS IN 1

Takes only 60" x 18" floor space —
only one motor (½ H. P.) powers all operations

Quick-converting **SHOPSMITH** changes from any one to any other of the five basic power tools shown here in less than a minute. It has greater work capacity in each position than comparable single-purpose tools. (**SHOPSMITH** converts also to buffer, grinder, router, drum sander, shaper, mortiser, etc.) **SHOPSMITH** is precision-engi-

neered for accurate work on big or small jobs. Ruggedly built—weighs 200 pounds. You can set up a **SHOPSMITH** in any corner of your basement or garage. See demonstration at any Montgomery Ward store, or your leading hardware or department store. Or mail coupon below for name and address of nearest dealer.

FIVE TOOL UNIT COMPLETE ONLY **\$159⁵⁰**
with ½ h.p. ball bearing motor \$195.50

MAGNA ENGINEERING CORPORATION

465 California Street—Dept. 82, San Francisco 4, California
Please send descriptive folder on **SHOPSMITH** and name of nearest dealer

Name _____
Address _____
City _____ Zone _____ State _____

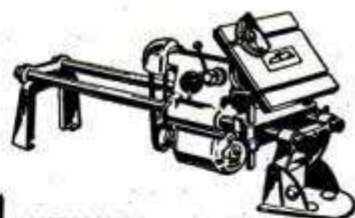

1 **SHOPSMITH** as an 8" Circular Saw. Depth of cut 2¼". Table 14½" x 17"—with extension 54" x 17". Up to 46" between blade and fence. Tilting table

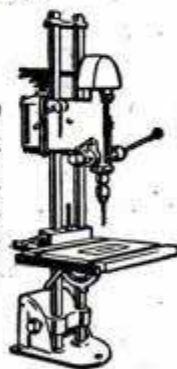

2 **SHOPSMITH** as a Vertical Drill Press. Drills to center of 15-inch circle. 27-inch maximum distance from table to chuck, ¼-inch feed

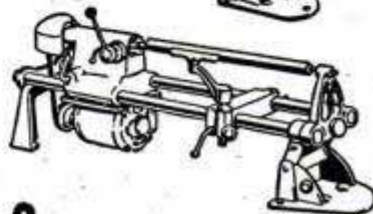

3 **SHOPSMITH** as a 34" Wood Lathe. (34" between centers) with a 15-inch swing. Quill feed ¼ inches. Tool rest always slides parallel to work piece

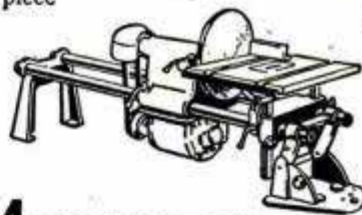

4 **SHOPSMITH** as a 12" Disc Sander. Adjustable mitre gauge. 14½" x 17" table tilts to 45 degrees. Discs can be removed and replaced in seconds

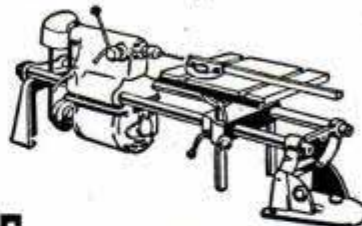

5 **SHOPSMITH** as a Horizontal Drill Press. Brand-new in the power tool field! Provides accurate drilling for doweling. No limit on length of work

-THAT'S

SHOPSMITH

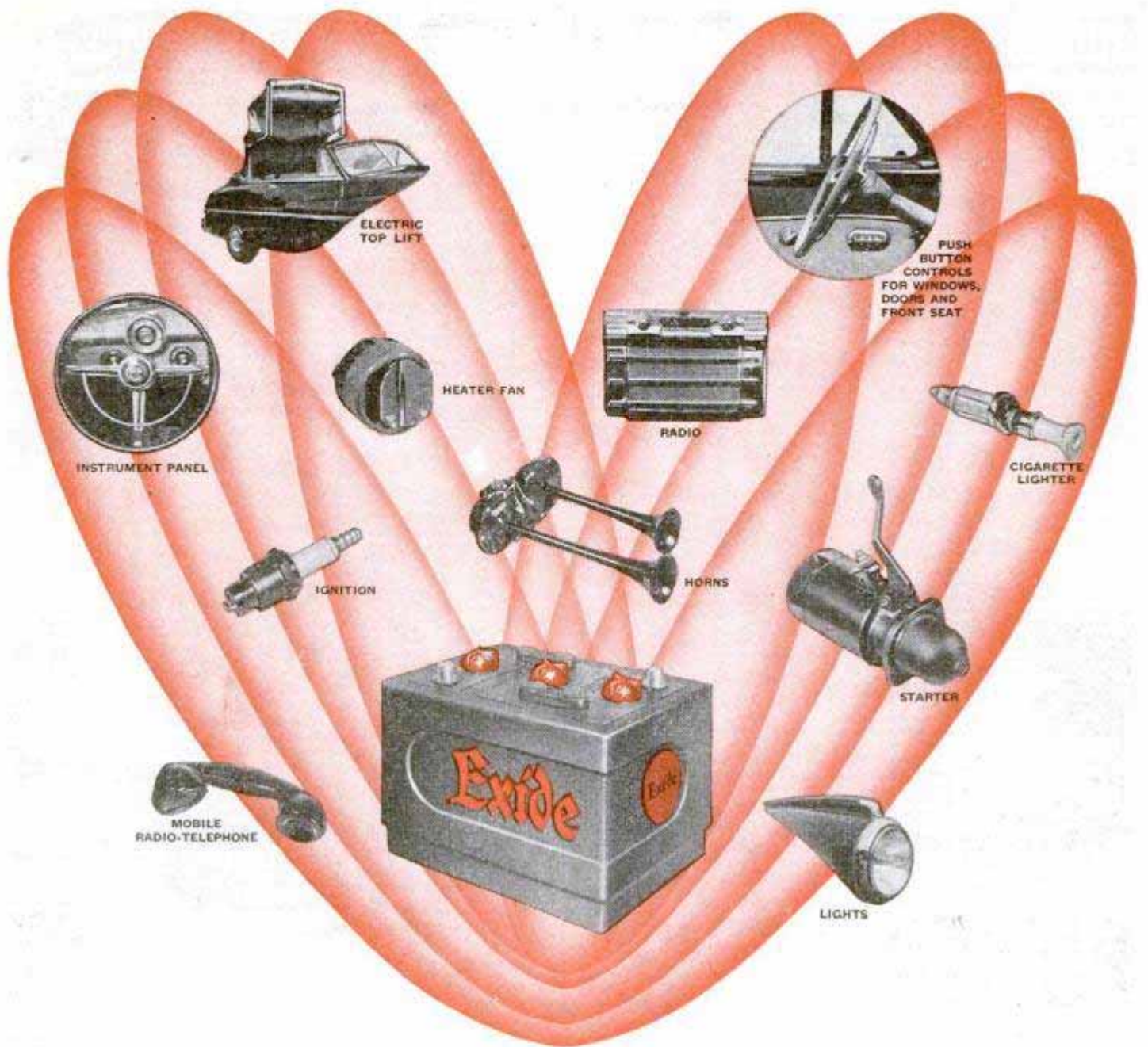

Electrical Heart

The electrical heart of your automobile is the battery. It is busier than ever in the newer cars for many of their added features are electrical. Thus there is a call for extra battery power, greater dependability and longer life.

When you buy an Exide Hycap Battery, you get extra high capacity. You average 48% greater starting power and 81% longer

battery life than are required by the standards set by the Society of Automotive Engineers. Buy starting assurance. Remember, a single starting failure can be far more costly than the little extra you pay for a trustworthy Exide Hycap Battery. THE ELECTRIC STORAGE BATTERY COMPANY, Philadelphia 32. Exide Batteries of Canada, Limited, Toronto.

1888 . . . Dependable Batteries for 61 Years . . . 1949

WHEN IT'S AN **Exide** ... YOU START

BUILD YOUR OWN TILTING ARBOR SAW!

Exclusive GIL-BILT Build-It-Yourself Features

- No machining—build easily with hand tools only
- No blueprint reading—step-by-step pictorial plans, full scale patterns, actual photographs
- Sturdy wood, aluminum, and steel construction
- Capacity and performance of commercial saws selling for \$60 and up

SAVE
\$50
OR MORE

GIL-BILT 10-INCH TILTING ARBOR SAW



- 27x28 in. table, 13 1/2 in. capacity in front of blade
 - 10 in. blade cuts 3 1/4 in. deep, tilts full 45 degrees
 - Floor model, 34" high table always stays level
 - New Departure ball bearing arbor, 3/4" precision shaft turned down for 5/8" bore blades, alum. housing, shipped ready to run
 - Jackscrew and 4 1/2 in. dia. handwheel lowers and raises blade
 - Cast aluminum miter gauge and self-aligning rip fence guide
- Gil-Bilt Metal Parts Kit includes Plans, Ball Bearing Arbor, Miter Gauge and Bar, Rip Fence Guide, Machined Lock Knobs, Jackscrew Mechanism and Handwheel, and All Other Metal Parts (less blade).....\$20.95
Same Kit with 10" comb. blade..... 25.90
Same Kit with 8" comb. blade..... 24.90

GIL-BILT 8-INCH TILTING TABLE SAW

- 21x27 in. table tilts full 45 degrees, 13 in. capacity in front of blade
- 8 in. blade cuts from 0 to 2 1/2 inches
- New Departure ball bearing arbor, 5/8" precision shaft turned down for 1/2" bore blades, alum. housing, ready to run
- Cast aluminum miter gauge and self-align. rip fence guide (same as above)



GIL-BILT Metal Parts Kit includes Plans, Ball Bearing Arbor, Miter Gauge and Bar, Rip Fence Guide, Machined Lock Knobs, Tilt Support Segments, and All Other Metal Parts (less blade).....\$15.95
Same Kit with 8" Combination Blade..... 19.90

GIL-BILT 12-INCH BAND SAW



- Cuts to center of 24 in. circle
- Handles stock up to 6 in. thick
- Fully enclosed mechanism for utmost safety
- Wheels turn on heavy 5/8 in. shafts, four Oilite bronze bearings

- 18x18 in. table tilts 45 degrees
- Upper wheel tension and tilt mechanism of cast aluminum; completely assembled
- Two blade guides, each has ball thrust bearing, self-lub bronze jaws
- Rubber tired wheels. Choice of cast alum. or make-your-own wood wheels on metal hubs
- Uses standard 78 in. blades up to 3/8 in. wide

GIL-BILT Metal Parts Kit includes Plans, rubber tires, 3/16" blade, hubs for wood wheels, bearings, shafts, tilt mechanism, guides, tilt support segments, and all other metal parts.....\$16.95

Same kit with two ready-to-install 12" cast aluminum wheels 20.95

NO DEALERS—ONE LOW PRICE! Prices include postage up to 600 miles. Send cash, check or money order for complete kit, or send \$1.00 for Step-by-Step Plans and Order kit later less cost of Plans. Plans sent postpaid anywhere in the world.

GILLIOM POWER TOOLS

P. O. Box 1-PB, Lambert Field, St. Louis 21, Missouri

COMPLETE
PLANS
only
\$1.00
EACH

Do it
Faster
and
Easier
with
the

WRITE FOR FREE CATALOG — shows attachments that save time and money!



PAGE Garden Tractor

New 1949 line with extra features! Riding and walking models, 1 1/2 to 5 HP. Complete gear drive, no cheap belts or chains. Large tires—high clearance—easy to handle—power turn. Low factory prices—\$188 to \$436 with cultivator. Get benefits of 24 years of garden tractor experience!

PAGE DAIRY and FARM EQUIPMENT
1904A S. 81st STREET • MILWAUKEE 14, WIS.

CONFIDENTIAL LOAN SERVICE

Borrow **\$50 to \$300**

Need money? No matter where you live you can borrow **BY MAIL** \$50.00 to \$300.00 this easy quick confidential way.

BY MAIL

IT IS EASY TO
BORROW
BY MAIL!

Completely confidential and private
CONVENIENT MONTHLY PAYMENTS

NO ENDORSERS NEEDED
EMPLOYED MEN and women of good character can solve their money problems quickly and in privacy with loans **MADE BY MAIL**. No endorsers or co-signers. Your employer, relatives and friends will not know you are applying for a loan. Convenient monthly payments. Send us your name and address and we will mail application blank and complete details **FREE** in plain envelope. There is no obligation. Act now!

STATE FINANCE COMPANY
216 Savings & Loan Bldg., Dept. P107K, Des Moines 8, Iowa

WHEELS + WHEELS

- 5-in. disc wheel, 3/8-in. tire, 5/16-3/8 sleeve.....\$.30
- 6-in. disc wheel, 3/8-in. tire, 5/16-3/8 sleeve.....\$.35
- 7-in. disc wheel, molded tire, 3/8-in. sleeve.....\$.45
- 8-in. disc wheel, 1 1/8 tire, 1/2-in. sleeve.....\$.70
- 7-in. disc wheel, 1-in. tire, 1/2-in. B.B.....\$.80
- 8-in. disc wheel, 1 1/8 tire, 1/2-in. B.B.....\$1.00
- 10-in. disc wheel, semi-pneumatic 1 1/4 tire, 1/2-in. B.B....\$1.50

Above wheels painted red.

10-in. alum. wheel, semi-pneumatic 2 3/4 tire, 5/8-in. B.B....\$4.50
Hub caps for 5", 6", 7" wheels \$.03 extra. Plus Postage

UNITED WHEEL STAMPING CO., 2756 W. 115th St., Chicago, Ill.



ELECTRIC WELDER

AC or DC 110 Volts
Pre-war type—All metal—No chemical—5 year written guarantee. Welds 1/8" thick metal or money back. Repairs tanks, tools, fenders, machine parts, etc.
Comes complete with rods, unit directions and eye shield.

On C.O.D. mailing charges extra.
ESSAY MFG. CO., INC., Dept. P.M., Quincy 69, Mass.

\$6.45
COMPLETE

BRILLIANT SILVERPLATING!

DO IT AT HOME
NO ELECTRIC CURRENT!

Only **\$3.75**
— PINT —
\$2.00 1/2 Pint
POSTPAID

Now you can silverplate by just rubbing on Silver-47 with a cloth! Plates brass, copper, bronze, with durable genuine silver. Use on homeware, electrical, mechanical parts. Renews luster tarnished silverware. No acids or mercury. Send check or money order now. Money back guarantee. A few plating jobs for others pays for your bottle.

UNITED TECHNICAL LABS, Box 425-S MORRISTOWN, N. J.

STATION WAGONS CABS

AND BODIES FOR ALL JEEPS — WOOD OR ALUMINUM



Cabs in kiln dried hardwoods, bodies of aluminum. Safety glass, finest hardware, locks, full opening rear door.

CABS \$144.50 Plus Tax

FOB Cleveland, Complete, semi-assembled. Full bodies slightly higher. Send 25% with order, balance COD.

STATION WAGONS, INC. (PM) 6619 Euclid Avenue, Cleveland, O.

Free
LEATHERCRAFT
Instructions

All materials for making easy-to-assemble leather goods. Free instructions included. No experience necessary.

MAKE AS GIFTS—OR TO SELL



Belts, gloves, purses, wool-skin toys and mittens, 100 other practical, money-making items. Largest complete stock of leather and leathercraft supplies in America. Immediate delivery.

Send 10 cents for new catalog of gift suggestions and profitable ideas. Write today.

J. C. LARSON COMPANY
824 S. Tripp Avenue, CHICAGO 24, ILL.



The **BEST** costs you **LESS** at these
FACTORY-TO-YOU SAVINGS

Get De Luxe SEAT COVERS



Way Below Retail!

ACTUALLY THE VERY SAME MATERIAL USED IN COVERS SELLING UP TO \$25!

Our direct-factory prices offer you tremendous savings. Richer! Stronger! More Luxurious! GAYLARK'S New Auto Seat Covers are TOPS in quality, smart styling and value. Stunning plaid designs in softly harmonious multi-color weaves.

Every GAYLARK FIBRE Auto Seat Cover is carefully finished with elasticized slip-over sides for snug, smooth fit. Just the handsome, thoroughbred accent of elegance your car deserves.

MONEY-BACK GUARANTEE

We insist—you must be entirely 100% satisfied, or your money will be cheerfully refunded at once.

JUST NAME THE CAR—WE HAVE THE COVERS

To Fit Every Popular Make Auto—New or Old Models

- | | | |
|----------|------------|------------|
| FORD | PACKARD | STUDEBAKER |
| PLYMOUTH | FRAZER | OLDSMOBILE |
| DODGE | CADILLAC | BUICK |
| CHRYSLER | LA SALLE | HUDSON |
| PONTIAC | CHEVROLET | KAISER |
| MERCURY | DeSOTO | LINCOLN |
| WILLYS | NASH | LAFAYETTE |
| | TERRAPLANE | |

EASY TO INSTALL—on all types and makes of cars!

Be sure to specify which type covers you wish when you order. Note styles illustrated below:



1. Solid back for 4-door sedan—front or rear. Rear for coach or coupe
2. Divided back, solid seat for front coupe or coach
3. Individual seats or bucket type for divided back and seat

\$398 for 3-passenger solid back coupe, or rear seat of coach or sedan
FRONT SEAT COVER \$4.98
\$895 complete set of covers for sedan or coach



BUY DIRECT AND SAVE BY MAIL

Our Factory-to-You Prices Mean Guaranteed Savings

SEND NO MONEY

GAYLARK PRODUCTS, Dept. G1
615 N. Aberdeen, Chicago 22, Ill.

Gentlemen. Rush Gaylark Seat Covers on 5-day money-back guarantee

- | | |
|---|---|
| <input type="checkbox"/> Complete front and back covers \$8.95 | <input type="checkbox"/> Front seat cover only \$4.98 |
| <input type="checkbox"/> 3-pass. divided back coupe \$4.98 | My car is a 19.... Make..... |
| <input type="checkbox"/> 3-pass. solid back coupe or rear seat of coach or sedan \$3.98 | |
| <input type="checkbox"/> Type 1 | <input type="checkbox"/> Type 2 |
| <input type="checkbox"/> Type 3 | <input type="checkbox"/> 2-door |
| <input type="checkbox"/> Rush postpaid—\$.....enclosed. | <input type="checkbox"/> Send C.O.D. plus postage. |

Name.....
(please print)

Address.....

City..... Zone..... State.....

- | |
|--|
| <input type="checkbox"/> Please include one pair Fibre Door Protectors to match, at \$1.00 per set |
| <input type="checkbox"/> Wedge cushion to match, \$1.00 |

GAYLARK PRODUCTS 615 N. Aberdeen, Chicago 22, Ill.

IF You CAN HUM or WHISTLE a TUNE... You Can PLAY Any of these NOVELTY INSTRUMENTS



**The Musical Saw — The Glass-O-Phone
The Jazz-O-Nette — The Musical Pitchfork**

Why envy others who play? If you can sing, hum, or whistle a tune you can play any of our novelty instruments. They are PLAYED BY EAR. No notes to study. No scales to learn. You don't have to know anything about music. Just follow our simple instructions and soon you'll be playing popular tunes. You, too, can start a novelty band for your Church, Club, School, Lodge, etc.

YOU PLAY or NO PAY Write for **FREE LITERATURE and 5-DAY TRIAL OFFER**

Our instruments are low-priced, yet give unlimited pleasure. They are NOT toys, nor noisemakers—they make sweet music that never fails to charm. There is a tremendous demand today for novelty bands, especially in Radio and Television. To prove YOU CAN PLAY our instruments after a few hours' practice we will send the one you select on 5 days trial plan. Write for FREE details.

MUSSEHL and WESTPHAL
500 Fort St.
Fort Atkinson, Wisconsin

Can You Equal This Home for 2475

Shipped Direct from Our Mill



Save 30% to 40% on Your New Home. **Act Now!**

Don't pay several hundred dollars more than necessary when you build a home! Buy it direct from our mill at our low factory price. We ship you the materials—lumber cut-to-fit, ready to erect. Paint, glass, hardware, nails, etc., all included in the price—no extra charges. Plans furnished—also complete building instructions. No wonder our customers write us that we saved them 30% to 40%. Prices subject to change without notice.

BIG BOOK of House Plans in Colors 25¢

Handsome Big CATALOGUE
Pictures wonderful homes in colors at money-saving prices. Designs to suit everyone. Send 25c for catalogue today.
LEWIS MANUFACTURING CO.
1292 Lafayette Ave., Bay City, Michigan

LIFETIME WRITTEN GUARANTEE CERTIFICATE



ARMY TYPE BINOCULARS
6x25 \$26.75
7x50 \$44.00
8x30 \$34.75
7x50 Coated \$54.00

Made to rigid military specifications. Four to choose from. For top quality performance consider these all purpose 6x25, 8x30 and 7x50 binoculars. All have superb optics, lightweight metal bodies. Individual focussing. Moisture and dust proofed. These brand new glasses come complete with genuine leather, plush lined case and straps. Coated price means entire optic system is precision coated. Superb binoculars for we send purchasers a **LIFETIME WRITTEN GUARANTEE CERTIFICATE!** Add 20% for Federal tax. Cash orders rushed postpaid or send \$2.00 deposit and we will ship C.O.D. for balance plus postal charges. United Products Co., 7941 S. Halsted, Dept. ARF-1008, Chicago 20.

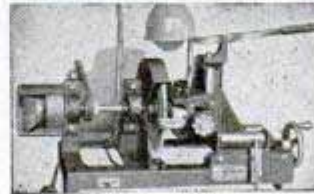

Pat. applied for

Start a NEW BUSINESS Or Add to Your Present Repair Business
Sharpen Dull Pipe Wrenches
Pipe Taps & Dies
"Gum" Circular Saws

Write for information.

J. C. MOORE INDUSTRIES P. O. Drawer 276 FREDONIA, PA.



TARPAULINS

These brand new Army surplus tarpaulins are ideal for trucks, trailers, etc. They are olive drab, 7' x 10', and water-repellent. Order yours now while they last. **\$6.95** Complete with ropes, grommets, etc. Send for free surplus catalogue. Post-paid
ACE TRADING CO., Dept. M
61st and Chestnut Sts. Philadelphia, Pa.

Tune in the **AUTO-LITE Show**

"Suspense!" THURSDAY NIGHTS—CBS



ENSHRINE THEIR MEMORIES WITH

U.S. MONUMENTS

Erected. Freight paid.

There is none better. Our free catalog is ready for you. Write today. A-18, U. S. Marble & Granite Co., Oneco, Fla.

NEVERSLIP PULLEY

Transmits more power with less belt wear, unaffected by weather. No pulley covering, no belt dressing required. Replace troublesome pulleys with NEVERSLIPS. All sizes. Money-back guarantee. Ask for NEVERSLIP Pulleys on ALL power machinery you buy. Write for folder and prices.
ROSENTHAL CORN HUSKER CO.
Box 16 Milwaukee, Wisconsin.



Expanding Mandrels

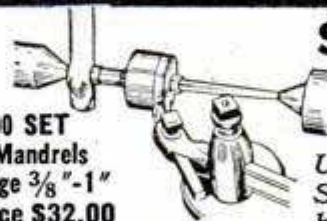

Simple—Inexpensive

M90 SET
3 Mandrels range 3/8"-1"
Price \$32.00

Accurate to .001"
Unique Expanding Sleeve on taper arbor, holds work solidly for

TURNING—GRINDING—MILLING
Sizes 3/8" to 5 1/2" capacity. Available singly or sets in steel box. See your "KNOCK-OUT" Dealer or ORDER DIRECT from

1150 1st Ave. S. E. **K. O. LEE CO.** Aberdeen, S. D.

MAKE YOUR OWN!

WITH

Griffin READYCUT LEATHER PROJECTS

Over 100 KITS in every kind of Tooling and Carving Leather, accurately cut, all parts included. Only Top Grade Leathers used. You do the choosing. You do the tooling, carving, stamping, the punching and assembling.



SEND FOR COMPLETE CATALOG Please send 10c to cover mailing.

SINCE 1924

OUT OF THE WEST, THE HOME OF LEATHER CARVING

Griffin Craft Supplies

5515-A GROVE STREET OAKLAND 9, CALIFORNIA

EVERYTHING FOR THE LEATHER WORKER

Largest, most complete stock of Leathercraft Tools and Accessories in U. S. A.



HIDES AND SKINS of Craft Leathers of every kind if you prefer to cut your own.

Print Your Own

Cards, stationery, circulars, tags, labels, photo and movie titles, advertising, etc. Save money. **Print for Others, Good Profit; easy rules sent.** Raised Printing like Engraving, too. Send dime for press samples, supply book, all details and advice on your needs. No obligation. **KELSEY INC., B-37, Meriden, Conn.**



RELIABLE LOW COST FOOT-SWITCH

Famous Smith-Switch frees both hands for work at machine. Gives instant control of drill press, power saw, etc. Supplied with cord and plug. No soldering, wiring. Heavy duty tungsten points, bronze spring. Only \$3.00 postpaid, or send \$1.00 for C.O.D. plus fee. (Foreign \$4.00). Money back guarantee.

NATHAN R. SMITH MFG. CO.
SOUTH PASADENA, CALIF.

105 B PASADENA AVE.

New 1949 PLASTICS SUPPLIES CATALOG

Just off press. Full details on Plexiglas, Lucite, rods, sheets, tubes, Acetates, cements, dyes, buffs, molding sets, tools, carving kits, accessories. Everything in plastics. Gives prices, sizes, colors, etc. Price 10c, stamps or coin, with ad for catalog.

PLASTICS MFG. & SUPPLY CORP.

DEPT. PM-2 • 4707 EUCLID • CLEVELAND 3, OHIO

BUILD YOUR OWN ZEOLITE WATER SOFTENER

You can do it inexpensively with only a wrench and a little spare time. Famous Zeolite process as used by leading manufacturers. Send \$1 for easy-to-follow directions and list of materials. (Materials available locally or from us.) Or inquire about factory-built LARCO Softeners \$45.75 up. **LAKE REGION MFG. CO., INC., 3920-A Lynn Ave., Minneapolis 16, Minn.**

With this **HOBART** "Build your own" Combination A.C. Welder and Power Generator **Saves you \$300 to \$500**

over cost of factory built machine. This one, that you can build yourself, ARC WELDS and POWERS TOOLS and ELECTRIC LIGHTS ANY-PLACE. Valuable to garages, farmers, contractors and others who want to double their earnings by doing repair and construction work in places where electric power is not available.



Furnished with pulley or shaft for coupling to your own engine

Hobart Brothers Company Box M-291, Troy, Ohio
One of the World's Largest Builders of Arc Welders.

arc weld
your way to
\$ucce\$\$!

...Hobart
makes it easy for you



Hobart Build Your Own (Generator Only)

to earn big money and you can pay for your arc welder as you go. Many large, prosperous welderies of today had their start with a Hobart low cost "Build Your Own" portable arc welder and paid for it out of their profits.

Save \$300 to \$500 by "Building Your Own"

gasoline engine drive portable arc welder. It's easy with the Hobart generator, a reconditioned auto engine and chassis. Send coupon today for FREE book "How to Build Your Own Portable Arc Welder," no obligation.

You're in Business for Yourself,

you're your own boss and a welding job shop is one of the most profitable businesses today. Make repairs to household, farm, automotive and other equipment. You'll get plenty of construction work too, from contractors, plumbers, sheet metal workers and manufacturers. The Hobart School of Arc Welding will train you for a profitable welding business if you're new at arc welding. Enroll now if you're dissatisfied with your present job and want to earn more money. Modern buildings, individual instruction. Qualified under G. I. Bill. Check coupon for FREE booklet "Learn Arc Welding."

Hobart Bros. Co., Box M-29, Troy, Ohio

One of the world's largest builders of

Arc Welders"



Gas drive welder

Industrial type AC

Free arc welder catalog — send coupon today

Hobart

HOBART BROS. CO., BOX M-29, TROY, OHIO
I'm interested in the profit-making possibilities of Hobart Arc Welders and how to get started by "Building Your Own Arc Welder." Send me Free books, and details on items checked.

- | | |
|---|--|
| <input type="checkbox"/> "Build Your Own Book" | <input type="checkbox"/> A.C. Welder |
| <input type="checkbox"/> "Learn Arc Welding Book" | <input type="checkbox"/> Electric Drive Welder |
| | <input type="checkbox"/> Arc Welder Catalog |

NAME

ADDRESS

SAY YOU SAW IT IN POPULAR MECHANICS

SAVE \$\$\$



COMPACT PORTABLE ARMY FIELD TELEPHONES

Buy 2 phones and SAVE \$1.50

**This SPECIAL offer good only thru
March 31, 1949. ACT NOW!**

Amazingly simple to install and operate. Just hook up terminals of two or more phones to any two-strand wire and you are ready to talk up to 17 MILES! Powered by standard flashlight batteries. **HUNDREDS OF USES** for quick, low-cost, dependable 2-way communication around **HOME, SHOP, FARM, INDUSTRY**. Each phone complete with self-contained hand-operated ringer. Every phone checked for perfect operation and fully guaranteed.

	Buy 1 Phone Regular Price	Buy 2 Phones Save \$1.50
NOW USED —excellent condition	\$ 8.95	SPECIAL 2 FOR \$16.40
RECONDITIONED —(By U. S. Signal Corps).....	10.75	SPECIAL 2 FOR 20.00
LIKE NEW , Slightly used	12.95	SPECIAL 2 FOR 24.40
NEW, HEAD AND CHEST SETS , ea.....		4.95

ARMY FIELD TELEPHONE WIRE

Weatherproof, Durable. 2-conductor, twisted, 3 copper and 4 steel strands, tinned, insulated. On Original Steel Reels.



W-110B. Unused, new, but stored in open. Half-mile reels (2500 to 2750 feet). Wt. 85 lbs. Each.....\$14.25
500-foot coil (14 lbs.).....\$3.50
1000-foot coil (28 lbs.).....\$6.50

W-130 LIGHTWEIGHT ASSAULT WIRE. Weighs only 16 lbs. New, half-mile reels (2600 feet) each.....\$15.00

**WRITE for FREE FOLDER and prices on Other
Specials. Switchboards, Head and Chest Sets, etc.**

All prices F.O.B. Sacramento. No C.O.D. California residents add 2 1/2% for sales tax. Small orders sent postage collect plus small handling charge.

SEND CHECK OR
MONEY ORDER

LORIS SALES

P. O. Box 1896-B-2

Sacramento, California

READY CUT HOMES

Order Now

Homes \$1835.00 and up, freight paid. Orders filled in order received. Save up to \$1000 on modern production method homes. Much more compared with builders' prices. Anyone can assemble with simple plans furnished. Complete, including paint, hardware, roofing, glass, nails, etc. for full color catalog showing 57 modern low-priced homes and floor plans. Complete low cost building plans ready for filing. Sold separately if desired.



**NEW COLOR CATALOG
FOR ONLY**

Dept. PM-29
**INTERNATIONAL MILL
& TIMBER CO.**
Bay City,
Mich.

35c



SAY YOU SAW IT IN POPULAR MECHANICS

LOOK! 3 Terrific Buys!

**Amazing 4-in-1
Saw Nest-only \$1.98**

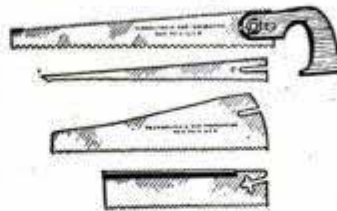

Consists of varnished beech handle and 4 blades. (a) 16" utility with teeth on both edges, (b) 14" compass, (c) 14" panel, (d) 10" back or mitre blades. Only \$1.98.

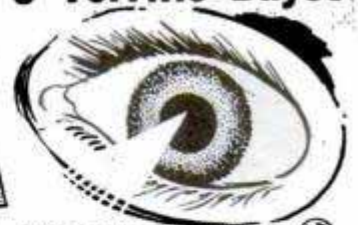

MILLERS FALLS AUTOMATIC DRILL
—Set holds 8 drill points in handle, sizes 1/16"-11/64". Turn handle, size wanted comes out! 9-1/8" long, nickel plated. Complete only \$3.39



MILLERS-FALLS CARVING TOOL
6 tools for all effects on wood, linoleum. Length 6-1/4". Only \$4.39



Send no Money. Merchandise shipped on approval. Send name, address. Pay on delivery, plus charges. Or enclose check, M.O. or postal note and we pay all charges. Money Back if you can beat these values!

INDUSTRIAL TOOL CO., 19 Warren St., New York 7, N.Y.

FOR BIG MEN ONLY!



**SHOES
IN SIZES 10 to 16**

We specialize in large sizes only—sizes 10 to 16; widths AAA to EEE. Wing Tips, Loafers, Mocassins, Hand Woven Oxfords, Dress Oxfords, High Dress Shoes, Work Shoes, Sox. Styling specially designed for large sizes. Satisfaction guaranteed. Sold by mail only. Write now for FREE Catalog.

KING-SIZE Inc.
756, Brockton, Mass.

WRITE FOR
FREE
CATALOG

RICH OPPORTUNITY FOR MEN IN THEIR 50's!



Capable, mature salesmen are now needed for fascinating, healthful outdoor occupation. No investment needed. 150 of our men made \$500 to \$3,000 in one month—many just beginners. Read actual certified earnings. J. D. Wallace, \$164.95 first 2 hours; D. A. Crowley, \$224.00 first day. Incomes listed are exceptional. Openings available—earnings paid immediately. No collections—we make deliveries. Write Today!

PRESIDENT, P. O. Box 711, Dept. PM, Fort Worth 1, Texas

LOOK!

FIN-DER SAX-SLING

NEVER SLIP OR KINK
HIGH SPEED ADJUSTING
BALLBEARING

\$1.00

AT ALL GOOD DEALERS
OR ORDER DIRECT

NEW!

FIN-DER 1251 • 4th Avenue, San Diego 1, Calif.

LOOK! DO FACTORY FINISH PAINTING WITH THIS AMAZING, ALL-ALUMINUM, LOW COST PAINT SPRAYING UNIT



**Factory Set—Easy to Operate
FOR PAINT, LACQUER,
STAIN AND WAX
Needs No Cleaning!**



Complete with
AIR COMPRESSOR
6 FT. THICK-WALL HOSE
2-6 OZ. CONTAINERS
WITH JET CAPS
LIFETIME
COLOR-DABBER HANDLE
FULL INSTRUCTIONS
WITH UNIT
A Cesco Product

Spray automobile fenders, furniture, woodwork, machinery, etc. 50 lb. pressure obtained with easy foot-operated compressor—needs pumping only at intervals to keep air supply constant. Containers may be refilled as often as required. Disposable spray jets. Perfect for home use or in automotive repair shops, woodworking shops, factories, boat yards, hobby shops, etc. Entire unit weighs only 3 lbs.

**ALL FOR
\$9.95
POSTPAID**

THE HOWARD COMPANY
Dept. 12—615 Davis St.
Evanston, Illinois

MONEY BACK GUARANTEE

NEW Versatility for Your Shop Projects

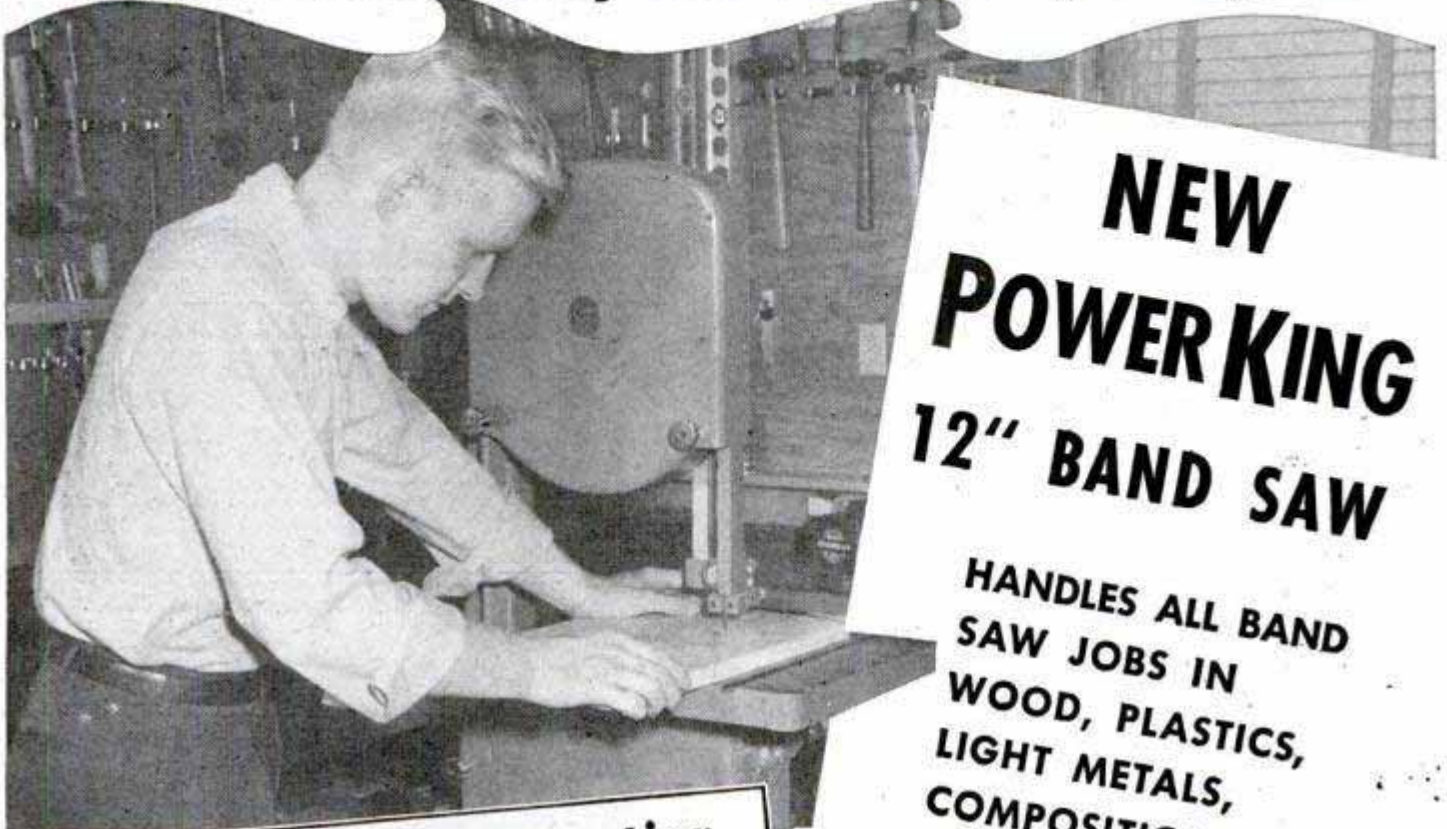

NEW POWER KING 12" BAND SAW

HANDLES ALL BAND
SAW JOBS IN
WOOD, PLASTICS,
LIGHT METALS,
COMPOSITIONS

Outstanding Construction for a Lifetime of Service

The properly engineered weight that is a "must" for smooth band sawing is achieved in the Power King with heavy cast iron base, arm, and table. These are balanced and braced to minimize vibration.

Upper and lower saw wheels turn on precision ball bearings and are equipped with replaceable rubber tires to protect the blade and provide positive traction. Upper wheel tilts for correct blade alignment — easily adjusted to maintain proper blade tension.

Four oilite bronze guides keep the blade accurately in work position. In addition, the back of the blade is supported above and below the table by large sealed ball bearings.

You can increase the usefulness of your shop a dozen-fold with the new low-cost Power King 12" Band Saw — turn out "professional" work fast and easy!

A big-capacity tool that cuts up to 6 1/4" deep, the Power King zips through wood, wallboard, cardboard, plastics, aluminum, and other light metals — cuts clean and true every inch of the way, straight or curved.

An important feature of this saw is the big cast iron table — 14" x 14". It is precision ground for smooth sliding of stock to blade — tilts 45° for angle sawing. Other design and construction highlights include heavy grey-iron castings for base and arm, ball bearing equipped saw wheels for smooth running and long wear, oilite bronze blade guides.

Your Power King dealer will be glad to demonstrate the Power King 12" Band Saw and show you how it will increase the efficiency of your shop. See him soon — and send for the new complete Power King catalog today.

NEW! FREE CATALOG SHOWS ALL 8 POWER KING TOOLS

Send a Postcard



ATLAS PRESS Company

235 N. Pitcher Street, Kalamazoo, Michigan



MATCHED PRECISION TOOLS FOR
WOODWORKING AND METALWORKING

**YOU CAN'T BEAT SWEDISH STEEL
FOR A BETTER CUTTING EDGE**

GENSCO (MADE IN SWEDEN)



TANGED BUTT CHISELS

The finest steel you can get in a wood chisel—Charcoal Steel blades individually heat treated, tempered and honed. Tough curly birch handles metal reinforced. 1/4" to 2" widths.

**SLOYD
CARVING
KNIVES**

Tough Swedish steel blades, hand honed and razor sharp. For working wood, leather, plastic, linoleum, Curly birch handles. Lengths 6 1/8", 6 7/8" and 7 1/2".

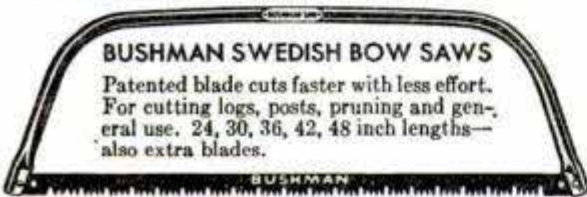

BUSHMAN SWEDISH BOW SAWS

Patented blade cuts faster with less effort. For cutting logs, posts, pruning and general use. 24, 30, 36, 42, 48 inch lengths—also extra blades.

Available at Leading Hardware Stores or write:

GENSCO TOOL DIVISION
General Steel Warehouse Co., Inc.
1832 N. Kostner Ave., Chicago 39, Illinois

World's Finest Roof

You can earn big money in the Duntile business—100% to 150% mark-up on basic costs. You can manufacture for a selective market—uncrowded and minus price-competition—because Duntile is exclusive and much-wanted. Duntile is the world's most beautiful roof. With all the safety, endurance and economy of masonry at its best. Wide range of smart fused-on colors. French or Spanish type. Truly the roof that every owner wants, because the roof is the most noticed part of the house.



Outstanding Manufacturing Opportunity

Swing into Duntile production NOW. Tie in with the biggest building cycle in history. High income potentials on low investment. Manufacturing is easy, interesting, profitable. Automatic power equipment enables maximum production at minimum costs. We supply all machinery necessary. Instruct you fully. Back you with aggressive cooperation. Write for descriptive literature and Manufacturing Analysis.



W. E. DUNN MFG. CO.
619 W. 23rd Street
HOLLAND, MICHIGAN

DUNTILE

NEW Pocket Thickness Measure

A pocket-watch size precision dial micrometer weighing only 1 1/2 oz. for accurately measuring the thickness of sheets, strips or tubing, round, square, or hexagonal stock, tissues, fibres or filaments of materials such as rubber, metal, paper, plastics, leather, glass, cloth or wood.

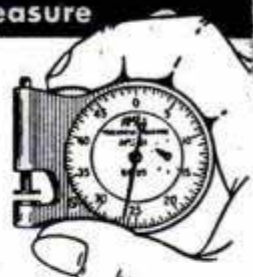

4 MODELS: .0005", .001", and .01 mm graduations. Range of all models 5/16" (8mm).

PRICE \$15.10 Post-paid complete with leather case and full instructions.

B. C. AMES CO. 68 AMES STREET WALTHAM 54, MASS.

MFR. OF MICROMETER DIAL GAUGES & INDICATORS

**DRAINS CELLARS, WASH TRAYS
CIRCULATES OIL**

Pumps 1800 GPH 300 gal. 30' high, use 1/8 to 1/3 HP **\$6.50** motor. Will not clog.

Postpaid if cash with order. (Add 50c for west of the Mississippi.)
Thousands in use since 1936

LABAWCO PUMPS, BELLE MEAD 7, N. J.

LAWN ORNAMENT-NOVELTY PATTERNS

28 Lawn Ornament Patterns, 25c. Other patterns; 15-20" high; Dutch Girl, Dutch Boy, Pirate, Bull Terrier, Mexican Girl, Mexican Boy, Dwarf, Penguin, Flower Girl, 10c each. 25 Novelty Patterns, 30c. All 62 Full Size Patterns, \$1.00 Postpaid. Strother Pattern Service, Dept. AW-8, Box 128, Belington, W. Va.

RED GARDEN TRACTOR

NO BELTS • NO CHAINS
POWER TURNING

PLow, DISC, HARROW, CULTIVATE and PLOW SNOW
3-4.5 H.P.
Easy to Operate • Economical

RED-E IS DIRECT DRIVE-ALL GEARS ENCLOSED.

BUY DIRECT from FACTORY at FACTORY DISCOUNT write for BIG, FREE CATALOG

RED-E TRACTOR CO.
232 Pond du Lac Rd., RICHFIELD, WIS.

MARCOT KEY MACHINE

Immediate Delivery

MARCOT No. 8 KEY MACHINE, mounted on Cabinet, less motor. \$ 95.00
Auto Code Book and Auto Depth Keys 12.50
100 Dz. Popular Cylinder Key Blanks 60.00
Set — Key File, Follow-Through Rods, Lock Picks, Bit Key Gauge, Thimble, Pins, Springs 10.50
"Locksmith Trade Books" 6.75
How to Open Locks without Keys or Picks; Secret of Locksmithing; How to Make Keys by the Impression Method; Master Key Systems.

TOTAL COST \$184.75

A. J. MARCOTTE CO., 1200 N. Kedzie Ave. Dept. PM, Chicago 51, Ill.

CASH FROM YOUR WORKSHOP

Send postcard today for FREE catalog of modern saleable projects—kitchen cabinet units, trellises, lawn furniture on wheels, highball server, home bars, electric pencil, children's room furniture, keep-off-grass signs, etc.

Craftplans, 7241 Madison, Dept. P-137, Kansas City 5, Mo.

SAY YOU SAW IT IN POPULAR MECHANICS

**We PAY YOU for YOUR
TOY IDEAS
Outright Purchase or Royalties**

Nationally known manufacturer of metal toys retailing for 50c or under will buy your ideas or pay you royalties. Our line is sold in chain stores. All ideas will be considered. References furnished.

APEX NOVELTY CO., 70 Marshall St., Newark 2, N. J.



Here are Real **WAR SURPLUS BARGAINS!**



CLUTCH
for motor-scooters,
motor-bikes,
lawn mowers, etc.
Mercury centrifugal clutch for use
with any small gas engine. 3"
"A" belt pulley, 5/8" bore. Brand \$995
new only. (Stock #400)

BALL BEARING ARBORS



Grinding and saw arbor, has 1 1/2" double end
shaft, 11 1/2" long with 2" center pulley. New
Departure double roll ball bearings. Right
and left hand thread. Self aligning Dodge
pillow block. 10,000 RPM. Bearings alone
list at \$10. Complete arbor new. \$495
(Stock #305)

HI-SPEED GRINDER (not pictured). Has 2
step pulley driven thru rear or base. \$1095
(Stock #328)

**Electric Rubber Cable
(ALL NEW)**



CORD SETS

Extension cords, 100 ft. heavy
duty. Plug, socket and guard.
Number 10 wire. Worth at
least \$10.
OUR PRICE \$535
(Stock #310)
Same as above—50 ft. \$385
length. (Stock #311)

HEAVY DUTY ELECTRIC CABLE

3 wire #10 rubber Tyrex cable—with lugs.
65 ft. lengths. \$1300
Stock #365. NEW

3 wire #10 submarine cable and lugs—can
be placed underwater, underground or over-
head. Also for portable tools. Will carry 40
amps. Stock #312

50 ft.	100 ft.	250 ft.	500 ft.
\$12.00	\$20.00	\$45.00	\$85.00

4 conductor neoprene covered #18 stranded
tinned copper wire (two blacks & two whites).
Run in parallel gives you #16 gauge. Lugs
furnished for parallel run. Water & oil resis-
tant. (Stock #346)

100 ft. 250 ft. 500 ft. 1320 ft. reel
\$4.25 \$10.00 \$19.00 \$36.00

150 ft. reels, 3 wire #6 with 4, 60 amp
Crouse & Hines connectors—2 male & 2 fe-
male. Perfect for welders, hay loaders, saws,
electric ranges, etc. List price \$6500
\$190. per reel. OUR PRICE \$6500
(Stock #313)

**FURNACE
BOOSTER FAN**



8" ball bearing fan Mfg. by Rob-
bins & Meyers. Can be run ver-
tically or horizontally. 110 volt
AC 60 cycle motor with plug and
cord. New in original box.
(Stock #401) \$1195

HALF TON WAGON
"ASSEMBLED OR IN KIT FORM"

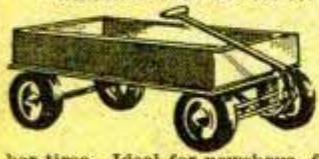

Heavy duty
wagon with
plate alumi-
num body
24" x 42"
5/8" steel
axle with
ball bearing
wheels.
Heavy rub-
ber tires. Ideal for newboys, farms, grocers,
parts dept, etc. Approx. wt. 88 lbs. Nothing
like it now on the market.

WRITE FOR FREE CIRCULAR. (Stock #332)

**U. S. Signal Corps
TELEGRAPH
KEY**
High quality professional type. Cost \$125
Gov't. \$7 per pr. OUR PRICE only, each
\$198
2 for \$398
We Pay Postage On This Item (Stock #402)

**AC ARMY
LIGHT
PLANTS**



New 750 watt 110 volt 60 cy. light plant
with Briggs-Stratton model AP gas engine. (Stock #315) \$14950

New 1000 watt 110 volt
60 cy. light plant with
Briggs-Stratton model BP
gas engine. \$17950
(Stock #316)

New 2500 watt 110
volt 60 cy. light plant
Briggs-Stratton model Z
6 HP gas engine.
Used. \$22500
like new... (Stock #317)

New \$26500
Add \$10 for tools and spare parts.
Rebuilt 5000 watt 110 volt 60 cy. light plant
with automatic remote control. Powered by
Jeep 4 cyl. gas engine. Rebuilt like
new and guaranteed. (Stock #318) \$62500

7,500 watt, 110 volt AC light plant powered
by VE-4 Waukesha 4 cyl gas engine. Conti-
nental or Hollingsworth Generator. Remote
control starting with 100 ft. starting cable,
and 100 ft. of 3 wire #6 cable. Complete
switch board. Used, like new and \$67500
guaranteed. (Stock #347)

Add \$65.00 for transformer to make plant 3
phase 220 volt.
10,000 watt 110 and 220 volt 60 cy. light
plant with automatic remote control. Pow-
ered by Jeep 4 cyl. gas engine. Rebuilt
like new and guaranteed. \$90000
(Stock #319)

**PORTABLE
DC LIGHT PLANT**

3000 watt 110 volt DC powered by new 6
HP Briggs-Stratton model Z2P gas engine.
Rebuilt generator. Generator alone lists at
\$245.00. Has volt meter, rheostat, 4 female
plugs, and ball bearing 2.75 x 10 rubber
wheels. Guaranteed.
(Stock #320) \$18500

GENERATORS

DC-3000 watt, 110 volt. Has voltmeter,
rheostat & 4 female plugs. Lists at \$7500
\$243.00. (Stock #321). OUR PRICE \$7500

AC-750 watt 110 volt 60
cycle with voltmeter,
rheostat, 3/4" shaft. Di-
mensions: 9"H x 12"W x
13"L. Wt. 52 lbs. Shielded
to prevent radio inter-
ference. Mfg. by Elicor.
\$125.00 value. \$5950
OUR PRICE, new
(Stock #322)

AC 1000 watt—\$6950
(Stock #403)

DC-300 watt, 12 volt, 2900 RPM. Heavy
duty, with current cut-out relay, high and
low switch, 30 amp. meter. Can be bought
less shaft and base to be used direct mount-
ed to Briggs-Stratton 1 HP engine. \$700
NEW (Stock #323)

Complete with base, shaft and bear-
ing. (Stock #324) \$1595

HORNS and HOWLERS

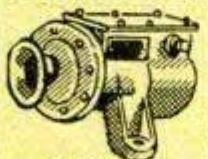

Motor driven (not a vi-
brator). Heavy duty with
great power and long
life. Adjustable for high,
medium or low tone.
110 volt AC current.
Weather proof. For alarm
or signal horn on boats,
school yards, factories,
etc. List price \$47.00.
OUR PRICE, \$945
new. (Stock #302)

**Portable
BUZ SAW**



Powered by 6 1/2 HP
Briggs & Stratton air
cooled gas engine. Ad-
justable hinge, requires
no clutch. 28" blade,
will take up to 12" hard-
wood. 1 3/8" ball bearing
mandrel. Has power take-
off. Complete unit mount-
ed on two wheels with 400 x 8 pneumatic
tires. Has tow bar for trailing. Wt. approx.
400 lbs. Sold complete or less blade, engine
or wheels. Make \$25 to \$50 a day sawing
wood with this sturdy unit.
WRITE FOR FREE CIRCULAR. (Stock #350)

**Electro-Lift
HOIST**



500 lb. Electro-Lift
Hoist. 17 ft. of cable—
up and down button and
trolley. 3 phase, 220
or 440 volt, 60 cycle. Used, in A-1
shape. List price \$185.00. OUR \$9000
PRICE. (Stock #301) Specify 220 or 440 volt

**Automatic
AIR
COMPRESSOR**



Complete. Piston type
with 10 gal. tank, 1/2 HP
capacitor type, AC, 110-
220 volt 60 cycle mo-
tor. Will develop 75 lb. pres-
sure—approx. 2 cu. ft. Brand new \$7950
(Stock #340) \$7950

Assemble yourself and save \$10.

ABOVE tank with legs \$1195
and saddle.

AS ABOVE—1/2 HP motor, 2 cyl. Westing-
house compressor. \$10950
3 CFM at 75 lbs.

**Portable
AIR
COMPRESSOR**



Electric motor driven, port-
able spray painting unit
for jobs requiring a larger quantity of material.
Piston type, single cyl. air compressor
has 2" bore by 1 3/4" stroke, 2.86 CFM.
Max. working pressure 40 lbs. Mounted on
base. Equipped with safety valve & drain
cock. 1/2 HP capacitor type motor, 110 volt
AC, with cord and plug, 20 ft. air hose and
fittings. Ship. wt. 45 lbs. Brand \$4250
new. (Stock #348) \$4250

**Westinghouse
AIR COMPRESSOR**



Brand new piston type, 2
cyl. compressor with auto-
matic clutch. Westinghouse
model T-1. Can be run off
power take-off or 1/2 HP mo-
tor. Delivers oil free air. Suggest-
ed operating pressure, 75 P.S.I.
Approx. displacement 3.27 CFM
at 600 RPM. Ideal for spraying,
industrial work, tire inflation,
painting, etc. Approx. wt. 23
lbs. (Stock #345) \$2250

**KELLOG AIR
COMPRESSOR**



Kellog Model 241 air compressor.
Piston type with 2" x 1 3/4" bore.
Capacity of 2.8 CFM at 100 lbs.
V-belt drive. 3/4" shaft. Can
be run with 1/2 or 1/4 HP motor.
Delivers oil free air. Max. recommended
working pressure 150 lbs.
(Stock #349). NEW \$1495

Get Acquainted Offer

War surplus tobacco pouch with
built in humidifier. \$1.25 value to-
gether with our free illustrated
circular for only \$0.20c
COINS OR STAMPS ACCEPTED—
WE PAY POSTAGE ON THIS ITEM

ALL ITEMS GUARANTEED C & H ELECTRIC Co.
AS REPRESENTED
434 W. JUNEAU AVE.
MILWAUKEE 3, WISCONSIN

All prices F.O.B. Milwaukee. 25% de-
posit required on all C.O.D. orders. No
C.O.D.'s under \$10.00. Use stock num-
ber when ordering. Many other bar-
gain items not listed—write for our
free circulars.



Here's your future

- * \$35 TO \$50 A DAY
- * STEADY WORK * LIFETIME SECURITY * PLEASANT INDOOR WORK * SMALL INVESTMENT
- * NO SPECIAL SCHOOLING
- * NO TIME CLOCK TO PUNCH
- * YOU ARE BOSS!

with American

This wonderful future can be yours—as a floor surfacing contractor with an American Machine! We have the "formula" that has brought success to thousands—it can do the same for YOU. Floor sanding is a down-to-earth service that's needed every day. No big overhead... no large investment (a new car costs 3 times as much). Easy to operate an American Sander. Plenty of prospects—new or old homes—a year 'round opportunity to make BIG MONEY and be your own boss! Send for "money-making" booklet entitled "Opportunities in Floor Surfacing"—use coupon and enclose 25c in coin or stamps to cover handling.



AMERICAN FLOOR MACHINES

The American Floor Surfacing Machine Co.
535 So. St. Clair St., Toledo 3, Ohio

Enclosed find 25c in stamps or coin for booklet "Opportunities in Floor Surfacing," telling me how I can start my own floor sanding business.

Name
Street
City State



The Power Line Comes to Yellowknife

(Continued from page 136)

Of the enormous volume of freight brought in from Canada's "Deep South," 1200 tons were hauled by steamer and barges for 700 miles from the railhead at Waterways, along a chain of streams and lakes with many portages around rapids and falls. In summer, steamers carried the equipment across Great Slave Lake, larger than Lake Erie or Lake Ontario. Urgently needed materials were flown in from Hay River, a Great Slave Lake port, or from Edmonton, 100 miles away.

In winter more than 226 tons of the heavier equipment were hauled by tractor-trains over the ice-covered lake and then by trails to the power site. Heavy tractors pulled 28 huge sleds and a caboose, used as a dining room and kitchen. These long trains, averaging about 50 miles a day, hauled 125 tons a trip. The crew consisted of two drivers, two brakemen and a cook.

The winter hauling season, limited to about 100 days, begins as soon as the lake ice is sufficiently thick, about the middle of January. Rough ice is a constant problem. An airplane, scouting ahead, spots dangerous fissures in the ice and signals areas of clear passage to the crew.

Even though the extremely cold weather provides a heavy ice layer, there were times when tractors broke through the ice. In every case, however, the equipment was recovered, and no lives were lost.

The 91-mile power line from Snare River to Yellowknife travels across very rocky country, spotted with many lakes of varying sizes. Almost 10 miles of the 91-mile distance is over water. Digging postholes was a Herculean chore since all but 1½ percent of the holes were cut in rock.

The line crews wore parkas made of caribou skins, warm caps, heavy mitts and felt boots. Mechanical equipment took a terrific beating from the combination of sub-zero weather and rugged terrain.

As far north as it is, the Snare River development may soon be considered in the "South" as the industrialization of Canada's Northwest continues. Canadian engineers are planning to push 200 miles north to Great Bear Lake where there are rich deposits of uranium ore.

But today the Snare River project marks the industrial "frontier" of the Northwest. With its power, the residents of Yellowknife can laugh at the sub-zero weather as they live in their modern homes, enjoying the comforts and luxuries of abundant electric lighting and heating.

DELTA MILWAUKEE

Delta-Milwaukee 14" Band Saws can be found in shops of all kinds — wherever accurate cutting must be done easily and economically.



Hobbyists who want the best in power tools equip with a Delta-Milwaukee 14" Band Saw.



\$115.85*

without motor or switch

Double table-supports help you get greater accuracy—even on big, heavy work... with a DELTA-MILWAUKEE® 14" Wood-cutting Band Saw

Cuts wood, felt, corrugated board, paper, other materials

Two trunnions — widely spaced — one on either side of the blade — support the table of the Delta-Milwaukee 14" Band Saw. This gives you a steadier surface to work on. The table stays rigid, at any angle. You're able to saw more accurately.

That's only one reason why this Delta-Milwaukee machine is first choice of those who know fine tools. There are many other quality construction features:

- Ball bearings are used, giving trouble-free performance — and they are lubricated for life.
- The table is big — 14" x 14". It has a 3/8" x 3/4" miter-gage groove. Tilts 45° right and 10° left.
- Blade guide controls can be adjusted safely at the front of the table.
- Aluminum wheels are carefully balanced, so that the blade is true-running.
- Upper and lower wheels are completely guarded, to protect you. Guard covers saw blade at rear; sliding guard covers all but working surface of blade in front.
- Rip gage is available for ripping.

Have your nearby Delta distributor tell you more about these features for safety, accuracy, economy, and convenience. Inspect the Delta-Milwaukee 14" Band Saw there now — and see his complete Delta-Milwaukee line.

Look for the name of your Delta distributor under "Tools" in the classified section of your telephone directory.



One of the 2 trunnions that are spaced 9 inches apart to support table.



Upper wheel has blade-tension adjustment. Index shows correct tension for various widths of blades.



You can independently adjust blade guides and blade supports with micrometer accuracy.

Widely used wherever folks insist upon highest-quality tools:
 Cabinet Shops
 Carpenter Shops
 Display Shops
 Furniture Factories
 Home Workshops
 Hotels
 Pattern Shops
 Sign Shops
 Theatres
 Upholsterers
 — and other places!

\$235.75*

without motor or switch rod



Simple attachment increases capacity from 6 1/4" under the guide to 12 1/4". Can be added any time.

Two machines mounted together — to save space, time, and money — DELTA-MILWAUKEE SAW-JOINTER COMBINATION

Circular saw and jointer mounted on one steel stand and driven by same motor. Both may be operated singly or together. 10" circular saw cuts 3 1/4" stock. Rips to center of 50" panel. Jointer surfaces boards 6" wide; cuts rabbets 1/2" deep. Both tools have lubricated-for-life ball bearings. See this dual-purpose machine at your Delta distributor.

*Prices subject to change without notice

TEAR OUT COUPON AND MAIL TODAY!



DELTA MANUFACTURING DIVISION
 Rockwell Manufacturing Company
 680B E. Vienna Ave., Milwaukee 1, Wis.

Send me free copy of Delta-Milwaukee Catalog B-48.

Name.....

Title.....

Company.....

Address.....

City..... (.....) State.....

HM-65



Send for free catalog!

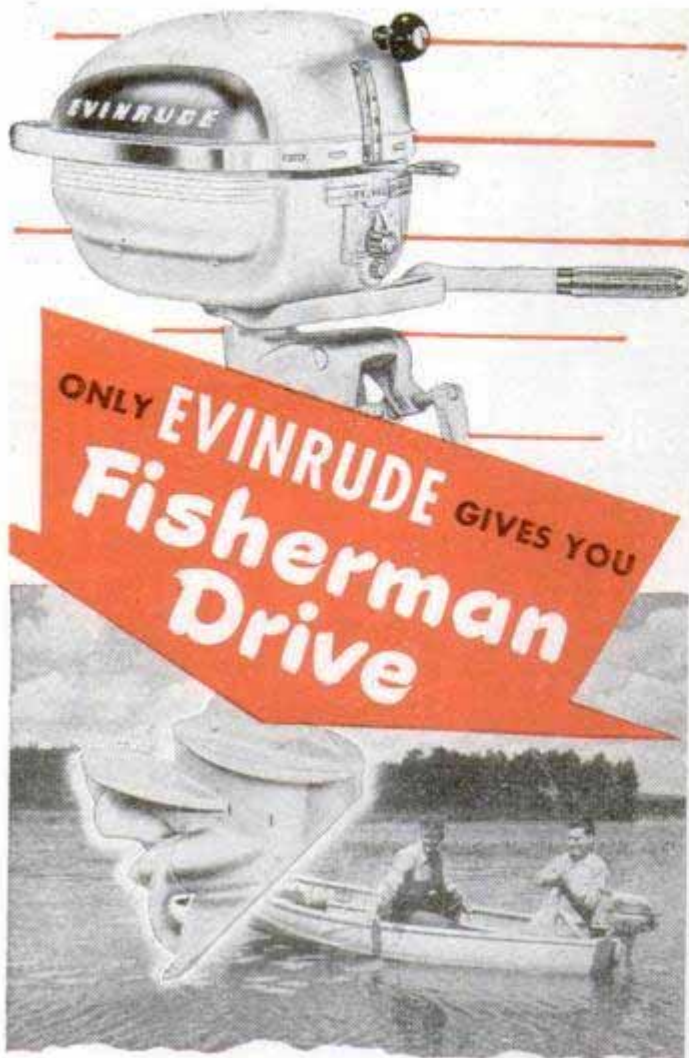

FOR *better fishing* EVERY TRIP!

Why *better* fishing? Because an Evinrude with FISHERMAN DRIVE takes you where the *biggest* fish love to hide! You power confidently through waters you'd never tackle with another motor! Over murderous stretches of snags, stumps, shoals... your motor "bobs" unharmed over obstacles, keeps right on driving! Straight through reeds, rushes, lily pads... your FISHERMAN DRIVE "eels" magically along... speeding you to the best fishing spots... taking you "anywhere there's water to float your boat."

For '49 this revolutionary Drive is yours on three favorite fishing motors, including the famed four-cylinder Zephyr. See your Evinrude Dealer... look for his name in the yellow pages of your phone directory under "Outboard Motors."



SEND FOR FREE CATALOG on the complete line of 40th Anniversary Evinrudes... the right motor for every boat... 1.5 to 50 certified horsepower. Address EVINRUDE MOTORS, 4224 N. 27th Street, Milwaukee 9, Wisconsin.

In Canada, Evinrude Motors, Peterboro, Ontario.

EVINRUDE
FIRST IN OUTBOARDS • 40th YEAR

Life Line to Berlin

(Continued from page 121)

times that long for the same procedure.

Many stories are told at Tempelhof in praise of GCA. One night, pilots relate, the all-seeing radar miraculously guided them to perfect landings through fog so thick they couldn't find their way to the unloading line. Jeeps had to be sent out to lead them in.

Despite the constant demand for high tonnage, safety remains a major Task Force requirement. Lives are not needlessly risked. Flying around the clock, in all kinds of weather, the lift maintains an accident record better than the Air Force's composite world mark. There were seven fatal accidents in the first 96,640 flights.

The lift's most dramatic accomplishments are in the sky, but it is far from a completely air operation. The important jobs of securing supplies and moving them to and from planes are just as efficiently done by the Army's Quartermaster and Transportation Corps. Supplementing the general commodity breakdown of 69 percent fuel and 26 percent food, there is cargo as varied as fire engines, snowplows, bulldozers and heavy rolls of newsprint.

Ground time is as precious as air time to the clock-conscious people who run Operation Vittles. They know they have to squeeze out the utmost in loading and unloading performance during good flying periods. Streaming back and forth between planes at Tempelhof, for example, are 75 ten-ton and "six by six" trucks. Assigned to each are 12 to 14 German laborers, a driver and a soldier from the Army's Constabulary force, who acts as both checker and guard for the load.

As each plane taxis to the unloading line a truck assigned to handle its entire load moves toward the aircraft. Handling time varies with the character of the cargo. Items like flour and coal, in uniform-size sacks, move fastest. At Fassberg 180 sacks of coal were put aboard in seven minutes.

Average time, however, runs about 35 to 40 minutes on the ground at loading and approximately a half hour for the turnaround at Berlin. Ramp expeditors in jeeps maintain a constant patrol to push along any operation that lags. Two Air Force men are inside the plane during loading, supervising the placement of cargo and tying it down securely with steel cable, ropes and rods. Most of the weight has to be kept well forward in the fuselage, just behind the crew compartment.

A technique known as "marrying" insures a safe balance of the 10 tons of weight

(Continued to page 288)



OWN A FAMOUS MOTO-TOOL

The "Pocket-Size Machine Shop"

HIGH-SPEED STEEL CUTTERS
— AT NO EXTRA COST

No modern home workshop is completely equipped without MOTO-TOOL . . . the correctly balanced motor-in-hand tool. It grinds, drills, routs, carves, polishes . . . without vibration. Higher speed does work better, faster, on practically any material. MOTO-TOOL Kit No. 2 includes high-speed-steel cutters for longer life, better work. MOTO-TOOL is backed by over 12 years of industrial use . . . packs years of pleasure. Due to wide popularity and increased production, Dremel's pre-war prices still prevail!



MOTO-TOOL No. 2
With Emery Point
\$16.50

MOTO-TOOL KIT No. 2
With 23 Accessories
(High-Speed Steel Cutters, Grinding Wheels, Polishing Accessories)

\$23.50



NEW DRILL PRESS
This 12" high precision drill press is ideal for model making, wood carving, routing, etc. Utilizes No. 2 Moto-Tool. Only \$9.95 (Less Moto-Tool).



Look For These Moto-Tool Features

Approximately 27,000 R.P.M. plus dynamically balanced armature provides vibrationless finger-tip control. Moto-Tool has oilless, sealed bearings • Patented automatic chuck lock pin • Over-size armature shaft—hardened, ground, polished • 110 Volt, AC-DC motor • Sliding snap-type switch • Cord protector • Shockproof bakelite housing • Dust-filtered air-cooling system • Weighs only 13 oz.

MONEY-BACK GUARANTEE: Buy Dremel Moto-Tools from you, order direct on 5-day trial, money-back guarantee. Shipped postpaid for payment in full (Send check or money order); or, send only \$2 now and pay postman balance plus postage upon delivery. Catalog of Dremel Tools and Accessories FREE.

DREMEL MFG. CO. • Dept. T119-B • Racine, Wis.

Now CHEAP OIL BURNER

FOR HEATING AND COOKING STOVES—FURNACES
HEAT YOUR HOME, COOK YOUR MEALS
WITH CHEAP FURNACE OIL

NO MORE SHOVELING COAL OR ASHES. Sensational Fuelizer Starter Vaporizing System turns Cheap No. 1 Furnace Oil, also Range, Heater, Tractor Distillate, Kerosene and like oils into oil heat—one of the quickest, hottest fires known. **LIFETIME GUARANTEE. \$1.00 Bonus Offer for Testing.**

We will let you try it in your own stove or furnace for one month. Get yours for introducing. Big profits QUICK. Be first. Send in your name today for details and cash in on the tremendous demand for this Amazing Invention.

NORTHWEST MFG. CO., 634-B, Mitchell, S. Dak.

Announcing CHAMPION V-Glow Plugs

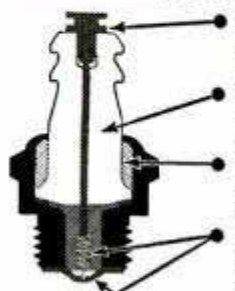

- **CHAMPION TERMINAL**—assures better center electrode seal and provides sturdier electrical connection.
- **CHAMPION-CERAMIC INSULATORS**—proved dependable in millions of Champion Spark Plugs.
- **CHAMPION SILLMENT SEAL**—prevents excessive compression leakage between insulator and shell.
- **CHAMPION "THERM-O-FLEX" CONSTRUCTION**—longer element life, more dependable performance.

Follow recommendations of plug types and fuels approved by engine manufacturer.

CHAMPION

SPARK PLUG COMPANY, TOLEDO 1, OHIO



AMAZING Patented MOTO-SANDER AND POLISHER

Saves Time — Saves "Elbow Grease"

Here's a machine that takes the hard work out of two tough jobs . . . sanding and polishing. "Moto-Sander" is so easy to handle that a child can use it . . . so fool proof that, with it, even a novice can do a craftsmanlike job. Moto-Sander's fast, straight-line action (non-rotary) eliminates any possibility of wood burns or scratches. Does a magically smooth job of sanding . . . gets into corners and places others can't reach. All you do is guide it! There are dozens of time and money-saving uses in every home and shop for this inexpensive machine. Use Moto-Sander to get smooth sanded finish on furniture, painted walls, boats, bird houses, scale models, etc. Use it also for speedy, effortless polishing of waxed furniture, automobiles and other surfaces—simply by removing sandpaper and clamping on polishing pad. Moto-Sander is the lightest, most practical electric sander on the market—the only one of its kind. Furnished with 6 assorted sheets Garnet paper for sanding . . . plus felt pad and sheepskin for wax polishing. Operates on alternating current. Thousands of satisfied users.

USE MOTO-SANDER AROUND THE HOUSE

- Sand Furniture and Bookcases
- Sand Stairways, Doors, Woodwork
- Sand Walls before painting
- Polish the Family Car
- Polish Pianos and Cedar Chests
- Polish Waxed Furniture

MONEY-BACK GUARANTEE: Buy Moto-Sander from your dealer. If he cannot supply you send only \$14.85 (check or money order) and we will ship postpaid; or, send only \$2 now, and pay postman balance plus postage upon delivery. Your MONEY-BACK if not delighted after 5 days' trial.

DREMEL MANUFACTURING CO.
DEPT. SP-119-B • RACINE, WIS.



EASY FOR
AWKWARD PLACES



SANDS FLAT
SURFACES EVENLY



GETS INTO
TIGHT CORNERS



ROUNDS CORNERS
LIKE MAGIC

SAY YOU SAW IT IN POPULAR MECHANICS



SAFE AS A HAND SAW JUST GUIDE IT!

The versatile Moto-Saw is as safe as a hand saw. A touch of the trigger switch sets it going . . . releasing stops it instantly.



SAWS TO CENTER OF 19" WIDTHS

No Limit to Length of Stock it Will Cut

THOUSANDS OF SATISFIED USERS

AVERAGE CUTTING SPEED ONE FOOT PER MINUTE

Moto-Saw works more like magic than any tool you ever saw! Takes no effort to run . . . no perceptible pressure to feed . . . only a trifle heavier than a hand scroll saw, and better balanced in your hand. Runs 7,200 strokes a minute . . . leaves no rough edges . . . easily cuts intricate scroll designs in medium hard wood up to 3/4" thick. Blade holder faces blade 4 ways . . . permits sawing sideways as well as forward and backward. Sturdily constructed . . . only two moving parts . . . never needs oiling . . . requires no bench room or floor space. Operates on alternating current. Thousands of satisfied users.

MONEY-BACK GUARANTEE: Buy Moto-Saw from your dealer. If he cannot supply you, send only \$5.85 for Moto-Saw and 3 blades, postpaid; or, send only \$1.00 now, and pay postman balance plus postage upon delivery. MONEY-BACK if not delighted after 5 days' trial.

DREMEL MFG. CO. • Dept. S119-B • Racine, Wis.



BUILD YOUR OWN BOAT with EASI-BILD* Pattern Method!

Easy... Inexpensive... Better! You can build this 11½-foot boat yourself—without special tools or skill. Just trace pattern on wood; saw, and assemble. Step-by-step directions plus assembly illustrations make the job simple and foolproof. And with **CASCOPHEN**, CASCO'S new completely durable, water-proof glue, you're assured of a permanent job which will give you many years of trouble-free fun.

Send for Utility Boat Pattern and colorful 32-page Pattern Book. Mail the coupon today.

*Reg. U.S. Pat. Off. by Easi-Bild Pattern Co.

How to choose a glue!

These directions will solve your gluing problems:



For boats, outdoor furniture, sports equipment—joints that must withstand outdoor exposure—**CASCOPHEN** (Resorcin Resin Glue). The first completely durable glue available to home-craftsmen.



For furniture, toys, heavy-duty home repairs—strong, stainfree, moldproof, highly water-resistant **CASCAMITE** (Urea Resin Glue). Mixes quickly with cold water!



For models, photo prints, labeling—general home, school, or office gluing, use the new clean, white, fast-setting **CASCOREZ** (Polyvinyl Resin Glue). Liquid, ready to use!

SEND COUPON FOR BOAT PATTERNS TO:

Casco Pattern Dept. PM-29
P. O. Box 215, Pleasantville, N. Y.
Enclosed is \$..... for patterns checked below.
() Utility Boat, Pattern No. 85—\$1.00
() 32-page Pattern Book, illustrating 94 pattern projects—20¢

Name _____

Address _____

City _____ Zone _____ State _____

THE BORDEN CO. • CHEMICAL DIVISION
Makers of Casco Glues

and bulk in each air load. Heavy items, like 230-pound drums of carbides, are mixed in with shipments of cigarettes or medical supplies. Objects too awkwardly shaped for even the C-82 "Boxcars" that handle most such shipments are either dismantled or cut in sections by blowtorches, to be welded together at the destination.

Most of the blockaded city's coal is moved in from Fassberg, in 110-pound sacks, while Rhein-Main and Wiesbaden specialize in foodstuffs and miscellaneous loads. Displaced Europeans are included in trips out of Berlin and as many as 700 children a week have been flown to parts of Germany where food and heating are less critical problems. Goods made in Berlin, a prewar manufacturing center, are loaded in air-lift planes and carried out for distribution to the rest of the country.

No time limit has been set for Operation Vittles' existence. Presumably it will go on until surface access to Berlin is restored. Additional planes are expected to boost the average daily input to about 8000 tons, which is 100 times more than that first day's total.

Mothered by necessity and vastly improved by experience, the aerial arch to the German capital has made the entire world acutely aware of the possibilities of mass movement of goods by air. It has pointed the way to better and faster cargo handling, streamlined maintenance that keeps planes working in the air more hours, improved instrument-flying techniques and necessitated stricter air-traffic control discipline. Lessons that normally take years had to be learned in weeks and months.

It is making all men accept the slogan of General Tunner and his British and American flyers: "We can fly anything, any time, anywhere!"

In addition to the all-important purpose of keeping Berliners alive, the lift has vastly increased respect for the Allies throughout Western Europe, as well as in Russia.

Chemical Added to Hay and Grain Prevents Spontaneous Combustion

Hay and grains are protected from fire due to spontaneous combustion by treatment with a chemical compound that neutralizes the toxins set up by mold and bacteria action. The compound prevents dangerous heat from occurring by shutting off the supply of oxygen. An attachment for any commercial baler meters the compound into the bales in the proper quantities at a cost of less than 50 cents a ton.

Every ITEM
WILL SAVE
YOU Money



RADIO KITS FOR TRAINING AND PLEASURE

HEATHKIT VACUUM TUBE VOLTMETER KIT

Complete kit to build precision electronic volt-ohmmeter. Measures AC or DC voltages with 6 ranges between 3 Volts and 1,000 Volts. Ohm-meter measures 1/10 ohm to 1 billion ohms. Burn-out proof meter — balanced circuit — everything supplied with detailed instructions. Shipping weight 8 pounds.



\$24.50

G.E. ARMY TRANSMITTER- RECEIVER

No. 201. Beautiful 15 tube transmitter-receiver. Operates in new citizens band 460-470 Mc. Supplied new in original G.E. sealed cartons with 15 tubes (tubes worth over \$40.00) and conversion instructions to operate between home and car, boat, office, etc. Only a limited number available. Order early. Shipping weight 25 lbs. each. **\$19.50 2 for \$35.00**

ACCESSORIES FOR BC-645
PE-101C. Dynamotor for car use, **\$3.95**
110V. 60 cycle power supply for home or office use.....\$14.50

HEATHKIT FM TUNER KIT

Complete kit to assemble frequency modulation tuner. Connects to any radio to receive the new static free FM band. Easily assembled — no coils to wind, clear detailed instructions anyone can read — comes complete with tubes and all other parts — slide rule calibrated dial, 110V. 60 cycle transformer operated, etc. Shipping weight 6 pounds.
Mahogany Cabinet (extra) **\$3.75**



\$14.75

HEATHKIT 3 TUBE ALL WAVE RADIO KIT

No. K-1. Enjoy the thrill of building your own set which receives broadcast, police, aircraft, amateur, marine and foreign stations. Simple easy instructions make assembly fun. Every part included — coils for 550 to 6000 Kc. tubes, 110 Volt power transformer, ready punched chassis, calibrated dial. Has power output tube operates loudspeaker (not included). Ideal start in radio. Shipping weight 3 lbs.
Loudspeaker 2 1/2" PM (extra) **1.95**
Headphones **\$1.00**



\$8.75

THE NEW 1949 HEATHKIT 5" KIT OSCILLOSCOPE

No. 03. Complete kit to build a beautiful 5" oscilloscope. Ideal for studying and servicing television and FM radio. 6 tubes including 5BP1 cathode ray tube. 1500 Volt power supply operates from 110V 60 cycle A.C. Has compensated vertical and horizontal amplifiers and 15 cy to 30 KC sweep generator. Detailed instructions make assembly easy. Nothing else to buy. Shipping weight 35 pounds.



\$39.50

METER SPECIAL

No. 237. Beautiful Dejur 3" Square Precision Milliammeter 0—800 MA range. 0—10 MA basic movement. Probably the best buy ever offered in a war surplus meter Shipping weight 1 lb.



\$2.95

MINIATURE ELECTRIC MOTOR

No. 211. Tiny Delco motor only 1" x 4 1/4" x 2" 10,000 RPM. Operates from 6 to 24V Excellent for models. Shipping Wt., 1 pound.



\$2.95

HOME WORKSHOP GRINDER KIT

No. 230. Easily assembled 110V. AC. or DC ball bearing fully enclosed motor from Army surplus dynamotor. Purchaser to make simple changes and shaft extensions, detailed instructions and all parts supplied. Motor approximately 5,000 R.P.M. Ideal for tool-post grinder, flexible shaft tool, model drill press, saw Shipping weight 6 lbs.



\$3.95

50 AMP. CIRCUIT BREAKER

No. 204. New General Electric 50 Amp., 220 Volt A.C. circuit breakers. Add postage for 4 lbs. **\$2.95**



HEATHKIT HIGH FIDELITY AMPLIFIER KIT

No. A2. A truly fine 110V. 60 cy transformer operated High Fidelity Amplifier Kit. Ideal for reproducing quality music at home, churches, mortuaries, outdoor gatherings, etc. Output over 10 watts. Complete with all tubes (push pull circuit) transformers, punched chassis and detailed assembly instructions. Shipping weight 20 lbs. High Fidelity 12" PM Speaker for above **\$6.95**
Mahogany speaker cabinet size 14 1/2" x 14 1/2" x 8" for above speaker **8.75**



\$14.95

FM PUSH BUTTON TUNER

No. 224. Brand new ten push button tuning assembly from Army FM receiver. Contains 4 gang 100 MMF silver plated tuning condenser. Shipping weight 10 lbs. **\$2.50**



G.E. 1000 VOLT 350 MA DYNAMOTOR

No. 213. An ideal dynamotor for mobile operation in taxi cabs, police cars, sound systems and amateur stations. Supplies above voltage from 12 Volts or 500V, at 350 MA from 6 Volts. Complete with starting relay, and fuses. New. Our Dynamotor A. Shipping weight 72 lbs.



\$5.95

HEATHKIT PHOTO TIMER KIT

An electric phototimer anyone can afford. Complete kit includes every part, all punched, formed, ready to assemble. Push button operation. Already calibrated from 1 to 45 seconds. Has focusing switch, line cord and enlarger socket. Complete pictorial diagrams make assembly easy Shipping weight 4 lbs.



\$8.75

HEARING AID HEADPHONES



No. 216. Hearing aid type, comfortable, keeps out outside noise, one of the Army's best types. Add postage for 2 lbs. **\$1.00**

Give part number and description. Add postage for weight shown. No orders under \$2.

How TO
ORDER

HEATH COMPANY
BENTON HARBOR 17,
MICHIGAN

WE WILL SHIP
C.O.D.



Amazing NEW TOY GUN

"Shoots" Like a Real Gun

ONLY \$1.00

INCLUDES 10,000 SHOTS

COMPLETELY SAFE

Here is the gun that will thrill every boy. When you pull the trigger, it cracks out like a real gun and smoke puffs out of the muzzle. The American Rangers Automatic is a quick acting, repeating pistol that never misses. It shoots 60 to 75 shots without re-loading. Looks like a real gun. Absolutely SAFE. Contains no explosives. Each gun comes boxed with 10,000 shots of smoke powder or enough ammunition to last a full year. This smoke powder is harmless. Will not hurt the eyes and may even be eaten. Only \$1.00 each or 3 guns for \$2.00. Only limited quantity available. Write for yours NOW.

SEND NO MONEY Try 10 Days - At Our Risk

Just send name and address. On arrival deposit only \$1.00 plus C.O.D. postage for one gun or \$2.00 plus C.O.D. postage for three guns. If not completely satisfied return and your money refunded. Save money. If you send cash with order, we pay postage. Write TODAY. No foreign orders accepted.

SPECIALTIES MFG. CO., Dept. 508

1367 N. Sedgwick

Chicago 10, Ill.

PLASTI-LINER



Easy to Use Strips

ONE APPLICATION

Makes False Teeth Fit

For the Life of Your Plates

If your plates are loose and slip or hurt, use this amazing, pliable, non-porous strip to refit them yourself, for instant and permanent comfort. It's easy. Just lay the strip on your upper plate or lower plate, then bite and it molds perfectly. Hardens for lasting fit and comfort. Helps stop the embarrassment of slipping, rocking plates or the misery of sore gums. Eat anything and talk freely without fear your teeth will loosen. Ends forever the mess and bother of temporary applications that last only a few hours or months.

Easy to Re-Fit and Tighten False Teeth

PLASTI-LINER is tasteless and odorless. Won't injure your plate. Guaranteed to give satisfaction or your money back. Removable as per directions. Users say: "Until I used Plasti-Liner I used several kinds of liners without success. Now I can eat anything." H. H. M. "My plates are now better fitting than new." E. H. C.

At Drug Stores, or write us for PLASTI-LINER today.

SEND NO MONEY: Just order \$2.25 package of PLASTI-LINER to reline both upper and lower plates or \$1.25 to reline one plate. Pay Postman when he delivers. Or send money now and save. C.O.D. charges. Trial size special plate cleaner included free.

PLASTI-LINER CO., Dept. 43-H, Buffalo 15, N. Y.

Ball-Bearing SPEED WHEELS



JUVENILE WHEELS

(No bearing, solid tires)

4".....45c 6".....65c
7".....75c

(Semi-pneumatic tire, ball bearing)

6x1.....1.65 8x2.....2.20
8x1.25.....1.85 10x1.25.....2.20
8x1.75.....1.05 10x1.75.....2.30
12x1.75.....3.45

INDUSTRIAL WHEELS FOR HEAVY LOADS

6x2 Welded...3.45 10x2.75 HC... 5.70
6x2 Bolted...4.35 10x2.75 Pne. 7.60
8x1.....5.25 12x2.00... 6.90
8x2.00.....5.20 12x3.00... 10.60
8x2.50.....5.40 4.00x8-2... 14.70
10x2.00.....6.10 4.00x8-4... 15.85
16x4.00.....15.15

DEALERS, JOBBERS, AND MANUFACTURERS: OUR NEW PRICES WILL INTEREST YOU.

WRITE US NOW FOR COMPLETE NEW CATALOG

Send check with order. No C.O.D.

JIM BROWN TOY COMPANY

1097 Home Ave.

Akron 10, Ohio

Full Length SAW CLAMP



SPEEDS UP SAW FILING!

Grips entire length of your hand saw... a full 30 inches. Attaches or releases from your bench in 15 seconds. Also can be used for hand saws. Sturdy, all steel construction. Made to last a lifetime. Gripping edges ground to hold entire length of saw true without vibration. Order today \$4.95, prepaid. (COD postage extra.)

\$4.95
POSTPAID

SPEEDCOR PRODUCTS, 2025 N.E. Sandy, Portland 12, Ore.

THEY'RE SUPER SCOPES!



36" 17 POWER

Extends to 36 inches, Precision and Polished Lenses. Ideal for Studying Stars, Plane Spotting, etc. Satisfaction Guaranteed or Money Refunded. Send Check or Money Order to.....

\$2.50
Post Paid

CRITERION CO., Dept. PM3

438 Asylum St.

Hartford 3, Conn.

Entirely NEW Auto Wax

Rayflex Weatherwax:

- Is EASIER to apply
- OUTLASTS others 2 to 1
- CLEANS as it WAXES
- Doesn't STREAK
- Doesn't RAIN SPOT

Send \$1.00 for generous can, postpaid.

Agents wanted

RATNGEBER LABORATORIES - 224 County St., New Haven 11, Conn.

SPECIAL Fishing Line

YOUR CHOICE FOR 1.00

750' 2-PLY NYLON 25 lb. T
150' 3-PLY NYLON 85 lb. T
250' 3-PLY NYLON 45 lb. T
300' SILK LINE 30 lb. T
500' 3-Ply Nylon 35 lb. T
500' Linen Line 32 lb. T
3 Ply Nylon Rope 1/2" dia.
6c Ft. Braided Nylon Line
1/16 dia. 250 lb. T 2c ft. Pachner &
Koller Lite Wght. Fly Reel \$2. Braided Nylon Line 1/4" dia. 550 lb. T
8c ft. All lines available in longer lengths. Send Check. M.O., no C.O.D.'s.

MAC-MILLS Dept. K2 Pleasant Valley, New York, N. Y.

SAY YOU SAW IT IN POPULAR MECHANICS

Easy way to remove paint

In refinishing furniture, woodwork, etc. all cracked or peeling portions of the old finish should be removed. It's easy with **WONDER-PASTE REMOVER**. Applied with an ordinary paint brush, this remarkable paste quickly softens up the toughest finish, whether paint, varnish, enamel, lacquer or shellac. Will not run, even on an upright surface. Turns the finish into a soft sludge that comes off easily at every stroke of the scraper. A long-time favorite of painters. Get Wonder-Paste at your paint or hardware store. Write for Wonder-Paste leaflet, and for advice on your particular removing problem.

Wilson-Imperial Co., 119 Chestnut Street, Newark 5, N. J.

Replace with a
DELCO BATTERY
for **GOOD SERVICE**
for a **LONG TIME**



DELCO BATTERIES FOR PASSENGER CARS, TRUCKS, BUSES AND TRACTORS ARE SOLD BY DELCO BATTERY DEALERS EVERYWHERE

DELCO-REMY *WHEREVER WHEELS TURN OR PROPELLERS SPIN*

A SENSATION with CRAFTSMEN EVERYWHERE!



THIS AMAZING, NEW, LOW-PRICED OSCILLATING, SANDER AND POLISHER!

\$14⁹⁵
DU-FAST ATTACHMENT ONLY

CRAFTSMEN! . . . Here's the new, remarkably efficient oscillating Sander and Polisher attachment for Black & Decker Home Utility 1/4" Electric Drill.

Now, in a fraction of the time, and with far less "elbow grease", the DU-FAST SANDER AND POLISHER* gives you certain, superior finishes every time . . . plus a definite saving in time and money!

- ATTACHED AND DETACHED IN A JIFFY
- WEIGHS ONLY 5 LBS. (with drill) — ELIMINATES FATIGUE
- EASY TO USE IN CORNERS, ON OPEN STOCK, AND ON CURVED SURFACES

If you use a B & D Home Utility 1/4" drill . . . you'll want the Du-Fast Oscillating Sander and Polisher attachment. In any case, don't fail to see it and try it at any hardware dealer who carries B & D Home Utility Tools.

*PAT. APPLIED FOR

MANUFACTURED BY **DU-FAST, Inc.**
32 EAST FOURTH STREET, NEW YORK 3, N. Y.

Available only at hardware dealers carrying Black & Decker Home Utility Tools. Stop at one today!

NO SQUINTING OR GUESSING With This Steel Tape!



The sharp contrast of the jet black numerals on the white crack-proof protective coating on the Brite-Blade makes it easy to read a measurement even in poorly lighted places. This porcelain-like finish is impervious to acids, oils and dampness. The rugged case is chrome plated and its design and "feel" makes it a favorite among men who want and demand only the finest in tools. 6 or 8 foot lengths. Blades replaceable. See your hardware dealer or use coupon.

MASTER

REG. U.S. PAT. OFF.

WOOD AND STEEL TAPE RULES

MASTER RULE MFG. CO., INC.
201 Main Street, White Plains, New York

P.M.-2

Please send me

- 306W— 6 ft. Brite-Blade—\$1.75
- 308W— 8 ft. Brite-Blade—\$1.90
- 310W—10 ft. Brite-Blade—\$2.25

My check (or Money Order) is enclosed.

NAME _____
ADDRESS _____
CITY _____ STATE _____

STOP CHANGING MOTOR OIL!



End this needless waste and expense forever with

RECLAIMO Today's Most Advanced OIL RE-REFINING Filter

Continuously cleans and RE-REFINES motor oil as you drive (by utilizing motor heat)—keeps oil in high grade lubricating quality at all times—reduces motor wear to a minimum! Proves conclusively that "Oil Does Not Wear Out Mechanically" as stated by U. S. Bureau of Standards, (Bulletin 86).

"RECLAIMO"

- REMOVES SOLIDS (by filtration)
- REMOVES WATER (by distillation)
- PREVENTS Excess Fuel Dilution
- PREVENTS Acid and Sludge Formation

MAINTAINS Stable Viscosity ELIMINATES All Oil Changes
CAR • TRUCK • TRACTOR OWNERS!

You'll want to know more about Reclamo's Oil, Motor and Money-Saving Features. FREE 40-PAGE BOOK "OIL FACTS" gives you the complete "Reclamo" story plus details about our New 90-Day No Risk-No Cost TRIAL OFFER! WRITE for YOUR COPY TODAY!

NEW ADDED FEATURE!
Gas - Moisture Vapor Injector
Increases Mileage with Smoother Performance



RECLAIMO MFG. CO.

5083 ELSTON AVE., Dept. 88, CHICAGO 30, ILL.

This Machine Should Cost \$69.95

5 POWER TOOLS in ONE

Drill press pulls 1/2" drill in steel; saw takes 8" blade; lathe 10" swing, 30" centers; sander 3"; emery wheel 5". Handles big, heavy work—tools easily interchangeable—uses 1/4 to 1/2 H.P. motor. Factory-to-you price only \$39.95 complete. Send \$18.00 (balance COD) on 10-day FREE trial, money-back guarantee, or write today for FREE catalog.



HOME WORKSHOP

See it - Use it!

FREE TRIAL-10 DAYS

EMRICK, INC., 1732 Clinton, Kalamazoo, Michigan

MAKE MONEY MAKING DOUGHNUTS

Make new greaseless doughnuts at home on electric machine. Sell for cash to grocers, cafes, drug stores, etc. No exp. nec. Good profits. Small investment. Send for free recipes and plans.

MART RAY CO. • 3605 S. 15 Ave. • Minneapolis 7, Minn.

PLYWOOD BOAT KITS \$54.00

(Including Freight)



This READY-CUT 12

ft. fishing boat can be assembled in 8 hrs. without forms or special tools. Kits are complete including all hardware, paint, and etc. Send for free folder.

TAFT MARINE WOODCRAFT

Dept. K 636 39th Ave. N.E.

Minneapolis 21, Minn.

One Year Written Guarantee! ARMY AIR CORPS 16 JEWEL

ELGIN \$19⁹⁵



Made for Pilots and Navigators of the U. S. Army Air Forces. They had to be good. Sturdy 16 Jewel Elgin men's wrist watches. Shock resistant. Sweep second hand. Luminous hands and dial. Stainless steel back. Unbreakable crystal. Water repellent. Made by ELGIN one of America's outstanding watch manufacturers. Fully reconditioned. One year written guarantee sent with each watch. Supply limited! SEND NO MONEY. Simply pay postman \$19.95 plus 10% tax and postage on delivery. Cash orders sent postpaid. UNITED PRODUCTS CO., 7941 S. Halsted, Dept. RES-1409, Chicago 20.

Troubled with DEAFNESS?

— then you'll be thrilled with the new revolutionary Zenith "75" Radionic Hearing Aid.† You can order it by mail without risking a penny. Let a 10-Day Trial* at home, at church, at business prove it's the finest hearing aid you can buy regardless of price. Saves you over \$100.00.

HEAR BETTER OR PAY NOTHING

Light, compact single unit. Costs less than a cent an hour for battery consumption. Comes ready to wear. Accepted by the Council on Physical Medicine, American Medical Association. Send postcard now (no obligation) for full particulars telling how tens of thousands of hard-of-hearing men, women and children have found new joy and happiness with this amazing new hearing aid.

*This Trial offer available on direct sales by Zenith Radio Corporation or its subsidiaries.

Makers of the World-Famous Zenith Radios. Leaders in Radionics Exclusively for Over 30 Years.



Look only to your doctor for advice on your ears and hearing



ZENITH
RADIO CORPORATION
HEARING AID DIVISION

Dept. PM29, 5801 W. Dickens Avenue
Chicago 39, Illinois †®

IT'S NEW! THE REVOLUTIONARY BOICE-CRANE FRICTION-MATIC WET TOOL GRINDER



\$16⁵⁰

F.O.B. Factory

Simplified Self-Adjusting Friction Roll Drive. No countershaft or extra belt • Peripheral Speed Remains Constant As Wheel Wears. Exclusive feature • No Water Thrown On Operator. Has "controlled-water action" • Permits Proper Pressure Control. Operator takes a comfortable standing position and works on top of the wheel • Larger Tool Rest (2½" x 5"). Perfect for long, slim knives, wide tools • Accurate Controls For Grinding Angles From Zero To 30°. First tool rest with adequate adjustment • 8" Diameter and 1½" Face Sandstone Wheel. 135 r.p.m. increasing as wheel wears to maintain peripheral speed of approximately 280 feet per minute • Gray Enamelled Steel Case. 16 gauge. Weight 14 lbs. net; 17 lbs. packed.

Order Today from Power Tool Dealers Everywhere.

BOICE-CRANE COMPANY • 943 CENTRAL AVENUE • TOLEDO 6, OHIO

THICKNESS PLANERS • SPINDLE SHAPERS • SAW-JOINTERS • LATHES • TILTING-ARBOR
SAWS • BELT SANDERS • SPINDLE SANDERS • BAND SAWS • JIG SAWS • DRILL PRESSES

SURPLUS BRAND NEW AIR COMPRESSORS

for Garage - Shop - Factory - Farm or Home
Height 9" - Weight 7½ lbs. Uses ½ HP Motor

A sturdy, well built air compressor of steel and die cast metal constructed to give satisfactory and lasting service. 20-30 lbs. continuous pressure. Higher pressure for intermittent service. Formerly sold for \$14.50. (Spray gun and hose also available, write for prices.)

COMPRESSOR CORPORATION OF AMERICA
St. Joseph, Mich.

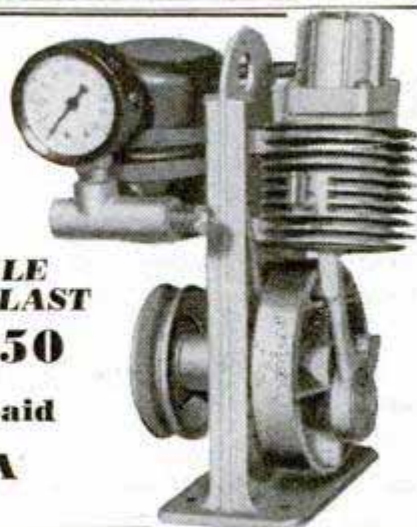

WHILE
THEY LAST
\$8⁵⁰
Prepaid

M-SCOPE TREASURE-MINERAL LOCATORS

WRITE FOR FREE, ILLUSTRATED 16-PAGE BOOKLET

M-SCOPE TREASURE-MINERAL LOCATORS. Low priced, unsurpassed efficiency, lightweight models. Factory guaranteed. Immediate shipment. Credit plan available. Write for free 16-page booklet.

GEIGER COUNTERS for finding Uranium ores. Several models, Simple operation. Low priced. Immediate shipment. Interesting free literature.



URANIUM

FISHER RESEARCH LAB., INC., PALO ALTO, CALIF.

GOLD

PRESSURE QUEEN

Outperforms them all!

THE only portable air compressor having 4 cylinders in space usually required for one—absolutely no pulsation. Does more painting in an hour than hand brushing in a day. Lubricates machinery, inflates tires. Ideal for home,

farm, service station, machine shop and contracting painter. Powered by gas engine or electric motor.

Write for Literature and Prices

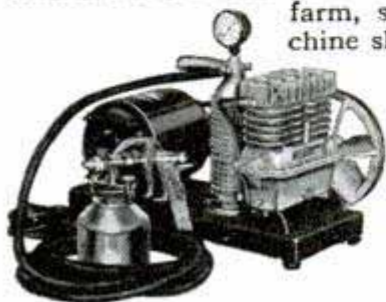

THE CAMPBELL-HAUSFELD CO.

1046 RAILROAD AVENUE HARRISON, OHIO



*best known
name in power-lawn-mowers
for thirty years*

"MOTO-MOWER"

Why push a hand mower when you can drive a "Moto-Mower" . . . builders of quality power mowers for thirty years . . . write for literature and the name of the nearest dealer . . . a MOTO-MOWER is worth insisting upon.

The . . . sizes 20" to 71".
MOTO-MOWER
4615 Woodward, DETROIT 1
. . . since 1919 *Company*

CIGARETTES

ALL POPULAR BRANDS - LUCKIES - CAMELS - CHESTERFIELDS
OLD GOLD - PHILLIP MORRIS - RALEIGHS. AS LOW AS

\$1.52 Per Carton

ORDERS SHIPPED IMMEDIATELY — FRESH STOCK DAILY

WE PAY PARCEL POST

50 Cartons — \$1.52 Each \$76.00
25 Cartons — \$1.53 Each \$38.25
10 Cartons — \$1.57 Each \$15.70

5 Cartons — \$1.59 Each \$7.95

MINIMUM ORDER

GUM All Brands — 20 Pkgs. 85c with cigarette order. Send check or money order.

Have your friends and fellow Employees join you in placing a large order at

DIRECT SALES 921 W. 17th St. Kansas City, Mo. **\$1.52 Per Carton**

CARBURETOR TOO RICH MAKES MOTORIST TOO POOR



Car owners who are wasting money and not getting proper gas mileage due to over-rich mixtures will be pleased to learn how to save gasoline by VACU-MATIC over-rich mixtures. VACU-MATIC fits all cars, trucks and tractors. It is automatic and operates on the supercharge principle. Easily installed in a few minutes.

SALESMEN WANTED! Big Profits! Send name, address on penny postcard for free particulars and how to get yours for introducing.

VACU-MATIC CO., 7617-1467 W. State St., WAUWATOSA, WIS.



TYPEWRITERS!

For Sale At Big Savings

ALL MAKES — REBUILT LIKE NEW

For School, Business or Home Use

Write for Information

M. & M. TYPEWRITER CO.
84 W. Washington St. Chicago, Ill.

Save Your Feet



Thousands relieved from pain walk freely with **HEEFNER ARCH SUPPORTS**

Write for Free Booklet

"FOOT FACTS"

HEEFNER ARCH SUPPORT CO., 670 Logan Bldg., Salem, Virginia

MAGNETS OF ALL TYPES—10c UP
AMAZINGLY POWERFUL!!
4 oz. Alnico Magnet, lifts 10 lbs.
\$1.00. Our Leader, 15 oz. Magnet,
lifts 40 lbs. \$2.50. New alloy—will not
weaken! Useful for lifting valuables from tanks,
lakes, or rivers easily! 7 small magnets \$1.00 with
list of many shop and home uses. Satisfaction guaranteed.
R. EYRICH, 2566 N. 49TH ST., MILWAUKEE 10, WIS.

STEADY PROFITS



**YOUR OWN
BUSINESS WITH
CORADIO**

The Coin Operated Radio

Place these specially built radios that play 1 or 2 hours for 25c in the thousands of available hotel rooms, tourists courts, etc. They yield immediate profits and steady income. Install Coradio, the finest made. Limited capital required. Send for further information. Write today.

CORADIO Coin Operated Radio
DEPT. C

212 Broadway, Phone: BEekman 3-0038-9
NEW YORK 7, N. Y.

Q.D. WOOL SHIRTS
13 to 15
269

PANTS
28 to 34
295

Perfect condition, designed for reissue. All have been cleaned and pressed by the Q. M. Corps. 100% all wool serge. Priced less than the cheapest work clothes. Add 12c postage per garment.

BRAND NEW KHAKI SHIRTS-PANTS
14 to 17
299

28 to 42
379

NEW. Neatly tailored of B-2 chino khaki suntan material. Shirts have 2 button-down flap pockets, pants have cuffs. Add 10c postage per garment.

GEN. NYLON 50 FT
59c

PARACHUTE CORD

NEW. Ideal for clotheslines, drapery and venetian blind cords. 550 lbs. tensile strength. 3/16" diameter. Add 7c postage.

50% WOOL HOSE
39c

NEW. Medium weight, rugged and warm. Post 3c.

CUSHION SOLES
49c

NEW. 63% wool, double sole. These are known as the desert sox. Khaki and white. Add 4c postage per pr.

NAVY T-SHIRTS
WHITE
69c

NEW. Combed yarn, full cut. Small, medium, and large. 5c postage.

WAR SURPLUS
AND OTHER
BARGAINS
ORDER FROM THIS AD PLEASE

MAIL ORDERS

Please send remittance with order. Include postage. Guaranteed satisfaction. You are privileged to return an unsatisfactory purchase for refund.

WATCH CAPS
77c

NEW. Navy watch caps. Color, blue. 100% pure wool knit. Please add 5c postage each.

all wool WRISTLETS
13c 8 PAIR \$1.00

NEW. 100% O.D. wool knit. Ideal for glove and mitt inserts, wristlet replacements, etc. Worth 75c per pair. Add 3c postage per pair.

1399

B-15 style FLIGHT JACKET

NEW. Renders greatest warmth per oz. of weight. Mountain cloth outside, pile lined body and sleeves. Genuine mouton collar. 4 pockets—2 outside, 2 inside. Wool knit cuffs and waistband. Add 27c postage.

AVIATOR'S A-6 STYLE FLIGHT BOOTS

NEW. 10" high—leather top, rubber bottom—baby sheep lining, add 27c post.

1099

USED FLIGHT BOOTS

Like above—used almost like new—27c post.

695

SLEEPING BAGS DOWN & FEATHER

Down & Feather filled—water repellent—poplin shell—complete with carrying case—NEW—add 40c post.

1595

SIZZLING SPECIALS

ARMY STYLE 688 COMBAT BOOTS

NEW. For sportsmen and outdoor wear. 10" high. Reversed uppers, full oak leather sole, with composition outer sole. Add 27c post.

6 TO 12

WAR SURPLUS CIRCULAR

SEND FOR FREE

Over 150 War Surplus bargains, also other items.

SIoux FALLS SURPLUS STORE

113 NO. PHILLIPS SIOUX FALLS, S. DAK.

DUST MASKS
33c

NEW. \$1.50 value. Ideal for millers, farmers, paint and insecticide spraying. Add 6c postage for each.

NAVY STYLE FIELD SHOES
499

NEW. Rugged, comfortable. Reversed uppers, full oak leather inner sole, extra composition outer sole. Add 22c post.

6 TO 12

O.D. WOOL SERGE O'SEA CAPS
66c

OFFICER STYLE OXFORDS
695

NEW. Finest quality uppers, best quality oak bend leather outer sole. Half leather lined. Add 20c post.

*BROWN *BLACK

PORTER MUFFLERS INCREASE SPEED POWER MILEAGE

REDUCES BACK PRESSURE UP TO 50%

TWIN SETS FOR FORD AND MERCURY STATION WAGON STACKS

DUAL-TONE & MELLOW-TONE

Twin exhaust for pep and power. Sets complete include 2 scoop design, thru type mufflers with left side head and tail pipes and all brackets.

Easy installed—No cutting or welding.

Ford and Mercury 1935 to 1948 complete **\$17.50**

Finest mufflers made. Heavy 16 gauge steel casing, shredded steel packed. Cannot blow out or burn out. Lifetime Guarantee.

Complete sets, 1935 to 1948—**\$23.00**
1949 Ford & Merc.—**\$25.00**

Illustrated catalog with diagrams—25c

Heavy chrome finish... Specify year and model, also RIGHT or LEFT... Ford and Mercury, '42 thru '48, with brackets—**\$14.95** each

Porter Mufflers for all cars. "Steel Pack"—Lifetime Guarantee. Free Folders and Price List... All prices quoted F.O.B. Hollywood, California.

PORTER MUFFLER CO., INC.
5401 Sunset Blvd., Hollywood 27, Calif.

Save BUILD YOUR OWN BOAT



BIG SAVINGS AWAIT THE HOME BUILDER THRU MARINE MART'S MAIL ORDER SERVICE

World Famous "PACKAGED BOAT" Kits

18 models—outstanding design—8-18 ft.—dinghies to runabouts—inboard—outboard—sail. \$34.50 up. Finest kits available. Easy home assembly. All parts pre-cut, frames pre-assembled. Send 25c (coin) for "Packaged Boat" literature or, send \$1.00 for literature plus booklet, "Plywood Boats."

BOAT PLANS—PATTERNS—100 DESIGNS

100 modern designs by Deed, Lord, Crandall, etc. Planked, steel, plywood—all types—6 to 35 ft. Detailed blueprints, full size paper patterns available.

Send 25c (coin) for Catalog, or send \$1.00 for Catalog plus booklet, "Boat Building."

MARINE PLYWOOD

Plywood: Fir, hardwood. Lumber: Oak, spruce, cedar, etc. Send 35c (coin) for stock list and booklet, "Plywood Hints."

MARINE HARDWARE

Complete stock of fittings, accessories. 15,000 items. Prompt delivery. Send \$1.00 for 250-page, illustrated catalog.

CONVERSIONS

Vee- and Stern-drives; reduction and reverse gears; kits, engines, accessories. Catalog 35c (coin). With booklet, "Conversion Hints," \$1.00.

MARINE MART-DEPT. 24-BUFFALO 7, N. Y.

BUY! THE GENERAL

FOR YOUR SPECIALS

Make 'em Yourself - Concrete Blocks



**AMAZING GENERAL
SPECIALTY
BLOCK MACHINE**
CAPACITY 1000 BLOCKS PER DAY
Only \$199 LESS MOTOR
F.O.B. PLANT
SHIPPING WEIGHT 400 lbs.

SPECIALTY BLOCK IN BIG DEMAND. SELL ALL YOU PRODUCE TO BUILDING SUPPLY YARDS, CONTRACTORS AND OTHER BLOCK PLANTS AT 25¢ TO 50¢ each - 100% MORE PROFITS.

General Block Machine with wonderful new split type expansion Mold Box makes it easy to produce different design blocks. Changes to any width block from 4" to 16" in less than 20 minutes. A real money saver. The General more than pays for itself by saving your labor costs and lost production in the time it takes to make three changeovers on your regular machine. Machine ruggedly constructed. Vibrator Shaft mounted in sealed ballbearings, produces up to 1000 8x8x16 blocks per 8-hr. day. Superior Three Core Type meeting all building Code requirements. Full Operating Instructions and Mixing Formula's with each machine. Immediate Delivery. Full Details sent Free without obligation.

Wonderful book written and illustrated by our staff of experts.

HOW TO BUILD YOUR OWN CONCRETE BLOCK HOME
Only \$1 Prepaid

Shows you 8 ways to save money and how to make and lay blocks, laying out building lines, mixing your own concrete, building steps, porches and concrete floors, includes floor plans for 6 beautiful easy to construct concrete block bungalows. Mail 'at once with \$1.



It's a Cesspool & Silo Block Mch.



It's a Chimney Block Machine.



It's a Partition Block Machine.



It's a Bull Nose Block Machine.



It's a Foundation Block Machine.

Also Makes Regular 8, 10, 12, 14, 16, 18, 20, 22, 24, 26, 28, 30, 32, 34, 36, 38, 40, 42, 44, 46, 48, 50, 52, 54, 56, 58, 60, 62, 64, 66, 68, 70, 72, 74, 76, 78, 80, 82, 84, 86, 88, 90, 92, 94, 96, 98, 100, 102, 104, 106, 108, 110, 112, 114, 116, 118, 120, 122, 124, 126, 128, 130, 132, 134, 136, 138, 140, 142, 144, 146, 148, 150, 152, 154, 156, 158, 160, 162, 164, 166, 168, 170, 172, 174, 176, 178, 180, 182, 184, 186, 188, 190, 192, 194, 196, 198, 200, 202, 204, 206, 208, 210, 212, 214, 216, 218, 220, 222, 224, 226, 228, 230, 232, 234, 236, 238, 240, 242, 244, 246, 248, 250, 252, 254, 256, 258, 260, 262, 264, 266, 268, 270, 272, 274, 276, 278, 280, 282, 284, 286, 288, 290, 292, 294, 296, 298, 300, 302, 304, 306, 308, 310, 312, 314, 316, 318, 320, 322, 324, 326, 328, 330, 332, 334, 336, 338, 340, 342, 344, 346, 348, 350, 352, 354, 356, 358, 360, 362, 364, 366, 368, 370, 372, 374, 376, 378, 380, 382, 384, 386, 388, 390, 392, 394, 396, 398, 400, 402, 404, 406, 408, 410, 412, 414, 416, 418, 420, 422, 424, 426, 428, 430, 432, 434, 436, 438, 440, 442, 444, 446, 448, 450, 452, 454, 456, 458, 460, 462, 464, 466, 468, 470, 472, 474, 476, 478, 480, 482, 484, 486, 488, 490, 492, 494, 496, 498, 500, 502, 504, 506, 508, 510, 512, 514, 516, 518, 520, 522, 524, 526, 528, 530, 532, 534, 536, 538, 540, 542, 544, 546, 548, 550, 552, 554, 556, 558, 560, 562, 564, 566, 568, 570, 572, 574, 576, 578, 580, 582, 584, 586, 588, 590, 592, 594, 596, 598, 600, 602, 604, 606, 608, 610, 612, 614, 616, 618, 620, 622, 624, 626, 628, 630, 632, 634, 636, 638, 640, 642, 644, 646, 648, 650, 652, 654, 656, 658, 660, 662, 664, 666, 668, 670, 672, 674, 676, 678, 680, 682, 684, 686, 688, 690, 692, 694, 696, 698, 700, 702, 704, 706, 708, 710, 712, 714, 716, 718, 720, 722, 724, 726, 728, 730, 732, 734, 736, 738, 740, 742, 744, 746, 748, 750, 752, 754, 756, 758, 760, 762, 764, 766, 768, 770, 772, 774, 776, 778, 780, 782, 784, 786, 788, 790, 792, 794, 796, 798, 800, 802, 804, 806, 808, 810, 812, 814, 816, 818, 820, 822, 824, 826, 828, 830, 832, 834, 836, 838, 840, 842, 844, 846, 848, 850, 852, 854, 856, 858, 860, 862, 864, 866, 868, 870, 872, 874, 876, 878, 880, 882, 884, 886, 888, 890, 892, 894, 896, 898, 900, 902, 904, 906, 908, 910, 912, 914, 916, 918, 920, 922, 924, 926, 928, 930, 932, 934, 936, 938, 940, 942, 944, 946, 948, 950, 952, 954, 956, 958, 960, 962, 964, 966, 968, 970, 972, 974, 976, 978, 980, 982, 984, 986, 988, 990, 992, 994, 996, 998, 1000.

GENERAL ENGINES CO.
(EASTERN DIVISION) DEPT. M - DREXEL BLDG., PHILA. 6, PA.

SAY YOU SAW IT IN POPULAR MECHANICS

FIRE...YOUR OWN MODEL ROCKET

There's a new thrill coming as you send a real rocket soaring up high into the sky... And you can fire them over and over again, having fun or experimenting seriously. Using actual jet principles, this rocket will help you to learn the secrets behind inter-planetary flights.



Rocket being fired at Wendover Field, Utah.

SOARS OVER 200 FEET IN THE AIR

V-2 ROCKET

For only \$2.95 your rocket comes equipped ready to fly with special launching stand and full instructions on how to make your rocket zoom over 200 feet into the sky.

When payment is sent with order, we pay postage. Or send no money and pay postman \$2.95 plus mailing costs. Write Dept. M-2.

\$2.95

WALSH PRODUCTS, INC.
209 N. MAPLE AVENUE, EAST ORANGE, N. J.

PRINT YOUR OWN POST CARDS

COMPLETE OUTFIT
only \$7.50



Amazing results in sales, inquiries and contacts... saves time and money... very easy to use GEM STENCIL DUPLICATOR is ideal for Advertising, Announcements, Notices, Labels, Forms, Price Lists—hundreds of uses for every type of business and organization. Comes complete with all supplies, instructions and 60-page Book of Ideas.

FREE TRIAL OFFER: Try it before you buy it! Write and a GEM OUTFIT will be sent you postpaid. After 10 days, send only \$7.50 or return the GEM, no questions asked. The GEM must sell itself; you be the judge.

BOND EQUIPMENT CO. • Dept. 135
6633 Enright • St. Louis 5, Mo.

SEND NO MONEY • FREE TRIAL OFFER

SUIT YOURS AS A BONUS



AND BIG MONEY IN SPARE TIME, TOO

We want you to wear this fine made-to-measure suit! Make it yours by sending a few orders, & earn BIG CASH PROFITS in spare time. Your suit will help you get more orders with scores of rich, quality fabrics, tailored-to-measure to newest styles. Also Ladies' Tailored Suits—complete line. Write today for FREE SAMPLES. NO EXPERIENCE, no money needed. For quick action tell us about yourself.

J. C. FIELD & SON, INC.

Harrison and Throop Sts., Dept. P-1716, Chicago 7, Ill.

SPECIAL OFFER!

LOCK-STITCH SEWING AWL

\$1.
Postpaid

Famous, patented lock-stitch sewing awl complete with needles, waxed thread and direction folder. Hundred uses — sewing, repairing leather goods, canvas, belting, harness, saddles, gun cases, awnings, golf bags. Extra needles and thread available. Satisfaction guaranteed or money back. Send currency, check or money order. Yates Mfg. Co., 611-H Main St., Lake Geneva, Wisconsin

NEW BAND SAW RIPPING FENCE



Fits all band and jig saw tables from 7" to 15". 10-day money-back guarantee. Send name and address for C.O.D. or send \$1.98 now, and we ship prepaid.

Only \$1.98

Dealers order direct.

WASCO MFG. CO., Box 111, Blue Island, Ill.

WHAM-O SPORTSMAN

Powerful - New - Accurate
Kills rabbits, squirrels, etc.

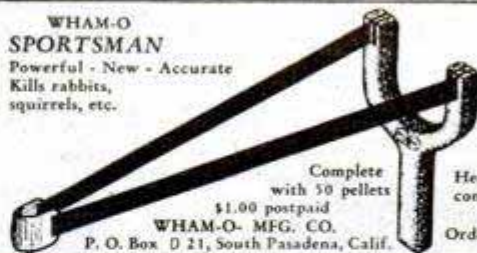

Complete with 50 pellets
\$1.00 postpaid

WHAM-O MFG. CO.

P. O. Box 0 21, South Pasadena, Calif.

Heavy duty construction

Order several

RUPTURED?

Get Relief This Proven Way

Why try to worry along with trusses that gouge your flesh—press heavily on hips and spine—enlarge opening—fail to hold rupture? You need the Cluthe. No leg-straps or cutting belts. Automatic adjustable pad holds at real opening—follows every body movement with instant increased support in case of strain. Cannot slip whether at work or play. Light. Waterproof. Can be worn in bath. Send for amazing FREE book, "Advice To Ruptured," and details of liberal truthful 60-day trial offer. Also endorsements from grateful users in your neighborhood. Write:

CLUTHE SONS, Dept. 31, Bloomfield, New Jersey

GET THIS AMAZING

ELECTRIC TOY AUTO

NO WINDING
RUNS FOR HOURS

A
Collectors
Item!



A scale-model car that will bring exciting joy to any child (and grown-ups, too). It is packed with fun and instructive play—Just put it in gear and away it goes—in low, second, high—touch it and it goes in reverse.—Driven by the exclusive VIBRO-ROLL MOTOR powered with two flashlight batteries easily replaced after many hours of running—Safe, economical. Over 10" long, broad, low and handsome—Realistic plastic headlights, balloon-type rubber tires—Comes completely assembled in shiny durable plastic—Lasts indefinitely. SEND YOUR ORDER TODAY!

\$2.98 Complete—Postage Paid—C.O.D. you pay postage

Only
\$2.98

ALL ELECTRIC PRODUCTS CO.

172-G Northfield Ave. Pittsburgh 4, Pa.

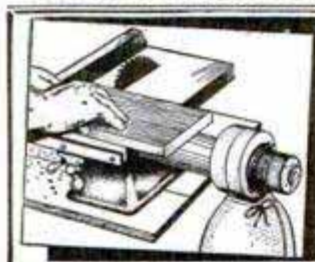

DUST-O-VAC THE DUST & CHIP COLLECTOR

FOR HOME WORKSHOPS & INDUSTRY

DUST-O-VAC actually collects and bags wood and plastic chips, wood and metal dust, and wood shavings. Bag Supplied Free. DUST-O-VAC attaches to any circular saw, planer, band saw, grinder, belt or disc sander, shaper, drill press with shaper or sander attachment, spindle shaper, wood lathe or jig saw. COMPLETE MOUNTING INSTRUCTIONS INCLUDED. DUST-O-VAC has solid cast alum. housing. Cont. duty motor. 110V., A.C., D.C. WRITE FOR FREE LIT.

UNIVERSAL YONKERS CORP. 137 Alexander St., M-2
Yonkers 2, New York

\$19.95

Free shipping east of Miss., add \$1. Send check, money order.



BASS IS BEST
WEEJUNS
LEISURE
COMFORT



BASS IS BEST
QUAIL
HUNTERS
FIELD and STREAM



BASS IS BEST
SKI BOOTS
EXTRA
CONTROL



BASS IS BEST
SPORTCASINS
GOOD GOLF STRATEGY



G. H. BASS & CO.
60 MAIN STREET
WILTON, MAINE

MAKE ANY CUT WITH THESE NEW WOODSHAPERS for YOUR CIRCLE SAW or DRILL PRESS!

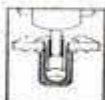

MODEL #60—Originally designed for heavy industrial use, now priced for home workshop. Can be attached directly in chuck of your drill press. Exclusive pilot bearing (see illustration) eliminates side thrust, chatter and vibration—assures smooth cutting action. Blades can't come out—set screws hold them securely. Complete, with YOUR CHOICE OF ANY 6 PAIR DOUBLE-GROUND BLADES SHOWN BELOW, only \$12.95.

MODEL #50—Same as Model #60 but without exclusive pilot bearing. Designed for intermittent shaping; over 100 different shapes can be cut. Complete, with ANY 6 BLADES OF YOUR CHOICE SHOWN BELOW, only \$8.95. All Aladdin tools are guaranteed. Postage prepaid with all cash orders. C. O. D. plus postage. GET YOUR ORDER IN TODAY.

ALADDIN MFG. CO., INC.

3121 Main Street

Kansas City, Missouri

Dealers Write Today



MODEL SA-10—Heavy-duty, industrial-type shaper of solid steel, now priced in home workshop range. Absolutely safe—blades locked in position with screws all the way through. In ordering, state diameter of shaft. Complete WITH ANY 6 PAIR OF READY-GROUND BLADES SHOWN BELOW, only \$14.95.

For Your Circle Saw

ALADDIN WOODSHAPING BLADES

Specify by number the blades you want. Additional blades \$1.50 each, \$3.00 per set.

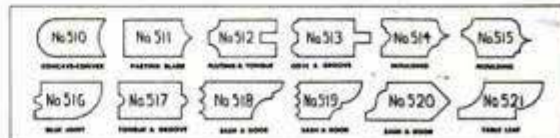



For Loose Caster Guides

Remove the guide, fill the hole with a putty-like mixture of Smooth-On No. 1 Iron Cement and drive the guide back in. It will stay in place, because Smooth-On, in hardening, expands slightly and takes hold tight. Use Smooth-On for tightening other loose parts and also for stopping leaks in boilers, furnaces, piping, radiators, etc. Buy Smooth-On No. 1 in 1 3/4-oz. or larger sizes at your hardware store. If they haven't it, write us.

FREE Repair Handbook

Shows how to save time and money, making many household repairs. 40 pages. 170 pictures. Clear directions. Send today.

50-313

SMOOTH-ON MFG. CO., Dept. 37B
570 Communipaw Ave., Jersey City 4, N.J.

Do it with

SMOOTH-ON

THE IRON CEMENT OF 1000 USES



"ADVANCE SEASON" OFFER

Make Ur Own POWER
LAWN MOWER

Just add Engine or Motor

- Lightweight "easy to operate."
- Cast aluminum base with 18" Rotary Blade (Hardened Steel).
- Ball-bearing rubber tired wheels.

Now is the time to install your own gasoline or electric motor on a well built new aluminum chassis. Will accommodate up to 2 1/2 hp engines or 1/2 hp motor.

- WE can also furnish gasoline and electric power mowers at big savings. Inquiries invited.

Send check or M.O. No COD's.

ATLAS EQUIPMENT CO.

229 S.W. Blvd.

Kansas City, Mo.



Plastic Coasters
and Tiles

EMBED REAL FLOWERS in NEW Magic PLASTIC



Now, create many unusual things like the distinctive pansy coaster shown—made by embedding real pansies in Castolite—the "magic" liquid plastic that "pours cold like honey... sets at room temperature like glass." Comes crystal-clear or may be dyed for brilliant color effects. Embed other flowers, too, also coins, medals, stamps, butterflies. Cast gorgeous bookends, art objects, figurines for gifts or to sell. New pleasure, fine profits are possible. No special artistic ability required.



EMBED YOUR PHOTOS

Preserve your treasured photos in Castolite. Make beautiful medallions like the one shown, unusual photo-lampshades, lamp bases, distinctive paperweights with embedded photos. Sell your photos in unique plastic mounts. Use only home utensils. Follow simple step-by-step method. Send 25c today for exciting new Instruction Manual, packed with pictures showing how to get started. Write today!

MANUAL
25c

The Castolite Co., Dept. B-1
Box 391, Woodstock, Ill.

NONE
BETTER!

SUPER DRILL GRINDER



Sharpens round shank drills from 3/32" to 1/2" in diameter, up to 6" long. Grinds old drills like new in 4 different point angles, using hand or power grinding wheels. Money-back guarantee.

Price only \$2.95

At Dealers or Postpaid

CRANDALL MFG. CO. 1512 W. Slauson, Dept. FA-38, Los Angeles 44, Calif.



BUILD FINE GRANDFATHER CLOCK NOW

The simple sensible Red-i-Kut way as thousands have—SAVE HALF. SHOP TESTED PLANS "SPIRIT OF THE CENTURY" Narrow waist 83" tall or stately "SPIRIT OF AMERICA" straight side model with pictures. EASY-TO-FOLLOW PLANS tell all—plus BROCHURE of fine brass weight Westminster, tube chime, movements, dials and mahogany case kits. Send \$1.00 today—Both Plans \$1.50 NOW.

KUEMPEL CHIME CLOCK CO., #2 Kuempel Bldg., Minneapolis 16, Minn.

MILITARY TRUCK PARTS



Every part for every G.I. type vehicle from jeep to 20-ton prime mover 6x6 40% to 80% below list.

NORTHWESTERN AUTO PARTS CO.

834 NORTH SEVENTH ST. • MINNEAPOLIS 11, MINN.

Paint It With Rayon

Revolutionary. For business or pleasure. Write for information
DONJER PRODUCTS CO., 1115 Sterling Place
Brooklyn 13-D, New York



WAR SURPLUS BARGAINS

\$500,000.00 INVENTORY
for QUICK LIQUIDATION

Surplus items—hundreds of them for home, shop, factory, farm and outdoor use. New items, used items, reconditioned items—all at tremendous savings—all priced for quick sale.

Page After Page of Values

This big catalog shows page after page of amazing money saving values. Write for your copy today. Send 10c to cover postage, mailing, etc. Write today!

SEND
TODAY
FOR YOUR
COPY

10c

STARK'S Dept. PM2 509 So. STATE STREET
CHICAGO 5, ILLINOIS

STOPS LEAKS PERMANENTLY

Cut your fixture replacement, water and fuel bills with Economy Renewable Seats. Make economical, permanent repairs quickly and easily with the Junior Kit (illus.). Repair bathroom, kitchen and laundry fixtures. Everything you need included in steel box. This is a natural for the "Fixit" shops—get extra income from making permanent repairs on your customers' faucets.

Senior Master Kit also available—repairs faucets and valves up to 1" pipe. Write for illustrated circular and prices.

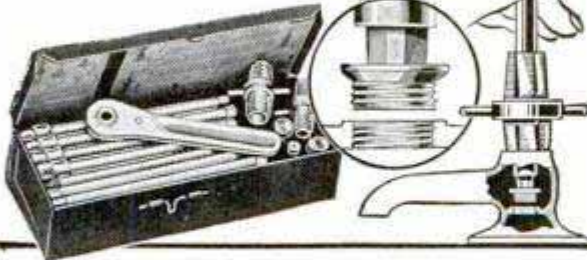

ECONOMY VALVE SEAT CO.

3122 N. California Ave. Chicago 18, Ill.

for AMAZING acceleration

DIXIE-WESTERN
DUAL INTAKE MANIFOLDS for V-8 FORDS AND MERCURYS

\$1500 Gas Line and Throttle Kit \$2.50 extra
Chrome Plated Velocity Stocks — \$1.50 ea.

By Test: Increased Acceleration by 26%
Increased Power and Speed by 11%

All DIXIE-WESTERN manifolds are brightly polished cast aluminum.

DIXIE-WESTERN MANIFOLD CO.
Box 364 • Los Angeles 43, California

Dealers Wanted

SCREWS-NUTS-WASHERS-BOLTS

Big savings in all types screws, nuts, washers, bolts, etc. This is not a miscellaneous kit but a complete service. We sell you what you want in quantities as low as one dozen. Send 25c in coin for catalogue which will be applied toward initial purchase.

METAL PRODUCTS SALES CO. 70 1/2 Stone Street Newark 4, N. J.

PRINT ANY PHOTO
ON PAPER, CLOTH, LEATHER OR WOOD

SIMPLE. INEXPENSIVE.
Send stamp for particulars.

TIFFANY'S, 2128 Montrose JC, Chicago 18, Ill.

ORIGINALLY \$30 to \$55

MENS FULLY GUARANTEED NEW 15-JEWEL WRIST WATCH \$13.95 PLUS TAX

Sacrificed because they're post-war surplus

MOISTURE PROOF—HEAVY DUTY

Luminous dial . . . sweep second hand . . . Super-accurate . . . imported Swiss precision movement and case. You get them now for a small fraction of original prices. Don't delay! Order now . . . while they last. Send only \$1 down payment with order. Pay balance to postman on arrival, plus postage. Or we pay postage if you enclose \$13.95 plus \$1.39 Fed. Tax. Handsome expansion band included with prepaid order. Money back in 5 days if not delighted. Order now.

MARYLAND DISTRIBUTORS, Dept. 274
501 E. Baltimore St. Baltimore 2, Md.

Get This VALUABLE BOOK of SHOP TRICKS!

Thousands sold at 15c... now it's yours for the cost of handling and mailing!

19 UNUSUAL USES
FOR YOUR **DRILL PRESS OR LATHE**

CONTAINS 19 EXTRA USES FOR YOUR LATHE AND DRILL PRESS . . . SHOP KINKS TO HELP YOU GET MORE AND BETTER WORK FROM THESE VERSATILE TOOLS

Just Mail Coupon and 10¢ . . .

Booklet Will Be Sent You By Return Mail

Be sure to see the new Jacobs Hand-Tite and Hex-Key Chucks. Both have the amazing new Rubber-Flex Collet that gives terrific gripping power, better accuracy, longer life. They'll put more work in your workshop. At your hardware dealer's.

IF IT'S A JACOBS . . . IT HOLDS

HEX-KEY CHUCK . . . fits drill press spindles — motor shafts — jack shafts. With Morse taper arbor, fits lathe headstock, tailstock. 4 models, capacities to 1/2"; fits 1/2" or 3/8" shafts.

HAND-TITE CHUCK . . . fits threaded spindle hand and power tools. . . used on polishing heads, bench grinders, flexible shafts, etc. 3 sizes . . . capacities to 1/2". Models to fit 3/8-24, 1/2-20 and 1/2-24 threaded spindles.

ONLY **JACOBS Chucks**

Have The Rubber-Flex Collet
Its Parallel Bite Holds True and Tight

THE JACOBS MANUFACTURING COMPANY

150 Jacobs Road, Hartford 2, Conn.

Please rush my copy of "19 Unusual Uses For Your Drill Press And Lathe". I enclose 10¢ for handling.

Name

Street

City.....Zone.....State.....

**SO HANDY FOR
SO MANY USES
AT HOME
OFFICE AND SHOP**

**THE
JIFFY
METAL
CABINET**

**Now you can keep
nuts, bolts, screws,
nails, parts, wash-
ers, stamps, hobby-
ist needs, etc., at your fingertips.**



**32 DRAWER
MODEL PICTURED
ONLY
\$5.95
POST PAID**

Just think, 32 or 64 drawer cabinet to keep those small items that usually get mislaid. Spot welded steel cabinet, enamel finish, metal drawer guides. Looks good anywhere. Send check or money order please—no C.O.D.'s. Prices below. Your money refunded if not satisfied.

SPECIFICATIONS	WITH ALUMINUM DRAWERS	WITH CARDBOARD DRAWERS
32 Drawer Unit 6" Deep 12 3/4" Wide 15 1/4" High	One piece rustproof aluminum drawers for heavy service—good for work bench and industry use.	Suitable for most home uses. Heavy board kraft covered. Metal drawer pulls.
64 Drawer Unit 6" Deep 25 1/2" Wide 15 1/4" High		
Drawer Size 1 1/4" Deep 2 3/4" Wide 6" Long	32 drw. \$8.95	32 drw. \$5.95
	64 drw. \$15.95	64 drw. \$9.95
	POSTAGE PAID	POSTAGE PAID

KAYTEE PRODUCTS DEPT. M, BOX 588, CANTON, O.

**Color Film Users!
BUY NO MORE
COSTLY FILTERS!**



... And still take perfect INDOOR flash-color pictures with NO exposure increase necessary!

Sounds unbelievable? Revolutionary JEN-DIP "RED LABEL" coats ordinary flash-bulbs AMBER, and instantly converts them to perfect spectral balance for ALL TUNGSTEN-TYPE color film!

Coats 300 bulbs

\$1.50 with Beaker

- NON-INFLAMMABLE!
- For use with any TUNGSTEN-TYPE color film.
- No Rinse—No Wipe
- Dries almost instantly!

This means you eliminate breakable, quick-to-fade filters; save money enough to buy extra color film and bulbs. And you'll get no more cold, bluish pictures!

Don't waste another exposure of expensive color film. Order Jen-Dip today by mail, and start saving money!

Send Check or Money Order, Please.

Write today for literature on other amazing Jen-made equipment.



JEN PRODUCTS SALES CO.

419 West 43rd Street, New York 18, N. Y.

**It's EASY!
ECONOMICAL!**

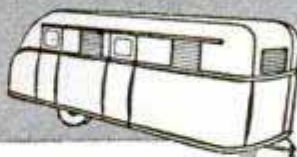

**Build Your Own Trailer with
NATIONAL'S Simplified Plans**

Beat the housing shortage with a full-size house on wheels or add new pleasure to your vacations and week-ends with a sleek sport trailer. Step-by-step instructions and complete bill of materials with every plan. *Three different models.*

- NATIONAL MODEL 27:** A 27-ft. luxury liner with 3 rooms, lavatory, sleeping space for six. Plans **\$1.00**
 - NATIONAL MODEL 28:** A 20-ft. cabin trailer that's good-looking and sturdy, with beds for four. Plans **\$1.00**
 - NATIONAL CAMPER:** The sport trailer you've wanted for hunting, fishing, vacations. Sleeps two. Plans **.50**
- ORDER ALL THREE—AND GET ONE FREE**
Complete set **\$2.00**

Big parts catalog **FREE!**
FREE with any order!

NATIONAL TRAILER STORES

Dept. 51 • Box 2353 Terminal Annex • Los Angeles 54, Calif.

**FOUNTAIN BRUSH: SCRUBS, WASHES,
RINSES HOUSES, CARS, TRUCKS, ETC.,
IN ONE OPERATION.**



Fits any garden hose. All aluminum, 5 1/2" round, horsetail mixture bristles, mar-proof rubber bumpers. Send cash, check or money order. C.O.D. plus postage. 2'-4'-6' extensions—50c ft. Complete **\$4.95** with 2' handle postpaid

LITTLE WONDER, Dept. P, 320 E. 13th, Kansas City, Mo.

\$4.95 REAL ENGINE VALUE

A miniature gas engine that really operates.



Thousands of Buzz "B" gasoline engines have been sold at twice the price. Now is your chance to buy a real 1/6 H.P. gas engine for only \$4.95. Turns up over 8,000 r.p.m. For boats, planes, midget cars, etc. Guaranteed and ready to run. Includes Champion spark plug and tank. Send only \$1.00, engine shipped collect for balance, same day.

WRITE FOR FREE CATALOG OR SEND 10c FOR NEW MAMMOTH ILLUSTRATED CATALOG OF THOUSANDS OF HOBBY ITEMS.

America's Hobby Center, Inc., Dept. B-29, 156 West 22nd St., N. Y. 11

FULLSIZE, CUT-TO-SHAPE BOAT PATTERNS

and specifications. Designed by Naval Architect. Cruisers, runabouts, sloops, outboards, sailing canoe, etc. Low prices. Send 10c (coin) for illustrated catalog. SPECIAL: Send \$1.00 for "HOW TO BUILD BOATS" book, postpaid. PolyWog Houseboat Plans, \$10. Cleveland Boat Blueprint Co. Dept. 666, Cleveland 13, Ohio



SPEED AND POWER HANDBOOK



Very latest methods! Construct your own Superchargers, "Water Injectors," Hi-Compression Heads, Fuel Saving Devices—easily. **SAVE MANY DOLLARS!** Get racing speed, acceleration, dynamic power increases from any automobile! Build fast stock cars! California roadsters! Hotrods! Get ingenious formulas! Speed secrets! Illustrations! Conversion ideas! Also "Economy Information"—Mileage tricks! Tuning techniques! Instructions! Picture catalogues. Including "California Restyling Ideas"—Glossy photographs! Drawings! Model revising! Customizing! Streamlining! Leatherlike bound—\$1.98 complete.

Newhouse Automotive Industries, 5941-B4 Hereford, Los Angeles 22, Calif.



NEW Catalog

**ATTACHMENTS AND
ACCESSORIES FOR LATHES**

*Describes equipment that will make
your lathe more versatile, such as:*

- Milling Attachments
- Center and Steady Rests
- Taper Attachments
- Steel and Brass Collets
- Bed Turrets
- Collet Attachments
- Electric Grinders
- Chucks, Tools, etc.

SOUTH BEND LATHE WORKS, 455A E. MADISON ST., SOUTH BEND 22, IND.

WRITE FOR CATALOG 77-U TODAY!

100 Fireplace Ideas FREE

For Home, Playroom, Cottage, or Camp

If You're Building Your Own Fireplace
HERE'S AN EASIER FOOL-PROOF WAY TO DO IT

Choose a design that will look well with the materials you have available. Prepare a concrete or brick slab the size of your fireplace. Center your FYRO-PLACE, the warm-air circulating form, on the base, and build round it. You will have a well-engineered, successful fireplace. You can't fail.

WRITE FOR BOOK TODAY
Small Book 4 1/4 x 5 1/2 sent free. Larger Book, 8 1/2 x 11, beautifully illustrated, 25c
Ask for Free Data on Outdoor Fireplaces



PRICE FIREPLACE HEATER & TANK CORP.
172 Austin Street, Buffalo 7, New York

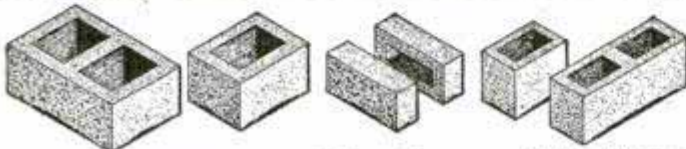

Make Concrete Blocks and Bricks

New superior method makes square, true, easy-to-lay units which will pass any building code. Small investment, high production, big profits. One \$30.00 machine will make four 5"x8"x12" blocks per minute—1000 per day. Pays for itself in a few days. Sell blocks or save 2 1/2 building cost by making and laying your own.

POST CARD BRINGS FREE FOLDER

Economy Manufacturing Company
Dept. P Stone Mountain, Georgia



ARC WELDER

A sturdy, compact, metal Arc Welding Outfit, 110 AC-DC. Guaranteed. Used by garages, mechanics, farmers, etc. Repairs tools, auto fenders, toys, etc. Everything you need—Welder, large Helmet, Rods, Attachments, Instructions. Only \$5.95 postpaid, or C.O.D. plus few cents postage. Ten-day Trial Offer. Money Back if not satisfied.

COMPLETE \$595

M I N E X 172 DEBOLT ST. NEWTON, OHIO



GEIGER COUNTERS

FOR LOCATING RADIOACTIVE MINERALS - FOR HOSPITAL AND INDUSTRIAL USE.

Write for Details and Prices
OMAHA SCIENTIFIC SUPPLY CORP.
Dept. F, 3623 LAKE ST., OMAHA 4, NEBR.

CHARLEY-HORSE?

SORE MUSCLES?



When muscles are stiff and sore from unusual exercise or strain, use HEET®, the liniment that's strong yet does not burn the skin. Wonderful relief from muscular soreness comes as comforting HEET quickly starts to penetrate. Just brush it on with the applicator. HEET starts at once to ease muscular pain and keeps on working for hours. Ask your druggist for HEET liniment.

Thousands of Parts For Military TRUCKS

We have for immediate delivery genuine parts for all makes and models, 4x2 - 4x4 - 6x4 and 6x6. All models from 1/4 ton to 20 tons. All makes: Autocar, Biederman, Brockway, Chevrolet, Diamond T, Dodge, Federal, Ford, GMC, International, Mack, Oshkosh, Reo, Studebaker, White, Willys and Jeeps. We have parts lists available on some models. Write stating model of Truck.



JEEP TOPS and CURTAINS

(Weatherizing Kit), complete top with back curtain and side curtains with zip-in-doors. 5 windows. Waterproof O.D. color. Shipping weight 40 lbs. Wonderful value. FOB, K.C. **\$34.50**

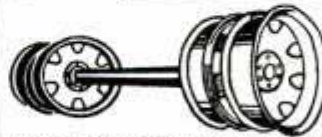

TRAILER AXLE

Heavy duty trailer axle suitable for many types of trailer construction. Also excellent for building of heavy farm trailers and wagons. It is a 15,000 lb. capacity square type straight trailer axle complete with Timken roller bearings, hubs, and 6 hole 750 x 20 Budd Wheels. Without brakes. Axle is 2 1/2 inches square and 70 inches between wheel mounting flanges. Std. width. AN EXCELLENT BUY.
With Single Wheels. \$59.50 With Dual Wheels. \$69.50

NEW POWER WINCHES

Govt. Surplus. All are Brand New and Suitable for front or rear mounting.

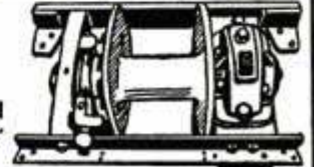

WINCH CABLE—With Chain and hook. 1/2" in diameter. 200 ft. length. **\$2500**
New
WINCH, GARWOOD OR HEIL—15,000 lb. capacity. **\$1500**

WINCH CABLE—New, with hook. 3/8" in diameter. 300 ft. length. **\$3750**
GARWOOD WINCH—25,000 lb. capacity. **\$2000**

New All Purpose WINCH

3,000 LBS. RATED CAPACITY
— IDEAL FOR JEEP

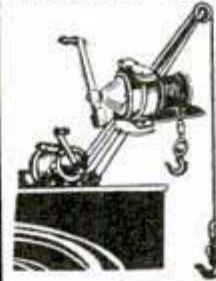

Spur gear type winch complete with crank, 50 ft. 1/4 inch cable and hook and 89 inch boom with pulley. Ideal for lifting or pulling. Winch bracket can be mounted on truck or at material location. Plenty of power, 27 to 1 ratio. Weight of entire unit unpacked 142 lbs., boxed 238 lbs. Special, each. **\$59.50**

DIAMOND T 4 Ton WRECKER



With 3 power axle. Equipped with Hercules RXC engine. Complete with Twin Booms, Holmes Wrecker Crane, 9:00 x 20 tires. Complete unit with all steel cab. **\$4250.00**

With Canvas Top Cab. **\$3750.00**

HYDRAULIC JACKS



Government Surplus, slightly used 5 ton Hydraulic Jacks of popular brands. Guaranteed serviceable, complete with handle. Shipping weight, 25 lbs. Each **\$7.95**

UTILITY GAS TANK

6 QUARTS—New Surplus. Cylindrical 5 1/2" diameter, 15 1/2" length. Brackets for mounting in horizontal position. Complete with Filler cap in center, drain plug in bottom and pet-cock on end. Ideal fuel tank for small gas engines, stoves, etc. **99c**

All prices quoted are FOB, Kansas City. 25% deposit required on COD orders.

American AUTO PARTS CO.
1830 LOCUST — DEPT. PM
KANSAS CITY, MISSOURI.



SAY YOU SAW IT IN POPULAR MECHANICS

Send for this **FREE DIESEL BOOKLET**



See how the economy and long life of a

Sheppard

D I E S E L

reduces power costs by at least 75%!

Send for this new Sheppard Diesel booklet. It tells the complete Sheppard story of simplified fuel injection . . . full diesel operation on any 1 of 15 different fuels . . . 3 to 5 times longer engine life. Send for your free copy today.



5.4 H.P. AIRCOOLED single cylinder power unit. Others up to 100 H.P. Generating sets from 2 to 36 K.W.

Sheppard Diesels Hanover 4, Pa.

DEALERS—Send for details on profitable Sheppard franchise.

STATIONARY • AUTOMOTIVE • MARINE

DIESEL'S THE POWER... *Sheppard's* THE DIESEL

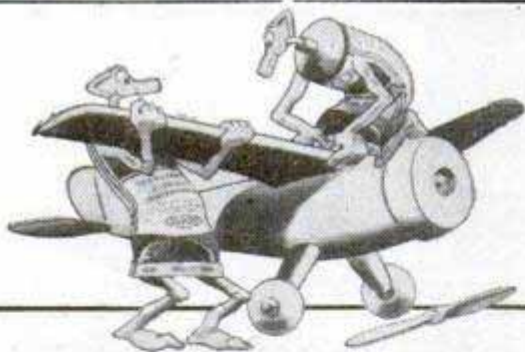

BUILD STRONGER MODELS

It's transparent, waterproof flexible and durable. Get a tube today.



DUOCO CEMENT

REG. U. S. PAT. OFF.

ACE LATHE TOOL SET



Be permanently tooled-up for every operation on your Metal Cutting Lathe

The ACE Set is complete—there's nothing more to buy. Drop forged by the manufacturers of cutting tools used by 96 per cent of the plants and shops in industry they are correctly designed, are of special steel, are finely finished, are stronger—will last a lifetime. You can cut easier, faster and more accurately with ACE TOOLS.

At your Hardware Store—**ARMSTRONG BROS. TOOL CO.**

"The Tool Holder People"

5268 W. Armstrong Ave., Chicago 30, U.S.A.

3 Turning Tools, 7 Cutting Tools, Knurling Tool, Boring Tool, Threading Tool, High Speed Steel Cutters and Blades, and 2 Wrenches in Fitted Steel Case.

MACHINE SHOP EQUIPMENT



The 1949 edition of the famous Center Tool Co. Catalog is now ready! Every workshop owner should have a copy. 240 pages full of illustrations, descriptions, and prices of the latest tools made by best known manufacturers in U. S. You pay the cost of printing—50c. **We refund your 50c with your first order of \$10.00 or more.** Prompt delivery on most tools. Send check or money order today!

CENTER TOOL CO., 153 Centre Street, Dept. C, New York 13

GOOD MONEY IN WEAVING

Earn money at home weaving rugs, carpets, etc. from old rags or new yarn—in your community! No experience necessary. 31,000 doing it with easy running *Union Looms* costing less than \$50.00! Send for our free booklet today.

UNION LOOM WORKS • 464 Post St. • BOONVILLE, N. Y.

SHARPEN CIRCULAR SAWS LIKE AN EXPERT



With SURE-SHARP you can precision file circular saws in your own workshop. No experience necessary. Adjustable to any pitch or angle. Gets hollow-ground, cross-cut and combination saw blades true and sharp. Fits 6" to 12" circular saws with 1/2, 5/8, 3/4 or 13/16" centers. Complete with file, instructions, 4-different size mandrels. Money-back guarantee! Cash with order, \$6.95 postpaid. Dealer inquiry invited.

\$6.95

SURE-SHARP MFG. CO., Box 24, Dept. 11, Santa Ana, Calif.

RACING CAR EQUIPMENT FOR ALL CARS

Engines, Racing Heads, Manifolds, Carburetors, Mufflers, etc. Speed Instructions and literature \$1.00—refunded first order.

LEE MOTORCRAFT CO.

1412 Great Northern Bldg.

Chicago, Ill.

NOW! MAKE YOUR OWN

LEATHER BELTS & HANDBAGS

Portfolio of 10 NEW handbag patterns, full size, easy to follow instructions for transferring, tooling, etc. No. 332 only \$1.30 47 NEW Western and Novelty Belt Designs No. 397 set only 75c

A full stock of quality leather and lucite fittings. Large catalog included with first order for materials.

OSBORN BROS., Dept. M, 225 W. Jackson Blvd., Chicago 6, Ill.

FENDER SKIRTS \$17.20 PER PAIR

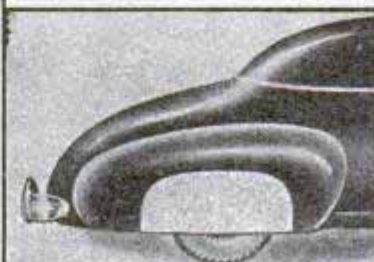

For Ford Chev. Merc. Plym., DeSoo, Chry., Dodge Kaiser-Frazer and Buick Beautify your car—bring out the flowing lines inherently designed there. Sparkling beauty you'll like. Constructed of heavy gauge body steel, finished in prime, perfect fit.

SANDEE MUFFLER CO
Box 256, La Tijera Sta.
Los Angeles 43, Calif

Gentlemen Please send me one set of Sandee Fender Skirts to fit my

(year and make of car)

Check for \$17.20 enclosed
 Ship C.O.D.

GENUINE DIAMONDS
SAVE UP TO 50% AND MORE



Approx. 1/2 Carat
\$95 Tax Incl.
 Retail Value \$200

SEND FOR **FREE**
 Diamond Catalog

BERMAN'S
 Illustrated Catalog
OUT OF PAWN GENUINE DIAMONDS
 VALUES FROM \$10 TO \$10,000

All Diamonds Reset in new Mountings
IRON CLAD
 Money-Back Guarantee

The BERMAN Corp.
 DIAMOND BROKERS
 America's Great Diamond Values
 DEPT. P BERMAN BLDG., BALTO. 1, MD.

BUILD YOUR OWN BOAT—Only \$35
NEW Guaranteed Complete Kit

Write for FREE folders to Dept. P.M.



Includes all PRE-CUT Marine wood parts, screws, glue, hardware, building jig. Easy to build in few spare hours. Simple directions. Aircraft shell design gives amazingly tough 65 lb. V-bottom boat for hunters, fishermen, yachtsmen, boys 8 to 80. Converts to fast, stable sailer—any time with extra kit.

PRITCHARDSONS' • 3744 W. 37th PL. CHICAGO 32, ILL.

SAVE ON TOOLS  **MECHANICS NET PRICES**

Send 25c in stamps for "Illustrated Catalog." Hundreds of Nationally Known, NEW & GUARANTEED Hand & Specialty Tools at Mechanics NET prices. Guaranteed by manufacturers. NOT War Surplus.

GIZMO TOOL CO. BOX 656-A SAN FRANCISCO 2, CALIF.

RUPTURE-EASER

A strong, form fitting, washable support. Back lacing adjustable. Snaps up in front. Adjustable leg strap. Soft, flat groin pad. No steel or leather bands. Unexcelled for comfort. Also used as after operation support. For men or women. Mail orders give measure around the lowest part of the abdomen. Specify right or left side or double. Save postage—send money with order—or sent C.O.D.



Right or left Side **\$3.95**
 Per. Pend. Double **4.95**

PIPER BRACE CO. Dept. PM-2 Kansas City 6, Mo.
 308 East 12th

LATHE CUTTER BIT GRINDING GAUGE
 For checking clearance and rake angles.



50¢ post paid

SOUTH BEND LATHE WORKS
 455H E. MADISON ST., SOUTH BEND 22, INDIANA

AMAZING NEW SAFE JIG SAW READY!



FREE CIRCULAR!

At last—a revolutionary, new electric jig saw small children may use, yet powerful enough to be the basic tool in Dad's workshop! Make "Standing Photo Silhouettes" of favorite snap shots... fancy what-nots, toys, for fun and profit! Just plug in—and Saw! No motor to buy—no oiling. Thousands sold. Use in living-rooms, apartments, etc. Patented. Nothing else like it. Mail postal NOW for illustrated, Free Circular, low price! (Dealers write!)

SYNCO CORPORATION, Dept. H-29, Rochester, Mich.

Shakespeare
GLASS WONDEROD
Does Everything Right
says
JASON LUCAS, Famous Angling Editor

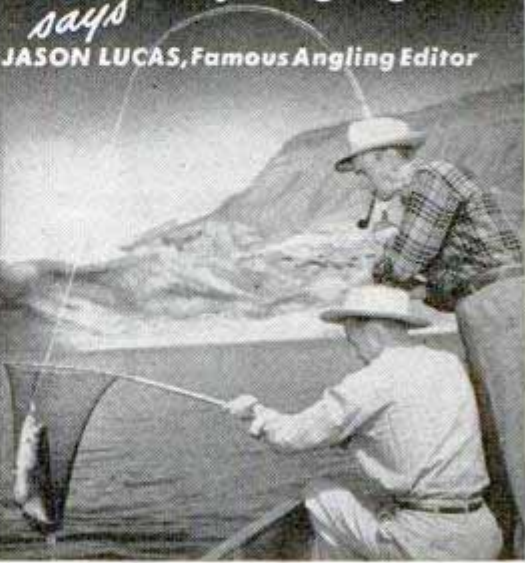

Nothing like it for ACTION and POWER!

What a thrill you'll get out of casting amazing WONDEROD, feeling its remarkable ACTION and POWER. That's why JASON LUCAS, famous Angling Editor, says: "I had over three months of fishing with WONDEROD, and I found nothing to alter my first high opinion of it."

The secret is HOWARD PROCESS *resinated glass fibers*, processed and precision controlled exclusively by Shakespeare.

Make WONDEROD yours for more skillful fishing fun. *Won't rust, rot or set...* in Bait or Fly Casting, Salt Water, combination Fly and Spinning. At sports stores.

FREE 1949 Tackle Book and Pocket Fishing Calendar. Newest in Reels, Rods, Lines, Accessories, Fishing Tips. Write Shakespeare Co., Dept. 82, Kalamazoo 2, Mich.

Shakespeare
FINE FISHING TACKLE
HONOR BUILT FOR OVER 50 YEARS

EASY PROFIT IN PAINT SPRAYING



Paints walls, ceilings, screens, furniture and machinery faster, better. All complete as shown less motor. Carry anywhere. Fully guaranteed. Could be used with 1/4 H.P. motor or less. Price **\$35.00** less motor F.O.B. Chicago. \$5.00 deposit balance C.O.D. or see your dealer. With motor \$55.00.

IDEAL AUTOMATIC PUMP CO., Dept. P.M. 8
 801 W. Washington Blvd. Chicago 7, Ill.

SAY YOU SAW IT IN POPULAR MECHANICS

Amazing Shave Invention!



VESTPOK is the perfect answer to between-shaves stubble trouble. Match book size. Needs no soap, mirror or electricity. Use any time, any place. Formerly nationally advertised at \$3. Now only \$1., with 10 blades of finest razor steel. Immediate shipment. Satisfaction guaranteed. Vestpok Division, Dept. V4, Ward Machine Co., Inc., Brockton 64, Mass.



GANGWAY!
I'M
DOING
50!



Incorporates
same scientific
principle used on
aircraft air-speed
indicators!

Amazing New

AIR-FLIGHT BICYCLE SPEEDOMETER

Patents Applied For

for
BICYCLES
•
SCOOTERS
•
TRICYCLES
•
MOTOR
SCOOTERS
etc!

No gears, no cables, no complicated mechanism . . . Just snap it on your handlebars . . . and go! Large, easily-read dial gives accurate speeds up to 50 miles per hour. Not a toy . . . a precision instrument at a fantastically low price.

39c

Get yours today! Complete

At Bicycle, Toy, Variety, Chain and Dept. Stores

PRODUCT OF INSTRUMENT DIVISION

KNICKERBOCKER PLASTIC CO., INC.

4101 San Fernando Road, Glendale 4, California

Supreme HOMESHOP BAND and CIRCULAR SAWS



**HAIRLINE CONTROL • LESS RESHARPENING
FASTER, SMOOTHER CUTTING • LONGER LIFE**
NOW—for your home shop! Famous SUPREME Band and Circular Saws nationally used by industry—now available in the SUPREME HOMESHOP Line to fit any size or make of home power tool! Special Nickel Alloy Steel. Free from kinks and other imperfections. SUPREME HOMESHOP SAWS are precision-engineered for highest cutting efficiency under heaviest punishment. End saw troubles, cut costs, speed your best work.

SUPREME BAND SAWS

6' 6" — \$1.00 7' 9-1/2" — \$1.10 9' 6-3/4" — \$1.30
in any of the following widths: 1/8, 3/16, 1/4, 3/8".
8" Flat-Ground Combination Circular Saw — \$3.65
IMMEDIATE DELIVERY — ALL STANDARD SIZES

ACT TODAY! ORDER DIRECT, stating Size, Make and Model. Or at your dealer. Write for Free Illustrated Circular.

THE SAW & KNIFE SPECIALTY CO.

6526 CARNEGIE AVENUE • CLEVELAND 3, OHIO

**NOW YOU TOO CAN BUILD
15 RADIOS**

COMPLETE KIT
\$14.75



Absolutely No Knowledge
of Radio Necessary

You Need NO Additional Parts

The **PROGRESSIVE RADIO KIT**

is THE ONLY COMPLETE KIT. Contains everything you need. Instruction Book, Metal Chassis, Tubes, Condensers, Resistors and all Radio parts. The 36-Page Book written by Expert Radio Instructors teaches you to build radios in a Professional Manner. You start with a 1-tube receiver. Before you are done with this kit, you will have built 11 Receivers, 1 Public Address System and 3 Transmitters. **SPECIAL FREE OFFER!**

Electrical and Radio Tester sent absolutely FREE with each Progressive Radio Kit. PLUS FREE membership in Progressive Radio Club. Entitles you to free expert advice and consultation service with licensed radio technicians.

Write for further information, or **ORDER your KIT \$14.75**

NOW! ONLY
Postage prepaid with check or money order
(Postage not prepaid with C.O.D. orders)

PROGRESSIVE ELECTRONICS CO., Dept. PM-19
497 Union Avenue Brooklyn 11, N. Y.

USE YOUR BENCH SAW



With Our six in. tool steel cutters. Make mouldings, casings, drop-leaf tables, grooves, beading & jointing 1" wide \$1.75. 1 1/2" \$2.25. Postpaid. State size hole, List & folder free.
John A. Sandstrom, Rt. 2-D, Clearwater, Fla.

Build YOUR OWN BOAT



Complete parts cut to exact size—ready to assemble. Marine waterproof plywood, rustproof oarlocks. Ideal for car top. Also models with laminated frames; mahogany decked runabouts. Build for sale at attractive profit. Exclusive franchise to local builders. Send 10 cents (dime) for illustrated literature.

\$39.50
and up

OZARKA 726 WASHINGTON AVE.
WOODSTOCK, ILL.

NU-WAY HEAVY DUTY CUTTING UNIT

with Timken Roller Bearings

PRICE
\$16.50
WHY PAY MORE



Build your own rotary type lawn or weed cutter. Take the hard work out of weed cutting. Build yourself an up-to-date weed and lawn mower with the Nu-Way heavy duty unit.

Write for Free Circular—We Supply Cutting Unit Complete
TRACTOR-LITE MFG. CO., Spirit Lake, Iowa

EARN MONEY servicing STOVES and
accurately and rapidly. OVEN PYROMETER shows heat
without opening oven door. Satisfaction guar- **\$2100**
anteed. 3" scale. 0-750°F. Complete.
ASSEMBLY PRODUCTS, INC. Chagrin Falls, Ohio

SAY YOU SAW IT IN POPULAR MECHANICS

Takes Less Than 3 Hours to Convert HAND MOWERS to POWER MOWERS

Handy-Dandy Lawn Mower Kit fits any hand mower from the 16 to the 20 inch size. Kits furnished separately or with power units.

Available

Kits available for Power Products, Maytag, Lauson, Briggs Stratton, Clinton, other small gas engines or electric motors. In stock 3/4 or 1 1/2 h.p. Lauson engine and 19" heavy duty Pennsylvania Mowers.

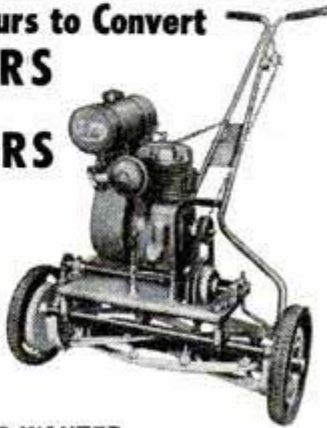

DEALERS WANTED

LE CLAIRE MANUFACTURING CO., LE CLAIRE, IOWA
DEPT. P.M. 149

WITH MOLLY YOU CAN FASTEN ANYTHING
and do it quickly, neatly and safely. MOLLY will hold fixtures securely to floors, ceilings or any hollow wall construction... Simple to install, all you need is a screw driver. Sold by leading hardware stores everywhere.

Write for Free Descriptive Folder

MOLLY CORPORATION 522 COURT ST. READING, PA.

MOLLY
SCREW ANCHORS

WHERE SCREWS
WON'T HOLD!
...USE MOLLYS...

GLOWS IN THE DARK

AN EASY WAY TO MAKE BIG MONEY

Be the first to sell sensational luminous house numbers, light switch plates, wall protectors, cord pulls, etc. Also luminous pictures, statues, decals, and a host of religious, nursery and other objects THAT GLOW IN THE DARK. Sell on sight. GET INTO THIS NEW AND GROWING INDUSTRY. ENORMOUS DEMAND... NO COMPETITION... BIG PROFITS. Represent a large manufacturer, established over 34 years. WRITE AT ONCE for liberal MONEY-MAKING offer and FREE SAMPLE to show you how they GLOW IN THE DARK. MADISON MILLS, 303 Fourth Ave., Dept. P-4, New York 10, N. Y.

Write for Free Sample!

WRITE FOR YOUR FREE COPY OF THE NEW KRW HYDRAULIC PRESS BOOK

Describes all manner of Production and Shop Work on KRW Hydraulic and Bench Type Presses. 32 pages illustrating the new KRW Hand-operated, Electric-operated and Air-operated Hydraulic Presses. 25 to 100-ton capacities.

Write for your copy today.

K. R. WILSON, DEPT. 17, 215 MAIN ST., BUFFALO 3, N. Y.

\$64.40 PROFIT IN 4 HOURS

That's Pollack's FIRST DAY Record with ROTO-CLEAN—Amazing New Non-Electric Whirling Glass Cleaner

FREE Demonstrator Offer. Mail Coupon

I've been in Direct Selling a long time. In my day, I've run across some terrific money-makers. But believe me, for quick and spectacular and steady profits, I've never seen the equal of ROTO-CLEAN! Pollack worked just 4 Hours and made \$64.40 profit for himself.

ROTO-CLEAN is the non-electric glass cleaner that works on an amazing new principle. Just press a glass over the brush and it WHIRLS! Bartenders, tavern owners, soda fountain and restaurant operators grab on sight. Because ROTO-CLEAN actually cleans glasses cleaner—cleans them quicker and easier than many electric glass cleaners costing ten times as much.

I'm not trying to sell you a bill of goods. In this ad, I'm not trying to sell you anything. All I want you to do is let me send you the facts so you can see for yourself. To prove I mean business, I even send real salesmen a sample ROTO-CLEAN without a penny of cost, as explained in my Special Offer to new men.

Don't send a cent. But rush the coupon. This simple step may give you the biggest, quickest cash clean-up of your life. Mail coupon now to:

L. B. Patterson,
MAXILUME CO., Dept. X-82,
125 W. Hubbard St., Chicago 10, Ill.

L. B. Patterson, Maxilume Co., Dept. X-82
125 W. Hubbard St., Chicago 10, Illinois
Rush complete information about ROTO-CLEAN and FREE SAMPLE Offer to new men.

Name _____
Address _____
City _____ Zone _____ State _____

EARN BIG MONEY AND BE YOUR OWN BOSS Sharpening Lawn Mowers

BUILD A THRIVING BUSINESS WITH A UNIVERSAL GRINDER

In your own garage or basement, and earn \$25.00 a day or more. Mr. Hardy writes, "I am doing a fine business with the UNIVERSAL GRINDER. One customer sends another. I spent 40c for a newspaper ad and have done nearly \$500.00 worth of business." Mr. Helmeck of Canada writes, "We sharpened 750 mowers last year and are 1056 on this year's run. The Universal surely makes satisfied customers." Mr. Barton of California says, "The lawn mower business, with the Universal Grinder, has been a gold mine these last two years."

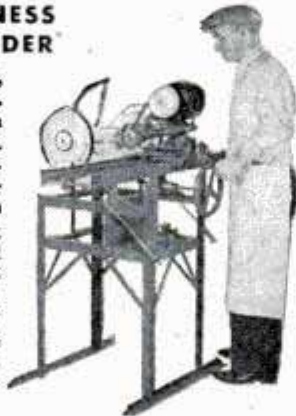

A Complete Single Unit • No Attachments Necessary
• Precision-Built • Simple to Operate • Sharpens
Reel Blades at Proper Angle • Grinds a Keen
Cutting Edge Full Length of Blade

Only on the UNIVERSAL GRINDER can the inside face and edge of the stationary blade, as well as the reel blades, be ground to proper clearance

ALL IN ONE SET-UP

WITHOUT REMOVING ANY BLADE FROM THE MOWER

Write for FREE Folder today!

Rogers Mfg. Co., Dept. M-29, Lindsey, Ohio

BUILD UP TOP SOIL . . . INCREASE CROP YIELDS SAVE TIME and MONEY with a SEAMAN ROTARY TILLER

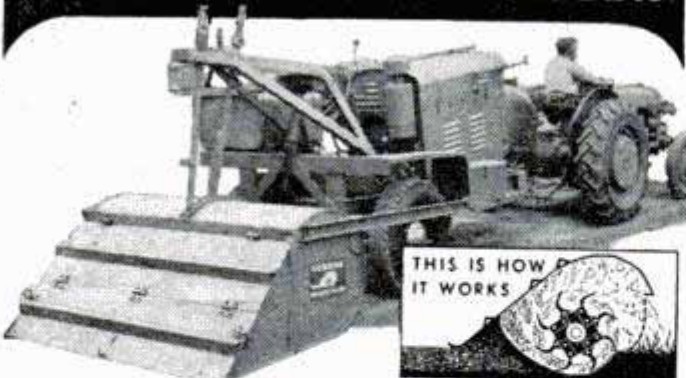

From all parts of the country, Seaman Tiller users, growing all kinds of crops on all sorts of land, tell of amazing results. Many report 10% to 35% increased crop yields; more acreage tilled and planted with less labor, in shorter time, using fewer Horsepower Hours . . . plus better quality crops, produced at lower cost.

Instead of merely turning under cover crops, surface trash and fertilizer, the Seaman Rotary Tiller mixes this material uniformly throughout the entire GROWING AREA of the seedbed so that it actually builds up and improves Top Soil.

The complete job of seedbed preparation is usually handled with this ONE MACHINE and ONE OPERATOR—and frequently in ONE PASS over the ground. Many Seaman owners till and plant at the same time.

See your Seaman Dealer and write us for a copy of Bulletin NST, telling about interesting Seaman farm applications and new improvements.

SEAMAN MOTORS, INC.

364 NO. 25TH ST., • MILWAUKEE 3, WISCONSIN

EAR NOISES?

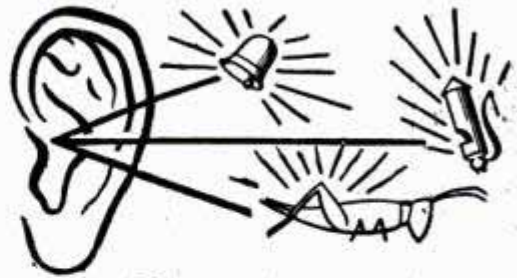

If you suffer from those miserable ear noises and are Hard of Hearing due to catarrh of the head, write us NOW for proof of the good results our simple home treatment has accomplished for a great many people. NOTHING TO WEAR. Many past 70 report ear noises gone and hearing fine. Send NOW for proof and 30 days trial offer.

THE ELMO CO., Dept. 162, Davenport, Iowa

RUPTURE!

An amazing Air-Cushion Invention allows body freedom at work or play. Light, neat, cool, sanitary. Durable, cheap. Day and night protection helps Nature support weakened muscles gently but surely. No risk. Sent on Trial! Write NOW for free Booklet and Proof of Results. All correspondence confidential.



Brooks Company, 161-D State St., Marshall, Mich.

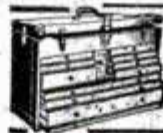

GERSTNER Tool Chests

in fine design, and stronger construction. For the good tools of Machinists and Toolmakers. Free Catalog.

GERSTNER TOOL CHESTS
449 Columbia St. Dayton 7, Ohio

30" SHEET METAL BRAKE

Forms angles, channels, vees, flanges, locks, zees. Handles 26 gage sheet steel, heavier gages of aluminum, copper, plastic, etc. Portable. Can be held in a bench vise, or bolted down. All steel. Wt. 40 lbs. Shipped exp. collect. \$24.50.
12" BRAKE. Fits in vise to form difficult and compound bends, up to 20 gage steel 12" wide, \$12.50.



SHEET METAL PLIERS. 2 1/2" wide, \$2.00; 5", \$3.50. We also make a low priced iron bender and curve former. Immediate delivery. Order direct, cash or C.O.D., or send for folder.
WISE BRAKE MFG. CO.
 1116 So. 27th St. Dept. P2 Omaha 5, Nebr.

SAY YOU SAW IT IN POPULAR MECHANICS



ITALIAN ACCORDIONS

Hand Made. Very Best. Lowest Prices. Buy Direct from Factory Representative and Save Money. Send Name and Address for FREE catalog.

ITALIAN ACCORDION MFG. CO.
7600 Cottage Grove Ave., Dept. PM2, Chicago Ill.

New...Self-Contained SPRAY GUN

No Hose! No Tanks! No Pumps!
No Motor!

It's true! A high-pressure spray gun as self-contained, as compact and portable, as a flashlight! Uses no current. Pressure comes from inexpensive CO2 cartridge. A cartridge sprays 10 to 20 oz. of liquid (depending on viscosity). Use gun for paints, liquid insecticides, oils, etc. For home, farm, workshop, garden, garage. Comes with 3 cartridges. Fully guaranteed. The Becker Spray Gun is shipped postpaid for only \$18.50; or send only \$2 — we'll ship C.O.D., you pay postman balance plus postage. Extra cartridges, 10 for \$1, postpaid.



\$18.50

(With 3 cartridges)
POSTPAID

SULLIVAN-BECKER CO., Dept. 119-B, KENOSHA, WIS.

You Can Be a Local COLORCRETOR



You can build a profitable, lifetime business with Colorcrete. Large waiting market. Work is easy and interesting. Moderate investment; high return. Large waiting market. Full instructions and liberal cooperation.

Sprayed-On Beauty

Colorcrete is modern beauty treatment for masonry surfaces—exterior and interior. Fuses to concrete, stucco, etc. Applied by air pressure. Range of many smart colors. Proven by 20 years of use on all kinds of buildings. Write or wire for Opportunity Book.

Colorcrete Industries, Inc.
570 Ottawa Ave., Holland, Mich.

**Outstanding
Business
Opportunity**



WALL MODEL

TELEPHONES



NOW—Telephones of Deluxe quality at low prices, incorporating latest improvements in design and technique. Honest to goodness first class material and finest workmanship. Lowered cost due to increased volume makes it possible for us to sell at the special low price of \$15.95 for Two of either model, complete with wire, power supply and instructions.

\$15.95 FOR 2 OF EITHER MODEL

Common talking and common ringing. Any number of phones can be connected in same circuit. Simple installation—absolutely no technical knowledge required. 25% deposit required on all orders. F.O.B. Brooklyn.

EASTERN TELEPHONE CO.

Dept. PM-1

320 18th St. Brooklyn, N. Y.



DESK MODEL

**MAKE MONEY
WITH YOUR CAR**

**EARN A SWELL LIVING
THE EASY McNESS WAY**

Use your car as a McNess Store On Wheels. Sell things farmers need and consume. Serve same families year after year. Everything guaranteed. Big demand already exists, as farmers know only best quality products carry McNess name. You start right in making money the first day. No selling experience necessary. Advertising—premiums—offers—sales know-how supplied.

USE OUR CAPITAL—Get started at once. Write today for FREE Book that explains all. Tell what county and state you wish to serve. No obligation.

THE McNESS CO., 745 Adams St., Freeport, Ill.



Provides PRECISION CONTROL..

because
**FOREDOM #99
FLEXIBLE SHAFT
MACHINE with
PENCIL-SIZE
HANDPIECE..**



KEEPS YOUR WORK WELL IN VIEW

35"
FLEXIBLE
SHAFT
\$15.95
COMPLETE
WITH
MOTOR

**GRIND - POLISH - SAW - SAND -
ETCH - ENGRAVE - ROUT - CARVE -
MILL - CLEAN**

**Use on all metals, wood, plastics,
glass, leather, linoleum, etc.**

REMEMBER that in the precision-made FOREDOM you get MORE POWER—LONGER MOTOR LIFE because MOTOR IS NOT DWARFED TO FIT HAND. DOES HUNDREDS OF JOBS WITH MARVELOUS EASE because pencil-size handpiece gets into hard-to-reach places—provides positive, easy, precision control.

Profit by experience of many thousands of Foredom users—over a quarter century experience stands behind the product. Other heavier-duty models at proportionately reasonable prices. No. 25 Accessory Set (a truly versatile assortment) \$5.50 extra. Also No. 999 Kit, comprises No. 99 Machine, illustrated, and set of 12 accessories, all in wooden case for only \$19.95. 6-step Foot Rheostat \$4.85. Over 70,000 Foredoms in use.

AND HERE'S ANOTHER AMAZING FOREDOM PRODUCT

← YOUR MOTOR
**Foredom PRESTO-FLEX
with PENCIL-SIZE Handpiece \$5.95**



Now turn your old motor, drill press, or electric drill into a Flexible Shaft Tool. Simply attach to your electric drill, drill press or motor. Presto—a flexible shaft machine! Off again in a jiffy! Pencil-size handpiece gives you finger-tip control. Gets into tight places you can't reach with any other tool. Handy 35" overall length. And—only \$5.95 complete! Not to be confused with inferior imitations. Precision made, backed by 1/4 century experience in this field. All parts replaceable. Order NOW. If ordered for use on motor, specify motor shaft diameter and add 50c for coupling. (Available for 1/4", 5/16", 3/8", and 1/2" shafts.) No. 50 Accessory Set available \$1.50 extra. Order TODAY!

FOREDOM ELECTRIC CO., Dept. A-1114 Mail Coupon

27 Park Place, New York 7, N. Y. **Now**
Please send me FOREDOMS checked below on 10-day trial.
 Presto-Flex Tool (\$5.95) No. 25 Accessory Set (\$5.50)
 Motor Coupling (50c) Foot Rheostat (\$4.85)
Specify motor shaft diameter _____ No. 50 Accessory Set (\$1.50)
 No. 99 Machine (\$15.95) No. 999 Kit (\$19.95) Free Catalog
 Send C.O.D. plus postage. I will pay postman.
 I enclose payment. Send postpaid.
(Money back either way if not delighted)

Name _____
Address _____
City _____ Zone _____ State _____

You're the Boss!

...With Crosman Controllable Power

Your Crosman high-powered air rifle is your genie and makes you the boss on the target range or in the field. It shoots with consistent accuracy and speaks with a whisper as you command and control the power and velocity of every shot. Available in .22 or .177 calibers at leading hardware and sporting goods stores. Send for literature.

Crosman Arms Co., Inc.
3 Henrietta Street, Rochester 7, N. Y.





YOU CAN BUILD A 2500 WATT ELECTRIC LIGHT PLANT

You don't need to be an electrician to assemble a light plant that will produce enough electricity to light fifty 50-watt bulbs, and you can do it far cheaper than any factory with high overhead expenses.

All you need is a 6 H.P. gasoline engine, a welded angle iron base, 2 dual sheaves or pulleys, 2 V belts, and a 2.5 KVA, 120 volt, 60 cycle, single phase, alternating current, Leland Generator, such as illustrated above.

Electric generators are always the most expensive part of a light plant, and here is where we can save you plenty of money. We can furnish you the 2.5 KVA Leland Generator shown above, brand new, for \$125.00 freight prepaid anywhere in the U. S. You buy the engine, base, belts and pulleys locally.

Just start figuring and you'll soon discover that we are asking about half what others want for a standard, new, AC generator that will produce the same kind of juice power companies furnish.

Send us cashier's check or bank draft for \$125.00 and avoid time lapse for personal checks to clear. Act today, as these generators will not last long at such low prices.

HOPFER & COMPANY
3124 EAST 14TH STREET, OAKLAND, CALIFORNIA

Now for EVERY WORK SHOP! NEW Invention Electroplates by BRUSH



**Easy to Plate CHROMIUM
GOLD, SILVER, NICKEL, COPPER
... For Pleasure and Profit!**

If you have a workshop—at home or in business—you need this new Warner Electroplater. At the stroke of an electrified brush, you can electroplate models and projects—you can replate worn articles, faucets, tools, fixtures, silverware, etc. with a durable, sparkling coat of metal... Gold, Silver, Chromium, Nickel, Copper or Cadmium. Method is easy, simple, quick. Everything furnished—equipment complete, ready for use. By doing a bit of work for others, your machine can pay for itself within a week. So make your shop complete by getting a Warner Electroplater right away. Send today for FREE SAMPLE and illustrated literature. ACT AT ONCE! Mail Coupon.

WARNER ELECTRIC CO., DEPT. A-2
1512 Jarvis Avenue, Chicago 26, Ill.

FREE Details & Sample!

WARNER ELECTRIC CO., 1512 Jarvis Avenue, Chicago 26, Dept. A-2

Gentlemen: Send Free Sample and Details to:

Name _____

Address _____

City _____ State _____

New!

FOR PLEASURE CARS

Fits Under Car Hood!

GROVER AIR HORNS

NOW, a powerful... more compact... easily installed high pressure air horn and air tank assembly that fits on firewall or side splash pan under car hood!

GET FACTS NOW! Spun brass bells, true-tone harmony, heard for miles! Complete assembly features two matched GROVER air horns, self-filling air pressure reserve tank, bronze diaphragms, brass valve, control handle and all necessary copper tubing, rubber hose and fittings. Instructions furnished. Satisfaction guaranteed. If your dealer cannot supply you, write for facts NOW with INQUIRIES make, model and year of your car to

DEALERS JOBBERS INQUIRIES INVITED

GROVER PRODUCTS CO., 1217 S. Hope St., Los Angeles 15, Calif.

ATTENTION

WAR SURPLUS BARGAINS

Electric Flares 80c
24 hour burning

Vacuum Gauge Testers. \$3.90
5 Dials, worth \$25

LINCO BRAKE BLEEDERS
New \$4.50

Slightly used \$3.00
Adapter kits \$3.42

Orders sent COD only

MOTOR RIM MANUFACTURERS CO.
1825 EAST 24th ST. CLEVELAND, OHIO

Battery Charger Kit

BUILD YOUR OWN AND SAVE MONEY

All necessary electrical parts furnished. Just assemble them according to instructions and have your own low priced, highly efficient battery charger. PAYS FOR ITSELF IN A SHORT TIME. Parts may be fastened directly to wall of garage or on a small board. Provides a tapering charge of 4 amps to 2 amps, which prevents damage to battery plates as charge builds up. For 6 volt batteries only. 110-120 volt 60 cycle AC power supply necessary. NOTHING ELSE TO BUY. Price only \$7.50 Postpaid. Cash with order.

The LESTER Company, P.O. Box 5939, Chicago 7, Illinois

make your own Gems 29.50 F.O.B.

All necessary lapidary equipment is furnished, including a super-charged diamond blade for sawing, and all wheels for grinding, shaping and polishing; also complete instructions. The complete equipment as shown, less motor and belt, for only \$29.50, f.o.b., Burlington, Wisconsin. Write today for information and literature.

B&I MANUFACTURING CO.
Dept. S Burlington, Wis.

MAKE YOUR OWN JOINTER WITH LEWIS CASTINGS!

THIS HEAVY DUTY LEWIS JOINTER planes, rabbets and produces excellent surfaces on all work up to 6" wide! Castings available rough or semi-finished. Build it yourself and save!

SEND 10c FOR 32 PAGE CATALOG showing all Lewis Power Tool Projects

LEWIS MACHINE TOOL CO. P.O. Box 7446, Ste. L, Dept. M, Los Angeles 23, California

BUILD YOUR POWER TOOLS

WITH POLY BALL BEARING ARBORS

HEAVY DUTY GRINDER

Model D-12 Pictured

3/4" x 17 1/2" precision spindle, self-lubricating ball bearings, heavy casting, V belt, 3 step pulley driven through rear or base.

ONLY \$18.25

Ship, wt. 13 pounds

POLY BALL BEARING ARBORS

C4-1/2 x 12 1/2 spindle, housing 2x8, \$7.95 pp.
C5-5/8 x 12 1/2 spindle, housing 2x8, \$8.45 pp.
C6-3/4 x 12 1/2 spindle, housing 2 1/4 x 8, \$9.45 pp.
D8-1 x 17 1/2 spindle, housing 2 5/8 x 11, \$18.75 pp.

SHAPER ARBORS—Free literature on request.

POLY PRODUCTS, 2032-A E. Walnut, Pasadena 8, Calif.

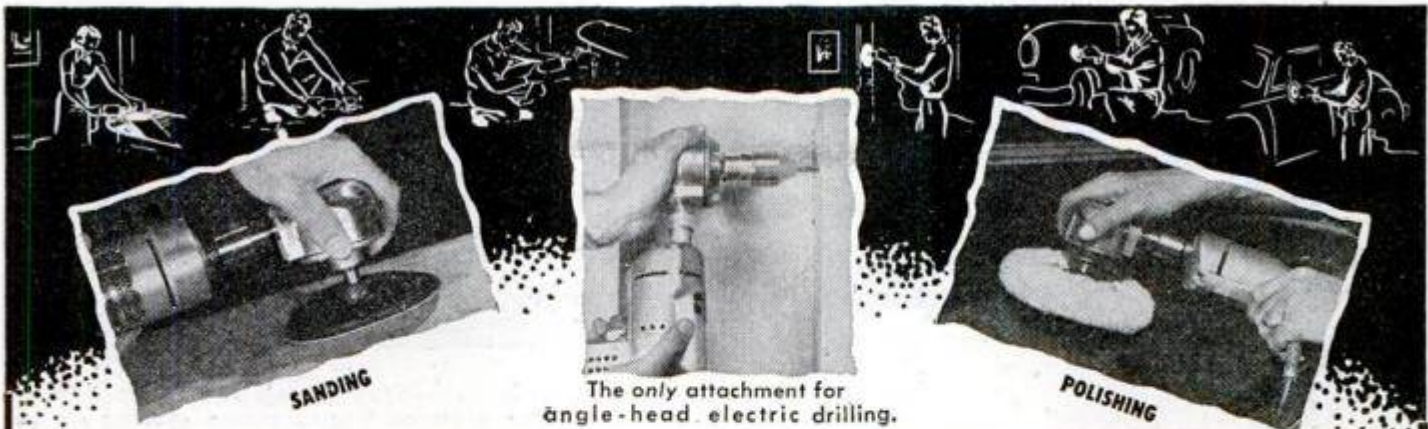

SANDING

The only attachment for angle-head electric drilling.

POLISHING

Why Pay More and Get Less? Only the BULL BUFFER

Has everything you want in a polisher-sander!

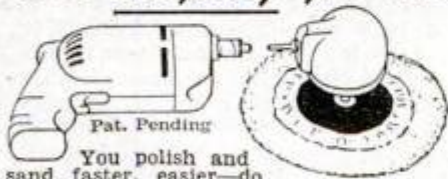

Pat. Pending

You polish and sand faster, easier—do beautiful, professional work—with this amazing attachment for your electric drill. (You can also drill up to $\frac{1}{2}$ " with your $\frac{1}{4}$ " drill and at right angles never before possible!) Bull Buffer more than pays for itself the very first time you make your car, floors, woodwork, furniture gleam like new. It's built of lifetime materials and guaranteed. Thousands and thousands of satisfied users. At your dealer or send cash, check or money order for your Bull Buffer, complete as pictured. Only

\$9.95

1. Fits any chuck on an electric drill or flexible shaft—no extra power unit to buy!
2. Only Bull Buffer has gear reduction—the power to do any job without injury to your electric drill!
3. Only Bull Buffer has swivel action—turns in complete circle when drill is stationary!
4. Only Bull Buffer has angle head for electric drill—gets to all hard-to-reach surfaces, curved or flat!
5. Only Bull Buffer has 3 speeds* — "same as," $\frac{1}{2}$ -speed, or twice speed of your drill!

*See description under photo of Bull Buffer kit.

BERTRAM L. ENGINEERING CO.
3121 MAIN ST. Dealers Write for Information KANSAS CITY, MO.



Bull Buffer comes complete with sheepskin bonnet and two sanding discs, only \$9.95. Bull Buffer alone cuts drill speed $\frac{1}{2}$; for direct drive (or "same as") drill speed, order Adapter A with Bull Buffer; for twice drill speed, order Adapter B.

ORDER THESE ACCESSORIES FOR YOUR BULL BUFFER

$\frac{1}{2}$ " Jacobs No. 6425 key chuck; with Bull Buffer, increases $\frac{1}{4}$ " drill to $\frac{1}{2}$ " capacity — reduces speed, increases power	\$5.00
Extra sanding discs (000-00-0-1-2 $\frac{1}{2}$ -3-4) each	.10
2 $\frac{1}{2}$ " cup wire brush for removing paint, rust, scale, etc.	1.75
Extra sheepskin bonnet	1.25
Adapter A—for direct drive at "same as" drill speed	1.00
Adapter B Set—for sanding at twice drill speed	2.00
Bull Buffer car cleaner	.50
Bull Buffer car polish	1.00

NOW YOU CAN EARN UP TO \$6 PER HR.
in your own WEAVING BUSINESS!

Amazing All Weave Electric Loom weaves rugs, draperies, textiles in hundreds of colors and patterns. Produces up to 40 feet of 42-inch material per hour. Ideal business for physically handicapped. Entirely automatic... easy to operate... no experience necessary... free instruction booklet... working materials easily obtained. Uses 110 volt A.C. power. (Special voltage or gasoline motors supplied at extra cost.)

The All Weave Electric is a full size loom, capable of heavy-duty, production-line work, yet reasonably priced. Write for descriptive folder TODAY! Dept. P.

ALL WEAVE LOOM CORP. 9128 St. Charles Rock Rd. Saint Louis 14, Missouri

Eager Beaver BENCH SAW

A man-sized Ball Bearing Bench Saw

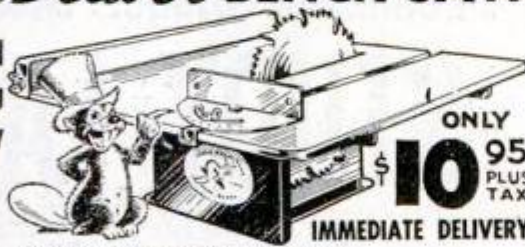

Guaranteed to Cut 2 x 4's

ONLY \$10.95 PLUS TAX

LOOK AT THESE FEATURES

1. All Metal Construction
2. Rugged Ball Bearings
3. Light and Portable
4. Adjustable Rip Fence
5. Indexed Mitre Gauge
6. 1 $\frac{1}{2}$ inch Arbor Pulley
7. Full 2 inch Cut
8. Designed for Safety
9. Table Size 12 $\frac{1}{2}$ " x 13 $\frac{1}{2}$ "
10. 6" Combination Blade

If your dealer cannot supply you send check or money order with dealers name. We'll ship prepaid. Price does not include motor. No C.O.D.'s please.
SIERRA TOOL CO., INC., 1618-B North Vermont Ave. Los Angeles 27, California

PROFESSIONAL DRAWING SET



5 CLEAR PLASTIC INSTRUMENTS

ONLY \$1.50

Complete drafting set... 12" T-square with calibrated arm — Protractor — French curve — 45° Triangle and 60° Triangle in transparent plastic... all for only \$1.50. For use at home, in the workshop, at school, in the laboratory — hundreds of handy uses. Buy this junior drafting set, and dozens of other C-Thru Drawing Supplies at your dealers today!

RULERS - TRIANGLES - SLIDE RULES - CURVES - STENCILS - PROTRACTORS - T-SQUARES

C-THRU Ruler Company

HARTFORD, CONNECTICUT U S A

7 x 50 BINOCULARS

MADE TO RIGID MILITARY SPECIFICATIONS

Brand New
\$44



Actual
Photograph
Ht. 7"
Wt. 39 oz.

With
COATED
Lenses
& Prisms
\$54

These magnificent 7x50 prism binoculars were obtained through the Supreme Commander of the Allied Powers. They have the brilliant luminosity, precise clarity, and wide, undistorted field of view obtainable only with a good large glass. Because 7x50 glasses give the highest performance obtainable they are now the official choice of the Army, Navy and Marine Corps. This is your opportunity to purchase a brand new 7x50 AT 1/3 OF THE USUAL COST. Lifetime construction. Lightweight aluminum body. Individual eye focusing. Ultra-precise optics, sealed against moisture and dust. Unsurpassed by any other binoculars, regardless of price. Richly finished case and straps included. Sold with a guarantee of complete satisfaction or money refunded.

Price With
Regular Optics
\$44*

Price With
Coated Lenses & Prisms
\$54*

*Plus 20% Federal Tax

IMMEDIATE DELIVERY WE PAY THE SHIPPING COST

BROWNSCOPE CO.

Dept. 2M, 24 West 45th St., New York 19, N. Y.

STOP SANDING BY HAND! use the new SAND-O-FLEX on curved and irregular surfaces



Only \$4.98
The most versatile
sander ever made!
Money-Back
Guarantee

Use Sand-O-Flex on contoured and flat surfaces alike. This low-cost sander reaches into recesses, around intricate curves, and handles all those tedious finishing jobs that were formerly done only by hand. Fasten it to your motor shaft or any of your present stationary or portable power tools. The ideal sander for a hundred home uses. Finishes any material—woods, metals, compositions. Satin finishes stainless steel!

Sand-O-Flex consists of 6 abrasive strips backed by 6 separate brushes in a light-weight aluminum body. When rotated at usual motor speed the brushes "cushion" the abrasive cloth and mold it to the work shape. Abrasive unwinds as ends are worn. All parts are replaceable. Refill abrasive cartridges 3/4" wide, available in coarse, medium and fine for wood and metalworking. Fits 1/2" or 5/8" shafts. Adapters furnished on request.

Use it on a



PORTABLE DRILL



FLEXIBLE SHAFT



DRILL PRESS



LATHE



MOTOR SHAFT

Over a quarter million Sand-O-Flex wheels are in use today! Imagine! Only \$4.98 fully assembled, complete with one refill cartridge. Instruction sheet included. Attractively boxed. Fully guaranteed. If not more than satisfied, return within 30 days and your money will be promptly refunded. Enclose check or money order with coupon, below, or send \$1 deposit and pay balance on delivery. State shaft size. MAIL COUPON TODAY!

L. P. ENTERPRISES, DEPT. P-1, 424 S. BEVERLY DR., BEVERLY HILLS, CALIF.

- Enclosed \$4.98 for Sand-O-Flex, postpaid. For 1/2" Shaft
- Enclosed \$1.00, send Sand-O-Flex C.O.D. plus postage. For 5/8" Shaft

(PRINT NAME AND ADDRESS PLAINLY IN MARGIN)

SAY YOU SAW IT IN POPULAR MECHANICS

END BATTERY TROUBLE

with sensational new
POWERMATER
Wattage Regulator

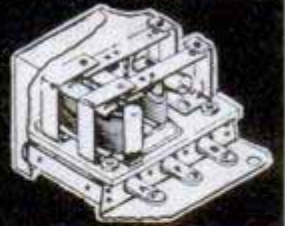

Replace your car's voltage regulator with the New Powermaster Wattage Regulator and prolong life of your battery . . . have it up at all times . . . for easier starting, brighter lights, better radio performance . . . even in coldest weather. Quick-charge characteristic and burn-proof contacts put more power into battery • Ideal for short-hop driving. Permits you to drive even with a dead battery or broken cables. Self-cleaning contacts won't stick or stay open . . . last a lifetime. Powermaster is easy to install . . . no garage mechanic required. Guaranteed 1 year or 100,000 miles. Only \$8.00, Prepaid. State make and model of car. Write for free bulletin.

SCIENTIFIC ELECTRIC CO. P. O. Box 2162PM
Station H, Cleveland, Ohio

SEE "U. S. MACHINE TOOL LIST" FIRST!

Buy used Foley, Delta, Atlas, South Bend, Do-All, etc. Over 800 machines and motors listed by States. Next two issues — 50c.

Sell your used equip., — 25 words — \$1.00
Give model and price. Proof mailed.

MACHINERY EXCHANGE, 254 — 1st No. Mpls., Minn.

JET PERFORMANCE

For Your Car With VAPOJET

Install this amazing new water injector on your car, easily, quickly, and then notice the difference! Easier starting, amazing power, increased gas mileage are yours with VAPOJET, the war-developed water injector that prevents vapor lock, removes carbon and stops over heating. Only VAPOJET gives you aircraft performance at the surprisingly low price of just \$9.75 postpaid, or C.O.D. plus postage. Fits all cars. Specify car and number of cylinders. Complete, nothing else to buy. Send TODAY! VAPOJET MANUFACTURING COMPANY Box 95, Dept. 2, Bay Cities Airport, Tarzana, Calif.



\$9.75
Postpaid

Pat. No.
2,188,175

BARGAIN!

HIGH SPEED ROTARY FILES

Set of 5 Assorted	\$ 2.00
" " 10 "	3.75
" " 20 "	7.25
" " 30 "	10.00

1/4" shank

WE BUY SURPLUS TOOLS

SID TOOL CO., 183 Grand St., N. Y., N. Y.

Command Bigger Money!

STUDY LAW

STUDY AT HOME for BUSINESS SUCCESS and LARGER PERSONAL EARNINGS. 40 years expert instruction — over 114,000 students enrolled. LL.B. Degree awarded. All text material furnished. Easy payment plan. Send now for FREE BOOK — "Law and Executive Guidance." It explains the course — how you may enroll and the many ways you can profit from Law Study. Write TODAY to:

AMERICAN EXTENSION SCHOOL OF LAW
Dept. 11-PM, 646 N. Michigan Ave., Chicago 11, Ill.

POPULAR MECHANICS

QUALITY TILTING TABLE SAW

TABLE INCLUDING EXTENSION 18" x 14"

\$24.95

Complete as shown
F.O.B.
Royersford, Pa.

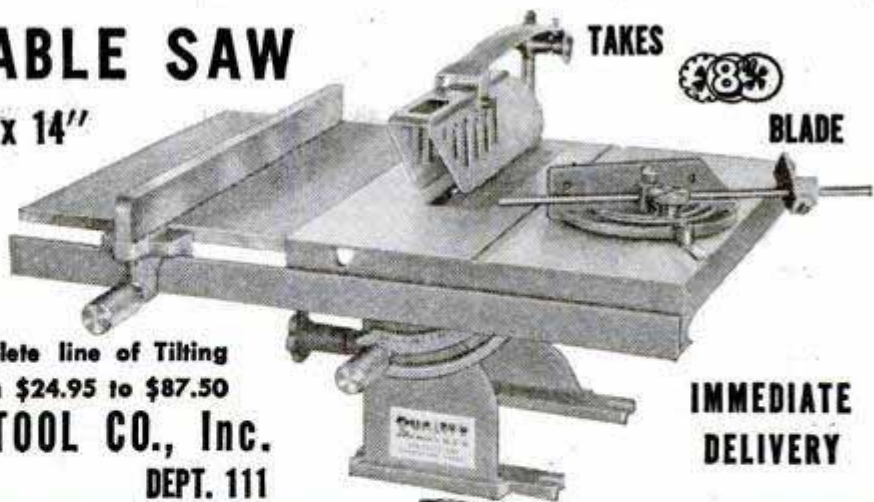

IMMEDIATE
DELIVERY

Send for catalogue showing complete line of Tilting
Table and Tilting Arbor Saws, from \$24.95 to \$87.50
AMERICAN MACHINE & TOOL CO., Inc.
ROYERSFORD, PA. DEPT. 111



AMAZING BURGLAR ALARM GUARANTEED TO STOP THIEVES

FOR CARS • HOMES • FARM BUILDINGS

A South Dakota manufacturer has discovered an easy way to protect cars, homes, farm buildings from Burglars, sneak and chicken thieves. The manufacturer is so sold on his sensational DEVIL DOG Burglar Alarm that he is willing to let you try it for ten days and will offer you \$1.00 for testing it. New sales plan promises big money to hustlers. Be first to get your DEVIL DOG Burglar Alarm for introducing in your territory. CASH-IN on the tremendous demand this device will create. Shipped prepaid from factory on ten year guarantee. Rush name and address for details to

NORTHWEST ELECTRIC CO., Dept. B-303, Pukwana, S. Dak.

Sensational Bargains: LOWEST PRICES!

All Items Guaranteed
As Represented



BACKGEAR VOLUME BLOWER made by ILG
MOTOR

90 RPM 110V, 60 cycle, A.C. slow speed motor. All brass construction. Sturdy gears & Bearings. Drives

window displays, toys & useful experimental work. 6 1/2 x 2 1/2", 5/32" shaft. Pulley FREE. \$3.50 ea. Postpaid. 6 only \$2.95 each.



6 in. Wheel—1000 CFM Complete with 1/6 H.P. Motor, 110 V, 60 cycle A.C., 1750 RPM. Height 12"—Intake 6" dia. Outlet 6x5—Weight 60 lbs. No. B-54 . . . \$45.00 Fob Chgo.



MOTORS: Westinghouse, Leland, AC-110-220, 60 cycle 1750 RPM. Like new—Totally enclosed 50° C—Fully Guaranteed . . . ONLY \$19.75 Fob Chgo.
NEW G.E. Capacitor Type, 110 V—60 cyc—3450 RPM . . . ONLY \$23.50 Fob Chgo.
NEW G.E. Capacitor Type, 220 V—60 cyc—3450 RPM . . . ONLY \$21.00 Fob Chgo.



THE VAPORITE Automatic HUMIDIFIER for Warm Air Furnaces . . .



THERMOSTATICALLY controlled water supply puts more moisture in the air. Gives healthier air. Easily installed in bonnet of air furnace. Complete with Thermostat Water Control Valve, Tubing and parts for complete installation. POSTPAID ONLY \$7.50

STAIN-
LESS
STEEL

Write for our Illustrated Price List on Other Bargains and SAVE MONEY—

C. MARSHALL SALES, 3546 W. Fullerton Ave., Dept. P-2, CHICAGO 47, ILL. • RUSH ORDER TODAY

GIVE YOUR CAR THE "WOLF CALL"

of Deep Tone DUAL MUFFLERS

The rich, low, mellow sound of "straight thru" ADVANCE mufflers is something all your friends will admire.

Also greater power, speed, and economy result from the reduced back pressure of this scientific design. Rugged steel tube throughout (no aluminum); blowout-proof.

SIMPLE TO INSTALL. No welding, cutting, or holes to drill. Complete with rubber mounted clamps (no rattle) and all necessary fittings.

ADVANCE MUFFLERS, 6800 S. Vermont Ave., Dept. PM-29, Los Angeles 44, Calif.
Send Check, Money Order, or we will mail C.O.D.
You pay postage upon receipt.

Dual Muffler Set (Ford, Mercury only) \$20.00 Single Muffler (other makes) \$5.50
Single Muffler (Ford, Chev., Plym.) 4.86 2 1/2" Chrome tail pipe tips 1.75

Car make _____ Year _____ Model _____

Name _____

Address _____ City _____ State _____



ADVANCE MUFFLERS

6800 S. Vermont Ave., Los Angeles 44, Cal.

A "BIG" drill
in a small package



No. 24 Drill

The Stanley No. 24 packs big drill punch in a handful of drill. Light, compact, easy to handle anywhere, any position! Takes twist drills up to 1/4". Only 8 1/4" long. Weighs just 3 1/4 lbs. See this new drill at your dealer's or write for illustrated folder. Stanley Electric Tools, 488 Myrtle St., New Britain, Conn.



No. 514 Drill Stand converts this small drill into a handy drill press.

STANLEY

Reg. U.S. Pat. Off.

HARDWARE • HAND TOOLS • ELECTRIC TOOLS • STEEL STRAPPING

PROVED!
— AND APPROVED
America's
LOWEST COST
Transportation
Cushman
MOTOR SCOOTER

GET UP TO
75 MILES PER GAL.

OWN IT! MAINTAIN IT!
OPERATE IT! ALL FOR LESS
THAN 1¢ A MILE

CUSHMAN MOTOR SCOOTERS are the world's best buy in low-cost transportation. Motor to work, to play, to market, to school—EVERYWHERE—quickly, conveniently, economically! No parking worries—no garage problem! No battery or radiator to maintain! No expensive upkeep or replacements! There's a CUSHMAN for every transportation need. Get the facts today. See your dealer or write Dept. PM-19.

DEALER INQUIRIES INVITED

CUSHMAN MOTOR WORKS, Inc
LINCOLN NEBRASKA USA



The MUSGRAVE
ALL-JOB
DOKTER



THE
HANDY
POWER
HELPER

Fast weed and lawn cutter. Other attachments:—Wood Saw, Cultivator, Spray Outfit, Air Compressor, Saw Rack for logs and lumber, Snow Sweeper, Hand Mower Attachment. Travels under its own power. Wheels automatically adjust to uneven ground. Get our free circular and low prices. Write today. Available in 2 1/4 or 4 h.p.

MUSGRAVE MANUFACTURING CO.
2936 Arnett Rd. Springfield, Ohio

Guaranteed by mfr. for FULL YEAR

Handsome Swiss wrist watch...

Marvelous value in a good-looking watch, built by skilled Swiss craftsmen. So well-made that a printed one-year guarantee is given. Has sweep second hand, glow-at-night dial, rugged chrome case, unbreakable crystal. Timed and tested movement; leather strap.

Send no money—10 day trial
Pay postman \$6.95, plus tax and postage (or send check and we pay postage). Return in 10 days, if not delighted.

Swiss Watch Distr.

211 Paramount Bldg.
(Dept. 902C) Atlanta, Ga.



ONLY
\$6.95
plus
63¢
tax

BARGAINS FROM WORLD WAR II



Thousands of Bargains in Military, Outdoor & Sport Goods for Hunter, Farmer, Scout. Send 10c for NEW 32-page catalog, just issued, returned with first order.

A and N SUPPLY CO.

4720 LESTER ST.

RICHMOND 15, VA.

RUPTURE



RELIEF...OR YOUR MONEY BACK

A simple... sturdy truss support built nature's way by old surgical appliance manufacturer. You risk nothing... relief or your money back. Send now for free booklet.

WEB TRUSS CO., Dept. M-21, Hagerstown, Md.

S AGENTS 300% Profit **SIGN LETTERS**

For Store Fronts and Office Windows. Anyone can put them on. Free Samples. Liberal Offer to General Agents.

METALLIC LETTER CO., 430 N. Clark, Chicago 10

SAY YOU SAW IT IN POPULAR MECHANICS

MUFFLERS
STEELS and ALUMINUMS
with a motorboat tone

SINGLES, Chev., V-8, Plymouth, Steels \$5.50, Aluminum \$7.00. Chry., Olds., Buicks, etc., Steels \$7.50, Aluminum \$9.00. V-8 and MERCURY DUALS, Steel \$17.50, Aluminum \$21.00, '49 FORD DUALS, \$2.50 extra. Split Manifold Sets, Steels \$35.00, Aluminum \$45.00. Aluminums are guaranteed for life of your car.

DEALERS WANTED

SANDEE MUFFLER CO.
BOX 296 LA TIJ., LOS ANGELES 43, CALIF
2624 W. SLAUSON AVE., LOS ANGELES, CALIF.

Do a Better Job WITH ONE OF THESE EMPIRE LEVELS

EMPIRE TORPEDO LEVEL
Smallest, most handy and accurate level made. "Cigar-shaped"—no sharp corners to tear pocket. Aluminum stock. Only 3 oz. wt. 9" long. Has Level, Plumb, 45° Vials.
No. 26\$2.00



ALUMINUM LEVEL — No. 151
Cast and Machined, a Beautiful Tool, with Patented, Removable Level and Vial.
With 2 Plumb, 2 Levels, 2 — 45° Vials. 18"..... \$6.40
24".....\$6.80 28".....\$7.80
Order **EMPIRE LEVELS** from your local dealer.
Write direct for literature.

EMPIRE LEVEL MFG. CO.
BOX 97, DEPT. P-256 MILWAUKEE 13, WISCONSIN

POWERFUL! ECONOMY TRACTOR



Lightweight, Low-priced, Big capacity for all jobs, Ideal for small acreage, Implement attachments available.
Write for folder.

Tractor Features: Adjustable Trend, High Clearance, 7 H.P. Air Cooled Engine, Automatic Clutch, Differential and Transmission.

ENGINEERING PRODUCTS CO. 915 Niagara Court
Waukesha, Wis.

WRITE NOW FOR FREE CATALOG NO. MF

THE FOSTER LINE POWER TOOLS

FOSTER MFG. CO., 1 KINSEY AVE., BUFFALO 17, N. Y.

PLASTICS Material and supplies. Retail and wholesale. Beginner's outfit \$1.25. FUN & PROFIT! Get FREE Catalog.

PLASTIC LETTER INDUSTRIES
DEPT. M 188 N. WELLS ST. CHICAGO 6

AUTOMATIC RETOOTHER

MAKES NEW PROFITS

Cuts new teeth in 50 seconds — any size 4 to 16 points. Old teeth fall off as chips. Easy to operate. A perfect job.

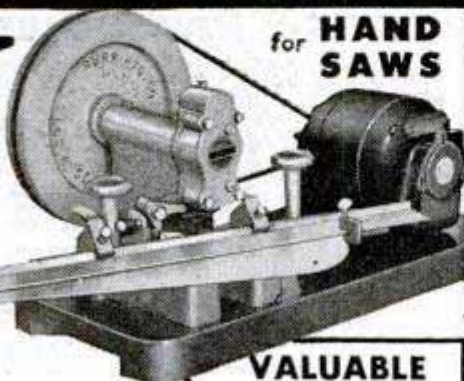

for **HAND SAWS**

IMMEDIATE DELIVERY

BURR MFG. CO.
8934-A VENICE BLVD.
LOS ANGELES 34, CALIFORNIA

VALUABLE BOOK

Order Burr's Blue Book of Coast to Coast prices for saw shop services.

25c

"HAWAIIAN WIGGLERS ...NEVER LET YOU DOWN"

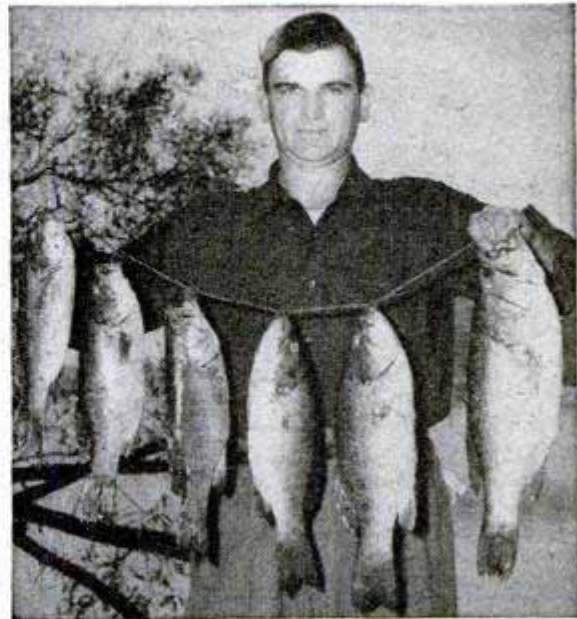

"Game fish go crazy when Hawaiian Wigglers hit the water," says Stan Pogo, of Akron, Ohio, who took these beauties from Pidgeon Lake, Ontario, Canada. "I just rely on old reliable No. 1 . . . the bait that never lets you down." Stan's heaviest Large Mouth weighed 5 lbs., 11 oz., while the largest Small Mouth hit the scales at 4 lbs., 2 oz.

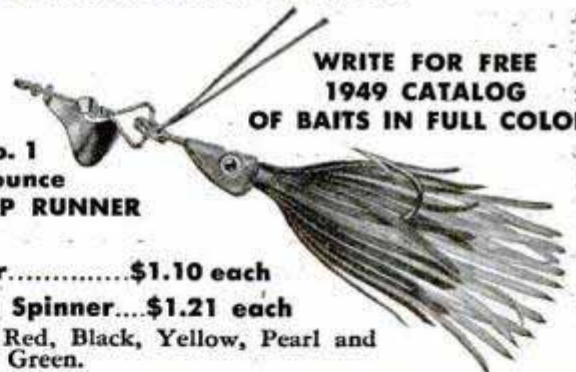

WRITE FOR FREE
1949 CATALOG
OF BAITS IN FULL COLOR

No. 1
3/8 ounce
DEEP RUNNER

Single Spinner.....\$1.10 each
Double Spinner...\$1.21 each

Colors: Red, Black, Yellow, Pearl and Green.

Extra Hula Skirts (large).....28c each

A-249-22

Old reliable No. 1 functions where it's impossible to use treble hook lures. It's easy to cast. For all game fish anywhere . . . especially Small Mouth Bass and Walleyes.
Hawaiian Wiggler—T. M. Reg. U. S. Pat. Office

FRED ARBOGAST & CO., Inc., 1612 W. North St., Akron 3, O.

SAY YOU SAW IT IN POPULAR MECHANICS

FASTEST PLANER in the WORLD at this Low Price... \$215.00

BELSAW Multi-Duty Planer

Speed up production! Increase your profits! BELSAW power self-feeds at 24 feet per



minute. . . The lowest-priced surfacer that will handle 12 x 6 in. stock. Planes green or dry sawed lumber into smooth, worked forms. Three high-speed steel knives make 42 cuts per inch. Multi-duty BELSAW takes inexpensive attachments for all planing mill operations — Jointing, Rabbeting, Grooving, Matching. BELSAW is the only 12 in. planer providing attachments for jointing and grinding its own knives. Start planning NOW for BIGGER VALUE and BETTER PERFORMANCE, with BELSAW. Write for FREE specifications, illustrations and low prices.

● LARGER CAPACITY ● FASTER OUTPUT ● KNIFE SHARPENING ATTACHMENT
BELSAW MACHINERY CO. B1014 Field Bldg., 315 Westport Rd., Kansas City, Mo.

WAR SURPLUS AND OTHER BARGAINS

PNEUMATIC AIR TOOLS

Made by Chicago Pneumatic and other Manufacturers

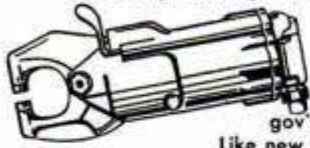

Squeeze Riveter with Alligator Yoke

For all types of metal and auto body work. Purchased from an active gov't. tool crib. Original cost about \$80.00 Like new. Weight 4 lbs. Each **\$12.95.**

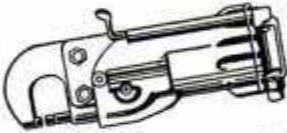

C-Type Yoke Riveter Compression Squeeze Type

Like new. Wgt. 5 lbs. . . . Each **\$12.95.**



Thor Pistol Grip Riveter & Chipping Hammer

Ideal for fender, brake lining, concrete breaking work. Like new. Six rivet sets and bucking bar included, making a complete combination. Wgt. 9 lbs. . . Each **\$6.95.**

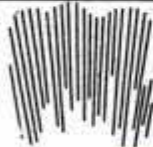

HIGH SPEED DRILL BITS
Like new! Original value over \$16.00. 25 assorted sizes and lengths.. **\$2.50**



MICROMETERS
Chrome plated, precision engineered and carefully tooled to give long life. All new. 0-1" capacity **\$2.25**
1-2" capacity . . . **\$3.50** Each

SEND CHECK, MONEY ORDER or CASH
CLAMPS—Adel Aluminum Co., Rubber lined, hundreds of uses in any shop. Assorted sizes, all new 5 Doz. **\$1 — 500 \$5**

TRANSFORMERS

Jefferson Electric step up or step down transformer. Input, primary 110-117 Volts A.C. Output, from 5 Volts to 650 Volts. Suitable for use with war surplus gadgets, heater relays, radio test filaments, electric trains, house chimes, etc. Weight 10 Lbs New **\$7.95** Each

Automatic Winding Company Transformer. 60 cycles A. C. Input 75-125 volts. 4 step output 5-6.3 volts. Single winding. For radio, radar, television, chimes, and all low voltage gadgets. Wgt. 5 lbs. New! Each **\$3.50.**

25% deposit required on C.O.D. orders. All prices F.O.B. Culver City, Calif.

AIRBORNE SALES CO., INC. DEPT. PM 2-9 CULVER CITY, CALIF.

Free Booklet on FLEX-O-SHAFT

Illustrating this all-purpose power machine with hand-piece that handles as easily as a pen. Motor with switch, foot-operated rheostat, and 66 accessories at special low price. Write

FLEX-O-SHAFT SALES CO.

Dept. C Prairieview, Illinois.

MOTORIZED YOUR TREADLE SEWING MACHINE

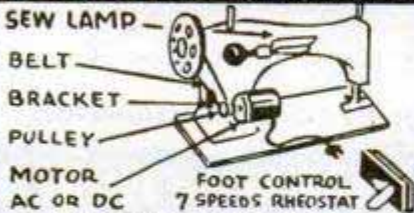

only **\$15.95**
COMPLETE

FREE SEWING LAMP

A PERFECT GIFT
For MOTHER or WIFE

MONEY BACK GUARANTEE

INSTRUCTIONS INCLUDED
PORTABLE CASES **\$11.50**
For Any Type Machine

DEALER'S INVITED

PM-2-9 BRANT'S SEWING MACHINE CO., INC.
1720-22 Race Street, Cincinnati 10, Ohio

Rush your \$15.95 kit. My machine is a _____
Hand wheel turns toward me away from me.

NAME _____

ADDRESS _____

CITY _____ ZONE _____ STATE _____

I am enclosing \$15.95 check money order or send C. O. D. and I pay postman \$15.95 plus a few cents postage.

"HOME WORKSHOP" BLADES

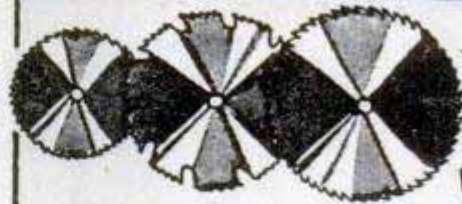

Made of Tough Steel, With Teeth Set for Side-Clearance FOR WOOD CUTTING

"HOME WORKSHOP"

No. 244 4 in. Cross...\$.38
No. 254 6 in. Cross...\$1.00
No. 264 6 in. Comb...\$1.00
No. 274 7 in. Comb...\$1.35
No. 284 8 in. Comb...\$2.00
All Blades supplied with 1/2", 5/8" 3/4" Bore. Also Blades to fit Mallsaws, Skilsaws.

"HYCARBON"

HAND FILED
No. 254T 6 in. Cross. \$2.00
No. 264T 6 in. Comb. \$2.00
No. 274T 7 in. Comb. \$2.50
No. 284T 8 in. Comb. \$3.00

MIDWEST SURPLUS SALES CO.

2533 INDIANA

KANSAS CITY, MO.

Write for NEW CATALOG Dept. PM

BUILD AN ARC WELDER PLANS 35c

We Show You How to build this new powerful welder without rewinding. For light or heavy work. Uses coils taken from old auto generators. Works on 110 or 220 volts A. C. Has 20 different heats. Send 35c for complete PLANS and valuable Catalog. Write today.



LEJAY MFG. CO., 3347 LeJay Bldg., Minneapolis 8, Minn.

OVER 250 SURPLUS BARGAINS

Write for FREE Catalog PM-7 TODAY!

FISLER SALES CO. 721 Walnut
Kansas City 6, Mo.



MAKE YOUR OWN LEATHER

BELTS-BILLFOLDS

LEATHER CRAFT . . . Learn this easy and simple way to make money. Make all kinds of hand-tooled leather goods. Hinkley-Tandy has everything for Leather Craft . . . Modelling Tools, Leather, etc. Write today!

Send For FREE CATALOG DEPT. PM

HINCKLEY-TANDY LEATHER COMPANY

P. O. BOX 791 • FORT WORTH 1, TEXAS

BRUSH PLATING OUTFITS

for re-plating articles in the home and shop. No tanks necessary. Free particulars.
GUNMETAL CO., AVE. M, DECATUR, ILLINOIS

AMES UNIVERSAL DIAL INDICATOR SETS NEW SURPLUS

OUR \$15.00 PRICE **\$15**

Reg. sold for **\$23.00**

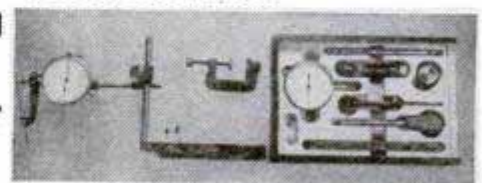

You get a complete set including Dial Gage with hole Attachment, Bar with Upright, Clamp sliding swivel, Dial holding rod and three contact points. Hole attachment also, can be adjusted to almost any position, and used in places inaccessible to ordinary indicators. All this along with a beautiful box for only \$15.00. Write today before limited supply of these AMES KITS are exhausted.

Catalogue of other tools—40c—refunded on first \$10 purchase. Free with indicator set.

VETERAN TOOL AND SUPPLY CO.
88 Baxter Street New York 13, N. Y.

A TOOLSHOP IN YOUR HAND



There's Only One Genuine Handee
First tool of its kind—today's finest. Smooth, steady power at your fingertips. Easy to handle. Make ship, plane and train models, bookends, costume jewelry. Grinds, drills, polishes, routs, carves, sands, saws, engraves on metal, wood, plastic, glass, leather, etc. 25,000 r.p.m. AC or DC. Wt. 12 oz. With 7 accessories \$20.50. In case with 40 accessories \$27.50. At stores or sent postpaid. A fine gift for a friend or yourself. CHICAGO WHEEL & MFG. CO., 1101 W. Monroe St., Dept. PM, Chicago 7, Ill. Free 52-page manual.

HANDEE TOOL OF 1001 USES

BUILD HEAVY DUTY MACHINES

SAVE UP TO 90%—You can build, using our practical, easy-to-read plans, all kinds of machines, for home, farm or shop—scooters, portable sawmills, metal working machines, concrete machinery of all kinds; printing equipment, woodworking machines, midget autos, dish washers, farm equipment, freezers, tractors.

NICHOLS EQUIPMENT COMPANY
D-1910 PURVIS, MISS.

FREE CATALOG HANDBOOK
183 SETS OF PLANS
VALUABLE INFORMATION

SHARP-TUNER RADIO RECEIVER

A completely new, really efficient

The best signal-powered set ever offered. Single control actually separates stations, even in large cities! New circuit developed by leading electronics company. Costly precision parts—Germanium detector, Leitz coil, modern capacitors. Beautiful durable enclosed cabinet 2 1/2" long! Uses no batteries or electricity—lasts indefinitely—reception guaranteed. Set alone with leads and directions, \$3.69. Trim single headset included \$1.00 more. Foreign orders 10% extra, prepaid only.

CARING PRODUCTS Dept. AB, Box No. 1308
Chicago 90, Ill.



MACK'S GAS TORCH AND SOLDERING IRON
4,000 B.T.U. attaches to any gas hose; furnished with 2 jets for natural and bottled gas; equipped with adjustment set screw.
\$2.00 Postpaid

Mack's GAS BURNER
Jet Power, Self-Acting, (Pat. pending), 24,000 B.T.U., for natural and bottled gas, industrial and home use.
\$2.00 Guaranteed. Postpaid

Mack's Automatic Water Heater
Approx. 26 gal. capacity and larger for home and industry. Easily installed. Amazingly low-priced. Guaranteed.
\$32.50 Del.



AUTO-PERFECT CURB INDICATORS

Master car parking immediately—forget fender, body, hubcap, and tire damage by curb. Must for Whitewalls. Nickel plated INDICATORS under front and rear fenders signal perfect curb clearance on contact. Easily installed any car. Price only \$2.00. M.O. Check postpaid. C.O.D. plus postage. J. F. GRYNKRAUT, 37 Gale Rd., Swampscott, Mass.

ELECTRICITY Anywhere

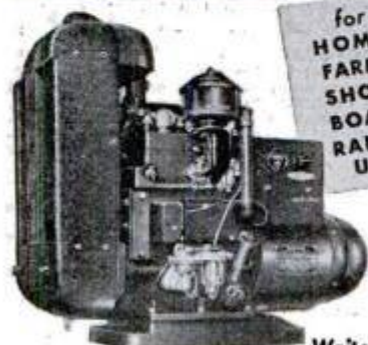

for
HOMES
FARMS
SHOPS
BOATS
RADIO
USE

Onan gasoline-engine-driven Electric Plants supply reliable, economical electric service for any use. Portable, stationary or standby models. Water or air-cooled, compact and rugged.

A.C.: 350 to 35,000 watts in all standard voltages and frequencies. D.C.: 600 to 10,000 watts, 115 and 230 volts. BATTERY CHARGERS: 500 to 3,500 watts; 6, 12, 24, 32 volts.

Write for folder

D. W. ONAN & SONS INC.
2549 Royalston Ave., Minneapolis 5, Minn.



FEBRUARY 1949



Made
in U.S.A.

Big new CROSLEY

Coming or going, it's the Smartest car on the road!

Crosley is truly a fine car. Again Crosley leads the way with America's highest compression ratio—7.8 to 1. Even more power, and greater economy—up to 50 miles a gallon. Costs less than an 8-year-old high-keep used car. Prices range downward from the Station Wagon at only \$929 F.O.B., Marion, Ind.

NEW CROSLEY SEDAN DELUXE

is bigger! New speed line styling, rich interior, choice fabrics. Seats 4 with ample luggage room.

NEW CROSLEY STATION WAGON

with larger, longer body lines. Seats 4, or 2 with 1/4 ton load. All steel. No increase in price.

CROSLEY a FINE car

See all five Crosley models at your dealer's. Or write for catalogue—Crosley Motors, Inc., 2530-HB Spring Grove Ave., Cincinnati 14, Ohio.



SAY YOU SAW IT IN POPULAR MECHANICS



COMPLETE ALL-IN-ONE SPRAYER

... JUST **\$12.95**
PLUG IN AND SPRAY Post Paid

Unconditionally guaranteed for 90 days.
Large size—24 oz. capacity.
Over-all size—8 1/4" high x 6 1/4" deep.

For home, garage, farms, etc. Fast, economical for paint, varnish, oils, insecticides, etc. Plugs into any 115V A.C. outlet. Off-on switch, rubber cord and plug.

SEND CHECK OR MONEY ORDER
Enclose \$1.00 with C.O.D.'s

GENERAL AIRE CO.

447 W. Norris St. Dept. D Phila. 22, Pa.

PROFITS AND SPEED

THE MODERN LAWN MOWER SHARPENER

PRICE
\$241.50
LESS
MOTOR

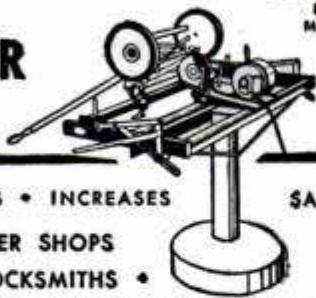

INCREASES PROFITS • INCREASES SALES
FOR LAWN MOWER SHOPS
FIXIT SHOPS • LOCKSMITHS •
HARDWARE STORES • GOLF COURSES • SCHOOLS
PARKS • PLAYGROUNDS • INSTITUTIONS •
CEMETERIES • AND ALERT INDIVIDUALS!

Sharpens All Reel Type Mowers • Hand, Power or
Gang • 10 to 20 Minutes • No Dismantling
No Extra Attachments Needed

All reel type mowers, from 5-inch edgers to 36-inch power mowers, are quickly sharpened to extreme ends of both left and right twist reel blades. Handle, wheels, roller and motor remain in place when sharpening is in process. Bed knife is sharpened in same brackets that hold mower in grinding position. No extra attachments required. One lever puts mower or bed knife in grinding position. 100% steel construction. Grinding head rides on five ball bearing races. Small, compact, easy to operate. Sharpens wood chisels, joiner knives and planer blades without extra attachments.

ORDER
NOW
Immediate
Delivery

Skate Sharpener Attachment Available
Send For Free Bulletin No. 10B

MODERN MFG. CO. 160 N. FAIR OAKS AVE.
PASADENA 1, CALIFORNIA

NOW, YOU TOO CAN WELD! IT'S EASY—WITH THE

HIGH IN
PERFORMANCE
—LOW IN
COST!

Complete
\$89.00



miller
"Hobby
Arc"
HOME
WELDER
110 VOLTS

Designed and built by the men who make the Miller Industrial welders. Compact, light in weight, low in cost yet able to do a man sized welding job with electrodes up to 1/8". Operates on AC current on a 30 ampere fuse. Shipped complete with electrodes, electrode holder, helmet and cables.

TRY IT IN YOUR WORKSHOP

miller ELECTRIC MANUFACTURING CO.
APPLETON, WISCONSIN

HAUCK FLAME GUN KILLS WEEDS



KILL WEEDS, crab grass, Canada thistle—stalks, seeds and roots. Destroy brush, caterpillar nests, diseased trees, grasshoppers, chinch bugs, etc. Clear irrigation ditches, split rocks, burn tree stumps . . . Sterilize poultry houses, kennels, barns. Use as portable home forge. Melt ice, thaw pipes. Safe, inexpensive. Burns only 6% kerosene, 94% air! Thousands satisfied users. 7 models. Write for FREE CATALOG.

HAUCK MFG. CO., 74 Tenth St., Brooklyn 15, N.Y.

EXTRA PROFITS FOR SAW SHOPS WITH BEMACO RAPID SAW SET

IT'S AUTOMATIC

Sets hand saw teeth in 60 seconds—Approx. 400 band saw teeth. 4 1/2 to 12 points with one adjustment. Hammer and anvil action does precision job. Every tooth alike—no breakage.

IMMEDIATE DELIVERY

WRITE TODAY



BEAVER MFG. CO.

802-B South
Isis Avenue,
Inglewood,
California

HEAVY CAST ALUMINUM DOUBLE EXHAUST BLOWER ONLY \$16.85

Excellent for Coal Furnace Blower. Use cheap Buckwheat, Rice coal instead of expensive Stove coal. Gives hotter water, faster . . . Removes gas fumes from garages. Install it yourself with any household tools. Double intake and exhaust from 2 balanced wheels. Flanges for attachment to ducts. Cont. duty motor. 110 V., A.C. 50-60 cycles. SINGLE EXHAUST BLOWER—Delivers App. 100 CU. FT. AIR per MINUTE—\$11.25. Add 50¢ handling; \$1 west of Miss. Send check, M.O. Money Back Guarantee. Free lit. Universal Yonkers Corp., (M-2), 137 Alexander St., Yonkers 2, N.Y.



OTTAWA Buzz Master

A faster brush cutter and wood sawing machine. Propels itself while cutting saplings and brush. 7 H-P motor. Many outstanding and exclusive features. Available attachments: sickle bar, rotary tiller, sprayer, air compressor, snow plow and pulley for belt work. Thousands in use. Send for FREE booklet.



OTTAWA MFG. CO., 1-927 Brush Ave., Ottawa, Kansas

WALL TENT 9'x9' waterproof canvas, front and back windows, 3'6" \$19.95

wall, open at back. Ends 8' high. Only CANVAS COVERS Waterproof tarpaulins, war surplus (Used), perfect condition. Originally made for tents. Approx. 5'x8'. Two buttoned together make approx. 80 sq. ft. Complete with buttons attached. Suitable for use as canvas dams, hay covers, truck covers, machinery and equipment covers, etc. Packed in bales of 30, priced 30 covers, \$1.25 ea.; 15 covers, \$1.50 ea. Less than 15, \$1.75 ea. All FOB, Kansas City.

AMERICAN SUPPLY CO.
329 W. 5TH DEPT. PM KANSAS CITY, MO.

LEATHERCRAFT FOR FUN FOR PROFIT

Make your own Leather Novelties, Belts, Bags, etc., in spare time. A hobby you will love. Complete kits and equipment, for tooling, carving and embossing at very low cost. Send for FREE catalog describing tools, leather and instructions.

JONAS HANDICRAFT CO. (Dept. M.), 226 William St., N. Y. 7, N. Y.

RENOVATE YOUR JACKET

Your old leather jacket will look like new when our service department repairs, cleans and restores the leather to its original shade and finish.

Send for FREE descriptive circular and itemized price list today!
BERLEW MANUFACTURING CO., INC.
DEPT. M MERRICK, NEW YORK

SEND FOR THESE AUTOMATIC SHUT-OFFS

Timers for Water Heaters and Incinerators

FULL MONEY BACK GUARANTEE on these automatic shut-offs which eliminate return trips to the basement! Installed in a few minutes with ordinary tools. Come with simple, complete instructions. Order direct from factory. GET ERIE-TIME-O-GAS for your water heater or incinerator. Described in Popular Mechanics October issue. Replaces regular gas-cock on inlet pipe. Easy to install. To operate, set knob to burn for 2 to 55 minutes. ERIE-TIME-O-GAS shuts off gas automatically! Works on manufactured, natural, mixed gas. Use with or without pilot. Pilot lighter included FREE with each unit. Other Models Available for Many Other Applications. Send only \$8.95 for postpaid ERIE-TIME-O-GAS, or C.O.D. plus postage; or write for FREE information. (Specify if ERIE-TIME-O-GAS is for heater or incinerator.)



ERIE MFG. CO., Dept. P4, 300 N. 8th St., Milwaukee 3, Wis.



RAMYR SELENIUM PLATERS
10 amps to 250 amps.
Model Shown, 10 amps... \$39.95



**"Tops" IN MOUNTINGS, EQUIPMENT
and SUPPLIES for the
BRONZED BABY SHOE INDUSTRY**

Bases of Unbreakable Metal--Also of Onyx or Marble

Complete Shop Assemblies—any capacity from 10 to 500 pairs weekly. Priced \$97.50 to \$3,500.

99 times out of 100 when your plating isn't right...it's your solution that's wrong.

ANALYZING KIT

Complete with simple instructions \$17.95.
Will pay for itself many times over.



Descriptive literature and wholesale prices on request.

Your inquiries invited.

Our engineering service is at your disposal at all times without charge.

World's Oldest and Largest

HOLLYWOOD BRONZE SUPPLY

Headquarters: 1770 N. Vermont Ave., Hollywood 27, California



THIS 5 ROOM ALADDIN \$1396 FREIGHT PAID

HOW TO BEAT THE BUILDING GAME

The Aladdin Readi-Cut System of construction enables you to save 18% lumber waste and up to 30% labor costs, and guarantees you will receive the highest quality lumber and a COMPLETE house as specified, shipped anywhere, all in one shipment.



65 DESIGNS TO CHOOSE FROM—HERE'S WHAT YOU GET



You get all the lumber cut to fit by fast machinery production line methods—marked and numbered, ready to erect practically without the use of a saw; also siding, flooring, trim, all millwork, doors, windows, glass, hardware, nails, roofing, paint and complete drawings with instructions. During the past 40 years many Aladdin home buyers have erected their own homes.

IMMEDIATE DELIVERY SEND 25c FOR CATALOG 9
THE ALADDIN CO. BAY CITY, MICHIGAN

HEADQUARTERS FOR SHOP EQUIPMENT HOME COMMERCIAL
HEAVY DUTY FOR PROFESSIONAL WORK IN YOUR HOME SHOP



Precision milling table for professional work on home shop drill press or other shop equip. Table 7 1/2" x 7 1/2". T slot machined for 3/8" bolt. 1/2" lead screw, some thread Bronze nut—slide travels 7/8". has two 3/8" mounting holes. **FINEST QUALITY** — wt. 70 lbs. SENT POSTPAID for only \$19.00.

With Brown Converter Drill press has a 1000 uses. **SLOTING, DIE FILING, SAWING, ETC.** 1" STROKE—sealed ball bearings—Durable metal housing. Long wearing, only 3 moving parts complete with adapting spacer. State make, model of Drill press when ordering. Sent Postpaid, only \$23.00.



Send for FREE Catalog

DIRECT FACTORY PRICES - ORDER YOURS TODAY
LEO G. BROWN ENG. CO., 1531 S. SUNOL DR., LOS ANGELES 23, CALIF.

Take along COMFORT and SAFETY



Marble's Water-proof Match Box
Keeps matches dry, even under water
Price 75c



Marble's Compasses
Pin-on, Pocket and Wrist models, No. 182 "Pin-on" shown
Price \$2.00

For Every Hour in the Open

MARBLE'S OUTING EQUIPMENT



Marble's Woodcraft No. 49
Beautiful leather handle. Extra keen 4½ in. forged steel blade, with sheath. \$3.00.



Marble's Expert No. 545
Hunters' and Trappers' favorite. 5 in. blade. With sheath, \$3.50. No. 60 Sport Knife—4 in. blade. With sheath, \$2.50.



Marble's Ideal No. 45
All-purpose for field, forest and camp. Extra sturdy. With sheath, 5 in. blade, \$3.50; 6 in. blade, \$4.00.

Ask your Dealer, or write for Catalog (287)

Marble Arms & Mfg. Co. 578 Delta Ave. Gladstone, Mich., U.S.A.

AVIATORS' BOOTS



THE IDEAL ALL-ROUND BOOT!

Styled like the famous Army Air Corps boots—made for perfect comfort even in sub-zero weather. Ideal for sports, hunting, ice fishing, outdoor work, riding, flying, school and stadium wear. Warm, rugged, handsome! • Completely sheep-lined. • Heavy waterproof rubber bottoms; non-slip soles; spring-lock zipper with rawhide pull. • Soft, flexible, brown leather uppers weatherproofed with Aqualac. Full 11" height. • Two adjustable straps for real snug fit. Wear them with or without shoes, in every kind of weather!



ORDER BY MAIL TODAY—check, money order, or C.O.D.
Only \$11.95 per pair, plus 50c for postage and handling. Mention your shoe size. Immediate delivery. Satisfaction guaranteed, of course.

ONLY \$11.95
per pair

HUGH CLAY PAULK, Dept. J-67

813 NO. KANSAS AVE., TOPEKA, KANSAS
or, 49 Falmouth St., Boston 15, Mass.

Drill Masonry Fast, Easy



\$1.40 and up

Kennametal Masonry Drills

- Drill Tile, Stone, Marble, Brick, etc.
- Drill up to 5 times as fast
- Last up to 100 times as long

Now, you can drill clean, accurate holes in practically every construction material. You can zip in masonry and save big money on drilling cost. Use the drill that gives contractors, electricians, plumbers, post control operators and sign hangers these results: "8,000 holes in brick, 8 hours," "1 inch holes in limestone, 3½ seconds," "50 holes in glazed tile, 33 minutes." Drill sizes are from ¼" to 1½" in diameter, can drill 6" to 10" holes. Fits hand braces, drill presses, rotary drills.

Write for special introductory offer Bulletin MK3 now.

KENNAMETAL Inc. Latrobe, Pa.

BUILD ARC WELDER

For Light or Heavy Work. 75-200 amps. No previous experience needed. Complete PLANS and valuable Catalog 35c.
LEJAY MANUFACTURING CO.
1347 LeJay Bldg., Minneapolis 8, Minn.

FROM OLD GENERATOR



"Turn Miles into Smiles" WITH HANDE-FEED



FINGER-TIP GAS CONTROL

Fits steering post of any car. Lets you DRIVE RELAXED! Simply lift lever to increase speed; when released, engine idles. Lever swings with wheel, can be used with either hand. Does not cut out foot pedal. Hand buffed chrome finish. Easy to install. Instructions furnished.

\$7.95

POSTPAID

Tuck-A-Way AUTO AWNING



SOMETHING NEW UNDER THE SUN

Made of green and white striped waterproof duck with steel brackets. Screw on top of door yourself. No holes to drill. Folds up for storage in glove compartment. Adjustable for Sedans, Coaches, Coupes.

\$4.95

PAIR POSTPAID

Handy Andy COIN DISPENSER



QUICK CHANGE WHEN YOU NEED IT!

No more fumbling in Pockets or purse. Easily attached under dash or arm rest. Just slip out change for news boy, parking lot, bridge toll, parking meter, soft drinks, etc. Holds up to 40 Nickels and 50 Pennies or Dimes. Hand buffed chrome finish.

\$2.95

POSTPAID

TRANS-CONTINENTAL Inc. Dept. 10 Box 3812, St. Louis, Mo.

Send me: I'm enclosing Check M.O. Send C.O.D. plus postage Dealer Inquiries Invited

HANDE-FEED
 AUTO AWNING
 COIN DISPENSER
 ALL 3 ITEMS for only \$12.95
 FREE CIRCULAR

Name _____
Street _____
City _____ State _____

Superette Dual Vacuum Auto Horns

The Voice of Authority on The Highway



One blast and those "road hogs" really move over. Superette Horns compare favorably to air horns costing \$75 to \$100. Can be installed under hood or on front fender. Beautiful lacquer finish. Operates from intake manifold of your car. No tank needed. Cost is only \$8.95 complete with all necessary fittings, control valve and simple installation instructions. Send check or money order today or order C.O.D. - - Adds much to your car.

THE PROTECTROD COMPANY Dept. 253
4033 Windsor Road, Youngstown 7, Ohio

ONE-MAN SAWMILL LESS THAN \$225.00

Easy To Turn Trees Into Money



Belsaw Models in 10 to 24 foot sawing lengths.

MECHANICAL FEED, accurate set works and positive dogs. Use tractor or old auto engine for low cost power. Thousands used for commercial sawing. Pays for itself quickly. Send post card today for FREE booklet, "How To Make Lumber" and Catalog of Woodworking Equipment.

BELSAW MACHINERY CO., 811N Field Bldg.
315 Westport Road Kansas City 2, Mo.

New MILLING ATTACHMENT



SIZES FOR 8" to 16" METAL LATHES

Build it yourself from our sets of semi-machined castings and save \$8. Can be finished on your lathe alone. Complete drawings and instructions furnished with castings.

Mill keyways, slots, splines, dovetails, flutes for reamers, special cutters. Produce gears, ratchets, racks; bore, face, etc. with this precision attachment.

FREE Illustrated folder and price list of castings, milling cutters, etc. Write today. Mention your lathe.

HURON MACHINE AND TOOL CO.
YALE 4, MICHIGAN

A TOOL... NOT A BRUSH



\$1.00 POST PAID

PAINTERS' STRIPING TOOL

NOW! PAINT STRIPING MADE EASY!

Easy to use as a pencil! Draws parallel lines, straights, curves, circles with paint, enamel, lacquer, etc. Do your own striping on autos, furniture, toys, bikes, model planes, signs, linoleum... make wall board look like tile. Painters - craftsmen, order today! Type "M" Master Painters' Striping Tool complete with tip for 1/16" stripe, \$1.00. Tool with choice of 1/64", 1/32", 3/64", 5/64", 3/32", 1/8" tip—\$1.50... all tips 75c ea. Tool with complete set of 7 tips \$5.00. (COD's postage collect.) Dealers write!

WENDELL MFG. CO.
4234-B Lincoln Ave., Chicago 18, Illinois

LEARN LEATHERCRAFT

Increase your income and start a spare time profitable business. Leathercraft can be mastered in no time. Start with an investment of only \$10.50 for leathercraft kit, which includes: tools, complete instruction book and designs, billfold project ready to be completed, lacing, tool catalogue, tips on how and where to sell finished leather goods, and employment fields for leathercrafters. Start now to increase your income—Don't miss this opportunity. Mail your order today—Cash or C.O.D.

CONTINENTAL LEATHER CO., Dept. 1
201 1/2 West Magnolia Fort Worth 4, Texas

Binocular Eye Loop

Objects Are Greatly Magnified With Clarity of Normal Vision



Speeds work, lowers costs, gives third-dimensional vision, eliminates distraction, fits comfortably over any regular eyeglasses.

Always Free Use of BOTH Hands

4 SIZES

Focal Length	— 20" — 14" — 10" — 8"
Actual Power	— 1.50 — 1.75 — 2.25 — 2.75

Made of durable "Hazard-Safe" plastic. Featherweight (3 oz.); adjustable headband. Dual-mounted prismatic lenses. Objects have needlepoint sharpness. This is a **NECESSITY** for the Workshop and in trades and professions of all kinds.

\$8.50 POSTPAID

Satisfaction Guaranteed. Prompt Shipment.

SCHOENIG & CO., INC.
Dept. 2M, 9 Rockefeller Plaza New York 20, N. Y.

The Chief

WORK BENCH

Built to Last a Lifetime!

With Bottom Shelf and 18" Sq. Drawer. 2"x6", Solid Plank, Grooved and Dovetailed Top and 1"x8" Back Rail, Shelled to a Smooth, Satiny Finish.

• 6 Ft. Long • 34" High • 26" Deep. Shipped Knock-down, with Bolts, Nuts and Screws and ABC Chart for Quick, Simple Assembly.

Prompt Delivery

MOHAWK LUMBER CO.
14525 W. Chicago Blvd. Detroit 27, Mich.
Enclosed Check Money Order for \$
Ship... **CHIEF WORK BENCHES** at
Quantity
\$16.95 each, F.O.B. Detroit, Mich.
 Send C.O.D., \$5 Deposit Enclosed.

NAME.....
ADDRESS.....
CITY..... STATE.....
No Priority Necessary!

Choice of Professionals...



METAL MASTER COMPOUND ACTION SNIPS

WISS

These famous snips easily cut 18 gauge. M3 cuts curves and circles as well as straight... ideal for the home workshop. \$4.25. Rubber grips recommended, 60¢ extra.



WISS

HY-POWER PRUNERS #908-8"

Finest pruners you can buy... and easiest cutting. Test before buying. They cut instantly... with less pressure... leave a clean "unchewed" clip. Anvil type blade stays keen and sharp indefinitely. \$2.50.

Prices slightly higher in Denver and west.

WISS Quality for more than a Century

J. WISS & SONS CO.
Newark 7, N. J.

SAVES FUEL!

Thermostatic

RADIATOR VALVE...

Automatically

LETS YOU HEAT ANY ROOM INDIVIDUALLY AT THE MOST COMFORTABLE TEMPERATURE.



Replaces ordinary air valves. Radiator heats only when temperature drops below valve setting and shuts off vent when setting is again reached. May be installed in one-pipe steam system.

\$4.95 prepaid

SEE YOUR LOCAL DEALER OR WRITE **HEAT-TIMER CORP., 160 Fifth Ave., N. Y. C.**



\$16.95
F.O.B. DETROIT

Send Check or Money Order, or Will Ship C. O. D. (\$5 Deposit)

DARK ROOM VENTILATORS

13 1/2"
D
I
A
M
E
T
E
R

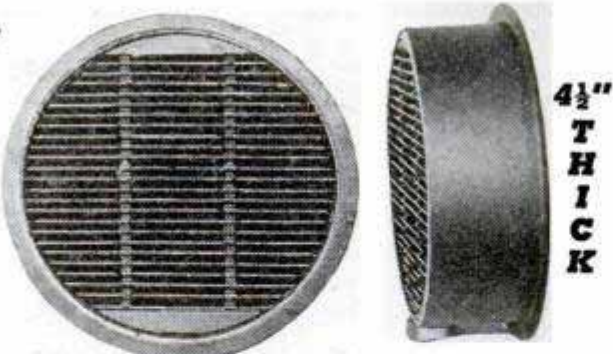

4 1/2"
T
H
I
C
K

VENTILATE YOUR DARK ROOM

\$25 VALUE—Price \$7.50 Set, \$4.00 Each
— New Government Surplus —

Air flows through these louvers freely. Due to arrangement of baffle plates, light does not show through ventilators. Hundreds of these vents have been installed in dark rooms. You will need two for your dark room. Install one in or near ceiling and one near floor.

\$7.50 Set of two, or \$4 each. Pay by money order or check. 25% with order on C.O.D.s. Prices FOB Fresno, Calif. Shipping weight 29 lbs. per set of two.

ARMY SURPLUS SALES of FRESNO
1820 TULARE ST. FRESNO, CALIF.

FREE
CATALOG

Marine Engines—Conversions Marine Supplies...

REAL BARGAINS—New, used, rebuilt marine motors—all makes, types, sizes. Also all kinds of conversion equipment, fittings, propellers, shafts, hardware, and marine supplies. Buy from STOKES by mail and SAVE MONEY!

STOKES MARINE SUPPLY CO.

Write DEPT. F COLDWATER, MICH.

BE YOUR OWN BOSS!

We Show You How To Set Up Your Own Profitable Mfg. Business



CASTING NOVELTIES FOR MONEY

with Complete Tested Instructions as to how you can start your own business even in your own home.



Even In Spare Time In Your Own Home

Here's Your big opportunity. Exciting chance to start your own business even at home. No experience or special education needed. "Casting Novelties For Money" tells all. Every page chock-full of ideas... tested ideas hundreds of men and women have used to make big money. Every chapter just bulging with ideas for your financial freedom. Here's some of them: • Picture directions on how to make your own flexible rubber molds for large novelties. • Making hollow casting all types of novelties. • Step-by-step photo and word instructions for making professional reinforcement shells for your molds. A big Must when casting castings for piggy banks, etc. Speed production methods explained. • How to preserve a precious baby's handprint in plaster plaque form. • Tells what Liquid Marble is and its uses for novelties and tiles. • Complete chapter on Floc-Rite, the amazing new material of 1001 uses. With colorful Floc-Rite you can create surfaces that take on the appearance of plush, velvet, velour, or suede. Big full page of complete color samples of actual Floc-Rite. • A complete chapter on "Selling Aids" is most valuable if you're now in the Mfg. business or plan to get into it. Space limits us to properly do justice to this booklet. We'd like you to have this marvelous booklet free but high printing cost forces us to send it only to those who mean business and are not mere curiosity seekers. Thus the \$1.00 price. If not more than completely satisfied, return booklet in one week and we will refund your \$1.00 promptly. Or if you feel that it means your financial independence, keep it, and you'll get \$1.00 credit on your first \$5.00 materials order. Can we make it any easier for you to reap big profits in a business of your own? Send your \$1.00 today - check, cash or money-order. Tomorrow You Be The Boss.

BING PRODUCTS, Dept. PM2F, 88 Broad St., Boston, Mass.

King Midget



- HOME ASSEMBLED
- MASS PRODUCED
- LOW-COST AUTOMOBILE

Drive this car for as low as 50c per week. Up to 90 miles per gallon. 45 to 50 m.p.h. Large enough for a husky six footer. A pleasure to assemble. Just bolt together our precision built parts. Get the facts. Send 25c for detailed circular with large photo, 4 view drawings, price of all parts. Better still, send \$1 (refunded first order) for this plus actual assembly book with 42 photos, drawings, blueprints of snow and ice conversions, etc.

WORLD'S LOWEST PRICED CAR

MIDGET MOTORS MFG. CO., Athens 1, Ohio

ELECTRIC MOTORS



1/3 hp, 1 phase, 115 volts, 60 cycles, 1725 r. p. m.

Rigid base \$15.35

Rubber base 16.45

For heavy starting load Capacitor type

Rigid base \$21.30

Rubber base 22.40

Get this 1/3 hp Jack & Heintz electric MOTOR for your GRINDER, BUFFER, WASHING MACHINE, HOME WORKSHOP EQUIPMENT—MANY HOME AND INDUSTRIAL USES—ORDER to-day. Send cashiers check, draft or moneyorder. Prices fob-Kansas City.

LANCE ELECTRIC COMPANY

311 WEST 10th STREET

KANSAS CITY, MO.

FLASH Your Turns



SIMPLEX Directional Switch

signals your intention of making a right or left hand turn. There are no bulky arrows or clumsy bumper attachments. The additional bulbs flash at your parking and rear lights as well as at the switch.

\$7.95

There is no need to disrupt your present wiring.

You can install it yourself in less than one hour. Easy to attach. Flashes 60 to 80 times per minute. Especially adaptable to Chrysler, DeSoto, Dodge, and Plymouth cars, all models 1942 through 1948.

The LESTER Company, P.O. Box 5939, Chicago 7, Ill.

New MASTER ADDRESSER

PAYS FOR ITSELF IN 2 OR 3 MAILINGS!

AMAZING LOW COST!

Imprints addresses on envelopes, cards, etc. Ideal for businesses, churches, lodges, unions, etc. Handles any size list. Fast, easy to operate. Compact Machine \$24.50. With all supplies for 500 names, tax paid, \$30.47. PREPAID. FREE literature. Write today or save time by sending remittance with name and address. Satisfaction guaranteed.

DONALD F. ROSSIN CO.
216-Z 50. FOURTH ST.
MINNEAPOLIS, MINN.

Hagerty Sea Shell



Length 8' Depth 16"
Beam 4' Wght. 65 lbs.

Assemble your own boat
... Save up to \$100.

\$35
Complete Kit



The Sea Shell is an inexpensive, all-purpose man-sized boat for salt water or fresh. Ideal for fishermen, duck hunters, yachtsmen and youngsters. It's easy to assemble, with precision-cut wood and waterproof plywood parts. Everything is furnished — all you need is a few hand tools, a little leisure time, and a pot of paint. Fun to build and fun to use — you can row it, tow it or use it with an outboard. Sailing kit extra. Ample freeboard makes the Sea Shell sturdy and safe. Fully guaranteed. Send for free illustrated booklet.



Rugged for hunting and fishing



Easy to handle, light to carry.



Takes small outboard

● If not available at your dealer's, order direct. Dealers — write for attractive franchise information

HAGERTY—11 Border Street, Cohasset, Mass.

Send free booklet: name of nearest dealer.

Send Sea Shell freight collect. Enclosed is \$35.

Name _____

Address _____

City _____ State _____

COMPLETE LOCKSMITH SHOP *only*

ALL NEW MERCHANDISE!
POPULAR STANDARD EQUIPMENT

\$149.00

START YOUR SHOP NOW!

At Home, Garage, Basement, or rent a small store, or add a key department to your present business.

- A. 1 Champion Precision Key Machine.
- B. 1,000 Popular Key Blanks.
- C. 1 Key Board with Key Hooks.
- D. 4 Popular Locksmith Books.
- E. 2 Locksmith's Warding Files.
- F. 1 Set Lock Picks in Case.
- G. Big Assortment Parts and Tools.



ALL FOR ONLY \$149.00. EASILY WORTH \$175.00!

Slightly higher out of U.S.A. 25% deposit on C.O.D. orders. Start making money at once! Order your outfit today! Complete satisfaction guaranteed! Write for FREE catalog today!

REPAIR SHOP SERVICE • Box 264M • SKOKIE, ILL.

PARKA COAT

New Army Air Force Type B-9
Finger tip length
Quilted lining with mouton fur
parka hood Zipper and
button front
Sizes 36 thru 46

24.95

PLUS 25¢
FOR MAILING

SHEEPLINED

FLIGHT PANTS

Reissue, excellent condition.
All leather. Sizes small,
med., large

4.98

PLUS 25¢
FOR MAILING

Money Back Guarantee

WAR SURPLUS VALUES

AVIATORS' JACKET

Brand new Air Corps Type B-15. Fully alpaca lined, including sleeves. Zipper front. Large mouton fur collar
Sizes 34 thru 44

13.88

PLUS 25¢
FOR MAILING

NAVY JACKET

Brand new. Navy N-1 Jacket. Fully alpaca lined. Zipper and button front.
Sizes 36 thru 44

13.88

PLUS 25¢
FOR MAILING

NATIONAL JOBBING CO.

BOX 1485 Dept. N-2 Omaha, Nebr.

OFFICERS' PINKS

Brand new Fine quality of-
ficers' elastique trousers.
Sizes 29 thru
42 Reg.
\$17.95 value... **11.50**
plus 25¢ for mailing.

SHEEPLINED JACKET

Air Corps Type B-3. Like
new. All leather with full
sheep lining and large
sheepskin collar Zipper
front. Sizes 36, 38, 40,
42. Plus 25¢
FOR MAILING

14.95

Send for FREE CATALOG



Powell SETS THE PACE

DEALER INQUIRIES
INVITED

- 7 H.P. Motorcycle-type Engine
- Solid steel frame
- Faster pick-up than a car
- Highway cruising speed of 45 miles per hour
- Automatic clutch
- Chrome-plated fenders,
- Smooth, simplified control
- handlebars, and sport muffler —looks like a custom job
- Costs no more than ordinary scooters

Powell MANUFACTURING COMPANY DEPT. PM249 COMPTON, CALIF.

Write for FREE FOLDER and address of nearest dealer



Modernizing?
Remodeling? Use...
CHROMTRIM
"Trim-it-Yourself"
METAL MOULDINGS

You'll find hundreds of uses for this handy metal trim around your home. Kitchen, bathroom, stairs or attic can be streamlined in a jiffy. Chromtrim comes in convenient 6' lengths, 8 shapes, all ready to tack on.

Chromtrim is easy to cut — Economical to use — Bends simply to any shape.

Send 10¢ for "Trim Ideas"—16 pages brimming with Chromtrim projects, ideas, and directions for use

R. D. Werner Co., 295 Fifth Ave., N. Y. 16

Enclosed is 10¢ for CHROMTRIM "Trim Ideas" booklet PM-2.

Name _____

Address _____

City _____ Zone _____ State _____

R. D. WERNER CO., INC.

295 Fifth Avenue, New York 16, N. Y.



REBUILT MOTORS FOR CARS & TRUCKS

You Can Save A Lot of Money at Our Low Prices. Also

AUTO PARTS & ACCESSORIES

Write for Our Low Prices. Prompt Attention.

J. C. WHITNEY & CO.

1917 ARCHER AVE.

CHICAGO 16, ILL.

"ROYAL" ROTARY MOWER

IT'S NEW! IT'S PERFECT! IT'S TRULY A BEAUTIFUL ECONOMICAL MOWER—THE MOST PRACTICAL EVER MADE

Have a Beautiful Lawn • Mosquito Free Surrounding

Cuts with a SMOOTH FINISH through any LAWN, Spike Grass, Dandelions and High Weeds. Easy to Adjust Cutting Height. Clippings are Scattered Evenly. NO NEED for RAKING or after TRIMMING. SOLD Direct to YOU, at FACTORY PRICES. Light Weight (only 34 lbs.) Royal Mower for Either Gasoline or Electric Motor — 20 Inch Cut — Without Engine..... \$50.00

"Precision Built" to Last a Life Time



OUR DEPENDABLE GASOLINE ENGINE. 2 H.P. 4 Cycle AIR COOLED. Light Weight 30 lb. Quick Easy Starting at any Temperature. No Vibration. \$55.50 Best Engine Ever Made. SAVE MONEY: ROYAL MOWER and Gasoline Engine, \$100.00 Complete as Shown only

ALL PRICES F.O.B. ROYAL OAK MICH. Prompt Shipment. Order Today. If you Prefer Send Check or Money Order for \$20.00. We Ship C.O.D. for Balance. Absolute Money Back Guarantee.

ROYAL OAK LAWN MOWER SHOP

Dept. A—Box 48

ROYAL OAK, MICHIGAN

Electrically Welded Endless

Paramount

BAND SAW BLADES



Made in widths from 1/8" to 1-3/4"

Make your band saw do more work for you. The proper width of blade will extend the scope of this important machine. Burrill's Paramount Blades are made from tough Nickel Alloy Steel properly tempered. Teeth accurately set and filed, and all saws carefully straightened. Send order and check today. Delivery will be made as promptly as conditions permit, from a few days to a week or two. You can obtain these saws at the following prices:

1/8"-3/16"-1/4"-5/8" wide, 5'6" long.....\$1.04 each
1/8"-3/16"-1/4"-5/8" wide, 6'6" long.....\$1.16 each
1/8"-3/16"-1/4"-5/8" wide, 7'6" long.....\$1.27 each

Other sizes at proportional prices

NO C.O.D. SHIPMENTS ACCEPTED

State Make of Machine

Your satisfaction is guaranteed

BURRILL SAW & TOOL WORKS

407 E. Main St., Ilion, N.Y.

GENUINE DIAMOND SCRIBER!

\$2.00 Postpaid

Writes on glass, metals, plastics. Hex. aluminum 6". Money back. No C.O.D.'s; send cash, M.O., check.

CLIPPER DIAMOND TOOL CO., INC. 21-B W. 46 ST., N. Y. 19

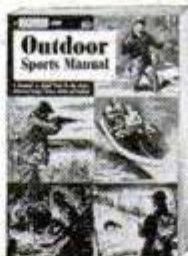

POPULAR MECHANICS

Outdoor Sports Manual!

All sportsmen, attention! Here are 156 pages of helpful hints for the Hunter, Fisherman, Trapper, Camper, Archer, and Boatman. How to make your own decoys, recondition your fishing rod, outwit the fur bearers, make an insect and vermin proof tent, shoot a modern crossbow, and service your outboard motor. These and a pack bag full of other articles for outdoor men. Your News Dealer has it in the 60c paper edition and we can supply the beautifully bound \$2.00 library edition.

Popular Mechanics Press

200 E. ONTARIO ST.

CHICAGO 11

100% PROFIT - For YOU

AGENTS MAKE BIG MONEY

Needed: Every Home and Farm
LOW COST MEANS QUICK SURE SALES

Write Today For Sales Plan

\$795 each

WAK-EM FIRE ALARM

Plano 1, Ill.

CAMILLUS BLADES ARE HAND HONED AND HAND STOPPED

Camillus #21—most popular, quality pocket knife in America

CAMILLUS has the edge!

2 3/8" closed

Ka-MILL-us

CAMILLUS CUTLERY COMPANY, N. Y. 17, N. Y.

Choose Your "22" From This Great Line-up



FIRST IN THE FIELD

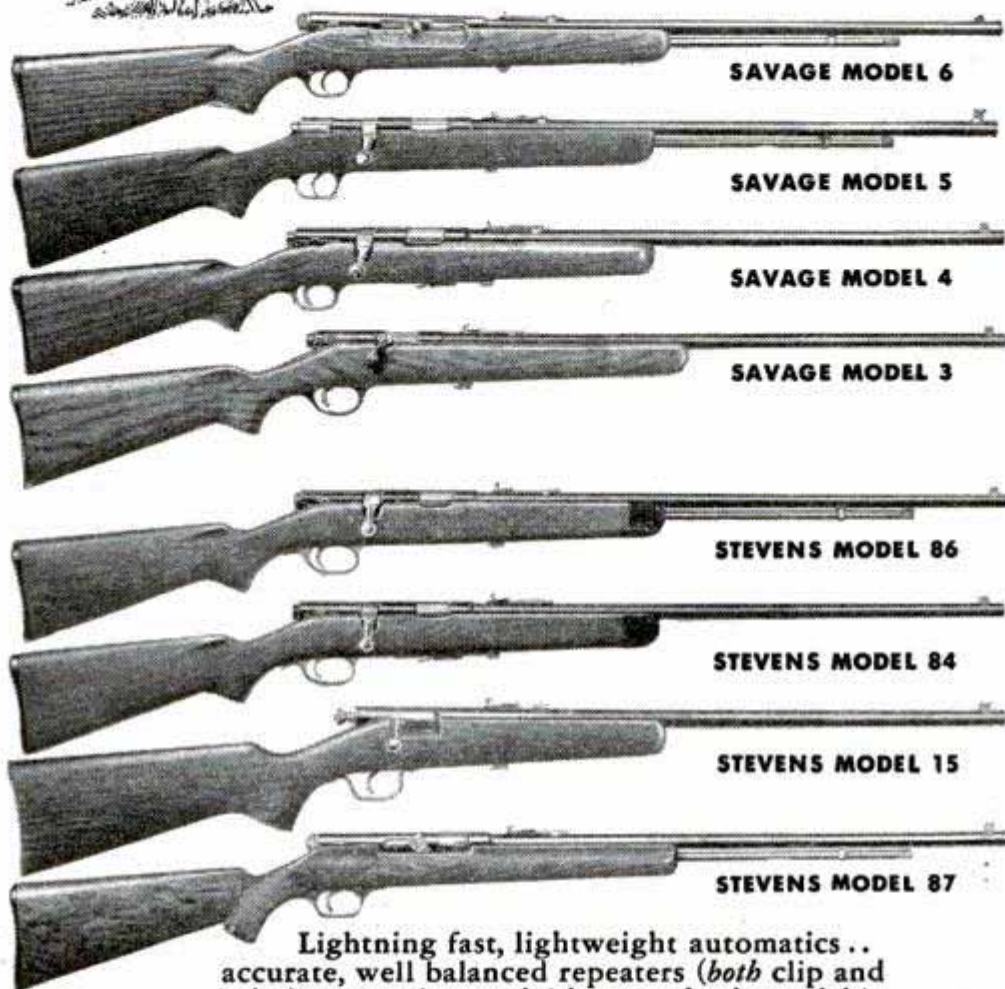

SAVAGE MODEL 6

SAVAGE MODEL 5

SAVAGE MODEL 4

SAVAGE MODEL 3

STEVENS MODEL 86

STEVENS MODEL 84

STEVENS MODEL 15

STEVENS MODEL 87

Lightning fast, lightweight automatics . . . accurate, well balanced repeaters (both clip and tubular magazine models) . . . sturdy, dependable "single shots". Take your pick and *pick a Stevens or Savage "22" rifle for highest quality — greatest value. See these models at your dealer's — write for free catalog.*

SAVAGE ARMS CORPORATION
Firearms Division Chicopee Falls, Mass.

MAN-SIZED STOCKS

Stocks and forestocks of Savage and Stevens "22" rifles are full size, attractively finished, and properly proportioned for steady holding.



No. 150

MICRO PEEP SIGHT

Micrometer elevation and windage adjustment. Precision built. Helps build top marksmanship.

TENITE

The beautiful, durable, service-proven gunstock material—permits custom stock features and appearance on guns priced with the lowest. Now available on the Stevens model 87 (illus. at left) as well as other Stevens rifles and shotguns.



STEVENS .22 Rifles — First in value

Model 86 — .22 cal. Bolt Action Tubular Magazine Repeating Rifle. Magazine holds fifteen .22 long rifle; seventeen .22 long or twenty-one .22 short cartridges. Military style stock with pistol grip.

Model 84 — .22 cal. Bolt Action, Clip Magazine Repeating Rifle. Detachable clip holds five .22 long rifle; .22 long or .22 short cartridges. Self-cocking, bolt action. Independent safety.

Model 15 — .22 cal. Bolt Action, Single Shot Rifle. Chambered for .22 long rifle; .22 long or .22 short cartridges. The lowest priced lightweight "22" in the field.

Model 87 — Semi-Automatic .22 cal. Rifle. Shoots 15 shots as fast as trigger can be pulled. Also, instantly adjustable as single shot or bolt action repeater, shooting .22 long rifle; .22 long or .22 short cartridges.

Stevens Models 86S - 84S - 87S; same as above with No. 150 Micro Peep Sight illustrated above.

SAVAGE .22 Rifles — First in quality

Model 6 — .22 cal. Auto-Loading Rifle — shoots fifteen long rifle cartridges as fast as you can pull the trigger. Also, instantly adjustable as bolt action repeater; shooting .22 long rifle; .22 long or .22 short cartridges.

Model 5 — .22 cal. Bolt Action Tubular Magazine Repeating Rifle. Magazine capacity — fifteen .22 long rifle; seventeen .22 long or twenty-one .22 short cartridges.

Model 4 — .22 cal. Bolt Action 5-shot Clip Magazine Rifle. Chambered for .22 long rifle; .22 long or .22 short cartridges. Stock and forestock of walnut.

Model 3 — .22 cal. Single Shot Bolt Action Rifle. Shoots .22 long rifle; .22 long or .22 short cartridges, regular or high speed. Positive safety. Walnut stock and forestock.

Savage Models 6S - 5S - 4S - 3S; same with No. 150 Micro Peep Sight illustrated and described above.

**THIS IS
THE WAY
to
MAKE
MONEY!**

"My lowest month sharpening lawn mowers was \$80.00 and highest \$582.00. Summer months are best." W. W. L., Okla. "Last year we sharpened and repaired about 1000 lawn mowers for a net profit of \$2600." says E. G.

**REPEAT CASH BUSINESS
-PART OR FULL TIME**

The Foley Lawn Mower Sharpener turns out perfect work — uses same system as lawn mower factories. Simply put mower in machine with handle on — sharpens all sizes and types in 15 or 20 minutes — no experience needed.

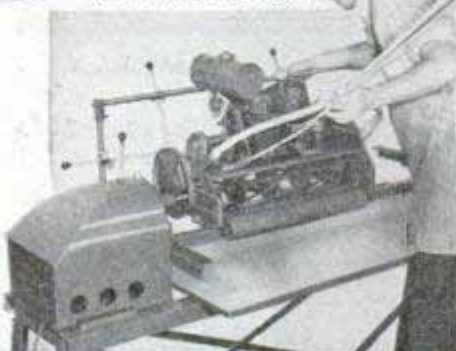

**SEND FOR
FREE PLAN**

Tells how to start — no canvassing necessary. 99c out of every dollar you take in is clear profit. Available now. Mail coupon today!

FOLEY LAWN MOWER SHARPENER

**FOLEY MFG. CO., 207-9 Foley Bldg.
Minneapolis 18, Minn.**

Send FREE PLAN on Foley Lawn Mower Sharpening business.

Name _____

Address _____

**WAR
SURPLUS
BARGAINS**

● **POWER PLANTS.** 110-volt, 60-cycle, 2500-watt & 3000-watt sizes. Some types with remote switch starting. Army's best plants with tools, parts, maintenance manuals. Ideal for farmers, sportsmen, contractors. Both new & used plants. Orig. cost over \$700 on 3000-watt. Prt. prepaid. Some units low as \$199. (Write for details.)

● **MARINE ENGINES.** New single cylinder Briggs 3.5 h.p. air cooled, flame arrestor, thrust bearing, shaft coupler. Ideal for fishing boats. Complete installation instructions. Standard price \$130. Our prepaid price only\$89.90
Same engine with Arnolt clutch.....\$99.90

● **POWER PRESSURE SPRAYER.** Portable engine driven unit. Briggs 1½ h.p. engine. Westinghouse 2 cyl. compressor. Gauge, regulator, valves—complete. (No gun or hose.) Nearly new and guaranteed. Cost over \$250. Special prepaid\$99.50

● **GAS ENGINES.** Nearly new & excellent. Genuine Briggs ZZ 6.5 h.p. Useful tractors, grain elevators, weed & paint sprayers, pumps, scooters, saws. Cost \$140. Our freight paid price.....\$86.90

● **A-C MOTORS.** New 110-volt, 60-cycle, with marvelous speed reduction gear. Speeds of 8, 32, 320 & 4000 r.p.m. on four separate shafts simultaneously. Useful buffers, grinders, drills, coil winders, photo room, window displays. Cost over \$30.00. Our prepaid price..... \$8.75

● **ROTARY GEAR PUMPS.** Precision unit. New condition. High vacuum and pressure. Dozens of uses. ½ drive shaft. Full instructions. Cost \$36. Our prepaid price.... \$3.95

- DeLuxe Electronic Exp. Kits..... \$6.77
- Tulsa 6-ton Winches & Cable.....\$110.50
- \$25.50 Western Ohmmeters.....\$12.90
- \$35.00 Hydraulic Cylinders.....\$8.50
- \$20.00 Desk Phones & Ringer.....\$3.98

● **\$30.00 HYDRAULIC CYL. PUMPS.....\$7.90**
Order direct from ad or send for bargain catalog. We prepay all freight and P.P. We accept personal checks or send M.O. Our reference Natl. Bank of Comm. and 17 years in business in Lincoln.

LECO ENGINEERING CO.

BOX 908 PM-15

LINCOLN, NEBR.

**Say You Saw It in
POPULAR MECHANICS**

Sensational Value! **PAINT SPRAYER
WITH ELECTRIC MOTOR**

**Best Results Say Thousands of
Satisfied Users**

**Complete
Only
\$19.95**

**Shipped
Anywhere**

**Does all Ordinary Paint
Spray Jobs. Uses Paints,
Lacquers, Varnishes, Etc.**

Positively unheard of 'til now—an electric powered sprayer outfit at such a low price. Not a toy! Not a makeshift. It's a real, practical all-purpose sprayer outfit complete with compressor, 110 volt A.C. or D.C. electric motor, suction type, continuous flow spray gun, paint container, 10 ft. air hose, 6 ft. electric cord and plug. Use it for home shop, auto and 'round the house jobs, and do a good job — quick. Rush order today. Only \$19.95 complete. Send check or M.O. If C.O.D. send a five dollar bill for deposit.



Weights Only 8 lbs.

Portable. Use it Anywhere.

Outside U. S.—Remittance with order—\$21.95

HOME SHOP PRODUCTS CO.
DEPT. 12, 4821 SHERIDAN ROAD CHICAGO 40

New BANDSAW
Unheard of value — Sturdy all metal 10-inch bandsaw, cuts wood, metal, etc. Compares with saws costing \$45 or more. Special introductory price \$29.95 for limited time only.
FREE literature. Write today for details or save time by sending remittance with name and address. **SATISFACTION GUARANTEED.**
RAYMOND TOOLS CO.
1305-K Glenwood Ave. Minneapolis, Minnesota

TRACTOR MOWERS

7 foot Cutter Bar with Hydraulic Control. Easily attached to tractor; no complicated brackets or changes on drawbar. Fits most tractors. Standard cutting parts used. Write for complete details.

TUFFORD HARVESTER
529 SO. 7th ST. MINNEAPOLIS 15, MINN.

SMALL D.C. MOTOR ONLY ¾ OZ.
Works on flashlight batteries 1½ to 6 volts. Can be reversed. Ideal for model planes, cars, etc. Dealer inquiries invited. C.O.D.'s accepted—send money we pay mailing costs.
\$1.50
GOLD GAME CO.
Dept. HS, 315 Gold St., Brooklyn 1, N. Y.

FARM AND HOME "HANDY PUMP"
An all 'round ¾" pump for farm and home utility use. Weighs only 20 pounds—self-priming. Fits pipe or garden hose. 8 GPM at 40 lbs. pressure (more at lower pressures). Lifts up to 25 ft. Electric. Complete. Guaranteed.
HANDY
Send your name on a post card for complete literature.

GORMAN RUPP PUMPS
THE GORMAN-RUPP CO.
MANSFIELD, OHIO

THOUSANDS BUILD



U-MAK-IT BOATS

START NOW!

EASY TO ASSEMBLE KITS

Everything Complete in Kit. Quality Material. Simple as ABC instructions. Immediate Delivery.

NO EXPERIENCE NECESSARY
Save Money, Big Value, Sturdy

ROWBOATS, KAYAKS, DINGHIES, INBOARDS, OUTBOARDS, RUNABOUTS, CABIN CRUISERS

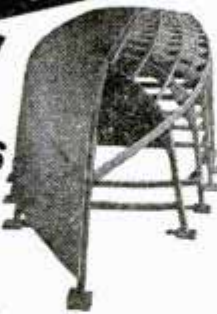

SEND 25¢ (COIN) FOR CATALOGS
Colorful Illustrations show all '49 Models, 8 to 23 Ft., and Construction Details.

U-MAK-IT PRODUCTS
MARINE DIVISION
Formerly Kayak Boat Co.
703P- WHITTIER ST., N. Y. 59, N. Y.



NEW FLUORESCENT FIXTURE
with **CIRCLINE LAMP!**

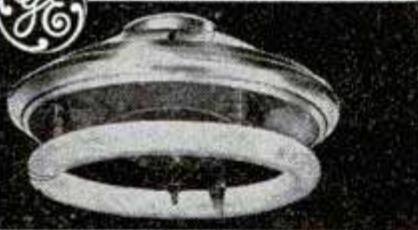

GUARANTEED FOR 1 YEAR!

A strikingly beautiful fixture in polished aluminum finish. Suitable for every room. Model C-32AP (illustrated), \$8.95. Model C-32S with etched glass shade, \$12. Sent POSTPAID anywhere in the U. S. upon receipt of cash order. C. O. D.'s sent F. O. B. factory.

Write for free literature on full line.
HANOVER
Box 186D **LIGHTING** **\$8.95** POST
Dept. SC, Hanover, Pa. **SALES** PAID

Say You Saw It in
POPULAR MECHANICS

Gadgeteer's Corner

U.S. SURPLUS

PAINT
for only **20c**
per Gal.

Self-sizing, washable casein paint. Sea green color only — for interior walls. Can be applied over almost any surface. 10 lb. package makes 5 gal. of quality paint. Will not crack or peel.

SEND **\$1.00**



GOGGLES

Complete with eye protecting light green lens. Protects against dust, wind and glare. Easily folded and carried in pocket. Only **59c**



Genuine Leather Case

5 7/8 x 2 7/8 x 3 1/2" with leather strap. Perfect for small tools, camera accessories, etc. Brand **\$1.00** new, only

ELECTRIC FLIGHT SUITS

Genuine all wool one-piece Coverall with zipper front and elastic cuffs at wrist and ankles. Electric element wired thru garment is so light that you would hardly notice it. Perfect for outdoorsmen. **\$295**
New, only...



CHRONOGRAPH

WRIST WATCH



2 push buttons, Chrome case, sweep second hand. Use it as a wrist watch and a stop watch. Measures speed and distance. Precise Swiss workmanship with 1 year service guarantee. **\$9.95**
Only... tax included
Add 50c for metal expansion band.

3X GUN SIGHT



Precision optical instrument; powerful achromatic color corrected lens; waterproof shockproof. All bronze and brass body. Long distance observation. 22 1/2" long. Gov't cost approx. **\$175.** **\$4.95**

SURPLUS DISTRIBUTORS

924-B N. Plankinton Ave.
Milwaukee 3, Wisconsin

All orders shipped FOB Milwaukee, postage collect. Send money order or check. On C.O.D. orders, enclose 20% deposit, balance plus postage on arrival. Money cheerfully refunded if not satisfied.

ARC WELDING
FOR PROFIT OR PLEASURE

60 LBS. OF READY MADE PARTS

Only **\$24.95**

BUILD YOUR OWN HEAVY DUTY WELDER

SAVE Buy Only NECESSARY PARTS

All parts Ready-Made and easy to assemble. You can do all around welding on steel, cast iron and other metals after only a few hours practice. Illustrated instruction manual included. Sold on 30-Day Money-Back Guarantee!

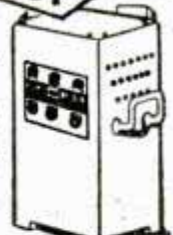

FREE: Write today for fully illustrated Pamphlet P-2

ATOMIC ARC WELDER CO.
1037 So. 19th St. OMAHA, NEBR.

Gives 100% penetration. Welds are stronger than original metal. Operates on 110 or 220 AC.

BARGAIN! ELECTRICAL & MECHANICAL EQUIPMENT BARGAIN!

300-GAL. HEAVY DUTY RECIRCULATING PUMP

For pools, cellars, evaporative coolers, bilges and 1001 other uses.

Supreme's outstanding heavy duty unit will deliver 300 gal. p. h. at 8 ft. head. Completely enclosed 1/30 HP 110-V 60-cycle motor with self-oiling long life feature. Non-corrosive shaft and bronze pump 10 1/2" high. 3/8" I. P. T. **\$19.50**
also in 6 Volts DC for bilge pump.



GENERAL ELECTRIC AND WESTINGHOUSE MOTORS
(Brand New. Not Gov't Surplus)

HP	Volts	Type	Price
1/6	110	Split Phase	\$11.95
1/6	110	Capacitor	17.50
1/4	110	Split Phase	12.50
1/4	110	Capacitor	19.50
1/3	110	Split Phase	15.50

Special Assortment of nuts, screws, bolts, rivets, \$2 gears, etc. 9 lbs. You Pay Postage



HERE'S A REAL BOY'S GIFT



A GENUINE TRAINING REPLICCA of the U. S. Army's Officers Carbine Rifle. It Clicks. PERFECTLY HARMLESS only **\$2.50** Two for **\$4.00**
No C. O. D.

ELECTRIFY YOUR SEWING MACHINE

Simple to attach and operate

This Supreme Set consists of AC-DC 115-v 60 cy. double shaft motor, foot control, rheostat, bracket, belt, pulley, mounting screws, PLUS a FREE complete sewing light. **\$15.50**

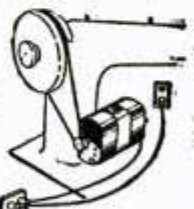

CASH or C.O.D. 20% Dep. on orders
CANAL ELECTRIC CO.
Dept. PM2
310 Canal St., New York 13, N. Y.

PUT THIS RUGGED TRACTOR TO WORK IN YOUR GARDEN!

There's an attachment for every job!



Garden-All

LAWN and GARDEN TRACTOR

WRITE FOR FOLDER

Model "53"
3 h.p. Tractor, with PB Plow. Plows 6 to 6½-inches deep; takes cut 8 to 8½-inches wide.

There's no end to the work you can do with a Garden-All! Because there's a tool for every job—Plow, Disc, Spike Tooth Harrow, Cultipacker, Seeder, Cultivator, Lawn Mower, Sickle Bar and Utility Scraper, too! See your Garden-All dealer and select the model that best fits your power and price requirements.

GARDEN-ALL TRACTOR, INC.

Dept. P, 110 W. UNION STREET, LIBERTY, INDIANA

Sensational Value in AC-DC POCKET TESTER



This analyzer, featuring a sensitive repulsion type meter housed in a bakelite case, represents the culmination of 13 years achievement in the instrument field by a large company specializing in electronic test equipment.

Specifications of the AC-DC Model Volt-Ohmmilliammeter:

AC Volts—0-25, 50, 125, 250
DC Volts—0-25, 50, 125, 250
Milliamperes AC—0 to 50
DC Milliamperes—0 to 50
Ohms Full Scale—100,000
Ohms Center Scale—2400
Capacity—.05 to 15 Mfd.

Total Price, prepaid anywhere in the USA—\$7.00
Similar DC Meter, lacking the AC operated ranges of above, \$5.50 prepaid.

BUFFALO RADIO SUPPLY

219-221 Genesee St.

Dept. PM

Buffalo 3, N. Y.

One Swipe of NEW PLASTIC Makes these LEATHER and LEATHERETTE Items LIKE NEW

Get Into A Money Making Business

Make like new, worn, scuffed or faded leather and artificial leather equipment. Either your own to renew, recolor and beautify, or cafe, restaurant and hotel equipment as a business. Single stroke with a brush renews. Does not crack, peel or scuff. Resists acid, alcohol, caustics and weather. All colors. Mail coupon for free sample.

FREE Sample SHOWS EFFECT



\$50 to \$500 Profit On One Job Possible

Let me show you how, as I have shown others. Get your own exclusive territory while available. Mail coupon today, I'll do the rest. — Jack Edwards, Sales Mgr.

LEATHER-NEW PRODUCTS, 6082 Sunneslope, Kansas City, Mo.
Send me without obligation a sample of Leather-New coated material so I can inspect it.

Name _____
Address _____
City _____ State _____

Don't Risk Engine Overheating

Keep cooling systems ALWAYS up to par with regular **Warner** care



Warner Liquid Solder (Non-Metallic)

• Deposits tiny fibers to repair leaks anywhere in the cooling system.

Warner Radiator Cleaner

• Thoroughly cleans cooling system of rust, oil muck and grease.

Warner Cooling System Protector

• Prevents rust, scale and corrosion.

No delays—just pour in and keep on driving. Do it yourself, or ask your service man.



Warner-Patterson Co., 920 S. Michigan Ave., Chicago 5

Build Your Own BICYCLE TRAILER or UTILITY CART



Enjoy camping trips, make extra money running errands. Will carry up to 200 pounds. Handy cart around home. Change bicycle hitch to cart handle in second. Kit of complete parts, including special hitch to bicycle with body and tongue metal parts already shaped.

COMPLETE PARTS for only \$7.95

FOR UTILITY CART HANDLE with easy attachable joint, add \$1.85

Full instructions how to build. Easy and enjoyable. If not completely satisfied return in five days for refund. You pay return post charges. Send cash or money order to Dept. T-4 or write for free literature.

WHIPPLE MFG. CO., Inc.
SPIRIT LAKE, IOWA

HELPFUL BOOKS

Send post card asking for FREE catalog

Popular Mechanics Press, 200 E. Ontario, Dept. 601, Chicago 11

- BINOCULARS, 6 x 30 Universal, used, good condition, with case..... \$42.50**
 - BINOCULARS, U. S. Navy 7 x 50, used, good cond., with case..... \$95.00**
 - BINOCULARS, Coated U. S. Army 6 x 30. New, with Case..... \$57.50**
 - BINOCULAR CASES, 6 x 30, two grades, leather, new..... \$5.00 and \$7.50**
 - 7 x 50 Leather BINOCULAR CASE, new..... \$7.50**
 - TELESCOPES, U. S. Navy, 16 power, with case. Val. \$125..... \$29.50**
 - 5 Power Ranger TELESCOPES..... \$2.00**
 - SIGHTING LEVELS, New, Engineers Metal Army Type..... \$2.00**
 - SURPLUS GOVT. TRIPODS for Level, Transit, Cameras, etc. Used. Good Condition..... \$5.95**
 - NEW TRIPODS for Transits, Levels, etc. Value \$75.00. Special..... \$13.50**
 - TRANSFORMERS, Western Electric, 5 volt to 650, New..... \$4.95**
 - CANVAS SAFETY BELTS, Metal Snaps, New, \$3.00 Val..... 75c**
- Many unadvertised specials. What do you Need?
4th Edition Annual Gun Digest, \$1.50.

Public Sport Shops

11 S. 16th St., Phila. 2, Pa. No COD'S

POPULAR MECHANICS

NEW PLANI-DRIVE BAND SAW CONVERTER

Convert your wood cutting band saw to a metal and wood cutting tool. Plani-Drive is a 2-speed gear type transmission mounted on a stamped steel "V" belt pulley. Equipped with speed change lever to change from wood to metal cutting speeds.



"Now you can use your wood cutting band saw to cut such metals as aluminum, copper, brass, iron, steel."

COMPLETE UNIT
only
\$29.75

F.O.B.
Crystal Lake,
Ill.

Easy to install. Simply remove large drive wheel from your band saw, and replace with Plani-Drive. Secure torque lever to base or frame of saw and replace belt. Unit comes complete with torque lever and bottle of high pressure lubricant.

(When Ordering State Shaft Size)

Send your **THE ERWOOD COMPANY**
order to Dept. PD, 214 Woodstock St., Crystal Lake, Ill.

FOR ACCURACY — DEPENDABILITY
YOU WILL WANT THIS PRECISION-MADE
17 JEWEL SWISS WATCH

CHECK ALL THESE FEATURES: **ONLY \$23.75**

• Waterproof • Radium Dial
• Shockproof • Sweep Second Hand (Includes Fed. Tax)
• Anti-Magnetic • Chrome Case with Stainless Steel Back

SPECIAL! A sturdy stainless steel expansion band furnished with every watch. Order this smart, dependable watch today! ONE YEAR GUARANTEE. Send no money. Pay postman or save C.O.D. charges—send check or money order. Satisfaction guaranteed or your money promptly refunded!

REGISTERED JEWELERS Dept. PM-2, 545 Fifth Avenue New York 17, N. Y.

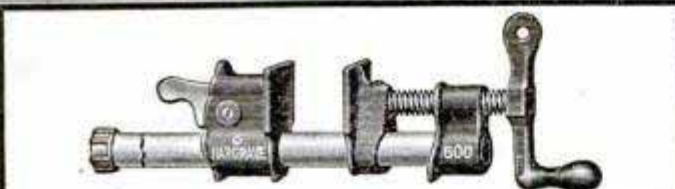

No. 600

CLAMP FIXTURE

Fits 3/4" pipe, can be applied to any length. Easy to assemble. Hardened steel cam holds tight, releases easily. Made of best malleable. Also wood bar and 1/2" pipe clamp fixtures available.

At Hardware and Mill Supply Dealers Everywhere.

Write for Catalog of Complete Line

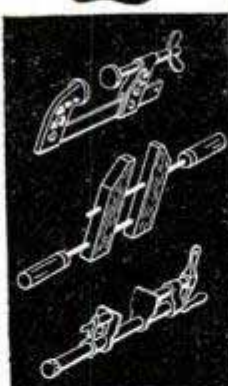

HARGRAVE

1954 Waverly Ave.
Cincinnati 12, Ohio

The Cincinnati Tool Co.

BUILD THIS BEAUTIFUL "CUBSTER" BODY WITH OUR BODY KIT—(Low Cost)

Fits Over Our Model "D" Chassis

- NO METAL FORMING
- NO SPECIAL TOOLS



The New 1949 Model "D"

90" Long
40" Wide

IMMEDIATE DELIVERY

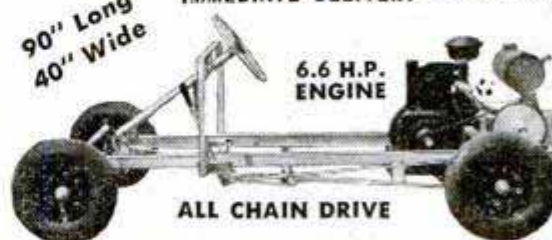

6.6 H.P. ENGINE

10 inch CLUTCH

ALL CHAIN DRIVE

Chassis as Shown ONLY \$299.50 (Plus \$7.50 crating)

As Shown Less Engine, Jack Shaft and Clutch

ONLY \$159.50 F.O.B. (Plus \$7.50 crating)

F.O.B. Doylestown

Pulls Up Hills With Ease. Runs as low as 2 miles per hour or UP TO 35 MILES PER HOUR. Safe and Easy to Operate for Work or Play. ANY AGE. Equipped with 4.00 x 8 High Speed Wheels and Many Other Features.

OTHER MODELS FROM \$59.50 up.
Ride Around in Your Own Car



- BALL BEARING STEEL WHEELS •

12"x21 1/2" Ball Bearing Heavy Steel Wheels with Gates 225 lb. Load Semi-Pneumatic Tire, For 1/2" or 5/8" Axles.

Two for Only \$10.50

Four for Only \$21.00

25% DEPOSIT ON C.O.D. ORDERS.

Add 10% for prepaid Shipment in U.S.A.

32 other sizes and type wheels in stock.

ORDER NOW

Descriptive Circulars and Lists of our products will be mailed promptly if you enclose 10c in your letter.

OSBORN WHEEL CO., 115 So. Main St., Dept. P-2, Doylestown, Penn.

FINE TOOLS
NEED
FINE OIL!



- Lubricates



- Prevents Rust

- Cleans • Polishes

SOLD EVERYWHERE

3-IN-ONE Oil

THE MILBURN CUB

2 1/2 H.P. Only \$69.50

\$10.00 Deposit on C.O.D.

WORLD'S LOWEST PRICED PRECISION-BUILT

2 1/2 H.P. OUTBOARD MOTOR

Get set NOW for Spring—A REAL 2 1/2 H.P. outboard motor—precision built and rugged too—Trolls at 1 M.P.H. and speeds up to 8 M.P.H.—All wanted features. Full 2 1/2 H.P.—Air cooled—Safety gas tank—Under-water exhaust—Automatic tilt—convenient

carrying handle. ALL THIS coupled with easy starting and economy. 2 1/2 quarts of fuel give 2 hours cruising—360° steering \$3.00 extra... See your dealer or ORDER DIRECT from factory... Shipping charges prepaid if cash is received with order...

30-DAY FACTORY GUARANTEE plus 5-day return privilege... full refund if not satisfied.

VALUABLE TERRITORIES OPEN TO DEALERS AND DISTRIBUTORS
H.B. MILBURN CO., Dept. PM-2, 11861 South Main Street, Los Angeles 3, California

DIAL your SAW CUTS!



AMAZING NEW

Warren

DADO SAWING WASHERS MAKE ALL THESE CUTS ON YOUR SAW!

Smooth, accurate grooves—12 widths, any angle. No chatter, no burning, chewing, or sanding! Just dial desired width with Micro-matic adjustment! 5 sizes fit any saw arbor— $\frac{1}{8}$ ", $\frac{3}{16}$ ", $\frac{1}{4}$ ", 1 ", $1\frac{1}{2}$ ". See your dealer or use coupon below! Satisfaction guaranteed.

DEALERS, ORDER DIRECT!

WARREN WASHERS CO., DEPT. 22
70 Medbury Ave., Detroit 2, Michigan

Enclosed \$4.95 for one set of Warren Washers, postpaid. My arbor size is _____

NAME _____

ADDRESS _____

CITY _____ STATE _____



\$4.95 set

pat. pend.

An Outstanding METAL HAND PUNCH

with unusual performance

Needed by every Mechanic in every Shop



No. 5 Jr. HAND PUNCH
CAPACITY— $\frac{1}{4}$ " THRU 16
Ga. Mild Steel. $\frac{3}{32}$ " —
 $\frac{1}{8}$ " — $\frac{5}{32}$ " — $\frac{3}{16}$ " —
 $\frac{7}{32}$ " — $\frac{1}{4}$ " — $\frac{9}{32}$ " —
Punches and Dies Furnished.

THROAT
DEPTH
2 inches

Weights
 $2\frac{3}{4}$ lbs.

only **\$8.75**

ORDER YOURS TODAY!

Write for FREE Catalog on other tools.

Postpaid in U.S.A.

WHITNEY METAL TOOL CO., Dept. P-2, Rockford, Ill.

HOW TO CUT RAFTERS

New vest pocket book gives lengths, side cuts, plumb cuts, deductions. For all rafters for any building from one inch to forty feet wide. Gives numbers to cut on square. Also degrees for same cuts for Radial Saws. All standard pitches from $\frac{1}{8}$ to $\frac{3}{8}$. Just open book to pitch page and there are your lengths, side cuts, etc. Anyone who knows what a jack rafter is can frame a roof if he has this great book. Price \$1.50 prepaid. Builders' Topics, Dept. M, Lock Box #28, Seattle, Washington. CARPENTERS, PLUMBERS, PLASTERERS, ELECTRICIANS, ETC., subscribe for Builders' Topics, the monthly magazine for HE-MAN CONSTRUCTION WORKERS. Only \$2.00 per year. Sample copies 25c.

FIVE ACRES AND INDEPENDENCE

A Practical Guide to the Selection and Management of the Small Farm
By M. G. Kains

This book is a complete, practical guide to the selection and management of a small farm. It explains how a small farm can be self-supporting. What farms not to buy. How to choose the right farm, based on proper soil, location, irrigation, elevation, climate, etc. Then a detailed explanation of what crops to plant and how to make them yield results, sure-fire methods of grafting, rotation, transplanting, etc. Finally, how to make a profit by selling your excess crops, livestock and preserves. Written by an expert who has made a

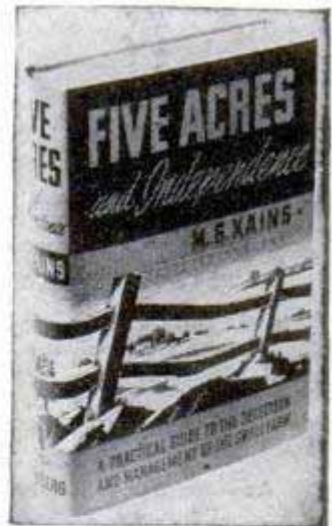

real success with many small farms. Revised, enlarged edition. 413 pages, profusely illustrated. Price \$2.50 Only \$2.50, Postpaid in U.S.A. (Outside U.S. \$2.75). Order Today

POPULAR MECHANICS PRESS Room 490 • 200 East Ontario St., Chicago

SURPRISE VALUE
100 Pieces \$1.00
A Bagful of Bargains at Post Paid in U.S.A.
Grinding Wheels, Cut-off Wheels, Sanding Discs, Mounted Stones, Sharpening and Honing Stones, Rotary Cutting Saws, Abrasive Cartridges, and many other items. Rush check or Money Order.

18 ROTARY CUTTERS \$5.85
\$13.50 Value Post Paid in U.S.A.
Assorted sizes cutter on $\frac{1}{4}$ " or $\frac{3}{32}$ " shank. Will fit all hand grinders. Ideal for cutting wood, metal, or plastic. Brand new.

2 CIRCULAR SAWS \$1.50
AT A RECORD BREAKING PRICE—BOTH AT ONLY
1" diameter saws on $\frac{1}{4}$ " Mandrels. For cutting wood, plastic, or soft metals. Order at once! Send Check or Money Order for this big bargain. Post Paid in U.S.A.
SCHUPACK SUPPLY CO., 7331 Cottage Grove, Dept. M2, Chicago 19, Ill.

Sensational New Electric ① WELDER ② CUTTER!



USES 110-115 AC or DC • WELD-BRAZE-CUT-SOLDER-HEAT TREAT

The WELDRITE combination—tested and proven by countless commercial and amateur users, is now offered direct to you at the amazingly low price of only \$15.00. No Gas—No Gauges—No Spark Lighter needed. Always ready for immediate use—Just plug WELDRITE into 110-115 AC or DC outlet.

Uses standard welding and brazing materials available at all welding supply stores. WELDRITE furnished complete with Converter Unit #1 Single Holder with attached Alligator clip, for welding metal up to $\frac{3}{16}$ " thickness, using up to $\frac{3}{32}$ " rod, and #2 Double Holder with Copper Coated Dual Carbon Electrodes for Cutting, Brazing, Heat Treating, Soldering, etc. Starting welding materials and instructions included.

Ideal for home workshop. Invaluable for body and fender shops, garages, repair and machine shops, manufacturers, etc.

SEND NO MONEY! 10 DAY TRIAL OFFER. Order your WELDRITE Electric WELDER-CUTTER C. O. D. today. Pay postman \$15 plus postage charges (wt. 5 lbs.) or send \$15 and we will pay postage. Either way, if not satisfied, return WELDRITE in 10 days, and money will be refunded. **WELDER HOOD**—Approved lens found in hoods costing to \$10—only \$3.95. Free Folder on Request. California order please add 2 $\frac{1}{2}$ % sales tax.

CALIFORNIA TECHNICAL PRODUCTS CO. 448 So. Hill St., Dept. A-2 Los Angeles 13, Calif.

BOTH only \$15
INSTRUCTIONS INCLUDED



NEW COMBINATION

TIRE INFLATOR FIRE EXTINGUISHER

Only 1 7/8" x 13", weighs only 3 lbs. Inflates a tire in only a few seconds; contains enough pressure to inflate 3 to 5 average size tires. Saves bother of changing tires. Easily refilled. Fully guaranteed.

The CO₂ (carbon dioxide) in this cylinder is the modern fire fighting chemical that quickly smothers gasoline, grease, oil and electrical fires. This is a 'must' for all car owners. Steel alloy cylinder (ICC app.).

\$4.95

ACEY'S 626 KANSAS AVE. H
TOPEKA, KANSAS

Send check, M.O. (add 25c for postage and handling) or order C.O.D. Immediate delivery. Satisfaction guaranteed.

CENTRIFUGAL CLUTCHES

AT 1/4 REGULAR PRICE

Centrifugal Mercury Clutch (3/8-inch shaft). Suitable for motor scooter, garden tractor, lawn mower or other units powered by electric motor or gas engine. Use as replacement or spare. Special purchase stock, each unit perfect and in original package. A \$28.50 value—your price, only \$7.95, postpaid. Not Warranted. Send check or M. O.

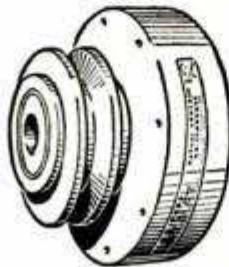

WEISHOR CORPORATION

1029 N. 7th St. Dept. P.M. Milwaukee, Wis.

POWER HACKSAW \$47.25

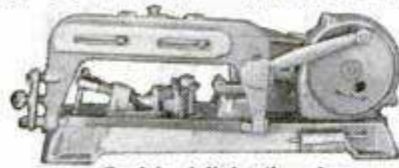

LESS MOTOR
F. O. B. Benton Harbor

No other saw like it. Rugged cast iron construction. Bronze bearings. Quick action vise—jaws swivel to 45°. Draw cut. Automatic shut-off switch. Capacity 4" x 4".

Send for full details and name of nearest dealer.

EXCEL MACHINE TOOLS DEPT. PM-29 BENTON HARBOR, MICHIGAN

UTILITY GRINDERS



Lifetime lubricated ball bearings. Two 6 x 3/4 inch wheels, one coarse, one fine. 115 V., single phase, 60 cycle—3450 rpm. Bright red glossy finish.

LAD PRODUCTS ARE GUARANTEED FOR ONE YEAR

1/4 hp—\$25.00 net
1/3 hp—\$27.50 net

SEND CHECK OR MONEY ORDER. WE PAY FREIGHT EXCEPT FOR SLIGHT CHARGE WEST OF MISSISSIPPI RIVER.

WRITE TO **LAD, INC.** DEALERS' IN-QUIRIES INVITED
161 W. Wisconsin Ave. Milwaukee 3, Wis.



It's NORTHLAND SKI Time!

THE TIME OF THE YEAR
for the time of your life!

Pack the season with thrills. Race your favorite slope with the sure-footed control of perfectly matched, hand-crafted Northland Skis. Northlands are ideal to own, ideal to give. Send 15c for the famous Northland Ski Manual, or, write for free pamphlet.

NORTHLAND SKI MFG. CO.

Supplier to the U.S. Olympic Ski Team
95 MERRIAM PARK • ST. PAUL 4, MINNESOTA



CEMENT DRAIN TILE

Money-Making Manufacturing Opportunity

Today's tremendous market for drain tile opens up opportunities for men of vision and aggressiveness to establish local drain tile plants. Particularly in rural communities, where supply lags far behind demand.

The Champion machine makes all sizes of tile up to 12-inch diameter. With such a range you can supply not only the huge farm market, but many others where drain tile is urgently needed—reclamation projects, home building, road construction, subdivision activities, etc.



LOW COST — HIGH PROFITS

Tile made on the Champion are outstanding in quality—dense, strong, uniform. Far better than clay tile yet can sell for less—even after allowing a handsome profit. Machine is simple, compact, easy to operate.

Get the facts. Write for interesting literature about the business and the moderate priced equipment.

CONCRETE EQUIPMENT CO.

522 Ottawa Ave. Holland, Mich.

JONES Model 48 POLISHER 3 TOOLS IN 1

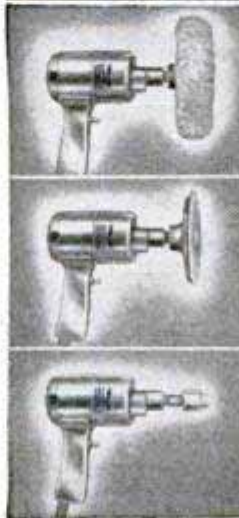

For POLISHING...SANDING...DRILLING

For Simonizing the family car—**BUFFING—POLISHING** (furniture), metal, wood, plastics, and other hard surfaces.

For **SANDING** woodwork and other materials, removing paint, etc.

For **DRILLING** anything—with the Jacob's 1/4" chuck attachment.

Write for Bulletin

JONES MOTROLA CORP.
STAMFORD, CONN.

NEW... RED DEVIL KNEE and FLOOR SWITCH gives you a "3RD HAND"

The touch of your toe, or a feather-like push of your knee, and your power tools are in motion—both hands free to guide and hold your work in place. Power begins the instant you touch this NEW Red Devil Switch. Power stops the instant you lift your foot or knee.

ADD SAFETY—ADD SPEED REDUCE POWER COSTS

Equip each of your power tools with a "3rd Hand." So simple, a 10-year-old can install them. So safe, you'll never have a worry.

SATISFACTION GUARANTEED

Any Red Devil Switch may be returned for full refund within ten days, if you are in any way dissatisfied. Order one for each of your power tools today. Clip and mail coupon NOW!

\$0.50
POSTPAID
CASH WITH ORDER



C.O.D. Orders acceptable if you prefer it.

RED DEVIL MFG. CO., 1400 N. OGDEN AVE., CHICAGO 10, ILL.

SEND ME

QUANTITY

NAME

ADDRESS

CITY STATE

RED DEVIL SWITCHES

Bill Me Enclosed

By C.O.D.

Take Perfect Pictures
... with this TINY
Scientific
Wonder!
Petal
CAMERA

1/2 Actual Size



Imagine a precision camera so tiny, you carry it on a key chain, in watch pocket or hang it from lapel, ready for INSTANT use! For all sports, trips, parties, go LIGHT-WEIGHT, and shoot instantaneous pictures!

PETAL takes brilliant pictures; 6 exposures. Each Petal enlargement is over three times the size of the camera itself!

Be a Johnny-on-the-spot photographer, anywhere. Order your PETAL today!

Only \$20.00 postpaid incl. tax

Send Check or Money Order.

Money-back guarantee within 10 days!

Film \$1.00 (includes SIX superior, fine grain Enlargements)

MYCRO CAMERA CO., INC. Dept. 1A
527 FIFTH AVENUE, NEW YORK CITY



PRACTICAL BOOKS ON HOME PLANNING BUILDING · REPAIRS

MAIL ORDER TODAY

Plan Now—Build When You Can
Books Sent C.O.D. Anywhere in U.S.A.

Select from this list of helpful books. In U. S. books sent postpaid if remittance accompanies order. Outside U. S. include 15% extra for shipping charges.

- How to Plan a House \$5.00
- Your Home and How to Build It Yourself \$3.00
- Painting, Decorating \$1.75
- Carpentry \$2.50
- Painting, Furniture Finishing and Repairing
Includes floor renewal \$1.50
- How to Remodel a House Complete, practical \$5.00
- Building Insulation \$4.50
- Concrete Handbook
Do work for yourself, others \$1.50
- Blueprint Reading for Building Trades \$1.50
- Practical Bricklaying \$2.00
- Primer for Home Builders \$2.50

FAMOUS PLAN BOOKS

Books contain floor plans, photos, descriptions of homes.

AMERICA'S BEST LOW COST HOMES. 125 designs \$1.00

DE LUXE SMALL HOMES. 210 designs \$1.00

OUR FUTURE HOME. Wide selection of residences, summer homes, garage apartments \$1.00

MODERN HOME & GARDENING. 42 popular designs. Improvements, garden short-cuts, etc. \$50c

Set of Four Books \$3.50



Stair Building \$2.50

POPULAR MECHANICS PRESS
DEPT. 646 • 200 E. ONTARIO STREET, CHICAGO 11

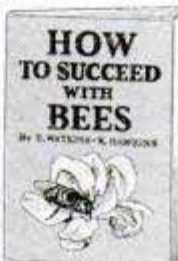

BEE RAISING PAYS BIG PROFITS

Get HOW TO SUCCEED WITH BEES, written by two outstanding experts, which gives more than 100 successful plans to produce big crops of honey. Join the ranks of spare time moneymakers and send for this guaranteed 96-page book today. Tells all about queens, equipment, summer, winter and spring management, swarming, increasing colonies, how to produce section honey and extracted honey, etc. 19th edition, fully revised, only \$1.00.

POPULAR MECHANICS PRESS
200 E. Ontario St. Chicago 11, Ill.

Say you saw it in
POPULAR MECHANICS



PRE-CUT HARDWOOD TEA WAGON SET

Easily assembled. All parts, including the two trays, are smoothly sanded hardwood, ready to paint or stain. Necessary hardware and rubber rollers included. Perfect for teas, parties, buffet suppers—everywhere. Size 18" x 28" x 31" high. Kit also available finished in Mahogany, Maple, Natural, Chinese Red, Green, Canary Yellow or Black Lacquer at \$4.75 additional.

Please send check or money order to

PLEASANT HILLS INDUSTRIES, Dept. P 700 THIRD AVE. BROOKLYN 32, N. Y.

NEW! RADIANT GLASS HEAT ELECTRIC PORTABLE HEATER

**MATERIALS SCARCE
But While They Last
ONLY \$29.95**

Satisfaction Guaranteed
or Money Back



**SAFE—WILL NOT IGNITE PAPER OR FABRIC
Kick It Over or Stand on It — It Won't Break**

APPROVED BY: Underwriters Laboratories, Commissioner NYC Dept. Water, Gas & Electricity.

EFFICIENT: Uses about 1000 watts, or approximately a Kilowatt per hour. Heats you directly. Floor-ceiling heat variation only about 4 degrees; puts heat near floor where needed.

RADIANT heat makes you comfortable at several degrees lower room temperature. Continues to give off heat for over half hour after it is disconnected.

Invented in France. Used to heat Maginot Line. Lessens effect on humidity and oxygen. No flames—no glow—no fumes—no light. No moving parts or blowers. No more roasting on one side, freezing on other. No more red-hot coils. Designed for toughness. Element consists of aluminum alloy fused into back of tempered, break-resisting glass at high temperature. A glass on both sides radiates heat in all directions. Excellent source of supplementary heat. Handsomely framed 15"x20" in polished aluminum, fitting any decorative scheme. AC or DC. Made for 110 volts; 220 volts on request. Just plug it in. 7' electric cord. H. B. of N. J. writes: "It is all you said it is and more."

Send check or money order today. Shipped express charges collect. Shipping weight 21 lbs.

CARNAGEY'S 29 Central Ave., Dept. RH-1800
Tarrytown, New York

SURPLUS BARGAINS

Good merchandise—accurately described—priced at rock bottom. You can buy with confidence from Aero.

- HEADPHONES, Army Type. Used but serviceable. Pr. \$ 1.10
- MIKE, Hand Type T17 with cord and plug. Good cond. Each \$ 1.50
- GENERATOR, 24 volt, 25 amp, airplane type L3. Each only \$17.50
- LIGHT PLANT, powered by approx. 3 H.P. gas engine, 14 volts, 70 amp. capacity. On pneumatic wheels, with dolly. Crated. Homelite type. Each only \$74.50
- SEXTANT, Navigator's Link, with case, components, and comp. instructions. Perfect. New reduced price \$14.95
- VOLTMETER, 0-30, 25 $\frac{1}{2}$ inch or 0-300, 25 $\frac{1}{2}$ inch. Requires 50 MV shunt, not furnished. Each only \$ 2.95
- SAFETY GOGGLES, optically ground lenses, metal frames and guards, adj. ear loops. Made by Bausch & Lomb. Brand new—in metal case. \$ 1.00
- 4-IN-1 TOOL, Shears, bends, punches and rivets, works up to 1/4 inch. New. Ea. \$ 9.95
- AIRPLANE HDW. Mixed assort. of screws, rivets, washers, clamps, bolts, etc. All new. 10 lbs. only \$ 1.95
- FOOD WARMER or dry ice box. Portable. Heats on 24 volt DC or 110 V. AC. Measures 11x17x17. Doors fold out to make table. Has two shelves and large top drawer. Fitted with 6, 4 1/2 inch stainless steel cups with lids, 4 stainless steel food containers (7x9x1 1/2 in.) usable also as plates. Six each knives, spoons and forks; salt and pepper, water container, etc. Furnished complete with all wires, plugs, etc. Plug in at home to keep foods and liquids warm or pack with dry ice to keep them cold. Shp. wgt. 35 lbs. Each \$19.95

Send check or money order. All F.O.B. Houston. Can ship mail, express or freight, transportation charges collect. Order today while these bargains are available.

AERO PARTS SUPPLY, Dept. PM2

MUNICIPAL AIRPORT HOUSTON 17, TEXAS

UNIVERSAL HAND DRILL



Pat.
Pdg.

**A
MARVELOUS
BUY at
\$3.00**

**REACHES SPOTS
NO OTHER DRILL
CAN REACH**

Patented adjustable hand drill has chuck that can be positioned at any angle over a range of 270° to permit drilling into close corners by just a twist of a thumb screw. Capacity up to 1/4".

Shipped anywhere in the U.S.A. postpaid

NO C.O.D.'s NO STAMPS PLEASE PRINT

Samor Engineering Co., Dept. PM, 37-25 33rd St., Long Island City 1, N. Y.

Enclosed find \$..... Send me..... Universal Hand Drills.

Name.....

Address.....



Save THIRD!

Genuine High Quality

GABARDINE Dress Trousers

7.95
\$12.50
VALUE

AMAZING BARGAIN! Best virgin wool and fine-spun rayon blended. Twill weave resists wrinkles, holds crease, gives amazing wear. Expert fashion tailored for perfect fit. Zipper front. Roomy pockets. Blue, Tan, Sand, Lt. and Dk. Brown, Blue-Gray. WAIST: 28-38 pleated, 28-50 plain.

SEND ONLY \$1 with name, waist size, 1st and 2d col- or selection. Pay postman balance plus C.O.D. Or, send entire amount, save C.O.D. Money back within 10 days if not pleased.

FREE
Write for sample of material.

LINCOLN TAILORS Dept. PM-2 Lincoln, Nebr.

The New Improved All-Purpose DYNAMIC Super Charged ARC WELDER

Industrial Transformer Type

IDEAL FOR AUTO HOME APPLIANCE AND FARM IMPLEMENT REPAIRS

WORKS ON IRON, STEEL and other metals. Does work you'd expect from a larger costlier machine. Portable, easily carried. OPERATES from any properly wired 110 Volt Line. Also available for 220 volt current at slight additional cost.

IT WELDS • IT BRAZES • IT SOLDERS

EASY TO OPERATE TRANSFORMER TYPE WELDER. If inexperienced you can learn to do professional work by following the SIMPLIFIED WELDING and OPERATING INSTRUCTIONS FURNISHED—comes complete ready to operate with helmet, rods, cable, instructions. SAVE TIME and MONEY—Do your own welding. Just a few repair jobs will pay for this machine. A practical and profitable machine tool for any workshop. Make money doing repair work for others. Write today for full particulars.

DYNAMIC WELDER CO., Dept. 29-T, 15 E. 23rd St., Chicago 16, Ill.

ONLY \$28.50 COMPLETE



SPECIAL GIFT OFFER! ARC TORCH WORTH \$6.80 YOURS at NO EXTRA COST!

TWIN CARBON TORCH (illustrated) for use with DYNAMIC is unsurpassed for brazing, soldering, pre-heating and cutting iron, steel, brass, bronze and other metals. With it you greatly increase profitable uses of your welder. Does work of oxy-acetylene torch. Comes complete with instructions, carbons and cables. For LIMITED TIME ONLY we are giving a

Twin Carbon Electric Arc Torch worth \$6.80 with every DYNAMIC WELDER. Act now to get this valuable premium at the single low price of welder alone.



Mail Coupon FOR FREE FACTS

10-DAY TRIAL OFFER

DYNAMIC WELDER CO., Dept. 29-T, 15 E. 23rd St., Chicago 16, Ill. Send me FREE details of your ELECTRIC Arc Torch Gift Offer and Dynamic Welder 10-Day TRIAL OFFER.

NAME.....
ADDRESS.....
CITY..... ZONE..... STATE.....

**DOWN
COMES
THE
PRICE!**



**4-POWER INTERNAL
ADJUSTMENT SCOPES
NOW \$935**



There's no inflation at Mossberg! So many thousands of shooters have bought Mossberg's fine, 4-power scopes that now we can bring them to you at a substantial saving—and with no sacrifice in quality.

● Mossberg 4-power Scopes Fit Practically All Rifles up to .25-.20 cal.

So, almost regardless of what make of small bore rifle you have, you can enjoy better vision and better shooting with a Mossberg telescope sight.

SEE THEM AT
YOUR DEALER'S
FREE folder on
request. No sales
at factory.



96502 ST. JOHN ST., NEW HAVEN 5, CONN.

Say You Saw It in
POPULAR MECHANICS

**BEFORE YOU BUY ANY
SMALL TRACTOR**



SEE THE POWERFUL
5-H. P. GRAVELY—
the world's finest, yet most
moderately priced Garden
Tractor. Complete line of
exclusively designed power
tools for every Garden,
Lawn and Field job.

**GRAVELY
TRACTOR**

FIELD-TESTED FOR 27 YEARS

MAIL NOW! FOR NEW **FREE BOOKLET!**

GRAVELY MOTOR PLOW & CULTIVATOR CO.
BOX 263 DUNBAR, W. VA.

NAME _____
ADDRESS _____
TOWN _____ STATE _____

SOLVING YOUR LAWN & GARDEN PROBLEMS

**PAY RAISING—EXTRA MONEY
BOOKS**

Use these books to prepare for a better job—bigger pay—to start a profitable spare time or full time business of your own, improve your home, start a hobby. Popular Mechanics' specialists in

supplying outstanding self-help books on many subjects. Send for our FREE catalog.

- Outdoor Sports Manual
Hunters, Fishermen, Trappers, Campers, Archers, Boatmen, here is your book! . . . \$2.00
- Shop Notes Library
3 Vols. — 1949, 48, 47, 44, (No. Dup. Mat.) . . . \$3.00
- Painting, Furniture Finishing and Repairing . . . \$1.50
- Rewinding and Servicing Electric Motors (No. 75) . . . 25c
- Drake's Cyclopedia of Radio and Electronics
New revised edition with hundreds of illustrations to explain the simply written up-to-date text . . . \$5.00
- High School Self Taught
Covers 25 subjects with study guide and self-testing quizzes. Completely revised and enlarged edition, 1280 pages, 300 illustrations, . . . \$3.95
- Garden Book
Build own trellises, lawn furniture, fireplaces, ornaments, etc. . . . \$1.00
- Diving, Cutting and Welding in Underwater Salvage Operations
Only book of its kind . . . \$2.00
- Picture Framing
Modern methods for making and painting picture frames. Fully illustrated, . . . \$2.75
- Frog Industry
Breeding, feeding, dressing and marketing . . . \$2.00
- New Fields for the Writer
Television, radio, film, drama . . . \$1.00
- Everyday Mathematics
Businessmen, tradesmen, executives and secretaries apply this arithmetical brush-up-type . . . 50c
- Breaking Into Advertising
Into the Freezer and Out
A complete handbook on the home freezing of foods. \$2.50
- Concrete Handbook
New book on using concrete around home, garden, farm . . . \$1.50
- Zero Storage in Your Home
How to prepare, store and freeze food properly . . . \$2.50
- This Way Up
The successful philosophy of practical business men \$2.00
- Welding, Brazing and Soldering
How to build own equipment and how to use it effectively . . . \$1.25
- Modern Refrigeration
Electric, Gas. Be service expert . . . \$5.00
- Dyke's Auto Encyclopedia (includes Diesels, airplane engines)
New 20th Ed. World's greatest book for mechanics \$7.00
- Household Mechanics
The "fix-it" book to end all "fix-it" books. Covers electric appliances, painting, carpentry, etc. . . . \$2.75
- Oil Burner Handbook . . . \$2.50
- Build Your Own Boat
Describes 17 popular boats—rowboats, sailboats, plywood outboard, etc. 192 pages \$1.50
- House Wiring (No. 89) . . . 25c
- Turn Scrap Into Money
Convert old auto generators into motors, welders, etc. . . . \$1.00
- Popular Mechanics Farm Manual
Packed with practical ideas and usable information that can easily be worth hundreds of dollars to every farm family and to homeowners everywhere. Send for free descriptive folder giving complete contents! . . . \$3.00
- Woodworking for Every body . . . \$2.75
- Sheet Metal Work . . . \$3.00
- Tool and Saw Sharpening (No. 92) . . . 25c
- Forging Practice . . . \$1.50
- Action Toys (No. 66)
Plans for 21 easy-to-make toys . . . 25c
- Foundry Work . . . \$2.25
- Pattern Making
Wood, metal . . . \$2.25
- Forty Power Tools
Build own saw, drill, lathe, sander, etc., from scraps—save money . . . \$1.25
- Carpentry . . . \$2.50
- The Young Craftsman
Over 450 things boys can make . . . \$1.50
- Five Acres and Independence
How to make money on small farm . . . \$2.50
- Your Home and How to Build It Yourself
Step by step construction of the famous POPULAR MECHANICS house. Wonderfully illustrated . . . \$3.00
- Everyday Law
A lawyer tells laymen about negotiable instruments, partnerships, contracts, real estate and wills. . . . 50c
- Motorist's Handbook
Popular Mechanics scores again. A 160 page guide to automotive happiness . . . \$2.00
- Knots, Ties and Splices
For everyone who uses rope . . . \$1.25
- What to Make for Children
Junior tough on toys? Build him playthings that will last . . . \$2.00
- LeJay Manual of Homemade Electric Equipment
How to construct 100 items that are scarce and valuable . . . \$1.50
- How to Estimate for the Building Trades: Material and labor costs for masonry, plumbing, electricity, carpentry, heating, hardware, painting, etc. 628 pp . . . \$3.50
- Pay Dirt
How to make soil fertile by obeying Nature's laws . . . \$3.00
- Rabbits for Food and Fur . . . \$2.50
- Tool Making . . . \$4.00
- Tool Design . . . \$4.50
- Plumbing Installation & Repair Manual . . . \$2.00
- Ropp's Calculator
Figuring made easy . . . 75c
- Slide Rule Simplified . . . \$2.75
- Drake's Refrigeration Service Manual . . . \$2.00
- Primer for Home Builders
All the information you need to know in building a house . . . \$2.50
- Oxy-Acetylene Welding and Cutting
Up-to-date handbook on gas welding and cutting . . . \$2.75
- Toys You Can Make of Wood . . . \$2.50
- A.B.C. of Poultry Raising \$2.50
- Ice Cream for Small Plants
Some technical formulas for ice cream, ices and frozen desserts on a commercial scale . . . \$2.50
- Furniture Joinery . . . \$2.50
- Essentials of Upholstery . . . \$3.25
- Radio Physics Course
A thorough training in radio fundamentals . . . \$5.00
- Modern Home Medical Adviser
How to recognize diseases, practice proper hygiene, and know what to do in medical emergencies. 900 pages, 136 illustrations . . . \$2.49



MAIL THIS COUPON TODAY

Check the books you want, write your name and address below, and mail this advertisement with money order or check. Outside U. S. A. include 15% additional for shipping charges.

Books selected will be mailed promptly on our "money back if you're not entirely satisfied" guarantee.

Name _____
Address _____
City _____ State _____

Mail to **POPULAR MECHANICS PRESS**
Dept. 651—200 East Ontario St., Chicago 11, Ill.

"Wellworth" Sensational Offer! WESTINGHOUSE AIR COMPRESSOR

plus Spray Gun, 20 Ft. Hose, Pulsation Chamber Filter, Air Gauge and Pop Valve. ALL ITEMS BRAND NEW. 6 Items All For **\$32.50**

IDEAL FOR HOME, FARM, FACTORY—wherever compressed air is needed. A fortunate purchase from the Government enables us to offer this amazing buy at a small fraction of its original cost. All brand new. You get the genuine Westinghouse air compressor, spray gun, 20 ft. hose, pulsation chamber filter, air gauge and pop valve all for \$32.50. Shipping weight 35 lbs. Designed for automotive truck or tractor mounting. Can be run off fan belt or power takeoff, or mounted horizontally. Comes with automatic clutch. Can be installed for use on farm trucks, jeeps, tractors, tire or garage service trucks, contractor or road building machinery, pneumatic devices, etc. Can be operated with 1/2 H.P. or more electric motor or equivalent portable gas engine.

6 Items All For **\$32.50**

THE COMPRESSOR

Piston Type, 2-cylinder, 2 inch bore, 1 1/2" Stroke Ball Bearing. AUTOMATIC CLUTCH. OIL. FREE AIR. 3.27 C.F.M. at 600 R.P.M. 6.54 at 1200. Suggested operating pressure 75 P.S.I. DIMENSIONS: 9" wide, 11 7/8" high, 6 5/8" deep. Wt. 23 lbs.

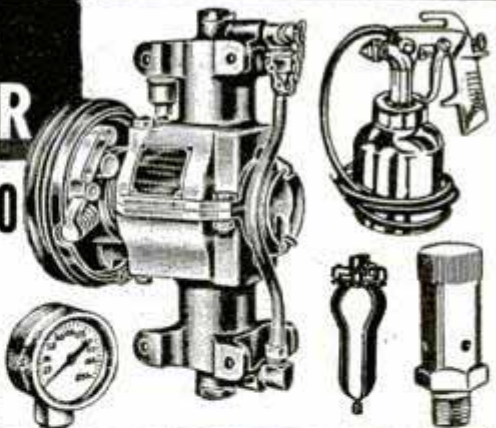

HERE'S THE DEAL:

Westinghouse Air Compressor, Spray Gun, 20 Foot Hose, Pulsation Chamber Filter, Pop Type Valve, Air Gauge — Complete outfit **\$32.50** only. Compressor only, \$22.50.

"WELLWORTH" OFFER AIR COMPRESSOR COMBINATION



Piston type, size 2 x 1 3/4, head in valves, bronze bearings, splash lubrication, "V" Belt drive. Intake muffler and cleaner. Capacity 2.8 c.f.m. at 100 lbs. continuous pressure or 150 lbs. intermittent, with 1/2 HP motor. Can be used with 1/4 HP or 1/2 HP at lower speed. Weight 14 lbs. Operating instructions furnished.

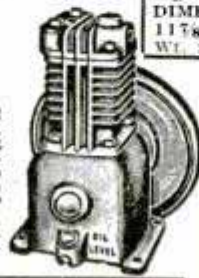

Outfit Includes:

- Piston type air compressor
- 2-nozzle spray gun
- 20 ft. hose
- Pop type valve.
- Air gauge
- Pulsation chamber filter



6 ITEMS ALL FOR ONLY \$29.75

Compressor only	\$17.95
Compressor with Pulsation chamber filter	\$19.95
Spray gun and hose	\$10.45

AIR REGULATOR & GAUGE



The buy of a lifetime in a standard make air pressure regulator. Used on liquid carbonic tanks and air pressure tanks of all kinds to regulate the pressure. Fitted with standard 1/2 inch pipe thread. Dial calibrated 0 to 200 lbs. Reduced pressure 0 to 150 lbs. Made by Kidde.

Wt. 4 lbs. Value **\$7.50**

AIR HOSE



Heavy Duty. 20 Ft. with 1/4" fittings. Leak proof. Wt. 5 lbs.

\$2.95

100 CFM TWIN-BLOWER BUY



Best 100—CFM Twin-Blower for ventilators, heaters, exhausters, dryers, furnace blowers, etc. Quiet running, 110V., 60C., A.C. motor. Steel housings and wheels. Easy to mount.

WT. 10 LBS. Charges prepaid on this item only **\$12.50**

AUTOMATIC PRESSURE SWITCH WITH UNLOADER

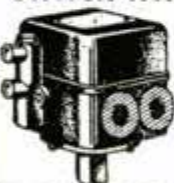

Double pole, with 2 way release valve. Set at 125 to 150 lbs. pressure. For use on compressor units 1/4 to 3 H.P. Pressure range 20 to 200 lbs. Weight 4 lbs. **\$10.25**

AUTOMATIC WATER PRESSURE SWITCH

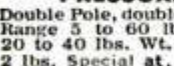

Double Pole, double break. Range 5 to 60 lbs. Set 20 to 40 lbs. Wt. 2 lbs. Special at **\$5.50**

"Wellworth" 1/4" REDUCING VALVE & GAUGE



Oil resistant, pressure 0-to-200 lb. Reduced pressure 0-to-75 lb.; 3 outlets 1/4". Wt. 2 lbs. **\$5.75**

2 1/2" Gauge only **\$1.75**

PNEUMATIC AIR TOOLS

Riveting and chipping hammers for many uses: riveting, chipping, hammering, auto body work, concrete breaking, etc.; used, guaranteed like new.

Chicago Pneumatic Riveter & Chipping Hammer



CP4X Pistol grip handle with air control. Takes up to 3/16" rivet. Weight 6 lbs. List price \$73.00.

Special Price **\$12.95**
Same as above, brand new **\$19.50**
Size CP3—Takes 5/32" Rivet **\$8.95**

CHICAGO PNEUMATIC LEVER TYPE AIR DRILL



With 1/4" Jacob Chuck. Wt. 2 lbs. List price \$55.00. Only **\$15.00**

INGERSOLL RAND



Push button, takes 5/32" rivet. Wt. 3 lbs. List price \$85.00. Only **\$8.95**

Ingersoll Rand AIR DRILL



With 1/4" Jacob Chuck. Wt. 2 lbs. List price \$55.00. Only **\$15.00**

Chicago Pneumatic SQUEEZER



Model 351. Takes 3/16" rivet. List price \$220.00. Wt. 12 1/2 lbs. **\$22.50** Only

A.V.C. 10 Ingersoll Rand CHIPPING HAMMER



Takes 1/4" rivet. Wt. 3 lbs. List price \$80.00. **\$8.95** Only

"Wellworth" Pressure Tank

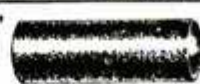

8" x 42" Welded Steel. 3/4" opening on each end. 1/4" and 3/8" openings at centers. Convex Head and Bottom. 100 lbs. working pressure. Shipping Wt. 35 lbs. SPECIAL **\$8.75** PRICE only

SPEEDWAY 1/4" DRILL



Snap release chuck. 6 ft. cord and plug. 110 Volt, AC-DC. **\$11.80** Prepaid—this item only.

"Wellworth" Check Valves



1/4" valve **\$2.75**
1/2" valve **\$4.50**

6 FT. STOW

FLEXIBLE SHAFT

Heavy Duty, 3/8" Core. Best piano wire. Ball bearing handle and arbor, rubber covered housing; for 1/2" motor shaft; for 1/2" bore wheels. Operates on 1/4 H.P. Motor at 1725 or 3450 R.P.M., \$29.00 Value, **\$14.50**. Wt. 8 lbs.



Reduced Price **Only \$14.50**

HEAVY DUTY ELECTRIC MOTORS

Ball Bearing 110/220 volts—1 phase—60 cycle—1750 R.P.M.—Continuous duty, 300% full load starting Torque, outlet box, operates clockwise or counter-clockwise, carries one year guarantee against mechanical defects. Also in 3450 R.P.M. at same price:
1/2 HP Wt. 36 lbs. **\$33.50**
3/4 HP Wt. 50 lbs. **42.00**
1 HP Wt. 80 lbs. **54.00**
1 1/2 HP Wt. 80 lbs. **56.00**

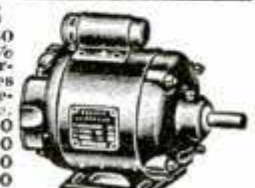

All items advertised are brand new unless otherwise stated. Sold on money back guarantee. Terms: F.O.B. Chicago. Send check or money order. Prompt shipments.

**ORDER FROM THIS AD
WELLWORTH TRADING CO.**

Merged with
C & M Equipment Co.

1831 S. STATE ST., DEPT. D-2
CHICAGO 16, ILL.

Make a DRILL PRESS Your Most Versatile Workshop Tool

● You can plane woods and plastics, rabbet, tenon, panel, groove, bead, contour, rout, mortise, surface sand, drum sand, cut moldings, shape, dovetail, grind and drill with Barron's time-tested and proved precision workshop tools. They save time, money, broaden your workshop technique. A full line of drill press spindle adapters and 1/2" Dovetail cutter also available. All tools sold on 10 day money back guarantee.



**ROTARY WOOD
PLANER**

3" dia. safety planer fits any drill press. Over 100,000 now in use.

\$7.50 Complete



**2 1/2 x 3" DRUM
SANDER**

A "must" for sanding contours and straight edges. Also available in 1" dia. at \$2.10

\$3.95 With 5 Sleeves



**ROTARY SURFACE
SANDER**

4" dia. aluminum housing and heavy rubber pad. A perfect finishing sander.

\$5.95 With 20 Discs



**AUXILIARY
DRILL PRESS TABLE**

Fits any drill press. Has 234 sq. inch working surface for holding work pieces flat and true. Equipped with adjustable steel fence.

\$9.85 F.O.B. Detroit



**ALL-METAL
SHAPER FENCE**

Ideal for shaping and molding operations, other uses. All metal, nothing to warp. A real buy at

\$8.25 F.O.B. Detroit



**ROUTER & ROUND END
MORTISING BITS**

Newtype hi-speed steel spiral flute bits. Available in individual sizes or sets of 6 attractively packaged from 1/8" to 1/2" at \$9.50



WRITE
FOR
FREE
WORKSHOP
GUIDE



**SAFETY SHAPER &
MOLDING CUTTER**

New, patented design eliminates set screw. More versatile than any other similar design on market. \$9.00 with 3 Sets Standard Blades

See Your Dealer . . . Or Write Direct

BARRON TOOL CO., INC.

569 Architects Bldg., Detroit 1, Mich.

BARRON PRECISION WORK SHOP TOOLS

DIE-LESS DUPLICATING

Many small parts can be formed without dies, to duplicated accuracy of .001" with DI-ACRO Precision Machines. — Benders, Brakes, Shears. Save die expense and time delay. Ideal for experimental and research work, making samples, models, etc., as well as regular production runs. Write for descriptive literature.

O'Neil-Irwin Mfg. Company

341 8th Ave.
Lake City, Minnesota



SHEAR



BENDER



BRAKE

SAY YOU SAW IT IN POPULAR MECHANICS

WORLD'S LOWEST PRICED ADDING MACHINE

VEST POCKET SIZE
IDEAL FOR INCOME TAX!

FREE TRIAL
ONLY \$2.95
TOTAL COST
SEND NO MONEY

FREE!!

Each Baby Calculator in Beautiful, rich-looking Leatherette case—at no extra cost.



Fits vest pocket or purse. Guaranteed accurate. Operated as easily, and as reliable, as machines costing many times as much. Not a toy. Precision made, very durable—guaranteed for life against defects in construction. You positively can't buy a calculator of equal quality for as little money. ACCEPTED AS THE FINEST LOW PRICED CALCULATOR FOR OVER 35 YEARS! Operates with a flick of your finger. Adds, subtracts, multiplies, divides—counts up to one billion. Pays for itself over and over in mistakes avoided, and time saved.

MAKES IDEAL GIFT

Sold on a positive money back guarantee. Send only \$2.95. Calculator sent postpaid, or send name and address and pay postman \$2.95 plus postage. MONEY BACK IN 10 DAYS IF NOT DELIGHTED! (If outside U. S., send \$3.50.)

AGENTS WANTED

CALCULATOR MACHINE CO., (Mrs.)

Dept. 211, P. O. Box 248, Glenview, Illinois

LAWN MOWER SHARPENER



lawn mower sharpening
at low cost!

\$4250

less motor,

turn spare time
into dollars

Order direct from
**QUAD CITY PRODUCTS
Company, Inc.**
Box 42, Rock Island, Ill.

SUPER JET MINIATURE BLOWTORCH

NO PRE-HEATING REQUIRED—STARTS IMMEDIATELY
You can use this amazing new tool for soldering, brazing, melting glass, plastic polishing. Take it on camping trips. Its 2000° F. flame will light even the wettest wood in an instant. Complete with 2 hour supply Super Jet Tablet Fuel. Money back guarantee if not completely satisfied.

\$135
Post Paid

GADGET MART, 63 W. 44 St., New York 18, N. Y.
"Home of Mail Order Gadgets."



**MEN! THIS FINE
SUIT YOURS
WITHOUT PAYING ONE CENT!**

BIG CASH EARNINGS TOO!

Big news! Wear this fine tailored suit without paying one cent and earn big cash income too! It's easy! Just take orders from a few friends and neighbors. Show actual samples of dozens of rich new fabrics superbly tailored in choice of all the latest styles at low prices. Money back guarantee on every order.

Write for FREE SAMPLES! Rush letter or post-card giving your name and address, and telling us about yourself—age, etc. We'll send you big profit of actual samples FREE, and details of amazing new BONUS SUIT and money-making plans. No experience needed. Send no money!

W. Z. Gibson, Inc., 500 S. Throop St., Dept. P-516, Chicago 7, Ill.

UP TO 85% OFF IN WAR SURPLUS-SENSATIONAL VALUES

When visiting California come in and say "Hello".

New Hydraulic Cylinders, Valves, Pumps, Fittings, Hose and Tanks

51 SIZES AND TYPES. WORLD'S LARGEST SUPPLY 1001 Labor Saving Adaptations for Pulling, Pushing, Lifting Operations. Finest Precision workmanship and materials. Liquid and Air Operation, developing terrific power. 20,000 Available. Write for Catalogue. Priced to sell at 15% Gvt. Cost

PUMPS, New Hydraulic, Vacuum, Air

P-1 HYDRAULIC PESCO TYPE

Positive displacement gear type. Capacity: 1 gal. per minute, at 1500 R. P. M. at 1500 P. S. I. Operating speed: 3700 R. P. M. intermittent maximum 4500 R. P. M. Rotation: either direction with slight adjustments. — \$9.49

800 GPH at 30 PSL can also be used as hydraulic for 4 GPM at 400 PSL or for Vacuum drawing 15 in. mer. at 1500 R. P. M. — \$6.29 ea.

WINCH HOISTS

Thousands of satisfied users. Hundreds have written the most wonderful tool in the world.

No. 100 WINCH HOIST

Cap. 2500 lbs. with 20-1 ratio controlled bronze worm gear, 19" 1/4" alloyed steel cable with hook, two speed handle. Ideal for Garage, Truck Idng. Mach. Shops. Boat Bldrs., etc. A \$100 Value — \$15.99

PNEUMATIC AND AIR TOOLS

10,000 in various popular makes, sizes, types. Cleco, Aro, Ingersoll Rand, Chicago, Pneumatic, Buckeye, etc.

RIVET

#180
#181 Pistol

GUNS

Pistol & Goose-neck Type
101 Uses. Clipping, Sawing, Hammering, Breaking cement and auto body work.

Chicago Pneumatic, Cleco, Ingersoll Rand Makes.
E3, E2, 3X, 2X, OY
\$55 Value
\$8.95
\$80 Value
\$15.95

NEW PRESSURE TANKS

Stainless Steel - Shatter Proof. Rustless. 10,000 available in 6 different sizes. 1001 uses. G-1 13 1/2" x 24 inches - 2100 Cu. in. capacity — \$4.75

D-2 8 1/2" x 24 in. - 500 Cu. in. capacity - 7 cu. ft. — \$2.49

F-3 - 18" x 18" 1900 Cu. in. capacity — \$3.95

F-2 8 x 45 in. - 1200 Cu. in. capacity 14 cu. ft. — \$3.95

A-4 5" x 8" 104 cu. Capacity — \$3.95

A-6 5 1/2" x 15" 280 cu. in. Capacity — \$1.35

Excellent portable tanks for carrying oil in car or trailer. Ideal for painting, cooking, spraying, ocean buoy, underwater fishing or diving. #OR-1 Oxygen Regulator with 100 lb. gauge will fit all tanks — \$1.39

Giraffe Neck Winch Hoist

31 in. overall length. 48 in. Tube with 7/8" diameter. Ketchel brake on extension. Brakes hold load in any position and is Automatic. Perfect for height, swing about. Truck or platform loading. 12 ft. 3/16" cable with eye hook. Will take 2000 lbs. — \$15.99

TINY MITE WINCH HOIST

1000 lb. Capacity, with 30 to 1 Bronze worm gear, 4" x 1 1/4" Cable drum. Ratchet on handle, safety factor to hold load, with pin release lowering loads, tightening lances, etc. — \$7.49 ea.

AIR DRILLS OR MOTOR SPECIAL

with 1/4" JCB Chuck

THOR #210R Model 4526 REVERSIBLE AIR DRILL

1000 R.P.M. Xint. for Tapping — \$19.95

PNEUMATIC ANGLE DRILL

With Terry Adapter ea. — \$12.50

CHI. PNU. IMPACT WRENCH

Model 337rs 3/8" sq. dr. 1/2wd. 6 revts. 6 sqd. cntl. — \$22.50

Send for Catalogue and List of Other Sizes, Types of Pneumatic Tools.

DC GENERATOR 140 AMP

Direct Current Generator, especially suited for adaptation to homemade welding unit. A fast moving item at \$17.95

T-1 GENERATOR 12 V., 25 Amps

at 1800 to 4200 R.P.M. Trucks, Aircraft, Radio, A Real Value — \$13.95

D. C. METERS

0 - 30 AMMETERS
0 - 120
0 - 300
0 - 600
\$4.25 \$3.95

Comb. Voltmeter-Ammeter
30V - 30 Amp. \$4.95
30V - 60 Amp.
30V - 120 Amp.
30V - 240 Amp.
30, 60, 120, 240 or 300 Amp.

SHUNTS

use of DC Meter \$1.00 ea.

New Westinghouse Air Compressor

Thousands now in use for spraying, inflating, tractors, trucks, garage, laboratory, air tools, industrial use, etc. Lightweight but powerful, can be run by 35 H.P. Motor or Gas Engine. Operates efficiently in either direction or rotation. Gives approx. 3.27 CFM at 600 RPM, 6.54 CFM displacement at 1200 RPM. Has 2 inch bore 1 1/4 inch stroke. Suggested pressure 75 P.S.I. Size 9" x 12" x 6". Wght. approx. 23 lbs. A MOST PLEASING VALUE AT — \$24.95

CONTINENTAL GAS ENGINE

standard equipment inc. Mesh type air cleaner, flywheel, magneto, heat type carburetor, blower housing, muffler, fuel tank, fuel filter with shut off valve, starter pulley, etc. The ideal power package for light tractors, lighting plants, compressors, boats, lawn mowers, etc. And cost your eyes at this price. A \$75.00 VALUE While they Last. Net weight 43 lbs. for only \$48.49

PORTABLE POWER UNIT

Model GKB12-24-100 Single Cylinder Air Cooled. 4 Cylinder, Bigg-Stratton Gas Engine, 6 H. P. 3" Bore, 3 1/4" Stroke. Speed 2603 - 3200 RPM. Generator 2800 watts, 28.5 V., 100 Amps. Complete with Gas Tank, Wheeled Cart... All set to operate. Use for Power source or for Lighting Plant SPECIAL — \$89.75

S & K ROLL-A-WAY TOOL CARRIER

Not Tippy, but made of heavy gauge red crackle finish steel. 32" x 27" x 19". With 1 dividing drawer, 1 drawer with clamp-on rack for tools. Locks on upper drawer and pull out lid for locking lower chamber with drawer. Rubber Wheel Ball Bearing Swivel Castors with 2 Extra Portable Tool Trays. We have 80 of 'em now, but they won't last long at \$32.95

PIANO HINGE

Overall Width	Length	Price
1 1/4" (1/2" side)	72" alum.	\$1.00 ea.
2" (1/2" side)	72" alum.	\$1.18 ea.
1 1/2" (1/2" side) 33" cad. steel		.75 ea.
3 1/2" (1 1/2" side)	33" steel	\$1.00 ea.

GADGET MIX

Especially prepared for the HOBBIST. Rives, Spoons, Bobs, Screws, Nuts, Gears, etc. A gold mine. #106, 2 LBS. — \$1.19

BEARING MIX

Needle, Ball & Roller Bearings in excellent assortment. Sizes from 1/8" to 2". One of our "BEST SELLERS". 15 BEARINGS #170 FOR ONLY \$2.95

HINGE MIX

12 pieces of atom and butt Hinges. Sizes 1" x 1" to 1 1/2" x 4" in length to 8" wide. #170L. A \$3.00 Value FOR ONLY \$1.09

ABRASIVE AND GRINDING WHEEL MIX

50 Pieces including grinding stone, pencil rolls, wheels, abrasive sheets, etc. & available by sharp value. #109AG. 99c

SPRING MIX

Tension Compression & Torsion Springs, auto, sizes. A treasure trove for mechanics. #205, 2 LBS. for ONLY 89c

COMBO-MIX

Comb. of all above, all in one pkg. deal. At special introductory price \$5.79

FILE MIX

Ten Assorted Files of 6", 8", 10", 12". Includes 3 Vixen's half rounds, bastard's, mill's, etc. in seconds and used but in good condition. 1 Vixen alone worth our price for the entire mix 99c

SW #2 HEATER NEW

Compact Car-like Gasoline Road Heater with motor, fan blower, Automatic Thermostat, Copper element, glow type spark plug, Mtd. by Stewart-Warner, 24V D. C. - Can operate on 9 Volt. Ideal for Auto, Boat, Light Aircraft, etc. A Steal at. \$6.95

NEW FLEXIBLE GOOSENECK LAMP

110 V. A. C. 13 H. wire with socket, switch and plug. In mounting bracket suitable for home or workshop. Wire alone worth our price of 99c each.

FIRE EXTINGUISHER

Kiddie Use Car Type. Built to Ger's spec. wirebound shatterproof Heavy Case. Fully recharged. 1 1/2 lb. - 18" x 4" - Topper control with horn 4TB type. \$25 Value. #501A \$13.25

3 lb. Car type \$25 Value #502 \$11.75

15 lb. Break Disc type New #503A \$29.75

15 lb. Wheel Control #503B \$32.95

15 lb. Square top. New #503C \$39.95

All above Car type, fully charged and with horn. Indispensable for small or large planes, Trucks, Auto, Home, Factory, etc.

CARBON TETRACHLORIDE (Red)

The Best Cleaner you ever saw for parts and machinery. Also Fire Extinguisher fluid. In One Gallon Cans \$1.59 Gal.

New Electric Motors

#500 new 1/2 H.P. 27 Volt D. C. 24 Volt A. C. This motor can be readily adapted to 110 A. C. by the simple method of rearranging armature brush leads. We furnish free diagram of instructions with each order. A Sensational Value @ \$5.95

Converted to 110 A. C. Equipped with plug and 3/16" Heavy Duty Cord \$8.49 ea.

1/8 H. P. 24 Volt D. C. Motor, Series Wound. New. #501. \$3.95 ea.

#502 - 2 H.P. 24 V D.C.M. used \$8.95

U. S. ELECTRICAL 28V MOTOR

1 1/2 H.P., 8400 R.P.M., 16.5 Amps. Continuous Duty \$5.49 ea.

GREENLEE - HAND TUBE BENDER

Designed for fast, free action in bending steel, copper, brass, aluminum tubing. Fits in std. vise up to 180 degree bend, makes smooth, small radius bends, free of kinks, scratches, etc. Available in the following sizes: 1/4" @ \$4.50, 5/16" @ \$4.95, 3/8" @ \$6.95, 1/2" @ \$8.25, 5/8" @ \$9.75, 3/4" @ \$11.25

Comp. Set of 6 Benders \$43.95

PLASTIC PARALLEL STRAIGHT EDGE

with knobs and rubber pads for use alongside on such sections. A must for navigators, mechanics, draftsmen, and engineers... You've never seen 'em at 97c ea.

AIRCRAFT CABLE

Alloyed steel, rust resistant, 3/16" dia., 18 ft. long, with turnbuckle ends. 99c

On reels in any length

1/16"	3c ft.	5.32	5c ft.
3/32	4c ft.	3.16	6c ft.
1/8	4 1/2c ft.	9.32	8c ft.

RUBBER GOODS

NEOPRENE SHEET RUBBER

Thickness	Width	Price per sq. ft.
#325 .020"	1/4 36"	.75
#328 .032	1/2 22"	\$1.39
#329 .125"	1/8 46"	\$4.75

New #328 is laminated rubber sheet with cloth center. Flexible but very fine for heavy wear. Rubberized Hosp. or Bed Sheet. \$2.29

ELECTRIC SOLDERING IRON

#198 110 Volt A. C. Vulcan \$8.50 Value

#198 200 Watt \$3.95 \$7.00

#198A 100 Watt \$2.95 VALUE

PALLEY THE LARGEST FIRM OF ITS TYPE SUPPLY CO. IN THE WORLD Order from this Ad. All sales final. All Prices F. O. B. Los Angeles. Pay by M. O. or Check, P. O.'s Accepted. from D & B firms. 1/3 deposit with C. O. D's. DEPT. P. M. 29 6321 SAN FERNANDO RD GLENDALE 1, CALIF. Now Available New 1949 Edition 90-Page Freely Illustrated Catalogue with valuable information tables, data. Send 25c to cover handling, mailing chgs. etc.

SOUTH BEND PRECISION LATHES have solved the production of precision parts for many manufacturers. Their accuracy, speed and adaptability to a wide range of operations contribute to efficient machining. Perhaps you are running some small, precision jobs on slow, heavy machines. If so, you should find out about South Bend Precision Lathes. These are the kind of jobs for which they are built. Their use can often effect appreciable savings. And, being reasonable in price, they can be installed without excessive capital investment.

Call our local distributor for complete information. You will find his name listed under "Machine Tools" or "Lathes" in your classified telephone book. Or, write today for catalog.

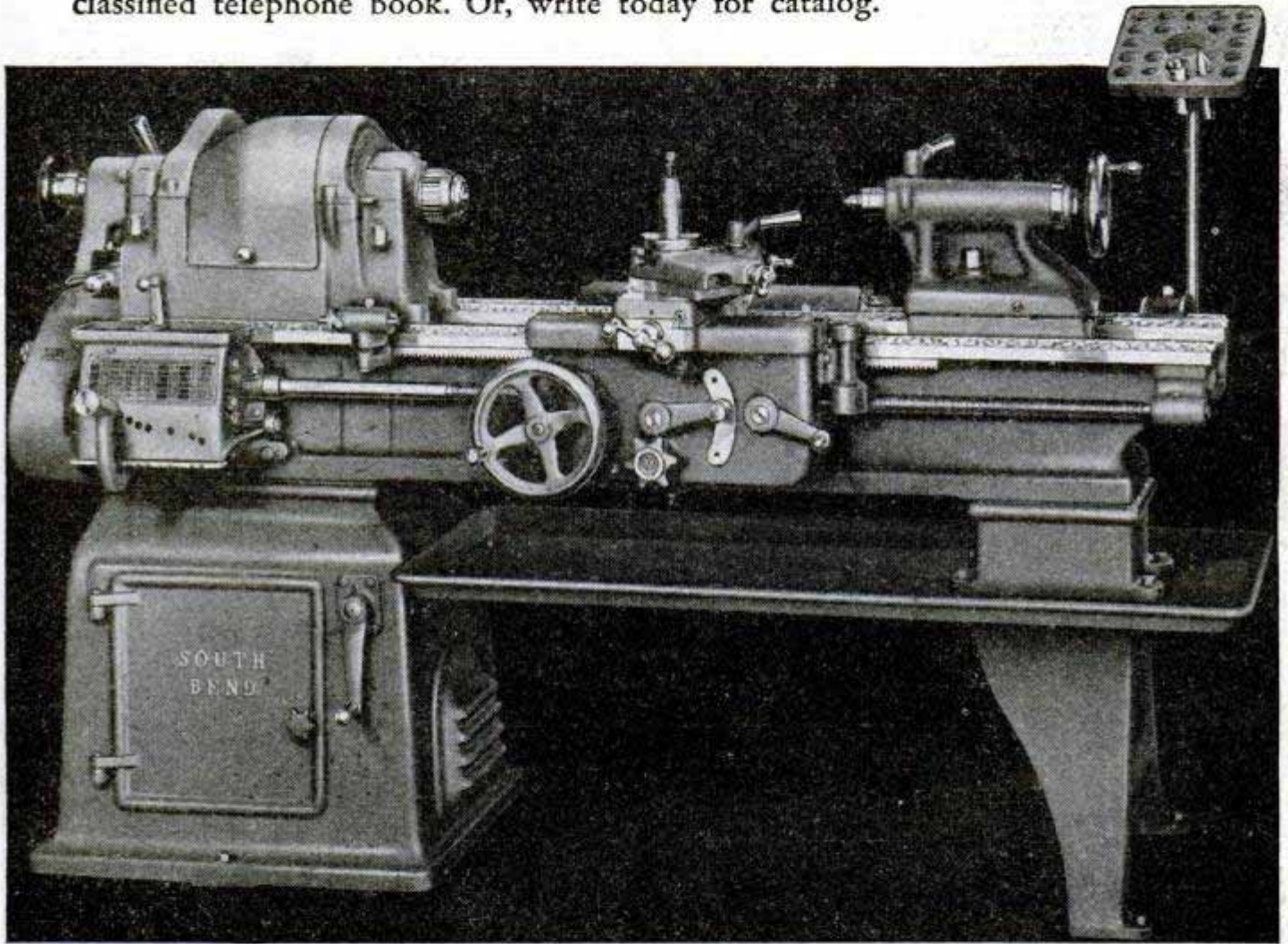

16" X 6' TOOLROOM LATHE with handwheel collet attachment; collet rack; taper attachment; micrometer carriage stop; chip pan; thread dial; 3 phase, 60 cycle, 220 volt motor; and drum switch. Catalog No. 8117-C.

\$2145.25

PRICES OF SOUTH BEND LATHES

LATHE SIZE	16" x 6' LATHE	14½" x 5' LATHE	13" x 5' LATHE	10" x 3' LATHE	9" x 3' BENCH LATHE
QUICK CHANGE GEAR MODEL	\$1729.25	\$1466.25	\$1227.25	\$924.35	\$335.45
TOOLROOM MODEL	2145.25	1843.25	1577.25	1231.35	516.45

Prices include 3 phase, 60 cycle, A. C. motor and drum switch—f.o.b. factory

SOUTH BEND LATHE WORKS

Building Better Tools Since 1906

455 EAST MADISON STREET, SOUTH BEND 22, INDIANA



Printed by Popular Mechanics Company, Chicago, Ill., U. S. A.

SPEEDEX

BIG BOY AND MODEL C GARDEN TRACTORS

SPEED WORK • SAVE MONEY

LOW PRICES

ONLY \$155⁰⁰

MODEL C WITH CULTIVATOR

Big Boy

**6 HP — \$285.00
WITH CULTIVATOR**

Write today for complete
information. Use a penny
postcard.

SPEEDEX

Has many
outstanding features. Our
illustrated circular will tell
all about them. *Canadian
inquiries invited.*

P-149-10

ALL PRICES F.O.B. RAVENNA

SPEEDEX GARDEN TRACTOR CO.

5821 1st AVE. SO.
SEATTLE 8, WASH.

← ADDRESS OFFICE NEAREST YOU →

367 FREEDOM ST.
RAVENNA, OHIO

PROVE CAMEL MILDNESS *IN YOUR "T-ZONE"!*

MAKE THE CAMEL 30-DAY MILDNESS TEST in your "T-Zone." Smoke Camels, and only Camels, for 30 days.

IN A RECENT TEST, hundreds of men and women, from coast to coast, smoked Camels, and only Camels, for 30 days — an average of 1 to 2 packs a day. Each week, their throats were examined by noted throat specialists. After a total of 2470 thorough examinations, these doctors reported

***NO THROAT
IRRITATION
due to smoking
CAMELS!***



Money-Back Guarantee!

Try Camels and test them as you smoke them. If, at any time, you are not convinced that Camels are the mildest cigarette you ever smoked, return the package with the unused Camels and we will refund its full purchase price, plus postage.

(Signed) R. J. Reynolds Tobacco Co.
Winston-Salem, N. C.

According to
a Nationwide survey:

**MORE DOCTORS
SMOKE CAMELS
THAN ANY OTHER CIGARETTE**

Doctors smoke for pleasure, too! And when three leading independent research organizations asked 113,597 doctors what cigarette they smoked, the brand named most was Camel!