

ANC



# POPULAR MECHANICS

## MAGAZINE

WRITTEN SO YOU CAN UNDERSTAND

REG'D. TRADE MARK, GREAT BRITAIN, No. 410426

REG. U.S. PAT. OFF.

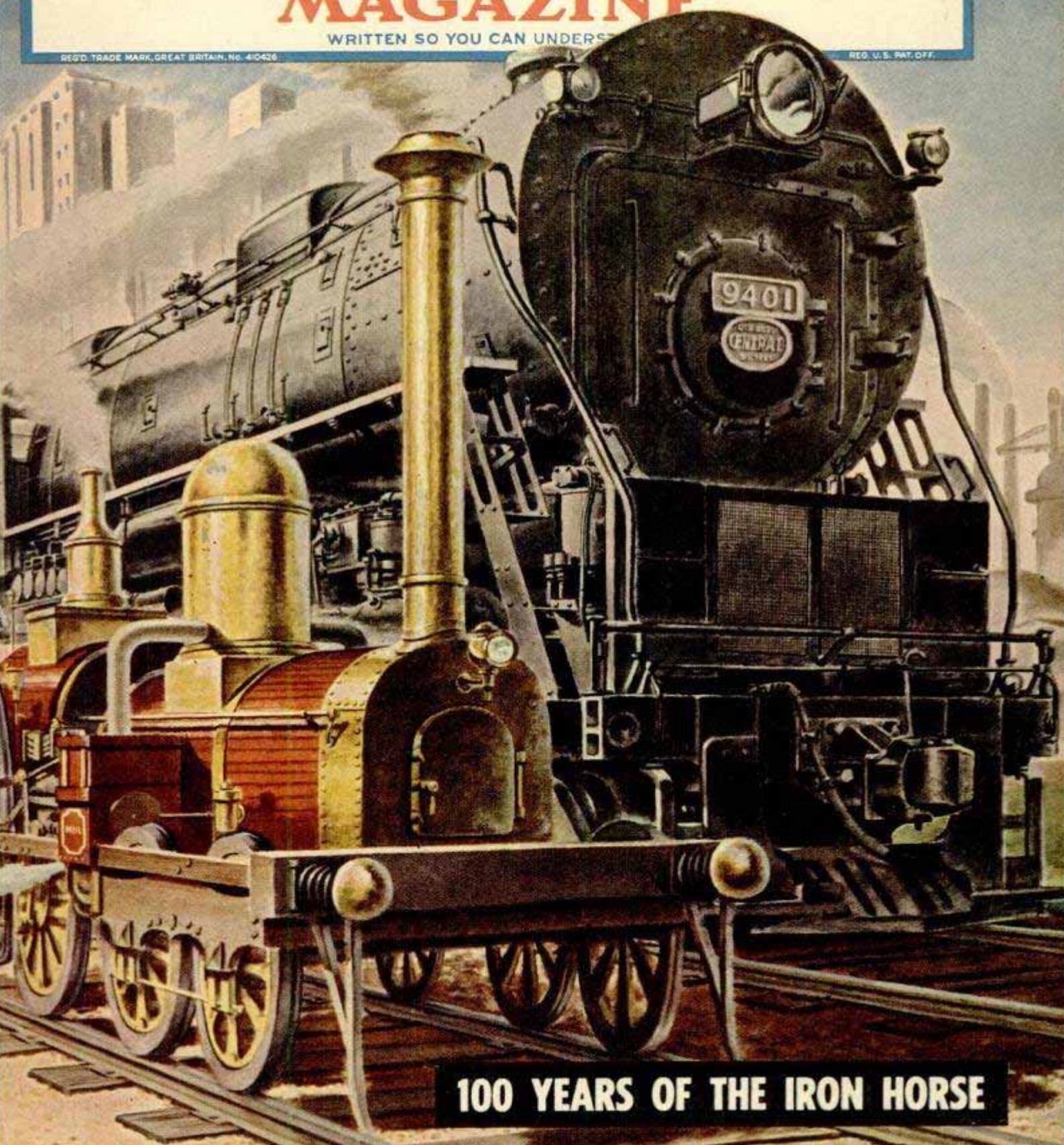

**100 YEARS OF THE IRON HORSE**

# **SPEEDEX**

## **BIG BOY AND MODEL C GARDEN TRACTORS**

**SPEED WORK • SAVE MONEY**

**LOW PRICES**

**ONLY \$155<sup>00</sup>**

**MODEL C WITH CULTIVATOR**

**Big Boy**

**6 HP — \$285.00  
WITH CULTIVATOR**

Write today for complete  
information. Use a penny  
postcard.

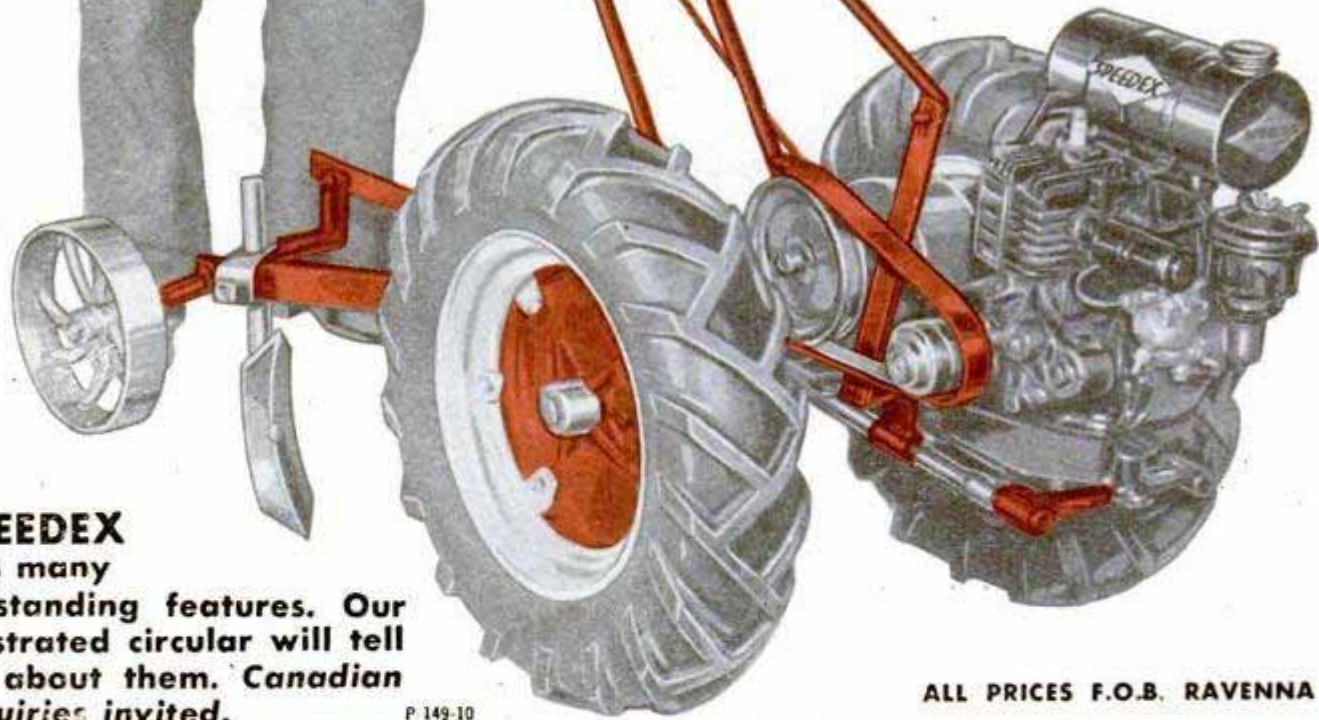

### **SPEEDEX**

Has many  
outstanding features. Our  
illustrated circular will tell  
all about them. *Canadian  
inquiries invited.*

P. 149-10

ALL PRICES F.O.B. RAVENNA

## **SPEEDEX GARDEN TRACTOR CO.**

5821 1st AVE. SO.  
SEATTLE 8, WASH.

← ADDRESS OFFICE NEAREST YOU →

367 FREEDOM ST.  
RAVENNA, OHIO

**B. F. G. SILVERTOWN**  
Lowest cost per mile

**PREMIUM SILVERTOWN**  
Highest quality

**B. F. G. EXTRA-CUSHION**  
Easiest riding

**B. F. G. MUD-SNOW**  
Best traction



*that's why users get MORE MILES with B.F. Goodrich tires*



**1.** THIS B. F. GOODRICH SILVERTOWN has rolled up 46,687 miles, reports D. J. Sanders, Junction City, Kas. The BFG tread travels farther because it's wider, more level. Weight and wear are *evenly* distributed.



**2.** H. E. REEDER of Bloomington, Ill., has driven this BFG Silvertown 60,801 miles—all *safe, comfortable* miles. The stronger tire body resists bruises. Riding tests prove BFG tires give a smoother ride.



**3.** 55,000 MILES on this BFG Silvertown, reports "Tex" Martin. You get more miles because BFG research—now backed by industry's most complete research center—pioneers the best in tires.



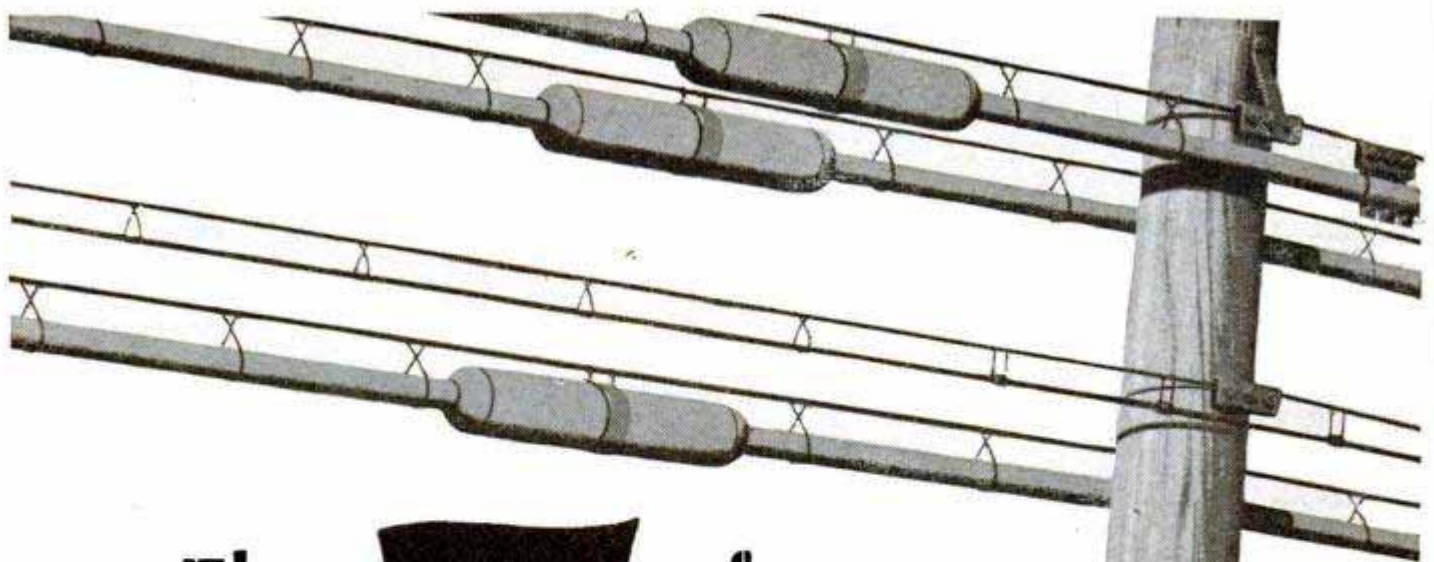

# The **case** of the Creeping Sleeve

Lead sheathing on telephone cable meets many stresses—the tug of its own weight, wind pressure, contraction and expansion from cold and heat. Then, too, there's the pressure of nitrogen gas put in Long Distance cable to warn of sheath breaks and keep out moisture.

And, sometimes, lead is subject to "creep"—a permanent stretching—even when the stress is but a fraction of the normal tensile strength. Creep is especially likely at the lead sleeves used where two lengths of cable are joined. The sleeve may stretch and break open exposing telephone circuits to the elements.

So Bell Laboratories scientists have developed methods to test and control creep. In a special testing room, weights are applied to scores of samples of lead, under controlled conditions. Exact records of the amount of creep are obtained with a precision instrument.

Years of careful study have produced a lead composition which resists creep and yet has all the other properties required of sleeves. This means better telephone service for you and helps give that service at lowest possible cost. It is an example of the way Bell Telephone Laboratories scientists study and improve every part of the great telephone plant.

## **BELL TELEPHONE LABORATORIES**

*EXPLORING AND INVENTING, DEVSING AND PERFECTING, FOR CONTINUED IMPROVEMENTS AND ECONOMIES IN TELEPHONE SERVICE.*



# Popular Mechanics Magazine

Registered in U. S. Patent Office and Canada

H. H. WINDSOR, Founder

H. H. WINDSOR, Jr., Editor and Publisher

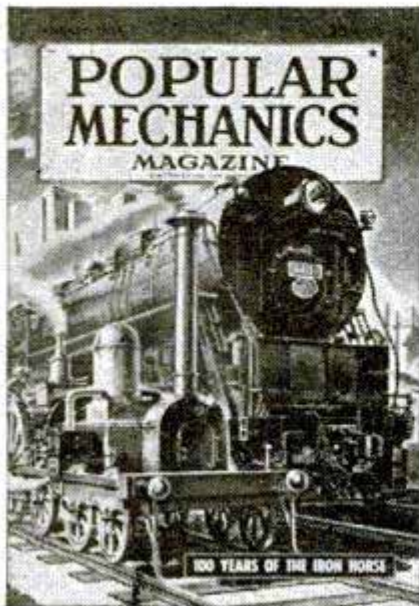

THE NEW YEAR will be brighter for *Popular Mechanics*' readers because there will be more full-color illustrations than have ever been used in the history of the magazine. All of the color photos, drawings or paintings will be the products of our new five-color sheet-fed rotary press built for *Popular Mechanics* by C. B. Cottrell & Sons. The big rotary, which is the pride of our press-room, can turn out 88,000 pages an hour. Look at the picture above—a black-and-white reproduction of the cover painting by Lou Nulsen—and then turn to the cover of the magazine for a full appreciation of what color can add to an illustration.

The use of full color—the reproduction of every color in the rainbow—opens new vistas in layout possibilities for both the News and Craftsman sections of the magazine. Turn to pages 97 and 98 for the color feature on the outboard cabin cruiser. Then turn to pages 179 and 180 in the Craftsman section. These color photos with the novel toys were made in our own studio. Next month a full-color layout will illustrate the really colorful story of "Hell's Canyon Mailman."

Volume 91                      JANUARY 1949                      Number 1

Managing Editor.....Roderick M. Grant  
Assistant Managing Editor.....Wayne Whittaker  
Shop Notes and Crafts Editor.....James R. Ward  
Radio-Television, Electronics Editor.....Frank L. Brittin  
Associate Editor, Aviation.....Aubrey O. Cookman, Jr.  
Associate Editor.....Clifford B. Hicks  
Eastern Editor.....Bill Reiche  
Western Editor.....Thomas E. Stimson, Jr.  
Art Director.....Frank Beatty

#### Assistant Editors

Donald R. Brooks              Dorothy E. Hoffmann              Arthur R. Railton

#### Assistant Editors, Shop Notes and Crafts

W. Clyde Lamney      Wayne C. Leckey      Frank N. Stephany      A. E. Youngquist

## In This Issue

End of an Era - - - - -	81
Your Feet Go Fishing Too - - - - -	92
Outboard Cabin Boat - - - - -	96
Shrine to the Hamburger - - - - -	101
Cruiser on Wheels - - - - -	110
Ceramics Is a Family Affair - - - - -	115
A Cave Gives Up Its Treasure - - - - -	125
The Stratocruiser Goes to Work - - - - -	131
Big Builders - - - - -	142
Ship-to-Shore Television - - - - -	148
Pets in Predicaments - - - - -	158
Steel With a Memory - - - - -	164

## For the Craftsman

Gate-Leg Table for Dining Room -	172
Seven Homemade Toys - - - - -	178
Repairing Damaged Rugs Yourself	188
Build Your Own Riflescopes - - - - -	198
Drill-Press Routing - - - - -	209
Fastening Wheels to Shafts - - - - -	214
How to Rivet Aluminum - - - - -	221
Radio-Television, Electronics - - - - -	225
Clinic for Homemakers - - - - -	236

*Other items, and manufacturers of available products described, are listed on pages 8 and 10*

Published monthly by POPULAR MECHANICS COMPANY, 200 East Ontario Street, Chicago 11, Ill. H. H. Windsor, Jr., president; Paul H. Dunakin, vice president and general manager; D. F. Windsor, vice president and secretary-treasurer; William Harrison Petridge, vice president and assistant to the publisher; Clover L. Perkins, advertising manager; Alan M. Deyoe, circulation manager. Single copy in the United States and Canada, 35 cents; subscription rates in United States and possessions, Canada, Philippines and countries of the Pan-American Postal Union, 1 year, \$3.50; 2 years, \$6.00; 3 years, \$8.00. To all other countries add \$1.00 a year over United States prices for overseas postage. If you plan to move, notify us at least 30 days in advance so you will not miss an issue. Give both old and new addresses. Entered as Second Class Matter, September 15, 1963, at the Post Office at Chicago, Illinois, under Act of March 3, 1879. Entered as Second Class Matter at Post Office Dept., Canada. Copyright 1949 by Popular Mechanics Company. Copyright under International Copyright Union. Copyright in France. All rights reserved under Pan-American Copyright Union. Printed in the United States of America.

# HIGH SCHOOL SENIORS: Get Paid While Finishing Your Education

Prepare for a Career with Uncle Sam!

When you finish high school in January or June, plan to complete your education in one of the U. S. Army specialty schools. You'll get good pay while learning, plus free board and room, free clothing and equipment, medical and dental care. And you'll share in the U. S. Army's great retirement plan. After you have finished high school, select the army



course you want. Get the facts... without obligation... at your nearest U. S. Army Recruiting Station.

## Take Your Choice of the World's Finest Specialist Schools

*These are just a few of the courses offered in more than 60 Specialty Schools of the U. S. Army. In these schools you use the latest equipment... learn from the finest instructors.*

**Liaison Airplane and Engine Mechanic.**  
**Construction Equipment Maintenance and Repair.**  
**Refrigeration Equipment Installation and Repair.**  
**Carburetion and Fuel Induction.**  
**Laundry Machine Operation, Maintenance and Repair.**  
**Office Machine Repair.**  
**Power Generators.**  
**Teletype Repair.**  
**Engineer Drafting.**  
**Army Administration.**  
**Medical Technician.**

**Automotive Maintenance and Minor Repairs.**  
**Locomotive Repair.**  
**Marine Engine Lubrication and Maintenance.**  
**Marine Engineer Repair.**  
**Power Shovel Operation.**  
**Air Compressor Operation.**  
**Dozer Operation.**  
**Water Supply and Purification.**  
**Railway Bridge Construction and Repair.**  
**Pipe System Installation and Repair.**  
**Ship Fitting.**  
**Electric and Acetylene Welding.**  
**Sheet Metal Work.**  
**Time Rebuilding.**  
**Tailoring.**  
**Leather and Canvas Work.**  
**Cable Splicer.**  
**General Electricity.**  
**Telephone and Telegraph Installation and Repair.**  
**Stenography.**  
**Radio Operation.**  
**Precision Tool Repair.**  
**The Coaching of Physical Training and Athletics.**

**PEACE IS AMERICA'S  
MOST IMPORTANT BUSINESS**

The new peacetime Army and Air Force offer young men...

- ★ WIDEST CHOICE OF CAREER JOBS
- ★ BEST OPPORTUNITY FOR ADVANCEMENT
- ★ UNUSUAL RETIREMENT BENEFITS

**U.S. ARMY and U.S. AIR FORCE  
RECRUITING SERVICE**

# FREE BOOK

tells how to

# Make BIG MONEY

in

# EXPORT

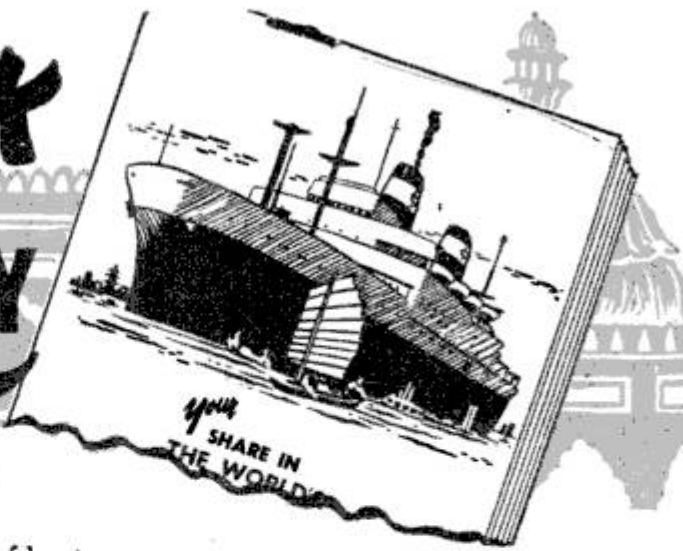

Send for this  
**FREE book today**

From cover to cover you'll thrill to the breath-taking new opportunities it opens to you. Never before have the doors to World Trade been opened to the ambitious and alert newcomer on such a practical, low cost basis.

### New Opportunities

See for yourself how and why there are new opportunities in World Trade many times greater than ever before. Get acquainted with the truly big money possibilities and the World Travel opportunities Export-Import offers to men and women with the right training.

### Streamlined Method

Understand why you may now learn at home, in spare time, in months or even weeks the practical essentials of World Trade knowledge that used to require experience with an Export-Import company or a lengthy course of full time class work.

### No Obligation

There is no obligation to you when you send for this amazing book. No salesman will call on you. You yourself will be the one to decide whether you will accept this opportunity for a highly paid career in the world's richest industry.

**THE MELLINGER CO., Exporters - Importers**  
1422-DD Westwood Blvd., Los Angeles 24, Calif.

## MAIL COUPON NOW

S. L. Mellinger, Director, The Mellinger Co.  
1422-DD Westwood Blvd., Los Angeles 24, Calif.

Please send **FREE BOOK** showing how I may enter the profitable career of World Trade.

Name \_\_\_\_\_

Address \_\_\_\_\_

City \_\_\_\_\_ State \_\_\_\_\_

Veteran? \_\_\_\_\_ Occupation? \_\_\_\_\_ Age? \_\_\_\_\_

Location preferred? \_\_\_\_\_

### GREECE



If you are tired of looking forward to a life of humdrum, low paid work in overcrowded fields, this is for you! U.S.A. World Trade was over 19 Billion Dollars in the year ending last July. Yet look in any telephone book under Exporters and Importers. See how few you find compared to "struggle to live" businesses.

### HIGH INCOME—Travel—ADVENTURE

Would you like to travel to far away lands on salary and expense account or in your own business? Do you want a career that becomes more interesting every day? Biggest demand for Export-Import the world has ever known. Commissions on one good sized order may well exceed a year's earnings in ordinary work.

### I TEACH YOU AT HOME IN SPARE TIME

To help ambitious men and women enter World Trade and start earning in the minimum possible time, I have prepared a streamlined course based on my own 25 years' practical experience. No waiting for grading of lessons, tests, etc. A full year's unlimited consultation service on my course even though you finish in just a few weeks.

### BUY-SELL WORLD-WIDE WITHOUT CAPITAL

You can conduct your own business from your home with almost no investment and do business by mail order the world over without investing your own capital in the goods. I've done it and I'll show you how.

### MAKES NO DIFFERENCE WHERE YOU LIVE

There are products for export in every state. You can operate your business anywhere, on the sea coast, in the middle west, the south, the north—yes, anywhere.

### PREVIOUS EXPERIENCE UNIMPORTANT

No previous special experience or schooling is necessary. Many successful traders have only common school education. You use my experience. World Trade Certificate awarded on successful completion. Low cost of my course will surprise you. World Trade expansion is at fever heat. Act now.

### CHINA



### INDIA



### ITALY



### AFRICA



**Rush coupon today for FREE book on World Trade. Air Mail reaches me overnight.**



KNOWLEDGE  
THAT HAS  
ENDURED WITH THE  
PYRAMIDS

## A SECRET METHOD FOR THE MASTERY OF LIFE

**W**HENCE came the knowledge that built the Pyramids and the mighty Temples of the Pharaohs? Civilization began in the Nile Valley centuries ago. Where did its first builders acquire their astounding wisdom that started man on his upward climb? Beginning with naught they overcame nature's forces and gave the world its first sciences and arts. Did their knowledge come from a race now submerged beneath the sea, or were they touched with Infinite inspiration? From what concealed source came the wisdom that produced such characters as Amenhotep IV, Leonardo da Vinci, Isaac Newton, and a host of others?

Today it is known that they discovered and learned to interpret certain *Secret Methods* for the development of their inner power of mind. They learned to command the inner forces within their own beings, and to master life. This secret art of living has been preserved and handed down throughout the ages. Today it is extended to those who dare to use its profound principles to meet and solve the problems of life in these complex times.

### This Sealed Book—FREE

Has life brought you that personal satisfaction, the sense of achievement and happiness that you desire? If not, it is your duty to yourself to learn about this rational method of applying natural laws for the mastery of life. To the thoughtful person it is obvious that everyone cannot be entrusted with an intimate knowledge of the mysteries of life, for everyone is not capable of properly using it. But if you are one of those possessed of a true desire to forge ahead and wish to make use of the subtle influences of life, the Rosicrucians (not a religious organization) will send you *A Sealed Book* of explanation without obligation. This *Sealed Book* tells how you, in the privacy of your own home, without interference with your personal affairs or manner of living, may receive these secret teachings. Not weird or strange practices, but a rational application of the basic laws of life. Use the coupon, and obtain your complimentary copy.

## The ROSICRUCIANS

SAN JOSE

(AMORC)

CALIFORNIA



AMENHOTEP IV  
Founder of Egypt's  
Mystery Schools

Use this  
coupon for  
**FREE**  
copy of book

SCRIBE K. S. V.  
The Rosicrucians (AMORC)  
San Jose, California

Please send free copy of *Sealed Book*, which I shall read as directed.

NAME.....

ADDRESS.....

CITY.....



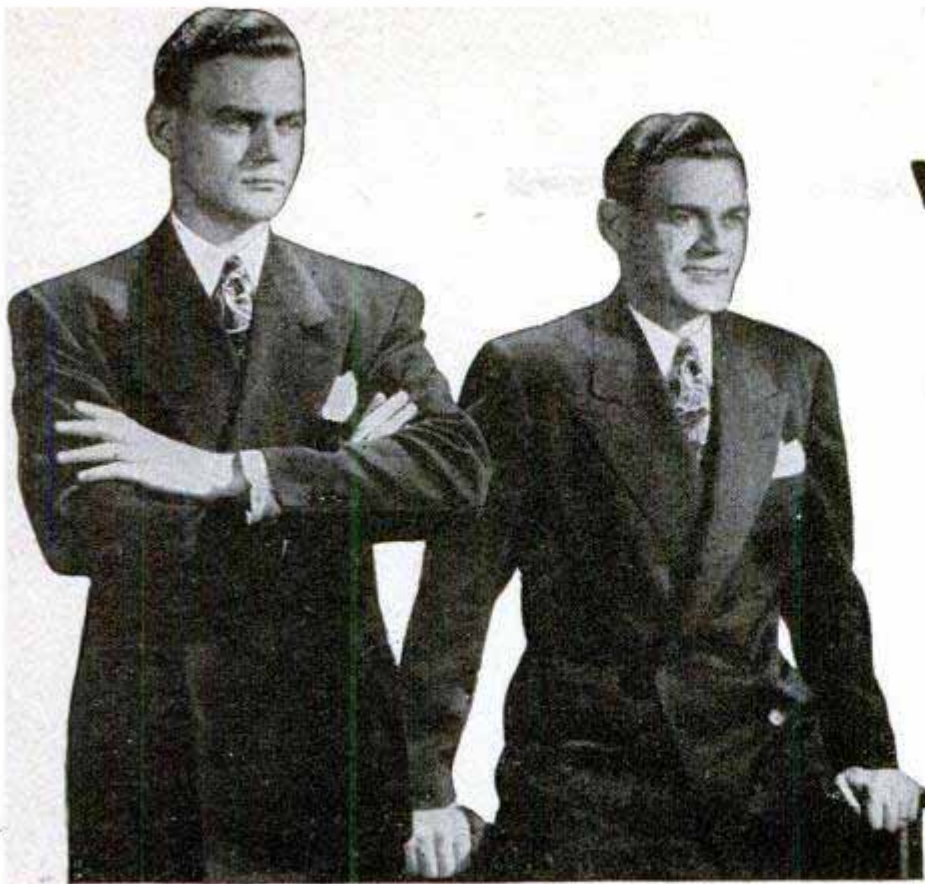

# If YOU were Boss would YOU promote "YOU"?

Business is always willing to pay the man who knows—and pay him well. The man who is ready and will-

## Be honest now—

suppose that a better job had opened up in your company—carrying with it promotion and more money—could you qualify?

*If you were boss, would you select "YOU" for that better job?*

Consider before you answer.

First of all, could you *fill* the job? Has your experience fitted you for the step forward—have you been preparing for promotion apart from experience gained on the job?

Or have you just been filling a niche, doing daily tasks well but making no real and intelligent effort to learn and qualify for the job ahead so that if an opening should occur you would be ready to fill it?

The man who gets real promotion is the one who makes his own breaks—the man who slaves in the ordinary job at low pay just wishes and dreams of promotion and more money. Which are you?

ing to take responsibilities—and capable of directing the efforts of other men is a valuable asset to any business organization. He never wants for a good job and above average earnings. He gets ahead.

We have helped thousands of men achieve promotion and more money—success sometimes beyond their dreams—a success that was started by a coupon similar to the one below.

Get out of that rut—don't be satisfied with a mediocre job at small pay—be a success in business—this coupon may be your first step.

Mail the coupon and we'll include "Ten Years' Promotion in One"—a book which has helped many men. Do it today—tomorrow never comes for the man who consistently puts things off.

## LASALLE EXTENSION UNIVERSITY A Correspondence Institution

Dept. 164-R, 417 S. Dearborn, Chicago 5, Ill.

Please send me your free 48-page booklet telling how I can succeed in the field I have checked below—plus "Ten Years' Promotion in One" without obligation.

- |  |  |
|--|--|
| <input type="checkbox"/> Higher Accountancy  | <input type="checkbox"/> Traffic Management    |
| <input type="checkbox"/> C.P.A. Coaching     | <input type="checkbox"/> Foremanship           |
| <input type="checkbox"/> Bookkeeping         | <input type="checkbox"/> Industrial Management |
| <input type="checkbox"/> Law: LL.B. Degree   | <input type="checkbox"/> Stenotypy             |
| <input type="checkbox"/> Business Management | <input type="checkbox"/> (Machine Shorthand)   |
| <input type="checkbox"/> Salesmanship        |  |

Name..... Age.....

Address.....

City, Zone, State.....

**LASALLE EXTENSION UNIVERSITY**  
A Correspondence Institution  
Dept. 164R 410 S. Dearborn, Chicago 5, Illinois

# STOP Battery Drain with PYROIL

The very small cost of PYROIL is inexpensive insurance against battery drain these cold days. Pyroil in your lubricating system gives low viscosity winter oil the property of clinging to cylinder walls. This provides ready lubricated surfaces which permit easy starting. You save precious battery energy, you prevent scoring of cylinder walls, corrosion, formation of gum and sludge when you add Pyroil. Ask your gas station attendant.

## Pyroil For Aircraft Engines

Use Aircraft Pyroil B for lubricating oil, Aircraft Pyroil A for gasoline.

**GIVEN!!** An attractive Pyroil metal savings bank — takes coins up to 50c pieces — is yours for the asking — sent postage paid.

Manufactured and Guaranteed by Pyroil Company, 87 Pyroil Bldg., La Crosse, Wisconsin.

Canadian Distributors: Central Purchasing Agencies, Ltd. Toronto, Ontario



**PYROIL COMPANY**  
87 Pyroil Bldg., La Crosse, Wisconsin

I want my car to last and run properly. Please tell me more about Pyroil and how it can accomplish this for me.

Name \_\_\_\_\_

Address \_\_\_\_\_

City or Town \_\_\_\_\_ State \_\_\_\_\_



## WHERE-TO-BUY-IT INDEX

Source of supply appears after items commercially available

### AUTOMOTIVE

Lighter motor oil (Freedom-Valvoline Oil Co., Freedom, Pa.)	100
Two-way key container (Rohden Mfg. Co., 4739 Montrose Ave., Chicago 41)	106
Safety bar doubles as armrest (Ellis Sales Corp., 300 W. Burlington, Fairfield, Iowa)	106
Emergency lighting system (Dit Lighting Systems, 218 Bristol St., Thomaston, Conn.)	106
Upholstery protectors for car doors (Crest Co., 5756 Cass Ave., Detroit, Mich.)	106
Electric shaver operates on 6 or 110 volts (Remington Rand, Inc., Electric Shaver Div., Bridgeport, Conn.)	107
Water-level indicator (Lindberg Instrument Co., 830 Folger Ave., Berkeley 10, Calif.)	107
Universal tester for car batteries (Pay Darling & Co., 331-333 E. 55th St., Kansas City 2, Mo.)	107
Car has wheels placed in diamond shape	109
Fluid transmission uses no drive shaft	121
Aluminum cab for jeep (Willys-Overland Motors, Inc., Toledo, Ohio)	130
Crankcase-oil tester (Wix Accessories Corp., Gastonia, N. C.)	136
Wheel-block "cradle" (NoRol Car Block Corp., Concord, Mich.)	140
Pygmy Cadillac	153
Radiator-flow tester (Inland Manufacturing Co., 1108 Jackson St., Omaha 8, Neb.)	163

### AVIATION

Tailless glider	86
Twin-jet flying wing	86
Russian bombers and fighters	88
Flyers lift gas from speeding car	99
First ramjet plane to fly	99
Jets boost Navy heavyweights	104
Asphalt "coat" for rockets	108
Aluminum-foil suits protect fire fighters	108
Safety aids for Air Force ground crews	113
First jet-propelled airliner (Kaman Aircraft Corp., Bradley Field, Windsor Locks, Conn.)	157
Stairway is self-contained in plane	157
Square-tip propellers	157
Helicopter designed for agricultural and industrial use (Kaman Aircraft Corp., Bradley Field, Windsor Locks, Conn.)	157
Portable dock for Navy's largest seaplanes	163

### FARM

Lift-type disk (Dearborn Motors Corp., 14300 Woodward, Detroit, Mich.)	130
Almond harvester	136
Wire-fence stretcher (Moline Iron Works, Moline, Ill.)	147
"Knee action" plow	147
Ancient log carrier goes modern	151
Versatile farm tool (Yetter Mfg. Co., Colchester, Ill.)	156

### HOUSE AND HOME

Railroad ties form "log" cabins	90
Anti-dust spray (L. S. Green Associates, New York City)	114
Paint roller for picket fence (Labhart Mfg. Co., 11086 Sue Ave., Lynwood, Calif.)	120
Glass blocks set in wood (American Structural Products Co., Toledo 1, Ohio)	124
Plastic chair (General American Transportation Corp., S. La Salle St., Chicago 90)	135
Two-hour house (Reliance Homes, Inc., Box 9176, Lester, Pa.)	152
Needle threader (The Del Hagens of Westchester, Larchmont, N. Y.)	154
Aluminum awning (Andal Mfg. Co., 140 Ash St., Akron 8, Ohio)	154
Heated serving table (Salton Mfg. Co., Inc., 74 Reade St., New York City 7)	154
Round ice "cubes" (Brooks Machine Co., Unadilla, N. Y.)	155
Steak tenderizer (The Harder Co., Box 7021, Dallas 9, Tex.)	155
Disposable bottle for baby (Shellmar Products Corp., Mt. Vernon, Ohio)	155
Spring-type screen and storm-window fasteners (Ludwig Mfg. Co., Inc., 2401 Durand Ave., Racine, Wis.)	155
Smoking stand includes electric lighter (Geo. E. Watson Co., 164 W. Lake St., Chicago 1)	155
Adjustable ironing board (Rieter Woodwork Specialty, Cedarburg, Wis.)	155

### INDUSTRY

Motorcycle test room	87
"Static" photo printing	91
Office machine makes plates for offset printing press (Remington Rand, 2 Main St., Bridgeport, Conn.)	100
Acres of aluminum	122
Sealed-in vapor makes packaged steel rustproof (Charles Stevens & Co., 2018-24 Crotona Pkwy., New York City)	124
Gas chambers fumigate ship's cargo	124
Ice cubes in concrete make lighter blocks	163
Magnetism used to spot flaws in boring	170
Instrument analyzes color (ANSCO, Binghamton, N. Y.)	170

### MISCELLANEOUS

Black light shows up bad eggs	86
War crane ferries rail cars	90
Outboard cabin boat (Liberty Coach Co., Inc., Bremen, Ind.)	96
"Acoustical opera glass" aids hearing in theater (Aurex Corp., 1117 N. Franklin, Chicago)	100
Camera fits in watch pocket	100
Cellulose-tape dispenser (Colton Mfg. Corp., 82 W. Washington St., Chicago 2)	105
Electric toy trucks (Schwien Engineering Co., 5736 W. Washington, Los Angeles, Calif.)	105
Whittled cathedrals	108
Surveying instrument (Fenton Crafts, Fenton, Mich.)	114
Inverted "Y" fitting aids sewer cleanup (Standard Fire Brick Co., 24th and Albany, Pueblo, Colo.)	114
Dye detects wheat weevils	114
Hearing-aid attachment clarifies phone talk (Aurex Corp., 1117 N. Franklin, Chicago)	120
Screen shows slides in bright room	120
Cooling system for radios	130

(Continued to page 10)

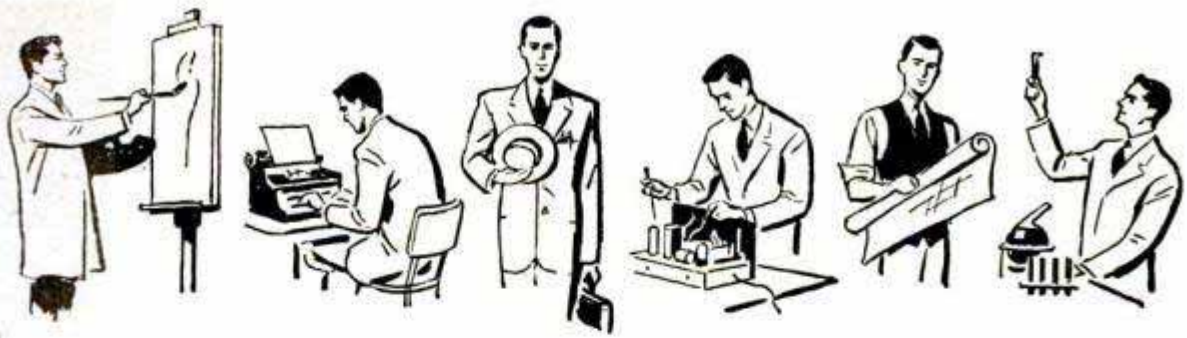

## CASH IN on your HIDDEN TALENTS

Locked in your mind may be the germ of a valuable idea . . . an undeveloped aptitude . . . a hidden talent. And the key that can help unlock those capabilities of yours is *training*—sound, practical, down-to-earth training!

Helping men and women bring out the best that's in them has been the job of I. C. S. for more than 57 years. In every field of industry, you'll find leaders whose skills were developed through study with I. C. S.

They are the ones who sensed a latent ability within themselves — *and who proceeded to do something about it.* While others (equally gifted, perhaps) plodded along in routine jobs, they mastered I. C. S. Courses . . . qualified themselves for rich rewards.

You can develop your hidden talents the same way they did. Start *today* and be ready for tomorrow's opportunities. Here's the coupon to mail:

### INTERNATIONAL CORRESPONDENCE SCHOOLS



BOX 5643-K, SCRANTON 9, PENNA.

Without cost or obligation, please send me full particulars about the course BEFORE which I have marked X:

- |  |   |   |   |  |  |
|--|---|---|---|--|--|
| <p><b>Air Conditioning and Plumbing Courses</b></p> <p><input type="checkbox"/> Air Conditioning<br/><input type="checkbox"/> Heating<br/><input type="checkbox"/> Refrigeration<br/><input type="checkbox"/> Chemical Engineering<br/><input type="checkbox"/> Chemistry, Analytical<br/><input type="checkbox"/> Chemistry, Industrial<br/><input type="checkbox"/> Chemistry, Mfg. Iron &amp; Steel<br/><input type="checkbox"/> Petroleum Refining<br/><input type="checkbox"/> Pulp and Paper Making</p> <p><b>Civil Engineering, Architectural and Mining Courses</b></p> <p><input type="checkbox"/> Architecture<br/><input type="checkbox"/> Architectural Drafting<br/><input type="checkbox"/> Bridge and Building Foreman<br/><input type="checkbox"/> Building Estimating<br/><input type="checkbox"/> Civil Engineering<br/><input type="checkbox"/> Coal Mining<br/><input type="checkbox"/> Contracting and Building<br/><input type="checkbox"/> Highway Engineering<br/><input type="checkbox"/> Lumber Dealer<br/><input type="checkbox"/> Reading Structural Blueprints<br/><input type="checkbox"/> Sanitary Engineering<br/><input type="checkbox"/> Structural Drafting</p> | <p><input type="checkbox"/> Plumbing<br/><input type="checkbox"/> Steam Fitting</p> <p><b>Chemistry Courses</b></p> <p><input type="checkbox"/> Plastics</p> <p><b>Electrical Courses</b></p> <p><input type="checkbox"/> Electrical Drafting<br/><input type="checkbox"/> Electrical Engineering<br/><input type="checkbox"/> Electric Light and Power<br/><input type="checkbox"/> Lighting Technician<br/><input type="checkbox"/> Practical Electrician</p> <p><b>Internal Combustion Engines Courses</b></p> <p><input type="checkbox"/> Auto Technician<br/><input type="checkbox"/> Diesel-Electric<br/><input type="checkbox"/> Diesel Engines<br/><input type="checkbox"/> Gas Engines</p> <p><b>Mechanical Courses</b></p> <p><input type="checkbox"/> Aeronautical Engineer's, Jr.<br/><input type="checkbox"/> Aircraft Drafting<br/><input type="checkbox"/> Forging<br/><input type="checkbox"/> Heat Treatment of Metals<br/><input type="checkbox"/> Industrial Engineering</p> | <p><input type="checkbox"/> Structural Engineering<br/><input type="checkbox"/> Surveying and Mapping</p> <p><b>Communications Courses</b></p> <p><input type="checkbox"/> Electronics<br/><input type="checkbox"/> Practical Telephony<br/><input type="checkbox"/> Radio, General<br/><input type="checkbox"/> Radio Operating<br/><input type="checkbox"/> Radio Servicing<br/><input type="checkbox"/> Telegraph Engineering</p> <p><b>Electrical Courses</b></p> <p><input type="checkbox"/> Electrical Drafting<br/><input type="checkbox"/> Electrical Engineering<br/><input type="checkbox"/> Electric Light and Power<br/><input type="checkbox"/> Lighting Technician<br/><input type="checkbox"/> Practical Electrician</p> <p><b>Internal Combustion Engines Courses</b></p> <p><input type="checkbox"/> Auto Technician<br/><input type="checkbox"/> Diesel-Electric<br/><input type="checkbox"/> Diesel Engines<br/><input type="checkbox"/> Gas Engines</p> <p><b>Mechanical Courses</b></p> <p><input type="checkbox"/> Aeronautical Engineer's, Jr.<br/><input type="checkbox"/> Aircraft Drafting<br/><input type="checkbox"/> Forging<br/><input type="checkbox"/> Heat Treatment of Metals<br/><input type="checkbox"/> Industrial Engineering</p> | <p><input type="checkbox"/> Industrial Metallurgy<br/><input type="checkbox"/> Machine Shop<br/><input type="checkbox"/> Mechanical Drafting<br/><input type="checkbox"/> Mechanical Engineering<br/><input type="checkbox"/> Mold-Loft Work<br/><input type="checkbox"/> Patternmaking—Wood, Metal<br/><input type="checkbox"/> Reading Shop Blueprints<br/><input type="checkbox"/> Sheet-Metal Drafting<br/><input type="checkbox"/> Sheet-Metal Worker<br/><input type="checkbox"/> Ship Drafting<br/><input type="checkbox"/> Tool Designing<br/><input type="checkbox"/> Welding Engineering<br/><input type="checkbox"/> Welding—Gas and Electric</p> <p><b>Railroad Courses</b></p> <p><input type="checkbox"/> Air Brake<br/><input type="checkbox"/> Diesel Locomotive<br/><input type="checkbox"/> Locomotive Engineer<br/><input type="checkbox"/> Locomotive Fireman<br/><input type="checkbox"/> Locomotive Machinist<br/><input type="checkbox"/> Railroad Section Foreman</p> <p><b>Steam Engineering Courses</b></p> <p><input type="checkbox"/> Boiler Making<br/><input type="checkbox"/> Combustion Engineering<br/><input type="checkbox"/> Engine Running<br/><input type="checkbox"/> Marine Engineering<br/><input type="checkbox"/> Steam Electric</p> | <p><b>Textile Courses</b></p> <p><input type="checkbox"/> Cotton Manufacturing<br/><input type="checkbox"/> Loom Fixing<br/><input type="checkbox"/> Textile Designing<br/><input type="checkbox"/> Woolen Manufacturing</p> <p><b>Business and Academic Courses</b></p> <p><input type="checkbox"/> Accounting<br/><input type="checkbox"/> Bookkeeping<br/><input type="checkbox"/> Business Administration<br/><input type="checkbox"/> Business Correspondence<br/><input type="checkbox"/> Certified Public Accounting<br/><input type="checkbox"/> Commercial<br/><input type="checkbox"/> Cost Accounting<br/><input type="checkbox"/> Federal Tax<br/><input type="checkbox"/> Foremanship<br/><input type="checkbox"/> Good English<br/><input type="checkbox"/> Higher Mathematics<br/><input type="checkbox"/> Motor Traffic<br/><input type="checkbox"/> Retailing<br/><input type="checkbox"/> Retail Store Management<br/><input type="checkbox"/> Salesmanship<br/><input type="checkbox"/> Sign Lettering<br/><input type="checkbox"/> Spanish<br/><input type="checkbox"/> Traffic Management</p> | <p><input type="checkbox"/> Rayon Weaving<br/><input type="checkbox"/> Textile Designing<br/><input type="checkbox"/> Woolen Manufacturing</p> <p><b>Business and Academic Courses</b></p> <p><input type="checkbox"/> Advertising<br/><input type="checkbox"/> Aviation<br/><input type="checkbox"/> Bookkeeping<br/><input type="checkbox"/> Business Administration<br/><input type="checkbox"/> Business Correspondence<br/><input type="checkbox"/> Certified Public Accounting<br/><input type="checkbox"/> Commercial<br/><input type="checkbox"/> Cost Accounting<br/><input type="checkbox"/> Federal Tax<br/><input type="checkbox"/> Foremanship<br/><input type="checkbox"/> Good English<br/><input type="checkbox"/> Higher Mathematics<br/><input type="checkbox"/> Motor Traffic<br/><input type="checkbox"/> Retailing<br/><input type="checkbox"/> Retail Store Management<br/><input type="checkbox"/> Salesmanship<br/><input type="checkbox"/> Sign Lettering<br/><input type="checkbox"/> Spanish<br/><input type="checkbox"/> Stenography</p> |
|--|---|---|---|--|--|

Name \_\_\_\_\_ Age \_\_\_\_\_ Home Address \_\_\_\_\_  
 City \_\_\_\_\_ State \_\_\_\_\_ Working Hours \_\_\_\_\_ A.M. to \_\_\_\_\_ P.M.  
 Present Position \_\_\_\_\_ Employed by \_\_\_\_\_

Special tuition rates to members of the Armed Forces. Enrollment under G.I. Bill and P.L. 16 approved for World War II Veterans.  
 Canadian residents send coupon to International Correspondence Schools Canadian, Ltd., Montreal, Canada.

# MEN-IF YOU VALUE Your Future- read this FREE BOOK

SEND  
FOR IT  
Today!

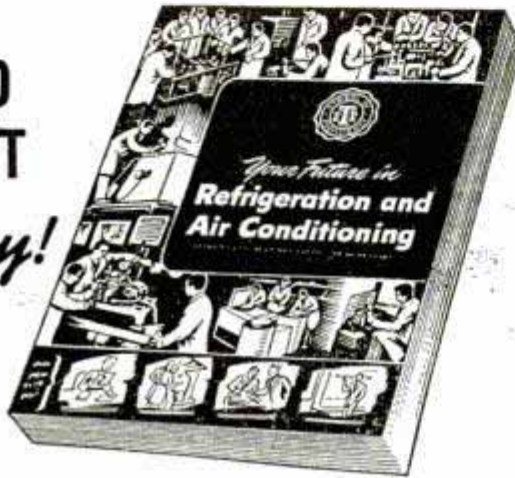

## Tells You How to Win Bigger Pay and Real Security

This book is yours without a penny of cost. "Your Future in Refrigeration and Air Conditioning" tells you what's in store for you in this fast moving, big pay field. No obligation. We want you to have this big, fascinating book. We want you to have the opportunity to read it—and to decide for yourself whether this is the field for you. You'll see pages of interesting pictures showing men on-the-job in Refrigeration and Air Conditioning. You'll read all about the fine opportunities in this amazing industry. This can easily be the most important book you'll ever receive and read—because it concerns your own future! Refrigeration and Air Conditioning has plenty of room for trained men—to handle good paying jobs in the many branches of this great industry. Almost unlimited future for men who know this work. Now you may learn Refrigeration and Air Conditioning at home in spare time. No need to give up present job or income while preparing to step into a better job. Act now! Simply write your name and address on the coupon below and mail today. Get your free copy at once . . .

### INDUSTRIAL TRAINING INSTITUTE

2150 Lawrence Avenue, Dept. N-1, Chicago 25, Ill.

**MAIL COUPON NOW** No Cost  
No Obligation

Mr. C. H. Smith, President,  
Industrial Training Institute, Dept. N-1  
2150 Lawrence Avenue, Chicago 25, Illinois

Please send me a FREE COPY of "Your Opportunity in Refrigeration and Air Conditioning" by return mail.

Name \_\_\_\_\_  
Address \_\_\_\_\_  
City and Zone \_\_\_\_\_ State \_\_\_\_\_

(Continued from page 8)

Sound waves test paint.....	130
"Scarecrows" frigaten coyotes.....	136
Ships have cabins in funnel.....	137
Operation icicle.....	138
Full-view golf bag (Ful-Vue Golf Kit Mfg. Co., 3814 W. 117th St., Hawthorne, Calif.).....	140
Drinking fountains for children (The Ebco Mfg. Co., Columbus 8, Ohio).....	140
Paper personalities.....	141
Silk-screen printing outfit (George E. Watson Co., 164 W. Lake St., Chicago 1).....	147
New spindle holes for records (FERN Manufacturing Co., 3915 Pleasant Ave., South, Minneapolis 8, Minn.).....	151
Gas-tank boat.....	153
Standardized spot-welding guns (Progressive Welder Co., 3050 E. Outer Drive, Detroit 12, Mich.).....	156
Seals with mystery collars.....	170

## Craftsman and Shop Notes Index

<b>AUTOMOTIVE</b>	
Back seat of car converted to playpen.....	174
Releasing tight wrist pins from connecting rods.....	220
Repairing hydraulic brake lines.....	224
<b>ELECTRICAL</b>	
Unused ceiling-fixture circuit adapted for wall receptacle.....	176
Protecting electric-iron cord.....	197
Using split-knob insulators to hold one wire.....	224
<b>HOUSE AND HOME</b>	
Roller bracket anchors shade.....	174
Oilstove supplies hot-water heat to bathroom.....	175
Hot air warms bathroom floor.....	176
Asphalt base molding simulated with hardboard strips.....	184
Siding is spaced quickly with spool gauge.....	186
Solving home problems.....	194
Stimulating growth of indoor plants.....	196
Reinforcing tubular-steel chairs.....	196
Graduated level determines joint variation.....	197
Lower edge of door grooved to prevent leaks.....	204
Child's bed has rope springs.....	205
<b>NOVELTIES</b>	
Wallpaper provides decorations.....	175
Slip-joint picture frame.....	187
Novel pin-up vases made of sheet copper.....	197
<b>PHOTOGRAPHY</b>	
Tripod projector base has built-in utility light.....	206
Graphite lubricates cable release for smooth operation.....	208
Film-holder slide cuts box seal.....	208
Substitute photoflood reflector.....	208
Cork tied to photo-solution bottle cannot be mislaid.....	208
Coil spring supports funnel.....	208
Tripod supported in sand or snow by wooden platform.....	208
<b>PLASTICS</b>	
Cutting plastic on bandsaw.....	184
Coloring scribed lines on plastic aids following-pattern.....	192
Plastic poppies.....	193
<b>RADIO-TELEVISION, ELECTRONICS</b>	
Television set is portable.....	225
1949 low-cost progressive broadcast set unit no. 1.....	226
Radio and electronics today.....	228
Television antenna booster.....	232
<b>RECREATION</b>	
Bamboo ski poles strengthened.....	176
Skaters' portable fireplace is made from oil drum.....	184
Microscope slides projected for study and entertainment.....	186
<b>SHOP</b>	
Motor-switch guard and lock.....	192
Oiler fastened to workbench keeps handsaws rustfree.....	196
Motor mount has handwheel for belt-tension adjustment.....	213
Counterweight on door returns it to preset stop.....	219
Apron carries stenciled reminder.....	220
Burr aids concentrating heat when cutting round bars.....	224
Hot-air heat for repair stall provided by auto radiator.....	224
<b>TOOLS</b>	
Dowel centers turned from metal rod.....	175
Cold chisel has shockproof grip.....	186
Metal trim provides tool rack.....	192
Emery boards sand small work.....	196
Channel iron extends C-clamp.....	204
Drill-press routing.....	209
Gauge measures with accuracy of depth "mike".....	211
Glove provides small-tool holder.....	212
Turning tapers on bar stock.....	212
Split nut protects bolt threads when clamped in vise.....	212
Rotating tool stand holds lathe accessories.....	213
Flanged tap wrench takes four shank sizes.....	219
Tin-can guard catches shavings when drilling overhead.....	220
Finger grip for measuring tape.....	220
Grease fitting on hand gun permits pressure filling.....	220
Thumbtack feet on triangle prevent smudged drawing.....	224
<b>WOODWORKING</b>	
Inclined planks support plywood to simplify sawing.....	176
Chucking wood for internal boring.....	184
Fancy woods from your back yard.....	185
Fitting plywood panels.....	186
Hint for applying oak stain.....	196
Tile patterns scored in hardboard with power handsaw.....	204
<b>MISCELLANEOUS</b>	
Cracking hard-shelled nuts.....	176
Use a plate scraper for.....	177
Handle to carry chopping block.....	184
Notebook buttoned to pocket is protected from loss.....	192
Newspaper in pot-type burner absorbs excess fuel oil.....	192
Brass screws improve boots.....	204
Thumbtack fastens ink pad in convenient position.....	207
Inexpensive paper punch.....	211
Prolong life of stock tank by proper mounting and care.....	212

**IMPORTANT NOTICE**—It is the intention of this magazine to provide its readers with information regarding the latest developments in the mechanical arts. We take no responsibility as to whether the disclosures contained in our articles are covered by patents and advise readers to investigate this subject before making, using, or selling any of the products, machines, or processes described in order to avoid possible liability for patent infringements.

**AUDELS CARPENTERS & BUILDERS GUIDES—(4 Book Set).....\$6**

A practical illustrated trade assistant on modern construction for carpenters, joiners, builders, mechanics and all woodworkers. 4 vols., 1600 pages, 3700 illustrations. Fully indexed, flexible covers. Each volume sold separately \$1.50 a vol.

**AUDELS PLUMBERS & STEAMFITTERS GUIDES—(4 Book Set).....\$6**

A Practical Trade Assistant & Ready Reference. Explains in plain language & by clear illustrations, diagrams, charts, graphs, pictures principles of modern plumbing practice including Marine Pipe Fitting and Air Conditioning. 4 Vols.—1670 Pages—3642 Diagrams & Illustrations. Each Vol. Sold Separately \$1.50 a Vol.

**AUDELS OIL BURNER GUIDE.....\$1**

384 Pages Covering Installation, Servicing & Repairs All Types Domestic & Industrial Burners. Illustrated. Highly Endorsed.

**AUDELS HOUSE HEATING GUIDE.....\$4**

1000 Pages Covering Working Principles, Installation, Service of All Modern House Heating, Ventilating & Air Conditioning Systems. Explains New Radiant Heating. Fully Illustrated & Indexed.

**AUDELS REFRIGERATION & AIR CONDITIONING GUIDE.....\$4**

New from Cover to Cover—1280 Pages, Fully Illus. Covering basic principles, servicing, operation & repair of household, commercial & industrial refrigeration & air conditioning. A gold mine of essential important facts for engineers, servicemen, users.

**AUDELS SHEETMETAL WORKERS HANDY BOOK.....\$1**

Practical inside information. Fundamentals of Sheet Metal Work. 388 pages. Illustrated. 11 sections. Clearly written. Essential & important facts, figures, pointers in everyday language. Ref. Index.

**AUDELS SHEETMETAL PATTERN LAYOUTS.....\$4**

Developed by Experts for Sheet Metal Workers, Layout Men & Mechanics. A Practical Encyclopedia in 10 Sections, size 7 x 10 x 2—1125 Pages—350 Layouts—1600 Illustrations. 1001 Key Facts. Fully indexed for ready reference in answering your layout problems. Covers all phases of sheet metal work including Pattern Cutting, Pattern Development & Shop Procedure.

**AUDELS BLUE PRINT READING.....\$2**

For Mechanics & Builders. Covers all types of blue print reading including ship & airplane. 416 pages, fully illustrated.

**AUDELS MATHEMATICS & CALCULATIONS FOR MECHANICS \$2**

Mathematics for home study or reference. 700 pages, 550 illus. Practical mathematics from beginning. How to figure correctly. Easy, correct methods covering complete review. Illus. & Indexed.

**AUDELS AUTOMOBILE GUIDE.....\$4**

A practical quick ready reference book for auto mechanics, service men, operators & owners. Explains theory, construction & servicing of modern motor cars, trucks, buses & auto type Diesel engines. 1700 pages, fully illustrated. 55 chapters. Indexed. A standard book for mechanics. New Hydraulic drive covered.

**AUDELS DIESEL ENGINE MANUAL....\$2**

A practical, concise treatise with questions and answers on the theory, operation and maintenance of modern diesel engines. Over 400 pages, fully illus. All details plainly brought out, this book is of extreme value to engineers, operators & students.

**AUDELS WELDERS GUIDE.....\$1**

A concise, practical text on operation & maintenance of all welding machines for all mechanics. Over 400 pages, illustrated. Covers all methods of electric and acetylene welding including airplane work.

**AUDELS MACHINIST & TOOLMAKERS HANDY BOOK.....\$4**

Covers modern machine shop practice in all its branches. Tells how to set up & operate lathes, screw and milling machines, shapers, drill presses & all other machine & hand tools. 1600 pages, fully illustrated. Indexed. 5 sections. 1—Modern Machine Shop Practice. 2—Blue Print Reading & How to Draw. 3—Calculations & Mathematics for Machinists. 4—Shop Physics. 5—How to Use the Slide Rule, 60 chapters. Easy to read and understand. A shop companion that answers your questions.

**AUDELS ELECTRIC MOTOR GUIDE \$4**

Practical Information Covering Construction, Control, Maintenance & Wiring Hookups of All Types Electric Motors also Armature Winding. 1000 Pages Fully Illustrated & Indexed.

**AUDELS ELEC. WIRING DIAGRAMS \$1**

210 Pages. Illustrated. Gives practical facts on wiring of electrical apparatus. It shows clearly how to wire apparatus for practically all fields of electricity. Each diagram is complete & self-explanatory. Highly Endorsed Pocket Companion.

**AUDELS PRACTICAL ELECTRICITY \$4**

A key to a practical understanding of Electricity. For maintenance engineers, electricians & all electrical workers. 1440 Pages, 2600 Illus. Covers important electrical information in handy form—including wiring for Light & Power. Indexed.

**AUDELS RADIOMANS GUIDE.....\$4**

A key to the practical understanding of radio including Frequency Modulation, Television, etc., Aircraft & Marine Radio. For radio engineers, servicemen, amateurs. 914 Pages, 633 Illustrations & Diagrams. Photos. Review Questions & Answers, Reference Index.

**AUDELS PUBLISHERS, 49 W. 23 ST., N.Y. 10**

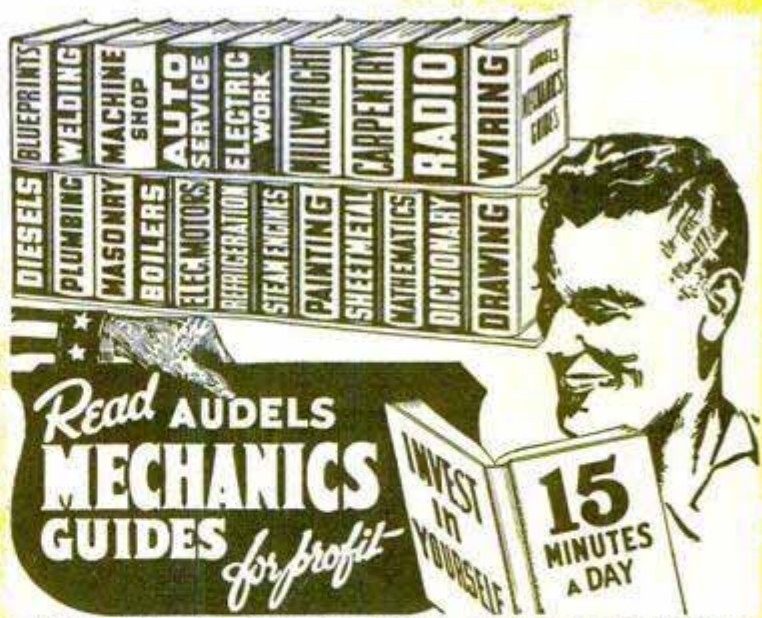

**AN AUDEL GUIDE IS A GOOD FRIEND!**  
Step Up Your Own Skill with the Practical Facts and Figures of Your Trade. Save time and money with right methods, short cuts, labor saving ideas. CHECK NOW! You can look over any Audel Guide in your home. Start the Easy Payments if satisfied.

**CUT HERE MAIL ORDER**

AUDEL, Publishers, 49 W. 23 St., New York 10, N. Y.

Please mail me for 7 days' free examination the books marked (X) below. I agree to mail \$1 in 7 days on each book or set ordered, and to further mail \$1 a month on each book or set ordered until I have paid the purchase price. If I am not satisfied with Guides I will return them.

- AUTOMOBILE GUIDE, 1700 Pages . . . . . \$4
  - DIESEL ENGINE MANUAL, 400 Pages . . . . . 2
  - WELDERS GUIDE, 400 Pages . . . . . 1
  - CARPENTERS & Builders Guides (4 Book Set) . . . . . 6
  - PLUMBERS & Steamfitters Guides (4 Book Set) . . . . . 6
  - MASONS and Builders Guides (4 Book Set) . . . . . 6
  - BLUE PRINT READING, 416 Pages . . . . . 2
  - MASTER PAINTER & Decorator, 320 Pages . . . . . 2
  - GARDENERS & GROWERS GUIDES (4 Book Set) . . . . . 6
  - OIL BURNER GUIDE, 384 Pages . . . . . 1
  - HOUSE HEATING GUIDE, 1000 Pages . . . . . 4
  - REFRIGERATION & Air Conditioning Guide, 1280 Pages . . . . . 4
  - SHEET METAL WORKERS Handy Book, 388 Pages . . . . . 1
  - SHEET METAL PATTERN LAYOUTS, 1100 Pages . . . . . 4
  - AIRCRAFT WORKER, 240 Pages . . . . . 1
  - MECHANICAL DRAWING GUIDE, 160 Pages . . . . . 1
  - MECHANICAL DRAWING & DESIGN, 480 Pages . . . . . 2
  - MATHEMATICS and CALCULATIONS, 700 Pages . . . . . 2
  - MECHANICAL DICTIONARY, 968 Pages . . . . . 4
  - MACHINISTS & Toolmakers Handy Book, 1600 Pages . . . . . 4
  - MILLWRIGHTS & Mechanics Guide, 1200 Pages . . . . . 4
  - POWER PLANT ENGINEERS GUIDE, 1500 Pages . . . . . 4
  - ENGINEERS & FIREMANS EXAMINATIONS, 528 Pages . . . . . 1
  - PUMPS, HYDRAULICS & Air Compressors, 1658 Pages . . . . . 4
  - MARINE ENGINEERS Handy Book, 1280 Pages . . . . . 4
  - ENGINEERS and Mechanics Guides (8 Book Set) . . . . . 12
  - Answers on Practical ENGINEERING, 254 Pages . . . . . 1
  - ELECTRIC WIRING DIAGRAMS, 210 Pages . . . . . 1
  - ELECTRICIANS EXAMINATIONS, 250 Pages . . . . . 1
  - ELECTRIC DICTIONARY, 9000 Terms . . . . . 2
  - ELECTRIC MOTOR GUIDE, 1000 Pages . . . . . 4
  - PRACTICAL ELECTRICITY Handy Book, 1440 Pages . . . . . 4
  - ELECTRICAL POWER CALCULATIONS, 425 Pages . . . . . 2
  - RADIOMANS GUIDE, 914 Pages . . . . . 4
  - ELECTRONIC DEVICES, 216 Pages . . . . . 2
  - NEW ELECTRIC LIBRARY, 7000 Pages (12 Book Set) . . . . . 18
- Vols. I, II, III, IV, V, VI, VII, VIII, IX, X, XI, XII—\$1.50 Each

Name \_\_\_\_\_  
Address \_\_\_\_\_  
Occupation \_\_\_\_\_  
Employed by \_\_\_\_\_

I Will  
Show You  
How to

# Learn RADIO

## You Build This Modern Superheterodyne Receiver

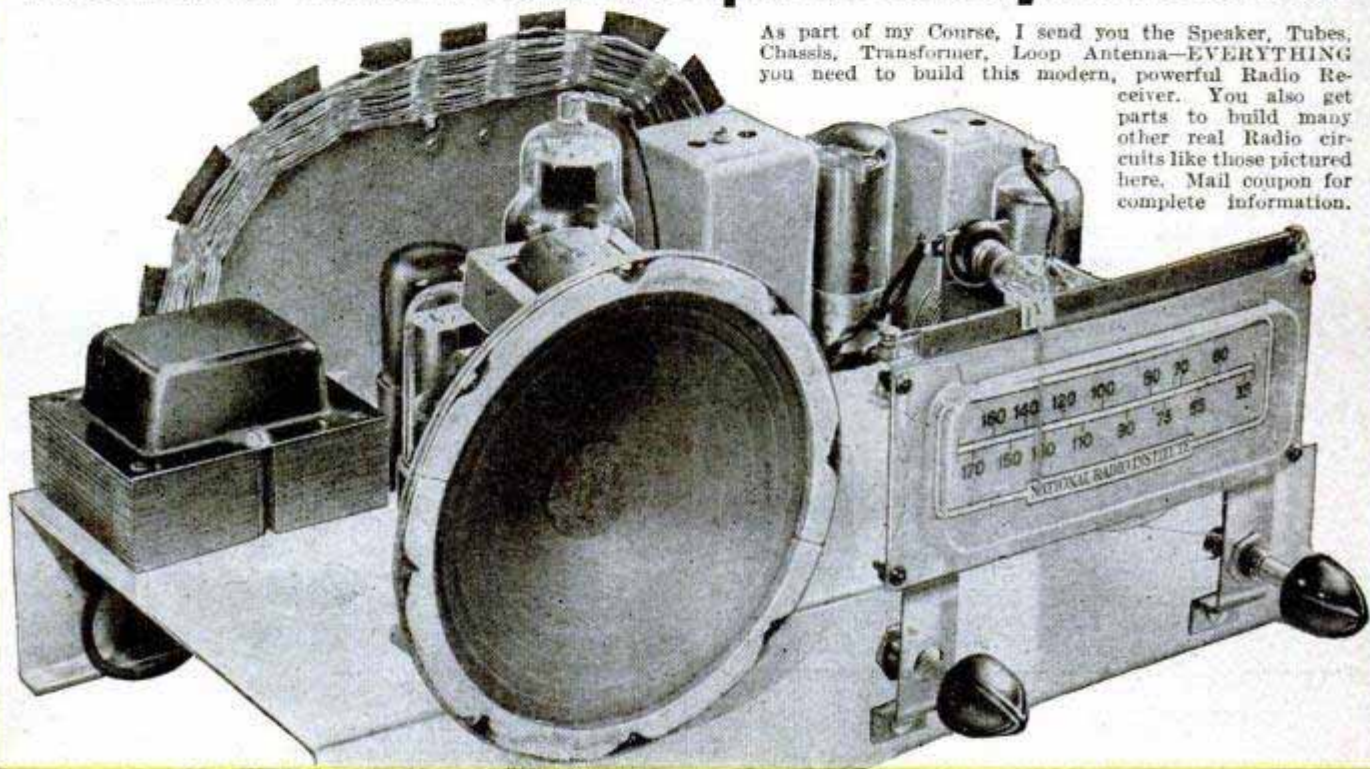

As part of my Course, I send you the Speaker, Tubes, Chassis, Transformer, Loop Antenna—EVERYTHING you need to build this modern, powerful Radio Receiver. You also get parts to build many other real Radio circuits like those pictured here. Mail coupon for complete information.

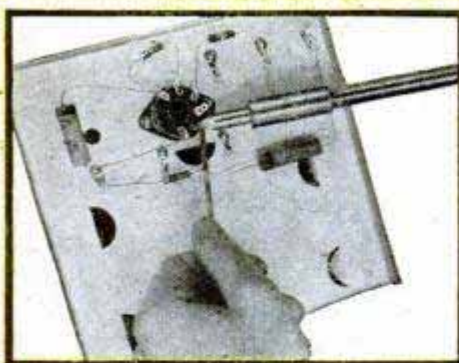

**YOU PRACTICE** Radio soldering with Soldering Equipment and Radio Parts I send you. Get practical experience mounting and connecting parts.

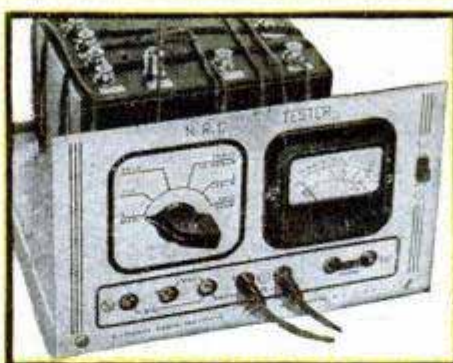

**YOU BUILD** this Tester with parts N. R. I. sends early in course. Soon helps you fix neighbors' Radios and **EARN EXTRA MONEY** in spare time.

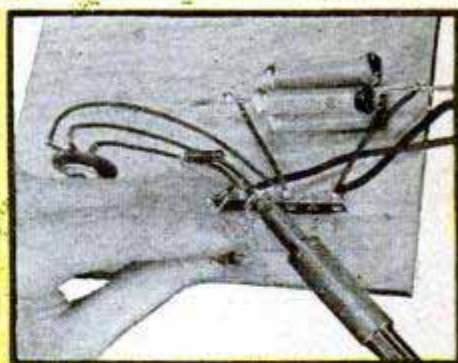

**YOU TEST** Radio Circuits like this built with parts I send. Build special circuits; learn how to locate and repair circuit defects.

## MEN I TRAIN AT HOME GET GOOD JOBS LIKE THESE

### MADE \$1500 WHILE LEARNING

"By the time I finished my NRI training I had made \$1500. When I started the Course I did not know a resistor from a condenser. I have bought my home. My income from Radio work, etc., is about \$3,000 a year." — **WILLIAM THOMAS**, Baldwin, Mississippi.



### ASSISTANT TO CHIEF ENGINEER AT STATION WHJB

"Have been employed for the past two years as assistant to the chief engineer at Radio Station WHJB. Knew nothing about Radio when I enrolled for the NRI Course." — **CECIL J. GIUNIPERO**, Greensburg, Pennsylvania.



### KNEW NOTHING ABOUT RADIO

"I knew nothing about Radio when I enrolled. At present I am doing spare time work. I have more than paid for my Course and I have about \$200 worth of equipment which has paid for itself." — **RAYMOND HOLT-CAMP**, Vandalia, Illinois.



### FULL-TIME JOB BEFORE FINISHING COURSE

"After completing about two-thirds of my Course I entered a Radio Repair shop. Later I branched out for myself and opened a shop in my own home. I am much pleased with the work I had during my first year of business." — **A. H. AYERS**, Washington 10, D. C.



# by Practicing in Spare Time

I Send You  
Big Kits  
of Radio Parts



## KNOW RADIO *Win Success* I Will Train You at Home

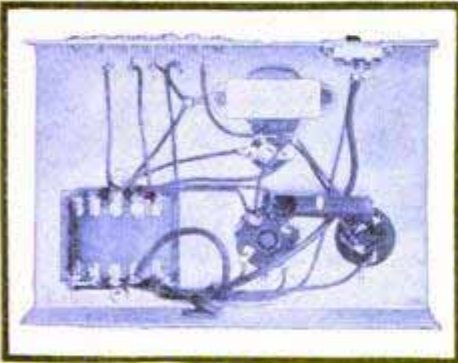

**YOU BUILD** Vacuum Tube Power Pack; make changes which give you experience with packs of many kinds. Learn how to correct Power Pack troubles.

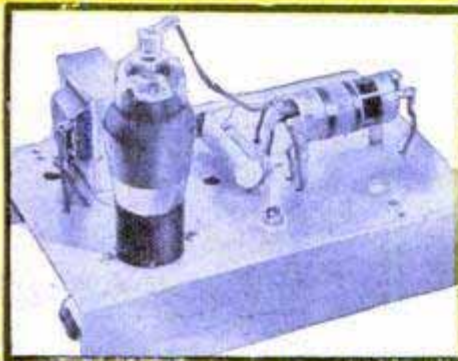

**YOU BUILD** this A. M. Signal Generator for more valuable experience. It provides amplitude-modulated signals for many tests and experiments.

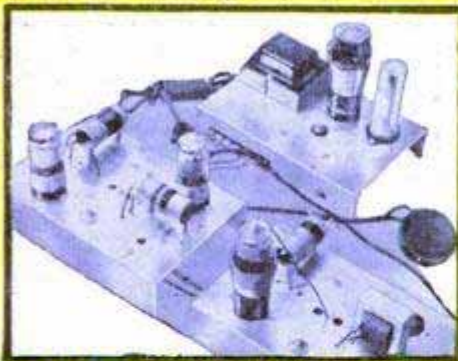

**YOU PRACTICE FM** (Frequency Modulation) experiments, get more experience with this Superheterodyne Receiver Circuit you build with parts I send.

### SAMPLE LESSON FREE

Gives hints on Receiver servicing, locating defects, repair of Loudspeaker, I. F. Transformer, Gang Turner, Condenser, etc. Mail coupon.

**My Radio Course Includes  
TELEVISION • ELECTRONICS  
FREQUENCY MODULATION**

Want a good-pay job in the fast-growing RADIO-TELEVISION Industry? Want a money-making Radio-Television shop of your own? I've trained hundreds of men to be Radio Technicians . . . MEN WITH NO PREVIOUS EXPERIENCE. My tested and proved train-at-home method makes learning easy. Learn Radio-Television principles from illustrated lessons. Get practical experience with MANY KITS of PARTS I send. All equipment yours to keep.

### VETERANS

You Can Get  
This Training  
Under  
G. I. Bill.  
Mail Coupon.

#### Make EXTRA MONEY in Spare Time

The day you enroll, I start sending SPECIAL BOOKLETS that show you how to make EXTRA MONEY fixing neighbors' Radios in spare time. From here it's a short step to your own shop, or a good-pay Radio-Television servicing job. Or get into Police, Aviation, Marine Radio, Broadcasting, Radio Manufacturing or Public Address work. And think of getting in on the ground floor of the booming Television Industry. Trained men are already in demand . . . new stations are going on the air, manufacturers are building over 100,000 sets a month, more and more homes are getting sets. The man who prepares now will reap rich rewards.

#### See What N. R. I. Can Do For You

Act now! Send for my DOUBLE FREE OFFER. Mail coupon for lesson and 64-page book, "HOW TO BE A SUCCESS IN RADIO AND TELEVISION - ELECTRONICS." Tells how quickly, easily you can get started. Send coupon in envelope or paste on penny postal. J. E. SMITH, President, Dept. 9AP, National Radio Institute, Pioneer Home Study Radio School, Washington 9, D. C.

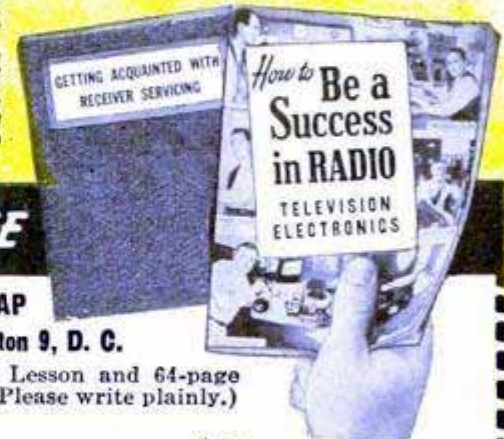

**Good for Both - FREE**

MR. J. E. SMITH, Pres., Dept. 9AP

National Radio Institute, Washington 9, D. C.

Mail me FREE, your Sample Lesson and 64-page book. (No salesman will call. Please write plainly.)

Name..... Age.....

Address.....

City..... Zone..... State.....

Check If Veteran

**Approved for Training under GI Bill**

# MAKE BIG MONEY FAST



**STEVINSON TRAINED  
AUTO, ELECTRICAL, and  
REFRIGERATION EXPERTS  
GET TOP MONEY**

WITH STEVINSON TRAINING

Our 26 years of Successful Training of men in chosen careers in automotive, air-conditioning, refrigeration, and electrical appliance industries, has perfected the famous **Stevinson classroom-shop system** of instruction... a technical, plus practical experience method... which speeds your progress... assures quick qualification for top incomes.

**APPROVED FOR CIVILIAN AND VETERANS TRAINING**

The steady work, backed by proved time-saving methods of Stevinson training and experience has won approval from civilians and veterans alike. If you are a qualified G. I., don't delay a day. Write today. Approved under laws 346 and 16.

**EARN WHILE YOU LEARN**

No wasted time. Be an expert in latest modern methods... you work with most advanced new equipment. We help you arrange part-time work... help you get best jobs or set up your own business on graduating. Don't limit yourself. Get on the quick road to success with a solid Stevinson foundation.

**GET FULL FACTS FREE. MAIL COUPON NOW!**

Stevinson Auto & Electrical School,  
Dept. PMJ, 2008 Main St., Kansas City 8, Mo.

Common sense tells me the practical 26 years success of Stevinson classroom-shop training means faster earning of big money for me. Send me full facts on the training courses I have checked, at no cost or obligation:

- Auto
- Air Conditioning
- Refrigeration
- Electrical Appliance
- Auto Body & Fender Rebuilding

Name \_\_\_\_\_  
Street \_\_\_\_\_  
Town \_\_\_\_\_ State \_\_\_\_\_

**FREE BOOK  
TELLS HOW  
TO BE AN ...**

*Accountant  
Salesman  
Secretary  
Stenographer*

**SECURED FUTURE...  
FREE EMPLOYMENT SERVICE**

Enter one of the "substantial earnings" fields through Hill's "Success Plan" training. A lifetime opportunity to join thousands of successful graduates in positions secured through our nation-wide employment service. No matter where you live, what you are doing now, Hill's can train you by study at home or in the resident school. Big Free book shows you the way to substantial earnings and an assured future. G. I. Approved.

Hill's Extension School & Business University  
Dept. PM-19, 619 W. Main St., Oklahoma City 2, Okla.  
Please send your free book, "Through Hill's to Success."

NAME \_\_\_\_\_  
ADDRESS \_\_\_\_\_  
CITY \_\_\_\_\_ STATE \_\_\_\_\_  
 Check here if eligible under G.I. Bill.  
Please check course and training plan preferred.  
Course \_\_\_\_\_  Resident  Home Study

**EASY-TO-USE COUPON TODAY**

# SUCCEED IN THE POULTRY BUSINESS!



Poultry is providing many trained men and women with a good, comfortable living, either part or full time. You, too, can enjoy country life, home-grown food, increased income, if you have the specialized knowledge that is so important.

For 28 years our Home Study Course has been helping thousands to greater success. Proper knowledge and "Know How" mean extra income from the start. Don't delay—write today for prospectus describing courses, methods, opportunities, service.

**NATIONAL POULTRY INSTITUTE**  
DEPT. 50 — ADAMS CENTER, N. Y.

# REAL ESTATE

**BE A BROKER**

**PAYS BIG! SEND FOR FREE, BIG, ILLUSTRATED CATALOG NOW!** No obligation. Graduates report making substantial incomes. Start and run your own business quickly. Men, women of all ages, learn easily. Course covers Sales, Property Management, Appraising, Loans, Mortgages, and related subjects. **STUDY AT HOME** or in our classrooms in big cities. Diploma awarded. G. I. approved. Nationally known.

**WEAVER SCHOOL OF REAL ESTATE (Est. 1936)**  
15 E. Pershing Road Dept. NT-2 Kansas City, Mo.

**FREE BOOK TELLS HOW**

# WHY DON'T YOU WRITE?

Writing short stories, articles on business, homemaking, decorating, shop crafts, sports, local and club activities, etc., will enable you to earn extra money. In your own home, on your own time, the New York Copy Desk Method teaches you how to write the way newspaper men learn—by writing. Our unique "Writing Aptitude Test" tells whether you possess the fundamental qualities essential to successful writing. You'll enjoy this test. Write for it, without cost or obligation.

**Veterans: This course approved for Veterans' Training.**  
**NEWSPAPER INSTITUTE OF AMERICA**  
SUITE 5599-A, ONE PARK AVENUE, NEW YORK 16, N. Y.

## Get this Great Catalog of MAGIC



Amazing tricks, mystifying and spooky stage and party illusions. Easy to do—no skill—perfect instructions. Fool your friends. Loads of fun. Add "life" to any party. 850 pages. 600 illustrations. Mail \$1.00 for catalog, credited on your first order for \$5.00 or more.  
**NATIONAL MAGIC COMPANY**  
119 S. State St., Dept. P-1  
Chicago 3, Ill.

# CODE SPEED SHORT CUT

Be an expert. Learn to be a Telegraph or Radio Operator. Qualify for amateur or commercial license. Intensely interesting work—good pay. Learn at home or wherever you are, quickly, easily with the famous Candler Speed System. Book of particulars Free.

**CANDLER SYSTEM CO., Dept. 5-A, Box 928, Denver 1, Colo., U.S.A.**



**YOU can draw!**

**AMAZING NEW HOLLYWOOD PLAN**  
Yes, YOU can draw GIRLS, CARS, FRIENDS and even MAGAZINE COVERS. It's so simple, no matter what your age. Many artists make more than \$150.00 per week in advertising and cartoons. Be your own boss, draw for money anywhere. Our Commercial Artists will teach you the secrets from HOLLYWOOD. Drawing materials furnished. Be a success. Write NOW for free details

## HOLLYWOOD SCHOOL OF ART

**DIVISION OF AXELSON STUDIOS**

6533 Hollywood Blvd.  
Hollywood 28, Calif.

Name \_\_\_\_\_  
Address \_\_\_\_\_  
City \_\_\_\_\_ Zone \_\_\_\_\_ State \_\_\_\_\_





# INVENTORS



Learn how to protect your invention. The U. S. Patent Laws provide that any new and useful art, machine, article of manufacture, or composition of matter, or any new and useful improvement thereof, may be patented if the act of invention is involved. Therefore, every inventor with a valuable invention should take advantage of the Patent Laws and proceed for patent protection in order to safeguard his rights.

A patent gives the inventor the exclusive right to prevent others from making, using, or selling the invention claimed in the patent for a period of seventeen years.

The Patent Laws were enacted for the benefit of the inventor to give him protection for the features of his invention which are patentable. These features must be properly and concisely set forth and claimed in a formal application for patent, in order to comply with the requirements of the Patent Laws. For that reason, unless the inventor is familiar with patent matters, he should engage a competent registered patent attorney or agent to represent him. We are registered to practice before the U. S. Patent Office and are prepared to serve you in the handling of your patent matters.

A specially prepared booklet entitled "Patent Guide for the Inventor", containing detailed information with respect to patent protection and procedure, together with a "Record of Invention" form will be promptly forwarded to you without obligation upon request.

## CLARENCE A. O'BRIEN & HARVEY JACOBSON

*Registered Patent Attorneys*

91-A DISTRICT NATIONAL BUILDING • WASHINGTON 5, D. C.

*Patents*  
*Trademarks*  
*Copyrights*

CLARENCE A. O'BRIEN & HARVEY JACOBSON

Registered Patent Attorneys

91-A District National Bldg., Washington 5, D. C.

Please send me copy of "Patent Guide for the Inventor" and also "Record of Invention" form. This request does not obligate me.

Name \_\_\_\_\_

Address \_\_\_\_\_

City \_\_\_\_\_ State \_\_\_\_\_

(Please write or print plainly.)

I'll Send You 8 Big Kits of Training Equipment  
including

**TWO-BAND 6 TUBE SUPER RECEIVER  
AND 16 RANGE METER SET-UP**  
for Testing

Learn Fast... Earn Fast  
**HOME TRAINING**  
Planned For Your Needs  
*You Build All These*  
**TESTERS... and MORE!**

I give you a fine, moving-coil type Meter Instrument on Jewel Bearings—with parts for a complete Analyzer Circuit Continuity Tester. You learn how to check and correct Receiver defects with professional speed and accuracy.



**Practice Does It!**

Soldering, wiring, connecting Radio Parts... building circuits with your own hands—you can't beat this method of learning. When you construct this Receiver and Filter Resistor and Condenser Tester, etc., you get a really practical slant on Radio that leads to a money-making future.

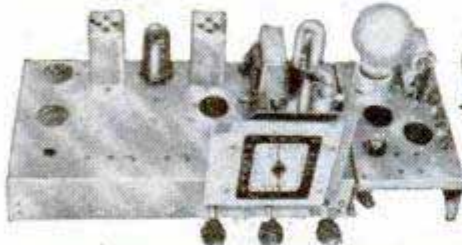
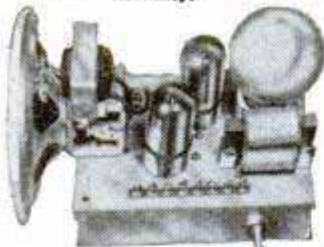

Building this Signal Generator and multi-purpose Tester will give you the kind of valuable experience and practice that is so important as a foundation for making good money in Radio. It makes a breeze out of fixing Radios, and you don't have to spend money on ready-made Equipment.

**NOW! TWO LOCATIONS**  
TO SERVE YOU BETTER  
**Mail Coupon to Location**  
Nearest Your Home

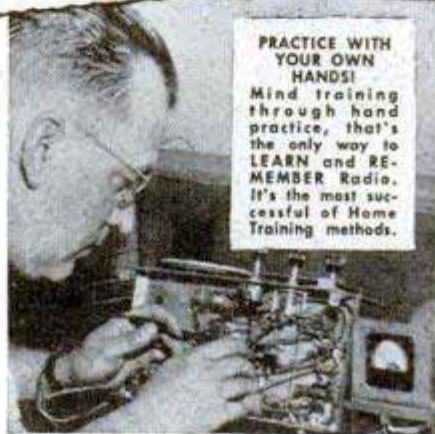

**PRACTICE WITH YOUR OWN HANDS!**  
Mind training through hand practice, that's the only way to LEARN and REMEMBER Radio. It's the most successful of Home Training methods.



**OVER 175 PRACTICAL EXPERIMENTS**  
You'll find out how to build countless Radio Circuits. You'll learn a new, fast way to test Radio Sets without mfg. Equipment.

**LOW COST HOME RADIO TRAINING!**  
**Easy Monthly Payments!**

My perfected Radio Training prepares you to start your own Radio Service Shop—or to land a big pay Radio job. With my help you get neighborhood Radio jobs while learning—for extra cash and rich experience. I train you RIGHT—by putting you to work with your hands in your own home during spare hours. You get 8 big kits of real professional Radio Parts and Equipment—and use them to build, test and trouble-shoot a powerful 6 tube superhet receiver, a 16 range test meter set-up and over 175 fascinating, instructive Radio experiments. My Training is down-to-earth, really PRACTICAL—it's the Training you

need to make money in Radio. Theory is cut to the bone—you don't need any previous schooling or experience. Sprayberry Training starts you out at the very beginning of Radio—the lessons are completely illustrated, simply written and easy to understand.

**GET THE FACTS About Sprayberry Training Now... Find Out What It Can Do For You!**  
Prepare for amazing opportunities in Radio Servicing, Television, FM, Radar and Industrial Electronics. Fill out and mail coupon for my two big Books—FREE. No obligation—and no salesman will call. Mail coupon TODAY!

**MAIL COUPON FOR THESE 2 BOOKS!**



**VETERANS: Approved for G.I. Training under Public Laws 16 and 346**

**SPRAYBERRY ACADEMY OF RADIO, Dept. 10-N, SPRAYBERRY BUILDING, PUEBLO, COLORADO or 20 NORTH WACKER DRIVE, CHICAGO 6, ILLINOIS**  
Please rush my FREE copies of "How To Make Money In Radio, Electronics, and Television" and "How To Read Radio Diagrams and Symbols."

Name \_\_\_\_\_ Age \_\_\_\_\_

Address \_\_\_\_\_

City \_\_\_\_\_ State \_\_\_\_\_

(Mail in envelope or paste on penny postcard)

# INVENTORS

Patent laws encourage the development of inventions.

We recommend that an inventor employ a registered Patent Attorney or agent, if the inventor is not familiar with patent matters. This is because the value of a patent depends largely upon the skillful preparation of the specification and claims in the patent application.

The firm of McMorrow, Berman and Davidson is registered to practice before the United States Patent Office. Additionally it engages patent attorneys able to readily understand inventors' disclosures, to advise concerning patentability, and to prepare appropriate specifications and claims.

If an inventor believes he has an invention, a search of the most pertinent prior U. S. patents should be made and a report obtained relative to its patentability. Where such report indicates that the invention appears patentable, in order to secure protection, diligence should be exercised in making application for a patent.

Send for a copy of Patent Booklet entitled "How To Protect Your Invention." This booklet contains information on patent protection and procedure. You will also receive an "Invention Record" blank. This will be promptly forwarded to you upon request—no obligation.

## McMORROW, BERMAN & DAVIDSON

*Registered Patent Attorneys*

PATENTS • TRADE MARKS • COPYRIGHTS

135-V VICTOR BUILDING, WASHINGTON 1, D. C.

### McMORROW, BERMAN & DAVIDSON

*Registered Patent Attorneys*

135-V Victor Building, Washington 1, D. C.

Send me your Patent Booklet, "How To Protect Your Invention", and also "Invention Record" form at once. I understand this request does not obligate me.

Name.....

Address.....

City.....

(WRITE OR PRINT NAME CLEARLY)

# Lend Me 15 Minutes A Day

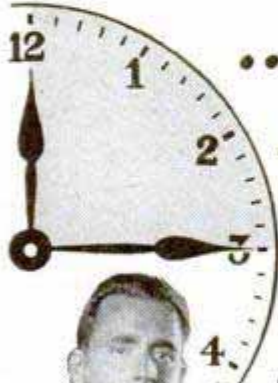

..and I'll prove  
I can make you  
a **NEW MAN**

I'M trading in old bodies for new! I'm taking men who know that the condition of their arms, shoulders, chests and legs—their strength, "wind," and endurance—is not 100%. And I'm making NEW MEN of them!

If you can simply raise your arm and flex it, I can add **SOLID MUSCLE** to your biceps—yes, on each arm—in double-quick time! I can broaden your shoulders, strengthen your back, develop your whole muscular system **INSIDE and OUTSIDE!**

## What Only 15 Minutes a Day Can Do

I can add inches to your chest, give you a vise-like grip, make those legs of yours lithe and powerful. I can shoot new strength into your old backbone, exercise those inner organs, help you cram your body so full of pep, vigor and red-blooded vitality that you won't feel there's even "standing room" left for weakness and that lazy feeling! Before I get through with you I'll have your whole frame "measured" to a nice, new, beautiful suit of muscle!

## I Was a 97-lb. Weakling

All the world knows I was **ONCE** a skinny, scrawny 97-pound weakling. And **NOW** it knows that I won the title, "The World's Most Perfectly Developed Man." Against all comers! How did I do it? How do I work miracles in the bodies of other men in only 15 minutes a day? The answer is "Dynamic Tension," the amazing method I discovered and which changed me from a 97-pound weakling into the champion you see here!

## FREE THIS FAMOUS BOOK "EVERLASTING HEALTH AND STRENGTH"

Almost two million men have sent for and read my book, "Everlasting Health and Strength." It tells you exactly what "Dynamic Tension" can do. And it's packed with pictures that **SHOW** you what it does. Results it has produced for other men. **RESULTS** I want to prove it can get for **YOU!** Learn how you can actually become

a **NEW MAN**, right in the privacy of your own home and in only 15 minutes a day! Mail this coupon **NOW!** **CHARLES ATLAS**, Dept. SN, 115 East 23rd St., New York 10, N. Y.

*Charles Atlas*

Actual photo of the man who holds the title, "The World's Most Perfectly Developed Man."



**CHARLES ATLAS**, Dept. 8N,  
115 East 23rd St., New York 10, N. Y.

I want the proof that your system of "Dynamic Tension" will help make a New Man of me—give me a healthy, husky body and big muscular development. Send me your free book, "Everlasting Health and Strength."

Name \_\_\_\_\_ Age \_\_\_\_\_  
(Please Print or Write Plainly)  
Address \_\_\_\_\_  
City \_\_\_\_\_ State \_\_\_\_\_

**SAY YOU SAW IT IN POPULAR MECHANICS**

# Command Bigger Money! STUDY LAW

STUDY AT HOME for BUSINESS SUCCESS and LARGER PERSONAL EARNINGS. 40 years expert instruction — over 114,000 students enrolled. LL.B. Degree awarded. All text material furnished. Easy payment plan. Send now for **FREE BOOK** — "Law and Executive Guidance." It explains the course — how you may enroll and the many ways you can profit from Law Study. Write **TODAY** to:

**AMERICAN EXTENSION SCHOOL OF LAW**

Dept. 10 - PM, 646 N. Michigan Ave., Chicago 11, Ill.

FREE  
BOOK



## RAISE HAMSTERS

The new wonder animals from Syria. Often called Toy Bears. Delightful pets. Everyone wants them. Laboratories need thousands. Clean, odorless. Raise anywhere. A profitable and interesting hobby or business. We furnish breeding stock with manual of instructions.

Write today for free illustrated literature.

**GULF HAMSTERY, 1536 BASIL, MOBILE, ALA.**

## "How to Make Money with Simple Cartoons"



A book everyone who likes to draw should have. It is free; no obligation. Simply address

FREE  
BOOK

**CARTOONISTS' EXCHANGE**

Dept. 91-D Pleasant Hill, Ohio

AIR  
RIFLES

# BENJAMIN

AIR  
PISTOLS

PIONEERS - LEADERS

**SEND FOR FREE FOLDER OF LATEST MODELS TODAY** If you want a **REAL GUN** for **PRACTICAL USE** inside or outdoors get a **SAFE - CLEAN - ECONOMICAL - BENJAMIN** with Adjustable Power and Amazing Accuracy. For **BEST RESULTS** use **BENJAMIN H-C PELLETS**. **WRITE AT ONCE, BENJAMIN AIR RIFLE CO., 812 MARION ST., ST. LOUIS 4, MO.**



## SEND FOR THIS FREE!

Make money. Know how to break and train horses. Write today for this book **FREE**, together with special offer of a course in Animal Breeding. If you are interested in Gaiting and Riding the saddle horse, check here ( ) **Do it today—now.**

**BEERY SCHOOL OF HORSEMANSHIP**

Dept. 1101-D Pleasant Hill, Ohio

# Photography



for

## PLEASURE or PROFIT

Learn at home. Spare time. Practical basic training. Long-established school. Many have earned while learning. Send coupon below for free booklet, "Opportunities in Modern Photography" and full particulars.

**AMERICAN SCHOOL OF PHOTOGRAPHY**

1315 Michigan Avenue Dept. 1351 Chicago 5, Illinois  
Send booklet, "Opportunities in Modern Photography," full particulars and requirements. No salesman will call.

Name \_\_\_\_\_  
Address \_\_\_\_\_  
City \_\_\_\_\_ Zone \_\_\_\_\_ State \_\_\_\_\_

# BETTERIN' the VETERAN

## —a story about



had three choices back in 1946:

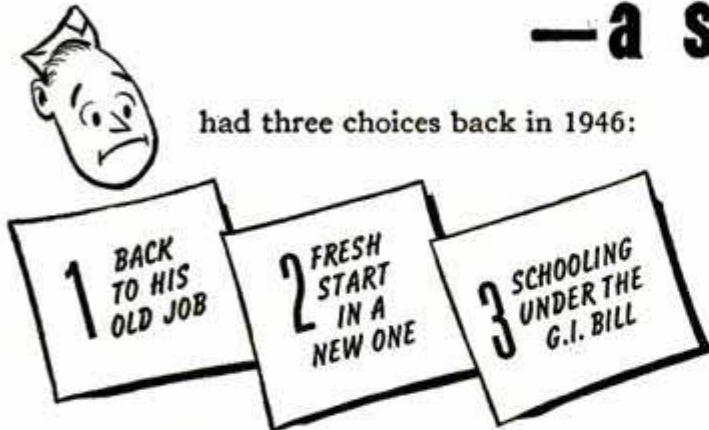

He picked No. 2; came up with a brand-new job. He did well—too well, in fact, got stuck.



He reached a point where he could go no further . . .

### WITHOUT ADDITIONAL TRAINING.



was entitled to that training under the

### G. I. BILL.

But he couldn't afford to quit work to go to school. He had to learn and earn at the same time.



### SO HERE'S WHAT HE DID:

mailed a coupon. It put him in touch with the largest school in the world,

## INTERNATIONAL CORRESPONDENCE SCHOOLS

# 400

He learned he had some **400** courses to choose from. Each course sound, authoritative, easy to follow. Each course a *gold mine* of practical information.

So enrolled with I. C. S. and studied



### IN HIS SPARE TIME.

Now is making good—in his studies and



### ON THE JOB.

As a trained man, there will be practically no limit to how far he can go.



is like thousands of veterans who are cashing in on their opportunities through **I. C. S.**



**WHAT ABOUT YOU?** Do you have enough training to carry you to the top? Here's the coupon that can help open the door to a fuller, brighter, more rewarding future for you. **MAIL IT TODAY!**

## INTERNATIONAL CORRESPONDENCE SCHOOLS



BOX 5644-K, SCRANTON 9, PENNA.

Without cost or obligation, please send me full particulars about the course BEFORE which I have marked X:

- |  |  |  |   |
|--|--|--|---|
| <p><b>Business and Academic Courses</b></p> <ul style="list-style-type: none"> <li><input type="checkbox"/> Accounting <input type="checkbox"/> Advertising</li> <li><input type="checkbox"/> Bookkeeping</li> <li><input type="checkbox"/> Business Administration</li> <li><input type="checkbox"/> Business Correspondence</li> <li><input type="checkbox"/> Certified Public Accounting</li> <li><input type="checkbox"/> Commercial</li> <li><input type="checkbox"/> Commercial Art</li> <li><input type="checkbox"/> Cost Accounting</li> <li><input type="checkbox"/> Federal Tax</li> <li><input type="checkbox"/> First Year College</li> <li><input type="checkbox"/> Foremanship <input type="checkbox"/> French</li> <li><input type="checkbox"/> Good English <input type="checkbox"/> High School</li> <li><input type="checkbox"/> Higher Mathematics</li> <li><input type="checkbox"/> Motor Traffic <input type="checkbox"/> Postal Civil Service</li> <li><input type="checkbox"/> Retailing <input type="checkbox"/> Retail Store Management</li> <li><input type="checkbox"/> Salesmanship <input type="checkbox"/> Secretarial</li> <li><input type="checkbox"/> Sign Lettering</li> <li><input type="checkbox"/> Spanish <input type="checkbox"/> Stenography</li> <li><input type="checkbox"/> Traffic Management</li> <li><b>Air Conditioning and Plumbing Courses</b></li> <li><input type="checkbox"/> Air Conditioning</li> <li><input type="checkbox"/> Heating <input type="checkbox"/> Plumbing</li> <li><input type="checkbox"/> Refrigeration <input type="checkbox"/> Steam Fitting</li> </ul> | <p><b>Chemistry Courses</b></p> <ul style="list-style-type: none"> <li><input type="checkbox"/> Chemical Engineering</li> <li><input type="checkbox"/> Chemistry, Analytical</li> <li><input type="checkbox"/> Chemistry, Industrial</li> <li><input type="checkbox"/> Chemistry, Mfg. Iron &amp; Steel</li> <li><input type="checkbox"/> Petroleum Refining <input type="checkbox"/> Plastics</li> <li><input type="checkbox"/> Pulp and Paper Making</li> <li><b>Civil Engineering, Architectural and Mining Courses</b></li> <li><input type="checkbox"/> Architecture</li> <li><input type="checkbox"/> Architectural Drafting</li> <li><input type="checkbox"/> Building Estimating</li> <li><input type="checkbox"/> Civil Engineering <input type="checkbox"/> Coal Mining</li> <li><input type="checkbox"/> Contracting and Building</li> <li><input type="checkbox"/> Highway Engineering</li> <li><input type="checkbox"/> Lumber Dealer</li> <li><input type="checkbox"/> Reading Structural Blueprints</li> <li><input type="checkbox"/> Sanitary Engineering</li> <li><input type="checkbox"/> Structural Drafting</li> <li><input type="checkbox"/> Structural Engineering</li> <li><input type="checkbox"/> Surveying and Mapping</li> <li><b>Communications Courses</b></li> <li><input type="checkbox"/> Electronics</li> <li><input type="checkbox"/> Practical Telephony</li> <li><input type="checkbox"/> Radio, General <input type="checkbox"/> Radio Operating</li> <li><input type="checkbox"/> Radio Servicing</li> </ul> | <p><input type="checkbox"/> Telegraph Engineering</p> <p><b>Electrical Courses</b></p> <ul style="list-style-type: none"> <li><input type="checkbox"/> Electrical Drafting</li> <li><input type="checkbox"/> Electrical Engineering</li> <li><input type="checkbox"/> Electric Light and Power</li> <li><input type="checkbox"/> Lighting Technician</li> <li><input type="checkbox"/> Practical Electrician</li> <li><input type="checkbox"/> Power House Electric</li> <li><input type="checkbox"/> Ship Electrician</li> <li><b>Internal Combustion Engines Courses</b></li> <li><input type="checkbox"/> Auto Technician <input type="checkbox"/> Aviation</li> <li><input type="checkbox"/> Diesel-Electric</li> <li><input type="checkbox"/> Diesel Engines <input type="checkbox"/> Gas Engines</li> <li><b>Mechanical Courses</b></li> <li><input type="checkbox"/> Aeronautical Engineer's, Jr.</li> <li><input type="checkbox"/> Aircraft Drafting <input type="checkbox"/> Flight Engineer</li> <li><input type="checkbox"/> Forging <input type="checkbox"/> Foundry Work</li> <li><input type="checkbox"/> Heat Treatment of Metals</li> <li><input type="checkbox"/> Industrial Engineering</li> <li><input type="checkbox"/> Industrial Metallurgy</li> <li><input type="checkbox"/> Machine Shop</li> <li><input type="checkbox"/> Machine Shop Inspection</li> <li><input type="checkbox"/> Mechanical Drafting</li> <li><input type="checkbox"/> Mechanical Engineering</li> </ul> | <ul style="list-style-type: none"> <li><input type="checkbox"/> Mold-Loft Work</li> <li><input type="checkbox"/> Patternmaking—Wood, Metal</li> <li><input type="checkbox"/> Reading Shop Blueprints</li> <li><input type="checkbox"/> Sheet-Metal Drafting</li> <li><input type="checkbox"/> Sheet-Metal Worker</li> <li><input type="checkbox"/> Ship Drafting <input type="checkbox"/> Ship Fitting</li> <li><input type="checkbox"/> Tool Designing <input type="checkbox"/> Toolmaking</li> <li><input type="checkbox"/> Welding—Gas and Electric</li> <li><input type="checkbox"/> Welding Engineering</li> <li><b>Railroad Courses</b></li> <li><input type="checkbox"/> Air Brake <input type="checkbox"/> Car Inspector</li> <li><input type="checkbox"/> Diesel Locomotive</li> <li><input type="checkbox"/> Locomotive Engineer</li> <li><input type="checkbox"/> Locomotive Fireman</li> <li><input type="checkbox"/> Locomotive Machinist</li> <li><input type="checkbox"/> Railroad Section Foreman</li> <li><b>Steam Engineering Courses</b></li> <li><input type="checkbox"/> Boilermaking</li> <li><input type="checkbox"/> Combustion Engineering</li> <li><input type="checkbox"/> Engine Running</li> <li><input type="checkbox"/> Marine Engineering</li> <li><input type="checkbox"/> Steam Electric <input type="checkbox"/> Steam Engineer</li> <li><b>Textile Courses</b></li> <li><input type="checkbox"/> Cotton Manufacturing <input type="checkbox"/> Loom Fixing</li> <li><input type="checkbox"/> Rayon Weaving <input type="checkbox"/> Textile Designing</li> <li><input type="checkbox"/> Woolen Manufacturing</li> </ul> |
|--|--|--|---|

Name \_\_\_\_\_ Age \_\_\_\_\_ Home Address \_\_\_\_\_

City \_\_\_\_\_ State \_\_\_\_\_ Working Hours \_\_\_\_\_ A.M. to \_\_\_\_\_ P.M.

Present Position \_\_\_\_\_ Employed by \_\_\_\_\_

Special tuition rates to members of the Armed Forces. Enrollment under G.I. Bill and P.L. 16 approved for World War II Veterans. Canadian residents send coupon to International Correspondence Schools Canadian, Ltd., Montreal, Canada.

# I N V E N T O R S

Unless an inventor is thoroughly familiar with such matters, he is advised to employ a competent registered patent attorney or agent as the value of patents depends largely upon the skillful preparation of the specification and claims.

For his guidance, the following are the usual preliminary steps which the inventor takes toward patent protection.

The "Evidence of Invention" form mentioned below is offered as a convenience to the inventor in making his disclosure of invention.

The inventor should date and sign his disclosure and have it witnessed by two or more persons who are capable of understanding his invention. The disclosure should then be mailed to the registered patent attorney or agent whom he

selects to assist him. The disclosure should be accompanied by a letter authorizing the patent attorney or agent to conduct a preliminary search among previously granted U. S. patents for similar types of invention. The patent attorney or agent then prepares a report of the probable patentability of the invention and recommends the further course the inventor should take, provided the report indicates possible patentability.

This firm is registered to practice before the U. S. Patent Office and is available to assist inventors in the preparation and prosecution of their cases. The coupon below is suggested as a convenience to the inventor in starting action on his invention.

**VICTOR J. EVANS & CO.** • *Merlin M. Evans*

REGISTERED PATENT ATTORNEY

430-A MERLIN BUILDING, WASHINGTON 6, D. C.

• • • • •  
• **VICTOR J. EVANS & CO.** • Merlin M. Evans •

• *Registered Patent Attorney* •

• 430-A Merlin Building, Washington 6, D. C. •

• *Please send me without obligation a copy of your booklet "Patent Protection For Inventors" together with your convenient "Evidence of Invention" form.* •

• Name..... •

• Address..... •

• City and State..... •

• • • • •  
PATENTS

TRADEMARKS

COPYRIGHTS

These Men are Learning

# ELECTRICITY

ON REAL EQUIPMENT

in the GREAT SHOPS of COYNE



**Why Spend Years Preparing for a Good Job?  
Train Quickly at COYNE—Be Making Real  
Money While Others are Still Puttering Along!**



B.W. COOKE

Yes, you can get ready for Good Pay—a Big Future in **ELECTRICITY**—by coming to **COYNE** in Chicago to train on actual equipment! Here you work on real motors, armatures, switchboards—do actual wiring and trouble-shooting—get the “all-around” training you need.

**Not a “Home-Study” Course**

We do not teach by mail. All training is given in our Great Shops, plus necessary theory. Expert instructors guide you. No advanced education or previous experience needed.

**EARN WHILE LEARNING**

If you need part-time work to help out with living expenses while at Coyne, we'll help you get it. Don't be held back by lack of money.

**COYNE** **B. W. COOKE, Pres.**  
**ELECTRICAL AND RADIO SCHOOL**

500 S. Paulina St., Dept. 19-72, Chicago 12

This modern fireproof building is occupied entirely by COYNE. Located in Chicago, the Electrical Center of the World.

FOUNDED 1899



**50th ANNIVERSARY YEAR**

**Electrical Refrigeration Included**

Added training now included in great new field of Electric Refrigeration—Industrial Electronics also included. Both mean added opportunities.

**GI Approved—Finance Plan for Non-Vets**

COYNE is authorized to train men under the G.I. Bill. Non-veterans may enroll now, pay most of tuition after graduation. Special plan for men of draft age. Coupon brings details

**GET THE FACTS!**

**BIG FREE BOOK** tells all about your future in Electricity and how you can get ready quickly at COYNE. Dozens of pictures. Rush coupon today!

**PREPARE FOR PERMANENT  
JOBS LIKE THESE**

- Light and Power Wiring
  - Power Plant Work
  - Armature Winding
  - Substation Operator
  - Maintenance Electrician
  - Electrical Testing
  - Signal Maintenance
  - Industrial Electronics
  - Electric Refrigeration and many others
- Our Employment Bureau for graduates gives **FREE** Lifetime Job Service.

**FREE  
BOOK**



**B. W. COOKE, Pres.**  
**COYNE ELECTRICAL  
AND RADIO SCHOOL, Dept. 19-72**  
500 S. Paulina St., Chicago, 12, Ill.

Send me your big **FREE BOOK** on **ELECTRICITY** and Special plan for men of draft age. This does not obligate me in any way and **no salesman** will call on me.

**MAIL  
NOW**

NAME.....

ADDRESS.....

CITY..... STATE.....

BE A WINNER AT ANYTHING YOU TACKLE WITH **PROGRESSIVE POWER**

Now **ALL 5 FAMOUS JOWETT COURSES** in 1 Volume for only **25c**

**WHAM!** DARLING, THAT BULLY WON'T PICK ON YOU AGAIN.

JOE YOUR NEW ENERGY AND APPEARANCE SURE DO A GOOD JOB YOU EARNED YOUR PROMOTION.

"The Jowett System is the greatest in the world!" says E. F. Kelly, Physical Director, Atlantic City



Let's Go, Pal! I'll prove I can make YOU an **"ALL-AROUND" HE-MAN**

**FAST — OR NO COST!** says George F. Jowett, World's Greatest Body Builder

Enjoy My "Progressive Power" Strength Secrets! Give Me 10 Easy Minutes a Day — Without Strain! I'll teach you the "Progressive Power Method" through which I rebuilt myself from a physical wreck the doctors condemned to die at 15, to the holder of more strength records than any other living athlete or teacher! "Progressive Power" has proven its ability to build the strongest, handsomest men in the world. And I stand ready to show you on a money back basis—that no matter how flabby or puny you are I can do the same for you right in your own home. Let me prove I can add inches to your arms, broaden your shoulders, give you a man-sized chest, powerful legs and a Rock-like back—in fact, power pack your whole body so quickly it will amaze you! Yes, I'll help you with power and confidence to master any situation—to win popularity—and to get ahead on the job! Through my proven secrets I bring to life new power in you inside and out, until YOU are fully satisfied you are the man you want to be.

**PROVE IT TO YOURSELF IN ONE NIGHT!** Send only 25c for my 5 easy-to-follow, picture-packed courses now in 1 complete volume "How to Become a Muscular He-Man." Try it for one night! Experience the thrilling strength that surges through your muscles.

**George F. Jowett**  
Whom experts call "Champion of Champions"

- World's wrestling and weight lifting champ at 17 and 19.
- World's Strongest Arms.
- 4 times World's Perfect Body — plus other records.

I am making a drive for thousands of new friends fast—REGARDLESS OF COST!

**SO GET NOW MY 5 Muscle Building COURSES** (Valued at 55 each)

**All in 1 Great Complete Volume Packed With How-To-Do-It Pictures!**

Now, this "get-acquainted," extremely low price of only **25c** is your chance to build a body you'll be proud of! Follow Jowett's easy method of muscle building NOW!

For **Only 25c**

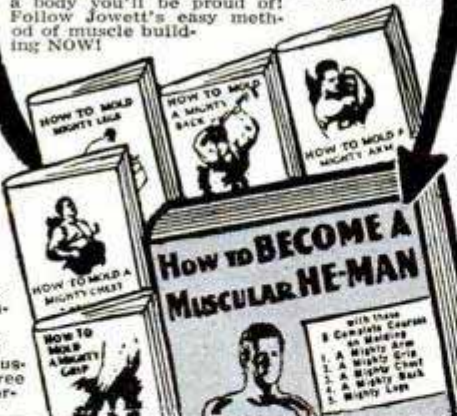

**10 DAY TRIAL!** Think of it—all five of these famous courses now in one picture-packed muscle-building volume for only 25c. If you don't actually FEEL results within ONE WEEK, send it back and your money will be promptly refunded! Photo Book of Famous Strong Men!

**FREE!**

Photos that inspire you to might and muscle. Free with order.

**FREE GIFT COUPON!**

Jowett Institute of Physical Culture DEPT. PM-91  
230 Fifth Avenue, New York 1, N. Y.

Dear George:—Please send by return mail, prepaid, **FREE** Jowett's Photo Book of Strong Men, along with all 5 Muscle Building Courses. 1. Molding a Mighty Chest. 2. Molding a Mighty Back. 3. Molding a Mighty Grip. 4. Molding a Mighty Arm. 5. Molding Mighty Legs—Now all in One Volume "How to Become a Muscular He-Man." Enclosed find 25c. NO C.O.D.'S.

**George F. Jowett**  
Champion of Champions

NAME \_\_\_\_\_ AGE \_\_\_\_\_  
(Please Print Plainly, Include Zone Number)

ADDRESS \_\_\_\_\_

**Aviation NEEDS YOU NOW!**

Urgent demand for Embry-Riddle mechanic and flight graduates -- for proof and information on training, write: Registrar Dept. 89 A

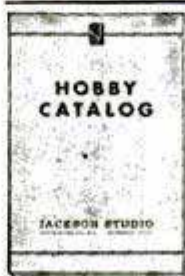

**CRAFT CATALOG**

NEW 1949 edition, 84 pages crammed with big selection of tools and materials for plastics, ceramics, hand power tools, plans, etc., etc. A gold mine of hard-to-find items such as foam rubber, kits, books and "How To" information. Every crafter should have a copy. Send 25c now to

**JACKSON, Dept. 74**  
5440 N. Shoreland Ave., Milwaukee 11, Wis.

**NEW! LOW COST! RESPIRATOR**

Wear when sanding, grinding, paint spraying, sweeping, dusting, furnace cleaning, etc. Handy as a pair of glasses. Just keep mouth closed and breathe through nose is all you do to operate. Protects against nuisance dusts, lint, coal, cement, grain dust, hay fever pollen. Has 9 sq. in. filter. For EYE protection against paint spray, dusts, gases, fumes, smoke, order our Fog-Proof Rubber GOGGLES ..... \$2.00 p.p.



Order Today \$1.00 POST PAID

**JERRY BRYANT, Dept. PM**  
919 N. Michigan Ave. Chicago 11, Ill.

**Learn to Write at Home in spare time**

Be a Good Penman—Win Prestige, Success—Right in your own home, regardless of how you Now write, you can become a Good Penman during your spare moments by my Simplified Method, for your Social and Business Advancement. Investigate NOW! Write for Complete Information and my FREE BOOK, "How to Become an Expert Penman," which contains specimens of penmanship and shows what others have accomplished by taking my Courses. If you wish, enclose 10c for Special Penpoint and your name with a flourished bird written on a card. Write TODAY.

**T. M. TEVIS, BOX 25K, CHILlicothe, MO.**

**Watch Repairing Pays Big Money Learn at home**



Watch makers in great demand. Train step-by-step, under experts. We furnish tools. No interference with present job. Opportunity to get in business for yourself. 10 easy lessons. Low cost. Send for FREE book today.

**WATCH REPAIRING** Dept. PM-1 2870 Elston Ave. Chicago 18, Ill.



**LABORATORY TECHNICIAN**

BE A LABORATORY SPECIALIST; complete course. Big demand from hospitals, doctors, clinics. We teach all branches of medical laboratory work, including Medical and Dental X-Ray.

Approved by American College of Medical Technologists  
Co-educational Free Placement Bureau  
Free Catalog

Accredited for "veteran" training  
**CHICAGO COLLEGE OF LABORATORY TECHNIQUE**  
Dept. P.M., 431 S. Wabash Ave. Chicago 5, Illinois



**Thrilling Work COLORING PHOTOS**

Fascinating vocation learned at home by those with aptitude. Thrilling pastime. National method brings out life-like colors. Free booklet.

**NATIONAL PHOTO COLORING SCHOOL**  
1315 S. Michigan, Dept. 1351, Chicago 5



# WHICH OF THESE *Opportunities* INTERESTS *You* MOST?

Accounting  
Air Conditioning  
Architecture & Building  
Automotive Engineering  
Aviation—Practical  
Aviation Drafting & Design  
Better Foremanship  
Bookkeeping  
Business Management

Contracting  
Diesel Engineering  
Drafting & Design  
Electrical Engineering  
Electricity—Practical  
Electronics, Industrial  
High School Courses  
Machine Shop Operations  
Mechanical Engineering

Plastics Engineering  
Plumbing—Practical  
Private Secretary  
Radio Operating & Servicing  
Railway Training  
Refrigeration  
Sheet Metal Pattern Drafting  
Shop Management  
Tool Making

## THINK! LOOK FORWARD!

Business is making big, new plans

Men and Women are preparing for the future

### WHAT ARE YOU DOING ABOUT YOUR TOMORROWS?

● *Today*, choose the job you want—and prepare for it. Or if you are already engaged in the work you like best, start training *now* for quicker promotion. Acquire the knowledge that will help you to get ahead faster, make more money and have greater security.

Invest part of your spare time in more rapid progress. Start training now, in spare time in your own home. Be ready to grasp your opportunity and step out ahead of those who lack the ability you have attained.

American School, founded in 1897 as an educational institution *not for profit*, can help you to reach your goal just as it has helped others during the past fifty-two years. Give serious thought to the list above. Pick one or more subjects that interest you. Then check the coupon at right, add your name and address and mail it at once. The school will send you details on its training plan and outline of study prepared by specialists. There is no charge, no obligation, so send the coupon immediately.

**HOME - STUDY TRAINING SINCE 1897**  
Take This First Easy Step

### CHECK, CLIP AND MAIL COUPON NOW

AMERICAN SCHOOL, Dept. G-145, Drexel at 58th, Chicago 37, Ill.  
*Without obligation, Please send FREE and postpaid, bulletin and details of the Subject checked.*

- |  |  |  |
|--|--|--|
| <input type="checkbox"/> PLASTICS ENG'R            | <input type="checkbox"/> Accounting            | <input type="checkbox"/> Drafting and Design for Men and Women |
| <input type="checkbox"/> Refrigeration             | <input type="checkbox"/> Electrical Engr.      | <input type="checkbox"/> Radio                                 |
| <input type="checkbox"/> Architecture and Building | <input type="checkbox"/> Electricity-Pract.    | <input type="checkbox"/> High School                           |
| <input type="checkbox"/> Contracting               | <input type="checkbox"/> Electronics, Industr. | <input type="checkbox"/> Air Conditioning                      |
| <input type="checkbox"/> Practical Plumbing        | <input type="checkbox"/> Bookkeeping           | <input type="checkbox"/> Mechanical Eng.                       |
| <input type="checkbox"/> Automotive Engineering    | <input type="checkbox"/> Private Secretary     | <input type="checkbox"/> Shop Management                       |
| <input type="checkbox"/> Aviation Drafting         | <input type="checkbox"/> Diesel Engineering    | <input type="checkbox"/> Tool Making                           |
| <input type="checkbox"/> Aviation                  | <input type="checkbox"/> Sheet Metal           | <input type="checkbox"/> Better Foremanship                    |
| <input type="checkbox"/> Business Mgmt             | <input type="checkbox"/> Pattern Drafting      | <input type="checkbox"/> Machine Shop Operations               |
| <input type="checkbox"/> Railway Training          |  |  |

Name..... Occupation.....

Address..... Age.....

City..... State.....

**AMERICAN SCHOOL**

Dept. G-145, Drexel at 58th Street, Chicago 37

**Free!**  
7-Day Trial  
Just Mail Coupon NOW

# How to Bring Your Kitchen Up-to-Date

**How to Plan the Space—Build the Cabinets  
Install and Finish Like a Professional**

"How to Build Modern Kitchen Cabinets" makes dream kitchens come true. Only book of its kind. Amazing! Helps select best cabinets for needs. Guides every step. Then shows how to install, finish for perfect job! And it's yours on free trial if you act now. Just mail coupon.

**Save Money Building Your Own!** Shows you how to build one cabinet or combination. A style for every purpose, a size for every kitchen. Simply measure space, refer to "Modern Kitchen Cabinets" complete lumber list. Easy as that! Simplified so you find the help you need. Assembled in workshop and brought to kitchen ready to install!

**Secrets of Planning Revealed** Should cabinets be near door? Sink? Work counters? Where should dishes be kept? Answers are in "Modern Kitchen Cabinets." An architect works with the same facts. Read chapter on "Secret of Planning" and you'll learn fundamentals.

Then select the RIGHT CABINETS and locate them to save steps. You'll pick best combinations to fit space. Be sure of work-counters where needed!

To save time and error, the designer has prepared a cutting list in chart form. There's a chart for each cabinet, complete for whatever size you choose. This cuts work in HALF. Simply cut single pieces of wood to size given. When ready, assemble into finished cabinet!

**Gives You Answer to Every Problem**

Every step, operation fully described. Details clearly shown. How to cut joints, what size to cut every piece in every style. Nothing missing! Plywood, solid wood, plastic, or metal moulding. Types, how to install hardware. How to hang. How to cement linoleum to tops. How to insert grilles, ventilate. Special drawer-runner construction.

**Mail Free Examination Coupon Now**

Beautiful book, life-time hard-cover binding. Will be sent for 7 days' free trial. Now you can build the kitchen you need. You can plan your own kitchen. Why delay? Why be old-fashioned? Get started now.

**Which of these MODERN KITCHENS do YOU want?**



TYPICAL kitchen schemes. Many combinations by selecting cabinets for special needs and in widths that fit available space.



**Wide Variety of Floor and Wall Models**  
Sink, Drawer, cupboard, All drawer, Corner, Double-door wall, Single-door wall, Broom closet or storage, Desk. Every Style Cabinet!



PLAN C has broom closets.



PLAN D cabinets along one wall, corner for convenient dinette.

**SEND NO MONEY JUST MAIL COUPON**

Pay postman only \$1.50 plus postage, or send \$1.50 (check or money order) and WE pay postage. Read and study it for 7 days at our risk. If not delighted—if not worth every penny of \$1.50 to you, send it back at our expense. We will refund your \$1.50 by AIR MAIL.

"HOW TO BUILD MODERN KITCHEN CABINETS" was compiled by the Editors of HOME CRAFTSMAN MAGAZINE.

**HOME CRAFTSMAN**  
115 Worth Street, Dept. PM1  
New York 13, N. Y.

*What Others Say:*  
"made quite a few; received in order."—M.F.  
"Excellent. Such complete detail—greatly appreciated."  
W.J.R. Aberson, N. J.

**HOME CRAFTSMAN, Dept. PM1,**  
115 Worth St., New York 13, N. Y.

Send me "How to Build Modern Kitchen Cabinets" on 7 days' Free Trial. If not delighted refund my \$1.50 at once.

Name \_\_\_\_\_

Address \_\_\_\_\_

City \_\_\_\_\_ Zone \_\_\_\_\_ State \_\_\_\_\_

I enclose \$1.50. Send postpaid.  
 Send C.O.D. I will pay postman \$1.50 plus postage.

## 9 BIG BUILDING BOOKS



**12th EDITION FOR EXAMINATION SEND NO MONEY**

Learn to draw plans, estimate, be a live-wire builder, do remodeling, contracting. These 9 practical, profusely illustrated books cover subjects that will help you to get more work and make more money. Masonry, concrete forms, carpentry, steel square, roof framing, construction, plumbing, heating, painting, decorating and many other subjects. More than 4000 pages—2750 illustrations.

**BETTER JOBS — BETTER PAY UP-TO-DATE EDITION**

A nationwide building boom is in full swing and trained men are needed. Big opportunities are always for MEN WHO KNOW HOW. These books supply quick, easily understood training and handy, permanent reference information that helps solve building problems.

**Coupon Brings Nine Big Books for Examination**

**AMERICAN TECHNICAL SOCIETY—Publishers since 1898**  
Dept. G119 Drexel at 58th Street Chicago 37, Ill.

You may ship me the Up-to-Date edition of your nine big books, "Building, Estimating and Contracting," without any obligation to buy. I will pay the delivery charges only, and if fully satisfied in ten days, I will send you \$2.00, and after that only \$3.00 a month, until the total price of only \$34.80 is paid. I am not obligated in any way unless I keep the books.

Name \_\_\_\_\_

Address \_\_\_\_\_

City \_\_\_\_\_ State \_\_\_\_\_

Please attach a letter stating your age, occupation, employer's name and address, and name and address of at least one business man as a reference. Men in service, also please give home address.

**SAY YOU SAW IT IN POPULAR MECHANICS**

## Be an INVESTIGATOR

**JAMES S. BOLAN, FORMER POLICE COMMISSIONER OF NEW YORK CITY** offers MEN & WOMEN an attractive opportunity to prepare for a future in *Investigation & Criminology* by comprehensive Home Study Course. Free placement service assists graduates to obtain jobs. APPROVED UNDER G. I. BILL OF RIGHTS. Write for Free Booklet PM.

**THE BOLAN ACADEMY, INC.**  
EMPIRE STATE BLDG., NEW YORK 1, N. Y.

## WATCH REPAIRING

Be a Master Watchmaker! Graduates earn big money—many in business for themselves. The famous Swezey System of Instruction teaches you quickly and easily. Our 41st year.

Write today for free information.

**CHICAGO SCHOOL OF WATCHMAKING**  
Dept. 119, 1608 Milwaukee Ave. Chicago 47, Ill.

## ANALYZE Handwriting

Unrewarded, fascinating field. Gratifying earnings reported by graduates in Employment, Credit, Social Service, Police and Entertainment fields. Others have developed profitable private practice, full or spare time, as Personal Problem and Vocational Counselors. Send for 3000 word TEST LESSON and Grapho Analyst FREE.



A. I. G. A. Inc.  
Wilheit Bldg., Dept. 120 Springfield, Mo.

## Learn BAKING At Home

Baking is one of America's high industries in wages. Nearly depression-proof. Thorough basic home course lays sound foundation. If you have aptitude, write for FREE BOOKLET, "Opportunities in Commercial Baking." National Baking School, 1315 Mich. Ave., Dept. 1351, Chicago 5



POPULAR MECHANICS

Our  
GREATEST OFFER  
in **17**  
YEARS

Amazing New **EQUIPMENT** Helps

Prepare You **FASTER, EASIER** for . . .

# TELEVISION Radio...Electronics

Here's good news . . . big news . . . our **BIGGEST NEWS** in 17 years. The equipment pictured at left gives a partial idea of D.T.I.'s remarkable, new combination of shop-method training aids . . . to prepare you **AT HOME** for your start in Television-Radio-Electronics.

### Get 48-Page Book **FREE**

Mail coupon today for D.T.I.'s big new 48-page **OPPORTUNITY GUIDE BOOK**. See how this amazing *newer method* helps you get started toward a **GOOD JOB** or your **OWN BUSINESS** in one of America's most promising, thrilling fields . . . that includes Television . . . F.M. Train, 2-Way Taxi, Aviation, and Broadcast Radio . . . Industrial Electronics . . . and other fast-developing branches.

In addition to well-illustrated lessons, you work over 300 instructive experiments from 16 shipments of Radio-Electronic parts. Among these projects you build and keep a commercial-type **CATHODE RAY OSCILLOSCOPE** . . . that helps you get practical Television circuit training. You also build and keep a double-range **R-F SIGNAL GENERATOR**, a jewel-bearing **MULTI-METER** and a quality 6-tube **SUPERHET RADIO**.

**YOU BUILD AND KEEP ALL OF THE EQUIPMENT AT LEFT . . . MAKE OVER 300 HOME EXPERIMENTS!**

### MODERN CHICAGO LABORATORIES

If you prefer, you can get **ALL** your preparation in our new, Chicago training laboratories . . . one of the finest of its kind. Ample instructors . . . modern equipment . . . Write for details!

You also use **HOME MOVIES** . . . a **D.T.I. Exclusive!**

D.T.I. alone includes the modern, visual training aid . . . **MOVIES** . . . to help you learn faster, easier at home. You see electrons on the march and other fascinating "hidden action" — a remarkable home training advantage that speeds your progress.

### You Get D.T.I.'s Effective EMPLOYMENT SERVICE

When you complete your training, our effective Employment Service is available to you without extra cost, to help you get started.

**MAIL TODAY!**

DeForest's Training, Inc.  
2533 N. Ashland Ave., Dept. PM-F1  
Chicago 14, Illinois

Send me **FREE** your 48-page **OPPORTUNITY GUIDE BOOK** showing how I may make my start in Television - Radio - Electronics.

Name \_\_\_\_\_ Age \_\_\_\_\_  
Street \_\_\_\_\_ Apt. \_\_\_\_\_  
City \_\_\_\_\_ Zone \_\_\_\_\_ State \_\_\_\_\_

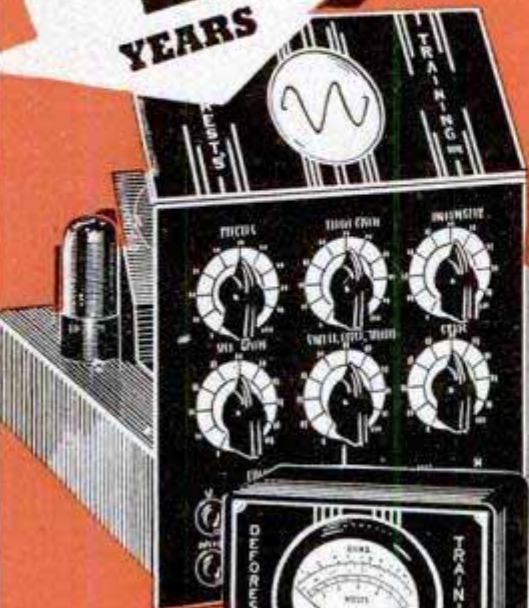

OSCILLOSCOPE

MULTI-METER



R-F SIGNAL GENERATOR

6-TUBE RADIO RECEIVER

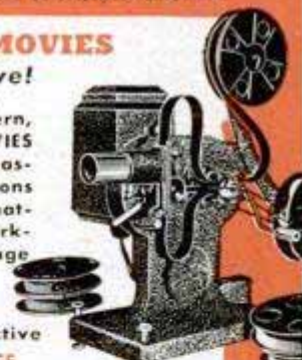
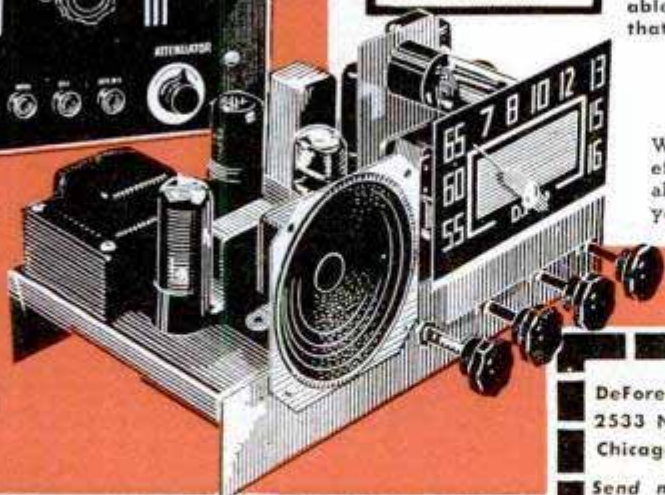

**DeFOREST'S TRAINING, INC.**  
CHICAGO, ILLINOIS

Affiliated with the De Vry Corporation  
Builders of Electronic and Movie Equipment

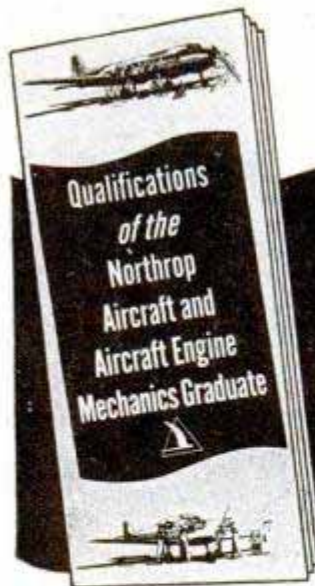

Get This  
Free Booklet

Learn  
why it pays  
to be a  
Northrop-Trained  
A & E  
Mechanic

This booklet tells future employers of Northrop graduates about the Northrop-trained A & E Mechanic's superior qualifications. Our Graduate Placement Department has placed it in the hands of over 5000 airlines, repair stations, flying schools, airports, and aircraft sales agencies; and executives of aircraft, engine, and propeller manufacturers.

This booklet will tell YOU the important advantages YOU can enjoy during your training, on entering Aviation, and all through your career. Here are the answers to: why the Northrop-trained A & E mechanic is in demand—why Northrop graduates hold good jobs with many leading aviation firms—how Northrop training prepares men for better starting jobs, faster advancement, successful careers.

Read this description of training at a technical institute that is part of a famous aircraft company, a school in the midst of important engineering, manufacturing, and maintenance work—where you get many advantages that make your first job simply a continuation of the very same practical duties you learned and performed during your Northrop training.

Get this booklet—if you are interested in Aviation—if you want to make the most of Aviation's big opportunities. Send the coupon for your free copy.



# NORTHROP AERONAUTICAL INSTITUTE

Division of Northrop Aircraft, Inc.  
James L. McKinley, Managing Director

1527 E. Broadway, Hawthorne, Los Angeles County, Calif.  
APPROVED FOR VETERANS

**NORTHROP AERONAUTICAL INSTITUTE**  
1527 E. Broadway, Hawthorne, Los Angeles County, Calif.

Please send my free copy of the booklet, "Qualifications of the Northrop Aircraft and Aircraft Engine Mechanics Graduate," also the Institute catalog and complete information on Northrop training, including starting dates of classes. I am interested in:

Aircraft and Engine Mechanics       Aeronautical Engineering

Name \_\_\_\_\_

Address \_\_\_\_\_

Age \_\_\_\_\_

City \_\_\_\_\_

Zone \_\_\_\_\_

State \_\_\_\_\_

Check one:  Veteran       Non-Veteran

## Have an OFFICE of YOUR OWN!

LEARN NEW PROFITABLE PROFESSION  
At Home in 60 Days, Men & Women, 18 to 70!

Be Your Own Boss and  
the Boss of Others. Be  
Respected. Meet Inter-  
esting People.



Earnings of men and women in this profession run as high as \$5,000-\$15,000 yearly. Others make good money in spare time. Little money needed to start. A business where your earnings begin sooner. Easy to learn. No selling or goods to buy. No experience necessary. A depression-proof business. A course of action to guide you step by step as you earn. All 53 lessons sent at once to use as operating manuals. Easy terms. Diploma. Money-back agreement. Write for FREE BULLETIN.

FRANKLIN CREDIT SCHOOL  
Dept. 75-A      ROANOKE 7, VIRGINIA

BY MAIL in  
Easy Lessons

## BE AN ARTIST

Send for interesting picture book  
"BUILDING A FUTURE"

Explains the unique position of the professional artist in American life. Gives examples of huge professional income. Tells definitely how YOU can acquire PROFESSIONAL skill—AND PROFESSIONAL INCOME—within one year—in spare time at home. No obligation. Book is free. Write name, address and age on penny postcard and mail TODAY to:

GRANT SCHOOL OF ART  
Dept. 11, 53 W. Jackson Blvd., Chicago 4, Ill.



## LEARN WATCH REPAIRING



AT HOME. By our modern and original system of instruction you can learn every part of the WATCH REPAIRING TRADE AT HOME. Prepare yourself for a well-paying position or start in business after completing our course of instruction. Good watch repairers are in demand and generally earn very good salaries. For particulars apply to the Wisconsin School of Watch Repairing 759 North Milwaukee St., Milwaukee 2, Wis.

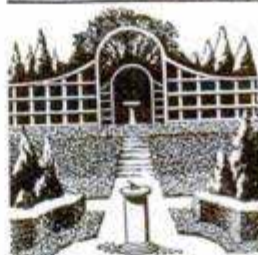

## LEARN LANDSCAPING

Profitable career—absorbing hobby for men and women! Thorough home-study course in landscaping, garden design. 45 lessons beautifully printed and illustrated. Learn in spare time 8-12 months. Hundreds of successful graduates all over the world. 32nd year. Write for Free Catalog.

AMERICAN LANDSCAPE SCHOOL  
6530 Grand Ave., Des Moines 12, Ia.

## LAW FREE BOOK



Your FREE copy of "The Law-Trained Man" shows how to gain prestige and greater earnings through Blackstone home law study. All instruction material furnished including 18-volume Law Library written by 65 well-known law authorities. Lawyers, judges among our graduates. LL.B. degree. Low cost; easy terms. Write today.

BLACKSTONE COLLEGE OF LAW      225 N. Michigan Ave.  
Dept. 51, Chicago 1, Ill.  
A Correspondence Institution Founded in 1890

## LEARN TRIG QUICKLY—EASILY

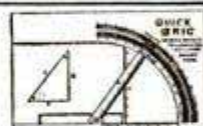

BY COMPETITIVE TESTS

It was found that QUICK TRIG gave answers faster to one with a slight knowledge of trig than to an expert on trig with a slide rule. Simply set the slides and read the answers for all three sides and angles of a triangle. Also gives degrees, sines, cosines and tangents of angles. Entirely automatic. Easy instructions included FREE. We mail C.O.D. plus postage or enclose \$1.00, the full price, and we will mail postpaid. Send now for your QUICK TRIG, to

REED MFG. CO., 11350-H Burbank Blvd., N. Hollywood, Calif.

Say You Saw It in Popular Mechanics

## ANY BOOK IN PRINT



Delivered at your door. We pay postage. Standard authors, new books, popular editions, fiction, reference, medical, mechanical, children's books, etc. Guaranteed savings. Send for Clarkson's 1949 catalog.

FREE Write for our great illustrated book catalog. A short course in literature. The buying guide of 300,000 book lovers. Free if you write now—today!

CLARKSON PUBLISHING COMPANY

Dept. PM-49, 1257 So. Wabash Ave., Chicago, Ill.



*There is always a Big Demand for*

**YOU** CAN DEMAND BIG MONEY  
 HAVE SECURITY—INDEPENDENCE  
 WORK SHORT HOURS  
 OWN YOUR OWN BUSINESS

**TRAINED  
 ELECTRICAL  
 TECHNICIANS**

There are millions of electrical equipment units in daily use . . . in factories, in homes, on farms, in office buildings. Skilled electrical technicians are needed to keep this equipment in good running condition.

Charge <sup>★</sup>\$5.00 to  
 \$6.00 AN HOUR  
 AS A  
**SKILLED  
 ELECTRICAL  
 MECHANIC!**

YOU can now BE TRAINED to fill this BIG NEED . . . A need that grows day by day because of new electrical inventions for factory and home.

If you are mechanically inclined, can hold and use tools, we can give you the training and time-saving kits that will enable you to . . . Command More Money At Work . . . A Better Paying Job Elsewhere . . . Or a Business of Your Own!

The Electronic Kit, a multi-purpose trouble detector, and other valuable Shop Method Training kits are sent to you! All instruction material is written in simple, easy-to-understand language chock full of detailed photographs and drawings.

Get Full Facts how you can get this training at home, in your spare time, and pay for it out of your earnings while learning!

**WE SEND  
 YOU THIS  
 ELECTRONIC  
 KIT WHEN  
 YOU ARE  
 READY FOR  
 IT!**



**RUSH COUPON  
 for FREE BOOK!**

CHRISTY TRADES SCHOOL  
 2835 N. Central Ave., Dept. D-6503  
 Chicago 34, Illinois

Gentlemen:  
 Please rush me FREE BOOK and full facts about America's Fastest Growing Industry—ELECTRICAL EQUIPMENT SERVICING.

Name \_\_\_\_\_ Age \_\_\_\_\_  
 Address \_\_\_\_\_  
 City \_\_\_\_\_ Zone \_\_\_\_\_ State \_\_\_\_\_

# To the man who wants to enjoy an ACCOUNTANT'S

## IF CAREER

you're that man, here's something that will interest you. Not a magic formula—but something more substantial, more practical.

Of course, you've got to pay the price, study earnestly. Still, wouldn't it be worth while for a brief period—provided the rewards were good—a salary of \$4,000 to \$10,000? An accountant's duties are interesting, varied, of real worth to his employer. He has *standing*.

Why not, like so many before you, let LaSalle's Problem Method start *you* climbing?

Suppose you could work in a large accounting firm under the personal supervision of an expert accountant—solving easy problems at first, then more difficult ones. With his advice, soon you'd master them all.

That's what LaSalle's Problem Method gives you. You cover Principles, Systems, Income Tax, Auditing, Cost Accounting, Law, Organization, Finance—on up through C.P.A. preparation. You progress as rapidly as you care to—start cashing in while still learning.

Will recognition come? You know success *does* come to the man really trained. Yes—trained accountants are the executives of tomorrow.

For your own good, write for free 48-page book, "Accountancy, the Profession that Pays"—plus "Ten Years' Promotion in One," a book which has helped many men. Mail the coupon NOW.

Over 2800 C.P.A.'s among LaSalle alumni

**LASALLE EXTENSION UNIVERSITY**  
A Correspondence Institution  
Dept. 164-HR Chicago 5, Ill.

**LASALLE EXTENSION UNIVERSITY**  
A Correspondence Institution

417 S. Dearborn St., Dept. 164-HR, Chicago 5, Ill.

I want to be an accountant. Send me, without cost or obligation, the 48-page book, "Accountancy, the Profession that Pays," and full information about your accountancy training program—also "Ten Years' Promotion in One."



- Higher Accountancy
- Other LaSalle Opportunities
- |  |  |
|--|--|
| <input type="checkbox"/> C.P.A. Coaching     | <input type="checkbox"/> Traffic Management    |
| <input type="checkbox"/> Bookkeeping         | <input type="checkbox"/> Foremanship           |
| <input type="checkbox"/> Law: LL.B. Degree   | <input type="checkbox"/> Industrial Management |
| <input type="checkbox"/> Business Management | <input type="checkbox"/> Stenotypy             |
| <input type="checkbox"/> Salesmanship        | <input type="checkbox"/> (Machine Shorthand)   |

Name.....Age.....

Address.....

City, Zone, State.....

## CAUGHT BY THEIR FINGER PRINTS

**YOU**

Can Train for **CRIMINAL INVESTIGATION and IDENTIFICATION WORK AT HOME!**

Send Now for "BLUE BOOK of CRIME" Thrilling, Inspiring, helpful. Be sure to state your age when sending for book. **FREE!**

**INSTITUTE OF APPLIED SCIENCE**  
Dept. 1351, 1920 Sunnyside Ave., Chicago 40, Ill.

During the past 30 years the I. A. S. has trained hundreds of men at home to fill positions of responsibility and steady pay as finger print experts. This fascinating, profitable profession can be learned at home during spare time. More than 800 American Identification Bureaus employ I.A.S. graduates or students. Write today for complete list of these Bureaus.

## EXPERT ADVICE ON COUNTRY LIVING!

Our new catalog offers you a wealth of up-to-the-minute books on how to do wonders with your garden, fruits, berries, poultry, livestock, quick freezer, garden tractor, scientific layout of your country home and acreage, etc., etc. If you'd like to make the very most of the garden, farm or country home you now have or plan to have some day—just send us a postcard now. We'll send you our latest catalog of good books and bulletins **FREE** by return mail. **COUNTRY BOOK STORE**, Box 2701, Noroton, Conn.

## ENGINEERING DEGREE IN 27 MONTHS

**INDIANA TECHNICAL COLLEGE**

Aeronautical, Chemical, Civil, Electrical, Mechanical, and Radio Engineering (inc. television), Drafting, 1-yr. Gov't approved for G.I.'s. Low rate. Earn board. Large industrial center. Students from 48 states, 18 countries. Demand for graduates. Enter March, June, September, December. Catalog.

519 E. Washington Blvd., Ft. Wayne 2, Ind.

## MAKE BIG MONEY Become An Artist!

**CASH IN ON BIG ART MARKET!**  
LEARN Cartooning, Commercial Art, Lettering, Showcard Writing, Photo Coloring, etc., QUICKLY with our **NEW, EASY METHODS.**

Interesting Catalog **FREE**  
**NATIONAL ARTISTS BUREAU**  
P. O. Box 4248 Dallas 8, Texas

## SADDLE HORSES

LEARN HORSE TRAINING AND MANAGEMENT

SUBSCRIBE FOR **The "EXPERT HORSEMAN"**

**FREE BOOK**—You will also receive a booklet that tells how you can learn to Break Collis, Gait Show Horses, Train Rodeo, Stock, and Race Horses, Break Bad Hobbies, Handle any horse, Train Circus Trick Horses

**ANIMAL LOVERS ASSOCIATION**  
BOX KA-111 TARZANA, CALIFORNIA

ONLY \$1.00 YEAR (1st COPY MAILED AT ONCE)

SAY YOU SAW IT IN POPULAR MECHANICS

## 500 TRICKS MAGIC TRICKS

**It's FUN to do MAGIC**

Be popular! Amaze—mystify—entertain! For 30 years Douglas has satisfied customers all over the world. Now, you can enjoy this fascinating hobby. Only 10c brings our new 1949 Catalog 500 Tricks, containing brand new tricks for pocket, parlor, stage. Join in the fun—send 10c today!

**Douglas Magicland, Dept. C, Dallas, Texas**



# NOW! Build Your Future On

# DIESEL

## OPPORTUNITIES

IN INDUSTRY

ON LAND

ON WATER



## DIESEL POWER IS GOING PLACES!

### COMPACT DIESEL TRUCK ENGINE

6 cylinders, 5 1/2" bore and 6" stroke, maximum horse power rating 200 H.P. at 2100 RPM.

You don't have to look far to see Diesel Power in action these days. Trucks, buses, tractors, streamliners and switching engines, ocean-liners and small watercraft, power and lighting plants, farm and road equipment — more and more depend on Diesel each day. And now aircraft are experimenting with the lighter units. On the farm, in factories, in communities large and small — Diesel is growing as it proves to be efficient, economical, dependable, streamlined power.

### Diesel Knowledge is Earning Power

THE NEW AND INCREASING USES OF DIESEL open a broad field for trained men who can install, maintain, operate and repair DIESEL EQUIPMENT. Diesel engines need DIESEL-trained men! Now is the time to prepare for these opportunities.

### LEARN NOW WHILE YOU KEEP YOUR JOB

If you are between 17 and 60 and mechanically inclined, you can get thorough, individual instruction right in your home. Through UEI balanced training, you learn first through home study the fundamentals of Diesel in all its phases, given to you in practical, easy to understand lessons from men with years of successful experience training this way. You will learn how Diesel Engines operate, how fuel systems work, how to make repairs, all about the latest accessories and auxiliary equipment, and a world of other Diesel basic "know how."

### Actual Shop Practice

Then you get valuable practice in our big shop, working on costly equipment under Diesel men who really "know their stuff". This course is new and up to the minute, including latest techniques for handling new and old equipment under today's conditions. UEI offers placement service for graduates and has numerous other features which have contributed to the reputation of this outstanding school—now in its 20th success-making year. Coupon below brings complete information.

**DO IT NOW!** It costs you nothing to get all the facts about Diesel opportunities and training. Simply mail the coupon below. Time is important—and the time to begin is NOW! Make up your mind after you get the facts, but write for them at once. Send coupon today!

### OTHER U.E.I. Training Opportunities

Practical Shop Training Follows Preliminary Home Study

**AUTO BODY AND FENDER REPAIR**  
Includes Welding, Metal Work, Spray Painting and Refinishing.

**MECHANICAL REFRIGERATION**  
Servicing and Installation for all commercial and domestic types.

**AIR CONDITIONING**  
Installation, operation and maintenance of home and industrial equipment.

**RESIDENT COURSES**  
Day and evening classes in Diesel, Air Conditioning, Refrigeration are also available.

Founded 1927



## UTILITIES ENGINEERING INSTITUTE

2521 SHEFFIELD AVE. CHICAGO 14, ILL.

### Mail Coupon FOR FREE FACTS

UTILITIES ENGINEERING INSTITUTE, Dept. 119-D, 2521 Sheffield Ave., Chicago 14, Illinois

Please send me FREE facts about UEI training and opportunities in the field checked below.

- DIESEL
- REFRIGERATION     AIR CONDITIONING
- AUTO BODY AND FENDER REPAIR

Name \_\_\_\_\_ Age \_\_\_\_\_

Address \_\_\_\_\_

City \_\_\_\_\_ Zone or County \_\_\_\_\_ State \_\_\_\_\_

Check here for special information if you are under 17.

# DRAFTING BOOKS ON APPROVAL SEND NO MONEY



**5 VOLUMES, LATEST EDITION AND ALL-METAL SLIDE RULE**

**For MEN and WOMEN**  
**Beginners or Experts**

Written so you can understand every word, by well-known engineers. De Luxe modernistic, washable cloth binding, over 1600 pages, hundreds of blueprints, charts and diagrams; prepares you for a good drafting job in mechanical lines. Sent for 10 days' free use if you mail coupon immediately.

With these 5 WONDER BOOKS you can prepare for a well-paid drafting job and a good future. With your set, at no extra cost, we will send a Light Weight, All-Metal Slide Rule with manual on use. Learn drafting room practice, PLUS engineering, from simple work to complex plans. Our easy-to-understand books were produced for those who are eager to get ahead. 400 pages on tool design and over 300 on machine design. Included is special volume on blueprint reading with full size actual production blueprints, as well as question and answer sheets.

## Big Field • Big Demand • Big Pay

Competent draftsmen are urgently needed in all manufacturing lines at good salaries. That's just the beginning—FOR DRAFTSMEN HAVE GOOD CHANCES FOR ADVANCEMENT. Pleasant, fascinating work, easy to learn and do. Learn quickly with these books—send coupon for a set and our slide rule gift and see for yourself.

[ A year's consulting service now given to all buyers of this famous cyclopedia of drafting. ]

## AMERICAN TECHNICAL SOCIETY

Publishers since 1898

American Technical Society, Dept. D119, Drexel at 58th St., Chicago, Ill. Send for 10 days' trial. Brand New 5 volume set of "Drafting for Machine Trades." I will pay the delivery charges only. If I wish, I may return books in 10 days and owe you nothing, but if I decide to keep them, I will send \$4.00 after 10 days, then only \$3.00 a month until \$19.80. The total price, is paid. Send latest edition and include Consulting Service Certificate.

Name \_\_\_\_\_

Address \_\_\_\_\_

Please attach letter stating age, occupation, employer's name and address and name and address of at least one business man as a reference.

# PRACTICAL AUTO INFORMATION

**Keeps Cars Rolling by Making Repairs and Adjustments Easy!**

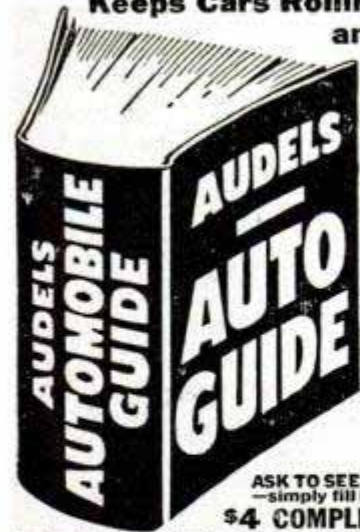

**AUDELS AUTO GUIDE**  
For Every Mechanic, Driver, Owner and Repair Shop.

**Sent on 7 Days Approval**  
Shows How to Tune Up—Keep Brakes Safe—Batteries Powerful—Tire Mileage Up—Save Gas—Lubricate Correctly.

**ANSWERS YOUR QUESTIONS**  
Contains all you need to know about 1—Construction, 2—Operation, 3—Service, 4—Repair of Modern Motor Cars, Trucks, Buses & Diesel Engines in every detail.

**NEW FLUID DRIVE TREATED**  
Easy to understand—1540 Pages, 1540 Illustrations. Gives definite directions on How to handle service jobs.

ASK TO SEE IT—Get this information for yourself—simply fill in and mail coupon today.

**\$4 COMPLETE • PAY ONLY \$1 A MO.**

**AUDEL, Publishers, 49 West 23rd St., New York**  
Mail AUDELS AUTOMOBILE GUIDE (\$4) for free examination. If O. K., I will send you \$1 in 7 days; then remit \$1 monthly until \$4 is paid. Otherwise, I will return book promptly.

Name \_\_\_\_\_

Address \_\_\_\_\_

Occupation \_\_\_\_\_

Employed by \_\_\_\_\_

SAY YOU SAW IT IN POPULAR MECHANICS



I HAVE SOMETHING VALUABLE TO GIVE YOU

I would like to send you my **PICTURE TOUR BOOK** absolutely FREE about one of America's largest and oldest Poultry Farm and Hatchery organizations.

My book is very complete and full of interesting and instructive color pictures. I know you'll enjoy and profit by reading it.

## AMAZING POULTRY SECRETS

This book reveals many secrets you should know about profitable chicken raising, and especially **HYBRIDS** and **PURE BREDS**. It is **ABSOLUTELY FREE**. A postcard will bring it.

If you are interested in raising good chickens that make better profits and more pleasure write me **TODAY**.

**MRS. HARRY HAM**

**ROUTE 56 ATCHISON, KANSAS**

## LEARN TO WRITE a Good Hand!

**FOR BUSINESS AND SOCIAL SUCCESS!**

Easy to improve your handwriting at home quickly with my new instruction books just off the press. Master all the secrets of better penmanship. Simple and easy, fully illustrated, highly endorsed. Begin today. Write for:  New Free Book, "How to Become a Good Penman," or check books wanted, \$1.00 each.  Business Writing  Artistic Writing  Card Writing  Engraving Alphabets  Bird and Design Flourishing.  Complete Set \$4.50  Enclose 10c for your name beautifully written and special penpoint for shaded writing. S. A. Ziller, President, **TAMBLYN SCHOOL OF PENMANSHIP**, 441 Ridge Bldg. In Business Over 52 Years Kansas City, Mo., U.S.A.

## BE A DETECTIVE

**WORK HOME or TRAVEL. Experience unnecessary. DETECTIVE Particulars FREE. Write to GEO. P. M. WAGNER, 125 W. 86th St., N. Y.**



## CARTOONING

**HAVE FUN! MAKE MONEY!** Cash in on your sense of humor **AT HOME—BY MAIL**. No experience needed to start. Write today **FOR FREE TRIAL LESSON** and full particulars. **MOON Gag Cartoon School, Dept. M, Fall Creek, Wis.**

## EXPERT PHOTOGRAPHY MADE EASY

**LEARN PHOTOGRAPHY NOW**  
—for both a sound and secure future and immediate opportunities. Ever-increasing demand for trained men and women. Excellent earnings. Resident or home study. 39th year. Write for full details.

**NEW YORK INSTITUTE OF PHOTOGRAPHY**  
Dept. "49," 10 West 33 Street New York 1, New York

## NOTARY PUBLIC

Be a Notary Public. Largest legal supply house, 22 cities, guarantees your appointment by governor if you qualify, equips you completely for \$16.97. Respected public office. You certify legal papers, use official seal made with your name, collect fees. Easy. Notaries needed everywhere. Be one. Write—

**STATIONERS EXCHANGE — BOERNE 14, TEXAS**

## SHORTHAND in 6 Weeks at Home

Famous Speedwriting system. No signs; no symbols; no machines; uses ABC's. Easy to learn; easy to write and transcribe. Fast preparation for a job. Surprisingly low cost. 100,000 taught by mail. Used in leading offices and Civil Service. Write for free booklet. **SPEEDWRITING, Dept. 1501-9, 55 W. 42 St., New York 18**

**Learn Public Speaking**  
Learn theory and fundamentals at home—in spare time. Then acquire actual experience and practice. Send for **FREE** booklet "Power of Effective Speech."

**NORTH AMERICAN SCHOOL, Dept. 1351**  
1315 S. Michigan Ave., Chicago 5, Illinois





# Learn RADIO

TELEVISION, ELECTRONICS  
by  
SHOP METHOD HOME TRAINING

Let NATIONAL SCHOOLS, of Los Angeles, a practical Technical Resident Trade School for almost 50 years, train you for today's unlimited opportunities in Radio

You receive all parts, including tubes, for building this fine, modern Superheterodyne Receiver. This and other valuable standard equipment becomes your property.

these two **FREE** books will tell you how



## Good Jobs Await the Trained Radio Technician

You are needed in the great, modern Radio, Television and Electronics industry! Trained Radio technicians are in constant and growing demand at excellent pay—in Broadcasting, Communications, Television, Radar, Research Laboratories, Home Radio Service, etc. National Schools Master Shop Method Home Study Course, with newly added lessons and equipment, can train you in your spare time, right in your own home, for these exciting opportunities. Our method has been proved by the remarkable success of National Schools-trained men all over the world.

## You Learn by Building Equipment with Standard Radio Parts We Send You

Your National Schools Course includes not only basic theory, but practical training as well—you learn by doing. We send you complete standard equipment of professional quality for building various experimental and test units. You advance step by step until you are able to build the modern superheterodyne receiver shown above, which is yours to keep and enjoy. You perform more than 100 experiments—build many types of circuits, signal generator, low power radio transmitter, audio oscillator, and other units. The Free Books shown above tell you more about it—send for them today!



## NOW! NEW PROFESSIONAL MULTITESTER INCLUDED



This versatile testing instrument is portable and complete with test leads and batteries. Simple to operate, accurate and dependable. You will be able to quickly locate trouble and adjust the most delicate circuits. You can use the Multitester at home or on service calls. It is designed to measure AC and DC volts, current, resistance and decibels. You will be proud to own and use this valuable professional instrument.

GET THE DETAILS—SEND THE COUPON

## LESSONS AND INSTRUCTION MATERIAL ARE UP-TO-DATE, PRACTICAL, INTERESTING

National Schools Master Shop Method Home Training gives you basic and advanced instruction in all phases of Radio, Television and Electronics. Each lesson is made easy to understand by numerous illustrations and diagrams. All instruction material has been developed and tested in our own shops and laboratories, under the supervision of our own engineers and instructors. A free sample lesson is yours upon request—use the coupon below.

### You Get This and Other Valuable Information in the Free Sample Lesson:

1. Basic Receiver Circuits and How They are Used.
2. Construction of the Antenna Circuit.
3. How Energy is Picked Up by the Aerial.
4. How Signal Currents are Converted into Sound.
5. How the Tuning Condenser Operates.
6. How the R-F Transformer Handles the signal, and other data, with diagrams and illustrations.

Both Resident and Home Study Courses Offered

**APPROVED FOR VETERANS**  
CHECK COUPON

## NATIONAL SCHOOLS

LOS ANGELES 37, CALIF. • EST. 1905



### MAIL OPPORTUNITY COUPON FOR QUICK ACTION

National Schools, Dept. PM-1  
4000 South Figueroa Street  
Los Angeles 37, California

(Mail in envelope or paste on penny postcard.)

Mail me FREE the book "Your Future in Radio" and a sample lesson of your course. I understand no salesman will call on me.

NAME \_\_\_\_\_ AGE \_\_\_\_\_

ADDRESS \_\_\_\_\_

CITY \_\_\_\_\_ ZONE \_\_\_\_\_ STATE \_\_\_\_\_

Check here if veteran of World War II

*New Easy Way*  
TO MAKE  
**BIG MONEY!**

FULL  
OR SPARE  
TIME

AT  
HOME

*Permanently*  
**METALLIZED**  
**BABY SHOES**

**Costs You Only 5¢-You Get \$6.00**

Now is the time to cash in on this big-paying, easy-to-operate year 'round business, and you need no experience! With actual illustrations and step by step instructions, YOU can start earning money in only one week—up to \$1000 per month full time, or

**LARGEST NUMBER OF SUCCESSFUL BUSINESSMEN**

Our course has the largest number of successful businessmen in this field today! They are all men and women who acted and are making money. This course is guaranteed—your money will be fully refunded if you are not more than satisfied. There is nothing to lose, so act or once.

- Money Back Guarantee
- Most Successful Name in Metallizing
- Big Income
- Huge Demand
- Sales Plans
- Future Security
- Your Own Boss

\$50 to \$75 per week spare time . . . at \$5.00 per hour. Working only a few hours you can make more money than most people make working an entire week.

**IMMEDIATE RESULTS**

This tested and proven method shows you complete details, so that you may start at once, metallizing Baby Shoes, with real GOLD, SILVER or BRONZE. They will last forever, retaining every priceless detail of the natural shoes; something for which there are 5 million new customers waiting to buy every year.

**BEGIN AT HOME**

Don't pass up this real opportunity to start your own business on a shoestring right at home. **ACT NOW!** We will send you all the details absolutely free.



**FREE!**  
Two actual metallized Baby Shoes guaranteed to be the most attractive on the market—or a pair of your own Baby Shoes metallized if you prefer.

Name \_\_\_\_\_  
Address \_\_\_\_\_  
City \_\_\_\_\_ State \_\_\_\_\_

USE THIS COUPON

**KIKTAVI**  
Company Dept. PM-1  
2111 W. Manchester  
Los Angeles 44, California

Rush me FREE full particulars at once.

**START A BUSINESS at HOME...**

others make **BIG MONEY**

**DOES THE WORK OF 6 TOOLS IN 1**  
Holds 20 times its weight in water

"Enclosed find 56 orders representing 9 1/2 hours work on Monday and Tuesday." "Enclosed are 12 orders secured after supper this p.m."



Hands Never Touch The Water . . . Can Be Put In Boiling Water

**Housewives Pleased**  
Everyone that sees this outstanding CELL-U-MOP immediately want one . . . That's the reason our distributors are so successful . . . For MOPPING, WAXING, WALLS, WINDOWS, AUTOS and CLEANING RUGS. Sells quick to Taverns, Clubs, Hotels, Hospitals, Stores, Restaurants, Homes, etc. Drain Bracket squeezes out water thoroughly. Write for FREE particulars

**CELL-U-MOP CO., Dept. P-1 FREEPORT, ILL.**

**Easy-to-Raise PROFIT SENSATION BERRY'S AUSTRALIAN WHITES**



3 1/2-4 WKS OLD  
**AUSTRALIAN WHITES**  
SAVE CHICK LOSS, WORK

**EGGS YEAR 'ROUND**  
THE ANSWER—if you're dissatisfied with old-style chickens. Thousands changing to new discovery. Amazing early maturity and growth, calm disposition turn feed into more meat and eggs, at astonishing low cost. Extra high livability. Big, fancy eggs early as 4 1/2 months. Day-old or started chicks. **LOW FARM PRICES. CATALOG FREE.** Write either

**GEORGE BERRY, 1117 Berry Road, QUINCY, ILLINOIS**  
or **ERNEST BERRY, 1117 Berry Road, NEWTON, KANSAS**

**GREAT PROFITS**  
MAKE YOUR OWN RUBBER MOLDS

**X.L. RUBBER MOLDS**  
will realize your great profits quickly!  
WRITE FOR NEW FREE CATALOG

YOU can EASILY learn to cast thousands of perfect plaques, book ends, figurines, ash trays, etc. IT'S EASY, FUN, PROFITABLE!  
X.L. Rubber, Pts. \$2.00; Qts. \$3.50; Gallons \$8.95; Models and enough rubber for 3 molds \$1.00—plus postage.



SEND FOR FREE FACTS

**PLASTIC ARTS STUDIO • Route 2 • Dept. 21 Muncie, Ind.**

**STAMMER?**

This new 128-page book, "Stammering, Its Cause and Correction," describes the Bogue Unit Method for scientific correction of stammering and stuttering—successful for 48 years. **Benj. N. Bogue, Dept. 4914, Circle Tower, Indianapolis 4, Ind.**

GET THIS FREE BOOK!



**HAMSTERS!**  
Get the unique Golden Hamster today. Profitable, Prolific, Educational, friendly. 1000's needed by labs and pet shops. Raised anywhere. No experience required. Send 10c for literature or \$5 for pair and literature.

**Azalea City Hamstery, 1412 East Linwood Dr., Dept. F, Mobile 18, Alabama**

**"LEARN-BY-DOING"**  
**NATION'S LARGEST EXCLUSIVE ELECTRICAL SCHOOL**  
**ELECTRICITY**  
PRACTICAL TRAINING NOT "HOME STUDY"

**G.I. APPROVED** Get actual experience in great shops of M.T.I. Learn all phases Practical Electricity; Housewiring, Motors, Const., Maintenance, etc. Living arrangements, Part-time jobs, etc.

Send coupon TODAY.  Veteran

**MICHIGAN TECHNICAL INSTITUTE**  
2281 W. Fort St., Detroit, Mich., Dept. PM-1

Name \_\_\_\_\_  
Street \_\_\_\_\_  
City \_\_\_\_\_ State \_\_\_\_\_

# Draw Me!

COPY THIS GIRL AND SEND US  
YOUR DRAWING



## \$1000.00 IN 16 VALUABLE PRIZES Scholarships and cash to amateur artists

EXTRA! Whether you win or not, our instruction staff will grade your drawing and write you . . . if they feel that you have enough talent to develop profitably.

● If you *do* have a worth while talent, Art Instruction, Inc. can bring you *individual* teaching and criticism, no matter where you live. Our famous home study course makes your own room an extension of one of the world's largest art schools. Art Instruction has been turning out successful, money-making graduates for 34 years.

Splendid opportunities are available for *trained* Commercial Artists, Illustrators, Cartoonists, Designers. Look ahead! Find out how much ability you really have. Take this Drawing Test FREE.

**ART INSTRUCTION, INC.**  
500 South Fourth Street, Minneapolis 15, Minnesota

### 1st, 2nd, 3rd Prizes

... COMPLETE ART COURSES including Drawing Outfits (Value of each course . . . \$240.00).

4th Prize \$100.00 cash

5th Prize 50.00 cash

6th Prize 30.00 cash

10 Prizes 10.00 each

#### RULES OF CONTEST

Contestants must be amateurs. Make copy of girl 5 inches high on paper 7 inches high. (Omit lettering.) Use only pencil or pen. No drawings returned. All drawings must be received by January 31, 1949. Winners notified by mail. Names of all winners available on request . . . send stamped, self-addressed envelope.

#### MAIL THIS COUPON WITH YOUR DRAWING

Art Instruction, Inc., Dept. 1139-C, 500 South 4th St., Minneapolis 15, Minn.

Please enter my drawing (attached) in your FREE \$240 ART COURSE CONTEST. (Please Print)

Name \_\_\_\_\_ Age \_\_\_\_\_

Address \_\_\_\_\_

City \_\_\_\_\_ Zone \_\_\_\_\_ County \_\_\_\_\_

State \_\_\_\_\_ Occupation \_\_\_\_\_

# Be a RADIO TECHNICIAN!

## TELEVISION - F.M. - ELECTRONICS INCLUDED



Get PRACTICAL Training in the

## Great Shops of COYNE

**B**IG opportunities are waiting for men who know the practical and technical end of Radio and Television. That's what you get at COYNE—besides practical Shop training in F.M., Electronics and other branches of this giant field.

COYNE offers both a Practical Course and a Practical Technicians Course in the field of Radio and TELEVISION SERVICE. Coupon brings details on both courses. Mail it today.

**NOT A CORRESPONDENCE COURSE!**



## OLDEST, LARGEST, BEST EQUIPPED SCHOOL OF IT'S KIND IN AMERICA



Established 1899—50th ANNIVERSARY YEAR. The better your training, the brighter your future. At Coyne you train on a vast outlay of real Radio and Television equipment. We don't teach by mail.

**G.I. APPROVED... FINANCE PLAN FOR NON-VETERANS**

Don't be held back by lack of cash. Start now, pay most of tuition later. Coupon brings special plan for men of draft age.

### Send for BIG FREE BOOK

Dozens of big pictures, all the facts about COYNE Practical Course and Practical Technicians Course in Radio-Television. No obligation. No salesman will call. Rush coupon now!

**COYNE** B.W. COOKE, Pres.  
ELECTRICAL & RADIO SCHOOL  
500 S. Paulina, Dept. 19-3H, Chicago 12



## FREE BOOK COUPON

B.W. COOKE, Pres.;  
COYNE Electrical & Radio School  
500 S. Paulina St., Dept. 19-3H, Chicago 12, Ill.

Send me FREE BOOK and information about your Practical Course and Practical Technicians Course in RADIO-TELEVISION. Also details of special plan for men of draft age.

NAME.....  
ADDRESS.....  
CITY..... STATE.....

## DON'T BE A JOB SLAVE! LEARN WATCH REPAIRING AT HOME



### WITH OUR SELF TRAINING KIT

Get started NOW in this uncrowded field! EASY to learn! BIG MONEY! SECURE FUTURE! Earn while you learn! Even as a sideline you can make \$50 and up each week.—Our new PRACTICAL SELF-TRAINING KIT is all you need. Contains set of PROFESSIONAL TOOLS: (Loupe, 3-4 power; complete set of 5 special screw drivers—finest tempered steel blades; Tweezer, AA; Plastic Material Tray) and COMPLETE BOOK on Modern Watch Repairing. Fully illustrated, easy to understand, shows every step in repair, adjustment and use of tools. Now only \$6.25 Paid (if C.O.D., plus charges.) Money Back Guarantee. If ordered separately: book \$3.25; set of tools, \$3.50. Special WATCH REPAIR DEPT for advanced jobs. Lowest prices. Send watch for free estimate.

MODERN TECHNICAL SUPPLY CO.

Dept. MMC, 55 W. 42nd Street, New York 18, N. Y.

New All Inclusive Precision Tool, Material Catalog for Watch-Clockmakers, Jewelers, Tool-Instrument Makers, Handcrafters, Over 600 ILLUSTRATIONS. All books in these and OTHER TECHNICAL fields; write for literature. SEND 25c for catalog—FREE with order.

## Only \$16.95 Complete DUAL PURPOSE SPRAY GUN



USES ONLY 25 LBS. AIR PRESSURE  
FLOCKS AND SANDBLASTS  
AT HOME: You can refinish Lamps, Radios, Book Ends, Statues and hundreds of things with lovely colorful flocking. ETCH GLASS: Many designs and initials can be sandblasted on shower doors, ash trays, glassware. AUTO INTERIORS: Transform ugly dirty auto interiors to "new car beauty" with a BLASTO DUAL PURPOSE SPRAY GUN. Merely spray flock similar to Velvet, Plush, Suede and Mohair inside your car. ANTIQUE WOOD... REMOVE PAINT. MAKE EXTRA MONEY by doing any or all the above for profit. BLASTO is highest quality and carries a 5 day money-back guarantee. Operates on small air compressor. Send \$16.95 cash, check or money order for postpaid delivery. Write for free information. Full line of Flocking Supplies.

BLASTO SPRAY GUN MFG. Dept. PM-1, 7007 Haas Avenue Los Angeles 44, California

## MEN IN DEMAND!

Trained men are needed now, and no end to this need is in sight in the tremendously growing billion \$ AIR CONDITIONING AND REFRIGERATION INDUSTRY! Two big fields are open to you after you have completed the practical low-cost and complete training course. You may enter industrial air conditioning and refrigeration where the demand for trained men is unlimited OR you may build your own business around maintenance and repair. No previous schooling is necessary. . . . You can train in your spare time at home. Start this training program that will make you a valuable specialist in the profitable air conditioning and refrigeration industry. Write today for free information!

AIR CONDITIONING TRAINING CO., 789-791 Wick Avenue, Youngstown, Ohio

## RARE BREEDS



Cornish, Light Brahmas, Silver Laced Wyandottes, Sussex, and other rare breeds. From breeders who have spent a lifetime on these breeds only. Crossbreeds, too. Cornish-X-Hampshires; Cornish-X-Rocks, etc. CATALOG FREE. STANDARD HATCHERIES, Box 749A, Decatur, Ill.

## CHINCHILLA

CLEAN • GENTLE • HARDY  
RAISE THEM FOR PROFIT—FREE INFORMATION—BREEDERS FOR SALE—SUPPLY & FEED CATALOG FREE... HISTORY & HANDBOOK—PRICE \$2.50.

NEED LITTLE SPACE | ALLIED DISTRIBUTORS  
Write for facts to | GARDENA, CALIFORNIA



## Drafting PAYS BIG

Learn in Spare Time — At Home or at Allied School in Chicago  
KEY POSITIONS OPEN IN INDUSTRY

- Mechanical Drafting
  - Structural Drafting
  - Aircraft Drafting
  - Tool and Die Making
  - Tool and Die Designing
  - Machinist Trade
  - Product Designing
  - Product Illustrating
- Approved for Civilians and Veterans . . .

**Train Now!**  
in  
Nationally Known,  
Fully Approved  
School and  
Endorsed by  
Industry . . .

Established in 1928  
FREE EMPLOYMENT SERVICE

Write For Catalog — A 1c Postcard will do  
ALLIED SCHOOL OF MECHANICAL TRADES  
1338-1340-1342 So. Michigan Ave.  
421 Allied Bldg. CHICAGO 5, ILL.

# House Wiring

**AUDELS ELECTRIC LIBRARY VOL VII HOUSE LIGHT POWER WIRING**

**Vol. VII TELLS HOW!**

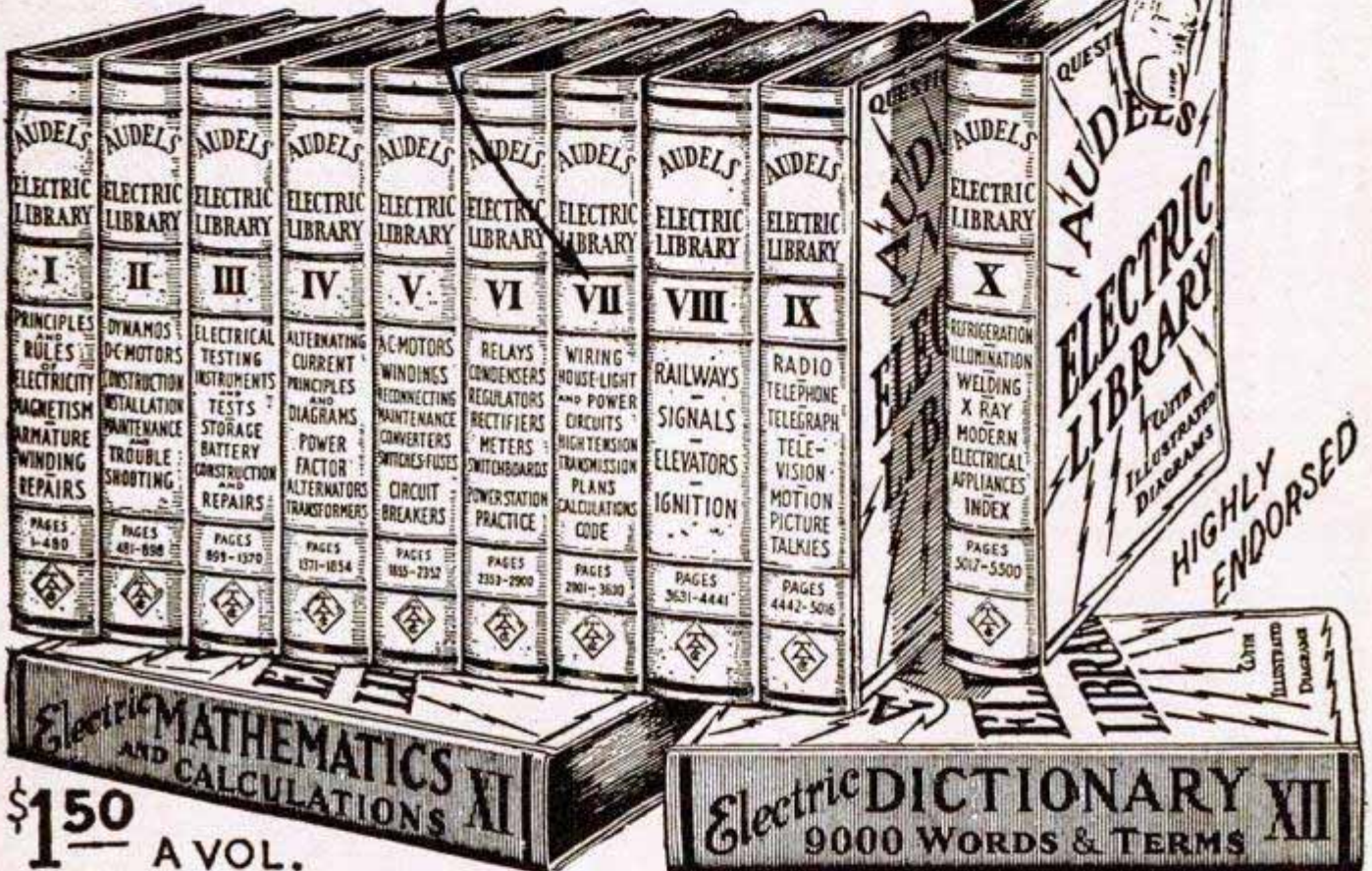

**\$1.50**  
A VOL.

**HERE ARE THE ANSWERS**

**MAIL THIS COUPON TODAY**

Audels Electric Library gives thousands of answers to your electrical problems. Every Electrician, Engineer, Mechanic, Maintenance Man and Student should know about these very helpful books.

The 12 volumes contain 9500 clear, simplified illustrations of the Theories and Applications of Electricity, and 7200 interesting pages of Practical Trade Information relating to Construction, Operation and Maintenance. Valuable for Ready Reference or Home Study. Price only \$1.50 a volume, sold separately.

Audels Electric Library is truly a progressive home study course in Practical Electricity. Devote 15 to 30 minutes a day to its easy reading - acquire a practical working knowledge of Electricity in all its branches. Written in plain language.

AS A REFERENCE LIBRARY it is valuable. The Quick Finder Index helps you locate the desired information quickly. These books have helped thousands of men by giving them a broader knowledge of the whole field of Electricity. Take this opportunity to use our Book-A-Month Plan; mail the coupon today. No obligation unless satisfied.

**AUDELS BOOK-A-MONTH PLAN**  
You will receive your first book for 7 days' Free Trial and Examination. If you are satisfied, send us only \$1.50. If not O.K., return the book to us and you owe us nothing. When we receive your payment for the first book, we send you the second book.

**REMEMBER:** You can Start Your Subscription with Any Number you choose or Stop at Any Time. Not a cent to pay until you get the books. No obligation to buy unless satisfied.

**AUDELS, PUBLISHERS**  
49 West 23rd St., New York 10, N.Y.

Please enter my subscription for AUDELS ELECTRIC LIBRARY, price \$1.50 a volume. Mail one volume each month, for which I will remit \$1.50 promptly.

Start with Volume Number \_\_\_\_\_  
Name \_\_\_\_\_  
Address \_\_\_\_\_  
Occupation \_\_\_\_\_  
Employed by \_\_\_\_\_

**AUDELS, PUBLISHERS, 49 WEST 23rd ST., NEW YORK 10, N. Y.**

PM

# AUDELS Carpenters and Builders Guides 4 vols. \$6

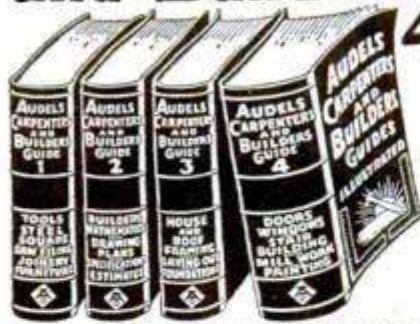

Inside Trade Information for Carpenters, Builders, Joiners, Building Mechanics and all Woodworkers. These Guides give you the short-cut instructions that you want—including new methods, ideas, solutions, plans, systems and money saving suggestions. An easy progressive course for the apprentice and student. A practical daily helper and Quick Reference for the master worker. Carpenters everywhere are using these Guides as a Helping Hand to Easier Work, Better Work and Better Pay. To get this assistance for yourself, simply fill in and mail the FREE COUPON below.

## Inside Trade Information On:

How to use the steel square—How to file and set saws—How to build furniture—How to use a mitre box—How to use the chalk line—How to use rules and scales—How to make joints—Carpenters arithmetic—Solving mensuration problems—Estimating strength of timbers—How to set girders and sills—How to frame houses and roofs—How to estimate costs—How to build houses, barns, garages, bungalows, etc.—How to read and draw plans—Drawing up specifications—How to excavate—How to use settings 12, 13 and 17 on the steel square—How to build hoists and scaffolds—skylights—How to build stairs—How to put on interior trim—How to hang doors—How to lay floor—How to paint



AUDEL, Publishers, 49 W. 23rd St., New York 10, N. Y. Mail Audel's Carpenters and Builders Guides, 4 vols., on 7 days free trial. If OK I will remit \$1 in 7 days and \$1 monthly until \$6 is paid. Otherwise I will return them. No obligation unless I am satisfied.

Name \_\_\_\_\_  
 Address \_\_\_\_\_  
 Occupation \_\_\_\_\_  
 Employed by \_\_\_\_\_ PM

## HIGH PAY JOBS FOR MEN WHO QUALIFY IN DIESEL

**ASSURE YOUR FUTURE.** Steady, big pay jobs await men qualified in Diesel, Tractor and Heavy Equipment. Can you take advantage of Diesel job and advancement opportunities in this fast-growing field?

**COMPLETE DIESEL COURSE AVAILABLE.** If you are ambitious and want to get ahead in this lucrative field, you'll want to know about the complete training in Diesel provided by Interstate. Trains you at home in spare time. Does not interfere with your present job. Covers all phases of operation. Up to the minute. Revised regularly to cover new developments. Free placement advisory service.

### YOU OWE IT TO YOURSELF

to investigate I.T.S. home Diesel training. Thousands of students agree it has helped them to better jobs... better pay. It can do the same for you!

### SEND FOR FREE BOOK TODAY!

We'll gladly send you our big 24-page book "Getting Ahead In Diesel" FREE! Paste coupon on penny card and mail to

INTERSTATE TRAINING SERVICE  
 4035 N. E. Sandy, Portland 13, Oregon

Please see that I receive FREE BOOK "Getting Ahead In Diesel":

Name \_\_\_\_\_ Age \_\_\_\_\_  
 Address \_\_\_\_\_  
 City \_\_\_\_\_ Zone \_\_\_\_\_ State \_\_\_\_\_ (3)

## LEARN MEAT CUTTING

through actual practice. Profitable Meat Cutting and Successful Meat Merchandising taught easily, quickly in large cutting rooms and big modern retail meat department in just six short weeks.

### LEARN BY DOING AT TOLEDO

Training given under actual meat market conditions. For beginners or men with experience. Thousands of successful graduates throughout the United States.

### COMPLETE TRAINING IN 6 WEEKS

All related subjects taught thoroughly and completely. Diploma given upon graduation. Job help. Get a money-making store of your own. Assured future. PEOPLE MUST EAT. School in operation for over 25 years.

### APPROVED FOR GI TRAINING

Send today for FREE 52-page illustrated catalog. No obligation. No salesman will call.

**NATIONAL SCHOOL OF MEAT CUTTING**  
 Dept. 50-1 Toledo 4, Ohio

## An ASSURED FUTURE for You

### Learn Profitable WATCH REPAIRING

**BIG MONEY WHILE LEARNING**  
 Study at Home — or at Our Accredited School  
 Complete Home Correspondence Course or G. I. Approved Residence School Plan. Also, Post-Graduate Plan at school for correspondence students.

Write Today for COMPLETE DETAILS to  
**American Institute of Specialized Watch Repair**  
 Dept. No. 100 270-76 East Building Grand Rapids, Michigan

## ELECTRICIANS' SCHOOL

HOUSE AND COMMERCIAL WIRING • MOTOR REPAIR  
 AND REWINDING • ELECTRIC REFRIGERATION

Approved for Veterans Training

**PENNSYLVANIA INSTITUTE SCHOOL OF ELECTRICITY**  
 42nd and SPRUCE STS. PHILADELPHIA 4, PENNA.

## WANTED

A chicken raiser in each community to Prove that Sunflower Strain Austra-Whites will make **BIG PROFITS**. More than 55,000 Leghorns crossed with Record Australorp males. Write for prices.

**SUNFLOWER POULTRY FARM**  
 Box 152 Newton, Kansas

## Learn WOOD PRODUCTION ENGINEERING

VETERANS training is FREE under G. I. BILL.

GET THIS FREE BOOK Today

It tells you how you can learn to become a successful WOOD PRODUCTION ENGINEER... by the Klok Home Study Correspondence Method... or by studying here in Grand Rapids in our Resident School... Training in WOOD PRODUCTION ENGINEERING offers you great opportunities... either to get a top position or to operate your own plant successfully.

The Klok Course teaches you SKETCHING, ROD-MAKING, DETAILING, STOCK BILLING, TIME STUDY, COST and MANAGEMENT.

WRITE FOR FREE BOOK TODAY! State preference whether Home Study or Resident course, with name, age, occupation and if veteran.

**KLOK INSTITUTE**  
 LOUIS ST., N.W.  
 GRAND RAPIDS, MICHIGAN

# They Never Knew It Was SO EASY To Play

## Thousands Now Play Popular Songs Who Didn't Know a Note of Music Before

You, too, can learn your favorite instrument at home, without a teacher, this quick, easy, money-saving way

**T**HINK of the fun YOU are missing! The popularity, friendship, good times! Why? Because you think it's hard to learn music. You have an idea that it's a slow, tedious task, with lots of boring drills and exercises.

That's not the twentieth-century way! Surely you've heard the news! How people all over the world have learned to play by a method so simple a child can understand it—so fascinating that it's like playing a game. Imagine! You learn without a teacher—in your spare time at home—at a cost of only a few cents a day! You learn by the famous print-and-picture method—every position, every move before your eyes in big, clear illustrations. You CAN'T go wrong! And best of all, you start playing real tunes almost at once, from the very first lesson.

No needless, old-fashioned "scales" and exercises. No confused, perplexing study. You learn to play by playing. It's thrilling, exciting, inspiring! No wonder hundreds of thousands of people have taken up music this easy way. No wonder enthusiastic letters like those reproduced here pour in from all over the world.

Sound interesting? Well, just name the instrument you'd like to play and we'll prove you CAN! (Instruments supplied when needed. Cash or Credit.) Mail the coupon or write. Do it now! 51st year.

**U. S. SCHOOL OF MUSIC**  
71 Brunswick Bldg.  
New York 10, N. Y.



**Learned Quickly at Home.** "I didn't dream I could actually learn to play without a teacher. Now when I play for people they hardly believe that I learned to play so well in so short a time." \*H. C. S., Calif.

Music is the magic key to friendship, fun, romance. The person who can play a musical instrument is always sure of a welcome. Why not let music open up a new world for you. Thousands have discovered unexpected pleasure and profit in music, thanks to the unique method that makes it amazingly easy to learn.

**Send for FREE Booklet and Print and Picture Sample**

See for yourself how this wonderful self-instruction method works. Sit down, in the privacy of your own home, with the interesting illustrated booklet, "How to Learn Music at Home." No salesman will call—decide for yourself whether you want to play this easy way.



**Invited to Parties.** "Before I took your course I didn't know one note of music. Then three months later I started to play for dances. I've been invited to many parties. The course is easy and interesting." \*R. M., Vancouver, B. C.



**Well Worth Money.** "The course is fully self explanatory. When one is finished with it there is little one need learn. It is well worth the money and I fully believe you have the finest course on the market today." \*R. E. G., Clarksburg, W. Va.



**Surprised Friends.** "People who hear me play don't understand how I do it. They ask if I haven't had lessons from a teacher. To their surprise they find I haven't. I'm glad to be a student of your School." \*M. H., Athol, Kans.

**U. S. SCHOOL OF MUSIC**  
71 Brunswick Bldg., New York 10, N. Y.

I am interested in music study, particularly in the instrument indicated below. Please send me your free booklet, "How to Learn Music at Home" and the free Print and Picture Sample.

Piano  
Guitar  
Hawaiian Guitar  
Violin  
Piano Accordion  
Saxophone  
Trumpet, Cornet

Reed Organ  
Tenor Banjo  
Ukulele  
Clarinet  
Trombone  
Flute  
Piccolo

Modern  
Elementary  
Harmony  
Mandolin  
Practical Finger  
Control

Name \_\_\_\_\_ Have You  
(PLEASE PRINT) This Instru.? \_\_\_\_\_

Address \_\_\_\_\_

City \_\_\_\_\_ State \_\_\_\_\_

Note: If you are under 16 yrs. of age, parent must sign coupon.

SAVE 2c—Stick coupon on penny postcard.

\*Actual pupils' names on request. Pictures by Professional models.

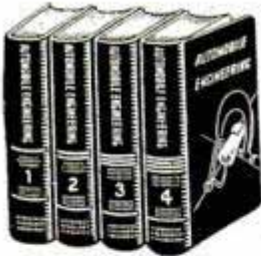

# AUTO BOOKS ON APPROVAL



**SEND NO MONEY.** Just mail the coupon for a complete set of 4 Big, Thick Auto Books. 26th Edition. Over 2700 Pages! Whether you are a mechanic or helper, expert or apprentice, auto owner or driver, take immediate advantage of this **FREE EXAMINATION OFFER.**

### MAKE GOOD MONEY NOW HOLD A PERMANENT JOB

America wants its automobiles kept in good repair. Men with "know how" are in demand, at big pay. These books will help you get and hold an important job, or give you a chance to go into business for yourself now or later. Any man who half tries to improve himself can learn auto servicing and repairing by this quick reference method. Use the **JIFFY INDEX** to find easily understood answer to any auto problem. These wonder books prepared by eleven of America's great automobile engineers. Many hundreds of valuable illustrations. Send the coupon **TODAY.**

**A year's consulting privileges with our engineers now given with these books without extra charge.**

*Publishers Since 1898*

### CAN YOU FIX IT?

These wonder books tell step by step **HOW** to make difficult repairs and adjustments, how to keep a car at maximum efficiency, including latest improvements in car design and operation. Engine troubles and how to correct them well covered.

### 4 BIG, THICK VOLUMES

Over 2700 pages, 2000 illustrations, wiring diagrams, etc. Beautiful modernistic, washable cloth binding.

**AMERICAN TECHNICAL SOCIETY, Dept. A119**  
Drexel Ave. at 58th St., Chicago 37, Ill.

I would like to examine your 4-Volume Set of Auto Books. I will pay the delivery charges only, but if I choose I may return them express collect. If after 10 days' use I prefer to keep them, I will send you \$2 and pay the balance at the rate of only \$3 a month until \$24.80 has been paid. Include consulting service as offered above.

Name \_\_\_\_\_

Address \_\_\_\_\_

City \_\_\_\_\_ State \_\_\_\_\_

Please attach letter stating age, occupation, employer's name and address and name and address of at least one business man as reference. Men in service, also please give home address.

# INVENTORS

When you are satisfied that you have invented a matter of value—write me, without obligation, for full information as to what steps you should take to secure a Patent.

The usual first step is to have a search of the prior U. S. Patents conducted, so that I can report to you on the question of Patentability.

### PATRICK D. BEAVERS

(Formerly RANDOLPH & BEAVERS)

*Registered Patent Attorney*

934 Columbian Building Washington 1, D. C.

**PATRICK D. BEAVERS, Registered Patent Atty.**

934 Columbian Bldg., Washington 1, D. C.

Please send me full information on how to secure Patent Protection and Trademark Registration.

Name \_\_\_\_\_

Street \_\_\_\_\_

City \_\_\_\_\_

State \_\_\_\_\_

**SAY YOU SAW IT IN POPULAR MECHANICS**

## Learn FINGERPRINTING AND IDENTIFICATION



### IN YOUR OWN HOME IN YOUR SPARE TIME

Specially prepared correspondence courses make it easy to learn this fascinating study essential in the field of **CRIME DETECTION.**

**FREE Booklet**

Under the Private Correspondence School Law of Pennsylvania, Licensed by the Dept. of Public Instruction.

### PENNA. INSTITUTE OF CRIMINOLOGY

Dr. W. Nisson Brenner, Director  
DEPT. NO. 17  
Extension Division  
135 So. 2nd Street  
Philadelphia 6, Pa.



# INVENTORS

IF YOU WISH TO PROTECT YOUR INVENTION, You should take steps to protect it by a U. S. Patent. Write me for "Record of Invention" form.

### CARL MILLER REGISTERED PATENT ATTORNEY

Woolworth Bldg., 35th Floor, Dept. 19-A, New York City  
Please send me "Record of Invention" form.

NAME \_\_\_\_\_

ADDRESS \_\_\_\_\_

# PATENTS AND TRADE MARKS

## C. A. SNOW & CO.

REGISTERED PATENT ATTORNEYS

WRITE FOR INFORMATION TO

428 SNOW BUILDING, WASHINGTON 1, D. C.

# INVENTORS

Whether an invention is patentable can be substantially determined by a search of the U. S. Patent records. Without obligation, write for information explaining the steps you should take to secure a patent.

### JOHN N. RANDOLPH

*Registered Patent Attorney*

201 Columbian Building, Washington 1, D. C.

## PATENTS

"Proof of Invention" Folder mailed without obligation.

### E. E. VROOMAN, Registered Patent Atty.

505 McKim Building, Washington 5, D. C.

## WATCHMAKING

Millions of watches and clocks need repairing. Start your training now for a better paying job or own profitable business. Qualified watchmakers in demand. Outstanding training by experts. Write for free catalog. Approved for Veterans.

**SCIENTIFIC SCHOOL OF WATCHMAKING, Dept. PM-1**  
3923 San Fernando Road Glendale 4, Calif.

# LEARN MONEY-MAKING CARTOONING

IN SPARE TIME — by Easy Picture Chart Method

Same Simplified Method that has helped train creators of "Terry & Pirates," "Freckles," "Out Our Way," "Winnie Winkle," "Regular Fellers," "Strange As It Seems," "The Neighbors," and many others. Earn while learning. Send 10c for Picture Chart (to test your ability), and full details. (State age.)



THE LONDON SCHOOL, 4901 Clevel. Transit Bldg., Cleveland, O.



## AJAX LIGHT BRAHMAS

WONDERLAY STRAIN Egg-show winners. Gigantic size. Quick growing. Heavy layers. Exceptional capons. Illinois-U. S. Approved-Pullorum Controlled. Thousands hatching weekly. Low farm prices. Catalog **FREE.** Write **TODAY.**  
AJAX HATCHERY, BOX 434, QUINCY, ILLINOIS



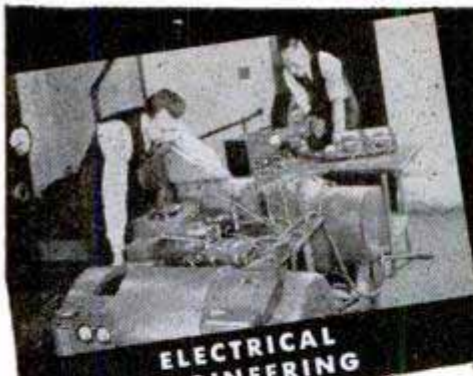

**ELECTRICAL ENGINEERING**



**ELECTRONICS**



**REFRIGERATION AND AIR CONDITIONING**

**B.S. DEGREE**  
in Electrical Engineering  
Major in Electronics or Power

**OTHER COURSES**

- SERVICE—**  
6 to 12 months
- Practical Electricity
  - Practical Welding
  - Refrigerator Service
  - Heating Service

- TECHNICIAN—**  
1 to 2 years
- Electrical Power
  - Radio and Television Technician
  - Electronics Technician
  - Refrigeration, Heating and Air Conditioning Technician

- PROFESSIONAL—**  
3 years
- Electrical Engineering Degree
  - Bachelor of Science Major in Electronics and Power



**BECOME AN**

**ELECTRICAL ENGINEER**

Industry needs technically trained men. Our time-tested Concentric System enables you to build your career step by step in 6 to 36 months at vocational, technician and professional level. Select the course in which you are most interested. More than 1,500 students now enrolled from 48 states and 18 overseas countries. Faculty of 85 specialists. 35,000 former students in industry all over the world. Alumni counselors everywhere. Terms start April, July, September, January. **SEND COUPON TODAY.**

**MILWAUKEE SCHOOL OF ENGINEERING**

*A Technical Institute Founded 1903*

**MILWAUKEE SCHOOL OF ENGINEERING**  
Dept. PM-1-49, N. Broadway and E. State, Milwaukee, Wis.  
Without obligation send me free booklet "Career Building" and more details on course in \_\_\_\_\_

Name \_\_\_\_\_ Age \_\_\_\_\_

Address \_\_\_\_\_

City \_\_\_\_\_ State \_\_\_\_\_

**How to Write**

The demand for writers is creating great new opportunities for people with an urge to write. It's not as hard to succeed as you may imagine. Most famous authors come from ordinary walks of life. At home, you too may learn fiction writing, the best basis for all fields—short stories, features, articles, technical, mechanical and business items. Palmer Institute's Home Study Training (Established 1917) is endorsed by

**Short Stories, Mysteries, Novels, Articles—at home in spare time**

Rupert Hughes, Gertrude Atherton, Keith Monroe, and other famous authors and by scores of successful graduates. Complete instruction material and professional coaching to develop your own style. **FREE** book and lesson show how you may enjoy an ideal part time or full time career. Write today (no salesman will call). Veterans: advise us if you are eligible for G.I. Training.

**PALMER INSTITUTE OF AUTHORSHIP • Desk T-19 • 1680 N. Sycamore • Hollywood 28, Calif.**

**LEARN MEAT CUTTING EASILY - QUICKLY At Home - In Spare Time**



The steady, dependable trade of Meat Cutting taught easily, quickly by improved HOME METHOD. National School, established over 25 years, has organized its famous "Learn By Doing" Classroom, Cutting room and Retail Market training system into sound, practical HOME STUDY form.

Now, by the miracle of this EXTENSION TRAINING you can prepare in Your Spare Time At Home, for a better job, bigger responsibilities or success and security in a store of your own. Remember, **PEOPLE MUST EAT!**

Buying, cutting, percentage, pricing, advertising, selling—a complete meat education. For beginner or men with ex-

perience. Thousands of successful graduates. Send coupon for **FREE Bulletin NOW!**

**MAIL THIS COUPON TODAY FOR FREE BULLETIN**

**National School of Meat Cutting Div. U-101, Toledo 4, Ohio**

Send me your **FREE** Bulletin on Meat Cutting and Meat Merchandising. No obligation. No Salesman will call.

Name \_\_\_\_\_

Street \_\_\_\_\_

City \_\_\_\_\_ State \_\_\_\_\_

**Bigger Opportunities  
Than Ever in . . .**



**AUTO  
BODY  
AND  
FENDER  
REPAIR**

●THE FIELD IS STILL GROWING after more than 40 years . . . expanding with the giant auto industry! Millions of new cars are getting to market, millions of old ones are still on the road—THE NEED for MAN-POWER in the service field is INCREASING!

**TRAIN NOW . . . FOR THE  
OPPORTUNITIES AHEAD!**

Don't be stuck in a low-pay job! Opportunity here is big enough for thousands to find big-pay work either in a reliable job or in their own shops. UEI teaches Auto Body & Fender Repairing the *easy* way. No special education or experience needed . . . you can start in your spare time, right at home . . . keep your job while you learn. Then, when home study is finished, you continue at the well-equipped UEI shops getting practical experience. Fix and refinish damage, replace panels and tops. Learn up-to-date methods in use of tools, spray painting, welding, metal work—all under expert supervision.

**GET THE FACTS . . . FREE!**

UEI HAS TRAINED THOUSANDS for opportunity fields, and students are making good. If you want to get ahead, send coupon today for free facts on AUTO BODY AND FENDER REPAIRING. Don't delay!

**AUTOCRAFTS DIVISION  
UTILITIES ENGINEERING  
INSTITUTE**

2523 Sheffield Ave. Chicago 14, Illinois

Founded  
1927



**FILL OUT AND MAIL . . . TODAY!**

Autocrafts Division  
Utilities Engineering Institute, Dept. 119-X  
2523 Sheffield Ave., Chicago 14, Ill.  
Yes, I'm interested! Send me those Free Facts about  
Auto Body and Fender Repairing.

NAME \_\_\_\_\_ Age \_\_\_\_\_

ADDRESS \_\_\_\_\_

CITY \_\_\_\_\_ Zone or County \_\_\_\_\_ STATE \_\_\_\_\_

Check here for Special Information if under 17.

**MAKE YOUR OWN!**

WITH

**Griffin READYCUT  
LEATHER PROJECTS**

Over 100 KITS in every kind of Tooling and Carving Leather, accurately cut, all parts included. Only Top Grade Leathers used. You do the choosing. You do the tooling, carving, stamping, the punching and assembling.



SEND FOR  
COMPLETE CATALOG  
Please send  
10c to cover  
mailing.

SINCE 1924

OUT OF THE WEST, THE HOME OF LEATHER CARVING

**Griffin Craft Supplies**

5515-A GROVE STREET  
OAKLAND 9, CALIFORNIA

**EVERYTHING FOR THE  
LEATHER WORKER**

Largest, most complete stock  
of *Leathercraft Tools and Acces-  
sories* in U. S. A.



HIDES AND  
SKINS of Craft  
Leathers of every  
kind if you prefer  
to cut your own.

**BE YOUR OWN BOSS!  
Start Your Own Business!**

Amazing Post-war Product gives You Fast Money-making Opportunity

Make beautiful saleable articles from liquid marble. No machinery or tools needed. No heating or pressure. You can work in your own cellar or attic. Big kit contains all: 5 lbs of liquid marble dry mix, liquid mixing agent, assortment of colors and 2 pints of Pro-mold rubber molding material to make your own rubber molds. Directions included. Complete kit \$6.95 post paid, \$7.95 outside U. S. A. Send check or money order and turn a hobby into a fast growing business of your own. Positive money-back guarantee.

**BING PRODUCTS, Dept. PM1C, 88 Broad St., Boston, Mass.**

**COMPLETE  
KITS**

Ready to  
assemble.  
No steaming  
or bending



**America's Biggest  
KAYAK VALUES**  
STRONG • LIGHT • SAFE  
• SPEEDY • LOW IN  
COST • EASY TO BUILD  
• STAINCH AND SEA-  
WORTHY.

REQUEST LITERATURE, DEDHAM KAYAKS, DEDHAM, MASS., DEPT. O-B

**HYDROPONICS\$**

Grow *out-of-season* vegetables, rare flowers or house plants by hydroponics—WITHOUT SOIL— Start a fascinating hobby or a profitable business in your own home. No experience needed for top results. Only small space gets big returns. Easy, clean, pleasant way to grow *any* plant indoors or out every day in the year. Fast growth, increased yields, unlimited profit opportunities. Send today for FREE 16 page picture book showing how others from every state are succeeding in this wide open field. Send postcard for complete facts.

**CHAPMAN-GILBERT, 824 W. IVY, SAN DIEGO, CALIF.**

**WILL YOU WEAR THIS SUIT**



**AND MAKE UP TO \$12.00 IN A DAY!**  
YOU CAN GET this fine, tailored-to-measure suit as a bonus, without paying one penny cash, by taking a few orders from friends. My plan also helps you make up to \$12.00 in a day **without experience or house-to-house canvassing.** Big opportunity—full or spare time.

**Send for Samples—FREE!** Write today for FREE CLOTH money-making plans. For quick action write fully giving age, etc.

SEND NO MONEY. H. J. Collin, **PROGRESS TAILORING COMPANY,** 500 South Throop Street, Dept. N-216, Chicago 7, Illinois

**PLAY THE ACCORDION IN FEW WEEKS**

Thru Startling New "SEE—HEAR—and LEARN" method



Makes learning to play the accordion **SURER . . . FASTER . . . EASIER . . .** and it's great fun while learning.

Get all the thrilling details.  
Write to

**O. PAGANI & BRO.**  
289 Bleecker St., New York 14, N. Y.



# Learn ELECTRIC APPLIANCE Service & Repair

## AT HOME IN YOUR SPARE TIME

We teach you this interesting, good-paying business from A to Z—at home. Our practical, thorough, shop-method course qualifies you to take a job at once, or start in for yourself. A grade school education is all you need. This is an ideal time for men of all ages (up to 60) to get into this active, constantly expanding field, for every year sees millions of new homes wired for electricity . . . and multiple millions of new electric appliances produced. Everyone, literally, is a customer for the man who knows how to service and repair electric devices.

This business is particularly suited to the man who is handy with tools, and likes to keep busy with his hands . . . the men who are the makers, builders, and servicers of life. If you are not completely happy in your present work, there is a WIDE-OPEN OPPORTUNITY for you in this field . . . which is getting bigger and better every day.

### YOU LEARN

How To Repair  
Washing Machines  
Vacuum Cleaners  
Electric Ranges  
Lamps, Motors,  
Irons, etc.  
REFRIGERATION  
and  
House Wiring

This  
ELECTRICAL  
APPLIANCE  
TESTER

and a  
BIG KIT OF TOOLS  
INCLUDED  
at No Extra Cost!

### Earn While You Learn

You can actually start earning before your course is finished with the Kit of Tools and Tester we send you. With your first set of lessons, I show you easy jobs that can be done in your spare time, at home. And remember—just one good repair job can pay for the complete cost of the course. A business can be started in your garage or basement—expanding from there, as you grow. Let's talk it over by mail.

Make it a point to get posted about our course by sending TODAY—without obligation—for our free booklet telling the entire story.

## OPEN YOUR OWN SHOP Be Independent and Secure

No new-fangled machine can ever take your place in this work . . . as it calls for trained hands to service appliances—so your job is safe, even in a depression. If you open your own shop, you not only enjoy security and independence . . . and can have others work for you . . . it's just a step to a prosperous appliance business where the **BIG PROFITS LIE**. There's no satisfaction like being your own boss, and here's a real opportunity to make that a reality. Or, of course, you can take a well paid job in this active line, as trained men are needed. Remember, this is AN ELECTRICAL AGE. Getting into this field now is to ride the tide of progress.



Send  
for this  
FREE  
BOOKLET



No Salesman Will Call

### MAIL COUPON TODAY

PACIFIC TRAINING SCHOOL — Dept. P-91  
7217 So. Broadway, Los Angeles 3, Calif.

Please send me your FREE BOOKLET:  
"Today's Big Opportunity — Appliance Servicing"

NAME \_\_\_\_\_ AGE \_\_\_\_\_

ADDRESS \_\_\_\_\_ ZONE \_\_\_\_\_

CITY \_\_\_\_\_ STATE \_\_\_\_\_

Please print plainly

# 1949 GOVERNMENT JOBS



**RAILWAY  
POSTAL  
CLERKS**

and other  
**Civil Service  
Positions**

**Start as high as \$3,351  
A YEAR**

(Veterans Get Special Preference)

**Get Ready Now for Next Examinations**

### City Mail Carriers, Post Office Clerks

Clerks and Carriers now get \$2,550 the first year of regular employment and automatically increase \$100 a year to \$3,550. Open to Men—Women 18 to 50. Clerks and Carriers can be promoted to other postal positions paying as high as \$7,550.00.

### Railway Postal Clerks

Railway Postal Clerks get \$2,750 the first year of regular employment, being paid on the first and fifteenth of each month. (\$114.60 each pay day.) Their pay is automatically increased yearly to \$3,850 and \$4,050 in large organizations. Advance may be had to Chief Clerk at \$5,850 a year. Male Veterans only.

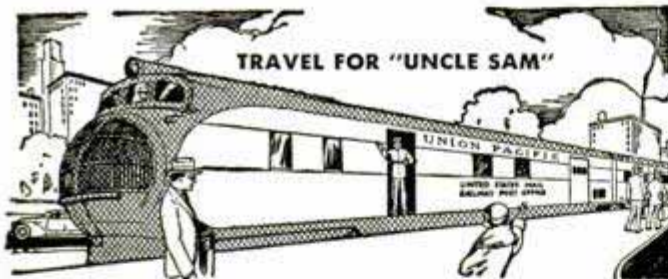

### 3 Days On—3 Days Off—Full Pay

Railway Postal Clerks on long runs usually work 3 days and have 3 days off duty or in the same proportion. During this off duty their pay continues just as though they were working. They travel on a pass when on business. When they grow old, they are retired with a pension.

### Many Other Positions

Many other positions are obtainable. Rural Carriers—Stenographers—Typists—Patrol Inspectors—Assistant Statistical Clerks—etc. Those wishing these positions should qualify at once.

### Get Free List of Positions

Fill out the following coupon. Tear it off and mail it today—NOW, at once.

Although not government controlled, this can result in your getting a big paid government job.

**FRANKLIN INSTITUTE, Dept. K86, Rochester 4, N. Y.**

Rush to me, entirely free of charge (1) a full description of U. S. Government Jobs; (2) Free copy of illustrated 40-page book, "How to Get a U. S. Government Job" with (3) List of U. S. Government Jobs; (4) Tell me how to qualify for one of these jobs.

Name \_\_\_\_\_

Address \_\_\_\_\_ Veteran? \_\_\_\_\_

Use This Coupon Before You Mislaid It.  
Write or Print Plainly.

**SAY YOU SAW IT IN POPULAR MECHANICS**

**ENTIRE FAMILY (2 to 4 Persons) INSURED! ONLY 3¢ A DAY**



**Genuine Legal Reserve LIFE INSURANCE**

Insurance for every member of your family (2 to 4 persons) . . . only 3c a day (not per person, but for all!)

**Pays You** for death of any member of your family group. **Pays your family** should you die. Unusual protection at unbelievably low cost! Send for sample policy today! No cost, nor obligation. No salesman will call. Write—



**SERVICE LIFE INS. CO. Dept. 43, Omaha 2, Nebr.**

**I WANT EVERY READER of this Paper to have my big new SENSATION TOMATO**



**"KING OF THE EARLIES"**  
Big solid, scarlet fruit, disease resistant, heavy yielder. Ideal for table or canning. Send only 3c stamp today to cover postage for 125 seeds and I will include my Big New **FREE** Seed, Plant and Nursery Catalog.

**R. H. SHUMWAY SEEDSMAN** Box 699 Rockford, ILL.

## SPECIALIZE . . .

### Industry Needs Technically Trained Men

Build your career here. Prepare in 6 to 36 months for specific occupational objectives through practical technical training. Specialize in Electrical Power, Radio, Television, Electronics, Welding, Refrigeration, Heating, Air Conditioning, Electrical Engineering, (B.S. Degree). 35,000 former students in industry all over the world. Faculty of 85. Write for booklet "Career Building".

**MILWAUKEE SCHOOL OF ENGINEERING**  
A Technical Institute Founded in 1908  
PM-149, N. Broadway and E. State, Milwaukee, Wis.

## LIQUID MARBLE COMPOSITION FLOORS FLEXIBLE MOLDS

Mold, Brush, Trowel, Spray It! MOLD Novelties, Statuary, Art Goods in Flexible Plastic Molds; 5c material makes \$1 seller. Make Marbleized floors, Tile Walls. Colorful, glossy, amazing! Easily learned; start in garage or basement. Particulars free. **MARBLEIZING SERVICE, Dept. 10-F, Edwardsville, Ill.**

## AGENTS 300% Profit SIGN LETTERS

For Store Fronts and Office Windows. Anyone can put them on. Free Samples. Liberal Offer to General Agents. **METALLIC LETTER CO., 430 N. Clark, Chicago 10**

## RENOVATE YOUR JACKET

Your old leather jacket will look like new when our service department repairs, cleans and restores the leather to its original shade and finish. Send for FREE descriptive circular and itemized price list today!

**BERLEW MANUFACTURING CO., INC.**  
DEPT. M MERRICK, NEW YORK

# CIGARETTES

**ALL POPULAR BRANDS - LUCKIES - CAMELS - CHESTERFIELDS OLD GOLD - PHILLIP MORRIS - RALEIGHS. AS LOW AS \$1.52 Per Carton**

ORDERS SHIPPED IMMEDIATELY—FRESH STOCK DAILY

### WE PAY PARCEL POST

50 Cartons — \$1.52 Each . . . . . \$76.00  
25 Cartons — \$1.53 Each . . . . . \$38.25  
10 Cartons — \$1.57 Each . . . . . \$15.70

### 5 Cartons — \$1.59 Each . . . . . \$7.95

**GUM** All Brands — 20 Pkgs. 85c with cigarette order. Send check or money order. Have your friends and fellow Employees join you in placing a large order at

**DIRECT SALES** 921 W. 17th St. Kansas City, Mo. **\$1.52 Per Carton**



# Learn BUILDING

AT HOME • All Blue Print Building Plans, Specifications, Lessons Furnished

Earn more money as a building tradesman. Prepare for advancement and increased pay as a building foreman, superintendent, inspector, estimator, material buyer or salesman. Train to be a building contractor, have your own money-making business in this busy, prosperous building field.

More than 19 million new homes needed in U. S., say experts. New building now at rate of one million homes a year, plus 200,000 commercial buildings, plus expanding farm building construction.

Mail coupon today. FREE book tells how you learn Building Construction — How to Read Blue Prints, and Estimate Building Costs — at home in your spare time. Learn modern construction methods and materials, how to lay out work and direct all building operations. This is the training needed for rapid advancement to higher-paid jobs, or your own successful building business.

## FIND OUT ABOUT TRAINING AND OPPORTUNITIES FOR YOU IN BUILDING

Established in 1904, Chicago Technical College offers you thorough, practical training in Building, by home-study. Mail coupon for free information. See what this Course has done for others, what it can do for you. Read what Chicago Tech graduates say about their work, earnings, success. Learn the rewards awaiting you as a trained builder — and how quickly, easily you can get started. Simply MAIL COUPON TODAY in an envelope or paste on a penny postcard.



**CHICAGO TECHNICAL COLLEGE**  
A-153, Tech Building, 2000 South Michigan Ave.  
Chicago 16, Illinois

## MAIL COUPON NOW

**CHICAGO TECHNICAL COLLEGE**  
A-153, Tech Bldg., 2000 So. Michigan Ave.  
Chicago 16, Illinois

Mail me FREE building Lesson with information about big opportunities in BUILDING and how I can train at home.

Name \_\_\_\_\_ Age \_\_\_\_\_

Address \_\_\_\_\_

City \_\_\_\_\_ Zone \_\_\_\_\_ State \_\_\_\_\_

THESE 5 TRADES ASSURE YOU

# HIGH PAY • Future Security

- **PLUMBING** Every phase of plumbing: Pipe-Cutting and Threading, Lead-Wiping, Rough-in Projects on Installations, Completed Installations of entire plumbing systems, Blueprint reading, Estimating.
- **DRAFTING** College-level courses in General Machine and Architectural Drafting, with fundamentals in Drafting Mathematics—all under graduate engineers.
- **SHOE REPAIRING** From simplest repairs on boots and shoes to the finest details of reconditioning and rebuilding, under expert craftsmen.
- **ELECTRICAL** Technical and shop training include Basic Electricity, Residential Wiring, Industrial Wiring, General Testing and Trouble Shooting, and Appliance Repair.
- **AUTOMOTIVE & TRACTOR** Applied training on latest model automobiles and tractors, including engine overhaul, transmission and differentials, carburetion, generator and ignition systems, engine tune up, Hydramatic and Vacamatic Transmissions, and general service.

*Choose One of these 5 Essential Trades*

Our complete courses of thorough training prepare you to go right into the field as a Qualified Tradesman at High Pay in only 34 weeks (39 in Shoe Repair). All courses under especially trained instructors with practical experience. 6 Hour Classes 5 Days a Week. Our Employment Department helps you.

**VETERANS** "Approved for veterans' training by the State Department of Education under Public Law 346."  
"Approved for veterans' training by the Veterans' Administration under Law 16."

*Send Coupon for Free Information Now*

*"There's Always a Demand for the Man who KNOWS!"*

## CHOOSE ONE OF THESE 5 LEADING TRADES

Get Out of that Rut... Be a Skilled Tradesman! Have a Lifetime Career... Own Your Own Business and Be Secure in Your Old Age.

**NOW** while Enrollment is still open, send for FREE information.

THE 5 DIVISIONS OF

## NATIONAL TRADE SCHOOL

2610 Grand Ave., Kansas City 8, Mo.

- \_\_\_ ● Plumbing
- \_\_\_ ● Shoe Repairing
- \_\_\_ ● Drafting
- \_\_\_ ● Electrical
- \_\_\_ ● Automotive & Tractor

NAME \_\_\_\_\_

ADDRESS \_\_\_\_\_

CITY \_\_\_\_\_ STATE \_\_\_\_\_

VETERAN \_\_\_\_\_ OCCUPATION \_\_\_\_\_



YOU  
can  
acquire

## LAW NIGHTS AT HOME! L. L. B. DEGREE

LaSalle's famous Law Library—used as reference in many Law libraries and Law offices—has enabled thousands to master Law surprisingly fast, in spare hours at home, for business and professional advancement.

These 14 remarkable volumes, compiled by leading professors and lawyers, cover the whole basic field of Law in condensed, orderly, simplified manner.

You advance rapidly with this great library, plus special lectures furnished. We guide you step-by-step with personalized Problem Method of instruction . . . you learn by doing—handling legal problems—not by memorizing rules.

Send for two FREE 48-page booklets, "Law Training for Leadership," and "Evidence," answering questions about Law and its value to you, and telling how LaSalle Law graduates are winning rapid advancement in business and public life. Mail coupon below. No obligation.

### LA SALLE EXTENSION UNIVERSITY

A Correspondence Institution

417 S. Dearborn St. Dept. 164-L Chicago 5, ILL.

Send me your two FREE booklets described above; without obligation.

Name..... Age.....

Street.....

City, Zone & State.....

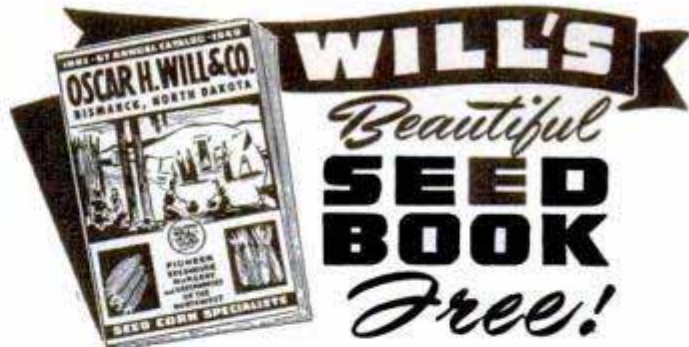

**WILL'S**  
*Beautiful*  
**SEED BOOK**  
*Free!*

Ready now, the marvelous new 1949 WILL'S CATALOG celebrating our 67th year. 80 pages, FREE. Beautiful, colorful, filled with finest illustrations and valuable information about Will's hardy, dependable Pioneer Seeds and Plants. Everything in flowers, vegetables, fruits, berries, trees, evergreens, farm seed and original Pioneer Hybrid Corn. Many lovely floral novelties from our Great Plains country—rich, meaty "High C" Tomato and other exclusive vegetable varieties. SPECIAL LOW PRICES on orders by mail. Write today for your free copy.

OSCAR H. WILL & CO., Box 945, BISMARCK, N. DAKOTA

## GET THIS FINE SUIT NO MONEY TO PAY!



### BIG CASH EARNINGS, TOO!

Big news! This fine tailored suit yours without paying one cent—and big cash earnings, too! It's easy! Just take a few orders. Earn up to \$10 in a day and get your own suit as extra bonus. Dozens of rich new fabrics, superbly tailored in latest styles, at low prices produce orders on sight. Money-back guarantee. FREE SAMPLES! etc. for big complete outfit of actual samples and details of amazing new BONUS SUIT and money-making plan—All Sent Free! No experience. SEND NO MONEY! W. Z. GIBSON, Inc. 500 S. Throop, Dept. N-516, Chicago 7, ILL.

## Save Your Feet

Thousands relieved from pain walk freely with HEEFNER ARCH SUPPORTS



Write for Free Booklet

"FOOT FACTS"

HEEFNER ARCH SUPPORT CO., 669 Logan Bldg., Salem, Virginia

**START YOUR OWN BUSINESS.** Wonderful opportunity backed by world-wide industry. 200 Home Necessities on credit. Hundreds average \$6,000—\$25,000 sales year after year. Write Rawleigh's APM, Freeport, Ill.

SAY YOU SAW IT IN POPULAR MECHANICS

# BLISS Electrical Training

ELECTRICAL SCHOOL

Intensive 32 weeks' residence course in fundamentals of industrial electrical engineering, including radio and electronics. Extensive laboratory, shop work, drafting. Prepares for electrical technician and engineering aides

in communications, power, manufacturing, business machines, sales, service. 56th year. Classes begin April 4, Sept. 6. Catalog. 7624 TAKOMA AVENUE WASHINGTON 12, D. C.



## WILL YOU HELP?

Estimated needs of the government are \$100 millions a day. The Army, Navy, Air Force, and other government agencies urgently need materials. Hundreds of orders are being placed everyday. If you have any type of equipment available for wood or metal working, you are urged to participate.

Complete step by step procedure on how you may secure government defense work or contracts, including what is purchased, by whom, how, where etc. rushed to you for only one dollar.



\*\*\*\*\*  
★ DETROIT RESEARCH INSTITUTE, BOX 444 JOYFIELD STA., Detroit 28, Mich. ★  
★ Enclosed find one dollar for booklet containing information on how I may obtain war defense contracts. ★  
★ NAME..... ★  
★ ADDRESS..... ★  
★ CITY..... ZONE..... STATE..... ★  
★\*\*\*\*\*

## Who's Your Boss?

IF YOU AREN'T YOUR OWN, NOW YOU CAN BE—AND PROFITABLY!

How Does \$1000 A Month Sound?

If your business and sales ability is now an asset to your boss or firm, capitalize on the experience in a profitable, prestige business of your own! SILENTONE Hospital Radio Service franchise holders coast to coast now enjoy earnings up to \$1000 monthly. Initial training and set-up by Silentone representatives to qualified parties. Good sound business with permanent growing future, and you're the boss! Write now for proof and exclusive territory openings — Dept. PM-149.

SILENTONE HOSPITAL RADIO SERVICE 5104 N. Monroe SPOKANE, WASH.

# NOW YOU CAN "Breeze Through" ANY AUTO REPAIR JOB!

**Free**  
7-DAY OFFER!

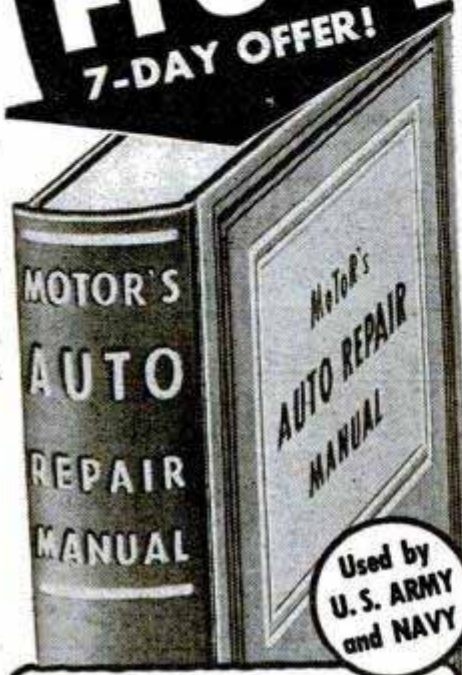

Yes—EVERY Auto Repair Job is a "Snap"—with This Big Time-Saving, Money-Saving Manual. It Shows You How to Service and Repair ANY Part of ANY Standard Car!

DON'T squander time and patience trying to "dope-out" difficult car repairs! With this amazing new book you can "whiz" through ANY job confidently — *in almost no time!* Just look up make, model, and the job in MoToR's AUTO REPAIR MANUAL — and every repair job from radiator to rear end becomes a "push-over"!

### Try It FREE For 7 Days!

Nothing like MoToR's AUTO REPAIR MANUAL has ever been published! It's just as if plain-talking engineers from every auto plant in America actually got together to show you everything you need to know about the cars they themselves designed. Every sentence, every picture, is crystal clear—easy-to-follow. That's why the publishers say: Try this big, 701-page book FREE for 7 days. Put it to every possible test in the shop, or on your own car. Then, unless you're convinced *beyond doubt* that this book is the greatest time-saver and money-saver you've ever seen, just return it. You pay nothing—you owe nothing.

### See How Much You Get!

This book combines information from over 150 Official Factory Shop Manuals. OVER 200,000 service, repair, adjustment, replacement, tune-up facts on all makes and models, 1935 to 1948. More than 1700 cut-away photos, diagrams, drawings show you exactly WHAT to do and HOW to do it. Used by U. S. Army, tech schools; thousands of auto servicemen.

Published by MoToR, the leading Automotive Business Magazine. MoToR's manuals assure high standards of repair work.



### WORTH BIG MONEY TO:

- Mechanics
- Handymen
- Garagemen
- Farmers
- Repair Men
- Service Station Operators
- Taxi Owners
- Part-Time Mechanics
- Army and Navy Personnel

### WHAT USERS OF THIS BOOK SAY:

"A boy can easily follow its instructions. I fixed a motor on which another mechanic had worked half a day. With your Manual, I did it in 30 minutes."

—C. Auberry, Tenn.



"MoToR's Manual paid for itself on the first two jobs and saved me valuable time by eliminating 'guess work.'"

—W. Schrop, Ohio

"Have done jobs with this Manual that I would not have attempted without it. Explanations are easy to understand and complete."

—C. L. Vanerstrom, Mich.



### Clear, Pictured Instructions on Every Job on Every Car Built from 1935 to 1948!

American Bantam • Auburn • Austin • Buick • Cadillac • Chevrolet • Chrysler • Cord • Crosley • De Soto • Dodge • Ford • Frazer • Graham • Hudson • Hupmobile • Kaiser • Lafayette • La Salle • Lincoln • Lincoln Zephyr • Mercury • Nash • Oldsmobile • Packard • Pierce Arrow • Plymouth • Pontiac • Reo • Studebaker • Terraplane • Willys.

Nearly 200,000 service and repair facts on all 32 makes. 701 big pages; including 70 pages of carburetor text covering all models. Over 200 charts, tables; Tune-up Chart; Valve Measurements; Torque Wrench Reading; Starting Motor; Engine Clearances; Generator; Body Service; Dash Gauges; Brake Specifications; Front End Measurements; etc.; Engines, Electric, Fuel, Cooling, Lubricating Systems; Transmissions; Universals; Front Ends; Wheels; Rear Ends, etc.

### SEND NO MONEY

Without risk, see for yourself how quickly this book covers every job on every car! Just mail coupon — without money — for FREE 7-Day Trial. Unless you're convinced it's worth many times its cost, return book in 7 days and pay nothing! MoToR Book Dept., Desk 11, 250 West 55th Street, New York 19, N. Y.

### MAIL COUPON NOW FOR 7-DAY FREE TRIAL

MoToR BOOK DEPT., Desk 11, 250 West 55th Street, New York 19, N. Y.

Rush to me at once: (check box opposite book you want)

MoToR's AUTO REPAIR MANUAL. If O.K. I will remit \$1 in 7 days (plus 35c delivery charge), then \$2 monthly for 2 months and a final payment of 95c a month later. Otherwise I will return book postpaid in 7 days. (Foreign price, remit \$8 cash with order.)

MoToR's TRUCK REPAIR MANUAL. (Described at left.) If O.K. I will remit \$2 in 7 days, and \$2 monthly for 3 months, plus 35c delivery charges with final payment. Otherwise I will return book postpaid in 7 days. (Foreign price, remit \$10 cash with order.)

Print Name \_\_\_\_\_ Age \_\_\_\_\_

Print Address \_\_\_\_\_

City \_\_\_\_\_ Zone No. \_\_\_\_\_ (if any)

State \_\_\_\_\_ Occupation \_\_\_\_\_

Check box and SAVE 35c delivery charge by enclosing WITH coupon entire payment of \$5.95 for Auto Repair Manual (or \$8 for Truck Repair Manual). Same 7-day return-refund privilege applies.

## Same FREE 7-Day Offer Applies on MoToR's TRUCK REPAIR MANUAL

Covers EVERY job on EVERY truck made since 1936! 1400 pictures, 952 pages, 300,000 facts. Used by Armed Forces.

All types Gasoline Engines, Diesels, Hesselmans, Fuel Systems, Generators, Clutches, Transmissions, Axles, Torque Dividers, Transfer Cases, Brakes, Steering, etc.

ALSO SERVICES buses, farm and industrial tractors, etc. (on all parts described in Manual). Check box in coupon.



# GET INTO DIESEL-AUTO MECHANICS MASTER ALL PHASES

SHOP METHOD HOME TRAINING

by an Established Resident School prepares you for Many Good Jobs!

Get Complete Training

Diesel-Automotive Industry needs trained men, to install, maintain and repair all types Diesel and Automotive engines — AND allied equipment. Now, National Schools offers you practical, proved home study training covering

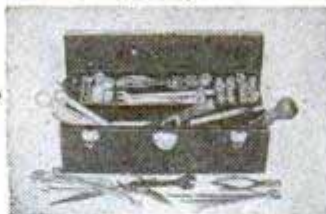

You Receive Tools and Equipment as Part of Your Course.

ALL phases. Basic instruction and specialization in field of your choice. All-embracing instruction. Valuable, large engine manual — TOOLS and EQUIPMENT included. Earn while you learn. INVESTIGATE—get full information.



APPROVED FOR VETERANS

## NATIONAL SCHOOLS

LOS ANGELES 37, CALIF. • EST. 1905

FIND OUT NOW... MAIL COUPON TODAY

NATIONAL SCHOOLS, Dept. PMD-1  
4000 South Figueroa Street  
Los Angeles 37, California

(Mail in envelope or paste on penny postcard)

Mail me FREE the book, YOUR FUTURE IN DIESEL, together with the Sample Lesson. I understand I may keep and use the information with no obligation.

Name \_\_\_\_\_ Age \_\_\_\_\_

Address \_\_\_\_\_

City \_\_\_\_\_ Zone \_\_\_\_\_ State \_\_\_\_\_

Check here if Veteran of World War II

CREI Prepares Young Men for Professional Careers with Industry-Recognized Training in a minimum of time

## RADIO - ELECTRONICS TELEVISION ENGINEERING

GRADUATES of CREI residence school are preferred by industry because of their training and ability. This recognition is the reason that CREI men quickly find good jobs. With 22 years of practical teaching experience in these highly technical fields, CREI offers an outstanding faculty, modern and complete laboratories, shops and equipment. New students are accepted twice monthly and each may advance as rapidly as he is capable. The basic course with one specialized course requires an average of 20 months to complete. CREI is recognized as one of the country's leading technical institutes.

Its work is of college level. It prepares the young man for a good job in industry in a minimum of time.



APPROVED FOR VETERANS' TRAINING

## CAPITOL RADIO ENGINEERING INSTITUTE

An Accredited Technical Institute Founded in 1927

MAIL COUPON FOR FREE CATALOG

Capitol Radio Engineering Institute, Dept. 171A  
16th and Park Road, N. W., Washington 10, D. C.

Please send me your illustrated catalogue and complete details.

Name \_\_\_\_\_ Age \_\_\_\_\_

Street \_\_\_\_\_

City \_\_\_\_\_ Zone \_\_\_\_\_ State \_\_\_\_\_

Get This Now!



SPRAY PAINTING New Book Makes Money Saves Money

COMPLETE INSTRUCTION FOR PROFESSIONAL USE AND 'ROUND-THE-HOUSE JOBS — INCLUDES AUTO PAINTING AND REFINISHING

Get this new 1948 spray painting book to help you on the job or for better and time-saving paint work around the home and car. Thoroughly practical—covers every phase of spray painting technique. Tells what paint or other finish to use, how to mix colors, how to make perfect jobs, easy, quick.

New edition has over 160 pages. Cloth binding, illustrated. Send \$2.00 for postpaid delivery or we will send C.O.D. Money back if not satisfied.

FREDERICK J. DRAKE & CO.

117 GREEN BAY ROAD

DEPT. 11

WILMETTE, ILL.

## MONEY FOR MEN ALL DATA FREE

THE PLASTEX Industry needs manufacturers on small scale and for big production of Lamp and Clock Stands, Art Goods and Novelties in Plastex and Marble imitation. Experience unnecessary. 1/2c material makes regular 10c store sellers. Rubber moulds furnished for speed production. Small investment brings good returns. Big chain store orders now being placed. Ambitious men have chance for real prosperity. Our Free booklet will interest and benefit you.

PLASTEX INDUSTRIES, Dept. A  
3400 Third Ave. New York 56, N. Y.

## EASY TO LEARN CODE

Learn or increase speed with an Instructograph—the Code Teacher that takes the place of an operator-instructor and enables anyone to master code without further assistance. Available tapes from beginners alphabet to typical messages on all subjects. Speed range 5 to 40 WPM. Always ready—no QRM. Thousands have "acquired the code" with the Instructograph System. Write today for convenient rental and purchase plans.



INSTRUCTOGRAPH COMPANY

4701-V Sheridan Road, Chicago 40, Illinois

## WATCHMAKING

Be a Watchmaker—Be Independent

Get practical training at the only school in Chicago accredited by the Horological Institute of America. Day and Evening Classes—Approved for Veterans

Write today for free information

CHICAGO INSTITUTE OF WATCHMAKING

7 So. Pulaski Road Dept. PM-1 Chicago, Illinois

## FREE MRS. BERRY'S POULTRY BOOK

BABY CHICKS or STARTED. Champion-Mated, Licensed, Inspected, B.W.D. TESTED. 52 BREEDS, 6 HYBRIDS. Sexed or straight. Mature fowls, Hatching Eggs and Remedies. LOW PRICES. The ORIGINAL Berry's Farm—over 50 years' service. LARGE BEAUTIFUL BOOK FREE. Stamps appreciated. BERRY POULTRY FARM, Bx. 29, CLARINDA, IOWA

## FIBRE ARMS AND LEGS!

Light, correctly fitted, strong and comfortable. Natural appearance. Braces for all deformities. Scientific design. Fair Terms.

BUCHSTEIN-MEDCALF

223 S. 6th St., Minneapolis, Minn.

## NEW WAY TO CHOOSE YOUR CAREER

Today, with many careers open, it is more important than ever that you choose wisely the exact work or profession for which you are best fitted. Aptitude tests can accurately determine this for you, in advance. Vocational guidance may be worth thousands of dollars to you and mean your future happiness. You owe yourself the advantages of this scientific analysis.

FREE: Send your name on a penny postcard for a Free booklet explaining this new proven way to greater success.

OXFORD VOCATIONAL BUREAU

DEPT. 21, 4737 BROADWAY

CHICAGO 40, ILL.

LET SCIENCE PICK A JOB FOR YOU



# GET INTO DRAFTING

The Draftsman Plays a most  
Important Part in INDUSTRY



## DRAWING OUTFIT INCLUDED with Drafting courses

All the tools you need including folding drawing table. With them you can put your ideas on paper quickly and with accuracy. With training you are all set to master Drafting in months, — not years — at home.

### Learn in Spare Time—At Home!

(or at the College in Chicago)

A few hours of pleasant home study every week — that's all. With Chicago Tech's help, you train yourself step by step. This tested method — developed over 44 years of C.T.C. progress — prepares men for good positions in industry.



**CHICAGO  
TECHNICAL COLLEGE**  
A212 Tech Building, 2000 South Michigan Ave.  
Chicago 16, Illinois

Practically everything that's built or manufactured these days is constructed from blue print drawings prepared by the draftsman. He is the KEY man in industry. No new machines can be built, no bridges erected, no buildings constructed until the draftsman has completed his work.

Drafting is clean, interesting, professional-type work. The draftsman is paid well to start. And he has real opportunities for advancement to high-pay jobs in Engineering. The tremendous production programs ahead in industry will require more draftsmen than ever before.

Send today for free information. See what this training has done for others, what it can do for you. Simply MAIL COUPON TODAY in an envelope or use a penny postcard.

## MAIL COUPON NOW

Chicago Technical College  
A212 Tech Bldg., 2000 So. Michigan Ave.  
Chicago 16, Illinois

Mail me FREE Drafting Lesson with information about big opportunities in DRAFTING and how I can train at home.

- Architectural Drafting       Electrical Drafting  
 Machine Drafting         Structural Drafting  
 Builders' Course

Name \_\_\_\_\_ Age \_\_\_\_\_

Address \_\_\_\_\_

City \_\_\_\_\_ Zone \_\_\_\_\_ State \_\_\_\_\_

## DRAW for MONEY... Be an ARTIST!

Trained Artists are Capable of Earning  
**\$60, \$75 and MORE a WEEK!**

YOU CAN learn to draw at home in your spare time the well-known WSA way, COMMERCIAL ART, DESIGNING, CARTOONING all in ONE complete course. No previous Art experience necessary—we teach you step-by-step. Prepare for a fascinating hobby or profitable career. For 35 years WSA graduates have been making good—WHY NOT YOU?



**VETERANS! WSA Approved for Training Under G. I. Bill.** Write for FREE BOOK, "Art for Pleasure and Profit," fully describes course, our method of instruction and commercial opportunities for you. TWO ART OUTFITS included with training. Mail coupon now.

Washington School of Art, Studio 121M  
1115—15th St., N.W., Washington 5, D. C.

Please send me full information and your Free Book, "Art for Pleasure and Profit."

Name \_\_\_\_\_ AGE \_\_\_\_\_

Street \_\_\_\_\_

City \_\_\_\_\_ Zone \_\_\_\_\_ State \_\_\_\_\_

I am entitled to training under "G.I." Bill

## TRAVEL - for 'UNCLE SAM'

### ARE YOU JOB-SATISFIED?

GET A 1949 U. S. GOVERNMENT JOB

### Railway Mail Clerk Test Expected Soon

Postoffice Clerks—Mail Carriers—Stenographers—Typists. Statistical Clerks—Storekeeper-Gaugers, etc. 40-Page Civil Service Book—FREE.

**MEN - WOMEN  
Veterans Get Preference**

Mail Coupon immediately—today sure.

Although not government controlled, this can be your first step toward a secure Civil Service Career.

As high as \$3,351.00

**FIRST  
YEAR**

### COUPON

FRANKLIN INST., Dept. K-87, Rochester 4, N. Y.

Gentlemen: Rush to me without charge, 40 page book with list of U. S. Government big paid positions. Advise me also regarding salaries, hours, work, vacation, etc. Tell me how to qualify for a position.

Name.....

Address.....Vet?.....

# ELECTRICIANS

Get this Great Book **FREE**

Book of 150 Shop Prints, Wiring Diagrams, Full Size 8 1/2 x 11"



For Merely Examining Coyne's NEW Pay Raising

## 8 Volume Set APPLIED ELECTRICITY

Here's a brand new set of electrical books to give you the "know how" on all branches of electricity from appliance repairing to D.C. and A.C. equipment, electrical refrigeration, Industrial Electronics, etc. 3-400 subjects, 11,500 facts, latest methods explained in easy to follow instructions. To prove how valuable and Practical this set can be to you, I'll give you a FREE copy of my book "150 Shop Prints and How to Read Them" just for looking over this set. Written by the Coyne Staff and backed by 47 years' experience, this set has helped many ambitious electrical workers to bigger pay and added opportunity.

**OFFER LIMITED • ACT NOW!** If you act promptly, I'll send you the 8 volume set Applied Practical Electricity for 7 days FREE examination . . . together with the 150 Shop Print Book. Look the set over 7 days. If you like it send either \$22.75 cash or \$3.00 after 7 days and \$3.00 per month until \$24 is paid. If you don't want the set, return it and **YOU OWE NOTHING.** In either event you keep the 150 Shop Print Book absolutely FREE.

Coupon below is just a request to see the books free and to get my gift book for doing it. **ACT—Send coupon Today!**  
 Technical Book Div. COYNE ELECTRICAL SCHOOL  
 500 S. Paulina St., Dept. 19-R6, Chicago 12, Ill.

**FREE BOOK**  
 Coupon



SEND NO MONEY

B. W. Cooke, Director COYNE ELECTRICAL & RADIO SCHOOL  
 500 S. Paulina St., Dept. 19-R6, Chicago 12, Ill.  
 O. K. send me, postpaid, Coyne's new 8 volume, "Applied Practical Electricity" for 7 Days FREE TRIAL per your offer. Also send, absolutely FREE, the book of 150 Shop Prints as a gift.

Name \_\_\_\_\_ Age \_\_\_\_\_  
 Address \_\_\_\_\_  
 Town \_\_\_\_\_ Zone \_\_\_\_\_ State \_\_\_\_\_

## STUDY AVIATION

BUILD YOUR FUTURE IN THE *Fastest Growing* INDUSTRY . . .



**SUCCESS IS Speedier, TOO . . .**

Increase your earnings. Train for a successful career at this internationally-famous aeronautical school. Government Approved and industry recognized. You learn on "live" aircraft—the same type you will work on after graduation.

Complete, thorough courses in Engineering, Flight, Mechanics, Radio and Electronics, Meteorology, Airport Management and Operations, Instruments, Link Trainer and Parachutes.

Spartan's 21 years of experience is your assurance of getting the greatest amount of training in the shortest possible time.

Investigate the many opportunities and the training required.

## SPARTAN SCHOOL OF AERONAUTICS

TULSA, OKLAHOMA

**MAIL COUPON TODAY**

Spartan School of Aeronautics  
 Tulsa, Oklahoma Dept. PM-19  
 Please send me complete information on: Course \_\_\_\_\_  
 Name \_\_\_\_\_ Age \_\_\_\_\_  
 Street \_\_\_\_\_  
 City \_\_\_\_\_ State \_\_\_\_\_



## Famous BAILEY TECHNICAL SCHOOLS

OFFER THE FOLLOWING COURSES:  
**PRACTICAL DIESEL ENGINEERING**  
**REFRIGERATION - AIR CONDITIONING**  
**COMMERCIAL ELECTRICITY**  
**RADIO - TELEVISION MECHANICS**

Your future success depends largely on the reputation of the school you attend. Don't take chances! Train at America's foremost school of mechanical specialization. Bailey is recognized and approved by industry. Bailey graduates get the top pay jobs! G.I. Approved. Send for FREE Catalog.

**BAILEY TECHNICAL SCHOOLS**  
 1655 So. Grand Blvd., St. Louis, Mo.

## BRAZIL STAMPS

50 different stamps mailed direct from Brazil to you.

ONE DOLLAR BILL, POSTPAID

**OTTO HUFFENBÄCHER**

Caixa Postal 653

São Paulo, BRAZIL



### CLUB PINS AND GUARDS

Latin, Spanish, Hi-Y, Tri-Y, G. A. A., etc.

**J. A. MEYERS & CO., Inc. Dept. K**  
 1031 W. 7th St., Los Angeles 14, Calif.

## RUPTURE Troubles ENDED

Advanced method. No leg straps, no elastic, no steel. Entirely different. Guaranteed. Write:

**SMITH MANUFACTURING COMPANY**  
 DEPT. PM PRESTON, ONT., CAN.

## GOOD MONEY IN WEAVING

Earn money at home weaving rugs, carpets, etc. from old rags or new yarn—in your community! No experience necessary. \$1,000 doing it with easy running *Union Looms* costing less than \$50.00! Send for our free booklet today.

UNION LOOM WORKS • 464 Pest St. • BOONVILLE, N. Y.

## STRENGTHEN Your VOICE!

YES—you can now build yourself a powerful speaking and singing voice with this amazing new scientifically sound tested method. Self-training . . . no music or piano required. Results GUARANTEED. Just send your name for the sensational details. FREE chart of your vocal mechanism included!

PERFECT VOICE STUDIOS, Studio A-10, Kimball Hall Building, Chicago 4, Ill.

## BECOME AN EXPERT DRAFTSMAN

You can qualify easily for splendid openings in Industry. The Triangle School, established 1943, is approved for Veterans and offers the training you need. (High School education required for entrance). Living quarters arranged.

Send for information.

## TRIANGLE SCHOOL OF DRAFTING

DEPT. M—347 FIFTH AVE., PITTSBURGH, PA.



# LEARN THE BUILDING TRADES

## Big Earning Opportunities



### DO YOU WANT TO BE ON THE INSIDE IN THE BUILDING BOOM AHEAD?

#### BUILDING CONTRACTING **FREE...**

Important Information Telling How To Get Started.

#### LEARN ABOUT the HOME BUILDERS TRAINING INSTITUTE PLAN...

Essential facts whether you are a tradesman in the building field or whether you have no previous experience.

Action Going On Now in the Building Industry.

**MAIL COUPON TODAY FOR FREE ILLUSTRATED BROCHURE**

■ Big years right ahead in Building. Right now eighteen million Americans who do not own homes are being educated to advantages to them in home ownership! Do you want to be on the inside in the building boom—where big money is made? This is your chance now. Learn about opportunities for Building Tradesmen whether or not you have previous experience in this field. Millions of dollars are going to be made in home and farm buildings, in construction of stores, garages, small industrial buildings.

#### GETS PAY RAISE

"Just recently I was rewarded with a raise in salary and a promotion as a result of introducing an idea on the job which I acquired from studying the C.T.I. Building Course." — *Michael Ruscigno, Arizona.*



#### BUILDS OWN HOME

"I had been planning to build a house for some time but did not feel qualified to do so until I started my course. Now after four months of building I have completed my house and have just moved in. I have saved a considerable amount of money and know the house has been constructed soundly." — *John Samos, Virginia.*



### PRACTICAL HOME STUDY TRAINING—EASY TO LEARN BY THIS PLAN

■ Commercial Trades Institute has developed a training program that makes rapid progress possible. Gives you the all around training you want to prepare you for your advancement. Modern methods making use of visual aid illustrations make it easy to learn. From very first lesson assignments the type of information provided is the kind that can be useful to a man taking part in building.

#### VETERANS

Just mail coupon — we will handle all details.

#### NON-VETERANS

Don't let the lack of ready cash prevent you from taking this training now. Investigate our low Easy-Payment Plan and our Pay-After-Graduation Plan.

#### HAS OWN BUSINESS

"When I first started the C.T.I. Building Course, I planned on using the knowledge gained in fixing my own home. Now I am getting jobs faster than I can handle them. The course has paid for itself, the repairs on my home, and put extra money in my pocket besides." — *Stanley Radwanski, Indiana.*

Commercial Trades Institute, Dept. D2-1



### → FILL OUT—CUT OUT—MAIL TODAY ←

Facts Free for Men Who Want to Get Ahead in One of These Great Fields

COMMERCIAL TRADES INSTITUTE, Dept. D2-1  
1400 W. Greenleaf, Chicago 26, Ill.

Send free illustrated brochures and other information about the field I have checked below.

- |   |                                      |   |
|---|--------------------------------------|---|
| <input type="checkbox"/> Diesel Mechanics         | <input type="checkbox"/> Radio       | <input type="checkbox"/> Refrigeration and Air Conditioning |
| <input type="checkbox"/> Auto Mechanics           | <input type="checkbox"/> Television  | <input type="checkbox"/> BUILDING TRADES                    |
| <input type="checkbox"/> Body & Fender Rebuilding | <input type="checkbox"/> Electricity | <input type="checkbox"/> Drafting                           |

Name \_\_\_\_\_  
Address \_\_\_\_\_  
City \_\_\_\_\_ State \_\_\_\_\_  
 Veteran       Non-Veteran

The building boom will last for many years. Prompt action now will get you started now — will put you in line for a big-paying job or a business of your own.

# Learn A Trade NOW! PRACTICAL SHOP TRAINING!

## In Our Chicago Shops

- |   |  |
|---|--|
| <input type="checkbox"/> AUTO MECHANICS   | <input type="checkbox"/> WELDING—ARC and GAS |
| <input type="checkbox"/> DIESEL MECHANICS | <input type="checkbox"/> MACHINIST           |
| <input type="checkbox"/> REFRIGERATION    | <input type="checkbox"/> PIANO TUNING        |
| Above Approved For G. I.'s and Civilians  |  |
| <input type="checkbox"/> BODY-FENDER      |  |

One of America's Leading Practical Schools  
7 Floors of Fully Equipped Shops  
Over 48,000 Successful Graduates  
Expert Individual Instruction  
Learn by Doing—Low Living Expense  
Established 1902—Day and Evening Classes

## Also the following Home Study Courses

- |                                  |  |                                 |
|----------------------------------|--|---------------------------------|
| <input type="checkbox"/> PLASTIC | <input type="checkbox"/> REFRIGERATION | <input type="checkbox"/> DIESEL |
|----------------------------------|--|---------------------------------|

## —CALL IN PERSON OR MAIL THIS AD TO— GREER SHOP TRAINING

(Dept. PM-29) 460 South State St., Chicago 5, Ill.  
Please send without obligation free information regarding trade checked above. (Specify whether you are a Veteran  or Civilian )

Name \_\_\_\_\_ Age \_\_\_\_\_  
Address \_\_\_\_\_  
City \_\_\_\_\_ State \_\_\_\_\_



## START AS HIGH AS \$3,351.00 YEAR

Many 1949 Examinations Expected. Prepare NOW! Veterans Get Special Preference! 40-Page Civil Service Book FREE  
Mail Coupon Today SURE

Franklin Institute  
Dept. K-85  
Rochester 4, N. Y.

(Not Government Controlled)

Gentlemen: Rush to me, FREE of charge, list of U. S. government big pay jobs. Send FREE 40-page book describing salaries, vacations, hours, work, etc. Tell me how to qualify for one of these jobs.

Name \_\_\_\_\_

Address \_\_\_\_\_ Vet? \_\_\_\_\_

## LUMINOUS PAINT GLOWS IN THE DARK!



NOW you can paint any article or part of an article Brilliant Green, Misty Violet, Bright Blue, Radiant Orange, Ruby Red, Golden Yellow and Orchid. Beautiful, standard colors by day that glow brilliantly at night! Thousands of uses! Liberal size can any color sent postpaid for only 89c. FREE illustrated catalog shows how RADI-GLOW paints can be used.

CHEMICAL PRODUCTS COMPANY  
1412 Great Northern Bldg.,  
Dept. 101, Chicago 4, Ill.

**89¢**  
PER CAN

SEND FOR FREE CATALOG!

## Save on CIGARETTES

All Popular Brands \$1.57 Carton!

We pay all postage and insurance on 5 cartons or more to any point in the U. S. Add 5c per carton on less than 5 cartons. Send Remittance with Order.

SIDNEY SMITH, INC.

BOX 1025 — DEPT. PM1 — JOPLIN, MO.

## INVENTING

—FOR PROFIT! If you have an inventive turn of mind, write for free 28-page booklet explaining how the Institute of American Inventors is helping inventors pre-test the profit possibilities of proposed devices to fill today's unprecedented demand for useful new inventions.

## INSTITUTE OF AMERICAN INVENTORS

Dept. 4, 1926 Eye St., NW, Washington 6, D. C.



## ITALIAN ACCORDIONS

Hand Made. Very Best. Lowest Prices. Buy Direct from Factory Representative and Save Money. Send Name and Address for FREE catalog.

ITALIAN ACCORDION MFG. CO.  
7600 Cottage Grove Ave., Dept. PM1, Chicago, Ill.

## TRI-STATE COLLEGE

B. S. Degree in 27 months in Civil, Electrical, Mechanical, Chemical, Aeronautical, Radio Engineering; Bus. Admin., Acc't and Sec. Science. Graduates successful. 65th year. Enter Jan., March, June, Sept. Catalog. 419 College Ave., Angola, Ind.

## Sources of HOME-BUILDING INFORMATION

FREE List of hundreds of sources of home-building books, folders, leaflets, plans, ideas—most of which are free or cost only few cents. Worth real money to you—and! You may copy it all down if you wish and return it for your money back! How can you lose? Send \$1 now to WESTPORT PUBLISHING CO., Westport 2, Conn.

## MOVIE MAKERS' FAVORITE SINCE 1937

SATISFACTION GUARANTEED  
Solar Type 12-Film (Weston 12 Outdoor) \$1.59  
Ortho, Non-Halo, Fine Grain

16MM 50 Ft. \$1.90 • 16MM 100 Ft. \$3.30 DOUBLE 8mm

24-HOUR FREE PROCESSING SERVICE

Order now. Send cash and save shipping cost or \$1.00 deposit on C.O.D. Illinois residents add 2% sales tax.

Write For Circular

SOLAR CINE PRODUCTS, INC.

4247 So. Kedzie Dept. PM1 Chicago 32, Illinois

## Army Air Corps JACKETS

Type B15. Alpaca lined. Fur collar. Heavy outer shell. 2 slash pockets. Full front zipper. \$10.95  
Only, each Add 25c handling & mailing



## OXFORDS

Genuine U. S. Navy Last. A real comfortable shoe made of finest quality leather. Nationally known makes. In all widths.



Supply limited. Order today. State size... \$6.79  
Add 25c handling & mailing

SEND FOR FREE ILLUSTRATED CATALOG  
CLEVELAND ARMY STORES 3810 E. 15th St. Kansas City, Mo.

"I love to teach dancing

# The New Arthur Murray Way

*My pupils learn so much faster!"*



Lola Arnaux,  
typical Arthur  
Murray teacher



"The Rumba's a great favorite," says Madeleine Murphy. "It's such fun to see a beginner do this gay dance after just one lesson. Teaching really is fun this new way."



"The Samba's such fun and looks so tricky that everybody loves to do it," says Joyce Lyons. "And, you can learn it in an hour thanks to 'The New Arthur Murray Way.'"

**Even beginners become popular partners in a fraction of the usual time!**

"I'm so excited about 'The New Arthur Murray Way' of teaching dancing. It seems like magic the way the Fox Trot, Waltz, Samba, Rumba, all develop out of his new discovery, 'The First Step To Popularity'.

"Beginners are thrilled to find they go dancing after only one hour . . . and amazed how little it costs to learn. And right now we have a special half-off price that saves you even more. But why don't you come in to the Studio for a FREE dance analysis and see for yourself what 'The New Arthur Murray Way' can do for you."

## **PROOF** You Can Dance After One Lesson!

See how quickly you can learn to dance "The New Arthur Murray Way." Send for the "Murray-Go-Round" now! It contains fascinating, entertaining instructions on all dances. Clip coupon below.



Copy. 1949—Arthur Murray Inc.

# ARTHUR MURRAY

**DANCE STUDIOS FROM COAST TO COAST**

Visit the one nearest you  
for a FREE dance analysis

**ONLY 25¢**

ARTHUR MURRAY STUDIOS, Dept. 9B (Consult telephone directory for address of nearest studio, or write Arthur Murray Studios, 11 East 43rd St., New York 17, N.Y.) Please send me your magazine, "Murray-Go-Round", 44 pages of pictures, dance news, instructions. I enclose 25c.

NAME \_\_\_\_\_

ADDRESS \_\_\_\_\_

CITY \_\_\_\_\_ ZONE \_\_\_\_\_ STATE \_\_\_\_\_

Pop. Mech.—Jan. 1949

**NOW AT MY RISK!**  
 I want you to read the  
**WARNER SUCCESS PLAN**



**It shows you how to...**  
**METALIZE BABY SHOES**  
**AND OTHER KEEPSAKES**

- how you can start in spare time with your home as headquarters.
- how to build—step by step—to big profits and personal independence.

This is the famous Warner Success Plan—the Plan for Personal Success in your own fascinating business that many men, married couples credit with freeing them from the limits of a pay check and from the drudgery of a time clock.

It gives the exact step by step instructions for starting a business in spare time—without risking the job or steady pay. It shows with pictures, photographs, and drawings exactly how to Metalize Baby Shoes and other keepsakes. It shows how to get the orders coming in—how to expand—how to get others working for you—how to be SURE of at least twice your present pay before you give up your job for a life of personal independence.

**15 Million Prospects**

There are 15 MILLION pair of Baby Shoes in the country right now ready to be Metalized. Last year alone, more than THREE MILLION more babies were born.

There's not one of these mothers who doesn't want her baby's first shoes preserved forever. The Business is tremendous... and never ending.

The Warner Success Plan shows you how to turn this exciting opportunity into cash. Shows exactly how to prepare the shoes, how to put on them a coating of genuine gold, silver, or bronze metal by simple Warner Electroplating process. Shows how to get the business coming in, how to start in spare time, how to pyramid profits. Shows you how the whole family can have fun while building for an independent future. My own Shop here in Chicago does a Big Business by the very secrets I will now unfold to you.

**Read The True Facts**

Don't say "Yes" now. You must have ALL THE FACTS. Then decide. First, I want you to read the entire Plan—at my risk. After investigating—after discussing it with your family—then and only then do you decide whether to use the plan and make the small investment necessary to start.

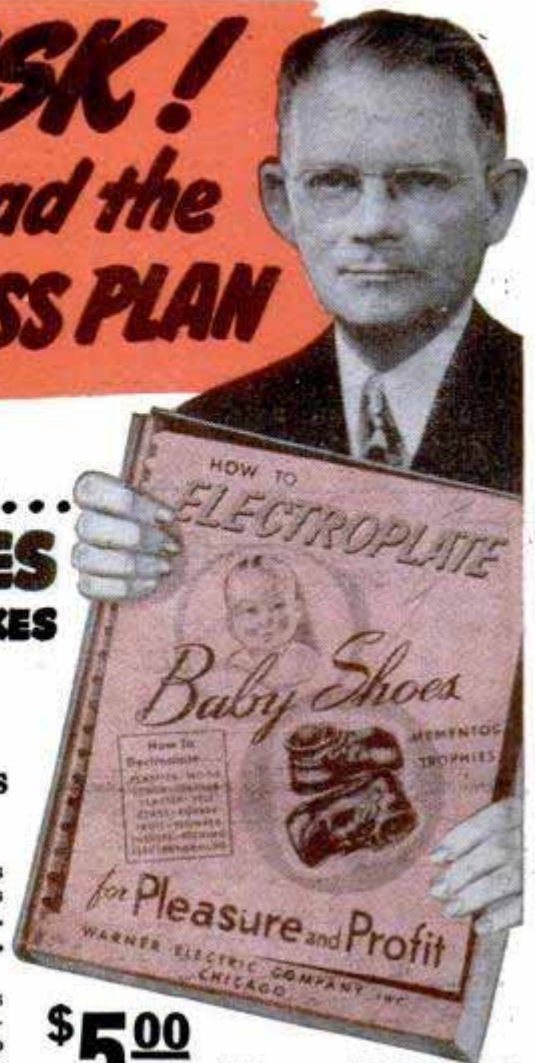

**\$5<sup>00</sup>**  
**An Hour PROFIT**

Yes, even in spare time it is possible for a man to finish enough work to pay \$5.00 an hour for his time. Think what this can pyramid into when the family helps.

**3c MAY START A FORTUNE**

Today I want you to do only one thing. Send the coupon. Let me give you all the facts. Remember, what I send you does not cost you a cent beyond the postage you put on your letter to me. With an opportunity like this, a man who has a serious interest in his future MUST investigate, MAIL the COUPON TODAY and see for yourself why so many families have called the WARNER SUCCESS PLAN a "godsend".

**DON'T SEND A PENNY**  
**JUST MAIL THIS COUPON TODAY!**

**Raymond E. Brandell, Mgr., WARNER ELECTRIC CO.**  
 1512 Jarvis Ave., Dept. 31, Chicago 26, Ill.

As long as it doesn't cost me a cent, I'm willing to read the facts, investigate, then give you my decision. Send the facts by next mail. No cost to me now or at any other time.

NAME \_\_\_\_\_  
 ADDRESS \_\_\_\_\_  
 CITY \_\_\_\_\_ Zone \_\_\_\_\_ STATE \_\_\_\_\_

**MAKE 12 TIMES**  
**YOUR MATERIAL COSTS**

Remember, the Warner Process is not a cheap imitation "PAINT" process. It is the genuine METALIZING through real Electroplating. And in spite of being the best, your materials cost so little that your profits are 12 Times your material cost. Then, when mothers order the shoes mounted as book-ends, as pictures, as ash-trays or pen sets, you make the BIG EXTRA PROFITS on the beautiful mounts.

**WARNER-ELECTRIC CO.**  
 1512 Jarvis Avenue  
 DEPT. 31  
 Chicago 26, Illinois



**WE SUPPLY ALL**  
**MATERIALS**

You don't have to go "hunting" when Warner is behind you. We supply all materials, all mounts, chemicals, and metals. And you get the low prices made possible by our big quantity purchases and our own manufacture. You send for just what you need and never have any big investment tied up in stock.

**WORLD'S  
BEST  
WANT AD  
MEDIUM**

# CLASSIFIED Advertisements



Advertisements in this section 75 cents per word, each insertion, minimum 10 words, payable in advance.  
To be inserted under proper classification, copy must be in our office the 22nd of the  
second month preceding date of issue

F. W. Johnson, Manager, Classified Advertising  
Popular Mechanics Magazine, 200 East Ontario Street, Chicago 11, Illinois

## 1081

## CLASSIFIED ADVERTISEMENTS

## 1081

## OPPORTUNITIES FOR YOU

### AUTOMOBILES, MIDGET CARS

**"VAPO-STEAMATIC"** Water Injection. Build your own—easily (about \$1.00 cost). Finest "Moist-Humidity" system, completely automatic! Engineering triumph; many more miles per gallon! Increases horsepower! Speed! Acceleration! Eliminates knocking, carbon, overheating. Reduces wear! Engines last longer! Copyrighted "Installation Handbook" (illustrated), detailed diagrams, parts lists, automobile equipment catalogues including "Mileage Information." \$1.00 complete. Newhouse Automotive Industries, 5941-B1 Hereford, Los Angeles 22.

**HOT Rod racing book.** 90 photographs, illustrations famous record holders used California Dry Lakes. Contains hotrod tips, closeup action shots, specifications, 8 beautiful drawings suitable framing. \$1.50 postpaid. Clymer, Dept. A-1V, 1268 So. Alvarado, Los Angeles 6, Calif.

**R & R Mfg. Co., Robert M. Roof, Box 546, Anderson, Indiana, U.S.A.** We sell direct to our customers over 200 speed equipment parts mfg. by us. Complete racing engines for cars and boats for Fords A, B, V8—6-4-40 Studebaker Champion, Willys, Chevrolets. Dual intake manifolds, cylinder heads, Lynite flywheels, oversize valves, camshafts new or yours reground, compound springs and other supplies. \$1.00 to cover cost of literature and mailing.

**SEE Our ad under motorscooters for midget car bargains.** Midget Motors Directory, Athens, Ohio.

**FAMOUS Car catalog reprints.** Duesenberg, Italian Maserati racing and new sport car, Mercedes-Benz, new rear-engine Isotta-Fraschini V-8, Rolls-Royce "Silver Wraith," Miller race cars, Cord, Rayfield Cyclecar, V-8 Chevrolet, Stanley Steamer, Doble Steamer. Specify catalog desired. \$1.00 each postpaid. Clymer, Dept. A-1X, 1268 So. Alvarado, Los Angeles 6, Calif.

**"SPEED And Power" Handbook—Very latest methods!** Construct your own superchargers, "water injectors," hi-compression heads, fuel saving devices—easily. Save many dollars! Get racing speed, acceleration, dynamic power increases from any automobile! Build fast stock cars! California roadsters! Hotrods! Get ingenious formulas! Speed secrets! Illustrations! Conversion ideas! Also "Economy Information"—mileage tricks! Tuning techniques! Instructions! Picture catalogues. Including "California Restyling Ideas"—glossy photographs! Drawings! Model revising! Customizing! Streamlining! Leatherlike bound—\$1.98 complete. Newhouse Automotive Industries, 5941-B2 Hereford, Los Angeles 22.

**INTERCHANGEABLE Parts book.** New book tells every automobile part that interchanges with others. Same parts many times vary 100% in price. This book enables garages, mechanics, dealers, owners to buy under cheapest listing. Tremendous savings for users. \$15.50 postpaid. Clymer, Dept. A-1P, 1268 So. Alvarado, Los Angeles 6, Calif.

**AUTOMOBILE Spray painting.** Complete instructions 25c. Mohan, 942 Moss St., Reading, Penna.

**CLYMERTONE.** Twin muffler sets, beautiful sound, complete with necessary welded pipes, E-Z installation. Ford V-8, \$20.00. Chevrolet set with split manifolds, \$37.50. Specify car model. Clymer, Dept. A-14, 1268 So. Alvarado, Los Angeles 6, Calif.

**CLYMER'S Test reports on post-war Kaiser-Frazer, Studebaker, 1949 Ford, 1949 Mercury, gives impartial, uncensored report 3000-mile economy, speed, record tests. Part-by-part equipment analysis. 3000 owner tabulations in each book. 200 owner letters. Good, bad comments about each make, no punches pulled. Learn the truth. Specify make car interested in. \$1.50 postpaid. Clymer, Dept. A-TR, 1268 So. Alvarado, Los Angeles 6, Calif.**

**PHOTOGRAPHS.** World's finest automobiles. List, sample, 10c. Box 1028, Minneapolis, Minnesota.

**"TWIN-TONE" Mufflers** that produce that deep mellow-tone. For V-8 and Mercurys 35 to 48. Dual sets \$22.50. 49 models \$25.00. Mufflers are straight-thru type. Also single thru-type mufflers for all cars, chrome exhaust extensions, 2 1/2" dia. \$1.85 ea. Elmer's Muffler Shop, 139 East Manchester Ave., Los Angeles 2, Calif.

**FORD V8 Magneto, 6500 r.p.m. 400 in use.** Fits hotrod, midget, private auto. \$100. Photo 25c. Pounden, 336 West F, San Diego, Calif.

**AUTOMOTIVE Trouble shooting.** 500 questions and answers. \$1.00 postpaid. Charles Nelson, 2908 Washington Ave., Santa Monica, California.

**MAKE Your Model "A" do 100 m.p.h.** Lightning acceleration, breath-taking top speed. Complete details, photographs, \$1 postpaid. Four Barrel, Box L-1, Eaglerock, Los Angeles 41, Calif.

**CALIFORNIA Custom styling headquarters.** Buy direct from original designers and save. Solid hood sides, grille panels, lowering blocks, fender skirts, mufflers, speed equipment. Picture catalogue with scores of beautifying accessories—25c. Eastern Auto Supply, 3319P South Grand, Los Angeles 7, Calif.

**HIGH Compression heads, V-8.** More speed, acceleration, power. Offenhauser or Edebrock \$75.00 complete set. Dual manifolds complete with throttle kit, fuel lines. Edebrock \$49.00, Offenhauser \$55.00. Give make, model V-8. Catalog 10c. Clymer, Dept. A-13, 1268 So. Alvarado, Los Angeles 6, Calif.

**CHEVROLET Speed manual** now available to discriminating Chevrolet owners who desire real "hotrod" performance from their 1937 to 1948 Chevrolets. Filled with photographs, complete information, proven methods showing you how to make your road car into a genuine 110 m.p.h. job, or how to build 134.52 m.p.h. Chevrolet hotrod. Every page worth the purchase price of only \$2.00 postpaid. California Bill, Box L-1, Eaglerock, Los Angeles 41, Calif.

**RACING Car Builder Book.** 22 drawings. Racing rules. Contains information on cams, compression, balance, midgets, big cars, roadsters, V-8 speed data. \$2.00 postpaid. Clymer, Dept. A-RB, 1268 So. Alvarado, Los Angeles 6, Calif.

**DUALTONE Crystalline packed California mufflers** for all automobiles. Large chrome tailpipe extensions. Chromed carburetors, fuel pumps, long shackles, dual manifolds, hi-compression heads, flywheels, camshafts, fender skirts, plexitops. Send 20c illustrated catalogue, deduct from first order. Streamlining Manual \$2.00. Dualtone Mufflers, 2636C India Street, San Diego 1, Calif.

**CONSTRUCT Water injection carburetor yourself.** Illustrated plans \$1.00. L. D. Blythe, White City 1, Kans.

**NEW Custom Kar-Kit** builds 4 smart custom body styles, hot-rod roadster, convertible, racer, sedan. Now plus extra heavy spring steel clock type mechanical motor, complete \$6.95. No c.o.d. please. Von Esser's, 2840 No. Kedzie, Chicago 18, Illinois.

**INSTALL V-8 engine** in your Model A for extreme acceleration, more top speed, smoother performance. Complete details, photographs. \$1 postpaid. A-V-8, Box L-1, Eaglerock, Los Angeles 41, Calif.

**CLYMER'S 1948 Indianapolis Race Year Book.** Complete information, 100 photographs, charts, drawings, cartoons. \$1.50. DeLuxe Fabrioid bound \$2.50 postpaid. Clymer, Dept. A-548, 1268 So. Alvarado, Los Angeles 6, Calif.

**MAKE Big money!** Sell new and used cars. Our Sales Manual, based on the experience of scores of America's most successful automobile salesmen, tells you how to get the job and be a top-flight salesman in this profitable and fascinating business. Get started today! Send \$2 and complete manual will be sent you by return mail. Hurry! Jobs are waiting for the trained man! Jandor Distributors, 613 Voris, Peoria, Illinois.

**BRITISH Racing cars.** Illustrations, photographs, historical information on British racers, Sunbeam, Bentley, M.G., Riley, Lagonda, Austin, others. Just published. \$1.50 postpaid. Clymer, Dept. A-1L, 1268 So. Alvarado, Los Angeles 6, Calif.

**INTERESTED In automobiles?** Send for free sample copy. Franson's Weekly Motor News, Box 254, Eugene, Oregon.

**MAKE Your Ford fast!** Complete details, photographs. How to construct 120 m.p.h. Hotrod. \$1 postpaid. California Bill, Box L-1 Eaglerock, Los Angeles 41, Calif.

**MODEL "A" and "T" Ford book.** 572 pages, complete information repairing, maintenance, servicing both models and Fordson tractor. \$3.50. Model "A" book only \$1.00 postpaid. Clymer, Dept. A-ATA, 1268 So. Alvarado, Los Angeles 6, Calif.

**FULL Line popular speed equipment,** dual, single mufflers, custom doll-up accessories. Konverti-Kovers, black or tan, saves your top in winter. Not plastic material. Latest 1949 catalogue 25c (A step ahead in the automotive field). Von Esser's, 2840 North Kedzie, Chicago 18, Ill.

**STEAM Automobile books.** Clymer's Steam Scrapbook 224 pages, 100 steam cars illustrated, described, \$2.00. Modern Steam Car Book \$2.00. Original catalog reprints Stanley, White, Doble \$1.00 each postpaid. Specify title wanted. Clymer, Dept. A-SS, 1268 So. Alvarado, Los Angeles 6, Calif.

**FROM Speedway to roadway!** Track-proved hi-speed heads and manifolds now available for your passenger car! No special tools needed! Increase horsepower 25%! Astounding getaway! Free illustrated catalog. Speedsport, 6215AA Diversey, Chicago 39.

**AUTOMOBILE Racing book,** fifth edition, well illustrated. Instructions on building bodies, frames, engines. Ford A and B conversions. Plans, AAA rules, specifications. Roadster racing. Indianapolis cars. \$1.00 postpaid, \$1.30 C.O.D. Ray Kuns, Dept. 47, Madisonville, Cincinnati 27, Ohio.

NEW Sensational seat cover. Mono, 6545 Santa Monica Blvd., Hollywood, California.

NEW Consumers Gasoline Guide Book. Tells 15 ways save gasoline. Describes all octane gasolines, anti-knock fuels. 72 charts, drawings. \$1.50 postpaid. Clymer, Dept. A-GG, 1268 So. Alvarado, Los Angeles 6, Calif.

**AUTOMOBILE Racing, Sixth Edition.** 100 illustrations. Working drawings with building instructions for Ford-60 midget, California roadster, Offenhauser racer. Details on racer parts. Sample entrance blank. World's record 158.5 m.p.h. rear engine four-wheel drive car. Interesting information for fans, drivers, mechanics. \$2.00 postpaid; \$2.25 c.o.d. Ray Kuns, Department 63, Cincinnati 27, Ohio.

"CUSTOM Styling" Manual—Quickly make car look Hollywoodized, custom, ultra-beautiful by easy, inexpensive methods! 100 photographs, drawings, instructions on customizing, restyling, streamlining; new and old cars! Thrilling sport changes! Latest custom, sportster, convertible, speed, model conversions. Accessories: Mufflers: Engine "soup up" specifications! (Custom car catalog included). Most complete book \$2. Almqvist Engineering, Milford 47, Pennsylvania.

"SPEED & Mileage" Manual—Easily obtain greater speed, mileage, racing performance from any automobile! Famous (original) book shows soup up methods: Speed tuning; Mileage secrets: Racing tricks! "Customizing Ideas!" Photographs! Instructions on building inexpensive speed equipment! Economizers! Superchargers! "Water injectors!" Mufflers! "Hot-rods!" Speedsters! Racing conversions! Engines! All about "Economy tuning," compression, manifolds, ignition, lubricants, cams, fuels! Latest "Hollywood styling;" streamlining; sports car conversions! Plans: "Fascinating Pictorial Supplement!" Catalogues: Charts: Parts lists! Deluxe enlarged edition, \$1.98. (Guaranteed). Almqvist Engineering, Milford 47, Pennsylvania.

**CUSTOMIZE Your car!** Authentic California restyling plans galore! Working sketches, specific model changes. Comprehensive; complete! 130 photographs! Largest, finest, or refund! \$2 postpaid. Post Publications, Box 723-BE, Arcadia, California.

**SPEED Equipment.** Marine and automotive. We have only the best, made by leading southern California manufacturers including—Edelbrock, Meyers, Weiland, Winfield, Jahns, Offenhauser, etc. Complete line of high compression heads, dual manifolds, racing pistons, camshafts, dual ignitions, etc. Send 25c for 32 page illustrated catalog. So-Cal Speed Shop, 1104 S. Victory, Burbank, California.

**SPEED Equipment bargains!** Dual manifolds \$12.95, racing heads \$29.00. California mufflers \$4.50, duals \$17.50, water injectors \$4.95, chrome echo cans \$1.75, supercharger stacks \$3.50, others! Beautiful "Handbook-Catalog" 20c. Almqvist Engineering, Milford 47, Pennsylvania.

**USED-CAR Buyer's handbook.** Includes authoritative late model evaluations! Complete tests, dealers' tricks, graphic photographs! \$1.50 airmail! Post Publications, Box 723-TFE, Arcadia, California.

**MELLO-TONE Mufflers.** Singles for all cars. Duals for Ford and Mercury. See our free catalog and low prices before you buy. So-Cal Mufflers, 11142M Washington Place, Culver City, Calif.

#### AUTO SUPPLIES AND EQUIPMENT

**GASKETS** For obsolete cars, 1910-35. No list. State wants. Bishop Gaskets, Box 1906, New Haven, Conn.

**NEW Used auto parts.** all cars. Immediate shipment, transmissions, rear ends. North Auto Parts, 1601 Clybourne Ave., Chicago 14, Ill.

**MOTORISTS** Protect your car with this new auto automatic self-regulating burglar alarm. Guaranteed to stop thieves. Easily installed. Only \$2.98. Novak Company, 1358 Chase, Gary 1, Indiana.

**SAVE 6c Per gallon** with Gane Air-Flow Needles. Shipped C.O.D. \$1.50 (8 cyl. cars take 2). Advanced Automotive Products, 563-18 Lake Road, Webster, N. Y.

**SMOKO** Is here! Lay gigantic, impenetrable smoke screens with amazing new invention! Satisfaction guaranteed or money refunded! Complete apparatus only \$2.49! Postpaid or c.o.d.! Send postcard for information! Smoko Engineering Company, Huntington, Indiana.

**TIRE Mileage boosted.** All pressures. Engineered economy. Free literature. Alto, 2319 Walnut, Texarkana, Texas.

**SMITHYS Mufflers** for Fords \$5.95 each. Bucks Auto Parts, Box 1296H, Merced 4, Calif.

**CIG-STICK Parks** your cigarette safely on dashboard or other metal surface, handy. \$1.00 pair. Edwards Industries, 4268 Shenandoah, St. Louis 10, Mo.

**CARBURETORS,** Fuel pumps, starters rebuilt in up-to-date plant. Rebuilding done for garages, automotive jobbers and other automotive supply outlets. All rebuilding done with best replacement parts, and by experienced personnel. Write for additional information and prices to Chamberlain's Service, Limerick, New York.

**BUICK Parts.** We stock a complete line of new Buick parts and engines. Same day service on orders and inquiries. We ship anywhere. Write today. Robertson Buick Co., 1001 S. Wabash, Chicago 5, Ill.

**MOTORISTS** Save gasoline by vacuumating overrich mixtures. Fits all cars. For free particulars write Vacuumatic, Dept. 1438, Wauwatosa, Wis.

**D-FROST** Emergency defroster fluid prevents ice, sleet, steam from freezing on auto, home, store windows. \$1.00 postpaid. Elk Supply Co., 817-1 Elk St., Buffalo 10, N. Y.

**SOLID Brass auto bells.** Two tones, plunger operated, \$8.50. Details free. Bermuda Auto Bells, Dept. 21, 16 Concord St., West Hartford 7, Conn.

**CONVERTIBLE Tops—**Completely sewn. Easily installed. Reasonable prices. Free literature. Rio Top Company, 1370 Roanoke, Newport News 22, Virginia.

**PISTONS—**American and foreign makes. M. Merryman Co., Lawndale, Calif.

**KLEERSPOUT** Will steamproof your windshield and car windows. Quick, easy to use. \$1.00 postpaid. Elk Supply Co., 817-1 Elk St., Buffalo 10, N. Y.

**WELDING Blocks** and bodies, repairing fenders easy with Hobart welders and electrodes. Low cost. Adds dollars to your profits. Free catalogs. Write Hobartweid, Box M-192, Troy, Ohio.

**NEW Grilles** for all cars. Wagner Grille Co., Route 2, Bernville, Penna.

**PATENTED—**Lachapelle's motor and motor fuel treatment takes out ping. More power for the same fuel used. Enough for 100,000 miles for \$3.00 postpaid. Ferns Products, 8120 Walnut Dr., Los Angeles 1, Calif.

**REPAIR Your car.** Motor parts for all engines, chassis parts, ignition and carburetor parts, etc.; new replacement parts. Genuine and highest quality at manufacturers' retail prices. Orders receive priority over inquiries. Briggs Automotive Engineering, Box 3454, Merchandise Mart, P.O. Chicago 54, Ill.

**HOLLYWOOD "Razz"** horn. Humorous efficient signal with a smile. \$3.50. Ki-Yi barking dog horn \$3.50. Cadet vacuum twin air horns, spun brass, chrome finish. Complete \$29.75 postpaid. E-Z installation any car. Clymer, Dept. A-KY, 1268 So. Alvarado, Los Angeles 6, Calif.

**CARBURETOR—**Repair your own and save money. Make money renewing your friends carburetor. Complete kit with instructions. All Fords \$2.50, all Plymouth and Chevrolet \$3.50, all others \$4.00. West Products Co., Box 45, Station D, Los Angeles 7, Calif.

**PRES-A-LITE.** The amazing safety invention which automatically hands you a lighted cigarette ready to smoke while driving. Holds 23 cigarettes. Fits any car. Precision built, foolproof, attractive. Price only \$6.95 postpaid. The Winchester Company, 6411 Hollywood Blvd., Hollywood 28, California.

**AIR Horns—"Strombos"** most powerful of all signals: Complete passenger car kits; all cars. Models available for boats, trucks, buses, and diesel locomotives. For the "right of way" right away! Buy Strombos. Illustrated bulletins on request. Strombos Company, 4525 Twelfth, Detroit 8, Michigan.

"SEAL Cracked batteries!" Cement \$1.00 can. Guaranteed! Postpaid! Batteryman, Grand Junction, Colorado.

**WATER Injection.** Free, descriptive, illustrated information. Neher Industries, La Verne, Calif.

**SAVE Gas!** Quick winter starting! 1949 "Lektron" spark intensifier. Easily installed. Only \$2.00. Money-back guarantee. Specify car. Electronic Industries, Cleveland 11, Ohio.

**HARD-TO-GET** Auto body parts. We supply. Miller, 192 N. Clark Street, Chicago.

**GOVERNMENT Surplus.** Low voltage circuit tester in steel box. Cost \$202.00. Our price \$27.50. Will test batteries, starters, generators, voltage regulators, grounds, short circuits. Wilt Electrical Company, 7829 S. Racine Ave., Chicago 20, Ill.

**NEW And used automobile and truck parts.** Lowest prices. Complete stock. Prompt reply. Babbitt Auto Parts, 2833 W. Chicago Ave., Chicago 22.

**BRUSH** Plating outfits connect to a battery. No tanks or shop required. Free particulars. Gunmetal Co., Avenue J, Decatur, Illinois.

**CAR Trouble?** Million new, used parts. Describe needs. Automotive, 2928A North Western, Chicago 18.

**AUTO Parts.** Buy direct. Get dealers' prices. Represent us in your territory. Write requirements. Specify car make. Mechanics Auto Parts, Factory Warehouse, 3807-PM N. Ashland, Chicago 13.

**AUTO Parts** for all cars, transmissions, motors, differentials, fenders, carburetors. Security Auto Parts, 1923-PM Grace, Chicago 13.

#### AUTO TRAILERS

**TRAILER Plans,** parts, accessories—complete line. Prompt delivery. Catalog 35c (coin). Catalog plus booklet, "Trailer Building," \$1.00. Marine Mart, Buffalo 7-B, New York.

**BUILD Your own trailer!** Save money! Have every feature you want! Plans for house, sport, camp and utility trailers. Catalog describing 9 models 10c. 15c in Canada and overseas. Jim Dandy, Box 125-A, Wausau, Wisconsin.

#### MOTORCYCLES, BICYCLES, MOTORSCOOTERS AND SUPPLIES

**MOTORBIKE** Less motor \$5; new motor bike conversions \$5; used motors \$3 up; 4 h.p. Merkel bicycle motor \$25; Briggs motorbike complete \$38; factory built motorscooter complete \$40, others as low as \$7; midget racer and parts \$40. January special: Four balloon tires \$3. Mail-order only. Over 6000 tires in stock. Plenty new midget cars, motorscooters, automatic clutches, transmissions, engines at factory prices. Send 25c for big war-bargain catalogue Number 28 just out listing the above and almost 400 other bargains. (35c by first class mail). Midget Motors Directory, Athens, Ohio.

**BRIGGS Motor** \$15. Maytag, \$15. 3 h.p. motor, \$50. Motorbike, \$40. Cushman scooters, Whizzer motorbikes, race cars and motorcycles. 25c in coin or 35c first class mail. Behnke's, Dept. B, 5721 Leland, Chicago 30, Ill.

**BICYCLE Supplies.** Wholesale, retail list 10c. Universal, 4713 Virginia, St. Louis, Missouri.

**MOTORIZED Vehicle manual.** How to build scooters, midgets, conversion, water injections, streamlined trailer, lightplane, air-cooling Ford motor, etc. \$1.00. Craftsmann Books, Box 1153, Milwaukee, Wis.

**MOTORCYCLE Pistons** and parts, new, used. Harley, Indian, Henderson, Super-X. List 10c. Ballak, 811 N. 9th, St. Louis 1, Missouri.

**REVOLUTIONARY** New Weber high-compression aluminum cylinder heads for Whizzer motorbikes and Cushman motorscooters. Increased power, greater economy, eliminates gasket troubles. Whizzer head \$5.95; Cushman head \$6.95. C.O.D. or cash with order. Dept. 1-49, Weber Tool Co., 4200 Whiteside, Los Angeles 33, California.

**DRI-SEAT.** Newest all weather, bright colored plastic bike saddle cover. Retail 39c. Agents \$2.40 dozen. Sample 25c. Main Supply, Fairfield, Illinois.

**MOTOR Scooters,** bicycle engines. 120 miles gallon. Dime for catalog. Clymer, Desk A-15, 1268 So. Alvarado, Los Angeles 6, Calif.

**MOTORSCOOTERS.** New design, 6 big features. Literature 10c. Rollaway Motors, Lancaster, N. H.

**MOTORCYCLE News,** monthly. Yearly subscription \$1.00. Latest worldwide information. Sample 15c. Motorcycle News, 5424-A Sawyer, Chicago 25.

**MODERN Motorcycle Mechanics Manual**—Latest third edition 600 pages 275 illustrations, covers all British and American motorcycles, most complete motorcycle book available; \$4.00 postpaid. Nicholson Bros., Saskatoon, Canada.

**RECONDITIONED Motorcycles** and motors. Chromium accessories. Complete stock Indian parts. Expert rebuilding. Fast service. Indian Motorcycle Sales, Kansas City 1, Mo.



**COMPLETE One Stop Harley Davidson Sales Service, 813 Ohio Street, Wichita Falls, Texas.**

**HARLEY-DAVIDSON** Parts, accessories, oil, expert service. Tires all sizes. Rebuilt 45" motors. Send \$2.25 for Army 45 Motorcycle Manual. 25c for accessory catalog and bulletins. Knuth's (Harley-Davidson Dealers), 2491 Fondulac, Milwaukee, Wis.

**WHEELS!** Build wagons, scooters, mowers, trailers, wheelbarrows, grocery carts, baby carts, play pens, baby carriages. 4" to 16". Free list. Trulsen Mfg. Co., 811 E. 31, Kansas City, Mo.

**TIRES** And industrial wheels, suitable for scooters, wheelbarrows, farm equipment, etc. All sizes. Bicycles and accessories. Largest assortment in America. Send dime for list. Cycle Transport Company, 1241 So. Michigan Ave., Chicago 5, Illinois.

## AVIATION

**FAMOUS "Zweng Texts"** include Mechanic's Rating \$3.00; Flight Engineer \$4.00; Pilot's Rating \$3.00; surplus sextants \$12.50. (Free catalog). Pan American Navigation Service, 12021-6 Ventura Blvd., North Hollywood, Calif.

**AERO-SLED** Blueprints \$3.00. Open model. Supplies. Adastik Engineering, Grand Rapids, Mich.

**LIGHTPLANE** Manuals, blueprints. Circular illustrating designs, motors 20c. Craftsman Books, Box 1153, Milwaukee 1, Wis.

**DURALIUM** SnowPlane skis—12"x96"—\$180.00. Complete fittings. Call Air, Afton, Wyoming.

**MAN-Carrying** primary glider folder 25c. McFarland Aircraft Co., Greenville, Ohio.

**PROPELLERS**—2-3 Blade for sleds, air-drive boats. Catalog. Standard Aero Craft, Box 387, Ft. Worth, Texas.

**PROPELLERS**, Plans for ice sleds, snow sleds, air boats. Catalog 10c. Banks-Maxwell, Ft. Worth.

## BATTERIES, GENERATORS

**EDISON** Non-Acid lifetime storage batteries for home lighting, motors, industrial uses, radios, etc. Free interesting literature. Hawley Smith Co., Croton Falls 1, N. Y.

## ELECTRICAL SUPPLIES

**ELECTRIC** Pencil: Engraves all metals \$1.25. Beyer Mfg., 10511-H Springfield, Chicago 43.

**FREE** Catalog—Motors, welders, welding supplies, generators, home freezers, rotary snow plows, many other electrical bargains. LeJay Company, Minneapolis, Minnesota.

**NEW**, New—Amazing simple kit for single, two or three phase motor group connections. Complete \$3.00. Motor Winding Calculator Service, Box 124, Hasbrouck Heights, N. J.

**LAMPS**—Build own originals. Parts wholesale any amounts. Catalogue 10c. Brown Lamp Co., Box 501, Wellston, St. Louis, 12, Mo.

**TRANSFORMERS**—120 volt input, 10 ampere capacity, 12 to 120 volts in 16 steps. Operates on many voltages. Swell for electric trains, can be used in plating outfits. Runs surplus a.c. motors, etc. Transformer heavily built to last. Shipped in waterproof cartons. Diagram furnished indicating leads and voltages. Each \$10 f.o.b. Dale Z. Maisel, Baltimore 28, Md.

**MOTORS**, New General Electric  $\frac{1}{3}$  horsepower \$12.50. Free literature. Plenge, 114 Elliot Place, Bronx 52, New York.

**RECONDITIONED** G.E., Westinghouse, wattour meters. Ideal for cabins, trailers, shops. \$2.95. T. Price, 310-14th, Raymond, Washington.

**LAMPS**—If you build or repair, send 10c for 36 page, illustrated catalog showing every part necessary. If dealer send business card for quantity discount. Gyro Lamps, 5402P Clark, Chicago 40.

**TWO** Alnico (V) magnets, booklet, literature, 25c. Terry Sales Company, 1915-23 Nebraska, Toledo 1, Ohio.

## WELDING, SOLDERING, PLATING

**RADIATOR** Repairing, cleaning, re-coring. Our instructions tell how, how to equip a small shop at low cost, where to buy. Radiator Book. McBain, Michigan.

**WELDER**, Cutter: 110 a.c.-d.c. \$12.00. Standard welding materials. Trowbridge, 653 West 81st, Chicago 20.

**BUILD** Your own arc welder. Save money. Welder transformer parts kit only \$18.95. Easy to assemble and operate. Simplified instructions furnished. 75 ampere capacity from 110 volt line. Build or repair auto, home appliance and farm implements for yourself and others. Does brazing, soldering, welding, cutting. Write for free particulars. Order today. Money refunded if not satisfied in 30 days. Dynamic Welder Co., 17 E. 23rd St. MA, Chicago 61, Ill.

**USED** Welding helmets \$2.50. Electrode holder \$2.50. Gas and electric welding wire. We repair, sell, trade all kinds of welding equipment. Welding Headquarters, 2425 Milwaukee Ave., Chicago 47, Ill.

**WELDING**—Learn a profitable trade quickly at best equipped school in U. S. G.I. approved. Free catalog. Write Hobart Welding School, Box M-194, Troy, Ohio.

**"BUILD-UR-OWN"** a.c. welder and a.c. power plant. Weld, run tools, lights, motors away from power lines. Save \$350. Easy with Hobart generator plus auto engine. Write for free instruction book. Hobartweld, Box M-193, Troy, Ohio.

**ACETYLENE** Welding outfits, new \$54.50; arcwelders. Eagle Welding, Dept. PM, 5085 Broadway, Chicago 40, Ill. Distributors wanted.

**WELDER!** New portable Champion Special transformer welder; 110/120 volts a.c. develops to 75 amps.; 9 heat stages. Welds, brazes, solders, cuts all metals. Easy to use. Simple instructions. Special flame weld torch free. Splendid for shop, farm, home repairs. Saves hundreds of dollars yearly. Only \$27.50. Also heavier models. 10 day free trial. Magic Welder Co., 239 MP Canal St., New York, N. Y.

**BUY** Welders direct from manufacturer. Save dealers commission. Hoigerson's Service, Canton, Kans.

**WELDERS** 110v. Welds  $\frac{1}{2}$ " steel \$32.50. Morris Welding Service, 1850A State, Schenectady 4, N. Y.

**BUY** Direct from factory. Welding outfit, \$48.36. Soldering outfits \$7.76 to \$10.16 complete prepaid. Box 331, Hamilton, Ohio.

**OWN** Mirror shop. Resilver mirrors. Glass sign making. Electroplating. Supply prices. John Sprinkle, V55, Marion, Indiana.

**RECTIFIERS:** Ramyr Selenium platers, 10, 30, 50, 100 amp. sizes. Immediate shipment. Complete line of bronze baby shoe mounts. Write for list. Hollywood Bronze Supply, 1770 N. Vermont, Hollywood 27, Calif.

## MACHINERY, TOOLS, SUPPLIES

**FREE** Sample! Weekly "Surplus Reporter," Tipp City 15, Ohio. Rush name.

**BENCH** Saws. All metal, ball bearing, arbor pulley, adjustable rip fence, indexed mitre gauge, 6" circular blade, cuts 2x4s. Unconditionally guaranteed. \$35.00 value. While they last, only \$10.95 postpaid. Hurry! No c.o.d.s. R. M. S. Products Company, P.O. Box 229, Hollywood, Calif.

**VARIABLE** Speed attachment, fits almost all drill presses, \$27.50. Also bench model for lathes and other machinery, \$21.00. When ordering specify make and model of your machine. Era Meter Co., 3934 N. Kilpatrick Ave., Chicago 41, Ill.

**FIRE** Extinguishers, C-O-2, \$5.95. Agents wanted. Fess-Co., 98 Vermont, Newark 6, New Jersey.

**CHUCK** Adapters for  $\frac{1}{4}$ " drills. For arbor hole rotary attachments. \$1.00 each. Mailed prepaid. Send check, money order: Ajay Sales Associates, 140 West 42nd Street, New York 18, N. Y.

**POWER** Tools. Build your own with Lewis castings. Save up to 80%! Complete castings, materials and blueprints supplied for 23 woodworking and metalworking tools. Free catalog. Write today. Lewis Machine Tool Co., 3217 Union Pacific Avenue, Dept. M, Los Angeles 23, Calif.

**GAS** Drive arc welders. "build-ur-own" portable. Goes everywhere after profitable jobs. Free instruction book. Write Hobartweld, Box M-195, Troy, Ohio.

**ARMY** Weasels (snow tractors). New M-29C \$1,695. Reconditioned \$900. Parts. Symington. Union Bay Place, Seattle 5, Washington.

**DRILL** Press attachment instantly converts to shaper. Shaper head with 5 blades, \$3.98 postpaid. Free circular. Thayercraft, Box 182, Culver City, Calif.

**HYDRAULIC** Transmission, Vickers, \$14.00. Other big bargains in war surplus geared speed reducers, motors, switches, etc. Send for free catalog. Delta Sales, P.O. Box 968, Shreveport, Louisiana.

**BALL** Bearings one-fourth list price. Free list. Burgess, Box 168, Ferguson, Mo.

**PRECISION** Tools, used micrometers, verniers, height gages, etc., bought, sold, exchanged. Precision Exchange, 30 Church Street, New York 7, N. Y.

**DRILL** Grinder for twist drills, \$2.95. See ad on page 268.

**V-BLOCKS** With clamp. Big value \$3.45. Guaranteed accuracy. Write Miles Products, Lyons, Ill.

**HOME** Lathe owners—Build your own attachments. Send for picture, sample of work and list of blueprints. Cut gears, ratchets, etc. Make neat screws easy way. The Home Shop, 415 Raymond Ave., Glendale 1, Calif.

**CHUCKS**, (Genuine Westcott) Independent, Universal, threaded  $1\frac{1}{2}$ "-8 for South Bend, Atlas, Logan, Clausen, Craftsman lathes. Also other chucks to 16". Top value. Free literature. Westcott Chuck Co., 3600 Walnut, Oneida, N. Y.

## BOATS, OUTBOARD MOTORS

**BOATS** And all about them. How to select, build, repair and operate. For 40 years the leading practical boating magazine. Half price trial subscription. 12 issues for \$1.00. Motor Boat, 62 Gold Street, New York 7.

**CROSLY** 26 h.p. motors. Convert outboards. \$265 including conversion parts. Weight 120 lbs. Send dime. Robinson Boats, Osceola, Iowa.

**P-38** BELLY Tanks. New, steel, 10 foot or 6 foot size, \$9.95. Anzio Boat Company, 89H, Merced 9, Calif.

**MARINE** Reverse gears and air-cooled motors, propellers, shafts, etc. Complete kits or separately. Rowboats, outboards, inboards 14', 16' reasonable. Special discounts dealers and liveries. Free literature. Steffy Screw Products, New Baltimore, Michigan.

**HOW** To Make Money With Boats—15,000 word copyrighted book makes boating profitable. Includes chartering, commercial fishing, sport fishing, world cruising, marine photography, water taxi and sight seeing service. Earnings to \$1,000 month. \$1.00 postpaid. The Boat Company, 6227-A 32nd Avenue N.E., Seattle, Wash.

**FISHING** Boat plans—For pleasure and profit. \$1. Albert Schantz, Baden, St. Louis 15, Mo.

**OUTBOARD** Motorboating handbook. 252 pages, 89 charts, drawings. Complete service information every make outboard. Greatest outboard book ever. Just published. \$3.50 postpaid. Clymer, Dept. A-OM, 1268 So. Alvarado, Los Angeles 6, Calif.

**BOAT** Plans, kits, hardware, conversions, plywood. See display adv. page 269. Marine Mart, Buffalo 7-B, New York.

**TWENTY** Plywood boat plans \$1.00. Catalog boat building plans 10c. The Rudder, 15 Murray Street, New York 7.

**BOAT** Steer wheels, windshield brackets \$8.95. Modern hardware kits, bargains galore. Folder. Marine, Box 681, Mendota, Minnesota.

**NEPTUNE** Outboard motors. Wholesale prices all sizes. Outboard Sales, 820 Dryades St., New Orleans, Louisiana.

**BOAT** Plans by graduate naval architects. Send specific requirements for free suggestions. Westlawn Associates, Montville 5, N. J.

**BUILD** Your own boat by the Welch System, ready cut parts. No experience necessary. Save  $\frac{2}{3}$  cost. Rowboats to cruisers. Illustrated catalog 25c. Midwest Boat Company, Menomonee Falls, Wis.

**OUTBOARD** Motors—Good values, used motors. Also used parts for most makes and models. Crandall-Hicks Co., 911 Commonwealth, Boston, Mass.

**MARINE** Conversions for Ford and Jeep engines. Catalog 10c. Lehman Manufacturing Company, Department D, Newark 2, New Jersey.

**NEW**, Used, rebuilt marine motors. Marine conversions, fittings. Free catalog. Stokes Marine Supply, Dept. 24, Coldwater, Michigan.

**OUTBOARD** Motor parts. New-used, all makes. New pistons (standard, oversize). Cylinders rebored. Outboard Motor Mart, 309 Atlantic Ave., Boston 10, Mass.

**COMPLETE** Constructional details on seventeen low-cost boats—power, sail, row. Designed for home builder with limited tools, no experience and little money to spend \$1.25. Popular Mechanics Press, (C-43), 200 E. Ontario, Chicago.

## ENGINES, MOTORS, DYNAMOS

**GAS** Drive arc welders, "build-up-own" portable. Get profitable jobs anywhere. Save \$350 with Hobart generator plus auto engine. Free instruction book. Write Hobart Weld, Box M-196, Troy, Ohio.

**MOTORS!** 1/2 H.P. D.C. converted to A.C. All new. High speed 110 volt, 25 or 60 cycle, ball bearing motors. Actual value about \$75.00. Now \$15.00 each or 3 for \$40.00. Countless uses for home mechanics. Can be used in any position. Order today! Immediate delivery! No c.o.d. orders. "Amazing Bachman's," 27 Herman Street, Rochester 5, New York.

**WELDING** Generators, 150 ampere \$47.50. 1/2 horse, 1750 r.p.m. motors \$19.75. 3/4 horse, 3450 r.p.m. \$23.50. 1 horse \$28.50. Compressors \$17.50. Butler, 1885 Milwaukee, Chicago.

**WINDING** Data, listing 225 motors, single and three phase. \$1.00. Motor Data Co., Box 7631, Kansas City 3, Mo.

**MOTOR** Repair men, send for bulletins on motor winding tester and a.c. motor winder. Motor Industries, Quincy, Illinois.

## ATHLETIC EQUIPMENT, BODY BUILDING COURSES

**BARBELLS**, Exercise equipment. Courses. Free booklet. Good Barbell Co., Reading, Penna.

**DEADLY** Judo—Fiercest fighting technique. Trick knockouts. (200 photographs, plus illustrations.) Expert instructions, three volumes. Complete \$2.25. Variety House, Box 46-B, Wall Station, New York 5.

## SPORTING GOODS, GUNS, FISHING TACKLE, ARCHERY, TRAPPING

**USHER'S** 1949 Fishing calendar. Reveals very best fishing days. 85% correct. \$1.00. Reuben Usher, House of Usher, Dallas 11, Texas.

**PLASTIC** Fish hook holder, cane pole fishing, no line tangle, sample 50c postpaid, agents wanted. Berning, 606 Haynes Street, Dayton 10, Ohio.

**BOAT** Seat. Really relax while fishing. Postpaid \$3.95 or build it yourself, drawings complete 25c. Comfyseat, Box 350, Kenosha, Wis.

**SINKER** Molds for fishermen. Free catalogue. Sweet's Molds, Tonawanda, N. Y.

**SEND** 10c For list used and new guns. Frayser's, Willmar, Minn.

**PISTOLS:** Mechanically perfects; 9m/m Luger \$65.00. Walther P-38 9m/m \$50.00. Colt .45 Auto \$55.00. Walther .32/7 .65m/m \$50.00. Mauser .32/7 .65m/m \$50.00. Beretta .32/7 .65m/m and/or 9m/m \$50. Complete firearms; ammunition lists postpaid 25c. Frank Farish, Vicksburg, Miss.

**SHOTGUNS**, Rifles, revolvers, over 500 modern, obsolete. Also cartridges, list 10c coin. Ed Howe, 52 Main, Coopers Mills, Maine.

**SHOTGUNS**, Rifles, handarms, ammunition, rods, reels. List 10c. Rudolph's, Atchison, Kansas.

**5000 BARGAINS**, Firearms, binoculars, war relics. Catalog 40c. Smith Firearms, Rummene, New Jersey.

## TAXIDERMY

**LEARN** By mail to mount birds, animals, game-heads, fish and all specimens. Tan furs, make leather. You can learn at home, quickly, easily, from our simple lessons. Tuition fee very low. We have taught over 500,000 students during 40 years. Wonderful hobby. Great fun and profits. Have a home museum, decorate your den, mount for others. Rush postal today for free strange 44 page book with over 100 game photos. No obligation. State your age! Northwestern Taxidermy School, 2541 Elwood Bldg., Omaha 2, Nebr.

## BINOCULARS, TELESCOPES, MICROSCOPES, MAGNIFIERS

**BINOCULARS**, Telescopes, watches, guns. Buy, sell, trade. Schweer's, Donnellson, Iowa.

**FOLDING** Telescope. Brings objects five times closer. \$2.00 postpaid. Grossman, 100 West 42nd, New York.

**REFLECTING** Telescopes. 60X, completely assembled \$25.00. Guaranteed observatory clearness. Free information. Skyscope, 475 Fifth Avenue, New York 17.

**BINOCULAR** Bargains. Write for free illustrated circular. Thayercraft, Box 182, Culver City, Calif.

**"TERRIFIC"** Bargains — Government surplus telescopes, binoculars. Send \$1.00 for 10 piece hobbyist lens set. Contains magnifying and reducing lenses. Send stamp for "bargain" list. P. Jaegers, 93-08 95th Ave., Ozone Park 16, N. Y.

**GIANT** Astronomical telescope 100 diameters magnification, with tripod. Full power, clear vision. \$15.00. Suffolk Science Service, Manorville, N. Y.

**POWERFUL** Astronomical telescopes easily made. Perfect lenses and instructions; 100X \$3.00, 100X and 200X \$4.00, 100X, 200X and 400X \$6.00. Clear vision, full power guaranteed. Instructions alone 10c. Suffolk Science Service, Manorville, N. Y.

**ASTRONOMICAL** Telescopes, binoculars, microscopes; bought, sold, repaired. Books. Lists 10c. Rasmussen-Reece, Amsterdam, N. Y.

**TELESCOPES**, Binoculars, microscopes, big bargain catalog free. Brownscope Company, 24 West 45th Street, New York.

## DOGS, PETS, BIRDS, RABBITS

**RAISE** Guinea pigs. Make money at home. Big demand. Booklet free. Taylor, Box 462A, Hapeville, Georgia.

**HOHL'S** Hamsters. Clean, odorless pets. Literature and picture free. Lab. stock. 317 Mt. Vernon Rd., Newark, Ohio.

**MINKS**, Raccoons, bred females. Baby skunks. Catalog, 25c. Shady Fur Farm, Springfield, Minnesota.

**RABBIT** Hutch and housing. New, revolutionary patented features, automatic, economical enabling two persons care for 1000 does. Plans, photographs \$5.00 postpaid. Reliable Fur Industries, Dept. P. M., Montebello, Calif.

**BEAUTIFUL** Pure white pedigreed police puppies. Ansonia Kennels, Mose, North Dakota.

**\$3000 YEARLY** Raising Angora rabbits. Circular free. Vaughn's Rabbitry, Otley, Iowa.

**SEE** Golden Hamsters ad on page 18. Shows picture of Hamster.

**\$50.00 WEEKLY** Raising Angoras for us. Free literature. Associated Angora Breeders, 610 Marshall, St. Paul, Minn.

**RAISING** "Hamsters is profitable." Information. Pem's Hamstervy, 3010-10th Ave. No., St. Petersburg 6, Fla.

**\$1.00 FOR** Booklet "Canary, Its Care, Breeding and Training," and three copies cage-bird magazine. American Canary, 2839P N. Halsted, Chicago 14, Ill.

**ANGORAS**, Giant Chinchillas, White Giants. World's most profitable rabbits. Finest pedigreed, heavy-producing, prize-winners. Literature free. Grinsteeds, Edwardsville, Illinois.

**RAISING** Rabbits, Cavies, Hamsters, Chinchillas is profitable. Big demand. Instruction book and magazine 25c. Book and magazine (monthly) one year, \$1. Small Stock Farmer, Fairlawn 2, New Jersey.

**MINK** Raising information free. Complete. Lake Superior Mink Farm, Superior, E.E. Wisconsin.

**MAKE** Extra cash. Raise giant chinchilla rabbits. Waters Rabbit Farm, Glennville, Ga.

**RAISE** Chinchilla rabbits. Year-round money-makers from furs, meat, breeders. Experience unnecessary. Folder 25c. Willow Farm, Sellersville 15, Penna.

**\$250.00 MONTHLY** Raising angora rabbits. Particulars free. White's Rabbitry, Newark, Ohio.

**MINK** Raising amazingly profitable. Free folder gives inside "secrets" on feed; care. Lawrence Molgard, Brigham City 12, Utah.

**INCREASE** Your income by raising domestic rabbits. Small space needed. Ready market for delicious meat, fur and wool. Largest magazine in the industry tells you how. \$1.50 per year. Sample 15 cents. No stamps. Small Stock Magazine, Lamoni 20, Iowa.

**\$3000 YEARLY** Raising Angora rabbits. We buy your output. Contract particulars free. Kise's Enterprises, St. Paul 8, Minn.

## PLANTS, SEEDS, NURSERY AND GARDEN SUPPLIES

**RAISE** Your own trees and shrubs from seed for shade, windbreak, snow fence, etc. Write for free planting guide and price list. Woodlot Seed Co., Norway 4, Michigan.

**GROW** Newest marvels of science. Mid-get vegetables, prize-taking flowers, hybrid hullless popcorn. See latest garden gadgets in big free Seed and Nursery Annual. Write Farmer Seed & Nursery Company, 34 No. 32 St., Faribault, Minnesota.

**WE** Sell on the installment plan. Best varieties peach and apple trees, low as 12c; grapevines 4c; shrubs 13c; evergreens 15c. Berries and plants. Catalog free. Benton County Nursery, Box 542, Rogers, Arkansas.

**GLADIOLUS**—New varieties, novelties, list. Robinson, Box 31, Sebastopol, Calif.

## FARMS, FARM LANDS, REAL ESTATE

**BIG** Lists farms, ranches, water frontage properties. Free descriptive folders, prices. Splendid opportunities, Washington, Idaho, Montana, Dakotas, Upper Michigan, Wisconsin, Central Corn Belt. Information regarding Columbia and Missouri River Basin irrigation projects. L. H. Robbins, Milwaukee Railroad, 736K Union Station, Chicago 6, Illinois.

**\$1,000 BUYS** 40-Acre farm. Improved 40-acre Ozark farm with bearing 3-acre orchard, all sacrificed by owner with other interests, requires only half down! Two towns within 10 minutes, mile highway and electric line; 20 acres cultivated, balance woodland pasture watered by spring and well, woven and barb fencing, 110 apple trees, 14 other assorted fruit trees; good-to-fair 3-room house, composition siding, well at back porch, good 36-ft. barn, poultry house needs repair; taxes only \$8; 30-day possession, demands your immediate attention at only \$1,000, half down. Details page 31 big free winter catalog many states. United Farm Agency, 220-PM South State St., Chicago 4, Ill.

**STROUT'S** Fall-Winter farm catalog—free! Red cover. Chock-full of bargains coast-to-coast. Eqpd. and uneqpd. farms, groves, retirement places, etc., etc. Write today for your free copy. Strout Realty, 255P 4th Ave., New York 10, N. Y. 20 W. 9th St., Kansas City 6, Mo. 453 S. Spring, Los Angeles 13, Calif.

**GOOD** Farms—Ranches. Washington, Minnesota, Montana, Idaho, Oregon, North Dakota. Dependable crops, favorable climate. Write for literature, lists describing typical farm opportunities. Specify which state. J. W. Haw, 119 Northern Pacific Railway, St. Paul 1, Minn.

**\$5.00 MONTHLY** Buys 40 acres. Near town; price \$200.00. Free list; Box 425-P, Carthage, Mo.

**OZARK** Magazine. Eureka Springs 11, Arkansas. For homeseekers, tourists. Year, \$1.50.

**SOLD** For taxes, Calif., Oregon, Washington timber, grazing, ranch and mining lands. 25c to \$3 acre min. bid, 10c (coin) brings circulars, photos, maps. Pacific Lands, Box 2350-PM, Hollywood, Calif.

**LOTS** \$300—Convenient payments, California's finest garden section. On Morro Bay's scenic shores. Wonderful fishing, hunting, boating, bathing. Fertile soil, softest water, temperate climate, congenial community. Free literature. Richard Otto, Department M, San Luis Obispo, California.

**OZARK** Lands for all purposes. Actual river frontages, 5 acres \$90.00 and upwards. Free list and literature. Hubbard, 424-I Minnesota Ave., Kansas City 4, Kansas.

## POULTRY, FARM SUPPLIES

**COLONIAL** Chicks. World's largest production means lowest prices. Leading breeds. U. S. approved. Catalog free. Colonial Poultry Farms, Route 31, Pleasant Hill, Missouri.

**\$6.95 BUYS** Smith Money-Maker chicks. Assortments. Purebreds. Blood-tested. Pedigree-sired sexed pull-ts, males, too. 100% live delivery. Catalog free. Smith Chickeries, Box 262-32, Mexico, Missouri.

**1949 EXCELLENT** Poultry profit year! Demand greater, prices higher. Our editors help you make more money. Mail \$1.00 two-year trial subscription today! Poultry Tribune, Dept. 16, Mount Morris, Illinois.

**RAISE** Fryers new easy way. One man home plant earns \$500 monthly. Farm proven methods. Circular 10 free. Poultrymen's Institute, 1046 So. Olive, Los Angeles 15, Calif.

**BABY** Chicks, champion mated. 52 varieties, 6 hybrids, licensed inspected, bloodtested. Rush postal, large colored book free, low prices. Berry's Farm, Route 12, Clarinda, Iowa.

**RAISE Turkeys the new way.** Write for free information explaining how to make up to \$3000.00 in your own backyard. Address National Turkey Institute, Dept. 3, Columbus, Kansas.

**EARN \$4 To \$12 hourly.** Chick sexing, culling and caponizing. G.I. approved. Pilch's School, Box PM, Thompsonville, Connecticut.

**KNOW How to raise poultry for profit.** Read Northeastern Poultryman. Every issue packed with helpful hints and practical suggestions. Latest articles on breeding, feeding and management. Subscribe now. 1 year 65c. 2 years one dollar. Foreign subscriptions \$1.00 a year. Northeastern Poultryman, Dept. P.M., 376 Boylston St., Boston 16, Mass.

### PROFITABLE OCCUPATIONS

**MUSHROOMS** Grown, boxes, barrels. Instructions 50c. Spawn \$1.00. Manureless process \$2.95. Gordons, 553 William, Winnipeg, Manitoba.

**CONSTRUCTION** Report—Send \$1.00 for world wide job project listings. Up-to-minute facts for construction men. Global Reports, P.O. Box 883-DX, Hollywood 28, Calif.

**MAKE Flexible molds!** Cast plaques, novelties, bookends! Free sample! H. Tooker, Hamilton 9, Ohio.

**GOOD Profits easily earned** decorating new, fast selling line of beautiful wall plaques. Special process decorates in 90 seconds. Plastex Products, 1025 Prague, San Francisco.

**MAKE Liquid marble, artificial marble flooring.** Flexible molds, statuary, art goods, novelties. Literature free, Kemico, Park Ridge 50, Ill.

**EARN \$50.00 Or more weekly** operating nut and gum vending machines in your spare time. Details free. Danco Coin Machine Co., Dept. PM, 1304 E. Baltimore St., Baltimore 31, Maryland.

**MAKE Men's and ladies' plastic wallets.** Everything furnished. Details free. Lakeshore Supply, Dept. PM-1, 534 Surf St., Chicago 14, Ill.

**START Profitable business:** paint figurines; full instructions. Art Industries, 314 Westport, Kansas City, Mo.

**FOREIGN Employment?** List of overseas projects and sample application form. C.O.D. \$1.27 or \$1.00 cash. Foreign Service Institute, Box 3934, Miami 24, Fla.

**YOU Can make real money** raising Golden Hamsters. New tiny animal. Easily raised at home. Write for details. Hudson Hamstery, R.F.D. No. 1, Newfoundland, N. J.

**MODERN Trapping \$1.00.** Also free catalogue interesting books. A. Fallor Company, 201 Dewey Street, Newark 8, New Jersey.

**START Your own business** on our capital. Always your own boss. Hundreds average \$8,000 to \$25,000 annual sales year after year. We supply stocks, equipment on credit. 200 home necessities. Selling experience unnecessary to start. Wonderful opportunity to own pleasant, profitable business backed by world-wide industry. Write Rawleigh's, Dept. A-U-PPM, Freeport, Ill.

**PROFITABLE Business** making and building with easy-laying interlocking building blocks. Rex Products, Dept. 10, Piqua, Ohio.

**EXCELLENT Profits.** Make, sell holiday flowers, novelties. Literature free. Velva Artercrafts, 324-M East 14, New York 3, N. Y.

**"FROG-RAISING"**—New book explains everything! Marlboro, 1035 Marlborough, Detroit 15, Michigan.

**BE The Popular Mechanics** representative in your neighborhood and earn big profits in your spare time. Write Popular Mechanics Magazine, Room 408M, 200 E. Ontario St., Chicago, Ill.

**"MOST Everybody likes candy."** Learn to make in a professional manner. (Our 38th year.) Ragsdale Candies, D6, East Orange, New Jersey.

**\$46 FROM Square foot plywood;** jigsaw necessary. Write, Woodarts, P-38, Bridgewater, Mass.

**LOCKSMITHING Secrets**—Key fitting, lock opening, repairing, prices to charge, supply sources. Illustrated book only \$1.00. Wechsler Supply, 7 W. 36, New York City.

**WOULD You pay 3¢—first \$350 made?** Color-illustrated book "505 Odd, Successful Enterprises" free! Some offer occasional "day off." Work home. Expect something odd! Pacific, Oceanside, Calif.

**OWN Mirror shop.** Resilver mirrors. Glass sign making. Electroplating. Supply prices. John Sprinkle, V50, Marion, Ind.

**\$40.00 WEEKLY** Made growing mushrooms, fresh, dried. Dominion patent 331583. Free spawn. North American, 169P Yonge, Toronto, Canada.

**INTERESTED** in Latin American and foreign employment? \$1.00 brings Foreign Service Directory listing exporters and importers, oil, construction, mining, aviation companies. Hot tips for applications. Global Reports, Box 883-M, Hollywood 28, Calif.

**OPERATE A letter shop.** Unlimited opportunity. Send for free prospectus. Dougherty, 255 Washington, Phillipsburg, N. J.

**ALASKA**—The Last Frontier offers unlimited opportunities. \$1 brings government map and directory listing firms in fishing, construction, mining, aviation, fish and game rules, homestead data. Alaska Opportunist, Box 883-M, Hollywood 28, Calif.

### BOOKS, PERIODICALS, PICTURES, POSTCARDS

**EASY Profits** taking magazine subscriptions, handling greeting cards. Full details free! Cassell Publishers, Westfield, N. J.

**SHIP Photographs.** Lists free. Scozzafava, 1648 59th Street, Brooklyn 4, N. Y.

**LEARN Amazing secrets** of guerrilla self defense. Send for free particulars of book. Michael Wrona, 2027 N. Park Ave., Tucson, Arizona.

**WILL Pay up to \$5,000** for certain old books. Catalog 10c. Ohio Historical Publishing Co., PMJ, Columbus 1, Ohio.

**FREE Particulars** for book bargains. Rosenthal, 200 Ross, Brooklyn 11, N. Y.

**BOOKS**—Instructive, entertaining, money makers. Send wants. F. Dupont, Kenneth Ave., Arnold, Penna.

**GOLDEN Jubilee Parade,** New York. Decorated floats, girls in gay nineties costumes, drum majorettes, 10 different glossy snapshots \$1.00. 22 different \$2.00. Frederick Forman, 868 Lorimer, Brooklyn 22, N. Y.

**BOOK Bargains.** Books—used, new, library surplus, publishers' overstock, 25c up. Novels, mysteries, love, general. Free catalog. Bookland PM, CollegePoint, N. Y.

**BIG Money** selling books. Two samples and proposition, 25c. Story, 10 Prospect, Rockport, Mass.

**STARTLING Revelations!** Read "Prophetic Years 1947-1953." Free literature. Progress Company, 4033 Chown, Minneapolis 10, Minn.

**BOOKFINDERS!** (Scarce, out-of-print, unusual books). Quickly supplied. Send wants. Clifton, Box 1377-PM, Beverly Hills, Calif.

**SELF-EXPLAINING Bible:** Illustrated circular free. Box 446-P, Minneapolis, Minn.

**EXCITING And strange books.** Send 25c (coin) for catalog and private collector list. Rare Book Co., 1219 1/2 North La Brea Ave., Hollywood 38, California.

**BOOKHUNTERS!** All subjects. Send wants! Jaher Book Service, 620-P East 178 Street, New York 57.

### GAMES, ENTERTAINMENT

**ORDER Now**—Pay later. First advance in playing and pinocle card design in 90 years. Clubs are green, spades black, diamonds orange, hearts red. Plastic coated, wipe clean with damp cloth. Two decks in handsome suedette box \$1.50 postpaid. S. Friend, 304 Garfield, Brooklyn 15, N. Y.

### MAGIC TRICKS, PUZZLES, JOKER NOVELTIES

**BOOK "84 Card Tricks."** magazine "Magic Is Fun." catalog 500 tricks. all only 50c. Robbins Co., 152-P West 42nd Street, New York.

**279 MAGIC Tricks** revealed 50c, or write F. Dupont, Kenneth Ave., Arnold, Penna.

**MYSTIFYING "Magic Library."** Free folio. Lynch, 402-10 Hazlett, Baltimore 29, Md.

**ILLUSTRATED Catalogue** of quality tricks 10c. DeLuxe Magic, Box 2606, New Orleans, Louisiana.

**BLACKSTONE'S Tricks** 14—\$1.00. George Christian, 4915 24 Place, Cicero, Ill.

**ENTERTAIN, Mystify!** 96 page catalog magic, joke and party goods, 25c. Riley-Borin, P-7909 Rhodes, Chicago 19.

**500 TRICKS.** New 1949 edition. Send 10c for Douglas famous catalog showing best in good magic, lowest prices, fastest same-day service. 30 years in business. Douglas Magicland, Dept. 1, Dallas, Texas.

**LARGE 160 Page catalog,** just published, 35c. We have supplied the best tricks to beginners and professionals for 38 years. Chicago Magic Company, 2300-Y No. Mason Avenue, Chicago 39.

**400-PAGE Catalogue** of 2000 tricks, pocket, parlor, stage. World's finest magic. Send \$1.00 for catalogue (refunded first \$5.00 order). Kanter's, M-1311 Walnut, Philadelphia 7.

**DOLLAR Magic set free** with mammoth catalog 25c. "Mysto," 4462-PM Germantown, Philadelphia.

**"VENTRILLO."** Professional voice throwing instrument and "unusual" catalog 25c. POB-971, Philadelphia.

**SNEEZING, Itching, powders.** Eighteen other tricks free with joker's catalog 25c. 2404-N Fifteenth, Philadelphia.

**TRICKS, Joke novelties** of all kinds. Illustrated literature free. Rone's, Box 97, Katonah, New York.

**PROFESSIONAL Catalog.** 124 pages, 25c. Williams, 900 Plymouth, Ellwood City, Penna.

**VENTRILLOQUISM Taught.** 3c stamp bring particulars. Smith, 801 Bigelow, Peoria 5, Ill.

**WORLD'S Largest professional magic shop.** keeps you in touch with latest tricks. To receive mailings, send 50c for new catalog. Holden's, M220 West 42nd St., New York.

**MAGIC Tricks, puzzles, books, cards, punch boards.** Catalog 10c. Specialty, Box 671, St. Louis 1, Mo.

**LARGE Catalogue** of the best magic for professionals and amateurs. Send 25c. Mazda Magic Co., 1135 Westgate Ave., Oak Park, Ill.

**LEARN Magic, ventriloquism, mind-reading.** Write for particulars. Quackenbush, Big Flats, N. Y.

**VANISHING Half dollar trick** and catalog 25c. Sterling Magic Co., Royal Oak, Mich.

**200 ELECTRIC Stunts,** 110 volts, \$1.00. Kutting Sons, Campbell, Calif.

### COINS, TOKENS, CURRENCY

**35 WORLD Coins \$1.00.** List free. Harry Elsholz, Box 9014, Pittsburgh 24, Penna.

**COIN Collectors Magazine.** Sample free. Largay, Box 575, Lowell, Massachusetts.

**FREE 1931D Lincoln cent,** complete retail price lists. Reynolds Coins, Flint 3, Michigan.

**FOREIGN Coins and bills,** six different 10c. Webb, Box 473, San Bruno, Calif.

**OLD Money wanted.** Will pay fifty dollars for nickel of 1913 with Liberty head (no buffalo). We pay cash premiums for all rare coins. Send 4c for large coin folder. May mean much profit to you. Numismatic Co., Dept. 20, Fort Worth, Texas.

**INDIAN Head penny** with list 10c. Charles Banker, Salina, Kansas.

**18 DIFF. Coins 50c,** free lists. Approvals upon application. Bishop, Box 2201, Kansas City, Mo.

**LOOK At your change!** We will pay \$10.00 to \$50.00 for 1916 Liberty standing quarter, 1901-S quarter \$5.00 to \$15.00, 1913-S quarter \$2.00 to \$35.00, 1923-S quarter \$4.50 to \$20.00, 1885 nickel \$4.00 to \$12.50, 1895-O dime \$2.50 to \$50.00, 1894-S dime \$250.00 to \$800.00 and hundreds of others. Know the true value of rare coins. Send 25c for our complete buying and selling catalogue. 25c is refunded after you have bought or sold \$5.00 worth. Bargain! Rare collection 12 different dates United States large cents over 90 to 145 years old \$3.00. Worthy Coin Corporation, 294 Washington, Boston, Mass.

**MEXICAN Coins**—9 piece set. Fine to uncirculated \$1.50. 5 peso silver, \$1.35. The Border Coin Co., Sta. A, Box 3535, El Paso, Texas.

**GET Profit and pleasure** in collecting old coins. Send 10c for 56 page illustrated coin catalog. You'll be delighted with it. Send for it now. B. Max Mehl, 370 Mehl Bldg., Fort Worth, Texas. Largest rare coin establishment in U. S. Established 49 years.

**FREE!** Foreign coin, banknote and coin collectors illustrated catalog to approval service applicants. Send 3c postage. Tatham Coinco, Springfield 30, Mass.

**4-IN-1 Special \$1.00 bargain offer:** (1) United States 1893 Columbian world's fair half dollar; (2) album for holding coins; (3) large 56 page coin catalog; (4) genuine wooden nickel. Yes! All four items for only \$1.00. Order today. Money back if not pleased. Ben's Coin Company, 72 W. Washington, Chicago 2, Illinois.

SEND Dime for sales list No. 16. Acorn Stamp & Coin Co., Box 53, So. Norwalk, Conn.

WE Pay \$2.00 to \$500 each for hundreds of old coins. Indianhead, Lincoln, foreign wanted. Get posted now. Send 20 cents for illustrated coin value book. 4 by 6. Guaranteed, buying, selling. 40 years business. Coin Exchange, (7), Le Roy, N. Y.

25 COINS And bills, 25c. Oddehon, Box 482, St. Louis, Mo.

U. S. Foreign. Free lists, Slikes, 1831 E. Allegheny, Philadelphia 34, Penna.

COINS Wanted, will pay up to \$2000 for certain coins, send 25c for catalogue. Burton's, 111 So. Third, Columbus, Ohio.

COMMEMORATIVE \$1/2, Oregon, Texas, Kentucky, Cleveland, Long Island, \$2.00 ea. Illustrated catalogue 25c. Norman Shultz, Salt Lake 9, Utah.

### STAMP COLLECTING

FREE! Canadian sets, royal visit, George VI, George V, coronation, jubilee, others, to approval applicants. Ensign, Box 118-M, South Orange, N. J.

GIBRALTAR Packet free—Nice collection Gibraltar, New Zealand Centennial, British Uganda, French Colonials, early British Colonial, West Indies, South American, war stamps plus Philatopic Monthly Magazine. All for 5c postage. Empire Stamp Company, Dept. PM, Toronto 5, Canada.

EXCHANGE Stamps universe. Particulars free. "Exchangers," Bry 126, Seine, France.

"MAN Size" United States approvals! Illustrated catalog! Sullivan, Endicott Arcade, St. Paul 1, Minn.

ABSOLUTELY Free — Gilbert, Ellice, Cook Islands, Tonga, Seychelles, Ascensions. Free to approval applicants. Viking, 130Z Clinton St., Brooklyn, N. Y.

U. S. Price list, Send postage. Stanley Gibbons, 38-P Park Row, New York.

FREE—Famous Americans set, plus Flag Set, plus the National Parks Set, plus the Presidential Set to the \$5. A total of 90 stamps absolutely free to customers for our unsurpassed U. S. or foreign selections. Send 3c postage for 15 of the above mentioned stamps and full particulars. Triboro Stamp Company, 145 Nassau St., Dept. 101, New York.

FREE! 10 Mint stamps! Approvals. Wonder Stamps, 3401-B, Council Bluffs, Iowa.

STAMP Buyers' Guide plus 50 different Germany for 10c. Stampguide, Box 1649P, Oakland 4, California.

FREE: China Confucius issue with foreign approvals. Modern Stampco, Box 12, Wakefield Station, N. Y.

66 DIFFERENT Stamps, including U. S. battleships 6c. World wide approvals. Telic-Arts, Devon, Conn.

FREE! Roosevelt 4 different. Approvals. Kyle Powell, 619 Franklin, Lynchburg, Virginia.

BARGAIN. Brunei, Cayman, Cook, Leeward Islands, Toza, Grenada, Dominica, Mauritius, Tangiers, Samoa, Fiji—10c. Approvals. Seligman Stamps, 346 Lewis, Brooklyn 33, New York.

TRADE 100 Different and dime for 100 different. Stamps. Gillett, Texas.

ILLUSTRATED Album with spaces for 2000 stamps, plus stamps cataloging over \$1, hinges, gauge, 10c with approvals. Momblow, 740 Hegray, Bronx 56.

WORLD'S Most attractive stamps. Free illustrated folder. San Marino, six large colorful stamps commemorating Pres. Roosevelt, only 10c. Nations Stamps, 3338 Monterey, Detroit 6, Mich.

SIX-FINGERED Roosevelt stamp (engraving error) plus 111 different stamps from 40 countries only 5c with six-ways-better approvals. Frank P. Nagel, 674 Franklin, Denver 3, Colo.

U. S. Stamp mixture. Pound 60c. Nichols, 746 River, Mattapan 26, Mass.

WORLD War drama and color in picturesque stamps. Sailor at Sea of Azov, Flier at Sevastopol, Infantryman at Stalingrad, Panzer Division at Don River; two gorgeous souvenir sheets of 8 stamps; complete from Croatia. Only 10c. Beautifully illustrated catalogue included. Trans World Stamps, Dept. PM-2, 131 W. 42nd St., New York 18, N. Y.

100 DIFF. U. S. 50c with free price list. Carl Kloster, 4126 Winona St., San Diego 5, Calif.

STAMPS For collectors. G. D. Ridings, Melvin Hill, N. C.

50 VAR. U. S. commemoratives, 20c with approvals. Scioto Stamp Shoppe, 1141 2nd St., Portsmouth, Ohio.

STAMPS Of the United States, Canada, Newfoundland, worldwide upon request. Dan Hayden, Box 703, Bloomington, Ill.

AROUND The world—30 different countries; Basutoland, Nyassaland, Tangier, Cyprus, St. Helena, 10c with approvals. Excello Stamps, P.O. Box 95, Hackensack, N. J.

LIBERAL Premium with carefully selected approvals. Wayne Bosley, Broken Bow, Nebraska.

FREE \$6.00 Scott's International Junior Album to approval customers. Hal Buck, Box 1287, Stockton, California.

BIGGER, Better, lower priced United States approvals. Box 488, Minneapolis.

USED 1938 Presidentials 5c, 10c, 15c, 18c, 19c, 20c, 25c, 50c, \$1. Given to approval applicants. R. B. Rossom, 218 West 59th St., Chicago 21, Ill.

FREE! St. Helena pictorial, and surprise packet of triangles, airmails, to approval applicants. Pioneer, Box 414, Pasadena 18, California.

GENUINE "Goya Nude" set complete 35c. Approvals. Royal Stamp Company, Tamaqua, Penna.

RUSSIA—25 different only 10c with approvals. Douglas, Hawkesbury, Ontario.

FREE Copy stamp newspaper. Southern Philatelist, 3240 NW 27th Ave., Miami 37, Florida.

FIRST Day cover approvals. Knobel, 1918 SW 12th Street, Miami 35, Florida.

QUALITY U. S. old and new mixture, including interesting (and often valuable) perforation and watermark varieties, etc. 2 lbs. \$1.50, 5 lbs. \$3.00, 10 lbs. \$5.75. Halay, 132J West 63rd, New York 23.

U. S. Lists, fine stamps! Free! Cole, 43-A Rinewalt, Buffalo 21, N. Y.

FRENCH Colonies, 50 colorful, large pictorials, 10c only with approvals. Fields, 1939 E. 85, Cleveland 6, Ohio.

GERMANY "War Packet," assault-boats, warplanes, tanks, Hitler; interesting approvals—10c. William Deems, Ravenswood, W. Va.

BARGAINS. Unusual accumulations, mixtures, collections. Lists free. Alateo, Maynard, Massachusetts.

\$1.00, \$2.00, \$5.00 U. S. Free to approval applicants. Flamingo, Box 4038, Miami 38, Florida.

ECUADOR 25 Different 10c with bargain pricelist, and approvals. Chase, 1026 Walker Avenue, Oakland 10, California.

55 DIFFERENT U. S. stamps 20c to approval applicants. Polzin, 1138 N. 21 St., Milwaukee, Wis.

20 ASSORTED U. S. Commemorative stamps 15c. Five U. S. Air Mail 10c. Ideal, Box 179, Park Ridge, Ill.

FLAG Stamp free with U. S. approvals. Wenigman, 1933 Patterson, Chicago.

FREE Lists—Albums, packets, sets. H. Favill, Box 2005, Madison 5, Wis.

GIFT Southern Rhodesia royal visit set to approval applicants. Deane Stamps, Box 87, Miami 35, Florida.

UNITED STATES Collection. Thirty-seven different unused commemoratives, including Columbians 1893-1943 issues only. Price \$1.00 approval applicants only. "Stamps," Box 87M, Albany 1, New York.

25 NETHERLANDS Free. Approvals. Country Stamps, 7810-E Wilkeson, Tacoma, Washington.

WOW! Over 120 different including Iceland, Norfolk, Leewards, Rhodesias, Congo. Everything 10c, approvals. Lee Stamps, Acushnet, Mass.

72 DIFFERENT U. S., 10c with approvals. Album Service, Soledad 6, Calif.

1/2c UP U. S. or foreign approvals by countries. Free lists. Hurt & Fosse, Blue Ridge, Virginia.

FREE! 33 Haiti, Congo, Rhodesia, others. Approvals. Robert Keating, Box 267M, Forest Hills, N. Y.

VATICANS—25 Different mint beauties only 10c. Approvals. Wilhelms, 14646 58th Road, Flushing, New York.

77 DIFFERENT U. S. 17c approval applicants. Standard, 3817 Sackett, Cleveland 9, Ohio.

EIGHT Bicolored French Colonies free to approval applicants. Everglades, 279 N. W. 57th St., Miami, Florida.

MOZAMBIQUE Triangulars, unused. Set 10c with approvals. Vargo Stamps, 6044 South Fairfield, Chicago 29, Illinois.

AMAZING "Queer Countries" packet—Free with approvals! Saxon, Walden, N.Y. 50 DIFFERENT United States 10c. Pricelist free. Seidenberg, Eustis, Fla.

FREE, 25c Worth of stamps to U. S. approval applicants. Village Stamp Co., 90-39P 214 St., Queens Village 8, N. Y.

SAVE Money with dime-sets. Set #1, 125 stamps. 10c. Pritchard, 1119 S.E. 2th, Minneapolis, Minn.

NEWFOUNDLAND 75 Unsorted 25c. Real value. Mayfair, Regal Rd., Toronto 10, Canada.

BECOME Successful stamp dealer. Proven method. Details free. Largentiere Company, 6462 83rd Place, Forest Hills, New York.

FREE! Fifty different worldwide. Approvals. Jack Dudak, P.O.B. 150-B-1, Streator, Illinois.

TRIANGLES! Diamonds! Octagons! Midgets! Giants! Roosevelts! Hitlers! U. S. \$2.00-\$5.00! Stamp magazine. Everything 5c with approvals! Thrifty Stamps, Silver Spring, Maryland.

POSITIVELY Greatest free offer—Rare octagonal (eight sided) stamp, gorgeous diamond, giant triangle, also mammoth and midget stamps, total value \$2.00, all free to foreign approval buyers. Plus free, Scott's International \$6.00 album and latest Scott stamp catalogues. Odd Stamps, Santa Ana, California.

U. S. Catalogue free. Contains over 3000 good buys. Stone, Box 52-P, Derchester 24, Mass.

UNITED STATES Unused. Complete set 13 flag stamps plus 5c China commemorative only \$1.00. Fine approvals. Willett Stamps, Box 507, Port Chester, N. Y.

PENNY Approvals. Premiums each selection. Ruches, 941 Enfield, Thompsonville, Conn.

500 DIFFERENT World off paper 75c. Arthur Terrosson, Box 479, Bellmore, N.Y.

MIXTURE And job lot lists free. William Waugh, 2140 N. W., Washington 7, D.C.

FREE Illustrated list. Elbe dealer. "Treasure Hunt" penny approvals on request. Reed Company, Box 980, Chicago 90, Illinois.

FREE! United States commemorative price list. Historical Stamp Co., 1280 Ocean Ave., Brooklyn 30, N. Y.

TREMENDOUS Values in our unusual penny approvals. Roscoe Stamp, 1321 Roscoe, Chicago 13.

25 DIFFERENT Stamps 10c. Approvals on request. J. W. Reilly, P.O. Box 787, Ocala, Florida.

SPECIAL! 13 Different 10c sets \$1.00. Link, Box 183, Union, New Jersey 12.

50,000 STAMP Grabbags 25c each. Anderson, 630 Bingaman 1, Reading, Penna.

WANTED Unused U. S. postage stamps, small discount. Advance Stamp Company, 24 East 23rd Street, New York.

WORLDWIDE Different. 200, 25c; 500, 50c; 1000, \$1.25; 2000, \$3.00, 5000, \$15.00. Beacon Sales, Maynard 2, Mass.

CANADA Peace set 10c with attractive approvals. Rheume, 8949 Routhier, Montreal 12, Canada.

15,000 DIFFERENT Stamps 2c each! Gordon Davison, Box 1019B, Manchester, N. H.

U. S. Price list. Send postage. State Stamp Service, 1225 Park Building, Pittsburgh 22, Penna.

WORLDWIDE Packet 50 stamps 5c with approvals. Carlins Approval Service, Box 307, Fresno, Calif.

200 DIFFERENT Including Roosevelt triangle, 5c to approval applicants. M. Avalon Stamp Company, Springfield, Mass.

MURDER! Heydrich the Nazi hangerman (Bohemia-Moravia #B20 black cataloging 40c) sent to you for 3c. Special offer made strictly to introduce general approvals. Act now! Eisenmac, 3518 Cummings, Cleveland 18, Ohio.

50 DIFFERENT Stamps, triangle, airmails, etc., 5c with approvals. Carlton's, 10243 Silverton, Tujunga, California.

GIANT Bicolored royal visits, Malta pictorials, gorgeous Guianas, Goose airmail, Scandinavian packet and illustrated stamp publication, 10 cents with approvals. Crown Stamps, Box 331, Toronto, Canada.

100 ALL Different from China! Includes airmails! High values! Mint sets! Others! Only 10c to approval applicants. Star Stamp Company, Jamestown, New York.

U. S. Foreign lists free. Slikes, 1831 E. Allegheny, Philadelphia 34, Penna.

## PHOTO FINISHING

ROLLS Developed. 8 prints and one 5x7 enlargement, 25c. A trial order will convince you that our quality is the finest. Sterling, Box 2442-A, East Cleveland, Ohio.

PHOTOGRAPHY For pleasure or profit. Learn at home. Practical basic training. Long established school. Write for booklet. American School of Photography, 1315 Michigan, Dept. 3452, Chicago 5.

35 ENLARGED Reprints \$1.00. MacDonald's Photos, Box 228-J, Congress Park, Illinois.

VERY Special. Twenty; just think of it; twenty finest quality prints from your own negatives; and include, without additional cost a new roll of film, any size up to 116 (616) for only \$1.00. Send dollar bill with order. Hitone, Box 2426-A, East Cleveland, Ohio.

ENLARGEMENTS. Process flexibility permits individual perfection: 5"x7", send negative, 15c; 8"x10", 25c. Brandt Photo, Box 222F, Kenilworth, Illinois.

BEAUTIFUL Enlargement from each picture on roll 30c. Cut Rate Photos, Dept. B4, Janesville, Wis.

10 REPRINTS 25c. 50 For \$1.00. Dick's Photo, Louisville, Ky.

FREE Price list on quality developing, printing, enlarging. Write for it today. Bryan's Photo Shop, Dept. M, Panama City, Florida.

NO Negative? 8x10 glossy print and 4x5 negative of print \$1.00. Original returned. Satisfaction guaranteed. Parolen Photo, 4 Center St., Woonsocket, R. I.

WALLET Photos, cards sealed in plastic 25c each. Quick service. Dura-Seal, Laminating Dept., Box 1384, Baltimore 3, Md.

FILMS Developed and enlarged double size. 8 exposures only 30 cents. 12 exposures 45 cents. 16 exposures 60 cents. Prompt service. Mailing envelopes on request. Real Fotos, P.O. Box 172, Station B, Brooklyn, N. Y.

EXPERT Finishing. Roll developed and 8 prints 30c. Rancho Photo, Dept. P, Ontario, Calif.

TWO Beautiful prints from each picture on roll 30c. Twenty-seven years of satisfied customers. Quick service. Lens Photos, Dept. J4, Janesville, Wis.

8 BEAUTIFUL Double size pictures and roll developed 30c. 8 hour service. Free mailers. Pacific Photo Service, Box 666, San Francisco, Calif.

2 BEAUTIFUL Hi-Gloss prints each good negative and enlarging coupon with each 8 exposure roll developed 28c. Free mailers. Owlphoto Co., Weatherford, Oklahoma.

ENLARGEMENTS! 5x7, 15c; 8x10, 25c, glossy or dull. Gorgeously oil colored, 50c extra. Negatives made from your favorite photos, 50c. Rolls developed, printed, 25c. L. R., Box 1476-c, Milwaukee 1, Wisconsin.

OVERSIZE Prints; overnight service; 35c. Films developed and 8 prints near postcard, only 35c. Electronic process, non-fade, glossy pictures. Write for free mailers. Peachtree Photo Finishers, Dept. PM, P.O. Box 4324, Atlanta, Georgia.

8 PRINTS All enlarged to nearly postcard size from your roll or negatives 25c; 16-50c. (Trial offer). Willard Studios, Box 3535A, Cleveland, Ohio.

## MOTION PICTURES AND SOUND EQUIPMENT

VICTOR 16MM. sound projector, \$295. Excellent. Ampro sound projector. Excellent \$295. Robert Salmon, 3558 So. 11th East, Salt Lake City, Utah.

35MM. Sound-silent films, projectors bought, sold. Edward Elwell, Brockport, N. Y.

16 35MM. Silent sound film. Bedner, 5300 So. Talman, Chicago.

FREE. Movie catalog; samples 10c. Projectors, cameras, supplies. Goodwill Company, Jackson, Tennessee.

WRITE—Towers, 935 North 40th, Philadelphia 4. Extraordinary bargains! Films! Equipment!

NEW! Complete! 16mm. sound cartoons \$8.95. Other bargains. Waverly, 5707 South Christiana, Chicago 29.

EXCLUSIVE Movies—Sports, select films. Projectors, screens. Free catalog. Home Pix, 1674 Broadway, New York 19.

UNITED States approvals complete coverage, fine quality, attractive prices. Seminole Stamps, Box 1138-P, Coral Gables, Florida.

START Your own stamp business. Write for free circular. Donald Shepard, Box 5139, Chicago.

POUND Stamps containing thousands \$1.00. Longacre Shop, 108 West 42nd, New York 18.

BERLIN Bears, complete set of eight and 100 different stamps only 10c to approval applicants. Reich Stamp Co., 4647 Kenmore, Chicago 40, Ill., Dept. M11.

NICARAGUA "Tin Pan Alley" diamond. Ecuador showing George Washington, and American flag in natural colors. Fezzan, Trieste, "American Army" stamp, first U. S. commemorative, \$100.00 Shanghai, Corsica, Anzac, Antique, others. All 5c. Approvals. Capital Stamp Co., Dept. 2, Little Rock, Ark.

## PRECIOUS STONES, MINERALS

GEMSTONES, Rough, polished. Crystallized specimens. Every variety, lowest prices. List free. Plummer's, 5068 Brighton, San Diego 7, California.

METAL Detectors. The very latest circuit. Free literature. Hedden Metal Detectors, 3329 Liberty Avenue, Pittsburgh 1, Penna.

## HOBBIES AND COLLECTIONS

HOBBIES Catalog. Send stamp. Hobby Sales, 709 8th St. S.E., Washington, D.C.

AUTOMOBILE Radiator emblems 20 years old! Rare items. Photo and prices 50c. Bishop Emblems, Box 1906, New Haven, Conn.

POSTCARDS Your hobby? Samples, lists, dime. Wilkins, 417 Hill, London 13, Canada.

HOBBY News-letter presents latest information of lesser-known hobbies. Official organ of Hobby Enterprise Program, new and different world-wide hobby club. Sample copy, full details, twenty cents. Hep, Box 369, GPO, Brooklyn, New York.

NEW—15 Different match covers 10c. Box 202, Rochester 1, N. Y.

UNPAINTED Figurines. Illustrated list free. Oman, 642 Broadway, St. Paul 1, Minn.

WANTED Old cigarette cards. Write Charles Bray, East Bangor, Penna.

UNUSED Matchbook covers; 100 different \$1.00; free catalog. Charles Edelman, 1311C East 84, Cleveland 3, Ohio.

INVENTING Can be an interesting and profitable hobby. Write for complete particulars. Institute of American Inventors, Dept. 40-E, 1926-Eye St. N. W., Washington 6, D. C.

50 DIFFERENT Army embroidered patches \$1. Other bargains. Insignia Mart, 703A Broadway, New York 3, N. Y.

## CAMERAS, PHOTO SUPPLIES

PHOTOGRAPHY For pleasure or profit. Learn at home. Practical basic training. Long established school. Write for booklet. American School of Photography, 1315 Michigan, Dept. 3431, Chicago 5.

PHOTOCOPY Anything—Papers, books. No darkroom. \$6.95 complete. Fotoflek, 4801 Yarmouth, Cincinnati 29, Ohio.

OIL Coloring photographs can be a fascinating hobby or profitable sideline for those with artistic talent. Learn at home. Easy simplified method. Send for free booklet. National Photo Coloring School, 1315 Michigan, Dept. 3431, Chicago 5, Ill.

YOUR Prized negatives make prize winning photo enlargements with new Precise enlarger, only \$22.20 complete. Write Tam Products CM1, 3814 Wrightwood, Chicago 47, Ill.

BASS Says! At the sign of the old "Horse Trader," 38th year. Thousands of satisfied customers everywhere! Finest brands including Kodak, Bell & Howell, Argus, Zeiss, Leitz, etc. Satisfaction always guaranteed, or your money back! Bass buys 'em, sells 'em, trades 'em. Write or wire. Bass Camera Company, Dept. AG, 179 W. Madison St., Chicago 2.

FREE! 116-Page illustrated photographic catalog, send 3c stamp. Bloom's Camera Center, 1657 Main, P.M., Springfield, Mass.

200X TELEPHOTO Camera easily made. Trifling cost. Telephoto lens and instructions \$3.00. Instructions alone 10c. Suffolk Science Service, Box 208, Manorville, N. Y.

307 ALL Different 10c. You will find scores of new varieties here for your collection! Big and little stamps, bisected stamp, commemoratives, triangles, high values! Bicolored beauties! Strange countries! Every stamp is different. All for only 10c to approval applicants. Write today and receive special Ionian Island stamp extra. Garcelon Stamp Company, Box 400, Calais, Maine.

COLORFUL Chinese "victory" set, complete, mint, catalogs \$2.30, only 10c with approvals. Kalumet Stamps, 523 Detroit, Hammond, Ind.

300 DIFFERENT Given free with approvals. Postage 3c. Windsor Stamps, 1435 East 67th Place, Chicago 37.

128-PAGE United States catalog—1000 illustrations, 10c. Harris & Co., 202 Transit Bldg., Boston.

FREE! Crystal-mount samples! Harisco, 202 Transit Bldg., Boston.

GREAT "\$5.00 Catalog price for 10c" offer! (1) Big collection of 112 all different genuine stamps from Africa, South America, South Sea Islands, etc. Includes airmails, triangle and animal stamps; many others. (2) Four scarce unused United States, catalog price 40c. (3) Fine packet 25 different British Colonies—Burma, Hong Kong, Solomon Islands, etc. (4) U. S. \$5.00 high value. Total catalog price over \$5.00! Everything for only 10c to approval applicants! Big lists of other bargains given. Crystal Stamp Co., Littleton 16, N. H.

BINGO! Jackpot collection! Triangles, maps, animals, midgets. All for 5c to approval applicants only. Southwest Stamps, Box 117, Long Beach 1, California.

200 BRITISH Empire stamps; only 3c. Kenmore Stamp Co., Arlington 74c, Massachusetts.

FREE—Illustrated catalog! Kenmore Stamp Co., Arlington 74c, Massachusetts.

YOU'LL Like our American and British Colonial approvals. Write now. Chesapeake Stamps, 748 Overbrook, Baltimore 12, Maryland.

FREE. Irish commemorative collection, including rebellion issue with approvals. Raymax, 123-Z William St., New York City 7.

FREE U. S. price list, postage 3c. Mark Hanna, 335 5th Ave., Pittsburgh 22, Penna.

FREE. Triangle, Roosevelt, Vatican, Ethiopia, Hitler heads. Request approvals. Florida Stamp Company, Box 807, Miami 5, Fla.

WORLD—500 Diff. 50c, 1000 \$1.25, 75 Canada 25c, approvals, lists. Victoria Stamp Co., London 4, Canada.

WORLD'S Largest stamp (7 1/2 x 14 inches). A real curiosity! Retail for 50c, only 3c to approval applicants. Tatham Stamp Co., Springfield 30, Mass.

25 ALL Different stamps 10c. Tunis, Wakeman Ave., Newark 4, New Jersey.

ZOWIE-E! A barrel of fun for only a dime. 500 United States stamps—absolutely unpicked and unsorted—just as received from church missions. Many varieties, including large commemoratives, airmails, high denominations up to \$5.00! Stampdom's biggest package of fun—and you might find something really valuable! Price only 10c to serious approval service applicants. Money back if not delighted. Illustrated bargain lists with each order. Mystic Stamp Company, Dept. 80, Camden, New York.

WOW! \$10.00 Worth of fun. Only 10c! What a treasure hunt! Big package 500 foreign stamps from foreign missions, other sources. Includes stamps from Africa, South America, Free French, Somalia, Palestine, etc. Includes airmails, commemoratives and stamps worth up to 50c. This offer sent for 10c to approval applicants only. Jamestown Stamp Co., Dept. 22, Jamestown, N. Y.

FREE! 100 Worldwide different stamps to approval buyers. Big U.S. and illustrated bargain lists sent with approvals. Bookman, Maplewood, N. J.

BRITISH, Spanish and French Colonies. Vatican. Hitler heads, and airmail packet, free with approvals. Pan-American Stamp Co., Box 145, New York 33, N. Y.

STAMP Collections wanted. Complete collections, duplicate lots, surplus stock, mint and used. Prefer trade for printing or other items, buy outright if priced right. What have you, what's wanted? Vanroy Shirk, Lebanon, Penna.

DEALERS—Wholesale list, Postage 3c. Frank, 5031 Queensberry, Baltimore 15, Md.

OLD Scarce U. S. seconds on approval. Slightly defective, bargain prices. Hernefield, Clintonhill Station, Newark 8, N. J.

UNUSUAL Home movies. Free lists. Loja, Box 74-B, Brevort, Brooklyn 16.

EARN \$8.00 to \$10.00 daily with your movie projector. Details free. Metcalf (MJ) 10806 Glenroy, Chicago 43, Ill.

LIMITED Quantity famous DeVry Model RSND30 16mm. sound projector, fully re-conditioned, ready to operate. Excellent quality picture and sound. \$247.00 f.o.b. New York City. Paromel Company, 475 Fifth Avenue, New York City 17.

WE Buy, sell, rent, exchange home movies. Details for dime. Midland, Box 429, Oak Park 4, Ill.

FILM—Free processing 100 ft. 16mm. Weston 12 \$3.25. Weston 24 \$4.90. Weston 64 \$4.95. 25 ft. double 8mm. Weston 12 \$1.50. Weston 24 \$1.89. Weston 64 \$1.99. Free circulars. Fromader Genera, Davenport 4, Iowa.

BRAND New 16mm. sound projectors \$129.50. Send 10c for 1948 Christmas gift photographic catalogue. Sterling's, 679 Northampton, Easton, Pennsylvania.

LARGEST Selection 8-16mm. movies. Giant lists 10c. American Films, 6711 Sunset, Hollywood 28, Calif.

"MISS America of 1948" 8mm., 50 ft. Kodachrome, \$7.50. (black-white, \$2.00). 16mm., 100 ft. Kodachrome, silent, \$14.75. (black-white, \$4.00). Big movie catalog, 25c. World in Color Productions, Elmira, N. Y.

RENT 16mm. sound films 50c reel. Large selection, free catalog. Film Service, 128 Chestnut St., Roselle Park, N. J.

8MM. Sound projector for the price of a silent machine. Write Standard Sales, Box 7525, North Kansas City, Missouri.

BASS Says! 38 years of leadership means satisfaction to you! Finest equipment, 8 and 16 mm., sound cameras, sound projectors. Bass buys 'em, sells 'em, trades 'em. Satisfaction always guaranteed, or your money back! Bass Camera Company, Dept. A, 179 W. Madison St., Chicago 2.

GUARANTEED Fresh anti-halo outdoor movie film! Weston 12! Daylight loading! Processing free! Three spools double 8 mm. \$3.45! Six single 8 mm. for Univex, \$4.60! Postpaid! Catalog. Eso-S, 47th Holly, Kansas City 2, Missouri.

8-16MM. Silent-sound films. Complete rental library. All latest subjects. Free catalogue, (sample film 10c). Garden Film, 317 West 50th, New York 19.

LEARN Professional motion picture technique at home. Approved for veteran training under G.I. Bill. Free catalog. Motion Picture Institute, Birmingham 4, Mich.

LEARN Movie projection, management. Free catalog. Theatre Institute, Elmira, N. Y.

### MUSIC AND MUSICAL INSTRUMENTS

POEMS Wanted for musical setting. Send poems for free examination. Five Star Music Masters, 630 Beacon Bldg., Boston, Mass.

CORRESPONDENCE Lessons: Piano; accordion; guitar; saxophone; trumpet; drums; bass. \$2.00 each lesson. Caroli, Box 21, Lefferts, Brooklyn 25, N. Y.

HILLBILLY Polka records—New, old, rare numbers. Catalogue 3c. F-L Shop, Box 19-L, New York City 35, N. Y.

PLAY Piano quickly! Entirely different. Free lesson. Beejay Piano Clinic, Lafayette, Indiana.

SONGWRITERS—Set all your songs to music! "Write Your Own Music" shows you how for \$1.25. Newmount Publishing Co., 505 Fifth Avenue, New York 17, N. Y.

POEMS Wanted—Expert composer. Send poems. Radio composers. WDP, Clinton, N. C.

SONG-POEMS, Titles wanted. Outstanding proposition. Send material today! Special Service, 2115-M Kenilworth, Berwyn, Ill.

SONGWRITERS—Your songs need professional touch and smoothness. Send poems. Free examination. Lee Ice, Marietta, Ohio.

PHONOGRAPH Records 20c. Catalogue. Paramount, M-313 East Market, Wilkes-Barre, Penna.

YOUR Poems set to music, recorded by professional artists. Free booklet, attractive offer. Write. Song Service, 331-C West 46th, New York.

MUSIC Written to song-poems. Write: Frank Wildt, Lancaster, Pennsylvania.

POEMS Set to music. Ace Song Service, 27 Spring St., Elizabeth, N. J.

SONGWRITERS—Publication, collaboration, Newark Publications, GPO Box 1226, Syracuse, N. Y.

STREAMLINE Accordions below wholesale. Circular. Metro, 44 North Albany, Chicago.

SONGWRITERS Attention! The amazing demand for phonograph records, accelerated by countless juke-boxes, warrants your immediate investigation. We are offering new writers the rare opportunity of having celebrated "hit" composer furnish music on reduced percentage basis for any likely poems received this month. The Petrillo ban does not affect us. Recola Records, Hollywood 28, Calif.

POEMS Wanted for musical setting. Send poems for free examination. Hamann Service, 614 Manhattan Building, Milwaukee, Wisconsin.

AMPLIFY Your accordion with our new mike \$22.50. Sounds like organ. Installed in minute. Use any amplifier. Amplifier and mike \$72.50. Write Del Principe, 307 So. Wabash Ave., Chicago.

POEMS Wanted to be set to music. Free examination. Send poems. McNeil, Master of Music, 510-PM S. Alexandria, Los Angeles, California.

SONGWRITERS: Send poems for free examination and outstanding offer. United Music Service, 150, Salem, Indiana.

WRITE Songs. Big money and reputation. Write for information. J. Gordon Pub. Co., 201 N. Hoyle Ave., Chicago.

ACCORDIONS—Guitars, trumpets and all musical instruments, new and used. Direct from national distributors, cash and terms. Save money. Del Principe, 307 So. Wabash Ave., Chicago.

### RADIOS, SUPPLIES, INSTRUCTION

FIX Any radio. Amazing new instrument locates radio troubles double quick. Simple instructions show you how. Thousands now in use. Write today for free 28-page illustrated technical manual. "The Inside Story." Feiler Engineering Company, Dept. 1PM9, 945 George St., Chicago, Illinois.

LONG Playing record turntables, 33 $\frac{1}{3}$  and 78 r.p.m., take 12" record, volume control, pickup input. Modify these high quality precision made, units for use with your record player. Regularly \$49.50. Our price \$4.99. Ask for bargain list amplifier and radio parts. Mogull's, 68 West 48th Street (P), New York 19, New York.

MAKE "Loudest" crystal radios. Instructions, loudest crystal, catalog: 25c. Amorose, Route Four, Richmond, Virginia.

FREE Morse code lesson. Dept. M. Otto Luther, New Preston, Conn.

WESTERN Electric crystal detector. No adjusting 99c. Free list. Radio City Labs., 30 Church St., New York, N. Y.

"RADIO Amateur Newcomer" — 160-page beginner's book. Comprehensive; building, passing license examinations, operating, \$1.10 postpaid. Editors-Engineers, 1304 Kenwood, Santa Barbara, Calif.

"RADIOBUILDER" For crystal, 1-tube experimenters. 3 issues 25c. Laboratories, Eye-c, San Carlos, California.

RADIO Builders! Interesting catalog free. Communications, 110-H University, Seattle 1, Wash.

YOU Can have 26 years radio experience at your fingertips. I've repaired over 45,000 radios. Have perfected simple, easy system anyone can follow step by step. No calculations, no formulas. Total price \$2.00 postpaid or c.o.d. Money-back guarantee. Ross Radio, 14615-M Grandriver, Detroit 27, Michigan.

BUY Everything at wholesale prices! Radio parts, equipment for the amateur, service man and experimenter. Lowest prices anywhere. Write Mid America, Dept. CF-10, 2412 S. Michigan, Chicago 16, Ill.

BUYING Agents, radios, electronic equipment. Spada Enterprises, 10 Lexington, Wethersfield 9, Conn.

MAKE Crystal radio "boosters." Ten times volume. Designs, instructions, catalog. 25c. Radio Leader, La Verne, Calif.

PLASTIC Boxes—Molded, 3 $\frac{1}{2}$ " x 2 $\frac{1}{2}$ " x  $\frac{5}{8}$ ". Small parts containers. Opaque, transparent colors. Eight assorted \$1. Stampade, 1219 Huron, Cleveland 15, Ohio.

FREE Lists. Radios, television, records, appliances. Bargain prices. Mail post card today. JMAD Company, 122 Clinton St., Buffalo 3, N. Y.

RADIO Tubes, surplus radio equipment, bargains. Ask for list. Kay Electronics, Box 25, Hollis, New York.

MAKE Simple, tubeless, batteryless, distance-getting crystal radios. Crystal and illustrated instructions 25c postpaid. Allen, 427-P, Clinton, Missouri.

### BUSINESS OPPORTUNITIES

IMMEDIATE Cash profits by mail. I'll show you how. Write me today. B. C. Fryer, Department A-1, Box 1895, Atlanta, Georgia.

BIG Money. Spare or full time in your home. No selling! Spray new miracle finishes, plush and suede, on signs, radios, automobiles, figurines, lamps, toys, etc. Our business is booming—new easy Flock-Kraft methods. Material costs few pennies, you get dollars. Free samples, complete powerful money making plan free. Write now: Coast, 1505A West Manchester, Los Angeles 44, California.

AMAZING Screw holding drivers! Remove, hold, insert screws inaccessible places. Factories, mechanics, stores big buyers. Exclusive territory. Millicco, 701 Miller Bldg., Boston, Mass.

MAKE Money in your own spare or full-time business, casting new 1949 metal toys and novelties. Latest scale model autos, original ashtrays, savings banks, water pistols, etc. Enormous wholesale and chain store demand keeps manufacturers busy. No experience or special place necessary. Write for details and illustrations of patterns needed. Metal Cast Products Co., Dept. A, 1696 Boston Road, New York 60, N. Y.

"COLLECT And grow rich" is a free booklet that's yours for the asking. Learn of this opportunity for a lifetime, spare or full-time office business of your own, where you can make a profit on the work of hundreds of others. T. J. Surface, Pres., Dept. 230A, Roanoke 4, Virginia.

COLLECT Your old bills. Easy, inexpensive. Free folder. 613 Commonwealth Annex, Pittsburgh 22, Penna.

TRADE Magazines help you get ahead. Latest single copies. Over 1000 covering every trade, business and interest. List of publications with prices free. Commercial Engraving Publishing Co., 34C North Ritter, Indianapolis 19, Indiana.

START Candy kitchen. Make extra money. Literature free. Center Products, 211-C Church Street, Mt. Auburn, Illinois.

MAIL Order opportunities galore. Literature 10c. Sanchez, Box 66, Chelsea Station, New York 11.

BUILD A profitable real estate business, spare time. Particulars free. Roseman Agency, 55 Clifford St., Boston 19, Mass.

MAKE Money from own home by mail selling office supplies. Tremendous demand. Snyder, 5-B Spring, Beachwood, New Jersey.

MAKE Perfume. Learn how free. Write "International," 6347 Parnell P.M., Chicago 21.

INTERESTED In mail order work? Progressive Mail Trade Magazine, twelve issues, one year, one dollar. Information in each issue worth more. Houston Mail Order House, 5306 Pease Avenue, Houston 3, Texas.

FREE Sample! Weekly "Surplus Reporter," Tipp City 14, Ohio. Rush name.

EARN At home casting novelties. Make your molds with our liquid rubber. Dry sample and instructions. Major Chemical Co., 131 Inman St., Cambridge 39, Mass.

SMALL Business advisory service. Expert advice in selecting and starting businesses; obtaining supplies; marketing products; capital needs, etc. Nominal fee. Save time, money, costly mistakes. 9804 Brunett, Silver Spring, Md.

OPERATE Profitable mail-order business. Write Fred Smith, Box 8, Austell, Ga.

\$250.00 MONTHLY. Raise Angora rabbits backyard easy way. Wool \$9.00 pound. Details free. White's Rabbitry, Newark, Ohio.

MAKE Music boxes—Big demand. We supply Swiss musical units, \$2.25 each. Scott Mfg. Co., Wallingford, Connecticut.

MAKE Rubber stamps, metalize baby shoes, repair dolls, silver mirrors, make plaster novelties. Catalogue of "30 ideas" free! Universal, Box 1076-A, Peoria, Ill.

SCIENCE Of memory simplified. Free booklet "Memory Development." Memorology Club, 2016 Sunnyside Ave., Chicago 25, Ill.

AMAZING Opportunity. Start oriental art shop selling rare imported oriental art, curios, and silks. Free information. A. Andrade, Importer, 5932 Foothill Blvd., Oakland 5, California.

**SAWDUST.** Turn it into cash. Six methods. Instructions 25c. Charles, 12-BR, Norwood, Ohio.

**MAKE Flexible molds!** Cast plaques, novelties, bookends! Free sample! H. Tooker, Hamilton 44, Ohio.

**SELL** By mail! Ideas galore! Join Mail Selling Opportunities Club! Details free! G. Wehner, Box 142-A, Roxbury 19, Mass.

**NEW Industrial hand cleaner.** Free manufacturing-distributing plans. Unusual money-making proposition. "Acro-Sol-Ex," 623 West 14th Ave., Denver 4, Colorado.

**FREE Electroplating booklet.** Money making plans. Send postcard for your copy. Highly paid, interesting, uncrowded field. D. Hyde, Box 2099—Station V, Los Angeles 3, California.

**GET Ahead faster in any business, profession or job.** Learn to publicize yourself. Tested methods. Details free. Publicity Systems, Box 322-A, Jacksonville, Ill.

**LEARN Designing, modeling, molding, plastics, plasters, compositions.** Simplified, inexpensive methods. Immense profits. Literature free. Plastics Digest, 2917-B Michigan, Kansas City 3, Mo.

**GLASSY-CAST:** New and finest liquid plastic on the market. Cold set. 15 to 30 minutes for finished product. Free instructions. Easy to make novelties, toys, jewelry, machinery parts, etc. \$2.50 per quart. Elasto-Mold: Flexible, transparent, permanent production molds made in 20 minutes. Free details and samples on request. Also quality rubber latex. Wholesale prices. Plastic Service, 294 Washington St., Room 813, Boston 5, Mass.

**START Home manufacturing business** making Cleaning Compounds, Soaps, Insecticides, Cosmetics, Polishes, Food Flavors. No machinery. Literature free. Kemix, Park Ridge, Ill.

**COMPLETE Courses in flocking, copper tooling.** Free details. Home Industries, 1655 West 80th St., Los Angeles 44, Calif.

**YOU** may have exclusive advertising service franchise. Proven money maker—complete detailed program furnished. Small investment. Write Thomas, 115 Northside Branch, Atlanta, Ga.

**NOW Available!** 1949 edition of Official Concessionaire's Guidebook. Jam-packed with money-making ideas, games, formulas, equipment for concessions, roadside stands, carnivals, medicine business, etc. Buyers guide. Send \$1.00 today for copy. Concessionaire's Guidebook, Box 133B Sta. B., Toledo 6, Ohio.

**EARN Money** by mail, like I do. Literature free. Satterfield, 521-K North Pine, Little Rock, Ark.

**SEALTEC** Collection money making plans. Local—mail order. Sixth edition. Particulars free. Flasco Sales, 2505VJ 150 St., Flushing, New York.

**BECOME A** finance man. Particulars free. George Lenhoff, Lincoln 8, Nebr.

**BUY 800,000** Articles direct from manufacturers. Details free! Schibani, Box 1576-A, Birmingham 1, Alabama.

**YOUR Own profitable home business.** Preserve live flowers to last forever. New simple discovery. Enormous demand all year round. Tremendous profits! Light fascinating work. Send \$2.00 for working equipment, instructions, and valuable sales plans. Satisfaction guaranteed or money promptly refunded. Alfred Hermansen, 210 Fifth Ave., Suite 1102A, New York 10, N. Y.

**RESURFACE** Butcher blocks with portable machine. Butchers pay well for this service. You can easily make \$50 to \$100 per week for part time work. Write for details. Hill Machine Co., Box 677, Rockford, Illinois.

**GET It** for them wholesale. Be community buyer nationally-known merchandise; radios, refrigerators, washers, sweepers, typewriters, appliances. Savings up to 40%. This pleasant easy work can earn up to \$5000 year. Write, Giard, Aurora, Mo.

**HALF Million** articles wholesale. Directory 25c. Publishers, Box 1302-P1, Detroit 31.

**DOUBLE** Your money back if not more than pleased with "Opportunities Preferred"—the big 32 page 8 1/2 x 11, slick paper magazine jam packed with ideas for operating a profitable "mail order" business. Latest issue 25c. Griffin & Company, 756 Broadway, Everett 49, Mass.

**BUY** Nationally advertised merchandise for others: radios, appliances, etc. Low wholesale prices. Make commission each purchase. Up to \$5,000 year possible. Easy, fascinating new business. Free information. Cox, Saugus 10, Massachusetts.

**BE Independent**—Operate America's lowest price penny vending machine. Big profits. Immediate shipments. Write for bulletin and prices. Fielding Mfg. Co., Desk 19, Jackson, Mich.

**AUTO** Body mechanic's tools that sell on sight. No demonstrating. Big profit. Douglass, 3615A South Grand, St. Louis 18, Missouri.

**USE** Your home as magazine subscription station. Represent all magazines. Liberal commissions. No experience—no capital needed. Catalog, full details, free. Write McGregor Magazine Agency, Dept. 22, Mount Morris, Ill.

**METALLIZE** Baby shoes. Excellent profits. New system assures success. Free details. Treasures Forever, 89 Henry Ave., Lynn, Mass.

**GET The facts!** Splendid year-round profits your own business. Manufacture Insulite and cement building blocks. Small investment. Lotz Mfg. Company, Dept. K, Escondido, Calif.

**POPCORN** Equipment, potato chip outfits. Long Eakins Company, 4960 Hi Street, Springfield 99, Ohio.

**PROFITABLE** Mail order plans. Details free. Alfred Haseman, Beecher, Ill.

**YOUR** Home or garage has space needed for mfg. new mechanics hand cleaner. \$500-\$750 monthly. No machinery needed. Exclusive territory. Trade-mark and formulae free. Tiffany Products, 289 E. 6th, St. Paul, Minn.

**SAVE** Money. Get all bronze baby shoe supplies from one source. Prompt deliveries. Low costs. All types of mountings—book ends, ash trays, pen sets; plating compounds, equipment. Also complete course in electroplating baby shoes that shows easy way to start profitable business in spare time at home. Read details page 52 this magazine. Send name for free facts. Warner Electric Company, 1512 Jarvis Ave., Dept. C-31, Chicago 26, Ill.

**STRING** Pearls, beads of all kinds, at home or open your own shop. Free information. Poynter's, 310 13th Street, Richmond, Calif.

**MAIL** Order opportunities. Read "Dollars and Sense." Copy 10c. Brown, Gracie Station, New York 28.

**FOR** More business, whether you have merchandise, service, or patent to sell, rent New York individual office. Rates, only \$12.00-\$24.00 yearly. Established 1926. Co-operative Office Service, 126 Lexington Avenue, New York 16.

**PROFITABLE** Home business. Start in spare time. Experience unnecessary. Complete information. Useful Products Co., 166-29 88th Ave., Jamaica 3, N. Y.

**SOAPS, Cleaners, etc.** made without machinery. Easy instruction booklet. Formulas, \$1.00. Brown, 9111-M Hoyne, Chicago 20.

**OPERATE** Profitable mail-order business. Splendid opportunity. Write S.A.K. Supply, 1421 St. Vincent St., Philadelphia 11, Penna.

**OWN** Your mail order business. Sell envelopes, bags, boxes. Big profits. No investment. Omaha Envelope Service, 4721-E California, Omaha 3, Nebr.

**FREE** Colorful book "372 Unusual Worldwide Business Adventures!" Photos! Pictures! True; successful. Australia, Africa, South America, New Zealand, Mexico! Not hokum. Work home. Refreshingly "different" plans. Publishers-F. Carlsbad, Calif.

**BIG** Money in antiques—Sell by mail or start profitable business at home. Old Antiquer, 11652-A Collins St., North Hollywood, Calif.

**BABY** Shoe metallizing. Secrets never before revealed. Amazing offer. Schoettle, Friendship, Ohio.

**RED** Hot home-mail manufacturing business opportunity. Everything furnished. 300% profit. Facts free. Bridges, 286-G Third Ave., New York 10, N. Y.

**FREE** Literature—How to have profitable home mail business supplying popular self-help books to millions. Big demand, good earnings, everything furnished. Rush name: National, Box 88-G, Dorchester, Mass.

**MAIL** Business opportunities. New plans, proven propositions. "What to sell" service. Different, profitable. Write: Smith, Box 2592-G, Hines, Ill.

**OWN** Growing business. Clean, moth-proof rugs and upholstery "in the home." Profits up to \$20 day on each service man. See DuraClean advertisement, page 246.

**WAX-O-GLASS;** Cleans glass; polishes metals amazingly quick. Make it yourself. Formula \$1.00. Ideal Service, Park Ridge 3, Ill.

**MAKE \$50.00 Weekly,** home, spare time, handling our mail business your territory. Lynn, 5710 Bankfield, Culver City, Calif.

**OWN** And operate a profitable venetian blind laundry. Complete details and instructions \$10.00. Proven money maker. A. J. Gebhart, 1434 10th, Seattle, Wash.

**THINKING** Of South America? Send \$2.00 for up-to-date list of 240 varied, important businesses in Mexico, Central and South America, Foreign, U. S. addresses given. Pan American Information Bureau, Box 3483, Shreveport, Louisiana.

**RUBBER**—Molds, models, casting, finishing, metallizing materials; wholesale catalog, sample free. Plastic Products, 3151-3 Southport, Chicago.

**MAKE** Money—Easier! \$3-\$10 hourly operating your own dignified money making service business. Big demand everywhere. Instructions, supplies furnished. Little capital. Lifetime opportunity. Pura-clean, 17-A East 42nd, New York 17.

**START** Your own business on our capital. Always your own boss. Hundreds average \$6,000 to \$25,000 annual sales year after year. We supply stocks, equipment on credit. 200 home necessities. Selling experience unnecessary to start. Wonderful opportunity to own pleasant, profitable business backed by world-wide industry. Write Rawleigh's, Dept. A-U-PPM, Freeport, Ill.

**\$3.41 PROFIT** Per hour interest you? Easy, amazing process velvetizes interiors, signs, novelties, radios, lamps at low cost. Free sample. Sparks, 1145 Queen Ann, Los Angeles 6.

**HOME** Business making statuettes, plaques, artificial marble, rubber molds. Metallizing baby shoes. Silvering mirrors. Formulas. Folder free. Creative, 236-L, Winnetka, Illinois.

**IT'S** Easy to convert hand mowers to power mowers with Handy-Dandy Lawn Mower Conversion Kits. Installed on any mower in 3 hours. Used with any small gasoline or electric motor. (Lauson engines and Pennsylvania mowers in stock. Immediate delivery.) Kits can be purchased with or without engines. Fits 16 to 20 inch mower. Dealers wanted. LeClaire Manufacturing Co., LeClaire, Iowa, Dept. PM.

**NO** Selling, operate vendors, amazing profits, details free. Silver-King, Suite B, 622 Diversey, Chicago 14, Ill.

**FIREPROOF** Mattresses, curtains, homes, almost anything. Earn big. Save big. Be independent. Eldorado Fireproofers, Lotus, California.

**OPERATE** Profitable home mail order business on small capital. Details free. Jordan, 743 Dorrence Street, Philadelphia 46, Penna.

**MAIL** Order success even for beginners. Details free. Condello, 39 McArthur Dr., Fords, N. J.

**START** Profitable air conditioning business. Don Nelson, Warner Robins 2, Georgia.

**RUBBER** Molds! Genuine latex! Low cost! Catalog free! Castcraft Studios, 2027-P Fulton St., Brooklyn 33, N. Y.

**MAIL** Order system of successful operators now revealed. Smallest capital. Different, dynamic. Quick action. Details free. Schroder, 221 Bush, Covington 5, Ky.

**LEARN** Roofing and siding business! Pays amazing profits. Our simple instructions course covers everything. Very easy to master. No tedious study. Act now! Free details. Roy J. Peytons Sr., 415 Southeast First Street, Evansville 9, Indiana.

**RAISE** Ginseng. Roots bring \$10.00 pound. Circular free. Fezler Seed Co., Patchogue, N. Y.

**INCOME** From local information. Interesting. Sparetime. Neher Company, La Verne, Calif.

**"ELECTROPLATING Know-How"**—Get the professional know-how of modern electroplating, fascinating money making field, simply and quickly! Write for free illustrated booklet. Joseph B. Kushner, Electroplating Engineer, Stroudsburg 23, Penna.

**"STOCK"** Molded plastic boxes. 3 1/2" x 2 1/2" x 3/8". Opaque, transparent colors. Modern packaging new products. Sample eight \$1. Stampade, 1218 Huron, Cleveland 15, Ohio.

**MAKE** Money making new greasless doughnuts at home on electric machine. Wholesale to grocers, drug stores, cafes, hamburger shops. Send for free recipes and plans. M. Ray Company, 3605 South 15 Ave., Minneapolis 7, Minnesota.

**GET** Hundreds money making deals, business ideas, plans and manufacturing. Amazing folio free. Austin Mail Service, 5538 Lexington, Chicago, Illinois.

**ANNOUNCING** Home study course in commercial baking. Practical basic training. Good field for those with aptitude. Nearly depression proof. Send for free booklet, "Opportunities in Baking Industry." National Baking School, 1315 Michigan Ave., Dept. 3438, Chicago 5, Ill.

**ENORMOUS** Opportunity developing inventive ideas. List of eleven ideas free. Jack Kester, Deckerville, Michigan.

**MAKE** Tough, hard plastic 1c pound. Makes durable floors, walls, mantels, roofs, 101 uses. Build attractive home yourself. Material cost \$150 room. Bays Laboratory, Oklahoma City 9.

**LIQUID** Rubber. Make flexible molds. Free sample. Chaney, 1130 E. 16th St., Jacksonville 6, Fla.

**MECHANICALLY** Inclined? Resurface butcher blocks. Lifetime business. Roy Crawford, Keyport, New Jersey.

**MAKE** Money addressing envelopes. Our instructions reveal how. Glen Glenway, 5713 Euclid, Cleveland 3, Ohio.

**I MAKE** Big money in the mail-order business. You can do the same at home with copyrighted system. Write me. I'll tell you how. F. Little, R.D. #1, Glenshaw, Penna.

**ENVELOPES** Addressed accurately, reasonably. Fast service. We have capable addressers in your city. Glenway System, 5713-Y Euclid, Cleveland 3, Ohio.

**EXCELLENT** Manufacturing propositions. Request circular. Richards, 44 North Albany, Chicago.

**READ "Advance"**—The voice of mail order. Offers money-making opportunities, sources of supply, personal guidance, etc. Issued monthly. Sample copy 25c. Yearly subscription \$2.00. Advance Publishing Company, 313 East 21st Street, Suite 450, New York 10, N. Y.

**A BUSINESS** In your own home! Our chemicals, plus free water and cheap "grocery store" materials can bring you over \$500 monthly earnings. Plans and formulas free. Chemica Division, 1269 S. Norton, Los Angeles 6.

**A FACTORY** In your home garage! Mfg. and sales rights, mechanics' waterless hand cleaner, \$500-\$800 monthly. No special equipment necessary. Formula free. Western Aircraft Mfg., Dept. D, Los Angeles 6, Calif.

**HOME** Workers wanted to hand-spin Angora wool. Either sex. House of Angora, Springfield, Ill.

**BUY** The new Concession popcorn machine. Biggest low priced popper on market. \$100 puts you in business, complete. Also caramel corn, candy floss, candy pullers, kettles, heating equipment. Write for new catalog. Concession, Dept. A, Toledo 6, Ohio.

**WHOLESALE** Supply sources and money making plans offer security, success, in your own business. Details free. Reynard Publications, Smithfield 3, Ohio.

**MAKE** Money by mail. Howard, 1778A Hamburg St., Schenectady 4, N. Y.

**START** Bottled natural gas business. New, amazing opportunity. Demand enormous. Pays big profits. Literature free. Enso, Pasadena 16, California.

**LEARN** Piano tuning, repairing, at home. Tremendous field! Piano parts, tools furnished. Established 1935. Empire School of Piano Tuning, 606-B East University Ave., Champaign, Ill.

**UNPAINTED** Bookends, plaques, statues, figurines. List. Haverty Products, 1219 8th Ave., Altoona, Penna.

**NATURAL** Molding Latex. Extra thick. Free sample. W. Wooley, 115-A Donald, Peoria, Ill.

**MAKE** Money sharpening saws at home on electric machine. No experience necessary. Hardware dealers act as your agents to secure work. Send for free book "Independence After 40" shows complete plan for starting in spare time. Foley Mfg. Co., 47 Foley Bldg., Minneapolis 18, Minn.

**RUBBER!** White liquid rubber! America's finest flexible moulding rubber! New! Extra heavy viscosity! Quick drying! Ideal for home, classroom, or industry. Only \$7.95 per gallon, \$2.95 per quart, and \$1.00 per half-pint sample. Parcel post prepaid! Plastercraft Supply Company, 3051 St. Clair Avenue, Cleveland 14, Ohio.

**CASH** For your idea, 280 manufacturers need inventions, patented or unpatented. List free. Invention Bureau, 208M Clinton, Oak Park, Illinois.

**YOUR** Own mail order business at home. New, illustrated course. Free booklet. Registrar, 7219 South Broadway, Los Angeles 3.

**VENDING** Machines earn big money! An investment as low as \$10.50 will start you in this fascinating, profitable business that can lead you to the road of success and independence. Routes can be established and operated in either full or spare time with no experience needed. Write for full details and our free catalog illustrating our nut, candy, gum and stamp vendors; also slot machines, amusement games, etc. Parkway Machine Corporation, 623 W. North Avenue, Dept. 7, Baltimore 17, Maryland.

**SPECIAL** Rubber for making molds. Literature and sample free. Universal, Box 1076-A, Peoria, Ill.

**HOW** And where to obtain capital. Small and large loans. Free particulars. Star Service, Wapakoneta, Ohio.

**OWN** Mirror shop. Resilver mirrors. Glass sign making. Electroplating. Supply prices. John Sprinkle, V60, Marion, Indiana.

**BRONZED** Baby shoe mountings and supplies. All metal bronze bookends, picture frames, ash trays, etc. Onyx ash trays, desk sets, plaques. Hardening solution, 30-amp. plating rectifiers with powerstat control, \$85.00. Geared motors for agitation \$20.00. Lead lined tanks. Write for list. Hollywood Bronze Supply, 1770 N. Vermont, Hollywood 27, Calif.

**QUICK** Money. "Repairing car batteries." At home! Easy too! Batteryman, Grand Junction, Colorado.

**346** FROM Square foot plywood. Jigsaw necessary. Write, Woodarts, X-38, Bridgewater, Mass.

**OPERATE** Profitable mail order business. Write Walter Service, 4159-A East 112th, Cleveland 5, Ohio.

**RECAST** Old batteries into new. Latest achievements. Battery Laboratories, Minneapolis.

**RE-NEW** Leather and leatherette—Make cloth into imitation leather with plastic discovery called Leather-New. Opportunity to make real profits taking care of sales resulting from national advertising. Write for free sample of Leather-New covered material and complete deal. 4723A Troost, Kansas City, Missouri.

**COLORGLAZED** Concrete pottery made without molds. Patented method. Cemetery products, novelties, tiles. Basement leak-sealing. Money-making projects. Booklet, details free. Men only. National Potteries Company, Grand Rapids, Minnesota.

**SPECIALTY** Manufacturing, the big money business that can be operated anywhere, start on a very small capital; we supply dependable formulas and complete instructions; get interesting free booklet, "Money-making Opportunities in Specialty Manufacturing." Howard Robinson, Ph.G., 1300-A South Ohio Street, Sedalia, Mo.

**START** Mailorder bookshop—Everything furnished. 25c brings booklet, samples, exciting ideas. General Publications, Ossining, N. Y.

**\$25** WEEKLY Working two hours daily. No canvassing. No manufacturing. Lycke, Box 2471, Cleveland 12, Ohio.

**137** WAYS To make money, in home or office, business of your own. Full particulars free. Elite Co., 220 Grand St., New York 13.

**BRUSH** Plating outfits connect to a battery. No tanks necessary. Good paying business at home plating autoparts, bathroom fixtures, bicycles, reflectors, silvering mirrors. No shop or experience required. Outfits furnished. Free booklet. Gunmetal Co., Ave. H, Decatur, Ill.

**WOULD** You pay 3%—first \$350 made? Color-illustrated book "505 Odd, Successful Enterprises" free! Some offer occasional "day off." Work home. Expect something odd! Pacific, Oceanside, Calif.

**MAILING** Postcards selling repeat merchandise is profitable. Everything supplied. Details free. Gordaa Publishers, Box 23, Pawtucket, R. I.

**RUBBER** Molds, natural liquid rubber, flock filler (for making sectional molds), statuary plasters, felt finishes for novelties. Catalog and "Plastercraft" course free. Blue Rapids Supply, Blue Rapids, Kansas.

**CO-PUBLISH** And advertise in The Central Mail Advertiser. Sample copy for stamp. Low rates. Large circulation. Bagby Printing Co., Georgetown, Ohio.

**MAIL** Order opportunities. Full or spare time. Hundreds of chances. No charge. Postal brings copy. Blackstone Press, Somerville, New Jersey.

**START** Home plaster novelty business. Amazing course tells how. Literature free. Kemo-Courses, Dept. A, 4862 Catalpa, Chicago 30, Ill.

**EARN** \$200 Weekly installing new amazing "Styron" plastic wall tile in homes, offices. Easily applied. Tile your own kitchen, bathroom, top. Instructions, everything furnished. Literature free. U. S. Tile Co., 30 W. Washington St., Chicago 2, Ill.

**COPUBLISH** Leading m.o. paper. Latest copy Mail Sale Advertiser and proposition, dime. Vanroy W. Shirk, Lebanon, Penna.

**LIQUID** Marble—Colorful, glossy! Molded, brushed, sprayed! Cast novelties, statuary, colored tiles. Flexible molds. Composition floors. Particulars free. Marbleizing Service, Edwardsville, Illinois.

## MONEYMAKING OPPORTUNITIES

**WIN** Cash, cars in prize contests! Write for copy filled with current contests, winning hints and tips. Send only 25c. Wright Contest Digest, Dept. 17-A, P.O. Box 2266, St. Louis 9, Missouri.

**NOTARY** Public. Be one. Largest legal supply house, 22 cities, guarantees your appointment by governor if you qualify, equips you for \$16.97. Respected public office. You certify legal papers, use official seal made with your name, collect fees. Easy. Notaries needed everywhere. Write Stationers Exchange, Boerne 15, Texas.

**EARN** \$25 Distributing 50 boxes of greeting cards. Over 20 different top quality assortments for Xmas, birthday plus deluxe boxed stationery. Also make extra money taking magazine subscriptions. Details free! Cassell Co., 11D Elm St., Westfield, N. J.

**SEWING** Machine—Millions need repair, modernized, electrified, etc. This is it! Write Taylor Service Co., Hamilton, 2A, Ohio.

**METALIZE** Baby shoes for fun and profit. We show you all trade secrets and furnish supplies to start you in big profit business or spare time hobby. Write for details. Shuplate, Dept. A, Lawton, Okla.

**FOWL**, Muncie, Indiana. Money at home with imprints. Samples free.

**LEARN** To have your own mail order business. Read my successful way proved since war. \$1.00. R. S. Kennedy, 419 Dime Bldg., Detroit 26, Michigan.

**\$12.00** PROFIT On 25c investment. Write immediately. Suproco, Ogema 5, Wisconsin.

**FOR** Sound, sensible, proven successful mail order methods, send 10c for details to C. A. Griffith, 132 Water St., Fredonia, N. Y.

**I MADE** \$1000.00 On 1000 tomato plants. Instructions, \$1.00 (refundable). Alfred Dinsmore, Marlborough, Mass.

**"WATERLESS** Hand Cleaner." Make, sell. No machinery. Build profitable business. Complete formula \$1.00. Ideal Service, Park Ridge 2, Illinois.

**"HOW** To Make Money with Hamsters." Latest information. \$1 postpaid. Free details. Englewood Publishers, 4015 So. Lincoln, Englewood 3, Colorado.

**READ** Progressive Mailtrade, the magazine that tells how to make money by mail. Dime brings sample and special offer. Progressive Mailtrade, Box 357, Sheboygan, Wisconsin.

**FREE** Offer. Cash income for life. Succeed, 317 American Bank Building, Portland 5, Oregon.

**PROFIT** With Larson Leathercraft. Belts, purses, 100 other ideas. Largest supply in U. S. Catalog 10c. Larson, Dept. C, 824 S. Tripp, Chicago 24.

**EARN** Money evenings, copying and duplicating comic cartoons for advertisers. Adservice, Argyle 1, Wisconsin.

**FREE** Literature on money making ideas. Write: Lighthouse, 1023-J Hamilton Street, Lockport, Illinois.

**LEARN** To sell by mail. Pound of literature 25c. W. E. Martin, Bassett, Va.

**CANDY** Manufacturing and marketing, complete course \$6.00. Literature 10c. Philip Pate, Kissimmee 1, Florida.

**WORRIED** About a job? Learn how to make \$5000 a year, depression or no depression. Yes, anyone can operate this plan successfully, no matter where they live, no matter how old they are—man or woman. Anyone can put this plan to work and make good money! Free information. M. H. DeSpain, Box 473, Port Huron, Mich.



**INCREASE** Your earnings: Local business opportunities; mail order information; wholesale supply sources; valuable money-making tips; information, free details, rush name. Wilkin Company, Hillsboro, Ohio.

**METALLIZE** Baby shoes. Further information 3c stamp. Metal Crafts, Box 125-R5, Tampa 4, Florida.

**15 M'NOTES** Masters advertising and sign lettering; complete system \$1; free circular. Abenteprizes, Box 875-M, Peoria, Illinois.

**THOUSANDS** Articles wholesale. "Supply Source Directory" 10c. Ideal Service, Park Ridge 40, Illinois.

**WIN** Contest money. General Contest Bulletin gives hundreds of tips. Lists current contests and rules. Sample 25c. General Contests, 1609 1/2 East 5th, Duluth, Minn.

**ANALYZE** Handwriting for profit! Complete outfit \$1.00. Graphologists, POB-971, Philadelphia.

**UNPAINTED** Figurines. Illustrated list free. Oman, 642 Broadway, St. Paul 1, Minn.

**UNPAINTED** Plaster ornaments. Beautiful designs, easily decorated with water colors or oil paints. Profit or hobby. Free illustrated list. Firestone product dealers wanted. Distributors: Lexite Natural Latex for molds. Midwest Novelty Mfrs., 524 E. Park, Anaconda, Montana.

**EARN** Money at home! Thousands do! "Home Worker Magazine" tells how. Sample, 25c. Sizemore, Box 7, 4917 Kostner, Chicago 30, Ill.

**MAKE \$100** Per week or more in a full or spare time baby shoe metalizing business of your own. Write now for free literature on this easy to learn highly profitable business. Joseph B. Kushner, Metal Finishing Engineer, Stroudsburg 23, Penna.

**MEN, Women**—"Most everybody likes candy." Learn to make in a professional manner. (Our 38th year). Ragsdale Candies, D4, East Orange, New Jersey.

**RESILVER** Mirrors at home. Formula 25c. Ideal Service, Park Ridge 6, Illinois.

**PRIZE** Contest bulletin gives various contests now operating, and valuable hints. 3c stamp. National Contest Bulletin, Box 2685P, Miami, Florida.

**WOULD** You pay 3%—first \$350 made? Color-illustrated book "505 Odd Successful Enterprises" free! Proven! Work at home, office. Expect something odd! Pacific, Oceanside, Calif.

**PUBLISH** Your own magazine. Hand-some 52 page format, well edited, illustrated. Cost low as \$1.00 month. Brings you prestige, profits. 25c brings sample, details. National, Ord. Nebr.

## FORMULAS, PLANS, ETC.

**DAZZLING** White mineral paint. \$2. Paints six room masonry house. Formula 50c. Thos. Wolverton, Blacklick, Ohio.

**PLANS**—New patent sewage disposal system. Requires less drainage, build it yourself. Specifications and drawings by registered professional engineer. \$2.00. De Haviland, Mundelein, Illinois.

**CHEMICAL** Analysis, formulas, research. Central Laboratories, David Whitney Bldg., Detroit 26, Mich.

**FORMULAS** For nearly everything. Catalog free. Write Creative, Winnetka, Ill.

**ANY** Formula \$1.00. Satisfaction or refund. Brown, 9111-J Hoyne, Chicago 20.

**PRODUCTS** Analyzed. Duplicated. Improved. Formulas. Consulting Scientific Company, Swarthmore, Pennsylvania.

**10,000** FORMULAS And trade secrets. Free literature. Stillman, 555 Kingston Ave., Brooklyn 3, N. Y.

**MAKE**—Sell cleaners, soaps, polishes, flavors, cosmetics. No machinery. Formula literature free. Kemico, Park Ridge 16, Illinois.

**\$1.00** GETS You 21 money-making popcorn, candy apple formulas. We supply equipment. Concession Supply Company, Dept. A, Station "B," Toledo, Ohio.

**TESTED** Formulas. Interesting descriptive booklet free. Pont, Box 635-PM, Terre Haute, Indiana.

**REAL** Manufacturing formulas. Lists free. Cummings, Chemist, Gordon Ave., Syracuse 4, N. Y.

## PLASTICS

**CELLULOSE** Acetate—Clear, matte, colors. Generous assortment \$1.00. Gift wrappings. Major's, 3510 Palmer, Chicago 47.

**NEW** Low prices on Plexiglas, jewelry findings, initials, sequins, tools, etc. Free catalog. G. Baker Company, River Edge, New Jersey.

**PERMANENT** Carved roses, orchids, swans, goldfish, butterflies, etc. Jewelry and gifts. Crystal Floral Novelty Co., Bound Brook, New Jersey.

**PLASTICS**—Supplies, findings, shells. Illustrated fabricating manual, bargain catalog, 10c. Gem-O'-Lite, Box 686F, North Hollywood, Calif.

**PLEXIGLAS**—12" x 12" Masked sheets. 1/16"-\$1.00, 1/8"-\$1.25, 3/16"-\$1.55, 1/4"-\$1.85. Include 10% postage. Dyes, rods, tubes, luminous powders, carving blanks, drills, jewelry findings. Free catalogue. Craft Plastics, Somerville, New Jersey.

**RENEW** Leather and leatherette—Make cloth into imitation leather with plastic discovery called Leather-New. Opportunity to make real profits taking care of sales resulting from national advertising. Write for free sample of Leather-New covered material and complete deal. 4723B Troost, Kansas City, Missouri.

**BARGAINS** In plastics. Lucite, Plexiglas, Catalin. Many colors and sizes. Details free. George Plastics, 6938A George St., Chicago 34, Ill.

**PLASTIC** Materials and supplies for your hobby or business. Catalog and internal carving instructions free. Art Plastics of Calif., 8125 East 14th Street, Oakland 3, Calif.

## CHEMISTRY

**FREE** Catalog: Chemistry, mineralogy, physics, biology. Special—39 chemicals in 2-oz. bottles \$3.90. Tracey Laboratories, Evanston, Illinois.

**UNIVERSITY** Professor teaches chemistry by mail. Details free. Box 1295, Toledo, Ohio.

**NEW** Laboratory supply catalog of chemicals and apparatus. Contains many thousands of items with illustrations. Send 25c. Standard Science Supply Company, 1232 N. Paulina St., Chicago 22, Ill.

**NEW** Used equipment, chemicals. Catalog. At-la-s, 21 Wenham, Boston, Mass.

**CHEMICALS** For chemistry set renewals at low prices. Large general catalogue 15c. National Scientific Company, 2204 North Ave., Chicago 47, Ill.

**CHEMICALS** And apparatus for industrial, analytical, and private laboratories. Catalog 10c. Dept. M-26. Biological Supply Co., 1176 Mt. Hope Ave., Rochester 7, N. Y.

**HANDBOOK** For chemical experiments. Illustrated. Hundreds of experiments. 50c. Experiment booklet 15c. Supply catalog 5c. Reading Scientific Company, Reading, Penna.

**LABORATORY** Chemicals, apparatus, books. Catalog 10c. Fleischer's Laboratories, Everett 49, Mass.

## HELP WANTED

**BOYS** Wanted. Over \$2.00 hour! Sell name plates for front doors. Free sample. Write Dept. 44. National Engravers, 214 Summer, Boston, Mass.

**FREE** Details. Action novelties, airplanes. Kolinski, 759 South 25th, Milwaukee 4, Wisconsin.

## AGENTS WANTED

**FREE** Samples. Big profits showing amazing glow-in-the-dark specialties. House numbers, pictures, plastic novelties, religious and nursery objects, etc. Large manufacturer, Madison Mills, 303 Fourth Ave., New York, N. Y.

**NEW** "Sponge" wall cleaner. Erases dirt like magic. Wallpaper, painted walls, ceilings. Saves redecorating. Lightning seller. Samples sent on trial. Kristee, 112, Akron, Ohio.

**AT** Last! Something new and sensational in everyday cards. Gorgeous satin and velour designs. Get orders fast. Big profits. Imprinted stationery. Floral charmettes, napkins. 25 assortments for all occasions, retail 60c to \$1. Samples on approval. Puro Co., 2801 Locust, Dept. 940-A, St. Louis 3, Mo.

**NEWEST** Money making sensation. Sell hand painted ties with personal initial. 100% profit. Experience unnecessary. Special offers. Write for free 20 page catalog complete line ties, mufflers. Philip's Neckwear, 20 West 22nd St., Dept. K-31, New York 10.

**PROFITS.** Big demand and repeat orders selling rubber mats for home or auto. Free sales plan. Mitchell, 2140A San Fernando Road, Los Angeles 41.

**400% PROFITS** Selling genuine, guaranteed. "Nu Silver Polish and Plating Liquid." Apply with cloth. Stores, offices, homes. NuProcess Products, Aurora, Illinois.

**BIG** Money career. Sell guaranteed Nylon uniforms; white, colors. No investment. Highest commissions. Easy, quick sales to waitresses, beauty shops, hotels, nurses, etc. Complete variety fabrics. Exclusive styles. Free catalog sales kit. Up-land Uniform, 255 West 28th Street, Dept. G-1, New York.

**SCHOOL** Seniors! Your postal will bring our wonder, Kwick-Sell cardalog of popular graduation name cards. Biggest profits! Only firm giving free souvenir chest and card case. Don't miss out! Hurry that postal! Craftcards, Box 235L, Pittsburgh 30, Pennsylvania.

**STRANGE** "Dry" window cleaner. Sells like wild. Replaces messy rags, liquids. Simply glide over glass. Samples sent on trial. Kristee, 113, Akron, Ohio.

**SELL** Personalized napkins, stationery, matches. Samples free. Dunbar, Sanford, Florida.

**I'LL** Put a "shoe store business" in your pocket! Nation's leader trains you to make big money! Fit men, women. Free sample outfit. Write today! Consolidated Shoe System, Dept. S-210, Chippewa Falls, Wis.

**A DRESS** For you with every 3 you order for yourself and family. Amazing new plan. Everything free. Harford Frocks, Dept. W-9128, Cincinnati, Ohio.

**PLASTIC** Tablecloth covers, curtains, drapes, baby pants, bowl covers and other plastic articles selling like wildfire! Make big money now! Free details. Write L & M Co., Dept. 58-A, 510 St. Charles, St. Louis, Mo.

**ABSOLUTELY** Free! Big package actual sample fabrics and style presentation of dresses, lingerie, hosiery, etc. Take orders. Commissions big. Send no money. Melville Co., Dept. 4774, Cincinnati, Ohio.

**EARN** Big money. 21 Sunshine everyday cards with six lined envelopes \$1. 48 Sunshine notes for \$1. Sensational values. Costs 50c. Sells \$1. Also 1949 21 card Easter asst. Birthday, get well, napkins, gift wraps, stationery. Write today. Samples on approval. Sunshine Art Studios, 115 Fulton St., Dept. PM-1, New York 8, N.Y.

**SELL** Refrigerator motor oil. Good profit. No competition. Free details. Warco, 2689-E Coolidge, Oakland 1, Calif.

**MAKE** Money calling on friends. Show greeting card assortments—Birthday, get-well, others. Floral stationery. Gift wrappings. Experience unnecessary. Samples on approval. Wallace Brown, 225 Fifth Ave., Dept. D-4, New York 10.

**POCKET** Pal: Replaces pocket knives. New safe, beautiful. Always razor sharp. 50c seller. 321% profit. \$15.00 or more daily. Agents, salesmen, distributors. Sample 10c. Nelson Mfg. Co., 222 W. Kellogg, St. Paul 2, Minn.

**HOTTEST** Seller of all time. Details free. C & C Sales, Box 1046P, Chicago 90, Ill.

**INFORMATION**—Wholesale supply sources. Money-making plans. Increase your income! Write Reynard Service, Smithfield 3, Ohio.

**GREETING** Card money-makers. Birthday, everyday, Valentine. Catalog free. Greenport Art Company, Dept. 918P, Brooklyn 15, New York.

**SELL** Easter, Mother's, Father's day Bible text mottoes and signs. 6 samples \$1.00. Made in beautiful colors. Special Kut Signs, Dept. J, Sidney, Ohio.

**MAKE** Sensational profits! New, sell-on-sight plastic line: Tablecloths, aprons; many other splendid fast-selling items, novelties. Postal brings free details, special deals. Hurry! Royalty, Box 748-H, Passaic, New Jersey.

**MAKE** Big money with the wonderful new, "Pink Satin" cream shampoo! Sells fast! Sales repeat! Splendid money-maker for you! Rush name for interesting free details, today. Demo Laboratories, Bogota, New Jersey.

**BUY** Thousands of nationally advertised products direct from manufacturers. Write for "Buy Direct and Save." Consumers Assn., 287-A Lebanon Ave., Mt. Lebanon, Penna.

**MAKE \$100** A week selling subscriptions for "Jr." The Modern Magazine for boys and girls. Every parent a prospect. See the possibilities? Write "Jr." Dept. G., 812 North Dearborn, Chicago 10, Illinois.

**FREE Nylons** given if Kendex hosiery runs or snags! World's only women's hosiery sold with written guarantee amazing everybody. Mere words could not express unbelievable money-making opportunity. Fantastic earnings become reality. Armstrong earned \$202 in 9 days. Watkins sent 92 orders in one day. Imagine replacing hosiery free regardless of cause—whether use or abuse! Truly sales dynamite for terrific profits. Even if you never sold before, three magic words: "Guaranteed Against Everything" will open doors for you—make women listen and pour money in your pocket. Complete line from sheerest to service (15-20-30-40-60 denier) all lengths 28 to 35 inches—latest colors—seamed full fashioned and seamless. No competition because Kendex guaranteed nylons not sold in stores. Also complete line men's hosiery actually guaranteed for one full year! Nothing like this anywhere. Includes rayon, nylon, lisle, wool, cotton, mixtures, etc. All styles, patterns, colors, prices to please everybody. Thousands shipped daily. 100,000 pairs constantly in stock for fast delivery. Over 30 years in business. You need no money or experience. Nothing to pay now or later. Show free outfits. Write orders. We deliver and collect. Big advance cash plus huge bonus. Earn money spare or full time—exclusively or side line. No restrictions. Become manager—appoint others to sell for you—earn steady income on their sales. Complete money-making outfits including salesbooks in color, samples of hosiery materials, etc. furnished free and prepaid. Simply mail name and address to: Kendex Company, Babylon 13, N. Y.

**SELL \$2 Fire extinguishers.** Locally, mailorder. Lorrac Products, Albany 1, N. Y.

**SELL Ultra-blue stock signs to stores.** 1000 slogans, comedy, general, religious. "7x11" cost 6c, sells 35c. Make money. 15 samples ultra-blue signs "7x11" \$1.00 postpaid. Lowy, 8 West Broadway, Dept. 438, New York City 70.

**EARN Big money year 'round.** Be a one-person-department-store. Take orders for shirts, ties, hosiery, lingerie, household linens, etc. For information, Corporate Merchandisers, Dept. PM-10, 110 West 34 Street, New York City 1.

**BIG Bargains for big profits.** Over 100 sensational wholesale values. Men's used suits \$2, pants 35c, topcoats \$1.25, overcoats \$2, shoes 20c. Experience unnecessary. Free catalog. Superior, 1250-A Jefferson, Chicago 7.

**AMAZING Offer—\$50 is yours for selling** only 100 boxes entirely different, new deluxe all-occasion cards. Patented feature television card included. Each box sells for \$1.00, your profit 50c. Surprise items. It costs nothing to try. Write today for samples. Cheerful Card Co., 499, White Plains, N. Y.

**WANT Pleasant outdoor work in a business** of your own? Good profits selling over 200 widely advertised Rawleigh home/farm necessities. Pays better than most occupations. Hundreds in business 5 to 20 years or more! Products—equipment on credit. No experience needed to start—we help you. Write today for full particulars. Rawleigh's, Dept. A-145-PPM, Freeport, Ill.

**SELL The famous \$3 "Fire-Killer" extinguisher** with bracket, wholesale or direct; big profits; exclusive territory. "Fire-Killer," Syracuse 1, N. Y.

**FAST Money!** Take orders for new sensationally different picture enlargements. No competition. Everybody buys. Gotham Products, Box 5427 M, Philadelphia 43, Penna.

**LOOK Here! Wanted—Men and women** to start in business on credit. Sell some 200 farm-home products. Thousands our dealers now make quick sales, big profits. For particulars write Rawleigh's, Dept. A-192-PPM, Freeport, Ill.

**HOUSE To house salesmen for the best** in brushes. Write Argon Brush Co., 511 8th Ave. N.E., Minneapolis 13, Minnesota.

**QUALITY Plastics at new low prices!** Tablecloths, aprons, garment bags, utility covers. Free illustrated pricelist M91. Acclaim Products, 25 Hillside Ave., New York 34, N. Y.

**SELL Books by mail.** Mammoth sales and huge profits. Everything furnished. Send 3c stamp for complete details. Business Plans Foundation, Box 56, Madison Square Station, New York 10, N. Y.

**SELL By mail books, novelties, bargains!** Ready made circular service! Large profits! Catalog free! Elfco, 432 North Wells, Chicago 10.

**SCHOOL Seniors—Earn 40% commission** selling classmates America's most beautiful graduation name cards. Largest selection. Outsells all others. Free sample kit. Printercraft, Dept. M, 1425 E. Elm St., Scranton 5, Penna.

**BIG Money selling cast iron and aluminum** cooking utensils direct to consumer, exclusive designs. Free illustrations. Jones Machine & Foundry Co., Chattanooga 2, Tenn.

**GUARANTEED Product in protected** territory, if you are now selling or intend to sell house-to-house. For full 1 qt. sample amazing High Shine Windsor No Rubbing Wax, send only 25c covering handling and postage. (Sells for \$1.25.) Windsor Wax Co., Inc., Dept. P.M.-2, Hoboken, N. J.

**MAGIC Cleaner—Laundry soap deal.** Hotter than a firecracker. Big profits. Sample free. Bestco, 4642 No. Central, Chicago.

**MAKE More money selling personal** initialed individualized belts, buckles, cap badges, tie holders, name plates. 2,000 emblems to choose. Big profits, whole or part time. Write today; special outfit offer. Hookfast Specialties, Box 1425, Dept. 6, Providence, Rhode Island.

**AGENTS: Stamping names on pocket-**key protectors. Sample check with your name, address, 25c. Stamping outfits. Emblem checks, check-fobs, name plates. Hart Mfg. Co., 303 Degraw St., Brooklyn, N. Y.

**GOLD Lacquered window sign letters.** Large sizes penny each. New foils. Absolutely beautiful. Free samples. Atlas, 544 W. 79th, Chicago 20.

**EXCELLENT Sideline for printing and** advertising salesmen. Decalomania name plates in small quantities. Great demand. Also, make money with our line of automobile initials and sign letters. Free samples. "Ralco" XL-Roxbury, Boston 19, Mass.

**AGENTS—300% Profit selling genuine** gold window letters; stores and offices. Free samples. Metallic Letter Co., 438-B North Clark, Chicago.

#### AGENCIES WANTED

**IF You manufacture counter hardware** items or novelties and are looking for a sales outlet contact us. Ingle & Company, Murray Theatre Bldg., Richmond, Indiana.

#### HIGH-GRADE SALESMEN

**IN '49 Sell the "big" line—"The** world's latest" Sinco calendars and advertising specialties. Write today. H. W. Singleton Company, Dept. PM, Salt Lake City, Utah.

**ADVERTISING Book matches—Cash** in on big demand; sell union label matches. Cuts for all businesses and political parties. Free powerhouse selling kit, low prices, protection guaranteed on repeat orders. Cash commissions. Superior Match Co., Dept. M-19, 7530 Greenwood, Chicago.

**BIG Profit opportunity for salesmen.** Decalomania nameplate, sells to all businesses. Repeats often. Sensational manufacturing methods beat competition with low prices, immediate delivery, small quantities. Make money without investment. Sideline or full time. Free samples and complete information will convince you. International Industries, Culver City 1, California.

**BABY Shoes metalized and mounted.** Big profits. We do work. Ellisons, 2419 Wylie Ave., Pittsburgh, Penna.

**QUICK Earnings selling dealers.** Complete line. Power units. Farmco, M-2001, Excelsior Springs, Mo.

**FANS—Fans—Salesmen making \$50 to** \$100 per day selling our electric fans and sump pumps. Write—Universal Fan Co., Inc., Peru, Indiana.

**SALESMEN—Put yourself in line for** big money and real future. Keep stores supplied with 5c-10c counter goods. Nationally advertised merchandise. Top profits for you and merchants. Liberal deals boost sales. Sideline or full time. World's Products, Dept. 10-M, Spencer, Ind.

**UP To \$50.00 in a week and tailored suit** for yourself without paying one cent. Write for plan. Progress Tailoring Co., Dept. N-217, Congress and Throop, Chicago 7, Ill.

**OVER 100 "Automatic fire extinguisher"** experienced dealers have changed to Red Ball Inc. since Oct. 25. There is a reason. Make us prove it. Write Box 1655, Salt Lake City, Utah.

**POPCORN Machines, all electric un-**peanut roasters, carameltcorn, heating appliances. No inside Sales, Indianapolis, Iowa.

**NEW Jobs open in selling! Send name,** address for free issues of Opportunity Magazine's money-making guide, listing hundreds of companies who'll pay you well, full or part-time. No experience needed. Opportunity, 28 E. Jackson, Dept. 17, Chicago 4, Ill.

**AMAZING Discovery.** Master Glaze puts brilliant glass-like surface on cars. Free sample, information. Big commissions. Master Glaze, Dept. 665, 7720 Harwood, Milwaukee, Wisc.

**SALESMAN! Make over \$30.00 a day.** Sell nationally advertised adding machine for only \$22.95 complete. A desk model portable precision built, fully guaranteed, every inch a business machine. Easy to operate, easy to sell, easy for you to make big money at 49% profit! For life-size color photo and full details, write today to Lightning Adding Machine Co., Inc., Dept. ZD-6, 543 So. Spring Street, Los Angeles 13, Calif.

**BALLOONS, Toys, novelties, etc.,** wholesale. For full information write Dutz Enterprises, 109-A Sangamon, Lincoln, Illinois.

**QUICK Sure money. Selling Annie Blain** flavors. Highland Park 1, New Jersey.

**SELL 7 x 11 Signs, no trespassing, etc.,** 25 different. 100-\$2.50. Postpaid. Retail \$10.00. Information write, Feld, 813 Ellison, Cincinnati, Ohio.

**BIG Money selling tooth powder.** Write today. James Walker, 633 Plymouth Ct., Chicago, Ill., Dept. 3.

**BIG Money taking orders. Shirts, ties,** socks, pants, jackets, sweaters, shoes, uniforms, etc. Sales equipment free. Experience unnecessary. Nimrod, 4922-AN Lincoln, Chicago.

#### EDUCATIONAL AND INSTRUCTION

**"HOW To Break and Train Horses"—A** book every farmer and horseman should have. It is free, no obligation. Simply address, Beery School of Horsemanship, Dept. 1101C, Pleasant Hill, Ohio.

**IF You'd like a profitable office busi-**ness, operate a collection agency. Our inexpensive short course quickly qualifies you. Write Cole & Associates, Syracuse 2, New York.

**GOOD Jobs and a sound substantial fu-**ture await you in hotel and institutional field. Men and women, all ages, needed for well-paid positions that offer color, excitement, ever-new and fascinating duties. Record breaking travel means even greater opportunities for trained men and women in hotels, clubs and institutions. Lewis School receiving calls for managers, assistant managers, stewards, hostesses, purchasing agents and 55 other types of important positions! From coast to coast there are important positions that offer splendid opportunities for advancement in a business where you are not dropped because you are over 40. Previous experience proved unnecessary! No need to leave your job to qualify. A good grade school education, plus Lewis Training qualifies you at home, in spare time. Our National Placement Bureau helps to place you; and our amazing Certified Job Plan actually certifies you will "make good" when placed. Write today for free book! Veterans: Course approved for Veteran's training. Lewis Hotel Training School, Room PA-368, Washington 7, D.C. (First and only school of its kind—now in its 33rd year.)

**INVESTIGATOR Training.** Phillips Secret Service. 1917B North Kenneth, Chicago 39, Illinois.

**BOOKKEEPERS! Increase your earnings.** Operate your own simplified "Dollar-A-Week" bookkeeping and tax service. Full or spare time. Details free. No obligation. Ellis, Box 200, Cedar Grove, North Carolina.

**NOW You can have an office. Learn** credit-collection business by new home study course. Many earn up to \$5,000-\$15,000 annually. Free bulletin. Franklin Credit School, Dept. 202A, Roanoke 7, Virginia.

**NOW You can learn professional lock-**smithing at home. The same professional course taught in our famous resident school now available as extension course. All locks mailed your home for study. Young, old, disabled, become independent. Operate your own business. Only approved school in nation. The professional course you've always wanted. If you cannot attend our resident school, we'll bring our Government approved school to you. National Locksmithing School, 1074 Valencia St., San Francisco.

1949 GOV'T. Jobs! Many new openings. Start high as \$3,351. Secure positions. Men-women. Qualify now. Free 40-page book, sample coaching. Write Franklin Institute, Dept. K24, Rochester, N. Y.

MAKE Up to \$30-\$40 week as a trained practical nurse! Learn quickly at home. Booklet free. Chicago School of Nursing, Dept. M-1, Chicago.

SCIENCE Of memory simplified. Free booklet "Memory Development." Memory Club, 2016 Sunnyside Ave., Chicago 25, Ill.

HOME Study courses. Over 500 subjects. Courses include text, lessons, examinations, etc. Complete, only \$9.95. Write DeVoto Schools, 35 Vicente, San Francisco 16 Calif.

NEW Style home study course in advertising art now ready. Free portfolio "Your Career in Art." Applied Art Studio, 1662 Lincoln Avenue, Cleveland 7, Ohio.

WANTED. Watch repairing. International and other good used correspondence courses. Bought. Sold. Rented. Baker, 5509-B Winthrop, Chicago 40.

BECOME A Doctor of Psychology or Metaphysics. Teach secret of contentment, happiness. Win degree of Ps.D. or MsD. Solve mental worries. Free book. College of Universal Truth, 5153-C North Clark, Chicago.

SPECIAL Offer radio instruction publication. Radio Maintenance. How to service. install, profit in radio, television, sound. Six editions, 200 pages \$1 postpaid. Radio Maintenance, Montclair, N. J.

BOOKKEEPING Easily learned! Rapid, simplified instruction. Introductory lesson 35c—15 lesson course, \$5.00. B. Buchalter, 1280 Ocean Ave., Brooklyn 30, N. Y.

OIL Painting—Economic, home study course. Write Carlos Art Academy, Correspondence Division, Watertown, N. Y.

INVESTIGATOR Courses. Free literature. Criminology Institute, 1324 West Broadway, Dept. P-3, Spokane, Wash.

WELDING—Learn a profitable trade quickly at best equipped school in U. S. G. I. approved. Free catalog. Write Hobart Welding School, Box M-197, Troy, Ohio.

EARN More quicker; amaze with Super-memory, established 1938. Facts, figures, names, stick like burrs. Write Thor Books, CMI, Box 1210, Chicago.

EXPORT! Learn at home from established world trader. Big paying positions. Your own profitable world-wide business by mail order without capital; or travel abroad. Experience unnecessary. Free booklet. Mellinger, 101W, Los Angeles 24, Calif.

LEARN Air conditioning, refrigeration, and heating. Write today for free booklet. Detroit Air Conditioning Institute, 4125 Grand River, Detroit, Michigan.

SPANISH—Learn fast—with Speed-O-Way phonograph records and textbook, \$7.95 complete. Write for free folder. Speed-O-Way Publications, Box 2301, Houston 1, Texas.

DENTAL Technician's practice kit. Artificial teeth, plastic, etc. Free instructions with kit. Grant Laboratory, S-219 W. 7th, Los Angeles, Calif.

BE A real estate broker through home study or classroom instruction. Write for free book. Approved for veterans. Weaver School of Real Estate, 15 E. Pershing Rd., Box CP-1, Kansas City 8, Mo.

MEDICAL Laboratory technicians in great demand. We train you in your own home, in your spare time. Also home study course in general chemistry. Free catalog. Imperial Technical Institute, Box 973-J, Austin, Texas.

USED Correspondence courses and books bought, sold, rented and exchanged. Catalog free. Lee Mountain, Pisgah, Alabama.

LEARN Photo-engraving at home or in oldest, largest school in America. Work for newspaper or establish own profitable business. New Tasope! Photo-Engraving equipment available soon. Write for information. Veterans ask about G.I. training. The Aurora School of Photo-Engraving, Tasope! Bldg., Aurora, Mo.

LINGUAPHONE Makes languages easy. At home learn to speak Spanish, Portuguese, Italian, French, German, Russian, by quick, easy Linguaphone Conversational Method. Save time, work, money. Linguaphone correspondence courses are available to veterans under G.I. bill of rights. Send for free book. State if G.I. Linguaphone Institute, 83 RCA Bldg., New York, 20, N. Y.

SECRET Investigation. Experience unnecessary. Investigators particulars free. George Wagner, M 125 West 86th, New York.

### PLAYS, STORIES, MANUSCRIPTS

I WANT New writers to cash hundreds of checks for \$1 to \$100, offered each month. The easiest way to write for pay. No previous experience necessary. Send for free details. No obligation. Saunders M. Cummings, 468-M Independence Bldg., Colorado Springs, Colo.

### BUSINESS SERVICE

HOLLYWOOD Remail service, or what? Everson, Box 133, West Los Angeles 25, Calif.

WE Receive, reforward letters; \$3.00 monthly or 25c each. "Hawkins," 1300 Tailor, Washington 11, D. C.

### SPECIAL SERVICES

POSTMARK Your letters Lisbon, or Estoril, the Portuguese Riviera, 50c, air-mailed \$1.00. Inquiries about Portugal, \$1.50. Only bank money order accepted. A. Feio, Apartado 202, Lisbon, Portugal.

PHOTOSTATIC Copies. Write for prices. Hamy, 214 Robinson, Hudson, N. Y.

### INFORMATION

3,670 MISSING Relatives located. Heirs traced. Many pointers! Bulletin 25c. Chaffee, 308 Washington, Chicago 6.

### CARTOONING, COMMERCIAL ART, SHOWCARD WRITING, SIGN PAINTING

"HOW To Make Money With Simple Cartoons"—a book everyone who likes to draw should have. It is free; no obligation. Simply address Cartoonists' Exchange, Dept. 91-C, Pleasant Hill, Ohio.

LEARN Showcard writing at home in spare time. Fascinating, profitable. Free information. Sherwood Publishing Co., Irvington 11-6, N. J.

FAMOUS 875 Lockwood art course now only \$6 postpaid. Other smashing art bargains. Catalog 10c. Art Book Shop, Arnold 5-B, Missouri.

SIGN Letters; ready made, just paste them on easily; all colors, sample free. "Artistic," 74 Edmund Pl., Detroit.

CARTOONIST'S Magazine, 25c. Lessons, hints. Cartoonist Hartman, 2776 California Ct., Lincoln 8, Nebraska.

BECOME Professional lettering artist. Make money. Design stationery. New, amazing device. Major-Art System, 3510 Palmer, Chicago 47.

FIGURE Drawings by French artist Lalire. Over hundred female poses, body details, \$1.00. Art Headquarters, 1160 25th Avenue North, St. Petersburg, Florida.

CHALK Talks. Laugh producing program, \$1.00. Catalog 10c. Balda The Cartoonist, Oshkosh, Wisconsin.

### ADVERTISING AGENCIES, LETTER WRITERS, FOR ADVERTISERS

FREE! 1948 Advertisers Rate and Data Directory, 52 pages! E. H. Brown Advertising Agency, 20 N. Wacker, Chicago 6.

ADVERTISING Sensation! Reach 2,100,000 families, \$32.90 inch. Display, classified, ratebook (newspapers, magazines, mailing lists), advertising assistance, free. Chicago Advertising Agency, 20-PM West Jackson, Chicago 4.

ADVERTISE: 24 Words, 40 newspapers \$3.50. Lists free. Advertising Bureau, 10511-C Springfield, Chicago 43.

MAILORDER Advertising! Complete planning, writing, placing service. Quarter-century reputation. Les Finkle-Advertising, 257 South Spring, Los Angeles 12, California.

COPY-Writing—Forceful sales messages! Letter for little as \$3.00. Prospectus. Fred Schmaus, 895P East 241st Street, New York 66, N. Y.

COMPLETE Service for mail advertisers, planning, preparation, printing, placing. Write: National, Box 88-A, Dorchester, Mass.

SALES Letter writing our specialty! Production facilities. Particulars on request. Commercial Record, Saugatuck, Michigan.

CHOICE Mailing lists. E. J. Eller, Broker, 1000 Sutter Street, San Francisco 9, Calif.

EXPENSIVE But sure. Selected retail customers eager for sporting, trapping, miscellaneous goods. \$15 list of 1000. Check with order or c.o.d. Mer-Kel Mdse. Mart, Box 99b, Station A, Brooklyn 16, N. Y.

ADVERTISERS! Reach nearly 18,000,000 readers. 25 Sunday national key newspapers, 18 words, \$49.75. "Terrific pullers," 20 popular newspapers, \$10.00. "Free booklet," Special—One inch display 2,-821,198 circulation, \$48.30. Newmark's Advertising Agency, (Established 1893), 217-7th Ave., New York 11.

24 WORDS In 50 weeklies, \$4.96. J. Darnell, 730 Hays, Jackson, Tennessee.

ADS Placed in out of town newspapers and magazines. Low rates. Catalogue free. Ideas that pay. Baker Advertising Agency, Successors Ankrum Agency, 189 W. Madison, Chicago 2.

MAILING Lists, certified, productive, inexpensive, \$5.00 1000. Homeworkers, agents, buyers, etc. Write Dixie Service, King, N. C.

### TYPEWRITERS, DUPLICATORS, OFFICE DEVICES

ADDRESSING Machine complete with supplies \$32.50. Samples and folder free. Mail Addresser, San Marcos, Texas.

AMAZING New portable addressing machine only \$24.50! Complete details free. Addresso Sales, 1409A Southeast 6th Street, Minneapolis-14.

"PRINT-O-PRESS" DeLuxe self-feeding duplicators, legal size, \$29.50. Starts you in business. Fred Schmaus, 895M East 241st Street, New York 66, N. Y.

BOOM Your business with postcard stencil duplicator, \$4.75. Guaranteed performance. Postagraph, Box 181, Cincinnati 1, Ohio.

PRINT-O-MATIC Mimeographing post card typeless stencil duplicator printer \$13.50. Office duplicators—Hilcos, Speedprints. Typewriters, portable adding machines, addressettes, automatic envelopers, sealers. All office machines. Duplicator supplies. Literature free. Pittsburgh Typewriter Supply, 336-4 Fourth Avenue, Pittsburgh 22, Penna.

STANDARD Typewriters \$25.00; duplicators \$12.50; adders \$12.50. Ship all states. "Typewriters," 118 Spruce, Wichita, Kansas.

RECONDITIONED Typewriters, mimeograph, multigraph printing devices, appliances, supplies. Catalog. Dixiegraph Service, King, N. Carolina.

### RUBBER STAMPS AND OFFICE SUPPLIES

RUBBER Stamps. Send for catalog. Excello, Box 500, Shreveport, La.

3 LINES 50c. Printing. Catalogue. Johnson Press, Box 6-A, New York City 26.

LINE 20c; 2-35c; 3-50c. Stamp Works, Auburn, Nebraska.

### PRINTING, MULTIGRAPHING, MIMEOGRAPHING, GUMMED LABELS

MIMEOGRAPHING. Prompt service, reasonable. Sautt Company, Box 127-A, Mattapan 26, Massachusetts.

1000 EMBOSSED Business cards \$3.00 postpaid. Free sample; style chart. Lynn, 5710 Bankfield, Culver City, California.

BUSINESS, Personal stationery. State requirements. Samples, pricelists free. How Printing Company, 721-23 Eunice, Webster Groves 19, Missouri.

QUALITY Printing reasonable. Estimates. Standard Press, Box 381, St. Louis, Mo.

POSTAL Brings dollar printing specials, samples. Hughes Service, Shillington, Penna.

KROME-KOTE Shipping labels. America's finest. Printed in red and blue, 1000-\$4.95, 5000-\$12.50. Samples free. Peters Associates, Troy 1, Ohio.

100 ENVELOPES Printed, 2-colors \$1.00. Samples. Box 523, Rochester 2, N. Y.

2000 BUSINESS Cards \$3.50 postpaid. Messenger, Box 144, Clinton, Mass.

CALENDAR Novelties. Samples for stamp. Cassel, Route 4, Middletown, N. Y.

BUSINESS, Personal stationery. State requirements. Samples. Mero Products, 100 Morrison, Punxsutawney, Penna.

100 8 1/2 x 11 HAMMERMILL Letterheads with 100 envelopes \$2.00 Postpaid. Benneville, Box 1931, Pittsburgh 30, Penna.

**GLO-BRITE Letterheads** "Increase" business. Beautiful combination colors. Samples free. Rienzi Press, 24 North 7th Street, Newark 7, New Jersey.

**BETTER** Grade printing reasonable. Estimates on anything. Economic Press, Leonia, N. J.

**BARGAINS**—Hand presses, supplies. Catalogs 10c. Customprint, 211-P, Springfield, Missouri.

**LETTERHEADS, Billheads, ruled forms, mimeographing.** Inexpensive. United Printing, Pottstown, Penna.

1949 **PRICE List** free. Mango Printing Co., 555-A South 20th, Newark 3, N. J.

100 8 $\frac{1}{2}$ x11 **HAMMERMILL** Letterheads, 100 envelopes (5 lines) \$2.00. R. Cook (Dept. 219), 730 West Gift, Peoria 5, Ill.

1000 **BUSINESS** Cards, \$2.50 prepaid. Samples free. Reliable Print Shop, 905 East Jefferson, Louisville 6, Ky.

**BLOTTERS**—2x4, 1949 Calendar and your ad. Samples. Blotter-Ad, 5303 Atlantic Ave., Ventnor, N. J.

**SAVE** Money on your printing. Write today for new, low price list and offset ordering chart PM-1 free. We photograph your copy and reproduce it on white or colored paper. Advertisers Service Litho, 161 W. Harrison, Chicago 5, Illinois.

**BLOTTERS, Cards** exclusively; lowest prices; samples. Box 174, Niagara Falls, New York.

**SEND** 10c Now, for our 48 page 1949 price list—refunded first order. McCall Press, 1326 South 27th, Omaha, Nebraska.

1000 **BUSINESS** Cards (embossed) \$2.95 postpaid. Zephyr Printing, Box 312pm, Venice, California.

500  $\frac{3}{4}$ x2 $\frac{1}{4}$  **FOUR** Line gummed stickers 35c; red border 50c. Moritz Printery, Saginaw, Mich.

**QUALITY** Printing—Reasonable prices. Fast service on catalogs, folders, publications. Write for prices. Bagby Printing Co., Georgetown, Ohio.

**MIMEOGRAPHING**—Letters, pricelists, formulas, instructions. Lowest prices. Lem's Letter Shop, 5710 Stanton, Detroit 8.

#### PRINTING OUTFITS AND SUPPLIES

**MAKE** Your own plastic printing cuts. New plexiglass process. Plexiservice, Argyle 1, Wisconsin.

**HEMOCRAFT** Presses, supplies. Catalog 10c, refundable. Riegel, 1111 Harrison, Philadelphia 24, Penna.

**PRINTING** Presses, type, supplies. Lists 3c. Turnbaugh Service, Loysville, Penna.

**PRINTING** Presses, type, supplies. Send dime for complete illustrated printer's supply book, details and press samples. Kelsey, Inc., A-11, Meriden, Connecticut.

**INEXPENSIVE** Home-made printing press. Details free. Novelty Shop, Downsville, Louisiana.

#### PATENT ATTORNEYS

**PATENTS, Trade marks.** Sanders, 6430 Evans, Chicago. Registered U. S. Patent Office.

**INVENTORS**—Patent laws encourage the development of inventions. The Rules of Practice of the U. S. Patent Office advises—unless an inventor is familiar with such matters—that he employ a competent registered attorney or registered agent, as the value of patents depends largely upon the skillful preparation of the specifications and claims. Write for further particulars as to patent protection and procedure and "Invention Record" form at once. No obligation. Mc Morrow; Berman & Davidson, Registered Patent Attorneys, 134-Y Victor Building, Washington 1, D. C.

**INVENTORS:** When you are satisfied that you have invented something of value write me, without obligation, for information as to what steps you should take to secure a patent. Write Patrick D. Beavers (Formerly Randolph & Beavers) Registered Patent Atty., 935 Columbian Bldg., Washington 1, D. C.

**PATENT** Protection—Unless an inventor is thoroughly familiar with such matters, he is advised to employ a competent registered Patent Attorney as the value of a patent depends largely upon the skillful preparation of the specification and claims. Send for booklet, "Patent Protection for Inventors," outlining preliminary steps to take to obtain patent protection. Victor J. Evans & Co., 431-A Merlin Building, Washington 6, D. C.

**INVENTORS:** Learn how to protect your invention. Unless the inventor is familiar with patent matters, he should engage a competent registered patent attorney or agent to represent him. We are registered to practise before the U. S. Patent Office and prepared to serve you in handling your patent matters. "Patent Guide for the Inventor" containing detailed information concerning patent protection and procedure with "Record of Invention" form will be forwarded to you upon request—without obligation. Clarence O. O'Brien & Harvey Jacobson, Registered Patent Attorneys, 91B-A District National Building, Washington, D. C.

**GUSTAVE** Miller—Patents and trade marks, 19-A Warner Building, Washington 4, D. C. Registered Patent Attorney. Associate Patent Examiner, U. S. Patent Office 1922-1929.

**PATENTS.** "Proof of Invention" folder mailed without obligation. E. E. Vrooman, Registered Patent Attorney, 505 McKim Building, Washington 5, D. C.

**C. A. SNOW & Co.**—M-427, Snow Building, Washington 1, D. C. Registered Patent Attorneys. Write for information.

**PATENTS**—Trade marks, Irving L. McCathran, 315 McLachlen Bldg., Washington 1, D. C. Registered Patent Attorney.

**INVENTORS.** For "Record of Invention" form, contact Carl Miller, Registered Patent Attorney, Woolworth Building, New York.

**INVENTORS:** Without obligation, write for information explaining the steps you should take to secure a patent. John N. Randolph, Registered Patent Attorney, 203 Columbian Bldg., Washington 1, D. C.

"**INVENTOR'S** Guide" free on request. Frank Ledermann, Registered Patent Attorney, 154 Nassau St., New York 7, N. Y.

**PATENT** Practice before U. S. Patent Office. Validity and infringement investigations and opinions. Booklet and form "Evidence of Conception" forwarded upon request. Lancaster, Allwine & Rommel, Registered Patent Attorneys, Suite 411, 815-15th Street, N.W., Washington 5, D. C.

**INVENTORS:** Write for free brochure "Evidence of Invention." Labiner, World Building, New York 7.

#### FOR INVENTORS

**INVENTORS**—Patent laws encourage the development of inventions. The Rules of Practice of the U. S. Patent Office advises—unless an inventor is familiar with such matters—that he employ a competent registered attorney or registered agent, as the value of patents depends largely upon the skillful preparation of the specifications and claims. Write for further particulars as to patent protection and procedure and "Invention Record" form at once. No obligation. Mc Morrow; Berman & Davidson, Registered Patent Attorneys, 134-X Victor Building, Washington 1, D. C.

**PATENT** Searches \$5.00. Reports airmailed within 4 days. Invention protection forms free. Write Patent Research Service, 703M Albee Bldg., Washington 5, D. C.

**INVENTORS:** The usual first step is to have a search of the U. S. Patents conducted, so I can report on patentability. Write, without obligation, Patrick D. Beavers (Formerly Randolph & Beavers) Registered Patent Atty., 936 Columbian Bldg., Washington 1, D. C.

**INVENTORS:** Learn how to protect your invention. Unless the inventor is familiar with patent matters, he should engage a competent registered patent attorney or agent to represent him. We are registered to practise before the U. S. Patent Office and prepared to serve you in handling your patent matters. "Patent Guide for the Inventor" containing detailed information concerning patent protection and procedure with "Record of Invention" form will be forwarded to you upon request—without obligation. Clarence A. O'Brien & Harvey Jacobson, Registered Patent Attorneys, 91A-A District National Building, Washington, D. C.

**INVENTORS**—This firm is registered to practice before the U. S. Patent Office and is available to assist inventors in the preparation and prosecution of their cases. "Patent Protection for Inventors" booklet containing detailed information and steps to take toward patent protection will be sent upon request. No obligation. Victor J. Evans & Co., 432-A Merlin Building, Washington 6, D. C.

**INVENTORS:** Small fee displays model and drawings to manufacturers 6 months. Particulars free. American Inventors Exhibit, 184 W. Washington, Chicago.

**PATENT** Searches \$6.00. Five day service. Invention protection forms free. Write Raymond L. Smith, Patent Searcher, 410-M Bond Building, Washington 5, D. C.

**PATENT** Searches \$6.00. Reports airmailed in five days. Invention protection forms free. Write Miss Ann Hastings, Patent Searcher, P.O. Box 176, Washington 4, D. C.

**INVENTORS'** Financial assistance. Investment Development Company, Box 1462, Amarillo, Texas.

**MAKE** Ideas earn money. Literature free. Grayland, 5312 Grace, Chicago 41.

**IDEAS** Are worth money. Free booklet. Eto Development Company, Long Island City 1.

**PATENTED, Unpatented, inventions** promoted. M. Joyce Humphries, 1424 Landtite, Philadelphia 10, Penna.

**INVENTORS**—Possibly I can help you. Many years experience. Charles A. Scott, 773 Garson Avenue, Rochester 9, N. Y.

"**INVENTOR'S** Guide" free on request. Frank Ledermann, Registered Patent Attorney, 154 Nassau St., New York 7, N. Y.

**INVENTORS:** If you have an invention for sale, patented or unpatented, write Institute of American Inventors, Dept. 40A, 1926 Eye St. N.W., Washington 6, D. C.

**INVENTORS:** Without obligation, write for information explaining the steps you should take to secure a patent on your invention. John N. Randolph, Registered Patent Attorney, 202 Columbian Bldg., Washington 1, D. C.

**CASH** For your idea. 280 manufacturers need inventions, patented or unpatented. List free. Invention Bureau, 208M Clinton, Oak Park, Illinois.

#### INVENTIONS WANTED

**CASH**—Royalty. We manufacture, nationally advertise inventions. Fast action! Federal Identification Co., Robert Burbridge, Pres., 1713-35 West Grand Ave., Oklahoma City 6, Okla.

"**INVENTORS**"—Charges from royalties only. Inventors-Manufacturers Associates, 5 Beekman Street, New York, Dept. PM.

**INVENTORS.** If you have an issued patent ready to work as state franchises on commission, write me. Ingles, 15 W. Ontario, Chicago.

**WE** Sell patents. Submit full details. Universal Guaranty Co., Lakewood, N. Y.

**HIGHEST** Royalties—Cash. Official U. S. I. R. C. certification. Request free Booklet "M". Universal Marketing Co., 354 South Spring St., Los Angeles 13, Calif.

**CASH** For your idea. 280 manufacturers need inventions, patented or unpatented. List free. Invention Bureau, 208M Clinton, Oak Park, Illinois.

**INVENTORS:** Hundreds of manufacturers have requested our assistance in locating marketable new products. Complete information, free. Institute of American Inventors, Dept. 40-D, 1926-Eye St. N.W., Washington 6, D. C.

**SMALL** Inventions wanted by manufacturers. I'll help you sell your invention. Write for circular. Stanley Hull, 7829 Euclid, Cleveland, Ohio.

**BOOKS**—All Kinds—Homecraft, Radio, Plastics, Boat Building, Photography, Model Building. Catalog free. Popular Mechanics Press, 200 E. Ontario St., Chicago 11, Ill.

#### PATENTS FOR SALE

**PLASTIC** Trolling float. Pulley turns on long screw. Adjustable stop regulates depth of hooks. Patent pending. Jack J. Kirschman, 223 Oriental Ave., Atlantic City, N. J.

**PATENTED** Poultry watering system. Nothing like it on the market. For sale or on royalty. Darus Shaw, East Jordan, Michigan.

**IGWT.** Hot Springs, New Mexico, still has licenses available on starterless fluorescent lamp bulb. Screws in any socket.

"**SUNBURST**" Novelty lamp. Reflecting bases. Sale or royalty. Sample postpaid \$3.00. Free circular. Sommerville, 431 North Fair Oaks, Pasadena, California.

**INVENTORS:** Test the commercial value of your patented or unpatented inventions, quickly and inexpensively. Write for free information. Institute of American Inventors, Dept. 40-B, 1926-Eye St. N.W., Washington 6, D. C.

## MANUFACTURING

**MODELS**, Experimental work; designing; manufacturing. Henry, Engineer, 2815 Hudson Blvd., Jersey City 6, N. J.

**WOLVERINE** Stool for barbers \$26.75 f.o.b. Monroe, Michigan. Higher prices do not guarantee superior quality. Compare! Send for literature today. Wolverine Mfg. Company, P.O. Box 202, Monroe, Michigan.

**MODELS**—Small lot manufacturing. Metals, plastics, etc. Milburn, Burlington, Kentucky.

**PLASTIC** Moulds, progressive stamping, production, tools and dies. Models, free estimates. Steffy Screw Products, New Baltimore, Michigan.

**PERMANENT** Moulds for plastics, aluminum castings. Unamit Mould & Machine Company, Bunker Hill, Ill.

**MODELS**, Tools, dies, experimental work; large and small lot manufacturing. Van-Ess Specialties Company, 212 W. 14th Street, Covington, Ky.

**MODELS**—Small lot manufacturing. Metals, plastics, etc. Milburn, Burlington, Kentucky.

## MODELS, MODEL SUPPLIES

**POWER** Models—Steam and gasoline engines, steam traction engine, metals, tools. Catalog 35c. Chas. Cole, Ventura, Calif.

**BUILD** Model buildings the way builders do. Framed, boarded, finished, introductory house kit \$1.00. Mayberry's, Beverly Farms, Mass.

**COVER** Your flying models properly with Grafiglu cement. Contains plasticizer. Also an excellent adhesive for cloth, plastics, metals, and their combinations. Economy jar (4 oz.): \$1.00 prepaid parcel post. Cumer Laboratories, 4053 Lindell Blvd., St. Louis 8, Mo.

**SHIP** Model kits. Send 15c for 1949 catalog. Model Shipways, Folio 60, 476 Main Street, Fort Lee, New Jersey.

**SHIP** Models—Kits, fittings, plans, books, engines. Illustrated catalog 25c. James Bliss & Co., Inc., 220 State Street, Boston, Mass.

**BRASS** Gears and model supplies, send 10c for catalog. Pierce Model Works, Tingley Park, Ill.

**SHIP** And yacht model fittings; blueprints. Send 25c for illustrated catalog No. 21—listing hundreds of items. A. J. Fisher, 1002-1 Etowah Ave., Royal Oak, Mich.

**RAILROADERS**—50c Gets new 1949 catalog reference manual. State O or HO gauge. Walthers, 247 Erie, Milwaukee 2, Wis.

**LARGE** Illustrated catalog Lionel trains and accessories, 10c. Bens Hobby Shop, 72 West Washington, Chicago 2.

**200 SHIPS** Drawings, clippers to landing barges, shipfittings, engines. List dime. Gullmars, Westhill, Ontario.

**STEAM** Engines, boilers, castings. Catalog 25c. Anton Bohaboy, 2297 Price, Rahway, New Jersey.

**MINIATURE** Steam locomotives, 1/4", 1/2", 3/4" scales. Castings, parts, rail, steam fittings! Thorough drawings with instructions. Catalog 35c. Little Engines, Wilmington, Calif.

**SHIP** Models and yacht supplies complete. Large 64 page catalogue 30c. Bill Wild's, 510 East 11 St., New York City 9.

**LANDLOCKED** Sailors! Here's a beautiful, richly illustrated, fully descriptive catalogue of famous model ships—whalers, slavers, corvettes, etc., authentic in every detail. Send for it today. Only 25c. Halesite Yacht Service, Inc., Halesite, Huntington, N. Y.

**BUILD** Historic ship models, complete kits 39c to \$8.50; send 10c for catalog. Ideal Models, 19 West 18th Street, New York 11, N. Y.

**KEEP** In touch with the activities of the British modelmaking fraternity. Send a dollar bill for year's subscription (4 issues) Modelcraft Magazine and list. 77 Grosvenor Road, London, S. W. 1.

## HOME CRAFTSMEN

**SWISS** Musical units \$2.25 each. Scott Mfg. Co., Wallingford, Connecticut.

**TURN** Your workshop into cash. Send postcard for catalog of modern saleable projects. Craftplans, 7241-P Madison, Kansas City 5, Mo.

**SWISS** Musical units \$3. Music Boxes, 131 West 42nd, New York 18.

**LAWN** Ornaments. Ready cut patterns, full size. 20 assorted \$1.00 postpaid. Lincoln Craft Studio, Farmington, Conn.

**LAWN** Chairs, garden figures, furniture, novelties, toys, etc., 68 popular plans with full size patterns, \$1.00. Mastercraft 1M, 7041 Olcott, Chicago 31, Illinois.

**FREE** Catalog: make money by making beautiful, dainty sea shell jewelry. Artcraft Shell Supply, P.O. Box 2181, Sarasota, Florida.

**LUCITE**, Plexiglas. Special assortment, clear, white, black, butterscotch. Make bracelets, tie clasps, etc. Simple. Cameos, Instructions, included, \$1.00. Plastech, Arverne, N. Y.

**BOOKLET**, Hobbycraft tips 10c. Leisure Hour Products, 416 Rose, West Hazleton, Penna.

**LEATHERCRAFTERS**: Special on unborn calf and various other hides and skins. We carry a complete line of leathers from world's leading tanneries, also complete stock of tools and supplies. Send now for new catalog and prices. Jonas Handicraft Co., 226 William St., New York 7, N. Y.

**FLOCKING** Kits \$5.00. Plaster casting supplies. Kalamazoo Mail Order, 705 Barney Rqad, Kalamazoo 84, Michigan.

**WINTER** Shop project deals. Designs and materials for lamps, tables, etc. Veneers. Sedlo Company, P.O. Box 7161, New Orleans, La.

**LEATHERCRAFT** Lace bargains! Francis Byrd, 3406 Montrose Ave., Richmond, Va.

**SEA-SHELLS**, Plastics, metal findings, free catalog. "Secors," 238, Bradenton Beach, Florida.

**DECORATIVE** Ornaments, brass filigree stampings, miniatures. Free catalog. Trinity, 2498 65th St., Brooklyn 4, N. Y.

**STREAMLINED** Kitchen plans 25c. Plywood Cabinets, 4617 Johnson Avenue, Western Springs, Illinois.

**LEATHERCRAFT** Tools. Professional type for craftsman or amateur. Free illustrated price list. Thayercraft, Dept. A, Box 182, Culver City, Calif.

**LEATHERCRAFTERS**: Belt kits, projects, leather, supplies. Free catalog. Art Leather, 411 Joseph Ave., Rochester 5, N. Y.

**NEW 1949** Illustrated catalogue. 84 pages showing thousands of items for the leather crafter. Leathers, copper, tools, supplies, designs, patterns, books, and ready cut projects. Send 10c today to cover handling charges. Russo Handicraft Supplies, 239 South Spring Street, Dept. PM1, Los Angeles, California.

**LEATHERCRAFTERS**: Free! 3 sheets new designs with latest catalog. Enclose 25c handling charge. Leather Specialties, 358 E. Broadway, Long Beach 2, California.

**PRESWOOD** Discs, 8 inch diameter, perfect die-cut circles. Dozens of uses, wall plaques, toys, novelties, etc. Five cents each plus postage. \$1.00 minimum order. Farwell Studio, 1100 N. 6th, Quincy, Ill.

**LEATHERCRAFTERS**—Get your new second 1948 edition of "The Leatherworkers' Bible"! Completely illustrated catalogue and textbook; instructions, descriptions and actual leather samples—\$1.65 postpaid. Guaranteed to exceed any expectation or your money refunded. Artercraft Leather, 271 12th St., Dept. PM-1, Oakland 7, Calif.

**GOLD**, Silver, aluminum. Ring casting instructions 25c. Lauckner, 624-2A S.W., Great Falls, Mont.

**TORTOISE** Shell makes beautiful costume jewelry. Bracelet, earring, and pin blanks. Polished. All four \$1.00. Earring blanks free for stamp. Sam Patchett, 5053, Cristobal, Canal Zone.

**TEXAS** Ebony. America's most beautiful lathe turning wood. Large piece \$1.00, prepaid. Sample 10c. Information on southern woods, stamp. StarCraft (1), Edinburg, Texas.

**FREE** Price list, instructions, with 2 sample packages different colored flock for 25c. A & M Crafts, 672-C East 91 Street, Brooklyn 12, N. Y.

**BANDSAW**, Jigsaw owners, let your machine bring extra profits, fun. Free details. Nu-Art, 33 Rosemont, Weymouth 91, Massachusetts.

**LEATHERCRAFT**, Tandy Leather Company, Tulsa 1, Oklahoma. Monthly price sheet guarantees best prices. Catalogue free upon request.

**SPECIAL** 77 Full sized patterns. Lawn ornaments, toys and novelties \$1.00. Modern Woodcraft, Saginaw, Michigan.

**LEATHERCRAFT**—Silversmith. Tools, dies, engravers. Made to order. Belt toppers, billfolds, key cases. Louis Jones, 1405 Throckmorton, Ft. Worth, Texas.

**COSTUME** Jewelry supplies. Low prices. Myles-Herber, 1360-A Hicks, New York 67

**SHELLCRAFT!** Make beautiful seashell jewelry. Income or hobby! Large illustrated catalog! Supplies, instructions, 10c postage. (Buy direct from manufacturer.) Pace's, Box 279M, Bradenton, Florida.

**MAKE** Your own jewelry! All types of findings, metal and plastic; cameos, beads, shell kits, illustrated catalog, 20c. Hobby Art, P.O.B. 276, Dept. 7, New York 18, N. Y.

**SHELLS**, Plastics, findings. Lowest prices. Free catalog. Frances Jones, Box 251, Sarasota, Fla.

**HOBBYISTS**: Send 25c for biggest value in hobby catalogs. 64 pages, 500 illustrations. Materials, books, tools, kits for 26 hobbies. Jar Hobby Mart, Dept. C6, Box 137, Iselin, N. J.

**50 PATTERNS** Toy furniture, action toys, etc., \$1.00. Continental Homecrafters, 907 Birch, Eau Claire 3, Wisconsin.

**CATALOG**: Patterns plywood novelty furniture, lawn ornaments, letters, numerals, plaques, frames, silhouettes, weathervanes, toys. Decal transfers. Over 100 other items. 200 articles illustrated. 25c. refunded first order. (No stamps please). Wo-Met Shop, Box 167, Ashburn, Georgia.

**LEATHER**, Retail, mail orders, catalog, tools, lacing, supplies. National Handicraft Co., 30 Frankfort St., New York City 7.

**PLASTIC** Jewelry supplies. Free catalog. J & M Novelties, Box 464P, Griffith, Indiana.

**KNOCKDOWN** Cedar chests. Lumber and veneers. Free price list. Giles & Kendall Company, Huntsville, Ala.

**LEATHERCRAFT!** Complete stocks of leathers, tools, supplies. Immediate shipment. Free catalog. Kit Kraft, 3203 W. Washington Blvd., Los Angeles 16, California.

**CERAMIC** Jewelry supplies, bar pins, ear screws, for ceramic and woodworkers; also glass and seashell assemblers. Free catalog. Philadelphia Badge Co., Dept. B-1, 1007 Filbert St., Philadelphia, Penna.

**COPPER** And brass materials. Complete line for craftsmen and workshops. Catalog A free. Groundmaster Company, Boulder, Colorado.

**SEA** Shells. Interested in making shell jewelry, lamps, novelties. We have all supplies at wholesale. Write for price list. Sea Shells, 269 W. Flagler Street, Miami, Fla.

**SPECIAL** Offer: 80 full size toy, novelty, and lawn ornament patterns only \$1.00 postpaid. Lynds, Box 193D, Medway, Mass.

## MAKE IT YOURSELF

**ELECTRIC** Eye kit—Parts and simple assembly instructions only \$5.95 postpaid. Legrin Mart, 360 Tremont St., Boston, Mass.

**IMAGINE** A table in your car. Complete instructions \$1.00. Mumpower's, Fairfield, Alabama.

**DON'T** Cuss! Make moisture-proof salt shaker that always works! Instructions \$1.00. Sunlande, Box 662, Hialeah, Fla.

**"CONCRETE** Block Homes." 32 page booklet: drawings, instructions on how to build. \$1.00. Other home building booklets, \$1.00. H. C. Lightfoot, Civil Engineer, Richboro 1, Penna.

**ELECTRIC** Operator, for overhead garage doors up to 7 1/2 feet lift, sectional or one piece, simple to install. Open or close and lock door, also switch garage light from drivers' seat of your automobile. Choice of electronic or key control. Automatic clutch permits manual operation of door from within. In case of power failure, key controlled model, complete including 110 v. 60 cy. motor \$187.50. Electronic dash control model \$222.50. Prices f.o.b. factory. Sales Incorporated, 3934 North Kilpatrick Avenue, Chicago 41, Ill.

**SAVE** Up to half on hot water bills. Average tank poorly insulated, if at all. Use \$5 worth locally obtained material. Complete illustrated instructions 50c. Satisfaction guaranteed, long experience. Economic Enterprises, 65 Saville Row, Quincy, Massachusetts.

**DELIGHTFUL** Profitable hobby. Make chocolates with cream centers. Three dimes and self-addressed stamped envelope. Pearl Morin, 9116 Quincey, Detroit 4, Michigan.

**SUPERVISE** My self-prefabricated houses. 182 drawings. Instructions \$1.00. Nelson Frissell, Civil Engineer, Gardner 101, Massachusetts.

**OIL Burner** from oil drums. Plans \$1.00. Parts available. Hugh Mfg. Co., Box 145, Hartley, Iowa.

**MAKE** Your own handy lightweight concrete blocks quickly with new block-maker. Circular stamp. Manual 25c. Peerless, New Lenox, Illinois.

**GRANDFATHER** Clock easily built. Big savings. See ad page 268.

**GARDEN** Tractor plans, 1½ and 2½ h.p. Six large sheets of drawings, instructions, details and pictures. \$3.50. Clearprint Plans, Box 265, Muskegon, Mich.

**BUILT-IN** Kitchen cabinets. \$1.00 brings detailed plans and specifications showing construction methods. Will fit any kitchen. Thombert Co., Box 447M, Newton, Iowa.

**SOLAR** Water heater systems efficient any locality. Standard materials, low cost and easily built. Free facts. Solar Water Company, Box 175, Coral Gables, Florida.

**BUILD** Concrete block machine. Inexpensive. Practical. Motor vibrator or hand. Free details. Clyde Lee, Dept. A, Mountain View, Okla.

**ANYONE** Can build heavy duty garden tractor from old auto and junk parts obtainable anywhere. Send \$1.00 for plans, easy instructions. Ellsworth Tractor Co., Dept. A, Camptonville, California.

**25 SHELVES** You Can Make. Booklet describing everything from wall shelf for dishes to knickknack shelf of white enameled wire and blue glass. 25c. Popular Mechanics Press, (C-43), 200 E. Ontario, Chicago.

### WATCHES, OLD GOLD, JEWELRY

**EXPERT** Watch repairing. 6 months written guarantee by master watchmakers. All makes repaired. Reasonable prices. Send watch insured mail for free estimate. No obligation. Bonded Watch Repair Company, Dept. 20, 219 W. Chicago Ave., Chicago 10, Ill.

**GOLD** \$35.00 Ounce—Mail old gold teeth, jewelry, watches, diamonds—receive cash by return mail. Satisfaction guaranteed. Free information. Dr. Weisberg's Gold Refining Company, 1500-Q Hennepin, Minneapolis, Minn.

**YOUR** Watch repaired the factory way. Guaranteed service. M. Present, 21 East Van Buren, Chicago 5, Ill.

**IGWT**, Hot Springs, New Mexico, presents Slyp. New squeeze proof lubricant stops mainspring breakage or your dollar back.

**HIGHEST** Prices paid for old gold, silver, platinum, diamonds, watches, gold teeth, old jewelry. Send now. Cash immediately. Goods returned if offer is not satisfactory. United Smelting Works, (The Old Reliable), 39-B South State, Chicago 3.

**LEARN** Watchmaking. Correspondence or G. I. courses. Stewart Watch-Tool-Material Co., 727 Market, St. Louis, Mo.

**WATCHMAKERS'** Tools, supplies sold—bought. Catalogue! Bengal Company, Culver City, California.

**COSTUME** Jewelry findings and supplies. Conner, Box 188, National Park, N. J.

**HIGHEST** Cash for old, broken jewelry. Mail gold teeth, watches, rings, silverware, diamonds, spectacles. Satisfaction guaranteed. Free information. Rose Smelting Co., 29-A East Madison, Chicago.

**GEMS**, Precious and semi-precious, all genuine, from world wide sources. Deal direct, no overhead, save money. Catalog 10c. Hill Co., Route 7, Salem, Oregon.

### TOBACCO, SMOKERS' SUPPLIES

**CIGARETTES**—Popular brands; minimum 3 cartons. Price \$1.50 per carton; postpaid. Add 3c per carton for west of the Mississippi. Send check or money order. King Co., Box 569-D, Dover, Delaware.

**SECONDS** \$5.00 Pipes, 2 for \$1.00. Briar blocks, bits, silver bands, screw connectors. Free literature. Carvapipe, 2829-G Dixie, Hamilton, Ohio.

### FOR THE HOME

**CESSPOOL** Sense. Free copy on request. Septic Bend Co., Rockland, Mass.

### FOR SALE — MISCELLANEOUS

**PECANS**—Large Stuarts. Send \$2.50 for 5 pounds postpaid. (\$2.65 west of Denver). Beverly Produce, Ochlocknee, Georgia.

**"SUPER"** Door latch, for garages, barns, sheds, warehouses. Simple to install. No strain to open and close door. The best ever made. Price \$1.25. Dahlgren Manufacturing Co., Grandy, Minn.

**INSTALL** Your own oil burner. Perma-Glo plans \$1.00. Easy. Be a dealer. Hugh Mfg. Co., Box 145, Hartley, Iowa.

**WAR** Surplus tents all sizes, clothing, paints, camping equipment, cots, canvas covers. Morsan, 10-17C 50th Ave., Long Island City 1, New York.

**USED** Dresses 89c, skirts 59c, blouses 49c, ties 7½c. Suits, O coats. List free. Calumet Sales, 4719 Kennedy Ave., East Chicago, Indiana.

**WAR** Surplus, aircraft items, shop equipment, machinery and a million other items. Free catalog. Atlas Equipment, 229 Southwest Blvd., Kansas City 8, Mo.

### WANTED—MISCELLANEOUS

**HOW** To swap, buy, sell anything. Free details. Swappers' Guide, Box 415, Evansville, Indiana.

**WANTED** Direct mail ideas—Inventions or finished items. What have you? Eagle & Co., 23 N. Walnut, Hutchinson, Kansas.

**GOLD** Coins wanted. Nice condition only. Will pay 80% above face value. Ralph Shaw, 707 So. Broadway, Los Angeles 14, California.

**ANYTHING** Of value. Robert, 207 North 5th Street, Springfield, Illinois.

**QUICKSILVER** (Mercury) urgently needed! Immediate payment. Wholesale Terminal, Norwood, Massachusetts.

### PERSONAL

**TIE** Exchange, Inc. Mail six neckties and \$1.00; receive six beautifully reconditioned ones and coupons for valuable free gift. C.O.D. plus postage. 159 N. Wabash, Dept. C, Chicago 1, Illinois.

**FOOT** Sufferers get instant relief with a pair of soft sponge rubber arch supports. Send \$1.00 to Cadwallader, 311 Crosby Bldg., Buffalo 2, N. Y.

**MEXICAN** Law. General practice attorney. 1203 Arizona Street, El Paso, Texas.

**RECEIVE** "Interesting Mails"—25c keeps your name on mailing list for six months. Bentz, Jr., Chatawa 44, Mississippi.

**LOSING** Hair? Have dandruff? Write for free, confidential booklet on care of scalp and hair. Eugene Burt, 1928 State Ave., Kansas City, Kansas.

**FEDERAL** Income tax prepared by mail. Request questionnaire. Box 464, Saratoga Springs, N. Y.

**MEXICAN** Mailing service. Letters received, forwarded 20c. Photographic postcards 15c. Remailed free. Remit stamps. Tillotson, Apartado 1405, Guadalajara, Jalisco, Mexico.

**WAR** Surplus clothing! Amazing bargains for men, women. Free catalog. New York Clothing Co., 2079-A Second Ave., New York 29.

**SWAP** Neckties! Mail six, receive six cleaned different ties. \$1.00 or sent c.o.d. The Tie Exchange, Box 1505, Decatur, Alabama.

**SEND** Dozen ties and \$1.00, receive dozen different ones. Ties Club, 2712 North 37, Milwaukee 10, Wis.

**GLOBAL** Viewcard selection; worldwide remailing service. Free particulars. Travelpost, Box 5453, Tucson, Arizona.

**HOW** You can find out! Information discreetly developed, any matter, person, problem, anywhere. Personal-business assignments, representations undertaken. Nation-wide. Officially licensed, bonded service established 1922. Reasonable. Confidential. William Herman, 170 Broadway, New York.

**HAIR** Falling? Dandruff? Write Trichologist, 137 Lewis St., Phillipsburg, N. J.

### MISCELLANEOUS

**SQUARE** Dance instructions. Call, 25 sets, \$1.00. Rayburne, Eureka Springs, Arkansas.

**YOUR** Name engraved on beautiful brass plate 1½"x9". Postpaid \$1.00. H. V. Ackerman, Malden on Hudson, N. Y.

**BARTOLET'S** Forecast 1949 Almanack, 25c. 9 East 7th St., Williamsport, Penna.

**ATTENTION** Salesmen: For practical household advertising specialties, side line or full time job. Well-known line by a long established manufacturer. Write for details on open protected territories. Patent Novelty Co., Fulton, Illinois.

**WANTED** 1000 Foot sufferers to test Kindschi Foot Balancers at our risk. Rush name for free trial offer. Kindschi Foot Appliances, Dept. A6, 321 W. Jefferson, Dallas 8, Texas.

**BE** Fiction magazine publisher. Starting outfit. Details. Fezler, Patchogue, N. Y.

**MAKE** Your own "Scotch-Lite" 24-hour visibility signs; all colors, 17"x17"; government surplus; \$1.00 sheet, six for \$5.00; guaranteed. Order today. Consolidated Equipment Co., 420 Lexington, New York, N. Y.

**CHAMPION** Belt 1¼ inch \$1.00, \$1.50. Leathercraft Mfg. Institute, 108 N. Pearl St., Baltimore 1, Md.

**RECEIVE** Magazines, moneymaking offers. Name listed 10c. Bellet, 70 W. Mapledale, Hazel Park, Mich.

**NEW** Idea for using small mouse traps effectively 25c. Elmer Stassen, Wanatah, Indiana.

**RECEIVE** Mails, magazines, samples. Your name in numerous mailing lists 10c. Sully Greenwood, 273 Broadway, New York 7.

**WE** Purchase Indianhead pennies. Complete all coin catalogue 10c. Rupert Fairview, 277 Broadway, New York 7.

**SMOKING** Pipe sweetener. Patented. Three for \$1.00. Morris, 613 Bonaventure, Atlanta 6, Ga.

**25c SAVES** You dollars. Amazing bargain catalog. Watches, clothing, etc. Save to 50% (25c refunded first order). Tip Top Sales, Box 9083PM, Dallas, Texas.

**OUT** Of print books found quickly. Send wants, no obligation, free catalog. Coast Bookfinders, Box 1886, Los Angeles, Calif.

**\$10,000 OFFERED** By U. S. government for each usable uranium find. Goldak now offers an all-purpose Geiger Counter to prospectors of radioactive ore. For free bulletin, write The Goldak Co., Dept. M, 1542 W. Glenoaks, Glendale 1, Calif.

**BOOKS**—All Kinds—Homecraft, Radio, Plastics, Boat Building, Photography, Model Building. Catalog free. Popular Mechanics Press, 200 E. Ontario St., Chicago 11, Ill.

**KRYSTAL** Kleer lens pencil prevents steaming, fogging your eye glasses. Fast, easy, leaves no greasy smear. 25c postpaid. Elk Supply Co., 817-1 Elk St., Buffalo 10, N. Y.

**BRASS** Or nickel silver name plates or keytags. Individual stamping 40c each, 3 for \$1.00. Duplicate stamping 8 for \$2.00, 50 for \$6.00. Stamping equipment. Booklet free. Dealers wanted. Send 10c for sample. Tagco, Box 38 X.C. Wingdale, N. Y. See display adv. on page 241.

**TREE-RIPENED** Oranges, ruby-red grapefruit; from orchard. McCants Products, Weslaco, Texas.

**CIRCLE** Divider—Any division, halves to sixteenths, instantly. 50c coin. P.O. Box 57, San Anselmo, Calif.

**APPLY** Labels, stickers faster with new type moistener. Provides right amount moisture, even distribution. No brushes, felts, rollers. \$4.95. Market Services, 936 N. Michigan, Chicago.

**5" DEEP** Sea scallop shells. Ideal decoration or ash tray. \$1 per pair, check, m.o., cash. Barco, Monmouth Beach, N. J.

**24 KARAT** Gold framed porcelain miniatures made from any photo. Send for prices. Robert Daly, Studio M-1, 203 W. 69 St., Box 91, New York 23.

**PANNING** GOLD — Free instruction booklet. Catalogue mining books; supplies. Old Prospector, B-207, Dutch Flat, Calif.

**BIG** Mail. Everlast ball pen 25c, 4 for dollar. Capener, 849 Almaden, San Jose, Calif.

**THE** Capper—New work glove. Outwears ordinary gloves up to seven times. Material contains thousands of tiny loops which form natural insulation against heat. Same principle makes it resist cutting and abrasion. Beats leather for handling rough or sharp materials. Safety cuff for easy removal. Washable. Ideal for open hearth, blast furnace, hot mill, foundry, recapping, kiln work. \$1.19 a pair. Three pairs \$3.50. Postpaid. Send check, money order, or postal note. Sorry, no c.o.d.'s. Please print address plainly. Practical Glove Co., Box 515, Johnstown, Penna.

**TREASURE Locators.** New electronic lightweight M-Scope mineral and metal finders are now available for immediate shipment. Built for arctic-tropic use. Revolutionizes locating of minerals, gold, silver, metal objects. Unsurpassed efficiency, factory guaranteed. Low prices, time payment plan available. Send for free 16-page illustrated booklet. Fisher Research Laboratory, Inc., Palo Alto, California.

**LUMINOUS Powdered pigments.** Trial offer and listing. \$1.00 prepaid. Glowelco, 475-MP Fifth Ave., New York 17.

**"RECEIVE Mail."** Moneymaking offers, opportunities, catalogs. Name listed 10c. Ideal Service, Park Ridge 10, Ill.

**GEIGER Counters** for finding uranium ores. Simple operation. Low prices. Interesting literature free. Fisher Research Laboratory, Inc., Palo Alto, California.

**FOR Big men only—Quality shoes** sizes 10-16. Widths AA-EEE. Dress, work shoes, loafers, wing tips, moccasins, hitops, sox. Guaranteed. Write for free catalog. King-size, 696, Brockton, Mass.

**THE Lord's coming!** Get free proofs. International Evangelism, Box 263-X, Duluth, Minnesota.

**WIN Prize contests!** 34 pages; rules, hints, winning entries, etc. Rush 50c. Dueffy, Covington, Ky.

**TREASURE Finders!** Goldak's new 11 pound lightweight, gold, silver and mineral locator, money-back guaranteed superior any other device. Free information. The Goldak Co., 1542 West Glenoaks Blvd., Glendale 1, Calif.

**BUILD Modern console type radio cabinet** with sliding free-panel, doors of natural wood. Simple, easy-to-read blueprints. Order number 1100. 25c. Popular Mechanics Press, 200 E. Ontario, Chicago 11, Ill.

**TATTOOING Machines, outfits.** Free catalogue. Jensen, 120 West 83rd Street, Los Angeles 3.

**LUCITE Bar, name pin, safety clasp.** Price \$2.00. Made to order. Nightingale Pin Co., P. O. Box 1772, West Palm Beach, Florida.

**70 BIBLE Lessons, 25c.** Bulletin, Box 87, Cathedral Station, New York 25.

**MEDICAL Laboratory technicians** in great demand. We train you in your own home, in your spare time. Also home study course in general chemistry. Free catalogue. Imperial Technical Institute, Box 973-J, Austin, Texas.

**NOW Ready:** New, amazing Classified Advertising Record Book—prepared especially for classified advertisers. Here is a book that tells you instantly whether or not your advertising in any publication is paying you real results. You can tell immediately how many inquiries each publication produced—how much cash received from every ad. Spaces are provided for the name and address of the publication, date of issue, space used, rate, cost of ad, key number, etc. You have a complete record of each publication right before your eyes. Plenty of space to keep accurate record of 28 separate publications. You can have a copy by sending only 10c to cover postage and handling. Send for your copy now. W. F. Johnson, Classified Adv. Mgr., Popular Mechanics Magazine, 200 E. Ontario Street, Chicago 11, Illinois.



**SENSATIONAL  
7 PIECE PRECISION MADE  
PLASTIC ARMCHAIR  
DRAFTING SET**

MODEL BUILDERS, INVENTORS, DRAFTSMEN, STUDENTS, ENGINEERS, ARCHITECTS. Now you can make accurate mechanical sketches at home with this unique drafting set. Precision made of Polystyrene, the armchair drafting outfit consists of 10" T square, 30°-60° and 45° triangles, French curve, protractor and 2 ship curves. This handy little outfit will help you develop many big ideas. Order yours today!

**SEND NO MONEY.** Pay postman plus postage or send \$1 and we pay postage.

**PRACTICAL PLASTICS**  
818 Harrison St., Oak Park, Ill.

**7 PIECE SET \$1.00 POSTPAID**

# WORK GLOVES



**Riegel WORK GLOVES**

Riegel makes the right glove for every job.

Riegel Textile Corp.  
342 Madison Avenue  
New York 17, N. Y.

**"THIS TRADE MARK IS YOUR GUARANTEE OF VALUE"**

## Here's how to prepare for GOOD PAY, a STEADY JOB in AUTO MECHANICS



**AUTO MACHINIST**  
Student in engine rebuilding learning to operate a crankshaft grinder. Specialized training puts you in line for better jobs and higher pay.

**ENGINE REBUILDING**  
Up-to-date practical training on latest equipment. You learn machine shop, auto electricity, carburetion, trouble shooting, motor tune-up and transmissions.

**GENERAL AUTO MECHANICS**  
Practical training for general garage work. Engine overhaul, auto electricity and many other subjects. See shops and equipment in our FREE booklet.

**VETERANS:** American Trade School is G. I. Approved. Please state if Veteran.

**WRITE TODAY FOR FREE BOOKLET**

**AMERICAN TRADE SCHOOL**  
2417 McGee, Kansas City, Mo.

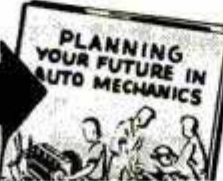

## I'LL SHOW YOU HOW TO MAKE MONEY IN WATCHMAKING!



You want to get out on your own—I'll show you how to make your future secure. Train yourself for a profitable business or a career in watch repairing—a craft which has no age or physical requirements. Trained men are always needed in watchmaking.

**IT'S A FASCINATING BUSINESS!**  
Enjoy the thrill of accomplishment—when you're able to disassemble and repair any make watch! I'll show you all the methods to make you a skilled watchmaker—dispel the mysteries of the trade! You'll like this clean work, unusually good pay, short hours and the satisfaction of offering a service that is needed in almost every community. Write for free book today!



**WHAT YOU LEARN**  
You'll get nationally-accredited training in: material classification and ordering, approved repair methods, crystal grinding, history of the profession, lathe operation, and watch-rate recording machine operation. In delightfully cool Denver, Colorado—at the foot of the Rocky Mountains, you'll get practical work-bench experience plus visual and sound instruction, demonstration by working models, books and lectures in complete hair-spring manipulation, balance and escapement work, escapement adjusting.

**Approved for Veterans**

**MAIL COUPON FOR FREE BOOK.**  
American Academy Inc., School of Horology  
1549 Lawrence St., Dept. E, Denver 2, Colo.

Yes, Mr. Hagans—rush your free booklet on how to make money in watch repair! No obligation. No salesman will call.

Name \_\_\_\_\_  
Address \_\_\_\_\_  
City \_\_\_\_\_ Zone \_\_\_\_\_ State \_\_\_\_\_  
 Check here if veteran (Paste on penny postcard)

# Pay Is Good

for Trained mechanics in these Big Industries

LEARN IN A FEW WEEKS IN OUR BIG MODERN TRAINING SHOPS—

## AUTOMOTIVE MECHANICS

## DIESEL MECHANICS

NOW IS THE TIME TO PREPARE FOR YOUR PLACE IN A GIANT INDUSTRY

OR BEGIN TRAINING AT HOME AND COME TO SHOPS LATER.

## BODY & FENDER REBUILDING

Automobile and Diesel industries making up for lost time! There may never again be such opportunities for men who want better jobs or business of their own to get in on ground floor and go up fast! Yes—FOR MEN WHO ACT FAST, THINGS CAN HAPPEN FAST!

**AUTO MECHANICS** needed to keep millions of cars, busses, trucks rolling. Efficient auto mechanics get fine pay. Can service, install, repair all mechanical and electrical parts of autos. Learn to overhaul and repair engines, transmissions, differentials and other assemblies.

**DIESEL MECHANICS** needed. Diesel engines are used in locomotives, ships, trucks, busses, power plants, tractors, farm equipment. Trained men needed to repair, rebuild, install, maintain, operate, equipment. A big field that promises even bigger things in the years right ahead.

**BODY AND FENDER REBUILDING** one of best paid branches of automobile industry. Trained men make good profits in garages, service stations. Practical, all around training—welding, aligning, mixing and matching colors, spray painting, power and hand tools.

### A NATIONALLY KNOWN INSTITUTION

C. T. I. was only civilian school selected by Army to train service men for refrigeration. C. T. I. executives were active in training Auto Mechanics for U. S. Army. Same quality training available to you now. The method that has made rapid progress possible.

**VETERANS**—Just mail coupon, we will handle all details.

**NON-VETERANS**—Don't let the lack of ready cash prevent you from taking this training now. Investigate our Low Easy-Payment Plan and our Pay-After-Graduation Plan.

**COMMERCIAL TRADES INSTITUTE**  
Dept. E2-1, 1400 W. Greenleaf Ave.  
Chicago 26, Ill.



FREE—Important Information Telling How To Get Started

CUT COUPON ALONG THIS LINE

Fill Out, Cut Out, Mail Today

FREE—IMPORTANT INFORMATION TELLING HOW TO GET STARTED IN ONE OF THESE GREAT FIELDS

COMMERCIAL TRADES INSTITUTE, Dept. E2-1  
1400 W. Greenleaf, Chicago 26, Ill.

Send free illustrated Brochures and other information about the field I have checked below.

- |  |                                      |   |
|--|--------------------------------------|---|
| <input type="checkbox"/> Body & Fender Repairing | <input type="checkbox"/> Radio       | <input type="checkbox"/> Building                           |
| <input type="checkbox"/> Automotive Mechanics    | <input type="checkbox"/> Television  | <input type="checkbox"/> Drafting                           |
| <input type="checkbox"/> Diesel Mechanics        | <input type="checkbox"/> Electricity | <input type="checkbox"/> Refrigeration and Air Conditioning |

Name \_\_\_\_\_

Address \_\_\_\_\_

City \_\_\_\_\_

State \_\_\_\_\_

Veteran

Non-Veteran

# Don't Envy The PLUMBER—Be One

## Make \$15 to \$50 a Day

Every skilled workman will tell you Plumbers have the best of it. WINTER and SUMMER the Plumber is busy at top wages. No skilled Plumber is ever out of a job. Compare his opportunities with any trade. To the man with know how, Plumbing means profit. Investigate Universal Plumbing School. Not a "war born School." but a plumbing school developed and operated by plumbers since 1923.



### Own Your Own BUSINESS

Have your own business and big profits with little other than training and a kit of tools.

### JOURNEYMAN Gets Good Salary

Master Plumbers own their own shop. A Journeyman works for a Master. With this training journey-men can depend on high wages.

### BE A PLUMBER IN JUST 32 WEEKS

Learn With Tools—Not Books

No need ever serve an apprenticeship. Don't envy the plumbers big profits—enjoy them. Learn every trick of the trade—Leadwork—Blueprint for plan reading, etc. under Licensed Master Plumbers.

Over 7,000 Successful Plumbers Recommend This School

This system has made more than 7,000 plumbers. Investigate our past performance. If you like to work with tools this is your opportunity. Become a Plumber in America's largest and only school devoted exclusively to plumbing. Write today for FREE information.

G. I. Approved. Established 1923

## UNIVERSAL PLUMBING SCHOOL

877 Holmes Street

Kansas City, Mo.

# Learn to Use the SLIDE RULE

SLIDE RULE and Famous Book Both for Only \$2.98

EASY! QUICK!

### Helps to Better Jobs—Bigger Pay for Everyone Who Uses Figures

Get this new 208 page simplified edition of the "Slide Rule and How to Use It" with full size, 10 inch Mannheim Type Slide Rule included. No other book like it. Contains complete instruction and removable work sheets that make the slide rule simple as A.B.C. Also five place logarithm tables and review of mathematics with complete answers to check yourself on every problem. It can easily be worth hundreds of dollars to you in promotions, better pay, saving time and error. It's a book for students, mechanics, business men—everyone should learn to use the slide rule, now that it is so easy.



### Learn in Few Hours to Do Many Calculations

There is nothing mysterious about the slide rule when you read this book. You'll be amazed at the problems you can solve in just a few hours. Mail the coupon now. Book and slide rule will be sent at once. Use the coupon. See money refund guarantee. Mail now.

AUSTIN PUBLISHING CO., Dept. 11  
165 N. Pine Ave., Chicago 44, Ill.

Send me "The Slide Rule and How to Use It" and 10" full size Mannheim Type Slide Rule. Total cost for both \$2.98. I understand you will refund amount paid you if I return them in 3 days.

Remittance Enclosed.

C.O.D. Plus Postage.

Name \_\_\_\_\_

Address \_\_\_\_\_

City \_\_\_\_\_

State \_\_\_\_\_



**LOW  
FACTORY  
PRICES!**

# ... on the Sensationally **NEW 1949** **MIDWEST RADIOS**

**NEW**  
**SERIES 16**  
**SUPER DE LUXE**  
**AM-FM**  
**CHASSIS**

**30 DAYS TRIAL**

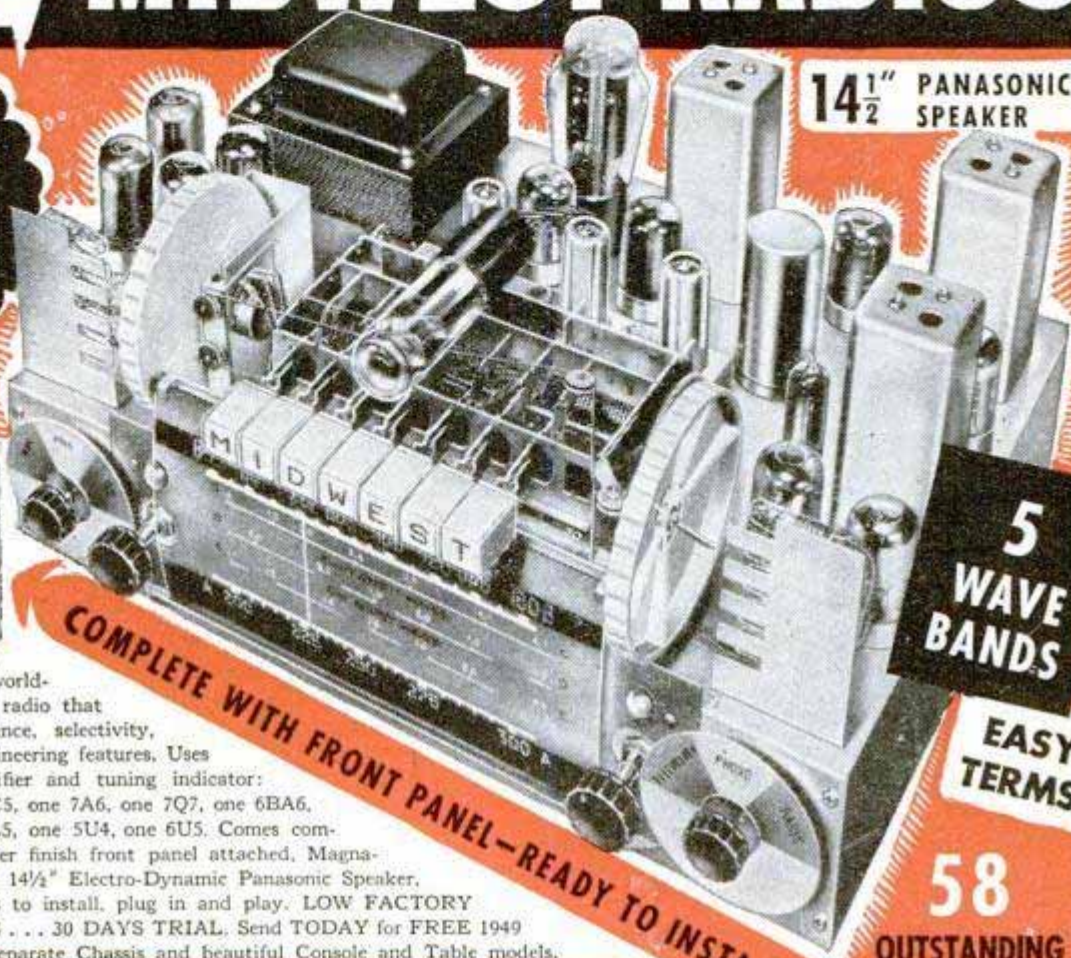

**14 1/2" PANASONIC  
SPEAKER**

**5  
WAVE  
BANDS**

**EASY  
TERMS**

**58**

**OUTSTANDING  
FEATURES**

*Including the  
Exclusive Midwest*

**FLASH-O-MATIC**  
Volume and Band Indication

**TELEVISION**  
Audio Switch-Over

**FIDEL-A-STAT**  
Color-Ray Tone Selection

**TRI-MAGNADYNE**  
Coil System

...Plus **NO-DRIFT FM**  
and many other features

**COMPLETE WITH FRONT PANEL—READY TO INSTALL!**

Here is the last word in radio engineering . . . a powerful, world-ranging, magnificently-toned radio that is unsurpassed for performance, selectivity, sensitivity, and advanced engineering features. Uses these latest-type tubes, rectifier and tuning indicator: three 7A7, three 7A4, two 7C5, one 7A6, one 7Q7, one 6BA6, one 6BE6, one 6C4, one 6AL5, one 5U4, one 6U5. Comes complete with satin stripe copper finish front panel attached, Magna-Tenna Loop Aerial and giant 14 1/2" Electro-Dynamic Panasonic Speaker. Requires only a few minutes to install, plug in and play. **LOW FACTORY PRICES . . . EASY TERMS . . . 30 DAYS TRIAL.** Send **TODAY** for **FREE 1949 Midwest Radio Catalog** of separate Chassis and beautiful Console and Table models.

**A Complete Line of FINE RADIOS and RADIO-PHONOGRAPHS . . . Available in SEPARATE CHASSIS Like the POWERFUL SERIES 16 AM-FM Model above or in COMPLETE CONSOLES like this...**



*Beautiful*  
**SYMPHONY GRAND**  
**AM-FM Radio-Phonograph with**  
**TELEVISION Audio Switch-Over**  
**and NEW Intermix AUTOMATIC**  
**RECORD CHANGER**

A Magnificent musical instrument and a masterpiece of cabinet design—the finest Midwest Radio in 29 years of manufacture. Offers world-ranging radio reception and newest automatic Intermix Record Changing Phonograph. Uses Series 16 Super DeLuxe AM-FM Chassis. Giant 14 1/2" Panasonic Speaker; Tri-Magnadyne Coil System; Built-In Loop Antenna. Other luxurious console and table model cabinets available with Series 16, 12, and 8 chassis—on Easy Terms and 30 Days Free Trial.

**Rush for Free Catalog!**

**FILL IN COUPON AND MAIL TODAY OR JUST SEND NAME AND ADDRESS ON 1c POSTCARD**

**MIDWEST RADIO & TELEVISION CORP.**  
Dept. 256, 909 Broadway, Cincinnati 2, Ohio  
Please send me your new **FREE 1949 Catalog.**

NAME \_\_\_\_\_  
ADDRESS \_\_\_\_\_  
CITY \_\_\_\_\_ ZONE \_\_\_\_\_ STATE \_\_\_\_\_

**BUY DIRECT FROM FACTORY and SAVE!**

**MIDWEST RADIO & TELEVISION CORP.**

Dept. 256      909 Broadway,      CINCINNATI 2, OHIO

# New Advertising Machine

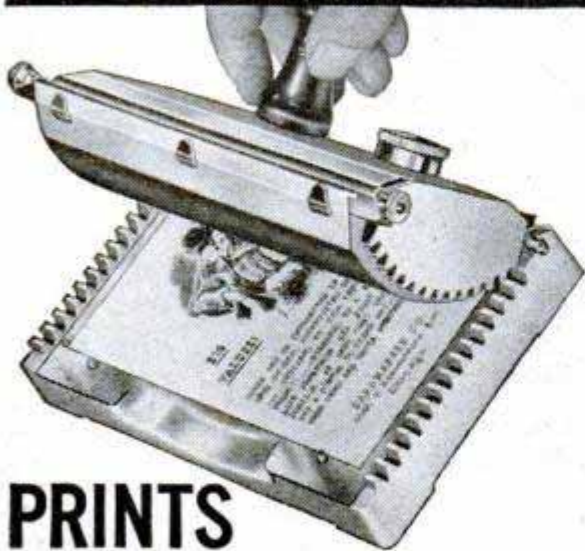

## PRINTS and ILLUSTRATES

1¢ Post Cards

**FREE**

Learn how thousands of business men, in every line, are boosting sales in spite of conditions—with 1¢ messages—printed and illustrated in a few minutes on gov't post cards—with amazing new patented **CARDMASTER**. Your "today's" ideas, read by your prospects next morning. Not a toy, but a sturdy advertising machine, built to last for years. Low price, sold direct. Guaranteed for five years. Send name today.

**SEND NAME** We'll send **FREE** illustrated book of money-making **IDEAS** for your business and complete, unique advertising plans. **RUSH YOUR NAME TODAY.**

**CARDMASTER COMPANY**  
4546 RAVENSWOOD, Dept. 131, CHICAGO 40, ILL.

# STUDY AT HOME

With An Educational Institution

Men with specialized training win higher positions, insure larger earnings, and are bigger successes in business and public life. Opportunities NOW greater than ever before. Send for our Catalog.

## ARTS and SCIENCES

Courses in Philosophy; Education; Letters; Public Health; Medical Jurisprudence; Psychology; Sociology; Physics; Chemistry; Plastics; Geology; Political Science; Theology; Business and Commerce; Accounting; Mathematics; Statistics; Agriculture.

## ENGINEERING

Courses in Electrical, Civil Mechanical, Drafting, Architectural, Steam, Aeronautical, Radio, Structural, Mining, Industrial, Petroleum, Marine, Chemical, Diesel, Automobile, Refrigeration, and Air Conditioning Engineering.

## LAW

Complete Professional Law Course includes 18 Hornbook Series college grade textbooks. Courses also in Commercial Law, Patent Law and Medical Jurisprudence.

McKinley-Roosevelt Incorporated, 4610-K, Sheridan Rd., Chicago 40, Ill.

# THERE'S MONEY IN CARTOONS!

RAYE BURNS will teach you HOW to CREATE ORIGINAL CARTOONS at home that you may SELL! Course contains 26 lessons and over 600 illustrations. All for Only... **\$2.85**

Send name and address for free details.

RAYE BURNS SCHOOL, Dept. M, Box 3583, Cleveland, Ohio

# DRAFTING is always the BIG PAY FIELD

Get Started Now! I Will Train You at Home Until You Get a Good Pay Job

**TOOLS DRAFTING TABLE and Complete Outfit Sent When You Start!**

Get a better job with more pay and pleasant working conditions. Get into Drafting—where all products start—where the Draftsman is the key man—where promotions to tool designer—industrial and product design—engineers—rate the very top pay. I will train you at home until you get a good pay job and give you real experience on the same kind of jobs you will do with the best paying firms. I furnish instruments and all equipment when you start. Write today for vital facts and **FREE** book. Give age.

**ENGINEER DOBE**  
DIVISION 11 LIBERTYVILLE, ILL.

# CARBURETOR TOO RICH MAKES MOTORIST TOO POOR



Car owners who are wasting money and not getting proper gas mileage due to over-rich mixtures will be pleased to learn how to save gasoline by **VACU-MATING** over-rich mixtures. **VACU-MATIC** fits all cars, trucks and tractors. It is automatic and operates on the supercharge principle. Easily installed in a few minutes.

**SALESMEN WANTED!** Big Profits! Send name, address on penny postcard for free particulars and how to get yours for introducing.

**VACU-MATIC CO., 7617-1436 W. State St., WAUWATOSA, WIS.**



# RAISE Money Making CHINCHILLAS

Several females and a male start a large herd which will furnish you an income for years. Just a few feet of space are required. No experience needed. We furnish all instructions. Write world's largest breeder today for free details.

**WILLOW BROOK FARM, R-36, Sellersville, Pa.**

# APTITUDE TESTS

discover the kind of work or studies best for your success! You get a personal report—a guide for life—more happiness—more prosperity. For men, women, boys and girls. Write for complete facts.

**VOCATIONAL COUNSELING INSTITUTE**  
956 Maccabees Bldg., Detroit 2, Michigan

# Free Booklet on FLEX-O-SHAFT

illustrating this all-purpose power machine with hand-piece that handles as easily as a pen. Motor with switch, foot-operated rheostat, and 66 accessories at special low price. Write

**FLEX-O-SHAFT SALES CO.**

Dept. C

Prairieview, Illinois.

# Learn RADIO-TELEVISION

## In Your Own HOME WORKSHOP

Build interesting Radio Circuits, acquire real experience, do scores of practical experiments—all through RTA's complete balanced training plus 10 BIG KITS of parts which RTA GIVES YOU! Get finest instruction direct from Hollywood, nerve-center of broadcasting, television and radio activities.

**FREE BOOK** Send postal for complete details plus **FREE BOOK** "How to Make Good in Radio-Television."

**RADIO TRAINING ASSOCIATION OF AMERICA**  
5620 Hollywood Blvd. Dept. 1-PM Hollywood 28, Calif.



# AJAX AUSTRALORPS

**Sensational WORLD CHAMPION LAYERS.** Mature fast. Excellent roasters-capons. Massive size. Illinois-U.S. Approved-Pullorum controlled. Low farm prices. **PROFIT SHARING PLAN.** Catalog **FR&E.** Write TODAY.  
**AJAX HATCHERY, BOX 432, QUINCY, ILLINOIS**

# CHEMISTRY

**LEARN AT HOME...** Chemical knowledge is essential for thousands of good jobs in industry, business, science. IPC enables you to master practical chemistry. It's the ONLY home study chemistry course which enables you to learn by performing actual experiments—using chemicals and apparatus supplied with the course—in addition to your IPC textbook studies. Compares with recognized college courses in General Chemistry. Write today for free descriptive booklet.

**INSTITUTE OF PRACTICAL CHEMISTRY**  
3 PROSPECT AVENUE, HAGERSTOWN, MD.

**DO ANY JOB.. EASIER.. QUICKER**  
**MAKE MORE MONEY** *in the*  
**BIG OPPORTUNITY**  
**FIELDS**

**SEND NO MONEY**  
 Select the Books  
 YOU Need Now!  
 We Ship C.O.D.  
 Anywhere in U. S.  
 and Will Refund  
 Amount Paid if  
 Not Satisfactory.

**Here's the Help You Need**  
**For Best Paying Jobs**  
**Right NOW!**

**FREE TRIAL**  
**IN YOUR OWN HOME**

Used by Army, Navy, Other Government  
 Depts., 200 Schools and Industrial Firms.

Do it now! Get the better pay that goes to men with specialized knowledge. Get into one of these big opportunity fields. Big money and many other advantages await you if you prepare now. Here is the help you need—EASY—QUICK—AT LOW COST. Thousands of men have already used these famous books. Beginners and experienced men alike have doubled and tripled their earnings with this help. You too, can now get the special knowledge you need for top pay, better jobs, or a business of your own. This is your GOLDEN OPPORTUNITY.

**AIR CONDITIONING**

Big air conditioning boom is Nation-wide and bigger than ever. Alive with new opportunities! Get this non-technical book by international authority and be ready for your share of millions to be spent. Covers whole field. 450 pages. Illustrated. \$4.00.

**SHEET METAL LAYOUT**

Makes sheet metal layout work so simple that anyone can learn. Get this new instructor and get into the easiest, cleanest and best paying part of all sheet metal work. 143 jobs worked out in drawings and carefully explained. Gives standard for all sheet metal fittings. \$3.50.

**BAILEY'S HANDBOOK**

World famous handbook of universal questions and answers for Stationary, Marine and DIESEL engineers and firemen. Prepares for any license examination in installation, maintenance and operation of Diesel and steam plants. Pocket size, \$2.00.

**MODERN WELDING**

Newest book on all types of welding and heat treatment of metals. Written by recognized specialists in training men for production jobs. 430 Pages, 277 Illus. Practical and Non-Technical. Covers everything you need to know. \$4.00.

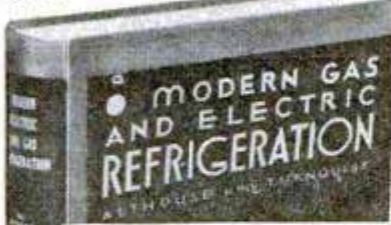

**REFRIGERATION—Book of the Hour!**

**Biggest Opportunity in Many Years!**

**LATEST PRINTING — ALMOST 1000 PAGES**

408 Pictures—17 Diagrams in Colors Makes All Refrigerator Service Maintenance, Repairs Simple as A. B. C.

Thousands of Refrigerators need repairs! Owners will pay big for competent service which will be needed more and more. Get MODERN GAS AND ELECTRIC REFRIGERATION, the non-technical guide to all types of refrigerators and get your share of this new profit. Get a job or start your own service business. This book will help you make money anywhere. It is the recognized standard book on the subject. Price \$5.00.

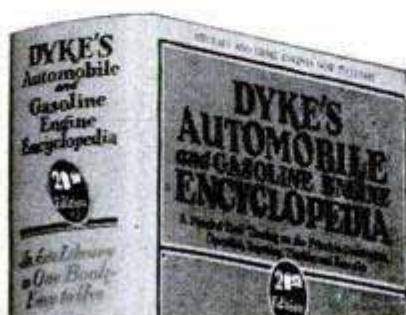

1948  
**21st**  
 EDITION  
 Leading  
 Auto  
 Book  
 for Over  
 32 Years

**World's GREATEST AUTO BOOK**

**New Material, Specifications,  
 1947 Cars, 1948 Trucks, Busses,  
 Tractors, Diesels**

Now with millions of cars needing repairs and thousands of men needed to do the work, you need the famous DYKE Auto Book more than ever before. New 21st Edition covers all principles, construction, repair, adjustments, testing, troubles and remedies. Over a half million copies of 20 editions of Dyke's have been sold. Buick Dynaflo, Farm and Outboard Motors and new electrical systems now covered. World's biggest book value. Only \$7.00.

This big book, a complete auto library in one volume, has 1483 pages—4600 illustrations and diagrams—weighs 6 lbs.—equal to 4 ordinary books.

**HOUSE WIRING — NEW EDITION**

Get this new sixth edition of this standard and practical electrical wiring book. It gives complete practical instruction on every phase of house wiring in one handy volume. Goes further than most books on subject. Handbook style. Gives National Electric Code. 400 pages, 669 illustrations. Electrical work will reach a new high with millions of new homes to be built. Get started now. \$3.00.

**CARBURETORS — Dyke**

The standard guide in the best paying auto work for a generation. It has helped thousands of men make money. New edition covers engine tune-up, compression, ignition, carburetion, fuel pump valves, etc. Use this book to specialize in this big field. 244 pages, 549 illustrations. \$3.50.

Mail Coupon to GOODHEART-WILLCOX CO., Dept. 11, 1321 S. Michigan Ave., Chicago

**20 Million Refrigerators  
 Need Service and  
 Repairs**

**SEND NO MONEY! Mail Coupon**

**GOODHEART-WILLCOX CO.**

1321 S. Michigan Ave., Dept. 11, Chicago 5, Ill.

Send books checked, C.O.D. I will pay postman, plus few cents charges. If not satisfactory I will return books in 3 days and you will refund money paid. (Outside U.S. or possessions remit with order.)

- |  |  |
|--|--|
| <input type="checkbox"/> Gas & Electric Refrigeration . . . . . \$5.00 | <input type="checkbox"/> Air Conditioning . . . . . \$4.00 |
| <input type="checkbox"/> Dyke's Auto Book . . . . . \$7.00             | <input type="checkbox"/> Engineers Handbook . . . \$2.00   |
| <input type="checkbox"/> Dyke's Carburetor Book \$3.50                 | <input type="checkbox"/> Body and Fender Repair \$3.50     |
| <input type="checkbox"/> Modern Welding . . . . . \$4.00               | <input type="checkbox"/> Shop Math. (2 vols.) . . . \$3.00 |
| <input type="checkbox"/> Airplane Welding . . . . . \$3.50             | <input type="checkbox"/> House Wiring . . . . . \$3.00     |
| <input type="checkbox"/> Sheet Metal Layout . . . . . \$3.50           | <input type="checkbox"/> A.C. Power Wiring . . . . \$4.00  |
|  | <input type="checkbox"/> D.C. Power Wiring . . . . \$4.00  |

If remittance accompanies order we will pay all postage charges under same return privilege.

Name \_\_\_\_\_  
 Address \_\_\_\_\_  
 City \_\_\_\_\_ State \_\_\_\_\_

# Now for EVERY WORK SHOP!

## NEW Invention Electroplates by BRUSH



**Easy to Plate CHROMIUM  
GOLD, SILVER, NICKEL, COPPER  
... For Pleasure and Profit!**

If you have a workshop—at home or in business—you need this new Warner Electroplater. At the stroke of an electrified brush, you can electroplate models and projects—you can replate worn articles, faucets, tools, fixtures, silverware, etc. with a durable, sparkling coat of metal... Gold, Silver, Chromium, Nickel, Copper or Cadmium. Method is easy, simple, quick. Everything furnished—equipment complete, ready for use. *By doing a bit of work for others, your machine can pay for itself within a week.* So make your shop complete by getting a Warner Electroplater right away. Send today for FREE SAMPLE and illustrated literature. ACT AT ONCE! Mail Coupon.

**WARNER ELECTRIC CO., DEPT. A-1  
1512 Jarvis Avenue, Chicago 26, Ill.**

**FREE Details & Sample!**

WARNER ELECTRIC CO., 1512 Jarvis Avenue, Chicago 26, Dept. A-1

Gentlemen: Send Free Sample and Details to:

Name \_\_\_\_\_

Address \_\_\_\_\_

City \_\_\_\_\_

State \_\_\_\_\_

## CORTINAPHONE Makes It EASY!

# Learn to SPEAK SPANISH

FRENCH • GERMAN • ITALIAN



Count Cortina

BIG OPPORTUNITIES await Americans who speak SPANISH. Learn as a child learns—“by listening” to these new CORTINAPHONE recordings. The CORTINAPHONE METHOD, famous for 65 years, teaches you to speak SPANISH as a NATIVE speaks! Right at home, relaxed and at ease.



Listen to this Record!

**Sent on 5 Days' Approval**

Write today for our amazing free book, "The Cortina Short-Cut." State language interested in.

**FREE CORTINA ACADEMY BOOK**  
Dept. 641 105 West 40th Street  
New York 18, N. Y.

**VETS**  
Spanish course available under G. I. Bill State if Veteran

## TURN SPARE TIME INTO PROFIT

with our RUB-BER-SPRA. Make Genuine Rubber Molds that cost ONLY A FEW CENTS EACH and then cast thousands of FAST SELLING NOVELTIES. Make Money Fast... Send 25c for catalog.

**KEN-DOR STUDIO, 949 George St., Dept. P-1, Lake Geneva, Wisc.**



## FREE BARGAIN CATALOG

Now ready for mailing. Thousands of Govt. and Civilian Surplus items. For the home, industry and farm. Machinery, motors, hdw., elec. Supplies, etc. Write NOW to

**MIDWEST SURPLUS SALES CO.**  
2533 Indiana, Kansas City 1, Mo.

SAY YOU SAW IT IN POPULAR MECHANICS

# How to Make a Good Commercial Drawing



Step 1



Step 2



Step 3



Step 4

## New Easy Way to Prepare at Home for Exciting, Money-making Art Career

Never was there such a demand for good artists as now. Advertising agencies, publishers, retail stores—all are looking for trained artists with fresh new ideas. They pay good salaries, pay well for free-lance work.

### Famous Artists Perfect Amazingly Simple Method

Thirteen of America's most famous commercial artists have a plan to help you get started on an exciting, money-making art career. They have perfected an entirely new home-study

method—the Famous Artists Course. Everything is made amazingly simple and easy through step-by-step directions and more than 4,000 drawings and sketches created especially for this course. They show you modern methods never before taught through home study. In the very first lesson you begin to make pictures. Complete outfit of art supplies included.

**First Step to Success  
—Send This COUPON**

These famous illustrators reveal their studio secrets to you.

Norman Rockwell  
Al Parker  
Ben Stahl  
Stevan Dohanos

Jon Whitcomb  
Robert Fawcett  
Peter Helck  
Gilbert Bundy

Austin Briggs  
Harold Von Schmidt  
John Atherton  
Fred Ludekens  
Albert Dorne

**Institute of Commercial Art, INC.**  
Westport, Conn.

INSTITUTE OF COMMERCIAL ART, INC.  
Box N-6, Westport, Conn.  
Please send book about Famous Artists Course.

Name \_\_\_\_\_

Street \_\_\_\_\_

City \_\_\_\_\_ Zone \_\_\_\_\_ State \_\_\_\_\_

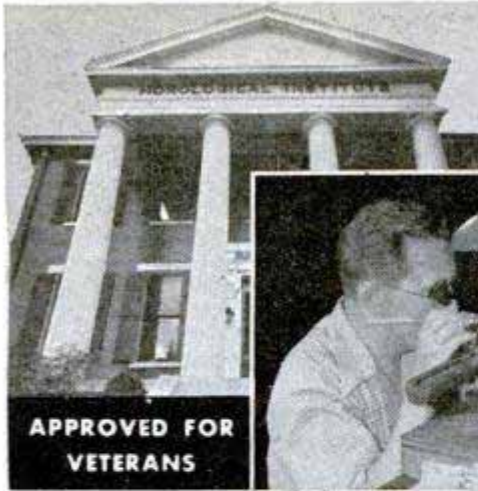

# Get the Feel of **WATCHMAKING** AT THE WORLD'S LARGEST WATCHMAKING SCHOOL



**APPROVED FOR  
VETERANS**

**BE A "WATCHMAKER FOR A DAY!"** We invite you to spend a day at Western Pennsylvania Horological Institute: Inspect our amazing layout of precision tools and equipment, then sit down at a watchmaker's bench and try *your* hand at watchmaking . . . see if you *like* this unusual, honored profession. There's no obligation, of course.

Our big 36-page colored photo book will give you a preview of this outstanding school. For your free copy, write Desk 40, WESTERN PENNSYLVANIA HOROLOGICAL INSTITUTE, Ridge Ave., Pittsburgh 12, Pa.

**• WHY THE LARGEST?** Enjoy the distinction of graduating from the largest school of its kind in the world: Largest student enrollment, largest faculty of horologists, largest quantity of working models and visual aids, largest research laboratory, largest number of electronic timing machines, watchmaker lathes, parts cleaning machine, etc.

**NATIONALLY ACCREDITED** by National Horological Schools Association, United Horological Association of America, National Council of Technical Schools, Washington, D.C.



## LEARN THIS FASCINATING, PROFITABLE PROFESSION!

Watchmaking tops all mechanical trades. It's depression-proof and age-proof . . . you're in demand—*independent for life*—as a Master Watchmaker. Start by working for reputable jewelers or by earning extra money at home . . . eventually become your town's most respected merchant with a profitable jewelry business of your own.

Avoid the crowded dime-a-dozen trades—start a lifetime of security and satisfaction in watchmaking . . . at the World's Largest Watchmaking School.

**ORIGINATORS OF THE WORLD'S FIRST COMPLETE CHRONOGRAPH COURSE**

# WESTERN PENNSYLVANIA HOROLOGICAL INSTITUTE, INC.

## Do you want

- ➔ ..to go to College?
- ➔ ..or to enter a Profession?
- ➔ ..or get an Office Position?

(Such as Accounting, Architecture, Nursing, Dentistry, Teaching, Social Work, Osteopathy, Beauty Culture, Optometry, Embalming, Chiropody, Law, Medicine, etc.)

To get anywhere, you practically **MUST** finish High School **FIRST**. You can complete our simplified High School Course in **SPARE** time at home, as **FAST** as your time and abilities permit. Equivalent to resident school work—prepares you for college, pre-professional examinations, business, industry. Standard texts furnished. Diploma. Credit for H. S. subjects already completed. Single subjects if desired. Low tuition, easy terms. American School, Chicago, est. 1897—endorsed by educators. Finish your high school education **NOW**, Write **TODAY!**

## High School Course at Home **Many Finish in 2 Years**

American School, Dept. H145, Drexel Ave. at 58th St., Chicago 37, Ill.

Gentlemen: Send me **FREE** information covering special training in subjects checked below. No obligation on my part.

- |  |  |
|--|--|
| <input type="checkbox"/> High School Course          | <input type="checkbox"/> Diesel Engineering                  |
| <input type="checkbox"/> Architecture and Building   | <input type="checkbox"/> Drafting and Design for Men & Women |
| <input type="checkbox"/> Automotive Engineering      | <input type="checkbox"/> Plastics                            |
| <input type="checkbox"/> Business Management         | <input type="checkbox"/> Private Secretary                   |
| <input type="checkbox"/> Electrical Engineering      | <input type="checkbox"/> Mechanical Engineering              |
| <input type="checkbox"/> Elec. and Gas Refrigeration | <input type="checkbox"/> Aviation                            |
| <input type="checkbox"/> Air Conditioning            | <input type="checkbox"/> Salesmanship                        |
| <input type="checkbox"/> Railway Training            | <input type="checkbox"/> Radio                               |
| <input type="checkbox"/> Electronics, Industrial     |  |

Name.....

Address.....

## THE OPPORTUNITY OF A LIFETIME



**For the electrical man who is prepared for advancement**

**WAS** there ever such an opportunity to get started in electrical maintenance and repair—and at top-notch wages? Are you ready—with experience and ability—to cash in on it? Others are getting just the sort of background needed—quick! practical!—to handle the great variety of electrical maintenance and repair work **TODAY**—from this well-known electrical library. You can too!

## THE LIBRARY OF ELECTRICAL MAINTENANCE AND REPAIR

**5 vols., 1913 pages, 1729 illustrations**

Gives you the "know-how" to tackle any wiring or motor job. Five books show you **HOW**—to install all types of motor and generator units—to inspect and repair motor starters and generators—to diagnose motor and generator troubles—to rewind small two and three phase motors—small DC and AC windings—to locate faults in small motors—test induction motors, etc., etc. One book is full of troubleshooting charts that show quickly symptoms, causes, specific remedies, etc.

**Take the first step toward improving YOUR future—Mail this coupon TODAY**

**No money down—special price—easy payments—FREE trial**

**McGraw-Hill Book Co., 330 W. 42 St., New York 18, N. Y.**

Send me for ten days' free examination the Electrical Maintenance and Repair Library. If satisfactory I will send you \$2.50 in 10 days and \$3.00 monthly until the price of \$17.50 is paid. If not wanted I will return books postpaid.

Name.....

Home Address.....

City.....Zone.....State.....

Company.....

Position.....PM-1-49

# LEARN AVIATION

AN ESSENTIAL INDUSTRY IN PEACE OR WAR  
**MAXIMUM TRAINING IN MINIMUM TIME**

for 19 years Cal-Aero Technical Institute has specialized in....

✓ **AERONAUTICAL ENGINEERING**

2 year course - kept abreast of new research and scientific development.

✓ **MASTER AVIATION MECHANICS**

1 year course - C. A. A. approved for Airplane and Engine License.

Modern "live" training equipment, including helicopters, jets, rockets, wind tunnel... Classes start monthly - Room and board available on our airport... Cal-Aero Tech Training is carefully designed for just one thing - **TO MAKE MORE MONEY FOR YOU.** More than 7000 successful graduates in addition to 26,000 pilots and 7500 mechanics trained for Army & Navy Air Forces, prove that our career training is unsurpassed. **APPROVED FOR VETERANS**



**MAIL THIS COUPON TODAY!**

Please send full information on Aviation Training FREE—without obligation.

Name \_\_\_\_\_ Birth Date \_\_\_\_\_

Street \_\_\_\_\_ Zone \_\_\_\_\_

City \_\_\_\_\_ State \_\_\_\_\_

CHECK ONE  VETERAN  NON-VETERAN **PM-1**

**Learn this Profitable Profession**

**IN 90 DAYS AT HOME**

**Money-Making Career Open to Men and Women, 18 to 50**



Hundreds of men and women between 18 and 50 make \$10 to \$20 in a single day giving scientific Swedish Massage and Hydro-Therapy treatments. There is big demand from doctors, hospitals, sanatoriums and clubs. Graduates earn large full time incomes from these or in private practice in their own offices. Others make good money from home treatments given in spare time. Learn this interesting, money-making profession in your own home, through our home study course. Same instructors as in our nationally known resident school. You can win independence and prepare for future security by qualifying for your Diploma. Course can be completed in 3 to 4 months. Many earn while they learn. Begin your training at once.



**Anatomy Charts & Booklet FREE**

Enroll now and we will include, at no extra cost, many needed supplies. Fit yourself to help meet growing demand for Scientific Swedish Massage. Send the coupon at once for complete details. Anatomy Charts and 32-Page Illustrated Booklet, FREE, postpaid.

**THE COLLEGE OF SWEDISH MASSAGE**  
 Dept. 964-A, 41 E. Pearson, Chicago 11, Illinois

Please send me FREE and postpaid, Anatomy Charts, 32-page Booklet and complete details on Home Training.

Name \_\_\_\_\_ Age \_\_\_\_\_

Address \_\_\_\_\_

City \_\_\_\_\_ State \_\_\_\_\_

**SAY YOU SAW IT IN POPULAR MECHANICS**

*for AMAZING acceleration*

**DIXIE-WESTERN**  
**DUAL INTAKE MANIFOLDS for V-8 FORDS AND MERCURYS**

**\$1500** Gas Line and Throttle Kit \$2.50 extra

Chrome Plated Velocity Stocks — \$1.50 ea  
 By Test: Increased Acceleration by 26%  
 Increased Power and Speed by 11%

All DIXIE-WESTERN manifolds are brightly polished cast aluminum.

**DIXIE-WESTERN MANIFOLD CO.**  
 Box 364 • Los Angeles 43, California

Dual Intake Manifolds  
 Dealers Wanted

**SHOE REPAIR OFFERS BIG INCOME**  
**LEARN IN 12 WEEKS TIME**

You can own your own shop or earn big income as skilled shoe repairman. Growing demand everywhere at top wages for men who know how. We teach you quickly by actually working on shoes and modern machines. School open to all from 18 to 60 years of age. FREE BIG 20 PAGE BOOK explains everything. Send for your copy today.

**MODERN SHOE REBUILDING SCHOOL**  
 Approved for Vets Established 1927 Dept. PM  
 2937 Belmont Ave., Chicago, Ill. Rush Postcard Today  
 806 So. Figueroa St., Los Angeles 14, Calif.

**REAL ESTATE**  
**BE A BROKER**

**PAYS BIG! SEND FOR FREE, BIG, ILLUSTRATED CATALOG NOW!** No obligation. Graduates report making substantial incomes. Start and run your own business quickly. Men, women of all ages, learn easily. Course covers Sales, Property Management, Appraising, Loans, Mortgages, and related subjects. **STUDY AT HOME** or in our classrooms in big cities. Diploma awarded, G.I. approved. Nationally known.

**WEAVER SCHOOL OF REAL ESTATE (Est. 1936)**  
 15 E. Pershing Road Dept. PM-1 Kansas City, Mo.

FREE BOOK TELLS HOW

**LEARN MOVIE PROJECTION THEATRE MANAGEMENT**

The Motion Picture Theatre Business offers big opportunities for trained men. Get into a fascinating field with a promising future. Train at home in spare time. Free Catalog. Established 20 years.

**THEATRE SCHOOL, 370 Washington St., Elmira, New York**

**CORRESPONDENCE COURSES IN RADIO and ELECTRICAL ENGINEERING**

**ELECTRICAL ENGINEERING.** Get good grasp of wide electrical field. Modern. Very understandable. Theory made easy.

**RADIO ENGINEERING.** Extra fine course in radio, public address, photo-electric work. Trains you to be super-service man, real vacuum tube technician. Tuition ONLY \$25, either course. Deferred payment plan. Servicing needed handy.

**FREE** Write for free copies of school catalogs, student magazines, etc.

**LINCOLN ENGINEERING SCHOOL, Box 931-P121, Lincoln, Nebr.**

Tuition \$25

**CHICKS on NO-RISK**

30-DAY TRIAL GUARANTEE. Money refunded on any chicks not true to breed. No need to take chances. 30 days to make sure chicks are as represented. Pullets or males. Low prices. All varieties. Easy buying plan. Chick Manual Free.

**MISSOURI STATE HATCHERY, Box 189, Butler, Mo.**

**ARTISTS MAKE MONEY**

Do you like to draw? Send name, address, age and occupation for **FREE ART TEST**, to find out your ability.

**ART INSTRUCTION, Inc.**  
 1139 ART INSTRUCTION BLDG., MINNEAPOLIS 15, MINN.

**PRACTICAL MATHEMATICS 4 BOOKS IN ONE! SAVE HALF PRICE!**

Easy self-instruction in 25 branches by college experts—all in one volume! Helps you qualify for a better job. 1280 pages, 600 illustrations. Sent for free trial. Only \$1.00 down, \$1.00 a month; total \$4.95 plus postage. (Cash price \$5.00 postpaid) 160-page Logarithm book free with order. National Educational Alliance, Inc., Dept. 561, 37 West 47th St., New York 19, N. Y.

**Learn ORNAMENTAL HORTICULTURE**

A thorough, constructive home training for employment or advancement in Nursery Operations, Park Supervision or maintenance, Landscape Designing or Landscape Gardening. My 3 way Plan shows you how to start your own business, get a better job, or earn extra money in spare time. Send for Free Book. **APPROVED FOR VETERANS.**

**NATIONAL LANDSCAPE INSTITUTE**  
 Dept. P-1, 310 So. Robertson Los Angeles 36, California

**POPULAR MECHANICS**

# Learn

TRADES WITH  
GREATER SECURITY

# WATCHMAKING ENGRAVING JEWELRY



Above Average Pay. Trained Men Always  
in Demand. Write Today for Free Catalog.

Approved for G.I. Training

## KANSAS CITY SCHOOL OF WATCHMAKING

America's Most Progressive Horological School

617-621 Wyandotte St. Kansas City 6, Mo.

# PUT YOUR FUTURE IN BRIGHT LIGHTS!

LEARN  
**NEON**  
TUBE BENDING  
AND  
NEON SIGN  
FABRICATION



You can earn \$100 weekly or better as one of the  
hundreds of properly trained men now desperately  
needed by the neon sign and fluorescent lighting  
industries.

Our GI-approved resident courses offer the most  
THOROUGH institutional training available in this  
field. Over 1800 hours of individual instruction and  
bench work covers every phase of luminous tube  
bending and installation — nothing is held back for  
"special courses." *This is not a correspondence course.*

Enrollment is strictly limited to those who are will-  
ing to undergo 15 months of thorough non-technical  
training. To date, *not one single graduate* has failed  
to qualify for or hold a well-paying job in the indus-  
try. For information, write for Bulletin "M," stating  
whether or not you are a veteran.

## GENERAL INDUSTRIAL TRAINING INSTITUTE

127 North Seventh Street Steubenville, Ohio



# Blue Print for PROFIT

## Here's Your Success Plan



a few cents worth  
of materials  
**BRINGS YOU DOLLARS!!**

*Have* Your Own Lasting,  
Successful Business—Be Your  
Own Boss—Help Fill Huge Demand  
... No Experience Is Necessary

*It covers*



TOYS  
old or new



LAMPS  
take on a new  
distinctive  
beauty



JEWELRY  
BOXES  
give perfect  
protection



DISPLAY  
PIECES  
become  
unusually  
eye-appealing



CAR  
DASHBOARDS  
made soft  
as velvet

Rich profits are waiting to be tapped in  
this new field. New MIRACLE finish gives  
a velvety, luxurious surface to radios,  
lamps, toys, signs, store displays, figur-  
ines, auto dashboards, and hundreds of  
other items. Make old objects beautiful  
and saleable — make new things worth  
much more with this soft, rich covering  
that can be applied to any surface, even  
if old and worn.

### START RIGHT AWAY

Yes, you can learn in a few days to start  
MAKING MONEY! Everything you need is  
furnished, including fully detailed, illus-  
trated instructions that are complete and  
easy to understand. Every point is explain-  
ed, to show you how to start on the road  
to big money, full or spare time, right in  
your own home.

### EVERYTHING COMPLETE

In addition to full instructions, you get a  
complete set of materials that enables you  
to start at once. A few cents worth of ma-  
terials can mean many dollars in return to  
you — you can earn up to \$500 or \$1,000  
per month full time; up to \$75 per week  
spare time.

### ACT NOW

Grasp this opportunity TODAY — start your  
own business. It's too good to miss! SEND  
NO MONEY — fill out the coupon and  
stick it on a post card or in an envelope  
and mail today for full details, FREE sam-  
ple of FLOK-KRAFT covered material, and  
hundreds of useful and profitable IDEAS.  
Do it NOW — be first!

Covers Wood,  
Fabric, Metal, Glass,  
Plaster, Plastic or  
any Surface

SEND NO MONEY  
USE THIS  
COUPON

COAST  
INDUSTRIES Dept.  
PM-1

1509 West Manchester,  
Los Angeles 44, Calif.

Please rush me all the details!

NAME \_\_\_\_\_

STREET \_\_\_\_\_

CITY \_\_\_\_\_ STATE \_\_\_\_\_



# WAR SURPLUS OPTICAL BARGAINS

ASSEMBLE YOUR OWN BINOCULARS!

Save More Than 1/2 Regular Cost



## GOVERNMENT'S 7X50 BINOCULARS

**Complete Optics!  
Complete Metal Parts!**

We supply full instructions

**METAL PARTS**—Set includes all Metal Parts—completely finished—for assembly of 7 X 50 Binoculars. No machining required. A sturdy Binocular carrying Case is optional with each set of Metal Parts.

Stock # 842-H ..... \$39.40

Postpaid, plus \$4.80 for Case—Total..... \$44.20

**OPTICS**—Set includes all Lenses and Prisms you need for assembling 7 X 50 Binoculars. These are in excellent condition—perfect or near-perfect—and have new low reflection coating.

Stock # 5102-H ..... \$25.00 Postpaid

(These are standard American made parts - not Jap, French or German.)

**NOTICE!** If you buy both Binocular Optics and Binocular Metal Parts, add 20% Federal Excise Tax to above prices.

## ARMY'S 6x30 BINOCULARS

**COMPLETE OPTICS & METAL PARTS**—Model M-13A1, 6 X 30 Binoculars. (Waterproof Model). Everything you need—ready for assembly. When finished will look like a regular factory job costing \$102. to \$120. The Optics are new, in perfect or near-perfect condition. Have new low reflection coating. Metal Parts are new and perfect, all completely finished. No machining required. Complete assembly instructions included.

Stock # 830-H ..... \$40.00 Postpaid  
plus \$8.00 tax—Total—\$48.00

**20X PRISM SPOTTING SCOPE SET**—Consists of all lenses and prisms (slightly chipped) you need to make a good, standard 20X Spotting Scope. Low reflection coated. 57 mm. dia. Achromatic objective. Some Metal Parts Included. We furnish Directions.

Stock # 5145-H ..... \$22.00 Postpaid  
(Also surplus Riflescopes — Write for Bulletin 18-H)

**SLIDE PROJECTOR SETS**—Consist of all unmounted lenses you need to make the following size projectors:

Stock # 4038-H—2 1/4"x2 1/4" ..... \$3.35 Postpaid

Stock # 4039-H—2 1/4"x3 1/2" ..... \$3.35 Postpaid

Stock # 4029-H—35 mm. .... \$2.85 Postpaid

**35MM KODACHROME PROJECTING LENS SET**—Consists of a mounted projecting lens, heat absorbing glass, 2 condensing lenses.

Stock # 4035-H ..... \$4.85 Postpaid

**MOUNTED ANASTIGMAT LENSES**—Use for Projectors, Enlargers, Copying Cameras. Complete with Shutter and Diaphragm. Value about \$20. An excellent buy. **WE WILL INCLUDE FREE ILLUSTRATED BOOKLET ON HOW TO MAKE YOUR OWN ENLARGER.**

Stock # 8004-H Speed f/7.7, focal length approx. 127 mms. Suitable for pictures, negatives, positives up to 3 1/2"x4 1/4". \$7.50 Postpaid

Stock # 8006-H Speed of f/7.7, focal length approx. 100 mms. Suitable for pictures, etc. up to 2 1/4"x3 1/4". .... \$8.50 Postpaid

We have literally millions of war surplus lenses and prisms for sale at 10c and up. Write for Catalog "H" — Sent Free!

Order by Stock No.

Satisfaction Guaranteed

## EDMUND SALVAGE COMPANY

P. O. AUDUBON, NEW JERSEY

## HELPFUL BOOKS

Send post card asking for FREE catalog

Popular Mechanics Press, 200 E. Ontario, Dept. 601, Chicago 11

# HOW TO BE STRONG

## SHORT CUTS TO MOLD MIGHTY MUSCLES

Strong men are not born...they are made. Here is your opportunity to learn how to train and build mighty muscles without a single cent of cost.



**Yours  
FREE**

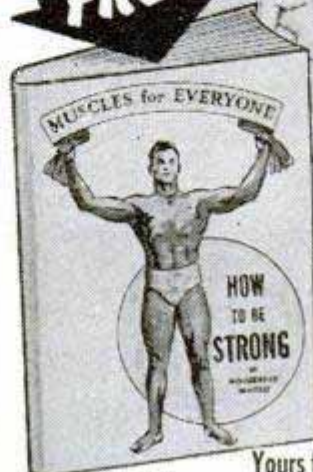

**Write Today!**

Get your free copy of "HOW TO BE STRONG". 48 pages of training and muscle building facts and advice. Expertly written by men who made the grade. Profusely illustrated.

Yours for the asking...10c appreciated to cover expense.)

Write to: **MOOSEHEAD SALES CO.** Dept. 501  
366 East 153rd St., New York, N. Y.

## Say You Saw It in POPULAR MECHANICS

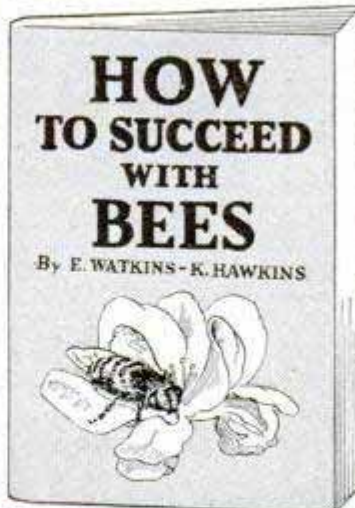

## RAISE BEES SELL HONEY MAKE MONEY!

Get How to Succeed with Bees, written by two experts, which tells you all you need to know. Contains 190 tested successful plans to produce big crops of honey. Easy work and little capital required. There is always a ready market for honey and working with bees is fascinating. This 96-page well-illustrated book is only \$1.00 and is absolutely guaranteed to satisfy you or we shall refund your money. **Send for your copy today!**

**POPULAR MECHANICS PRESS**  
200 E. ONTARIO STREET  
CHICAGO 11, ILLINOIS

*Profit and Fun*

## CARVING LEATHER

*at home spare time full time*

**New Device** makes it possible for beginners to **improve overnight**. Now is the time to cash in on this Big Paying business — year round profits are easy if you follow **new method** of instruction to be found **only** in Baird's home study course Big sale for bill folds, wallets, belts, purses gun holsters, saddles, and other leather articles. Make up to \$50.00 per week spare time or up to \$500.00 or more monthly full time

Start your own business. Make Xmas presents and other gifts. The Baird Course is **Complete**. Full instructions — Tools and equipment — Including new device that makes learning easy. Write for full details and interesting catalog — containing many profitable suggestions — **Sent Free** — **Write Now.** DEPT. PM-1

**BAIRD SCHOOL OF LEATHER CARVING** • 221 Manitou Ave., Manitou Springs, Colorado



**THE GREATEST THING IN PLASTICS!**

# PLASTICAST

**A NEW HOME INDUSTRY AND HOBBY!**

**PLASTICAST** is a transparent liquid plastic; can be poured into ANY kind of mold or container. Hardens in a few minutes into a transparent solid, clear-as-glass, tough as steel plastic! No tools machinery or skill required. IDEAL for imbedding pretty flowers, butterflies, photos, medals, souvenirs, biological specimens, etc. Makes a **PERMANENT** and **ATTRACTIVE** display. Make attractive jewelry, combs, lenses, knick-knacks, novelties. Easily cast into sheets, rods, blocks, ANY color, ANY shape! **EVERYTHING** furnished, including molds, for making about \$50.00 worth of unusual novelties! **PLASTICAST OUTFIT, Complete \$3.50** with 3 molds.

**PLASTIDUR . . . (LIQUID IVORY).** Ideal for casting all OPAQUE articles. Hardens in a few minutes into an extremely hard IVORY-like plastic! May be dyed any color or cast into any shape. Works in **EVERY** type of mold! Non-inflammable, waterproof. DURable. Ideal for statuary, novelties, figurines, toys, wadgets, tools, knobs, bases . . . a million useful applications! Outfit comes complete with molds, dyes, accessories, instructions, etc. for making about \$100.00 worth of attractive jewelry, etc! **\$5.00**

**BE A PLASTICS MANUFACTURER . . .** Sell your output on **CONTRACT** basis! We show you what to make and how. This offer open to **PLASTICAST** customers only.

Our Casting Plastics are as easy to use as pouring water out of a glass! **TERMS:** We pay the postage (U.S.A. & Canada only) if full cash accompanies your order. C.O.D. accepted (U.S.A. only) if \$1.00 deposit is included for each item ordered. C.O.D. orders not postpaid.

**FREE** A very attractive and useful novelty made with one of our plastics given absolutely free with every one of our catalogs! Catalog lists many new materials for making **MOLDS** and **CASTINGS** with Liquid Plastics, Liquid Marble, Latex, Elastex, Castwood, Wax, Metals, Plaster, Shellcraft, Internal Carving, Molds, Moulage, etc. Price of catalog only 10c. **DEALERS: WRITE FOR ATTRACTIVE WHOLESALE PRICE LISTS**

**PLASTICAST CO. (Dept. C)**  
 5961 Madison St. Chicago 44, Illinois (Order by mail only) P. O. Box 987 Palo Alto, Calif.

**RADIO ENGINEERING, Broadcasting, Television, FM, Servicing, Electronics, Aviation, Marine & Police Radio** taught thoroughly. Engineering course equivalent to 3 years' college radio work. Approved Veteran Training. Catalog free. **VALPARAISO TECHNICAL INSTITUTE, Dept. D, Valparaiso, Ind.**

**ENSHRINE THEIR MEMORIES WITH U.S. MONUMENTS** Erected. Freight paid. There is none better. Our free catalog is ready for you. Write today. A-18, U. S. Marble & Granite Co., Oneco, Fla.

**Say You Saw It in POPULAR MECHANICS**

**\$64.40 PROFIT IN 4 HOURS**

**That's Pollack's FIRST DAY Record with ROTO-CLEAN—Amazing New Non-Electric Whirling Glass Cleaner**

I've been in Direct Selling a long time. In my day, I've run across some terrific money-makers. But believe me, for quick and spectacular and steady profits, I've never seen the equal of **ROTO-CLEAN!** Pollack worked just 4 Hours and made \$64.40 profit for himself.

**ROTO-CLEAN** is the non-electric glass cleaner that works on an amazing new principle. Just press a glass over the brush and it **WHIRLS!** Bartenders, tavern owners, soda fountain and restaurant operators grab on sight. Because **ROTO-CLEAN** actually cleans glasses

# LINGUAPHONE



is your *Passport* to the World

In your own home, alone or in a group, you can now learn to speak

**SPANISH • PORTUGUESE  
 FRENCH • RUSSIAN  
 ITALIAN • GERMAN**

or any of 23 other languages by the world-famous

# LINGUAPHONE Conversational METHOD

You learn the new language by listening to voices of native teachers. It is amazingly simple; thousands have succeeded. Educators hail Linguaphone as a notable advance in simplifying the mastery of languages. That is why so many Linguaphone Sets are used in schools, colleges, universities, as an aid to fluent speaking.

Available to Veterans under **G I BILL OF RIGHTS**

SEND FOR FREE BOOK  
**LINGUAPHONE INSTITUTE**  
 98 RCA BUILDING, NEW YORK 20, N. Y.

**LINGUAPHONE INSTITUTE**  
 98 RCA Bldg., New York 20, N. Y.  
 Send me the FREE Linguaphone Book.  
 I am , am not  a World War II Veteran  
 I want to learn.....language.  
 Name .....  
 Address..... City.....

## New 1949 PLASTICS SUPPLIES CATALOG

Just off press. Full details on Plexiglas, Lucite, rods, sheets, tubes, Acetates, cements, dyes, buffs, molding sets, tools, carving kits, accessories. Everything in plastics. Gives prices, sizes, colors, etc. Price 10c, stamps or coin, with ad for catalog.

**PLASTICS MFG. & SUPPLY CORP.**  
 DEPT. PM-1 • 4707 EUCLID AVE. • CLEVELAND 3, OHIO

cleaner—cleans them quicker and easier than many electric glass cleaners costing ten times as much.

I'm not trying to sell you a bill of goods. In this ad, I'm not trying to sell you anything. All I want you to do is let me send you the facts so you can see for yourself. To prove I mean business, I even send real salesmen a sample ROTO-CLEAN without a penny of cost, as explained in my Special Offer to new men.

Don't send a cent. But rush the coupon. This simple step may give you the biggest, quickest cash clean-up of your life. Mail coupon now to L. B. Patterson, Maxilume Co. Dept. X-81, 125 W. Hubbard St., Chicago 10, Ill.

**FREE Demonstrator Offer. Mail Coupon**

L. B. Patterson, Maxilume Co., Dept. X-81  
 125 W. Hubbard St., Chicago 10, Illinois  
 Rush complete information about ROTO-CLEAN and FREE SAMPLE Offer to new men.

Name.....  
 Address.....  
 City..... Zone..... State.....

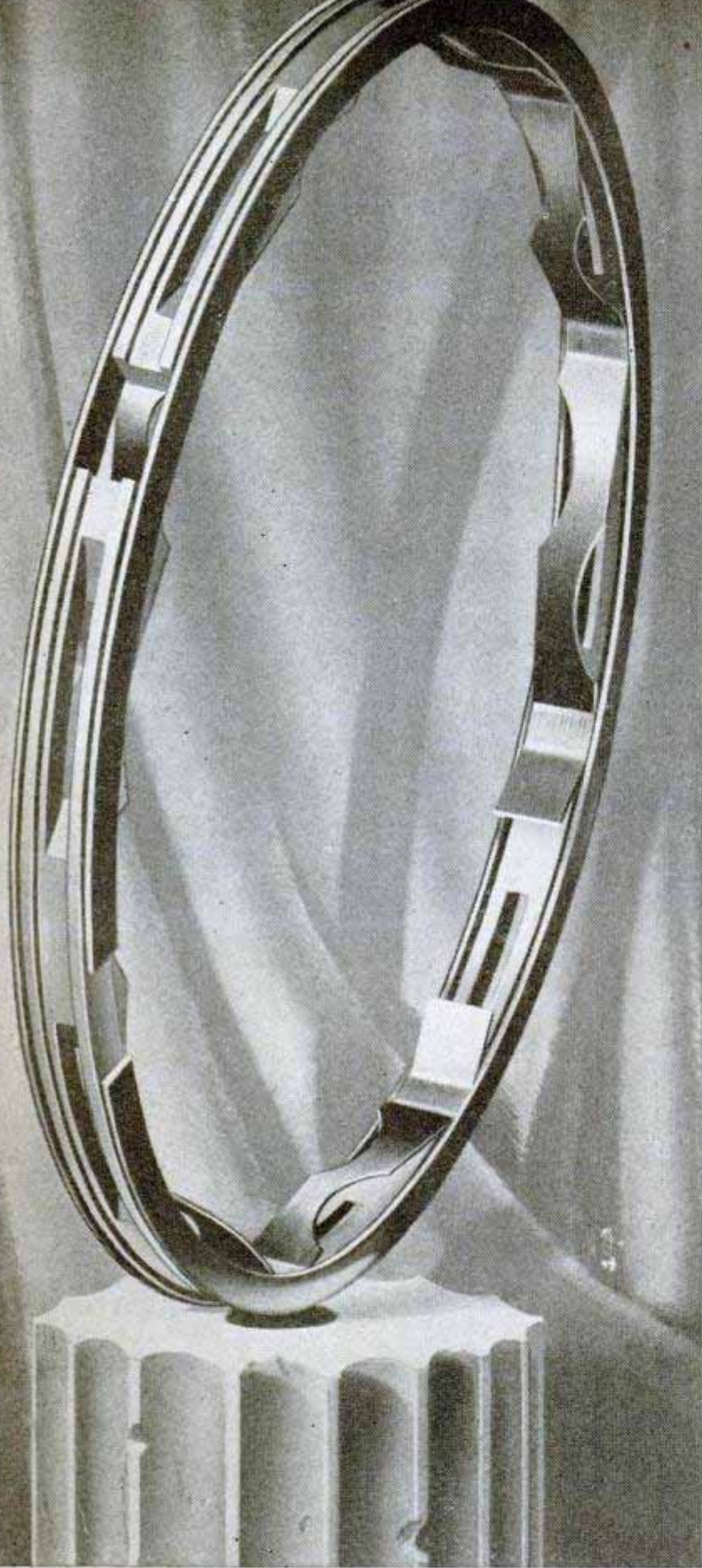

# Perfect Circle

## *The Most Honored Name in Piston Rings*

**Honored by** America's foremost automotive engineers, who recently acclaimed Perfect Circle Piston Rings as best engineered—4 to 1.\*

**Honored by** Doctors of Motors, America's expert mechanics, who actively express their piston ring preference by installing millions of Perfect Circles every year.

**Honored by** motor-wise car owners all over America, who in survey after survey have invariably named Perfect Circle their first choice by a wide margin.

*\* In an independent survey just completed among automotive engineers—maintenance men, fleet operators and designers of new equipment—Perfect Circle was first choice as the best engineered piston ring—first by more than 4 to 1—and received more votes than ALL other brands combined!*

**Look for this sign (right)** It identifies a place where your car will receive expert attention. Your local Doctor of Motors knows your car, knows the value of honest workmanship and reliable parts. He will install a set of Perfect Circle Piston Rings Custom Made for your car to restore power, save gas, stop oil burning.

*Perfect Circle Corporation Offices: Hagerstown, Ind., Toronto, Canada. Plants: Richmond, Newcastle, and Tipton, Indiana.*

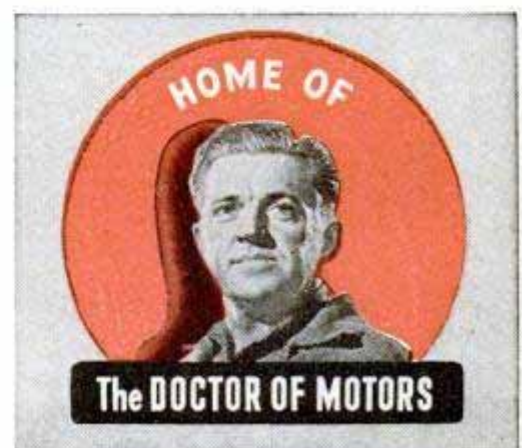

POPULAR MECHANICS

# POPULAR JANUARY 1949 MECHANICS

WRITTEN SO YOU CAN UNDERSTAND IT  
VOL. 91 NO. 1

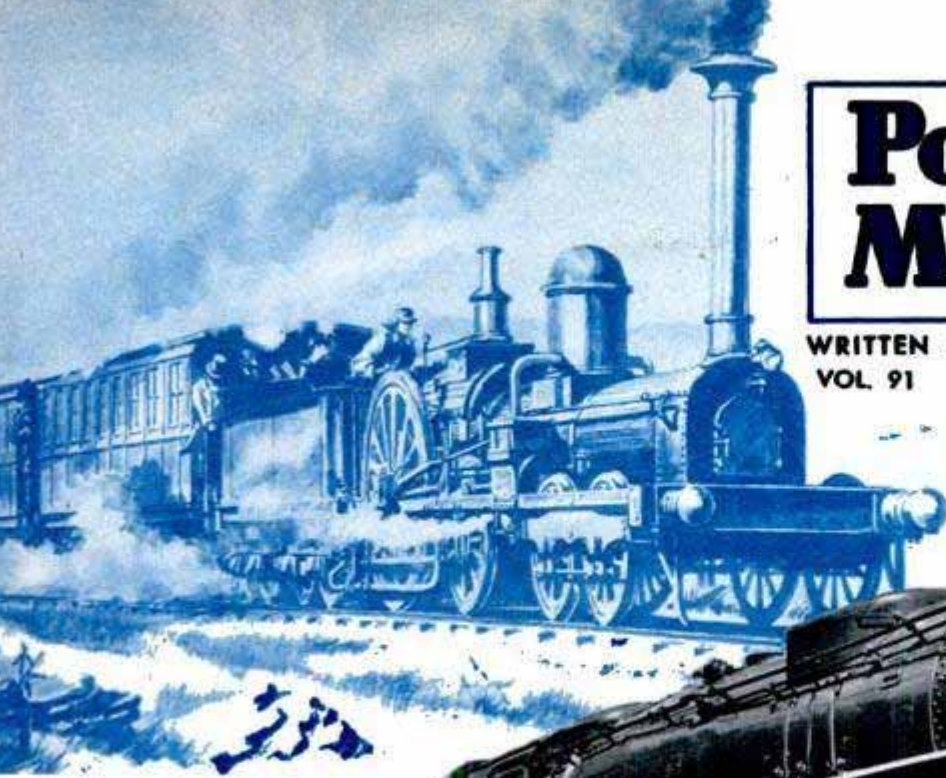

The Lightning, above, was the first steam locomotive built at the Schenectady works in 1848. Just 100 years and 75,000 locomotives later came the last one, shown at right

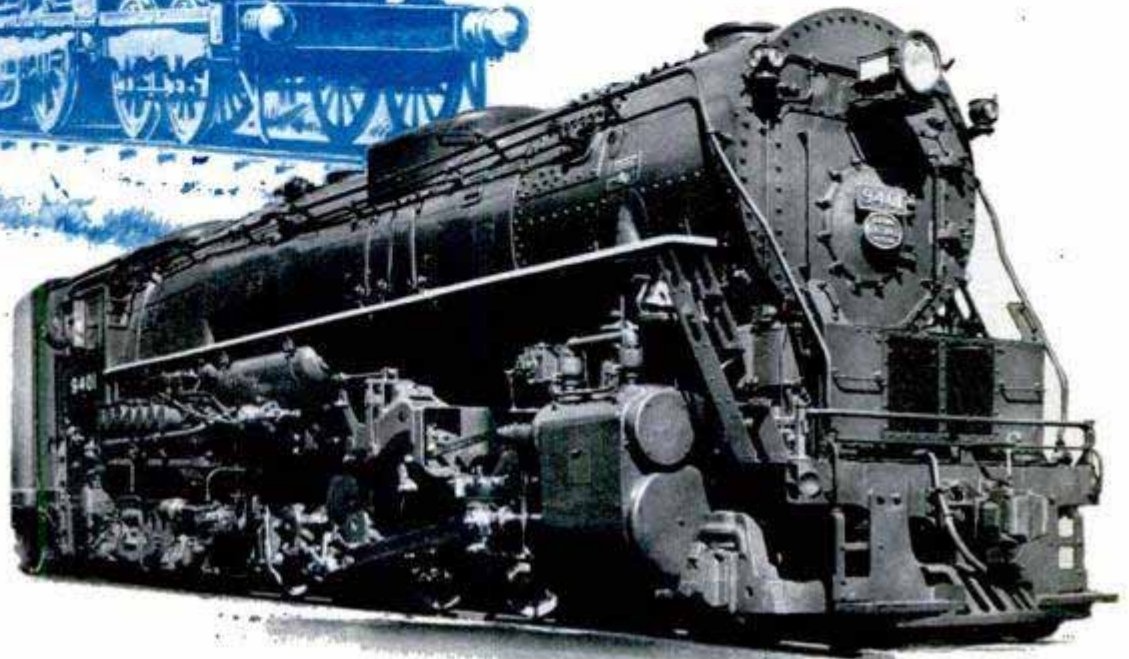

## END OF AN ERA



By Wayne Whittaker

**N**OBODY blew a whistle or rang a bell as the big steam locomotive was eased out of the erection building and pulled into the running shed. The pulling was done—prophetically enough—by a purring diesel-electric switcher.

Workmen from the far corners of the cavernous old erection building gathered around. They were strangely silent and appeared to be only half believing what they saw. To the casual observer there was nothing unusual about the looks of this locomotive—a conventional 2-8-4 type. It was built under contract by the American Locomotive Company in Schenectady for the Pittsburgh and Lake Erie Railroad.

"If anybody had ever told me—" said one of the workmen to Frank J. Close, superintendent of the steam shop. The man didn't finish his sentence, but Close and his assistant, F. L. McMahan, nodded their heads in perfect understanding.

The boiler of the new locomotive was

filled with water and she was coaled up. Still nobody budged. After a time the steam-pressure gauge registered full-boiler pressure. Then followed the familiar sequence of blowing out the boiler tubes and setting the safety valves. The injectors were tested. The water pumps. The air brakes. The stoker.

P. T. Egbert, vice-president in charge of the locomotive division, and several other top executives joined the waiting group. A photographer's flash bulb exploded. A foreman waved a "go ahead" signal to the test engineer and under its own steam the locomotive chugged out of the running shed to mark the end of an era in the shops of the American Locomotive Company.

This particular locomotive happened to be the last steam engine off the regular production line of the plant which has been building locomotives for 100 years. From now on, unless something unforeseen occurs, all of their production will be

4-4-0 Gov. Marcy, 1851



4-4-0 American type, 1860



4-4-0 American type, 1898 81





Stanton Mason, "junior engineer" of Scotia, N. Y., eyes 4500-hp. diesel

Back in 1848—the year before the California gold rush—an infant company known as the Schenectady Locomotive Engine Manufactory produced its first product. This was a spritely little engine with a high smokestack, lots of polished brass, red paint and gold trim. It must have been something of a curiosity to the boatmen and passengers traveling on the Erie Canal, which passed the doors of the plant. The rivermen, with their hundreds of miles of navigable waterways, laughed at the locomotive named *Lightning* and probably joked about it being all dressed up with no place to go. There weren't many miles of railroad track in the country at that time.

streamlined diesel-electric locomotives.

"We didn't plan it this way," says Mr. Egbert. "It's simply a matter of demand. All the railroads want diesels. The handwriting has been on the wall for a number of years and we've been preparing for this day since the early 1920s. That's when we built our first diesel."

Despite any handwriting on the wall, the decision of Alco (contraction for American Locomotive Company) to discontinue steam production comes as a blow to railroading fans throughout the world. There are volumes of statistics proving the economy of diesel operation as compared to steam. But statistics are a poor substitute for the thrill a railroad fan gets in watching an old iron horse under full steam flinging back its plume of smoke and splitting the air with its warning whistle. The sounds and the smells of a hurtling diesel in all its gleaming efficiency can never replace the colorful iron horse in the heart of a true steam-locomotive fan.

Time out for a backward glance over 100 years of locomotive building. This production record is a study in mechanical evolution during Alco's building of more than 75,000 locomotives. The record bridges three wars and several depressions; it embraces advancements in mechanics that have revolutionized our way of life.

The *Lightning* was a good engine; in fact, it was away ahead of its time. It weighed about 15 tons, had 84-inch drivers and, although it was built to haul nine cars at 9 to 15 m.p.h., it once pulled an eight-car train at 80 m.p.h. The little locomotive was sold to the Utica and Schenectady Railroad and was doomed to only one year of service. It was just too powerful for the roadbeds of that day.

Local railroad magnates were not impressed with the *Lightning's* performance and further orders were not forthcoming. After three years of struggle, the "manufactory" quietly folded up. The *Lightning* was its only product and if anybody had told the company directors that this locomotive would be famous a hundred years later they would have been dumfounded.

The company was quickly reorganized in 1851 by John Ellis, one of the early stockholders. Ellis and his four sons guided the company, now known as the Schenectady Locomotive Works, for more than half a century. In its first year they built five locomotives and one of these, the *Governor Marcy*, was destined for fame. Pictures of the *Marcy* have been widely reproduced as one of the first 4-4-0 types of locomotive. (To the uninitiated, the numerals from left to right tell the number of wheels composing the leading truck, the number of driving wheels and the number of wheels on

4-4-2 Atlantic type, 1905



2-6-0 Mogul type, 1906



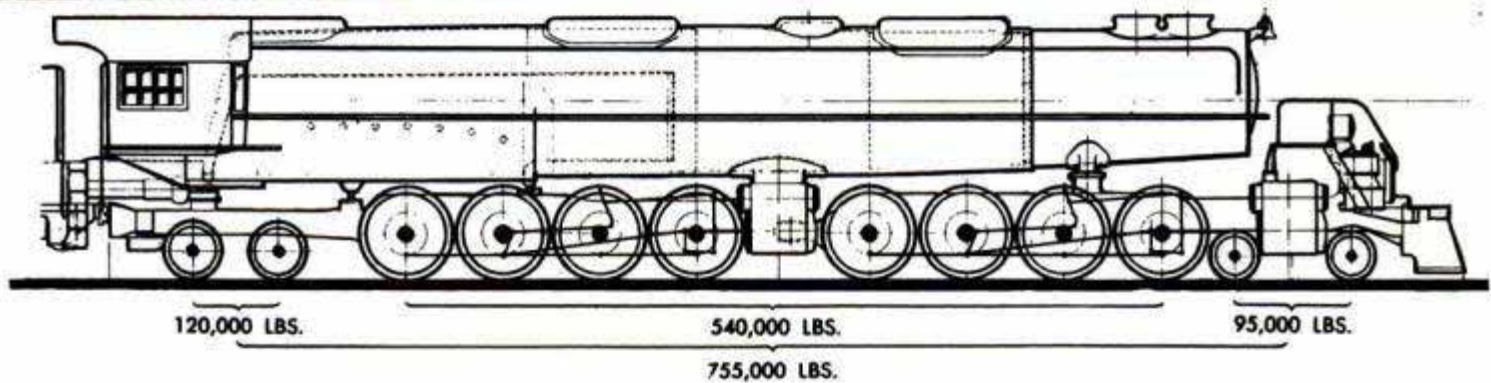

**Big Boy, the world's largest steam locomotive, weighs 755,000 pounds. Sketch shows the weight distribution**

the rear truck. The 4-4-0 is also known as the 8-wheel or American type.)

Walter McQueen, ingenious master mechanic and one of the greatest steam-locomotive builders of all time, served as superintendent and later as vice-president of the company. McQueen made things hum and by 1855 the plant was turning out one \$7500 locomotive every eight days. By this time, coal-burning locomotives were being generally accepted. The speedy Schenectady locomotives made record-keepers dizzy by breaking one record after another. One of the favorite speed runs of the day was to Niagara Falls. Jokesters of the era quipped that at breakneck speeds of 35 m.p.h. a passenger no more than opened his lunch basket than he was at the Falls.

In 1857 there was a general business panic and the plant with its 440 workers suffered a severe slump. The next year

only two locomotives were built and the company was reorganized. Three years later came the Civil War with high prices and government orders for as many locomotives as could be built. The plant delivered 84 locomotives to the government between 1861 and 1863. Historians agree that these locomotives played a vital part in the course of the war. The McQueen engine became nationally famous.

The proof of the quality of the engines built by McQueen may be seen today on a fruit-belt run between Stockton and Linden, Calif. The locomotive on this run was built in 1867, originally for the Central Pacific, and is now the property of the Stockton Terminal and Eastern Railroad.

During these early years the plant became known as the "Big Shop" and, although it was to change its official name many years later, the east side of the plant

4-6-0 10-Wheeler, 1906

4-6-4 Hudson type, 1937



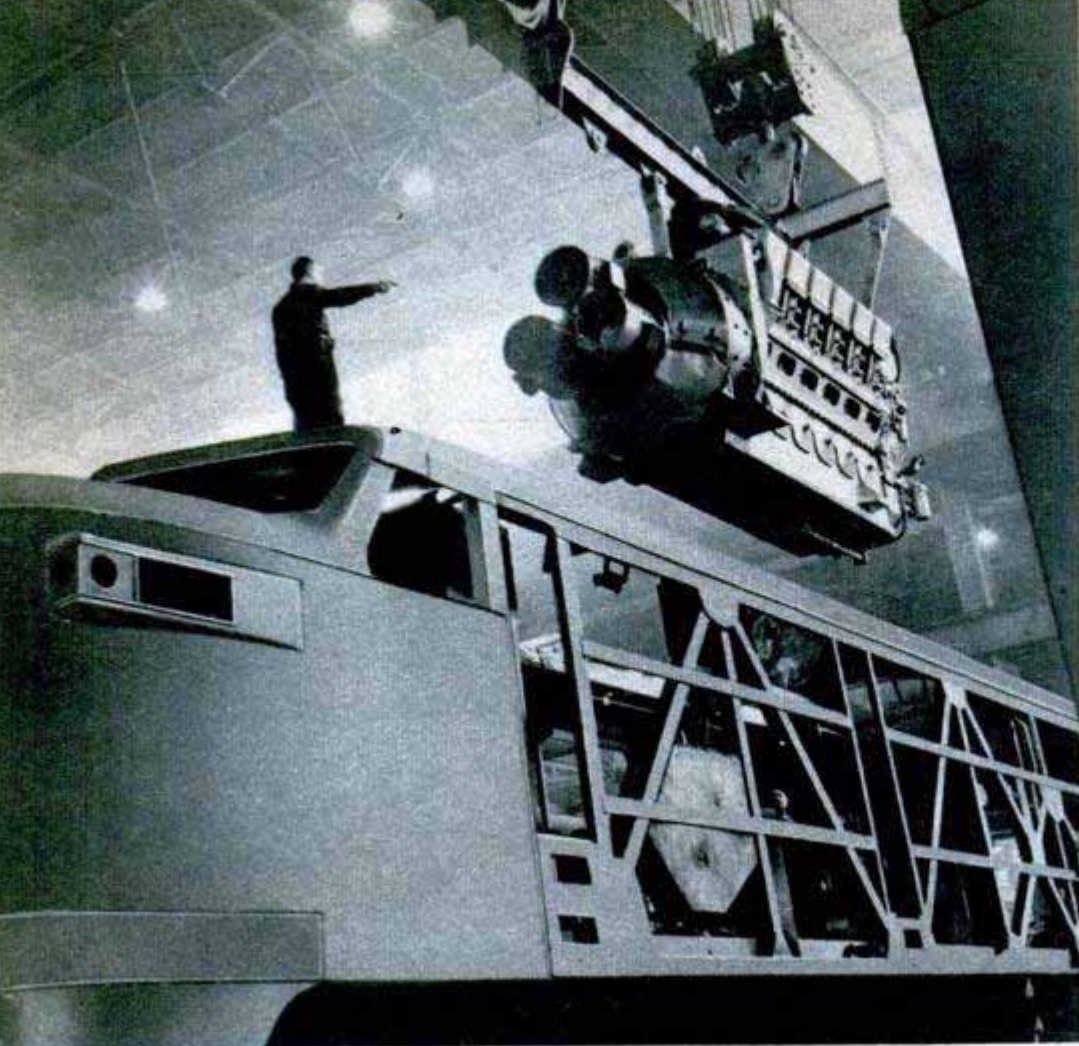

The scene has shifted at Alco to the building of diesel-electric locomotives; here a 1500-hp. diesel engine is being lowered into framework

Below, 4-8-4 Niagara-type locomotive is one of the most popular in U. S.

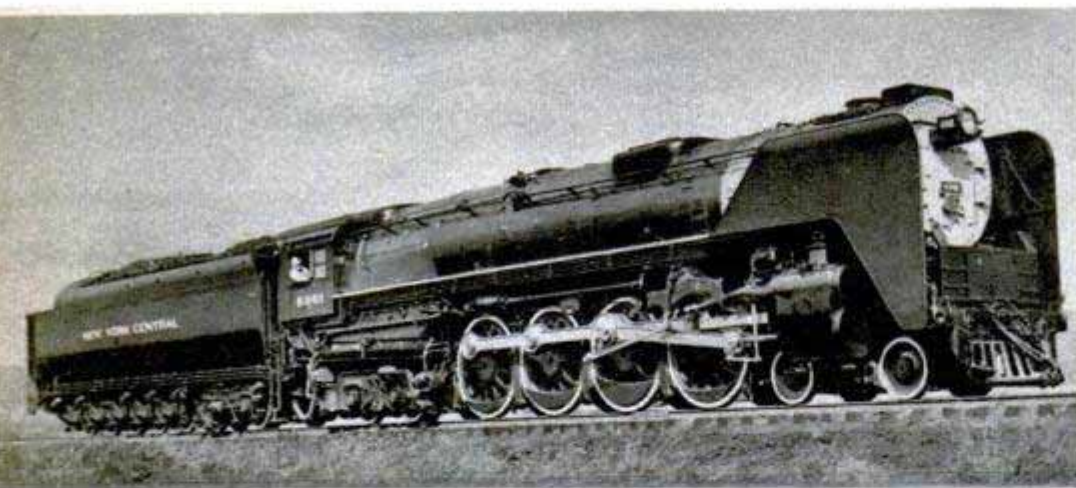

is still known as the Big Shop in Schenectady. In 1869, the company celebrated its coming-of-age 21st birthday with an appropriate occasion. The Schenectady-built locomotive, Jupiter, transported Governor Stanford and his party from Sacramento, Calif., to Ogden, Utah, for the golden-spike ceremony connecting the Central Pacific and Union Pacific Railroads. The Jupiter

aging four times as much in weight as those produced back in 1851. During the 80s and 90s, heavy American-type (4-4-0) locomotives set some remarkable records and led the way in the race for powerful express engines.

On June 24, 1901, the Schenectady Locomotive Works became the American Locomotive Company through a merger with

is said to have been the first locomotive to pass over these connecting rails which linked the East and West to inaugurate a great step in transportation which was to unite the nation.

Up until this time, the Ellises, McQueen and his top assistants had concentrated on the 4-4-0 type of locomotive. Their basic problem concerned boiler capacity because the bigger the boiler the faster the McQueen engines would run. In the two decades after 1870 other types were added to the line—the 2-6-0, 4-6-2, 4-8-0 and the 4-4-2. Albert J. Pitkin, noted for his work at the Baldwin Locomotive Works in Philadelphia, joined the company in 1882 as chief draftsman.

Pitkin was an exponent of heavy and powerful locomotives which were a boon to a rapidly growing freight and passenger business. He designed the first cross-compound locomotive which uses one high-pressure and one low-pressure cylinder. In this engine the steam is used twice, which saves coal and water. The compound locomotive was developed in various designs and not widely used until about 1910 when superheating became general.

After Pitkin joined the Big Shop the locomotives soon were aver-

2-8-0 Consolidation, 1937

2-8-2 Mikado, 1937





Painted by Alco artist Howard Fogg, a diesel-electric is shown on mountain run of Southern Pacific

seven other companies. These were boom days in transportation and in 1907 Alco set a production record by building 930 locomotives. Technical development of the steam locomotive was moving toward an all-time peak. Superheating had been proved a success. A locomotive superheater raises the temperature of the steam by passing it through loops of pipes which are exposed to the hot gases from the furnace. The superheater made it possible to raise the temperature of steam above that of saturation.

Another important locomotive development just after the turn of the century was that of the "articulated" locomotive. This type has two sets of driving wheels connected by a joint and providing great tractive force. The wheels in each group are driven by a separate pair of cylinders. Articulated locomotives are known as the Mallet type, named for the inventor of the most popular design used in the United States. Advantages of the Mallet for pulling heavy trains can readily be seen as compared with the conventional rigid wheelbase with a single group of driving wheels.

Mallet types built by Alco include the 0-6-6-0, 2-6-6-2, 4-6-6-4, 2-8-8-2 and the top

(Continued to page 246)

4-8-8-4 Big Boy, 1941



4-6-6-4 Challenger, 1944



2-6-6-2 Early Mallet type



0-6-6-0 First Mallet, 1904



4-8-2 Mountain, 1946



4-8-4 Niagara, 1945





### Black Light Shows Up Bad Eggs

Eggs that are too old to be good can be detected by the ultraviolet rays of black light, according to recent experiments. Westinghouse scientists have found that a fresh egg glows scarlet under the invisible rays, while an older egg shows up with a purple color. The outer shell and its protein covering are fluorescent, which makes the egg glow under the light. Presumably the color switch occurs when oxidation of an older egg causes a chemical change in the shell.



### Twin-Jet Flying Wing

Twin jet engines power a flying-wing aircraft developed for the British Royal Air Force. The plane consists of a wing with a nose section and two jet engines. It was shown recently at an aircraft constructor's exhibition in England. Of 60 aircraft at the show, 20 were powered either by turbojet or turboprop engines, and some attained speeds of 600 miles an hour.

### Tailless Glider Seating Two Completes 2400-Mile Trip

Similar in size and design to the U. S. Air Force's flying wing, a giant glider developed in Canada has no tail section. The

motorless craft, which carries two men, has a tricycle landing gear that is retractable. It recently completed a 2400-mile trip.

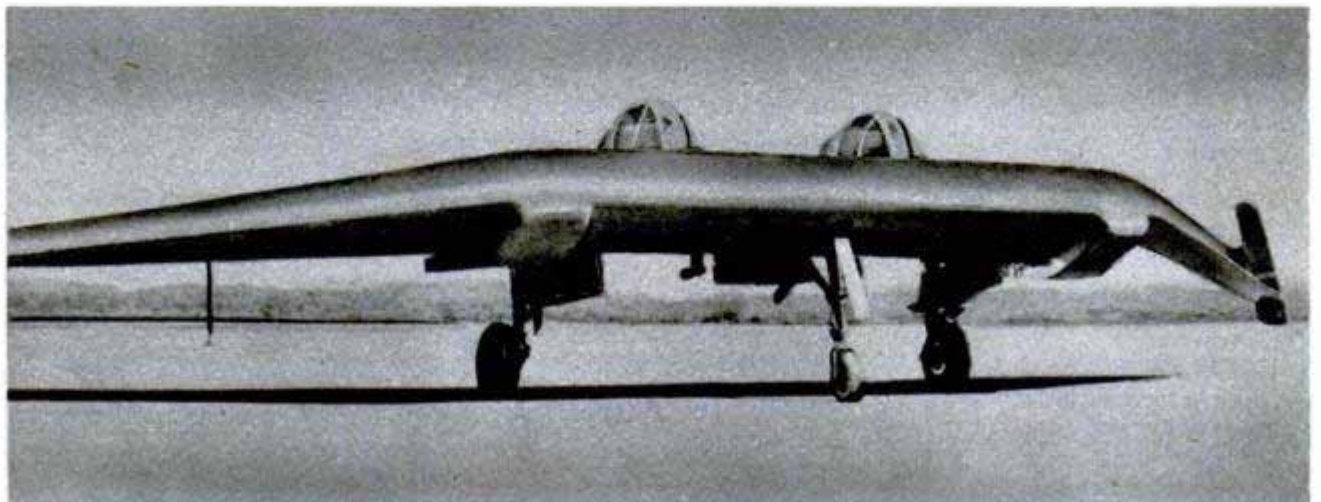



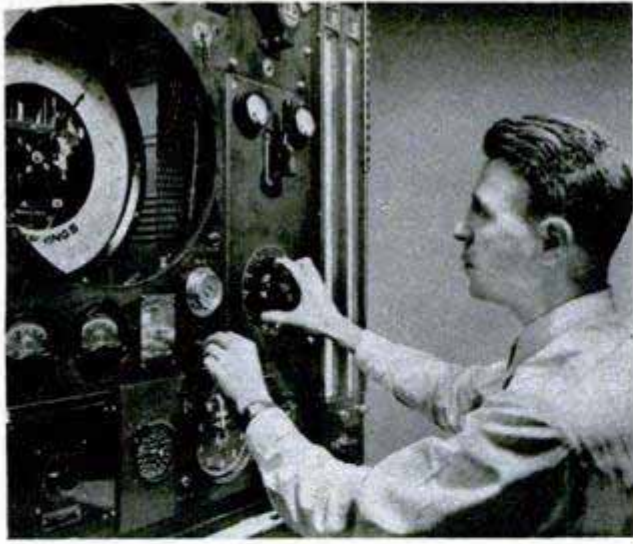

By moving dials and throttle, an engineer can "load" a dynamo to simulate any motorcycle speed

## MOTORCYCLE TEST ROOM

Motorcycle engines must pass rigid examinations before they can graduate from testing laboratory. Harley-Davidson engineers connect a score of instruments to the engines while they roar at full power. Right, an engineer inserts a thermocouple into the air cleaner to check the temperature. Cylinder head, crankcase, oil-in and oil-out heat also are checked

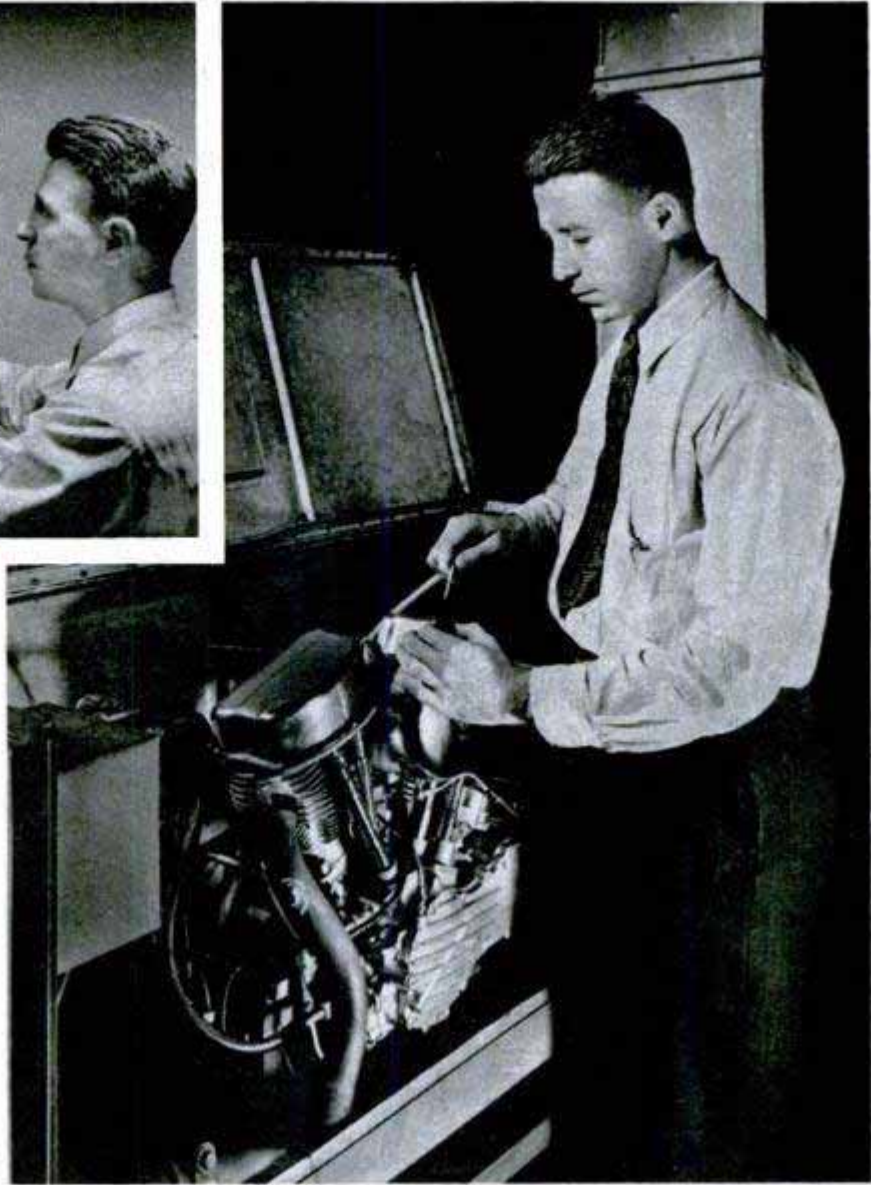

Water and mercury gauges show the pressure and vacuum measurements of the engine while running

Wave shapes on the screen of the oscilloscope are analyzed to determine whether contacts are correct

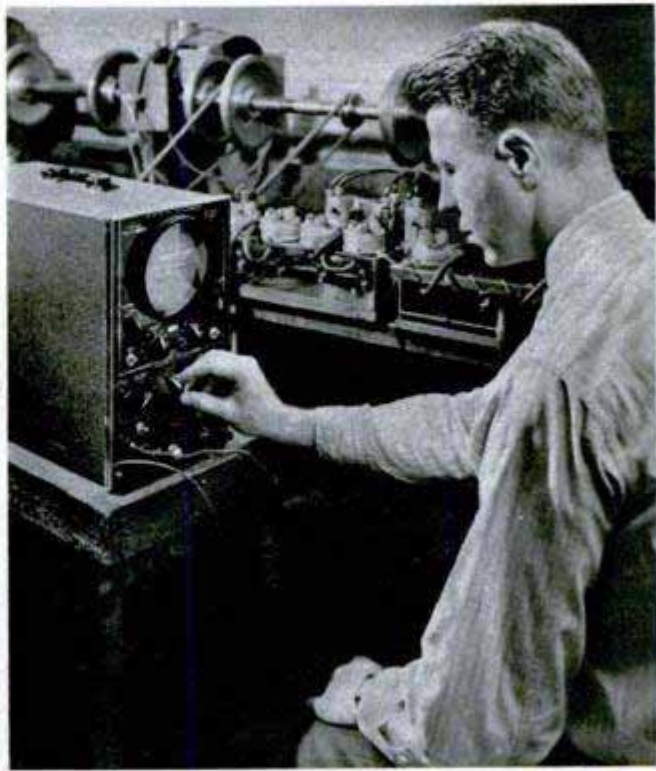

# SOVIET BOMBERS



SZ-82 AIR-COOLED RADIAL MOTOR, 1600 HP. (PORT AND STARBOARD)

IL-12 STANDARD TROOP TRANSPORT

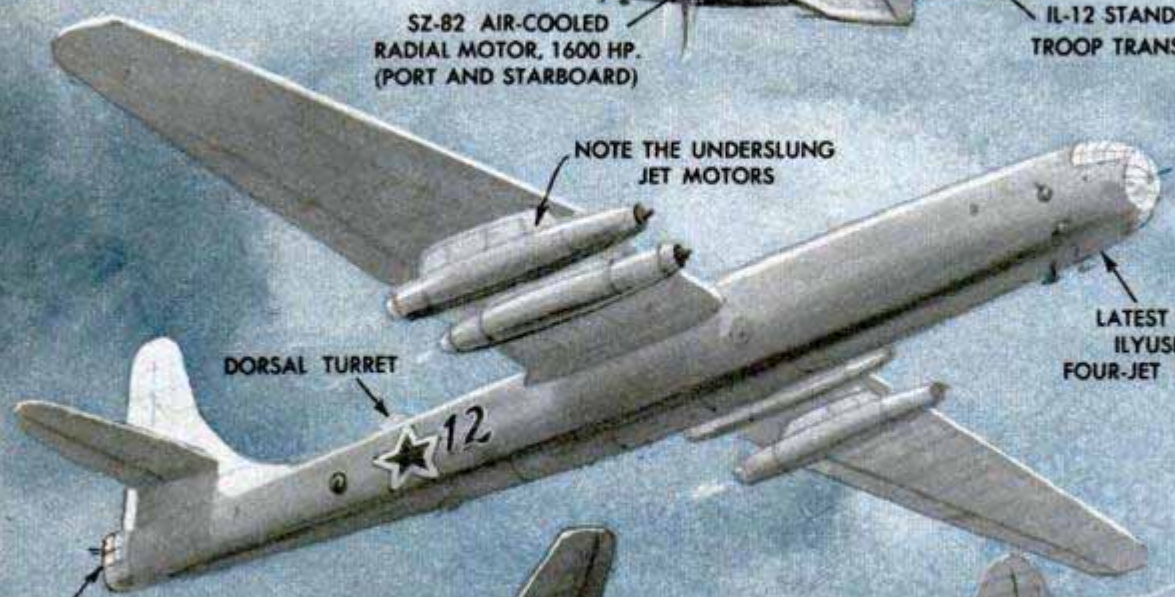

NOTE THE UNDERSLUNG JET MOTORS

DORSAL TURRET

LATEST TYPE ILYUSHIN FOUR-JET BOMBER

REAR TURRET TWO 20-MM. CANNON



TUPOLEV TWIN-JET BOMBER, ALL-METAL CONSTRUCTION. SPEED (APPROX.) 472 M.P.H.

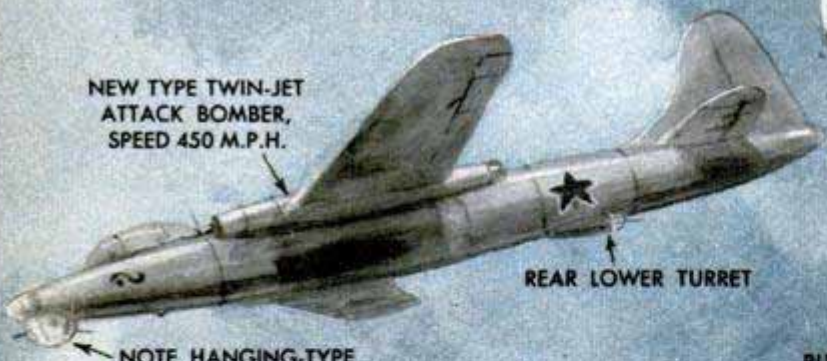

NEW TYPE TWIN-JET ATTACK BOMBER, SPEED 450 M.P.H.

REAR LOWER TURRET

NOTE HANGING-TYPE NOSE TURRET



TU-2 FIGHTER-BOMBER EARLY TYPE STILL IN USE IN CONSIDERABLE NUMBERS

1850-HP. ASH-82 RADIAL ENGINES

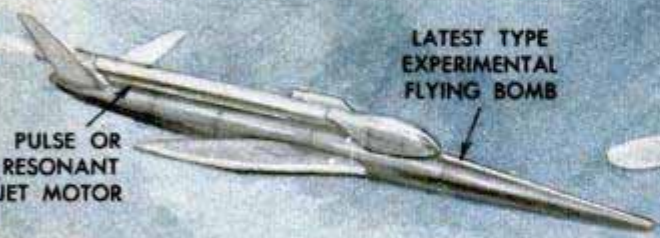

LATEST TYPE EXPERIMENTAL FLYING BOMB

PULSE OR RESONANT JET MOTOR

MIG-UTKA TAIL-FIRST PUSHER MONOPLANE FOR USE AS ARTILLERY OBSERVATION AIRCRAFT



PIECING together scraps of information from many sources, the famed British illustrator, G. H. Davis, presents for *Popular Mechanics* readers his impressions of Russia's front-line fighters and bombers. Most of the details were culled from photos and data in Swedish, Polish, French and British

technical papers and from direct observation at air displays over Moscow. Virtually no information has been released by Russia on new war equipment. Foremost among Soviet designers are Yakolev, Ilyushin, Migoyan, Gurevich, Lavochkin, Tupolev and Sukhoi, aided by German research

# SOVIET FIGHTERS

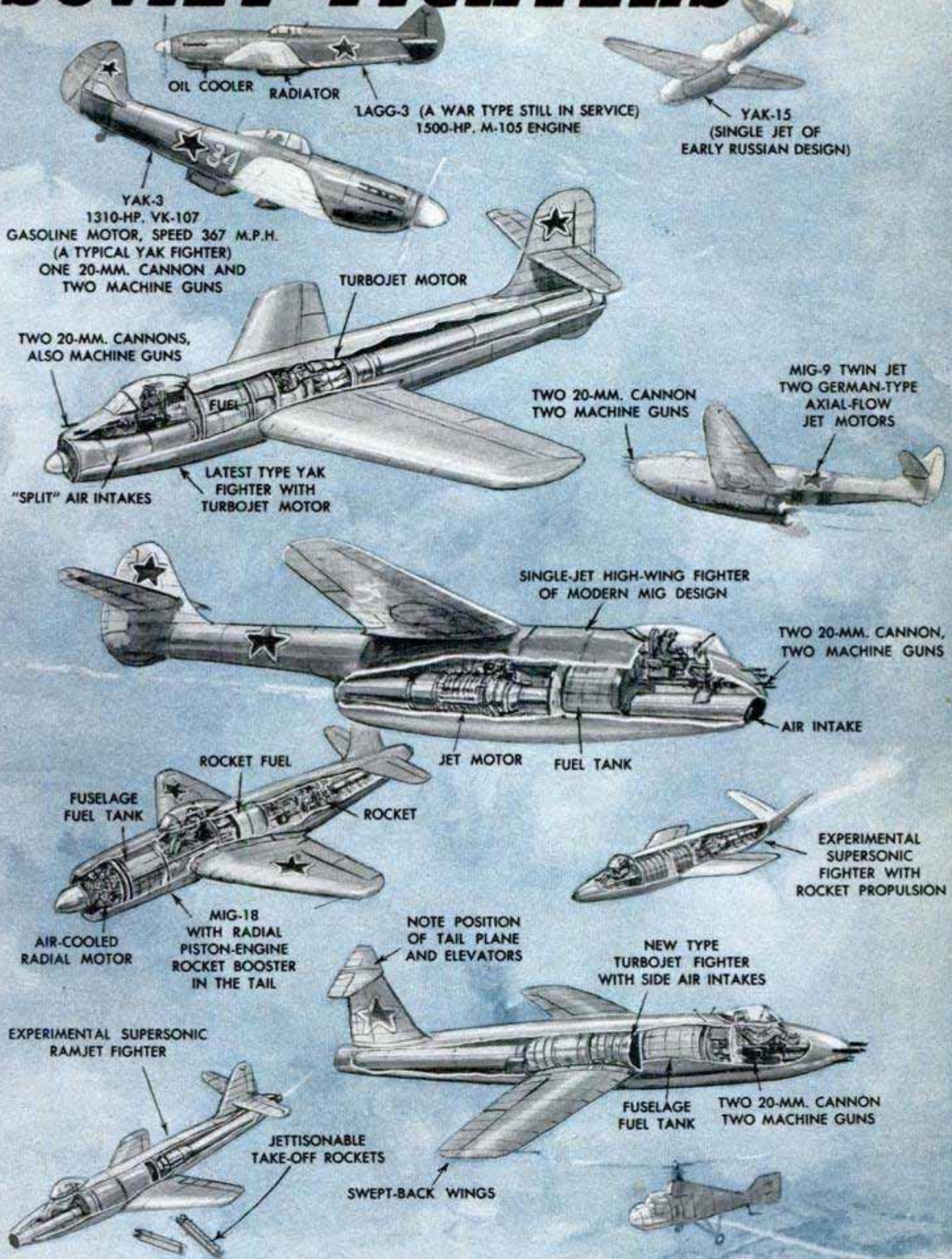

centers and technicians now under Russian control. Other than British Rolls-Royce turbojet engines, most of the power plants have a distinct German touch and Nazi-type rocket motors are used in their latest experimental supersonic craft. Some fuselages strongly resemble American planes,

like the new Yak fighter and Republic's F-84 and, earlier, the TU-70 and the Boeing B-29. The Yak's top speed is believed to be near 650 miles an hour. The main armament of Russian aircraft is apparently centered in the 20-mm. Sk-Yak cannon and the 12.7-mm. Beresin machine gun.

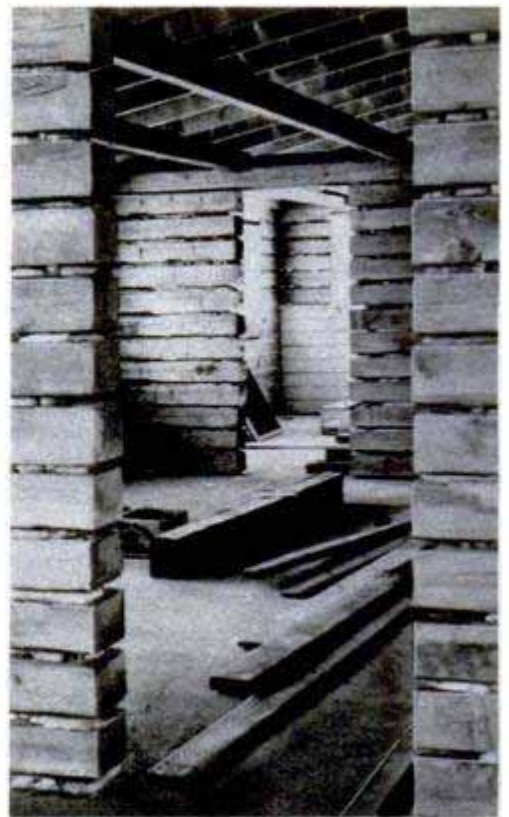

Top, a ranch-style home of railroad ties. Below, another home under construction. Right, the interior walls

## Railroad Ties Form "Log" Cabins

Secondhand railway ties are providing one solution to the building-material shortage on the Mojave Desert. Used for building homes, garages, markets and other structures, the ties are stacked up like logs in a log cabin and produce walls three times as strong as frame-stucco. The ties are power-planed on four sides and held securely in place by wooden dowels, three

feet long, running through them. About 400 ties are needed for an average six-room house. Exterior walls are laid with close fits between ties, but inside walls are laid more openly with mortar filling the spaces between the wood. The ties used in one living room were left uncovered and stained to resemble mahogany. The new vogue in building material was started when an abandoned railway put 750,000 ties on sale at 10 cents each.

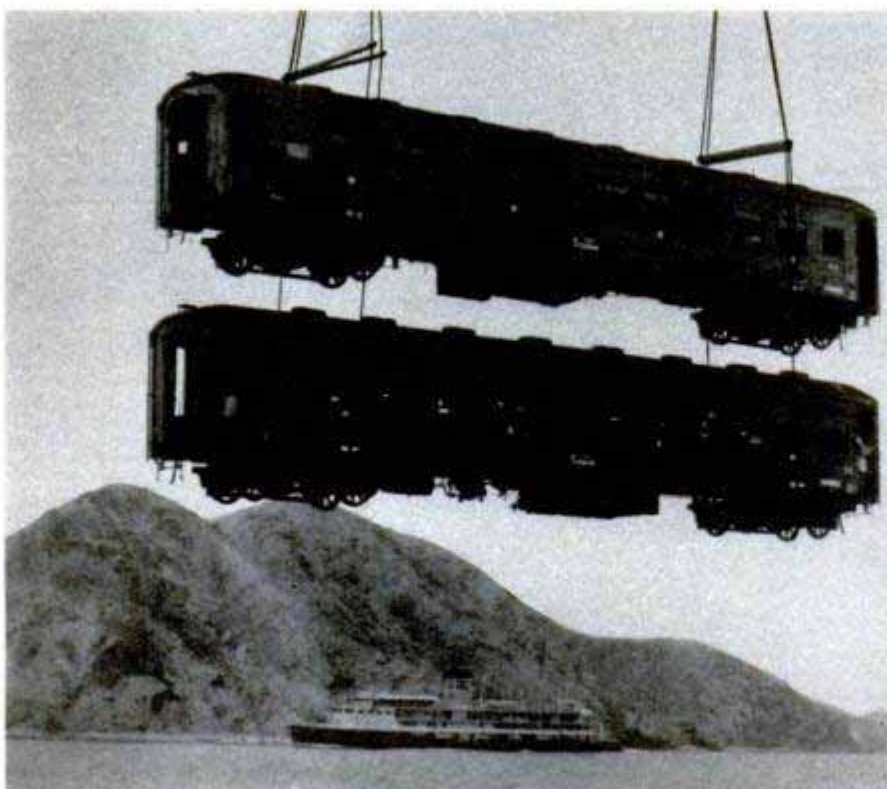
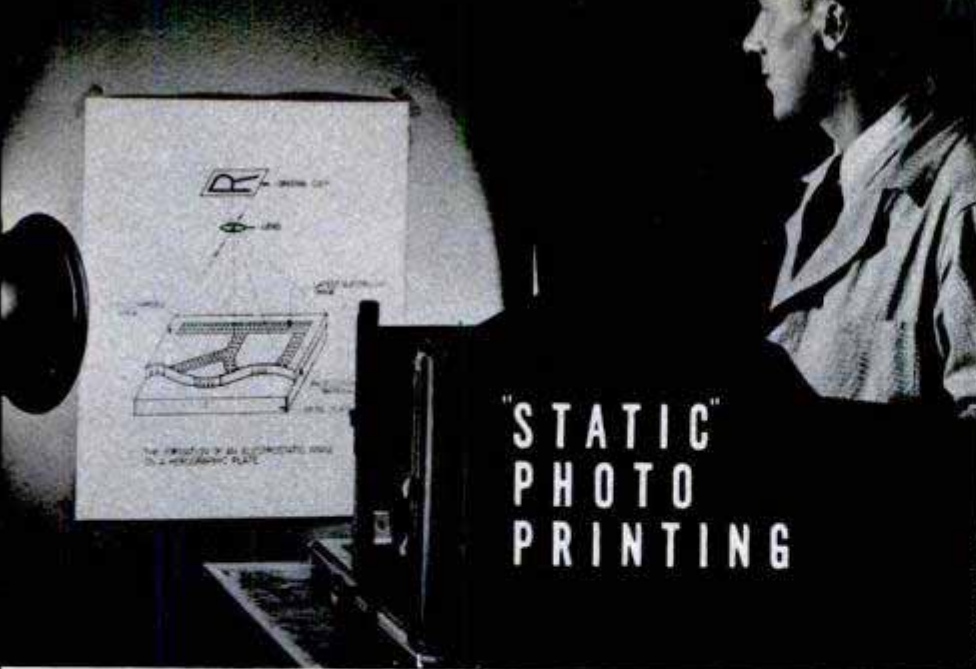

Photo courtesy Osaka Asahi

## Japan's War Crane Ferries Rail Cars

Once a valuable tool in Japan's wartime ship-building program, a large floating crane is now used to haul new railway cars over a short stretch of water. Overwater delivery saves expense by reducing the travel distance from the factory to the point of delivery. Suspended one above the other, the cars are lowered directly on the tracks at the end of the trip.

California leads in private-car ownership with 2,992,060; New York comes second with 2,481,478, and Pennsylvania is third with 1,985,275.



Printing without ink and photography without chemicals may seem impossible, but new technique, called xerography, performs these impossibilities and, what is more, can do them in a hurry. Prints are completed only 45 seconds after the shutter is clicked. Instead of silver crystals, as in photography, or ink, as in printing, the new process uses negatively charged powder which clings electrostatically to the positively charged paper. Diagram below explains how

Plate being exposed in camera, above, is first sensitized, right, by passage under fine wires that are visible through the reading glass

HERE'S HOW THE PROCESS WORKS



Left, surface of the coated plate is given an electrical charge as it passes beneath the wires. Right, the plate coating is now charged with positive electricity and it is all set for exposure

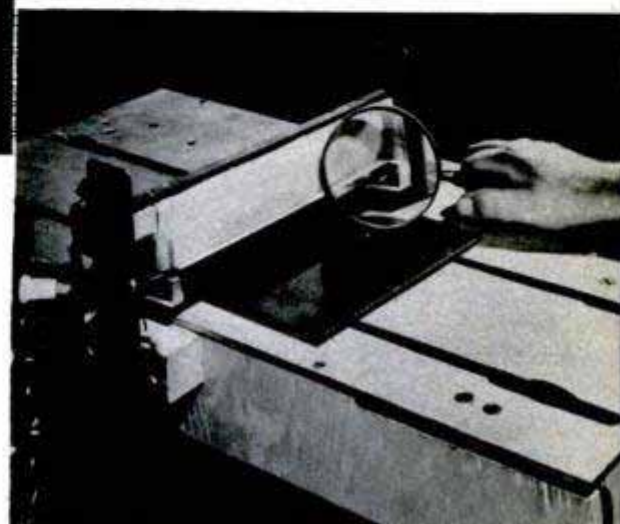
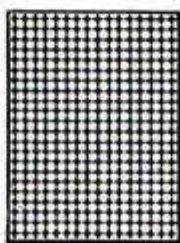

Below, stripping printed sheet from plate after electrostatic transfer

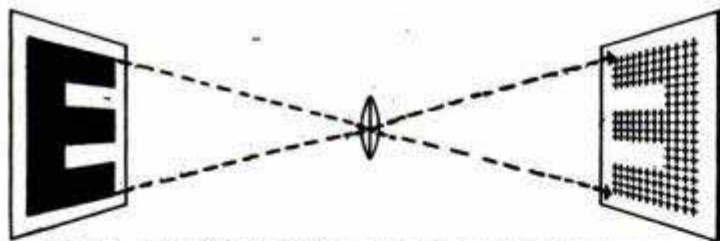

Above, copy (E) is projected on the plate by camera lens. Positive charges disappear in areas exposed to light. Area of image retains its positive charge



Dry printing press, below, uses no ink. Instead, a powder forms image

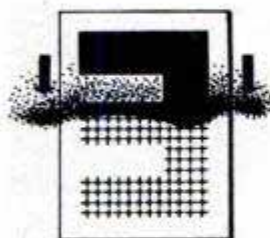

Left, powder of negative charge sprinkled on plate adheres only to positive image. At right, paper is placed over plate and is given a positive charge

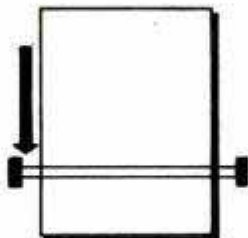

Left, positive charge on paper attracts the powder from plate, reproducing original image. Right, powder fuses when heated to form permanent print

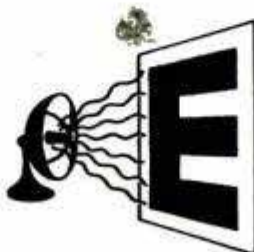

***Your feet  
go fishing  
too***



Best for nonskid grip on almost any surface except smooth bedrock, these husky, steel-calked loggers' boots have soft uppers that lace above the ankles

by Claude M. Kreider

photos by Ray Chapin

Below, the hip boot buckles comfortably around the legs. Left, this lake angler is wearing hip boots, but for real protection he should have long waders

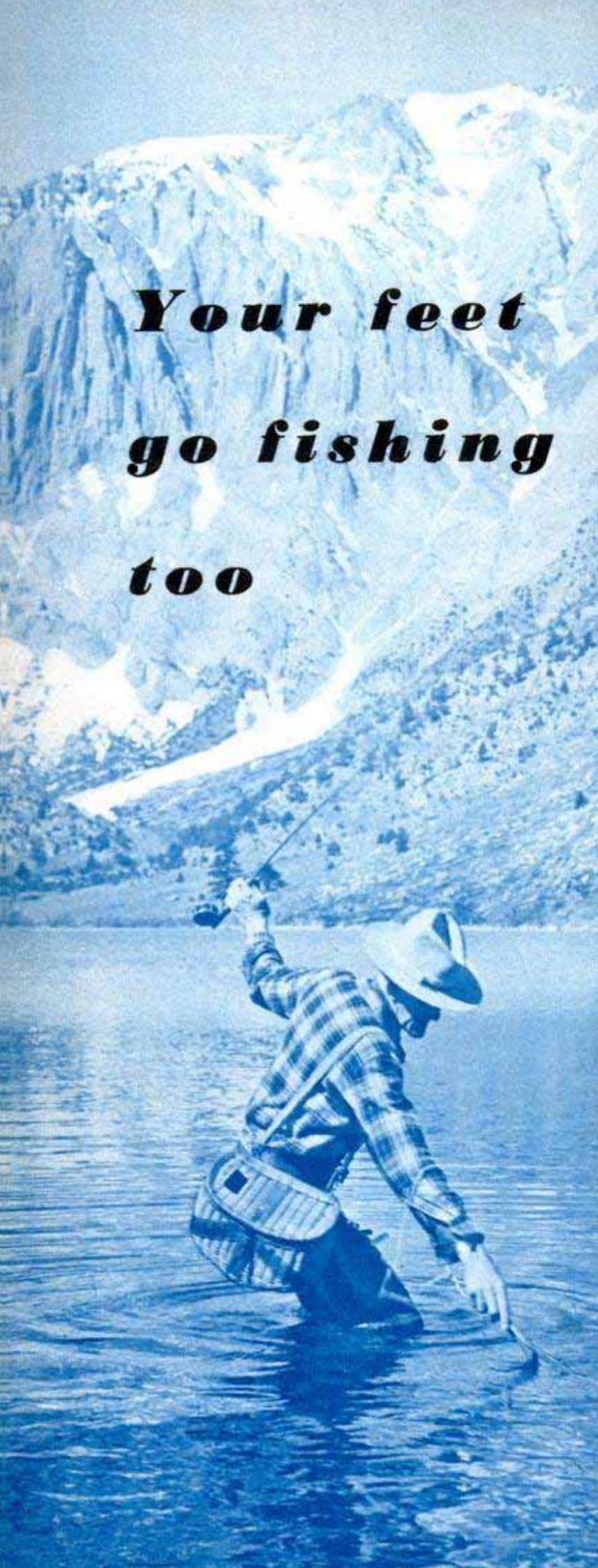

**T**HE OLD-TIME outdoorsman knows that proper care of the feet is imperative. The woods guide is as careful of his foot comfort as a movie star is of her complexion. And you, when planning that fishing vacation, should consider your feet and the proper footgear just as seriously. One bad blister on a toe can mean a wasted day in camp and can lead to a serious infection. A slip on a boulder or a mossy log can cause a serious—even fatal—fall.

First of all, to guard against blisters, wear wool socks. The soft yarn is a kind pad for delicate toes and it absorbs perspiration. Wool is warm, even when wet, so may prevent colds and more serious complications. With light footgear, used for camp and moderate walking, medium-weight wool is about right. For more strenuous trail work, particularly with a back pack, and for wear in hip boots or waders, buy the best grade of hand-knit, heavy-weight wool socks it is possible to find. These should be of knee length to provide warmth when wading and to permit tucking the trousers inside them when wearing low hiking shoes, such as basketball shoes or moccasin pacs.

Remember that in strenuous walking the feet spread, necessitating ample toe space, which is an additional reason, aside from the space needed for the thick socks, for purchasing footgear a size larger than the shoes worn at home. The one cardinal rule for outdoorsmen is to wear roomy shoes.

Always, there is the proper footgear for every use and this requires careful selection, with the view of just what demands you will make upon those feet of yours, each with its delicate bone structure.

#### FOR HIKING

In these days of heavily fished waters, many anglers "hike in," often carrying back packs. For woods travel and dry going, nothing is better than the moccasin boot or pac with an eight-inch top. It is light and very comfortable, with its full moccasin bottom, and high enough to tuck the trousers into the top to exclude dust and forest duff. The leather is usually oil treated, rendering it reasonably water resistant for walking in swampy ground.

If the hike promises to be a wet one, the rubber-bottom moccasin is best. It also is comfortable and weighs only four pounds to the pair. The soft, oil-treated leather uppers will exclude water for a considerable period. Both these and the pacs have corrugated nonskid soles, excellent except on mossy rocks and logs and ideal for rock work as well as forest travel. Both of these moccasins are useful for ordinary shore fishing too and, being soft and flexible, are suitable for canoe work as well.



Even though you're carrying a heavy pack, your feet won't complain when you wear roomy moccasin boots and thick wool socks. Below, chest-high waders have nonskid felt soles for safe travel in rocky streams





Getting close to that good spot may mean a wetting unless you're wearing a pair of armpit waders such as those shown above. With the uppers drawn tightly around the body, you are virtually waterproof. Below, a variety of footwear for fishing and hiking. Shown are: 1. felt-soled canvas shoes; 2. basketball shoes with rubber soles; 3. rubber half-boots; 4. rubber-soled moccasins; 5. high-top waders with attached suspenders; 6. hip boots; 7. moccasin boots or pacs with 8-inch uppers; and 8. leather walking shoes with 6-inch tops



In dry country, where there is a great deal of rock work, there is nothing better than the heavy basketball shoe. It is lightweight, easy on the feet, and with the corrugated rubber sole is absolutely nonskid so long as the ground is dry. This inexpensive shoe is worn by many mountain climbers as well as anglers along our Western trout streams.

Finally, the experienced hiking angler has found that the knee-length lace boot is an abomination. It is heavy, usually comes with a sole too thick and stiff to permit easy foot action, and its tightly laced top severely restricts the working muscles of the calf. This type of boot is good only for rough going in heavy brush and rocks and for rattlesnake protection in bad snake country.

#### FOR STREAMSIDE FISHING

Regardless of his good intentions, the shore angler who refuses to be bothered with rubber boots will sooner or later wet his feet, so he has only to consider foot comfort and a nonslip sole. Thus the basketball shoe is ideal, for it grips on rocks and, when



If you don't intend to wade in deep water, hip boots are satisfactory, but be wary of holes

wet, is quickly dried without harm. The pac and rubber-bottom moccasin are also good and will stand a limited amount of shallow wading before the water comes through.

Rubber half-boots are also good, especially along the lake shore, on gravel and swampy ground. But perhaps the best footgear for the stream angler is the hip boot with corrugated sole. Worn turned down below the knee and strapped to the leg, it is very easy to walk in and, of course, it insures dry feet. But the rubber sole will slip on rocks and logs that are wet or mossy. Under these conditions felt-soled boots are best, unless strap-on chains are carried to be put on the rubber soles. These are positively nonslip but uncomfortable to walk on and should be removed and carried in the knapsack when much walking is to be done.

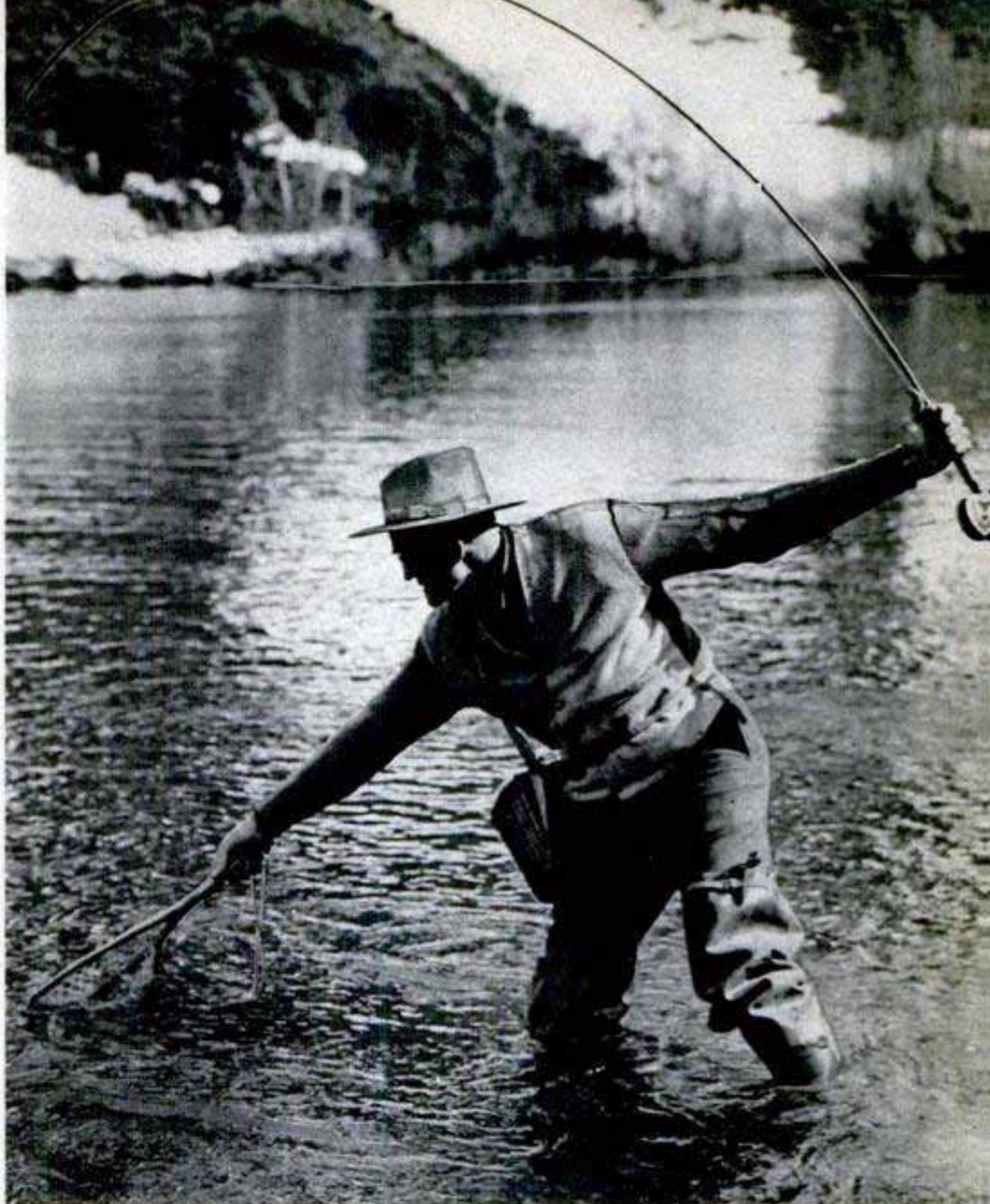

#### FOR WADING

More and more these days, the experienced angler wades and wades deep. In large streams he can cover a great deal more water than from shore and fish it better. In lake fishing he is able to wade out on the sloping gravel bar or rocky shelf and get his fly or bait into the deeper

waters that are denied the shore fisherman.

Again, the hip boot is useful, but will surely ship water over the top sooner or later. Chest-high waders are the real answer for the serious wader. They often come equipped with heavy suspenders and

(Continued to page 234)

Below left, for rock climbing and canoeing, basketball shoes are good. Low-cut moccasins are fine for camp wear and pacs for hiking. Right, these metal chains make your rubber-soled hip boots nonskid on wet rocks

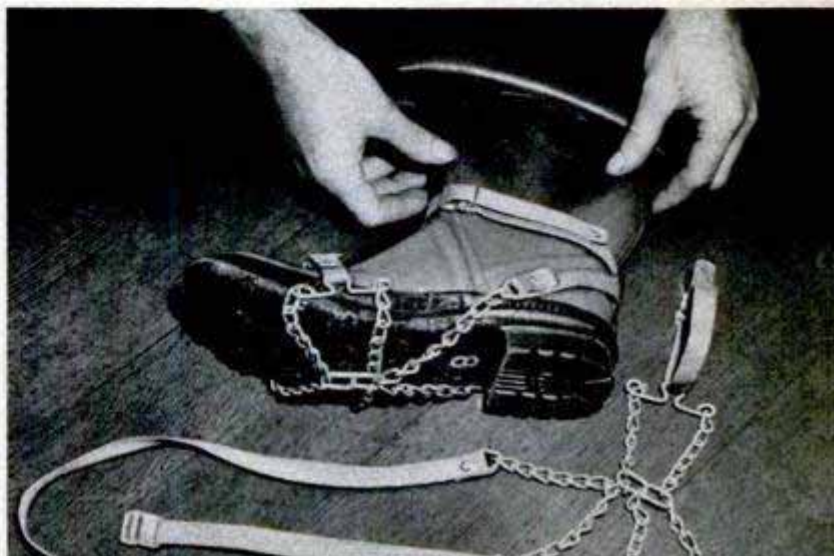

# Outboard cabin boat

for week ends afloat



There's plenty of room in the Cub for day cruising. The cabin will seat eight comfortably. For overnight fishing trips, two can sleep inside and two more in the cockpit

Below, stowage space was not forgotten in the small cruiser. Large lockers under each berth and this one forward in the cabin provide plenty of room. Berths are over six feet long



**YOU DON'T** have to be a millionaire to own your own yacht today. There's an economy-size cruiser being produced that promises to make the dreams of the week-end sailor come true.

Small enough to haul around behind the family car, the Cub cruiser has no expensive power plant. It's powered by an outboard motor and you can cruise all day on the gas one of its big brothers uses pulling away from a dock.

Nor do you have to live near deep water to get plenty of pleasure boating out of the lightweight craft. It has a scull-type hull that floats on less than six inches of water, which means you can launch it in just about any river or lake. With a two-wheel boat trailer, you can hitch the 750-pound craft behind your car and select your own lake for that week end on the water.

The enclosed cabin has two berths, each more than six feet long, and the open cockpit is roomy enough to take two air mattresses for additional sleeping facilities. If the weather turns bad, a canvas cover keeps the cockpit dry. Roomy stowage lockers under the berths and in the forward end of the cabin provide ample space for a small gasoline stove, bedding and other equipment. Its wide Lucite windows all open to let in the lake breezes.

The Cub sells for less than \$1000 complete with running lights, cabin light, cushions and cockpit





To launch the Cub, you back it into the water on its two-wheel trailer. It floats in six inches of water

cover. These are enough for day cruising, but if you plan on spending the week end aboard you'll probably want a folding table, ice chest and portable stove. These are extras, not included in the list price.

You won't need a dinghy, or a dock for that matter, because the Cub draws so little water it can be run right up on the beach. Launching is simple. You merely back the trailer into the water and the cruiser floats free.

About 15 feet long, the cruiser has a beam of 5½ feet. Three keels protect the marine-plywood bottom from damage during beaching. The top is insulated to keep out the heat.

The manufacturer, the Liberty Coach Co., is planning a new model with wheels that retract into the hull like airplane landing gear. This will make the Cub even more convenient for the weekend yachtsman. Also in the planning stage is a slightly larger model fitted with an inboard marine engine.

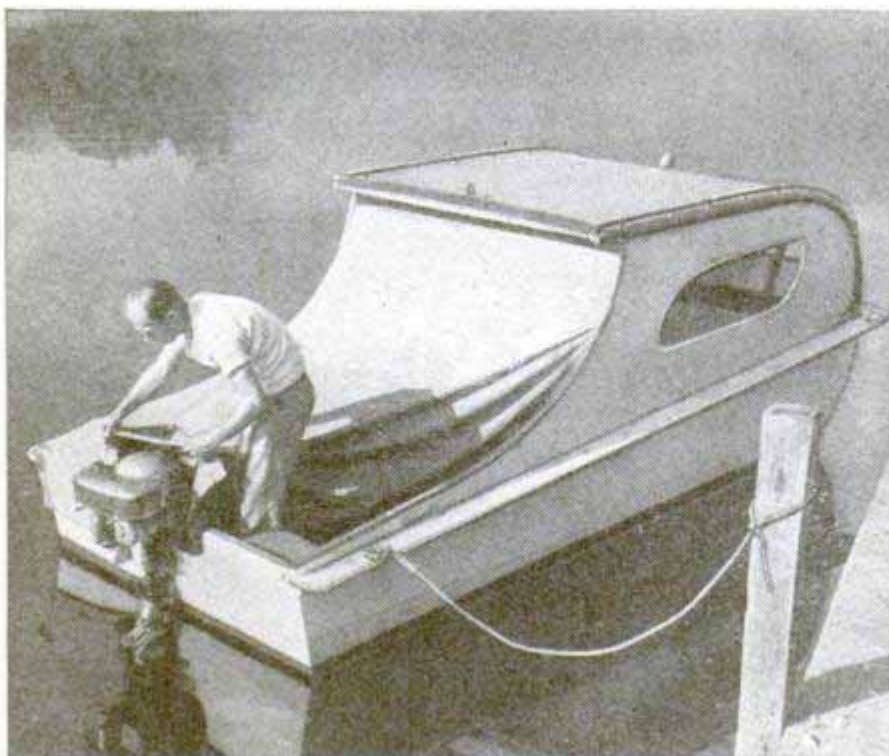

Canvas cover protects the open cockpit and motor when traveling or when tied up at the dock

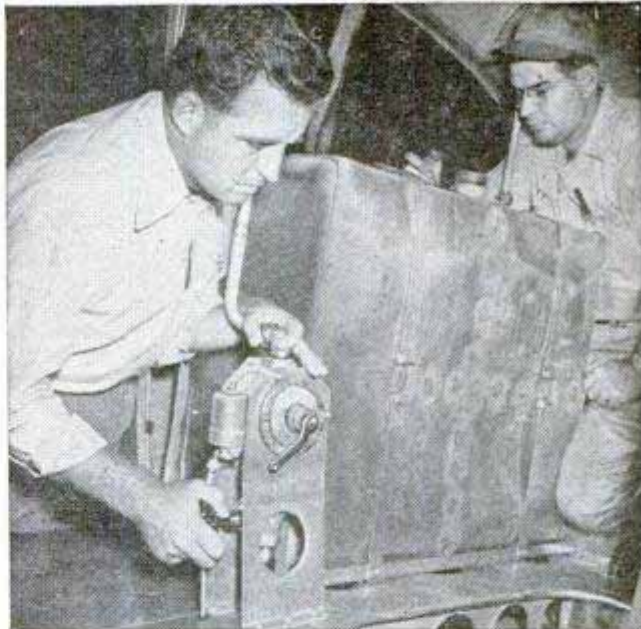
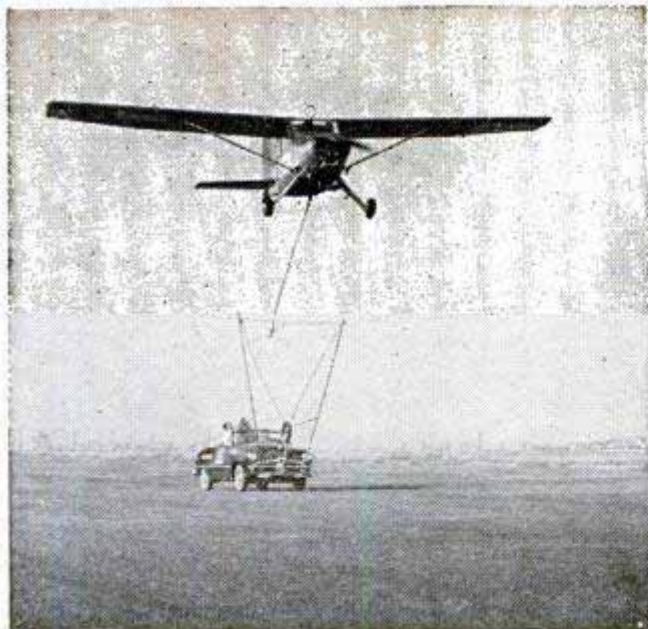

With the refueling auto speeding along at 70 miles an hour, above, hook from plane picks up the gas can. Upper right, pilot inspects pump that forces fuel to wing tanks. Lower right, close-up of can-holding rig

### Gas Lifted From Speeding Car Keeps Endurance Fliers Aloft

Auto-to-air pickups of five-gallon cans of fuel helped a pair of Dallas, Tex., fliers in their bid to break the 721-hour airplane endurance record. A grappling hook lowered through the plane floor lifts the cans from a specially built rig on the front of a convertible speeding along at 70 miles an hour. After being pulled manually into the plane, the gasoline is poured into an auxiliary tank and then forced out to the wing tanks. The 165-horsepower Luscombe used for the test holds 93 gallons of gasoline fully loaded. The pilots were forced down after 530 hours in the air, but plan a second attempt with the same equipment within a few months.



**FIRST RAMJET PLANE** to fly, a standard Lockheed F-80 with ramjet units at wing tips streaks through sky over Muroc Air Force Base, Calif. Tubes of stainless steel, ramjets used for flight were seven feet long and 20 inches in diameter. After the plane reached speed of about 400 m.p.h. through use of its regular turbojet engine, it flew solely on forward thrust provided by air rammed into tubes mixing with liquid fuel and burning

Lockheed Aircraft photo

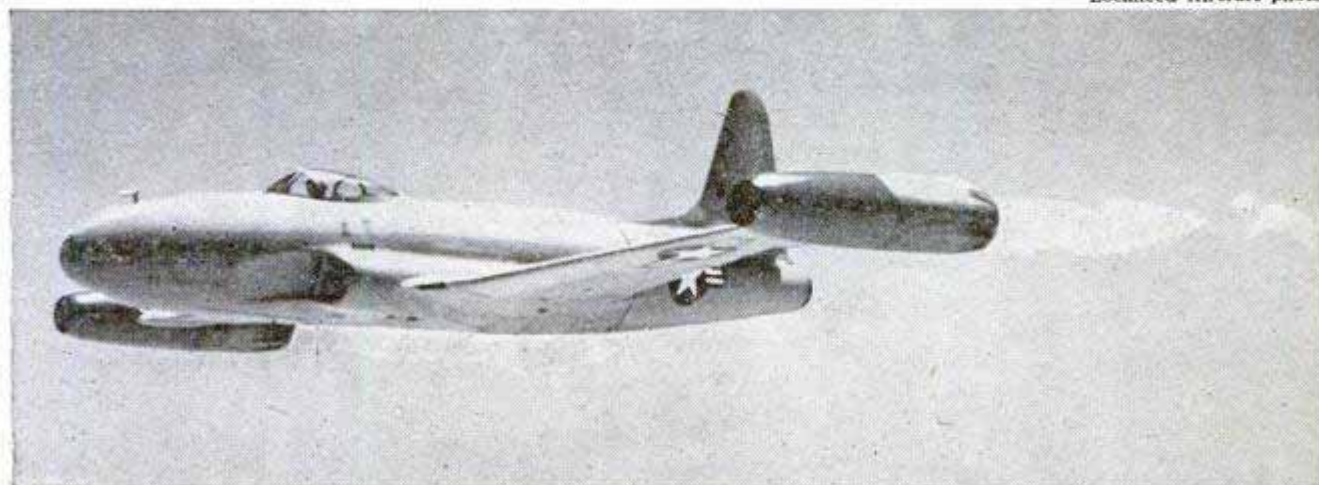



## Office Machine Makes Plates For Offset Printing Plates

Printing plates for offset and multilith presses can be made by an untrained office worker with a machine that requires only three square feet of floor space. The unit uses the new plastic duplicating plates. Because it eliminates the need of costly arc lights, vacuum frames and whirlers, it costs less than conventional plate-making units. The machine reproduces line or half-tone copy and is designed for the small office that uses direct-mail advertising.

## Camera Fits in Watch Pocket →

About as long as a standard-size cigarette and half as high, a tiny camera, produced in Japan, is small enough to fit in your watch pocket. It takes a special 10-exposure roll of panchromatic film; however, double 8-mm. film has been used successfully. The fixed-focus miniature has an all-metal focal-plane shutter with speeds of  $\frac{1}{25}$ ,  $\frac{1}{50}$  and  $\frac{1}{150}$ . Lenses are interchangeable, but the standard is an f:2.8 anastigmat. The tiny camera is popularly referred to as a "spy camera" in Japan.

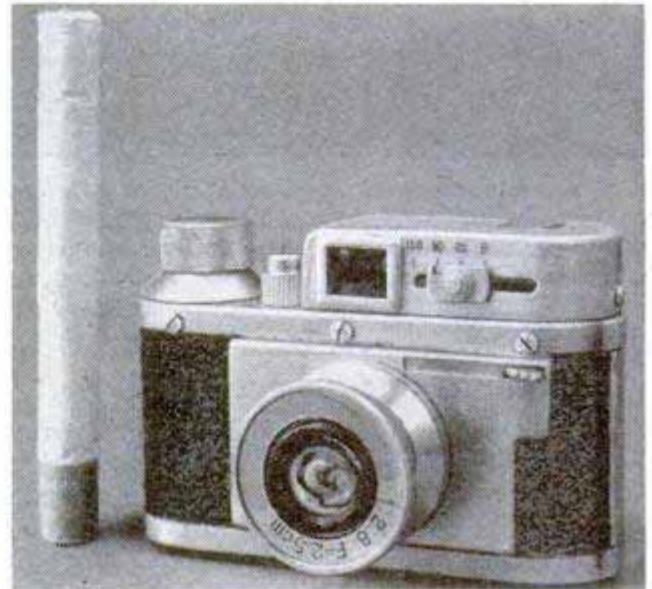

## Acoustical "Opera Glass" Aids Hearing in Theater

Even persons with normal hearing are helped by a hearing aid that is held in the hand. The aid is designed for use in theaters and other assemblies where speech sometimes is difficult to hear. Small enough to fit in the palm of the hand, the aid consists of a microphone, vacuum-tube amplifier, midget phone receiver and an earpiece. To pick up voices, the user inserts the projection into his ear and turns up the volume.

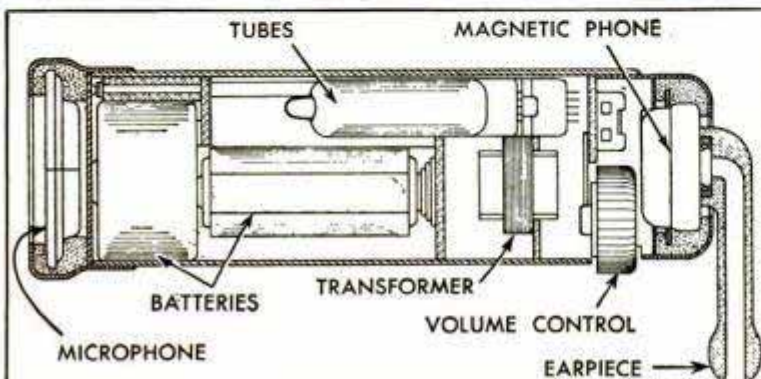

## Lighter Motor Oil

Available to motorists is a lighter oil, designated 5-W, for use in subzero temperatures. In some cases in the past the automotive industry has recommended the use of 10-W oil and an additional 10 percent kerosene in order to provide good lubrication in cold climates. The new oil has additives which resist oxidation, bearing corrosion and scoring.

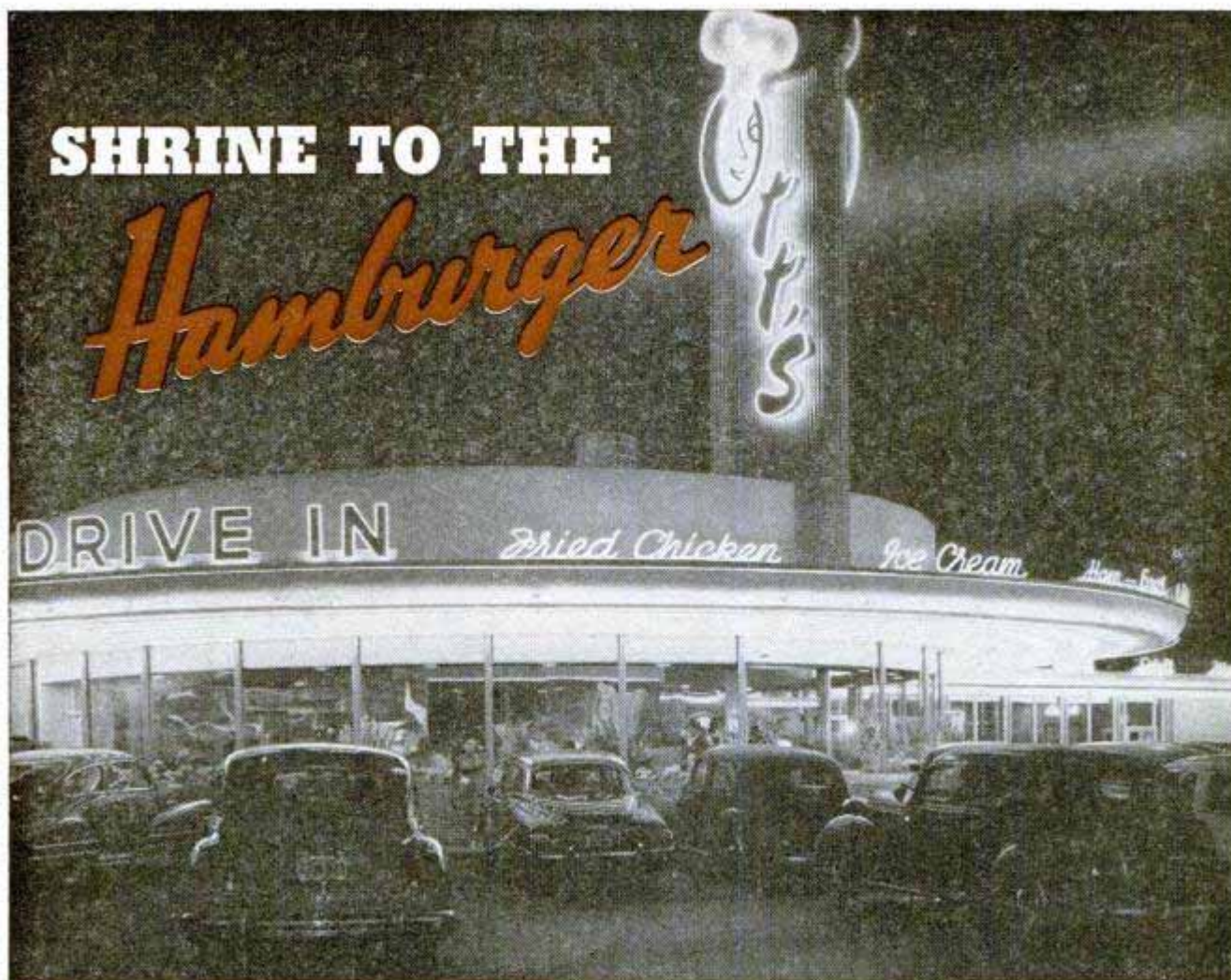

Open night and day, this super-eatery has its own traffic police. It serves about 7000 meals every 24 hours

**M**ORE THAN 7000 meals a day, each piping hot and cooked to order, pour out of the two gleaming kitchens of the world's biggest drive-in restaurant. Located near downtown San Francisco, the colossal eatery covers  $1\frac{1}{8}$  acres of land and employs 176 people including four traffic policemen who flag the customers into the correct spot in the 250-car parking area.

Six minutes after the average meal is ordered at the drive-in it's delivered to the patron, and some specialties are whipped out in 60 seconds. Order fried chicken and the drumstick and assorted parts will journey from the refrigerator to your car window in 14 minutes, cooked to your individual specifications. All written orders that pour into the kitchen are time-stamped, then stamped again when the victuals are delivered—an efficient check on kitchen speed. If a customer complains of slow service the management can tell at a glance who's to blame.

O. E. (Ott) Straub pored over

Orders are time-stamped and clipped on a plastic wheel. Infrared lamps keep food hot

the records of other drive-ins for eight years before he built his own super-eatery at a cost that approached \$750,000. Patrons can dine in their cars, enter the restaurant for booth or counter service, or linger over their meals in an enclosed patio. There's also a cocktail bar. For the staff there are a private dining room and two dressing rooms complete with showers.





More than 60 orders of fried chicken can be cooked simultaneously in the two identical kitchens. Below, the central cooling plant is a maze of refrigeration units. All the glasses are chilled before using

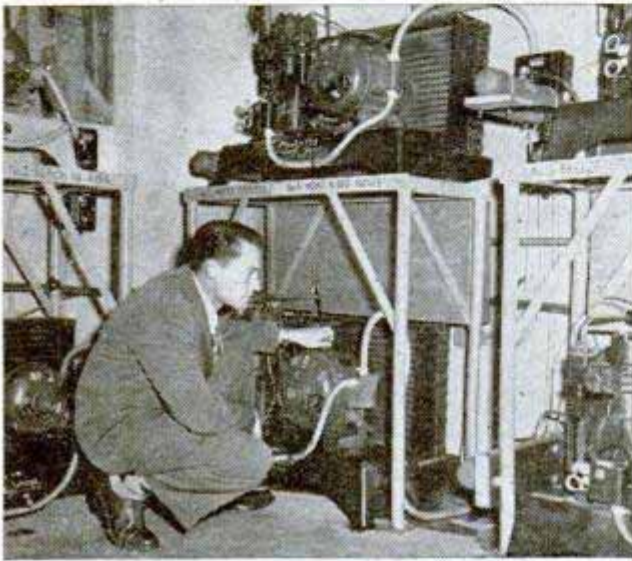

Girl carhops prepare trays inside glass-enclosed pantries, then pick up food orders from cashier's counter

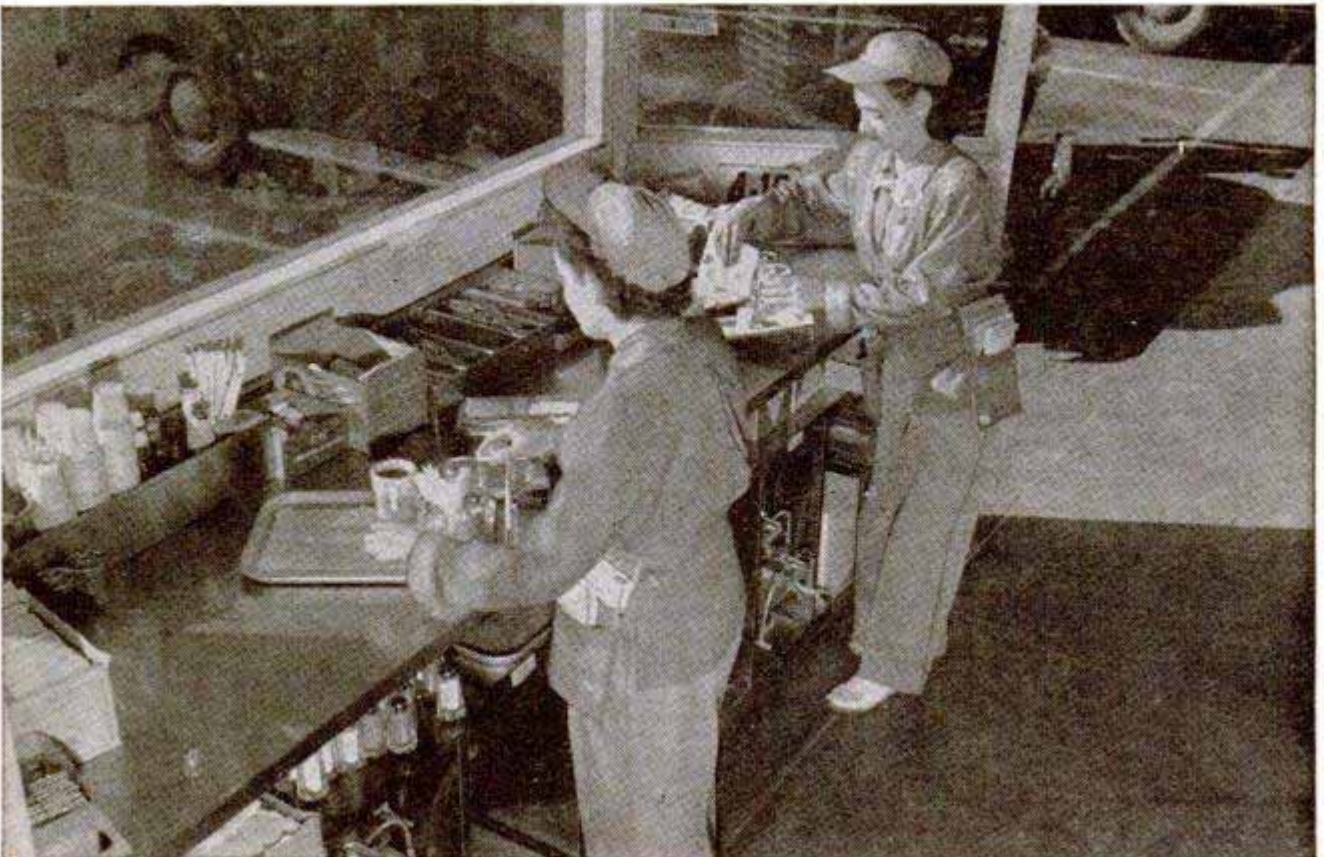

Enjoy music with your dinner? Just hand the carhop a nickel and tell her what number you want on the master juke box. Then tune in the music on your own car radio—it's broadcast from the drive-in's short-range transmitter.

The two kitchens double the capacity of the establishment. Air pumped into the kitchens is filtered, all dishes are kept warm by hot air and glasses are chilled by refrigeration. When the cook slides an order across the delivery counter to be picked up by a waitress, it's kept warm by a battery of overhead infrared lamps.

Inside the kitchens are all sorts of new wrinkles for speeding service to the eat-and-run patrons. One machine molds hamburger patties at a rate of 800 per hour, while another automatically slices buns at a rate of 1000 per hour. Automatic dishwashers and sterilizing equipment help keep the kitchens spic and span.

An intercommunication system with eight stations scattered over the restaurant keeps the owner in touch with all his departments. The coin-operated music system has 21 outlets spaced to avoid excessive blaring or dead spots.

Ott's also caters to the businessman who wants to tote home a dinner to the wife and children. He can call the restaurant from the office and place his order for the evening meal. By the time he arrives at the drive-in, the food will be waiting in a box, piping hot and ready to go.



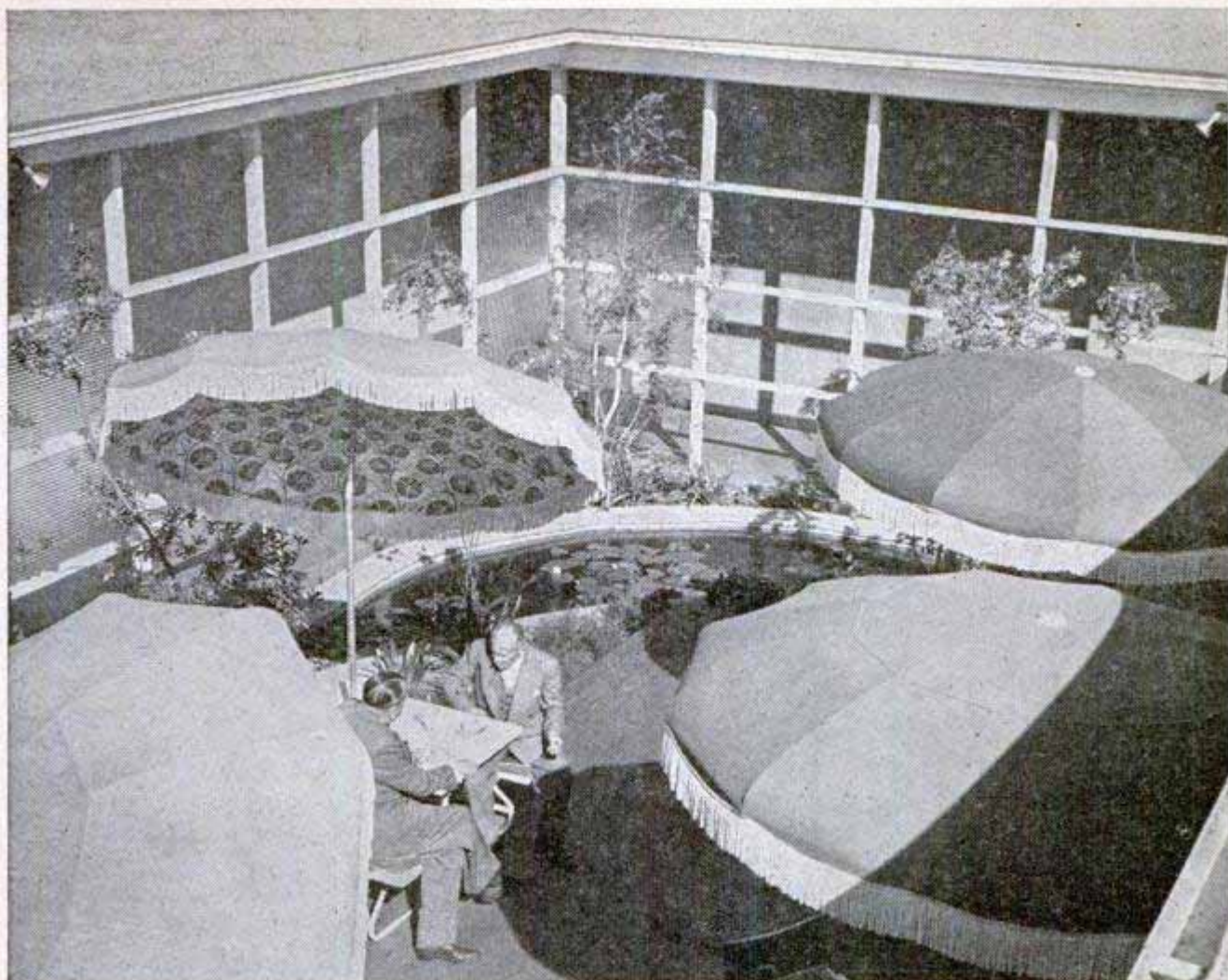

Patio has umbrella-shaded tables and a lily pond. Plastic roller-roof soon will cover patio when it rains

Owner Straub watches as a carhop steps on foot pedal to open the window which gobbles up the dirty dishes. Below right, molding machine stamps out hamburger patties at a rate of more than 800 portions an hour





Official U. S. Navy photos

With six JATO units boosting it, 184,000-pound Constitution, above, uses 24 percent less run on take-off. With aid from jets, a twin-engine Navy Neptune, below, becomes heaviest plane to fly off a carrier

## JETS BOOST NAVY HEAVYWEIGHTS

Using jet assistance, the Navy put into the air the heaviest plane ever to fly off a carrier and shortened the take-off run of its largest landplane 24 percent. Although the weight of the Lockheed P2V Neptune taking off from the USS Coral Sea was not announced, they weigh approximately 33,000 pounds empty. The twin-engine search plane has a 100-foot wingspan and is 78 feet long. A Neptune holds the world's nonstop distance record. Six JATO rockets added enough power to boost a 180-passenger Lockheed Constitution into the air with 24 percent less than its usual take-off run. The six rocket units approximately equaled the 3500 horsepower obtained from one of the plane's four engines. Tests were made with loads that brought the gross weight of the big transport to 184,000 pounds.

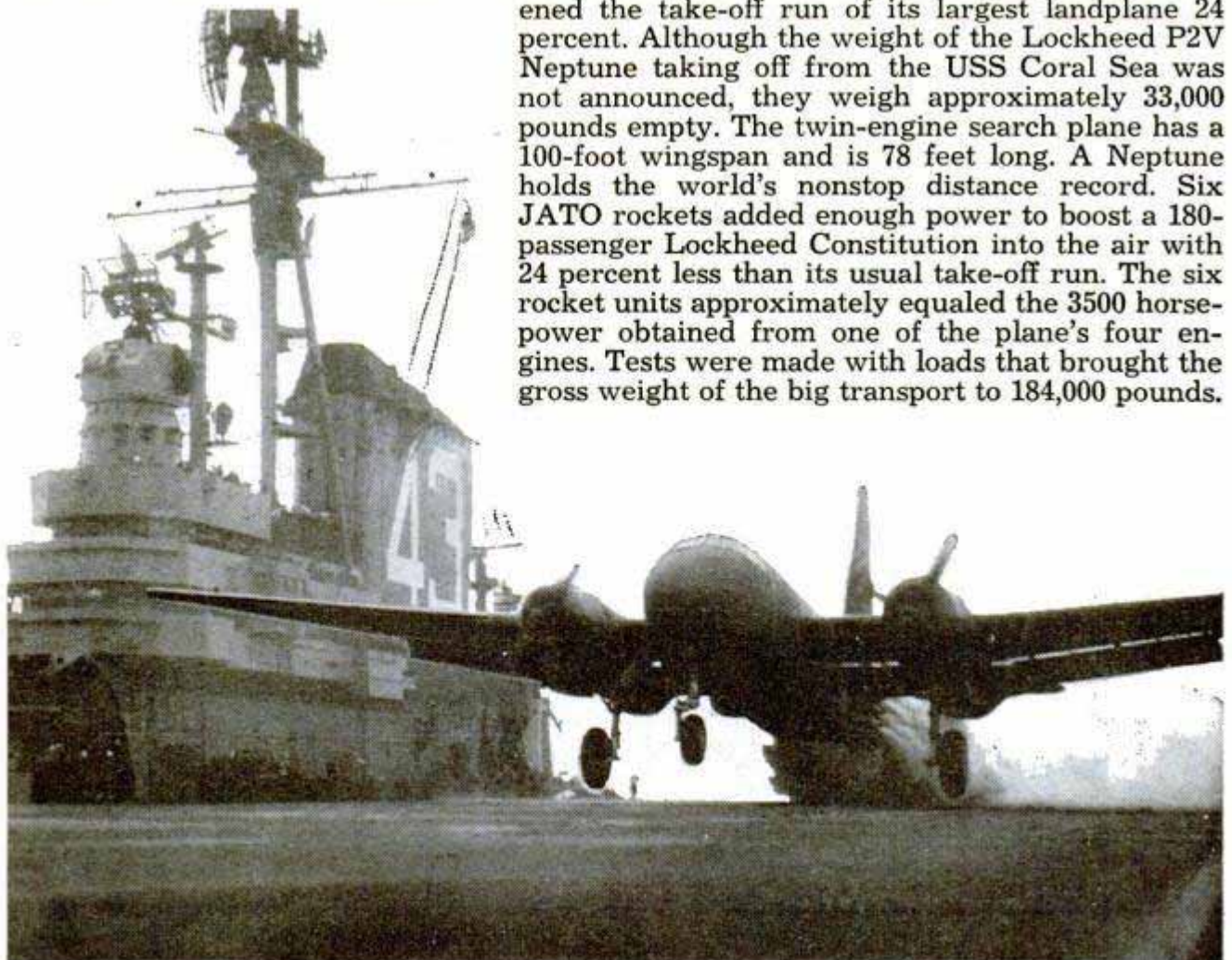

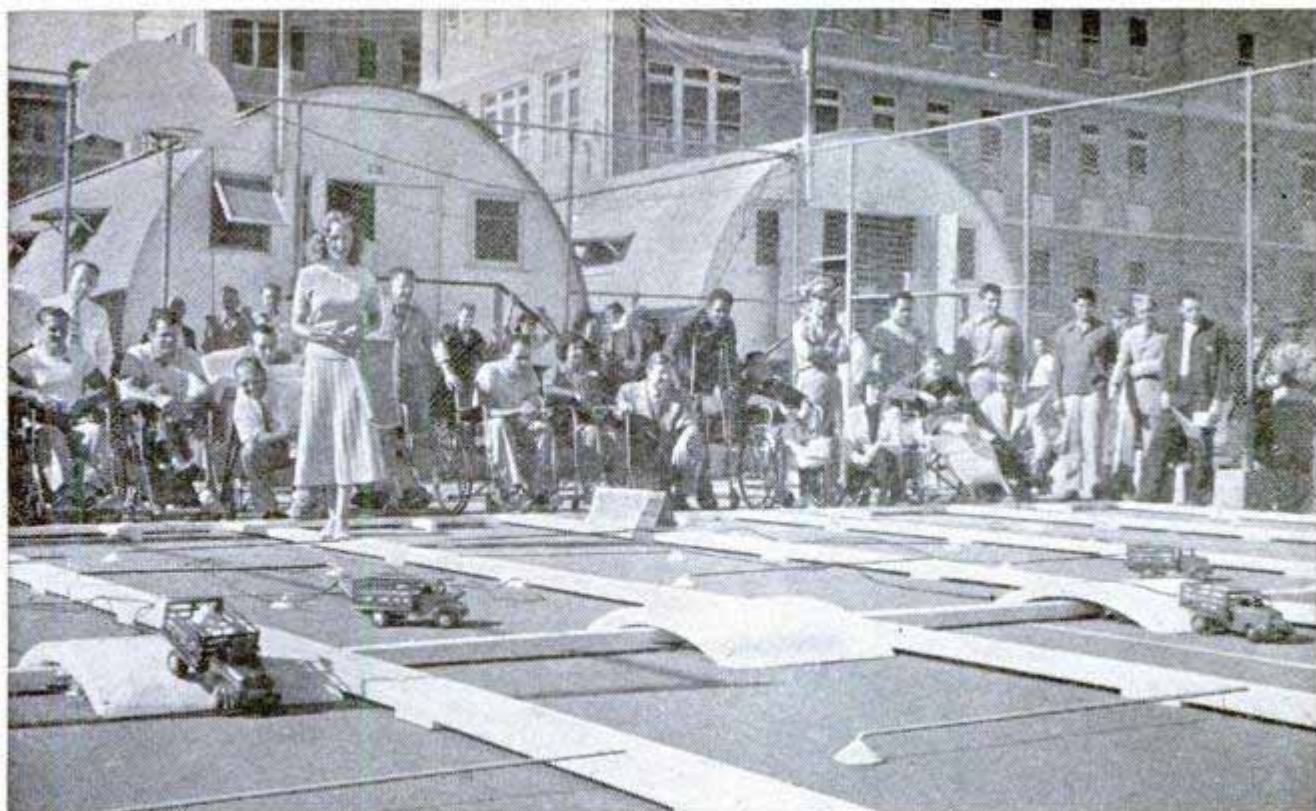

## Electric Toy Trucks Controlled Remotely

Everybody can be a truck driver and in the safety of his living room with a new electric toy truck that goes forward or backward and is steered by remote control. A small transformer, connected to the truck by a 35-foot wire, controls two electric motors that propel and steer the vehicle. A lever on the transformer shifts the truck through five speeds, forward and reverse. A small wheel on the transformer controls the steering motor. The trucks are operated from 110-volt current and were introduced at a Los Angeles veterans hospital.

Above, paraplegic veterans at a Los Angeles hospital race the toy trucks over a specially designed obstacle course. Below, testing one of the trucks. The control unit is in foreground

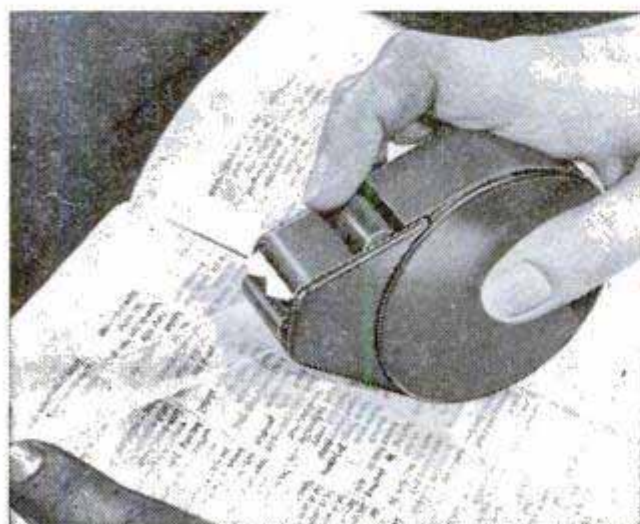
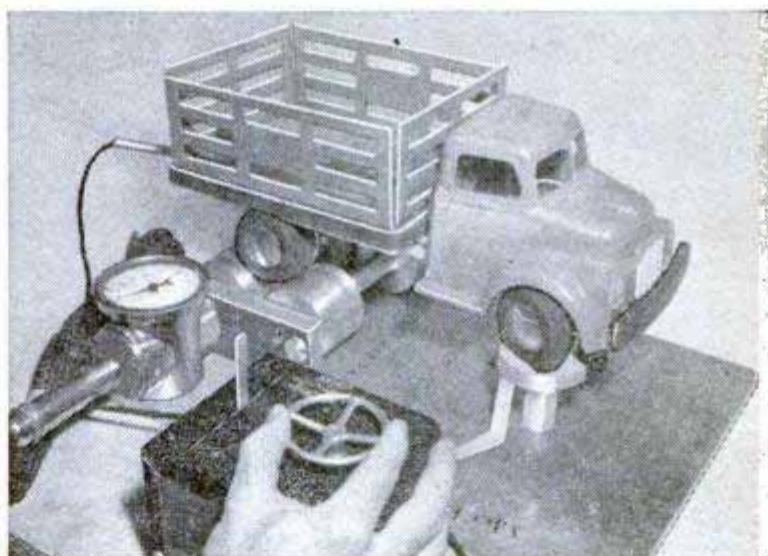

## Dispenser Clips Cellulose Tape At Any Desired Length

Cellulose tape can be rolled smoothly onto a surface with a dispenser that also cuts the strip at any desired length. The dispenser applies a strip of tape along a straight line or around corners. Pushing a lever on the side of the case against the working surface ejects a knife blade which clips the tape and leaves a short length in position for the next application.

☐ To be built near Des Moines, Iowa, an FM radio tower 1530 feet high will be the world's tallest man-made structure, topping the Empire State Building by 280 feet.

# SHOPPING



**Upholstery protectors** for the lower half of your car doors will keep scuff marks from destroying that new-car look. Made of transparent plastic, the kick-resistant sheets are quickly installed. Mud, grease and other soil are easily wiped away with a soft cloth.

**Emergency lighting system** for your car (not illustrated) assures you of safe driving lights should your headlights go out while you are speeding along the highway. A relay turns on auxiliary lights, such as fog lamps, the instant the headlight circuit is broken. It is simple to install in any car and no extra dash switch is required.

**Safety Bar** that doubles as an armrest protects passengers in the right front seat during crashes and sudden stops by keeping them from being thrown against the windshield or dashboard. When not in use, the bar swings back against the door where it makes a convenient armrest. In an emergency, the passenger pulls the bar in front of him and braces himself against the impact. It also keeps children from falling.

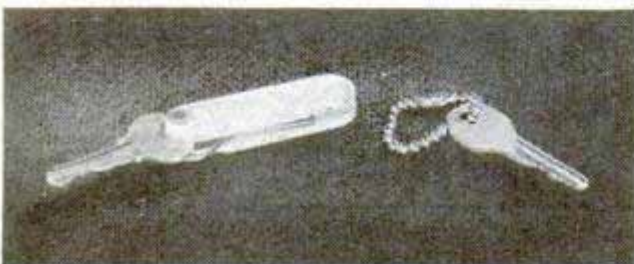
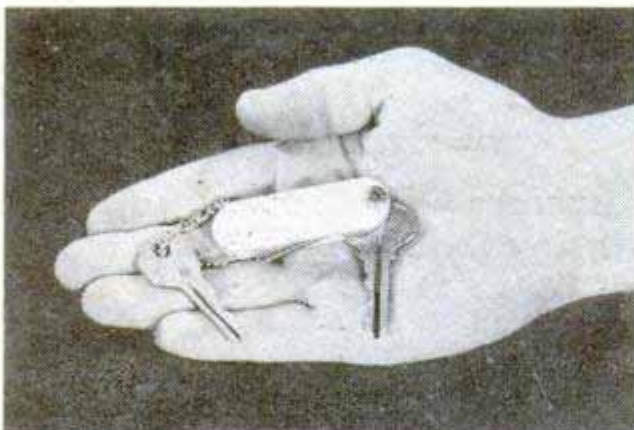
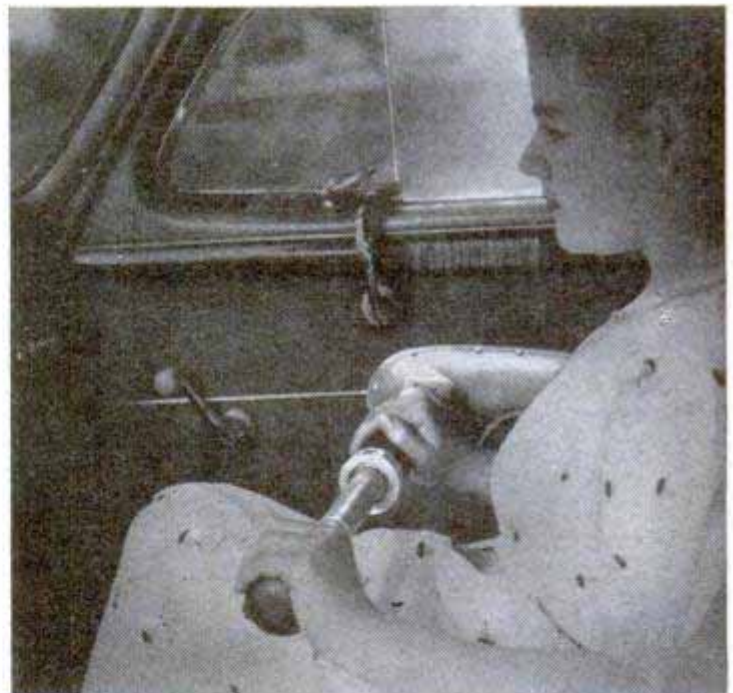

**Two-way key container** lets you slip one key out while leaving the others still on the key chain. With it, you can leave your ignition key in the car for the parking-lot attendant and take the other keys with you. The ignition key is fastened in one end of the plastic case while the additional keys go on the key chain. Spring action of the slotted plastic case enables you to pull the chain from the case when desired, but is strong enough to hold it for normal use.

# LIST for MOTORISTS

**Universal tester** for car batteries can also be used for checking cables, voltage regulators, generators and starter motors. It is a prod-type instrument and it is not necessary to disconnect the battery cables to make the tests. Made of solid copper, the instrument contains a voltmeter and ammeter. For testing voltage capacities under a load, a resistor is built into the unit. Cables and starter motors are tested without disconnecting by induction. The meters are illuminated for easy reading. An adjustment on the tester permits its use on large truck batteries.

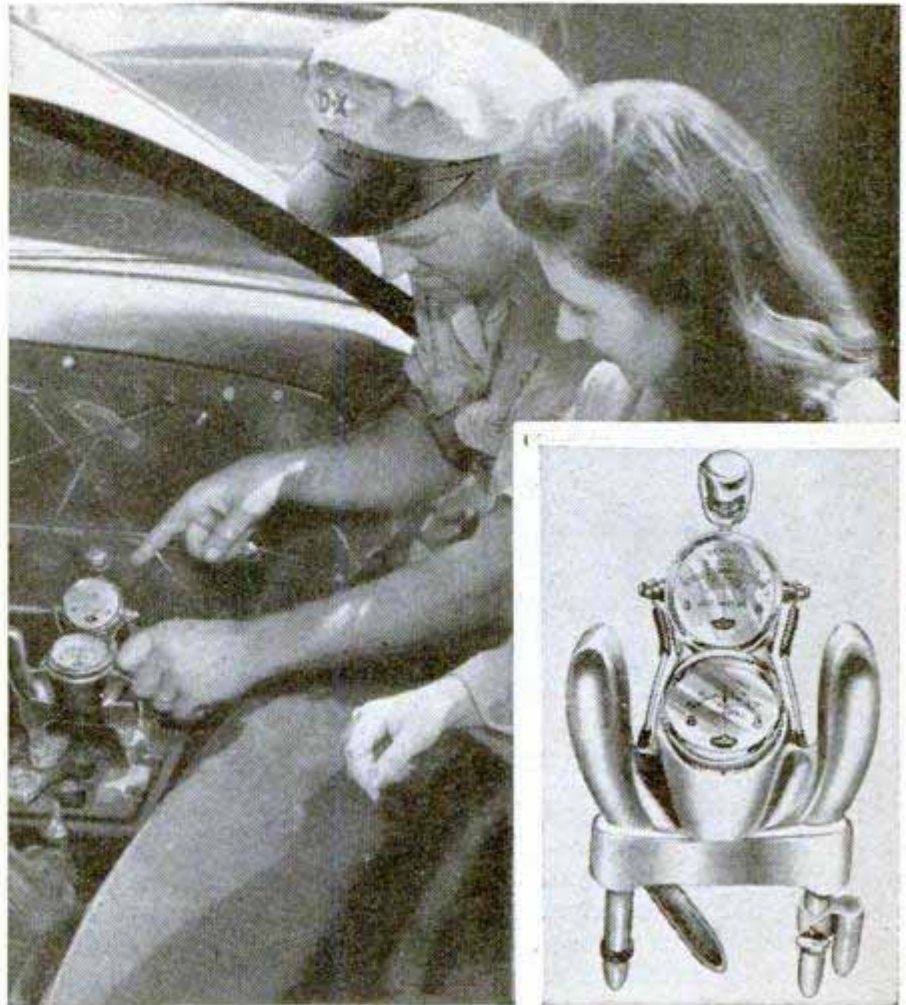

**Water-level indicator** signals you when the water in your radiator is too low for efficient cooling. A neon lamp mounted on the steering column flashes the warning. Current to flash the bulb comes from one of the spark-plug cables. The attachment can be installed on your car in 15 minutes.

**Shaving while traveling** is no problem with an electric shaver that operates on either 6 or 110 volts. The shaver has two cords, one for use in the automobile, the other for use at home on either a.c. or d.c.

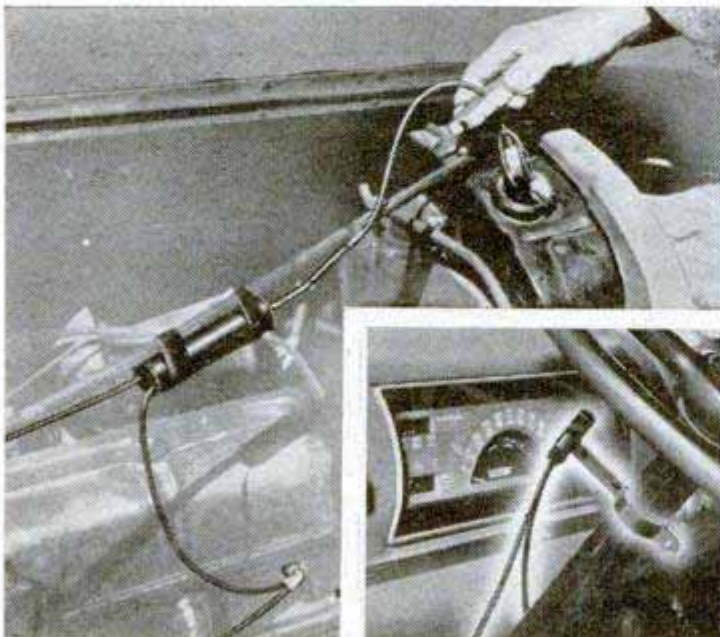



Air Materiel Command photo

## Suits Made of Aluminum Foil Protect Fire Fighters

Fire fighters dressed in suits made of aluminum foil can work in intense heat without being burned. The shiny suits, developed by the Air Materiel Command for fighting fires in crashed planes, reflect the heat to keep the wearer comfortable even when exposed to high temperatures. The aluminum foil is laminated to a cotton backing. The entire suit weighs less than eight pounds and consists of a helmet,

trousers, zippered jacket, gauntlets and spats which are worn over rubber overshoes. The helmet has an eyepiece made of heat-resistant glass which will withstand 2000 degrees of heat. During a test, three men dressed in fire-fighting suits walked toward a gasoline fire. The conventional suits had to be wet down, while the aluminum-foil suit was the most comfortable and suffered the least damage.



## Whittled Cathedrals

With a dime-store knife, discarded crates and wood scraps, and a supply of glue, a whittler has fashioned two model cathedrals. Marshall M. Smith of Kannapolis, N. C., built the models in 17 months. Both models contain storage compartments and one has an electric clock in the tower.

## Asphalt "Coat" for Rockets

Reducing heat flow to the walls of rocket-motor nozzles, an asphalt-composition coating prevents the extreme heat of the discharge gases from melting the metal. The composition is a thermoplastic which coats the conical passage leading to the nozzle throat. Vaporizing in the presence of heated gases, it absorbs the heat and protects the metal.

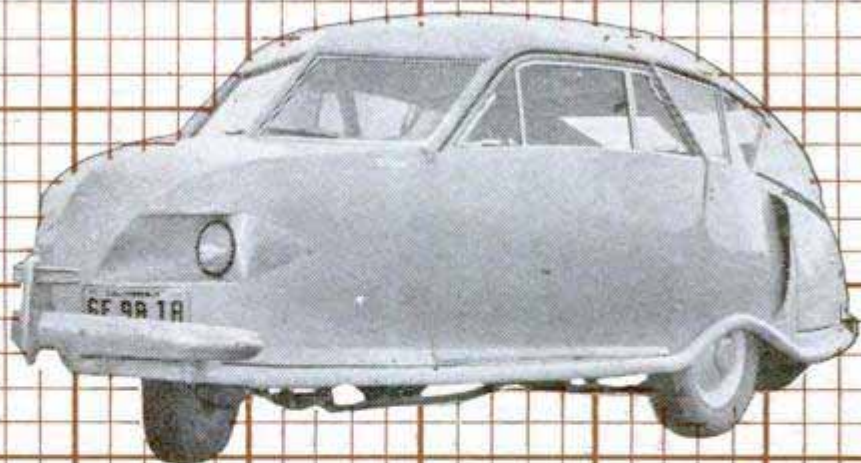

**DIAMOND-PATTERN WHEEL** placement is featured on the Gordon, an experimental car which has been driven 10,000 miles by its inventor, H. Gordon Hansen of San Lorenzo, Calif. The two driving wheels are in the center and single wheels under nose and tail are used for steering as well as balance. Although the Gordon's wheelbase is 156 inches, the car has a turning radius a third less than average cars. In photo at left, rear of car is at top of page. A V-8 engine is mounted in rear

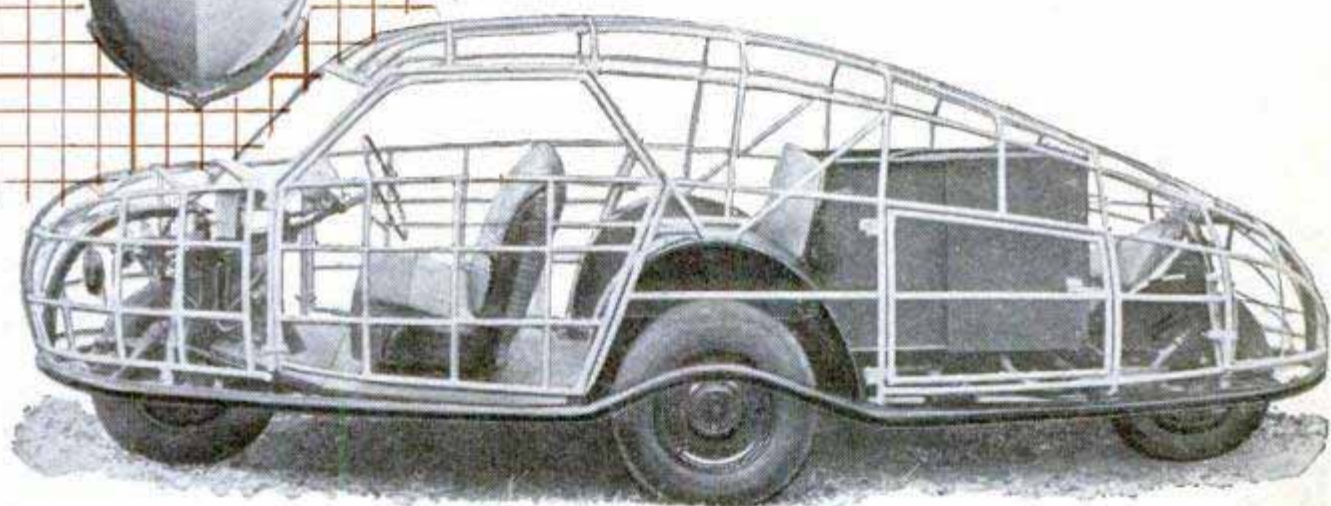

Above, steel-tubing framework protects all wheels of fenderless car. Engine is just aft two center wheels. Below left, instruments are grouped on single panel. Right, the model shows how car pivots on driving wheels



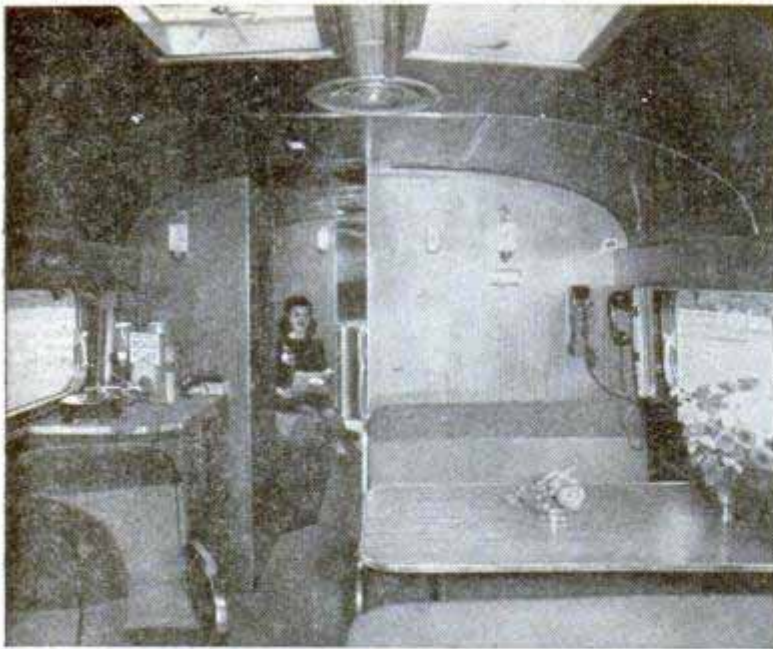

Comfortable lounges of luxury land cruiser gleam with shining mahogany. Note radio-telephone, indirect lighting cove over picture window, and the air-conditioning ports in the ceiling

## ***Cruiser on Wheels***

**Z**OOMING along U. S. highways are a number of custom-built "land cruisers" which from the outside look deceptively like ordinary busses. They are actually luxurious yachts on wheels with Honduras-mahogany-paneled walls, picture windows, "ship to shore" radio-telephones and comfortable accommodations for eight persons including the driver. One of these private land cruisers carries a "dinghy" in the form of a motor scooter. The owner reports that the scooter is one of his handiest accessories and is useful for exploring by-paths over which the heavy bus could not travel.

These rear-engine cruisers are the product of a Loudonville, Ohio, company and are built on a standard 29-passenger bus chassis. They contain kitchen, bathroom, sleeping quarters, daytime lounging and workroom and other home conveniences. The cruisers are air-conditioned and prospective buyers are urged to dream up special features which can be installed.

Aside from private use for

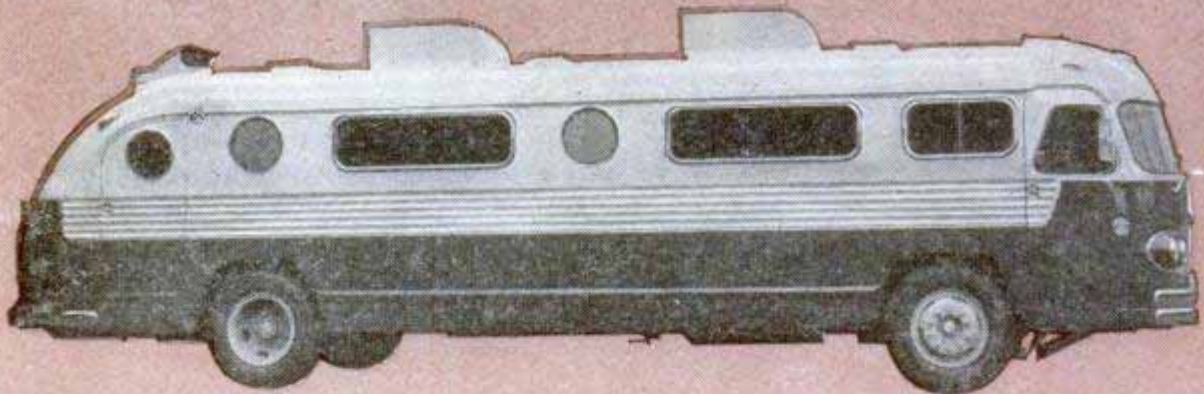

The custom-built Flexible land cruiser looks like an ordinary 29-passenger bus but it accommodates only eight persons. The humps on top are for air-conditioning equipment; air scoop at rear is for engine. Cutaway below shows general plan with kitchen at rear, center lounge with studio couch, bathroom, dinette-lounge and driver's compartment. Driver can speak by "intercom" to any section

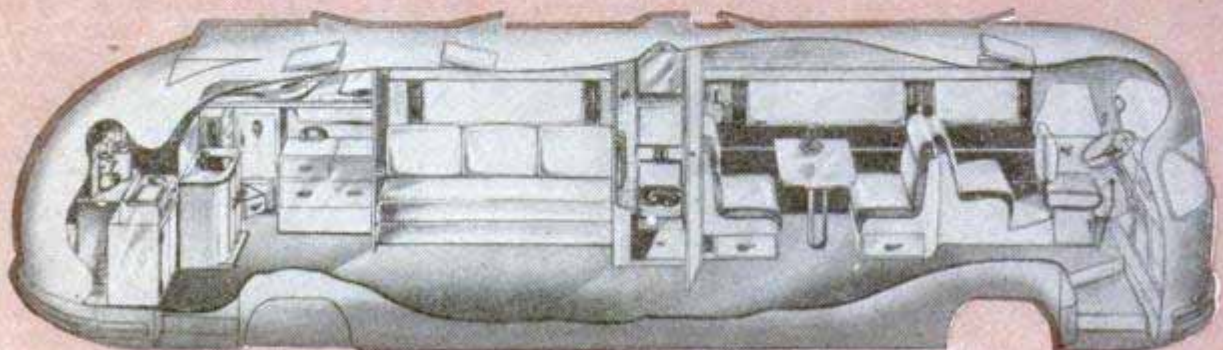





Table in dinette-lounge is removable so seats can be pushed together to form a comfortable double bed

touring, for hunting and fishing trips, the cruisers are used as mobile offices for construction companies, as traveling television broadcasting stations and portable rooms for processing photographs. During the 1948 National Air Races at Cleveland, one cruiser was used as headquarters by the Goodyear Company, sponsors of one race. An executive of the Flxible Company, which builds the land cruisers, recently completed a 30,000-mile six-month trip in one of them.

On first inspection a cruiser built for private touring appears to be a three-room yacht. Aside from the driver's cubicle in the front, there are a dinette-lounge, center lounge and kitchen in the rear.

By pushing a few buttons,

Modern kitchen features stainless-steel sink, electric stove, refrigerator and an ample storage space for food

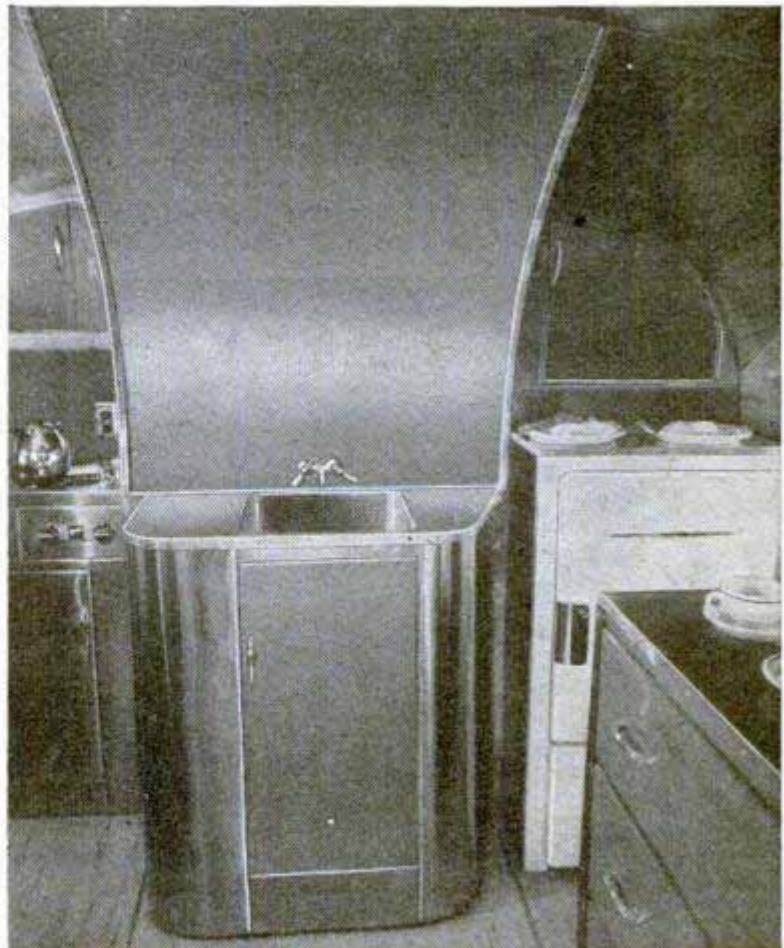

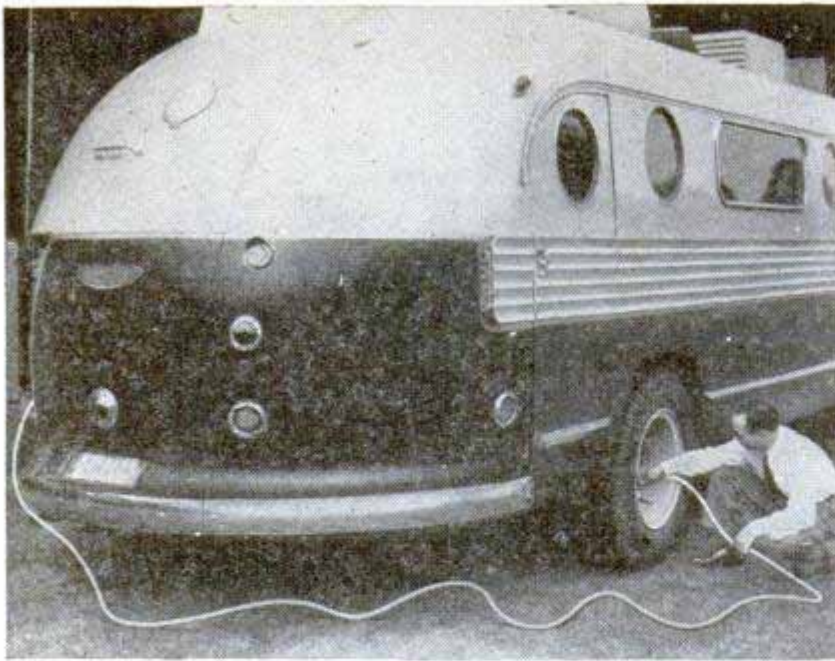

Tires are filled from the air-brake compressor reservoir on this land cruiser. The engine and radio-telephone equipment are in rear

the dinette-lounge (compartment just behind the driver) and the center lounge become bedrooms at night. Accordion-type doors close the center lounge off from the other rooms. The dinette-lounge, which also serves as office or cardroom, has dark-red-leather panels to set off the mahogany walls and chrome moldings. Along one sidewall is a cushioned alcove with a removable table. At night the table is taken out and the cushions pushed together to form a large double bed. Two deep-cushioned chairs in this section also form a single bed and just aft of the driver's seat is another reclining seat.

The dinette-lounge also boasts a snack

The two studio couches in the center lounge form two double-bunk beds. The sections are moved by concealed electric lift units



bar concealed in a chest of drawers containing space for storing refreshments and a built-in Thermos ice-cube container. A telephone hangs in one corner of the room. It can be used for incoming or outgoing calls.

Through a hallway a door opens to a compact bathroom, or shower room, with two-tone walls of tile and a stainless-steel floor with drain. This room has a fold-away railroad type of lavatory operated by a push button. Appointments range from a mirrored medicine cabinet to a slot for discarding old razor blades. A double-door arrangement permits the room to be made an auxiliary to either the front or center lounge.

The center lounge has two studio couches which convert to double-deck bunks at night. All you do is push a button which starts an electric mechanism to elevate the seat and back sections to form four bunks.

The kitchen at the rear is a sparkling stainless-steel and electric wonder. There are an electric range, an electric hot-water heater, a refrigerator and a thermostatically controlled automatic coffeemaker. There are adequate storage facilities for food and linens. All electricity on the cruiser is provided by a 110-volt generator operated by a four-cylinder gasoline engine. In addition, there is a 12-volt emergency lighting system. The gasoline engine which

operates the generator also provides heat for the cruiser. Wall thermostat controls regulate the heat. The cruiser's 80-gallon fresh-water system operates at 40 pounds pressure derived through a pressure-reduction unit from the cruiser's brake supply. Land cruisers normally carry a supply of air at 110 pounds pressure for operating brakes and other equipment. A hose connected to the air tank is useful for inflating tires and blowing out dust. The air hose is stored in a rear compartment that contains the radio-telephone equipment and such assorted items as fishing tackle, outboard motors and—at least in one instance—a cut-down motor scooter.

## Safety Aids for Air Force Ground Crews

Nine men can work at the same time on this portable stand in safety. Its steps always remain horizontal, no matter how high it is elevated. Railings prevent accidental falls



Safety first is more than a catch phrase to flyers and in the U. S. 15th Air Force it is taken just as seriously by ground crews as it is by airmen. Keeping giant planes in perfect flying condition can be a hazardous occupation, but safety engineers of the 15th Air Force designed these mechanical devices to cut down the number of strained muscles and broken toes. Right, two men had to tug and strain to lift airplane wheels into place. Now this wheeled rack, built entirely of scrap parts, does the heavy work for them. Below right, with this hydraulic lift, a mechanic can put huge wing tanks or other parts into position without straining his back. Below left, a retractable third wheel for crew stand supports its front end when it is moved around by mechanics

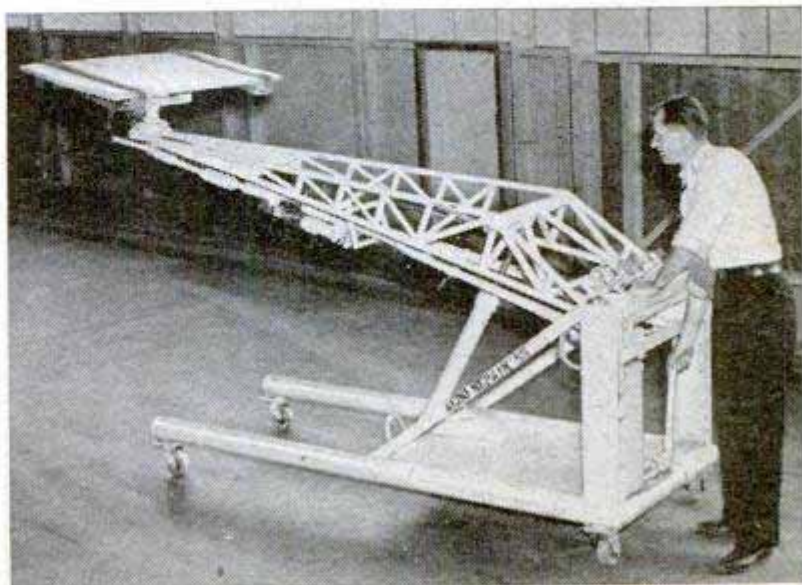
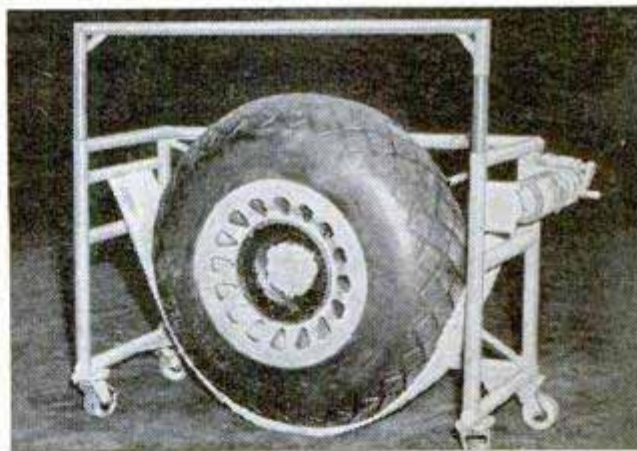

## Pocket-Size Surveying Instrument Also Useful As Two-Way Level

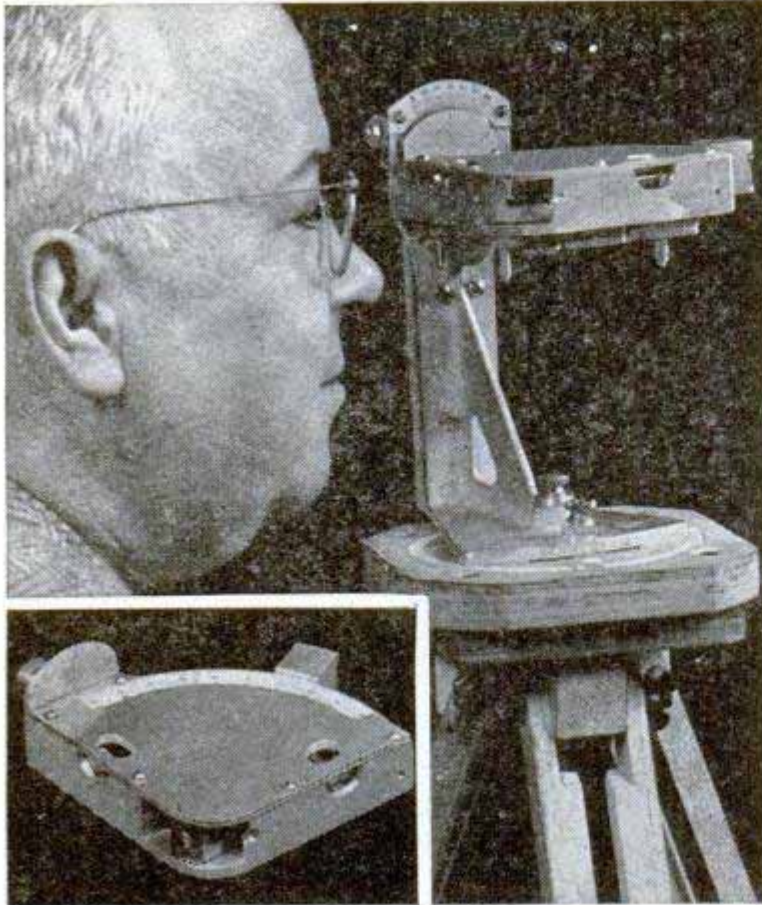

Accurate lines can be run for fences, building lots and foundations with a quadrant transit weighing only five pounds with tripod. It covers a full 360 degrees horizontally in arcs adjustable up to 60 degrees, with a similar vertical range up or down grade. Any angle or compound angle may be included between the adjustable sights. The aluminum head is pocket size and also can be used as a two-way level.

## Dye Detects Wheat Weevils

Weevil infestation in wheat, previously difficult to detect, can now be shown up easily by soaking grain samples in a dye containing acid fuchsin, a coal-tar product. During infestation, the female weevil gnaws a hole in the grain, deposits an egg in it and seals it with a jellylike material. This material is virtually invisible to the eye. When the grain is dyed, however, the sealing material shows up as a cherry-red dot.

## Inverted "Y" Fitting Aids Sewer Cleaning

Clogged sewer-pipe sections are located and cleaned more easily when an inverted "Y" fitting devised by Harry L. Fulton of Pueblo, Colo., is used. It permits two-way cleanout and visual inspection of the flow. The base of the Y-pipe, at ground level, is covered and the lower ends join the horizontal pipe.

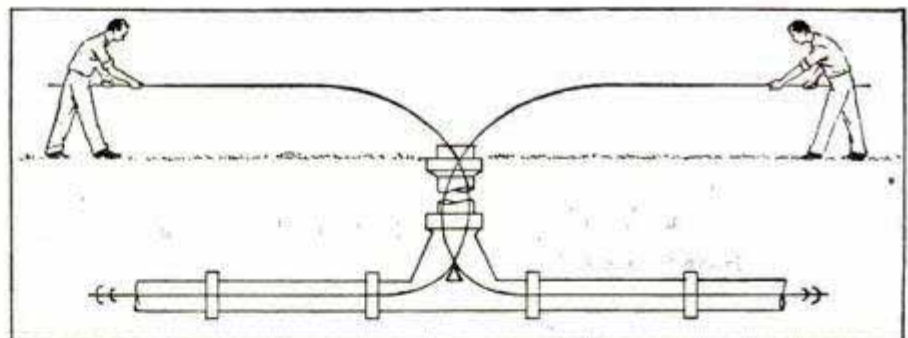

## Anti-Dust Spray For Allergy Relief

If you suffer with an allergic condition that is aggravated by house dust, you can reduce your suffering with a spray emulsion that literally "seals" dust at its source. An odorless white paste is mixed with water and sprayed on carpets, furniture and bedding. It prevents dust from becoming airborne.

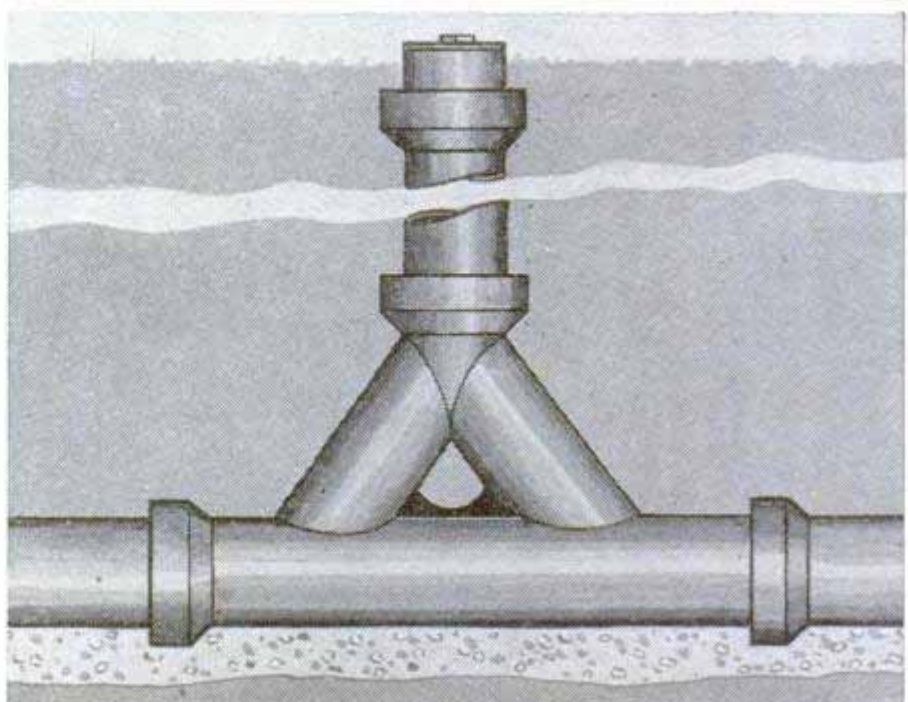

**Virdie Price solves ceramic problem of applying clay lace by dipping cotton lace in clay. Cotton burns away in kiln, leaving lace on figure**



## ceramics is a family affair . . . .

**W**HEN RAY MAXWELL left the Army three years ago he wanted to escape the commotion of city life—to shake loose from his former investment-banking business and live in peace beside his favorite fishing stream in Colorado.

With his wife and two daughters he moved to Aspen in the Rockies and built a home from native materials. Now all he had to do was find a way to earn a living.

One day Maxwell watched as his younger daughter, Joy, decorated some clay figurines preparatory to firing them. Why not learn something about pottery and open a ceramic studio, he wondered. His wife and daughter were both competent artists and could decorate the pieces. He could learn the technical end.

After surveying the field, he decided it was tailor-made to his needs, and his family was enthusiastic. So the family converted one daughter's hobby into a business. Today they are turning out personal ceramic pieces of such fine quality that they are in demand all over the country.

The Maxwells are among the scores of

**Ceramist slices mold marks from "green" piece before firing. Projections become needle-sharp in the kiln**



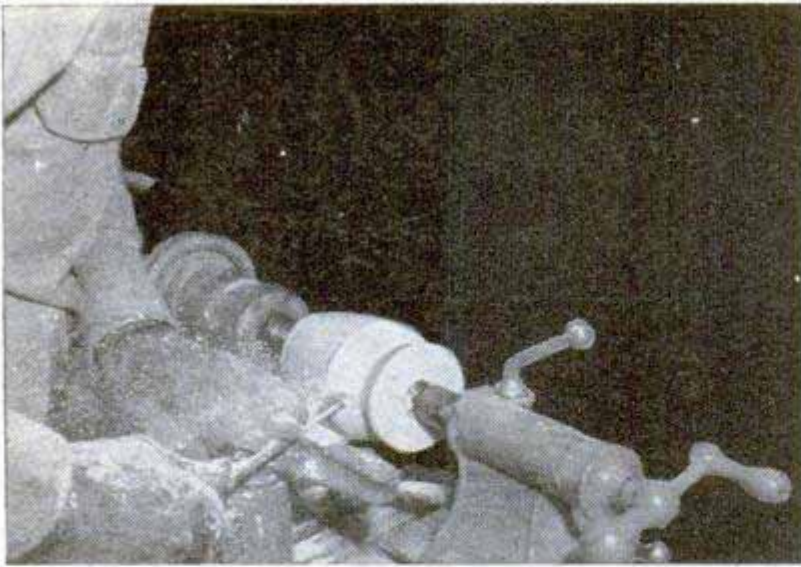

Maxwell turns his casting molds on an ordinary wood lathe. Right, clay body is poured into the final mold

persons who have learned ceramics from scratch to weld ingenuity and knowledge into a lucrative business. Ceramics demands both craftsmanship and artistic ability. It's an ideal hobby that can grow into a garage or spare-room business.

Clay is one of the most versatile materials existent. It goes into common bricks and fine dinnerware, sewer pipe and priceless porcelains. As a utility material, it is strong; as an art medium, it can be shaped into striking contours and decorated with beautiful colors. A common brick costs only a few cents, yet the same amount of clay (of a different kind) plus a cup of glaze and color materials can be shaped by an artist into a vase or figurine worth hundreds of dollars.

Ceramics is principally a handcraft and has been difficult to mechanize. But one of the ingredients that the Maxwells mix into their successful formula is ingenuity. One of Ray's former hobbies was woodworking so he hitched up several of his power tools to provide short cuts that have saved labor and in some cases increased volume. For example, the average potter builds up a model for a new clay mug or bowl by turning it on his potter's wheel. To do the same job, Maxwell casts a cylinder of plaster of paris in a tin mold. When the plaster has hardened, he clamps it in his wood lathe and turns out a new shape with ordinary woodworking tools. A final polishing with steel wool gives the model a smooth, perfect contour.

Hand-decorated mugs show Popular Mechanics covers. Most items turned out by the Maxwells carry messages



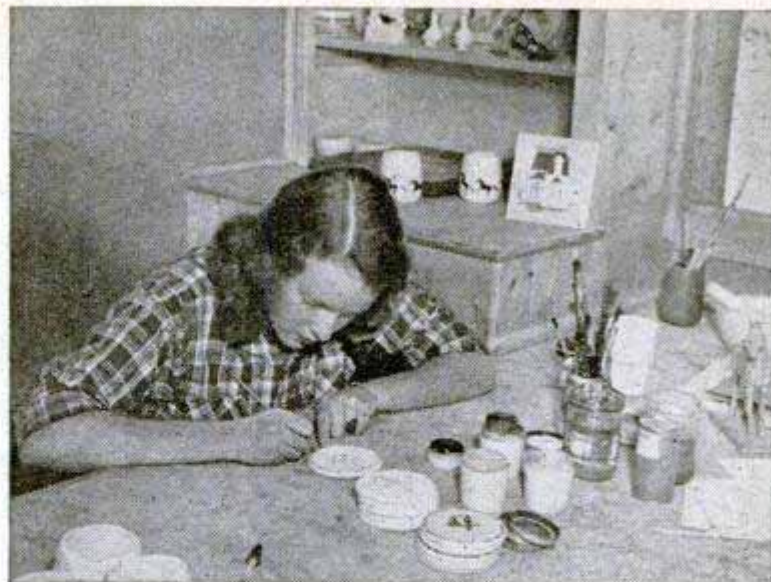
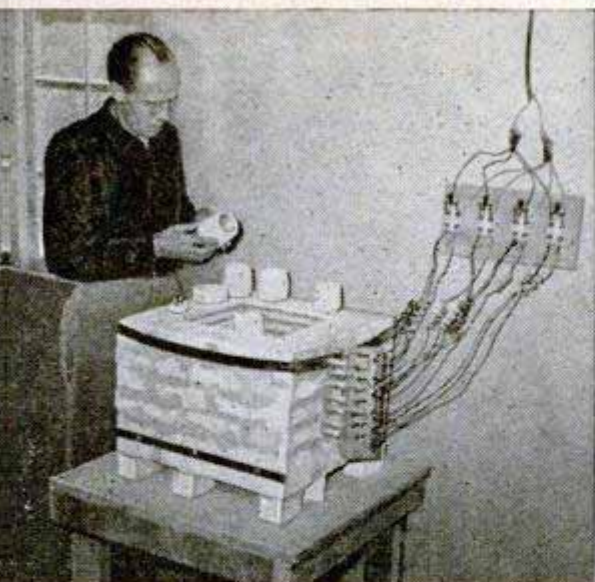

To aid in glazing clay objects, Maxwell built a spray booth above an old phonograph turntable. As the piece to be glazed spins on the turntable, he applies the glaze with a spray gun. An old vacuum cleaner behind the booth draws excess spray out of the air.

Maxwell built his own electric kiln out of refractory insulating brick and cement. He cut the grooves for the wires in the brick with his power saw. Hard on the blade, he admits, but much less expensive than buying a ready-made kiln. His kiln cost him about \$35, while one of comparable size would require an outlay of \$200 to \$400. Today, because of the family's increased output, the Maxwells also have a larger, gas-fired

Above left, Maxwell inspects pieces after their first firing in homemade electric kiln. They should ring when tapped. Above, daughter Joy decorates coasters with colorful birds of the West



Old phonograph provides turntable in the Maxwells' spray booth where glaze is applied with a spray gun. Below, Joy uses drill press to mix clay body while her parents prepare to fire pieces

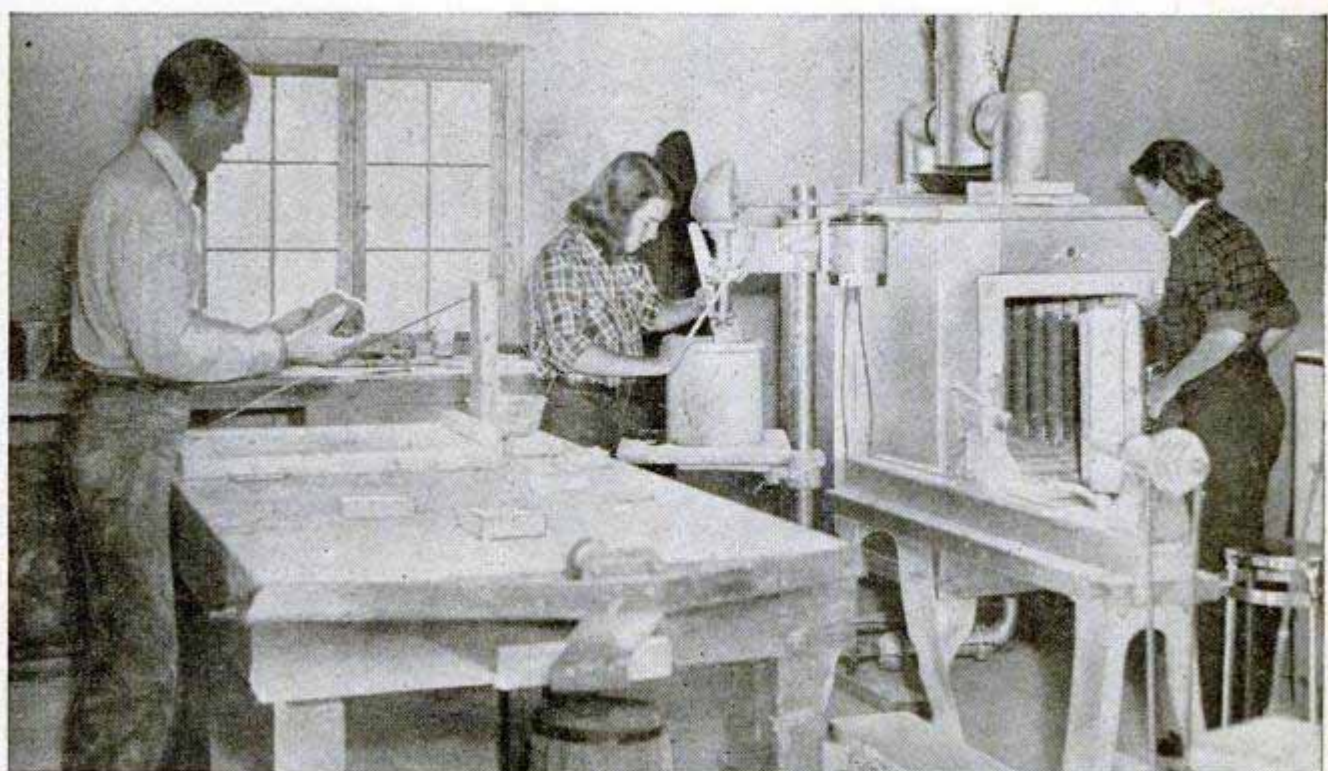



Products from Virdie Price's kilns range from salt and pepper shakers to miniature tea sets and decorative figures. All of them are handmade

Glen Lukens, artist-instructor, sprays glaze on one of his distinctive figurines. Right, sewing-machine treadle operates his potter's wheel

kiln. For mixing their clay formula, which must be perfectly smooth, they use a paddle attached to a drill press.

When they started learning the business, the Maxwells discovered that most small ceramic shops specialize in some kind of artware. They buy their clays, colors, glazes and other materials from supply houses and then develop an individual line of products. One man may produce large decorative plates and wall plaques; another may devote full time to turning out a menagerie of small animals. Depending on the workmanship, prices of individual pieces range from less than a dollar to five or ten dollars or more.

The Maxwells wanted to turn out pieces that not only were beautiful, but had unique decorations. Today their ceramic items are divided roughly into two classes: pieces which are decorated with wildlife native to the area or which reflect the lore of the old

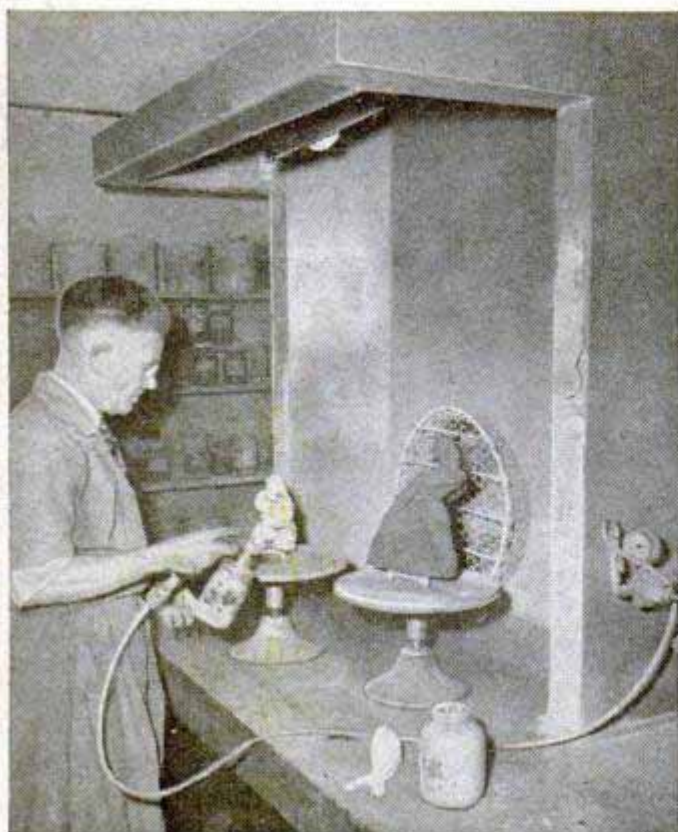



West, and pieces, specially ordered by each customer, that exhibit a personal message.

One man ordered a set of mugs each bearing the name of a member of his family. Another wanted several plates decorated with cartoon scenes depicting his wife and himself tumbling down a mountain on skis. A dude ranch ordered sets of mugs carrying scenes of life on the ranch. Mottos, bits of poetry, pictures of homes, all of these have been created on pottery for customers.

Each order is different, and they are piling up in the Maxwells' mountain home. Business became so good that Ray, his wife Ruth, and Joy were tempted to let the enterprise grow beyond the family stage, but finally decided they would lose the personal touch if it grew much larger. Ray is beginning to wonder when he'll do all that fishing he'd planned.

The Maxwells' shop is just one of scores of such family enterprises. Ceramics is an attractive hobby because it enables a man to create just what he wants and decorate his pieces in any way that appeals to him. One coffee drinker, for example, was dissatisfied with the small size of an ordinary cup; as soon as he became proficient at shaping and firing his pieces he turned out giant-size cups and saucers. Some hobbyists have made complete sets of dinnerware for their tables. Tilelike squares decorated with names and dates or with favorite scenes make unique pieces that may be set into the walls of a kitchen or bathroom. In fact, when a good ceramist builds a new home he may turn out all his own tile in the designs and colors he wants.

Some hobbyists haven't the time or space for installing their own kilns and other equipment. If they live near a commercial pottery they can buy cups, saucers and other objects from the pottery in bis-



Homemade kiln was shaped in two parts by mixing clay and sawdust in a cheese carton. When it was fired, the sawdust burned out, leaving air spaces in clay. Below, adjustable rests steady hands over potter's wheel



cuit form, ready for glazing. After decorating and glazing the pieces, they return them to the pottery for a final firing. This can be profitable for a small pottery.

Such is the case at the ceramic studio operated by Virdee Price in West Los Angeles. The Price studio creates a wide variety of art objects that range from miniature cups and saucers and odd salt and pepper shakers to large candy bowls, porcelain clocks and figurines decorated with ceramic lace. How to mold clay into an intricate, lacy weave is a puzzle that stumped many

(Continued to page 262)



### Paint Roller for Picket Fence

Individual pickets in a fence can be painted quickly with a roller small enough to fit between the boards. The applicator's roller is made of lamb's wool and holds enough paint to cover the average picket without a second dip in the paint pan. One stroke of the roller completely covers the surface with paint.



### Screen Shows Slides in Bright Room

Enlarged images of two by two-inch slides are projected so brilliantly on the screen of a new viewer that the unit can be used in a fully lighted room. The viewer consists of a slide projector, slide changer and screen built into one instrument which occupies less than 10 by 12 inches of desk



### Hearing-Aid Attachment Clarifies Phone Talk

Persons who use hearing aids can carry on a normal telephone conversation with a simple attachment for the handset. In most cases, those who are hard of hearing have difficulty in using a phone because sounds are induced which are uncomfortable when heard through a hearing aid. The attachment is merely a rubber tube which slips over the receiving end of the phone. In use, the phone is turned upside down and the rubber attachment held against the microphone of the hearing aid. The tube forms an air cell which prevents other sounds from reaching the microphone.

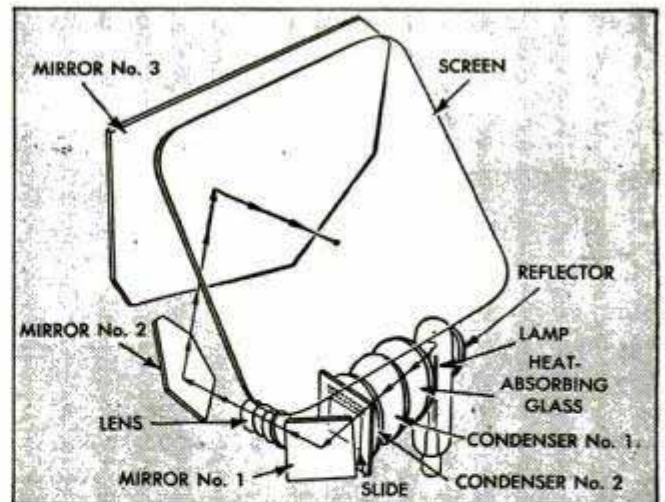

space. It holds 75 cardboard slides or 30 double-glass slides. Light from a 75-watt lamp is reflected through a heat-absorbing glass, two condensers and the slide. The image then is reflected by a mirror, passes through a lens and is reflected by two more mirrors to the rear-projection screen. The screen is made of dark-colored glass and measures 7½ by 7½ inches.

BUT PAUL THOMPSON,  
FOREST GUARD, OREGON,  
BUILT CAR

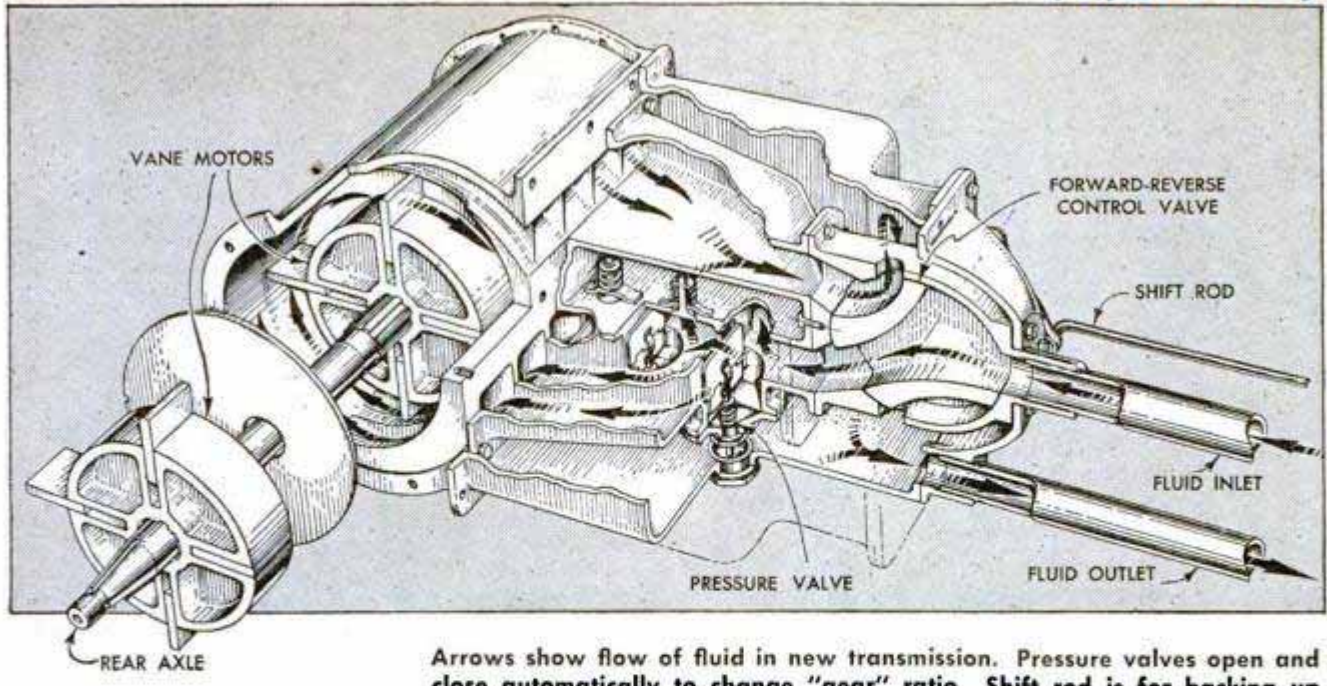

Arrows show flow of fluid in new transmission. Pressure valves open and close automatically to change "gear" ratio. Shift rod is for backing up

## FLUID TRANSMISSION USES NO DRIVE SHAFT

Completely hydraulic, a new fluid transmission, designed by an Oregon inventor, eliminates the clutch, geared transmission, drive shaft and differential gears. Called a hydraulic manifold, the unit replaces the differential in the rear-axle housing. Two tubes carry fluid under pressure from a pump at the motor to the manifold unit between the rear wheels. Six vane motors, three for each rear wheel, drive the car in low or reverse. The unit automatically cuts out two vane motors as speed increases to a point equivalent to second gear. As speed further increases, another pair of motors is cut out, and the car moves in high with one vane motor driving each wheel, providing a ratio equal to high gear in ordinary transmissions. No gears are used and the only control necessary is for shifting into reverse. Automatic "gear" changes are accomplished by spring-loaded pressure valves. As back pressure is built up by increased load at the wheels, these valves open and fluid is pumped into



Using parts from a junk yard, inventor Victor Jewel built this car to test his fluid drive. Total cost of parts: \$300. Below, no drive shaft is used. Fluid is carried by tubing from pump at motor to transmission

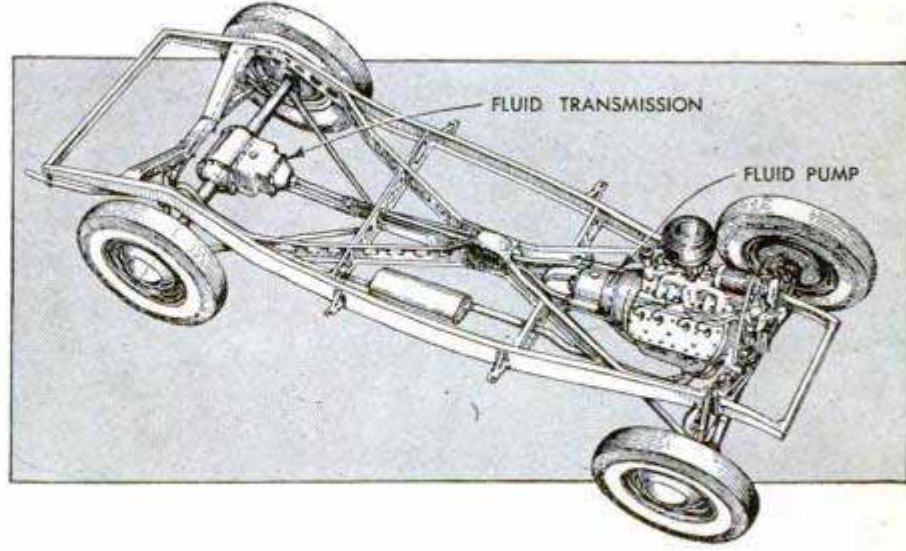

additional vane motors to provide more pulling power. The inventor plans to adapt the unit for powering rear axles of trailers and semitrailers by pumping fluid from the tractor through two hydraulic hoses.

# ACRES OF ALUMINUM

Right, the plant's three miles of exterior walls go up fast as workmen install panels consisting of two aluminum sheets separated by a thick layer of glass-fiber insulation. Panels interlock with a shiplap joint and are calked with aluminum-colored material

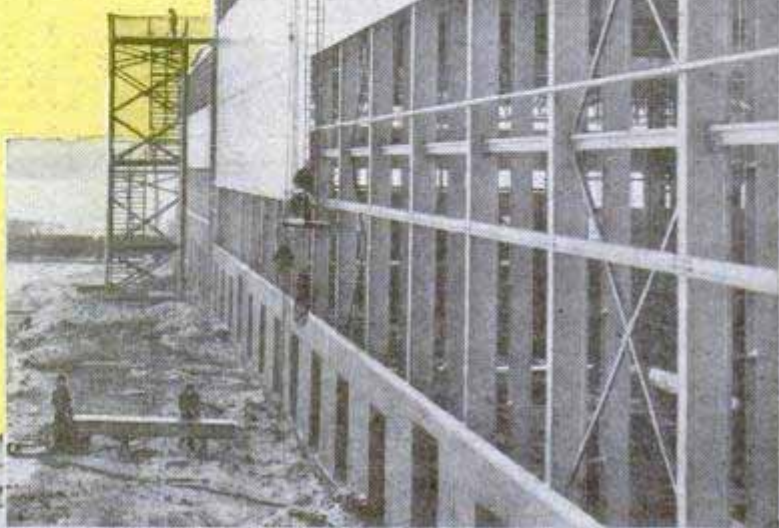

Below, boring holes in horizontal strip to mount the narrow trim over windows. Left, two men easily raise the aluminum sash. Later it is glazed from the inside



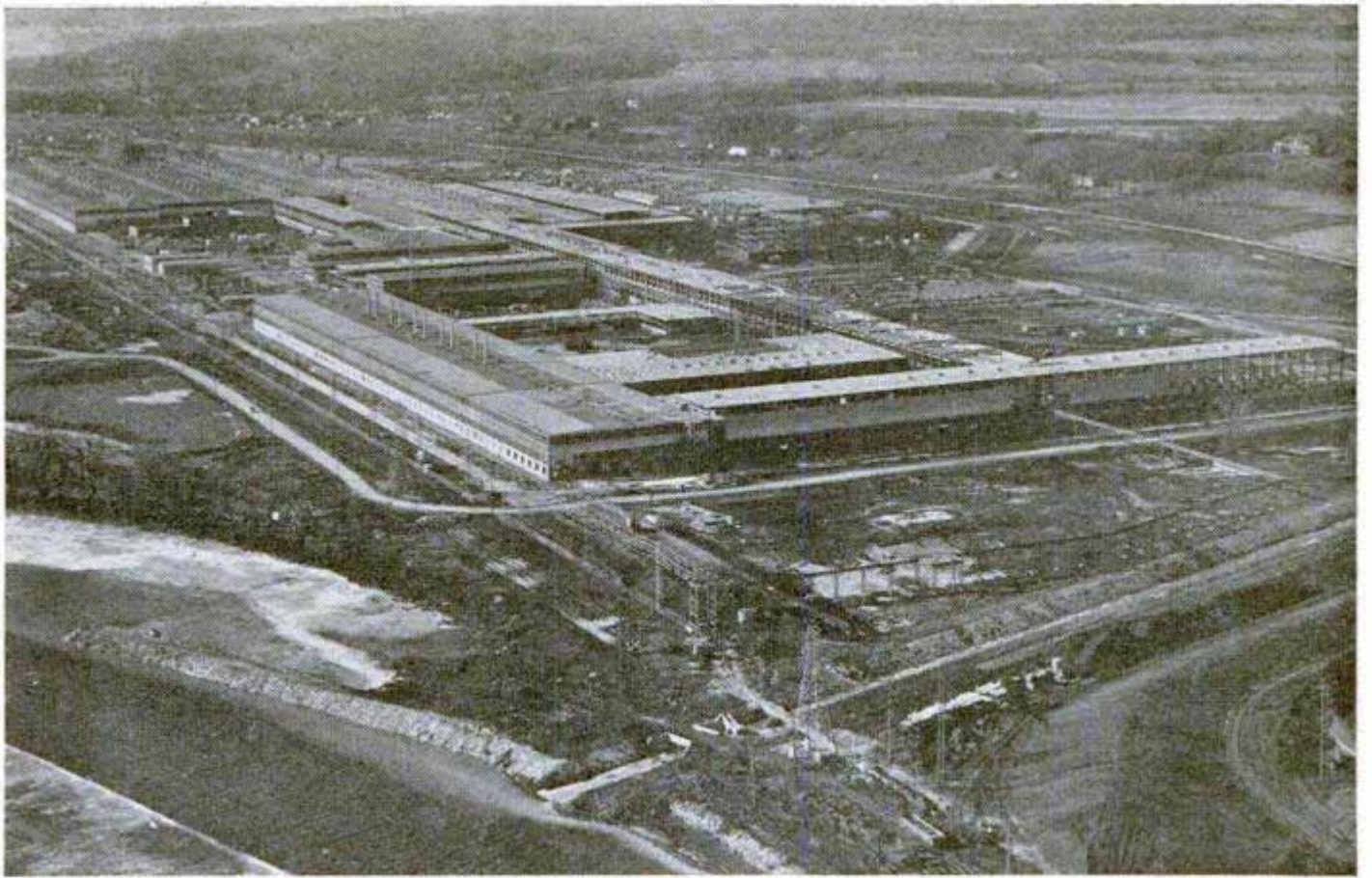

**Air view of the new Davenport rolling mill during construction. It will turn out aluminum sheet and plate**

**G**LISTENING in the sunlight like a shiny new dime, the giant new rolling mill of Aluminum Company of America at Davenport, Iowa, provides the nation with a preview of aluminum's future in factory construction. This sprawling plant, extending over 52 acres of flat land on the bank of the Mississippi River, is a practical demonstration of aluminum's versatility. Except for 25,000 tons of structural-steel framework, which, incidentally, is coated with more than three carloads of aluminum paint, the plant is basically an all-aluminum project.

It is not a wild experiment in aluminum usage, however. The lightweight metal was

used only where it has advantages over other metals. Adding up to a total of more than 6¼ million pounds of aluminum are exterior wall panels, window sash, roof deck, conduit for light and power circuits, roof drains, ventilators, movable office partitions and 1340 miles of light and power cables. Surrounding the mill is a shiny fence four miles long, the longest aluminum-mesh fence ever made. More than 100 workers and their families will learn the advantages of aluminum at first hand—they will live in neat, three-bedroom homes constructed almost entirely of the lightweight metal, located on the river bluff only a few miles from the plant.

**Below left, installing the aluminum battens on the 52-acre roof deck. Right, worker's home is aluminum, too**

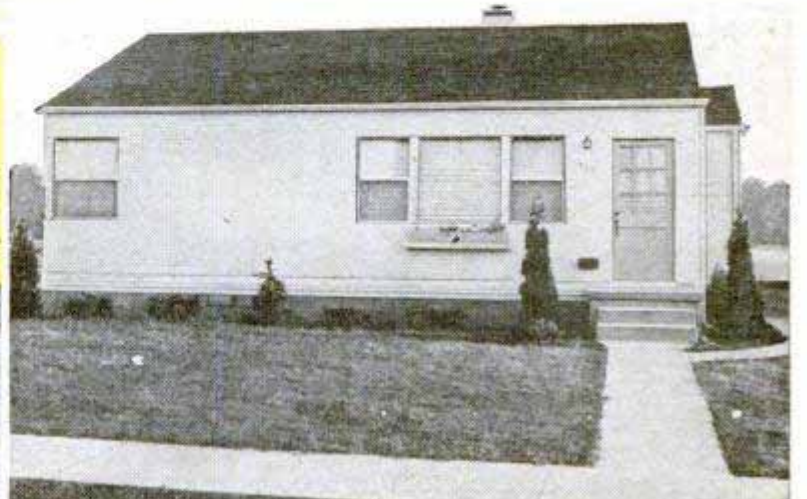
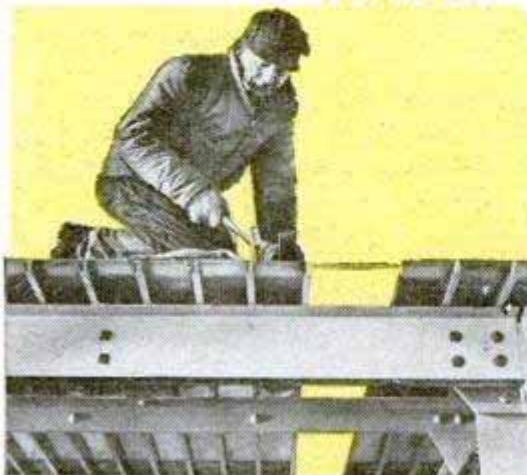

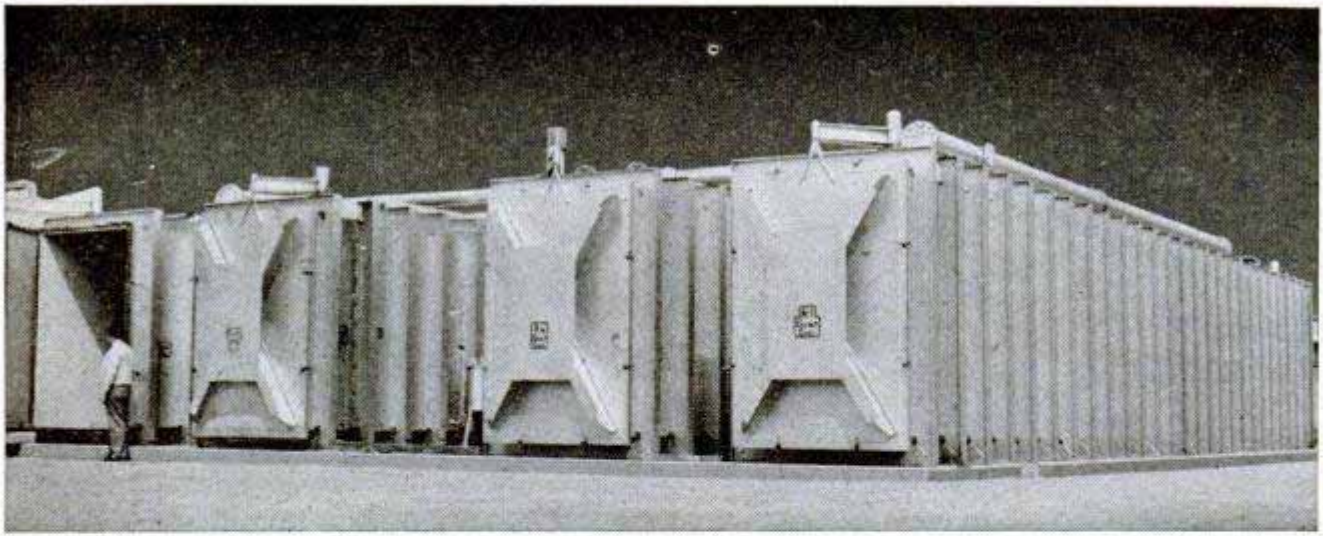

## Gas Chambers Fumigate Entire Ship's Cargo at Once

Four huge fumigating chambers at Norfolk, Va., are used to rid imported cotton and vegetable products of disease-bearing insects. The four 4000-cubic-foot chambers will hold the complete cargo of an average ship. Bales of cotton or other products are wheeled into the chambers and the gas-

keted doors sealed. Inside air is exhausted by a huge compressing motor and a deadly insecticide is introduced as a vapor. The vapor is pumped out and the chambers ventilated before workers, wearing gas masks, remove the material. Each treatment requires about two hours.

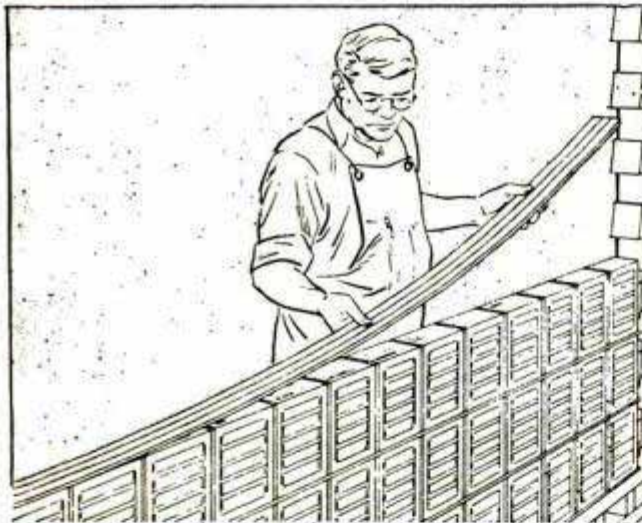

← Blocks set in tiers are separated by wood strips. Above, vertical strips are inserted between blocks. Right, glass wall is anchored in place with wedges

## Glass Blocks for Walls Set in Wood Instead of Mortar

Walls made of glass blocks can be built in openings of any size or shape by setting the blocks in wood instead of mortar. Only four basic parts are needed to build the wall: the Owens-Illinois glass blocks, vertical wood strips, horizontal wood strips and wedges. All the wooden parts are beaded to fit grooves in the blocks. After

the wall has been framed by two by fours, one of the horizontal wood strips is nailed in place. A course of glass blocks is laid on this base, with the blocks separated by vertical strips. Each course is anchored tightly in place by driving a wood wedge at each end to apply pressure to the blocks. Trim is nailed on to complete the wall.

## Sealed-In Vapor Makes Packaged Steel Rustproof in Storage

Rusting of bare steel during plant storage or shipment is prevented by a corrosion inhibitor known as CS-CI-501. This liquid is sprayed on the wrapping paper used to package the steel. As it evaporates, its vapor encloses the steel in a corrosion-

proof atmosphere. Even when moisture condenses on the steel surface, corrosion is prevented because the vapor dissolves in the water film, making it noncorrosive to steel. The vapor is odorless, nontoxic and will protect steel for as long as two years.

# A CAVE GIVES UP ITS SECRETS

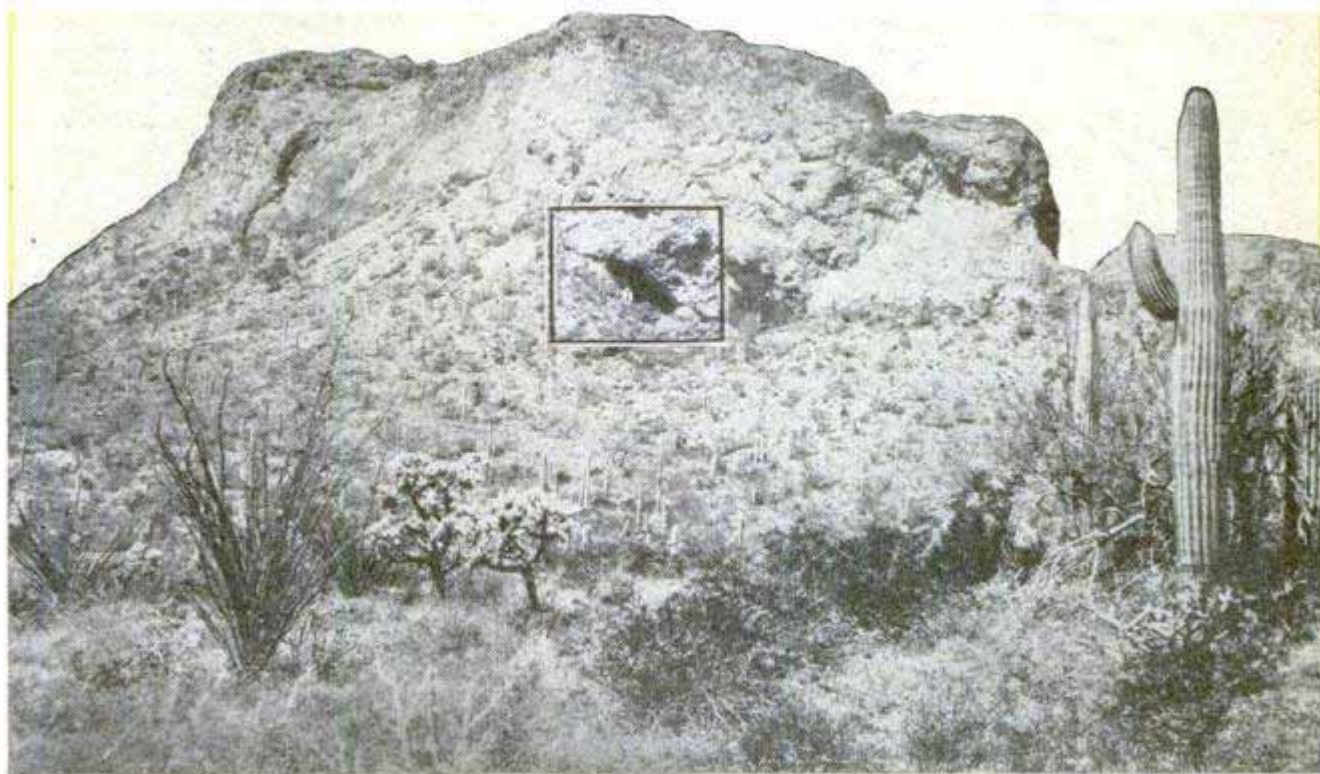

By Oren Arnold

Just a gash in the face of an Arizona mountain, Ventana Cave, center, is a veritable storehouse of history to archeologists

**D**ISPIRITED because an archeological project had just failed, Emil Haury, professor of anthropology at the University of Arizona, stopped his car one afternoon near a lone rock mountain on the wild desert of Arizona. Late sun had turned the near-by rock to crimson. Suddenly a black shadow caught his attention. He got out of his car and ambled toward it. This shadow seemed to open, revealing itself as a cave. Here was a chance to explore the legend that Spanish *conquistadores* once hid fortunes in silver in this region. Doctor Haury decided to peer into the cave.

Instead of silver bars, he found what has turned out to be one of the most important records of prehistoric Americans yet unearthed in North America. Whereas up to this time we had been able to go back about 15 centuries in the prehistory of our southwestern United States—through studies of cliff dwellings, pueblo mounds, pit houses and tools—this cave has enabled us to peer back an estimated 250 centuries. Each layer of deposit on its floor held an abundance of

**Modern archeologists, searching for secrets hidden in antiquity, discovered a gold mine of ancient history in this deserted cave in the side of an Arizona hill**

Hundreds of cubic yards of powder-dry soil had to be hauled outside the cave for screening because of the resultant dust

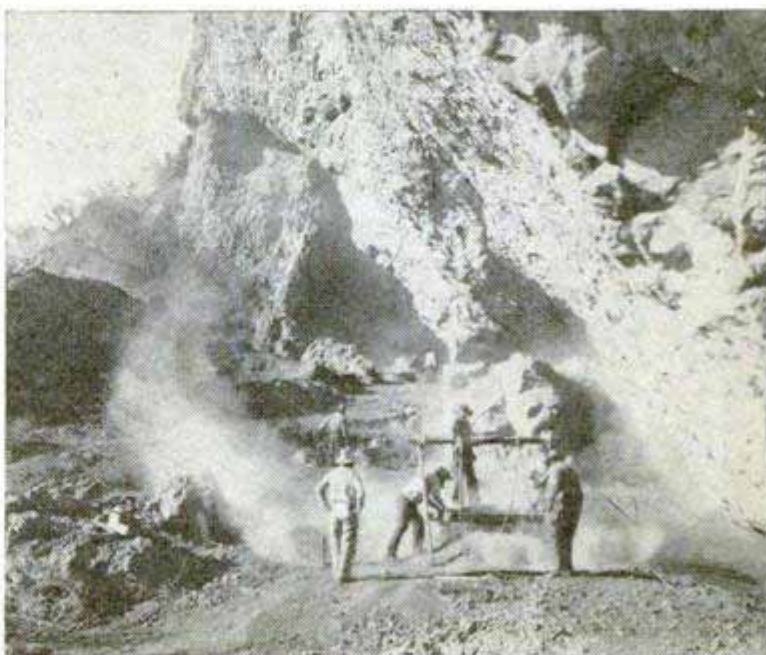

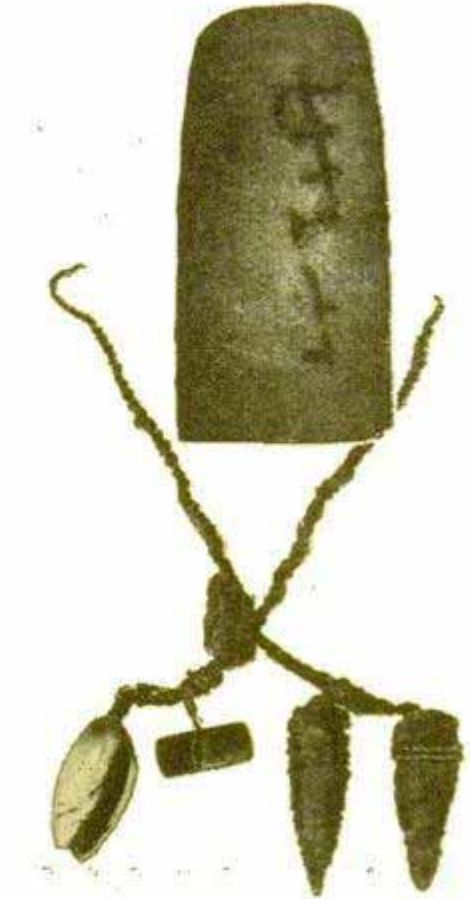
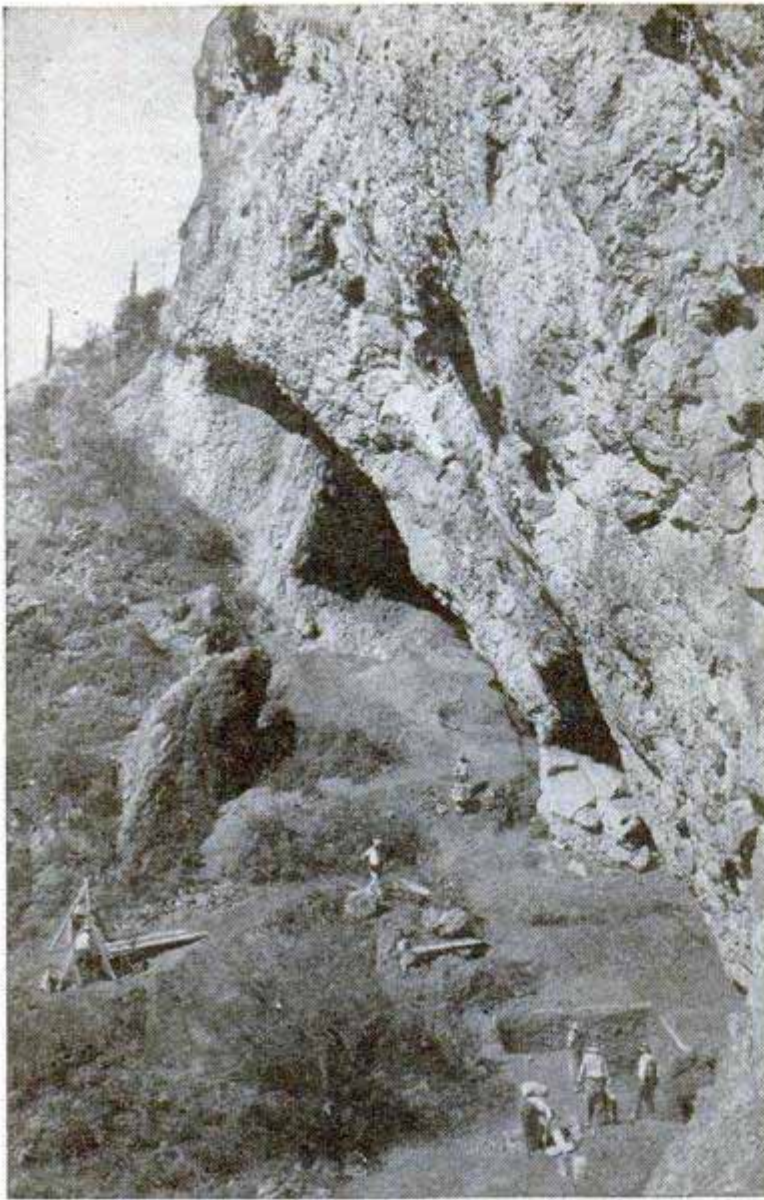

Left, view of cave entrance. Worker hauls soil in wheelbarrow from cave to screens. Above, an amulet string found with mummy contains sea shells, wooden nose plug and arrowheads. Top, the bowl of a stone pipe used for ritual smoking about 1100 A.D.

information, as if filed there for reference in drawers already labeled:

1948	to 1400	A.D.
1400	to 1	A.D.
1 A.D.	to 3000	B.C.
3000	to 8000	B.C.
8000	to 10,000	B.C.
10,000	to 25,000	(?) B.C.

These so-called drawers contained utensils, weapons, tools, clothing and ornaments, as well as bones and mummies.

As Doctor Haury entered the cave, the walls immediately caught his eye: starting about 10 feet up, mud daubs had been thrown all over them. He stood on a rock to chip one off, then grunted in surprise as a piece of ancient cloth tumbled out of the mud. Then with his archeologist's pick he began to dig in the dirt floor. After a few strokes he had gathered an arrow point and a piece of decorated pottery. Now he went at it hard; the floor was pay dirt at almost every stroke!

Twilight drove him back to his car, and in the vastness of the desert he cast about for a landmark. A few miles away he saw

a spot of turquoise sky through another cliff. "That's Ventana," he murmured; an Indian had told him of it. It was truly a "window" (Spanish *ventana*) high up. It would locate the cave, and serve also to name it—Ventana Cave. He hurried back to Tucson, 110 miles away.

Doctor Haury quietly rounded up his digging crew and returned to the desert. From Ventana Cave they could see blue smoke rising ominously from Papago Indian villages not many miles away. The Papagos had thwarted him once, withdrawing their permission for digging on another site for fear of evil spirits. So he left his camp on a diplomatic mission.

"I am working now in an old cave," he said to the Papagos, "and I need help. May I hire some of your strongest boys to do shoveling and push wheelbarrows? I will pay them well."

The Doctor carefully chose his boys from influential families. This vested interest in the project, he hoped, would give the Indians a sense of proprietorship.

For a while his trained university stu-



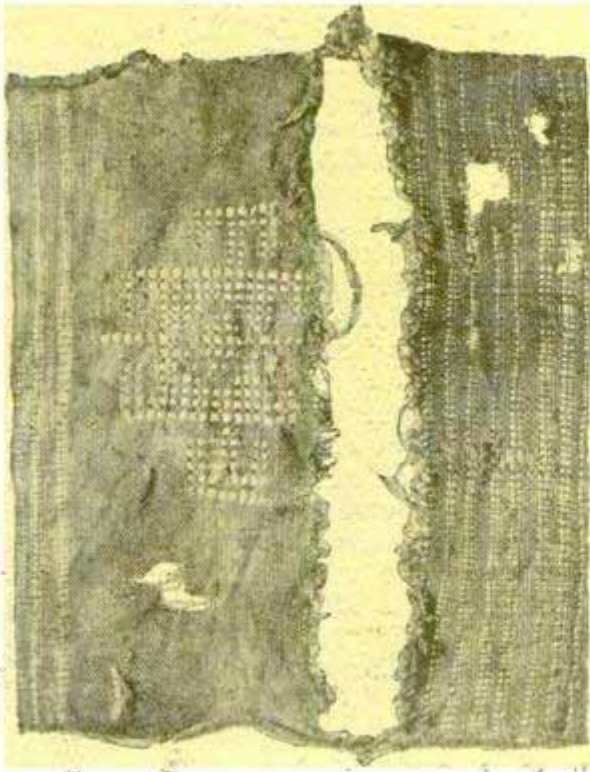

**This ragged piece of loosely woven cotton cloth was once used by the inhabitants of Ventana Cave. It was unearthed in the 1200 A.D. stratum and is still in fairly good condition, thanks to the dry Arizona atmosphere. Notice the intricate design which was woven into the primitive garment**

dents concentrated on screening the soil that the Indians removed. Haury himself had to commute to teach classes, but he left a competent foreman in charge. One day he had a long-distance call.

"Everything is fine," his foreman began cagily. "The Papago boys are good workers, and there's a very efficient Papago girl now serving as switchboard operator for this district."

"Excellent!" Doctor Haury was alert.

"I merely called to report that we found five objects today."

"Objects? I'll come at once."

Haury drove the 110 miles at breakneck speed. There, a few feet under the cave's topsoil, were five human mummies. Bones of men are common; well-preserved mummies are rare. These showed hints of antedating any others ever found in the Southwest. But the Papagos might claim them as sacred ancestors. The Indian workers would surely convey news of the discovery to rugged old Pia Machita, the Papago chieftain, who had the power to stop all work. In anticipation of just such

a moment, Doctor Haury had been doing some quiet investigation.

He had learned that Pia Machita had "acted up" and been sent to prison a while back, but that whites had helped salvage his dignity by getting the sentence shortened. A reciprocal courtesy to the whites would be in order now.

Haury went to the village and tactfully laid those facts before the native councilors. They nodded agreement, yet they had to save face. "The Thunder God," they informed the scientist, "lives in that cave. If you dig there you will release him."

But the professor was ready for this one. "Let him be released," said he. "Are you more cowardly than white men? The thunder, my friends, is only the noise of the storm. You have seen the Lightning God strike with great damage. But the Thunder God is merely a comical old man pounding a huge tom-tom."

Such logic convinced the red folk. Excavation at Ventana could proceed.

When first hint of the mummies had been revealed, the diggers put picks and shovels aside and began work with trowels, paintbrushes, nutpicks and tiny hand syringes, removing the soil almost grain by grain. Around the mummies were found exquisite pieces of pottery, stone implements, arrow points, pieces of clothing and even remains of food.

No spoon of sand was left unscreened from this point on; 700 cubic yards of earth were put through quarter-inch mesh so that no revealing item might escape notice. Indian guests came now, to look on. Haury tried, through interpreters, to explain each step to them, and also to convey some idea of a scientist's ideals.

Strange bones were uncovered from time to time. One set turned out to be a dog about 6000 years old, the oldest evidence of a domesticated dog in America. Technical studies showed it to be a true dog, not derived from any local wild strain. Teeth, for instance, showed details of crushing surfaces, cusps and cingula differing from those of coyotes and wolves.

One noon the students announced to Doctor Haury, "We have found a horse."

"Well, there's a meat shortage," said he, dryly. He knew they were down far beyond the days of the Spaniards, who brought the first horses to this continent. He also knew that students eternally try to pull a professor's leg; he had gotten even with them once by molding and firing a "prehistoric mustache cup" and burying it for them to unearth.

But they did have the teeth of a horse as large as an Indian pony. Students of our antiquity have long told us that our only native horse was a diminutive species, the



Inside the cave, workmen shovel away the accumulation of the centuries and haul it outside where it is carefully screened



Above, removing the deepest consolidated layer which produced the fossil fauna and the oldest cultural evidence in the cave

Descendants of the Papago Indians who used the cave for many centuries now live under this primitive shelter in the vicinity

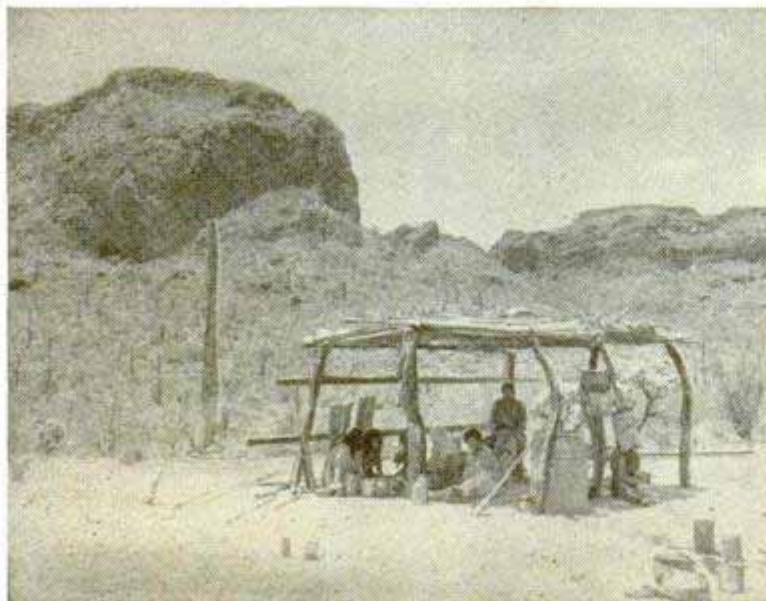

size of a lamb. This Ventana specimen, says Haury, definitely establishes the fact that a full-sized species had evolved in America long before the time of Christ. It had marked technical differences from the horses of Asia and why the species disappeared is anybody's guess.

One university student came upon the strong, sharp teeth of a jaguar, long extinct. They were in the stratum or "file drawer" labeled 8000 to 10,000 B.C. The creature may have made his lair in Ventana during some brief period when men did not live there.

In that oldest stratum, stretching back to a hazy 25,000 B.C., were found proofs that climate in the Southwest was very different from the arid environment today. Students found skeletal parts of a bison now extinct and much larger than our modern "buffalo" (which is actually a bison). There, too, were parts of a tapir, of a four-horned antelope, and of a sloth, all strangers to our Southwest. "These were succulent eaters which could never have survived in a desert. Unquestionably the region had much more moisture then than now," says Haury.

Full exploration of Ventana and correlation of findings has taken years. Time was needed for other scientists to lend their specialized knowledge before official announcement of the project could be made. The human skeletons and mummies had to be cleaned for X-ray studies. Plates were sent to Dr. Joseph Aronson at the University of Pennsylvania for skilled analysis. He found that our ancients suffered from arthritis as much as we do. Mummy tissue was sent to the Arizona State Department of Health where experts typed the blood that had flowed through the ancient veins. Of ten tests run, nine showed the blood to be Type O, one Type AB. This is almost exactly the same proportion of the two types as found in Papago Indians today.

In time, Haury made further study of those mud daubs that he had discovered when first entering the cave. Nearly 30,000 had been thrown on walls and ceiling. They ranged from walnuts to baseballs in size. Each had a

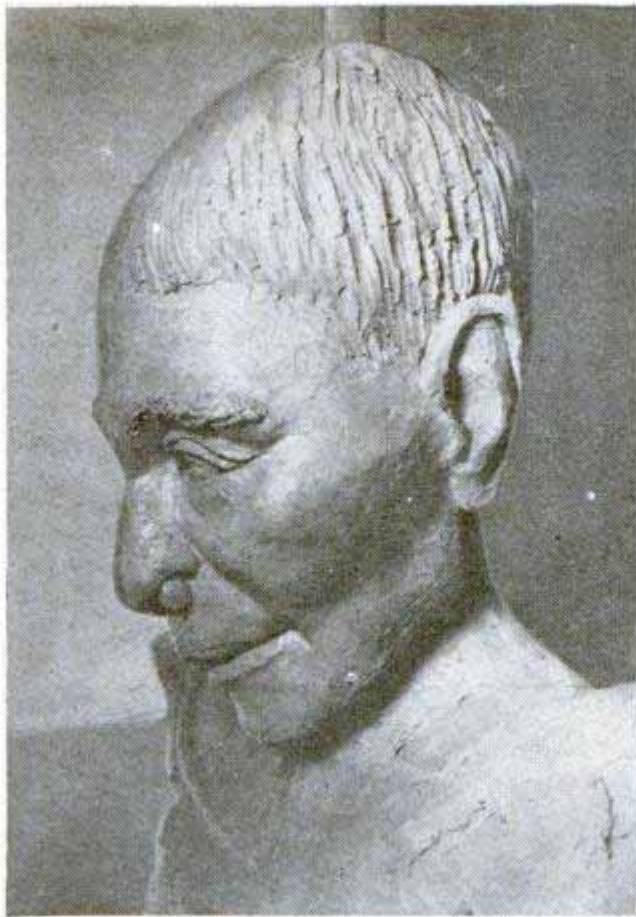

Right, Ventana mummy poses while sculptor works on clay bust of the ancient Indian. Left, the finished bust

piece of cloth inside it and some had a feather stuck on the outside. Many obviously had hardened there for centuries, and the cloth in them was ancient, but cloth in others was modern, indicating that the Papagos had added to the collection. Haury tried without success to learn the meaning of the daubs from the Papagos. The daubs are still a mystery.

Sheer abundance of findings, extending over so many centuries, makes Ventana Cave the most important single archeological ruin ever excavated in America, Doctor Haury feels.

"Heretofore we have had piecemeal facts from many different ruins," says he. "Ventana offers us a registration of the people in a cave open for century after century. We know that our Ventanans had lives similar to the so-called Folsom man, a few of whose artifacts were found near Folsom, N. Mex., in 1925. Our findings can vastly expand the conjectural possibilities there.

"From our 'file drawer' of that stone-age period prior to 10,000 B.C. we obtained not only an abundance of animal remains but many weapons and tools. From the very oldest stratum our students brought stone choppers. These were chipped into blades like hatchets or knives, and were useful for hunting game and skinning it. They were held in the fingers, without handles. We found large sea shells, five to

six inches across. These doubtless came by barter or raiding from the Gulf of California, and would have been prized as drinking cups."

Here were unearthed the first clues of the transition period when man on our continent changed from a culture without pottery to one with it, an epochal advance which occurred about the time Christ was on earth. At Ventana, as elsewhere, pottery became the mark of a sedentary, farming people. It is from such folk that most wisdom has sprung—perhaps because they, not the fierce raiders, found time for meditation.

This storybook cave revealed an exciting stacking—the remains of one culture found on those of earlier cultures. Scientists had thought this occurred in America only during the past few centuries, judging from remains elsewhere. At Ventana, stacks began centuries before Moses' time.

Here, too, was a partial fill-in of the "missing link" renowned in recent southwestern archeology. Ruins in the Mexican-border region already had turned up important facts about our desert folk just prior to the year 1400 A.D. and after 1700. But the period between had been barren. Ventana supplied many tools, pottery, weapons, even human remains, on which technical study of that period could start.

Most fascinating pursuit of the scientists

(Continued to page 264)

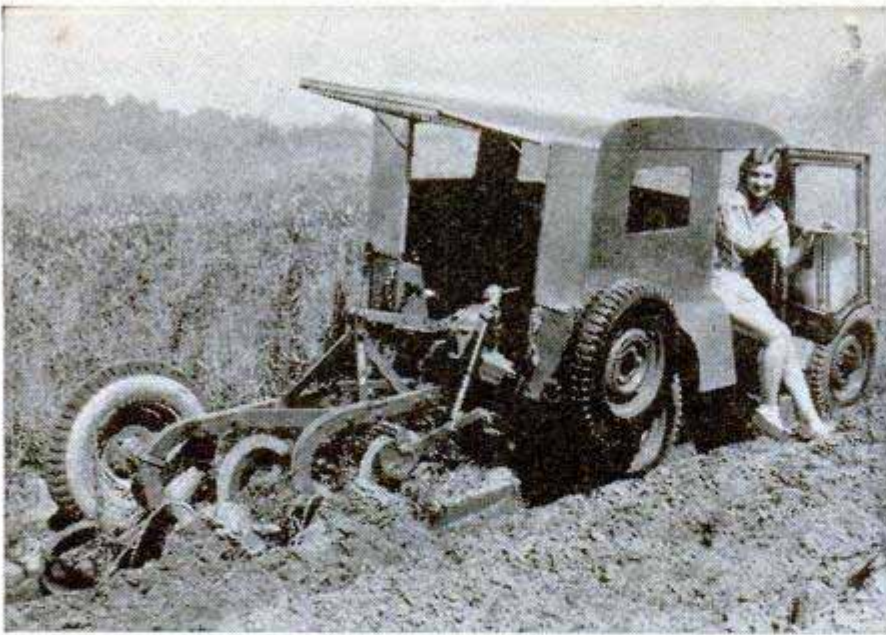

## Cab of Aluminum Fits on Jeep

Installed on a jeep, an aluminum cab protects the driver from the sun in summer and provides a warm cab in the winter. The aluminum shell, which forms a roof and sides for the vehicle, has an insulated lining and is sealed to the jeep body with rubber. The doors can be locked and the door windows raised. A large door at the rear can be swung up for easy access to the rear section of the vehicle.

## Lift-Type Disk

Hydraulic power has solved two farm problems—how to transport a disk harrow and control the depth of its cut. A lift-type tandem disk harrow is attached to the tractor and carried to the field. The depth of the cut is regulated hydraulically or the tractor can lift the harrow completely off the ground. The frame is rigid and the gangs are set at a 20-degree angle.

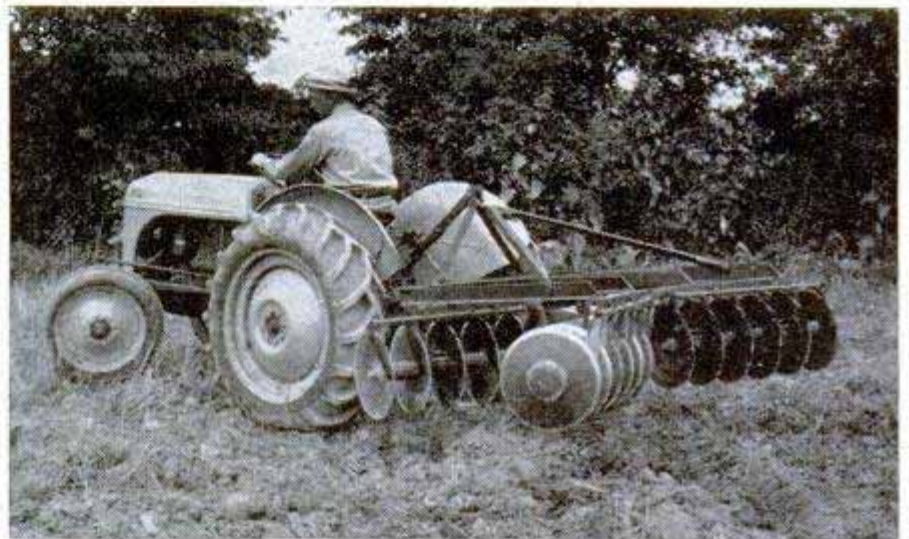

## Radio Operates in Liquid During Tests for Cooling



Engineers of the Air Materiel Command have developed a cooling system for a radio set by immersing it in liquid. They are seeking a way to reduce the size of electronic equipment used in aircraft. Engineers mounted one set in a watertight case and filled the case with Freon refrigerant. The liquid, through its cooling effect, permits components of the radio to be placed closer together without danger of burn-outs or explosions. It also protects the set from atmospheric damage.

## Sound Waves Test Paint By Causing It to Peel

Silent sound seems to be a jack-of-all-trades and its latest job is testing the wearing qualities of paint. A metal sheet, coated with the paint, is vibrated by sound waves too high to be heard. In less than one second, the life expectancy of the paint can be determined from the force of vibration necessary to make it peel.

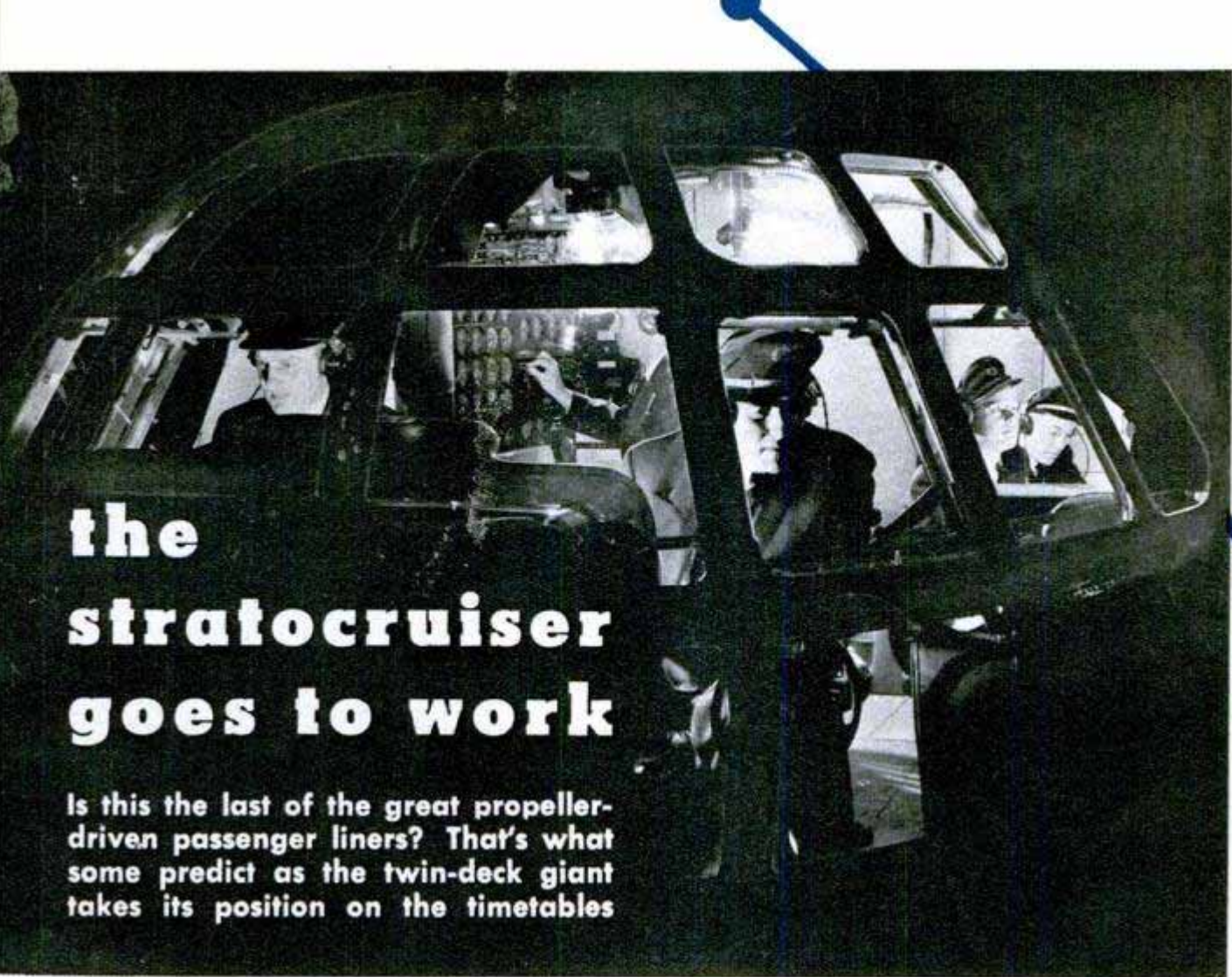

# the stratocruiser goes to work

Is this the last of the great propeller-driven passenger liners? That's what some predict as the twin-deck giant takes its position on the timetables

**N**EWEST and biggest of the de luxe airliners—the Boeing Stratocruiser that costs 1½ million dollars a copy—goes into regular service this year.

The great 114-passenger double-deckers will cut solid hours from existing schedules. New timetables will read: "New York to London, 11½ hours instead of 14½ hours," and "San Francisco to Honolulu, 8½ hours instead of 12 hours."

Not only is the Stratocruiser the latest conventional airliner, it probably is the last of them. Most engineers agree that the next big passenger planes will be powered by gas turbines and will be either jet propelled or will use the turbines to turn conventional propellers. The Stratocruiser, they think, is the last of the big passenger-carrying planes that will use reciprocating engines.

Lined up in front of a Boeing Stratocruiser is part of the 30 tons it carries into the air. It will accommodate 114 passengers on daytime runs or 27 in "Pullman" berths and 39 in chairs when used as combination sleeper-and-day plane





Berths are seven inches wider than those in standard rail sleeper cars



Spiral stairs, above, join two decks of the giant air carrier. For large families or groups of friends there are spacious staterooms, right, that are made up with divans or couches

Since the plane represents the end of an era from the design standpoint (not from the point of view of the flying public, because the big ships will be the best available for years to come), let's compare it with one of the first planes ever built for airline service.

Twenty years ago a popular airliner was the tri-motored all-metal Ford, whose three engines produced a total of 660 horsepower. Any one of the Stratocruiser's four engines develops more than five times as much.

The Ford carried 12 passengers in a compartment that measured 350 cubic feet. The same number of passengers can sit, with room to spare, in the big Boeing's cocktail lounge alone. The baggage and express compartments of the new plane are twice the volume of the Ford's passenger compartment.

The Ford cruised at 95 miles per hour, two miles an hour slower than the Stratocruiser's landing speed.

The Ford's fuel tanks held 235 gallons of gasoline. The Stratocruiser carries 32 times as much fuel and its drinking-water tanks alone are equal to one third the total fuel capacity of the Ford. The Stratocruiser can fly 4200 miles nonstop, a distance that would require seven intermediate landings for fuel by the earlier airliner.

A passenger on the Ford was deafened by noise, subjected to cold drafts and made uncomfortable by changes in altitude. Stratocruiser passengers never need to raise their voices and they breathe a manufactured atmosphere adjusted to a pleasant summer temperature and humidity. The cabin retains sea-level pressure up to 15,000 feet and is reduced to an apparent altitude of 6000 feet at the 25,000-foot ceiling.

Briefly, the Stratocruiser has a span of 141 feet, is 110 feet long and has a tail that stands 38 feet high. Four Pratt & Whitney Wasp Majors, each with 28 cylinders, individually develop 3500 horsepower for take-off. The loaded plane has a take-off weight of 71 tons and cruises at 340 miles per hour at air levels of up to 25,000 feet. One reached a speed of 498 miles an hour in a dive.

A fleet of 55 Stratocruisers is under construction in Seattle for Pan American World Airways, American Overseas Airlines, United Air Lines, Northwest Airlines, British Overseas Airways and others. When all deliveries are made, it will be possible for a passenger to fly around the world in less than 70 hours by transfer-





Looking toward rear of main passenger cabin on the upper deck of the 340-mile-an-hour luxury airliner

ring from one Stratocruiser to another.

As a day plane, the big carrier seats up to 114 passengers; as a combination day-and-sleeper plane it carries 25 chair passengers and 27 "Pullman" passengers on the upper deck plus 14 chair passengers in the lower-deck lounge. A spiral stairway

connects the two decks. A stewardess can change a berth-type seat into a bed in one minute. Upper berths fold out from the cabin walls.

Each seat has an armrest "control panel" that contains a call bell and a switch for the prefocused reading light, ash tray,

Upper and lower berths are curtained off for complete privacy. Right, food is loaded through special door



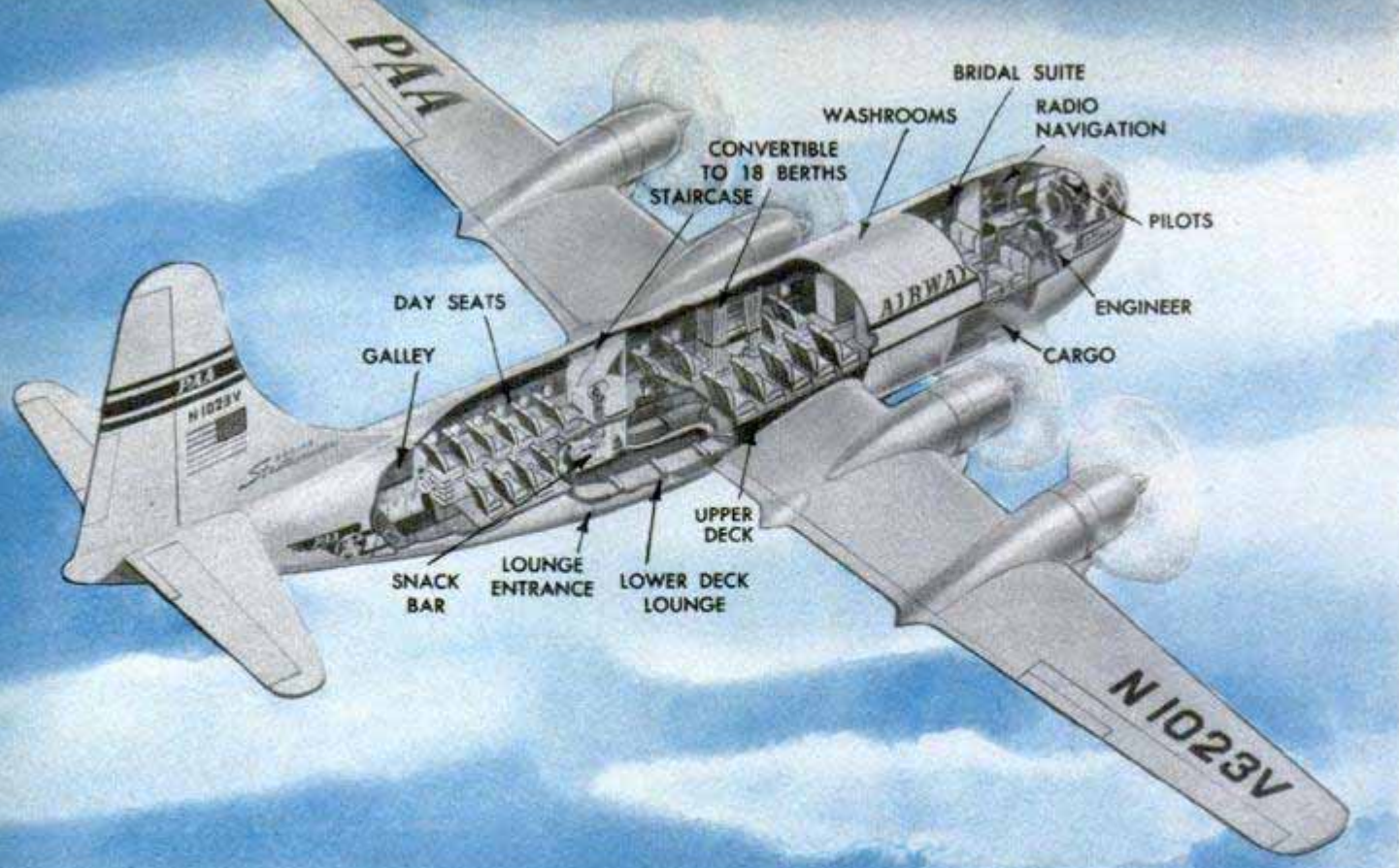

Cutaway view showing how Pan American World Airways will use two-deck space of the \$1,500,000 transport

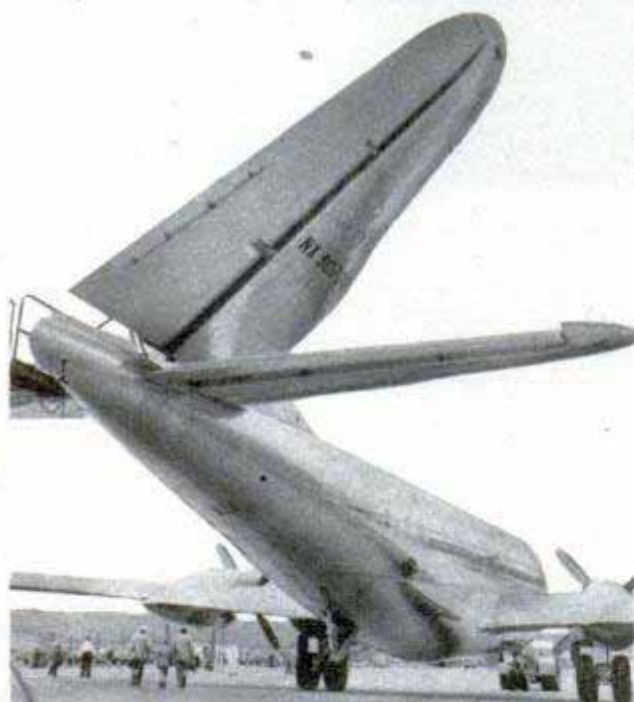

Hinged tail, above, allows big Boeing ship clearance getting through hangar doors. Upright, the rudder tip is 38 feet high. Below, large metal containers at left in galley hold fruit juices and hot soups



an "occupied" sign, seat number, reclining-back adjustment and a receptacle into which may be fitted the dining-tray leg.

The plane has an extra-large galley with its own side hatch so that food and supplies may be loaded or unloaded from the galley without being hauled through the passenger compartment. Commodious dressing rooms for men and women are provided. The crew, which may number up to eight, has its own toilet facilities in the control compartment.

Interior decoration was given considerable attention because a passenger's surroundings can contribute to travel sickness and fatigue or actually reduce them, depending on the colors and patterns used. Clashing colors and "busy" designs were ruled out. The basic color system employs dark colors at floor and seat level with light "high value" colors on the walls and ceiling. This treatment adds to the illusion of spaciousness and prevents eye fatigue when shifting the gaze from inside the plane to the outside. This is important because the Stratocruisers will normally fly above the clouds in constant sunshine during daytime hours.

Stratocruisers destined for different routes are given individualistic cabin color schemes. Planes for the bleak North Pacific run to the Orient are being finished inside with rough-textured fabrics of beige and reddish-brown to help create a feeling of comfortable warmth. Aircraft on the Honolulu run will have tropical interiors featuring bamboo trim. Conservative oak





Fourteen passengers can be seated comfortably in the air-conditioned lounge, situated on the lower deck

Flexwood paneling goes into ships ordered by British Overseas Airways. After testing several color mock-ups, however, it was decided that all control compartments will be the same. They will be finished in medium gray and dark maroon, with black nonreflective paint for instrument panels.

The control compartment has so little resemblance to the cramped cockpits of older transports that pilots are calling it the "pilot's parlor." Normal crew consists of pilot, copilot, flight engineer, radio operator and navigator. Each has a comfortable, roomy chair. Among other innovations are the paneled windows that give exceptional visibility.

The seven windows at eye level are of a new nonicing type and consist of two layers of plate glass separated by a plastic core and by a transparent three-molecule-thick layer of electrically conductive material. Electricity flowing through this layer keeps the window at a frost-and-ice-free temperature. Hot air prevents icing of the other windows.

Even severe icing conditions are no handicap at all to the plane. Leading edges are kept warm by hot air from eight combustion heaters flowing through special wing and tail passages. Even when it is 20 degrees below zero outside it is possible to keep all leading edges at 80 degrees above zero. The four-bladed reverse-pitch electric propellers are protected from ice by resistance heating elements running lengthwise in each blade.

With the exception of the hydraulic rudder-control system, the Stratocruiser is

virtually an electric airplane. Its six 28-volt d.c. generators create enough power to serve the domestic needs of a 114-home community.

There are 119 motors and 411 lights on the plane, 482 switches and 10 miles of wiring. Power demands range from the 616 amperes required for raising or lowering the landing gear to  $\frac{1}{100}$  ampere for burning a tiny compass light located in the control compartment. Two alternators and five inverters are used to supply current of the types needed, including 110-volt a.c. for electric shavers.

The multitude of lights on the plane includes a 50-watt spotlight in the nose-wheel

(Continued to page 244)

Cross-section view of a Stratocruiser showing paths of air flow inside two decks. At 15,000-foot altitude, the passenger cabins still maintain their pressure at sea level

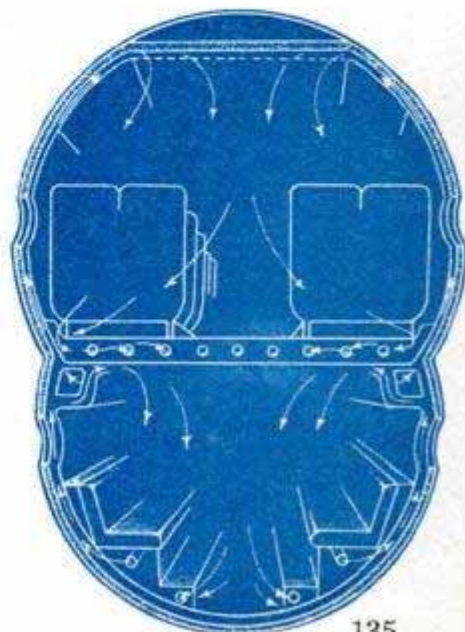

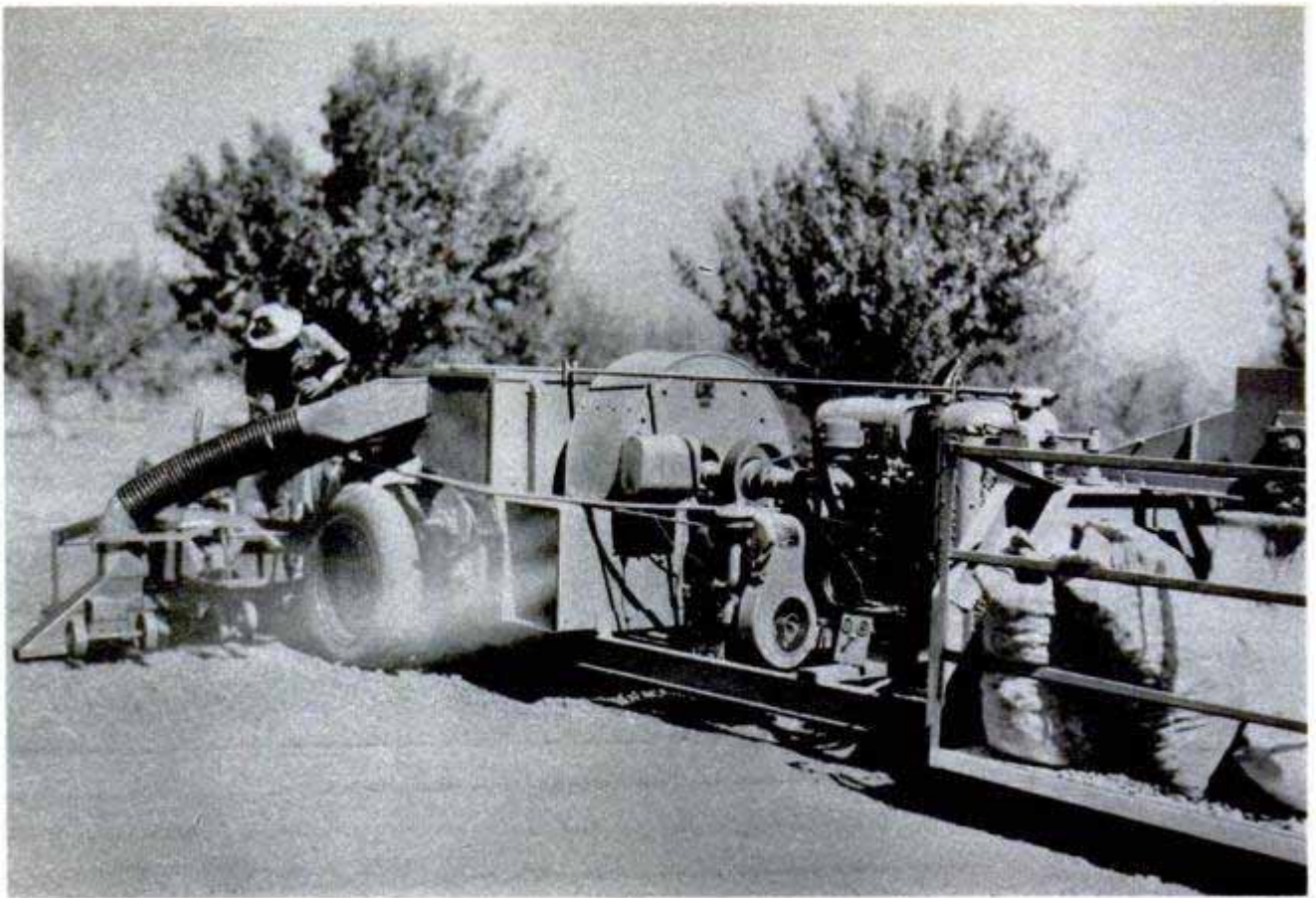

## Almond Harvester

Latest method of harvesting almonds is to sweep them up with a vacuum cleaner. The idea first was applied to a clover-seed harvester and then was adapted to a filbert

picker and an almond harvester. The heart of the machine is a reverse fan which sucks the almonds up a tube. The big vacuum cleaner has worked so well that ranchers say almost all almonds will be harvested by this method within a year.



## "Scarecrows" Frighten Coyotes

Sheep ranchers on the western plains are erecting coyote "scarecrows" to protect their flocks. They are made of sacking or other old cloth fastened to a wooden cross-bar. The flutter of the cloth frightens the coyotes. As many as a dozen of these scarecrows have been erected within a quarter-mile square.



## Crankcase-Oil Tester Shows Up Dirt

Filling-station attendants can show motorists when their oil is dirty enough to need changing by means of an illuminated disk that compares clean oil samples with oil from the crankcase. The disk contains two samples of clean oil. Oil from the dipstick is dropped into a third cavity. A flashlight behind the plastic disk illuminates the oil to disclose any harmful sludge or gritty particles.



FORWARD FUNNEL OF THE SILVERBRIAR CONTAINS WHEELHOUSE, PASSENGER AND OFFICERS' QUARTERS

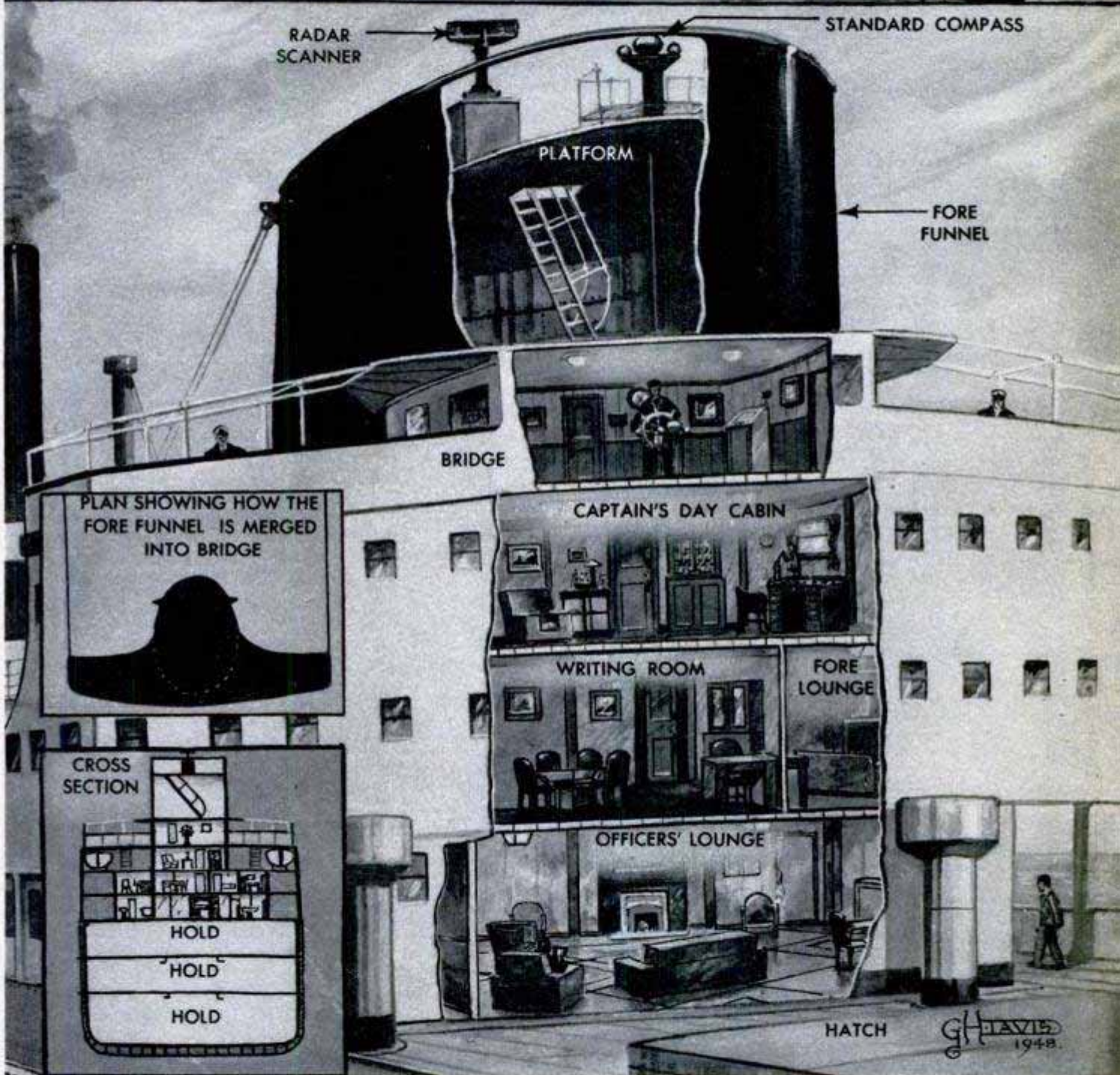

## SHIPS HAVE CABINS IN FUNNEL

No smoke rolls out of the forward funnel of two cargo liners built in England, the Silverbriar and the Silverplane. The stack is unnecessary but has been preserved for appearance. Inside the funnel are the wheelhouse, captain's cabin and a luxuri-

ous officers' lounge. Other features of the "new look" ships are well-fitted cabins and recreation rooms for the crews, and passenger rooms paneled in leather. Each of the ships is 10,700 tons, dead weight, and has geared turbines for propulsion.



Off Point Barrow, the starting point of the 300-mile trip to Barter, the two LSTs stand by as the icebreaker in distance breaks up the 12-foot ice

# OPERATION ICICLE

Bulldozer at Barter Island forms this gravel approach to the open bow doors of the LST to speed unloading of cargo during the brief period of open water



**O**NCE A YEAR the 62 officers and men of the U. S. Air Force outpost on Barter Island in the Arctic Ocean, only 1100 miles from the North Pole, anxiously watch the horizon for the first sign of the yearly supply boats. The island is isolated by solid ice 11½ months of the year, but in August the ice breaks up enough for supply ships to get through.

Last summer two LSTs proved their ruggedness by making the 600-mile round trip from Point Barrow behind the thick-skinned icebreaker Burton Island. Since Barter Island is open to shipping only a few days each year, speed in unloading cargo is essential. The gaping bow opening of the LST makes this craft an ideal ship for the run.

However, the LST was designed as an expendable, thin-skinned vessel. Steel reinforcements were added for the Arctic trip. Despite this precaution the ships came back looking like battle casualties. Propellers were bent, holes were gouged in the bow doors and side plates were buckled. The voyage proved that LSTs could make the run, unload and get away before the ice closed in.

Two helicopters, stationed on the icebreaker, maintained reconnaissance 20 miles ahead of the slow-moving procession. After six days of sliding between ice floes, the ships arrived at Barter and unloaded 40,000 tons of supplies—enough to maintain the communications detachment until the ice breaks again.



Loaded with supplies for the Air Force detachment, an amtrack goes ashore at Barter after a six-day trip through ice floes



As ships near land, the helicopter comes down on the deckload of lumber on one of the LSTs. Helicopters maintained reconnaissance 20 miles ahead of ships during trip. Below, heavily loaded LST, foreground, waits for icebreaker to clear channel





### Full-View Golf Bag

All the clubs are in full view in a new golf bag made of aluminum and plastic instead of leather. The bag holds 12 clubs with each shaft locked in place. A trigger mechanism releases the individual club. The bag prevents clubs from being damaged by striking against each other. One compartment in the plastic base holds balls and tees and another has room for a sweater, shirt or light raincoat.



### Drinking Fountain for Children

You won't have to lift your youngster up when he wants a drink of cold water if the fountain has a children's bubbler mounted at a lower level. The extra bubbler can be mounted on either side of the fountain or, if desired, in a separate location up to 20 feet away. The recommended height is 30 inches. The combined units will provide enough cold water to quench the thirst of more than 70 people an hour.

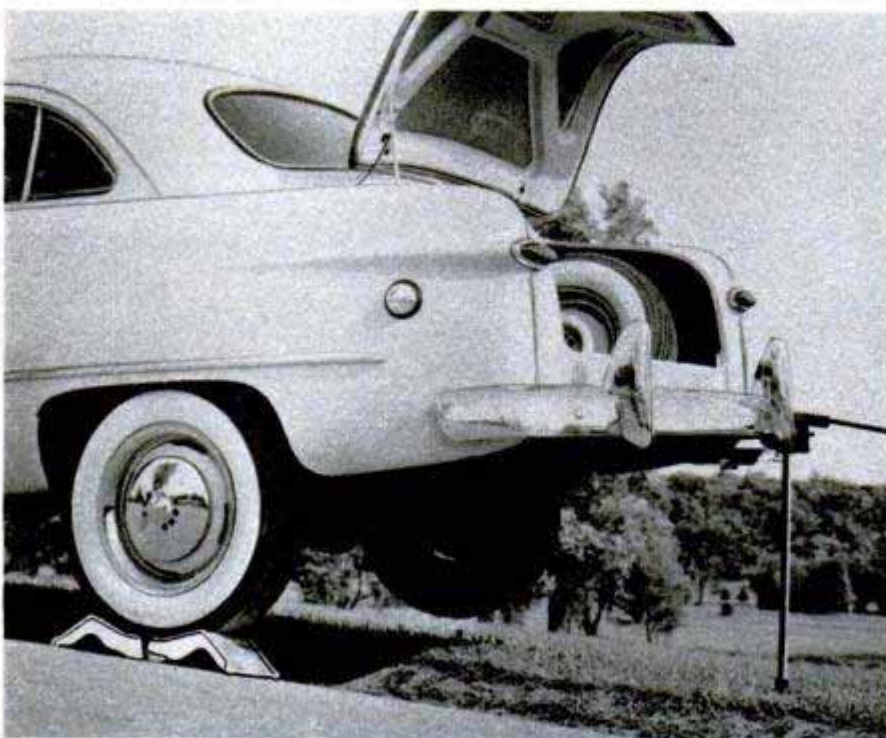

### Wheel-Block "Cradle" Folds for Storage

Your car won't roll off the jack right in the middle of a tire-changing operation when it's held immobile by a folding block that prevents movement in either direction. With one wheel rolled into the cast-aluminum "cradle," the car can't move even when a bumper jack is used. Hinged in the middle, the block folds for storage in the trunk.

☐ Chiggerproof cloth, developed by the Department of Agriculture, has remained deadly to chiggers after seven washings.

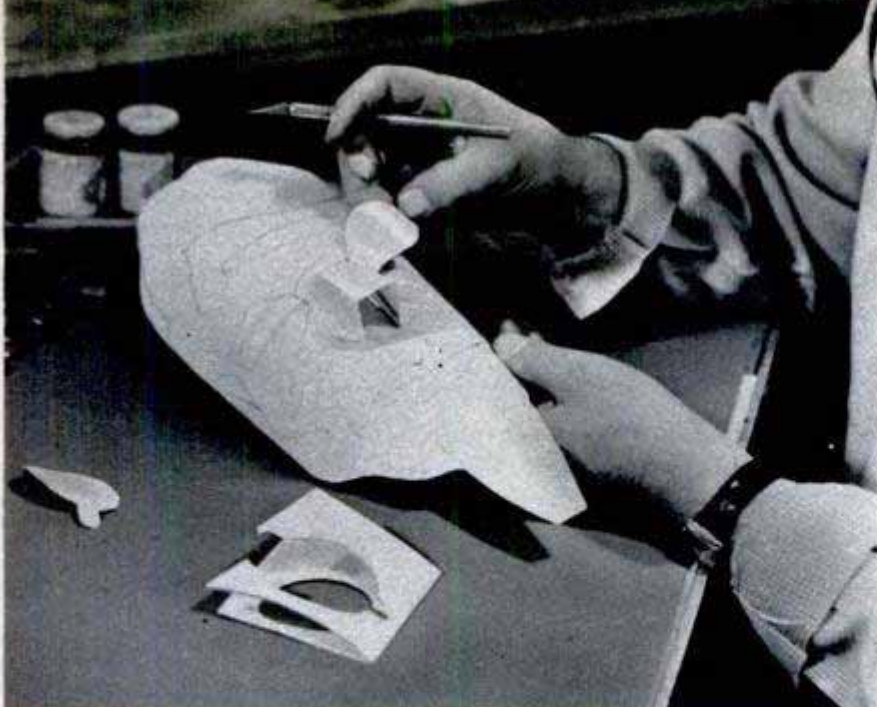

## PAPER PERSONALITIES

JACK EISNER, New York toy and game designer, makes caricatures of famous persons out of twisted pieces of paper and such odd accessories as ping-pong balls for muscles, pearls for eyes, pipe cleaners for mustaches, small wood balls for noses (such as is worn in the Thomas E. Dewey caricature, top right), bits of wire and scraps of wood. His working tools are shears, sharp knives, cellulose cement and an airbrush for coloring. Lincoln's dark hair and beard (right) are products of the airbrush. Eisner is shown using the airbrush below to bring color to the eyes of his caricature of Uncle Sam. The airbrush also made Uncle Sam's wrinkles. Eisner first sketches an outline of his subject, then cuts out separate features and pastes them (top left) in position. Sometimes he mixes the materials. The hair of Edward G. Robinson, movie tough guy (lower right) was made of part paper, part cord. The "ruby" stickpin is a red reflector button.

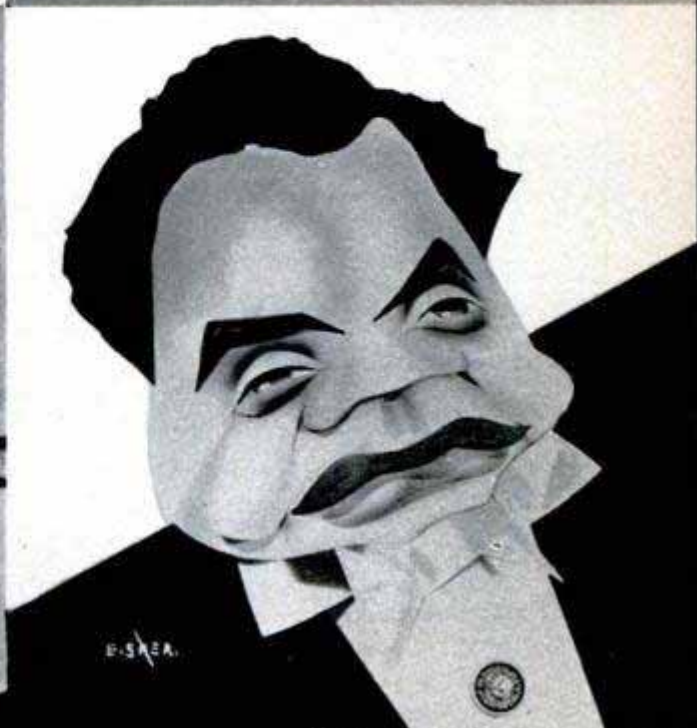
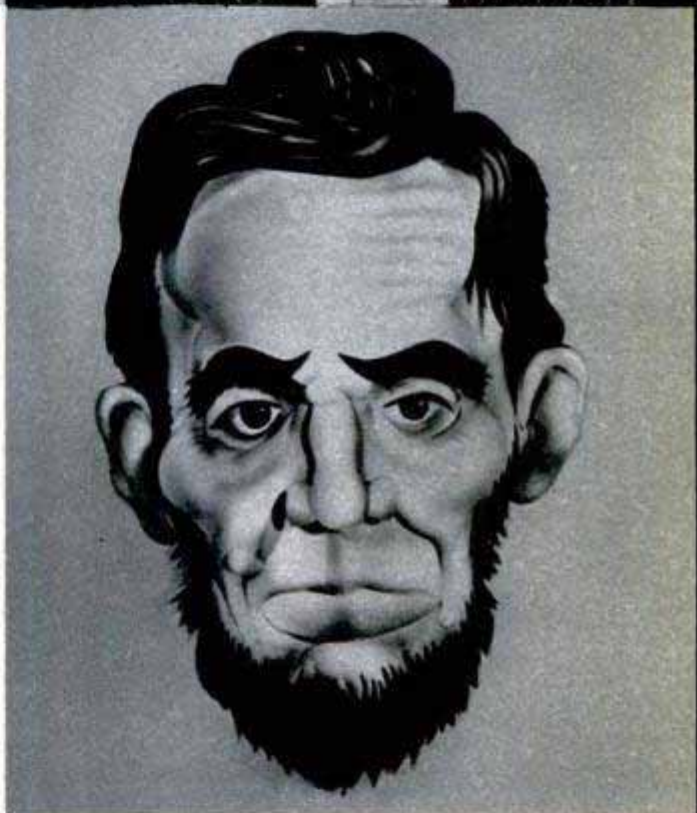

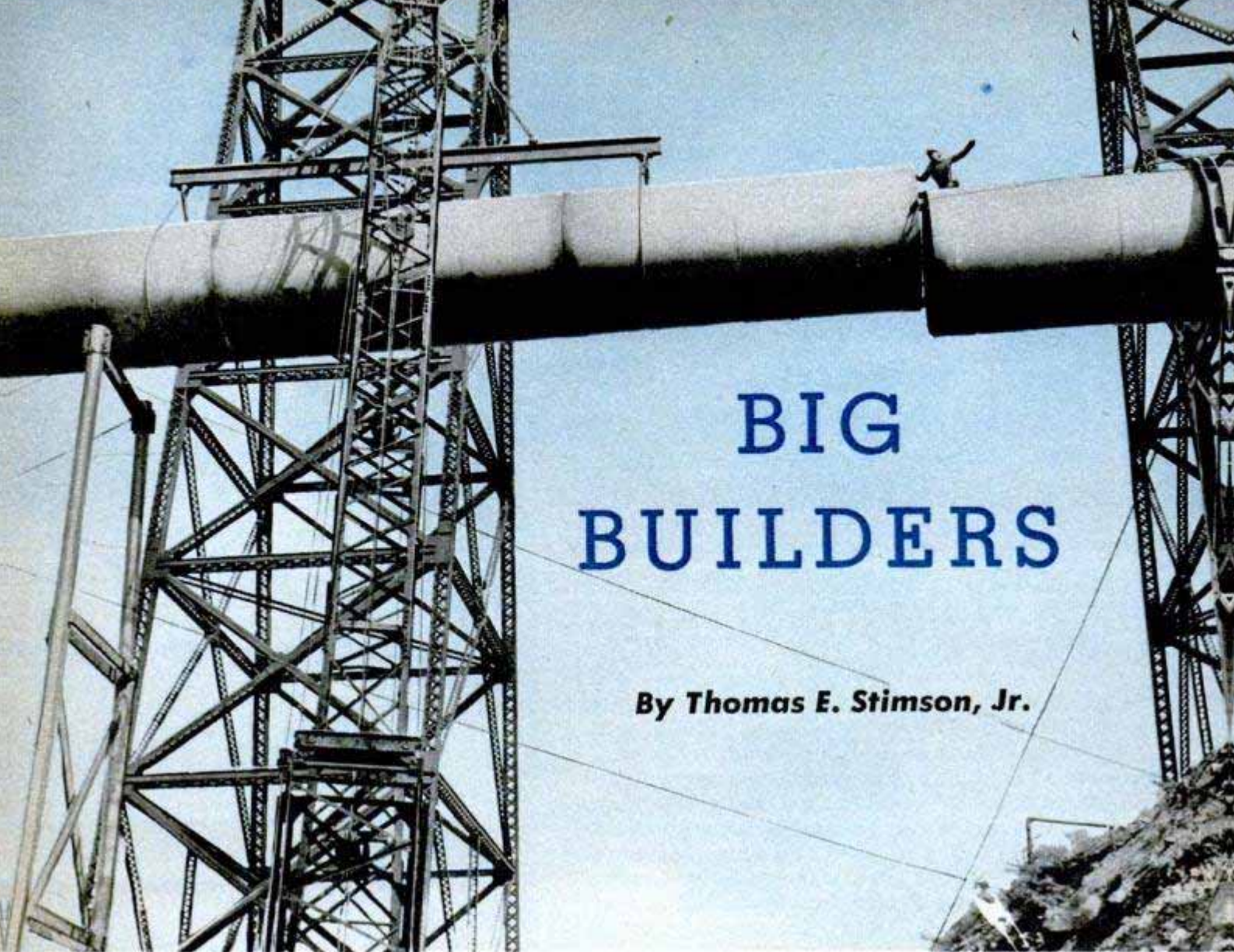

# BIG BUILDERS

By Thomas E. Stimson, Jr.

Two sections of eight-foot pipe slip into place. Giant pipe line will carry irrigation water across a canyon

**H**ELP WANTED — *Young engineers, draftsmen, welders, mechanics, to work in Afghanistan, Alaska, Brazil, China. Top wages, room and board. Transportation furnished.*

That's a composite of the advertisements recently carried in some newspapers. American contracting companies are busy around the globe, putting up dams and bridges and laying out roads and pipe lines

that will help raise foreign standards of living to the levels we know. Yankee construction engineers are the great builders of the century.

Today thousands of young Americans, living in temporary construction towns in the Middle East, are erecting big oil refineries and digging in pipe lines. In Afghanistan they are creating reservoirs and irrigation systems that will make that country blossom. Recently in Brazil, while relocating a railroad that will tap a mountain of metallic iron, they fought "phantom swamps" that seemed to have no bottom, swamps that swallowed entire trainloads of roadbed material. They are building or preparing to build great concrete dams in India and China and they are erecting modern steel bridges across rivers that never were tamed before.

Up in Alaska they are reconstructing the world's most northerly railroad that runs from Seward to Fairbanks, and in Mexico they are draining swamps and

No eight-hour shift for an M-K pavement roller. Fitted with two giant floodlights, it works around the clock





building high schools. In the Philippines, in Iran, in Venezuela, they are on the job.

It's no trick to build anything if there's no limit on time or money. That's the way the pyramids were built. The American specialty is to guarantee that a project—no matter how big—will be completed according to plans and specifications on a certain date for a certain amount of money. Often the American invents big machines to do much of the work, or devises unique construction methods to fit the job. Then he enters a bid that is so low his competitors are amazed.

Modern king-sized construction methods really got their start in 1931 when Harry W. Morrison, an Idaho contractor who specialized in railroad construction, realized that no one man or organization had the know-how or money to handle some of the stupendous projects that were being planned.

The Bureau of Reclamation was asking for bids on Hoover Dam and Morrison, like a lot of other contractors, wanted a crack at it. The job was too big for any one company he knew so he brought together a group including Henry Kaiser,

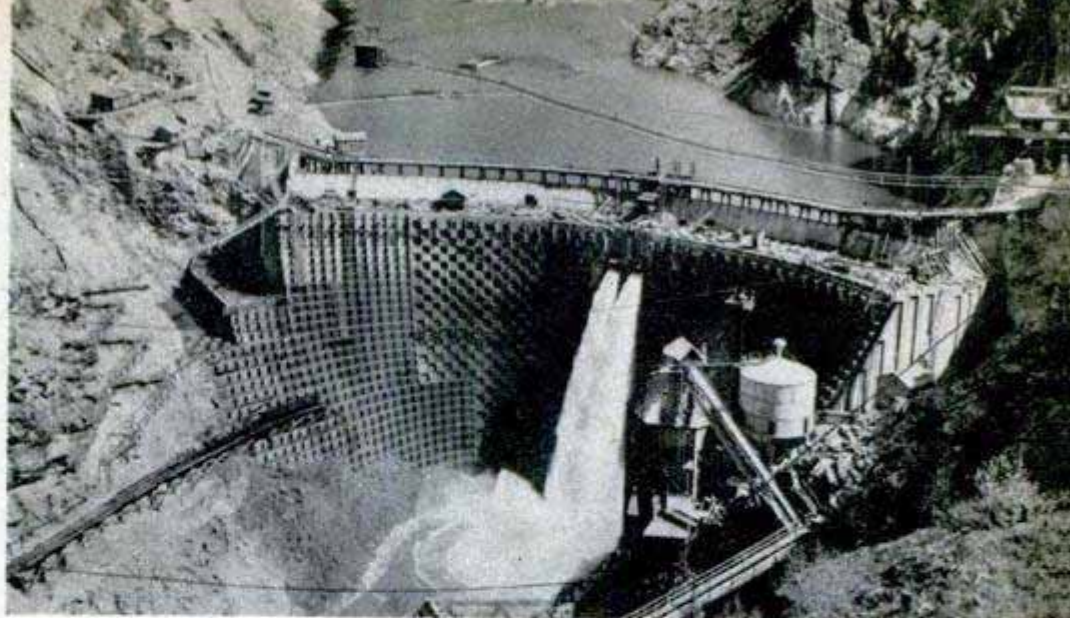

Designers must look into future. Waffled face of 540-foot Ross Dam, built by M-K Company in Washington, will be concrete bond if dam is enlarged

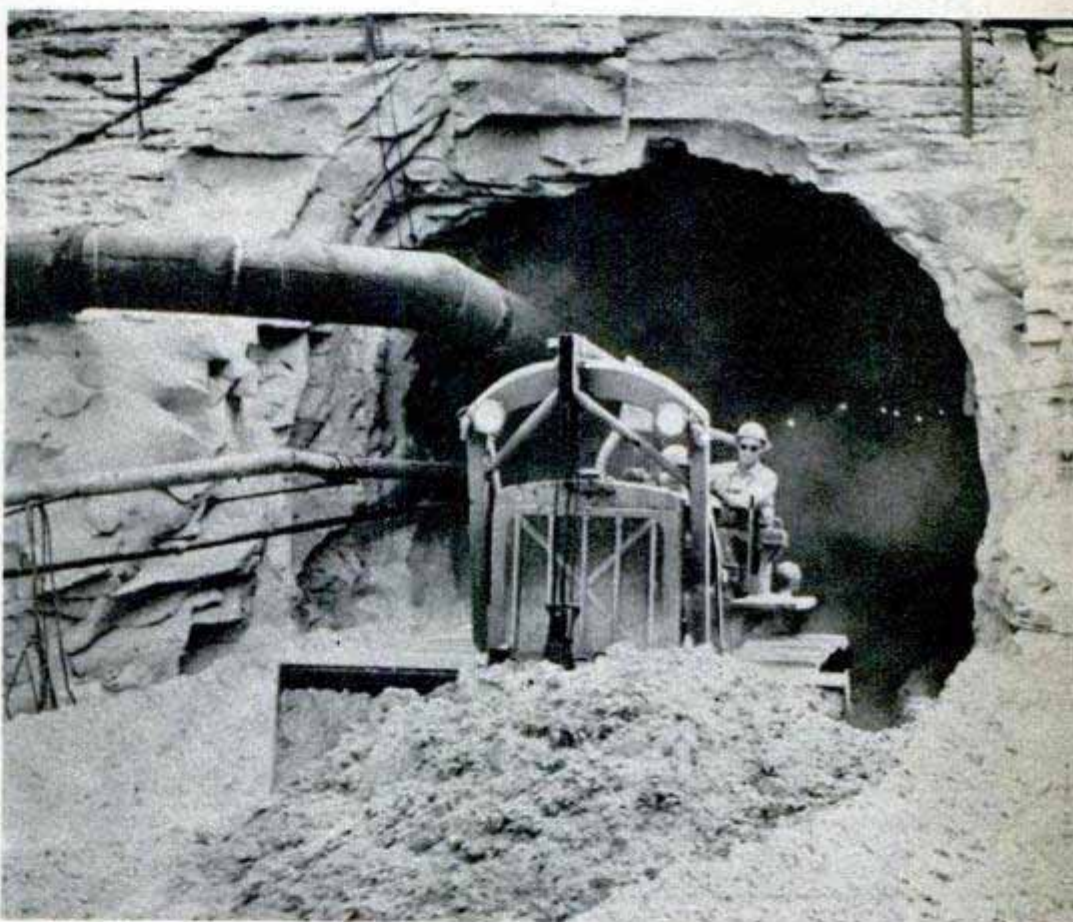

† Bulldozer pushes earth from a long tunnel which will hold fortifications designed to test the Army's experimental bombs and guided missiles

↓ Stretching beyond the horizon is the Southern Pacific's 12-mile trestle across Great Salt Lake. M-K Company rebuilt it with new piles 140 feet long

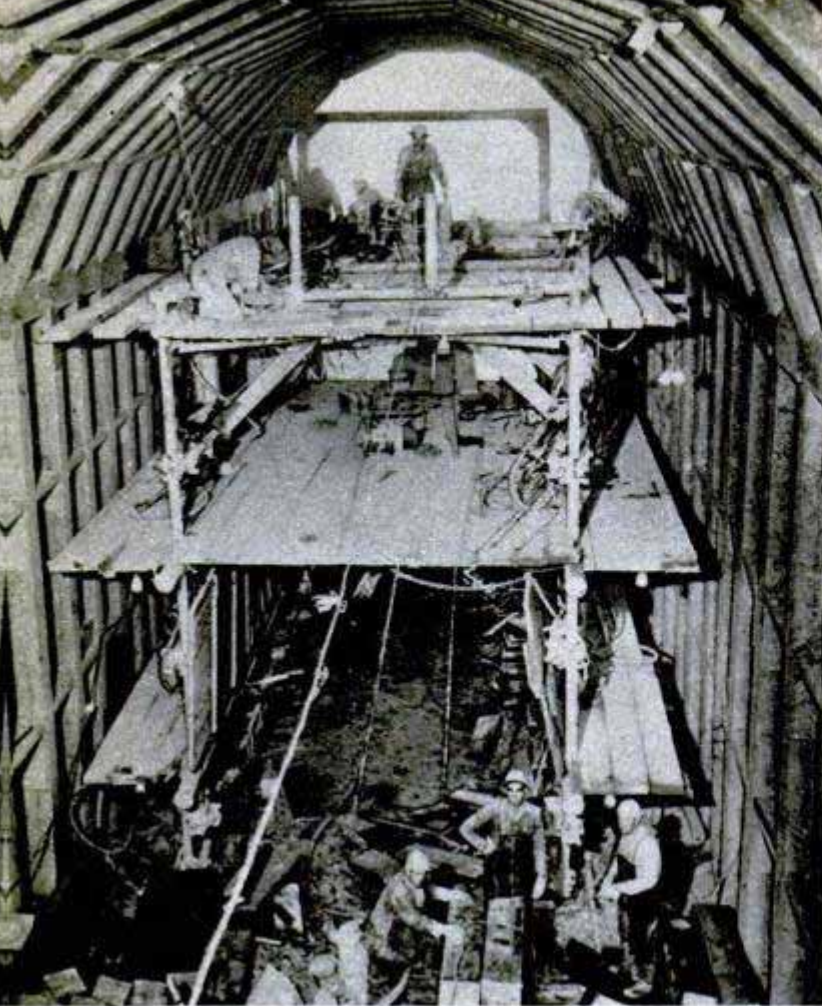

M-K "molemen" work from a three-story scaffold in setting timbers for a tunnel through a mountain. Below, five-mile freeway under construction along ocean near 'Frisco will cost a million dollars a mile

W. A. Bechtel, McDonald & Kahn, The Utah Construction Company and the Morrison-Knudsen Company. Calling itself Six Companies, Inc., the group made a successful bid on Hoover and built it in record time, then went on to handle Bonneville Dam, part of Grand Coulee Dam, and a portion of the San Francisco Bay bridge. The four construction contracts totaled 118 million dollars.

The Six Companies created the modern formula for successful large-scale construction: assemble a group of concerns, each of which is skilled in a particular branch of construction, and then let each use its talents on a particular part of the job. The group is temporary, united possibly for the one big job. Often some of its members participate in other alliances at the same time and compete against each other for other contracts.

Morrison's knack in dovetailing just the right companies into construction groups has helped make the Morrison-Knudsen Company one of the greatest, if not actually the greatest, construction outfits in history. Today the company's headquarters in Boise, Idaho, supervises construction on a worldwide basis. Instead of performing one job at a time, it often has scores under way simultaneously. To keep track of all these projects, the company publishes a



new "directory of operations" every 30 days. On some projects it acts as prime contractor, on others it engages on a joint-venture basis with other contractors, on still others it may operate as part owner of the company that is to do the work.

This complicated setup helps the company maintain a large volume of work, which in turn allows it to send experts in tunneling or hard-rock blasting, for example, to the particular jobs that need their special talents. Too, it helps keep large, expensive units of equipment busy all the time.

In all, Morrison-Knudsen's record of performance approaches two billion dollars. Aside from a dozen or so power lines, canals, tunnels and railroad contracts that look like small change by comparison, the company today is engaged on a joint-venture basis in about a dozen major projects.

One of these is the 43-million-dollar Hungry Horse Dam in Montana; another is the 22-million-dollar Bull Shoals Dam on the White River in Arkansas; a third consists of miscellaneous Pacific Ocean operations that include huge military construction on Guam, a project that by itself has employed as many as 6500 men at one time. It was an M-K construction crew of 1254 men, incidentally, that was marooned at Wake Island at the start of the



M-K plane at Seattle, part of a private "airlift," takes on equipment parts urgently needed in Alaska



Sketch of Hungry Horse Dam, being built in Montana. It will contain three million cubic yards of concrete. Below, earthmovers peeled back the earth's surface in digging this 200-foot pit which exposes vein of coal



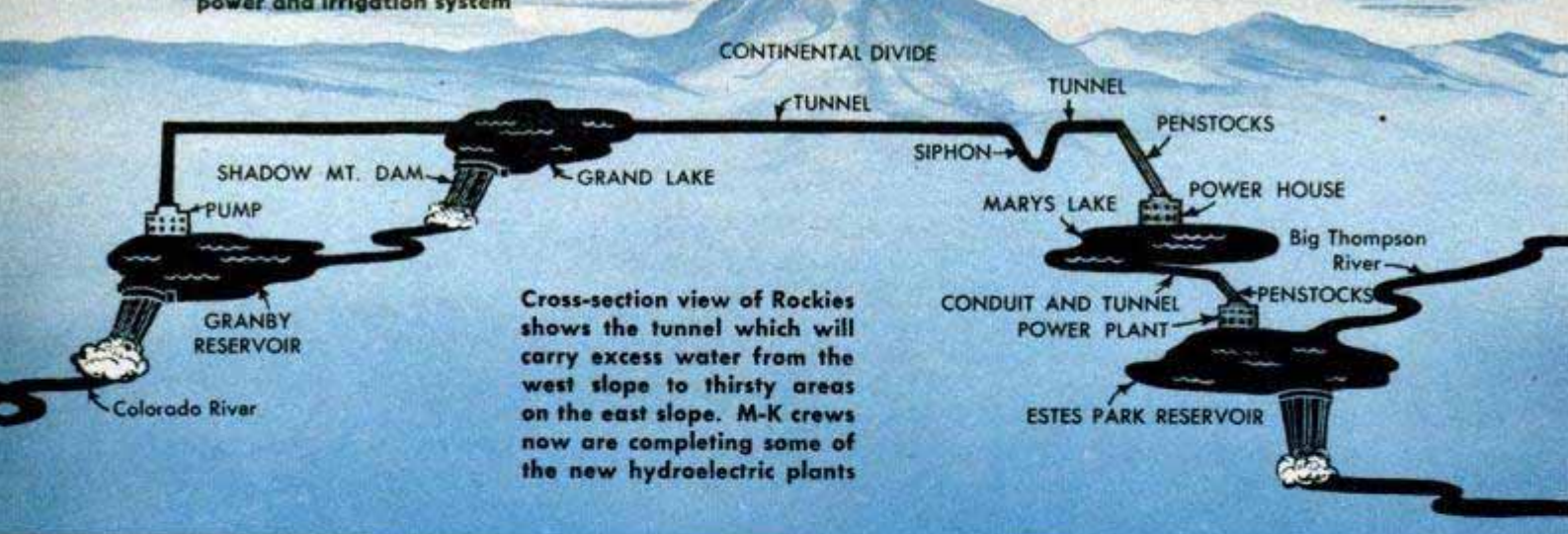

Cross-section view of Rockies shows the tunnel which will carry excess water from the west slope to thirsty areas on the east slope. M-K crews now are completing some of the new hydroelectric plants



Rail cars are shipped to China to rebuild railway



Anchorage, Alaska, needed additional power so M-K engineers moved section of broken tanker into place and used ship's engine to generate electricity. Below, this 1500-bed hospital was built in Honolulu



war and captured there by the Japanese.

In Colorado and Utah the company is building underground blockhouses and similar fortlike structures, some buried under mountains, that will be used by the Army to determine penetration characteristics of some of its new experimental bombs and guided missiles.

Opposite St. Louis the company has a hand in building the huge Locks No. 27 that will permit safe navigation of the Mississippi all the way from New Orleans to Minneapolis and St. Paul, a river distance of some 1100 miles. The 1200-foot locks plus eight miles of canal will cost nearly 17 million and will allow water traffic to detour around the treacherous Chain of Rocks Reach, the last big obstacle to upper-river navigation.

M-K forces and others are completing a series of hydroelectric plants in Colorado as part of the government's 130-million-dollar Colorado-Big Thompson project. This ingenious scheme will take water from the upper Colorado on the west slope of the Rockies and bring it east under the Continental Divide by means of a tunnel so that the water can irrigate parched areas east of the mountains.

In North Dakota, Morrison-Knudsen and Peter Kiewit Son's Company of Omaha are building a brand-new seven-million-dollar city to be known as Riverdale. Complete from brick office buildings and frame residences to paved streets and public utilities, the city will require two years to build and will serve as headquarters for workers who will build Garrison Dam.

M-K has a hand in the construction of Davis Dam, 67 miles downstream from Hoover Dam on the lower Colorado. Davis is a vast earth-and-rock embankment, 140 feet tall, containing 3,500,000 cubic yards of selected materials. The concrete that is going into the facings, spillway and other special portions of the structure is mixed with chilled water. River water that goes

(Continued to page 242)

## "Knee Action" Plow Rides Over Rocks and Stumps

Stumps and rocks can't damage a disk plow imported from Australia by the U. S. Forest Service. The implement is under test for killing sagebrush on great stretches of western land to be cleared for range or farming. Conventional plows have not been satisfactory for this work because they are rigid and therefore easily damaged by stumps and rocks. The Australian plow has disks mounted in pairs on spring-controlled arms. When the disks strike a rock or stump they ride up and over the obstacle to enter the ground again on the other side. Each pair of disks can be raised 12 inches without affecting the other disks. The depth of

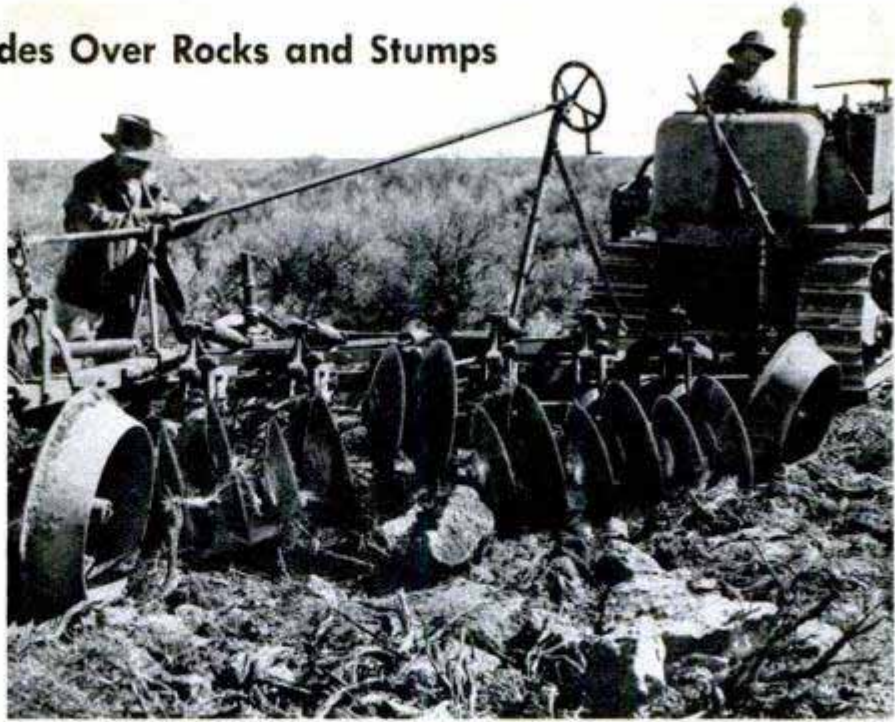

Bureau of Reclamation photo

cut can be adjusted up to seven inches and the width of cut from six feet four inches to seven feet six inches.

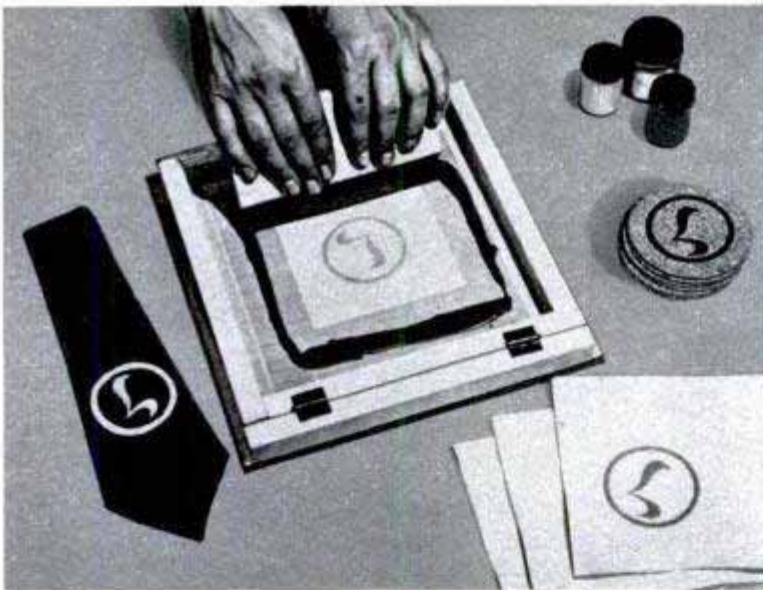

## Silk-Screen Printing Outfit

Personal monograms and designs can be stenciled on stationery, drapes, neckties and other articles with a silk-screen painting set. Included in the set are a stencil sheet, four jars of coloring, a stencil knife, paint paddle, silk-screen frame, squeegee and alphabet guide. After the stencil has been mounted on the screen, the paint is applied and the squeegee drawn across the surface to transfer the design to the object that is being decorated. The same stencil can be used thousands of times for making smooth and neat impressions.

## Wire-Fence Stretcher Has Tension Indicator

Wire fences go up faster and with the proper tension when a wire stretcher that attaches to a tractor, truck or automobile is used. The stretcher has a calibrated scale that shows the amount of pull, enabling the operator to put the same tension on each wire. Two models are available. One handles single strands of smooth or barbed wire and the other is a combination stretcher for use on both field fencing and single strands. The evener is adjustable for standard widths of field fence.



Television camera on carrier's "island" grinds as fighter plane prepares for take-off. Program showed complete naval air battle. Diagram below shows how it was relayed to the RCA Building in New York for rebroadcast

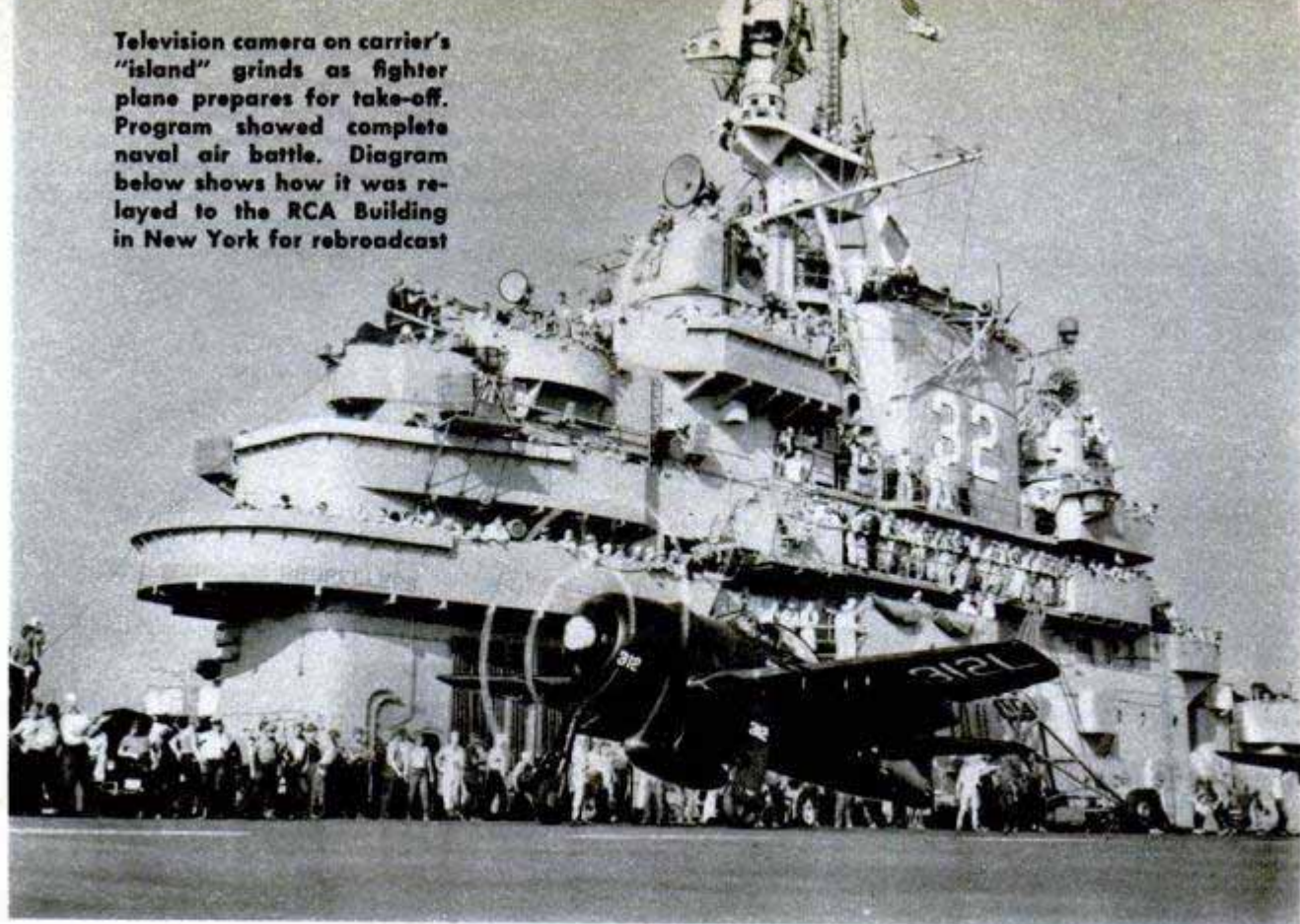

## ship-to-shore

# TELEVISION

Video fans, seated comfortably at home, are witnesses of a distant naval battle. It's a dramatic experiment that may foreshadow the use of TV in odd jobs from tracing guided missiles to docking giant ships

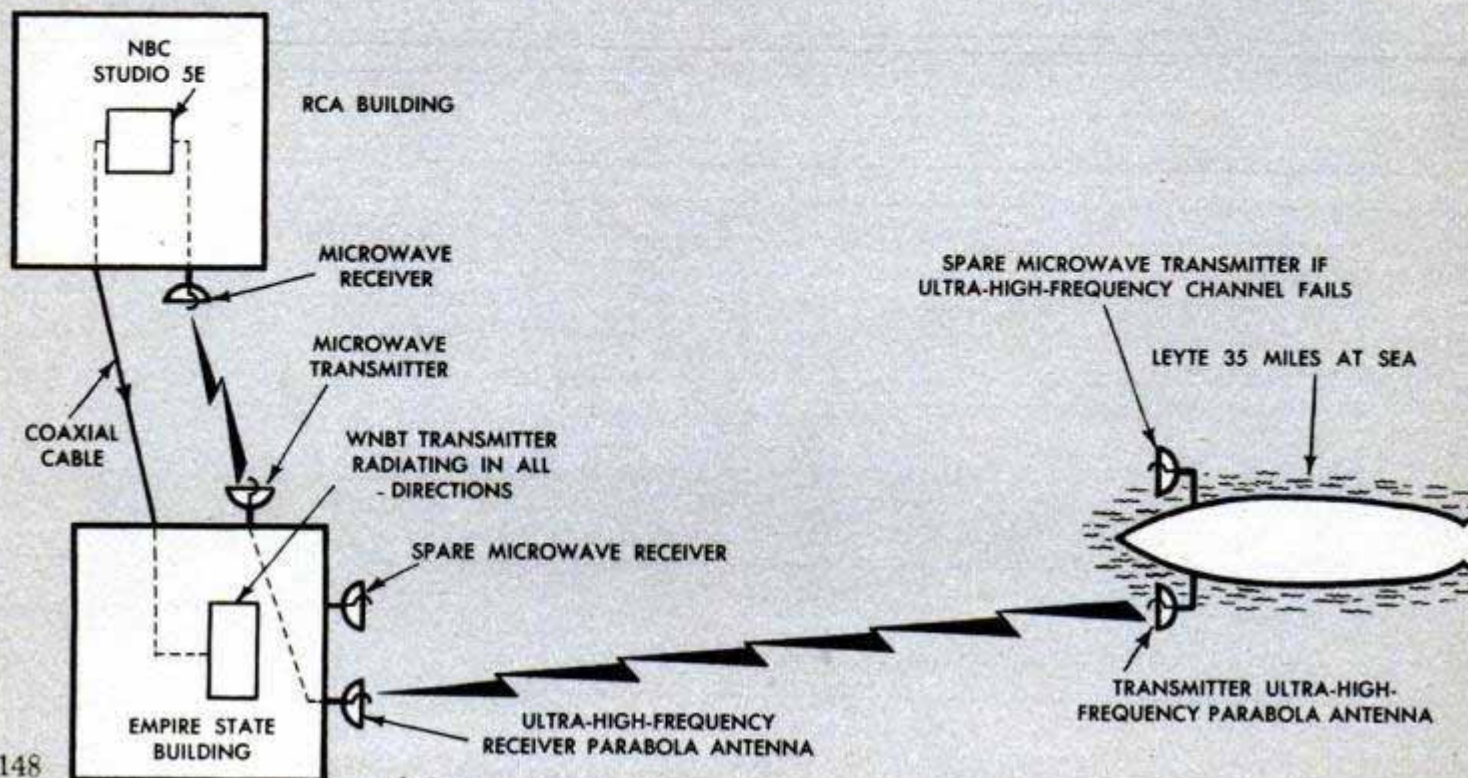

**T**ELEVISION, already land-based and airborne, now has gone to sea and is under consideration as an ally in naval combat and intelligence.

From the carrier *Leyte*, cruising in the Atlantic off Long Island, the National Broadcasting Company, in cooperation with the Navy, has brought into thousands of video-equipped Eastern homes an eye-witness drama of landings, take-offs and "attack" from the sky.

The broadcast has been described as the most difficult telecast ever accomplished. The major problem was to hit a parabolic antenna atop the Empire State Building with the narrow ultra-high-frequency video beam from a

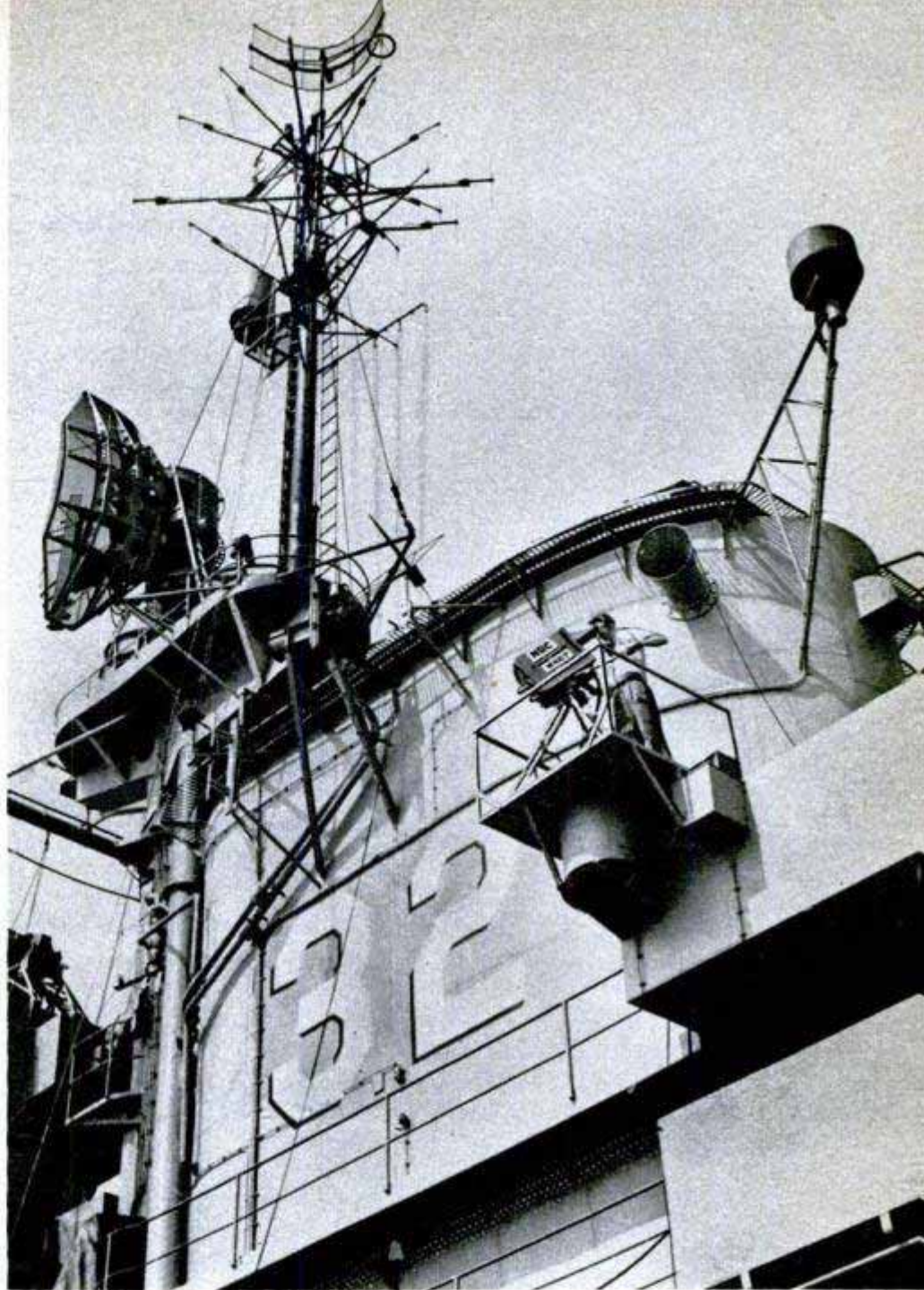
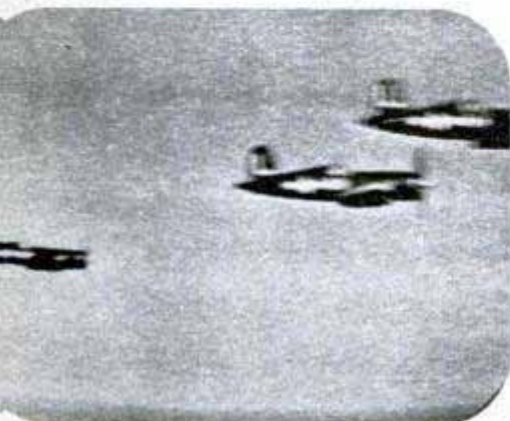

↑ Perched high on the superstructure, a cameraman catches the action on the flight deck. Below, most dangerous spot for the camera was on the edge of the flight deck. Cameraman wears life jacket in case he has to go over the side to escape a careening plane. Left, these photographs show that the program was relatively free from distortion as it was picked up by video receiver in New York

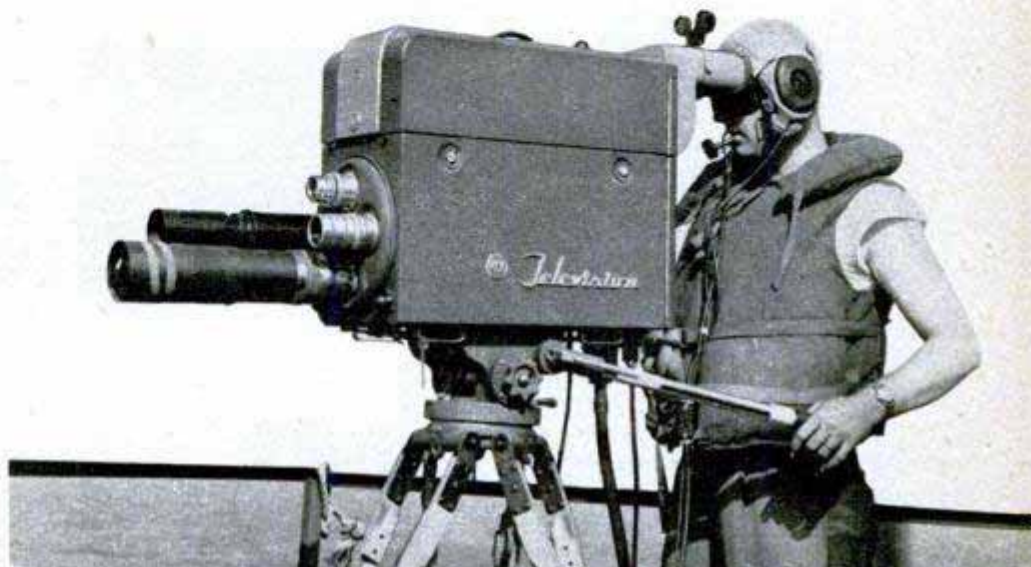

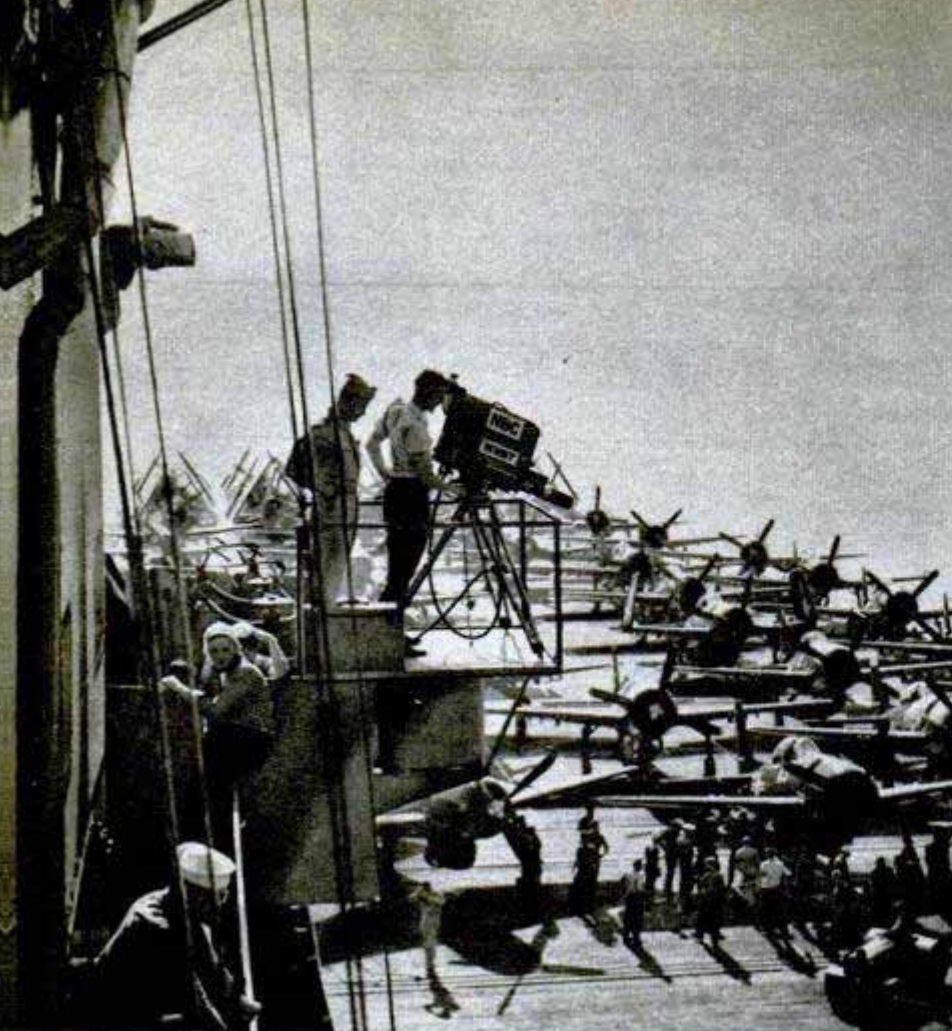

Cameraman focuses on the action below as planes are towed into position for the take-off during the telecast of the air battle. Portable transmitter, used in sending the pictures, is taken aboard carrier. Recently designed, it weighs only 130 pounds.

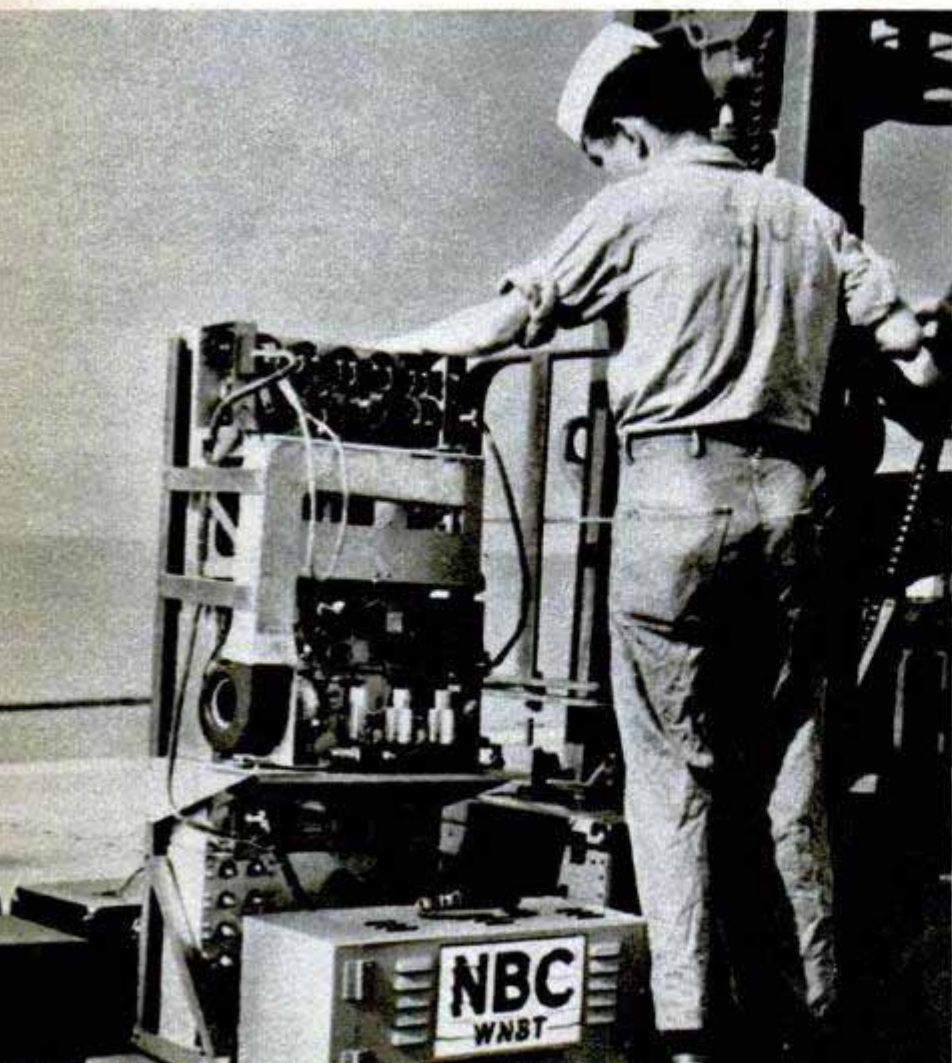

zigzagging ship 26 miles away. This was accomplished by installing the transmitter on the Leyte's search radar tower, which can be mechanically "homed" on a target by an electronic device which adjusts for such factors as the ship's speed, position and the wind.

The video signal was beamed via microwave transmitter from the Empire State Building to the NBC studios, where it was "mixed" with the audio signal. The latter had been sent via short-wave radio from the ship to receivers at Riverhead, Long Island, relayed by wire almost 100 miles to lower Manhattan and then to the RCA Building. The program was piped to the Empire State Building for transmission.

Two cameras on the carrier's "island" and one extending precariously over the water from the edge of the flight deck covered the 100 planes in the "battle" from warm-up, through take-off and maneuvers, to landing. A fourth camera, in the briefing room, showed the pilots receiving final instructions.

Navy spokesmen foresaw a number of possible uses for TV, both in combat and intelligence work. A video-equipped guided missile could send back a continuous picture of the terrain over which it was passing and, in its final seconds, show the target. Pilotless planes on reconnaissance could send back graphic information even when they failed to return. Television might also serve to reproduce instantaneously in various parts of a ship the chart board, and could be of help in docking large vessels.

It is conceivable that at some future time sea battles might be telecast for the benefit of high-ranking officers not at the scene or even for the general public. In the event any great distance was involved a scheme of airborne relay links, such as stratovision, might be employed. In any use of TV it is possible to make a permanent record on film via the kinescope recorder.

A succinct reaction to television was expressed by Rear Admiral Ralph Jennings, commander of Carrier Division 4, who said, "Radar shows where it is; television will show what it is."



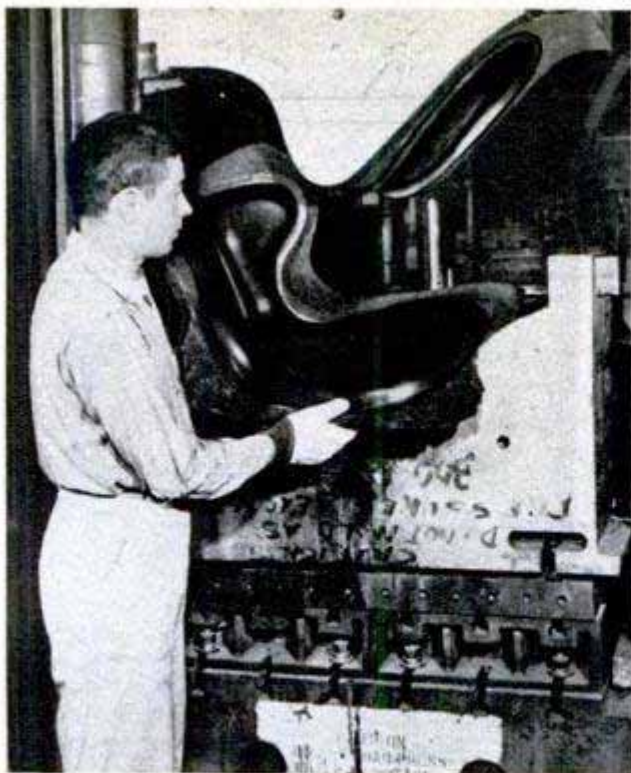

## Plastic Chair Can Be Given Any Kind of Undercarriage

Chairs with the seat and back molded from a single sheet of plastic can be mounted on any type of undercarriage from a swivel to a standard four-legged construction. The one-piece chair was designed after an analysis of the sitting postures of

hundreds of persons. A sheet of plastic-impregnated sisal is placed in a 500-ton compression mold to form the chair, which weighs about seven pounds. The plastic is impervious to moisture and some chemicals and is not scarred by cigarette burns.



## New Spindle Holes for Records

Enlarged holes in phonograph records are repaired with a kit that cuts out the center of the record and replaces it with a washerlike insert containing a new spindle hole. The kit includes a cutting tool that, when heated, burns through the center of the record leaving a clean hole into which the replacement insert is pressed. New label blanks are provided to be pasted on the record after the center insert has been installed.

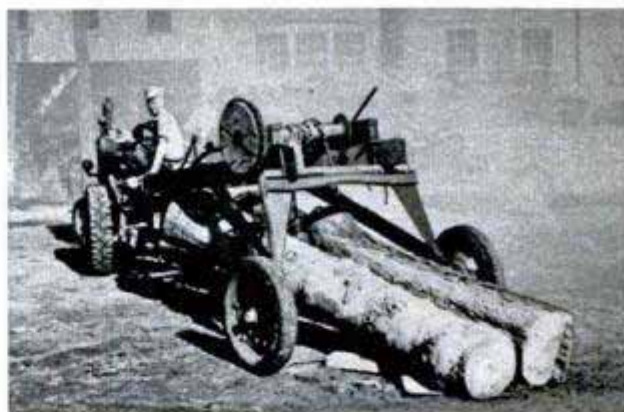

## Ancient Log Carrier Goes Modern

More than 75 years old, a log-lifting mechanism is back in service with a new chassis that is pulled by a tractor instead of a team of oxen or horses. John Moeke of Zeeland, Mich., rebuilt the log carrier, replacing the six-foot wheels and their wooden axle with auto wheels and an arched steel axle. The lifting mechanism was in operating condition and was retained. Now he uses the vehicle to haul logs from the Michigan forests.

☐ Average car speed on main rural roads was 46.8 miles an hour in 1947, according to a U. S. Public Roads Administration report.



# two- hour house

While members of a family take in a movie—even a single feature—a crew of workmen can erect a complete house on their vacant lot. Factory-built in seven sections, the house is erected merely by fastening the sections together. Above, one of the sections is lifted with a crane from a truck to the foundation

Right, a second section is moved into place. It will be anchored to the foundation and welded to the other factory-made room units



← Completed house, ready for occupancy two hours after trucks rolled up with the sections, has three bedrooms, a living-dining room, kitchen, bath, utility room and closets. Made of steel sheathed with aluminum on the outside, it is listed at \$8950

↓ Interior is roomy and has floor-to-ceiling windows. The house has been given a Class-A report by the Federal Housing Administration. Below left, plan shows room arrangement for maximum utility

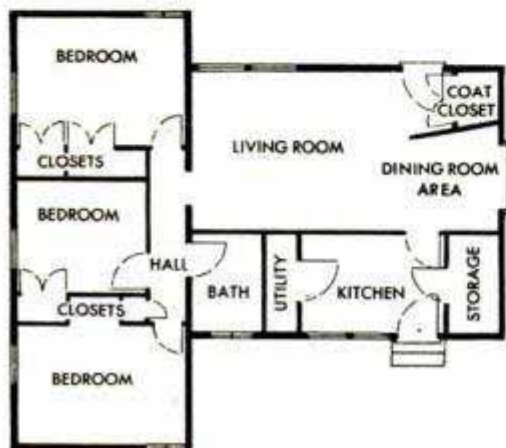



## Pygmy Cadillac Has Scooter Engine

Proudest boy in Montevideo, Uruguay, is six-year-old James N. Miller, Jr., who owns a convertible identical to his father's Cadillac except in size. The car, half the size of the real Cadillac, was built by Jose Latouskas, who works in the garage owned by James' father. A motor scooter and its engine serve as the chassis. Shock absorbers from a 1942 Chevrolet provide front-wheel suspension and coil springs were made for all four wheels. The sheet metal for the body was formed by hand, and white fog lamps serve as headlights. The steering-gear mechanism is from a Crosley car. The seat is adjustable for either a child or an adult and is upholstered in red leather. The midget car has a top speed of 45 miles an hour and cost about \$1500, including labor.



Top left, the engine and chassis are from a motor scooter. The miniature Cadillac has a chain drive. Top, the car is identical to the hub caps with a real Cadillac. Above, seat is adjustable for either child or adult

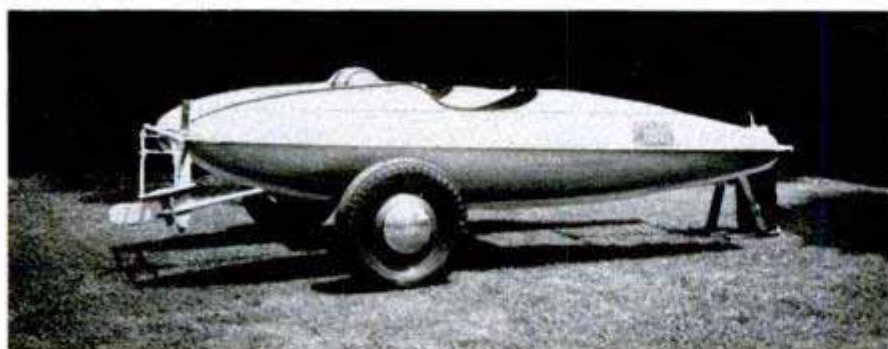

## Gas-Tank Boat Travels 10 M.P.H.

Constructed from two surplus aircraft belly tanks, a boat built by Bunny V. Ronco of Allentown, Pa., travels 10 miles an hour and draws only three inches of water. The boat seats two and is driven by a seven-horsepower, two-cylinder engine mounted between the two tanks. Bulkheads have been placed fore and aft of the passenger compartments, making the craft virtually unsinkable. Out of the water, the boat is easily transported on a two-wheel trailer.

☐ Directly or indirectly, it takes between 15 and 30 tons of water to produce a pound of beef.

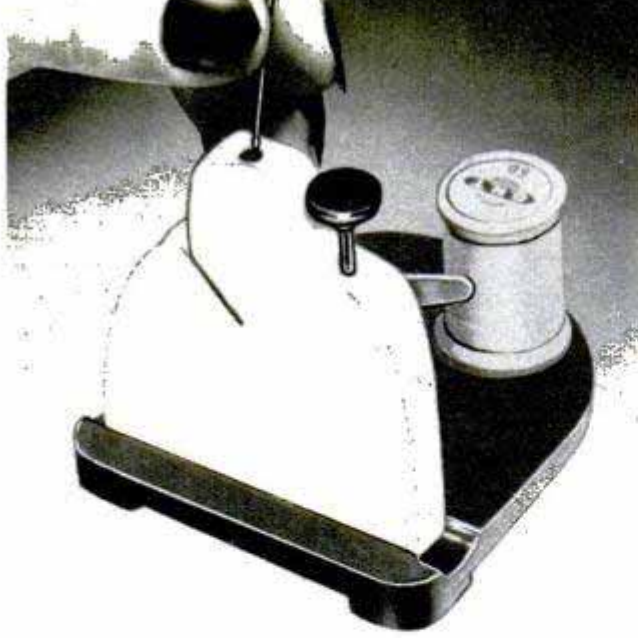

**NEEDLE THREADER** never misses! Push the button and the job's done. It even has a built-in scissors



**ALUMINUM AWNING** can be made to fit any width. You assemble six-inch sections on the job (below)

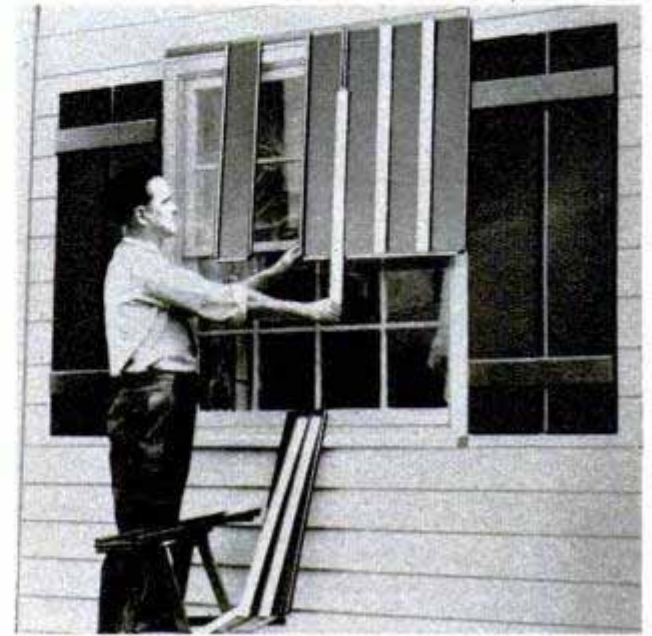

# WHAT'S NEW *For Your Home*

**HEATED SERVING TABLE** eliminates repeated trips to the kitchen. Food is kept hot during meal by electrically heated glass top. A thermostat keeps glass at 200 degrees when the cord is plugged into any outlet



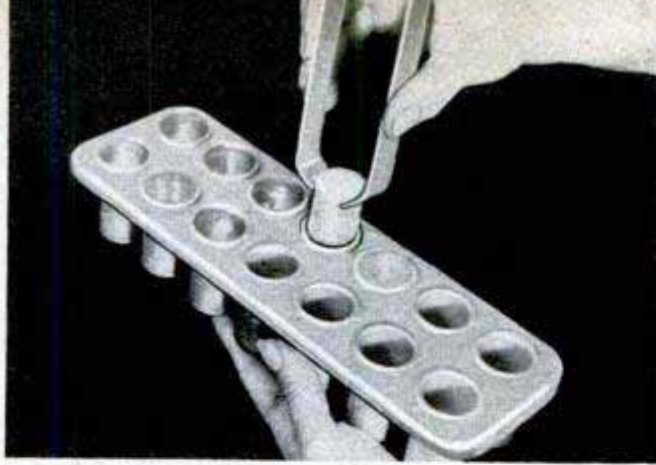

**ROUND ICE "CUBES"** for picnickers slip inside a Thermos bottle intact. The tray fits any refrigerator

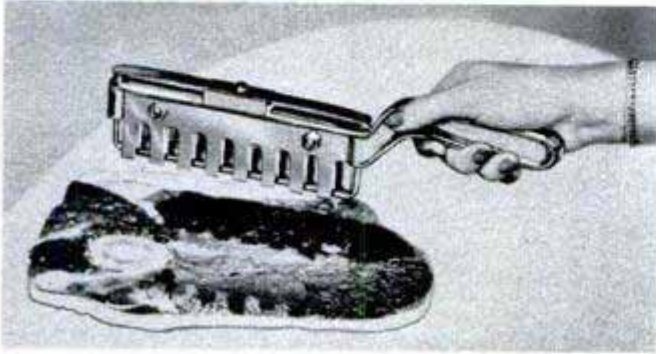

**STEAK TENDERIZER** has 16 blades that cut sinews without splatter of juices. Guard limits depth of cut

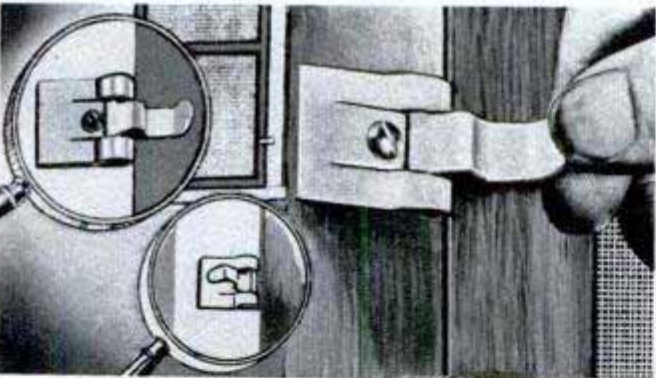

**DISPOSABLE BOTTLE** for baby is made of soft plastic. Below, covers keep the nipples germ-free

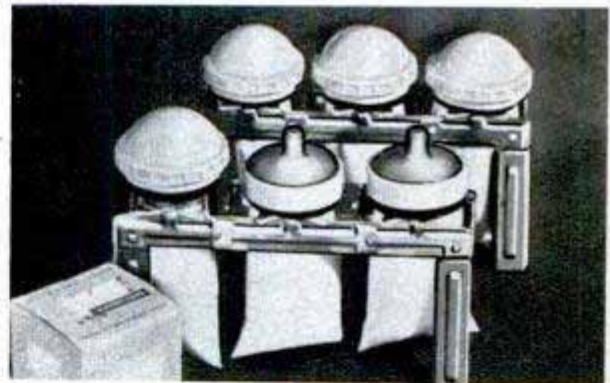

**FASTENER**, above left, holds screens and storm windows in place by the spring action of snap lever. Four of the fasteners are used per window

**IRONING BOARD** at right adjusts to any of 18 heights so the housewife can do her ironing standing or sitting. The sleeve board is movable too

**SMOKERS' AID** at left has an electric lighter that goes on automatically when it is lifted. The stand has an onyx base for use as a night light



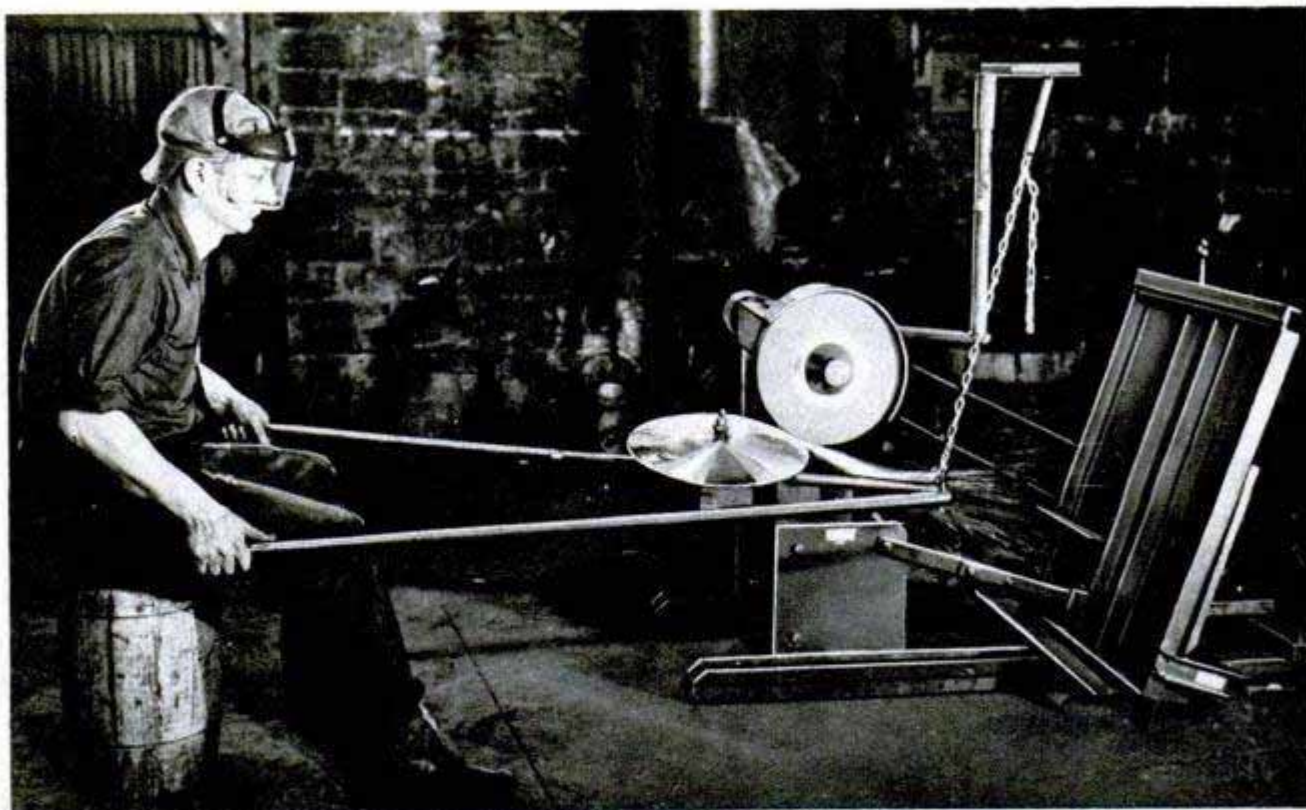

## Versatile Tool for Farm Use Sharpens Plow or Saws Wood

Several attachments can be fitted to a versatile power tool to make it an entire farm workshop. The primary part of the tool is an arbor powered by a two-horsepower electric motor, a five-horsepower gasoline engine or a tractor pulley. With a grinding attachment, sickles, scythes, plow points and hay-chopper blades can be sharpened at any bevel. Another attachment enables the farmer to grind and polish disk blades with uniform sharpeners around the circumference. Still another includes a saw table, which swings backward when not in use, and a circular saw. A 30-inch saw and table handles 12-inch material for cordwood sawing.

Top, grinding a disk blade on versatile farm tool. The blade revolves as it is ground. Right, ripping lumber. Saw table swings out of way when not in use



## Standardized Spot-Welding Guns Use Interchangeable Parts

With a single basic spot-welding gun chassis, 57,600 variations for specialized uses are made possible by the use of interchangeable jaw extensions and standard electrodes. According to the manufacturer, this standardization of basic parts permits the user to take care of 95 percent of all welding requirements with seven basic gun types. It also cuts maintenance time and cost by permitting the operator to replace worn or broken parts with standardized units. Any standardized gun can be con-

verted for a different job simply by changing one or two parts. Previously, gun designs were "tailor made" to fit the job. This meant high production costs. The new line will not only reduce costs, but also speed production, the manufacturer claims.

ⒾNinety percent of all cities and towns having local passenger transportation systems are served by busses only, according to a recent report of the Automobile Manufacturers Association.

**FIRST HELICOPTER** designed → specifically for agricultural and industrial work carries a pilot and two persons or equivalent load 235 miles at 75 miles an hour. All nonessential parts are eliminated to boost the pay load. It is engineered for use in aerial spraying, oil exploration and timber survey

**PROPELLERS** with square tips, below right, are wider and absorb more power than narrow blades. Installed on Western Airlines Convairs, they are reversible. "Orange peel" cowling exposes the entire engine within few seconds

↓ **STAIRWAY** on same plane is self-contained, saving passengers time and the airlines money. It operates hydraulically but pilot can also pivot it down manually



↓ **FIRST JET-PROPELLED AIRLINER** has been tested in England. The plane made a 200-mile flight from London to Paris in 37 minutes, hitting a top speed of 415 miles an hour. The two jets develop 20,000 horsepower



# Pets in Predicaments



Animal-rescue worker and puppy emerge from an eight-foot hole which almost became a deathtrap for the dog. The boy, playing in vicinity, called rescue agency when he heard the faint barks of the trapped puppy

**C**HASING a kitten for 10 blocks inside a sewer pipe or inching along the eaves of a tall building toward a trapped pigeon may be high on your list of undesirable occupations, but to some men and women these chores are part of a job they wouldn't swap for the softest berth in the world!

These hard-working people are the rescue experts of animal-welfare agencies who frequently risk their lives getting pets out of predicaments. Every large city has

By Arthur R. Railton

at least one such organization and its staff members are as devoted to their work as any doctor or social worker. They are called upon to climb trees like lumberjacks, crawl into smoke-filled rooms like firemen and to treat injured animals like veterinarians. At times they have to be as patient as the cats they rescue or as surefooted and nimble as mountain goats.

To the animal-rescue worker there's one cardinal rule: Don't let the animal suffer

Coastguardsmen come to the rescue of a dog that struggled for 45 minutes in icy water of the Chicago River





unnecessarily. With this rule as their guide, they are, like the firemen, always ready to go when a call comes.

Take, for example, the case of the lovesick peacock. A Chicago man kept a pair of peacocks as pets and things were as smooth as a peacock's tail until one day one of the birds died. The surviving peacock brooded for days, finally decided to find her himself and left through an open window.

It was midwinter and his owner, fearing he might freeze during the night, notified the animal-rescue workers. Answering the call in their rescue truck equipped with everything from hypodermic needles to long-handled nets, they soon spotted the bird roosting on a chimney atop a nearby apartment house. They rushed up the stairs and out on the snow-covered roof with nets ready for the capture, but it wasn't that simple. The peacock, probably sensing some plot to thwart his search for his mate, took off for another roof every time the would-be rescuers came within net's range.

Right, feline clothes-pole sitter got up but couldn't get down! With a noose and basket, rescuers brought cat down safely. Below, close-up of rescue noose

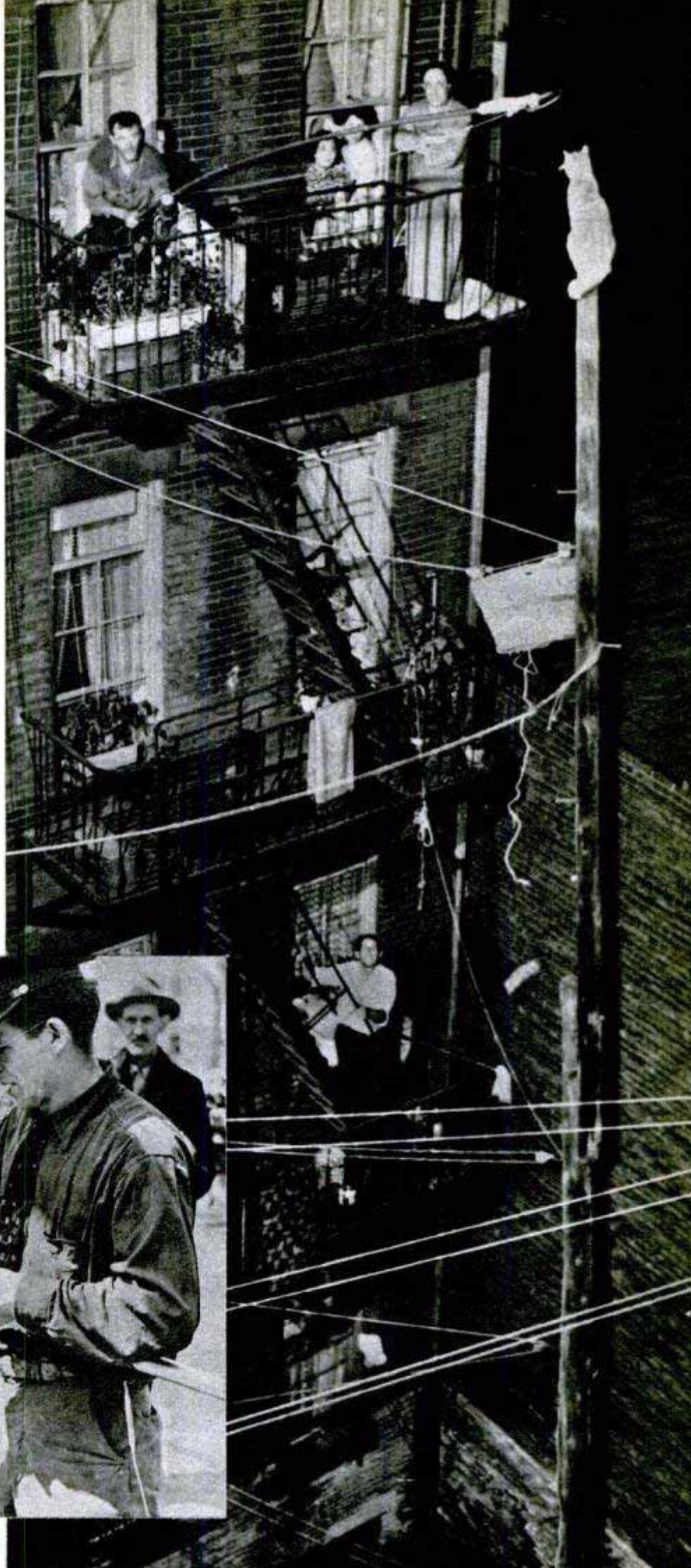



**This miss is unhappy about her puppy, trapped between walls of house, until rescuer fishes him out with rope**

After hours of flying from chimney to chimney, the peacock settled down for a nap. The rescuers, weary from climbing up and down stairs, crept up quietly and netted him just as he awakened and spread his wings for flight. By this time it was morning and the welfare people chalked up another sleepless night under the heading, "Peacock Rescue."

Most calls for help, though, don't involve such exotic creatures as peacocks. Cats

and dogs make up the vast majority of rescue cases. These pets seem to be continually getting themselves in dilemmas.

A common problem is how to get a puppy out of a partition without tearing a hole in the wall. Scampering around the open floor of an attic, puppies often fall between the walls and, of course, there's no way out for them. Rescue workers have two choices: Either tear open the wall or get the animal out the hard way. The hard

**Chained without food or water by thoughtless owner, dog becomes vicious and tries to fight off his rescuers. Woman holds leather thong for dog to bite on as the man waits for a chance to grab the animal from behind**



way consists of dropping a lasso between the walls and dangling it in front of the animal until he gets curious enough to step inside the loop. Then, with a gentle jerk, the rescuer tightens the loop around the dog's midsection and pulls him to safety. Sometimes, however, the animals fail to cooperate and then there's nothing to do but break open the wall.

Cats have a fondness for climbing high up trees and poles. But on occasion, they're afraid to climb down. After a few hours of listening to the cat's cries for help, the neighbors call the animal-rescue team. Standard equipment for this type of rescue is another noose, but this one is attached to the end of a long pole. Usually a basket or net is kept handy. The rescue worker gets as close to the cat as he can and then tries to work the noose around its body. Sometimes the cat acts hard-to-get and the resulting struggle dislodges it from its perch and it falls. That's when the net comes in handy. An assistant stationed on the ground scoops the cat into the net and another of its nine lives has been saved.

Rescuing horses and other large animals is a different problem. One day a tired work horse decided it was too hot to work and he dived from one of New York City's docks into the inviting river. The cool water was fine and apparently he enjoyed it for a while, but when he decided he'd had enough water for one day he couldn't find a landing. There were no sloping banks for miles—just high sea walls and dock pilings. The rescuers managed to get close enough to wrap a wide canvas belt around his midsection. Heavy ropes and cables were attached to the belt and, with the help of a powerful dock winch, the animal was hauled back to dry land. Horses sometimes break through old well covers or fall into excavations. Again a winch is required and the rescuers usually call on some auto-wrecking service. With or without the winch, it's a tough job and there's lots of grunting and heaving before Dobbin comes up safely.

Most rescue workers carry a pistol just in case, but they rarely use it. Occasionally an animal



Black cat is rescued after a 10-day imprisonment in San Francisco pipe line. Rescuer traveled 10 blocks on tiny "scooter" bringing cat to safety. Below, "grounded" when leg is caught in an eave board, pigeon is given freedom by nimble rescuer

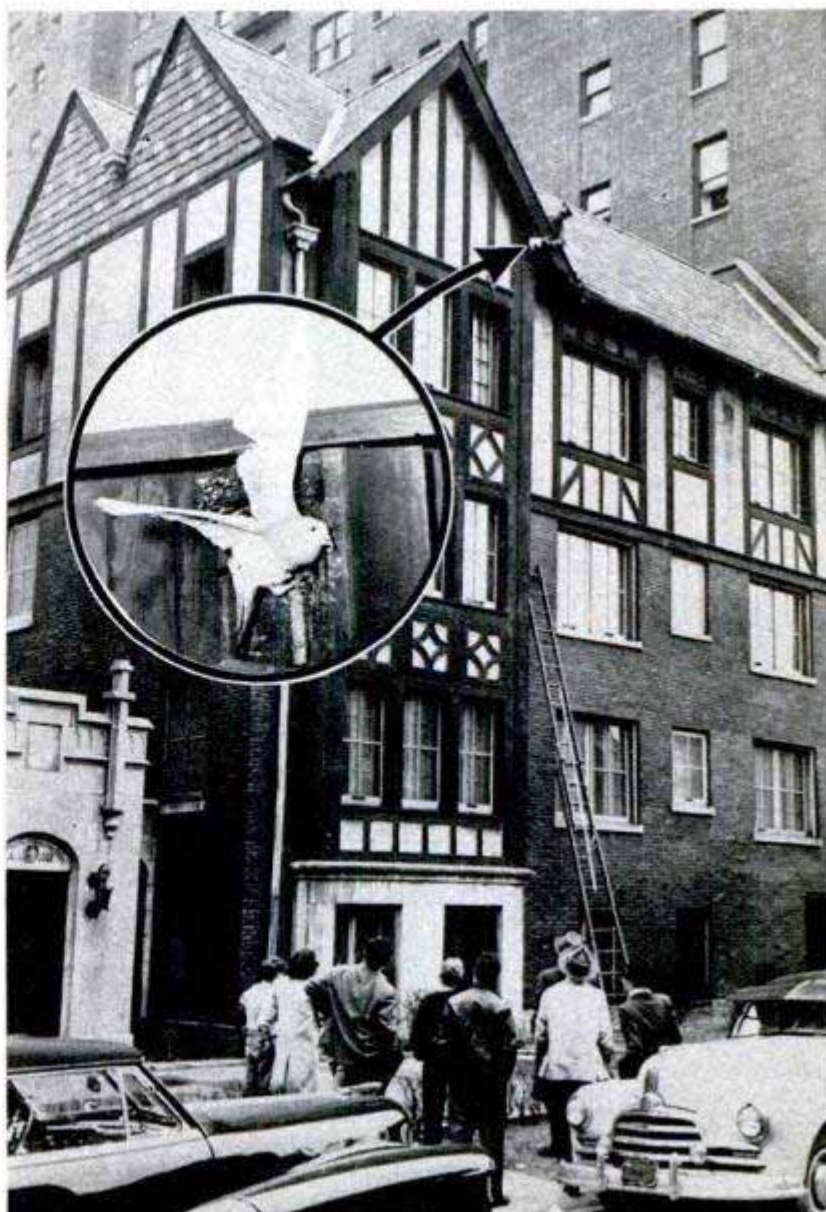



Chasing a rat got this dog into trouble. He rammed his head into wheel and had to have help to get out



Peacocks get into trouble, too. This one was netted after a cold chase from roof to roof. Below, not all rescue operations are small. When heavy work horse falls into well, it takes a derrick to get him out

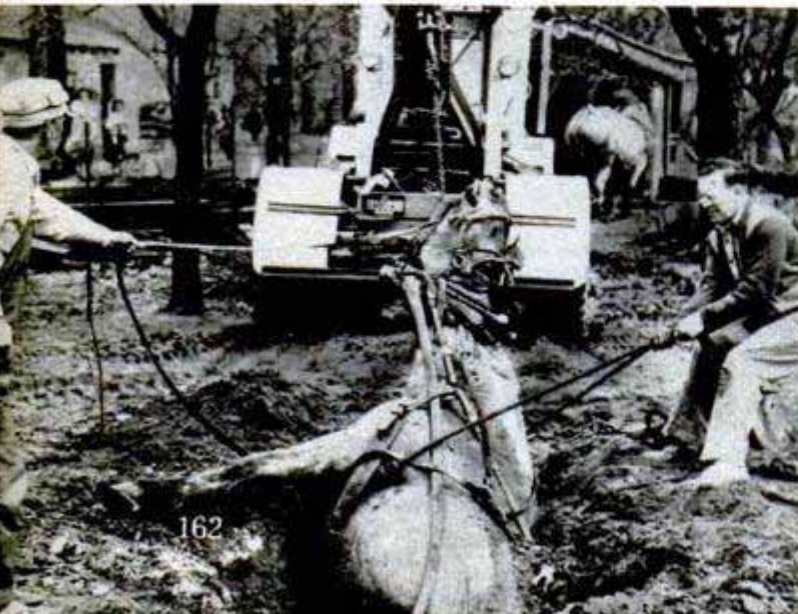

grows vicious during his hours of imprisonment or suffering and they are forced to shoot him, but this is rare. Usually the gun is used only when animals have become critically injured or diseased.

There are many tricks of the trade and most of them are learned only by experience. Treed cats are often dangerous and you have to know how to grab them. A few quick swipes of their sharp claws will make anybody more careful next time. Dogs that have been injured or have never become accustomed to gentle treatment may attack the rescuer. Animal workers know how to grab them safely. They tempt the dog with a heavy leather thong and when he sinks his teeth into it they grab him from behind. Cats are held by their legs or backs until they calm down.

Some animals are just too elusive to be caught without traps. For this a humane trap is used. It consists of a wire cage with a door that drops when the trap is sprung. Uninjured, the animal is caught inside.

Usually foolproof, the trap was almost fooled by a pet monkey that decided to "go native" in a wooded area. After chasing the elusive creature through the woods without success, the animal workers decided to use the trap. They baited it with an ear of corn and a banana. Then they retired to await results. The monkey scampered up to the trap, looked it over and succumbed to the temptation of food. But he was a cautious animal and, instead of going in after the corn, he just reached in and picked it up. The trap didn't spring and the monkey chewed away at the corn, still uncaught. After finishing the corn he decided he'd like the banana for dessert. Fortunately for the anxious rescue workers, the banana was out of his reach. This time he went in and the trap door closed.

Many animals of unknown ownership are rescued and if unclaimed are put up for adoption. The rescue organizations investigate the applicants and require the new owner to sign a contract stating he will provide proper food and shelter and will agree to periodic inspection by the agency.

Whatever the animal is and whatever its plight, the rescue crews never give up. One worker was called to rescue a small puppy that had fallen into a sewer. The dog was huddled far inside the pipe and if he weren't recovered a sudden rain might wash him off his perch and into the main. An onlooker asked the rescue worker, "What'll you do if you can't get him out?"

There was no hesitation in the answer. "What do you mean, can't get him out? We've got to get him out, that's all."

There's no "can't" in the rescue worker's dictionary. He's proud of the fact that he always "gets his animal."

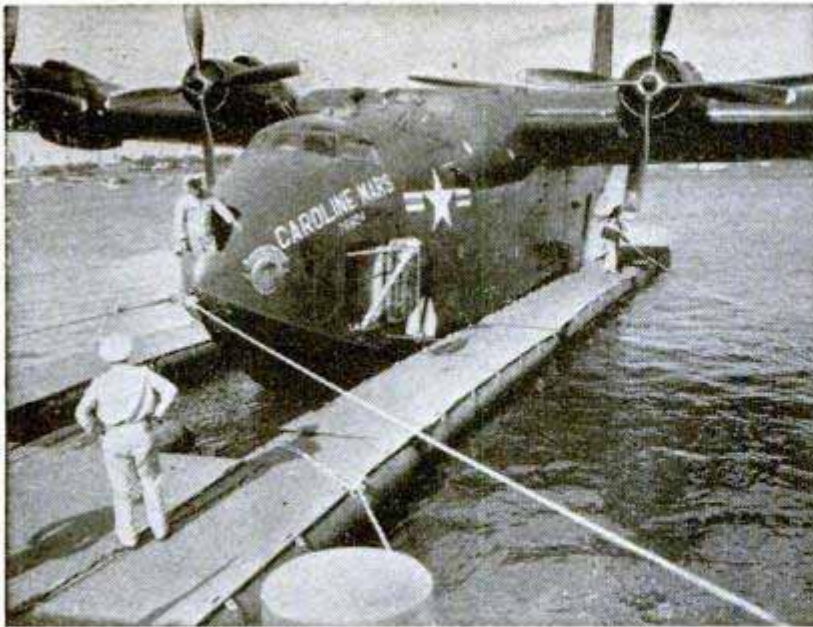

Goodyear photos

Rubber pontoon dock at left can be completely disassembled and stowed in plane, right, in a matter of hours

## Navy's Largest Seaplanes Tote Own Floating Docks

Nine inflatable rubber pontoons decked over with plywood provide a lightweight, portable dock for the Navy's largest seaplanes. The pontoons are arranged in an elongated "U." Deck panels are hinged to make them sufficiently rigid for unity, yet

flexible enough to undulate with water movement. The dock provides tie-up facilities for refueling and loading where there are no permanent installations. The 103-foot unit can be towed short distances or disassembled and flown in one plane.

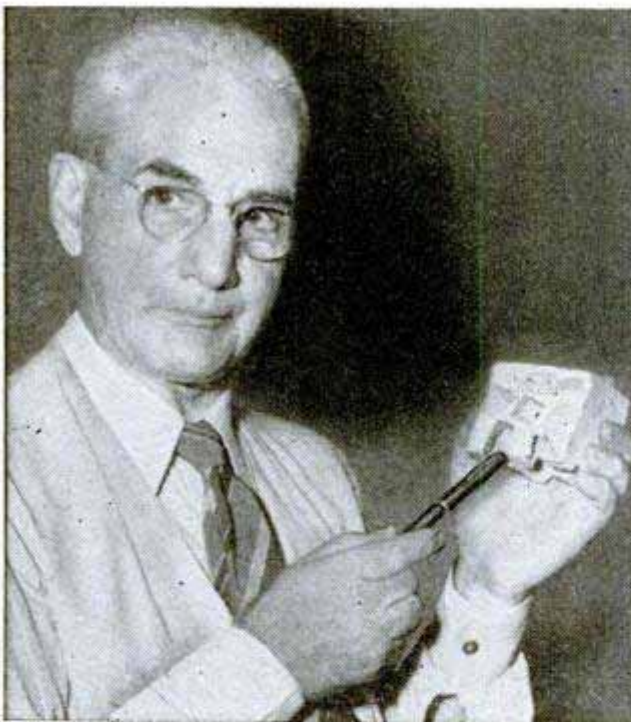

### Ice Cubes in Concrete Make Lighter Blocks

Ice cubes are one of the ingredients of a building block invented by W. R. Twiford of Miami, Fla. Twiford mixes the ice with concrete, then pours the mixture into a mold. When the concrete hardens, the ice melts, leaving cavities in the block. The result is a building material much lighter than conventional blocks.

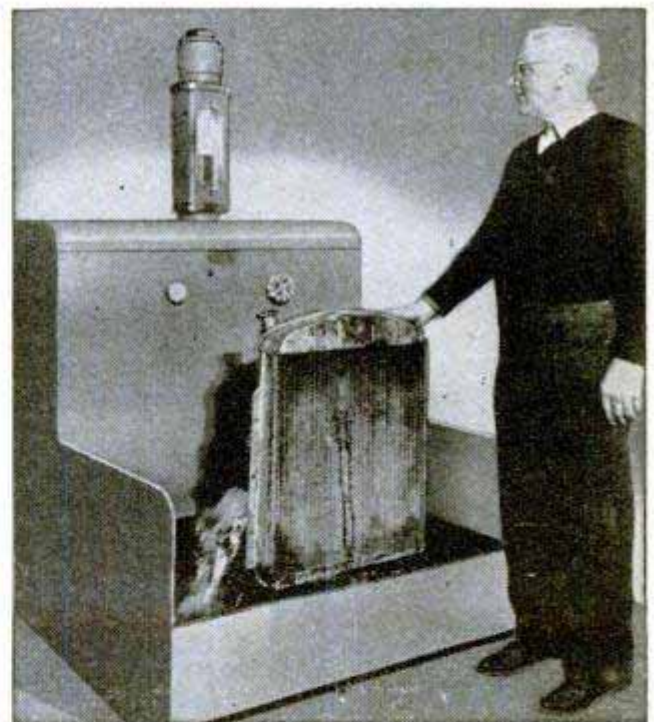

### Radiator-Flow Tester

Auto radiators that may be partially plugged are checked by a machine that indicates the gallons-per-minute flow. While the machine circulates water through the radiator, the operator compares the reading with the flow specifications of the auto manufacturer to determine whether plugging is present. No drain is required as a pump continuously circulates the water.

# STEEL

By Clifford B. Hicks



Feiree Wire Recorder Corporation photo

**Major drug firm speeds inventory with wire recorders. The information is typed from spools by stenographers**



Wire Recording Corporation of America photo

**"Sound diary" of the development of children is the most popular use. Note portability of this recorder. In college speech classes, below, students find out how they sound to each other, criticize their own work**

Feiree Wire Recorder Corporation photo



A CHICAGO apartment dweller, dazed from lack of sleep, finally lodged a complaint against his noisy neighbors. When the case came up for a hearing, the man walked into the courtroom carrying a portable wire recorder, turned it on and sat back triumphantly while the judge listened with growing amazement to the squawkings of the blatant tenants.

Ingenious owners of magnetic recorders are putting the instruments to work on jobs that couldn't be foreseen even by the manufacturers. An explorer totes a portable wire recorder into French Guiana to record native dances and jungle sounds for a motion picture. A doctor making his daily calls merely phones the office after each stop and a magnetic recorder automatically transcribes case histories, notes and recommended treatment for the patients. In Wichita, Kans., the head of the Detective Division records every question and reply when a suspect is being grilled—inflections often tell more than words.

Engineers have barely skimmed the surface in finding applications for this new recording system. To date, the most popu-

# with a MEMORY

lar use has been in the home—the owner keeps a “sound diary” of the development of his children, records favorite melodies from the radio or pirates the neighbor’s new disk records for copying. But other applications affect millions. If you lived west of the Eastern Standard Time zone last summer, you heard tape recording over the American Broadcasting Company stations 15 to 18 hours each day.

Magnetic recording also has become a tool of the scientist. Tape recorders are zooming through the ionosphere in V-2s. In the surgery room of a Chicago hospital, the patient, wide awake under a spinal anesthetic, listens as a wire recorder plays his favorite melodies during the operation. Records prove that he is more relaxed and recovers more quickly, as worry during an operation can put the brakes on the patient’s recovery.

A recorder plays an important role in UNIVAC, the mechanical brain that can answer almost any complicated problem. Problems fall into types, and a method for solving each type must be worked out in advance. Such patterns are recorded on

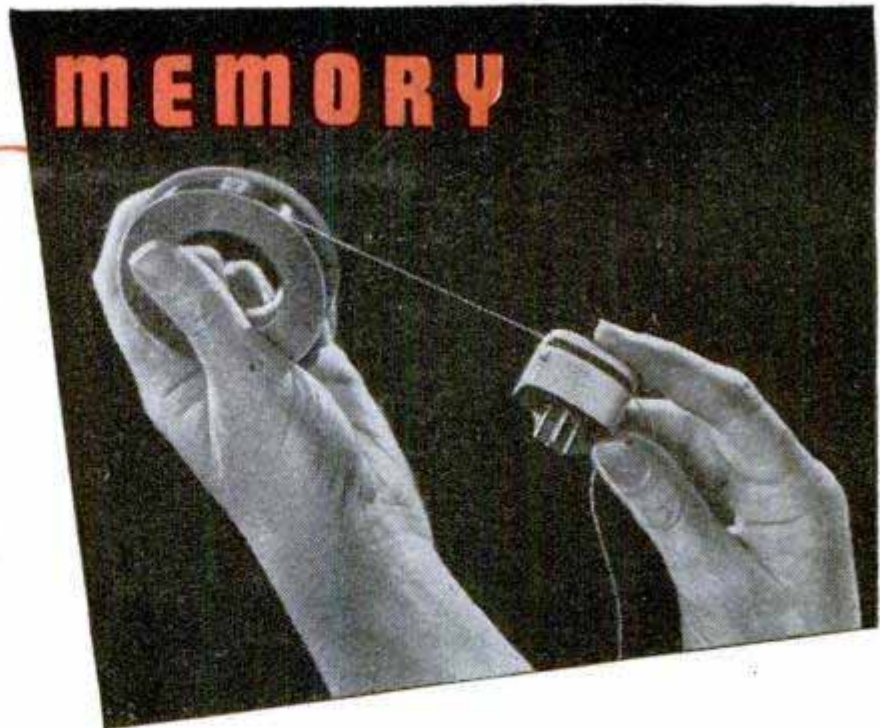

Heart of recorder is electromagnet called the “head.” More than a mile of fine wire can be wound on spool

reels of magnetic tape. Then, when the equations of a particular problem are fed into the machine, the corresponding spool is slipped into place and UNIVAC pops up with the answer.

Stereophonic or “three dimension” sound, soon to reach the market, will seat the listener in the middle of a symphony orchestra—at least that’s the impression he’ll get. And amateur movie makers soon will have that long-sought goal, inexpensive sound films, through a new application of magnetic recording.

Tape and wire recorders didn’t hit the market until after the war, but they are based on a principle discovered by Valdemar Poulsen in 1898. He shouted into a peculiar machine and the noise was recorded magnetically on a length of heavy wire. When the wire was played back, an echo of the shout could be heard. The method was of little use until the invention of the vacuum tube and other electronic devices in the ’30s, and until metallurgy could provide suitable recording mediums—the stainless-steel wire and iron oxides of today.

In the late ’30s Marvin Camras, a young scientist at Armour Research Foundation in Chicago, wanted to record the songs of a friend. Using the Poulsen principle as a point of departure, he came up with two vital developments: placing the magnetic patterns longitudinally on the wire instead of across it, and using a.c. instead of d.c., which gave him a better signal-to-noise



Magnetic Corporation of America photo

Stenographer wearing earphone takes dictation from recorder; foot pedal starts, stops and rewinds wire



Experimental recorder is said to have higher fidelity than any other because of faster wire speed, constant drive

If the equipment is the finest, the quality of reproduction is as good or better than the best disk recorder. Big 30-inch-a-second broadcasting models give tone variations from 30 to 15,000 cycles per second, whereas the phonograph-disk range is only from about 50 to 5000. A master recorder built at Armour (a commercial model will be on the market soon) reproduces any audible sound as well as some that are inaudible, and is said to have higher fidelity than any recorder in existence.

Ordinary disk records play for about six minutes, and even the new long-playing records are limited by the size of the platter, but a magnetic recorder will play more than an hour, on a wire a mile and a third in length, wound on a

ratio. The recorder looked so promising that the Navy ordered 1000 models for use aboard ship and the Marine Corps put portable instruments in the hands of its combat correspondents.

The Armour Research Foundation owns most of the patents on magnetic recording, and at present has licensed about 55 manufacturers to turn out a bewildering number of home recording and office dictation machines.

The person who sees a magnetic recorder in operation for the first time may be surprised that no "shavings" are taken from the wire or tape. In simplified theory, here's the way magnetic recording works: Audible sounds are picked up by a microphone and piped into an amplifier, where they are converted into electrical signals that vary in direction, length and intensity. These signals activate an electromagnet (the recording head) which magnetizes the wire or metal-surfaced tape in a corresponding pattern. If you can put such magnetic patterns on a wire you should be able to work the system in reverse to play back a recording. As the wire runs across the head, the magnetic patterns induce corresponding electrical signals which are boosted in the amplifier and converted into audible sounds in the speaker. Stainless-steel wire only .0036 or .004 inch in diameter, and paper tape with a coating of iron oxides less than .001 inch thick serve as the recording mediums.

pool smaller than a nickel doughnut. Furthermore, a disk usually starts getting noisy after 20 to 40 playings, but a wire or tape recording can be played indefinitely

## RECORDING

Diagram shows how the sound is picked up by microphone and converted in amplifier into varying electrical signals. Signals then pass through electromagnet which magnetizes wire or tape in similar pattern

Drawing adapted from "School Sound Recording and Playback Equipment" published by Radio Manufacturers Association





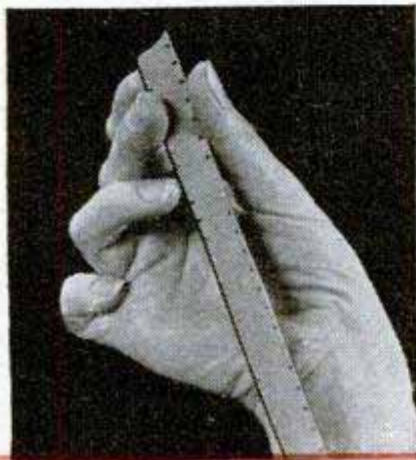
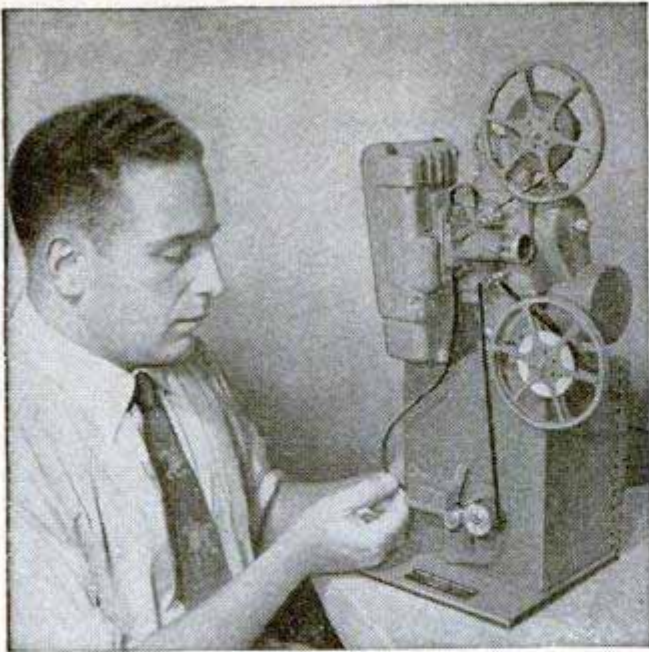

Top left, inventor Camras shows his latest laboratory development — magnetic sound on film. Film passes through recording head below projector. Left, magnetic track is placed on one side between sprocket holes and edge of film. Amateur movie fans soon will have this development

Above right, a miniature recorder built by Camras fits in coat pocket. Right, it is powered by two flashlight batteries. Recordings are played back on another machine



Armour Research Foundation photo

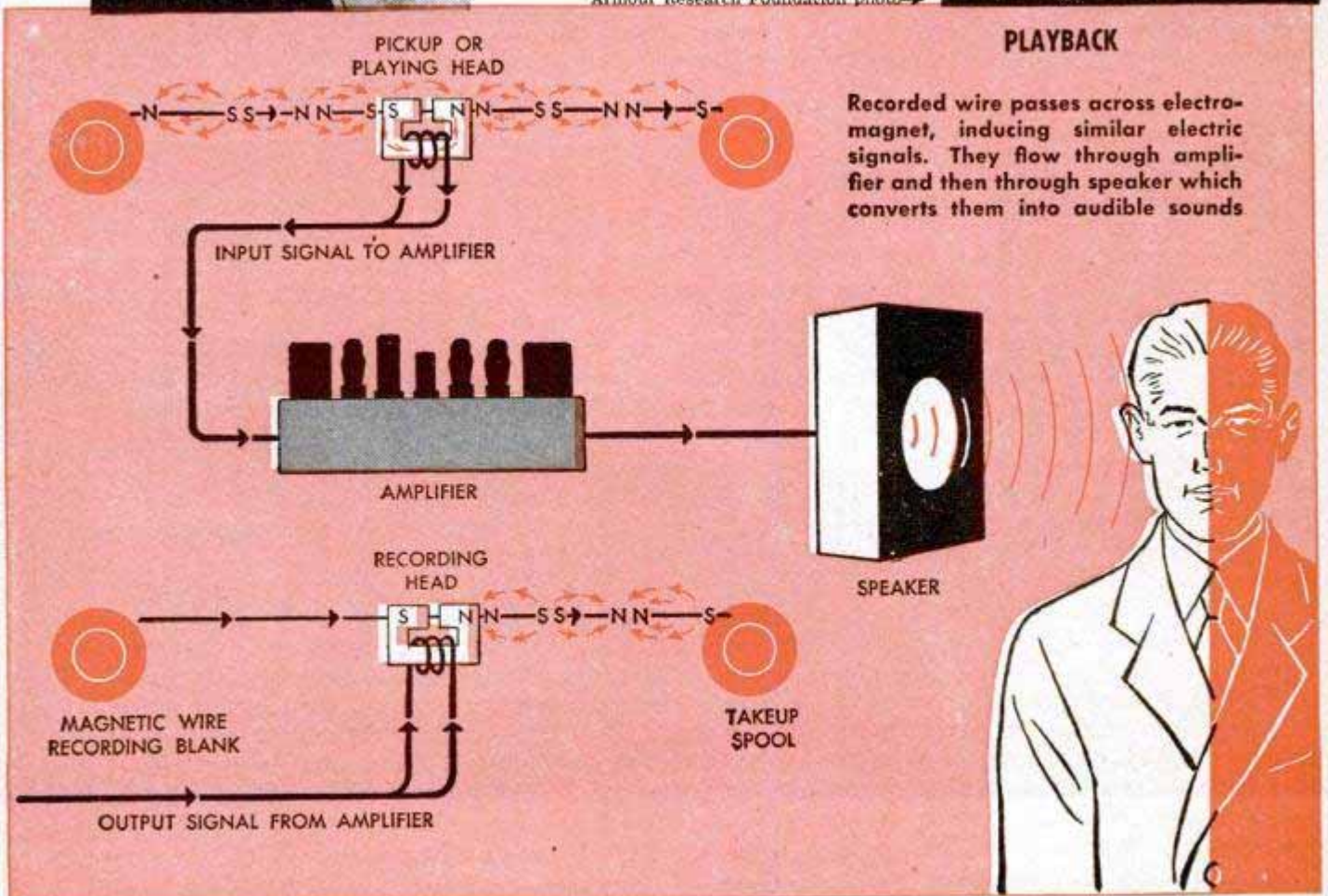



Smiley Burnette, Western film star, records important phone conversations on magnetic tape by placing telephone on top of an induction pad

without loss of quality. A recording at Armour has been played 19 million times, and the change in quality is so slight it can be measured only by instruments.

Disk records can't be altered, but it's no trick to "erase" a magnetic recording by demagnetizing the wire; and it's equally simple to edit a recording by snipping out the undesired section and tying the remaining ends in a square knot, which passes through the head without a pause. In the case of tape, the portion is clipped out with scissors and the ends secured with cellulose tape.

One of the principal advantages of the magnetic system is that many channels can be recorded simultaneously on a single strip of tape. For example, tape recorders are installed in the nose of V-2 rockets for experimental tests. Each instrument flashes electrical signals to its own track on the tape. When the tape is recovered and played back, it gives a complete picture of the flight at any instant, as all tracks are on one strip and all are replayed simultaneously. As many as 150 tracks have been recorded on one strip.

One recorder produced in Camras' laboratory is an experimental pocket model that operates from the power stored in two flashlight batteries. It is a recorder only—the wire spool is placed on another machine for the playback. The instrument is small enough to fit into a coat pocket or purse and is designed for news commentators, lawyers, doctors and insurance adjusters who want to record a witness' replies. Another recorder soon to hit the market can be attached to any car radio. And still another records on a paper belt that can be folded and slipped into a small envelope for mailing.

For the office or home machines there is a bewildering assortment of attachments and improvements. On one model, the stenographer stops the machine with a foot pedal and the recorder automatically rewinds a few inches of wire—when the wire moves forward again she hears the last couple of syllables and can pick up her place. A voice-

actuated microphone soon will be available for the executive. Whenever he speaks in the direction of the mike, his voice automatically will turn on the recorder and start the recording. Most manufacturers put out induction pads which automatically transcribe phone conversations without being connected to the phone.

Another development is half-inch tape with two parallel sound tracks. The machine records for a half hour on the upper track, reverses itself, and records another half hour on the lower track. Thus, whenever you play the recording for an hour, the tape automatically is rewound and ready for another play.

A drawback of magnetic recording is that it's difficult to find a desired section on an hour's spool. One answer is the automatic timer. As the operator watches the timer, he runs the spool through at super-speed until he comes to the desired portion. Another snag is that wire is difficult to handle. Cartridge-type spools that plug into the recorder eliminate any handling of wire on some machines.

(Continued to page 240)

# STEREOPHONIC SOUND

Three microphones pick up the sound and record it on three sound tracks on the same tape. When recording is played back, three heads pick up the tracks simultaneously and sound comes out of three speakers, giving listeners a sound image of depth and direction. Below right, this equipment plus microphones and speakers give stereophonic tone

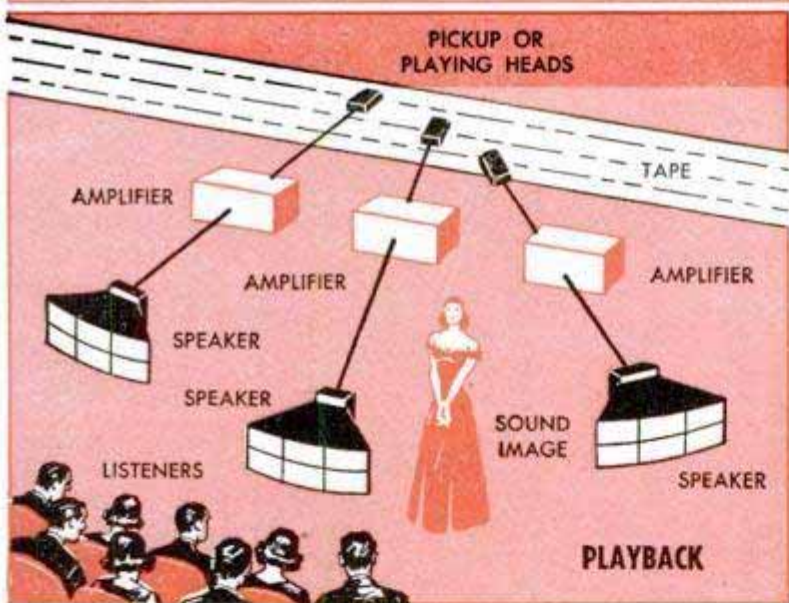
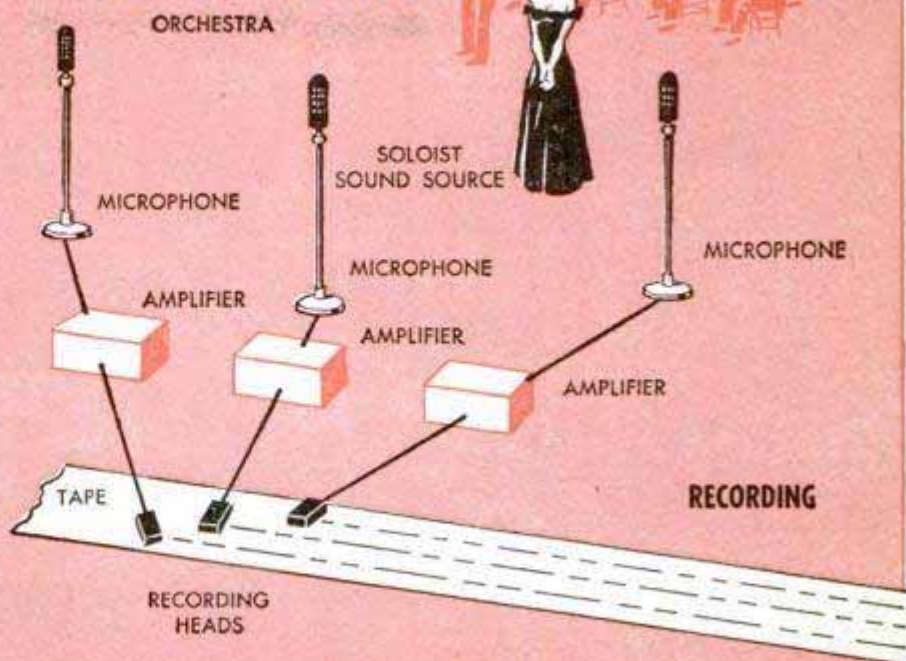

Experimental magazine eliminates wire handling. Right, radio network uses these high-fidelity tape recorders  
 Santay Corporation photo American Broadcasting Company photo

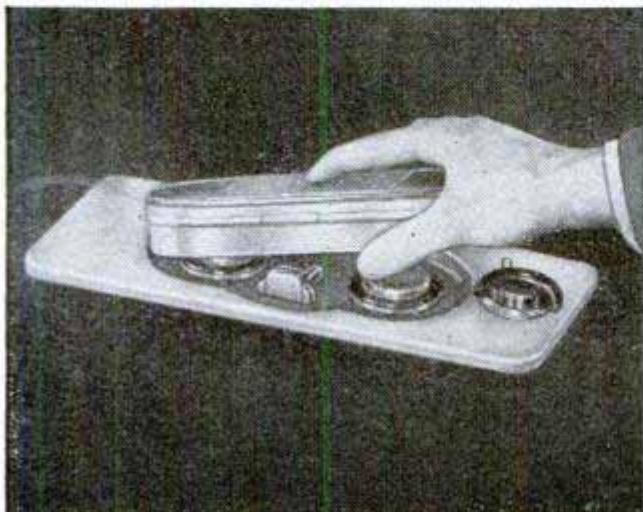

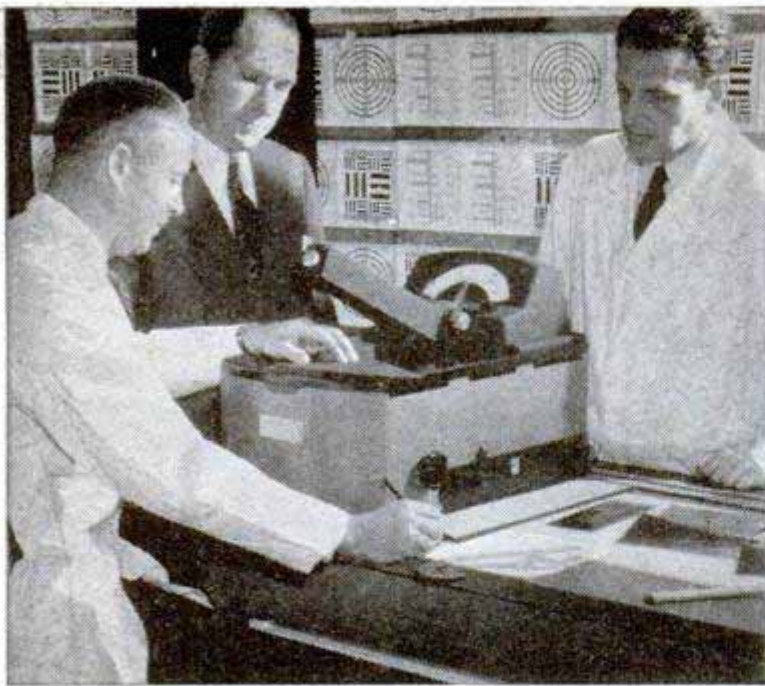

## Instrument Analyzes Color For Film Emulsions

Color density is determined by an electronic analyzer so sensitive that it can measure 1/100,000,000 of the amount of light from a car headlight. The analyzer is designed for use in color photography, but can also be used to measure or match colors in textiles, paints and dyes. The device, developed by Ansco, looks like an oversize record player. Inside the arm is an electron-multiplier phototube which gives the instrument its sensitivity. The measuring arm may be detached and used at distances up to six feet. The analyzer is used for making accurate emulsions for films.

## Seals With Mystery Collars Picked Up War Food Bags

Officials of the Fish and Wildlife Service believe they have the answer to the mystery of the rubber collars found on the necks of fur seals during the past five summers. The collars have baffled biologists since the first one was discovered on a seal in July, 1944. Officials now believe they are fragments of rubber bags used by the Japanese for aerial delivery of food to their besieged troops in the Aleutian Islands. Many of the bags missed their mark and parachuted into the water where they floated on the surface. Officials say the food attracted small pup seals which plunged through the narrow openings of the bags. The rubber containers then could not be dislodged and eventually crumbled away. All that remained when the seals were killed during sealing operations were the rubber collars.

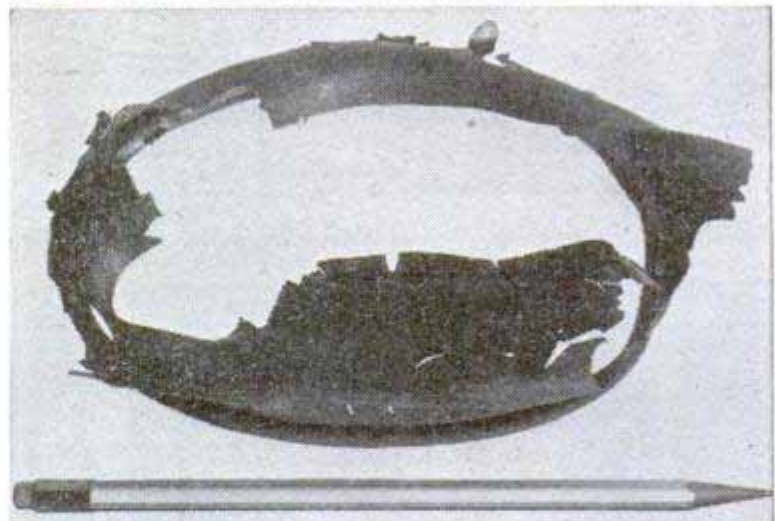

U. S. Fish and Wildlife Service photos

## Inspectors Use Magnetism To Spot Flaws in Boring

So minute that they are invisible to the naked eye, tiny flaws on the inside surfaces of borings 35 feet long are detected by a General Electric inspection technique. Used to inspect holes bored in long metal castings, the technique uses fluorescent lights, a mirror and a surveyor's telescope. The forging is magnetized and iron-oxide particles are blown into the hole. These particles align

themselves with the magnetic poles of any crack or flaw. A small cylinder containing three fluorescent tubes and a mirror is then drawn through the hole. The boring surfaces are reflected in the mirror and are examined from one end of the boring by an inspector aided by the telescope.

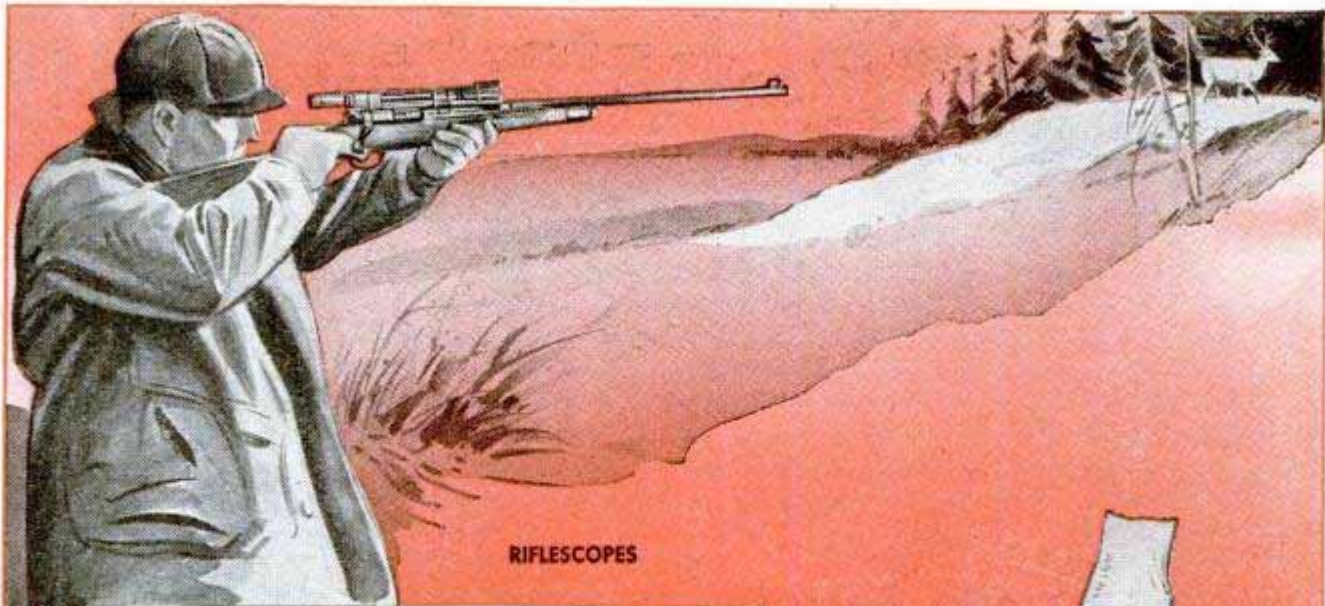

RIFLESCOPES

## The CRAFTSMAN

★ Why not assure yourself a prized big-game trophy next fall by fitting your favorite rifle with a good riflescope—one you made in your own shop? The article on page 198 gives complete instructions for building several hunting-type scopes. Some have both internal windage and elevation adjustments and are optically designed to give sharp definition and a brilliant field of view, features that are essential in a hunting scope.

★ For downright practical usefulness and lasting decorative value you can't beat a gate-leg table, especially a large one like that detailed on page 172. Opened, it makes a full-sized dining table, seating 12 people; closed, it makes an individual decorative piece that fits in anywhere.

★ It's easy to make needle-and-thread repairs on rugs having small warp breaks, holes due to burns or other causes, or worn fringes and spots. An article on page 188 shows the procedure in detail.

★ Our shop feature, page 214, explains approved methods of attaching pulleys, gears and other power-transmitting units to shafts.

FASTENING WHEELS AND PULLEYS



GATE-LEG TABLE

RUG REPAIRING

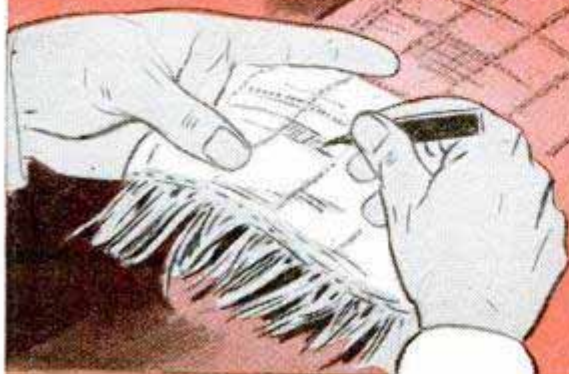

# Gate-Leg Table

By Wallace W. Buffmire

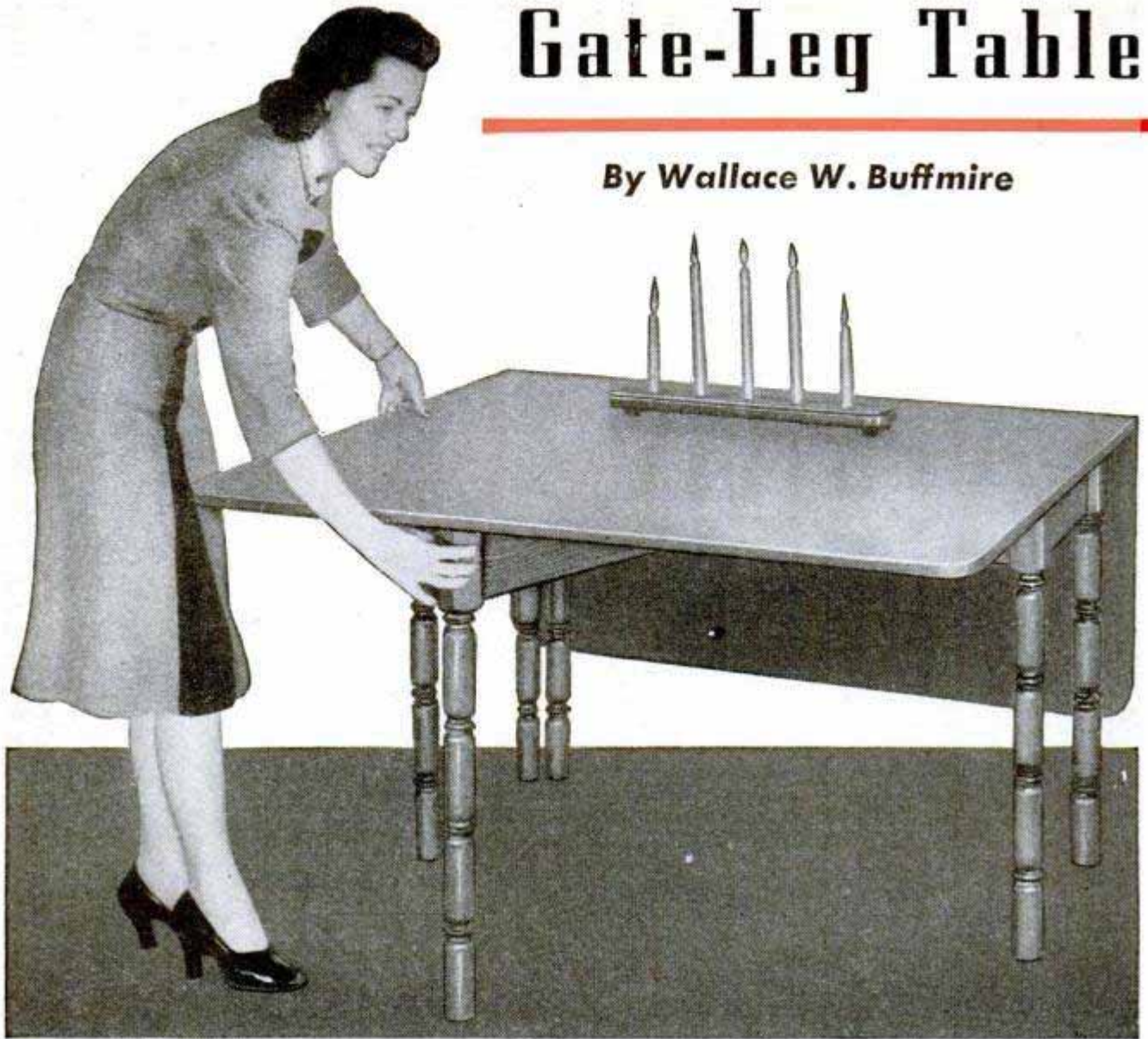

**H**ERE'S a dining table that really makes use of limited space. Folded and tucked away against a wall, Fig. 7, it requires only 20 in. of space, but when brought out into the open and fitted with two extra leaves its large top (40 x 84 in.) will accommodate a family gathering of 12 or more. It's a practical answer to the problem of space in the small home or apartment.

The original table was made of American black walnut, the top being walnut burl veneered to a core of poplar. This was done to cut cost, but the whole table, with the exception of the extension-slide assembly, can be made of solid stock. Turn the legs first. These are made from 2-in. turning squares, dressed on four sides. Note that each leg is left square for a distance at the top and the rest is turned to the largest diameter possible. This calls for accurate centering of the turning square in the lathe to assure that all legs have very nearly the

**Popular item for the combination living-dining room and small apartment. Takes little space when folded, yet opens to big-table size, seating twelve**

same diameter. After the leg is in the round, so to speak, spot the beads with dividers and finish with a roundnose chisel. Al-

though 1-in. stock was used for the rails,  $\frac{3}{4}$ -in. material will do. The rails are mortised into the legs as in Fig. 4, the tenons being glued and crosspinned to lock them in place. If you do not have a mortising attachment for the drill press, the leg mortises can be cut by drilling a series of overlapping holes and then cleaning and squaring up the mortise by hand with a chisel. Locate the mortises so that the rails set in about  $\frac{3}{16}$  in. from the face of the legs. Draw up each assembly with a bar clamp before nailing through the tenons.

The extension slides for the top are made from  $1\frac{1}{4}$ -in. hardwood as in Fig. 3. The members slide on a dovetail. Note that the female part of the dovetail has a  $\frac{1}{8}$ -in. groove cut in the bottom. This groove, which is stopped about 1 in. from the end of the slide, is for a stop pin which prevents

# for the Small Dining Room

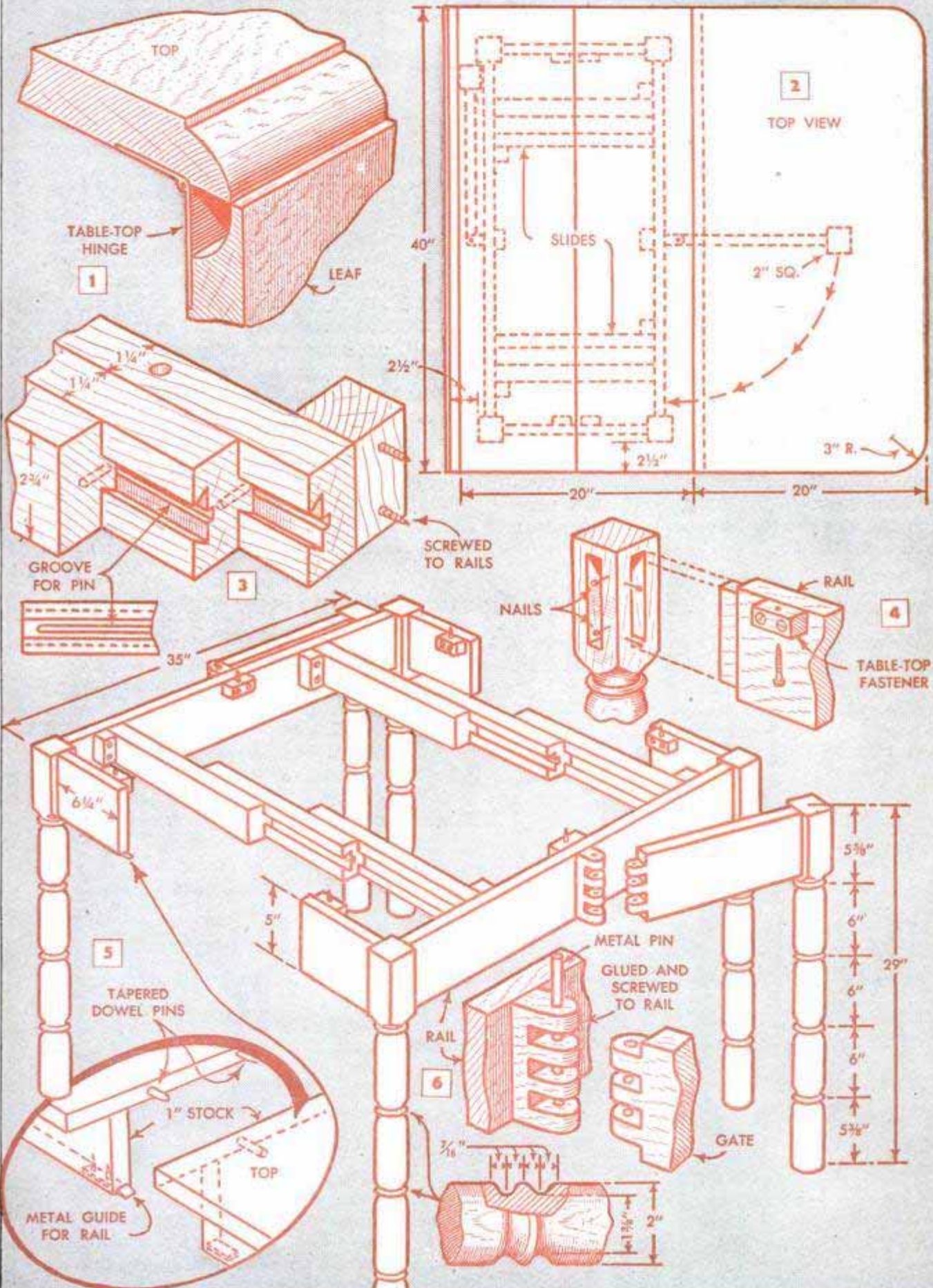



Fig. 2 shows how the gate legs nest against the side rails of the table. The wooden hinge detailed in Fig. 6 was used on the original table, although a regular butt hinge can be used if desired. If a butt hinge is used, glue a stop block to the underside of the leaf so that the gate leg can swing only at a right angle. Stock for the drop leaves must be edge-glued to build up the required width. The leaves are fitted to the top section by what is known as a rule joint, Fig. 1, and are hinged with special table-top hinges. Note that the hinges are mortised flush with the surface and that the pin of the hinge must be located directly below the shoulder cut of the rule joint. This is important, as otherwise both surfaces will

not be level when the leaves are raised or the joint will bind. To allow clearance for a varnish finish, the concave cut in each leaf must be of a slightly greater radius than that of the convex cut. Ladder-back or other colonial-style chairs will go well with this table, or matching chairs can be built. The legs should have the same spool design and seats woven with fiber or rush.

the extension from being pulled completely out. Both slide assemblies are fastened to the side rails of the table with screw blocks, as shown in Figs. 3 and 5. Finally, the outer members of each assembly are counterbored on the underside for short screws, which are used later to attach the two center panels of the top. Screw blocks also are used to fasten the top.

## Back Seat of Car Converted to Playpen Eliminates Safety Hazard

There'll be no need to worry about baby's being thrown from the back seat onto the floor of the car if the seat is converted to a padded playpen. It's easy to do as it only requires suspending a piece of canvas between the two seats. The canvas should be

slightly narrower than the width of the car and hemmed at each end to take a wooden pole. The rear pole is held between the seat back and the cushion, while the front one, equipped with a screw eye near each end, is attached to the hand straps of the car by means of snaps. Then, the mattress from baby's bed is placed on the seat. When this arrangement is not being used, the canvas can be rolled and stored on the car floor where it is out of the way.

Harold R. Willis, Chula Vista, Calif.

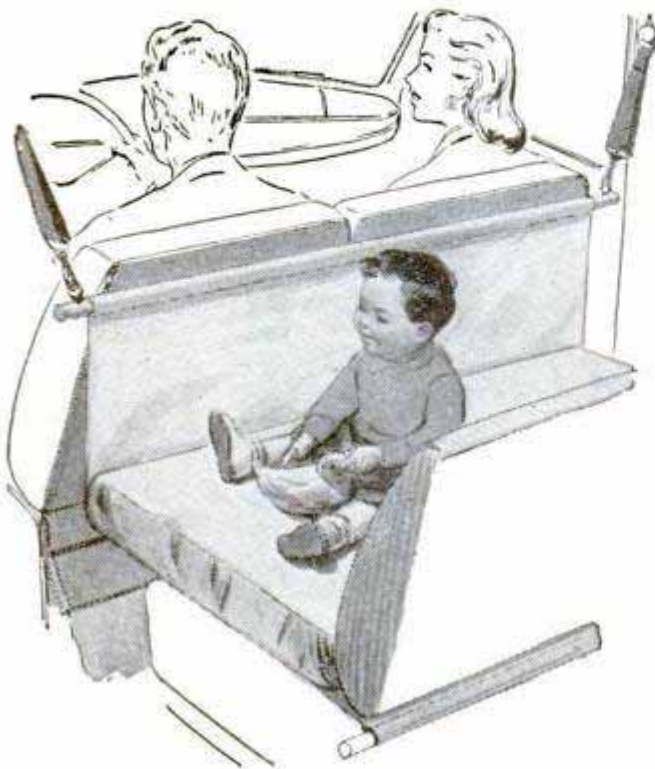

## Roller Bracket Anchors Shade

To keep a window shade from flapping when drawn over an open window, one man anchors it with a flattened shade-roller bracket. The bracket is attached with short screws

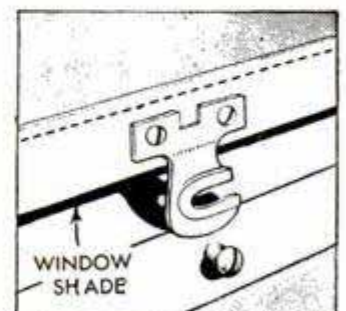

to the wooden slat at the bottom of the shade. The other end of the bracket is hooked over a roundheaded screw driven into the edge of the window sill.



As the oilstove used to heat his home is in a front room and therefore does not adequately heat the adjoining bathroom, one man devised a way to pipe hot water from the stove to a radiator in the bathroom. Having a double-burner oilstove, he made a water jacket of welded sheet metal to fit between the two burner chambers and welded a pipe fitting to the top and bottom of the jacket. He welded sheet-metal baffles to the inside walls of the jacket at an angle to cause the water to swirl as it ascends, and thus become evenly heated. Then, he ran pipe from the jacket to the radiator. Note that the radiator is equipped with an expansion tank for the water. He found that this arrangement provides more than enough heat to keep the bathroom comfortable even in the coldest weather and also that it does not noticeably affect the efficiency of the oilstove, which is operated at the same setting as before the installation. A similar unit for a single-burner stove is made, as

## Oilstove Fitted With Sheet-Metal Jacket Supplies Hot-Water Heat to Bathroom

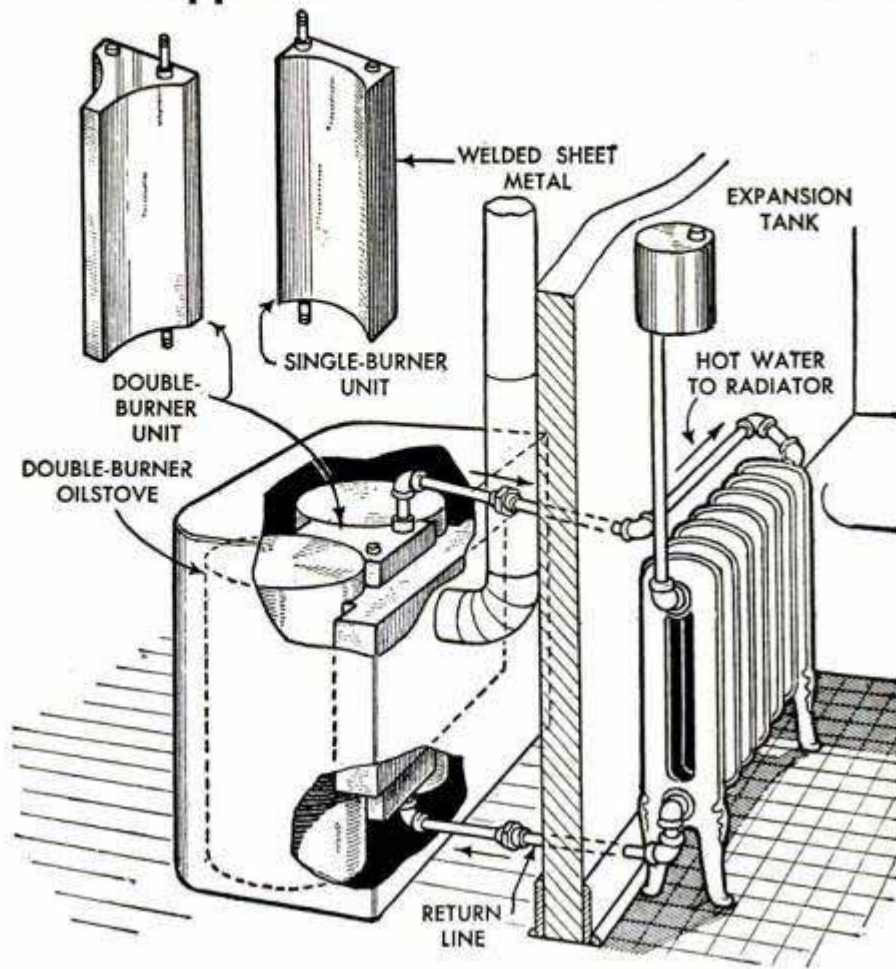

shown, to fit partially around the outside of the burner chamber.

Roland Diehl, Madison, Wis.

## Pointed Dowel Centers for Cabinet Makers Are Turned From Metal Rod

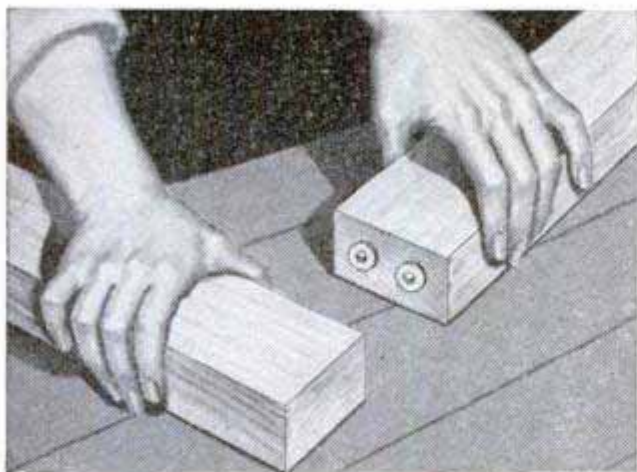

Should you need dowel centers for a cabinet-making job and find it difficult to buy them in your town, just turn a pair of the size required from a length of metal rod. Chuck the rod in the lathe and turn the shank and flange to the dimensions given in the chart. Then finish the center with a 90-deg. point on the flanged end. The length of the shank, dimension C, is not critical and depends largely on the length of dowel to be used.

John L. Alden, Maplewood, N. J.

## Wallpaper Provides Decorations

Attractive doilies and covers for matchboxes or cardboard coasters are made from waterproofed scraps of wallpaper. Waterproof the paper with either thinned cellulose cement or paraffin dissolved in cleaning fluid. Clear lacquer also may be used for this purpose.

☞ To remove crumbs from an electric toaster, use a new, small paintbrush.

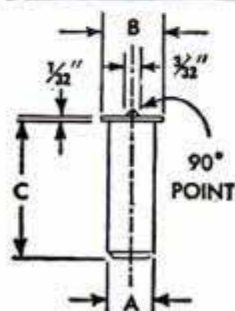

DOWEL	A	B	C
1/4"	.255	3/8"	3/4"
5/16"	.317	7/16"	13/16"
3/8"	.380	1/2"	1 1/8"
7/16"	.442	1/2"	1 3/8"
1/2"	.505	5/8"	1 1/2"

## Inclined Planks Support Plywood To Simplify Sawing Large Sheets



Handsawing a large sheet of plywood or hard-pressed board near the center usually is an awkward job, even with the sheet supported adequately in a horizontal position. However, if the work is rested on two planks placed parallel with the saw cut and leaned at an angle against a wall or bench, it can be sawed easily from a standing position as this brings the top center portion of the sheet within easy reach. A cleat nailed across the planks near the bottom prevents the sheet from sliding and keeps it off the floor to complete the cut.

John E. Reeves, East Aurora, N. Y.

## Unused Ceiling-Fixture Circuit Adapted for Wall Receptacle

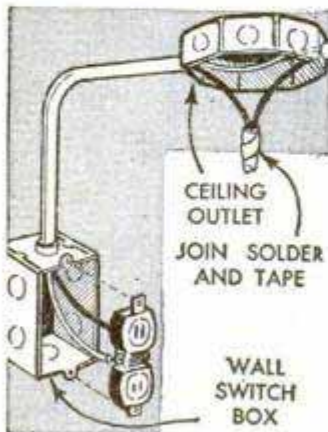

When the ceiling fixture has been removed from a living room, the unused wall switch usually is left intact. If this is the case in your home, you'll find it a simple matter to replace the switch with a convenience outlet. First, remove the decorative cover from the ceiling-outlet box and join, solder and tape together the ends of the two live wires inside the box. Then, disconnect the wall switch and wire a du-

plex receptacle in its place. This extra outlet will come in handy for a night light and numerous electrical appliances.

Roy C. Loughary, Portland, Ore.

## Hot Air Warms Bathroom Floor

Are you planning a new home with hot-air heat? Then, consider the added comfort of a warm floor in front of the bathtub. This is done by slotting the hot-air duct at a point between the bathroom floor joists and forming a baffle to deflect part of the warm air through the opening.

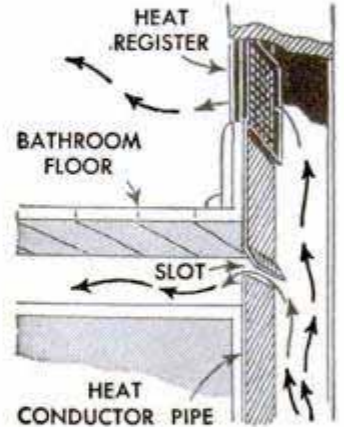

Of course, the bathroom will have to be laid out so the floor joists run parallel with the tub and the duct located in the wall between joists and immediately in front of the tub.—E. S. Norton, Pittsburgh, Pa.

## Bamboo Ski Poles Strengthened



Even though they are unusually strong and pliable, bamboo ski poles occasionally break under severe strain. However, if they are wrapped with friction tape the full length of the shaft, they will not splinter. Laminated-cane ski poles also may be reinforced in this manner.

## Cracking Hard-Shelled Nuts

If a large number of hard-shelled nuts are to be cracked with a hammer, the job is done faster and without danger of injury to the fingers when the nut is held by a clamp. The clamp consists of a section of tire casing having one end cut out to hold the nut and the other end nailed or screwed to a wooden block.

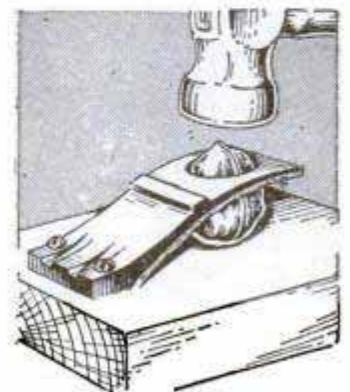

G. E. Hendrickson, Argyle, Wis.

# Use a plate scraper for—

By Kenneth Murray

Usefulness of ordinary rubber plate scrapers is by no means confined to dishwashing alone. Actually they have dozens of uses throughout the home, including the darkroom and workshop, and are also handy when cleaning car windows. A few of the applications for which they are especially suited are shown in the drawings. However, if the scrapers are kept in mind, many other practical uses will present themselves.

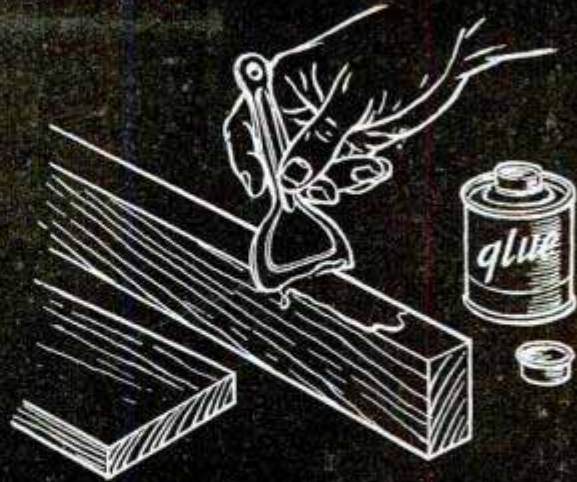

a glue spreader

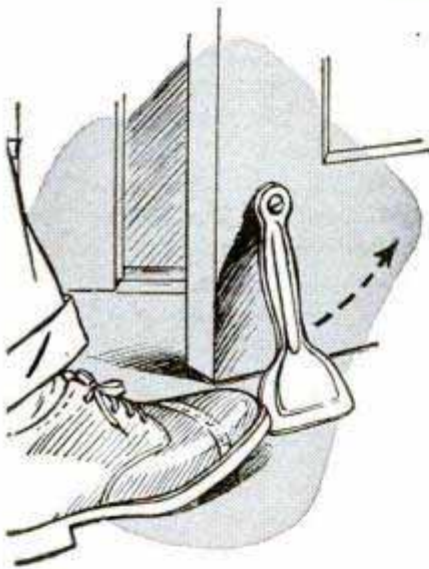

a doorstop

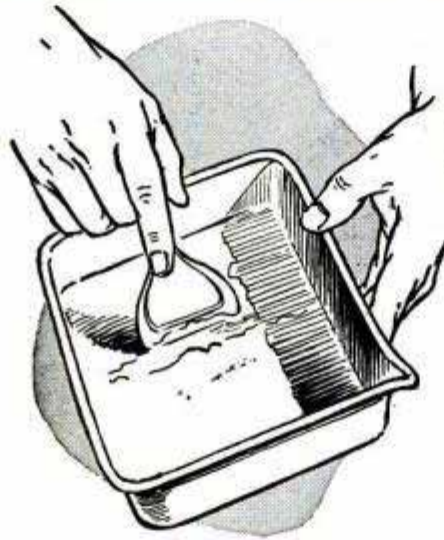

cleaning photo trays

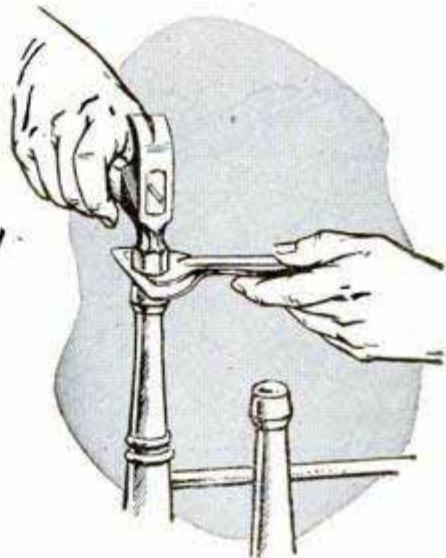

a hammer "cushion"

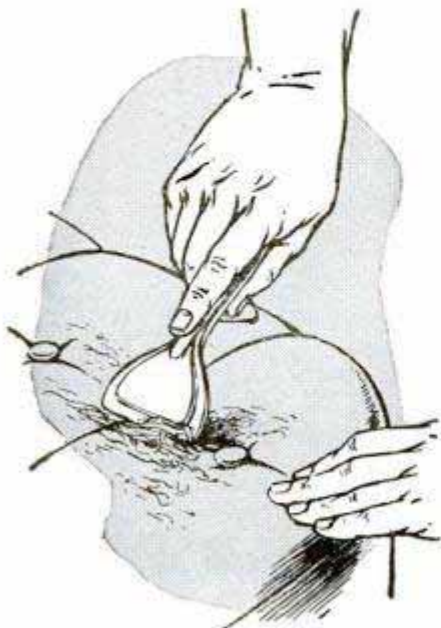

picking up lint

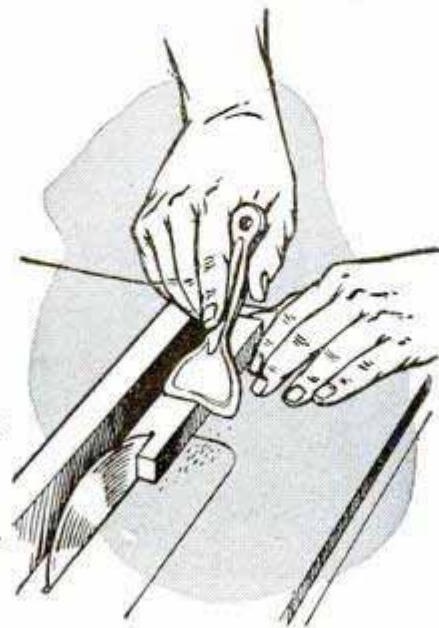

a hold-down

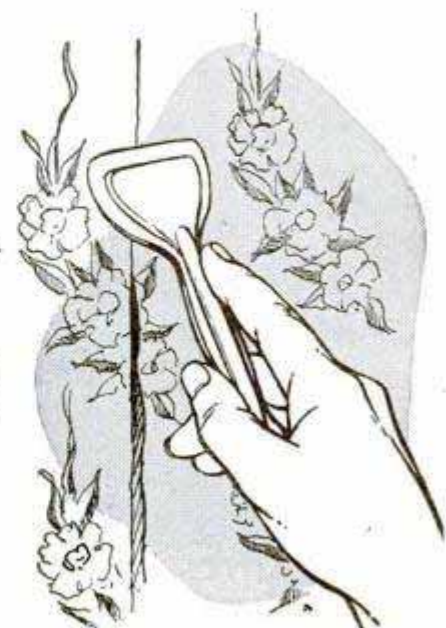

smoothing wallpaper

# Toys

Seven novel and exciting toys for playroom and outdoor use. All can be made inexpensively from stock lumber. Some require roller skates; others, wheels from discarded toys

By Marvin Hartley

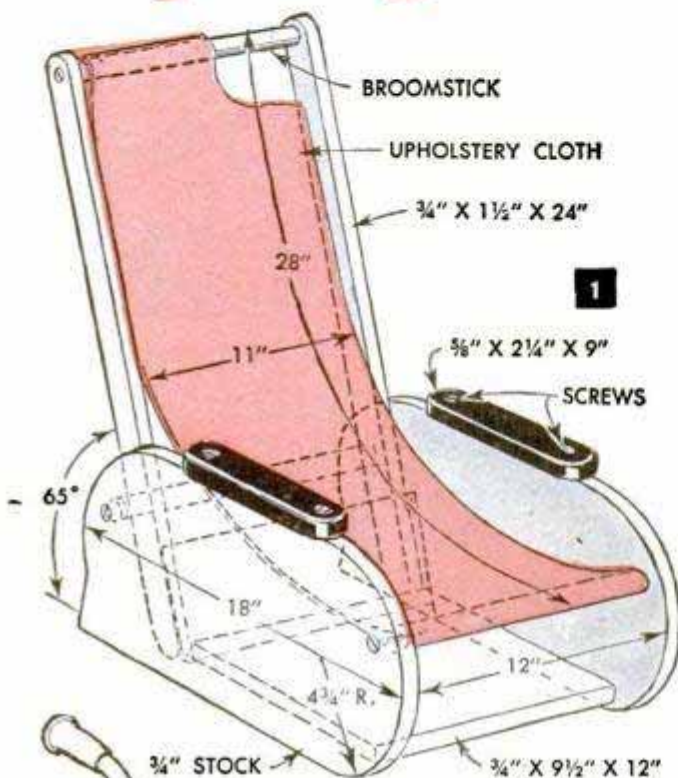

BY USING STOCK LUMBER, which is already cut for width and thickness, a jigsaw is the only power tool needed to make these novel toys. However, several of them can be made entirely with a few common hand tools. Pieces of broomstick, a pair of old roller skates and wheels from a discarded doll buggy or other toy, all of which usually are readily available, help to keep material cost at a minimum.

**Hammock chair:** Patterned somewhat after a steamer chair, this one, detailed in Fig. 1, features a compartment for picture books under the seat. Both sidepieces are cut from 1 x 10-in. stock, which actually measures about  $\frac{3}{4}$  x  $9\frac{1}{2}$  in. The sides are screwed to a third piece of the same stock placed  $\frac{1}{2}$  in. up from the bottom. The uprights for the back are 1 x 2s ( $\frac{3}{4}$  x  $1\frac{1}{2}$  in.), rounded at both ends and attached to the sidepieces at a 65-deg. angle with short screws from the inside. Note that a length of broomstick is screwed between the

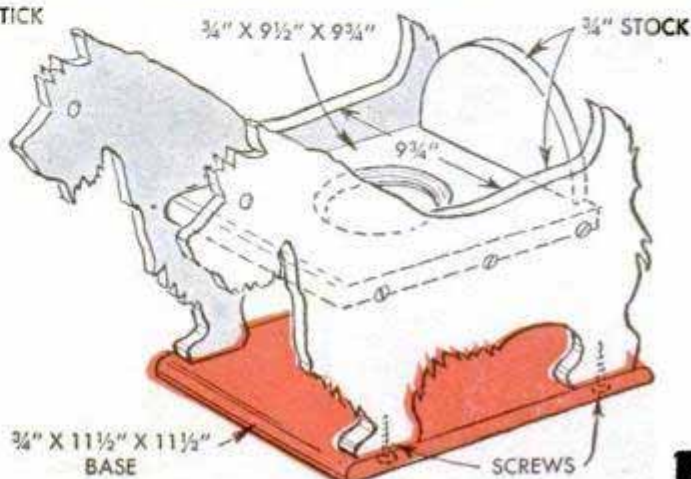
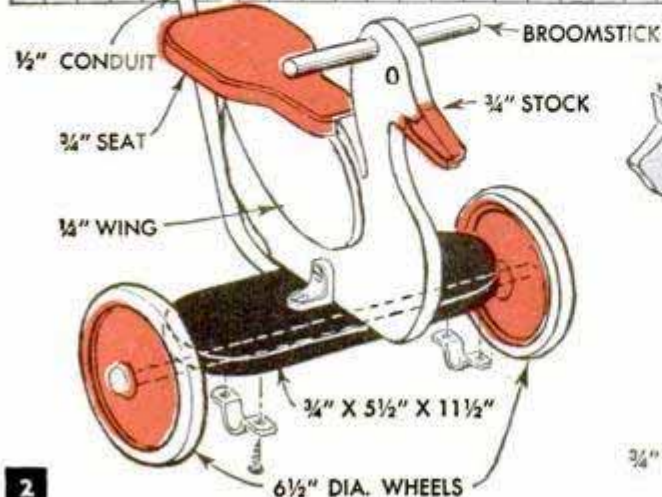
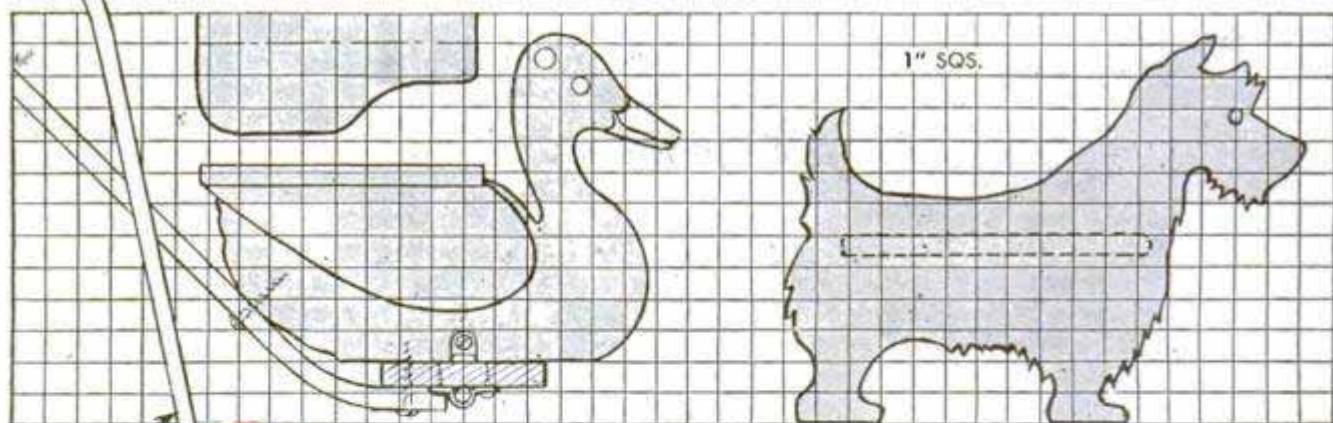



When rainy days keep lively youngsters penned indoors, they'll have a circus in the basement playroom with this rollicking merry-go-round. Propelled by the feet of the riders or pushed by a third person, the toy rotates in a five-foot circle. The colorful fish coaster shown below gives two riders a fast and merry trip downhill. The toy is steered by the feet of the driver, and the fish's fin provides a handhold for the rear rider





No toy is more appealing to a boy than a fire engine. This one has roller-skate wheels, a removable ladder and space for groceries when Mom sends Billy on an errand. Small tots will rock by the hour in the novel seesaw boat pictured below, which is a safe and sturdy toy. The scottie chair at the right can be used as a play chair or put to practical use as a training seat

sidepieces of the chair to support the back. A piece of 1 x 4, cut to fit between the sides, is screwed to the edges of the upright pieces at the bottom. Strong upholstery cloth is used for the seat and the ends are hemmed to slip over two lengths of broomstick, one being screwed between the sides and the other between the ends of the uprights. Finally, short blocks, rounded at both ends, are screwed to the edges of the sidepieces to provide armrests.

**Duck stroller:** Make a paper pattern of the duck first, following the squared drawing, Fig. 2. The duck is cut from a piece of 1 x 12 ( $\frac{3}{4}$  x 11 $\frac{1}{2}$  in.), the wings are  $\frac{1}{4}$ -in. stock and the seat and footrest are sawed from a 1 x 6 ( $\frac{3}{4}$  x 5 $\frac{1}{2}$  in.). The duck is attached to the center of the footrest with angle brackets. Then a handle, bent from  $\frac{1}{2}$ -in. conduit, is drilled for screws and fastened securely to the underside of the footrest and to the edge of the duck. The axle is fastened with small pipe straps.

**Scottie chair:** Designed for use either as a play chair or a training seat, the scottie chair, Fig. 3, consists of five pieces. As 1 x 12-in. material is too narrow for the scotties, extra blocks must be added to the edge of the board for the feet. The seat is a piece of 1 x 10 ( $\frac{3}{4}$  x 9 $\frac{1}{2}$  in.) with a semi-circular back screwed to the rear edge from below. The base is cut square from a piece of 1 x 12 ( $\frac{3}{4}$  x 11 $\frac{1}{2}$  in.). The scotties are fastened



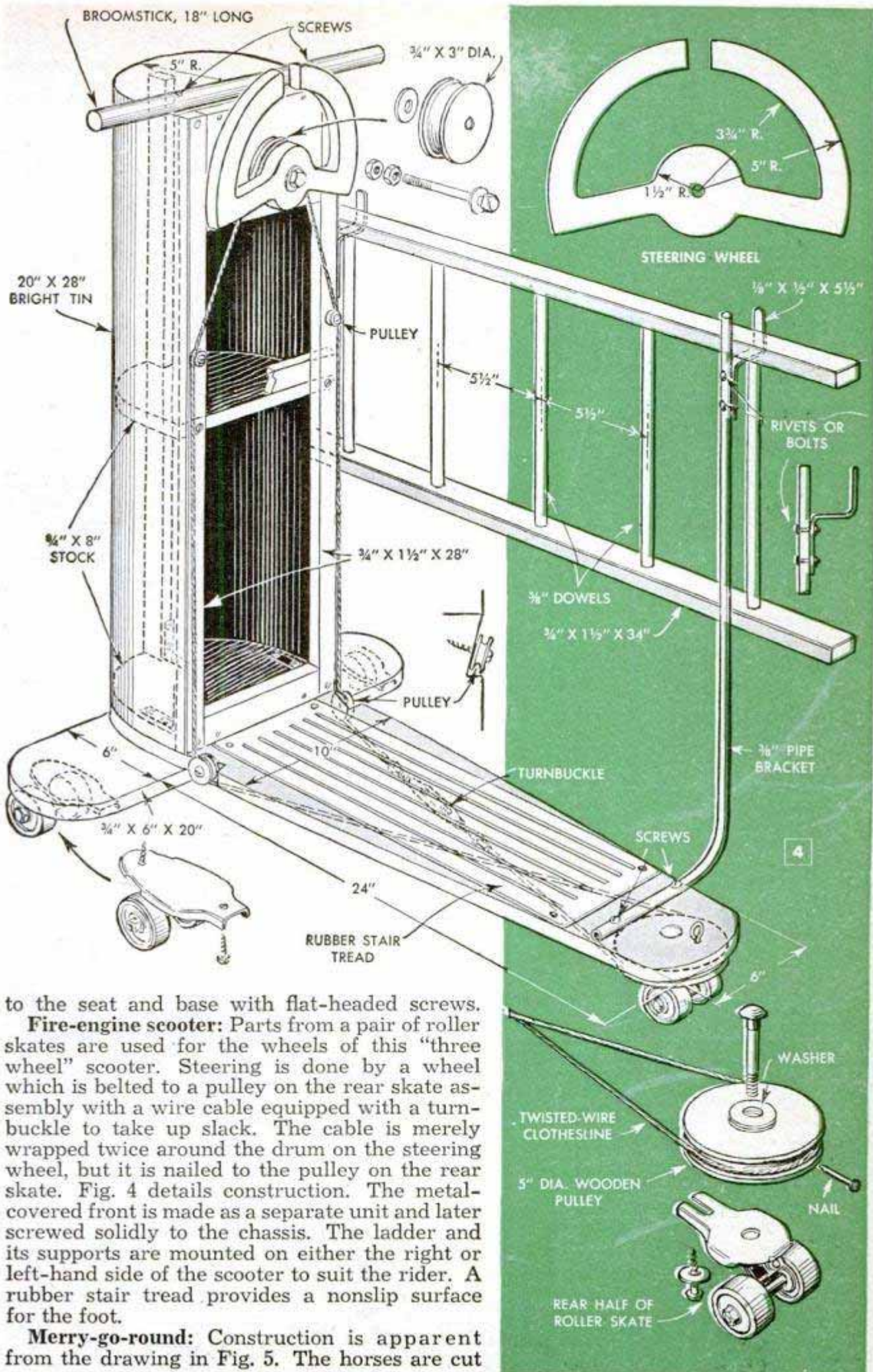

to the seat and base with flat-headed screws.

**Fire-engine scooter:** Parts from a pair of roller skates are used for the wheels of this "three wheel" scooter. Steering is done by a wheel which is belted to a pulley on the rear skate assembly with a wire cable equipped with a turnbuckle to take up slack. The cable is merely wrapped twice around the drum on the steering wheel, but it is nailed to the pulley on the rear skate. Fig. 4 details construction. The metal-covered front is made as a separate unit and later screwed solidly to the chassis. The ladder and its supports are mounted on either the right or left-hand side of the scooter to suit the rider. A rubber stair tread provides a nonslip surface for the foot.

**Merry-go-round:** Construction is apparent from the drawing in Fig. 5. The horses are cut



from two pieces joined together at a 45-deg. angle at the point indicated by the dotted line in the squared drawing. The base of the toy around which the horses rotate is of half-lap construction, bottom edges being covered with rubber to reduce slippage.

**Seesaw boat:** The entire boat is made from 1 x 12-in. stock and assembled with screws in the manner shown in Fig. 6. Screw eyes turned into the top edges are threaded with rope, the ends of which are knotted and frayed to form tassels. Anchor and life-belt motifs are jigsawed separately and nailed to both sides of the boat.

**Fish on wheels:** The body of the fish is built up of two stock pieces joined together with corrugated fasteners. Fins are braced with cleats screwed to each side. The squared drawing, Fig. 7, details the size and shape of all parts. The front-wheel assembly is lag-screwed to the fish.

Left, a beach or garden umbrella used as a canopy will add to the realism of the merry-go-round. A pipe flange and nipple will provide a socket for it

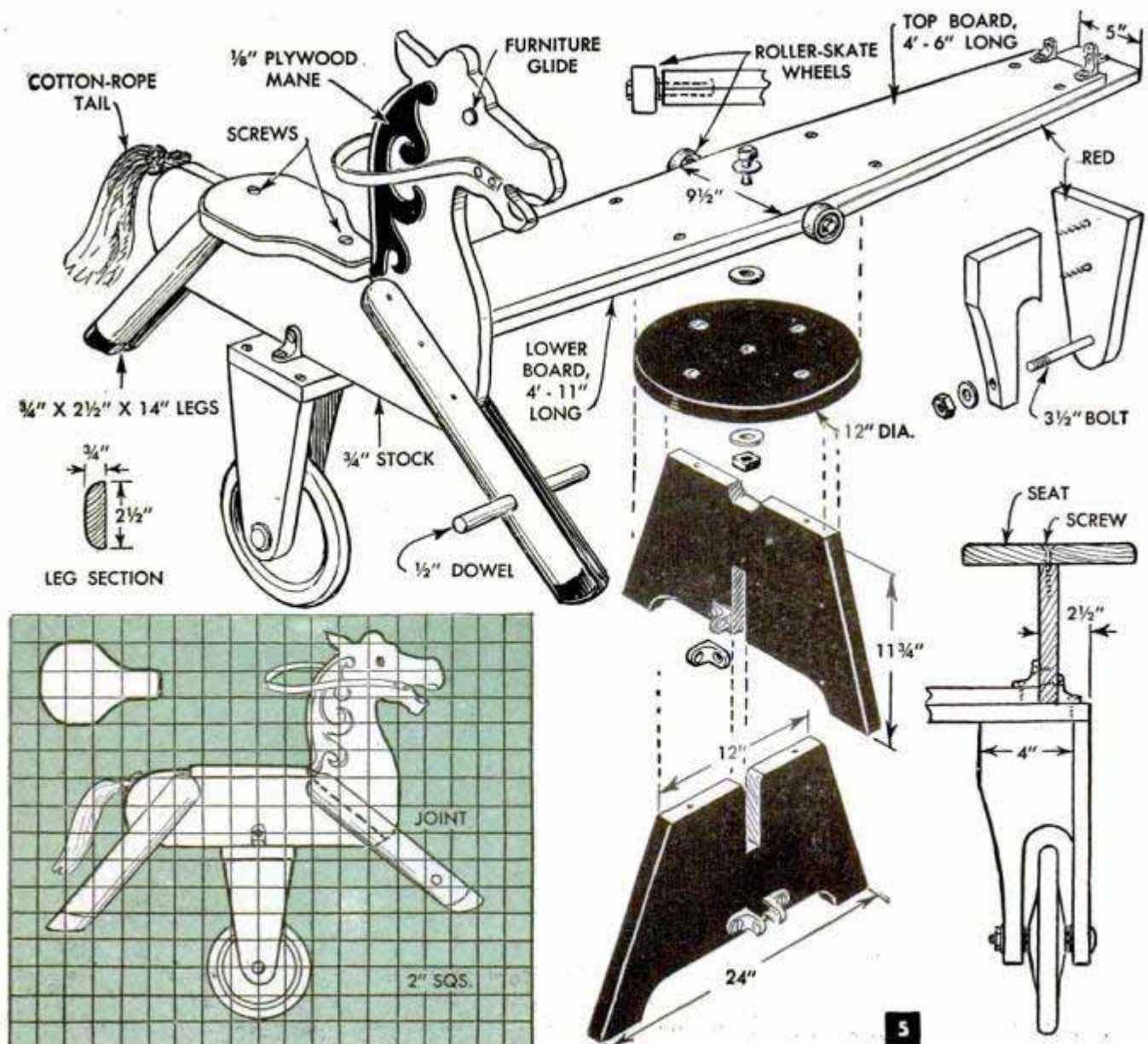



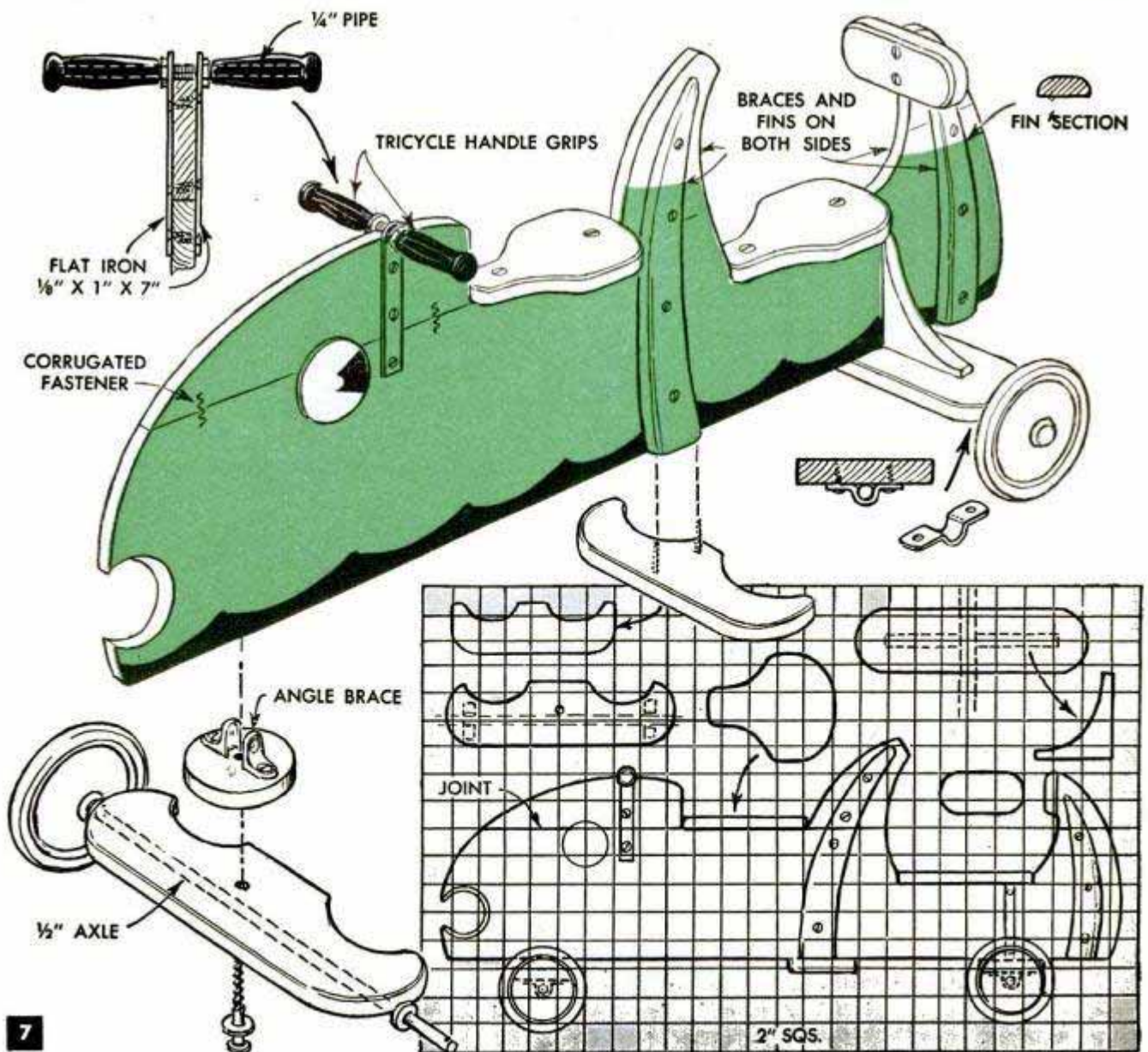
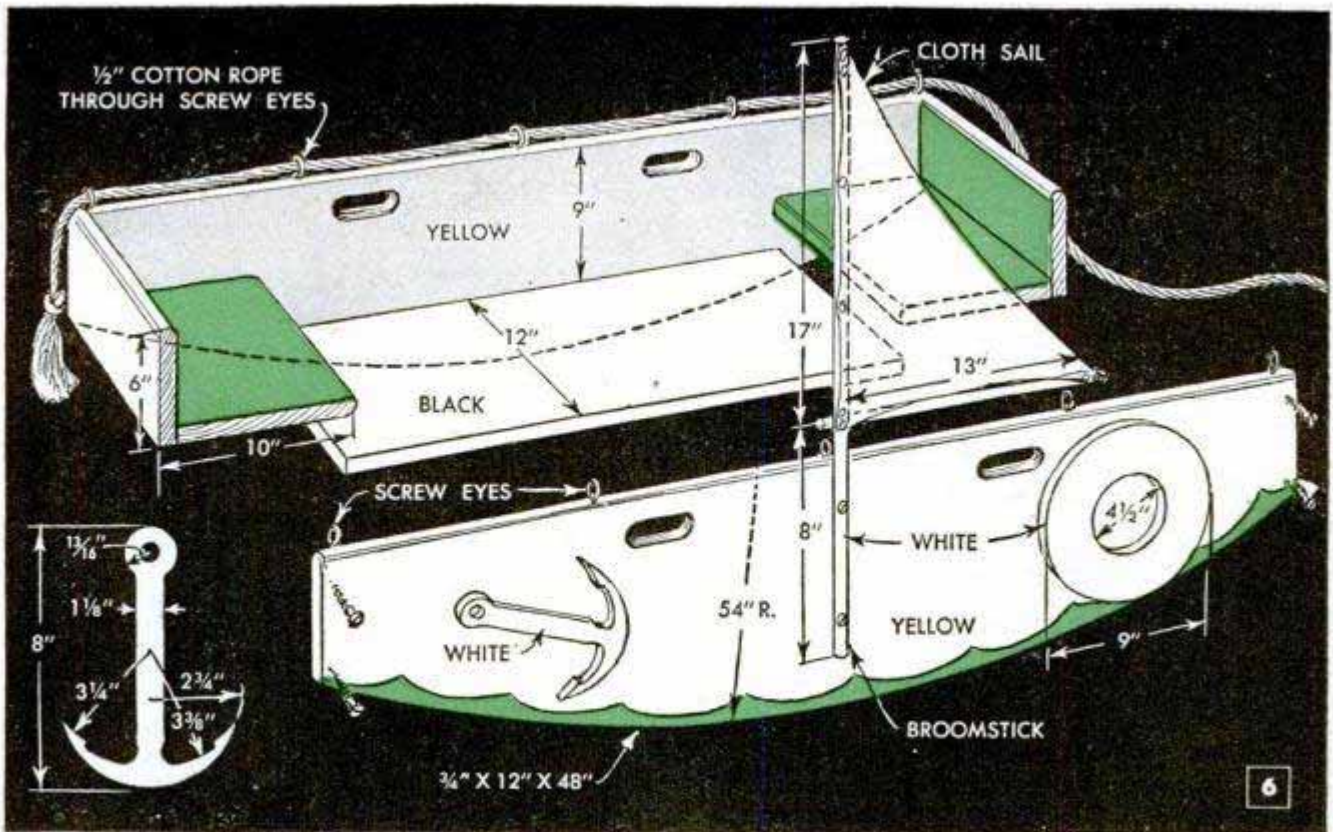

## Skaters' Portable Fireplace Is Made From Oil Drum

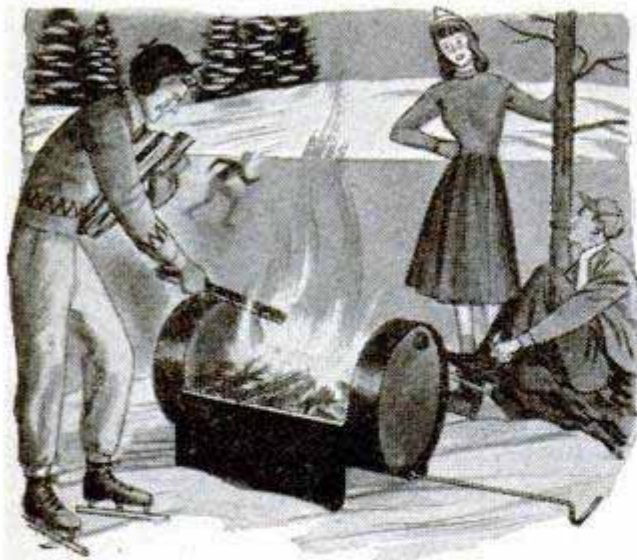

Just the thing for ice-skating parties in extremely cold weather, a sled-type fireplace made from an oil drum is easily towed on the ice. If the party decides to move to another location, the fireplace can be taken along. The side of the oil drum is cut and bent to form two runners, and a towing handle is made from a length of steel rod or stiff wire. A bed of sand or dirt insulates the bottom of the fireplace and permits it to be used offshore.

## Asphalt Base Molding Simulated With Hardboard Strips

If you would like an asphalt base molding in your kitchen and bathroom but feel that it is too expensive, you can imitate it by installing  $\frac{1}{4}$ -in. hardboard. Cut the board into strips of the desired width, chamfer the upper edges and cement or nail them in place. If you nail them, use



small finishing nails and countersink the heads. Use a narrow molding at the lower edge, such as quarter round. Or, if you like something different, try a narrow cove molding. Enamel the base to suit.

## Chucking Wood for Internal Boring

To chuck wood stock securely in a lathe for internal boring, use a piece of pipe coupling to increase the gripping surface of the chuck jaws. Hacksaw a section from the side of the coupling to permit clamping action and turn down the end of the work to fit in the coupling. Make this shouldered end the same length as the coupling clamp to give a positive grip.—L. D. Barner, Waco, Tex.

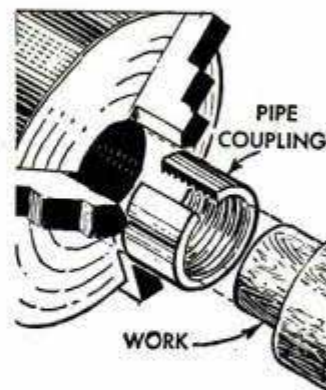

## Handle to Carry Chopping Block



It's not difficult to carry a chopping block if it is fitted with a handle. A good one that will not damage the cutting edge if it is accidentally struck with the ax is made by nailing a strip of old auto casing to the side of the block.

## Cutting Plastic on Bandsaw

Before cutting plastic with an ordinary bandsaw blade, turn the blade so that the teeth point upward as they pass through the table. This gives the necessary backward angle to the teeth and will prevent chipping of the plastic. Best results are obtained if the blade is lubricated with paraffin or wax.

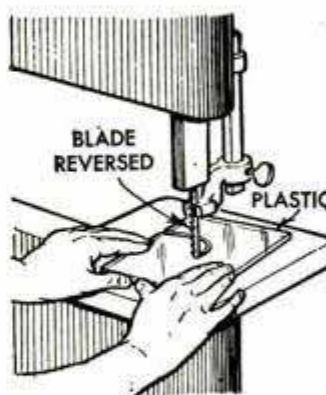

S. S. Palestrant, Bronx, N. Y.

☛ A handful of salt thrown at the base of a flame caused by burning grease will extinguish it quickly.



## FANCY WOODS from your back yard

By Walter E. Burton

**C**HOICE pieces of fancy woods that are ideal for small turnings, such as tool handles and similar projects, are available right in your own back yard. Wood from an apple or cherry tree finishes beautifully and is well suited to turnings and the carving of small novelties. Large stems of some rose bushes, being of tough and close-grain wood, are excellent for tool handles. Catalpa wood, while relatively soft, has an interesting grain.

Often, the dead branches of a bush or tree will be dry enough to use right away but in other cases the wood will have to be seasoned before working it to shape. This is done by stripping the bark from the branches and then storing them overhead in a garage or dry basement. Paint both ends of each piece with asphaltum to prevent checking. After a few months of air-drying, the pieces will be ready for use.

The spatula pictured in the photos at the right is an example of what can be done with home-grown wood. Here, wood from the stem of a rose bush was used to form the handle. First the wooden parts are planed flat on one side and cut roughly to size. Then they are clamped to each side of the spatula tang and all three parts drilled at one time for three flat-headed rivets. Holes in the wooden parts are countersunk slightly to take the rivetheads and the burrs on the peened ends. A file is used to dress the rivets flush with the wood and, finally, the handle is worked down to the desired shape with sandpaper. A coat of stain followed by two coats of clear lacquer and rubbed to a high polish brings out the beauty of the wood.

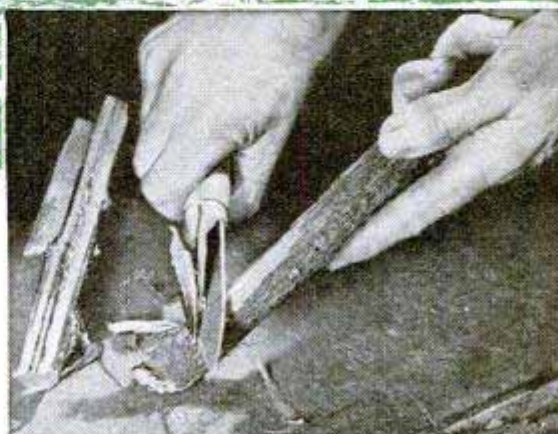

Removing bark of dead rose-bush cane. Wood is then allowed to dry thoroughly

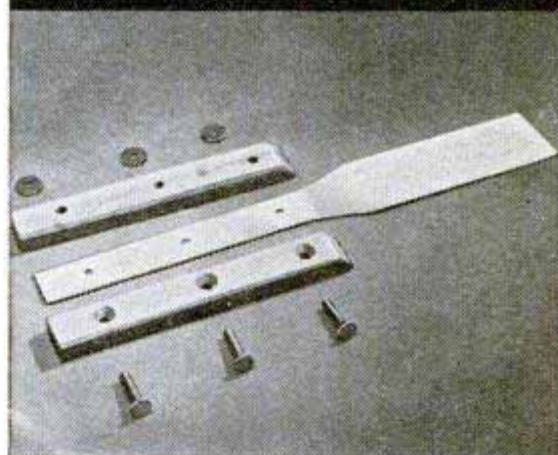

A length of rose-bush cane, split down the middle, is used for spatula handle

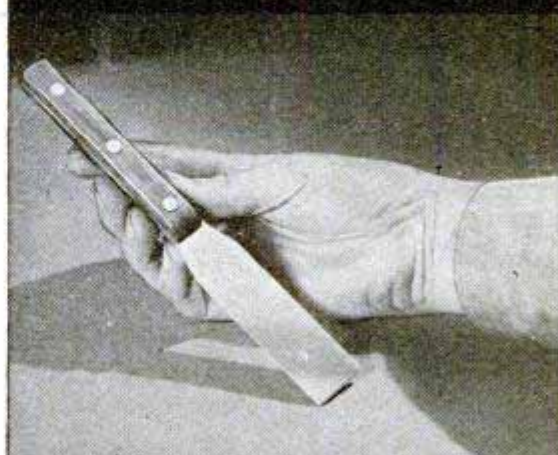

Assembled to spatula with brass rivets, handle is sanded, stained, lacquered

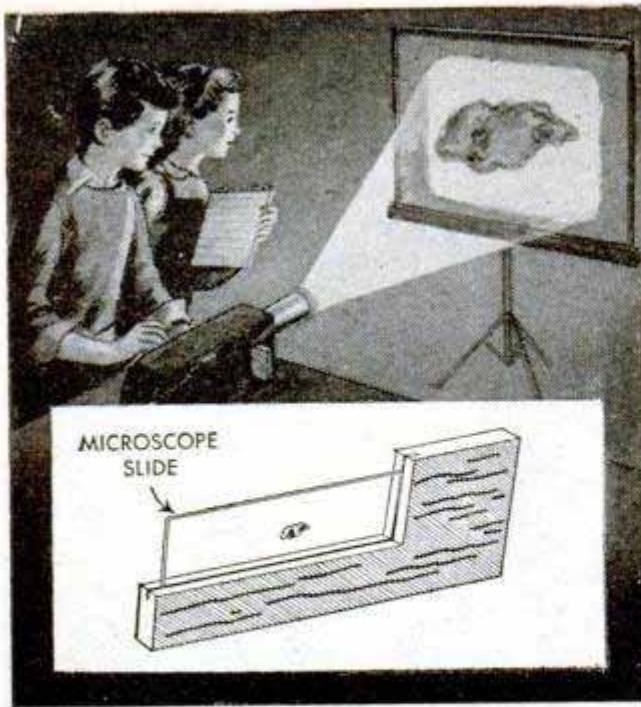

### Microscope Slides Are Projected For Study and Entertainment

In addition to being a study aid for high-school science courses, an ordinary transparency projector adapted for showing microscope slides provides hours of entertainment for the child hobbyist. The regular transparency carrier is replaced with a wooden slide carrier, the dimensions of which are determined by the particular projector. The wooden carrier is made L-shape from two separate blocks. Before the blocks are glued together, the adjacent edges are grooved to hold a microscope slide, as shown. The projector is operated in the same way as when used to show transparencies.

Leo J. Freiermuth, Moscow, Idaho.

### Fitting Plywood Panels



It is easy to fit a plywood panel into the grooved stiles and rails of a paneled cabinet or door frame if the edges of the panel which are to fit in the grooves are chamfered 45 deg. along each corner. The cham-

fers readily permit the edges of the panel to be aligned with the grooves. This is especially helpful when the panel is of a fairly large size.

Whitney K. Towers, Los Angeles, Calif.

☐ If you wrap silverware in flannel, use the unbleached type. The sulphur used in bleached flannel tarnishes silver.

### Cold Chisel Has Shockproof Grip

Using a cold chisel will be easier on your hand if a piece of rubber tubing or garden hose is slipped over the shank of the chisel. Soft, thick-walled tubing is best. If it is difficult to force over the chisel, lubricate the shank with a few drops of glycerin.

Jo Ro Jung, New Orleans, La.



### Siding Is Spaced Quickly With Spool Gauge

Once the starting strip of beveled siding is leveled and nailed in place, it's a simple matter to space and level each succeeding board with this spool-shaped wooden gauge. The gauge, turned to the dimensions indicated in the detail, is employed at intervals along the length of each piece of siding as in the photo. The length of the gauge shank is not given, as this depends upon the width of the siding and the height of the wall. Consideration of the latter is important if you would avoid having the last piece of siding considerably narrower than the others. Thus, if the siding is to be laid 6 or 8 in. to the weather, you should determine if the total height of the wall is a multiple of the desired spacing. You may find it necessary to vary the 6 or 8-in. spacing one way or the other. The figure for the correct spacing is also the dimension for length of the gauge, measuring from the outside edge of one flange to the shoulder of the other. As long as both flanges are 1/2 in. wide, the gauge can be used end-for-end.

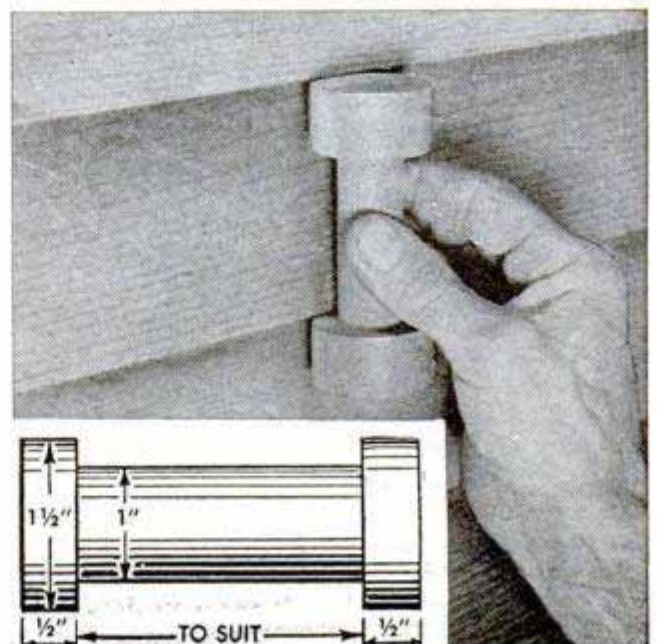

# SLIP-JOINT PICTURE FRAME

By Benj. Nielsen

ONE WOULD never guess that this unusual picture frame slides apart on hidden dovetail splines to release the photo. While the one shown is circular, only minor changes in dimensions are necessary to make the frame square, with a square picture recess. To make a circular frame, bandsaw the corners from a piece of stock  $\frac{3}{4}$  in. thick and 7 in. square, and make the five decorative saw cuts, indicated in the detail, parallel with the grain. Mount on a lathe faceplate and cut the picture recess, undercutting the edge as in section A-A. Then, turn to a 7-in. dia. and sand smooth. Bandsaw the disk to form the automatic ratchet-type catch which holds the two sections of the frame securely when they are slid together. Next, make the dovetail spline of hardwood and run a groove and dovetail in the two parts of the frame as in section B-B. Some hand-fitting probably will be necessary to assure that the parts operate properly. If a square frame is made, the work is somewhat simplified as no turning will be necessary. If desired, the shallow saw cuts can be respaced on the square frame. Use a fine cabinet wood of a uniform color and attractive grain, finishing the frame in the natural color of the wood.

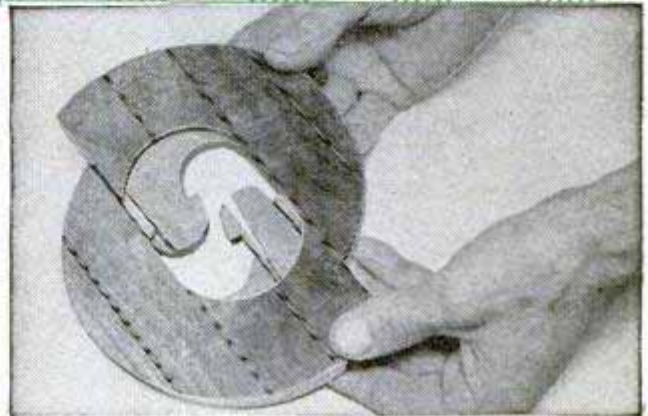
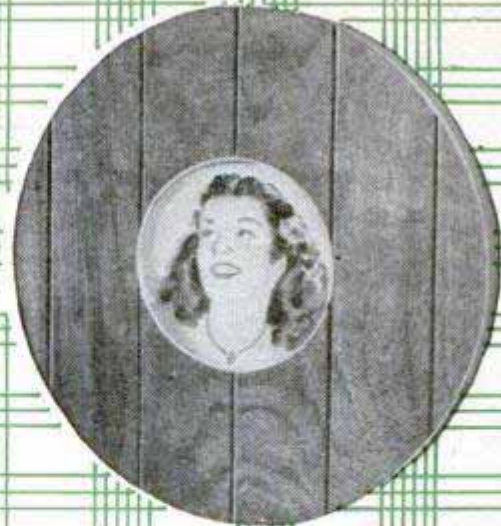

Unusual catch operating on ratchet principle holds sections of frame together and is quickly released

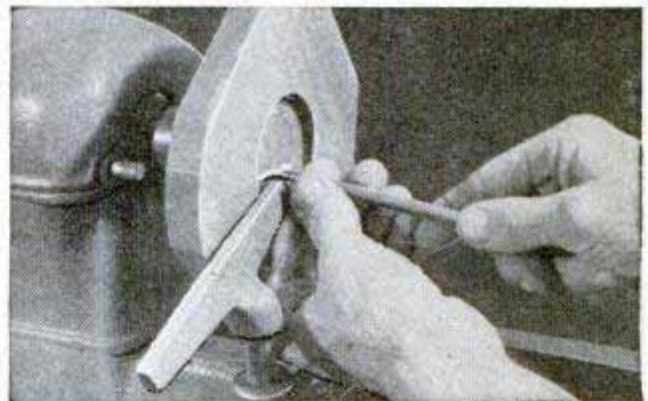

With rough frame mounted on lathe faceplate, edge of picture recess is undercut for glass and photo

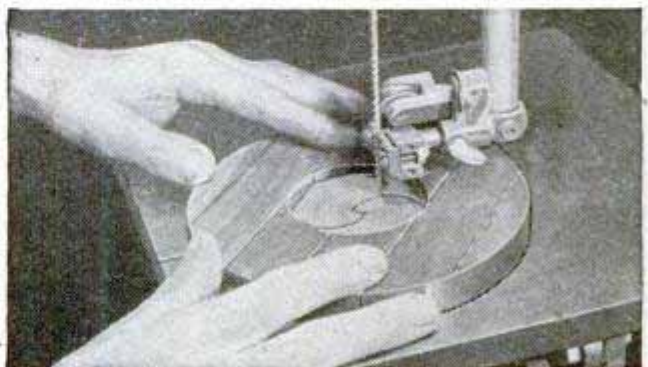

Bandsaw frame into two sections, forming ratchet-type catch. Then cut grooves and add dovetail splines

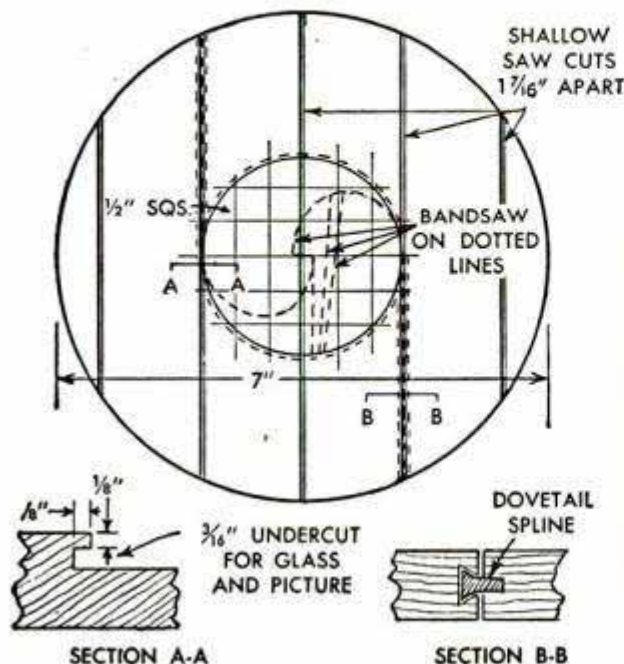

# REPAIR DAMAGED RUGS

**N**EW LIFE is added to torn, frayed and spotted rugs by simple needle-and-thread repairs that can be made right at home. Warp breaks, or tears, worn fringes and split selvages are the most common types of damage caused by prolonged heavy wear. Large throw rugs placed before doors and between rooms, and also room rugs unprotected by pads on uneven floors get the greatest amount of wear and become damaged quicker than rugs in the less-traveled areas of the house.

Rugs are of two common types: those that are woven, and those made by knotting or hooking threads through a loosely woven foundation, or web, through which the threads pass to form loops. These loops usually are sheared to a uniform height in the course of manufacture and form what is called the pile. In the woven type of rug, the warp and weft threads are woven flat, thus exposing the side of the thread to wear instead of the ends of the sheared loops as in the pile type of rug. Figs. 7, 8 and 9 show variations of weave. Special terms are used by manufacturers and dealers to identify the various types of rugs and certain designations determine the twist of the yarn and the finish or quality of the fiber. The type of floor covering woven in strips on narrow looms is commonly called carpeting. It is made in various widths and is generally woven in solid colors. Other types of rugs are usually woven in colored patterns. Rugs in colored patterns should always be cleaned before any repair is attempted, otherwise

By **Simon S. Palestrant**

the repair may not match the pattern. This is especially true when the rug is somewhat threadbare and the colors have been dulled by long wear, or have faded due to exposure to sunlight. Vacuum cleaning a rug thoroughly will remove the loose dirt and also some embedded dirt, but only washing or shampooing will restore the color in a worn pattern rug. If the repair, even though it is small, involves matching a part of an intricate pattern, Fig. 2, a thorough cleaning beforehand is doubly important.

Tears occur when a rug is scuffed while on the floor or when sudden pressure twists and breaks the warp threads of the web. Ordinarily a warp break of this type is easy to repair as no part of the rug is torn away or missing. The edges of the torn parts are matched carefully and sewed together either with an overcast stitch, Figs. 1 and 5, or, in some cases, with a cross-stitch as in Fig. 6. To make it easier to join the parts, the torn area of the rug is laid over a rounded piece of wood—a rolling pin is just the thing. After the repair is finished, wrinkles are flattened by spreading and stretching the threads with tweezers as in Fig. 18. Small sections of rugs or carpeting can be sewed together to form a larger piece in the same manner.

Repairing a threadbare rug where the pile is worn down to the web in spots calls for a more detailed procedure. The pile must be replaced with a wool yarn colored to match the pattern closely. The method of looping the repair yarn varies with the type of rug from the simple hooked loop,

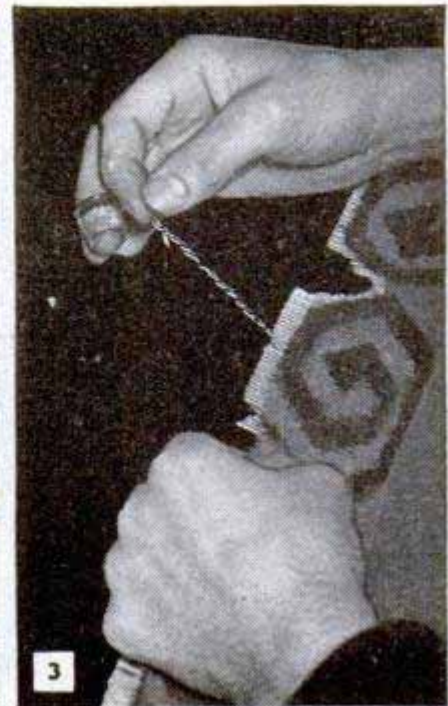
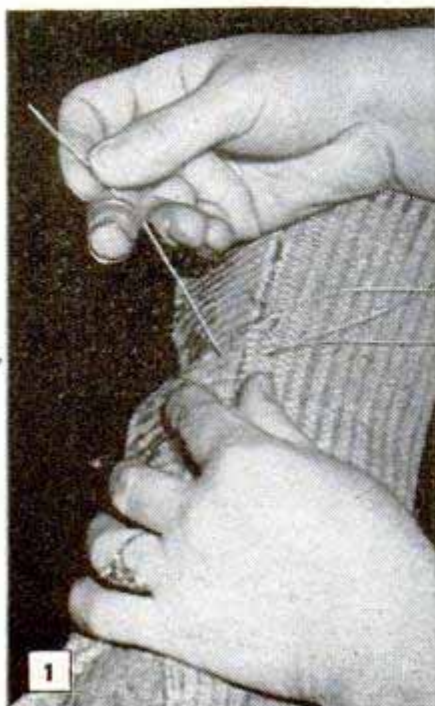

# YOURSELF

Fig. 7, to the intricate Persian weave in Figs. 8 and 9. In some cases, it is possible to match a design with yarn unraveled from an old rug as in Fig. 3. Remove the old pile knots in the threadbare portion to expose the web. Then tack this area over a wooden frame made from 1 x 3-in. stock. The frame serves the same purpose as embroidery rings, as it holds the rug flat and helps retain the flatness after the repair is made. Next, loop the wool threads into the web with the colors arranged according to the original pattern, Fig. 4. Knot the yarns and, when the area is covered, clip the tops of the loops to the same height as surrounding pile.

A small hole due to a burn or other cause makes it necessary to replace the web as well as the pile. Select a thread of the same size as the warp threads and start as in Fig. 11. After the opening is covered with the warp, cross-weave the weft threads as in Fig. 12 by threading the needle under one and over the next warp thread until the weft thread is carried across the hole. In taking the next weft thread across, the under-and-over weave must alternate with the first. Proceed alternately in this manner until all the weft is woven in. Then weave in the pile loops and shear to

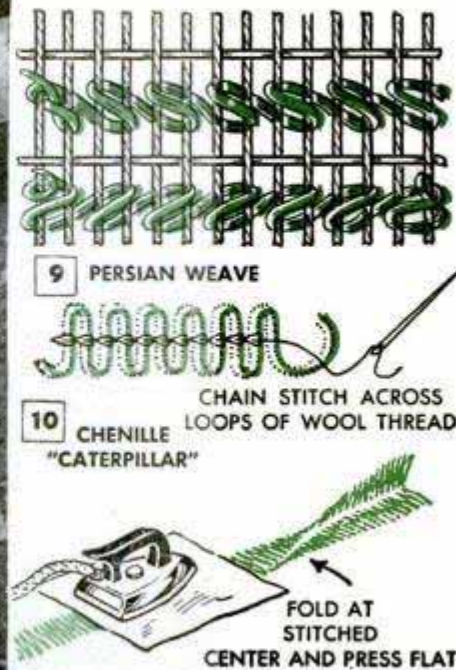
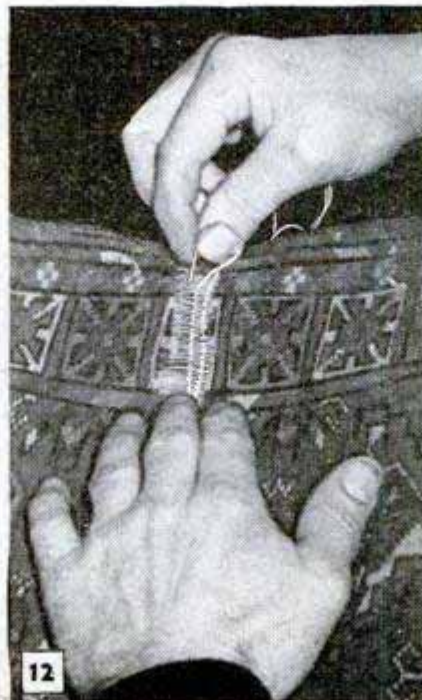
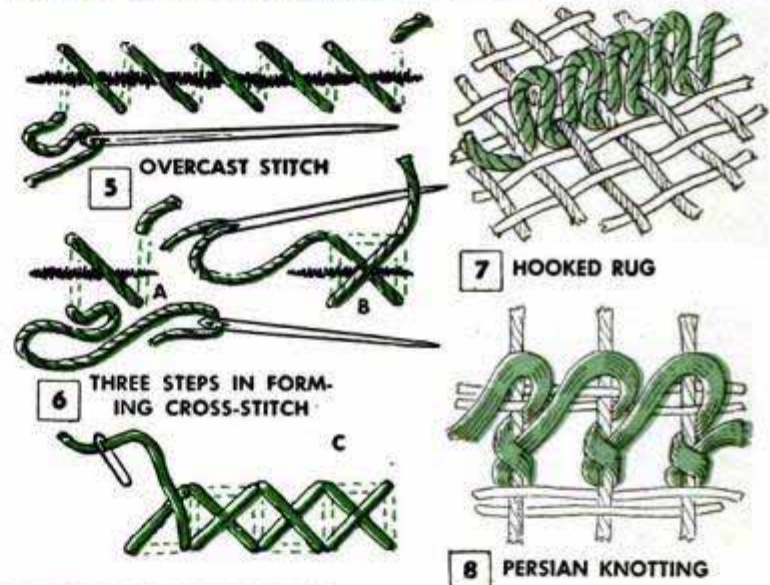

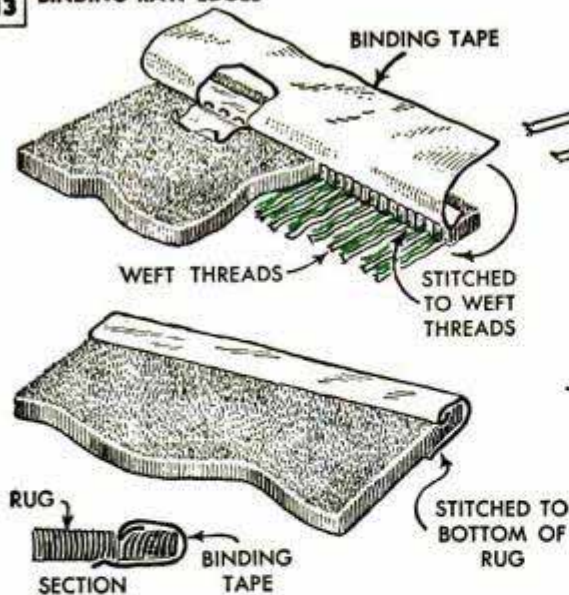
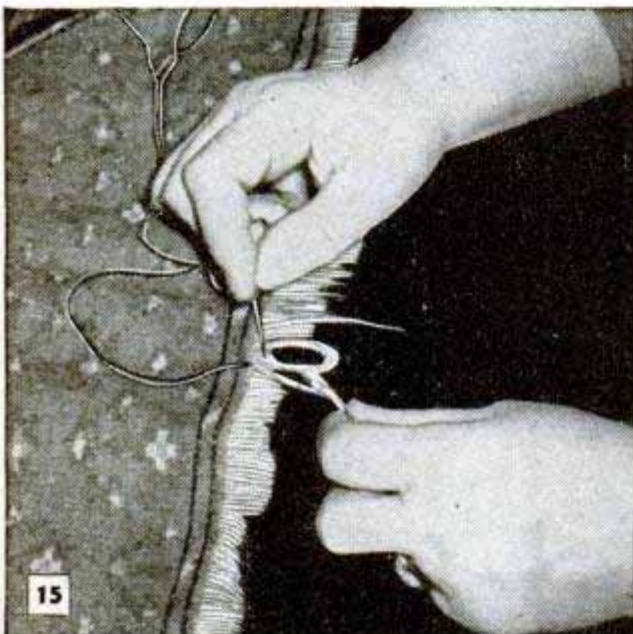
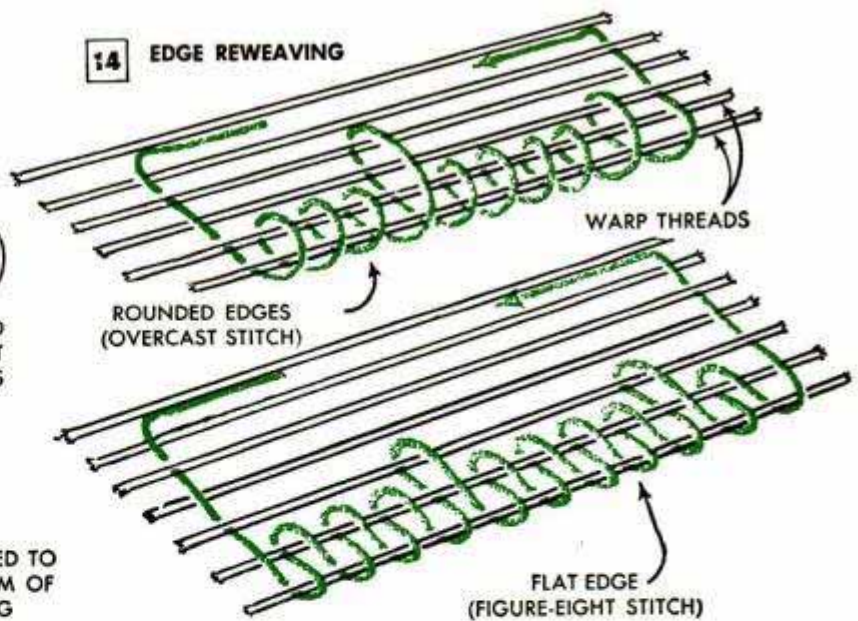
**13 BINDING RAW EDGES****14 EDGE REWEAVING**

**15** Above, in making a fringe, loops of wool yarn are sewed to the selvage. Below, uneven ends of the cut loops are trimmed straight to make a uniform edge



match the surrounding pile. In filling in a missing area of a chenille rug, a specially made fringe, or "caterpillar," is used as in Fig. 10. This is folded and pressed as shown before inserting in the opening in the rug.

When a piece of floor covering is cut to a narrower width or to an odd shape, the cut edge must be reworked to prevent it from raveling, Fig. 19. The last few rows of threads bordering the cut are sewed together with an overcast stitch, and the sewed edge is protected with binding tape as in Fig. 13. Where the edges of a rug are not cut but are frayed by long wear, they can be rewoven as in Fig. 14, using either an overcast stitch or a figure-eight stitch, depending on whether a rounded or flat edge is desired.

To replace torn or worn fringes, first cut off the old fringe and overcast the last two warp threads with ordinary sewing thread to keep the end of the rug from fraying. Some fringes on very old rugs are made of linen, but on most rugs the fringes are either wool or cotton. Linen and cotton fringes are sewed into the rug as they are made, detail A in Fig. 17, by simply drawing the cotton or linen threads into the selvage. Note that the thread is continuous, as in detail C in Fig. 17. When completed, the loops are laid flat and cut, Fig. 16. Then they are dampened, brushed flat and allowed to dry. If the fringe is to be made of wool yarn, alternate loops are made and the crest of each loop is sewed directly to a warp thread in the selvage with a separate cotton thread, detail B, Fig. 17, also Fig. 15. After sewing in place, using as many series of loops as are desired to form a light or heavy fringe, the loops are cut, dampened and flattened as before. Ready-made fringes, detail D, Fig. 17, are commonly used on small occasional rugs. These are stitched to the underside of



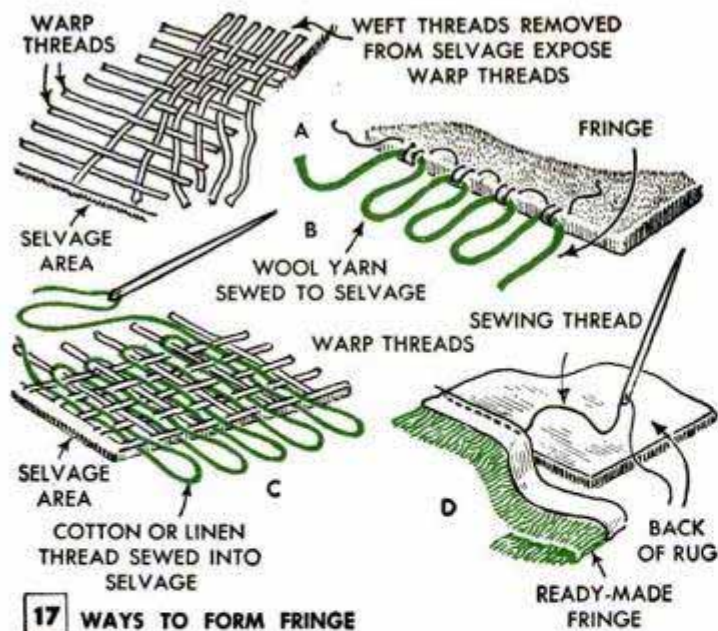

17 WAYS TO FORM FRINGE

the rug, Fig. 20, and may be attached all the way around the rug or only to the ends.

Older rugs may show small white spots, either singly or in groups, and sometimes they will appear widely scattered over the whole surface of the rug. Usually, this is due to small tufts or knots of the pile being pulled or torn out of the web. When these appear singly or widely scattered over the whole surface of the rug, they can be hidden effectively by touching up with aniline dyes, or waterproof inks will give the same result. Usually, the dyes must be mixed to match the adjacent colors. Unless the area is large, the new color need not match the old one exactly, but it should be close as otherwise the spot will show at some distance. The dyes are applied with a small brush as in Fig. 21 or with a pointed stick. In some cases a stick is better as the color can be worked down to the full depth of the pile. It should be noted that this repair is only a temporary one. If the rug is badly spotted over its whole surface, it can only mean that the warp is rapidly disintegrating to the point where the rug is no longer worth repairing.

Rugs that get exceptionally hard wear on an uneven floor are sometimes protected with a heavy lining sewed to the bottom. This can be applied only to those areas that get the hardest wear, or the lining may be attached to the whole underside of the rug. Use a heavy 6-oz. ticking or a lightweight awning cloth. When a lining is used it probably will be necessary to remove it before the rug can be cleaned properly. It should be remembered that a lined rug slides easily on a waxed hardwood floor. On a smooth floor the felt pad is usually more effective in minimizing wear.

☛ New inner soles for house slippers can be cut from an old felt hat.

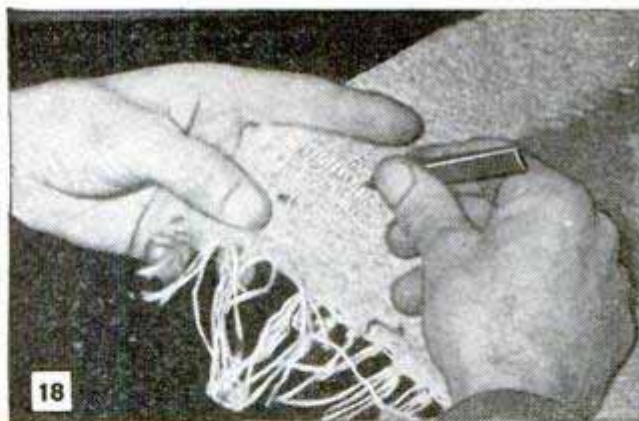

18 Wrinkles are flattened by spreading and stretching threads with tweezers. Threads then are respaced

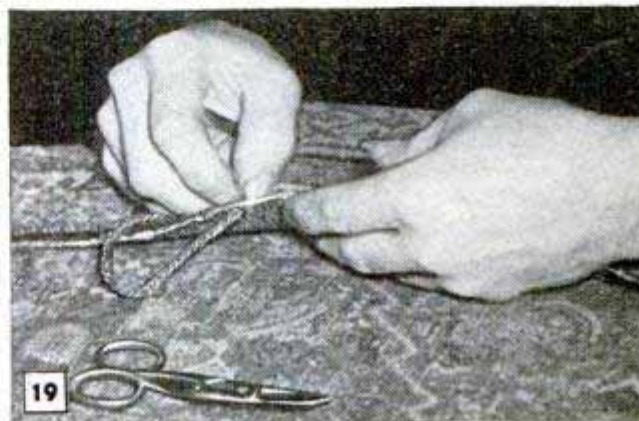

19 Reweaving the edge after cutting. New threads are pulled into the warp threads with an overcast stitch

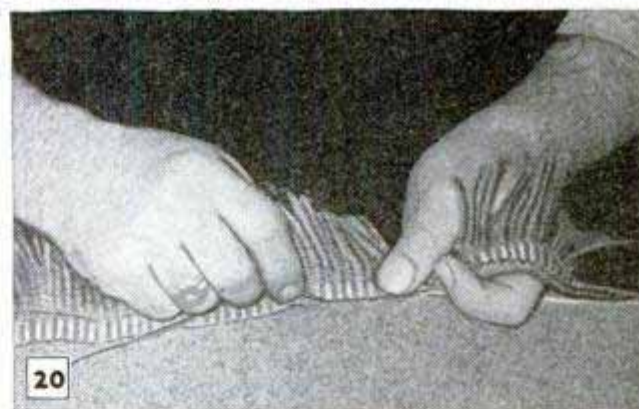

20 Ready-made fringe being sewed to a bound edge. Fringe should be sewed to the underside of the edge



21 Aniline dyes or waterproof inks are used to tint small light spots that show up where worn pile is pulled out of the web. This repair is considered temporary

## Notebook Buttoned to Pocket Is Protected From Loss

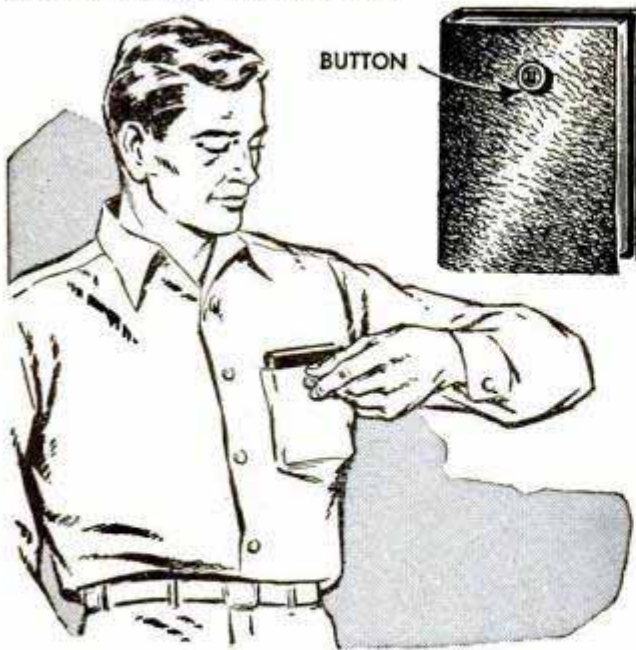

If you carry a notebook in a shirt pocket while on the job, it can be kept from dropping out when you bend over by buttoning it to the pocket. Simply sew a button to the cover of the notebook and make a corresponding buttonhole in the pocket. This idea is useful also when carrying an over-size notebook or wallet in the hip pocket.

Andrew Vena, Philadelphia, Pa.

## Coloring Scribed Lines on Plastic Aids Following Pattern

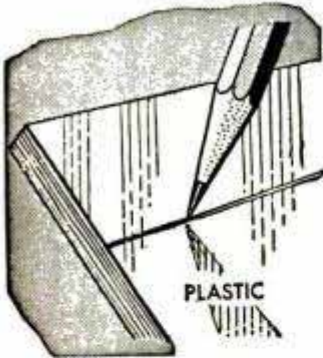

Guidelines scribed directly on plastic prior to cutting it are easier to follow if colored with a soft pencil. After filling the lines, wipe away excess color. —Frank Shore, New York City.

## Motor-Switch Guard and Lock

A piece of sheet metal cut and bent approximately as shown provides an excellent motor-switch guard and locking device for home-workshop equipment. It is particularly useful when the position of the switch is such that it is likely to be accidentally turned on while the machine is being adjusted.



The guard is held in place by the switch locknut. Holes drilled through the curved sides of the guard permit locking the switch in the off position with a padlock. This prevents unauthorized use of the equipment and is a necessary precaution when children have access to the shop.

Richard Hanscom, Elmhurst, Ill.

## Newspaper in Pot-Type Burner Absorbs Excess Fuel Oil

When a pot-type oil burner is turned on and forgotten without being lighted, a quantity of fuel will collect in the bottom of the pot. If ignited, this will generate extreme heat. Therefore, the excess fuel must first be removed before the burner can be used. An easy way to do this is to

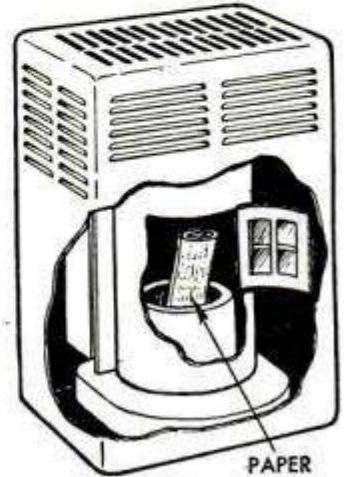

make a tight roll of newspapers and stand the roll upright in the pot. Turn off the valve, of course, before inserting the paper roll. After about an hour, the paper will have absorbed the oil and it then can be removed, leaving the burner in usable condition. As the oil-soaked paper is a dangerous fire hazard, do not allow it to remain in the house. Discard or burn it outdoors. —Hi Sibley, Nuevo, Calif.

## Metal Trim Provides Tool Rack

Metal trim or upholsterer's steel webbing nailed to a wooden backing rail makes a neat-appearing rack for small tools. Half-round bends are made in the trim at regular intervals and the rail is notched opposite the bends to form holes for inserting the tools. If hammers, tin snips or similar tools are to be hung from the rack, enlarge the holes to suit the sizes and shapes of the tools.

Arthur Trauffer, Council Bluffs, Iowa.

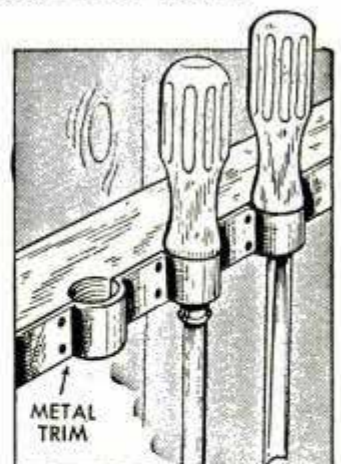

Wash the inside of your refrigerator with lukewarm water and borax to keep it sweet and clean. To absorb the odors, put a piece of charcoal on one of the shelves.

# Plastic Poppies

**P**OPPIES of crystal-clear plastic "planted" in a wooden bowl form an attractive centerpiece for the dining table. Arrange the flowers in a small salad bowl or in a bowl turned from hardwood. Use a bowl that is plain so it will not detract from the flowers. Cement the stems of the finished flowers in  $\frac{1}{8}$ -in. holes drilled in the bottom of the bowl or support them with a frog. The stems are cut from  $\frac{1}{8}$ -in. sheet plastic and their edges are rounded by scraping with a knife. Use a fine file or a knife to make round tenons,  $\frac{1}{8}$  in. in dia. and  $\frac{1}{4}$  in. long, on both ends of each stem. Then cut blanks for the flowers and leaves from  $\frac{1}{16}$ -in. crystal plastic and drill a  $\frac{1}{8}$ -in. hole through the center of each flower blank.

Each stem, leaf and flower is shaped individually by first heating it until pliable in an oven set at 250 deg. and then bending to suit. Handle the heated plastic with clean cotton gloves or a piece of cloth as, when pliable, it is too hot to handle comfortably with the bare hands. Bend the stems to a slight curve and cup the flower petals. Next, form the base of each leaf around one of the stems, holding it with the thumb and forefinger until it cools enough to retain its shape. Finally, attach the leaves and flowers to the stems with fast-setting plastic cement, holding the parts in place with the fingers.

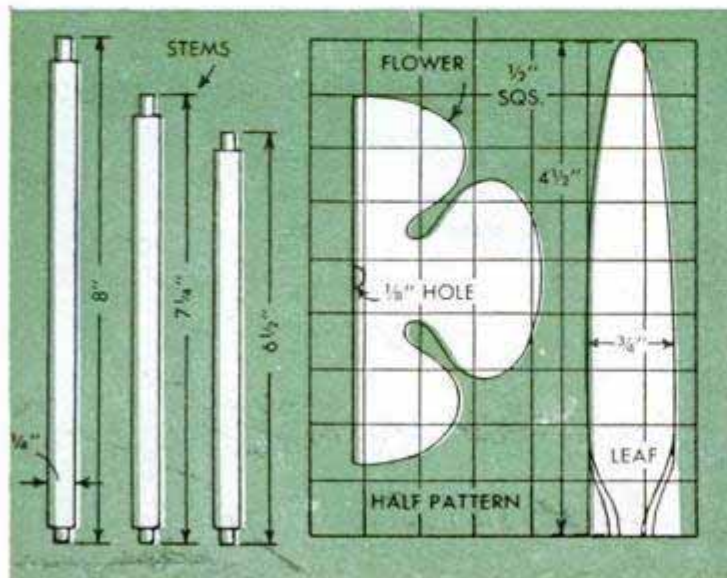
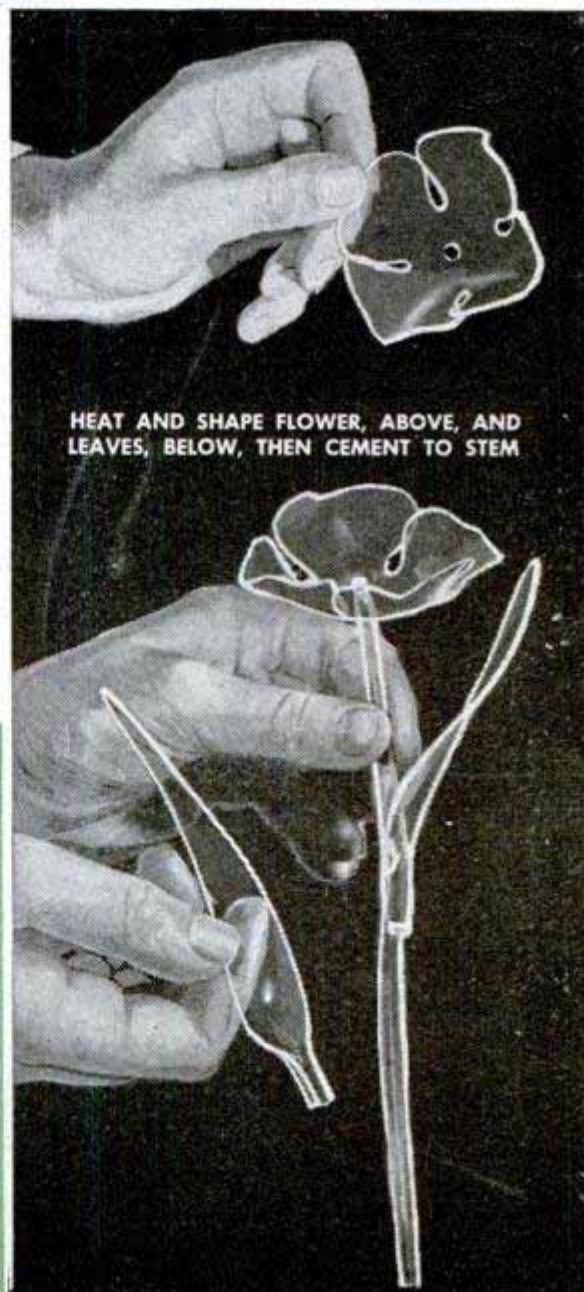

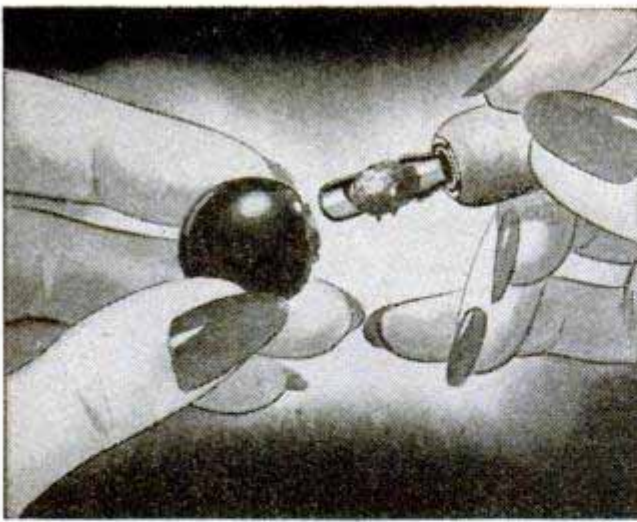

**PITTING CHERRIES** is easy if you use a clean pen point. Just insert it point first into a penholder, then insert the rounded portion into the stem end of the cherry and rotate it to remove the pit

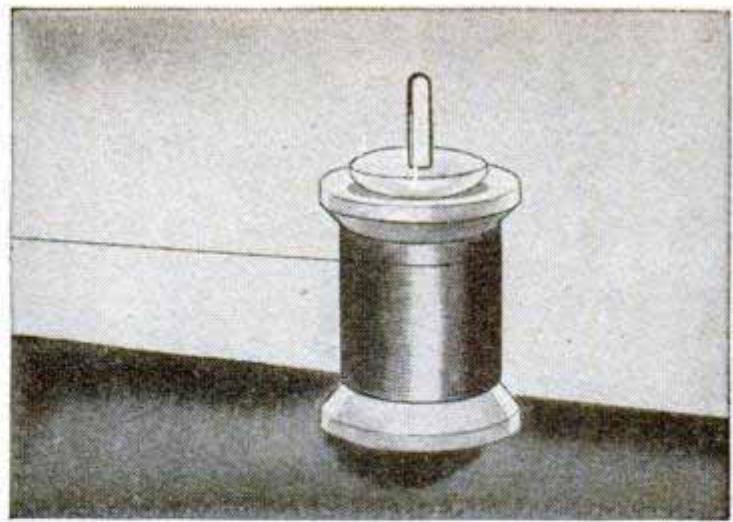

**RAPID SEWING** by machine will not cause the spool to spin and unwind the thread too rapidly if a rubber faucet washer is placed over the spindle and on top of the spool to serve as a friction brake

## SOLVING



**A DRINKING GLASS** is less likely to slip from the hand of a child if several wide rubber bands are placed over the glass. In addition to giving a nonslip grip, colored bands add decoration

**HAIRPINS FASTEN HEMS** of marquisette curtains for machine stitching, lower left. Using hairpins saves much time spent basting and removing threads and does not damage the curtains

**IF LOUD TICKING** of an alarm clock disturbs your sleep, you can muffle it and still read the time if a glass bowl is inverted over the clock as shown below. Use a bowl made of clear glass

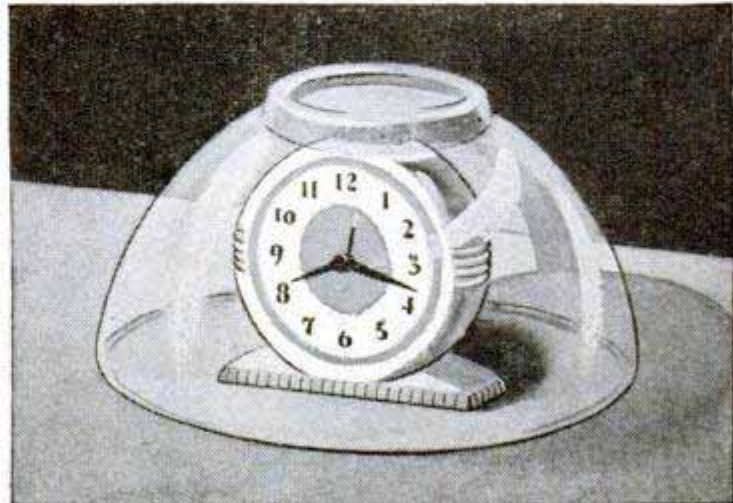
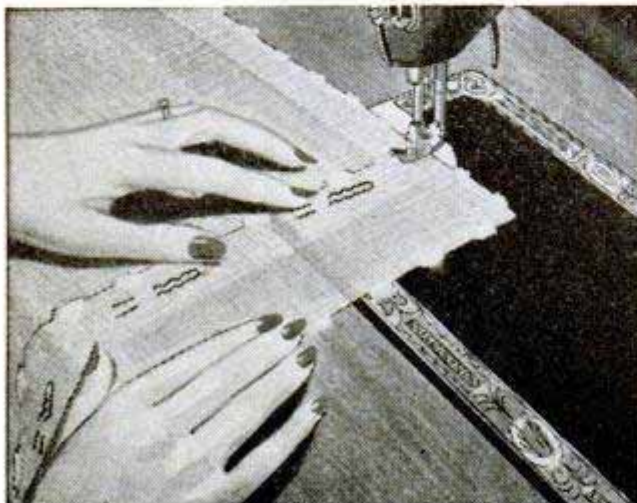

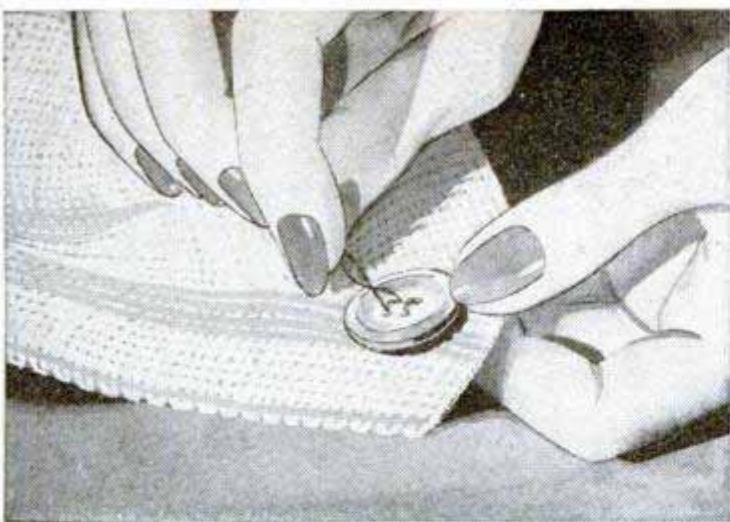

**A LARGE BUTTON** sewed to the corner of a dishcloth comes in handy to scrape hard-to-remove food from dishes and pans. This eliminates using a knife or scraper when cleaning burned or hardened food

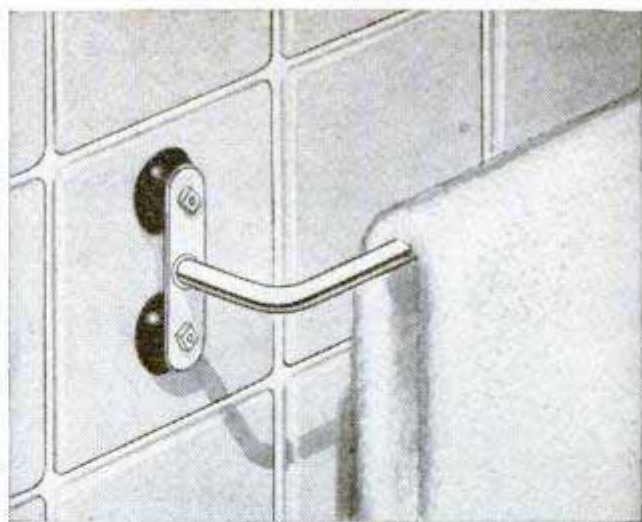

**MOUNTING TOWEL RACKS** on tile walls with suction cups makes it unnecessary to drill any holes through the tile and allows the racks to be readily rearranged. Moisten the cups before mounting

## HOME PROBLEMS

**BROOMSTICK HANDLE** on stepladder, right, helps keep your balance when standing on upper steps. Drill hole in top step and a block fastened to its underside and whittle broomstick end for tight fit in hole

**SOILED STOCKINGS** caused by rubbing against the tops of galoshes, lower right, are prevented by placing strips of adhesive tape around inside of galoshes at this point. Tape is replaced when soiled or worn

**PROTECTING PLANTS** kept on window sill from injury on cold nights, below, is done by standing a piece of cardboard between plants and window. The cardboard should be higher than tops of the plants

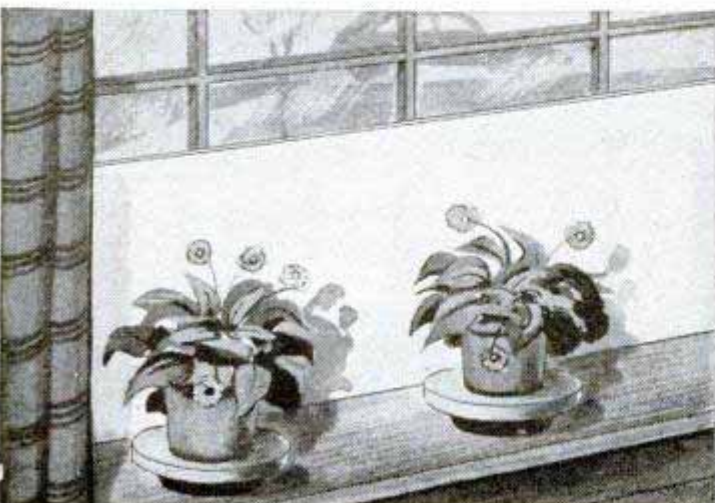

## Oiler Fastened to Workbench Keeps Handsaws Rustfree

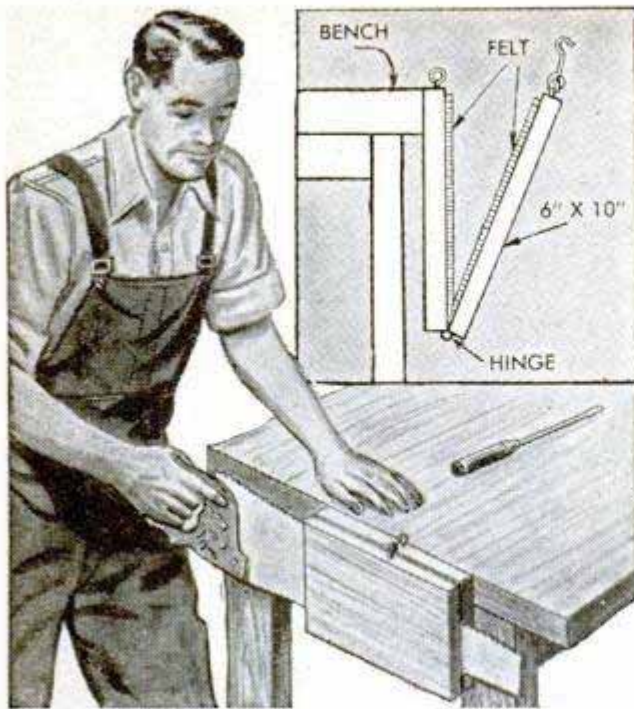

Handsaws that are stored in the basement are given a protective coating of oil by running them through this handy oiler before putting them away. Make the oiler by hinging together two 6 x 10-in. boards and fastening them to the end of a workbench top as shown. Felt or sponge rubber is glued to the inner faces of the boards to retain a light machine oil, and the oiler is held in the closed position with a screen-door hook and eye. The boards should close tight enough to exert a slight pressure on the saw.—C. C. Alleman, Santa Rosa, Calif.

## Stimulating Growth of Indoor Plants

Use an electric heater with a bowl-type reflector to stimulate the growth of house plants, substituting a lamp bulb of low wattage for the heating element. This will concentrate both heat and light on the plants.—Ken Murray, Colon, Mich.

## Emery Boards Sand Small Work

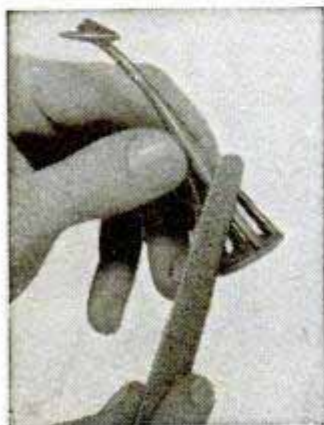

Emery boards used for fingernail manicuring are just the thing for sanding small carvings, model-airplane parts, etc. They are narrow, thin and easy to handle which makes them especially suited to this type of work. Or-

dinarily, one side of the board is coarse and the other fine, thus permitting both rough and finish sanding to be done quickly with the same emery board.

## Hint for Applying Oak Stain

To obtain an even color over the entire surface when applying a medium oak stain to softwood floors, first seal the surface with a filler of thinned, hot glue. Allow the glue to dry and rub it down with sandpaper before applying the stain to the floor.

A. E. Fenn, Chicago.

## Reinforcing Tubular-Steel Chairs

Tubular-steel chairs can be reinforced to withstand exceptionally hard use by strengthening the backs with wooden blocks and adding legs made from adjustable metal closet poles. To reinforce the back, shape a wooden block to fit snugly inside the formed upper end of each tubular frame member, as in the upper detail. Then screw and glue the blocks to the chair back, countersinking the screws. Fasten the frame members over the blocks with longer roundheaded screws driven in from the outside. The base of the chair is strengthened by means of two legs cut from the closet-pole sections. The flange of each section is screwed through a wedge-shaped block to the chair seat, and the lower ends of the legs, rounded to fit over the frame, are held by screws driven into wooden plugs. The plugs, of course, must fit tightly in the legs. Drill holes through the underside of the frame, as shown in the lower detail, to provide access for the screwdriver.—Harold E. Benson, Denver, Colo.

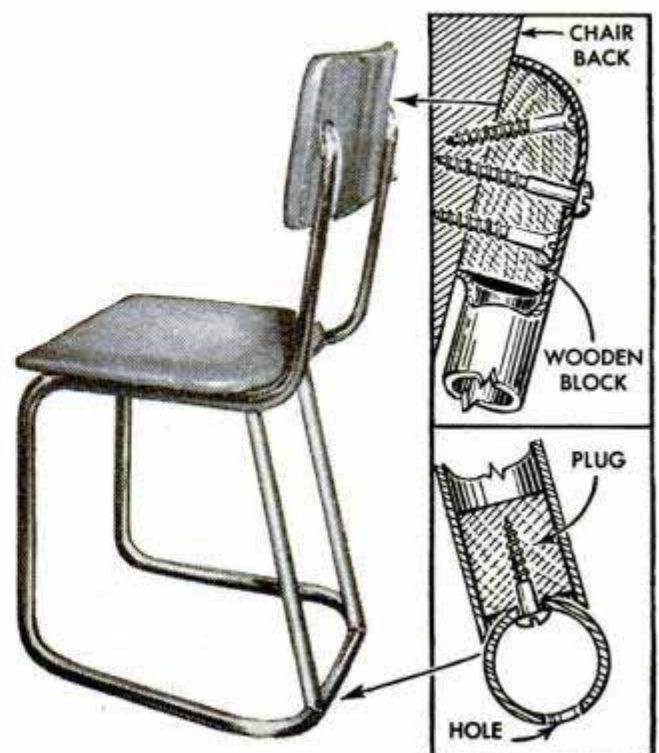

Made of sheet copper, these attractive vases are watertight for displaying freshly cut as well as artificial flowers. The partially opened umbrella design is suitable for almost any room, while the sugar-scoop design is ideal for the kitchen. The front of the umbrella is cut and bent, as shown, and soldered to a triangular-shaped back. The handle is a length of  $\frac{1}{4}$ -in. brass tubing and a piece of steel rod forms the tip. A brass ring at the top of the handle and copper wire wrapped around the tubing just below the ring complete the unit. The sugar scoop is cut from sheet copper, following the shape given in the half pattern, and bent round over a 2-lb. coffee can. The bottom of the vase is a copper disk fastened to a wooden handle with a roundheaded screw, the head of which is coated with solder. After the sides of the scoop are soldered to the disk, a copper strip is soldered on the joint to make the vase watertight.

## Novel Pin-Up Vases Made of Sheet Copper Display Either Natural or Artificial Flowers

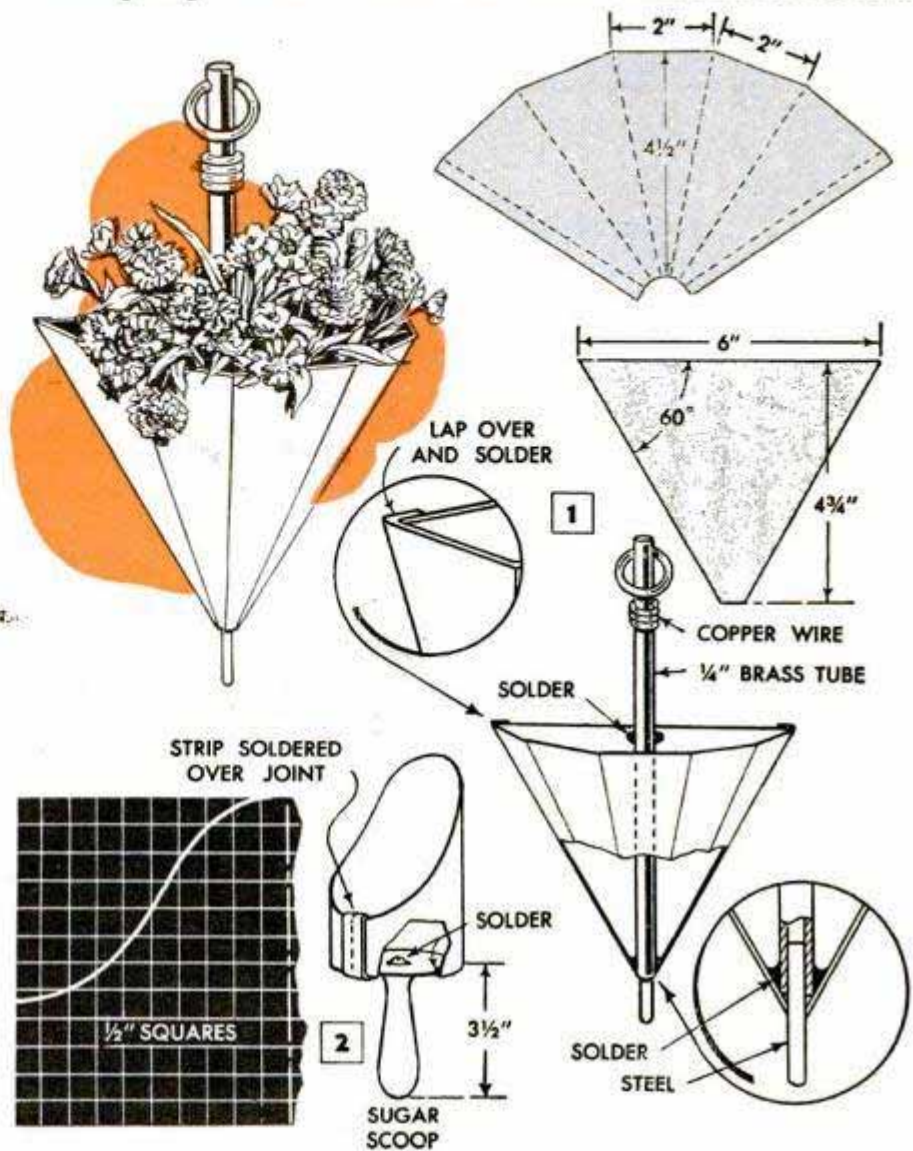

## Graduated Level Determines Joist Variation Before Installing Tile Ceiling

To cover the ceiling of a basement recreation room with tile, it probably will be necessary to shim the edges of some of the

joists before fastening the furring strips. The thickness of the shims required to level each joist can be determined quickly by using a carpenter's level graduated in inches at one end. Take a level and mark graduations in eighths of an inch from both edges inward toward the center. After using a straightedge to find the lowest joist, work from this point and place the level between the joists, as shown, noting the variation on the scale.



## Protecting Electric-Iron Cord

Insulation on an electric-iron cord will not become worn at the point where the cord emerges from the coil spring of the appliance plug if the cord is wrapped with a plastic spiral of the type used to prevent kinking of telephone cords. The spiral should extend from the end of the plug for several inches beyond the coil.

John F. Ewing, North Hollywood, Calif.

**3 TYPICAL SCOPES**

BUILT AT AN AVERAGE COST OF \$6.00 EACH, THESE SCOPES ARE EXCELLENT IN OPTICAL DESIGN AND MECHANICAL CONSTRUCTION. PHOTO TAKEN PREVIOUS TO BLUING



**1**

ALL MAIN TUBES ARE 18 GA., 7/8 IN. DIA.

# BUILD YOUR

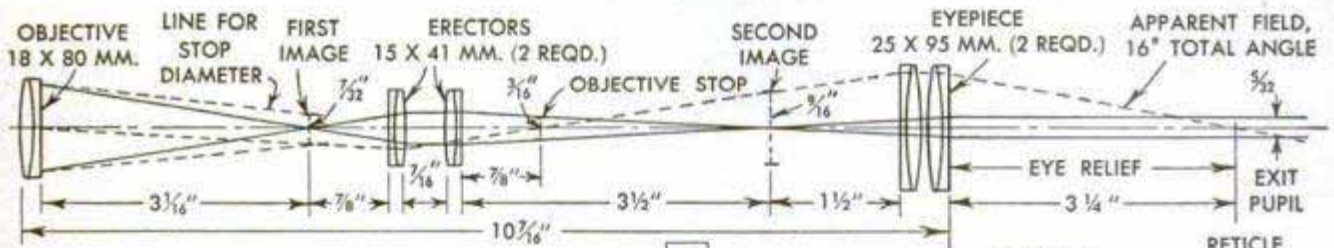

.005 SKIN CUT CLEANS OUTSIDE OF TUBING

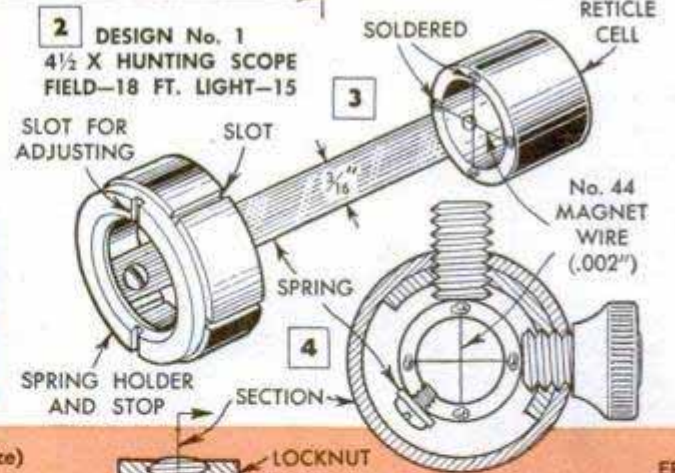

**6** CONSTRUCTION OF 4 1/2 X HUNTING SCOPE (Full Size)  
18-GA. STEEL TUBING, 7/8\"/>

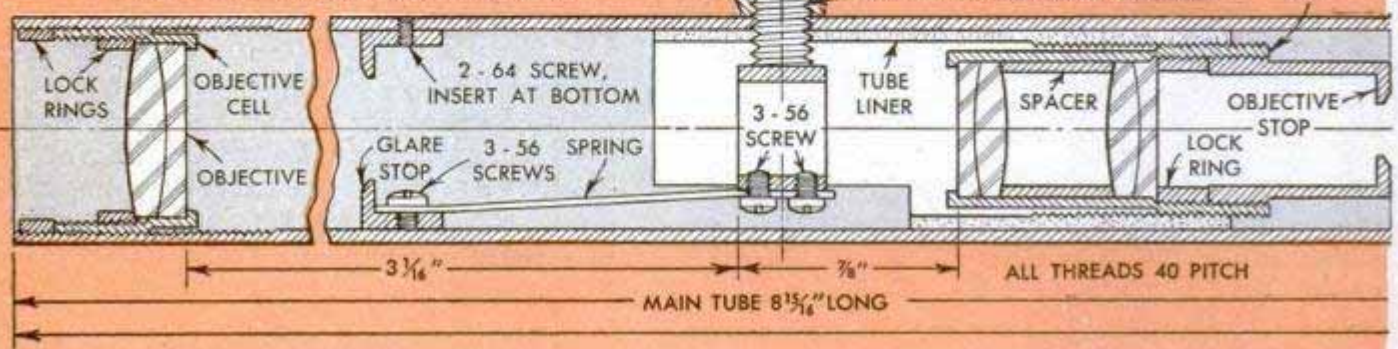



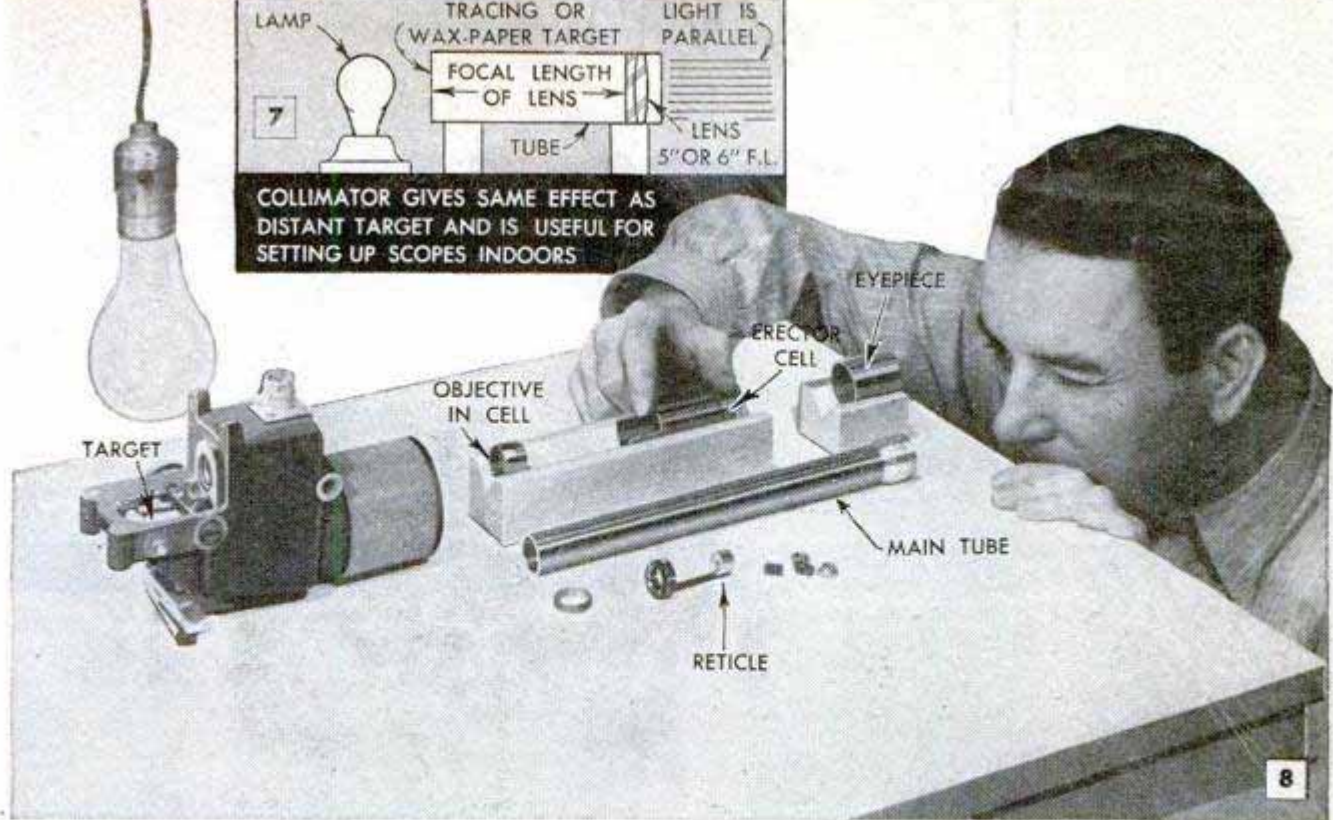

# OWN RIFLESCOPES *By Sam Brown*

**I**F YOU ARE a hunter and also like to run a lathe, you will enjoy both the work and the results of building one or more of these riflescopes. Three typical scopes shown in Fig. 1 were built at an exceptionally low cost. The eight designs cover about everything required in a hunting scope, and all of them are bench-tested, representing the best of 40 jobs set up and tested by the author.

**Selection of design:** The first thing to do is to go over the spacing layouts and select the power of scope you prefer. If you want a big-game scope, the power should not be over 3X, as the important things here are good illumination and a field of not less than 28 ft. at a 100-yd. distance. A scope for small game should be 3X to 5X, a good all-round choice being 4X or 4½X. Varmint

scopes can run to a little higher power, and designs Nos. 7 and 8 are excellent for this type of shooting. Order the lenses needed from any dealer handling stock lenses, as the ones used have been selected for availability as well as optical quality.

**Tubing:** Inside and outside diameters of various gauges of tubing are given in Fig. 11. The main tube of the scope should be 18 or 20-ga. seamless steel tubing, 7/8-in. o.d. (outside diameter). A .005-in. skin cut, Fig. 5, is used to clean up the outside of the tubing. Other sizes of tubing come in handy for the various individual parts, although most of these can be made from solid stock. Bar aluminum is recommended for the inside parts, as it is lightweight and easy to turn on the lathe.

**4½X hunting scope:** Fig. 2 shows the

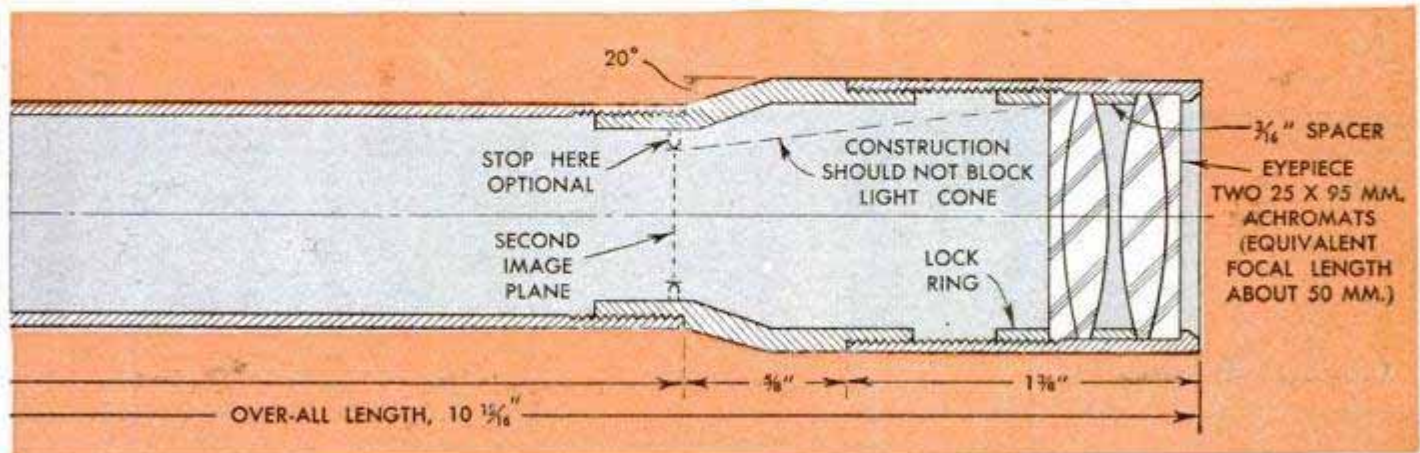

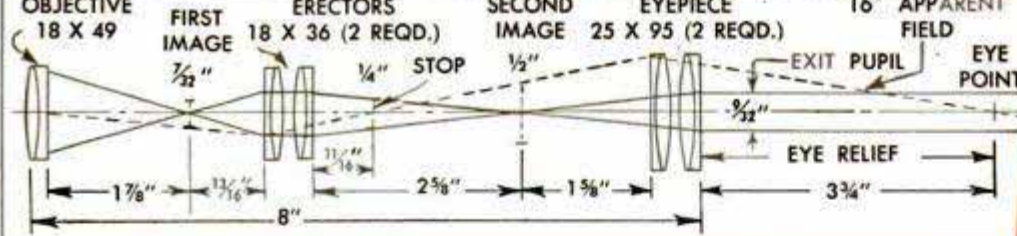

**DESIGN No. 2** 2 1/2 X FIELD - 33 FT. LIGHT - 40 (UNIVERSAL FOCUS)

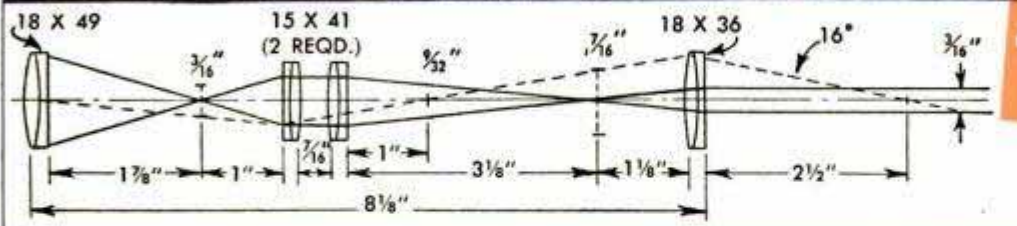

**DESIGN No. 3** 3 X FIELD - 28 FT. LIGHT - 25 (UNIVERSAL FOCUS BEYOND 10 YDS.)

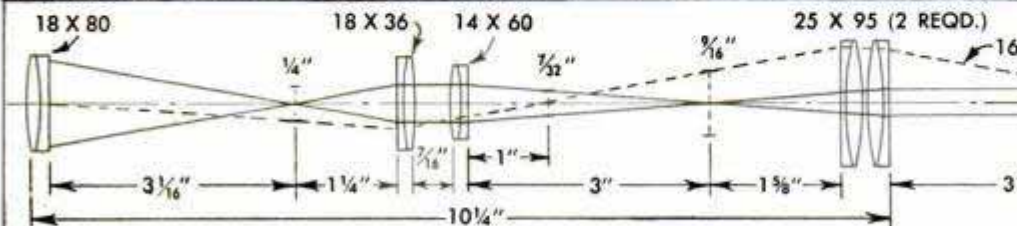

**DESIGN No. 4** 3 1/2 X FIELD - 24 FT. LIGHT - 21 (UNIVERSAL FOCUS)

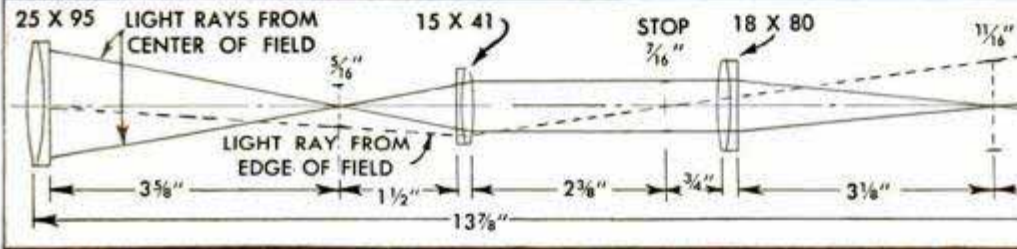

**DESIGN No. 5** 4 X FIELD - 26 FT. LIGHT - 36 (WIDE-SPACED ERECTORS DECREASE EYE RELIEF)

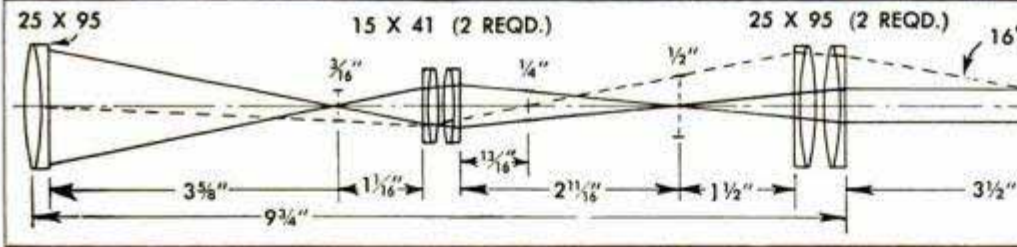

**DESIGN No. 6** 5 X FIELD - 18 FT. LIGHT - 21 (UNIVERSAL FOCUS BEYOND 20 YDS.)

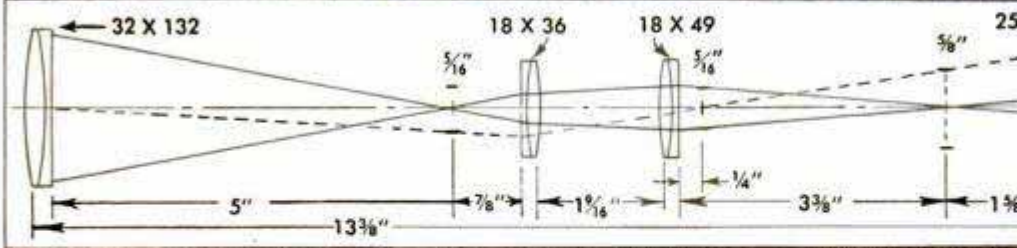

**DESIGN No. 7** 5 1/2 X FIELD - 18 FT. LIGHT - 30 (132 MM. FOCAL-LENGTH OBJECTIVE IS THE LONGEST THAT CAN BE USED FOR UNIVERSAL FOCUS)

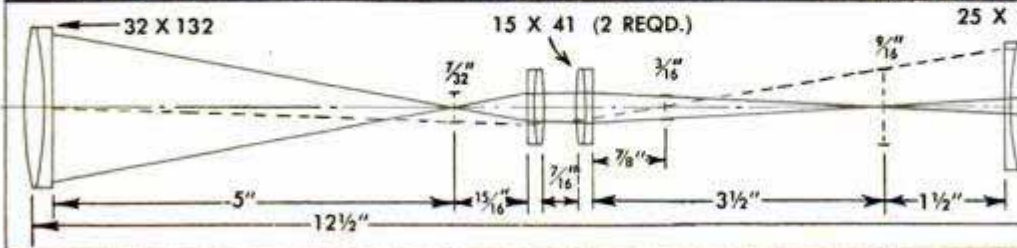

**DESIGN No. 8** 7 1/2 X FIELD - 12 FT. LIGHT - 16 (UNIVERSAL FOCUS BEYOND 30 YDS.)

**SPACING LAYOUTS**

- ALL DESIGNS ARE TO SAME SCALE
- ALL DIMENSIONS ARE GIVEN IN INCHES
- DIA. OF LENSES AND FOCAL LENGTH ARE SHOWN IN MM.
- FIELD OF VIEW IS EXPRESSED IN FT. AT 100 YDS. DISTANCE
- LIGHT VALUE IS THE DIA. OF THE EXIT PUPIL IN MM., SQUARED

optical layout for design No. 1 which is a good 4½X hunting scope. Like the other diagrams, this one shows how the lenses should be spaced, and also indicates the diameter of the stops. Every scope should have one glare stop between the objective and the first image plane. The diameter of this stop at any location is determined by drawing lines, Fig. 2, from the first image plane to the edge of the objective. The objective stop behind the erector-lens cell screens unwanted light from the second image. Fig. 6 details typical construction of the 4½X scope in full size, but this can be varied to suit particular requirements. The feature of this type of construction is that the objective and erector lenses are mounted in separate cells and thus are adjustable. The objective can be turned in or out and the erector lenses moved over a considerable distance in the threaded tube liner. With these two adjustments, it is perfectly safe to cut the main tube to net length before testing assembly. Take time to lap the inside of the tube with a brass plug, using fine abrasive and oil, Fig. 9, to assure easy fitting of the tube liner and glare stop. The main tube is short enough to permit threading in a four-jaw chuck, as shown in Fig. 10. Work all threads to full depth and make them somewhat loose for easy hand-turning, as tight threads are a nuisance. A 40 or 48 pitch is recommended for all the threads. The table, Fig. 12, lists double depth of threads which is subtracted from the major, or outside, diameter of the mating part to give the bore, or inside diameter, of the larger tube. Also listed is the amount of infeed needed to cut a full thread with the compound set at the usual 29-deg. angle. Turning the various lens cells and retaining rings is ordinary lathe work and should present no appreciable difficulty. The spring for the reticle cell, Fig. 3, can be made from a ¼-in. metal-cutting jigsaw blade with the teeth ground off.

**Assembly of riflescope:** After the main tube and various other units have been made, the scope should be given a bench test as in Fig. 8. The target should be a distant object. As one is not always available, it is convenient to make a simple collimator, Fig. 7, which will serve the purpose. Using a lens of 5 or 6-in. focal length, locate a tracing or wax-paper target at the focal-length distance and place a lamp directly in front of the target. The setup can be checked by holding a small mirror in the parallel emergent beam, Fig. 7, and redirecting the light back to the target. When the target is properly spaced, the mirror will refocus the target image on the target itself. If available, reflector sights or similar optical devices can be used as collima-

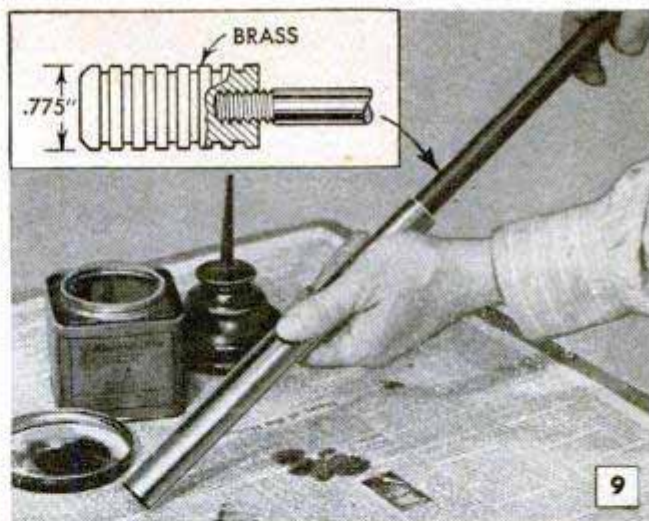

9 SIZING THE INSIDE OF MAIN TUBE

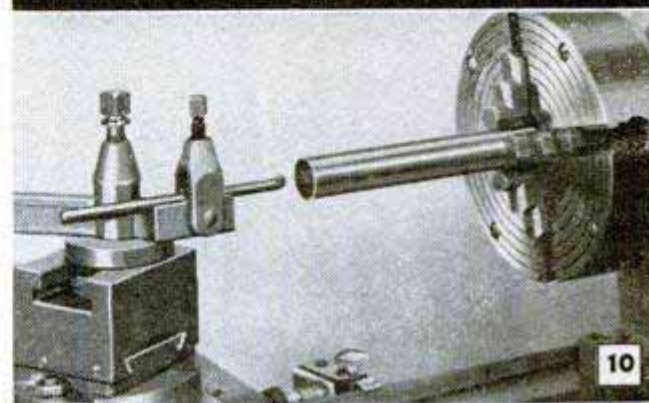

10 TUBE MOUNTED IN 4-JAW CHUCK FOR THREADING

11 TUBING SIZES				12 THREAD DATA		
Outside Dia.	Inside Dia.			Threads per in.	*Double Depth	*Compound Feed
	22 ga.	20 ga.	18 ga.			
¾"	.694	.680	.652	40	.038	.021
⅞"	.819	.805	.777			
1"	.944	.930	.902	48	.032	.018
1 ⅛"	1.069	1.055	1.027			

\*Using standard V-point threading tool

tors. As pictured in Fig. 8, the test setup is arranged alongside the main tube, placing the objective and eyepiece at the positions they will occupy when mounted. Then the target is brought into sharp focus by moving the erector cell back and forth. After this is done, the reticle cell is fitted in place and moved as needed to bring the cross hairs into sharp focus. When proper spacing of the parts has been attained, begin actual assembly of the scope by mounting the reticle cell and glare stop in the main tube. The tube liner also is inserted at this time. Note that the glare stop is turned so the spring holds the reticle cell against both adjusting screws, Figs. 4 and 6. The erector cell is approximately positioned in the same operation. When this much of the assembly has been completed, test the scope as shown in Fig. 18. Note that the eyepiece is reversed end-for-end to permit the lenses to be located the same distance from the end of the main tube as they will be when the eyepiece is actually screwed in place. The objective is not

mounted for the test. All that is done at this point is to focus sharply on the cross hairs, turning the erector cell in or out as required. A final check is made with the eyepiece screwed in place, and the objective is mounted and turned in until any distant object or the target of the collimator is in sharp focus. Move your head from side to side when looking through the scope and note if the cross hairs move over the target. If they do, continue adjusting the objective until the cross hairs stand still on the target regardless of your eye position or movement. After perfect focus is obtained, secure the erector cell with a few drops of shellac.

**Construction of design No. 3:** This scope,

shown in Fig. 17, features a screw-actuated elevation adjustment and, as it does not have a windage adjustment, the scope mount must incorporate this movement. When constructing an elevation adjustment of this type, all work must be done to hairline accuracy in order to make the device practical. Using a 3-56 adjusting screw in connection with a 16-division scale, Fig. 15, a turn equal to one division moves the reticle about .001 in. which, in this particular scope, moves the cross hairs (changes the point of impact) 2 in. on a target at a 100-yd. distance. Operations for milling the reticle slide and turning the elevation-adjustment base are shown in Figs. 13 and 14. The reticle slide is held in the slot of

the adjustment base with two screws as in Fig. 16. The other parts of the scope are similar to those in design No. 1 and, if desired, it also is practical to use the simpler spring-type reticle. This design, as well as any of the scopes shown, can be reworked to higher power by using an objective of longer focal length. To do this, use the spacing layout as is from the first image plane back and substitute the new objective, locating the objective a distance from the first image plane equal to the focal length of the objective. Compare the 4½X scope (design No. 1) with design No. 8, and you will note that the two systems are almost identical except for the objective.

**Building the 7½X:** As this scope, design No. 8, uses a large ob-

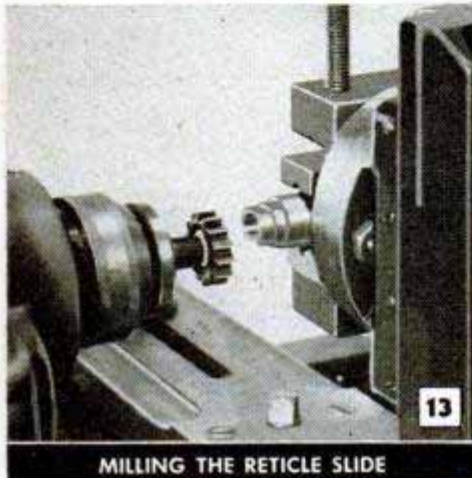

MILLING THE RETICLE SLIDE

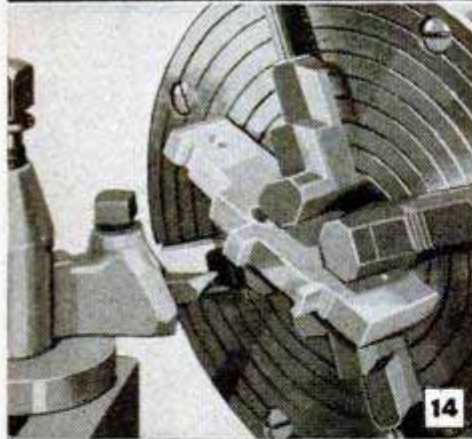

TURNING ELEVATION ADJUSTMENT BASE

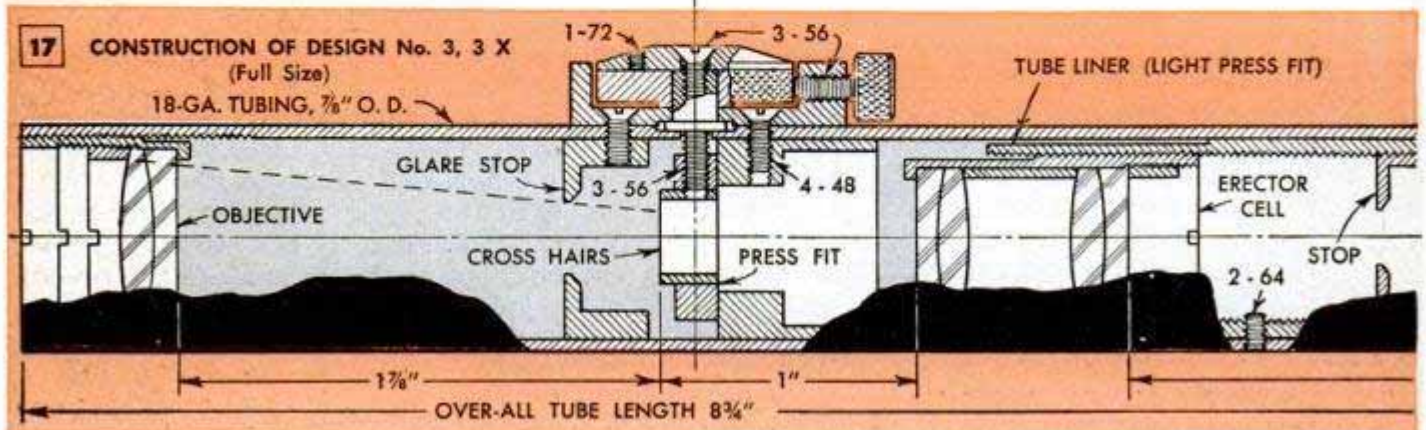
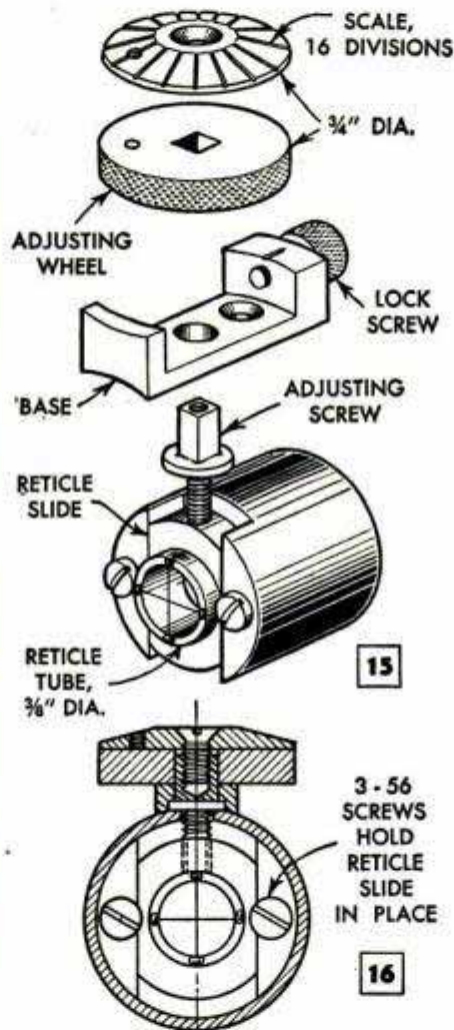

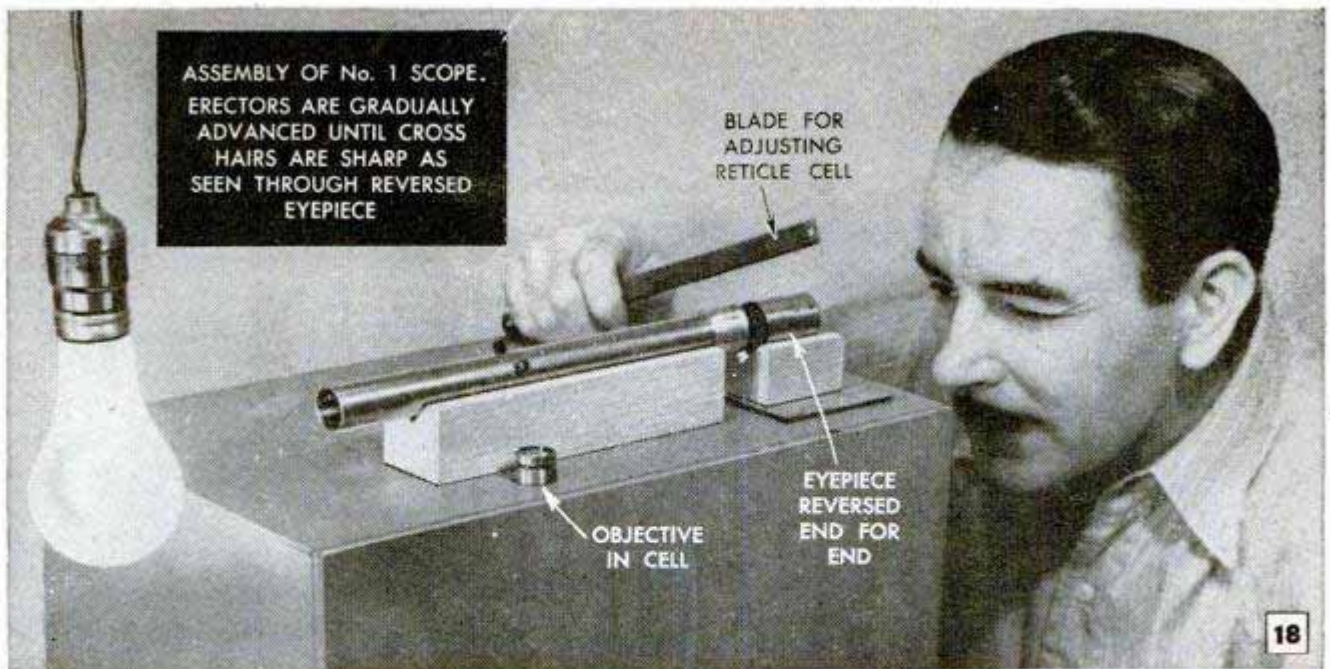

jective, it is necessary to make a front extension tube. This is done by internally threading a piece of solid or tube stock and then turning the work on to a threaded stub spindle as in Fig. 21. The free end is then bored and threaded as required to finish the piece, Fig. 22. The front end and reticle of the  $7\frac{1}{2}X$  scope are shown in Figs. 19 and 20. This reticle mounting is a simple type positioned by three screws and is intended for zeroing only. After it is set, the screws are affixed with a few drops of shellac.

**Other designs:** The construction details given for designs Nos. 1, 3 and 8 can be applied equally well to any other design, using the features you like best. Once it is begun, the construction automatically works itself out because each cell or mounting must thread into the tube and one part determines the size of the next part. For an all-round scope, design No. 1 is recommended. However, every design shown is a good scope and the optical quality, with the lenses specified, is excellent. In damp climates, the lenses should be protected from possible clouding by storing the scopes in a moistureproof container.

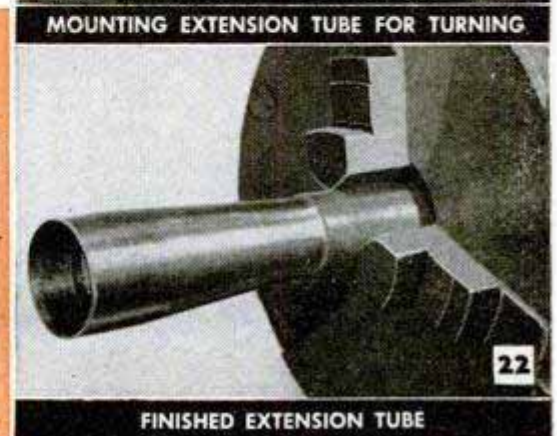
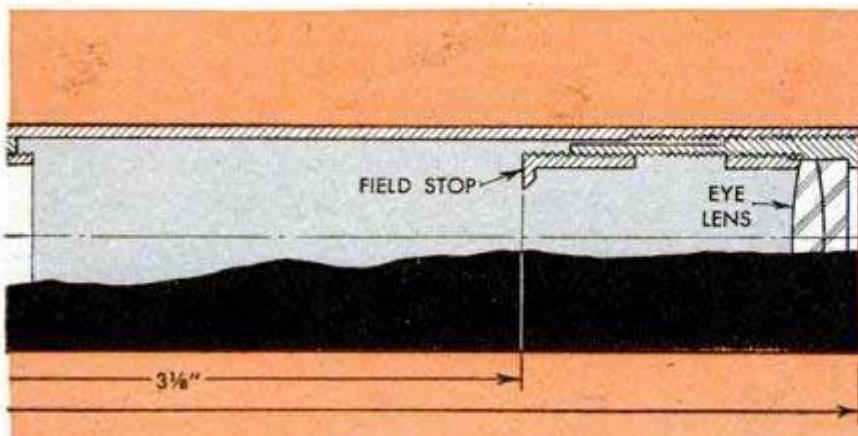
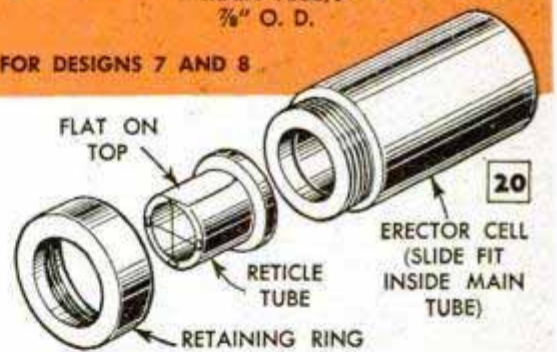
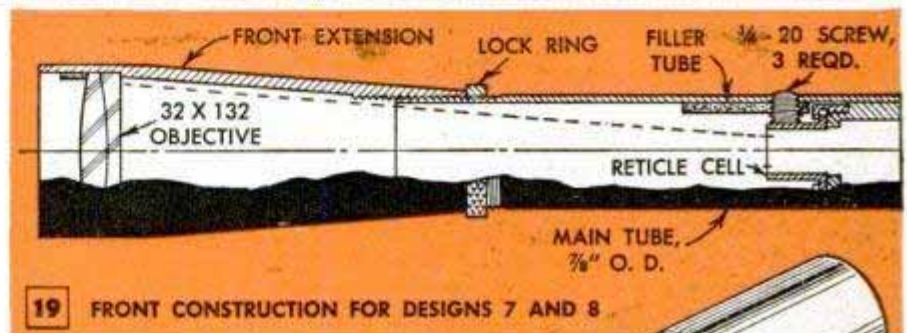

## Tile Patterns Scored in Hardboard With Power Handsaw



Desiring a special pattern that could not be had in standard tileboards created the problem of how to score the material. The size of the sheets made it impossible to score them on a bench saw, so the answer to the problem was a power handsaw. In my case, the job called for scored lines across the width of the sheets and, to assure even spacing, I used a straightedge and two blocks as shown. Planks on saw-horses were used to support the work and the blocks were nailed to the planks, one on each side of the sheet to allow it to be pushed between them. Thus, as each score was made, I simply advanced the sheet through the blocks until the score was even with a mark representing the desired spacing. An abrasive cutoff wheel is preferred to a saw blade as it produces a neat rounded groove that simulates closely the mortar joint of tile. It may be necessary to use a small blade as you may not be able to retract a standard one sufficiently.

Michael Ligocki, Gary, Ind.

## Channel Iron Extends C-Clamp

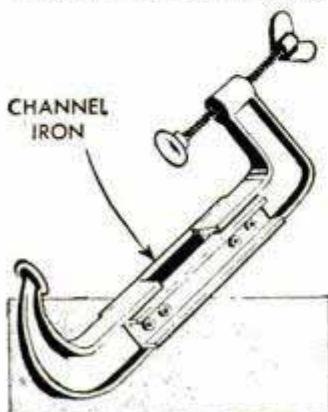

Cutting a C-clamp in two parts and fitting it with a channel-iron extension adapts the clamp to handle work of almost any desired size. The extension consists of two pieces of channel iron fastened with two bolts to each sec-

tion of the clamp. Of course, registering holes must be drilled through both the clamp and channel-iron sections. Keeping on hand several C-clamps altered in this way, along with a number of pairs of channel-iron strips cut to different lengths, will make available a wide variety of clamp sizes.—A. H. Waychoff, Phoenix, Ariz.

## Brass Screws Improve Boots

Many hikers recommend the use of roundheaded brass screws instead of hobnails on the soles and heels of hiking boots. The screws not only improve the gripping quality of the boots but can be replaced as they become worn. Use  $\frac{3}{8}$ -in. screws in the largest wire size obtainable.



Screws are driven in the usual manner after holes have been started with an awl. If the screws are arranged in the pattern shown, which has proved satisfactory, 20 of them will be required for each boot.

Will Stoll, Elmhurst, Ill.

## Lower Edge of Door Grooved To Prevent Leaks

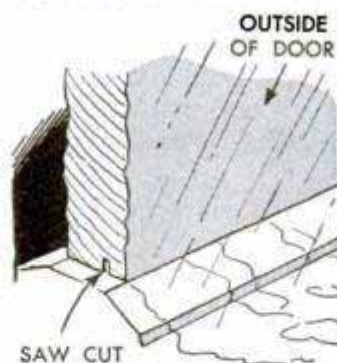

If water from a driving rain seeps under an outside door, this trouble can be corrected in most cases by merely making a shallow saw cut in the lower edge of the door as indicated. Drops of water passing under the door will, when they reach the groove, fall to the threshold and drain back outside. To cut the groove, remove the door from its hinges and nail two guide strips to the lower edge in the position you desire for the groove, spacing them just far enough apart to take the saw blade. A groove about  $\frac{1}{4}$  in. deep is sufficient.

E. T. Gunderson, Jr., Humboldt, Iowa.

Window screens are converted to temporary storm windows by coating them with thinned cellulose cement or clear lacquer. This fills the wire mesh but still admits light. In spring, the screens are restored to original condition with thinner.

# CHILD'S BED HAS ROPE SPRINGS

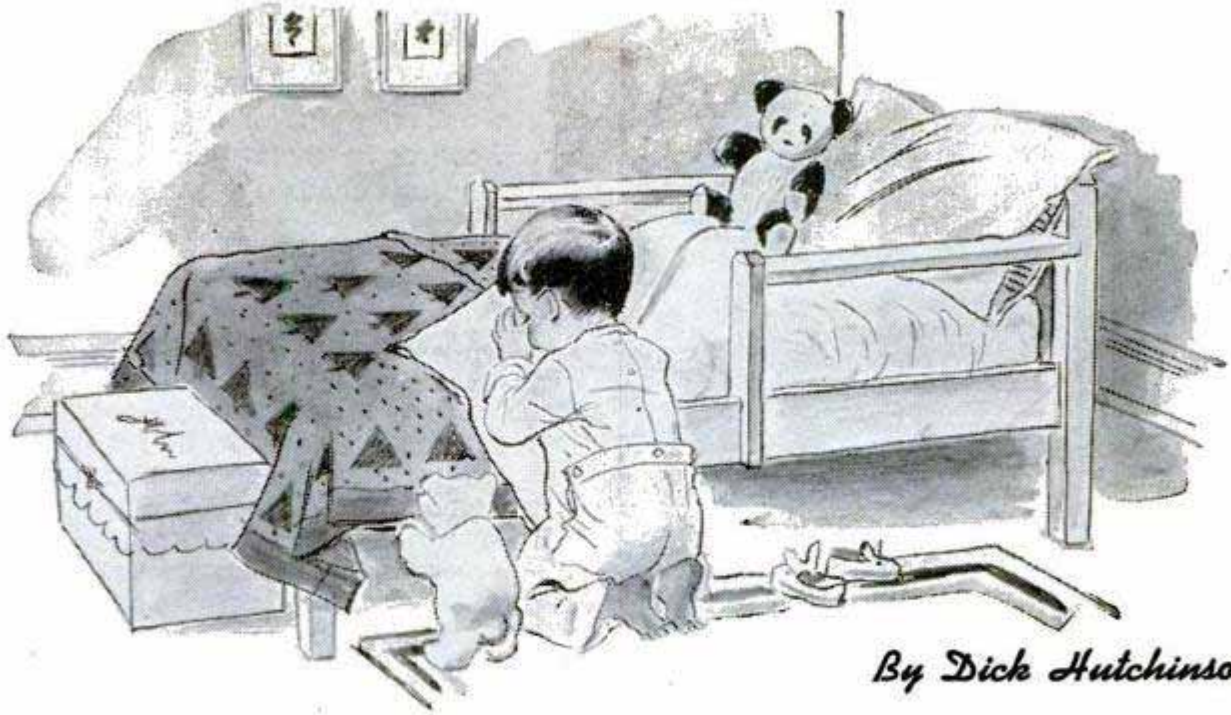

By Dick Hutchinson

Inexpensive and easy to build, this Hollywood-type youth bed is just the thing for baby when he begins to outgrow his crib. Except for a headboard panel of  $\frac{1}{4}$ -in. plywood, the bed is made entirely of solid stock. Over-all dimensions of the bed and the length of the guard rails are not given in the detail as these are determined by the size of the mattress, the guard rails being approximately half the length of the bed. Note that the bed rails are fastened perma-

nently to the headboard and the footboard by mitering the ends and gluing and nailing them into mortises in the tapered legs. After the bed is assembled, a rope spring (clothesline will do) is laced through notched strips of  $1 \times 1$ -in. stock screwed to the sides of the bed rails as well as to the headboard and the footboard. After all nails are set and puttied over, the bed is enameled, using either a two-tone effect or a color to harmonize with the bedroom.

Furniture You Can Build p.81

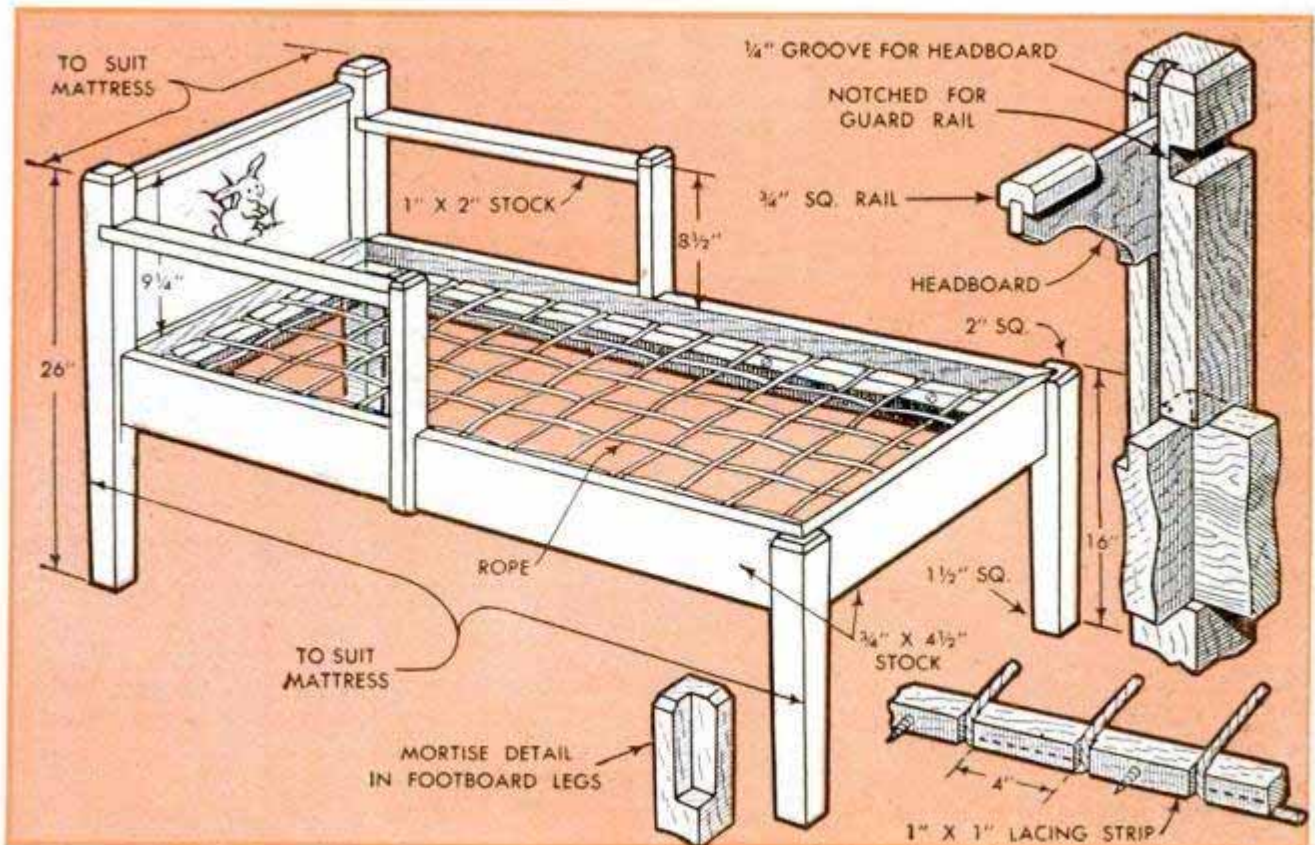

# TRIPOD PROJECTOR BASE

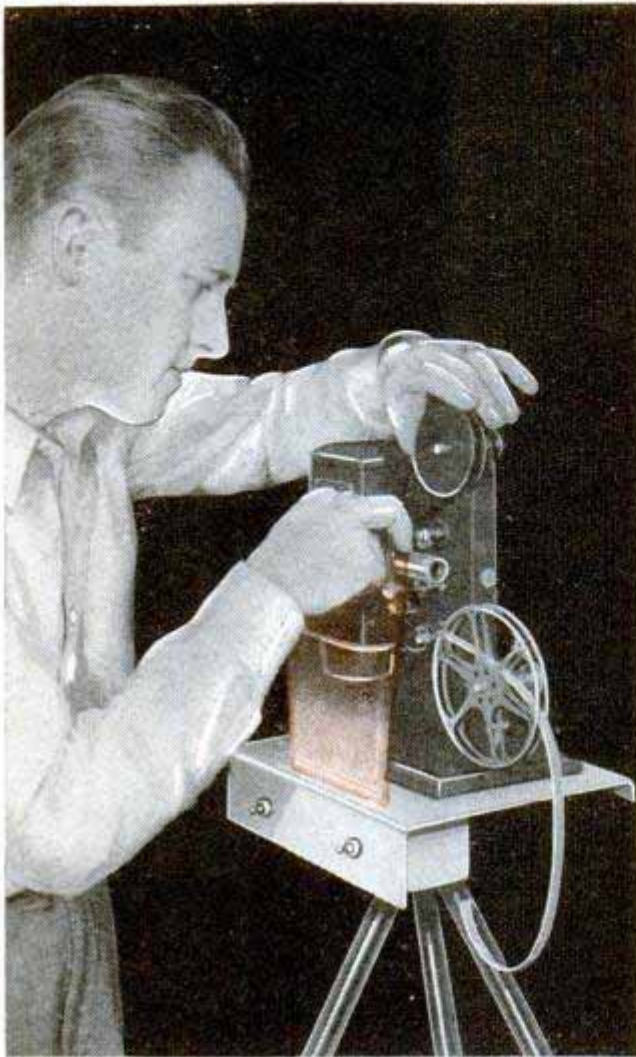

Projector base has two toggle switches. One controls light which illuminates the film gate and tracking mechanism. The other controls projector operation. Tripod permits setting projector at suitable height

If home movies are your hobby, a sturdy tripod projector base is practically indispensable when it comes to presenting a smooth-running show to your friends

By L. H. Georger

**A**N INVALUABLE accessory for your home-movie equipment, this projector base has two outstanding features. One permits the projector to be set up on any camera tripod, either wooden or metal, thus eliminating the bothersome job of setting up a table each time you wish to show movies. The other feature is a built-in utility light which provides sufficient indirect illumination for threading the projector and examining the film without turning on the room lights. Two switches, conveniently located on the side of the base, allow both the projector and the utility light to be turned on and off independently. The unit is compact and can even be stored in the back of some projector cases.

The base detailed in Fig. 3 was built for a specific projector and, of course, the dimensions may be varied to suit the particular requirements of your outfit. For rigidity, make the base from 16-ga. sheet metal, using 24-ga. metal for the lamp housing. The projector clamps are of sheet metal and are fastened to the base with wing nuts. These clamps are faced with felt so they will not mar the finish of the projector. Cut a  $\frac{1}{2}$  x 5-in. slot in the base directly over the lamp housing, making sure it will clear the edge of the projector when the latter is clamped in place. The slot can be made by first marking its length and width on the base and then drilling a hole at each end. The waste is removed with a hacksaw blade or a pair of duckbill tinner's snips. To diffuse the light, cover the underside of the slot with a piece of ground glass held

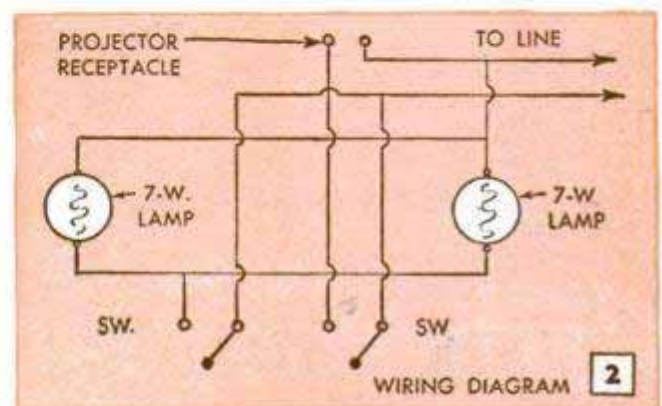
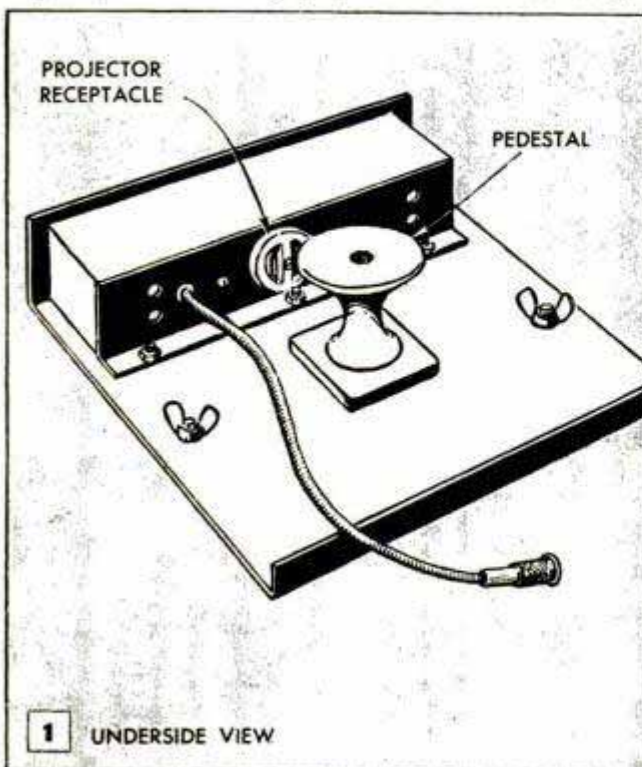



# HAS BUILT-IN UTILITY LIGHT

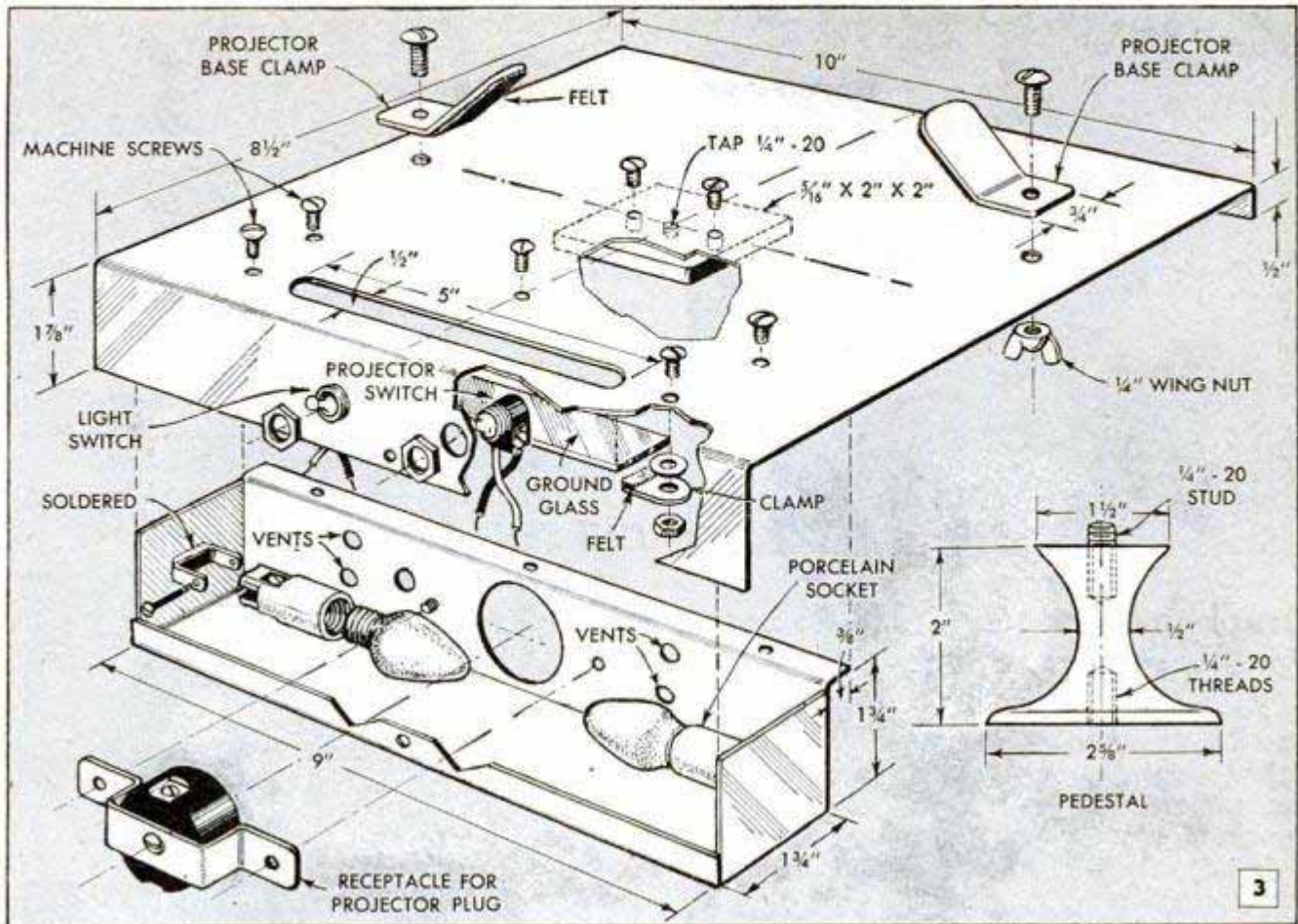

in place with felt-edged metal clamps fastened to the top of the base. If a piece of ground glass is not available, you can roughen the surface of a piece of ordinary window glass by rubbing an abrasive and oil over the surface with another piece of glass. Note that ventholes, as well as holes for the switches, are drilled through the side of the lamp housing. Two 7-watt lamps, two toggle switches and a receptacle for the projector plug are wired in the lamp housing as in the diagram, Fig. 2. Standard miniature porcelain sockets and U-shaped clamps are used to hold the lamps. The center of the base is reinforced with a piece of 5/16-in. steel, 2 in. square, and this is drilled and tapped to take either the tripod screw or the pedestal stud shown in Figs. 1 and 3.

The pedestal, which raises the base 2 in., is required only if the base is to be mounted on a wooden tripod, as the head of this type of tripod usually is too large to provide clearance for the lamp housing. The pedestal is merely a turned metal extension fitted with a threaded stud in one end and tapped for the tripod screw in the other. Although the over-all dimensions of the original pedestal are given in Fig. 3, they are not critical. In addition to its intended use, the pedestal also will come in

handy when taking high-angle movies using a pan head on a wooden tripod. It will raise the pan head sufficiently to keep the handle from striking the tripod top.

The extension cord, which connects the lamp housing to the 110-volt line, is connected by means of a plug and jack to a short cord which runs from the housing. This arrangement allows the longer cord to be rolled separately for carrying. For a neat appearance, the base can be chrome-plated or given a wrinkle finish.

## Thumbtack Fastens Ink Pad In Convenient Position

Inspectors and shipping clerks will find that a thumbtack soldered to the cover of a rubber-stamp pad often will come in handy for attaching the pad to a convenient wall, packing box or other vertical surface. The thumbtack is inserted through a hole punched in the pad cover and the top of the tack is soldered to the cover.

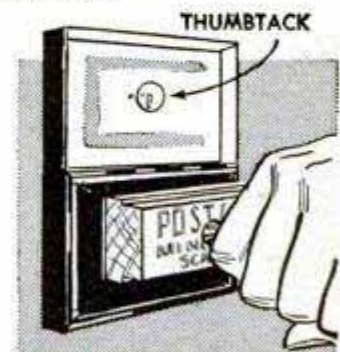

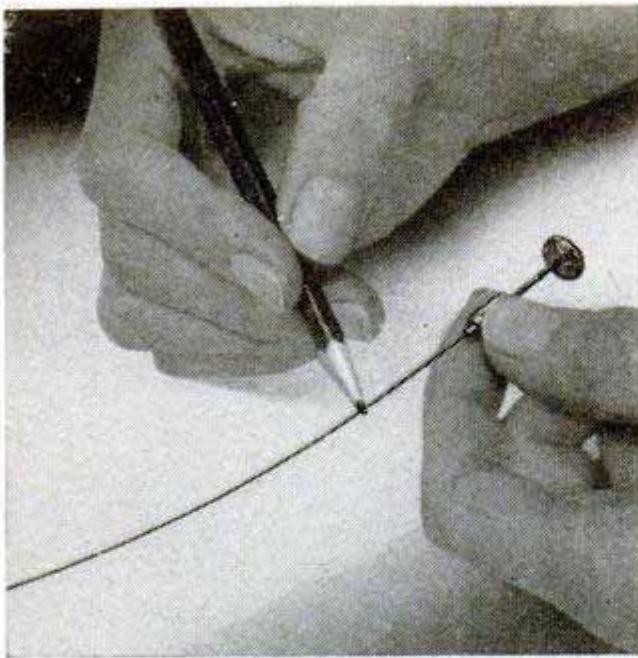

### Graphite Lubricates Cable Release For Smooth Operation

To keep a cable release operating smoothly and with a minimum of pressure, lubricate it frequently with graphite. Unscrew the button end from the sheath, remove the cable, and rub it with a pencil lead or powdered graphite. Never use oil to lubricate the cable.

### Film-Holder Slide Cuts Box Seal



When the tear string provided on a box of film fails to break the seal, it can be cut easily with a film-holder slide. The film holders are always at hand and using the slide may prevent a broken thumbnail.

### Substitute Photoflood Reflector



If an extra photoflood reflector is needed in an emergency, a radiant-type electric heater will serve the purpose. The heater is lined with tin foil and the heating element is replaced with a photoflood lamp. The tin foil is fastened with cellulose tape.

### Cork Tied to Photo-Solution Bottle Cannot Be Mislaid

Corks hinged to the neck of a photo-solution bottle with stiff wire cannot be mislaid or contaminated. A small, round-headed screw is driven into the top of the cork. Then one end of the wire is wound around the screw and the other end around the bottle. The wire should be stiff enough to hold the cork out of the way when pouring the solution.

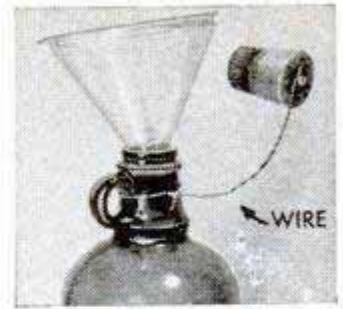

### Coil Spring Supports Funnel

A large coil spring of the type used in furniture upholstery is a handy item to keep in the dark-room as an excellent funnel support. It is especially helpful when using both hands to pour from large trays.



### Tripod Supported in Sand or Snow By Compact Wooden Platform

Sand or snow will not prevent setting up a tripod if it is supported by this folding platform. It consists of three pieces of  $\frac{1}{2} \times 3 \times 14$ -in. wood bolted together at one end. Several holes drilled partially through the outer ends of the arms permit adjusting the tripod legs and keep them from slipping. A few coats of shellac or varnish protect the platform from moisture. If desired, the platform can be made from sheet metal.

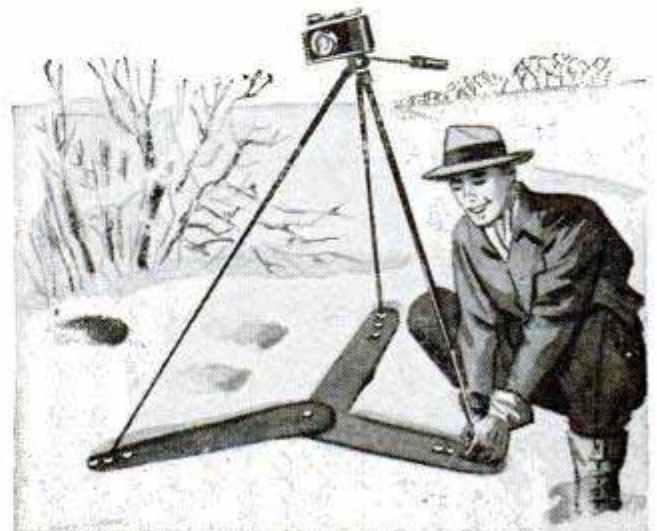



## DRILL-PRESS ROUTING

Easy-to-make jigs that clamp to the drill-press table guide the work for accurate uniform routing

By E. Waltner

A FEW SIMPLE JIGS plus an assortment of router bits are all that is needed to convert a drill press into a router. A spindle speed of about 5000 r.p.m. is satisfactory for most routing. However, when using small-diameter router bits or when production-routing, 8000 to 10,000 r.p.m. is recommended. In most cases, the jig or guide fence, shown in color on the illustrations, should be clamped to the drill-press table back of the work. The work is fed from left to right, or against the cutting rotation of the router bit. If it is necessary to clamp the fence in front of the work, the work must be fed from right to left. To avoid heating the router bit and thus drawing the temper, the work is fed slowly and uniformly.

Rabbeting is done by guiding the work against a straight fence having a semicircular cutout for the router bit, as in Fig. 1. The size of the rabbet is controlled by locking the spindle sleeve at the desired depth of cut and adjusting the fence forward or away from the router bit as required. Fig.

Varying distance of V-block jig from router permits accurate routing of wide range of circle sizes

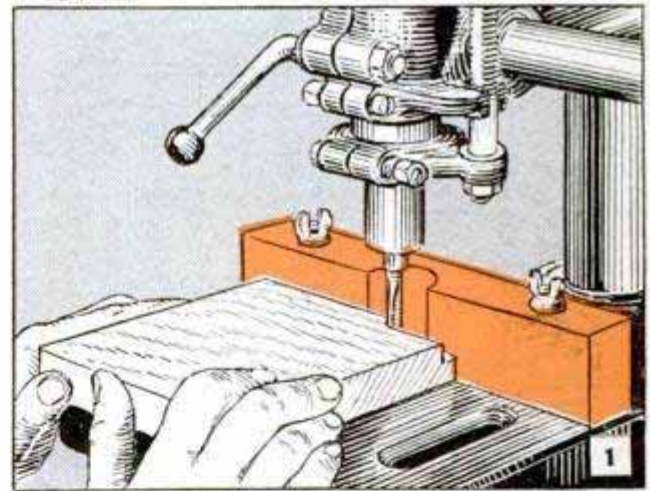
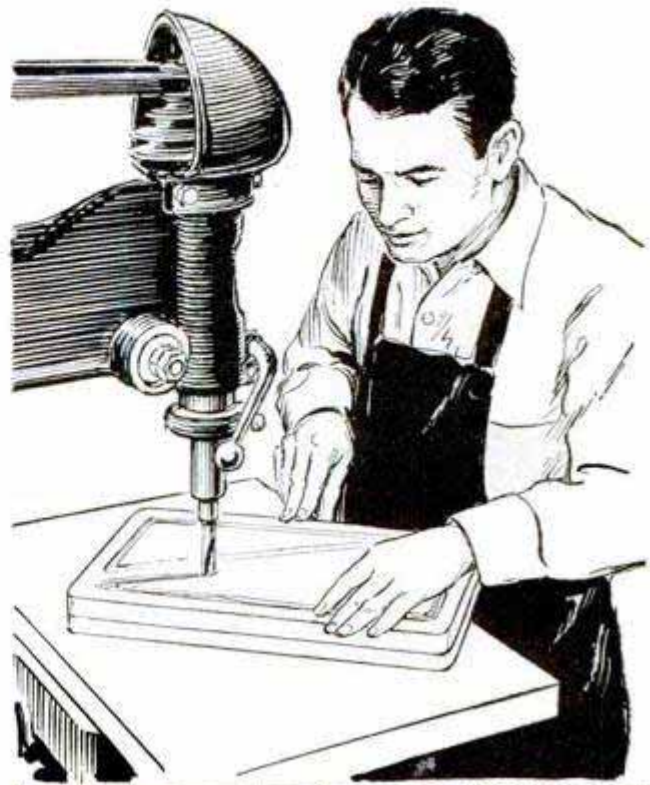

↑ Fence clamped to table guides work being routed.  
↓ Routing mortise with aid of fence and stop blocks

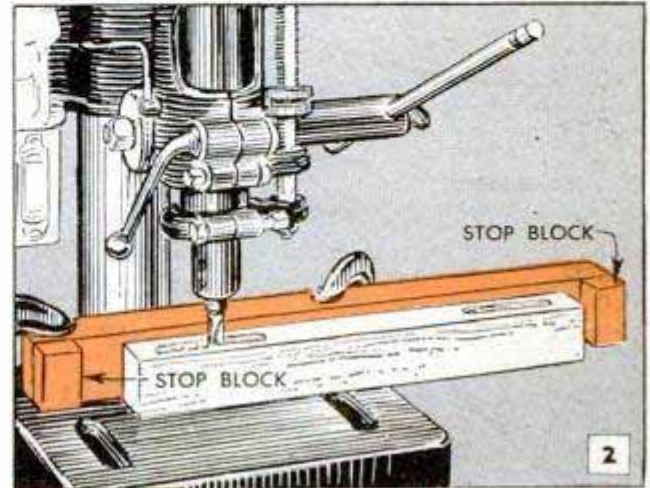
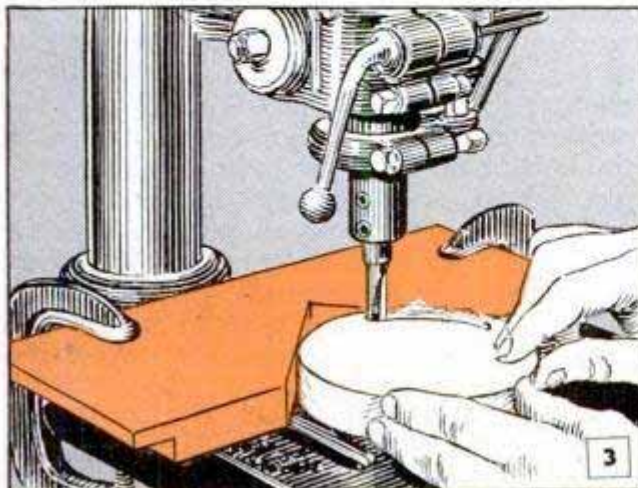

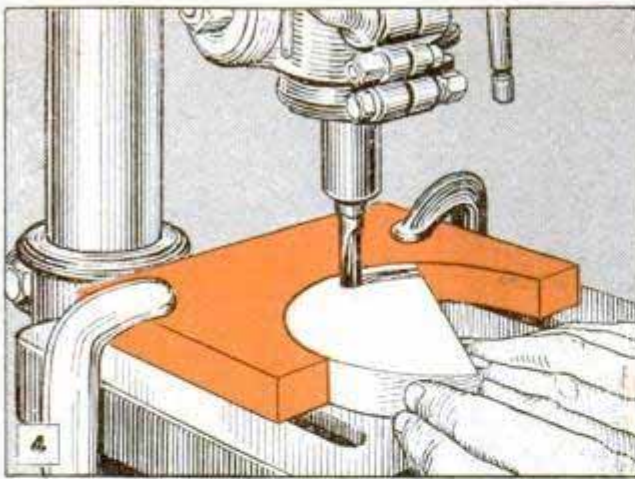

4 Routing semicircular piece using waste part as jig. Pin aligns work for routing rim of circular piece

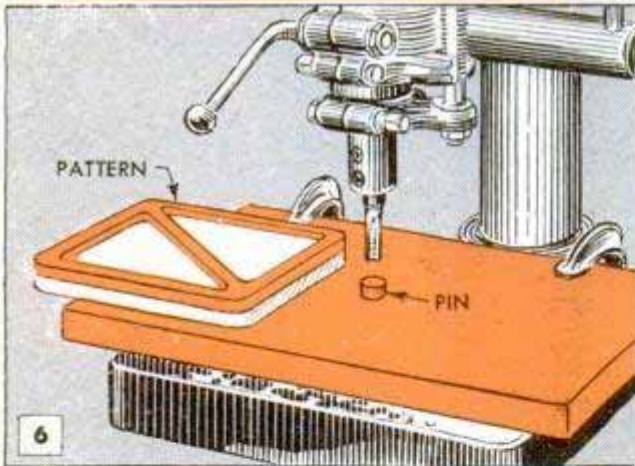
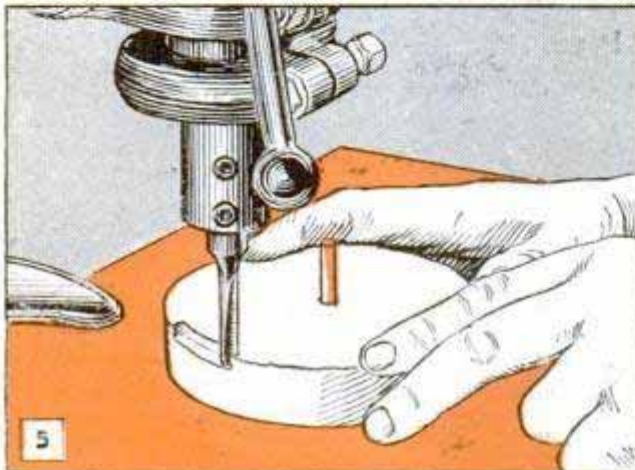

6 Pin-and-pattern jig for routing duplicate parts. Pattern is placed over pin and guided around it

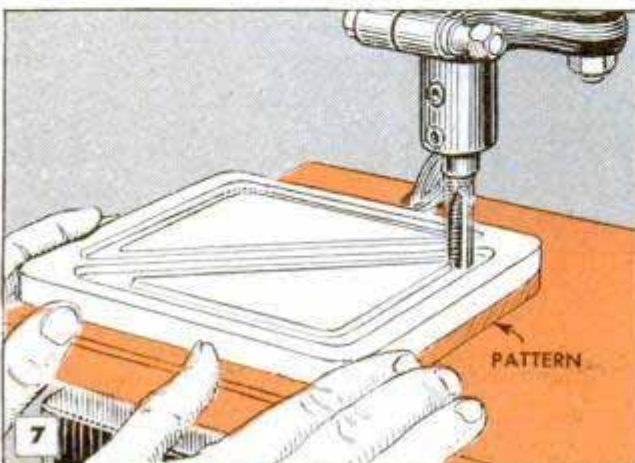

2 shows how to cut mortises. Note that stop blocks are fastened to the guide fence at each end to limit the length of the mortise. This method is particularly useful when making duplicate parts. Drill a hole at the start of the cut, using the router bit as a drill bit. Then with the bit in the hole, lock the spindle sleeve for depth and advance the work to the right-hand stop block. If the mortise is more than  $\frac{1}{2}$  in. deep, drill a series of overlapping holes along the length of the mortise and then rout out the remaining wood.

When routing circular work, use a V-block jig as in Fig. 3. The work is held against the two sides of the vee and slowly rotated. One jig of this type may be used for a wide range of circle sizes by simply clamping it to the table at the required distance from the router bit. When the work is only a portion of a circle, a jig cut to the same radius as the work is used as in Fig. 4. If the circle has been carefully band-sawed, the waste portion of the wood will serve as a jig. In addition to the V-block method, routing around the rim of a circular piece of work is done with a pivot pin as in Fig. 5. The pin is set in a board clamped to the drill-press table. With this method, the work must have a hole through its center. However, if this is objectionable, a shallow hole can be bored in the underside of the work, and the disk pivoted on a very short pin.

When routing special shapes covering an area too large to be removed with a single pass of the router bit, a pin-and-pattern jig, Fig. 6, is used. A full-size pattern is cut from  $\frac{1}{4}$ -in. plywood and tacked to the underside of the work. The pin, which can be either metal or wood, must be the same diameter as the router bit. It is set in a base-board so its projection above the surface of the board is slightly less than the thickness of the pattern. Then the base is clamped to the table with the pin directly below the router bit. If the pin is not the same diameter as the router bit or is not aligned exactly with the bit, the work will not be an identical copy of the pattern. In use, the work and pattern are placed over the pin, as in Fig. 7. The bit is locked for depth by clamping the quill, and the outline of the pattern is routed in the work by guiding the cutout edges of the pattern against the pin. The remaining stock is removed by guiding the work freehand against the router bit until the entire space has been cleaned out. In some cases, it will be found helpful in keeping the pattern against the pin if the design is sketched on top of the work to serve as a guide.

Electric push buttons can be seen in the dark if coated with luminous paint.



## Glove Provides Small-Tool Holder

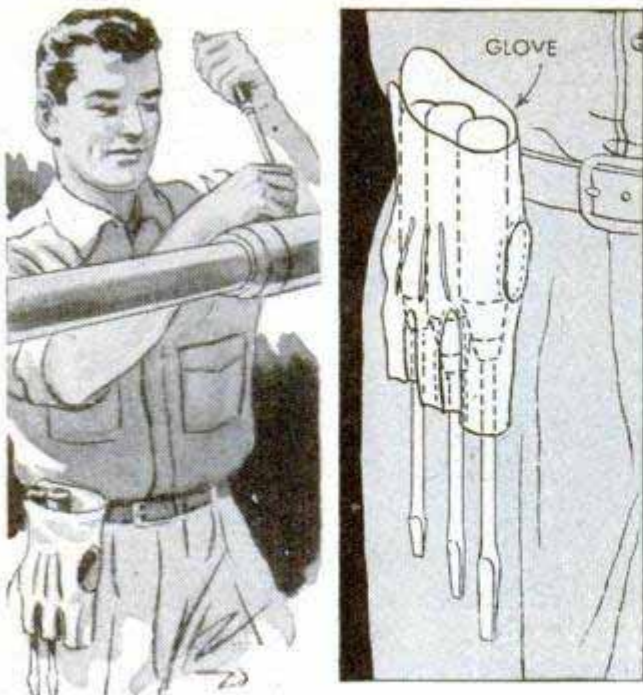

Several screwdrivers or other small tools can be carried conveniently in a holder made from a discarded glove. Slits are cut in one side of the glove to permit fastening it to a belt, and the thumb and finger tips are removed.—W. B. Eagan, Louisville, Ky.

## Prolong Life of Metal Stock Tank By Proper Mounting and Care

Proper mounting is important in prolonging the usefulness of a metal stock tank, particularly where special conditions, such as changing the herd from one pasture to another, make it necessary to move the tank. In any case, the tank should not be placed directly on the ground, especially in cinders, as the latter cause corrosion which is harmful to the zinc coating. It is better to support the tank 8 or 10 in. above the ground on a wooden platform made to conform to the shape of the bottom. Elevating the tank not only promotes sani-

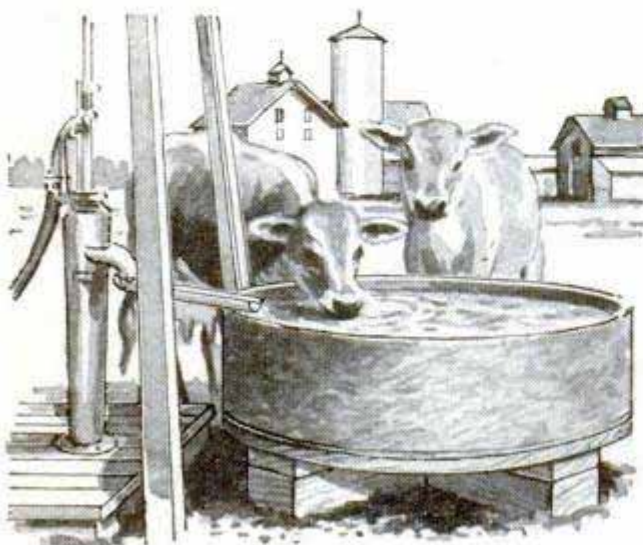

tation by preventing stock from stepping in the water, but also permits air to circulate under the tank and thereby keeps it dry. An excellent base for supporting the wooden platform is made by half-lapping 2 or more timbers and assembling them in the form of a cross as shown. Occasional cleaning and sterilizing of the tank is important. Use an old broom to clean the tank rather than a shovel or hoe, as scraping may injure the protective zinc coating. Let the tank dry in the sun to sterilize it. Draining and drying the tank periodically induces formation of protective zinc salts on the metal that prolong the life of the tank appreciably. If straw has been piled around a tank to insulate it during the winter, be sure to remove it when freezing weather is over.

## Turning Tapers on Bar Stock

Turning short tapers on small-diameter stock is done faster if the end of the stock is not supported by a center and the turning is done in 2 steps, feeding away from the chuck. With the taper attachment set, a cut is taken from points A to B, roughing out the taper to within  $\frac{1}{32}$  in. Next, a cut is taken from points C to A, and then a finish cut is made the entire length of the taper. For tapers on very small diameter stock, it is best to chuck the work almost to point A for turning the A-B portion. Rechuck it to turn the other section.

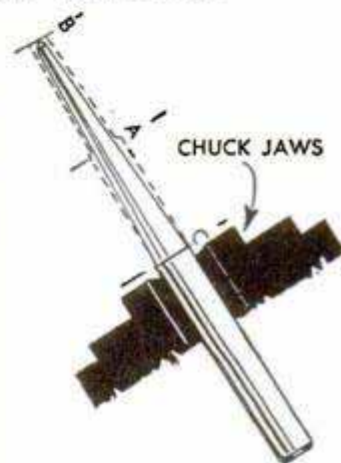

Earl R. Goddard, Denver, Colo.

## Split Nut Protects Bolt Threads When Clamped in Vise

Here is a simple way to protect the threads of a bolt which must be held in a vise for slotting or cutting. Just saw through one side of a nut having the same threads as the bolt. Then, turn the nut

on the bolt and clamp the nut in the vise. The slot in the nut will allow it to close tightly on the threads and hold the bolt securely, although the threads will be protected from damage.

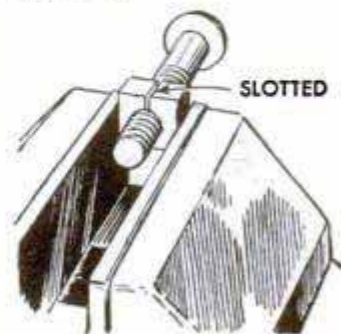

# Rotating Tool Stand Holds Lathe Accessories

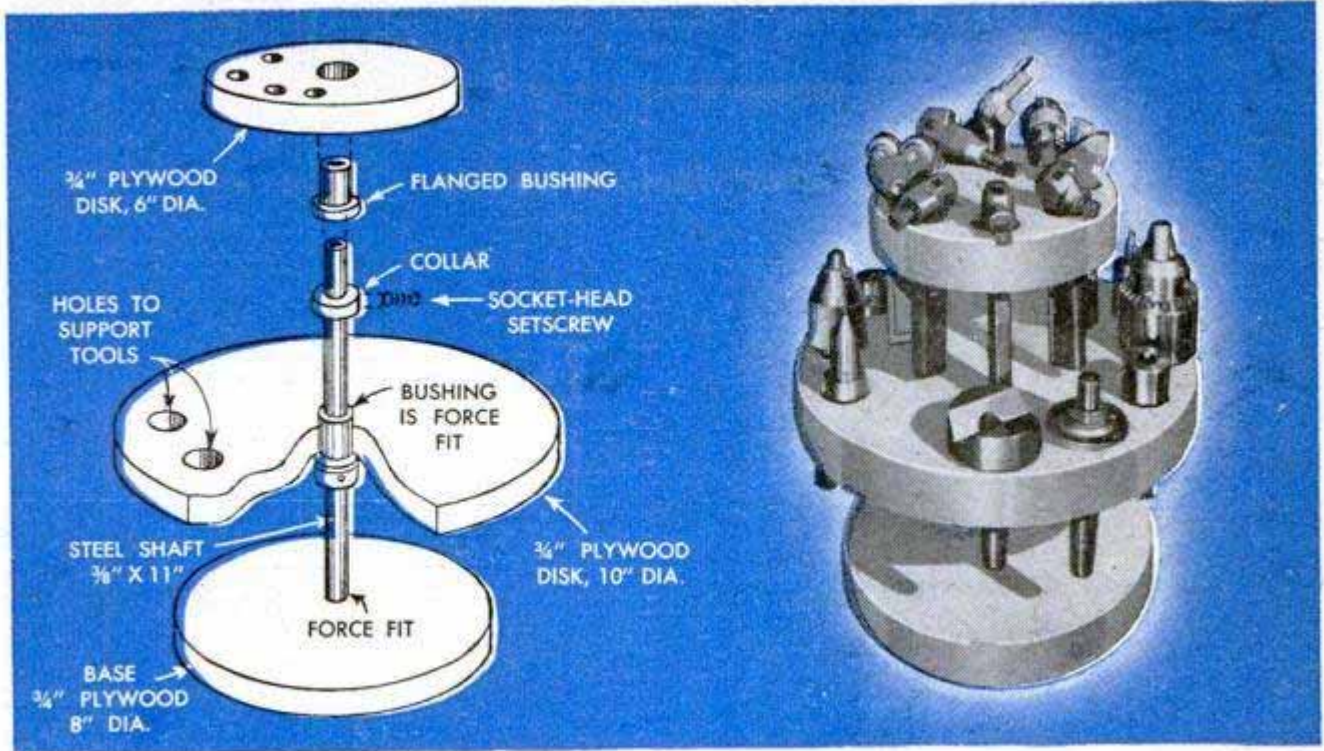

When work at a metal-turning lathe requires the use of a number of accessories on the same job, a rotating tool stand like this one is a timesaver. It also keeps the tools in order when they are not in use, preventing them from getting nicked or otherwise damaged by handling or storing in a drawer. Three plywood disks, a couple of flanged bushings and a short length of steel shafting are the principal parts of the stand and it takes only a few minutes to assemble them. Tools fit into holes drilled through the wooden shelves, a special hole

being drilled to accommodate each tool. Note that tools in the lower shelf can be removed and replaced without disturbing those in the upper shelf. Arrangement and size of the holes must be worked out by measurement of the tools. Each shelf is center-drilled to take a flanged bronze bushing in a force fit. The bushings bear on collars fastened to the shaft with set-screws. The hole in the base for the shaft should be drilled slightly undersize so that the shaft will be a tight, force fit.

W. S. Kals, Vancouver, Can.

## Hinged Motor Mount Has Handwheel for Belt-Tension Adjustment

Designed for use where a power tool is driven from below, this hinged motor mount provides for uniform belt tension

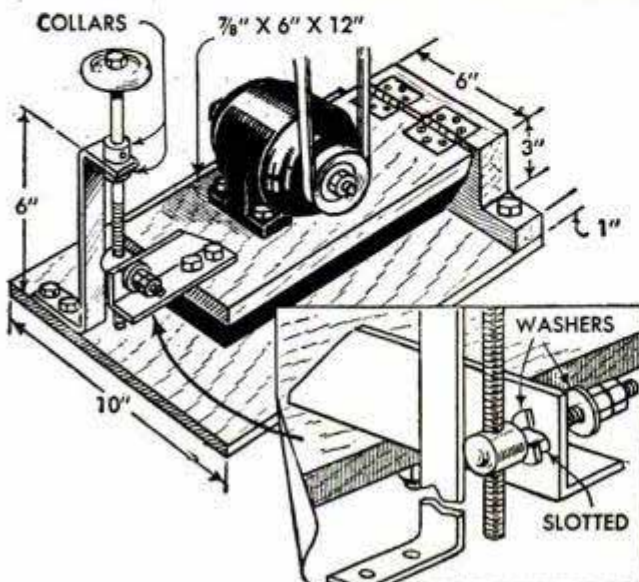

without imposing the weight of the motor directly on the bearings. Slack in the belt is taken up by turning a handwheel. This raises or lowers a hinged shelf to which the motor is fastened. The drawing shows how the device is made. The adjusting mechanism consists of a threaded shaft supported vertically by a flat-iron bracket and two collars. The shaft passes through a tapped hole in the head of a specially turned bolt and the end of the shaft rests on the bottom board. The turned bolt is supported by a piece of angle iron which is bolted to the end of the motor shelf. Two nuts on the bolt permit it to be tightened sufficiently to provide a sliding fit in the slot in the angle-iron support. Note that the rear edge of the motor shelf is cut at an angle to allow it to be lowered.

☞ To prevent unraveling of rope ends, dip them in varnish or shellac before using.

# Fastening WHEELS TO SHAFTS

Pulleys, gears and clutches transmit power from one machine part to another, but only the fasteners prevent the wheels from spinning idly

By W. S. Kals

**I**N DESIGNING or building homemade power-driven equipment and in attaching new gears, pulleys, wheels or clutches to machine units, methods of fastening these parts are governed by the size of the parts and the force, or torque, to be transmitted. The fastener must withstand pressures developed by the sustained load, or turning force, plus shock loads originating within the mechanism, and also must resist any lateral forces that may act on the rotating parts.

Some fasteners take care of these requirements in one application, but others require separate provisions for transmitting torque and for taking up lateral thrusts. Separate fasteners are of several types. These range from a simple nail or cotter pin to straight and taper transverse pins, which pass through the wheel hub. They also include setscrews, Figs. 9 and 11, and keys of various shapes and applications. In addition, there are the force-fit, shrink-fit and expansion-fit types of fastening in which the parts are simply forced together cold, or one or the other of the parts is cooled or heated.

**Force fit:** This is a common method of fastening where a smooth hub contour with no projecting keys or pins is required and where the sustained load is uniform with no possibility of shock. On very light work where turning forces are small and accuracy is of secondary importance, such as the gear in Fig. 2, dimpling the shaft or hub of the gear with light blows from a ball-peen hammer will provide sufficient friction between the hub and the shaft to carry the load and prevent any lateral movement of

Any lathe can be used as a light arbor press suitable for pressing small parts onto shafts. The shaft is held in drill chuck

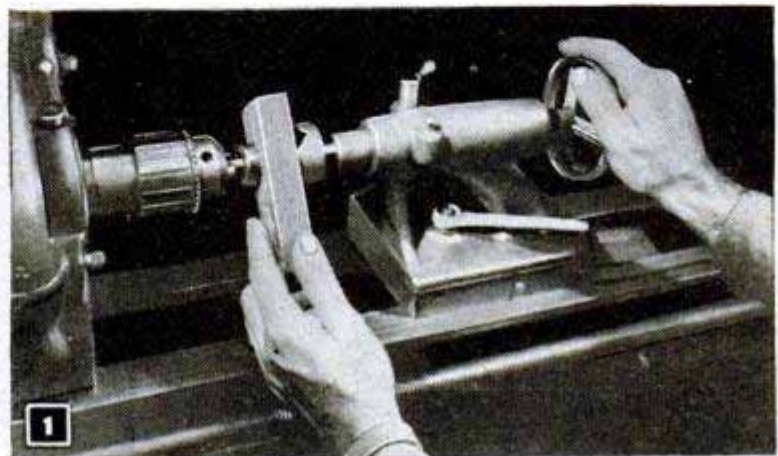
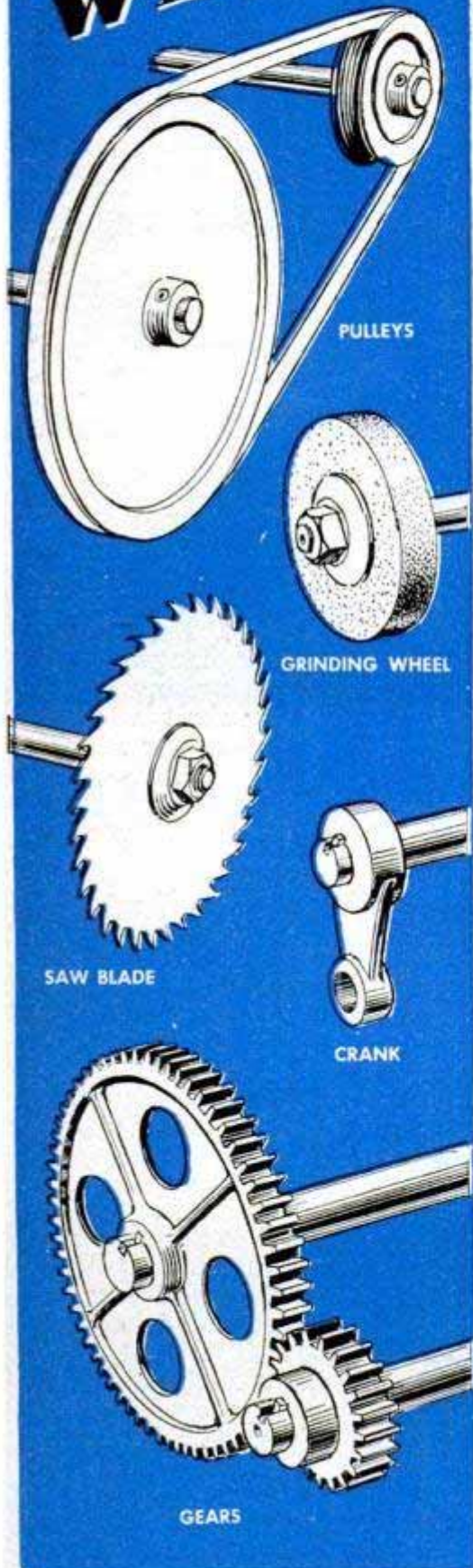





Force fits for small gears and other parts attached to standard shafting are achieved by simply knurling the shaft. The knurl has the effect of increasing the diameter of standard shafting as much as .003 in.

the gear. An arbor press is commonly used to force the gear on the shaft. When installing gears, pulleys or other parts carrying heavier loads, the shaft is made slightly larger than the diameter of the hole in the wheel hub. A common rule of thumb is to allow .001 in. for each inch of shaft diameter. Fig. 3 shows one method of achieving a force fit by simply knurling the end of the shaft in a lathe. The effective diameter of the shaft for purposes of a force fit may be increased as much as .003 in. in this manner. However, if the shaft or the wheel hub is of soft metal, the tips of the knurl either will flatten to some degree or bite into the hub. In this case, the effective diameter will be reduced. This method often is used where it is necessary to force-fit a wheel onto a shaft of exactly the same diameter as the hole in the hub. It is employed also in fitting parts onto cold-rolled-steel shafting which may run slightly undersize. Usually the knurl will provide the extra .002 in. needed for a force fit. A lathe can be made to serve as an arbor press for small parts by setting it up as in Fig. 1. Here the shaft is chucked and the fitting, in this case a small ball bearing, is started on the shaft by hand. Then the tailstock is brought up and a block of hardwood is placed between a crotch center and the bearing. It is possible to force-fit small parts in this manner with practically no distortion.

**Shrink fit:** Where the parts are fairly large and carry much heavier loads, some form of shrink fit is used. In some cases, a part can be heated sufficiently by immersing it in boiling water. Oil, which has a higher boiling point than water, gives a slightly greater expansion. Where the wheel is large and it is impractical to heat in this manner, the shaft can be shrunk by cooling. In ordinary work, the result will be the same.

**5** **TABLE**

Shrink-Fit: obtained by heating outer member  
 Expansion-Fit: obtained by cooling inner member  
 Compound-Fit: obtained by heating outer member and cooling inner member

Rule of thumb:  
 Interference needed, .001" per in. dia. of shaft.  
 Table gives the change per in. dia.

Material	Dry Ice	Boiling Water
Aluminum	-.0020	+.0017
Brass	-.0017	+.0015
Copper	-.0015	+.0012
Cast Iron	-.0010	+.0008
Steel	-.0011	+.0009

**6** BENT NAIL

**7** COTTER PIN

**8** SCREW SET OFF CENTER

**10** SCREW THROUGH HUB AND SHAFT

**11** SETSCREW

D=DIA. OF SHAFT

FLAT ON SHAFT EQUALS DIA. OF SCREW

  

**9** **TABLE**

Shaft Dia. (Inches)	Setscrew To Use
Up to 1/4	No. 8 - 32
5/16 - 3/8	No. 10 - 24
1/2 - 11/16	1/4 - 20
3/4 - 15/16	5/16 - 18
1 - 1 1/4	3/8 - 16

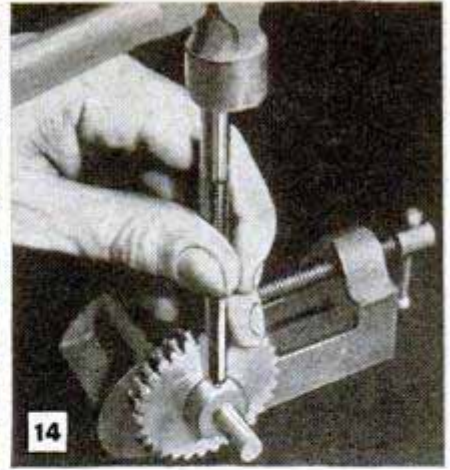
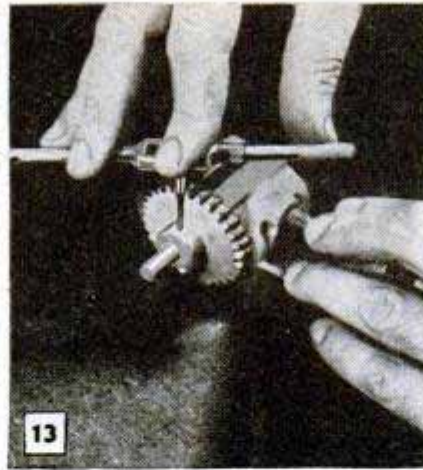

Small gear wheels to be fitted with setscrews are drilled and tapped as in Figs. 12 and 13. When seating a taper pin in the hub of a wheel, use a pin punch and tap it lightly, otherwise the pin may "freeze"

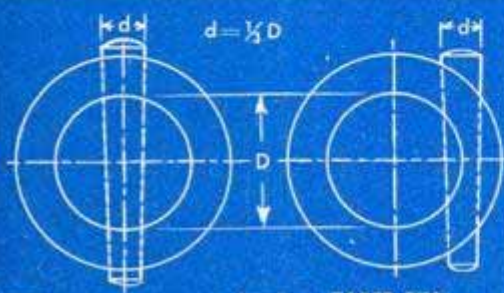

15 TAPER PIN

16 TAPER PIN SET OFF CENTER

17 TABLE

Shaft Dia. (Inches)	Pin Number	Large End Dia.	Approx. Fraction of In.
3/16	7/0	.062	1/16
1/4	5/0	.092	3/32
3/8	3/0	.125	1/8
1/2	0	.156	3/16
5/8	2	.193	1/4
3/4	4	.250	1/2
1	6	.341	11/32
1 1/2	8	.492	1 1/2
2 1/2	10	.706	2 3/32



TAPER REAMER

18 TABLE

Code Number	Small Dia.	Large Dia.	Smallest Drill
7/0	.045	.067	56
6/0	.061	.081	52
5/0	.072	.097	49
4/0	.087	.114	43
3/0	.103	.130	37
2/0	.114	.146	32
0	.129	.164	29
1	.145	.180	26
2	.161	.201	20
3	.181	.229	14
4	.207	.260	4
5	.241	.299	C
6	.278	.354	K
7	.330	.422	R
8	.397	.505	X
9	.481	.607	31/64
10	.580	.721	37/64

**Expansion fit:** In expansion fitting, the shaft is cooled so that it will fit into the hole in the hub. Solidified carbon dioxide (Dry Ice) provides a cheap and practical way of cooling a shaft for an expansion fit. (Caution: do not touch carbon dioxide with the bare hands.) As a rule, allowing work to remain packed in carbon dioxide for 10 to 15 min. will give sufficient shrinkage. The table in Fig. 5 shows the expansion and shrinkage values for several common metals. As an example in calculating the necessary shrinkage or expansion required, take a brass gear wheel with a bore of 2 in., the wheel to be shrink-fitted to a steel shaft. By the common rule, the required diameter of the shaft would be 2.002 in. By heating the gear in boiling water it would normally expand  $2 \times .0015$ , or .003 in. When heated, the bore of the gear wheel would measure 2.003 in. and should slip over the end of the shaft quite easily. By chilling the shaft in carbon dioxide, it is reduced  $2 \times .0011$ , or .0022. The diameter of the shaft then would be 1.9998. In cases where expansion or shrinkage of one of the parts is insufficient, the compound fit is used. The compound fit is accomplished as stated in Fig. 5, by heating the outer, or female member, and cooling the inner, or male member. This method also is used frequently in high-grade work.

**Pin fastenings:** The simplest of these are the bent nail and the cotter pin or key, Figs. 6 and 7. For slow driving speeds and light loads, these fasteners serve the purpose as they will transmit power on slow drives and also prevent the wheel moving laterally on the shaft. They do not, however, withstand shock loads or heavy thrust. Elaborations of the pin fastening are the off-center screw, Fig. 8, and the threaded key, which is turned into a hole tapped half in the shaft and half in the wheel hub as in Fig. 10. Socket-headed setscrews with flat and cup points are used to fasten machine pulleys, particularly pulleys on small motors. Small gear wheels on experimental equipment often are provided with this type of fastening as the wheels are removed easily when gear ratios must be changed. The wheel hubs are drilled and tapped for the screws as in Figs. 12 and 13. On small-diameter shafts, such as

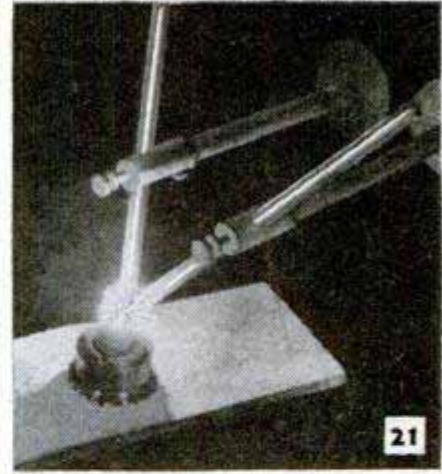
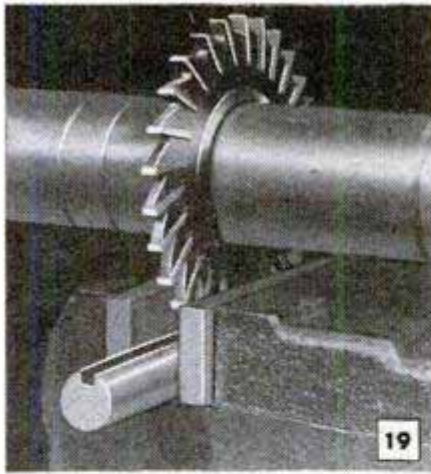

Keyways for both flat and square keys are milled in the shaft. By boring the hub of the wheel oversize and silver-soldering a slotted sleeve in the bore as in Fig. 21, the internal keyway is formed without milling

those on most motors of less than  $\frac{1}{2}$  hp., the setscrew seats on a flat milled on the shaft. A flat also can be ground on a shaft as in Fig. 4. Pulleys and other driving and driven wheels attached to the shaft with a square key or a flat key, Figs. 22 and 23, usually are provided with a setscrew, which is tightened on the key to hold it in place and also to prevent the wheel from moving laterally on the shaft. Figs. 15 and 16 and the table in Fig. 17 show two applications of the taper-pin fastener. This method of attachment gives the rigidity of the shrink and expansion fit but permits removal of the wheel by simply driving out the pin. Holes for taper-pin fastenings first are drilled with an ordinary twist drill of the required size and then reamed with a taper reamer. Fig. 18 lists the common sizes of small taper reamers and gives the drill sizes to use. Where the parts are not subjected to severe vibrations the taper pin is set lightly in the wheel hub with a pin punch as in Fig. 14.

**Key fasteners:** On drives which are subjected to variations in load and where the parts are too large to make pinning practical, wheels are keyed to the shafts. The driving and driven members of various types of clutches on stationary equipment often are fastened to the shafts in this manner. The square and flat keys, Figs. 22 and 23 and the Woodruff, or half-moon key, Fig. 25, are commonly used. Sizes of these keys have been standardized and the tables in Figs. 24 and 25 list common sizes. The position of the key with relation to the wheel hub and shaft has been more or less standardized also, as indicated by the key letters "a" and "b" in Figs. 22 and 23, and the letters "h" and "w" in Fig. 29. When installing either the flat or square keys, Fig. 20, a keyway is milled in the shaft as in Fig. 19. Standard gears, pulleys and other manufactured parts have the keyway formed in the hub. If these parts are being made in the home shop, hub keyways can be formed on a small bench shaper, or even with a hand file. Another way is to bore the wheel hub oversize, then turn a slotted sleeve to fit in the wheel hub. The sleeve is reamed to fit the shaft. It is then silver-soldered in the wheel hub as in Fig. 21. The slot in

$a = \frac{1}{4}D$ 
 $b = \frac{1}{4}D$

**22 SQUARE KEY**

**23 FLAT KEY**

Shaft Dia. (Inches)	Square Key	Flat Key	
		Width	Height
$\frac{1}{2}$ to $\frac{9}{16}$	$\frac{1}{8} \times \frac{3}{8}$	$\frac{1}{8} \times$	$\frac{3}{32}$
$\frac{5}{8}$ to $\frac{7}{8}$	$\frac{3}{16} \times \frac{3}{16}$	$\frac{3}{16} \times$	$\frac{1}{8}$
$\frac{1}{2}$ to $1\frac{1}{4}$	$\frac{1}{4} \times \frac{1}{4}$	$\frac{1}{4} \times$	$\frac{3}{16}$
$1\frac{1}{8}$ to $1\frac{3}{8}$	$\frac{5}{16} \times \frac{5}{16}$	$\frac{5}{16} \times$	$\frac{1}{4}$
$1\frac{1}{2}$ to $1\frac{3}{4}$	$\frac{3}{8} \times \frac{3}{8}$	$\frac{3}{8} \times$	$\frac{1}{4}$
$1\frac{13}{16}$ to $2\frac{1}{4}$	$\frac{1}{2} \times \frac{1}{2}$	$\frac{1}{2} \times$	$\frac{3}{8}$

**WOODRUFF KEY**

Length	Width					
	$\frac{1}{16}$	$\frac{3}{32}$	$\frac{1}{8}$	$\frac{5}{32}$	$\frac{3}{16}$	$\frac{1}{4}$
$\frac{1}{2}$	204	304	404			
$\frac{3}{8}$		305	405	505		
$\frac{3}{4}$			406	506	606	
$\frac{7}{8}$				507	607	807
1					608	808
$1\frac{1}{4}$					609	809
$1\frac{3}{4}$						810

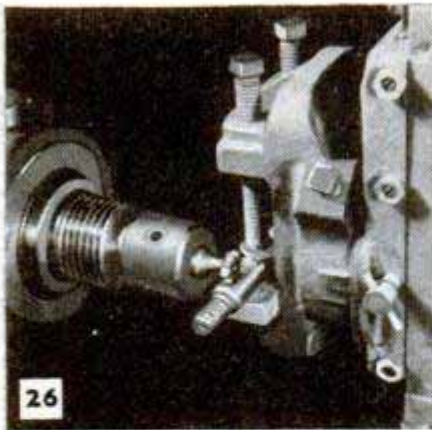

26



27

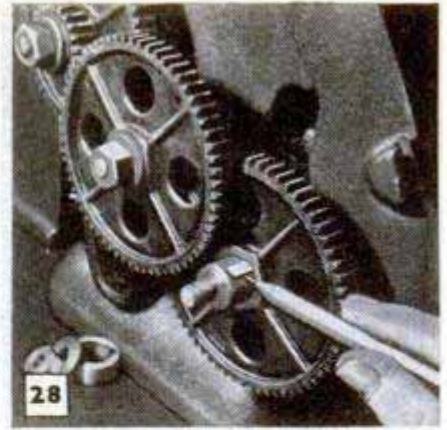

28

Slots for Woodruff keys are cut easily in the lathe with a milling attachment. Before removing the work, place a key in the slot and check depth with a micrometer. Right-hand photo shows application of the key

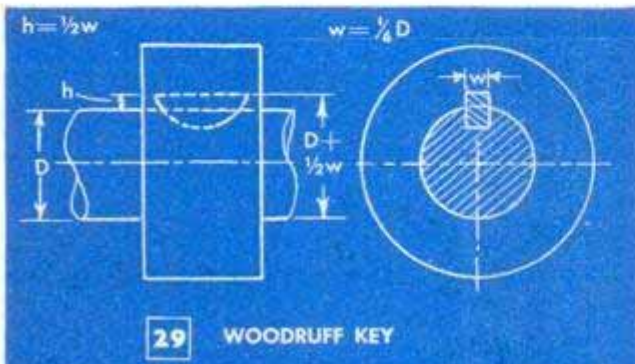

29 WOODRUFF KEY

30 TABLE		
Shaft Dia. (Inches)	Woodruff Key Width	Code Number
$\frac{5}{16}$ to $\frac{7}{16}$	$\frac{3}{16}$	204
$\frac{7}{16}$ to $\frac{1}{2}$	$\frac{3}{32}$	304 etc.
$\frac{9}{16}$ to $\frac{5}{8}$	$\frac{1}{8}$	404 etc.
$\frac{11}{16}$ to $\frac{15}{16}$	$\frac{5}{32}$	505 etc.
1 to $1\frac{1}{16}$	$\frac{3}{16}$	606 etc.
$1\frac{1}{4}$ to $1\frac{3}{4}$	$\frac{1}{4}$	807 etc.

Note: The Woodruff Key Code Number is derived as follows: First digit, width of key in 32nds. Second and third digits, length in 8ths. Thus 405 indicates a key  $\frac{1}{8}$  wide)  $\frac{5}{8}$  long.



31 MACHINED SHOULDER

32 GRINDING-WHEEL COLLAR



33 WELDED COLLAR

34 COLLAR AND SETSCREW

the sleeve allows the key to slip into place.

The lathe setup for cutting a Woodruff keyway with a milling attachment is shown in Fig. 26. After locating the position of the keyway, work is fed upward into the cutter by means of the vertical slide of the milling attachment. Before the shaft is removed from the milling-attachment vise, a key is inserted in the slot and the depth checked with a micrometer as in Fig. 27. A typical application of the Woodruff key is shown in Fig. 28. The table in Fig. 30 gives the recommended sizes of the Woodruff key to be used with a shaft of a given diameter. The special note directly below the table describes the meaning of the code numbers listed in the right-hand column.

**Threaded arbors:** Grinding wheels, circular-saw blades and circular-saw attachments, buffing wheels and wire scratch wheels are attached to the driving shaft or arbor by a compression-type fastening. Similar grinding and polishing accessories are attached to a flexible shaft in the same manner. The arbor is shouldered and threaded for a distance from one end, or both ends in the case of a motor-driven grinder, and is fitted with a nut and either one washer as in Fig. 31, or two loose washers, or flanges, as in Fig. 32. The latter is the common type of fastening used on saw arbors, although some are fitted with a welded inner collar or flange as in Fig. 33. Threads on the arbor are cut either right or left hand, depending on the direction of rotation of the shaft. In some applications where slight adjustments are necessary, the inner collar is attached to the shaft with a setscrew as in Fig. 34. Note that the grinding-wheel collars in Fig. 32 are recessed and that the outer flange is turned with a hub. Grinding wheels are fitted with lead sleeves and paper flanges on both sides to protect the arbor and the ground surfaces of the metal arbor flanges from abrasive action when attaching and removing the wheel. Paper flanges also help to prevent the wheel from loosening.

# Flanged Tap Wrench Takes Four Shank Sizes

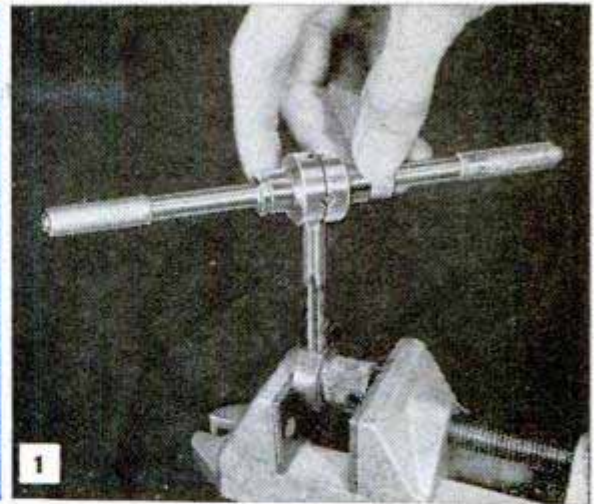
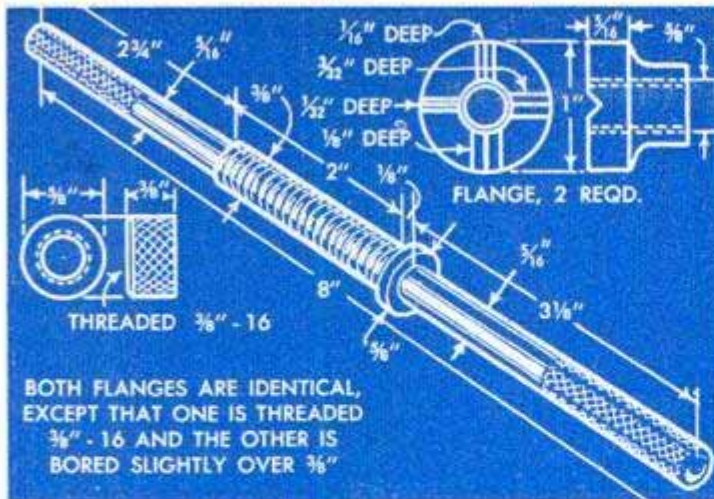

This versatile tap wrench, Fig. 1, makes an interesting and instructive project for either the home craftsman or the school shop. The handle unit is turned from  $\frac{5}{8}$ -in. cold-rolled steel to the dimensions given in the detail. After knurling the ends, the center section is threaded in the lathe, as in Fig. 2, or with a  $\frac{3}{8}$ -16 die. The flanges are turned from cold-rolled steel and then notched to take four sizes of tap shanks. The notches can be milled in each flange or they can be filed in the flanges by hand. If the notches are hand-filed, care must be taken to space them equidistantly. File the notches to exactly the same depth in both flanges so taps are gripped securely.

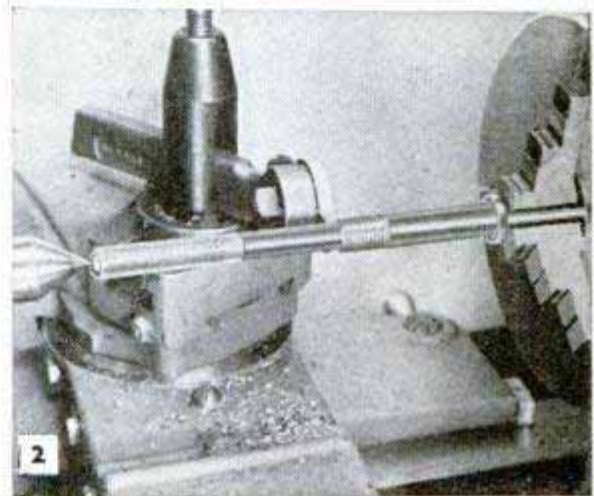

## Counterweight on Door Automatically Returns It to Preset Stop

Because it was necessary to keep an entrance door partially open for proper ventilation, the workers in one powerhouse made an adjustable doorstop that runs on a circular overhead track. A counterweight brings the door back against the

stop after someone passes through. The track is a length of square rod bent to a radius about 1 in. greater than the width of the door. The stop itself is made by bending a piece of flat iron to fit loosely around the track. A hole is drilled in the underside of this flat-iron sleeve and a nut is centered over the hole and welded in place. Then one side of the sleeve is welded to a piece of angle iron fitted with a 2-in. sheave as shown. An eyebolt, which serves as a setscrew to lock the stop in place, is turned in the nut by means of a steel-rod extension to which a valve handwheel is attached. A bracket bent from flat iron is fastened to the upper part of the door to take one end of the counterweight rope. This bracket may have to be offset slightly so the rope aligns with the doorstop sheave. Note that a short coil spring is brazed over the rope hole in the bracket to provide a shock absorber. Another sheave is attached to the wall at the same height as the stop and pivoted so it is always in line with the stop. A sash balance serves as a counterweight. This should slide in a wooden channel to protect the wall.

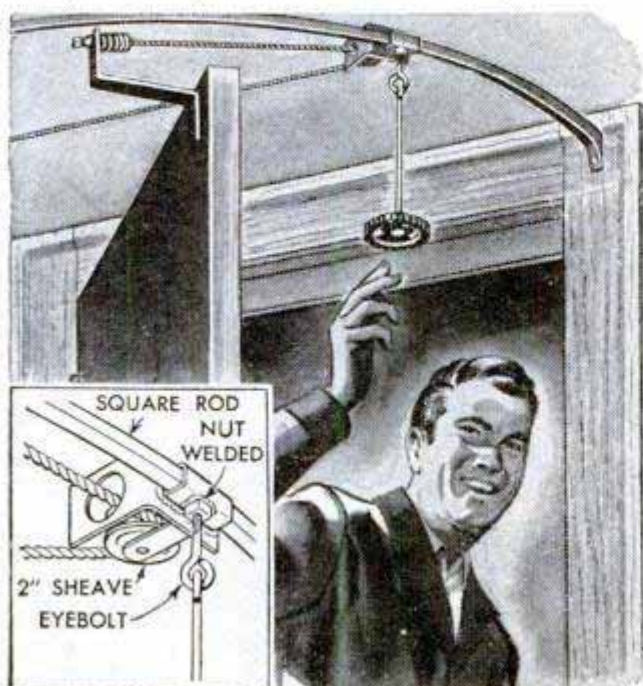

J. C. Montgomery, Bowness, Alta., Can.

## Tin-Can Guard Catches Shavings When Drilling Overhead

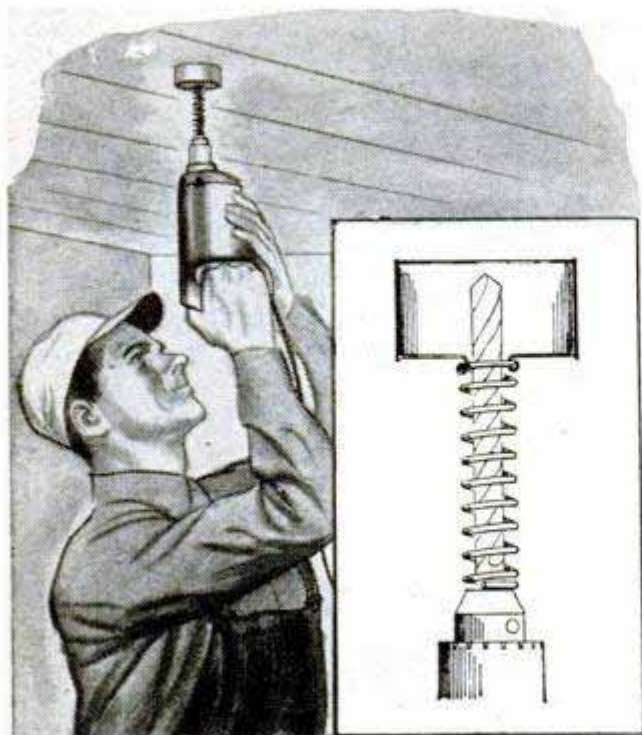

To protect his eyes from falling particles when drilling through ceilings, one electrician placed a small tin can over the end of the drill bit. A coil spring holds the can flush with the ceiling, as shown. Both the spring and the hole in the bottom of the can must, of course, be slightly larger than the bit. The hole is punched from the inside of the can and the metal is bent around the end coil of the spring to hold the can in place.

Stratis Simon, Long Island City, N. Y.

## Releasing Tight Wrist Pins From Connecting Rods

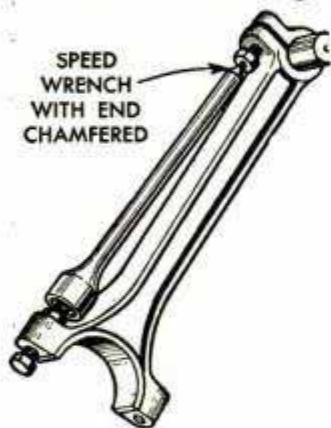

Here is a device used by one mechanic to release exceptionally tight wrist pins from connecting rods of the type shown. A shallow hole is drilled in the center of the head of the bolt which clamps the wrist pin and the bolt is loosened slightly.

Next, a bolt is inserted through the hole in the lower end of the connecting rod. This bolt, having a smaller diameter than the hole, is turned into a nut. One side of this nut is filed down to bear against the connecting rod so that it will not turn. Then, a speed-wrench fitting is pointed and placed

between the two bolts, as indicated. In this way, tightening the lower bolt exerts pressure on the wrist-pin bolt forcing the clamp open.

Arthur W. Carpenter, Blackbird, Del.

## Apron Carries Stenciled Reminder

Because he often forgot to lock up his apparatus when leaving the laboratory for the day, one chemist stenciled a reminder on the inside of his apron. Then, as he hung the apron on the wall, he would see the note to check the equipment.

Merle A. Stewart, Jr., Mars Hill, N. C.

## Finger Grip for Measuring Tape

When using a measuring tape, a better grip is had if a cotter pin is slipped over the end of the tape next to the metal ring. This is especially useful when wearing gloves to work outdoors in cold weather.

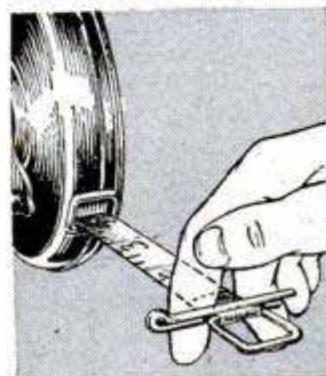

## Grease Fitting on Hand Gun Permits Pressure Filling

Hydraulic hand guns used to grease hard-to-reach places on a car are refilled in a jiffy with a compressed-air gun. Of course, before this can be done the casing of the hand gun must be drilled and tapped to take a  $\frac{3}{8}$ -in. hydraulic grease fitting.

Jerome Ford, Lancaster, Ohio.



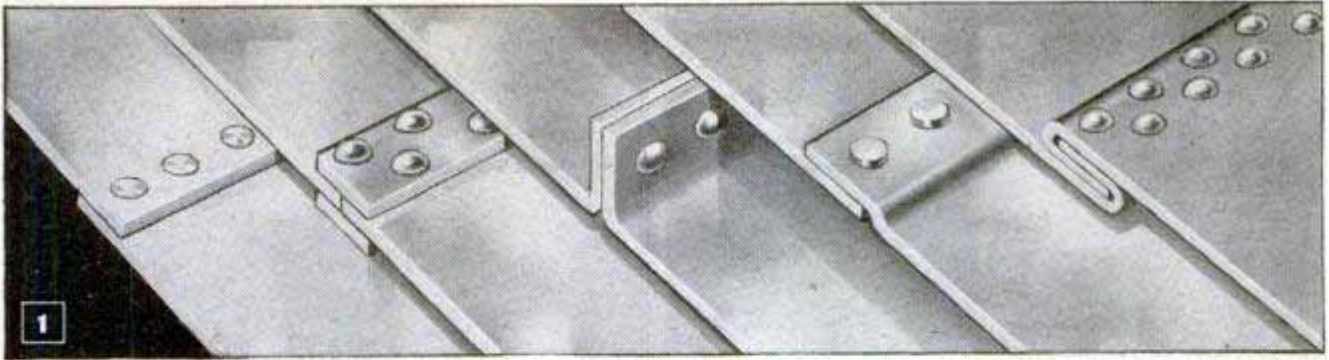

# HOW TO RIVET ALUMINUM

**R**IVETING aluminum sheets, either in factory production or in the home workshop, requires a specific procedure to produce maximum strength in the joint without any distortion of the material. In nearly all types of work the rivet pattern, Fig. 1, is important not only for decorative effect but for resistance to shearing or buckling of the joint. The type of rivet to be used is selected according to the nature of the work and the type of joint which is most suitable to the project in hand. The four rivet types shown in Fig. 2 will meet all ordinary requirements. If decorative value is a factor in the selection, then the round-headed and also the brazier-headed rivets usually are best. Use the round-headed type to join the heavier sheets where greater strength is required. The size and thickness of metal in the head is designed to strengthen the area around the rivet hole. When thin sheets are to be joined, a brazier-headed rivet is the one to use as its broad head gives a maximum grip on the

By R. J. De Cristoforo

area surrounding the rivet hole. In places where the structural members are a close fit, the flat-headed rivet provides that extra clearance so often needed for bucking with a flat bar. Rivets with countersunk heads are used when the surface of the riveted joint must be flush. It is important to remember that the length of the countersunk-head rivet is measured from the top of the head while in all the others the rivet length is the length of the shank and not the over-all length.

The length of the rivet in relation to the thickness of the work is illustrated in Fig. 3. Approved practice requires that when the head of the rivet is seated, the projection of the shank below the lower, or inside, surface of the metal should be  $1\frac{1}{2}$  times the diameter of the shank before upsetting, as in the right-hand detail, Fig. 3. In ordinary practice the rivet hole is made the same diameter as the rivet shank to give a very light press fit, but in production fabrication some specifications call for

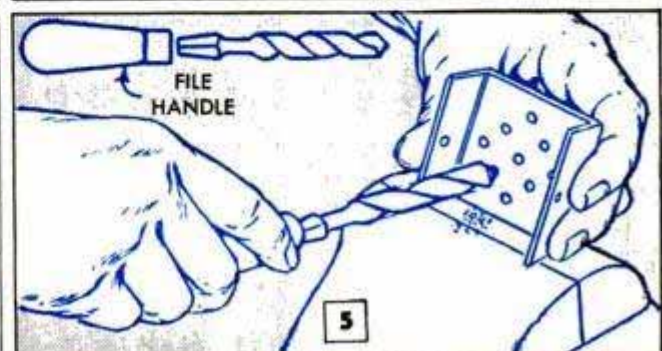
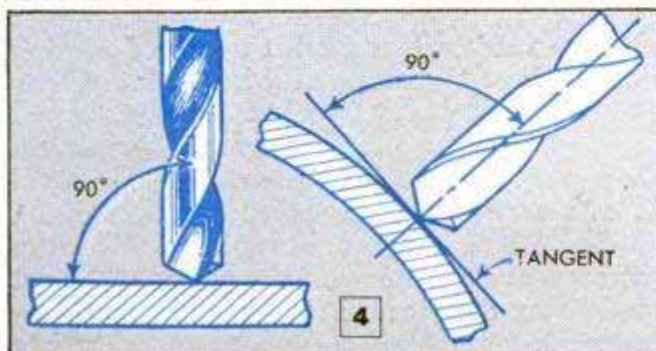
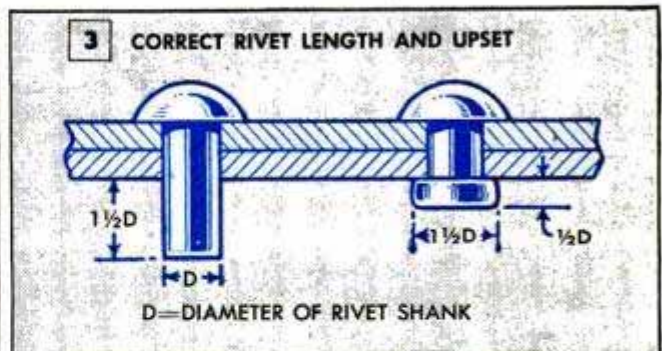
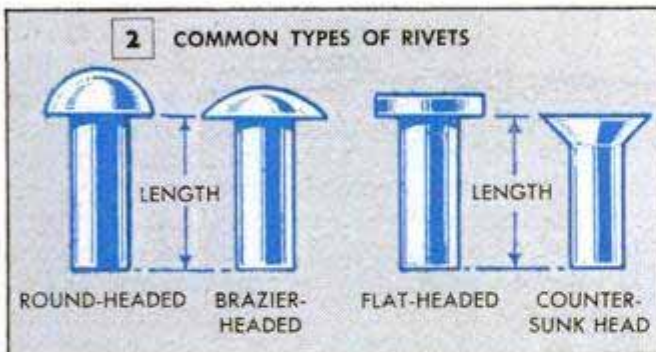

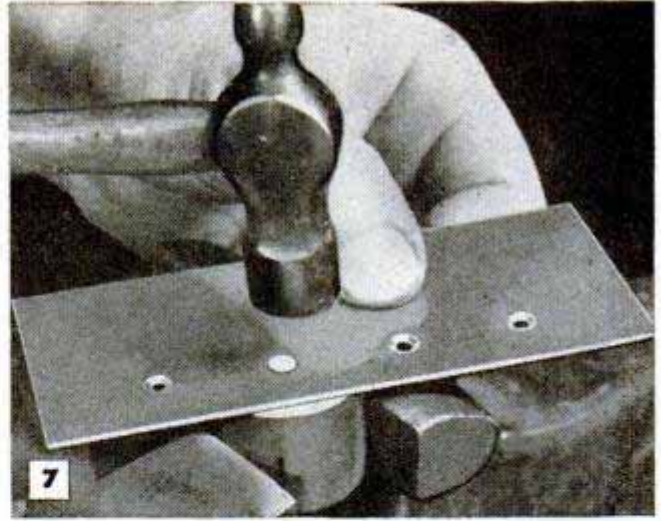
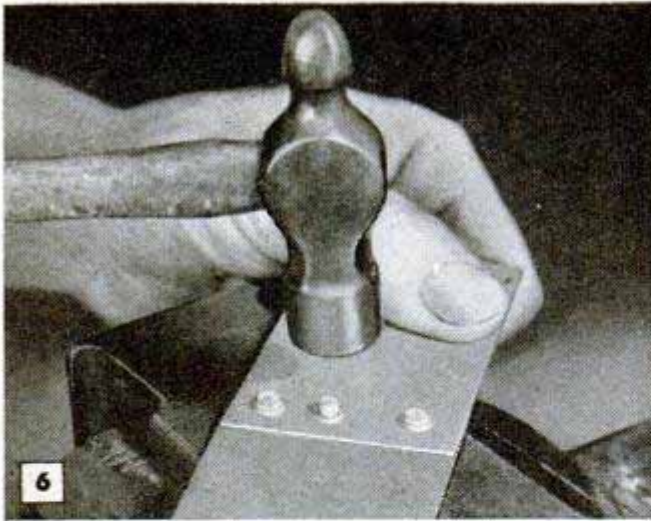

Rivets on dimples are upset in the usual manner. A rivet of the same size can be used as a dimpling die

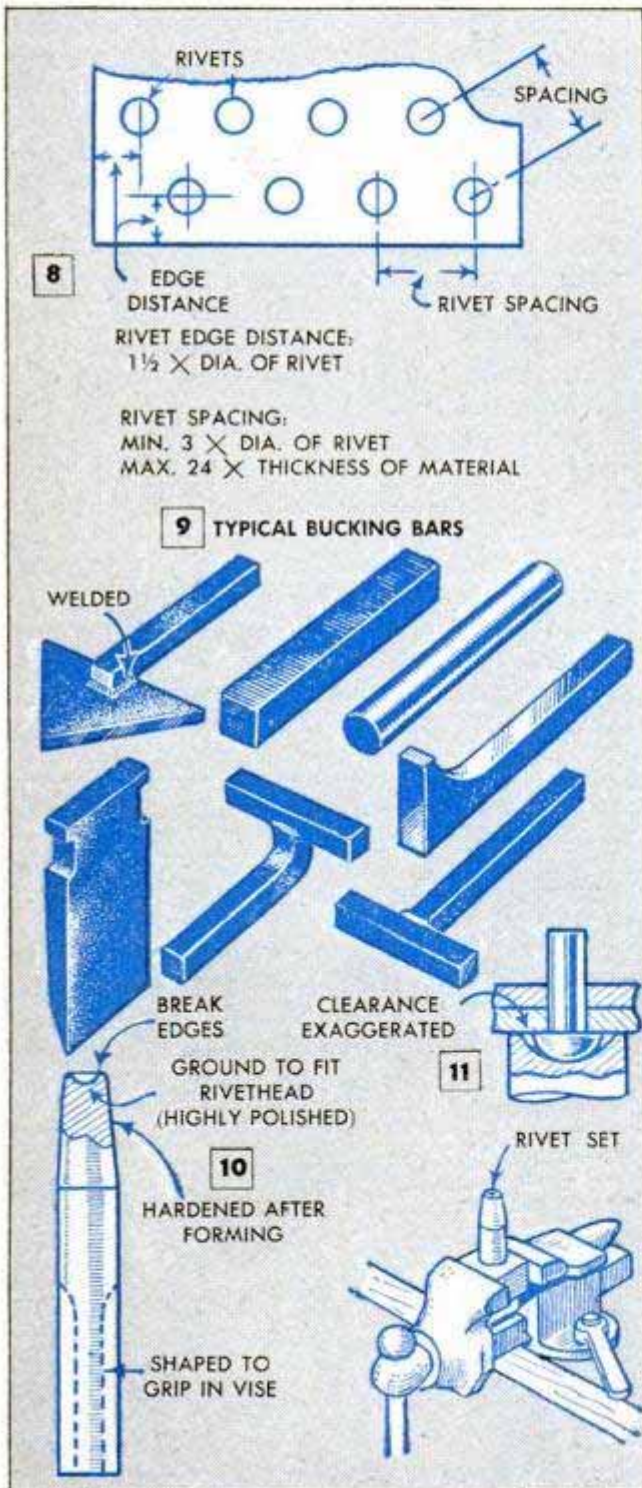

slight variations. In any case, the hole should be drilled with care to avoid undue burring. Be sure that the drill bit is properly sharpened for drilling aluminum. In breaking the hole through, care should be taken that the drill chuck does not spin against the metal surface and score it. After drilling, all holes are burred. In the small shop, this can be done with a burring tool made from an old square-shanked drill bit fitted into a file handle, Fig. 5. Be especially careful when burring thin metal to avoid depressing the metal around the hole. Good practice demands that, where the joints require a line of rivets, the holes be drilled in a precise pattern as in Fig. 8. Angle of the drill with the work, Fig. 4, should be uniform when drilling a series of holes. Both the lengthwise spacing and the edge spacing should be laid out to exact dimensions. If there are two lines of rivets, the holes are staggered and the lines are accurately spaced.

When riveting guns are used, the shank of the rivet is upset with a bucking bar, or dolly, Fig. 9. In some kinds of work, the bar also is used to bear on the head of the rivet while the shank is upset with a hammer. Bucking bars usually are made up in the shape required. In handwork, using round-headed rivets, the rivet set, or anvil, is used when upsetting. One end of the set is tapered as in Fig. 10 and the end is recessed to a radius slightly greater than that of the rivethead. This is done to give a clearance as in Fig. 11. Break the edges at the recessed end with a light beveling cut while the work is still in the lathe. The straight end of the rivet set can be shaped as in Fig. 10 so that it can be gripped in a vise or fitted in a hole drilled in a steel block as in the right-hand detail, Fig. 10. When using the set, be sure to hold the work square, otherwise the edges of the set may mar the work. Flat-headed and countersunk rivets can be upset neatly on any



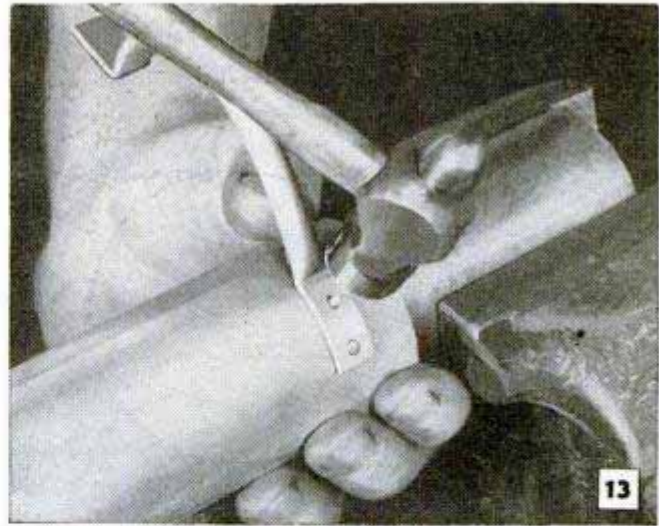
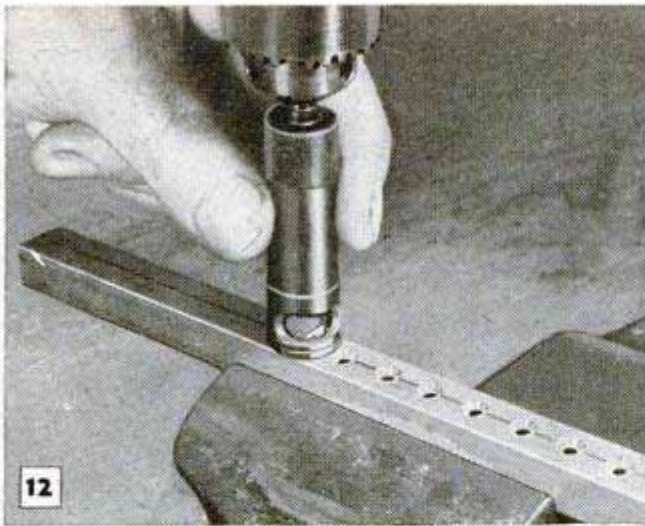

Automatic countersink assures uniform work. Tubing is riveted over a round bucking bar held in the vise

flat metal surface, but to assure that the rivethead will be flush after upsetting, it is necessary that the parts of the work be held tightly together. In order that countersunk rivets shall be perfectly flush when upset, it is necessary that the holes be countersunk to a uniform depth. Fig. 12 shows an automatic countersink in use. It is held in a drill chuck and can be set to countersink with exact uniformity at any average depth. Countersinking by hand will be less uniform of course, but with care it can be done with sufficient accuracy. In handwork, the tendency is to run the countersink too deep. When this happens, drill a hole in a small piece of steel and countersink it slightly undersize. Then spread the rivethead as shown in Fig. 15 so that it will fill the countersink flush when the shank is upset. When using rivets with countersunk heads on thin material where the depth of the head will not permit countersinking the metal, the rivet holes are drilled and then the two thicknesses of metal are dimpled as in Figs. 16 and 17. Make a dimpling bar by drilling a rivet-sized hole in a piece of round steel. Countersink the hole and break the edge, as indicated in Fig. 16, by simply beveling the edge slightly with a large drill bit held in the hand. Then use a rivet as a dimpling die as in Fig. 7. Burr the dimples lightly on one sheet only and when joining the work upset the rivets on the dimples as in Fig. 6.

Fig. 14 pictures the most common faults in riveting thin material. Although any one of these will produce a poor and unsightly job, the most frequent errors are in drilling holes oversize, using too short or too long a rivet and, on round work, Fig. 13, tending to upset the rivet too flat. For better results some riveters round the upset slightly on this type of work.

☞ To loosen a rusted screw, press a hot soldering iron against it for a few minutes.

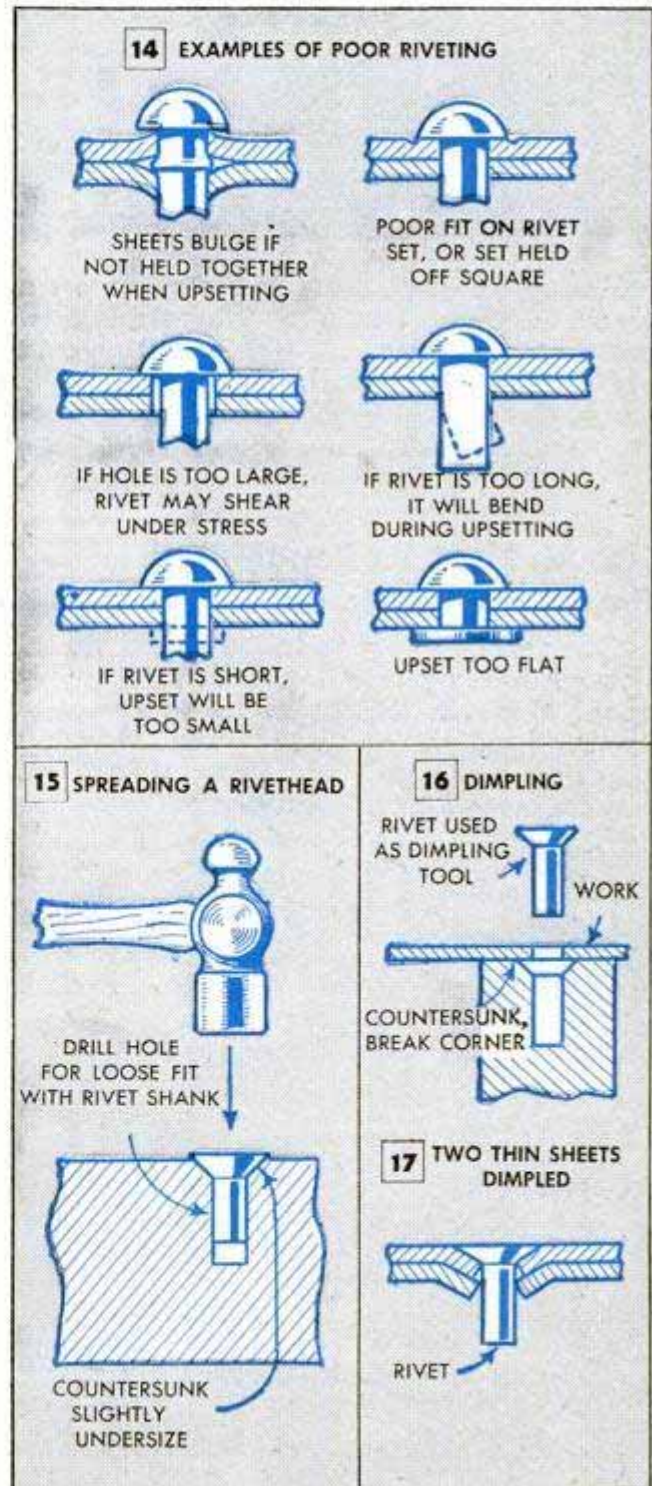

## Burr Aids Concentrating Heat When Cutting Round Bars

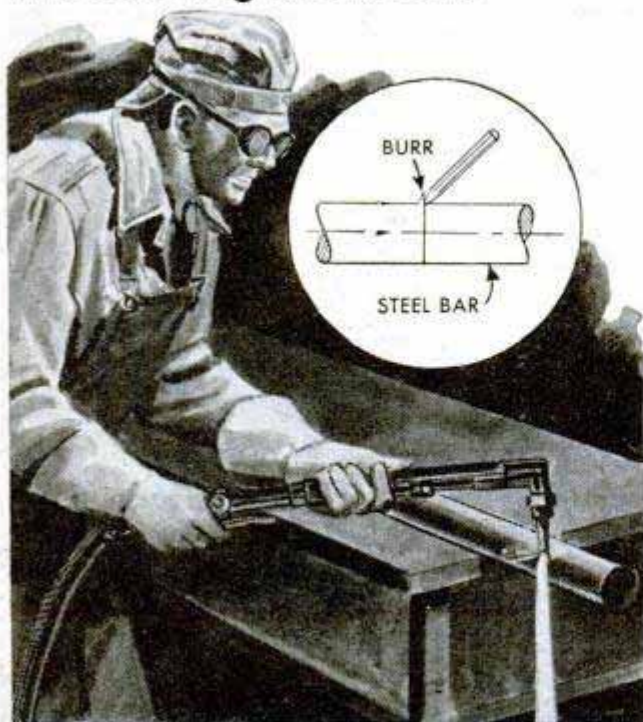

Before cutting round bar stock with a torch, one man speeds the job by raising a small burr at the starting point with a cold chisel. The burr absorbs the heat from the torch, thus reaching the kindling temperature more rapidly than a smooth surface.

Emil Wittmann, Philadelphia, Pa.

## Hot-Air Heat for Repair Stall Provided by Auto Radiator

One garage owner installed an individual hot-air heating unit for each stall in his shop. This was done by connecting an auto or truck radiator to the hot-water heating pipes near the stall and using an electric fan to blow air through the radiator. A

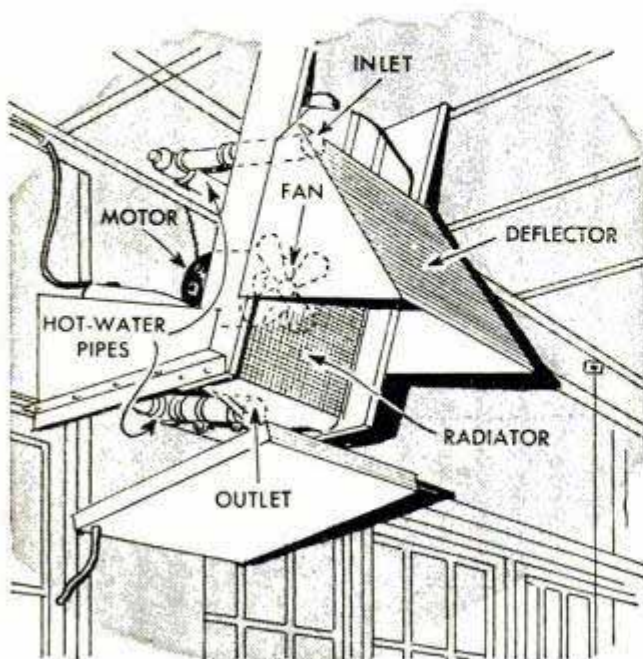

sheet-metal deflector directs the warmed air into the repair stall. The filler neck of the radiator is sealed and the unit is connected to the pipes with ordinary hose and clamps.—L. H. Houck, Jefferson City, Mo.

## Thumbtack Feet on Triangle Prevent Smudged Drawings

If you sometimes smudge a pencil drawing when sliding a triangle over it, fit the triangle with thumbtack feet which will raise it above the paper to prevent smudging. The tacks are pushed through the triangle near each corner and the projecting points cut off and filed flush with the surface.

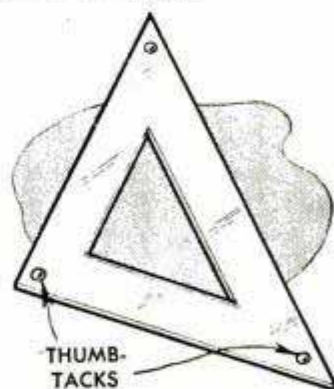

Bill Crowell, Raleigh, N. C.

## Repairing Hydraulic Brake Lines

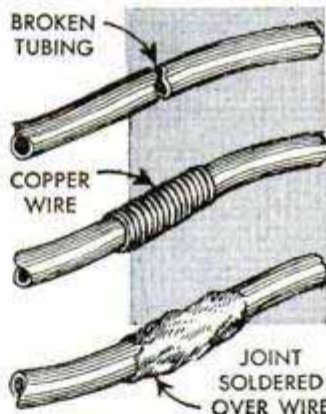

With the nearest garage miles away from my home, I was faced with the problem of a broken hydraulic line in the brake system of my car. I repaired the metal tubing simply by wrapping copper wire around the broken portion and covering

the wire with solder. This mend proved to be more than a temporary repair, as it is still holding after months of use.

Alfred G. Larson, Idaho City, Idaho.

## Using Split-Knob Insulators To Hold One Wire

When split-type insulators are used to carry single electrical wires in a barn or other outbuilding, put a short piece of the same wire in the unused slot of each insulator. The insulator will grip the wire better and there will be less chance of the insulator shattering when nailed in place.—W. H. McClay, Pasadena, Calif.

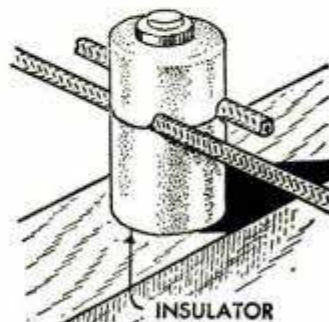

# Radio Television Electronics

## Television Set Is Portable

**T**AKE WITH YOU the very sound and sight of events you want to hear and see. Easy to carry as indicated in sketch B, this portable TV receiver employs a 7-in. electrostatic kinescope tube and the picture area is 26 square inches. It may be used wherever current is available.

Housed in a luggage-style leather-grain case  $11\frac{1}{2} \times 15\frac{1}{2} \times 17\frac{1}{2}$  in., the set may be placed on any standard-size end table, desk or other convenient spot where the picture will appear at eye level. The off-on-volume, brightness, channel-selector switch and contrast control are on the front of the cabinet as shown in photo A. Focusing, horizontal and vertical controls, used for adjustment at time of installation, are at the rear. Other features include a special safety interlock switch which guards all dangerous shock points.

Covering 12 TV channels, it may be used in any city. The portable antenna shown in photo C is optional equipment to be used wherever a regular TV antenna is not available. It works indoor or outdoors and is adjustable to proper station direction. Two telescoping extensions are employed for tuning to various TV channels.

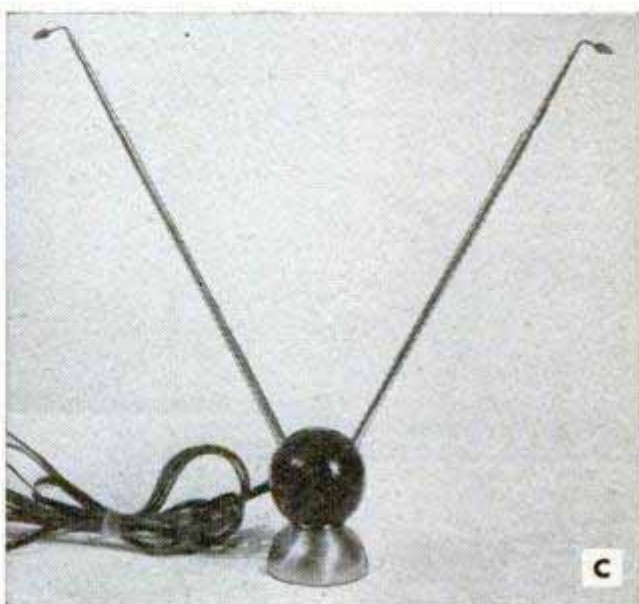

# 1949 Low-Cost Progressive

By S. A. Johnson

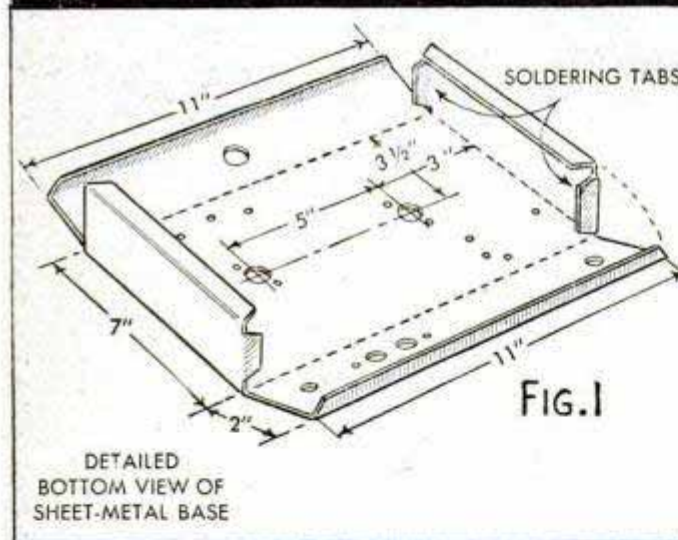
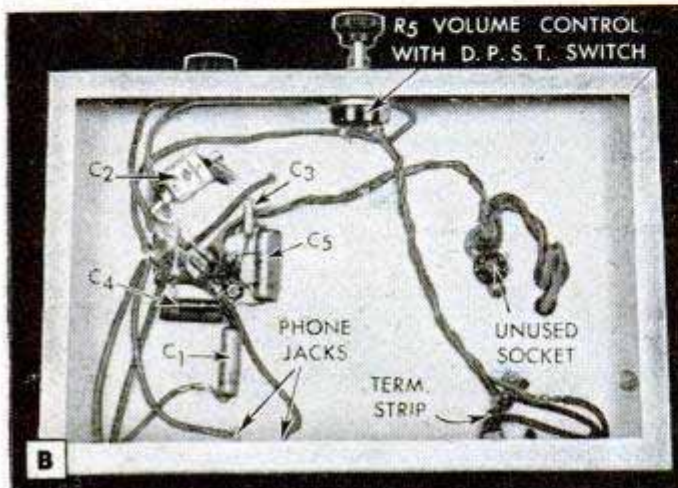
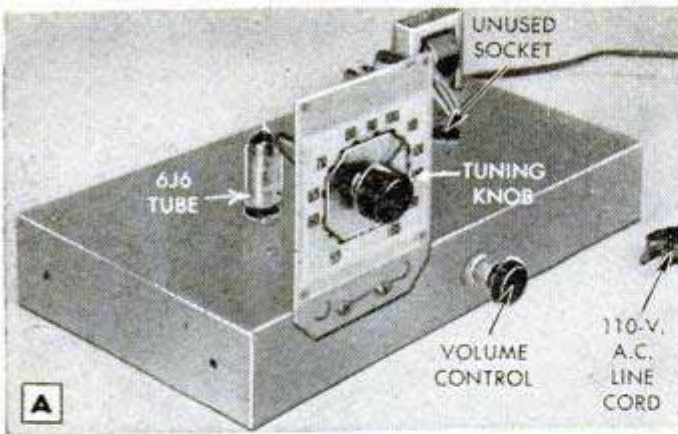

ONE MINIATURE dual-purpose tube does the work of two in this new progressive broadcast-band receiver which is especially designed for beginners and experimenters. All parts have been carefully selected for economy and simplicity of construction without sacrificing performance and with a view to adding another tube and a few extra parts at a later date to make an excellent 2-tube loudspeaker set that will operate on any 110-volt a.c. power line without using a B-battery. The same 6.3-volt 3-amp. filament-supply transformer and all other original parts will be employed except the switch on volume control, R5, which will be changed to a single-pole, single-throw type. Therefore, when buying the volume control, R5, select one that can be used with an attachable switch. Like its predecessors in the student progressive series, this set is complete in itself and should be carefully built and used by the beginner for some time until he is thoroughly familiar with its operation before starting unit No. 2 which will appear in the April issue.

Designed around an Aeromotive type-260 regenerative permeability tuner which provides an effective tuning arrangement that has few parts, it covers a tuning range from 540 to 1600 kc. This tuner is listed in the 1949 radio-parts house catalogs for \$1.44 and is complete with dial, coil and tuning knob. No single-gang, variable-tuning condenser is required. Before starting construction, study the diagrams carefully and note how the various parts are

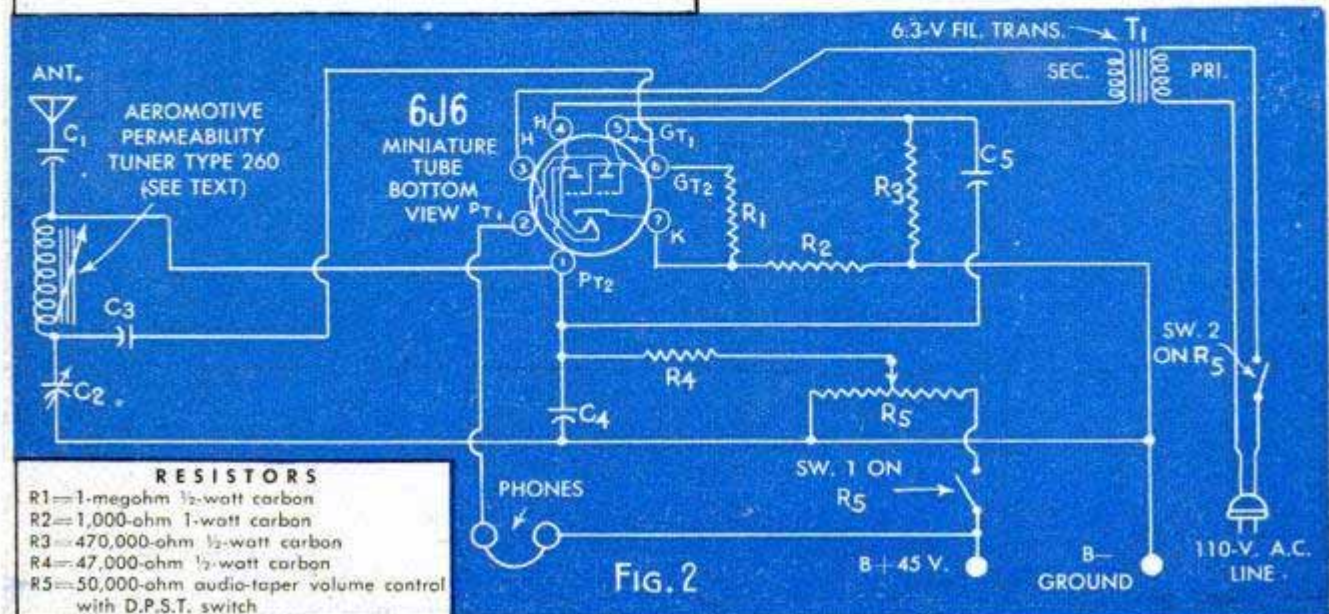

- RESISTORS**
- R1=1-megohm 1/2-watt carbon
  - R2=1,000-ohm 1-watt carbon
  - R3=470,000-ohm 1/2-watt carbon
  - R4=47,000-ohm 1/2-watt carbon
  - R5=50,000-ohm audio-taper volume control with D.P.S.T. switch

FIG. 2

# Broadcast Set . . . Unit No. 1

mounted in photos A, B, C and D. The sheet-metal chassis base detailed in Fig. 1 is a standard type and size available from most radio-parts supply houses; the builder may omit the tabs and turned-over edges if he forms his own. Drill the necessary holes in the positions indicated in the diagram, Fig. 1; the holes for the miniature tube sockets have  $\frac{5}{8}$ -in. diameters. These holes may be made with a smaller drill and enlarged to size with a tapered reamer.

Mount the various parts using short machine screws and nuts; there is plenty of room on the chassis and you will note that this set includes the socket for a second tube which is to be added in unit No. 2 of this series at a later date. Having the socket already mounted simplifies wiring the second set. Wiring is easy providing you are careful to make good soldered joints and are sure that every connection is exactly as shown in the diagrams, Figs. 2 and 3. It is good practice for the beginner to mark off each lead on the pictorial wiring diagram, Fig. 3, as the wiring progresses. This is usually done with a colored pencil.

(Continued to page 230)

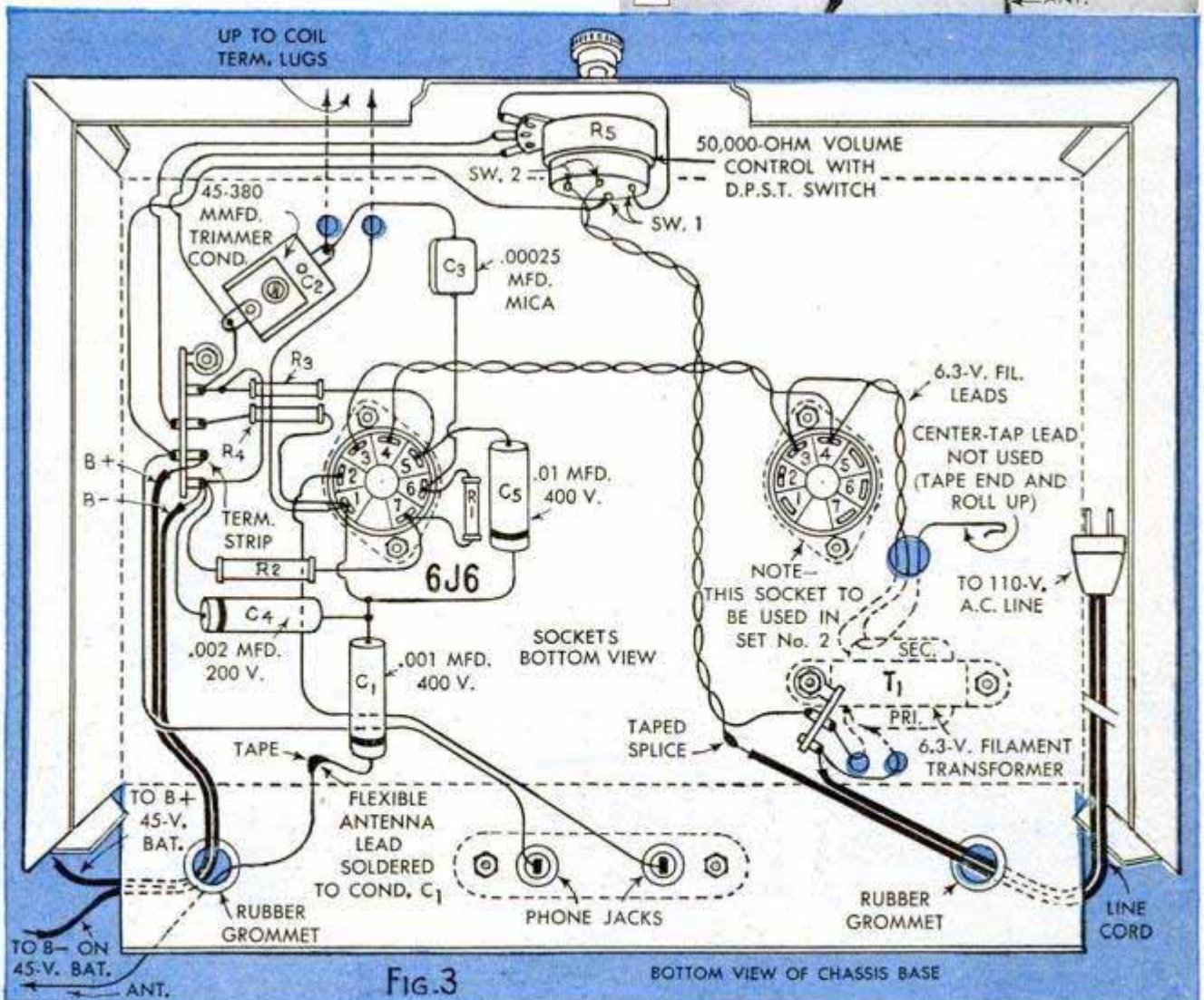
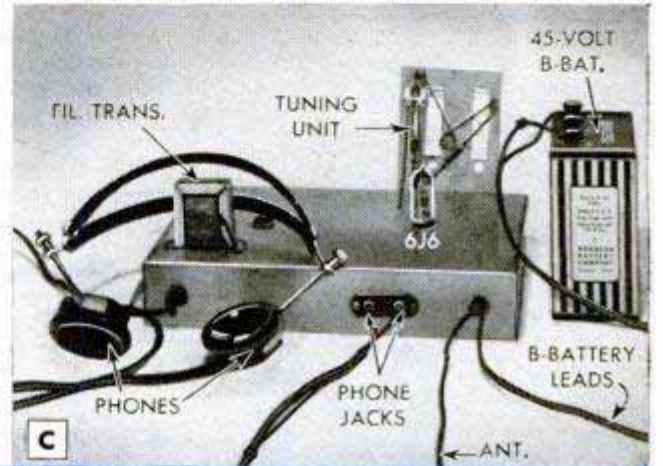

# RADIO AND ELECTRONICS TODAY



(A) Custom-built television receiver designed for decorators' in-the-wall use, shows a 520-square-inch picture claimed to be about 10 times the size of the most common television sets on the market today

(B) Front panel removed from the in-the-wall TV-set installation (A) shows the projection-type receiver, power-supply unit and speaker on separate shelves

(C) Portable, indoor, television-receiver antenna consists of a tubular-metal dipole with adjustable disks. It is claimed to be effective for local TV stations



(D) Pocket-size wavemeter and modulation indicator enables amateur, ship and police radio operators to monitor quality of transmission, plot field patterns, and keep a constant check on modulation limits

(E) Wave trap designed to eliminate interference when caused by amateur radio transmissions received through a.c. power line. It can be used in connection with any standard TV, AM or FM receiver

(F) Combination radio receiver and inter-call system for the home or office. It may be employed as a regular broadcast receiver and the same program may be channeled to the extension unit in another room. Can also be used for instant two-way communication between rooms by merely pushing a button. Employs four quick-heating tubes

(G) Hand-type hearing aid developed for persons whose hearing loss is slight and who will benefit by an improvement in hearing ability under certain conditions where the sound level is below the ordinary conversation level. Very compact, it has finger-tip control and includes microphone, receiver and power pack. It weighs 8½ oz.

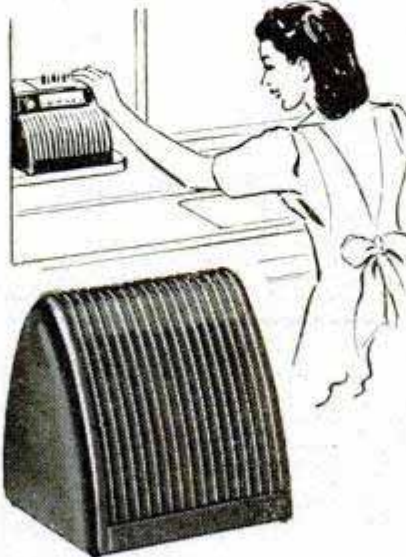
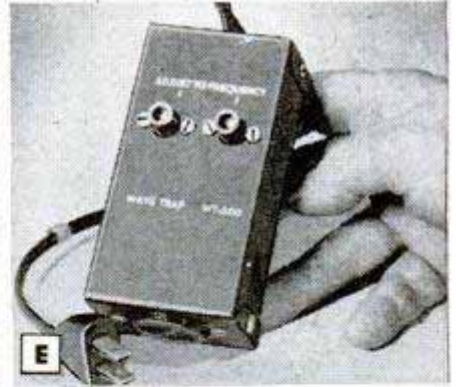
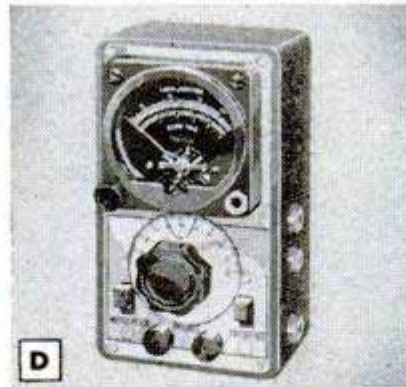
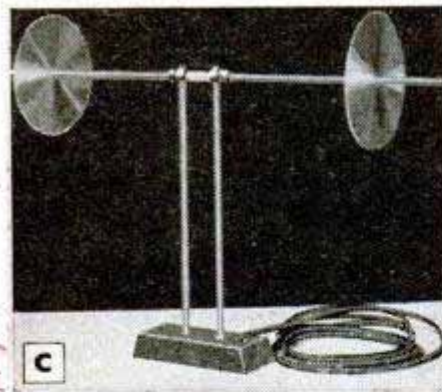

NOW... LIGHT  
WHEN YOU NEED IT!

Ray-O-Vac leak proof batteries  
stay fresh for years!

(because they're sealed in steel)

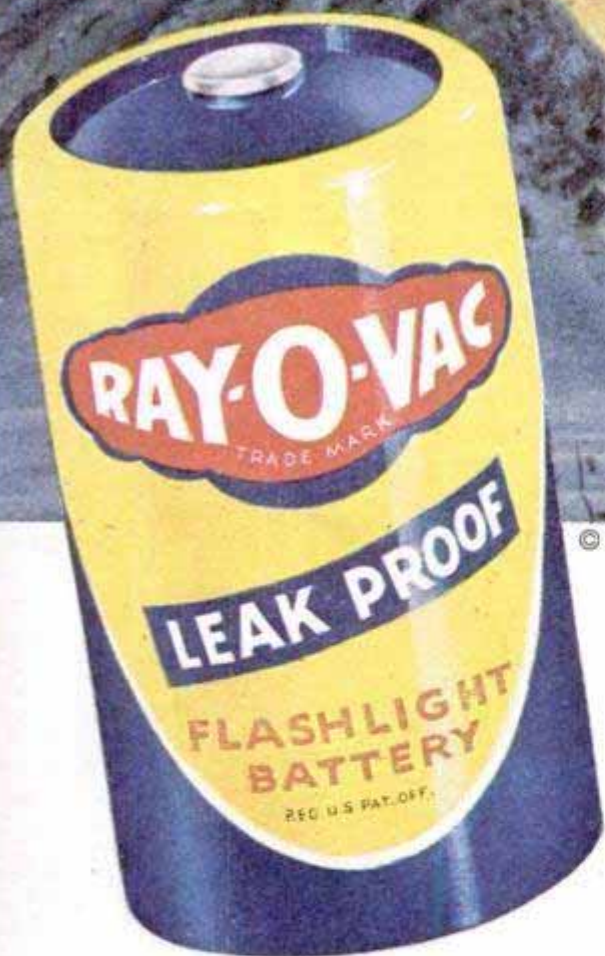

© 1948 BY RAY-O-VAC COMPANY, MADISON, WIS. RAY-O-VAC CANADA LTD., WINNIPEG, MAN.

**Guarantee:** If your flashlight is damaged by corrosion, leakage, or swelling of this battery, send it to us with the batteries and we will give you FREE a new comparable flashlight with batteries.

Ask for Ray-O-Vac Leak Proofs

**Buy Spares...** *they stay fresh*

An outstanding tool  
 added to the  
**SHOPMASTER**  
 Family of  
 Fine Woodworking  
 Tools . . .



**The NEW 8" TILTING  
 ARBOR BENCH SAW by  
 SHOPMASTER**

It's new, and by SHOPMASTER. This 8-inch Tilting Arbor Bench Saw brings new accuracy, new ease of operation for amateur and professional wood craftsmen.

The saw table is always level. Saw blade tilts a full 45 degrees, and saw can be raised to a 2 1/4 inch cut. Convenient controls, sealed-for-life ball bearings, and adjustable belt tightening are but three of the many outstanding features.

See this new SHOPMASTER Saw at your dealer today, and his complete display of the outstanding SHOPMASTER Tools and SHOPMASTER accessories.



**SHOPMASTER, INC.**



**SHOPMASTER, INC.**

1214 Third St. S., Minneapolis, Minn.

Please send me complete information and the illustrated full-color catalog on SHOPMASTER Power Tools and accessories.

Name \_\_\_\_\_

Address \_\_\_\_\_

City \_\_\_\_\_ State \_\_\_\_\_

*P.S. Remember there is a complete line of accessories to go with your SHOPMASTER tools.*



**VIEW your slides  
blown up nearly 5 times**



Introducing  
the

## **Kodaslide Table Viewer**

Good news for 35mm. and Bantam slide fans: For quick shows with 2 x 2-inch slides, small-group viewing, initial review and editing, it's the new Kodaslide Table Viewer. Ask your Kodak dealer for a demonstration and see for yourself. Price, \$95.

*Price subject to change without notice.*

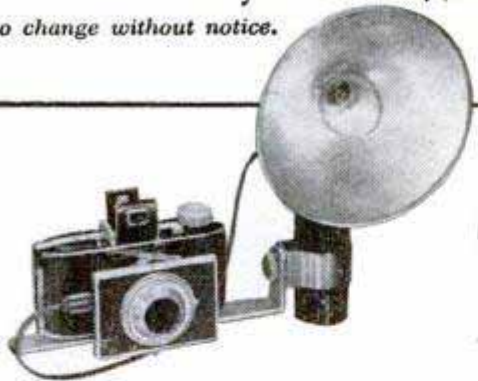

**FAST**—*f/4.5 Lumenized lens makes sparkling color pictures . . . salon black-and-whites.*

**TRIM**—Fits pocket or handbag . . . weighs only 13 ounces.

**EASY TO USE**—Body shutter release, automatic film stop, self-erecting front make picture-taking simple.

**EASTMAN KODAK COMPANY, ROCHESTER 4, N. Y.**

## **ENTIRELY NEW TYPE rear-projection screen shows brilliant image even in fully lighted room**

The 7½ x 7½-inch rear-projection screen, backed by the Kodak Ektalite Field Lens, both radically new, gives you even, over-all brilliance, detail, and freedom from distortion never before approached with a viewer.

Fine optical system includes *Lumenized* Kodak Projection Ektanon Lens *f/3.5*; 75-watt lamp; heat-absorbing glass; two *Lumenized* condensers; three front-surfaced projection mirrors.

Built-in slide changer takes up to 75 cardboard slides; also takes glass slides. Changer automatically switches on lamp when each slide is inserted, turns it off as slide is withdrawn.

Efficient cooling system (by convection) protects slides in Viewer.

The body is of die-cast aluminum, finished in buff and brown. Viewer uses AC or DC current; has eight-foot cord.

## **MIGHTY MIDGET—Kodak Flash Bantam f/4.5 Camera**

**ECONOMICAL**—8 exposures on black-and-white Kodak Films or full-color Kodachrome Film.

**SYNCHRONIZED**—Makes flash exposures up to 1/100 . . . straight shots up to 1/200.

*"Kodak" is a trade-mark*

**Kodak**

# ATKINS

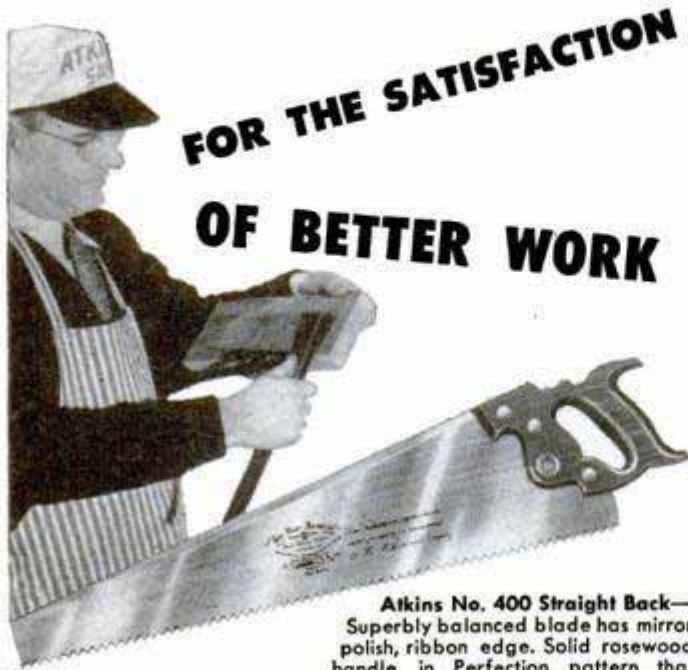

**FOR THE SATISFACTION  
OF BETTER WORK**

**Atkins No. 400 Straight Back**—Superbly balanced blade has mirror polish, ribbon edge. Solid rosewood handle in Perfection pattern that prevents wrist strain. Segment ground 5 gauges for easy clearance. Carefully hardened and tempered. Filed and set ready for use. Ship point pattern.

It's easier to achieve the fine workmanship that doubles the pleasure you get from your home workshop if you use Atkins Saws. Atkins have the balance and design that make them handle better—the extra keenness that means faster, cleaner cutting. Because they are made of "Silver Steel"—Atkins' special saw steel that takes a keener edge and holds it longer—it takes fewer sharpenings to keep an Atkins cutting smoothly for longer periods. There's an Atkins for every workshop need. To get the most in sawing satisfaction, get Atkins.

## 4 FAVORITES FROM THE COMPLETE ATKINS LINE

**No. 65 Straight Back**—Fine quality suited to general carpentry. Segment ground, Damascus polish blade, filed and set for use. Carved apple handle. Ship pattern.



**No. 2000 Straight Back**—Light but stiff tempered blade, segment ground, polished and etched. New "Perfect-Grip" apple handle is close to blade for easy handling. Ship pattern.



**No. 37 Compass Saw**—17 x 18 gauge hardened, tempered and polished. 8 points per in. Filed and set. Plastic handle.



**No. 39 Keyhole Saw**—Ground 18 x 19 gauge for easy clearance with minimum set. 10 points per inch. Uniform temper. Filed and set. Plastic handle.

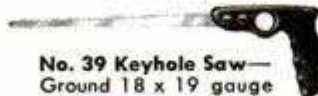

Buy at your Local Hardware Retailer  
**E. C. ATKINS AND COMPANY**  
INDIANAPOLIS 9, INDIANA

## 1949 Low-Cost Progressive Broadcast Set Unit No. 1

(Continued from page 227)

In this way, the builder does not miss any connection. Also check each lead with the schematic circuit diagram, Fig. 2. After the wiring has been completed, plug the power cord into an a.c. wall outlet and turn the set on; the tube should now light up. Next, connect the 45-volt B-battery and plug in the headphones. As the headphones are

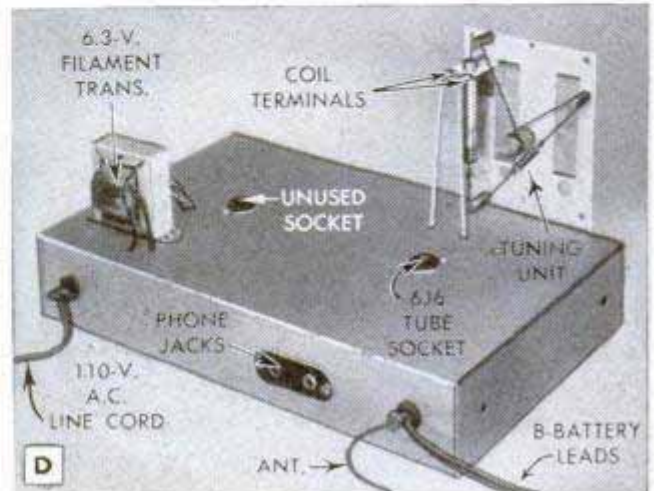

plugged in, you should hear a loud "click" in the phones. Now connect the antenna to the wire leading from condenser C1 at the point indicated in the pictorial wiring diagram, Fig. 3. The type of antenna will depend upon the location. In the city, where there are several powerful broadcasting stations, a short indoor antenna is recommended as it will give the best selectivity. For more distant stations, a longer outdoor antenna will give better pickup. The ideal antenna is the one which gives greatest signal strength without causing the stations to overlap on the dial.

If the set is operating correctly, you will hear a high-pitched whistle as the station is tuned in. "Backing off" on the volume control stops the whistle. Once you have tuned in a station which you can identify and for which you know the frequency, set the dial pointer to that frequency. Then adjust trimmer condenser C2, under base, with a small screwdriver so that the pointer will always indicate that station. Do not turn pointer past scale limits. For example: If the station has a frequency of 900 kilocycles, it should come in at approximately 900 on the dial. Detailed student material list R-373 for this one-tube progressive set unit No. 1 is available from Popular Mechanics Radio and Electronics department upon receipt of ordinary letter postage.

(See page 232 for Television Antenna Booster)

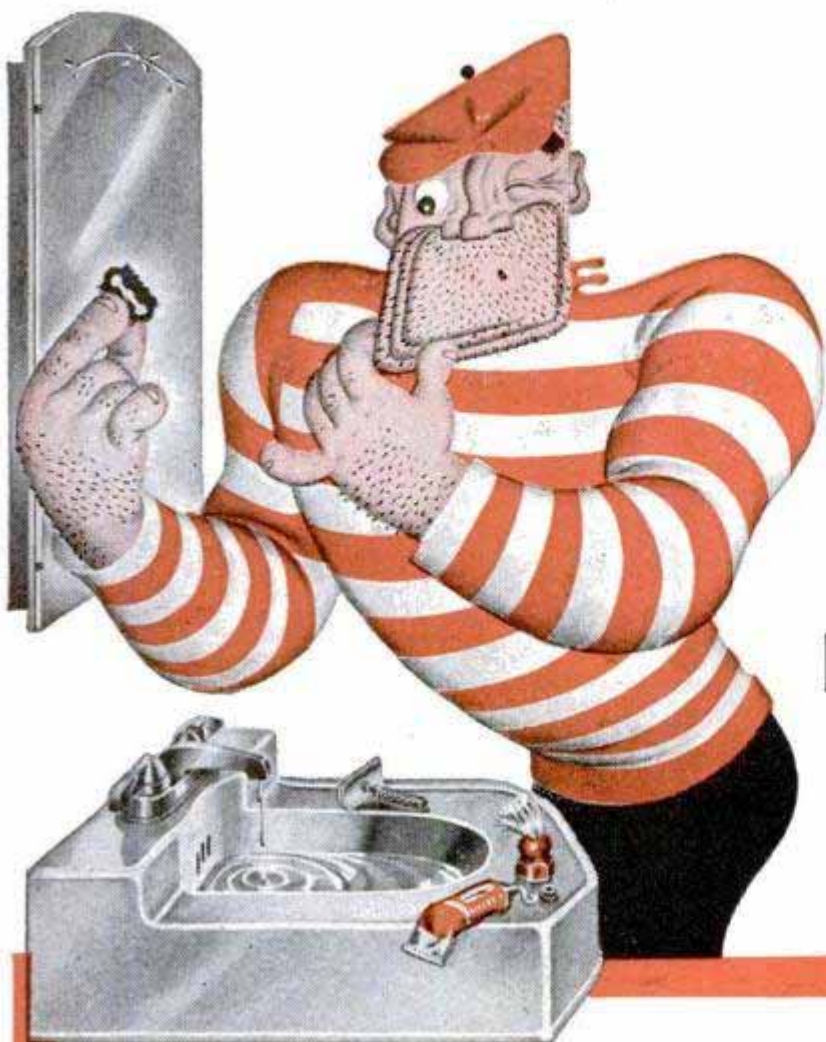

## Piston Rings need replacing, too!

**OIL-PUMPING** in your car warns that you need new piston rings. It's the *first* sign of worn-out rings and the danger signal of undue engine wear.

Fortunately, rings are *replacement* parts. And when you replace with Hastings Steel-Vent piston rings, you *stop* oil pumping, *check* cylinder wear and *restore* performance. It's the best money you can spend on your car. Hastings Manufacturing Company, Hastings, Michigan, Hastings Ltd., Toronto.

# HASTINGS

**STEEL-VENT PISTON RINGS**

**"TOUGH... BUT OH SO GENTLE"**

**TOUGH** on Oil-Pumping  
**GENTLE** on Cylinder Walls

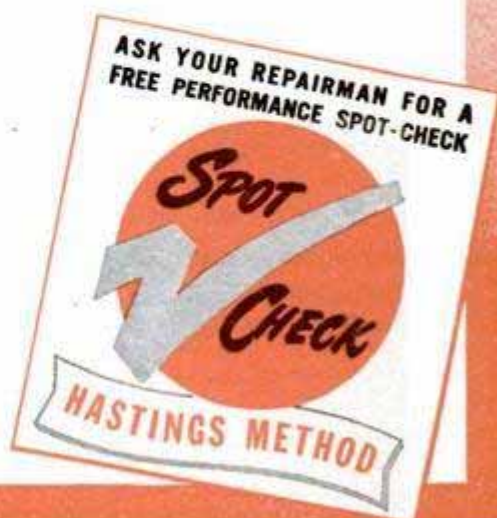

# Speed Sweep

**+ Arbitrin**



Speed Sweep, the brush with the steel back, is designed to sweep cleaner, faster, easier, and to outlast ordinary brushes 3 to 1. Arbitrin sweeping fluid, sprayed on the floor before sweeping, disinfects, deodorizes, and removes stains in the process of sweeping. These, plus many more advantages (16 in all) have proved to be the perfect answer to effective, low cost floor sanitation in over 60,000 factories, offices, schools, and stores. Mail coupon for complete facts. *Milwaukee Dustless Brush Co., 530 N. 22nd St., Milwaukee 3, Wis.*

**Milwaukee Dustless Brush Co.**  
530 North 22nd St • Milwaukee 3, Wis.

We are interested in complete information about Speed Sweep brushes and Arbitrin sweeping fluid.

Name .....

Address .....

City ..... Zone ..... State .....

## Television Antenna Booster

Increasing antenna gain to give a steadier and clearer picture, this antenna booster may be used with any television receiver. The unit is merely placed near the TV receiver and is connected in series with the antenna lead. It is claimed to make possible the use of indoor antennas in



many installations and to reduce inter-channel interference and interference from short-wave, FM and AM stations.

Among other features, it provides a means for using several television receivers on one antenna system. It has a self-contained power supply and is simple to connect and easy to use. The brown-finished cabinet is made of aluminum and the unit is available in two types; one operates on channels 2 to 6 inclusive and sells for \$24.95 and the other is a slightly larger unit which sells for \$29.95. This

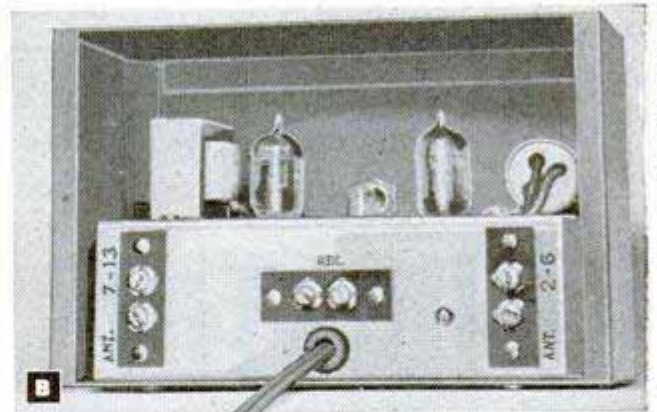

number TAB-98 unit employs two tubes, operates on all channels and has two antenna inputs. This feature eliminates the necessity of disconnecting the antenna when changing from low to high channels. Back and front views of this model are shown in photos A and B. Booster devices of this description are a valuable aid to good TV reception in fringe areas remote from broadcasting stations.

**Steady  
work . . .**

**big money  
with  
American**

**BE YOUR OWN BOSS!**

Now's the time to step out of the "hourly wage class"—and make **BIG PAY EVERY DAY** in a business all your own! Here's how—start a floor surfacing business with an American! Hundreds of men are doing this and making \$35 to \$50 a day—you, too, can make big money!

There's plenty of floor surfacing work all the year 'round in today's booming building industry. Pleasant, indoor work . . . sand both new and old floors. Easy to operate an American Sander—no big overhead—no large investment—no special schooling. Decide now that you want to get ahead and be your own boss!

Send for "money-making" booklet entitled "Opportunities in Floor Surfacing"—use coupon and enclose 25c in coin or stamps to cover handling.



**AMERICAN**  
FLOOR MACHINES

The American Floor Surfacing Machine Co.  
535 So. St. Clair St., Toledo 3, Ohio

Enclosed find 25c in stamps or coin for booklet "Opportunities in Floor Surfacing", telling me how I can start my own floor sanding business.



**Send Coupon Today!**

Name.....

Street.....

City.....State.....

# Everything in Radio at Lowest Prices!

## FREE

Send for  
**ALLIED'S**  
180 Page  
Catalog



**BUILDER'S KITS  
TELEVISION SETS  
HI-FIDELITY SOUND  
AMATEUR GEAR  
THOUSANDS OF PARTS  
TUBES, TOOLS, TESTERS  
BOOKS & DIAGRAMS**

*Everything for  
Servicemen, Engineers,  
Experimenters, Builders,  
Soundmen, Amateurs*



## Radio's Leading Buying Guide

Get ALLIED'S 1949 Catalog—biggest and most complete in Radio. Get *everything* you need from the world's largest stocks of top-quality equipment—at down-to-earth money-saving prices. Have the advantages of speedy reliable shipment, expert personal help, and complete satisfaction on every purchase. Get more for your money at ALLIED—Radio's Largest Supply House. Send today for your FREE ALLIED Catalog—the preferred Buying Guide to *everything* in radio and electronic equipment.



## ALLIED RADIO

ALLIED RADIO CORP.,  
833 W. Jackson Blvd., Dept. 5-A-9  
Chicago 7, Illinois

FREE

Send FREE 1949 ALLIED Catalog.

Name.....

Address.....

City.....Zone.....State.....

## Your Feet Go Fishing Too

(Continued from page 95)

a drawstring which closes the top tightly under the armpits. These are now being made of lightweight, thoroughly waterproof fabric and with comfortable boot feet, replacing the older type "stocking foot" wader with which a heavy brogue was worn.

The soles of these waders should be of heavy felt, sewn and cemented to the boot feet. This material provides a good grip on boulders and logs, but may slip on those covered with mud or moss. The experienced wader carries a pair of strap-on chains for use when needed. In very slippery going, such as over log jams and windfalls along heavily wooded streams, the steel-calked logger's boot is safest of all and, under these conditions, the angler who is determined to wade will wear them and choose wet feet rather than risk a serious fall.

### FOOTGEAR WHEN AFLOAT

For canoe work, where soft and flexible soles are required, nothing excels the low moccasin. The modern type with rubber sole is perhaps best, insuring dry feet when stepping ashore on sand bars. Almost as suitable are the all-purpose pacs or rubber moccasins, although these, with their thicker soles, are not so comfortable when one kneels at the paddle. Their advantage, of course, is that they are also suitable for walking and portaging.

For lake and ocean fishing boats, you have the choice of the basketball shoe, ideal on a wet deck because it will not slip, and the rubber half-boot with its nonskid, corrugated sole. It is especially good in rough weather when the waves sweep across the deck, perhaps up to your ankles.

### CAMP WEAR

The moccasin seems to come first when camp comfort is desired. Again, the modern type with rubber sole is best, for usually, somewhere close by, the ground will be damp. The rubber half-boot is also good and it is comfortable. It, like the leather half-boot, protects the ankles when the mosquitoes and other biting insects are abroad if the trousers are tucked inside.

There is always the correct footgear for your purpose and its choice is a matter for serious consideration. So choose it carefully. Buy those shoes or boots plenty large and try them out at home, with the proper socks, before you start out on that long-planned trip.

# Here At Last

## A Complete Electrode Service for Better, Easier, Faster Welding

**P & H Shop Packs —  
8 types of electrodes—fill every  
shop welding need**



These industrial and commercial arc-welding jobs are easier to do and cost less when you use P & H Welding Electrodes:

- All types of industrial welding
- Sub-contracting work for large manufacturers
- Air conditioning
- Home heating
- Truck body building
- Trailer building
- Automotive repairs { blocks fenders frames
- Fuel-oil tanks
- Contractors' welding
- Bridge work
- Construction equipment repairs { excavators tractors graders ditches, etc.
- Kitchen equipment
- Cabinet work
- Fabricated housing
- Fabricated garages
- Cast iron repairs
- Maintenance work for industrial plants
- Ventilating systems
- Bicycle repairs
- Stainless steel bar equipment
- Ornamental iron work
- Fabricating equipment of your own design

**Eight famous P & H industrial electrodes now conveniently packaged for automotive, general repair, job welding, and machine shops; foundries; schools; etc.**

You save welding time and do better work, when you always have the right electrode for the job.

P & H Shop Packs consist of eight different packages of electrodes. Detailed instructions are printed on each individual package so that you can use the right electrode for every job.

Guesswork is eliminated. Welds are stronger, better looking. Welding time is greatly reduced.

And you can weld anything made of steel, alloy or stainless steel, sheet metal, cast iron. You can also put hard, protective, long-life surfaces on new parts, or build up worn parts better than new. P & H Shop Pack electrodes let you do a wider variety of work — at lower cost.

#### Attractive Price

The cost of all 8 Shop Packs, individually packaged and labeled for your convenience, is only \$11.75.

#### Simplifies Inventory

The use of individual packages means that you only have to reorder the types you need — at little cost. Maintaining a complete range is easy. You can always handle any job that comes up.

#### Can be used on any type of welder

It pays to use P & H packaged electrodes. No matter what make of welder you have, no matter whether you use AC or DC current, order P & H Shop Packs today from your nearby P & H distributor.

#### Reduces Welding Costs

Purchase P & H Shop Pack electrodes (\$11.75). Check their speed, quality, easy manipulation, and wide variety of uses. This small investment paves the way to lower

welding costs. You will want to standardize on these efficient weld rods.

As a further aid to reducing costs, we suggest that you investigate the new P & H AC Arc Welder. This is the only welder with easy-to-use Dial-lectric control. It has no moving parts and needs no maintenance.

Connectible to 220 or 440 volt current, the P & H Dial-lectric machine requires only 2 1/4 feet of floor space. Built-in remote control; easy, quick-start arc; high-low welding range; elimination of arc blow; and the simple radio-like knob that provides complete welding range from 20 to 275 amps with a 3/4 turn — all these features make for better, faster welding.

Contact your nearby P & H distributor for complete details about America's most complete welding service, or mail the coupon below, clipped to your business letterhead.



Manufacturers of  
America's Most Complete Welding Service

**TEAR OUT COUPON, ATTACH TO YOUR BUSINESS LETTERHEAD, AND MAIL TODAY**

**HARNISCHFEGER CORPORATION**

4673 W. National Avenue, Milwaukee 14, Wisconsin

Yes, I'm interested in Shop Packs, P & H's complete electrode service, and the new P & H AC Arc Welder with revolutionary Dial-lectric control. I would like information on the items that I have checked below:

- P & H AC Welders
- Send address of distributor
- P & H Shop Pack Electrodes
- Send representative
- Send Free Book, "Simplified Welding."

Name.....

Position..... Company.....

Address.....  Home  Business

City..... (.....) State.....

# For Cabinet Finishing

use **PLASTIC WOOD**

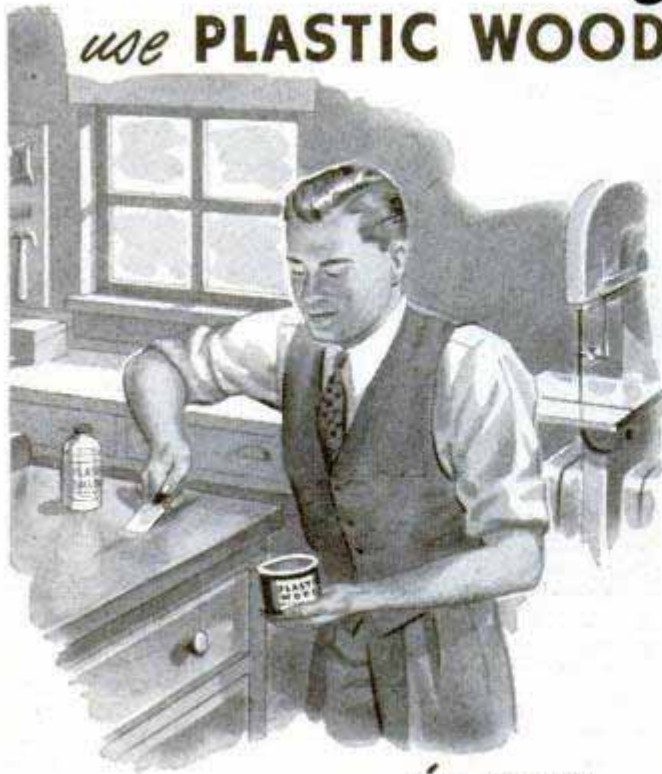

*in your*  
**HOME WORKSHOP!**

If you'd like a satiny smooth, professional finish on your next cabinet job—use Plastic Wood! It's an ideal filler for cracks or rough grains, dries tight and hard, sands to a swell finish and takes paint, lacquer or varnish perfectly. Here's an extra hint—knot holes or gouges just disappear when this handiest filler is used! *Handles like putty—hardens into wood!*

... dozens of other uses

**FOR FILLING . . .**

- Countersunk screws
- Chipped furniture
- Nail and screw holes

**FOR REPAIRING . . .**

- Loose casters
- Broken balusters
- Broken furniture

- You'll want Plastic Wood SOLVENT, too. Get both at one time. It is made especially to control the consistency of Plastic Wood . . . useful also in removing dried Plastic Wood from tools and fingers.

T. M. Reg. U. S. Pat. Off.

At all Hardware,  
Paint and 10c Stores

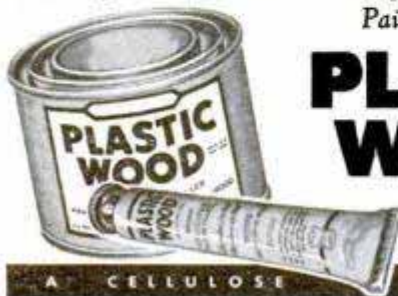

## PLASTIC WOOD

Tube or Can

A CELLULOSE FIBRE FILLER

*Clinic*



*for Homemakers*

As a service to our readers in solving the hundreds of problems pertaining to a home—inside or out—the editors of *Popular Mechanics* invite you to present your problems to The Clinic Editor for help and advice. Address your questions to The Clinic Editor, *Popular Mechanics Magazine*, 200 East Ontario Street, Chicago 11, Ill.

**Paint Peels From Porch Steps**

*Q—My front-porch steps are of the older type with wooden treads, risers and stringers. The space under the steps is enclosed. Paint simply will not stay on the treads or risers. It blisters and then peels back to the bare wood repeatedly. Why won't the paint stick to the wood?*

*P.T.—Oklahoma City, Okla.*

A—Perhaps the most common cause of paint blistering and then peeling as you describe is due to moisture penetrating the wood from the back, or unpainted side, and loosening the bond of the paint film. Due to the probable lack of ventilation under your porch steps, the unprotected side of the treads and risers absorbs an undue amount of moisture which works through the wood to the paint. One remedy which has been successfully used is to remove the treads and risers, dry them thoroughly and then prime and paint the back sides and edges. On your particular type of steps it also might help to cut an opening in both enclosed ends so that air can circulate more freely.



**Removal of Overroofing**

*Q—My house has been reroofed twice over an original roof of wooden shingles. The wooden shingles are badly rotted at the eaves. The slate surfacing is worn off in places. Should I reroof the top roof, or put on a new roof?*

*H.A.—Baltimore, Md.*

A—It would seem from your description that the whole roof is in rather bad condition. Just what you can best do depends to some extent on whether the roof boards are spaced or are laid edge to edge. If the boards are laid edge to edge, then probably the best recommendation is to remove everything down to the boards and lay a new roof. On the other hand, if the boards are spaced (a regular practice some years ago when wood-shingle roofs were more common), you have the choice of laying a new roof of wooden shingles or of filling the spaces between the original roof boards with narrow strips and then laying a roof of composition shingles.

**Possible Danger From Chimney Fire**

*Q—The chimney in my home is about 30 ft. high and is built in the center of the house. The chimney is quite old, unlined of course, and must be*

(Continued to page 238)





When your Ford needs a new part, make sure it's a Genuine Ford Part, an identical twin to the part built into your Ford at the factory. That saves you time and money and adds many extra years to your Ford's life.



*Made right*

Ford engineers know the vibration of an "off balance" clutch can cause serious engine trouble. That's why the clutch disc being made (at left) is carefully designed for perfect balance.

*Fit right*

When clutch discs are completed, some go to the production line, some to Genuine Ford Parts stocks as replacement parts. They're identical twins to the parts built into your Ford.

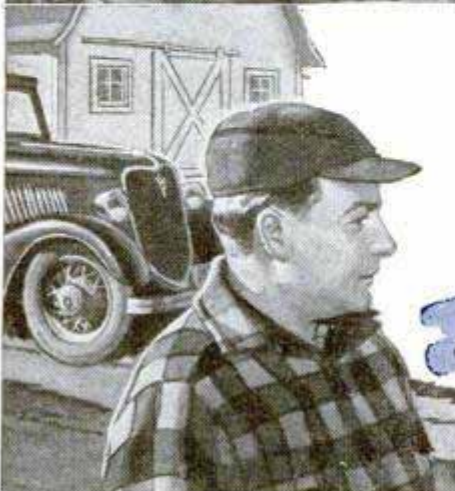

*Last longer!*

"I've driven Fords for 21 years now," says Mr. Ed Robinson of Wilton, Conn., "and there's no substitute for *real* Ford parts. I've found it pays to look for that Genuine Ford Parts sign." (At all Ford Dealers and selected independent garages.)

# BUILD IT, FIX IT

WITH

## AMBROID

"IT STAYS STUCK!"



For a quick job with permanent results use multi purpose, fast drying Ambroid liquid cement. For home workshop, household or factory. A quality leader for 39 years. Ready-to-use Ambroid is waterproof, transparent, quick drying, extra strong, flexible, heat and corrosion resistant. For assembling, repairing or mending jobs, keep Ambroid handy. At your dealer's or send 25c for a big 2 oz. tube postpaid. Money back guarantee.

Also 50¢ 4-oz. tube. Pts., qts., gals., for industrial use.



303 Franklin St., Boston 10, Mass.

## TAKES THE GUESSWORK OUT OF MEASURING!

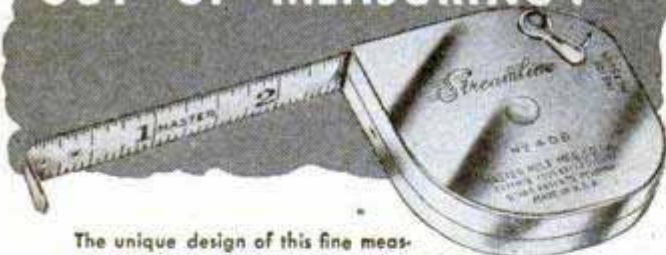

The unique design of this fine measuring instrument makes guesswork and inaccuracies in measuring a thing of the past. Note the lever brake for holding a reading on an inside measurement — which is read directly on the rule — no adding or subtracting. Extra long tip, graduations on both sides of the blade and smooth sliding action are only some of its outstanding features. Add to these its rugged construction, sleek polished chrome finish, and you have the finest in steel tapes. 6 and 8 foot lengths. Blades replaceable.

## MASTER

REG. U.S. PAT. OFF.

WOOD AND STEEL TAPE RULES

Master Rule Mfg. Co., Inc. PM-1  
201 Main Street, White Plains, N. Y.

I enclose \$2.25 for the 6 ft. Streamline  
\$2.50 for the 8 ft. Streamline  
Engrave my name (75c extra). Please print clearly.

NAME.....  
ADDRESS.....  
CITY..... STATE.....

rather badly clogged with soot. As the house is in the country I am afraid of a chimney fire during the winter months. I once had an experience with such a fire and want no more of it. How can I clean this tall chimney so as to minimize the danger or eliminate it entirely? G.H.—Minot, N.D.

A—If the house is in the open, exposed to high winds, the draft in the flue probably is very strong and if the chimney is straight it seems unlikely that it would be badly coated with soot. Recently, there was described in this column a method of cleaning a chimney by means of a length of chain lowered into the flue from the top. The method is quite effective in loosening excess soot which will drop to the bottom of the flue where it can be removed through the cleanout. In addition, a small shovelful of ordinary granulated rock salt thrown on a hot fire at intervals will help to remove ordinary accumulations of soot from the furnace and flue. Regular use of the salt in this manner will prevent the formation of heavy soot deposits. Prepared soot removers are even more effective. In tall chimneys having a strong draft it is important that the fire door, ash door and the lower damper and cleanout door on the stove or furnace seat tightly when closed. If the doors are loose or close improperly, the fire will be difficult to control with the regular check draft or turn damper, especially on days or nights when high winds are blowing.

### Leaf Disposal

Q—My home is in a wooded subdivision and disposal of the leaves is a problem. Due to the variety of trees on and near my property the work of raking and burning lasts well into the winter months. Isn't there some simpler and quicker way to get rid of leaves?

B.S.—Louisville, Ky.



A—The ashes from burned leaves of the common kinds of deciduous trees have some value as a fertilizer for certain plants and shrubs. Instead of burning the leaves each season, many owners of large wooded grounds either compost the leaves or dispose of them with leaf-shredding attachments available for some types of the larger power lawn mowers. These machines pick up the leaves, shred or pulverize them and drop the particles back on the ground in a thin, uniform covering. Those homeowners who prefer to compost leaves use the residues thus produced as a mulch for evergreens and certain shrubs, or as a top dressing for flower beds used for growing flowering plants which thrive in acid soils.

### Fence to Drift Snow Over Garden

Q—I'm told that a low fence erected on the side of the garden plot from which winter winds blow will cause snow to drift over the plot, which will be beneficial. Is this true? And can I build a fence near a strawberry bed?

M.B.—Madison, Wis.



A—It's true that a board or picket fence placed as you suggest will cause snow to drift over the garden plot if the plot is in the open where the prevailing winds sweep across it. The only direct benefit from the drifted snow is derived from the moisture which seeps slowly into the soil when the drift melts away in the spring. Also, under certain conditions, this additional moisture may tend to stimulate the activity of nitrifying bacteria and thus increase the available nitrates in the topsoil. The drift also will prevent the blowing of dry soil during the winter months. Drifting snow over a strawberry bed by means of a fence could, perhaps, be recommended for the same reasons, but it is advisable to mulch the bed after the ground freezes with coarse straw or other material. The mulch should be removed from the plants in the spring.

LOOK, DAD. IT ONLY COSTS JIMMY \$10 A YEAR TO RUN HIS WHIZZER!



IS THAT RIGHT, JIMMY? ONLY 25¢ A WEEK!

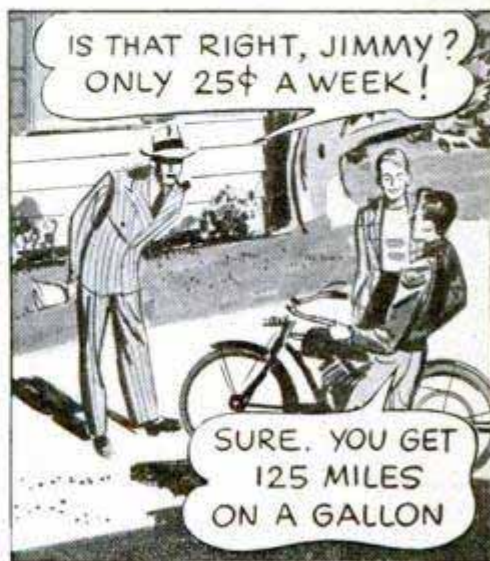

SURE. YOU GET 125 MILES ON A GALLON

SAY, THAT'S A GOOD IDEA FOR RUNNING ERRANDS AND TRAVELING TO SCHOOL



A BIKE'S MORE FUN, TOO, WITH WHIZZER DOING THE WORK. YOU REALLY GO PLACES

YOU DON'T HAVE TO BUY ME A NEW BIKE EITHER, DAD



THAT'S RIGHT, MR HOLMES. A WHIZZER CAN BE PUT RIGHT ON BILL'S BALLOON TIRE BIKE

FOR FUN!

FOR THRIFT!

FOR WORK!

IT'S WISE TO GO WHIZZER!

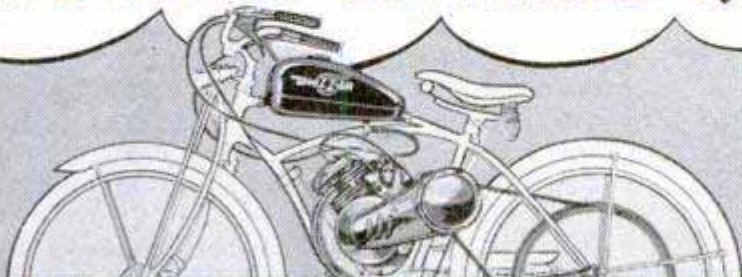

COMPLETE WITH ALL NECESSARY ATTACHMENTS

**\$109<sup>97</sup>**

Federal Tax Included. F. O. B. Pontiac, Mich.

Twist-Grip Controls

Chrome Trim

Steel Cable Core Notched V-belt Drive

2½ h.p. up to 35 m.p.h.

3800 Whizzer Dealers coast to coast

Whizzer Motor Company, Pontiac, Michigan, for free literature, or send 25¢ for a 20-page illustrated booklet.

# SAVE \$\$\$



## COMPACT PORTABLE ARMY FIELD TELEPHONES

Buy 2 phones  
and SAVE **1.50**

### SPECIAL DISCOUNT OFFERED LIMITED TIME ONLY

**Act Now!**

Amazingly simple to install and operate. Just hook up terminals of two or more phones to any two-strand wire and you are ready to talk! Powered by standard flashlight batteries. **HUNDREDS OF USES** for quick, low-cost, dependable 2-way communication around **HOME, SHOP, FARM, INDUSTRY**. Each phone complete with self-contained hand-operated ringer. Every phone checked for perfect operation and fully guaranteed.

<b>NOW</b>	Buy 1 Phone Regular Price	Buy 2 Phones Save \$1.50
USED—good, serviceable condition .....	\$ 7.45	Special <b>\$13.40</b>
USED—excellent condition .....	8.95	Special <b>16.40</b>
RECONDITIONED—(By U. S. Signal Corps).....	10.75	Special <b>20.00</b>
LIKE NEW, Slightly used .....	12.95	Special <b>24.40</b>

### ARMY FIELD TELEPHONE WIRE

Weatherproof, Durable. 2-conductor, twisted, 3 copper and 4 steel strands, tinned, insulated. **On Original Steel Reels.**



**W-110B.** Unused, new, but stored in open. Half-mile reels (2500 to 2750 feet). Wt. 85 lbs. Each. .... **\$14.25**  
**500-foot coil (14 lbs.)**..... **\$3.50**  
**1000-foot coil (28 lbs.)**..... **\$6.50**

**W-130 LIGHTWEIGHT ASSAULT WIRE.** Weights only 10 lbs. New, half-mile reels (2600 feet) each..... **\$15.00**

**WRITE for prices on Other Specials. Switchboards, Head and Chest Sets, etc.**

All prices F.O.B. Sacramento. No C.O.D. California residents add 2 1/2% for sales tax. Small orders sent postage collect plus small handling charge.

SEND CHECK OR MONEY ORDER **LORIS SALES**

P. O. Box 1896-B-1 Sacramento, California

## AUTHENTIC MODEL KITS



**Stage Coach Kit \$150**  
Plus 15c postage



**Covered Wagon Kit \$150**  
Plus 15c postage



**Army Truck Kit \$100**  
Plus 15c postage

**ALL 3 for Only \$375**  
Plus 25c postage

Pleasant leisure hours spent in building these realistic miniature replicas pay off in satisfaction and the pride of displaying your craftsmanship. Wells Fargo Stage Coach revives memories of the Old West; Conestoga Covered Wagon just like the Pioneers'; 2 1/2 ton Army Cargo Truck is backbone of U. S. Army combat supply service. Covered Wagon and Stage Coach 1/2" scale; Army Truck 1/2" scale. You'll enjoy working with precision parts, die-cut from white pine and plywood, for simple, accurate assembly: free-rolling wheels, real metal fittings, formed ribs, leather springs, etc., full size plans.

**HOLLYWOOD MODELS P. O. BOX 389, DEPT. 2 BURBANK, CALIFORNIA**

## Steel With a Memory

(Continued from page 168)

Sound-on-film is one of the latest developments and destined to be one of the most popular. Camras has coated the films with a strip of magnetic material. In most cases, this coating is applied between the sprocket holes and the edge of the film. All the amateur must do is install a recording head on his projector, attach it to an amplifier and speaker (even a radio) and he has sound films. He can dub in the sound immediately after taking the film, and in the future he will be able to record on the film as it is exposed. The fidelity is excellent. Processing has no effect on the track.

Warner Brothers has developed a similar sound system for Hollywood films which promises to be a money saver. The ordinary method of recording is to develop the film, then dub in the sound track. This often requires a good many recording "takes" before synchronization is perfect, and each take must be processed, which requires several hours. Furthermore, the films that are not synchronized are worthless. With the new system, the recording can be played immediately after it is made. If it is imperfect, it can be "wiped off" and others made immediately until synchronization is flawless.

The latest magic from Camras' laboratory is the application of magnetic recording to stereophonic sound, which definitely creates an illusion of depth and direction that is impossible with other systems. Stereophonic sound is based on the fact that a human being obtains a sense of depth and direction because he hears through two ears. Thus, a blindfolded man can, within limits, guess the direction and distance from which a sound originates. When a person in a concert hall listens to an orchestra, each of his ears picks up the sound of each instrument, even though the sounds are blended. Yet when a person listens to a radio, the sound comes from only one source—the speaker of the instrument.

In the new system, two or more microphones are placed in different positions. A battery of three microphones might be placed in a line in front of an orchestra. Each microphone is connected to a recording head so that three tracks are made simultaneously on a single roll of magnetic tape. For the playback, three speakers replace the three mikes and each speaker is connected to the pickup head corresponding to its track. When the recording is played, the music from three sources seems to flood the listener with sound so deep and rich that, once he's heard it, he'll forever be dissatisfied with other types of recording.



# OWN A FAMOUS MOTO-TOOL

The "Pocket-Size Machine Shop"

**HIGH-SPEED STEEL CUTTERS**  
— AT NO EXTRA COST

No modern home workshop is completely equipped without MOTO-TOOL. The correctly balanced motor-in-hand tool. It grinds, drills, routs, carves, polishes without vibration. Higher speed does work better, faster, on practically any material. MOTO-TOOL Kit No. 2 includes high-speed-steel cutters for longer life, better work. MOTO-TOOL is backed by over 12 years of industrial use . . . packs years of pleasure. Due to wide popularity and increased production, Dremel's pre-war prices still prevail!



MOTO-TOOL No. 2  
With Emery Point  
**\$16.50**



MOTO-TOOL KIT No. 2  
With 23 Accessories  
(High-Speed Steel  
Cutters, Grinding  
Wheels, Polishing  
Accessories)  
**\$23.50**

DRILL PRESS (Not Shown)  
This 12" high precision drill press is ideal for model making, wood carving, routing, etc. Utilizes No. 2 Moto-Tool.  
**\$9.95**  
(Less Moto-Tool)

## LOOK FOR THESE MOTO-TOOL FEATURES

Approximately 27,000 R.P.M. plus dynamically balanced armature provides vibrationless finger-tip control. Moto-Tool has oilless, sealed bearings • Patented automatic chuck lock pin • Over-size armature shaft—hardened, ground, polished • 110 Volt, AC-DC motor • Sliding snap-type switch • Cord protector • Shockproof bakelite housing • Dust-filtered air-cooling system • Weighs only 13 oz.

**MONEY-BACK GUARANTEE:** Buy Dremel Moto-Tools from you, order direct on 5-day trial, money-back guarantee. Shipped postpaid for payment in full (Send check or money order); or, send only \$2 now and pay postman balance plus postage upon delivery. Catalog of Dremel Tools and Accessories FREE.

DREMEL MFG. CO. • Dept. T119-A • Racine, Wis.

## BRASS NAME PLATES OR KEY TAGS

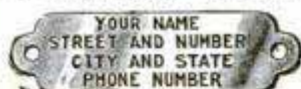

(Individual Stamping)  
**40c each**

Half actual size

Quantity Price — Same Stamping

8 for \$2. — 15 for \$3.

25 for \$4. — 50 for \$6.

LARGER QUANTITIES ON REQUEST

For quick identification, always use TAGCO enduring tags in brass or nickel silver. Our latest circular illustrates a large variety of tags of all sizes, also blanks. Prices reasonable. Send for it and booklet "A Name for your dog." Both Free.

DEALERS WANTED STAMPING EQUIPMENT  
TAGCO, BOX 38X, WINGDALE, N. Y.

Plastic Coasters  
and Tiles

## EMBED REAL FLOWERS in NEW Magic PLASTIC



Now create many lovely and unusual things like the distinctive pansy coaster shown—made by embedding real pansies in Castolite—the "magic" liquid casting plastic. Comes crystal clear, or may be dyed to produce gorgeous color effects. Make really different jewelry, book ends, picture frames, candle sticks, figurines. Embed butterflies, coins, medals, photos, for novel plaques, paper weights, tiles, other art objects. Use only home utensils. Follow simple step by step method. New pleasure, fine profits are possible. Send 25c for exciting new Home Project Manual showing how to get started. Write today! The Castolite Company, Dept. A-1. Box 391, Woodstock, Ill.

MANUAL  
**25c**

Send 25c for exciting new Home Project Manual showing how to get started. Write today! The Castolite Company, Dept. A-1. Box 391, Woodstock, Ill.



## AMAZING Patented MOTO-SANDER AND POLISHER

Saves Time — Saves "Elbow Grease"

Here's a machine that takes the hard work out of two tough jobs . . . sanding and polishing. "Moto-Sander" is so easy to handle that a child can use it . . . so fool proof that, with it, even a novice can do a craftsmanlike job. Moto-Sander's fast, straight-line action (non-rotary) eliminates any possibility of wood burns or scratches. Does a magically smooth job of sanding . . . gets into corners and places others can't reach. All you do is guide it! There are dozens of time and money-saving uses in every home and shop for this inexpensive machine. Use Moto-Sander to get smooth sanded finish on furniture, painted walls, boats, bird houses, scale models, etc. Use it also for speedy, effortless polishing of waxed furniture, automobiles and other surfaces—simply by removing sandpaper and clamping on polishing pad. Moto-Sander is the lightest, most practical electric sander on the market—the only one of its kind. Furnished with 6 assorted sheets Garnet paper for sanding . . . plus felt pad and sheepskin for wax polishing. Operates on alternating current. Thousands of satisfied users.

### USE MOTO-SANDER AROUND THE HOUSE

- Sand Furniture and Bookcases
- Sand Stairways, Doors and Wood-work
- Sand Walls before painting
- Polish the Family Car
- Polish Pianos and Cedar Chests
- Polish Waxed Furniture

**MONEY-BACK GUARANTEE:** Buy Moto-Sander from your dealer. If he cannot supply you send only \$14.85 (check or money order) and we will ship postpaid; or, send only \$2 now, and pay postman balance plus postage upon delivery. Your MONEY-BACK if not delighted after 5 days' trial.

DREMEL MANUFACTURING CO.  
DEPT. SP119-A • RACINE, WIS.



EASY FOR  
AWKWARD PLACES



SANDS FLAT  
SURFACES EVENLY



GETS INTO  
TIGHT CORNERS



ROUNDS CORNERS  
LIKE MAGIC



## New IMPROVED Electric MOTO-SAW

ONLY \$5.85  
(with 3 Saw  
Blades) Postpaid

SAFE AS A HAND SAW  
JUST GUIDE IT!

The versatile Moto-Saw is as safe as a hand saw. A touch of the trigger switch sets it going . . . releasing stops it instantly.



SAWS TO CENTER  
OF 19" WIDTHS

No Limit to Length  
of Stock it Will Cut

THOUSANDS OF  
SATISFIED USERS

### AVERAGE CUTTING SPEED ONE FOOT PER MINUTE

Moto-Saw works more like magic than any tool you ever saw! Takes no effort to run . . . no perceptible pressure to feed . . . only a trifle heavier than a hand scroll saw, and better balanced in your hand. Runs 7,200 strokes a minute . . . leaves no rough edges . . . easily cuts intricate scroll designs in medium hard wood up to 3/4" thick. Blade holder faces blade 4 ways . . . permits sawing sideways as well as forward and backward. Sturdily constructed . . . only two moving parts . . . never needs oiling . . . requires no bench room or floor space. Operated on alternating current. Thousands of satisfied users.

**MONEY-BACK GUARANTEE:** Buy Moto-Saw from your dealer. If he cannot supply you, send only \$5.85 for Moto-Saw and 3 blades, postpaid; or, send only \$2.00 now, and pay postman balance plus postage upon delivery. MONEY-BACK if not delighted after 5 days' trial.

DREMEL MFG. CO. • Dept. S119-A • Racine, Wis.



## "That's why This 1/4" DRILL Rates Aces-High with Me!"

"Take it from a guy who knows . . . this husky Home-Utility 1/4" Electric Drill belongs in your shop! I use mine all the time — drilling holes and driving sanding, light grinding and buffing attachments — for everything from building toys for the kids to repairing appliances and installing fixtures for the 'Mrs.' It's a honey of a Drill, with a powerful motor, husky housings, full-size gears and bearings. It's built by BLACK & DECKER, the folks who've been making quality electric tools for over 38 years. And at \$18.95, you're getting plenty of Drill for your money!"

Order your 1/4" Drill and other Home-Utility Tools from your hardware, electrical or implement dealer.

**ELECTRIC  
HOME-UTILITY  
TOOLS**

Products of THE BLACK & DECKER MFG. CO.  
Dept. H1M, Towson 4, Maryland

### HOLD-E-ZEE

AUTOMATIC GRIP  
SCREWDRIVERS

PATENTED

**MORE WORK  
IN LESS  
TIME!**



UPSON  
BROS., INC.,  
86 Exchange St.,  
Rochester 4, N. Y.

Hold-E-Zees do the job better, faster. They excel wherever screwdrivers are used. Gripper instantly released by spring action, sliding up out of way when not in use. All materials highest quality.

AT LEADING DEALERS EVERYWHERE

## Big Builders

(Continued from page 146)

into the mixers is first refrigerated and then is further cooled on hot days by the addition of 60 tons of crushed ice a day to bring it down to the low temperature that makes the strongest concrete.

Morrison-Knudsen, in fact, has participated in building each of the four big dams on the lower Colorado. Each job was vastly different. Hoover Dam is 726 feet tall and at the other extreme is Imperial Dam near Yuma, only 45 feet tall. Imperial is 3475 feet long and is called a "floating" dam because its weight rests partly on buried piles.

Other noteworthy dam projects include Anderson Ranch Dam in Idaho, the tallest earthen structure in the world, and Ross Dam in Washington, a 540-foot-tall concrete dam that has a unique "waffled" face which will serve as bonding if the dam is ever enlarged. Two M-K dams are under construction on the Feather River in California, and two others are being built in Wyoming, one on the Big Horn River and one on the North Platte.

Morrison-Knudsen's greatest construction efforts were performed during the war and included the building of steel plants and training camps. For the Navy it built a number of complete air stations in scattered parts of the Pacific. One unusual wartime project was the secret Red Hill operation near Pearl Harbor. This consisted of burrowing into a mountain to build 20 huge underground fuel-oil tanks, concrete lined, each so large that it could contain a 30-story building. This long-secret project was described in the November (1948) *Popular Mechanics*.

The company was one of the first to utilize mass "airlift" transportation when it acquired 17 aircraft and chartered other planes to haul thousands of tons of materials, including 30,000 barrels of asphalt, to build and pave isolated Alaskan airports during the war. More recently M-K completed its portion of the new 25-million-dollar Fairfield-Suisun Air Force Base in California, principal military trans-Pacific air terminal. Some of the runways at this field are almost two miles long and parts of them consist of 18-inch-thick solid concrete pavement laid on top of 58 inches of crushed rock.

Last year the M-K engineers finished five miles of million-dollar-a-mile freeway across marshy ground south of San Francisco. To avoid damage to the six lanes of pavement by the fluctuating tidal

(Continued to page 244)

# Crosley

**ANNOUNCES  
BIG NEW MODELS!**  
Hundreds of Improvements



**NEW Crosley Deluxe Sedan** is bigger! It's the latest word in American design—new speed line styling, sweep fenders. New, rich interior, choice fabrics. Seats 4 with ample luggage room.



**NEW Crosley Station Wagon** with larger, longer body lines making its country club styling smarter and finer. New luxury interior appointments. Seats 4, or 2 with 1/4 ton load. All steel. No increase in price.

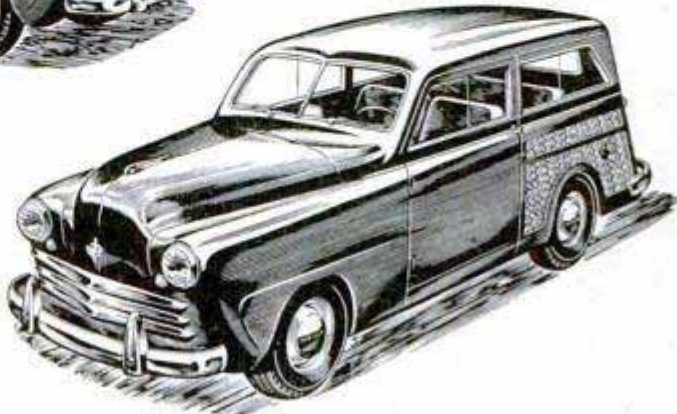

Crosley is truly a fine car. Again Crosley leads in the high compression field! Now 7.8 to 1 compression ratio! Even more power, better hill climbing and greater economy—up to 50 miles on a gallon of regular gasoline. And you can own a Crosley for the price of an 8-year-old high-upkeep used car. So drive a Crosley—the new style leader that saves you money by the mile!

**CROSLEY**  
a FINE car

See the startling new Crosley cars at your local dealer's—Sedan, Station Wagon, Convertible, Panel Delivery and Pickup. Or write direct for complete new catalog to Crosley Motors, Inc., 2530-HA Spring Grove Ave., Cincinnati 14, Ohio.

## CURIOUS?

ABOUT A  
**SHIP-IN-A-BOTTLE**

Here is the secret plus all of the material less bottle. See your dealer first. Catalog 10c.

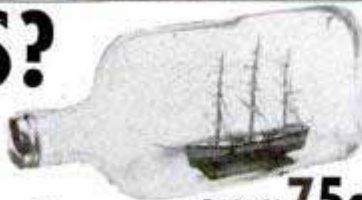

Postpaid **75c**  
in U.S.A.

BRAUN-CRAFT, 1232 Etowah, Dept. PM-1A, Royal Oak, Mich.

## 10 SHELF PLANS

NEW FULL SIZE

New, full size, easily built, beautiful wall shelf plans ready to trace on lumber, cut out and assemble. Corner and wall racks with 1 to 3 shelves. Stores charge about \$75.00 for these shelves. Make money selling them. Finest selection available. PLUS BONUS of 48 other novel cut-outs, Dutch Boys, Girls, Toys, etc., etc. PLUS FREE new 1949 Handicraft Catalog. Send only \$1 to

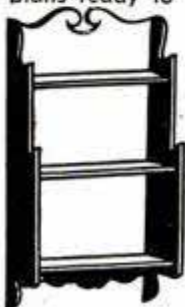

**\$1**



**JACKSON, Dept. 64**  
5440 N. Shoreland Ave.  
Milwaukee 11, Wis.

Can You Equal This Home for **2475**

Shipped  
Direct  
from Our  
Mill



Save 30% to 40%  
on Your New Home..

**Act Now!**

Don't pay several hundred dollars more than necessary when you build a home! Buy it direct from our mill at our low factory price. We ship you the materials—lumber cut-to-fit, ready to erect. Paint, glass, hardware, nails, etc., all included in the price—no extra charges. Plans furnished—also complete building instructions. No wonder our customers write us that we saved them 30% to 40%. Prices subject to change without notice.

**BIG BOOK**  
of  
House Plans  
in Colors  
**25¢**

**Handsome Big CATALOGUE**

Pictures wonderful homes in colors at money-saving prices. Designs to suit everyone. Send 25c for catalogue today.

**LEWIS MANUFACTURING CO.**  
1291 Lafayette Ave., Bay City, Michigan

# Supreme HOMESHOP BAND and CIRCULAR SAWS

**HAIRLINE CONTROL • LESS RESHARPENING  
FASTER, SMOOTHER CUTTING • LONGER LIFE**  
NOW—for your home shop! Famous SUPREME Band and Circular Saws nationally used by industry—now available in the SUPREME HOMESHOP Line to fit any size or make of home power tool! Special Nickel Alloy Steel. Free from kinks and other imperfections. SUPREME HOMESHOP SAWS are precision-engineered for highest cutting efficiency under heaviest punishment. End saw troubles, cut costs, speed your best work.

**SUPREME BAND SAWS**  
6' 6" — \$1.00    7' 9-1/2" — \$1.10    9' 6-3/4" — \$1.30  
in any of the following widths: 1/8, 3/16, 1/4, 3/8".  
8" Flat-Ground Combination Circular Saw — \$3.65

**IMMEDIATE DELIVERY — ALL STANDARD SIZES**  
ACT TODAY! ORDER DIRECT, stating Size, Make and Model. Or at your dealer. Write for Free Illustrated Circular.

**THE SAW & KNIFE SPECIALTY CO.**  
6526 CARNEGIE AVENUE • CLEVELAND 3, OHIO

## 5 GREAT MYERS WATER SYSTEMS

2 Ejectos  
3 Plunger Types



### TO FIT EVERY NEED

The construction of water systems to meet varied conditions is an interesting study. Booklet shows cross-section of famous Myers Ejecto and method of operation with only one moving part. Cross-sections of Plunger Types are also illustrated. These, with Selection Charts, help you understand why Myers builds five different types of water systems. They're all top quality and guaranteed in writing.



Free booklet — Mail coupon

**THE F. E. MYERS & BRO. CO.**  
Dept. N-100, Ashland, Ohio

Send your free water system book.

NAME \_\_\_\_\_  
TOWN \_\_\_\_\_  
COUNTY \_\_\_\_\_ STATE \_\_\_\_\_

ground waters it was necessary to provide some 7000 sand piles under the roadbed. These piles consist of 18-inch holes drilled to depths as great as 60 feet and filled with sand. Across the tops of the piles and under the roadbed itself a thick layer of sand was tamped into place. The combination of the piles and the drainage layer allows the water to move up and down without affecting the solid pavement above.

Some of the smaller but interesting jobs that M-K men have performed recently include the digging and concreting of a 1500-foot shaft in Wyoming to tap a rich deposit of sodium carbonate, the rebuilding of the 12-mile trestle that Southern Pacific uses as its main line across part of the Great Salt Lake, and constructing a 3000-foot ski lift at Sun Valley.

The company's heavy earth-moving equipment, normally used for making cuts and fills in highway construction, is being put to a new use between highway jobs these days. Once a vein of coal had to be mined by means of tunnels and shafts; now, with heavy equipment available, it is often most practical to remove the overburden and expose the coal so that it can be excavated with power machinery. Some of the M-K crews are moving millions of yards of dirt and rocks that blanket coal deposits in Arkansas and some other coal regions.

This is only a partial record of the accomplishments of one construction company. Morrison-Knudsen, its affiliates and hundreds of its competitors are changing the face of the earth, at home and abroad.

## The Stratocruiser Goes to Work

(Continued from page 135)

well to facilitate ground servicing, 36-inch fluorescent tubes for indirect lighting in the lounge, and "red and white" lighting in the control compartment. White lighting illuminates the instruments and controls at sunset to provide strong visibility and the white light gradually changes to red as the sky grows dark. The red illumination prevents night blindness and at the same time allows good vision. With the approach of dawn the red lighting gives way again to white.

The unique hydraulic rudder-control system is designed to provide pilot "feel" without undue effort. Two engine-driven pumps plus an accumulator in the tail provide enough power to move the huge rudder 20 degrees a second with no noticeable lag. If the hydraulic system should fail, a spring-tab control system automatically

(Continued to page 246)



**WORLD'S  
LOWEST  
PRICED  
ADDING  
MACHINE**



Fits vest pocket or purse. Guaranteed Accurate. Operated as easily, and as reliable, as machines costing many times as much. NOT A TOY OR GADGET. Precision made—very durable. Guaranteed for life against defects in construction. Beautiful looking, modernized design. Finished in silver with black numbers and red slides. You positively can't buy a Calculator of equal quality for as little money. ACCEPTED AS THE FINEST LOW PRICED CALCULATOR FOR OVER 35 YEARS! Now completely redesigned and improved. **BETTER THAN EVER BEFORE!** Operates with a flick of your finger. Adds, subtracts, multiplies, divides—counts up to one billion. Pays for itself over and over in mistakes avoided, and time saved.

**MAKES IDEAL GIFT**  
Baby Calculator makes an ideal gift for every Gift occasion. Birthday—Graduation—Christmas—Anniversaries. For men, women, children—teachers, business people, home or shop use. **COMES PACKED READY FOR GIFT WRAPPING.**

**TEN DAY TRIAL**

**Money Back Guarantee**  
Because we know that our machine is the very best calculator to be obtained at this low price, we make this 10 Day Trial offer on a positive money back guarantee!! Don't buy ANY Calculator without this guarantee! Send only name and address, pay postman \$2.95 plus postage (if cash is sent, we pay postage—you save up to 40c.) (Send full cash if outside U. S.) Money back within 10 days if not delighted.

**AGENTS WANTED**

**CALCULATOR MACHINE CO. (Mfrs.)**  
DEPT. 210, P. O. Box 248 GLENVIEW, ILL.

*Free Trial*

ONLY  
**\$2.95**  
TOTAL  
COST  
SEND NO MONEY

Each Baby Calculator enclosed in beautiful rich-looking Leatherette Case — at no extra cost.

**USE COUPON**

CALCULATOR MACHINE CO., (Mfrs.)  
P. O. Box 248, Dept. 210, Glenview, Ill.  
Your Calculator is just what I've been looking for. Send one at once (C.O.D.) or (I am enclosing \$2.95).  
Name \_\_\_\_\_  
Address \_\_\_\_\_  
City \_\_\_\_\_ State \_\_\_\_\_

*The* **"GRAB ALL" TOOL** The Most Useful Tool in the World!



Precision Work On Objects Too Small to Hold in Hands



Recovering That Nut That Always Falls Into the Pan

Truly the Tool of a 1000 uses. Mechanics, Radio and Appliance Repair Men, Hobbyists, Electricians, Machinists, Handy Men — Yes, even housewives say: "Wouldn't be without it." Precision-made of steel. Picks up any-shaped object from hard-to-reach places. Flexible — to work at any angle, around corners, any direction, even 5 turns. Grips and holds securely by tempered-spring action. Almost a million in use.

Mfg'd Since 1908



The "GRAB ALL" is guaranteed against ANY Mechanical Defect—with reasonable care it will last a lifetime.

**ONLY 75c**

If your dealer can't supply you, SEND 75c DIRECT TO FACTORY—WE WILL SEND POSTPAID. C.O.D. ACCEPTED.

**DEALERS**  
Here is a BIG PROFIT DEAL—write for complete information.

**IN THE HOME**



Fishing Object From Sink

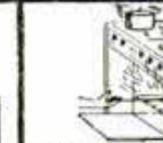

Getting Things Within Reach In the Oven

**GRAB ALL TOOL CO., 11703 South Main St., Los Angeles 3, Calif.**



**Powell SETS THE PACE**

**DEALER INQUIRIES INVITED**

- 7 H.P. Motorcycle-type Engine
- Solid steel frame
- Faster pick-up than a car
- Highway cruising speed of 45 miles per hour
- Automatic clutch
- Chrome-plated fenders,
- Smooth, simplified control
- handlebars, and sport muffler —looks like a custom job
- Costs no more than ordinary scooters

**Powell MANUFACTURING COMPANY**

**DEPT. PM-8 COMPTON, CALIF.**

Write for FREE FOLDER and address of nearest dealer

**M-SCOPE TREASURE -MINERAL LOCATORS**

WRITE FOR FREE, ILLUSTRATED 16-PAGE BOOKLET

M-SCOPE TREASURE-MINERAL LOCATORS. Low priced, unsurpassed efficiency, lightweight models. Factory guaranteed. Immediate shipment. Credit plan available. Write for free 16-page booklet.

GEIGER COUNTERS for finding Uranium ores. Several models, Simple operation. Low priced. Immediate shipment. Interesting free literature.



**URANIUM**

**FISHER RESEARCH LAB., INC., PALO ALTO, CALIF.**

**GOLD**

# Operate YOUR OWN Business

Easy To Learn

Quickly Established



increase your  
income . . . be  
your own boss

We'll Help  
Finance You

## Clean and Mothproof Rugs and Upholstery

Increase your income . . . with a business of **YOUR OWN**. We'll finance your dealership with this **NATIONAL 18 YEAR OLD** organization. You'll enjoy Two-way profit on both material and labor . . . gross profits up to \$15 and \$20 a day on EACH of your service men. If you are honest, dependable and willing to work, we can help you establish a business of your own. You use *proven* successful methods developed by hundreds of other long established *Duraclean* Dealers. Your services are advertised nationally and recommended by foremost furniture and department stores from coast-to-coast.

*Duraclean* safely cleans by absorption! Aerated foam absorbs the dirt holding it in suspension above the surface until removed. No harsh machine scrubbing. No soaking or shrinkage. Dirt, grease and many unsightly spots vanish as if by magic. Wool fibers come to life . . . matted pile rises . . . colors revive. Upholstery and floor coverings look newer, last longer.

*Duraproof* is another year 'round service. Not only kills moths and carpet beetles, but makes materials resistant to both. Protects against mildew too. *Duraproof*, to our knowledge, is the only moth-proof service backed by a National Money Back, 4 YEAR WARRANTY. Upholstery and floor coverings are serviced "in the home," office or public buildings. No experience needed. Almost every building in your territory houses a potential customer needing one or both these modern, **NATIONALLY ADVERTISED** services. Even auto dealers buy your service to revive upholstery in used cars. Portable equipment . . . no shop needed. However, some dealers establish a shop or an office after their business has grown. Start full or part time. It's easy to learn . . . quickly established. We'll supply Easy Terms to help finance you.

Open territories are limited! Send coupon today for **FREE** Booklet describing these unusual services and how you can become independent in a business of **YOUR OWN**. No obligation!

### "OWN a Business" Coupon

#### Duraclean Co.

Division of HOME SERVICE CO.  
16-1 Pl., Deerfield, Illinois

With no obligation to me, send booklet and letter giving full details. Tell me how I may OWN a growing business of my own built upon satisfied customers.

Name \_\_\_\_\_ Age \_\_\_\_\_  
Address \_\_\_\_\_  
City \_\_\_\_\_ State \_\_\_\_\_

Partly because of its size and complexity the Stratocruiser is believed to have been tested more thoroughly than has any other aircraft. Tests actually began in 1944 when the plane's military prototype, the C-97 Stratofreighter, was first flown. This cargo plane can carry as much as 20 tons of freight and has a ramp that permits the loading of four regular field ambulances into the fuselage.

Both cargo and passenger versions of the design use a new wing that is 16 percent stronger, 26 percent more efficient, and 650 pounds lighter than the wing of the B-29. This improvement comes in part from the use of the new 75-ST alloy of zinc, magnesium, copper and aluminum for the skin and some extrusions. Spot welding is used extensively.

Flight tests of the Stratocruiser itself resulted in two tall filing cabinets full of test reports, two miles of 16-mm. movie film and two miles of instrument tape. For parts of its flight test the first plane carried three tons of precision test instruments. It is estimated that the 700 hours of flying time involved in the tests cost nearly three million dollars. The test flights were equal to eight trips around the world at the equator.

Twenty years ago an airplane like the Stratocruiser hadn't even been dreamed of by serious engineers. The strides that air transport has made in two short decades makes one wonder what flying will be like in 1969, just 20 short years from now.

### End of an Era

(Continued from page 85)

development of this type—the giant 4-8-8-4. The latter, better known as Big Boy, was built during the last decade for mountain hauls. The Big-Boy type is the world's largest steam locomotive and weighs 604 tons. It has sixteen 68-inch drive wheels, can produce 7000 horsepower and hauls a mile-long freight train at 60 m.p.h. When Big Boy takes a drink he fills his boiler to capacity with 24,000 gallons of water.

Among the locomotive improvements from 1900 to World War I were the automatic stoker, the Walschaert valve gear, power-operated reverse gears, multiple throttle, booster engine on the trailing truck, cross-compound air pumps and many others. During this period the boiler pressure remained standard at about 200 pounds. (This was to be increased to 300 in the 1930s). The Walschaert gear is an improved system for opening and closing valves to extract full work from steam.

(Continued to page 248)

# harmony...



● **Harmony under the hood.** Today's AC Spark Plugs, with patented Coralox Insulator,\* are always in tune with your engine . . . whether it's cold or hot . . . loafing or under heavy load.

They surpass all previous spark plugs in their ability to fire steadily under a wider range of operating conditions.

They remain efficient through substantially longer life.

If you want your engine to sing a sweet song of smoothness and power, get a set of new AC's today.



## SPARK PLUGS

BUY WHERE YOU



SEE THIS SIGN

\* AC's patented processes make this the finest insulator in spark plug history. Improved electrical insulation, no matter how high the temperature. Better heat conduction. Maximum resistance to heat shock. Less fouling, harder, stronger, longer-lived.

AC SPARK PLUG DIVISION • GENERAL MOTORS CORPORATION

MORE NEW CARS AND TRUCKS  
ARE EQUIPPED WITH AC SPARK PLUGS  
THAN WITH ANY OTHER MAKE



**MOUNT your own Hunting Trophies**

## WHAT A HOBBY

**TAXIDERMISTRY** has become with **HUNTERS AND ANGLERS**. You would be amazed, Mr. Sportsman, at what you are **MISSING** by **NOT** knowing **TAXIDERMISTRY** and mounting your valuable trophies of the hunt!

**300,000 STUDENTS** are members of this great sportsman's school. Think of that! Join this throng of **SMART SPORTSMEN**. Save your **TROPHIES!**

**QUICKLY LEARNED AT HOME** The very first lesson teaches you to **MOUNT BIRDS**. You **QUICKLY** learn to mount animals, game heads, fish, pets. Your **HOME MUSEUM** with your prized trophies will quickly make you **FAMOUS**. **TRY IT. OPPORTUNITY KNOCKS.**

**WILD GAME NOT NEEDED** Mount squirrels, rabbits, chicks, yea, even frogs, to make book ends, doorstops and many other useful articles. You can do a **THOUSAND, WONDERFUL** things with taxidermy. The free book explains this.

**LEARN TO TAN** furs soft and pliable and learn **NEW** method to tan **GENUINE LEATHER** from all kinds of hides. Great spare time money maker.

**BIG, EASY PROFITS** Mount and tan for others. Many students make \$50 to \$75 a month in spare time—some, much more. If you need extra money, do not overlook this tremendous **OPPORTUNITY**.

**SEND COUPON TODAY for the Free Book —**

Tells how **YOU** can learn Taxidermy at home. 48 pages, 100 pictures of wild-game. A wonderful book, strange, unique. You never saw the like before. This book is **PRICELESS** to hunters, trappers and nature lovers. **ABSOLUTELY FREE** if you **WRITE AT ONCE**, this minute! Use the coupon or a postal will do. **STATE YOUR AGE.**

## FREE BOOK

Northwestern School of Taxidermy, 2501 Elwood Bldg., Omaha, Neb.

Send me your free illustrated book, "How to Mount Game". Also tell me how I may learn this fascinating art easily and quickly by mail. No obligation. State your age.

Name \_\_\_\_\_ Age \_\_\_\_\_

Address \_\_\_\_\_



*Be Sure To Send for Free Book Now!*

Over the years two general classifications of steam locomotives had been developed—passenger and freight. The most popular types in recent years have been the 4-6-2 (Pacific), 4-6-4, 4-8-4, and 4-8-2 (Mountain). Earlier types were the 4-4-0 (American), 4-4-2 (Atlantic) and the 4-6-0 (Ten-Wheeled). All of these types are still in service, many on branch lines. The principal freight types have either four or five pairs of coupled driving wheels with the lead and trailing trucks equipped with either one or two pairs of wheels. They include the 2-8-2 (Mikado), 2-8-4, 4-8-2, 4-8-4, 2-10-2, 4-10-2 and the 2-10-4. During recent years the freight requirements have been speeded up to such an extent that many passenger and freight locomotives of similar types are used interchangeably. This is particularly true of the Mallets ranging from two sets of four driving wheels to two sets of 10.

Also distinguished itself during World War I by promptly filling government contracts. After the war came the first rumblings of diesel talk throughout the locomotive industry. Was this an innovation or the possible harbinger of a new era in railroad transportation? Whatever it was, Alco wanted a part of it and in 1924 the plant turned out its first diesel-powered locomotive—the first commercially successful diesel built in the U. S. It is still in service as a switcher.

But while diesels were in their infancy Alco continued to build and improve on steam locomotives. A streamlined locomotive named Hiawatha was built for the Chicago, Milwaukee, St. Paul & Pacific Railroad. It was the 4-4-2 type and has a sustained speed of 100 m.p.h. with a top speed of 120 m.p.h.

When the U. S. entered World War II Alco was ready to do its part. The plant covered 112 busy acres and was ready to gear production to an all-time high. The peak in steam production was reached in 1944 when 1354 locomotives were built. In addition to more than 2000 steam and diesel-electrics, the plant's war production included 150 boilers for Liberty ships, hundreds of M-3 and M-4 tanks, tank destroyers, big guns and scores of other items ranging from turret rollers for battleships to diaphragm forgings for Navy torpedoes. Alco also built the big M-36 tanks called Sluggers which knocked out German Tiger tanks and helped turn the tide in the Battle of the Bulge. The Navy and War departments honored the company by awarding the Navy E with star and the joint Army and Navy E with two stars.

(Continued to page 250)

## SEALED POWER PISTON RINGS

Best in New Cars! Best in Old Cars!

Sealed Power Corporation, Muskegon, Michigan

# This Modern Masonry Has High Earning Power

An Outstanding Manufacturing Opportunity for Right Man



Tie in with today's demand for smart, colorful, low-cost masonry for homes and other buildings. Dunbrik-Dunstone has beauty, strength, modernity. Easily America's finest masonry, with tremendous appeal to building owners. Yet costs less than lumber because locally manufactured from local materials by local labor for local consumption.

More local plants are needed. You can be one of a national chain. Simple, compact equipment. Moderate in investment. 100%—150% mark-up on basic costs. Broad protection and liberal cooperation. Write for "Blueprints for Profit."

W. E. Dunn Mfg. Co.  
600 W. 24th St., Holland, Mich.

# DUNBRIK DUNSTONE SORE MUSCLES?



## BODY ACHES?

When muscles are stiff and sore from unusual exercise or strain, use HEET®, the liniment that's strong yet does not burn the skin. Wonderful relief from muscular soreness comes as comforting HEET quickly starts to penetrate. Just brush it on with the applicator. HEET starts at once to ease muscular pain and keeps on working for hours. Ask your druggist for HEET liniment.

# FOR BIG MEN ONLY!



## SHOES IN SIZES 10 to 16

We specialize in large sizes only—sizes 10 to 16; widths AAA to EEE. Wing Tips, Loafers, Moccasins, Hand Woven Oxfords, Dress Oxfords, High Dress Shoes, Work Shoes, Sox. Styling specially designed for large sizes. Satisfaction guaranteed. Sold by mail only. Write now for FREE Catalog. **KING-SIZE Inc.** 727, Brockton, Mass.

WRITE FOR FREE CATALOG

# New MILLING ATTACHMENT



**SIZES FOR 8" to 16" METAL LATHES**  
Build it yourself from our sets of semi-machined castings and save \$8. Can be finished on your lathe alone. Complete drawings and instructions furnished with castings.

Mill keyways, slots, splines, dovetails, flutes for reamers, special cutters. Produce gears, ratchets, racks: bore, face, etc. with this precision attachment.

**FREE** Illustrated folder and price list of castings, milling cutters, etc. Write today. Mention your lathe.

**HURON MACHINE AND TOOL CO.** YALE 4, MICHIGAN

# This Portable Power Plant and Arc Welder PAYS FOR ITSELF!

ARC WELDS, POWERS TOOLS, LIGHTS and APPLIANCES

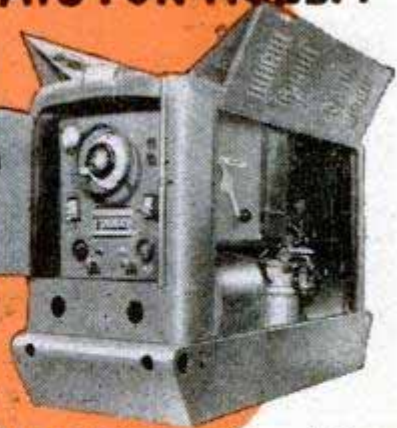

1 AC-AC Welder and Power Units

## Get in the MONEY with this new equipment.

Combination unit offers big income potential. Build Your Own.



A.C. or D.C. Generators and Arc Welders

- 2. AC-AC GENERATOR UNIT "Build Your Own." Do welding and other profitable work with this belt driven AC-AC Generator Unit.
- 3. DC-AC Welder-Generator Here is plenty of power for field work. Gas engine driven unit furnishes DC for welding or AC for aux. use.



- 4. UTILITY AC WELDER Transforms AC power supply into welding current. Ideal for light jobs
- 5. INDUSTRIAL AC WELDER For heavy duty welding, this AC transformer type is fast and efficient.
- 6. DC WELDER GENERATOR Build your own DC Welder with this generator plus your power source for other use
- 7. GENERATOR PLUS DC POWER With your motor you can build a DC Welder and have DC for other use

Complete Catalog **FREE!**

Check coupon below for full details and specifications on the largest line of electric welders built. No obligation. **HOBART BROTHERS COMPANY** Box M-191, Troy, Ohio

Enroll Now in **HOBART WELDING SCHOOL**  
Learn welding this easy, modern way. Cost is small. Qualified under G.I. Bill. Ask for details.  
**USE THE COUPON!**

**HOBART** "One of the world's largest builders of Arc Welders"

**HOBART BROS. CO., BOX M-191, TROY, OHIO**  
Please send more data on items checked

1  2  3  4  5  6  7  Catalog   
 I'm interested in the Welding School  
 My work is \_\_\_\_\_

**free** Welder's Guide  
With data, charts and other valuable information

NAME \_\_\_\_\_  
ADDRESS \_\_\_\_\_

write in margin if necessary  
**SAY YOU SAW IT IN POPULAR MECHANICS**



9 1/2" BAND SAW

# Save .. Earn Have Fun

Model 50  
8" TILT ARBOR SAW

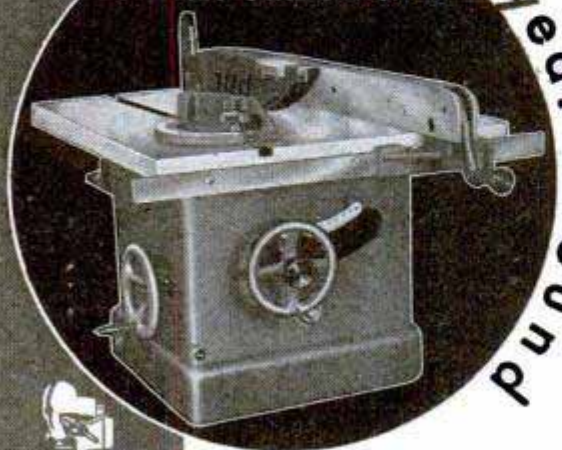

the Year Round  
PUN!



DRILL PRESS



SANDER



GRINDERS



4 1/2" JOINTER



8" Floor  
TILT ARBOR  
SAWS



Needle Bearing  
WOOD LATHE



TILT TABLE  
SAWS

Mail coupon  
below now



Save hundreds of dollars yearly on home repairs and improvements. Make your own furniture and gadgets . . . sell to others. It's easy and fun for D-J Craftsmen.

In  
Your Own  
**Darra-James**  
HOME SHOP

*toolkraft* CORP.

WATERBURY 91, CONN.

Please send bulletin describing  
DARRA-JAMES Home Shop Power Tools.

NAME \_\_\_\_\_ PM-2

ADDRESS \_\_\_\_\_

CITY \_\_\_\_\_ STATE \_\_\_\_\_

Now at the dawn of its second century, Alco is in the throes of diesel-electric production and at the same time alert to the fact that this type of locomotive may one day be outmoded like steam. Extensive research is going ahead on application of the gas turbine, and even atomic power is considered a possibility.

However, steam-locomotive fans will not be deprived of seeing their favorite iron horses in action overnight. At present in the U. S. there exists a total of 110,000,000 locomotive horsepower. This horsepower is composed of only 7,000,000 diesel, 3,000,000 electric and 100,000,000 steam. It is estimated that by 1955 this picture will be changed to the extent of 30,000,000 diesel-electric locomotive horsepower.

Despite this upsurge of diesel popularity the chances are that 50 years from now a few steam locomotives will still be chugging along somewhere in the U.S.A. The steam fans will see to that!

## Farmer "Fiddles" as He Sows



Copyright Fox photos

British farmers sow their fields with a seed broadcaster that is rotated by a "bowing" action similar to that used by a bass-viol player. The bow is strung with heavy thong that wraps around the shaft of the broadcasting blades. As the operator works the bow back and forth, it spins the blades, broadcasting the seed.

**STRIPE  
WITH  
PAINT  
EASY  
AS  
USING  
A  
PENCIL**

## PAINTERS' STRIPING TOOL

NOW you can do your own expert striping on furniture, bikes, model planes, bulletins, autos, toys, signs, linoleum, wall board . . . make plain walls look like tile! It's easy to paint straight, curved, circular, even parallel lines with any color. Handiest paint tool in your workshop! Type "M" Master Painters' Striping Tool complete with tip for 1/16" stripe, \$1.00. Tool with choice of 1/64", 1/32", 3/64", 5/64", 3/32", 1/8" tip—\$1.50 . . . all tips 75c ea. Tool with complete set of 7 tips \$5.00. (C.O.D.'s postage collect.) WENDELL MFG. CO., 4234-B Lincoln Ave., Chicago 18, Ill.

**A TOOL . . .  
NOT A BRUSH**

Dealers  
Write  
Today!



**\$1.00  
POST  
PAID**

## IT'S EASY TO REMOVE PAINT

VARNISH, ENAMEL, SHELLAC, LACQUER

Don't paint over a cracked or peeling surface. It's so easy to remove it with Wonder-Paste. Applied with a brush, Wonder-Paste softens up any number of coats of paint, varnish, enamel, shellac, or lacquer . . . reduces it to a soft, unresisting sludge that yields readily to a putty knife.

Ask for Wonder-Paste at your paint or hardware store. Used by painters everywhere.



## WONDER-PASTE

Write for  
Literature

Wilson-Imperial Company • 119 Chestnut Street, Newark 5, N. J.

## MIRACLE "BENCH KING"

The Revolutionary Vise in Solid Bronze . . . With Fingers . . . GIVES YOU AN EXTRA HAND! Comp. WITH ACCESSORIES . . . \$14.95

NOW . . . Our new model #65. For hobbyist or professional. Less Accessories . . . \$6.50

Send check or M.O. with order. We prepay postage. FREE! Our new catalogue.

**DEALER'S INQUIRIES  
INVITED!**

**BENJ. UYDESS & SONS, INC.**

964 E. 167th Street

Bronx 59, N. Y.



**6.50**

## GENUINE DIAMOND SCRIBER!

**WRITES ON GLASS,  
METALS, PLASTICS**

Never before at this price! Finest diamonds specially selected for cutting qualities. Set in hexagonal aluminum handle 6" long, by patented "Perma-Grip" method. Scribes or etches on glass, metals, plastics. Every scriber tested. Money back guarantee. Made by Clipper, foremost New York diamond tool manufacturer.

Agent and dealer inquiries invited.

No C.O.D.'s. Send cash, M.O., or check.

**\$2.00**

Postpaid

**CLIPPER DIAMOND TOOL CO., INC.**

21-B WEST 46 STREET, NEW YORK 19



## Do It ALL

WITH

*Mall*  
REG. U.S. PAT. OFF.

## HOBBYIST TOOLS

1/4" HOBBYIST

*Mall Drill*

**\$2250**

in U.S.A.  
(Drill Only)



Interchangeable attachments convert the 1/4" or 1/2" Hobbyist MallDrill into a:

- DRILL PRESS
- DISC SANDER
- METAL SHEARS
- HOLE SAW
- ROTARY FILE
- PAINT STIRRER
- POLISHER (1/2" MODEL ONLY)
- COUNTERSINKER

\$1750

in U.S.A.  
(Stand only)

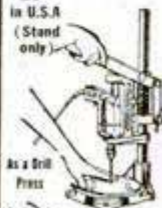

As a Drill Press



Drilling Masonry

Disc Sanding

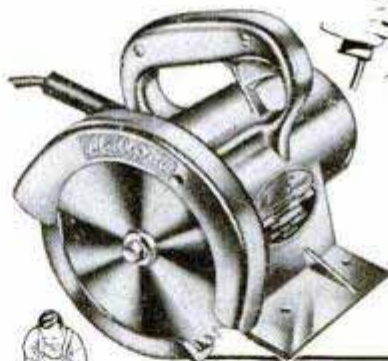

MODEL 60

*Mall Saw*

2" CAPACITY

**\$5495**

in U.S.A. (Saw only)



Cutting Concrete



Cutting Lumber



As a Table Saw

The handy Model 60 MallSaw cuts everything from wood to steel and in addition can be equipped as a:

- TABLE SAW
- BENCH GRINDER
- SHAPER
- DRUM SANDER
- WIRE BRUSH

\$3250

in U.S.A.  
(Stand only)

Write for FREE Booklet "Mall Portable Power Tools" or visit your Mall Dealer. He's listed in your Classified Telephone Directory.

## MALL TOOL COMPANY

7805 South Chicago Ave., Chicago 19, Ill.

SAY YOU SAW IT IN POPULAR MECHANICS

# HANDEE

## Homecrafters' Choice

This is it—the famous Tool of 1001 Uses — first tool of this type and today's finest. It's the tool for you whether you're an eager beginner or an expert.

**GRINDS  
DRILLS  
CARVES  
SANDS  
SAWS  
SHARPENS  
POLISHES  
ENGRAVES**

There's Only One  
**GENUINE HANDEE**

**FREE  
64-Page  
Manual**

### FOR PLEASURE OR PROFIT

You'll enjoy making ship, train and plane models, puppets, costume jewelry, wood carvings, bookends. You'll engrave monograms on glassware, tool leather billfolds, handbags, etc. And it's a dandy for all kinds of repairs. Used by industry for exacting production jobs—preferred by craftsmen and mechanics.

**EASY TO USE** as a pencil. Fits your hand comfortably. Lightweight, only 12 oz.

**WORKS ON ANY MATERIAL.** Metal, alloy, glass, plastics, wood, horn, bone, leather, etc.

**PACKED WITH POWER AND SPEED.** Runs at a cool 25,000 r.p.m. AC or DC current.

**DESIGNED RIGHT** in every detail—result of 50 years' experience. Close-fitting motor, non-breakable housing, 7-segment commutator, interchangeable spring collet clutch. Every part triple-tested to make Handee the perfect tool. With 7 accessories \$20.50. In carrying case with 40 accessories \$27.50.

**PLASTIC-CRAFT KIT.** All materials needed for internal carving (Handee not included) \$6.95.

**500 ACCESSORIES.** Start with a few, add more as needed.

With its Attachments and Accessories, Handee Performs More Operations with Greater Accuracy than any other Tool of this Type.

**GET AT STORES OR SENT POSTPAID**

CHICAGO WHEEL & MFG CO.  
1101 W. Monroe St., Dept. PM, Chicago 7, Ill.

Send  Handee Kit  Handee Tool  Plastic-Craft Kit  
 C.O.D.  Remittance enclosed  Send Manual

Name \_\_\_\_\_

Address \_\_\_\_\_

## Ruler Has Built-In Flashlight

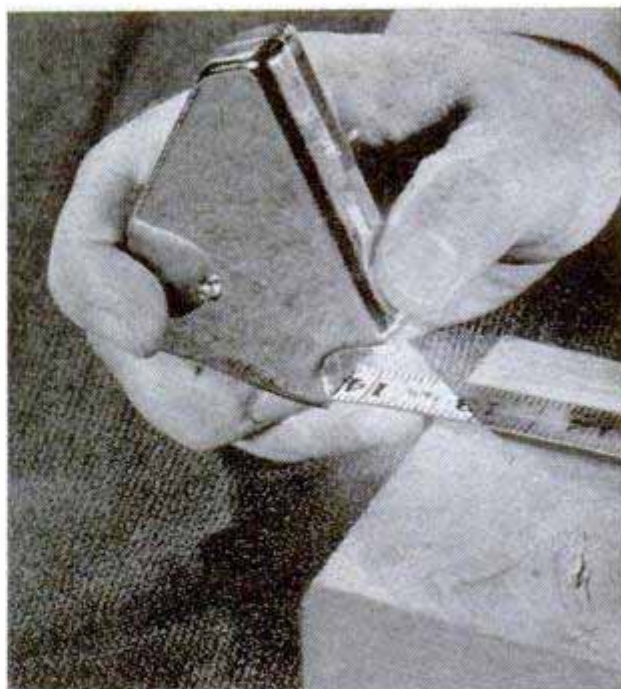

With a flexible ruler equipped with a miniature flashlight, measurements can be read at night or in restricted places where the light is poor. The six-foot tape is the snap-back type made of carbon steel. The tiny flashlight is mounted so that the beam is thrown directly on the figures. One side of the case is removed to replace the battery or bulb.

## Pillow for Heel Protects Shoe

Both the floor mat and the heel of the driver's shoe are protected from scuffing and wear by a heel pillow placed at the base of the accelerator. It is made of hard rubber covered with sheepskin on the upper side and anchors to the floor with sharp pins. Easy to remove and clean, it prevents stains on light-colored shoes.





**FINE TOOLS  
NEED  
FINE OIL!**



• Lubricates



• Prevents Rust

• Cleans • Polishes

SOLD EVERYWHERE

**3-IN-ONE Oil**

**Thompson  
BEATS  
the World  
on BOATS**



**Better Built  
Lower Prices**

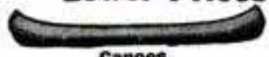

Canoes

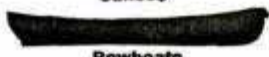

Rowboats



Outboards

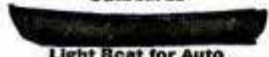

Light Boat for Auto

**Safe Boats With  
Full Length Spray Rails**  
Keep passengers perfectly  
dry—even at high speeds.  
Catalog also shows two new  
models of "Take-Along"  
Boats. Two big factories—  
save you freight.

**CATALOG FREE**  
Write for your copy. State kind of  
boat in which you are interested.

**THOMPSON BROS. BOAT MFG. CO. (151)**  
213 Ann St. PESHIGO, WIS. (Write to either place) 113 Elm St. CORTLAND, N.Y.

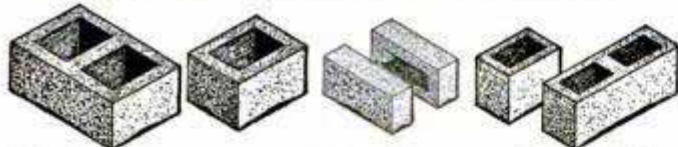

**Make Concrete Blocks and Bricks**

New superior method makes square, true, easy-to-lay units which will pass any building code. Small investment, high production, big profits. One \$30.00 machine will make four 5"x8"x12" blocks per minute—1000 per day. Pays for itself in a few days. Sell blocks or save 2/3 building cost by making and laying your own.

POST CARD BRINGS FREE FOLDER

**Economy Manufacturing Company  
Dept. P Stone Mountain, Georgia**

**QUALITY TILTING TABLE SAW**

TABLE INCLUDING EXTENSION 18" x 14"

**\$24.95**

Complete as shown  
F.O.B.  
Royersford, Pa.



TAKES

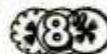

BLADE

**IMMEDIATE  
DELIVERY**

Send for catalogue showing complete line of Tilting  
Table and Tilting Arbor Saws, from \$24.95 to \$87.50  
**AMERICAN MACHINE & TOOL CO., Inc.**  
ROYERSFORD, PA. DEPT. 111



**It's  
NORTHLAND  
SKI  
Time!**

**THE TIME OF THE YEAR**  
*for the time of your life!*

Pack the season with thrills. Race your favorite  
slope with the sure-footed control of perfectly  
matched, hand-crafted Northland Skis. North-  
lands are ideal to own, ideal to give. Send 15c  
for the famous Northland Ski Manual, or, write  
for free pamphlet.

**NORTHLAND SKI MFG. CO.**

Supplier to the U.S. Olympic Ski Team

95 MERRIAM PARK • ST. PAUL 4, MINNESOTA

**START A BUSINESS  
OF YOUR OWN**

Like John Lehman, Who Says:

"The complete Fyr-Fyter extin-  
guisher line gives me a steady  
income and real independence."



Yes, capable men like John Lehman  
will find an outstanding opportunity  
with Fyr-Fyter. You can be your own  
boss . . . operate in your own town and  
vicinity . . . build a permanent, steady  
income. No capital needed. We carry  
accounts, make deliveries, pay profits  
weekly. Thousands of prospects due  
to the vast need for fire protection.

**Write for FREE BOOK**

Get details on Fyr-Fyter's famous  
sales kit . . . facts on the complete,  
Underwriters' approved Fyr-Fyter  
line . . . how you earn while you  
learn. Write today! No obligation.

**Fine Business  
for men past 40.**



**FYR-FYTER CO.** Dept. 90-49. Dayton, Ohio

SAY YOU SAW IT IN POPULAR MECHANICS

MR. ADVANCED F. H. ...  
 GENERAL MACHINE + TOOL WORKS  
 40261 13-MILE RD., WALLED LAKE, MICH.

# EARN BIG MONEY AND BE YOUR OWN BOSS

## Sharpening Lawn Mowers

### BUILD A THRIVING BUSINESS WITH A UNIVERSAL GRINDER

In your own garage or basement, and earn \$25.00 a day or more. Mr. Hardy writes, "I am doing a fine business with the UNIVERSAL GRINDER. One customer sends another. I spent 40c for a newspaper ad and have done nearly \$500.00 worth of business." Mr. Helmeck of Canada writes, "We sharpened 750 mowers last year and are 1056 on this year's run. The Universal surely makes satisfied customers." Mr. Barton of California says, "The lawn mower business, with the Universal Grinder, has been a gold mine these last two years."



**A Complete Single Unit • No Attachments Necessary**  
 • Precision-Built • Simple to Operate • Sharpens Reel Blades at Proper Angle • Grinds a Keen Cutting Edge Full Length of Blade

Only on the UNIVERSAL GRINDER can the inside face and edge of the stationary blade, as well as the reel blades, be ground to proper clearance

### ALL IN ONE SET-UP

WITHOUT REMOVING ANY BLADE FROM THE MOWER

Write for FREE Folder today!

Rogers Mfg. Co., Dept. M-19, Lindsey, Ohio

## CASH IN ON THE BUILDING BOOM!



**MAKE BUILDING BLOCKS RIGHT IN YOUR OWN BACKYARD**  
**AMAZING GENERAL BLOCK MACHINE**  
 CAPACITY 1000 BLOCKS PER DAY  
 \$199 LESS MOTOR F.O.B. PLANT  
 ONLY SHIPPING WEIGHT 400 lbs.

Cinder and Concrete Blocks in big demand. Sell all you produce, to contractors and builder supply yards, at 15c to 25c each. Easy to start your own profitable business.

GENERAL BLOCK MACHINE can be operated indoors or out, in floor space 9 ft. x 10 ft. All steel construction. Vibrator mounted in sealed ball bearings. Simple to run. Powered by 1/2 H.P. electric motor or 1 H.P. gas engine. Produces up to 1,000 8x8x16 blocks in 8 hour day. Superior 3 core type, meeting all building code requirements. Produces 4x8x16, 8x8x16, 12x8x16 blocks. Material for blocks, cinders; cement; and sand; obtainable anywhere. Full instructions and mixing formulas with each machine. Immediate Delivery. Mail coupon at once for full details, sent free without obligation.

**HOW TO BUILD YOUR OWN CONCRETE BLOCK HOME**  
 Only \$1 Prepaid

Wonderful book written and illustrated by our staff of experts.

## GENERAL ENGINES CO.

(EASTERN DIVISION) DEPT. M—DREXEL BLDG., PHILA. 6, PA.

Shows you 8 ways to save money and how to make and lay blocks, laying out building lines, mixing your own concrete, building steps, porches and concrete floors, includes floor plans for 6 beautiful easy to construct concrete block bungalows. Mail coupon at once with \$1.

Name .....

Address .....

City..... Zone... State.....

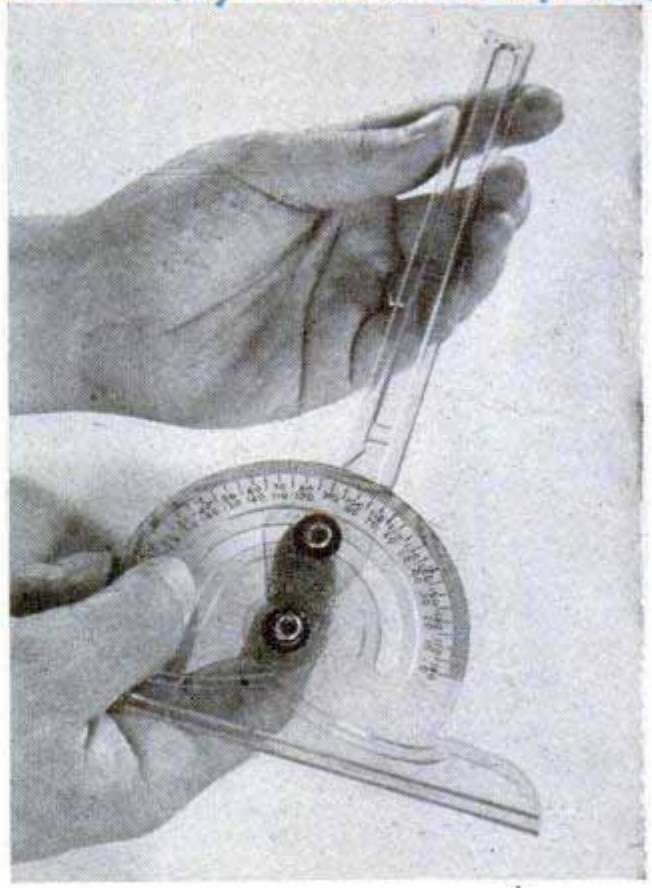

### Self-Clamping Protractor

Made of injection-molded plastic, a new protractor has a projecting arm that automatically locks in place. The arm is held tight by a spring clip. Pushing the bottom of the clip loosens it so the arm can be moved, but as soon as the finger is removed the clip locks the protractor. The scale on the instrument is reversible.

### Physicist Predicts Discovery Of New Subnuclear Particle

Although it may not be discovered for years, a new subnuclear particle bearing a magnetic charge instead of the plus or minus charge of the proton or electron has been predicted by a British physicist, Dr. P. A. M. Dirac. He estimates that the new particle could be created in the laboratory by an artificial collision having an energy of 500 million electron volts. This is beyond the range of even the 184-inch cyclotron at Berkeley, Calif., with its 400-million-electron-volt particles, which artificially created mesons. Until a more powerful atom smasher is built, the search for the new particle will be carried out in studies of cosmic rays.

Twenty-five thousand persons were injured in bicycle accidents in 1947, according to a recent report by the National Safety Council.

# URAC "185" NOW AVAILABLE... IN SMALL CONTAINERS

URAC RESIN  
ADHESIVE  
WITH  
HARDENER  
185-



Best bonding agent for gluing structures: furniture, toys, bows, arrows, plastic table tops, phenolic and melamine laminates, masonite, Etc.

Easy to Mix . . . Easy to Use . . . Water Resistant . . . Rot Proof . . . Stain Proof. Allows for lower pressures and heavier glue lines. Joints are stronger than wood itself.

This wartime development a must for quality production . . . Ideal for the Hobbyist.

Pts. \$1.50; Qts. \$2.25; Gal. \$5.50 and 5-gal. \$23.75 including Hardener.

Send Payment and Save postage and C. O. D. FEES.

\*TRADE NAME REGISTERED BY AMERICAN CYANAMID CO., MFR.

**THE NELSON COMPANY**  
IRON MOUNTAIN - MICHIGAN

## NEW Pocket Thickness Measure

A pocket-watch size precision dial indicator weighing only 1½ oz. for accurately measuring the thickness of sheets, strips or tubing, round, square, or hexagonal stock, tissues, fibres or filaments of materials such as rubber, metal, paper, plastics, leather, glass or cloth.

4 MODELS .0005", .001", and .01 mm graduations. Range of all models 5/16" (8mm).

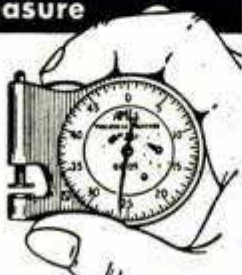

PRICE \$15.10 Post-paid complete with leather case and full instructions.

**B. C. AMES CO.** 68 AMES STREET  
WALTHAM 54, MASS.

MFR. OF MICROMETER DIAL GAUGES & INDICATORS

## BARGAIN!

HIGH SPEED ROTARY FILES

Set of 5 Assorted . . . . .	\$ 2.00
" " 10 " . . . . .	3.75
" " 20 " . . . . .	7.25
" " 30 " . . . . .	10.00

1/4" shank



WE BUY SURPLUS TOOLS

**SID TOOL CO., 183 Grand St., N. Y., N. Y.**



Ask Your Hardware Store for  
**FULLER'S**  
Unbreakable Amber Handle  
SCREW DRIVERS

America's most popular line of moderately-priced screw drivers! Wide range of sizes.  
FULLER TOOL CO., Inc.  
911 Faile St. New York 59  
World's largest makers of Amber-Handle Tools

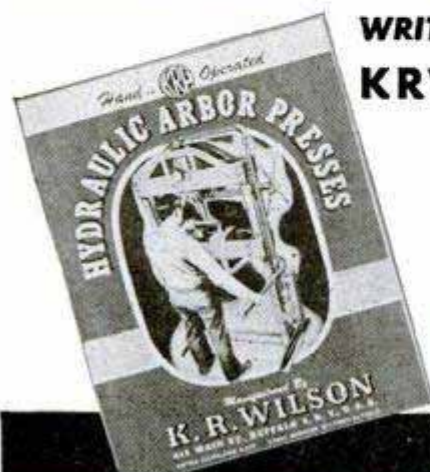

## WRITE FOR YOUR FREE COPY OF THE NEW KRW HYDRAULIC PRESS BOOK

Describes all manner of Production and Shop Work on KRW Hydraulic and Bench Type Presses. 32 pages illustrating the new KRW Hand-operated, Electric-operated and Air-operated Hydraulic Presses. 25 to 100-ton capacities.

Write for your copy today.



**K. R. WILSON, DEPT. 17, 215 MAIN ST., BUFFALO 3, N. Y.**



**NATURE'S REMEDY (NR) TABLETS**  
—A purely vegetable laxative to relieve constipation without the usual griping, sickening, perturbing sensations, and does not cause a rash. Try NR—you will see the difference. Uncoated or candy coated—their action is dependable, thorough, yet gentle as millions of NR's have proved. Get a 25c box and use as directed.



FUSSY STOMACH?

RELIEF FOR ACID  
INDIGESTION,  
GAS AND  
HEARTBURN



## Command Bigger Money! STUDY LAW

STUDY AT HOME for BUSINESS SUCCESS and LARGER PERSONAL EARNINGS. 40 years expert instruction — over 114,000 students enrolled. LL.B. Degree awarded. All text material furnished. Easy payment plan. Send now for FREE BOOK — "Law and Executive Guidance." It explains the course — how you may enroll and the many ways you can profit from Law Study. Write TODAY to:

**AMERICAN EXTENSION SCHOOL OF LAW**  
Dept. 10 - PM, 646 N. Michigan Ave., Chicago 11, Ill.

Say You Saw It in  
**POPULAR MECHANICS**

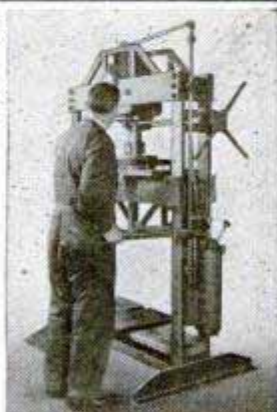

# PROFITS AND SPEED

## THE MODERN LAWN MOWER SHARPENER

PRICE  
**\$241<sup>50</sup>**  
LESS  
MOTOR

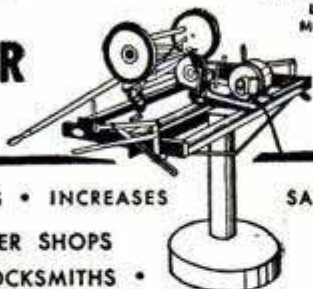

INCREASES PROFITS • INCREASES SALES  
FOR LAWN MOWER SHOPS  
FIXIT SHOPS • LOCKSMITHS •  
HARDWARE STORES • GOLF COURSES • SCHOOLS  
PARKS • PLAYGROUNDS • INSTITUTIONS •  
CEMETERIES • AND ALERT INDIVIDUALS!

*Sharpens All Reel Type Mowers • Hand, Power or  
Gang • 10 to 20 Minutes • No Dismantling  
No Extra Attachments Needed*

All reel type mowers, from 5-inch edgers to 36-inch power mowers, are quickly sharpened to extreme ends of both left and right twist reel blades. Handle, wheels, roller and motor remain in place when sharpening is in process. Bed knife is sharpened in same brackets that hold mower in grinding position. No extra attachments required. One lever puts mower or bed knife in grinding position. 100% steel construction. Grinding head rides on five ball bearing races. Small, compact, easy to operate. Sharpens wood chisels, joiner knives and planer blades without extra attachments.

**ORDER  
NOW**  
Immediate  
Delivery.

*Skate Sharpener Attachment Available  
Send For Free Bulletin No. 10B*

**MODERN MFG. CO.** 160 N. FAIR OAKS AVE.  
PASADENA 1, CALIFORNIA

## FASTEST PLANER in the WORLD at this Low Price... **\$215<sup>00</sup>**

### BELSAW Multi-Duty Planer



Speed up production! Increase your profits! BELSAW power self-feeds at 24 feet per minute... The lowest-priced surfacer that will handle 12 x 6 in. stock. Planes green or dry sawed lumber into smooth, worked forms. Three high-speed steel knives make 42 cuts per inch. Multi-duty BELSAW takes inexpensive attachments for all planing mill operations—Jointing, Rabbeting, Grooving, Matching. BELSAW is the **only** 12 in. planer providing **attachments for jointing and grinding its own knives**. Start planning NOW for BIGGER VALUE and BETTER PERFORMANCE, with BELSAW. Write for FREE specifications, illustrations and low prices.

● LARGER CAPACITY ● FASTER  
OUTPUT ● KNIFE SHARPENING  
ATTACHMENT  
**BELSAW MACHINERY CO.** 81013 Field Bldg., 315 Westport Rd.  
Kansas City, Mo.

## Announcing **CHAMPION** V-Glow Plugs

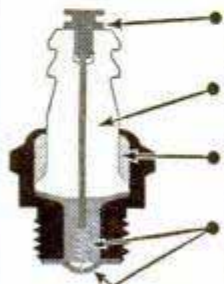

**CHAMPION TERMINAL**—assures better center electrode seal and provides sturdier electrical connection.  
**CHAMPION-CERAMIC INSULATORS**—proved dependable in millions of Champion Spark Plugs.  
**CHAMPION SILLMENT SEAL**—prevents excessive compression leakage between insulator and shell.  
**CHAMPION "THERM-O-FLEX" CONSTRUCTION**—longer element life, more dependable performance.

Follow recommendations of plug types and fuels approved by engine manufacturer.

**CHAMPION**  
SPARK PLUG COMPANY, TOLEDO 1, OHIO

## "Forks" Hold Nursery Gate



Quickly adjusted to fit any standard doorway, a portable nursery gate does not have to be permanently fastened to the doorframe. V-shaped metal forks on each end of the gate fit around the door casing and hold the gate securely when it is adjusted to the proper width by means of two bolts. The forks are rubber-covered to prevent damage to woodwork.

## One-Hand Portable Welder

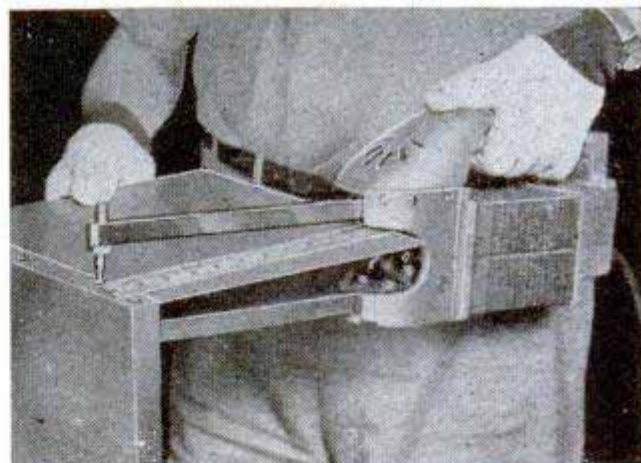

One-hand welding is possible with a portable unit that handles metals up to 1/8 inch thick. Because of its design—the top tong rests at the point of pressure—the unit cuts operator fatigue. A squeeze of one hand plus the 22-pound weight of the welder furnishes all the pressure needed. The other hand can be used to hold the work. The machine's portability makes it useful for off-location work. It welds mild stainless steel, terneplate, galvanized iron, magnesium and, when a special alloy tip is used, handles aluminum sheets. The welder is designed for use with 110 or 220-volt alternating current.

# Bargains FOR HOBBYISTS AND EXPERIMENTERS

ALL QUANTITIES LIMITED SUBJECT TO PRIOR SALES

## HEATHKIT 3 TUBE ALL WAVE RADIO KIT

No. K1. An Ideal Beginners Radio Kit covers 550 to 6000 KC including Broadcast, police, aircraft, amateur marine, and foreign broadcasts. All parts including 3 tubes supplied. 110V 60 cy AC. Transformer operated, calibrated dial complete instructions for assembly. Operates loud speaker (not included). Excellent boy's gift. Ship. wt. 3 lbs. Loud speaker 2½" PM (extra).....\$1.95 Headphones (extra).....\$1.00



**\$8.75**

## BC 645 GENERAL ELECTRIC TRANSCEIVER



No. 201. Complete 15 tube transmitter receiver. Ideal for new citizens band 460 Mc for communication between office and car, home, boat, etc. Conversion

article in August ELECTRONICS Magazine. Brand new in original G.E. cartons with tubes. Add postage for 25 lbs.

**\$19.50 . . . . 2 FOR \$35.00**

### ACCESSORIES FOR BC 645

PE 101C Dynamo motor 110V 60 cycle power supply for car use. . . \$3.95  
 supply for home or office use. . . \$14.50

## HOME WORKSHOP GRINDER KIT

No. 230. Easily assembled 110V AC or DC ball bearing fully enclosed motor from Army surplus dynamotor. Purchaser to make simple changes and shaft extensions, detailed instructions and all parts supplied. Motor approximately 5,000 R.P.M. Ideal for tool-post grinder, flexible shaft tool, model drill press, saw. Shipping weight 6 lbs.



**\$3.95**

## ARMY ELECTRONIC ALTIMETER



**\$34.50**

No. 200. Brand new 14 tube army transmitter receiver radar unit with indication in feet. Many applications such as electronic burglar alarm, radar set, etc. Complete with 14 tubes, controls, plugs, antennas and instruction manual. Shipping wt. 87 lbs.

## TANK TRANSMITTER POWER SUPPLY

No. 223. Army PE125 power supply provides 500 volts at 160 MA from 12 or 24 Volt storage battery. Heavy duty unit with filters starting relays, fuses, tubes, and diagram. Shipping wt. 73 lbs.



**\$12.95**

## T 32 TABLE MICROPHONE



No. 210. One of the Army's best. Built by Kellogg, ideal for factory call system, public address, amateur use. Brand new in original cartons. Add postage for 5 lbs. . . . . \$2.95

## INTERPHONE 2 WAY CALL SYSTEM KIT

No. 1P1. Saves many steps between house and barn, tenant house, workshops, etc.; can be used to watch baby from neighbors. Uses 2 wires and will operate up to 1-5 mile. More than one remote can be used. Kit is complete with tubes, one master, one remote speaker and detailed instructions. Shipping weight 5 lbs.

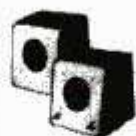

**\$14.50**

## ASTROGRAPHS WITH CASE



**Only \$3.95**

No. 259. New B29 navigation instrument which can easily be used to make a good contact printer, strip map holder, etc. The plywood case 14½" x 11" x 10" high is perfect as a tool kit, camera, projector case or for building a portable phonograph picnic kit, make up case, etc., has leather handle reinforced covers, 8 covered compartments in bottom. Cost Gov't \$125.00, Add postage for 20 lbs.

### GN 58

## GENERATOR

No. 275. Makes excellent home lighting plant, operated by wind propeller, waterfall, gas engine, or hand crank. Reduction gear allows full output at slow speed, supplies 6 volts at 2.45 amp., 425 volts at .115 amp. New. Add postage for 28 lbs.



**\$7.95**

## BC 746 TUNING UNIT

No. 257. Transmitter Receiver Tuning Unit from Army Walkie Talkie. Containing coils tuning condenser, transmitter crystal sockets, etc., excellent for building amateur station. Shipping wt. 1 lb.



**\$1.00**

## METER SPECIAL

No. 237. Beautiful Dejur 3" Square Precision Milliampmeter 0-800 MA range. 0-10 MA basic movement. Probably the best buy ever offered in a war surplus meter. Shipping wt. 1 lb.



**\$2.95**



**\$9.95**

## BENDIX DIRECTION FINDER LOOP

No. 219. Brand new loop excellent for aircraft or boat direction finder. Also useful as radio aerial to eliminate local interference. Rugged army construction. Shipping wt. 8 lbs.

## G.E. 50 AMP CIRCUIT BREAKER

No. 204. New General Electric 50 Amp. 220 Volt AC circuit breakers. 100 Amp. when used on 110V. Add postage for 4 lbs. \$2.95, 3 for \$7.50



**\$2.95**

## MINIATURE ELECTRIC MOTOR

No. 211. Tiny Delco motor only 1" x 1¼" x 2" 10,000 RPM. Operates from 6 to 24V. Excellent for models. Add postage for 1 lb.

## HEATHKIT HIGH FIDELITY AMPLIFIER KIT

No. A2. A truly fine 110V 60 cy transformer operated High Fidelity Amplifier Kit. Ideal for reproducing quality music at home, churches, mortuaries, outdoor gatherings etc. Output over 10 Watts. Complete with all tubes (push pull circuit) transformers, punched chassis and detailed assembly instructions. Shipping weight 20 lbs. High Fidelity 12" P.M. Speaker for above \$6.95 Mahogany speaker cabinet size 14½" x 14½" x 8" for above speaker. . . . . \$8.75



**\$14.95**

## BC375 TRANSMITTER TUNING UNIT



**\$2.49**

No. 203. A beautiful Army Tuner containing 3 precision variable condensers, tank coils, switches, vernier dials, worth over \$30.00. The best buy in surplus. Shipping wt. over 20 lbs.

## FM PUSH BUTTON TUNER

No. 224. Brand new ten push button tuning assembly from Army FM receiver. Contains 4 gang 100 MMF silver plated tuning condenser. Add postage for 10 lbs.



**\$2.50**

## G.E. 1000 VOLT 350 MA DYNAMOTOR



**\$5.95**

No. 213. An ideal dynamotor for mobile operation in taxicabs, police cars, sound systems and amateur stations. Supplies above voltage from 12 Volts or 500V. at 350 MA from 6 Volts. Complete with starting relay, and fuses. New. Our Dynamotor A. Shipping Weight 72 lbs.

## DM-36 DYNAMOTOR

No. 215. Western Electric 24 Volt input, 220V at 60 MA out. With filter assembly. Ship. weight, 6 lbs.



**\$2.95**

## POWER TRANSFORMER - SPECIAL



**\$3.95**

3 FOR \$9.95 Weight 11 lbs. each.

No. 226. Primary 117V. 60 cycle. Secondaries supply 746 V.C.T at 220 MA, 6.3V. at 4.5A., and 5V. at 4A. Will handle 13 tube radio receivers. Supply is limited, order early. Shipping

## HEARING AID HEADPHONES

No. 216. Hearing aid type, comfortable, keeps out outside noise, one of the Army's best types. Add postage for 2 lbs. . . . . \$1.00



## THE NEW 1948 HEATHKIT 5" KIT OSCILLOSCOPE



**\$39.50**

No. 03. Complete kit to build a beautiful 5" oscilloscope. Ideal for studying and servicing television and FM radio. 6 tubes including 5BP1 cathode ray tube. 1500-Volt power supply operates from 110-V 60 cy A.C. Has compensated vertical and horizontal amplifiers and 15 cy to 30 KC sweep generator. Detailed instructions make assembly easy. Shipping weight 35 lbs. Nothing else to buy.

## HOW TO ORDER

Give part number and description. Add postage for weight shown. No orders under \$2.00. We will ship C.O.D.

**HEATH COMPANY BENTON HARBOR 17, MICHIGAN**

## Turn of Crank Tightens Fence

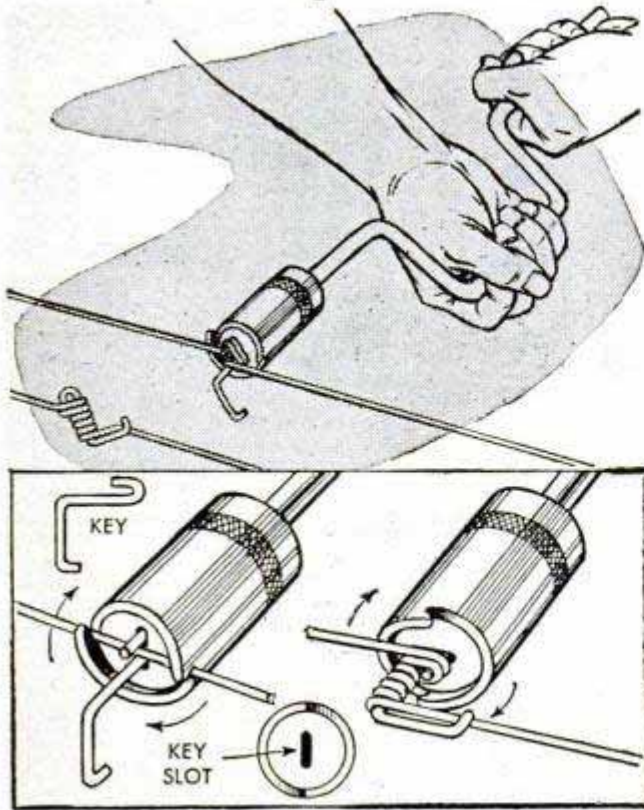

Fences are tightened permanently by a crank-type handle that reels up the surplus wire. The tightener works on plain, barbed or woven wire and can be used in

erecting new fences as well as taking the sag out of old ones. A hooked wire twister is installed in the crank, a strand of the fence inserted and the crank turned until the strand is tight. The twister then is hooked over the wire to keep it permanently taut. About nine inches of wire can be reeled up in this way, depending upon the gauge of the wire. Because each strand can be tightened individually, the tightener eliminates cutting the fence to compensate for unevenness.

## Turkish Water Pipe—Modern Style

Beneath the bowl of a new pipe is a glass jar which can be filled with water to provide a cooler smoke. The smoke passes through a tube to the bottom of the jar, then up through the water and stem. The jar can be filled with menthol to relieve head congestion.



## GROBAN'S—WAR SURPLUS BARGAINS

# WESTINGHOUSE AIR COMPRESSOR

BRAND NEW  
WAR SURPLUS SPECIAL

2-Cylinder Piston Type  
Ideal for:

- Paint Spraying
- Industrial Uses
- Tire Inflating
- Spraying Insecticide
- Operating Air Tools

For the:  
**HOME... FARM... FACTORY**

Designed for automotive truck or tractor mounting. Can be run off fan belt or power takeoff. Comes with automatic clutch. Can be installed for use on: farm trucks, jeeps, tractors, tire or garage service trucks, contractor or road building machinery, pneumatic devices, etc.

Can be operated with  $\frac{1}{2}$  H.P. or more electric motor or equivalent portable gas engine.

Light weight, compact and versatile unit... delivers "oil free air"... simple in operation; requires minimum of maintenance; operates under all climatic conditions; suggested operating pressure 75 P.S.I.; equally efficient operation in either direction of rotation; approx. displacement 3.27 CFM at 600 RPM, 6.54 CFM displacement at 1200 RPM. Has 2 inch bore— $1\frac{1}{2}$  inch stroke. Overall dimensions: width 9", height  $11\frac{1}{8}$ ", depth  $6\frac{5}{8}$ "; approx. wt. 23 lbs.

A REAL BUY...  
worth many times  
this price

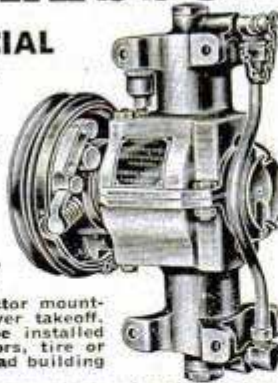

**\$26.95**

F.O.B. CHICAGO

WRITE FOR OUR FREE CATALOG!

## SHOP BY MAIL and SAVE

Better buys. Satisfaction guaranteed

## ALL-PURPOSE WATER PUMP

Mfd. by PACKARD MOTOR CAR CO.

Ready for use on  
any pumping need

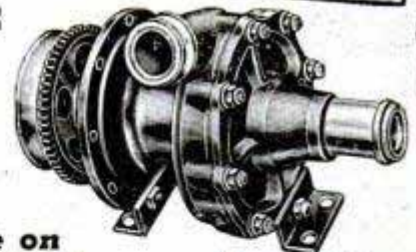

Brand New

## Belt Driven — Centrifugal Pump

- Use it for: DRAINING BASEMENTS
- HOME WATER SYSTEMS
- FIRE PROTECTION
- PRESSURE BOOSTER
- IRRIGATION
- DRAINING PONDS, TANKS, etc.
- SPRINKLING SYSTEMS
- STOCK WATERING
- INDUSTRIAL PUMPING

An extraordinary value for all types of intermittent or continuous pumping in the home... farm... factory. Built to exact specifications of Packard Motor Car Co. for use in Rolls-Royce Merlin Aircraft Engines. May be run with electric motor, gas engine or power take-off on tractor. Delivers up to 25 gallons a minute with  $\frac{1}{4}$  H.P. motor; 80 gal. a min. with one H.P. motor. Will deliver up to 44 ft. head or 25 ft. suction. Use 1" outlet hose; 1" or  $1\frac{1}{2}$ " inlet hose (recommended).

COMPLETE ENGINEERING REPORTS AND OPERATING INSTRUCTIONS FREE WITH PUMP

Has cast aluminum housing, accurately machined 5" bronze impeller;  $3\frac{1}{2}$ " V belt pulley and mounting brackets. Shaft rotates on ball bearing; has grease gun fitting.

Original cost approx. \$88.00. Shipping weight 10 lbs. A REAL BUY.

**\$21.50**

F.O.B. Chicago

ORDER DIRECT FROM AD SATISFACTION GUARANTEED  
Send payment or purchase order today

**GROBAN SUPPLY CO.**  
1507 S. MICHIGAN AVE., Chicago 5, Dept. PM-1

# GROBAN'S - WAR SURPLUS BARGAINS

SHOP BY MAIL  
and SAVE  
Better buys. Satisfaction guaranteed

BRAND NEW

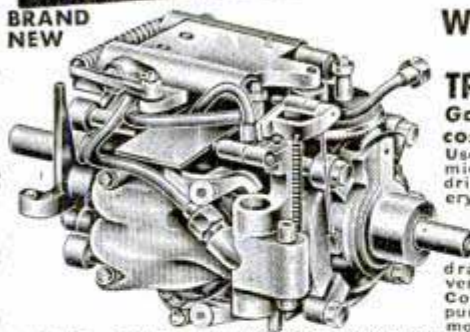

## WESTINGHOUSE HYDRAULIC TRANSMISSION

Gov't. Acquisition cost . . . . . \$300.00

Use it on chain saws, midget autos, lathes, drills, power machinery, chucking machines, farm machinery, potters' wheels, tractors, trucks, etc. Ideal as hydraulic torque converter. Contains hydraulic pump and hydraulic motor; has reversing

controls. Designed for use on 2 ton 40 mm anti-aircraft guns; contains 10 ball bearings and high quality precision workmanship, made to exacting specifications of ordnance department. Overall dimensions: 12" long x 5 1/2" wide x 6 1/2" high. Ship. wt. 19 lbs. Complete engineering report included. NOW ONLY

**\$18.95**

F.O.B. Chicago



## Vickers MF9 Hydraulic PUMP or MOTOR

Compact, powerful, rated 1,000 P.S.I., .507 cu. in. per revolution, 8 gal. per min. at 3750 r.p.m. Change rotation by reversing flow. Delivers up to 6 H.P. BRAND NEW. Requires 1 1/2 to 6 H.P. Wt. 4 1/2 lbs., \$60.00 value for . . . . .

**\$14.95**

Postpaid

Brand New CHECK and RELIEF VALVE. Adjustable for any pressure. . . . . **\$2.95** postpaid

FREE: New, 20-page illustrated Hydraulic Manual featuring diagrams, photographs and instructions — FREE with each hydraulic order.

## SCOOP! Brand New High Volume CENTRIFUGAL PUMP

For fire protection, irrigation, de-watering, industrial uses, farm uses, etc. Pumps rated 500 gallons per minute at 275 ft. head; equipped with 1 1/2" diameter straight splined shaft for direct coupling drive; 4 1/2" threaded suction intake; two—2 1/2" threaded discharge outlets; Hale Pump Co. Model CF volute type; requires 37 H.P.; dimensions: 21" x 24" x 28". Complete with full accessory kit including suction and pressure gauges, priming equipment, and instruction book. Ship. wt. 415 lbs.

Gov't. acquisition cost \$425.00

NOW

**\$149.50**

F.O.B. Chicago

## Self-Priming BRONZE PUMP

Positive Displacement

Gerotor Type

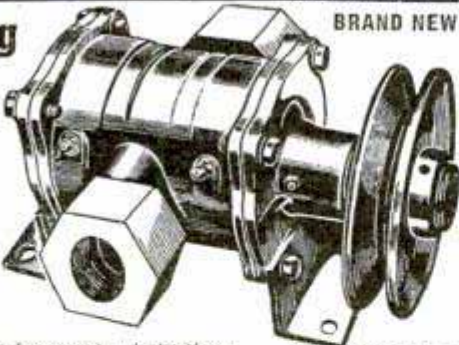

BRAND NEW

Perfect for draining basements, irrigation, fire fighting, sprinkling, pressure booster, insecticide and other spraying, fuel transfer, stock watering, industrial pumping, deep well jet pumping and home water systems. Rated 2 1/2 ft. suction and 150 ft. head pressure at 80 gallons. Use from 1/3 to 5 H.P. motor.

Mfd. by the Pump Division Eaton Mfg. Co.

Complete engineering report and instructions FREE with pump

Supplied with mounting brackets and 5" V belt pulley, ready for instant use. Standard 1 1/2" inlet and outlet pipe thread. Dimensions: 9 1/2" x 7 1/4" x 4 1/4". Ship. wt. 18 lbs. A \$142.00 value. . . . .

**\$32.50**

F.O.B. Chicago

WRITE FOR OUR FREE CATALOG!

BRAND NEW

## Air or Oil HYDRAULICS

Use hydraulics on arbor presses, hydraulic presses, hay lifts, manure loaders, lift trucks — push or pull, tilt or turn, press or squeeze, open or close, lift or lower — and other hydraulic and industrial applications. Use with either air or oil . . . of finest precision workmanship.



1. Double action, 1 1/2" bore, 5" stroke, will lift 1760 lbs. in one second with Vickers MF9 Pump. Wt. 3 lbs. A \$35.00 value. . . . . **\$8.95** postpaid

2. Double action, 1 1/2" bore, 9" stroke, will lift 1760 lbs. in one second with Vickers MF9 Pump. Wt. 4 lbs. A \$45.00 value. . . . . **\$10.95** postpaid

3. Use these cylinders on farm trucks, bulldozers, hay lifts, manure loaders, etc. Double action, 1 1/2" bore, 27" stroke. (Will lift 1760 lbs. in 2 seconds with Vickers Pump.) Wt. 8 lbs. A \$55.00 value for only . . . . . **\$12.95** postpaid

4. Double action, 2 3/4" bore, 8" stroke. (Will lift 4400 lbs. in one second with Vickers Pump.) Will withstand 1500 P.S.I. against wall. Wt. 7 lbs. A \$65.00 value. . . . . **\$14.50** postpaid

5. Double action, 3" bore, 10 1/2" stroke. All steel hydraulic cylinder, will lift up to 12,000 lbs. (7000 lbs. in 3 seconds with Vickers Pump.) Complete with fittings. Wt. 12 lbs. A \$78.00 value. . . . . **\$19.50** postpaid

6. Double action, 3 1/2" bore, 11" stroke. (Will lift 9600 lbs. in 7 seconds using Vickers MF9 Pump.) Complete with fittings. Wt. 15 lbs. A \$92.00 value . . . . . **\$22.50** postpaid

## Hydraulic Control Valves Brand New



1. Four-way control valve with built-in relief valve, for use with double action hydraulic cylinder, may be used with 1500 P.S.I. hydraulic system to open and close hydraulic cylinders.

Brand new. Ship. wt. 4 lbs. A \$38.00 value. . . . . **\$7.95** postpaid

2. Four-way control valve for use with two hydraulic double action cylinders. Each cylinder may be operated independently of the other or in conjunction with the other. Oil may be locked in any of the cylinders to hold the piston at any required position. Brand New. Ship. Wt. 6 lbs. A \$60.00 value. . . . . **\$10.95** postpaid

3. A two cylinder double action valve with a unique arrangement, allowing the operator to raise both cylinders simultaneously, to lower them simultaneously or to raise one and lower the other at any predetermined rate and speed. Brand New. Ship. Wt. 8 lbs. A \$75.00 value. . . . . **\$14.95** postpaid

BRAND NEW

## Vickers Heavy Duty HYDRAULIC PUMP



For tractors, bull-dozers, construction machinery, lift trucks, industrial applications, etc. Used on Ross carriers. Delivers 18 gal. per minute at 1000 P.S.I. at 1200 R.P.M. using 10 H.P. Has 1 1/2" intake; 1 1/4" outlet; threaded and keyed 3/4" shaft for direct or pulley drive. Wt. 40 lbs. Dimensions: 5 3/4" diameter, 7 1/2" high. Original value \$148.00. NOW . . . . . **\$39.50**

F.O.B. Chicago

## Brand New Vickers Heavy Duty HYDRAULIC CONTROL VALVE

This Vickers heavy duty 4-way control valve, Part C-2330, is ideal for use with the Vickers Heavy Duty Pump for double action cylinders. Has built-in relief valve with 50 to 1000 lbs. per sq. in. overload adjustment; max. capacity 24 GPM; pressure inlet connection from pump 3/4" pipe thread; cylinder connections 3/4" pipe thread; discharge connection to tank 1 1/4" pipe thread; Over. dimen.: 8 3/4" W. x 10 7/8" L. x 7 5/8" H. Ship. wt. 54 lbs. ORIGINAL COST MANY TIMES MORE. . . . . NOW **\$24.95**

F.O.B. Chicago

ORDER DIRECT FROM AD  
Send payment or purchase order today  
SATISFACTION GUARANTEED

## GROBAN SUPPLY CO.

1507 SOUTH MICHIGAN AVE.

Chicago 5, Ill. Dept. **PM-1**

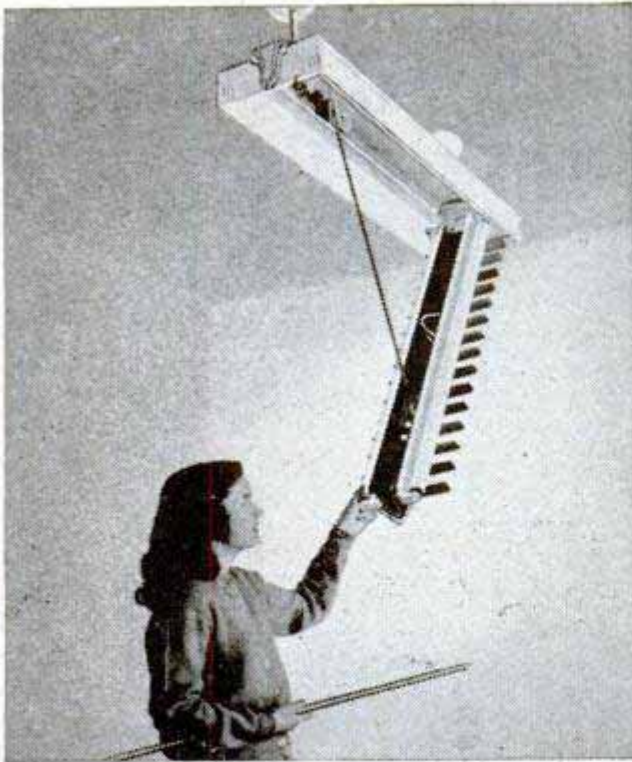

### Hinged Ceiling Light Pulls Down for Cleaning

Stepladders are unnecessary for maintenance work on a ceiling fluorescent light that is hinged at one end, permitting the reflector assembly to be pulled down with-

in easy reach. A lightweight maintenance rod is used to raise and lower the assembly. Tubes and starters can be changed quickly and the entire reflector unit can be removed and washed at floor level.

### Paint-Plaster Substitute

Surfaces need not be plastered or painted when finished with a new wall coating made of soybean oil, styrene, silica sand and pigment. The heavy coating has a sandy texture and will adhere to porous materials such as wallboard, concrete block and brick as well as polished surfaces such as glass and aluminum. No prime coat is required and the liquid can be applied to interior or exterior surfaces with a paintbrush or sprayer.

### Wallpaper Border for the Nursery

Produced by a new process that permits printing a 100-foot roll without repetition of design, two novelty wallpaper borders contain pictures and rhymes of interest to children. Designed for children's rooms, the borders come complete with paste and instructions. They are said to be of interest to children from 18 months to 10 years and are long enough to go around a room without any design being repeated.

# GLOWS IN THE DARK

## AN EASY WAY TO MAKE BIG MONEY

Be the first to sell sensational luminous house numbers, light switch plates, wall protectors, cord pulls, etc. Also luminous pictures, statues, decals, and a host of religious, nursery and other objects THAT GLOW IN THE DARK. Sell on sight. GET INTO THIS NEW AND GROWING INDUSTRY. ENORMOUS DEMAND... NO COMPETITION... BIG PROFITS. Represent a large manufacturer, established over 34 years. WRITE AT ONCE for liberal MONEY-MAKING offer and FREE SAMPLE to show you how they GLOW IN THE DARK. MADISON MILLS, 303 Fourth Ave., Dept. N-4, New York 10, N. Y.

Write for Free Sample!

## GIVE YOUR CAR THE "WOLF CALL"

### of Deep Tone DUAL MUFFLERS

The rich, low, mellow sound of "straight thru" ADVANCE mufflers is something all your friends will admire.

Also greater power, speed, and economy result from the reduced back pressure of this scientific design. Rugged steel tube throughout (no aluminum); blowout-proof.

**SIMPLE TO INSTALL.** No welding, cutting, or holes to drill. Complete with rubber mounted clamps (no rattle) and all necessary fittings.

**ADVANCE MUFFLERS, 6800 S. Vermont Ave., Dept. PM-19, Los Angeles 44, Calif.**  
 Send Check, Money Order, or we will mail C.O.D.  
 You pay postage upon receipt.

Dual Muffler Set (Ford, Mercury only)	\$20.00 <input type="checkbox"/>	Single Muffler (other makes)	\$5.50 <input type="checkbox"/>
Single Muffler (Ford, Chev., Plym.)	4.86 <input type="checkbox"/>	2 1/2" Chrome tail pipe tips	1.75 <input type="checkbox"/>

Car make \_\_\_\_\_ Year \_\_\_\_\_ Model \_\_\_\_\_  
 Name \_\_\_\_\_  
 Address \_\_\_\_\_ City \_\_\_\_\_ State \_\_\_\_\_

ADVANCE MUFFLERS

6800 S. Vermont Ave., Los Angeles 44, Cal.





Many a business saves time and cuts costs, by using a Delta-Milwaukee Scroll Saw.



A Delta-Milwaukee Scroll Saw is first choice of hobbyists who know the deep satisfaction that comes from using quality tools.



**\$94.00\***  
without motor or switch

Get *any* speed you need . . . from 650 to 1750 cutting strokes per minute . . . with a **DELTA-MILWAUKEE®** Variable-Speed 24" Scroll Saw

**Cuts wood, light metals, plastics, hard rubber, asbestos, bone, hard leather, etc.**

Preferred by those who know fine tools:

- Airports
- Cabinet Makers
- Carpenters
- Department Stores
- Display Shops
- Hobbyists
- Hotels
- Model Builders
- Pattern Makers
- Schools
- Sign Shops
- and others!

Convenient ball crank helps you pick the exact speed you require: High speed for fine work. Low speed for heavy work. Any speed in between.

That's an advantage the Delta-Milwaukee Variable-Speed Scroll Saw provides—one that is missing in machines with a limited speed range that is too slow for some materials and too fast for others.

There are other reasons why this quality scroll saw is so well known for accuracy, speed, and long life. These are just a few:

- Timken tapered-roller bearings are automatically lubricated from splash system in crankcase.
- Table tilts to right and left — and to front, for side-wise cutting as well as straight cutting.
- Spring hold-down tilts with table. It is effective on bevel cuts as well as on straight cuts.
- Continuous-flow air pump drives directly from crankshaft independent of blade, thus eliminates a source of blade breakage.

Ask your nearby Delta distributor for the whole story on the Delta-Milwaukee Variable Speed-Scroll Saw. And have him show you the complete line of dependable, low-cost Delta-Milwaukee tools that he has on display.

\*Prices subject to change without notice

**\$235.75\***

without motor or switch rod



You can cut work up to 1 3/4" thick. Distance to the overarm is 24" — big capacity for all kinds of jobs.



Universal chuck will take jeweler's blades, pin blades, saber blades, sanding drums, and round-shank files up to 3/4" dia. shank, without extra attachments.



You can adjust tension spring over saw blade to suit type of blade used. Graduations on tube permit accurate settings.

Two machines mounted together — to save space, time, and money  
**DELTA-MILWAUKEE SAW-JOINTER COMBINATION**

Circular saw and jointer mounted on one steel stand and driven by same motor. Both may be operated singly or together. 10" saw blade cuts 3 1/4" stock. Rips to center of 50" panel. Jointer surfaces boards 6" wide; cuts rabbets 1/2" deep. Both tools have lubricated-for-life ball bearings. See this machine at your Delta distributor.

Look for the name of your Delta distributor under "Tools" in the classified section of your telephone directory.



Send for free catalog!

**TEAR OUT COUPON AND MAIL TODAY!**



**DELTA MANUFACTURING DIVISION**  
Rockwell Manufacturing Company  
682A E. Vienna Ave., Milwaukee 1, Wis.

Send me free copy of Delta-Milwaukee Catalog B-48.

Name.....

Title.....

Company.....

Address.....

City..... (.....) State.....

HM-64

# Sockurls

Thrive  
on nuts!



You'll never be "out on a limb" for the right nut turner if you standardize on speedy Proto socket wrenches. They're accurate, thin-walled and extra strong. And they're available in all common sizes. Be as thrifty as a squirrel and buy these sockets, along with their handles and attachments — or complete sets — from your Proto dealer. Remember —

**Tools you need...  
we make!**

Write for catalog



4888



**Mfd. by PLUMB TOOL CO.**

2255-Z Santa Fe Ave., Los Angeles 54, Calif.

## Ceramics Is a Family Affair . . .

(Continued from page 119)

ceramists until Virdie Price came up with an answer. She dips cotton lace into a mixture of clay and water, sometimes rolling it in with a rolling pin to get complete impregnation. Then the lace is attached to the vase or figure and placed in the kiln. The heat burns out the cotton, leaving the clay design in place.

In spite of her commercial ceramic business, Miss Price finds time to hold morning classes in ceramics. Her students buy clays and other supplies from her at retail, purchase numerous objects in biscuit form and pay standard fees to have their work fired in her kilns. It's a profitable side line that she recommends to others.

Some potteries regard the formulas for their clays and glazes as trade secrets. Most supply houses sell standard formulas. Individuals then can experiment with variations to find materials that can be cast with especially thin walls or superior strength and resonance. One essential is that the clay body and the glaze both have the same coefficient of expansion; otherwise, the glaze develops many fine hairline cracks, or "crazes," after firing.

Original clay models can be fired provided they have thin wall sections or have been hollowed out so they won't crack in the kiln. For production of dozens or hundreds of duplicates, the ceramist usually uses the "slip casting" method, which is the Maxwells' technique.

After Maxwell has turned a solid plaster model of a mug on his lathe he makes a plaster mold of this model. The mold can be taken apart in three or more pieces. Its inner walls form the outer walls of the completed mug. "Slip" is the trade name for a gravylike mixture of clays, water and other ingredients. It requires a great deal of study and experimentation to develop the clay body that is ideal for a particular piece. To make a casting, the Maxwells pour slip into the mold. The plaster walls of the mold absorb the water in the slip, gradually forming a crust. When this crust is as thick as the walls of a mug, they merely pour the rest of the slip out of the mold and they have both inner and outer walls formed. The thickness of the piece depends on the length of time the slip is left in the mold. This process requires a great deal of patient experimentation before the results are satisfactory.

After the fragile casting is dry, it is carefully surfaced and fired in the kiln. The resulting "biscuit" of burned clay now is

(Continued to page 264)

# BALL BEARING STEEL WHEELS

Complete With Wheels, Tires & Bearings Made To Outwear Other Type Wheels

SIZE	TIRE	BEARINGS	LOAD Lbs.	ONE	TWO	FOUR
6" x 2"	Solid	Ball 1/2", 5/8"	300	\$ 3.25	\$ 6.25	\$12.00
8" x 2"	Solid	Ball 1/2", 5/8"	250	\$ 4.25	\$ 8.00	\$15.50
10" x 1 3/4"	Semi-Pneu.	Ball 1/2", 5/8"	125	\$ 3.00	\$ 5.50	\$10.50
10" x 2 1/2"	Semi-Pneu.	Ball 5/8"	250	\$ 5.50	\$10.00	\$19.00
12" x 2 1/2"	Semi-Pneu.	Ball 1/2", 5/8"	150	\$ 5.50	\$10.50	\$20.00
12" x 2 1/2"	Semi-Pneu.	Ball 1/2", 5/8"	225	\$ 5.75	\$11.00	\$21.00
12" x 3"	Semi-Pneu.	Ball 1/2", 5/8"	340	\$ 8.50	\$16.00	\$31.00
16" (4.00x8)	Pneumatic	Roller 3/4"	520	\$12.50	\$24.50	\$48.00
16" (5.00x8)	Pneumatic	Ball 3/4"	375	\$13.00	\$25.50	\$50.00

NOTE: Other wheels from 3" dia. to 23" with loads from 100 lbs to 1700 lbs. in fibre, solid rubber, semi-pneu., pneumatic 2 to 8 ply, axles to match.

## ORDER NOW

Add 10% for Prepaid Shipment in U.S.A.  
25% DEPOSIT ON C.O.D. ORDERS

Descriptive Circulars and Lists of our products will be mailed promptly if you enclose 10 cents in your letter.

## The New 1949 Model "E" CHASSIS

• TWO PASSENGER •  
36" Wide x 76" Long

COMPLETELY ASSEMBLED with 14" Steering Wheel and Dual Brakes  
**READY TO RIDE**

12" x 3" Wheels  
Semi-Pneumatic Tires

Built-In . . . Spillproof and Roadability . . .

Complete as Shown ONLY \$99.50 (Plus \$6.50 crating)

Model "E" Gift Kit . . . Same as Above Unassembled . . . ONLY \$79.50 (Plus \$4.50 crating)

FOR ADULTS or CHILDREN . . . A Splendid Father and Son Project. Can be purchased with Pneumatic High Speed Wheels. Also complete Model "D" 40" x 90" with 7.7 H.P. Engine.

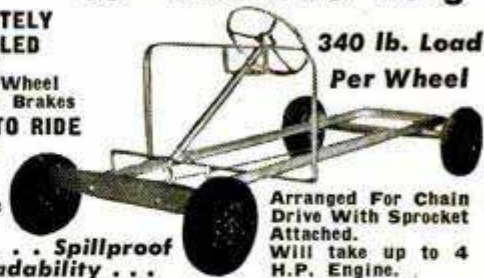

340 lb. Load Per Wheel

Arranged For Chain Drive With Sprocket Attached. Will take up to 4 H.P. Engine.

OSBORN WHEEL COMPANY, 115 So. Main St., Dept. P-1, Doylestown, Penn. Now Make Him Real Happy

"I'LL TAKE THE WHITE ONE EVERY TIME!"



**WYTEFACE**  
TRADE MARK  
**STEEL MEASURING TAPES**



KEUFFEL & ESSER CO.



for All Autos, Trucks, Tractors  
Pat'd and Pat. Pend.

### A SURE CURE for Cold Weather Starting... the new SHUR-HETE Motor Water Heater

Install a Shur-Hete unit on your engine—plug it into a 110 volt A.C. outlet and your car will start easily and quickly, even on the coldest mornings. Why? Because the water around the sealed electric element is heated, causing automatic circulation which keeps the entire engine block warm; therefore the oil in the crankcase and around the cylinder walls is always free-flowing.

Easy to install—Any garage mechanic can install a Shur-Hete in a short time. 1/4" connections into head block and into drain plug opening are all that are necessary. Fittings included—nothing else to buy.

Dealerships Open!

**JOHANSON MOTOR HEATER CO.**  
817 W. Webster St. Chicago 14, Ill.



### Save Time and Money with Shur-Hete!

Eliminate run-down batteries . . . towing charges . . . needless engine wear . . . and wasted gas.

Uses only 1/3 to 1/2c electric power per hour.

Safe to use with any standard anti-freeze.

Will not overheat engine or burn out.

#### GUARANTEED!

Shur-Hete Outfits for Autos only \$12.50

Truck and Tractor Outfits—\$13.50

Important: Give make and year of auto, truck or tractor. Shipped parcel post prepaid if remittance is enclosed; otherwise COD with postage added.

## Sensational New Electric ① WELDER ② CUTTER!

**BOTH only \$15**

USES 110-115 AC or DC • WELD-BRAZE-CUT-SOLDER-HEAT TREAT

The WELDRITE combination—tested and proven by countless commercial and amateur users, is now offered direct to you at the amazingly low price of only \$15.00. No Gas—No Gauges—No Spark Lighter needed. Always ready for immediate use—Just plug WELDRITE into 110-115 AC or DC outlet.

Uses standard welding and brazing materials available at all welding supply stores. WELDRITE furnished complete with Converter Unit #1 Single Holder with attached Alligator clip, for welding metal up to 3/8" thickness, using up to 3/8" rod, and #2 Double Holder with Copper Coated Dual Carbon Electrodes for Cutting, Brazing, Heat Treating, Soldering, etc. Starting welding materials and instructions included.

Ideal for home workshop. Invaluable for body and fender shops, garages, repair and machine shops, manufacturers, etc.

### SEND NO MONEY! 10 DAY TRIAL OFFER.

Order your WELDRITE Electric WELDER-CUTTER C. O. D. today. Pay postman \$15 plus postage charges (wt. 5 lbs.) or send \$15 and we will pay postage. Either way, if not satisfied, return WELDRITE in 10 days, and money will be refunded. WELDER HOOD—Approved lens found in hoods costing to \$10—only \$3.95. Free Folder on Request. California order please add 2 1/2% sales tax.

**CALIFORNIA TECHNICAL PRODUCTS CO.** 448 So. Hill St., Dept. A-1 Los Angeles 13, Calif.



# Last Year's Profit \$3,000!

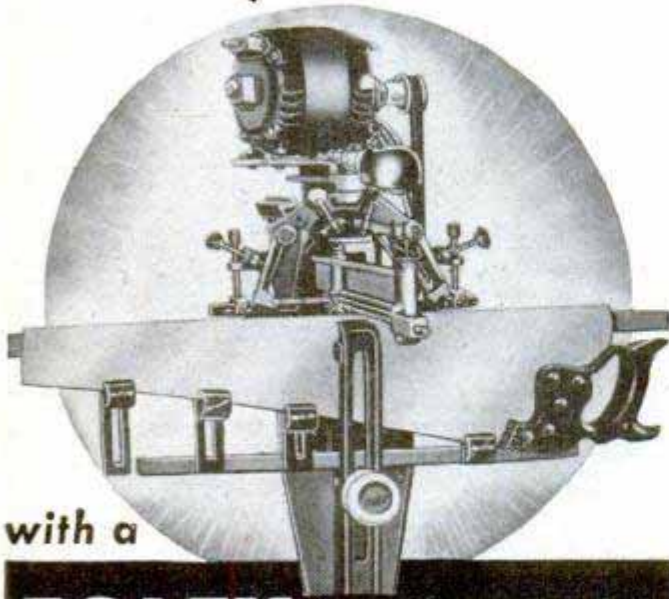

with a

## FOLEY automatic SAW FILER

"Last year's profit amounted to \$3000. Not so bad for a one-man outfit"—from C. C. H., Penn. From Ohio J. B. W. wrote us—"I made \$765 last year filing saws, and it sure comes in handy. I do this work in my spare time." Men in communities of all sizes make up to \$2 or \$3 an hour with the Foley Saw Filer working full time or part time. That extra money comes in mighty handy in these days of rising prices.

It's no trick to take care of the saw filing for your neighborhood hardware or lumber dealer—plus looking after the saws for farmers, townspeople, manual training departments and factories. The Foley files all hands saws, also band and cross-cut circular saws. It's a cash business, no canvassing, no eyestrain and no experience needed.

### FREE BOOK Shows How to Start

INDEPENDENCE AFTER 40 shows just how you can start at home in your spare time work—in your basement or garage. It's an immediate cash business that can develop into a full-time repair shop.



Send For **FREE BOOK**

FOLEY MFG. CO., 116-9 Foley Bldg.  
Minneapolis 18, Minn.

Send me free book "INDEPENDENCE AFTER 40."

Name \_\_\_\_\_

Address \_\_\_\_\_

decorated with mineral-oxide pigments. All of the Maxwells' work is hand decorated, but commercial stock transfers can be purchased at supply houses. After a coating of glaze has been applied, the piece goes back into the kiln again for a final firing. This turns the dull colors of the pigments into bright shades and converts the glaze into a glasslike surface.

Ceramics is a popular subject at night-school classes and at high schools and universities. The University of Southern California has a complete ceramics department under the direction of Glen Lukens, famous ceramic artist. Students come from every state to study under him. They learn that clays must be mixed thoroughly and then screened through a fine mesh to avoid lumpiness. They learn that clay always shrinks in drying and that no ceramic object is as large as the model from which it was cast. They learn never to leave a sharp edge on a clay piece because it will become needle-sharp when glazed and fired.

Finally, they learn that each step in ceramics is the most important. A mistake anywhere along the line can spoil a piece; perfect control can produce a gleaming piece that would be the pride of any professional ceramist.

## A Cave Gives Up Its Secrets

(Continued from page 129)

at Ventana was the piecing together of facts to reconstruct life as the ancients lived it.

"We can be sure they were gentle folk," Haury says. "Plainly they enjoyed a good family life, loved their mates, loved their children, worshipped in the simple ways they knew.

"They lived and let live, without greed, for their relics show many tools for grinding food and making household goods but relatively few weapons. Most of the weapons, moreover, were such as might have been needed for hunting, not defense.

"Of food, there was abundance. They enjoyed squash, corn, beans, cactus fruits, the meat from deer, sheep, gophers, rabbits and desert tortoises.

"We know they dressed well but did not overdress. Men wore only breechcloths and sandals. Women wore exquisite materials loomed in a complicated, open design. In winter, the ancients added blankets; we found well-preserved ones of woven yucca fibre with rabbit fur twisted around it, soft and warm.

"Burial pillows were found intact under the mummies' heads. We found bone awls

(Continued to page 266)

# Here are Real **WAR SURPLUS BARGAINS!**



**BALL BEARING ARBORS**

(A) Grinding and saw arbor. Has 1/2" double end shaft, 10" long with 2" center pulley. New Departure double roll precision ball bearings. Right and left hand thread. Self-aligning Dodge pillow block. 10,000 RPM Bearings alone list at \$10. Complete arbor new. Stock #305. . . . . only **\$495**

(B) DELUXE version of above arbor—has 2 and 3 inch center step pulley and 2 1/2" heavy cast aluminum pillow block. Brand new. Stock #306. . . . . only **\$595**

(C) HI-SPEED GRINDER. Heavy duty, ball bearing with heavy aluminum casting. 2 step pulley driven thru the rear or base. Precision spindle. 17" long by 3/4" or 5/8" shaft (specify size desired). 6" from base to center of spindle. Ship. wt. 12 lbs. Stock #328. NEW. . . . . only **\$1095**

**Electric Rubber Cable (ALL NEW) CORD SETS**

Extension cords, 100 ft. heavy duty. Plug, socket and guard. Number 18 wire. Worth at least \$10. OUR PRICE. . . . . **\$535** (Stock #310)

Same as above—50 ft. length. (Stock #311). . . . . **\$385**

**HEAVY DUTY ELECTRIC CABLE**

3 wire #10 rubber Tyrex cable—with lugs. 65 ft. lengths. Stock #365. NEW. . . . . **\$1300**

3 wire #10 submarine cable and lugs—can be placed underwater, underground or overhead. Also for portable tools. Will carry 40 amps. Stock #312

50 ft.	100 ft.	250 ft.	500 ft.
\$12.00	\$20.00	\$45.00	\$85.00

4 conductor neoprene covered #18 stranded tinned copper wire (two blacks & two whites). Run in parallel gives you #16 gauge. Lugs furnished for parallel run. Water & oil resistant. (Stock #346).

100 ft.	250 ft.	500 ft.	1320 ft. reel
\$4.25	\$10.00	\$19.00	\$36.00

150 ft. reels, 3 wire #8 with 4. 60 amp Crouse & Hines connectors—2 male & 2 female. Perfect for welders, hay loaders, saws, electric ranges, etc. List price \$285.00. Used—like new. OUR PRICE. . . . . **\$6500** (Stock #313)

**JARVIS GRINDERS**

2 HP, 60 cycle, 220-440 volt, 3450 RPM. Totally enclosed G.E. motor with 6 ft. flexible shaft. List price \$285.00. Used—like new. (Stock #326). . . . . **\$8500**

AS ABOVE with 1 1/2 HP motor (Stock #330). . . . . **\$7500**

AS ABOVE with 1 HP motor (Stock #331). . . . . **\$6500**

**HORNS and HOWLERS**

Motor driven (not a vibrator). Heavy duty with great power and long life. Adjustable for high, medium or low tone. 110 volt AC current. Weather proof. For alarm or signal horn on boats, school yards, factories, etc. List price \$47.00. OUR PRICE. . . . . **\$945** new. (Stock #302)



**AC ARMY LIGHT PLANTS**

New 750 watt 110 volt 60 cy. light plant with Briggs-Stratton model AP gas engine. (Stock #315). . . . . **\$14500**

New 1000 watt 110 volt 60 cy. light plant with Briggs-Stratton model BP gas engine. (Stock #316). . . . . **\$17500**

New 2500 watt 110 volt 60 cy. light plant Briggs-Stratton model Z. 5 HP gas engine. (Stock #317). . . . . **\$26500**

Add \$10 for spare parts and tools.

Rebuilt 5000 watt 110 volt 60 cy. light plant with automatic remote control. Powered by Jeep 4 cyl. gas engine. Rebuilt like new and guaranteed. (Stock #318). . . . . **\$62500**

7,500 watt, 110 volt AC light plant powered by VE-4 Waukesha 4 cyl gas engine, Continental or Hollinsworth generator. Remote control starting with 100 ft. starting cable, and 100 ft. of 3 wire #6 cable. Complete switch board. Used, like new and guaranteed. (Stock #347). . . . . **\$67500**

Add \$65.00 for transformer to make plant 3 phase 220 volt.

10,000 watt 110 and 220 volt 60 cy. light plant with automatic remote control. Powered by Jeep 4 cyl. gas engine. Rebuilt like new and guaranteed. (Stock #319). . . . . **\$90000**

**PORTABLE DC LIGHT PLANT**

3000 watt 110 volt DC powered by new 6 HP Briggs-Stratton model ZEP gas engine. Rebuilt generator. Generator alone lists at \$243.00. Has volt meter, rheostat, 4 female plugs, and ball bearing 2.75 x 10 rubber wheels. Guaranteed. (Stock #320). . . . . only **\$16500**

**GENERATORS**

DC—3000 watt, 110 volt. Has voltmeter, rheostat & 4 female plugs. Lists at \$243.00. (Stock #321). OUR PRICE **\$6000**

AC—750 watt 110 volt 60 cycle with voltmeter, rheostat, 3/4" shaft. Dimensions: 9" H x 12" W x 13" L. Wt. 52 lbs. Shielded to prevent radio interference. Mfg. by Elcor. \$125.00 value. **\$4950** OUR PRICE, new (Stock #322)

DC—300 watt, 12 volt, 2900 RPM. Heavy duty, with current cut-out relay, high and low switch, 30 amp meter, charge and discharge, Mfg. by Marathon Electric Co. 3/4 HP gas or 1/2 HP electric motor will drive it. Can be bought less shaft and base to be used direct mounted to Briggs-Stratton 1 HP engine. (Stock #323). NEW. . . . . **\$700**

Complete with base, shaft and bearing. (Stock #324). NEW. . . . . **\$1595**



**HALF TON WAGON**

Heavy duty utility wagon with plate aluminum body 24" x 42". Sides 5 1/2" H. 3/8" steel axle with ball bearing wheels and Goodrich puncture proof balloon tires, 23 1/2" W x 10" dia. Has heavy steel under frame. Will carry 1,000 lb. load. Wide tread tires for mud, snow, gravel, etc. Will not mar floors. Ideal for newsboys, farms, grocers, factories, etc. Approx. wt. 80 lbs. Nothing like it now on the market. Sold complete or in 5 different kits: wheels only; wheels & frame; wheels, frame & platform or body. WRITE FOR FREE CIRCULAR. (Stock #332)



**Electro-Lift HOIST**

500 lb. Electro-Lift Hoist. 17 ft. of cable—up and down button and trolley. 3 phase, 220 or 440 volt, 60 cycle. Used, in A-1 shape. List price \$185.00. OUR PRICE. . . . . **\$9000**

Stock #301. Specify 220 or 440 volt

**Automatic AIR COMPRESSOR**

Complete. Piston type with 10 gal. tank, 1/2 HP capacitor type, AC, 110-220 volt 60 cycle motor—approx. 2 cu. ft. Brand new. **\$7950** (Stock #340). . . . . only

**Assemble yourself and save \$10.**

ABOVE tank with legs and saddle. . . . . **\$1195**

AS ABOVE—1/2 HP motor, 2 cyl. Westinghouse compressor. 3 CFM at 75 lbs. . . . . **\$10950**

**Portable AIR COMPRESSOR**

Electric motor driven, portable spray painting unit for jobs requiring a larger quantity of material. Piston type, single cyl. air compressor has 2" bore by 1 3/4" stroke. 2.86 CFM. Max. working pressure 40 lbs. Mounted on base. Equipped with safety valve & drain cock. 1/2 HP capacitor type motor, 110 volt AC, with cord and plug. 20 ft. air hose and fittings. Ship. wt. 45 lbs. Brand new. (Stock #348). . . . . only **\$4250**

**Westinghouse AIR COMPRESSOR**

Brand new piston type, 2 cyl. compressor with automatic clutch. Westinghouse model T-1. Can be run off power take-off or 1/2 HP motor. Delivers oil free air. Suggested operating pressure, 75 P.S.I. Approx. displacement 3.27 CFM at 600 RPM. Ideal for spraying, industrial work, tire inflation, painting, etc. Approx. wt. 23 lbs. (Stock #345). . . . . only **\$2250**

**KELLOG AIR COMPRESSOR**

Kellog Model 241 air compressor. Piston type with 2" x 1 3/4" bore. Capacity of 2.8 CFM at 100 lbs. V-belt drive, 3/4" shaft. Can be run with 1/4 or 1/2 HP motor. Delivers oil free air. Max. recommended working pressure 150 lbs. (Stock #349). NEW. . . . . only **\$1495**

**PORTABLE BUZ SAW**

Powered by 6 1/2 HP Briggs & Stratton air cooled gas engine. Adjustable hinge, requires no clutch. 28" blade, will take up to 12" hardwood. 1 3/4" ball bearing mandrel. Has power take-off. Complete unit mounted on two wheels with 400 x 8 pneumatic tires. Has tow bar for trailing. Wt. approx. 400 lbs. Sold complete or less blade, engine or wheels. Make \$25 to \$50 a day sawing wood with this sturdy unit. WRITE FOR FREE CIRCULAR. (Stock #350)

**ALL ITEMS GUARANTEED C & H ELECTRIC Co. AS REPRESENTED**

434 W. JUNEAU AVE. MILWAUKEE 3, WISCONSIN

All prices F.O.B. Milwaukee. 25% deposit required on all C.O.D. orders. No C.O.D.'s under \$10.00. Use stock number when ordering. Many other bargain items not listed—write for our free circulars.

**WOODWORKERS—CRAFTSMEN**  
*Here is the Greatest*  
**MASTER MANUAL**  
*I have ever offered*



ALBERT  
 CONSTANTINE, JR.

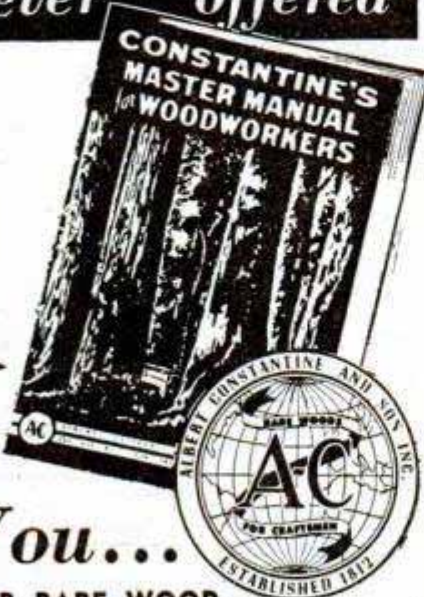

*Gives You...*

**NATURAL COLOR RARE WOOD IDENTIFICATION CHART** featuring 60 different woods, (suitable for framing). **8 PAGES IN FULL COLOR OF INLAYS AND BORDERS, 7 PAGES ON HOW TO MAKE INLAY PICTURES. COMPLETE STORY OF RARE WOODS AND OTHER INTERESTING, HELPFUL ARTICLES PLUS**

**A MULTITUDE OF MATERIALS**

- |                        |                           |
|------------------------|---------------------------|
| Rare and Fancy Veneers | Plastics and Supplies     |
| Lumber and Plywood     | Period Furniture Hardware |
| Inlays and Borders     | Casters and Gliders       |
| Inlay Pictures         | Hinges and Locks          |
| Finishing Materials    | Musical Movements         |
| Tools, Hand and Power  | Bed Hardware              |
| Veneer Press           | Moulded Wood Carvings     |
| Instruction Articles   | Jewelry Findings          |

**GREATEST SOURCE OF SUPPLY FOR**

... woodworking needs. Materials, hand and power tools, hard-to-get furniture hardware, fittings, locks, hinges, etc., etc. Dozens of plans from simple pipe racks to complete furniture sets. Acclaimed the greatest book of its kind ever offered. Send only 25c today and I will include free with each copy of my **MASTER MANUAL** a full year's subscription to "Chips and Chats", an interesting and newsy publication of craftsmen projects, activities and current bargains in tools.



**SEND THIS COUPON NOW**

Albert Constantine and Son, Inc.  
 791M 135th St., New York 54, New York.  
 Enclosed is 25c for a copy of your "MASTER MANUAL" with which I get FREE one Year's subscription to "Chips and Chats".

NAME .....

ADDRESS .....

CITY..... ZONE..... STATE.....

and cactus needles with cord still threaded. Such items had not decayed over the centuries because of the moisture-free soil and air of Ventana."

For the first time, we have learned accurately what the ancients actually looked like. At Ventana were found 40 skeletons and mummies, some in excellent preservation, dating from at least 6000 B.C. to 1400 A.D. Those of 6000 B.C. and prior had long heads, in contrast to the intermediate-long heads and the round heads of men in later centuries. In the university museum at Tucson is a bust of a man, carefully restored. This citizen of Ventana, of about 1000 A.D., was a dark gentleman of medium build with long, coarse hair and a refined face, obviously far removed from savage life.

"His tribe was so much like our Papago Indians of today," says Haury, "that I am sure they were Papago ancestors. The earlier roundheads are a linkage with the Pueblo Indians of northern Arizona and New Mexico. The variations undoubtedly mean that Ventana saw a changing population, a mixing of races, and an extension of Folsom people there in some period."

**Fluidless Lighter for Gas Lanterns**

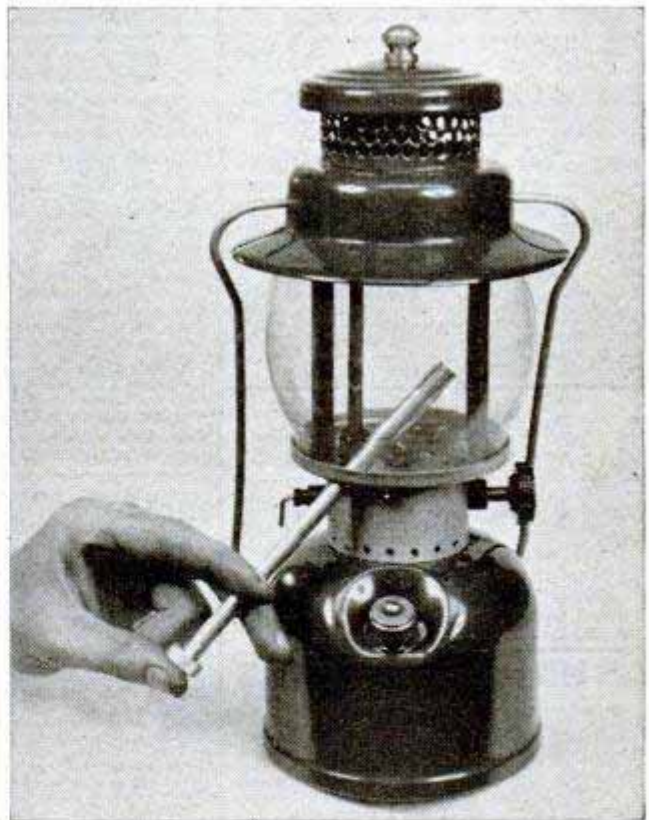

Operated by one hand, a fluidless flint-type lighter ignites gas-burning lanterns, driers, stoves and furnaces. The other hand is free to make burner-valve adjustments. A spare flint is carried in the lighter barrel.



# Every Feature You Want For Fast, Accurate Sawing

## Atlas 8" and 10" TILT/ARBOR SAWS

★ Blade tilts 45° — Table stays flat

★ Big precision-ground grey-iron table

★ Quick-positioning Rip Fence — Vernier adjustment

★ Precision Ball Bearings



**10"  
SAWS**

No. 3060 has 25" x 22" table — 12 3/4" ahead of blade, 12 1/2" from blade to fence. Cuts 3 1/4" deep. Has dual V-belt drive. Comes ready to run, less motor, for..... **\$115.00**



**8"  
SAWS**

No. 3020 has 22" x 18" table with 10 3/8" ahead of blade, 9 1/2" from blade to fence. Cuts 2 3/8" deep. Comes fully equipped, less motor, for only..... **\$89.75**

Any man looking for the best in equipping his shop will find *everything* he has in mind in these new Atlas saws.

Here are the new standards for saw equipment. Whatever you want to do — build a house, or make your own furniture — these saws will do the job to perfection.

They are built to full industrial quality standards — are used now by many commercial woodworking shops.

And they come to you at unusually low prices.

See them at your Atlas distributor's. Note the large *precision-ground grey-iron table* — the *tilting arbor* for angle cuts so that the *table is always flat* — the ball bearing equipped arbor. Try the new type *instant-positioning rip fence*, the smooth controls.

You'll quickly see why so many of America's foremost shop owners say, "Atlas is the saw for me."



### TABLE EXTENSIONS

No. 3243 for 10" saws adds 11 3/4" to width — gives 24 1/4" blade to fence and/or 19 3/4" left of blade, each \$15. No. 3240 for 8" saws adds 8 3/4" to either or both sides, each..... **\$12.75**

**SEND THIS COUPON**

All prices are F. O. B. Kalamazoo. Atlas motors available at low cost.

I am interested in the Atlas tools checked. Please send catalogs.

8"-10" Saws  Metal Lathes   
24" Jig Saw  12" Wood Lathe   
Drill Presses  Spindle Shaper   
Belt and Disc Sander

Name \_\_\_\_\_

Address \_\_\_\_\_

City, State \_\_\_\_\_

### Atlas TOOLS FOR YOUR SHOP



24" Jig Saw



Spindle Shaper



6"-10" Lathes



Drill Presses



Belt, Disc Sander



12" Wood Lathe

## ATLAS PRESS Company

143 N. Pitcher Street • Kalamazoo, Mich.



MATCHED PRECISION TOOLS FOR  
WOODWORKING AND METALWORKING

# PLASTI-LINER

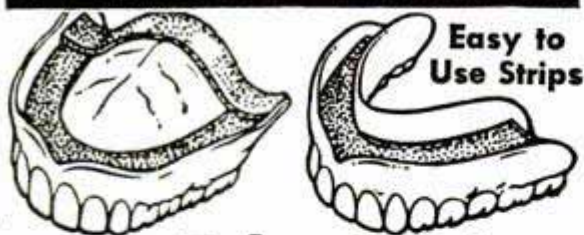

Easy to Use Strips

## Makes False Teeth Fit For the Life of Your Plates

If your plates are loose and slip or hurt, use this amazing, pliable, non-porous strip to refit them yourself, for instant and permanent comfort. It's easy. Just lay the strip on your upper plate or lower plate, then bite and it molds perfectly. Hardens for lasting fit and comfort. Helps stop the embarrassment of slipping, rocking plates or the misery of sore gums. Eat anything and talk freely without fear your teeth will loosen. Ends forever the mess and bother of temporary applications that last only a few hours or months.

### Easy to Re-Fit and Tighten False Teeth

PLASTI-LINER is tasteless and odorless. Won't injure your plate. Guaranteed to give satisfaction or your money back. Removable as per directions. Users say: "Until I used Plasti-Liner I used several kinds of liners without success. Now I can eat anything." H. H. M. "My plates are now better fitting than new." E. H. C.

At Drug Stores, or write us for PLASTI-LINER today.

**SEND NO MONEY:** PLASTI-LINER to reline both upper and lower plates or \$1.25 to reline one plate. Pay Postman when he delivers. Or send money now and save C.O.D. charges. Trial size special plate cleaner included free.

PLASTI-LINER CO., Dept. 43-G, Buffalo 15, N. Y.

## Sensational Value! PAINT SPRAYER WITH ELECTRIC MOTOR

Best Results Say Thousands of Satisfied Users

Positively unheard of 'til now—an electric powered sprayer outfit at such a low price. Not a toy! Not a makeshift. It's a real, practical all-purpose sprayer outfit complete with compressor, 110 volt A.C. or D.C. electric motor, suction type, continuous flow spray gun, paint container, 10 ft. air hose, 6 ft. electric cord and plug. Use it for home shop, auto and 'round the house jobs, and do a good job—quick. Rush order today. Only \$19.95 complete. Send check or M.O. If C.O.D. send a five dollar bill for deposit. Outside U. S.—Remittance with order—\$21.95



Shipped Anywhere

Does all Ordinary Paint Spray Jobs. Uses Paints, Lacquers, Varnishes, Etc.

Complete Only \$19.95

Weights Only 8 lbs. Portable. Use it Anywhere.

**HOME SHOP PRODUCTS CO.** DEPT. 11, 4821 SHERIDAN ROAD CHICAGO 40

## SAFETY GOGGLES \$1.00



Very strong, lightweight goggles with SAFETY LENS that protect your eyes against flying particles during any mechanical operation. Frames sturdily made entirely of noncorrosive metal. Flexible temples, fully insulated. SAFETY GOGGLES WITH PROTECTIVE SIDESHIELDS. \$1.50 No C.O.D.'s. Send Ck. or M.O. to SCHUPACK SUPPLY CO., Dept. M1 7331 So. Cottage Grove, Chicago, Ill.

# ARC WELDING FOR PROFIT OR PLEASURE

60 LBS. OF READY MADE PARTS

Only \$24.95

## EASY TO ASSEMBLE!

Easy to Operate. Now you can do all-around welding on Steel, Cast Iron and other Metals. Earn BIG PROFITS. Repair AUTO, HOME or FARM EQUIPMENT. This HEAVY-DUTY Welder gives 100% penetration. OPERATES ON 110 OR 220 AC current.

Complete with Instruction Manual. You Can Do Expert Welding in a Few Hours.

Sold on 30 Day Money-Back Guarantee

FREE: WRITE TODAY FOR FULLY ILLUSTRATED BOOKLET P-1.

ATOMIC ARC WELDER CO. 1037 So. 19th St., OMAHA, NEBR.



## NONE BETTER! SUPER DRILL GRINDER



Sharpens round shank drills from 3/32" to 1/2" in diameter, up to 6" long. Grinds old drills like new in 4 different point angles, using hand or power grinding wheels. Money-back guarantee.

Price only \$2.95

At Dealers or Postpaid

CRANDALL MFG. CO. 1512 W. Slauson, Dept. FA-37, Los Angeles 44, Calif.



## BUILD FINE GRANDFATHER CLOCK NOW

The simple sensible Red-i-Kut way as thousands have—SAVE HALF. SHOP TESTED PLANS "SPIRIT OF THE CENTURY" Narrow waist 83" tall or stately "SPIRIT OF AMERICA" straight side model with pictures. EASY-FOLLOW PLANS tell all—plus BROCHURE of fine brass weight Westminster, tube chime, movements, dials and mahogany case kits. Send \$1.00 today—Both Plans \$1.50 NOW. KUEMPEL CHIME CLOCK CO., #10 Kuempel Bldg., Minneapolis 16, Minn.

## make your own Gems 29.50 F.O.B.

All necessary lapidary equipment is furnished, including a super-charged diamond blade for sawing, and all wheels for grinding, shaping and polishing; also complete instructions. The complete equipment as shown, less motor and belt, for only \$29.50. f.o.b., Burlington, Wisconsin. Write today for information and literature.

**B & I MANUFACTURING CO.** Dept. S Burlington, Wis.

## OVER 250 SURPLUS BARGAINS

Write for FREE Catalog PM-7 TODAY!

**FISLER SALES CO.** 721 Walnut Kansas City 6, Mo.



## TYPEWRITERS!

For Sale At Big Savings

ALL MAKES—REBUILT LIKE NEW

For School, Business or Home Use

Write for Information

**M. & M. TYPEWRITER CO.**

84 W. Washington St. Chicago, Ill.

## MUFFLERS

STEELS AND ALUMINUMS with a motorboat tone

SINGLES, Chev., V-8, Plymouth, Steels \$5.50, Aluminum \$7.00. Chry., Olds., Buicks, etc., Steels \$7.50, Aluminum \$9.00. V-8 and MERCURY DUALS, Steel \$17.50, Aluminum \$21.00, '49 FORD DUALS, \$2.50 extra. Split Manifold Sets, Steels \$35.00, Aluminum \$45.00. Aluminum are guaranteed for life of your car.



DEALERS WANTED

## SANDEE MUFFLER CO.

BOX 296 LA TIJ., LOS ANGELES 43, CALIF. 2624 W. SLAUSON AVE., LOS ANGELES, CALIF.





Everybody Deduct 10%  
**OUR GUARANTEE**  
**OUR TIRES** must make good  
or **WE WILL**  
**NEEDLESS TO PAY MORE**  
**RISKY TO PAY LESS**  
Send this ad with order  
**TUBE GIVEN WITH EVERY TIRE**  
You get what we advertise  
Highest Quality Lowest Prices  
Slightly Used  
**POPULAR BRANDS**—Guaranteed to give A-1 SERVICE. Do not confuse  
these tires with re-caps or re-treads.

**HIGH ORIGINAL TREADS**  
**BUY IN CONFIDENCE** safe dependable selected  
**BRANDS**—Guaranteed to give A-1 SERVICE. Do not confuse  
these tires with re-caps or re-treads.

SELECTED O.K. for  
**TOUGHEST JOBS**  
Not just good...  
**THE BEST**

These are genuine  
Values!

One Trial will  
**CONVINCE YOU**

600-16... \$5.42  
650-15... 4.92  
650-16... 5.52  
700-15... \$5.52  
700-16... 5.82  
750-16... 6.82

**TOPS IN VALUE**    **TOPS IN SAFETY**

600-16... \$6.62	700-15... \$7.62
650-15... 6.62	700-16... 7.62
650-16... 6.62	750-16... 7.62

**World's Best Truck Tire Values**  
**Top Service Minimum Prices**

750-20 (10) \$11.42	600-20... \$7.92
825-20... 14.22	650-20 (6)... 8.42
900-20... 14.22	700-20 (8)... 9.92
1000-20... 16.22	32 x 6 (8)... 10.52
1100-20... 16.22	32 x 6 (10)... 12.42
1100-22... 18.42	750-20 (8)... 10.52

750-20 MILITARY 8 PLY \$11.98  
900-16 MILITARY 8 PLY \$7.92  
**ONE QUALITY THE BEST AVAILABLE**

Thousands of tires shipped to satisfied customers. We've  
made thousands of friends. **MAIL ORDERS** given personal  
Attention. Send money order or check. Dept 2

**STANDARD 834 N. Broad St., Phila. 30, Pa.**

### Get This CLAMP-MASTER KIT!

A simple, easy, inexpensive method of  
clamping, splicing, tying, mending, and  
banding for farms, shops, garages,  
homes and industry. In a few seconds  
you can repair many objects such as  
split or break in hose, posts, ladder  
rails or tool handles. Also useful for  
splicing cables, tying conduit to pipe  
lines; maintenance work on tools, ma-

chinery, electrical equip-  
ment, buildings, fences and end-  
less other possibilities. No skill  
needed. \$9.85, complete with 45  
flat steel clamps (assorted sizes  
from 1/4" to 10" dia.), locking tool  
and instructions. Send check or  
money order. No C.O.D.'s.

**ONLY \$9.85 Ppd.**

PUNCH-LOK CO., Dept. PM, 321 N. Justice St., Chicago 7, Ill.

### NEWEST OTTAWA LOG SAW

**SELF-PROPELLED — MOVES ANYWHERE ON OWN POWER**

World's fastest Log Saw. Pow-  
erful 6 H-P air-cooled motor.  
Attachments for sawing down trees,  
buzzing limbs, post hole digging and pulley for belt jobs. Big  
demand for wood, pulp, posts. Make big money sawing wood this  
easy way. Low factory-to-user prices. Nothing like it. **FREE** details.  
**OTTAWA MFG. CO., 7-927 Pine St., Ottawa, Kansas**



### HULL AUTOMOBILE COMPASS

A travel companion  
that shows directions  
anywhere, any time. Write for Circular.  
At your dealer's. Beaconlite, illuminated,  
\$5.95; Streamline, \$3.95.

**HULL MFG. CO., P.O. Box 246-D1, Warren, Ohio**



### "EVEREADY"

**THE FLASHLIGHT BATTERY WITH "NINE LIVES"**

Recovers Power Between Uses—  
Bounces Back for Extra Life!

Save

### BUILD YOUR OWN BOAT

**BIG SAVINGS AWAIT THE HOME BUILDER THRU MARINE MART'S MAIL ORDER SERVICE**

**World Famous "PACKAGED BOAT" Kits**

18 models—outstanding design—8-18 ft.—dinghies to  
runabouts—inboard—outboard—sail. \$34.50 up.  
Finest kits available. Easy home assembly. All  
parts pre-cut, frames pre-assembled. Send 25c (coin)  
for "Packaged Boat" literature or, send \$1.00 for  
literature plus booklet, "Plywood Boats."

**BOAT PLANS—PATTERNS—100 DESIGNS**

100 modern designs by Deed, Lord, Crandall,  
etc. Planked, steel, plywood—all types—  
6 to 35 ft. Detailed blueprints, full size  
paper patterns available.

Send 25c (coin) for Catalog, or send \$1.00 for Catalog plus booklet, "Boat Building."

**MARINE MART-DEPT. 24-BUFFALO 7, N. Y.**

JANUARY 1949

### Provides PRECISION CONTROL..

because  
**FOREDOM #99**  
**FLEXIBLE SHAFT**  
**MACHINE with**  
**PENCIL-SIZE**  
**HANDPIECE..**



**KEEPS YOUR WORK WELL IN VIEW**



35"  
**FLEXIBLE**  
**SHAFT**  
**\$15.95**  
**COMPLETE**  
**WITH**  
**MOTOR**

**GRIND - POLISH - SAW -**  
**SAND - ETCH - ENGRAVE -**  
**ROUT - CARVE - MILL - CLEAN**

Use on all metals, wood, plastics,  
glass, leather, linoleum, etc.

REMEMBER that in the precision-made FORE-  
DOM you get MORE POWER—LONGER MOTOR  
LIFE because MOTOR IS NOT DWARFED TO  
FIT HAND. DOES HUNDREDS OF JOBS WITH  
MARVELOUS EASE because pencil-size hand-  
piece gets into hard-to-reach place—provides  
positive, easy, precision control.

Profit by experience of many thousands of  
Foredom users—over a quarter century experi-  
ence stands behind the product. Other  
heavier-duty models at proportionately reason-  
able prices.

No. 25 Accessory Set (a truly versatile as-  
sessment) \$5.50 extra. 6-step Foot Rheostat  
\$4.85. Over 70,000 Foredoms in use.

AND HERE'S ANOTHER AMAZING FOREDOM PRODUCT

YOUR MOTOR



**Foredom PRESTO-FLEX**  
with **PENCIL-SIZE Handpiece \$5.95**

Now turn your old motor, drill press, or electric drill into a  
Flexible Shaft Tool. Simply attach to your electric drill, drill  
press or motor. Presto—a flexible shaft machine! Off again in  
a jiffy! Pencil-size handpiece gives you finger-tip control. Gets  
into tight places you can't reach with any other tool. Handy  
35" overall length. And—only \$5.95 complete! Not to be confused  
with inferior imitations. Precision made, backed by 1/4 century experi-  
ence in this field. All parts replaceable. Order NOW. If ordered for  
use on motor, specify motor shaft diameter and add 50c for coupling.  
(Available for 1/4", 5/16", 3/8", and 1/2" shafts.) No. 50 Accessory  
Set available \$1.50 extra. Order TODAY.

### FOREDOM ELECTRIC CO., Dept. A-1113 Mail Coupon

27 Park Place, New York 7, N. Y.

Now

Please send me FOREDOMS checked below on 10-day trial.

Presto-Flex Tool (\$5.95)     No. 25 Accessory Set \$5.50

Motor Coupling (50c)     Foot Rheostat (\$4.85)

Specify motor shaft diameter \_\_\_\_\_     Free Catalog

Flexible Shaft Machine (\$15.95)     No. 50 Accessory Set (\$1.50)

Send C.O.D. plus postage. I will pay postman.

I enclose payment. Send postpaid.

(Money back either way if not delighted)

Name \_\_\_\_\_

Address \_\_\_\_\_

City \_\_\_\_\_ Zone \_\_\_\_\_ State \_\_\_\_\_

SAY YOU SAW IT IN POPULAR MECHANICS

### MARINE PLYWOOD

Plywood: Fir, hardwood. Lum-  
ber: Oak, spruce, cedar, etc.  
Send 35c (coin) for stock  
list and booklet, "Plywood  
Hints."

### MARINE HARDWARE

Complete stock of fittings, ac-  
cessories. 15,000 items.  
Prompt delivery. Send \$1.00  
for 250-page, illustrated cat-  
alog.

### CONVERSIONS

Vee- and Stern-drives; reduc-  
tion and reverse gears; Kits,  
engines, accessories. Catalog  
35c (coin). With booklet,  
"Conversion Hints,"  
\$1.00.



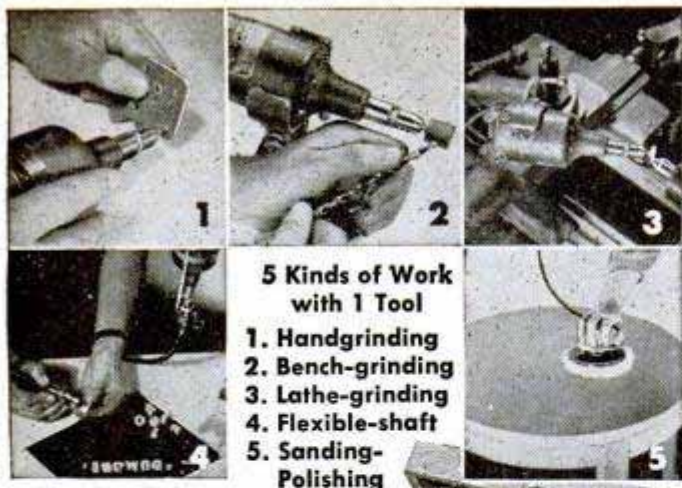

**5 Kinds of Work with 1 Tool**

1. Handgrinding
2. Bench-grinding
3. Lathe-grinding
4. Flexible-shaft
5. Sanding-Polishing

# DUMORE Duplex Handgrinder



**A versatile tool with plenty of power — to do your work faster and easier**

You can see by these pictures why home-workshop fans say, "The Dumore Duplex is the handgrinder to buy!" It's a real tool — rugged and powerful. And it's built to do everything from delicate carving in plastic and wood to tough clean-up jobs on hard weld-metal!

Just think of the advantages of these features:

1. A full 1/14 hp Dumore motor for no-stall power.
2. An extra-capacity chuck for 1/4", 1/8" and 3/32" tools.
3. Attachments that convert it instantly to Flexible Shaft Tool, Bench Grinder, Toolpost Grinder, Sander-Polisher.

It is almost impossible to list all of the hundreds of jobs you can do with this fine Dumore tool in any workshop. We hear of new ones every day from enthusiastic, satisfied users. And every job is done faster, easier, and better — thanks to the Duplex. Enjoy working with a tool that adds so much more fun to your hobby. Get a Duplex today.



**Tear out this coupon and mail today**

— for complete information on the Dumore Duplex Grinder, Flexible-shaft attachment, Handy-Sandy, Bench Stand, and Toolpost Bracket.

The Dumore Company, Dept. A-51, Racine, Wisconsin  
 Please send me the items checked:  
 Duplex Deluxe Kit with 27 accessories. \$27.50 enclosed  
 Duplex Standard Kit with 9 accessories. \$19.75 enclosed  
 Shipping Charges C.O.D. on all items  
 Complete information on the Duplex Grinder and all accessories.

Name \_\_\_\_\_  
 Address \_\_\_\_\_  
 City \_\_\_\_\_ (---) State \_\_\_\_\_

## The SPEEDY STITCHER

for repairing boots, shoes, leather coats; gloves, straps, auto tops, saddles, etc. Can be used to sew grain bags, burlap, wire cuts on horses and cattle. Sews quick and strong.



Each stitcher comes ready to use with a reel of waxed thread and 3 needles, assorted sizes. Needles are carried in handle. A handy tool for home or on hunting, fishing or camping trips.

Price Postage prepaid \$1.00.  
**LYMAN BRADFORD CO.**  
 Box #201 KINGSTON, MASS.

## Burn Your Name On Tools Electro Name Etcher Only

**Writes on Any Metal!**

Protect valuable tools from thieves or tool borrowers. Etcher burns your name, or any design, permanently on tools, instruments, dog collars, or any metal. EASY! Simple as writing with pen or pencil. Snaps on instantly to any car battery and used without removing battery from car; can also be used with dry cell batteries, or toy transformer. Rush order today. SEND NO MONEY! Pay postman only \$1.00 plus few cents postage on delivery. Use 10 days, money back if not satisfied.

**ELECTRO ETCHER** Cincinnati 26, Ohio  
 Dept. A-151, 259 Strader Ave.

## BUILD YOUR OWN ENLARGER

Enjoy Photography's most fascinating hobby at a fraction of usual cost. With simple step-by-step instructions and diagrams plus a screwdriver and pliers you assemble your own Enlarger and Saver! Get all features of more expensive Enlargers: precision machined aluminum alloy castings, 90° tilt for wall projection of prints, spherical aluminum lamphouse, helical rack and pinion focusing with extra large knobs, unconditional guarantee. For 35mm to 2 1/4 x 3 1/4 negatives. Time payment plan.

Write Today for Free Illustrated Folder  
**CALIFORNIA TECHNICAL PRODUCTS CO.**  
 448 S. Hill, Dept. M-1, Los Angeles 13, Calif.

## AIR FORCE FLIGHT BOOTS

Genuine A-6. Will keep your feet warm and dry in the coldest weather. Genuine shearling fully lined. Rubber soles and zipper closure. Reconditioned like new. State shoe size when ordering. No C.O.D.'s.  
**\$7.95** Postpaid  
**SURPLUS MERCHANDISE DEALERS, Dept. P. M.**  
 38 WEST 30th ST. NEW YORK, N. Y.



## GERSTNER Tool Chests

for protective care for the good tools of Machinists and Toolmakers. Free catalog.  
**GERSTNER TOOL CHESTS**  
 449 Columbia St. Dayton 7, Ohio

## STATION WAGONS CABS

AND BODIES FOR ALL JEEPS — WOOD OR ALUMINUM  
 Cabs in kiln dried hardwoods, bodies of aluminum. Safety glass, finest hardware, locks, full opening rear door.  
**CABS \$144.50** Plus Tax  
 FOB Cleveland. Complete, semi-assembled. Pull bodies slightly higher. Send 25% with order, balance COD.  
**STATION WAGONS, INC. (PM)**  
 6619 Euclid Avenue, Cleveland, O.



## TUBULAR STEEL AXLES \$6.95

**BUILD YOUR OWN TRAILER OR UTILITY FARM WAGON**

**58" tread width axle—1 ton capacity Fits Ford V8 or Plymouth wheels**  
 Higher tonnage axles and special tread widths available at reasonable prices. Axle also adaptable to Chevrolet wheels. Write for folder today. Send check or money order.  
**CARD BRINGS FREE FOLDER**  
**C.A.R. PRODUCTS CORPORATION**  
 1811 6th St. Wyandotte, Mich.



**FORGED COUPLER BALLS**  
 2 in. dia.  
**90c**  
 incl. Nut and washer

## AMAZING NEW SAFE JIG SAW READY!

At last—a revolutionary, new electric jig saw small children may use, yet powerful enough to be the basic tool in Dad's workshop! Make "Standing Photo Silhouettes" of favorite snap shots . . . fancy what-nots, toys, for fun and profit! Just plug in—and Saw! No motor to buy—no oiling. Thousands sold. Use in living-room, apartments, etc. Patented. Nothing else like it. Mail postal NOW for illustrated, Free Circular, low price! (Dealers write!)



SYNCRO CORPORATION, Dept. H-19, Rochester, Mich.

## BUILD HEAVY DUTY MACHINES

**SAVE UP TO 90%—** You can build, using our practical, easy-to-read plans, all kinds of machines, for home, farm or shop—scooters, portable sawmills, metal working machines, concrete machinery of all kinds, printing equipment, woodworking machines, midget autos, dish washers, farm equipment, freezers, tractors.

**FREE**

CATALOG HANDBOOK  
183 SETS OF PLANS  
VALUABLE INFORMATION

NICHOLS EQUIPMENT COMPANY  
D-1810 PURVIS, MISS.

## REAL PRECISION AT GREAT SAVINGS!



**\$8.75**  
IN 1" SIZE  
AS SHOWN

You can still get a fine Scherr micrometer at a low price—and with .0001 vernier in the 1" and 2" sizes. But you must hurry. Order now or write for our illustrated folder or for details of our shop agent plan.

GEO. SCHERR CO., INC. 202 Lafayette St.  
New York 12, N. Y.

## BUILD OR BUY A Rotary SNOW-PLOW

No More Strenuous Snow Shoveling!

Clean off your snow the easy LeJay Way. It is easy to build your own Snow Plow. Operates from small gas engine or electric motor. Cleans an 18 inch path. Swirls the snow to either side. Plan is thorough and easy to follow. Enjoy making one of these Snow Plows from new or used parts. Mail 35c today for complete plans and catalog.



LEJAY MFG.  
247 LeJay Bldg. Minneapolis 8, Minn.

Tune in the  
**AUTO-LITE**  
Show

**"Suspense!"**

THURSDAY NIGHTS—CBS

## 30" SHEET METAL BRAKE

Forms angles, channels, vees, flanges, locks, zees. Handles 26 gage sheet steel, heavier gages of aluminum, copper, plastic, etc. Portable. Can be held in a bench vise, or bolted down. All steel. Wt. 40 lbs. Shipped exp. collect. \$24.50.

**12" BRAKE.** Fits in vise to form difficult and compound bends, up to 20 gage steel 12" wide. \$12.50.

**SHEET METAL PLIERS.** 2 1/2" wide, \$2.00; 5", \$3.50. 20 page instruction booklet, 50c.

Immediate delivery. Order direct, cash or C.O.D., or send for folder.

1110 So. 27th St. VISE BRAKE MFG. CO. Dept. P1 Omaha 5, Nebr.

## RACING CAR EQUIPMENT FOR ALL CARS

Engines, Racing Heads, Manifolds, Carburetors, Mufflers, etc. Speed Instructions and literature \$1.00—refunded first order.

LEE MOTORCRAFT CO. 1412 Great Northern Bldg. Chicago, Ill.

## 30 Early American Designs

New designs . . . Early American pieces adapted to modern living . . . in 2 series, A and B. Each packet contains 15 sheets, 8 1/2 x 11", with photos and working drawings. Easy to make Christmas gifts . . . cricket, napkin holder, candle stand, etc. Each packet 25c postpaid. Send for both packets. Stanley Tools, 119 Elm St., New Britain, Conn.

**25¢**  
a packet of  
15 plans



**STANLEY**

Reg. U.S. Pat. Off.

THE TOOL BOX OF THE WORLD

# The NEW DUMORE Hobby-Flex

... a genuine Dumore flexible-shaft tool for faster, easier hobby-work

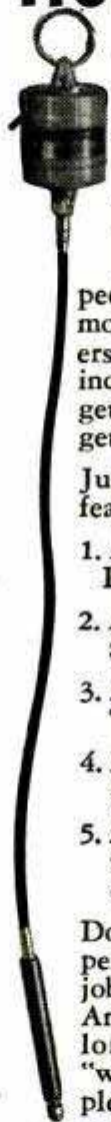

The new Hobby-Flex is "made to order" for you. And it's made by the same people who produce the famous Dumore precision grinders and flexible-shaft tools for industry. So you know you're getting the finest when you get a Hobby-Flex!

Just look at these special features:

1. A vibrationless 1/20 hp Dumore motor (15000 rpm).
2. A durable 36" flexible shaft; 8-foot cord.
3. A pen-size handpiece for "close control" on fine work.
4. A chuck that takes both 1/8" and 3/32" tools.
5. A handy hanger-ring to hold the motor on a hook or overhead pipe.

Doesn't that sound like the perfect tool for hundreds of jobs in any home workshop? And it is. That's why it belongs at the top of your "want" list. Send for complete information.



Sawing wood models



Grinding jewelry



Polishing plastic sculpture



Carving fine woods



Plastic carving



Filing and drilling metal models

Tear out this coupon and mail today!

Sawing  
Grinding  
Sanding  
Polishing  
Burring

Drilling  
Routing  
Finishing  
Carving  
Filing

Burnishing  
Cleaning  
Engraving  
Touching Up  
Shaping

The Dumore Company, Dept. A-51, Racine, Wisconsin

Please send me the items checked below:

- No. 19-021 Hobby-Flex, consisting of motor, flexible-shaft, handpiece, and wrenches. \$21.50 enclosed.
- No. 19-011 Deluxe Hobby-Flex, same as above, plus steel carrying case and 10 accessories. \$27.50 enclosed. (Cash or Money-order please. Shipping Charges C.O.D.)
- Literature giving complete information.

Name.....

Address.....

City..... State.....

SAY YOU SAW IT IN POPULAR MECHANICS

# WAR SURPLUS AND OTHER BARGAINS



**New Chicago Pneumatic PLANISHING HAMMERS**  
 Model CP-522 — Extremely versatile tool for working and ironing all types of sheet metal. Can be used to apply or remove curvature in sheet metal. Ideal for smoothing out dents, touch up work on large stampings and for finish forming. Easy adjustment of power and speed of vibrating hammer blows. Complete with gauge and drain cock. Original Government cost about \$300. Height 49 1/2". Shipping weight 170 lbs. . . . . Each **\$79.00**

**HIGH SPEED DRILL BITS**  
 Like new! Original value over \$16.00. 25 assorted sizes and lengths. . . **\$2.50**

**MICROMETERS**  
 Chrome plated, precision engineered and carefully tooled to give long life. All new. 0-1" capacity . . . . . **\$2.25**  
 1-2" capacity . . . **\$3.50** Each

**25% DEPOSIT REQUIRED ON C.O.D. ORDERS**

**TRANSFORMER:** Jefferson Electric step up or step down transformer. Input, primary 110-117 Volts A.C. Output, from 5 Volts to 650 Volts. Suitable for use with war surplus gadgets, heater relays, radio test filaments, electric trains, house chimes, etc. Weight 10 lbs. New. **\$7.95** Each.



**SEND CHECK, MONEY ORDER or CASH**  
**WILLARD WET PLATE BATTERY**

This extra long life rechargeable battery is ideal for portable radios, mobile units, bell circuits, alarm systems, rural telephones, Strobe bulbs, etc. 2 V. 20 Amps. Only 5" high. Visible ball float hydrometer built in Lucite case. Shipped dry. Any battery service will supply standard battery electrolyte. Used singly or in multiples. Shipping Wgt. 3 1/2 lbs. . . . . All new. **\$2.75** Each  
 All prices F. O. B. Culver City, Calif.

**AIRBORNE SALES CO., INC.** DEPT. PM 1-9 CULVER CITY, CALIF.

**Say You Saw It in Popular Mechanics**



**OUTSTANDING MANUFACTURING OPPORTUNITY**

## YOU CAN Get in this Growing Industry

The great building industry is your profitable market for masonry products. Low investment . . . high returns . . . wide-open opportunity to establish a lifetime business. The biggest building years in the nation's history are just beginning. New construction, involving billions of dollars, means huge demands for block, drain tile, and other masonry products which YOU can manufacture locally, from local materials with local labor for local consumption. Remember, MASONRY products mesh with today's building demands. Use our modern machines and equipment to insure the finest quality products at pared-to-the-bone manufacturing costs. Sold direct from factory to you. Backed by 40 years of pioneering and manufacturing. Liberal selling cooperation.

Write for catalog. Gives prices and full information.

**CONCRETE EQUIPMENT CO.**  
 512 Ottawa Ave., Holland, Mich.

# PLYWOOD BOAT KITS \$54.00 (Including Freight)



This **READY-CUT 12** ft. fishing boat can be assembled in 8 hrs. without forms or special tools. Kits are complete including all hardware, paint, and etc. Send for free folder.

**TAFT MARINE WOODCRAFT**  
 Dept. K 636 39th Ave. N.E. Minneapolis 21, Minn.



**MIRACLE WALL CLEANER**  
**Saves Costly Redecorating!**  
 AMAZING INVENTION. Banishes old-style housecleaning mess and mud. No rags—no sticky "dough"—no red, swollen hands. No more dangerous stepladders. Literally erases dirt like magic from walls, ceilings, window shades, upholstered furniture, etc. **Ends Redecorating!** SAVES REDECORATING!  
**SAMPLES FOR AGENTS** Sample offer sent immediately to all who send name at once. A penny postal will do. **SEND NO MONEY—just your name.** KRISTEE CO., 671 Bar Street, AKRON, OHIO.

## Projects in WOODWORK

One of the best books offered today. Detailed drawings for 109 projects, including birdhouses, game boards, waste baskets, child's rocker, trellis, book racks and furniture are given in **PROJECTS in WOODWORK** by Douglas & Roberts. For beginners as well as advanced workers. Photographs clearly show completed projects. At craft or book stores—or direct. \$3.50 postpaid or sent C. O. D. plus postage. Cloth cover. Order today. McKNIGHT & McKNIGHT, 137 W. Market St., Bloomington, Ill.

## DRAINS CELLARS, WASH TRAYS CIRCULATES OIL



Pumps 1800 GPH 300 gal. 30' high, use 1/8 to 1/2 HP **\$6.50** motor. Will not clog.

Postpaid if cash with order. (Add 50c for west of the Mississippi.)  
 Thousands in use since 1936  
**LABAWCO PUMPS, BELLE MEAD 7, N. J.**

**MICROSCOPES SUPPLIES-ACCESSORIES & SCIENTIFIC INSTRUMENTS**  
**SPENCER NEW & USED LEITZ**  
 BOUGHT-SOLD-EXCHANGED-REPAIRED  
 Send for FREE LIST  
**NATIONAL SCIENTIFIC INSTRUMENT CO. 119 CHAMBERS ST NY7**

**MACK'S GAS TORCH AND SOLDERING IRON**  
 6,000 B.T.U. attaches to any gas hose; furnished with 2 jets for natural and bottled gas; equipped with adjustment set screw. **\$2.00** Postpaid

**Mack's GAS BURNER**  
 Jet Power, Self-Acting (Pat. pending), 24,000 B.T.U., for natural and bottled gas, industrial and home use. **\$2.00** Guaranteed. Postpaid

**Mack's Automatic Water Heater**  
 Approx. 20 gal. capacity and larger for home and industry. Easily installed. Amazingly low-priced. **Guaranteed \$32.50** Del.

Prompt Delivery • Order Now • Factory Service • Send Check or Money Order  
**McDaniel MANUFACTURING CO., INC.**  
 12724 POWHATTEN ST. • DALLAS 7, TEX.

**WORLD'S FINEST MODELS**  
 17 1/2" GEE-BEE \$1.75

**CLEVELAND**  
 MAKE THE FINEST HOBBY GIFTS!

**SHOOT STAR**  
 29 1/2" M-KIT \$2.25

BUILD MODELS "EXACTLY LIKE REAL THINGS"  
 Great show value. World favorites since '19. Wide range free lance, commercial, military planes, old and new. 1/2" scale, 30" span and miss. sizes, 8" through 10 ft. giants. 25c to \$14.50. Solid frames. All by. for rubber, CO2 or gas motors. Kits less liquids, flying props. Add 25c pack-post. Products 30 yrs. designing. Avoid copied GET THE REAL THING. Send for catalog, 2, 3c stamps or 5 cents.

**SEA-BEE**  
 28" M, \$2.25

**30" LUSCOMBE SEDAN**  
 Kit, \$1

**CLEVELAND MODEL & SUPPLY CO.**  
 451321 LORAIN AVE., CLEVELAND 2, OHIO

# NOW

# YOUR PROJECTS CAN HAVE PROFESSIONAL SMARTNESS and FINISH



WITH  
**POWER KING**

4 1/2"  
Ball Bearing  
**JOINTER**  
\$44.75

F.O.B. Kalamazoo  
Less Motor

## SLICKEST WORK-SAVER FOR YOUR SHOP

The smooth finish and tight joints that distinguish professional woodworking and cabinetry can now be equalled quickly and easily on your home shop projects... with a Power King 4 1/2" Jointer-Planer. This modern, low-cost tool saves you time and work in planing, rabbeting, beveling, tonguing and all surfacing... makes your work like that of the experts.

The Power King is built extra-heavy for smooth work and long accurate service. Base and tables are massive iron castings, heavily ribbed. Table tops are ground so your stock slides smoothly. Front table widens to 8" at the cutter head, providing a rigid support for rabbeting.

Uniform bevels, another mark of professional-made furniture, are easy to cut with the



Power King. The ground iron fence tilts 45° both ways, locks rigidly for accurate work. 3-blade cutter turns on precision ball bearings.

You can save many dollars this year making the new furniture and household equipment you want and need — with a Power King 4 1/2" Jointer-Planer to help you do an accurate job. See it at your Power King dealers. Free catalog on request.



**NEW! FREE CATALOG SHOWS ALL 8 POWER KING TOOLS**

Send a Postcard

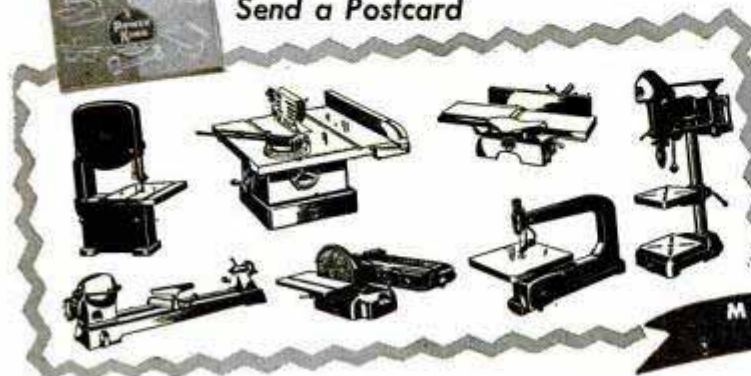

**ATLAS PRESS Company**

135 N. Pitcher Street, Kalamazoo, Michigan



MATCHED PRECISION TOOLS FOR WOODWORKING AND METALWORKING

# FIRE...YOUR OWN MODEL ROCKET

There's a new thrill coming as you send a real rocket soaring up high into the sky... And you can fire them over and over again, having fun or experimenting seriously. Using actual jet principles, this rocket will help you to learn the secrets behind inter-planetary flights.



Rocket being fired at Wendover Field, Utah.

SOARS OVER 200 FEET IN THE AIR

## V-2 ROCKET

For only \$2.95 your rocket comes equipped ready to fly with special launching stand and full instructions on how to make your rocket zoom over 200 feet into the sky.

When payment is sent with order, we pay postage. Or send no money and pay postman \$2.95 plus mailing costs. Write Dept. M-1.

**\$2.95**

**WALSH PRODUCTS, INC.**  
209 N. MAPLE AVENUE, EAST ORANGE, N. J.



SAVE on High Quality Dress Trousers

\$12.50 VALUE

SAVE ONE-THIRD!

Huge direct-to-you volume enables us to give exceptional value! Fully guaranteed. Genuine virgin wool and fine-spun rayon blended. Warm. Twill weave resists wrinkles, holds crease, gives amazing wear. Expert fashion tailored for perfect fit. Zipper front. Roomy pockets. Blue, Tan, Sand, Lt. or Dk. Brown, Blue-Gray. WAIST: 28-38 pleated or 28-50 plain.

Send Only \$1 with name, waist size, 1st and 2d color selection. Pay postman balance plus C.O.D. Or, send entire amount, save C.O.D. Money back within 10 days if you're not pleased.

**\$7.95** PR.

FREE! Write for sample of material.

**LINCOLN TAILORS** DEPT. PM-1 LINCOLN, NEBR.



MASTER CHAMPION LAWN MOWER SHARPENER Earns BIG PROFITS for you

Immediate Delivery

Write Today for folders on lawn mower sharpeners and saw filing machines

**FRANK'S MFG. CO.**

2501-A East Imperial Highway Los Angeles 2, California

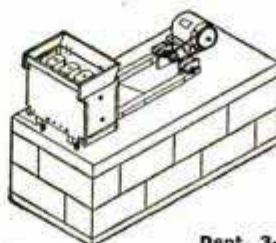

BUILD THIS CONCRETE BLOCK MACHINE

Sell blocks; or build your home, garage, barn at 1/3 cost by making and laying your own blocks.

This simple machine which you can build yourself at a cost of about \$15 (excluding motor) will make a block in 30 seconds using only one form. 2 to 4 forms can be used on each vibrator.

Power driven concrete mixer plants also. Write for further information. No obligation.

**U-BUILD-IT SERVICE**

Dept. 3-A, 206 West Wilder Ave., Tampa 3, Fla.



**CASH FROM YOUR WORKSHOP**

Send postcard today for FREE catalog of modern saleable projects—kitchen cabinet units, trellises, lawn furniture on wheels, highball server, home bars, electric pencil, children's room furniture, keep-off-grass signs, etc.

Craftplans, 7241 Madison, Dept. P133, Kansas City 5, Mo.

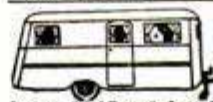

**TRAILER BUILDERS' SUPPLIES! TO BUILD, REPAIR OR MODERNIZE!**

And save money. You must have our big Catalog. We are the largest and most complete trailer supply house in the States. Our new large 1948 catalog 10c; blue prints and building instructions, 25c.

**NATIONAL TRAILER EQUIPMENT CO., 1007 N. Water St., Milwaukee 2, Wis.**



**EASY PROFIT IN PAINT SPRAYING**

Paints walls, ceilings, screens, furniture and machinery faster, better. All complete as shown less motor. Carry anywhere. Fully guaranteed. Could be used with 1/4 H.P. motor or less. Price \$35.00 less motor F.O.B. Chicago. \$5.00 deposit balance C.O.D. or see your dealer. With motor \$55.00.

**IDEAL AUTOMATIC PUMP CO., Dept. P.M. 8**  
801 W. Washington Blvd. Chicago 7, Ill.

## THERE'S PROFIT in ELECTRICITY—LEARN from PRACTICAL ELECTRICS, \$1.00



Whether you want to enter the electrical field as a profession — or whether you want to know more about fixing electrical gadgets around the house, you will find Practical Electrics a profitable investment. You can find the right answers quickly. It gives you the

fundamentals of electricity, electrical circuits, motors, transformers, electrical symbols, trouble shooting, etc. — all in plain, simple, understandable language. Send \$1.00 today for a copy of Practical Electrics, the ready reference book of electricity.

**AUTOPOWER, INC., 918 SOUTH THERESA, ST. LOUIS 3, MISSOURI**

### PARKA COAT

New Army Air Force Type B-11. Finger tip length. Fully alpaca lined with mouton fur parka hood. Zipper and button front. Sizes 36 thru 46

**21.95**

PLUS 35¢ FOR MAILING

SHEEPLINED

### FLIGHT PANTS

Reissue, excellent condition. All leather. Sizes small, med., large

**4.98**

PLUS 35¢ FOR MAILING

Money Back Guarantee

## WAR SURPLUS VALUES

### AVIATORS' JACKET

Brand new. Air Corps Type B-15. Fully alpaca lined, including sleeves. Zipper front. Large mouton fur collar. Sizes 34 thru 44

**13.88**

PLUS 35¢ FOR MAILING

### NAVY JACKET

Brand new. Navy N-1 Jacket. Fully alpaca lined. Zipper and button front. Sizes 36 thru 44

**13.88**

PLUS 35¢ FOR MAILING

## NATIONAL JOBBING CO.

BOX 1485 Dept. N-1 Omaha, Nebr.

### OFFICERS' PINKS

Brand new. Fine quality officers' elastic trousers. Sizes 29 thru 42. Reg. \$17.95 value... **11.50** plus 25¢ for mailing.

### SHEEPLINED JACKET

Air Corps Type B-3. Like new. All leather with full sheep lining and large sheepskin collar. Zipper front. Sizes 36, 38, 40, 42. Plus 25¢ for mailing **14.95**

Send for FREE CATALOG

# GET THIS AMAZING

# ELECTRIC TOY AUTO

NO WINDING  
RUNS FOR HOURS



A Collectors Item!

A scale-model car that will bring exciting joy to any child (and grown-ups, too). It is packed with fun and instructive play—Just put it in gear and away it goes—in low, second, high—touch it and it goes in reverse.—Driven by the exclusive VIBRO-ROLL MOTOR powered with two flashlight batteries easily replaced after many hours of running—Safe, economical. Over 10" long, broad, low and handsome—Realistic plastic headlights, balloon-type rubber tires—Comes completely assembled in shiny durable plastic—Lasts indefinitely. SEND YOUR ORDER TODAY!

**\$2.98 Complete—Postage Paid—C.O.D. you pay postage**

Only  
**\$2.98**

**ALL ELECTRIC PRODUCTS CO.**

171 G Northfield Ave. Pittsburgh 4, Pa.

## EMBED YOUR PHOTOS in Magic LIQUID PLASTIC

Preserve your treasured photos in Castolite—the "magic" liquid plastic that pours cold "like honey" . . . sets at room temperature "like glass." Makes beautiful medallions like the one shown, unusual photo lampshades, distinctive photo paperweights. Sell pictures in unique plastic mounts. Embed hundreds of other things . . . real flowers, butterflies, coins, medals, etc. Comes crystal clear or in many brilliant colors. You can make lovely gifts.

### POUR GORGEOUS BOOKENDS

Castolite makes it easy to cast exquisite bookends, too, like the one shown. Make duplicates of hundreds of art objects, figurines, candlesticks, etc. Use only home utensils. No artistic ability needed. With new, easy-to-use Casto-Mold compound, you can make your own molds in minutes. Follow simple step-by-step method. New pleasure, fine profits are possible. Send 25c for exciting new Home Project Manual showing how to get started. Write today! The Castolite Co., Dept. TA1, Box 391, Woodstock, Ill.

MANUAL  
**25c**

## A BARGAIN YOU CAN'T BEAT



**\$50 Value**  
**ELECTRIC HAND GRINDER OUTFIT**

- 300 ITEMS for Home or Shop—for CUTTING, SHAPING, GRINDING, or POLISHING Wood, Metal or Plastic**
- 3 Grinding Wheels 1 to 3" in diameter
  - 12 Mounted Stones 1/8, 3/32, 1/4" Shanks
  - 9 Rotary Cutters 1/8 and 3/32 Shanks
  - 30 Miniature Rotary Cutters 3/32 Shank
  - 10 Cut off Discs and Grinding Wheels up to 1" in diameter
  - 1 Drum Sander 1/8" Shank
  - 15 Abrasive Bands for Drum Sander
  - 15 Leather and Felt Polishing Wheels 1/2 to 1" in diameter
  - 15 Felt Polishing Cylinders with 3/32" Mandrel
  - 25 Abrasive Sanding Discs 1 1/2 to 2" dia.
  - 3 Rubber Wheels 7/8" diameter
  - 2 Speed Drills 3/32 Shank
  - 2 Mandrels 1/8 and 3/32" Shanks
  - 3 Bristle Brushes
  - 1 Rotary Wire Wheel Brush
  - 1 Circular Saw on Mandrel 1/8" Shank
  - 2 Rubber Cylinders with 3/32" Mandrels
  - 150 other items—all new and valuable

**The Master Kit**  
fits all hand grinders  
Complete in Sturdy Compact Container  
**\$9.75**  
Post Paid in U.S.A.

**AT NO EXTRA COST!**  
High Speed Steel Rotary File (list \$2.55) included if you order now.

**NOTE:** This Master Kit is brand new and fully guaranteed. Hurry! Get yours now while the getting's good! Rush check or M.O.

### 2 CIRCULAR SAWS



**AT A RECORD BREAKING PRICE—BOTH AT ONLY . . . \$1.50**  
1" diameter saws on 1/2" Mandrels. For cutting wood, plastic, or soft metals. Order at once! Send Check or Money Order for this big bargain. Post Paid in U.S.A.

### 2 DRUM SANDER SETS

**WITH 12 BANDS IN ASSORTED GRITS \$1.50**  
Two sizes 3/4" x 1 1/2" and 1 1/2" x 1 1/2". Both on 1/2" Mandrels. Sensational value at this price. Rush Check or Money Order. Post Paid in U.S.A.



Send Your Order with Check or Money Order to

**SCHUPACK SUPPLY CO. 7331 COTTAGE GROVE AVE. DEPT. M1, CHICAGO 19, ILL.**

## Now CHEAP OIL BURNER

FOR HEATING AND COOKING STOVES-FURNACES

HEAT YOUR HOME, COOK YOUR MEALS WITH CHEAP FURNACE OIL

**NO MORE SHOVELING COAL OR ASHES.** Sensational Fuelizer Starter Vaporizing System turns Cheap No. 1 Furnace Oil, also Range, Heater, Tractor Distillate, Kerosene and like oils into oil heat—one of the quickest, hottest fires known. **LIFETIME GUARANTEE. \$1.00 Bonus Offer for Testing.**

We will let you try it in your own stove or furnace for one month. Get yours for introducing. Big profits QUICK. Be first. Send in your name today for details and cash in on the tremendous demand for this Amazing Invention.

NORTHWEST MFG. CO., 634-A, Mitchell, S. Dak.

Please Mention Popular Mechanics When Answering Ads

All in This  
**FREE**  
MONEY-SAVING  
BOOK



The greatest radio catalog you ever saw, and it's FREE if you mail the coupon! 180 pages crammed with all the latest, nationally advertised TV, Hi-Fi, AM & FM Radios, P.A. Test Equipment, Parts, Kits, Tools, etc., at save-money prices. Our Lafayette-Concord Kit-Quarters has everything for the ham too, including sensational Build-It-Yourself Kits. Rock-bottom prices made possible by the purchasing power of the largest radio-electronics supply organization in the world! A postcard brings you this Value Book.

NEW YORK, N. Y.  
106 Sixth Avenue  
542 E. Fordham Rd.

CHICAGO, ILL.  
901 W. Jackson Blvd  
229 W. Madison St.

BOSTON, MASS.  
110 Federal St.

ATLANTA, GA.  
265 Peachtree St.

NEWARK, N. J.  
24 Central Ave.

**LAFAYETTE-CONCORD**  
world's largest radio supply organization

LAFAYETTE-CONCORD, DEPT. LA-9

901 W. Jackson Blvd., Chicago 7  
100 Sixth Avenue, New York 13  
265 Peachtree St., Atlanta 3, Ga.

Please Rush Free Catalog No. 89

Name \_\_\_\_\_  
Address \_\_\_\_\_  
City \_\_\_\_\_ Zone \_\_\_\_\_ State \_\_\_\_\_

**WORLD'S  
FINEST  
RADIO  
CATALOG  
FREE!**

PASTE THIS  
COUPON ON A  
PENNY POSTCARD

**PRINT YOUR OWN  
POST CARDS**

COMPLETE  
OUTFIT  
only  
**\$7.50**



Amazing results in sales, inquiries and contacts... saves time and money... very easy to use GEM STENCIL DUPLICATOR is ideal for Advertising, Announcements, Notices, Labels, Forms, Price Lists—hundreds of uses for every type of business and organization. Comes complete with all supplies, instructions and 60-page Book of Ideas.

**FREE TRIAL OFFER:** Try it before you buy it! Write and a GEM OUTFIT will be sent you postpaid. After 10 days, send only \$7.50 or return the GEM, no questions asked. The GEM must sell itself; you be the judge.

**BOND EQUIPMENT CO. • Dept. 135**  
6633 Enright • St. Louis 5, Mo.

SEND NO MONEY • FREE TRIAL OFFER

**Power Hacksaw \$47.25 LESS MOTOR**

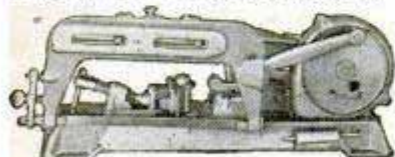

F. O. B. Benton Harbor  
No other saw like it. Rugged cast iron construction. Bronze bearings. Quick action vise—jaws swivel to 45°. Draw cut. Automatic shut-off switch. Capacity 4" x 4".

Send details and name of nearest dealer to:

Name \_\_\_\_\_  
Address \_\_\_\_\_  
City \_\_\_\_\_ State \_\_\_\_\_

EXCEL MACHINE TOOLS, Dept. PM-19, Benton Harbor, Michigan

Carry Your Heat From Room To Room  
Nationally Advertiser **ELECTRESTEEM**  
Office—Workshop—Garage—Store—  
Home—Any Room with Electrical Outlet **\$3735** each

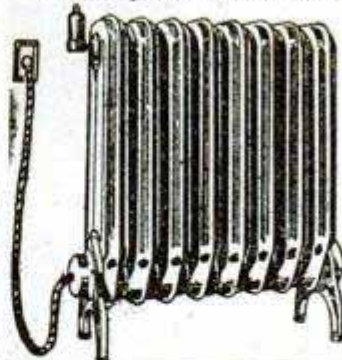

To have steam heat from any electrical outlet is unusual—but to have portable steam heat is indeed remarkable. Electresteam Radiators, 20 1/4" high, 23 1/4" long and weighing only 39 lbs., can easily be carried to any room where heat is required. Takes the place of oil or small coal heaters. Beautifully Finished—Operates on Any Current. Low Cost Operation—Will Heat the Average Room.

We can also use **Dealers**

If you send check or money order we will pay the freight.

**DIRECT SALES**

921 W. 17th St., Kansas City, Mo.

**IMPORTED SWEDISH STEEL  
FEELER GAUGE**

Tough! Accurate! Durable markings

26-3 1/2 inch blades  
.0015 to .025 size range

**SPECIAL**  
**\$2.65**  
post paid

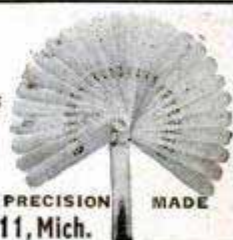

Order today—check, C.O.D. or money order to

Chap Associates, 2402 E. Milwaukee, Det. 11, Mich.

**ALL PURPOSE FOLDAWAY  
TABLE or BENCH LEGS**

Make sturdy folding tables, benches or work horses with these steel channel, riveted folding legs. Black enameled and rubber tipped. 30" high for table tops 5.98 pr.; 24" high for benches or work horses 4.98 pr. Send for free circular.



**THE DIAMOND MFG. CO.**  
1100 ALTAMONT AVE. SCHEENECTADY 7, NEW YORK

**\$4.98**  
(LEGS ONLY)

**MAKE MONEY MAKING DOUGHNUTS**

Make new greaseless doughnuts at home on electric machine. Sell for cash to grocers, cafes, drug stores, etc. No exp. nec. Good profits. Small investment. Send for free recipes and plans.

MART RAY CO. • 3605 S. 15 Ave. • Minneapolis 7, Minn.

**FULLSIZE, CUT-TO-SHAPE BOAT PATTERNS**

and specifications. Designed by Naval Architect. Cruisers, runabouts, sloops, outboards, sailing canoe, etc. Low prices. Send 10¢ (coin) for illustrated catalog. **SPECIAL:** Send \$1.00 for "HOW TO BUILD BOATS" book, postpaid. PolyWog Houseboat Plans, \$10. Cleveland Boat Blueprint Co. Dept. 666. Cleveland 13, Ohio

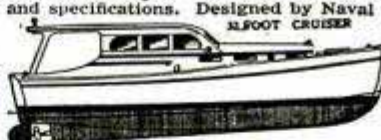

Balance 4" x 9" Base. With either **\$8.00** Metric or Avoirdupois Weights..

Catalog with 3000 illustrations of laboratory apparatus, and over 10,000 prices sent for \$1.50.

LABORATORY MATERIALS CO.  
7321 Vincennes Ave. Chicago 21, Ill.

**CONFIDENTIAL LOAN SERVICE**

**Borrow \$50 to \$300<sup>00</sup>**

Need money? No matter where you live you can borrow **BY MAIL** \$50.00 to \$300.00 this easy quick confidential way.

**BY MAIL**

**IT IS EASY TO BORROW BY MAIL!**  
Completely confidential and private  
**CONVENIENT MONTHLY PAYMENTS**

**NO ENDORSERS NEEDED**  
EMPLOYED MEN and women of good character can solve their money problems quickly and in privacy with loans **MADE BY MAIL.** No endorsers or co-signers. We do not contact employers, friends or relatives. Convenient monthly payments. Send us your name and address and we will mail application blank and complete details **FREE** in plain envelope. There is no obligation.

**STATE FINANCE COMPANY**  
216 Savings & Loan Bldg., Dept. N-107K, Des Moines 8, Iowa



# WAR SURPLUS BARGAINS

**\$500,000.00 INVENTORY for QUICK LIQUIDATION**

Surplus items—hundreds of them for home, shop, factory, farm and outdoor use. New items, used items, reconditioned items—all at tremendous savings—all priced for quick sale.

**Page After Page of Values**

This big catalog shows page after page of amazing money saving values. Write for your copy today. Send 10c to cover postage, mailing, etc. Write today!

**SEND TODAY FOR YOUR COPY 10c**

**STARK'S** Dept. PM1 509 So. STATE STREET CHICAGO 5, ILLINOIS

## CARBURETOR TOO RICH MAKES MOTORIST TOO POOR



Car owners who are wasting money and not getting proper gas mileage due to over-rich mixtures will be pleased to learn how to save gasoline by VACU-MATING over-rich mixtures. VACU-MATIC fits all cars, trucks and tractors. It is automatic and operates on the supercharge principle. Easily installed in a few minutes.

**SALEMEN WANTED!** Big Profits! Send name, address on penny postcard for free particulars and how to get yours for introducing.

**VACU-MATIC CO., 7617-1440 W. State St., WAUWATOSA, WIS.**

### SPECTACULAR NEW PLUMBING TOOL

#### CLEANS CLOGGED DRAINS

**ONLY \$1.00** Postpaid

Sold Only by Mail

**WESTWOOD SALES CO.**  
435 NE Victoria St., San Francisco, Calif.

**5-DAY MONEY-BACK GUARANTEE... You cannot Lose!**

## GEIGER COUNTERS

FOR LOCATING RADIOACTIVE MINERALS - FOR HOSPITAL AND INDUSTRIAL USE.

Write for Details and Prices

**OMAHA SCIENTIFIC SUPPLY CORP.**  
Dept. J, 3623 LAKE ST., OMAHA 4, NEBR.

## MAGNETS OF ALL TYPES—10c UP

AMAZINGLY POWERFUL!!

4 oz. Alnico Magnet, lifts 10 lbs. \$1.00. Our Leader, 15 oz. Magnet, lifts 40 lbs. \$2.50. New alloy—will not weaken! Useful for lifting valuables from tanks, lakes, or rivers easily! 7 small magnets \$1.00 with list of many shop and home uses. Satisfaction guaranteed.

**R. EYRICH, 2566 N. 49TH ST., MILWAUKEE 10, WIS.**

## It's EASY! ECONOMICAL!



**Build Your Own Trailer with NATIONAL'S Simplified Plans**

Beat the housing shortage with a full-size house on wheels or add new pleasure to your vacations and week-ends with a sleek sport trailer. Step-by-step instructions and complete bill of materials with every plan. *Three different models.*

**NATIONAL MODEL 27:** A 27-ft. luxury liner with 3 rooms, lavatory, sleeping space for six. Plans \$1.00

**NATIONAL MODEL 28:** A 20-ft. cabin trailer that's good-looking and sturdy, with beds for four. Plans \$1.00

**NATIONAL CAMPER:** The sport trailer you've wanted for hunting, fishing, vacations. Sleeps two. Plans .50

**ORDER ALL THREE—AND GET ONE FREE**  
Complete set \$2.00

Big parts catalog FREE with any order!

**NATIONAL TRAILER STORES**  
Dept. 51 • Box 2353 Terminal Annex • Los Angeles 54, Calif.

JANUARY, 1949

## Outstanding Surplus Value!

### BRAND NEW—GUARANTEED GRINDING WHEEL KITS

HUNDREDS OF ASSORTED ITEMS—A \$50 VALUE

**\$8.95** Per Complete Kit

F.O.B. Chicago

**SET INCLUDES OVER 300 ITEMS**

**Here is the list.**

35 Grinding and cut-off wheels, sizes 1 to 5 inches, 1/8 to 3/4 hole

10 Mounted stones—3/32", 1/4", 3/8"

3 Steel cutters 1/8"

5 Steel cutters 3/32"

1 Steel circular saw mounted on mandrel

1 Drum sander 1/2" mounted on 3/32" mandrel

6 Cut-off Wheels on 1/8" mandrel

1 One inch buff on 1/8" mandrel

1 One inch felt wheel on 1/8" mandrel

1 7/8" rubber wheel on 1/8" mandrel

2 High speed rotary files 1/4" shank

100 3/4" cloth butterfly abrasive discs

1 One inch wire wheel 5/8" hole, brass center

10 Cloth abrasive discs

3 Sheets crocus cloth 9 x 11

1 Box paper discs—100

2 Leather wheels

1 Roughing stone

1 Bristle brush 3", 5/8"

10 Sanding rolls

3 Honing stones

1 hole, brass center

6 Sanding sieves

2 Felt bobs

1 Rag wheel—4 inch

In sturdy compact container 13 1/4 x 9 1/4 x 2 1/2", weight 8 1/2 pounds; with installed rack for all drills.

**Satisfaction Guaranteed**

**8 HIGH SPEED ROTARY FILES**

1/4" Shank .. **\$3.95**



**20 MOUNTED STONES**

Assorted 1/8" and 1/4" Shank .. **\$3.95**



## DRILL-GRINDERS

Complete with full equipment. Home Craftsmen, Hobbyists, Small Shop Owners will find it indispensable. Motor features: Aluminum housing, full ball-bearing, hammered tone blue, cool-running, 1/20 horsepower, 60 cycles, 110 volts A.C., 3500 RPM, convenient on-and-off finger-control switch.

**\$8.95** Complete with Motor Chuck

I enclose \$ \_\_\_\_\_  Check  M.O.  Send C.O.D.

(Encircle items wanted)—WHEEL KIT, ROTARY FILES, MOUNTED STONES, DRILL GRINDERS.

Name \_\_\_\_\_

Address \_\_\_\_\_

City \_\_\_\_\_ Zone \_\_\_\_\_ State \_\_\_\_\_

**GROBAN SUPPLY CO.** 1522 So. Michigan Ave. Dept. PM-1, Chicago 5, Ill.

### Say You Saw It in Popular Mechanics



## The Modern PLASTIC for lasting Home Repairs

**PERMANENTLY** mends cracks or holes in wood, tile, stone or plaster. Sticks and stays put—Does not chip, shrink or fall out. Easy to use. Economical. Mold it, chisel it, polish or paint it. If unobtainable from your lumber, paint or hardware dealer, the big 4-lb. can will be sent you post-paid (in U.S.) for only \$1. Full money-back guarantee, order now.

**DONALD DURHAM CO.**  
Box 804-M, Des Moines, Ia.



# NOW YOU CAN SHAVE IN YOUR CAR!

Just plug this conversion Unit into your dash cigarette lighter receptacle—and connect your AC-DC electric shaver to unit! Prestol You're all set to shave right in your car anytime. Fast—simple—compact—durable—very low current drain. 6 Volt DC input. Unit is also ideal for operating 3-way portable radios in car. Unit is complete with cord and plugs. Order **\$7.95** post MF 102. Price: Only..... paid

## ELECTRIC MOTORS

Pictured at right: 110 Volt AC approx. 1/30th HP Motor. Heavy-duty construction, ball bearings, 3500 RPM, size: 6 1/2" long by 4" high, shaft size: 3/8"x3/16". Ideal for power tools, fans, models, blowers, etc. Order MH 102. **\$3.95** Post-Price..... paid



## GASOLINE ENGINE GENERATORS

—Homelite Engine: Consists of a 30 Volt DC, 50 ampere (1500 watt) generator driven by a single-cylinder, two cycle air-cooled gasoline engine, approx. 3 HP. Rope or electric starting. Illustrated at left. Shipped freight collect. Order MG 105.

Prices: As is... **\$39.50** Tested... **\$49.50**



**DELCO ENGINES:** Consist of a 12 Volt DC 750 watt generator driven by one cylinder, four cycle air-cooled gas engine approx. 2 HP, with self-starter and voltage regulator. Used to charge batt. in Gov't. vehicles. Tested. Shipped freight collect. Order MG 106. **\$79.50** Price:.....

ABOVE TWO ITEMS CAN BE SHIPPED C.O.D. WITH 25% DEPOSIT WITH ORDER — ADDRESS DEPT. PM-1

**FAIR RADIO SALES**  
132 SOUTH MAIN ST. LIMA, OHIO

# LAWN MOWER SHARPENER



lawn mower sharpening at low cost!

**\$4250**

less motor.

turn spare time into dollars

Order direct from **QUAD CITY PRODUCTS Company, Inc.**  
Box 42, Rock Island, Ill.

## PILOTS' JACKETS



(Right) B-15 STYLE BOMBER JACKET.

Sturdy water repellent mountain cloth. Wool alpaca lined. Genuine Mouton Fur (Beaver-dyed Lamb) collar and chin strap 34-46 ..... **\$12.95**  
**REGULATION B-15 JACKET.** Made same as for AAF. Heavy alpaca wool lining throughout. 34-46 ..... **\$15.95**  
**CAP (illustrated), O.D. wool outside, alpaca pile flaps.....\$1.25**  
B-3 & ANS-4 Sheepskin Leather Jacket (Left). Water repellent acrylic finish. Full shearing fleece inside. Sizes 34, 36, 38 **\$15.95**. Sizes 40-48 **\$18.95**. D-1 Sheepskin Leather Jacket. Army mechanic's, full shearing inside—re-issued. Similar to B-3 but lighter weight. Small, med., large **\$9.95**. B-2 Shearling Lined Leather Cap **\$2.50**; Sheepskin Leather Pants **\$7.50**.



Write for **FREE** illus. list clothing. Orders sent postpaid except C.O.D. Satisfaction or money back.  
**CONSUMERS CLOTHING CO., Inc.,** Box P, 20 Greene St., New York 13, N.Y.

## MILITARY TRUCK PARTS



Every part for every G.I. type vehicle from jeep to 20-ton prime mover 6x6 40% to 80% below list.

**NORTHWESTERN AUTO PARTS CO.**  
834 NORTH SEVENTH ST. • MINNEAPOLIS 11, MINN.

SAY YOU SAW IT IN POPULAR MECHANICS

## Send For This Automatic Shut-Off for your gas water heater



Installed in a few minutes with ordinary tools. Complete, simple instructions. Just replace regular gas-cock with **ERIE TIME-O-GAS**. Set knob to burn from 2 to 55 minutes. Device shuts off automatically! Works on manufactured, natural, mixed gas. Use with or without pilot. Pilot lighter included free with each unit. Described in October Popular Mechanics, page 121. Send **\$8.95** for postpaid **ERIE TIME-O-GAS**; or C.O.D. plus postage, or write for free information. Models for incinerators and other gas appliances also available.

**ERIE MFG. CO., Dept. P-3**  
300 N. 8th ST. MILWAUKEE 3, WIS.

## BURN WATER IN YOUR CAR! WITH OCTA-GANE WATER INJECTOR

Write today for particulars  
**COMMONWEALTH CARBURETOR CORPORATION**  
Div. 138, 1478 University Avenue  
Berkeley 2, California

## VIBRO-ARC ELECTRIC METAL ENGRAVING TOOL

Engraves, etches, marks, writes . . . on **BRASS, COPPER, SILVER, NICKEL, ALUMINUM, CHROMIUM, Hardened Steel**

Sole Distributors:

**BULLS (P. M.)** 246 HIGH ST., HARLESDEN N.W.10. LONDON, ENGLAND.

**\$3** With Instructions



Operates from 4 or 6 volt Accumulator or A. C. Transformer. Print your name and address and order with international money order only. Post Free.

POPULAR MECHANICS

New!

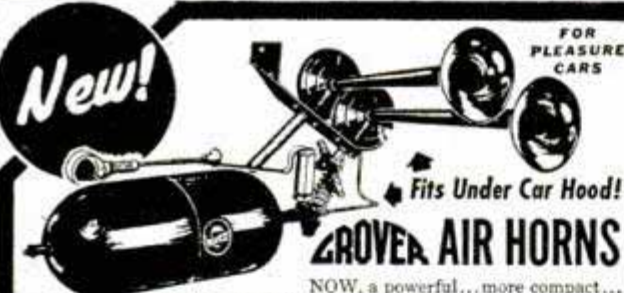

Fits Under Car Hood!  
**GROVER AIR HORNS**

NOW, a powerful... more compact... easily installed high pressure air horn and air tank assembly that fits on firewall or side splash pan under car hood! **FACTS NOW!** Spun brass bells, true-tone harmony, heard for miles! Complete assembly features two matched GROVER air horns, self-filling air pressure reserve tank, bronze diaphragms, brass valve, control handle and all necessary copper tubing, rubber hose and fittings. Instructions furnished. Satisfaction guaranteed. If your dealer cannot supply you, write for facts NOW with make, model and year of your car to **GROVER PRODUCTS CO., 1217 S. Hope St., Los Angeles 15, Calif.**

## MOTORIZE YOUR TREADLE SEWING MACHINE

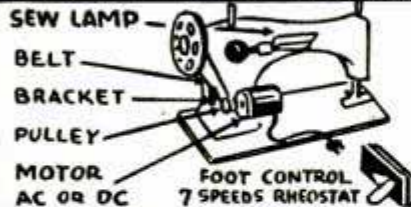

INSTRUCTIONS INCLUDED  
PORTABLE CASES **\$11.50**  
For Any Type Machine

only **\$15.95**

COMPLETE  
**FREE SEWING LAMP**

A PERFECT GIFT  
For MOTHER or WIFE  
**MONEY BACK GUARANTEE**

PM-1 **BRANT'S SEWING MACHINE CO., INC.**  
1720-22 Race Street, Cincinnati 10, Ohio

Rush your \$15.95 kit. My machine is a \_\_\_\_\_  
Hand wheel turns  toward me  away from me.

NAME \_\_\_\_\_  
ADDRESS \_\_\_\_\_

CITY \_\_\_\_\_ ZONE \_\_\_\_\_ STATE \_\_\_\_\_

I am enclosing \$15.95  check  money order or  send C. O. D. and I pay postman \$15.95 plus a few cents postage.



SANDING

The only attachment for angle-head electric drilling.

POLISHING

Why Pay More and Get Less? Only the BULL BUFFER

Has everything you want in a polisher-sander!

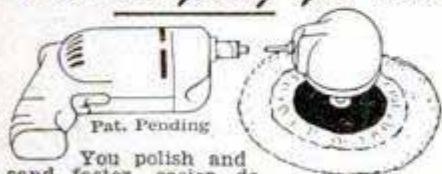

You polish and sand faster, easier—do beautiful, professional work—with this amazing attachment for your electric drill. (You can also drill up to 1/2" with your 1/4" drill and at right angles never before possible!) Bull Buffer more than pays for itself the very first time you make your car, floors, woodwork, furniture gleam like new. It's built of lifetime materials and guaranteed. Thousands and thousands of satisfied users. At your dealer or send cash, check or money order for your Bull Buffer, complete as pictured. Only

**\$9.95**

**BERTRAM K. ENGINEERING CO.**  
3121 MAIN ST. Dealers Write for Information KANSAS CITY, MO.

1. Fits any chuck on an electric drill or flexible shaft—no extra power unit to buy!
2. Only Bull Buffer has gear reduction—the power to do any job without injury to your electric drill!
3. Only Bull Buffer has swivel action—turns in complete circle when drill is stationary!
4. Only Bull Buffer has angle head for electric drill—gets to all hard-to-reach surfaces, curved or flat!
5. Only Bull Buffer has 3 speeds\* — "same as," 1/2-speed, or twice speed of your drill!

\*See description under photo of Bull Buffer kit.



Bull Buffer comes complete with sheepskin bonnet and two sanding discs, only \$9.95. Bull Buffer alone cuts drill speed 1/2; for direct drive (or "same as") drill speed, order Adapter A with Bull Buffer; for twice drill speed, order Adapter B.

**ORDER THESE ACCESSORIES FOR YOUR BULL BUFFER**

1 1/2" Jacobs No. 6425 key chuck; with Bull Buffer, increases 1/4" drill to 1/2" capacity — reduces speed, increases power	\$5.00
Extra sanding discs (000-00-0-1-2 1/2-3-4) each	.10
2 1/2" cup wire brush for removing paint, rust, scale, etc.	1.75
Extra sheepskin bonnet	1.25
Adapter A—for direct drive at "same as" drill speed	1.00
Adapter B Set—for sanding at twice drill speed	2.00
Bull Buffer car cleaner	.50
Bull Buffer car polish	1.00



**AMAZING BURGLAR ALARM GUARANTEED TO STOP THIEVES**

FOR CARS • HOMES • FARM BUILDINGS

A South Dakota manufacturer has discovered an easy way to protect cars, homes, farm buildings from Burglars, sneak and chicken thieves. The manufacturer is so sold on his sensational DEVIL DOG Burglar Alarm that he is willing to let you try it for ten days and will offer you \$1.00 for testing it. New sales plan promises big money to hustlers. Be first to get your DEVIL DOG Burglar Alarm for introducing in your territory. CASH-IN on the tremendous demand this device will create. Shipped prepaid from factory on ten year guarantee. Rush name and address for details to

**NORTHWEST ELECTRIC CO., Dept. 49-A, Pukwana, S. Dak.**

**AGENTS! Westinghouse Gives Fluorescent Sales a Tremendous Upward Spurt With New Circl-Arc Lamps**

**RUSH NAME for FREE** Selling Outfit



One of many fast selling combinations of straight and half circle tubes.

**BRAND** new — Cash in quick and big on tremendous demand for Fluorescent Fixtures with the sensational new WESTINGHOUSE Circl-Arc Lamp. Half circles of brilliant, economical, beautiful Fluorescent Light. Nothing like them ever shown before. Old-style straight tube fluorescents can be bought anywhere, but you'll be **FIRST** with WESTINGHOUSE Circl-Arc—the biggest lighting scoop in history. New buyers—new profits waiting everywhere!

**FREE** Send Name on Penny Post Card for Complete Selling Outfit showing more than 100 Different Fixtures. Rush name today —have profits next week.

**MAXILUME CO.**  
125 W. Hubbard St., Dept. 81, Chicago 10, Illinois

SCORES OF NEW MODERN DESIGNS SELL ON SIGHT



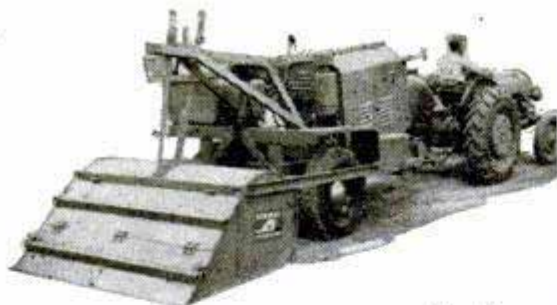

*Only a*  
**SEAMAN ROTARY TILLER**  
*Can do ALL THIS for You . . .*

- Prepare land for planting, generally in ONE PASS. Many Seaman owners till and plant at same time.
- Handle entire job of Seedbed Preparation with ONE MACHINE . . . at lower Horsepower Hours cost.
- Make Seedbed best suited to your soil and crop conditions . . . pulverize fine or coarse, as desired.
- Mix cover crops, fertilizer and surface trash throughout seedbed . . . saves soil, improves top soil, holds seedbed together. Seaman users report increased crop yields of 10% to 35%.
- Reduce erosion, control weeds and crop pests, renovate pastureland, clear light brush, hold moisture in seedbed longer, aerate ground when required, hasten early germination.

Also, latest motorized Seaman Tillers can be adapted to heavy-duty belt work or to operate our high-capacity portable irrigation unit. **ORDER YOUR SEAMAN TILLER NOW!** 20 models, 3 ft. to 7 ft. tillage widths, power take-off and gas- or diesel-powered. See your Seaman dealer and write for Bulletin NST.

**SEAMAN MOTORS CO.** 364 NO. 25th ST. MILWAUKEE 3, WIS.

**STOP FURNACE LEAKS**

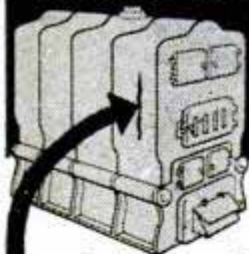

*Save*  
**Fuel Costs**

Seal up every heat-wasting crack, opened seam and other leak in your furnace, boiler, tank, radiators and piping *tight*—as professional repair men do—with Smooth-On No. 1 Iron Cement. Do it yourself—now—and cut this winter's fuel bills. You apply Smooth-On like putty, it hardens like metal, and *stays tight*, because it expands slightly as it sets. Buy Smooth-On No. 1 in 1 3/4-oz., 7-oz. or 1-lb. size at your hardware store. If they haven't it, write us.

**FREE Repair Handbook**

40 pages of ingenious, tested, short-cut repairs. Simple directions. 170 illustrations. Write today for YOUR free copy of the Smooth-On Handbook.

SMOOTH-ON MFG. CO., DEPT. 37-A, 570 Communipaw Ave., Jersey City 4, N. J.

*Do it with*

**SMOOTH-ON**

THE IRON CEMENT OF 1000 USES



**U-BUILD-IT TRAILER COMPANY**

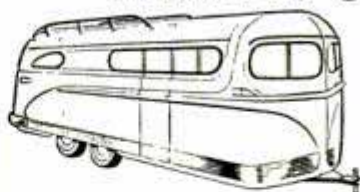

supplies all parts to size for quick, easy assembly of complete metal trailer body—Roof Caps, Roof Bows, Doors, Complete Chassis, Roof Corners, Roof Ends. Build this modern

streamlined design economically yourself.

*Write* for complete working plans showing detailed construction, location of parts for 12 ft., 16 ft., 20 ft., 24 ft., 28 ft. and 32 ft. lengths. Only **\$100**

U-BUILD-IT Trailer Co.

Dept. B

P.O. Box 611

Elkhart, Ind.

**DUAL TAIL PIPE EXTENSION**

*Fits all cars — chrome plated*  
**DEEP TONE**

produced by 2 1/2 inch outlets **\$2.95**  
 Postage free on prepaid orders

TRADE INQUIRIES INVITED

**LYONS PRODUCTS COMPANY**

PAT. PEND. 2426 So. LaBrea Ave., Dept. PM-1, Los Angeles 16, Calif.

**LOOK!**  
**FIN-DER SAX-SLING**  
*NEVER SLIP OR KINK*  
*HIGH SPEED ADJUSTING*  
*BALLBEARING*  
**\$1.00**  
 AT ALL GOOD DEALERS OR ORDER DIRECT  
**NEW!**  
 FIN-DER 1251 - 4th Avenue, San Diego 1, Calif.

**BUILD THIS SMART AND COLORFUL TRAWLER MODEL**

Kit contains carved hull and complete set of fittings. Send today for kit #1225 which will be sent postpaid for \$15.00. Our 40 page illustrated catalog mailed on receipt of 25c.

A. J. FISHER

1002 Etowah Ave., Dept. M

Royal Oak, Mich.



**Genuine Snap-on Tools**

Available Only Through Snap-on's Direct-To-User Tool Service

WRITE FOR INFORMATION

SNAP-ON TOOLS CORP. • Kenosha, Wisconsin

**Build your own SMITH Compressor**

Operates spray guns, rock drills, tampers, paving breakers, sandblasting . . . Uses only 1 gallon of gas an hour!



Save Money—build your own Smith Air Compressor! Famous the world over! Capacity 60 cu. ft.; pressure up to 100 lbs. per sq. inch. Just order the Smith Compressor Head and Accessories with complete instructions for assembling. All you need is a Ford Motor and shop facilities. Head equipped with high speed compressor valves; automatic unloading and idling.

Write for complete information!

GORDON SMITH & COMPANY, Inc.  
 410 College Street • Bowling Green, Ky.

Compare Your Present Rear Window with the Improved "FULL VIEW."



## GENUINE "FULL VIEW" REAR WINDOWS FOR CONVERTIBLE CARS ONLY

Made to Fit these Cars:  
 Buick, Cadillac, Chevrolet, Olds, Pontiac 1946-48, Ford and Mercury 1946-49, Lincoln 1949, Chrysler, DeSoto, Dodge and Plymouth 1946-48.

Convert your present rear view window to the new improved "FULL VIEW." Gives complete visibility—improves appearance—enhances beauty. Tailor made for your car of shatterproof Plexiglas. Rear vision increased more than five times—no blind spots. Simple to install. Specify exact year and model when ordering.  
 Shipped PREPAID anywhere in U.S.A., only. Each..... **\$25.00**

Carries the Same 90 DAY GUARANTEE As a New Motor Assy.

## Our Finest Precision REBUILT MOTOR BLOCK ASSEMBLIES

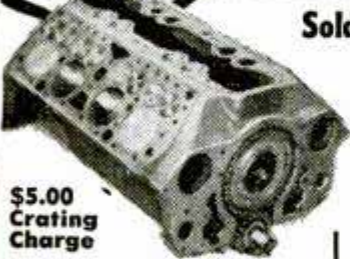

Sold Outright or Exchange

Rebuilt by skilled mechanics. Assembly has Rebornd Block with New Pistons, Pins, Rings, Reground Crankshaft, all New Bearings. Guaranteed 90 Days. Allowance on Old Motor We ship at outright price. Send your motor prepaid, must be suitable for rebuilding. Send in notarized bill of sale showing title number if any. We refund difference when we receive your motor.

\$5.00 Crating Charge

<b>BUICK</b>	Outright	Exch.
34-47 8 cyl.	\$219.00	\$175.00
<b>CHEVROLET</b>	Outr.	Exch.
29-47 6 cyl.	135.00	105.00
<b>CHRYSLER</b>	Outright	Exch.
34-47 6 cyl.	174.50	142.00
35-47 8 cyl.	219.00	175.00
<b>DE SOTO</b>	Outright	Exch.
34-47 6 cyl.	174.50	142.00
<b>DODGE—3 1/4" bore</b>		Exch.
33-47 6 cyl.	165.00	130.00
3 3/8" bore	Outright	Exch.
34-47 6 cyl.	174.50	142.00
<b>FORD</b>	Outright	Exch.
28-31 4 cyl.	129.00	97.00
32-34 V8	149.00	119.00
35-47 V8	169.00	119.00
37-39 60 HP.	169.00	119.00

<b>HUDSON-TERRA</b>	Outright	Exch.
35-36 6 cyl.	\$191.00	\$147.00
37-42 6 cyl.	209.50	159.50
<b>LINCOLN-ZEPHYR</b>		
36-37 also	Out'r.	Exch.
fits 38-39	252.00	202.00
39-40	394.00	244.00
<b>MERCURY</b>	Outright	Exch.
39-47 V8	169.00	119.00
Oldsmobile	Outright	Exch.
37-47 6 cyl.	187.50	147.50
35-47 8 cyl.	219.00	175.00
<b>PLYMOUTH</b>	Outr.	Exch.
1932 4 cyl.	149.00	124.00
33-47 6 cyl.	160.00	130.00
<b>PONTIAC</b>	Outright	Exch.
37-47 6 cyl.	187.50	147.50
35-47 8 cyl.	219.00	175.00
Studebaker	Outright	Exch.
35-47 Comm.	191.50	147.50
39-46 Cham.	169.50	136.50
35-47 8 cyl.	219.00	175.00

## NEW CONVERTIBLE TOPS

Choice of Black or Tan. All Tops Tailor Made for Easy Installation. Instructions for Simple Installation with Each Top

As Low as **\$24.95**

### "ZIPPER TYPE" REAR CURTAIN

Each top packed complete and consists of main top proper, rear curtain and all needed binding and fittings. (Glass is not supplied—use glass from top being replaced). Best quality, laboratory tested—equal to or better than the original. All metal parts are of heavy bright chrome plated rust resistant. Tops are heavily stitched with treated thread and sewed for durability and appearance.



Car	Year	Price	Car	Year	Price
BUICK	1936-48	\$41.75	Hudson also		
CADILLAC	1936-48	41.75	Terra to '38	1936-40	\$39.95
CHEVROLET	1936-48	39.50	HUDSON	1941-47	46.95
CHRYSLER	1935-38	33.00	LASALLE	1936-40	41.75
CHRYSLER	1940-48	39.50	MERCURY	1939-42	37.95
DE SOTO	1935-38	33.00	MERCURY	1946-49	39.95
DE SOTO	1940-48	39.50	NASH & LAFAYETTE	1937-41	39.95
DODGE	1935-38	33.00	OLDSMOBILE	1936-48	41.75
DODGE	1940-48	39.50	PACKARD	1936-48	45.95
FORD			PLYMOUTH	1935-39	33.00
1928-31 Roadster & Cpe.	24.95		PLYMOUTH	1940-48	39.50
1933-39 Rdstr. & 2 pas. Cpe.	33.00		PONTIAC	1936-48	41.75
1928-39 Phaet. & Sedan	42.95		STUDEBAKER 1948	44.15	
1936-42-5 Pas. Cib. Cpe.	37.95				
1946-48-6 Pas. Cib. Cpe.	39.95				

NOTE: Specify color wanted also Model or Series. Body Style, Year & Make when ordering.



## 60 HP. JEEP Engines

Reconditioned, Tested and Guaranteed in perfect running order and ready to run. Every part is checked to be perfect and carries a 90 Day Guarantee same as a new engine.

COMPLETE with . . . Generator, Starter, Distributor, Coll, Fan and Fan Belt, Water Pump, Fuel Pump, Intake and Exhaust Manifolds, Carburetor, Oil Filter, Spark Plugs, Flywheel, Clutch and Pressure Plate, Wiring.

Outright, **\$179.50**  
 PG58R-003, Ea.

\$5.00 Crating Charge

## FENDER SKIRTS for Modern Beauty

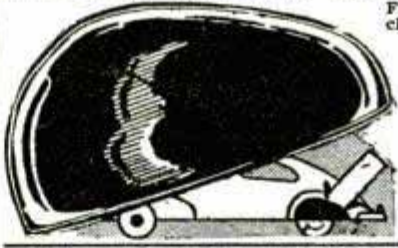

For most makes of cars including '49 Ford & Mercury. Made of all metal, prime finish, with Rubber beading to prevent rattle. Easy to install.

MC31N-9  
**\$12.95**  
 Per Pair  
 Be sure to specify year, make & model of car.

## GUTTED MUFFLERS FOR ALL CARS



Gives that Motorboat Tone  
 MD20N-210  
 Universal type to fit all cars. **\$4.95** ea.

**JEEP FRONT FLOOR MATS**  
 Rubber with Felt Back. For all Jeeps. Ea. **\$3.95**

SEND 25% CASH WITH ORDER, BALANCE C.O.D.  
**J.C. WHITNEY & Co.**  
 1917 Archer Ave. Chicago 16, Ill.

1935-48 FORD V8 & 1939-48 MERCURY  
**DUAL MUFFLERS**  
 Increases power. Reduces back pressure. Saves gas.  
 MD20N-208—Complete Set **\$17.95**

## SHARPEN CIRCULAR SAWS LIKE AN EXPERT



With SURE-SHARP you can precision file circular saws in your own workshop. No experience necessary. Adjustable to any pitch or angle. Gets hollow-ground, cross-cut and combination saw blades true and sharp. Fits 6" to 12" circular saws with 1/2, 5/8, 3/4 or 3/16" centers. Complete with file, instructions, 4-different size mandrels. Money-back guarantee! Cash with order, \$6.95 postpaid. Dealer inquiry invited.

**\$6.95**

SURE-SHARP MFG. CO., Box 24, Dept. 11, Santa Ana, Calif.

## AMAZING NEW TRAP CATCHES ANIMALS ALIVE!

CAN'T HARM CHILDREN, PETS, BIRDS, POULTRY  
 It's amazing how the new HAVAHART catches rats, rabbits, squirrels and other animals, yet it's harmless to children and pets. Simple to set, rustproof. No springs! No jaws! Animal walks in to get bait, and the doors close! Send postal for free booklet.

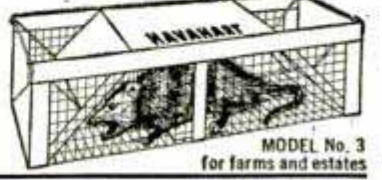

HAVAHART, 23 No. Water St. Ossining, N.Y.

MODEL No. 3 for farms and estates

# \$500<sup>00</sup> REWARD



We have a large stock of shell cases made of heavy waterproof fibre with metal ends.

We are looking for ideas whereby we can use these cases in the manufacture of some item having popular appeal. Home craftsmen can find many uses for these cases, such as bird houses, telescopes, giant Xmas candles, lamp bases, etc. But if you submit an idea we use in mass production, we'll pay you \$500.00 reward. All ideas become our property.

Three cases (one of each size) cost govt. approx. \$6. Send just \$1 and we will send all 3, postpaid. Offer good in U. S. only.

## Shell Case Outside Dimensions

LARGE	MEDIUM	SMALL
5-1/16" Diameter	3-7/8" Diameter	2-3/4" Diameter
28-3/4" Long	29-1/4" Long	3" Long

## ATTENTION MANUFACTURERS!

Rock bottom prices on quantity order.

## FOXBILT INC.

231 INSURANCE EXCHANGE BLDG.  
DES MOINES, IOWA

## NOW YOU TOO CAN BUILD 15 RADIOS

COMPLETE KIT \$14.75



Absolutely No Knowledge of Radio Necessary

You Need NO Additional Parts

### The PROGRESSIVE RADIO KIT

is THE ONLY COMPLETE KIT. Contains everything you need. Instruction Book, Metal Chassis, Tubes, Condensers, Resistors and all Radio parts. The 36-Page Book written by Expert Radio Instructor teaches you to build radios in a Professional Manner. You start with a 1-tube receiver. Before you are done with this kit, you will have built 11 Receivers, 1 Public Address System and 3 Transmitters.

### SPECIAL FREE OFFER!

Electrical and Radio Tester sent absolutely FREE with each Progressive Radio Kit. PLUS FREE membership in Progressive Radio Club. Entitles you to free expert advice and consultation service with licensed radio technicians.

Write for further information, or ORDER your KIT \$14.75 NOW! ONLY

Postage prepaid with check or money order (Postage not prepaid with C.O.D. orders)

PROGRESSIVE ELECTRONICS CO., Dept. PM-18  
497 Union Avenue Brooklyn 11, N. Y.

## "Does Same Work as High Priced Machines"

... so says L. E. Puterbaugh, Dayton, Ohio. YOU MUST SEE this amazing 5-in-1 EMRICK to fully realize what a wonderful bargain we offer. Handles big, heavy jobs. Tools quickly interchangeable — 83 operations. Needs only ONE motor (1/4 to 1/2 h.p.). Equals in performance equipment costing up to 8 times more. Dandy for man or boy — do home repairs; make scores of articles from wood, metals or plastic. Use it for operating profitable spare-time business. Thousands of satisfied users. Don't squander hard-earned money on high-priced outfits — GET AN EMRICK!

Mail coupon now, or write us.

**FREE TO-DAY OFFER** EMRICK, INC., 1731 Clinton, Kalamazoo, Mich.

I enclose \$18.00. Ship Emrick Workshop (complete less motor and saw blade) on balance c.o.d. basis. Unless completely satisfied, I may return within 10 days and get my money back.

Name \_\_\_\_\_ (PLEASE PRINT)  Send FREE catalog.  
Street \_\_\_\_\_  
City \_\_\_\_\_ State \_\_\_\_\_

## LIFETIME WRITTEN GUARANTEE CERTIFICATE



## ZEISS TYPE BINOCULARS

6x25	8x30
\$26.75	\$34.75
7x50	7x50 Coated
\$46.75	\$56.75

Made to rigid military specifications. Four to choose from. For top quality performance consider these all purpose 6x25, 8x30 and 7x50 binoculars. All have superb optics, lightweight metal bodies. Individual focussing. Moisture and dust proofed. These brand new glasses come complete with genuine leather, plush lined case and straps. Coated price means entire optic system is precision coated. Superb binoculars for we send purchasers a LIFETIME WRITTEN GUARANTEE CERTIFICATE! Add 20% for Federal tax. Cash orders rushed postpaid or send \$2.00 deposit and we will ship C.O.D. for balance plus postal charges. United Products Co., 7941 S. Halsted, Dept. ARP-908, Chicago 20.

## Guaranteed by mfr. for FULL YEAR

### Handsome Swiss wrist watch...

Marvelous value in a good-looking watch, built by skilled Swiss craftsmen. So well-made that a printed one-year guarantee is given. Has sweep second hand, glow-at-night dial, rugged chrome case, unbreakable crystal. Timed and tested movement; leather strap.

Send no money—10 day trial  
Pay postman \$6.95, plus tax and postage (or send check and we pay postage). Return in 10 days, if not delighted.

Swiss Watch Distr.  
211 Paramount Bldg.  
(Dept. 901C) Atlanta, Ga.



## LUMBER

### A BOARD OR A CARLOAD

Harold Hunt wants to send you big, new No. 15-B Catalog. Over 148 pages of woodworking ideas. 12 pages of rare woods in colors. UNEQUALLED BARGAINS in imported and American woods, supplies, hard-to-find hardware. Send only 15c to cover postage and handling.

CRAFTSMAN WOOD SERVICE CO.  
2729 S. Mary St. Dept. A-1 Chicago 8, Ill.

TOP GRADE KILN-DRIED WALNUT MAHOG. CHERRY WHITE HARD MAPLE POPLAR OAK AROMATIC RED CEDAR

## OTTAWA TRACTOR SAW



350 Cuts Per Minute—cuts them down, saws them up, one man operates. Thousands in use, stiff heavy blade, built to last, safety clutch control, uses power take-off any tractor. Low price, OTTAWA MFG. CO., 2-927 Forest Avenue, OTTAWA, KANSAS

## LAWN ORNAMENT-NOVELTY PATTERNS

28 Lawn Ornament Patterns, 25c. Other patterns; 15-20" high; Dutch Girl, Dutch Boy, Pirate, Bull Terrier, Mexican Girl, Mexican Boy, Dwarf, Penguin, Flower Girl, 10c each. 25 Novelty Patterns, 30c. All 62 Full Size Patterns, \$1.00 Postpaid. Strother Pattern Service, Dept. AV-8, Box 128, Belington, W. Va.

Look - ONLY \$39<sup>95</sup> for This 5-in 1 Machine



HAVE FUN SAVING MONEY

THOUSANDS OF SUFFERERS USE  
**BREATHEASY**  
FOR  
**ASTHMA**

CARRY IT WITH YOU  
USE IT ANYWHERE

Sold on Money-Back  
Guarantee

Write To Dept. PM

BREATHEASY DISTRIBUTORS, INC.  
65 CEDAR STREET  
SEATTLE 1 WASHINGTON

**TOOLS** at Mechanics' "NET" Prices



Send 10c for literature and price lists on "Nationally known" mechanics hand and specialty tools mfd. by Plomb, Utica, Channel-Lock, Herbrand, Vichek, Zim, S-K, Vim, Tool Companies, etc.

**GIZMO TOOL CO.** BOX 656  
SAN FRANCISCO 2, CALIF.

**1949 HARLEY-DAVIDSON**  
with HYDRA-GLIDE FORK



Sensationally smooth riding, even on roughest roads! Amazing new Hydra-Glide Fork "floats" you over bumps. Bigger, faster-acting brake gives increased stopping power. New sealed ray headlight turns night into day. Many other new features. See your dealer. Write for literature and FREE "Enthusiast" Magazine.

**HARLEY-DAVIDSON MOTOR CO.,** Dept. P, Milwaukee 1, Wis.

**BRUSH PLATING OUTFITS**

- for re-plating articles in the home and shop. No tanks necessary. Free particulars.

**GUNMETAL CO.,** AVE. M, DECATUR, ILLINOIS

**Gear Head ELECTRIC MOTOR**

Two speed 375-550 r. p. m. - 110 volt AC-DC. 3/4 - 1 H. P. Rotation either direction. Heat treated steel gearing enclosed. All bearings either ball or roller. Aluminum alloy housing blower cooling. Splined drive shaft as it fits standard pulleys and drives. Length over all 14 3/4 in. Width over all 7 3/4 in. Height over all 7 in. Two speed H. D. switch furnished with each motor. Manufactured by well known precision manufacturer and offered at about one fourth the manufacturing cost.

**\$37.50**

Send check or Money Order, No. C.O.D.'s. Guaranteed as represented new and unused. Order early as we only have a small stock available.

**PRONTO MOWERS**  
OLDSMAR, FLORIDA



**Thousands of Parts For Military TRUCKS**

We have for immediate delivery genuine parts for all makes and models, 4x2 - 4x4 - 6x4 and 6x6. All models from 1/4 ton to 20 tons. All makes: Auto-car, Biederman, Brockway, Chevrolet, Diamond T, Dodge, Federal, Ford, GMC, International, Mack, Oshkosh, Reo, Studebaker, White, Willys and Jeeps. We have parts lists available on some models. Write stating model of Truck.



**TOPS FOR MILITARY JEEPS**  
(Winterizing Kit), complete top with back curtain and side curtains with zip-in-doors. 5 windows. Waterproof O.D. color. Shipping weight 40 lbs. Wonderful value. FOB, K.C. **\$39.50**

**TRAILER AXLE**



Heavy duty trailer axle suitable for many types of trailer construction. Also excellent for building of heavy farm trailers and wagons. It is a 15,000 lb. capacity square type straight trailer axle complete with Timken roller bearings, hubs, and 6 hole 750 x 20 Budd Wheels. Without brakes. Axle is 2 1/2 inches square and 70 inches between wheel mounting flanges. Std. width. AN EXCELLENT BUY.

With Single Wheels. \$59.50 With Dual Wheels. \$69.50

**NEW POWER WINCHES**

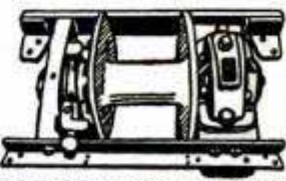

Govt. Surplus. All are Brand New and Suitable for front or rear mounting.

<b>WINCH CABLE</b> —With Chain and hook. 1/2" in diameter. 200 ft. length. <b>\$25.00</b>	<b>GARWOOD WINCH</b> —12,000 lb. capacity. <b>\$125.00</b>
New <b>WINCH, GARWOOD OR HEIL</b> —15,000 lb. <b>\$150.00</b>	<b>GARWOOD WINCH</b> —25,000 lb. capacity. <b>\$200.00</b>

A 25,000 lb. Winch with 3 speed power take-off, shafts, joints and attaching parts for International TD-9 and TD-14. **\$2500**  
For Front only. Shipping weight 1700 lbs. Only. . . . .

Above Winch adaptable to front or rear of H. D. Trucks. Available cables, power-take-offs, shafts and joints reasonable

**HYDRAULIC JACKS**



Government Surplus. Slightly used 5 ton Hydraulic Jacks of popular brands. Guaranteed serviceable, complete with handle. Shipping weight, 25 lbs. Each **\$7.95**

**OIL PAN GASKET SET**

Dodge Part No. 933438. For Dodges 33-47, Plymouth 33-47. Contains 4 gaskets for oil pan. 150 sets to wooden box. Shipping weight 69 lbs. In case lots, only, each **12c**

All prices quoted are FOB, Kansas City. 25% deposit required on COD orders.

**American AUTO PARTS CO.** 

1830 LOCUST — DEPT. PM  
KANSAS CITY, MISSOURI.

SAY YOU SAW IT IN POPULAR MECHANICS

Sand Casting — Forging — Heat Treating — Case Hardening

**BRONZE FOUNDRY**



In your own workshop allows you to design and build your own GASOLINE ENGINES, STEAM ENGINES, STATUARY, ART OBJECTS, SPECIAL TOOLS, NEW INVENTIONS, ETC. You can also make forgings and case harden steel. Your shop is not complete without a FOUNDRYETTE. Three sizes are available capable of making bronze castings of 1 1/2, 3 and 6 pounds weight, aluminum, copper, brass, etc., \$22.50, \$29.50, \$42.00 f.o.b. Kansas City. Domestic gas supply and 110 volt AC or DC energy required for operation. Write for circular.

**KANSAS CITY SPECIALTIES CO.**  
Box 6022, Dept. P-12 Kansas City, Mo.

## WAR SURPLUS BARGAINS



● **POWER PLANTS.** Army's famous PE-75. New condition and perfect. 110-volt, 60-cycle, 2500-watt. Excellent voltage regulation. Ideal size for farms, cabins, contractors, etc. Will handle all lights and motors on largest farm. Tools, spare parts and full instructions. A real buy. (Cost \$535.) **Frt. prepaid price...\$266.80**

● **POWER PLANTS.** Same as above except slightly used. Excellent condition, fully guar. Instructions but no tools, spare parts. (Cost \$535.) **Frt. prepaid price...\$229.80**

● **POWER PLANTS.** 3000-4000 watt, 110-volt, 60-cycle. Remote control push button start. Easily made automatic start. Hercules 4-cyl. eng. A wonderful plant. New condition and perfect. (Cost over \$700.)

**\$15 freight allowance...\$345.00**

● **GAS ENGINES.** Nearly new and excellent. Genuine Briggs ZZ (6.5 h.p.). Useful tractors, grain elevators, weed and paint sprayers, irrigation pumps, scooters, saws, etc. (Cost \$140.)

**Freight prepaid price...\$86.90**

● **ROTARY GEAR PUMP.** Precision type. New condition. High vacuum and pressure. Relief valve. Well made. Dozens uses. 1/2" shaft. Full instructions. (Cost \$36.50.)

**Exp. prepaid price...\$3.95**

● **A-C MOTORS.** New 110-volt, 60-cycle. Complete with marvelous speed reduction gear. Speeds of 8, 32, 320 and 4000 r.p.m. on 4 separate shafts. Useful for buffers, grinders, drills, coil winders, photo room, window displays, operating toys, fans, etc. Fine gift. (Cost \$38.75.)

**Exp. prepaid price...\$8.75**

● **EXPERIMENTAL LABORATORY UNIT.** Educational, fascinating, scientific. Consists large asst. finest apparatus. Includes tubes, capacitors, relay, potentiometers, resistors, receiver, 110-volt test unit, fuses, wire. "Plans for Home Laboratory." "Manual of Experiments." "Prints for Home Experimental Test Bench." and laboratory "HI-VOLTAGE" and "KEEP-OUT" signs. Dozens experiments for boys, men. (Cost over \$30.)

**Prepaid price...\$6.77**

● **OTHER BARGAINS.** Tulsa 5-ton winches, home telephones, hydraulic pumps and cylinders, compressors, gas solder units, meters, etc. Order direct from this ad or send for catalog. We will accept your personal check or send M.O. References: National Bank of Commerce and 17 yrs. in business.

**LECO ENG. CO., Box 908—PM-14, Lincoln, Nebr.**

## Your weight does the work with a "YANKEE" QUICK-RETURN SPIRAL SCREW DRIVER

● Save your wrist: drive and draw screws faster. Just push on a "Yankee" 130A Spiral Driver. Your weight and the spiral turns the screw without blisters or fatigue. Quick-return spring in handle holds blade in slot and returns the handle after every stroke.

★ Write for the "YANKEE" Tool Book .. FREE ..

"YANKEE" TOOLS NOW PART OF

**STANLEY**

THE TOOL BOX OF THE WORLD

**NORTH BROS. MFG. CO.**  
Philadelphia 33, Pa.

## POCKET-MITE PORTABLE PACKS AMAZING POWER!

Tiny enough to easily slip into pocket and featuring hearing-aid midget tubes and new long-life midget batteries all contained within beautiful plastic case. No ground or outside antenna needed for strong reception within 50 miles radius. Stations over 2,000 miles distance received with plug-in antenna. Complete set of finished midget parts including tubes and beginners picture diagram direct from lab to you. Ready to wire as shown. Only \$6.99 P.P. Foreign orders \$8.00 U.S. Cash.

**ELECTRONIC RESEARCH LABS., Dept. A**  
1216 PARK ROW BLDG. NEW YORK CITY 7



# READY CUT HOMES

## Order Now

Homes \$1835.00 and up, freight paid. Orders filled in order received. Save up to \$1000 on modern production method homes. Much more compared with builders' prices. Anyone can assemble. Complete. Plans furnished. Hardware, roof, including paint, nails, etc. tung, glass, etc. for full color catalogue showing 57 modern low-priced homes and floor plans. Complete building plans ready for filing at low cost. Sold separately if desired.

Dept. PM-19  
**INTERNATIONAL MILL & TIMBER CO.**  
Bay City, Mich.

**NEW COLOR CATALOG FOR ONLY 35c**

## BUILD YOUR OWN FAST FREEZER

PLANS \$1

It's easy to build this household appliance with LeJay Plans. Made from new or used parts. Save up to 50%. No expert knowledge needed. Plans show 6 sizes and are easy to follow. All details clearly explained. Enjoy making one of these freezers. Mail \$1 for set of plans and catalog. **LEJAY MFG. CO., 447 LeJay Bldg., Minneapolis 8, Minnesota**

6 sizes 8 to 40 cu.ft.

## SPEED AND POWER HANDBOOK

Very latest methods! Construct your own Superchargers, "Water Injectors," Hi-Compression Heads, Fuel Saving Devices—easily. **SAVE MANY DOLLARS!** Get racing speed, acceleration, dynamic power increases from any automobile! Build fast stock cars! California roadsters! Hotrods! Get ingenious formulas! Speed secrets! Illustrations! Conversion ideas! Also "Economy Information"—Mileage tricks! Tuning techniques! Instructions! Picture catalogues. Including "California Restyling Ideas"—Glossy photographs! Drawings! Model revising! Customizing! Streamlining! Leatherlike bound—\$1.98 complete.

**Newhouse Automotive Industries, 5941-B Hereford, Los Angeles 22, Calif.**

## WOODWORKERS... Get this!

### CONSTANTINE MASTER MANUAL

Get the Most Fun From Your Hobby Indispensable to woodworkers. Newest, biggest edition, more pages, more color, helpful how-to-do-it articles, pre-war and new items, more bargains. Send 25c today and we will include **FREE! FULL YRS. SUBSCRIPTION** to Chips and Chats, published bi-monthly. Keeps you up-to-date on everything in woodworking, offers big money-saving bargains. Send now.

**ALBERT CONSTANTINE & SON, Inc.**  
791-1 135th Street, New York 54, N. Y.

## LOCKSMITHING & Key Making

**PRACTICAL UP-TO-DATE COURSE—ONLY \$3.95**

Easy-to-learn modern information for self-instruction. How to work on locks, de-code, make master-keys, repair, install, service, etc. For every handyman, home owner, carpenter, mechanic, service station operator, fix-it shop, hardware dealer, gunsmith. 53 plain illustrated lessons. **FULL PRICE ONLY \$3.95. SEND NO MONEY.** Just pay postman plus C.O.D. postage. Or send \$3.95 with order, we'll ship postpaid. Satisfaction guaranteed or refund.

**NELSON-HALL CO., 1139 S. Wabash Ave., Dept. A-2, Chicago 5, Ill.**

## GIVES YOU 2 DRILLS IN 1

Converts any 1/4 inch Electric Drill to 1/2 inch capacity. Reduction gears reduce speed 5 to 1, the average speed of 1/2 inch Drill thereby increasing power.

**Jobbers write Price \$1195 for proposition**  
M.O. or check with order

**G. M. CO. MANUFACTURING, INC.**  
1308 43rd Avenue  
Long Island City 1, New York



# UTICA TOOLS

FOR MORE TOOL MILEAGE



No 91—4", 6", 8", 10", 12"  
Adjustable Steel Wrench

**UTICA DROP FORGE & TOOL CORPORATION**  
UTICA 4, NEW YORK

Profit by growing demand for belts, purses, gloves, woolskin toys and mittens—and 100 other popular leather items. No experience necessary; instructions free with materials.

Largest complete stock of leather and leathersupplies in America, including moderate priced tooling leathers and top quality calfskins. Immediate delivery. Write today.

## Make money

on  
Easy-to-Assemble  
*Larson*  
Leathercraft  
Items

Send 10 cents at once for new 24-page leathercraft catalog of gift suggestions and profitable ideas.



**J. C. LARSON COMPANY**  
824 S. Tripp Avenue, CHICAGO 24, ILL.

## DUAL CROSS and ROTARY FEED

### PALMGREN ROTARY, INDEX, MILLING TABLE

Has 8" table, 360° movement and 4" cross feed travel. Adjusting wheels and dials graduated in degrees and thousands. Stotted for bolting to table. No. 83 Priced \$49.50. No. 82 without rotary feed \$39.75.

Write for Circular No. 10  
**CHICAGO TOOL and ENGINEERING CO.**  
8365 South Chicago Ave., Chicago 17, Ill.



**RED GARDEN TRACTOR**

NO BELTS • NO CHAINS  
POWER TURNING

BUY DIRECT from FACTORY at FACTORY DISCOUNT write for BIG, FREE CATALOG

PLow, DISC, HARROW, CULTIVATE and PLOW SNOW  
3.4-5 H.P.  
Easy to Operate • Economical

RED-E IS DIRECT DRIVE-ALL GEARS ENCLOSED.

RED-E TRACTOR CO.  
231 Fond du Lac Rd., RICHFIELD, WIS.

## DIRECT OIL BURNERS Complete With 3 Electric Controls



Coordinated Air Tabulator and air deflector. New Heavy Duty Blast Tube. 1 to 4 gal. capacity. Easy servicing. Quiet operation. Immediate delivery. Specify nozzle size and gallonage. Complete with thermostat and all electric controls. The Most Efficient Burner Built.

Regular Price \$189.00  
Our Price **\$89.50**

FITS ANY TYPE FURNACE

In ordering Burners Specify number of rooms to be heated.

We Also Handle Tanks In All Sizes

WRITE FOR PRICES

If you send check or money order we will pay the Freight.

DIRECT SALES, 921 W. 17th St., Kansas City, Mo.

## BUILD YOUR OWN TILTING ARBOR SAW!

Exclusive GIL-BILT Build-It-Yourself Features

SAVE **\$50** OR MORE

- No machining—build easily with hand tools only
- No blueprint reading—step-by-step pictorial plans, full scale patterns, actual photographs
- Sturdy wood, aluminum, and steel construction
- Capacity and performance of commercial saws selling for \$60 and up

### GIL-BILT 10-INCH TILTING ARBOR SAW



- 27x28 in. table, 13 1/2 in. capacity in front of blade
- 10 in. blade cuts 3 1/4 in. deep, tilts full 45 degrees
- Floor model, 34" high table always stays level
- New Departure ball bearing arbor, 3/4" precision shaft turned down for 5/8" bore blades, alum. housing, shipped ready to run
- Jackscrew and 4 1/2 in. dia. handwheel lowers and raises blade
- Cast aluminum miter gauge and self-aligning rip fence guide

Gil-Bilt Metal Parts Kit includes Plans, Ball Bearing Arbor, Miter Gauge and Bar, Rip Fence Guide, Machined Lock Knobs, Jackscrew Mechanism and Handwheel, and All Other Metal Parts (less blade).....\$20.95  
Same Kit with 10" comb. blade..... 25.90  
Same Kit with 8" comb. blade..... 24.90

### GIL-BILT 8-INCH TILTING TABLE SAW

- 21x27 in. table tilts full 45 degrees, 13 in. capacity in front of blade
- 8 in. blade cuts from 0 to 2 1/2 inches
- New Departure ball bearing arbor, 5/8" precision shaft turned down for 1/2" bore blades, alum. housing, ready to run
- Cast aluminum miter gauge and self-aligning rip fence guide (same as above)



GIL-BILT Metal Parts Kit includes Plans, Ball Bearing Arbor, Miter Gauge and Bar, Rip Fence Guide, Machined Lock Knobs, Tilt Support Segments, and All Other Metal Parts (less blade).....\$15.95  
Same Kit with 8" Combination Blade..... 19.90

### GIL-BILT 12-INCH BAND SAW

- Cuts to center of 24 in. circle
- Handles stock up to 6 in. thick
- Fully enclosed mechanism for utmost safety
- Wheels turn on heavy 5/8 in. shafts, four Oilite bronze bearings
- 18x18 in. table tilts 45 degrees
- Upper wheel tension and tilt mechanism of cast aluminum; completely assembled
- Two blade guides, each has ball thrust bearing, self-lub bronze jaws
- Rubber tired wheels. Choice of cast alum. or make-your-own wood wheels on metal hubs
- Uses standard 78 in. blades up to 3/8 in. wide

GIL-BILT Metal Parts Kit Includes Plans, rubber tires, 3/16" blade, hubs for wood wheels, bearings, shafts, tilt mechanism, guides, tilt support segments, and all other metal parts.....\$16.95  
Same kit with 20 ready-to-install 12" cast aluminum wheels 20.95

NO DEALERS—ONE LOW PRICE! Prices include postage up to 600 miles. Send cash, check or money order for complete kit, or send \$1.00 for Step-by-Step Plans and Order kit later less cost of Plans. Plans sent postpaid anywhere in the world.

COMPLETE PLANS only **\$1.00** EACH

### GILLIOM POWER TOOLS

P. O. Box 1-PA, Lambert Field, St. Louis 21, Missouri

## Say You Saw It in POPULAR MECHANICS

### AMAZING NEW HOME PAINTING SET

#### "EASY DOES IT" ROLLER and TRAY

- Just Roll the Paint On Easily
- No Brush Needed — No Streaks
- Anyone Can Do a Neat Job
- Paints 3 to 8 Times Faster
- Roller Does as Good a Job as Expensive Brush. It Can Be Cleaned and Re-used
- Uses Any Paint — either Oil or Water Base Paint
- Save Time, Paint and Labor

Both Tray and Roller **\$2.89** post paid

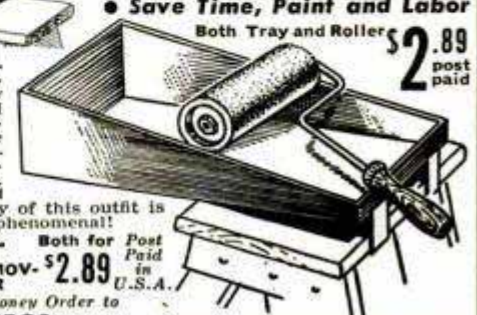

This wonderful invention enables anyone to paint any kind of surfaced wall and ceiling FAST, EASIER, more ECONOMICALLY—yet get a professional looking job. Save paint, time and money. The quality of this outfit is tops—the value is phenomenal!

TRAY WITH METAL FASTENER CLIPS  
ROLLER WITH REMOV. U.S.A. ABLE WOOL COVER

Both for Post Paid in U.S.A. **\$2.89**

Rush Check or Money Order to **GUGGENHEIM BROS.** 2224 So. State, Dept. A, Chicago 16, Ill.

**NOW! USE YOUR ELECTRIC DRILL for  
POLISHING!  
GRINDING!  
SANDING!**

**Work on curved  
or flat  
surfaces**

You can use it to fix bodies, fenders; wax; polish cars, floors, linoleum; re-finish furniture, wood, metal surfaces; smooth, reduce welds, etc.

**FITS ANY 1/4 IN. CHUCK or DRILL,  
FLEXIBLE SHAFT, MOTOR, etc.**

Designed and engineered for high speed sanding, polishing, finishing, etc. Full 6 1/2 inch rubber face plate bends into curved surface. New clamp arrangement mounts sanding discs instantly—no cementing. Draw-string lamb's wool bonnet slips on for high speed polishing, finishing, etc. Outfit includes 6 1/2" flexible rubber disc with 1/4" metal shank, fibre backed sanding disc and heavy lamb's wool polisher. Equals \$75.00 outfits in performance. You'll find hundreds of time saving uses for it. Fully guaranteed. Shp. wgt. 2 lbs. F.O.B. Chicago. Complete, only

**\$4.95**

At your favorite hardware store or direct.

**PREHLER PROVED PRODUCTS**

Division Norbert Prehler & Co. Dept. PM 1 — 1623-25 Milwaukee Ave. Chicago 47, Illinois

**EARN A STEADY INCOME**

*Sharpen*  
**CIRCULAR SAWS**

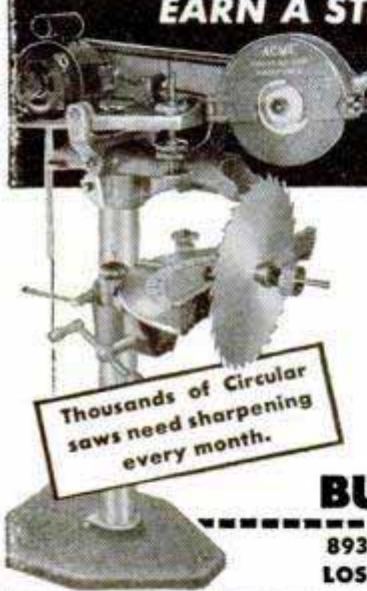

Improved Acme Circular Saw Sharpener sharpens saws 6" to 60" Rip, Cross-cut, Combination, Dado, even planer knives. Easy to operate, accurate—fast—safe. Bevels 45°, Gums, Joints. • You can profit with this machine.

Write for details.

**BURR MFG. CO.**

8933-Z VENICE BOULEVARD  
LOS ANGELES 34, CALIFORNIA

SAY YOU SAW IT IN POPULAR MECHANICS

**KEYLESS  
DRILL CHUCKS**

- 1/4" — \$ 6.00
- 3/8" — 8.00
- 1/2" — 10.00
- 5/8" — 12.00
- 7/8" — 18.00

**Fast  
SAVE**

Chuck grabs drill with an easy twist—tightens as drill works, will not slip. Save time, tools, money. No Keys to replace, no more chewed up drills.

**For Portable Drills, Drill Presses, Lathes**

See Your "KNOCK-OUT" Dealer or ORDER DIRECT (Send name and model of drill, or spindle specifications for correct adaptor).

1150 1st Ave. S. E. **K. O. LEE CO.** Aberdeen, S. D.

**DELCO MOTORS**



A REAL BUY! ALL-PURPOSE FACTORY TESTED and GUARANTEED HEAVY DUTY DELCO MOTORS. Efficient motor with fan blade for kitchen vents, unit heaters, furnaces, stoves, and refrigeration units. Woolpacked bearings insure years of actual running without oiling. Horseshoe stand with triple rubber mounts for perfect quiet operation.

SEND CHECK OR MONEY ORDER we will ship c.o.d.

HEAVY DUTY 1/75 H.P. MOTOR, 110 Volt A.C., 50-60 Cy., 900 R.P.M. 8 blade fan 7 1/2" Dia. Complete as shown. IMMEDIATE DELIVERY.

No. P7395 Blower Type

No. P7014 Suction Type . . . EACH **\$5.25** plus postage

Lots of 10, ea. \$4.90. Lots of 50, ea. \$4.75

**FREE**—Send for new G & E Appliance and Parts Catalog  
**G. & E. EQUIPMENT SUPPLY COMPANY**  
Ogden at Fulton Chicago 7, Illinois

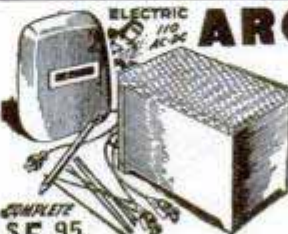

**ARC WELDER III**

A sturdy, compact, metal Arc Welding Outfit. Guaranteed. Used by garages, mechanics, farmers, etc. Repairs tools, auto fenders, toys, etc. Everything you need—Welder, large Helmet, Rods, Attachments, Instructions. Only \$5.95 postpaid, or C.O.D. plus few cents postage. Ten-day Trial Offer. Money Back if not satisfied.

COMPLETE \$5.95

**MINEX**

171 Debolt Street, Newtown, Ohio

**MARCOT KEY MACHINE**

Immediate Delivery



MARCOT No. 8 KEY MACHINE, mounted on Cabinet, less motor, \$ 95.00  
Auto Code Book and Auto Depth Keys . . . . . 12.50  
100 Dz. Popular Cylinder Key Blanks . . . . . 60.00  
Set—Key File, Follow-Through Rods, Lock Picks, Bit Key Gauge, Thumbie, Pins, Springs . . . . . 10.50  
"Locksmith Trade Books" . . . . . 6.75  
How to Open Locks without Keys or Picks; Secret of Locksmithing; How to Make Keys by the Impression Method; Master Key Systems.  
**TOTAL COST . . . . . \$184.75**

**A. J. MARCOTTE CO.,**

1200 N. Kedzie Ave. Dept. PM, Chicago 51, Ill.

**BUILD YOUR OWN POWER TOOLS**

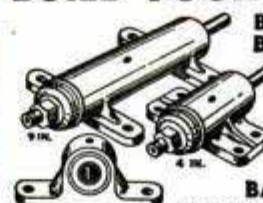

**BALL BEARING ARBORS \$6.95**

Reliable Guarantee  
Rugged aluminum alloy housing, heavy duty sealed ball bearings, precision steel shaft 1/2", 5/8" or 3/4". Right or left hand thread.  
Housing 2 1/4 x 4" 2 1/4 x 9" Overall 7 1/2 13 Price \$6.95 7.95

**BALL BEARING PILLOW BLOCKS**

Same bearings as Arbors. Sizes 5/8" and 3/4" \$3.00 Shipped immediately Postpaid. Order today, you will be pleased.

**O. V. HAWTHORNE TOOL CO., Dept. M, OTSEGO, MICH.**

**USE YOUR BEACH SAW**

With Our six in. tool steel cutters. Make mouldings, casings, drop-leaf tables, grooves beading & jointing 1" wide \$1.75. 1 1/2" \$2.25. Postpaid. State size hole. List & folder free. John A. Sandstrom Rt. 2-D, Clearwater, Fla.

**One Year Written Guarantee!**  
**ARMY AIR CORPS 16 JEWEL**  
**ELGIN**  
**\$19.95**

Made for Pilots and Navigators of the U. S. Army Air Forces. They had to be good. Sturdy 16 Jewel Elgin men's wrist watches. Shock resistant. Sweep second hand. Luminous hands and dial. Stainless steel back. Unbreakable crystal. Water repellent. Made by ELGIN one of America's outstanding watch manufacturers. Fully reconditioned. One year written guarantee sent with each watch. Supply limited! **SEND NO MONEY.** Simply pay postman \$19.95 plus 10% tax and postage on delivery. Cash orders sent postpaid. **UNITED PRODUCTS CO., 7941 S. Halsted, Dept. RES-1309, Chicago 20.**

**O. D. WOOL SHIRTS**  
13 to 15  
**269**

**PANTS**  
28 to 34  
**295**

Perfect condition, designed for reissue. All have been cleaned and pressed by the Q. M. Corp. 100% all wool serge. Priced less than the cheapest work clothes. Add 12c postage per garment.

**BRAND NEW KHAKI SHIRTS-PANTS**  
14 to 17  
**299**

28 to 42  
**379**

NEW. Tailored of 8.2 chino khaki suntan material. Shirts have flap pockets, pants have cuffs. 10c post. per garment.

**GEN. NYLON 50 FT**  
**59c**

**PARACHUTE CORD**

NEW. Ideal for many uses. 550 lb. tensile strength, 3/16" diam. Each hank 50 ft. Add 7c postage.

**150% WOOL HOSE**  
NEW. Medium wt. Khaki and nat. Please add 3c postage ea. pr. **39c**

**CUSHION SOLES**  
NEW. 65% wool, double sole. Desert sox. Khaki and white. Add 4c postage per pr. **49c**

**NAVY T-SHIRTS**  
**WHITE**  
**69c**

NEW. Combed yarn, full cut. Small, medium, and large. Please add 5c postage each.

**WAR SURPLUS**  
AND OTHER **ORDER FROM THIS AD PLEASE**

**BARGAINS**

**MAIL ORDERS**  
Please send remittance with order. Include postage. Guaranteed satisfaction. You are privileged to return any unsatisfactory purchase for refund.

**WATCH CAPS**  
**77c**

NEW. Color, blue. 100% pure wool knit. Please add 3c postage each.

**all wool WRISTLETS**  
**13c 8 PAIR**  
3/100

NEW. 100% O.D. wool knit. For glove and mitt inserts, wristlet replacements, etc. Worth 75c per pair. Add 3c postage per pair.

**1399**

**B-15 style FLIGHT JACKET**

NEW. Renders greatest warmth per oz. of weight. Mountain cloth outside, pile lined body and sleeves. Genuine mouton collar, 4 pockets—2 outside, 2 inside. Wool knit cuffs and waistband. Add 27c postage.

**SIZZLING SPECIALS**

- Army Style **Combat Boots 6.88**  
NEW. Rugged, comfortable, 10" High. Reversed uppers, full oak leather sole, with composition outer sole. Add 27c postage.
- Navy Style **Field Shoes 4.99**  
NEW. An excellent work shoe. Reversed uppers, full leather sole, composition outer sole. Add 22c postage.
- Down and Feather **Sleeping Bags 12.99**  
NEW. Mummy style. Filled with mixture of down and chicken feathers. Water repellent poplin cover. Zipper opening. Add 45c postage.

**DUST MASKS**  
**33c**

NEW. \$1.50 value. Ideal for millers, farmers, paint and insecticide spraying. Add 6c postage for each.

**NAVY SUN GLASSES**

NEW. \$4.00 value. Ground lenses. App. by Navy. Complete with case. Add 5c postage.

**66c**

**AVIATORS 24K Style GOLD PLATED RIMS**

NEW. 4-base curve, ophthalmic ground, shuts out 96% of the ULTRA-VIOLET RAY. 24K gold plated rims. Adjustable nose piece. New sensational price. **1.99**

**GREATEST WATCH VALUE in U.S.A.**

**17 JEWEL Military Style WRIST WATCH**

NEW. Genuine Incabloc, guaranteed one quality 17 jewel Swiss movement. Precision case with stainless steel back. WATER RESISTANT. SHOCK PROOF. ANTI-MAGNETIC. Sweep second hand, radium dial, fine leather strap. Save up to \$20.00. Please add \$2.00 federal tax. Money back guarantee.

**19.95 PLUS 10% FED. TAX**

**WAR SURPLUS CIRCULAR**

**SEND FOR FREE**

Over 150 War Surplus bargains, also other items.

**SIOUX FALLS SURPLUS STORE**  
113 NO. PHILLIPS SIOUX FALLS, S. DAK.

**IT'S NEW THE PUTTY MASTER**

**PLACES GLAZIERS SKILL IN YOUR HANDS**

**IT'S EASY**

A putty knife with the patented shaper that anyone can operate—packs, shapes and trims putty perfectly with one stroke and allows only the right amount of putty to be applied—a time and money saving item that will more than pay for itself.

**Only \$1.00 Postpaid**  
anywhere in the United States.

**PUTTYMASTER**

864 Fletcher St. Chicago 14, Ill.

**WANTED MAN TO RUN STORE ON WHEELS**

**USE OUR CAPITAL**

**NO SALES EXPERIENCE NEEDED**

The biggest opportunity ever, to quickly establish a money-making, lifetime business, now awaits you as a McNess Dealer. Sell things farmers need and use up. Serve same families year after year. Pleasant work--no bosses--easy to do. We supply capital to work on. Also provide offers--advertising--premiums and trade secrets that bring sales.

First to apply get best trading areas. Don't wait--write us today for McNess proposition. Tell us county and state you want to serve. Ask for free McNess Book. **7**

The McNESS CO., 744 Adams St., Freeport, Ill.

# DIAL your SAW CUTS!



**AMAZING NEW**  
*Warren*

**DADO SAWING WASHERS MAKE ALL THESE CUTS ON YOUR SAW!**

Smooth, accurate grooves—12 widths, any angle. No chatter, no burning, chewing, or sanding! Just dial desired width with Micro-matic adjustment! 5 sizes fit any saw arbor— $\frac{1}{2}$ ",  $\frac{3}{8}$ ",  $\frac{1}{2}$ ", 1",  $1\frac{1}{8}$ ". See your dealer or use coupon below! Satisfaction guaranteed.

**DEALERS, ORDER DIRECT!**

**WARREN WASHERS CO., DEPT. 21,**  
70 Medbury Ave., Detroit 2, Michigan

Enclosed \$4.95 for one set of Warren Washers, postpaid. My arbor size is \_\_\_\_\_

NAME \_\_\_\_\_  
ADDRESS \_\_\_\_\_  
CITY \_\_\_\_\_ STATE \_\_\_\_\_



**\$4.95**  
set

pat. pend.

## You Can Make Up to \$5.00 Per Hour with the IDEAL

There are hundreds of lawnmowers in your neighborhood that will need sharpening at least once or twice each season. You can build up a profitable business with the Ideal Lawnmower Sharpener, and earn up to \$5.00 an hour while doing it.

You need no experience to operate the Ideal Lawnmower Sharpener. Just place the lawnmower in the Ideal, make a few simple adjustments, and in a few minutes you have a smooth-running, perfect-cutting lawnmower. The Ideal is not a "make-shift" sharpener, it has 45 years of engineering design behind it, . . . is sturdily built, and grinds both straight blade and reel knives to a precision-cutting edge. Write today and learn what the Ideal Lawnmower Sharpener can do for you.

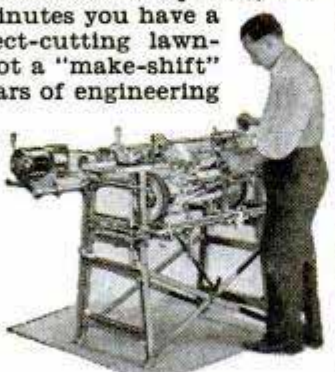

**DON'T DELAY**

**Send For FREE Book**

**The FATE-ROOT-HEATH CO.**

DEPT. D-3, PLYMOUTH, OHIO

## SURPLUS BARGAINS

- Good merchandise—accurately described—priced at rock bottom. You can buy with confidence from Aero.
- HEADPHONES, Army Type. Used but serviceable. Pr. . . . . \$ 1.10
  - MIKE, Hand Type T17 with cord and plug. Good cond. Each \$ 1.50
  - GENERATOR, 24 volt, 25 amp, airplane type L3. Each only \$17.50
  - LIGHT PLANT, powered by approx. 3 H.P. gas engine 14 volts, 70 amp. capacity. On pneumatic wheels, with dolly. Crated. Homelite type. Each only . . . . . \$74.50
  - SEXTANT, Navigator's Link, with case, components, and comp. instructions. Perfect. New reduced price. . . . . \$14.95
  - VOLTMETER, 0-30, 25 $\frac{1}{8}$  inch or 0-300, 25 $\frac{1}{8}$  inch. Requires 50 MV shunt, not furnished. Each only . . . . . \$ 2.95
  - SAFETY GOGGLES, optically ground lenses, metal frames and guards, adj. ear loops. Made by Bausch & Lomb. Brand new—in metal case. . . . . \$ 1.00
  - 4-IN-1 TOOL, Snears, bends, punches and rivets, works up to  $\frac{1}{4}$  inch. New. Ea. . . . . \$ 9.95
  - AIRPLANE HDW. Mixed assort of screws, rivets, washers, clamps, bolts, etc. All new. 10 lbs. only. . . . . \$ 1.95
  - FOOD WARMER or dry ice box. Portable. Heats on 24 volt DC or 110 V. AC. Measures 11x17x17. Doors fold out to make table. Has two shelves and large top drawer. Fitted with 6, 4 $\frac{1}{2}$  inch stainless steel cups with lids, 4 stainless steel food containers (7x9x1 $\frac{1}{4}$  in.) usable also as plates. Six each knives, spoons and forks; salt and pepper, water container, etc. Furnished complete with all wires, plugs, etc. Plug in at home to keep foods and liquids and pack with dry ice to keep them cold. Shp. wgt. 35 lbs. Each . . . . . \$19.95

Send check or money order. All F.O.B. Houston. Can ship mail, express or freight, transportation charges collect. Order today while these bargains are available.

**AERO PARTS SUPPLY, Dept. PM1**  
MUNICIPAL AIRPORT HOUSTON 17, TEXAS

## BUILD AN ARC WELDER FROM OLD GENERATOR

For Light or Heavy Work. 75-200 amps. No previous experience needed. Complete PLANS and valuable Catalog 35c.

**LEJAY MANUFACTURING CO.**  
1347 LeJay Bldg., Minneapolis 8, Minn.



**EARN MONEY** servicing STOVES and ranges. Set control accurately and rapidly. OVEN PYROMETER shows heat without opening oven door. Satisfaction guar. \$21.00 anted. 3" scale. 0-750°F. Complete. . . . .  
**ASSEMBLY PRODUCTS, INC.** Chagrin Falls, Ohio

## OWN A Printing Business

Cards, Tickets, Stationery, etc. Good profit in spare time. PRINT YOUR OWN greeting cards, movie titles, church work, etc. Save money. Easy rules supplied. Raised printing like engraving too. Have home shop. Sold direct from factory only. Send dime for supply book, suggested outfits, all details and advice on your needs. No obligation. **KELSEY, INC.** C-37, MERIDEN, CONN.

## Handy Mail Order List

**Little Library of Useful INFORMATION**  
5 for \$1.00  
12 for \$2.00  
25¢ Each

- Here at amazingly low cost is the practical help and information you have always wanted. Articles in previous issues of Popular Mechanics have been classified according to subject and are now available in these handy reprint booklets.
- How to Use Measuring Tools—Micrometers, Calipers, etc.—106.
  - Power Driven Saws—74.
  - Drill Presses, Grinders, Etc.—79.
  - Wood, Metal Turning—Lathes—81.
  - Filing Machine, Hack Saw, Cutoff Wheel, Shaper—82.
  - Lathe Tools You Can Make—101.
  - Workbenches—Tool Cabinets—47.
  - Spray Painting—94.
  - From Pattern to Casting—91.
  - Tool and Saw Sharpening—92.
  - Sharpening Drills, Wood Bits—90.
  - Successful Wood Turning—32.
  - How to Read Blueprint—71.
  - Metal Turning Lathe Kinks—99.
  - Operating a Metal Lathe—100.
  - Heat Treating, Hardening—102.
  - Working With Glass—103.
  - Servicing Elec. Motors—75.
  - Electromagnets & Solenoids—44.
  - Transformer Construction—41.
  - The Boy Electrician—43.
  - Soldering and Brazing—17.
  - Arc and Spot Welders—5.
  - Electroplating With Nickel, Chromium, Cadmium, Etc.—86.
  - Plating Leather, Wood, etc.—87.
  - Lower Your Fuel Costs—31.
  - Curing Leaky Basements—45.
  - Fitting Home Game Room—55.
  - Indoor & Outdoor Fireplaces—88.
  - Lackyard Gardens—39.
  - Lawn and Garden Novelties—72.
  - Trellises, Pergolas, Fences—76.
  - Lawn and Garden Furniture—77.
  - Playground Equipment—73.
  - How to Use Your Drill Press—125.
  - Making Serving Trays—53.
  - Knots and Ropework—105.
  - Sanders—80.
  - House Wiring—89.
  - Hanging Wallpaper—38.
  - Built-in Fixtures—78.
  - Bird Houses—7.
  - Magazine Racks—49.
  - Clock Cases—50.
  - Book Ends—52.
  - Small Tables—54.
  - Smoking Stands—56.
  - Desks—58.
  - Book Cases—59.
  - Action Toys—66.
  - High Flying Kites—57.
  - Telescopes—20.
  - Metal Craft—28.
  - Small Looms—37.
  - Gem Cutting—42.
  - Photo Enlargers—1.
  - Photo Kinks—98.
  - Cleaning Formulas—11.
  - Taxidermy—9.
  - Photo Lighting—119.
  - Training Dogs—35.
  - Small Furnaces—36.
  - Working With Plastics—61.
  - Simple Home Improvements—104.
  - Ridding Home of Insect Pests—107.
  - Children's Room Furniture—51.
  - Jigsawed Novelties—57.
  - Doll House & Doll Furniture—60.
  - 25 Shelves You Can Make—64.
  - Novelties Turned on Lathe—62.
  - Inlay Pictures—Veneering—63.
  - Wood, Soap Carving—65.
  - Windmills & Weathervanes—68.
  - Lamps from Wood, Metal—69.
  - Rustic Furniture—18.
  - Wood Finishing—40.
  - How to Fix Electrical Appliances—111.
  - Painting Your House—117.
  - Build Your Own Relays—123.
  - Rowboats, Small Dinghy—83.
  - Small Sail Boats—84.
  - Two Outboard Runabouts—85.
  - Build Own Canoe, Kayak—30.
  - Build Class-E Ice Yacht—22.
  - Auto Kinks. Shortcuts—10.
  - Lawn and Garden Equipment—124.
  - Motor-Drive Midget Cars—34.
  - Stop Auto Elect. Troubles—95.
  - Photo Printers and Dryers—25.
  - Photo Darkroom Equipment—96.
  - Trick and Table Top Photos—97.
  - Home Movie Equipment—118.
  - Poultry Houses—108.
  - Guns and Decoys—109.
  - Re-Silvering Mirrors—70.
  - Chemical Experiments—93.
  - Log Cabins, Tourist Houses—14.
  - Using Basic Tools—120.
  - Farm and Garden Tractors—8.
  - Building Extra Attic Rooms—23.
  - Attractive Basement Rooms—24.

POPULAR MECHANICS PRESS, Dept. 635, 200 E. Ontario, Chicago 11

**KEEP YOUR TOOLS AT YOUR Fingertips WITH THE DAVIS WIZARD TOOLRAK**

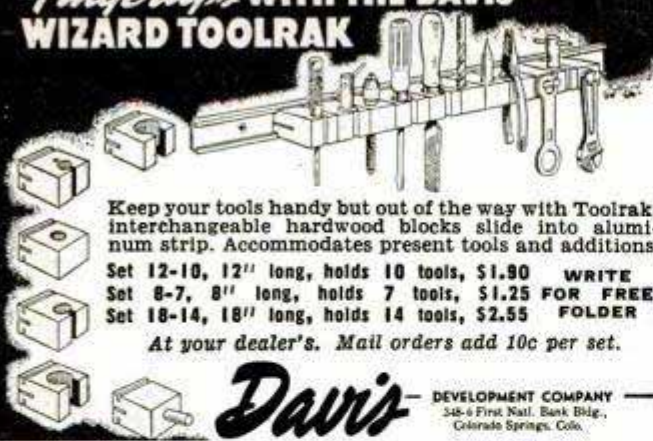

Keep your tools handy but out of the way with Toolrak: interchangeable hardwood blocks slide into aluminum strip. Accommodates present tools and additions.  
 Set 12-10, 12" long, holds 10 tools, \$1.90  
 Set 8-7, 8" long, holds 7 tools, \$1.25 FOR FREE  
 Set 18-14, 18" long, holds 14 tools, \$2.55 FOLDER  
 At your dealer's. Mail orders add 10c per set.

**Davis** — DEVELOPMENT COMPANY —  
 348-6 First Natl. Bank Bldg.,  
 Colorado Springs, Colo.

**MACHINE SHOP EQUIPMENT**



The 1949 edition of the famous Center Tool Co. Catalog is now ready! Every workshop owner should have a copy. 240 pages full of illustrations, descriptions, and prices of the latest tools made by best known manufacturers in U. S. You pay the cost of printing—50c. **We refund your 50c with your first order of \$10.00 or more.** Prompt delivery on most tools. Send check or money order today!

**CENTER TOOL CO., 153 Centre Street, Dept. C, New York 13**

**BUILD 3 ROOM HOUSE FOR \$500**



good constructions and durable by our methods with cheap wood and cement composition, barns low as \$50.00. 100 illustrations and 100 money and labor saving suggestions. Get this newly revised and enlarged, guaranteed book before you build. \$1.00, postpaid.

**SHEET METAL COTTAGES** and other buildings. Several new methods. Illustrated instructions, 50c.

**FURNITURE OF COMPOSITION.** Cement, sawdust, asbestos, scrap wood, metal, etc. illus. 50c.

**SHOP MACHINES FROM OLD AUTO PARTS:** Over 60 described, 50c.  
**HOME MFG. ENTERPRISE.** 50 home shop projects. illus., 50c.  
 Special: All five booklets described above, \$2.00 postpaid.

**HOME INDUSTRIES, 1116 So. 27th St., Dept. P1, Omaha 5, Nebr.**

**AUTO WHEEL BALANCER**

**\$22.50**

Designed for use by garage mechanics, service stations, home mechanics. Balance any popular make auto wheel—well built—easy to handle—fool proof—with complete instructions.

**ZAGAR TOOL INC., 23880 Lakeland Blvd., Cleve., Ohio**

**HOW TO CUT RAFTERS**

New vest pocket book gives lengths, side cuts, plumb cuts, deductions. For all rafters for any building from one inch to forty feet wide. Gives numbers to cut on square. Also degrees for same cuts for Radial Saws. All standard pitches from 1/8 to 5/8. Just open book to pitch page and there are your lengths, side cuts, etc. Anyone who knows what a jack rafter is can frame a roof if he has this great book. Price \$1.00, (\$1.25 in Canada). Builders' Topics, Dept. M, Lock Box 828, Seattle, Washington. CARPENTERS, PLUMBERS, PLASTERERS, ELECTRICIANS, ETC., subscribe for Builders' Topics, the monthly magazine for HE-MAN CONSTRUCTION WORKERS. Only \$1.50 per year, (In Canada—\$2.00). Sample copies 25c.

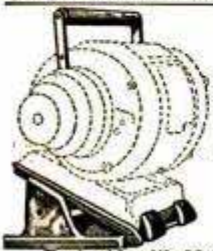

**SIMPLIFIED CLUTCH CONTROL FOR WOOD or METAL LATHES**

With the new **MOTOR HINGE** Pat. Pend. **\$8.95**

Quick speed changes for V Belt drives without stopping motor

The MOTOR HINGE mounts 1/4-1/2-3/2 H.P. motors Eliminates . . . countershafting—extra pulleys—belts, etc.

**LAWMOUNT PRODUCTS**

P.O. BOX 678 PROVIDENCE, R.I.  
 Postpaid with M.O. or checks—C.O.D. orders postage collect

**20 DIFFERENT BLADES**



**NO. 78 X-acto COMPLETE CARVING SET**

Here's everything you need for a super-slick job, from toothpicks to totem poles. Super-sharp blades, firm-grip handles for light and heavy work. Ideal for wood, linoleum, plastics, etc. Contains: 6 different gouges, 4 routers, 2 punches, 6 regular blades, 2 three-inch blades, one No. 1 knife, one No. 5 knife. On wooden block, complete.....**Only \$5.00**  
 \*Reg. U. S. Pat. Off.

Other X-acto Knives, Blades, Tools and Sets, 50¢ to \$50  
 Prices slightly higher in Canada

At hobby, gift, hardware and department stores

X-acto Crescent Prod. Co., Inc., 440—4th Ave., N. Y. 16  
 In Canada: Handicraft Tools, Ltd., Hermant Bldg., Toronto



**SWIVEL JAW**



**SEYMOUR SMITH**  
**"Snap-Lock"**  
**PLIER-WRENCH**

**3 NEW Features**

1. Swivel Jaw holds odd-shaped pieces.
2. Capacity Indicator pre-sets jaw spread.
3. Release unlocks jaws instantly by a touch of the finger.

Tremendous grip. Use as a plier or, when locked closed, for holding articles to be drilled, welded, ground, etc. 1000's of uses around home, farm, garage, shop. No. 2607, 7", \$1.75; No. 2610, 10", \$2.25. At your dealer or write direct. Free circular.

**CAPACITY INDICATOR**



**INSTANT LOCK RELEASE**



**SEYMOUR SMITH & SON, INC.**  
 900M Main St., Oakville, Conn.

**SO HANDY FOR  
SO MANY USES**

**AT HOME**

**OFFICE AND SHOP**

**THE  
JIFFY  
METAL  
CABINET**

**Now you can keep  
nuts, bolts, screws,  
nails, parts, wash-  
ers, stamps, hobby-  
ist needs, etc., at your fingertips.**



**32 DRAWER  
MODEL PICTURED  
ONLY  
\$5.95  
POST PAID**

Just think, 32 or 64 drawer cabinet to keep those small items that usually get mislaid. Spot welded steel cabinet, enamel finish, metal drawer guides. Looks good anywhere. Send check or money order please—no C.O.D.'s. Prices below. Your money refunded if not satisfied.

SPECIFICATIONS	WITH ALUMINUM DRAWERS	WITH CARDBOARD DRAWERS
<b>32 Drawer Unit</b> 6" Deep 12 3/4" Wide 15 1/4" High	One piece rustproof aluminum drawers for heavy service—good for work bench and industry use.	Suitable for most home uses. Heavy board kraft covered. Metal drawer pulls.
<b>64 Drawer Unit</b> 6" Deep 25 1/2" Wide 15 1/4" High		
<b>Drawer Size</b> 1 1/4" Deep 2 3/4" Wide 6" Long	<b>32 drw. \$8.95</b>	<b>32 drw. \$5.95</b>
	<b>64 drw. \$15.95</b>	<b>64 drw. \$9.95</b>
	POSTAGE PAID	POSTAGE PAID

**KAYTEE PRODUCTS DEPT. M. BOX 588. CANTON, O.**

## NEW BAND SAW BRAZER



**SAVES TIME  
AND MONEY...**

better than welding—easy to use—operates on 60 cycle lighting circuit Complete kit includes resistance brazer, silver solder, flux, and instructions.

**Introductory price \$18.50**

**THE ERWOOD COMPANY**  
214 WOODSTOCK STREET  
CRYSTAL LAKE, ILLINOIS

Send Your Order to  
DEPT. PM2

**\$2 PUTS YOU IN THE BIG MONEY!**

**Magic Glow**

Get a head start! Manufacture and sell "MAGIC GLOW" the miraculous luminous paint that shines brightly in the dark. Easy to make; no special tools or machinery required. This sensational product has hundreds of uses in homes, factories, public buildings. Huge profits, making and selling "MAGIC GLOW" for use on religious objects, house numbers, toys, jewelry, lamps, switches, etc.

Send \$2 today for large sample of "MAGIC GLOW" including illustrated catalog and complete confidential manufacturing instructions. Or send 25c for color card and illustrated catalog.

**CHEMICAL RESEARCH CO.**  
130 W. 42ND ST., NEW YORK 18, N.Y.

## BUILD A BOAT

**FOR PLEASURE OR PROFIT DESCRIBES 17 LOW COST BOATS**  
Get this outstanding book and build a boat at home for your own use or to sell at a profit. You can do it. Just the boat you've always wanted—power, sail or row boat—17 different kinds and sizes.

Order **BUILD A BOAT** on postal card and pay only \$1.50 plus postage on delivery. Return in 5 days if not pleased and get money back. Or send \$1.50 with order and we'll pay postage. (Outside U. S. \$1.70 with order.) Order today.

**POPULAR MECHANICS PRESS**  
Dept. 598, 200 E. Ontario, Chicago 11

**Row Boat—12 Foot**  
**Dinghy—8 Foot**  
**Dinghy—14 Foot Sailing**  
**Training 5 1/2—6 Foot**  
**Sea Sled—3 Foot**  
**Outboard—12 Foot**  
**Cruiser—18 Foot**  
**Bicycle Boat—Kayak**  
**Row Boat—Sectional**  
**Row Boat—Sailing**  
**Canoe—16 Foot**  
**Sailing—12 Foot**  
**Outboard—12 Foot**  
**Pontoons—Runabout**  
**Ice Yacht**

## Boy! What a Picture!

And boy, what a book is Popular Mechanics new **PHOTO HANDBOOK**. Gives you the big three of superior photography:

1. The secret of taking better shots.
2. The technique of clearer developing.
3. The way to build better photo equipment.

Be an expert! Have fun! Save money!

Paper covered edition on all newsstands... 60c  
Order colorfully bound library volume from  
**POPULAR MECHANICS PRESS... \$2.00**  
200 E. ONTARIO ST. CHICAGO 11

Say You Saw It in  
**POPULAR MECHANICS**

## SAVE MONEY DON'T BUY EXPENSIVE NEW BATTERY CABLES! USE THIS SENSATIONAL SOLDERLESS TYPE BATTERY TERMINAL

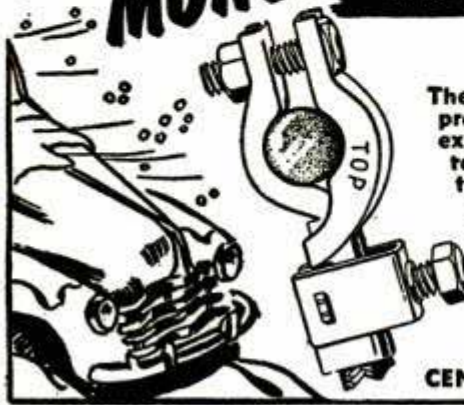

**Attach It Yourself  
In Only 2 Minutes!**

There's plenty of long life in your present battery cables. So why buy expensive new ones just because the terminals are worn out? Simply attach the new, patented **CENTRAL SLIP-YOKE TERMINAL**... no solder or special tools needed. Fits either post and any size cable. Do it yourself in 2 minutes!

**Saves Money!  
Captures Full Battery Power!**

A poor battery connection robs your car of needed power. **CENTRAL SLIP-YOKE TERMINALS** save cost of new cables... save mechanic's charges... grip cables like a vise, eliminate power loss, prevent overheating! Attach them yourself quickly and easily to ends of present cables. Then enjoy dependable, trouble-free battery connections.

**MAIL YOUR ORDER TODAY!**  
Only 55c each, 2 for \$1.00 postpaid, under money-back guarantee.  
Send for yours today!  
**CENTRAL EQUIPMENT CO., Dept. B1491 — 1020 W. Adams, Chicago 7, Ill.**

# EAR NOISES?

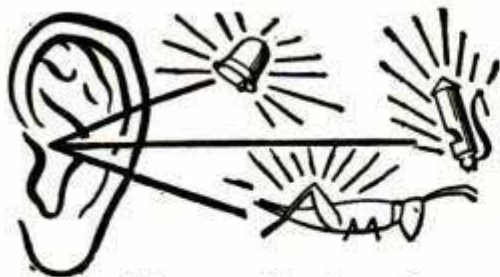

If you suffer from those miserable ear noises and are Hard of Hearing due to catarrh of the head, write us NOW for proof of the good results our simple home treatment has accomplished for a great many people. **NOTHING TO WEAR.** Many past 70 report ear noises gone and hearing fine. **Send NOW for proof and 30 days trial offer.**

THE ELMO CO., Dept. 162, Davenport, Iowa

WRITE NOW FOR FREE CATALOG NO. MJ



FOSTER MFG. CO., MJ KINSEY AVE., BUFFALO 17, N. Y.

## SPECIAL OFFER!

LOCK-STITCH SEWING AWL

**\$1.**

Postpaid

Famous, patented lock-stitch sewing awl complete with needles, waxed thread and direction folder. Hundred uses — sewing, repairing leather goods, canvas, belting, harness, saddles, gun cases, awnings, golf bags. Extra needles and thread available. Satisfaction guaranteed or money back. Send currency, check or money order. Yates Mfg. Co., 611-H Main St., Lake Geneva, Wisconsin

## FURNACES FOR HOME AND SHOP



COAL—LP—GAS—OIL. Fittings, pipes and registers. Water heaters, Ranges and floor furnaces. BLOWERS with motors. Get the parts you need and modernize your own heating system. Wholesale & Retail. Lowest prices.

FREE BOOKLET

**PEERLESS SALES & SUPPLY**  
4318 Sheridan Lincoln 6, Nebr.

## WAR SURPLUS

Lathes, Milling Machines, Drill Presses, Sawing equipment, Motors and thousands of miscellaneous items. Also information on Helicopters, Sleeper Trailers, Garden Tractors, Power Lawn Mowers, Welders, Jet Impulsion for Cars and Tractors etc. Rush name for free literature. THE WAYNE ENGINEERING CO., DEPT. 102, ELKINS, W. VA.

## SHARP-TUNER

## A completely new, really efficient RADIO RECEIVER



The best signal-powered set ever offered. Single control actually separates stations, even in large cities! New circuit developed by leading electronics company. Costly precision parts—Germanium detector, Leitz coil, modern capacitors. Beautiful durable enclosed cabinet 2 1/2" long! Uses no batteries or electricity—lasts indefinitely—reception guaranteed. Set alone with leads and directions, \$3.69. Trimm single headset included \$1.00 more. Foreign orders 10% extra, prepaid only.

CARING PRODUCTS Dept. AA, Box No. 1308 Chicago 90, Ill.



## THE NEW VISE-GRIP WRENCH

### WORLD'S MOST VERSATILE HAND TOOL

Does jobs no other tool can do. Double-lever action LOCKS jaws with tremendous grip—quickly adjusts to non-locking action. New Involute Jaw Curve holds all shapes—nuts, rounds, irregular shapes, with unbelievable ease. Has Knurled Jaw Tips that do not slip. Thin Nose. Super Wire-Cutter. New geometry gives more power—easier opening. Fine alloy steel. Nickel plated finish.

WITH Cutter—No. 7W—7", \$2.25; No. 10W—10", \$2.50  
WITHOUT Cutter—No. 7C—7", \$1.85; No. 10C—10", \$2.25

If not at your dealers, order direct.

Postage paid if price accompanies order.

PETERSEN MFG. CO., Dept. M-1, DeWitt, Nebr.

*"So Easy to Handle with the POWER TURN on The Culti-Vette"*

A New Light Duty, Economy Model

**Garden-All**  
LAWN and GARDEN TRACTOR



TRACTOR  
\$159.50

CULTIVATOR  
\$19.50

F.O.B. Factory

Note these features: Individual Drive and Power Turn, with individual wheel clutches; Positive Drive with V-Belts and Pulleys only moving parts; 16-inch Plant Clearance; Variable Tread Width—18 to 28 inches. Ask your Garden-All dealer to show you the amazing new "Culti-Vette."

**GARDEN-ALL TRACTOR, INC.**

Dept. P, 110 W. UNION STREET, LIBERTY, INDIANA

Make Use of  
**POPULAR  
MECHANICS  
BOOKS**

# STREAMLINED HELP



**BETTER JOBS  
HOBBIES  
AND PASTIMES  
HOME AND FARM  
WORKSHOPS  
HOME REPAIRS-  
IMPROVEMENTS**

## THE INEXPENSIVE PRACTICAL BOOKS WITH A MILLION READERS!

Want help on your job—extra knowledge that brings extra pay? Want to save money on home repairs? Want practical information to better enjoy hobbies and home and farm workshop projects? Then get a Popular Mechanics Book. These easy-to-use books, written in plain, everyday how-to-do-it English, and extravagant with pictures, plans, diagrams, etc., will give you the practical help you need. Full library size, cloth bound book unless otherwise described. Rush order on coupon today. Money back if not satisfied.



### FORTY POWER TOOLS YOU CAN MAKE

Have your own powered workshop at low cost. Tells how to make forty different machines such as lathes, drill press, jig saw, band saw, circular saw, sanders, from pipe fittings, old auto parts, wood, etc. New 1948 edition. \$1.50

### POPULAR MECHANICS PHOTO HANDBOOK

An entirely new and different book from our popular Photo Guide. It's a complete guide to better pictures and darkroom technique, and features dozens of handy gadgets you can make yourself. \$2.00

### BUILD A BOAT FOR PLEASURE OR PROFIT

How to build 17 low-cost boats at home—power, sail or row boat. Prepared especially for the home builder with limited tools, no experience and little money to spend. Plans, diagrams and illustrations. \$1.50

### WHAT TO MAKE FOR CHILDREN

A Popular Mechanics book for Dad, Mother and the whole family. Shows how to make toys, dolls, doll houses, slides, see-saws, rocking horses, furniture. 175 projects to make from discarded or inexpensive materials. \$2.00

### THE GARDEN BOOK

How to build your own trellises, fences, lawn furniture, outdoor fireplace, attractive ornaments and other things for your yard and garden. Beautify your grounds—enjoy attractive equipment—at low cost. \$1.00.

### OUTDOOR SPORTS MANUAL

220 helpful articles and hints for fishermen, hunters, campers, trappers, archers and boatmen. If you love the outdoors, double your enjoyment with the help of this new book. Contains 334 illustrations. \$2.00

### WHAT TO MAKE. 10 Volumes

**WHAT  
TO MAKE**



The famous annual craftsman's guide. Shows what to make and how to make hundreds of things in spare time for fun or profit. Novelties, gifts, toys, games, furniture, etc. Cloth bound and filled with instructive pictures. Single volumes, each \$1.75. Save money on 10 volume set, complete, only \$15.00.

### POPULAR MECHANICS SHOP NOTES

New 1949 volume. Latest in series of practical and helpful year books for every man who uses tools. Contains 240 pages and 750 illustrations. This book will make money for you and make your job easier. Soil-proof paper cover. \$1.00

### POPULAR MECHANICS MOTORIST'S HANDBOOK

For every man who drives a car and wants to do his own servicing and simple repairs. A money-maker for the professional auto repairman. Hundreds of ideas, helps, and kinks you can use every day. \$2.00.

### CONCRETE HANDBOOK

How to do all types of concrete work and make ornamental things of cement—walks, driveways, foundations, steps, vases, benches, etc. Ideal book for home owner, handyman and construction men. \$1.50

### WELDING, BRAZING AND SOLDERING

How to construct welding equipment and use it effectively—small arc welder, spot welder, arc torch. Best approved methods, tricks and kinks to use in soldering, brazing, heat treating iron and steel. \$1.25



### YOUR HOME and HOW TO BUILD IT YOURSELF

Step by step instruction by which anyone with ordinary knowledge of use of hand tools can build a five-room house complete. Every detail is shown in pictures with amazing clarity. Will save hundreds of dollars building any house. Spiral bound. \$3.00. Complete set regular builders plans \$12.50. Book and plans \$14.00.

### FARM MANUAL

Hundreds of articles on making farm implements and equipment, maintaining the home, farm workshop, live stock and poultry, many farm hints and kinks. A book for every member of every farm family. 284 pages. Hundreds of illustrations. \$3.00



### THE BOY MECHANIC

One of the most popular and best known Popular Mechanics publications. Describes hundreds of things for boys to do and make. Develops natural talents and industry. Crammed with how-to-do-it illustrations. The perfect gift for every boy. \$2.00

### PAINTING, FURNITURE FINISHING AND REPAIRING

A book for craftsmen, home owners, shop workers and furniture repairmen and finishers. Covers repairs and finishing, restoring antiques, spray and brush painting of all kinds. An all 'round book for everyone. \$1.50

**USE THIS HANDY COUPON • Mail Today**

POPULAR MECHANICS PRESS, Dept. 128, 200 E. Ontario St., Chicago 11

Send Popular Mechanics books checked.  I will pay postman, plus charges (U.S.A. only).  Remittance enclosed—send fully prepaid. I will return books in five days for return of money if not satisfactory. Outside U.S.A. please add 15% for postage and wrapping.

Forty Power Tools . . . \$1.50	What to Make (Children) . . . \$ 2.00	Boy Mechanic . . . . . \$ 2.00
Painting, Finishing, etc. 1.50	Garden Book . . . . . 1.00	Concrete Handbook . . . 1.50
Motorist's Handbook . . . 2.00	What to Make (1 Vol.) 1.75	Welding, Brazing . . . 1.25
Photo Handbook . . . . . 2.00	10 Volumes . . . . . 15.00	Your Home . . . . . 3.00
Build a Boat . . . . . 1.50	Shop Notes . . . . . 1.00	Book with Plans . . . 14.00
Sports Manual . . . . . 2.00		Farm Manual . . . . . 3.00

Name \_\_\_\_\_

Address \_\_\_\_\_

City \_\_\_\_\_ State \_\_\_\_\_

Check  
for  
**FREE  
Cata-  
log**



## FOR YOUR FAMILY'S SAFETY DEPEND ON US



**Golden Rule 14 Month Guarantee**

**ORIGINAL HIGH NONSKID TIRES** WORN SLIGHTLY  
B. F. Goodrich, Goodyear, U. S. & Others

**TUBE FREE** With These AAA Tires

600-16	.....\$5.55	550-16	.....\$5.55
650-16	.....5.75	550-17	.....7.75
650-15	.....5.05	700-16	.....6.15
700-15	.....5.75	750-16	.....7.15

**SPECIAL OFFER 600-20 \$9.35 700-20 \$12.25 825-20 \$14.10**  
**TRUCK TIRES 650-20 9.45 34x 7 12.25 900-20 14.25**



### 750-20 MILITARY TREAD

Fits 32 x 6 8 ply & 32 x 6 10 ply  
Regulars .....5 9.75 Guar. 9 mos.  
AAA Type .....\$13.00 Guar. 24 mos.  
600-16.....\$7.75 900-16.....\$7.95

SEND CK. OR MONEY ORDER & THIS AD FOR INSTANT SHIPMENT.  
31 Yrs. "Know-How" in Our Triple Inspection

**BLATT GIRARD & LANCASTER AVE., DEPT. E**  
**BLATT BUILDING, PHILADELPHIA 31, PA.**



100% PROTECTION

## TEAR GAS

**A REAL SURE-FIRE SELLER!**  
**THUGS AND THIEVES BEWARE!**

Here is a tear gas pen which discharges smothering clouds of tear gas to instantly stop, stun and incapacitate the most vicious man or beast. A safe and effective substitute for dangerous fire-arms. No permanent injury. Needed in Stores, Banks, Autos and Homes, everywhere to protect Life and Property. No skill required. Handle our tear gas as a side line and you'll soon give it full time. For a quick start send \$3.60 for complete demonstrator outfit consisting of an Automatic Pen Gun with 10 demonstrators and 3 powerful Tear Gas cartridges fully guaranteed. Many thousands now in use. Order your outfit today. Not sold to minors.  
**Hagen Supply Corp. Dept. G-401 St. Paul 4, Minn.**

## EVINRUDE Catalog Free



Describes complete 40th Anniversary line of Evinrude Outboard Motors... 3 models with revolutionary Fisherman Drive... 3 thrilling four cylinder models. Contains helpful information on boats, speeds, etc. Profusely illustrated. Write...

**EVINRUDE MOTORS**  
4216 N. 27th St., Milwaukee 9, Wis.

## REYNOLDS CIRCULAR SAW GRINDER



SAWS  
5"-30"

**FOR JOINTING GUMMING • SHARPENING**  
**ALL TYPES OF CIRCULAR SAWS**  
WRITE FOR CIRCULAR  
**PROVIDENCE SAW & KNIFE COMPANY**  
Reynolds Machinery Co. Bldg.  
305 Eddy St. Providence 3, R. I.

## MAKE SPARKLING GIFTS



Enjoy the thrill of making your own Clear Lucite ideal gifts, complete kit and detailed instructions including plastic to make ten useful gifts—picture frames, candlestick holders, dishes, etc. Fun and educational. Excellent for school projects. Order today. Complete kit \$2.00 prepaid.

**PLASTIKITS . . Lawrence, Mich.**

**Say You Saw It in  
POPULAR MECHANICS**

## BUILD YOUR OWN ZEOLITE WATER SOFTENER

You can do it inexpensively with only a wrench and a little spare time. Famous Zeolite process as used by leading manufacturers. Send \$1 for easy-to-follow directions and list of materials. (Materials available locally or from us.) Or inquire about factory-built LARCO Softeners \$45.75 up. **LAKE REGION MFG. CO., INC., 3920-A Lynn Ave., Minneapolis 16, Minn.**

## RISLONE with your oil makes winter starts quick and easy

—gets rid of gum and sludge  
for guaranteed smoother  
power within 10 miles



Your car runs better in any weather with Rislone in your oil to work its "motor magic."

In Winter — it keeps the oil free-flowing for quick, easy starting. It keeps grease from thickening, too. So put a little in your transmission and differential. That protects gears, makes shifting easy in spite of cold weather.

In any weather — Rislone frees sticking valves, restores lost compression, gives you smooth power in all gears, at all speeds.

Rislone is an oil-alloy that keeps modern motor-oils doing their best. It absorbs gum and sludge as you drive, to keep your car at peak performance all the time.

Prove it to yourself. Add a quart of Rislone to your oil today. If you can't feel a smooth-driving difference in 10 miles — you get a full refund. Available at car dealers, better garages, and service stations everywhere. The Shaler Co., Waupun, Wis.



whenever you change your oil

Add a quart of **SHALER**

## Rislone

(2 quarts for larger cars). As you add oil, make every fourth quart RISLONE.

## Is Your Rupture HERE?

Why continue to suffer with an uncomfortable truss if we can help you? Relief GUARANTEED or it costs you nothing. Send for the facts about my perfected truss invention—the Brooks Appliance for reducible rupture—with the patented AIR-CUSHION support that works silently with Nature to give protection. Thousands bought by doctors.

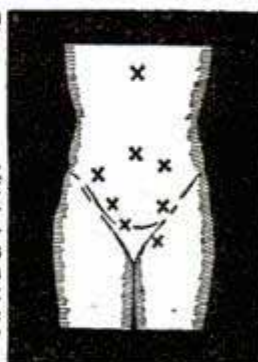

**Sent on Trial**—Made-to-measure, individual fitting for man, woman or child. Low-priced, sanitary, durable. No obnoxious springs or hard pads; no metal girdle to rust. Light weight, neat and comfortable. Not sold through stores or agents—beware of imitations. Write today for full information sent free in plain sealed envelope.

**BROOKS APPLIANCE CO.** 161-C State St. Marshall, Mich.

# STOP CHANGING MOTOR OIL!

End this needless waste and expense forever with

## RECLAIMO Today's Most Advanced Oil RE-REFINING Filter

Continuously cleans and RE-REFINES motor oil as you drive (by utilizing motor heat)—keeps oil in high grade lubricating quality at all times—reduces motor wear to a minimum! Proves conclusively that "Oil Does Not Wear Out Mechanically" as stated by U. S. Bureau of Standards, (Bulletin 86).

### "RECLAIMO"

- REMOVES SOLIDS (by filtration)
- REMOVES WATER (by distillation)
- PREVENTS Excess Fuel Dilution
- PREVENTS Acid and Sludge Formation

### MAINTAINS Stable Viscosity ELIMINATES All Oil Changes CAR • TRUCK • TRACTOR OWNERS!

You'll want to know more about Reclaimo's Oil, Motor and Money-Saving Features. **FREE 40-PAGE BOOK "OIL FACTS"** gives you the complete "Reclaimo" story plus details about our **New 90-Day No Risk-No Cost TRIAL OFFER!** WRITE for YOUR COPY TODAY!



**NEW ADDED FEATURE!**  
Gas - Moisture Vapor Injector  
Increases Mileage with Smoother Performance



## RECLAIMO MFG. CO.

5083 ELSTON AVE., Dept. 86, CHICAGO 30, ILL.

## CO<sub>2</sub> TIRE INFLATER and FIRE EXTINGUISHER

• Inflates 6 tires to 30 lbs. pressure. Can be refilled at low cost anywhere. Every motorist should carry one as insurance against tire trouble and fire.

Send check or money order. 20% advance deposit required on all C.O.D. orders

**\$3.95**  
EACH  
F. O. B.  
DETROIT



## RADIO CENTER

2530 E. Davison • Detroit 12, Mich.

## AUTOMATIC FLOOR LIGHT FOR FORD AND MERCURY CARS 1941 THRU 1948 MODELS

OPERATES WHEN DOOR IS OPEN  
Brightly Illuminates Floor and Running Board for Safety and Convenience.

Simple Installation—No Holes to Drill  
**\$3.00 PAIR — POSTPAID**

Send Postal Money Order—No C.O.D.  
**AIRCRAFT METAL PROD.**

4012 Richmond N.W., Grand Rapids 4, Mich.



## "SEA CRAFT" BLUEPRINTS READY NOW!

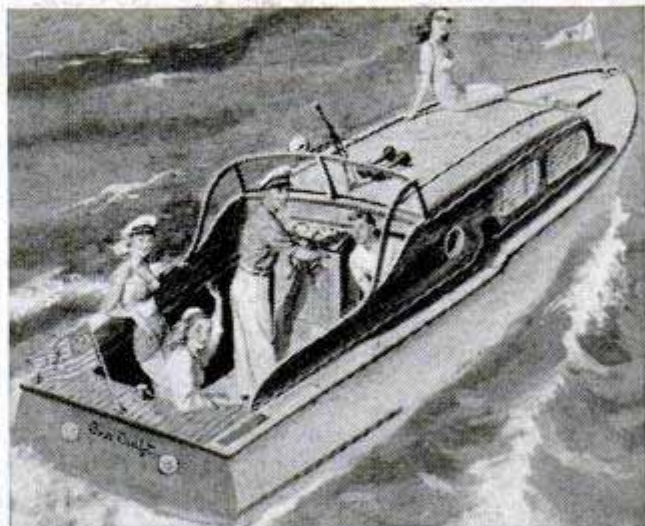

Build this luxurious cabin cruiser yourself and save money. What a beauty it is! A 25-foot boat readily adaptable as a sport fisher, express cruiser, or utility boat. Cruises effortlessly at 15 knots with a marine engine or converted auto motor. Its spacious cabin sleeps four and has a galley complete with fresh-water tank, sink, and cook stove. Has open cockpit large enough for fishing, lounging, etc.

During war the Coast Guard used "Sea Craft" for ship-to-shore travel. Order today your complete set of seven large-size blueprints scaled 1 inch to the foot. These, plus a 40-page two-color illustrated booklet giving step-by-step instructions, only \$10.00.

### POPULAR MECHANICS PRESS

200 EAST ONTARIO ST.

CHICAGO 11, ILL.

## HOW TO SUCCEED WITH BEES



## BEE RAISING PAYS BIG PROFITS

Get HOW TO SUCCEED WITH BEES, written by two outstanding experts, which gives more than 190 successful plans to produce big crops of honey. Join the ranks of spare time money-makers and send for this guaranteed 96-page book today. Tells all about queens, equipment, summer, winter and spring management, swarming, increasing colonies, how to produce section honey and extracted honey, etc. 19th edition, fully revised, only \$1.00.

### POPULAR MECHANICS PRESS

200 E. Ontario St.

Chicago 11, Ill.

## POPULAR MECHANICS SHOP NOTES



## For a Shipshape Shop!

Popular Mechanics SHOP NOTES 1949 is the book you need. 240 interest-packed pages for mechanic, painter, carpenter, auto-worrier, electrician, welder, farmer, plumber and home craftsman. Whether it's ball bearings or shotgun gauges, painting a car or mounting motors, the best and latest methods are here.

Hundreds of articles. Hundreds of ideas! See your news dealer or order direct from  
**POPULAR MECHANICS PRESS . . . \$1.00**  
200 E. ONTARIO ST. CHICAGO 11

## Introducing . . . THE UNIVERSAL

America's most revolutionary multi-purpose

## SANDING AND POLISHING KIT \$4.25 COMPLETE

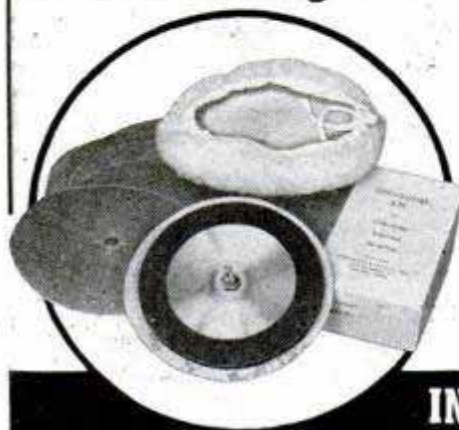

The ONLY one of its kind that easily and successfully sands and polishes hard-to-get-at places, like mouldings, irregular and scroll-cut surfaces, grooves, corners and carvings!

Sands and polishes any material—simonizes cars; sands floors, furniture; removes paint from cars, walls; polishes linoleum; and handy for many other uses.

- Drill Arbor is separate piece made to fit any electric drill, press or lathe with chuck 1/4" or larger.
- No more cementing of sanding paper to disc necessary! Centrifugal force securely

holds paper to disc. Screw cap easily removes and replaces paper in a jiffy.

- Rubber disc is fitted to light-weight aluminum special metal disc for flexible back up, allowing most unusual maneuverability.
- Lamb's wool 6" polishing bonnet supplied.
- 12 sanding discs also included in kit. Extra discs, only 10c each.
- First to incorporate principle and design used by automobile and furniture manufacturers.
- Allows switching to sander and polisher in a jiffy.
- Complete Satisfaction or money back guaranteed.

Postpaid—send check or M.O.

**INDUSTRIAL SUPPLY CO.**

**275-277 Franklin Street  
Boston 10, Mass.**

**NEW FLUORESCENT FIXTURE**  
with **CIRCLINE LAMP!**



**GUARANTEED FOR 1 YEAR!**

A strikingly beautiful fixture in polished aluminum finish. Suitable for every room. Model C-32AP (illustrated), \$9.50. Model C-32S with etched glass shade, \$12. Sent **POSTPAID** anywhere in the U. S. upon receipt of cash order. C. O. D.'s sent F. O. B. factory. Write for free literature on full line.

**HANOVER LIGHTING SALES**  
Box 186 Dept. SC, Hanover, Pa.

**\$8.95**  
POST PAID

**FREE parts catalog**



**Build Better Trailers with Safety-Engineered**

- ★ Torq-less Axles
- ★ Bull Dog Hitches
- ★ Parking Jacks

... Send for your copy **TODAY!**



**HAMMER BLOW TOOL CO.**  
Dept. 130, Wausau, Wisconsin

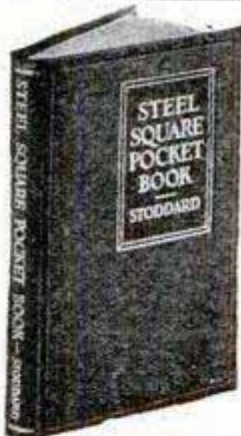

THIS BOOK SHOWS  
HOW TO DO IT.  
**STEEL SQUARE POCKET BOOK**  
*Completely Revised*

This concise and handy little book illustrates and describes the best methods of using the carpenter's steel square in laying out all kinds of carpentry work. It is easy to understand as a picture of the square laying directly on the work shows exactly how the various cuts are made. Its compact and handy size makes it convenient to carry in the pocket for quick reference.

Price \$1.25 Postpaid

**POPULAR MECHANICS PRESS**  
DEPT. 627 200 E. ONTARIO, CHICAGO 11, ILL.

Say You Saw It in  
**POPULAR MECHANICS**

**BOMB HOIST**



Wt. 7 $\frac{3}{4}$  lb., dimensions 6 $\frac{1}{2}$ x5 $\frac{1}{2}$ x5, pulley 4"x1" wide, 6 $\frac{3}{4}$ " between mounting brackets, bronze worm gears, 1500 lb. capacity, 30 to 1 ratio, holds 20 ft. 3/16" cable. Can use up to 50 ft. by changing pulley. Specially priced at \$9.75. We can furnish 3/16"-6 x 19 preformed cable at \$.05 ft.; 1/4" same at \$.06 $\frac{1}{2}$  ft.; 1/4" Hi Power Electric Drill, Regular \$17.95, Special \$12.75, factory guaranteed, U. L. Approved. Many other items available. Catalog available on request.

B & M DISTRIBUTING CO., P. O. Box 1343, Tacoma, Wash.

**MAKE MONEY at HOME!** 25¢ GETS YOU STARTED AS A

**MANUFACTURER** of Plastic & Marble-Rock Statuettes, Costume Jewelry, Figurines Plaques & Novelties

**FLEXI-FORM**

**READY-MADE MOLDS**



Why waste time wishing? Make your mark now, casting **PLASTIC** and **MARBLE-ROCK** figurines, art objects and novelties. Easy to make; no special tools or machinery required. Easy to sell to department stores, fairs, amusement parks, stationery stores, hobby shops and by mail. All you need are the molds and the materials. At wholesale cost we furnish artistic factory-made **MOLDS**, the same type used by large manufacturers and **PLASTIC** and **MARBLE-ROCK** materials for making the castings. Finish them in gleaming white, antique bronze, black and gold marble; or in mahogany, walnut, Chinese red and other attractive colors; also in luminous shades that shine in the dark.

25c gets you started Send 25c today for complete manufacturing instructions, price-lists and for illustrated catalog featuring over 130 objects which you can make easily and sell quickly at tremendous profits.

This is it! Lose no time.



**CHEMICAL RESEARCH CO.**  
130 W. 42ND ST., NEW YORK 18, N. Y.

**THOUSANDS BUILD**



**U-MAK-IT BOATS**

**EASY TO ASSEMBLE**  
**NO EXPERIENCE NECESSARY**  
Save Money, Big Value, Sturdy  
**ROWBOATS, KAYAKS, DINGHIES, INBOARDS, OUTBOARDS, RUNABOUTS, NEW CABIN CRUISERS**

Everything Complete in Kit. Quality Material. Simple as ABC instructions. Immediate Delivery.

**SEND 25¢ (COIN) FOR CATALOGS**

Colorful Illustrations show all '49 Models, 8 to 23 Ft., and Construction Details.

**U-MAK-IT BOAT CO.**

Formerly Kayak Boat Co.

703-P WHITTIER ST., N. Y. 59, N. Y.

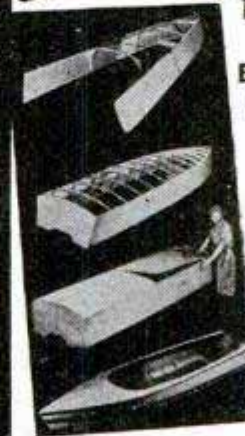

# PRESTO! ANYONE CAN MASTER GLAZE



LEAVES HARD GLASS-LIKE FINISH  
EASY TO APPLY  
PROTECTS THE SURFACE  
NO SMEAR OR STREAKS AS WITH WAX  
LASTS SIX MONTHS TO A YEAR

SEALS THE PORES OF THE SURFACE  
WILL NOT FINGER-MARK  
EASY TO KEEP CLEAN  
NO DILY FILM AS WITH POLISH  
SAVES YOU MONEY

Car Owners! Meet Master Glaze—the sensationally different luster for new and used cars! Not a wax—not an oil polish—not a paint!—nothing that “smears” over the surface.

**MASTER GLAZE** is a unique discovery—a creamy liquid—quick and easy to apply! Gives a hard, glass-like surface. Even gasoline cannot dull it! Lasts six months to a year! Amazing luster—beautiful, sparkling clean and brilliant! Doesn't finger-mark—doesn't smear! A match box full glazes an entire car. Seal the pores—protects! **NOTHING LIKE IT!**

### FREE SAMPLE

Just send your name and address to

**MASTER GLAZE CO., 7720-659 W. Harwood Ave., Milwaukee, Wis.**

### AGENTS

An unusual opportunity! Quick, flashy demonstrator. Big profits. Good territory. Write today!

## REAL DIESEL ENGINE

# \$2.95

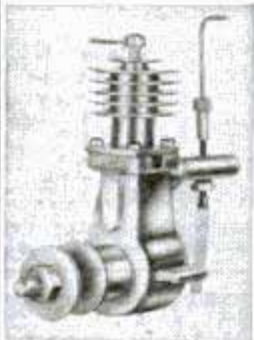

WE'RE CRAZY, they tell us, giving away a real diesel engine, complete with cylinder and piston, carburetor, crankshaft and connecting rod. All parts completely machined, ready for easy assembly. **ONLY \$2.95.** How do we do it? We're selling thousands of **DEEZILS**. So production's up; costs tumble down. **DEEZIL** is a precision engine. Actually runs at 7500 RPM. Produces 1/7 HP.

Ideal for planes, boats, midget cars. Send \$2.95 plus 15c postage today.

### GOTHAM HOBBY CORP.

107 East 126th Street New York 35, N. Y. Dept. "P"



Pat. applied for

**Start a NEW BUSINESS**  
Or Add to Your Present  
Repair Business  
**Sharpen Dull Pipe Wrenches**  
**Pipe Taps & Dies**  
**"Gum" Circular Saws**

Write for information.

**J. C. MOORE INDUSTRIES** P. O. Drawer 276 FREDONIA, PA.

## MAKE ANY CUT WITH THESE NEW WOODSHAPERS for YOUR CIRCLE SAW or DRILL PRESS



**MODEL #60**—Originally designed for heavy industrial use, now priced for home workshop. Can be attached directly in chuck of your drill press. Exclusive pilot bearing (see illustration) eliminates side thrust, chatter and vibration—assures smooth cutting action. Blades can't come out—set screws hold them securely. Complete, with **YOUR CHOICE OF ANY 6 PAIR DOUBLE-GROUND BLADES SHOWN BELOW**, only \$12.95.

**MODEL #50**—Same as Model #60 but without exclusive pilot bearing. Designed for intermittent shaping; over 100 different shapes can be cut. Complete, with **ANY 6 BLADES OF YOUR CHOICE SHOWN BELOW**, only \$8.95.

All Aladdin tools are guaranteed. Postage prepaid with all cash orders. C. O. D. plus postage. **GET YOUR ORDER IN TODAY.**

### ALADDIN MFG. CO., INC.

3121 Main Street Kansas City, Missouri  
Dealers Write Today

## PRACTICAL BOOKS ON HOME PLANNING BUILDING · REPAIRS



MAIL ORDER TODAY Plan Now—Build When You Can Books Sent C.O.D. Anywhere in U.S.A.

Select from this list of helpful books. In U. S. books sent postpaid if remittance accompanies order. Outside U. S. include 15% extra for shipping charges.

- How to Plan a House \$5.00
- Your Home and How to Build It Yourself \$3.00
- Painting, Decorating \$1.75
- Carpentry \$2.50
- Painting, Furniture Finishing and Repairing  
Includes floor renewal \$1.50
- How to Remodel a House Complete, practical \$5.00
- Building Insulation \$4.50
- Concrete Handbook Do work for yourself, others \$1.50
- Blueprint Reading for Building Trades \$1.50
- Practical Bricklaying \$2.00
- Primer for Home Builders \$2.50

### FAMOUS PLAN BOOKS

Books contain floor plans, photos, descriptions of homes.

- AMERICA'S BEST LOW COST HOMES. 125 designs \$1.00
- DE LUXE SMALL HOMES. 210 designs \$1.00
- OUR FUTURE HOME. Wide selection of residences, summer homes, garage apartments \$1.00
- MODERN HOME & GARDENING. 42 popular designs. Improvements, garden short-cuts, etc. \$0.50

Set of Four Books \$3.50



Stair Building \$2.50

## POPULAR MECHANICS PRESS

DEPT. 646 • 200 E. ONTARIO STREET, CHICAGO 11



### Happy Highways Ahead!

With Popular Mechanics new **MOTORIST'S HANDBOOK**. 160 pages of authoritative advice to keep your car rolling smartly—longer. Brakes, body, spark plugs, battery, starter—every automotive part is covered in this up-to-the-minute manual of year 'round driving pleasure.

Your news dealer has the 60c paper edition. Order the clothbound \$2.00 volume from

**POPULAR MECHANICS PRESS**  
200 E. ONTARIO ST. CHICAGO 11



## VOLUME 10 IS HERE!

Another great Popular Mechanics **WHAT TO MAKE!** This new 1949 edition has hundreds of practical ideas you can use around the home. Pictures and plans bring the words to life. Easy to understand. Easy on your budget.

Your news dealer has the gleaming \$1.00 Lamcote covered volume. . . . .

Order the clothbound from **POPULAR MECHANICS PRESS . . . \$1.75**  
200 E. ONTARIO ST. CHICAGO 11



**MODEL SA-10**—Heavy-duty, industrial-type shaper of solid steel, now priced in home workshop range. Absolutely safe—blades locked in position with screws all the way through. In ordering, state diameter of shaft. Complete with **ANY 6 PAIR OF READY-GROUND BLADES SHOWN BELOW**, only \$14.95.

**ALADDIN WOODSHAPING BLADES**  
Specify by number the blades you want. Additional blades \$1.50 each, \$3.00 per set.

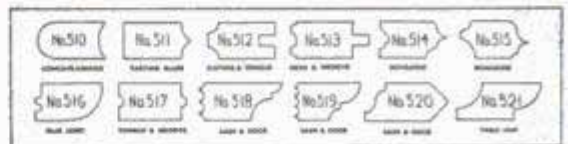

## BUILD YOUR POWER TOOLS



WITH OUR GUARANTEED INDUSTRIAL  
POLY BALL BEARING ARBORS

New Departure  
Self Lubricating  
Bearings

10,000  
R.P.M.



(No extra charge  
for left hand  
threads)

C4-1/2"  
Pictured

B33—\$5.45 PP.  
3/8 x 4 1/2 Spindle  
B15 Plain Spindle  
\$3.95 PP.

C4-1/2 x 12 1/2 spindle, housing 2x8... \$7.95 PP.  
C5-5/8 x 12 1/2 spindle, housing 2x8... \$8.45 PP.  
C6-3/4 x 12 1/2 spindle, housing 2 1/4 x 8... \$9.45 PP.  
D8-1 x 17 1/2 spindle, housing 2 3/4 x 11... \$18.75 PP.

SHAPER ARBORS 3 inches between collars, C4-1/2 \$14.25, C5-5/8 \$14.25, C6-3/4 \$15.25, D8-1 \$23.00, B25-1/2 x 2" cap. flange mount \$5.95.

POLY PRODUCTS, 2032-A E. Walnut, Pasadena 8, Calif.

## Amazing New WOOD-TURNING TOOLS

sharpen once in 12-years! (under normal use)  
These remarkable tools tipped with TUNGSTEN CARBIDE will astound you with their performance. They work FREE HAND equally well in wood, plastic or soft metals—and at the same time hold their razor-like edge almost indefinitely. Tests show that they will turn wood or plastic for days and days CONTINUOUSLY without showing any signs of dulling. They are the finest tools available at any price. Beautifully finished 5/8" blade—flush ground, polished tip—finest brass tube ferrule—5/8" hardwood handle—over all length 14"—10 tools to choose from; round and square nose from 1/8" to 1/2";—1/8" cut off; and 1/2" x 30° skew.

AVAILABLE IN THE FOLLOWING SIZES:

Square Nose		Round Nose	
7-21 1/2"	\$3.25	7-25 1/8"	\$3.50
7-22 3/4"	3.50	7-26 1/4"	3.75
7-23 3/8"	3.75	7-27 3/8"	4.00
7-24 1/2"	4.00	7-28 1/2"	4.25
7-40 1/8" Cut off	3.50	7-41 1/2" x 30° Skew	4.00

Send check or money order now. You must be delighted, or money back! Free Literature.

JOHNS CARBIDE MFG. CO., Dept. PM1, Dunellen, N. J.

## CRESCENT TOOLS

Give Wings to Work

ASK YOUR  
HARDWARE  
DEALER

## HEAVY CAST ALUMINUM BLOWER ONLY \$11.25

SINGLE EXHAUST BLOWER DELIVERS APP. 100 CU. FT. AIR PER MINUTE. Excellent for Coal Furnace Blower. Gives hotter water, faster... Removes gas fumes from garages. Install it yourself with any household tools. 110 V., A.C., 50-60 cycles. Cont. duty motor.

DOUBLE EXHAUST BLOWER. 2 heavy cast alum. housings. Double intake and exhaust. \$16.85. Add 50c handling; \$1 west of Miss.

Send check, M.O. Money-Back Guar. Free Lit.

UNIVERSAL YONKERS CORP.  
137 Alexander St. (M-1) Yonkers 2, N. Y.



## BARGAINS FROM WORLD WAR II

Thousands of Bargains in Military, Outdoor & Sport Goods for Hunter, Farmer, Scout. Send 10c for NEW 32-page catalog, just issued, returned with first order.

A and N SUPPLY CO.

4720 LESTER ST. RICHMOND 15, VA.

# Attention! Buyers!

Here's your directory of 10,000 items about plans, blueprints, tools, machinery, sports, and business opportunities. The latest on schools, courses, hobbies, patents, photography, autos and boats. Cross-indexed to use in a jiffy. Four and a half million readers must be right. You will be too with this HANDY GUIDE to POPULAR MECHANICS advertisers. Send for it today, only 25c!

POPULAR MECHANICS PRESS, 200 E. Ontario St., Chicago 11, Ill.

## HELPFUL BOOKS

Send post card asking for FREE catalog

Popular Mechanics Press, 200 E. Ontario, Dept. 601, Chicago 11



## POPULAR MECHANICS Outdoor Sports Manual!

All sportsmen, attention! Here are 156 pages of helpful hints for the Hunter, Fisherman, Trapper, Camper, Archer, and Boatman. How to make your own decoys, reconition your fishing rod, outwit the fur bearers, make an insect and vermin proof tent, shoot a modern crossbow, and service your outboard motor. These and a pack bag full of other articles for outdoor men. Your News Dealer has it in the 60c paper edition and we can supply the beautifully bound \$2.00 library edition.

Popular Mechanics Press  
200 E. ONTARIO ST. CHICAGO 11

## MILL IT...ON YOUR LATHE!

# PALMGREN

MILLING ATTACHMENT

3 SIZES

No. 250 Illustrated

2 1/2"  
JAW  
Only

24<sup>75</sup>

CONVERT LATHE  
IN 10 SECONDS

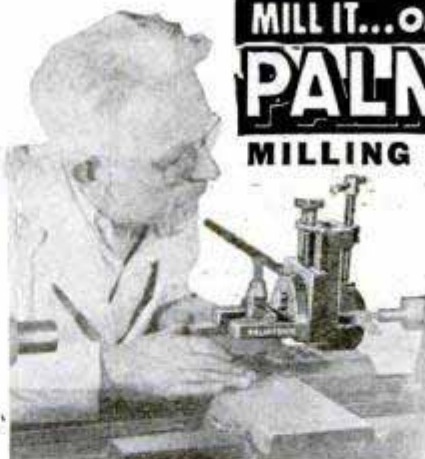

Now you can Mill, Slot, Grind, Groove, Square Shafts, Saw at Angles, Recess and many other important jobs. SAVE TIME and MONEY! Why send work out or use costly methods when a PALMGREN MILLING ATTACHMENT will solve your problem.

Precision built, it has accurate graduations for rotary angle adjustments, also graduated vertical feed screw. Fits South Bend, Atlas, Craftsman, Logan, Sheldon and all other lathes. Thousands now in use in small and large machine shops, repair shops, railroads, schools, home work shops, etc. ORDER SIZE NEEDED TODAY!—it will quickly pay for itself.

### IMMEDIATE DELIVERY

Nos.	Width Jaws	Depth Jaws	Jaws Open	Weight Pounds	Fits Tool Post	Price F.O.B. Factory
150	1 1/2"	1"	1 5/8"	6 1/2	1" Dia.	\$18.75
250	2 1/2"	1 7/16"	2 1/2"	11	1 1/4" Dia.	24.75
400	4"	1 1/2"	4"	25	2" Dia.	39.75

Order From Your Dealer or Jobber: Write for Circular No. 351  
Mfrs. of PALMGREN PRODUCTS  
Since 1915  
8365 South Chicago Ave.  
Chicago 17, Ill.

CHICAGO TOOL and  
ENGINEERING CO.

JUST A FEW OPERATIONS YOU CAN DO ON YOUR LATHE!

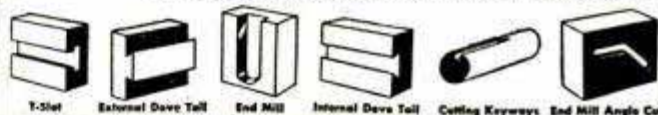

## "ADVANCE SEASON" OFFER

Make Ur Own

# LAWN MOWER

Just add Engine or Motor

- Lightweight "easy to operate."
- Cast aluminum base with 18" Rotary Blade (Hardened Steel).
- Ball-bearing rubber tired wheels.

COMPLETE  
AS  
SHOWN  
ONLY  
\$34<sup>95</sup>

F. O. B. K. C. MO.



Now is the time to install your own gasoline or electric motor on a well built new aluminum chassis. Will accommodate up to 2 1/2 hp engines or 1/2 hp motor.

We can furnish gasoline engines and electric power motors at big savings. Inquiries invited.

Send check or M.O. No COD's.

## ATLAS EQUIPMENT CO.

229 S.W. Blvd.

Kansas City, Mo.

**UP TO 25% MORE MILEAGE FROM YOUR CAR!**



**WITH A POWER DUAL MANIFOLD**

**INSTALL EASILY YOURSELF ON ANY V-8 FORD or MERCURY (Up to 1949 only)**

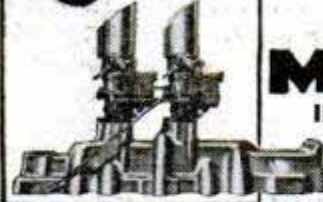

- More Mileage
- More Pickup
- More Efficiency
- Extra Horsepower
- Road Tested

Get smooth surging power, amazing acceleration. New type dual manifold gives up to 25% more mileage. For V-8 Fords and Mercurys up to 1949 models only. More evenly vaporized fuel gives better combustion, uses every drop. Easily installed. Detailed instructions furnished with each manifold.

25% Cash with Order. Balance C.O.D. **\$39.75**

DEALERS: Write today for special offer and complete line. Plus 5% Fed. Excise Tax F.O.B. St. Louis

**MAIL THIS COUPON TODAY**

POWER ENGINEERING CO., Dept. PM-1, 4506-R Delmar, St. Louis, Mo.

I am enclosing \$\_\_\_\_\_ Send me \_\_\_\_\_ Dual Manifolds. (For V-8 Fords, Mercurys only—up to 1949.)

Name \_\_\_\_\_

Street \_\_\_\_\_

City \_\_\_\_\_ Zone \_\_\_\_\_ State \_\_\_\_\_

**BEFORE YOU BUY ANY TRACTOR—**



SEE THE POWERFUL 5-HP GRAVELY—THE WORLD'S FINEST YET MOST MODERATELY PRICED GARDEN TRACTOR... COMPLETE LINE OF EXCLUSIVELY DESIGNED POWER TOOLS FOR EVERY GARDEN, LAWN AND FIELD JOB.

WRITE FOR FREE CATALOG

**GRAVELY TRACTOR**

FIELD-TESTED FOR 27 YEARS GRAVELY MOTOR PLOW & CULTIVATOR CO. BOX 163 DUNBAR, W. VA.

Say You Saw It in POPULAR MECHANICS

**ELECTRICITY Anywhere**

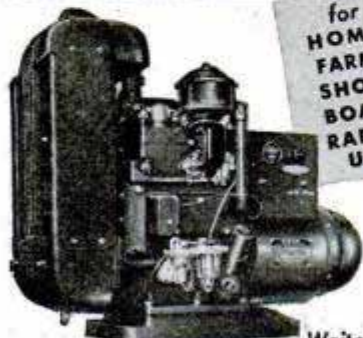

for HOMES FARMS SHOPS BOATS RADIO USE

Onan gasoline-engine-driven Electric Plants supply reliable, economical electric service for any use. Portable, stationary or standby models. Water or air-cooled, compact and rugged.

A.C.: 350 to 35,000 watts in all standard voltages and frequencies. D.C.: 600 to 10,000 watts, 115 and 230 volts. BATTERY CHARGERS: 500 to 3,500 watts; 6, 12, 24, 32 volts.

Write for folder

**D. W. ONAN & SONS INC.** 2549 Royalston Ave., Minneapolis 5, Minn.



**BUILD THIS HOUSE Yourself**



**The Famous Popular Mechanics House**

The picture below is from an actual photograph of the Build-It-Yourself House with breezeway and garage, as built by Jack Brownson, 23-year-old veteran, in Aurora, Illinois.

Designed by Popular Mechanics and Famous Architects. Every Detail Simplified and Explained. No Previous Experience Needed!

Can you use everyday tools as well as the average Popular Mechanics reader? Then you, too, can easily build this modern house in any of its five designs, doing every part of the job yourself. The new Popular Mechanics Book, "Your Home—How to Build it Yourself" will show you how.

**Space for Living and Family Growth**

This beautiful, modern house is 1½ stories, with basement, living room, kitchen, dining nook, two bedrooms, bath, plenty of closets and space for two additional bedrooms on second floor. The house itself is 35' 9" x 28' 11"; breezeway 20' 10" x 8'; garage 20' 10" x 12'.

**The House That Has Everything**

Designed for easy construction and the most living space for the least cost, the Build-It-Yourself House is also most attractive and suitable for any community and most income groups. The basic plan is adaptable to four other exterior designs.

**Get Book and Plans Now—Build When You Can**

You may never have thought about actually building a house yourself, but now that building restrictions have been lifted, it is easier than you think. So order book and plans today. Even if you engage a contractor to build for you, you will need the plans. And you certainly will want the book which can easily save you hundreds of dollars, whether you build this or any other house.

**Mail Coupon for New Book and Plans!**

**Build It Yourself or Have It Built—Save Hundreds of Dollars!**

**PLANS YOU CAN READ AND FOLLOW**

Plans consist of ten working-size blueprints—floor plans, elevations, construction notes, framing, joints, lumber and mill list, specifications, plumbing and wiring diagrams. Every measurement is marked—every detail made clear as ABC. Book has 100 pages—three-fifths are photographs and drawings. Some sections in colors, showing just how your house will look when finished.

**BIG BOOK 8½x11 inches**



**MAIL COUPON FOR BOOK AND PLANS**

POPULAR MECHANICS PRESS 200 E. Ontario St., Chicago 11

- I enclose \$\_\_\_\_\_ Send me the items checked at once.
- Your Home and How to Build It Yourself.....\$ 3.00
  - Complete set of plans for Popular Mechanics Home.. 12.50
  - Book and plans at reduced price..... 14.00
  - Duplicate sets of plans..... 5.00

Name \_\_\_\_\_

Address \_\_\_\_\_

City \_\_\_\_\_ Zone \_\_\_\_\_ State \_\_\_\_\_

# Make Your Own Electricity

with Portable  
**ELECTRIC  
POWER PLANTS**



Good Cond.  
**\$275.00**

New  
**\$325.00**

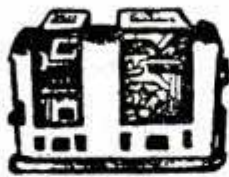

Made by Hobart or Merritt & O'Keefe.  
3 KVA single or 3 phase, 4 cylinder  
gas engines. Complete with control panel.

**REX TRAILER COMPANY, Inc.**  
1125 E. GEORGIA ST. INDIANAPOLIS, IND.

## MYSTERIOUS DEVICE WELDS BRAZES ANYONE CAN OPERATE SOLDERS & CUTS



Now, an electric welding, brazing and soldering Torch, complete with power unit, goggles and supplies. Works INSTANTLY off any light socket. Does a thousand and one repair jobs at amazingly LOW COST on aluminum, iron, steel and other metals. Indispensable for Auto, Body and Fender Repairs, and home repairs—shop, factory, farm engineer, janitor, sheet metal, radio and bicycle repairs. Anyone can handle without previous experience with our simple instructions. **10 DAY TRIAL OFFER** Write at once for Special Introductory Low Price Offer. Try Four-Way Welder for 10 days at our risk. Write today for free details.

**FOUR-WAY WELDER CO.**

3180 No. Clark Street, Chicago 14, Ill.

## ONE-MAN SAWMILL LESS THAN Easy To Turn Trees Into Money \$225.00

Makes lumber, ties, shingles, crates, lath, studding, siding.



**Belsaw Models**

in 10 to 24 foot  
sawing lengths.

**MECHANICAL FEED**, accurate set works and positive dogs. Use tractor or old auto engine for low cost power.

Thousands used for commercial sawing. Pays for itself quickly. Send post card today for FREE booklet, "How To Make Lumber" and Catalog of Woodworking Equipment.

**BELSAW MACHINERY CO., 811M Field Bldg.**  
315 Westport Road Kansas City 2, Mo.

**WALL TENT** 9'x9' waterproof canvas, front and back windows, 3'8" \$195 wall, open at back. Ends 8' high. Only.....

**CANVAS COVERS** Waterproof tarpaulins, war surplus (Used), perfect condition. Originally made for tents. Approx. 5'x8'. Two buttoned together make approx. 80 sq. ft. Complete with buttons attached. Suitable for use as canvas dams, hay covers, truck covers, machinery and equipment covers, etc. Packed in bales of 30, priced 30 covers. \$1.25 ea.; 15 covers, \$1.50 ea. Less than 15, \$1.75 ea. All FOB, Kansas City.

**AMERICAN SUPPLY CO.**  
329 W. 5TH DEPT. PM KANSAS CITY, MO.



**SPORTSMEN! GIANT SPOOL** Now Yours On  
**SPECIAL INTRODUCTORY OFFER**  
**DIRECT-TO-YOU FROM MILL** Only

**MEN!** Here's your chance to get this amazing strong, almost unbreakable \$1.69 5000 YD DuPont NYLON thread for sewing leather and canvas, salt water fishing, net mending, bamboo rod wrapping. Used by Air Force on parachutes. **SEND NO MONEY.** Just name and address. Specify black or white thread. On arrival pay postman \$1.69 plus

C.O.D. postage. Test for 10 days. If not delighted, return for money back. Limited offer. Order TODAY. 2 Spools... \$3.29  
**LEEWARD PRODUCTS, Dept. F-49A, 189 W. Madison, Chicago 2, Ill.**

Say you saw it in  
**POPULAR MECHANICS**



**PRINT ANY PHOTO**

ON PAPER, CLOTH, LEATHER OR WOOD

Send stamp for particulars

**TIFFANY'S, 2128 Montrose JB, Chicago 18, Ill.**

# For Fun & Money!

quick-selling  
money-making  
3-dimensional



## PLASTIC PHOTO STATUETTES

Easily Made From Any  
Photograph or Negative

Make lifelike Plastic Photo Statuettes at home for pleasure and profit Easy to make from any photograph or negative, no special tools or machinery required. We provide all necessary materials and advertising circulars at wholesale cost, and we furnish complete easy-to-follow instructions. Make these Statuettes for yourself, for your friends, or sell them. Drug and department stores, photographic stores and photo studios, will gladly act as your agent. Also, you can sell them easily house-to-house or by mail.

\$2 starts you on your way! For only \$2 we send you complete manufacturing instructions, sample of a finished Statuette, illustrated circular and FREE materials sufficient to produce two Statuettes. Send \$2 right now and get in on a good thing!



**CHEMICAL RESEARCH CO.**  
130 W. 42ND ST., NEW YORK-18, N. Y.

## 7 x 50 BINOCULARS

MADE TO RIGID MILITARY SPECIFICATIONS

Brand New

**\$44**



Actual Photograph  
Ht. 7"  
Wt. 39 oz

With  
COATED  
Lenses  
& Prisms  
**\$54**

These magnificent 7x50 prism binoculars were obtained through the Supreme Commander of the Allied Powers. They have the brilliant luminosity, precise clarity, and wide, undistorted field of view obtainable only with a good large glass. Because 7x50 glasses give the highest performance obtainable they are now the official choice of the Army, Navy and Marine Corps. This is your opportunity to purchase a brand new 7x50 AT 1/3 OF THE USUAL COST. Lifetime construction. Lightweight aluminum body. Individual eye focusing. Ultra-precise optics, sealed against moisture and dust. Unsurpassed by any other binoculars, regardless of price. Richly finished case and straps included. Sold with a guarantee of complete satisfaction or money refunded.

Priced With  
Regular Optics  
**\$44\***

Price With  
Coated Lenses & Prisms  
**\$54\***

\*Plus 20% Federal Tax

IMMEDIATE DELIVERY

WE PAY THE SHIPPING COST

**BROWNSCOPE CO.**

Dept. 1M, 24 West 45th St., New York 19, N. Y.

Do it  
Faster  
and  
Easier  
with  
the

WRITE FOR FREE CATALOG — shows attachments that save time and money!

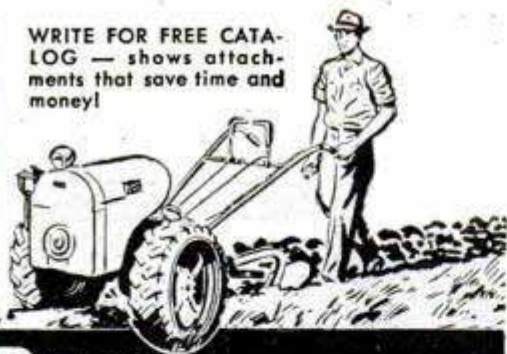

## PAGE Garden Tractor

New 1949 line with extra features! Riding and walking models, 1½ to 5 HP. Complete gear drive, no cheap belts or chains. Large tires—high clearance—easy to handle—power turn. Low factory prices—\$188 to \$436 with cultivator. Get benefits of 24 years of garden tractor experience!

**PAGE DAIRY and FARM EQUIPMENT**  
1904 S. 81st STREET • MILWAUKEE 14, WIS.

Phenomenal Value • Treasured Lifetime Gift

INCABLOC  
Shock  
Resistant  
Feature

17 JEWEL • 2 PUSH BUTTON  
**CHRONOGRAPH**

"4-in-1" Precision Instrument

- WRIST WATCH
- STOP WATCH
- TELEMETER
- TACHOMETER

Sweep second hand • Anti-magnetic • Radium dial • Stainless steel back • Unbreakable crystal. IDEAL for use in sports, sciences, engineering, medicine, photography, radio, aviation.

OUR FAMOUS  
GUARANTEE  
MONEY BACK  
in 10 DAYS  
if not satisfied  
for any reason



**\$29.75**  
plus  
10% tax  
(formerly  
\$71.50)

Also  
available  
in 18K  
Gold Case  
**\$64.50**  
plus 10% tax  
(formerly \$125)

Mail orders promptly filled. Shipped C.O.D. or send check or money order. Address all mail orders to: **ADLEW JEWELERS**, 152 W. 42 St. N.Y. 18 (Dept. 117A)

**Adlew JEWELERS**  
117 W. 42nd St., New York 18

MAIL THIS FOR

# New Catalog

of Attachments and  
Accessories for Lathes



**SOUTH BEND LATHE WORKS**  
455A E. Madison St., South Bend 22, Indiana

Name \_\_\_\_\_

Street \_\_\_\_\_

City \_\_\_\_\_ State \_\_\_\_\_

# King Midget

- HOME ASSEMBLED
- MASS PRODUCED
- LOW-COST AUTOMOBILE



Drive this car for as low as 50c per week. Up to 90 miles per gallon. 45 to 50 m.p.h. Large enough for a husky six footer. A pleasure to assemble. Just bolt together our precision built parts. Get the facts. Send 25c for detailed circular with large photo, 4 view drawings, price of all parts. Better still, send \$1 (refunded first order) for this plus actual assembly book with 42 photos, drawings, blueprints, snow and ice conversions, etc.

**WORLD'S LOWEST PRICED CAR**

MIDGET MOTORS MFG. CO., Athens 1, Ohio

## Ball-Bearing SPEED WHEELS

JUVENILE WHEELS

(No bearing, solid tires)

4".....45c 6".....65c  
7".....75c

(Semi-pneumatic tire, ball bearing)

6x1.....1.65 8x2.....2.20  
8x1.25.....1.85 10x1.25.....2.20  
8x1.75.....1.95 10x1.75.....2.30  
12x1.75.....3.45

INDUSTRIAL WHEELS FOR  
HEAVY LOADS

6x2 Welded...3.45 10x2.75 HC... 5.70  
8x2 Bolted...4.35 10x2.75 Pnc. 7.60  
8x1.....5.25 12x2.00... 6.80  
8x2.00...5.20 12x3.00...10.60  
8x2.50...5.40 4.00x8-2...14.70  
10x2.00...6.10 4.00x8-4...15.85  
16x4.00...15.15



DEALERS, JOBBERS,  
AND MANUFACTURERS!  
OUR NEW PRICES WILL  
INTEREST YOU.

WRITE US NOW FOR COMPLETE  
NEW CATALOG

Send check with order. No C.O.D.

**JIM BROWN TOY COMPANY**

1097 Home Ave.

Akron 10, Ohio

FENDER SKIRTS . . . . . \$17.20 PER PAIR

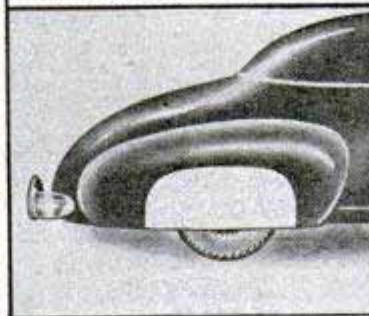

For Ford Chev., Merc., Plym., DeSoto, Chry., Dodge Kaiser-Frazer and Buick. Beautify your car—bring out the flowing lines inherently designed there. Sparkling beauty you'll like. Constructed of heavy gauge body steel, finished in prime, perfect fit.

SANDEE MUFFLER CO  
Box 296, La Tijera Sta.,  
Los Angeles 43, Calif.  
Gentlemen: Please send me one set of Sandee Fender Skirts to fit my \_\_\_\_\_ (year and make of car)  
 Check for \$17.20 enclosed  
Ship C.O.D.

SAY YOU SAW IT IN POPULAR MECHANICS

Hollywood **GOOSE HORN**

FOR BICYCLES • TRICYCLES •  
SCOOTERS



**RIDE SAFELY**

Many communities have laws requiring a warning signal for bicycles.

**\$1**  
POSTPAID

Be safe! Ride a fully equipped bike. Put the new, smart looking Hollywood Goose

Horn on your bike today. A precision built, bulb-type bicycle horn. Overall length 9 inches with 2½ inch flared bell. Black live-rubber bulb. Clamp fits securely to front of handle bar, near the steering post in PROTECTED position. Only \$1.00 Postage Paid. Send cash, check or M. O. Order direct today, if your dealer can't supply you. No COD's please.

**YODER MANUFACTURING COMPANY**

2403 21R E. 103rd Street, Los Angeles 2, California

POPULAR MECHANICS



# DYNAMIC Super Charged ARC WELDER

Industrial Transformer Type

The New Improved All-Purpose

## IT WELDS • IT BRAZES • IT SOLDERS

**IDEAL FOR AUTO—HOME APPLIANCE AND FARM REPAIRS.** This portable, industrial transformer type welder easily carried right to the job can be operated from any convenient properly wired 110 Volt 60 Cycle Line. Can also be supplied for 220 volt 60 cycle operation and other voltages and cycles at slight additional cost.

**EASY-TO-OPERATE.** If inexperienced you can easily learn to do a variety of high grade welding jobs by following the practical, simplified **Welding and Operating Instructions furnished.** Once you see the **DYNAMIC WELDER** in operation you won't want to be without it. Its simplicity will amaze you. In a year the **DYNAMIC** only costs you about 7c a day. Comes complete ready to operate with helmet, rods, cables, holder, operating and welding instructions, etc.

### SAVES YOU VALUABLE TIME AND MONEY!

**DESIGNED TO DO HIGH GRADE WELDING** inexpensively—Maintenance Men, Farmers, Mechanics, Machine Shops, Foundries, Auto, General Repair and Job Welding Shops, all using the **DYNAMIC** find it so indispensable and useful that they can not afford to be without it. **Works on Iron, Steel, Brass, Bronze and Other Metals.** Has metallic and carbon arc heat stages. Does work you would think only possible with a larger, more expensive machine.

**DYNAMIC WELDER CO., Dept. 19-T, 15 East 23rd St., CHICAGO 16, ILL.**

ONLY  
**\$2850**  
COMPLETE

### DO YOUR OWN WELDING

Just a few repair jobs will pay for this machine. A practical and profitable machine tool for any workshop. Make money doing repair work for others.

Write for Particulars Get Details on our 10 day Trial Offer Member Chicago Association of Commerce.



### SPECIAL GIFT OFFER! ARC TORCH WORTH \$6.80

YOURS at NO EXTRA COST!

**TWIN CARBON TORCH** (illustrated) for use with **DYNAMIC** is unsurpassed for brazing, soldering, pre-heating and cutting iron, steel, brass, bronze and other metals. With it you greatly increase profitable uses of your welder. Does work of oxy-acetylene torch. Comes complete with instructions, carbons and cables. For LIMITED TIME ONLY we are giving a

Twin Carbon Electric Arc Torch worth \$6.80 with every **DYNAMIC WELDER**. Act now to get this valuable premium at the single low price of welder alone.



### 10-DAY TRIAL OFFER

**DYNAMIC WELDER CO., Dept. 19-T, 15 E. 23rd St., Chicago 16, Ill.** Send me FREE details of your **ELECTRIC Arc Torch Gift Offer** and **Dynamic Welder 10-Day TRIAL OFFER.**

NAME \_\_\_\_\_  
ADDRESS \_\_\_\_\_  
CITY \_\_\_\_\_ ZONE \_\_\_\_\_ STATE \_\_\_\_\_

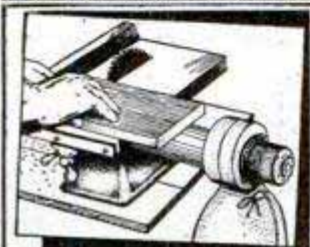

### DUST-O-VAC THE DUST & CHIP COLLECTOR

FOR HOME WORKSHOPS & INDUSTRY

**DUST-O-VAC** actually picks up wood and plastic chips, wood and metal dust, and wood shavings—and puts them into a bag (supplied free). **DUST-O-VAC** attaches to any circular saw, planer, hand saw, grinder, belt or disc sander, shaper, drill press with shaper or sander attachment, spindle shaper, wood lathe or jig saw. **COMPLETE MOUNTING INSTRUCTIONS INCLUDED.** **DUST-O-VAC** has solid cast alum. housing. Cont. duty motor. 110V., A.C., D.C. **WRITE FOR FREE LIT.**

**\$19.95**

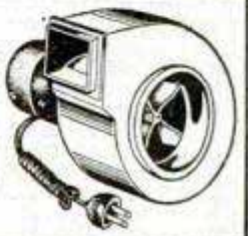

Free shipping east of Miss. West of Miss. add \$1. Send check, money order.

**UNIVERSAL YONKERS CORP.** 137 Alexander St., M-1 Yonkers 2, New York

### \$4.95 REAL ENGINE VALUE

A miniature gas engine that really operates. Thousands of Buzz "B" gasoline engines have been sold at twice the price. Now is your chance to buy a real 1/6 H.P. gas engine for only \$4.95. Turns up over 8,000 r.p.m. For Boats, planes, midget cars, etc. Guaranteed and ready to run. Includes Champion spark plug and tank. Send only \$1.00, engine shipped collect for balance, same day. **WRITE FOR FREE CATALOG OR SEND 10c FOR NEW MAMMOTH ILLUSTRATED CATALOG OF THOUSANDS OF HOBBY ITEMS.**

America's Hobby Center, Inc., Dept. B-19, 156 West 22nd St., N. Y. 11

## MADE \$582.00 in One Month

"My lowest month sharpening lawn mowers was \$80.00 and highest \$582.00. Naturally my best months are in the Summer." W. W. L., Okla.

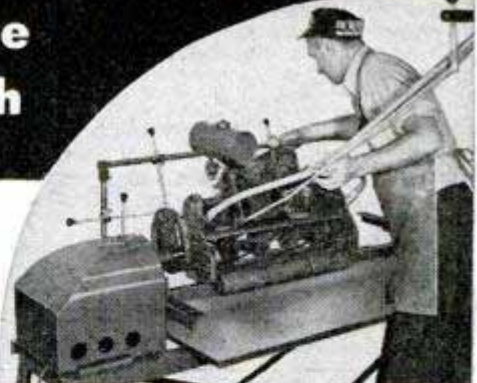

### WORK AT HOME — PART OR FULL TIME

Build a steady repeat CASH business with the **Foley Lawn Mower Sharpener**—uses same system as lawn mower factories. Simply put mower in machine with handle on—sharpens all sizes and types in 15 or 20 minutes—no experience needed.

Tells how to start—no canvassing necessary. The **Foley** sharpens 3 or 4 mowers an hour. 99c out of every dollar you take in is clear profit. Available now. Mail coupon today.

### FOLEY LAWN MOWER SHARPENER

**FOLEY MFG. CO., 107-9 Foley Bldg., Minneapolis 18, Minn.** Send FREE PLAN on the **Foley Lawn Mower Sharpener** business.

Name \_\_\_\_\_  
Address \_\_\_\_\_

### SAVE MONEY ON GUARANTEED CARBURETORS

Here's your chance to get a rebuilt carburetor at low cost. All fully rebuilt, motor tested, guaranteed. Ford ('34 to '48)—\$3.99. Chev. ('34 to '48)—\$4.99. Ply. ('33 to '48)—\$5.99—PLUS YOUR OLD CARBURETOR. Our big volume business permits us to offer these amazing prices! Send 1/3 cash with order PLUS \$2.00 deposit which will be refunded upon receipt of your old carburetor. Balance C.O.D. when you receive rebuilt carburetor.

**NATIONAL AUTOMOTIVE NECESSITIES** P. O. BOX 6225 PITTSBURGH 12, PA.

SAVE UP TO 50% AND MORE

SEND FOR **FREE** Diamond Catalog

All diamonds reset in new mountings. Sold with iron clad money-back guarantee

**BERMAN'S**  
America's Great Diamond Values  
Dept. P Berman Bldg. Baltimore, Md.

**BERMAN'S**  
Illustrated Catalog

**OUT OF PAWN GENUINE DIAMONDS**

Outstanding values from \$10 to \$5000

Approx. 1/2 Ct.  
**\$95** incl. tax  
\$200 Value

**Now! You Can Cut Internal Keyways on an Ordinary Drill Press Easily and Quickly with the** *Versatach*

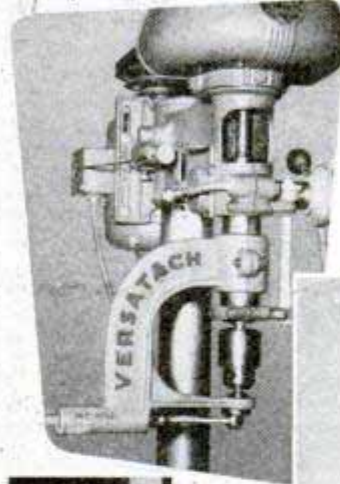

**FITS ANY STANDARD DRILL PRESS WITH SPINDLE QUILLS UP TO 1 1/8" DIAMETER**

**Also Does**  
 Power Filing Sawing  
 Form Filing Slotting  
 And many other operations  
 Saws and Holders are available for \$1.75 each  
 Additional files in 3/16", 1/4", 3/8" and 1/2" sizes.

**\$29.75**  
Postpaid

Price Complete with One 3/16" File and Holder  
 If additional files are desired add \$1.75 for each file and holder. FULLY GUARANTEED.

If your Local Dealer cannot furnish the VERSATACH Write Directly to THE SENEWA COMPANY, Dept. E., Box 1111, Hutchinson, Kans.

# PAY RAISING—EXTRA MONEY BOOKS

Use these books to prepare for a better job—bigger pay—to start a profitable spare time or full time business of your own, improve your home, start a hobby. Popular Mechanics specializes in Popular Mechanics specializes in popular books on many subjects. Send

- supplying outstanding self-help books on many subjects. Send for our FREE catalog.
- Outdoor Sports Manual**  
Hunters, Fishermen, Trappers, Campers, Archers, Boatmen, here is your book! . . . \$2.00
- Shop Notes Library**  
3 Vols. — 1949, 48, 47, 44, (No. Dup. Mat.) . . . \$3.00
- Painting, Furniture Finishing and Repairing** . . . \$1.50
- Rewinding and Servicing Electric Motors (No. 75)** . . . 25c
- Drake's Cyclopaedia of Radio and Electronics**  
New revised edition with hundreds of illustrations to explain the simply written up-to-date text . . . \$5.00
- High School Self Taught**  
Covers 25 subjects with study guide and self-testing quizzes. Completely revised and enlarged edition, 1280 pages, 300 illustrations, . . . \$3.95
- Garden Book**  
Build own trellises, lawn furniture, fireplaces, ornaments, etc. . . . \$1.00
- Diving, Cutting and Welding in Underwater Salvage Operations**  
Only book of its kind . . . \$2.00
- Picture Framing**  
Modern methods for making and painting picture frames. Fully illustrated, . . . \$2.75
- Frog Industry**  
Breeding, feeding, dressing and marketing . . . \$2.00
- New Fields for the Writer**  
Television, radio, film, drama . . . \$1.00
- Everyday Mathematics**  
Businessmen, tradesmen, executives and secretaries applaud this arithmetical brush-up . . . 50c
- Breaking Into Advertising** . \$1.00
- Into the Freezer and Out**  
A complete handbook on the home freezing of foods. \$2.50
- Concrete Handbook**  
New book on using concrete around home, garden, farm . . . \$1.50
- Zero Storage in Your Home**  
How to prepare, store and freeze food properly . . . \$2.50
- This Way Up**  
The successful philosophy of practical business men \$2.00
- Welding, Brazing and Soldering**  
How to build own equipment and how to use it effectively . . . \$1.25
- Modern Refrigeration**  
Electric, Gas, Be service expert . . . \$5.00
- Dyke's Auto Ency. (includes Diesels, airplane engines)**  
New 20th Ed. World's greatest book for mechanics \$7.00
- Household Mechanics**  
The "fix-it" book to end all "fix-it" books. Covers electric appliances, painting, carpentry, etc. . . . \$2.75
- Oil Burner Handbook** . . . \$2.50
- Build Your Own Boat**  
Describes 17 popular boats—rowboats, sailboats, plywood outboard, etc. 192 pages \$1.50
- House Wiring (No. 89)** . . . 25c
- Turn Scrap Into Money**  
Convert old auto generators into motors, welders, etc. . . . \$1.00
- Popular Mechanics Farm Manual**  
Packed with practical ideas and usable information that can easily be worth hundreds of dollars to every farm family and to homeowners everywhere. Send for free descriptive folder giving complete contents! . . . \$3.00
- Woodworking for Every** . . . \$2.75
- body** . . . \$2.75
- Sheet Metal Work** . . . \$3.00
- Tool and Saw Sharpening (No. 92)** . . . 25c
- Forging Practice** . . . \$1.50
- Action Toys (No. 66)**  
Plans for 21 easy-to-make toys . . . 25c
- Foundry Work** . . . \$2.25
- Pattern Making**  
Wood, metal . . . \$2.25
- Forty Power Tools** . . . \$2.25
- Build own saw, drill, lathe, sander, etc., from scraps—save money . . . \$1.25
- Carpentry** . . . \$2.50
- The Young Craftsman**  
Over 450 things boys can make . . . \$1.50
- Five Acres and Independence**  
How to make money on small farm . . . \$2.50
- Your Home and How to Build It Yourself**  
Step by step construction of the famous POPULAR MECHANICS house. Wonderfully illustrated . . . \$3.00
- Everyday Law**  
A lawyer tells laymen about negotiable instruments, partnerships, contracts, real estate and wills . . . 50c
- Motorist's Handbook**  
Popular Mechanics scores again. A 160 page guide to automotive happiness . . . \$2.00
- Knots, Ties and Splices**  
For everyone who uses rope . . . \$1.25
- What to Make for Children**  
Junior tough on toys? Build him playthings that will last. . . . \$2.00
- LeJay Manual of Homemade Electric Equipment**  
How to construct 100 items that are scarce and valuable . . . \$1.50
- How to Estimate for the Building Trades: Material and labor costs for masonry, plumbing, electricity, carpentry, heating, hardware, painting, etc. 628 pp.** . . . \$5.50
- Pay Dirt**  
How to make soil fertile by obeying Nature's laws . . . \$3.00
- Rabbits for Food and Fur** . \$2.50
- Tool Making** . . . \$4.00
- Tool Design** . . . \$4.50
- Plumbing Installation & Repair** . . . \$2.00
- Ropp's Calculator**  
Figuring made easy . . . 75c
- Slide Rule Simplified** . . . \$2.75
- Drake's Refrigeration Service Manual** . . . \$2.00
- Primer for Home Builders**  
All the information you need to know in building a house . . . \$2.50
- Oxy-Acetylene Welding and Cutting**  
Up-to-date handbook on gas welding and cutting . . . \$2.75
- Toys You Can Make of Wood** . . . \$2.50
- A.B.C. of Poultry Raising** . \$2.50
- Ice Cream for Small Plants**  
Some technical formulas for ice cream, ices and frozen desserts on a commercial scale . . . \$2.50
- Furniture Joinery** . . . \$2.50
- Essentials of Upholstery** . \$3.25
- Radio Physics Course**  
A thorough training in radio fundamentals . . . \$5.00
- Modern Home Medical Adviser**  
How to recognize diseases, practice proper hygiene, and know what to do in medical emergencies. 900 pages, 136 illustrations . . . \$2.49

- BINOCULARS, 6 x 30 Universal, used, good condition; with case** . . . \$42.50
- BINOCULARS, U. S. Navy 7 x 50, used, good cond., with case** . . . \$95.00
- BINOCULARS U. S. Army 6 x 30. New, with Case** . . . \$57.50
- BINOCULAR CASES, 6 x 30, two grades, leather, new** . . . \$5.00 and \$7.50
- 7 x 50 Leather BINOCULAR CASE, new** . . . \$7.50
- TELESCOPES, U. S. Navy, 16 power, with case. Val. \$125** . . . \$29.50
- 5 Power Ranger TELESCOPES** . . . \$2.00
- Engineers Metal Army Type and SIGHTING LEVELS, New** . . . \$2.00
- SURPLUS GOVT. TRIPODS for Level, Transit, Cameras, etc. Used. Good Condition.** . . . \$5.95
- NEW TRIPODS for Transits, Levels, etc. Value \$75.00. Special** . . . \$13.50
- TRANSFORMERS, Western Electric, 5 volt to 650. New** . . . \$4.95
- CANVAS SAFETY BELTS, Metal Snaps, New, \$3.00 Val.** . . . 75c
- Many unadvertised specials. What do you Need?**  
4th Edition Annual Gun Digest, \$1.50.

## Public Sport Shops

11 S. 16th St., Phila. 2, Pa. No COD'S

SAY YOU SAW IT IN POPULAR MECHANICS

### HOME WORKSHOP BARGAIN

1/2 H.P. CAP MOTORS

- Double 5/8" Shaft
- Sealed Ball Bearings
- High Starting Torque
- 3-Pole Reverse Sw.
- Overload Protected
- Rubber Cord & Plug

**\$35**

No. C.O.D.



Guaranteed for one year. 115 V., 60C., A.C., 1750 or 3450 R.P.M.

### GENERAL ELECTRIC & WESTINGHOUSE MOTORS

(Brand New Not Gov't Surplus)

HP	Volts	Type	Price
1/6	110	Split Phase	\$11.95
1/6	110	Capacitor	17.50
1/4	110	Split Phase	12.50
1/4	110	Capacitor	19.50
1/3	110	Split Phase	15.50

CANAL ELECTRIC CO., PM1, 310 Canal St., NYC 13, N. Y.

## MAIL THIS COUPON TODAY

Check the books you want, write your name and address below, and mail this advertisement with money order or check. Outside U. S. A. include 15% additional for shipping charges.

Books selected will be mailed promptly on our "money back if you're not entirely satisfied" guarantee.

Name \_\_\_\_\_

Address \_\_\_\_\_

City \_\_\_\_\_ State \_\_\_\_\_

Mail to **POPULAR MECHANICS PRESS**

Dept. 651—200 East Ontario St., Chicago 11, Ill.

# "Wellworth" Sensational Offer! WESTINGHOUSE AIR COMPRESSOR

plus Pressure Tank, Safety Valve (5 Items \$29.75

**Air Regulator, and Gauge**

**IDEAL for HOME — FARM — FACTORY  
Wherever Compressed Air is Needed**

A fortunate purchase from the Government enables us to offer you this amazing buy at a small fraction of its original cost. All brand new • You get the compressor, pressure tank, air regulator, gauge, and safety valve all for \$29.75. Shipping weight 58 lbs. • Designed for automotive truck or tractor mounting. Can be run off fan belt or power take-off, or mounted horizontally. Comes with automatic clutch. Can be installed for use on farm trucks, jeeps, tractors, tire or garage service trucks, contractor or road building machinery, pneumatic devices, etc. • Can be operated with 1/2 H.P. or more electric motor or equivalent portable gas engine.

Compressor Sold Separately \$21.50

**SAVE \$30.00 ON THIS "WELLWORTH"  
PORTABLE SPRAY OUTFIT**

1/3 H.P.

**ELECTRIC  
MOTOR  
DRIVEN**

**Complete  
With Base**

Well balanced Portable Spray Painting Outfit for use where painting job requires a larger quantity of material. Sprays all types of average viscosity paints, enamels, lacquers, varnishes, etc. Piston type, single cylinder air compressor has 2 in. bore by 1 3/4 in. stroke. Displacement 2.86 C.F.M.; maximum working pressure 40 lbs. Mounted on sturdy wood base with rubber feet attached. Pulsation chamber is equipped with safety valve, drain cock. 1/3 H.P. G-E motor, 110-volt AC, with cord and plug; 20 ft. air hose and fittings. Spray Gun is pressure feed type, internal atomizing, with one quart metal cup. Fan and round spray nozzle furnished. Shipping Wt. 50 lbs.



\$79.50 Value

Price only  
**\$49.95**

**YOU MAY BUY PARTS SEPARATELY**

Air Compressor with filter pulsation chamber—operates with 1/4 to 1/2 H.P. Wt. 15 lbs. \$19.95  
Spray Gun, 2 nozzles, 20 ft. hose. Wt. 5 lbs. \$10.45



**CHICAGO PNEUMATIC  
RIVETER & CHIPPING  
HAMMER**

Size CP3 — Takes 5/32" Rivet — \$7.95  
IR-AVC11 — Takes 5/32" Rivet — \$7.95

**PNEUMATIC AIR TOOLS**  
CP4X Pistol grip handle, with air control. Takes up to 3/16" rivet. Weight 6 lbs. List price \$73.00. **\$8.95**  
SPECIAL PRICE

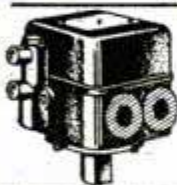

**Automatic Pressure  
Switch with Unloader**

Double pole, with 2 way release valve. Set at 125 to 150 lbs. pressure. For use on compressor units 1/4 to 3 H.P. Pressure range 20 to 200 lbs. Weight 4 lbs. **only \$10.25**

**WATER  
PRESSURE  
SWITCH**

Double Pole, double break. Range 5 to 60 lbs. Set 20 to 40 lbs. Wt. 2 lbs. **\$5.50**  
Special at



**"Wellworth"  
1/4"  
REDUCING  
VALVE &  
GAUGE**

Oil resistant, pressure 0-to-200 lb. Reduced pressure 0-to-75 lb.; 3 outlets 1/4". Wt. 2 lbs. **\$5.75**

2 1/2" Gauge only \$1.75

**"WELLWORTH"  
CHECK  
VALVES**

Dash pot check valve. Prevents leakage after pressure stops.  
1/4" air check valve .. \$2.75  
1/2" air check valve .. \$4.50

All items advertised are brand new unless otherwise stated. Sold on money back guarantee. Terms F.O.B. Chicago. Send check or money order. Prompt shipments.

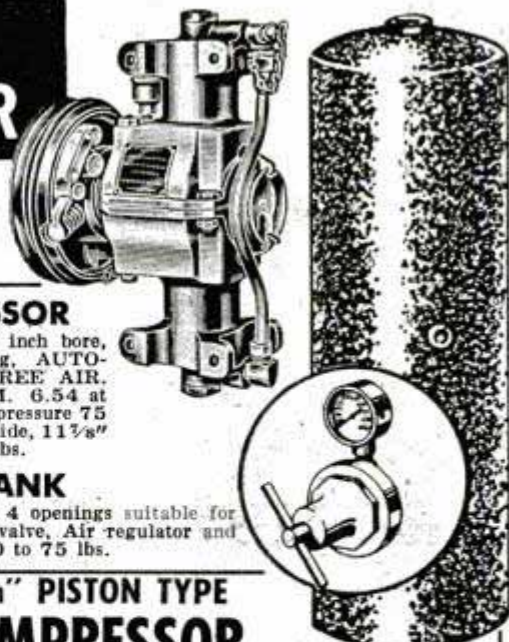

**THE COMPRESSOR**

Piston Type, 2-cylinder, 2 inch bore, 1 1/2" Stroke Ball Bearing, AUTOMATIC CLUTCH, OIL FREE AIR. 3.27 C.F.M. at 600 R.P.M. 6.54 at 1200. Suggested operating pressure 75 P.S.I. DIMENSIONS: 9" wide, 11 1/8" high, 6 5/8" deep. Wt. 23 lbs.

**THE TANK**

8 inches x 42 inches with 4 openings suitable for 100 lbs. pressure. Safety valve, Air regulator and Gauge, Regulates Pressure 0 to 75 lbs.

**"Wellworth" PISTON TYPE  
AIR COMPRESSOR**

Piston type, size 2 x 1 3/4, head in valves, bronze bearings, splash lubrication, V-belt drive, intake muffler and cleaner. Capacity 2.8 c.f.m. at 100 lbs. continuous pressure or 150 lbs. intermittent, with 1/3 HP motor. Can be used with 1/4 HP or 1/3 HP at lower speed. Weight 14 lbs. Operating instructions furnished.

only **\$17.95**

**AIR REGULATOR & GAUGE**

The buy of a lifetime in a standard make air pressure regulator. Used on liquid carbonic tanks and air pressure tanks of all kinds to regulate the pressure. Fitted with standard 1/2 inch pipe thread. Dial calibrated 0 to 200 lbs. Reduced pressure 0 to 150 lbs. Made by Kidde. **\$7.50**  
Wt. 4 lbs. Value



**POP TYPE VALVES**

Has a close range of closing after pop-off pressure is reached. 1/4" pipe thread. Only **\$1.50**



**G. E. MOTORS**

1 h. p.—115 Vt. DC. 2-SPEED 115 V. DC. shunt wound. 1 h.p. at 1750 RPM. B. Bearing, 40° cont. List price \$132.00. Special **\$67.50**  
2 h.p. at 860 RPM. Wt. 225 lbs. List price, \$325.00. Special **\$87.50**



**BALANCE TYPE POSTAL SCALE**

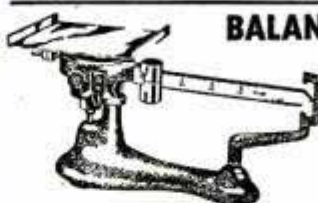

"DETECTO" Nationally known. Weighs every 1/2 ounce, up to 4 lbs. Regular Price \$20.00. **\$5.95**  
Special Price. Wt. 15 lbs.

4 for \$20.00

**SPEEDWAY 1/4" DRILL**

Maximum torque through 3 steps of precision cut gears. Makes straight drilling easier. Permits use of either carbon steel or high speed steel bits. Equipped with self-aligning porous bronze bearings; thumb switch; die-cast gear case. Pistol grip handle. Free speed 1000 R.P.M. Normal load speed 600 R.P.M. 1/4" capacity snap release chuck. 6 ft. flexible lead cord and plug. High-torque Speed Way motor 110-120 volts AC-DC



**\$11.80**

**ORDER  
FROM  
THIS  
AD**

**6 FT. STOW  
FLEXIBLE SHAFT**

Heavy Duty, 3/8" Core. Best piano wire. Ball bearing handle and arbor, rubber covered housing; for 1/2" motor shaft; for 1/2" bore wheels. Operates on 1/2 H.P. Motor at 1725 or 3450 R.P.M. \$29.00 Value, only **\$16.50**. Wt. 8 lbs.



Only \$16.50

**WELLWORTH TRADING CO.**

Merged with  
C & M Equipment Co.

1831 S. STATE ST., DEPT. D-1  
CHICAGO 16, ILL.

# Gadgeteer's Corner

U.S. SURPLUS



## ELBOW TELESCOPE

3-power, field view 13 degrees, 20 minutes. Achromatic, color-corrected. Can be converted by shopmen to a "center-scope" for drill press, jig and tool work. Lens suitable for photography and microscopes. Gov't cost approx. \$150.

**\$4.95**

## POLAROID GOGGLES

Rubber frame with head strap. Has interchangeable clear and tinted lens.



**69c**

## RUBBER BALLOONS

Air Corps target type balloon. Inflates up to 45".

**\$1.00**



## DISPATCH BAG

9x12x3 1/2". Shoulder strap. Canvas bag, 4 compartments. 6 pencil holders plus slots for rulers, etc. Perfect campers bag, for hikers, for school. Used in perfect condition.

**\$1.00**



## PORTABLE EXTENSION FLASHLIGHT



Uses 2 dry cell batteries. Excellent for mechanics who need to get into close quarters etc. O.D. color. Has rheostat to control brightness. Sold without batteries. Shpg. wt. 2 lbs.

**\$1.49**

## 3X GUN SIGHT



Precision optical instrument: powerful achromatic color corrected lens; waterproof shockproof. All bronze and brass body. Long distance observation. 22 1/2" long. Gov't cost approx. \$175.

**\$4.95**

## SURPLUS DISTRIBUTORS

924-B N. Plankinton Ave.  
Milwaukee 3, Wisconsin

All orders shipped FOB Milwaukee, postage collect. Send money order or check. On C.O.D. orders, enclose 20% deposit, balance plus postage on arrival. Money cheerfully refunded if not satisfied.

## Build YOUR OWN BOAT



Complete parts cut to exact size—ready to assemble. Marine waterproof plywood, rustproof oarlocks. Ideal for car top. Also models with laminated frames; mahogany decked runabouts. Build for sale at attractive profit. Exclusive franchise to local builders. Send 10 cents (dime) for illustrated literature.

**\$39.50** and up

## OZARKA

725 WASHINGTON AVE.  
WOODSTOCK, ILL.

## One Swipe of NEW PLASTIC Makes these LEATHER and LEATHERETTE Items LIKE NEW

### Get Into A Money Making Business

Make like new, worn, scuffed or faded leather and artificial leather equipment. Either your own to renew, recolor and beautify, or cafe, restaurant and hotel equipment as a business. Single stroke with a brush renews. Does not crack, peel or scuff. Resists acid, alcohol, caustics and weather. All colors. Mail coupon for free sample.



## FREE Sample SHOWS EFFECT

### \$50 to \$500 Profit On One Job Possible

Let me show you how, as I have shown others. Get your own exclusive territory while available. Mail coupon today, I'll do the rest. — Jack Edwards, Sales Mgr.

LEATHER-NEW PRODUCTS, 6082 Sunneslope, Kansas City, Mo. Send me without obligation a sample of Leather-New coated material so I can inspect it.

Name \_\_\_\_\_  
Address \_\_\_\_\_  
City \_\_\_\_\_ State \_\_\_\_\_

A Thousand and One Ideas You Can Use on the Farm!



# POPULAR MECHANICS FARM MANUAL

Use it to Step up Farm Efficiency — Increase Production — Improve Farm Appearance — Save Time, Labor, Money!

## A Must for Every Farm Family! Saves Money for City Homeowners Too!

Here is the experience of hundreds of successful farm operators brought together in one handy, easy-to-read, easy-to-use, working handbook by the editors of Popular Mechanics. It is brimful of short cuts, labor-saving ideas, ingenious apparatus and methods that will simplify the day's work and lighten some of the more tedious chores, make money and save money for you.



## HELPS IN THE FIELD — IN THE BARN — IN THE HOME

Every department of the farm is covered in the Farm Manual. Every member of the family will find in it something that he or she can use to tremendous advantage in farm operation, maintenance and improvement, from the building and care of equipment to painting the farm home and fast freezing fruits and vegetables. It covers farm buildings, the farmhouse and other homes and is of interest equally to the woman looking for home improvement, beauty and convenience and the man striving for easier and more profitable operation.

## ORDER TODAY — FOR YOURSELF — FOR A GIFT

Use the coupon below. Mail it today. Book will be sent at once, postpaid if you include payment with your order. If you don't think the Farm Manual is worth even more than you paid for it after five days' use, send it back by mail and your money will be refunded. This may be the best investment you ever made. Rush coupon today.

**284**  
**FACT-PACKED PAGES**  
**Hundreds of Illustrations**

Popular Mechanics Farm Manual is packed with practical ideas and usable information that can easily be worth hundreds of dollars to farm families and homeowners everywhere.

**Farm Machinery and Implements**  
How to make and get the most out of farm implements.

**Farm Workshop Equipment and Repairs**  
Ideas that can save hundreds of dollars.

**Poultry and Livestock**  
How to build equipment, gadgets, etc. Care of farm animals and poultry.

**Vegetable Storage—Processing**  
Winter storage, home freezing tips, make your own freezer.

**Farm Home Improvement**  
Fencing, repairing electrical appliances, plumbing, electrical wiring, saving coal, painting, curing leaky basements, hanging wall paper, making garden tools, garages, working with concrete, painting, etc.

**Farm Hints and Kinks**  
Forty pages of illustrated, practical ideas, short cuts, etc., that will save time, labor and money.

## MAIL COUPON • Money Back if Not Satisfied

POPULAR MECHANICS PRESS, Dept. 665  
200 East Ontario St., Chicago 11, Ill.

Send \_\_\_\_\_ copies of the Farm Manual at once.  
 Remittance (\$3.00 each) enclosed. Send postpaid. Add 15% if outside U.S.A.  
 Send C.O.D. (\$3.00 each) plus delivery charges. U.S.A. only.  
 If sent as a gift to another, send name and address on separate sheet.

Name \_\_\_\_\_  
Address \_\_\_\_\_  
City \_\_\_\_\_ Zone or Route \_\_\_\_\_ State \_\_\_\_\_

# RADIOMEN'S HEADQUARTERS \* WORLD WIDE MAIL ORDER SERVICE!

Buffalo Radio Supply, one of America's largest electronic distributors, is in a position to supply most of the requirements of foreign purchasers. Directly from its gigantic stocks or those of its affiliates. Export inquiries are solicited both from export houses and from foreign govt. purchasing commissions here and abroad. Expense can be reduced and requirements filled with a minimum of delay by contacting Buffalo Radio Supply initially.

## Our PE-109 Direct Current Power Plant

This power plant consists of a gasoline engine that is coupled to a 2000 watt 32 volt DC generator. This unit is ideal for use in locations that are not serviced by commercial power or to run any of the surplus items that require 24-32V-DC for operation. The price of this power plant tested and in good condition is only \$79.95 F.O.B. Buffalo, or we can supply in strictly "as is" condition for \$58.95 F.O.B. New York City. These latter are exactly as received, in heavy steel strapped govt cases, and we are unable to determine if the individual units are new, or what the condition is if used, while the \$79.95 are some of the same that we have brought to Buffalo for testing and repair if necessary. We do not recommend gambling on the "as is" condition, except for quantity purchasers. We can also supply a converter that will supply 110V AC from the above unit or from any 32V DC source for \$12.95.

## SOS EMERGENCY TRANSMITTER SOS

This is the famous Gibson Girl Transmitter that saved so many lives during the war. It is used as a distress call transmitter on boats and airplanes. The Gibson Girl is the easiest transmitter in the world to operate. No instruction or experience necessary. No external power supply required for operation. It is merely necessary to turn the crank on the top of the transmitter and power is generated and the distress signal is automatically sent out on the international distress frequency. Brand New Gibson Girl transmitter complete with tubes \$9.95. Antenna Kit for Gibson Girl transmitter. This kit was designed to improve the effectiveness of the Gibson Girl Transmitter by increasing the range several times. The kit includes 300 feet of special antenna wire, two balloons for raising the antenna in calm weather, two hydrogen generators to inflate the balloons, a special box kite for antenna erection in windy weather, and a searchlight, powered by the crank operated generator in the transmitter. Complete kit \$9.95.

**RADIO SET SCOOP.** Product of a famous aircraft radio manufacturer who has abandoned the manufacture of table model radios because of the flood of government orders. All in 5 ply genuine mahogany cabinets, both regular and bleached. Original list price given first—then your cost. Sensational discounts. Model 565 is 5 tube, all others are 6 tube.

Model 565, Mah. or blonde.....	\$ 34.95-\$ 16.97
Model 6618, Mah. or blonde.....	\$ 44.95-\$ 20.97
Model 663, Mah. or blonde.....	\$ 46.95-\$ 21.97
Model 612, Walnut.....	\$ 38.70-\$ 17.95
Model 613, Mahogany.....	\$ 42.05-\$ 19.95
Model 6612, Blonde Mahogany Console.....	\$215.00-\$105.00

### AUTO RADIO DEALERS ATTENTION

Nationally advertised brand 1949 car radio that will fit practically any car. These car radios will be sure fire hits with your customers. They have plenty of eye appeal plus a host of other features that no other radio regardless of cost can offer. Here are but a few of them: Built-in battery charger that will keep a car battery fully charged even if radio is played all day long. An outlet so an electric shaver or similar electrical appliance can be used while driving along highway. The radio is a powerful 6 tube superheterodyne that has a three gang condenser and a stage of radio frequency amplification for increased sensitivity. The radio, complete with the built in battery charger and power outlet, is a single compact unit that is easily installed. Sample—\$40.50; Dealer price—\$37.47 each in lots of two or more.

## Sensational Value in AC-DC POCKET TESTER



This analyzer, featuring a sensitive repulsion type meter housed in a bakelite case, represents the culmination of 15 years achievement in the instrument field by a large company specializing in electronic test equipment.

Specifications of the AC-DC Model Volt-Ohmmilliammeter:  
 AC Volts—0-25, 50, 125, 250  
 DC Volts—0-25, 50, 125, 250  
 Milliamperes AC—0 to 50  
 DC Milliamperes—0 to 50  
 Ohms Full Scale—100,000  
 Ohms Center Scale—2400  
 Capacity—.05 to 15 Mfd.  
 Total Price, prepaid anywhere in the USA—\$7.00  
 Similar DC Meter, lacking the AC operated ranges of above, \$5.50 prepaid.

RT-1655—11 tube crystal controlled SUPERHETERODYNE RECEIVER that covers the FM band. The ultra modern circuit uses the latest types of tubes. Beautiful chassis and aluminum cabinet. Tubes and schematic supplied—\$14.95.

## \$10.95 TAKES ALL THREE BIG BARGAINS

- 1. SENSATIONAL, FASCINATING, MYSTERIOUS SELSYNS.** Brand new Selsyns made by G.E. Company. Two or more connected together work perfectly on 110V AC. Any rotation of the shaft of one Selsyn and all others connected to it will rotate exactly as many degrees in the same direction, following unerringly as if the units were connected together by shafting instead of wire. This is true whether you twist the shaft of the master unit a fraction of a revolution or many revolutions. Useful for indicating direction of weather vanes, rotating directional antennas, or controlling innumerable operations from a distance. Complete with diagram and instructions. Per Matched Pair \$4.95.
- 2. ALUMINUM GEAR BOX 18x8x7** that contains two powerful electric motors and two matched gear trains, 62 gears in all varying in size from 1/2 to 4" in diameter. This unit is readily converted to rotate a beam antenna or any other similar use.....\$5.00
- 3. HOME WORKSHOP AT BARGAIN PRICE.** Accurate and precise 2 speed guaranteed hobby lathe, the essential machine for the home workshop. Sturdy enough for light production work or factory stand-by service. Supplied with 56" of belting for connecting to any available electric motor or power take-off. Also including in this unbelievable offer are such accessories as a 1/2" drill chuck with specially hardened tool steel jaws, a 4" electric furnace high speed grinding wheel, a cotton buffing wheel with a large supply of buffing compound, and a 4" steel wire scratch brush. Your cost \$6.00. Sole export agent. Distributor inquiries invited.

CABLE ADDRESS BUFRAD

All sales final and no returns unless otherwise specified in ad of item. Right reserved to change prices and specifications at any time.

**DUAL METER**—one 50 uA and one 200 uA movement in the same case. This meter is ideally suited for use as a combination modulation percentage and carrier shift indicator. If desired the movements may be removed from the case and used separately for voltmeters, ohmmeters, ammeters, etc. All meters set in perfect operating condition, but a few have cracked glasses. This super value costs only \$1.75.

TERRIFIC VALUE

ONLY

\$20.95

Equipped with 1/4" Jacobs Gearing Chuck and Key



## PORTABLE ELECTRIC DRILL

Not an intermittent duty drill, but a full size rugged tool. Most convenient type—switch, natural grip handle, and balance like a six-shooter. Precision cut gears—turbine type cooling blower—extra long brushes. No stalling under heaviest pressure because of powerful 110 Volt AC or DC motor and multiple ball bearing thrust. Other bearings self-aligning lifetime lubricated Oilite type. Made for toughest year in and wear out service in plant or on construction jobs. Amazing perpetual factory guarantee assures you of a lifetime of trouble-free use. Full refund (you pay transportation) if not pleased with drill after trial.

## STUPENDOUS VALUE in 3 Section PERMEABILITY TUNER

The entire variable tuning section of a deluxe current model General Motors radio. Amazingly tiny (4x3x2 1/2), though truly half of a radio. Shielded R.F. sections. Iitz wire wound. All 3 tuned circuits adjustable at both low and high ends of dial. Compact enough to be used to pep up any 2 or 3 gang superhet or 2 gang TRF. Will substitute for entire original tuning system including variable condenser or if desired the original tuning condenser can be connected to these coils, and the coils set to proper inductance (no instruments required), and the set tuned just as before, although much greater sensitivity and selectivity will result. Can be used as a multiple section wavetrapp that will cut out undesirable interference as with a knife. If only a little bit better than average results with a slug-tuned wavetrapp are necessary the unit can be split up in a couple of minutes into 3 coils that can be used on 3 different jobs. These coils, super-compact and really hot, can also individually replace any broadcast band RF, oscillator, or 1st detector coil with improvement in results in any set. After seeing one of these units, you'll order a dozen just for general repair or replacement work. Cost the manufacturer several dollars. Your cost—\$1.49.

**Super Special CRYSTAL MIKE** of topflight nationally known brand.....\$5.95  
 Book on DRY DISC RECTIFIERS by H. B. Conant, nationally recognized authority on the subject. Theory and practical applications \$ .25

**REMOTE CONTROL UNIT:** Aluminum case 4x3x2" containing 2 potentiometers, triple pole switch 4 knobs, gear mechanism, counter and phone jacks—99c.

## GENERAL ELECTRIC 15-TUBE TRANSMITTER AND RECEIVER SET

This brand new 15 tube transmitter-receiver was designed for mobile service on 12 volts, and will operate in the "Citizens Band," where no amateur license to transmit is necessary. It's a cinch for any experimenter to connect this unit for 110 VAC operation by following the instructions and diagrams supplied, which cover numerous applications, including television. For those intending to use on car or boat, a new dynamotor, exactly as originally supplied, costs only \$15.00. Don't fail to write for FREE descriptive bulletin. Order our RT-1248 for only \$29.95, or two for \$53.90.

## COMPRESSED AIR INSTANTLY, Anywhere!!

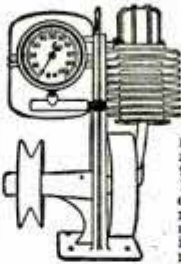

Portable Air Compressor and storage tank. Ruggedly built of best materials using lifetime lubricated ball-bearing on connecting rod and oil impregnated main bearing on shaft. Unusual design forever eliminates valve trouble, the most common fault in air compressors. Patented unique air intake system increases efficiency tremendously over other compressors so that air output is much greater than that from larger compressors powered by heavier motors. Will deliver approx. 3500 cu. in. air per min. at maintained pressure of 90 lbs. or will inflate a 90 lb. truck tire in less than 1 min. Complete with 100 lb. gauge, fingertip adjustment allows setting of output pressure at any value, which will automatically be maintained. Works from any 1/4 H.P. motor. Useful for spraying paints or lacquers, disinfectants, insecticides; annealing or brazing with natural gas, inflating tires; etc. Price \$14.50 postage prepaid anywhere in U. S. Efficient, adjustable syphon type spray gun complete with 12 ft. of 100 lb. tested hose for only \$7.75 with pint container, also prepaid. 25% required on C.O.D. orders. Send for free catalogs of radio parts and surplus items.

## SCR - 274N COMMAND SET

**THE GREATEST RADIO EQUIPMENT VALUE IN HISTORY**  
 A mountain of valuable equipment that includes 3 separate radio receivers covering 190 to 550 KC; 3 to 6 MC; and 6 to 9.1 MC. These receivers use plug-in coils, and consequently can be changed to any frequencies desired without conversion. Also included are two Tuning Control Boxes; 1 Antenna Coupling Box; four 28 V. Dynamotors (easily converted to 110 V. operation); two 40-Watt Transmitters including crystals, and Preamplifier and Modulator. 29 tubes supplied in all. Only a limited quantity available, so get your order in fast. Removed from unused aircraft and in guaranteed electrical condition. A super value at \$34.95 including crank type tuning knobs for receivers. Without these knobs the receivers can't be tuned, and are only useful for parts. Don't buy without knobs!

**BUFFALO RADIO SUPPLY, 219-221 Genesee St., Dept. PM, BUFFALO 3, N. Y.**

# Any Drill Press Gives 15 ESSENTIAL OPERATIONS With BARRON Workshop TOOLS

● You can plane woods and plastics, rabbet, tenon, panel, groove, bead, contour, rout, mortise, surface sand, drum sand, cut moldings, shape, dovetail, grind and drill with Barron's time-tested and proved precision workshop tools. They save time, money, broaden your workshop technique. A full line of drill press spindle adapters and 1/2" Dovetail cutter also available. All tools sold on 10 day money back guarantee.



**ROTARY WOOD  
PLANER**

3" dia. safety planer fits any drill press. Over 100,000 now in use.

\$7.50 Complete



**2 1/2 x 3" DRUM  
SANDER**

A "must" for sanding contours and straight edges. Also available in 1" dia. at \$2.10

\$3.95 With 5 Sleeves



**ROTARY SURFACE  
SANDER**

4" dia. aluminum housing and heavy rubber pad. A perfect finishing sander.

\$5.95 With 20 Discs



**AUXILIARY  
DRILL PRESS TABLE**

Fits any drill press. Has 234 sq. inch working surface for holding work pieces flat and true. Equipped with adjustable steel fence.

\$9.85 F.O.B. Detroit



**ALL-METAL  
SHAPER FENCE**

Ideal for shaping and molding operations, other uses. All metal, nothing to warp. A real buy at

\$8.25 F.O.B. Detroit



**ROUTER & ROUND END  
MORTISING BITS**

Newtype hi-speed steel spiral flute bits. Available in individual sizes or sets of 6 attractively packaged from 1/8" to 1/2" at \$9.50

See Your Dealer . . . Or Write Direct

**BARRON TOOL CO., INC.**  
569 Architects Bldg., Detroit 1, Mich.



**WRITE  
FOR  
FREE  
WORKSHOP  
GUIDE**



**SAFETY SHAPER &  
MOLDING CUTTER**

New, patented design eliminates set screw. More versatile than any other similar design on market. \$9.00 with 3 Sets Standard Blades

## BARRON PRECISION WORK SHOP TOOLS

SAY YOU SAW IT IN POPULAR MECHANICS



DEALERS WANTED

### MUFFLERS STEELS and ALUMINUMS with a motorboat tone

SINGLES, Chev., V-8, Plymouth, Steels \$5.50, Aluminum \$7.00. Chry., Olds., Buicks, etc., Steels \$7.50, Aluminum \$9.00. V-8 and MERCURY DUALS, Steel \$17.50, Aluminum \$21.00, '49 FORD DUALS, \$2.50 extra. Split Manifold Sets, Steels \$35.00, Aluminum \$45.00. Aluminums are guaranteed for life of your car.

**SANDEE MUFFLER CO.**  
BOX 296 LA TIJ., LOS ANGELES 43, CALIF  
2624 W. SLAUSON AVE., LOS ANGELES, CALIF.



## WHEELS AT BARGAIN PRICES

- ...4" wheel & tire, 5/16" sleeve bearing. \$0.45 ea.
- ...5" wheel 5/8" solid tire 5/16" shaft hole 0.65 ea.
- ...6" wheel 5/8" solid tire 5/16" shaft hole 0.75 ea.
- ...7" wheel 3/4" solid tire 3/8" shaft hole. 0.85 ea.
- ...8" wheel 1" solid tire 1/2" sleeve bearing 1.25 ea.
- ...8x2" wheel, semi-pneumatic tire 7/16" ball bearing . . . . . 2.50 ea.
- ...10x1.75 wheel semi-pneumatic tire 7/16" or 1/2" ball bearing . . . . . 3.25 ea.
- ...12x1.75 wheel semi-pneumatic tire 1/2" ball bearing . . . . . 4.00 ea.
- ...10x2.50 wheel semi-pneumatic 1/2" ball bearing . . . . . 4.50 ea.
- ...6x2" wheel 3/4" ball bearing, solid tires . . . . . 2.95 ea.

**BUILD YOUR OWN**—Wagons — Scooters — Soap Box Racers — Welding Carts — Baby Pens — Etc. To order above wheels write number wheels wanted in space provided, tear out and mail this ad with check or money order and your name and address. If other sizes are wanted write for FREE LIST.  
**TRULSON MFG. CO., 811 E. 31 St., Dept. PM-18, Kansas City, Mo.**

## FALSE TEETH

### KLUTCH holds them tighter

KLUTCH forms a comfort cushion; holds dental plates so much firmer and snugger that one can eat and talk with greater comfort and security; in many cases almost as well as with natural teeth. Klutch lessens the constant fear of a dropping, rocking, chafing plate. 25c and 50c at druggists . . . If your druggist hasn't it, **don't waste money on substitutes**, but send us 10c and we will mail you a generous trial box. © I. P. INC.

**KLUTCH CO. Box 4993-A ELMIRA, N. Y.**

## STOPS FOGGY WINDSHIELDS NEW Chemical Mitt



**Amazing Discovery!** Autoists will discover new "NO-FOG" Windshield Cleaner. Simply glide over windshield chemically-treated Mitt—at once glass sparkles crystal clear. Cloudy haze, mist, dust, grime disappear like magic. Stops fogging. *Sells like wild!*

**SAMPLES FOR AGENTS** Sample offer sent immediately to all who send name at once. A penny postal will do. **SEND NO MONEY**—just your name. **KRISTEE CO., 672 Bar Street, AKRON, OHIO**



**\$2.95  
EACH**

## NOW! FILE YOUR OWN SAWS

Do expert saw filing at home. Precision filing easy without experience. Two simple adjustments. Keeps any hand saw extra sharp and true-cutting. Complete with file. Money back guarantee. Cash with order, prepaid. (COD postage extra.) Order today.

**THE SPEED CORP., Dept. PM1  
2025 N. E. Sandy, Portland 12, Oregon**



## 13 new WORKBENCH PLANS

Constructional details on 13 sturdy, easy-to-build benches . . . large cabinet bench with 18 drawers; tool cabinet with 29 drawers, streamlined cabinet bench, drop-down bench for narrow garage, portable apt. bench, carpenter's folding-leg bench, etc. Send dollar bill today.

**CRAFTPLANS, Dept. P-134, 7241 Madison, Kansas City 5, Mo.**

## FREE RUPTURED?

### Get Relief This Proven Way

Why try to worry along with trusses that gouge your flesh—press heavily on hips and spine—enlarge opening—fail to hold rupture? You need the Cluthe. No leg-straps or cutting belts. Automatic adjustable pad holds at real opening—follows every body movement with instant increased support in case of strain. Cannot slip whether at work or play. Light. Waterproof. Can be worn in bath. Send for amazing FREE book, "Advice To Ruptured," and details of liberal truthful 60-day trial offer. Also endorsements from grateful users in your neighborhood. Write:

**CLUTHE SONS, Dept. 31, Bloomfield, New Jersey**

POPULAR MECHANICS

# UP TO 85% OFF IN WAR SURPLUS - SENSATIONAL VALUES

When visiting California come in and say "Hello".

### B-15 STYLE JACKET

A Garment You'll be PROUD TO WEAR! Water repellent, wind resistant, nice green, saten, genuine Zealand Sanforized Poplin, full zipper front with slash pockets and large genuine Mouton Fur Collar. Heavy Alpaca lined for Warmth. Sleeves also lined with Heavy Rayon Rib-knit cuff and bottom. Sizes 34 through 46.

**LOOK AT THE PRICE! \$11.95**

### SHARPSITE NIGHT DRIVING GLASSES

With 57 mm yellow amber lenses. These lenses are 6 base especially PRECISION Gmnd. and Polished to reduce Glare of headlights from on coming cars, also to focus objects sharply and more clearly during night driving. Absolutely one of the greatest boons for Safe Night Driving, or during stormy, murky weather, Highway Patrolmen, Truck Drivers swear by them. A must for your Vacation or Nite Driving.

### FOLDING STEEL COTS

With Tubular Headboards and sturdy double heavy wire twist springs. A Life Time Buy. \$2.95 ea. Navy Bunk Bed With steel angle head-stands, steel frame spring made of twisted heavy gauge wire reinforced with lateral staybars. Can be used as single bed or joined two-high to serve as double bunk bed. Specially suited to hard wear, active children, dormitory, camps, etc. Single \$2.15. Ea. \$3.95 In sets of two Ea. \$7.75

The cots or bed each weigh approximately 22 lbs. Consult your local motor freight for shipping cost due to 200lb. min. mattress shown below can be included at no extra ship. cost.

MATTRESS for above cot or bed, common filled, 31" thick spec. built not to flatten out, Tuffed edges, quilted top & white heavy ticking. \$6.95 Each

PILLOWS, Cuddled Chicken Feathers 26" x 17", blue & white Ticking .99c Each

Both Mattress and Pillows are removed and stored in accordance with laws of Calif. and Govt.

### AIR CORPS FLEECE LINED JACKET D-1 TYPE

These have been reconditioned, cleaned, and brushed. If you want a warm, rugged, full sheepskin felt, fleece lined collar, zippered front, leather jacket that has lots of outdoor wear left in it, that you can't beat for value \$7.95 ea. at this close-out price \$7.95 ea. You'd better write in fast, before they are all gone.

Ideal for Hunters, Farmers, Garage Mechanics, etc. Large Size Only.

### Navy Melton Cossack Style Jacket

NEW All Wool, Sturdy, Warm Zipper front 2 slash pockets, Taped Collar. Wonderful Buy For Utility and long lasting Qualities \$5.69

Sizes 34 thru 46

### TELEVISION! These glasses help wonderfully! SHARPEN FOCUS. Aid in eliminating Glare. DISCOVER GREATER ENJOYMENT.

INTRODUCTORY OFFER ND-1 \$16 VALUE \$5.89

In Men's size or Ladies Harlequin style. SAME GLASSES but clip on. Flip-over style without temple bars \$4.59

### GENUINE Aviators (AN-6530) Windproof & Dustproof GOGGLES

Go-45 Sponge and leather protected frame with ground lens in clear, amber and green. Clear set in replace-able metal frame with hinged nose bar. \$1.69 ea. Ideal for Motorcycles, etc.

### SUNGLASSES HERE'S THE REAL McCoy!

ARMY AIR FORCE 6 base, Precision Polished and Ground, Glass-Free lens with leather case that can be attached to belt. Gold plated adjustable frame. Feathered screw bar and pads. \$3.95

ARMY AIR FORCE TYPE SUNGLASSES 4 base, polished and ground lens, 22" Ultra Violet Ray, live gold plated frame, peroxide bar & pads, leatherette case. Our price \$2.39 ea.

### NEW 100% ALL WOOL BLANKET

7 x 7 ft. Extra heavy. Also Double warmth. Fits Wood's Robe sleeping bag. \$4.65

### HUNTING KNIFE #307

6" chrome vanadium blade handle, leather grip. In leather sheath. \$5.98 Value For Only \$1.99

Like above but black Parkerized Finish. #307A \$1.49

### BOLO KNIFE

10" x 2" Parkerized Blade 5" Gripped Handle. Weight 1 1/2 lbs. Ideal for Hunting, Clearing Brush, or Trails \$1.19 ea.

### HERE ARE PLASTIC KITS UNSURPASSED VALUES FOR ARTISTICALLY INCLUDED HOME HOBBYIST!

Start planning Mixed Xmas gifts Now!

Kit #1 contains 2 lbs. Plexiglass & Plastic sheet in various shapes, 1 ea. bottle of clear cement, 1 ea. bottle color set cement and 4 bottles of colors in Ochre, Red, Yellow, Peach, etc. Also a Handy Handbook of uses and instructions. This set easily worth \$5.35. Our Price \$2.19

Kit #2 contains 1 1/2 lbs. of plastic sheet, a 1 ea. bottle of clear cement, and the Plastic Handbook. A \$2.55 Value for ONLY 99c

### Get Ready for that Freezing Weather!

Preway OIL HEATER Model 1238 P size 34" x 14" x 17" complete with tank and oil control valve. Underwriters Inspected. Ideal for warehouse, shop, garage and home. \$17.95

### NEW TARPS HEAVY CANVAS

Mildew & Flame Resistant, Cheap Outside Storage. They are Really Moving at These Prices.

9' x 16' \$11.95 ea.  
16' x 32' \$29.95  
16' x 22' \$20.95

Rubberized Linen 7' x 11' NEW \$5.95

Only 3 lb. light weight yet waterproof! Ideal for outside car storage.

### MACKINAW

Made of heavy water repellent poplin cover. Wool blanket lined, thigh length, sleeve flap for adjustment. An ideal coat for the outdoor man, truck driver, hunter, farmer. Sizes 34 thru 46 \$7.95

### TEAR SHAPED PLEXI DOME

Overall length 21" width at widest point 11" at base 4" 6" deep. \$1.39 ea.

### CUSHIONS

Mid. for Aircraft Bucket seat, but can be used in trucks, autos, boats, tractors. Made to Gov't. Spec. of finest imitation leather, yellow pigskin col. filled with kapok. Will float. Same as shown in LIFE magazine saving a man from drowning.

New Back Rest 22" x 16" x 1 1/2" thick \$2.95  
Used Back Rest 22" x 16" x 1 1/2" thick \$1.95

SEAT, New, 17" x 16" x 3" thick \$3.49  
SEAT, Used, 17" x 16" x 3" thick \$2.29

### AAF FLYING SUIT OR BLUE BUNNY SUIT

Swell for hunting, water, sports, skiing or "bundling". As coveralls for cold outdoor, or farm work. Made of 100% woven wool with extra flannel inner lining giving double warmth & utility. Wiring so fine, Beriberi it does not interfere with movement. Can be used with or without heating. Sizes 36 thru 46. Only \$3.49

### NAVY FLYING SUIT OR COVERALLS

Made of "Byrd Cloth", Strong, Yet Light, With 3 large breast pockets, pencil pockets, 4 huge zippered pants pockets, military waist, full zipper front, a replica of the wonderful Val. of LIFE magazine saving a man from drowning. Sizes 36 thru 46 \$3.49

### MESS TRAY

6 compartments, rustless, stainless steel. Barbecue, outdoor cooking, save dishwashing. Hospital, Restaurant, Home, or roughing. #311 New \$3c ea.

#311A Used but in Fine Serviceable Condition 59c ea.

### Plexiglass Windows

In Alum. Frames, for your trailer, boat, or home ornamental use. Priced at the value of the sheet alone.

#703A 18 1/2" x 15 1/2" x 3/16" thick \$2.95  
#704A 12" x 9" x 3/16" \$1.59

Plexiglass & Nascobite Clear Plastic Shits. at Tremendous Savings to You!

NASCOLITE—Full sheets approx 1/2 x 37 1/2" x 48 1/2", approx 10 1/2 lbs. Per Sheet \$12.50  
PLEXIGLASS—Full Sheets, Approx 1/4 x 25" x 36" Per Sheet \$15.00

Fabricators write in for our special quantity prices. All above are new & washed. Also inquire about our other large stocks of Plexiglass.

### ROPE AT REAL VALUES!

3/16 dia. 3 strand, cotton .01 ft.  
1/4 dia. Treated Navy laynard, in 300 ft. rolls \$1.95  
3/8 dia. 3 strand, treated jute .02 ft.  
3/4 dia. 3 strand, jute .07 ft.  
3/4 dia. 3 strand, sisal .08 ft.  
7/8 dia. 3 strand, sisal .08 ft.

These prices speak for themselves, we also have other types and larger sizes in stock. We welcome your inquiry. No sales under \$1.00

### Loose Leaf BINDER

You ever saw a 3 metal post, cylindrical locking heavy duty 3 1/2" fabricated lined cover. End identification window. Ideal for price books, salesman catalogues, photo albums, students, publications, reference books, artist sketch books, etc. Will hold 300 sheets, 8 1/2" x 11". A \$5.00 Value for Only \$5.9c

50 Page Binder Bond Folders for 25c Extra.

### SLEEPING BAG

NEW! 100% wool, Prummy type Heavy duty 30" zipper. #303 Gov't. Cost \$27.00 \$1.55 extra for used water repellent cover. Sold only with Sleeping Bag \$3.95

### Hand Mike

Highly Sensitive with thumb control button on handle. Ideal for home recorders, public address systems, etc. Comp. with 2 ft. rub. cd. & telephone plug. Only \$1.19

### VINYLLITE TUBING

Capable of insulating up to 5000 volts. This Plastic tubing used for protecting wire, decorative purposes, water or other fluid hose. Price per ft.

1" Black, Clear, Red .15  
3/4" Clear, Red .12  
3/4" Grey, White .10c  
3/16" White .02  
3/16" Clear .02

No Sale Under \$1.00

Above sizes are only a sample of the stock we carry, should you desire other sizes or types please send us your inquiry.

### For the FOOTBALL SEASON and for those cold, hard, stadium seats RUBBERIZED HAIR CUSHIONS

#RCL 14" dia. x 1 1/2" 69c ea.  
#SCL 21" x 17" 69c ea.  
#CCL Canvas Cover 69c ea.  
#BCL 22" x 28" x 1 1/2" \$1.19 ea.  
#PCL 12" x 16" x 1 1/2" Suitable for two \$1.19 ea.

These cushions are used but in very good condition.

### FLYING HELMET

#407 Fleece or Chamois lined winter type. Ideal for cycle drivers, racers, sportsmen. Used. New Chamois lined with chin cup intermediate wt. \$1.95

### RADIO ANTENNA Reel

Just the thing for tuning beam antenna. Powered by 1 1/2 x 3/4 G. E. Motor, Removable 5' Reel-limit Switch. Can Warm gear, Rev. at gear. Solenoid clutch. Motor engaged to gear reduction only when electrical contact made. Operates in either direction. Ideal for auxiliary power, table-top opening and closing doors, etc. \$4.29

A TREMENDOUS VALUE

### Signal Corp Control Unit

Standard Rock Panel 17" x 5 1/2" x 7". Chassis 6 1/2" x 17" x 5" with numerous relays, condensers, 4 key switches, Jones plugs, jacks, resistors, transformers, rheostat. Unit enclosed in Recessed steel case. Fits alone with more than our asking Price of ONLY \$2.69

### U. S. Army ALL WOOL SOCKS

Reg. O. D. Bleached white, standard lgth., ribbed tops, sizes 11, 12, 13 now, but can be shrunk to sm. sizes. Really priced to sock you in the eye \$9c a Pair... 6 Pair for Only \$2.19

### RADIO HEAD

AN-BH-1 with Leather Sponge Rubber Pad A Wonderful Buy \$1

**PALLEY THE LARGEST FIRM OF ITS TYPE IN THE WORLD** Order from this Ad. All sales final. All Prices F. O. B. Los Angeles. Pay by M. O. or Check. P. O.'s Accepted. from D & B firms. 1/3 deposit with C. O. D's.

DEPT. P. M. 19 6321 SAN FERNANDO RD GLENDALE 1, CALIF

New Available New 1948 Edition 90-Page Freely Illustrated Catalogue with valuable information tables, data. Send 25c to cover handling, mailing chgs. etc.

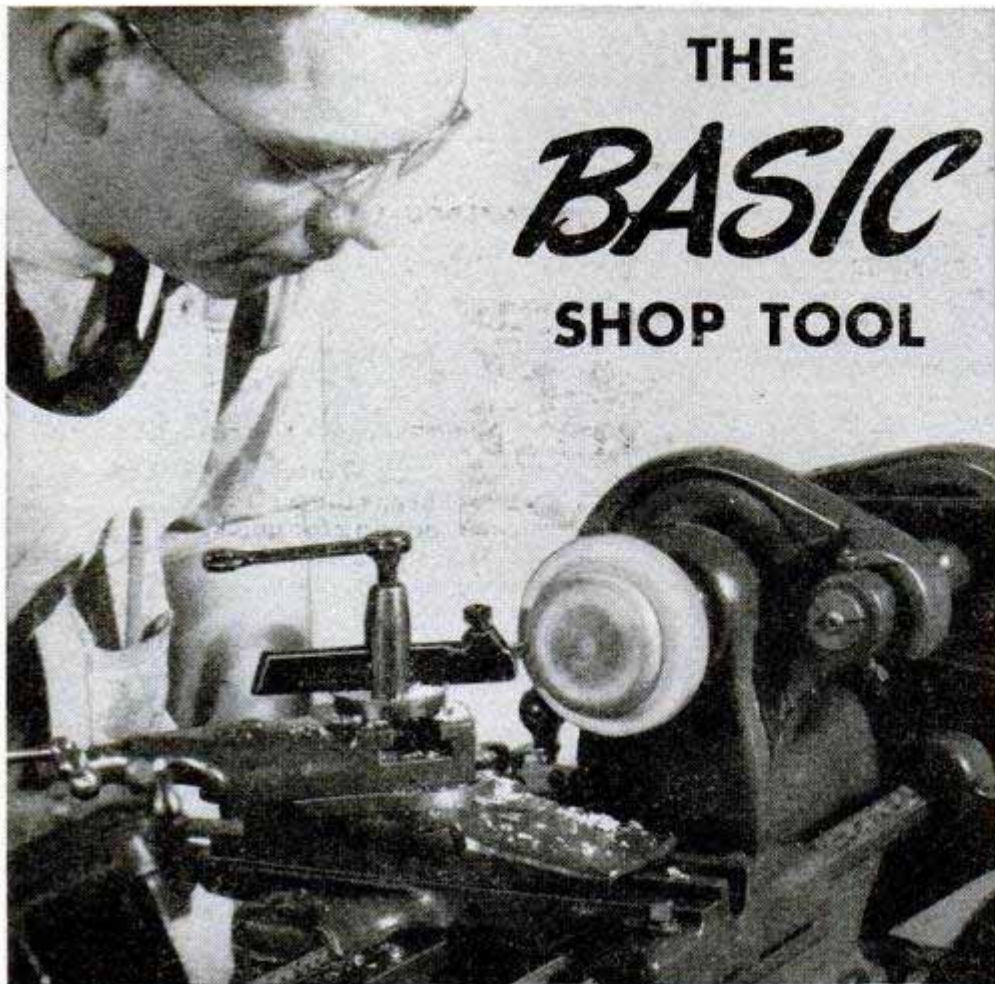

THE  
**BASIC**  
SHOP TOOL

9" x 3' Model C Bench Lathe \$187.35  
f. o. b. factory with 1/4 h. p. motor and drum switch

## 9" SOUTH BEND LATHE

This South Bend 9" Precision Lathe is the basic tool for your shop. It enables you to perform accurately the same full range of operations done on South Bend Lathes in industry. Also, operations ordinarily performed on other machine tools are made possible through the use of efficient attachments. You get more for your money in a South Bend 9" Lathe.

Write for Catalog 9-F or see local distributor—look under "Machine Tools" in your classified telephone directory.

**NEW 14" DRILL PRESS**—a ruggedly built tool unsurpassed for accuracy and dependability. Prices start at \$129.30, f. o. b. factory with 1/2 h. p., 1 ph., 60 cy., 115 v. motor and built-in light. Write for Catalog No. 400.



**SOUTH BEND LATHE WORKS**

*Building Better Tools Since 1906*

455 EAST MADISON STREET, SOUTH BEND 22, INDIANA

A Few of the Many  
Operations You Can Perform



TURNING

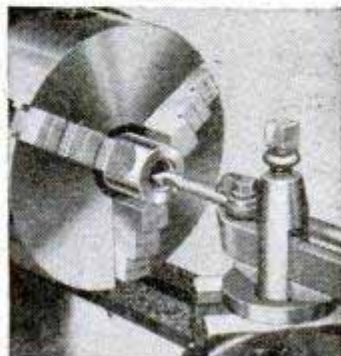

BORING

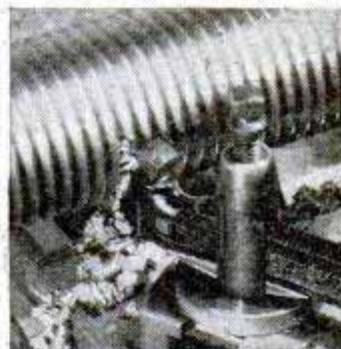

THREADING

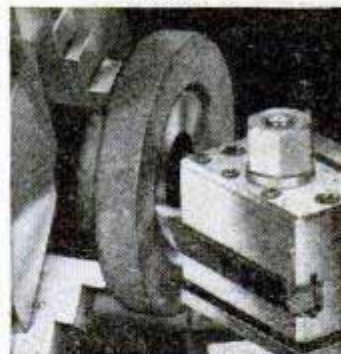

FACING



MILLING

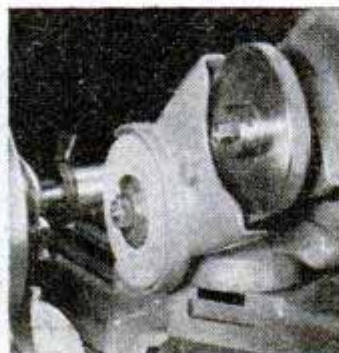

GRINDING

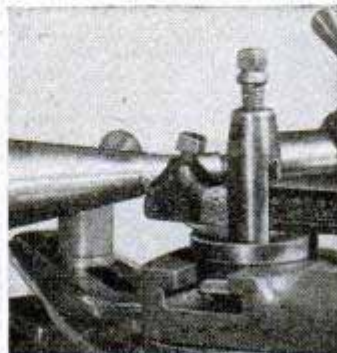

TAPER TURNING

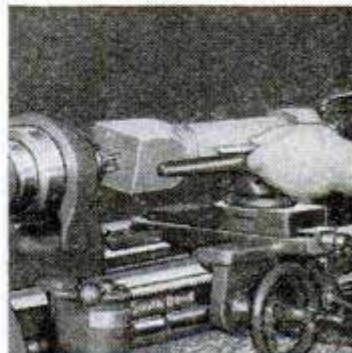

WOOD TURNING

Printed by Popular Mechanics Company, Chicago, Ill., U. S. A.



Save Time, Work, Money - Make Extra Profits  
with **SHAW**

**"DU-ALL" and "PEPPY-PAL" TRACTORS**

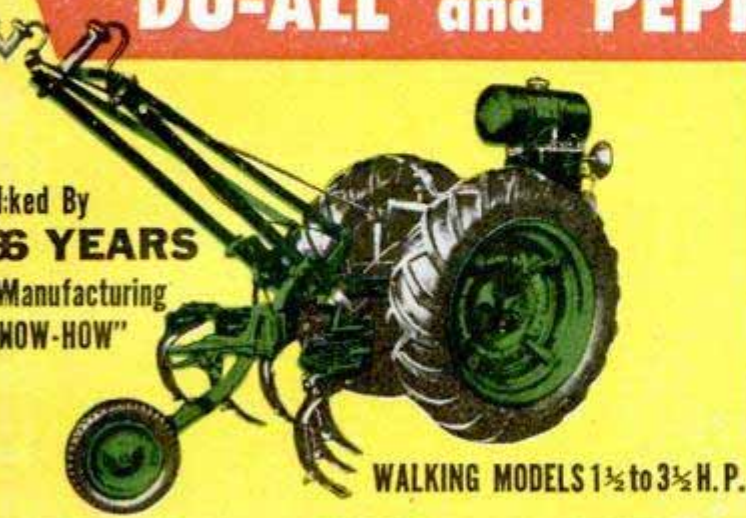

Backed By  
**16 YEARS**  
Manufacturing  
"MOW-HOW"

WALKING MODELS 1½ to 3½ H.P.



**PLOW**



**CULTIVATE**



**MOW**

and Dozens of Other Jobs

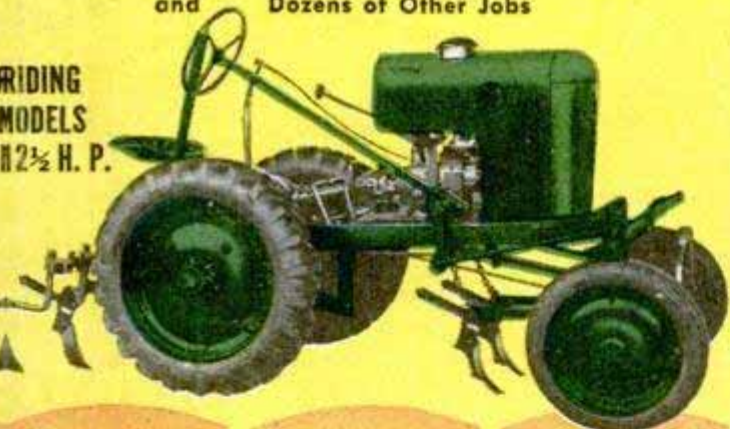

RIDING  
MODELS  
1½ to 2½ H.P.

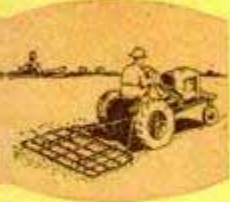

**HARROW**



**BULLDOZE, SNOWPLOW**



**RAKE**

and Many Other Jobs - Winter and Summer

**DO DOZENS OF JOBS  
QUICKLY AND EASILY  
WITH JUST ONE TRACTOR!**

Shaw tractors are always ready to plow, cultivate, bulldoze, harrow, mow, haul, rake, seed, spray, disc, saw and do scores of other jobs on a minute's notice. A child can operate these amazing machines and the low-cost Jiffy Hitch attachments are quick and easy to change.

**IDEAL TRACTOR FOR GARDENS, SMALL FARMS**

If you're gardening, farming, maintaining a golf course, chick hatchery, orchard, estate, cabin camp, truck farm, park, etc., you need a Shaw Du-All or Peppy-Pal. You'll get more jobs done, at lower cost, in a fraction of the time. You'll get top-quality work out of these dependable, efficient Shaw tractors.

**SOON PAYS FOR ITSELF - CHEAP TO OPERATE**

The remarkably low initial cost of Shaw tractors and attachments plus the low operating costs (only a few cents an hour) makes Shaw the buy of the year. It will soon pay for itself in time and labor-saving plus helping make extra profits for the man who job-contracts or likes to earn spare-time money.

**ECONOMICAL TO BUY - TOP QUALITY MATERIALS**

From big heavy duty tires to the smallest engine pin you receive only first quality materials—carefully and sturdily constructed, thoroughly inspected and tested for longer service and low maintenance. Precision engineering and efficient power utilization assure top performance on the toughest job.

**FULL GUARANTEE - PROMPT SHIPMENT**

Every Shaw tractor carries a full year's guarantee against any defect in workmanship or material. Check the many features of Shaw tractors—many different models ranging from 1½ to 12½ horsepower, variable speeds, power turn, forward and reverse, Timken roller bearings, Ross steering device and scores of other important features. Mail the coupon below, select and order your Shaw tractor for early delivery.

**SAW WOOD  
DO ALL KINDS OF BELT JOBS**

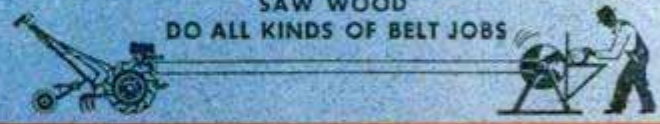

**LOW FACTORY PRICES**

A modern factory and streamlined production methods assure you substantial savings. Compare the price and the value—you'll agree that Shaw gives you more for your money.

**FREE!** NEW ILLUSTRATED  
ACTION-PICTURE BULLETIN AND PRICE LIST

**ACT NOW - SEND NO MONEY!**  
Mail Coupon for FREE Booklet and Price List

**SHAW MANUFACTURING CO.**  
4501 Front Street, Galesburg, Kansas, or  
668G North 4th Street, Columbus, Ohio

Please send me Free Booklet and price list.

Name .....

Address .....

# 30-DAY SMOKING TEST

## PROVES CAMEL MILDNESS!

**1** In a recent test, hundreds of men and women all across the country . . . of all ages and occupations . . . were closely observed as they smoked Camels—and only Camels—for 30 consecutive days. And they smoked on the average of one to two packages a day. But only Camels!

**2** Every week their throats were examined by noted specialists—a total of 2470 examinations. And among all these smokers, these throat specialists found not one single case of throat irritation due to smoking Camels!

**3** But prove it yourself. In your "T-Zone"—T for Taste and T for Throat. Let YOUR OWN TASTE tell you about the full, rich flavor of Camel's choice tobaccos. Let YOUR OWN THROAT tell you the story of Camel's cool mildness. Yes, prove for yourself that there's

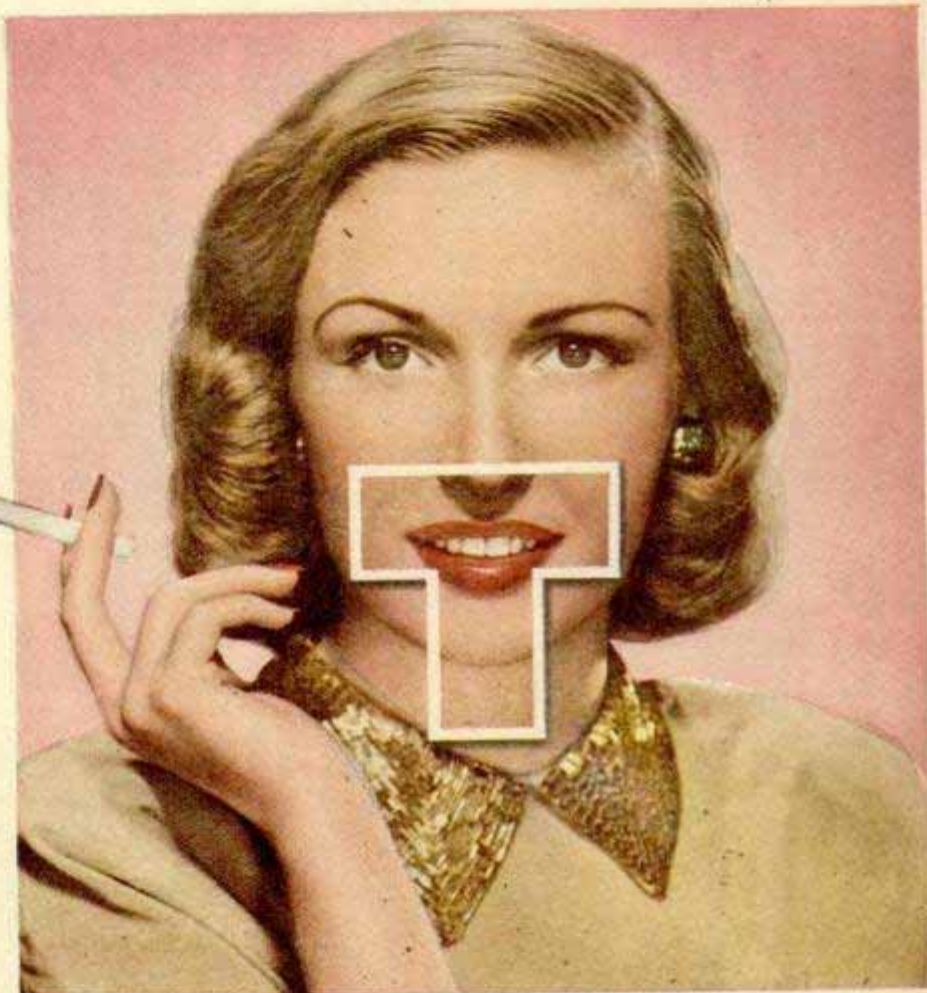

*No Throat Irritation due to smoking Camels!*

*Prove it Yourself! Make the Camel 30-Day Test in Your "T-Zone"*

**Money-Back Guarantee:** Smoke Camels for 30 consecutive days. Smoke only Camels. If, at any time during these 30 days, you are not convinced that Camels are the mildest cigarette you have ever smoked, return the package with the unused Camels and we will refund your full purchase price, plus postage. This offer is good for 90 days from this date. (Signed) R. J. Reynolds Tobacco Company, Winston-Salem, N. C.



According to a Nationwide survey:  
**MORE DOCTORS SMOKE CAMELS**  
than any other cigarette

Doctors smoke for pleasure, too! And when three leading independent research organizations asked 113,597 doctors what cigarette they smoked, the brand named most was Camel!