

DECEMBER 1948

35 CENTS

ANC



# POPULAR MECHANICS

## MAGAZINE

WRITTEN SO YOU CAN UNDERSTAND IT

REG. D. TRADE MARK, GREAT BRITAIN, No. 410426

REG. U.S. PAT. OFF.





Revere "88" 8mm  
Camera. F 2.5 lens.  
Incl. tax **\$77.50**

Revere "70" 8mm  
Magazine Camera.  
F 2.8 lens. Incl. tax  
**\$127.50**

Revere "26" 16mm  
Magazine Turret  
Camera. F 2.5 lens.  
Incl. tax **\$152.50**

Revere "85" 8mm  
Projector **\$120.00**  
Revere "48" 16mm  
Silent Projector. (Not  
illustrated) **\$120.00**

Revere "16" 16mm  
Sound Projector.  
**\$287.50**

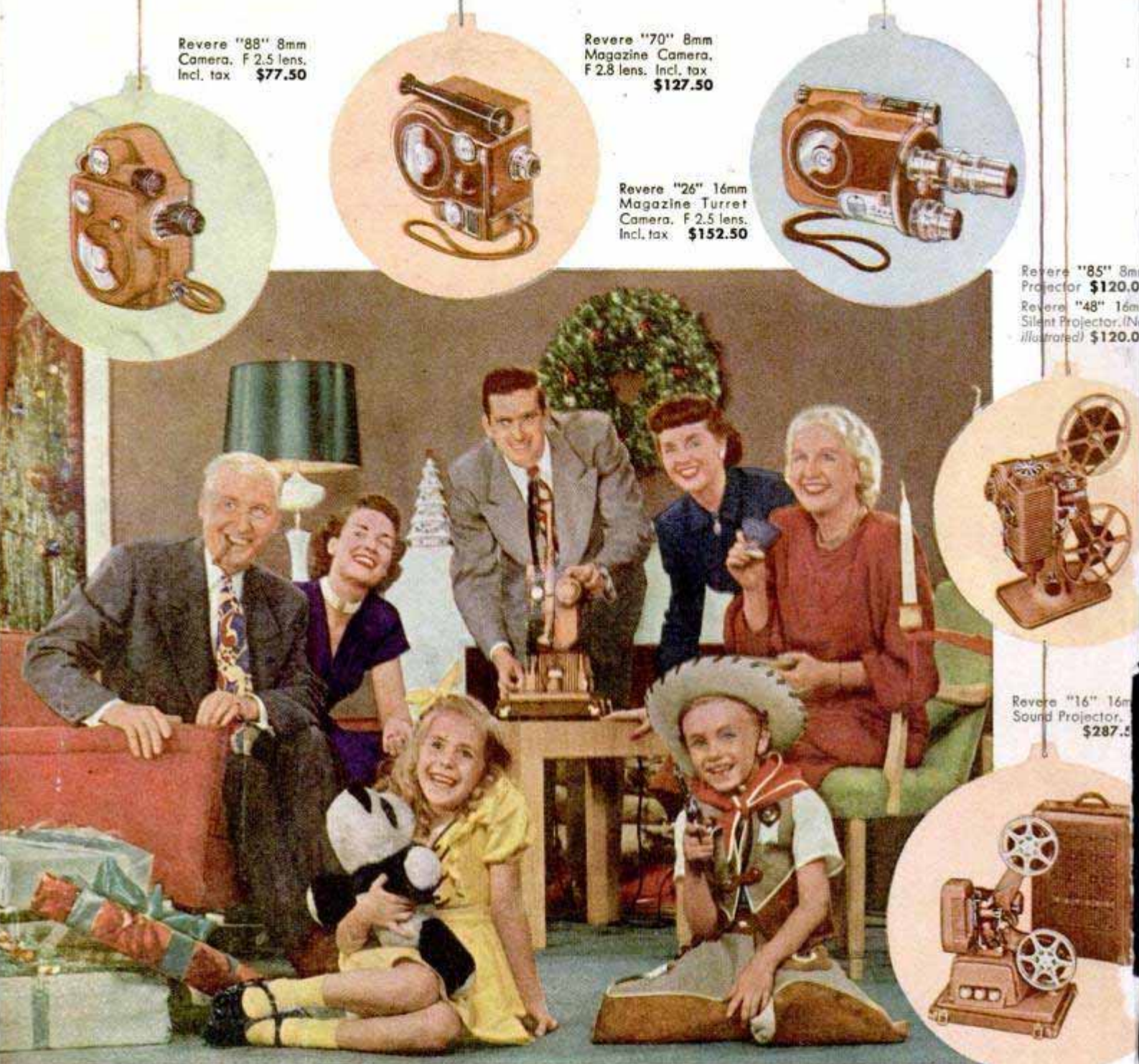

*This year give Revere...*

**for a Christmas they'll never forget!**

**H**ome movies are becoming a Christmas tradition. When dinner's over, everybody adjourns to the living room for the "big show". Taking movies, too, is part of the Christmas picture. You'll want glorious full-color movies of all the joyous events . . . of those many priceless scenes the whole family will enjoy re-living again and again. So make this a Christmas they'll never forget—give a Revere! See your dealer now.

REVERE CAMERA COMPANY • CHICAGO 16



**Revere**  
EIGHTS and SIXTEENS

**IN PURSUIT OF HAPPINESS REVERE ADDS TO YOUR PLEASURE**



*Research keeps*

**B.F. Goodrich**

**FIRST IN RUBBER**



**1** "...NEVER RECEIVED better service from any tire," says H. L. Smith, Unicolor, Tenn. His B. F. G. tires have gone 30,595 miles, half of it over rocky roads.



**2** "THESE TIRES had gone 49,723 miles when the picture was taken and I believe are good for another 10,000," writes P. U. Alexander, Goose Creek, Texas.



**3** WRITES E. B. PALMER of Denver: "I drive . . . at comparatively high speeds. This B. F. Goodrich tire has been driven 36,664 miles. It still has a good tread."

*...That's why users  
get more miles with  
B.F. Goodrich tires!*

**PREMIUM SILVERTOWN**  
Highest quality

**B. F. G. EXTRA-CUSHION**  
Easiest riding

**B. F. G. SILVERTOWN**  
Lowest cost per mile

**B. F. G. DEFIANCE**  
Lowest price



WITH THE OPENING of the world's finest rubber



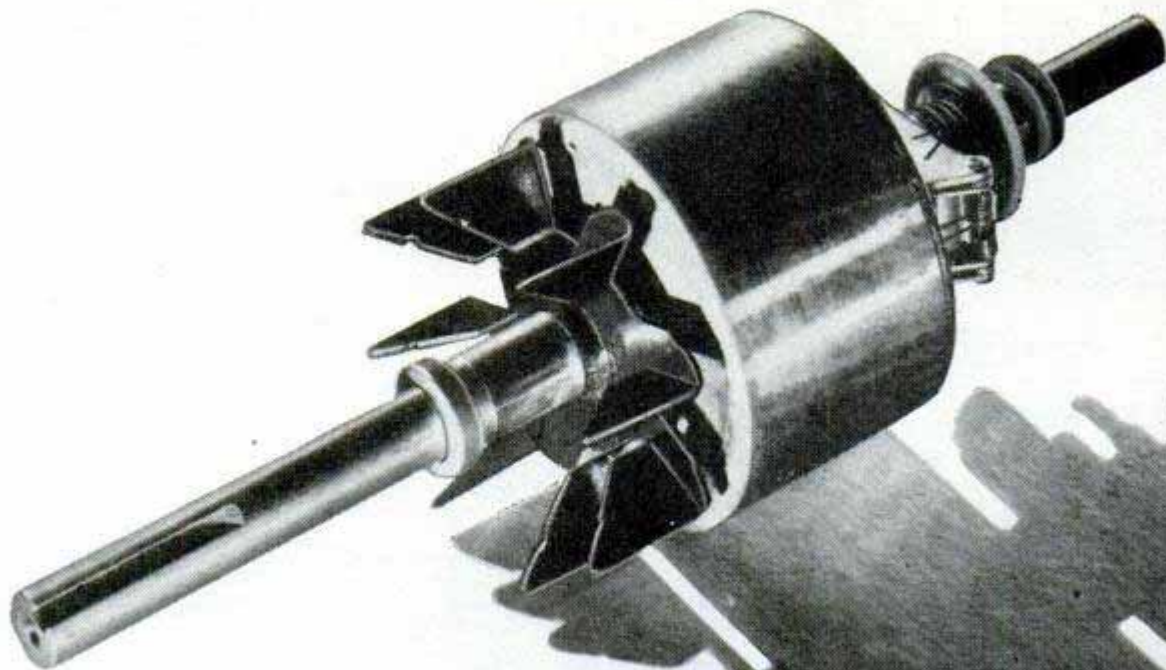

## HEART

This silicon steel rotor is the "heart" of the Hoover Motor. It is electrically welded with the laminations annealed. We show it this way to demonstrate the engineered efficiency that makes every Hoover Motor perform smoothly, quietly and remain cool even in continuous operation. New rigid or resilient Hoover Motors meet NEMA mounting dimensions. Both are available at your nearest dealer's. Order either sleeve or ball bearing Hoover Motors to meet your requirements.

Hoover Motors are made in ratings of  $\frac{1}{4}$  up to 1 hp by the makers of the world-famous Hoover Cleaners.



## HOOVER MOTORS

Electric Motor Division . . . The Hoover Company . . . North Canton, Ohio







# GET A JOB IN AVIATION

## No Experience Needed . . .

## Good Pay While Learning

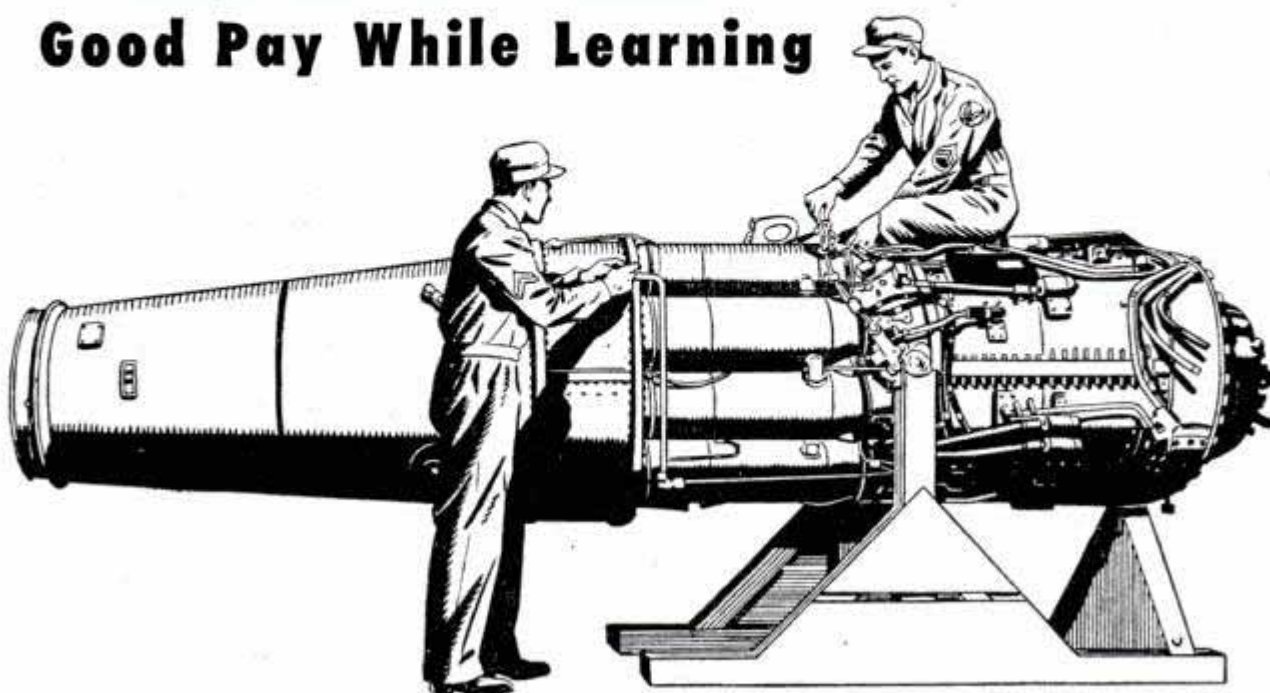

If you are looking for a job with a *real* future, get into aviation . . . NOW. Today's *best* deal for the aviation beginner is in the United States Air Force. Look into the opportunities it offers and see for yourself.

**EARN WHILE LEARNING.** You get good pay *right from the start* in the Air Force . . . \$75 a month in cash . . . *free* room and board . . . *free* clothing and equipment . . . *free* medical and dental care . . . *free* retirement plan. Air Force beginner's pay is equal to at least \$3,000 a year in civilian life. Where can you match that?

**BEST OF TRAINING.** Two kinds of training are open to men in the Air Force. You can learn on the job, under the world's most skilled experts. Or, if you qualify, you can go to the finest

Air Force technical schools while vacancies exist. It would cost hundreds of dollars to get such training elsewhere.

**PROMOTIONS.** Advancement in the Air Force is based on merit. Better jobs . . . non-commissioned ratings . . . go to the qualified men next in line. Right now skilled men are needed.

This is your *big* opportunity. Look into it *today*. You can get full details, without obligation, at your nearest Recruiting Station, Air Force Base, or by writing: Chief of Staff, U. S. Air Force, Att.: PMP-3A, Washington 25, D. C.

## VOLUNTEER TODAY



FOR THE  
**U.S. AIR FORCE**

U. S. ARMY and U. S. AIR FORCE RECRUITING SERVICE



**IF YOU WANT TO MAKE A HIT—**

# Give an X-acto Kit!

Here are just four of the dozens of X-acto kits and sets that will bring joy to the heart of beginner or expert hobby crafter. The handicraft kits each contain a complete project, plus all the tools and materials needed, and easy-to-follow instructions for turning out a finished job. X-acto refill-blade knives and specially designed hobby tools, in a wide range of sets and prices, provide the "dream gift" for hobby crafters of every age and taste. See the complete line at your hobby, art, gift, hardware or department store. Singly or in sets from 50¢ to \$50. (Prices slightly higher in Canada.)

**x-acto** 

## HANDICRAFT KNIVES & TOOLS

X-acto Crescent Products Co., Inc., 440 Fourth Ave., N. Y. 16  
In Canada: Handicraft Tools, Ltd., Hermant Bldg., Toronto  
\*Reg. U. S. Pat. Off.



### NO 82 X-ACTO KNIFE CHEST

Perfect set-up for beginners, helps them turn out fine-looking jobs. Designed for safety and sure control. Contains 3 knives, assortment of super-sharp extra blades. In wooden chest. \$3.50



### NO. 470 X-ACTO METAL TAPPING KIT

New! Contains tapping hammer and stippler, mounting boards, aluminum and copper foil with printed project, brads and instruction sheet. A fascinating hobbycraft! . . . \$1.50



### NO. 86 X-ACTO HOBBY CHEST

Ideal for modelbuilders, whittlers, woodcarvers, etc. Contains 3 knives, planer, sander, balsa stripper, spokeshaver, assorted blades, routers, gouges, punches. How about Dad? . . \$10.00

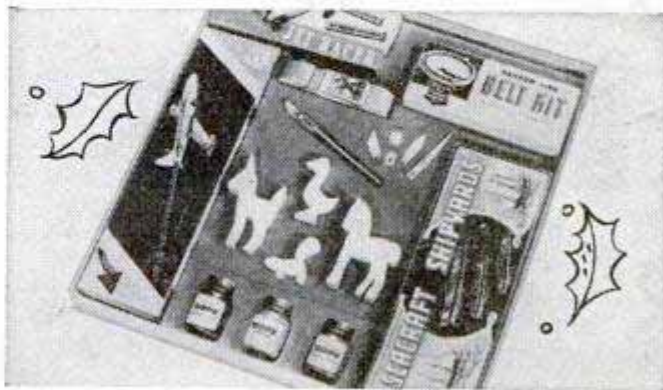

### NO. 450 X-ACTO 5-IN-1 KIT

Material and complete instructions for leathercraft project, model plane and boat, 4 whittling blocks, jet car; knife, blades, sanding block, dope paint. Teen-agers love it! . . . \$4.95







KNOWLEDGE  
THAT HAS  
ENDURED WITH THE  
PYRAMIDS

## A SECRET METHOD FOR THE MASTERY OF LIFE

**W**HENCE came the knowledge that built the Pyramids and the mighty Temples of the Pharaohs? Civilization began in the Nile Valley centuries ago. Where did its first builders acquire their astounding wisdom that started man on his upward climb? Beginning with naught they overcame nature's forces and gave the world its first sciences and arts. Did their knowledge come from a race now submerged beneath the sea, or were they touched with Infinite inspiration? From what concealed source came the wisdom that produced such characters as Amenhotep IV, Leonardo da Vinci, Isaac Newton, and a host of others? Today it is known that they discovered and learned to interpret certain *Secret Methods* for the development of their inner power of mind. They learned to command the inner forces within their own beings, and to master life. This secret art of living has been preserved and handed down throughout the ages. Today it is extended to those who dare to use its profound principles to meet and solve the problems of life in these complex times.

### This Sealed Book—FREE

Has life brought you that personal satisfaction, the sense of achievement and happiness that you desire? If not, it is your duty to yourself to learn about this rational method of applying natural laws for the mastery of life. To the thoughtful person it is obvious that everyone cannot be entrusted with an intimate knowledge of the mysteries of life, for everyone is not capable of properly using it. But if you are one of those possessed of a true desire to forge ahead and wish to make use of the subtle influences of life, the Rosicrucians (not a religious organization) will send you *A Sealed Book* of explanation without obligation. This *Sealed Book* tells how you, in the privacy of your own home, without interference with your personal affairs or manner of living, may receive these secret teachings. Not weird or strange practices, but a rational application of the basic laws of life. Use the coupon, and obtain your complimentary copy.

## The ROSICRUCIANS

SAN JOSE (AMORC) CALIFORNIA



AMENHOTEP IV  
Founder of Egypt's  
Mystery Schools

Use this  
coupon for  
**FREE**  
copy of book

-----  
SCRIBE A. E. S.  
The Rosicrucians (AMORC)  
San Jose, California

Please send free copy of Sealed Book, which I shall read as directed.

NAME.....

ADDRESS.....

CITY.....



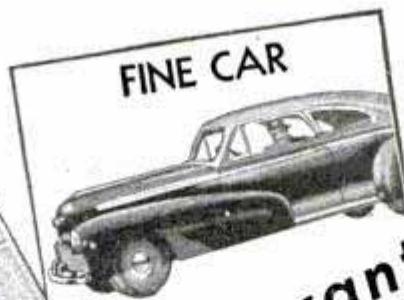

To the man who wants to enjoy  
**an ACCOUNTANT'S CAREER**



**IF** you're that man, here's something that will interest you.

Not a magic formula—not a get-rich-quick scheme—but something more substantial, more practical.

Of course, you need something more than just the desire to be an accountant. You've got to pay the price—be willing to study earnestly, thoroughly.

Still, wouldn't it be worth your while to sacrifice some of your leisure in favor of interesting home study—over a comparatively brief period? Always provided that the rewards were good—a salary of \$3,000 to \$10,000?

An accountant's duties are interesting, varied and of real worth to his employers. He has *standing*!

Do you feel that such things aren't for you? Well, don't be too sure. Very possibly they *can* be!

Why not, like so many before you, investigate LaSalle's modern Problem Method of training for an accountancy position?

Just suppose you were permitted to work in a large accounting house under the personal supervision of an expert accountant. Suppose, with his aid, you studied accounting principles and solved problems day by day—easy ones at first—then more difficult ones. If you could do this—and could turn to him for advice as the problems became complex—soon you'd master them all.

That's the training you follow in principle under the LaSalle Problem Method.

You cover accountancy from the basic Principles right up through Accountancy Systems and Income Tax Procedure. Then you add C. P. A. Training and prepare for the C. P. A. examinations.

As you go along, you absorb the principles of Auditing, Cost Accounting, Business Law, Statistical Control, Organization, Management and Finance.

Your progress is as speedy as you care to make it—depending on your own eagerness to learn and the time you spend in study.

Will recognition come? The only answer, as you know, is that success *does* come to the man who is really *trained*. It's possible your employers will notice your improvement in a very few weeks or months. Indeed, many LaSalle graduates have paid for their training—with increased earnings—before they have completed it! For accountants, who are trained in organization and management, are the executives of the future.

### Write For This Free Book

For your own good, don't put off investigation of *all* the facts. Write for our free 48-page book, "Accountancy, The Profession That Pays." It'll prove that accountancy offers brilliant futures to those who aren't afraid of serious home study. We'll also include "Ten Years' Promotion in One"—a book which has helped many men. Send us the coupon *now*.

**LASALLE EXTENSION  
 CHICAGO 5, ILL.**

Over 2800 Certified  
 Public Accountants among  
 LaSalle alumni

#### Other LaSalle Opportunities

- Higher Accountancy
- C.P.A. Coaching
- Bookkeeping
- Law: LL.B. Degree
- Business Management
- Salesmanship
- Traffic Management
- Foremanship
- Industr'l Management
- Stenotypy  
 (Machine Shorthand)

## LASALLE EXTENSION UNIVERSITY

### A CORRESPONDENCE INSTITUTION

417 S. Dearborn St. Dept. 1264-HR Chicago 5, Ill.

I want to be an accountant. Send me without obligation, "Accountancy, the Profession That Pays" training program—also "Ten Years' Promotion in One."

Name.....Age.....

Address.....

City, Zone & State.....





# For quicker Starts— Start using PYROIL

When you step on your starter, relieve your battery of the extra strain of piston-cylinder friction. Pyroil maintains a constant film of oil on metal surfaces. Winter oil ordinarily quickly drains from cylinder walls leaving them dry. Dry starts increase friction which increases battery drain and cylinder wear.

Add winter driving comfort, add battery life, add miles to your car—ADD PYROIL. Ask your gas station attendant.

### Pyroil for Aircraft Engines

Use Aircraft Pyroil B for lubricating oil, Aircraft Pyroil A for gasoline.

**GIVEN!** An attractive Pyroil metal savings bank—takes coins up to 50c pieces—is yours for the asking—sent postage paid.

Manufactured and Guaranteed by Pyroil Company, 86 Pyroil Bldg., La Crosse, Wisconsin.

Canadian Distributors:  
Central Purchasing Agencies, Ltd.  
Toronto, Ontario



**PYROIL COMPANY**  
86 Pyroil Bldg., La Crosse, Wisconsin

I want my car to last and run properly. Please tell me more about Pyroil and how it can accomplish this for me.

Name \_\_\_\_\_

Address \_\_\_\_\_

City or Town \_\_\_\_\_ State \_\_\_\_\_



## TABLE OF CONTENTS (Continued)

### AUTOMOTIVE

Overdrive for Chevrolet cars is an all-mechanical unit.....	98
Debut for the '49 Buick—Dynaflow for Supers.....	116
Chemical mixed with ice-melting salt reduces corrosion.....	116
Trailer tent sleeps four under double roof.....	121
"Honor" gas station.....	143
Synthetic-rubber gas nozzle prevents explosions.....	150
Back-seat windshield swings out of way.....	161
Front-seat back rest drops down to form double bed.....	173

### AVIATION

Pulse-jet engines on tips of rotors power helicopter.....	96
Plane for family trips built like a limousine.....	121
Engine using exhaust gases boosts range of plane.....	128
Navy tests danger area near intake of jet-plane engines.....	129
Mystery plane revealed to be B-17 with gas-turbine engine in nose.....	135
Pilot of "smallest" airplane lies prone when in cockpit.....	135
Blindfolded "pilot".....	151
Shimmy test made for airplane tail wheel.....	160

### BOATS

Powerful bowboat holds record for upstream run.....	99
Floating rocket launcher.....	117
Navy's 65,000-ton carrier to be world's largest warship.....	120
Navy tests seamless plastic hulls that never need painting.....	128

### FARM

Holly harvest.....	110
Tractor with lift frame built from war surplus.....	151
Lightweight tractor has front-wheel drive.....	176
90-degree turn made by wagon.....	176

### HOBBIES AND RECREATION

Loose-leaf album for coins.....	98
Aluminum cabinet for records.....	98
Metal-ski coaster has heel brake.....	105

### HOUSE AND HOME

What's new for your home.....	118
Damp cloth cleans enameled-steel wallpaper.....	142
Self-piloting lawn mower cuts grass in circles.....	161

### INDUSTRY AND RESEARCH

Forced felled gas splits open oil-bearing rocks.....	96
Isotopes available for research.....	112
Skyhook.....	112
"Growth resistant" cast iron won't expand under heat.....	129
Eye dropper samples steel.....	134
Glass defies sudden heat and cold.....	143
Tape seals paper blankets to cover fresh concrete.....	160
Paris engineers try new designs in hydraulic lab.....	162
Earth loader dumps ton per second into trucks.....	168
Skyscraper in the swamp.....	174

### MODELS, NOVELTIES AND TOYS

Rocket plane.....	97
Logs ride conveyor belt on model-train loader.....	105
Batteryless flashlight weighs only 2½ ounces.....	111
Cart kit makes centerpiece.....	129
Slivers and tissue become masts and sails of ship models.....	134
Plastic icicles for tree made in varied shapes.....	135
Toy grader scrapes miniature roads from dirt and sand.....	135
Edge-lighted plastic forms novel lamp.....	150
Cracker maker turns commercial.....	152
Christmas town beneath tree.....	153
Child's electric automobile has automatic brakes.....	173

### PHOTOGRAPHY

Photograph cosmic-ray tracks.....	111
Rocket-borne camera.....	114
"Fading" scenes now possible with small movie camera.....	128
Camera for tracing.....	142
Pocket-size flash unit.....	143

### SHOP AND TOOLS

Grinder motor powers jigsaw.....	112
Mobile blacksmith shop makes on-the-job repairs.....	150
Bricklayers' brackets hold sill strips.....	153
Taking shop.....	158

### MISCELLANEOUS

Inhaler for powdered penicillin is used orally or nasally.....	96
Snow-blower attachment.....	98
Almost-seedless watermelons.....	105
"Ultrafax" sends a million words a minute.....	113
Table-tennis balls aid tuberculosis patients.....	121
Screw-on Christmas-tree lights attached anywhere on cord.....	136
Writing board for the blind.....	143
Stencil on invoice saves retyping address for labels.....	136
Bun-weiner cooker makes hot dogs.....	161
Scale shows 129,000 weight and price figures.....	168
Brazier for cooking built from tank.....	176

(Continued to page 10)



# "Why, he knows all about me!"

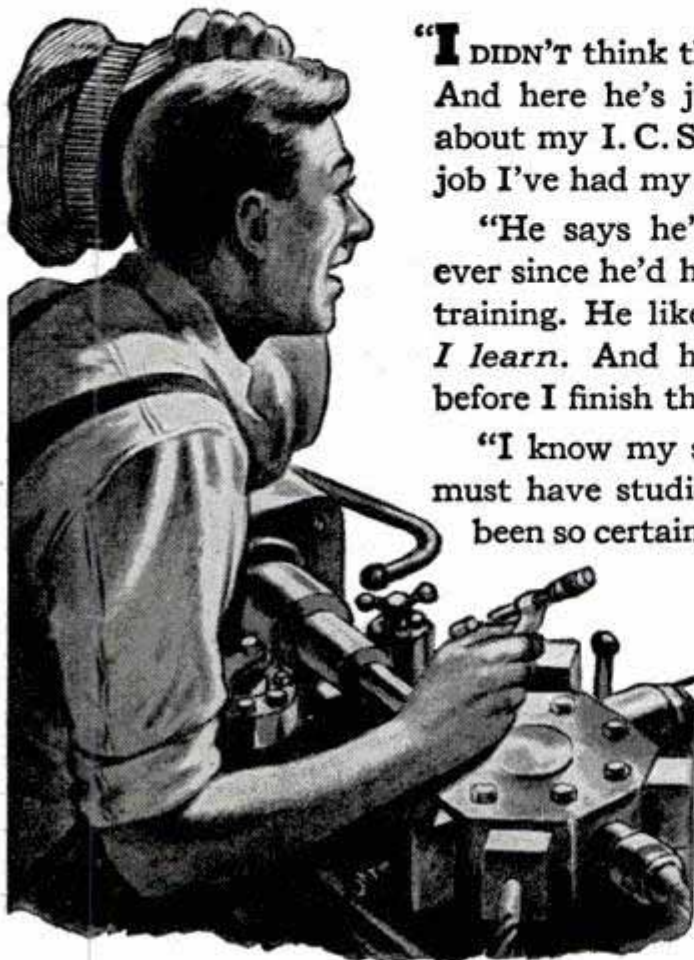

"I DIDN'T think the boss knew my name. And here he's just stopped by to talk about my I. C. S. Course and the bigger job I've had my eye on.

"He says he's had *his eye on me* ever since he'd heard I was getting that training. He likes the idea of my applying what I learn as *I learn*. And he says there'll be good news for me even before I finish the course.

"I know my studies showed in my work. But I guess he must have studied with I. C. S. himself or he couldn't have been so certain about just where I was getting my training."

Quite possibly the boss *is* an I. C. S. graduate. Thousands of employers are. Whether he is or isn't, however, he knows about your studies. I. C. S. regularly reports student progress to superiors. Letters of employer appreciation for this service are a regular part of our mail. So are student and graduate letters telling us of advancements—600 a month on an average. There *must* be a connection. Mail the coupon for full information."

## INTERNATIONAL CORRESPONDENCE SCHOOLS



BOX 5641-K, SCRANTON 9, PENNA.

Without cost or obligation, please send me full particulars about the course BEFORE which I have marked X:

- |   |   |  |  |
|---|---|--|--|
| <p><b>Air Conditioning and Plumbing Courses</b></p> <p><input type="checkbox"/> Air Conditioning<br/><input type="checkbox"/> Heating<br/><input type="checkbox"/> Refrigeration</p> <p><input type="checkbox"/> Plumbing<br/><input type="checkbox"/> Steam Fitting</p> <p><b>Chemistry Courses</b></p> <p><input type="checkbox"/> Chemical Engineering<br/><input type="checkbox"/> Chemistry, Analytical<br/><input type="checkbox"/> Chemistry, Industrial<br/><input type="checkbox"/> Chemistry, Mfg. Iron &amp; Steel<br/><input type="checkbox"/> Petroleum Refining<br/><input type="checkbox"/> Pulp and Paper Making</p> <p><b>Civil Engineering, Architectural and Mining Courses</b></p> <p><input type="checkbox"/> Architecture<br/><input type="checkbox"/> Architectural Drafting<br/><input type="checkbox"/> Bridge and Building Foreman<br/><input type="checkbox"/> Building Estimating<br/><input type="checkbox"/> Civil Engineering<br/><input type="checkbox"/> Coal Mining<br/><input type="checkbox"/> Contracting and Building<br/><input type="checkbox"/> Highway Engineering<br/><input type="checkbox"/> Lumber Dealer<br/><input type="checkbox"/> Reading Structural Blueprints<br/><input type="checkbox"/> Sanitary Engineering<br/><input type="checkbox"/> Structural Drafting</p> | <p><input type="checkbox"/> Structural Engineering<br/><input type="checkbox"/> Surveying and Mapping</p> <p><b>Communications Courses</b></p> <p><input type="checkbox"/> Electronics<br/><input type="checkbox"/> Practical Telephony<br/><input type="checkbox"/> Radio, General<br/><input type="checkbox"/> Radio Operating<br/><input type="checkbox"/> Radio Servicing<br/><input type="checkbox"/> Telegraph Engineering</p> <p><b>Electrical Courses</b></p> <p><input type="checkbox"/> Electrical Drafting<br/><input type="checkbox"/> Electrical Engineering<br/><input type="checkbox"/> Electric Light and Power<br/><input type="checkbox"/> Lighting Technician<br/><input type="checkbox"/> Practical Electrician</p> <p><b>Internal Combustion Engines Courses</b></p> <p><input type="checkbox"/> Auto Technician<br/><input type="checkbox"/> Diesel-Electric<br/><input type="checkbox"/> Diesel Engines<br/><input type="checkbox"/> Gas Engines</p> <p><b>Mechanical Courses</b></p> <p><input type="checkbox"/> Aeronautical Engineer's, Jr.<br/><input type="checkbox"/> Aircraft Drafting<br/><input type="checkbox"/> Forging<br/><input type="checkbox"/> Heat Treatment of Metals<br/><input type="checkbox"/> Industrial Engineering</p> | <p><input type="checkbox"/> Industrial Metallurgy<br/><input type="checkbox"/> Machine Shop<br/><input type="checkbox"/> Mechanical Drafting<br/><input type="checkbox"/> Mechanical Engineering<br/><input type="checkbox"/> Mold-Loft Work<br/><input type="checkbox"/> Patternmaking—Wood, Metal<br/><input type="checkbox"/> Reading Shop Blueprints<br/><input type="checkbox"/> Sheet-Metal Drafting<br/><input type="checkbox"/> Sheet-Metal Worker<br/><input type="checkbox"/> Ship Drafting<br/><input type="checkbox"/> Tool Designing<br/><input type="checkbox"/> Welding Engineering<br/><input type="checkbox"/> Welding—Gas and Electric</p> <p><b>Railroad Courses</b></p> <p><input type="checkbox"/> Air Brake<br/><input type="checkbox"/> Diesel Locomotive<br/><input type="checkbox"/> Locomotive Engineer<br/><input type="checkbox"/> Locomotive Fireman<br/><input type="checkbox"/> Locomotive Machinist<br/><input type="checkbox"/> Railroad Section Foreman</p> <p><b>Steam Engineering Courses</b></p> <p><input type="checkbox"/> Boilermaking<br/><input type="checkbox"/> Combustion Engineering<br/><input type="checkbox"/> Engine Running<br/><input type="checkbox"/> Marine Engineering<br/><input type="checkbox"/> Steam Electric</p> | <p><b>Textile Courses</b></p> <p><input type="checkbox"/> Cotton Manufacturing<br/><input type="checkbox"/> Loom Fixing<br/><input type="checkbox"/> Textile Designing<br/><input type="checkbox"/> Woolen Manufacturing</p> <p><input type="checkbox"/> Rayon Weaving</p> <p><b>Business and Academic Courses</b></p> <p><input type="checkbox"/> Accounting<br/><input type="checkbox"/> Bookkeeping<br/><input type="checkbox"/> Business Administration<br/><input type="checkbox"/> Business Correspondence<br/><input type="checkbox"/> Certified Public Accounting<br/><input type="checkbox"/> Commercial<br/><input type="checkbox"/> Cost Accounting<br/><input type="checkbox"/> Federal Tax<br/><input type="checkbox"/> Foremanship<br/><input type="checkbox"/> Good English<br/><input type="checkbox"/> Higher Mathematics<br/><input type="checkbox"/> Motor Traffic<br/><input type="checkbox"/> Retailing<br/><input type="checkbox"/> Retail Store Management<br/><input type="checkbox"/> Salesmanship<br/><input type="checkbox"/> Sign Lettering<br/><input type="checkbox"/> Spanish<br/><input type="checkbox"/> Traffic Management</p> <p><input type="checkbox"/> Advertising<br/><input type="checkbox"/> Ship Fitting<br/><input type="checkbox"/> Toolmaking<br/><input type="checkbox"/> Business Correspondence<br/><input type="checkbox"/> Commercial Art<br/><input type="checkbox"/> Commercial Art<br/><input type="checkbox"/> First Year College<br/><input type="checkbox"/> French<br/><input type="checkbox"/> High School<br/><input type="checkbox"/> Postal Civil Service<br/><input type="checkbox"/> Secretarial<br/><input type="checkbox"/> Stenography</p> |
|---|---|--|--|

Name \_\_\_\_\_ Age \_\_\_\_\_ Home Address \_\_\_\_\_  
 City \_\_\_\_\_ State \_\_\_\_\_ Working Hours \_\_\_\_\_ A.M. to \_\_\_\_\_ P.M.  
 Present Position \_\_\_\_\_ Employed by \_\_\_\_\_

Special tuition rates to members of the Armed Forces. Enrollment under G.I. Bill and P.L. 16 approved for World War II Veterans.  
 Canadian residents send coupon to International Correspondence Schools Canadian, Ltd., Montreal, Canada.



## Craftsman and Shop Notes Index

### AUTOMOTIVE

Car-battery charger and booster for cold-weather starting.....	194
Windshield sheet scraper will not scratch glass.....	209
Fender rebuilding.....	201
Pattern of car-door key carried in wallet.....	206
Lubricating windshield wiper.....	216
Adapter chucks spark plug in drill press for cleaning.....	223
Try this when grinding bolts.....	223
Alcohol damages fuel pump.....	224

### CHRISTMAS SPECIALS

Suggestions for a merry Christmas.....	186
Flashlight bulbs illuminate tree if electricity is not available.....	194
Testing Christmas-tree bulbs.....	200

### ELECTRICAL

Lantern-type battery operates bicycle headlight.....	196
Brushes held in released position simplify electric-motor assembly.....	216
Fishing wires between walls aided by bar magnets.....	224

### HOUSE AND HOME

Solving home problems.....	182
Storing sweet potatoes.....	184
Flour sifter separates chaff from home-shelled popcorn.....	184
Solution for fireproofing fabric.....	200
Repasting wallpaper seams.....	206

### METALWORKING

Brass candle scone gives emergency light.....	195
Burring simulates hammered effect on metalwork.....	206
Common materials provide substitute rivets.....	223

### PAINT AND PAINTING

Airtight seal of paraffin preserves oil paint in partially filled cans.....	193
Box aids painting drawer knobs.....	194
Adapting spray-gun suction tube for use with smaller jars.....	216

### PHOTOGRAPHY

Photoprint drier heated with lamp bulbs.....	207
Vise aids loading roll-film tank.....	208
Avoiding squint due to sunlight.....	208
Premeasuring developer solution.....	208
Repairing focal-plane shutter.....	208
Centering guide on printing frame aids production of lantern slides.....	208
Step-ladder serves as tall tripod for overhead shots.....	212
Replacing broken ground glass.....	212
Rack for cut-film hangers.....	212
Sink converted to print washer with drain-plug extension.....	212

### RADIO AND ELECTRONICS

Amplifier and loudspeaker for phone conversations.....	229
How to convert receiver into wire-recorder combination.....	230
Dynamic demonstrator aids teaching AM-FM radio.....	232

### TOOLS

Tin can holds electric drill on tool panel or wall.....	184
Refill-type sanding block takes roll of sandpaper.....	184
Grease "pincushion" holds drills to protect them from rust.....	196
Increasing blowtorch efficiency.....	206
Lenses of clear and colored glass improve welder's goggles.....	216
Adapter plate.....	217
Adjustable fixture locates milling cuts.....	222
Stop attached to lathe-limits travel of cross slide.....	224

### WOODWORKING

Quarter-round legs.....	185
Period clockcase.....	187
Lazy Susan's big sister.....	197

### MISCELLANEOUS

Tidbit servers.....	181
Semaphore for ice fishing.....	184
Replacing wheels with improvised runners converts stroller into easily handled sled.....	196
Glass cutting made easy.....	198
Stovepipes thoroughly cleaned with wire scratch wheel.....	200
Salt thaws vertical water pipe.....	200
Funnel for BB-shot container aids loading air rifle.....	206
Thawing short drainpipes.....	216
Temporary signs lettered with shoe polish and swab.....	224
Cloth-lined wire picker protects ripe fruit.....	224

**IMPORTANT NOTICE**—It is the intention of this magazine to provide its readers with information regarding the latest developments in the mechanical arts. We take no responsibility as to whether the disclosures contained in our articles are covered by patents and advise readers to investigate this subject before making, using, or selling any of the products, machines, or processes described in order to avoid possible liability for patent infringements.

The Biggest  
**Xmas Gift**  
THE NEW SENSATIONAL  
**SUN RAY**  
**Aristocrat**  
ENLARGER

ONLY \$14.95  
COMPLETE  
with lens



### MADE AND GUARANTEED BY ONE OF AMERICA'S LARGEST AND OLDEST M'F'G'S OF QUALITY ENLARGERS

Nothing will be so exciting and welcome to the photographic beginner as this remarkable new Sun Ray ARISTOCRAT enlarger for making fine enlargements AT LOW COST. Manufactured with precision and care, this ARISTOCRAT enlarger, for negatives up to 2 1/4" x 3 1/4", will not only give excellent long time performance but will produce smart, professional looking enlargements. By following the few simple instructions in the "HOW-TO-DO" instruction book accompanying the enlarger, any beginner can learn to make Hollywood prints from his negatives, almost at once. The entire enlarger is so compact it can be stored in its TUCK-A-WAY Carrying Carton and placed in a small corner of any closet. Order the ARISTOCRAT now in time for Xmas delivery... you will thrill with joy when you see the marvelous results it gives.

GIVE  
THE  
GIFT  
OF  
THE  
YEAR  
\$14.95

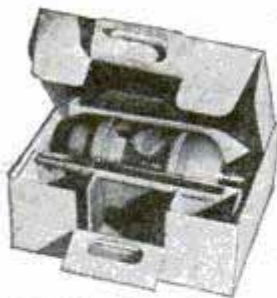

**Tuk-A-Way Carrying Carton Included**

The ARISTOCRAT is compact, portable, rugged... yet it has all of the features necessary for making fine enlargements. It accommodates all negatives from 35 mm up to 2 1/4 x 3 1/4. It contains bulb, diffusing glass and is wired for use on AC or DC. The lens is fitted into a precision focusing mount from which pin-point accuracy and sharpness is assured. Supplied with a durable, heavy, double fibre negative holder... easily accessible "in or out" of the enlarger's special "Open Jaw" arrangement. Its telescoping upright shaft fitted into a metal baseboard is collapsible so that the entire unit can be stored away in small space.

**PHOTO HOBBY INC., 489 FIFTH AVE., DEPT. P.M., NEW YORK 17, N.Y.**

Gentlemen:—Please send at once the ARISTOCRAT enlarger so that I can get started on my career as a photographer. I am enclosing check  money order  for \$14.95 Postpaid. (See note below).

Name.....

Address.....

City..... State.....

NOTE: Should you want the ARISTOCRAT sent C.O.D. plus postage please indicate same by checking here .



**AUDELS CARPENTERS & BUILDERS GUIDES—(4 Book Set).....\$6**

A practical illustrated trade assistant on modern construction for carpenters, joiners, builders, mechanics and all woodworkers. 4 vols., 1600 pages, 3700 illustrations. Fully indexed, flexible covers. Each volume sold separately \$1.50 a vol.

**AUDELS PLUMBERS & STEAMFITTERS GUIDES—(4 Book Set).....\$6**

A Practical Trade Assistant & Ready Reference. Explains in plain language & by clear illustrations, diagrams, charts, graphs, pictures principles of modern plumbing practice including Marine Pipe Fitting and Air Conditioning. 4 Vols.—1670 Pages—3642 Diagrams & Illustrations. Each Vol. Sold Separately \$1.50 a Vol.

**AUDELS OIL BURNER GUIDE.....\$1**

384 Pages Covering Installation, Servicing & Repairs All Types Domestic & Industrial Burners. Illustrated. Highly Endorsed.

**AUDELS HOUSE HEATING GUIDE..\$4**

1000 Pages Covering Working Principles, Installation, Service of All Modern House Heating, Ventilating & Air Conditioning Systems. Explains New Radiant Heating. Fully Illustrated & Indexed.

**AUDELS REFRIGERATION & AIR CONDITIONING GUIDE.....\$4**

New from Cover to Cover—1280 Pages, Fully Illus. Covering basic principles, servicing, operation & repair of household, commercial & industrial refrigeration & air conditioning. A gold mine of essential important facts for engineers, servicemen, users.

**AUDELS SHEETMETAL WORKERS HANDY BOOK.....\$1**

Practical inside information. Fundamentals of Sheet Metal Work. 388 pages. Illustrated. 11 sections. Clearly written. Essential & important facts, figures, pointers in everyday language. Ref. Index.

**AUDELS SHEETMETAL PATTERN LAYOUTS .....\$4**

Developed by Experts for Sheet Metal Workers, Layout Men & Mechanics. A Practical Encyclopedia in 10 Sections, size 7 x 10 x 2—1125 Pages—350 Layouts—1600 Illustrations. 1001 Key Facts. Fully indexed for ready reference in answering your layout problems. Covers all phases of sheet metal work including Pattern Cutting, Pattern Development & Shop Procedure.

**AUDELS BLUE PRINT READING.....\$2**

For Mechanics & Builders. Covers all types of blue print reading including ship & airplane. 416 pages, fully illustrated.

**AUDELS MATHEMATICS & CALCULATIONS FOR MECHANICS \$2**

Mathematics for home study or reference. 700 pages, 550 illus. Practical mathematics from beginning. How to figure correctly. Easy, correct methods covering complete review. Illus. & Indexed.

**AUDELS AUTOMOBILE GUIDE.....\$4**

A practical quick ready reference book for auto mechanics, service men, operators & owners. Explains theory, construction & servicing of modern motor cars, trucks, buses & auto type Diesel engines. 1700 pages, fully illustrated. 55 chapters. Indexed. A standard book for mechanics. New Hydraulic drive covered.

**AUDELS DIESEL ENGINE MANUAL....\$2**

A practical, concise treatise with questions and answers on the theory, operation and maintenance of modern diesel engines. Over 400 pages, fully illus. All details plainly brought out, this book is of extreme value to engineers, operators & students.

**AUDELS WELDERS GUIDE.....\$1**

A concise, practical text on operation & maintenance of all welding machines for all mechanics. Over 400 pages, illustrated. Covers all methods of electric and acetylene welding including airplane work.

**AUDELS MACHINIST & TOOLMAKERS HANDY BOOK .....\$4**

Covers modern machine shop practice in all its branches. Tells how to set up & operate lathes, screw and milling machines, shapers, drill presses & all other machine & hand tools. 1600 pages, fully illustrated. Indexed. 5 sections. 1—Modern Machine Shop Practice. 2—Blue Print Reading & How to Draw. 3—Calculations & Mathematics for Machinists. 4—Shop Physics. 5—How to Use the Slide Rule. 60 chapters. Easy to read and understand. A shop companion that answers your questions.

**AUDELS ELECTRIC MOTOR GUIDE \$4**

Practical Information Covering Construction, Control, Maintenance & Wiring Hookups of All Types Electric Motors also Armature Winding. 1000 Pages Fully Illustrated & Indexed.

**AUDELS ELEC. WIRING DIAGRAMS \$1**

210 Pages. Illustrated. Gives practical facts on wiring of electrical apparatus. It shows clearly how to wire apparatus for practically all fields of electricity. Each diagram is complete & self-explanatory. Highly Endorsed Pocket Companion.

**AUDELS PRACTICAL ELECTRICITY \$4**

A key to a practical understanding of Electricity. For maintenance engineers, electricians & all electrical workers. 1440 Pages, 2600 illus. Covers important electrical information in handy form—including wiring for Light & Power. Indexed.

**AUDELS RADIOMANS GUIDE .....\$4**

A key to the practical understanding of radio including Frequency Modulation, Television, etc., Aircraft & Marine Radio. For radio engineers, servicemen, amateurs, 914 Pages, 633 Illustrations & Diagrams. Photos. Review Questions & Answers, Reference Index.

**AUDEL, Publishers, 49 W. 23 St., N.Y. 10**

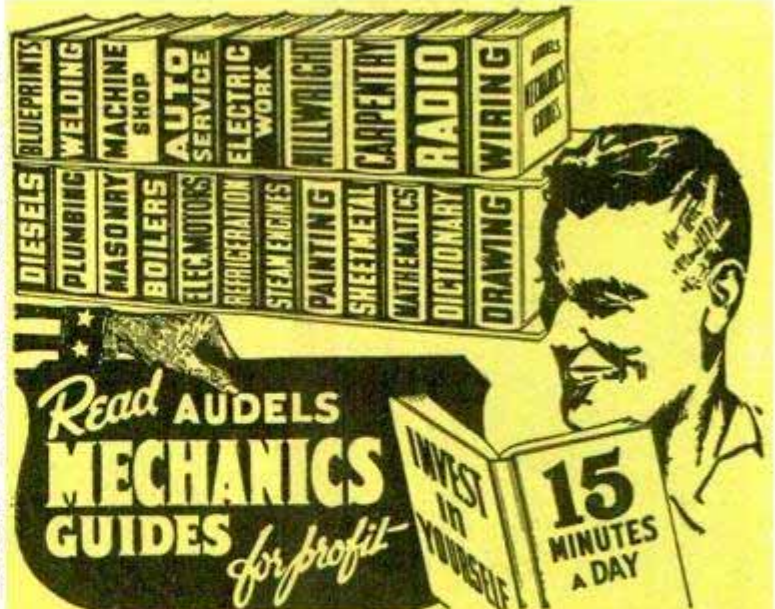

**AN AUDEL GUIDE IS A GOOD FRIEND!**

Step Up Your Own Skill with the Practical Facts and Figures of Your Trade. Save time and money with right methods, short cuts, labor saving ideas. CHECK NOW! You can look over any Audel Guide in your home. Start the Easy Payments if satisfied.

**CUT HERE MAIL ORDER**

AUDEL, Publishers, 49 W. 23 St., New York 10, N. Y.

Please mail me for 7 days' free examination the books marked (X) below. I agree to mail \$1 in 7 days on each book or set ordered, and to further mail \$1 a month on each book or set ordered until I have paid the purchase price. If I am not satisfied with Guides I will return them.

- AUTOMOBILE GUIDE, 1700 Pages . . . . . \$4
- DIESEL ENGINE MANUAL, 400 Pages . . . . . 2
- WELDERS GUIDE, 400 Pages . . . . . 1
- CARPENTERS & Builders Guides (4 Book Set) . . . . . 6
- PLUMBERS & Steamfitters Guides (4 Book Set) . . . . . 6
- MASONS and Builders Guides (4 Book Set) . . . . . 6
- BLUE PRINT READING, 416 Pages . . . . . 2
- MASTER PAINTER & Decorator, 320 Pages . . . . . 2
- GARDENERS & GROWERS GUIDES (4 Book Set) . . . . . 6
- OIL BURNER GUIDE, 384 Pages . . . . . 1
- HOUSE HEATING GUIDE, 1000 Pages . . . . . 4
- REFRIGERATION & Air Conditioning Guide, 1280 Pages . . . . . 4
- SHEET METAL WORKERS Handy Book, 388 Pages . . . . . 1
- SHEET METAL PATTERN LAYOUTS, 1100 Pages . . . . . 4
- AIRCRAFT WORKER, 240 Pages . . . . . 1
- MECHANICAL DRAWING GUIDE, 160 Pages . . . . . 1
- MECHANICAL DRAWING & DESIGN, 480 Pages . . . . . 2
- MATHEMATICS and CALCULATIONS, 700 Pages . . . . . 2
- MECHANICAL DICTIONARY, 968 Pages . . . . . 4
- MACHINISTS & Toolmakers Handy Book, 1600 Pages . . . . . 4
- MILLWRIGHTS & Mechanics Guide, 1200 Pages . . . . . 4
- POWER PLANT ENGINEERS GUIDE, 1500 Pages . . . . . 4
- ENGINEERS & FIREMANS EXAMINATIONS, 528 Pages . . . . . 1
- PUMPS, HYDRAULICS & Air Compressors, 1658 Pages . . . . . 4
- MARINE ENGINEERS Handy Book, 1280 Pages . . . . . 4
- ENGINEERS and Mechanics Guides (8 Book Set) . . . . . 12
- Answers on Practical ENGINEERING, 254 Pages . . . . . 1
- ELECTRIC WIRING DIAGRAMS, 210 Pages . . . . . 1
- ELECTRICIANS EXAMINATIONS, 250 Pages . . . . . 1
- ELECTRIC DICTIONARY, 9000 Terms . . . . . 2
- ELECTRIC MOTOR GUIDE, 1000 Pages . . . . . 4
- PRACTICAL ELECTRICITY Handy Book, 1440 Pages . . . . . 4
- ELECTRICAL POWER CALCULATIONS, 425 Pages . . . . . 2
- RADIOMANS GUIDE, 914 Pages . . . . . 4
- ELECTRONIC DEVICES, 216 Pages . . . . . 2
- NEW ELECTRIC LIBRARY, 7000 Pages (12 Book Set). 18

Name \_\_\_\_\_  
 Address \_\_\_\_\_  
 Occupation \_\_\_\_\_  
 Employed by \_\_\_\_\_





**MAKE EXTRA MONEY WHILE LEARNING**  
 Early in my Course I show you how to earn cash by fixing neighbors' Radios in spare time.

# Be a RADIO Learn by Practicing

MY  
**COURSE INCLUDES**  
**TELEVISION**  
**FM - ELECTRONICS**

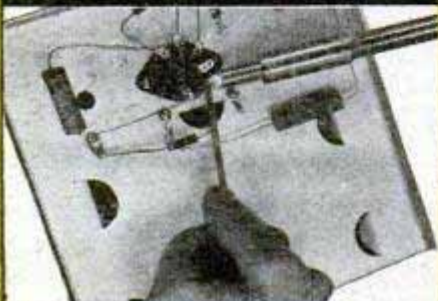

**YOU PRACTICE** Radio Soldering with Soldering Equipment and Radio Parts I send you. Get practical experience mounting and connecting parts.



**YOU BUILD** this Tester with parts N. R. I. sends early in course. Soon helps you fix neighbors' Radios and **EARN EXTRA MONEY** in spare time.

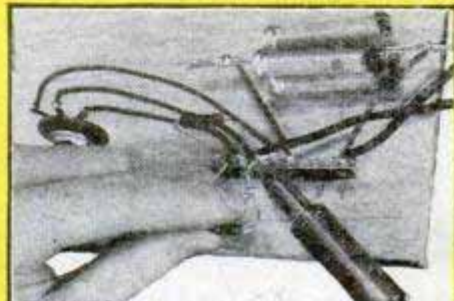

**YOU TEST** Radio Circuits like this built with parts I send. Build special circuits; learn how to locate and repair circuit defects.

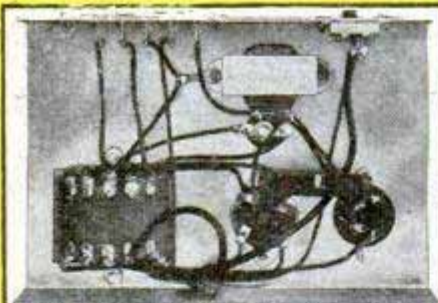

**YOU BUILD** Vacuum Tube Power Pack; make changes which give you experience with packs of many kinds. Learn how to correct Power Pack troubles.

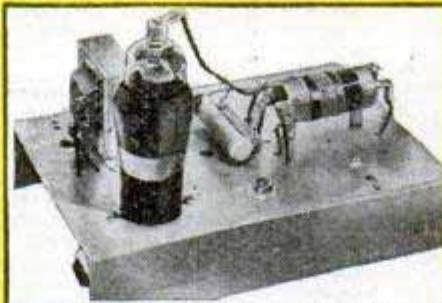

**YOU BUILD** this A. M. Signal Generator for more valuable experience. It provides amplitude-modulated signals for many tests and experiments.



**YOU PRACTICE FM** (Frequency Modulation) experiments, get more experience with this Superheterodyne Receiver Circuit you build with parts I send.

## I TRAINED THESE MEN FOR GOOD PAY JOBS

### Now My Own Boss



"N. R. I. trained my brother and me. We now have our own shop and more business than we can handle."—**JERRY McCARTHY**, Washington, D. C.

### Extra Cash In Spare Time



"For the past five years I have averaged \$15 and up a week in my spare time."—**STANLEY GENTON**, Cincinnati, Ohio.

### Radio Station Pays



"Am Broadcast Engineer for Station KROP. Fundamentals of Radio learned in N. R. I. training invaluable."—**JERRY G. COLLETT**, Brawley, Cal.

### Makes Extra Cash

"Service Radios three or four hours an evening and my monthly average is \$75."—**R. E. HAMRIOK**, Houston, Texas.



### Good Job In Radio Station

"Am Chief Engineer of Station WORD, in charge of four men. Owe all I know about Radio to N. R. I."—**CLYDE J. BURDETTE**, Spartanburg, S. C.



### Has Own Radio Business

"After finishing course, opened my own Radio shop. Can't praise your training too high. It's the best!"—**ERNEST T. SLATE**, Corsicana, Texas.



# VETERANS You Can Get This Training Under G. I. Bill



# TECHNICIAN

*at Home in Spare Time*

**I Send You  
BIG KITS  
of Parts**



**You Build This  
MODERN RADIO**

As part of your training . . . to give you practical experience . . . N. R. I. sends you the speaker, tubes, chassis, transformer, sockets, loop antenna, etc., to build this powerful receiver.

## KNOW RADIO-Win Success

### I Train You at Home

**ACTUAL  
LESSON  
FREE**



J. E. SMITH, President  
National Radio Institute

at-home method gives you practical experience with **BIG KITS OF PARTS** I send. All equipment yours to keep. You learn Radio and Television principles from easy, illustrated lessons.

**Make Extra Money In Spare Time**

The day you enroll, I send **EXTRA MONEY** booklets. Use your *know-how* to make **EXTRA MONEY** fixing Radios in spare time. The next step is your own Radio shop or a good-pay Radio job.

**N. R. I. Trained Men Face Bright Future**

Think of money-making opportunities in Police, Aviation, Marine Radio, Broadcasting,

Want a good-pay job in the fast-growing Radio and Television Industries? Want to be boss of your own money-making Radio shop? I've trained hundreds of men with no previous experience to be Radio technicians. I can do the same for you! My training

Radio Manufacturing, Radio Repairing, Public Address Work . . . think of even greater opportunities in fast-growing Television, FM and Electronics.

My special **DOUBLE FREE OFFER** gives you actual lesson on Radio repairing shortcuts absolutely free. You also get my 64-page book, "HOW TO BE A SUCCESS IN RADIO-TELEVISION-ELECTRONICS." See how quickly, easily you can get started. Send NOW! J. E. SMITH, President, Dept. 8NP, National Radio Institute, Pioneer Home Study Radio School, Washington 9, D. C.

Tells Radio repair shortcuts. Same coupon also entitles you to my 64-page book, "HOW TO BE A SUCCESS IN RADIO-TELEVISION - ELECTRONICS." Send NOW!

## Get Both FREE

MR. J. E. SMITH, Pres., Dept. 8NP  
National Radio Institute, Washington 9, D. C.

Mail me **FREE** Sample Lesson and 64-page book about how to win success in Radio and Television—Electronics. (No salesman will call. Please write plainly.)

Name..... Age.....

Address.....

City..... Zone..... State.....

Check If Veteran     Approved For Training Under G. I. Bill

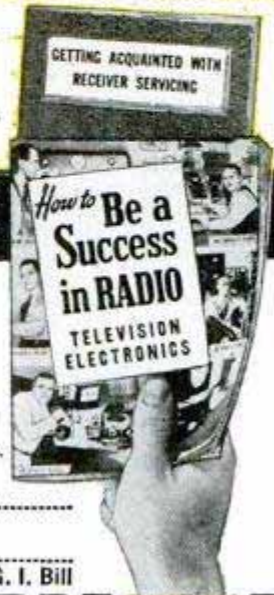

*Mail Coupon*



Make Use of  
**POPULAR  
MECHANICS  
BOOKS**

# STREAMLINED HELP



**BETTER JOBS  
HOBBIES  
AND PASTIMES  
HOME AND FARM  
WORKSHOPS  
HOME REPAIRS-  
IMPROVEMENTS**

## THE INEXPENSIVE PRACTICAL BOOKS WITH A MILLION READERS!

Want help on your job—extra knowledge that brings extra pay? Want to save money on home repairs? Want practical information to better enjoy hobbies and home and farm workshop projects? Then get a Popular Mechanics Book. These easy-to-use books, written in plain, everyday how-to-do-it English, and extravagant with pictures, plans, diagrams, etc., will give you the practical help you need. Full library size, cloth bound book unless otherwise described. Rush order on coupon today. Money back if not satisfied.



### FORTY POWER TOOLS YOU CAN MAKE

Have your own powered workshop at low cost. Tells how to make forty different machines such as lathes, drill press, jig saw, band saw, circular saw, sanders, from pipe fittings, old auto parts, wood, etc. New 1948 edition. \$1.50

### POPULAR MECHANICS PHOTO HANDBOOK

An entirely new and different book from our popular Photo Guide. It's a complete guide to better pictures and darkroom technique, and features dozens of handy gadgets you can make yourself. \$2.00

### BUILD A BOAT FOR PLEASURE OR PROFIT

How to build 17 low-cost boats at home—power, sail or row boat. Prepared especially for the home builder with limited tools, no experience and little money to spend. Plans, diagrams and illustrations. \$1.50

### WHAT TO MAKE FOR CHILDREN

A Popular Mechanics book for Dad, Mother and the whole family. Shows how to make toys, dolls, doll houses, slides, see-saws, rocking horses, furniture. 175 projects to make from discarded or inexpensive materials. \$2.00

### THE GARDEN BOOK

How to build your own trellises, fences, lawn furniture, outdoor fireplace, attractive ornaments and other things for your yard and garden. Beautify your grounds—enjoy attractive equipment—at low cost. \$1.00

### OUTDOOR SPORTS MANUAL

220 helpful articles and hints for fishermen, hunters, campers, trappers, archers and boatmen. If you love the outdoors, double your enjoyment with the help of this new book. Contains 334 illustrations. \$2.00

### WHAT TO MAKE. 10 Volumes



The famous annual craftsman's guide. Shows what to make and how to make hundreds of things in spare time for fun or profit. Novelties, gifts, toys, games, furniture, etc. Cloth bound and filled with instructive pictures. Single volumes, each \$1.75. Save money on 10 volume set, complete, only \$15.00.

### POPULAR MECHANICS SHOP NOTES

New 1949 volume. Latest in series of practical and helpful year books for every man who uses tools. Contains 240 pages and 750 illustrations. This book will make money for you and make your job easier. Soil-proof paper cover. \$1.00

### POPULAR MECHANICS MOTORIST'S HANDBOOK

For every man who drives a car and wants to do his own servicing and simple repairs. A money-maker for the professional auto repairman. Hundreds of ideas, helps, and kinks you can use every day. \$2.00

### CONCRETE HANDBOOK

How to do all types of concrete work and make ornamental things of cement—walks, driveways, foundations, steps, vases, benches, etc. Ideal book for home owner, handyman and construction men. \$1.50

### WELDING, BRAZING AND SOLDERING

How to construct welding equipment and use it effectively—small arc welder, spot welder, arc torch. Best approved methods, tricks and kinks to use in soldering, brazing, heat treating iron and steel. \$1.25



### YOUR HOME and HOW TO BUILD IT YOURSELF

Step by step instruction by which anyone with ordinary knowledge of use of hand tools can build a five-room house complete. Every detail is shown in pictures with amazing clarity. Will save hundreds of dollars building any house. Spiral bound. \$3.00. Complete set regular builders plans \$12.50. Book and plans \$14.00.

### FARM MANUAL

Hundreds of articles on making farm implements and equipment, maintaining the home, farm workshop, live stock and poultry, many farm hints and kinks. A book for every member of every farm family. 284 pages. Hundreds of illustrations. \$3.00



### THE BOY MECHANIC

One of the most popular and best known Popular Mechanics publications. Describes hundreds of things for boys to do and make. Develops natural talents and industry. Crammed with how-to-do-it illustrations. The perfect gift for every boy. \$2.00

### PAINTING, FURNITURE FINISHING AND REPAIRING

A book for craftsmen, home owners, shop workers and furniture repairmen and finishers. Covers repairs and finishing, restoring antiques, spray and brush painting of all kinds. An all round book for everyone. \$1.50

**USE THIS HANDY COUPON • Mail Today**

**POPULAR MECHANICS PRESS, Dept. 128, 200 E. Ontario St., Chicago 11**

Send Popular Mechanics books checked.  I will pay postman, plus charges (U.S.A. only).  Remittance enclosed—send fully prepaid. I will return books in five days for return of money if not satisfactory. Outside U.S.A. please add 15% for postage and wrapping.

Forty Power Tools . . . \$1.50	What to Make (Children) . . . \$ 2.00	Boy Mechanic . . . \$ 2.00
Painting, Finishing, etc. 1.50	Garden Book . . . 1.00	Concrete Handbook . . 1.50
Motorist's Handbook . . 2.00	What to Make (1 Vol.) 1.75	Welding, Brazing . . . 1.25
Photo Handbook . . . 2.00	10 Volumes . . . 15.00	Your Home . . . . . 3.00
Build a Boat . . . . . 1.50	Shop Notes . . . . . 1.00	Book with Plans . . 14.00
Sports Manual . . . . . 2.00		Farm Manual . . . . . 3.00

Name \_\_\_\_\_  
Address \_\_\_\_\_  
City \_\_\_\_\_ State \_\_\_\_\_

Check for  
**FREE  
Catalog**





# INVENTORS



Learn how to protect your invention. The U. S. Patent Laws provide that any new and useful art, machine, article of manufacture, or composition of matter, or any new and useful improvement thereof, may be patented if the act of invention is involved. Therefore, every inventor with a valuable invention should take advantage of the Patent Laws and proceed for patent protection in order to safeguard his rights.

A patent gives the inventor the exclusive right to prevent others from making, using, or selling the invention claimed in the patent for a period of seventeen years.

The Patent Laws were enacted for the benefit of the inventor to give him protection for the features of his invention which are patentable. These features must be properly and concisely set forth and claimed in a formal application for patent, in order to comply with the requirements of the Patent Laws. For that reason, unless the inventor is familiar with patent matters, he should engage a competent registered patent attorney or agent to represent him. We are registered to practice before the U. S. Patent Office and are prepared to serve you in the handling of your patent matters.

A specially prepared booklet entitled "Patent Guide for the Inventor", containing detailed information with respect to patent protection and procedure, together with a "Record of Invention" form will be promptly forwarded to you without obligation upon request.

## CLARENCE A. O'BRIEN & HARVEY JACOBSON

*Registered Patent Attorneys*

81-M DISTRICT NATIONAL BUILDING • WASHINGTON 5, D. C.

*Patents*

*Trademarks*

*Copyrights*

CLARENCE A. O'BRIEN & HARVEY JACOBSON  
Registered Patent Attorneys

81-M District National Bldg., Washington 5, D. C.

Please send me copy of "Patent Guide for the Inventor" and also "Record of Invention" form. This request does not obligate me.

Name \_\_\_\_\_

Address \_\_\_\_\_

City \_\_\_\_\_ State \_\_\_\_\_

(Please write or print plainly.)



HERE'S  
THE  
*Complete  
Sprayberry  
Course!*

# LEARN RADIO

*ELECTRONICS-  
TELEVISION!*

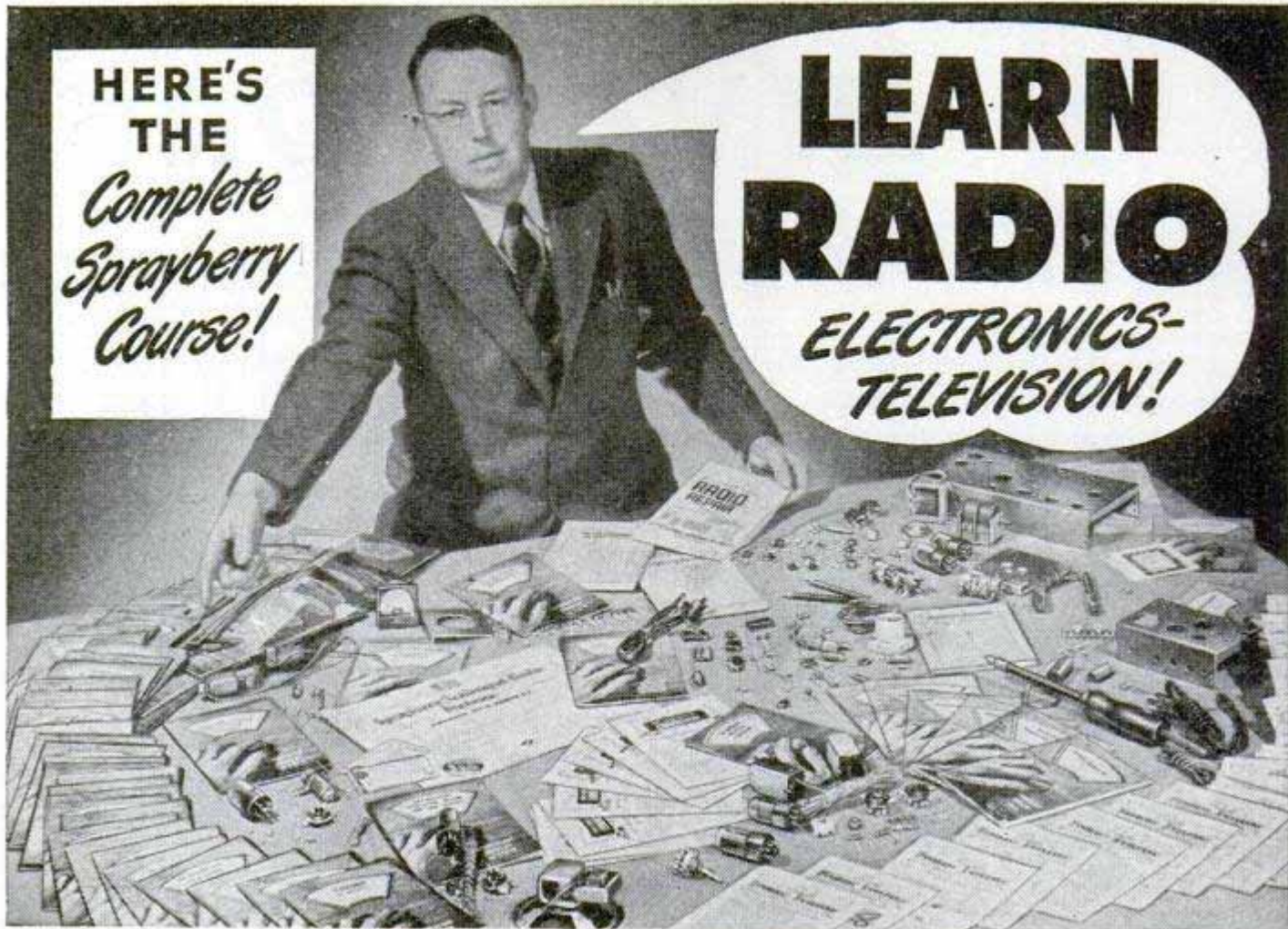

***I SEND YOU  
8 BIG KITS OF  
RADIO  
PARTS!***



↑ You build this complete 16-range AC-DC test meter set-up.



↑ I show you how to build this speaker tester and many other instruments.  
You build, test & troubleshoot this powerful 6-tube superhet Radio.

## I'LL TRAIN YOU AT HOME—BETTER—FASTER by Putting You to Work with Your Hands

In this picture I show you exactly what you'll get from me during your Sprayberry Radio Training. This actual photograph speaks for itself! Sprayberry Radio Training is **really COMPLETE**—I start you with interesting, easily understood basic knowledge and I keep the mailman busy bringing you valuable Service Manuals, profitable Business Builders, extra helps and books—and **8 Big Kits of Actual Radio Equipment!** My course is practical and down-to-earth. You get my personal help every step of the way. My method is **BEST** for you—because you train largely by working with your hands—building, testing, trouble-shooting with parts I supply. With these kits you build a powerful 6 tube superhet Radio, a big 16 range test meter and perform over 175 other fascinating practical experiments.

### EARN WHILE LEARNING

Shortly after you enroll I send you my famous **BUSINESS BUILDERS** that help you get and do profitable neighborhood Radio Service jobs while learning. These jobs pay well, and pave the way for a Service Business of your own.

All branches of Radio, Television and Electronics are booming! Trained men are needed NOW! I'll prepare you for your own profitable Radio Service Business or a big pay radio job in double quick time. You learn at home in spare time—you keep your present job and income while getting set for the future.

My course is so perfectly planned—so easy to grasp and understand—you need no previous knowledge or experience in Radio or Electricity. Get the facts now—find out what Sprayberry Radio Training can do for you. Mail the coupon below and by return mail I'll rush my big book, "How To Make Money in Radio, Electronics and Television" that tells all about Sprayberry Training. I'll also send you a Sample Lesson, "How To Read Radio Diagrams and Symbols"—all FREE. You'll read many letters from successful Radio men I've trained.

## LOW COST Complete TRAINING

Sprayberry Training is surprisingly Low in Cost—and if you desire, convenient monthly payments can be arranged. This is COMPLETE, UP-TO-DATE training—covering RADIO Repairing, Television and F. M., Industrial Electronics and many other new developments. Sprayberry Trained men really know Radio. This is training that sticks with you and makes money for you.

*Mail COUPON Today!*

**NOW!**

**2  
Locations  
To Serve You  
Better!**

Mail Coupon  
To Location  
Nearest Your  
Home

**SPRAYBERRY ACADEMY OF RADIO, Dept. 10-M  
Sprayberry Building, Pueblo, Colorado, or  
20 North Wacker Drive, Chicago 6, Illinois**

Rush my FREE BOOK and Sample Lesson.

NAME \_\_\_\_\_

ADDRESS \_\_\_\_\_

CITY & Zone \_\_\_\_\_ STATE \_\_\_\_\_

Check here if a Veteran

## FREE SAMPLE LESSON and Big Catalog

See how quickly and easily you can get your start in Radio, Electronics, Television with Sprayberry Training. Just fill out, clip and mail the coupon NOW for my big FREE book and FREE Sample Lesson. No obligation. No salesman will call. Read all the facts about Sprayberry Training—then decide. Take the first step TODAY—rush the coupon to me.

**VETERANS:** Approved for G. I. Training under Public Laws 16 and 345. Check coupon and mail today for complete facts.

**Sprayberry Academy of Radio, Dept. 10-M  
SPRAYBERRY BLDG. 20 N. WACKER DRIVE  
PUEBLO, COLORADO OF CHICAGO 6, ILLINOIS**





# INVENTORS

Patent laws encourage the development of inventions.

We recommend that an inventor employ a registered Patent Attorney or agent, if the inventor is not familiar with patent matters. This is because the value of a patent depends largely upon the skillful preparation of the specification and claims in the patent application.

The firm of McMorrow, Berman and Davidson is registered to practice before the United States Patent Office. Additionally it engages patent attorneys able to readily understand inventors' disclosures, to advise concerning patentability, and to prepare appropriate specifications and claims.

If an inventor believes he has an invention, a search of the most pertinent prior U. S. patents should be made and a report obtained relative to its patentability. Where such report indicates that the invention appears patentable, in order to secure protection, diligence should be exercised in making application for a patent.

Send for a copy of Patent Booklet entitled "How To Protect Your Invention." This booklet contains information on patent protection and procedure. You will also receive an "Invention Record" blank. This will be promptly forwarded to you upon request—no obligation.

## McMORROW, BERMAN & DAVIDSON

*Registered Patent Attorneys*

PATENTS • TRADE MARKS • COPYRIGHTS

135-T VICTOR BUILDING, WASHINGTON 1, D. C.

### McMORROW, BERMAN & DAVIDSON

*Registered Patent Attorneys*

135-T Victor Building, Washington 1, D. C.

Send me your Patent Booklet, "How To Protect Your Invention", and also "Invention Record" form at once. I understand this request does not obligate me.

Name.....

Address.....

City.....

(WRITE OR PRINT NAME CLEARLY)



# The 97 Pound Weakling

who became "The World's Most Perfectly Developed Man"

"I'll Prove that YOU, too, can be a NEW MAN!"

*Charles Atlas*

I KNOW, myself, what it means to have the kind of body that people pity! Of course, you wouldn't know it to look at me now, but I was once a skinny weakling who weighed only 97 lbs.! I was ashamed to strip for sports or undress for a swim. I was such a poor specimen of physical development that I was constantly self-conscious and embarrassed. And I felt only HALF-ALIVE.

Then I discovered "Dynamic Tension." It gave me a body that won for me the title "World's Most Perfectly Developed Man."

When I say I can make you over into a man of giant power and energy, I know what I'm talking about. I've seen my new system, "Dynamic Tension," transform hundreds of weak, puny men into Atlas Champions.

## Only 15 Minutes a Day

Do you want big, broad shoulders—a fine, powerful chest—biceps like steel—arms and legs rippling with muscular strength—a stomach ridged with bands of sinewy muscle—and a build you can be proud of?

Then just give me the opportunity to prove that "Dynamic Tension" is what you need.

No "ifs," "ands," or "maybes." Just tell me where you want handsome, powerful muscles. Are you fat and flabby? Or skinny and gawky? Are you short-winded, pepless? Do you hold back and let others walk off with the prettiest girls, best jobs, etc.? Then write for details about "Dynamic Tension" and learn how I can make you a healthy, confident, powerful HE-MAN.

"Dynamic Tension" is an entirely NATURAL method. Only 15 minutes of your spare time daily is enough to show amazing results—and it's actually fun! "Dynamic Tension" does the work.



**CHARLES ATLAS**  
Holder of title "The World's Most Perfectly Developed Man."

## Send for FREE BOOK

Mail the coupon right now for full details and I'll send you my illustrated book, "Everlasting Health and Strength." Tells all about my "Dynamic Tension" method. Shows actual photos of men I've made into Atlas Champions. It's a valuable book! And it's FREE. Send for your copy today. Mail the coupon to me personally, CHARLES ATLAS, Dept. 8M, 115 East 23rd Street, New York 10, N. Y.

**CHARLES ATLAS, Dept. 8M,  
115 East 23rd St., New York 10, N. Y.**

I want the proof that your system of "Dynamic Tension" will help make a New Man of me—give me a healthy, husky body and big muscular development. Send me your free book, "Everlasting Health and Strength."

Name \_\_\_\_\_ Age \_\_\_\_\_  
(Please print or write plainly)  
Address \_\_\_\_\_  
City \_\_\_\_\_ State \_\_\_\_\_

# 10 SHELF PLANS

NEW FULL SIZE

New, full size, easily built, beautiful wall shelf plans ready to trace on lumber, cut out and assemble.



Corner and wall racks with 1 to 3 shelves. Stores charge about \$75.00 for these shelves. Make money selling them. Finest selection available. PLUS BONUS of 48 other novel cut-outs, Dutch Boys, Girls, Toys, etc., etc. PLUS FREE new 1949 Handicraft Catalog. Send only \$1 to

**JACKSON, Dept. 63**  
5440 N. Shoreland Ave.  
Milwaukee 11, Wis.



## LEARN MEAT CUTTING

through actual practice. Profitable Meat Cutting and Successful Meat Merchandising taught easily, quickly. LEARN BY DOING at Toledo in just six short weeks under actual market conditions. For beginners or men with experience. All subjects taught thoroughly and completely. Diploma. Job help. Get store of own. People must eat. School in operation nearly 25 years. Approved for GI training. Send today for FREE illustrated catalog. No obligation. NATIONAL SCHOOL OF MEAT CUTTING, Dept. 50-H, Toledo 4, Ohio

## ENGINEERING DEGREE IN 27 MONTHS

**INDIANA TECHNICAL COLLEGE**

Aeronautical, Chemical, Civil, Electrical, Mechanical, and Radio Engineering (inc. television). Drafting, 1-yr. Gov't approved for G.I.'s. Low rate. Earn board. Large industrial center. Students from 43 states, 18 countries. Demand for graduates. Enter December, March, June, September. Catalog.

5128 E. Washington Blvd., Ft. Wayne 2, Ind.

## LEARN MONEY-MAKING CARTOONING

IN SPARE TIME — by Easy Picture Chart Method

Same Simplified Method that has helped train creators of "Terry & Pirates," "Freckles," "Out Out Way," "Winnie Winkle," "Regular Fellers," "Strange As It Seems," "The Neighbors," and many others. Earn while learning. Send 10c for Picture Chart (to test your ability), and full details. (State age.)



THE LONDON SCHOOL, 4812 Cleve. Transit Bldg., Cleveland, O.

## AVIATION TRAINING

**AERONAUTICAL ENGINEERING AIRCRAFT and ENGINE MECHANICS (A & E)**

Train on famous Northrop Field — New classes starting soon.

Write for illustrated catalog.

**Northrop Aeronautical Institute**

1527 E. BROADWAY HAWTHORNE Division of Northrop Aircraft, Inc. LOS ANGELES COUNTY CALIFORNIA

APPROVED FOR VETERANS

# Photography



for

## PLEASURE or PROFIT

Learn at home. Spare time. Practical basic training. Long-established school. Many have earned while learning. Send coupon below for free booklet, "Opportunities in Modern Photography" and full particulars.

**AMERICAN SCHOOL OF PHOTOGRAPHY**

1315 Michigan Avenue Dept. 1359 Chicago 5, Illinois  
Send booklet, "Opportunities in Modern Photography," full particulars and requirements. No salesman will call.

Name \_\_\_\_\_ Age \_\_\_\_\_  
Address \_\_\_\_\_  
City \_\_\_\_\_ Zone \_\_\_\_\_ State \_\_\_\_\_



# How to beat the High Cost of Living!



The surest way to keep ahead of rising living costs is to earn promotion to a higher pay bracket.

Many have found that one of the best ways to qualify for such advancement is spare-time study of I. C. S. courses.

In the final analysis the amount in your pay envelope depends on YOU. Ability, initiative and training determine how large it can be.

If you have the ability and initiative, I. C. S. has the training you need. Thousands of I. C. S.-trained men are in *top* executive posts . . . hundreds of thousands hold good positions and regularly collect promotions and pay raises.

Mark and mail the coupon and you can be on the way to joining them.

## INTERNATIONAL CORRESPONDENCE SCHOOLS



BOX 5642-K, SCRANTON 9, PENNA.

Without cost or obligation, please send me full particulars about the course BEFORE which I have marked X:

- |   |  |  |   |
|---|--|--|---|
| <p><b>Business and Academic Courses</b></p> <input type="checkbox"/> Accounting <input type="checkbox"/> Advertising<br><input type="checkbox"/> Bookkeeping<br><input type="checkbox"/> Business Administration<br><input type="checkbox"/> Business Correspondence<br><input type="checkbox"/> Certified Public Accounting<br><input type="checkbox"/> Commercial<br><input type="checkbox"/> Commercial Art<br><input type="checkbox"/> Cost Accounting<br><input type="checkbox"/> Federal Tax<br><input type="checkbox"/> First Year College<br><input type="checkbox"/> Foremanship<br><input type="checkbox"/> Good English <input type="checkbox"/> French<br><input type="checkbox"/> Higher Mathematics <input type="checkbox"/> High School<br><input type="checkbox"/> Motor Traffic <input type="checkbox"/> Postal Civil Service<br><input type="checkbox"/> Retailing <input type="checkbox"/> Retail Store Management<br><input type="checkbox"/> Salesmanship <input type="checkbox"/> Secretarial<br><input type="checkbox"/> Sign Lettering<br><input type="checkbox"/> Spanish <input type="checkbox"/> Stenography<br><input type="checkbox"/> Traffic Management <p><b>Air Conditioning and Plumbing Courses</b></p> <input type="checkbox"/> Air Conditioning<br><input type="checkbox"/> Heating <input type="checkbox"/> Plumbing<br><input type="checkbox"/> Refrigeration <input type="checkbox"/> Steam Fitting | <p><b>Chemistry Courses</b></p> <input type="checkbox"/> Chemical Engineering<br><input type="checkbox"/> Chemistry, Analytical<br><input type="checkbox"/> Chemistry, Industrial<br><input type="checkbox"/> Chemistry, Mfg. Iron & Steel<br><input type="checkbox"/> Petroleum Refining <input type="checkbox"/> Plastics<br><input type="checkbox"/> Pulp and Paper Making <p><b>Civil Engineering, Architectural and Mining Courses</b></p> <input type="checkbox"/> Architecture<br><input type="checkbox"/> Architectural Drafting<br><input type="checkbox"/> Building Estimating <input type="checkbox"/> Coal Mining<br><input type="checkbox"/> Civil Engineering<br><input type="checkbox"/> Contracting and Building<br><input type="checkbox"/> Highway Engineering<br><input type="checkbox"/> Lumber Dealer<br><input type="checkbox"/> Reading Structural Blueprints<br><input type="checkbox"/> Sanitary Engineering<br><input type="checkbox"/> Structural Drafting<br><input type="checkbox"/> Structural Engineering<br><input type="checkbox"/> Surveying and Mapping <p><b>Communications Courses</b></p> <input type="checkbox"/> Electronics<br><input type="checkbox"/> Practical Telephony<br><input type="checkbox"/> Radio, General <input type="checkbox"/> Radio Operating<br><input type="checkbox"/> Radio Servicing | <p><input type="checkbox"/> Telegraph Engineering</p> <p><b>Electrical Courses</b></p> <input type="checkbox"/> Electrical Drafting<br><input type="checkbox"/> Electrical Engineering<br><input type="checkbox"/> Electric Light and Power<br><input type="checkbox"/> Lighting Technician<br><input type="checkbox"/> Practical Electrician<br><input type="checkbox"/> Power House Electric<br><input type="checkbox"/> Ship Electrician <p><b>Internal Combustion Engines Courses</b></p> <input type="checkbox"/> Auto Technician <input type="checkbox"/> Aviation<br><input type="checkbox"/> Diesel-Electric<br><input type="checkbox"/> Diesel Engines <input type="checkbox"/> Gas Engines <p><b>Mechanical Courses</b></p> <input type="checkbox"/> Aeronautical Engineer's, Jr.<br><input type="checkbox"/> Aircraft Drafting <input type="checkbox"/> Flight Engineer<br><input type="checkbox"/> Forging <input type="checkbox"/> Foundry Work<br><input type="checkbox"/> Heat Treatment of Metals<br><input type="checkbox"/> Industrial Engineering<br><input type="checkbox"/> Industrial Metallurgy<br><input type="checkbox"/> Machine Shop<br><input type="checkbox"/> Machine Shop Inspection<br><input type="checkbox"/> Mechanical Drafting<br><input type="checkbox"/> Mechanical Engineering | <p><input type="checkbox"/> Mold-Loft Work<br/> <input type="checkbox"/> Patternmaking—Wood, Metal<br/> <input type="checkbox"/> Reading Shop Blueprints<br/> <input type="checkbox"/> Sheet-Metal Drafting<br/> <input type="checkbox"/> Sheet-Metal Worker<br/> <input type="checkbox"/> Ship Drafting      <input type="checkbox"/> Ship Fitting<br/> <input type="checkbox"/> Tool Designing      <input type="checkbox"/> Toolmaking<br/> <input type="checkbox"/> Welding—Gas and Electric<br/> <input type="checkbox"/> Welding Engineering</p> <p><b>Railroad Courses</b></p> <input type="checkbox"/> Air Brake <input type="checkbox"/> Car Inspector<br><input type="checkbox"/> Diesel Locomotive<br><input type="checkbox"/> Locomotive Engineer<br><input type="checkbox"/> Locomotive Fireman<br><input type="checkbox"/> Locomotive Machinist<br><input type="checkbox"/> Railroad Section Foreman <p><b>Steam Engineering Courses</b></p> <input type="checkbox"/> Boilermaking<br><input type="checkbox"/> Combustion Engineering<br><input type="checkbox"/> Engine Running<br><input type="checkbox"/> Marine Engineering<br><input type="checkbox"/> Steam Electric <input type="checkbox"/> Steam Engineer <p><b>Textile Courses</b></p> <input type="checkbox"/> Cotton Manufacturing <input type="checkbox"/> Loom Fixing<br><input type="checkbox"/> Rayon Weaving <input type="checkbox"/> Textile Designing<br><input type="checkbox"/> Woolen Manufacturing |
|---|--|--|---|

Name \_\_\_\_\_ Age \_\_\_\_\_ Home Address \_\_\_\_\_

City \_\_\_\_\_ State \_\_\_\_\_ Working Hours \_\_\_\_\_ A.M. to \_\_\_\_\_ P.M.

Present Position \_\_\_\_\_ Employed by \_\_\_\_\_

Special tuition rates to members of the Armed Forces. Enrollment under G.I. Bill and P.L. 16 approved for World War II Veterans.  
 Canadian residents send coupon to International Correspondence Schools Canadian, Ltd., Montreal, Canada.



# I N V E N T O R S

Unless an inventor is thoroughly familiar with such matters, he is advised to employ a competent registered patent attorney or agent as the value of patents depends largely upon the skillful preparation of the specification and claims.

For his guidance, the following are the usual preliminary steps which the inventor takes toward patent protection.

The "Evidence of Invention" form mentioned below is offered as a convenience to the inventor in making his disclosure of invention.

The inventor should date and sign his disclosure and have it witnessed by two or more persons who are capable of understanding his invention. The disclosure should then be mailed to the registered patent attorney or agent whom he

selects to assist him. The disclosure should be accompanied by a letter authorizing the patent attorney or agent to conduct a preliminary search among previously granted U. S. patents for similar types of invention. The patent attorney or agent then prepares a report of the probable patentability of the invention and recommends the further course the inventor should take, provided the report indicates possible patentability.

This firm is registered to practice before the U. S. Patent Office and is available to assist inventors in the preparation and prosecution of their cases. The coupon below is suggested as a convenience to the inventor in starting action on his invention.

**VICTOR J. EVANS & CO.** • *Merlin M. Evans*  
REGISTERED PATENT ATTORNEY  
330-P MERLIN BUILDING, WASHINGTON 6, D. C.

• • • • •  
• **VICTOR J. EVANS & CO.** • *Merlin M. Evans* •  
• *Registered Patent Attorney* •  
• 330-P Merlin Building, Washington 6, D. C. •  
• *Please send me without obligation a copy of your booklet "Patent Protection For* •  
• *Inventors" together with your convenient "Evidence of Invention" form.* •  
• Name..... •  
• Address..... •  
• City and State..... •  
• • • • •

PATENTS

TRADEMARKS

COPYRIGHTS



These Men are Learning

# ELECTRICITY

in the Great SHOPS of COYNE

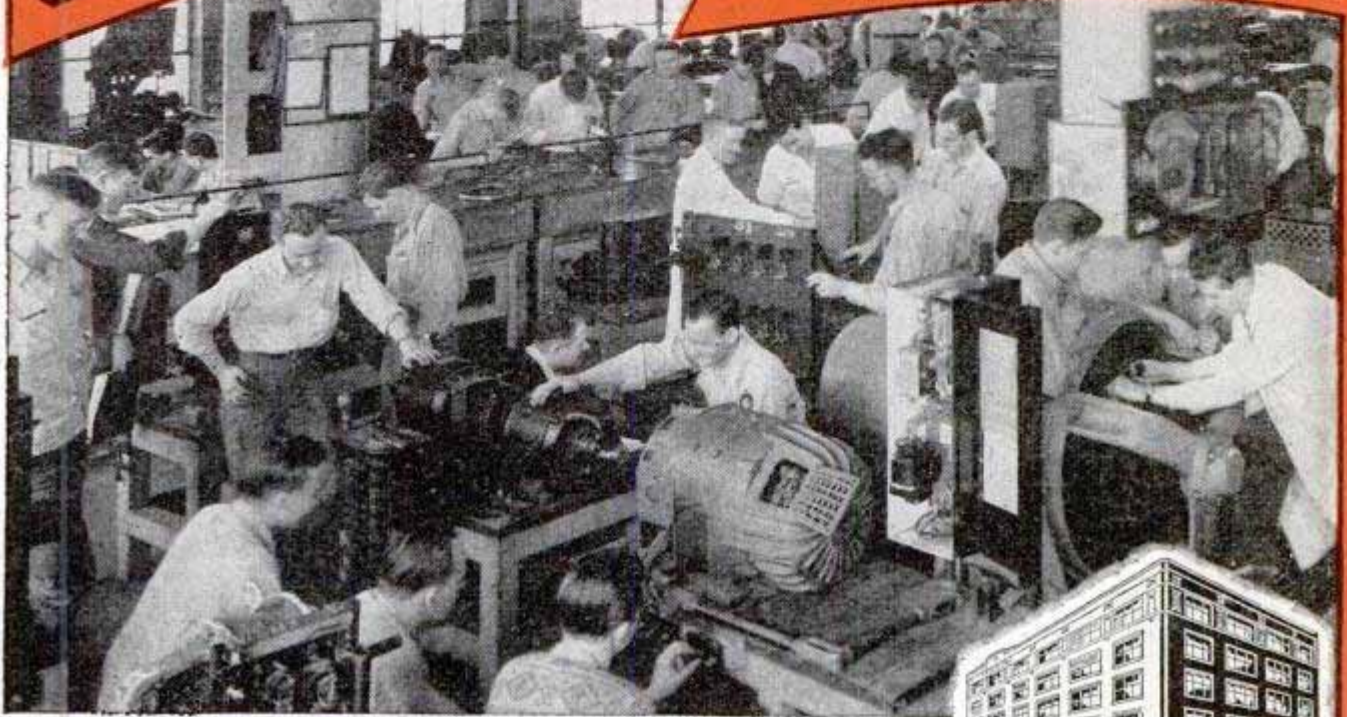

ESTABLISHED 1899  
Oldest, Largest, Best  
Equipped School of  
Its Kind in U. S.

**Why Spend Years Preparing for a Good Job?  
Train Quickly at COYNE—Be Making Real  
Money While Others are Still Puttering Along!**

### Learn on Real Equipment

Do as these fellows are doing! Get ready for Good Pay—a Big Future in ELECTRICITY—by training in the Great Shops of COYNE. Here you work on real motors, armatures, switchboards; do actual wiring and trouble shooting; get "all-around" training for dozens of well-paid job opportunities. Mail coupon today!

### Not a "Home-Study" Course

We do not teach by mail. All training plus necessary theory is given in our Great Shops. Expert instructors guide you. No advanced education or previous experience needed.

### EARN WHILE LEARNING

If you need part-time work to help out with living expenses while at Coyne, we'll help you get it. Don't be held back by lack of money.

### GI Approved—Finance Plan for Non-Vets

COYNE is authorized to train men under the G. I. Bill. Non-veterans may enroll now, pay most of tuition after graduation. Coupon brings details of our special plan for MEN OF DRAFT AGE.

### Electrical Refrigeration Included

Added training now included in great new field of Electric Refrigeration—also Industrial Electronics. Both mean added opportunities for you.

B. W. COOKE, President

**COYNE ELECTRICAL AND RADIO SCHOOL**

500 S. Paulina St., Dept. 98-72  
CHICAGO 12, ILLINOIS

### Get This Free Book!

See what COYNE offers in quick, pay-raising training. Send coupon for Big FREE BOOK, filled with pictures of our great shops and all the facts to help you. No obligation. No salesman will call. Rush coupon now!



B. W. COOKE, Pres.  
COYNE ELECTRICAL AND RADIO SCHOOL, 500 S. Paulina St., Dept. 98-72, Chicago 12.

Send me your big FREE BOOK on ELECTRICITY and special plan for men of draft age. This does not obligate me in any way and no salesman will call on me.

NAME.....

ADDRESS.....

CITY.....STATE.....

**PREPARE  
AT COYNE  
FOR REAL  
FUTURE**

in Jobs  
Like These



Switchboards  
House Wiring  
Power Wiring  
Maintenance  
Electric Mfg.  
Refrigeration  
Signal Work

Motor Testing  
Armature Work  
Industrial  
Electronics  
Power Plants  
Substations  
Your Own Shop

FREE Lifetime Job Service to  
COYNE Graduates.

**MAIL NOW!**





## Satisfied with my JOB and PAY? NOT ME!!

"Some day I'll really get a break and go right on to the top." That's wishful thinking.

You know that the "breaks" go to the man or woman who is prepared to take advantage of them—to the person who can fill the better job and is worth more money. He makes the "breaks" instead of waiting for them.

You can influence your own future by preparing now for the step forward—so that openings come because you are equipped for them—not as the result of luck.

Why not take the road that thousands of ambitious men and women have taken to help them to better jobs and more money.

Prepare now. Send the coupon below—check the business field of your choice and we'll send you without obligation our FREE 48-page book describing the opportunities and complete information on that field—plus "Ten Years' Promotion in One"—a book which has helped many men.

Send the coupon Now. It may be the turning point in your life to that better job and more money.

**LASALLE Extension University**  
A Correspondence Institution  
Dept. 1264-R Chicago 5, Ill.

### LASALLE Extension University A Correspondence Institution

417 S. Dearborn St., Dept. 1264-R, Chicago 5, Ill.

I want to make my own "breaks" by preparing for a better job. Send free 48-page book on the subject I have checked.

- |  |  |
|--|--|
| <input type="checkbox"/> Higher Accountancy  | <input type="checkbox"/> Salesmanship                  |
| <input type="checkbox"/> C.P.A. Coaching     | <input type="checkbox"/> Traffic Management            |
| <input type="checkbox"/> Bookkeeping         | <input type="checkbox"/> Foremanship                   |
| <input type="checkbox"/> Law: LL.B. Degree   | <input type="checkbox"/> Industrial Management         |
| <input type="checkbox"/> Business Management | <input type="checkbox"/> Stenotypy (Machine Shorthand) |

Name ..... Age .....

Address .....

City ..... Zone ..... State .....

## Have an OFFICE of YOUR OWN!

LEARN NEW PROFITABLE PROFESSION  
At Home in 60 Days, Men & Women, 18 to 70!

Be Your Own Boss and  
the Boss of Others. Be  
Respected. Meet Inter-  
esting People.



Earnings of men and women in this profession run as high as \$5,000-\$15,000 yearly. Others make good money in spare time. Little money needed to start. A business where your earnings begin sooner. Easy to learn. No selling or goods to buy. No experience necessary. A depression-proof business. A course of action to guide you step by step as you earn. All 53 lessons sent at once to use as operating manuals. Easy terms. Diploma. Money-back agreement. Write for FREE BULLETIN.

FRANKLIN CREDIT SCHOOL

Dept. 75-N ROANOKE 7, VIRGINIA

BY MAIL in  
Easy Lessons

## LEARN TO WRITE a Good Hand!

FOR BUSINESS AND SOCIAL SUCCESS!

Use to improve your handwriting at home quickly with my new instruction books just off the press. Master all the secrets of better penmanship. Simple and easy, fully illustrated, highly endorsed. Begin today. Write for:  New Free Book, "How to Become a Good Penman," or check books wanted, \$1.00 each.  Business Writing  Artistic Writing  Card Writing  Engraving Alphabets  Bird and Design Flourishing  Complete Set \$4.50  Enclose 10c for your name beautifully written and special penpoint for shaded writing. S. A. Ziller, President, TAMBLYN SCHOOL OF PENMANSHIP 441 Ridge Bldg. In Business Over 52 Years Kansas City, Mo., U.S.A.

## LEARN WATCH REPAIRING



AT HOME. By our modern and original system of instruction you can learn every part of the WATCH REPAIRING TRADE AT HOME. Prepare yourself for a well-paying position or start in business after completing our course of instruction. Good watch repairers are in demand and generally earn very good salaries. For particulars apply to the Wisconsin School of Watch Repairing 759 North Milwaukee St., Milwaukee 2, Wis.

## NEW! LOW COST! RESPIRATOR

Wear when sanding, grinding, paint spraying, sweeping, dusting, furnace cleaning, etc. Handy as a pair of glasses. Just keep mouth closed and breathe through nose is all you do to operate. Protects against nuisance dusts, lint, coal, cement, grain dust, hay fever pollen. Has 9 in. in. filter. For EYE protection against paint spray, dusts, gases, fumes, smoke, order our Fog-Proof Rubber GOGGLES ..... \$2.00 p.p.

JERRY BRYANT, Dept. PM  
919 N. Michigan Ave. Chicago 11, Ill.



Order Today \$1.00  
POST PAID

## 500 TRICKS MAGIC TRICKS



It's FUN to do MAGIC

Be popular! Amaze—mystify—entertain! For 30 years Douglas has satisfied customers all over the world. Now, you can enjoy this fascinating hobby. Only 10c brings our new 1949 Catalog 500 Tricks, containing brand new tricks for pocket, parlor, stage. Join in the fun—send 10c today!

Douglas Magicland, Dept. C, Dallas, Texas

## ANALYZE Handwriting

Uncrowded, fascinating field. Gratifying earnings reported by graduates in Employment, Credit, Social Service, Police and Entertainment fields. Others have developed profitable private practice, full or spare time, as Personal Problem and Vocational Counselors. Send for 3000 word TEST LESSON and Grapho Analyst FREE.

A.I.G.A. Inc.

Wilhoit Bldg., Dept. 120 Springfield, Mo.



## BE A REAL ESTATE BROKER PAYS BIG!

EASY TO LEARN—Start and run your own business quickly. Many graduates report making up to \$1000 a month. Course of study covers Sales, Property Management, Appraising, Loans, Mortgages and hundreds of related subjects. Course in home study or classroom instruction in leading cities. Big new illustrated catalog from this nationally known school. G. I. Approved. Send a Post Card Today.

WEAVER SCHOOL OF REAL ESTATE (Estab. 1936)  
15 E. Pershing Road Dept. PM-1 Kansas City, Mo.





# WHICH OF THESE *Opportunities* INTERESTS *You* MOST?

Accounting  
Air Conditioning  
Architecture & Building  
Automotive Engineering  
Aviation—Practical  
Aviation Drafting & Design  
Better Foremanship  
Bookkeeping  
Business Management

Contracting  
Diesel Engineering  
Drafting & Design  
Electrical Engineering  
Electricity—Practical  
Electronics, Industrial  
High School Courses  
Machine Shop Operations  
Mechanical Engineering

Plastics Engineering  
Plumbing—Practical  
Private Secretary  
Radio Operating & Servicing  
Railway Training  
Refrigeration  
Sheet Metal Pattern Drafting  
Shop Management  
Tool Making

## THINK! LOOK FORWARD!

Business is making big, new plans

Men and Women are preparing for the future

### WHAT ARE YOU DOING ABOUT YOUR TOMORROWS?

● *Today*, choose the job you want—and prepare for it. Or if you are already engaged in the work you like best, start training *now* for quicker promotion. Acquire the knowledge that will help you to get ahead faster, make more money and have greater security.

Invest part of your spare time in more rapid progress. Start training now, in spare time in your own home. Be ready to grasp your opportunity and step out ahead of those who lack the ability you have attained.

American School, founded in 1897 as an educational institution *not for profit*, can help you to reach your goal just as it has helped others during the past fifty-one years. Give serious thought to the list above. Pick one or more subjects that interest you. Then check the coupon at right, add your name and address and mail it at once. The school will send you details on its training plan and outline of study prepared by specialists. There is no charge, no obligation, so send the coupon immediately.

PRACTICAL, EFFECTIVE HOME - STUDY TRAINING SINCE 1897

Take This First Easy Step

**CHECK, CLIP AND MAIL COUPON NOW**

AMERICAN SCHOOL, Dept. G-945, Drexel at 58th, Chicago 37, Ill.  
Without obligation, please send FREE and postpaid, bulletin and details of the Subject checked.

- |  |  |  |
|--|--|--|
| <input type="checkbox"/> PLASTICS ENG'R            | <input type="checkbox"/> Accounting            | <input type="checkbox"/> Drafting and Design for Men and Women |
| <input type="checkbox"/> Refrigeration             | <input type="checkbox"/> Electrical Engr.      | <input type="checkbox"/> Radio                                 |
| <input type="checkbox"/> Architecture and Building | <input type="checkbox"/> Electricity-Pract.    | <input type="checkbox"/> High School                           |
| <input type="checkbox"/> Contracting               | <input type="checkbox"/> Electronics, Industr. | <input type="checkbox"/> Air Conditioning                      |
| <input type="checkbox"/> Practical Plumbing        | <input type="checkbox"/> Bookkeeping           | <input type="checkbox"/> Mechanical Eng.                       |
| <input type="checkbox"/> Automotive Engineering    | <input type="checkbox"/> Private Secretary     | <input type="checkbox"/> Shop Management                       |
| <input type="checkbox"/> Aviation Drafting         | <input type="checkbox"/> Diesel Engineering    | <input type="checkbox"/> Tool Making                           |
| <input type="checkbox"/> Aviation                  | <input type="checkbox"/> Sheet Metal           | <input type="checkbox"/> Better Foremanship                    |
| <input type="checkbox"/> Business Mgmt             | <input type="checkbox"/> Pattern Drafting      | <input type="checkbox"/> Machine Shop Operations               |
| <input type="checkbox"/> Railway Training          |  |  |

Name..... Occupation.....  
Address..... Age.....  
City..... State.....

**AMERICAN SCHOOL**

Dept. G-945, Drexel at 58th Street, Chicago 37





# AUTO BOOKS ON APPROVAL



**SEND NO MONEY.** Just mail the coupon for a complete set of 4 Big, Thick Auto Books. 20th Edition. Over 2700 Pages! Whether you are a mechanic or helper, expert or apprentice, auto owner or driver, take immediate advantage of this FREE EXAMINATION OFFER.

### MAKE GOOD MONEY NOW HOLD A PERMANENT JOB

America wants its automobiles kept in good repair. Men with "know how" are in demand, at big pay. These books will help you get and hold an important job, or give you a chance to go into business for yourself now or later. Any man who half tries to improve himself can learn auto servicing and repairing by this quick reference method. Use the JIPFY INDEX to find easily understood answer to any auto problem. These wonder books prepared by eleven of America's great automobile engineers. Many hundreds of valuable illustrations. Send the coupon TODAY.

**A year's consulting privileges with our engineers now given with these books without extra charge.**

*Publishers Since 1898*

### CAN YOU FIX IT?

These wonder books tell step by step HOW to make difficult repairs and adjustments, how to keep a car at maximum efficiency, including latest improvements in car design and operation. Engine troubles and how to correct them well covered.

### 4 BIG, THICK VOLUMES

Over 2700 pages, 2000 illustrations, wiring diagrams, etc. Beautiful modernistic, washable cloth binding.

**AMERICAN TECHNICAL SOCIETY, Dept. A919**  
Drexel Ave. at 58th St., Chicago 37, Ill.

I would like to examine your 4-Volume Set of Auto Books. I will pay the delivery charges only, but if I choose I may return them express collect. If after 10 days' use I prefer to keep them, I will send you \$2 and pay the balance at the rate of only \$3 a month until \$24.80 has been paid. Include consulting service as offered above.

Name \_\_\_\_\_

Address \_\_\_\_\_

City \_\_\_\_\_ State \_\_\_\_\_

Please attach letter stating age, occupation, employer's name and address and name and address of at least one business man as reference. Men in service, also please give home address.

# WATCHMAKING

## JEWELRY ENGRAVING AND REPAIR

Enter this high-paying, time-honored profession, or prepare for a business of your own. Watchmakers in great demand. More jobs than qualified workers. Study under expert instructors in a long-established, nationally recognized school. Receive recognized diploma and certificate. Placement service. Approved under G. I. Bill. Write for FREE booklet.



## The Baronian School, Inc.

2116 WALNUT ST. (DEPT. C) PHILA. 3, PA.

### FIBRE ARMS AND LEGS!



Light, correctly fitted, strong and comfortable. Natural appearance. Braces for all deformities. Scientific design. Fair Terms.

BUCHSTEIN-MEDCALF

223 S. 6th St., Minneapolis, Minn.

## SEND FOR FREE CATALOG!

*Out of Pawn!*

# GENUINE DIAMONDS



**Direct to You**—Save up to 50% and more on fine quality, Genuine Diamonds, reset in beautiful modern mountings, styled for Ladies and Men—Sold with an Iron-Clad Money-Back Guarantee. Over 100,000 satisfied customers. Order now from this ad. Write us for FREE ILLUSTRATED CATALOG of other Unredeemed Diamond Pledges from \$5.00 to \$5000. Send today. Reference: Any Bank or any Mercantile Agency.

1/5 CARAT  
\$125 Value

**\$49**  
Tax incl.

1/2 CARAT  
\$200 Value

**\$95**  
Tax incl.

### BERMAN'S COLLATERAL LOAN BANK

Dept. P.M., 636-38 W. Balto. St.,

Baltimore 1, Md.

# CHEMISTRY

**LEARN AT HOME...** Chemical knowledge is essential for thousands of good jobs in industry, business, science. IPC enables you to master practical chemistry. It's the ONLY home study chemistry course which enables you to learn by performing actual experiments—using chemicals and apparatus supplied with the course—in addition to your IPC textbook studies. Compares with recognized college courses in General Chemistry. Write today for free descriptive booklet.

## INSTITUTE OF PRACTICAL CHEMISTRY

3 PROSPECT AVENUE, HAGERSTOWN, MD.

# LAW FREE BOOK



Your FREE copy of "The Law-Trained Man" shows how to gain prestige and greater earnings through Blackstone home law study. All instruction material furnished including 18-volume Law Library written by 65 well-known law authorities. Lawyers, judges among our graduates. LL.B. degree. Low cost; easy terms. Write today.

**BLACKSTONE COLLEGE OF LAW** 225 N. Michigan Ave. Dept. 59, Chicago 1, Ill.

*A Correspondence Institution Founded in 1890*

## SHOE REPAIR OFFERS BIG INCOME

LEARN IN 12 WEEKS TIME

You can own your own shop or earn big income as skilled shoe repairman. Growing demand everywhere at top wages for men who know how. We teach you quickly by actually working on shoes and modern machines. Costs nothing under G.I. Bill of Rights. School open to all from 18 to 60 years of age. FREE BIG 16 PAGE BOOK explains everything. Send for your copy today.

### MODERN SHOE REBUILDING SCHOOL

Established 1927  
2937 Belmont Ave., Chicago, Ill. Rush Postcard Today.  
4577 Hollywood Blvd., Los Angeles 27, Calif.

# DRAW for MONEY... Be an ARTIST!

Trained Artists are Capable of Earning **\$60, \$75 and MORE a WEEK!**

YOU CAN learn to draw at home in your spare time the well-known WSA way. COMMERCIAL ART, DESIGNING, CARTOONING all in ONE complete course. No previous Art experience necessary—we teach you step-by-step. Prepare for a fascinating hobby or profitable career. For 34 years WSA graduates have been making good—WHY NOT YOU?



**VETERANS!** WSA Approved for Training Under G. I. Bill. Write for FREE BOOK, "Art for Pleasure and Profit," fully describes course, method of instruction and commercial opportunities for you. TWO ART OUTFITS included with training.

Washington School of Art, Studio 1212M  
1115—15th St., N.W., Washington 5, D. C.

Please send me full information and your Free Book, "Art for Pleasure and Profit."

Name \_\_\_\_\_ AGE \_\_\_\_\_

Street \_\_\_\_\_

City \_\_\_\_\_ Zone \_\_\_\_\_ State \_\_\_\_\_

I am entitled to training under "G.I." Bill



**Our  
GREATEST OFFER  
in 17  
YEARS**

Amazing New **EQUIPMENT** Helps

Prepare You **FASTER, EASIER** for . . .

# TELEVISION Radio...Electronics

Here's good news . . . big news . . . our **BIGGEST NEWS** in 17 years. The equipment pictured at left gives a partial idea of D.T.I.'s remarkable, new combination of shop-method training aids . . . to prepare you **AT HOME** for your start in Television-Radio-Electronics.

**Get 48-Page Book FREE**

Mail coupon today for D.T.I.'s big new 48-page **OPPORTUNITY GUIDE BOOK**. See how this amazing *newer method* helps you get started toward a **GOOD JOB** or your **OWN BUSINESS** in one of America's most promising, thrilling fields . . . that includes Television . . . F.M., Train, 2-Way Taxi, Aviation, and Broadcast Radio . . . Industrial Electronics . . . and other fast-developing branches.

In addition to well-illustrated lessons, you work over 300 instructive experiments from 16 shipments of Radio-Electronic parts. Among these projects you build and keep a commercial-type **CATHODE RAY OSCILLOSCOPE** . . . that helps you get practical Television circuit training. You also build and keep a double-range **R-F SIGNAL GENERATOR**, a jewel-bearing **MULTI-METER** and a quality 6-tube **SUPERHET RADIO**.

**YOU BUILD AND KEEP ALL OF THE EQUIPMENT AT LEFT . . . MAKE OVER 300 HOME EXPERIMENTS!**



**OSCILLOSCOPE**

**MULTI-METER**

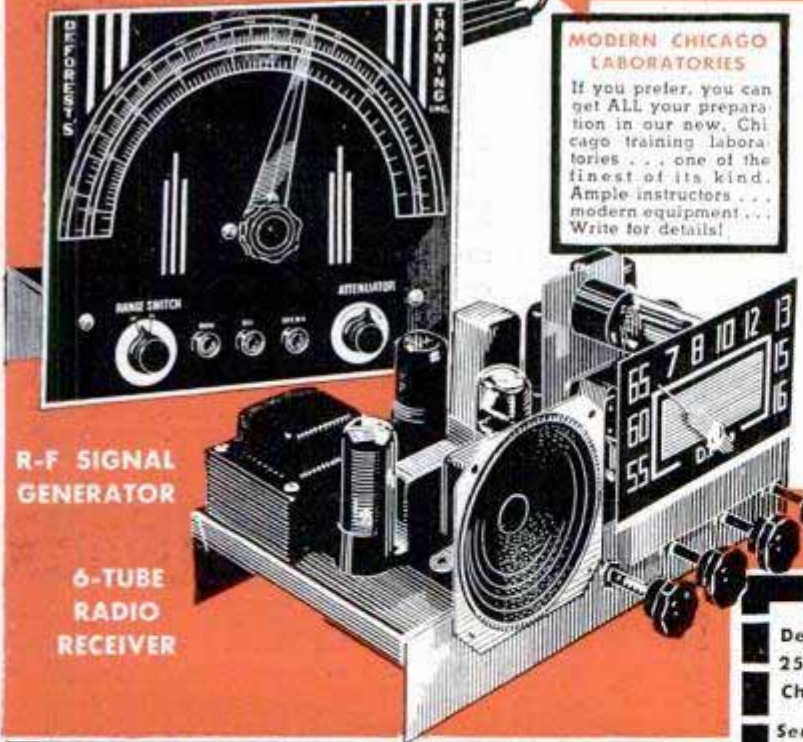

**R-F SIGNAL GENERATOR**

**6-TUBE RADIO RECEIVER**

**MODERN CHICAGO LABORATORIES**  
If you prefer, you can get **ALL** your preparation in our new, Chicago training laboratories . . . one of the finest of its kind. Ample instructors . . . modern equipment . . . Write for details!

You also use **HOME MOVIES** . . . a **D.T.I. Exclusive!**

D.T.I. alone includes the modern, visual training aid . . . **MOVIES** . . . to help you learn faster, easier at home. You see electrons on the march and other fascinating "hidden action" — a remarkable home training advantage that speeds your progress.



You Get D.T.I.'s Effective **EMPLOYMENT SERVICE**

When you complete your training, our effective Employment Service is available to you without extra cost, to help you get started.

**MAIL TODAY!**



DeForest's Training, Inc.  
2533 N. Ashland Ave., Dept. PM-E12  
Chicago 14, Illinois

Send me **FREE** your 48-page **OPPORTUNITY GUIDE BOOK** showing how I may make my start in Television - Radio - Electronics.

Name \_\_\_\_\_ Age \_\_\_\_\_  
Street \_\_\_\_\_ Apt. \_\_\_\_\_  
City \_\_\_\_\_ Zone \_\_\_\_\_ State \_\_\_\_\_

**DeFOREST'S TRAINING, INC.**  
**CHICAGO, ILLINOIS**

Affiliated with the De Vry Corporation  
Builders of Electronic and Movie Equipment



# Do you want

- ..to go to College?
- ..or to enter a Profession?

(Such as Accounting, Architecture, Nursing, Dentistry, Teaching, Social Work, Osteopathy, Beauty Culture, Optometry, Embalming, Chiropody, Law, Medicine, etc.)

- ..or get an Office Position?

To get anywhere, you practically **MUST** finish High School **FIRST**. You can complete our simplified High School Course in **SPARE** time at home, as **FAST** as your time and abilities permit. Equivalent to resident school work—prepares you for college, pre-professional examinations, business, industry. Standard texts furnished. Diploma. Credit for H. S. subjects already completed. Single subjects if desired. Low tuition, easy terms. American School, Chicago, est. 1897—endorsed by educators. Finish your high school education **NOW**, Write **TODAY!**

## High School Course at Home

Many Finish in 2 Years

American School, Dept. H945, Drexel Ave. at 58th St., Chicago 37, Ill.

Gentlemen: Send me **FREE** information covering special training in subjects checked below. No obligation on my part.

- |  |  |
|--|--|
| <input type="checkbox"/> High School Course          | <input type="checkbox"/> Diesel Engineering                  |
| <input type="checkbox"/> Architecture and Building   | <input type="checkbox"/> Drafting and Design for Men & Women |
| <input type="checkbox"/> Automotive Engineering      | <input type="checkbox"/> Plastics                            |
| <input type="checkbox"/> Business Management         | <input type="checkbox"/> Private Secretary                   |
| <input type="checkbox"/> Electrical Engineering      | <input type="checkbox"/> Mechanical Engineering              |
| <input type="checkbox"/> Elec. and Gas Refrigeration | <input type="checkbox"/> Aviation                            |
| <input type="checkbox"/> Air Conditioning            | <input type="checkbox"/> Salesmanship                        |
| <input type="checkbox"/> Railway Training            | <input type="checkbox"/> Radio                               |
| <input type="checkbox"/> Electronics, Industrial     |  |

Name.....

Address.....



## GOVERNMENT JOBS START

As High As \$3,351.00 Year  
Veterans Get Preference

### MEN—WOMEN

- Railway Postal Clerks
- Clerks
- Statistical Clerks
- Postoffice Clerks-Carriers
- Customs Inspectors
- Stenographers-Typists
- Many Other Jobs

GET READY IMMEDIATELY

Common Education Usually Sufficient

Mail Coupon TODAY—SURE

Franklin Institute

(Not Government Controlled)

Dept. J87

ROCHESTER 4, N. Y.

Gentlemen: Rush to me, **FREE** of charge, list of U. S. Government big pay jobs. Send **FREE** 40-page book describing salaries, vacations, hours, work, etc. Tell me how to get one of these jobs.

Name.....

Address..... Vet?.....

## CONFIDENTIAL LOAN SERVICE

Borrow \$50 to \$300<sup>00</sup>

Need money? No matter where you live you can borrow **BY MAIL** \$50.00 to \$300.00 this easy quick confidential way.

**BY MAIL**

**IT IS EASY TO BORROW BY MAIL!**

Completely confidential and private **CONVENIENT MONTHLY PAYMENTS**

**NO ENDORSERS NEEDED**

EMPLOYED MEN and women of good character can solve their money problems quickly and in privacy with loans **MADE BY MAIL**. No endorsers or co-signers. We do not contact employers, friends or relatives. Convenient monthly payments. Send us your name and address and we will mail application blank and complete details **FREE** in plain envelope. There is no obligation.

**STATE FINANCE COMPANY**

216 Savings & Loan Bldg., Dept. M107, Des Moines 8, Iowa



## LEARN TO REPAIR AND SERVICE

Sewing Machines, Motors, Bicycles, Refrigerators, Lawn Mowers, Etc. Start with a few common tools. Build equipment or buy at cost from directory of many jobbers. No complicated study of electricity or blueprints. Men with a little mechanical ability earn up to \$6 an hour. Free advisory service.

Send postal for details. 5 days free examination. **REPAIRMAN'S SERVICE**, Complete course, 222-B 4th Ave., Janesville, Wis. \$4.75 postpaid.

## BE AN ARTIST

Send for interesting picture book **BUILDING A FUTURE**

Explains the unique position of the professional artist in American life. Gives examples of large professional income. Tells definitely how YOU can acquire **PROFESSIONAL skill—AND PROFESSIONAL INCOME—** within one year—in spare time at home. No obligation. Book is free. Write name, address and age on penny postcard and mail **TODAY** to:

**GRANT SCHOOL OF ART**

Dept. 198, 53 W. Jackson Blvd., Chicago 4, Ill.

## LEARN LANDSCAPING

Profitable, healthful career—absorbing hobby, for men, women. Thorough 45-lesson home-study course takes 8-12 months spare time. Hundreds of successful graduates all over the world. 33rd year. Send for **FREE** catalog.

American Landscape School, 6529 Grand Ave., Des Moines, Iowa

## LAW

**STUDY AT HOME** for Business Success and **LARGER PERSONAL EARNINGS**. 39 years expert instruction—over 114,000 students enrolled. LL.B. Degree awarded. All text material furnished. Easy payment plan. Send for **FREE BOOK**—

"Law and Executive Guidance," **NOW!**

**AMERICAN EXTENSION SCHOOL OF LAW**

Dept. 96-PM 646 N. Michigan Ave. Chicago 11, Ill.

## SHORTHAND in 6 Weeks at Home

Famous Speedwriting system. No signs; no symbols; no machines; uses ABC's. Easy to learn; easy to write and transcribe. Fast preparation for a job. Surprisingly low cost. 100,000 taught by mail. Used in leading offices and Civil Service. Write for free booklet. **SPEEDWRITING**, Dept. 1512-8, 55 W. 42 St., New York 18



**CLEANS CLOTHES AT HOME!** SAVES DRY CLEANING BILLS!

**NEW INVENTION!**

Banishes old-style clothes cleaning... no messy chemicals, liquids, or powders. Use like brush. Simply glide over surface. Cleans Suits, Dresses, Coats, Hats, Ties, Suede Shoes. Also Window Shades, Wallpaper, Drapes, Upholstered Chairs, Day-ports, Carpets, Bugs, Automobile Cushions. Keeps them soft and supple. Saves costly cleaning bills. **Sells like wild!**

**SAMPLES for AGENTS!** Sample offer sent immediately to all who send name AT ONCE. A penny postal will do. **SEND NO MONEY—just your name.** KRISTEE CO., 695 Bar Street, AKRON, OHIO





# Learn ELECTRIC APPLIANCE

## Service & Repair

### AT HOME IN YOUR SPARE TIME

We teach you this interesting, good-paying business from A to Z—at home. Our practical, thorough, shop-method course qualifies you to take a job at once, or start in for yourself. A grade school education is all you need. This is an ideal time for men of all ages (up to 60) to get into this active, constantly expanding field, for every year sees millions of new homes wired for electricity . . . and multiple millions of new electric appliances produced. Everyone, literally, is a customer for the man who knows how to service and repair electric devices.

This business is particularly suited to the man who is handy with tools, and likes to keep busy with his hands . . . the men who are the makers, builders, and servicers of life. If you are not completely happy in your present work, there is a WIDE-OPEN OPPORTUNITY for you in this field . . . which is getting bigger and better every day.

### YOU LEARN

How To Repair  
Washing Machines  
Vacuum Cleaners  
Electric Ranges  
Lamps, Motors,  
Irons, etc.  
REFRIGERATION  
and  
House Wiring

This  
ELECTRICAL  
APPLIANCE  
TESTER  
and a  
BIG KIT OF TOOLS  
INCLUDED  
at No Extra Cost!

### Earn While You Learn

You can actually start earning before your course is finished with the Kit of Tools and Tester we send you. With your first set of lessons, I show you easy jobs that can be done in your spare time, at home. And remember—just one good repair job can pay for the complete cost of the course. A business can be started in your garage or basement—expanding from there, as you grow. Let's talk it over by mail.

Make it a point to get posted about our course by sending TODAY — without obligation — for our free booklet telling the entire story.

### OPEN YOUR OWN SHOP Be Independent and Secure

No new-fangled machine can ever take your place in this work . . . as it calls for trained hands to service appliances—so your job is safe, even in a depression. If you open your own shop, you not only enjoy security and independence . . . and can have others work for you . . . it's just a step to a prosperous appliance business where the **BIG PROFITS LIE**. There's no satisfaction like being your own boss, and here's a real opportunity to make that a reality. Or, of course, you can take a well paid job in this active line, as trained men are needed. Remember, this is AN ELECTRICAL AGE. Getting into this field now is to ride the tide of progress.



Send  
for this  
FREE  
BOOKLET



No Salesman Will Call

### MAIL COUPON TODAY

PACIFIC TRAINING SCHOOL — Dept. P-812  
7217 So. Broadway, Los Angeles 3, Calif.

Please send me your FREE BOOKLET:  
"Today's Big Opportunity — Appliance Servicing"

NAME \_\_\_\_\_ AGE \_\_\_\_\_

ADDRESS \_\_\_\_\_ ZONE \_\_\_\_\_

CITY \_\_\_\_\_ STATE \_\_\_\_\_

Please print plainly



→ LEARN ←

# AVIATION

AN ESSENTIAL INDUSTRY IN PEACE OR WAR  
**MAXIMUM TRAINING IN MINIMUM TIME**

for 19 years Cal-Aero Technical Institute has specialized in....

✓ **AERONAUTICAL ENGINEERING**

2 year course - kept abreast of new research and scientific development.

✓ **MASTER AVIATION MECHANICS**

1 year course - C. A. A. approved for Airplane and Engine License.

Modern "live" training equipment, including helicopters, jets, rockets, wind tunnel... Classes start monthly - Room and board available on our airport... Cal-Aero Tech Training is carefully designed for just one thing - **TO MAKE MORE MONEY FOR YOU.** More than 7000 successful graduates in addition to 26,000 pilots and 7500 mechanics trained for Army & Navy Air Forces, prove that our career training is unsurpassed. **APPROVED FOR VETERANS**



**CAL-AERO**  
**TECHNICAL INSTITUTE**

GRAND CENTRAL AIR TERMINAL  
 GLENDALE 1, CALIFORNIA  
 LOS ANGELES COUNTY

**MAIL THIS COUPON TODAY!**

Please send full information on Aviation Training **FREE**—without obligation.

Name \_\_\_\_\_ Birth Date \_\_\_\_\_

Street \_\_\_\_\_ Zone \_\_\_\_\_

City \_\_\_\_\_ State \_\_\_\_\_

CHECK ONE  VETERAN  NON-VETERAN PM-12

## Learn this Profitable Profession



**IN 90 DAYS AT HOME**

## Money-Making Career Open to Men and Women, 18 to 50

Hundreds of men and women between 18 and 50 make \$10 to \$20 in a single day giving scientific Swedish Massage and Hydro-Therapy treatments. There is big demand from doctors, hospitals, sanatoriums and clubs. Graduates earn large full time incomes from these or in private practice in their own offices. Others make good money from home treatments given in spare time. Learn this interesting, money-making profession in your own home, through our home study course. Same instructors as in our nationally known resident school. You can win independence and prepare for future security by qualifying for your Diploma. Course can be completed in 3 to 4 months. Many earn while they learn. Begin your training at once.



### Anatomy Charts & Booklet FREE

Enroll now and we will include, at no extra cost, many needed supplies. Fit yourself to help meet growing demand for Scientific Swedish Massage. Send the coupon at once for complete details. Anatomy Charts and 32-Page Illustrated Booklet, **FREE**, postpaid.

**THE COLLEGE OF SWEDISH MASSAGE**  
 Dept. 864-R, 41 E. Pearson, Chicago 11, Illinois

Please send me **FREE** and postpaid, Anatomy Charts, 32-page Booklet and complete details on Home Training.

Name \_\_\_\_\_ Age \_\_\_\_\_

Address \_\_\_\_\_

City \_\_\_\_\_ State \_\_\_\_\_

**GLOWS in the DARK** **FREE Sample!**

Be the first to sell luminous house numbers, light switch plates, wall protectors, pull cords. Also luminous pictures, statues, decals, and a host of religious, nursery and other objects that glow in the dark. Get into this new and growing industry. Enormous demand... no competition... sensational demonstration... big profits. Represent a large manufacturer, established over 84 years. Write today for liberal money-making offer and free sample to show how they glow in the dark.

**MADISON MILLS, 303 Fourth Ave. Dept. M-4 NEW YORK 10, N. Y.**

5

**DEVELOP MUSCLES LIKE MINE**  
 Says Dan Lurie "America's Most Muscular Man"

Learn how I built a powerful body. Find new strength, pep, vitality. Have the build you've always wanted, simply by following my amazing new course. It's easy and it's fun. Easy-to-understand, over 75 how-to-do-it pictures. Every Mr. America and the best built men in the world have used this proven method. Complete course only 50c postpaid. Do not send stamps please. INCLUDED FREE—4-11" x 22" illustrated wall charts to help you to learn.

**START IN AT ONCE — SEND FOR YOUR COURSE TODAY!**

Write to **DAN LURIE, Personal, Dept. 159**  
 1729 Rockaway Parkway Brooklyn 12, N. Y.

**NEW YORK SCHOOL of MECHANICAL DENTISTRY**

SINCE 1920—The outstanding Training Center for all phases of Dental Laboratory Technology. Licensed by New York and New Jersey States. Approved for Veterans G.I. BILL & P.L. 16. Visitors Welcome. Ask for Free Bulletin "P."

**NEW YORK SCHOOL OF MECHANICAL DENTISTRY**  
 America's Oldest School of Dental Technology  
 138 Washington St. NEWARK 2, NEW JERSEY  
 Also: 125 W. 31 Street NEW YORK 1, N. Y.  
 Immediate Enrollment — Day and Evening

**BOOK RAISE HAMSTERS**

The new wonder animals from Syria. Often called Toy Bears. Delightful pets. Everyone wants them. Laboratories need thousands. Clean, odorless. Raise anywhere. A profitable and interesting hobby or business. We furnish breeding stock with manual of instructions.

Write today for free illustrated literature.

**GULF HAMSTERY, 1536 BASIL, MOBILE, ALA.**

**Get this Great Catalog of MAGIC**

Amazing tricks, mystifying and spooky stage and party illusions. Easy to do—no skill—perfect instructions. Fool your friends. Loads of fun. Add "life" to any party. 350 pages. 600 illustrations. Mail \$1.00 for catalog, credited on your first order for \$5.00 or more.

**NATIONAL MAGIC COMPANY**  
 119 S. State St., Dept. P-12  
 Chicago 3, Ill.

**HOW TO CUT RAFTERS**

New vest pocket book gives lengths, side cuts, plumb cuts, deductions. For all rafters for any building from one inch to forty feet wide. Gives numbers to cut on square. Also degrees for some cuts for Radial Saws. All standard pitches from 3/4 to 5/8. Just open book to pitch page and there are your lengths, side cuts, etc. Anyone who knows what a jack rafter is can frame a roof if he has this great book. Price \$1.00, \$1.25 in Canada. Builders' Topics, Dept. M, Lock Box 828, Seattle, Washington. CARPENTERS, PLUMBERS, PLASTERERS, ELECTRICIANS, ETC., subscribe for Builders' Topics, the monthly magazine for HE-MAN CONSTRUCTION WORKERS. Only \$1.50 per year, (in Canada—\$2.00). Sample copies 25c.

**Thrilling Work COLORING PHOTOS**

Fascinating vocation learned at home by those with aptitude. Thrilling pastime. National method brings out life-like colors. Free booklet.

**EASY TO LEARN**  
**NATIONAL PHOTO COLORING SCHOOL**  
 1315 S. Michigan, Dept. 1359, Chicago 5



# BE A SUPERVISOR



**Franklin Technical Institute  
Helps Young People Get Ahead**

• The door to well-paid supervisory jobs in industry is wide open — to the man or woman with specialized technical training. 50,000 graduates of this Boston school have gone out to good jobs in engineering and technical fields.

Practical two-year day courses in industrial electricity and electronics, industrial chemistry, mechanical and machine design, structural and architectural design, automotive service and management, electric wiring and maintenance. Also preparatory and evening classes. G.I.-approved. 40th year.

**FRANKLIN TECHNICAL INSTITUTE**  
43 Berkeley St. Boston, Mass.  
Please send free information on all courses.

Name \_\_\_\_\_ Age \_\_\_\_\_  
Address \_\_\_\_\_  
City \_\_\_\_\_ State \_\_\_\_\_

## AIR RIFLES **BENJAMIN** AIR PISTOLS PIONEERS - LEADERS

SEND FOR FREE FOLDER OF LATEST MODELS TODAY  
If you want a REAL GUN for PRACTICAL USE inside or outdoors get a SAFE - CLEAN - ECONOMICAL - BENJAMIN with Adjustable Power and Amazing Accuracy. For BEST RESULTS use BENJAMIN H-C PELLETS. WRITE AT ONCE. BENJAMIN AIR RIFLE CO., 812 MARION ST., ST. LOUIS 4, MO.

All he's interested in is his Stewart Keith Water-Cooled Pipe



Any man will go for this new, amazing Stewart Keith Water-Cooled Pipe, with filter. The smoke is traveled thru leakproof passage in the

c-o-o-l water chamber—entering the mouth many degrees cooler. Makes your favorite tobacco smoke milder, cleaner, drier and much c-o-o-l-e-r.

Engineered light as ordinary pipes. Carry it with you — Smoke it anywhere. Genuine Imported Briar bowl.

### WATER-COOLED PIPE



**ONLY \$6.00**  
WE PAY POSTAGE

### THE IDEAL GIFT FOR HIM!

UNCONDITIONALLY GUARANTEED FOR 1 YR. Lifetime workmanship guarantee. PAT. PEND.



**SOLD MAIL ORDER ONLY**  
Order yours today, direct from

**Stewart Keith**  
WATER-COOLED PIPES

DEPT. P, 301 TENTH AVE., N. Y. 1, N. Y.

# THESE 5 TRADES ASSURE YOU HIGH PAY • Future Security

- **PLUMBING** Every phase of plumbing: Pipe-Cutting and Threading, Lead-Wiping, Rough-in Projects on Installations, Completed Installations of entire plumbing systems, Blueprint reading, Estimating.
- **DRAFTING** College-level courses in General Machine and Architectural Drafting, with fundamentals in Drafting Mathematics—all under graduate engineers.
- **SHOE REPAIRING** From simplest repairs on boots and shoes to the finest details of reconditioning and rebuilding, under expert craftsmen.
- **ELECTRICAL** Technical and shop training include Basic Electricity, Residential Wiring, Industrial Wiring, General Testing and Trouble Shooting, and Appliance Repair.
- **AUTOMOTIVE & TRACTOR** Applied training on latest model automobiles and tractors, including engine overhaul, transmission and differentials, carburetion, generator and ignition systems, engine tune up, Hydramatic and Vacumatic Transmissions, and general service.

**Choose One of these 5 Essential Trades**  
Our complete courses of thorough training prepare you to go right into the field as a Qualified Tradesman at High Pay in only 34 weeks (39 in Shoe Repair). All courses under especially trained instructors with practical experience. 6 Hour Classes 5 Days a Week. Our Employment Department helps you.

**VETERANS** "Approved for veterans' training by the State Department of Education under Public Law 346."  
"Approved for veterans' training by the Veterans Administration under Law 15."

Send Coupon for Free Information Now

*"There's Always a Demand for the Man who KNOWS!"*

**CHOOSE ONE OF THESE 5 LEADING TRADES**

Get Out of that Rut... Be a Skilled Tradesman! Have a Lifetime Career... Own Your Own Business and Be Secure in Your Old Age.

**NOW** while Enrollment is still open, send for FREE information.

THE 5 DIVISIONS OF

### NATIONAL TRADE SCHOOL

2610 Grand Ave., Kansas City 8, Mo.

- \_\_\_ ● Plumbing
- \_\_\_ ● Shoe Repairing
- \_\_\_ ● Automotive & Tractor
- \_\_\_ ● Drafting
- \_\_\_ ● Electrical

NAME \_\_\_\_\_

ADDRESS \_\_\_\_\_

CITY \_\_\_\_\_ STATE \_\_\_\_\_

VETERAN \_\_\_\_\_ OCCUPATION \_\_\_\_\_



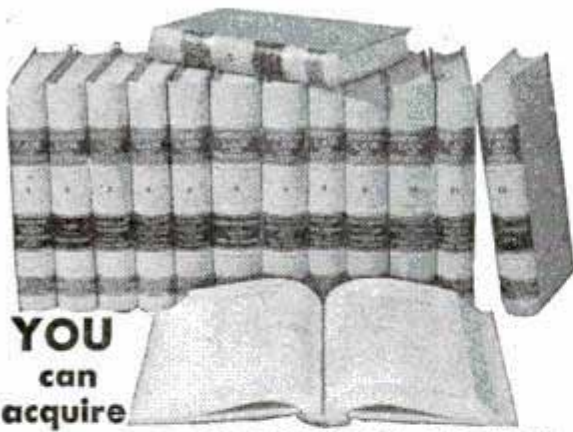

YOU  
can  
acquire

## LAW NIGHTS AT HOME! L. L. B. DEGREE

LaSalle's famous Law Library—used as reference in many Law libraries and Law offices—has enabled thousands to master Law surprisingly fast, in spare hours at home, for business and professional advancement.

These 14 remarkable volumes, compiled by leading professors and lawyers, cover the whole basic field of Law in condensed, orderly, simplified manner.

You advance rapidly with this great library, plus special lectures furnished. We guide you step-by-step with personalized Problem Method of instruction . . . you learn by doing—handling legal problems—not by memorizing rules.

Send for two FREE 48-page booklets, "Law Training for Leadership," and "Evidence," answering questions about Law and its value to you, and telling how LaSalle Law graduates are winning rapid advancement in business and public life. Mail coupon below. No obligation.

### LA SALLE EXTENSION UNIVERSITY

A Correspondence Institution

417 S. Dearborn St. Dept. 1264-L Chicago 5, ILL.

Send me your two FREE booklets described above; without obligation.

Name..... Age.....

Street.....

City, Zone & State.....

**FREE BOOK**

TELLS HOW TO BE AN . . .

*Accountant  
Salesman  
Secretary  
Stenographer*

### SECURED FUTURE . . . FREE EMPLOYMENT SERVICE

Enter one of the "substantial earnings" fields through Hill's "Success Plan" training. A lifetime opportunity to join thousands of successful graduates in positions secured through our nation-wide employment service. No matter where you live, what you are doing now, Hill's can train you by study at home or in the resident school. Big Free book shows you the way to substantial earnings and an assured future. G. I. Approved.

Hill's Extension School & Business University  
Dept. PM-12, 619 W. Main St., Oklahoma City 2, Okla.  
Please send your free book, "Through Hill's to Success."

NAME.....  
ADDRESS.....  
CITY..... STATE.....

Check here if eligible under G.I. Bill.

EASY-TO-USE COUPON TODAY

## "YOU ARE UNDER ARREST!"

There's a Thrill in Bringing a Crook to Justice Through Scientific



### CRIME DETECTION!

We have taught thousands this exciting, profitable, pleasant profession. Let us teach you, too, in your own home. Learn Finger Printing, Fire Arms Identification, Police Photography and Criminal Investigation Thoroughly, quickly and at small cost.

Be A  
**FINGER  
PRINT  
Expert**

Over 800 of All American Bureaus of Identification employ students or graduates of I. A. S. You, too, can fit yourself to fill a responsible crime-detection job with good pay and steady employment. But don't delay—get the details now. Let us show you how easily and completely we can prepare you for this fascinating work, during spare time, in your own home. You may pay as you learn. Write today . . . Now . . . Be sure to state age.

**FREE!!!**  
Send for Thrilling  
"BLUE BOOK  
OF CRIME"

**INSTITUTE OF APPLIED SCIENCE**  
1920 Sunnyside Ave., Dept. 1359, Chicago 40, Ill.



### LABORATORY TECHNICIAN

BE A LABORATORY SPECIALIST; complete course. Big demand from hospitals, doctors, clinics. We teach all branches of medical laboratory work, including Medical and Dental X-Ray.

Approved by American College of Medical Technologists  
Co-educational Free Placement Bureau  
Free Catalog

Accredited for "veteran" training

**CHICAGO COLLEGE OF LABORATORY TECHNIQUE**  
Dept. P.M., 431 S. Wabash Ave. Chicago 5, Illinois

## Become a Doctor of PSYCHOLOGY

Win the degree of Ps.D. Teach the secret of contentment, happiness. Solve mental worries. Experience the revelation of truth. Chartered college. Individual help. Write for FREE book. **COLLEGE OF UNIVERSAL TRUTH**, 5153-B North Clark St., Chicago.

## WATCH REPAIRING

Be a Master Watchmaker! Graduates earn big money—many in business for themselves. The famous Sweazey System of Instruction teaches you quickly and easily. Our 41st year.

Write today for free information.

**CHICAGO SCHOOL OF WATCHMAKING**  
Dept. 1128, 1608 Milwaukee Ave. Chicago 47, Ill.

## ELECTRICAL TRAINING

Intensive 32 weeks' residence course in fundamentals of industrial electrical engineering, including radio, electronics. Prepares for technician, engineering aides. Approved for veteran training. 56th year. Enter April 4. Catalog.

**BLISS ELECTRICAL SCHOOL**  
7646 TAKOMA AVENUE  
WASHINGTON 12, D. C.



## APTITUDE TESTS

discover the kind of work or studies best for your success! You get a personal report—a guide for life—more happiness—more prosperity. For men, women, boys and girls. Write for complete facts.

**VOCATIONAL COUNSELING INSTITUTE**  
956 Maccabees Bldg., Detroit 2, Michigan



## THERE'S MONEY IN CARTOONS!

RAYE BURNS will teach you HOW to CREATE ORIGINAL CARTOONS at home that you may SELL! Course contains 26 lessons and over 600 illustrations. All for Only... **\$2.85**

Send name and address for free details.

**RAYE BURNS SCHOOL**, Dept. M, Box 3583, Cleveland, Ohio



## LEARN MEAT CUTTING At Home — In Spare Time

Get into the vital meat industry. Concise, practical Home Training based on 25 years proven instruction methods used at National's famous resident school. Prepares you for bigger pay as Meat Cutter, Supervisor, meat manager or more money in your own store. Go as rapidly as your spare time permits. Diploma. Start NOW to turn your spare hours into money. Send for FREE bulletin today. No obligation.

**National School of Meat Cutting, Inc.**, Div. U-100, Toledo 4, Ohio



# EVEN IF YOU DON'T KNOW A NOTE OF MUSIC NOW...

## You Can Learn Your Favorite Instrument This Easy A-B-C Way

No special talent, no previous musical training needed. This remarkable U. S. School home-study method is so successful because you learn to play by playing real tunes by note, right from the very start.

With a U. S. School Course you look forward to the time you spend on your lessons. No tiresome exercises. No long-winded explanations. Instead of hard work, learning to play becomes a happy pastime. You begin with simple melodies. As you improve,



### EASY AS A-B-C



you take up more advanced tunes. Soon you'll be thrilled to find yourself playing many popular numbers by note. And no matter which instrument you take up, the cost is only a few pennies a day.

If you honestly want to learn music, to be invited everywhere, and get lots

more fun out of life, send in the coupon below for our FREE 36-page Booklet and Print and Picture Sample. They give full details. (Instruments supplied when needed, cash or credit.)



**U. S. SCHOOL OF MUSIC**  
712 Brunswick Bldg., New York 10, N. Y.

### FREE! Print and Picture Sample

U. S. School of Music, 712 Brunswick Bldg., New York 10, N. Y. Please send me free booklet and Print and Picture Sample. I would like to play instrument checked below.

<input type="checkbox"/> Piano	<input type="checkbox"/> Saxophone	<input type="checkbox"/> Modern Elementary Harmony
<input type="checkbox"/> Guitar	<input type="checkbox"/> Trumpet, Cornet	<input type="checkbox"/> Clarinet
<input type="checkbox"/> Violin	<input type="checkbox"/> Reed Organ	<input type="checkbox"/> Other Instrument
<input type="checkbox"/> Piano Accordion	<input type="checkbox"/> Tenor Banjo	

Name \_\_\_\_\_  
 Street \_\_\_\_\_  
 City \_\_\_\_\_ State \_\_\_\_\_

SAVE 2c - STICK COUPON ON PENNY POSTAL

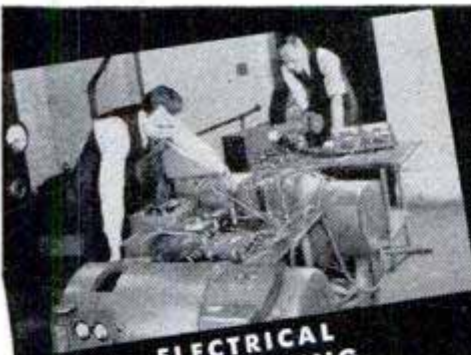

### ELECTRICAL ENGINEERING



### ELECTRONICS

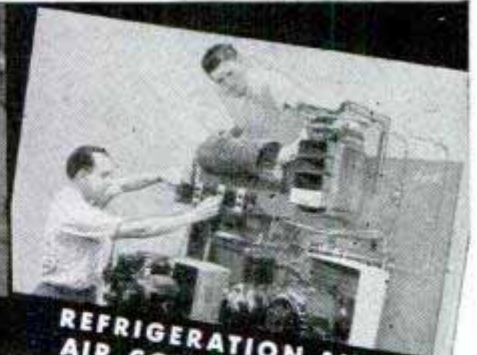

### REFRIGERATION AND AIR CONDITIONING

## SPECIALIZE In 6 Months to 3 Years COURSES

### SERVICE

6 to 12 Months

- Electricity
- Welding
- Refrigeration
- Heating

### TECHNICIAN

1 to 2 Years

- Electrotechnics
- Radio and Television
- Electronics
- Refrigeration, Heating, and Air Conditioning

### PROFESSIONAL

3 Years

- Electrical Engineering Bachelor of Science Degree  
Major in Machinery or Electronics



## PRACTICAL TECHNICAL TRAINING

Train for a substantial career in industry . . . or a business of your own. Our time-tested Concentric System enables you to build your career step by step. Each 6-month course is complete in itself, yet prepares you for advanced courses. Stay as long as circumstances permit, until you reach the top step in your technical training. More than 1,538 students now enrolled from 48 states and 13 overseas countries. Faculty of 72 specialists. World-wide alumni counselor committee. Terms start January, April, July and September. SEND COUPON TODAY!

### MILWAUKEE SCHOOL OF ENGINEERING

"A Technical Institute - Founded 1903"

Milwaukee School of Engineering  
 Dept. PM-1248, N. Broadway and E. State, Milwaukee, Wis.  
 Without obligation send me free booklet "Career Building" and more details on course

In \_\_\_\_\_  
 Name \_\_\_\_\_ Age \_\_\_\_\_  
 Address \_\_\_\_\_  
 City \_\_\_\_\_ State \_\_\_\_\_



# 9 BIG BUILDING BOOKS

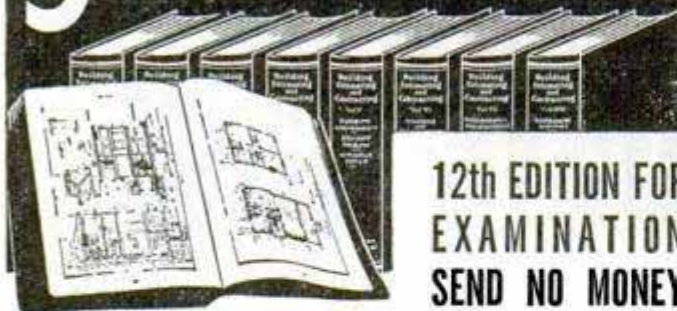

**12th EDITION FOR EXAMINATION SEND NO MONEY**

Learn to draw plans, estimate, be a live-wire builder, do remodeling, contracting. These 9 practical, profusely illustrated books cover subjects that will help you to get more work and make more money. Masonry, concrete forms, carpentry, steel square, roof framing, construction, plumbing, heating, painting, decorating and many other subjects. More than 4000 pages—2750 illustrations.

## BETTER JOBS — BETTER PAY UP-TO-DATE EDITION

A nationwide building boom is in full swing and trained men are needed. Big opportunities are always for MEN WHO KNOW HOW. These books supply quick, easily understood training and handy, permanent reference information that helps solve building problems.

These books are the most up-to-date and complete we have ever published on these many subjects.

### Coupon Brings Nine Big Books for Examination

**AMERICAN TECHNICAL SOCIETY—Publishers since 1898**  
Dept. G919 Drexel at 58th Street Chicago 37, Ill.

You may ship me the Up-to-Date edition of your nine big books, "Building, Estimating and Contracting," without any obligation to buy. I will pay the delivery charges only, and if fully satisfied in ten days, I will send you \$2.00, and after that only \$3.00 a month, until the total price of only \$34.80 is paid. I am not obligated in any way unless I keep the books.

Name \_\_\_\_\_

Address \_\_\_\_\_

City \_\_\_\_\_ State \_\_\_\_\_

Please attach a letter stating your age, occupation, employer's name and address, and name and address of at least one business man as a reference. Men in service, also please give home address.

# 4 Keys to SUCCESS IN AVIATION

Through Embry-Riddle Training

- |                               |                                  |
|-------------------------------|----------------------------------|
| ① AIRCRAFT & ENGINE MECHANICS | ② COMMERCIAL PILOTS              |
| ③ FLIGHT CREW TRAINING        | ④ A & E COMBINED WITH COMMERCIAL |

**AVIATION NEEDS YOU NOW!** We have hundreds of urgent requests for Embry-Riddle ground and flight graduates. Take advantage of Embry-Riddle's modern equipment... a quarter century of training experience... Florida's perfect flying weather. Start your career now -- write today for full information and proof of job opportunities.

### Authorized G. I. Training

Dean of Enrollments -- Dept. 99A  
Embry-Riddle School of Aviation  
MIAMI 30, FLORIDA

Please Print  
NAME \_\_\_\_\_  
ADDRESS \_\_\_\_\_  
City \_\_\_\_\_  
State \_\_\_\_\_ Age \_\_\_\_\_

I am interested in...

- A.&E. Mechanic  
 Commercial Pilot  
 Air Carrier Training  
 A.&E. Combined with Commercial Pilot  
 Flying Mechanic

Check One  Veteran  Non-Veteran

**TRAIN IN MIAMI--AIR CAPITAL OF THE WORLD**

## Famous BAILEY TECHNICAL SCHOOLS

OFFER THE FOLLOWING COURSES:  
**PRACTICAL DIESEL ENGINEERING**  
**REFRIGERATION-AIR CONDITIONING**  
**COMMERCIAL ELECTRICITY**  
**RADIO-TELEVISION MECHANICS**

Your future success depends largely on the reputation of the school you attend. Don't take chances! Train at America's foremost school of mechanical specialization. Bailey is recognized and approved by industry. Bailey graduates get the top pay jobs! G.I. Approved. Send for FREE Catalog.

**BAILEY TECHNICAL SCHOOLS**  
1655 So. Grand Blvd., St. Louis, Mo.

## ACCOUNTING

STUDY AT HOME for C.P.A. and BIG PAY Accounting opportunities with 44 year old school. No previous training needed. Texts furnished. EASY PAYMENTS. Send for FREE BOOK: G. I. APPROVED.

**MACCORMAC EXTENSION SCHOOL**  
Dept. M 1170 E. 63rd St. Chicago 37, Ill.



## Be an INVESTIGATOR

**JAMES S. BOLAN, FORMER POLICE COMMISSIONER OF NEW YORK CITY** offers MEN & WOMEN an attractive opportunity to prepare for a future in *Investigation & Criminology* by comprehensive Home Study Course. Free placement service assists graduates to obtain jobs. APPROVED UNDER G. I. BILL OF RIGHTS. Write for Free Booklet PM.

**THE BOLAN ACADEMY, INC.**  
EMPIRE STATE BLDG., NEW YORK 1, N. Y.

## Learn BAKING At Home

Baking is one of America's high industries in wages. Nearly depression-proof. Thorough basic home course lays sound foundation. If you have aptitude, write for FREE BOOKLET, "Opportunities in Commercial Baking." National Baking School, 1315 Mich. Ave., Dept. 1359, Chicago 5.



## ARTISTS MAKE MONEY

Do you like to draw? Send name, address, age and occupation for FREE ART TEST, to find out your ability.

**ART INSTRUCTION, Inc.**  
12138 ART INSTRUCTION BLDG., MINNEAPOLIS 15, MINN.

## STAMMERER?

This new 128-page book, "Stammering, Its Cause and Correction," describes the Bogue Unit Method for scientific correction of stammering and stuttering—successful for 47 years. Benj. N. Bogue, Dept. 4824, Circle Tower, Indianapolis 4, Ind.



## WATCHMAKING

Millions of watches and clocks need repairing. Start your training now for a better paying job or own profitable business. Qualified watchmakers in demand. Outstanding training by experts. Write for free catalog. Approved for veterans.

**SCIENTIFIC SCHOOL OF WATCHMAKING, Dept. PM-12**  
3923 San Fernando Road Glendale 4, Calif.

## WHY DON'T YOU WRITE?

Writing short stories, articles on business, politics, sports, shop crafts, local and club activities, etc., will enable you to earn extra money. In your own home, on your own time, the New York Copy Desk Method teaches you how to write the way newspaper men learn, by writing. Our unique "Writing Aptitude Test" tells whether you possess the fundamental qualities essential to successful writing. You'll enjoy this test. Write for it, without cost or obligation.

**Veterans: This course approved for Veterans' Training.**  
**NEWSPAPER INSTITUTE OF AMERICA**  
SUITE 5598-W, ONE PARK AVENUE, NEW YORK 16, N. Y.



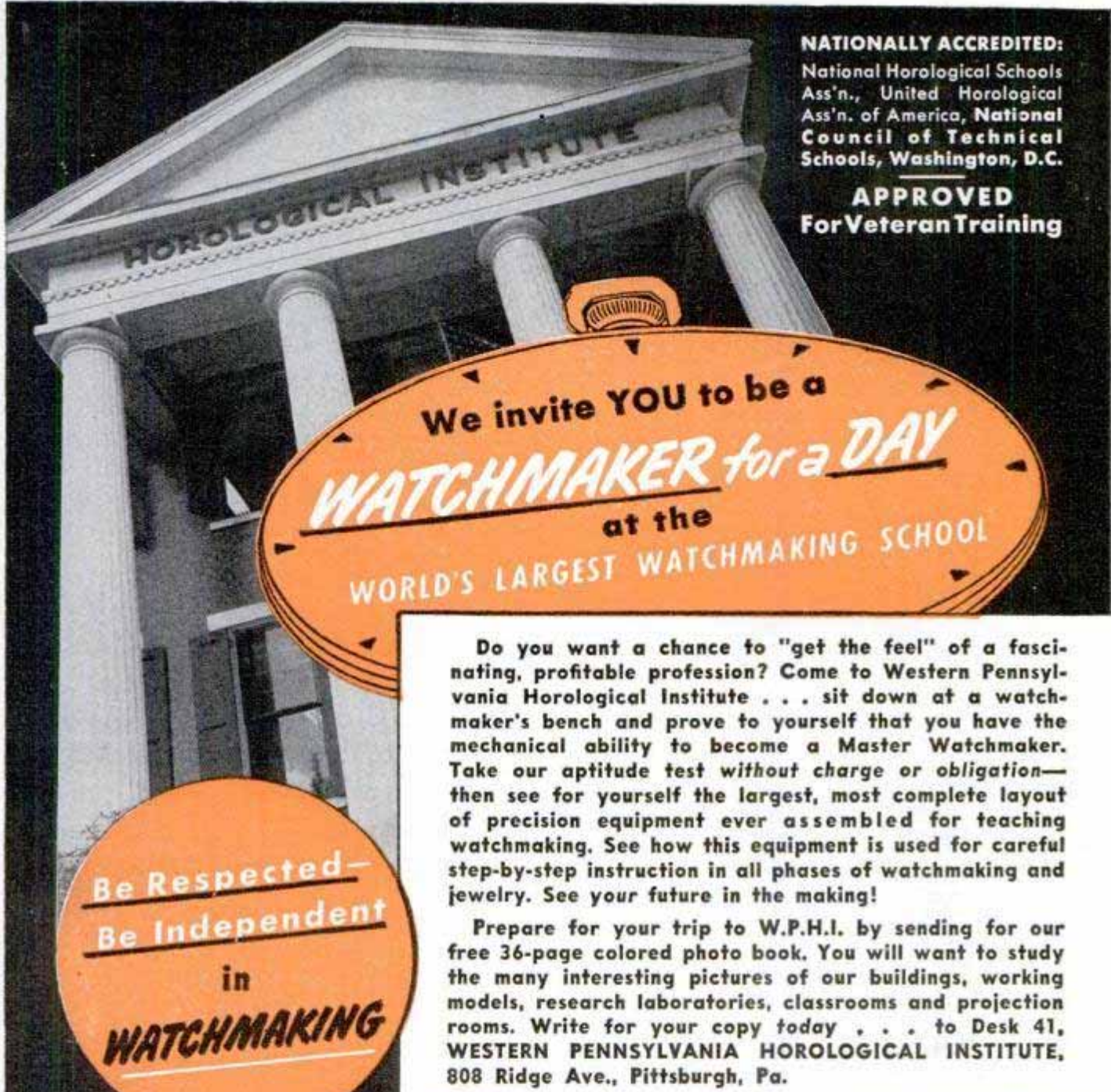

**NATIONALLY ACCREDITED:**  
 National Horological Schools  
 Ass'n., United Horological  
 Ass'n. of America, National  
 Council of Technical  
 Schools, Washington, D.C.

**APPROVED**  
**For Veteran Training**

We invite YOU to be a  
**WATCHMAKER** for a **DAY**  
 at the  
 WORLD'S LARGEST WATCHMAKING SCHOOL

Do you want a chance to "get the feel" of a fascinating, profitable profession? Come to Western Pennsylvania Horological Institute . . . sit down at a watchmaker's bench and prove to yourself that you have the mechanical ability to become a Master Watchmaker. Take our aptitude test *without charge or obligation*—then see for yourself the largest, most complete layout of precision equipment ever assembled for teaching watchmaking. See how this equipment is used for careful step-by-step instruction in all phases of watchmaking and jewelry. See your future in the making!

Prepare for your trip to W.P.H.I. by sending for our free 36-page colored photo book. You will want to study the many interesting pictures of our buildings, working models, research laboratories, classrooms and projection rooms. Write for your copy today . . . to Desk 41, WESTERN PENNSYLVANIA HOROLOGICAL INSTITUTE, 808 Ridge Ave., Pittsburgh, Pa.

Be Respected—  
Be Independent  
 in  
**WATCHMAKING**

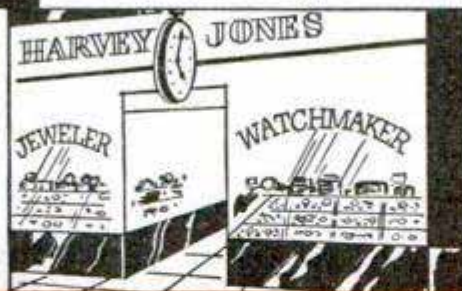

**YOU'RE WANTED** by select jewelers everywhere for high-paying, pleasant watch repair. Avoid ordinary dime-a-dozen trades and seek the unusual. Watchmaking has been a guarded profession for generations.

**KEEP YOUR TOWN** on time and become its most respected merchant. Watchmaking is your start to independence and a profitable jewelry business of your own. Start building your future solidly, carefully—NOW!

**SECURITY FOR LIFE** is yours in watchmaking, one of the few mechanical trades you can conduct at home. Watchmaking is depression-proof and age-proof . . . your skill is your security as long as you live.

**ORIGINATORS OF THE WORLD'S FIRST COMPLETE CHRONOGRAPH COURSE**

**WESTERN PENNSYLVANIA HOROLOGICAL INSTITUTE, INC.**



# Learn **RADIO** -TELEVISION F.M.-ELECTRONICS



## in the GREAT SHOPS OF **COYNE**

Get ready for a better job, bigger pay NOW in Radio. Cash in with "All-around" knowledge of Radio—Television. Train on actual equipment. You learn easily at COYNE because it's real shop training. Thousands of graduates in Industry.

### Not a "Home-Study" Course!

You get actual shop work on full-size equipment plus necessary theory. Whether you had previous experience or not makes no difference at Coyne.

### Easy To Start Own Shop

Right along with our course, we include special training on how to operate your own Radio Shop.

GI Approved—Finance Plan for Non-Vets  
Special Plan for Men of Draft Age

If you need part-time work to help out with living expenses while at Coyne we'll help you get it. Don't be held back by lack of money. Free employment service to graduates.

### SEND FOR FREE BOOK

Get the facts! BIG FREE BOOK tells about your future in Radio and Television and how you can prepare at Coyne. Dozens of pictures. No obligation—no salesman will call.

Established 1899

### MAIL COUPON TODAY!

B.W. COOKE, President  
COYNE Electrical and Radio School  
500 S. Paulina St., Dept. 98-3H, Chicago 12, Ill.

Please send me your Big Free Radio and Television Book and all facts, including plan for men of draft age.

NAME.....

STREET.....

CITY..... STATE.....

**COYNE**  
Gives You All-Around Shop Training in:  
**RADIO**  
**ELECTRONICS**  
**TELEVISION**  
**FREQUENCY MODULATION (FM)**  
**RADIO SERVICE (Your own shop)**  
**SOUND SYSTEMS**



SAY YOU SAW IT IN POPULAR MECHANICS

## OWN Your Own Business



## Lifetime Income

Clean and Mothproof rugs and upholstery "in the home" or public buildings. Start full or part time. Gross profits up to \$15 and \$20 a day on EACH of your service men. Easy to learn . . . quickly established.

**DURACLEAN** cleans by absorption! No scrubbing, soaking or shrinkage. Dirt and grease vanish . . . matted pile rises . . . colors revive. Furnishings used again same day.

**DURAPROOF** resists moths, mildew and carpet beetles. Your service backed by a National Money Back 4 Year Warranty.

We furnish enough material to return your total investment. EASY TERMS. Territories limited. Send for FREE booklet . . . full details.

**Duraclean Co.** 16-D Ct. Deerfield, Ill.

## "How to Make Money With Simple Cartoons"

A book everyone who likes to draw should have. It is free; no obligations. Simply address  
**CARTOONISTS' EXCHANGE**

Dept. 912-D Pleasant Hill, Ohio

## DO IT WITH ANTIQUES

A Profitable Hobby or full time business at home buying, selling, repairing or restoring Antiques and other old things. Learn how to make big money from "Antiques for Profit." \$2.98 post paid or write for free folder.

**THE OLD ANTIQUER, 11652-N Collins St., North Hollywood, Calif.**

## LEARN EXPORT



Buy and sell world-wide without capital. Travel abroad if desired. Export men and women in demand. Your own business — profits unlimited. Salaried jobs in many branches of Export-Import. Practical, low cost **WORLD TRADE COURSE** teaches you quickly at home in spare time. No previous special experience or schooling needed. World Trade Certificate awarded. Write today for **FREE BOOKLET**. No obligation. State if veteran. Airmail reaches us overnight. **THE MELLINGER CO., Exporters-Importers, 1422-CK Westwood, Los Angeles 24, Calif.**



## CORRESPONDENCE COURSES IN RADIO and ELECTRICAL ENGINEERING

Tuition \$25

**ELECTRICAL ENGINEERING.** Get your grasp of wide electrical field. Modern. Very understandable. Theory made easy.  
**RADIO ENGINEERING.** Extra fine course in radio, public address, photo-electric work. Trains you to be super-service man, real vacuum tube technician. Tuition ONLY \$25, either course. Deferred payment plan. Servicemen needed badly.

**FREE** Write for free copies of school catalogs, student magazines, etc.  
**LINCOLN ENGINEERING SCHOOL, Box 931-P120, Lincoln, Nebr.**

## Lathe Centers and Drill Pads

Description	No. 2 Taper	No. 3 Taper
L—SCREW CENTER	\$3.15	\$3.50
G—DRILL PAD	2.65	2.90
H—CROTCH CENTER	2.65	3.50
J—HOLLOW CENTER, 60°	2.15	2.90
I—60° CENTER	2.40	3.15
P—CARBIDE TIP CENTER	4.75	8.50
Q—HALF CENTER	2.40	3.15
N—CUP CENTER	2.15	2.90
M—SPUR CENTER	3.15	3.50

Prices Postpaid

**SOUTH BEND LATHE WORKS**  
455A E. Madison St.  
South Bend 22, Indiana



# OIL BURNER

INFORMATION IN A HANDY FORM



A POCKET COMPANION THAT ANSWERS YOUR QUESTIONS!

## AUDELS OIL BURNER GUIDE

- A new practical, concise treatise, 384 pages-31 Chapters - 321 Diagrams and Illustrations - covering Domestic and Industrial Oil Burners.

New from Cover to Cover, for mechanics interested in Oil Burners. Gives practical inside working knowledge of theory, construction, installation, operation, testing, servicing and repair of all types of oil burners. Includes electrical hook-ups and wiring diagrams of automatic control systems.

PRICE \$1 POSTPAID

Get this information for yourself. Mail coupon today. No obligation unless satisfied.

ASK TO SEE IT

AUDEL, Publishers, 49 W. 23rd St., New York 10, N.Y.

Please mail AUDELS OIL BURNER GUIDE (Price \$1). If satisfactory, I will remit \$1 on its safe arrival, otherwise I will return the book.

Name \_\_\_\_\_

Address \_\_\_\_\_

Occupation \_\_\_\_\_

Employed by \_\_\_\_\_ PM

# PRACTICAL AUTO INFORMATION

Keeps Cars Rolling by Making Repairs and Adjustments Easy!

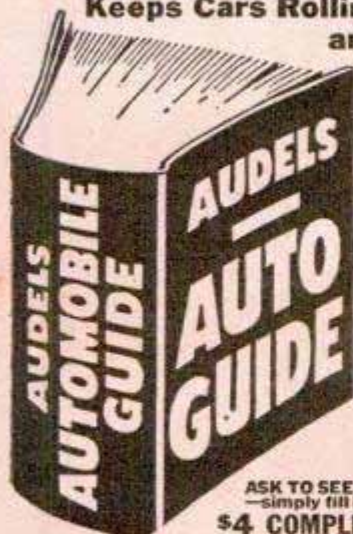

**AUDELS AUTO GUIDE**  
For Every Mechanic, Driver, Owner and Repair Shop.

Sent on 7 Days Approval

Shows How to Tune Up—Keep Brakes Safe—Batteries Powerful—Tire Mileage Up—Save Gas—Lubricate Correctly.

**ANSWERS YOUR QUESTIONS**

Contains all you need to know about 1—Construction, 2—Operation, 3—Service, 4—Repair of Modern Motor Cars, Trucks, Buses & Diesel Engines in every detail.

**NEW FLUID DRIVE TREATED**

Easy to understand—1540 Pages, 1540 Illustrations. Gives definite directions on How to handle service jobs.

ASK TO SEE IT—Get this information for yourself—simply fill in and mail coupon today.

\$4 COMPLETE • PAY ONLY \$1 A MO.

AUDEL, Publishers, 49 West 23rd St., New York  
Mail AUDELS AUTOMOBILE GUIDE (\$4) for free examination. If O. K., I will send you \$1 in 7 days; then remit \$1 monthly until \$4 is paid. Otherwise, I will return book promptly.

Name \_\_\_\_\_

Address \_\_\_\_\_

Occupation \_\_\_\_\_

Employed by \_\_\_\_\_ PM

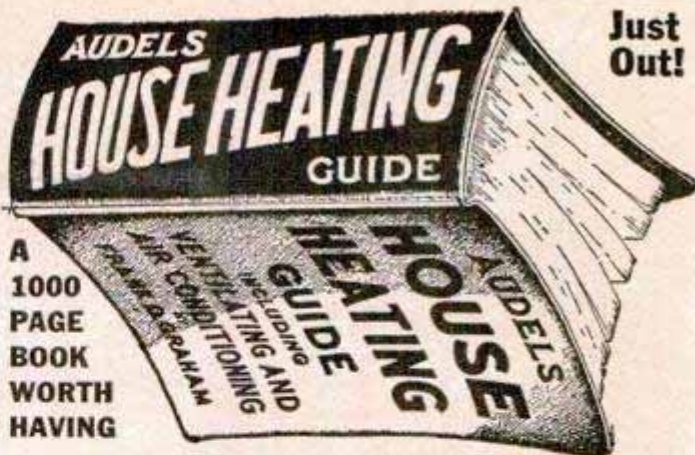

Just Out!

A 1000 PAGE BOOK WORTH HAVING

For Heating, Ventilating and Air Conditioning Engineers, Plumbers, Maintenance Men, Contractors, Building Superintendents and Mechanics seeking practical, authentic information on Heating, Ventilating, Air Conditioning. 1000 Pages—910 Illustrations—57 Chapters explaining the working principles of all Modern House Heating, Ventilation and Air Conditioning systems. Fully illustrated and indexed. This up to date book of reference gives answers to 1001 questions on Heating, Ventilating, Air Conditioning & Radiant Heating.

\$4 COMPLETE • PAY ONLY \$1 A MONTH

To get this assistance for yourself, fill in and

--- MAIL ORDER ---

AUDEL, Publishers, 49 W. 23rd St., New York 10, N. Y.

MAIL AUDELS HOUSE HEATING GUIDE for free examination. If O. K. I will send you \$1 in 7 days; then remit \$1 monthly until price of \$4 is paid. Otherwise, I will return it.

Name \_\_\_\_\_

Address \_\_\_\_\_

Occupation \_\_\_\_\_

Employed by \_\_\_\_\_ PM

# AUDELS Carpenters and Builders Guides

4 vols. \$6



Inside Trade Information for Carpenters, Builders, Joiners, Building Mechanics and all Woodworkers. These Guides give you the short-cut instructions that you want—including new methods, ideas, solutions, plans, systems and money saving suggestions. An easy progressive course for the apprentice and student. A practical daily helper and Quick Reference for the master worker. Carpenters everywhere are using these Guides as a Helping Hand to Easier Work, Better Work and Better Pay. To get this assistance for yourself, simply fill in and mail the FREE COUPON below.

## Inside Trade Information On:

How to use the steel square—How to file and set saws—How to build furniture—How to use a mitre box—How to use the chalk line—How to use rules and scales—How to make joints—Carpenters arithmetic—Solving mensuration problems—Estimating strength of timbers—How to set girders and sills—How to frame houses and roofs—How to estimate costs—How to build houses, barns, garages, bungalows, etc.—How to read and draw plans—Drawing up specifications—How to excavate—How to use settings 12, 13 and 17 on the steel square—How to build hoists and scaffolds—skylights—How to build stairs—How to put on interior trim—How to hang doors—How to lay floor—How to paint



AUDEL, Publishers, 49 W. 23rd St., New York 10, N. Y.

Mail Audels Carpenters and Builders Guides, 4 vols., on 7 days free trial. If O.K. I will remit \$1 in 7 days and \$1 monthly until \$6 is paid. Otherwise I will return them. No obligation unless I am satisfied.

Name \_\_\_\_\_

Address \_\_\_\_\_

Occupation \_\_\_\_\_

Employed by \_\_\_\_\_ PM





**Start As High As \$3,351 a Year**  
**Get Ready Now for 1949 Examinations**  
**In Your Locality**  
**Veterans Get Preference**

**City Mail Carriers, Post Office Clerks**

Clerks and Carriers now get \$2,550 the first year on regular and automatically increase \$100 a year to \$3,550. Open to men, women 18 to 50.

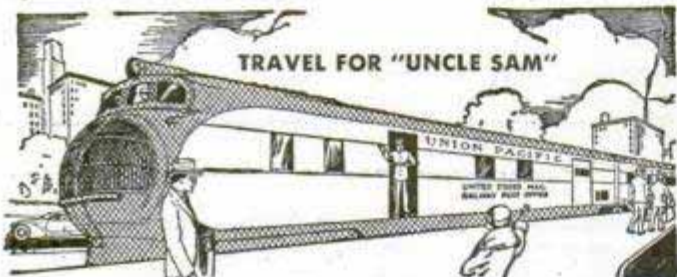

**Railway Postal Clerks**

Railway Postal Clerks get \$2,750 the first year regular, being paid on the first and fifteenth of each month. (\$114.60 each pay day.) Their pay is automatically increased yearly to \$3,850. Advance may be had to Chief Clerk at \$5,850 a year. (\$243.75 each pay day.) Male veterans only.

**3 Days On—3 Days Off—Full Pay**

Railway Postal Clerks on long runs usually work 3 days and have 3 days off duty or in the same proportion. During this off duty their pay continues just as though they were working. They travel on a pass when on business. When they grow old, they are retired with a pension.



**Many Other Positions**

Many other positions are obtainable. Rural Carriers—Stenographers—Typists—Assistant Statistical Clerks—Customs Inspectors—Office Machine Operators—etc. Those wishing these positions should qualify at once.

**Get Free List of Positions**

Fill out the following coupon. Tear it off and mail it today—NOW, at once.

Although not government sponsored this investment can result in your getting a big paid government job.

**FRANKLIN INSTITUTE, Dept. J86, Rochester 4, N. Y.**

Rush to me, entirely free of charge (1) a full description of U. S. Government Jobs; (2) Free copy of illustrated 40-page book, "How To Get A U. S. Government Job"; (3) List of U. S. Government Jobs; (4) Tell me what to do to qualify for one of these jobs.

Name \_\_\_\_\_

Address \_\_\_\_\_ Vet? \_\_\_\_\_

Use This Coupon Before You Mislay it. Write or Print Plainly.

**NEW Pocket Thickness Measure**

A pocket-watch size precision dial indicator weighing only 1½ oz. for accurately measuring the thickness of sheets, strips or tubing, round, square, or hexagonal stock, tissues, fibres or filaments of materials such as rubber, metal, paper, plastics, leather, glass or cloth.

4 MODELS .0005", .001", and .01 mm graduations. Range of all models 5/16" (8mm).



PRICE \$15.10 Post-paid complete with leather case and full instructions.

**B. C. AMES CO.**

68 AMES STREET  
WALTHAM 54, MASS.

MFR. OF MICROMETER DIAL GAUGES & INDICATORS

**MONEY for MEN ALL FREE**  
DATA

THE PLASTEX Industry needs manufacturers on small scale and for big production of Lamp and Clock Stands, Art Goods and Novelties in Plastex and Marble imitation. Experience unnecessary. 1/2c material makes regular 10c store sellers. Rubber moulds furnished for speed production. Small investment brings good returns. Big chain store orders now being placed. Ambitious men have chance for real prosperity. Our Free booklet will interest and benefit you.

PLASTEX INDUSTRIES, Dept. A  
3400 Third Ave. New York 56, N. Y.

**INVENTORS: Place Your Invention on Display at the AMERICAN INVENTORS EXHIBIT**

—the only permanent exhibit of inventions in this country. Here Chicago and visiting manufacturers will have an opportunity to see and arrange to purchase your invention.

Write for free particulars.

AMERICAN INVENTORS EXHIBIT  
184 W. WASHINGTON CHICAGO 2, ILL.

**LEARN MOVIE PROJECTION THEATRE MANAGEMENT**



The Motion Picture Theatre Business offers big opportunities for trained men. Get into a fascinating field with a promising future. Train at home in spare time. Free Catalog. Established 20 years.

THEATRE SCHOOL, 370 Washington St., Elmira, New York

**RENOVATE YOUR JACKET**

Your old leather jacket will look like new when our service department repairs, cleans and restores the leather to its original shade and finish.

Send for FREE descriptive circular and itemized price list today!

BERLEW MANUFACTURING CO., INC.  
MERRICK, NEW YORK

**ITALIAN ACCORDIONS**

Hand Made. Very Best. Lowest Prices. Buy Direct from Factory Representative and Save Money. Send Name and Address for FREE catalog.

ITALIAN ACCORDION MFG. CO.  
7600 Cottage Grove Ave., Dept. PM12, Chicago, Ill.

**LUMBER MEASUREMENT BOOK FOR A SQUARE FT. COUNT**

Teaches lineal Square and Board ft., of all size lumber by pc. or bundle. Contains tables, tallies, formulas and illustrations. P.P. \$1.50, 2 for \$2.00.

R. C. MORRONE, P. O. BOX 8911, PHILADELPHIA 35, PA.  
(Ideal XMAS GIFT for the Apprentice, etc.)

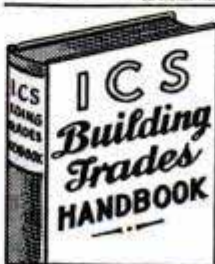

**Yours for only \$1.75**  
MONEY BACK GUARANTEE

The world-famous I. C. S. BUILDING TRADES HANDBOOK  
Hundreds of thousands of satisfied users!

• 366 pages... 347 illustrations... Quick reference index... Packed with facts, formulas, techniques to help you profit on job or hobby! Your money back if returned in 10 days. Tear out this ad. Mail with only \$1.75 to I.C.S., Dept. 111 1001 Wyoming Avenue, Scranton 9, Pa.



**DO ANY JOB.. EASIER.. QUICKER**  
**MAKE MORE MONEY** in the  
**BIG OPPORTUNITY**  
**FIELDS**

**SEND NO MONEY**  
 Select the Books  
**YOU Need Now!**  
 We Ship **C.O.D.**  
 Anywhere in **U. S.**  
 and Will Refund  
 Amount Paid if  
 Not Satisfactory.

**Here's the Help You Need**  
**For Best Paying Jobs**  
**Right NOW!**

**FREE TRIAL**  
**IN YOUR OWN HOME**

Used by Army, Navy, Other Government  
 Depts., 200 Schools and Industrial Firms.

Do it now! Get the better pay that goes to men with specialized knowledge. Get into one of these big opportunity fields. Big money and many other advantages await you if you prepare now. Here is the help you need—EASY—QUICK—AT LOW COST. Thousands of men have already used these famous books. Beginners and experienced men alike have doubled and tripled their earnings with this help. You too, can now get the special knowledge you need for top pay, better jobs, or a business of your own. This is your **GOLDEN OPPORTUNITY**.

**AIR CONDITIONING**

Big air conditioning boom is Nation-wide and bigger than ever. Alive with new opportunities! Get this non-technical book by international authority and be ready for your share of millions to be spent. Covers whole field. 450 pages. Illustrated. \$4.00.

**SHEET METAL LAYOUT**

Makes sheet metal layout work so simple that anyone can learn. Get this new instructor and get into the easiest, cleanest and best paying part of all sheet metal work. 143 jobs worked out in drawings and carefully explained. Gives standard for all sheet metal fittings. \$3.50.

**BAILEY'S HANDBOOK**

World famous handbook of universal questions and answers for Stationary, Marine and DIESEL engines and firemen. Prepares for any license examination in installation, maintenance and operation of Diesel and steam plants. Pocket size, \$2.00.

**MODERN WELDING**

Newest book on all types of welding and heat treatment of metals. Written by recognized specialists in training men for production jobs. 430 Pages, 277 Illus. Practical and Non-Technical. Covers everything you need to know. \$4.00.



**REFRIGERATION—Book of the Hour!**

**Biggest Opportunity in Many Years!**  
**LATEST PRINTING — ALMOST 1000 PAGES**

408 Pictures—17 Diagrams in Colors Makes All Refrigerator Service Maintenance, Repairs Simple as A. B. C.

Thousands of Refrigerators need repairs! Owners will pay big for competent service which will be needed more and more. Get **MODERN GAS AND ELECTRIC REFRIGERATION**, the non-technical guide to all types of refrigerators and get your share of this new profit. Get a job or start your own service business. This book will help you make money anywhere. It is the recognized standard book on the subject. Price \$5.00.

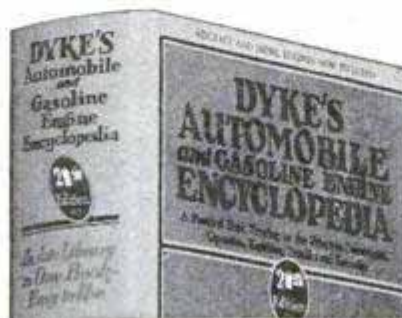

1948  
**21st**  
 EDITION  
 Leading  
 Auto  
 Book  
 for Over  
 32 Years

World's **Greatest AUTO BOOK**

**New Material, Specifications,  
 1947 Cars, 1948 Trucks, Busses,  
 Tractors, Diesels**

Now with millions of cars needing repairs and thousands of men needed to do the work, you need the famous DYKE Auto Book more than ever before. New 21st Edition covers all principles, construction, repair, adjustments, testing, troubles and remedies. Over a half million copies of 20 editions of Dyke's have been sold. Buick Dynafo, Farm and Outdoor Motors and new electrical systems now covered. World's biggest book value. Only \$7.00.

This big book, a complete auto library in one volume, has 1483 pages—4600 illustrations and diagrams—weighs 6 lbs.—equal to 4 ordinary books.

**HOUSE WIRING — NEW EDITION**

Get this new sixth edition of this standard and practical electrical wiring book. It gives complete practical instruction on every phase of house wiring in one handy volume. Goes further than most books on subject. Hand-book style. Gives National Electric Code. 400 pages, 669 illustrations. Electrical work will reach a new high with millions of new homes to be built. Get started now. \$3.00.

Mail Coupon to **GOODHEART-WILLCOX CO., Dept. 19, 1321 S. Michigan Ave., Chicago**

**20 Million Refrigerators  
 Need Service and  
 Repairs**



**The Easy Way to a  
 Profitable Business  
 Of Your Own!**

Owners will spend big money to keep their good older cars looking like the new ones coming out. This is a practical money-making guide, ideal for shop owners and every man who wants a share of the millions to be spent in keeping old cars looking new. Tells how to get a good job or start business of your own with small capital. Covers everything including tools, methods and materials. Only book of its kind. 325 pages, 232 illustrations. \$3.50.

**CARBURETORS — Dyke**

The standard guide in the best paying auto work for a generation. It has helped thousands of men make money. New edition covers engine tune-up, compression, ignition, carburetion, fuel pump valves, etc. Use this book to specialize in this big field. 244 pages, 549 illustrations. \$3.50.

**SEND NO MONEY! Mail Coupon**

**GOODHEART-WILLCOX CO.,  
 1321 S. Michigan Ave., Dept. 19, Chicago 5, Ill.**

Send books checked, C.O.D. I will pay postman, plus few cents charges. If not satisfactory I will return books in 5 days and you will refund money paid. (Outside U.S. or possessions remit with order.)

- Gas & Electric Refrigeration . . . . . \$5.00
- Dyke's Auto Book . . . . . \$7.00
- Dyke's Carburetor Book . \$3.50
- Modern Welding . . . . . \$4.00
- Airplane Welding . . . . . \$3.50
- Sheet Metal Layout . . . . . \$3.50
- Air Conditioning . . . . . \$4.00
- Engineers Handbook . . . \$2.00
- Body and Fender Repair . \$3.50
- Shop Math. (2 Vols.) . . . \$3.00
- House Wiring . . . . . \$3.00
- A.C. Power Wiring . . . . . \$4.00
- D.C. Power Wiring . . . . . \$4.00

If remittance accompanies order we will pay all postage charges under same return privilege.

Name \_\_\_\_\_

Address \_\_\_\_\_

City \_\_\_\_\_ State \_\_\_\_\_



# EARN MORE

\$\$\$\$\$



## SEND FOR THIS FREE BOOK NOW!

• Increase your earning power. Become thoroughly trained in a well-paid profession. Without obligation, find out about the opportunities in Electrical, Mechanical, Plastics, Civil, Mining and other engineering fields. Our free 118-page handbook, lists details of home study courses, compiled by world authorities. See for yourself how you can soon earn more dollars. Write today, to: Canadian Institute of Science and Technology, Ltd., 468 Century Building, 412, 5th Street, N.W., Washington, D. C.

*Special discounts for Veterans and Servicemen.*

**MAIL THIS COUPON NOW**

Canadian Institute of Science & Technology, Ltd.,  
468 Century Building, 412, 5th Street N.W.,  
Washington, D.C.

Please forward free of cost or obligation of any kind your 118-page handbook "Engineering Opportunities".

Name..... Age.....

Address .....

CANADIAN ENQUIRIES: 219 Bay Street, Toronto 1.

**Say You Saw It in Popular Mechanics**

# INVENTORS

When you are satisfied that you have invented a matter of value—write me, without obligation, for full information as to what steps you should take to secure a Patent.

The usual first step is to have a search of the prior U. S. Patents conducted, so that I can report to you on the question of Patentability.

## PATRICK D. BEAVERS

(Formerly RANDOLPH & BEAVERS)

Registered Patent Attorney

934 Columbian Building Washington 1, D. C.

**PATRICK D. BEAVERS, Registered Patent Atty.**  
934 Columbian Bldg., Washington 1, D. C.

Please send me full information on how to secure Patent Protection and Trademark Registration.

Name.....

Street.....

City..... State.....

# Drafting PAYS BIG

Learn in Spare Time — At Home or at Allied School in Chicago

**KEY POSITIONS OPEN IN INDUSTRY**

- Mechanical Drafting
- Structural Drafting
- Aircraft Drafting
- Tool and Die Making
- Tool and Die Designing
- Machinist Trade
- Product Designing
- Product Illustrating

**Train Now!**

In Nationally Known, Fully Approved School and Endorsed by Industry . . .

Established in 1928  
**FREE EMPLOYMENT SERVICE**

Approved for Civilians and Veterans . . .

• • • Write For Catalog — A 1c Postcard will do

**ALLIED SCHOOL OF MECHANICAL TRADES**

1338-1340-1342 So. Michigan Ave.

4212 Allied Bldg.

CHICAGO 5, ILL.



## HAPPY READING

Send for my free lists of 1845 Little Blue Books and 737 Larger Books priced from 10c up. Send \$1 for a year of my monthly, The American Freeman.

**E. HALDEMAN-JULIUS**

Dept. A-2467

Girard, Kansas



## WILL YOU RISK \$1.50

For An Extra Paycheck Each Week?  
**MAKE LEATHER GOODS TO SELL FOR PROFIT AND GIVE AS GIFTS FOR CHRISTMAS**

Beautiful belts, bags, billfolds and many other sure sellers can be made in no time. Send \$1.50 and receive our complete illustrated leathercraft instruction book.

**DO AS HUNDREDS OF OTHERS HAVE DONE AND INCREASE YOUR INCOME**

If you wait you may forget! Write for your book today.

**CONTINENTAL LEATHER CO.**  
201 1/2 W. Magnolia, Fort Worth, Tex.

## PRACTICAL MATHEMATICS 4 BOOKS IN ONE! SAVE HALF PRICE!

Easy self-instruction in 25 branches by college experts—all in one volume! Helps you qualify for a better job. 1280 pages, 600 illustrations. Sent for free trial. Only \$1.00 down, \$1.00 a month; total \$4.95 plus postage. (Cash price \$9.00 postpaid). 160-page Logarithm book free with order. National Educational Alliance, Inc., Dept. 5612, 37 West 47th St., New York 19, N. Y.

# INVENTORS

IF YOU WISH TO PROTECT YOUR INVENTION, You should take steps to protect it by a U. S. Patent. Write me for "Record of Invention" form.

**CARL MILLER**  
REGISTERED PATENT ATTORNEY

Woolworth Bldg., 35th Floor, Dept. 128-A, New York City  
Please send me "Record of Invention" form.

NAME.....

ADDRESS.....

# PATENTS AND TRADE MARKS

## C.A. SNOW & CO.

REGISTERED PATENT ATTORNEYS

WRITE FOR INFORMATION TO  
428 SNOW BUILDING, WASHINGTON 1, D. C.

# PATENTS

"Proof of Invention" Folder mailed without obligation.

**E. E. VROOMAN, Registered Patent Atty.**  
505 McKim Building, Washington 5, D. C.

# TRI-STATE COLLEGE

B. S. Degree in 27 months in Civil, Electrical, Mechanical, Chemical, Aeronautical, Radio Engineering; Bus. Admin., Acc't and Sec. Science. Graduates successful. 65th year. Enter Jan., March, June, Sept. Catalog. 4128 College Ave., Angola, Ind.

POPULAR MECHANICS



# STUDY AT HOME

With An Educational Institution

Men with specialized training win higher positions, insure larger earnings, and are bigger successes in business and public life. Opportunities NOW greater than ever before. Send for our-Catalog.

## ARTS and SCIENCES

Courses in Philosophy; Education; Letters; Public Health; Medical Jurisprudence; Psychology; Sociology; Physics; Chemistry; Plastics; Geology; Political Science; Theology; Business and Commerce; Accounting; Mathematics; Statistics; Agriculture.

## ENGINEERING

Courses in Electrical, Civil, Mechanical, Drafting, Architectural, Steam, Aeronautical, Radio, Structural, Mining, Industrial, Petroleum, Marine, Chemical, Diesel, Automobile, Refrigeration, and Air Conditioning Engineering.

## LAW

Complete Professional Law Course includes 18 Hornbook Series college grade textbooks. Courses also in Commercial Law, Patent Law and Medical Jurisprudence.

McKinley-Roosevelt Incorporated, 4610-K, Sheridan Rd., Chicago 40, Ill.

## Learn ORNAMENTAL HORTICULTURE

A thorough, constructive home training for employment or advancement in Nursery Operations, Park Supervision or maintenance, Landscape Designing or Landscape Gardening. My 3 way Plan shows you how to start your own business, get a better job, or earn extra money in spare time. Send for Free Book. APPROVED FOR VETERANS.

### NATIONAL LANDSCAPE INSTITUTE

Dept. P-12, 310 So. Robertson Los Angeles 36, California

# ELECTRICIANS' SCHOOL

HOUSE AND COMMERCIAL WIRING • MOTOR REPAIR AND REWINDING • ELECTRIC REFRIGERATION

Approved for Veterans Training

## PENNSYLVANIA INSTITUTE SCHOOL OF ELECTRICITY

42nd and SPRUCE STS. PHILADELPHIA 4, PENNA.

## New 1949 PLASTICS SUPPLIES CATALOG

Just off press. Full details on Plexiglas, Lucite, rods, sheets, tubes, Acetates, cements, dyes, buffs, molding sets, tools, carving kits, accessories. Everything in plastics. Gives prices, sizes, colors, etc. Price 10c, stamps or coin, with ad for catalog.

### PLASTICS MFG. & SUPPLY CORP.

DEPT. M-12- • 4707 EUCLID AVE. • CLEVELAND 3, OHIO

## HAMSTERS!

Get the unique Golden Hamster today. Profitable, Practical, Educational, friendly, 1000's needed by labs and pet shops. Raised anywhere. No experience required. Send 10c for literature or \$5 for pair and literature. Azalea City Hamstery, 1412 East Linwood Dr., Dept. F, Mobile 18, Alabama

## DON'T BE A JOB SLAVE! LEARN WATCH REPAIRING AT HOME

### WITH OUR SELF TRAINING KIT

Get started NOW in this uncrowded field! EASY to learn! BIG MONEY! SECURE FUTURE! Earn while you learn! Even as a sideline you can make \$50 and up each week. —Our new PRACTICAL SELF-TRAINING KIT is all you need. Contains set of PROFESSIONAL TOOLS: (Loupe, 3-4 power; complete set of 6 special screw drivers—finest tempered steel blades; Tweezer AA; Plastic Material tray) and

COMPLETE BOOK on Modern Watch Repairing. Fully illustrated, easy to understand, shows every step in repair, adjustment and use of tools. Now only **\$6.25** Post Paid

(if C.O.D., plus charges.) Money Back Guarantee. If ordered separately: book \$3.25; set of tools, \$3.50. MODERN TECHNICAL BOOK & TOOL CO. Dept. MMC, 55 W. 42nd Street, New York 18, N. Y.

New All Inclusive Precision Tool, Material Catalog for Watch-Clockmakers, Jewelers, Tool-Instrument Makers, Handcrafters. Over 600 ILLUSTRATIONS and IDENTIFICATION CHART. NEW REDUCED PRICES. All books in these and OTHER TECHNICAL fields; write for literature. SEND 25c for catalog—FREE with order.

Train Now in Spare Hours at Home for a Better Job at Better Pay in...

# REFRIGERATION and AIR CONDITIONING

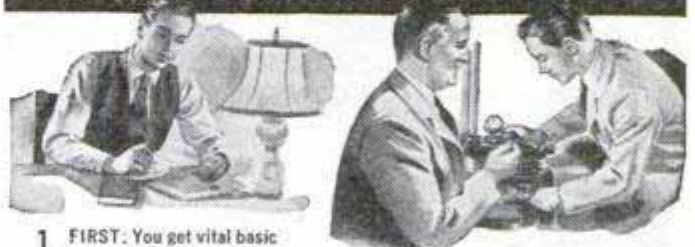

1. FIRST: You get vital basic knowledge at home—during spare hours. Train as fast or as leisurely as you like.

2. THEN: You come to ITI's giant shops in Chicago—for a Full Four Weeks of practical instruction and actual work on newest, most modern equipment.

## RICH Rewards for the Trained Man

Now is the time to lay your plans for a better job at better pay! Get the facts about your future in the amazingly FAST GROWING field of Refrigeration, Air Conditioning and Heating! Men who know how to install, repair, rebuild and maintain this equipment are going ahead FAST! But many more fine jobs are open NOW in this rapidly expanding industry in both the home and commercial equipment fields. Experts say the opportunities are almost unlimited. . . . BUT ONLY PROPERLY TRAINED MEN CAN QUALIFY FOR THE BETTER PAYING JOBS!

Investigate the Industrial Training Institute's 2-Way Course in Refrigeration, Air Conditioning AND Heating. In a few months this training gives you solid, practical, down-to-earth knowledge and experience you need. You don't need any special schooling or experience to master the ITI course. It's so simple, easy, and practical that you can finish your Training in a short few months' time. And after completing your Training ITI's wonderful job placement service is available to you without extra cost!

### TRAINING MEN FOR INDUSTRY SINCE 1916!

ITI Training is backed by more than 30 years of success and experience. We have given training to over 400,000 men since 1916. Today thousands of ITI graduates hold down top paying jobs. ITI occupies five large buildings, with over \$500,000.00 invested in shops and training facilities. Instruction staff of more than 100 men.

### VETERANS!

ITI residence training is fully approved under the G I Bill of Rights. Check coupon for special veterans' bulletin.

## THIS BIG BOOK FREE!

Find out about ITI Training. See for yourself how easy and simple it is to start at home, in your spare time, and prepare yourself for a fine job with a real future. It's all in ITI's fascinating, illustrated FREE book, "Your Future in Refrigeration & Air Conditioning." Just fill out and mail the coupon below NOW! Take this first step toward success TODAY!

### INDUSTRIAL TRAINING INSTITUTE

Dept. M-1  
2150 Lawrence Avenue, Chicago 25, Ill.



INDUSTRIAL TRAINING INSTITUTE  
2150 Lawrence Avenue  
Dept. M-1, Chicago 25, Ill.

Please send me FREE the ITI book, "Your Future in Refrigeration and Air Conditioning" and information about the opportunities for trained men in this fast growing field. I understand I'm under no obligation.

Name \_\_\_\_\_ Age \_\_\_\_\_

Address \_\_\_\_\_

City \_\_\_\_\_ Zone \_\_\_\_\_ State \_\_\_\_\_

Are You A Veteran? \_\_\_\_\_



# ELECTRICIANS

Get this Great Book

# FREE

Book of 150 Shop Prints, Wiring Diagrams, Full Size 9 1/2 x 11"



For Merely Examining  
Coyne's NEW Pay Raising

## 8 Volume Set APPLIED ELECTRICITY

Here's a brand new set of electrical books to give you the "know how" on all branches of electricity from appliance repairing to D.C. and A.C. equipment, electrical refrigeration, Industrial Electronics, etc. 3,400 subjects, 11,500 facts, latest methods explained in easy to follow instructions. To prove how valuable and Practical this set can be to you, I'll give you a FREE copy of my book "150 Shop Prints and How to Read Them" just for looking over this set. Written by the Coyne Staff and backed by 47 years' experience, this set has helped many ambitious electrical workers to bigger pay and added opportunity.

**OFFER LIMITED • ACT NOW!** If you act promptly, I'll send you the 8 volume set Applied Practical Electricity for 7 days FREE examination... together with the 150 Shop Print Book. Look the set over 7 days. If you like it send either \$22.75 cash or \$3.00 after 7 days and \$3.00 per month until \$24 is paid. If you don't want the set, return it and YOU OWE NOTHING. In either event you keep the 150 Shop Print Book absolutely FREE.

Coupon below is just a request to see the books free and to get my gift book for doing it. ACT—Send coupon Today!

Technical Book Div. COYNE ELECTRICAL SCHOOL  
500 S. Paulina St., Dept. 98-R6, Chicago 12, Ill.

FREE BOOK  
Coupon

SEND NO MONEY



B. W. Cooke, Director COYNE ELECTRICAL & RADIO SCHOOL  
500 S. Paulina St., Dept. 98-R6, Chicago 12, Ill.

O. K. send me, postpaid, Coyne's new 8 volume, "Applied Practical Electricity" for 7 Days FREE TRIAL per your offer. Also send, absolutely FREE, the book of 150 Shop Prints as a gift.

Name \_\_\_\_\_ Age \_\_\_\_\_  
Address \_\_\_\_\_  
Town \_\_\_\_\_ Zone \_\_\_\_\_ State \_\_\_\_\_

## NOW! Build Your Future On



# DIESEL Opportunities

LOOK around you. See the way tractors, trucks, buses, railroads, ships, power plants and equipment of many kinds are "going Diesel." Every day new opportunities are opening—in industrial and farming communities—for trained men who can install, maintain, operate and repair Diesel engines. Plan now to build your future in this growing field.

## Diesel Knowledge is Earning Power

You don't have to give up your present job. Now, you can begin learning DIESEL in spare time at home. UEI practical training teaches you, step by step, how Diesel engines operate, how fuel systems work, repairs, accessories and auxiliary equipment; a world of Diesel "know how." Includes actual practice on Diesel equipment in our shop under expert guidance. UEI training methods are successful. For 20 years they have helped mechanically inclined men better themselves.

## NOW IT'S UP TO YOU!

Coupon below brings you all the facts without cost or obligation. Get going today! MAIL COUPON NOW.

**UTILITIES ENGINEERING INSTITUTE**  
Diesel Division  
2521 Sheffield Ave.  
Dept. 1128-D  
Chicago 14, Ill.

Founded 1927



Send Coupon for FREE FACTS

UTILITIES ENGINEERING INSTITUTE, Diesel Division  
2521 Sheffield Ave., Dept. 1128-D, Chicago 14, Ill.

Please send me Free Facts about Diesel opportunities and training.

NAME \_\_\_\_\_ Age \_\_\_\_\_  
ADDRESS \_\_\_\_\_  
CITY \_\_\_\_\_ Zone or County \_\_\_\_\_ STATE \_\_\_\_\_  
 Check here for special information if you are under 17.

# SUCCEED IN THE POULTRY BUSINESS!



Poultry is providing many trained men and women with a good, comfortable living, either part or full time. For 27 years our Home Study Course has been helping thousands obtain training and "know how" that means extra income from the start. Don't delay—Write today for prospectus describing courses, methods, service, opportunities.

NATIONAL POULTRY INSTITUTE  
DEPT. 50 ADAMS CENTER, N. Y.

## Attention! Buyers!

Here's your directory of 10,000 items about plans, blueprints, tools, machinery, sports, and business opportunities. The latest on schools, courses, hobbies, patents, photography, autos and boats. Cross-indexed to use in a jiffy. Four and a half million readers must be right. You will be too with this HANDY GUIDE to POPULAR MECHANICS advertisers. Send for it today, only \$2c!

POPULAR MECHANICS PRESS, 200 E. Ontario St., Chicago 11, Ill.

## HELPFUL BOOKS

Send post card asking for FREE catalog

Popular Mechanics Press, 200 E. Ontario, Dept. 601, Chicago 11



## For a Shipshape Shop!

Popular Mechanics SHOP NOTES 1949 is the book you need, 240 interest-packed pages for mechanic, painter, carpenter, auto-worker, electrician, welder, farmer, plumber and home craftsman. Whether it's ball bearings or shotgun gauges, painting a car or mounting motors, the best and latest methods are here.

Hundreds of articles. Hundreds of ideas! See your news dealer or order direct from  
**POPULAR MECHANICS PRESS... \$1.00**  
200 E. ONTARIO ST. CHICAGO 11

## Handy Mail Order List

### Little Library of Useful INFORMATION

5 for \$1.00  
12 for \$2.00  
25¢ Each

Here at amazingly low cost is the practical help and information you have always wanted. Articles in previous issues of Popular Mechanics have been classified according to subject and are now available in these handy reprint booklets.

- How to Use Measuring Tools—Micrometers, Calipers, etc.—106.
- Power Driven Saws—74.
- Drill Presses, Grinders, Etc.—79.
- Wood, Metal Turning Lathes—81.
- Filing Machine, Hacksaw, Cutoff Wheel, Shaper—82.
- Lathe Tools You Can Make—101.
- Workbenches—Tool Cabinets—47.
- Spray Painting—94.
- From Pattern to Casting—91.
- Tool and Saw Sharpening—92.
- Sharpening Drills, Wood Bits—90.
- Successful Wood Turning—32.
- How to Read Blueprint—71.
- Metal Turning Lathe Kinks—99.
- Operating a Metal Lathe—100.
- Heat Treating, Hardening—102.
- Working With Glass—103.
- Servicing Elec. Motors—75.
- Electromagnets & Solenoids—44.
- Transformer Construction—41.
- The Boy Electrician—43.
- Soldering and Brazing—17.
- Arc and Spot Welders—5.
- Electroplating With Nickel, Chromium, Cadmium, Etc.—86.
- Plating Leather, Wood, etc.—87.
- Lower Your Fuel Costs—31.
- Curing Leaky Basements—45.
- Fitting Home Game Room—55.
- Indoor & Outdoor Fireplaces—88.
- Backyard Gardening—39.
- Lawn and Garden Novelties—72.
- Trellises, Pergolas, Fences—76.
- Lawn and Garden Furniture—77.
- Playground Equipment—73.
- How to Use Your Drill Press—125.
- Making Serving Trays—53.
- Knots and Ropework—105.
- Sanders—80.
- House Wiring—89.
- Hanging Wallpaper—38.
- Built-in Fixtures—78.
- Bird Houses—7.
- Magazine Racks—49.
- Clock Cases—50.
- Book Ends—52.
- Small Tables—54.
- Smoking Stands—56.
- Desks—58.
- Book Cases—59.
- Action Toys—66.
- High Flying Kites—67.
- Telescopes—20.
- Metal Craft—28.
- Small Looms—37.
- Gem Cutting—42.
- Photo Enlargers—1.
- Photo Kinks—98.
- Cleaning Formulas—11.
- Taxidermy—9.
- Photo Lighting—119.
- Training Dogs—35.
- Small Furnaces—36.
- Simple Home Improvements—104.
- Ridding Home of Insect Pests—107.
- Children's Room Furniture—51.
- Jigsawed Novelties—57.
- Doll House & Doll Furniture—60.
- 25 Shelves You Can Make—64.
- Novelties Turned on Lathe—62.
- Inlay Pictures—Veneering—63.
- Wood, Soap Carving—65.
- Windmills & Weather-vanes—68.
- Lanes from Wood, Metal—69.
- Rustic Furniture—18.
- Wood Finishing—40.
- How to Fix Electrical Appliances—111.
- Painting Your House—117.
- Build Your Own Relays—123.
- Rowboats, Small Dinghy—83.
- Small Sail Boats—84.
- Two Outdoor Runabouts—85.
- Build Own Canoe, Kayak—30.
- Build Class-E Ice Yacht—22.
- Auto Kinks, Shortcuts—10.
- Lawn and Garden Equipment—124.
- Motor-Driven Midget Cars—34.
- Stop Auto Elect. Troubles—95.
- Photo Printers and Dryers—25.
- Photo Darkroom Equipment—96.
- Trick and Table Top Photos—97.
- Home Movie Equipment—118.
- Poultry Houses—108.
- Guns and Decoys—109.
- Re-Silvering Mirrors—70.
- Chemical Experiments—93.
- Log Cabins, Tourist Houses—14.
- Using Basic Tools—120.
- Farm and Garden Tractors—8.
- Building Extra Attic Rooms—23.
- Attractive Basement Rooms—24.

POPULAR MECHANICS PRESS, Dept. 635, 200 E. Ontario, Chicago 11





You receive all parts, including tubes, for building this fine, modern Superheterodyne Receiver. This and other valuable standard equipment becomes your property.

# Learn RADIO TELEVISION, ELECTRONICS

by

## SHOP METHOD HOME TRAINING

Let NATIONAL SCHOOLS, of Los Angeles, a practical Technical Resident Trade School for almost 50 years, train you for today's unlimited opportunities in Radio

these two **FREE** books will tell you how



### Good Jobs Await the Trained Radio Technician

You are needed in the great, modern Radio, Television and Electronics industry! Trained Radio technicians are in constant and growing demand at excellent pay—in Broadcasting, Communications, Television, Radar, Research Laboratories, Home Radio Service, etc. National Schools Master Shop Method Home Study Course, with newly added lessons and equipment, can train you in your spare time, right in your own home, for these exciting opportunities. Our method has been proved by the remarkable success of National Schools-trained men all over the world.

### You Learn by Building Equipment with Standard Radio Parts We Send You

Your National Schools Course includes not only basic theory, but practical training as well—you learn by doing. We send you complete standard equipment of professional quality for building various experimental and test units. You advance step by step until you are able to build the modern superheterodyne receiver shown above, which is yours to keep and enjoy. You perform more than 100 experiments—build many types of circuits, signal generator, low power radio transmitter, audio oscillator, and other units. The Free Books shown above tell you more about it—send for them today!



### NOW! NEW PROFESSIONAL MULTITESTER INCLUDED



This versatile testing instrument is portable and complete with test leads and batteries. Simple to operate, accurate and dependable. You will be able to quickly locate trouble and adjust the most delicate circuits. You can use the Multitester at home or on service calls. It is designed to measure AC and DC volts, current, resistance and decibels. You will be proud to own and use this valuable professional instrument.

### LESSONS AND INSTRUCTION MATERIAL ARE UP-TO-DATE, PRACTICAL, INTERESTING

National Schools Master Shop Method Home Training gives you basic and advanced instruction in all phases of Radio, Television and Electronics. Each lesson is made easy to understand by numerous illustrations and diagrams. All instruction material has been developed and tested in our own shops and laboratories, under the supervision of our own engineers and instructors. A free sample lesson is yours upon request—use the coupon below.

#### You Get This and Other Valuable Information in the Free Sample Lesson:

1. Basic Receiver Circuits and How They are Used.
2. Construction of the Antenna Circuit.
3. How Energy is Picked Up by the Aerial.
4. How Signal Currents are Converted into Sound.
5. How the Tuning Condenser Operates.
6. How the R-F Transformer Handles the signal, and other data, with diagrams and illustrations.

Both Resident and Home Study Courses Offered

**APPROVED FOR VETERANS**  
CHECK COUPON

### NATIONAL SCHOOLS

LOS ANGELES 37, CALIF. • EST. 1905



#### MAIL OPPORTUNITY COUPON FOR QUICK ACTION

National Schools, Dept. PM-12  
4000 South Figueroa Street  
Los Angeles 37, California

(Mail in envelope or paste on penny postcard.)

Mail me FREE the book "Your Future in Radio" and a sample lesson of your course. I understand no salesman will call on me.

NAME \_\_\_\_\_ AGE \_\_\_\_\_

ADDRESS \_\_\_\_\_

CITY \_\_\_\_\_ ZONE \_\_\_\_\_ STATE \_\_\_\_\_

Check here if veteran of World War II

GET THE DETAILS—SEND THE COUPON





# Talk AS FAR AS 17 MILES WITH ARMY FIELD TELEPHONES

Amazingly simple to install and operate. Just hook up terminals of two or more phones to any two-strand wire and you are ready to talk! Powered by standard flashlight batteries. Compact . . . rugged . . . portable.

Hundreds of uses for quick, low-cost, dependable 2-way communication around home, shop, farm, industry. Performance equals present-day commercial telephones. No maintenance required. Phones complete with self-contained ringer. Every phone checked for perfect operation and fully guaranteed. Cost govt. \$39.90 each.

USED—good, serviceable condition . . . . . \$ 7.45 ea.  
 USED—excellent condition . . . . . 8.95 ea.  
 RECONDITIONED—(by U. S. Signal Corps) . . . 10.75 ea.  
 LIKE NEW, slightly used . . . . . 12.95 ea.

## ARMY FIELD TELEPHONE WIRE

**Weatherproof-Durable**  
 2-conductor, twisted, 3 copper and 4 steel strands, tinned, insulated.

**On Original Steel Reels**

W-110B Unused, new, but stored in open. Half-mile reels (2500 to 2750 feet). Wt. 85 lbs. **\$14.25**  
 Each . . . . .  
 500-foot coil (14 lbs.) . . . . \$3.50  
 1000-foot coil (28 lbs.) . . . . 6.50  
 W-130 LIGHTWEIGHT ASSAULT WIRE. Weighs only 16 lbs. New, half-mile reels (2600 feet). Each. **\$15.00**

All prices FOB Sacramento. No COD. California residents add 2 1/2% for sales tax. Small orders sent postage collect plus small handling charge.

**WRITE FOR FREE FOLDER!**

SEND CHECK OR MONEY ORDER

## LORIS SALES

P. O. Box 1896-B-12

Sacramento, California

## CARBURETOR TOO RICH MAKES MOTORIST TOO POOR



Car owners who are wasting money and not getting proper gas mileage due to over-rich mixtures will be pleased to learn how to save gasoline by VACU-MATING over-rich mixtures. VACU-MATIC fits all cars, trucks and tractors. It is automatic and operates on the supercharge principle. Easily installed in a few minutes.

**SALESMEN WANTED! Big Profits!** Send name, address on penny postcard for free particulars and how to get yours for introducing.

VACU-MATIC CO., 7617-1417 W. State St., WAUWATOSA, WIS.

## 1949 NEW CAR OWNERS

## HUSKY HITCH



Your New Car Deserves This Streamlined Trailer-Hitch with Railroad Coupling Construction

Beautify your car with the handsome new Husky Hitch. 12 percent stronger than SAE requirements, custom-designed to fit . . . satisfaction guaranteed or your money back! Also serves as rugged bumper guard. No extras to buy . . . all reinforcing members and bolts furnished with kit.



- Permanent gleaming Chrome plate.
- Streamlined cap covers cadmium-plated rust-proofed hitch ball.
- Patented elastic stop-nuts guard against failures and rattles.
- Smooth, streamlined contours prevent snagging or soiling clothing.

Free Descriptive Folder Write Today! Give car make, year

Altadena Products Company • Altadena, California

## Profit and Fun CARVING LEATHER

at home spare time full time



New Device makes it possible for beginners to improve overnight. Now is the time to cash in on this Big Paying business — year round profits are easy if you follow new method of instruction to be found only in Baird's home study course Big sale for bill folds, wallets, belts, purses gun holsters, saddles, and other leather articles. Make up to \$50.00 per week spare time or up to \$300.00 or more monthly full time

Start your own business. Make Xmas presents and other gifts. The Baird Course is Complete. Full instructions — Tools and equipment — including new device that makes learning easy. Write for full details and interesting catalog — containing many profitable suggestions — Sent Free — Write Now. DEPT. H

BAIRD SCHOOL OF LEATHER CARVING • 221 Manitou Ave., Manitou Springs, Colorado

# RUPTURE-EASER

A strong, form fitting, washable support. Back lacing adjustable. Snaps up in front. Adjustable leg strap. Soft, flat groin pad. No steel or leather bands. Unexcelled for comfort. Also used as after operation support. For men or women. Mail orders give measure around the lowest part of the abdomen. Specify right or left side or double.



Right or left Side **\$3.95**  
 Double...4.95

PIPER BRACE CO.

308 East 12th Dept. PM-12 Kansas City 6, Mo.

## PILOTS' JACKETS



(Right) B-15 STYLE BOMBER JACKET.

Sturdy water repellent mountain cloth. Warm fleecy all-wool lining. Genuine Mouton Fur (Beaver-dyed Lamb) collar and chin strap. 34-46 . . . . . \$12.95

REGULATION B-15 JACKET.

Made same as for AAF. Heavy alpaca wool lining throughout. 34-46 . . . . . \$16.95  
 CAP (Illustrated). O.D. wool outside, alpaca pile flaps. . . . . \$1.25  
 B-3 SHEEPSKIN & J-4 LEATHER JACKET (Left). Water repellent acrylic finish. Full shearing fleece inside. All sizes 34-48 . . . . . \$16.95  
 D-1 SHEEPSKIN LEATHER JACKET. Army mechanic's, full shearing inside-reissued. Similar to B-3 but lighter weight. Small, med., large . . . . . \$9.95  
 B-2 Shearing Lined Leather Cap \$2.50; Sheepskin Leather Pants \$7.50  
 Write for FREE illus. list clothing. Orders sent postpaid except C.O.D. Satisfaction or money back.



CONSUMERS CLOTHING CO. Inc., Box P, 20 Greene St., New York 13, N. Y.

## SHOE REPAIR OFFERS BIG INCOME LEARN IN 12 WEEKS TIME

You can own your own shop or earn big income as skilled shoe repairman. Growing demand everywhere at top wages for men who know how. We teach you quickly by actually working on shoes and modern machines. School open to all from 18 to 60 years of age. FREE BIG 20 PAGE BOOK explains everything. Send for your copy today.

MODERN SHOE REBUILDING SCHOOL

Approved for Vets . . . . . Established 1927 . . . . . Dept. PM  
 2937 Belmont Ave., Chicago, Ill. . . . . Rush Postcard Today  
 806 So. Figueroa St., Los Angeles 14, Calif.

## YOU CAN BE AN All Around HE-MAN

All 5 famous courses by George F. Jowett, world's greatest body builder in 1 complete muscle building volume (valued at \$5 each) now only 25c. Packed with How-to-Do-it pictures. 1. How to Mold a Mighty Arm. 2. Mighty Chest. 3. Mighty Back. 4. Mighty Grip. 5. Mighty Legs. Free strong men photo book. Quick results or money back! Send 25c. name, address, age, JOWETT INSTITUTE, Dept. PM-812, 230 Fifth Avenue, New York City

25c

## FENCING EXCITING FUN HARMLESS



### Musketeer Fencing Set!

The sport of heroes. Active, developing alertness, speed and agility. Become a Champion fencer. Set contains pair of 3 ft. spring steel foils (swords) and FIVE instruction books by former OLYMPIC COACH. ONLY \$1.98 Postpaid. Send Check or M.O. today. Satisfaction Guaranteed!

CASTELLO 232 E. 9th St. NEW YORK 3, N. Y.



## NEW ADVERTISING MACHINE

Prints & illustrates 1c Post Cards Boost sales with CARDMASTER like thousands are doing. Not a toy but a sturdy advertising machine guaranteed for 3 years. Get money-making facts NOW SEND NAME to CARDMASTER, 4546 Ravenswood, Dept. 1312, Chicago 40, Ill.

FREE

Illustrated Book of Plans and Ideas For Your Own Business







# Learn BUILDING

AT HOME • All Blue Print Building Plans, Specifications, Lessons Furnished

## FIND OUT ABOUT TRAINING AND OPPORTUNITIES FOR YOU IN BUILDING

Established in 1904, Chicago Technical College offers you thorough, practical training in Building, by home-study. Mail coupon for free information. See what this Course has done for others, what it can do for you. Read what Chicago Tech graduates say about their work, earnings, success. Learn the rewards awaiting you as a trained builder — and how quickly, easily you can get started. Simply MAIL COUPON TODAY in an envelope or paste on a penny postcard.



**CHICAGO TECHNICAL COLLEGE**  
S-152, Tech Building, 2000 South Michigan Ave.  
Chicago 16, Illinois

## MAIL COUPON NOW

**CHICAGO TECHNICAL COLLEGE**  
S-152, Tech Bldg., 2000 So. Michigan Ave.  
Chicago 16, Illinois

Mail me FREE building Lesson with information about big opportunities in BUILDING and how I can train at home.

Name \_\_\_\_\_ Age \_\_\_\_\_  
Address \_\_\_\_\_  
City \_\_\_\_\_ Zone \_\_\_\_\_ State \_\_\_\_\_

# NOW-YOU, TOO, CAN HAVE THE PROVEN SECRETS OF SUCCESSFUL LIVING!

You can change your life RIGHT NOW — have money, friends, health and influence. Enjoy life the SURE way, proven by thousands

That's too good to be true, you say? Then how do successful and happy people get what they want? They have no magic — they either get the right formula by luck, by "trial and error," or by learning the secrets of those who have succeeded.

Now—you, too, can have this vital knowledge—right from the lives of successful and famous people—and use these strong forces yourself. Powerful keys to success, tested and proved by thousands, leads successful living within your grasp.

Think what this means to you! You CAN live the life you want! You CAN fulfill your desires and gain your goals! You can begin to really LIVE, with the satisfactions of real ac-

complishment and the joy of knowing that you, too, have found the SURE way to successful living.

You don't have to struggle aimlessly or trust to luck through life. Here is your chance to KNOW the simple, easy way to "get places." This can be the turning point in your life. It's up to you!

If you really want to get the most out of life the SURE way, use the free trial coupon right now — this minute. Start things coming your way! You take no risk. If not convinced that this book can change your life and increase your chances for success and happiness, return it in seven days and your money will be cheerfully refunded.

**FREE 7 DAY TRIAL**



BEN ABBOTT, Author

## HERE'S PROOF!

Not just one idea but a broad program that has helped me to organize my thinking and action toward material success and spiritual satisfaction. I'll read it again and again. H.L.G.

Bolsters my ability to solve daily problems. L.E.F.

Clearly and simply stated in such a way as to bring ambition to the least aspiring. L.L.K.

As a youth, it spurs me to chart my course rather than struggle aimlessly. R.W.

Vivid, forceful formula for happier living—makes you vow to follow it immediately. K.L.W.

A firm foundation for success and happiness. J.F.C.

## The revealing chapters include:

- Powerful success qualities of the winners.
- How to get quick results.
- A plan to create unlimited opportunities.
- How to make ideas earn rich rewards.
- Seven aids to making correct decisions.
- Tested formula to get more done in less time.
- How to get the "vital spark" that wins.
- Two great essentials to successful living.
- Proven methods to gain sure self-confidence.
- Eight ways to discover hidden talents.
- The easy way to make friends and win respect.
- How to influence others by a human trait.
- Four ways to get people to do what you want.
- A time-tried system to solve problems.
- How to develop unused mental powers.
- A sure way to make habits lead you to success.
- How to overcome fears and banish worries.
- Three rules can change your life amazingly.
- The mysterious power that guides many to success and happiness.

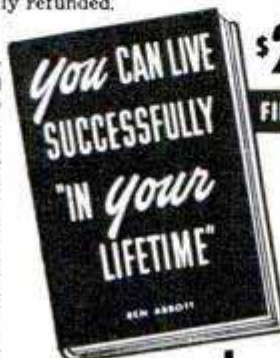

\$2.75 219 Pages Beautifully cloth-bound

FIND OUT HOW YOU CAN WIN SUCCESS!

FREE TRIAL COUPON

CHALLENGE PUBLISHERS • 936 65th Street • San Diego 2, California

Please send me "YOU Can Live Successfully in YOUR Lifetime" for 7 days free trial. If I am not completely satisfied, I may return the book at the end of this time, in good condition, for full refund.

Send C.O.D. I will pay postman \$2.75 plus postage.

Send postpaid. I enclose \$2.75 (Plus 7c state tax in Calif.)

NAME \_\_\_\_\_ PLEASE PRINT  
ADDRESS \_\_\_\_\_  
CITY \_\_\_\_\_ ZONE \_\_\_\_\_ STATE \_\_\_\_\_

A-21



# MONO-CYCLE BIKE MOTOR... A REAL CHRISTMAS PRESENT



**\$89.50**  
Plus Tax  
3 H.P. ENGINE

**FITS ANY BIKE EASY TO INSTALL**

Mono-Cycle is the rugged Bike Motor with plenty of power. Its light weight mono-cycle engine weighs only 18 lbs., does not alter balance of bicycle, has only three moving parts, set world endurance record. Fits any bicycle, boy's or girl's. Can be installed in less than one hour. Built for real service, Mono-Cycle starts easy, provides smooth power with minimum vibration. Belt release lever enables rider to pedal bicycle as easily as before bike motor was installed.

## SEND COUPON TODAY

- Please send me full information on Mono-Cycle Bike Motor.  
 Please send me Mono-Cycle Bike Motor. I enclose check \_\_\_\_\_, money order \_\_\_\_\_, for \$93.98 which includes \$4.48 Federal Excise Tax.

NAME \_\_\_\_\_

ADDRESS \_\_\_\_\_

CITY \_\_\_\_\_

**SENSATION MOWER, INC.** BOX PM 12, RALSTON, NEBR.

# Learn A Trade NOW! PRACTICAL SHOP TRAINING!

## In Our Chicago Shops

- AUTO MECHANICS     WELDING—ARC and GAS  
 DIESEL MECHANICS     MACHINIST  
 REFRIGERATION     PIANO TUNING  
 BODY-FENDER

Above Approved For G. I.'s and Civilians

One of America's Leading Practical Schools  
 7 Floors of Fully Equipped Shops  
 Over 48,000 Successful Graduates  
 Expert Individual Instruction  
 Learn by Doing—Low Living Expense  
 Established 1902—Day and Evening Classes

## Also the following Home Study Courses

- PLASTIC     REFRIGERATION     DIESEL

—CALL IN PERSON OR MAIL THIS AD TO—

## GREER SHOP TRAINING

(Dept. PM-28) 460 South State St., Chicago 5, Ill.

Please send without obligation free information regarding trade checked above. (Specify whether you are a Veteran  or Civilian )

Name \_\_\_\_\_ Age \_\_\_\_\_

Address \_\_\_\_\_

City \_\_\_\_\_ State \_\_\_\_\_

## Get This Fascinating New Popular Mechanics Book

# WHAT TO MAKE for Children



**175 Things  
Dad and Mother  
can Make for  
Young Folks  
at Home!**

This is a book by the editors of Popular Mechanics. It will show you how to make, at little or no cost, many of the

things so dear to the hearts of younger children—things that money won't buy, such as play-room and nursery toys and trappings, dolls and dollhouses, gymnasium equipment, things to ride on, toys that "work" and go.

**A BOOK FOR THE ENTIRE FAMILY**  
 Mother and Dad and Big Sister and Brother can save many dollars and have worlds of fun too, making all these things for the little tots. Only discarded materials or inexpensive new materials and only simple tools are needed, with WHAT TO MAKE FOR CHILDREN as a guide.

### SIMPLIFIED INSTRUCTIONS— ANYONE CAN FOLLOW

The book contains 175 different projects with detailed "how-to-do-it" instructions, dimensions and more than 250 sketches, drawings, plans and photographs covering every detail of construction.

Order WHAT TO MAKE FOR CHILDREN today. Mail coupon below for immediate delivery. Money back if not satisfied.

## 175 PROJECTS 250 ILLUSTRATIONS

Action Toys—Dolls—Pull

Toys—Play Houses—  
Games

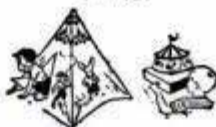

Swings—Furniture—

Sleds—Playground Equip-  
ment—Desks—Sandboxes



Wagons—Coasters—

Merry-go-round—Animals

—Cribs—Dozens of Others



POPULAR MECHANICS PRESS, Dept. 49C  
 200 East Ontario St., Chicago 11, Ill.

Send at once \_\_\_\_\_ copies of WHAT TO MAKE FOR CHILDREN at \$2.00 each. Remittance enclosed. I understand I may return the book in 5 days if not satisfactory and you will refund my money.

Name \_\_\_\_\_

Address \_\_\_\_\_

City \_\_\_\_\_ State \_\_\_\_\_



# NOW ANY Auto Repair Job is a "Cinch" for YOU!

MoToR's AUTO REPAIR MANUAL is Showing Thousands of Men How To Handle ANY Job on ANY Car—Faster and Easier! Now Let It Go to Work For YOU!

Actual Size  
A Big 8 1/2 x 11 Inches

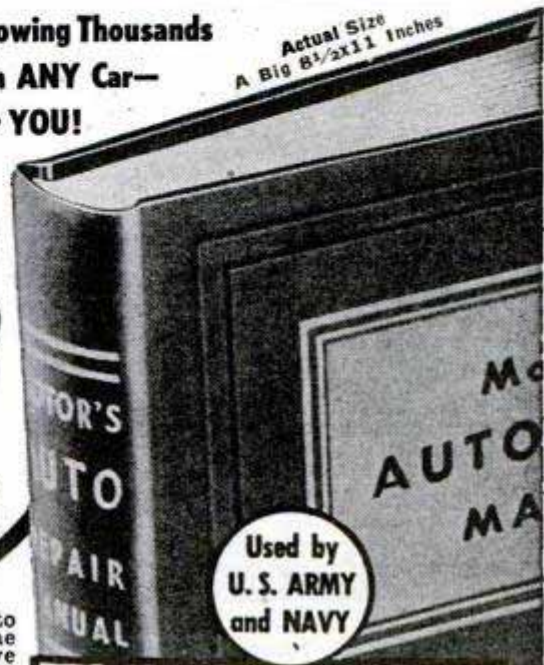

**Free**  
7-DAY  
OFFER

WITH MoToR's amazing AUTO REPAIR MANUAL you can whiz through ANY job—in LESS time, and with LESS work! Just look up make, model, and job—and go to it! With this easy-to-follow book, any job—from radiator to rear end—becomes a pushover for you!

**"EVERYTHING You Need to Know about EVERY Make and Model Car Since 1935!"**

Nothing like MoToR's AUTO REPAIR MANUAL has ever been published! It's just as if plain-talking engineers from every auto plant in America got together to show you everything you need to know about the cars they themselves had designed. It brings you the complete "dope" from over 150 Official Factory Shop Manuals, boiled down in simple easy-to-read and easy-to-understand language.

Here, right at your fingertips—are over 200,000 service, repair, adjustment, replacement, tune-up facts on all standard makes and models built from 1935 to 1948! More than 1700 cut-away photos, diagrams, and drawings SHOW you exactly what the clear text TELLS you! Used by the U. S. Army and Navy and technical schools! No wonder thousands of auto repairmen call it their auto "Bible"!

**Why Thousands Rave About It**  
Thousands of men have already discovered what a

**WORTH BIG MONEY TO:**  
Mechanics Repair Men  
Handymen Service Station  
Garagemen Operators  
Farmers Taxi Owners

timesaver MoToR's Auto Repair Manual is. (At the left are just a few who have told us they just "wouldn't be without it.")

This is a BIG 700-page book, measuring 8 1/2 x 11 inches. Simple to use, too, because it opens flat for "working while you read." All you have to do is look up the quick index—and it leads you to the right page in a jiffy. Then you just follow the simple instructions, step by step. Everything is set forth so clearly you simply CAN'T go wrong!

**SEND NO MONEY**

Find out for yourself—without risking a cent—how this book pays for itself the first few times you use it. Mail the coupon, without money. Try it out—FREE—for 7 days. Then,

if not convinced it's the greatest time-saver and work-saver you ever saw, return the book and pay nothing. MoToR Book Dept., Desk 1P, 572 Madison Ave., New York 22, N. Y.



"A boy can easily follow its instructions."—Curtis Auberry, Murfreesboro, Tenn.



"MoToR's Manual paid for itself on the first two jobs and saved me valuable time by eliminating 'guess work.'"—Wilson J. Schrop, Akron, Ohio.



"I have done jobs with this Manual that I would not attempt without it."—G. L. Vanerstrom, Hazel Park, Mich.



"Instructions so clear, I have no trouble learning anything about any car."—Sam Ordonez, Cal.

**Same FREE 7-DAY Offer Applies On MoToR's TRUCK REPAIR MANUAL**

Covers EVERY job on EVERY truck made since 1936! 1400 pictures, 952 pages, 300,000 facts. Warranted to contain every essential fact you need.

Covers all types Gasoline Engines; Diesels and Hesselmanns. Fuel Systems, Governors, Lubrication Systems, Ignition Systems, Starters, Generators, Clutches, Transmissions, Axles, Torque Dividers, Transfer Cases, Brakes, Steering, etc. Offered on same FREE 7-day examination as Auto Repair Manual. Check box in coupon.



**Covers Every Job on Every Car Built from 1935 to 1948!**

Nearly 200,000 service and repair facts on all these makes:

- |           |                |            |
|-----------|----------------|------------|
| American  | Ford           | Nash       |
| Bantam    | Frazer         | Oldsmobile |
| Auburn    | Graham         | Packard    |
| Austin    | Hudson         | Pierce     |
| Buick     | Hupmobile      | Arrow      |
| Cadillac  | Kaiser         | Plymouth   |
| Chevrolet | Lafayette      | Pontiac    |
| Chrysler  | La Salle       | Reo        |
| Cord      | Lincoln        | Studebaker |
| Crosley   | Lincoln Zephyr | Terraplane |
| De Soto   | Mercury        | Willys     |
| Dodge     |                |            |

**MAIL COUPON NOW FOR 7-DAY FREE TRIAL**

MoToR Book Dept., Desk 1P, 572 Madison Ave., New York 22, N. Y. Rush to me at once (check box opposite book you want):

- MoToR's AUTO REPAIR MANUAL. If O.K., I will remit \$1 in 7 days (plus 35c delivery charges), \$2 monthly for 2 months and a final payment of 95c one month after that. Otherwise I will return book postpaid in 7 days. (Foreign price, remit \$8 cash with order.)
- MoToR's TRUCK REPAIR MANUAL. (Described at left.) If O.K., I will remit \$2 in 7 days, and \$2 monthly for 3 months, plus 35c delivery charges with final payment. Otherwise I will return book postpaid in 7 days. (Foreign price, remit \$10 cash with order.)

Print Name \_\_\_\_\_ Age \_\_\_\_\_

Print Address \_\_\_\_\_

City \_\_\_\_\_ State \_\_\_\_\_

Check box and save 35c delivery charge by enclosing WITH coupon entire payment of \$5.95 for Auto Repair Manual (or \$8 for Truck Repair Manual). Same 7-day return-refund privilege applies.



# Here's how to prepare for GOOD PAY, a STEADY JOB in AUTO MECHANICS

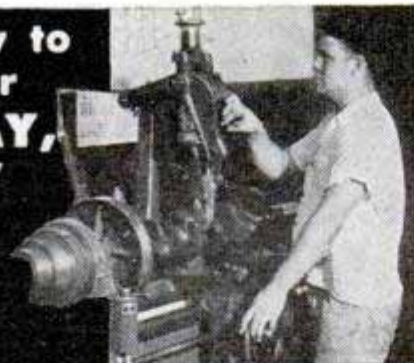

### AUTO MACHINIST

Student in engine rebuilding learning to operate a crankshaft grinder. Specialized training puts you in line for better jobs and higher pay.

Earn more money in Auto Mechanics when you choose one type of work and specialize in it. Get ready for a top pay job with security and a real future. New FREE booklet tells how to get specialized training and what to learn to move ahead faster. Get the full facts on opportunities today. See why trained men get the best jobs. Write for your Free copy today.

### ENGINE REBUILDING

Up-to-date practical training on latest equipment. You learn machine shop, auto electricity, carburetion, trouble shooting, motor tune-up and transmissions.

### GENERAL AUTO MECHANICS

Practical training for general garage work. Engine overhaul, auto electricity and many other subjects. See shops and equipment in our FREE booklet.

**VETERANS:** American Trade School is G. I. Approved. Please state if Veteran.

**WRITE TODAY FOR FREE BOOKLET**

**AMERICAN TRADE SCHOOL**  
2417 McGee, Kansas City, Mo.



# Draw Your Own PLANS



of **HOMES**  
**DESIGNS**  
**MACHINES**  
**WOODCRAFT**  
**SHOP WORK**  
**ALTERATIONS**  
**LAYOUTS—LETTERING**

Accurate to Scale—101 Different Uses

Here is a new mechanical drawing board every home worker, hobbyist, machinist, artist, or student will want. It incorporates modern drafting principles used by professionals. The combination one-piece 90° angle and calibrated scale moves at any angle to any point on board in quick, smooth movements. Makes drawings up to 16" x 22" without T-square, triangles, protractor or ruler. Table of decimal equivalents, etc. mounted on board.

**SEND COUPON TODAY! MONEY BACK GUARANTEED.** Special Cash Offer for limited time—Only \$9.95 Postpaid. If not fully satisfied—return in 10 days and we will cheerfully refund purchase price.

**REPLOGLE, Inc., Dept. PM-12**  
317 No. Hoyne Ave.  
Chicago 12, Ill.

Please send me Mechanical Drawing Board at Only \$9.95 postpaid. Enclosed find check or Money Order.

Please send C.O.D. for \$9.95 plus postage

NAME \_\_\_\_\_

ADDRESS \_\_\_\_\_

CITY \_\_\_\_\_

STATE \_\_\_\_\_



# 5 NEW 26" SCALE MODELS



**CHRIS-CRAFT Fast Express Cruiser** \$4.95 each

Full Size—"How To Build" Plans COMPLETE CONSTRUCTION KIT—ALL MODELS

NOW Build Owens, Harco, Chris-Craft—Cruisers, Yachts for racing or display. HOW TO BUILD Plans—actual boat Co. scale drawings furnished. COMPLETE KIT has everything: 22' balsa planking, cement, shellac, brush, blade, shaft-trim wire, twin propellers, decking, flag, etc. Build same as regular boat const. Speeds to 41 MPH. \$4.95 each. Drive Kit \$2.75. Order Now For Xmas!

Send for FREE Booklet

TRIM CRAFTS - 312E. Wis. Ave. - Room 207 PM - Milwaukee, Wis.

# An ASSURED FUTURE for You Learn Profitable WATCH REPAIRING

**BIG MONEY WHILE LEARNING**  
*Study at Home — or at Our Accredited School*  
Complete Home Correspondence Course or G. I. Approved Residence School Plan. Also, Post-Graduate Plan at school for correspondence students.

Write Today for COMPLETE DETAILS to  
**American Institute of Specialized Watch Repair**  
Dept. No. 100 270-76 East Building Grand Rapids, Michigan

# EXPERT PHOTOGRAPHY MADE EASY

LEARN PHOTOGRAPHY NOW  
—for both a sound and secure future and immediate opportunities. Ever-increasing demand for trained men and women. Excellent earnings. Resident or home study. 39th year. Write for full details.

**NEW YORK INSTITUTE OF PHOTOGRAPHY**  
Dept. "49," 10 West 33 Street New York 1, New York

**NOTARY PUBLIC**  
Be a Notary Public. Largest legal supply house, 22 cities, guarantees your appointment by governor if you qualify, equips you completely for \$16.97. Respected public office. You certify legal papers, use official seal made with your name, collect fees. Easy. Notaries needed everywhere. Be one. Write—  
**STATIONERS EXCHANGE — BOERNE 1, TEXAS**

*Learn to Write at Home in spare time*  
You can become a Good Penman at home in spare moments by my Simplified Method regardless of how you now write. Good penmanship will pay you big dividends in social and business ways.  
**FREE BOOK** Write for Full Details and my FREE BOOK, "How to Become an Expert Penman," which explain all. If you wish, enclose 10c for Special Penpoint and your name with a flourished bird written on a card. Write TODAY.  
T. M. TEVIS, Box 25K, Chillicothe, Mo.

# Learn CARTOONING

**HAVE FUN! MAKE MONEY!** Cash in on your sense of humor at HOME—BY MAIL. No experience needed to start. Write today FOR FREE TRIAL LESSON and full particulars.  
Moon Gag Cartoon School, Dept. M, Fall Creek, Wis.

# How to Make Liquid Marble

Make amazing Liquid Synthetic Marble at home in your kitchen, basement or garage. Terrific demand! BIG PROFIT! No heat, pressure or machinery needed. No experience necessary. MOLD, TROWEL or BRUSH—make in almost any color.

**FLEXIBLE MOLDS:** Valuable information for novelty casting. 3c material makes \$1.00 item. PERMA-TEX Plastic Flooring! Make lifetime floors in any color or shade. Can be laid over wood, concrete, brick, etc. Work out beautiful patterns in contrasting and harmonious colors. WRITE FOR FREE CATALOG!

**BING PRODUCTS** Dept. PM-12B  
88 Broad St., Boston 10, Mass.





# GET INTO DRAFTING

The Draftsman Plays a most Important Part in INDUSTRY

## DRAWING OUTFIT INCLUDED with Drafting courses

All the tools you need including folding drawing table. With them you can put your ideas on paper quickly and with accuracy. With training you are all set to master Drafting in months, — not years — at home.

### Learn in Spare Time—At Home!

(or at the College in Chicago)

A few hours of pleasant home study every week — that's all. With Chicago Tech's help, you train yourself step by step. This tested method — developed over 44 years of C.T.C. progress — prepares men for good positions in industry.



Practically everything that's built or manufactured these days is constructed from blue print drawings prepared by the draftsman. He is the KEY man in industry. No new machines can be built, no bridges erected, no buildings constructed until the draftsman has completed his work.

Drafting is clean, interesting, professional-type work. The draftsman is paid well to start. And he has real opportunities for advancement to high-pay jobs in Engineering. The tremendous production programs ahead in industry will require more draftsmen than ever before.

Send today for free information. See what this training has done for others, what it can do for you. Simply MAIL COUPON TODAY in an envelope or use a penny postcard.

**CHICAGO  
TECHNICAL COLLEGE**  
S-211 Tech Building, 2000 South Michigan Ave.  
Chicago 16, Illinois

## MAIL COUPON NOW

Chicago Technical College  
S-211 Tech Bldg., 2000 So. Michigan Ave.  
Chicago 16, Illinois

Mail me FREE Drafting Lesson with information about big opportunities in DRAFTING and how I can train at home.

- Architectural Drafting       Electrical Drafting  
 Machine Drafting           Structural Drafting  
 Builders' Course

Name \_\_\_\_\_ Age \_\_\_\_\_  
Address \_\_\_\_\_  
City \_\_\_\_\_ Zone \_\_\_\_\_ State \_\_\_\_\_

# HOW TO BE SUCCESSFUL IN THE FAST GROWING PLASTICS INDUSTRY



## LEARN at HOME in Spare Time —

Consider the important Plastics field for your future career. More products are being manufactured from plastics than ever before—making more opportunities for trained men and women. Mail the coupon below for illustrated literature which shows the many uses of plastics and what trained men must know to succeed in the Plastics Industry.

You Get 7 BIG Plastic Material KITS with your course and can make these and many other attractive, useful articles while learning.



SEND FOR  
FREE CATALOG  
TODAY

PLASTICS INDUSTRIES TECHNICAL INSTITUTE  
Dept. PM 12-8, 1601 S. Western Ave., Los Angeles 6, Calif.

Gentlemen: Please send me free literature and information on job opportunities. I am interested in Home Training  attending school in Los Angeles

Name \_\_\_\_\_ Age \_\_\_\_\_  
Street \_\_\_\_\_ Zone \_\_\_\_\_  
City \_\_\_\_\_ State \_\_\_\_\_  
Veteran \_\_\_\_\_ Non-Veteran \_\_\_\_\_

### STUDY AT HOME

### OR COME TO CALIFORNIA

Take famous Plastics Institute home training or come to Los Angeles for practical work in modern laboratories and shops. Students from foreign countries and many states now attending.

START YOUR TRAINING NOW—mail coupon and get started on the road to success in the great and growing field of Plastics.

## PLASTICS INDUSTRIES TECHNICAL INSTITUTE

Approved for Veterans • Available for Non-Veterans





**A MUST FOR EVERY FARM FAMILY!  
SAVES MONEY FOR HOME OWNERS  
A PRICELESS GIFT TO SEND TO  
A FAMILY ON THE FARM!**

**Farm Help That Works  
Every Day in the  
Year For  
Only \$3**

*A Thousand and  
One Ideas You Can  
Use on the Farm!*

Popular Mechanics Farm Manual is packed with practical ideas and usable information that can easily be worth hundreds of dollars to every farm family and to home owners everywhere. Here are a few of the things it covers:

**Farm Machinery and Implements**

How to make tractors, scoops, scrapers, cordwood saws, buckrake, power driven elevator, "Farm-ette" — odd job tractor, hoists, dump trucks, spreaders, seed-grain duster, posthole auger, etc.

**Farm Workshop Equipment and Repairs**

Welding on the farm, soldering, workshop power saws, home built air compressor, small shop forge, workbenches, curing gas engine troubles, hydraulic rams, drive your own wells, etc.

**Poultry and Livestock**

How to build poultry houses, incubators, brooders, at low cost, feeding, stock care hints, hog care gadgets, etc.

**Vegetable Storage — Processing**

All-winter vegetable storage, preparing food for home-freezer storage, how to make your own home freezer, charts, guides.

**Farm Home Improvement**

Fencing, repairing electrical appliances, plumbing, electrical wiring, saving coal, painting, curing leaky basements, hanging wall paper, making garden tools, garages, working with concrete, painting, etc.

**Farm Hints and Kinks**

Forty pages of illustrated practical ideas, short cuts, etc., that will save time, labor and money around every farm and city home.



**POPULAR MECHANICS  
FARM  
MANUAL**

**Use This Book to Step up Farm Efficiency—  
Increase Farm Production—Improve Farm  
Appearance—Save Time, Labor, Money!**

This is the book that thousands of farmers and home owners have waited for. It is the experience of hundreds of successful operators brought together in one handy, easy-to-read, easy-to-use, working handbook by the editors of Popular Mechanics. It is brimful of short cuts, labor-saving ideas, ingenious apparatus and methods that will simplify the day's work and lighten some of the more tedious chores, make money and save money for you.

**284 FACT  
PACKED PAGES  
•  
HUNDREDS OF  
ILLUSTRATIONS  
•  
FULL SIZE  
Library Binding**

**HELPS IN THE FIELD — IN THE BARN — IN THE HOME**

Every department of the farm is covered in the Farm Manual. Every member of the family will find in it something that he or she can use to tremendous advantage in farm operation, maintenance and improvement, from the building and care of equipment to painting the farm home and fast freezing fruits and vegetables. It covers all farm buildings, the farmhouse and other homes and is of interest equally to the woman looking for home improvement, beauty and convenience and the man striving for easier and more profitable operation.

**ORDER TODAY — FOR YOURSELF — FOR A GIFT**

Use the coupon below. Mail it today. Book will be sent at once, post-paid if you include payment with your order. If you don't think the Farm Manual is worth even more than you paid for it after five days' use, send it back by mail and your money will be refunded. This may be the best investment you ever made. Rush coupon today.

**MAIL COUPON • Money Back if Not Satisfied**

**Popular Mechanics Press, Dept. 49C  
200 East Ontario St., Chicago 11, Ill.**

Send \_\_\_\_\_ copies of the Farm Manual at once.  
 Remittance (\$3.00 each) enclosed. Send postpaid. Add 15% if outside U.S.A.  
 Send C.O.D. (\$3.00 each) plus delivery charges. U.S.A. only.  
(If sent as a gift to another, send name and address on separate sheet.)

Name \_\_\_\_\_

Address \_\_\_\_\_

City \_\_\_\_\_ Zone or Route \_\_\_\_\_ State \_\_\_\_\_

**POULTRY  
HOUSES You Can Build**



**Keep Your Tractor Rolling**



**MECHANICAL  
"Nerd Men"**

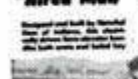

**INCUBATORS  
you can make**



**Learn Dump Truck Sides Shovel Off Load**



**Storing Vegetables for Winter**





**WORLD'S  
BEST  
WANT AD  
MEDIUM**

# CLASSIFIED Advertisements



Advertisements in this section 75 cents per word, each insertion, minimum 10 words, payable in advance  
To be inserted under proper classification, copy must be in our office the 22nd of the  
second month preceding date of issue

F. W. Johnson, Manager, Classified Advertising  
Popular Mechanics Magazine, 200 East Ontario Street, Chicago 11, Illinois

**1117**

**CLASSIFIED  
ADVERTISEMENTS**

**1117**

**OPPORTUNITIES  
FOR YOU**

## AUTOMOBILES, MIDGET CARS

"SPEED And Power" Handbook—Very latest methods! Construct your own superchargers, "water injectors," hi-compression heads, fuel saving devices—easily. Save many dollars! Get racing speed, acceleration, dynamic power increases from any automobile! Build fast stock cars! California roadsters! Hotrods! Get ingenious formulas! Speed secrets! Illustrations! Conversion ideas! Also "Economy Information"—mileage tricks! Tuning techniques! Instructions! Picture catalogues. Including "California Restyling Ideas"—glossy photographs! Drawings! Model reviving! Customizing! Streamlining! Leatherlike bound—\$1.98 complete. Newhouse Automotive Industries, 5941-B2 Hereford, Los Angeles 22.

CLYMER'S Test reports on post-war Kaiser-Frazer, Studebaker, 1949 Ford, 1949 Mercury, give impartial, uncensored report 3000-mile economy, speed, record tests. Part-by-part equipment analysis. 3000 owner tabulations in each book. 200 owner letters. Good, bad comments about each make, no punches pulled. Learn the truth. Specify make car interested in. \$1.50 postpaid. Clymer, Dept. A-TR, 1268 So. Alvarado, Los Angeles 6, Calif.

"SPEED & Mileage" Manual—Easily obtain greater speed, mileage, racing performance from any automobile! Famous (original) book shows soup up methods: Speed tuning; Mileage secrets; Racing tricks! "Customizing Ideas!" Photographs! Instructions on building inexpensive speed equipment! Economizers! Superchargers! "Water injectors!" Mufflers! "Hot-rods!" Speedsters! Racing conversions! Engines! All about "Economy tuning," compression, manifolds, ignition, lubricants, cams, fuels! Latest "Hollywood stylizing;" streamlining; sports car conversions! Plans; "Fascinating Pictorial Supplement;" Catalogues; Charts; Parts lists! Deluxe enlarged edition, \$1.98. (Guaranteed). Almqvist Engineering, Milford 47, Pennsylvania.

CUSTOMIZE Your car! Authentic California restyling plans galore! Working sketches, specific model changes. Comprehensive; complete! 130 photographs! Largest, finest, or refund! \$2 postpaid. Post Publications, Box 723-BE, Arcadia, California.

SPEED Equipment. Marine and automotive. We have only the best, made by leading southern California manufacturers including—Edelbrock, Meyers, Weiland, Winfield, Jahns, Offenhauser, etc. Complete line of high compression heads, dual manifolds, racing pistons, camshafts, dual ignitions, etc. Send 25c for 32 page illustrated catalog. So-Cal Speed Shop, 1104 S. Victory, Burbank, California.

SPEED Equipment bargains! Dual manifolds \$12.95, racing heads \$29.00. California mufflers \$4.50, duals \$17.50, water injectors \$4.95, chrome echo cans \$1.75, supercharger stacks \$3.50, others! Beautiful "Handbook-Catalog" 20c. Almqvist Engineering, Milford 47, Pennsylvania.

USED-CAR Buyer's handbook. Includes authoritative late model evaluations! Complete tests, dealers' tricks, graphic photographs! \$1.50 airmail! Post Publications, Box 723-TFE, Arcadia, California.

MELLO-TONE Mufflers. Singles for all cars. Duals for Ford and Mercury. See our free catalog and low prices before you buy. So-Cal Mufflers, 11142M Washington Place, Culver City, Calif.

CLYMERTONE, Twin muffler sets, beautiful sound, complete with necessary welded pipes, E-Z installation. Ford V-8, \$20.00. Chevrolet set with split manifolds, \$37.50. Specify car model. Clymer, Dept. A-124, 1268 So. Alvarado, Los Angeles 6, Calif.

CALIFORNIA Custom accessories—ideal Christmas gifts. Buy direct from original designers and save. Solid hood sides, grille panels, lowering blocks, fender skirts, dual pipes, chrome motor accessories. Picture catalogue with scores of items—25c. Eastern Auto Supply, 3319L South Grand, Los Angeles 7, Calif.

PRES-A-LITE Hands you lighted cigarette as you drive auto! Only \$6.95! Free circular. United Technical Laboratories, Morristown 1, N. J.

CALLAIR SnowCar working drawings. Use any aircraft engine 65-125 h.p. \$5.00. CallAir, Afton, Wyoming.

STOP-LIGHT Flasher \$3.00. Free information. Radio Roy, Box 2225, Portland 14, Oregon.

ELECTRIC Pencil—Writes, engraves all metals. \$2.95 postpaid. Reb Industries, 265-DM, Elmhurst, Illinois.

STRAIGHT From Detroit! Henry Ford biography and motor history of America. Illustrated. Over 300 pages, \$3.00 each, both \$5.50. Sent postpaid. Postal Hobby House, 18470 New Hampshire, Detroit 19, Michigan.

SEE Our ad under motorscooters for Midget Car bargains. Midget Motors Directory, Athens, Ohio.

"VAPO-STEAMATIC" Water injection. Build your own—easily—(for about \$1.00 cost). Finest "moist-humidity" system—completely automatic! Engineering triumph—many more miles per gallon! Increases horsepower! Speed! Eliminates knocking, carbon, overheating. Reduces wear! Engines last longer! Copyrighted "Installation Handbook"—(illustrated)—Diagrams, plans, including "mileage information," parts lists, speed equipment catalogues—\$1.00 complete. Newhouse Automotive Industries, 5941-B1 Hereford, Los Angeles 22.

"CUSTOM Styling" Manual—Quickly make car look Hollywoodized, custom, ultra-beautiful by easy, inexpensive methods! 100 photographs, drawings, instructions on customizing, restyling, streamlining; new and old cars! Thrilling sport changes! Latest custom, sportster, convertible, speed, model conversions; Accessories: Mufflers; Engine "soup up" specifications! (Custom car catalog included). Most complete book \$2. Almqvist Engineering, Milford 47, Pennsylvania.

IDEAL Xmas gifts. Write us your needs. Save freight cost from California. Full line popular speed equipment, dual single mufflers with that mellow tone, chrome and doll-up accessories. Catalogue 25c. Von Esser's, 2840A Kedzie, Chicago 18, Ill.

SURE Car start, zero. Proven booster hook up. Instructions \$1.00. Kenneth Sears, 4208 Van Buren, Sioux City, Iowa.

FAMOUS Car catalog reprints. Duesenberg, Italian Maserati racing and new sport car, Mercedes-Benz, new rear-engined Isotta-Fraschini V-8, Rolls-Royce "Silver Wraith," Miller race cars, Cord, Rayfield Cyclecar, V-8 Chevrolet, Stanley Steamer, Doble Steamer. Specify catalog desired, \$1.00 each postpaid. Clymer, Dept. A-12X, 1268 So. Alvarado, Los Angeles 6, Calif.

SAVE Money. "How to Be an Expert Car Buyer" covers everything—tricks used to defraud; detecting mechanical defects; fair prices, trade-ins, financing, insurance; repair, operating costs. 96 pages. Commended by Robert J. Schmunk, President, American Automobile Association. Obtainable Macys, New York; Gimbels, Philadelphia; Marshall Field, Chicago. \$1.00; c.o.d. \$1.25. Cummings Enterprises, Keystone State Bldg., Philadelphia.

DUALTONE Crystalline packed California mufflers for all automobiles. Large chrome tailpipe extensions. Chromed carburetors, fuel pumps, long shackles, dual manifolds, hi-compression heads, flywheels, camshafts, fender skirts, plexitops. Send 20c illustrated catalogue, deduct from first order. Streamlining Manual \$1.00. Dualtone Mufflers, 2636C India Street, San Diego 1, Calif.

MODEL "A" and "T" Ford book. 572 pages, complete information repairing, maintenance, servicing both models and Fordson tractor. \$3.50. Model "A" book only \$1.00 postpaid. Clymer, Dept. A-ATA, 1268 So. Alvarado, Los Angeles 6, Calif.

CLYMER'S 1948 Indianapolis Race Year Book. Complete information, 100 photographs, charts, drawings, cartoons. \$1.50. Deluxe fabrioid bound \$2.50 postpaid. Clymer, Dept. A-548, 1268 So. Alvarado, Los Angeles 6, Calif.

FORD-MERCURY Owners, Attention! Supertone dual exhaust systems reduce back pressure 50%. Increase mileage, beautiful tone. Leaf or coil springs weak or flat? Free spring and muffler catalog; all cars. Trucks 1 ton or less. Supertone Mufflers, 2470 E. Slauson, Huntington Park 3, Calif.

NEW Sensational seat cover. Mono, 6545 Santa Monica Blvd., Hollywood, California.

FROM Speedway to roadway! Track-proved hi-speed heads and manifolds now available for your passenger car! No special tools needed! Increase horsepower 25%! Astounding getaway! Free illustrated catalog. Speedsport, 6215AA Diversey, Chicago 39.

AUTOMOBILE Racing book, fifth edition, well illustrated. Instructions on building bodies, frames, engines. Ford A and B conversions. Plans. AAA rules, specifications. Roadster racing. Indianapolis cars. \$1.00 postpaid, \$1.30 C.O.D. Ray Kuns, Dept. 47, Madisonville, Cincinnati 27, Ohio.

WE Sell direct to customers over 200 speed equipment parts manufactured by us. Ford A-B-V8-6-4- (Ferguson), Studebaker Champion, Chevrolets and Willys. Cylinder heads, dual intake manifolds, lynite flywheels, oversize valves, compound springs, camshafts and other supplies. Complete engines ready for race for cars, boats and midgets. \$1.00 to cover illustrated literature and price sheet. R & R Mfg. Co., Robert M. Roof, Box 546, Anderson, Indiana.

AUTOMOBILE Racing, Sixth Edition, 100 illustrations. Working drawings with building instructions for Ford-60 midget, California roadster, Offenhauser racer. Details on racer parts. Sample entrance blank. World's record 158.5 m.p.h. rear engine four-wheel drive car. Interesting information for fans, drivers, mechanics. \$2.00 postpaid; \$2.25 c.o.d. Ray Kuns, Department 63, Cincinnati 27, Ohio.



**BUILD** Speedy midget track racer from castoff parts! Plans, specifications, construction information, \$1.00. Motor Supply, Box CS-1682, Toledo, Ohio.

**EASILY** Built professional midget racer, motorscooter, midget roadster, or midget motorcycle from cast off parts. Plans, specifications for all four contained in illustrated handbook, 25 cents. Directory of bargain priced used parts and motors included free! Midwest, 3839 Drummond, Toledo, Ohio.

### AUTO SUPPLIES AND EQUIPMENT

**BUICK** Parts. We stock a complete line of new parts and engines. Immediate shipment anywhere. Write today. Robertson Buick Co., 1001 S. Wabash, Chicago 5, Ill.

**AIR Horns**—"Strombos" most powerful of all signals: Complete passenger car kits; all cars. Models available for boats, trucks, buses, and diesel locomotives. For the "right of way" right away! Buy Strombos. Illustrated bulletins on request. Strombos Company, 4525 Twelfth, Detroit 8, Michigan.

**WONDER** Discs inserted between auto spring leaves eliminates squeaks, prevents broken springs, wonderful riding. \$2.00 per set—satisfaction or money returned. Wonder Disc, Tarzana, Calif.

**STOP** Rear main bearing oil leaks without overhaul. Martin, 2161 Cate Street, Brunswick, Ga.

**FILCOOLATOR**—Filters and cools oil. Patented, practical, guaranteed. \$14.50 complete. Filcoolator, Inc., 703 South Palm Avenue, Alhambra, California.

**SMITHYS** Sport mufflers for Ford V8, 1942 to 1948, \$5.95 each. Bucks Auto Parts, Box 1296H, Merced 3, Calif.

**SMOKO** Is here! Lay gigantic, impenetrable smoke screens with amazing new invention! Satisfaction guaranteed or money refunded! Plans, \$1.00. Generator, \$2.49. Send postcard for information. Smoko Company, Huntington, Indiana.

**BATTERY** Weld Stick! Repairs cracked batteries. Free sample for letterhead. Northlako, Peoria 4, Ill.

**"SEAL** Cracked batteries!" Cement \$1.00 can. Guaranteed! Postpaid! Batteryman, Grand Junction, Colorado.

**VARIABLE** Speed gearing, can keep engine at its upmost revolution. No time out for shifting. Send \$1.00 for diagrams giving principle and details to C. E. Smith, Box 8023 Leads Station, Kansas City, Missouri.

**MOTORISTS** Save gasoline by vacuumating overrich mixtures. Fits all cars. For free particulars write Vacuumatic, Dept. 1419, Wauwatosa, Wis.

**WELDING** Bodies and blocks, repairing fenders easy with Hobart Welders. Low cost, adds profits. Free catalog. Write Hobart Welders, Box M-1282, Troy, Ohio.

**WATER** Injection. Free, descriptive, illustrated information. Neher Industries, La Verne, Calif.

**SAVE** Gas! Quick winter starting! 1949 "Lektron" spark intensifier. Easily installed. Only \$2.00. Money-back guarantee. Specify car. Electronic Industries, Cleveland 11, Ohio.

**RACING** Camshafts. Ford, Mercury, others. Increases power and speed. Write for particulars and free pamphlet, "Valve Timing for Maximum Output." Edward Iskenderian, 4807 West Adams, Los Angeles 16, California.

**MECHANICS**—Farmers! Buy King McCoy spark plug and coil checker. Simplifies automotive maintenance, quick easy to use, accurate, pocket size, guaranteed. \$4.95. Fast seller for agents. Write King McCoy Inc., 101 Pine St., Dayton 2, Ohio.

**1948 SUPERIGNITIONER**. Quick starting, pep, mileage. \$4.85. Dealers. EG Mfg., Elmsford, N. Y.

**CONVERTIBLE** Tops—Completely sewn. Easily installed. Reasonable prices. Free literature. Rio Top Company, 1370 Roanoke, Newport News 20, Virginia.

**HARD-TO-GET** Auto body parts. We supply. Miller, 192 N. Clark Street, Chicago.

**PISTONS**: Custom made, American and foreign cars. Merryman Co., Lawndale, Calif.

**CHOICE** Dealer franchises available. See Bumper Re-Nu ad page 298.

**GRILLES** For all cars. 1939 Plymouth shells; 1940 Plymouth shells. Wagner Grille Co., Route 2, Bernville, Penna.

**THE ABC** of water injection. Complete information free. Advanced Automotive Products, 563-12 Lake Road, Webster, N. Y.

**REPAIR** Your car. Motor parts for all engines, chassis parts, ignition and carburetor parts, etc.; new replacement parts. Genuine and highest quality at manufacturers' retail prices. Orders receive priority over inquiries. Briggs Automotive Engineering, Box 3454, Merchandise Mart, P.O. Chicago 54, Ill.

**GOVERNMENT** Surplus. Low voltage circuit tester in steel box. Cost \$202.00. Our price \$27.50. Will test batteries, starters, generators, voltage regulators, grounds, short circuits. Wilt Electrical Company, 7829 S. Racine Ave., Chicago 20, Ill.

**NEW** And used automobile and truck parts. Lowest prices. Complete stock. Prompt reply. Babbitt Auto Parts, 2833 W. Chicago Ave., Chicago 22.

**BRUSH** Plating outfits connect to a battery. No tanks or shop required. Free particulars. Gunmetal Co., Avenue J, Decatur, Illinois.

**SAVE** 6c Per gallon with Gane Air-Flow Needles. Shipped C.O.D. \$1.50 (8 cyl. cars take 2). Advanced Automotive Products, 563-18 Lake Road, Webster, N. Y.

**CAR** Trouble? Million new, used parts. Describe needs. Automotive, 2928A North Western, Chicago 18.

**AUTO** Parts. Buy direct. Get dealers' prices. Represent us in your territory. Write requirements. Specify car make. Mechanics Auto Parts, Factory Warehouse, 3807-PM N. Ashland, Chicago 13.

**AUTO** Parts for all cars, transmissions, motors, differentials, fenders, carburetors. Security Auto Parts, 1923-PM Grace, Chicago 13.

### AUTO TRAILERS

**BUILD** Folding camp unit. Attaches to box trailer or pick-up truck, sleeps four. Plans \$1.00, or write for folder describing kits. C. W. Gray, 600 Sixteenth Street, Oakland 12, California.

**STREAMLINER** 17 Ft. trailer. Plans, manual, parts list \$1.00. Circulars 20c. Craftsman Books, Box 1153, Milwaukee 1, Wisconsin.

**TRAILER** Plan catalog—All types, house, camp, boat, etc.; including complete line trailer parts and accessories, plus booklet, "Trailer Building;" send \$1.00. Marine Mart, Buffalo 7-B, New York.

**BUILD** Your own trailer! Save money! Have every feature you want! Plans for house, sport, camp and utility trailers. Catalog describing 9 models 10c. 15c in Canada and overseas. Jim Dandy, Box 125-A, Wausau, Wisconsin.

### MOTORCYCLES, BICYCLES, MOTORSCOOTERS AND SUPPLIES

**MOTORBIKE** Less motor \$5; new motorbike conversions \$5; used motors \$3 up; 4 h.p. Merkel bicycle motor \$25; Briggs motorbike complete \$38; factory built motorscooter complete \$40, others as low as \$7; midget racer and parts \$40. November and December special: Four balloon tires \$3. Mailorder only. Over 6000 tires in stock. Plenty new midget cars, motorscooters, automatic clutches, transmissions, engines at factory prices. Send 25c for Big War-Bargain catalogue Number 28 just out listing the above and almost 400 other bargains. (35c by first class mail). Midget Motors Directory, Athens, Ohio.

**LARAY** Motor bike \$50. Maytag motor \$20. Briggs motor \$20. Motorbikes, scooters, race cars, motorcycles. Bulletin containing hundreds of bargains 25c. Mail order only. 35c First Class mail. Behnke's, Dept. B, 5721 Leland, Chicago 30, Ill.

**MOTORSCOOTERS**, New design, 6 big features. Literature 10c. Rollaway Motors, Lancaster, N. H.

**BICYCLE** Supplies. Wholesale retail list 10c. Universal, 4713 Virginia, St. Louis, Missouri.

**MOTORCYCLE** News, monthly. Yearly subscription \$1.00. Latest worldwide information. Sample 15c. Motorcycle News, 5424-A Sawyer, Chicago 25.

**MODERN** Motorcycle Mechanics Manual—Latest third edition 600 pages 275 illustrations, covers all British and American motorcycles, most complete motorcycle book available; \$4.00 postpaid. Nicholson Bros., Saskatoon, Canada.

**JET** Propelled bicycle. Assemble your own. Photo and instructions \$1.00. Rush order. Maupin, Tipp City 5, Ohio.

**MOTOR** Scooters, bicycle engines, 120 miles gallon. Dime for catalog. Clymer, Desk A-125, 1268 So. Alvarado, Los Angeles 6, Calif.

**NEW** Bicycles \$29.95. Wholesale. Retail. Bulletin 10c. Century Cycle, 3447 Lawrence, Chicago.

**MIDGET** Car with three-speed transmission \$35. Cushman motorscooter \$15, Shaw bicycle motor \$15, Harley-Davidson motorcycle \$15, motorbike outfit \$15. Rush 25 cents for special new catalog listing amazing bargains in motorscooters, used motors, tires, parts, midget cars, etc. Gall, 538 Erie, Toledo, Ohio.

**COMPLETE** One Stop Harley Davidson Sales Service, 813 Ohio Street, Wichita Falls, Texas.

**RECONDITIONED** Motorcycles and motors. Chromium accessories. Complete stock Indian parts. Expert rebuilding. Fast service. Indian Motorcycle Sales, Kansas City 1, Mo.

**HARLEY-DAVIDSON** Parts, accessories, oil, expert service. Tires all sizes. Rebuilt 45" motors. Send \$2.25 for Army 45 Motorcycle Manual. 25c for accessory catalog and bulletins. Knuth's (Harley-Davidson Dealers), 2491 Fondulac, Milwaukee, Wis.

**WHEELS!** Build wagons, scooters, mowers, trailers, wheelbarrows, grocery carts, baby carts, play pens, baby carriages. 4" to 16". Free list. Trulsen Mfg. Co., 811 E. 31, Kansas City, Mo.

**MOTO-SCOOT** \$35. Midget racer \$15, Indian motorcycle \$30, Cushman motorscooter with extra tire \$20, motors \$3 and up, homemade motorscooter \$10. Send 25c for new catalog listing these and many other sensational bargains in used motors, wheels, tires, motorscooters, midget cars, motorbikes, etc. Associated, Box 1764-CS, Toledo, Ohio.

**TIRES** And industrial wheels, suitable for scooters, wheelbarrows, farm equipment, etc. All sizes. Bicycles and accessories. Largest assortment in America. Send dime for list. Cycle Transport Company, 1241 So. Michigan Ave., Chicago 5, Illinois.

**HARLEY-DAVIDSON** Parts, accessories, batteries, and tires, 24 hour service. Authorized factory dealer. Philadelphia Harley-Davidson Company, 857 North Broad Street, Philadelphia 23, Penna.

### AVIATION

**PROPELLERS**—2-3 Blade for sleds, air-dive boats. Catalog. Standard Aero Craft, Box 387, Ft. Worth, Texas.

**FAMOUS** "Zweng books" include: Mechanics rating \$3.00; Flight Engineer \$4.00; Link Instructor \$4.00; Flight Dispatcher \$4.00; Pilots Rating \$3.00. (Free catalog). Pan American Navigation Service, 12021-C, Ventura Blvd., North Hollywood, Calif.

**AIRPLANE** Parts, engines, instruments. Cheap. Send 25c for list. Aircraft, 2300 Flagler Street, Miami 35, Florida.

**LIGHTPLANE** Manual. Blueprints. Circular illustrates ten designs, motors, 20c. Craftsman Books, Box 1153, Milwaukee 1, Wis.

**PROPELLERS**, Plans for ice sleds, snow sleds, air boats. Catalog 10c. Banks-Maxwell, Ft. Worth.

### BATTERIES, GENERATORS

**EDISON** Non-Acid lifetime storage batteries for home lighting, motors, industrial uses, radios, etc. Free interesting literature. Hawley Smith Co., Croton Falls 1, N. Y.

### ELECTRICAL SUPPLIES

**MOTORS**. New General Electric 1/2 horsepower \$12.50. Free literature. Plenge, 114 Elliot Place, Bronx 52, New York.

**PORTABLE** Electric plants mounted on one ton trailers. These are surplus and are new. 5 kilowatt, single phase, 50-cycle, 115 volts, a.c. Complete with ground, power cables and spare parts. Price \$500 each. Ideal for hunting and fishing lodges, farmers, contractors, etc. L. Morton Company, 333 North Michigan Avenue, Chicago 1, Illinois.

**METERS**—5-Amp. 2-wire 110-volt. Rebuilt, accurately calibrated, year guarantee. \$4.95 postpaid. Rebuilt Meter Co., 104 East Mason, Milwaukee 2, Wisconsin.

**BOOKS**—All Kinds—Homecraft, Radio, Plastics, Boat Building, Photography, Model Building. Catalog free. Popular Mechanics Press, 200 E. Ontario St., Chicago 11, Ill.



**ELECTRIC Pencil:** Engraves all metals, \$1.00. Beyer Mfg., 10511-H Springfield, Chicago 43.

**MECHANICS**—Build own portable shop light, adjustable floor to any height. Instructions 10c. Roy Hefti, 1927-23rd St., Des Moines, Iowa.

**RECONDITIONED G.E.** Westinghouse, wattour meters. Ideal for cabins, trailers, shops. \$2.95. T. Price, 310-14th, Raymond, Washington.

**ELECTRIC Pencil**—Writes, engraves all metals, 110 volts. \$2.95 postpaid. Battery model \$1.00. Reb Industries, 265-DL, Elmhurst, Illinois.

**LAMPS**—If you build or repair, send 10c for 36 page, illustrated catalog showing every part necessary. If dealer send business card for quantity discount. Gyro Lamps, 5402P Clark, Chicago 40.

**WIND** Your own transformers! Laminations, wire, instructions. Lectralabs-2, Wakefield, Rhode Island.

**LAMPS**—Build own originals, parts wholesale any amounts. Catalogue 10c. Brown Lamp Co., Box 501, Wellston, St. Louis 12, Mo.

**FREE Catalog**—Rotary snow plows, scooters, bicycle motor attachments, home freezers, motors, welders, generators, many other items. LeJay Company, Minneapolis, Minnesota.

**LAMP Parts** sold wholesale! Parts you need for building, repairing and assembling. Save money on orders large or small. New catalog 10c. Gearon Company, Dept. 400A, 27 S. Desplaines, Chicago 6.

**CHRISTMAS Tree** light sets and bulbs. Jeannette Electric, 159 West 23rd St., New York 11, N. Y.

**TWO Alnico (V)** magnets, booklet, literature, 25c. Terry Sales Company, 1915-23 Nebraska, Toledo 1, Ohio.

## REFRIGERATION

**REFRIGERATION Graduates:** Booklet helps you earn more money; \$1.00. Send for free details. Refrigeration Advisory Service, 3155 Chippewa, St. Louis 18, Mo.

## WELDING, SOLDERING, PLATING

**WELDERS!**—New portable Champion special transformer welder; 110/120 volts, a.c.; develops to 75 amps, 9 heat stages. Welds, brazes, solders, cuts all metals. Complete with electrode holder, helmet, rods, carbons, fluxes, cables. Also special flame weld torch. Easy to use. Full directions. Splendid for shop, farm and home repairs. Guaranteed. Only \$27.50. Also other models. Magic Welder Co., 239 MP12 Canal St., New York, N. Y.

**"BUILD-UR-OWN"** Portable arc welder. Save \$300. Easy with Hobart generator plus auto engine. Free instruction book. Write Hobart Welders, Box M-1283, Troy, Ohio.

**ACETYLENE** Welding outfits, new \$54.50; arcwelders. Eagle Welding, Dept. PM, 5085 Broadway, Chicago 40, Ill. Distributors wanted.

**WELDING Rods**—Lincoln FW5, Aircro 78, G.E. W-20, W-22 any size 6c lb. f.o.b. DuPont Smith, Box 74, Oak Ridge, Tenn.

**WELDERS** For all requirements. Free catalog. Write Hobartweld, Box M-1284, Troy, Ohio.

**WELDERS** 110v. Welds 1/2" steel \$32.50. Morris Welding Service, 1850A State, Schenectady 4, N. Y.

**BUY Direct** from factory. Welding outfit, \$48.36. Soldering outfits \$7.76 to \$10.16 complete prepaid. Box 331, Hamilton, Ohio.

**WELDING**—Learn quickly at best equipped school in U. S. A profitable trade. Demand for trained men. G.I. approved. Free catalog. Write Hobart Welding School, Box M-1285, Troy, Ohio.

**RADIATOR** Repairing, cleaning, explained. How to equip the shop at low cost. Supply sources, trade secrets told. Instruction system \$2. Radiator Service & Supply, McBain, Michigan.

**OXY-ACETYLENE** Welding outfit—New. Includes everything: two full oxygen and acetylene cylinders, torches, goggles, lighter, regulators, hose, welding rod, and carrying case. Only \$89.75. Cylinders refilled anywhere. Ideal for hobbyists, garages, repair shops. Guaranteed. Burdett Oxy-Weld Co., 3397 Lakeside Ave., Cleveland 14, Ohio. Welding supplies since 1923.

**OWN Mirror** shop. Resilver mirrors. Glass sign making. Electroplating. Supply prices. John Sprinkle, V55, Marion, Indiana.

**RECTIFIERS:** Ramyr Selenium platers, 10, 30, 50, 100 amp. sizes. Immediate shipment. Complete line of bronze baby shoe mounts. Write for list. Hollywood Bronze Supply, 1770 N. Vermont, Hollywood 27, Calif.

## MACHINERY, TOOLS, SUPPLIES

**YOUR Own** machine shop will save time and money on your repairs. Your neighbors work will pay you \$2-\$4 per hour. Our surplus machines are accurate, low-priced and delivered at once. Screw-cutting engine lathes \$150 and up. Powerful upright drill press from \$110. Milling machines \$150, some higher. Shapers, welders, band saws, grinders. Our guarantee; satisfaction or your money back. Conversion Parts Co., 278 Adams St., Boston 22, Mass. U. S. A.

**SOMETHING Special** in dado saws for wood grooving and rabbeting. Write for particulars. Advance Mfg. Co., 2129 East Lake Street, Minneapolis, Minnesota.

**16" AND 26"** Size jigsaws. Ten dollars and fourteen dollars. Mail money order. Shellington Machinery, 2055 W. Hunting Park Avenue, Philadelphia 40, Penna.

**BALL Bearings:** New Fafnir S5K. Bargain. 1 1/2" O.D. by 1/2" I.D. by 1/4" thick. Metalcraft Toy, Paul Brown Bldg., St. Louis.

**BARGAINS** In war surplus hydraulic transmissions, switches, motors, geared speed reducers, etc. Delta Sales, P.O. Box 968, Shreveport, Louisiana.

**WAR Surplus** in small tools for machine shop. Send 15c for bulletin. Travers Tool Co., Dept. P, 5 Court Square, Long Island City 1, N. Y.

**V-BLOCKS** With clamp. Big value \$3.45. Guaranteed accuracy. Write Miles Products, Lyons, Ill.

**SAW Jointer**—Perfection without file 50c. Simplex, Route 7, Palestine, Texas.

**BAND Saw**, ripping fence, for tables 7" to 15" \$1.98 postpaid. Circular, Wasco Manufacturing, Box 111, Blue Island, Illinois.

**SANDING Belts**, 6"x54 1/2", new aluminum oxide, 60-240 grit, 37c. Raynix, 5736 Calmont, Ft. Worth 7, Texas.

**GAS Drive** arc welders. "Build-Ur-Own" portable. Get profitable jobs anywhere. Save \$350 with Hobart Generator plus auto engine. Free instruction book. Write Hobart Welders, Box M-1287, Troy, Ohio.

**ARMY Weasels**, new and used. Parts. Symington's, 4535 Union Bay Place, Seattle 5, Washington.

**FOR Surplus** and factory close out bargain lists on tools, motors, generators, gadgets, etc. send 25c to Surplus Sales, 224 24th St., Niagara Falls, N. Y.

**FIRE Extinguishers**, 15-lb. C-O-2, Kiddy. Alrite cutter-head assemblies, \$4.50 each. Domonkos, 98 Vermont, Newark 6, New Jersey.

**TOOL Kits**. Exceptional values. Wonderful Xmas gifts for boys, homeowners, mechanics. Precision Tool Service, Dept. M, 55 E. Washington, Chicago 2, Ill.

**NEW Grey iron** drill press with 1/4" Jacobs chuck. Delivered, only ten dollars. Cordray Motor Co., Wellington, Ohio.

**SAW Arbors**, ball bearing permanently lubricated with hardened shaft 3/8" x 12". Tubular cast housing assures perfect alignment. Write for circular. \$8.95 postpaid. Money-back guarantee. Craft Specialties, 61 Bridge Street, Springfield, Vermont.

**POWER Tools**, motors. Equipment wholesale prices. Free list. Homecrafters Co-Operative, Grand Rapids 6, Michigan.

**LARGE Glass jar** assortments, postpaid. Machine screws, bolts, washers, nuts 85 cts. Springs, extension and compression 95 cts. American, 1211 Bedford Ave., Brooklyn, N. Y.

**DRILL Grinder** for twist drills, \$2.95. See ad on page 253.

**NEW Band saw** for home workshop or factory use, ideal for hobbyists. Special \$14.95. Circular free. Woodcraft Tools, 147 E. Lake, Minneapolis, Minn.

**BANDSAW**—\$17.95! "World's lowest-priced!" Self-lubricating bearings. Modern, enclosed mechanism. Investigate! Free illustrated literature. Accro, 4610-D Alaska, Saint Louis 11, Missouri.

**CONCRETE** Block machines \$39.50 up. Catalog free. Concrete Machine Company, 5466 Gravois, St. Louis 16, Missouri.

**HOME Lathe** owners—Build your own attachments. Send for picture, sample of work and list of blueprints. Cut gears, ratchets, etc. Make neat screws easy way. The Home Shop, 415 Raymond Ave., Glendale 1, Calif.

**CHUCKS.** (Genuine Westcott) Independent, Universal, threaded 1 1/2"-8 for South Bend, Atlas, Logan, Clausing, Craftsman lathes. Also other chucks to 16". Top value. Free literature. Westcott Chuck Co., 3600 Walnut, Oneida, N. Y.

## BOATS, OUTBOARD MOTORS

**MARINE Plywood** sheets (fir, mahogany, etc.) and boat building lumber. Send 25c (coin) for "Plywood Hints" with stock list. Marine Mart, Buffalo 7-B, N. Y.

**TWENTY Plywood** boat plans \$1.00. Catalog boat building plans 10c. The Rudder, 15 Murray Street, New York 7.

**BOAT Steer** wheels, windshield brackets \$8.95. Modern hardware kits, bargains galore. Folder. Marine, Box 681, Mendota, Minnesota.

**CONVERSION Kits** for Ford, Willys, etc. Also air cooled engines, clutches, vee drives and stern drives. Send 50c (coin) for catalog and booklet. "Conversion Hints." Marine Mart, Buffalo 7-B, N. Y.

**NEPTUNE** Outboard motors. Wholesale prices all sizes. Outboard Sales, 820 Dryades St., New Orleans, Louisiana.

**BUILD Your** boat from our accurate paper patterns, thirty designs, 7-54 feet. Forty years careful designing. Send 10c for folders. Illustrated book, small boat construction, \$1.50 postpaid. German Boat Company, W. Saginaw, Michigan.

**OUTBOARD** Motorboating handbook, 252 pages, 89 charts, drawings. Complete service information every make outboard. Greatest outboard book ever. Just published. \$3.50 postpaid. Clymer, Dept. A-OM, 1268 So. Alvarado, Los Angeles 6, Calif.

**BOAT Plans**, kits. See display ads, pages 272 and 276. Marine Mart, Buffalo 7-B, New York.

**P-38 BELLY** Tank speed boat. Complete plans and instructions \$1.00. Twintank Boat Company, 1032 62nd Street, Oakland, Calif.

**MARINE Conversions** and reverse gears for all Ford and Jeep engines. Catalog 25c. Dept. P. Arthur Gershel, 51 Chambers St., New York 7.

**MARINE Supply** catalog—Thousands of deliverable items; priced and beautifully illustrated. Send \$1. Arthur Gershel, 51 Chambers St., New York 7.

**BOAT Plans** by graduate naval architects. Send specific requirements for free suggestions. Westlawn Associates, Montville 5, N. J.

**BUILD Your** own boat by the Welch System, ready cut parts. No experience necessary. Save 2/3 cost. Rowboats to cruisers. Illustrated catalog 25c. Midwest Boat Company, Menomonee Falls, Wis.

**MARINE Fittings**, accessories. Thousands of items (pictured, prices). Prompt delivery. Catalog \$1.00. Marine Mart, Buffalo 7-B, New York.

**OUTBOARD Motors**—Good values, used motors. Also used parts for most makes and models. Crandall-Hicks Co., 911 Commonwealth, Boston, Mass.

**MARINE Conversions** for Ford and Jeep engines. Catalog 10c. Lehman Manufacturing Company, Department D, Newark 2, New Jersey.

**NEW, Used**, rebuilt marine motors. Marine conversions, fittings. Free catalog. Stokes Marine Supply, Dept. 24, Coldwater, Michigan.

**OUTBOARD Motor** parts. New-used, all makes. New pistons (standard, oversize). Cylinders rebored. Outboard Motor Mart, 309 Atlantic Ave., Boston 10, Mass.

## ENGINES, MOTORS, DYNAMOS

**WELDING** Generators, 150 ampere \$47.50. 1/2 horse, 1750 r.p.m. motors \$19.75. 3/4 horse, 3450 r.p.m. \$22.50. 1 horse \$28.50. Compressors \$17.50. Butler, 1885 Milwaukee, Chicago.

**SENSATIONAL Offer**—New 100 h.p. engine for only \$450. Here is what you get: 1 Ford factory new 100 h.p. V-8 engine, 1 V-8 conversion kit complete with marine manifolds; also "Joe's" or "Paragon's" marine reverse gear. By assembling the engine yourself you save more than \$350. Only simple tools required. Nationwide Motors, 650 Sunrise Highway, Rockville Centre, Long Island, N. Y.



9 BRAND New Clinton 1½ h.p. air cooled engines (in original cartons) with integral 6 to 1 reduction gear; rope starting; \$49.50 each. F.O.B. Chicago. Mead Specialties Co., 4114 N. Knox Ave., Chicago 41, Illinois.

GAS Drive arc welders, "Build-Up-Own" portable. Goes everywhere after profitable jobs. Free instruction book. Write Hobart Welders, Box M-1286, Troy, Ohio.

MOTORS: ¼ H.P. General Electric \$8.50, ½ h.p. Century \$12.50. Send m.o. Rebuilt. A. C. Motors, 3101 N. 32nd, Philadelphia 32, Penna.

NEW G.E. utility motors, 110 a.c., speed 1725, capacitor type, rubber mounted; ½ h.p. \$26.50, ¾ h.p. \$17.50. Write for other bargains. Send m.o. to Marshall Electric, 3546 Fullerton, Chicago.

WIZZ Electric motor: (3" x 1¾"). Flashlight cell operates. Parts complete plus instructions 30c postpaid. Eltro, Deer Park, N. Y.

WINDING Data, listing 225 motors, single and three phase. \$1.00. Motor Data Co., Box 7631, Kansas City 3, Mo.

MOTORS! ½ H.P. D.C. converted to A.C. All new. High speed 110 volt, 25 or 60 cycle, ball bearing motors. Actual value about \$75.00. Now \$15.00 each or 3 for \$40.00. With forward and reverse switch \$19.50, 3 for \$50.00. Countless uses for home mechanics. Can be used in any position. Order today! Immediate delivery! No c.o.d. orders. "Amazing Bachman's," 27 Herman Street, Rochester 5, New York.

MOTOR Repair men, send for bulletins on motor winding tester and a.c. motor winder. Motor Industries, Quincy, Illinois.

#### ATHLETIC EQUIPMENT, BODY BUILDING COURSES

NAT Berent's body building course. \$1.00 postpaid. Nat Berent, 1090 West 43rd, Norfolk 8, Va.

BIG Bargains, 12 different courses, (27,000 words) for only \$1.00. (Guaranteed world's best.) News, etc. 10c. Sid's System, Southgate, Calif.

BARBELLS, Exercise equipment. Courses. Free booklet. Good Barbell Co., Reading, Penna.

BARBELLS, Olympic types, stamp for folders. Jackson Barbells, Springfield, N. J.

THE Worlds strongest men are built by: The Key Institute of Physical Culture, Titusville, Florida.

DEADLY Judo—Fiercest fighting technique. Trick knockouts. (200 photographs, plus illustrations.) Expert instructions, three volumes. Complete \$2.25. Variety House, Box 46-B, Wall Station, New York 5.

BARBELLS—Finest quality \$8.98 and up. Free catalog. Lurie Barbell Co., 1729-M Rockaway Parkway, Brooklyn, N. Y.

#### SPORTING GOODS, GUNS, FISHING TACKLE, ARCHERY, TRAPPING

SINKER Molds for fishermen. Cast aluminum, handled and hinged or pinned type, \$1.50 up. Special molds made to your order. E. L. Sweet & Son, Tonawanda 8, New York.

MINUTE Man gun blue one application cold chemical process takes minutes. ¼th pint, enough to blue five guns, \$1.00. Money back if not satisfied. New Method Co., Box PMG-24, Bradford, Penna.

SLINGSHOTS, New, powerful, kills rabbits, squirrels, etc. Complete with ammunition, 75c postpaid. Wham-O, Box 21, South Pasadena, Calif.

SEND 10c For list 100 used guns. Frayseth's, Willmar, Minn.

LARGE Calibre revolvers converted to .22. S. Morse, Peabody, Kansas.

PISTOLS: Mechanically perfects: 9m/m Luger \$65.00. Walther P-38 9m/m \$50.00. Colt .45 Auto \$55.00. Walther .32/7 .65m/m \$50.00. Mauser .32/7 .65m/m \$50.00. Berettas .32/7 .65m/m and/or 9m/m \$50. Complete firearms; ammunition lists postpaid 25c. Frank Farish, Vicksburg, Miss.

WONDER-ALL The new action bouncing stick. Entertainment for the entire family. 35c. 3 all different, one dollar. Agrillo, 33 West 6th St., Gilroy 1, Calif.

SHOTGUNS, Rifles, revolvers, over 500 modern, obsolete. Also cartridges, list 10c coin. Ed Howe, 52 Main, Coopers Mills, Maine.

SHOTGUNS, Rifles, handarms, ammunition, rods, reels. List 10c. Rudolph's, Atchison, Kansas.

5000 BARGAINS, Firearms, binoculars, war relics. Catalog 40c. Smith Firearms, Runnemed, New Jersey.

BOWS—Arrows, write headquarters for archery equipment. Quality products. Popular prices, catalog 10c. Large illustrated handbook instructions, aiming and shooting, 50c. Archery, 617-B So. State, Chicago 5.

#### TAXIDERMY

FINEST Glass eyes; taxidermy supplies. Catalog free. Elwood Company, Department 234, Omaha 2, Nebr.

#### BINOCULARS, TELESCOPES, MICROSCOPES, MAGNIFIERS

"TERRIFIC" Bargains — Government surplus telescopes, binoculars. Send \$1.00 for 10 piece hobbyist lens set. Contains magnifying and reducing lenses. Send stamp for "bargain" list. P. Jaegers, 93-08 95th Ave., Ozone Park 16, N. Y.

6x30 NEW U.S. army, War II Model M3. Coated—\$48.95. 7x50 New U.S. army M6. Coated; \$78.00. 8x30 New Carl Zeiss. Featherweight. Coated; \$98.00. Case, straps included. Add 20% federal tax. Money back guarantee. United, 7941 So. Halsted, Dept. ARF-808, Chicago 20.

POWERFUL Astronomical refracting telescope, equatorially mounted, all metal, two eyepieces, \$16.50. Bluhm Optical Lab., 4213 Gifford Ave., Cleveland 9, Ohio.

GIANT Astronomical telescope 100 diameters magnification, with tripod. Full power, clear vision. \$15.00. Suffolk Science Service, Manorville, N. Y.

POWERFUL Astronomical telescopes easily made. Perfect lenses and instructions; 100X \$3.00, 100X and 200X \$4.00, 100X, 200X and 400X \$6.00. Clear vision, full power guaranteed. Instructions alone 10c. Suffolk Science Service, Manorville, N. Y.

BINOCULARS, Telescopes, watches, guns. Buy, sell, trade. Schweer's, Donnellson, Iowa.

ASTRONOMICAL Telescopes, binoculars, microscopes; bought, sold, repaired. Books. Lists 10c. Rasmussen-Reece, Amsterdam, N. Y.

TELESCOPES, Binoculars, microscopes, big bargain catalog free. Brownscope Company, 24 West 45th Street, New York.

#### DOGS, PETS, BIRDS, RABBITS

BEAUTIFUL, Pure white pedigreed police dogs. Ansonia Kennels, Mose, N. Dak.

RAISE Guinea pigs. Make money at home. Big demand. Booklet free. Taylor, Box 426A, Hapeville, Georgia.

\$3000 YEARLY Raising pedigreed and registered Angora rabbits. Circular free. Vaughn's Rabbitry, Otley, Iowa.

\$1.00 FOR Booklet "Canary, Its Care, Breeding and Training," and three copies cage-bird magazine. American Canary, 2839PM N. Halsted, Chicago 14, Ill.

GIVE Christmas "Golden Hamsters" pair \$3.75. Trios \$6.00. Pem's Hamstery, 3010-10th Ave., No., St. Petersburg, Fla.

ANGORAS, Giant Chinchillas, White Giants. World's most profitable rabbits. Finest pedigreed, heavy-producing, prize-winners. Literature free. Grinsteads, Edwardsville, Illinois.

RAISING Rabbits, Cavies, Hamsters, Chinchillas is profitable. Big demand. Instruction book and magazine 25c. Book and magazine (monthly) one year, \$1. Small Stock Farmer, Fairlawn 2, New Jersey.

SEE Golden Hamsters ad on page 28. Shows picture of Hamster.

REPTILE Bulletin 5c. Hobby catalog 10c. Pair golden hamsters \$2.75. Alligator \$2.50. Chameleon 25c. Quivira Specialties, Topeka, Kansas.

ST. BERNARD Puppies! Details, delightful pictures free! Manitou Kennels, Watrous, Sask., Canada.

MINK Raising information free. Complete. Lake Superior Mink Farm, Superior, EEl, Wisconsin.

MAKE Extra cash. Raise giant chinchilla rabbits. Waters Rabbit Farm, Glennville, Ga.

RAISE Chinchilla rabbits. Year-round money-makers from furs, meat, breeders. Experience unnecessary. Folder 25c. Willow Farm, Sellersville 15, Penna.

\$250.00 MONTHLY Raising angora rabbits. Particulars free. White's Rabbitry, Newark, Ohio.

\$50.00 WEEKLY Raising Angoras for us. Free literature. Angoraville, 1215-34th Northeast, Cedar Rapids, Iowa.

MINK Raising amazingly profitable. Free folder gives inside "secrets" on feed; care. Lawrence Molgard, Brigham City 12, Utah.

INCREASE Your income by raising domestic rabbits. Small space needed. Ready market for delicious meat, fur and wool. Largest magazine in the industry tells you how. \$1.50 per year. Sample 15 cents. No stamps. Small Stock Magazine, Lamoni 20, Iowa.

\$3000 YEARLY Raising Angora rabbits. We buy your output. Contract particulars free. Kise's Enterprises, St. Paul 8, Minn.

RAISE Rabbits, market provided. Breeding stock furnished on production pay plan. Literature 25c, with hutch plans \$1. Hansen's Rabbit Institute, 1347 Miller Avenue, Salt Lake City 6, Utah.

#### PLANTS, SEEDS, NURSERY AND GARDEN SUPPLIES

WE Sell on the installment plan. Best varieties peach and apple trees, low as 12c; grapevines 4c; shrubs 13c; evergreens 15c. Berries and plants. Catalog free. Benton County Nursery, Box 542, Rogers, Arkansas.

GLADIOLUS—New varieties, novelties, list. Robinson, Box 31, Sebastopol, Calif.

#### FARMS, FARM LANDS, REAL ESTATE

UNITED'S Winter catalog. Bargains galore! Farms, ranches, groves, businesses, homes. Exciting free catalog of up-to-the-minute values. Great Lakes, Midwest, famous Ozarks, to California. America's biggest bargains! Write for free copy today. United Farm Agency, 1408-PM Consumers Bldg., Chicago 4, Ill.

FREE Farm lands available in sunny Florida. Details, method of application, only 25c. Century Publications, 5803½ Central, Tampa, Florida.

650 FARMS, Ranches, water frontage properties. Free descriptive folders, price lists. Splendid opportunities, Washington, Idaho, Montana, Dakotas, Upper Michigan, Wisconsin, central corn belt. Information regarding Columbia and Missouri River Basin irrigation projects. L. H. Robbins, Milwaukee Railroad, 736K Union Station, Chicago 6, Illinois.

STROUT'S Fall-Winter farm catalog—Free! Red cover. Chock-full of bargains coast-to-coast. Eqpd. and uneqpd. farms, groves, retirement places, etc., etc. Write today for your free copy. Strout Realty, 255-P 4th Ave., New York 10, N. Y. 20 W. 9th St., Kansas City 6, Mo. 453 S. Spring, Los Angeles 13, Calif.

FARMS, Acreage, beach sites. Exceptional crop, livestock, poultry production. Good markets and transportation. All year pleasant climate, rainfall averages sixty inches annually, productive soils, reasonable prices. Salt and fresh water fishing, boating, hunting and other sports. Wonderful locations for retired persons. Choice of the gulf coastal sections of northwest Florida, south Alabama or south Mississippi. Write for illustrated information, specify preferred state and purpose for which land is wanted. E. J. Hoddy, Desk 2, Room 108, General Office Building, Louisville & Nashville Railroad, Louisville 1, Ky.

\$5.00 MONTHLY Buys 40 acres, near town. Price \$200.00. Free list. Box 425-P, Carthage, Mo.

LOTS \$300—Convenient payments. California's finest garden section. On Morro Bay's scenic shores. Wonderful fishing, hunting, boating, bathing. Fertile soil, softest water, temperate climate, congenial community. Free literature. Richard Otto, Department M, San Luis Obispo, California.

GOOD Farms—Ranches, Washington, Minnesota, Montana, Idaho, Oregon, North Dakota. Dependable crops, favorable climate. Write for literature, lists describing typical farm opportunities. Specify which state. J. W. Haw, 119 Northern Pacific Ry., St. Paul 1, Minn.

OZARK Lands for all purposes. Actual river frontages, 5 acres \$90.00 and upwards. Free list and literature. Hubbard, 424-I Minnesota Ave., Kansas City 4, Kansas.

MAKE Money building bird houses. Illustrated instruction book. 25c. Popular Mechanics Press, (C-43), 200 E. Ontario, Chicago.



## POULTRY, FARM SUPPLIES

**BABY Chicks**, champion mated. 52 varieties, 6 hybrids, licensed inspected, bloodtested. Rush postal, large colored book free, low prices. Berry's Farm, Route 12, Clarinda, Iowa.

**LEADERS** Predict big 1949 poultry profits. Make plans now! Our experimental farm advice helps thousands. Will help you. 24 months, \$1.00. Order today! Poultry Tribune, Dept. 16, Mount Morris, Illinois.

**RAISE** Turkeys the new way. Write for free information explaining how to make up to \$3000.00 in your own backyard. Address National Turkey Institute, Dept. 3, Columbus, Kansas.

**EARN \$4 To \$12 hourly.** Chick sexing, culling and caponizing. G.I. approved. Pilch's School, Box PM, Thompsonville, Connecticut.

**RAISE** Fryers new easy way. One man home plant earns \$500 monthly. Details free. Fortune Fryer Farm, Box A, Simi, California.

**KNOW** How to raise poultry for profit. Read Northeastern Poultryman. Every issue packed with helpful hints and practical suggestions. Latest articles on breeding, feeding and management. Subscribe now. 1 year 65c. 2 years one dollar. foreign subscriptions \$1.00 a year. Northeastern Poultryman, Dept. P.M., 376 Boylston St., Boston 16, Mass.

## PROFITABLE OCCUPATIONS

**MAKE** And save money on electrical appliances. Price list free. Belmont Appliances, 202 Hinsdale St., Brooklyn.

**START** Your own business on our capital. Always your own boss. Hundreds average \$6,000 to \$25,000 annual sales year after year. We supply stocks, equipment on credit. 200 home necessities. Selling experience unnecessary to start. Wonderful opportunity to own pleasant, profitable business backed by world-wide industry. Write Rawleigh's, Dept. L-U-PPM, Freeport, Ill.

**NO** Selling, operate coin machines, amazing profits, details free. Parkway Corporation, Dept. 4, 623 W. North Avenue, Baltimore 17, Maryland.

**BUILD** Ming trees, complete kit supplied in every detail. \$5.00. P.O. Box 329, Sparks, Nevada.

**PROFITABLE** Business making and building with easy-laying interlocking building blocks. Rex Products, Dept. 10, Piqua, Ohio.

**SENSATIONAL!** It's easy to earn big money with your own profitable business! Earn \$10-\$50 a day! Make lamps at home. General illustrated course teaches you quickly. Course and wholesale supply catalog only \$2.00. Gearon Company, Dept. 400, 27 S. Desplaines, Chicago 6.

**WORLD** Wide construction job listings published monthly for overseas and U.S.A. \$1.00 postpaid. Global Reports, P.O. Box 883-DX, Hollywood 28, Calif.

**EXCELLENT** Profits. Make, sell holiday flowers, novelties. Literature free. Velve Artcrafts, 324-M East 14, New York 3, N. Y.

**"FROG-RAISING"**—New book explains everything! Marlboro, 1035 Marlborough, Detroit 15, Michigan.

**BE** The Popular Mechanics representative in your neighborhood and earn big profits in your spare time. Write Popular Mechanics Magazine, Room 408M, 200 E. Ontario St., Chicago, Ill.

**"MOST** Everybody likes candy." Learn to make in a professional manner. (Our 38th year.) Ragsdale Candies, D6, East Orange, New Jersey.

**\$46 FROM** Square foot plywood; jigsaw necessary. Write, Woodarts, P-38, Bridgewater, Mass.

**FOREIGN** Employment? List of 100 firms with overseas projects, and sample letter of application. COD \$1.30 or \$1.00 cash. Foreign Service Institute, Box 3934, Miami 24, Fla.

**LOCKSMITHING** Secrets—Key fitting, lock opening, repairing, prices to charge, supply sources. Illustrated book only \$1.00. Wechsler Supply, 7 W. 36, New York City.

**WOULD** You pay 3%—first \$350 made? Color-illustrated book "505 Odd, Successful Enterprises" free! Some offer occasional "day off." Work home. Expect something odd! Pacific, Oceanside, Calif.

**\$40.00 WEEKLY** Made growing mushrooms, fresh, dried. Dominion patent 331583. Free spawn. North American, 169P Yonge, Toronto, Canada.

**OWN** Mirror shop. Resilver mirrors. Glass sign making. Electroplating. Supply prices. John Sprinkle, V50, Marion, Ind.

**INTERESTED** In Latin American and foreign employment? \$1.00 brings Foreign Service Directory listing exporters and importers, oil, construction, mining, aviation companies. Hot tips for applications. Global Reports, Box 883-M, Hollywood 28, Calif.

**OPERATE** A letter shop. Unlimited opportunity. Send for free prospectus. Dougherty, 255 Washington, Phillipsburg, N. J.

**ALASKA**—The Last Frontier offers unlimited opportunities, \$1 brings government map and directory listing firms in fishing, construction, mining, aviation, fish and game rules, homestead data. Alaska Opportunist, Box 883-M, Hollywood 28, Calif.

**TYPISTS**—Profitable business at home. Complete copyrighted information, 50c. Gaunt, 3521A Broadway, Chicago 13, Ill.

## BOOKS, PERIODICALS, PICTURES, POSTCARDS

**EASY** Profits taking magazine subscriptions, handling greeting cards. Full details free! Cassell Publishers, Westfield, N. J.

**FREE** Particulars for book bargains. Rosenthal, 200 Ross, Brooklyn 11, N. Y.

**BOOKWORMS'** Bargain swap. Send 4 recent fiction, good condition, with \$1.00. Receive 4. Re-mailing service. Collins, 1951 Branciforte, Route 1, Santa Cruz, California.

**BOOKS**, Out-of-print. Hard-to-find. Any book. Banker Book Co., Dept. 18, Sherman Oaks, Calif.

**BOOKS**, In or out of print. Mailed anywhere. Magabook Shop, 168 West 4th, New York 14.

**WE** can supply you with almost any book. (Magazine subscriptions). House of Kilroy, (Booksellers), Box 772, Detroit 31, Mich.

**STARTLING** Revelations! Read "Prophetic Years 1947-1953." Free literature. Progress Company, 40333 Chown, Minneapolis 10, Minn.

**BOOKFINDERS!** (Scarce, out-of-print, unusual books). Quickly supplied. Send wants. Clifton, Box 1377-PM, Beverly Hills, Calif.

**SELF-EXPLAINING** Bible: Illustrated circular free. Box 446-P, Minneapolis, Minn.

**EXCITING** And strange books. Send 25c (coin) for catalog and private collector list. Rare Book Co., 1219 1/2 North La Brea Ave., Hollywood 38, California.

**BOOKHUNTERS!** All subjects. Send wants! Jaher Book Service, 620-P East 178 Street, New York 57.

## GAMES, ENTERTAINMENT

**FILIPINO** Twirler. Amusing. Send 10c and stamp to Beneco, 223 Vernon, Roseville, Calif.

**BOOK** Of parlor games 35c. Free catalogue, interesting books. A. Faller Company, 201 Dewey Street, Newark 8, New Jersey.

**CHRISTMAS** Gift for young and old a delightful game. Special introductory price 50c. Satisfaction guaranteed or money refunded. Hix Novelty Works, 1568 East 22nd Street, Los Angeles 11, California.

## MAGIC TRICKS, PUZZLES, JOKER NOVELTIES

**400-PAGE** Catalogue of 2000 tricks, pocket, parlor, stage. World's finest magic. Send \$1.00 for catalogue (refunded first \$5.00 order). Kanter's, M-1311 Walnut, Philadelphia 7.

**MAGICIANS** School. Licensed, first of its kind. Approved for veterans. Experience unnecessary. Free particulars. Chavez College of Magic, 729 West Ninth Street, Los Angeles 15, California.

**DOLLAR** Magic set free with mammoth catalog 25c. "Mysto," 4462-PM Germantown, Philadelphia.

**ENTERTAIN**, Mystify! 96 page catalog magic, joke and party goods, 25c. Riley-Borin, P-7909 Rhodes, Chicago 19.

**"VENTRILLO,"** Professional voice throwing instrument and "unusual" catalog 25c. POB-971, Philadelphia.

**LARGE** 160 Page catalog, just published. 35c. We have supplied the best tricks to beginners and professionals for 38 years. Chicago Magic Company, 2300-X No. Mason Avenue, Chicago 39.

**SNEEZING**, Itching, powders. Eighteen other tricks free with joker's catalog 25c. 2404-N Fifteenth, Philadelphia.

**TRICKS**, Joke novelties of all kinds. Illustrated literature free. Rone's, Box 97, Katonah, New York.

**PROFESSIONAL** Catalog. 124 pages, 25c. Williams, 900 Plymouth, Ellwood City, Penna.

**500 TRICKS**, New 1949 edition. Send 10c for Douglas famous catalog showing best in good magic, lowest prices, fastest same-day service. 30 years in business. Douglas Magicland, Dept. 1, Dallas, Texas.

**WIZARD** Aviator cards. Ten illustrated tricks. Send one dollar. John Swenie, 1139 North Kedvale Avenue, Chicago 51.

**EARN** Big money! Learn easily how to be a magician. For complete information write Stallard Enterprises, 1888 Richmond Drive, Louisville 5, Kentucky.

**VENTRILLOQUISM** Taught. 3c stamp bring particulars. Smith, 801 Bigelow, Peoria 5, Ill.

**WORLD'S** Largest professional magic shop, keeps you in touch with latest tricks. To receive mailings, send 50c for new catalog. Holden's, M220 West 42nd St., New York.

**MAGIC** Tricks, puzzles, books, cards, punch boards. Catalog 10c. Specialty, Box 671, St. Louis 1, Mo.

**BE** A magician. Large professional magic catalog of latest tricks, 35c. Ireland, C-109 North Dearborn, Chicago 2.

**LARGE** Catalogue of the best magic for professionals and amateurs. Send 25c. Mazda Magic Co., 1135 Westgate Ave., Oak Park, Ill.

**LEARN** Magic, ventriloquism, mind-reading. Write for particulars. Quackenbus, Big Flats, N. Y.

**BIG** Magic magazine, trick and price lists—25c. Lloyd M. Jones, 4064 39th Avenue, Oakland 2, California.

**VANISHING** Half dollar trick and catalog 25c. Sterling Magic Co., Royal Oak, Mich.

**200** ELECTRIC Stunts, 110 volts, \$1.00. Kutting Sons, Campbell, Calif.

## COINS, TOKENS, CURRENCY

**OLD** Money wanted. Will pay \$100.00 for 1894 dime, S. mint, \$50.00 for 1913 Liberty head nickel (not buffalo). Big premiums paid for all rare coins. Send 4c for large coin folder. May mean much profit to you. Numismatic Co., Dept. 20, Fort Worth, Texas.

**U. S.** Coins bought. Free price list. Doyle's, 32 American, Long Beach 2, California.

**PRIVATE** Coin collection. Lewis Brown, 6826 Rockhill, Kansas City, Mo.

**15** DIFFERENT Fine coins 50c. Free lists. Approval selections sent. Bishop, Box 2201, Kansas City, Mo.

**25** COINS And bills, 25c. Oddehon, Box 482, St. Louis, Mo.

**MONTHLY** Price list for coin collectors. 24 pages. Single copy 15c. Six months 75c. James Randall, 116 South Michigan Avenue, Chicago 3, Illinois.

**BARGAINS**—Large \$1.00 bill \$1.60; large \$2.00 bill \$3.40; 3-legged buffalo nickel \$1.25; 20 different Indian cents \$1.00; 4 Whitman coin folders \$1.00, handbook 75c; 254 page guidebook \$1.50. Large retail catalogue 15c. Bebee Coin Company, 1180 East 63rd, Chicago 37, Illinois.

**U. S.** Foreign. Free lists. Slikes, 1831 E. Allegheny, Philadelphia 34, Penna.

**COINS** Wanted. Will pay up to \$2000 for certain coins, send 25c for catalogue. Burton's, 111 So. Third, Columbus, Ohio.

**GET** Profit and pleasure in collecting old coins. Send 10c for 56 page illustrated coin catalog. You'll be delighted with it. Send for it now. B. Max Mehl, 370 Mehl Bldg., Fort Worth, Texas. Largest rare coin establishment in U. S. Established 48 years.

**FREE!** Foreign coin, banknote and coin collectors illustrated catalog to approval service applicants. Send 3c postage. Tatham Coinco, Springfield-125, Mass.

**4-IN-1** Special \$1.00 bargain offer: (1) United States 1893 Columbian world's fair half dollar; (2) album for holding coins; (3) large 56 page coin catalog; (4) genuine wooden nickel. Yes! All four items for only \$1.00. Order today. Money back if not pleased. Ben's Coin Company, 72 W. Washington, Chicago 2, Illinois.



COMMEMORATIVE  $\frac{1}{2}$ , Oregon, Texas, Kentucky, Cleveland, Long Island, \$2.00 ea. Illustrated catalogue 25c. Norman Shultz, Salt Lake 9, Utah.

### STAMP COLLECTING

FREE—Famous Americans set, plus Flag Set, plus the National Parks Set, plus the Presidential Set to the \$5. A total of 90 stamps absolutely free to customers for our unsurpassed U. S. or foreign selections. Send 3c postage for 15 of the above mentioned stamps and full particulars. Triboro Stamp Company, 145 Nassau St., Dept. 112, New York.

BIGGEST Offer yet: Snake triangle from Mozambique, China stamp with colored flags of America, Britain and China, Eritrea high value air, Nicaragua picturing Roosevelt the stamp collector, San-Marino showing first American stamp, premium coupon plus stamps cataloging over \$1 only 3c. Approvals, B. Moulblow, 740 Hegney, Bronx 56, N. Y.

FREE Illustrated list. Elbe dealer. "Treasure Hunt" penny approvals on request. Reed Company, Box 980, Chicago 90, Illinois.

FREE: New illustrated catalogue picturing world's most beautiful stamps in complete sets from 5c up. Write today. Trans World Stamps, Dept. PM-1, 131 W. 42nd St., New York 18, N. Y.

FREE! Africa, Asia, Europe packet. Approvals. Standard, Box 43 West Farms, New York 60, New York.

FREE! Complete Balkan aviation set with approvals. Beaman, Leeds, Alabama.

FREE! United States commemorative price list. Historical Stamp Co., 1280 Ocean Ave., Brooklyn 30, N. Y.

MINT Block files, 4x6 16 pockets, heavy blue cover, only 15c. Appleman, 2300 Monterey, Detroit 6, Mich.

FIFTY Stamps ten cents; bargain approvals. George, 220 Orizaba, San Francisco 25.

20 ASSORTED U. S. Commemorative stamps, 10c. Five U. S. Air Mail 10c. Ideal, Box 179, Park Ridge, Ill.

TREMENDOUS Values in our unusual penny approvals. Roscoe Stamp, 1321 Roscoe, Chicago 13.

EIGHT Bicolored French Colonies free to approval applicants. Everglades, 279 N.W. 57th Street, Miami, Florida.

LIBERIAN Triangulars, 10c with approvals. Vargo Stamps, 6044 South Fairfield, Chicago 29, Illinois.

VICTORY Packet free—Includes stamps from Tanganyika, British Cayman Islands, animal, scarce babyhead, Coronation, early Victorian, airmail, map stamps. Including big illustrated catalogue. Send 5c for postage. Gray Stamp Company, Dept. PM, Toronto, Canada.

PENNY Approvals that satisfy. Neil Gronberg, Box 5441-P, Philadelphia 43, Penna.

FREE Stamp catalog! New, different, saves you money on stamps, albums, packets. Ewing, 109 N. Dearborn, Chicago 2.

ROOSEVELT Stamps from 3 foreign nations, including beautiful, big triangle, 5c with approvals. Reid, 100 Pearl Street, Framingham, Massachusetts.

SENSATIONAL! Capejuby, Brunei, Perak, Honduras, Paraguay, Nigeria, and over 100 different others. Everything 10c with approvals. D. O'Keefe, 7517 Merrill Ave., Chicago 49, Ill.

GOLIATH Bargain! Over 100 different with set Bolivia commemoratives, set San Marino commemoratives; also Africa, Latin America, etc. Everything 10c to approval applicants. Mesago, Box 546, Cortez, Colorado.

AUSTRALIA, 10 unused, 2 used different \$1.00. Robertson, 17 Poath Rd., Bentleigh East, S.E. 15, Victoria, Australia.

FREE! Mint British Colonies from Solomon Islands, Caymans, Grenada, Dominica, Turks Caicos. Absolutely free to new approval applicants. Viking, 130-Z Clinton St., Brooklyn 2, N. Y.

25 DIFFERENT Stamps 10c. Approvals on request. J. W. Reilly, P.O. Box 787, Ocala, Florida.

SPECIAL! 13 Different 10c sets \$1.00. Link, Box 183, Union, New Jersey 12.

50,000 STAMP Grabbags 25c each. Anderson, 630 Bingaman 1, Reading, Penna.

WANTED Unused U. S. postage stamps, small discount. Advance Stamp Company, 24 East 23rd Street, New York.

POSITIVELY Greatest free offer—Rare octagonal (eight sided) stamp, gorgeous diamond, giant triangle, also mammoth and midget stamps, total value \$2.00. All free to approval buyers. Plus free, Scott's International \$6.00 album and latest stamp catalogues. Odd Stamps, P.O. Box 510, Bell, California.

500 SUPERIOR Mixed U.S., 25c. Gaspar, Box 1492, Pittsburgh 30, Penna.

FREE—30 Different U. S. with approvals. Taubers, 1755 Ocean Parkway, Brooklyn, N. Y.

FREE! Tiny Chinese "midget" war set. Approvals. Seminole, Leeds, Alabama.

FREE! Large assortment stamps from numerous countries to approval applicants. Send postcard. Eastern Company, Box 1295, Grand Central Station, New York 17.

FREE 25 Different Canada. Approvals. Knight, Box 3770, Portland 8, Oregon.

1000 WELL Mixed U. S. 25c. Monjar, 1750 Fairmount, Cincinnati 14, Ohio.

FREE, 25c Worth of stamps to U. S. approval applicants. Village Stamp Co., 90-39P 214 St., Queens Village 8, N. Y.

50 DIFFERENT U. S.; commemoratives, dues, etc. All for 5c. Ed Keller, 3042 Belonda, Pittsburgh 11, Penna.

"1898," EIGHT Countries, free. Approvals, Martin, Box 1128, Miami Beach, Florida.

\$96,000 FACE Value set free. Request approvals. Gehling, 1834 Fuller, Philadelphia 15, Penna.

100 ALL Different locomotives, trains. Chicago Railroad Fair commemorative poster stamps. Full sheet plus 48-page historical album \$1, include additional 50c for extra sheet. Van-Millard Publishers, 28 E. Huron, Chicago, Ill.

FREE! Fifty different worldwide. Approvals. Jack Dudak, POB, 150-B-12, Streator, Illinois.

AMAZING Stamp bargains on approval. Fast airmail replies from N. H. Philatelic Assoc., Inc., Deerfield 12, N. H.

SUPERB Approvals, net prices. Stamps  $\frac{1}{3}$  to  $\frac{1}{2}$  catalog. P. G. Beals, 170A Tremont St., Boston, Mass.

PRISONERS Of war, Austria. Unusual complete mint set. Special! 5c to approval applicants only. GeeKay, 13E. Overlea Ave., Baltimore 6, Md.

YOUR Choice! 100 different French or British Colonial for ten cents with approvals. Free monthly stamp bulletins included. Charles Ernest, 64 Wayne Terrace, Staten Island 10, New York.

WORLDWIDE Different. 200, 25c; 500, 50c; 1000, \$1.25; 2000, \$3.00, 5000, \$15.00. Beacon Sales, Maynard 2, Mass.

FREE: China Confucius issue with foreign approvals. Modern Stampco, Box 12, Wakefield Station, New York.

STAMP Buyers' Guide plus 50 different China for 10c. Stampguide, Box 1649P, Oakland 4, California.

NICE Stamps  $\frac{1}{4}$ c up. Trusty Stamps, 1106 Concord, Detroit 7, Michigan.

25 DIFFERENT Commems 10c. Approvals, Page, Manners Ave., Haverhill, Mass.

BIGGER, Better, lower priced. United States Approvals, Box 488, Minneapolis.

FREE—Description "How to Become a Successful Stamp Dealer" by Fairbrook, Box 180, New York 19.

50 DIFFERENT Free to approval applicants. Buckeye Stamps, Urbana, Ohio.

FREE! St. Helena pictorial, and surprise packet of triangles, airmails, to approval applicants. Pioneer, Box 414, Pasadena 18, California.

GERMANY, "Nazi army issue;" ships, planes, (13) free to approval customers. William Deems, Ravenswood, W. Va.

24 NETHERLANDS Free. Approvals. Country Stamps, 7810 East Wilkeson, Tacoma, Washington.

CANADA Peace set 10c with attractive approvals. Rheume, 8949 Routhier, Montreal 12, Canada.

INNER Mongolia—Country complete 20c. Approvals, Jewells "Stamps," Tamaqua, Penna.

U. S. Price list free. Over 1000 spectacular bargains. Sam'l Stone, Box 52, Dorchester 24, Mass.

EXCHANGE 100 Different and dime for 100 different. Stamps, Gillett, Texas.

FREE, China airmail set, 5 large pictorials with attractive approvals. Fields, 1939 E85, Cleveland 6, Ohio.

BARGAIN Collections, odd lots, accumulations, packets, used albums. Lists 3c. Alatalo, Maynard 2, Massachusetts.

COLLECTION 50 Different Belgium or complete Will Rogers airmail issue 5 stamps. Applicants enclosing 3c postage and requesting approvals may have their choice of these sets. Lemke Stampco, R-2 Box 965, Bremerton, Wash.

19 MINT Hitler heads. Catalogues \$1.74, 25c with approvals. Andrew Peck, Box 114B, Battle Creek, Mich.

THE Explorer's outfit, containing album, stamps, etc., is wonderful for Christmas presents or ideal for yourself. Write for details. Sharpe, 419 N. Graham, Odessa, Texas.

COLORFUL Croatian Legion issue (4) complete 3c with approvals. George Richie, 840 Oak, Alameda, California.

FREE! Volcano pictorial! Nigeria, Burmese! Mozambique! Approvals. Keating, 637-P Bergen, Jersey City, N. J.

15,000 DIFFERENT Stamps 2c each! Gordon Davison, Box 1019B, Manchester, N. H.

UNITED States bargain price list. Send 3c postage. Chassy, 38-P Park Row, New York 7.

STAMPS Of the world. Try a selection of Canada and Newfoundland. Dan Hayden, Box 703, Bloomington, Illinois.

RUSSIA, 20 Different, 10c. Approvals. Reidenbach, Lexington Ave., Troy, New York.

35 DIFFERENT Greece or 100 different world, 10c. Approvals  $\frac{1}{2}$ c up. Kingman, Highbridge Box 42, New York 52.

5 DIFFERENT United States \$5.00 stamps 5c to approval applicants. Mohawk, Box 524, Albany, New York.

66 DIFFERENT Stamps, including U. S. battleships 6c. World wide approvals. Telic-Arts, Devon, Conn.

U. S. Price list. Send postage. State Stamp Service, 1225 Park Building, Pittsburgh 22, Penna.

WORLDWIDE Packet 50 stamps 5c with approvals. Carlins Approval Service, Box 307, Fresno, Calif.

200 DIFFERENT Including Roosevelt triangle, 5c to approval applicants. M. Avalon Stamp Company, Springfield, Mass.

MURDER! Heydrich the Nazi hangman (Bohemia-Moravia #B20 black cataloging 40c) sent to you for 3c. Special offer made strictly to introduce general approvals. Act now! Eisenmac, 3518 Cummings, Cleveland 18, Ohio.

50 DIFFERENT Stamps, triangle, airmails, etc., 5c with approvals. Carlton's, 1024 $\frac{1}{2}$  Silverton, Tujunga, California.

SPANISH Air set free. Approval applicants. Flamingo, Box 4038, Pinewood Station, Miami 38, Florida.

GIANT Bicolored royal visits, Malta pictorials, gorgeous Guianas, Goose airmail, Scandinavian packet and illustrated stamp publication, 10 cents with approvals. Crown Stamps, Box 331, Toronto, Canada.

77 DIFFERENT U. S. 17c. Approval applicants only. Standard, 3817 Sackett, Cleveland 9, Ohio.

100 ALL Different from China! Includes airmails! High values! Mint sets! Others! Only 10c to approval applicants. Star Stamp Company, Jamestown, New York.

GENUINE "Goya Nude" set complete 35c. Approvals. Royal Stamp Company, Tamaqua, Penna.

INTRODUCTORY Packet 10c. Free lists. Schneider, Box 441, Route 3, McHenry, Illinois.

UNPICKED: 5000 U. S. \$2.00; 5000 foreign \$3.00; 1000 British Colonials \$2.00. Kuhn, 81-10 Broadway, Elmhurst, New York.

U. S. Foreign lists free. Slikes, 1831 E. Allegheny, Philadelphia 34, Penna.

307 ALL Different 10c. You will find scores of new varieties here for your collection! Big and little stamps, bisected stamp, commemoratives, triangles, high values! Bicolored beauties! Strange countries! Every stamp is different. All for only 10c to approval applicants. Write today and receive special Ionian Island stamp extra. Garcelon Stamp Company, Box 400, Calais, Maine.

25 UNUSED Stamps. Pictorials, airmail, triangle, etc., only 3c with approvals. Paul Bauer, 31 Wilkshire, Lancaster, N. Y.

COLORFUL Chinese "victory" set, complete, mint, catalogs \$2.30; only 10c with approvals. Kalumet Stamps, 523 Detroit, Hammond, Ind.

300 DIFFERENT Given free with approvals. Postage 3c. Windsor Stamps, 1435 East 67th Place, Chicago 37.



**GREAT \$5.00 Catalog price for 10c offer!** (1) Big collection of 112 all different genuine stamps from Africa, South America, South Sea Islands, etc. Includes airmails, triangle and animal stamps; many others. (2) Four scarce unused United States, catalog price 40c. (3) Fine packet 25 different British Colonies—Burma, Hong Kong, Solomon Islands, etc. (4) U. S. \$5.00 high value. Total catalog price over \$5.00! Everything for only 10c to approval applicants! Big lists of other bargains given. Crystal Stamp Co., Littleton 16, N. H.

**ILLUSTRATED Stamp magazine,** 26 weeks 25c. Stamp Journal, Kalamazoo, Michigan.

**128-PAGE United States catalog—1000 illustrations,** 10c. Harris & Co., 202 Transit Bldg., Boston.

**MIXTURES** Worldwide, 1,500, \$1.00. Missions Outlet, Reverend Marshall, Paterson 1, New Jersey.

**FREE!** Crystal-mount samples! Harisco, 202 Transit Bldg., Boston.

**UNION South Africa.** Thirty different 25c, forty different 50c with approvals. Douglas, Hawkesbury, Ontario.

**POSITIVELY** Your money's worth! Seychelles, Djibouti, Angola, Chinese hunger stamps, together with 100 different others, 10c to approval applicants. Atlas Stamps, 4220 West 16th, Little Rock, Ark.

**100 ASSORTED U. S. old and new.** 25c. Weatherby, Medina, Ohio.

**100 U. S. including commemoratives,** airmails, 10c, 300, 25c. Box 457, Newark 1, N. J.

**BINGO!** Jackpot collection! Triangles, maps, animals, midgets. All for 5c to approval applicants only. Southwest Stamps, Box 117, Long Beach 1, California.

**200 BRITISH Empire stamps;** only 3c. Kenmore Stamp Co., Arlington 74c, Massachusetts.

**FREE—Illustrated catalog!** Kenmore Stamp Co., Arlington 74c, Massachusetts.

**YOU'LL Like** our American and British Colonial approvals. Write now. Chesapeake Stamps, 748 Overbrook, Baltimore 12, Maryland.

**FREE.** Irish commemorative collection, including rebellion issue with approvals. Raymax, 123-Z William St., New York City 7.

**FREE U. S. price list,** postage 3c. Mark Hanna, 335 5th Ave., Pittsburgh 22, Penna.

**FREE!** U. S. monthly lists. Cole, 43-A Rinewalt, Buffalo 21, N. Y. Precancels also available!

**FREE.** Triangle, Roosevelt, Vatican, Ethiopia, Hitler heads. Request approvals. Florida Stamp Company, Box 807, Miami 5, Fla.

**WORLD—500 Diff.** 50c, 1000 \$1.25, 75 Canada 25c, approvals, lists. Victoria Stamp Co., London 4, Canada.

**10 DIFFERENT Iraq** 5c to approval applicants. Jeffery Stamp Co., 9726 Chappel, Chicago 17, Illinois.

**WORLD'S Largest stamp** (7½x14 inches). A real curiosity! Retails for 50c, only 3c to approval applicants. Tatham Stamp Co., Springfield 30, Mass.

**FLAG Stamp** free with U. S. approvals. Wenigman, 929 Oakdale, Chicago.

**25 ALL Different stamps** 10c. Tunis, Wakeman Ave., Newark 4, New Jersey.

**ZOWIE-E!** A barrel of fun for only a dime. 500 United States stamps—absolutely unpicked and unsorted—just as received from church missions. Many varieties, including large commemoratives, airmails, large denominations up to \$5.00! Stampdom's biggest package of fun—and you might find something really valuable! Price only 10c to serious approval service applicants. Money back if not delighted. Illustrated bargain lists with each order. Mystic Stamp Company, Dept. 80, Camden, New York.

**WOW! \$10.00 Worth of fun.** Only 10c! What a treasure hunt! Big package 500 foreign stamps from foreign missions, other sources. Includes stamps from Africa, South America, Free French, Somali, Palestine, etc. Includes airmails, commemoratives and stamps worth up to 50c. This offer sent for 10c to approval applicants only. Jamestown Stamp Co., Dept. 22, Jamestown, N. Y.

**DANDY United States approvals.** Write immediately. Sullivan, Endicott Building, St. Paul, Minnesota.

**FREE!** 100 Worldwide different stamps to approval buyers. Big U.S. and illustrated bargain lists sent with approvals. Bookman, Maplewood, N. J.

**50 DIFFERENT United States 10c.** No approvals. Seidenberg, Cassopolis, Mich.

**BRITISH, Spanish and French Colonies.** Vatican, Hitler heads, and airmail packet, free with approvals. Pan-American Stamp-co, Box 145, New York 33, N. Y.

**STAMP Collections wanted.** Complete collections, duplicate lots, surplus stock, mint and used. Prefer trade for printing or other items, buy outright if priced right. What have you, what's wanted? Vanroy Shirk, Lebanon, Penna.

**DEALERS—Wholesale list.** Postage 3c. Frank, 5031 Queensberry, Baltimore 15, Md.

**U. S. Price list.** Send postage. Stanley Gibbons, 38-P Park Row, New York.

**UNITED States approvals complete coverage,** fine quality, attractive prices. Seminole Stamps, Box 1138-P, Coral Gables, Florida.

**OLD Scarce U. S. seconds** on approval. Slightly defective, bargain prices. Hernefield, Clintonhill Station, Newark 8, N. J.

**START Your own stamp business.** Write for free circular. Donald Shepard, Box 5139, Chicago.

**POUND Stamps** containing thousands \$1.00. Longacre Shop, 108 West 42nd, New York 18.

**BERLIN Bears,** complete set of eight and 100 different stamps only 10c to approval applicants. Reich Stamp Co., 4647 Kenmore, Chicago 40, Ill., Dept. M11.

**NICARAGUA "Tin Pan Alley"** diamond, Ecuador showing George Washington, and American flag in natural colors, Fezzan, Trieste, "American Army" stamp, first U. S. commemorative, \$100.00 Shanghai, Corsica, Anzac, Antique, others. All 5c. Approvals, Capital Stamp Co., Dept. 2, Little Rock, Ark.

### ANTIQUES, RELICS, INDIAN GOODS, CURIOS

**ANTIQUE Toys.** Illustrated price list dime. Kowal, 1846 Cullerton, Chicago.

### PRECIOUS STONES, MINERALS

**"GENUINE"** Deep red Arizona rubies (garnets). Send quarter for packet. Mineral Specimens Company, Box 2651, Phoenix, Arizona.

**ZIRCONS, Sapphires, rubies, others.** Direct importation guarantees best quality; lowest prices. Illustrated, colored list free. Imhusex, Box 232, White Plains, N. Y. Agents wanted.

**ZIRCONS.** Loose. Genuine Siam imports. Pure white. Special: 3 genuine zircons, from ½ kts. to 1½ kts., \$6.00 tax included. We can supply zircons in all sizes and mountings of all types. Send order or write for details today. B. Lowe, Holland Bldg., Dept. PM, St. Louis, Mo.

**GEMSTONES.** Rough, polished. Crystallized specimens. Every variety, lowest prices. List free. Plummer's, 5068 Brighton, San Diego 7, California.

**METAL Detectors.** The very latest circuit. Free literature. Hedden Metal Detectors, 3329 Liberty Avenue, Pittsburgh 1, Penna.

**BEAUTIFUL Arizona agates,** polished samples and listings \$2.00. Unpolished samples \$1.00. Arizona Agate Mines, Cave Creek, Arizona.

### HOBBIES AND COLLECTIONS

**UNPAINTED Figurines.** Illustrated list free. Oman, 642 Broadway, St. Paul 1, Minn.

**WANTED Old cigarette cards.** Write Charles Bray, East Bangor, Penna.

**UNUSED Matchbook covers;** 100 different \$1.00; free catalog. Charles Edelman, 1311C East 84, Cleveland 3, Ohio.

**INVENTING** Can be an interesting and profitable hobby. Write for complete particulars. Institute of American Inventors, Dept. 40-E, 1926-Eye St. N. W., Washington 6, D. C.

**50 DIFFERENT Army embroidered patches \$1.** Other bargains. Insignia Mart, 703A Broadway, New York 3, N. Y.

### CAMERAS, PHOTO SUPPLIES

**YOUR Prized negatives** make beautiful photo enlargements easily, economically with the new Precise Photo Enlarger, only \$22.20 complete, nothing else to buy. Send postcard for details. Tam Products, CM-12, 3814 Wrightwood, Chicago 47.

**EXPERT Camera repair.** Advance Camera Supply, 1626 Lunt, Chicago 26, Illinois.

**BARGAINS!** Roll film, all popular sizes 19c each, 36 exposure 35mm film, Weston 80, not reloads, 3 for \$1.00. Surplus contact paper, assorted sizes 50c gross. Professional type pan heads, fit any tripod, \$2.27. G.I. developer, same as D76-D72 (specify which) gallon size 28c each, 6 for \$1.39. O.D. Kodachrome Bantam 828, Type A, 75c, 3¼ x 4¼ Kodachrome, six sheets, \$1.75, processing included. Kodacolor 1948 dates, 116 and 616, \$1.69, 120-\$1.29. Super pan press 2¼ x 3¼ film packs, guaranteed, 3 packs for \$2.98. Minimum order \$2.00, include postage. All types photographic equipment accepted in trade. Write for bargain lists. Mogull's, 65 West 48th St., New York 19, N. Y.

**SELL Cameras, vacuums, typewriters, Revere, Kodak, Weston, Royal.** Large discounts. Diamond Company, 17 E. 42 Street, New York City.

**YOUR Enlargements** made easier with new precise all metal enlarging easel. Only \$7.50 complete. Nothing finer at any price. Send postcard for details. Tam Products, EM-12, 3814 Wrightwood, Chicago 47.

**BASS Says!** At the sign of the old "Horse Trader," 38th year. Thousands of satisfied customers everywhere! Finest brands including Kodak, Bell & Howell, Argus, Zeiss, Leitz, etc. Satisfaction always guaranteed, or your money back! Bass buys 'em, sells 'em, trades 'em. Write or wire. Bass Camera Company, Dept. AG, 179 W. Madison St., Chicago 2.

**FREE!** 116-Page illustrated photographic catalog, send 3c stamp. Bloom's Camera Center, 1657 Main, P.M., Springfield, Mass.

**200X TELEPHOTO Camera** easily made. Trifling cost. Telephoto lens and instructions \$3.00. Instructions alone 10c. Suffolk Science Service, Box 208, Manorville, N. Y.

### PHOTO FINISHING

**THIS Christmas** instead of sending an ordinary greeting card why not send a photo greeting card, a card that will always be remembered. Just send your negative along with 25c to Anthony Arcolec, 416 East 9 Street, New York 3, N. Y. 10 different cards to choose from. New Year cards included.

**COSTUME Button photo brooches** and earrings are something new and different. You can make them yourself for only few cents each by mounting your own snapshot photos in beautifully styled Lucite costume buttons. No equipment needed. Write for free information. William E. Moore, Costume Button Jewelry, Box 546, Winnemucca, Nevada.

**PHOTO Christmas cards,** only \$1.00 for 25 beauties with envelopes (your negative returned). For 3 different samples with your photo, send 15c with favorite negative. Photo Finish Studio G, Box 1268, Fresno, California.

**HIGHEST Quality finishing,** 8 exposure roll developed, printed, 30c. Jumbo or regular reprints 3c. Send for free mailer. Photo Finish Studios X, Box 1268, Fresno, California.

**BARGAINS—24 Prints** from roll or negatives 50c; 16, 35c. Enlarged prints, 2 alike, 5c pair. New rolls 25c. Wholesale Camera Co., Albany, Wis.

**WALLET Photos,** cards sealed in plastic 25c each. Quick service. Dura-Seal, Laminating Dept., Box 1384, Baltimore 3, Md.

**ROLLS Developed,** 8 prints, one 5x7 enlargement 25c. Sterling, Box 2442-A, E. Cleveland, Ohio.

**ENLARGEMENTS,** Process flexibility permits individual perfection: 5"x7", send negative, 15c; 8"x10", 25c. Brandt Photo, Box 222E, Kenilworth, Illinois.

**FILMS Developed** and enlarged double size, 8 exposures only 30 cents. 12 exposures 45 cents. 16 exposures 60 cents. Prompt service. Mailing envelopes on request. Real Fotos, P.O. Box 172, Station B, Brooklyn, N. Y.

**EXPERT Finishing.** Roll developed and 8 prints 30c. Rancho Photo, Dept. P, Ontario, Calif.

**ROLLS Developed** and printed in newest continuous strip, 8 exposures—35c; 12 to 16—50c. Hitone A, Box 2426, E. Cleveland, Ohio.

**WHY Not pay a little more** and get the best? Automatic machine development. Electronic exposed prints in album form. 8 exposure rolls, 50c—over 8 add 5c per exposure. 35 years in business. Hifoto A, Box 2133, Cleveland 8, Ohio.



TWO Beautiful prints from each picture on roll 30c. Twenty-seven years of satisfied customers. Quick service. Lens Photos, Dept. J4, Janesville, Wis.

8 HOUR Service, Box 468, San Francisco. Your 8 exposure roll printed jumbo or regular size 30c; 12 exposures 35c; 16 exposures 50c; 36 exposures \$1.00. Reprints, jumbo or regular 3c. Regular prints deckled. Fine grain developing. Send for free mailers. Quality Photo Service, Box 468, San Francisco 1, Calif.

8 BEAUTIFUL Double size pictures and roll developed 30c. 8 hour service. Free mailers. Pacific Photo Service, Box 666, San Francisco, Calif.

2 BEAUTIFUL Hi-Gloss prints each good negative and enlarging coupon with each 8 exposure roll developed 28c. Free mailers. Owipphoto Co., Weatherford, Oklahoma.

ENLARGEMENTS! 5x7, 15c; 8x10, 25c, glossy or dull. Gorgeously oil colored, 50c extra. Negatives made from your favorite photos, 50c. Rolls developed, printed, 25c. L. R. Box 1476-c, Milwaukee 1, Wisconsin.

OVERSIZE Prints; overnight service; 35c. Films developed and 8 prints near postcard, only 35c. Electronic process, non-fade, glossy pictures. Write for free mailers. Peachtree Photo Finishers, Dept. P.M., P.O. Box 4324, Atlanta, Georgia.

YOU'LL Be delighted. Eight Never-fade prints now only 25c. Two prints each only 35c. Free mailers and price list showing other services. Write today. Hammond Sales Co., Hannibal, Mo.

NEW Process developing and printing. 8 exposure rolls 35c. Mayfair Photo Service, Box 261K, Toledo, Ohio.

JUMBO Or photo pack prints, 8 exp. roll 25c. 16 exp. roll 65c. NuTone Fotos, Box 228, Pottstown, Penna.

8 PRINTS All enlarged to nearly postcard size from your roll or negatives 25c; 16-50c. (Trial offer). Willard Studios, Box 3535A, Cleveland, Ohio.

16 DECKLEDGE Prints from any standard 8 exposure roll 25c. Quick service. Professional work. Skrudland, Lake Geneva, Wis.

PORTRAIT Quality 5x7 enlargements 15c. 2 for 25c. NuTone Fotos, Box 228, Pottstown, Penna.

## MOTION PICTURES AND SOUND EQUIPMENT

VICTOR 16MM. sound projector. Excellent. \$295. Ampro sound projector. Excellent. \$295. Robert Salmon, 3558 So. 11th East, Salt Lake City, Utah.

BARGAINS! 16MM. sound film, miscellaneous subjects "as is," one cent per foot. Sound features from \$42.50, shorts from \$4.25, silent films from \$3.75. 1600' reels \$1.00. 1600' storage cans, hold two reels 95c, 6' x 4' sound screens, on roller, silver or white \$4.98. Wire take up belts for all types projectors 49c. Minimum order \$2.00, include postage. All types film bought, sold, exchanged and rented. Send for free bargain lists. Mogull's, 65 West 48th St., New York 19, N. Y.

EXCLUSIVE Movies, select films, projectors, screens, slides, free catalog. Home Pix, 1674 Broadway, New York 19.

FREE Movie catalog and sample films. Projectors, cameras; bargains. Goodwill Company, Jackson, Tennessee.

16MM. Films exchanged free, list 10c. Oliver Meadows, Seaboard, Va.

BARGAINS—16MM. sound projectors from \$112.50. 35mm. sound projectors from \$125. Lowest prices on screens, reels, cans, amplifiers, speakers, microphones, splicers, developing equipment, lenses, cameras. All types equipment, bought, sold and traded. Write for bargain lists. Mogull's, 65 West 48th St., New York 19, N. Y.

BARGAINS In good used 16mm. sound films. Complete one reel subjects often available at \$2.95. List for stamp. Blackhawk Films, Davenport, Iowa.

WRITE—Towers, 935 North 40th, Philadelphia 4. Extraordinary films, equipment bargains!

A RARE Opportunity to buy prints of year's outstanding documentary film, "Here Is China," beautifully photographed, magnificently directed with lovely musical score. A treat for any audience. This film will be timely always, a collector's item. Three reels, 16mm. sound. \$22.50. Mogull's, 65 W. 48 St., New York 19, N. Y.

FILM—Free processing 100 ft. 16mm. Weston 12 \$3.25. Weston 24 \$4.90. Weston 64 \$4.95, 25 ft. double 8mm. Weston 12 \$1.50, Weston 24 \$1.89. Weston 64 \$1.99. Free circulars. Fromader Genera, Davenport 4, Iowa.

BRAND New 16mm. sound projectors \$129.50. Send 10c for 1948 Christmas gift photographic catalogue. Sterling's, 679 Northampton, Easton, Pennsylvania.

INDOOR And outdoor 8mm. and 16 mm. movie camera films. Write Ambassador, 479-A Quincy Street, Brooklyn 21, N. Y.

LARGEST Selection 8-16mm. movies. Giant lists 10c. American Films, 6711 Sunset, Hollywood 28, Calif.

PROJECTORS—16MM., 35 mm. silent-sound. Nusslock, 4614 Green-Tree, Milwaukee 9, Wis.

EXCITING Films. Thrill your audiences with unusual movies. For "Glamorous Exciting Stars" (state 8-16mm.) send only \$1.00 to Exciting Films, 1071-E El Centro, Hollywood, Calif.

8MM. Cinex projectors, 100-150w. Frammer, blower, etc., only \$22.50. Becco, Box 675, Charleston, S. C.

FREE Bargain list! 16mm. sound films. Supplies. Waverly, 5707 South Christiana, Chicago 29.

EXCITING Unusual films for sportsman, traveler, artist and adventurer. Catalogue. Reamy, 718 E. San Miguel, Colorado Springs, Colo.

"MISS America of 1948" 8mm., 50 ft. Kodachrome, \$7.50. (black-white, \$2.00). 16mm., 100 ft. Kodachrome, silent, \$14.75. (black-white, \$4.00). Big movie catalog, 25c. World in Color Productions, Elmira, N. Y.

FINEST Movie screen paint, used on all screens, literature. Snow White Screen Company, Danville, Illinois.

16 35MM. Silent sound films. Bedner, 5300 So. Talman, Chicago.

"THE World's Greatest Passion Play." 8mm. 16mm. and 35mm. Specify silent or sound. Rent or purchase. Hemenway Film Co., 33-F Melrose St., Boston 15, Mass.

RENT 16mm. sound films 50c reel. Large selection, free catalog. Film Service, 128 Chestnut St., Roselle Park, N. J.

8MM. Sound projector for the price of a silent machine. Write Standard Sales, Box 7525, North Kansas City, Missouri.

BASS Says! 38 years of leadership means satisfaction to you! Finest equipment, 8 and 16 mm., sound cameras, sound projectors. Bass buys 'em, sells 'em, trades 'em. Satisfaction always guaranteed, or your money back! Bass Camera Company, Dept. A, 179 W. Madison St., Chicago 2.

I BUY, exchange, swap movies. What have you? What do you want? Lowest exchange rates in world. Catalogue \$1.00. Refundable. Harvey Iris, Box 539, Brockton, Mass.

GUARANTEED Fresh anti-halo outdoor movie film! Weston 12! Daylight loading! Processing free! Three spools double 8 mm. \$3.45! Six single 8 mm. for Univex, \$4.60! Postpaid! Catalog. Eso-S, 47th Holy, Kansas City 2, Missouri.

8-16MM. Silent-sound films. Complete rental library. All latest subjects. Free catalogue. (sample film 10c). Garden Film, 317 West 50th, New York 19.

LEARN Professional motion picture technique at home. Approved for veteran training under G.I. Bill. Free catalog. Motion Picture Institute, Birmingham 4, Mich.

LEARN Movie projection, management. Free catalog. Theatre Institute, Elmira, N. Y.

WE Buy, sell, rent, exchange home movies. Details for dime. Midland, Box 429, Oak Park 4, Ill.

8-16MM. Film specialties. Catalog dime. Warrington Films, 1418 Knecht Ave., Halthorpe 27, Maryland.

PROCESS Own movie film. Free literature. Duro Products, 1519 Eggert, Buffalo 21, N. Y.

## MUSIC AND MUSICAL INSTRUMENTS

SENSATIONAL Prices. Guitars, accordions, harmonicas. Many other musical instruments. Listings 10c. Thompson's, 29 East Eighth, Eugene, Oregon.

SWISS Music movements, assorted tunes \$1.90. Direct from manufacturers agent. Helax Company, 233 West 72 Street, New York.

PHONOGRAPH Records 20c. Catalogue. Paramount, M-313 East Market, Wilkes-Barre, Penna.

JIMMIE Rodgers, Ernest Tubbs, other records bought, sold. Evans, 2215-A, 7th, Lubbock, Texas.

YOUR Poems set to music, recorded by professional artists. Free booklet, attractive offer. Write. Song Service, 331-C West 46th, New York.

LEARN Song writing! Fun-profitable. Wonder Wheel jiffy composer, perfect harmony, any note, any chord. Folders free. Barnes, Box 490, Times Square Station, New York 18, N. Y.

SONGWRITERS. Honest outstanding music writing offer. Len-Tex Studios, Leonard 2, Texas.

MUSIC Written to song-poems. Write: Frank Wildt, Lancaster, Pennsylvania.

POEMS Set to music. Ace Song Service, 27 Spring St., Elizabeth, N. J.

POEMS Wanted for musical setting. Send poems for free examination. Five Star Music Masters, 630 Beacon Bldg., Boston, Mass.

HOHNER Harmonicas, Cameras, Accordions, all musical instruments. Hawes Music Store, Portland, Maine.

MUSIC Songwriters: Frank Furlatts 96 page instructions \$1.00 postpaid. Printing professionals 1,000 two pages, \$12.00 plus engravings. Master Music Press, 1507 East 55 St., Chicago, Ill.

PLAY Piano quickly! Entirely different. Free lesson. Beejay Piano Clinic, Lafayette 3, Indiana.

SONGWRITERS—Publication, collaboration, Newart Publications, GPO Box 1226, Syracuse, N. Y.

ACCORDIONISTS: Sensational 3-way charts (diagrams, notes, letters), enable immediate performance all chords, scales: \$1.00. Free catalogues. Caroli, Box 21, Lefferts, Brooklyn 25, N. Y.

HILBILLY Western records, late numbers 29c. Catalog 3c. F-L Shop, Box 19-L, New York 35, N. Y.

STREAMLINE Accordions below wholesale. Circular. Metro, 44 North Albany, Chicago.

POEMS Wanted for musical setting. Send poem for immediate consideration and free rhyming dictionary. Richard Brothers, 24 Woods Building, Chicago.

SONGWRITERS Attention! The amazing demand for phonograph records, accelerated by countless juke-boxes, warrants your immediate investigation. We are offering new writers the rare opportunity of having celebrated "hit" composer furnish music on reduced percentage basis for any likely poems received this month. The Petrillo ban does not affect us. Recola Records, Hollywood 28, Calif.

POEMS Wanted for musical setting. Send poems for free examination. Hamann Service, 614 Manhattan Building, Milwaukee, Wisconsin.

AMPLIFY Your accordion with our new mike \$22.50. Sounds like organ. Installed in minute. Use any amplifier. Amplifier and mike \$72.50. Write Del Principe, 307 So. Wabash Ave., Chicago.

POEMS Wanted to be set to music. Free examination. Send poems. McNeil, Master of Music, 510-PM S. Alexandria, Los Angeles, California.

SONGWRITERS: Send poems for free examination and outstanding offer. United Music Service, 150, Salem, Indiana.

WRITE Songs. Big money and reputation. Write for information. J. Gordon Pub. Co., 201 N. Hoyle Ave., Chicago.

ACCORDIONS—Guitars, trumpets and all musical instruments, new and used. Direct from national distributors, cash and terms. Save money. Del Principe, 307 So. Wabash Ave., Chicago.

## RADIOS, SUPPLIES, INSTRUCTION

BUY Everything at wholesale prices! Radio parts, equipment for the amateur, service man and experimenter. Lowest prices anywhere. Write Mid America, Dept. CF-10, 2412 S. Michigan, Chicago 16, Ill.

ONE Tube experimental F.M. tuner, amazing performance; complete with tube, punched chassis, full instructions \$2.95. York Distributors, 523 Knickerbocker, Brooklyn 21, N. Y.

BUILD Supersensitive crystal radio. Instructions and meter tested crystal 50c postpaid. Lowry Radio, 222 East Roosevelt, Phoenix, Arizona.

IDEAL Christmas gift—Build FM tuner, costs about \$6.00 complete. Instructions, diagrams, \$1.00. Glenn Marsh, 226 Franklin, Crystal Lake, Ill.



**EXPERIMENTERS.** Beginners. "Radio-builder," 12 issues \$1.00. Sample free. Laboratories, Eye-c, San Carlos, California.

**BUYING** Agents, radios, electronic equipment. Spada Enterprises, 10 Lexington, Wethersfield 9, Conn.

**MAKE "Loudest"** crystal radios. Instructions, loudest crystal, catalog: 25c. Amorose, Route Four, Richmond, Virginia.

**FREE** Radio and television catalog! Money saving prices on radios, hard-to-get-parts, record changers, wire and disc recorders, amplifier systems, tubes, books, amateur and test equipment. Write today! Radionic Equipment Co., Dept. 2012, 170 Nassau Street, New York 7, N. Y.

**KEEP** Posted on television-progress, opportunities, techniques. A money field! Valuable! Interesting! 12 issues yearly. Send \$1. Television Opportunities, "Monthly Newsletter," Box 208, Planetarium Station, New York 24.

**MAKE** Crystal radio "boosters." Ten times volume. Designs, instructions, catalog, 25c. Radio Leader, La Verne, Calif.

**PLASTIC** Boxes—Molded. 3½" x 2½" x 5/8". Small parts containers. Opaque, transparent colors. Eight assorted \$1. Stampade, 1219 Huron, Cleveland 15, Ohio.

**YOU** Can have 26 years of radio experience at your fingertips. I've repaired over 45,000 radios and have perfected a simple, easy system anyone can follow step by step. No calculations, no formulas. Total price \$2.00 postpaid or c.o.d. Money back guarantee. Ross Radio, 14615-M Grand-river, Detroit 27, Michigan.

**MEISSNER** Educational kits. Literature free. Communications, 110-F University, Seattle 1, Wash.

**ORDER** Your Sky Prancer radio kit complete with tube, phone and batteries. Only \$6.95. Richard Cramer, P.O. Box 307, Syracuse, N. Y.

**FREE** Lists. Radios, television, records, appliances. Bargain prices. Mail post card today. J.M.A.D. Company, 122 Clinton St., Buffalo 3, N. Y.

**RADIO** Tubes, surplus radio equipment, bargains. Ask for list. Kay Electronics, Box 25, Hollis, New York.

**MAKE** Simple, tubeless, batteryless, distance-getting crystal radios. Crystal and illustrated instructions 25c postpaid. Allen, 427-P, Clinton, Missouri.

## BUSINESS OPPORTUNITIES

**HOME** Business making statuettes, plaques, artificial marble, rubber molds. Metallizing baby shoes. Silvering mirrors. Formulas. Folder free. Creative, 236-L, Winnetka, Illinois.

**IT'S** Easy to convert hand mowers to power mowers with Handy-Dandy Lawn Mower Conversion Kits. Installed on any mower in 3 hours. Used with any small gasoline or electric motor. (Lauson engines and Pennsylvania mowers in stock. Immediate delivery.) Kits can be purchased with or without engines. Fits 16 to 20 inch mower. Dealers wanted. LeClaire Manufacturing Co., LeClaire, Iowa, Dept. PM.

**TRADE** Magazines help you get ahead. Latest single copies. Over 1000 covering every trade, business and interest available through our easy-to-get-acquainted service. Full particulars and price-list free. Commercial Engraving Publishing Co., 34C North Ritter, Indianapolis 19, Indiana.

**UNUSUAL** Financial opportunity for you in "Community Club Merchandising." Organize clubs—hold weekly drawings. Distribute wide variety household utility merchandise. Amazing profits—up to \$600 month. No investment. Interested? Write, Kraft, Aurora, Missouri.

**NO** Selling, operate vendors, amazing profits, details free. Silver-King, Suite B, 622 Diversey, Chicago 14, Ill.

**"WATERLESS** Hand Cleaner." Make, sell. No machinery. Build profitable business. Complete formula \$1.00. Ideal Service, Park Ridge 2, Illinois.

**BIG** Money. Spare or full time in your home. No selling! Spray new miracle finishes, plush and suede, on signs, radios, automobiles, figurines, lamps, toys, etc. Our business is booming—new easy Flok-Kraft methods. Material costs few pennies. You get dollars. Free samples, complete powerful money making plan free. Write now: Coast, 1507 West Manchester, Los Angeles 44.

**POPCORN** Machines, all electric units, peanut roasters, carameltcorn, heating appliances. Northside Sales, Indianapolis, Iowa.

**BUILD** A profitable real estate business, spare time. Particulars free. Roseman Agency, 55 Clifford St., Boston 19, Mass.

**LOOK** Here! Wanted—Men to start in business on our capital. Sell some 200 farm-home products. Thousands our dealers now make quick sales, big profits. For particulars write Rawleigh's, Dept. L-192-PPM, Freeport, Ill.

**BE** Independent—Operate America's lowest price penny vending machine. Big profits. Immediate shipments. Write for bulletin and prices. Fielding Mfg. Co., Desk 128, Jackson, Mich.

**MAKE** Ornamental concrete products at home. Start your own money making business. Write or wire Concrete Machinery, Hickory 5, N. C.

**SEAL**ECT Collection money making plans. Local—mail order. Sixth edition. Particulars free. Flasco Sales, 2505VJ 150 St., Flushing, New York.

**PROFITABLE** Home business. Start in spare time. Experience unnecessary. Complete information. Useful Products Co., 166-29 88th Ave., Jamaica 3, N. Y.

**FREE** Electroplating booklet. Money making plans. Send postcard for your copy. Highly paid, interesting, uncrowded field. N. Hyde, 412 West Sixth Street, Room 209, Los Angeles 14, California.

**FIGURINES** Unpainted: Profitable business can be started. Art Industries, 314 Westport, Kansas City, Mo.

**ONYX**, Plastic, metal—Mountings for bronzed baby shoes, 20 styles, hardening solution. Wholesale, Box 2095, Wichita, Kansas.

**IS** Your line of merchandise complete? Nice profits selling costume jewelry. Home of "Nadine" pearls, rosaries. Free information. Master Makers, P.O. Box 207 DuBois, Penna.

**MAKE** Money from own home by mail selling office supplies. Tremendous demand. Snyder, 5-B Spring, Beachwood, New Jersey.

**LOOKING** For something to sell mail order or housewives. New product under your name assures you of all repeats. Large profits. Everything furnished. Wave Products, Dept. PM-3, 900 E. Taylor, Kokomo, Ind.

**NEW** French fried popcorn dispenser. Makes big money. Write for details. Jack Nelson Co., 2318 Milwaukee Ave., Chicago 47, Ill.

**FIREPROOF** Mattresses, curtains, homes, almost anything. Earn big. Save big. Be independent. Eldorado Fireproofers, Lotus, California.

**OPERATE** Profitable home mail order business on small capital. Details free. Jordan, 743 Dorrence Street, Philadelphia 46, Penna.

**WANTED:** 400,000 Men and women for big-pay gov't jobs! Get yours; send \$1.00 for helpful civil service handbook. Arco, 480 Lexington Ave., New York 17, N. Y.

**YOUR** Own plastic business at home. Produce costume jewelry, novelties, statuettes. Liquid plastic, liquid marble. Flexible molds. Write for free book. American Trades, Box 1473-A, Cincinnati 1, Ohio.

**START** Home manufacturing business making Cleaning Compounds, Soaps, Insecticides, Cosmetics, Polishes, Food Flavors. No machinery. Literature free. Kemix, Park Ridge, Ill.

**LEARN** To metallize baby shoes. Instructions \$1.00. Don Brady, 1618 Sage, Topeka, Kan.

**OWN** Nice little spare time business. Information free. Schenck, 717 W. Penn St., Butler, Penna.

**\$250.00** MONTHLY. Raise Angora rabbits backyard easy way. Wool \$9.00 pound. Details free. White's Rabbitry, Newark, Ohio.

**ELECTRIC** Pencil—Writes, engraves all metals. \$2.95 postpaid. Reb Industries, 265-DN, Elmhurst, Illinois.

**BUY** 800,000 Articles, radios, refrigerators, washers direct from hundreds manufacturers. Details free! Schibani, Box 1576-A, Birmingham 1, Alabama.

**MAIL** Order success even for beginners. Details free. Condello, 39 McArthur Dr., Fords, N. J.

**CASHABLE** Opportunities for numerous, small capital, spare time home business plans. Amazing literature free. H. Colloid, 1610-1 Rucker, Everett, Wash.

**START** Profitable air conditioning business. Don Nelson, Warner Robins 2, Georgia.

**MAKE** Any mailing pay big profits. Free plan, details. Alban Burke, 1212 Franklin Ave., Bronx 56, N. Y.

**BRONZING** Baby shoes is big business. Start your own business for \$3.95 total cost materials and instructions. No equipment required. Particulars free. Metaloids, Box 2095, Wichita, Kansas.

**LIQUID** Marble—Make in any color. Soundproof plastic flooring. Flexible molds. Cast novelties, plaques, statuary. Big money, your own business. Catalog free. Write, Bing Products, 88-A12A Broad Street, Boston 10, Mass.

**SELL** By mail! Ideas galore! Join Mail Selling Opportunities Club! Details free! F. Wehner, Box 142-A, Roxbury 19, Mass.

**HALF** Million articles wholesale. Directory 25c. Publisher's, Box 1302-P12, Detroit 31.

**MAKE** Your products, details free. Pharmacist, 939 East Euclid, Detroit 11.

**METALLIZING** Baby shoes. Sells \$1 everywhere. 25c prepaid. Plus other trade secrets. Clarence Woodfall, Publisher, R.3, Charleston, Illinois.

**PERFUME**—Make it yourself. Profitable, sparetime, home, business for men and women. Free information tells how. Write "International," 6347 Parnell X12, Chicago 21, Illinois.

**START** Home business. Small capital. 30 proven "get ahead plans" \$1. Details free. Fill Bledsoe, 121A East 21, North Little Rock, Arkansas.

**OWN** Your mail order business. Sell envelopes, bags, boxes. Big profits. No investment. Omaha Envelope Service, 4721-B California, Omaha 3, Nebr.

**SAWDUST.** Turn it into cash. Six methods. Instructions 25c. Charles, 12-BP, Norwood, Ohio.

**LEARN** Upholstering. Source of supplies. Upholstering, 602 Main, Nashville 6, Tenn.

**RUBBER** Molds! Genuine latex! Low cost! Catalog free! Castcraft Studios, 2027-P Fulton St., Brooklyn 33, N. Y.

**WATCHES.** All kinds, new, used; retail \$3.65-\$345.00; big discounts; show catalogue, get orders. Brookins, B-1975AM, Little Rock, Ark.

**MAIL** Order system of successful operators now revealed. Smallest capital. Different, dynamic. Quick action. Details free. Schroder, 221 Bush, Covington 5, Ky.

**MOLD** Plastics, plaster, compositions. Simplified inexpensive methods, nice income. Start now. Literature free. Plastics Digest, 2917-B Michigan, Kansas City 3, Mo.

**LEARN** Roofing and siding business! Pays amazing profits. Our simple instructions course covers everything. Very easy to master. No tedious study. Act now! Free details. Roy J. Peytons Sr., 415 Southeast First Street, Evansville 9, Indiana.

**RAISE** Ginseng. Roots bring \$10.00 pound. Circular free. Fezler Seed Co., Patchogue, N. Y.

**BECOME** Independent operating mail order business from own home. Write—Printer's, 3006-P12 Williams, Detroit 16.

**GIGANTIC** Mail, magazines, listing three times 25c, twelve times 50c. Waddell's Directory, 341 East 76th, New York 21.

**INCOME** From local information. Interesting. Sparetime. Neher Company, La Verne, Calif.

**FREE** Colorful book "372 Unusual Worldwide Business Adventures"! Photos! Pictures! True; successful. Australia, Africa, South America, New Zealand, Mexico! Not hokum. Operate some at home. Refreshingly "different" plans. Publishers-C, 1199 Oak, Carlsbad, Calif.

**USE** Your home as magazine subscription station. Represent all magazines. Liberal commissions—we supply everything. Big year around business. Catalog, full details, free. McGregor Magazine Agency, Dept. 22, Mount Morris, Illinois.

**GUARANTEED** Powerful mailorder letters, literature, campaigns, written. Investigate! Finkle, 1201½ South Ogden, Los Angeles 35.

**IMMEDIATE** Cash profits by mail. I'll show you how. Write me today. B. C. Fryer, Department A-12, Box 1895, Atlanta, Georgia.

**VENDING** Machines—A postcard may mean a sound permanent business for you if you desire additional income or a full time job. Very little is required with which to begin. Write for information. Ball gum, candy, nut, cigarette, or any other type vending machine you might think of. Advance Vendors, Dept. 7, 1645 Bedford Avenue, Brooklyn 25, N. Y.



**INCOME** From leisure hours—Coin operated radios work for you day and night in cabins, hotels, etc. Write today for special offer bulletin. Box 150, Manchester, N. H.

**"ELECTROPLATING Know-How"**—Get the professional know-how of modern electroplating, fascinating money making field, simply and quickly! Write for free illustrated booklet. Joseph B. Kushner, Electroplating Engineer, Stroudsburg 23, Penna.

**MORE Money—Easier!** Operate your own dignified money-making service business. Big demand everywhere. Instructions, supplies furnished. Little capital. Lifetime opportunity. Puraclean, 17 East 42nd, New York 17.

**GUARANTEED** Powerful mailorder letters, literature. Campaigns prepared. Finkle, 1201½ South Ogden, Los Angeles 35.

**SOAPS, Cleaners.** Make in home or garage without machinery. Manufacturing and formula handbook. \$1.00 (includes waterless hand cleaner). Brown, 9111-B Hoyne, Chicago 20.

**IF** You have merchandise, service, or patent to sell, and want results, rent New York individual office. Yearly rates—Individuals \$12.00, Firms \$24.00. Established 1926. Co-operative Office Service, 126 Lexington Avenue, New York 16.

**"STOCK"** Molded plastic boxes. 3½" x 2½" x ½". Opaque, transparent colors. Modern packaging new products. Sample eight \$1. Stampade, 1218 Huron, Cleveland 15, Ohio.

**LIQUID Marble—Colorful, glossy!** Molded, brushed, sprayed! Cast novelties, statuary, colored tiles. Flexible molds. Composition floors. Particulars free. Marbleizing Service, Edwardsville, Illinois.

**FLOCKING Kits.** Complete \$5.95. "Leather-Tex" plastic paint sample \$1.00. Pagewood Products, 1259 No. Clark, Chicago 10, Ill.

**REVOLUTIONARY.** Organize H-H crew. Excel. terr. Nat. advert. See Pop. Mech. Aug. issue back cover. Nothing like it. Connects with garden hose. Washes cars, insecticide spray, opens clogged plumbing, etc. Sells on sight \$9.75. Terrific money maker. Repeat features. Moto-Sway Corporation of America, South Pasadena, Calif.

**MAIL Moneymaker.** 25c. Dignified, profitable. McLaran, Box 623, Springfield, Ohio.

**EARTHWORMS** — Revised booklet, \$1.00; on soil building, and better composting. Coolville Earthworm Farm, Coolville, Ohio.

**LADIES'** Sheerest nylons. First quality 51/15 \$16.00 dozen. Robert Celaya, Brownsville, Texas.

**GET** Hundreds money making deals, business ideas, plans and manufacturing. Amazing folio free. Austin Mail Service, 5538 Lexington, Chicago, Illinois.

**ANNOUNCING** Home study course in commercial baking. Practical basic training. Good field for those with aptitude. Nearly depression proof. Send for free booklet. "Opportunities in Baking Industry." National Baking School, 1315 Michigan Ave., Dept. 3433, Chicago 5, Ill.

**ORCHIDS** Metallized! Real flowers preserved! Inexpensive to start. New field. Details free. Write, R. O. Morgan, 6230 Myrtle Avenue, Long Beach 5, California.

**ENORMOUS** Opportunity developing inventive ideas. List of eleven ideas free. Jack Kester, Deckerville, Michigan.

**MAKE** Liquid marble, artificial marble flooring, flexible molds, statuary, art goods, novelties. Complete formulas, instructions \$1.00. Kemico, Park Ridge 5, Ill.

**MAKE** Money making new greaseless doughnuts at home on electric machine. Wholesale to grocers, drug stores, cafes, hamburger shops. Send for free recipes and plans. M. Ray Company, 3605 South 15 Ave., Minneapolis 7, Minnesota.

**MAKE** Tough, hard plastic 1c pound. Makes durable floors, walls, mantels, roofs. 101 uses. Build attractive home yourself. Material cost \$150 room. Bays Laboratory, Oklahoma City 9.

**MAKE** Hollywood style cement pottery, birdbaths, mantels, miniature castles; without moulds. Washing-wells, stucco-rock walls, fountains. Dime brings colored sample, amazing pictures. Hollywood Cementcraft, 8527-R Wonderland, Hollywood 46, Calif.

**BIG Money** in vending machines. Smallest capital start brings immediate profits that build permanent profitable business. Starting instructions free. Becker Vendors, 105-A Dewey, Brillion, Wis.

**LIQUID Rubber.** Make flexible molds. Free sample. Chaney, 1130 E. 16th St., Jacksonville 6, Fla.

**NEW** Mail order manual tells how, what, where to sell. Details free. Everett, 542A Barclay, Naperville, Illinois.

**MECHANICALLY** Inclined? Resurface butcher blocks. Lifetime business. Roy Crawford, Keyport, New Jersey.

**MAKE** Money addressing envelopes. Our instructions reveal how. Glen Glenway, 5713 Euclid, Cleveland 3, Ohio.

**I** MAKE Big money in the mail-order business. You can do the same at home with copyrighted system. Write me. I'll tell you how. F. Little, R.D. #1, Glenshaw, Penna.

**ENVELOPES** Addressed accurately, reasonably. Fast service. We have capable addressers in your city. Glenway System, 5713-Y Euclid, Cleveland 3, Ohio.

**EXCELLENT** Manufacturing propositions. Request circular. Richards, 44 North Albany, Chicago.

**CAST** Metal, plaster, plastic products. Pricopoulos, 761 Worthington, Springfield 5, Massachusetts.

**METALLIZE** Baby shoes. Excellent profits. New system assures success. Free details. Treasures Forever, 89 Henry Ave., Lynn, Mass.

**EARN** Money at home. Many others do. Free lesson. Werts Shellcraft, Sharp Park, Calif.

**READ "Advance"**—The voice of mail order. Offers money-making opportunities, sources of supply, personal guidance, etc. Issued monthly. Sample copy 25c. Yearly subscription \$2.00. Advance Publishing Company, 313 East 21st Street, Suite 450, New York 10, N. Y.

**CANDY** Manufacturing and marketing, complete course \$6.00, information free. Box 670, Kissimmee, Florida.

**INFORMATION**—Supply sources, trade secrets, ideas, money making facts. Be your own boss! 24 page booklet tells how. \$1.00. Tip-Top, Box 9083PM, Dallas, Texas.

**METALLIZE** Baby shoes and other non-metallic articles. Fascinating work. Big profits. Shuplate, Box 1388, Lawton, Okla.

**MAKE** Money selling quilt pieces by mail. One man ran \$200 into quarter million. Write Lovell, 2166 South Shore, Erie, Pennsylvania.

**A BUSINESS** In your own home! Our chemicals, plus free water and cheap "grocery store" materials can bring you over \$500 monthly earnings. Plans and formulas free. Chemica Division, 1269 S. Norton, Los Angeles 6.

**A FACTORY** In your home garage! Mfg. and sales rights, mechanics' waterless hand cleaner. \$500-\$800 monthly. No special equipment necessary. Formula free. Western Aircraft Mfg., Dept. D, Los Angeles 6, Calif.

**HOME** Workers wanted to hand-spin Angora wool. Either sex. House of Angora, Springfield, Ill.

**BUY** The new Concession popcorn machine. Biggest low priced popper on market. \$100 puts you in business, complete. Also caramel corn, candy floss, candy pullers, kettles, heating equipment. Write for new catalog. Concession, Dept. A, Toledo 6, Ohio.

**WHOLESALE** Supply sources and money making plans offer security, success, in your own business. Details free. Reynard Publications, Smithfield 3, Ohio.

**MAKE** Money by mail. Howard, 1778A Hamburg St., Schenectady 4, N. Y.

**BABY** Shoe metallizing. Trade secrets never before revealed. Everything you need to know. Amazing offer. Send card. Schoettle, Friendship, Ohio.

**LEARN** Import-export! Represent manufacturers! Sell-buy abroad, make 1000% profit. Send \$1 for two bulletins, supplying hundreds of overseas addresses seeking connections. Money refunded if unsatisfied. Benko, 246-P Fifth Ave., New York 1.

**START** Bottled natural gas business. New, amazing opportunity. Demand enormous. Pays big profits. Literature free. Enco, Pasadena 16, California.

**LEARN** Piano tuning, repairing, at home. Tremendous field! Piano parts, tools furnished. Established 1935. Empire School of Piano Tuning, 606-B East University Ave., Champaign, Ill.

**UNPAINTED** Bookends, plaques, statues, figurines. List. Havery Products, 1219 8th Ave., Altoona, Penna.

**NEW** Method of casting metal toys and novelties opens opportunity for full or spare time business and profits. Latest 1948 scale model autos, original ashtrays, savings banks, water pistols, etc., easily cast with bronze moulds. Enormous wholesale and chain store Xmas demand keeps manufacturers busy. No experience or special place necessary. Write for details and illustrations of patterns needed. Metal Cast Products Co., Dept. A, 1696 Boston Road, New York 60, N. Y.

**NATURAL** Molding Latex. Extra thick. Free sample. W. Woolley, 115-A Donald, Peoria, Ill.

**CASH** For your idea, 280 manufacturers need inventions, patented or unpatented. List free. Invention Bureau, 208M Clinton, Oak Park, Illinois.

**MAKE** Money sharpening saws at home on electric machine. No experience necessary. Hardware dealers act as your agents to secure work. Send for free book "Independence After 40" shows complete plan for starting in spare time. Foley Mfg. Co., 47 Foley Bldg., Minneapolis 18, Minn.

**RUBBER!** White liquid rubber! America's finest flexible moulding rubber! New! Extra heavy viscosity! Quick drying! Ideal for home, classroom, or industry. Only \$7.95 per gallon, \$2.95 per quart, and \$1.00 per half-pint sample. Parcel post prepaid! Plastercraft Supply Company, 3051 St. Clair Avenue, Cleveland 14, Ohio.

**YOUR** Own mail order business at home. New, illustrated course. Free booklet. Registrar, 7219 South Broadway, Los Angeles 3.

**VENDING** Machines earn big money! An investment as low as \$10.50 will start you in this fascinating, profitable business that can lead you to the road of success and independence. Routes can be established and operated in either full or spare time with no experience needed. Write for full details and our free catalog illustrating our nut, candy, gum and stamp vendors; also slot machines, amusement games, etc. Parkway Machine Corporation, 623 W. North Avenue, Dept. 7, Baltimore 17, Maryland.

**SPECIAL** Rubber for making molds. Literature and sample free. Universal, Box 1076-A, Peoria, Ill.

**HOW** And where to obtain capital. Small and large loans. Free particulars. Star Service, Wapakoneta, Ohio.

**OWN** Mirror shop. Resilver mirrors. Glass sign making. Electroplating. Supply prices. John Sprinkle, V60, Marion, Indiana.

**BRONZED** Baby shoe mountings and supplies. All metal bronze bookends, picture frames, ash trays, etc. Onyx ash trays, desk sets, plaques. Hardening solution, 30-amp. plating rectifiers with powerstat control, \$85.00. Geared motors for agitation \$20.00. Lead lined tanks. Write for list. Hollywood Bronze Supply, 1770 N. Vermont, Hollywood 27, Calif.

**QUICK** Money. "Repairing car batteries." At home! Easy too! Batteryman, Grand Junction, Colorado.

**POPCORN** Machines. Potato chip outfits. Long Eakins Company, 4860 Hi Street, Springfield 99, Ohio.

**\$46** FROM Square foot plywood. Jigsaw necessary. Write, Woodarts, X-38, Bridgewater, Mass.

**OPERATE** Profitable mail order business. Write Walter Service, 4159-A East 112th, Cleveland 5, Ohio.

**RECAST** Old batteries into new. Latest achievements. Battery Laboratories, Minneapolis.

**RE-NEW** Leather and leatherette—Make cloth into imitation leather with plastic discovery called Leather-New. Opportunity to make real profits taking care of sales resulting from national advertising. Write for free sample of Leather-New covered material and complete deal. 4723A Troost, Kansas City, Missouri.

**COLORGLAZED** Concrete pottery made without molds. Patented method. Cemetery products, novelties, tiles. Basement leak-sealing. Money-making projects. Booklet, details free. Men only. National Potteries Company, Grand Rapids, Minnesota.

**SPECIALTY** Manufacturing, the big money business that can be operated anywhere, start on a very small capital; we supply dependable formulas and complete instructions; get interesting free booklet, "Money-making Opportunities in Specialty Manufacturing." Howard Robinson, Ph.G., 1300-A South Ohio Street, Sedalia, Mo.



**START** Mailorder bookshop — Everything furnished. 25c brings booklet, samples, exciting ideas. General Publications, Ossining, N. Y.

**\$25 WEEKLY** Working two hours daily. No canvassing. No manufacturing. Lycke, Box 2471, Cleveland 12, Ohio.

**137 WAYS** To make money, in home or office, business of your own. Full particulars free. Elite Co., 220 Grand St., New York 13.

**BRUSH** Plating outfits connect to a battery. No tanks necessary. Good paying business at home plating autoparts, bathroom fixtures, bicycles, reflectors, silvering mirrors. No shop or experience required. Outfits furnished. Free booklet. Gunmetal Co., Ave. H, Decatur, Ill.

**WOULD** You pay 3%—first \$350 made? Color-illustrated book "505 Odd, Successful Enterprises" free! Some offer occasional "day off." Work home. Expect something odd! Pacific, Oceanside, Calif.

**MAILING** Postcards selling repeat merchandise is profitable. Everything supplied. Details free. Gordon Publishers, Box 23, Pawtucket, R. I.

**RUBBER** Molds, natural liquid rubber, flock filler (for making sectional molds), statuary plasters, felt finishes for novelties. Catalog and "Plastercraft" course free. Blue Rapids Supply, Blue Rapids, Kansas.

**CO-PUBLISH** And advertise in The Central Mail Advertiser. Sample copy for stamp. Low rates. Large circulation. Bagby Printing Co., Georgetown, Ohio.

**MAIL** Order opportunities. Full or spare time. Hundreds of chances. No charge. Postmail brings copy. Blackstone Press, Somerville, New Jersey.

**START** Home plaster novelty business. Amazing course tells how. Literature free. Kemo-Courses, Dept. A, 4862 Catalpa, Chicago 30, Ill.

**MAKE** Rubber stamps. Metalize baby shoes, silver mirrors, make plaster novelties. Catalogue of "20 Ideas" free. Universal, Box 1076-A, Peoria, Ill.

**EARN** \$200 Weekly installing new amazing "Styron" plastic wall tile in homes, offices. Easily applied. Tile your own kitchen, bathroom, too. Instructions, everything furnished. Literature free. U. S. Tile Co., 30 W. Washington St., Chicago 2, Ill.

**OWN**—Operate ball gum, nut, cigarette vending machines. Amazing profits, no selling. Write for free details. Cameo Vending, Dept. P, 432 West 42nd, New York.

**COPUBLISH** Leading m.o. paper. Latest copy Mail Sale Advertiser and proposition, dime. Vanroy W. Shirk, Lebanon, Penna.

### MONEYMAKING OPPORTUNITIES

**EARN** \$25 Distributing 50 boxes of greeting cards. Over 20 different top quality assortments for Xmas, birthday plus deluxe boxed stationery. Also make extra money taking magazine subscriptions. Details free! Cassell Co., 11D Elm St., Westfield, N.J.

**MAKE** Novelty candles for big profits! Complete instruction folio \$1.00. Details free. Robins, W. Sylvan Lake, Mundelein, Illinois.

**EARN** Up to \$520 month part or full time keeping books for small firms. Simplified system. Write Tax-Saver System, Dept. O. Ft. Worth, Texas.

**15 MINUTES** Masters advertising and sign lettering; complete system \$1; free circular. Abenterprizes, Box 875-M, Peoria, Illinois.

**BOOKLET** "Making Money Mailing Circulares" 25c. Artistic, 217P Longwood, Merchantville, N. J.

**MONEYMAKERS** Merchandisers, Reimer's wholesalers directory \$1.00. E-1119 Chestnut, Saginaw, Michigan.

**START** Your own business! Big money manufacturing novelties, plaques, statuary. Free catalog. Write Bing Products, 88-A12B Broad Street, Boston 10, Mass.

**THOUSANDS** Articles wholesale. "Supply Source Directory" 10c. Ideal Service, Park Ridge 40, Illinois.

**ACTION** Novelties, airplanes. Details free. Kolinski, 759A South 25th, Milwaukee 4, Wisconsin.

**FREE** Literature on money making ideas. Write: Lighthouse, 1023-B Hamilton Street, Lockport, Illinois.

**NO** Selling, operate coin machines, amazing profits, details free. Parkway Corporation, Dept. 5, 623 W. North Avenue, Baltimore 17, Maryland.

**FOR** Sound, sensible, proven successful mail order methods, write for details to C. Griffith, 132 Water, Fredonia, N.Y.

**LOOK** Here! Wanted—Men to start in business on our capital. Sell some 200 farm-home products. Thousands our dealers now make quick sales, big profits. For particulars write Rawleigh's, Dept. L-192A-PPM, Freeport, Ill.

**NOTARY** Public. Be one. Largest legal supply house, 22 cities, guarantees your appointment by governor if you qualify, equips you for \$16.97. Respected public office. You certify legal papers, use official seal made with your name, collect fees. Easy. Notaries needed everywhere. Write Stationers Exchange, Boerne 2, Texas.

**START** A mail order business for as low as \$15.00 investment. Free circular. George's Business Plans, Box 126, Epping, New Hampshire.

**WIN** Contest money. General Contest Bulletin gives hundreds of tips. Lists current contests and rules. Sample 25c. General Contests, 1609½ East 5th, Duluth, Minn.

**ANALYZE** Handwriting for profit! Complete outfit \$1.00. Graphologists, POB-971, Philadelphia.

**\$12.00 PROFIT** On 25c investment. Write immediately. Suproco, Ogema 5, Wisconsin.

**MFG.** Chemists' gold bond sales offer. Factory distributorship. Box 5903, Chicago.

**THE "How"** of mail-order. Book on setting up and running mail-order business. Lazy man's way of getting rich. \$1. Haldeman-Julius, Desk 5040, Girard, Kans.

**METALLIZE** Baby shoes. Further information 3c stamp. Metal Crafts, Box 125-Route 5, Tampa 4, Florida.

**UNPAINTED** Figurines. Illustrated list free. Oman, 642 Broadway, St. Paul 1, Minn.

**UNPAINTED** Plaster ornaments, beautiful designs, easily decorated with water colors or oil paints. Profit or hobby. Free illustrated list. Firestone product dealers wanted. Distributors: Lexite Natural Latex for molds, Midwest Novelty Mfrs., 524 E. Park, Anaconda, Montana.

**PROFITABLE** Business at home, spare time. Write Treasure-Trove Bookshop, Box 125-R5, Tampa 4, Florida.

**EARN** Money at home! Thousands do! "Home Worker Magazine" tells how. Sample, 25c. Sizemore, Box 7, 4917 Kostner, Chicago 30, Ill.

**MAKE** \$100 Per week or more in a full or spare time baby shoe metalizing business of your own. Write now for free literature on this easy to learn highly profitable business. Joseph B. Kushner, Metal Finishing Engineer, Stroudsburg 23, Penna.

**SEWING** Machines—Millions need repair, modernized, electrified, etc. This is it! Write Taylor Service Co., Hamilton 2, Ohio.

**"STOP."** We will set you up in your own mail order business and make you make money. Free info. Write United Syndicate, 205 Baynes Bldg., Havre de Grace, Maryland.

**EARN** Money evenings, copying and duplicating comic cartoons for advertisers. Adservice, Argyle 1, Wisconsin.

**CHRISTMAS** Money! Helicopter flies indoors, outdoors! 14" rotors, rubber motor. \$5.50 2 doz. Refundable. \$1.00 two samples. Hellotoy Co., R.R.8, Dallas 11, Tex.

**FARMERS;** Dealers; big profits! Sell new amazing light aluminum combination sawing, pruning, trimming, picking and shaking poles. From 4 to 50 feet. 30 foot pole weighs 10 lbs. Six attachments; 3 saws, hook, picking bag, limb-cutter. Year around sales; every farmer and fruit grower a red hot prospect. Sebrell Corporation, 300 So. Los Angeles Street, Los Angeles. Phone Madison 6-9397.

**OPERATE** Successful mail business with our tested plans. Free details. Reynolds, Box 103Y, McAlester, Penna.

**GOOD** Profits, showing fast moving items to men and women. Sells on sight. "Adams," 1143 Oley St., Reading, Penna.

**MEN, Women**—"Most everybody likes candy." Learn to make in a professional manner. (Our 38th year). Ragsdale Candies, D4, East Orange, New Jersey.

**RESILVER** Mirrors at home. Formula 25c. Ideal Service, Park Ridge 6, Illinois.

**MONEY-MAKING** Service. Particulars free. BC Company, 760 North Main St., Fall River, Mass.

**BABY** Shoes preserved. Formulas, instructions \$1.00. Supplies and bases. Novelty Bronzing, Box 56, Hyde Park 36, Mass.

**EARN** \$3.00 Hour! Service aquariums! Professional booklet \$1.00. Aquarium Assembling Service, Box 47, Cathedral Station, New York 25.

**\$3.41 PROFIT** Per hour interest you? Easy, amazing process velvetizes interiors, signs, novelties, radios, lamps at low cost. Free sample. Sparks, 1145 Queen Anne, Los Angeles 6.

**PRIZE** Contest bulletin gives various contests now operating, and valuable hints. 3c stamp. National Contest Bulletin, Box 2685P, Miami, Florida.

**WOULD** You pay 3%—first \$350 made? Color-illustrated book "505 Odd Successful Enterprises" free! Proven! Work at home, office. Expect something odd! Pacific, Oceanside, Calif.

**PUBLISH** Your own magazine. Hand-some 52 page format, well edited, illustrated. Cost low as \$1.00 month. Brings you prestige, profits. 25c brings sample, details. National, Ord. Nebr.

**FREE** Booklet "How To Raise Worms For Bait." Tells how to propagate, package, sell. Send postcard. El Sobrante Earthworm Farm, 749-A Rincon Road, El Sobrante, California.

### FORMULAS, PLANS, ETC.

**PRODUCTS** Analyzed. Duplicated. Improved. Formulas. Consulting Scientific Company, Swarthmore, Pennsylvania.

**FORMULAS.** Ten thousand trade secrets. 900 pages. \$3.00 postpaid. Natco's, 1090 West 43rd, Norfolk 8, Va.

**10,000 FORMULAS** And trade secrets. Free literature. Stillman, 555 Kingston Ave., Brooklyn 3, N. Y.

**ANY** Formula \$1.00. Satisfaction or refund. Brown, 9111-D Hoyne, Chicago 20.

**CONVERT** Your toilet to prevent overflow. Instructions \$1.00. H/A Publishers, 116 North 11th Street, Allentown, Penna.

**FORMULA** Raised letter embossing ink and catalog other formulas 25c. Process Specialties, 3821 Marlmount Ave., Weirton, W. Va.

**FORMULAS.** Processes, analysis. Free literature. Pricopoulos, 761 Worthington, Springfield 5, Massachusetts.

**MAKE**—Sell cleaners, soaps, polishes, flavors, cosmetics. No machinery. Formula literature free. Kemico, Park Ridge 16, Illinois.

**\$1.00 GETS** You 21 money-making popcorn, candy apple formulas. We supply equipment. Concession Supply Company, Dept. A, Station "B," Toledo, Ohio.

**TESTED** Formulas. Interesting descriptive booklet free. Pont, Box 635-PM, Terre Haute, Indiana.

**REAL** Manufacturing formulas. Lists free. Cummings, Chemist, Gordon Ave., Syracuse 4, N. Y.

### PLASTICS

**NEED** Additional income? Build your own plastics business on a solid foundation. Do highly skilled professional work at home. This is not "gadgets," your clients are in the industrial and educational fields. Short training by mail necessary. Exceptional opportunities for intelligent men and women. Write Plastics Laboratories, Dept. B, 3324 Park Blvd., Oakland 11, California.

**EMBED** Flowers, insects; make bookends, figurines, other objects, with new liquid casting plastic. Clear or colors. Fascinating, profitable. Saw, carve, turn, drill. Use home tools. Exciting new home project, only 25c, shows how. The Castolite Co., Dept. P-101, Box 391, Woodstock, Ill.

**PLASTICS**—Supplies, findings, shells. Illustrated fabricating manual, bargain catalog, 10c. Gem-O-Lite, Box 686F, North Hollywood, Calif.

**PLEXIGLAS**—12" x 12" Masked sheets, 1/16"-\$1.00, 1/8"-\$1.25, 3/16"-\$1.55, 1/4"-\$1.85. Include 10% postage. Dyes, rods, tubes, luminous powders, carving blanks, drills, jewelry findings. Free catalogue. Craft Plastics, Somerville, New Jersey.

**PLEXIGLAS.** Lucite, acetate, sheets, rods, tubes, jewelry findings, craft supplies, over 1700 items. 25c which brings catalog internal carving folder, information on fabricating plastics, deducted from first order. Plastic Parts, Dept. H-2128, 1157 S. Kingshighway, St. Louis, Mo.

**BEAUTIFUL** Hand carved pins or earrings \$1.00. Box 661, Rochester 2, N. Y.



**MAKE Your own Christmas gift jewelry.** Internally carved flowers beautifully colored in Plexiglas ready for assemblage. Kit contains earrings, brooch, and pendant, with silver-plated bow-knot pin. Complete with findings, cement, and instructions \$3.95. Pilot Plastics Co., 69 Beekman St., New York City 7.

**DON'T Throw away broken plastic articles.** Use WestCol plastic cement, 40c postpaid. WestCol Mfg. Co., 108 North 3rd, Grand Junction, Colorado.

**INTERNAL Carved roses, orchids, swans, goldfish, butterflies, etc.** Jewelry and gifts. Crystal Floral Novelty Co., Somerville, New Jersey.

**RENEW Leather and leatherette—Make cloth into imitation leather with plastic discovery called Leather-New.** Opportunity to make real profits taking care of sales resulting from national advertising. Write for free sample of Leather-New covered material and complete deal. 4723B Troost, Kansas City, Missouri.

**PLASTIC Injection machine.** Plexiglas, jewelry findings, sequins, dyes, cements, tools, drills. Catalog. G. Baker Company, River Edge, New Jersey.

**BARGAINS In plastics.** Lucite, Plexiglas, Catalin. Many colors and sizes. Details free. George Plastics, 6938A George St., Chicago 34, Ill.

**PLASTIC Materials and supplies for your hobby or business.** Catalog and internal carving instructions free. Art Plastics of Calif., 8125 East 14th Street, Oakland 3, Calif.

## CHEMISTRY

**NEW Laboratory supply catalog of chemicals and apparatus.** Contains many thousands of items with illustrations. Send 25c. Standard Science Supply Company, 1232 N. Paulina St., Chicago 22, Ill.

**UNIVERSITY Professor teaches chemistry by mail.** Free details. P.O. Box 1295, Toledo, Ohio.

**COMPLETE Supply catalog.** 10c. Pilgrim Chemical, 348CB Edith, Salt Lake City 4, Utah.

**HOME Laboratory supplies at low prices.** Catalogue chemicals and apparatus 15c. Microscopic stains 20c or both for 25c. National Scientific Company, 2204 North Ave., Chicago 47, Ill.

**CHEMICALS And apparatus for industrial, analytical, and private laboratories.** Catalog 10c. Dept. M-26. Biological Supply Co., 1176 Mt. Hope Ave., Rochester 7, N. Y.

**LEARN Chemistry at home, from the house of Winn.** Home of supplies for student chemists. New idea chemical and apparatus outfits for home experimenting. Photographic scales, semi-professional microscopes and accessories. Send 15c for retail catalogue. Established 1931. John H. Winn, 124A West 23 Street, New York 11, N. Y.

**FREE Catalog: Chemistry, mineralogy, physics, biology.** Tracey Laboratories, Evanston, Illinois.

**HANDBOOK For chemical experimenters, illustrated, hundreds of experiments, 50c.** Experiment booklet 15c. Supply catalog 5c. Reading Scientific Company, Reading, Penna.

**LABORATORY Chemicals, apparatus, books.** Catalog 10c. Fleischer's Laboratories, Everett 49, Mass.

## HELP WANTED

**ACT.** Sell new Xmas photo greeting folders. Big profits, we deliver, free kit. Spooner, 115 Chauncy, Boston, Mass.

## AGENTS WANTED

**PLASTIC Tablecloth covers, curtains, drapes, baby pants, bowl covers and other plastic articles selling like wildfire!** Make big money now! Free details. Write L & M Co., Dept. 58-N, 510 St. Charles, St. Louis, Mo.

**A DRESS For you with every 3 you order for yourself and family.** Amazing new plan. Everything free. Harford Frocks, Dept. V-9128, Cincinnati, Ohio.

**EXCEPTIONAL Bargain:** Two magnificent Mexican handpainted pictures (10" x 12") and two ladies silver rings. \$5.00 prepaid. Duty extra. Gieda, Lucerna 63-8, Mexico City, D. F.

**QUICK Money!** Free apron with beautiful plastic lace tablecover. Terrific seller! Rush dollar sample outfit. Refundable. Star, 261M Fifth Ave., New York.

**I'LL Put a "shoe store business" in your pocket!** You get everything free! We train you to pile up big profits through exclusive factory fitting service. Year 'round repeat business. You draw on 100,000 pairs for men, women. Leading line of its kind. Nationally advertised. Write today for free sample outfit! Consolidated Shoe System, Dept. S-209, Chipewa Falls, Wis.

**AGENTS Wanted for our coin operated amusement and slot machines in every town and community.** Sell, or start your own route. Big profits! Write for free wholesale catalog and deal. Aerobit Products Co., Dept. 27, 3767 Druid Station, Baltimore 17, Maryland.

**ABSOLUTELY Free! Big package actual sample fabrics and style presentation of dresses, lingerie, hosiery, etc.** Take orders. Commissions big. Send no money. Melville Co., Dept. 4773, Cincinnati, Ohio.

**SELL Exclusive line imported pipes.** Retail \$2.50 each. Sample line of distinctive styles available now at wholesale cost. 4 for \$5.00. House of Lawrence, Dept. P., 509 Fifth Avenue, New York 17, N. Y.

**AGENTS—100% Profit selling retail, 20% profit selling wholesale, easy device for putting chains on tires.** Details free. Harrison, Box 595, Brattleboro, Vt.

**SELL Exquisite sachet packets!** Agents profits better than 125%. Card brings full details. Ciraulo's Products, 1066 Aileen Street, Oakland 8, California.

**400% PROFITS Selling genuine, guaranteed silver plating liquid (NuSilver).** Apply with cloth. Stores, offices, shops, homes. NuProcess Products, Aurora, Ill.

**NEWEST Money making sensation.** Sell hand painted ties with personal initial. 100% profit. Experience unnecessary. Special offers. Write for free 20 page catalog complete line ties, mufflers, Philip's Neckwear, 20 West 22nd St., Dept. K-30, New York 10.

**SCHOOL Seniors!** Your postal will bring our wonder, Kwick-Sell Cardalog of popular graduation name cards. Biggest profits! Only firm giving free souvenir chest and card case. Don't miss out! Hurry that postal! Craftcards, Box 235(L), Pittsburgh 30, Pennsylvania.

**MEN—Women.** Revolutionary no-splash mop selling like wild! Pennsylvania man sold 38 one day. Free sample offer. Hurry! D & H, 4359-C North 25th, Milwaukee, Wis.

**SELL Ultra-blue stock signs to stores.** 1000 slogans, comedy, general, religious. "7x11" cost 6c, sells 35c. Make money. 15 samples ultra-blue signs "7x11" \$1.00 postpaid. Lowy, 8 West Broadway, Dept. 431, New York City 70.

**"NO-FOG" Windshield cloth.** Instantly removes blurry mist, frost, sleet, snow. Stops windshield fogging. Samples sent on trial. Kristee, 128, Akron, Ohio.

**WANT Pleasant outdoor work in a business of your own?** Good profits selling over 200 widely advertised Rawleigh home/farm necessities. Pays better than most occupations. Hundreds in business 5 to 20 years or more! Products-equipment on credit. No experience needed to start—we teach you how. Write today for full particulars. Rawleigh's, Dept. L-145-PPM, Freeport, Ill.

**POCKET Pal:** Replaces pocket knives. New, safe, beautiful. Always razor sharp. 50c seller. 321% profit. \$15.00 or more daily. Agents, salesmen, distributors. Sample 10c. Nelson Mfg. Co., 222 W. Kellogg, St. Paul 2, Minn.

**DIGNIFIED Profits!** Sell school authorities, stores. Exclusive "Trigonometry Simplified" chart. Sample 50c. Edco Scientific; Box 531, Hollywood, California.

**EARN Big money year 'round.** Be a one-person-department-store. Take orders for shirts, ties, hosiery, lingerie, household linens, etc. For information, Corporate Merchandisers, Dept. PM-9, 110 West 34 Street, New York City 1.

**SCHOOL Seniors—Earn 40% commission selling classmates America's most beautiful graduation name cards.** Largest selection. Outlets all others. Free sample kit. Printerart, Dept. M, 1425 E. Elm St., Scranton 5, Penna.

**REPRESENTATIVES Wanted to handle Ming tree line.** P.O. Box 329, Sparks, Nevada.

**SELL By mail books, novelties, bargains!** Ready made circular service! Large profits! Catalog free! Elco, 432 North Wells, Chicago 10.

**AGENTS—Unbelievable, until you have tried this amazing foot bath powder.** Fast dollar seller. 98% people need it. 50% profits. Excellent repeater. Agents Christmas special 2 cans \$1.00. Saari, 1916 Sheffield, Chicago 14, Ill.

**FREE Nylons given if Kendex hosiery runs or snags!** World's only women's hosiery sold with written guarantee that amazes everybody. Mere words could not possibly express the unbelievable opportunity you have to make money. Fantastic and "impossible" earnings become a reality. Armstrong earned \$202 in 9 days. Watkins sent 92 orders in one day! Can you imagine replacing hosiery free even when it is wearer's fault? Here is sales dynamite to blast earnings sky high. Even if you never sold before, three magic words: "guaranteed against everything" will open doors for you—will make women listen and will pour money in your pocket. Kendex guaranteed nylons are not sold in stores—you have no competition. Complete line including extra sheer, sheer and service weight; lengths 28 to 35 inches; latest colors; seamed full fashioned and seamless. Also complete line men's guaranteed hosiery including nylon, rayon, lisle, wool, cotton, mixtures etc. Styles and prices to please all. Thousands of pairs shipped daily. 100,000 pairs in stock constantly for fast delivery. Over 30 years in business. No money or experience needed. Nothing to pay now or later. Show free outfits; write orders. We deliver and collect. Big advance cash plus huge bonus. Write orders full or spare time—exclusively or as side line. Become manager—appoint others to sell for you with steady income on their sales. Complete money-making outfits including salesbooks in color, samples cut from actual hose etc. furnished free and prepaid. Just write name and address on postcard and mail to: Kendex Company, Babylon 196, N. Y.

**MUSIC Greeting cards.** All occasions. Dorby Music Cards, P.O. Box 738, Morristown, New Jersey.

**BUY Thousands of nationally advertised products direct from manufacturers.** Write for "Buy Direct and Save." Consumers Assn., 287-A Lebanon Ave., Mt. Lebanon, Penna.

**SILVER King bottle openers, unique efficient beautiful.** Large profits. Sample \$1.00. Mac-Hill Products, Box 172, Wauwatosa, Wis.

**USE Your home as magazine subscription station.** Represent all magazines. Liberal commissions—we supply everything. Big year around business. Catalog, full details, free. McGregor Magazine Agency, Dept. 12, Mount Morris, Illinois.

**DECAL Letters and insignias.** Lowest prices. All sizes. Send quarter for personal sample initials and quick profit details. Barbarr Sales, 3828 Gresham, Chicago 24.

**MAKE Sensational profits!** New, sell-on-sight plastic line: Tablecloths, aprons; many other splendid fast-selling items, novelties. Postal brings free details, special deals. Hurry! Royalty, Box K-748, Passaic, N. J.

**MAKE Fast, easy, 100% profit sales!** Smart, new type plastic drying rack with convenient "Fold-Away" rods—your brand-new, big money-maker! Rush name for details. Hurry! Nev-Mar, 75-D Franklin Avenue, Ridgewood, N. J.

**CONSISTENT Commissions, bonuses with free sales portfolio.** Men's shirts, pajamas, Ladies' lingerie, housedresses. Jarod Manufacturing Corporation, Rockville Centre 35, New York.

**NEW Warning safety signal, fits all cars.** Sample 35c prepaid. 4-\$1.00. 10-\$2.00. Al's Radio Sales, Sioux City 7, Iowa.

**WHAT'S New?** Our "New Products Buying Guide" tells you, describing 100 to 150 newest specialty items and products; tells supply sources, prices; live selling opportunities for agents, retail stores, distributors, mail order. Issued monthly. Get sample copy offer. H. Glass Pub. Co., Ellwood City, Penna.

**AMAZING Profits selling advertising coasters.** Single order paid \$108.00 commission. Sales outfit containing pencils, plastic, leather and metal specialties postpaid \$1.10. Refundable first order. Eric Howlett, Huntington, N. Y.

**IT'S New, sample 25c (Crystal-Flex) in beautiful reflecting colors.** Store and Bible text mottoes. Also colored tinselled holiday signs. Special Kut Signs, Dept. N. Sidney, Ohio.

**PHOTO-Salesmen-agents.** Sell beautiful hand-colored plastic enlargements. Collect deposit, we deliver. Profitable sideline. Send card, for free sample kit. Novel Portrait Co., 3343 North Ave., Chicago, Ill.

**BIG Money selling cast iron and aluminum cooking utensils direct to consumer, exclusive designs.** Free illustrations. Jones Machine & Foundry Co., Chattanooga 2, Tenn.



**BIG Profits.** Sell nationally famous guaranteed Dans wrist watches. Illustrated circular. Brooks, B120M, Arkansas, Wis.

**GUARANTEED Product** in protected territory, if you are now selling or intend to sell house-to-house. For full 1 qt. sample amazing High Shine Windsor No Rubbing Wax, send only 25c covering handling and postage. (Sells for \$1.25.) Windsor Wax Co., Inc., Dept. P.M.-2, Hoboken, N. J.

**I'LL Put a "shoe store business"** in your pocket! Nation's leader trains you to make big money! Fit men, women. Free sample outfit, write today! Consolidated Shoe System, Dept. S-139, Chippewa Falls, Wis.

**FREE Sample!** Big profit opportunity with amazing Glow-in-the-Dark house numbers, switch plates, pictures, decals, religious articles. Represent large manufacturer. Madison Mills, 303 Fourth Avenue, New York 10, N. Y.

**MAKE More money** selling personal initialed individualized belts, buckles, cap badges, tie holders, name plates, 2,000 emblems to choose. Big profits, whole or part time. Write today; special outfit offer. Hookfast Specialties, Box 1425, Dept. 6, Providence, Rhode Island.

**FREE Water** and our concentrates, makes flavors, lotions, shampoos, 72 products, labels, bottles furnished. Qualco, E-20030 Russell, Detroit.

**MAGIC Cleaner** — Laundry soap deal. Hotter than a firecracker. Big profits. Sample free. Bestco, 4642 No. Central, Chicago.

**AGENTS:** Stamping names on pocket-key protectors. Sample check with your name, address, 25c. Stamping outfits, Emblem checks, check-fobs, name plates. Hart Mfg. Co., 303 Degraw St., Brooklyn, N. Y.

**INFORMATION** — Wholesale supply sources. Moneymaking plans. Increase your income! Write Reynard Service, Smithfield 3, Ohio.

**GOLD Lacquered window sign letters.** Large sizes penny each. New foils. Absolutely beautiful. Free samples. Atlas, 544 W. 79th, Chicago 20.

**EXCELLENT Sideline** for printing and advertising salesmen. Decalomania name plates in small quantities. Great demand. Also, make money with our line of automobile initials and sign letters. Free samples. "Ralco" XL-Roxbury, Boston 19, Mass.

**AGENTS—300% Profit** selling genuine gold window letters; stores and offices. Free samples. Metallic Letter Co., 438-B North Clark, Chicago.

**GREETING Card agents!** Double your income with profitable sidelines. Write today! Mosher's, Vineyard Haven, Mass.

**\$1 STARTS You** in business. Write, Successful Income Builders, 508, Hollywood 28, California.

### HIGH-GRADE SALESMEN

**ADVERTISING Book matches—Cash** in on big demand; sell union label matches. Cuts for all businesses and political parties. Free powerhouse selling kit, low prices, protection guaranteed on repeat orders. Cash commissions. Superior Match Co., Dept. M-128, 7530 Greenwood, Chicago.

**STOP! Read carefully!** Today's rapid-fire money maker. Only complete giant volume World War II. Profits to distributors already over \$2,000,000. Surface only scratched. Sells on sight. Over 20,000,000 prospects—every home, shop, school, office. Don't miss these landslide profits. Write quick! Universal House, 1014-F Arch Street, Philadelphia, Penna.

**SHARP-N-QUICK:** For all kitchen, butcher, hunting, pocket knives. Better, faster than finest oil stone. 25c. Agents send 50c for 4 samples. Argie, 1425 N. Milwaukee, Milwaukee 2, Wis.

**LOOK Here! Wanted—Men** to start in business on our capital. Sell some 200 farm-home products. Thousands our dealers now make quick sales, big profits. For particulars write Raleigh's, Dept. L-192B-PPM, Freeport, Ill.

**MANUFACTURERS' Agents.** Hot hardware lines. Sales kit—free. Farmco, M-2002, Excelsior Springs, Mo.

**SELL Diamolite ring line** house to house on credit. Write for full information. Acme Mercantile Co., P.O. Box 726, Nashville, Tenn.

**BALLOONS, Toys, novelties, etc.,** wholesale. For full information write Dutz Enterprises, 109-A Sangamon, Lincoln, Illinois.

**QUICK Sure money.** Selling Annie Blain flavors. Highland Park 1, New Jersey.

**SALESMEN—Put yourself** in line for big money and real future. Keep stores supplied with 5c-10c counter goods. Nationally advertised merchandise. Top profits for you and merchants. Liberal deals boost sales. Sideline or full time. World's Products, Dept. 10-L, Spencer, Ind.

**ADVERTISING Specialties.** Liberal commission. Samples, catalog, 25c. Levine's, 15-X Boulevard Station, New York 59, N. Y.

**SELL 7 x 11 Signs,** no trespassing, etc., 25 different, 100-\$2.50. Postpaid. Retail \$10.00. Information write, Feld, 813 Ellison, Cincinnati, Ohio.

**LUMA-NITE Emergency light** for automobiles sells on sight. Floodlight for work.—red warning light for safety, clings magnetically to metal. Up to 100% profits. Sample \$3.50. Particulars free. Business Equipment House, 420-P So. Wells Street, Chicago 7, Illinois.

**EASY Money.** Specialty salesmen, jobbers, selling C-Rite for eye glasses, car windshields, etc. Cleans, keeps clear. No fogging. Needed by millions. No competition, whirlwind seller. Sample 25c. Write C-Rite Mfg. Co., Mt. Erie, Ill.

**INTRODUCTORY Offer:** mail \$2.00 for cologne and perfumes retailing \$6.60. Not samples! Tremendous market—Huge profits. Beau-Belle Creations, 3740M North Paulina, Chicago 13.

**BIG Money** selling tooth powder. Write today. James Walker, 633 Plymouth Ct., Chicago, Ill., Dept. 3.

**AUTOMATIC Fire extinguishers,** it really sells. Guaranteed top profits. Exclusive territory available. Red Ball Inc., Box 1552, Salt Lake City, Utah.

**BIG Money** quickly and easily taking orders for complete line personalized initialed buckles, belts, cap badges, 2,000 emblems. Fast repeats. Write today, Hook-Fast Company, Box 480-PM, Roanoke, Virginia.

**JOBS Open** in selling! Send name, address for free copy Opportunity Magazine, listing hundreds of companies who need men now, full or spare time. Experience not essential. Opportunity, 28 E. Jackson, Dept. 17, Chicago 4, Ill.

**BIG Money** taking orders. Shirts, ties, Sox, pants, jackets, sweaters, shoes, uniforms, etc. Sales equipment free. Experience unnecessary. Nimrod, 4922-AN Lincoln, Chicago.

### EDUCATIONAL AND INSTRUCTION

**LEARN Mechanical dentistry:** World-wide opportunities. Start own business. Resident school gives practical instruction at the bench. G.I.-approved. Housing available. Write for folder PM. Franklin Schools, 719 Liberty, Pittsburgh 22, Penna.

**GOOD Jobs** and a sound substantial future await you in hotel and institutional field. Men and women, all ages, needed for well-paid positions that offer color, excitement, ever-new and fascinating duties. Record breaking travel means even greater opportunities for trained men and women in hotels, clubs and institutions. Lewis School receiving calls for managers, assistant managers, stewards, hostesses, purchasing agents and 55 other types of important positions! From coast to coast there are important positions that offer splendid opportunities for advancement in a business where you are not dropped because you are over 40. Previous experience proved unnecessary! No need to leave your job to qualify. A good grade school education, plus Lewis Training qualifies you at home, in spare time. Our National Placement Bureau helps to place you; and our amazing Certified Job Plan actually certifies you will "make good" when placed. Write today for free book! Veterans: Course approved for Veteran's training. Lewis Hotel Training School, Room NX-368, Washington 7, D.C. (First and only school of its kind—now in its 33rd year.)

**MAKE Up to \$30-\$40** week as a trained practical nurse! Learn quickly at home. Booklet free. Chicago School of Nursing, Dept. M-12, Chicago.

**"HOW To Break and Train Horses"**—A book every farmer and horseman should have. It is free, no obligation. Simply address, Beery School of Horsemanship, Dept. 11012, Pleasant Hill, Ohio.

**LEARN Air conditioning,** refrigeration, and heating. Write today for free booklet. Detroit Air Conditioning Institute, 4125 Grand River, Detroit, Michigan.

**LOW Cost** home study courses. Over 500 subjects. Free bulletin. DeVoto Schools, 35 Vicente, San Francisco 16, Calif.

**NOW You** can have an office. Many earn up to \$5,000-\$15,000 annually in the collection business. Learn by home study course. Experience unnecessary. Write for free bulletin. No obligation. Franklin Credit School, Dept. 228-N, Roanoke 7, Virginia.

**LAW Home-study,** three-year, 150-lesson college course (LL.B. degree). First lesson \$1.00. Osborne University, 392 Court, San Bernardino, California.

**MAGICIANS School.** Licensed, first of its kind. Approved for veterans. Experience unnecessary. Free particulars. Chavez College of Magic, 729 West Ninth Street, Los Angeles 15, California.

**BE A mathematical wizard.** Add figures faster than adding machine. No special education needed. Free details. Write, Vanderdrift, 517 Lincoln Place, Orange 2, New Jersey.

**MEMORY Stunts** revealed. Actually memorize rapidly newspapers, home work, catalogs. Impress employers, teachers, customers. Practical application guaranteed. Book \$1.00. Rabinowitz, 27 E. 3rd, New York 3.

**INVESTIGATORS** Trained, men-women, learn fascinating profession. Spare time study. Big pay. Folders free. Investigator, Box 490, Times Square Station, New York 18, N. Y.

**HOME Study** course, drugless therapy. Free literature. Institute of Drugless Therapy, Tama, Iowa.

**DEVELOP** Photographic mind by supermemory. Write Thor Books, CM-12, Box 1210, Chicago.

**WELDING—Learn** quickly at best equipped school in U. S. A profitable trade. Demand for trained men. G.I. approved. Free catalog. Write Hobart Welding School, Box M-1288, Troy, Ohio.

**SPANISH—Learn** fast—with Speed-O-Way phonograph records and textbook, \$7.95 complete. Write for free folder. Speed-O-Way Publications, Box 2301, Houston 1, Texas.

**INVESTIGATOR** Training, other. Scientific crime detection courses. Free literature. Write today! State age. Institute of Scientific Criminology, Dept. J, 1324 West Broadway, Spokane, Washington.

**DENTAL Technician's** practice kit. Artificial teeth, plastic, etc. Free instructions with kit. Grant Laboratory, S-219 W. 7th, Los Angeles, Calif.

**LEARN Oil painting:** Simplified course. Inexpensive. Roland Prickett, Box PM, Reno, Nevada.

**3800 LATEST Used** correspondence courses cat. 50c. EG, Elmsford, N. Y.

**NEW Profession.** Pedemetry—Foot correction. Unlimited field. Learn at home. Write Registrar, American Foot Health Institute, 55 East Washington, Chicago, Ill.

**BE A real estate broker** through home study or classroom instruction. Write for free book. Approved for veterans. Weaver School of Real Estate, 15 E. Pershing Rd., Box CP-1, Kansas City 8, Mo.

**PIANO Tuning** pays. Learn this profitable profession at home. Our Tonometer and mechanical aids make learning easy. No knowledge music necessary. Diploma granted. Largest and oldest school—50th year. G.I. approved. Write for booklet. Niles Bryant School, 78 Bryant Bldg., Washington 16, D.C.

**MEDICAL Laboratory technicians** in great demand. We train you in your own home, in your spare time. Also home study course in general chemistry. Free catalogue. Imperial Technical Institute, Box 973-J, Austin, Texas.

**INVESTIGATOR** Training. Phillips Secret Service, 1917B North Kenneth, Chicago 39, Illinois.

**BOOKKEEPERS!** Increase your earnings! Operate your own simplified "dollar-a-week" bookkeeping and tax service. Full or spare time. Details free. No obligation. Ellis, Box 200, Cedar Grove, North Carolina.

**USED Correspondence** courses and books bought, sold, rented and exchanged. Catalog free. Lee Mountain, Pisgah, Alabama.

**LEARN Photo-engraving** at home or in oldest, largest school in America. Work for newspaper or establish own profitable business. New Tasope' Photo-Engraving equipment available soon. Write for information. Veterans ask about G.I. training. The Aurora School of Photo-Engraving, Tasope' Bldg., Aurora, Mo.



**LINGUAPHONE** Makes languages easy. At home learn to speak Spanish, Portuguese, Italian, French, German, Russian, by quick, easy Linguaphone Conversational Method. Save time, work, money. Linguaphone correspondence courses are available to veterans under G.I. bill of rights. Send for free book. State if G.I. Linguaphone Institute, 83 RCA Bldg., New York, 20, N. Y.

**SECRET** Investigation. Experience unnecessary. Investigators particulars free. George Wagner, M 125 West 86th, New York.

**USED** Correspondence courses and educational books bought, sold, rented. Catalog free. Educational Exchange, Summerville, Ga.

### PLAYS, STORIES, MANUSCRIPTS

**I WANT** New writers to cash hundreds of checks for \$1 to \$100, offered each month. The easiest way to write for pay. No previous experience necessary. Send for free details. No obligation. Saunders M. Cummings, 468-M Independence Bldg., Colorado Springs, Colo.

### SPECIAL SERVICES

**BULLETINS** About new products 25c each. Chaffee, 308 Washington, Chicago 6.

**WE** Receive reforward letters; \$3.00 monthly or 25c each. "Hawkins," 1300 Taylors, Washington 11, D.C.

**PHOTOSTATIC** Copies. Write for prices. Hamy, 214 Robinson, Hudson, N. Y.

### INFORMATION

**FOREIGN** Employment for you. Excellent permanent job opportunities for U. S. citizens. Wages at least 20% higher, less taxation, lower living costs. Improved social position. Transportation and housing furnished. Choice of climate and location. South and Central America, Far East, China, Alaska, Africa. Send \$1.00 for copyrighted Digest showing oil, shipping construction, mining, etc. Companies working and hiring. Includes sample application letter, advice on wages, tips, etc. World Wide Company, Dept. PM-11, Madison 1, Wisconsin.

### ADVERTISING AGENCIES. LETTER WRITERS, FOR ADVERTISERS

**ADVERTISERS!** Reach nearly 18,000,000 readers. 25 Sunday national key newspapers, 18 words, \$49.75. "Terrific pullers," 20 popular newspapers, \$10.00. "Free booklet," Special—One inch display 2,821,198 circulation, \$48.30. Newmark's Advertising Agency, (Established 1893), 217-7th Ave., New York 11.

**COMPLETE** Service for mail advertisers. Planning, preparation, printing, placing. Write: National, Box 88A, Dorchester, Mass.

**SELL** Anything by mail. Dynamic ads, prospectus, letters written. Classified mailing lists. Millions! School teachers, students, investors stockholders, etc. Faultless Advertisers, P-3439 Michigan, Chicago 16.

**CHOICE** Mailing lists. E. J. Eller, Broker, 1000 Sutter Street, San Francisco 9, Calif.

**ADVERTISE:** 24 Words, 40 newspapers \$3.50. Lists free. Advertising Bureau, 10511-C Springfield, Chicago 43.

**24 WORDS** In 50 weeklies, \$4.96. J. Darnell, 730 Hays, Jackson, Tennessee.

**EARN** Money in your spare time. Progressive Mail Trade tells you how. Large 64 page magazine for a dime. Progressive Mail Trade, 822 Center Ave., Sheboygan, Wisconsin.

**ADS** Placed in out of town newspapers and magazines. Low rates. Catalogue free. Ideas that pay. Baker Advertising Agency, Successors Ankrum Agency, 189 W. Madison, Chicago 2.

**MAILING** Lists, certified, productive, inexpensive, \$5.00 1000. Homeworkers, agents, buyers, etc. Write Dixie Service, King, N. C.

### CARTOONING, COMMERCIAL ART, SHOWCARD WRITING, SIGN PAINTING

**FAMOUS** \$75 Lockwood art course now only \$6 postpaid. Other smashing art bargains. Catalog 10c. Art Book Shop, Arnold 5-A, Missouri.

**WE** Do silk screen process of all kinds. Kolortone Signs, Detroit Lakes, Minn.

**"HOW To Make Money With Simple Cartoons"**—a book everyone who likes to draw should have. It is free; no obligation. Simply address Cartoonists' Exchange, Dept. 912-C, Pleasant Hill, Ohio.

**LEARN** Showcard writing at home in spare time. Fascinating, profitable. Free information. Sherwood Publishing Co., Irvington 11-4, New Jersey.

**CARTOONISTS'** Magazine 25c. Lessons, markets. Hartman Studios, 2776 California Ct., Lincoln 8, Nebraska.

**LEARN** Drawing at home. Sixteen easy steps. Low cost. Constructive criticism. Money-back guarantee. Pacific Art Institute, Box 1284, San Jose, California.

**EARN** Money evenings, copying and duplicating comic cartoons for advertisers. Adservice, Argyle 1-B, Wisconsin.

**SIGN** Painting course prepared by one of America's best sign artists. \$2.00 postpaid. Progressive Signs, 3611 Thirteenth Avenue, Chattanooga 7, Tennessee.

**SIGN** Painting taught at home. Test lesson free. Ben Kerns Studios, Box 812, Greenville, S. C.

**9 ALPHABET** 3 Numeral pattern sets and catalog, \$1.00. Sign Letter Distributors, P.O. Box 101, Mineola, N. Y.

**FIGURE** Drawings by French artist Lalire. Over hundred female poses, body details, \$1.00. Art Headquarters, 1160 25th Avenue North, St. Petersburg, Florida.

**CHALK** Talks. Laugh producing program, \$1.00. Catalog 10c. Balda The Cartoonist, Oshkosh, Wisconsin.

### TYPEWRITERS, DUPLICATORS, OFFICE DEVICES

**PRINT-O-MATIC** Mimeographing post card typeless stencil duplicator printer \$13.50. Office duplicators—Hilcos, Speedoprints. Typewriters, portable adding machines, addressettes, automatic envelope sealers. All office machines. Duplicator supplies. Literature free. Pittsburgh Typewriter Supply, 336-4 Fourth Avenue, Pittsburgh 22, Penna.

**STANDARD** Typewriters \$25.00; duplicators \$12.50; adders \$12.50. Ship all states. "Typewriters," 118 Spruce, Wichita, Kansas.

**REVOLUTIONARY** New addresser. No plates. \$32.50 complete. Cunningham, 1463 East 50th, Chicago.

**PHOTOCOPY** Anything—Papers, books. No darkroom. \$6.95 complete. Potoflek, 4801 Yarmouth Place, Cincinnati 29, Ohio.

**RECONDITIONED** Typewriters, mimeograph, multigraph printing devices, appliances, supplies. Catalog. Dixiegraph Service, King, N. Carolina.

### RUBBER STAMPS AND OFFICE SUPPLIES

**3 LINES** 50c. Printing. Catalogue. Johnson Press, Box 6-A, New York City 26.

**LINE** 20c; 2-35c; 3-50c. Stamp Works, Auburn, Nebraska.

### PRINTING, MULTIGRAPHING, MIMEOGRAPHING, GUMMED LABELS

**BUSINESS.** Personal stationery. State requirements. Samples, price lists free. How Printing Company, 721-23 Eunice, Webster Groves 19, Missouri.

**8 1/2x11** LETTERHEADS; Envelopes; 100 either. printed \$1.00. Benneville, Box 1931, Pittsburgh 30, Penna.

**100 8 1/2x11** HAMMERMILL Letterheads, 100 envelopes (5 lines) \$2.00. R. Cook, (Dept. 2128), 730 West Gift, Peoria 5, Illinois.

**MIMEOGRAPHING:** 100 8 1/2x11—\$1.10. Additional hundreds 50c. Mimeographing, Madison, Tennessee.

**SAVE** Money on your printing. Write today for new, low price list and offset ordering chart PM-1 free. We photograph your copy and reproduce it on white or colored paper. Advertisers Service Litho, 161 W. Harrison, Chicago 5, Illinois.

**BUSINESS.** Personal stationery. State requirements. Samples. Mero Products, 100 Morrison, Punxsutawney, Penna.

**100 8 1/2x11** LETTERHEADS Or envelopes \$1.00. 100 each \$1.85. D'Yarmett Printing, Newark, Ohio.

**BLOTTERS.** Cards exclusively; lowest prices; samples. Box 174, Niagara Falls, New York.

**SEND** 10c Now, for our 48 page 1949 price list—refunded first order. McCall Press, 1326 South 27th, Omaha, Nebraska.

**AUTOMATIC** Eraser holder, attach to any make typewriter. Eraser always at fingertips. New. Sensational. 50c; 3 for \$1.00. Tobe, 801 Lee Bldg., Kansas City, Mo.

**500 LETTERHEADS** And envelopes \$9.50. Sumar Press, 81 W. Van Buren Street, Chicago, Ill.

**250 LETTERHEADS** \$1.00. Envelopes, billheads, statements same. Klopffleisch, Crosby, Minnesota.

**BLOTTERS—2x4,** 1949 Calendar and your advertisement. 200 \$1.75. Samples. Blotter-Ad, 5301 Atlantic Ave., Ventnor, N. J.

**BETTER** Grade printing reasonable. Estimates on anything. Economic Press, Leonia, N. J.

**100 LETTERHEADS** (8 1/2x11), 100 Envelopes, beautifully printed, \$1.85. Calder's, Box 3422-MP, Philadelphia 22, Penna.

**1949 CALENDAR** Novelties. Samples for stamp. Cassel, R4, Middletown, N. Y.

**150 SHEETS,** 75 Envelopes printed \$1.75 prepaid. Miller Stamp, Highland Avenue, Malden 48, Massachusetts.

**1000 BUSINESS** Cards (embossed) \$2.95 postpaid. Zephyr Printing, Box 312pm, Venice, California.

**LETTERHEADS.** Envelopes, circulars. Small, large quantities. H.M.G. Company, Mecca, Indiana.

**500 3/4x2 1/4** FOUR Line gummed stickers 35c; red border 50c. Moritz Printery, Saginaw, Mich.

**1000 BUSINESS** Cards, \$2.50, prepaid. Samples free. Reliable Print Shop, 905 E. Jefferson, Louisville 6, Ky.

**QUALITY** Printing—Reasonable prices. Fast service on catalogs, folders, publications. Write for prices. Bagby Printing Co., Georgetown, Ohio.

**MIMEOGRAPHING**—Letters, pricelists, formulas, instructions. Lowest prices. Lem's Letter Shop, 5710 Stanton, Detroit 8.

### PRINTING OUTFITS AND SUPPLIES

**REBUILT** Presses, bought, sold. List 3c. Exchange, 212 Curtis, Meriden, Conn.

**HOME**CRAFT Presses, supplies. Catalog 10c. refundable. Riegel, 1111 Harrison, Philadelphia 24, Penna.

**GOLD** Imprinter \$3.25. Samples 10c. Garza, 8 Walden, Cambridge 40, Mass.

**MAKE** Your own plastic printing cuts. New plexiplate process. Plexiservice, Argyle 1, Wisconsin.

**HAND** Presses, automatics, type, cutters, bulletins 3c. Requirements? Box 918, New York 8.

**BARGAINS**—Hand presses, supplies. Catalogs 10c. Customprint, 211-N, Springfield, Missouri.

**PRINTING** Presses, type, supplies. Lists 3c. Turnbaugh Service, Loysville, Penna.

**PRINTING** Presses, type, supplies. Send dime for complete illustrated printer's supply book, details and press samples. Kelsey, Inc., A-11, Meriden, Connecticut.

**INEXPENSIVE** Home-made printing press. Details free. Novelty Shop, Downsview, Louisiana.

### PATENT ATTORNEYS

**PATENT** Protection—Unless an inventor is thoroughly familiar with such matters, he is advised to employ a competent registered Patent Attorney as the value of a patent depends largely upon the skillful preparation of the specification and claims. Send for booklet, "Patent Protection for Inventors," outlining preliminary steps to take to obtain patent protection. Victor J. Evans & Co., 331-P Merlin Building, Washington 6, D. C.

**IF** An inventor believes he has an invention, a search of the most pertinent prior U. S. patents should be made and a report obtained relative to its patentability. Write for further particulars as to patent protection and procedure and "Invention Record" form at once. No obligation. McMorrow, Berman & Davidson, Registered Patent Attorneys, 134-V Victor Building, Washington 1, D. C.

**PATENTS.** "Proof of Invention" folder mailed without obligation. E. E. Vrooman, Registered Patent Attorney, 505 McKim Building, Washington 5, D. C.

**GUSTAVE** Miller—Patents and trade marks. 128-A Warner Building, Washington 4, D. C. Registered Patent Attorney. Associate Patent Examiner, U. S. Patent Office 1922-1929.



**PATENTS, Trade marks, Sanders, 6430 Evans, Chicago, Registered U. S. Patent Office.**

**INVENTORS:** Learn how to protect your invention. Unless the inventor is familiar with patent matters, he should engage a competent registered patent attorney or agent to represent him. We are registered to practise before the U.S. Patent Office and prepared to serve you in handling your patent matters. "Patent Guide for the Inventor" containing detailed information concerning patent protection and procedure with "Record of Invention" form will be forwarded to you upon request—without obligation. Clarence A. O'Brien & Harvey Jacobson, Registered Patent Attorneys, 81B-K District National Building, Washington, D. C.

**C. A. SNOW & Co.—M-427, Snow Building, Washington 1, D. C. Registered Patent Attorneys. Write for information.**

**PATENTS—Trade marks, Irving L. McCathran, 315 McLachlen Bldg., Washington 1, D. C. Registered Patent Attorney.**

**INVENTORS.** For "Record of Invention" form, contact Carl Miller, Registered Patent Attorney, Woolworth Building, New York.

**INVENTORS:** Without obligation, write for information explaining the steps you should take to secure a patent. John N. Randolph, Registered Patent Attorney, 203 Columbian Bldg., Washington 1, D. C.

**"INVENTOR'S Guide" free on request, Frank Ledermann, Registered Patent Attorney, 154 Nassau St., New York 7, N. Y.**

**PATENT Practice before U. S. Patent Office.** Validity and infringement investigations and opinions. Booklet and form "Evidence of Conception" forwarded upon request. Lancaster, Allwine & Rommel, Registered Patent Attorneys, Suite 411, 815-15th Street, N.W., Washington 5, D. C.

**INVENTORS:** Write for free brochure "Evidence of Invention." Labiner, World Building, New York 7.

**INVENTORS:** When you are satisfied that you have invented something of value write me, without obligation, for information as to what steps you should take to secure a patent. Write Patrick D. Beavers (Formerly Randolph & Beavers) Registered Patent Atty., 935 Columbian Bldg., Washington 1, D. C.

#### FOR INVENTORS

**INVENTORS—This firm is registered to practice before the U. S. Patent Office and is available to assist inventors in the preparation and prosecution of their cases. "Patent Protection for Inventors" booklet containing detailed information and steps to take toward patent protection will be sent upon request. No obligation. Victor J. Evans & Co., 332-P Merlin Building, Washington 6, D. C.**

**IF An Inventor believes he has an invention, a search of the most pertinent prior U. S. patents should be made and a report obtained relative to its patentability. Write for further particulars as to patent protection and procedure and "Invention Record" form at once. No obligation. McMorow, Berman & Davidson, Registered Patent Attorneys, 134-W Victor Building, Washington 1, D. C.**

**LIST Of 100 inventions manufacturers are now asking for. \$1.00. Engineer, 8 N. Alexander, Danville, Ill.**

**INVENTORS' Financial assistance. Investment Development Company, Box 1462, Amarillo, Texas.**

**PATENT Searches \$6.00. Five day service. Invention protection forms free. Write Raymond L. Smith, Patent Searcher, 410-M Bond Building, Washington 5, D. C.**

**PATENT And trade-mark searches \$6.00. Reports airmailed in five days. Invention protection forms free. Write Miss Ann Hastings, Patent Searcher, P.O. Box 176, Washington 4, D. C.**

**MAKE Ideas earn money. Literature free. Grayland, 5312 Grace, Chicago 41.**

**WOW! Genuine air force electric B-17 gunsights. Only \$2.95, brand new. Includes filters, optical mirrors, reticles, springs, bolts, die cast body, etc. Postpaid. Less lens. Cost gov't. much more. Spartan Surplus, 4350 Camellia, North Hollywood, California.**

**IDEAS Are worth money. Free booklet. Elo Development Company, Long Island City 1.**

**PATENTED, Unpatented, inventions promoted. M. Joyce Humphries, 1424 Landtite, Philadelphia 10, Penna.**

**INVENTORS! Have you good, patentable ideas? Write Patent Agent Metzler, 11 West 42nd, New York.**

**INVENTORS:** Learn how to protect your invention. Unless the inventor is familiar with patent matters, he should engage a competent registered patent attorney or agent to represent him. We are registered to practise before the U.S. Patent Office and prepared to serve you in handling your patent matters. "Patent Guide for the Inventor" containing detailed information concerning patent protection and procedure with "Record of Invention" form will be forwarded to you upon request—without obligation. Clarence A. O'Brien & Harvey Jacobson, Registered Patent Attorneys, 81A-K District National Building, Washington, D. C.

**INVENTORS—Possibly I can help you. Many years experience. Charles A. Scott, 773 Garson Avenue, Rochester 9, N. Y.**

**"INVENTOR'S Guide" free on request, Frank Ledermann, Registered Patent Attorney, 154 Nassau St., New York 7, N. Y.**

**INVENTORS:** If you have an invention for sale, patented or unpatented, write Institute of American Inventors, Dept. 40A, 1926 Eye St. N.W., Washington 6, D. C.

**INVENTORS:** Without obligation, write for information explaining the steps you should take to secure a patent on your invention. John N. Randolph, Registered Patent Attorney, 202 Columbian Bldg., Washington 1, D. C.

**CASH For your idea. 280 manufacturers need inventions, patented or unpatented. List free. Invention Bureau, 208M Clinton, Oak Park, Illinois.**

**INVENTORS:** The usual first step is to have a search of the U. S. Patents conducted, so I can report on patentability. Write, without obligation, Patrick D. Beavers (Formerly Randolph & Beavers), Registered Patent Atty., 936 Columbian Bldg., Washington 1, D. C.

**PATENT Searches; reliable, efficient, air-mail service; \$6.00. Write for free invention protection form. Patent Research Service, 703P Albee Bldg., Washington 5, D. C.**

#### INVENTIONS WANTED

**YOU Need us for quick profit. We create demand for good ideas. Direct to industry all parts U. S. Submit details now! Creative Service, 312 Fay Bldg., Los Angeles 13, Calif.**

**WE Sell patents. Submit full details. Universal Guaranty Co., Lakewood, N. Y.**

**EARN Up to \$2,000 year, inventing simple items. Special cash markets. Hendrickson, Argyle 7, Wisconsin.**

**FAST Sales, cheap protection, details free. McLoughlin, 1101 Meade Avenue, Scranton 8, Pennsylvania.**

**HIGHEST Royalties—Cash. Official U. S. I. R. C. certification. Request free Booklet "M", Universal Marketing Co., 354 South Spring St., Los Angeles 13, Calif.**

**CASH For your idea, 280 manufacturers need inventions, patented or unpatented. List free. Invention Bureau, 208M Clinton, Oak Park, Illinois.**

**INVENTORS:** Hundreds of manufacturers have requested our assistance in locating marketable new products. Complete information, free. Institute of American Inventors, Dept. 40-D, 1926-Eye St. N.W., Washington 6, D. C.

**SMALL Inventions wanted by manufacturers. I'll help you sell your invention. Write for circular. Stanley Hull, 7829 Euclid, Cleveland, Ohio.**

**INVENTIONS Wanted. Patented or pending only. Inventors' Exchange-B, Hartford 1, Conn.**

#### PATENTS FOR SALE

**\$1,000,000 HOUSEHOLD Utility snap on off handle, applicable to all sizes circular glass or tin containers. Handle, Box 32, Creston, Iowa.**

**INVENTORS:** Test the commercial value of your patented or unpatented inventions, quickly and inexpensively. Write for free information. Institute of American Inventors, Dept. 40-B, 1926-Eye St. N.W., Washington 6, D. C.

#### MANUFACTURING

**PERMANENT Moulds for plastics, aluminum castings. Unamit Mould & Machine Company, Bunker Hill, Ill.**

**COMPLETE Design, model, light manufacturing facilities. Jones Sporting Goods Manufacturing Co., Banning, Calif.**

**MODELS, Tools, dies, experimental work; large and small lot manufacturing. Van-Ess Specialties Company, 212 W. 14th Street, Covington, Ky.**

**MODELS—Small lot manufacturing. Metals, plastics, etc. Milburn, Burlington, Kentucky.**

#### MODELS, MODEL SUPPLIES

**JET Powered rocket kit. Parts cut to shape. 18" long. Propulsion units and guide wire included. Postpaid \$2.95. Assembled metal jet racer with propulsion units. Postpaid \$1.95. Pilot MO-I, 5450 Belmont, Chicago 41, Ill.**

**BRASS Gears and model supplies, send 10c for catalog. Pierce Model Works, Tinley Park, Ill.**

**DOWMETAL Magnesium for all model makers. Rod, bar, sheet and scale structural shapes. The Craftsmiths, 15427 Robson, Detroit 27, Michigan.**

**BUILD Your own model homes, garages, doll houses, displays, etc. Strong wood panels milled to faithfully reproduce shingles, lapsiding and brick in three scale sizes. Write postcard for free picture folder. Scale-Built Materials Inc., 4624 Ravenswood Ave., Chicago 40, Ill.**

**STEAM Engine models—Ten new vertical and horizontal miniature designs. Complete casting kits and other model supplies. Illustrated catalog 35c. Century Models, 337C Guaranty Building, West Palm Beach, Florida.**

**BUILD A model house realistically, frame it, board it, finish it. Mayberry's, Beverly Farms, Mass.**

**SHIP And yacht model fittings; blueprints. Send 25c for illustrated catalog No. 21—listing hundreds of items. A. J. Fisher, 1002-1 Etowah Ave., Royal Oak, Mich.**

**TINY Power steam engines, boilers, locomotives finished ready-to-run. Also castings, prints. New catalog 25c. Chas. Arnold, Philomath, Oregon.**

**RAILROADERS—50c Gets new 1949 catalog reference manual. State O or HO gauge. Walthers, 247 Erie, Milwaukee 2, Wis.**

**LARGE Illustrated catalog Lionel trains and accessories, 10c. Bens Hobby Shop, 72 West Washington, Chicago 2.**

**THE Speed King steam engine, casting kits, water tube boilers. Literature 5c. H & P Machine Co., 1617 Fulton, Kalamazoo 25, Mich.**

**200 SHIPS Drawings, clippers to landing barges, shipfittings, engines. List dime. Gullmars, Westhill, Ontario.**

**STEAM Engines, boilers, castings. Catalog 25c. Anton Bohaboy, 2297 Price, Rahway, New Jersey.**

**MINIATURE Steam locomotives, 1/4", 1/2", 3/4" scales. Castings, parts, rail, steam fittings! Thorough drawings with instructions. Catalog 25c. Little Engines, Wilmington, Calif.**

**SHIP Models and yacht supplies complete. Large 64 page catalogue 30c. Bill Wild's, 510 East 11 St., New York City 9.**

**LANDLOCKED Sailors! Here's a beautiful, richly illustrated, fully descriptive catalogue of famous model ships—whalers, slavers, corvettes, etc., authentic in every detail. Send for it today. Only 25c. Halesite Yacht Service, Inc., Halesite, Huntington, N. Y.**

**MODEL Railroads exclusively—Complete stock scale; Lionel, American Flyer. Send for catalog, 15c, state gauge. Eric Fuchs, 26 Tremont Street, Boston 8, Mass.**

**BUILD Historic ship models, complete kits 39c to \$8.50; send 10c for catalog. Ideal Models, 19 West 18th Street, New York 11, N. Y.**

**KEEP In touch with the activities of the British modelmaking fraternity. Send a dollar bill for year's subscription (4 issues) Modelcraft Magazine and list. 77 Grosvenor Road, London, S. W. 1.**

#### HOME CRAFTSMEN

**TORTOISE Shell makes beautiful costume jewelry. Bracelet, earring, and pin blanks. Polished. All four \$1.00. Earring blanks free for stamp. Sam Patchett, 5053, Cristobal, Canal Zone.**

**TEXAS Ebony, America's most beautiful lathe turning wood. Large piece \$1.00, prepaid. Sample 10c. Information on southern woods, stamp. StarCraft (1), Edinburg, Texas.**



**BUSY-WORK** Velcoat kit, with which you can give any surface a soft velvet-like finish in six exciting colors. Each color in individual gun, ready to use. Matching adhesives, brush, designs, work-booth and instruction book. A beautiful gift, \$4.95 postpaid. One-color junior kit \$1.00. Free color chart and literature available for you. Busy-Work Shops, Box 8715, Pittsburgh 21, Penna.

**OREGON** Myrtlewood turning squares. Information on request. M. Weaver, 3923 S E Tibbetts, Portland 2, Oregon.

**LEATHERCRAFT** Catalogue and text-book. America's finest. The leatherworker's bible. Mail postcard for details. Artcraft Leather, Dept. PM-12, 271 Twelfth St., Oakland 7, California.

**SWISS** Music units. Xmas and popular tunes \$3.50. Double tunes \$4.50. Irv Meyers, 126 Lexington Ave., New York 16, New York.

**LAWN** Chairs, garden figures, furniture, novelties, toys, etc., 68 popular plans with full size patterns, \$1.00. Mastercraft 12M, 7041 Olcott, Chicago 31, Illinois.

**LEATHERCRAFTERS:** Free: 3 sheets new designs with latest catalog. Enclose 25c handling charge. Leather Specialties, 358 E. Broadway, Long Beach, California.

**MAKE** Toys for fun and profit. We supply beautifully formed 2 3/4"x1 1/2" metal wheels, 8 for \$1.00, postpaid. Spee-D Wheels, 1420 West 17th, Long Beach, California.

**ELECTRIC** Pencil—Writes, engraves all metals. \$2.95 postpaid. Reb Industries, 265-DO, Elmhurst, Illinois.

**BRITAIN'S** Foremost home craftsmen's monthly Practical Mechanics. Up-to-the-minute ideas, articles by experts, model making, science, electricity, woodwork, photography, special home workshop section. Lavishly illustrated. Mailed direct from London for one year (12 issues). Send only \$2.00 to George Newnes Ltd., (PM.9), 342, Madison Avenue, New York 17.

**SCULPSTONE**—Make gifts. Make money at home. For artist, sculptor, hobbyist, designer, etc. Imported Oriental stone. Beautiful in grain and color! Cuts easily with pocketknife. Endorsed by professionals! Work kits \$1.60 & \$2.60 p.p.d. Thousands satisfied! Far Eastern Sculptstone Co., Inc., 159 East 28th St., Dept. M, New York 16.

**LATHE** Owners—1/4" round steel 5c foot. Other sizes comparable. Catalog free. Shop Supply, Box 573, Chelsea, Michigan.

**JARS** For nuts, bolts, screws, small parts; easy to quickly select what you need. Valuable for repairshops and hobbyists. Costs little. Literature free. Dratz, Lake Geneva, Wis.

**LEARN** To make seashell jewelry, pins, earrings, hair ornaments, novelties. Design and instruction book free with \$2.00 and \$5.00 kits. Also artificial flower supplies. Herbert Diamond Co., Box 4619, Miami 31, Florida.

**FREE** Price list, instructions, with 2 sample packages different colored flock for 25c. A & M Crafts, 672-C East 91 Street, Brooklyn 12, N. Y.

**ASSEMBLE** And finish your own cedar chest. Save up to 50% of retail price. We furnish veneered "water fall" lid, panels, hardware, everything needed. Finest quality materials; full, easy assembly instructions. Write quick for details. Supply limited. Cook Chests, 1125 Third Street N.E., Massillon, Ohio.

**BANDSAW**, Jigsaw owners, let your machine bring extra profits, fun. Free details. Nu-Art, 33 Rosemont, Weymouth 91, Massachusetts.

**MAKE** Your own Christmas, birthday, anniversary gifts at home. 3 pounds costume jewelry needing repair, \$5.00. Use stones and parts to make beautiful things for yourself. Rush order. Money back guarantee. B. Lowe, Dept. PM, Holland Bldg., St. Louis, Mo.

**LEATHERCRAFT**, Tandy Leather Company, Tulsa 1, Oklahoma. Monthly price sheet guarantees best prices. Catalogue free upon request.

**TRY** These clever unusual patterns—25 different lawn ornaments fit 12" stock \$2.00; 106 woodwork \$2.50; 50 toy \$1.25; 110 pin and lapel 75c; all patterns \$6.00. Catherine Schilder, Cresbard, S. Dak.

**SPECIAL** 77 Full sized patterns. Lawn ornaments, toys and novelties \$1.00. Modern Woodcraft, Saginaw, Michigan.

**SHELLCRAFTERS:** Shells, findings, Kit \$2.95. (Stamp) catalogue. Dixie Shell Service, Lakeland, Fla.

**LEATHERCRAFT**—Silversmith. Tools, dies, engravers. Made to order. Belt toppers, billfolds, key cases. Louis Jones, 1405 Throckmorton, Ft. Worth, Texas.

**COSTUME** Jewelry supplies. Low prices. Myles-Herber, 1360-A Hicks, New York 67.

**SHELLCRAFT!** Make beautiful seashell jewelry. Income or hobby! Large illustrated catalog! Supplies, instructions, 10c postage. (Buy direct from manufacturer.) Pace's, Box 279M, Bradenton, Florida.

**MAKE** Jewelry and other items, everything furnished. Free circular. Leisure Hour, 416 Rose Street, West Hazleton, Penna.

**MAKE** Your own jewelry! All types of findings, metal and plastic; cameos, beads, shell kits, illustrated catalog, 20c. Hobby Art, P.O.B. 276, Dept. 7, New York 18, N. Y.

**SHELLS**, Plastics, findings. Lowest prices. Free catalog. Frances Jones, Box 251, Sarasota, Fla.

**HOBBYISTS:** Send 25c for biggest value in hobby catalogs, 64 pages, 500 illustrations. Materials, books, tools, kits for 26 hobbies. Jar Hobby Mart, Dept. C6, Box 137, Iselin, N. J.

**PROJECT** Deal for Christmas. Table, lamp, etc. Designs and lumber. Veneer deals. Sedlo Company, PO Box 7161, New Orleans, Louisiana.

**50 PATTERNS** Toy furniture, action toys, etc., \$1.00. Continental Homecrafters, 907 Birch, Eau Claire 3, Wisconsin.

**CATALOG:** Patterns plywood novelty furniture, lawn ornaments, letters, numerals, plaques, frames, silhouettes, weathervanes, toys. Decal transfers. Over 100 other items. 200 articles illustrated. 25c, refunded first order. (No stamps please). Wo-Met Shop, Box 167, Ashburn, Georgia.

**JEWELRY** Making is simple with our metal, plastic, and sterling findings, wire, chain; chemicals, kits, rosary parts. Everything. Lowest prices. Catalog 25c (refunded first order). Pittshire, Box 90-E, Pittsfield, Mass.

**LEATHER**, Retail, mail orders, catalog, tools, lacing, supplies. National Handicraft Co., 30 Frankfort St., New York City 7.

**PLASTIC** Jewelry supplies. Free catalog. J & M Novelties, Box 464P, Griffith, Indiana.

**KNOCKDOWN** Cedar chests. Lumber and veneers. Free price list. Giles & Kendall Company, Huntsville, Ala.

**LEATHERCRAFT!** Complete stocks of leathers, tools, supplies. Immediate shipment. Free catalog. Kit Kraft, 3203 W. Washington Blvd., Los Angeles 16, California.

**CERAMIC** Jewelry supplies, bar pins, ear screws, for ceramic and woodworkers; also glass and seashell assemblers. Free catalog. Philadelphia Badge Co., Dept. B-1, 1007 Filbert St., Philadelphia, Penna.

**COPPER** And brass materials. Complete line for craftsmen and workshops. Catalog A free. Groundmaster Company, Boulder, Colorado.

**SEA** Shells. Interested in making shell jewelry, lamps, novelties. We have all supplies at wholesale. Write for price list. Sea Shells, 269 W. Flagler Street, Miami, Fla.

**SHELLCRAFT** Jewelry kit \$1.69 postpaid. Free instructions, catalogue. Shell-Art Novelty, Fifth and Moore, Philadelphia 48, Penna.

**SHELL** Jewelry supplies. Wholesale only. McFarland Plastic Co., Sarasota, Fla.

**SPECIAL** Offer: 80 full size toy, novelty, and lawn ornament patterns only \$1.00 postpaid. Lynds, Box 193D, Medway, Mass.

#### MAKE IT YOURSELF

**GARDEN** Tractor plans, 1 1/2 and 2 1/2 h.p. Six large sheets of drawings, instructions, details and pictures, \$3.50. Clearprint Plans, Box 265, Muskegon, Mich.

**SUPERVISE** Myself prefabricated houses. 182 drawings, instructions \$1.00. Nelson Frissell, Civil Engineer, Gardner 101, Massachusetts.

**AUTOMATIC** Alarm to warn you when your electric current fails. Full information, 25c. Wm. J. Geoghegan, Box 291, Cynthia, Ky.

**ANYONE** Can build heavy duty garden tractor from old auto and junk parts obtainable anywhere. Send \$1.00 for plans, easy instructions. Ellsworth Tractor Co., Dept. A, Camptonville, California.

**COAL** Saver: Fits all stoves, furnaces. New invention. Save price of installing, on one ton of coal. Save heat on one-fourth less coal. Write for instructions. Enclose \$2.00. Henry Harvey, Box 158, Lewistown, Montana.

**MAKE** Your own power lawn mower with our easy to assemble kit, only \$9.95. Free folder. Arthur Gershel, 51 Chambers St., New York 7.

**BUILT-IN** Kitchen cabinets, \$1.00 brings detailed plans and specifications showing construction methods. Will fit any kitchen. Thombert Co., Box 447M, Newton, Iowa.

**SOLAR** Water heater systems efficient any locality. Standard materials, low cost and easily built. Free facts. Solar Water Company, Box 175, Coral Gables, Florida.

**BUILD** Concrete block machine. Inexpensive. Practical. Motor vibrator or hand. Free details. Clyde Lee, Dept. A, Mountain View, Okla.

**"CONCRETE** Block homes." 32 page booklet: drawings, instructions on how to build. \$1.00. H. C. Lightfoot, Civil Engineer, Richboro 1, Penna.

**ZEOLITE** Home water softener. Plans for building your own \$1. Materials available from us. Lake Region Mfg. Co., Inc., 3920-J Lynn Ave., Minneapolis 16, Minn.

#### WATCHES, OLD GOLD, JEWELRY

**HIGHEST** Prices paid for old gold, silver, platinum, diamonds, watches, gold teeth, old jewelry. Send now. Cash immediately. Goods returned if offer is not satisfactory. United Smelting Works, (The Old Reliable), 39-BA South State, Chicago 3.

**WATCHMAKERS'** Journal contains helpful hints on watch repairing. Sample copy 15c. Dean Co., 116 Nassau St., New York 7, N. Y.

**WATCHMAKERS'** Tools, supplies sold—bought. Catalogue! Bengal Company, Culver City, California.

**NEW YORK'S** Leading pawnbroker offers out-of-towners bargains in unredeemed ladies' and gentlemen's wrist watches. Bulova, Benrus, Elgin, Waltham. Fifteen Jewels-\$15.00; 17 Jewels-\$19.50. Send money order. State first and second choice. Kaskel's, Established 1882, 9 Columbus Avenue, New York 23, N. Y.

**WATCHMAKERS,** Beginners: watches; movements. Price list! Box 1874, Chicago 90, Ill.

**ZIRCONS,** Sapphires, rubies, others. Direct importation guarantees best quality; lowest prices. Illustrated, colored list free. Imhusex, Box 232, White Plains, N. Y. Agents wanted.

**"FREE"** \$1 Waterman's ball pen free with purchase Capt. Marvel (boys') wrist watch \$9.95 or Mary Marvel (girl's) wrist watch \$7.95. Genuine Swiss movement. Guaranteed. C.O.D.s, accepted. Standard Shopping Service, 51 Argyle Road, Brooklyn 18, New York.

**COSTUME** Jewelry findings and supplies. Conner, Box 188, National Park, N. J.

**SEND** Your discarded jewelry, watches, crowns, bridges, spectacles, silver, etc., for cash offer. Goods returned promptly if offer unsatisfactory. Old State Metal Co., P.O. Box 1054, Houston 1, Texas.

**HIGHEST** Cash for old, broken jewelry. Mail gold teeth, watches, rings, silverware, diamonds, spectacles. Satisfaction guaranteed. Free information. Rose Smelting Co., 29-A East Madison, Chicago.

**GEMS,** Precious and semi-precious, all genuine, from world wide sources. Deal direct, no overhead, save money. Catalog 10c. Hill Co., Route 7, Salem, Oregon.

#### TOBACCO, SMOKERS' SUPPLIES

**SECONDS** \$5.00 Pipes, 2 for \$1.00. Briar blocks, bits, silver bands, screw connectors. Free literature. Carvapipe, 2829-G Dixie, Hamilton, Ohio.

**FREE**—For greater pipe satisfaction tell us your brand of tobacco and get package Green River free. Pete Moberly, Box 791, Owensboro, Kentucky.

#### SURVEYING INSTRUMENTS

**GUARANTEED** Factory rebuilt transits and levels, sale, or rent, with purchase option. We will repair, trade or buy old instruments. Write for list M-48. Warren-Knight Co. (Manufacturers of Surveying Instruments), 136 North 12th St., Philadelphia 7, Penna.



## RAZORS, BLADES, SHARPENING

100 RAZOR Blades, free gift, \$1. Weiss.  
3518 32nd Street, Union City, N. J.

## FOR THE HOME

**RAINBOW** Hue-logs! Beautifully colored flames for wood burning fire places. Box of 18 postpaid \$1.50. Dealers and jobbers solicited. Goetz Petro-Chemical Co., 73 Gillette Ave., Buffalo 14, N. Y.

## FOR SALE — MISCELLANEOUS

**SPECIAL!** New army sterling silver identification bracelets. Sold for \$22.50, now only \$4.50. Akron Army & Navy, 4379 Sunset, Los Angeles 27, Calif.

875 **CARTONS**, 5 1/8 x 5 1/8 x 9 1/2; 325 cartons, 6 15/16 x 6 15/16 x 12 1/2; 270 round paper cans, 6 3/4 x 12. Reinhart Vohs, New Knoxville, Ohio.

**PECANS** Large Stuarts. Send \$2.50 for 5 lb. carton postpaid. (15c extra West of Denver). Beverly Produce, Oghlocknee, Georgia.

**ARMY 2 Way** combat phones. No batteries needed! New! 2 sets \$2.50. Akron Army-Navy, 4379 Sunset, Los Angeles 27, Calif.

**MARINE** Compasses \$31.50; barometers (brass) \$39.50; sextants \$12.50; imported officer model binoculars, coated, 7x50, \$59.00 plus tax; deck clocks \$37.50. (Free catalog). Pan American Navigation Service, 12021-C, Ventura Blvd., North Hollywood, Calif.

**WAR** Surplus, aircraft items, shop equipment, machinery and a million other items. Free catalog. Atlas Equipment, 229 Southwest Blvd., Kansas City 8, Mo.

**COASTER** Wagons—Red, all metal \$3.73. Hail Co., 518 East 6th St., Cincinnati 2, Ohio.

**USED** Dresses 89c, skirts 59c, blouses 49c, ties 7 1/2c. Suits, O'coats. List free. Calumet Sales, 4719 Kennedy Ave., East Chicago, Indiana.

## WANTED—MISCELLANEOUS

**BRILLIANT** Waterproof material for outdoor banner signs. Burnside, 14915 Telegraph, Detroit 23, Mich.

**WILL** Pay up to \$5,000 for certain old books. Catalogue 10c. Ohio Historical Publishing Company, PMD, Columbus 1, Ohio.

**GOLD** Coins wanted. Nice condition only. Will pay 80% above face value. Ralph Shaw, 707 So. Broadway, Los Angeles 14, California.

**WE** Have swappers, sellers, cash buyers for anything. Free lists. Swappers' Guide, Box 415, Evansville, Indiana.

**ANYTHING** Of value. Robert, 207 North 5th Street, Springfield, Illinois.

**QUICKSILVER** (Mercury) urgently needed! Immediate payment. Wholesale Terminal, Norwood, Massachusetts.

## PERSONAL

**ANYTHING** You need reasonable. Schickler, 323 Stockton St., Brooklyn, New York.

**MEXICAN** Law. General Practice Attorney, 1203 Arizona Street, El Paso, Texas.

**GLOBAL** Viewcard selection; worldwide remaining service. Free particulars. Travelpost, Box 5453, Tucson, Arizona.

**SEND** Seven ties and \$1.00, receive seven cleaned ties. Mail Me Ties, Box 4411-A, Philadelphia 40, Penna.

**HOW** You can find out! Information discreetly developed, any matter, person, problem, anywhere. Personal-business assignments, representations undertaken. Nation-wide. Officially licensed, bonded service established 1922. Reasonable. Confidential. William Herman, 170 Broadway, New York.

**MEXICAN** Mailing service. Letters received, forwarded 20c. Photographic postcards 15c. Remailed free. Remit stamps. Tillotson, Apartado 1405, Guadalajara, Jalisco, Mexico.

**HAIR** Falling? Dandruff? Write Trichologist, 137 Lewis St., Phillipsburg, N. J.

## MISCELLANEOUS

**BRASS** Or nickel silver name plates or keytags, individual stamping 40c each, 3 for \$1.00. Duplicate stamping 8 for \$2.00, 50 for \$6.00. Stamping equipment, Booklet free. Dealers wanted. Send 10c for sample. Tagco, Box 38 X.C. Wingdale, N. Y. See display adv. on page 281.

**SCOTCH** Tape printed your name, address, business, 6 rolls \$18.00. Give type set-up, color desired. Julien, 444 Drumm St., San Francisco.

**"PERFECT Gift"** only one dollar, called "The Bakerman." Is humidistat that controls moisture when placed with mom's bread; sis's candy or dad's tobacco. Prevents dryness and hardness. Order two or three now. Write Stetson, Box 525A, DeLand, Fla.

**TREASURE** Locators. New electronic lightweight M-Scope mineral and metal finders are now available for immediate shipment. Built for arctic-tropic use. Revolutionizes locating of minerals, gold, silver, metal objects. Unsurpassed efficiency, factory guaranteed. Low prices, time payment plan available. Send for free 16-page illustrated booklet. Fisher Research Laboratory, Inc., Palo Alto, California.

**LUMINOUS** Powdered pigments. Trial offer and listing. \$1.00 prepaid. Glowelco, 475-MP Fifth Ave., New York 17.

**"RECEIVE** Mail." Money-making offers, opportunities, catalogs. Name listed 10c. Ideal Service, Park Ridge 10, Ill.

**25c SAVES** You dollars. Amazing bargain catalog. Watches, clothing, etc. Save to 50% (25c refunded first order). Tip Top Sales, Box 9083, Dallas, Texas.

**BIG** Mail. Everlast ball pen 25c. Capener, 849 Almaden, San Jose 10, Calif.

**CHARACTER** Analysis of handwriting. \$1.00. Earl Conway, 309 1/2 S. 3rd, Livingston, Montana.

**GEIGER** Counters for finding uranium ores. Simple operation. Low prices. Interesting literature free. Fisher Research Laboratory, Inc., Palo Alto, California.

**RECEIVE** "Interesting Mails"—25c keeps your name on preferred mailing list for six months. Bentz, Jr., Chatawa 33, Mississippi.

**VENETIAN** Blind parts: Repair your own blinds. Simple, easy instructions sent with all orders. Price list free. Division Products, Dept. P-1, 804 23rd St., N.W., Washington 7, D. C.

**ANDIRONS**, Iron railings, sign brackets. For photos, prices, Attleboro Forge, Attleboro, Mass.

**PANNING** GOLD—Free instruction booklet. Catalogue mining books; supplies. Old Prospector, E-198, Dutch Flat, Calif.

**THE** Lord's coming! Get free proofs. International Evangelism, Box 263-X, Duluth, Minnesota.

**STOP!** Think! Save! Keep informed. Read magazines. Hurry. Xmas rates end December 31. Rush penny postal for free circular. Charles Hansen, 1569 So. Carmona Avenue, Los Angeles 35, Calif.

**SCRAP** Leather, assorted colors, 3 lbs. \$1.00. Cunningham Enterprises, 3-C Marble St., Haverhill, Mass.

**RECEIVE** Interesting mails. Your name on preferred lists, immediately. Opportunities, wealth, catalogs. Send 10c stamps. "Ruanova," 2807 Apartado, Mexico City, Mexico.

1949 **CALENDARS**, Attractive pictures of children in color. \$1.00. Vari-Service, Box 7, Highlands Station, Denver, Colorado.

**WIN** Prize contests! 34 pages; rules, hints, winning entries, etc. Rush 50c. Dueffy, Covington, Ky.

**NYLONS**, Seconds, small flaws, \$9.25 dozen. Kiddies felt animal purses, sew yourself, 3 for \$1.00. Lombard, Box 144, Merchantville, New Jersey.

**MATCHED** Set fountain pen, ball pen, and mechanical pencil. Written guarantee. State color—maroon, blue, black, gray. Money back if not delighted. \$2.00 postpaid. Ramapo Sales, 92 South Road, RD1, Paterson, New Jersey.

**70 BIBLE** Lessons, 25c. Bulletin, Box 87, Cathedral Station, New York 25.

**HOT** Water quickly with new portable heater, 101 uses, plugs in light socket. \$2.48 postpaid, factory guaranteed, illustrated folder free. Hobnob Co., Box 1191, Dept. A10, St. Louis, Mo.

**\$10,000 OFFERED** By U. S. government for each usable uranium find. Goldak now offers an all-purpose Geiger Counter to prospectors of radioactive ore. For free bulletin, write The Goldak Co., Dept. M, 1542 W. Glenoaks, Glendale 1, Calif.

**NAME** Pin of beautiful Spanish olive wood. Any name, \$1.00. Shook's Novelities, Summit, San Bernardino County, California.

**METAL** Mountings for bronzed baby shoes. Urbans, 2806 Holliday, Wichita Falls, Texas.

**ARTIFICIAL** Eyes—Assortments mailed you from world's largest, finest selection imported glass and all-plastic unbreakable eyes. Write for free booklet and color chart. Established 1906. Denver Optic Company, 1101 University Bldg., Denver 2, Colo.

**FOR** Big men only—Quality shoes sizes 10-16. Widths AA-EEE. Dress, work shoes, loafers, wing tips, moccasins, hipops, sox. Guaranteed. Write for free catalog. King-size, 696, Brockton, Mass.

**CESSPOOL** Trouble cured by the new Septic Bend Co., Rockland, Mass.

**GROW** Colorful metallic gardens. Formula 50c. Marshall, Box 5356, Chicago, Illinois.

**COMPASSES**, Officers wrist or pocket models. New, choice \$1.00 postpaid. Central Sports, Delphos 5, Ohio.

**PERSONALIZED** Pencils—Individual or firm name. Dozen 60c, gross \$4.80. Cash delivered. Pencil Market, 611 15th St., Knoxville 16, Tenn.

**MEDICAL** Laboratory technicians in great demand. We train you in your own home, in your spare time. Also home study course in general chemistry. Free catalogue. Imperial Technical Institute, Box 973-J, Austin, Texas.

**TATTOOING** Machines, outfits. Free catalogue. Jensen, 120 West 83rd Street, Los Angeles 3.

**LUCITE** Bar, name pin, safety clasp. Price \$2.00. Made to order. Nightingale Pin Co., P. O. Box 1772, West Palm Beach, Florida.

**TREASURE** Finders! Goldak's new 11 pound lightweight, gold, silver and mineral locator, money-back guaranteed superior any other device. Free information. The Goldak Co., 1542 West Glenoaks Blvd., Glendale 1, Calif.

**NOW** Ready: New, amazing Classified Advertising Record Book—prepared especially for classified advertisers. Here is a book that tells you instantly whether or not your advertising in any publication is paying you real results. You can tell immediately how many inquiries each publication produced—how much cash received from every ad. Spaces are provided for the name and address of the publication, date of issue, space used, rate, cost of ad, key number, etc. You have a complete record of each publication right before your eyes. Plenty of space to keep accurate record of 28 separate publications. You can have a copy by sending only 10c to cover postage and handling. Send for your copy now. W. F. Johnson, Classified Adv. Mgr., Popular Mechanics Magazine, 200 E. Ontario Street, Chicago 11, Illinois.



## 2 TERRIFIC BUYS FOR YOUR CAR

**ACE AUTO VISOR** makes driving safer, more restful. Keeps rain, sun, and snow off of windshield. Streamlined design and heavy chrome trim beautifies your car. Adjustable to any angle. Tested at 100 miles per hour for no rattles. **INSTALL WITH ONLY A SCREWDRIVER—NO HOLES TO DRILL.** Specify:  Prime finish for painting.  Hi-Polish finish requires no paint.

**ACE FENDER PANTS** give your car that "NEW LOOK!" Hooks on in a jiffy to any 1935 to 1949 model car—all makes. Made of heavy gauge body steel, prime finished, with rubber stripping to prevent rattles and scratching. Specify car make, year and model. Order by mail now!

Enclose check or money order... or \$5.00 deposit, pay balance on delivery

**ACE AUTO PRODUCTS • DEPT. PM12 • Box 366, Huntington Park, California**





# GET INTO DIESEL-AUTO MECHANICS MASTER ALL PHASES

## SHOP METHOD HOME TRAINING

by an Established Resident School prepares you for Many Good Jobs!

### Get Complete Training

Diesel-Automotive Industry needs trained men, to install, maintain and repair all types Diesel and Automotive engines — AND allied equipment. Now, National Schools offers you practical, proved home study training covering

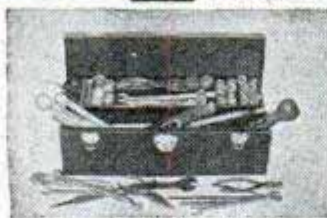

You Receive Tools and Equipment as Part of Your Course.

ALL phases. Basic instruction and specialization in field of your choice. All-embracing instruction. Valuable, large engine manual — TOOLS and EQUIPMENT included. Earn while you learn. INVESTIGATE—get full information.

Big Book and Sample Lesson FREE

APPROVED FOR VETERANS

## NATIONAL SCHOOLS

LOS ANGELES 37, CALIF. • EST. 1905



### FIND OUT NOW... MAIL COUPON TODAY

NATIONAL SCHOOLS, Dept. PMD-12  
4000 South Figueroa Street  
Los Angeles 37, California

(Mail in envelope or paste on penny postcard)

Mail me FREE the book, YOUR FUTURE IN DIESEL, together with the Sample Lesson. I understand I may keep and use the information with no obligation.

Name \_\_\_\_\_ Age \_\_\_\_\_

Address \_\_\_\_\_

City \_\_\_\_\_ Zone \_\_\_\_\_ State \_\_\_\_\_

Check here if Veteran of World War II

## EXPLORE WITH ELECTRONICS



WITH THE

# ELECTROD TELE-PICKUP

Fun or profit for the amateur or professional alike with the ElectroD TELE-PICKUP. Perfect for the detection of hum in radio circuits... monitoring... isolating noise or signal in all electronic or electrical devices... radio or telephone recordings... Geiger counter... metal or mineral location... endless opportunities for experimentation and exploration in all fields of communication.

**\$698**

SPECIALTY SALES CO.  
9219 VENICE BLVD., LOS ANGELES 34

Send \_\_\_\_\_ ElectroD TELE-PICKUPS to

Name \_\_\_\_\_

Address \_\_\_\_\_

City and State \_\_\_\_\_

Send postpaid, check ( ) or M.O. ( ) enclosed, I'll pay the postage; send C.O.D. ( )

Guaranteed by mfr. for FULL YEAR

## Handsome Swiss wrist watch...

Marvelous value in a good-looking watch, made by skilled Swiss craftsmen. So well-made that a printed one-year guarantee is given. Has sweep second hand, glow-at-night dial, rugged chrome case, unbreakable crystal. Tined and tested movement; leather strap.

Send no money—10 day trial

Pay postman \$8.95, plus tax and postage (or send check and we pay postage). Return in 10 days, if not delighted.

Swiss Watch Distr.

211 Paramount Bldg.  
(Dept. 812C) Atlanta, Ga.



ONLY \$6.95 plus 69c tax

# INVENTORS

## HIGHEST ROYALTIES and CASH

FOR YOUR INVENTIONS INVENTION MARKETING SERVICE "UNPARALLELED" BY ANY OTHER AGENCY IN THE WORLD Write for FREE booklet without obligation

UNIVERSAL MARKETING CO.

354 South Spring St. (Suite M)

Los Angeles 13, Calif.

# BE A DETECTIVE

WORK HOME or TRAVEL. Experience unnecessary.

DETECTIVE Particulars FREE. Write to GEO. P. M. WAGNER, 125 W. 86th St., N. Y.

POWER KIT FOR ELECTRIC JEEP with WAR SURPLUS HYDRAULIC TRANSMISSION and

a direct connected 2HP, 6-24 volt DC motor. Spline shaft, Hydraulic Oil, and Motor Fittings. For Use in Electric Jeep Shown in Popular Mechanics "What to Make" 1949 Issue. Complete Kit.

\$22.50

Hydraulic Transmission Only—\$14.00. Prices, F.O.B. Shreveport, La. DELTA SALES, P.O. Box 968, Jefferson Rd., Shreveport, La.

# HELPFUL BOOKS

Send post card asking for FREE catalog

Popular Mechanics Press, 200 E. Ontario, Dept. 601, Chicago 11



## PRACTICAL BOOKS ON HOME PLANNING BUILDING • REPAIRS

MAIL ORDER TODAY

Plan Now—Build When You Can Books Sent C.O.D. Anywhere in U.S.A.

Select from this list of helpful books. In U. S. books sent postpaid if remittance accompanies order. Outside U. S. include 15% extra for shipping charges.

How to Plan a House \$5.00

Your Home and How to Build It Yourself \$3.00

Painting, Decorating \$1.75

Carpentry \$2.50

Painting, Furniture Finishing and Repairing

Includes floor renewal \$1.50

How to Remodel a House Complete, practical \$5.00

Building Insulation \$4.50

Concrete Handbook

Do work for yourself, others \$1.50

Blueprint Reading for Building Trades \$1.50

Practical Bricklaying \$2.00

Primer for Home Builders \$2.50

## FAMOUS PLAN BOOKS

Books contain floor plans, photos, descriptions of homes.

AMERICA'S BEST LOW COST HOMES. 125 designs \$1.00

DE LUXE SMALL HOMES. 210 designs \$1.00

OUR FUTURE HOME. Wide selection of residences, summer homes, garage apartments \$1.00

MODERN HOME & GARDENING. 42 popular designs. Improvements, garden short-cuts, etc. \$50c

Set of Four Books \$3.50

Stair Building \$2.50

Stair Building \$2.50



## POPULAR MECHANICS PRESS

DEPT. 646 • 200 E. ONTARIO STREET, CHICAGO 11



**SURPLUS BARGAINS** **LONG WEARING LEATHER JACKETS**

**OFFICIAL B15 BOMBER JACKETS**



Brand New! Genuine Air Corps. type with high pile alpaca lining and mouton collar. Zipper closure. Knitted cuffs and waist band. Buttoned pockets. High quality, durable jungle cloth body—windproof—water repellent—wear resistant. Will give years of service. Easily worth \$25.00. Sizes 34 to 46. EACH ONLY

**\$16.95**

**TYPE A2 AIR FORCE JACKET**

Your best buy! Choice of selected capeskin or full front quarter horsehide, finest dark skins only. Lined throughout. Covered zipper—snap button pocket flaps and collar points. Leather collars. Top quality only—do not confuse with ordinary civilian types. Will give years of rugged service. Sizes 36 to 46.



**TYPE A2 IN CAPEKIN.**  
A \$25.00 value at ONLY.....

**\$16.95**

**TYPE A2 IN HORSEHIDE**  
A \$32.50 value at ONLY.....

**\$19.95**

Guaranteed brand new! Add 25c per garment for postage, packing, etc. Immediate delivery. Complete satisfaction guaranteed. Send check or money order.

**CHICAGO OUTLET, Inc.** 1618 W. Chicago Ave. Dept. PX, Chicago 22

**MAKE BIG MONEY!**



Be a floor surfacing contractor and sand both new and old floors. Sanders are easy to operate and better still, you're your own boss. Write for latest "tell-all" booklet entitled "Opportunities In Floor Surfacing", enclosing 25 cents in coin or stamps to cover handling.

**AMERICAN**

FLOOR SURFACING MACHINE CO.  
535 So. St. Clair Street - Toledo 3, Ohio

**VETERANS**  
training is FREE  
under G. I. BILL.

**Learn WOOD PRODUCTION ENGINEERING**

**GET THIS FREE BOOK**  
Today

It tells you how you can learn to become a successful **WOOD PRODUCTION ENGINEER**... by the Klok Home Study Correspondence Method... or by studying here in Grand Rapids in our Resident School... Training in **WOOD PRODUCTION ENGINEERING** offers you great opportunities... either to get a top position or to operate your own plant successfully.

The Klok Course teaches you **SKETCHING, ROD-MAKING, DETAILING, STOCK BILLING, TIME STUDY, COST and MANAGEMENT.**

**WRITE FOR FREE BOOK TODAY!** State preference whether Home Study or Resident course, with name, age, occupation and if veteran.

**KLOK INSTITUTE**  
LOUIS ST., N.W.  
GRAND RAPIDS, MICHIGAN



**22 Big Money-Makers in a Single Line!**  
**Amazing New Fluorescent Lights with Circular Tubes**

**THE HOMELITER**

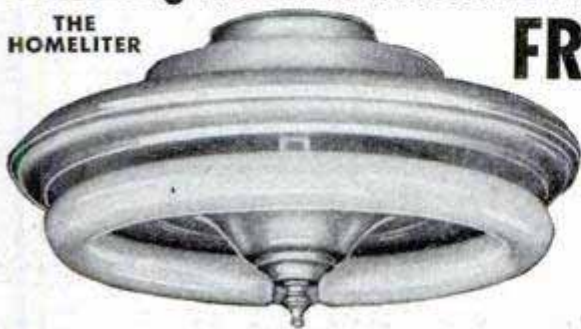

**FREE Sales Outfit**

Don't send a penny. Sample Outfit is FREE. Rush name on penny post card for money-making facts about sensational new "CIRCLINE" Fluorescents. Latest scientific development gives you 22 new type circular tube fixtures for kitchens, dinettes, halls, and play rooms. Also Floor and Table lamp for living rooms and pin-ups for shaving and vanity tables. Sells on sight to homes, restaurants, stores, offices. No other fluorescents like **CIRCLINE**. Salesmen who order samples quickly reorder in large quantities. All fixtures complete with tubes. No waiting. Also immediate delivery on all standard type Fluorescent Fixtures. This is too good to miss. Big, quick profits waiting. Rush name on postcard today for **FREE Sales Outfit.**



**NEW MAXILUME PIN-UP MIRROR LIGHT**

**MAXILUME COMPANY • 125 W. HUBBARD • DEPT. 812 • CHICAGO 10, ILLINOIS**



With all necessary attachments  
**\$109.97**  
Fed. Tax incl.  
F. O. B.  
Pontiac, Mich.

This Christmas give—or get—a lively Whizzer Bike Motor. It's America's thriftiest power transportation... 125 miles to the gallon... 35 mph... 2½ rugged horsepower... time-tested 4-cycle design. PLUS steel cable core notched V-belt drive. Twist-Grip controls... deluxe chrome trim. Fits any man's balloon tire bike.

**RIDE ONE AND YOU'LL BUY ONE!**

See your Whizzer Dealer—or write Whizzer Motor Co., Pontiac, Michigan. For 10 years—world's largest bike motor builder.

**The PERFECT GIFT**

for Father, Brother, Sweetheart or Friend



**The RICHARDSON R-5**

uses any 12 gauge shell with slug, buckshot, etc. Barrel guaranteed explosion proof. The only gun that will not explode when dropped.

Sample \$9.95

Dealers price submitted on receipt of your written inquiry.  
½ DEPOSIT WITH ORDER, BALANCE COD

**CAMEO VENDING**

432 W. 42 St.

New York City, N. Y.



# MAKE BIG MONEY FAST



**STEVINSON TRAINED  
AUTO, ELECTRICAL, and  
REFRIGERATION EXPERTS  
GET TOP MONEY**

**WITH STEVINSON TRAINING**

**Our 26 years of Successful Training** of men in chosen careers in automotive, air-conditioning, refrigeration, and electrical appliance industries, has perfected the famous **Stevinson classroom-shop system** of instruction... a technical, plus practical experience method... which speeds your progress... assures quick qualification for top incomes.

**APPROVED FOR CIVILIAN AND VETERANS TRAINING**  
The steady work, backed by proved time-saving methods of Stevinson training and experience has won approval from civilians and veterans alike. If you are a qualified G I, don't delay a day. Write today. Approved under laws 346 and 16.

**EARN WHILE YOU LEARN**  
No wasted time. Be an expert in latest modern methods... you work with most advanced new equipment. We help you arrange part-time work... help you get best jobs or set up your own business on graduating. Don't limit yourself. Get on the quick road to success with a solid Stevinson foundation.

**GET FULL FACTS FREE. MAIL COUPON NOW!**

**Stevinson Auto & Electrical School,  
Dept. PMD, 2008 Main St., Kansas City 8, Mo.**

Common sense tells me the practical 26 years success of Stevinson classroom-shop training means faster earning of big money for me. Send me full facts on the training courses I have checked, at no cost or obligation:

- Auto
- Refrigeration
- Air Conditioning
- Electrical Appliance
- Auto Body & Fender Rebuilding

Name \_\_\_\_\_  
Street \_\_\_\_\_  
Town \_\_\_\_\_ State \_\_\_\_\_

**SAY YOU SAW IT IN POPULAR MECHANICS**

**New! Pencil-size POCKET MICROSCOPE**  
MAGNIFIES AREA 400 TIMES (20X)  
PRECISION-BUILT SHARP IMAGE  
NOTHING TO ADJUST

**ONLY \$2.98**

Now! A powerful pocket microscope to reveal hidden things. Amazing power. Sand looks like expensive gems, a handkerchief like a net. Has a multitude of uses. Replaces many costly microscopes. An excellent inspection instrument in many industries. Instant focus. No adjustments. Perfect wide field. Aluminum body beautifully finished. Amazingly low price. Marvelous for everyone. Multiplies the pleasures of hobbies. Opens a WONDERLAND FOR CHILDREN. Order today. Send 3 dollar bills. Will ship return first class mail. Full refund end 3 day trial. No c.o.d.

- 4 LENS OPTICAL SYSTEM**
- Used by:
- HOBBYISTS
  - STUDENTS
  - TEACHERS
  - PRINTERS
  - BANKERS
  - ENGRAVERS
  - ENGINEERS

**DU MAURIER CO., Dept. 2012 Elmira, New York**

## Cooker Speeds Greasemaking

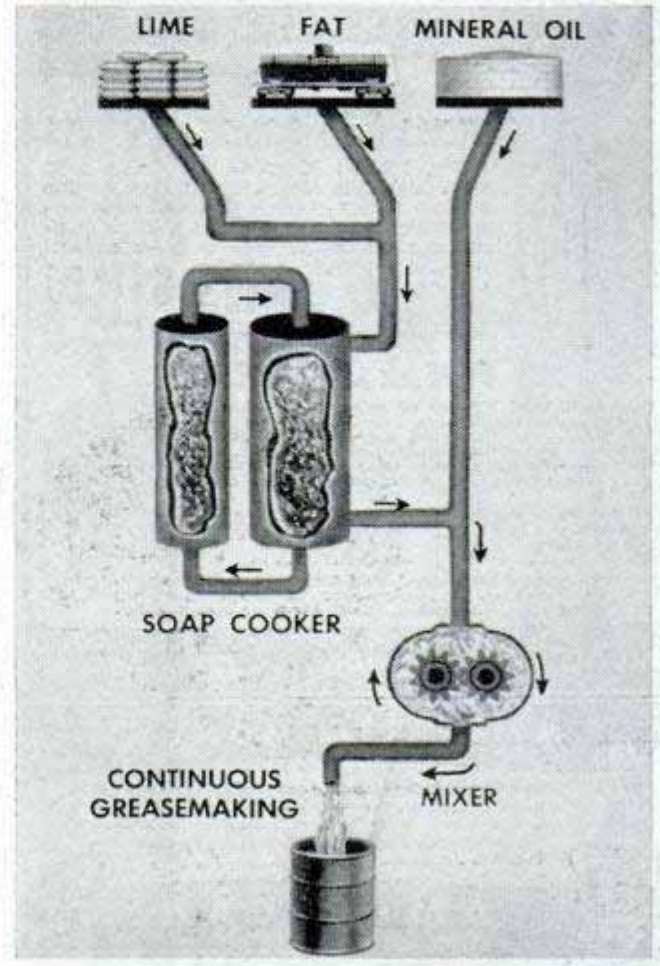

Lime-soap grease, among the most widely used for lubrication, is produced continuously by a new process that reduces cooking time from 3½ hours to 45 minutes. The process uses three newly designed cooking tanks, one of which is always turning out grease as the other two are being filled and cooked respectively. From the cooking tank, where lime and fat become lime soap, the material is piped into a mixer and mineral oil blended with it by a system of loose gears revolving 3600 times a minutes. The finished grease is forced steadily out through a filling pipe ready for packaging.

## DDT "Cousin" Spares Humans

Bugs untouched by other insecticides are killed by methoxychlor, a "cousin" to DDT that doesn't poison humans or animals. The new insecticide is so safe it can be swallowed in moderate quantities. One of the principal disadvantages of DDT has been that it is dangerous to animals, particularly cats. Methoxychlor's low toxicity makes it a safe control for lice, flies and other insects. The Mexican bean beetle, not completely controlled by DDT, is killed by the new insecticide. The chemical costs slightly more than DDT but is more effective in small concentrations.



# Nu-WAY

## WEATHER STRIP FOR WINDOWS AND DOORS

### KEEPS COLD OUT • HEAT IN

Easiest strip in the world to put on. Can be used on any type door or window. 100% all-wool felt, reinforced with white metal.



Macklanburg-Duncan Co.  
Oklahoma City 1, Oklahoma



AT LEADING LUMBER YARDS  
AND HARDWARE STORES

## Outstanding Surplus Value!

### BRAND NEW — GUARANTEED

# GRINDING WHEEL KITS

HUNDREDS OF ASSORTED ITEMS — A \$50 VALUE



FOR CUTTING,  
SHAPING,  
GRINDING,  
& POLISHING  
WOOD, METAL  
OR PLASTIC.

## \$8.95

Per Complete Kit  
F.O.B. Chicago

While supply still lasts, only

SET INCLUDES OVER 300 ITEMS

Here is the list.

35 Grinding and cut-off wheels, sizes 1 to 5 inches, 1/8 to 3/4 hole

10 Mounted stones—3/32", 1/8", 1/4"

3 Steel cutters 1/8"

5 Steel cutters 3/32"

1 Steel circular saw mounted on mandrel

1 Drum sander 1/2" mounted on 3/32" mandrel

6 Cut-off Wheels on 1/8" mandrel

1 One inch buff on 1/8" mandrel

1 One inch felt wheel on 1/8" mandrel

1 7/8" rubber wheel on 1/8" mandrel

2 High speed rotary files 1/4" shank

100 3/4" cloth butterfly abrasive discs

1 One inch wire wheel 3/8" hole, brass center

10 Cloth abrasive discs

3 Sheets crocus cloth 9 x 11

1 Box paper discs—100

1 Roughing stone 1 Bristle brush 3", 5/8" hole, brass center

1 Rag wheel—4 inch

In sturdy compact container 13 1/4 x 9 1/4 x 2 1/2", weight 8 1/2 pounds; with installed rack for all drills.

Satisfaction Guaranteed

2 Leather wheels

10 Sanding rolls

6 Sanding sleeves

1 Roughing stone

3 Honing stones

2 Felt bobs

1 Sheet crocus cloth 9 x 11

1 Box paper discs—100

1 Bristle brush 3", 5/8" hole, brass center

1 Rag wheel—4 inch

Enclose \$8.95  Check  M. O.  Send C. O. D.

Name \_\_\_\_\_

Address \_\_\_\_\_

City \_\_\_\_\_

Zone \_\_\_\_\_

State \_\_\_\_\_

**GROBAN SUPPLY CO.**

1522 So. Michigan Ave.  
Dep't. PM-3, Chicago 5, Ill.

## HERE IT IS . . . REVOLUTIONARY

# RITE-WAY DRAIN CLEANER

### Double Action Principle

1. Employs water pressure.
2. Employs powerful vacuum suction.



At last . . . a drain cleaner that flushes away stoppages, such as grease and dirt accumulations, lint, lime deposits, sewer gas and foul smelling odors from both the drain and pipes at the same time. Solve the drain cleaning problem in your home, apartment, factory, shop, store, etc. with the New Rite-Way Drain Cleaner. (Complete with simple operating instructions.)

The RITE-WAY Can Pay For  
Itself THE FIRST TIME  
YOU USE IT

## ONLY \$4.95

prepaid  
anywhere in  
the U.S.A.

DEALERS INQUIRIES INVITED.

**U. S. PLUMBING SUPPLY COMPANY**  
7305 VINCENNES AVENUE  
CHICAGO 21, ILLINOIS

# Get into BUSINESS for Yourself!

## METALIZING BABY SHOES AT HOME IN SPARE TIME



Get facts now about amazing money-making Warner Success Plan that shows you every easy step in completely charted path to personal independence—with your home as your headquarters . . . This proved and tested Plan is working like magic. It's backed by an old, reliable company . . . And we send it to you on a No-Risk Trial Money Back Guarantee.

### QUICK CASH WAITING

Demand for METALIZED Baby Shoes and other keepsakes is growing bigger daily. Our Tested Plan Shows How to Do the Work, How to Bring in the Business, How to Make as much as \$5 an Hour. Spare or full time, big steady profits are waiting for you. Send penny postcard or mail coupon for FREE Facts. Act! Time is precious.

**FREE**  
offer of  
**COMPLETE  
MONEY  
MAKING  
PLAN**  
•  
**SEND NO  
MONEY**  
Just Mail  
**COUPON**

Ray Brandell, Mgr., Warner Electric Co.,  
1512 JARVIS AVE., DEPT. 312, CHICAGO 26, ILL.

Please rush complete details about your No-Risk Trial Money Back Plan for Metalizing Baby Shoes. Everything you send is FREE and costs me nothing—now or ever.

NAME \_\_\_\_\_

ADDRESS \_\_\_\_\_

CITY \_\_\_\_\_

ZONE \_\_\_\_\_

STATE \_\_\_\_\_



# NOW you can make Your BIKE a "Motorbike"



**\$69.95**

for ONLY **\$69.95** Fed. Tax Incl.

Including all necessary attachments  
In Illinois Add \$1.40 State Tax

**NOW**, at this new, low price, everyone can own and drive a "motorbike." No installation cost. Apply DYNOMITE Motor yourself in less than half an hour, on any new or old bicycle (except front spring type). Mounted on front fork, driving on front wheel, away from driver. Quickly, easily disengaged. Anyone can operate it immediately.

**5 to 25 SAFE Miles per Hour**  
Authorities say bicycles are built for top speed of not over 25 mph. Ride in Safety—and Go Ten Miles for a Cent. Students, shop and office workers; savings on car and bus fares soon pay low cost of DYNOMITE "Bike" Motor.

**LIGHTWEIGHT; but Built to Last**  
Complete power-package weighs only 17 lbs. Ruggedly built, two-cycle, 1 H.P. completely enclosed, smooth-running air-cooled motor. Safe. No moving parts exposed; no belts; no pulleys; no gears. Weatherproof; all parts covered and protected; will operate in rain, snow, any weather.

**PRECISION Engineered**  
Aluminum cylinder with cast-iron sleeve; cast aluminum piston. Ball bearing throughout; drop-forged

## "DYNOMITE"BIKE MOTOR

crankshaft, fully counterbalanced; self-contained magneto; automobile type carburetor; motor-cycle control.

**Fully Guaranteed**  
Workmanship and material fully guaranteed. Return motor in 10 days if not completely delighted with it, and money will be refunded.

**How to Get Yours at Once**  
Send check or money order for \$69.95 and we will ship, postage prepaid (or send \$25 and we will ship C.O.D. for balance plus shipping charges). Thrilling gift for anyone, any age. Send for complete descriptive literature.

**DEALERS . . .**  
Write for liberal proposition.  
**TRAVIS PRODUCTS COMPANY**  
224 A West Huron Street, Chicago 10, Ill.

# DRAFTING *is* always the BIG PAY FIELD

Get Started Now! I Will Train You at Home Until You Get a Good Pay Job

Get a better job with more pay and pleasant working conditions. Get into Drafting—where all products start—where the Draftsman is the key man—where promotions to tool designer—Industrial and product design—engineers—rate the very top pay. I will train you at home until you get a good pay job and give you real experience on the same kind of jobs you will do with the best paying firms. I furnish instruments and all equipment when you start. Write today for vital facts and FREE book. Give age.

**TOOLS DRAFTING TABLE and Complete Outfit Sent When You Start!**

**ENGINEER DOBE**  
DIVISION 19 LIBERTYVILLE, ILL.

# LOCKSMITHING & Key Making

**PRACTICAL UP-TO-DATE COURSE—ONLY \$3.95**

Easy-to-learn modern information for self-instruction. How to work on locks, de-code, make master-keys, repair, install, service, etc. For every handyman, home owner, carpenter, mechanic, service station operator, fix-it shop, hardware dealer, gunsmith. 53 plain illustrated lessons. **FULL PRICE ONLY \$3.95. SEND NO MONEY.** Just pay postman plus C.O.D. postage. Or send \$3.95 with order, we'll ship postpaid. Satisfaction guaranteed or refund.

**NELSON-HALL CO., 1139 S. Wabash Ave., Dept. M-02, Chicago 5, Ill.**

# \$295 REAL DIESEL ENGINE

DEEZIL'S so popular we're selling thousands. So—production's up . . . cost to you is way down for a real diesel engine. **LOWEST PRICE ON THE MARKET. DEEZIL is a precision engine.** As carefully machine-tooled as a giant Army motor. Actually runs at 7500 RPM. Produces 1/7 HP. Send for your **DEEZIL KIT TODAY \$2.95 plus 15c postage.**

*Ideal for planes, boats, midjet cars.*

**GOTHAM HOBBY CORP.**  
107 East 126th Street, Dept. P2, New York 35, N. Y.

**for All Autos, Trucks, Tractors**  
Pat'd and Pat. Pend.

## A SURE CURE for Cold Weather Starting... the new SHUR-HETE Motor Water Heater

Install a Shur-Hete unit on your engine—plug it into a 110 volt A.C. outlet and your car will start easily and quickly, even on the coldest mornings. Why? Because the water around the sealed electric element is heated, causing automatic circulation which keeps the entire engine block warm; therefore the oil in the crankcase and around the cylinder walls is always free-flowing.

*Easy to install*—Any garage mechanic can install a Shur-Hete in a short time. 1/4" connections into head block and into drain plug opening are all that are necessary. Fittings included—nothing else to buy.

**Dealerships Open!**  
**JOHANSON MOTOR HEATER CO.**  
817 W. Webster St. Chicago 14, Ill.

## Save Time and Money with Shur-Hete!

Eliminate run-down batteries . . . towing charges . . . needless engine wear . . . and wasted gas.

Uses only 1/3 to 1/2c electric power per hour.

Safe to use with any standard anti-freeze.

Will not overheat engine or burn out.

**GUARANTEED!**  
Shur-Hete Outfits for Autos only \$12.50  
Truck and Tractor Outfits—\$13.50

*Important:* Give make and year of auto, truck or tractor. Shipped parcel post prepaid if remittance is enclosed; otherwise COD with postage added.

# YOU can draw!

**AMAZING NEW HOLLYWOOD PLAN**  
Yes, YOU can draw GIRLS, CARS, FRIENDS and even MAGAZINE COVERS. It's so simple, no matter what your age. Many artists make more than \$150.00 per week in advertising and cartoons. Be your own boss, draw for money anywhere. Our Commercial Artists will teach you the secrets from HOLLYWOOD. Drawing materials furnished. Be a success. Write NOW for free details

**HOLLYWOOD SCHOOL OF ART**  
DIVISION OF NEXELON STUDIOS

6533 Hollywood Blvd.  
Hollywood 28, Calif.

Name \_\_\_\_\_  
Address \_\_\_\_\_  
City \_\_\_\_\_ Zone \_\_\_\_\_ State \_\_\_\_\_

# SPEECH DEFECTS

... overcome in the privacy of your own home!

Your money back if our system fails to correct your stuttering, stammering, lispings.

Send for this FREE booklet today

It contains a valuable Analysis Chart and all details.

**VOCALON Institute**  
264 W. 40th St., New York 18, N. Y.



# ELECTRIFY YOUR SEWING MACHINE WITH WESTINGHOUSE MOTOR

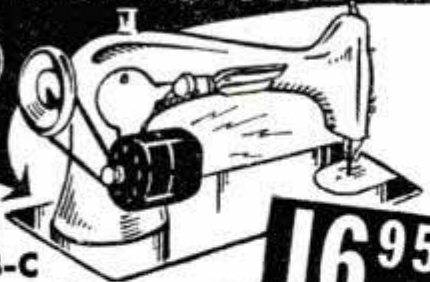

**SIMPLE AS A-B-C**

Directions are easy to follow:

**HERE'S WHAT YOU GET:**

- WESTINGHOUSE MOTOR. AC-DC fan cooled.
- FOOT CONTROL, 8 speeds
- COMBINATION SEWLIGHT, nickel plated shade and bulb.
- CORD SET, dual purpose, for light and motor.
- RUBBER BELT
- MALE PLUG
- PULLEY, Steel hubbed.

**16.95 COMPLETE MOTOR KIT**

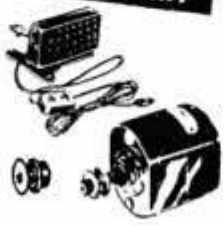

**GIFT**  
Button Attachment. Sew's on buttons, zippers, mends, quilts, overcasts, seams. \$1 value.



**MONEY BACK GUARANTEE**

Specify Make of Your Machine. Enclose check or Money Order to Save C.O.D. Charges.

**S. REINHARD**

38 W. 32 ST., N. Y. 1, N. Y.

Dept. PM

**GRAND FOR CHRISTMAS GIVING**

**Order This Educational, Entertaining WORLD DIE CASTER today!**



More than a toy! Makes clever, colorful clay figures, plaques, party favors. Play-tested for boys, girls 5 to 12. Provides hours of entertainment. Develops creative ability. Set includes die caster, dies, 4 extrusion dies, clay, water colors, modeling tool, instruction book. Circus box package. Only \$4.95 postpaid. Send check or M.O.

TAYLOR SALES, INC., 1213 S. Akard St., Dallas, Texas

**LEARN CARPENTRY AND MASONRY**

Write for FREE Catalog  
Train in Big Shops. G.I. Approved

MIDWEST SCHOOL OF BUILDING TRADES, Dept. PM-12  
411 N. Center St. Bloomington, Ill.

# WAR SURPLUS OPTICAL BARGAINS

ASSEMBLE YOUR OWN BINOCULARS!

Save More Than 1/2 Regular Cost

## GOVERNMENT'S 7X50 BINOCULARS



**Complete Optics! Complete Metal Parts!**

We supply full instructions

**METAL PARTS**—Set includes all Metal Parts—completely finished—for assembly of 7 X 50 Binoculars. No machining required. Bodies have been factory hinged and covered. A sturdy Binocular Carrying Case is optional with each set of Metal Parts.

Stock #842-H ..... \$39.40  
Postpaid, plus \$4.80 for Case—Total..... \$44.20

**OPTICS**—Set includes all Lenses and Prisms you need for assembling 7 X 50 Binoculars. These are in excellent condition—perfect or near-perfect—and have new low reflection coating.

Stock #5102-H ..... \$25.00 Postpaid  
(These are standard American made parts . . . not Japanese, French or German.)

**NOTICE!** If you buy both Binocular Optics and Binocular Metal Parts, add 20% Federal Excise Tax to above prices.

## ARMY'S 6x30 BINOCULARS

**COMPLETE OPTICS & METAL PARTS**—Model M-13A1, 6 X 30 Binoculars. (Waterproof Model). Everything you need—ready for assembly. When finished will look like a regular factory job costing \$102. to \$120. The Optics are new, in perfect or near-perfect condition. Have new low reflection coating. Metal Parts are new and perfect, all completely finished. No machining required. Bodies factory hinged and covered. Complete assembly instructions included.

Stock #830-H ..... \$40.00 Postpaid  
plus \$8.00 tax—Total—\$48.00

**20X PRISM SPOTTING SCOPE SET**—Consists of all lenses and prisms (slightly chipped) you need to make a good, standard 20X Spotting Scope. Low reflection coated. 57 mm. dia. Achromatic objective. Some Metal Parts Included. We furnish Directions.

Stock #5145-H ..... \$22.00 Postpaid  
(Also surplus Riflescopes — Write for Bulletin 18-H)

**SLIDE PROJECTOR SETS**—Consist of all unmounted lenses you need to make the following size projectors:

Stock #4038-H—2 1/4"x2 1/4" ..... \$3.35 Postpaid  
Stock #4039-H—2 1/2"x3 1/2" ..... \$3.35 Postpaid  
Stock #4029-H—35 mm. .... \$2.85 Postpaid

**MOUNTED ANASTIGMAT LENSES**—Used for Projectors, Enlargers, Copying Cameras. Complete with Shutter and Diaphragm. Value about \$20. An excellent buy. WE WILL INCLUDE FREE ILLUSTRATED BOOKLET on HOW TO MAKE YOUR OWN ENLARGER.

Stock #8004-H Speed f/7.7, focal length approx. 127 mms. Suitable for pictures, negatives, positives up to 3 1/2"x4 1/4". \$7.50 Postpaid  
Stock #8006-H Speed of f/7.7, focal length approx. 100 mms. Suitable for pictures, etc. up to 2 1/4"x3 1/4". . . . \$8.50 Postpaid

We have literally millions of war surplus lenses and prisms for sale at bargain prices ranging 10c and up. Write for Catalog "H" — Sent Free!

Order by Stock No. Satisfaction Guaranteed

# EDMUND SALVAGE COMPANY

P. O. AUDUBON, NEW JERSEY

SAY YOU SAW IT IN POPULAR MECHANICS

New Method...



You too can make these beautiful copper pictures and plaques right in your own living room.

# BIG PROFITS!

Can be Yours... Right in Your Own Home

## No Experience Needed

At last a way to get in on the Big Money made every day in Copper Art—Plaques—Bowls—Trays—Gifts—Souvenirs of all kinds. No art talent necessary—our NEW METHOD makes it so easy, even a child can do it. Big Markets waiting. Anyone can learn quickly—you start making money right from the start. Don't miss this opportunity to cash in at once on this big-paying easy to operate business. Be your own boss. SEND NO MONEY—act NOW to get all the free details—just send your name on a penny postcard today—Do it Now! Write today—



No Selling Money-Back Guarantee

**HOLLYWOOD COPPER ART STUDIO Dept. M3**

7266 Sunset Boulevard  
Hollywood 46, California



**HERE'S A NEW AND VITAL BUSINESS!**



**LEARN ELECTRICAL EQUIPMENT SERVICING**



**OFFERS BIG MONEY — INDEPENDENCE**

Learn in spare time at home. **NEW Shop Method Training System.** Work as many hours as you wish — the Electrical Equipment Technician is his own boss. It is not unusual for a technician to charge on the basis of \$5.00 to \$6.00 an hour!

**NO PREVIOUS EXPERIENCE NEEDED**

We furnish everything! Tool kits, training kits, including the famous Christy trouble-detecting **ELECTRONIC KIT.** Plus illustrated instructions written in simple, easy-to-understand language, check full of photographs and drawings. Shows you how to repair factory and household electrical units. Power machinery, refrigerators, washing machines, vacuum cleaners, irons, etc. Gives you a working knowledge of electricity, welding, nickel plating, etc. Shows how to build power tools you need, how to solicit business and what to charge. Many report paying for their entire course, tools, etc. on earnings made at home while learning!

**FREE BOOK SENT TO YOU**

Send your name for **FREE** booklet on Electrical Equipment Servicing and instructions for paying us later from your **EARNINGS WHILE LEARNING!** **CHRISTY TRADES SCHOOL, Dept. D-6403, 2835 N. Central Ave., Chicago 34, Ill.**

**Now! Broadcast through your Radio with this New WIRELESS MICROPHONE!**



**No Connections—No Hookups of any kind—Completely Wireless BROADCAST IMMEDIATELY!**

**\$9.95 complete**

Broadcasts through any radio indoors—outdoors—anywhere. It's a completely self-contained wireless transmitter—a marvel of modern electronic engineering. Talk into it—sing into it—and without plugging in—without connecting wires your voice comes booming through any radio set within a 50-foot radius. Use it for fun at gatherings, parties, etc. *Ultra-Mike is not a toy—it's a rugged, scientifically engineered transmitter in mike form that gives high fidelity—performance.*



*Hear baby while you're in another room.*

**Loads of Fun—and Practical, Too**

Ultra-Mike is highly efficient over a full 50-foot range. It is completely self-contained, with its own tube and long life (easily replaceable) battery. No hook-up or connections are needed. Carry it with you—talk as you walk—and you'll marvel at its fine modulation—its full-bodied volume—the clearness with which your voice is reproduced.

**ORDER TODAY. SEND NO MONEY.**

Just send name and address and we'll send C.O.D. plus postage, or send \$10.00 and we ship postpaid. Don't delay.

**MAIL MART INC.**

Dept. EP-72

230 Grand Street, New York 13, N. Y.



**Low-Drain Soldering Iron Converts to Any Voltage**

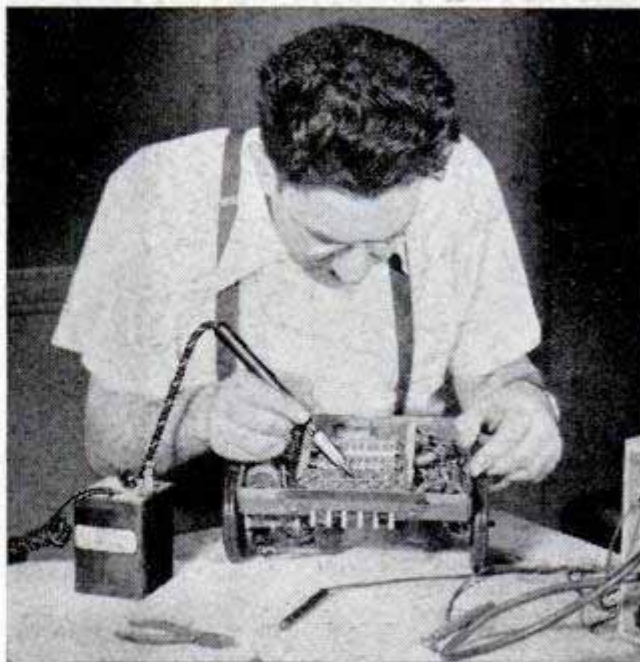

Consuming only 35 watts, a lightweight soldering iron designed for heavy-duty use puts out heat equivalent to that of a 100-watt iron. According to the manufacturer, the iron operates on a wattage-expanding principle that creates the maximum concentration of heat in the tip where it is needed. The iron, shaped like a long fountain pen, weighs only 3½ ounces and has a replaceable thermo cartridge for conversion to any voltage. A six-volt battery will heat it when the proper cartridge is used.

**Bazooka Driller for Oil Wells**

Shaped charges similar to those used in the war-famed bazookas now are increasing the flow of petroleum into partly exhausted oil wells within reach of pumps. The bazooka charge is lowered into the casing of the well and detonated to perforate the casing walls so the oil can flow through. Explosion direction of shaped charges can be controlled, making the force much greater than that of ordinary charges.

**Kit Reclaims Silver From Hypo**

Silver in exhausted hypo solutions, normally thrown away by photo fans, is reclaimed by a kit especially designed for users of small amounts of hypo. The kit consists of 50 filaments, each capable of reclaiming silver from one half to one gallon of fixing solution. One of these filaments is placed in the exhausted hypo and allowed to stand overnight. The silver-covered filaments are sent to a refining company where the silver is salvaged.



# ELECTRIFY YOUR SEWING MACHINE

IDEAL GIFT FOR MOTHER  
WIFE OR SISTER

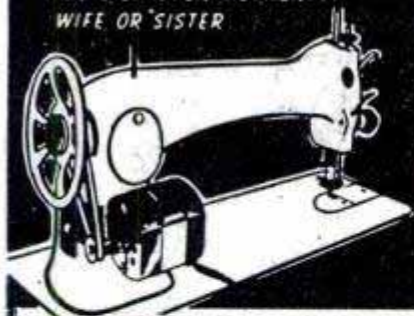

## SEWING MACHINE MOTOR KIT...

90 DAY GUARANTEE  
**\$16<sup>75</sup>**  
COMPLETE!

ANYBODY CAN INSTALL IT!  
ADJUSTABLE FOR USE WITH  
ANY TYPE OF SEWING MACHINE

FULL SATISFACTION OR MONEY BACK

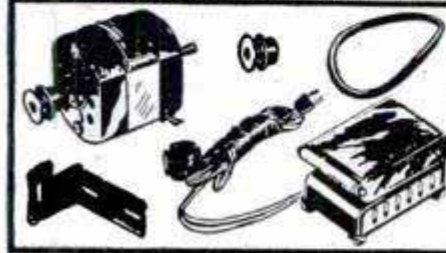

- COMPLETE SET CONSISTS OF:
- MOTOR—Fan-Cooled, Universal AC or DC, 60 cycle, 115 volts.
  - BELT—Long wearing rubber
  - PULLEY—Single grooved steel hubbed pulley.
  - BRACKET—New and improved.
  - FOOT CONTROL—7 step rheostat.
  - CORD SET—Extension cord with plug and socket.
  - Installation Instruction Sheet.

### SPECIAL OFFER!

If you send your order within a twenty day period we include a FREE Sewing Machine Light complete with attachment Socket & Light bulb (value \$2.75) with your kit.

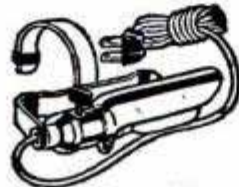

PM 1248 **BROWNELL DISTRIBUTORS, INC.**  
308 Canal Street, New York 13, N. Y.

Please rush your kit at \$16.75. The make of my machine is ..... Handwheel turns:  towards me  away from me.

NAME.....

ADDRESS.....

CITY..... ZONE..... STATE.....

To save postage and C.O.D. charges, I am enclosing \$16.75 , check , money order . Send C.O.D. I'll pay postman \$16.75 plus C.O.D fees

SAY YOU SAW IT IN POPULAR MECHANICS

# GIFT OF THE YEAR for a photographer

the meter with a  
MEMORY!

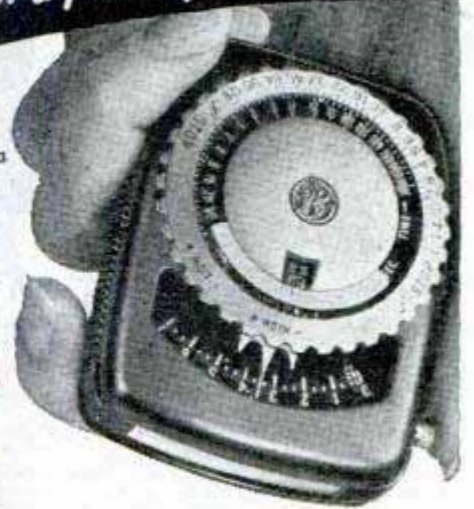

the new



exposure

## METER

Versatile! Complete. Good for movies and stills, incident or reflected light. And so easy to use! Give the new G-E photographic exposure meter for a thrilling Christmas! Type PR-1, \$32.50\*. General Electric, Schenectady 5, New York.



Also famous Type DW-58 . . . \$19.95\* and \$21.95\*

\*Fair Trade price. Fed. tax inc.

# GENERAL ELECTRIC

606-47K



## ARC WELDER III

A sturdy, compact, metal Arc Welding Outfit. Guaranteed. Used by garages, mechanics, farmers, etc. Repairs tools, auto fenders, toys, etc. Everything you need—Welder, large Helmet, Rods, Attachments, Instructions. Only \$5.95 postpaid, or C.O.D. plus few cents postage. Ten-day Trial Offer. Money Back if not satisfied.

COMPLETE \$5.95

MINEX

1712 Deboit Street, Newtown, Ohio

# GIVE YOUR CAR THE "WOLF CALL"

## of Deep Tone DUAL MUFFLERS

The rich, low, mellow sound of "straight thru" ADVANCE mufflers is something all your friends will admire.

Also greater power, speed, and economy result from the reduced back pressure of this scientific design. Rugged steel tube throughout (no aluminum); blowout-proof.

SIMPLE TO INSTALL. No welding, cutting, or holes to drill. Complete with rubber mounted clamps (no rattle) and all necessary fittings.

ADVANCE MUFFLERS, 6800 S. Vermont Ave., Dept. PM 12-8, Los Angeles 44, Calif.  
Send Check, Money Order, or we will mail C.O.D.  
You pay postage upon receipt.

Dual Muffler Set (Ford, Mercury only) \$20.00  Single Muffler (other makes) \$5.50   
Single Muffler (Ford, Chev., Plym.) 4.86  2 1/2" Chrome tail pipe tips 1.75

Car make..... Year..... Model.....

Name.....

Address..... City..... State.....



## ADVANCE MUFFLERS

6800 S. Vermont Ave., Los Angeles 44, Cal.



It's MORE FOOD for LESS MONEY

Send

**CARE**

Food Packages Abroad... \$10.

INSURED · GUARANTEED DELIVERY  
DUTY FREE · RATION FREE  
NON-PROFIT · GOVERNMENT APPROVED



**CONTENTS:**

- 1 lb. Braised Beef
- 2-8 oz. tins of Liver Pâté
- 2-8 oz. tins of Corned Beef Loaf
- 2 lb. Shortening
- 1 lb. Chocolate
- 2-8 oz. tins of Cocoa
- 2 lb. Whole Milk Powder
- 8 oz. Egg Powder
- 1 lb. Apricots
- 1 lb. Raisins
- 7 lb. Flour
- 2 lb. Sugar
- 1 lb. Coffee (For Britain: 1/2 lb. tea)
- 2-3 oz. Bars of Soap
- 1/4 oz. Yeast

The entire cost of this advertisement has been donated.

**CARE** Cooperative for American Remittances to Europe, Inc., 50 Broad Street, New York 4, N. Y.  
CARE Food Packages may be sent to: Austria, Belgium, Bulgaria, Czechoslovakia, Eire (Ireland), Finland, France, Germany (American, British and French Zones and all of Berlin), Great Britain, Greece, Hungary, Italy, Netherlands, Poland

Your Name and Address:

\_\_\_\_\_  
\_\_\_\_\_  
(Street and Number)  
\_\_\_\_\_  
(City and State)

Prompt Delivery Depends on Clear, Correct Address.  
**PLEASE PRINT**

Enclosed is ten dollars for each CARE package  
To Be Delivered To:  Check  Money order

\_\_\_\_\_  
(Name)  
\_\_\_\_\_  
(Street and Number)  
\_\_\_\_\_  
(Town and Country)

A RECEIPT, SIGNED BY THE BENEFICIARY YOU NAME, WILL BE RETURNED TO YOU.

(signature of sender) (Date)



# WAR SURPLUS

## TERRIFIC BARGAINS

**ELECTRIC MOTOR** 1/2 H.P. 27 V.D.C. R.P.M. 4000 No. 750, FOR INTERMITTENT OR CONTINUOUS DUTY. 3/4" SHAFT. VARIABLE SPEED MOTOR. Can readily be adapted to 110 V.A.C. or R.E.A. line by simple method of rearranging armature brush leads. UNUSED. Instructions incl. Ea. **\$5.50**

**VALUABLE GEARS BARGAINS.** Selsyn Control Trans-  
Speed Reducer G.E. 10 to 1 or 5 **FORMERS** Model #231G1,  
to 1 ratio, 90 degree angle. Shaft 57.5 Volts, 400 cycle. Can be  
Driven; 1/2" Spine Shaft with used on 110 V. 60 cycles.  
3 mounting holes **\$450** ea. Instructions incl. **\$250** ea.  
5/16". New.....

**LUBE PUMP.** Brand new precision Gear Im-  
peller pump. Pumps liquid up to 3 G.P.M.  
Pressure up to 200 lbs. per sq. in. For high  
vacuum, air pressure, operating Hydraulic  
units, etc. St'd. 1/2" threaded and keyed **\$495**  
Shaft Instructions Incl.....



**PESCO GEAR TYPE UTILITY HYDRAULIC PUMP.** At 1750 exerts  
1000 P.S.I. Hydraulic pressure and pumps over 2 gal per **\$750**  
minute. Brand new. Ea.....

**VICKERS PUMP.** High Pressure Hydraulic pump. Use it  
for any type liquid pumping job. 400 gal. per hr. at **\$750**  
3750 R.P.M. rated 1000 P.S.I. Brand New. Only....

**BRAND NEW WONDERFUL ROTATOR MOTOR.**  
For rotating Ham, FM. Antennas, Turntables,  
Telescopes, etc. Operates directly on 110 V.  
A.C. 60 cycles requires only 12 MFD Con-  
denser) 3/4 H.P.M. Fine for operating Ven-  
ilating Louvers such as used with Attic Fans, Fur-  
nace Dampers or check drafts. Complete in-  
structions incl. Ea. **\$395**



**GREATEST PUMP VALUE IN YEARS. THOMPSON BOOSTER PUMP.**  
Use them for HOMES, FARMS, RANCH AND SHOPS. Motor Driven  
centrifugal pump will empty 50 gs. drum of water in ap- **\$750**  
prox. 20 min., runs on 24 V. D.C./A.C. New..... ea.

**DYN. new.** Type 8-3416. Input 9V., out-  
put 400 V., 7 Amps. and .08 Amps. Ea. **\$250**

**DYN. New Model PE-73-CM. G.E.** Input 28 V.  
A19. Output 1000 V. D.C. at 350 MA. Wt. **\$495**  
38 lbs. Ea.....

**DYN. New Model DY-22/ARC.** Input 28 V. D.C.  
Output 210 V. D.C. Cont. Duty. **\$150**  
Ea.....

**DYN. New Model #23350.** Input 27  
V. D.C. Output 285 V. D.C. **\$135**  
Ea.....

**NEW CUNO OIL FILTER** aircraft type-keeps oil clean  
without cartridge replacement. For all AUTOS,  
TRUCKS and TRACTORS. Install at home in a few  
minutes. STOP CHANGING MOTOR OIL. In- **\$495**  
structions incl. Ea.....

SEND CHECK OR MONEY ORDER. NO C.O.D.'s. PRICES F.O.B. K.C.  
**GENERAL SALVAGE COMPANY**  
Dept. 77, 2920 E. 27th St. Kansas City, Mo.

# START A BUSINESS at HOME... others make BIG MONEY

DOES THE WORK OF  
6 TOOLS IN 1  
Holds 20 times its  
weight in water



Hands  
Never  
Touch  
The  
Water  
..  
Can Be  
Put In  
Boiling  
Water

"Enclosed find 56 orders representing 9 1/2 hours work on Monday and Tuesday." "Enclosed are 12 orders secured after supper this p.m."

**Housewives Pleased**  
Everyone that sees this outstanding CELL-U-MOP immediately want one... That's the reason our distributors are so successful... For MOPPING, WAXING, WALLS, WINDOWS, AUTOS and CLEANING RUGS. Sells quick to Taverns, Clubs, Hotels, Hospitals, Stores, Restaurants, Homes, etc. Drain Bracket squeezes out water thoroughly. Write for FREE particulars

CELL-U-MOP CO., Dept. P-12 FREEPORT, ILL.

# WILL BUY ANYTHING!

(meeting my specifications)  
**A. E. BERGER - 134 N. LaSalle St.**  
CHICAGO 2, ILLINOIS

# Give yourself the Backing of a GREAT GROWING INDUSTRY



# REFRIGERATION AIR CONDITIONING

Refrigeration and Air Conditioning have leading place in fast growing fields of our time. Trained men paid well to service, install, maintain, repair, rebuild household and commercial refrigerators. Important new developments such as Frozen Foods and many new industrial uses. Demand for commercial installations in restaurants, butcher shops, taverns, florists, bakeries, etc. — air conditioning in homes, offices, shops.



## START NOW—Full and Part Time Earnings

There may never again be such opportunities for men who want better jobs or business of their own to get in on ground floor and go up fast! Many started with small investment who built good, growing business. If over 17 and under 60 learn how you can get started. **CONSULTATION AND PLACEMENT SERVICE WHETHER YOU ARE INTERESTED IN WORTHWHILE JOB OR SETTING UP YOUR OWN BUSINESS.**



### Begin Training at Home or Come Directly to Shops

Begin your training at home in spare time, finish in our big, modern shops, or come directly to shops. At home you get C.T.I.'s SHOP PROVED HOME STUDY instruction—actual shop experience has gone into the practical lesson assignments. That is why it is easy for mechanically inclined men to learn by our Home Study training and start on actual refrigeration work.



### A NATIONALLY KNOWN INSTITUTION

C.T.I. was only civilian school selected by Army to train service men for refrigeration. C.T.I. executives were active in training Auto Mechanics for U. S. Army. Same quality training available to you now. The method that has made rapid progress possible.

#### VETERANS

Just mail coupon—we will handle all details.

#### NON-VETERANS

Don't let the lack of ready cash prevent you from taking this training now. Investigate our low Easy-Payment Plan and our Pay-After-Graduation Plan.

**COMMERCIAL TRADES INSTITUTE**  
Dept. A2-12  
1400 W. Greenleaf Ave., Chicago 26, Ill.



**FREE—Important Information Telling How to Get Started**  
CUT OUT COUPON BELOW

## Fill Out, Cut Out, Mail Today

FREE—Important information telling how to get started in one of these great fields.

**COMMERCIAL TRADES INSTITUTE, Dept. A2-12**  
1400 W. Greenleaf, Chicago 26, Ill.

Send free illustrated Brochures and other information about the field I have checked below.

- Body & Fender Repairing
- Automotive Mechanics
- Diesel Mechanics
- Radio
- Television
- Electricity
- Building
- Drafting
- Refrigeration and Air Conditioning

Name \_\_\_\_\_

Address \_\_\_\_\_

City \_\_\_\_\_ State \_\_\_\_\_  
 Veteran  Non-Veteran



# Don't Envy The PLUMBER-Be One

**Make \$15 to \$50 a Day**  
(and work every day)

Every skilled workman will tell you Plumbers have the best of it. WINTER and SUMMER the Plumber is busy at top wages. No skilled Plumber is ever out of a job . . . compare his opportunities with any trade, and decide where your opportunity is.



The  
Plumber  
Protects  
The  
Health  
of the  
Nation

## Own Your Own PLUMBING BUSINESS

No other business offers you the opportunity of starting in your own business, and making good profits, with little other investment than Universal's training and a kit of tools.

## JOURNEYMAN PLUMBER Gets Good Salary

Master Plumbers own their own shop. A Journeyman works for a Master. With Universal's training a journeyman can depend on high wages from the start.

## FREE DETAILS SHOW YOU HOW TO START

You can start now to success as a plumber by simply filling out the coupon and mailing it . . . or just write Universal Plumbing School, 839 Holmes, Kansas City, Mo. FREE details showing how will be sent by return mail.

Plumbing, to the man with know how, means profit. Investigate Universal's unique "Shop Method" system . . . This system, developed over a quarter century ago by a master plumber, offers you the opportunity to quickly get into the plumbing business. This is not a "war born school" . . . but a plumbing school developed and operated by plumbers since 1923.

## BE A PLUMBER In Just 32 Weeks

Now, just 32 weeks of intensive training equips you to be a plumber. No need ever serve an apprenticeship. Don't envy the plumber's big profits . . . enjoy them.

### System Shows How With Tools . . . Not Books

Universal's highly developed method makes plumbers by a special developed system showing how to use plumbing tools . . . not books. Every instructor is a Licensed Master Plumber capable of showing every trick of the trade . . . Lead Work . . . Blueprint for plan reading, etc. This offers a wonderful opportunity for the man who likes to work with tools.

### Over 7,000 Successful Plumbers Recommend This School

This system has made more than 7,000 plumbers. Each will testify it was the Universal Plumbing School that started him on the road to profits. Investigate our past performance . . . then decide. Universal is the largest and only school in America devoted exclusively to plumbing. It was established in 1923 under a system developed by a plumber and is owned and operated by licensed plumbers.

Don't waste your time looking over "war born schools" . . . investigate this system . . . then get into the profitable plumbing business.

## JUST MAIL COUPON

Send me FREE details about the plumbing business and tell me how to make profits as a plumber . . . I understand there is no obligation.

Name \_\_\_\_\_

Address \_\_\_\_\_

City \_\_\_\_\_ State \_\_\_\_\_

G. I. Approved. Established 1923

**UNIVERSAL PLUMBING SCHOOL**  
815 HOLMES KANSAS CITY, MO.

## Tile-Joint Filler Applied by Fingers



Because it dries by chemical action rather than by evaporation, a grouting compound which is applied with the fingers does not draw away from the tiles as it sets. Designed for pointing up joints in ceramic, metal or plastic tiles, the white compound is water-resistant and nonporous. It is pressed into the joints with the fingers and is sufficiently resilient so that it won't crack under temperature changes.

## Acids Cause Most Engine Wear

Acids—not friction as is generally assumed—are the major cause of automobile engine wear, according to research scientists of the Shell Oil Company. The acids are caused by low operating temperatures on short trips (to the grocery store, office or bank) when the engine is run for a brief period of time. Tests show that a "cold" running engine results in incomplete combustion with partially burned fuel gases and moisture left to attack the smoothly polished metal.

## Tiny Insects Spread Elm Disease

Many western elm trees are victims of a disease carried from tree to tree by small insects known as leaf-hoppers, research workers at the Department of Agriculture have discovered. The tiny insect responsible for the transmission of the disease is called *Scaphoideus luteolus* by the scientists. The western disease is quite different from the more familiar tree malady known as Dutch elm disease which is common east of Ohio. The department is now seeking an insecticide that will protect elms from this disease.



**MENDS**  
BROKEN CHINA, TOYS, ETC.

It's transparent,  
waterproof,  
flexible and  
durable.

**DU PONT**  
REG. U. S. PAT. OFF.

**DU CO CEMENT**  
REG. U. S. PAT. OFF.

**Learn RADIO-TELEVISION  
In Your Own HOME WORKSHOP**

Build interesting Radio Circuits, acquire real experience, do scores of practical experiments—all through RTA's complete balanced training plus 10 BIG KITS of parts which RTA GIVES YOU! Get finest instruction direct from Hollywood, nerve-center of broadcasting, television and radio activities.

**FREE BOOK**  
Send postal for complete details plus **FREE BOOK** "How to Make Good in Radio-Television."

**RADIO TRAINING ASSOCIATION OF AMERICA**  
5620 Hollywood Blvd. Dept. PML Hollywood 28, Calif.

**MAKE MONEY MAKING DOUGHNUTS**

Make new greaseless doughnuts at home on electric machine. Sell for cash to grocers, cafes, drug stores, etc. No exp. nec. Good profits. Small investment. Send for free recipes and plans.

MART RAY CO. • 3605 S. 15 Ave. • Minneapolis 7, Minn.

**MAKE YOUR OWN!**  
WITH

**Griffin READYCUT LEATHER PROJECTS**

Over 100 KITS in every kind of Tooling and Carving Leather, accurately cut, all parts included. Only Top Grade Leathers used. You do the choosing. You do the tooling, carving, stamping, the punching and assembling.

SEND FOR COMPLETE CATALOG  
Please send 10c to cover mailing.

SINCE 1924  
OUT OF THE WEST, THE HOME OF LEATHER CARVING

**Griffin Craft Supplies**  
Dept. PM 5515-21 GROVE STREET  
OAKLAND 9 CALIFORNIA

**EVERYTHING FOR THE LEATHER WORKER**  
Largest, most complete stock of Leathercraft Tools and Accessories in U. S. A.

HIDES AND SKINS of Craft Leathers of every kind if you prefer to cut your own.

*No Finer Gift!*

**CHICAGO FLYING SCOUT**  
Roller Skates

*The World's Greatest...  
the Choice of Champions*

You'll find a "CHICAGO" Roller Skate for every purpose—RINK, RACING, DANCING, HOCKEY, SIDEWALK.

Write for Booklets:  
"SECRETS OF RINK SKATING" Booklet for Grow-ups. Enclose 10c for mailing.  
"HOW TO ROLLER SKATE" Booklet for Youngsters FREE. GOLD F. SKATE PIN 10c

**CHICAGO ROLLER SKATE CO.**  
Mfgs. of Rink & Sidewalk Roller Skates.  
Industrial Fuses—Screw Machine Products  
4414 W. Lake St. Chicago 24, Ill.

**SAY YOU SAW IT IN POPULAR MECHANICS  
THE OPPORTUNITY OF A LIFETIME**

**For the electrical man who is prepared for advancement**

WAS there ever such an opportunity to get started in electrical maintenance and repair—and at top-notch wages? Are you ready—with experience and ability—to cash in on it? Others are getting just the sort of background needed—quick! practical!—to handle the great variety of electrical maintenance and repair work TODAY—from this well-known electrical library. You can too!

**THE LIBRARY OF ELECTRICAL MAINTENANCE AND REPAIR**

5 vols., 1826 pages, 1724 illustrations

Gives you the "know-how" to tackle any wiring or motor job. Five books show you HOW—to install all types of motor and generator units—to inspect and repair motor starters and generators—to diagnose motor and generator troubles—to figure new windings for old cores—DC and AC windings—to test armature windings—test induction motors, etc., etc. One book is full of trouble-shooting charts that show quickly symptoms, causes, specific remedies, etc.

Take the first step toward improving YOUR future—Mail this coupon TODAY

No money down—special price—easy payments—FREE trial

**McGraw-Hill Book Co., 330 W. 42 St., New York 18, N. Y.**

Send me for ten days' free examination the Electrical Maintenance and Repair Library. If satisfactory I will send you \$2.50 in 10 days and \$3.00 monthly until the price of \$17.50 is paid. If not wanted I will return books postpaid.

Name \_\_\_\_\_  
Home Address \_\_\_\_\_  
City \_\_\_\_\_ Zone \_\_\_\_\_ State \_\_\_\_\_  
Company \_\_\_\_\_  
Position \_\_\_\_\_

PM-12-48



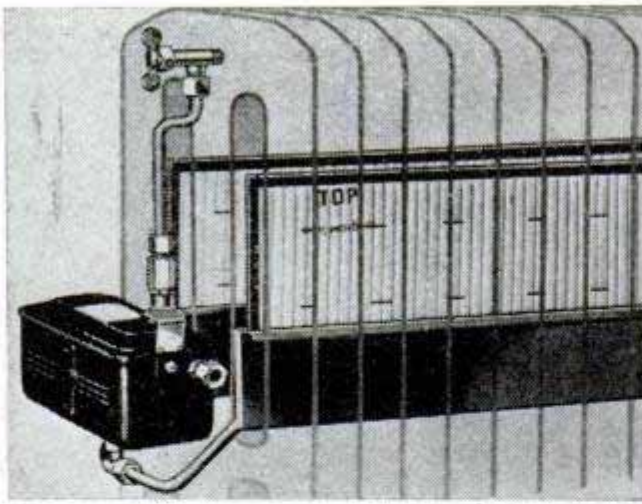

## Humidifiers Work Automatically On Steam or Hot-Water Systems

Humidity for steam-heated rooms is provided by a vaporizer that replaces the air valve on radiators. The humidifier vaporizes one pint of water hourly at one pound steam pressure, discharging enough moisture to humidify a large room. The steam is drawn directly from the heating system. Another humidifier, designed for hot-water radiators, applies water to paper pads, which then discharge the moisture into the room by evaporation. A float-controlled valve maintains a constant water supply.

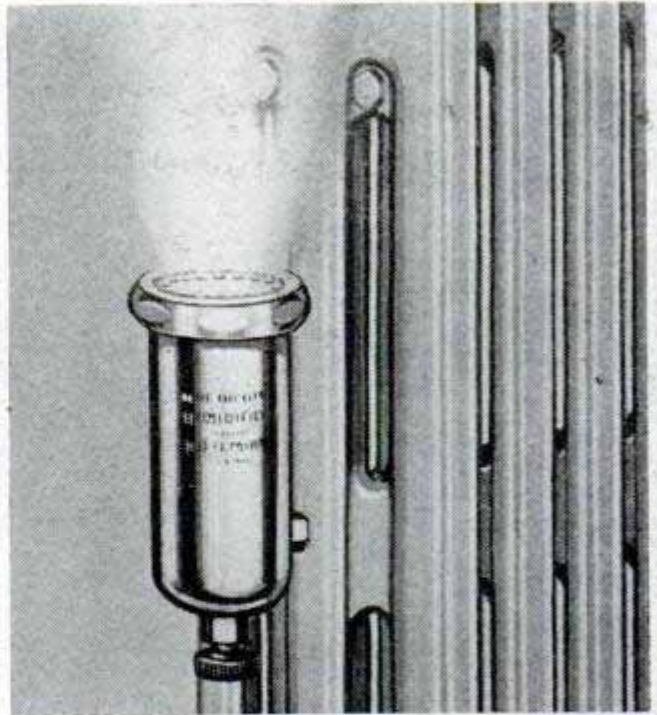

Above, steam-radiator humidifier vaporizes one pint of water hourly at one pound steam pressure. Left, automatic unit for hot-water radiators draws water from the system, assuring continuous operation and also providing an automatic vent for each radiator

Since the water is drawn from the radiator, the unit provides automatic venting as well as humidification. The unit is available in three sizes.

## GROBAN'S - WAR SURPLUS BARGAINS

SHOP BY MAIL and SAVE  
Better buys • Satisfaction guaranteed

### ALL-PURPOSE WATER PUMP

Mfd. by PACKARD MOTOR CAR CO.

Ready for use on any pumping need

Use it for:  
DRAINING BASEMENTS

HOME WATER SYSTEMS

FIRE PROTECTION

PRESSURE BOOSTER

IRRIGATION

DRAINING PONDS, TANKS, etc.

SPRINKLING SYSTEMS

STOCK WATERING

INDUSTRIAL PUMPING

Complete with pulley and mounting brackets, ready for use.

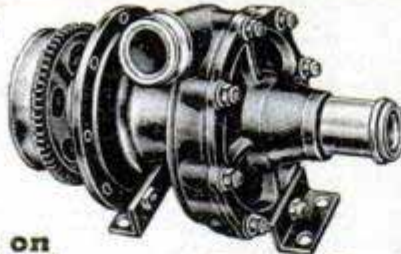

### Brand New Belt Driven — Centrifugal Pump

An extraordinary value for all types of intermittent or continuous pumping in the home . . . farm . . . factory. Built to exact specifications of Packard Motor Car Co. for use in Rolls-Royce Merlin Aircraft Engines. May be run with electric motor, gas engine or power take-off on tractor. Delivers up to 25 gallons a minute with 1/4 H.P. motor; 80 gal. a min. with one H.P. motor. Will deliver up to 44 ft. head or 25 ft. suction. Use 1" outlet hose; 1" or 1 1/2" inlet hose (recommended).

COMPLETE ENGINEERING REPORTS AND OPERATING INSTRUCTIONS FREE WITH PUMP

Has cast aluminum housing, accurately machined 5" bronze impeller; 3 1/4" V belt pulley and mounting brackets. Shaft rotates on ball bearing; has grease gun fitting.

Original cost approx. \$88.00. Shipping weight 10 lbs. A REAL BUY.

**\$21.50**

F.O.B. Chicago

## WESTINGHOUSE AIR COMPRESSOR

BRAND NEW WAR SURPLUS BARGAIN

2-Cylinder Piston Type

Ideal for:

- Paint Spraying
- Industrial Uses
- Tire Inflating
- Spraying Insecticide
- Operating Air Tools

For the:

HOME... FARM... FACTORY

Designed for automotive truck or tractor mounting. Can be run off fan belt or power takeoff. Comes with automatic clutch. Can be installed for use on: farm trucks, jeeps, tractors, tire or garage service trucks, contractor or road building machinery, pneumatic devices, etc.

Can be operated with 1/2 H.P. or more electric motor or equivalent portable gas engine.

Light weight, compact and versatile unit . . . delivers "oil free air" . . . simple in operation; requires minimum of maintenance; operates under all climatic conditions; suggested operating pressure 75 P.S.I.; equally efficient operation in either direction of rotation; approx. displacement 3.27 CFM at 600 RPM, 6.54 CFM displacement at 1200 RPM. Has 2 inch bore—1 1/2 inch stroke. Overall dimensions: width 9", height 11 7/8", depth 6 5/8"; approx. wt. 23 lbs. . . . .

A REAL BUY . . . worth many times this price

**\$26.95**

F.O.B. CHICAGO

WRITE FOR OUR FREE CATALOG!

ORDER DIRECT FROM AD SATISFACTION GUARANTEED  
Send payment or purchase order today

**GROBAN SUPPLY CO.**  
1507 S. MICHIGAN AVE., Chicago 5, Dept. PM-12



# GROBAN'S-WAR SURPLUS BARGAINS

SHOP BY MAIL and SAVE  
Better buys. Satisfaction guaranteed

## Self-Priming BRONZE PUMP

Positive Displacement Gerotor Type

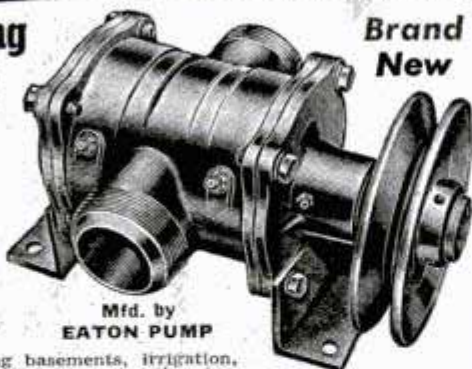

Brand New

Mfd. by EATON PUMP

Perfect for draining basements, irrigation, fire fighting, sprinkling, pressure booster, insecticide and other spraying, fuel transfer, stock watering, industrial pumping, deep well jet pumping and home water systems. Rated 25 ft. suction and 100 ft. head pressure at 65 gallons a minute with 1725 RPM at one H.P.

Complete engineering report and instructions FREE with pump

**\$32.50**

Supplied with mounting brackets and 6" V belt pulley, ready for instant use. Standard 1 1/2" inlet and outlet pipe thread. Dimensions: 9 1/2" x 7 1/4" x 4 1/2". Ship. wt. 18 lbs. A \$142.00 value. F.O.B. Chicago

## Self-Priming ELECTRIC PUMP

APPLICATIONS: oil burners, aquariums, fluid metering, fuel pump, tool post grinder, coolant pump, pressure lubricating pump, general industrial, etc.



Compact - BRAND NEW

MOTOR MFD. BY BLACK & DECKER; double ball bearing series wound, continuous duty, 1/30 H.P. electric motor, rated 12,000 R.P.M. Transformer included for use on 110 VAC current. Also applicable for 24-32 VDC.

PUMP MFD. BY WELDON TOOL CO. with standard 1/4" tubing ports; rated 2 G.P.H., remove pump and use motor as high speed grinder. OVERALL DIMENSIONS: 7 3/4" long x 3 1/4" high x 3 1/4" wide. Approx. wt. 5 lbs. \$51.00 value. postpaid

**\$12.95**

## Brand New Three-in-One MULTI-PURPOSE PUMP

Three independent pump sections running off of one shaft, for single or multiple pumping. Use one as a vacuum pump capable of drawing 25 inches of mercury. Use one or two as a liquid pump for hydraulics, insecticide spraying, pond and basement draining, stock watering, aeration, etc.

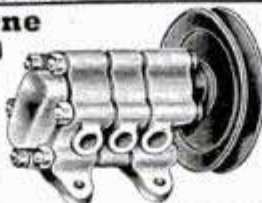

Supplied with 4" V belt pulley. Inlets and outlets 3/8". Easy to use - foot mounting. Constructed of bronze and aluminum to exacting ordinance specifications. Dimensions: 6" x 5" x 4 3/8". Ship. wt. 10 lbs. Government acquisition cost \$74.00. YOUR PRICE..... F.O.B. Chicago

**\$19.75**

## BRAND NEW

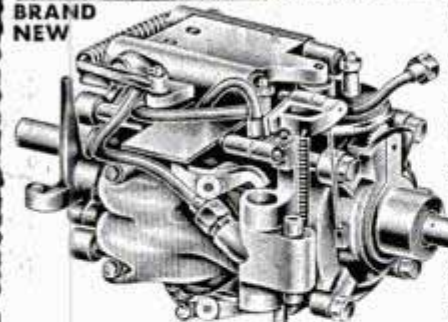

## WESTINGHOUSE HYDRAULIC TRANSMISSION

Gov't. Acquisition cost..... \$300.00

Use it on chain saws, midget autos, lathes, drills, power machinery, chucking machines, farm machinery, potters' wheels, tractors, trucks, etc. Ideal as hydraulic torque converter. Contains hydraulic pump and hydraulic motor; has reversing

**\$18.95**

controls. Designed for use on 2 ton 40 mm anti-aircraft guns; contains 10 ball bearings and high quality precision workmanship, made to exacting specifications of ordinance department. Overall dimensions: 12" long x 8 1/2" wide x 6 1/2" high. Ship. wt. 19 lbs. NOW ONLY..... F.O.B. Chicago

FREE: New, 20-page illustrated Hydraulic Manual featuring diagrams, photographs and instructions - FREE with each hydraulic order.

## BRAND NEW

## AIR OR OIL HYDRAULICS



Use hydraulics on arbor presses, hydraulic presses, hay lifts, manure loaders, lift trucks - push or pull, tilt or turn, press or squeeze, open or close, lift or lower - and other hydraulic and industrial applications. Use with either air or oil... of finest precision workmanship.

- Double action, 1 1/2" bore, 5" stroke, will lift 1760 lbs. in one second with Vickers MF6 Pump. Wt. 3 lbs. A \$35.00 value..... postpaid **\$8.95**
- Double action, 1 1/2" bore, 9" stroke, will lift 1760 lbs. in one second with Vickers MF6 Pump. Wt. 4 lbs. A \$45.00 value..... postpaid **\$10.95**
- Use these cylinders on farm trucks, bulldozers, hay lifts, manure loaders, etc. Double action, 1 1/2" bore, 27" stroke. (Will lift 1760 lbs. in 2 seconds with Vickers Pump.) Wt. 8 lbs. A \$55.00 value..... postpaid **\$12.95**
- Double action, 2 3/4" bore, 8" stroke. (Will lift 4400 lbs. in one second with Vickers Pump.) Will withstand 1500 P.S.I. against wall. Wt. 7 lbs. A \$65.00 value..... postpaid **\$14.50**
- Double action, 3" bore, 12" stroke. All steel hydraulic cylinder, will lift up to 12,000 lbs. (7000 lbs. in 3 seconds with Vickers Pump.) Complete with fittings. Wt. 12 lbs. A \$78.00 value..... postpaid **\$19.50**
- Double action, 3 1/2" bore, 11" stroke. (Will lift 9600 lbs. in 7 seconds using Vickers MF6 Pump.) Complete with fittings. Wt. 15 lbs. A \$92.00 value..... postpaid **\$22.50**

## Hydraulic Control Valves Brand New



Outlets are standard 1/8" pipe thread and inlet takes standard 1/4" copper tubing fitting.

- Four-way control valve for use with two hydraulic double action cylinders. Each cylinder may be operated independently of the other or in conjunction with the other. Oil may be locked in any of the cylinders to hold the piston at any required position. Brand New. \$10.95 Ship. Wt. 6 lbs. A \$60.00 Value. postpaid
- A two cylinder double action valve with a unique arrangement, allowing the operator to raise both cylinders simultaneously, to lower them simultaneously or to raise one and lower the other at any predetermined rate and speed. Brand New. \$14.95 Ship. Wt. 8 lbs. A \$75.00 value. postpaid

## Vickers MF6 Hydraulic PUMP or MOTOR



Compact, powerful, rated 1,000 P.S.I., .507 cu. in. per revolution, 8 gal. per min. at 3750 r.p.m. Change rotation by reversing flow. Delivers up to 6 H.P. BRAND NEW. \$14.95 Wt. 4 1/2 lbs., \$60.00 value for... Postpaid

Brand New CHECK and RELIEF VALVE. Adjustable for any pressure... \$2.95 post-paid

## BRAND NEW

## Vickers Heavy Duty HYDRAULIC PUMP



For tractors, bull-dozers, construction machinery, lift trucks, industrial applications, etc. Used on Ross carriers. Delivers 18 gal. per minute at 1000 P.S.I. at 1200 R.P.M., using 10 H.P. Has 1 1/2" intake; 1 1/4" outlet; threaded and keyed 3/4" shaft for direct or pulley drive. Wt. 40 lbs. Dimensions: 5 3/4" diameter, 7 1/2" high. Original value \$148.00. NOW..... F.O.B. Chicago

**\$39.50**

## VICKERS HEAVY DUTY HYDRAULIC CONTROL VALVE

BRAND NEW This Vickers heavy duty 4-way control valve, Part C-2330, is ideal for use with the Vickers Heavy Duty Pump for double action cylinders. Has built-in relief valve with 50 to 1000 lbs. per sq. in. overload adjustment; max. capacity 24 GPM; pressure inlet connection from pump 3/4" pipe thread; cylinder connections 3/4" pipe thread; discharge connection to tank 1 1/4" pipe thread; Over. dimen.: 8 3/4" W. x 10 7/8" L. x 7 3/8" H. Ship. wt. 54 lbs. ORIGINALLY COST MANY TIMES MORE.....NOW **\$24.95** F.O.B. Chicago

WRITE FOR OUR FREE CATALOG!

ORDER DIRECT FROM AD  
Send payment or purchase order today  
SATISFACTION GUARANTEED

## GROBAN SUPPLY CO.

1507 SOUTH MICHIGAN AVE.  
Chicago 5, Ill. Dept. PM-12



## Mechanically Inclined Men

**GET GOING  
IN A TRADE  
YOU LIKE**

Make the most of your ability by training for Auto Body and Fender Repair, Diesel, Refrigeration, or Air Conditioning. These are live fields with high wages . . . and plenty of opportunities to get ahead.

### This is YOUR Opportunity

Now you can keep on earning on your present job while you learn at home in spare time. High school diploma not required. Famous U. E. I. practical training methods are proved successful over 21 years. Can include actual shop practice in Chicago. Day or evening resident courses also available.

### ACT NOW—GET SET FOR LIFE

Today you can choose the field you like best for your career. Just check coupon and send it in today for full information without obligation. Better do it right now.

**UTILITIES ENGINEERING INSTITUTE**  
Dept. 1128, Chicago 14, Ill.

Founded 1927

### Mail Coupon for FREE Facts Now

**UTILITIES ENGINEERING INSTITUTE**  
Dept. 1128, 2525 Sheffield Ave.,  
Chicago 14, Illinois

Please rush FREE FACTS about the opportunities and U.E.I. training in the trade checked below.

- Auto Body & Fender Work       Diesel  
 Air Conditioning                       Refrigeration

NAME \_\_\_\_\_ AGE \_\_\_\_\_

ADDRESS \_\_\_\_\_

CITY \_\_\_\_\_ ZONE or COUNTY \_\_\_\_\_ STATE \_\_\_\_\_

Check here for special information if you are under 17.

## REAL FACTS ABOUT DEAFNESS

### YOURS IN FREE BOOKLET

Authoritative new booklet, fully illustrated, can help you solve *your* hearing problems. Get the facts about your hearing loss—its causes—its correction.

MAIL COUPON TODAY

**Western Electric** Dept. 380-PM12  
195 Broadway, New York 7, N. Y.

Send free copy of "Modern Science and Your Hearing." Also booklet on two new all-in-one Western Electric Hearing Aids.

Name \_\_\_\_\_

Address \_\_\_\_\_

City \_\_\_\_\_ State \_\_\_\_\_

## Earth Auger Drills Shallow Wells



Shallow wells are drilled by hand with an earth auger that bores a hole large enough to take a two-inch pipe. The drill is three feet long and, by the addition of extension pipes, can be used to depths of 75 feet. Made of tempered steel, the drill is hard enough to break through small rocks.

## Swivel Iron Cord

Free to move in any direction, a new cord for electric irons won't kink or twist, preventing broken wires and burned-out fuses. The cord's plug has a double joint which can be turned around or swung from side to side. The cord is seven feet long. The swivel plug is molded of Bakelite.

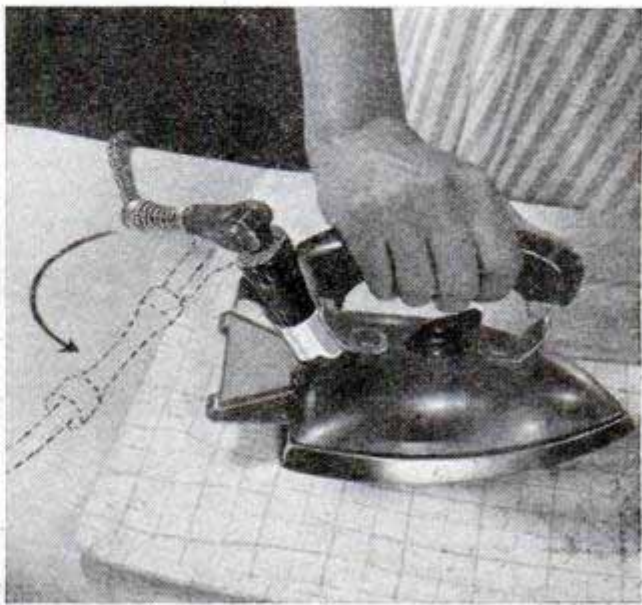



**"That hammer?**

**You're kidding!"**



**FRED:** It's a fact, Bill. I've been using this same hammer for 29 years. It helped to build the house you were born in.

**BILL:** Well, I don't know how you do it. I hardly ever *use* a hammer, and yet I've broken two of them in the last year or so.

**FRED:** That so? What kind of hammers were they? What brand, I mean.

**BILL:** Gosh, I don't know. Guess they didn't *have* any brand names. But they were good bargains.

**FRED:** That's where the trouble is, Bill. Look . . . see the name on this hammer? Whenever you see that brand name, you

*know* it's a good hammer. Stick to the well-known, advertised brands when you buy tools, and in the long run you'll save a lot of money.

**BILL:** That makes sense, Fred. I'll remember it.

**FRED:** And do your buying at the hardware store, where they don't try to sell you anything but quality tools. That way you'll always get your money's worth.

**Your HARDWARE DEALER sells QUALITY tools  
and hardware... Buy from HIM.**



# POPULAR MECHANICS



ORDER BY MAIL

**THE NEW Automatic WAY TO... WASH CARS, WALLS, WALKS!**

Washing your car is now as easy as lifting your thumb! The new Rivo Bubble Shampoo Gun fits any standard garden hose, has no moving parts, and is guaranteed forever.



**Wash your car in ten minutes for less than three cents!**



Switch from aerated water to millions of dirt chasing bubbles, and back to rinse again just by moving your thumb. Enough Rivo Bubble Shampoo included with gun to wash the average car 26 to 30 times. Provides a beautiful streakless finish which dries without streaking. No wiping needed. The Rivo gun may also be used to wash walks, porches, walls; has many other uses around home.

**Free**

For a limited time we will include a bottle of the famous Rivo Auto-Glaze with your purchase. (ON MOTOR NOT SURFACES)

**Sold on a money back guarantee.**

**RIVO AIRMOTIVE PRODUCTS** — Dept. P. M.  
 6203 S. HOOVER ST., LOS ANGELES 44, CALIFORNIA

Please send ( ) complete Rivo Cleaning and Glazing Kits (including glaze).  
 Enclosed is \$6.45 for each kit.  Send C. O. D.

NAME \_\_\_\_\_  
 ADDRESS \_\_\_\_\_ CITY \_\_\_\_\_

**VETERANS Learn WATCHMAKING**

**JEWELRY ENGRAVING**

Above Average Pay  
 No Age or Physical Limitation  
 In One of the Most Highly Respected Careers  
 Trained Men Always in Demand

**Trades with Greater Security**



Approved G. I. Training

Learn by our Advanced Training Method . . . Only Latest Scientific Equipment and Facilities.

Write Today for Complete Information and Catalog

**KANSAS CITY SCHOOL OF WATCHMAKING**  
 America's Most Progressive Horological School  
 617-621 Wyandotte St. Kansas City 6, Mo.

**NOW YOU CAN OWN A GENUINE CALIFORNIA**

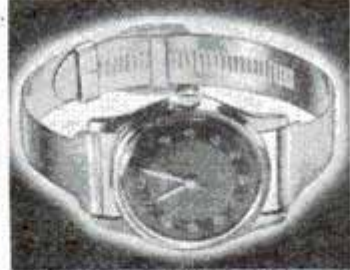

**Ideal STAINLESS STEEL WATCH BAND**

FOR **\$1.00** ONLY FULL PRICE

Flexible • Secure  
 Sanitary • Comfortable  
 Closely Adjustable

Used by **ENGINEERS MACHINISTS • FARMERS SPORTSMEN • FLYERS**  
**Order Yours Today!**

Fits any wrist up to 8-in. Ends of band at watch  $\frac{3}{8}$ " wide. If your dealer cannot supply you, send \$1 cash or money order. Band sent at once postpaid.

**MARQUARDT MFG. CO.** 1825 N. MAIN STREET LOS ANGELES 31, CALIF.

**REAL ESTATE BE A BROKER**

**PAYS BIG! SEND FOR FREE BIG, ILLUSTRATED CATALOG NOW!** No obligation. Graduates report making up to \$1000 monthly. Start and run your own business quickly. Men, women of all ages, learn easily. Course covers Sales, Property Management, Appraising, Loans, Mortgages, hundreds of related subjects. **STUDY AT HOME** or in our classrooms in big cities. Diploma awarded. G.I. approved, Nationally known.

**FREE BOOK TELLS HOW**

**WEAVER SCHOOL OF REAL ESTATE (Est. 1936)**  
 15 E. Pershing Road Dept. NT-2 Kansas City, Mo.

**STRENGTHEN YOUR VOICE!**

YES—you can now build yourself a powerful speaking and singing voice with this amazing new scientifically sound tested method. Self-training . . . no music or piano required. Results GUARANTEED. Just send your name for the sensational details. FREE chart of your vocal mechanism included!

**PERFECT VOICE STUDIOS, Studio M-10, Kimball Hall Building, Chicago 4, Ill.**

**METALS**

sold in small quantities for the home workshop. Steel, Brass, Copper, Aluminum, etc. In Bars, Shapes, Tubes and Sheets. Write for free price list.

**CASHMETALS CO., 2720 California Ave., Pittsburgh 12, Pa.**



**Print Your Own**

Cards, stationery, circulars, tags, labels, photo and movie titles, advertising, etc. Save money. **Print for Others, Good Profit!** easy rules sent. Raised Printing like Engraving, too. Send dime for press samples, supply book, all details and advice on your needs. No obligation. **KELSEY INC., B-37, Meriden, Conn.**

**RADIO**

**ENGINEERING.** Broadcasting, Television, FM, Servicing, Electronics, Aviation, Marine & Police Radio taught thoroughly. Engineering course equivalent to 3 years' college radio work. Approved Veteran Training. Catalog free.

**VALPARAISO TECHNICAL INSTITUTE, Dept. D, Valparaiso, Ind.**

**SAY YOU SAW IT IN POPULAR MECHANICS**

**"LEARN-BY-DOING"**

**NATION'S LARGEST EXCLUSIVE ELECTRICAL SCHOOL**

**ELECTRICITY**

PRACTICAL TRAINING NOT "HOME STUDY"

**G. I. APPROVED** Get actual experience in great shops of M. T. I. Learn all phases Practical Electricity; Housewiring, Motors, Const., Maintenance, etc. Living arrangements, Part-time jobs, etc.

Send coupon TODAY.

**MICHIGAN TECHNICAL INSTITUTE**  Veteran  
 2281 W. Fort St., Detroit, Mich., Dept. PM-12

Name \_\_\_\_\_  
 Street \_\_\_\_\_  
 City \_\_\_\_\_ State \_\_\_\_\_



# MAKE \$ MORE M \$ O \$ N \$ E \$ Y

Applying or Selling

## CORKSTONE

A General Purpose Magnesium Oxychloride Flooring

THE MODERN PLASTIC FLOORING

**EASY TO APPLY**  
Here's your opportunity to get into business for yourself applying or selling Corkstone, the economical, top-grade plastic flooring. Plenty of profit Act without delay!



**Dealers & Agents Wanted**

WRITE FOR DETAILS

**LASTING PRODUCTS COMPANY**

Franklinton Road Plant,

Baltimore 23, Md.

does SHE borrow  
YOUR Steel Tape Rule?



... only \$1<sup>00</sup>  
**Surprise HER with a LADY'S MAN!**

The new, feminine addition to famous MASTER RULES is designed especially for the SHE in your life! Every inch a superb measuring tape, LADY'S MAN is extremely flexible for use in sewing, knitting and general home use.

- Full 72" porcelainized, snow-white tape
- Colorful, smooth Tenite case in choice of 3 colors
- Fits neatly in purse, pocket or kit
- Tape won't stretch, twist or wrinkle
- The only steel tape rule for women

You couldn't give her a better, more useful gift.

See your hardware dealer now, or use the coupon

**MASTER RULES**

WOOD AND STEEL TAPE RULES

MASTER RULE MFG. Co., Inc.  
201 Main Street, White Plains, N. Y.

PM-12

Gentlemen: Here's.....dollars. Rush.....LADY'S MAN rules.

NAME .....

ADDRESS .....

CITY..... ZONE.... STATE.....

Color desired: Pastel Yellow.. Powder Blue.. Coral Red..  
(please state quantity of each)

# LEARN **DIESEL**

THE QUICK, EASY WAY



## THE FAMOUS HEMPHILL WAY!

Wherever Diesels are used, the name "HEMPHILL" is famous. It stands for TRAINED MEN—men who know Diesel. Many trained Diesel graduates of Hemphill Schools are successfully engaged in work where their Diesel training is "paying off." Perhaps they are assembling Caterpillar Tractors, or servicing Cummins-powered trucks, or installing and maintaining General Motors' Diesels. Perhaps they are working with these and other makes of Diesel engines in trains, ships, drilling rigs, sawmills or construction equipment—but no matter what the Diesel job, Hemphill trained men

have the "know how" to handle it.

Prepare YOURSELF for the great industrial swing to Diesel power which is now here. Get complete details of Hemphill Diesel training now!

**STUDY AT HOME**—you can learn Diesel at home, quickly and easily, in your spare time. Hemphill Home-Study lessons are fully illustrated, easy to understand—have helped many to success. Mail coupon below for complete details and free booklet "March of Diesel."

**AUTOMOTIVE TUNE-UP SPECIALIST TRAINING**  
available in Los Angeles. See coupon.

**APPROVED for VETERANS  
and NON-VETERANS**

RESIDENT SCHOOLS LOCATED AT:

NEW YORK 31-28 Queens Blvd. Long Island I. N. Y.	LOS ANGELES 1601 S. Western Ave. Los Angeles 6, Calif.	MEMPHIS 311 S. Main St. Memphis 3, Tenn.
--	--	--

34 weeks practical training. If you would prefer to train at one of these three schools, indicate by check on coupon.

### HEMPHILL DIESEL AND AUTOMOTIVE SCHOOLS

Administrative Office: 1601 South Western Ave., Dept. PM-12-8  
Los Angeles 6, California

Gentlemen: Please send me FREE BOOKLET and information on your Diesel Courses. I am interested in Home Study  Resident School  at New York  Memphis  Los Angeles  (Check school desired.) Automotive Tune-Up

Name \_\_\_\_\_ Age \_\_\_\_\_  
Street \_\_\_\_\_ Zone \_\_\_\_\_  
City \_\_\_\_\_ State \_\_\_\_\_  
Veteran \_\_\_\_\_ Non-Veteran \_\_\_\_\_

**MAIL COUPON NOW!**



# Sensational New Electric **1** WELDER **2** CUTTER!

**BOTH only**  
**\$12**  
LOWEST PRICE  
IN HISTORY!



Uses 110-115 AC or DC • INSTRUCTIONS INCLUDED  
WELD - BRAZE - CUT - MELT - SOLDER - HEAT TREAT

The WELDRITE combination—tested and proven by countless commercial and amateur users, is now offered direct to you at the amazingly low price of only \$12.00. No Gas—No Gauges—No Spark Lighter needed. Always ready for immediate use—Just plug WELDRITE into 110-115 AC or DC outlet. Uses standard welding and brazing materials available at all welding supply stores. WELDRITE furnished complete with Converter Unit, #1 Single Holder with attached Alligator clip, for welding metal up to 3/16" thickness, using up to 3/32" rod, and #2 Double Holder with Copper Coated Dual Carbon Electrodes for Cutting, Brazing, Heat Treating, Soldering, etc. Starting welding materials and instructions included.

and fender shops, garages, repair and machine shops, manufacturers, etc.

**SEND NO MONEY!** 10 DAY TRIAL OFFER  
Order your WELDRITE Electric WELDER-CUTTER C.O.D. today. Pay postman \$12 plus postage charges (wt. 4 lbs.) or send \$12 and we pay postage. Either way, if not satisfied, return WELDRITE in 10 days, and money will be refunded. WELDER HOOD—Approved lens found in hoods costing to \$10—only \$3.95. Calif. orders add 2 1/2% tax. **FREE FOLDER CALIFORNIA TECHNICAL PRODUCTS CO.**  
448 So. Hill St., Los Angeles 13, Calif. Dept. A-12

## Navigation Plotter Made For USAAF By **BRUNING-WALLACE** Brand New—In Fitted Oak Case

Slightly modified Drafting Machine without vertical scale chuck.



Non-Magnetic, Non-Corrosive, Ball Bearing, Full Rotating 360° Protractor, 36" Overall Reach.

- Extra Set of Bands
- 2 Extra Anchor Bases
- 12" & 18" Aluminum Scales

Engineers, draftsmen, architects, research inventors, map makers, navigators, manufacturers  
**Here is your Chance!**

THIS IS  
A SPECIAL  
CLOSE-OUT  
SUPPLY LIMITED  
**\$2975**

You have always wanted a  
**DRAFTING MACHINE**

to save many labor hours on plans, details and sketches...

SEND CHECK OR MONEY ORDER  
WE GUARANTEE PROMPT SHIPMENT

POSTPAID IN U. S. A.

**F. J. SIEFKE & CO.**

919 E. Delavan Ave., Buffalo 15, N. Y.

## HIGH PAY JOBS FOR MEN WHO QUALIFY IN DIESEL

**ASSURE YOUR FUTURE.** Steady, big pay jobs await men qualified in Diesel, Tractor and Heavy Equipment. Can you take advantage of Diesel job and advancement opportunities in this fast-growing field?

### COMPLETE DIESEL COURSE AVAILABLE.

If you are ambitious and want to get ahead in this lucrative field, you'll want to know about the complete training in Diesel provided by Interstate. Trains you at home in spare time. Does not interfere with your present job. Covers all phases of operation. Up to the minute. Revised regularly to cover new developments. Free placement advisory service.

#### YOU OWE IT TO YOURSELF

to investigate I.T.S. home Diesel training. Thousands of students agree it has helped them to better jobs... better pay. It can do the same for you!

#### SEND FOR FREE BOOK TODAY!

We'll gladly send you our big 24-page book "Getting Ahead In Diesel" FREE! Paste coupon on penny card and mail to

INTERSTATE TRAINING SERVICE  
4035 N. E. Sandy, Portland 13, Oregon

Please see that I receive FREE BOOK "Getting Ahead In Diesel":  
Name \_\_\_\_\_ Age \_\_\_\_\_  
Address \_\_\_\_\_  
City \_\_\_\_\_ Zone \_\_\_\_\_ State \_\_\_\_\_ (3)

SAY YOU SAW IT IN POPULAR MECHANICS

## AIR FORCE FLIGHT BOOTS

Genuine A-6. Will keep your feet warm and dry in the coldest weather. Genuine shearing fully lined. Rubber soles and zipper closure. Reconditioned like new. State shoe size when ordering. No C.O.D.'s.



**\$795**  
SURPLUS MERCHANDISE DEALERS, Dept. P. M.  
38 WEST 30th ST. NEW YORK, N. Y.

### FOOLISH TO PAY MORE — DANGEROUS TO PAY LESS



**OUT-OF-TOWN FOLKS—TAKE 10%**

ORIGINAL HIGH-Non-Skid TIRES WORN SLIGHTLY  
U.S., GOODYEAR, FIRESTONE & OTHERS  
GOLDEN RULE 15 MONTH GUAR.  
INNER TUBE GIVEN WITH THESE

475-19	.....\$6.66	600-16	.....\$5.35	650-15	.....\$4.95
525-18	.....6.66	650-16	.....3.45	700-15	.....5.55
		700-16	.....5.85	550-19	.....7.75
		750-16	.....7.20	550-17	.....7.25

SPECIAL OFFER	32-6 (8)	\$11.10	650-20	\$9.50	825-20	\$14.95
TRUCK TIRES	32-6 (10)	12.80	700-20	11.85	900-20	14.95

750-20 MILITARY TREAD (Fits 32-6 and 700-20)  
STANDARD GRADE — GUARANTEED 8 Months .....\$12.00  
BEST AAA GRADE — GUARANTEED 15 Months .....\$14.00

Send Check or Money Order and This Ad  
**BLATT** COR. GIRARD & LANCASTER STS., DEPT. E  
BLATT BUILDING, PHILADELPHIA 31, PA.

## PLYWOOD BOAT KITS \$54.00

(Including Freight)



This READY-CUT 12 ft. fishing boat can be assembled in 8 hrs. without forms or special tools. Kits are complete including all hardware, paint, and etc. Send for free folder.

**TAFT MARINE WOODCRAFT**

Dept. K 636 39th Ave. N.E. Minneapolis 21, Minn.  
**POPULAR MECHANICS**



**NOW** YOU CAN EARN UP TO **\$6.00** PER HR. **in your own WEAVING BUSINESS!**



Amazing All Weave Electric Loom weaves rugs, draperies, textiles in hundreds of colors and patterns. Produces up to 40 feet of 42-inch material per hour. Ideal business for physically handicapped.

Entirely automatic... easy to operate... no experience necessary... free instruction booklet... working materials easily obtained. Uses 110 volt A.C. power. (Special voltage or gasoline motors supplied at extra cost.)

The All Weave Electric is a full size loom, capable of heavy-duty, production-line work, yet reasonably priced. Write for descriptive folder TODAY! Dept. P.

**ALL WEAVE LOOM CORP.** 9128 St. Charles Rock Rd. Saint Louis 14, Missouri

## LEARN AT HOME TO MOUNT BIRDS



Animals, Heads, Fishes, Pets; to TAN. Be a Taxidermist. Profit and FUN.

Hunters, save your valuable TROPHIES. Mount ducks, squirrels, everything. Learn to TAN for leather and furs. Wonderful HOBBY Have a HOME MUSEUM - BIG PROFITS mounting for others. INVESTIGATE NOW.

**FREE BOOK** With 100 fine game pictures. NOW absolutely FREE. Write TODAY.

Send Postal TODAY for FREE BOOK. State AGE. N. W. SCHOOL OF TAXIDERMISTRY, Dept. 2572, Omaha, Neb.



There's No "Mystery" in Watchmaking!  
**YOU CAN LEARN THIS PROFITABLE SKILL!**

For 300 years, watchmakers' skills have been closely-guarded secrets. Now, you can learn skilled watchmaking in scenic, mile-high Denver. I'll give you everything in practical benchwork from hair-spring manipulation to position adjustment. Nationally accredited, veteran approved. Write Orville R. Hagans for information, no obligation. No salesman will call. FREE BOOKLET.

AMERICAN ACADEMY INC.  
SCHOOL OF HOROLOGY  
1549 Lawrence St., Dept. D, Denver 2, Colo.

## INVENTING

**—FOR PROFIT!** If you have an inventive turn of mind, write for free 28-page booklet explaining how the Institute of American Inventors is helping inventors pre-test the profit possibilities of proposed devices to fill today's unprecedented demand for useful new inventions.

**INSTITUTE OF AMERICAN INVENTORS**  
Dept. 4, 1926 Eye St., NW, Washington 6, D. C.

**MAKE UP TO \$5.00 AN HOUR IN YOUR OWN BIG-PROFIT BUSINESS!**

National Organization teaches, helps, supplies everything — for establishing Rug, Upholstery, etc. Cleaning Business. Do work in customers' homes, buildings—new, easy way. Only a few dollars needed to start. BIG, year-around demand everywhere. Write for FREE details! AMERICLEAN CO., INC.; 211 North 7th St.; Dept. G-22; St. Louis 1, Mo.



SAVE on High Quality Dress Trousers  
**GABARDINE**

SAVE ONE-THIRD!

Huge direct-to-you volume enables us to give exceptional value! Fully guaranteed. Genuine virgin wool and fine-spun rayon blended. Warm. Twill weave resists wrinkles, holds crease, gives amazing wear. Expert fashion tailored for perfect fit. Zipper front. Roomy pockets. Blue, Tan, Sand, LL or Dk. Brown, Blue-Gray. WAIST: 28-38 pleated or 28-50 plain.

Send Only \$1 with name, waist size, 1st and 2d color selection. Pay postman balance plus C.O.D. Or, send entire amount, save C.O.D. Money back within 10 days if you're not pleased.

\$12.50 VALUE

**\$7.95** PR.

**FREE!** Write for sample of material.

**LINCOLN TAILORS** DEPT. PM-12 LINCOLN, NEBR.

New Easy Way TO MAKE **BIG MONEY!** AT HOME

FULL OR SPARE TIME

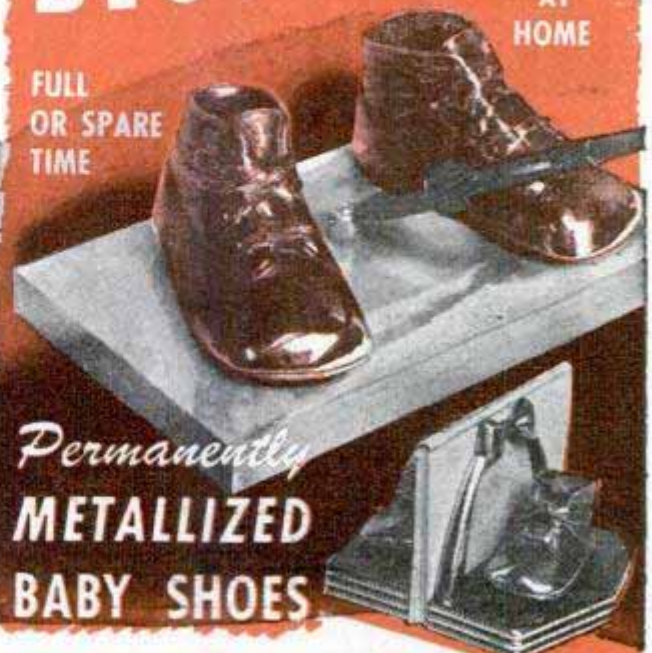

Permanently METALLIZED BABY SHOES

Costs You Only 5¢-You Get \$6.00

Now is the time to cash in on this big-paying, easy-to-operate year 'round business, and you need no experience! With actual illustrations and step by step instructions, YOU can start earning money in only one week—up to \$1000 per month full time, or

LARGEST NUMBER OF SUCCESSFUL BUSINESSMEN

Our course has the largest number of successful businessmen in this field today! They are all men and women who acted and are making money. This course is guaranteed—your money will be fully refunded if you are not more than satisfied. There is nothing to lose, so act at once.

- Money Back Guarantee
- Most Successful Name in Metallizing
- Big Income
- Huge Demand
- Sales Plans
- Future Security
- Your Own Boss

\$50 to \$75 per week spare time... at \$5.00 per hour. Working only a few hours you can make more money than most people make working an entire week.

IMMEDIATE RESULTS

This tested and proven method shows you complete details, so that you may start at once, metallizing Baby Shoes, with real GOLD, SILVER or BRONZE. They will last forever, retaining every priceless detail of the natural shoes; something for which there are 5 million new customers waiting to buy every year.

BEGIN AT HOME

Don't pass up this real opportunity to start your own business on a shoestring right at home. ACT NOW! We will send you all the details absolutely free.



**FREE!**

Two actual metallized Baby Shoes guaranteed to be the most attractive on the market—or a pair of your own Baby Shoes metallized if you prefer.

SEND NO MONEY USE THIS COUPON

**KIKTAVI** Company Dept. P-6  
2111 W. Manchester  
Los Angeles 44, California

Rush me FREE full particulars at once.

Name \_\_\_\_\_

Address \_\_\_\_\_

City \_\_\_\_\_ State \_\_\_\_\_



**WAR SURPLUS**

**NYLON THREAD**



*Amazing Strong Thread used to sew Parachutes*

**NOW AVAILABLE For Home Use...**

This genuine Du Pont Nylon thread is practically unbreakable. What every hobbyist, sportsman, sailor, camper wants. Used in model making, sail mending, tent repairing, bow and arrow winding, bamboo rod wrapping, kite flying and repairing, and many other uses. Used by Air Force on parachutes because of its amazing strength and dependability. Here is your chance to get a giant spool of 5000 feet—almost a mile of Nylon thread at the sensational low war surplus close-out price of only \$1.69. Black or white. Order TODAY.

**GIANT SPOOL**  
only  
**\$1.69**  
BLACK or WHITE  
APPROX 5000 FEET

**SEND NO MONEY, TEST AT OUR RISK**

Just send your name and address. Specify white or black or two giant spools for only \$3.29. On arrival, deposit only \$1.69 per spool (\$3.29 for two spools) plus C.O.D. postage on our guarantee if you are not delighted, you can return in 10 days and your money back. Cash with order, we pay postage. Limited Supply. Write Today.

**LEEWARD PRODUCTS**

Dept. F49S, 189 W. Madison St., Chicago 2, Illinois

**New!**



FOR PLEASURE CARS

**GROVER AIR HORNS**

*Fits Under Car Hood!*

NOW, a powerful... more compact... easily installed high pressure air horn and air tank assembly that fits on firewall or side splash pan under car hood! Spun brass bells, true-tone harmony, heard for miles! Complete assembly features two matched GROVER air horns, self-filling air pressure reserve tank, bronze diaphragms, brass valve, control handle and all necessary copper tubing, rubber hose and fittings. Instructions furnished. Satisfaction guaranteed. If your dealer cannot supply you, write for facts NOW with make, model and year of your car to

DEALERS INQUIRIES INVITED

**GROVER PRODUCTS CO., 1217 S. Hope St., Los Angeles 15, Calif.**

SAY YOU SAW IT IN POPULAR MECHANICS



Learn.....

**WATCH REPAIRING**

**TRAINED WATCH MAKERS ALWAYS IN DEMAND**

The need for trained Watch Makers everywhere is increasing daily with increased watch production. Watch Repairing is a big pay profession—steady the year around. No dull seasons. Work for others or start your own shop!

From The LARGEST APPROVED SCHOOL of its kind

just as ambitious men and women are doing right now. As an expert Watchmaker you can enter an uncrowded field with big pay possibilities and an assured future. No previous mechanical experience needed.

**ACTUAL WATCH REPAIRING** is taught you with each Lesson. All necessary tools and watch is furnished for actual, professional watch repairing use. We teach you how to take any watch apart and make all repairs and part replacements. You EARN AS YOU LEARN with actual repair jobs, with a Diploma issued upon completion of our highly practical Course.

**ILLINOIS SCHOOL of WATCH REPAIRING**

2870-DF ELSTON AVE.

CHICAGO 18, ILLINOIS

**WRITE TODAY!**  
No Salesman Will Call

**63 PRACTICAL PROJECTS FOR Making Money at Home**

**NEED EXTRA INCOME?**

This is YOUR Book!

**BIGGEST** dollar's worth of sound, usable home-money-making plans ever compiled (for men and women). What to do; how to do it; where to get materials, supplies, working plans; **HOW** and **WHERE** to sell products or services.

**ORDER TODAY**

5-Day Return Privilege  
You'll find it more absorbing than a mystery thriller! Send check, M.O. or dollar bill.  
A-101, Postpaid \$1.00



7" x 10" ...  
64 Pages  
MORE THAN 100 ILLUSTRATIONS

Get Acquainted with LUCTO'S big mail-order merchandise line. Just say: "Put me on your mailing list."

LUCTO PRODUCTS CO., 308-Y W. Washington, Chicago 6, Ill.

**LITE**



**LARM-Lite**

ALARM CLOCK and FLASH LITE in thin case. Used under pillow does not disturb others. Easy to see time at night. Ideal for TRAVEL. Perfect for roommates, Hunting or Camping. Uses penlite cells. Written guarantee. \$5.00 plus 10% tax. Send check or M.O. and we pay postage.

**FACILITY PRODUCTS, 73 S.W. 8th St., Miami, Fla.**

**WILL YOU WEAR THIS SUIT**

AND MAKE UP TO \$12.00 IN A DAY!

YOU CAN GET this fine, tailored-to-measure suit as a bonus, without paying one penny cash, by taking a few orders from friends. My plan also helps you make up to \$12.00 in a day without experience or house-to-house canvassing. Big opportunity—full or spare time.

Send for Samples—FREE! Write today for FREE CLOTH SAMPLES and "Sure-Fire" money-making plans. For quick action write fully giving age, etc.

SEND NO MONEY. H. J. COLLIN, PROGRESS TAILORING COMPANY, 500 South Throop Street Dept. M-216 Chicago 7, Illinois

make **MONEY CASTING AT HOME**



Make your own rubber molds quickly, cheaply with X.L. RUBBER. Cast thousands of perfect figurines, book ends, plaques, ornaments, ash trays, etc. **GREAT PROFITS!**

Write for NEW Catalog.  
X.L. Rubber, Pts. \$2.00; Qts. \$3.50; Gallons \$8.95; Models and enough rubber for 3 molds \$1.00 plus postage.

FACTS SENT FREE

**PLASTIC ARTS STUDIO Route 2 • Dept. 2 • Muncie Ind.**

**BUILD YOUR OWN ENLARGER**



Enjoy Photography's most fascinating hobby at a fraction of usual cost. With simple step-by-step instructions and diagrams plus a screwdriver and pliers you assemble your own Enlarger and Save! Get all features of more expensive Enlargers: precision machined aluminum alloy castings, 90° tilt for wall projection of prints, spherical aluminum lamphouse, helical rack and pinion focusing with extra large knobs, unconditional guarantee. For 35mm to 2 1/4 x 3 1/4 negatives. Time payment plan.

Write Today for Free Illustrated Folder

**CALIFORNIA TECHNICAL PRODUCTS CO.**  
448 S. Hill, Dept. M-12, Los Angeles 13, Calif.

**In Your SPARE TIME At Home**





**LOW  
FACTORY  
PRICES!**

*... on the Sensationally NEW 1949*  
**MIDWEST RADIOS**

**NEW  
SERIES 16  
SUPER DE LUXE  
AM-FM  
CHASSIS**

**30 DAYS TRIAL**



**14 1/2" PANASONIC  
SPEAKER**

**5  
WAVE  
BANDS**

**EASY  
TERMS**

**58**

**OUTSTANDING  
FEATURES**

- Including the Exclusive Midwest*
- FLASH-O-MATIC  
Volume and Band Indication
- TELEVISION  
Audio Switch-Over
- FIDEL-A-STAT  
Color-Ray Tone Selection
- TRI-MAGNADYNE  
Coil System
- ...Plus NO-DRIFT FM  
and many other features

**COMPLETE WITH FRONT PANEL—READY TO INSTALL!**

Here is the last word in radio engineering . . . a powerful, world-ranging, magnificently-toned radio that is unsurpassed for performance, selectivity, sensitivity, and advanced engineering features. Uses these latest-type tubes, rectifier and tuning indicator: three 7A7, three 7A4, two 7C5, one 7A6, one 7Q7, one 6BA6, one 6BE6, one 6C4, one 6AL5, one 5U4, one 6U5. Comes complete with satin stripe copper finish front panel attached, Magna-Tenna Loop Aerial and giant 14 1/2" Electro-Dynamic Panasonic Speaker. Requires only a few minutes to install, plug in and play. **LOW FACTORY PRICES . . . EASY TERMS . . . 30 DAYS TRIAL.** Send TODAY for FREE 1949 Midwest Radio Catalog of separate Chassis and beautiful Console and Table models.

**A Complete Line of FINE RADIOS and RADIO-PHONOGRAPHS . . . Available in SEPARATE CHASSIS Like the POWERFUL SERIES 16 AM-FM Model above or in COMPLETE CONSOLES like this...**



**Beautiful  
SYMPHONY GRAND  
AM-FM Radio-Phonograph with  
TELEVISION Audio Switch-Over  
and NEW Intermix AUTOMATIC  
RECORD CHANGER**

A Magnificent musical instrument and a masterpiece of cabinet design—the finest Midwest Radio in 29 years of manufacture. Offers world-ranging radio reception and newest automatic Intermix Record Changing Phonograph. Uses Series 16 Super DeLux AM-FM Chassis. Giant 14 1/2" Panasonic Speaker; Tri-Magnadyne Coil System; Built-In Loop Antenna. Other luxurious console and table model cabinets available with Series 16, 12, and 8 chassis—on Easy Terms and 30 Days Free Trial.

*Rush for Free Catalog!*

**FILL IN COUPON AND MAIL TODAY OR JUST SEND NAME AND ADDRESS ON 1c POSTCARD**

**MIDWEST RADIO & TELEVISION CORP.**

**Dept. 255, 909 Broadway, Cincinnati 2, Ohio**

Please send me your new FREE 1949 Catalog.

NAME \_\_\_\_\_  
ADDRESS \_\_\_\_\_  
CITY \_\_\_\_\_ ZONE \_\_\_\_\_ STATE \_\_\_\_\_

**BUY DIRECT FROM FACTORY and SAVE!**

**MIDWEST RADIO & TELEVISION CORP.**

Dept. 255      909 Broadway,      CINCINNATI 2, OHIO





Here's Smoking Joy  
and Comfort  
all dressed up for Christmas!



● Gaily decked out in its new Santa Claus suit—Prince Albert Smoking Tobacco “stars” under any tree. If he loves his pipe or roll-your-own cigarettes, crimp cut Prince Albert is the answer. Rich, mild, and easy on the tongue—P.A. says Merry Christmas in a big way!

1-LB. TIN . . . ALSO  
AVAILABLE IN 1/2-LB. SIZE

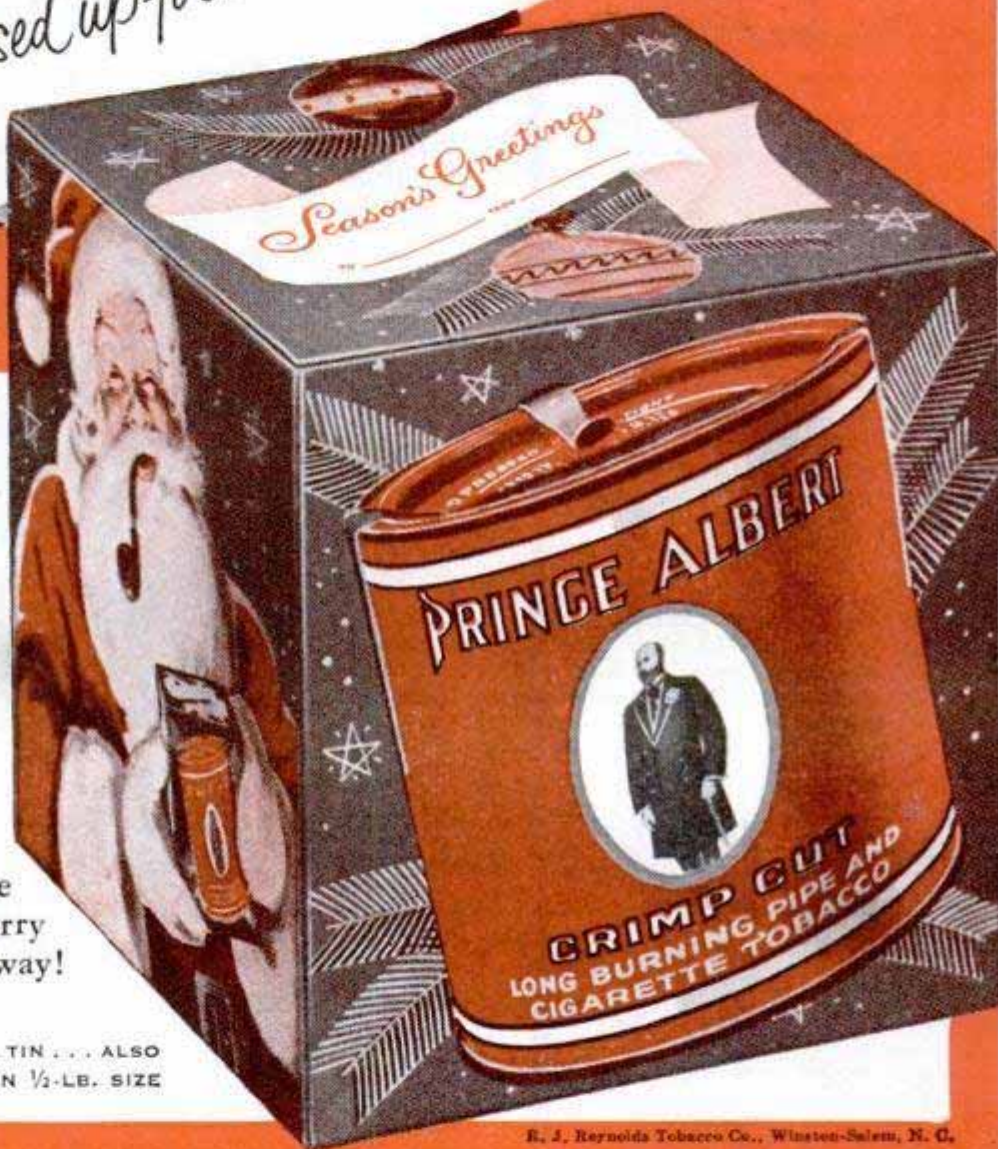

R. J. Reynolds Tobacco Co., Winston-Salem, N. C.

# Prince Albert

Smoking tobacco.

THE NATIONAL JOY SMOKE



# POPULAR DECEMBER 1948 MECHANICS

WRITTEN SO YOU CAN UNDERSTAND IT  
VOL. 90 NO. 6

Hoyt S. Vandenberg, four-star General and Chief of Staff who is shaping the 70-Group Air Force, presents a progress report on his team

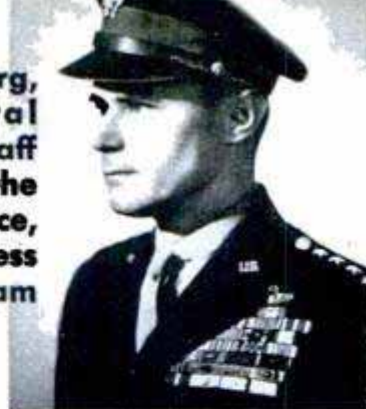

## *Our 70-Group Air Force Emerges*

**By Gen. Hoyt S. Vandenberg  
Chief of Staff, United States Air Force**

**A**IR SECURITY is synonymous with survival. No nation can hope to survive in modern war unless it is capable of defending itself from enemy air attacks and eventually commanding the enemy's airspace. The National Security Act of 1947, charging the United States Air Force with the responsibility for sustained defensive and offensive air operations, made it accountable for these missions.

The expanded capabilities of aircraft in speed, range and bomb-carrying capacity, and the state of world affairs since V-J Day make the status of our Air Force and its immediate plans for the future of ut-

most importance to the citizens of the United States and the other democracies of the world.

The Air Force has not yet attained the minimum strength we consider necessary to provide air security for the United States, although substantial progress has been made toward that goal. That minimum is a 70-group *air-force-in-being*, fully manned and equipped with the best aircraft and weapons in the world. It is to be augmented by 22 specialized squadrons and supported by the necessary civilian components, such as, Air National Guard, Air Reserve and Air Reserve Officers Training Corps, and industrial organizations in a state of ready expansion.

A 70-group air force is not a large air

**Grim reminder of war's new-found destructiveness, the underwater atomic bomb explodes in test at Bikini**  
Joint Army-Navy Task Force One photo

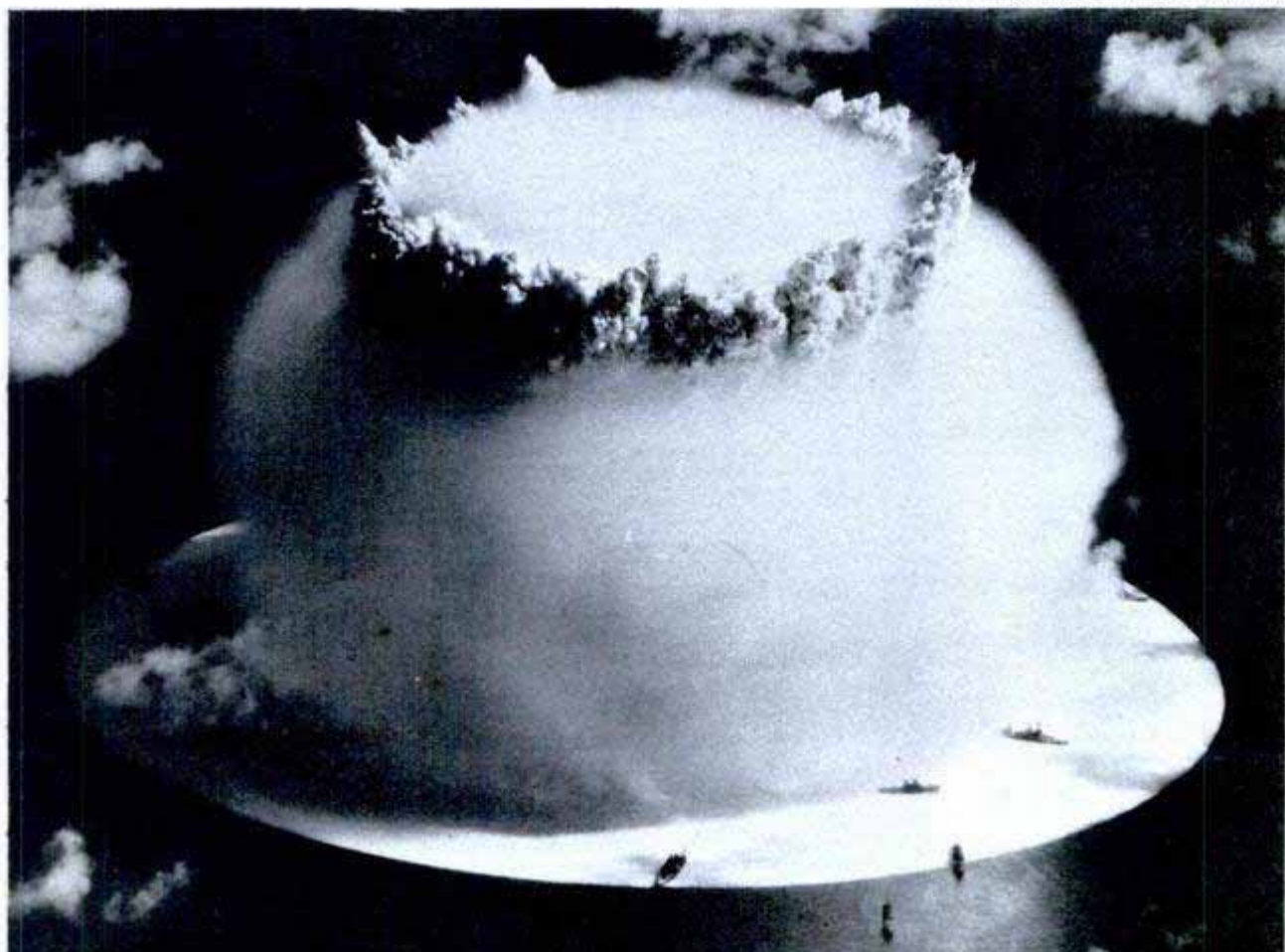





U. S. Air Force photo

Problems of swept-wing, semi-tailless planes at extremely high speeds will be researched in the Northrop X-4. This tiny plane, powered by gas-turbine engines, can stay aloft much longer than a rocket-powered craft

force. The answer to its effectiveness lies in its composition and its readiness. If the United States had 350 groups manned by a proportionate number of men but equipped with inferior aircraft and weapons, it would neither give security nor be a force for peace. The security that lies in

the 70-group air force is in its quality—not quantity. There is no such thing in the present air age as gaining security through the mere mass of equipment and personnel. Military quality is as significant as military quantity.

An *air-force-in-being* is a total air or-

Most of the large wartime Air Force bases have been retained for combat groups, training or research work

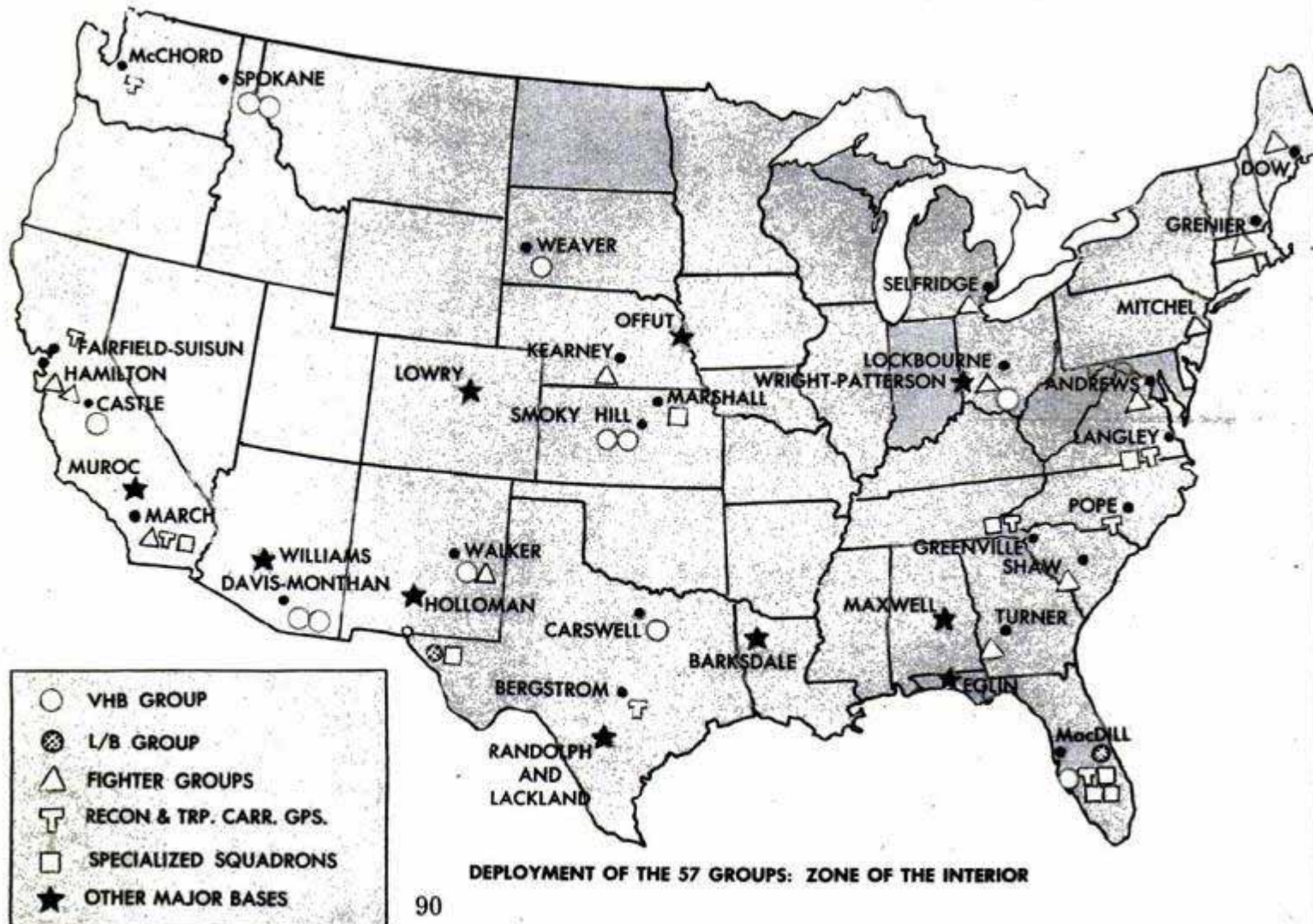





U. S. Air Force photo

Beadlike trail behind the Bell X-1 is caused by exhaust bursts from liquid fuel in rocket engines. This plane, on Oct. 14, 1947, was first to exceed speed of sound

ganization, all the units of which, both tactical and supporting, are formed and ready to function effectively on a moment's notice.

In order to comprehend fully the Air Force program, certain terms must be understood. A *group* is the smallest tactical air organization employed as a self-contained unit; it is the combat force of a parent organization known as the Base Wing. The wing is mobile, self-supporting and able to operate in the field or at an established station.

Groups vary in numbers of aircraft and men. A typical medium bombardment group consists of three squadrons—four in wartime—of 10 aircraft each, or a total of 30 aircraft during peacetime and 1850 officers and airmen. The personnel is supplemented, when operating in the United States during peace, by additional personnel at its base which brings a group's total military and civilian strength to between 2500 and 3000 persons.

Fighter groups normally employ 75 aircraft, but when operating in the United States during peacetime, their total personnel requirement is between 1700 and 2000—two thirds that of a bombardment group. Other types of Air Force groups, such as troop-carrier and light bombardment, usually have 48 aircraft per group.

Specialized squadrons are tactical units about one third the size of a normal group. They are equipped and trained for certain specific tasks, such as reconnaissance, liaison and rescue. They are based with and use the ground facilities of one or more groups.

The Air Force now consists of 58 combat groups and 17 specialized squadrons, all operational. We have a heavy bomb group and 14 medium bomb groups, 3 light bomb groups, 8 troop-carrier groups,

## MAKEUP OF TYPICAL COMBAT GROUPS



Heavy Bomber: B-36  
18 planes



Medium Bomber: B-50  
30 planes



Light Bomber: B-45  
48 planes



Day Fighter: P-86  
75 planes



Medium Troop Carrier: C-119  
48 planes

### The 70-group air force will consist of:

2 heavy bomb groups.....	36 planes (B-36s, etc.)
18 medium bomb groups.....approx.	540 planes (B-50s, etc.)
5 light bomb groups.....approx.	240 planes (B-45s, etc.)
25 fighter groups.....approx.	1875 planes (F-86s, 84s, 80s, etc.)
10 troop-carrier groups.....approx.	480 planes (C-119s, etc.)
6 strategic reconnaissance groups.....approx.	200 planes (C-45s, B-17s, etc.)
4 tactical reconnaissance groups.....approx.	200 planes (A-26s, F-80s, 51s etc.)
22 specialized squadrons.....	? planes (mixed, probably about 1/3 size of average group)





NORTH AMERICAN F-86

4 tactical reconnaissance groups, 3 strategic reconnaissance groups, 3 all-weather fighter groups, and 22 fighter groups.

Last month a program began for equipping at least one new group each month until the 66-group phase is attained, which will be by June 30, 1949. Four other groups, two light bomb groups and two troop-carrier groups, plus five additional specialized squadrons will be activated during 1950.

By June 30, 1949, we will receive approximately 1400 aircraft of the latest types to equip these new groups. Orders have been placed for over 2000 more, with deliveries to begin in 1950 and be completed in 1951.

When the 70-group air force is fully constituted, it will consist of 2 heavy and 18 medium bomb groups, 5 light bomb groups, 25 fighter groups (of which 3 will be all-weather), 4 tactical reconnaissance groups, 6 long-range or strategic reconnaissance groups (which will include 2 weather, 3 photographic and 1 mapping group), 10 troop-carrier groups, and 22 specialized squadrons—the total manned and supported by 502,000 men.

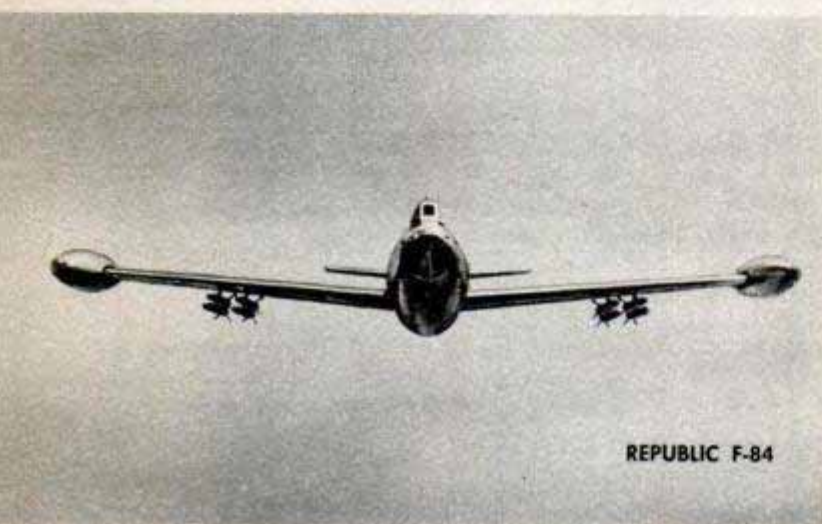

REPUBLIC F-84

**HEAVY BOMBERS**

Heavy bombers are designed to strike deep into enemy territory and to carry a sufficient bomb tonnage to damage their targets decisively. The Air Force now requires that these aircraft have a combat radius of over 2500 miles.

As an example of how size and speed requirements have changed since World War II began, we can compare our heaviest bomber then—the B-17, with a design gross weight of 44,560 pounds—with our present heavies, which have a design gross weight as high as 278,000 pounds. The largest—the Consolidated-Vultee B-36—is more than six times the weight of the once-formidable Flying Fortress.

The B-36, the only type of heavy bomber we have in production, is the largest and longest-range bomber yet built. This plane, of which 94 have been ordered, is capable of carrying 10,000 pounds of bombs 10,000 miles, or 72,000 pounds a shorter distance. Because of its size and resultant engineering and production problems, the plane required 6½ years for design and development. One group is already equipped with B-36s.

Another heavy bomber, the Northrop B-35 Flying Wing, is in the service-testing stage. It will fly in excess of 350 miles per hour and have the approximate range and bomb capacity of the B-36.

The Strategic Air Command will be partially equipped with what we now term medium bombers. One of these is the World War II B-29. The Air Force has 2600



NORTHROP XF-89



LOCKHEED F-80



of these planes, with 400 of them now active. No others are being produced, but the Boeing B-50, an improved design of the B-29 with increased range and speed, is now coming off the production line.

The only jet bomber presently in development which may join the heavy bombers is the YB-49, the largest jet plane yet built. It will have a speed greater than 500 miles per hour and will carry over 30,000 pounds of bombs.

In the meantime, we have in the drawing-board stage a six-engine, turbo-prop bomber, the Boeing XB-52, which might possibly join the heavy bombers.

## LIGHT BOMBERS

Light bombers are very fast and designed to cooperate with the surface forces. They will operate as part of the Tactical Air Command, generally at ranges much shorter than those of medium bombers.

The four new types of light bombers under development are jet-propelled—the North American B-45, Consolidated XB-46, Boeing XB-47, and the Martin XB-48. All have speeds of more than 500 miles per hour and a bomb capacity of 10 tons. Orders for B-45s have been placed, but only experimental models of the others have been ordered. The first B-45s are expected to join active units shortly.

The development of jet bombers is a new field and it was not until late in 1946 that the first one was flown. Their present range is limited by the high rate of fuel consumption, but it is adequate for tactical support and their high speed lessens the chance of interception by hostile jet fighters. Before jet aircraft suitable for long-range bombardment missions are developed, their range will have to be increased. Some satisfactory answers to this problem are being found through the refinement of engines and design and in the improvement of operating techniques.

## FIGHTERS

As in light bombardment, the fighter trend is toward jets. We have established military characteristics for four distinct categories of fighter aircraft to perform special missions.

The penetration fighter is designed for operations against aircraft and ground targets deep in enemy territory. It will be similar in function to the P-51s and P-47s of World War II.

The interceptor fighter is a local-defense plane capable of destroying enemy aircraft. It is characterized by a very high rate of climb—requiring but two to three minutes to reach an altitude of 50,000 feet. Its speed is high but its endurance short.

The all-weather fighter, known during



NORTH AMERICAN F-82



CURTISS XF-87



McDONNELL XF-88



McDONNELL XF-85





Eight jet engines, with a combined thrust of 32,000 pounds, power Northrop's Flying Wing YB-49

the war as the night fighter, operates at night or during inclement weather. Automatic gun-laying or aiming equipment, and radio and radar navigational aids will enable it to fight under adverse conditions.

The parasite fighter is a new approach to the problem of defending very long range bombers. It is designed to be carried in one of the bomb bays of heavy bombardment planes and released near the target. It has no landing gear but uses equipment on the mother plane for mid-air take-offs and landings. This type must have a high speed and an endurance of at least an hour.

The Air Force has not yet developed aircraft to fit all these categories, but it has initiated projects for planes which are the potential prototypes of production fighters designed to replace the fighters used in World War II.

Currently the Air Force has two jet fighters in operation, the Lockheed F-80 and the Republic F-84, developed during the war years but not produced for operational use. The F-80, the first American jet to fly the Atlantic, has been with operational units for some time. It has a speed in the 600-mile-per-hour class and can be armed with six .50-caliber machine guns and ten wing rockets.

The F-84 is also in the 600-mile-per-hour class and carries armament similar to the F-80. Some units of the Air Defense Command and the Tactical Air Command have been equipped with F-84s.

The North American F-86, a jet fighter with swept-back wings, has entered production, but none of the first models has as yet joined active units. On September 17, 1948, an F-86, carrying six .50-caliber machine guns, ballast equal to the weight of the ammunition, and oxygen equipment, set a new world's speed record of 670 miles per hour. This is the first time in history that a speed record has been set with a tactically equipped aircraft. It has a range of more than 1000 miles and is equipped with a pressurized cockpit and a pilot-ejection seat.

The Curtiss-Wright F-87 is an all-weather jet fighter in the 600-mile-per-hour class and has a combat radius of more than 1500 miles. All-weather groups are equipped with the North American F-82. A plane of this type, powered by two conventional engines, made the longest flight ever attempted by a fighter, flying from

Hawaii to New York—5000 miles—non-stop. It can be armed with as many as fourteen .50-caliber machine guns and 25 five-inch rockets or with 7200 pounds of bombs. A number of units are equipped with this plane.

The McDonnell F-85 is the first parasite fighter designed. It is still in the experimental stage, but it has made its first flight and pickup. Two were ordered for testing.

Our newest penetration fighter is the McDonnell XF-88, designed to operate either as a fighter-bomber deep in enemy territory or as a bomber escort. Still in the experimental stages, it is undergoing tests at Muroc Air Force Base.

The new Northrop XF-89 is a jet fighter designed for night and all-weather missions. It carries a crew of two, seated in tandem, and is powered by two turbojet engines located beneath the fuselage. The XF-89 has been successfully flown, but it will be extensively tested before quantity production is considered or undertaken.

We are developing three other new fighters also, the Lockheed XF-90, the Republic XF-91, and the Consolidated XF-92.

Strategic reconnaissance groups are now equipped with modified C-45, B-17 and B-29-type planes. B-29s have been converted into flying weather stations to enable the Air Weather Service to cover wider areas and move with heavy-bomber groups on a global basis. Tactical reconnaissance units will be equipped with converted light bombardment and fighter-type planes. The present development of jet aircraft is sufficient to provide excellent tactical reconnaissance equipment for the Tactical Air Command.

## TROOP CARRIERS

The expanding range of air operations has placed a new emphasis on troop-carrier aircraft. It is at times the only means of delivering troops or cargo to an area and it is always the fastest means.

Wartime Douglas C-47s and C-54s are currently in use, but planes with greater capacity and range are in production. The Fairchild C-119, an extensively modified version of the C-82, is in production. This plane will carry a load of 9 tons for 2000 miles, or accommodate 42 fully equipped combat troops and 20 parachute cans of supplies. It can carry heavy equipment

(Continued to page 250)





**CONSOLIDATED-VULTEE'S FOUR-JET XB-46**



**BIGGEST OF ALL, CONSOLIDATED'S B-36**



**BOEING'S FAST XB-47 STRATOJET BOMBER.  
BELOW, THE SPEEDY NORTH AMERICAN B-45**



**BOEING'S B-50, POSTWAR VERSION OF B-29.  
BELOW, GLENN L. MARTIN'S SIX-JET XB-48**





## Inhaler for Powdered Penicillin Is Used Orally or Nasally



Dry, powdered penicillin is inhaled into the upper respiratory tract and lungs by means of an inhaler that can be used for oral or nasal treatments. It consists of a discharge chamber with interchangeable mouth and nose pieces. A sifter cartridge with 100,000 units of finely powdered penicillin G sodium is inserted in the inhaler. By inhaling and exhaling, the powder is spread into the respiratory passages.

## Forced Jellied Gas Splits Open Oil-Bearing Rocks

Jellied gasoline, used in flame throwers during the war, is now cracking rock thousands of feet underground to permit oil to flow to wellholes where it is pumped to the surface. The jellied gasoline combined with sand looks like a thick mush. It is pumped into the well under high pressure and spreads through underground

rock formations, causing the rock to split open. Sand suspended in the jelly prevents the cracks from closing again. A liquid chemical then is pumped into the well; this breaks the jelly into a liquid, and the gasoline flows out with the oil. Through the new technique, many abandoned wells may be put into operation again.

## Pulse-Jet Engines on Tips of Rotors Power Helicopter

Pulse-jet engines, one on the tip of each rotor wing, power an experimental helicopter that will carry about twice the payload of conventional helicopters. The pulse-jet engine is an explosion type engine having reedlike valves in the air inlet providing power in bursts instead of continuously. Larger payload are made possible

because the jets eliminate a heavy engine. The jet-propelled rotor transmits no torque to the fuselage, eliminating the need for an auxiliary tail rotor. Fuel and ignition are provided to the wing-tip jets through lines inside the rotor blade. The experimental craft weighs 1000 pounds and has a rotor diameter of 29 feet.





## ROCKET PLANE

Powered by a six-ounce rocket, a model plane built by a Chicago artist drops open its "bomb bay" to expel the rocket after the charge is burned. This lightens the plane and adds distance to its run before it falls in a gentle glide to the ground. The rocket model, designed and built by Roswell Brown, is still in the experimental stage. It was built around the dimensions of a six-ounce rocket which resembles the old-fashioned, tubelike Roman candle. This rocket is suspended by tiny hooks inside the plane with the fuse protruding at the rear. The forward end of the rocket is held by a string to a spring. This string is burned after the charge is spent and the spring kicks the rocket back about one eighth of an inch to free it from the hooks. The rocket then falls against the "bomb bay" doors which open at a slight touch to expel the rocket. The plane is launched from a six-foot ramp with guide rails for the three-wheel dolly which drops away as the plane soars into the air. Brown's aerodynamic problem was to design a model that would hold its course under extreme acceleration and still be a good glider.



Designer and builder, Roswell Brown, lights fuse of Strato-Rocket model plane built for take-off from a launching ramp

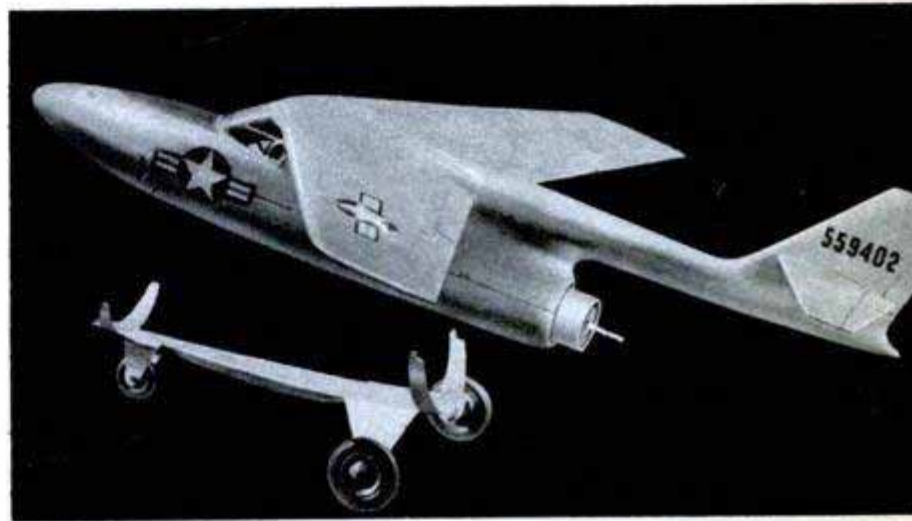

As the Strato-Rocket lifts into the air, its three-wheel dolly falls off and when the rocket is burned out it drops against the "bomb bay" doors which are opened by the weight of the rocket. This adds distance to the Strato-Rocket's glide run



Wendell Kling gives the artist's conception of take-off in this cover painting. The model is awaiting rocket-thrust tests

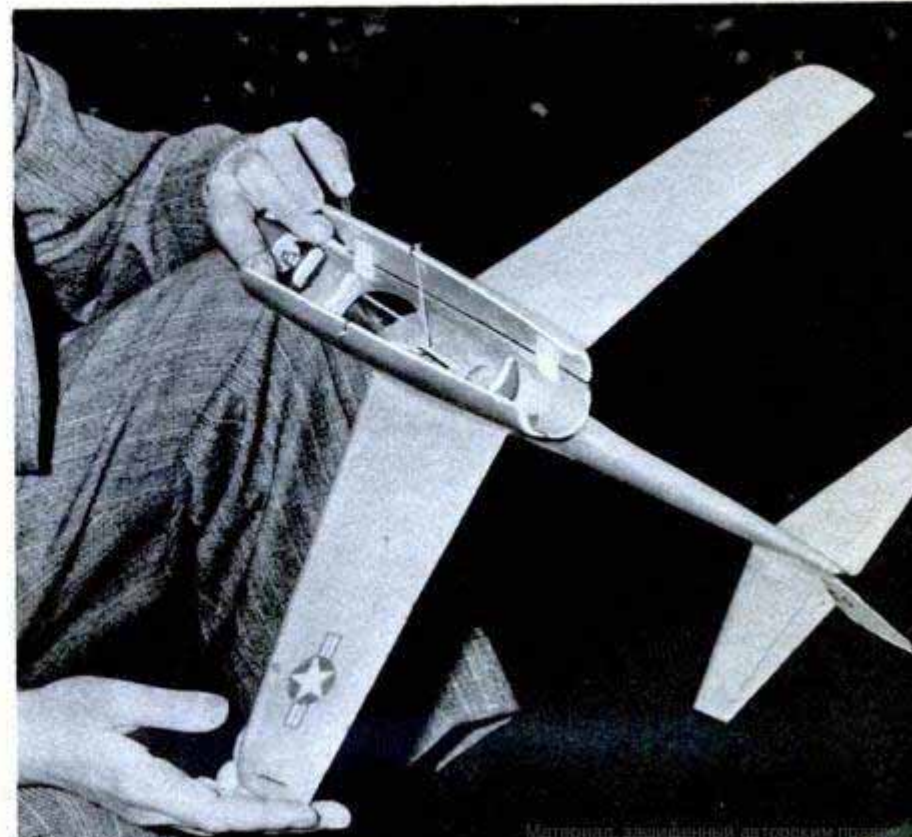



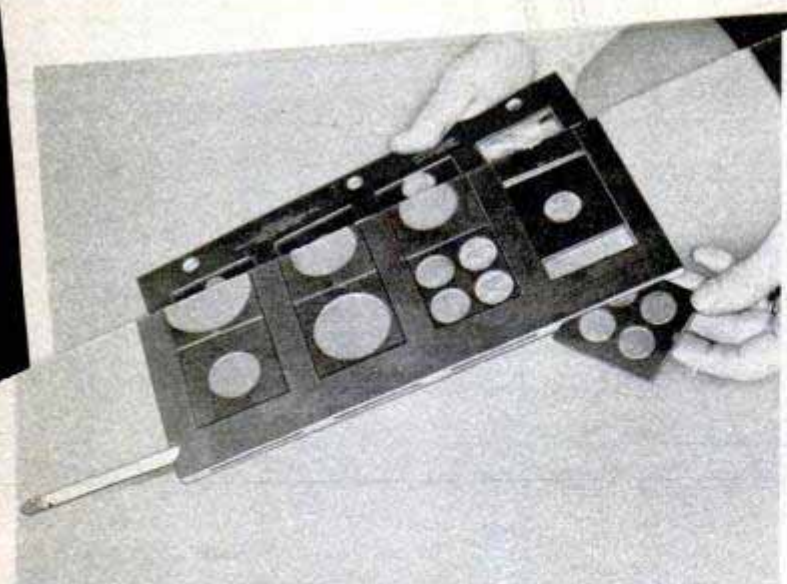

### Loose-Leaf Album for Coins

As many as 48 coins can be displayed on a single page of a coin-collector's album that features interchangeable holders punched to display coins of 55 different sizes. The coins are protected on both sides by clear plastic sheets. The various holders are easily removed for inserting new coins. A locking key that runs the length of the page prevents the inserts from dropping out. Smaller albums are also available.

### Snow-Blower Attachment

Snow is blown off sidewalks and driveways by a revolving attachment for a power mower. As the machine is guided along the sidewalk, the snow is funneled into the mechanism and then ejected through either one of two tubes. The snow falls 15 to 20 feet from the sidewalk. The attachment fits a machine that also can be used for mowing, cultivating, hauling, crop dusting and spraying.

Attached to a power mower, the blower funnels snow into mechanism and throws it 15 to 20 feet away

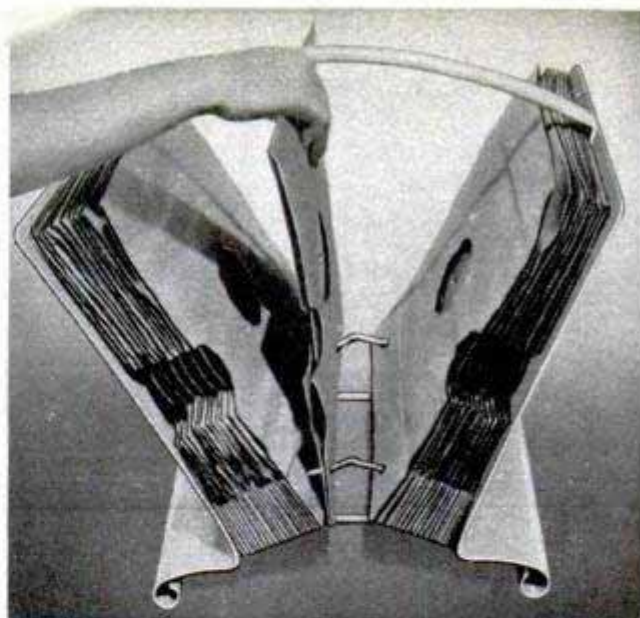

### Aluminum Cabinet for Records

Individual phonograph records can be found and removed quickly from a new storage album made of aluminum. The album holds the records at an angle, like the open pages of a book, so the titles can be seen easily. As a record title is read, the envelope is moved across a hump in the retaining bar until it rests on the other side of the album. Records are removed from the side of the envelopes, leaving the tops closed to keep out the dust. Similar albums are available for photographs.

### Overdrive for Chevrolet Cars Is an All-Mechanical Unit

Built by an accessory manufacturer, an overdrive is now available for Chevrolet cars. It slows the engine revolutions to 50 miles-per-hour speed when the car is traveling 70 miles-per-hour. Advantages claimed for the overdrive are quietness of operation, longer engine life, and increased oil and gasoline mileage. This overdrive, known as Tip-Toe-Matic, is an automatic all-mechanical unit and is designed for installation on the torque tube. Neither gearbox nor rear axle has to be modified. The overdrive operates in all forward speeds and "free wheeling" is eliminated in all speeds. A hill holder makes it unnecessary to use the foot brake if the car is stopped and started on a hill. For a quick pickup in passing, the accelerator pedal is pushed all the way down to shift the car back to direct drive. Partial depression of the clutch pedal has the same effect but assures return to direct drive when the car is stopped. Accelerator control permits the car to remain in the overdrive range. The automatic control is set by depressing the clutch and pulling out the overdrive knob near steering column.



football game in the Rose Bowl and draws a million and a half spectators.

This winter, the theme of the 60th annual tournament is "Childhood Memories." One float will depict a scene from Alice in Wonderland, another may represent Humpty Dumpty. The tournament is a competition and trophies are awarded for the most beautiful floats. Floats are entered by countries, states, cities, civic and fraternal organizations and by a number of business firms.

Designing and building the floats is almost a year-round task. Sketches are made in the spring, approved by midsummer, and construction starts in early fall. Today, about half the entries are built by firms that specialize in float construction, at prices that range up to \$15,000 for a single float.

The float builder starts with a bare, stripped-down truck chassis, usually extended to a length of 25 feet. The average float is low in the front, tall in the rear, and because of this shape the truck sometimes is backed up for the entire five



↑ High-school students try flower combinations in selecting blossoms to cover an entry

Chicken wire is → coated with plaster to form horses. Cloth may be used instead of plaster

↓ Completed float won sweepstake prize the year it paraded in Tournament of Roses

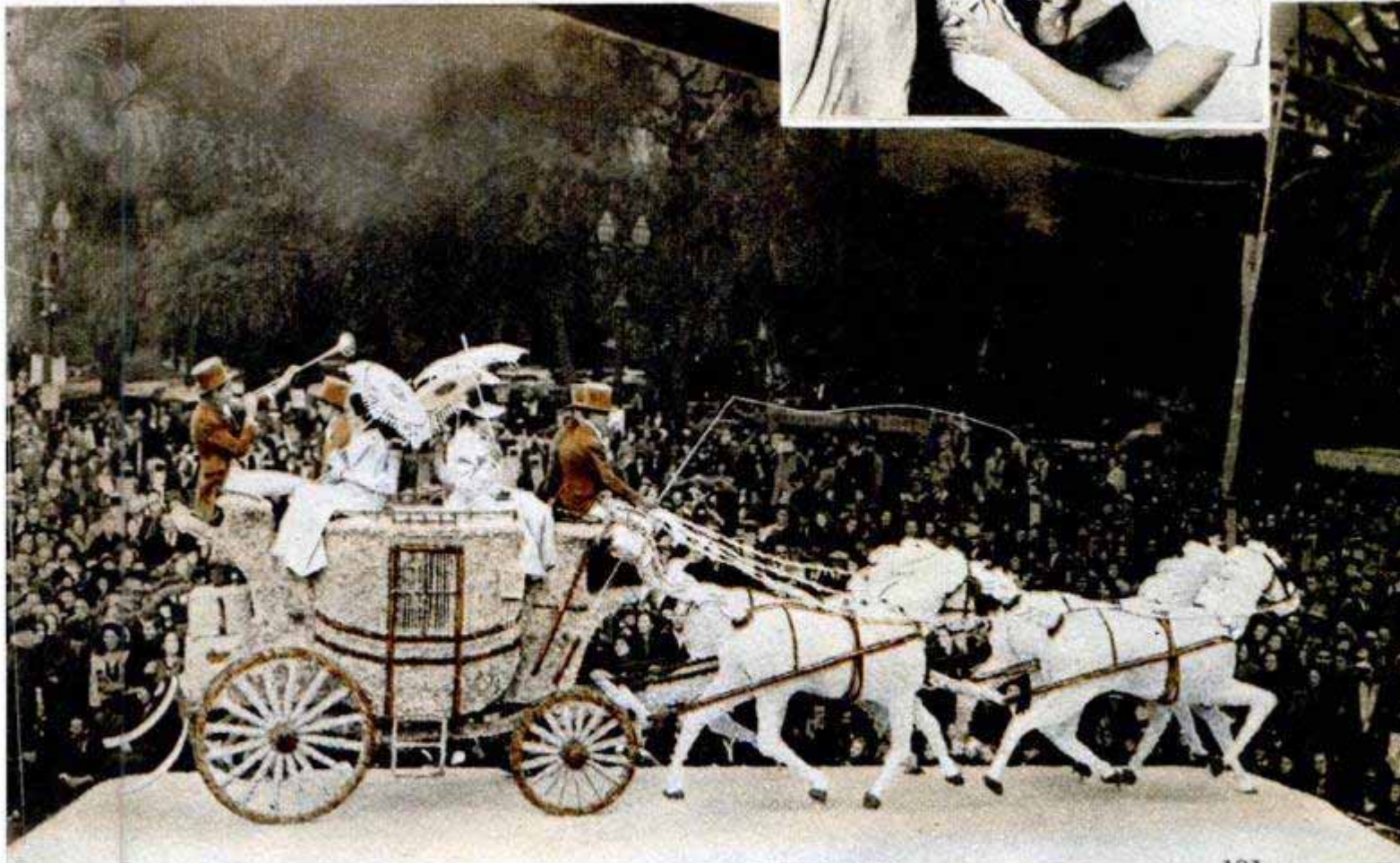



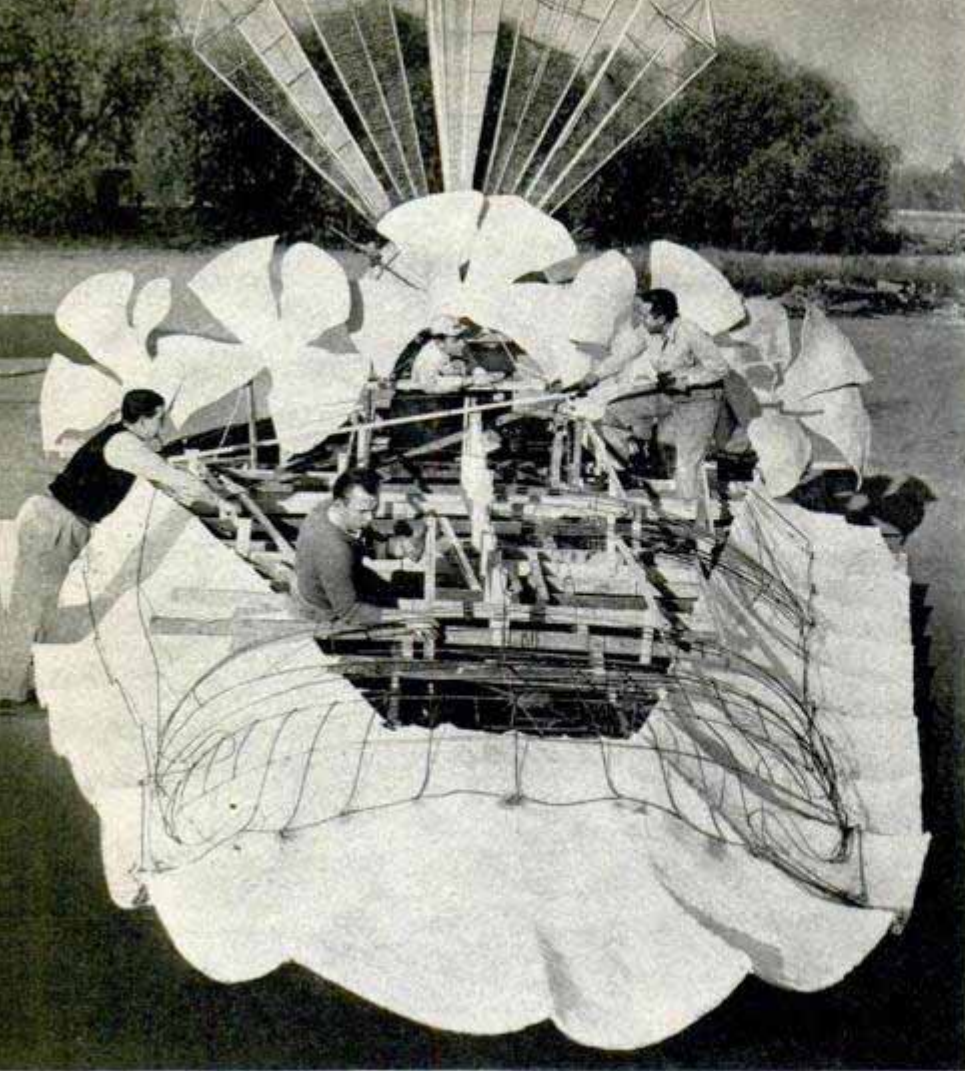

Wooden framework is covered with wire to shape the float. Then chicken wire is attached to the frame and covered with cloth, which is painted in various colors to guide the workers in gluing on the flowers. Every surface is covered with blossoms

miles of the parade. More often, however, the truck chassis is rebuilt with the engine installed at the rear. Two driver's seats are placed behind the engine and the steering rods are extended to the front wheels.

Room for two drivers is necessary because it is hot and uncomfortable under the framework of the float and a driver may faint. Steering is done through a peep-hole in the flowers and, in some cases, with the help of a steersman, concealed under the front of the float, who gives directions to the driver by telephone. The engine, too, will run hot, so it is equipped with an extra-large radiator plus a large-capacity water tank.

Over the chassis a wooden framework is built, shaped roughly to the dimensions of the finished float. Floats that are to be entered in the Tournament of Roses may be up to 45 feet long, 20 feet wide and 15 feet high. The final shaping is done with heavy steel wire that is attached to the wooden frame. One-inch mesh chicken wire then is stretched and fastened over the entire float, and strong cheesecloth is sewn to the chicken wire. Then the cloth is

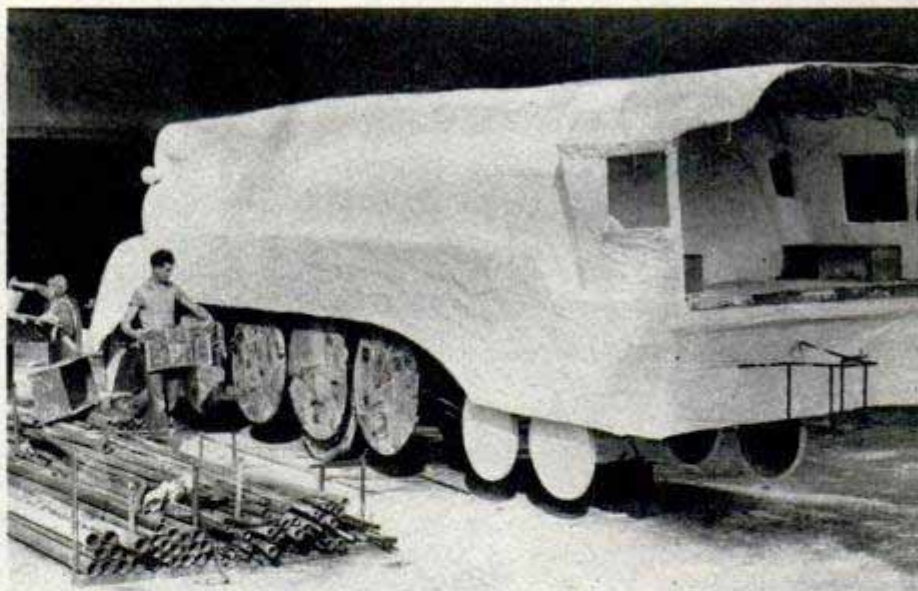

↑ Newspapers form papier-mache cover for locomotive float built of wood and wire. Finished product was hit of recent parade

← Truck chassis is lengthened and rebuilt with engine in rear to carry a float in the famed Pasadena New Year's Day parade



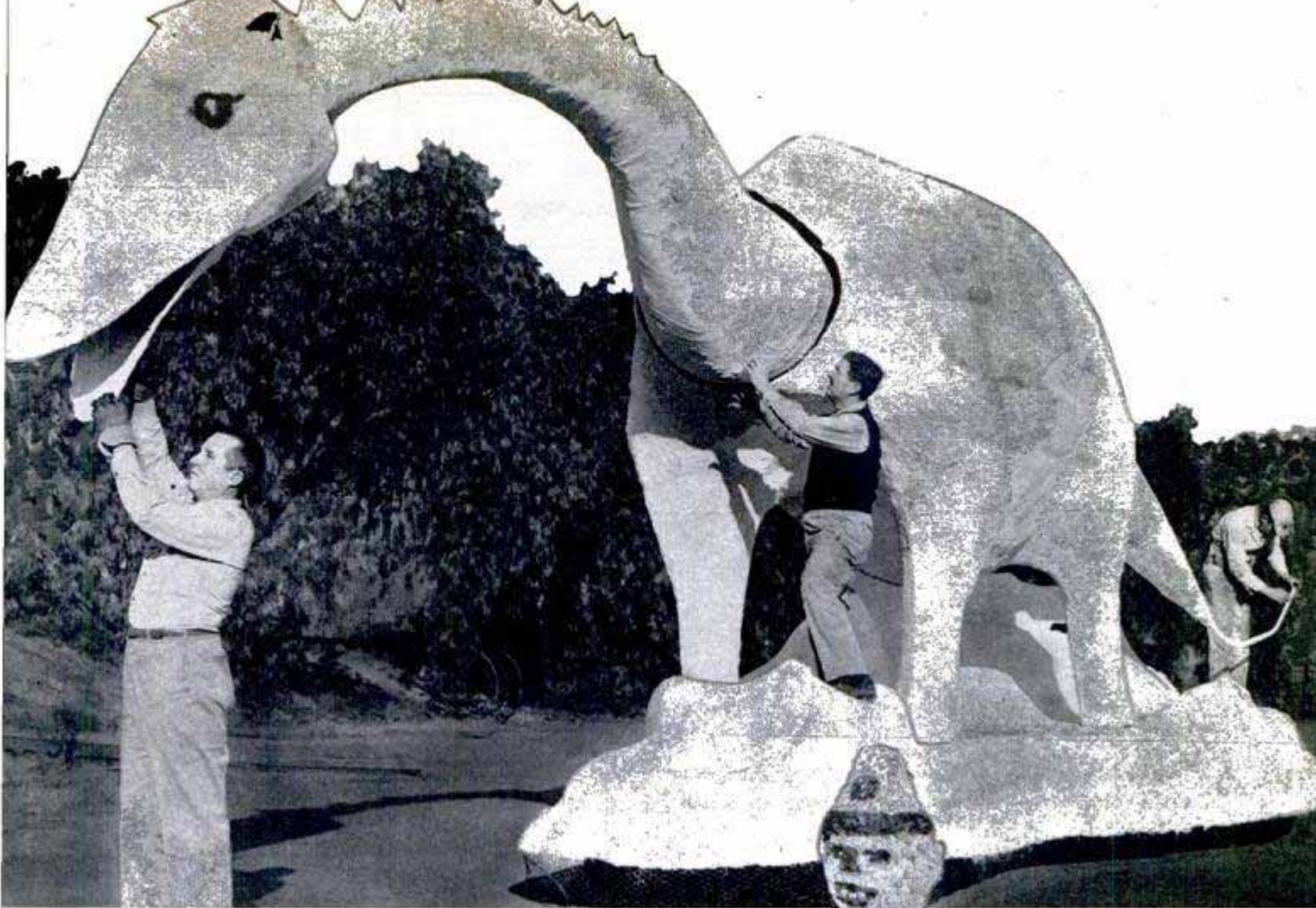

doped with calcimine to tighten and stiffen it. Plaster or papier-mache may be used instead of cheesecloth for finishing the shapes.

Decorating the floats begins about 24 hours before the parade, as it is an all-day and all-night task. For a large float 700,000 blossoms may be required.

Eighty percent of the flowers used to decorate the floats are chrysanthemums because they keep well. Marigolds, calendulas, stocks, delphinium and roses also are used, as well as pansies, bird of paradise, orchids and gardenias. Special acreages of the varieties that are desired are contracted for by wholesale florists, and the flower crops are timed to bloom a day or two before the parade.

The hardy chrysanthemums are the first

Workers touch up the framework of animated dinosaur. Head and neck moved during the parade

Flowers are stapled to a figure for an elaborate float. No artificial blossoms are permitted

Imitation fountain with trailing lines of flowers forms spectacular float





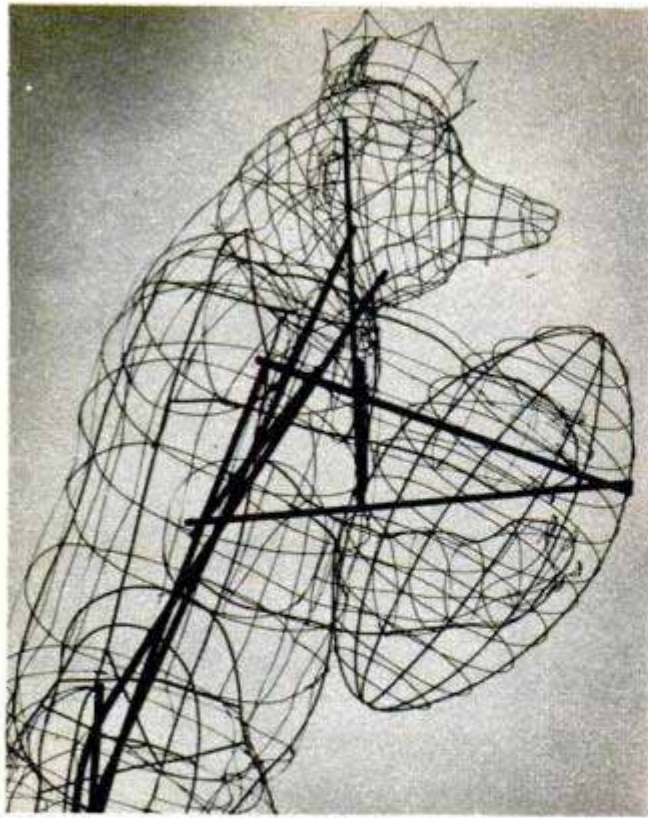

**Framework of wire forms a bear carrying a football**

flowers to be applied to a float; the most delicate blooms are put in place only an hour or two before the parade begins. Each flower must be fresh; no dyed or dead blooms are permitted. A backing of wet moss is sometimes used so that a delicate variety will retain its freshness all through the parade. Several years ago, one entrant

decided to place 3000 tulips among the other flowers that would be used, and 3000 test tubes, each filled with water, were wired into place on the float. One tulip was placed in each test tube on the morning of the parade and the display was a success.

Chrysanthemums and most other flowers ordinarily are glued into place. The flowers are applied by first painting the entire float with rubber glue and then brushing some glue on the back of each flower. Then each flower is pressed into place on the surface.

Float designers have new and ingenious ideas every year and the trend, aside from the streamlined and tailored shapes that have been popular during the past few years, is toward animation. A huge flower-covered dinosaur with moving head and neck, a tandem bicycle with rotating wheels, a train with moving figures, a ferry boat with churning paddle wheels—all these have appeared in recent parades. One innovation that may be completed in time for this winter's spectacle is a float that consists of nine connected units, representing a miniature circus parade. One unit consists of a flower-decorated calliope, another carries a trained-seal act done in flowers. One hundred feet long, the train of floats would snake along from one side of the street to the other.

The tournament-float committee approved the extra length of the circus float but last year, for safety reasons, it turned

(Continued to page 246)

**In the completed float, which was part of the parade in 1947, a flowery King Bruin, representing UCLA, is shown welcoming the University of Illinois team to the afternoon football game in the Rose Bowl**

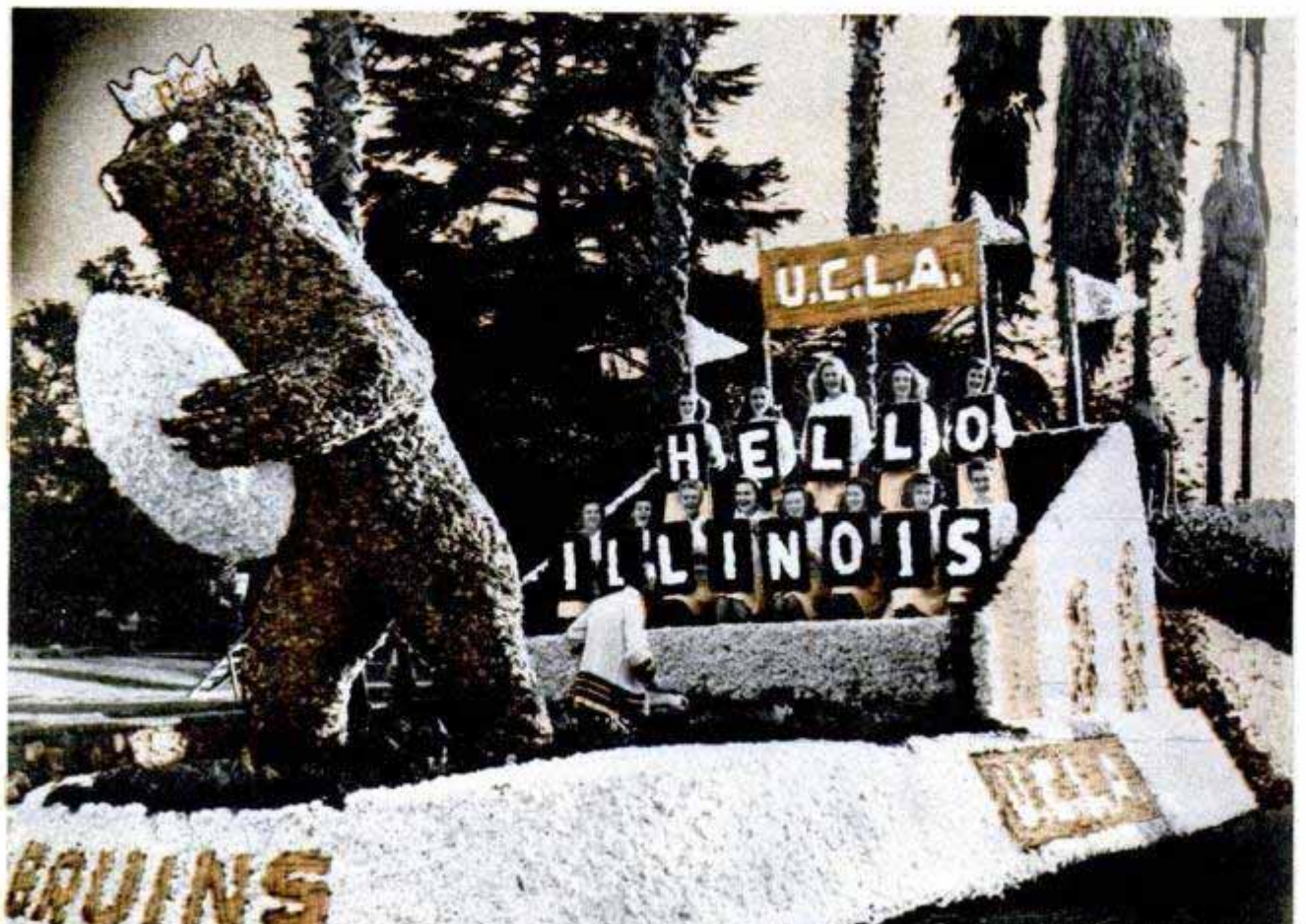



## Metal Ski-Coaster Has Heel Brake

Combining the thrills of skiing with the safety of coasting, a new winter sport for children uses a pair of metal skis connected by a bicycle grip handle at the front end. No straps are used for the feet. An all-metal footrest has a protective toe guard that adjusts for various foot sizes. A brake, attached to the heel of each footrest, digs into the snow when weight is shifted to the rear of the foot. The brakes are used for steering the skis as well as for stopping. The handle tilts forward for pulling.

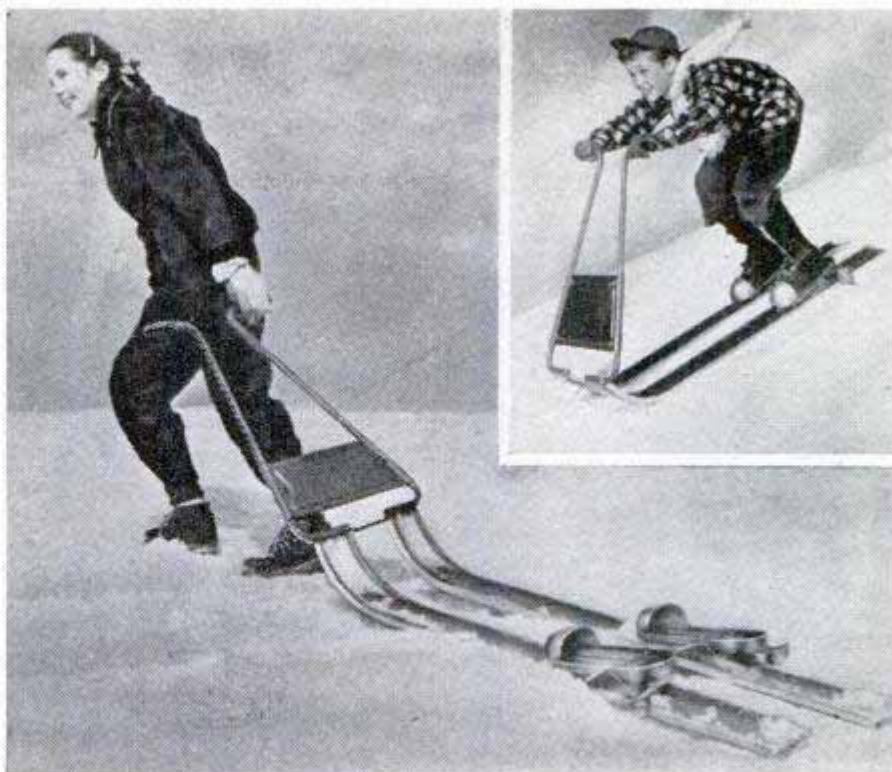

## Almost-Seedless Watermelons

Watermelon seeds, generally regarded as a nuisance, may soon be things of the past. A Japanese scientist has produced an

almost-seedless watermelon at Kyoto Imperial University. The new melons have only a few seeds compared with more than 500 in usual varieties. They also have seed-like sections similar to those in cucumbers.

## Logs Ride Conveyor Belt on Model-Train Loader

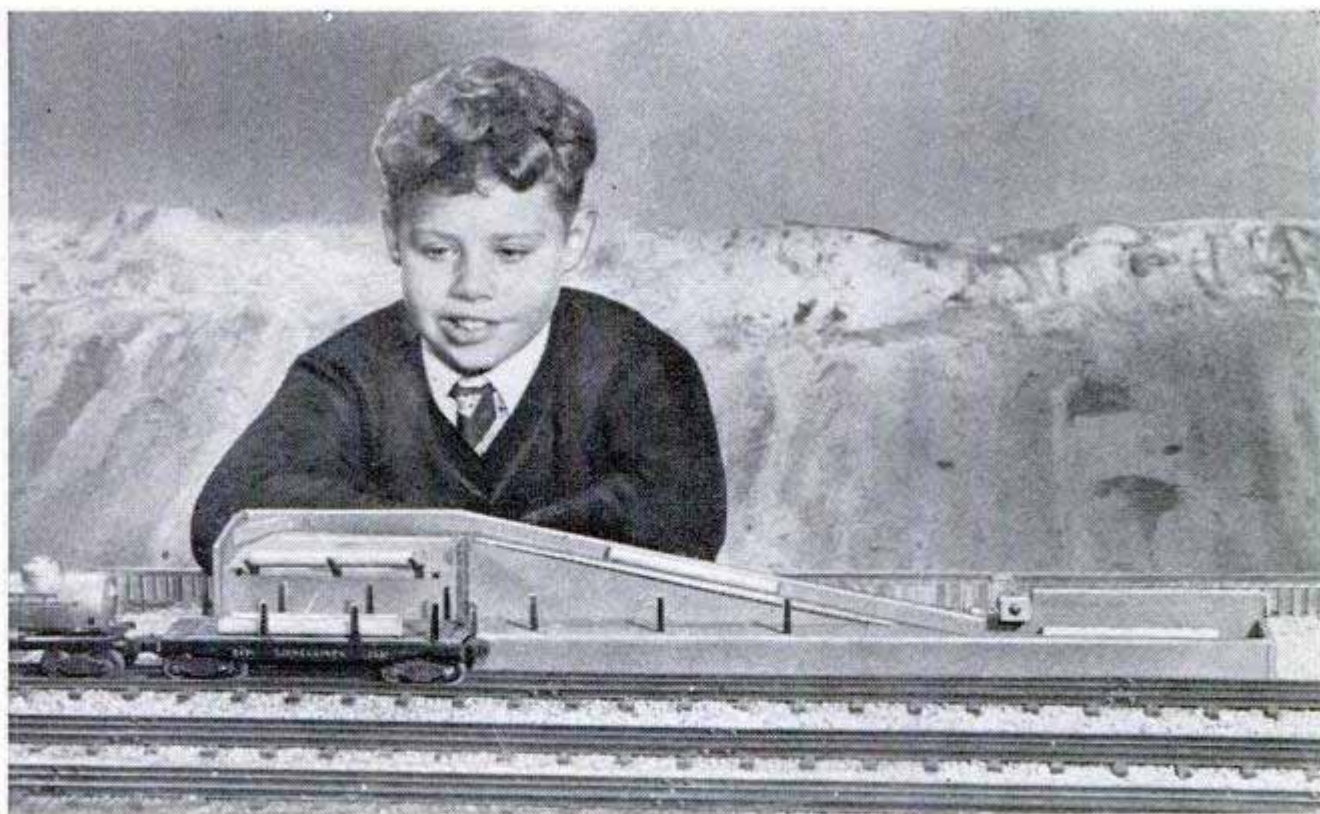

Completely automatic, a loader for model trains carries logs up a conveyor belt and rolls them on a flatcar standing on an adjacent track. The cars are automatically unloaded into a storage bin at the base of

the conveyor. The operation is started and stopped by remote control. The unit can be set up alongside one track, eliminating the need for sidings. An illuminated red-green signal lamp is built into the loader.





## Now They're Weaving HOUSES

What's happening on a hundred-acre tract in California may set a new style for home builders. The pencil-steel skeletons that frame these houses resemble bedsprings

By Ina Louez Morris

**T**HE steel panel-concrete dwellings being erected on the 100-acre subdivision known as Hughston Meadows, 15 miles east of Los Angeles, offer a new trend in home construction. Easy to construct, proof against rodents, fire, earthquake, dry rot, termites and sound, they cost no more than the conventional wood or stucco structure. Except for possible replacement of plumbing, there is nothing to wear out. Besides, the steel panel-concrete construction has the advantages of the ease in which plumbing, heating units and wiring can be installed and the availability at low cost of the light aggregates or furnace cinders which are used.

Any basic floor plan can be employed; actual building time is said to be half that of conventional construction.

The prototype house is shown at top. Two trained workers (left) set up the woven-steel framework in two days

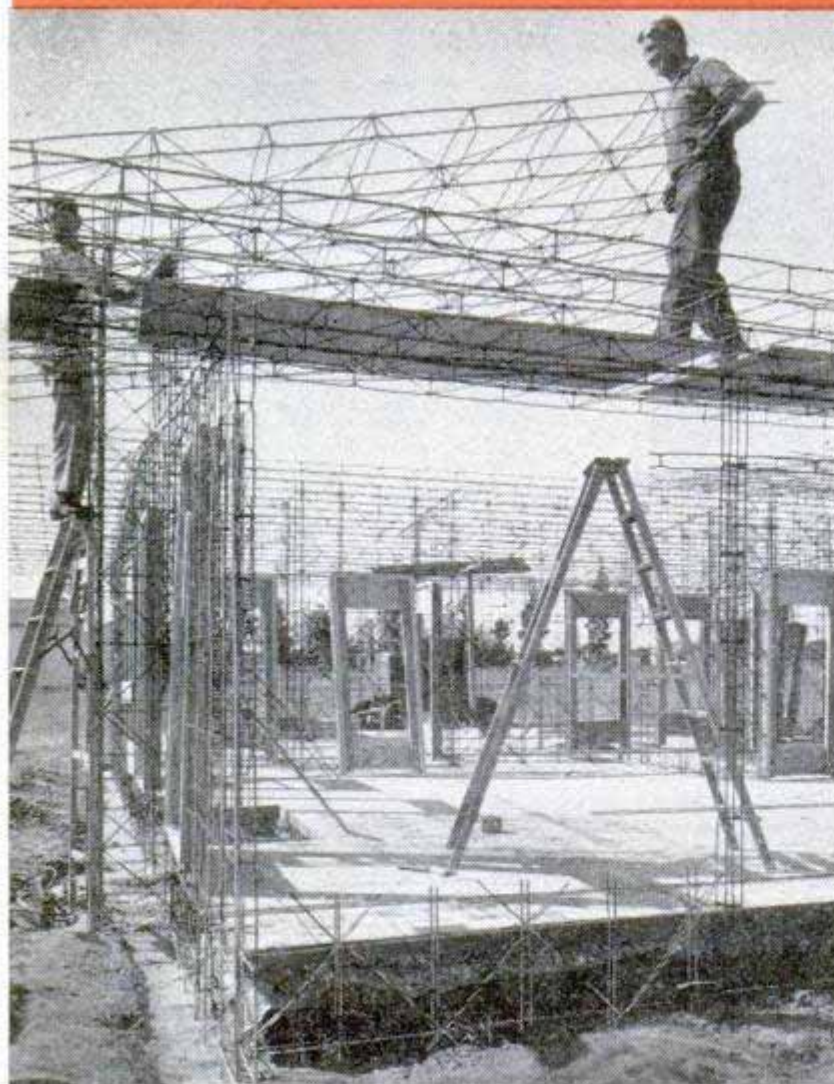



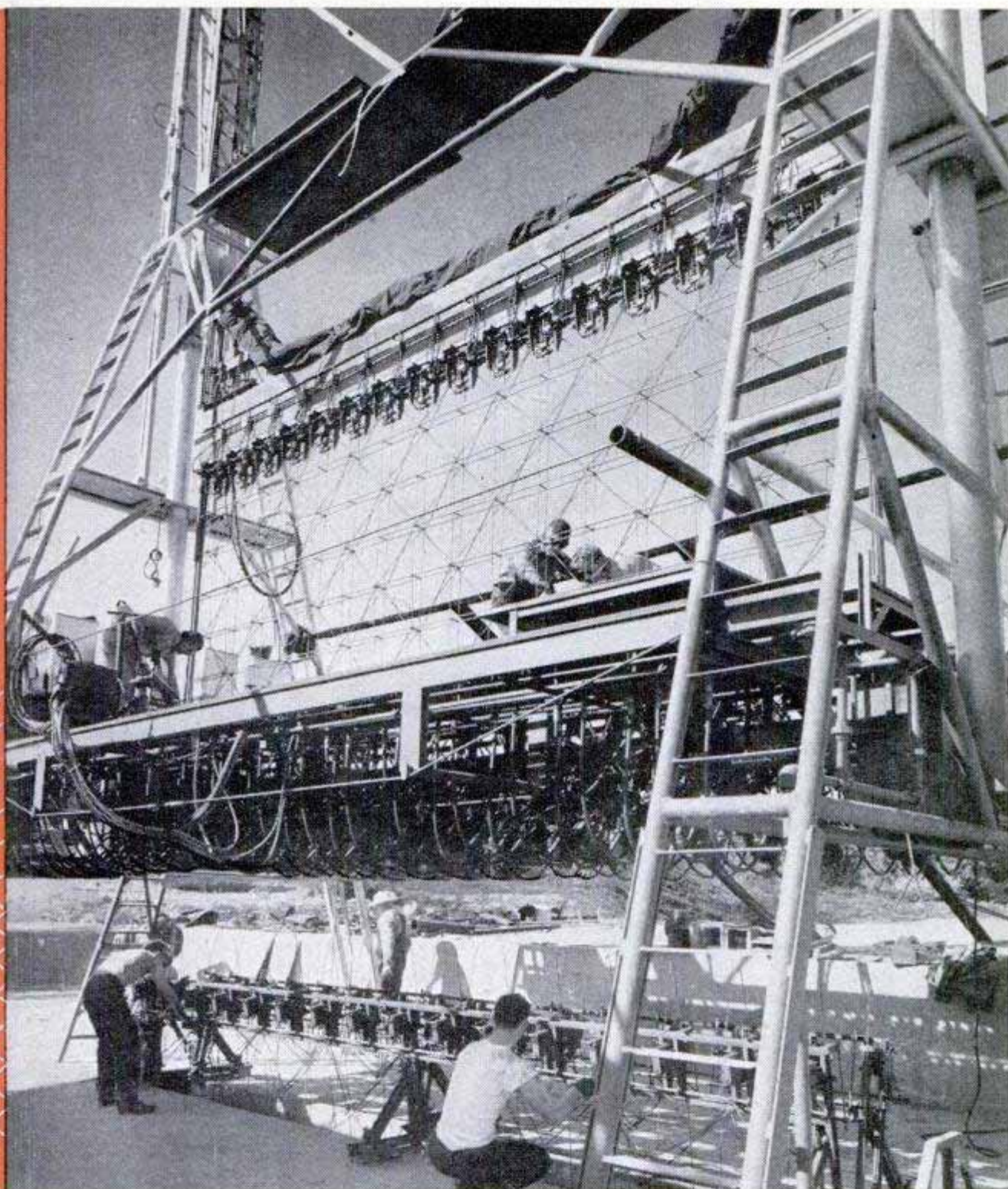

At bottom of photo, diagonals are being looped over steel frame. Studs will be drawn through diagonals and the whole then lifted by hydraulic power to the platform, where the cross sections are welded together

Fabricated, pre-stressed steel panels, manufactured from pencil steel, form the framework. The walls and roof of the first dwelling, shown here, are composed of a mixture of cement and light aggregate, although any lightweight material such as pumice, diatomaceous earth, desert cinders or coal-furnace cinders can be used.

The development evolved from a study of the use of pencil steel as a reinforcing agent. The Hughes brothers knew it had no equal, but how to cut, assemble and make it available to builders ready to set

up was the problem. The woven panel was the answer. Engineers were called in, and building of machinery for manufacture of the panels got under way as soon as men could be trained to operate the machines and handle material.

When sufficient panels for an ultramodern six-room house had been completed, erection of the "test" house began. First, the ground was waterproofed. Next came a layer of gravel and installation of sewer, water and radiant-heat water pipes. Over all went a three-inch cement slab.



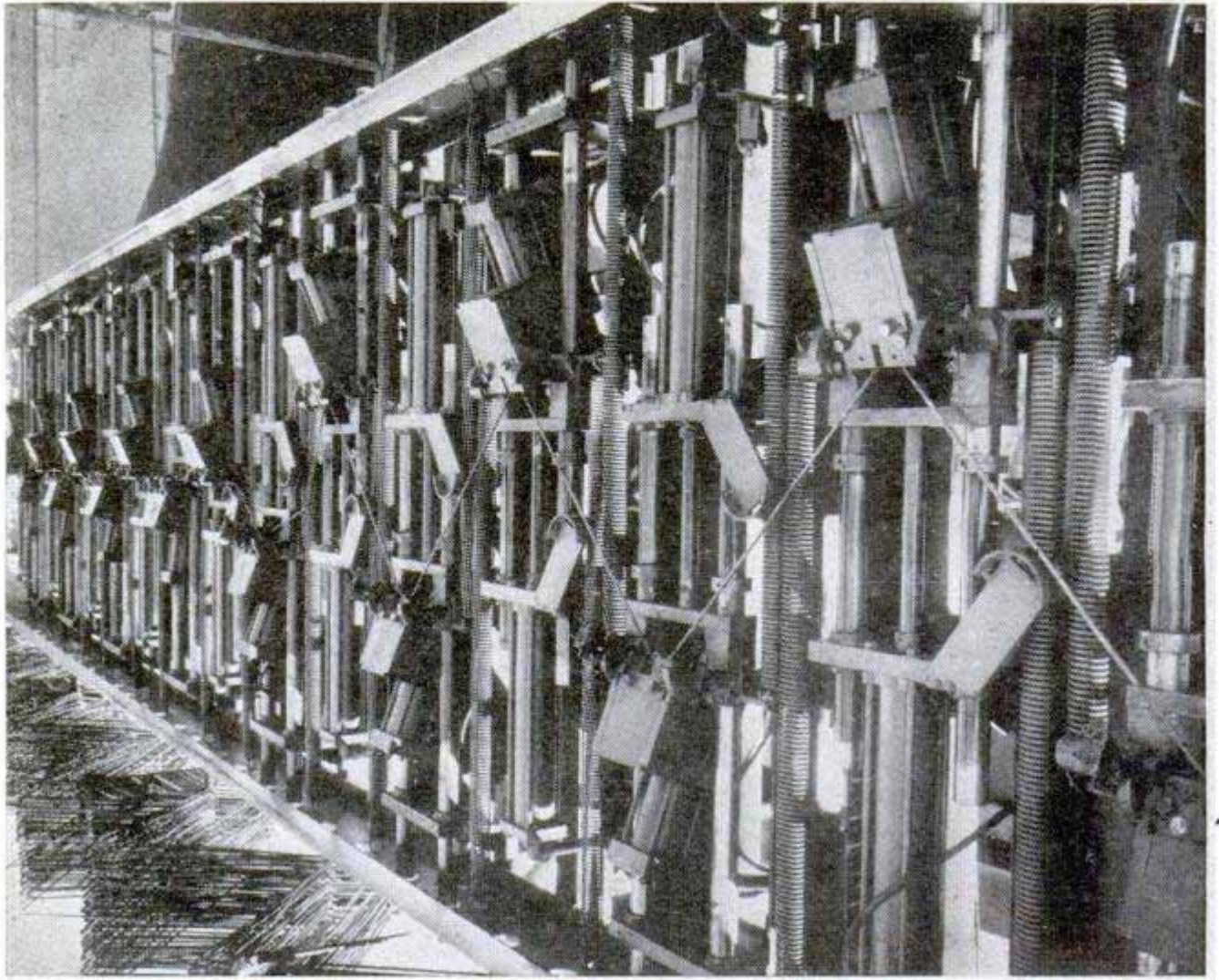

Rods are being formed on automatic diagonal machine from left to right, above; completed diagonals are shown stacked at left, ready for assembly. Below, the inventors, W. T. and J. N. Hughes, test rigidity of the steel panels sliding off assembling machines

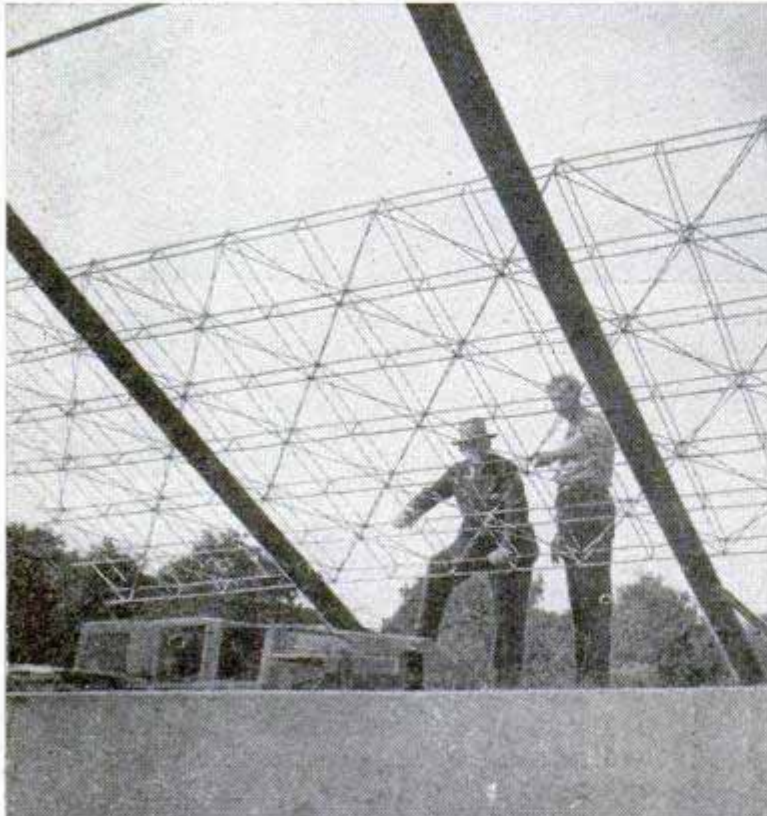

Into a trench, flush with the cement slab, the steel panels were then set, locked together, and 14 inches of cement poured to form the foundation.

Next came laying of the roof, cutting out of doors and windows, and installation of conduits. When door and window frames were mounted, plywood panels, 4x8 feet by  $\frac{3}{4}$  inch thick, were "buttoned" to the inside of the steel panels with a special clamp. Since these plywood panels can be used again, cost of this item is minimized.

After moistening the plywood panels, a Guniting operator "shot" concrete against the panels and over the steel frames to a depth of about two inches, then moved to the adjoining panel.

When the second panel was covered, the first was ready for another coat. Repeated applications followed, until the steel panel was completely covered; the finishing coat, one-eighth inch thick, is hand-applied.

The roof was made in the same manner as the walls, but the pan-



els were six inches thick, walls and partitions five. When the wood panels were removed, the inside walls, except for a light sanding, were ready for decorative finish.

Since all houses in the tract are to be air-conditioned, windows do not open, eliminating screens.

The house illustrated, with floor coverings, draperies, two-car garage and one-third acre lot, sold for \$20,000.

At present, the Steel Building Units Corporation, of which W. T. Hughes is president, is fabricating steel panels only for a few California projects. However, they plan to install plants along the Pacific Coast and throughout the East.

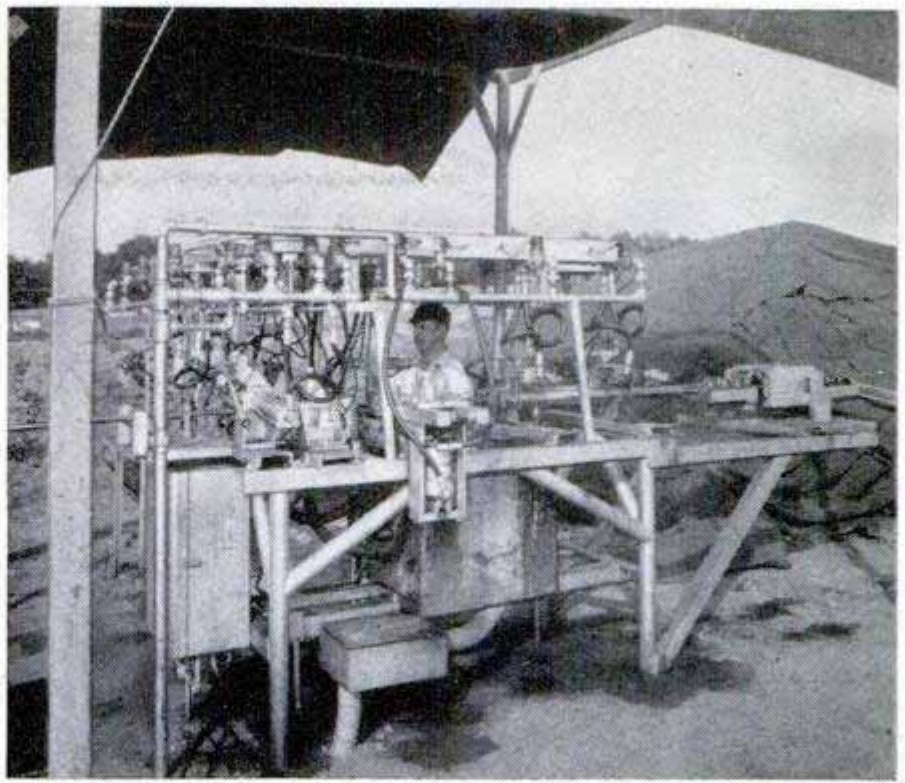

Pencil steel for framework passes from spools through the straightener

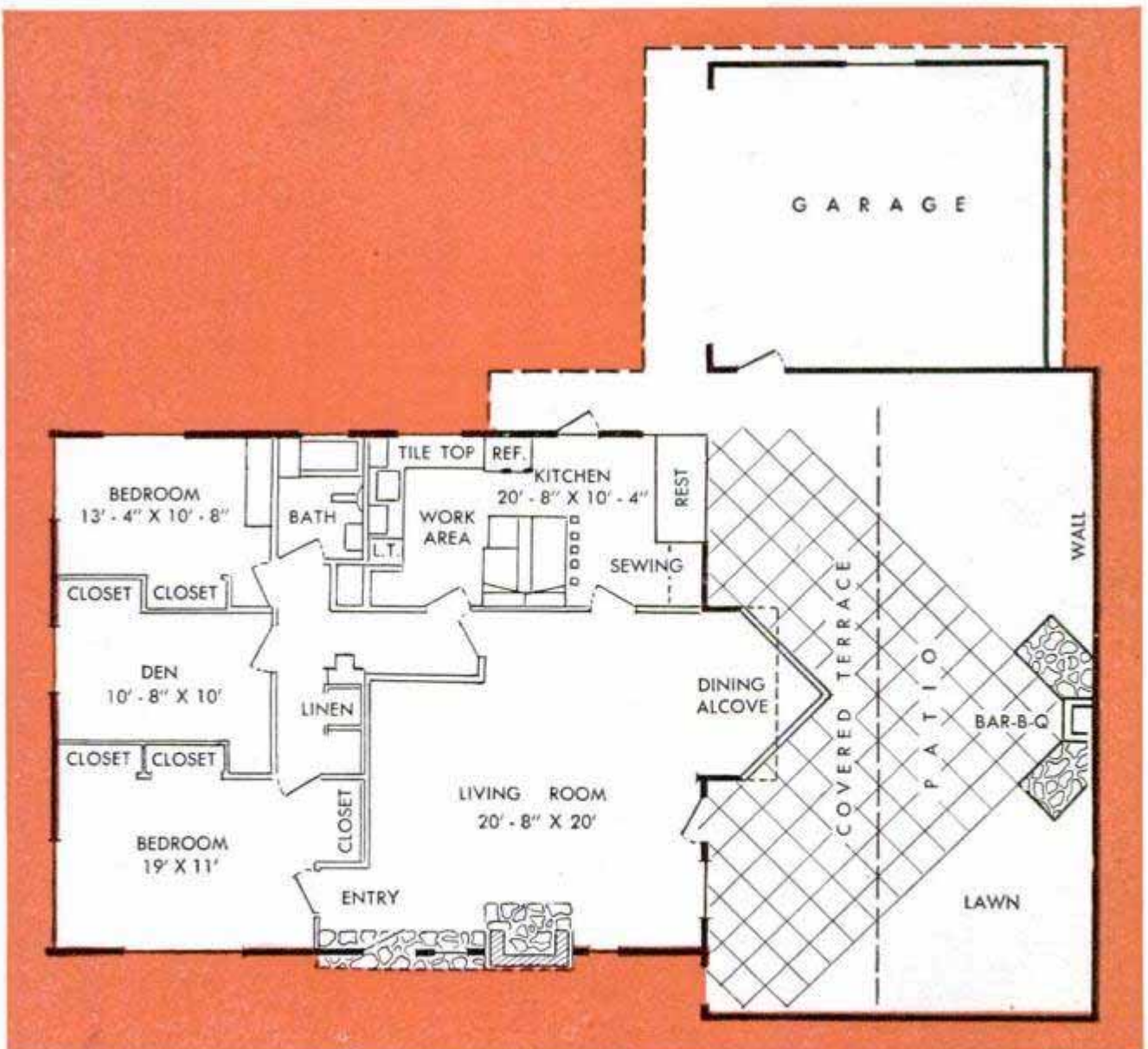





# HOLLY HARVEST



Photos by Richard Harrington

Holly growers on Vancouver Island, Canada, dip their crop in a special hormone bath for one minute. They claim it delays leaf and berry drop and makes the holly last much longer. Below, after sorting and drying, the holly is made into wreaths and studded with blobs of red-berried twigs. The trees are long-lived, some in England having lasted 400 years



By Lyn Harrington

**F**FIFTY YEARS ago holly was first offered on the commercial markets of Chicago and New York. Today, it is still the most popular Christmas green, providing an income of over a quarter-million dollars to the state of Delaware, alone.

Of 290 varieties in the holly family, the native American holly, *Ilex opaca*, is claimed to be the finest by residents on the Atlantic coast. But in Oregon, Washington and southern British Columbia, they all root for the shiny, spiny English holly, *Ilex aquifolium*. English holly thrives best where summers are cool, winters mild and the humidity high. Holly trees live to a great age. Some in England have been known to last 400 years.

There's a 12 to 15-year wait for a commercial crop. After all those years of cultivating, pruning, fertilizing and spraying, the grower gets perhaps 10 pounds of berried twigs. In another 10 years, the yield





To insure new crops, only second-year growth is clipped. It is collected in baskets and crated

should be double or triple that amount.

Young trees are set out in deep soil, 70 to 100 per acre, and intercrops may be taken off while they develop. The hollies have few enemies, all of which can be controlled by proper spraying. Dust alighting on damp leaves causes black spots, another source of worry to growers, so five miles per hour is top speed around a holly farm.

Small white flowers appearing in early summer change to green berries which become scarlet early in November. The leaves of most varieties remain green all year 'round. The holly harvest starts about the middle of November and lasts until mid-December. Only second-year growth is clipped, leaving terminal growth so there will be a crop the next year. The cut twigs are dropped gently into basket or sheets, crated and trucked to a packing plant where the sprays are swiftly sorted and the inferior holly is discarded.

All holly may look alike, but growers on Vancouver Island, Canada, figure their holly lasts at least twice as long because of the one-minute hormone bath they provide. It delays leaf and berry drop. The twigs drip dry and are then sorted and conveyed into a supply loft. Boxes and holly clippings are fed down chutes to the packers below who snip off any heavy leafless twigs that remain.

A perennial favorite is the holly wreath, studded with bright blobs of scarlet berries. Pinned and wired to a foundation of moss and cedar, the wreaths are always in great demand during the holidays.

## Photograph Cosmic-Ray Tracks

Navy researchers have made the first direct photos of cosmic-ray tracks above the earth's atmosphere. They were taken inside a V-2 rocket that climbed 98 miles at the White Sands, N. Mex., proving grounds. Every 25 seconds after the rocket left the ground, a gas-and-vapor mixture inside a glass cylinder was allowed to expand so quickly that liquid droplets condensed on any ions formed along the path of cosmic-ray particles. Twelve photographs of the droplet-traced tracks were made during the flight. The film cartridge was found six feet below ground at the bomb's impact point, 50 miles from the launching site.

## Batteryless Flashlight Weighs Only 2½ Ounces

Smaller than a pack of cigarettes, a batteryless flashlight is powered by a tiny built-in generator driven by an easy-to-operate plunger. Weighing 2½ ounces, the flashlight can be carried easily in pocket or handbag ready for use at all times. The standard bulb is not shielded, but exposed so that light rays illuminate a wide area when the light is operating.

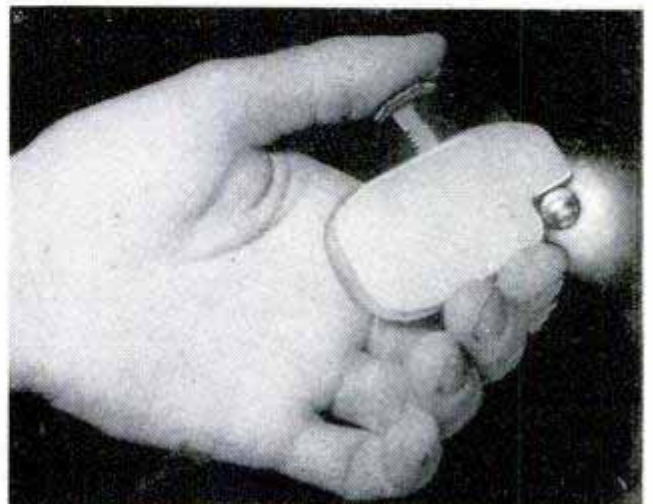
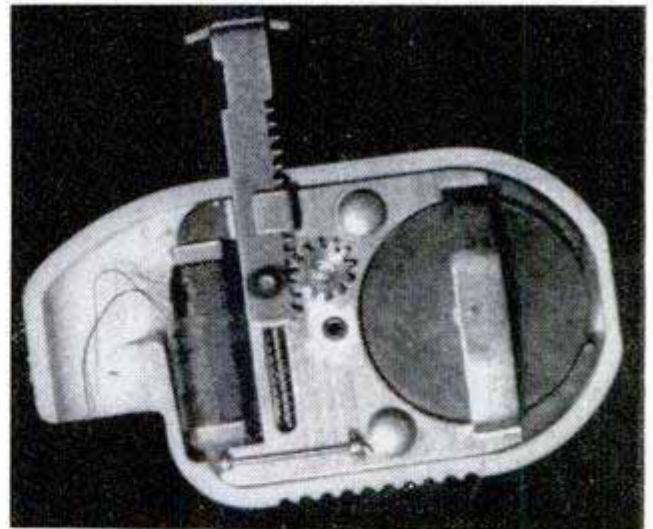



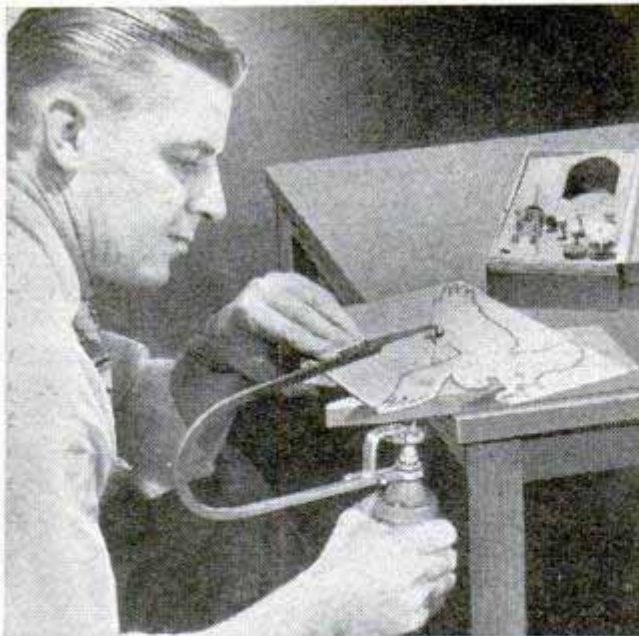

### Grinder Motor Powers Jigsaw

Intricate designs are cut quickly with a jigsaw attachment that is powered by the small motor furnished in a grinder set. The drive shaft of the motor is set in a ball bearing and moves the saw blade up and down by means of an eccentric cam. The saw will cut wood up to three quarters of an inch thick. It takes only a few seconds to attach the motor to the saw mechanism which is covered by a housing. When the saw attachment is removed, the motor can be used for grinding, drilling, buffing or other purposes.

### Two Isotopes From Atomic Pile Available for Research



Chemist carefully prepares a vial of rare tritium for shipment from the Argonne National Laboratory

Two new materials produced by an atomic pile are available in limited quantities for research. They are hydrogen-3 and helium-3, isotopes of the parent elements.

Hydrogen-3, also called tritium, is a radioactive gas with a half life of about 12 years. It is the only radio isotope of hydrogen and should be valuable as a tracer in medical and chemical research. Helium-3 may help scientists learn more about the helium nucleus.

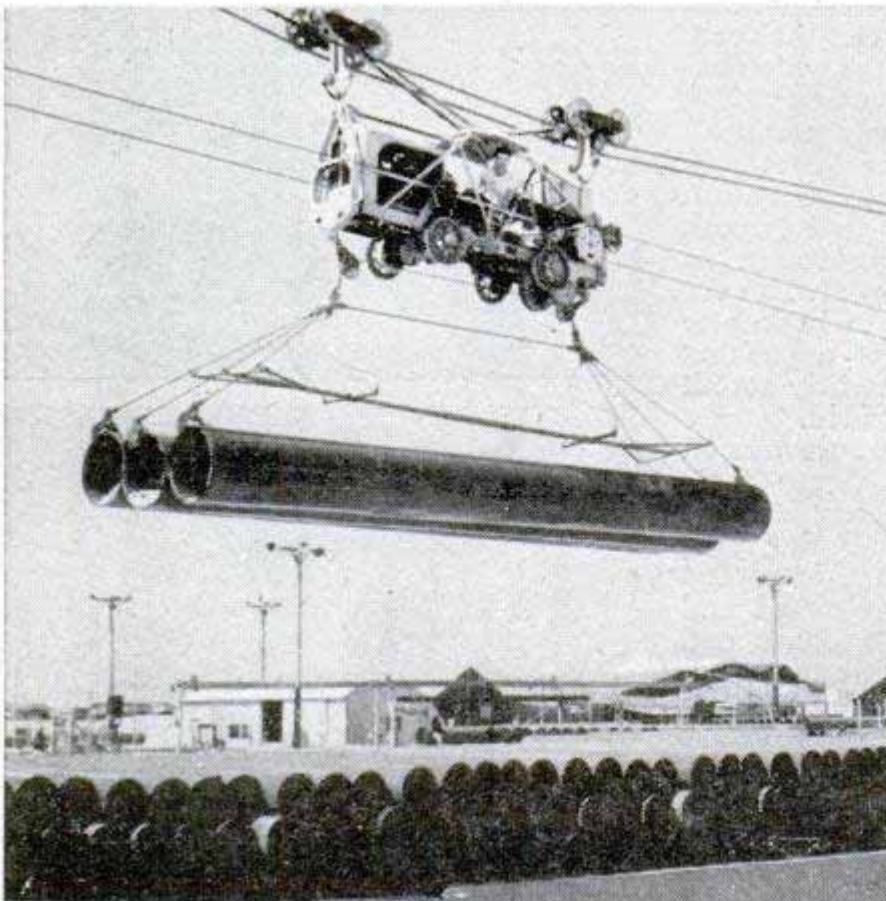

### Skyhook

Large sections of steel pipe are carried three miles through the air on a driver-controlled skyhook to a supply base in Saudi Arabia. The sky carrier moves the pipe from vessels to the base, completing each trip in five minutes. The pipe is for use in the trans-Arabian pipe-line project, designed to supply vitally needed oil for European industry.



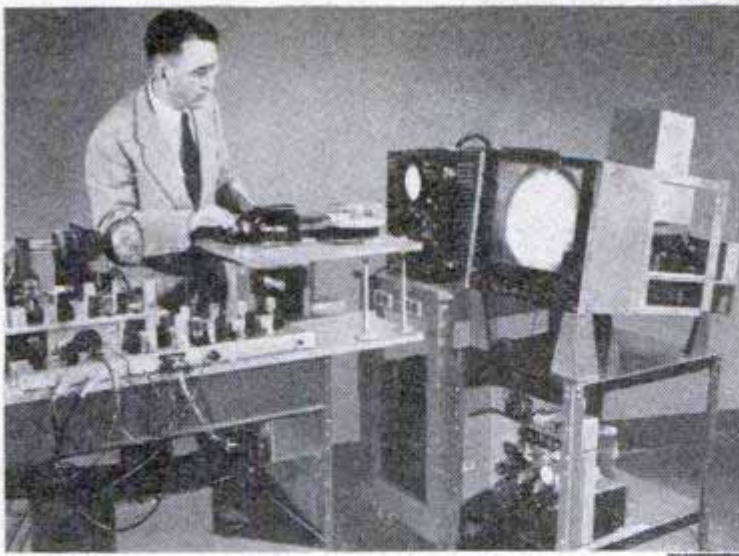

Film reel moves across table in front of scanner. Right, light from cathode-ray tube scans messages



## "ULTRAFAX" Sends a Million Words a Minute

Pages of information are transmitted as television pictures at a rate of 15 to 30 each second through a new communication system called "Ultrafax." The system, developed by RCA, makes it possible to transmit a million words a minute. The information must first be recorded on a reel of microfilm. As the film passes through the transmitter, a "flying spot" scanner converts

the image into a television picture, which is sent out as a radio signal. A television receiver projects the message on motion-picture film or directly on photographic paper. The film can be developed, fixed and dried within 40 seconds in a special processing unit. Graphic material including charts, fingerprints, maps and advertising layouts can be transmitted by the system.

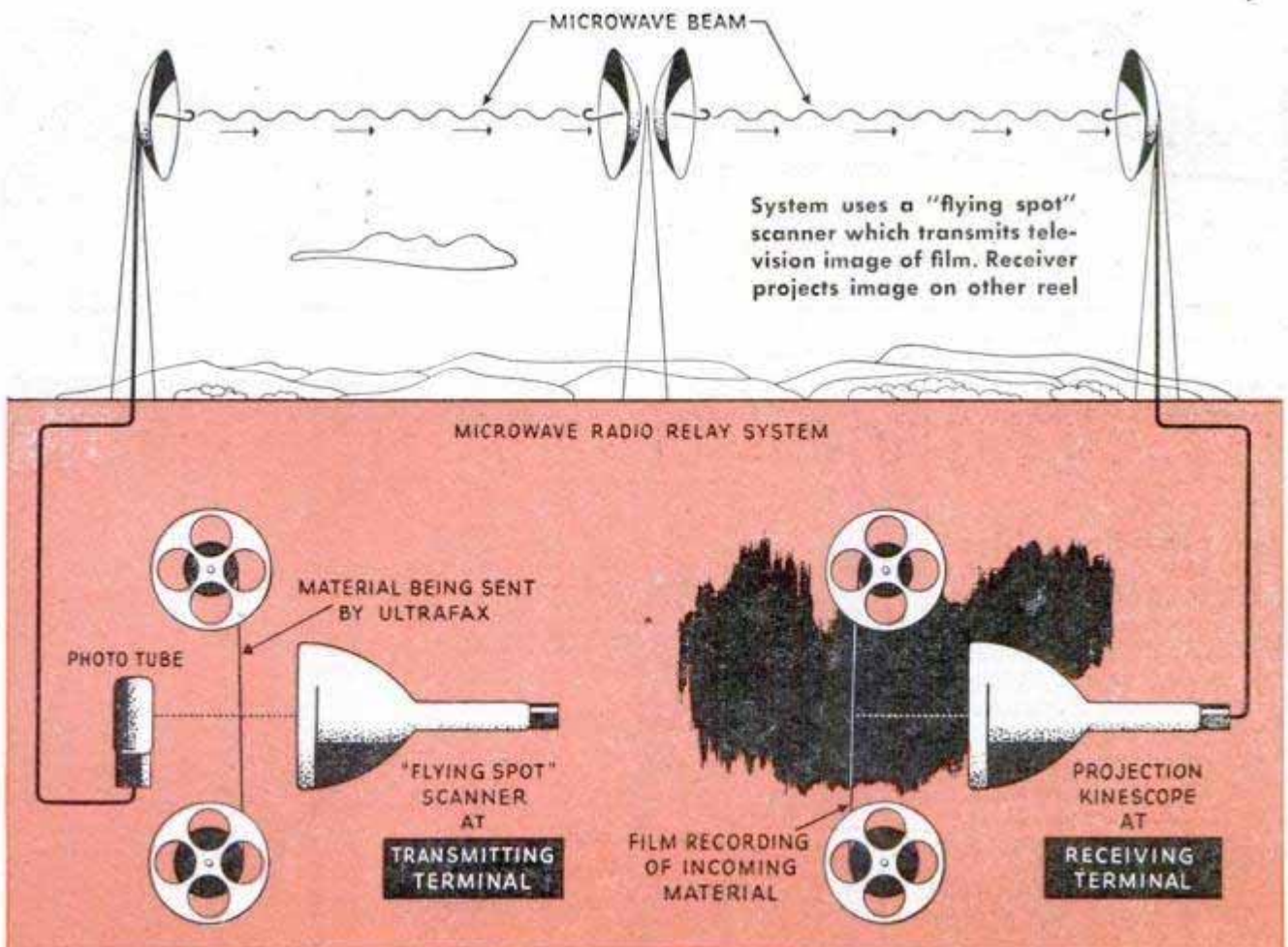



# rocket-borne camera

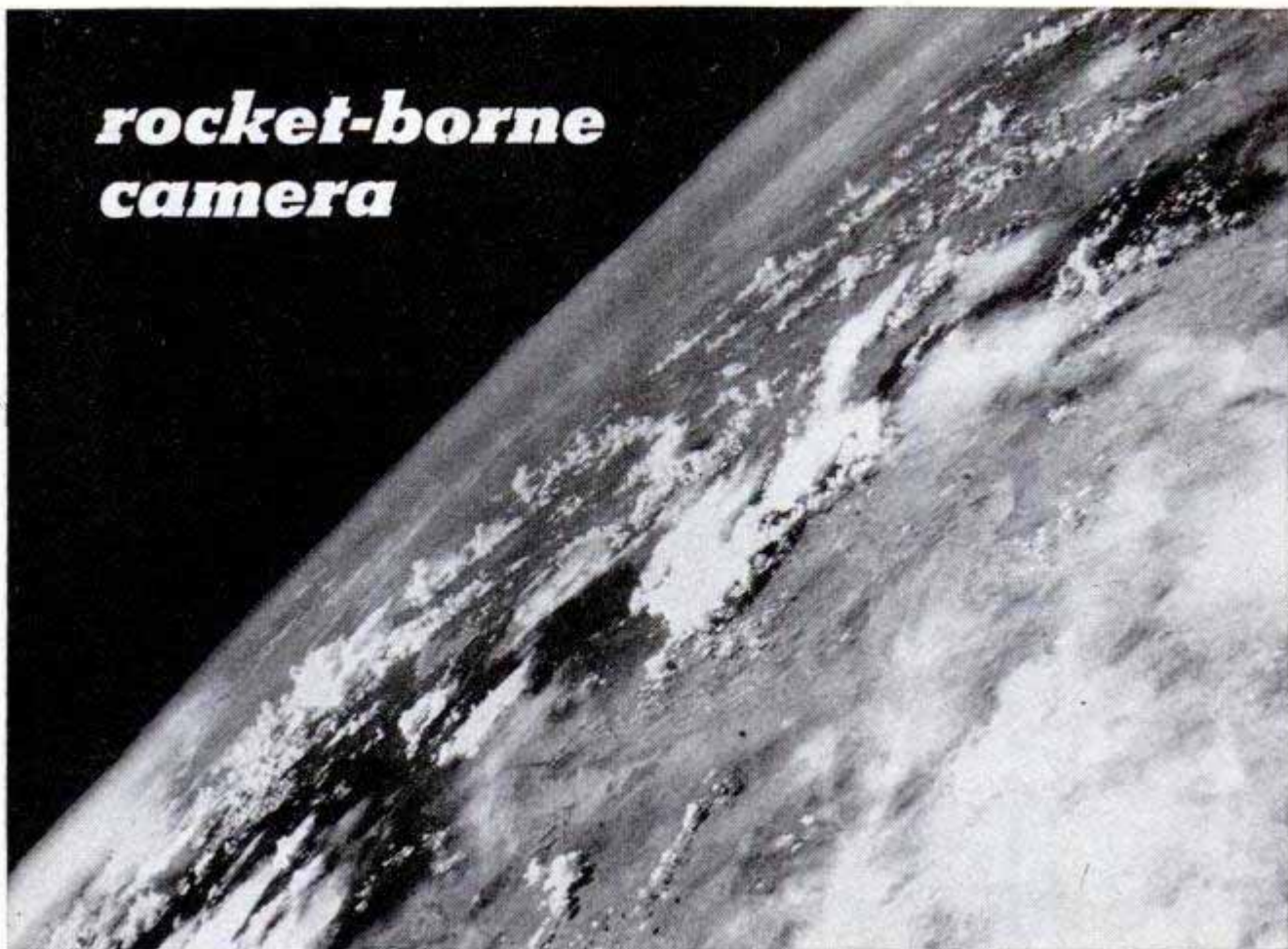

Photograph snapped from Aerobee rocket at a height of 57 miles plainly shows the curvature of the earth

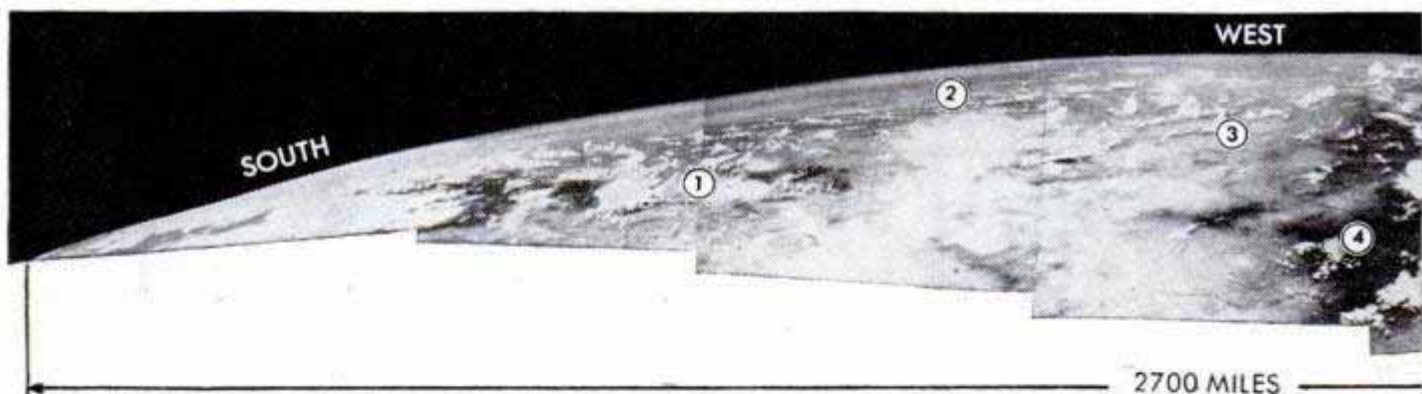

U. S. Navy-Johns Hopkins (APL) photos

Right, mosaic from Aerobee rocket shows: 1, Mexico; 2, Texas; 3, Rio Grande River; 4, El Paso, Texas; 5, Southern Pacific Railroad; 6, rocket-launching site; 7, White Sands National Monument; 8, Air Force Base; 9, Sacramento Mountains; 10, lava beds; 11, first A-bomb test site; 12, Albuquerque, N. M.

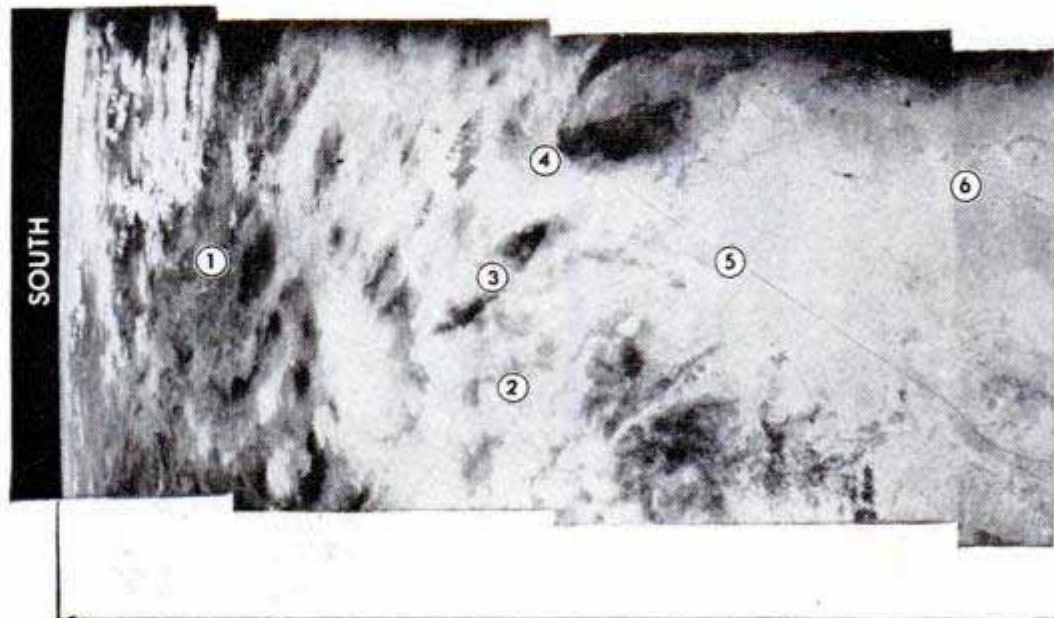



**C**AMERAS installed in rockets zoomed more than 60 miles above the earth recently, clicking off a photograph every 1½ seconds to record on film huge land areas of western United States and northern Mexico. The rockets, one a Navy Aerobee and the other a German V-2, were launched within 76 minutes of each other at the White Sands Proving Grounds, N. Mex.

The Aerobee rocketed upward at a speed of 2700 miles an hour, reached a peak altitude of 70 miles and then dropped about 40 miles before an explosive charge was fired by radio to blow off the tail section, thereby making it possible to recover the camera. When the photographs were found, developed and mounted, the resulting mosaic showed a strip of terrain about 1400 miles in length stretching from upper Wyoming to deep into Mexico. The total area photographed was approximately 300,000 square miles.

The V-2 was spinning slowly as it reached its peak, slightly over 60 miles. The camera lens looked out at right angles to the rocket's axis, sweeping the horizon.



Camera at left was in the V-2, the other in the Aerobee rocket. Neither of the cameras was badly damaged in the desert crash

The mosaic made from these photographs shows a land area of 800,000 square miles. Shutter speeds of 1/500 second with an aperture opening of f:8 were used in taking the photographs. Despite the rocket's speed, the pictures are clear. They show the curvature of the earth, mountains, rivers, highways, railroads, airfields and cities.

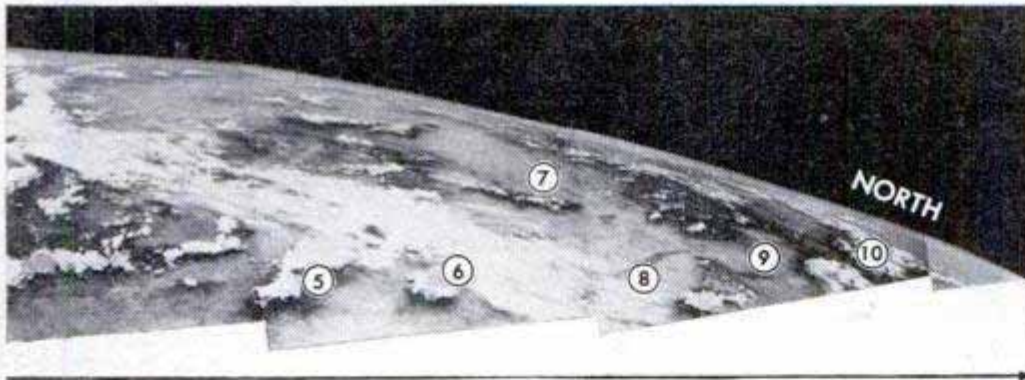

← Mosaic from V-2 photos shows: 1, Mexico; 2, Gulf of California; 3, Gila River; 4, Mogollon Mountains; 5, San Mateo Mountains; 6, Magdalena Mountains; 7, Mount Taylor; 8, Albuquerque, N. Mex.; 9, Rio Grande; and 10, Sangre de Cristo Range

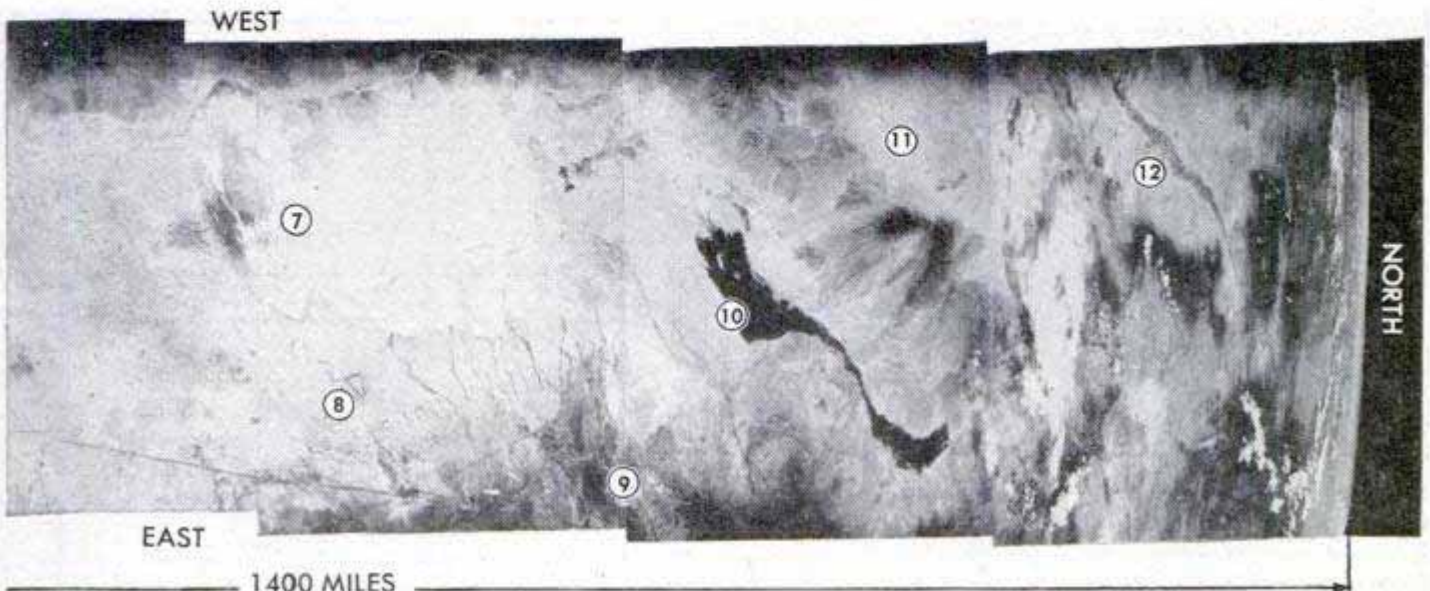



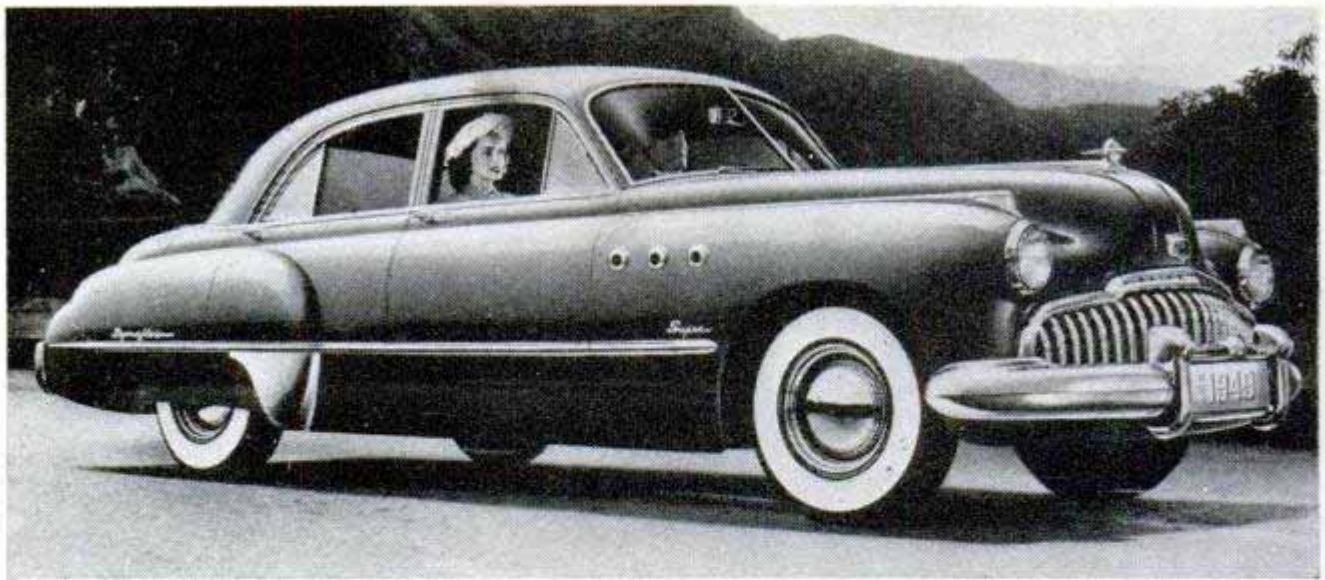

## Debut for the '49 Buick—Dynaflow for Supers

Complete new styling, Dynaflow torque-converter transmission for the Super as well as Roadmaster, and hydraulic valve lifts are outstanding features of the 1949 Buick line. The sedans have 22 percent greater visibility with a total of 25 square feet of glass area. The valve-in-head straight-eight engine is retained in all models with 110 horsepower in the 40 Series (Special); 115 horsepower in the conventional-transmission 50 Series (Super), and 150 in the 70 Series (Roadmaster). The

Supers with Dynaflow are upped in horsepower to 120. Front seats are wider in the Super and Roadmaster models and new footrests, incorporated into the floor instead of the back of the front seat, assure full leg room. The wheelbase of the '49 Super (121 inches) is three inches shorter than the '48 model and the '49 Roadmaster wheelbase (126 inches) is also three inches shorter than previous models. The Dynaflow transmission will be standard on the '49 Roadmasters and optional on Supers.

## Chemical Mixed With Ice-Melting Salt Reduces Corrosion of Cars



Research worker inspects the damage to a 12-year-old Akron car. Salt used to melt winter ice on city streets corroded the car's fender. After a chemical was added to the salt, 96 percent of the autos driven one winter showed no corrosion.

Corrosion of autos from the salt used to melt ice and snow on city streets can be reduced by adding sodium dichromate to the mixture, according to the results of an experiment conducted in Akron, Ohio. Salt corrodes fenders and bodies and may be trapped in body joints, resulting in summer corrosion every time the car becomes wet. About two parts of sodium dichromate are added to 100 parts of salt to make a snow-removal mixture that has little corrosive power. The mixture has no harmful effects on synthetic or natural-rubber tires according to Goodyear chemists, who made the Akron survey.

You may wish to obtain additional information about the new products described monthly in Popular Mechanics. Should you want to know the name and address of manufacturer or distributor, write Bureau of Information, Popular Mechanics Magazine, 200 East Ontario Street, Chicago 11, Illinois



# Floating Rocket Launcher



Above, a stern view of the Norton Sound, Navy's floating rocket launcher, showing adjustable launching racks on afterdeck

Right, the rocket-launching racks. Below, forward deck of ship has a landing platform for helicopter. Ocean-going lab will be used by all branches of Armed Forces

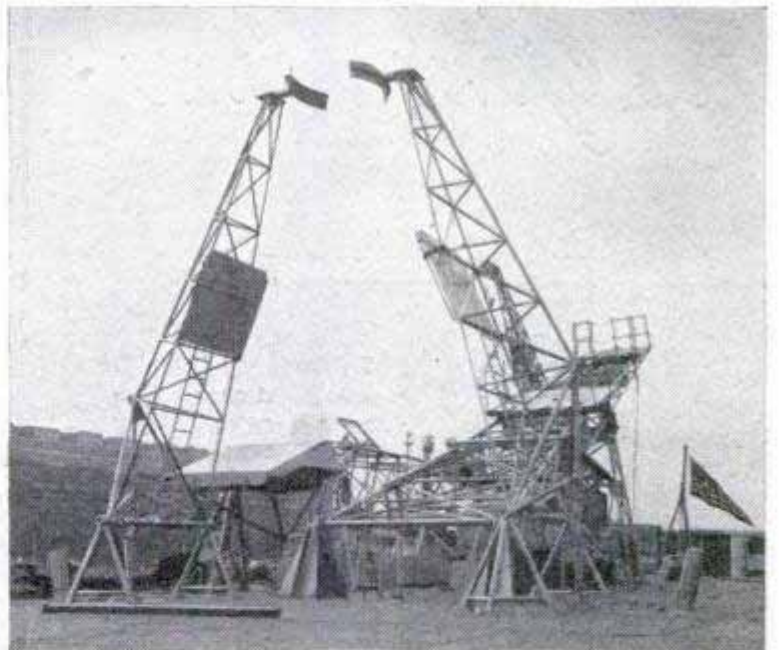

Like a colossal fireworks barge, the Navy's floating rocket laboratory, the USS Norton Sound, will launch giant rockets, including the 14-ton V-2s, into the skies over the Pacific. Once a seaplane tender, the ship was modified to withstand the hot blasts of the projectiles. Its helicopter will recover instruments from the rockets after they have fallen harmlessly into the sea. The crew will track the rockets by radar and will receive automatic broadcasts from rocket-borne radios.





**TWO-SPEED MIXER** enables you to shift into low for thick batters and into high for thin mixtures

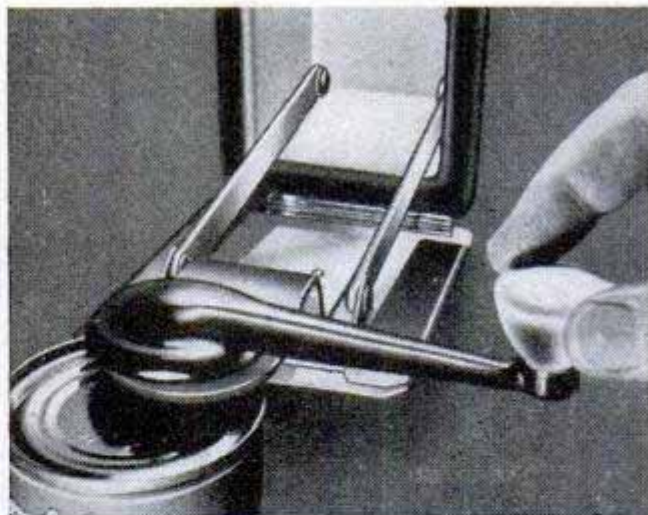

**CAN OPENER** folds back into a wall recess when not in use, out of sight behind a flush panel. Cutter removes the lid from the side



**DOUGHNUT MAKER** eliminates rolling and cutting. You pour batter in base of utensil, doughnuts are formed as you push plunger

## WHAT'S NEW *For Your Home*



**POTATO MASHER** with a double action has two sets of cross rods. They are forced together with each downstroke, squeezing "spud" thoroughly

**NUT SHELLER** enables you to remove the nut meat undamaged. It "bites" off the ends and sides of the shells, releasing the meat

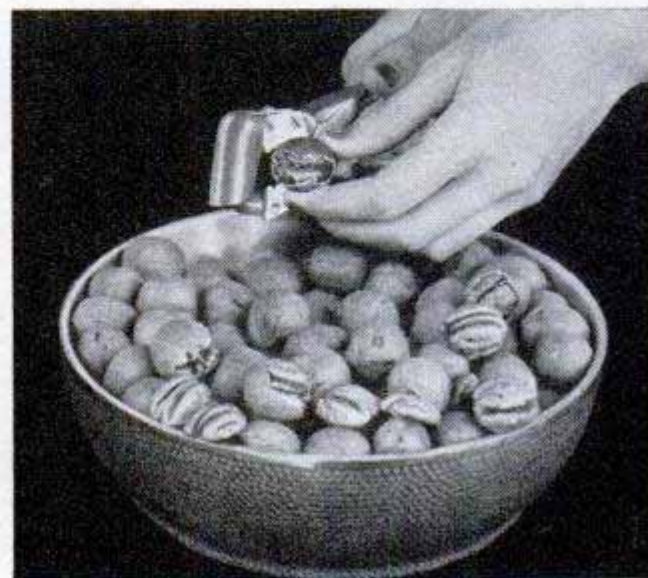





**ICE BUCKET** consists of two separate bowls with airtight covers. The Bakelite-plastic bowls nestle together, forming an insulated bucket for ice cubes

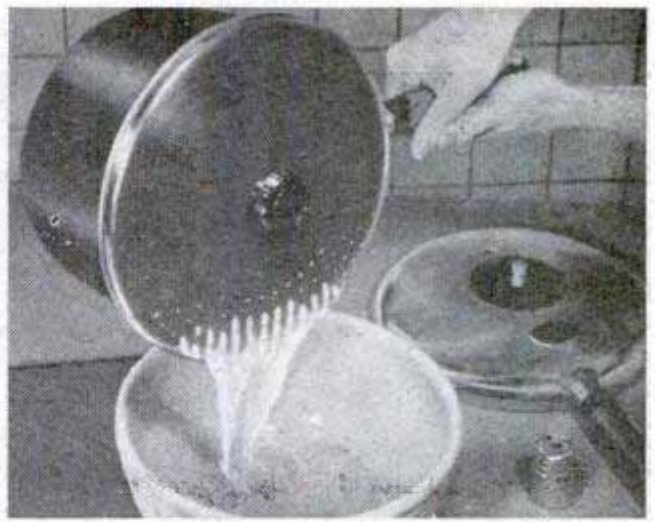

**COLANDER COVER** for pressure cookers locks in place and lets you pour off hot liquids without the danger of splashing. It's made of polished aluminum

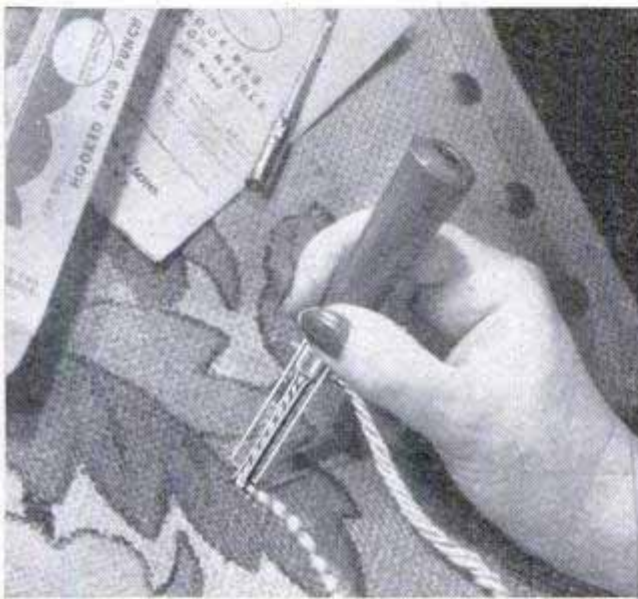

**PUNCH NEEDLE** for making hooked rugs is as easy to use as a pencil. Punching needle through burlap forms an even half-inch pile

**ADJUSTABLE STOPPER** for bottles fits a wide variety of openings. One model is for vacuum bottles; others for various beverage bottles

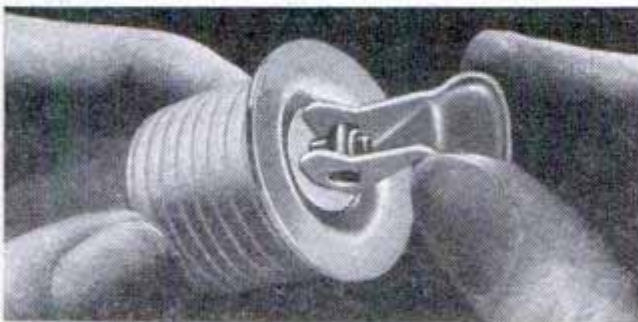

**NAILLESS HANGER** holds up to 10 pounds by adhesive action of its backing material. It can be used on tile, glass, plaster or papered walls

**JUNIOR CLOTHES ROD** for children provides two levels for the tiny clothes. The lower level enables youngsters to hang up their own garments











# Navy's 65,000-Ton Carrier To Be the World's Largest Warship



Official U. S. Navy photo

Officially released artist's conception of Navy's giant plane carrier reveals a clean operating deck, minus usual "island" on starboard side. Below, comparison of \$124,000,000 supercarrier with its predecessors

	YEAR COMMISSIONED	STANDARD DISPLACEMENT TONS	OVER-ALL LENGTH FEET	BEAM WATER LINE FEET
 LANGLEY	1922	11,050	542	65
 LEXINGTON CLASS	1927	33,000	888	112
 RANGER	1934	14,500	769	80
 YORKTOWN CLASS	1937	19,900	827	95
 ESSEX CLASS	1942	27,100	872	93
 MIDWAY CLASS	1945	45,000	968	113
 LATEST CARRIER		65,000	1090	130

There'll be no "island" on the world's largest warship — a 65,000-ton aircraft carrier to be built for the U. S. Navy. Command bridges, formerly on the island, will be telescopic. In addition to allowing more space for planes, the flush deck will make the ship less easy to detect. It will be 1030 feet long, have a maximum width above the water line of 190 feet, and be capable of handling planes weighing well over 100,000 pounds. Elevators to transfer planes between the hangar and flight decks will be along the sides and there will be four plane-launching catapults. The additional catapults, one at each side and two on the bow, will shorten the plane-launching interval. The carrier's top speed will be about 33 knots. Costing \$124,000,000, the warship is expected to be completed in less than four years. The new carrier, following the trend of bigger and bigger ships, will be too wide to navigate the Panama Canal.





### Plane for Family Trips Built Like a Limousine

Newest addition in the family-plane field is the four-place, all-metal Silvaire Sedan with an interior as luxurious as a fine automobile. The new monoplane has a top speed of 140 miles an hour and a service ceiling of 17,000 feet. It has a 38-foot wingspan and weighs 1340 pounds empty. Among its accessories are landing lights, prop spinner, ash trays with individual lighters and four ventilators. Its range of 500 miles makes it ideal for taking the family on cross-country trips.

### Trailer-Tent Sleeps Four Under Double Roof

Inside a camping unit designed in Italy are sleeping accommodations for four, a table and chairs, and a double tent roof for insulation. The equipment folds into a small trailer and can be set up in less than a half hour. Hammocks are slung between uprights to form beds for two campers. The outfit sells for about \$1200.

### Table-Tennis Balls Aid Tuberculosis Patients

Lucite table-tennis balls are helping tuberculosis patients back to health and in a way far removed from their primary purpose. The balls, sometimes as many as 100 of them, are placed in the patient's chest. They hold the diseased lung collapsed and prevent the chest from caving in as it often does under usual methods.





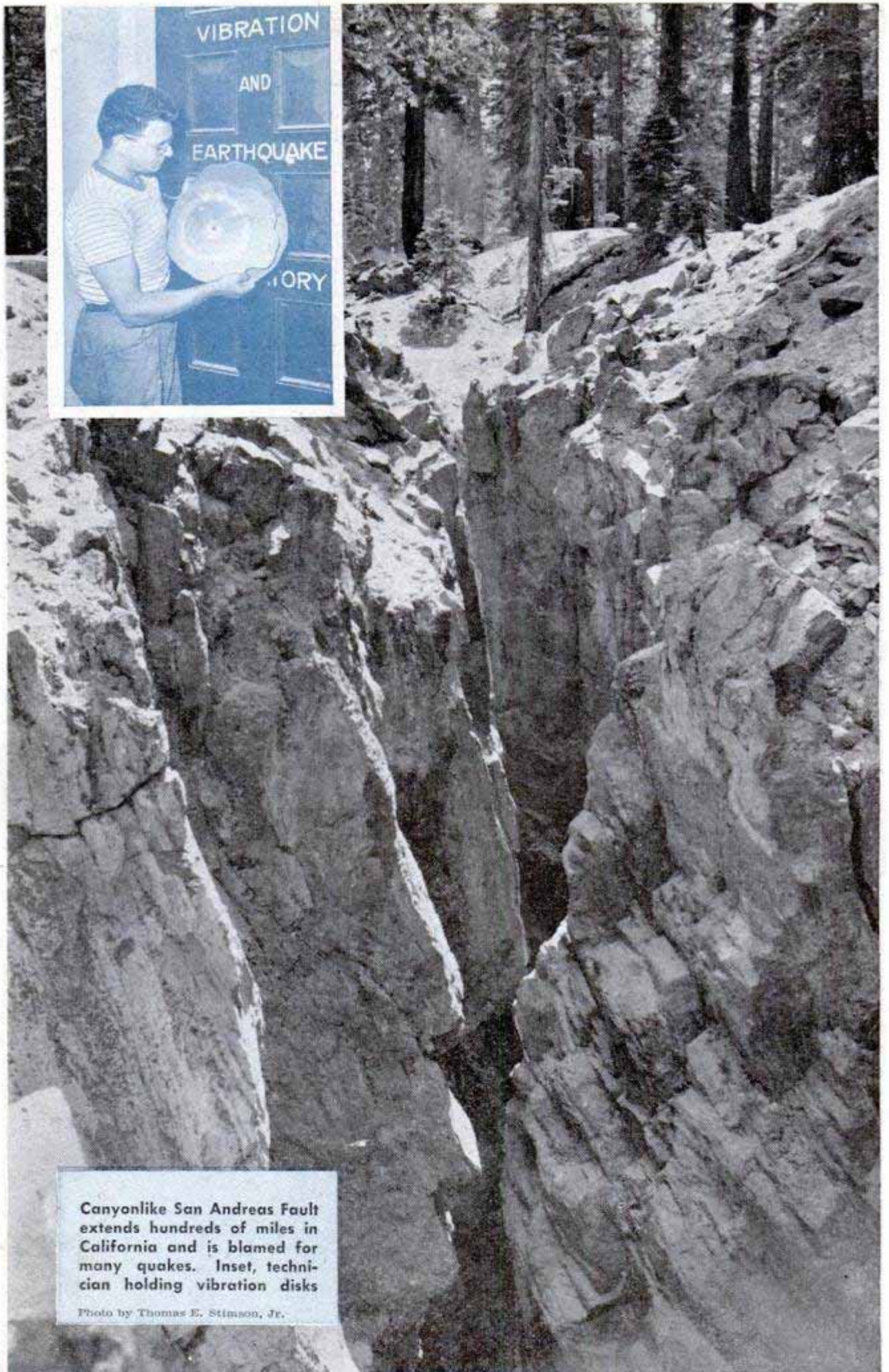

**Canyonlike San Andreas Fault extends hundreds of miles in California and is blamed for many quakes. Inset, technician holding vibration disks**

*Photo by Thomas E. Stimson, Jr.*



# WARNING: EARTHQUAKE AHEAD

**How soon and where will it strike? No one can forecast with certainty, but a California laboratory tells how to prepare for the next one**

CALIFORNIA is getting ready for its next major earthquake. Millions of dollars' damage will be done if the quake occurs in a metropolitan area. Depending partly on the time of day, several persons, or several hundred, may be killed.

The disaster may strike today or tomorrow or it may not happen for decades. There is no way of predicting an earthquake, except in the words of Dr. Bailey Willis, 91-year-old earthquake expert of Stanford University. Dr. Willis says: "There is just one sure thing about earthquakes—the farther you are from the last one the nearer you are to the next one."

Based in part on this reasoning, at least one insurance company has drastically raised its rates for coverage against earthquake damage and has stopped soliciting new business. Earthquakes of strong or moderate intensity seem to happen along the West Coast every couple of years, usually in sparsely populated areas. Not since 1933, when Long Beach and much of Los Angeles County were shaken severely, has a strong temblor occurred in a built-up area. To keep property damage and loss of life at a minimum when a big shake comes, California towns and cities have strengthened their building codes to help make all new structures comparatively safe. Once it was thought that buildings which could withstand a strong wind were also earthquakeproof. Now it is understood that wind load is proportionate to

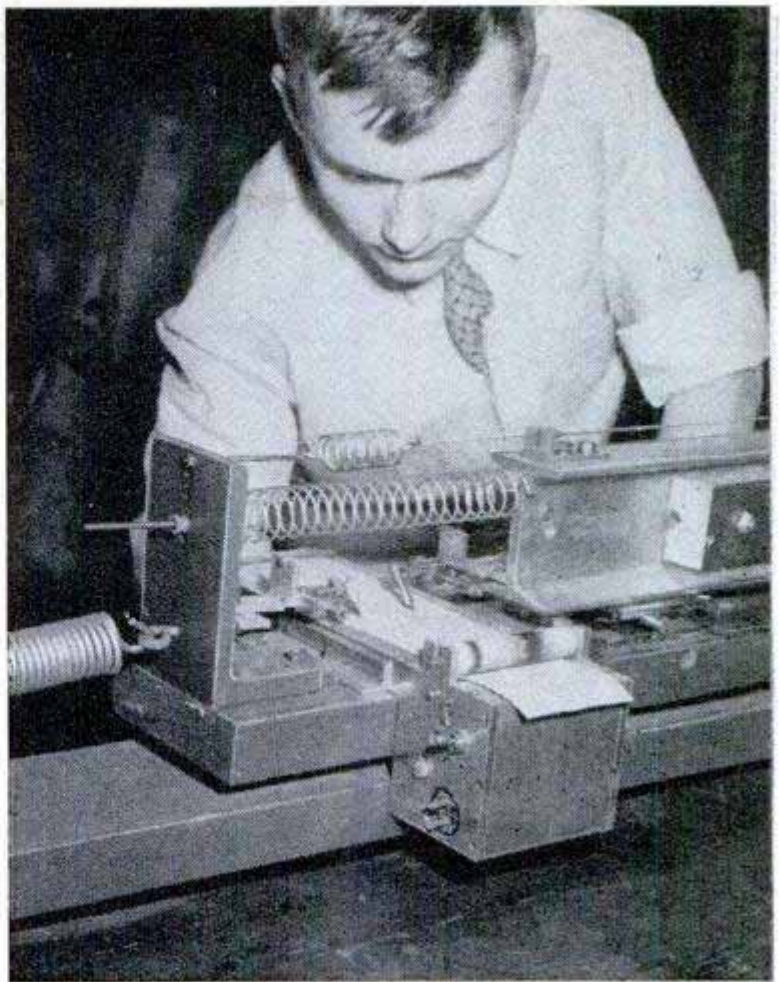

Above, models are tested for resistance to earthquakes with miniature seismograph in Stanford University laboratory. Below, a model is shown on platform where it is shaken by a "quake" machine. Motion is same as recorded in real quakes

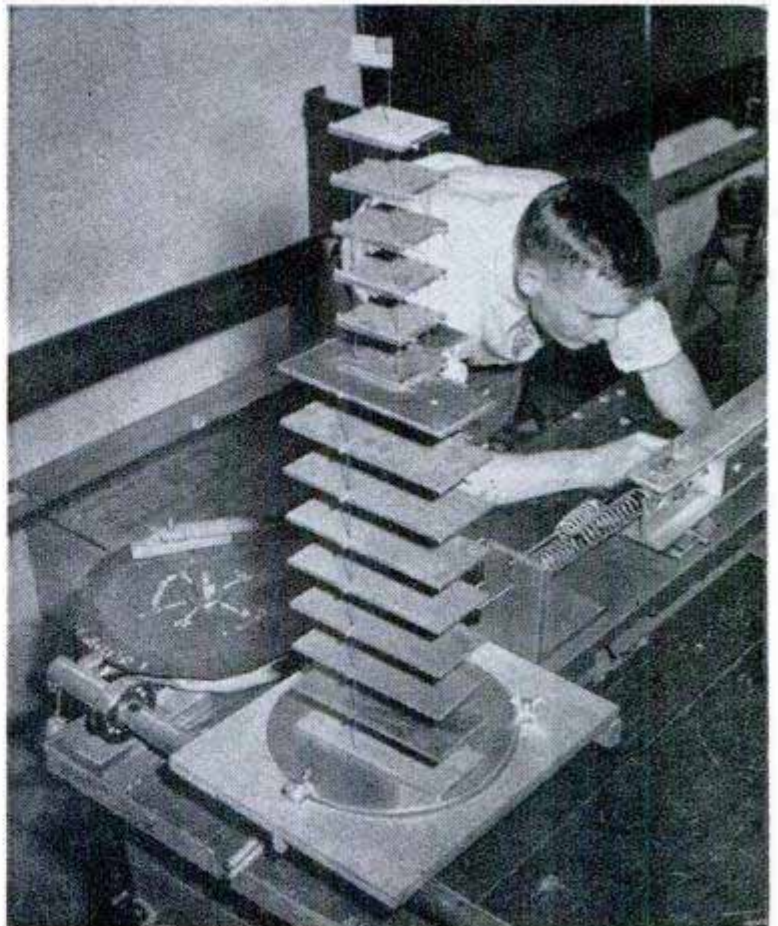



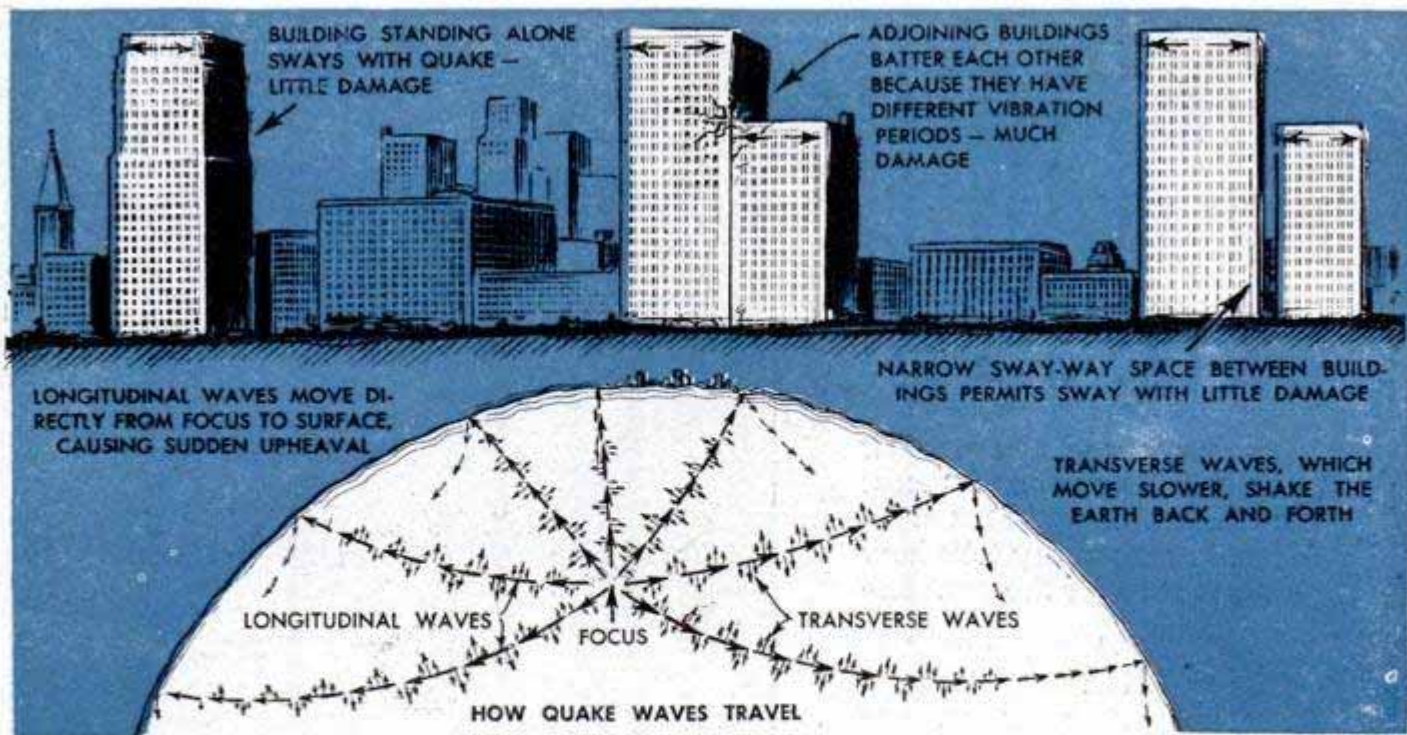

the exposed area of a building, while earthquake load is proportionate to the weight of a building and building-code requirements are rewritten to comply.

Meanwhile, numerous older buildings have been overhauled and strengthened. Cornices and parapets that might be jarred loose have been reinforced or removed. Marquees that overhang sidewalks have been strengthened. Large advertising signs on the tops of buildings have been rebuilt. Water tanks, fuel tanks and swim-

ming pools on roofs or in upper stories are provided with stronger foundations.

Some of these precautions have resulted from experiences in past earthquakes, some are based on research performed at such centers as the Vibration and Earthquake Laboratory operated by Stanford University.

There, under the direction of Dr. Lydik S. Jacobsen, head of the department of mechanical engineering, suitably designed scale models of buildings and other structures are shaken and vibrated to determine what happens to them when an earthquake occurs. For some types of research, a model of a multistory building is placed on a heavy metal platform and the platform is struck a powerful side blow by a weighted

Left, Dr. Lydik S. Jacobsen preparing scale model of multistory building for shaking test. Dials are at every floor level. Below, technicians assemble a "strong motion" accelerograph for heavy quakes

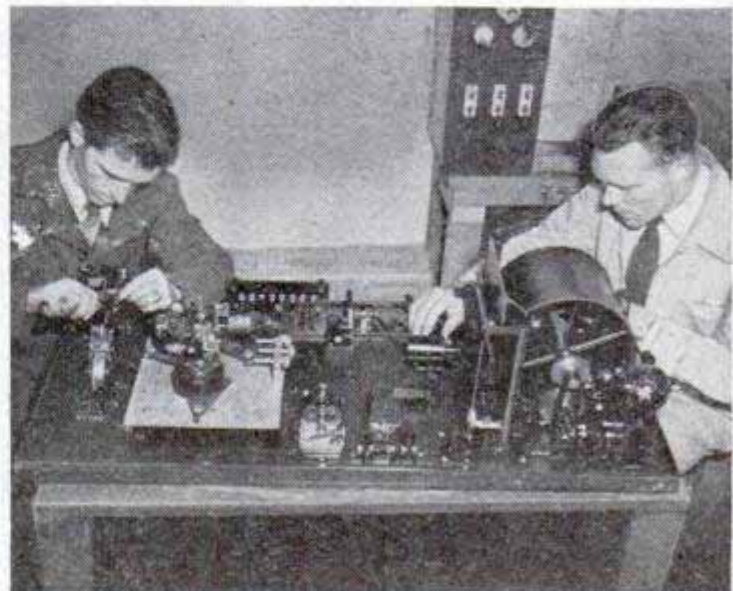
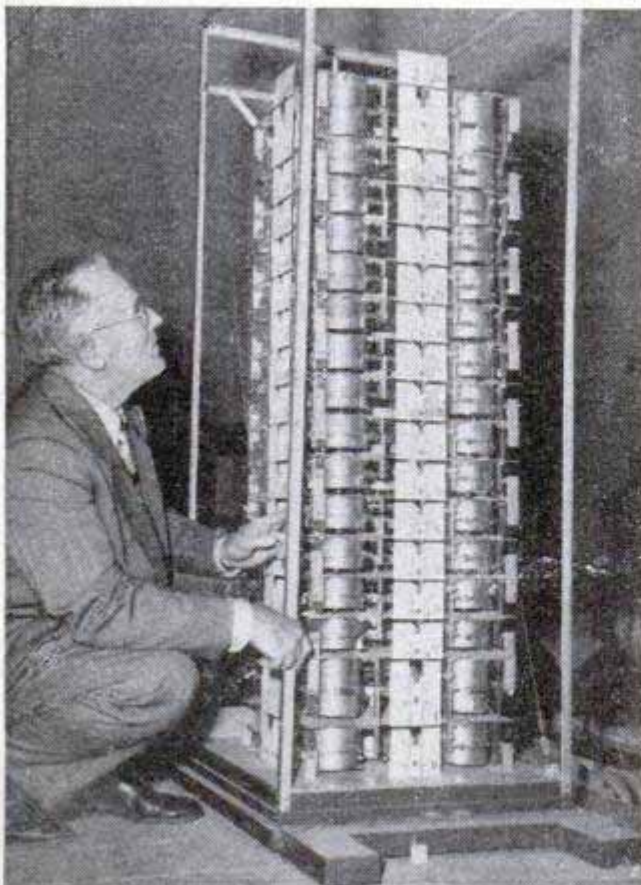



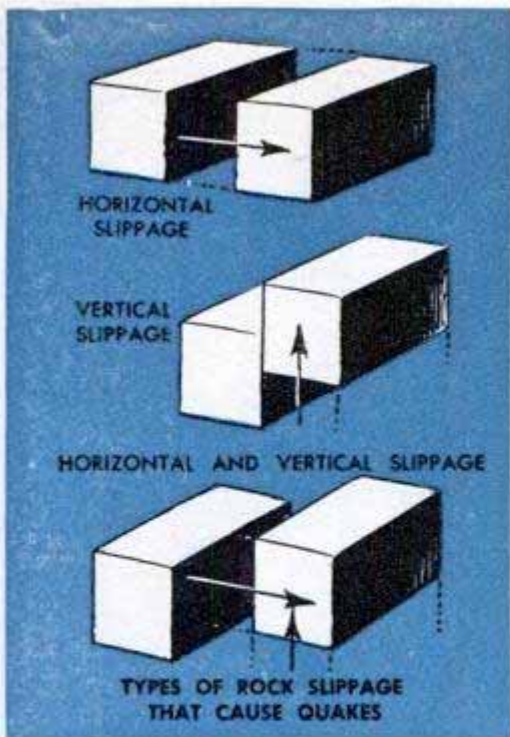

Left, some reasons for earthquakes. Right, Dr. Bailey Willis keeps china on swinging "quakeproof" shelves

pendulum. In other experiments a scale model is secured to a platform which then is subjected to scaled-down duplicates of the motions that were recorded by seismic instruments during actual earthquakes. Engineering data compiled from the research is made available to interested architects and engineers.

"Two types of structures are extremely resistant to earthquakes," Doctor Jacobsen says. "One is the rigid mass exemplified by the Egyptian pyramids, the other is the pliant structure of which the California redwood tree is a good example. Both pyramids and redwoods have experienced numerous heavy quakes and yet each type

has stood for thousands of years. Neither, however, is quite suitable for our needs.

"The best compromise is to construct small buildings as stiff and strong as is practicable and to construct tall buildings with a certain amount of flexibility. The lower stories in particular must be flexible so as to avoid a 'crack the whip' effect in the upper stories."

One way of avoiding earthquake damage is to mount an entire building on balls

Below, shaking machine consists of a heavy pendulum which is drawn back and crashed against spring to shake platform. Right, vibration machine has two unbalanced wheels rotated by small electric motor

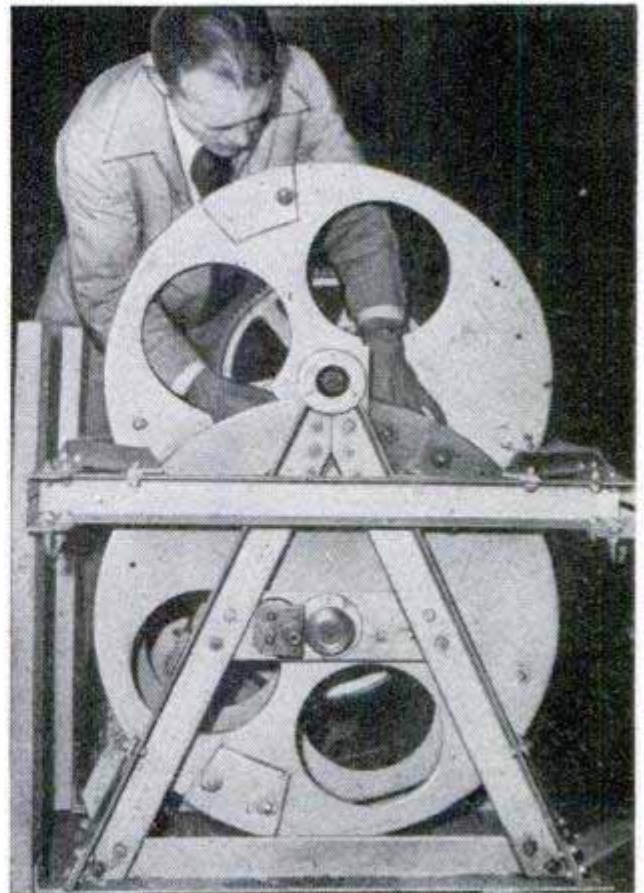
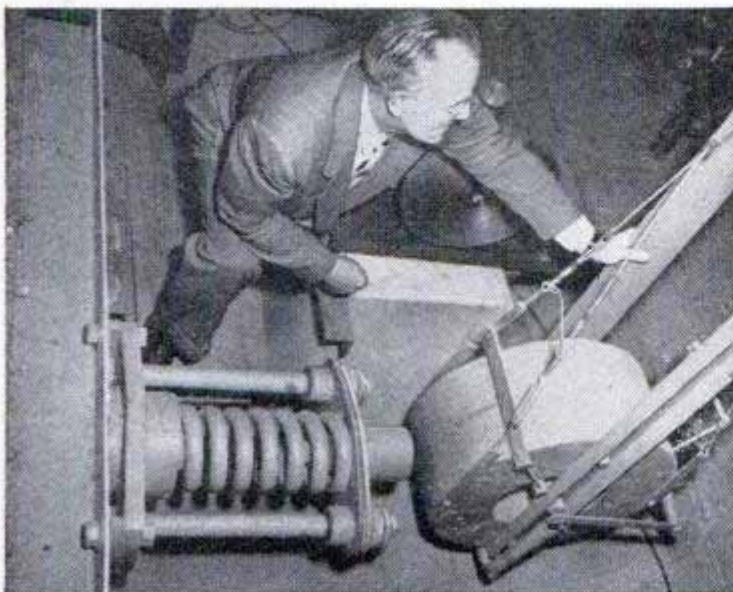





Above, these photos of devastation of the recent earthquake in Japan show how poorly constructed building crumbled. Below, the sturdy structure built years ago withstood the sharp vibrations



Below, top-heavy Japanese houses were flattened by the earthquake. The cheaply constructed buildings stand little chance when a big shake occurs. Right, Japanese train was flipped over like a toy



or rollers. This has been tried in New Zealand where some buildings are placed on thick foundations of loose, spherical gravel. The idea is hardly practicable for huge structures of the office-building type. Owners of valuable and fragile heirlooms make use of the same principle when they lock their treasures inside cabinets that rest on smooth gliders. Such a cabinet can slide around safely on a floor during a quake.





"Buildings do odd things in an earthquake," Doctor Jacobsen states. "A low building of only a few stories, located next to a taller structure, is apt to batter its tall neighbor with its roof. Even two buildings, side by side, of the same height may slam into each other like a pair of gladiators. The reason in each of these cases is that the buildings have different periods of vibration. They get out of step because of different heights or types of construction.

"The recommended procedure in active seismic regions is to provide an air space or sway-way between all large, adjoining structures, particularly for buildings in excess of 15 stories. A sway-way of six inches is usually considered sufficient to prevent one building from damaging another building adjacent to it.

"When an open sway-way is undesirable, it is customary to provide the space and then fill it with some friable filler material that will crumble under pressure. Quite often a church tower is protected from the rest of the church structure by a wall of this type of material.

Not only do earthquake scientists use scale models of buildings in their studies but they subject

(Continued to page 256)

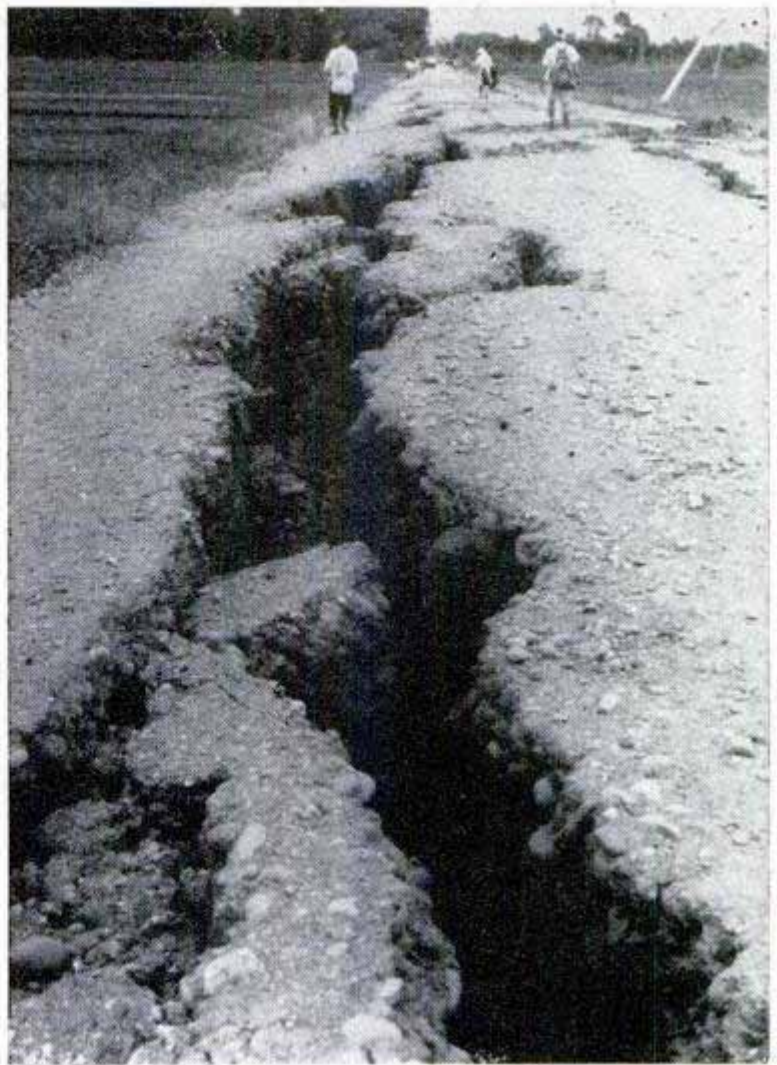

Above, tremendous force of recent Japanese earthquake literally pulled the earth apart, leaving deep faults. Below, an aerial view of the devastated city of Fukui. Fires burned for days after the quake. More than 30,000 persons suffered injuries

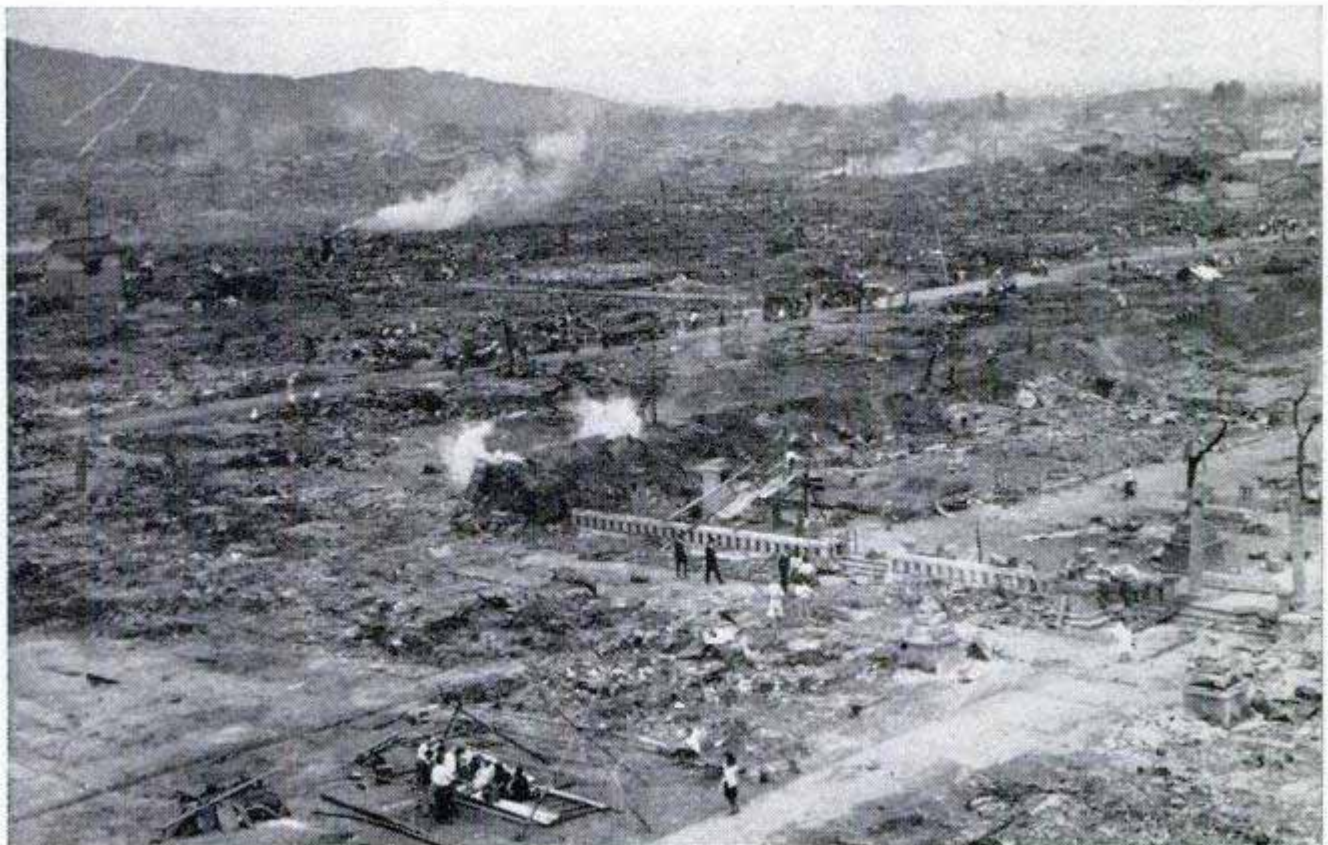



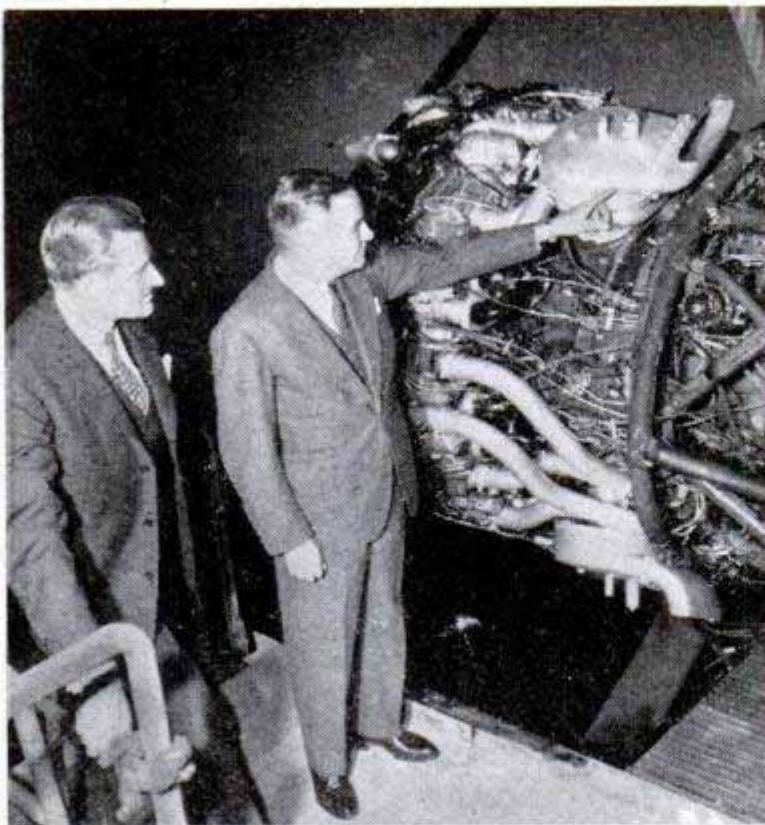

## Engine Using Exhaust Gases Boosts Range of Plane

Exhaust gases that formerly were wasted supply the added energy to a compound engine that gives planes 20 percent more range and power. Developed by the Wright Aeronautical Corporation, the power plant uses the gases to run three gas turbines in combination with a conventional air-cooled piston engine. Power that is generated by the turbines is geared directly back to the crankshaft. The engine functions efficiently from sea level to high altitude and is easily adapted to existing aircraft. As an illustration of the engine's added power, its developers say it could be installed in Lockheed Neptunes currently powered by another Wright engine, and would increase that plane's nonstop record from 11,236 to 13,483 miles.

## U. S. Navy Tests Seamless Plastic Hulls That Never Need a Coat of Paint

Seamless plastic hulls that never need painting are being tested by the U. S. Navy as a possible method for mass-producing small landing craft and boats. Molded from resins and Fiberglas, they are lighter and can be built 10 times faster than wooden hulls. Pigment mixed with the materials during molding makes painting unnecessary. Hull maintenance is practically eliminated since there are no seams to caulk, fastenings to loosen or adverse weathering effects. Trial-run comparisons with plywood boats of the same size indicate the plastic hulls ride much easier in rough water.



## "Fading" Scenes Now Possible With Small Movie Camera



Fade-out movie scenes can now be made with a home-size 8-mm. camera. Fading is accomplished on one model by pushing a lever and on another by pressing a button. The camera has six speeds instead of four, and runs 10 feet at a winding. It has single-shot control for stills, animated titling and cartoons.



## U. S. Navy Tests Danger Area Near Intake of Jet-Plane Engines



How close can a man stand to the intake of a jet aircraft without being sucked in by the powerful draft? If careful, he can stand within two or three feet without being caught. The Navy has been seeking the answer to this question since a civilian me-

chanic was killed in this manner a year ago in California. During tests at the Naval Air Test Center, Patuxent River, Maryland, a lieutenant donned safety lines and walked toward the nose of a plane as the engine turned at full power.

### Cart Kit Makes Centerpiece

Patterned after a Cuban sugarcane cart, an attractive table centerpiece is packaged in kit form. The miniature cart can be used to hold fruit or flowers. All the parts are pre-cut ready for sanding and assembly. Most of the parts are fastened with ornamental tacks and strips of leather. The completed cart can be stained or left with a natural finish.

### "Growth Resistant" Cast Iron Won't Expand Under Heat

Cast iron that has no permanent "growth" when repeatedly heated to high temperatures has been developed for use in stoves, furnaces and gas or oil burners. Ordinary cast iron, when subjected to repeated heating, becomes permanently larger, warping and opening close-fitting joints. The new iron, developed by Battelle Memorial Institute, is a high-silicon product, the silicon being the element that resists growth.



☐ The U. S. now leads the world in the number of bicycles (17,500,000) for the first time in history with Germany a close second (17,000,000). The British Isles come third with a total of 10,000,000, according to the latest registration figures compiled.



# Painting in Wood and Stone



Paper sketch of the Atlantic Charter mosaic was drawn freehand, in reverse, by Burfitt. Quarter-inch-thick blocks of stone cut on diamond saws are secured to paper sketch with wallpaper cement; special cement is then flowed over the back of the assembled mosaic. Final backing is three inches of concrete and reinforcing steel

By Tom Riley



To keep honeycombed mahogany from bulging, only one square inch of mosaic is casein-glued at a time and pressed overnight. Above, Walter P. Chrysler portrait; below, details of the Eisenhower face



**I**N A ROOMY SHOP at 11626 N.E. Sandy Blvd., Portland, Ore., are displayed the beautiful examples of a craftsman's skill, masterpieces of portraiture in wood and stone. There is no sign to indicate what is going on in this shop—not even a telephone—and the front door is usually locked. The craftsman-artist, Frank F. Burfitt, is much more interested in creating another mosaic than in selling the one last completed.

Frank F. Burfitt calls himself a portrait mosaicist. His specialties are inlays in wood and mosaic portraits in both wood and stone. A plumber until his retirement four years ago, he is a hobbyist who has perfected his creations for forty-odd years. His inlays are true inlays, not pieces of thin veneer glued and pressed together but scenes with one or two carefully chosen pieces of hardwood to form the background. All the rest of the scene is carefully chiseled from the background and appropriate colors and shapes of wood are fitted into the chiseled spaces. The inlays are incredibly intricate. In one of his favorite subjects, sailing scenes, the



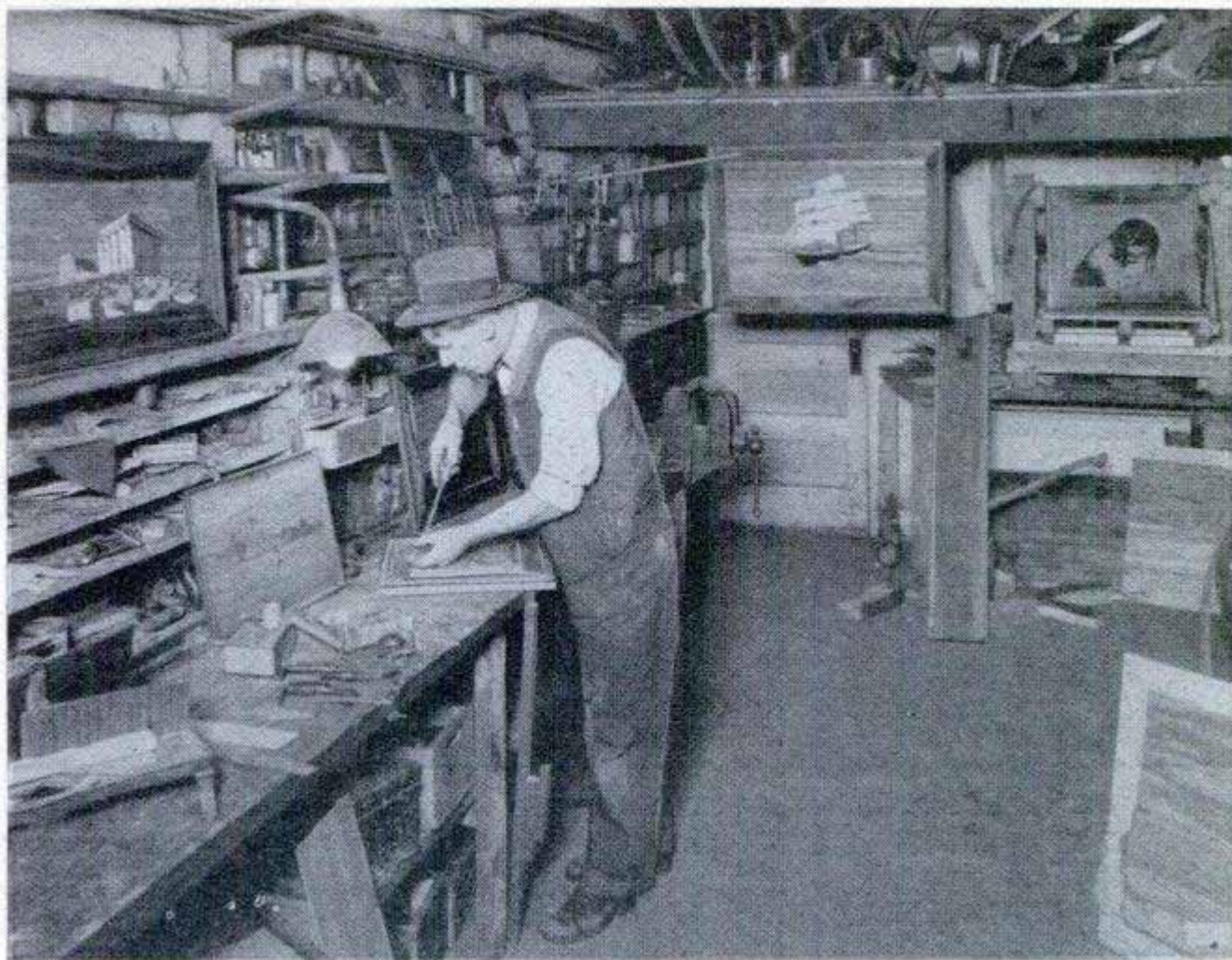

rigging of sailboats is made of pencil-line widths of ebony laid into the background.

His wood mosaics are portraits of famous men. Burfitt says he started to make these mosaics simply because art critics told him it was impossible to create a mosaic portrait in wood that had "life" or realism. His results have astonished the critics. His mosaics are even more intricate than his inlays. Quarter-inch-square holes are cut in a solid mahogany board. Then tiny blocks are cut to fit into these holes, leaving only a  $\frac{1}{16}$ -in. width of the original mahogany board between the mosaic pieces. To accomplish such honeycombing of solid mahogany requires extreme patience and skill. Also needed is the ability to choose woods of the variety and color that will give "life" to the portrait. Burfitt uses 34 different kinds of wood in his mosaics, wood sent to him from all over the world, and he is always hunting for more.

"There is no blue wood," he laments and, being a true artist, he will not artificially stain any material in order to do a wood mosaic of a celebrity who has blue eyes. "And the eyes are the most difficult. In General Eisenhower's mosaic I had to use white holly, Oregon holly, mahogany, ebony, acacia, ebony root, birch, black walnut, French walnut, rhododendron and catalpa to catch the right expression."

Above, Burfitt at work in his shop. Below, the finished Churchill mosaic holds 14,000 pieces of stone

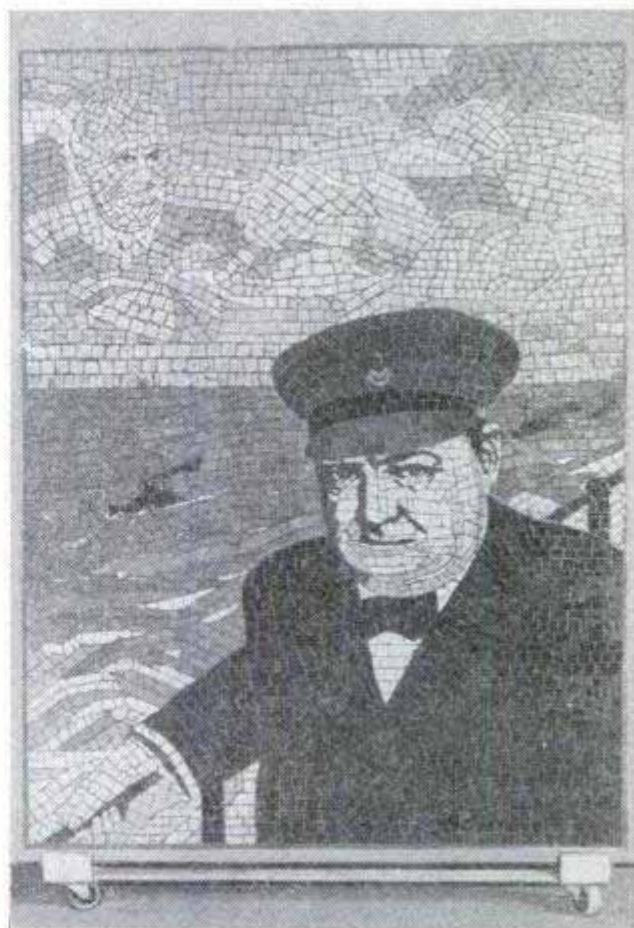



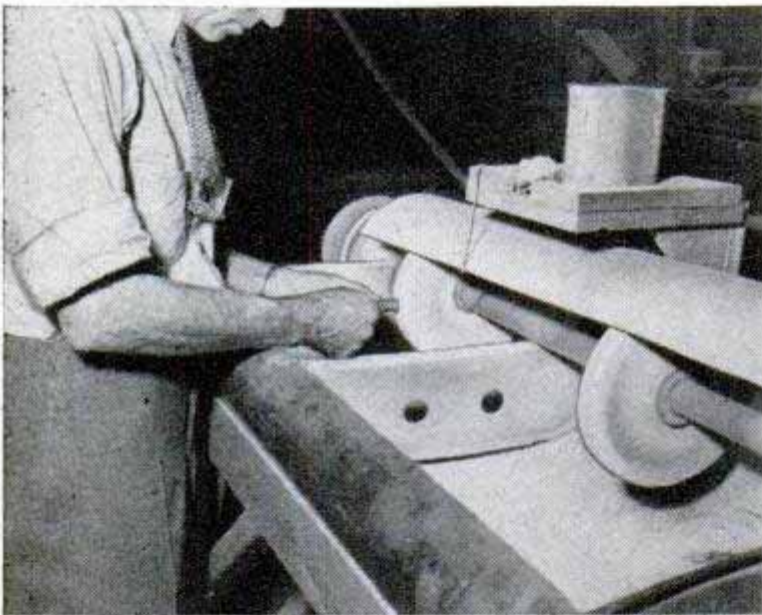
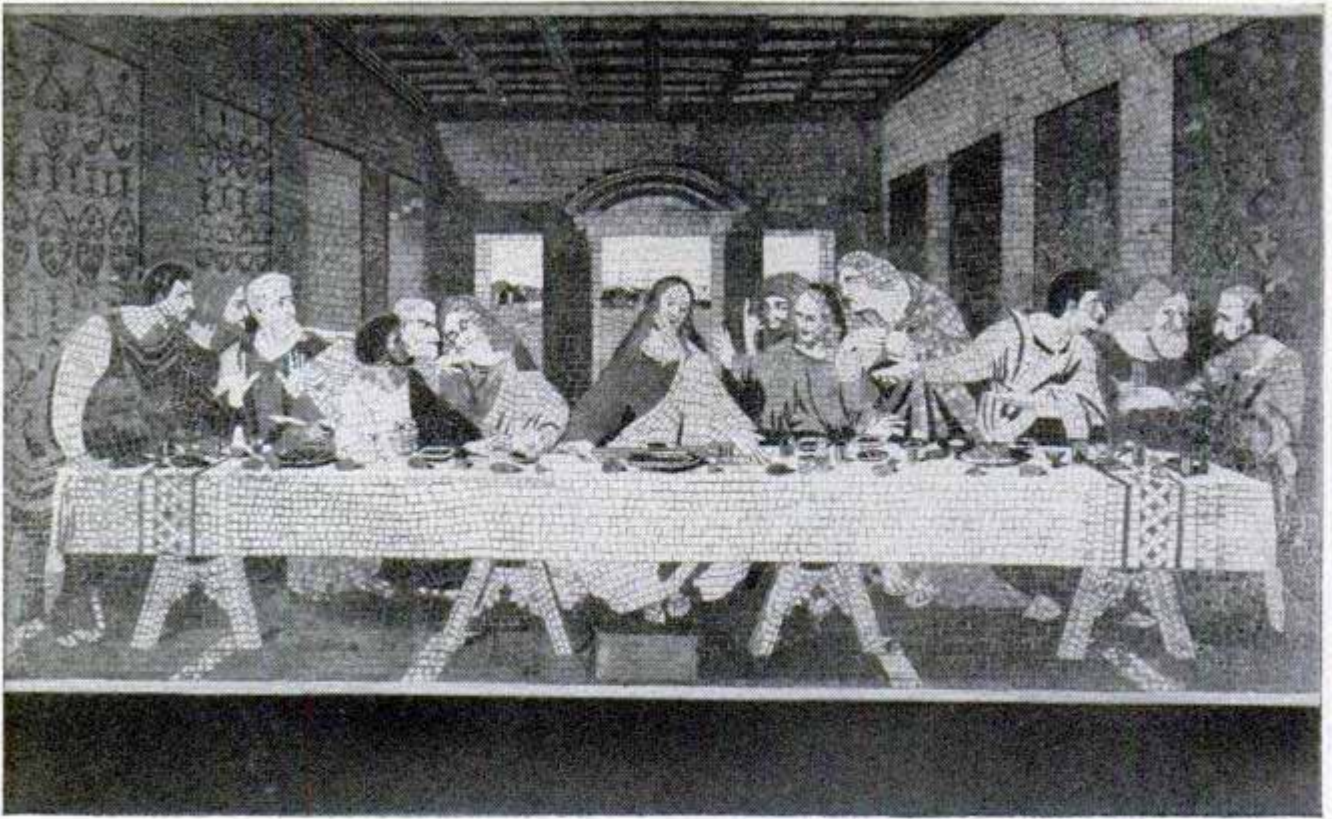

Leonardo da Vinci's "Last Supper" is reproduced by 49,000 stone blocks. At left, grinding the stones to shape on lapidary wheels; below, diamond-tooth saw cuts stones into one-fourth to one-inch slices



Stone is his most recent medium. During the last few years he has been experimenting with stone mosaics, personally gathering hundreds of colors and types of rock. Burfitt now has a shopful of lapidary tools. Grinding and polishing wheels line one wall. Two diamond-tooth saws are used to cut the rocks into small mosaic blocks. He has tried all types of prepared cements but has found that the best one for bonding stones is a simple cement mixed in his own shop. This is a market brand of household cement which he mixes with a fine grade of sharp-cut sand.

Burfitt has completed wood mosaics of General MacArthur, Bing Crosby, Henry Kaiser, Franklin D. Roosevelt, and General Eisenhower. He has finished two stone mosaics, "The Last Supper" and "The Atlantic Charter," the latter including a very unusual portrait of Winston Churchill.

Other celebrities need not feel slighted because they are excluded from Burfitt's collection—he chooses only those whose faces can be reproduced successfully and, in the wood mosaics, only



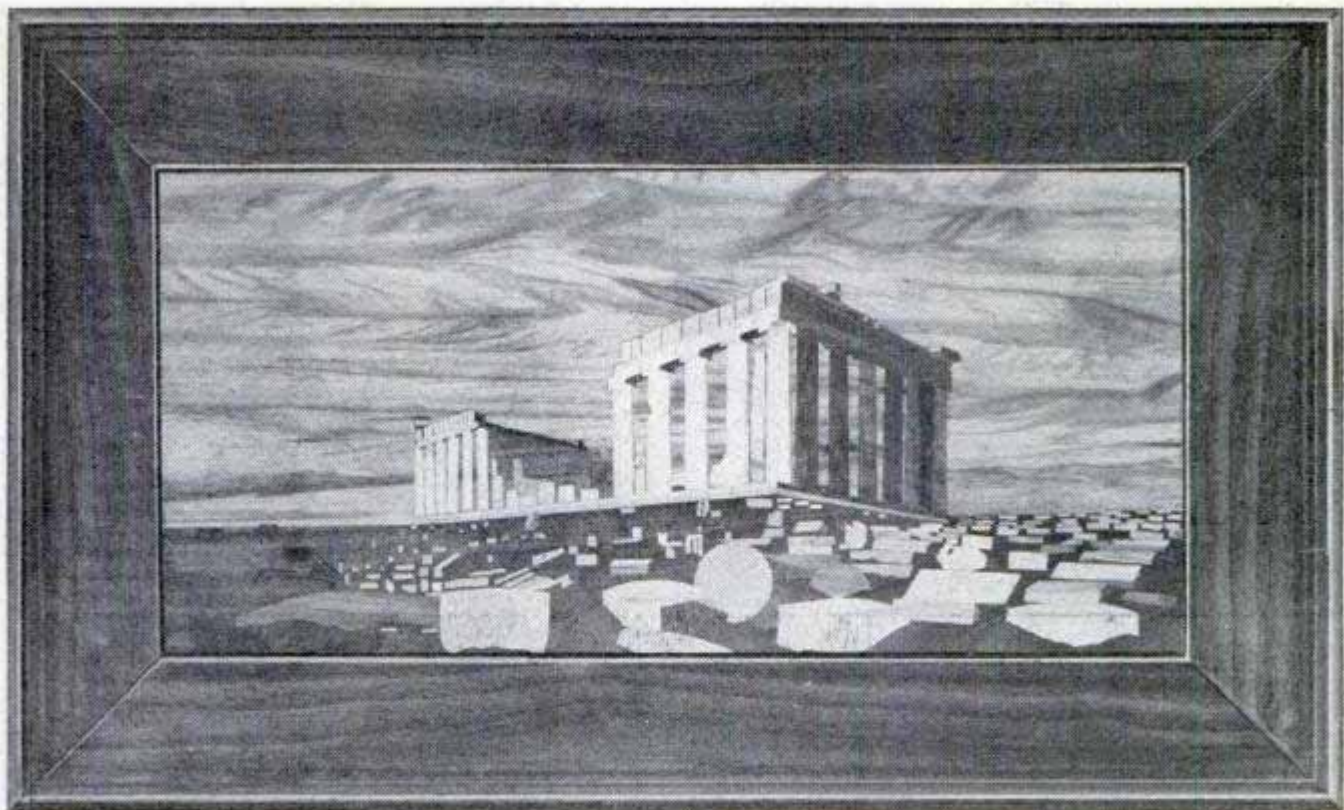

More than 600 pieces of wood, representing over 20 varieties, were used in this inlay of the Parthenon

celebrities with brown eyes. At the present time Burfitt is considering a mosaic made entirely of jade. Burfitt says jade can be found in every color from white to dark green and the possibility of creating a full-color mosaic from just one material delights him not only from a practical standpoint but artistic as well.

Burfitt has honestly tried to teach his skill to several students but has found no one with all three requirements: mechanical ability, patience, and an artistic touch.

No coloring is used in the mosaics; Burfitt relied on natural color of 34 hardwoods in Roosevelt mosaic. Scene at right portrays the famous last race of Sir Thomas Lipton's Shamrock against the Enterprise

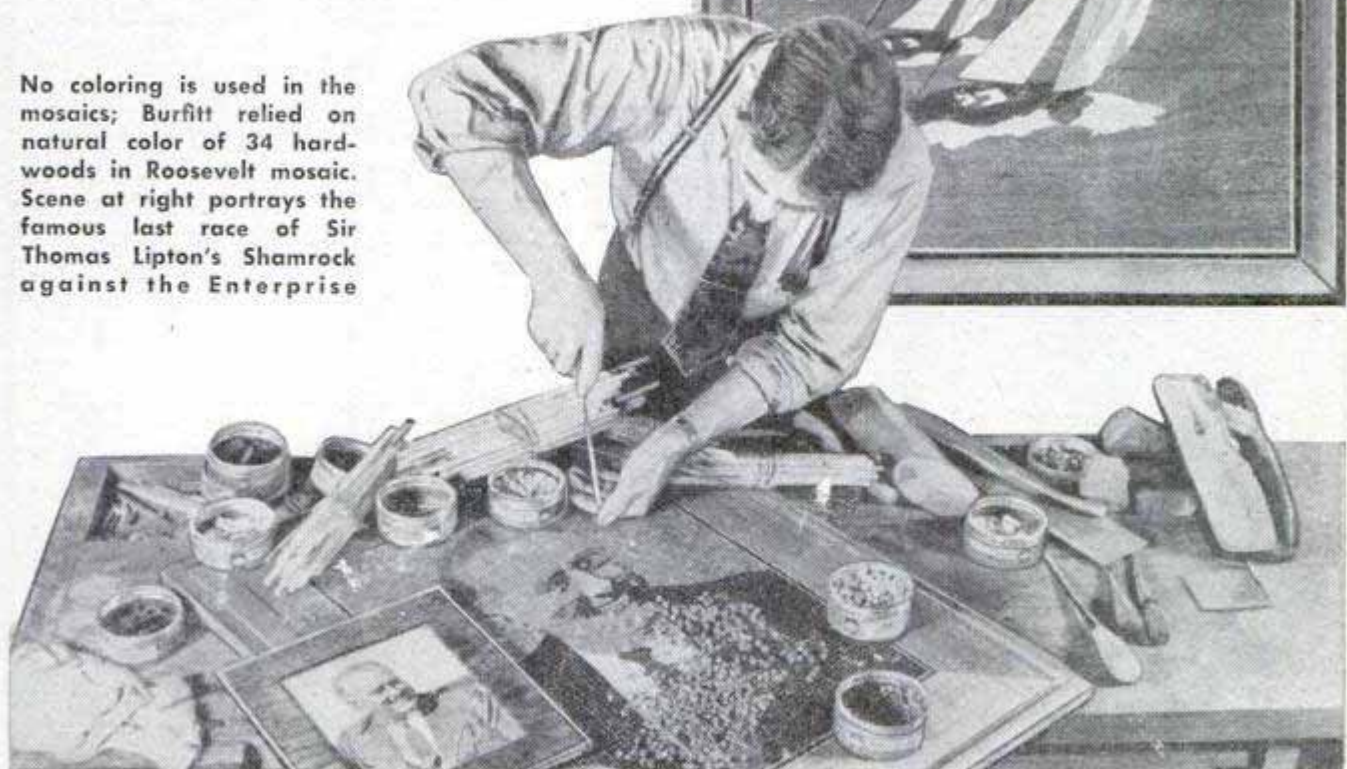



## Slivers and Tissue Paper Become Masts and Sails of Ship Models

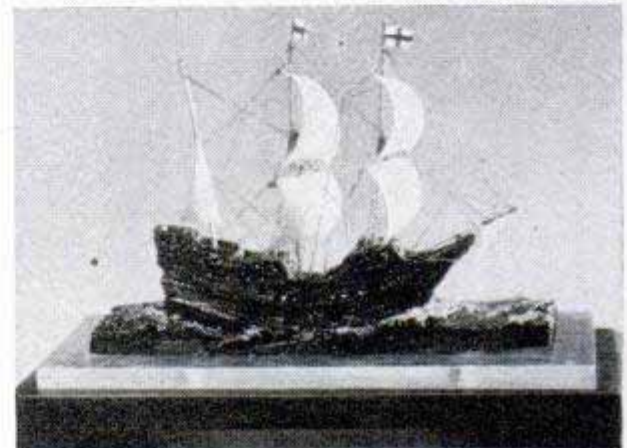
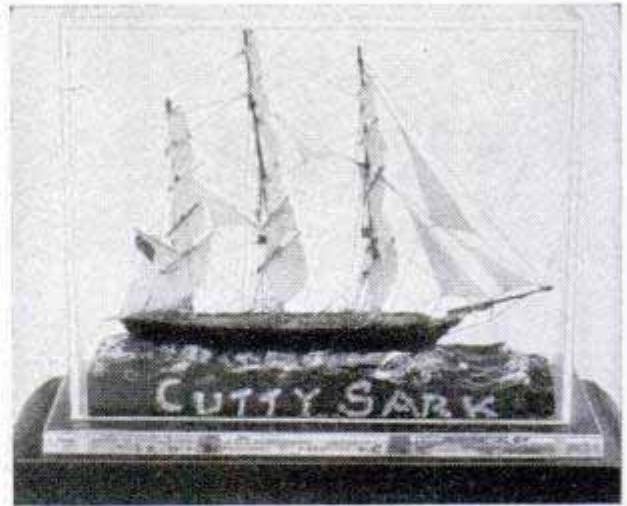
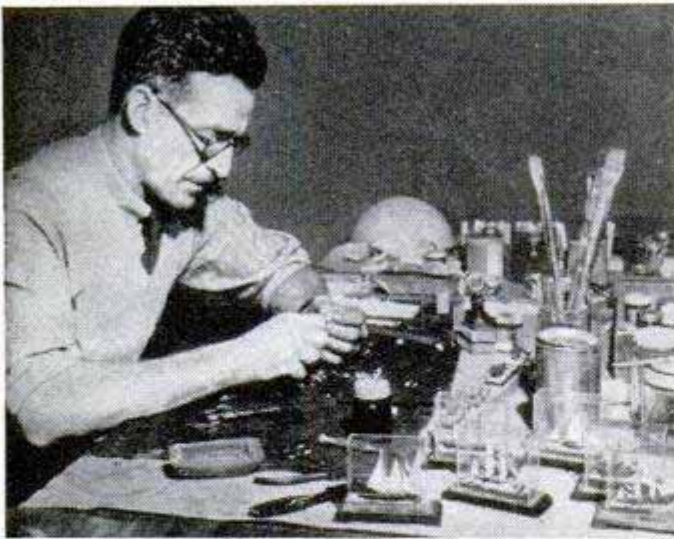

Making ship models is not only the hobby but the business of William Parker of Victoria, B. C. After Parker had whittled a one-inch boat for his son he decided to make a career of marine-model building. Now he's loaded with orders from casual purchasers as well as collectors. Parker's stockroom is the corner of a drawer and his matchbox bins are filled with binnacles, fighting tops and riding lights so small they must be picked up with tweezers. In order to save time he carves a master hull and makes a rubber mold of it. The mold is filled with plaster to make each ship model. The resulting hulls, when stained, appear to be wood and show even the grain irregularities. Slivers of bamboo are fashioned into masts and yardarms. Cigarette paper is lacquered and clipped to form wind-filled sails. The mainstays and all fixed rigging are made from horsehair. Once the masts and the horsehair are in place, Parker dips a bamboo sliver

**Top left, Parker makes sails from cigarette papers and masts from seasoned bamboo. Some ships have more than 20 sails. Above, two models show the detailed work. Plastic case seals finished ships**

into a plastic solution and quickly spins a complicated web of rigging. The models have a main mast only two inches high, yet some ships support more than 20 sails and 90 lines.

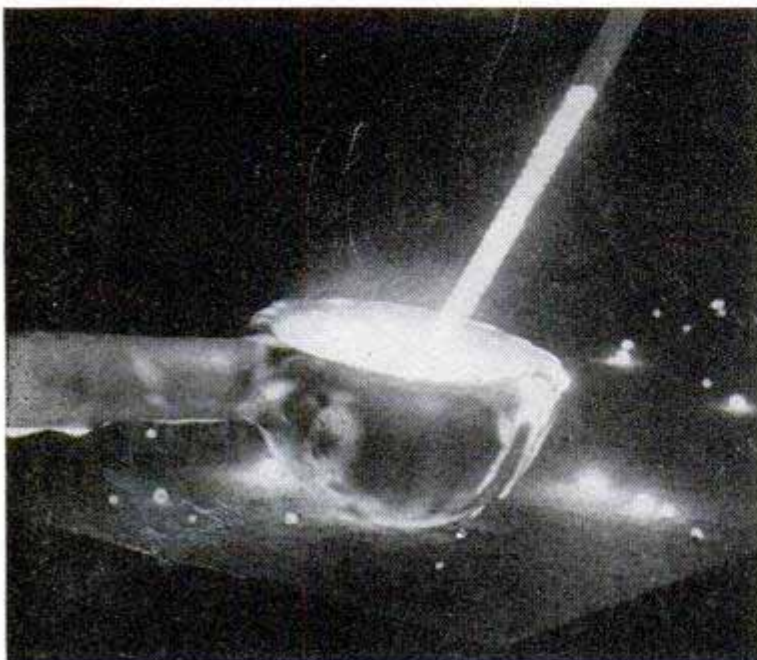

## Eye Dropper Samples Steel

Sampling molten steel at a temperature of 2700 degrees Fahrenheit is now done with an eye dropper made of heat-resistant glass tubing. Drawn into the glass tube by suction created by a rubber bulb, the liquid steel solidifies into a smooth rod in about five minutes. The glass is cracked from it and the test rod is checked for quality. Older sampling techniques required long hours and involved cutting and machining a rod from a steel block.

❏ Ice "pyramids" six inches thick form on airplane antenna masts in an hour's flight during moderate icing conditions.





## Mystery Plane Revealed to Be B-17 With Gas-Turbine Engine in Nose

For months observers along the East Coast have been wondering about the identity of a five-engined airplane which looked strangely like a B-17 Flying Fortress with an extra power plant buttoned on its nose. The secret came out recently, and the guessers were right. The Air Force had been using the B-17 as a flying lab-

oratory to test Wright Aeronautical Corporation's new T-35 Typhoon gas-turbine engine. To accommodate the test engine the cockpit was moved aft four feet, the nose extended and the fuselage, frame and skins reinforced. Results of the high-altitude tests of the gas-turbine engine have not yet been disclosed by the Air Force.

## Plastic Icicles for Tree Made in Varied Shapes

Artificial icicles made of transparent plastic lend an out-of-doors effect to Christmas-tree decorations. The icicles, made in many sizes and shapes including canes, have both smooth and "bubble" surfaces. Viewed from a few feet away and when lighted from behind by artificial light, they look like real icicles. Because of an unusual production method, no two of the icicles are alike.



## Toy Grader Scrapes Miniature Roads Out of Dirt and Sand



Children can scrape miniature roads out of dirt and sand with a toy road grader that looks and operates like the real machine. Another new toy is a cement mixer that actually turns out concrete. Both toys are patterned after full-size machinery. They reflect a trend toward toys that can be manipulated, according to toy manufacturers at a recent exhibition.

☐ Since 1923, when 12 chinchillas were brought here from the Andes Mountains for breeding purposes, the number has increased until today 50,000 of the valuable fur-bearing animals are alive in this country.



## Screw-On Christmas-Tree Bulbs Are Attached Anywhere on Cord

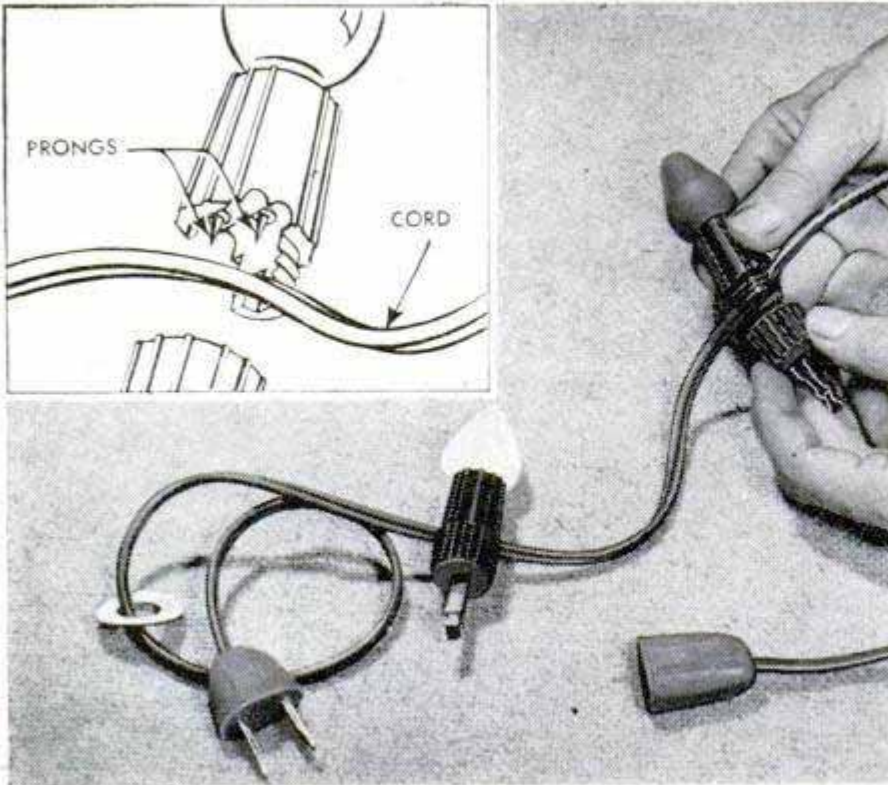

Christmas-tree lights that can be attached anywhere on the cord offer greater flexibility in lighting arrangements. Each socket has two threaded parts. In decorating a tree, the cord is strung through the branches as desired. When a spot for a bulb has been chosen, the two parts of the socket are unscrewed and the cord placed between them. Screwing the parts together pierces the insulation for contact. Each light socket is independent of the others so one bad bulb has no effect on the others. The set includes 12 feet of cord, 8 bulbs and sockets.

## Stencil on Invoice Saves Retyping Address for Labels

Address stencils for labeling packages are cut at the same time the address is typed on the invoice by means of a miniature stencil that fastens to the printed form. The stencil is then sent to the shipping department where it is inserted in a holder containing an ink supply. The holder prints the address on the label, eliminating the need for printing or retyping.

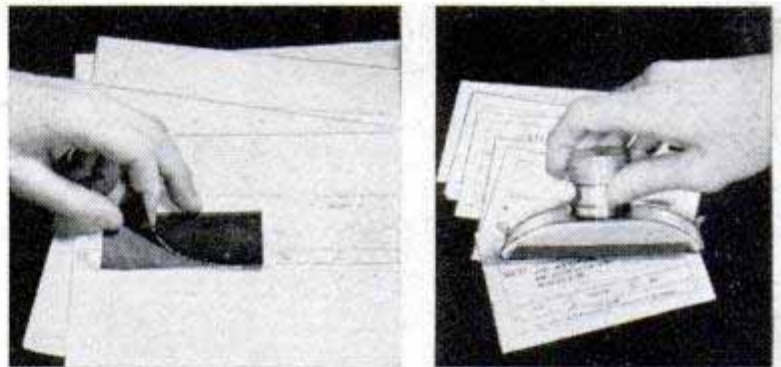

## Pilot of "Smallest" Airplane Lies Prone When in Cockpit

Described by its designer as the world's smallest airplane, a tiny craft weighing only 170 pounds is being tested near San Diego, Calif. The pilot, sole occupant of the plane, lies prone on a foam-rubber

cushion and maneuvers with a conventional control stick and two rudder pedals. A panel in front of the pilot's face has three instruments—an air-speed indicator, altimeter and tachometer. The plane has a wingspan of 15 feet and a fuselage of the same length. Powered by an 18-horsepower engine, the craft has a two-gallon gas tank which provides fuel for one hour. The plane was designed by an engineer, Ken S. Coward, who built it with the aid of two friends.



Electricity is now helping the farmer do his chores on 68.6 percent of the nation's farms.



In race between fast quarter horse and motorcycle, the horse was in the lead for the first 90 yards



# DON'T BET AGAINST A COW PONY

By Thomas E. Stimson, Jr.

Quarter horse slides to fast stop as cowboy throws his rope to catch a running calf to be branded



WHEN AN ARIZONA cow pony beats a famous race horse, that's news.

When a California mustang outraces a motorcycle, that, too, is news.

But when the average Western rancher hears of events like these he doesn't get excited. The chances are that he remarks quietly, "Well, what did you expect?"

The modern cow horse, he tells you, is the fastest animal in the world for short distances. It is bred and trained to start fast and to reach top speed in a couple of jumps. Known as the quarter horse, it can't be beaten for distances of up to a quarter of a mile.

A lot of people didn't know that last fall when, after an argument with a rancher, Charles S. Howard of Seabiscuit fame entered his famous Irish sprinter, Fair Truckle, against a quarter horse in a special match race at Hollywood Park. The race was to prove, once and for all, the superiority of the thoroughbred. To make it interesting the two owners each put up \$50,000. Distance: 440 yards. Winner: Barbara B, a quarter horse, owned by Roy Gill of Tucson, by 2½ lengths.

Recently, too, M. L. Taylor of Long Beach, Calif., matched his quarter horse, Red Ben, against a racing motorcycle ridden by Bud Hare. The motorcycle won, of course, but for the first 90 yards the quarter horse was in the lead. The horse got away so rapidly the motorcycle couldn't accelerate fast enough to overtake it until just before the finish of the race.

What kind of animal is the quarter horse, anyway? It is an old breed now being brought back to national recognition by the American Quarter Horse





As calf springs from training chute, the cowboy and horse get some good practice in roping animals. Most ranches maintain special training area

Association and affiliated groups. It is a working animal with extraordinary cow sense, ideal for range and rodeo work. The fastest quarter horses are valued at thousands of dollars. Some enthusiastic owners use their best horses only for racing.

The quarter horse got its start in colonial days when the holding of impromptu races along village streets was a popular sport. The average street was hardly more than a quarter of a mile long and the horses were bred and trained for this distance. In the late 1700s the owners would sometimes bet 100,000 pounds of tobacco on the out-

come of a match race. The best quarter horses were distinguished in books of the period by the abbreviation C.A.Q.R.H., meaning "Celebrated American Quarter Running Horse."

Later on, when the long-distance thoroughbred race horses were imported, the "short" horses fell out of popularity. Then, with the opening of the West, it was found that the quarter horse was a perfect saddle animal for working cattle. No other horse had the early speed for racing after cows that were breaking away from a herd; no other horse could start as fast or maneuver as rapidly when rounding up calves for the branding iron.

Over the decades, the quarter horse was bred to Spanish stock and, in some cases, a small amount of thoroughbred was brought into the blood lines.

"The quarter horse," says Tom Harris, secretary of the Pacific Coast Quarter Horse Association, "is a compact, blocky animal with powerful muscles that give it the strength for short bursts of high speed. Most quarter horses are smaller than other saddle horses and stand no more than 14 or 14.2 hands high. Short heads, shallow mouths and small ears are common.

"A good quarter horse is tractable and

An overhead sprinkling system irrigates this grass pasture for quarter-horse brood mares and their colts







intelligent. He isn't skittish on a narrow trail and will stand quietly at the end of a hard run. At the same time he is always on the trigger, ready for action. The quarter horse is the top working animal on ranches all the way from east Texas to the Pacific."

Cattle ranching is pretty well mechanized these days. Ranchers use small aircraft for getting into town and back and they use trucks and jeeps for carrying salt blocks out onto the range and for hauling supplies and equipment. But no one has ever found a substitute for the man on horseback when cattle must be worked. Cowhands have tried jeeps and even helicopters but found the horse most efficient.

With a horse a man can push through heavy brush to round up stray animals and can work his way up into small ravines and gullies, combing the country. With a horse he can travel along narrow trails and across steep hillsides. Not even a motorcycle could ford some of the deep streams or pick its way through heavy timber. In the cattle country the horse is indispensable, even though it often rides to work in a horse trailer towed behind a truck or automobile.

In the old days, a big cattle ranch often grazed as many as 2000 horses from which riding stock

Look at 'em go! Ranchers come for miles to the quarter-horse races held at modern Del Rio, Tex., track

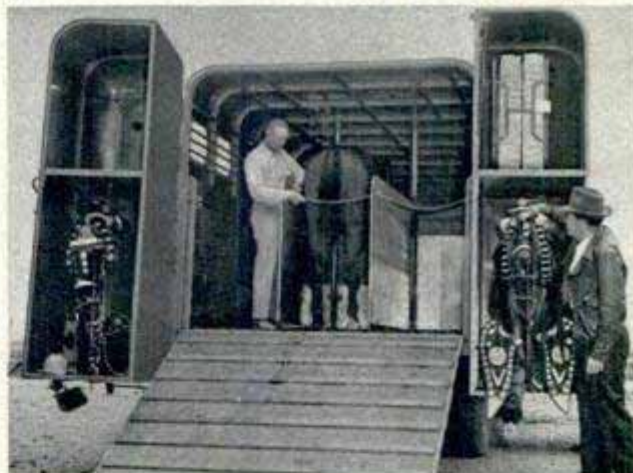

Door panels on horse truck have racks for saddles and other gear. Note folding bed. Below, cow pony changes mind of a deserter fleeing from the herd. Quarter horses are trained to start and stop quickly







Even a jeep would find rough going over some of the terrain on ranges

was drawn at need. Now the same ranch may require no more than 300 head, and yet, the same amount of work gets done. The reason is that second-rate range animals of the past have been weeded out and quarter horses have come into more general use. Instead of having to depend on natural forage, the horses now are fed hay, grain and oats, and this diet gives them the stamina and endurance for working from sunup to sundown, day after day. Now that all ranch horses are shod with the proper shoes, they no longer become tenderfooted.

Big outfits, such as the King Ranch in Texas, breed their own strains of quarter horses to bring out characteristics suited to the country. Medium-size animals seem to be preferred on ranches that are fairly flat, while an owner whose property is hilly or mountainous is apt to select horses with

at least a little thoroughbred blood in them because of the longer legs, useful in climbing, that the thoroughbred line contributes. Too much "hot" blood, however, produces a nervous temperament that makes the animal unsuited for working stock. Some ranchers have found that it pays to design new shapes of snug-fitting saddles for quarter horses that do much climbing.

Another owner likes the heavier "bulldog" animal that excels at calf roping and rodeo work. The big horse can absorb the shock of the sudden tightening of the rope when a heavy calf is lassoed and stopped.

Quarter horses that are to be used for working cattle begin their schooling while they are still colts. First they are gentled by being led around with older horses, then they are gradually accustomed to the bridle and saddle. By the time they are two-year-olds they have become used to being ridden and the trainer starts to bring out their hidden talents. Most of the training consists simply in working the horse in practical maneuvers. The horse is urged into sudden starts, is spun around in tight turns and is pulled back in abrupt stops.

An exhibition by a champion quarter horse always attracts spectators. Western horsemen will drive miles out of their way to visit the W. F. Stoddy ranch near Whittier, Calif., just to watch foreman Charlie Shields ride TipTop in a demonstration. TipTop's movements are coordinated to

Trained quarter horse backs up to hold tight rope on calf while cowboy gets the legs tied. Calf is then ready for branding or medical treatment if sick

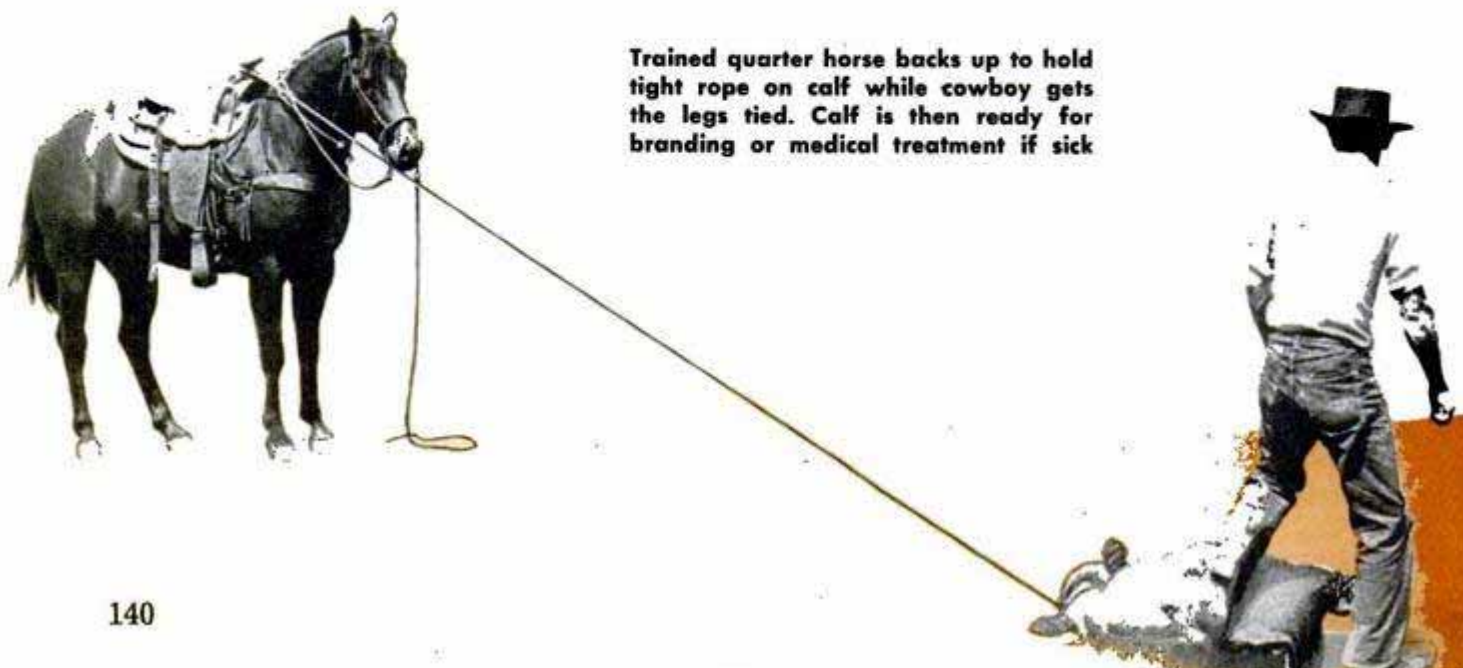





Quarter horse and cowboy show a rodeo crowd how it's done. Here the cowboy is getting ready



the desires of his rider and the horse responds to the slightest pull of the reins or pressure of the knees and feet. When a cow is breaking away from the herd, TipTop races ahead of it and dodges back and forth to stop the animal and turn it back. When a cow is to be separated from the herd, the horse moves in and seems to know which animal Shields is after, blocking its path so that the cow automatically moves off to one side.

The best part of the exhibition is the calf-roping demonstration in which TipTop stands quietly until a calf is released from a chute and then pounds after it at top speed. Shields throws his rope and the horse sets his feet and slides through the dust to a fast stop. The horse is stopping even before the rope has settled over the calf's neck and Shields dismounts while

(Continued to page 244)

He lets the rope fly in perfect throw over the calf's head. His horse has already slowed up



As horse backs off to hold rope tight, cowboy leaps off to run and tie up the struggling calf





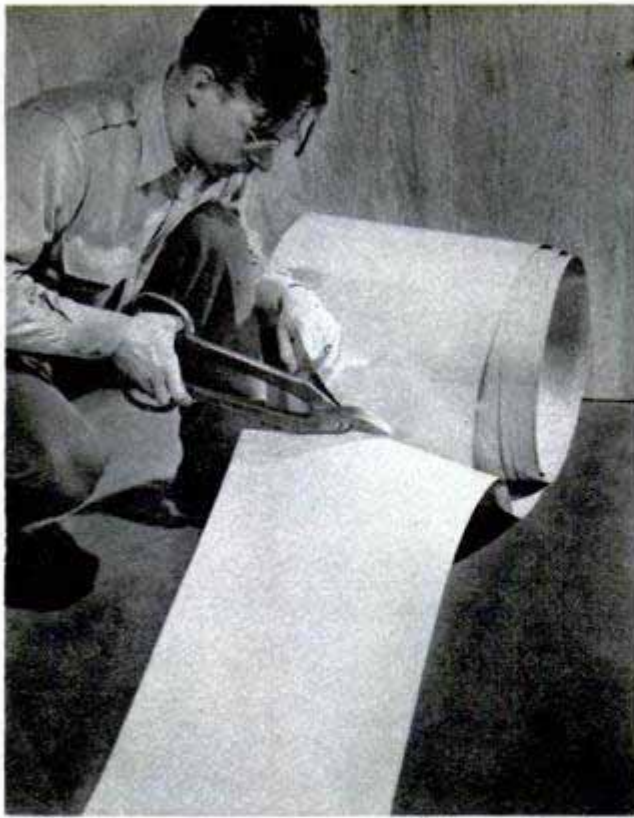

Photos courtesy Steelways

## Damp Cloth Cleans Enameled-Steel Wallpaper

Steel wallpaper coated with flexible porcelain enamel can be cleaned with a damp cloth. The new wallpaper is made of 32-gauge steel so flexible it can be rolled into coils with a minimum radius of six inches. It is cut with tin shears and can be fastened to the wall with cement, nails or trim strips.

The material is heat and acid resistant and is proof against rust, moisture, discoloration, insects and rodents. Designed for home use in kitchen, bathroom, laundry, recreation room and nursery, it is also being applied to hospital rooms and medical offices. It is available in several colors.

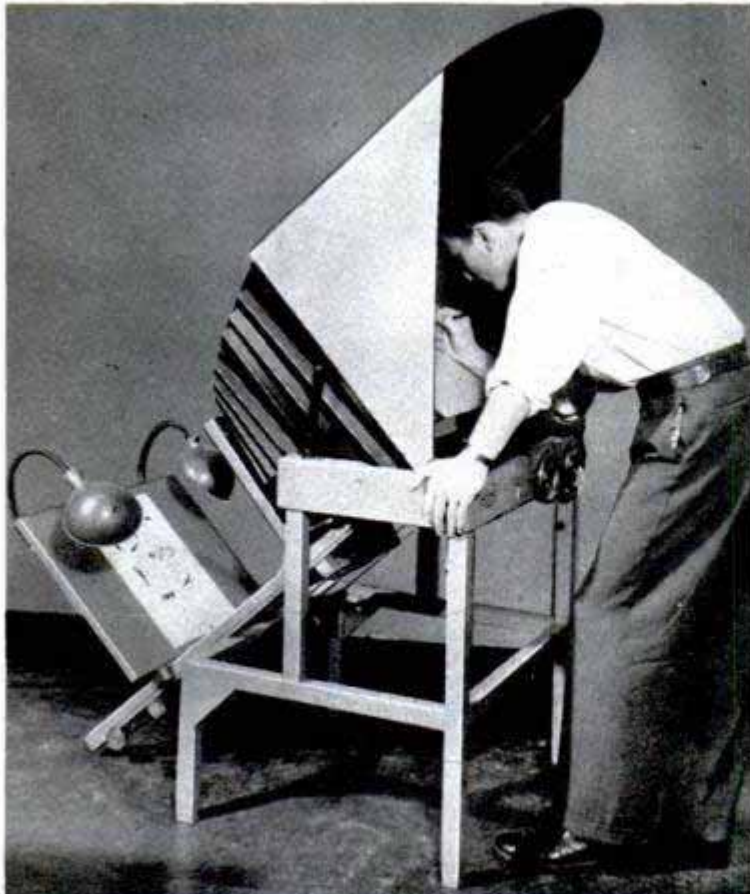

## Camera for Tracing

Tracings of drawings, photographs or lettering are made in enlargement or reduction with a tracing camera that projects the image on the underside of the paper, thus eliminating shadows and interference by the hand. Even solid objects such as packages, tools and other small articles can be placed on the easel and accurate drawings made by tracing the projected image. The device also can be used for projecting transparencies. No darkroom is necessary and the machine has a maximum enlargement and reduction range of four diameters.

☐ Although developed primarily for use in foggy weather at sea, radar equipment on ships is proving valuable for navigation on the Persian Gulf during dust storms that frequently cut visibility to one mile or less for prolonged periods.



## "Honor" Gas Station

When a motorist runs out of gasoline on the superhighway between Amsterdam and The Hague in the Netherlands, he helps himself to as many gallons as he needs from the nearest emergency self-



service gas station. The unattended stations were installed by the government. If the motorist hasn't enough change for the gas, he signs a receipt and sends the money later. In three months of operation, not one gallon of gas has been stolen.

## Glass Defies Sudden Heat and Cold

Suitable for use in sun lamps and laboratory glassware, a new type of glass can be heated to 1800 degrees Fahrenheit and rapidly cooled without breaking. The glass, developed by the Corning Glass Works, consists almost entirely of silica. It is made from a soft glass which is molded in the conventional way, then immersed in hot acid. When the glass is heated, the pores close and the glass shrinks to about two thirds its original volume. The final product can be heated to 1800 degrees without losing its strength.



## Pocket-Size Flash Unit

Small enough to be carried in the shirt pocket, a stroboscopic flash unit for photographers operates on four regular flashlight batteries. It uses a half-size gas bulb that has 25 percent more efficiency than previous models and has a life expectancy of 30,000 flashes. The four batteries will produce about 90 flashes, each having a light output equivalent to a "peanut" bulb. Weighing 2 $\frac{3}{4}$  pounds, the unit recharges itself in 12 seconds after each flash.

## Writing Board for the Blind

Blind persons can write neat, legible letters with the aid of a writing board equipped with a paper clamp and two guide lines, one for longhand and the other for printing. The board guides the hand of a sightless person so his words cannot run off the edge of the paper or his lines run together. It also is recommended by some hospitals for those who have a manual handicap which impairs their writing.





# WE DROVE TO

# Alaska

Part 3

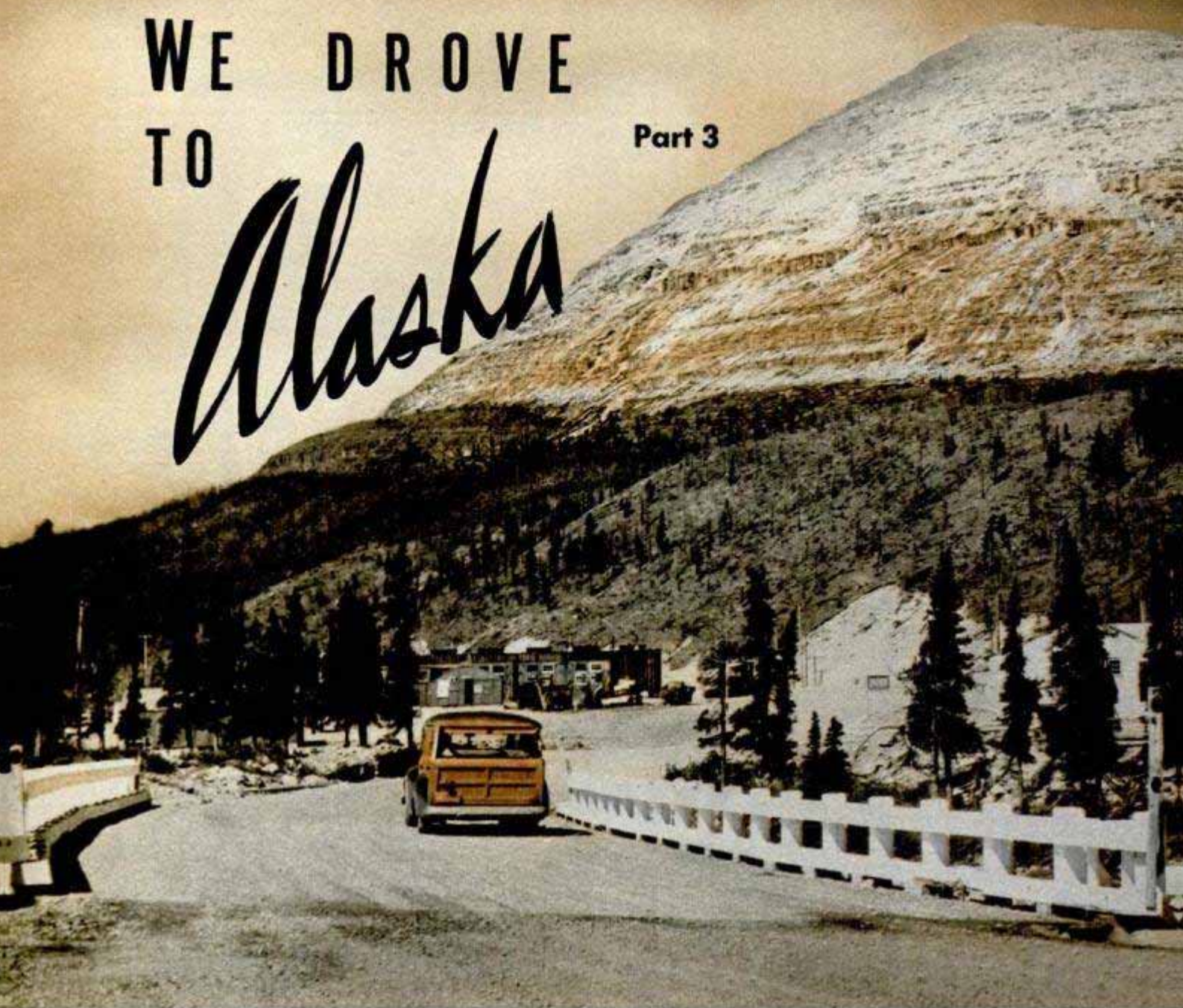

By Aubrey O. Cookman, Jr.  
Photos by Frank Fritz

**A**LL THE WILD life and spectacular scenery we had been hoping for sprang into view during the final 600 miles of our drive from Chicago to Fairbanks, Alaska.

Surprised while moping along the Alaska Highway, a red fox pup whisked by our Plymouth, headed in the general direction

of Chicago. A large beaver matched our pace for some 75 yards before angling off into the brush. Most cooperative of all was a cow moose that politely paused while we stopped the car, then "mugged" by the roadside until photographer Frank Fritz made the shot that appears on page 145.

North of Whitehorse is the scenic cream of the entire trip. There are towering peaks of the St. Elias range, thickly coated with snow, miles of pines broken only by swift

Relics of town's wartime role, one of Quonset huts in background housed magazine's travelers at Whitehorse





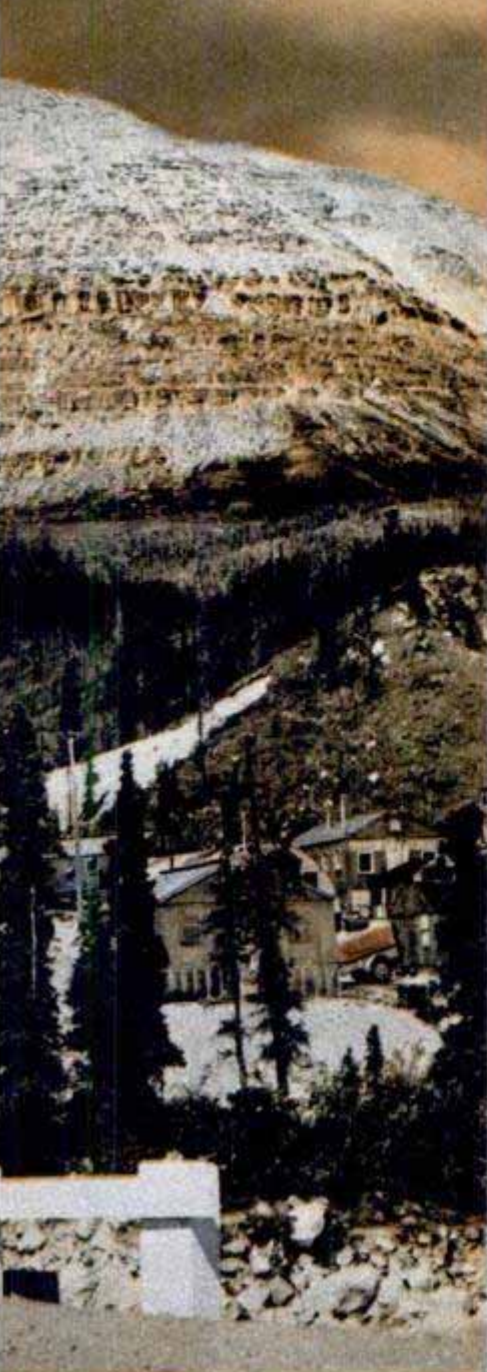

← Though mountains 9000 feet high tower above it for many miles, highway's greatest altitude is 4256 feet at Summit Lake, Mile 392. One of the road's 18 maintenance stations in Canada is in the background



Everything but the kitchen sink might describe the interior fittings of this 1923 Reo. Its young owner was en route to school at the University of Alaska. Cow moose below was photographed along the road

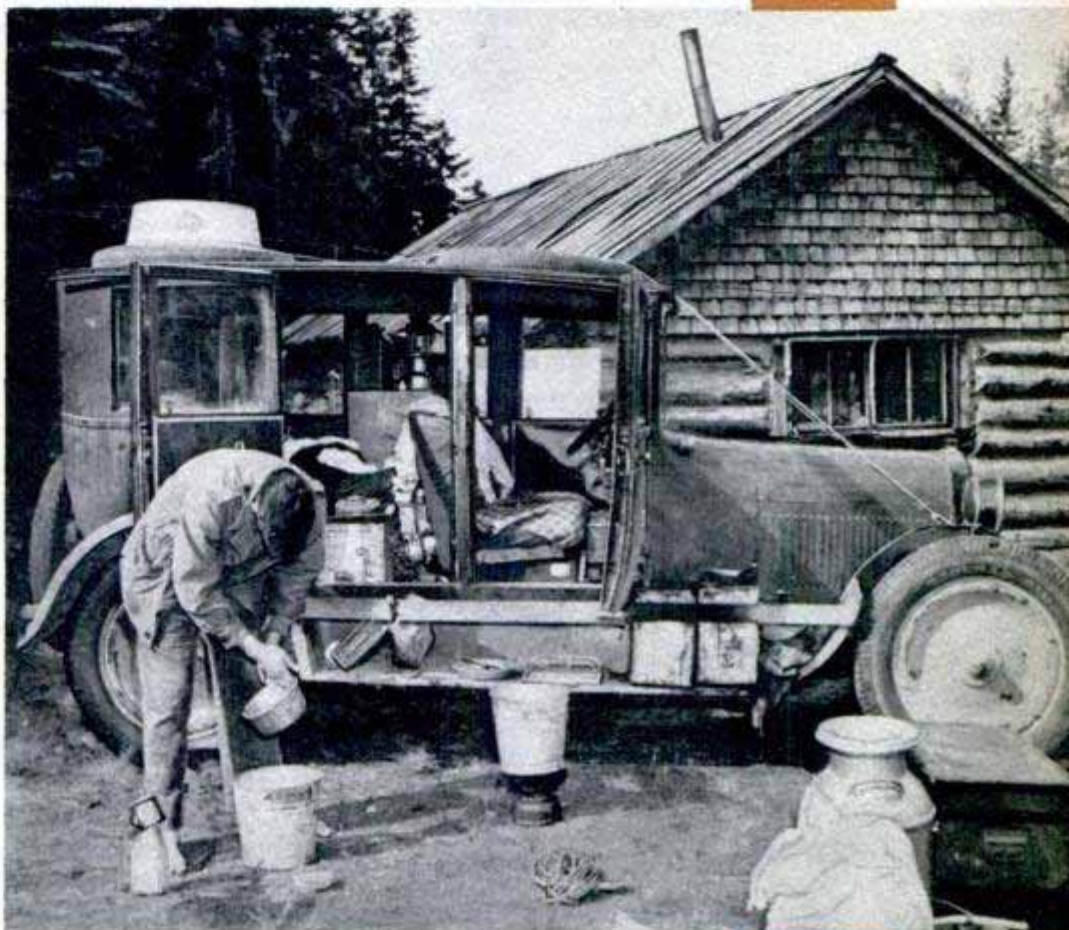

streams and beautiful lakes like Kluane, and one of the small but picturesque imprints man has made on the vast wilderness—an old trading post and a mission at Burwash Landing, Mile 1094.

The only town of any size along the Alaska Highway, Whitehorse, centers much of its activity around its Canadian air force and army detachments. The houses are neat, gaily painted and small, except for a couple of curious two and three-story log cabins. The 100-room Whitehorse Inn equals hotels in American cities of 50,000 population. Improvements nearing completion while we were there included a spacious ballroom and totaled \$300,000. The town also is an important link on Pan American Airways' northern route.

Whitehorse is an excellent stop for side trips. One is over the White Pass and Yukon Railroad, 110 miles to Skagway, a colorful gold-rush boom town half a century ago. It is a twisting six or seven-hour run over narrow-gauge tracks for a closeup view of spectacular mountain scenery that delights camera fans. The other choice, a ride on one of the big stern-paddle steamers on the Lewes and Yukon Rivers to Dawson, requires several days.

At Whitehorse, Maj. George K. Wade, senior superintendent of the highway's maintenance on its 1221 miles in Canada, said about 200 men, divided among 18 camps, are busy all year long keeping the road open.

Washouts in April and May give the most trouble. During 1947 most of them were around Coal River, Mile 533, but this year it was the Swift River section, Miles 680 to 770. Worst single delay of 1948 has been the







10 days it took to put a new bridge over the Lower Rancheria River, Mile 687. In addition to patrolling constantly for trouble spots, the crews regravell about 200 miles of the highway yearly.

Trucks and busses, Major Wade pointed out, are big users of the highway and their number is growing. Three young Indiana war veterans, for example, have applied for permission to send convoys of 10 to 15 trucks to Alaska the year around, hauling



Title to homesteads like this one near Fairbanks, above, is gained by living on the land three years, building a house and cultivating a prescribed acreage. Left, a "must" stop is Canadian customs office at Snag, where it was 81 degrees below zero in 1947

tractors, bulldozers and heavy construction equipment from midwestern cities.

There are two schools of thought on the best time of the year to drive to Alaska. One insists that the winter cover of several inches of smooth, hard-packed snow is an ideal surface. Some of these snow travelers claim they average 70 miles an hour and better with perfect safety. Snow is unquestionably easier on tires than summer's sharp, exposed gravel.

A few, however, admit they'd face a serious problem if a mechanical mishap stranded them along an isolated stretch at temperatures around 50 degrees below zero. As we discussed this, driving north from Whitehorse, going 171 miles before seeing another car headed in either direction, I confess our own preference leaned to warm weather, despite the dust and possible washout delays.

Take your time as you wind the 45 miles along the edge of blue Kluane Lake, Mile 1053, because it will prove one of the trip's unforgettable sights. We were there at sunset, when lights and shadows heightened the scene's rugged splendor. In the heart of wild, big-game country, it is reputed to be well-populated with caribou, moose and grizzlies. The lake has trout weighing up to 50 pounds.

At the end of our "loneliest"—and most beautiful—day of driving we

Faulty wooden culverts put the regularly used span at Mile 907 temporarily out of commission







This is what the Alaska Highway looks like near Fairbanks. The Tanana River is flowing along at the left

headed for the government-maintained camping ground at Lake Creek, Y. T., Mile 1152. In one of those once-in-a-million probabilities, we found the sole occupants to be Mr. and Mrs. L. C. Risk of Hillsdale, Mich., probably the only people we knew within several thousand miles. We'd first struck up an acquaintance with them two days before, helping to pull their car out of sand at a campground, a favor they promptly repaid by transporting our punctured spare tire on ahead to Rancheria for repairs.

A retired businessman, Risk and his wife are ardent motorists, spending a couple of months each year enjoying new scenery. In addition to complete cooking equipment, their car had a full-length double bed over the back seat, a comfortable precaution for wilderness touring.

We were impressed by the well-ordered appearance of Lake Creek, as we were by six other campgrounds en route. Each was near water and had neat stacks of firewood, which users are on their honor to replenish. Lake Creek had a green frame building also, with picnic tables and a cookstove inside, which could be an excellent haven in cold or wet weather.

We got an early start the next morning for the Canadian immigration and customs office at Snag, Mile 1206. It was there in 1947 that the temperature plunged to 81



Projected paving of the final 70 miles, next year, will eliminate hazardous dust clouds shown above

degrees below zero, the coldest ever recorded in the Western Hemisphere. It was a brief stop, with no inspection, and mainly involved relinquishing our vehicle permit, a safeguard against unauthorized sale of cars in Canada.

As a side light on traffic flow, the Snag inspector said 571 northbound and 240 southbound passengers cleared his station the month before, in addition to 25 Alaska-bound trucks and 71 trucks headed south.

END  
ALASKA MILITARY HIGHWAY  
ENTERING  
FAIRBANKS CITY LIMITS  
SPEED LIMIT 15 MPH  
PLEASE DRIVE CAREFULLY





Twenty-one busses also had passed the station.

On his recommendation we paused a short distance ahead at the Sourdough Inn, run by Miss Neeta Eakin, for a midmorning meal. A pretty, young woman in her early twenties, native of Portland, Ore., she is the lone operator of a 14-bed inn and restaurant in what seemed the middle of nowhere.

She doesn't think her role surprising. "I like plenty of elbowroom and beautiful scenery, and I get both here," she explained. "Besides, there are always new folks driving through and it is interesting to talk with them." Keeping the place neat and doing the cooking keep her busy, but she finds time to exercise an excellent shooting eye, as pelts on the wall attest.

At the Alaska border, Mile 1221.4, we began looking for the U. S. customs station, thinking about the probable penalty for illegal entry. Finally, some 40 miles into Alaska, a gas-station attendant ended our worries by explaining that the customs office was at Tok Junction, nearly 100 miles north of the border. Gasoline, by the way, costs about the same on either side of the border. Our previous gas at Burwash Landing had come to 56 and a fraction cents for a five-quart imperial gallon. The first Alaska pump charged 45 cents an American four-quart gallon. In Fairbanks, the price was 40 cents a gallon.

The final 100 miles to Fairbanks was probably the poorest section of the entire

Alaska Highway. There the gravel road's ever-present dust changed from a minor nuisance to a driving hazard. Aggravating the problem was added traffic from local airfields and the Richardson Highway to Anchorage, the territory's biggest city. Passing around vehicles that were laying a constant dust screen wasn't safe, so we spaced ourselves as comfortably distant behind other cars as possible and groped along the rest of the way to Fairbanks.

That experience, happily, is one tourists probably won't have to face next year. Frank Nash, Alaska Road Commission superintendent at Fairbanks, said Congress had approved paving the highway's heavily traveled last 70 miles and the job would be done in 1949.

The sign marking the end of the Alaska Highway was a welcome sight. We had covered 4115 miles from Popular Mechanics' home office in Chicago in 13 driving days, with no ill effects that 48 hours of sleep in comfortable beds wouldn't correct.

From our experience we offer these suggestions: (1) don't start unless you are 100 percent certain of your car mechanically, whether it is old or new; (2) have good tires, preferably six-ply; (3) wear comfortable clothes, remembering that Alaska temperatures will average in the 60s and 70s during May, June, July and August; (4) carry mosquito repellent, and tent netting if you camp out; (5) allow plenty of time, plan on making no more than 200 to 300 miles daily to enjoy the trip; (6) take

Only 125 miles from the Arctic Circle, but well-stocked shops line both sides of this street in Fairbanks

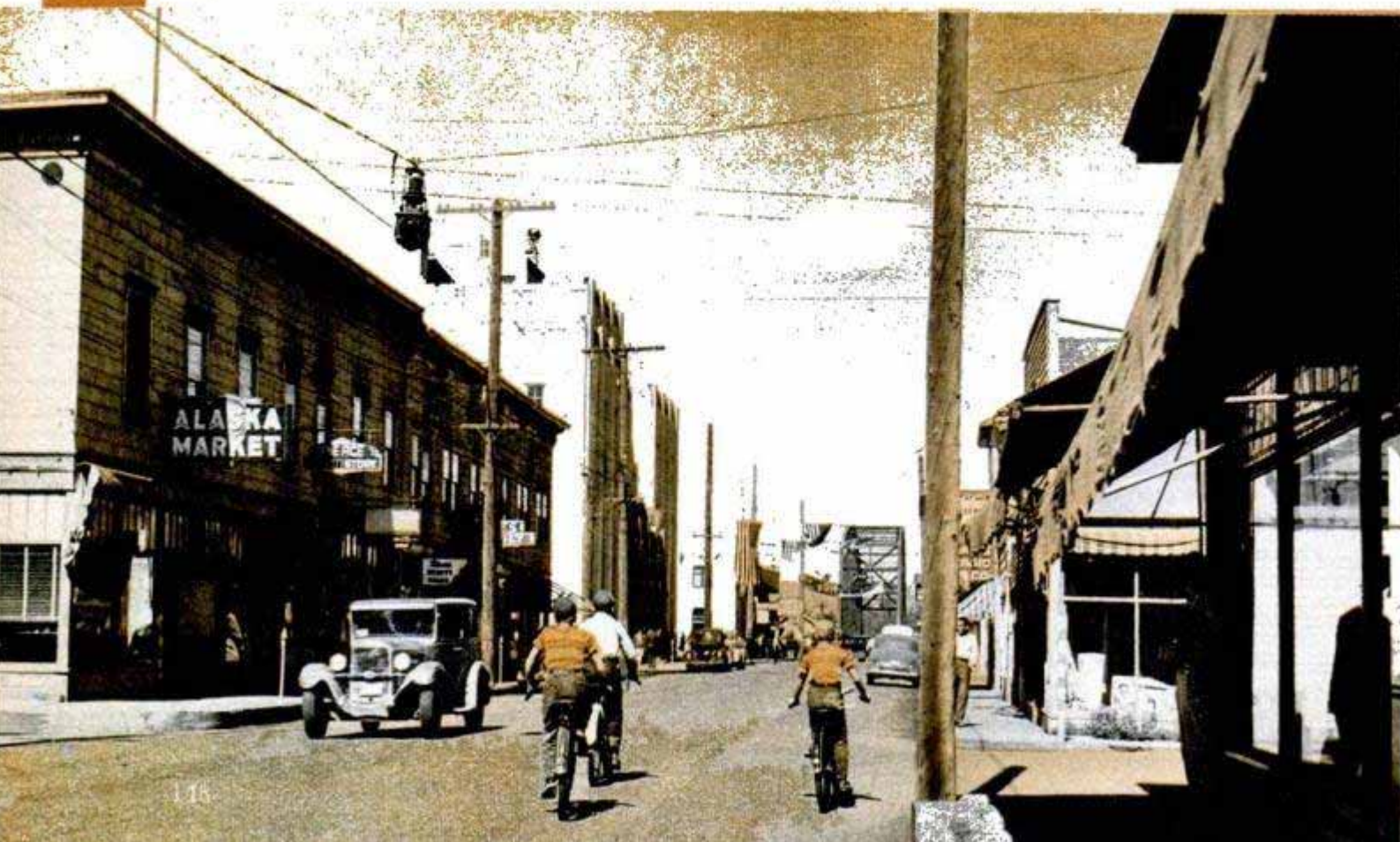



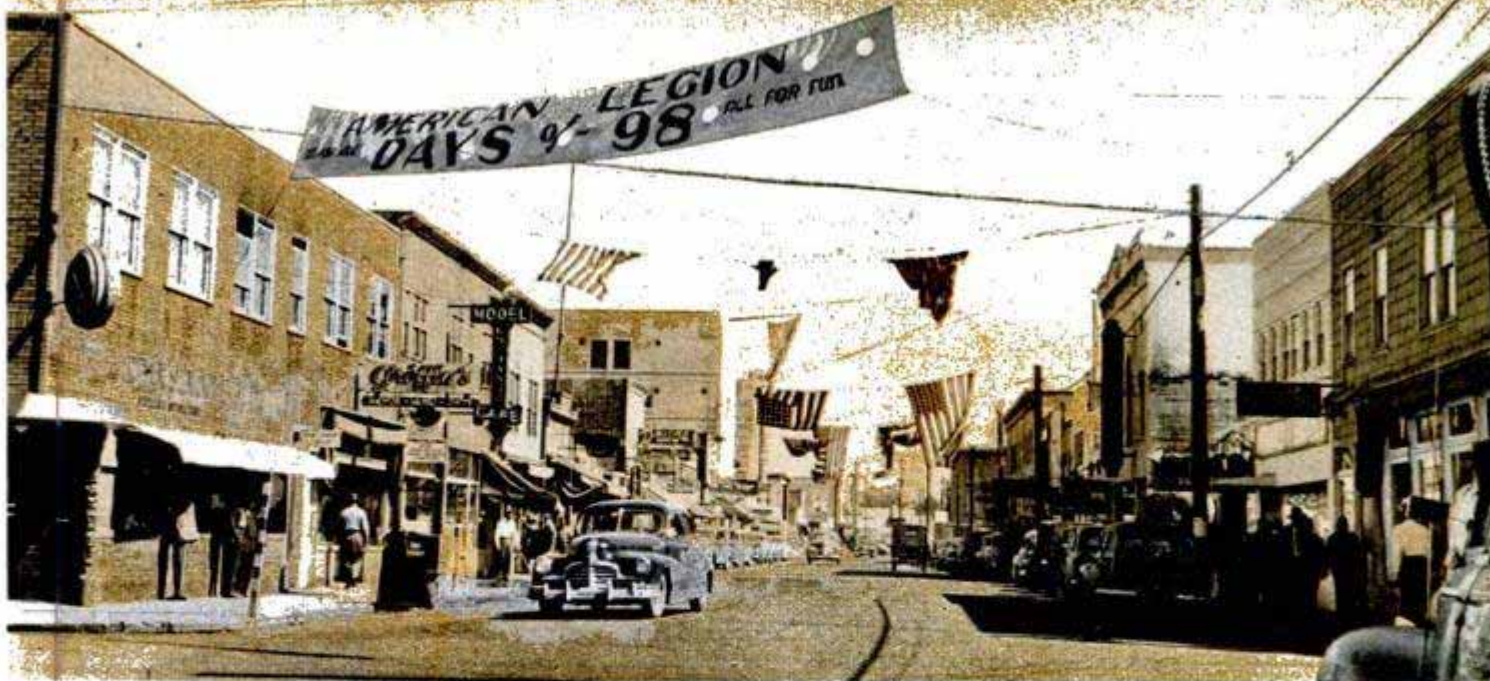

Because of a sizable military population nearby, Fairbanks is much busier than most towns of 8500 people

along several hundred dollars in safe and easily negotiable form for expenses and emergencies and (7) accept the fact that some nights will be spent in very plain accommodations.

Our 1948 Plymouth behaved perfectly all the way, so we had no problems on that score. The brand-new tires were six-ply, but we collected six punctures by driving too fast over gravel and clay. After slowing to about a 40-mile-an-hour average we had none.

Blue jeans, khaki shirts, Army shoes and lightweight jackets proved useful all-purpose touring clothes. Mosquitoes, while never the menace we feared, were made much less bothersome by a repellent smeared over exposed skin. War-surplus head nets were also helpful.

Expenses for two men from Chicago to Fairbanks ran about \$300, with gasoline accounting for about a third. Food and lodging were the next two most expensive items. We kept the bulk of our funds in U. S. and Canadian travel checks, which were readily accepted everywhere.

We were fortunate in finding excellent and reasonably priced tourist cabins, particularly at Calgary and Edmonton. Once the next day's driving goal is determined, it is a wise move to telephone ahead—and there are telephone facilities all the way—for accommodations. Carrying camping equipment affords an alternate solution in case space isn't available.

Starting in late June should insure no delays from washouts and promise good weather. Nature's attractions are also putting on a colorful show at that time of the year. After August there are many nights when, for most people, sleeping outdoors

(Continued to page 248)



Modern counterparts of the old prospectors are the enormous gold dredges working north of Fairbanks. Gravel is scooped up and carried inside where the ore is separated, and waste is expelled at the rear

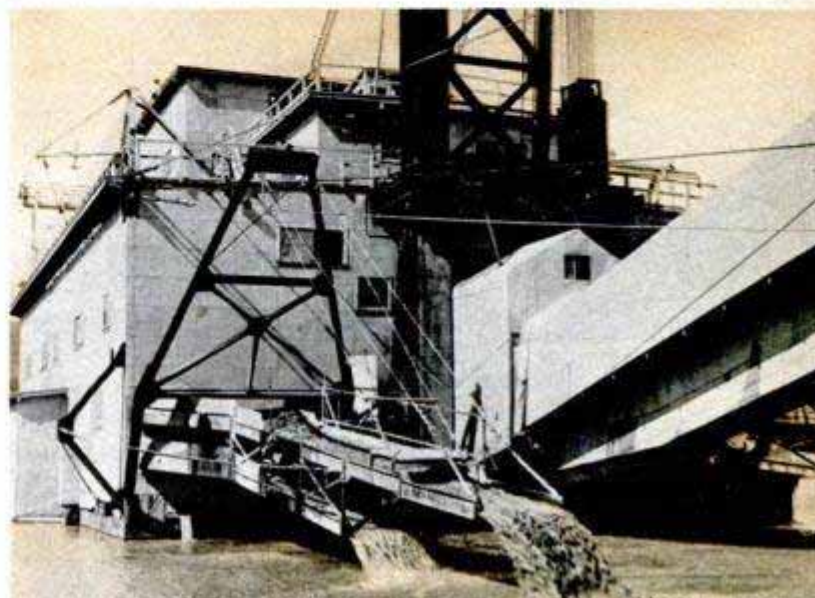





### Mobile Blacksmith Shop Makes On-the-Job Repairs

Blacksmith and welding jobs, too big to be taken to a shop, are repaired on the site with a truck equipped with a forge and all the necessary tools. The mobile shop is

operated by Kern County, Calif., and covers jobs over an area of 8170 square miles. The truck-shop was designed for such areas that require on-the-job repairs.

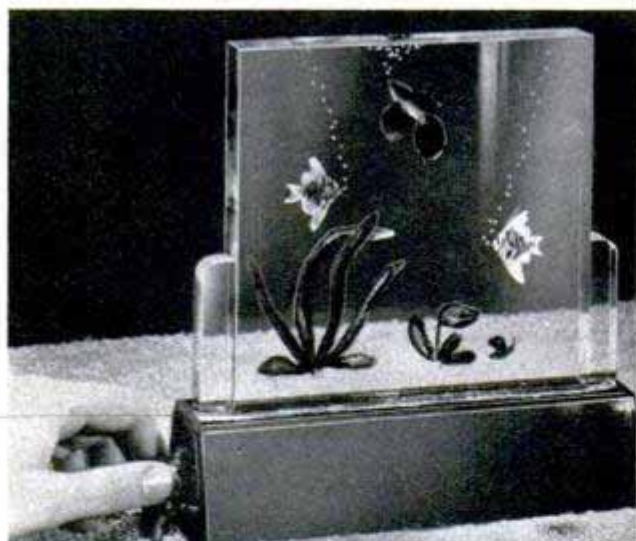

### Edge-Lighted Plastic Forms Novel Lamp

Adding decorative lighting to hall tables or corner settings, an edge-lighted plastic carving shows a group of tropical fish in natural colors. The fish are actual size and are hand-carved for realistic reproduction. The light is hidden in the black base. Because of its low wattage, the light can also be used as a night light.



### Synthetic-Rubber Gas Nozzle Prevents Explosions

Made of static-conducting synthetic rubber, a new gasoline-hose nozzle outwears metal nozzles two to one and prevents fire or explosion from static electricity. No metal reinforcement is used in the flexible hose. It can't mar automobile finishes and its smooth lining reduces drip and turbulence. The nozzle fits any type of valve.



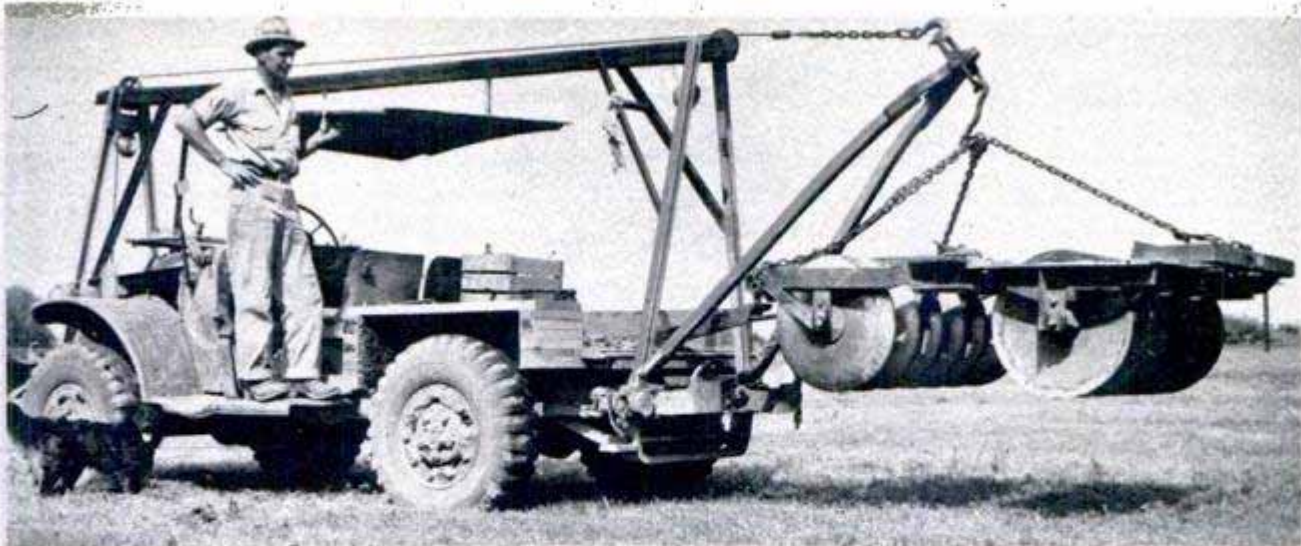

### Tractor With Lift Frame Built From War Surplus

By converting an Army-surplus weapons carrier, Liggett Richardson of White Swan, Wash., built himself a versatile tractor that not only pulls standard farm implements, but also picks them up for traveling over the highway. A hinged A-frame at the rear of the truck raises the implements and holds them off the ground when not in use. The cable from the front winch runs over pulleys on a horizontal girder above the truck body to raise and lower the A-frame. The tractor's complete cost was about \$750. Richardson now has a machine that plows, disks, cultivates and ditches.



Top, built from an Army weapons carrier, this versatile tractor not only pulls farm implements but lifts them for road travel. Above, A-frame drops disk to the ground ready for use



### Blindfolded "Pilot"

Guided entirely by radio signals, a blindfolded "pilot" carries a model plane through a maze of chairs, simulating off-course mountains, in a demonstration of on-the-beam flying. It is one of the techniques used by lecturer Glen Morris to popularize some of the scientific aspects of aviation. For it, he has devised a miniature radio range station that can be set up on a stage. Morris uses a volunteer pilot from the audience for the demonstration after explaining how the beam signal functions and how it is followed.

☐ About half the nation's output of primary aluminum is produced with power generated at the Bonneville and Grand Coulee Dams on the Columbia River.



Because he liked to do chemistry experiments in his home workshop, Fred V. Richardson of Victoria, B. C., now has a prosperous cracker business. Each year his 30 employees turn out millions of Christmas crackers — not the eating kind, but those cylindrical party favors that bang when cardboard strips at the ends are yanked. Essential to the Christmas celebrations in British Columbian homes, the crackers are popular all over the world for

other festive occasions. They consist of cardboard tubes covered with gaily colored papers and containing favors, paper hats and fortune-telling cards.

Richardson first made crackers as an experiment with the chemicals in the snappers. Since 1939 he has been producing them commercially. Several machines used are of his own design. No longer limited to Canada for a market, Richardson now sends his crackers as far as South Africa.

## cracker maker

his business outgrew the home workshop



Crimping machine designed by Fred V. Richardson and built in his shop puts the crimp in sheets of crepe paper used in making the crackers. Below, "squeeze" machine puts the final touch on these party favors



Gaily colored Cellophane is laid over the crimped paper so just the fluted ends are thrust out. Below, core of the cracker is cardboard tube which contains paper hat, plastic toy and "your fortune"





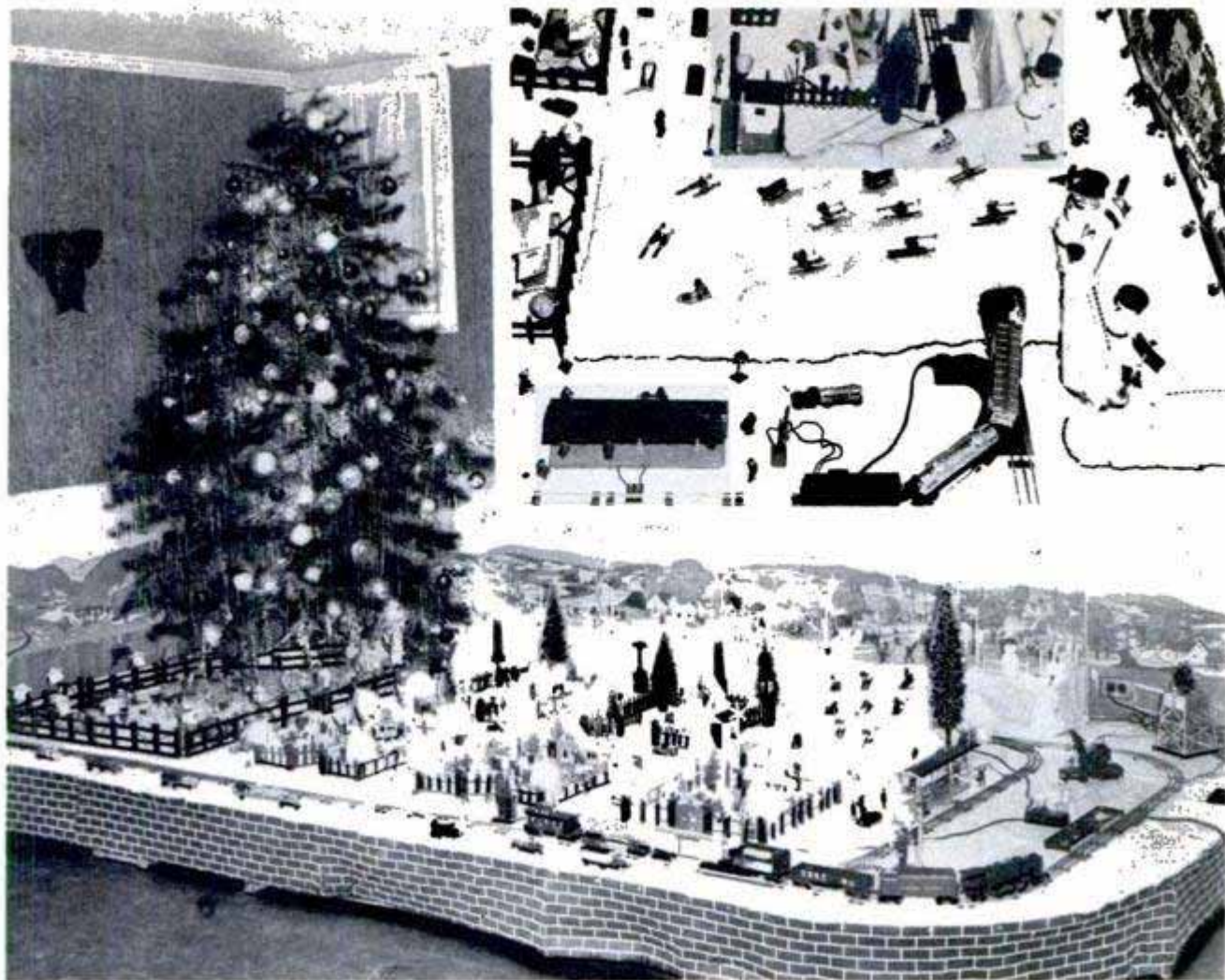

## Christmas Town Beneath Tree

Christmas begins a month early for Nicholas Del Balso of New York, who starts in November to build a complete town beneath his Christmas tree. The scene is a miniature village in winter and includes cardboard houses, figures skiing

down a cotton hill, a railroad, automobiles and snowmen. Del Balso builds the village from materials he has accumulated for 20 years. The project is assembled on a platform measuring 10 by 20 feet. The fences are made of twigs and dowels; the lights are tree bulbs, and most of the figures and vehicles came from the dime store.



## Bricklayers' Brackets Hold Sill Strips

Bricklayers save time and labor in setting brick sills with a pair of adjustable brackets that clamp the edging strip in place and permit accurate adjustments by means of thumbscrews. One man can make the necessary adjustments for a perfectly aligned sill in a few minutes, saving considerable time and labor as compared with the usual methods. When not being used, the compact brackets fit easily in the tool kit.

Every day new products for homes and workshops, farms and factories, are appearing on the nation's markets, and every month you'll find them described in Popular Mechanics. For additional information about any of these products, write to Bureau of Information, Popular Mechanics Magazine, 200 East Ontario Street, Chicago 11, Illinois



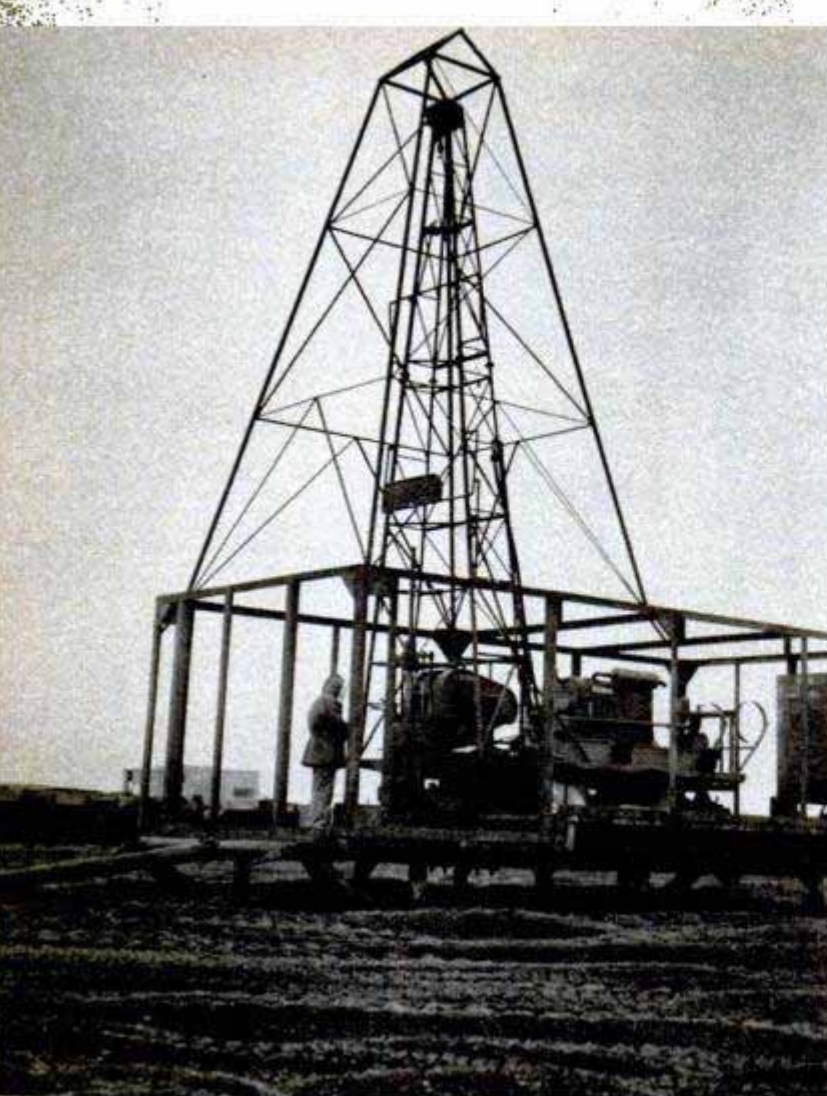

Official U. S. Navy photo

Left, the skeleton of an enclosed portable drilling rig. Plywood housing and specially insulated canvas will protect workers from intense cold. Right, seismograph "shooter" placing fuse in a charge of explosives



## BLACK GOLD UNDER ARCTIC ICE

By Aubrey O. Cookman, Jr.

**O**ILMEN expect their troubles underground, but they are experiencing something new in northern Alaska. There, where the United States Navy is directing an extensive search for petroleum, they face a grim day-to-day battle above-ground as well.

The Navy says only that its Far North oil sleuthing has been "promising"—with no hint of having discovered the 400 to 500-million-barrel reserve believed necessary to make the operation economically self-supporting—but they are unquestionably learning valuable know-how in cold-weather petroleum exploration. Congress has granted \$14,600,000 for the search.

Before they even scratch the surface, oil detectives have to contend with weather that drops under 50 degrees below zero and winds that whip across the arctic waste at 70 miles an hour. In the 35,000-square-mile Naval Petroleum Reserve No. 4, Petfour to the Navy and oilmen, there are no rail

lines, roads or even trails. Every piece of heavy equipment, tools of the trade, has to be freighted hundreds of miles over ice and snow on tractor-towed sled trains. Summer thaws change that same surface to a marsh of knee-deep mud.

After the labored effort of getting it to the scene, the equipment runs into more difficulties. Drill bits that have to chew their way through ground frozen as deep as 900 feet last only half as long. With precision work sometimes making gloves impractical, there is the constant, painful danger of metal surfaces freezing to the skin. Wounds heal slowly in the cold, where the blood's reduced circulation promotes the development of gangrene. To solve this problem, the Navy is trying to develop a plastic coating for metals.

A special kind of dirt, needed in making mud that is circulated in drill holes, has to be brought all the way up from Merced, Calif. Twenty-seven tons of it were hauled



Ice, snow, high winds and temperatures 50 degrees below zero are just a few of the problems facing the U. S. Navy in its search for vast, hidden oil deposits on our 35,000-square-mile arctic reserve

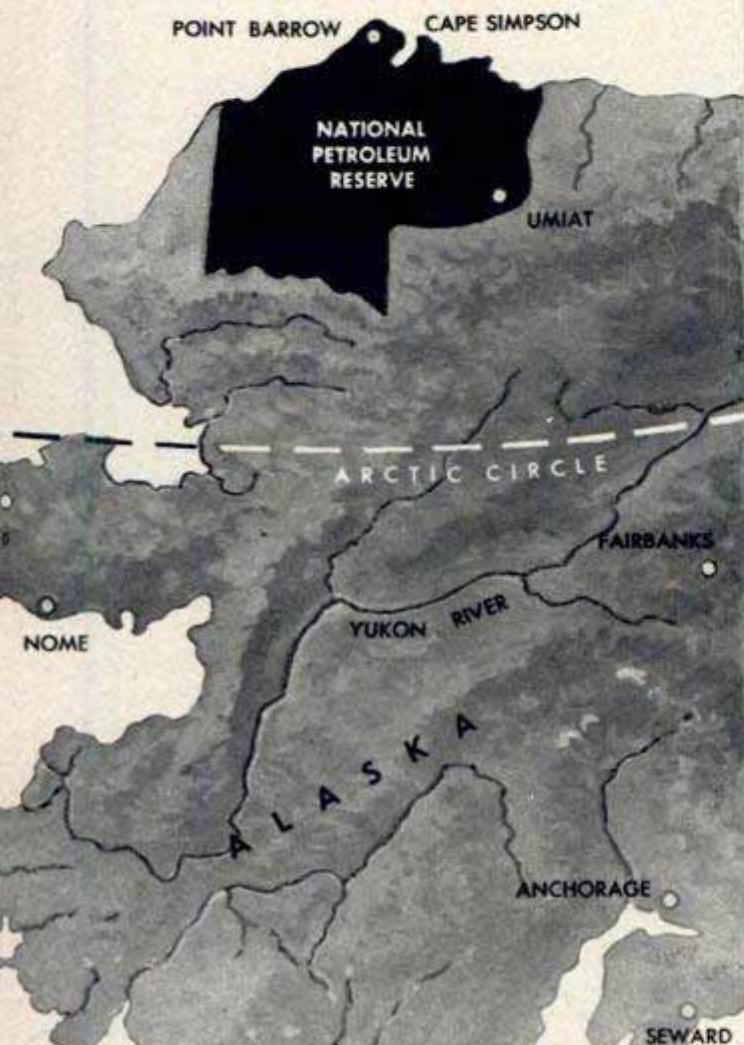

in recently by a water, rail and air route.

Another problem is moving up as much as 40,000 tons of supplies on the single flotilla of supply ships that can outrun the ice hazard each year. Barrow has no dock and the entire cargo has to be raced ashore in a week, before ice can lock the ships in for the winter. It is virtually an invasion exercise for supply ships, transferring about twice as much cargo as any beach received in wartime.

Geologists for more than a quarter of a century have considered northern Alaska potentially oil-rich. It has thousands of feet of sedimentary rock of marine origin, a formation similar to those in Montana and the Gulf Coast area, and Eskimos early told of surface oil seepage.

On the heels of a short-lived exploration by two California oil companies, President Harding, in 1923, set the area aside as a government reserve. For the next three years U. S. Geological Survey parties roamed the area, mapping seepages and

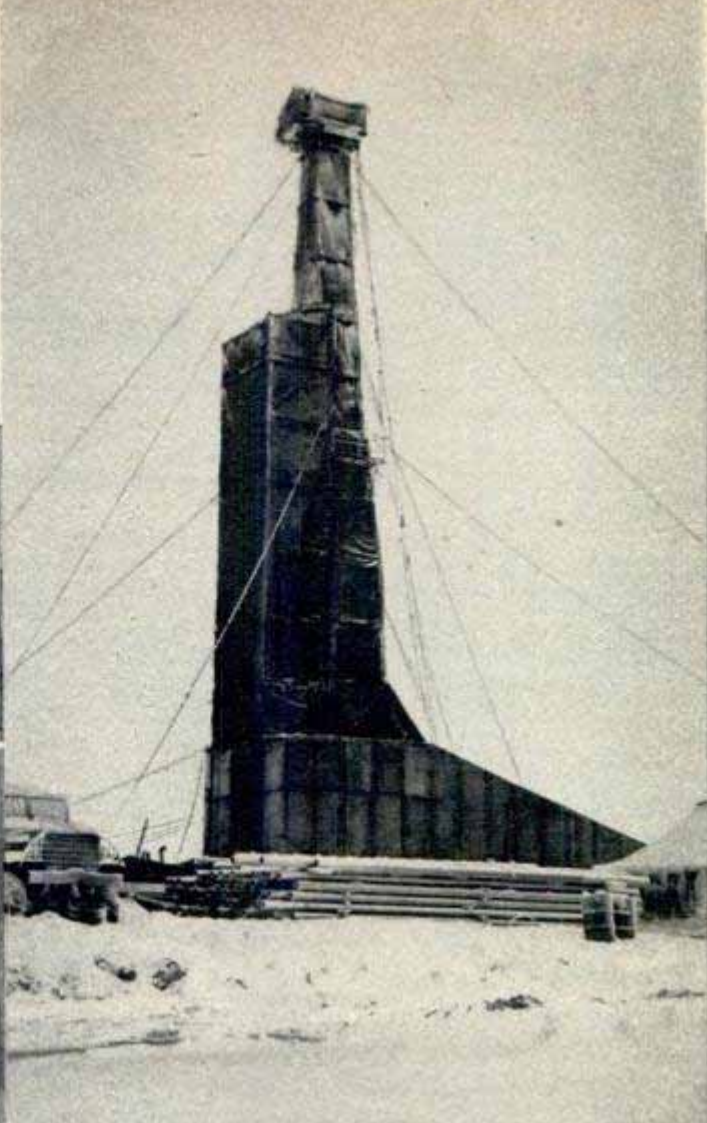

Official U. S. Navy photos

Exploration at Petfour continues the year around. For winter, equipment has to be weathertight against temperatures 50 degrees below zero. Below, drill rig on a Weasel, the "jack of all trades" in the Arctic







Always on guard at the remote Barrow base is "cat"-borne fire equipment, manned by a former Seabee officer

river outcroppings. Despite encouraging results, the project was dropped in 1926 because of new finds in the states and the Barrow Basin's cold weather.

It stayed dormant until revived by wartime oil shortages in 1944, when a Seabee battalion was sent to Alaska's northernmost tip to build a base, set out landing strips and reopen the oil hunt. A new technique, trimetragon aerial photos, was used in making a preliminary base map of the reserve. The very first test well—spudded in at Umiat in June 1945—revealed oil in small amounts at several levels.

Shortly afterward, the work was put on its present basis with civilian firms doing the actual exploration and drilling under Navy contracts. One of the civilians in charge is former Navy captain, Bart W.

Gillespie, who headed the wartime Seabee venture there. At the top is Commodore William G. Greenman, director of Naval Petroleum Reserves, who frequently shuttles by air between Washington and Barrow to check the progress. From 300 to 400 men are based at Barrow, Alaska, on the Arctic Ocean.

Virtually all except light cargo movement has to be completed during the coldest months, January, February, March and April, since most of the sled routing is over Arctic Ocean, lake and river ice. Ski-equipped bush planes fly out first, scanning carefully for traces of weak ice and dropping weighted stakes with red flags every mile to mark a route.

Next a Weasel-trailer combination on skis moves out over the air-marked route.

Pressure cracks and glaciers are an ever-present danger, so the two-man crew is required to radio reports back to the base every morning and evening, with the Barrow station always monitored to pick up emergency calls. Visibility is generally less than a mile during this twilight period. As the Weasel pushes ahead, further marking the route and testing the ice with an auger, food and gasoline are air-dropped to its occupants.

Sturdy sleds that carry gross loads of 23 tons make year-around operations possible at Petfour. Freight trains generally have 5 tractors pulling 10 to 14 bobsleds. If possible, routes over ocean ice are used

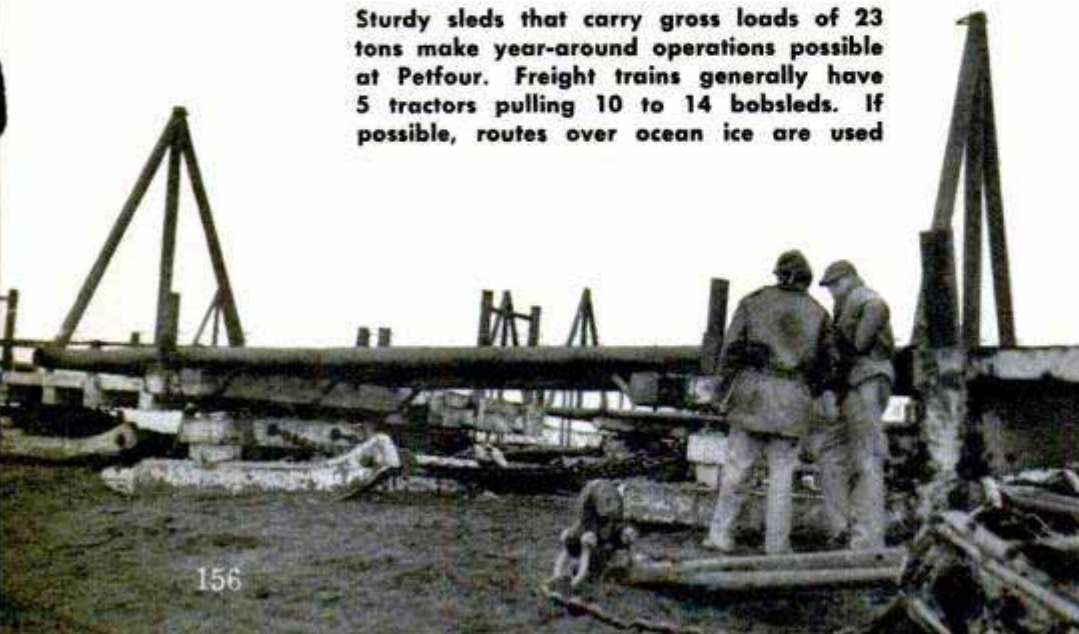



Behind the scout Weasel follows the supply train, usually composed of 5 tractors pulling 10 to 14 bobsleds, each with a net capacity of close to 18 tons. They move from 5 to 15 miles an hour for 15 hours daily, sometimes on routes that extend 400 miles or more from Barrow. Wanigans, 16 by 24-foot wooden shacks mounted over two sleds, provide sleeping quarters and a galley.

Though the Barrow Basin's yearly snowfall is only about 15 inches, it remains dry and powdery, swirling into drifts that make it necessary to build the sturdy sleds high off the surface. This also makes it dangerous for men to venture far from shelter or travel any distance without a compass.

Three test wells have been drilled, the most recent at Simpson No. 1 going below 7000 feet and showing signs oilmen regard as promising. Low-viscosity oil, at the rate of 24 barrels daily, has been pumped from a shallow hole in the permafrost at Umiat.

To enable men to work at extreme temperatures, derricks and drilling rigs are protected with plywood housing and specially insulated canvas. Dynamite charges have to be nonfreezing, water-resistant and packaged to withstand severe exposure. There are no dry storage magazines and the boxed explosives have to be stacked outdoors like cordwood.

Every new technique of expediting oil exploration is used at Petfour. The flying magnetometer, which is suspended from a plane, flying at low altitude, to gauge the magnetic strength of the earth over which it flies, was first tested in Alaska. The measurements, electronically recorded within the plane, can be translated into contour maps that reveal in some areas oil-bearing geological structures. The device

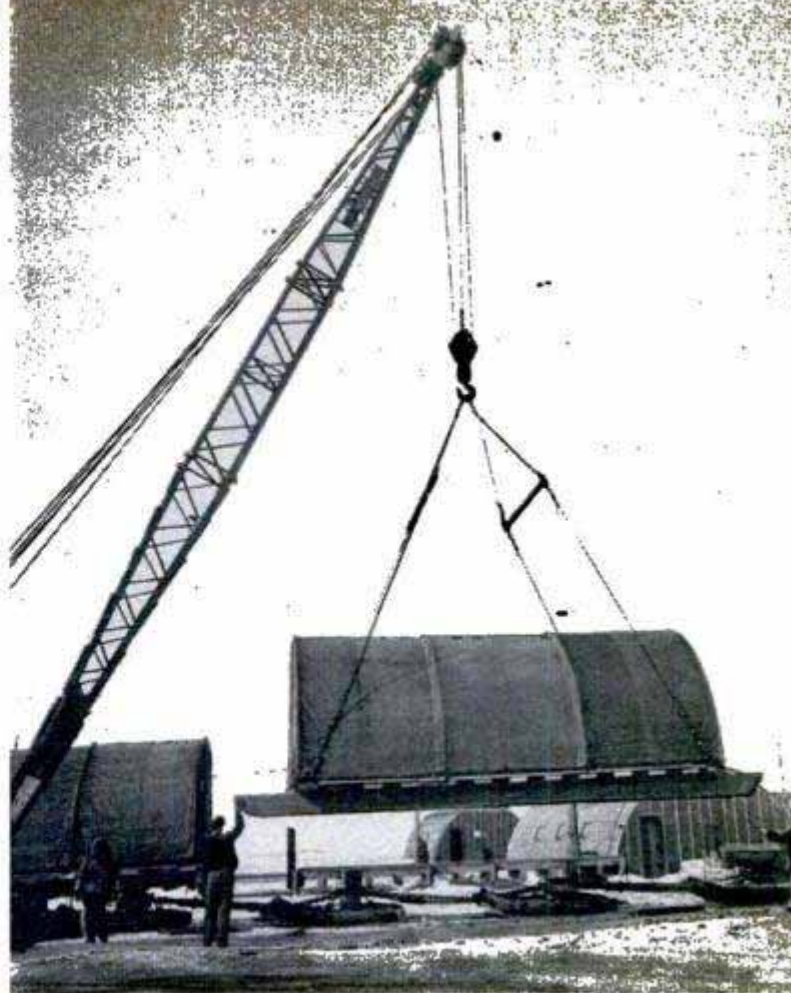

Lowering mobile hut onto sled runners. Materials for all construction have to be shipped from the U. S.

doesn't locate oil, but it can point a finger to its probable presence.

An added scientific aid is the gravimeter, which measures the earth's gravitational pull as a clue to rock structure and denseness in the area.

The Navy is playing a hunch in the shadow of the North Pole, backed by the best scientific reasoning available. If it proves right, we may own an ice-capped oil trove that ranks with the richest in the world.

Only about 15 inches of snow fall yearly in the Barrow Basin, but drifts make plows for lead "cat" a must





# TALKING



**CLAMP-ON STOOL** gives drill-press operators and other industrial workers a chance to relax on the job. The stool has a padded seat and can be adjusted six inches both laterally and vertically. Another model of the same stool can be used with a barber chair

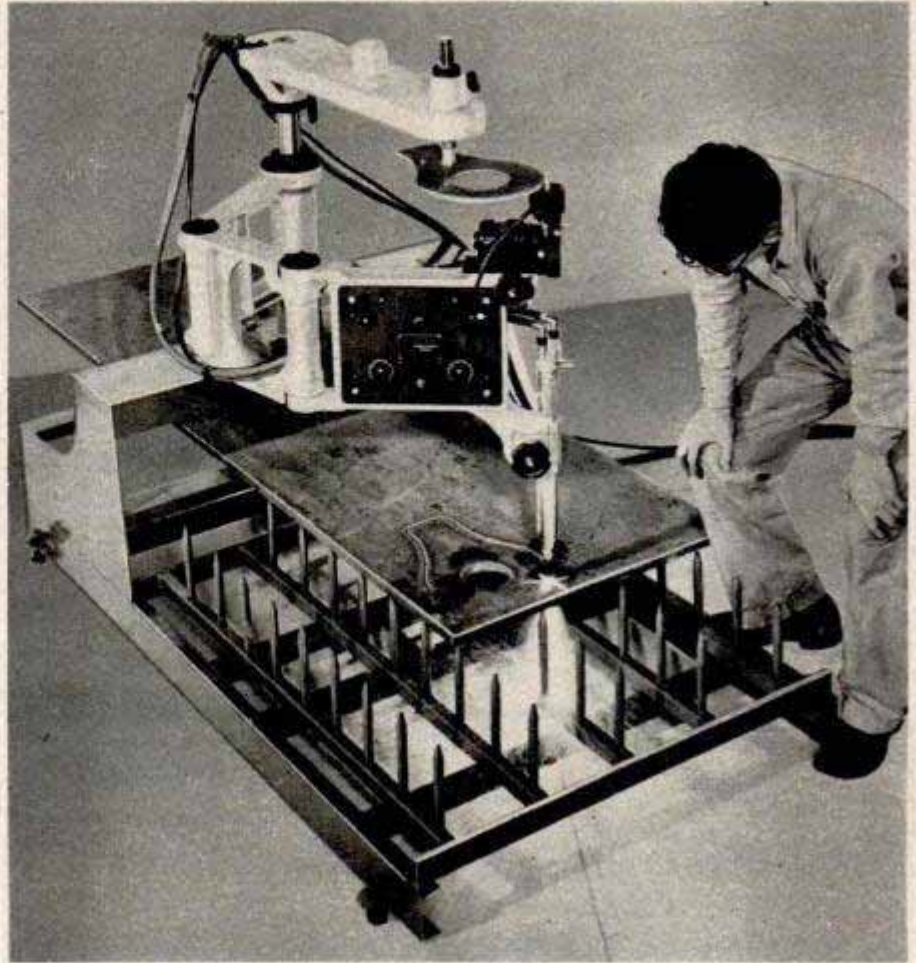

**FLAME CUTTER** melts through metal plate to cut out intricate shapes. A tracer follows a master template in guiding the cuts. When a steel template is used, the tracer follows the edge magnetically to make the flame-cutting operation automatic. Templates that are shaped from plywood also can be used

**SAW "TABLE"** for portable saw consists of sliding arms that clamp to a sawhorse. Saw can be operated with one hand and adjusted to make bevel cuts to 45 degrees



**ROLLING MAGNET** picks up small objects made of ferrous material. The rotary magnet, which is permanent and requires no electric supply, is mounted on plastic wheels. The operator removes the load by pushing a plastic wiper ring along the tube, which forces all the material across a nonmagnetic area

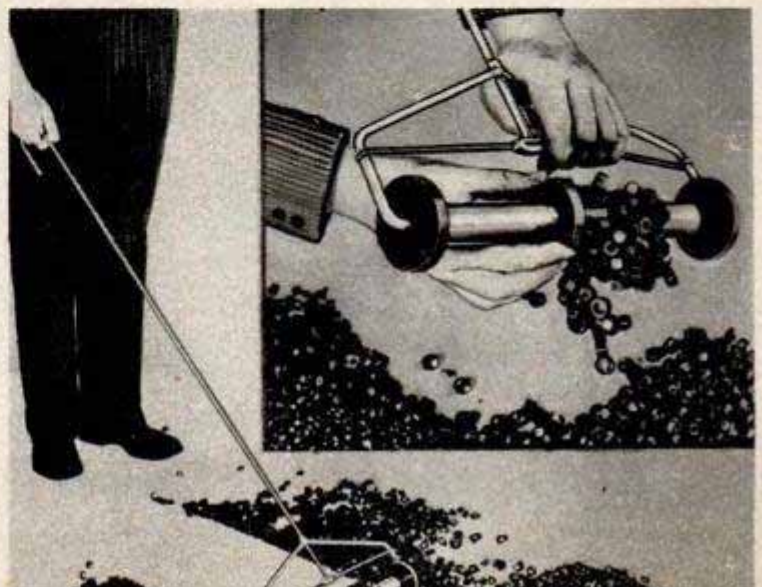



# SHOP . . .

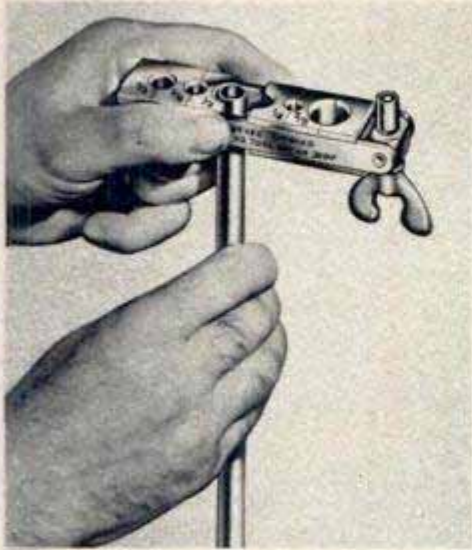

**FLARING TOOL** has a series of sliding dies for soft-metal tubing of standard diameters. Tubing is clamped between the two halves of the proper die, and the yoke slid over the die. When the operator screws down the cone firmly, the die forms a precise 45-degree flare without scoring the soft tubing



**THREAD CLEANER** scrapes rust and dirt ↑ from bolt threads. The cleaner reconditions right or left-hand threads on bolts or studs up to 2-9/16 inches in diameter. A locknut on the handle adjusts the cleaning blades to size. Flattened and damaged threads also can be restored with the tool

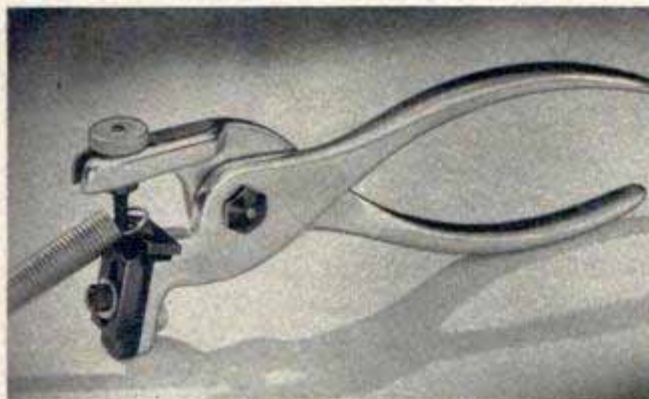
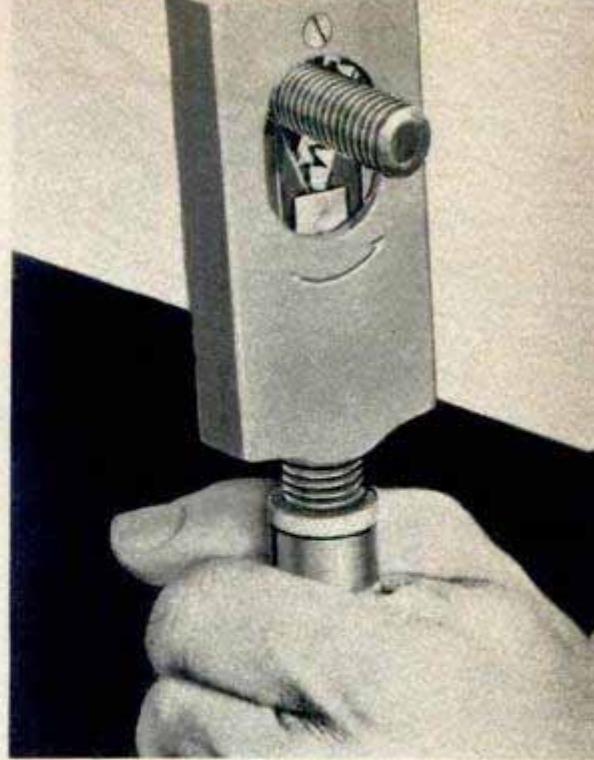

← **SPRING LOOPER** forms the last coil of a spring into a hook or loop. When the handles are squeezed, a forming punch and anvil shape the loop. Tool forms single or double loops and hooks, and side loops

↓ **ADAPTER FOR DRILL PRESS** converts it into a jigsaw that cuts wood, light metal, plastic and leather. The adapter comes complete with table top and saw blade. It can be used on any speed drill press up to 3800 revolutions per minute. Rotated 90 degrees, the saw will rip any length

**TOOL HANDLE** has a gripping mechanism that operates similar to a drill chuck. Any shape shank can be slipped into the mechanism, which is tightened by turning the hilt. The handle can be installed on most hand tools such as hacksaw blades, various sizes of files, reamers, bits, scrapers or razor blades

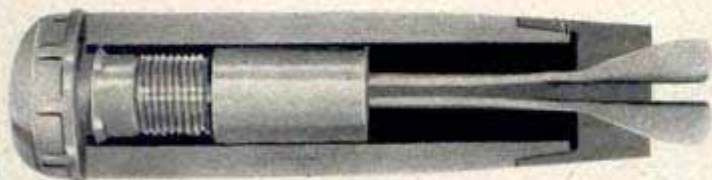



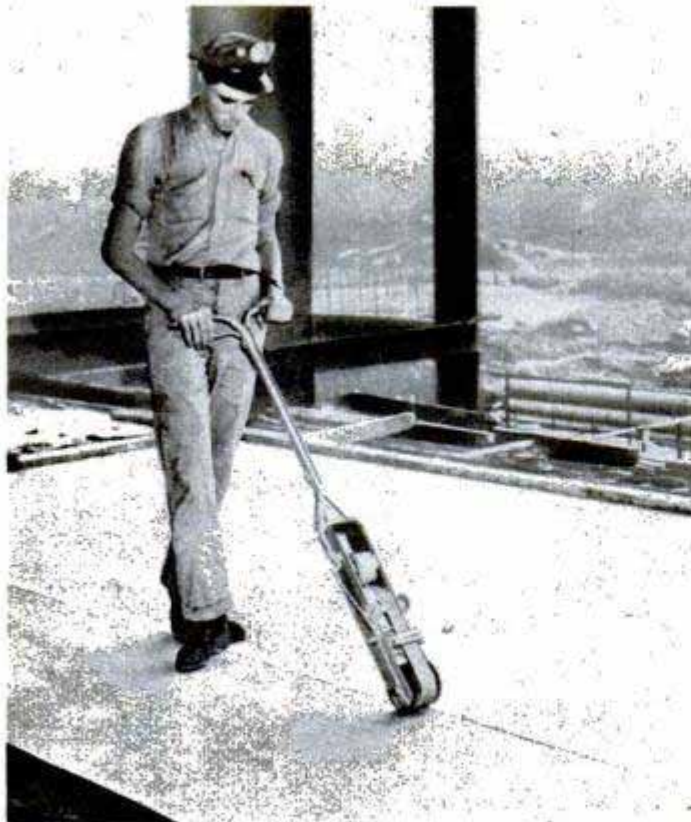

### Tape Seals Paper Blankets to Cover Fresh Concrete

Applied by a roller machine, a masking tape provides a bond between strips of asphalt paper used to cover newly poured concrete. The concrete is covered to cure it properly by retarding evaporation from the surface. The strips of paper are held

together to make them wind resistant and impervious to rain. The 1½-inch tape is rolled along the joint by an applicator which presses it down firmly. At the end of the curing period, the tape can be stripped away without damaging the paper.

### Shimmy Test Made for Airplane Tail Wheel

To make sure it could stand rough operational use, Convair engineers towed a newly designed L-13 tail wheel over 724 miles of the roughest roads in southern California. Their only problems en route were answering what-is-it questions posed by curious ranchers and farmers. The new

design has a hydraulic cylinder which prevents shimmy by changing the oscillation frequency of the tail-wheel fork. With the assembly pulled along at speeds ranging from 10 to 40 miles an hour, the test simulated approximately 1400 landings and take-offs, with attendant ground handling.

Consolidated-Vultee Aircraft photo

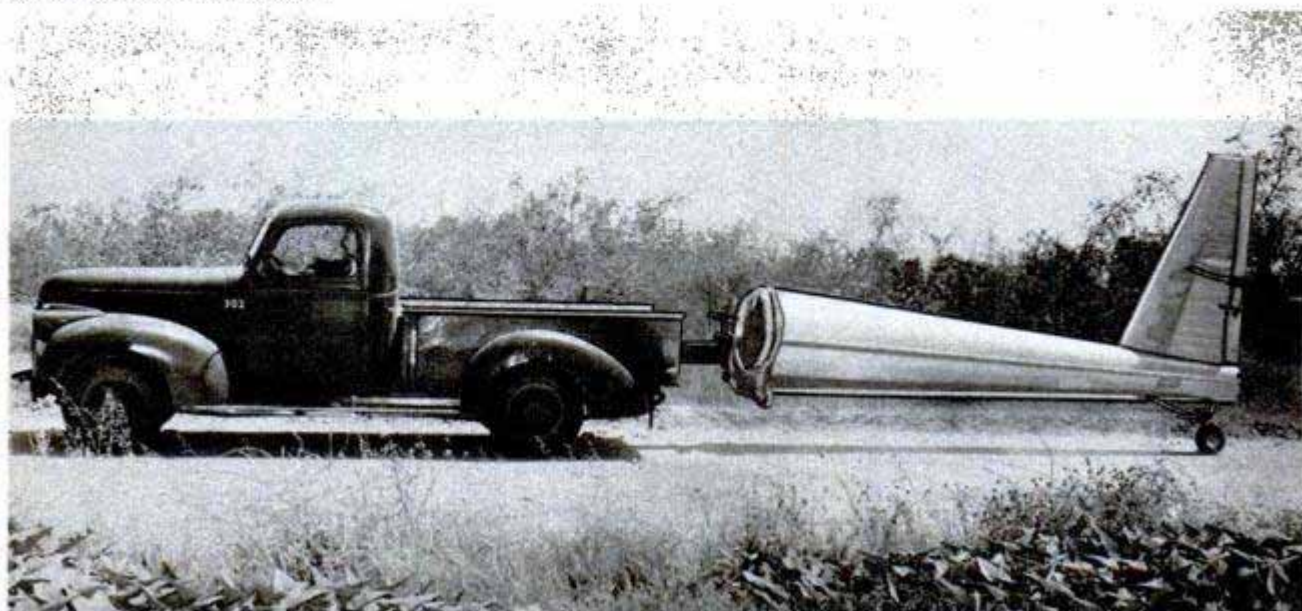



## Back-Seat Windshield Swings Out of Way

Ingenious side brackets support a rear windshield for convertibles and permit it to be swung from either side to allow passengers ready access to the back seat. Each bracket has a cam-locking, rattleproof hinge mechanism and a turn of the handle releases the lock. The windshield, made of optical-quality Plexiglas, can be quickly removed by unlocking both ends.

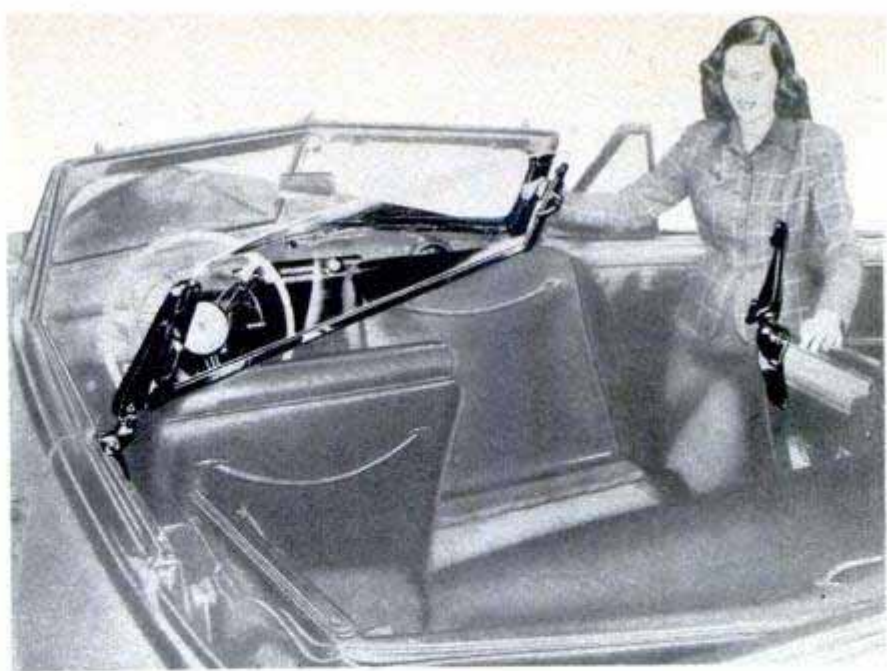

## Bun-Wiener Cooker Makes Hot Dogs

Hot dog and bun are rolled into one by a mechanical cooker that turns out "red hots" in assembly-line fashion. Carried by conveyors, the frankfurters are rolled in batter and then plunged into a long vat of hot grease that cooks the roll and wiener simultaneously. At the end of the cooking vat, the hot dogs roll down a ramp ready to eat. Where do you put the mustard and relish? Small paper cups of condiments are provided and you dunk the wiener between bites to suit your taste!

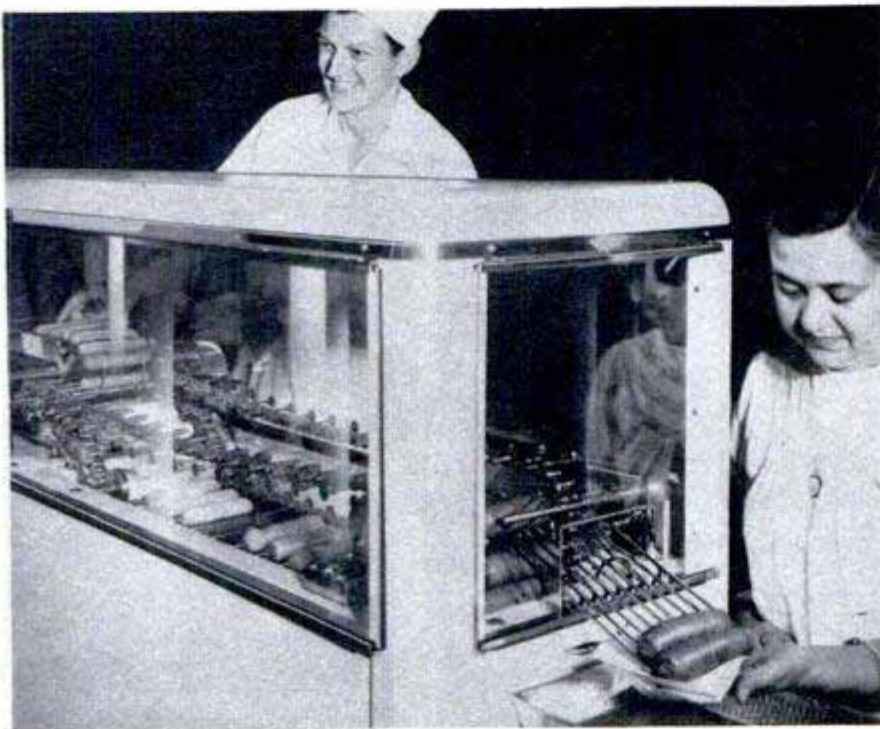

## Self-Piloting Lawn Mower Cuts Grass in Circles

When his lawn needs mowing, M. B. Hansell of Independence, Mo., just sits in the shade and watches his lawn mower go round in circles. Powered electrically, the lawn mower goes round and round a stake set in the lawn. The power cable is wound on a drum at the base of the stake and as it unwinds it guides the mower in a spiral course around the stake until a 56-foot circular area has been mowed. Hansell has six sockets for the stake scattered around his half acre of lawn. By moving the stake to each of the sockets, Hansell gets all the mowing done, except for border trimming, with a minimum of effort.

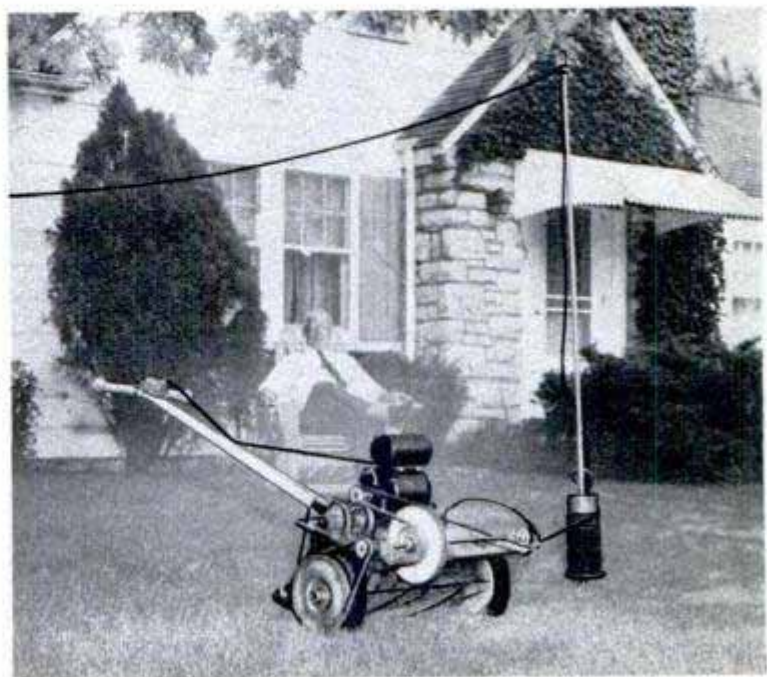



## Paris Engineers Try New Designs By Scale Models In Hydraulic Lab

← Scale models of harbors, dams, hydroelectric installations help engineers of the Central Hydraulic Laboratory near Paris solve European water problems. Here a worker checks gates of a lock that will be installed on Flanders canal

Below, left, technician floats candles on the water of a model harbor to determine the direction of currents. Candle movements are recorded on photographic film

Worker uses the liminimeter, a measuring instrument, to check the swell behind breakwater

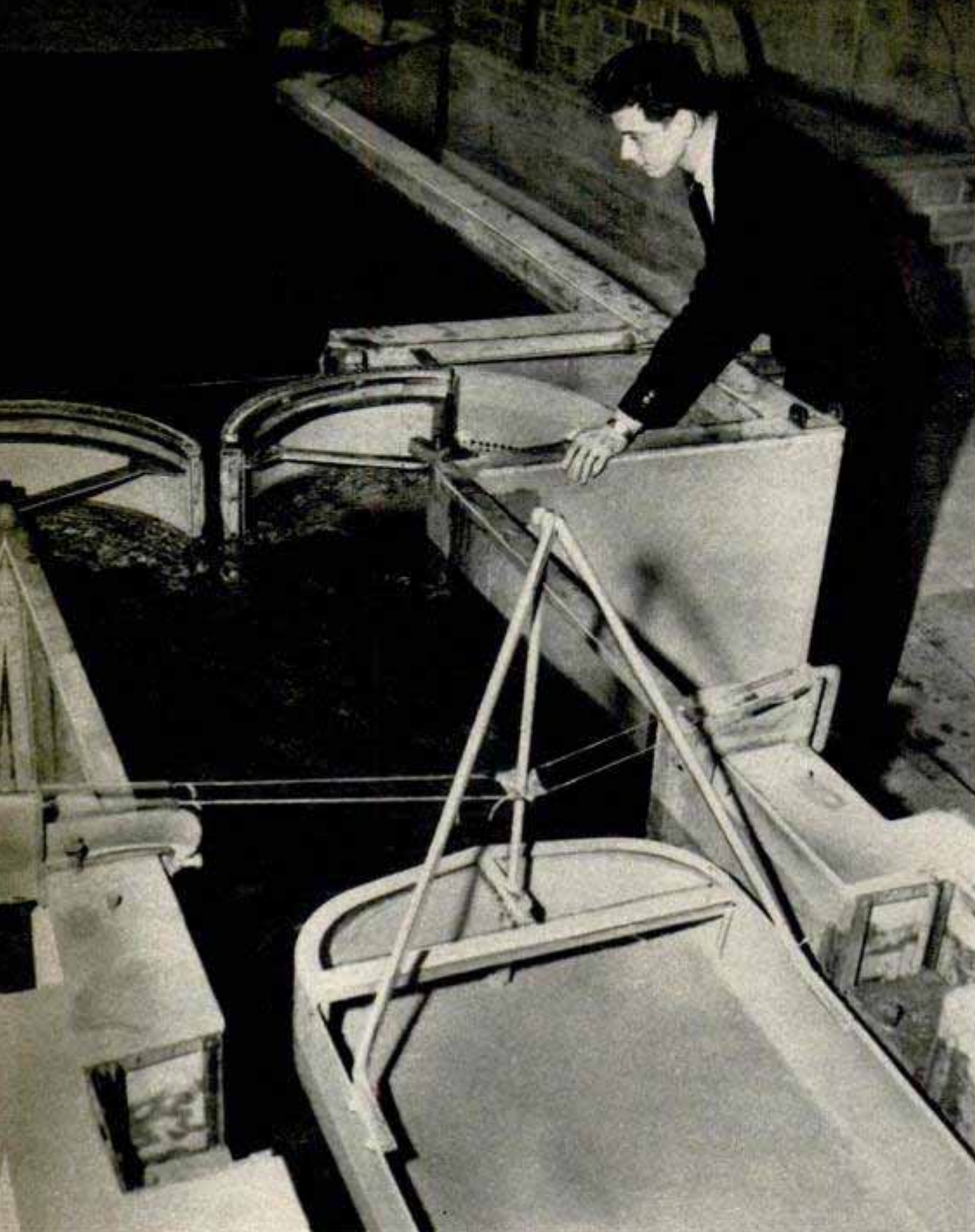



Water in a glass-walled channel pours across a miniature spillway during a design experiment

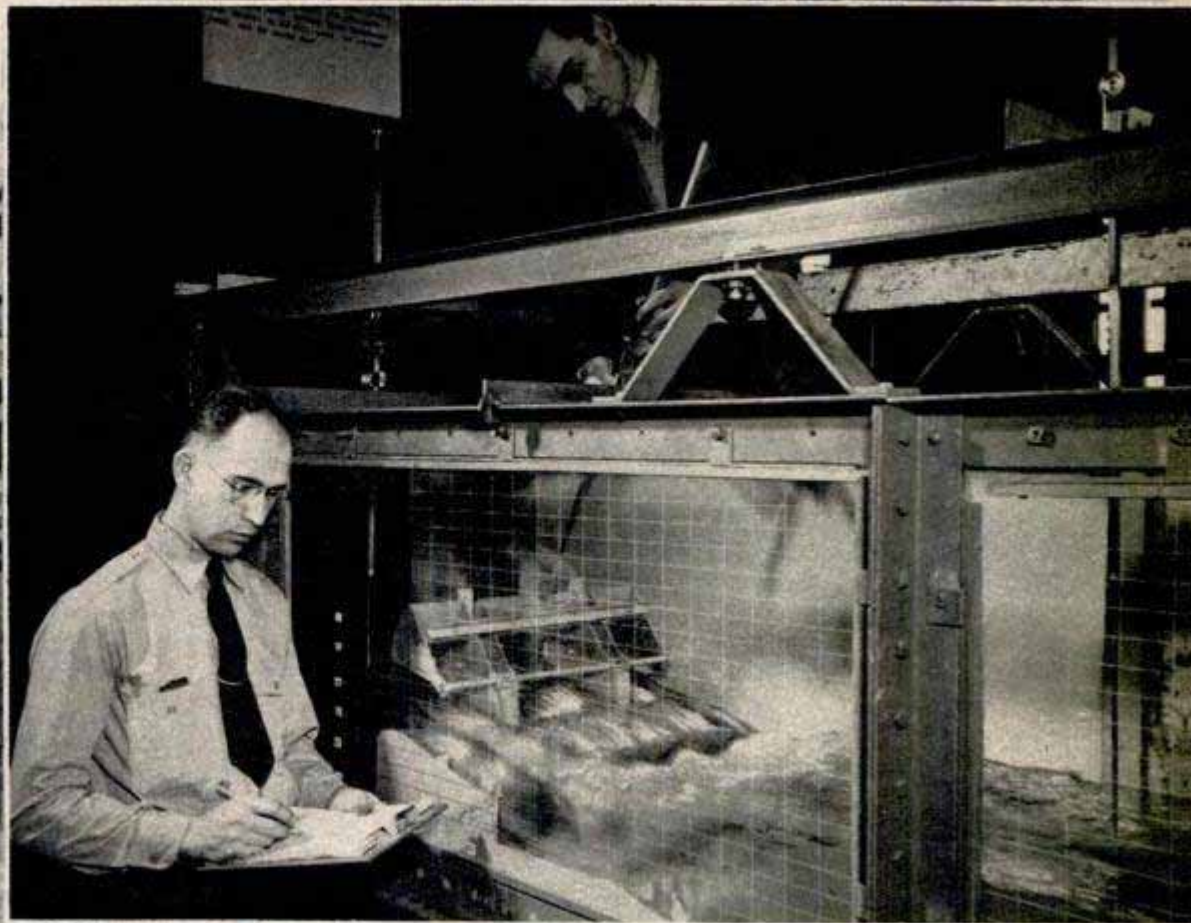

## RUNNING WATER IS THEIR PROBLEM:

Puzzles of liquid behavior flow into this Minneapolis hydraulic laboratory. Answers flow out in the form of better street drains or million-dollar dams

**A** MINNESOTA FARMER watched as spring rains gushed from a pipe outlet and cut a deep gully across his fields. He put in a call to the district engineer of the Soil Conservation Service to explain that water was draining away his land. The engineer, after an examination of the silt-laden stream, tossed the problem to the St. Anthony Falls Hydraulic Laboratory for a solution.

When research men of the laboratory examined the land they found that this single problem was typical of the conservation problems of many other farmers across the country. So they undertook the project because a solution not only would

By  
Clifford B. Hicks

Proposed locks for Mississippi River are tested by regulating the flow of water through models

DECEMBER 1948

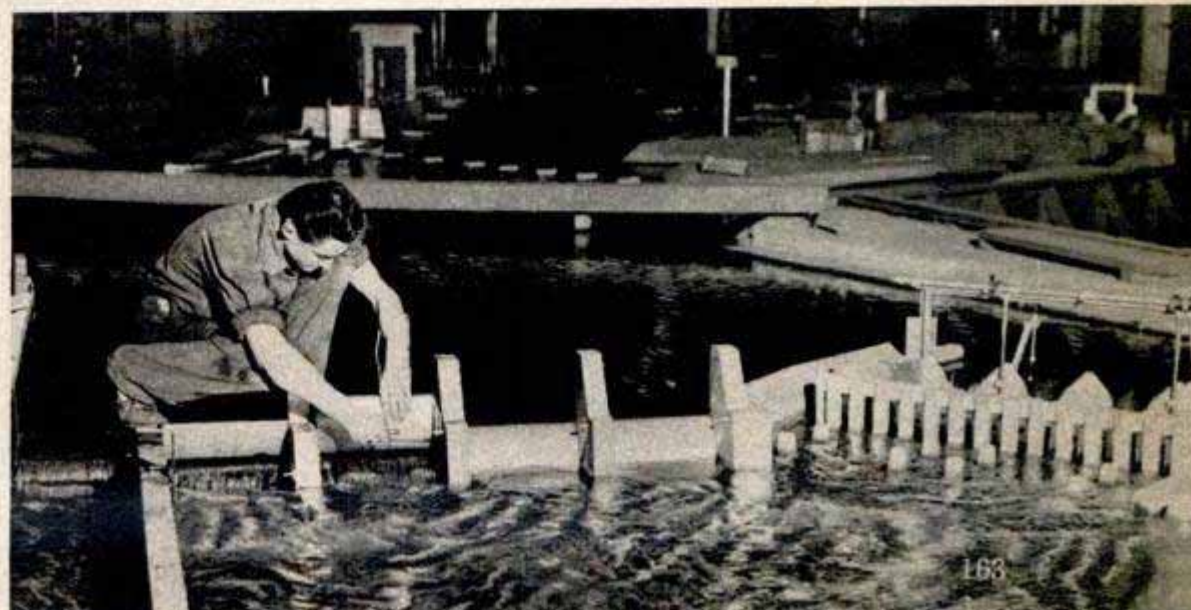



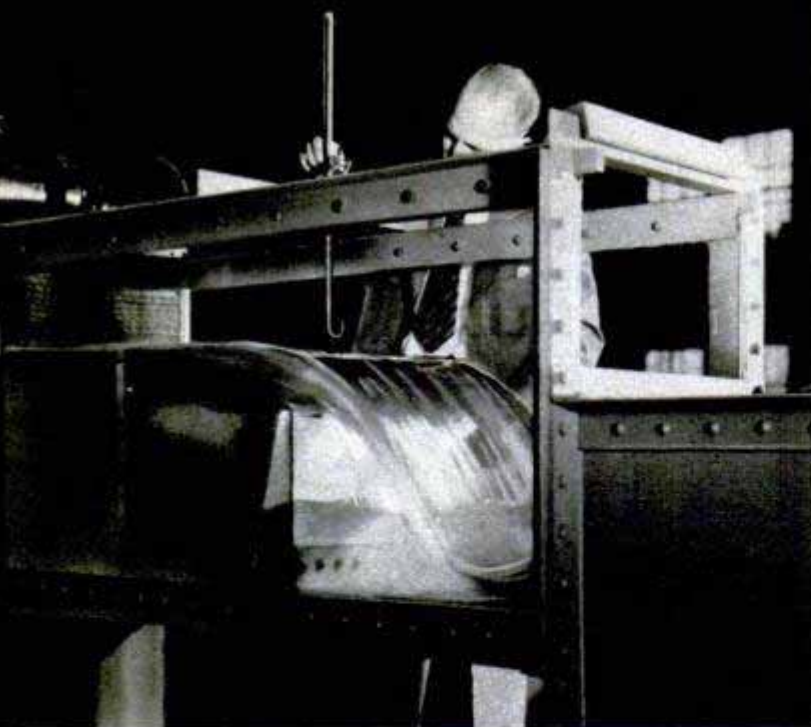

Doctor Straub checks depth of flow over a sharp-crested weir mounted in the glass-walled channel. ↓ Model sand dam failed due to erosion of downstream slope. Model's failure showed flaw in design

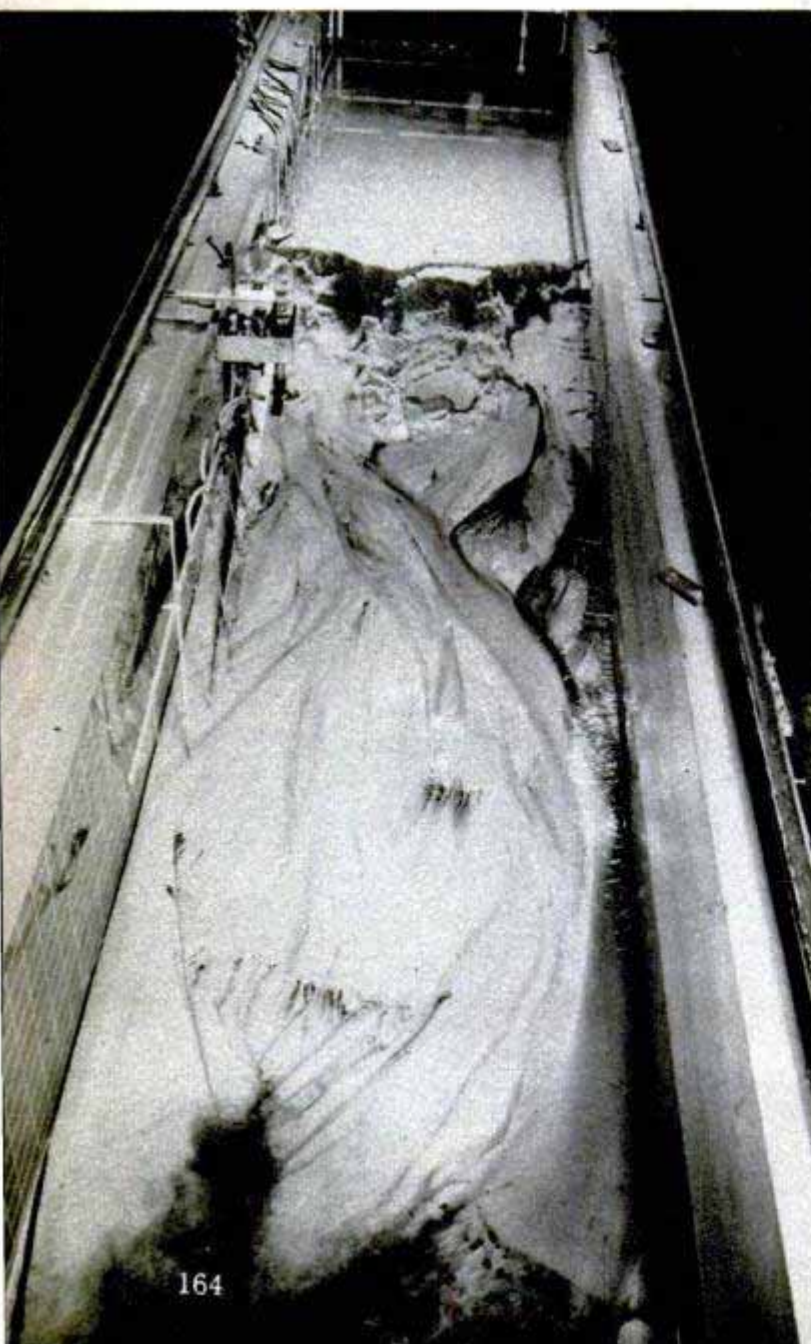

save a few acres of Minnesota farmland but could prevent loss of thousands of tons of rich earth over the country.

Laboratory workers built models of various types of culverts and outlets to find one which would break up the energy of the farmer's stream. They came up with a new design which can be installed on thousands of erosion-threatened farms.

This research was a lifesaver to the farmer, who could not pay a staff of scientists to solve the conservation problems of his land. Neither could he afford to stand by and watch his fields float away.

Soil conservation is only one of the many fields of research undertaken at the St. Anthony Falls Hydraulic Laboratory of the University of Minnesota. How do liquids behave? Why? How can these behavior patterns help in designing a simple street drain or a multimillion-dollar dam to be built halfway around the world?

Through this Minneapolis laboratory flows the Mississippi River. Water from above St. Anthony Falls is diverted into flumes, conducted through a maze of rooms and then passed back into the river after a total drop of 50 feet. Scientists put this flow to work to predict how water will act as it flows across a given construction project. They break basic textbook rules by making water run uphill and flow at full capacity through a sloping drainpipe.

Director of the laboratory is Dr. Lorenz G. Straub. He supervised its design and construction and has been in charge of its operation since it was completed in 1938 except for a period during the war when the laboratory was dormant and he worked with the British on undersea ordnance.

Locked in flowing water is energy. Scientists of the laboratory attempt to harness this energy for human use, or to see that Nature does not release it in a way that causes disaster.

Take one research problem as a typical example. The Government plans to build a huge flood-control dam on the south fork of the Park River in North Dakota. This dam's spillway must be built on a very loose foundation material that is subject to deep erosion and underscour. Army engineers tossed the problem of controlling this erosion to the laboratory, where a time-tested method was used to find a solution. A large model of the proposed dam was built to an exact 1 to 36 scale. When all was ready, engineers opened a valve and the waters of the Mississippi came rolling down on the model. More and more water flowed against the dam until the spillway was releasing water at a rate that corresponds to 23,500 cubic feet per second in nature. Workers tossed confetti on the water to discover the flow pattern. When



the flow was cut off, the stream bed, dam and spillway were examined for damage. By using the model, the Army engineers could predict exactly what will happen to the Park River dam.

Houston, Tex., brought in a project concerning the design of a city reservoir. A model was built. Water flowed across the spillway corresponding to a flood rate in nature of 650,000 cubic feet and engineers stationed on a movable carriage measured the downstream erosion to check the design.

Some problems, says Doctor Straub, are easier than others to solve with experimental models. In many situations, his models give results that enable him to predict the behavior of water and underwater structures within three percent. In other words, he can tell engineers that the underscour of a dam will be a certain number of feet, and hit the figure practically on the button.

The scientist currently is working on the design for a dam that will be the second largest in the world. It will be built on the Godavari River in India at a cost of 300 million dollars. It will provide two-crop irrigation for more than a million acres of land now barren for lack of water, one-crop irrigation for another million acres, and a tremendous amount of hydroelectric power. Eight million cubic yards of concrete will be required.

The most difficult problem in constructing the dam is to divert the river for two years. There is a tremendous annual variation in flow, from a minimum of 3000 cubic feet per second to



Laboratory, shown at right center, is a hospital for sick dams. Water from the Mississippi flows through maze of channels and back to river. ↓ Torpedolike instrument picks up an exact specimen of sediment. The sample then is used to calculate the amount of sediment in the stream





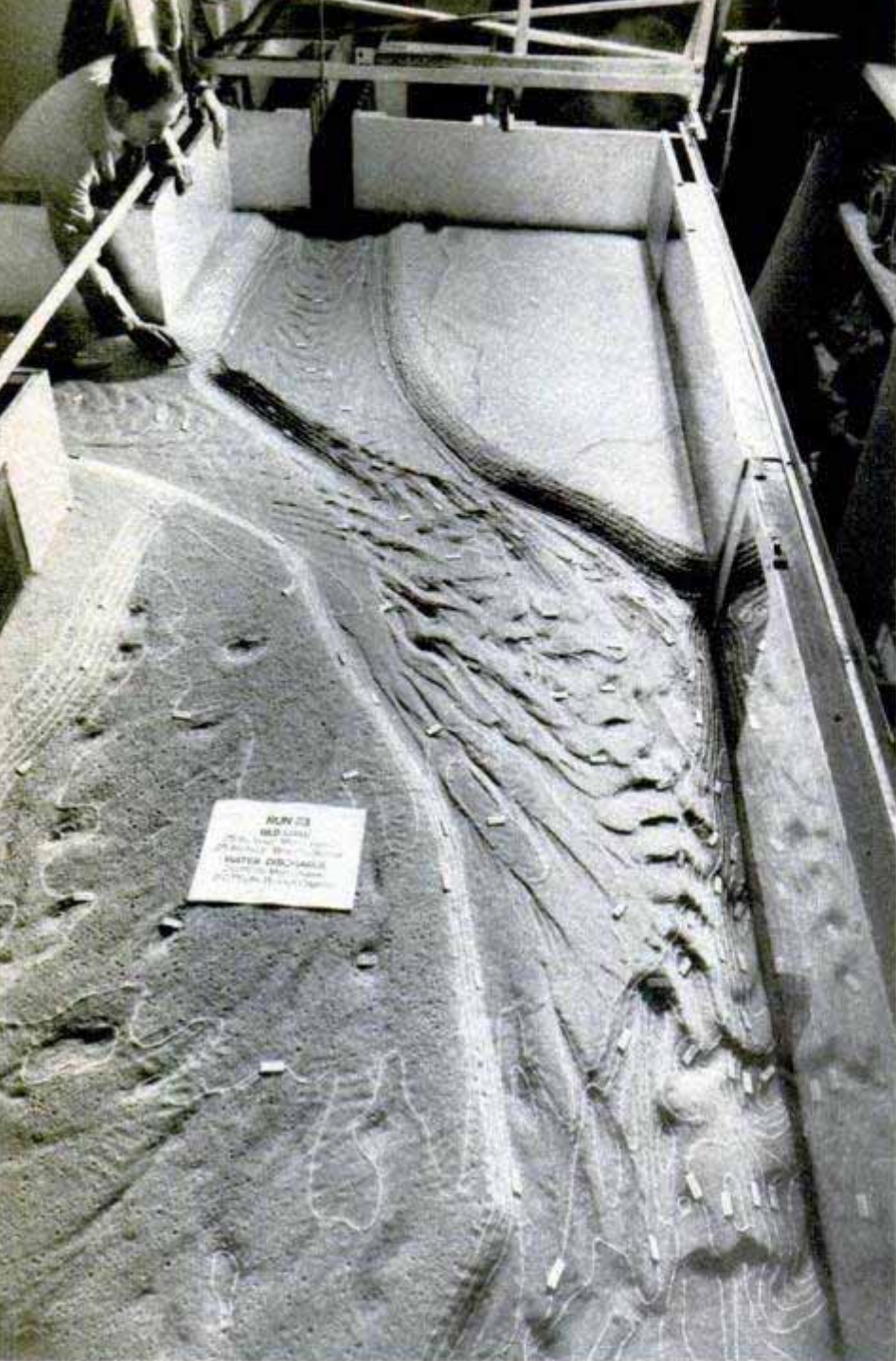

Study with models shows how sediment is carried away at junction of two streams. Note deep channel where the streams converge. Below, small water tunnel was built to check design of a larger one for the Navy, which will test underwater missiles

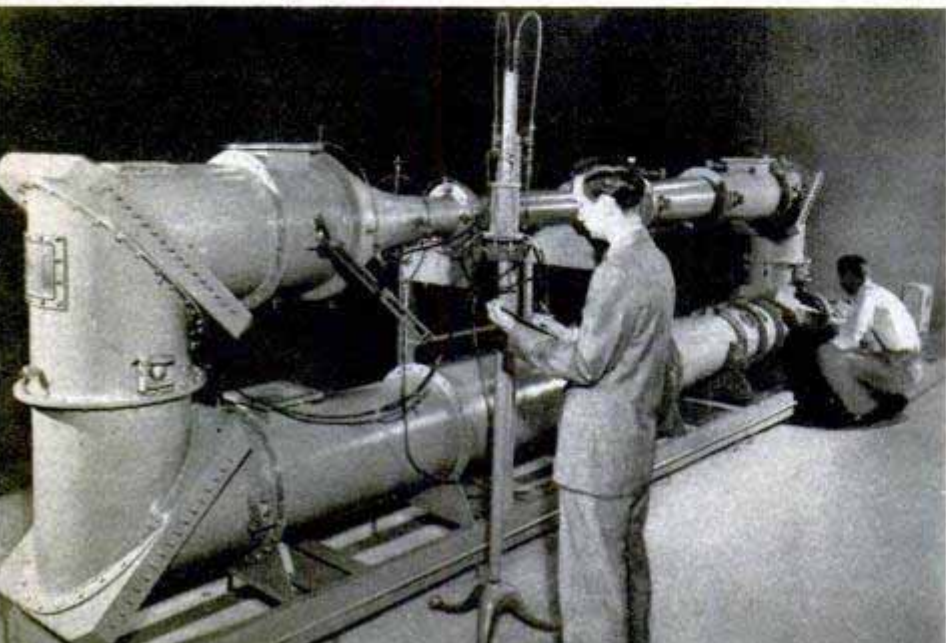

a maximum of three million cubic feet per second.

Doctor Straub went to India as a consulting engineer to discover methods for controlling this flow. As a result of his studies, he is recommending that a certain type of cofferdam be built which will handle the variation. He's now building a large model of the Godavari River in the laboratory to discover exactly what can be expected when the cofferdams are used.

"The project is so tremendous that it will be a major achievement of the new government of India," says Doctor Straub. "Although it will cost 300 million dollars, it will yield crops and hydroelectric power estimated at more than 100 million dollars a year, so it will pay for itself in a very short time."

Another laboratory project under scrutiny is a model water tunnel. Such water tunnels are used for hydraulic research in the same way that wind tunnels are used for aerodynamic research. Model submarines and torpedoes are suspended in the tunnel and water circulated at high speed to determine flow characteristics. The Navy plans to build a huge tunnel capable of circulating water at a speed of 80 feet per second. The tunnel, five feet in diameter at the smallest throat, will cost several million dollars. In order to predict the exact efficiency of this tunnel and to find out whether changes should be made in its design, the Navy commissioned the laboratory to build a model on a scale of 1 to 10.

The model, recently completed, has a test section six inches in diameter which can be viewed through a transparent window. Actually the tunnel is a closed pipe built in the shape of a rectangle through which the water is circulated at high speed. Guide vanes turn the flow around the corners. Models suspended in the test section resist this flow of water. The pattern made by the flow shows what will happen if that particular torpedo or other underwater device is launched and moves at a certain speed. In exchange for a grant of \$100,000 to build and



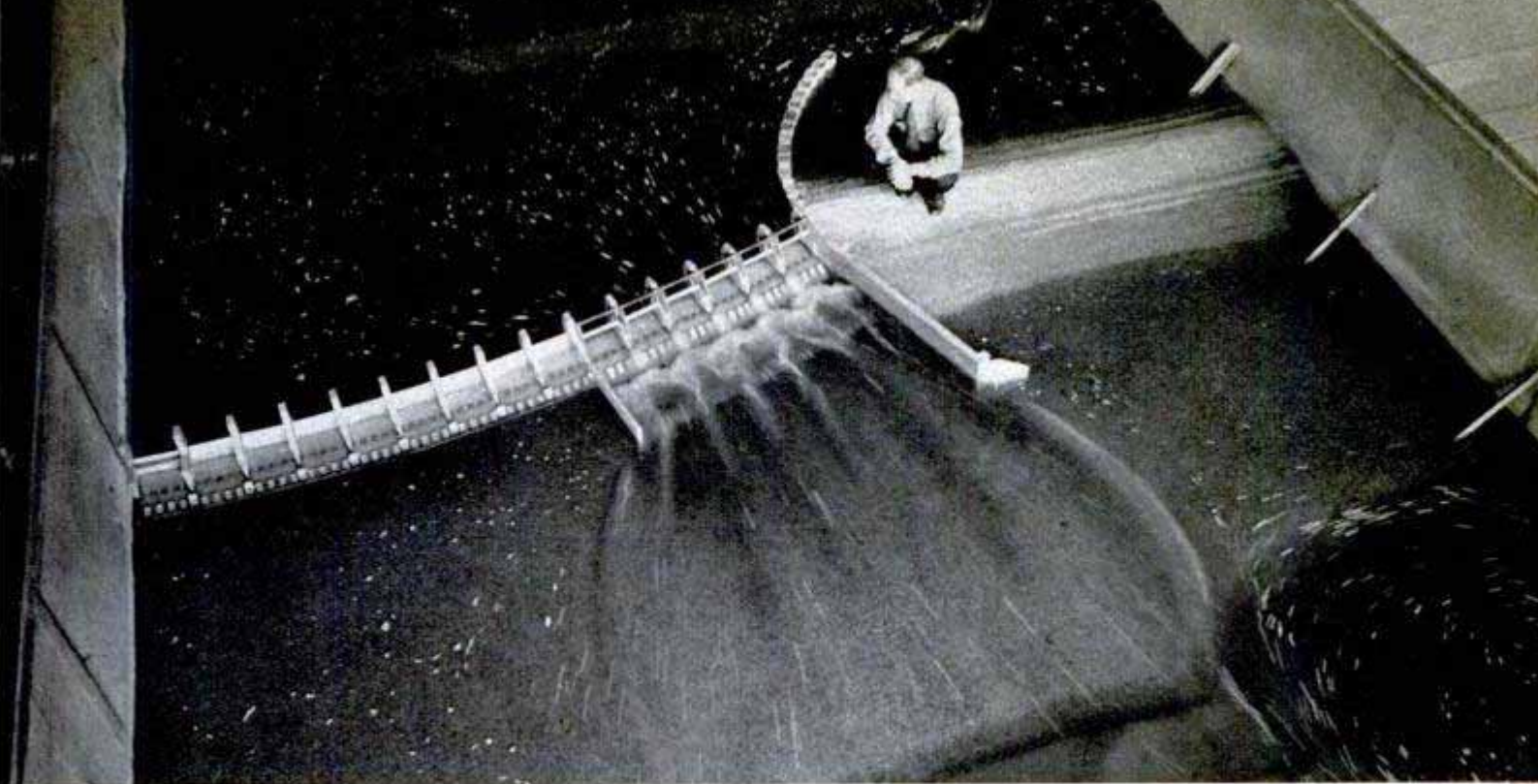

Confetti tossed across the water as it approaches a spillway model indicates the direction of the currents

test the smaller tunnel, the Navy stands to save money on its multimillion-dollar project and to improve its design.

One of the most down-to-earth projects completed at the laboratory recently is a design for a simple street drain for the Minnesota Highway Department. The efficiency of any drain corresponds to the amount of water it will pass. This efficiency is cut down when leaves and trash clog the openings. The new drain is self-cleaning because the bars are mounted in the frame at a 45-degree angle to the line of water flow. The force of the water pushes trash diagonally along the bars to the drainage opening at the curb. This simple drain has an efficiency 75 to 100 percent greater than former drains. Because of its increased capacity, fewer drains are required along any given stretch of pavement. Doctor Straub estimates that the cost of this research can be saved in a few miles of highway construction.

Soil scooped up by flowing water often is deposited in downstream reservoirs or on fertile fields at flood time, thus causing double damage. One farmer's field may be lifted, carried and dropped like a blanket across a downstream farmer's crops. How much sediment will a stream carry when it flows at a given rate? How permeable are the materials carried by the water? The answers to these questions are

sought in other projects, some in collaboration with the Soil Conservation Service.

Doctor Straub's latest project is a study of airport-drainage problems in the Arctic, in cooperation with the Army Corps of Engineers. Arctic drainage is a much different problem from drainage in a temperate climate. There's 100 percent difference in viscosity, or resistance to flow, of water at 50 degrees and water at 150 degrees. Still lower temperatures naturally increase the viscosity even more.

There's a backlog of five years' work awaiting Doctor Straub, his staff and his models. Working with models will eliminate costly failures in future constructions.

Erosion below baffles is measured by gauge on movable carriage

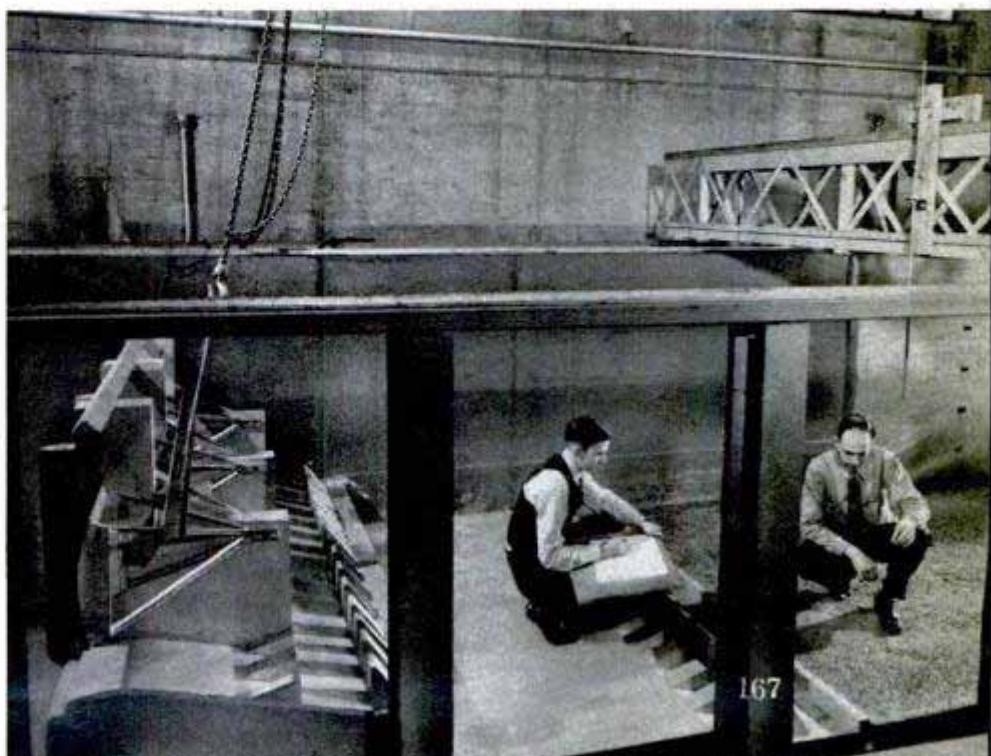



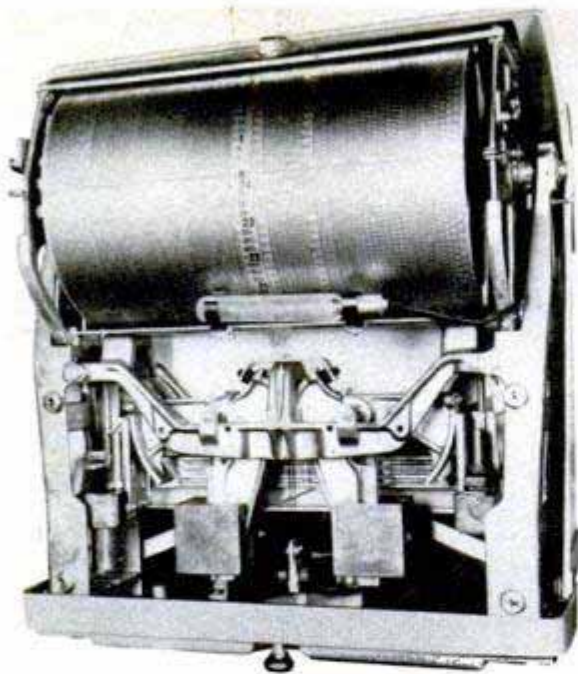

### Scale Shows 129,000 Weight and Price Figures

More than 129,000 computation characters appear on the weight and price chart of a new scale for food stores. There are 70 prices indicated for each pound, eliminating the need for doubling, adding or subtracting by the store clerk. Despite the large number of characters, the chart

measures only 13 inches by 27 $\frac{1}{4}$  inches. A series of lenses magnifies the small figures to make them easily readable. The scale need not be on a perfectly level surface, as two pendulums in the mechanism compensate for out-of-level conditions or the yield of the shelf or counter.

### Earth Loader Dumps Ton Per Second Into Trucks

Maximum discharge capacity of a huge earth-loading machine is one ton per second. The loader, which handles most types of dirt and gravel, scrapes the surface off the ground, loads the material on a conveyor belt and then dumps it into waiting trucks. The machine is being used on the Cherry Creek Dam project near Denver. It is pulled by a tractor with the dump truck moving beside the unit, receiving the dirt as fast as it is scraped and lifted on the belt. Crawler tracks support the unit at

the rear. The 54-inch belt is powered by a 150-horsepower Diesel engine with all controls mounted so that one man can drive the tractor and operate the machine. The blade scrapes to a maximum depth of 24 inches and can be set at an angle for slope and grading work. The Cherry Creek Dam is a \$15,000,000 flood-control project, part of a plan for the Missouri Valley. The rolled-earth dam will be built of 13,000,000 cubic yards of sandy clay. It will hold back cloudbursts of the mountain foothills.





**O**UT IN THE OKLAHOMA portion of the Red Plains, a pair of agricultural agencies are doing away with the ax and muscle and are doing an old job the modern way by using mowers, beaters, cutters and various types of saws and chemicals.

The work is returning some eight million acres of woodland pastures to higher beef production by removing rank growths of weeds, shrubs and trees. In most instances where the undesirable growth was removed, the areas more than doubled their cattle-carrying capacities and are now producing upwards of 90 pounds of beef per acre. Other fully cleared lands are producing five times as much grass as land 90 percent shaded.

The brush situation does not concern the Sooner state alone. The Red Plains involves some 36 million acres of level-to-rolling lands in south-central Kansas, western Oklahoma and northwest Texas. An estimated 50 percent of the total is classed as woodland pastures, with each state bearing a near equal burden of the low-quality areas.

Texas is also concerned with 60 million acres of mesquite, and Kansas is in a position similar to that of Oklahoma. Other states in the timber areas of the nation have similar problems.

What brought about this brush problem? The introduction of agriculture into these areas marked its beginning. Settlers broke the sod, starting the rapid decrease of soil fertility and the rapid increase of erosion and land abandonment. Lands not plowed were turned to pastures, which were improperly managed and overgrazed. As the native grass

# *Clearing the range for beef*

By Norris A. Jackson

Crawler tractors pull heavy cables over mesquite lands in Texas to clear 100 acres a day. Dozer blades uproot tree

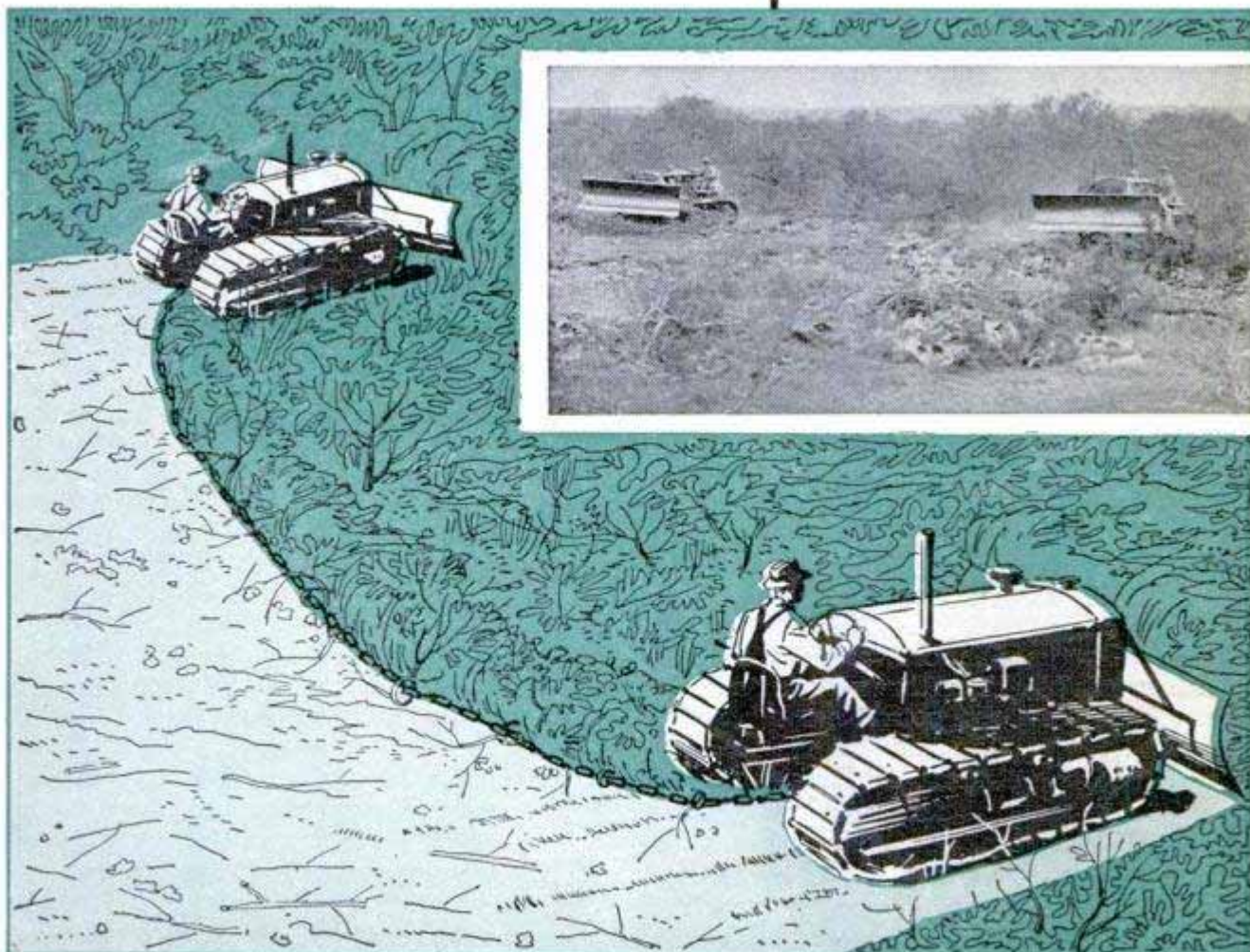



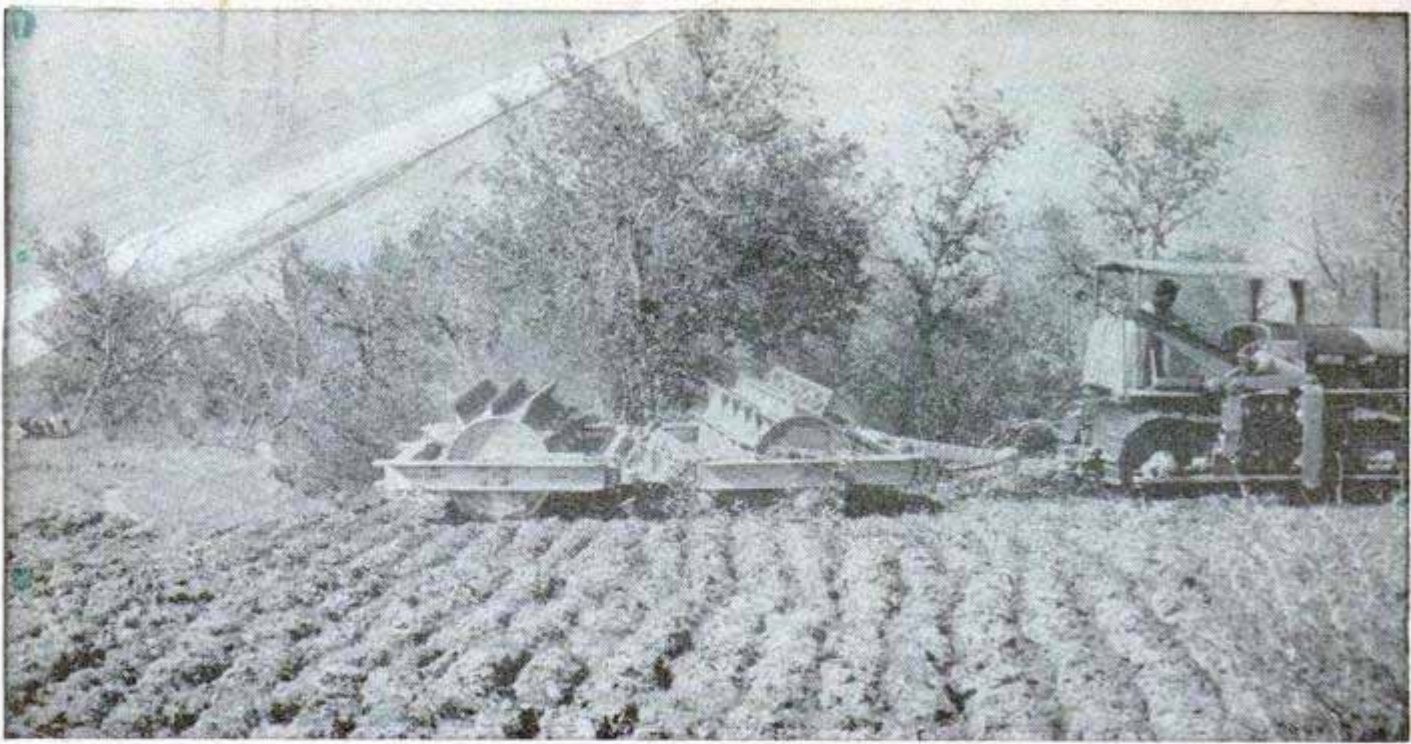

Three-ton brush cutter clears a seven-foot swath through the heavy brush; it also lightly cultivates the soil

was destroyed and the competition removed, the brush came in.

Today, the area consists of small amounts of native grass intermingled with scrubby, woody vegetation ranging through sage, sassafras, mesquite, persimmon, creosote brush and blackjack and live-oak thickets to large trees such as elm, honey locust, hickory and hackberry—a marked contrast to the former lush green native-grass pastures consisting of big and little bluestem, Indian switch and side oats grama grasses.

The first large-scale land-clearing work in Oklahoma was conducted in 1935 at the Red Plains Conservation Experiment Station near Guthrie. Since then the program has expanded until the problem now is being attacked by both machines and chemicals. Characteristics of the work make it possible for the information obtained from the studies to have wide application.

Located in the heart of the “cross timbers” of Oklahoma (on lands typical of the Red Plains), the station was established in 1929 and is operated cooperatively by the U. S. Soil Conservation Service and the Oklahoma Agricultural Experiment Station. It was the first station of its kind in the world.

Machines used most extensively for brush removal in the three-state area include brush mowers, portable and tractor-operated power saws, dozers, brush beaters, giant stalk cutters, cables attached to heavy crawler tractors and brush buck rakes. The type of brush determines the type of machine, for a piece of equipment designed to handle brashy material such as sage and creosote brush is quite different

from one for tough, taller growing material such as blackjack or persimmon.

Vegetation such as sage and creosote brush and low growths of tough brush and weeds are easily removed and controlled by the universal mowing machines found on practically all farms throughout the nation. When equipped with special stub guards and heavy sections, the machine can be operated through fairly dense growths of brush (up to 1½ inches in diameter) at a cost of \$2 per acre. Additional mowings are about the same as for mowing alfalfa, while returns from the mowed lands amount to \$3.50 per acre under present beef prices. The machine is especially useful for annual spring mowings of areas initially cleared by other machines. Cattle may be turned in for grazing after the third or fourth mowing.

The “Iron Billy Goat” or brush beater, which literally beats the brush and weeds to pieces with whirling chains, also works efficiently on small shrubs. Its chief advantage is for use on rough or stony ground where mowing machines cannot operate.

Designed and built at the Red Plains station, the beater consists of a series of weighted chains driven by a horizontal shaft. The shaft receives its power from a tractor power take-off. Station agricultural engineers are in the process of building a new low-slung beater with an eight-inch horizontal shaft that is expected to prove more efficient than the older model.

Trees ranging in trunk size from 2 to 10 inches are felled with portable power saws, while larger trees are more easily handled with saws mounted on tractors. The tractor





saws also work well on smaller trees, and can be operated when the tractor is in motion or by swinging the saw into the tree trunk. A high dozer bar or push frame prevents the tree from falling on the tractor or operator. Either portable or tractor-operated saws may be turned from a horizontal to a vertical cutting position for logging felled trees.

Texas research workers are using bulldozers and treedozer to clear mesquite and other woody vegetation, but the methods increase soil erosion if the area is not quickly replanted to either fast-growing

Above, brush beater or "Iron Billy Goat" flails low growths of shrubs with whirling chains. New beater below has shorter chains and shaft with power unit

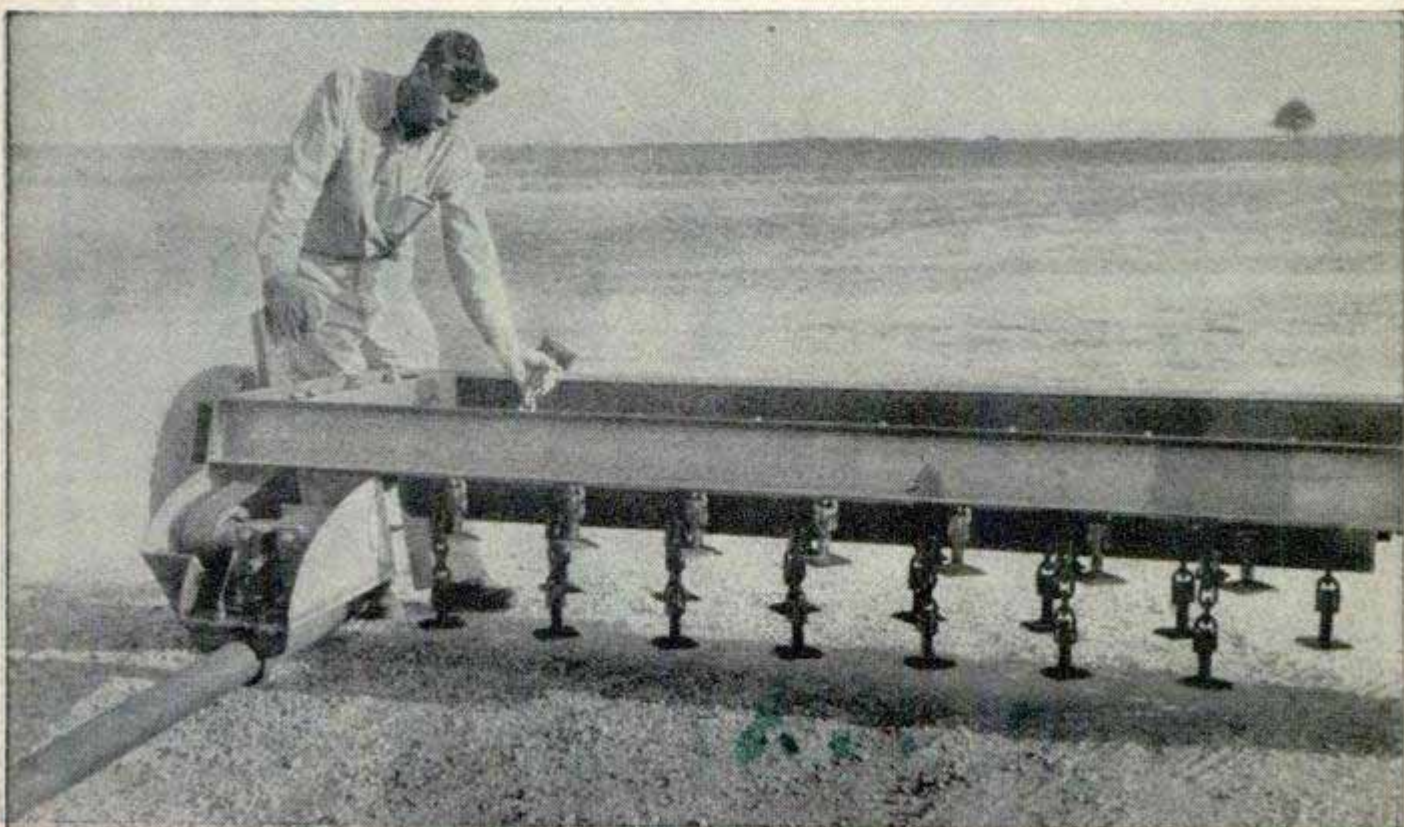



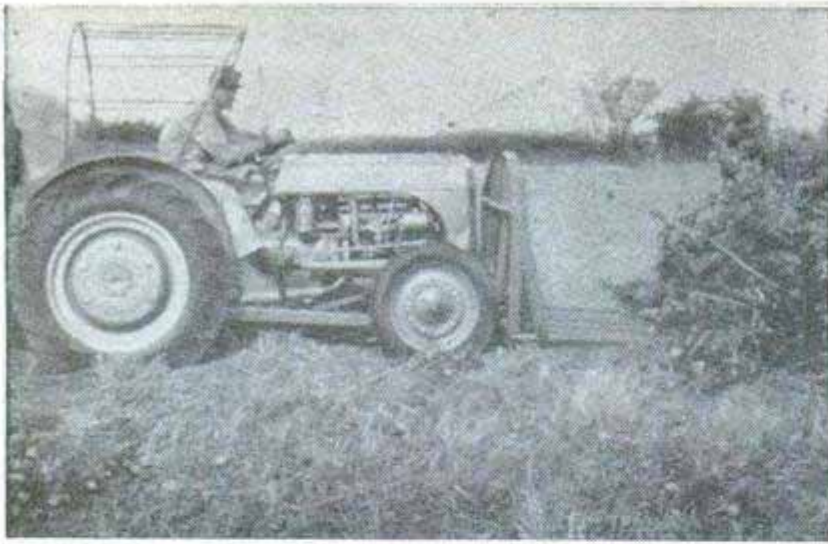

This small power-lift buck rake can lift and transport 1000 pounds of brush. It has a power saw mounted on rear of tractor. The rake-saw combination can clear an acre of woodland pasture in 2½ hours

grasses or legumes. The dozers often strip the ground of all vegetation, frequently leaving huge holes in the earth where the trees were uprooted.

Mesquite also is cleared by use of two bulldozers pulling four strands of 1¼-inch cable, 400 feet long, through the underbrush. The method works best when the ground has sufficient moisture to let the trees fall over, thereby pulling out most of the roots. This method also strips the ground of all vegetation, making erosion more probable.

A new machine that does a light cultivation of the soil as it removes the brush and trees is gaining popularity in the cross timbers. It is an extra-heavy stalk cutter, which consists of 12 cutter blades, seven feet long, mounted on large water-filled steel cylinders. The manufacturers recommend the use of two or more seven-foot cutters pulled at high speeds.

Used extensively in Texas for removing mesquite, the cutter works satisfactorily on all types of brittle plants. It also is very effective for breaking down small trees and brush that have been killed with chemicals.

The brush which has been cut up and partially stirred into the soil by the cutter will lie in place pending complete disintegration, resulting in soil improvement. The mulch formed by the cut brush also will conserve moisture and reduce erosion.

Three years ago, the Red Plains station began using chemicals as a means of brush control, and interest in the method is growing steadily. Chemicals now being tested are 2,4-D and ammonium sulfamate, or "Ammate." The latter material is not

(Continued to page 238)

Blades on the portable saws can be turned to a vertical position for logging the felled trees and brush





## Front-Seat Back Rest Drops Down to Form Double Bed in Auto



Within one minute, a six-foot double bed can be formed in any standard car equipped with a special front seat. This seat is installed in the framework of the original seat. A fingertip release causes the back rest to be lifted out of its frame and placed horizontally against the rear seat. Adjustable legs fold down to hold it in a level position. The bed then consists of three units, the front and back seats and the back rest. The special seat is available in two styles; one can be used as a single or double bed or can be tilted back for the most comfortable riding position. The bed seat can be removed and reinstalled in another car without damage to the original seat or its framework. Doctors have used the seats to convert their cars into emergency ambulances.



Top left, fingertip release is pressed and the seats fold down and out. Legs support the back rest. Top, readjusted seats form a double bed. Above, in another model, half of seat folds back for single bed

## Child's Electric Automobile Has Brakes That Are Applied Automatically

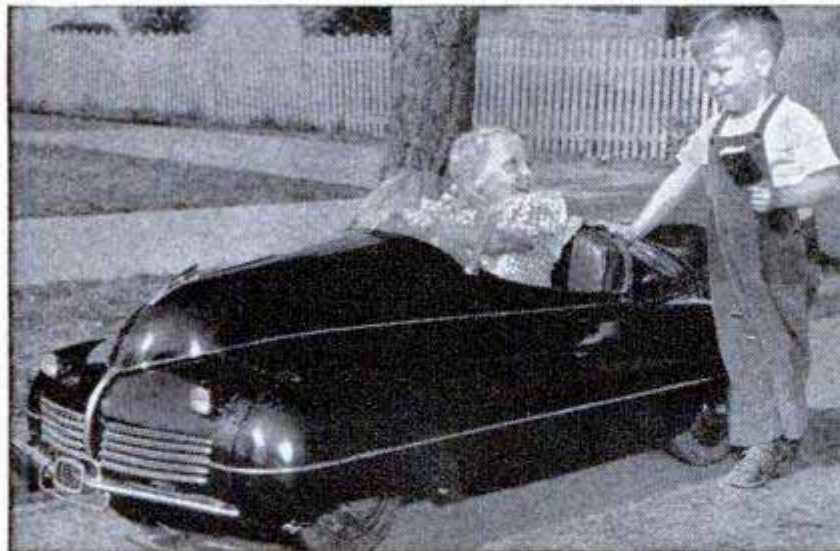

Just about foolproof in operation, a tiny, electric-motor-driven automobile provides the four-year-old daughter of a Northrop-Aircraft-plant worker with her own car. Built of discarded parts, the miniature car is driven by an automobile starter motor. A six-volt battery provides the current.

Only one control pedal is used. When the pedal is depressed, it acts as an accelerator. When released, it automatically shuts off the motor and applies the brakes. The car has a top speed of 13 miles an hour and the motor, located in the rear, runs for one hour on a charge.



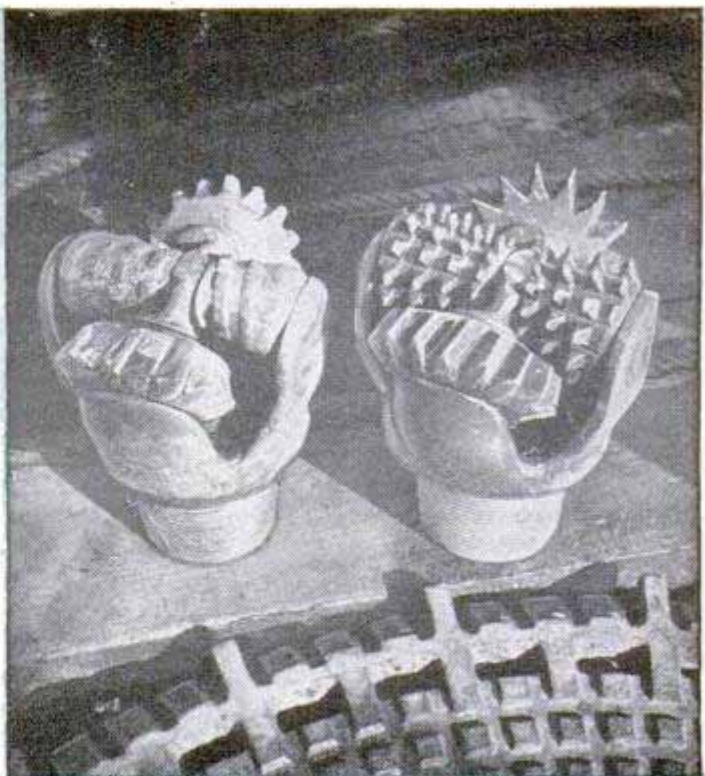
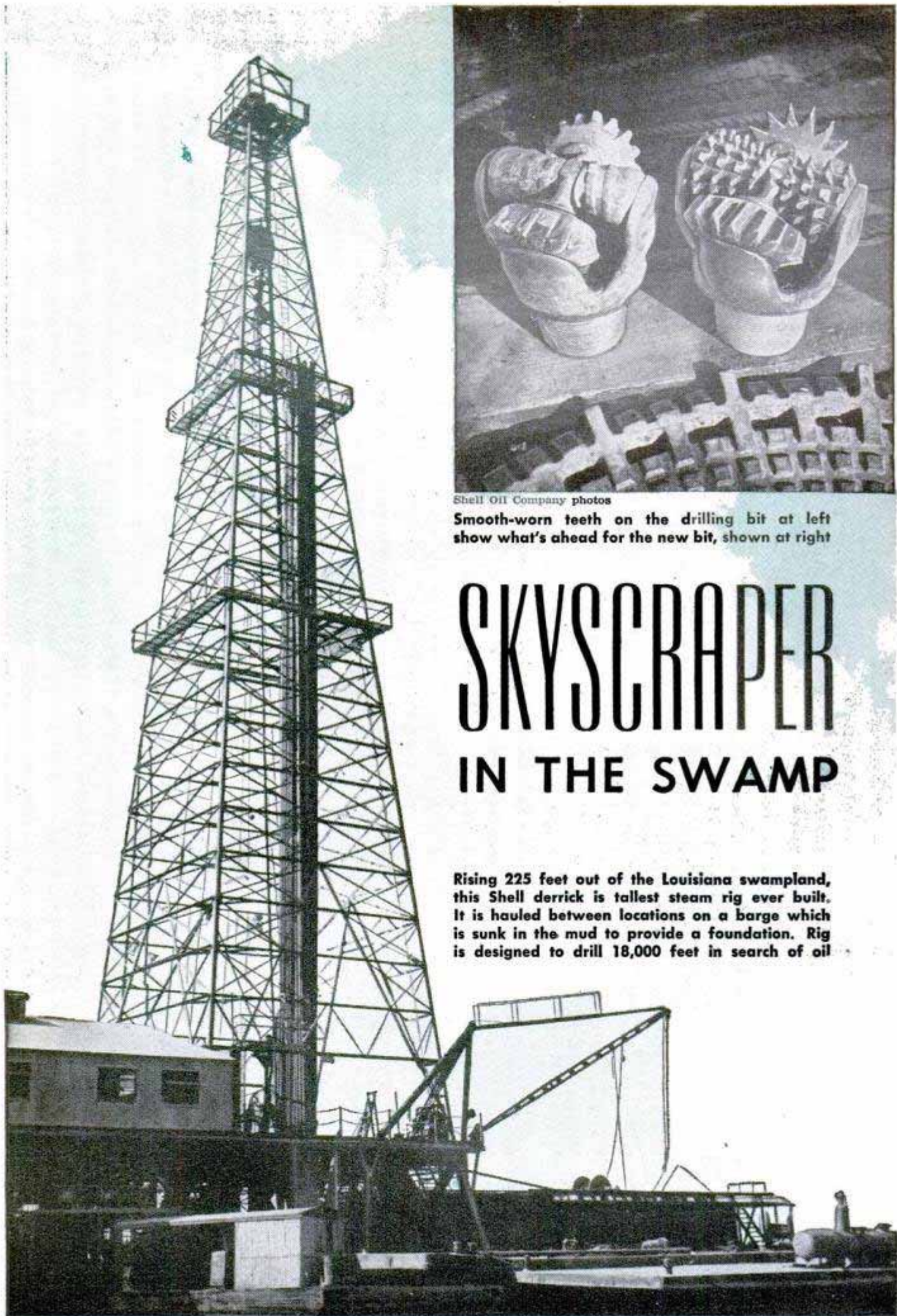

Shell Oil Company photos

Smooth-worn teeth on the drilling bit at left show what's ahead for the new bit, shown at right

# SKYSCRAPER IN THE SWAMP

Rising 225 feet out of the Louisiana swampland, this Shell derrick is tallest steam rig ever built. It is hauled between locations on a barge which is sunk in the mud to provide a foundation. Rig is designed to drill 18,000 feet in search of oil





Working 125 feet above the derrick floor, a worker manhandles a 135-foot stand of 5-inch pipe

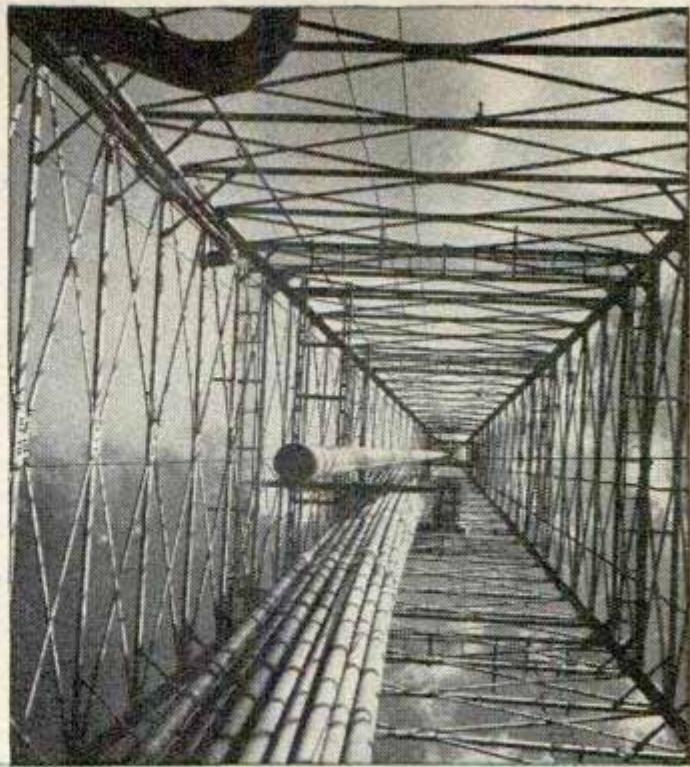

Pipe 135 feet long dangles from the crown block. It will be fastened to pipe already in the well hole

Rig's traveling block tips the scales at 19,000 pounds, has working capacity of 950,000 pounds

Dial panel tells the driller the weight of pipe, pump pressure, torque and revolutions per minute

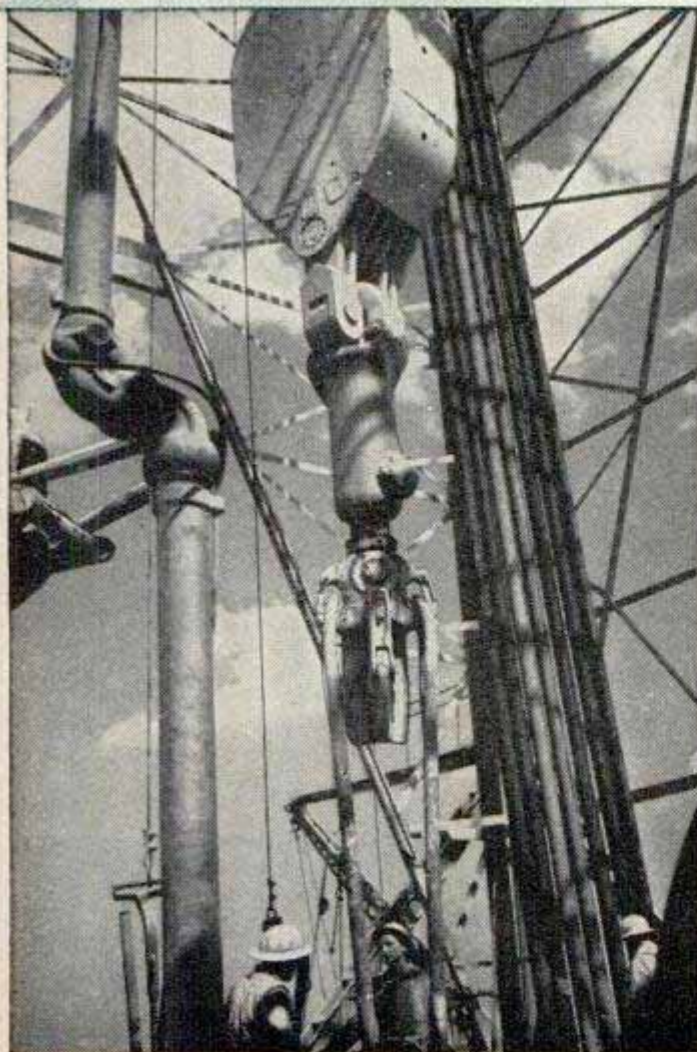





## Brazier for Cooking Built From Tank

When Smiley Burnette of the movies needed a brazier for outdoor cooking, he made one from scrap metal in his home workshop. The main part of the brazier is the rounded end cut from a large metal tank found in a junk yard. Burnette built a base by welding together angle irons. A hole was cut in the bottom of the brazier to prevent the accumulation of rain water, and an iron handle was welded to each side. The result is an attractive outdoor fireplace.

## Lightweight Tractor Has Front-Wheel Drive

With its five-horsepower engine mounted ahead of the front wheels, a 725-pound tractor has front-wheel drive and excellent visibility. The operator rides just above the implements and can make tool adjustments while the tractor is in motion. The two front driving wheels are mounted close together to give the tractor maneuverability. The rear wheels can be adjusted for widths from 38 to 72 inches. For night operation, the tractor has a headlight and a floodlight under the frame.

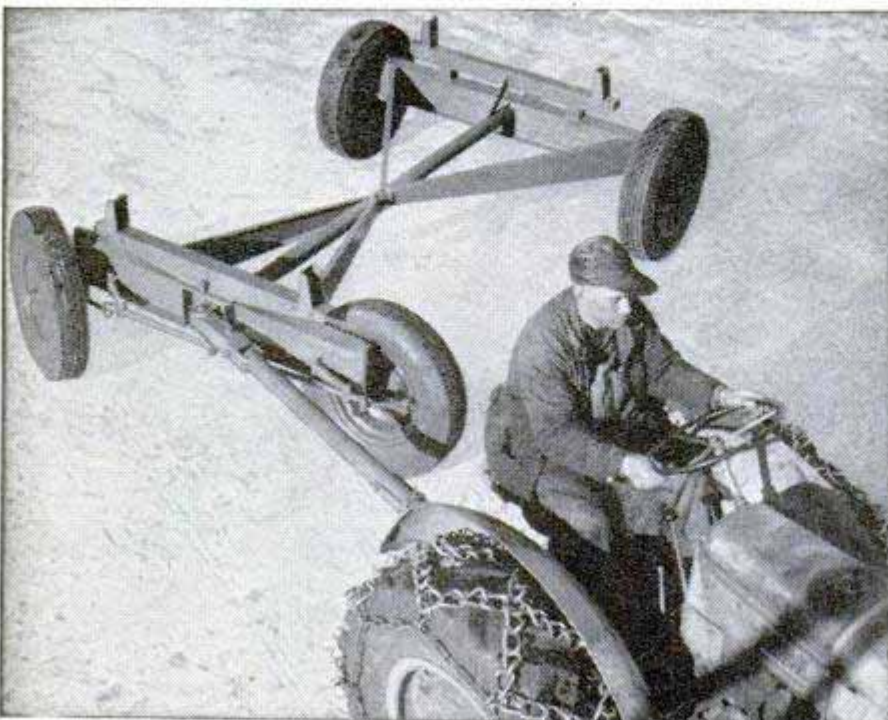
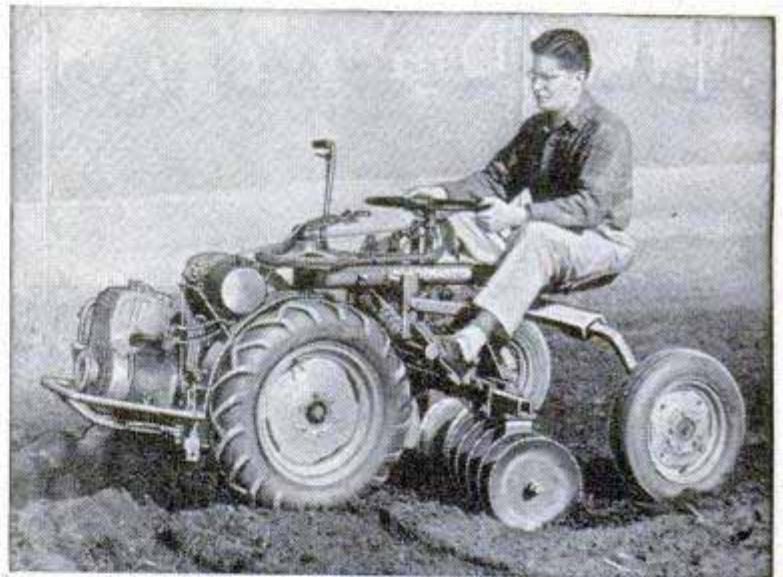

## 90-Degree Turn Made by Wagon

Through a secondary arm attached to its front wheels, a farm wagon can make space-saving, 90-degree turns without upsetting. The rubber-tired wheels are interchangeable with those on other pieces of farm equipment. The wagon weighs 837 pounds and has a capacity of 5000 pounds.

☞ Death Valley in California is the hottest spot in North America, and records indicate a high of 180 degrees on the valley floor can be expected once every seven years.





BRAIDING



GLASS CUTTING

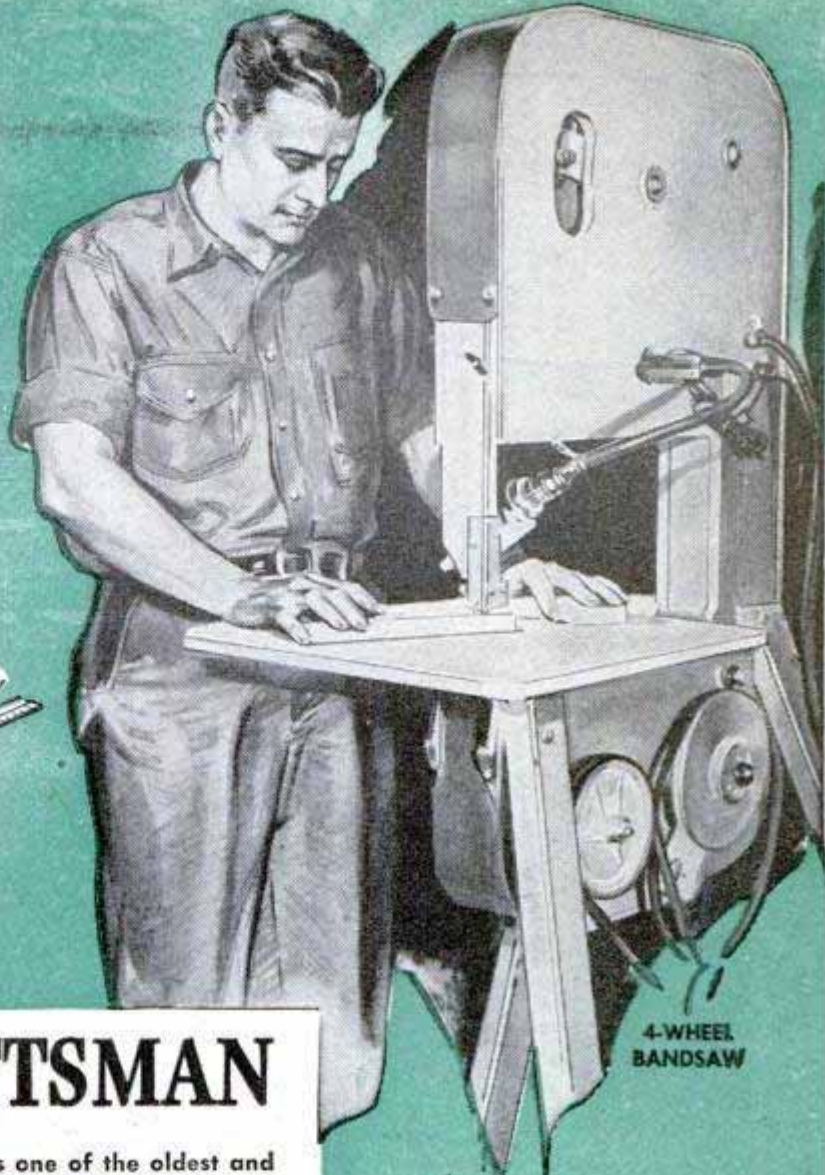

4-WHEEL  
BANDSAW

## The CRAFTSMAN

★ Braiding with colored gimp is one of the oldest and simplest of the handicrafts. Once you acquire the knack of laying the braid, it takes only a few minutes to produce novelties and apparel accessories that are durable, colorful and attractive. Color design and types of braiding are the important points. An article on page 188 pictures the process in complete detail.

★ Have you ever watched a glazier cut glass to the exact size he needs? A quick sweep of the glass cutter along a straightedge, or a curved pattern, a light pressure of the fingers and he gets a clean, true break every time. It's easy—if you know how. A story on page 198 takes you through the procedure step by step.

★ Craftsmen know the advantages of having a bandsaw with a deep throat and variable speeds. The 4-wheel bandsaw detailed on page 225 has an 18-in. throat, which means that it will work to the center of material 36 in. wide. The machine is supported on three sturdy legs that give it unusual stability.

★ Candid baby photos are easy to take if you do some quick thinking and use a bit of ingenuity. Only the simplest lighting and camera equipment are needed. A professional photographer gives you the essential pointers on page 209.



PHOTOGRAPHING  
BABIES



# TIN-CAN

There is no limit to the number of useful and decorative items that can be made for practically nothing from common tin cans. Here are a few to get you started

By W. Clyde Lamme



KITCHEN FILE

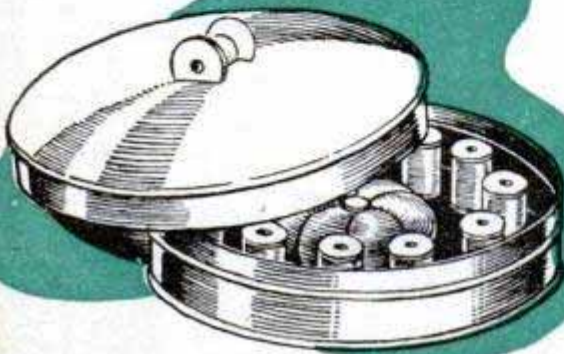

SEWING KIT



COOKIE CAN  
SALT AND PEPPER SHAKERS

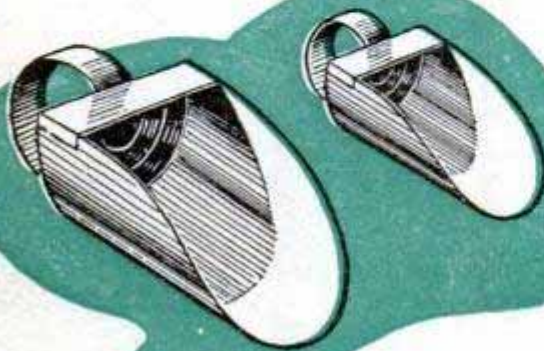

HAND SCOOPS

1

USING ordinary tin cans for material and employing the simplest techniques of the tinsmith and metalcraft worker, any hobbyist can make home accessories that are both useful and attractive. These range from the simple recipe file shown in Fig. 1, which merely requires cutting off the top half of a rectangular can, to the more involved candle lanterns, lamps and sconces used in colonial days.

The sewing kit, cookie can, and salt and pepper shakers in Fig. 1 are made without altering the cans except that holes are punched in the lids of the shakers. Screw-top cans, lacquered in bright colors, are used for the shakers and cookie can. The sewing kit is made from a metal candy box. A spool, cut to fit the contour of the lid and attached with a small screw, forms an appropriate handle. Next, a wooden bottom is cut from  $\frac{1}{4}$ -in. plywood to fit snugly inside the box. Spindles to hold the spools of thread are  $\frac{1}{8}$ -in. hardwood dowels glued in holes equally spaced in the plywood false bottom. A suitable pincushion can be added if desired. Enamel or lacquer the can in a color that suits your fancy.

A rectangular  $\frac{1}{2}$ -gal. can is the right size for the recipe file. Measure and mark the required height of the file. Then remove the top of the can and, with tin snips, cut straight down the corners of the can to the marks. Cut all the way around the can  $\frac{1}{2}$  in. above the marks. Then bend the  $\frac{1}{2}$ -in. projections down inside the can and hammer the bends flat to make a smooth edge. Solder spacers inside the can so that the file cards can be separated according to subject matter. Lacquer the file inside and out and add the decal letters of the label and a decal decoration. The cookie can is labeled and decorated in the same way. Handy scoops for sugar, flour and coffee are made from cans of various sizes simply by cutting away the can as in the lower detail of Fig. 1 and soldering on a handle and finger guard cut from that part of the can which is cut away. File cut edges smooth.

Youngsters who like to play store should



# CRAFT



BUD VASE

## TECHNIQUES

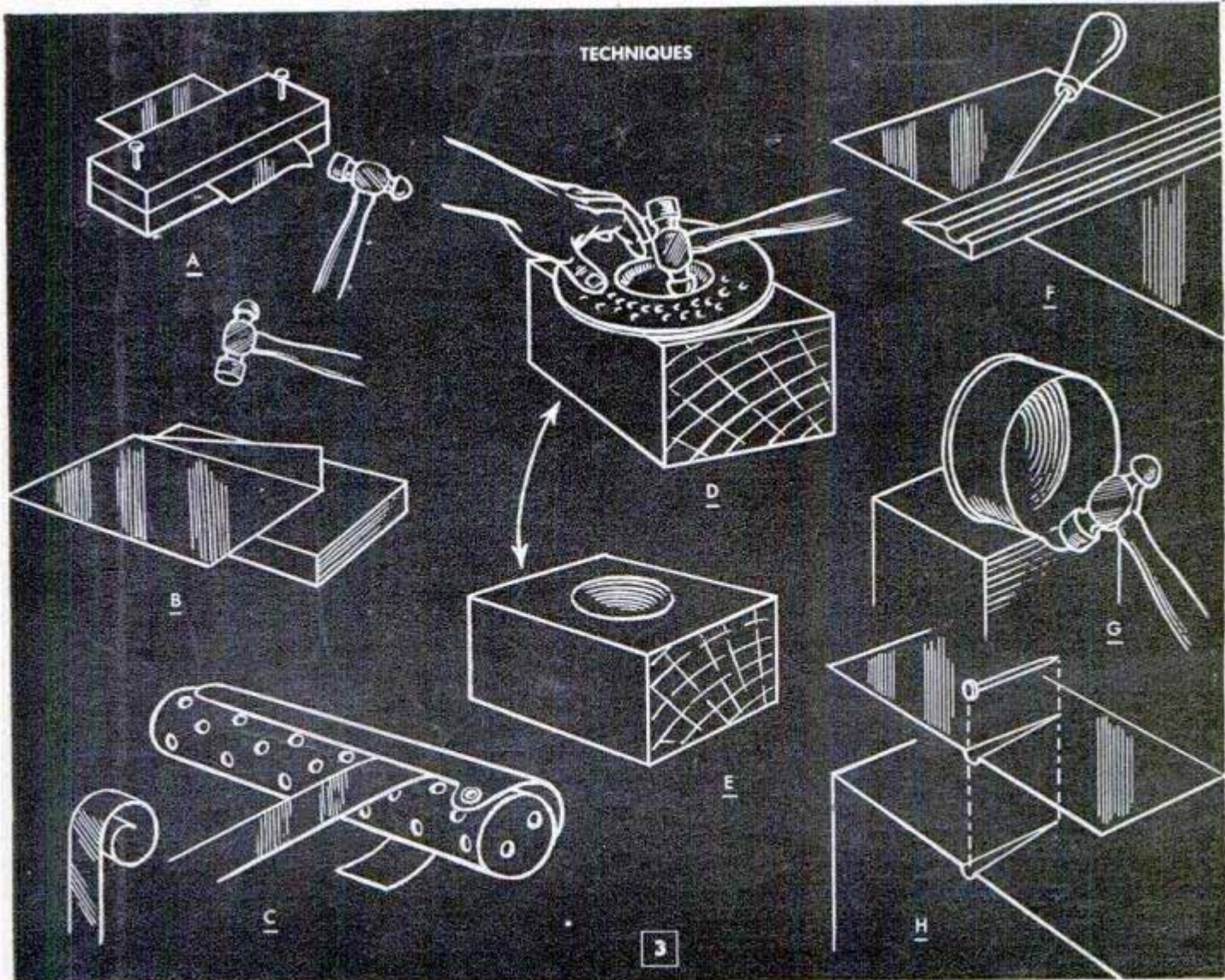



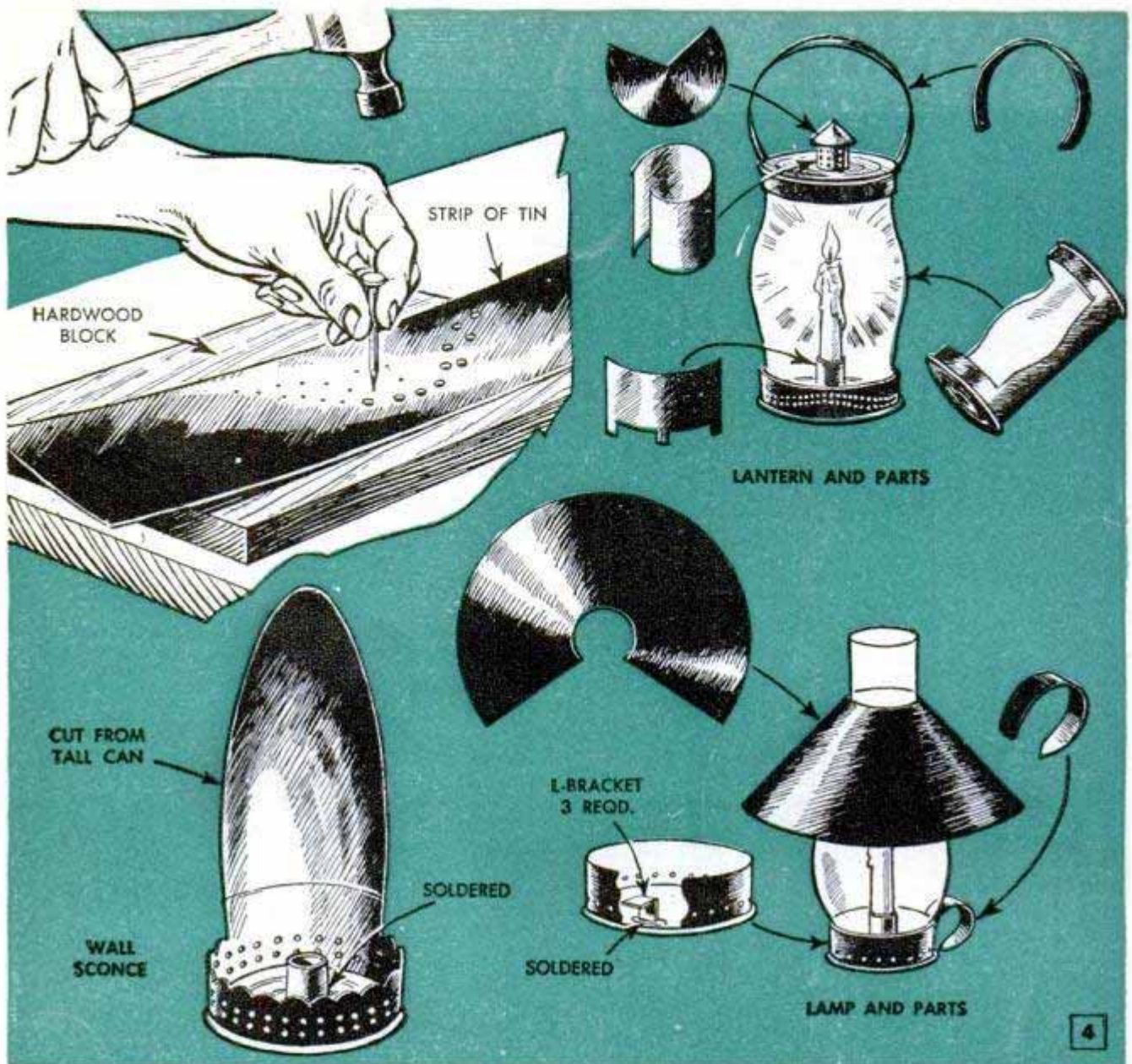

ask mother to open cans from the bottom and try not to damage the labels. In this way, the cans may be stacked as in Fig. 2 or placed on shelves with the labels right side up.

The base of the bud vase, also shown in Fig. 2, is made from the bottoms of two cans, one larger than the other as shown. Before cutting off the bottom of the larger can, invert it and depress the bottom by tapping with a wooden mallet. Repeat the process on the smaller can. Then cut the bottoms off, smooth the cut edges, and fasten the parts together with a small stove bolt. Cut a strip of tin 2 in. wide, roll it around a broom handle and solder the joint. Then solder to the base. Purchase a glass test tube to fit in the holder.

Fig. 3, details A to H inclusive, shows simple methods of bending, marking, flaring, dishing and beading sheet metal which will be found useful when one tackles such projects as those shown in Fig. 4. It should be understood that these are not reproduc-

tions, but are merely typical of the pierced sheet-metal ware of colonial times. The candle sconce, Fig. 4, is made from a single can of a large size. Don't try to cut the reflector to shape in one pass of the snips. Make vertical cuts first, then trim to shape. Form the scalloped edge of the tray by making equally spaced V-cuts with the snips and then trim to the curved form. Smooth all cut edges with a fine file. Piercing of the metal can be done with a nail as in the upper left-hand detail or with a hand-operated metal punch. The lantern also is made from a single large can. The flared edges of the reflector are formed by holding the work on a hardwood block as in Fig. 3, detail G. Construction of the lamp is very similar. Various types of trays also can be made by cutting up cans and peening the metal on dishing blocks as in Fig. 3, detail D. Very attractive work can be produced by wire-brushing the peened surface and finishing with metal lacquer.

Certain information and construction details courtesy Rival Mfg. Co.



# TIDBIT

# SERVERS

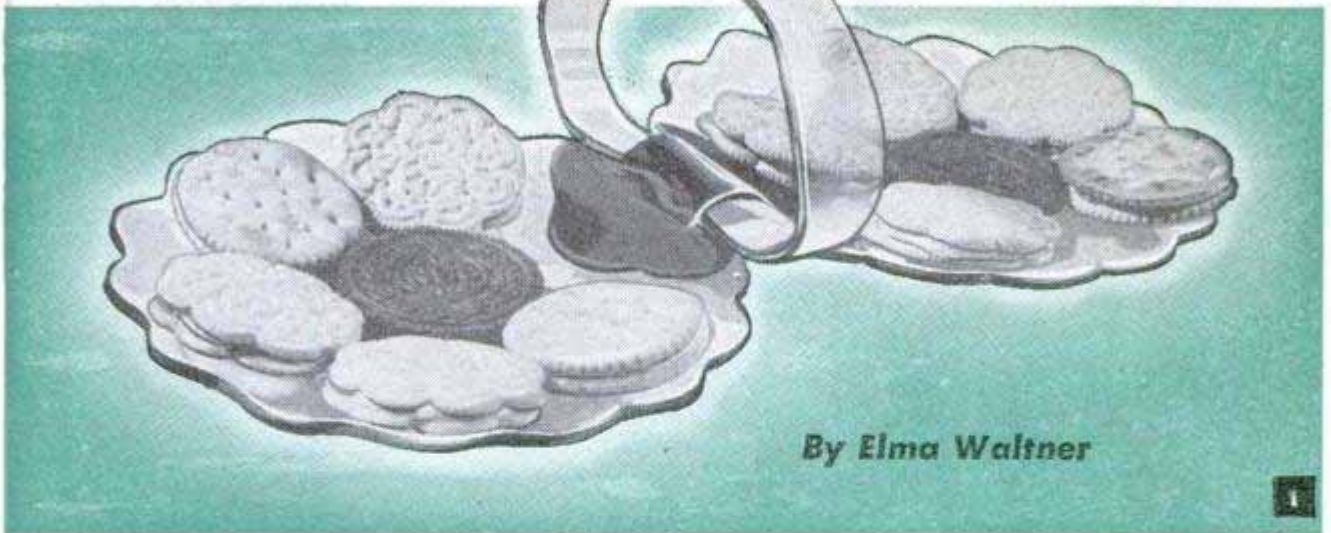

By Elma Waltner

**P**OSSESSING the novelty and simplicity of items found in expensive gift shops, these two plastic tidbit servers provide excellent projects for the beginner. Both trays of the server shown in Fig. 1 are formed from a single sheet of clear  $\frac{1}{8}$ -in. heat-forming plastic. The pattern for the tray, Fig. 2, is traced directly onto the protective paper which covers the plastic, making it easy to follow the line in sawing the parts to shape. The paper covering is removed after sawing and the edges of the plastic are smoothed with a fine file and polished on a cloth buffer charged with rouge. To dish the trays, the plastic is first heated in the kitchen oven at 250 deg. F., which makes it very pliable. Then, handling it with gloves, lay the plastic over two saucers placed side by side. Only light pressure is required to make it conform to the shape of the saucers. Work rapidly as the plastic cools quickly. The handle is heated and attached to the server as in Fig. 3, the ends being bent upward against the underside of the trays. Finally, the hole through which the handle passes is covered with a shield of colored plastic, Fig. 4, and a colored decoration is cemented to the top of the handle.

The server in Fig. 5 is dished in the manner described above and four feet are added by heating and coiling  $\frac{1}{8}$ -in. plastic rod around a broomstick and threading it through holes drilled in the edge of the server as indicated.

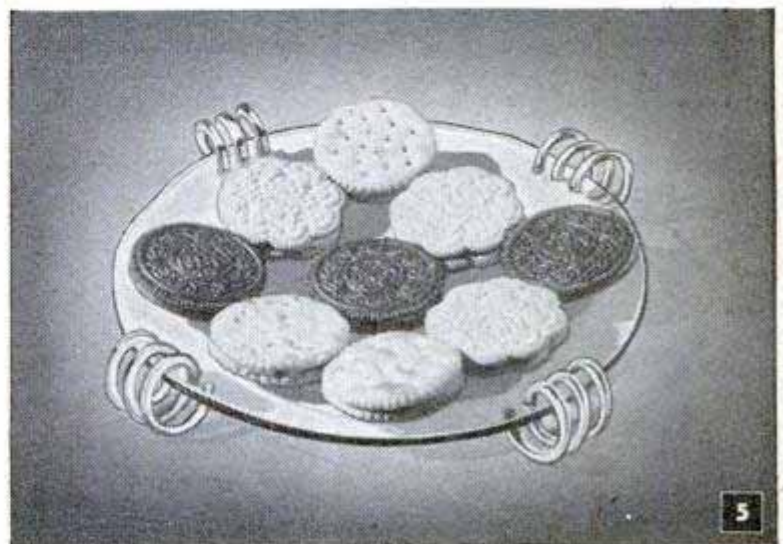
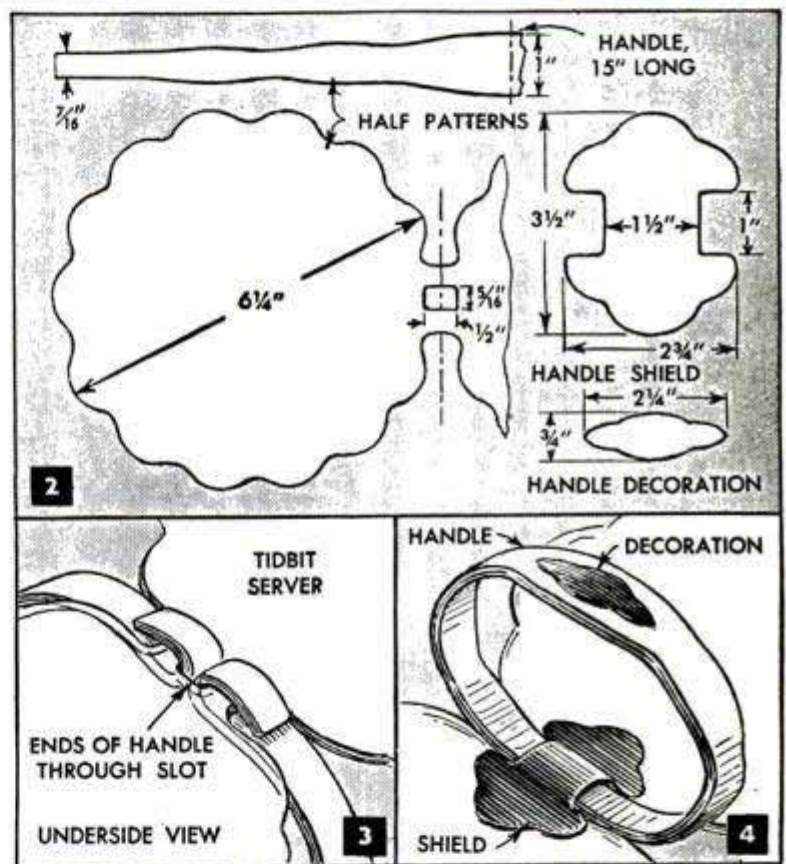



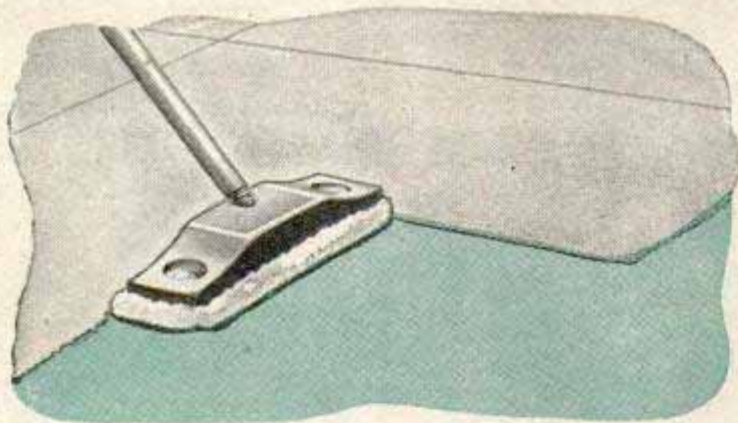
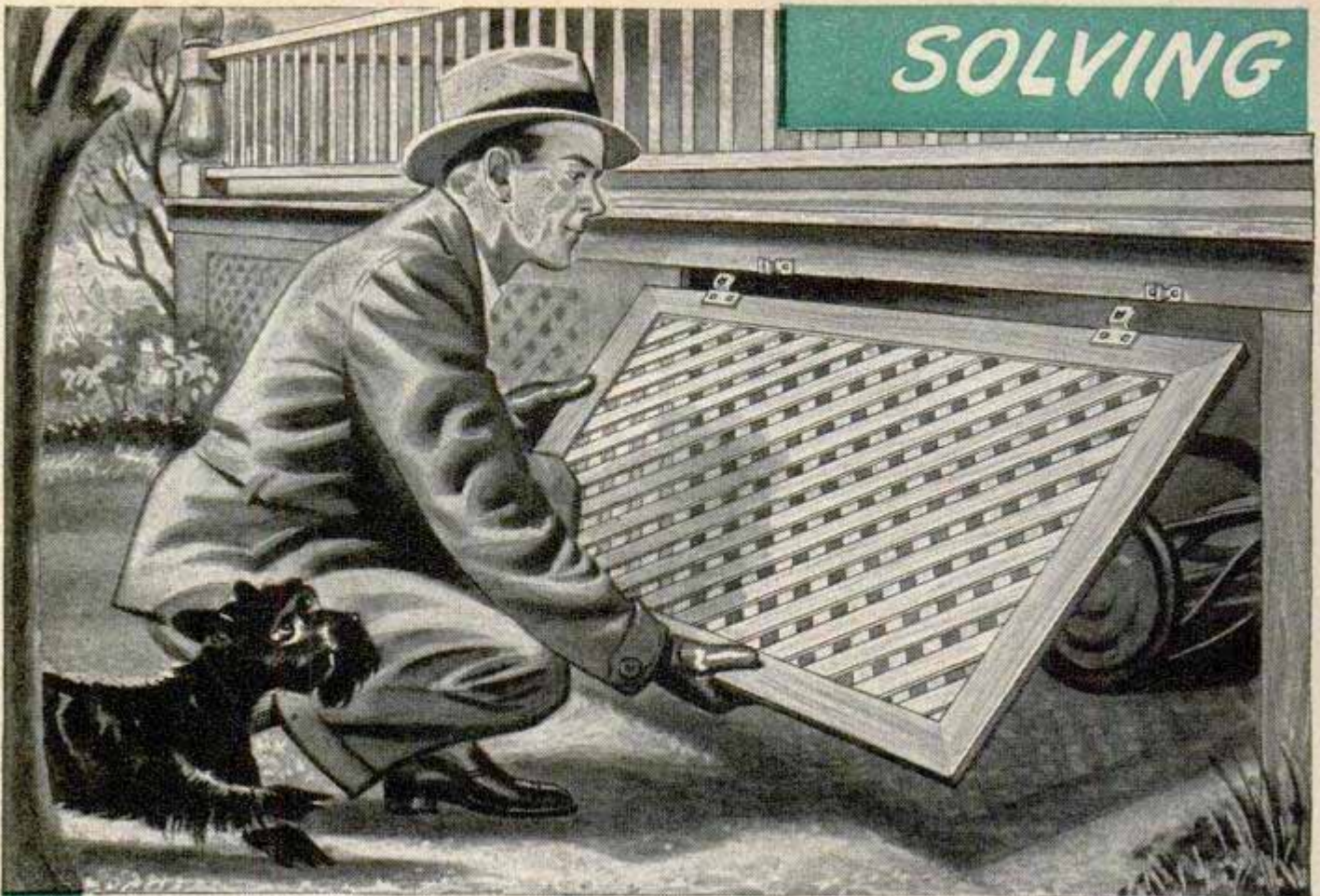

**WASTE SPACE** under a porch is put to good use for storing garden tools by hinging a section of the lattice. Storm-sash hangers permit the lattice panel to be removed when access is desired

**FLOOR-WAX APPLICATOR** makes play of applying paint to concrete floor. It spreads the paint evenly and permits the job to be done from a standing position. Pour the paint in a shallow pan to apply

**A CARD TABLE** stored on end against a closet wall will not fall if a towel bar is used as a cleat under which a corner of the table can be placed

**RUST RINGS** caused by setting scouring-powder cans on porcelain fixtures in the kitchen or bathroom are prevented by covering the bottom edges of the cans with strips of cellulose tape

**THE POINTED SHAFT** of a stove-pipe damper will be less likely to cause injury if it is shielded with an empty .22-caliber cartridge. In addition, the brass cartridge adds a neat finish to the tip

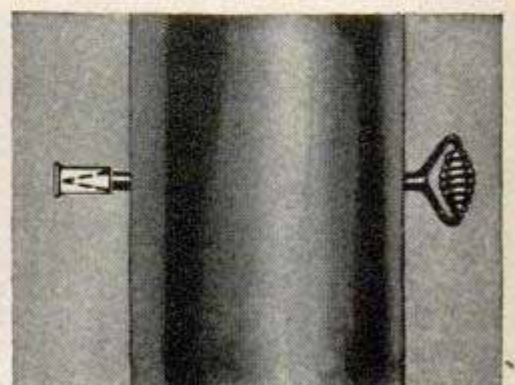
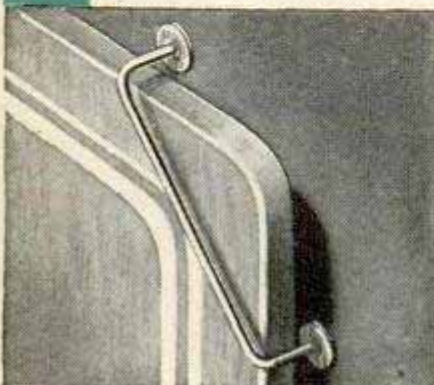



# HOME PROBLEMS

**USE TALL CANDLES** for wicks when molding large holiday candles. Simply stand the candle upright in the center of the mold before the wax solidifies

**MARKING A PATTERN** on two pieces of cloth at the same time is made easy by inserting carbon paper between the pieces of material. Place two squares of carbon back-to-back and mount in a cardboard frame

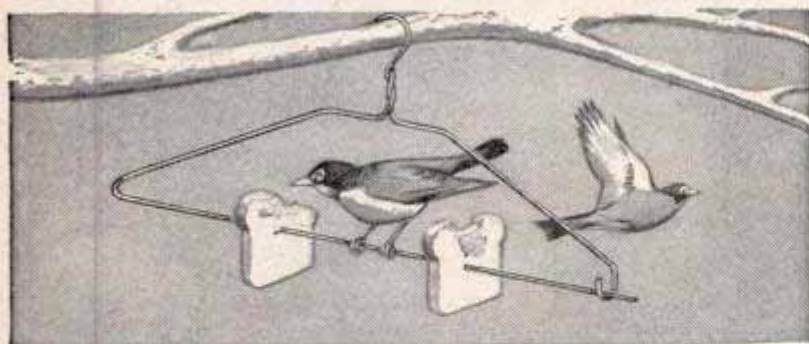
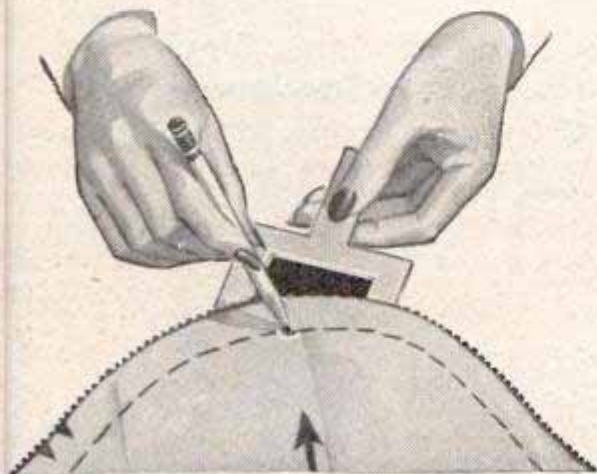

**DAMP KITCHEN MATCHES** that are difficult to light will ignite readily if they are rubbed through the bristles of a clothesbrush several times before striking. The friction produced by rubbing a match briskly, in most cases, dries it sufficiently

**FEEDING BIRDS** in wintertime by impaling bread on wire coat hanger suspended from a tree limb allows the birds to feed out of the reach of cats. One end of the hanger is cut apart and bent so that it can be opened and closed like a safety pin

**COFFEE-CREAM STAINS** on the tablecloth will be considerably reduced if a small amount of butter or lard is placed just under the spout of the pitcher. This keeps the drippings from running down the side of the pitcher and soiling the tablecloth



## Semaphore for Ice Fishing

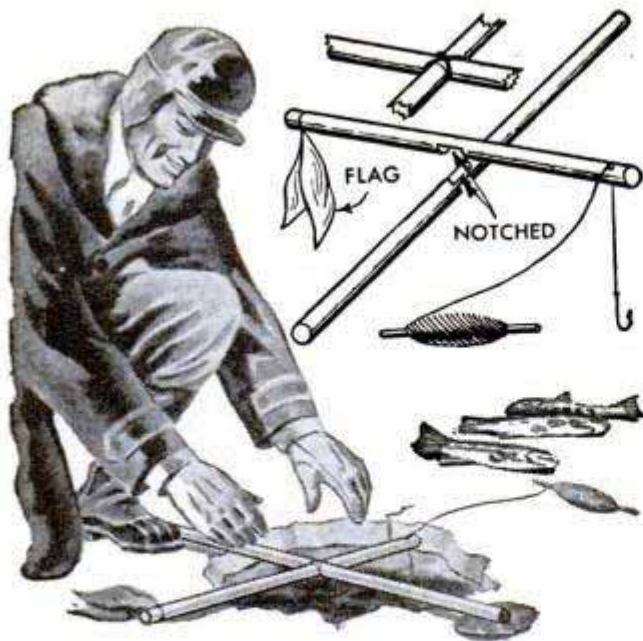

Two saplings or  $\frac{3}{4}$ -in. dowels, one 12 in. long and the other 24 in., and a flag make up this simple semaphore for ice fishing. The sticks are notched and half-lapped at the center, then bound together with cord to form a cross. The signal flag is tied to one end of the short stick, and the fishline is threaded through a  $\frac{1}{4}$ -in. hole in the opposite end. The line is given a half hitch around the stick to keep it from slipping. In use, the ends of the long stick rest on the edge of the hole and pivot to raise the flag when a tug is made on the line.

R. A. Jenkins, Los Angeles, Calif.

## Storing Sweet Potatoes

Sweet potatoes will remain firm if they are first cleaned and then stored by packing them in a basket between layers of oats. The basket of potatoes should be kept in a warm, dry place.

## Tin Can Holds Electric Drill On Tool Panel or Wall



Wanting to get my small electric drill out of the way and protect it from possible damage, I hit upon the idea of placing it in a holder made from an empty tobacco can. After cutting the bottom from the can, I nailed the can to

the wall at a convenient height from the floor. In this way, the drill is always within easy reach when needed and is not exposed

to rough handling when not being used. Disconnect the drill before placing it in the holder.—H. Leeper, Canton, Ohio.

## Flour Sifter Separates Chaff From Home-Shell'd Popcorn

When shelling popcorn it's usually difficult to remove the chaff thoroughly. However, an easy way to do this is to pour the popcorn into an ordinary flour sifter and turn the handle. This will separate the chaff which will drop from the bottom of the sifter.—G. E. Hendrickson, Argyle, Wis.

## Refill-Type Sanding Block Takes Roll of Sandpaper

Changing sandpaper in this block is just a matter of forcing out a small wedge, tearing off the old paper, pulling new paper onto the sanding surface and wedging it. The paper is cut into a long strip of suitable

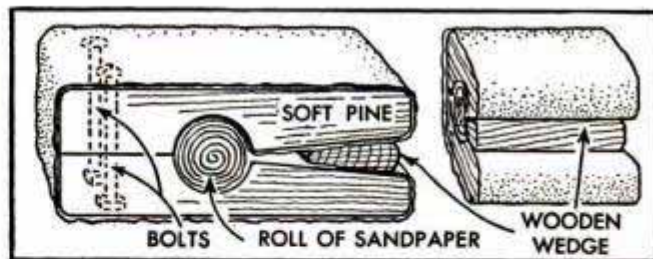

width, rolled tightly and inserted in the opening in the center of the block. The block consists of two pieces of soft pine shaped as indicated, bolted together and then drilled through the sides to provide a container for the sandpaper roll. The bolt heads and nuts are countersunk below the surface of the blocks. The paper, of course, is unrolled and pulled over the top, bottom and one end of the block and held by the wedge in the slotted end.

John W. Cook, Park Rapids, Minn.

☞ To mend leather gloves, use cotton thread instead of silk as the latter will tend to tear the leather.



# QUARTER-ROUND LEGS

Easy way to turn tapered and straight furniture legs four at a time. The pieces are screwed together in the waste at the ends and then turned as a single block



Above, mount the work in the lathe, turn as required, sand and cut off. Below, blocks are screwed together through waste ends

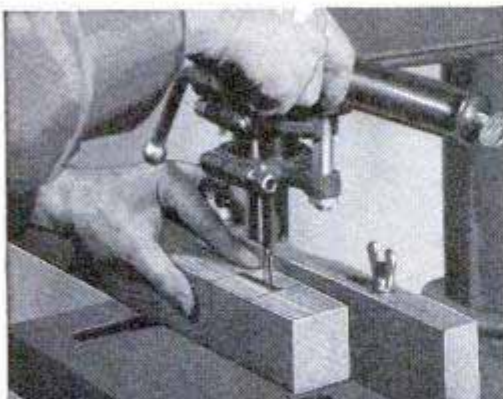

If mortises are needed, cuts should be made while the work is "in the square"

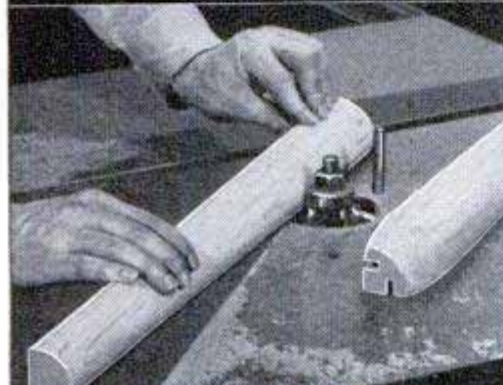

If it is desired to round the inside corners of the legs, form with shaper

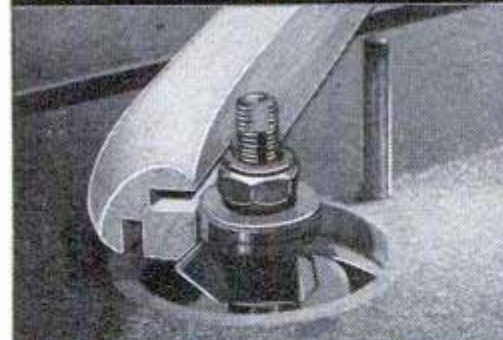

Beveling inner corner of legs also is done on shaper, using a V-type cutter

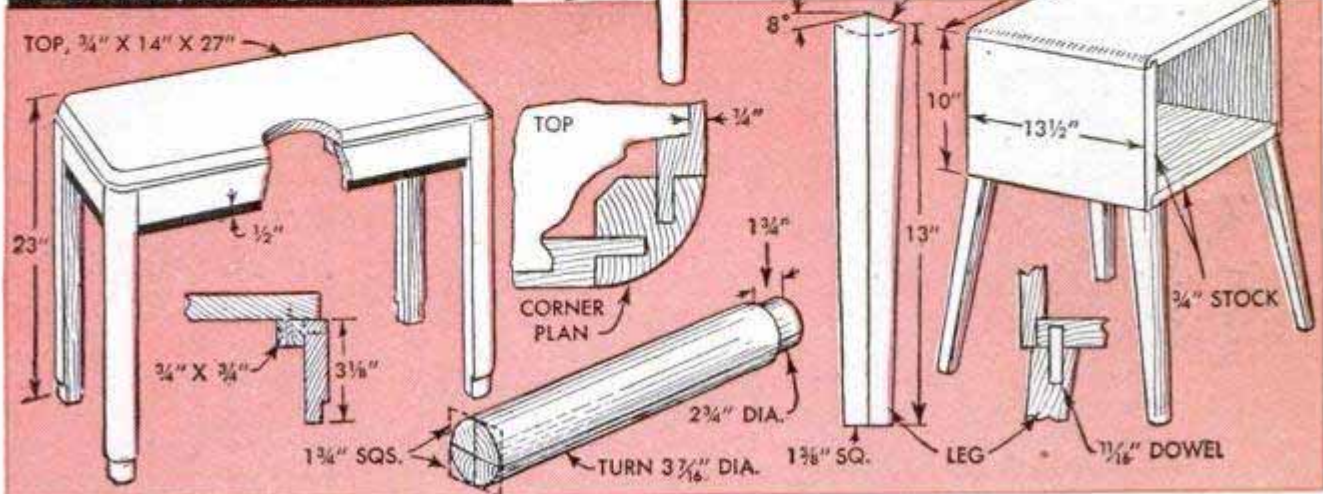
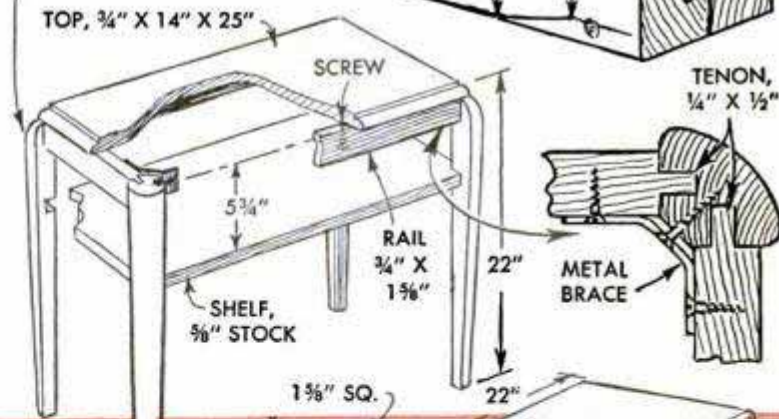
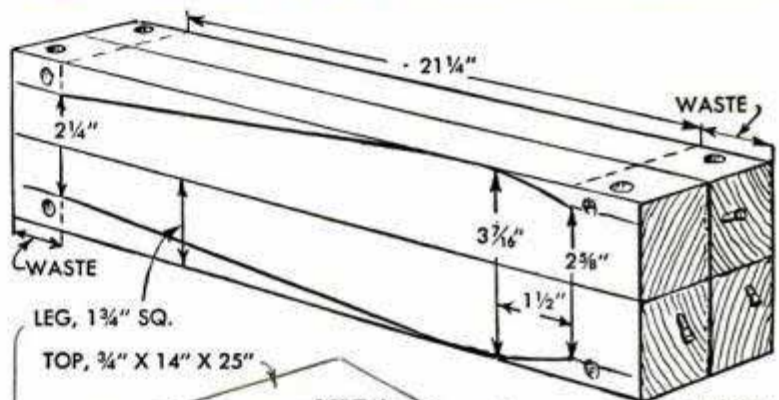



# Suggestions for a MERRY CHRISTMAS



**Dry pine cones** painted in gay colors provide beautiful Christmas-tree ornaments at little cost. Tied with ribbon and combined with holly, they also make attractive

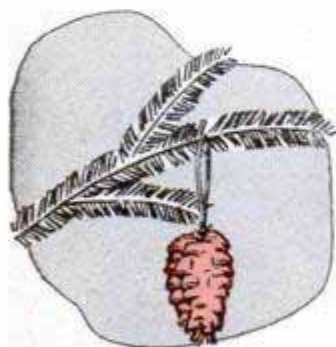

table decorations for parties and novel window or wall ornaments for the holiday season. Dip the cones in silver or gold paint or brightly colored enamel and place on a piece of old window screen to dry.

## Standing a Christmas tree in water

is a practical and satisfactory method of keeping the fire hazard to a minimum while prolonging the fresh, green appearance of the tree. To use the water treatment, obtain a tree that has been cut as recently as possible. Then, saw off the end of the trunk diagonally at least 1 in. above the original cut. After doing this, immediately stand the tree in a container of water and keep the water level above the diagonal cut during the entire time the tree is in the house. Even though the tree is not to be set up and decorated for several days, stand it in water, as above, and keep it in a cool place. If started in time, this will prevent the needles from drying out and thus becoming flammable. In addition, it retards the fall



of needles from types of trees which ordinarily lose them quickly. Although freshly cut spruce or balsam-fir trees kept in water are not easily ignited by candle or match fires, they, of course, will not withstand intense heat. For this reason, take all possible fire precautions in the vicinity of the tree, including the elimination

of defective electrical connections, and special care to see that combustible material does not accumulate on or beneath the tree.

**Removing candle drippings** from clothing or furniture upholstery is done in the following way. First, scrape off the excess with the fingernail or a knife. Then, place a piece of blotter over the spot and press a hot iron over the blotter to melt the wax. Repeat this as often as necessary. If any of the wax remains in the fabric, remove it by sponging the spot with alcohol.

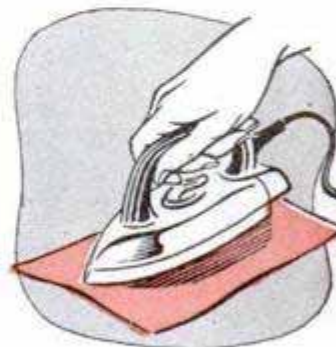

**Scattering needles** throughout the house when carrying out the Christmas tree can be eliminated simply by cutting off the

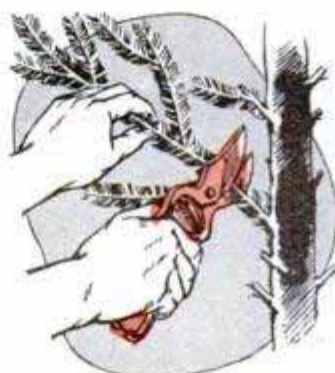

branches with pruning shears while the tree is still in its stand. Cut the branches in pieces small enough to fit in a bushel basket. In this way they are easily carried to the rubbish pile or saved for burning in the fireplace.

**Yule logs** that burn with a beautiful, multicolored flame add a novel touch to holiday gatherings around the fireplace. The logs are made by immersing tightly rolled newspapers in a strong solution of salt, blue vitriol (copper sulphate) and water. This solution should be kept either in a wooden barrel or a large earthenware crock. After the rolls have soaked for a week and are dried thoroughly, they will burn for a long time, giving off flames of various colors. *Caution:* As it is poisonous, keep the solution out of the reach of children.

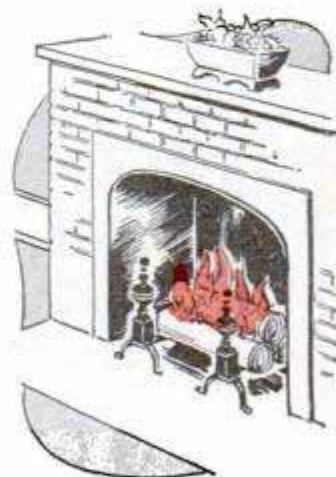



wlm-51

# PERIOD CLOCKCASE

By Ralph A. Hinde

THIS SMALL clockcase is just the project for the craftsman who likes to work with fine veneers. The original case was made from flame-grained rosewood veneer glued to a core of  $\frac{1}{4}$ -in. pine with a backing veneer of mahogany. The case is proportioned for an electric movement having a 3-in. dial. First, cut the pine core stock  $\frac{3}{4}$  in. oversize. Next, select the face veneers and trim roughly to the size of each piece of core stock. Also, cut the backing veneers to size. Then glue the veneers to both sides of the core. Scrolled parts of the broken-pediment top are of  $\frac{1}{4}$ -in. plywood which is faced on one side with a matching veneer. When the work is dry, cut the opening for the dial and run a  $\frac{3}{8}$ -in. rabbet along each edge of the front piece of the case, the depth of the rabbet being equal to the thickness of the piece less the face veneer. Then join the sides to the front with a butt joint as in the lower left-hand detail, using glue and glue blocks. Finish the corner of the joint by sanding carefully. With this method of joining, the end grain is not exposed. The scrolled parts of the base are veneered with the grain running vertically to match the case and the pediment top. Use  $\frac{1}{4}$ -in. plywood as a core and join at the corners in the same manner as described above. Pressed moldings add decorative detail but plain, straight moldings can be used. Finish the wood in the natural color and add the finials which are the brass type used on table lamps. These are attached to the case in the positions shown with dowels which are turned into the threaded holes of the finials.

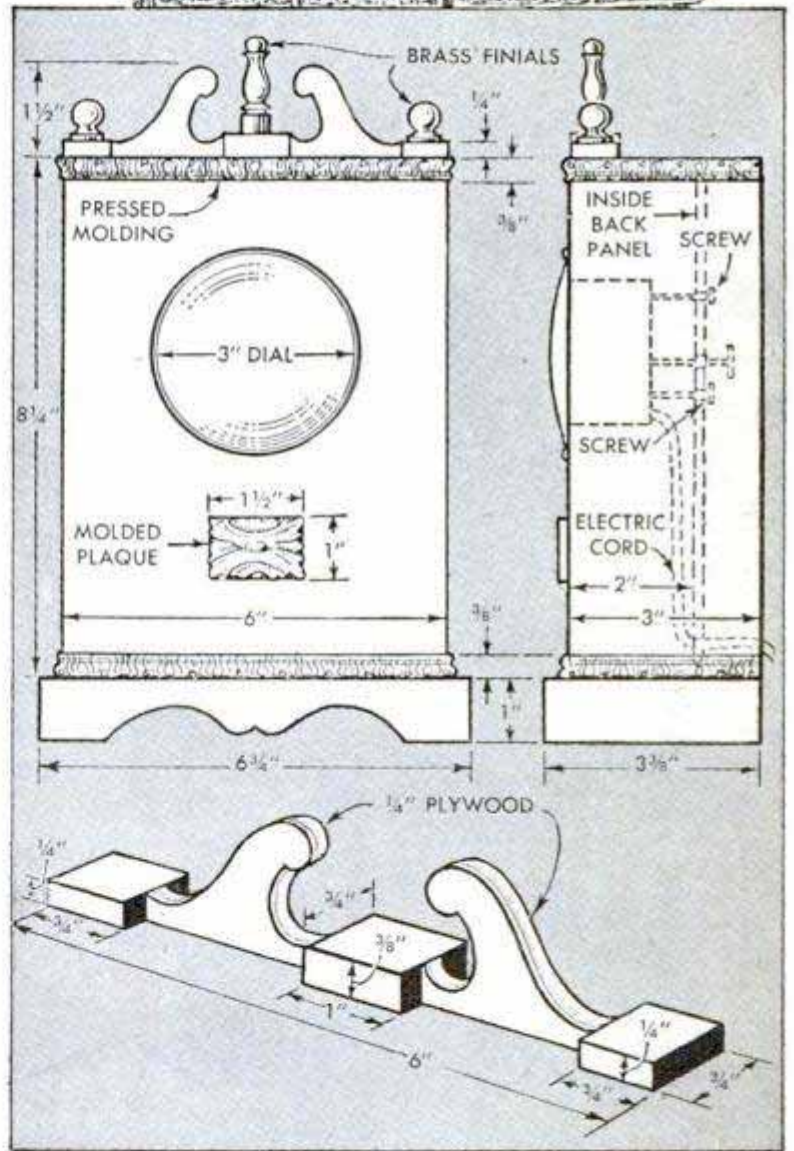
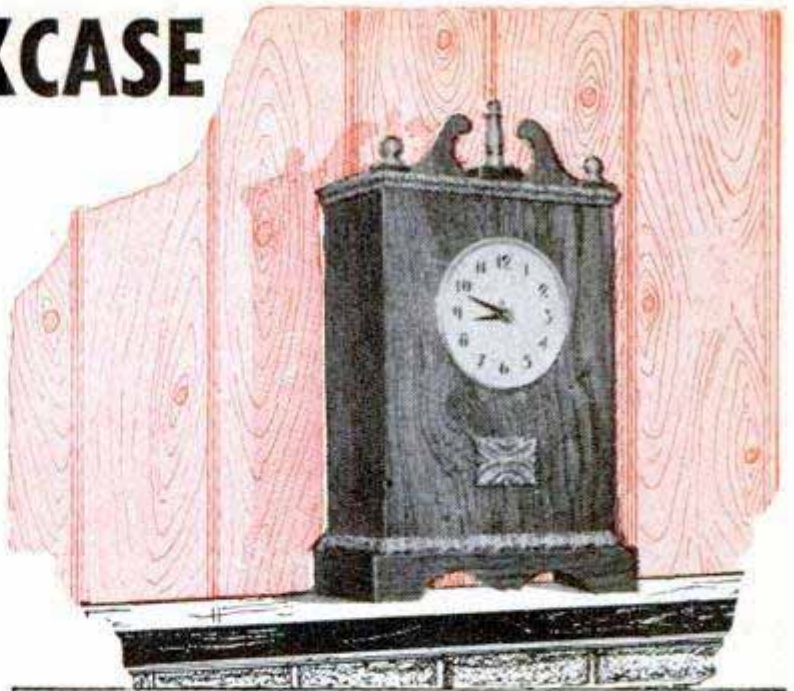

Furniture you can build p/35

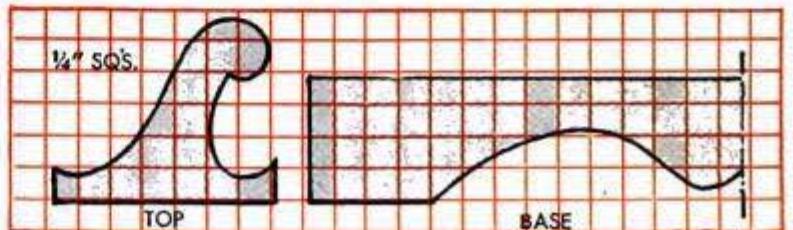
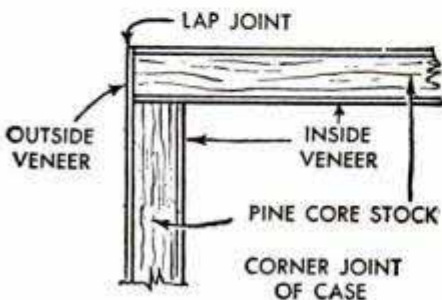



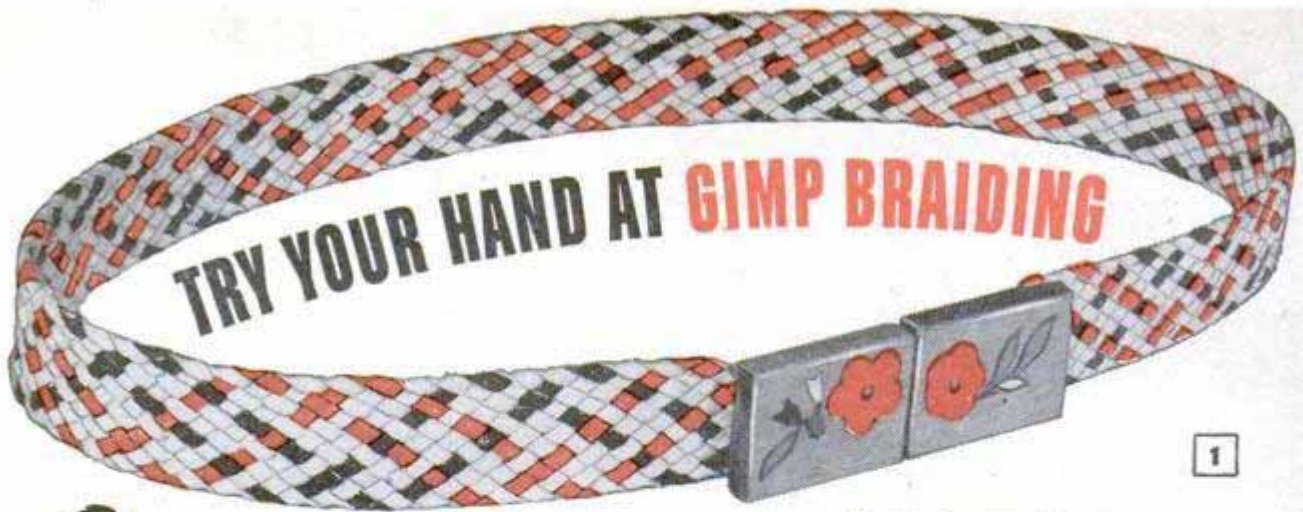

1

By Lela M. Brown

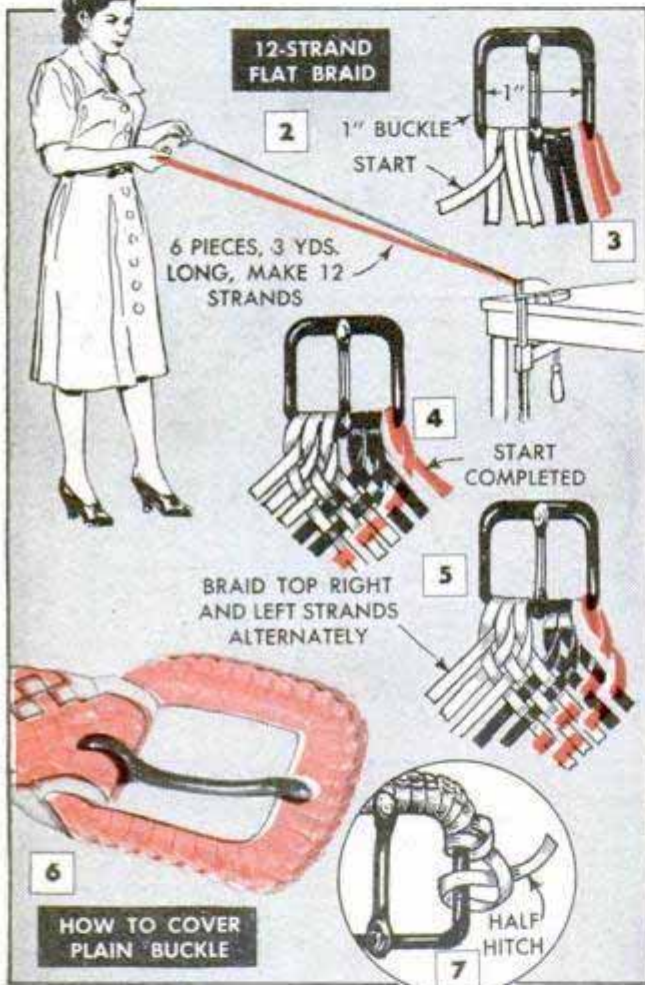

FEW CRAFTS require so little equipment as gimp braiding for, in addition to the gimp, about all that is needed is a pointed stick. In this article, the steps in braiding belts and bracelets are given but, with a little practice, you can braid many other attractive and useful articles.

**Materials:** Gimp consists of cotton tape covered with tough, flexible lacquer and is available by the yard or in 50 and 100-yd. spools in various colors. Standard widths are  $\frac{3}{8}$  and  $\frac{1}{8}$  in., although wider gimp can be obtained. Plastic gimp also is available. Most of the projects pictured in this article were braided from  $\frac{1}{8}$ -in. flat gimp.

**Flat braid (12-strand):** To make a belt braided with 12 strands, use six pieces of gimp 3 yds. long and loop them through a suitable buckle as shown in Fig. 2. The buckle is slipped over nails driven into a block of wood which is clamped to a table as in Fig. 16. Start braiding by turning the left-hand strand over itself, Fig. 3. Then braid the remaining strands as in Fig. 4. This is the completed starting position. Now, tighten the braid and then start the running braid. This is done by taking the top right-hand strand and weaving it over

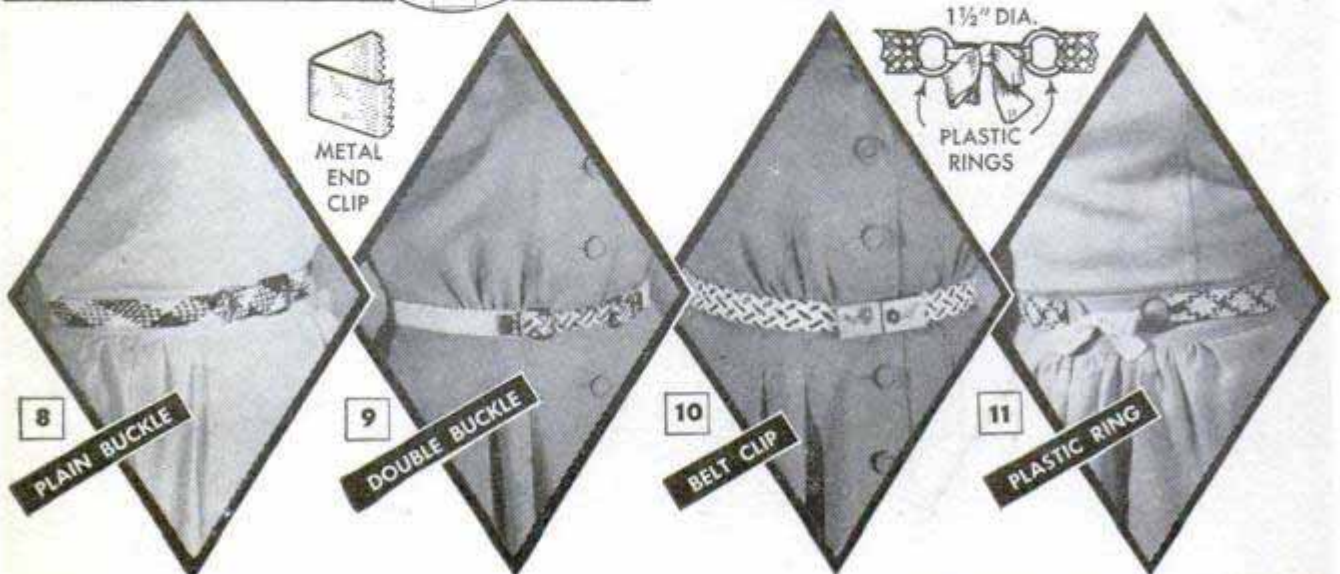



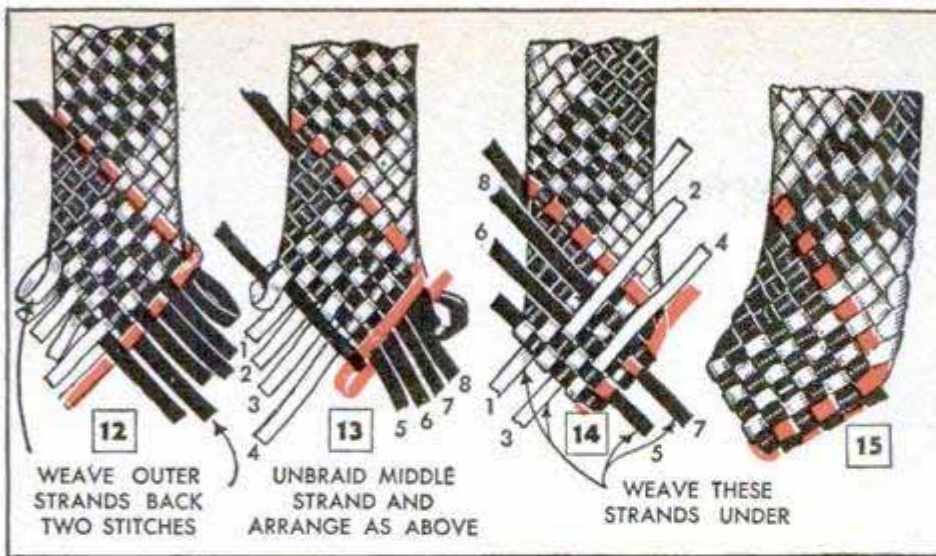

and under the others as shown in Fig. 5. Repeat the procedure with the top left-hand strand and braid right and left-hand strands alternately in this way until the belt reaches the desired length. To finish the braid, Fig. 12, tuck the two outer strands, shown by loops, back under the braid, for about two stitches. Unbraid the two middle strands (red and black) and turn them under and through the loops as in Fig. 13. Then braid the even-numbered strands back over the top for a distance of one or two stitches, Fig. 14, and cut off the excess gimp. Braid the remaining strands in the same way, but turn them under. This will produce the belt shown in Figs. 15 and 17.

**Belt styles:** Many different kinds of belts can be made with 12-strand flat braiding. The pattern itself has numerous variations and depends upon arrangement of strands at the beginning. The strongest pattern is produced with two colors braided as in Fig. 19. Popular variations are



16 BELT PATTERNS DEPEND ON HOW STRANDS ARE ARRANGED AT START. FIGS. 19, 20 AND 21 SHOW THREE VARIATIONS



17 END THE BRAID BY WEAVING EACH STRAND BACK ALONG ITSELF

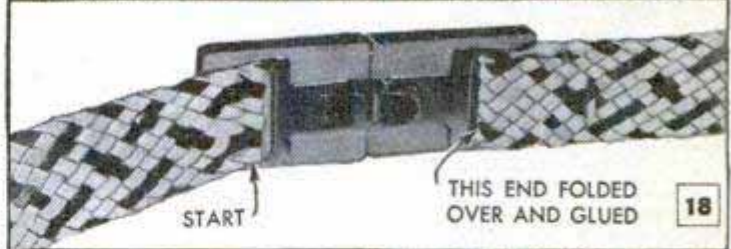

18 THIS END FOLDED OVER AND GLUED

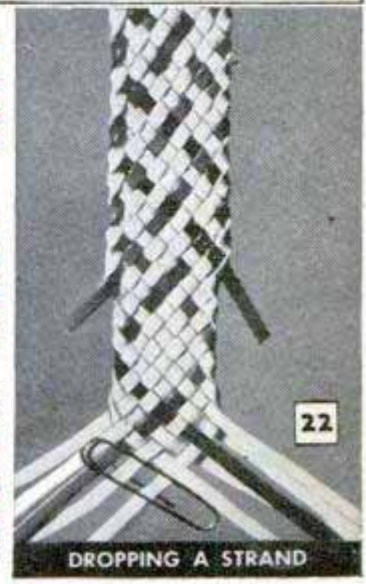
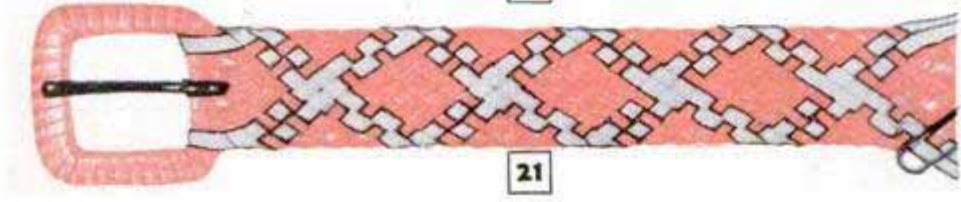
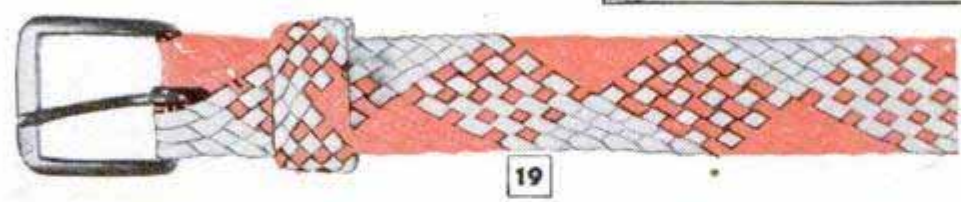

22 DROPPING A STRAND



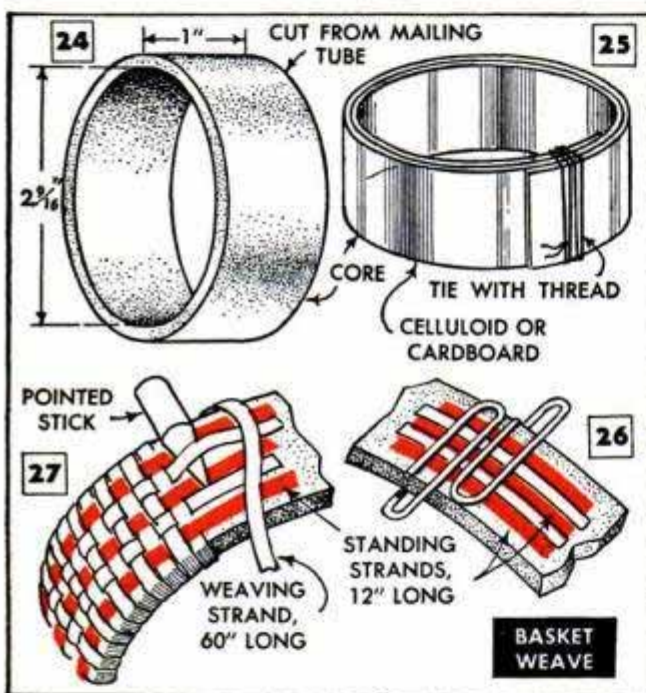
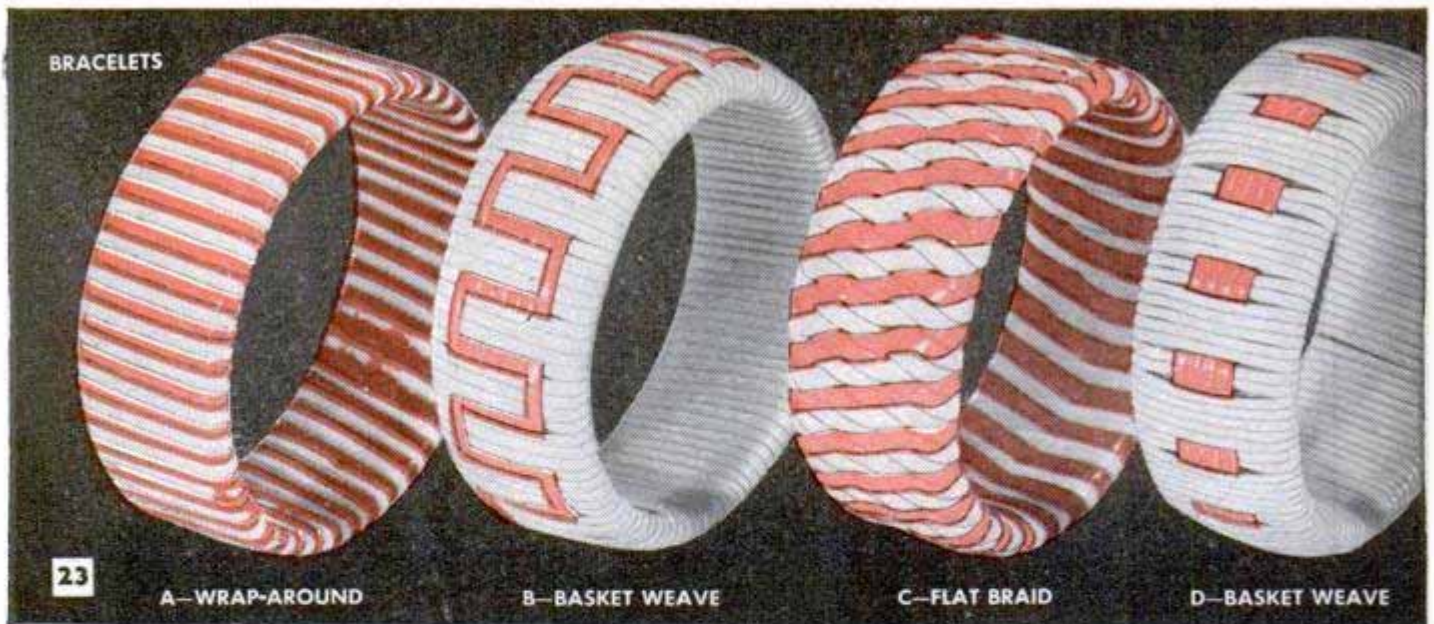

shown in Figs. 20 and 21. Belts are most effective when the pattern is simple and of not more than three colors. One-color belts are very attractive. Fig. 8 shows a conventional buckle style. In Fig. 9 the belt has a buckle at both ends, the second buckle being fastened by folding the braid over and cementing or sewing it. The two buckles are spanned by a short length of flat braid, the ends of which are finished with metal clips. The belts in Figs. 1 and 10 are fitted with a belt clip set. Method of attaching the clips is shown in Figs. 18 and 20. The belt in Fig. 11 is braided and glued around plastic rings and is fastened with a tie ribbon. A 12-strand flat braid of  $\frac{1}{8}$ -in. gimp will produce a belt 1 in. wide. If you want a narrower belt, do the braiding exactly the same but use 8 or 10 strands instead of 12. If the end is to be folded over a buckle, it is best to drop one strand, as shown in Fig. 22. Plain buckles are much more at-

tractive if covered with gimp as in Fig. 6. To do this, the gimp is applied by the half-hitch method as in Fig. 7.

**Bracelets:** Various styles of bracelets are shown in Figs. 23 and 28; all are braided around a cardboard core. This can be cut from a mailing tube, Fig. 24, or made up from a strip of cardboard tied or held with gummed tape as in Fig. 25. The wrap-around style, Fig. 23, detail A, is the simplest, and is made by wrapping two strands of different colors around the core, tucking the ends under. The wrapping can be straight across as in detail A, or diagonal, as in detail E.

**Basket weave:** This popular style of braiding is done with any number of short standing strands fastened to the core with paper clips as shown in Fig. 26, after which the single weaving strand is carried round and round and over and under to make the pattern. The fastest method of working is to pick up the standing strands with a pointed stick, Fig. 27, rather than lace the weaving strand under. The basket-weave pattern looks best when  $\frac{3}{16}$ -in. gimp is used because it is thinner than the  $\frac{1}{8}$ -in. gimp and permits closer weaving. Plastic gimp, being tough and elastic, can be laced with a needle after the entire core is covered in a wrap-around manner. In either case, the ending is made by weaving the standing strands double and carrying the weaving strand to the inside where it is tucked under or glued.

**Flat braid (8-strand):** This takes more time than any other kind of braiding but is very effective, especially with narrow gimp. Start by looping four strands of gimp through the bracelet core, as in Fig. 29. Braid the strands together, Fig. 30, to complete the starting end and tighten the braid. Then proceed with the running braid. This is done by passing the top right-hand





E—WRAP-AROUND (DIAGONAL)

F—FLAT BRAID



28

COLORFUL BRACELETS ARE EASY TO MAKE IN WRAP-AROUND, BASKET WEAVE OR 8-STRAND FLAT BRAID

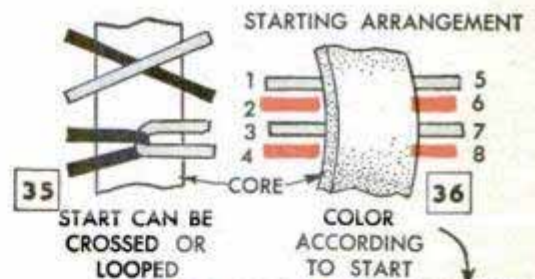
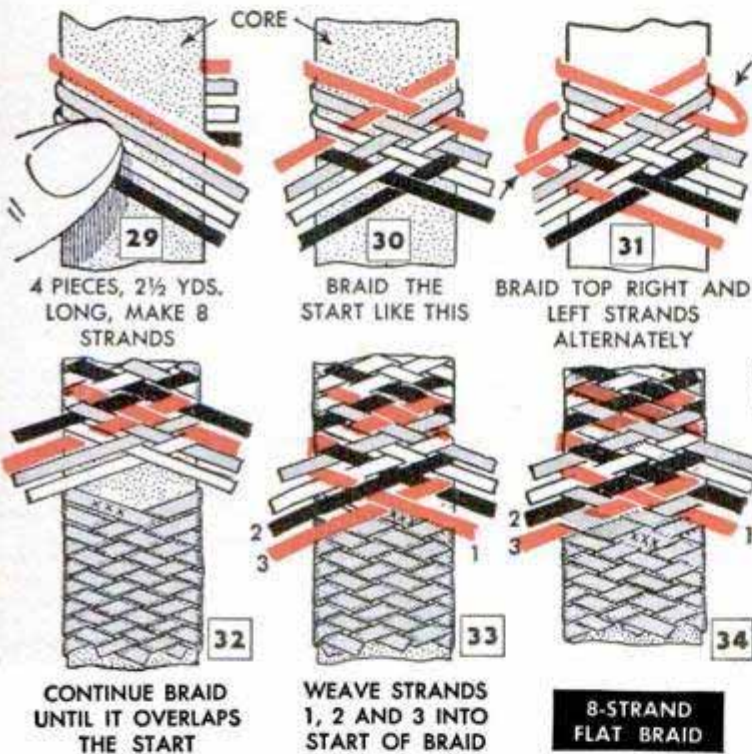

strand through the inside of the core and out between the two middle strands on the opposite side, Fig. 31. The left-hand top strand is worked in the same way and from then on the braid alternates right and left. Fig. 32 shows the braid nearly completed. Continue until you completely cover the starting end as in Fig. 33, and then weave strands 1, 2 and 3 into the beginning ends of the braid, Fig. 34. This brings all strands to the outside where they can be cut off or folded to the inside and glued. Numerous patterns can be made with 8-strand flat braid, the pattern depending on how the strands are arranged at the start. Fig. 35 shows two starting methods and Fig. 36 gives a pattern chart. Make a tracing of the chart and color the diamonds to form the desired pattern. Then arrange the strands of gimp according to the numbers in the chart and the starting arrangement. Each number must always appear in the same color of diamond.

**Crown braid:** This can be either square or round. Both use the same starting knot, Figs. 39 to 42, inclusive. After making the knot, turn it over as in Fig. 43, and begin braiding. The square crown is made by carrying each strand squarely

	1		4		3
7		8		5	
8	2		1		6
	3		6		7
5		4		3	
6	4		7		8
	1		7		4
7		8		5	
8	2		1		6
	3		6		7
5		4		3	
6	4		7		8
	1		7		4
7		8		5	
8	2		1		6
	3		6		7
5		4		3	
6	4		7		8
	1		7		4
7		8		5	
8	2		1		6
	3		6		7
5		4		3	
6	4		7		8
	1		7		4
7		8		5	
8	2		1		6
	3		6		7
5		4		3	
6	4		7		8
	1		7		4
7		8		5	
8	2		1		6
	3		6		7
5		4		3	
6	4		7		8
	1		7		4
7		8		5	
8	2		1		6
	3		6		7
5		4		3	
6	4		7		8
	1		7		4
7		8		5	
8	2		1		6
	3		6		7
5		4		3	
6	4		7		8
	1		7		4
7		8		5	
8	2		1		6
	3		6		7
5		4		3	
6	4		7		8
	1		7		4
7		8		5	
8	2		1		6
	3		6		7
5		4		3	
6	4		7		8
	1		7		4
7		8		5	
8	2		1		6
	3		6		7
5		4		3	
6	4		7		8
	1		7		4
7		8		5	
8	2		1		6
	3		6		7
5		4		3	
6	4		7		8
	1		7		4
7		8		5	
8	2		1		6
	3		6		7
5		4		3	
6	4		7		8
	1		7		4
7		8		5	
8	2		1		6
	3		6		7
5		4		3	
6	4		7		8
	1		7		4
7		8		5	
8	2		1		6
	3		6		7
5		4		3	
6	4		7		8
	1		7		4
7		8		5	
8	2		1		6
	3		6		7
5		4		3	
6	4		7		8
	1		7		4
7		8		5	
8	2		1		6
	3		6		7
5		4		3	
6	4		7		8
	1		7		4
7		8		5	
8	2		1		6
	3		6		7
5		4		3	
6	4		7		8
	1		7		4
7		8		5	
8	2		1		6
	3		6		7
5		4		3	
6	4		7		8
	1		7		4
7		8		5	
8	2		1		6
	3		6		7
5		4		3	
6	4		7		8
	1		7		4
7		8		5	
8	2		1		6
	3		6		7
5		4		3	
6	4		7		8
	1		7		4
7		8		5	
8	2		1		6
	3		6		7
5		4		3	
6	4		7		8
	1		7		4
7		8		5	
8	2		1		6
	3		6		7
5		4		3	
6	4		7		8
	1		7		4
7		8		5	
8	2		1		6
	3		6		7
5		4		3	
6	4		7		8
	1		7		4
7		8		5	
8	2		1		6
	3		6		7
5		4		3	
6	4		7		8
	1		7		4
7		8		5	
8	2		1		6
	3		6		7
5		4		3	
6	4		7		8
	1		7		4
7		8		5	
8	2		1		6
	3		6		7
5		4		3	
6	4		7		8
	1		7		4
7		8		5	
8	2		1		6
	3		6		7
5		4		3	
6	4		7		8
	1		7		4
7		8		5	
8	2		1		6
	3		6		7
5		4		3	
6	4		7		8
	1		7		4
7		8		5	
8	2		1		6
	3		6		7
5		4		3	
6	4		7		8
	1		7		4
7		8		5	
8	2		1		6
	3		6		7
5		4		3	
6	4		7		8
	1		7		4
7		8		5	
8	2		1		6
	3		6		7
5		4		3	
6	4		7		8
	1		7		4
7		8		5	
8	2		1		6
	3		6		7
5		4		3	
6	4		7		8
	1		7		4
7		8		5	
8	2		1		6
	3		6		7
5		4		3	
6	4		7		8
	1		7		4
7		8		5	
8	2		1		6
	3		6		7
5		4		3	
6	4		7		8
	1		7		4
7		8		5	
8	2		1		6
	3		6		7
5		4		3	
6	4		7		8
	1		7		4
7		8		5	
8	2		1		6
	3		6		7
5		4		3	
6	4		7		8
	1		7		4
7		8		5	
8	2		1		6
	3		6		7
5		4		3	
6	4		7		8
	1		7		4
7		8		5	
8	2		1		6
	3		6		7
5		4		3	
6	4		7		8
	1		7		4
7		8		5	
8	2		1		6
	3		6		7
5		4		3	
6	4		7		8
	1		7		4
7		8		5	
8	2		1		6
	3		6		7
5		4		3	
6	4		7		8
	1		7		4
7		8		5	
8	2		1		6
	3		6		7
5		4		3	
6	4		7		8
	1		7		4
7		8		5	
8	2		1		6
	3		6		7
5		4		3	
6	4		7		8
	1		7		4
7		8		5	
8	2		1		6
	3		6		7
5		4		3	
6	4		7		8
	1		7		4
7		8		5	
8	2		1		6
	3		6		7
5		4		3	
6	4		7		8
	1		7		4
7		8		5	
8	2		1		6
	3		6		7
5		4		3	
6	4		7		8
	1		7		4
7		8		5	
8	2		1		6
	3		6		7
5		4		3	
6	4		7		8
	1		7		4
7		8		5	
8	2		1		6
	3		6		7
5		4		3	
6	4		7		8
	1		7		4
7		8		5	
8	2		1		6
	3		6		7
5		4		3	
6	4		7		8
	1		7		4
7		8		5	
8	2		1		6
	3		6		7
5		4		3	
6	4		7		8
	1		7		4
7		8		5	
8	2		1		6
	3		6		7
5		4		3	
6	4		7		8
	1		7		4
7		8		5	
8	2		1		6
	3		6		7
5		4		3	
6	4		7		8
	1		7		4
7		8		5	
8	2		1		6
	3		6		7
5		4		3	
6	4		7		



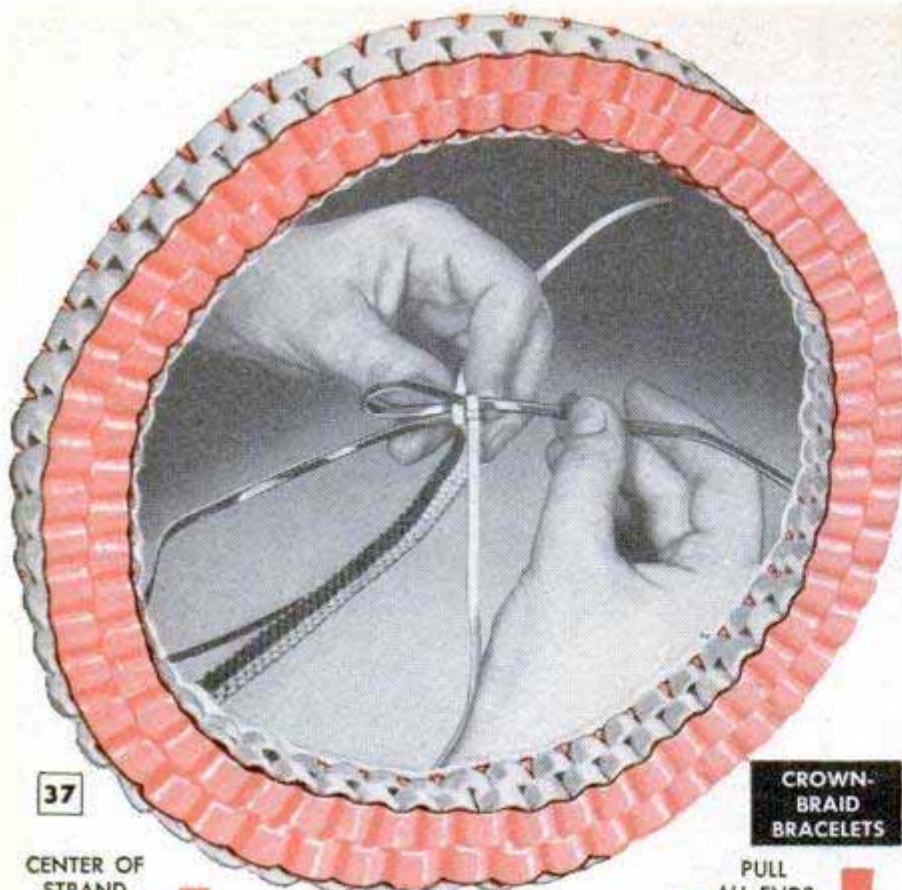

37

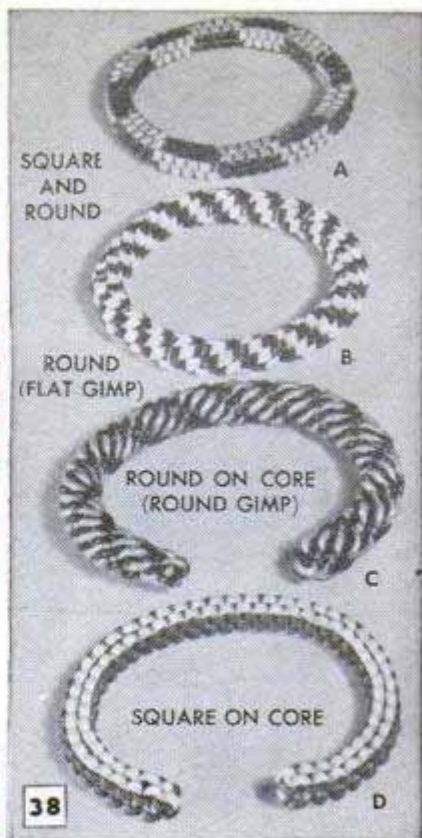

38

CROWN-BRAID BRACELETS

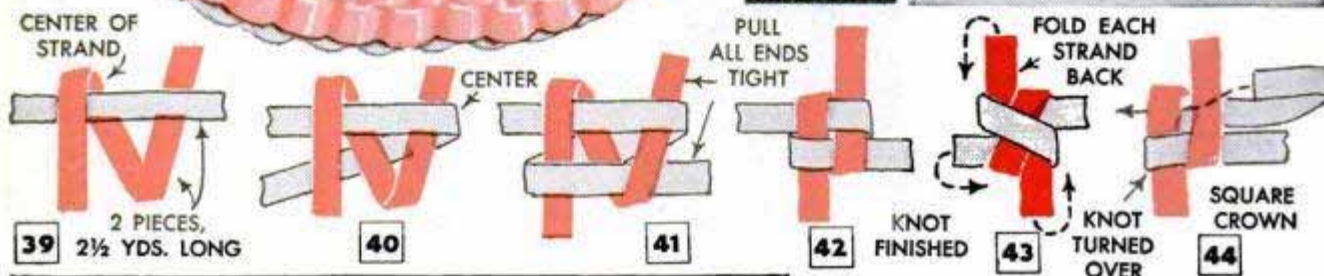

SAME STARTING KNOT IS USED FOR SQUARE OR ROUND CROWN

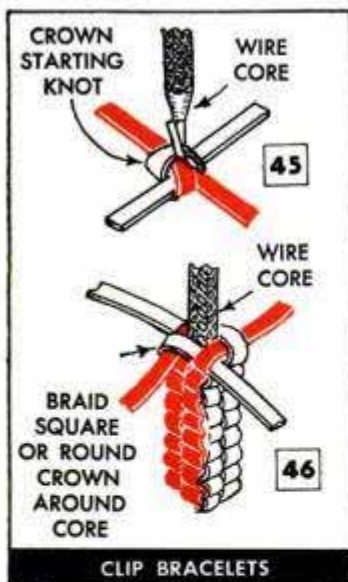

CLIP BRACELETS

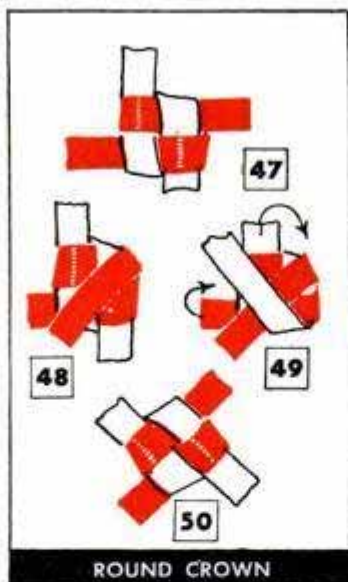

ROUND CROWN

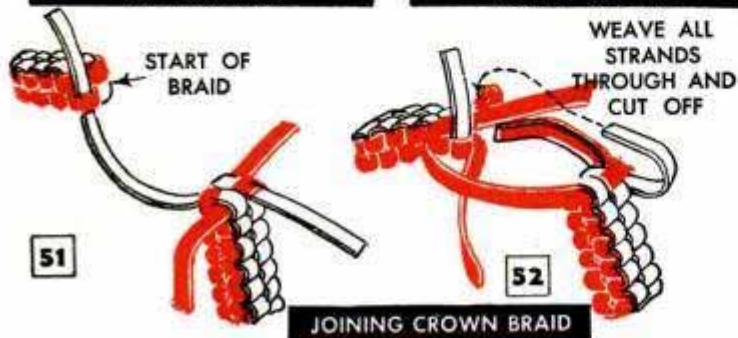

JOINING CROWN BRAID

across, as shown in Fig. 44. This produces the square, braided effect shown in Fig. 37. Although the round crown is done with flat braid, it results in a round, ropelike braid. At any stage of braiding the round crown, the top braid looks just like the square braid, Fig. 47. However, each succeeding layer is made by carrying the strands across diagonally, as in Figs. 48, 49 and 50. This braid often is called a spiral braid because it turns like a corkscrew, as can be seen in Fig. 38, details B and C. By braiding several layers of square crown and then one layer of round crown, the color pattern can be changed, producing the effect shown in Fig. 38, detail A.

**Clip bracelets:** These bracelets, Fig. 38, details C and D, fit snugly on the wrist and are popular for that reason. They can be made in either round or square crown, the braiding being done around a wire core. Begin by hooking the wire into the starting knot, as shown in Fig. 45, and work the braid exactly



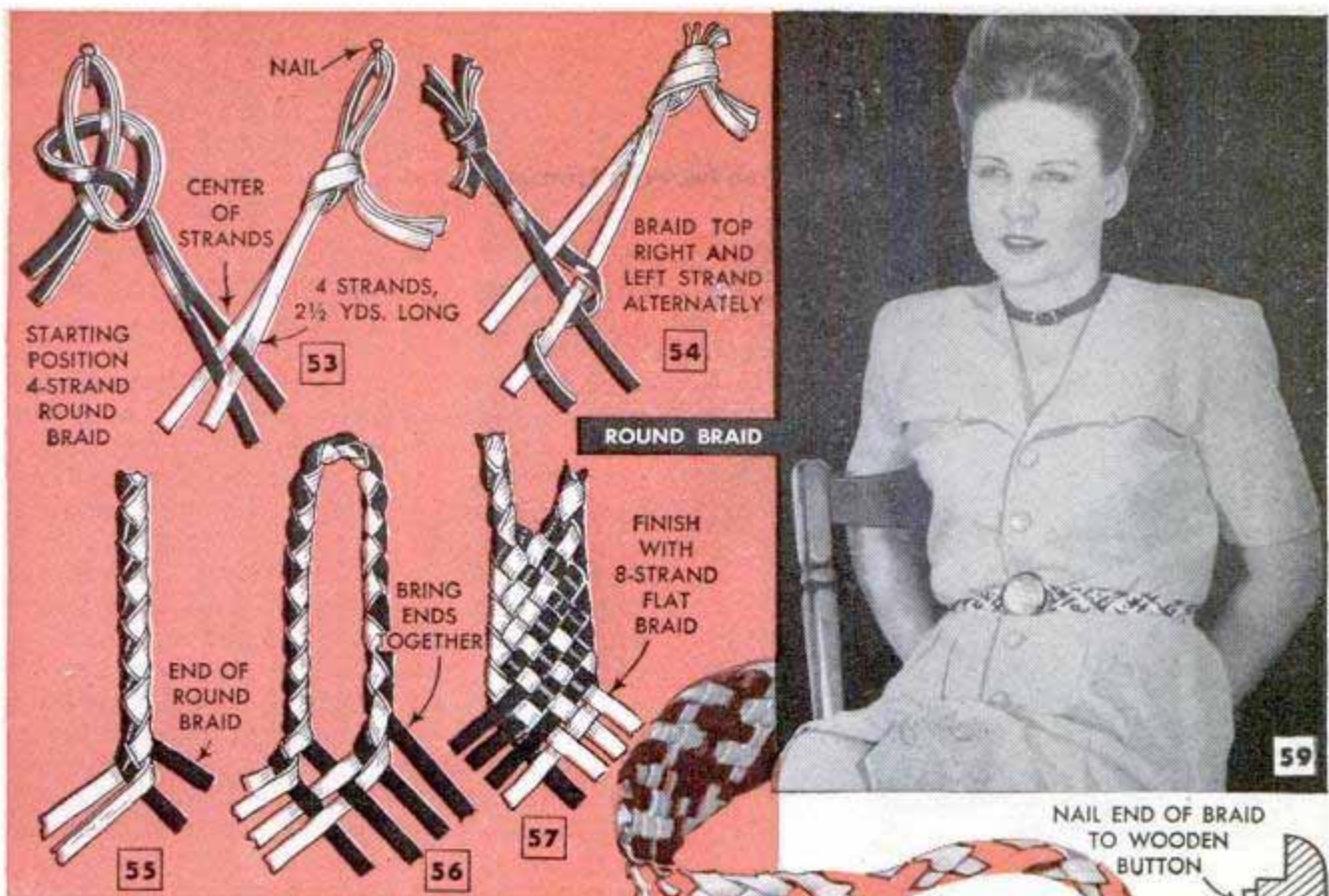

as previously explained. Fig. 46 shows the square crown. After desired length is reached, the wire core is cut off and the braiding continued for two or three layers beyond the end of the wire, at which point the final layer is pulled tight and the ends woven back into the main part of the braid.

**Joining crown braid:** Figs. 51 and 52 illustrate the joining of crown braid to make a complete ring or bracelet. This is done by weaving the strands back into the starting braid. Crown bracelets can be made a fairly close wrist fit because the braid has a certain amount of stretch which permits slipping the bracelet over the hand.

**Round braid:** This braid is used mainly for leashes, but is shown worked into a loop-and-button belt. To do this, start by locating the center of four strands. Tie off one end and arrange the four strands as shown in Fig. 53. From this position, take the top right-hand strand and carry it under the braid and over between the two

strands, Fig. 54. Do the same with the top left-hand strand and continue right and left alternately until the desired length is attained. The result is an attractive round braid, Fig. 55. Bring the two ends of the braid together and arrange the strands as shown in Fig. 56. You now have an 8-strand flat braid. Run this to the length desired, Fig. 57, and then staple the end to a wooden button. The loop also can be made 6-strand round braid, running into a 12-strand flat braid, the effect being as shown in Fig. 58. Besides showing the loop-and-button belt, Fig. 59 pictures the currently popular "dog collar." This one is 8-strand flat braid, dropped to 6-strand at the end to permit easy threading through a small chrome-plated buckle.

## Airtight Seal of Paraffin Preserves Oil Paint in Partially Filled Cans

Ordinary methods of resealing partially used cans of oil paint usually fail to preserve the paint for long periods of time. However, one man found that covering the paint with an airtight seal of paraffin keeps it in perfect condition. To do this, melt the paraffin in a can which is placed in a saucepan filled with water. This is done because paraffin melted directly over the fire may

burst into flame. After the paraffin has melted, pour a 1/8-in. layer over the paint. When this cools, pour a second layer, tilting the can slightly so the wax forms a seal with the sides of the can.

H. M. Nichols, Mattapan, Mass.

☛ A few drops of gun oil will prevent garment slide fasteners from sticking.



## Flashlight Bulbs Illuminate Tree If Electricity Is Not Available



One man, whose home is not wired for electricity, illuminates his Christmas tree with a battery-operated string of flashlight bulbs, thus eliminating the fire hazard of candles. He removed the male plug from an ordinary light string and connected the ends of the string to the terminals of a car battery. For convenience, he wired a feed-through switch into the circuit. The length of the base of the flashlight bulbs was increased to fit the sockets by adding a drop of solder to the contact point of each bulb. To give the tree a more pleasing appearance, he tinted each one of the bulbs with water colors.—Gilbert S. Hesse, St. Calixte de Kilkenny, Que., Can.

## Box Aids Painting Drawer Knobs

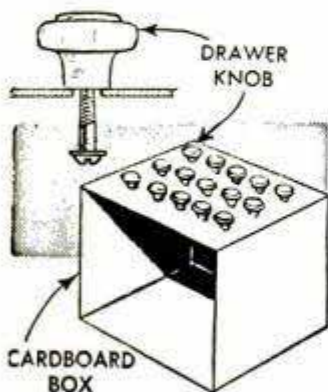

When hand painting a number of drawer knobs, one home craftsman found that the job was simplified greatly by using a cardboard box to support the knobs. Rows of holes to take the knob screws are first punched through

the side of the box and then the screws are inserted in the holes in the manner shown. Thus, by reaching in through the open side of the box, each knob can be rotated by its screw without actually handling the knob itself. This not only makes the job less

messy but it permits each knob to be coated evenly. The cardboard box catches drippings and allows the painted knobs to be set aside for drying without touching them. This stunt is particularly useful for production painting in small shops.

Joseph A. Knight, Oneonta, N. Y.

## Car-Battery Charger and Booster Assure Cold-Weather Starting

For the man whose car is a "must" for year-round driving, here is a compact booster unit for those cold-morning starts, along with a charger to keep the car battery in its best condition. The unit consists of a 6-volt charger and battery, a d.p.d.t. (double-pole, double-throw) switch, a toggle switch for the 110-volt line, three polarized outlets and a rubber extension cord with polarized plugs. The d.p.d.t. switch permits charging either the car battery or the booster battery, and the latter provides the increased amperage needed for cold starting. Positive to positive and negative to negative is the method used for connecting the charger through the switch to the booster battery and charger outlet, the booster battery to the booster-aid outlet, and the car battery to its outlet in the car. The glove compartment is an excellent, out-of-the-way place for the car-battery outlet, and the extension cord may be stored in the compartment so it is always at hand. When using the booster circuit to start the car, be sure that the d.p.d.t. switch is in the "off" position and, after the motor is running, disconnect the extension cord from the booster-aid outlet.—Alfred J. Seymour, Jr., Salmon Falls, N. H.

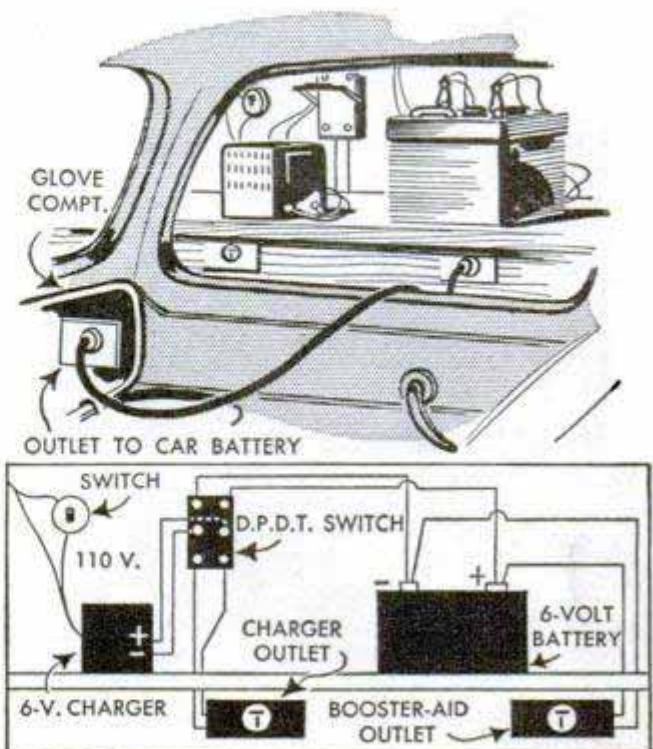



# BRASS CANDLE SCONCE

## *gives emergency light*

WHEN STORMS damage the power lines and leave you in the dark, you'll appreciate this attractive candle sconce to furnish an emergency light while service is being restored. It consists of a chimney of eight strips of glass held vertically by two bands of hammered brass, part A, the bands being attached to an oval plaque of fancy wood. Four of the glass strips measure 1 x 8 in. and the others are cut about 1 in. shorter. Each one is drilled for attaching to the bands with short machine screws. One of the best ways to drill glass is with a piece of rod chucked in a drill press. Putty is used around the hole to retain an abrasive mixture of turpentine and emery which is used to grind through the glass. Parts B, C and D are cut according to the patterns and assembled in the order given. Drip cup, C, is formed over the edge of a wooden disk as shown in the photo.

Bertram Brownold, Woodmere, N.Y.

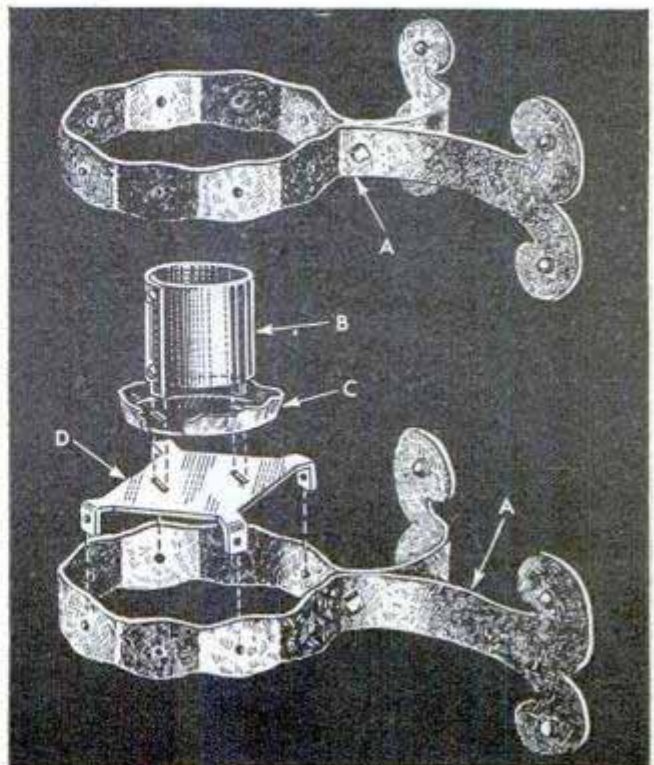
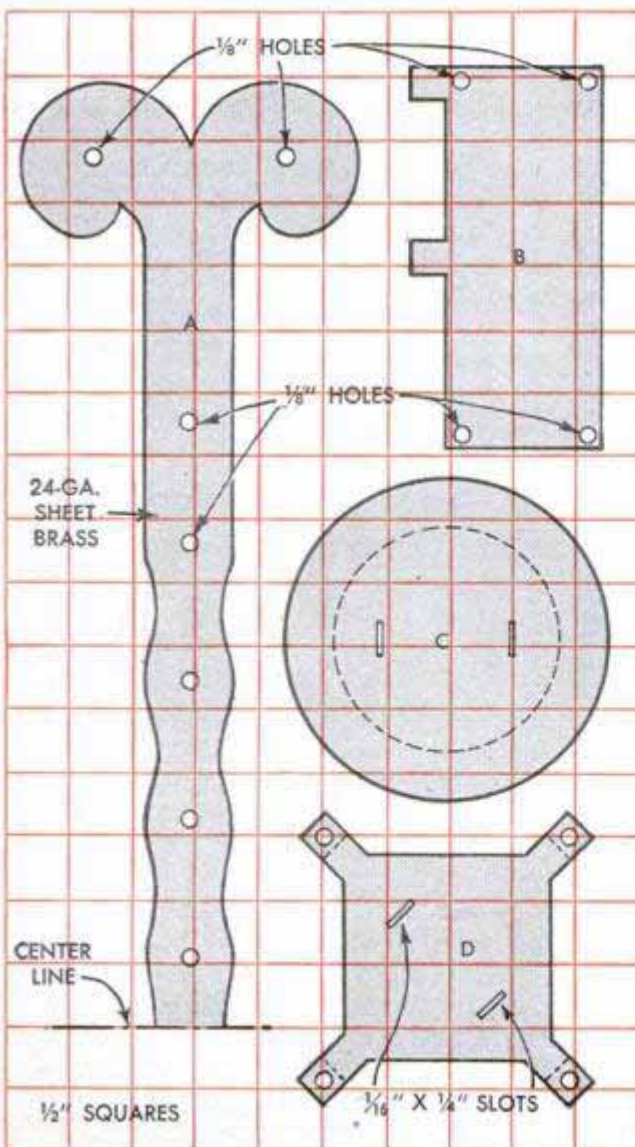
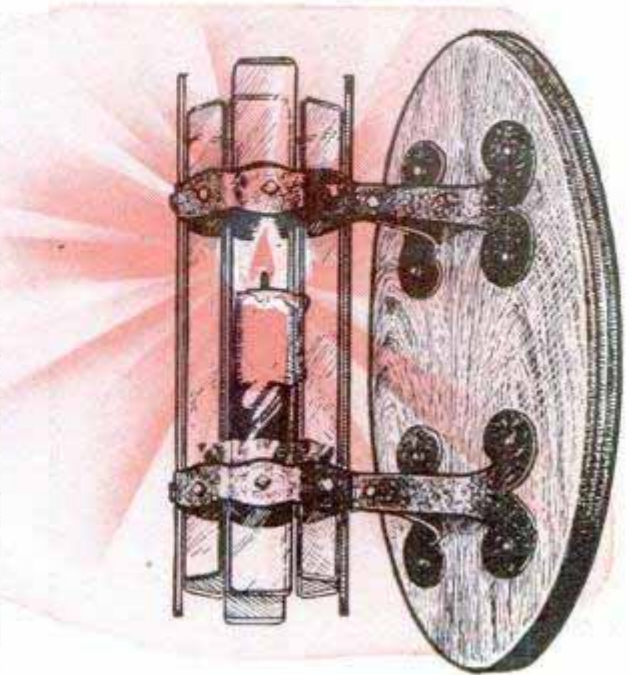



## Replacing Wheels With Improved Runners Converts Stroller Into Easily Handled Sled

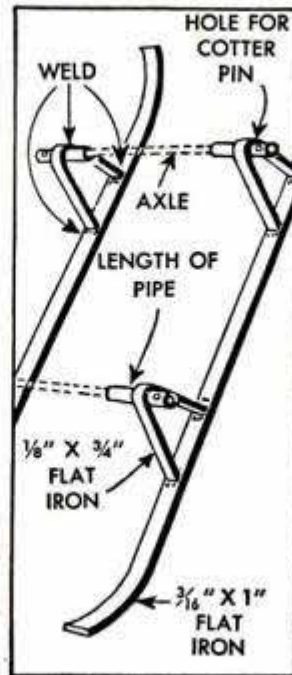

If the baby's stroller is fitted with removable sled runners, snow-covered sidewalks will no longer present an obstacle to his daily airing. U-shape brackets of flat iron are welded to runners, also of flat iron. Then, a short length of pipe, having an inside diameter large enough to fit over the axle, is drilled for a cotter pin and welded to the upper part of each bracket. After the wheels are removed from the stroller, the runner assemblies are attached by slipping the pieces of pipe over the axles and locking them in place with the cotter pins which are normally used to hold the wheels.—C. H. Thomas, Taunton, Mass.

## Lantern-Type Battery Housed in Tin-Can Case Operates Bicycle Headlight

A tin can fitted with a wooden cover, two binding posts and a toggle switch makes a weatherproof case for a 6-volt lantern battery. This is ideal for a bicycle headlight and excellent for general-purpose lanterns. Both the battery and the wooden-disk

cover should be a snug fit in the can. The cover is held in place with small wood screws. Flat-headed bolts, countersunk in the underside of the cover, form binding posts, one of them making direct contact with the center terminal of the battery. Two contact strips of sheet metal are soldered to the bolt heads flush with the bottom of the cover and a third strip is embedded in the cover over the other battery terminal. This strip is wired to one side of the switch, the other side of which is wired to the off-center binding post.

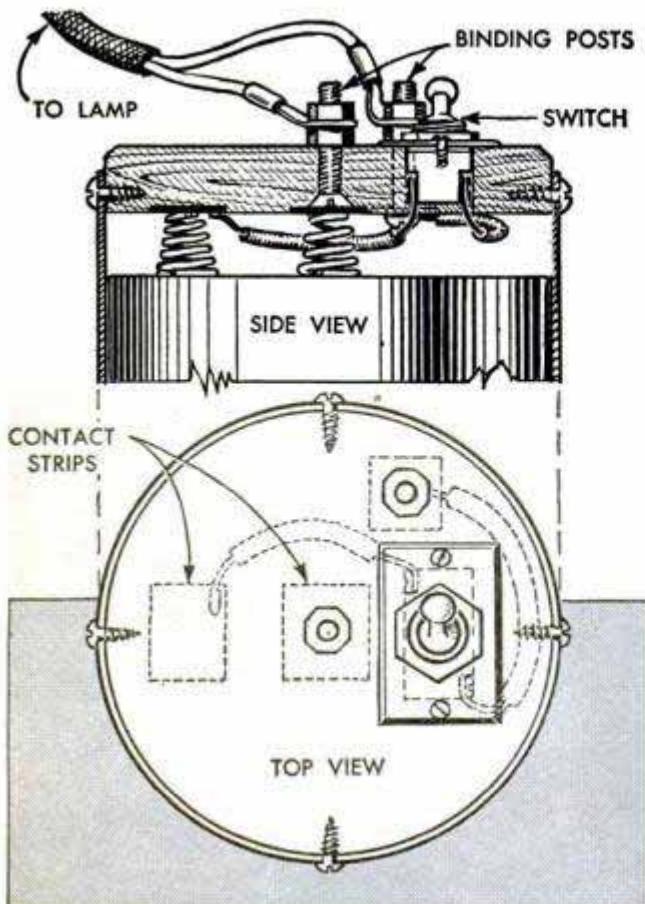

## Grease "Pincushion" Holds Drills To Protect Them From Rust

Here's a novel and practical way of storing twist drills to promote the best of care. In addition to protecting their cutting edges from rust and wear, it prelubricates them for drilling metal. Select a shallow can to suit the length of the longest drill, fill the can with cup grease and stick the drills in the lubricant. Before using a drill, wipe off the excess grease to prevent splattering.

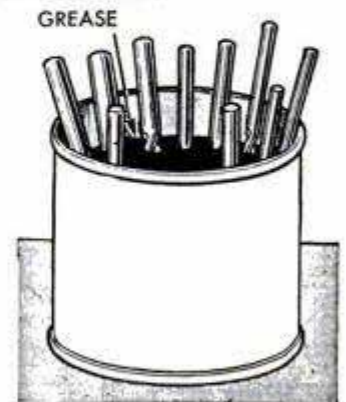

Simon S. Palestrant, Bronx, N. Y.



# LAZY SUSAN'S BIG SISTER

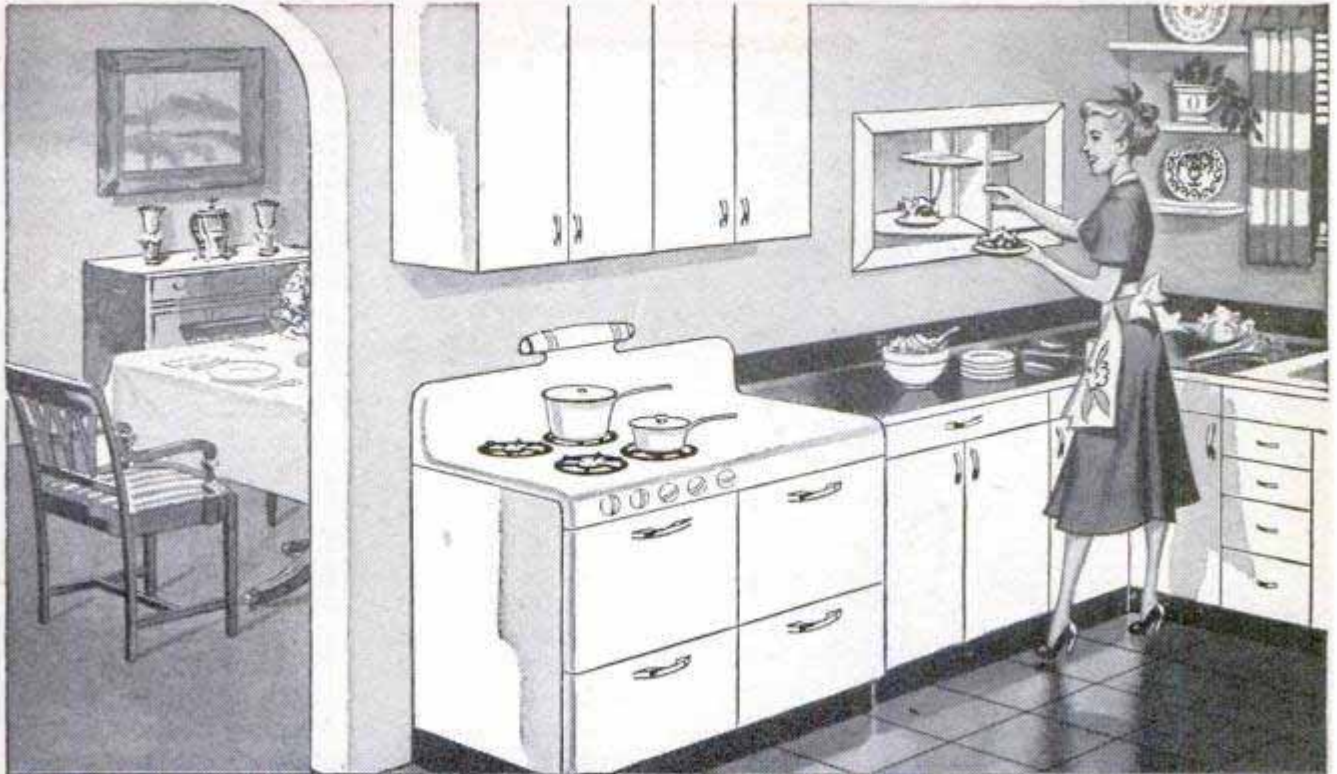

WHEN it comes to serving dinner or clearing the table after a meal, a Lazy Susan set in the wall between the kitchen and dining room is a real step-saver. The unit rotates on a  $\frac{1}{2}$ -in. rod held to the top of the opening with a bearing bracket and to the bottom with a plate set flush with the framing. A ball thrust bearing carries the weight for smooth operation.

Disks of  $\frac{1}{2}$ -in. plywood form two shelves which are braced with plywood uprights. Note how the uprights and plywood partition are fastened around the rod, and also how the partition is pinned to the rod. A cleat under the upper shelf adds rigidity to the partition. The unit is locked by a simple latch which engages notches in the bottom of the lower shelf.

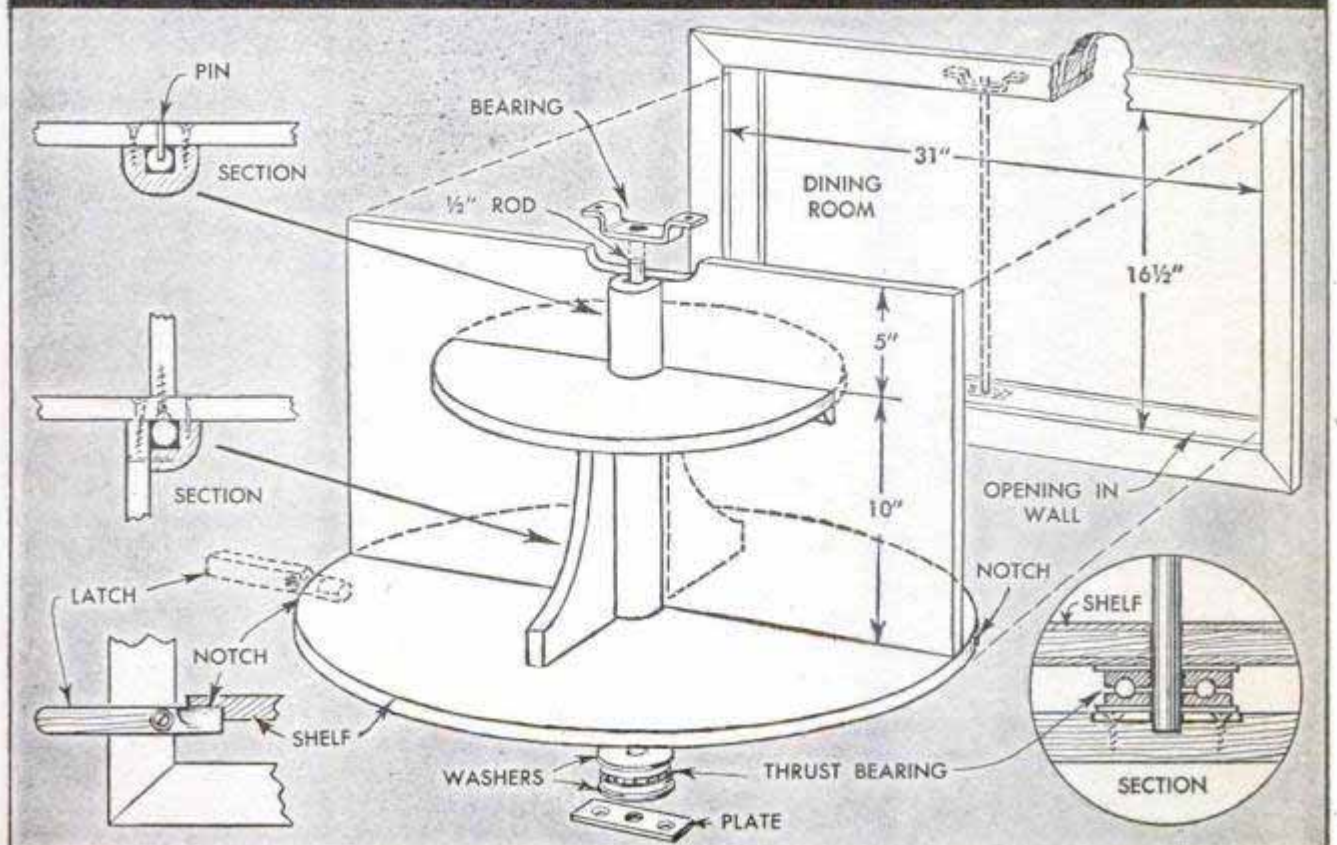



# GLASS CUTTING



While it is true that most homeowners can have window glass cut to exact size at the store where they buy it, many times scrap glass around the home will do to reglaze a window. That's when it pays to know how to cut the glass yourself

By Ralph E. Moore

**I**F I EVER TRIED to cut a piece of glass like that I would break it in a thousand pieces." No doubt you have heard this said before and, perhaps, have even found it so. But cutting window glass is as easy as the professional glazier makes it look, and not necessarily because his cutter may have a diamond point. It is due more to the way the cutter is held and to the tricks of the trade. With a little practice anyone can become adept at using a glass cutter and score a clean break every time.

First of all, get the feel of holding the cutter properly and recognize the sound it should make when it is actually cutting. When the tool is cutting properly, it should sound similar to paper or cloth being torn. The best way to get the feel of the cutter is to practice on an old piece of glass. Never try to cut dirty glass. Grit will prevent uniform cutting of the wheel. The glass should be placed on a flat surface. A small carpet or a piece of old rug, Fig. 1, makes the best surface on which to cut glass. Fig. 2 shows the proper way to hold the cutter. Note that it is not held vertically but at a slight, backward angle and also that the notches point downward.

To make a trial cut, first apply kerosene along the line of cut. Kerosene has been found to give "bite" to the cutter. A small brush or swab on a stick is handy to apply the kerosene to the glass. Next, using a yardstick as a straightedge, dip the cutter in light oil and start the cut at the far edge of the glass. Draw the cutter toward you with a swift, continuous movement, bearing down with a steady, firm pressure. The amount of pressure required is determined by the sound of the cutter. If it skips, pressure should be increased. Remember that the cutter actually cuts the glass and does not merely scratch it. *Never go over the same cut twice.* This is an important point to remember. Besides dulling the cutting wheel, scoring the glass a second time blunts the taper on the inside of the first cut and the glass will not break cleanly. For this reason, if the cutter does

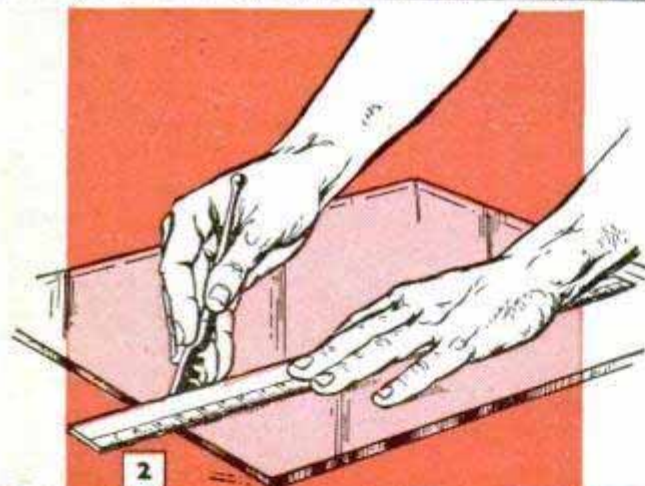

For a clean break, dip the cutter in light oil and apply kerosene to the glass before scoring

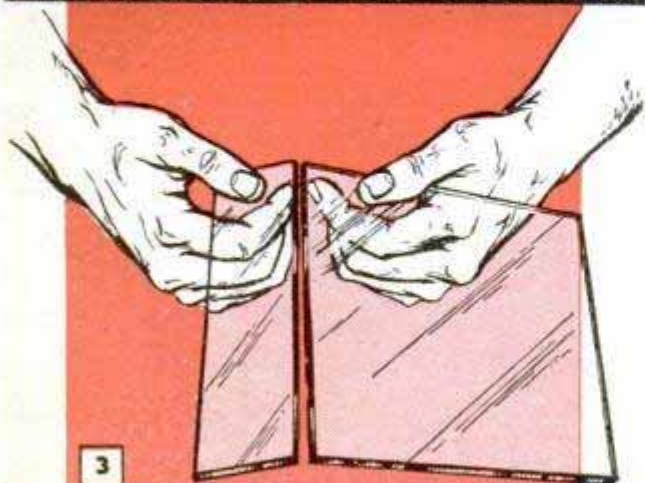

Break off scored strip 1 to 2 in. wide by placing index fingers on score and bending downward



# MADE EASY

skip, run it over only the spots missed.

The professional glazier classifies glass as being either window glass (single or double strength) or plate glass. In cutting window glass it is advisable to use a sharp cutter as window glass, being lighter than plate glass, will not stand great pressure.

Where it is required that a strip as narrow as  $\frac{1}{8}$  in. be cut from the edge of window glass, lay the yardstick  $\frac{1}{16}$  in. to the left of the line of cut to allow for the overhang of the cutter. Next, apply kerosene to the glass where it is to be cut, using a small brush or an oilcan, and dip the cutter in oil to lubricate the wheel. If this is not done, the wheel may "freeze" when the cut is half completed and merely slide the rest of the way. To break off the strip, use the notches provided in the cutter as shown in Fig. 5, selecting the notch that fits the thickness of the glass. Don't insert the edge of the glass all the way in the notch of the cutter. The proper distance varies with the width of the strip. In most cases, strips less than  $\frac{3}{16}$  in. break off in little pieces. When breaking off strips 1 to 2 in. wide, grip the glass as shown in Fig. 3. Place the fingers and thumb of each hand close together on each side of the cut. Then, using the index fingers as pivots, snap off the waste piece by bending the glass downward with a quick twist of the wrists. To break off pieces wider than 2 in., place the yardstick directly under the cut, as shown in Fig. 4, and press downward on each side.

The procedure for cutting plate glass is the same as that used for cutting window glass. However, a somewhat different method is used to break off narrow pieces. Where the waste strip is 1 in. wide or less, parallel-jaw pliers with paper between the jaws are used to remove the strip as in Fig. 6. Strips 1 to 4 in. wide are snapped off in a manner similar to the yardstick method, except that in the case of plate glass, it is recommended that a pencil be placed directly under the cut.

If glass is being cut for purposes other than glazing, such as a new top for a coffee table, the sharp edges of the glass may require rounding slightly. This can be done with an oilstone and water. The stone is soaked in water and then rubbed across the edge of the glass with the stone held at a 45-deg. angle. Rubbing is done with a circular motion and the stone is dipped in water occasionally as the work progresses. In polishing the edges of plate glass, the stone is held lengthwise and at right angles to the surface of the glass.

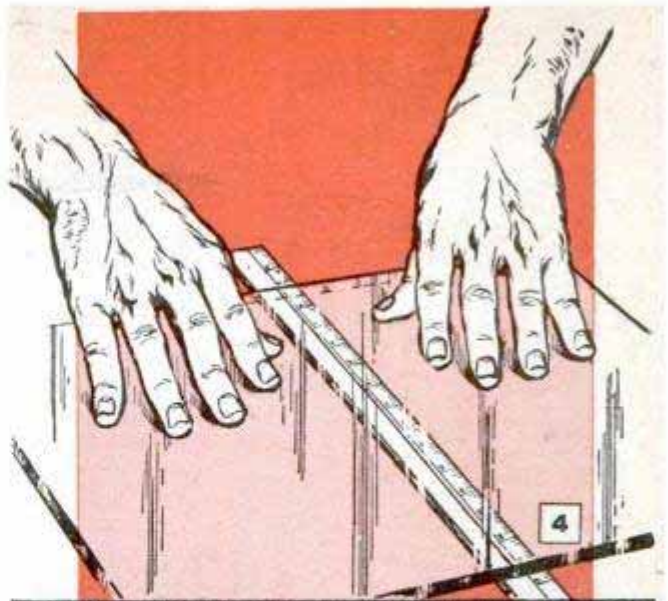

When parting large pieces, place a yardstick under the scored line and press down on each side

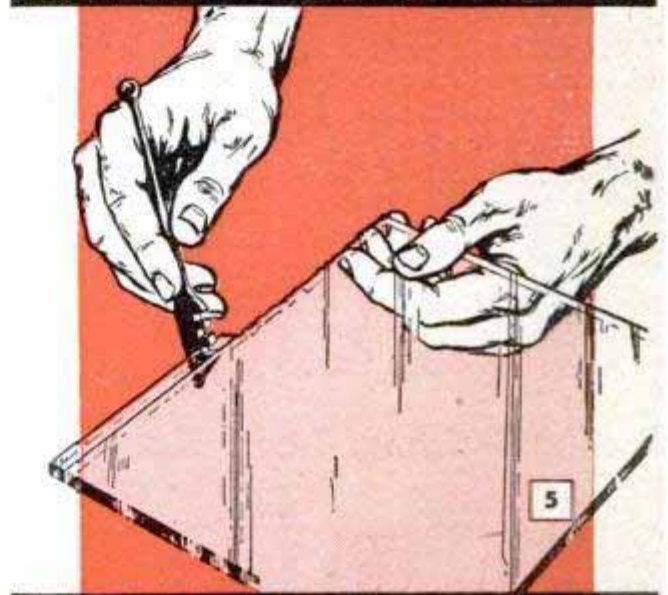

Narrow strips  $\frac{1}{16}$  to  $\frac{1}{8}$  in. wide are pried off by inserting edge of glass in notches of cutter

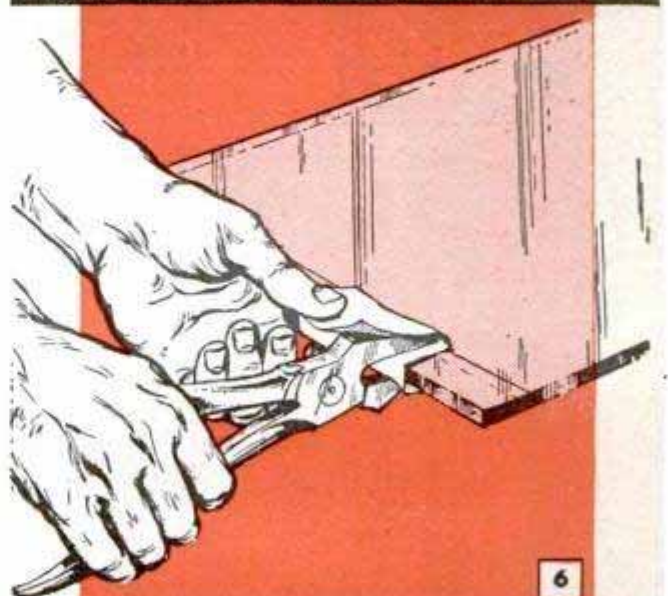

Parallel-jaw pliers provide greater leverage for removing narrow strips from edge of plate glass



## Windshield Sleet Scraper Will Not Scratch Glass

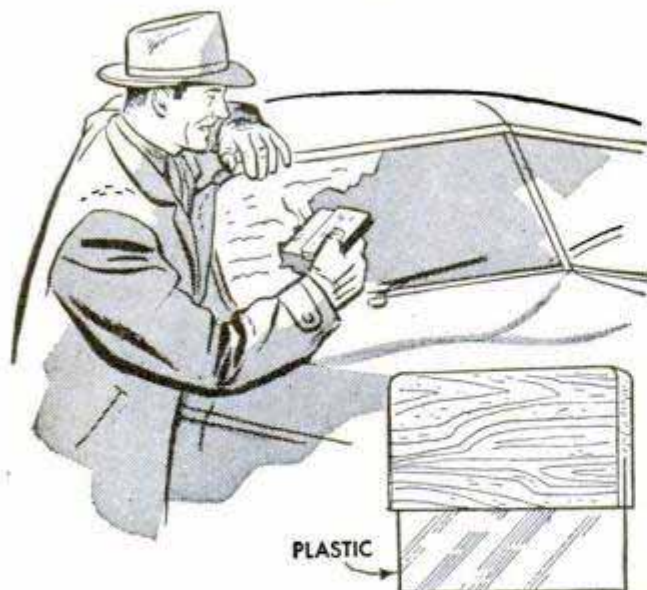

If you have had the unhappy experience of returning from shopping or a movie to find the windshield of the car covered with ice, you'll appreciate this efficient little scraper. It features a plastic blade which will not scratch the glass. One edge of the plastic is beveled 45 deg. and the other edge is forced tightly in a saw cut made in the edge of a wooden block. Make the blade from  $\frac{1}{8}$ -in. plastic, about 3 x 5 in.

Richard Hanscom, Elmhurst, Ill.

## Testing Christmas-Tree Bulbs

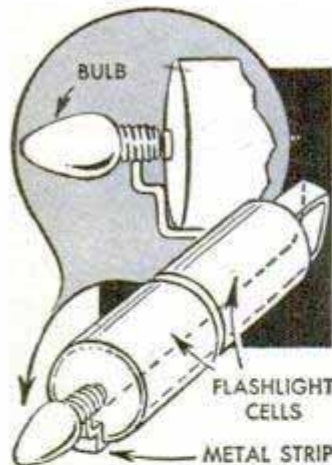

Locating a burned-out lamp bulb in a string of series-wired Christmas-tree lights is done quickly with this little tester. It consists of two flashlight cells and a metal strip bent as shown to hold the cells. To test a bulb, hold the bottom contact

against the front-cell contact and let the threaded part of the base touch the metal strip. The flashlight cells are strong enough to make the bulb glow dimly if it is not burned out.

## Solution for Fireproofing Fabric

In many cases it's a wise safety precaution to fireproof garments or household articles such as curtains and drapes. These can be fireproofed by immersing them in a solution made by dissolving boric acid, 3 oz., and borax, 7 oz., in hot water, 2 parts by

volume. After the article is thoroughly saturated, wring it out and allow it to dry. This treatment must be repeated after each laundering.—I. M. Fenn, Chicago.

## Salt Thaws Vertical Water Pipe

When water is piped to a poultry house, barn or other building it may freeze in the exposed portions of the pipe during a sudden cold snap. Usually the water freezes at a point just below the tap and you can save the trouble of carrying hot water from the house to thaw out the pipe by using ordinary table salt. Remove the faucet, chip away some of the ice and pour in a little salt. Then replace the faucet and turn it to the "on" position. The salt will thaw the ice in a short time.—Opie Read, Jr., Chicago.

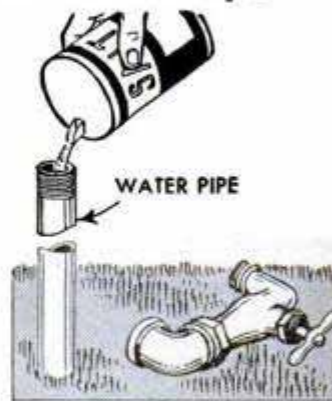

## Stovepipes Thoroughly Cleaned With Wire Scratch Wheel

Looking for something with which to give the inside of my stovepipes a thorough cleaning, I found that a wire scratch wheel is the ideal tool for the job. In addition to removing the accumulation of soot, the wire wheel loosened the hard crust that, in the past, had seemed almost impossible to clean out. To permit working the brush through the lengths of pipe, I fastened a broom handle to the wheel hub with a long screw, using two wooden washers for additional strength. Although a wheel of the same diameter as the pipes is most suitable, a smaller one will serve the purpose.

Arthur F. Hird, Lakeview, Ont., Can.

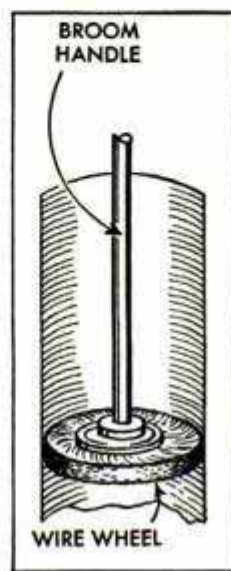



# FENDER REBUILDING

**H**AVE you noticed that the right rear fender of a car usually is the first one to rust through? Small stones and fine abrasive material thrown up by the wheel wear away the protecting finish and expose bare metal to water and road chemicals which tend to wash toward the curb in stormy weather. In time, rust eats away the metal to a paper thinness, necessitating either a new fender or a repair patch. Such a repair is made in a short time by following the simple procedure shown in Figs. 1, 2 and 3. Remove the fender, lay it on a bench as in Fig. 1, and place a sheet of heavy paper over the damaged area, holding the paper in place with tape. Mark the paper as indicated, the heavy pencil line following the lower edge of the fender. Also mark the fender along the top edge of the paper. Then cut the paper on the pencil line to get a pattern. Lay this on a piece of sheet metal of the same gauge as the fender, Fig. 2, mark, and cut to size with snips. Cut the fender along the line previously marked at the top edge of the pattern. Then weld the parts as in Fig. 3. Grind the joint flush and hammer the lower edge to shape over a bumping dolly, taking special care to draw the metal to the exact shape of the original fender to assure an accurate fit on the body. Fig. 4 shows the completed fender ready for installation and refinishing to match the body color.

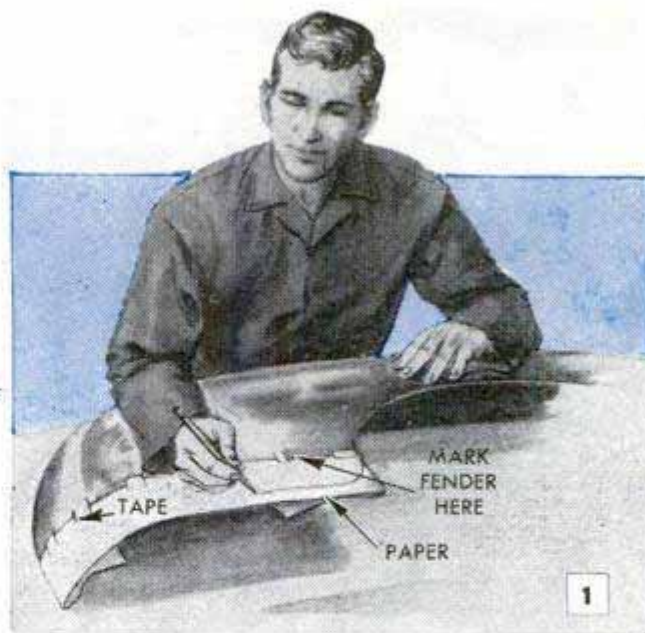

Paper is taped over the damaged area of the fender and the outline of the damaged portion is marked on it to make a pattern for cutting the repair part

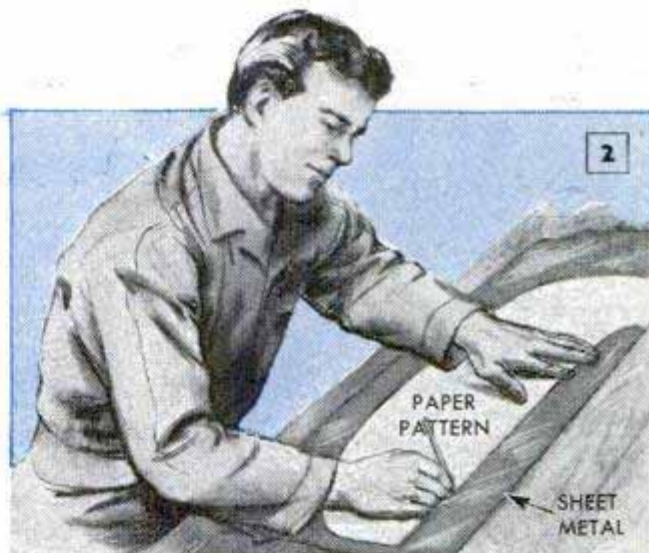

Then the pattern is cut out and its outline transferred to soft sheet metal of the same gauge as the fender. After marking, the sheet metal is cut to size

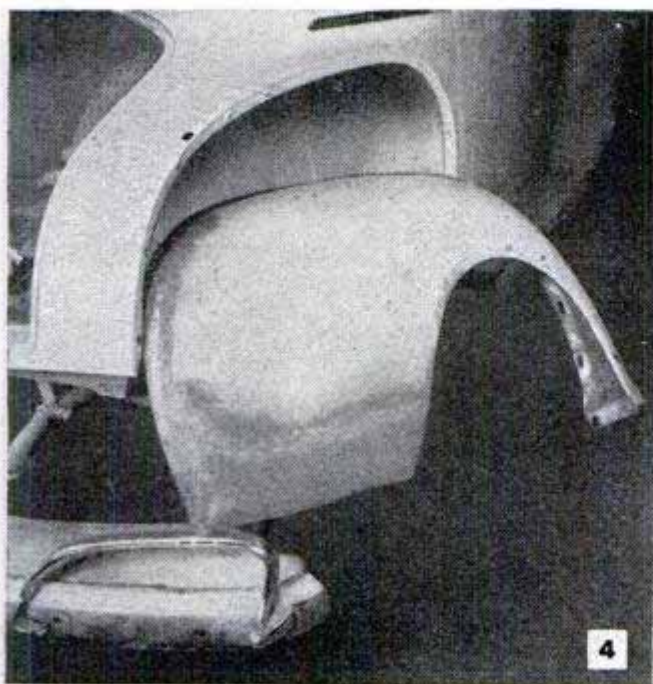

Finally, the repair part is welded to the fender and hammered to conform to shape at the lower edge



# STRETCH

Four major parts of your car require careful periodic checks if you are to get top performance and best possible fuel economy

## Part II

**I**N MAKING your car-fuel dollar go as far as possible, it isn't enough to check brakes, wheel alignment and lubrication as described in Part I. To get high operating efficiency and economy from your car, it is necessary that the service and repair schedule include the engine and the ignition, fuel and cooling systems. Servicing and repairing only one or two units and neglecting others that may need attention is not likely to make any noticeable difference in either performance or economy. It's the regular servicing of all units of the power plant that pays off in the long run.

The engine cannot operate efficiently unless it quickly warms to normal operating temperature after starting. Ordinarily, this should range from 160 to 180 deg. F. If the temperature ranges below 160 deg. F., the thermostat should be adjusted. If it runs above 180 deg. F., the cooling system likely needs a thorough check. The carburetor heater valve, generally located in the exhaust manifold, warms the fuel-and-air mixture coming from the carburetor. When the engine is cold, a maximum amount of exhaust heat is deflected to warm the incoming fuel. As the engine warms up, the bimetallic spring, one end of which rests on the anchor pin and the other in the valve shaft, causes the valve to open.

Check this mechanism often to make certain it is working properly. The com-

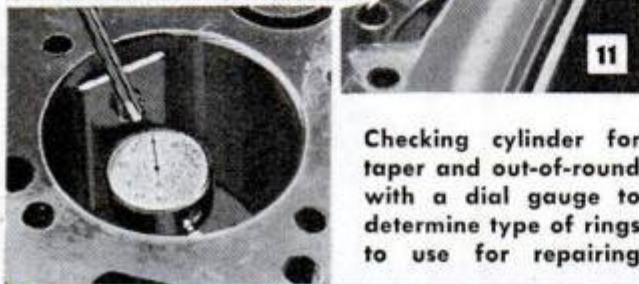

Checking cylinder for taper and out-of-round with a dial gauge to determine type of rings to use for repairing

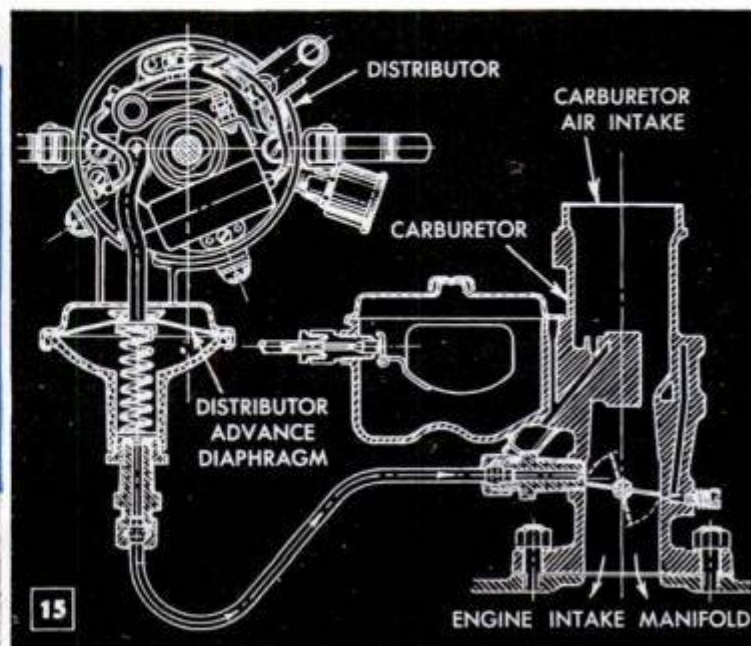
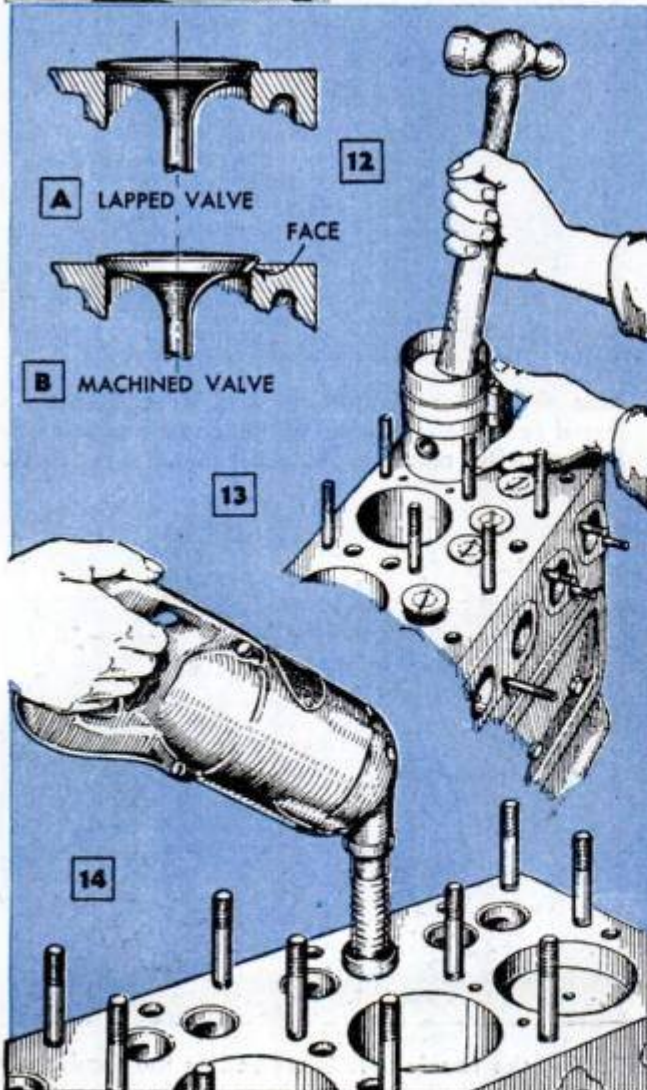



# your **GASOLINE DOLLAR**

pression of all cylinders should be tested regularly and recorded. Cylinders with pressure noticeably above average no doubt are badly carboned and any that are 10 lbs. below the average pressure may have scored walls, worn rings or bad valves. Such conditions call for the removal of the head. Careful mechanics start engine overhaul with an instrument check of cylinder condition, Fig. 11. The dial gauge shows at a glance how much each cylinder bore is out of round and also records the degree of taper. If taper exceeds .015 in., most mechanics will recommend a complete reboring job. When putting in special oil rings, breakage will be prevented by removing the ridge at the top of the cylinder bore before the pistons are pulled. And, of course, a ring compressor, Fig. 13, is used when installing pistons fitted with new rings. While the engine is open, the water jackets should be flushed out.

Having the valves refaced and resealed, Fig. 14, usually results in greatly improved gasoline mileage. Fig. 12, detail A, shows a valve with a groove worn in the face. If such a valve is "lapped in" with the engine cold, it may not seat properly when engine temperature rises. The valve face should be machined as in Fig. 12, detail B, and the seat in the block renewed by grinding.

A worn timing chain causes what mechanics call "valve lag"; that is, the intake valve opens after the piston passes top dead center on the intake stroke. This creates a partial vacuum inside the cylinder that tends to pull oil past the piston. Many stubborn cases of oil pumping are traceable to a worn timing chain.

With the engine in good mechanical

shape, the ignition generally is rated next in importance in a thorough tune-up. If a spark plug "oils up," it often means that it is running cold. Install plugs of the correct heat range. Sometimes the high-tension wire to the oily plug is in bad condition or making poor contact. Replacing the wire often cures the trouble. If the inside of the distributor cap shows evidence of arcing and is dirty or cracked, it will pay to install a new one. On some distributors there are five places, Fig. 18, that need lubricating at regular intervals. The grease cup, A, should be turned down regularly. Also, place a drop of oil at B every 1000 miles. An occasional smear of grease applied to the breaker cam, D, will prolong the life of the fiber bushing. At 5000-mile intervals, a drop of oil applied with a toothpick at C is desirable. And, at the same time, a drop of oil on the ball bearings of the advance mechanism, E, is recommended. A typical vacuum spark-advance mechanism is shown in Fig. 15. The importance of proper spark advance in efficient engine operation is illustrated by the ignition timing-advance curve in Fig. 16. The straight arrow at the bottom indicates the spark advance in degrees as engine speed and power increase.

Although burned breaker points should be replaced, those only slightly pitted can be removed from the distributor and resurfaced with an oilstone as in Fig. 17. Mount the points on a block of hardwood and groove the block to support the bracket firmly. If the ground point is of the screw type, a hole should be drilled in the wood to receive the threaded end in a tight fit. The distance that the points open in any

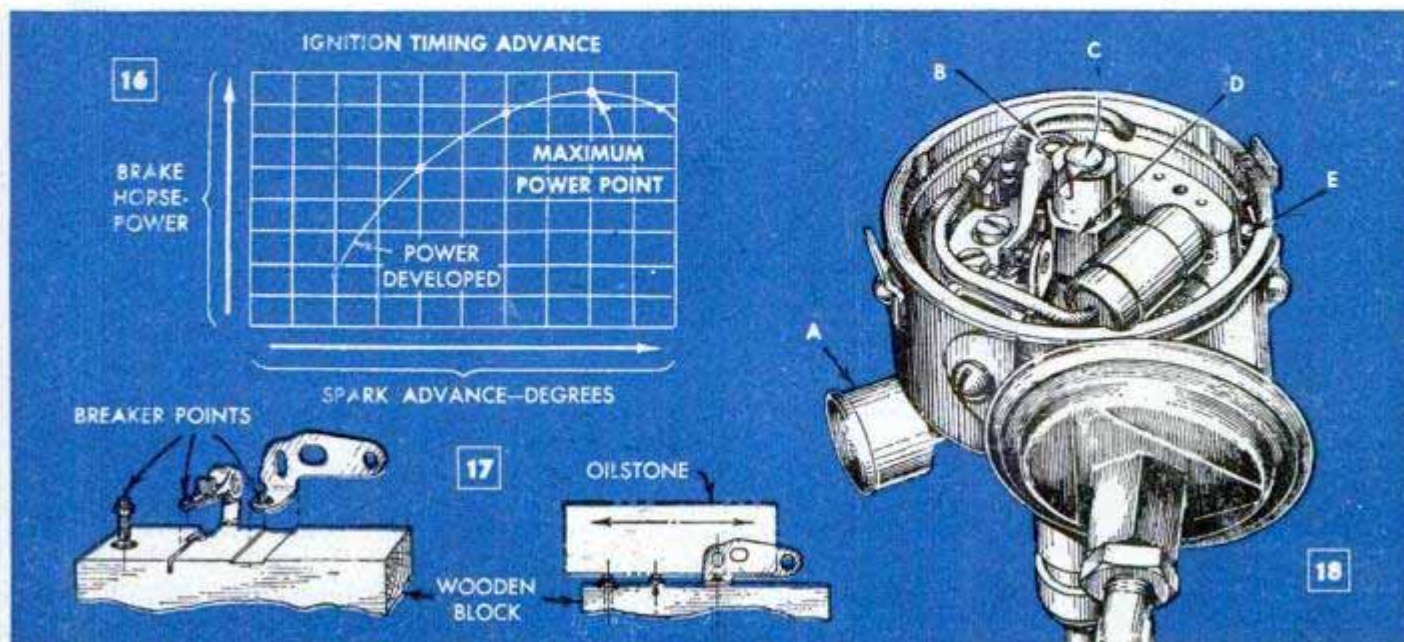



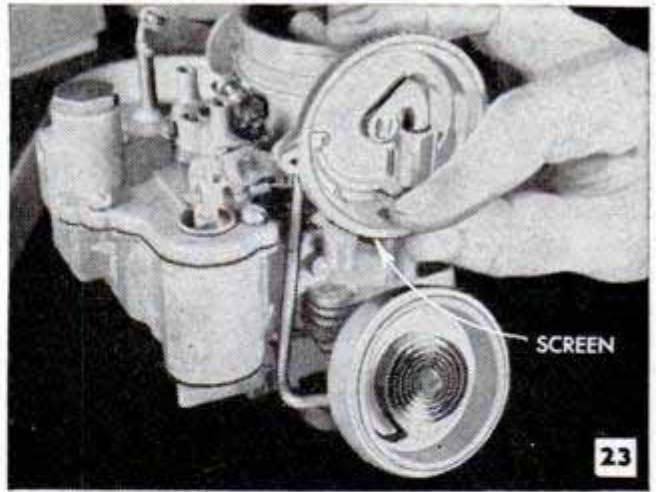

Above, checking screen in choke-control heater. Left, testing fuel pump. It should lift fuel 30 in.

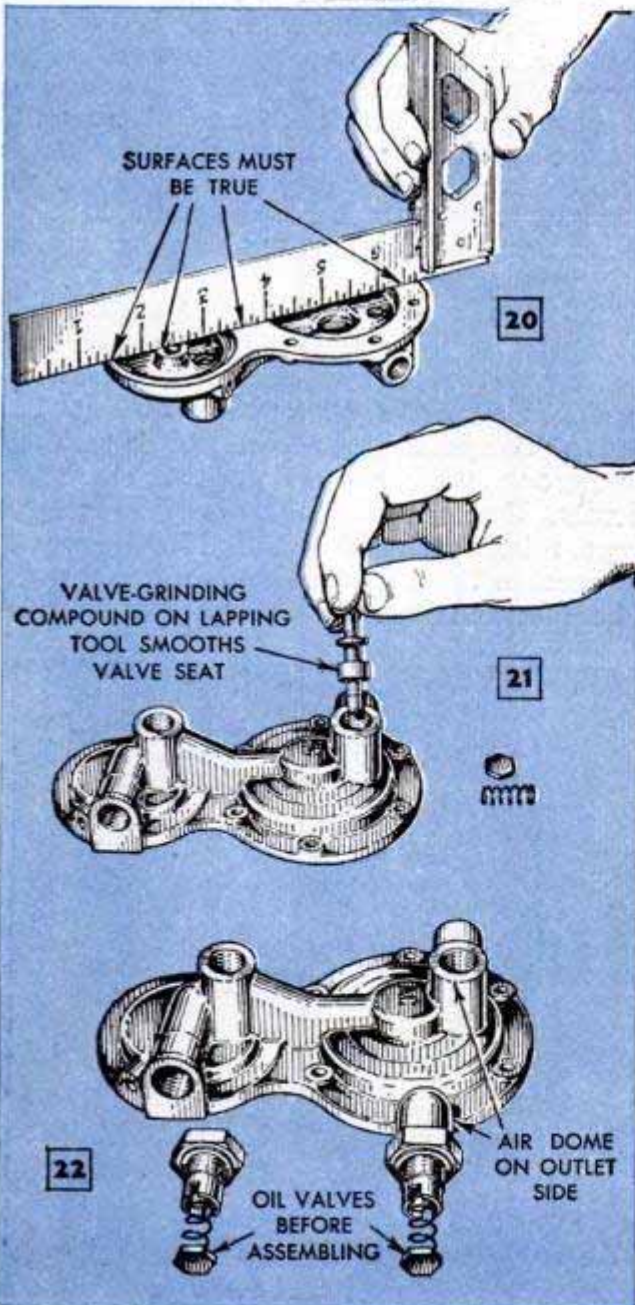

particular distributor determines the cam angle. If there is any doubt about the correctness of the cam angle, have the mechanism checked on a precision tester.

Complete service kits for most fuel pumps and carburetors can be purchased from auto-supply dealers. When overhauling either of these units, lay the parts out in order on a tray. Then the new parts from the repair kit can be substituted for the old ones as the unit is rebuilt. In servicing the fuel pump, a very important check is made with a straightedge to see that the joining surfaces of the housing are true, Fig. 20. If only slightly distorted, they may be made serviceable by rubbing them on a sheet of coarse emery cloth.

Fuel-pump service kits include diaphragms, and these should be soaked in kerosene before assembling. See that the holes are correctly lined up and held in alignment while tightening the diaphragm nut. Also, see that the glass sediment bowl makes a gasoline-tight contact with the gasket. New valves should be used in rebuilding the fuel pump. Always examine the valve port to see if the brass valve seat is smooth. If not, a lapping tool, Fig. 21, coated with valve-grinding compound will restore the seat. These seats, in many cases, are small brass rings, and can be forced out of the pump casting and replaced. When building up the valve assembly, the parts should go in the order shown in Fig. 22. The composition valves lie flat on the brass seats, the springs bear on the valves and the port plugs are tightened firmly in place. The airdome type of port plug must always be on the outlet side of the pump to equalize the fuel-pump pressure and to prevent surging. Test the pump by hand as in Fig. 19. It should lift gasoline at least 30 in. Fuel-pump pressure suitable for slow driving will tend to starve the engine at high speeds. But, you cannot have maximum fuel economy and high-speed performance.





Carburetor-float level, A, is adjusted by bending the float arm. Consult instruction book for dimension

One or the other must be sacrificed. For greatest economy some motorists cut one turn off the fuel-pump diaphragm spring or use extra shims under the fuel-pump flange to move it out farther from the camshaft. This reduces the stroke of the pump.

Complete carburetor repair kits are available for the common later types. Carburetor jets can be removed with a screwdriver, but the sides of the blade should be ground as in Fig. 26 so that the threads in the carburetor bowl will not be damaged. After disassembling, wash all passages and clean the parts with alcohol or acetone to remove any gum deposits. Then blow out the passages with air from a tire pump. Using a jet one size smaller than standard saves fuel. When inserting the leather accelerator plunger, a feeler gauge can be used to help slide this part into place. In Fig. 24, A indicates the float level which is adjustable by bending the float arm. Just how and where the arm is bent, and what the dimension A is, will vary in different cars. Consult instruction data. When assembling the carburetor, all plugs below the gasoline level should have the threads lightly coated with shellac before being installed. With the carburetor installed on the car, the engine should be warmed up thoroughly and the low-speed idle adjustment set so the engine just "ticks" over. The mixture adjustment should be as lean as it can be set without having the engine die or pop back through the carburetor when accelerating. One method of adjusting the length of the accelerating-pump stroke is shown in Fig. 27. With the linkage in position A, pump movement is at a minimum. For more powerful acceleration and cold-weather performance, the linkage is changed to position B.

Some types of automatic chokes depend for operation on the heating of a coiled bimetallic spring, Fig. 23, to open and close the choke valve. Sometimes the screen

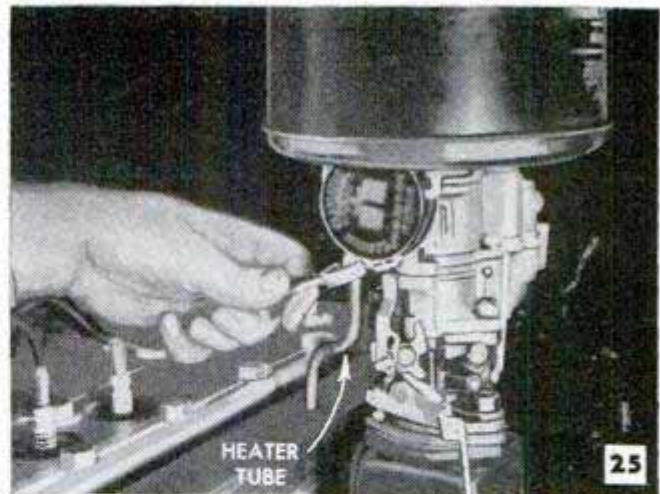

Remove choke-heater tube and blow out with compressed air to make sure it is not clogged with carbon

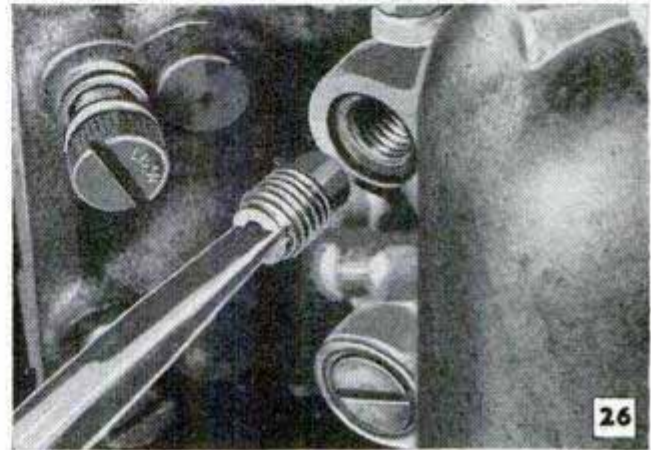

When removing the carburetor jets, grind the screwdriver blade to prevent damaging the fine threads

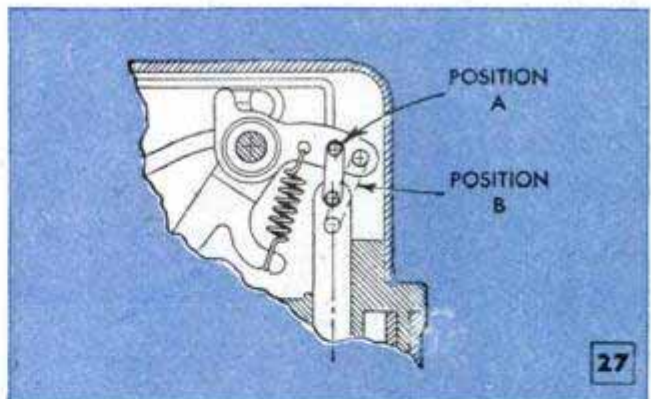

Accelerating-pump linkage has two settings, A and B. The former gives best economy with slow acceleration

over the end of the heater tube, Fig. 23, becomes clogged and cuts off the flow of heat. This lack of heat causes the valve to be held in a semichoked position, wasting a great amount of fuel. The heater tube, Fig. 25, running from the exhaust manifold to the control should be checked to be sure that it is not clogged. Automatic chokes generally have a winter and summer setting. It's important that they be properly reset at the end of each season. By carefully following manufacturer's directions, the car owner can adjust the choke himself.

THE END



## Burring Simulates Hammered Effect On Cylindrical Metalwork



Producing a hammered finish on cylindrical metalwork with a ball-peen hammer is likely to cause distortion which is difficult to remove. However, if the walls of the metal are thick enough, a similar effect can be attained without the possibility of distortion simply by using a small ball-shape burr or rotary file chucked in a hand grinder. Use the file as shown, holding it at right angles to the length of the cylinder.

A. C. Saffron, Pittsburgh, Pa.

## Funnel for BB-Shot Container Aids Loading Air Rifle

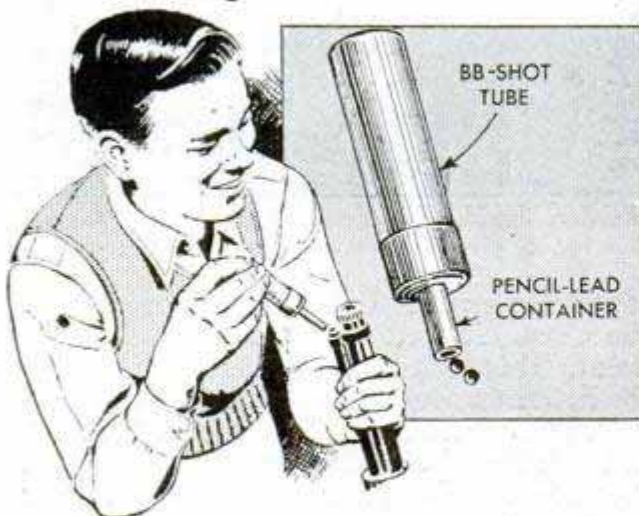

You can load the magazine of your air rifle in a jiffy and without spilling a single BB if you use the cap from an empty BB-shot tube as a funnel. Just punch a hole in the center of the cap and glue a pencil-lead container over the hole to form a

spout. Of course, the bottom first must be cut from the pencil-lead container. Then, simply place the cap on the full tube of shot and invert it over the magazine opening, shaking the tube slightly to release the shot.

Richard Almquist, Fayetteville, N. Y.

## Increasing Blowtorch Efficiency

As the performance of a blowtorch depends on the maintenance of the proper generating temperature, it can be improved by insulating the nozzle with asbestos paper. Wrap two or three layers of this paper around the nozzle, covering about 1 in. of the end, and fasten it with wire. In addition to insulating, the asbestos paper will permit the torch to be relighted without preheating if the flame is extinguished accidentally.



## Pattern of Car-Door Key Carried in Wallet

A pattern of the car-door key silhouetted on a piece of photo or blueprint paper is a handy item to carry in your wallet. Then, if the door is locked with the key still in the ignition switch, a new key can be duplicated from the pattern. This will save the cost of removing the door lock or breaking a window.

R. F. Donovan, Jersey City, N. J.

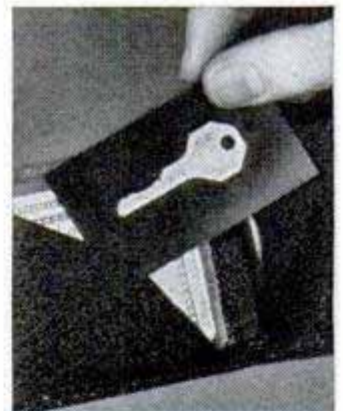

## Repasting Wallpaper Seams

If some of the seams on a papered wall have loosened, try an applicator like this one to repaste them. It will enable you to do the job without getting paste on the exposed surface of the paper. It consists of a short strip of screen wire folded double and nailed into a slotted wooden handle.

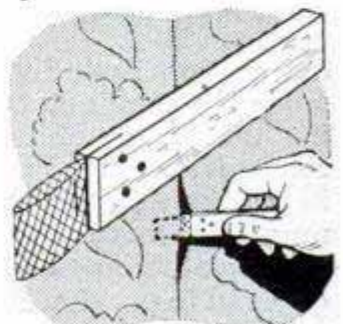



# PHOTOPRINT DRIER heated with lamp bulbs

By J. Allen Martin

WAITING for glossy prints to come off a ferrotype plate is the slowest part of processing photos at home when they are being air-dried on one or two plates. Not only is this a slow process, but the prints curl and many times stick like glue to the plate. This was my trouble until I made a simple and inexpensive electric drier. Now, the prints dry in about eight minutes, and with two plates I can really speed the process by keeping one loaded to place in the drier when the other is ready to come out.

Instead of using a Nichrome element to heat the plate, I used the heat from four lamp bulbs as shown in Fig. 3. This made the drier economical to operate and provided ample heat, as the latter is transmitted directly to the underside of the ferrotype plate. The wooden box which houses the lamp bulbs, Fig. 1, is made to fit a standard ferrotype plate. The one shown was made to take the 14 x 20-in. size. Note that the sides and center partition of the box are curved and that guide strips are nailed to the outer edges of the sides to provide a rabbeted edge for the ferrotype plate. The latter merely rests on top of the drier and is held curved by a canvas curtain which is brought down over the plate and tied at the front as shown in Fig. 2. Thus, when pulled down firmly, the canvas keeps the prints in constant contact with the ferrotype plate, preventing excessive curling. Curling can be reduced also by immersing the prints in a solution of glycerin before squeegeeing them to the ferrotype plate. Any slight curl usually will straighten upon cooling.

The canvas cover serves the dual purpose of holding the prints in contact with the ferrotype plate and also curving the plate to minimize curling of prints

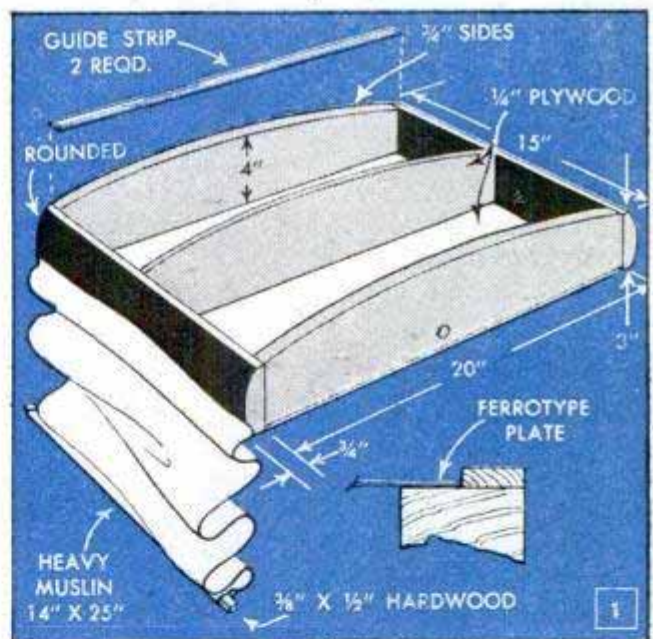
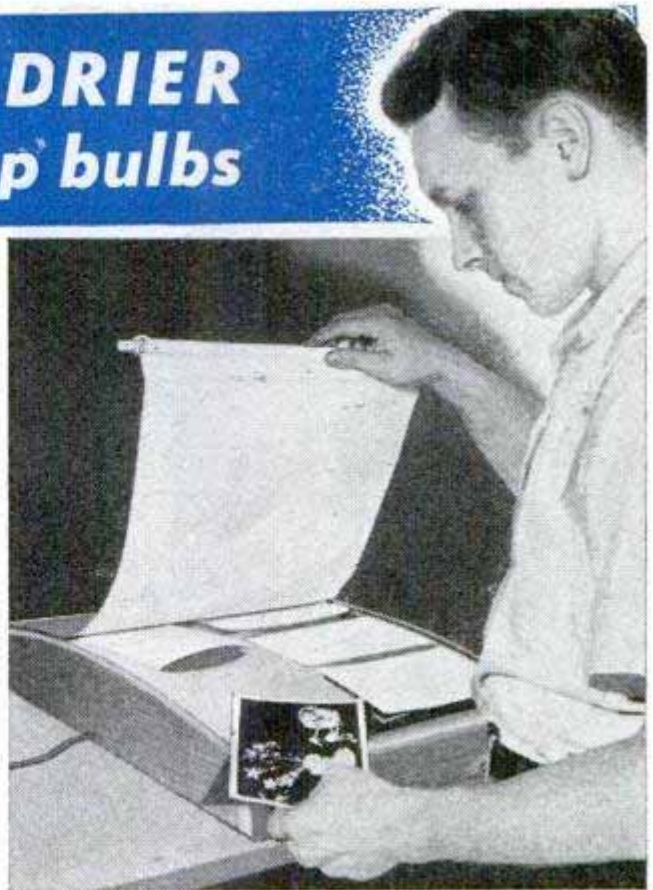

Four 60-watt lamp bulbs wired in parallel provide the heating element for this print drier. Note that disks of asbestos paper are placed under the bulbs

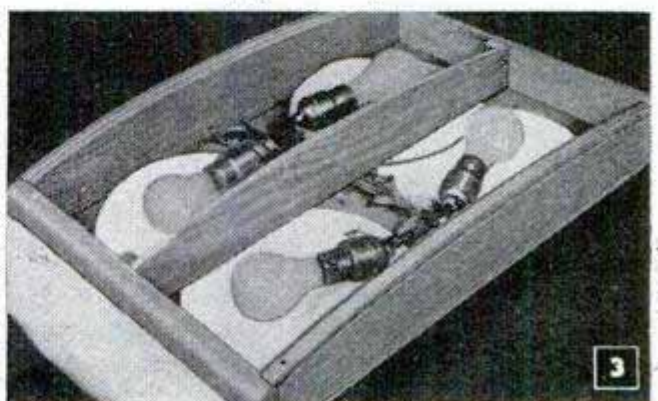
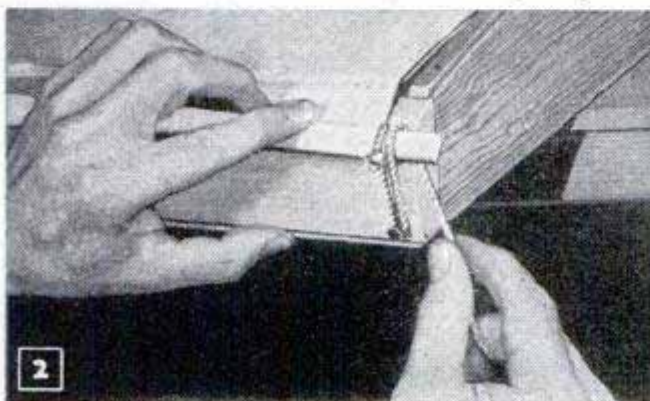





### Vise Aids Loading Roll-Film Tank

If you process your own photos, you know what an irksome job it can be to load the reel of a roll-film tank, especially when it involves film of No. 120 or 620 width and working in total darkness. The most difficult part of the job usually is starting the film in the grooves of the reel, and that's when you wish you had three hands—an extra one to hold the reel itself. Holding the reel between the knees is not always convenient. However, a little bench vise will do the trick. Simply clamp the reel lightly between the jaws and both hands will be free to feed the film.

### Avoiding Squint Due to Sunlight

To keep a model from squinting when taking pictures in bright sunlight, one photographer has him close his eyes for a moment before the picture is snapped. The picture must be taken the instant the model opens his eyes.

A. M. Wettach, Mt. Pleasant, Iowa.

### Premeasuring Developer Solution



Premeasuring amounts of stock solution required to fill a roll-film tank and keeping the amounts in brown-glass jars will permit saving slightly used developer from one day to the next without contaminating the concentrated supply. The stock solution stored in each jar is diluted only at the time of use, and if a mark is made on the side of

the jar indicating the amount of water to be added to the developer, it is a simple matter to dilute the stock solution according to the proportions recommended by the manufacturer. This saves measuring so many ounces of stock and so many ounces of water each time. You merely add water to the mark.

### Repairing Focal-Plane Shutter

Until the worn curtain of a focal-plane shutter can be replaced, coating it with a thin film of rubber cement and rubbing powdered graphite over the cement will keep out unwanted light. This repair does not affect the flexibility of the curtain.

Marion Schwerman, Sylvan Lake, Ill.

### Centering Guide on Printing Frame Aids Production of Lantern Slides

When printing 2 x 2-in. lantern slides from small-size roll film, this cardboard guide permits quick and easy centering of the image on a sensitized glass plate. To make the guide, take a 4 x 4-in. piece of cardboard and cut a 2-in.-square hole in its center to take a transparency mask. Then fasten the mask with a piece of tape. The thickness of the cardboard should

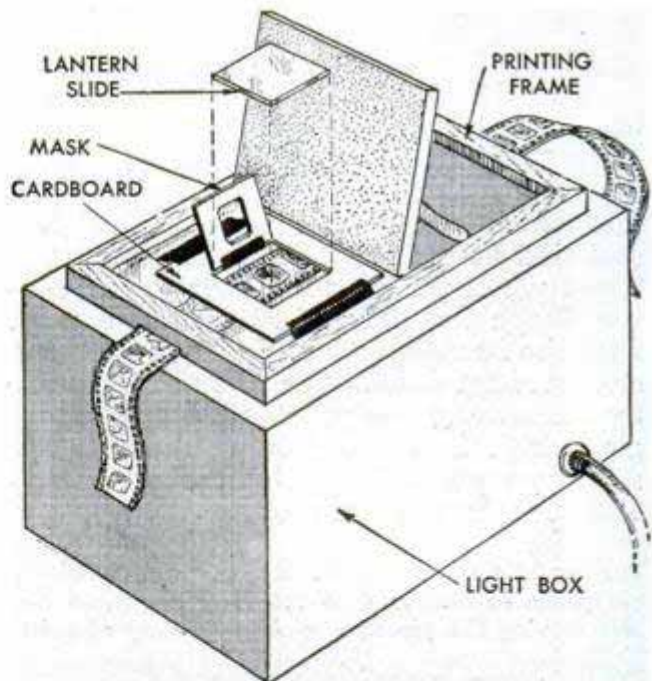

equal the combined thickness of the mask and glass plate. After taping the cardboard to the glass top of the contact printer, slide the film under the cardboard and center the image in the opening of the mask. When this has been done, place the glass plate in the square and make the exposure in the usual way. Note that the printing frame must be notched at each end to permit the film to slide through flat on top of the glass.

George Lauer, Chicago.



# FOCUS ON BABY

**G**OOD BABY PICTURES are not difficult to shoot, but they do require advance planning, quick thinking and fast action on the part of the photographer. Lack of preparation or hesitation at the wrong moment may result in the loss of a photo possibility seldom if ever again to be presented. The following pointers will help you capture baby in action.

Infants photograph best when they are relaxed and absorbed in whatever they are doing. For this reason, the easiest way to get a child to assume a natural pose is to let him play outdoors in bright sunlight. If possible, restrict the movements of the baby to a particular area, as this facilitates focusing and makes taking the picture simply a matter of waiting for the right expression. The two photos on this page are excellent examples of an obviously planned setup which was accomplished without making the baby suspicious. The chair in each case sufficiently limits all movements of the subject, while the typewriter holds the attention of the baby in the lower photo. However, there is one problem presented by outdoor shots. This is the tendency



Above, chair which limits baby's movements permits easy focusing outdoors. Below, child's interest is held by typewriter, resulting in an unassumed pose

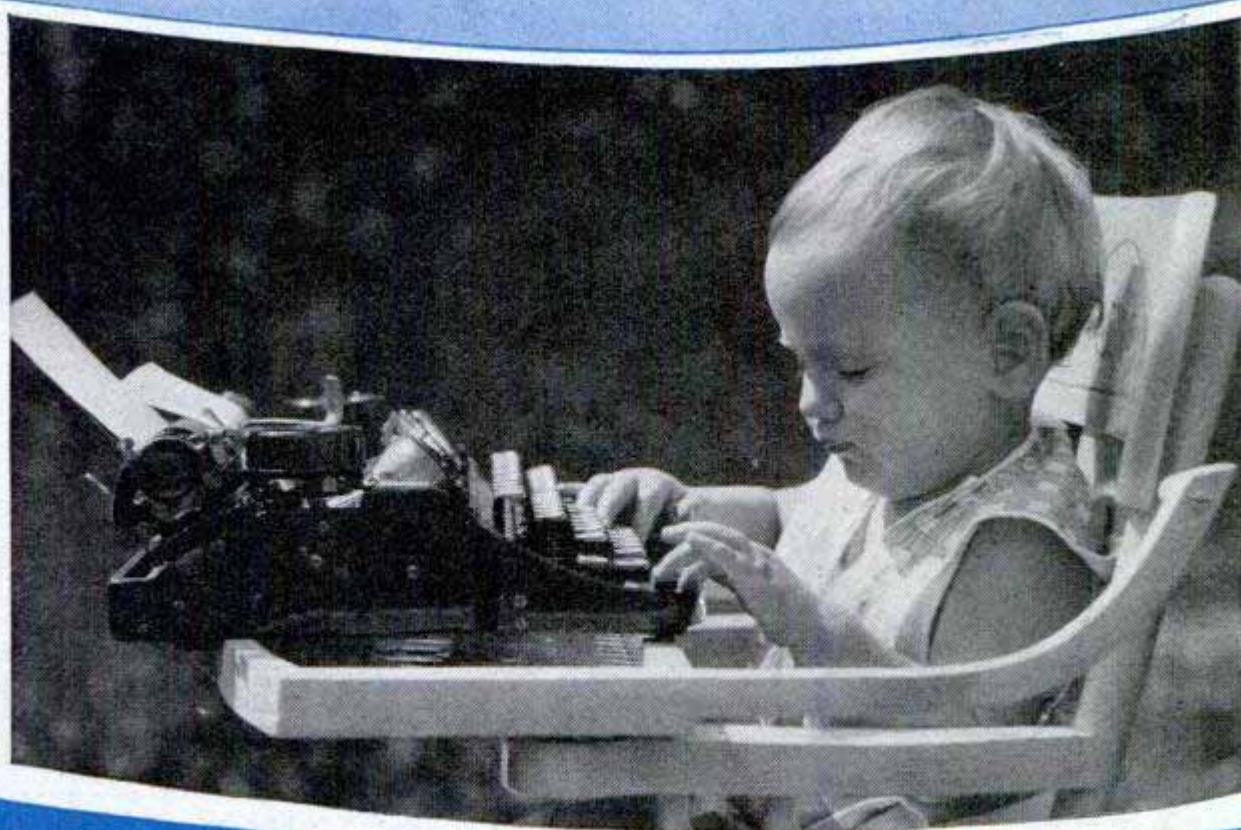





The baby in the photo above was too young to sit by himself, so he was placed prone on a couch cushion tilted upward toward the camera. The shiny flash equipment aroused his curiosity, affording this striking picture

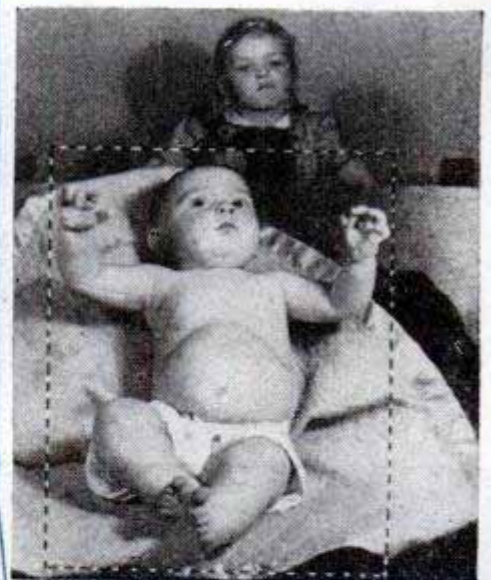
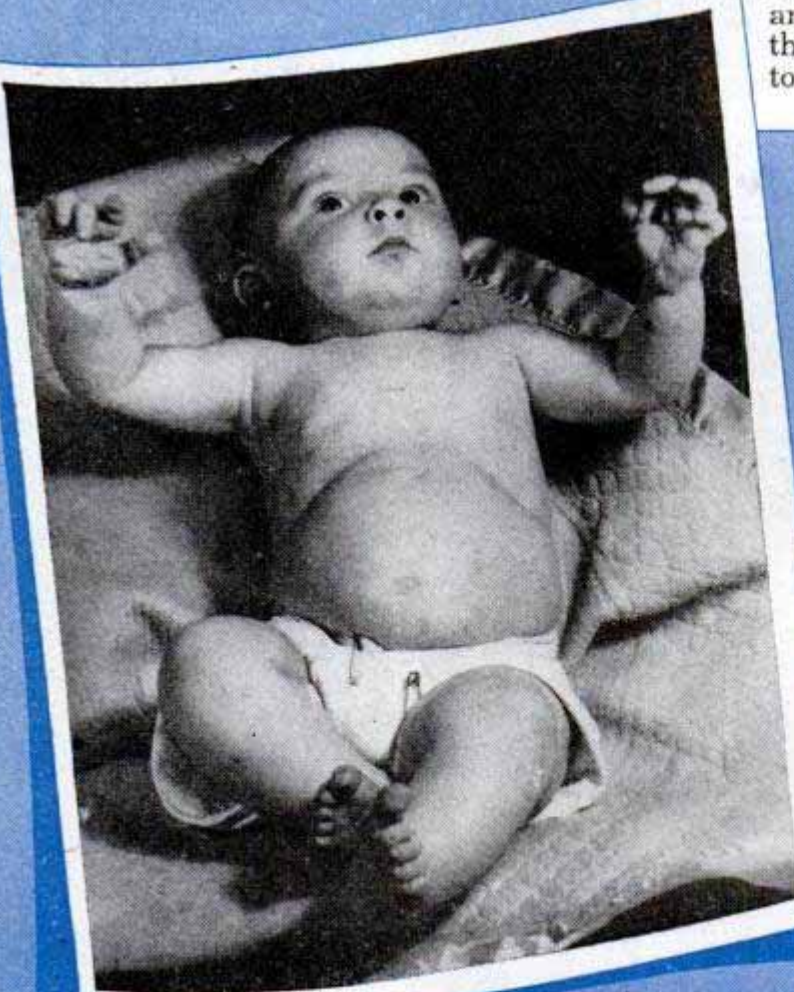

This unusual shot was achieved by having the baby's older sister raise his back with a blanket-covered prop. Enlargement at left was made from area included within the dotted lines. Note that the top of enlargement was overprinted to exclude background

of children to look down and away from the sunlight, thus placing their faces in deep shadow. Where possible, highly reflecting surfaces such as water, light beach sand or concrete sidewalks can be used to soften the shadow on the features. Keeping these ideas in mind, patience and a little forethought will be rewarded with outdoor shots that are your most prized baby pictures.

Photographing babies indoors becomes more complicated due to the necessity of having to provide artificial light. Photofloods permit easy focusing and allow lighting flexibility but children, like pets, do not enjoy posing when they are confronted with bright lights. If photofloods are used, it is a good idea to have a helper who knows how to amuse the baby, the logical person being the child's mother. Photograph the baby in his high chair, crib or any place where he is likely to be in a happy frame of mind. Giving him a favorite toy usually will result in the desired expression. If the child cannot be coaxed into sitting alone, having his mother hold him may be the answer to the problem. However, the mother should turn her back to the camera so as not to detract



attention from the baby. Good procedure is to have the baby face in the general direction of the main lamp, focus accurately, and use fast film and short exposures. Keep the subject under the lights no longer than is absolutely necessary. If you want the baby to look in the direction of the camera, keep talking to him to hold his interest. Don't try for close-ups, but take the picture from a distance and enlarge the best portion of the negative. This is preferable because the depth of focus at a given lens stop decreases the closer the camera is to the subject.

One way to be fairly certain of good results indoors is to use photoflash lamps. With these you are less dependent on the baby's constant urge to move and, in addition, the pupils of the child's eyes will be larger and his expression more radiant and less forced. Flash pictures are particularly suitable when photographing baby in his crib as the reflection from white sheeting will provide enough back lighting to soften shadows. A good stunt to remember in getting baby's attention is to show him something he hasn't seen before. A lighted candle seldom fails to produce the right expression.



Above, when child refuses to pose for photo alone, a good shot can be taken by having mother hold her. Mother should turn away from camera to minimize distraction

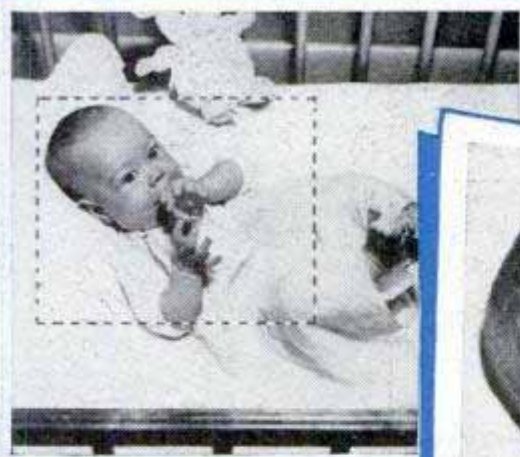

Above right, reflecting surfaces, such as water or concrete, help reduce shadow on features when subject faces downward. Above, photo in crib was taken with flash gun, utilizing reflection from sheets to soften shadow. Enlarged portion of negative provided interesting photo at right. The crib is an excellent place to take a pleasing photograph





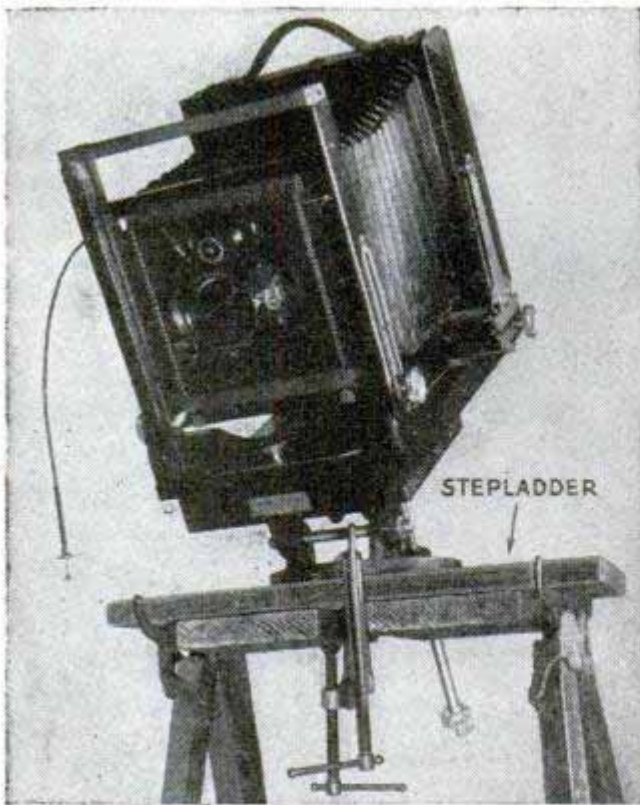

### Stepladder Serves as Tall Tripod When Taking Overhead Shots

If an overhead shot must be made from a height greater than your tripod will permit, a household stepladder provides an excellent support for the camera. Besides the additional height, the steps of the ladder make it convenient to focus and load the camera. The camera is left on the pan head and C-clamps are used to clamp the head securely to the top step. Unless the ladder is so tall that you must stand on it to reach the shutter release, it is best to stand on the floor when clicking the shutter to avoid any movement.

### Replacing Broken Ground Glass

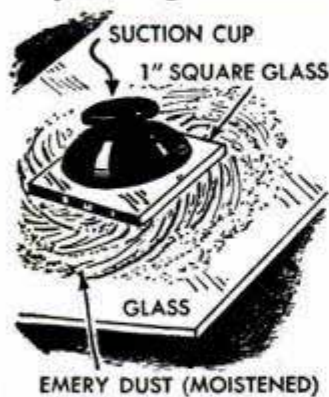

When a replacement for a broken ground glass on a camera or contact printer cannot be found at the photo-supply store, one can be made from a piece of ordinary window glass cut to size. Just sprinkle a small amount of fine abrasive over the surface of the glass and wet with water. Then, attaching a rubber suction cup to the back of a 1-in.-square piece of glass, rub the square in a circular motion over the entire surface of the glass to be ground. Do this until the glass is made sufficiently opaque. If a suc-

tion cup is not available, a block of wood attached to the glass with sealing wax will provide a suitable handle.

### Rack for Cut-Film Hangers

One photographer found that a handy place to keep cut-film hangers is on a rack under the shelf over the darkroom sink. The hangers are suspended between T-shaped rails made by nailing together two strips of wood and fastening them with screws to the underside of the shelf.

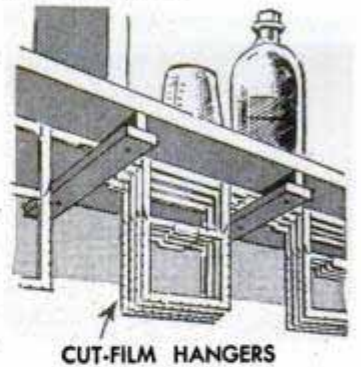

Madison Devlin, San Francisco, Calif.

### Sink Converted to Print Washer With Drain-Plug Extension

Any convenient washbasin or laundry tub can be converted to a print washer by fitting it with this copper drain-plug extension. The extension consists of a length of tubing with copper screen wire soldered around the top to provide an overflow. Then, a disk is soldered over the top of the screen wire. A solid-rubber stopper is drilled about  $\frac{1}{32}$  in. smaller than the outside diameter of the tube, and this is held in place by pressing it over a retainer ring of  $\frac{1}{16}$ -in. wire, soldered to the tube near the lower end, as shown in the detail.

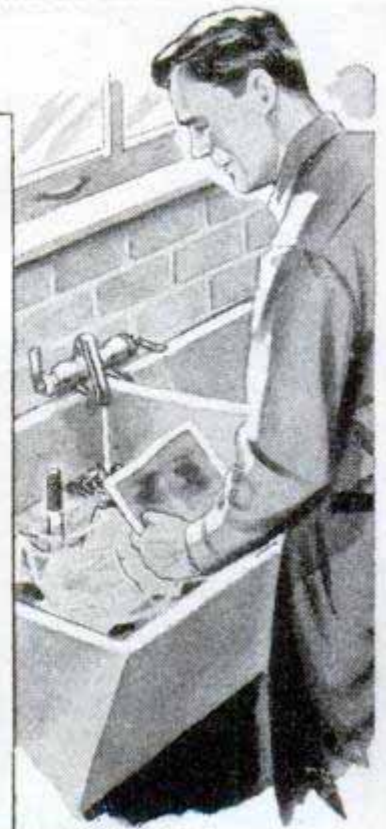
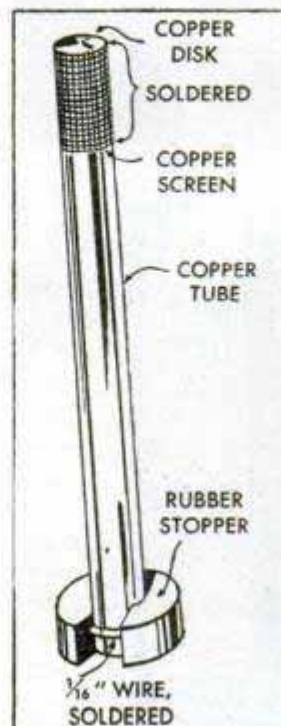





# Shop Notes

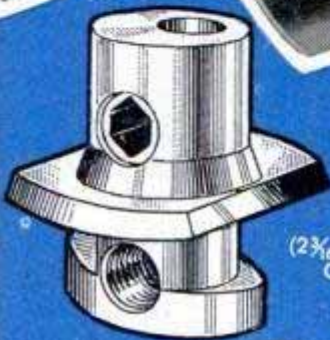
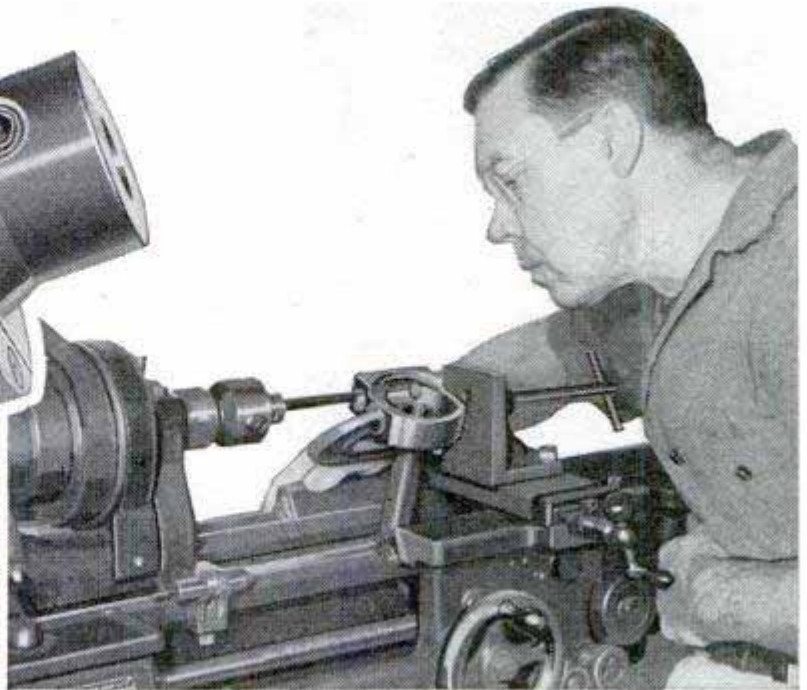
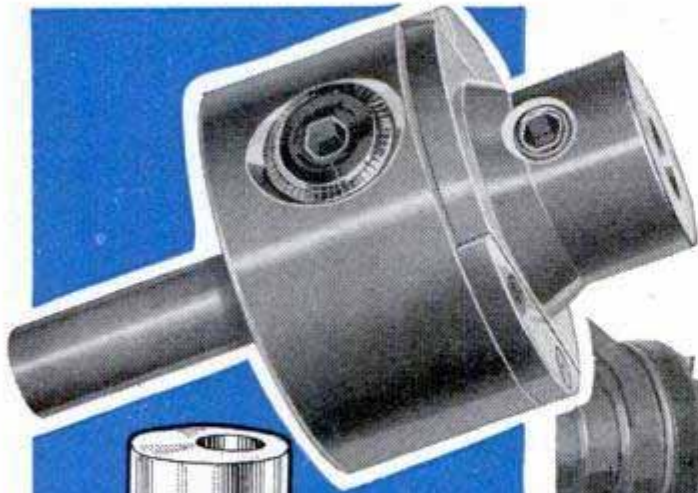

1

COLLET  
(2 7/16" DIA. X 2 1/4"  
C. R. STEEL)

1/2" BORE,  
1" DEEP

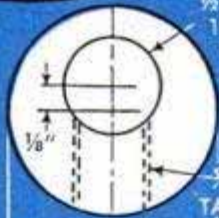

2

3/16" DRILL  
TAP 3/16" - 16

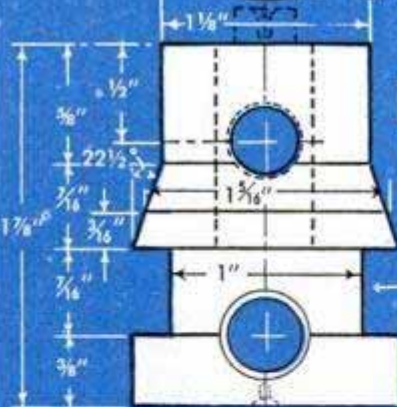

3

REMOVE  
SEGMENTS

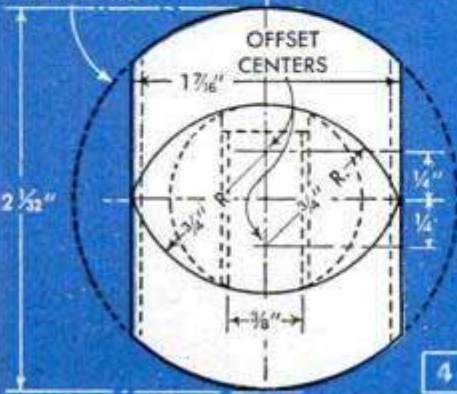

4

## OFFSET BORING HEAD

By E. W. Holt

AN ADJUSTABLE offset boring head is an attachment that greatly increases the range of work that can be done on a small metal lathe or a drill press. Used in a drill press, it permits boring holes of greater size than are possible with common-size drill bits. When chucked in a lathe, the offset head will handle many boring jobs otherwise beyond the swing of the lathe. Also, where a lathe is not equipped with a taper attachment, the boring head can be used in the tailstock spindle for taper turning, thereby eliminating the time-consuming operation of resetting the tailstock.

Beginning with the collet, Fig. 1, turn a piece of 2 7/16-in. stock to 2 1/32 in. in dia. and face both ends. Scribe a center line completely around the work and center-drill two offset center marks on each end as indicated in Fig. 4. Scribed lines on metal will stand out more clearly if the work is coated with a saturated solution of sulphate crystals and water. After turning the 7/16-in. groove in the collet, Fig. 3, A, mount the work first on one offset center and then the other to turn the bottom flange elliptical shape, as in Fig. 5. Set aside the collet for the time being.

Next, center-drill 2 1/4-in. stock for the body, Fig. 7, and turn it down to 2 1/8 in. in dia. Turn the spindle to 1/2 in. and face the large end. If a tapered spindle is preferred, it should be made somewhat shorter than the standard length for a Morse taper and the end tapped for a draw-in rod. A threaded plug will bring it up to the standard length required for ejection



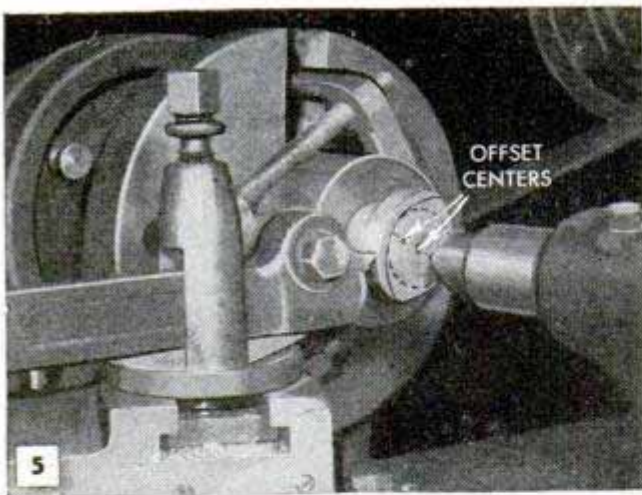

5 Mount collet off center to turn elliptical flange

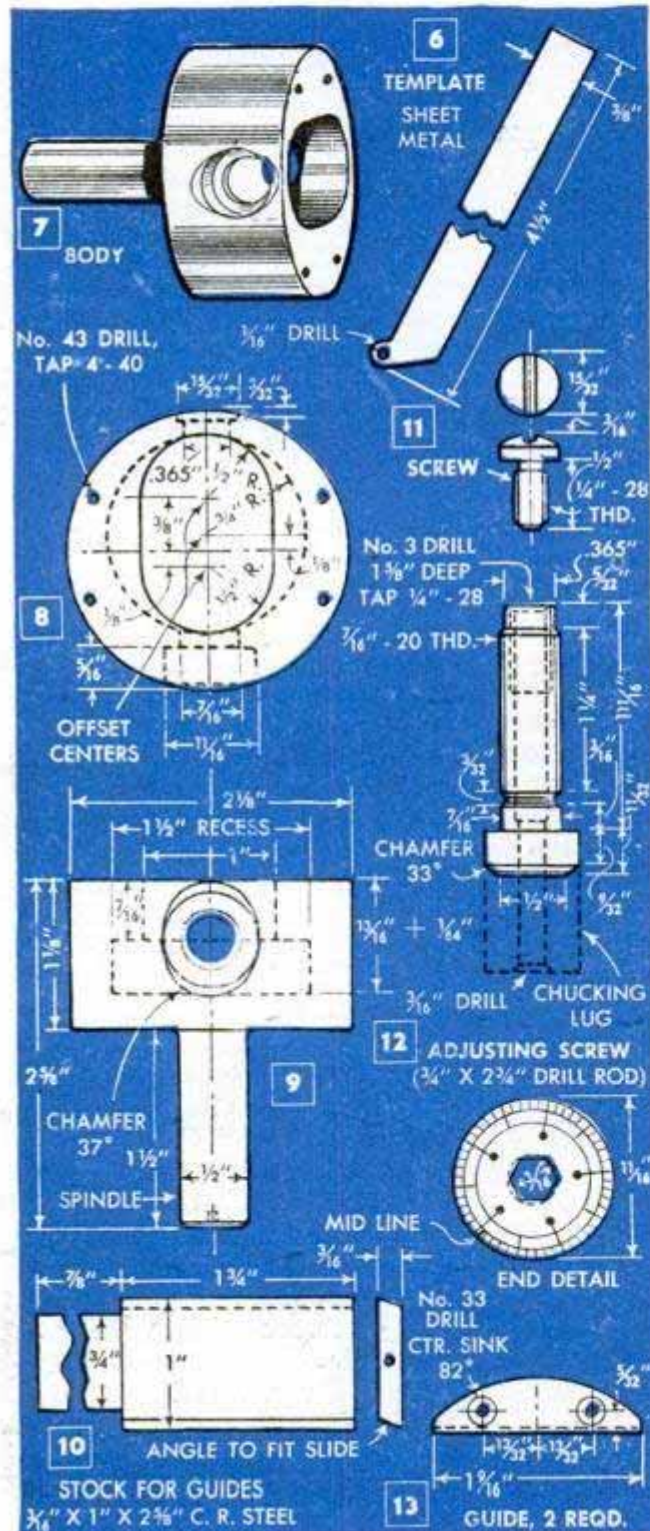

from the tailstock spindle. When this is done, scribe a center line across the face and along both sides. Then lay out the elongated hole and the two outer offset center marks, Fig. 8. After center-drilling the offset marks, mount the body in a four-jaw chuck and scribe index marks on two opposite jaws to align with the marks on the side of the body. With the work mounted off center, using the  $\frac{1}{2}$ -in. radius, run up the tailstock center to locate and hold the turning while chucking. Use a band of copper or other thin stock to protect the work from jaw marks and tighten the chuck so that the scribed lines (witness marks) on both chuck and work coincide. Bore a hole in the face 1 in. in dia. and  $1\frac{3}{16}$  in. deep. Then rechuck the work on the other offset center and bore another hole of the same size and depth. This will produce two overlapping holes which are formed into one elongated hole by filing away the remaining waste. Now locate the middle offset center ( $\frac{3}{4}$ -in. radius). The work is mounted on this center and the bottom of the hole is undercut on two sides, as indicated by the dotted lines in Figs. 8 and 9. The boring-bar cutter, used to form the undercut, should not be more than  $\frac{1}{8}$  in. wide and the recess formed by undercutting the work should fit the elliptical end of the collet in a snug, twist fit.

Next, a hole is made in the thick side of the body and the collet for an adjusting screw, Fig. 12. To bore this hole, place the collet inside the body and align the center lines of each one. Then, using a V-block, clamp the work to an angle plate. Next, clamp the whole assembly to a lathe faceplate, Fig. 14. Check to see that the work is centered by running up the tailstock center and balance the setup with a counterweight. Now, drill a  $\frac{3}{16}$ -in. hole through the thick side of the body and completely through the shank of the collet. Next, bore and ream a  $\frac{7}{16}$ -in. hole through the opposite side of the body. This hole provides a bearing for the end of the adjusting screw. The  $\frac{3}{16}$ -in. hole in the thick side of the body is reamed to  $\frac{7}{16}$  in., after which the hole is counterbored  $1\frac{1}{16}$  in. for a depth of  $\frac{5}{16}$  in. to provide a recess for the head of the adjusting screw. Then the work is remounted and the  $\frac{365}{1000}$ -in. hole is counterbored. Finish by removing the collet and tapping the hole  $\frac{7}{16}$  in.-20.

The adjusting screw, Fig. 12, is drilled through its center, one end being tapped for a threaded retaining screw, detailed in Fig. 11. The shank of the adjusting screw is threaded to fit snugly in the tapped hole in the collet. Next, a midline is scribed on the chamfered edge of the adjusting screw and the  $\frac{3}{16}$ -in. hole in the screwhead is filed to take a socket-head setscrew wrench.



The graduations on the chamfered edge of the head of the adjusting screw are scribed in the following manner: Draw a 6-in. circle on sheet metal or heavy paper. Mark five equal spaces around the circle and divide each space into ten equal parts. Draw two additional circles of any radius and lay out the graduations as shown in the end detail below Fig. 12. Next, make the template, Fig. 6, and turn a plug for a push fit in the hexagon hole. A  $\frac{1}{16}$ -in. pivot pin in one end of the template fits a hole in the plug. Fasten the paper to a board and drill a  $\frac{7}{16}$ -in. hole through the board at the center of the circle. Insert the adjusting screw and, with the template pivoted on the pin, proceed around the circle using a sharp scriber to mark the graduations on the edge of the screw, Fig. 15.

The next step is to machine the two beveled edges on the flange of the collet. These are cut roughly with a hacksaw first, leaving enough stock to finish to size. Beveling the edges is done in the lathe by mounting the collet on a  $\frac{7}{16}$ -in. threaded arbor, 3 in. long, held between centers, and clamping the collet to a faceplate. Position the work at a  $22\frac{1}{2}$ -deg. angle with a protractor and clamp a cutting tool to an angle plate bolted to the cross slide as in Fig. 16. The edges are beveled by traversing the lathe carriage by hand, using the cross-feed to advance the tool each stroke. Depth of the cut is adjusted by tapping the tool lightly with a hammer.

The guides for the collet, Fig. 13, are machined from one piece, Fig. 10, using the same setup as before to bevel the edges to match the ones on the collet. The stock for the guide is mounted edgewise between centers and at a  $22\frac{1}{2}$ -deg. angle. Then it is clamped to the faceplate, the edges milled as in Fig. 17, and the piece sawed lengthwise into two parts. Drill two holes in each guide in the position indicated and then place the collet in the body, at the same time installing the adjusting screw and retainer screw. Clamp the guides to the body temporarily with paper between. Drill and tap four holes with a No. 43 drill and a No. 4-40 tap, and countersink. Saw away the waste stock around the outer edges of the guides leaving enough stock to finish-turn the parts flush with the body.

Now, fasten the guides permanently to the body. The collet should fit snugly between the guides. A  $\frac{1}{2}$ -in. hole, Fig. 2, is bored in the end of the collet to take a  $\frac{1}{2}$ -in. tool shank. This is done after turning the adjusting screw clockwise as far as possible. Then the collet is returned to the center position and the outer edges of the guides are turned. Finally, drill and tap the collet for a  $\frac{3}{8}$  in.-16 socket-head set-screw which locks the tool bit in position.

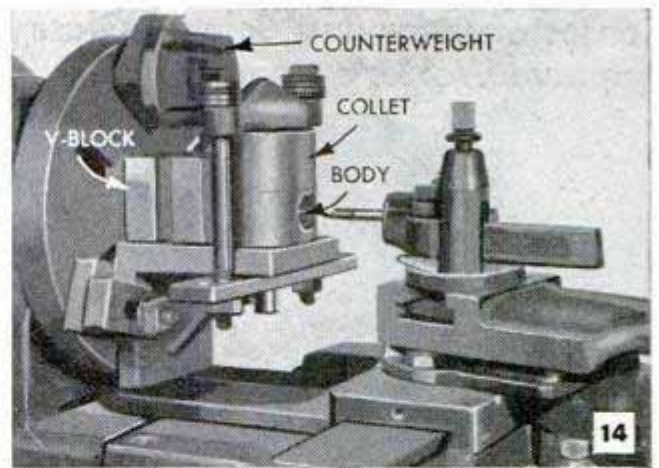

Collet and body bored together for adjusting screw

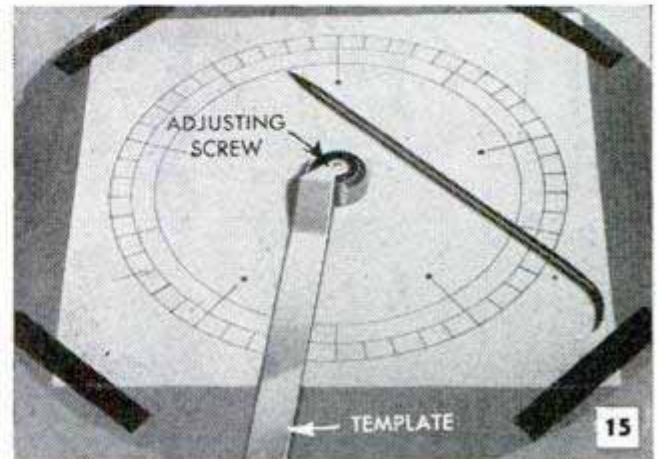

Template is used to calibrate head of adjusting screw

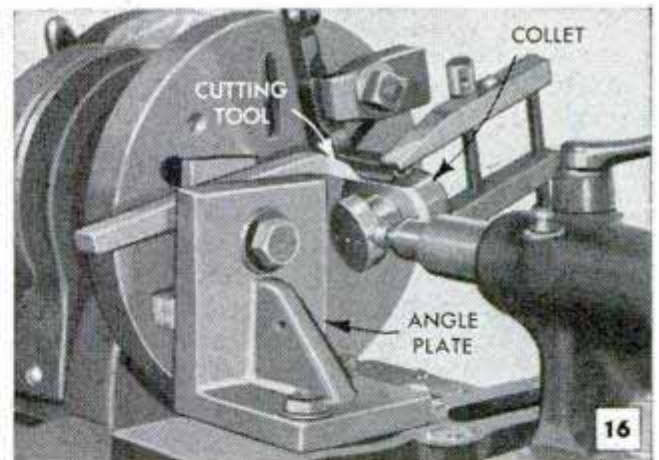

Setup for milling beveled edges on flange of collet

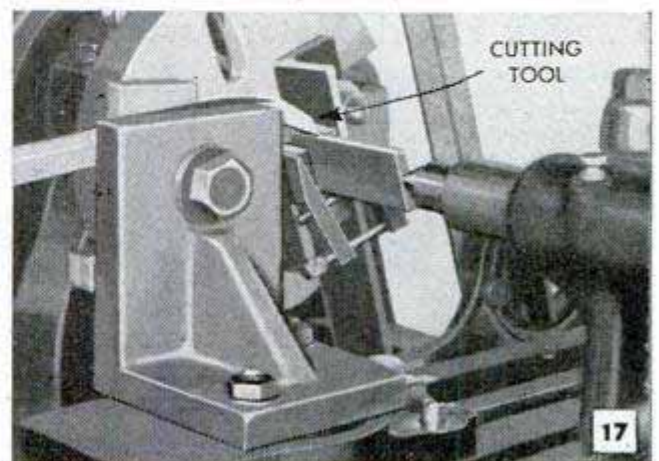

Manner of chucking stock for beveling collet guides



## Lenses of Clear and Colored Glass Improve Welder's Goggles

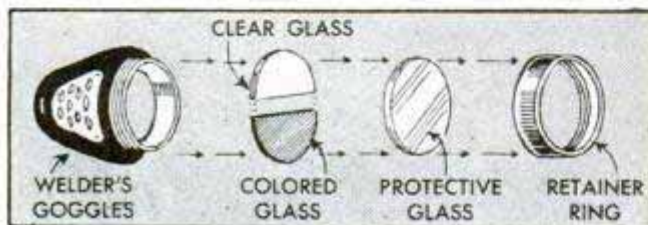

A pair of ordinary welder's goggles can be converted for both clear and protected vision by fitting them with lenses of half-clear and half-colored glass. This is excellent for burning or welding jobs that require occasional unobstructed vision. A clear lens and a colored one are cut in half and mounted in the goggles as shown. A paper disk cut the same size as the lens and folded in half will indicate the line along which the lens should be cut. To convert the goggles back to all-clear or all-colored glass, just place both halves of the particular lens in one side of the frame and insert an unbroken matching lens in the other side.—Andrew Vena, Philadelphia, Pa.

## Brushes Held in Released Position Simplify Electric-Motor Assembly

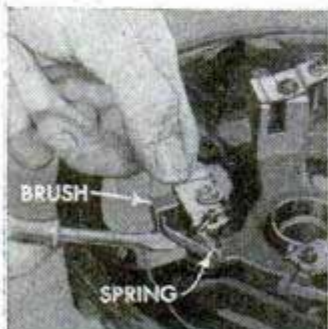

Assembly of some induction motors or generators is facilitated if the brushes are wedged in a released position so they will slide over the commutator without trouble when the bell, or end cap, is replaced. Each brush is pushed back in its holder to the point where the pressure of the spring will bear against the

side of the brush. Then, after the motor is completely assembled, the brushes are pushed down with a screwdriver, inserted through the opening in the cap, until the spring returns to its normal position.

## Adapting Spray-Gun Suction Tube For Use With Smaller Jars

The standard, 1-qt. jar of a spray gun often is too cumbersome for touch-up jobs that require only a small amount of paint. However, jars of a convenient size can be used with the gun if the suction tube is cut off to fit



them and a connecting sleeve is employed to permit bringing the tube back to its original length when desired. The saw cut is made at an angle and a short length of copper tubing pressed over the cutoff section of the suction tube provides the connecting sleeve. With the tube cut at a suitable angle to fit close to the bottom of the jar, practically all the paint can be siphoned.—Ken Murray, Colon, Mich.

## Lubricating Windshield Wiper

Brake fluid is an excellent lubricant for a sluggish windshield wiper as it will not thicken and clog like motor oil. Simply remove the wiper unit and immerse the whole unit in the fluid. Then move the wiper arm back and forth until fluid has been pumped through the unit several times.—R. O. Griffith, Atkins, Ark.

## Thawing Short Drainpipes

Drains for barns and other out-buildings consisting only of a short length of pipe running through the wall at the floor line can be thawed quickly if a piece of 1/4-in. pipe or tubing slightly longer than the drain is placed inside the drainpipe. The end of the tubing which will be inside the building is bent to point upward when in place, and the tubing is set in asphalt or tar in the bottom of the pipe. Then, when the drain freezes over, hot water is poured into the upright end of the tubing.

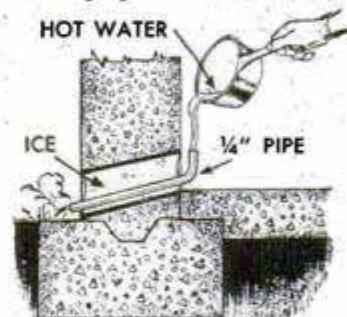



# ADAPTER PLATE

By Frank Faber

OWNERS of small metal-turning lathes will find an adapter plate a handy accessory to have when machining duplicate parts and work that is too large to be chucked. Mounted on top of the compound rest in place of the tool post, the adapter plate becomes an integral part of, and swings with, the compound so that duplicate machining operations on multiple setups can be done in a manner similar to using a turrethead. In addition, the adapter plate permits a drill vise or angle plate to be used to hold the work. This arrangement provides a fast and positive means of clamping the work at just the right height. A few of the various setups that the adapter plate makes possible are pictured in the series of three photos.

The adapter plate consists of three main parts: a surface plate which has tapped holes in the top and edges for hold-down fixtures, a tongue which fits the narrow width of the T-slot, and an anchor plate which clamps the unit to the compound by means of two socket-head machine screws. The tongue is fastened to the underside of the plate with two flat-headed screws set flush in tapped holes. Dowel pins, in addition to the screws, are used to anchor the tongue rigidly. The tapped holes in the plate are located according to the drawing and are chamfered slightly.

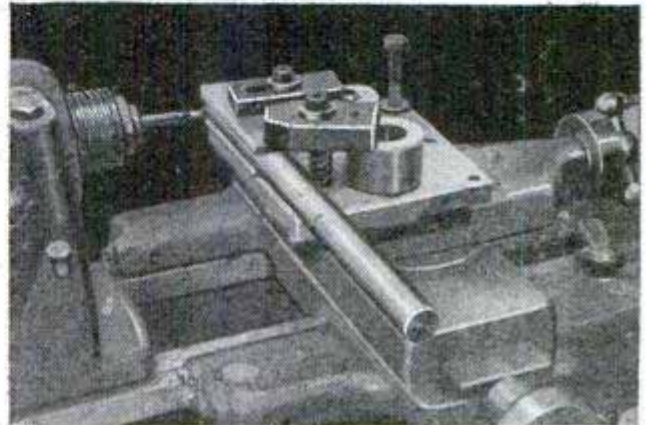
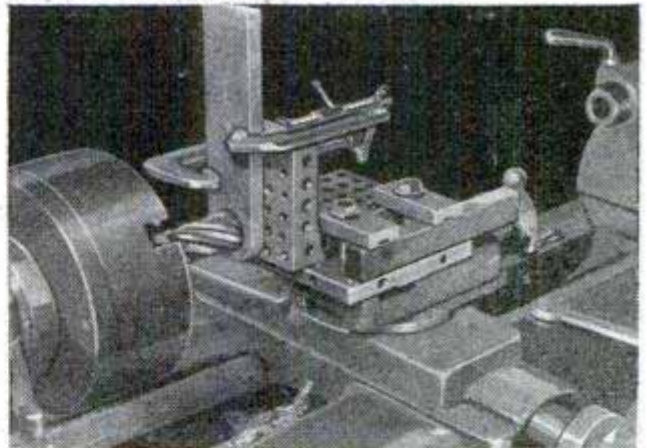

Plate permits milling keyways in round or bar stock



Reaming and boring is done with aid of angle plate

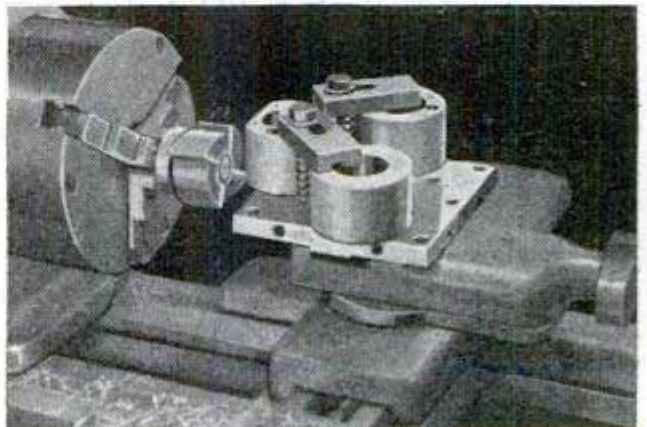
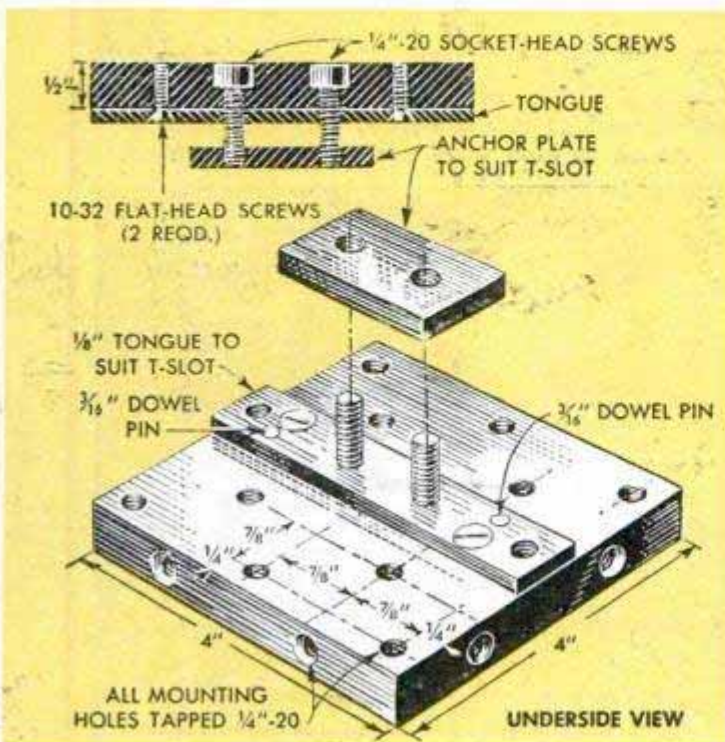

Plate speeds machining of work in multiple setups





# MILLING PRACTICE

**PRODUCING accurate work efficiently with a** **By H. J. Chamberland**

horizontal-spindle milling machine requires accessories that clamp and support the work rigidly on the machine table. These are necessary to resist the machining forces caused by the milling cutter removing material from the work, as these forces create vibration which results in chatter, the worst enemy of machining.

Maximum rigidity is attained when the table and the cutter are as close to the frame of the machine as possible. Before clamping the work to the table, the arbor, which is the "heart" of the milling machine, should be tested for runout with a dial indicator fastened to the table as in Fig. 1. Runout, which is the difference in parallelism between the arbor and the table and ways, should not exceed .002 in. A runout of .005 or .006 in. increases with higher spindle speed and, if permitted to exist, will ruin the arbor and its support bearing, shorten cutter life and result in poor work. Arbor runout is due to various causes, such as a bent arbor, resulting from taking excessively deep cuts or too fast a feed, wear in the arbor-support bearing and burrs on the arbor shank or in the tapered bore of the spindle. When making a cutter assembly, the arbor support should be positioned before tightening the arbor nut. If the arbor was true when tested with the dial indicator and the cutter is untrue after assembly, check between the collars for chips or dirt. If the cutter runs out radially, its bore is larger than the diameter of the arbor. The bearing in the arm support must be kept well-lubricated. When the arbor is removed, it should be cleaned thoroughly and when not in use it should be wrapped in cloth and placed in a drawer or cabinet.

Accessories for clamping the work consist of simple T-slot bolts and strap clamps, as in Figs. 5 and 6; a milling-machine vise, Fig. 8, or the more complicated indexing equipment shown in Figs. 11 and 12. The correct and incorrect locations of the T-slot bolt in relation to the work are shown in Fig. 3. The casting being machined internally with an end mill in Fig. 2 presents no clamping problem, as the flat surfaces of the casting rest on the table and the T-slot bolt projects through a hole in the work. The comparatively larger casting in Fig. 5, also being machined internally, is clamped at each end with a T-slot bolt and blocks. Milling forces in this case are much less than in Fig. 6 where

they are increased by the wider cut being taken with a shell end mill. Where a number of different machining operations are to be done, the clamping naturally should be sufficient to take care of the heaviest load. An irregularly shaped casting, such as the one shown in Fig. 7, must be blocked at the bottom to align the work accurately and prevent distortion due to clamping. Machining forces are reduced to a minimum when the milling machine is used, as in Fig. 4, to lay out and center-drill holes that are to be drilled and bored later. Nevertheless, the high degree of accuracy involved still makes clamping a major factor.

The milling vise, shown in use for contour milling, Fig. 8, offers an efficient method of holding some types of work. The base of the vise is bolted to the milling-ma-

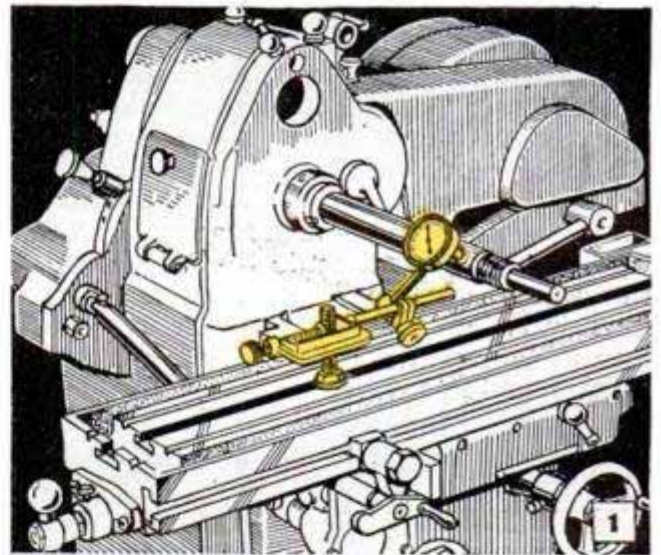

Above, a dial indicator is used to test accuracy of milling-machine arbor. Below, only one T-slot bolt is needed to hold small casting in place on table

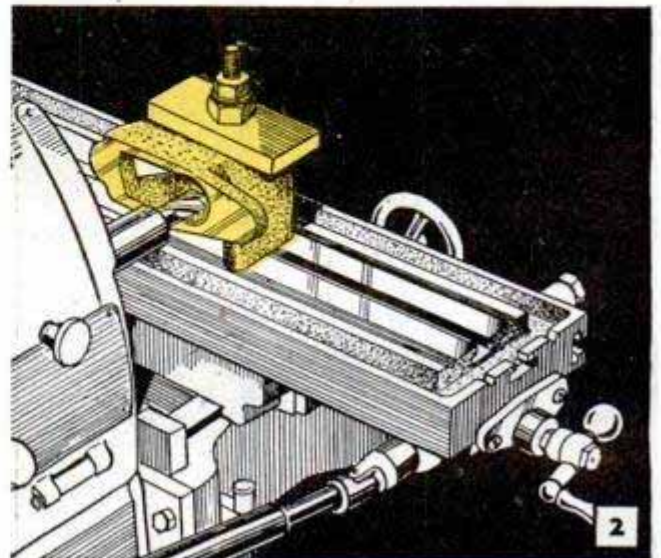



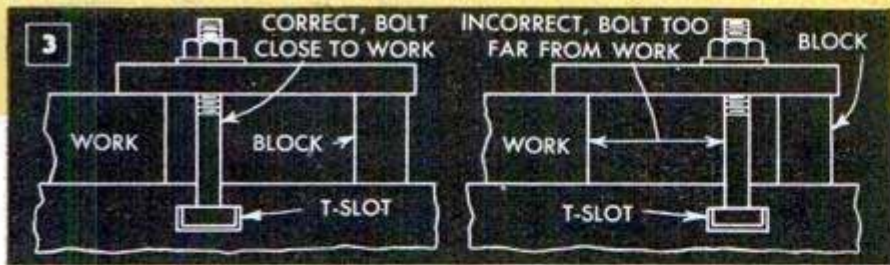

chine table and the work is held between the vise jaws. Many such vises are equipped with a graduated swivel base which permits the work to be set at any angle to the table ways.

Two types of indexing equipment are in general use. These are the rotary indexing table, Fig. 11, and indexing heads, or centers, Figs. 9 and 13. The rotary indexing table is used for cutting straight or circular slots and grooves in flat work, usually circular in shape. The base of the indexing table is bolted to the milling-machine table and the work is clamped to the indexing table, which can be rotated and locked

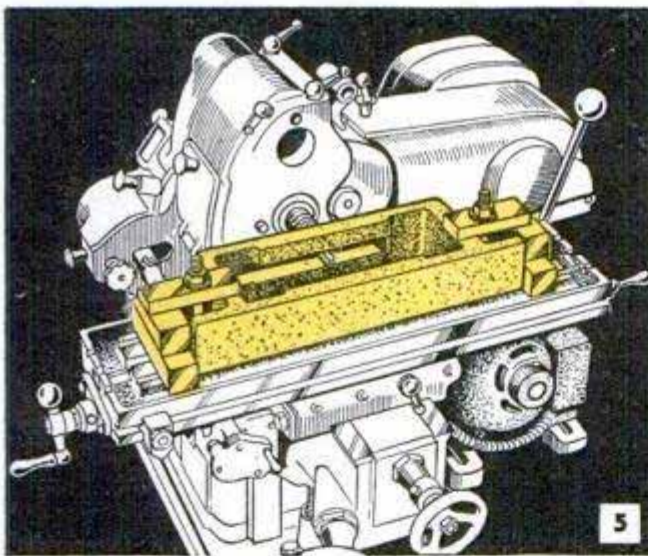
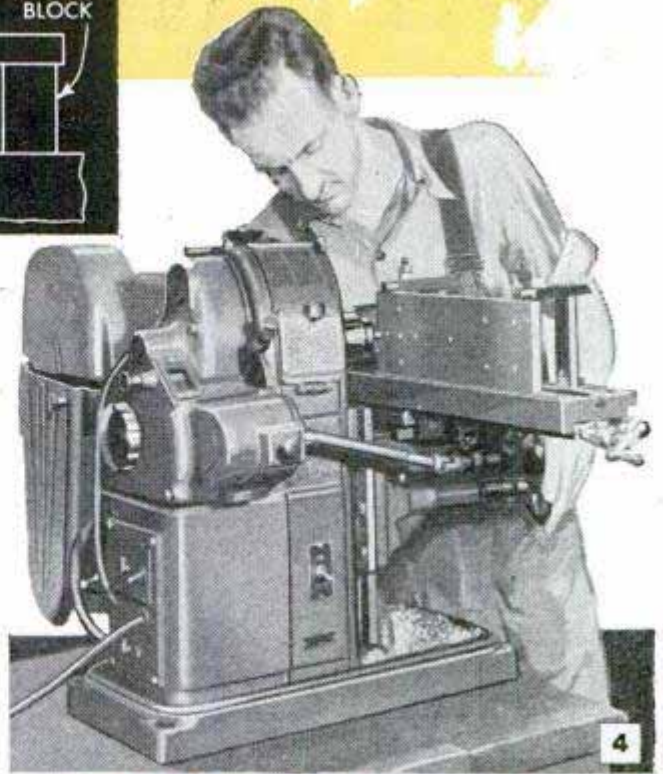

Large castings, as shown above and below, must be clamped down at each end. See Fig. 3 for the correct position of T-slot bolt in relation to the workpiece

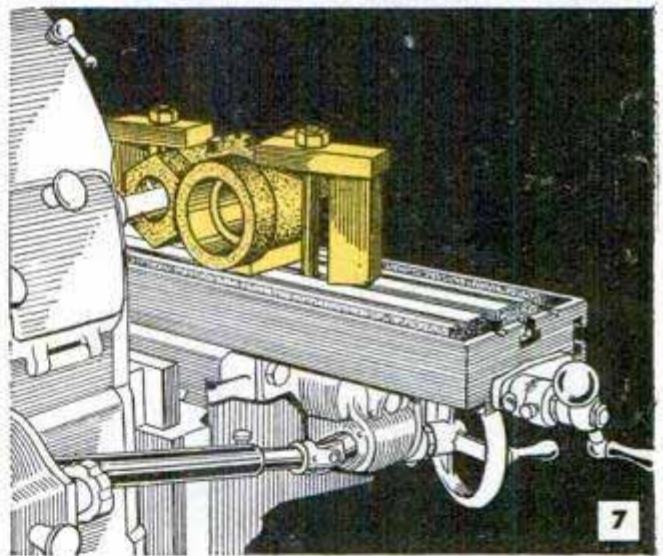

Above, irregularly shaped work is blocked at bottom. Below, milling-machine vise, which is bolted to top of table, is used to hold work for contour milling

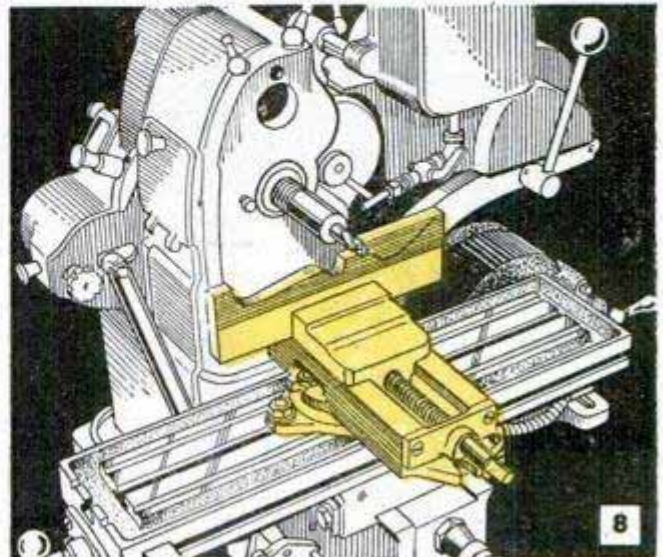
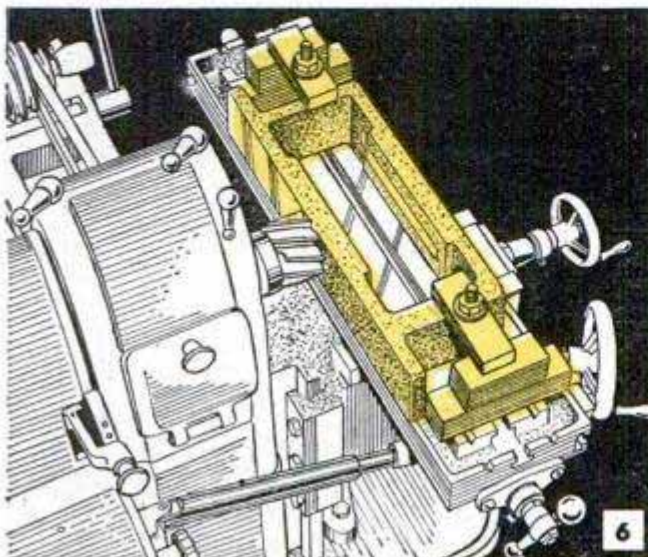



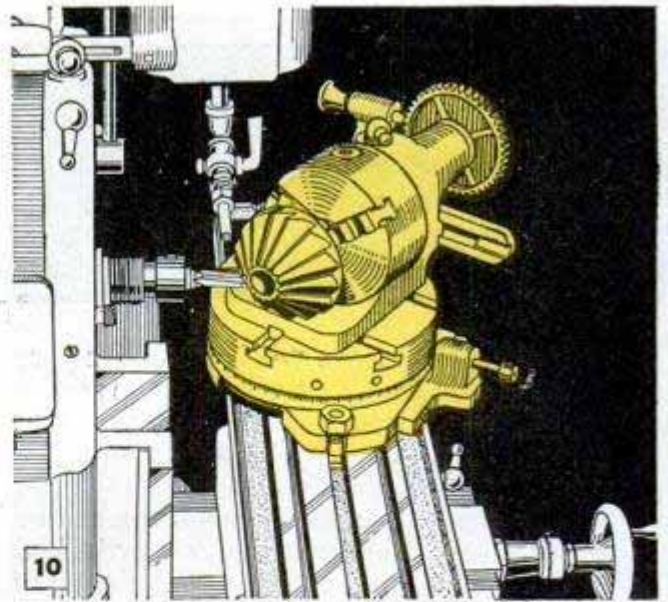
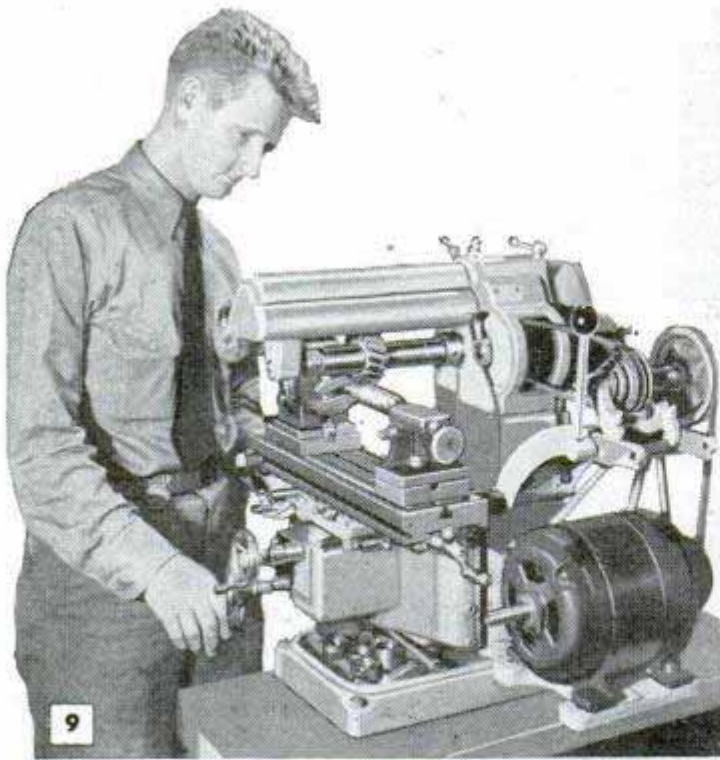

Accurate spacing for milling the teeth of an angular cutter is accomplished by mounting the work in a chuck fastened to an indexing center which, in turn, is bolted to an indexing table. Angular cutter is then heat-treated and ground

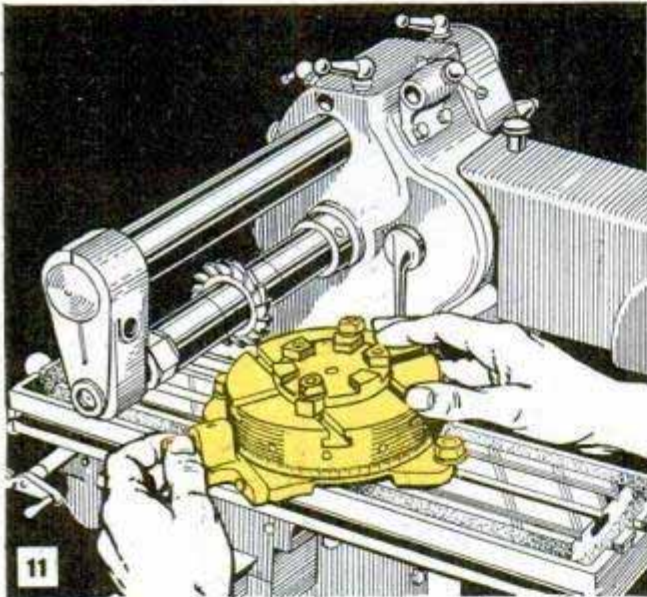

Above, work is clamped to a rotary indexing table which is bolted to milling machine. Below, gear is used to position work held between indexing centers

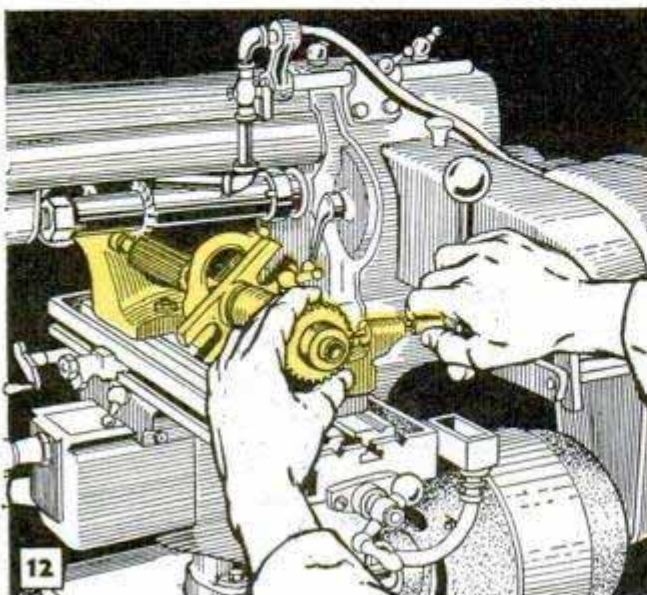

in place at the desired position. Indexing centers, which resemble the head and tailstock assemblies of a lathe, are used to position work, ordinarily cylindrical in form, for machining equally spaced grooves or surfaces across the periphery of the work. Milling splines on a shaft, as in Fig. 13, and making a gear, as in Fig. 18, are good examples. The method of indexing or positioning the work varies with the type of centers used. With the centers shown in Fig. 12, this is accomplished by rotating a gear fastened to the spindle of the headstock indexing center. A sliding pin, which engages the teeth of the gear, locks it in position. The lockpin support bracket is adjustable for various gear diameters, thus making accurate indexing merely a matter of selecting a gear on which the number of teeth is divisible by the number of spacings required on the work. The tailstock indexing center has a handwheel for adjusting its center longitudinally.

Angular indexing is accomplished by mounting a headstock indexing center, equipped with a chuck to hold the work, on a rotary indexing table. Fig. 10 shows this type of setup being used. Here the rotary table provides the angular adjustment and the indexing center permits accurate spacing to produce the teeth of an angular cutter.

On a production basis, teeth or flutes are milled with special-formed cutters. However, as an ample supply of these cutters would be expensive, an assortment of standard cutters is, in most cases, sufficient for small shops. Gear cutting requires a formed milling cutter. Fig. 14 shows what is known as an involute spur-gear cutter.



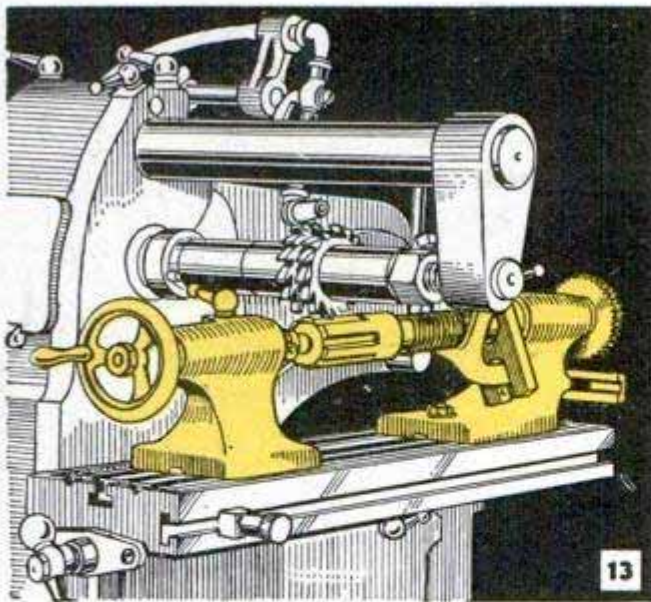

13 Milling spline on shaft with side milling cutters. Shaft held between indexing centers is rotated the required amount and locked in position for each cut

Eight different forms of these cutters comprise a set that will handle gear-cutting jobs within the ranges indicated in Fig. 16. These cutters are designed so their forms are correct for the lower numbers of teeth in each range, but if extreme accuracy is desired in the higher range, intermediate-numbered cutters, such as  $1\frac{1}{2}$ ,  $2\frac{1}{2}$ ,  $3\frac{1}{2}$ , etc., should be used.

Therefore, knowing the exact diameter and number of teeth required for a gear, the mill operator can readily select a cutter of the correct diametral pitch for the job. The exact diameter of a gear is neither the outside diameter of the gear blank nor the diameter at the bottom of the teeth. Instead, it is the pitch diameter, indicated in Fig. 17 as P.D. Circumference of this diameter is an imaginary line known as the pitch circle. To find the diametral pitch of a given gear, simply divide the number of teeth by the pitch diameter. The diametral pitch is not an actual dimension but the ratio between the number of teeth in a gear and its pitch diameter. For example, a four-diametral-pitch gear has four times as many teeth as it has inches of pitch diameter. The two details of Fig. 15 show the actual sizes of gear teeth of five and ten diametral pitch.

For accurate work, gear cutters must be sharp. Frequent sharpening by removing only a slight amount of metal is better than allowing the cutter to become so dulled that a single sharpening will depreciate it from 10 to 15 percent. In sharpening, only the faces of the cutter teeth are ground. This must be done on a machine equipped with a dish-type grinding wheel and a sliding toolholder that will permit cutter movement as indicated in Fig. 19. Gear cutters having radial faces, Fig. 20, upper

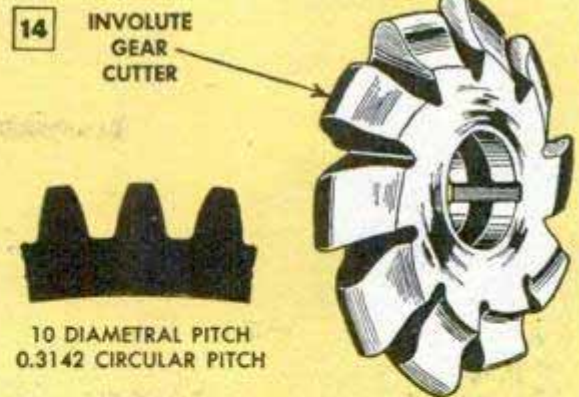

14 INVOLUTE GEAR CUTTER  
10 DIAMETRAL PITCH  
0.3142 CIRCULAR PITCH



15 5 DIAMETRAL PITCH  
0.6283 CIRCULAR PITCH

16	SIZE OF CUTTER	GEAR-CUTTING RANGE
No. 1	will cut gears from	135 teeth to a rack
No. 2	will cut gears from	55 teeth to 134 teeth
No. 3	will cut gears from	35 teeth to 54 teeth
No. 4	will cut gears from	26 teeth to 34 teeth
No. 5	will cut gears from	21 teeth to 25 teeth
No. 6	will cut gears from	17 teeth to 20 teeth
No. 7	will cut gears from	14 teeth to 16 teeth
No. 8	will cut gears from	12 teeth to 13 teeth

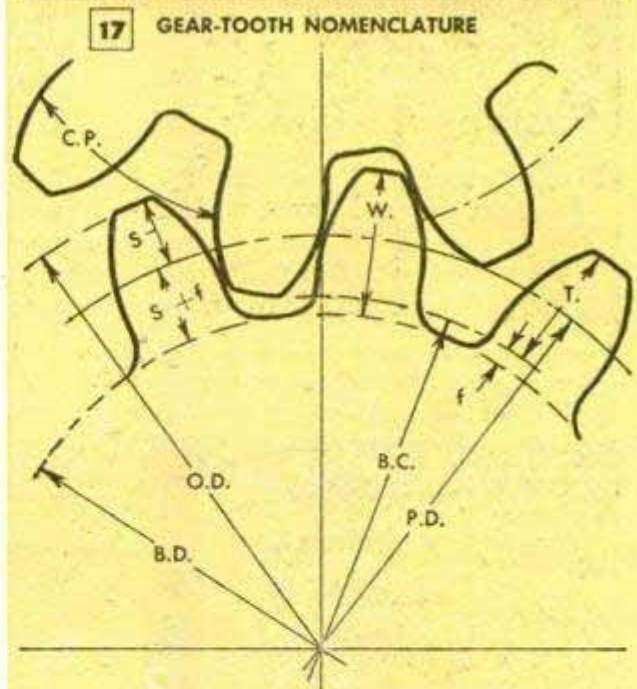

- O.D. ———— OUTSIDE DIAMETER
- P.D. ———— PITCH DIAMETER
- B.C. ———— BASE CIRCLE
- B.D. ———— BOTTOM DIAMETER
- C.P. ———— CIRCULAR PITCH
- W ———— WHOLE DEPTH OF TOOTH
- T ———— WORKING DEPTH OF TOOTH
- f ———— CLEARANCE
- S ———— ADDENDUM
- S+f ———— DEDENDUM



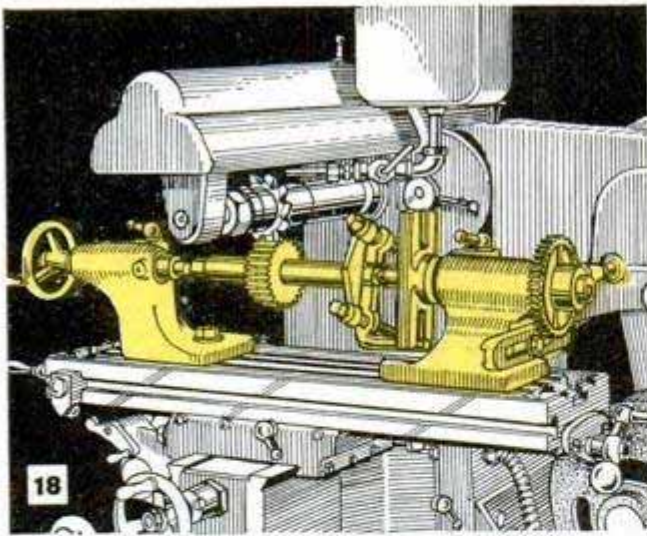

18 Typical setup for making gears with milling machine

detail, must always be sharpened radially. Gear cutters with rake—faces back of center—as in Fig. 20, lower detail, must be ground to the rake angle stamped on the side of the cutter. After sharpening, the cutter should be checked for uniform depth of cut. A suitable fixture for checking this can be made as shown in Fig. 21. In use, the cutter is rotated and each tooth checked with the micrometer head. A variation of .001 in. is permissible between the extreme high and low teeth. Gear cutters, when properly sharpened, will produce duplicate work throughout their entire lives. Place gear cutters on individual racks when not in use. Never store loosely in a drawer.

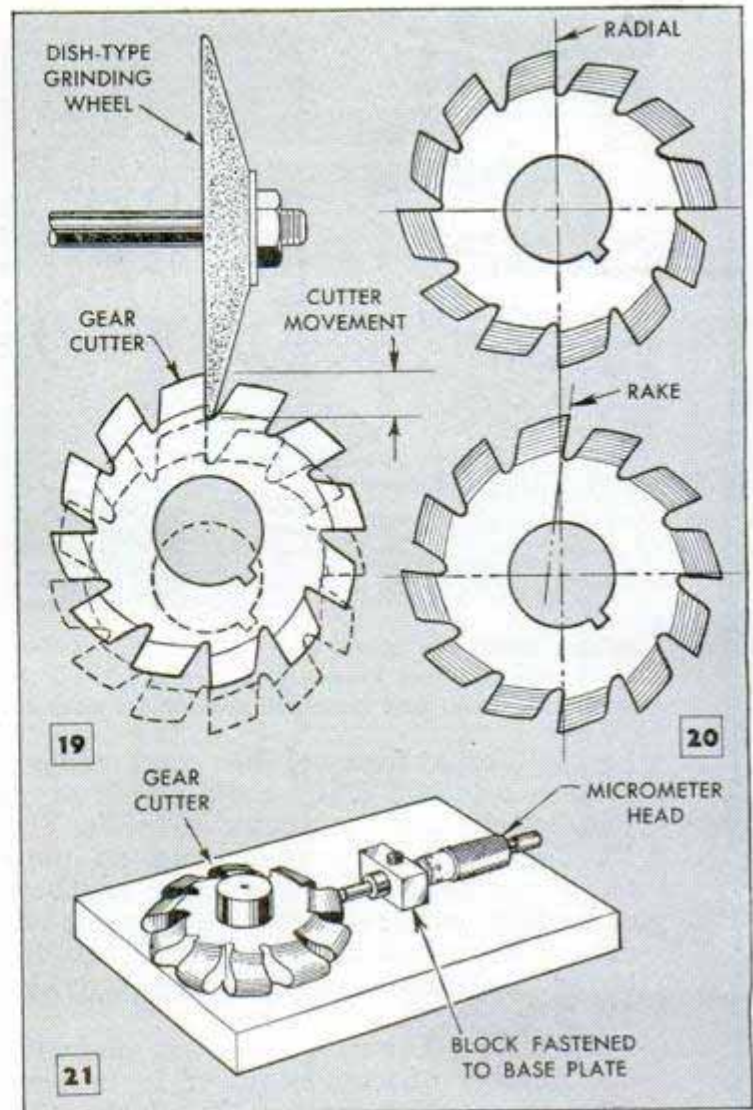

## Adjustable Fixture Locates Milling Cuts on Round and Flat Work

Milling cuts are accurately located on both round and flat work with this adjustable double-end fixture which is designed to clamp over a milling cutter in the position shown. One end of the fixture forms a

vee to take round work while the other end contains a spring-loaded pointer for locating the cut on flat surfaces. Using the fixture for centering the cutter over a line scribed on the work, is merely a case of advancing the work until the line and the pointer coincide. This automatically centers the cutter over the line. When a keyway is to be cut in round work, the fixture is turned end-for-end and the work is positioned to cradle in the vee formed by the ends of the fixture. Construction is apparent from the drawing. Dowel guide pins and clamping screws are fitted in each end of the fixture which is made from two pieces of square bar stock beveled at the ends. The pointer, crosspinned by the dowel, passes through the exact center of a collar which is held by spring tension against the end of the fixture.

H. Moore, Leeds, England.

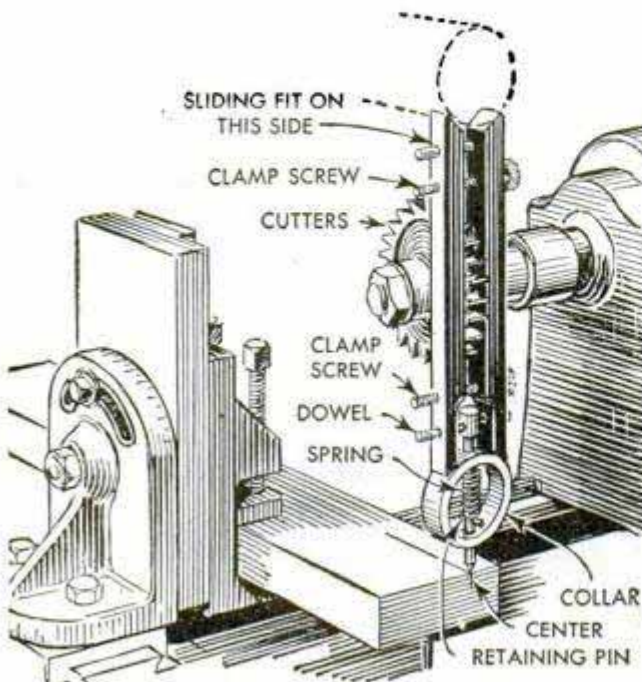

☞ To detach a badly corroded car-battery terminal from the battery post, drench with boiling-hot water to remove the corrosion. Then, loosen the nut, spread the terminal with a screwdriver and lift off.



# Common Materials Provide Substitute Rivets

If you need a few rivets and none are at hand, they can be improvised from nails, wire or small-diameter copper or brass tubing. The wire and nails provide solid rivets and the tubing supplies hollow ones. Detail A shows how to use a nail as a rivet. Countersink the top hole in the work and, inserting the nail from the bottom, cut off its shank about  $\frac{1}{8}$  in. above the surface of the work. Then, just peen the projecting end of the nail flat. Roundheaded brass nails make excellent rivets for model work and ornamental metal projects. Detail B describes the method of riveting with short pieces of copper, aluminum, brass or steel wire. Note that in this case the hole on each side of the work is countersunk. The wire should fit the hole snugly, projecting an equal distance at each end, and a sharp hammer blow flattens both sides at the same time. Copper or brass tubing is used as in detail C. The operation is similar to that for wire,

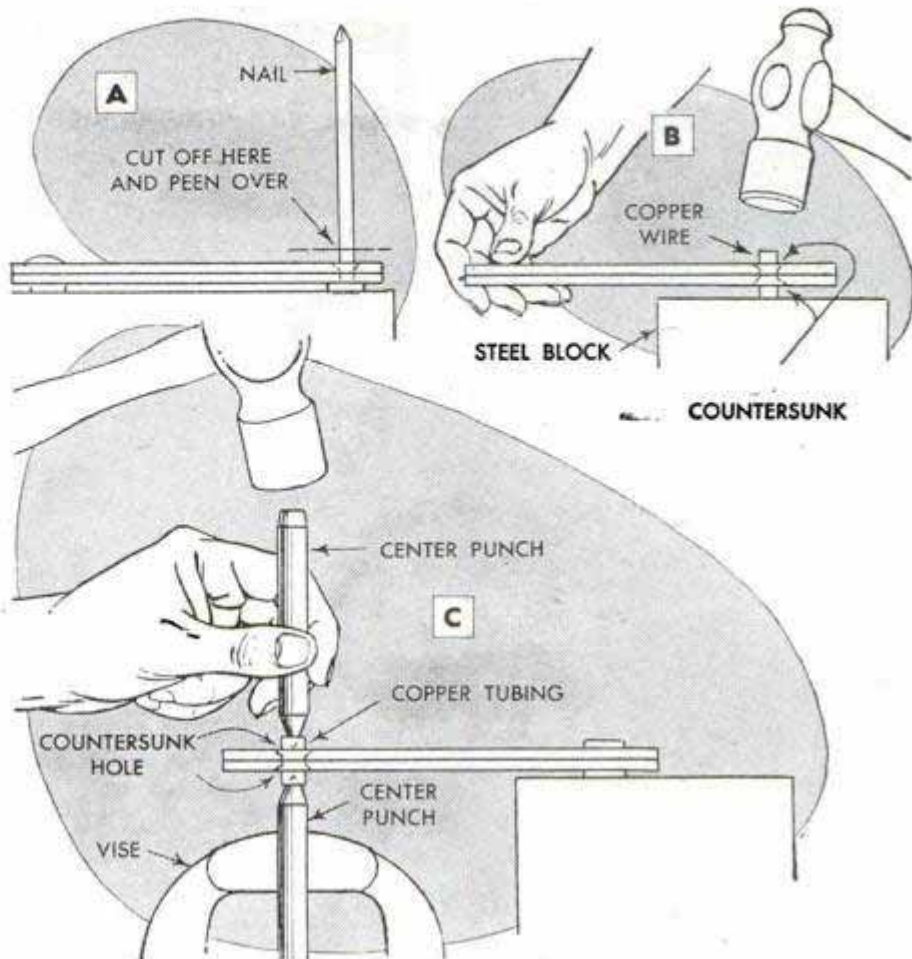

except that two center punches are used to bend over the ends of the tubing. After this is done, they are flattened by hammering on a steel block.

Arthur Trauffer, Council Bluffs, Iowa.

## Adapter Chucks Spark Plug in Drill Press for Cleaning of Exterior



After cleaning the inside of a spark plug, one mechanic chucks it in a drill press and gives the outside of the plug a quick and thorough cleaning by rotating it against a wire brush. He uses several adapters, like the one shown, to fit various sizes of plugs. The shank is turned to suit the chuck and a blind hole is drilled and tapped in the other end to take the threaded base of the spark plug. When the outside of a plug is clean, he applies a little black lacquer to the steel shell, which makes the plug look like new. In using the wire brush be careful that the porcelain insulator is not damaged.—Ed. Packer, Chicago.

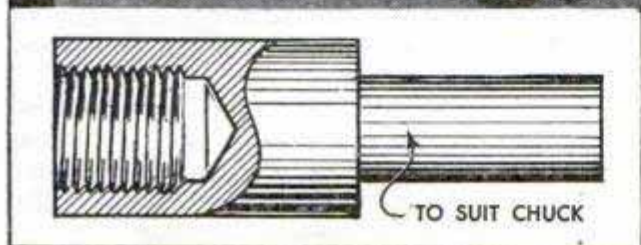

## Try This When Grinding Bolts

Before reshaping a bolt head on a grinder, one auto mechanic turns a nut halfway up the threads. The nut absorbs sufficient heat to permit him to hold the lower end of the bolt comfortably with his fingers.

John W. White



## Temporary Signs Lettered Rapidly With Shoe Polish and Swab



Where neatness of lettering is not too important, shoe polish applied with a cloth swab will be found more convenient for lettering temporary signs than a brush and paint. It saves the job of cleaning a brush, the polish will not run, and opening and stirring paint is eliminated. The swab is made by wadding a piece of cloth around the end of a pencil and tying it with string.

## Stop Attached to Lathe Carriage Limits Travel of Cross Slide

If your metal lathe is not equipped with a threading stop, here's a simple one consisting of only three parts. It is designed to fasten to the rear side of the carriage, and a knurled adjusting screw, set to suit the work, restricts travel of the cross slide. Such a stop is especially useful as a depth stop either in threading or machining duplicate parts. The L-shape bracket for the stop is fashioned from a

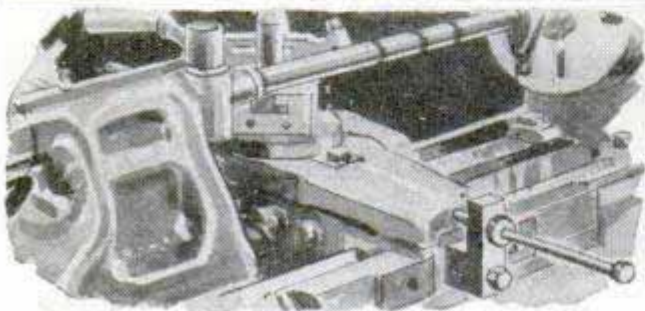
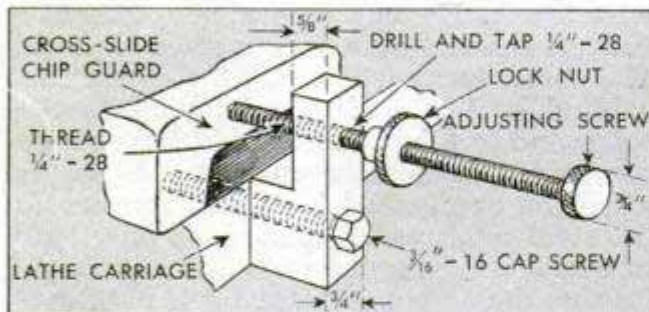

piece of 3/4-in. cold-rolled steel. It has a tapped hole at the top for the adjusting screw, which bears against the cross-slide chip guard, and also a hole at the bottom for bolting it to the lathe carriage. The original stop was mounted by using a pre-tapped hole that was provided for a taper-turning attachment. If a similar hole is not provided, it's not a difficult job to drill and tap one for a small cap screw.

Jesse Oppenheimer, Kansas City, Mo.

## Fishing Wires Between Walls Aided by Bar Magnets

When fishing electrical wires or cable between walls, try using two strong bar magnets instead of the usual wire and hook. Tie one magnet to the string that is dropped from above and tape the other one to a stiff

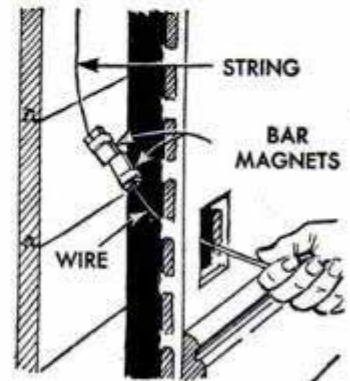

wire which is inserted through the switch or convenience-outlet opening. You will find that it is much easier to bring the two magnets in contact and thus pull the string through the opening than it is to use a hook on one end of the wire with which to get hold of the string. As soon as the magnets come reasonably close together, they will attract each other and thus save considerable probing, which often is necessary when using a wire hook.

M. Freeman, Clinton, Iowa.

## Alcohol Damages Fuel Pump

Frequent fuel-pump breakdown in cold weather may be due to the practice of putting alcohol in the gas tank. The alcohol settles to the bottom of the tank and, when pumped through in quantity, causes the fuel-pump diaphragm to become porous.

Marion L. Rhodes, Knightstown, Ind.

## Cloth-Lined Wire Picker Protects Ripe Fruit

Padding a fruit picker with cloth protects ripe fruit from being bruised by the wire arms. To make the pad, sew one end of a piece of cloth to the bottom of the picker and, stretching the cloth taut, sew its other end to the arms near the top of the picker.





# 4-Wheel BANDSAW

By  
**H. Tuttle and R. E. Knoll**

**BY USING** four band wheels instead of two, big-machine capacity is built into this bandsaw of home-workshop size. The 18-in. throat makes it possible to work at the center of panels up to 36 in. wide. Except for ball bearings and retainers, metal yokes, sheet-metal cover, and such shafts and bolts as are necessary in the assembly, the machine is made entirely of wood. Most of the parts are cut from a single piece of  $\frac{5}{8}$ -in. plywood as in Fig. 1. The box-type spacer frame between the front and back plywood cover plates, Figs. 2 and 8, is made from oak. When assembling the frame, special care must be taken to build it to exact dimensions, as the frame alone is depended upon for strength and rigidity to maintain exact alignment of the band wheels. Attach all the hardwood parts of the box frame to the back plate first, using screws and glue at all the joints. Next, make each band wheel by gluing together two disks of  $\frac{5}{8}$ -in. plywood. True up the wheels in the lathe and crown each tread  $\frac{1}{16}$  in. The wheels are fitted with rubber treads which consist of bands cut from a truck-tire inner tube. Details of the ball-bearing wheel hubs are shown in Figs. 3, 13, 14 and 15. Construction of the idlers, wheels No. 2 and 3 in Fig. 2, is shown in Fig. 14, but it should be noted that the bearing construction of wheel No. 2 can be the same as that of wheel No. 1. This provides two driving wheels and each can be fitted with a V-pulley of a different size, thus permitting two speeds by merely shifting the belt. Fig. 3 shows how the tracking wheel is tilted by two eccentrics

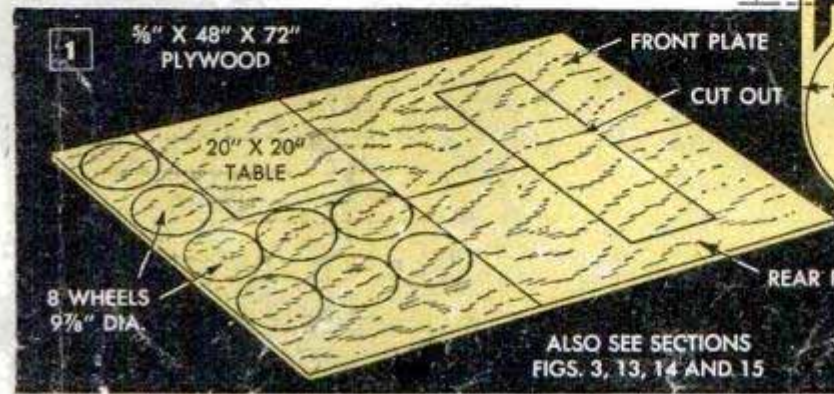
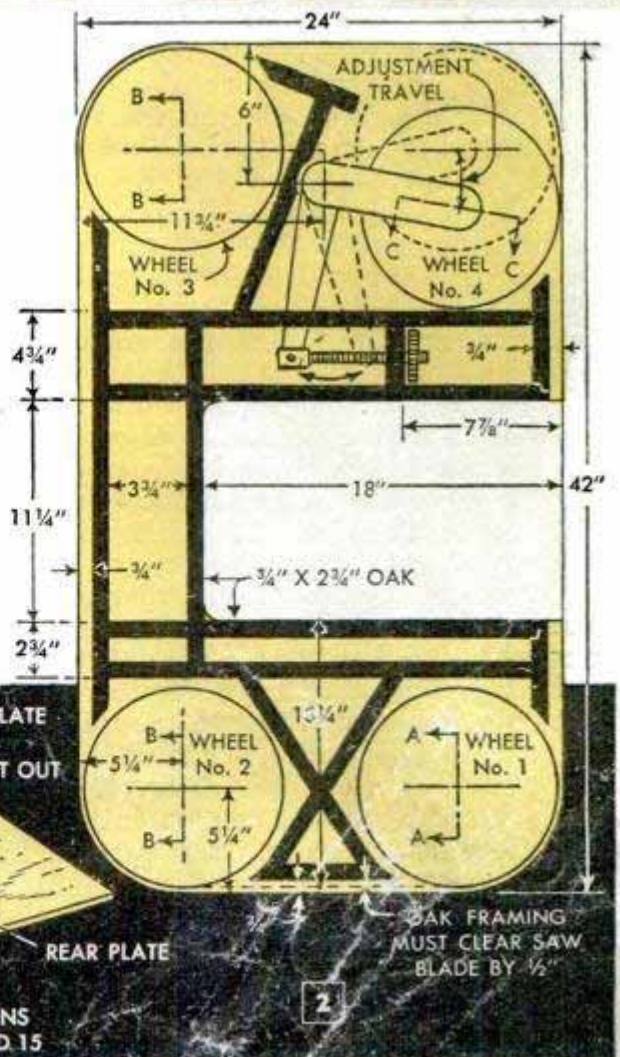
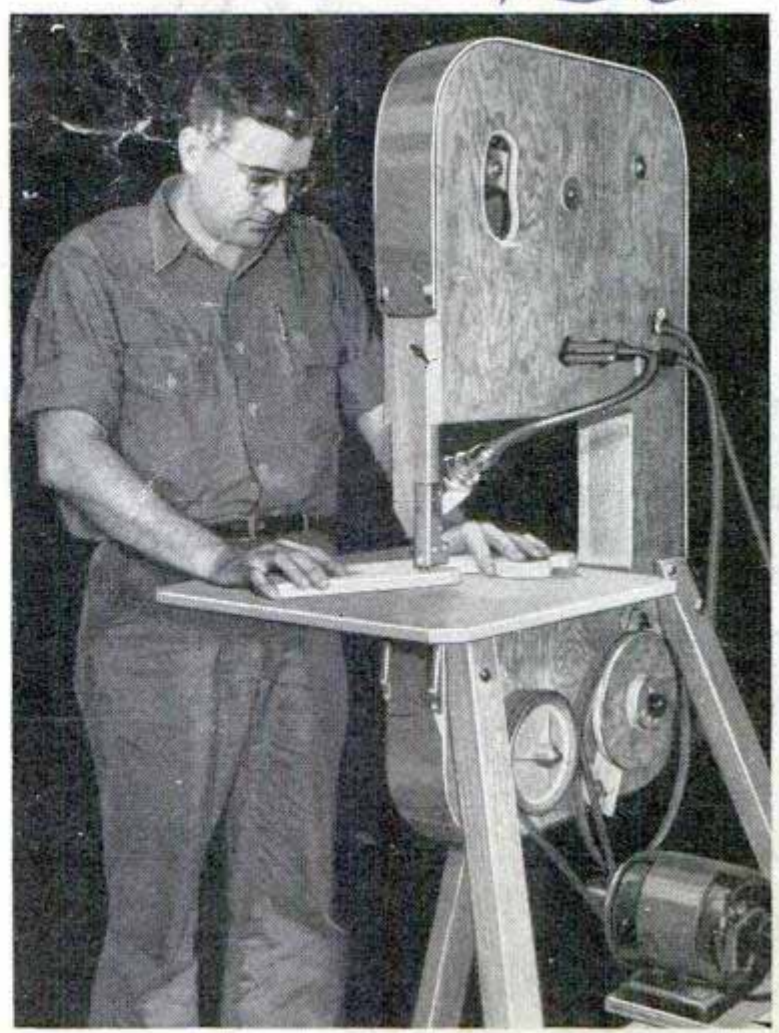

ALSO SEE SECTIONS  
FIGS. 3, 13, 14 AND 15



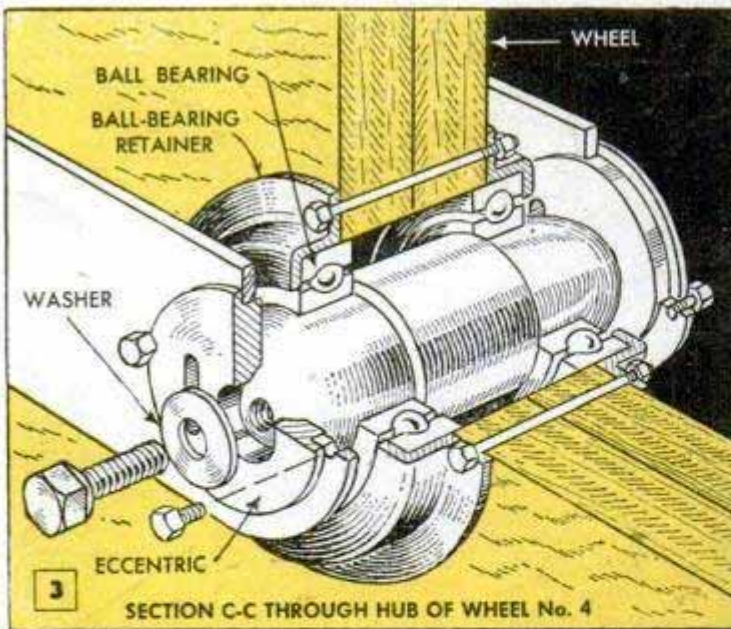

which support the shouldered shaft on which the wheel bearings are mounted. The sectional view, Fig. 15, shows the assembly of the bearing with the eccentrics mounted on the tensioning yoke. Construction of the eccentrics and yoke is shown in Figs. 4 and 5.

Locate the wheel centers on both the front and back plates and cut the curved access slots in both plates to expose the hub of the tracking wheel. Then mount the tracking wheel on the yoke and pivot the wheel unit in the frame. After attaching the clevis bolt and the thumb nut, Fig. 7, mount the front plate with screws only, so that it may be removed if necessary. Install the upper and lower idlers, checking to see that they line up. Note that holes for the driving-wheel bearings are counterbored in both the front and back plates, Fig. 13. This must be done with care so that when in place the wheel will line up with the other three wheels. Now, mount the machine on its three hardwood legs to stand at a convenient working height. The table, Fig. 8, is slotted in from one edge to a hole drilled at the center to allow easy removal of the blade. Swivel latches are fitted near the edge on the underside to level the adjoining sections of the table. Hardwood tilting quadrants, or trunnions, are bolted to the bottom of the table in the manner shown in Fig. 6. Lower halves of the trunnions are screwed to the front and rear plates. A locking bolt, passing through curved slots cut in the upper halves of the two trunnions, provides a means of locking the table in both the level and tilted positions. A leveling bolt is attached to the frame at some point under the table. Both blade guides, the upper one being detailed in Fig. 11, consist of three ball bearings mounted between the legs of a piece of channel iron. The lower guide is the shorter of the two and is bolted to the box frame, Fig. 8, while the upper guide is bolted to a length of hardwood, grooved as in Fig. 9 to allow for

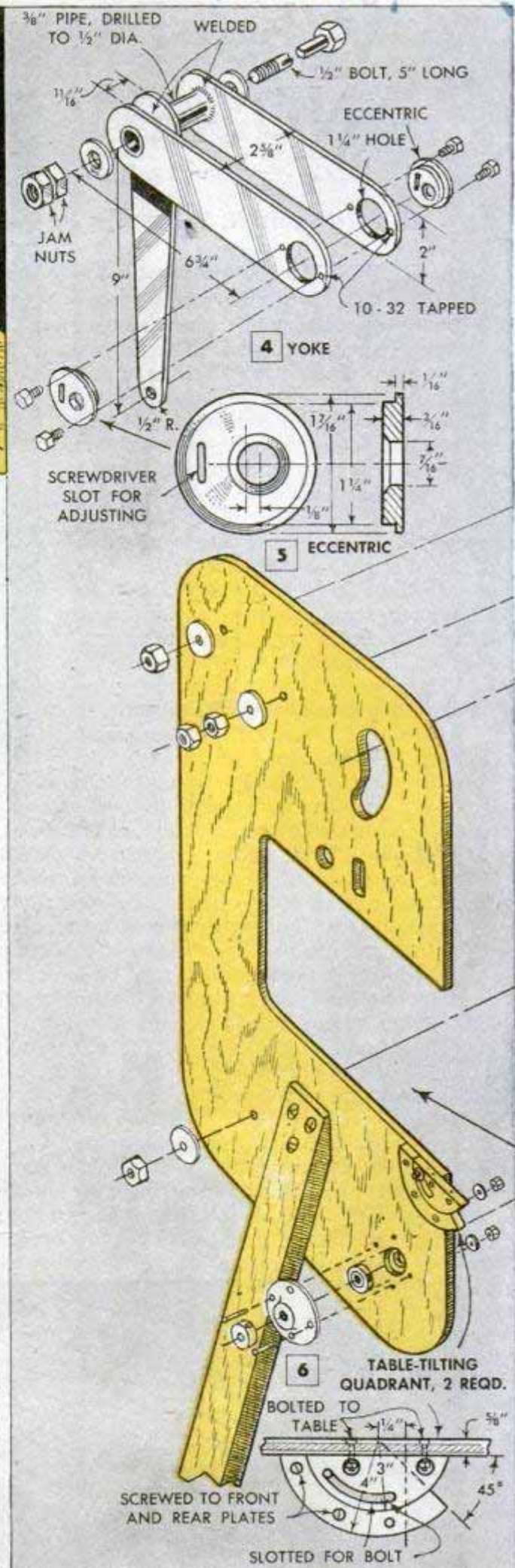







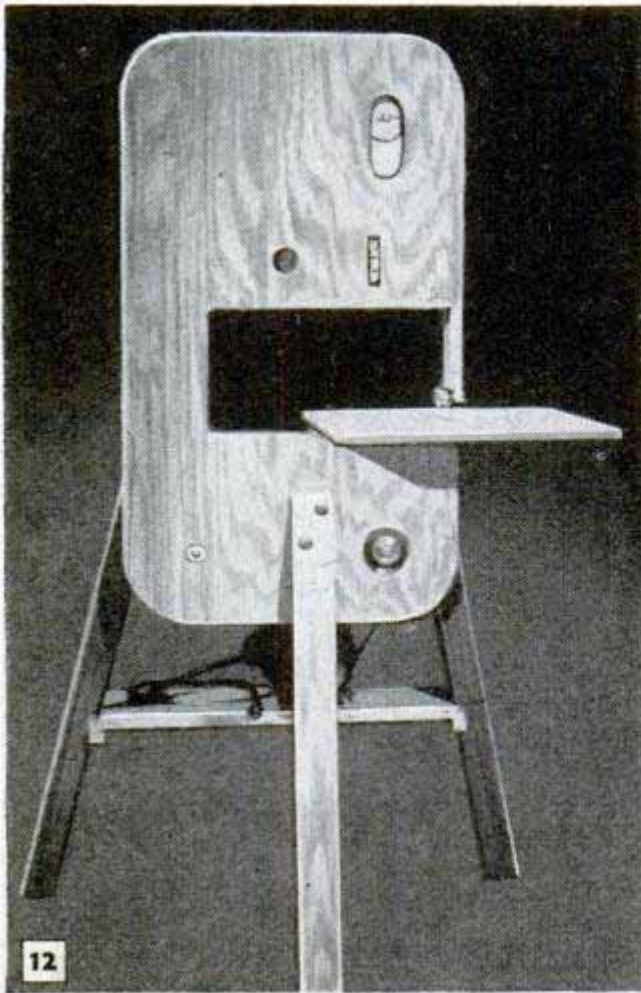

12

clear passage of the blade. Note how the hardwood support is slotted and attached to the frame so that the guide can be moved up and down to clear different thicknesses of stock. Projecting edges of the front and back plates serve as a guide for the hardwood supports. Blade length on the original machine is 10 ft. (120 in.), and blades up to 1/2 in. wide may be used, although narrower blades have a somewhat longer life. After installing the blade, check alignment on the wheels, adjusting the tracking wheel and guides so that the blade runs smoothly and centers on the wheels. Set the guides so that all three rollers turn when the blade is moved, but be sure that they are not too tight, as this will cause the blade to vibrate and possibly break. Then, make and fit the sheet-metal cover. The toggle handle, Fig. 10, provides a quick, easy way of locking the cover in place. Attach the motor support to the two back legs, as in Fig. 12. The position of the support depends on the length of V-belt used. Although a 1/3-hp. motor will supply ample power for light work, a 1/2-hp. motor is recommended as being more satisfactory for all-around work. The speed of the band wheels should not exceed 600 r.p.m. for the best results in average woodworking. For cutting light metals the speed of the band wheels should be reduced and a metal-cutting blade used.

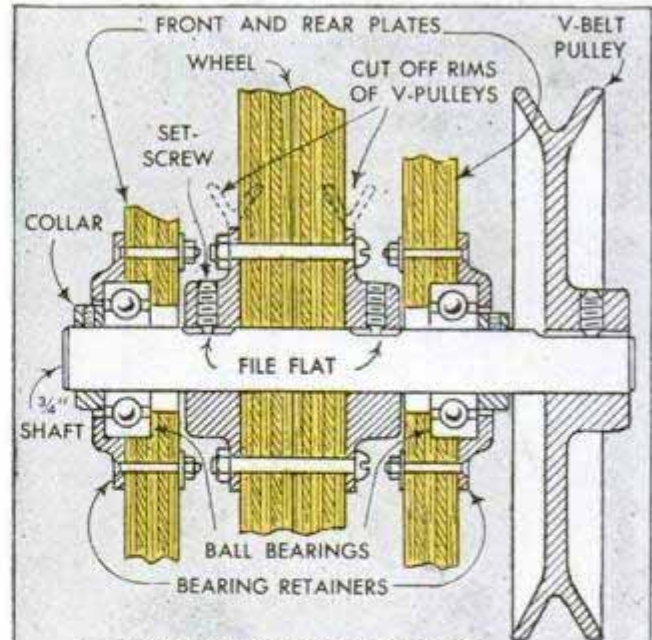

13 SECTION A-A THROUGH HUB OF WHEEL No. 1 (DRIVING WHEEL)

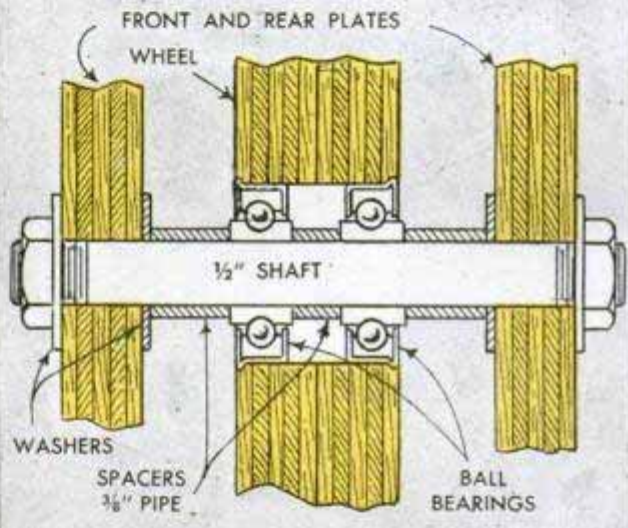

14 SECTION B-B THROUGH HUBS OF WHEELS No. 2 AND No. 3 (IDLERS)

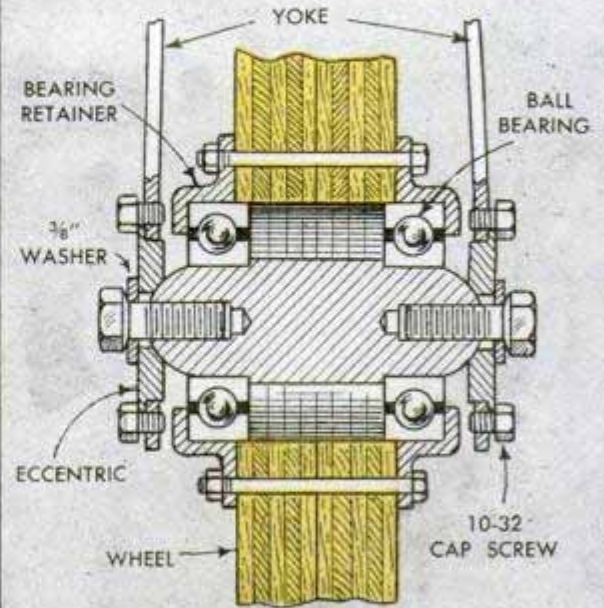

15 SECTION C-C THROUGH HUB OF WHEEL No. 4 (TRACKING WHEEL)





## Amplifier and Loudspeaker For Phone Conversations

**N**OW YOU can rest your telephone handset on what resembles a small table-model radio and have both hands free for taking notes or typing a stenographic record of the conversation, as shown in photo A. This compact desk-telephone amplifier also provides group-listening facilities. You merely place your handset in a molded plastic cradle on top of the instrument in the position indicated in photos D and C and the voice of the person on the other end of the line comes to you through a loudspeaker.

A rear view of the chassis base appears in photo B. The circuit consists of a well-filtered four-tube amplifier with an adjustable magnetic pickup coil mounted on a bracket directly under the receiver end of the telephone handset, as illustrated in photo D. Quick-heating tubes bring the amplifier in operation almost at once by means of the combination line switch and volume control.

The instrument is self-powered and operates from 110-120-volt a.c. or d.c. power lines. Housed in a cabinet approximately  $4\frac{1}{2} \times 5 \times 9\frac{1}{2}$  in., it is available in finishes to harmonize with office furniture and fixtures. The manufacturer suggests several other applications, for example, its use for invalids, because it will make it unnecessary to bring the phone to the patient's ear.

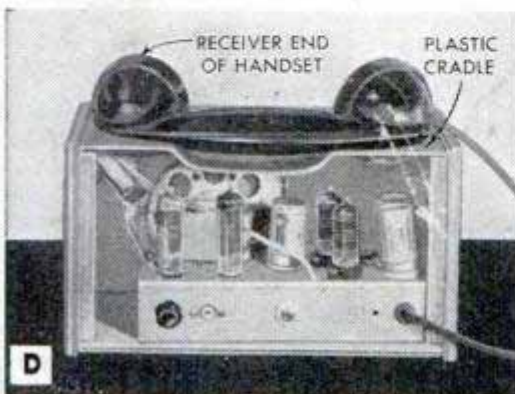
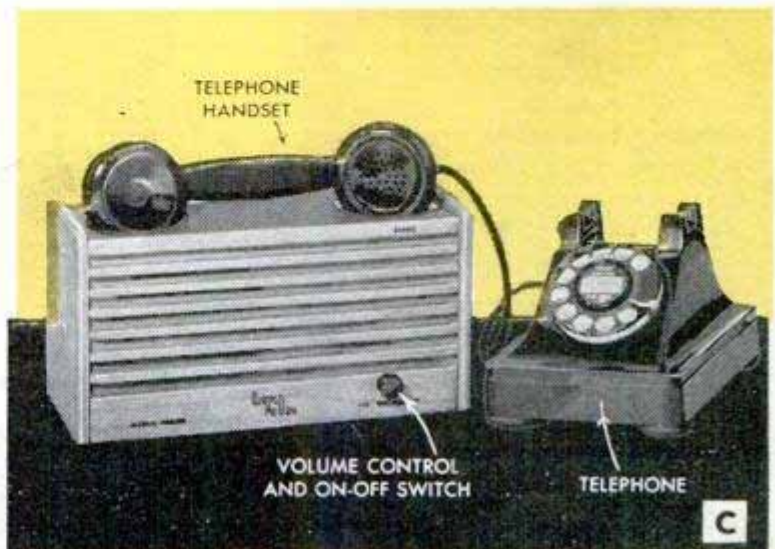
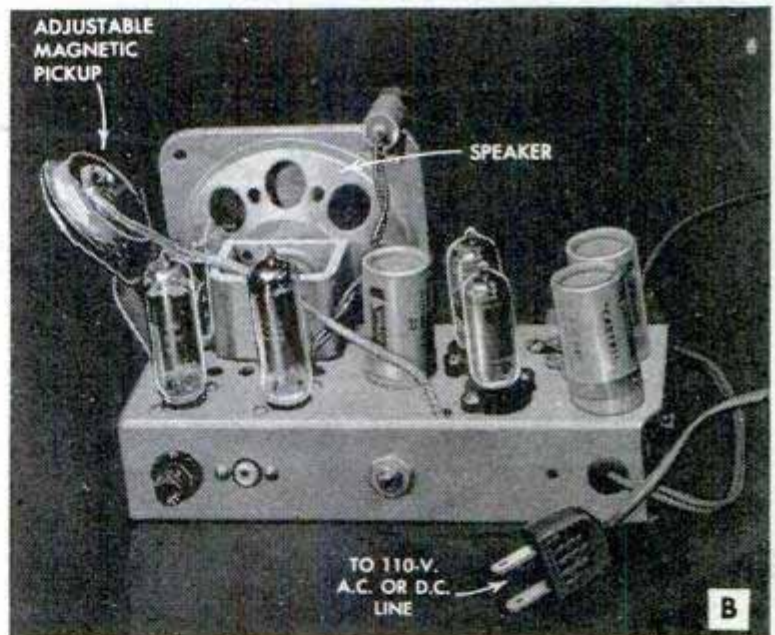



# HOW TO CONVERT YOUR RECEIVER



MAGNETIC recording on a wire has interested every radio experimenter and set owner ever since it came to general public notice during the war when correspondents carried portable wire recorders into battle areas. Such recorders have been quite expensive as they usually include a speaker and an audio amplifier. The average student, experimenter and set owner already has a good amplifier and speaker in his receiver, and many have a separate high-fidelity amplifier, so there has been an insistent demand for a wire-recorder foundation unit that could be employed with the equipment at hand. These foundation units have been available for some time but they were not complete and had to be fitted into a receiver circuit by a skilled engineer. A new "front end" model which is not a foundation device alone, but a complete wire-recorder unit which includes the necessary oscillator and bias circuits and lacks only the audio stages and speaker, is now available. This is the self-

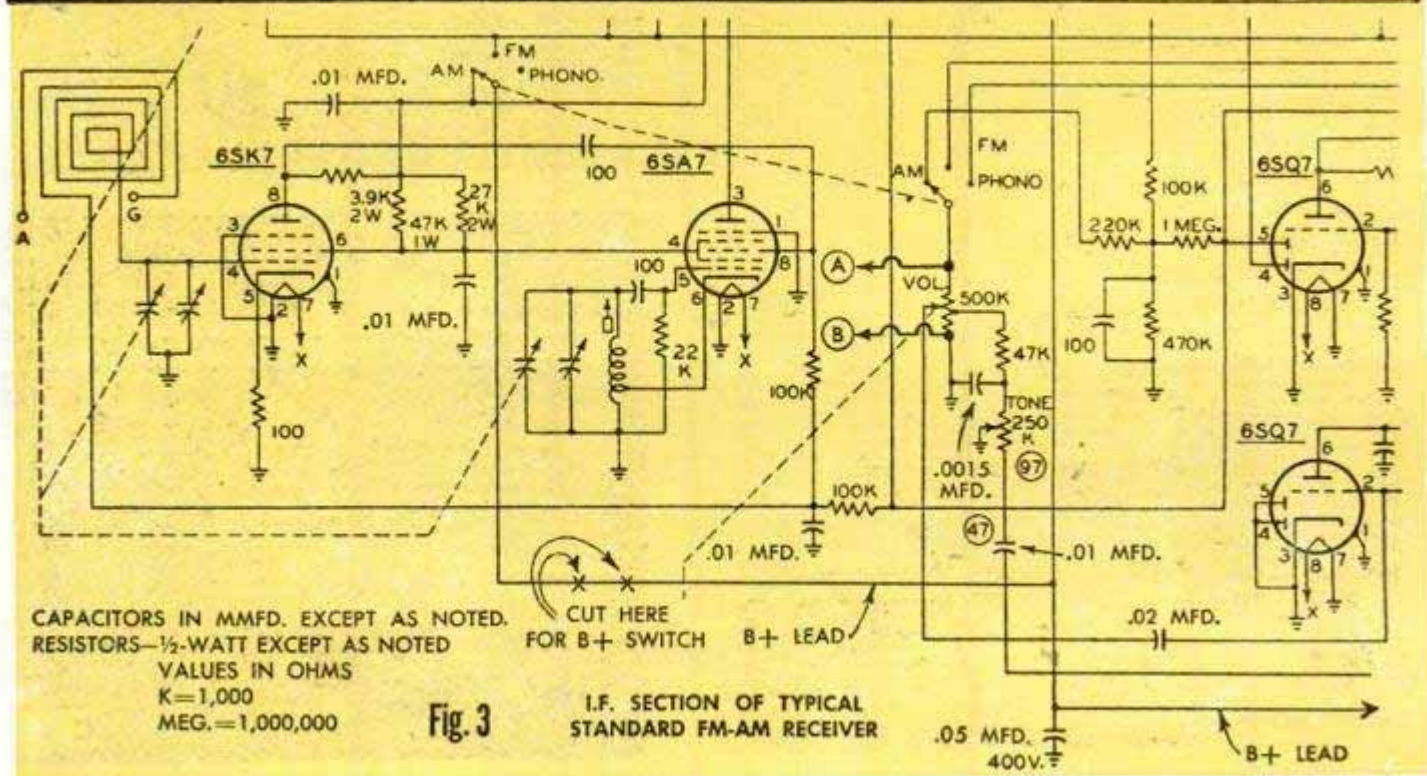
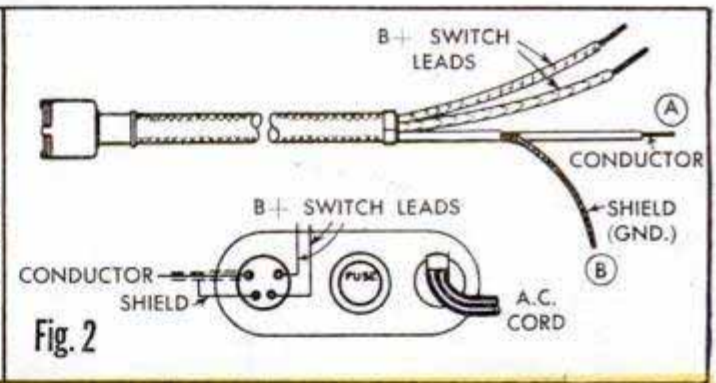
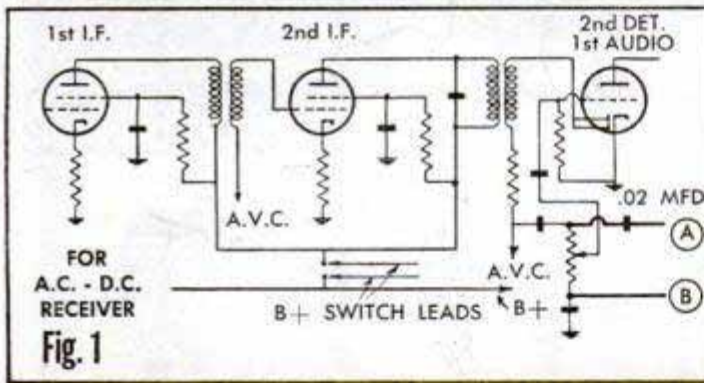
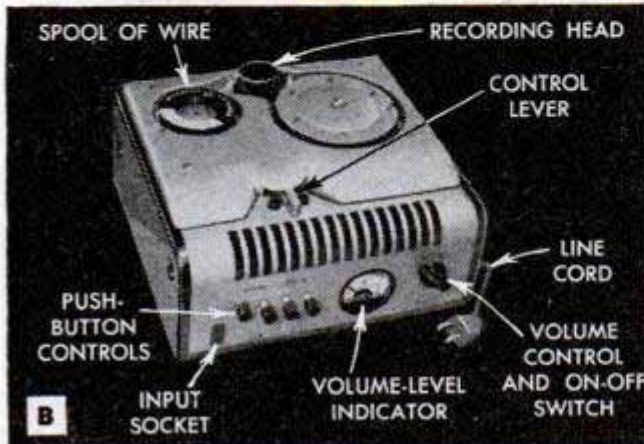



# INTO A WIRE-RECORDER COMBINATION

contained unit shown in photos B, C and D.

Any radio experimenter or serviceman can install this Webster-Chicago model-78 unit, the operation of which is far less critical than disk recording. Programs as long as one hour in length are possible, however, in most cases the recording will be shorter. If desired, recorded material may be "erased" with no damage whatever to the wire. Among the many useful applications in the home is the recording of the voices of relatives and friends at birthday parties, wedding celebrations and other important events. In addition to its entertainment value in the home, it also serves as an aid to students of singing or speech.

These units are also being used for recording favorite FM and AM programs as received by your radio. Installation in the ordinary console set is usually practicable, as illustrated in sketch A. Amateur radio operators are using these versatile wire-recorder units with their short-wave receivers to make recordings of phone and CW transmissions from their fellow operators at distant points, sketch E.

Although the wire-recorder unit can be used with practically any receiver, even a.c.-d.c. sets as indicated by the connections shown in Fig. 1, best results are obtained with a high-grade receiver of standard type, a portion of the circuit of which appears in Fig. 3. By means of simple push-button controls, recording can be made either with a microphone or off-the-air.

(Continued to page 234)

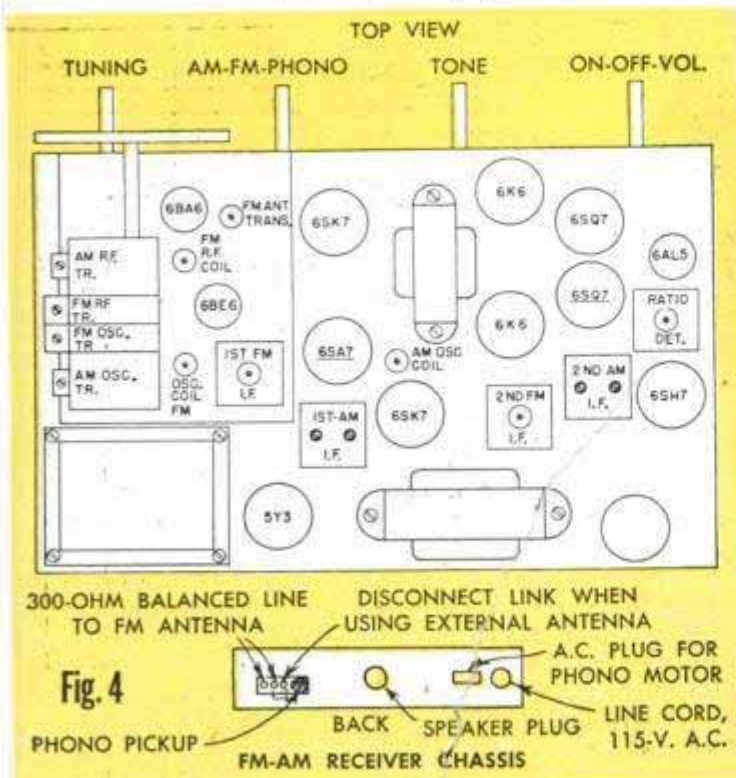
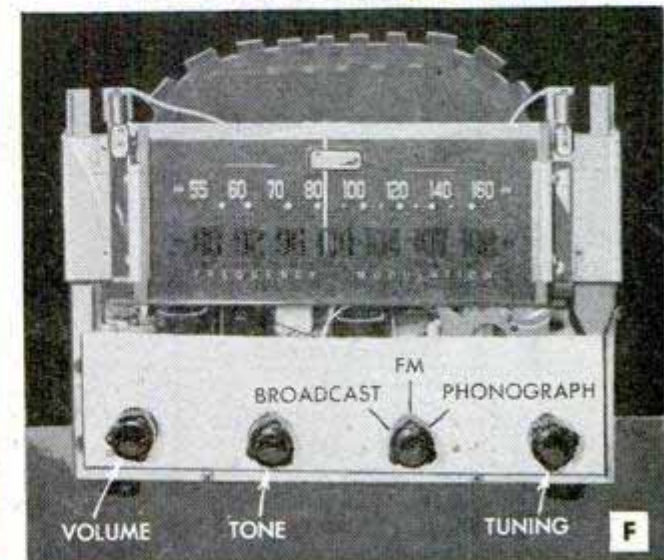
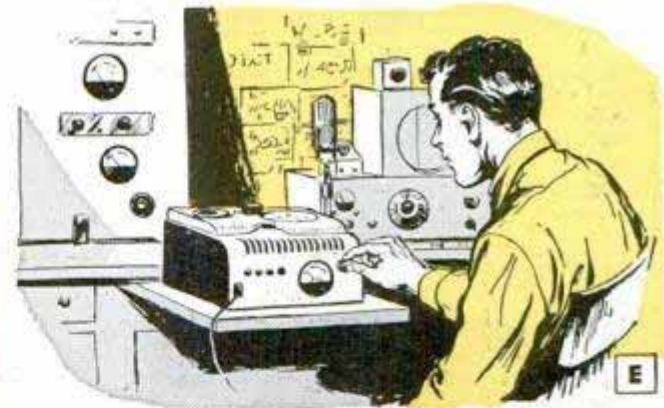



## Dynamic Demonstrator Aids Teaching AM-FM Radio

CONSIDERED a most practical and efficient tool for the teaching of radio theory, operation and maintenance for which earlier models were used during the war, this improved unit that now includes an FM section is also useful for demonstrating the application of test equipment to radio servicing. Developed by the test-and-measuring-equipment division of the RCA Tube Department, the instrument is a complete, operating, six-tube radio receiver with its circuits and components laid out flat on a panel 45 in. long and 33 in. high. All parts are easily accessible and clearly exposed for study while in operation.

Photo A shows the dynamic demonstrator in use before a classroom group. It includes all possible aids to a clear understanding of the function of the elements in a radio receiver. The background of the panel is divided into six large color blocks, defining the six basic functional sections of a six-tube AM-FM radio. Each radio part is accompanied by its schematic symbol to familiarize the students with the reading of circuit diagrams and technical data. Jumpers to close or break the operating circuit are inserted at selected points on the panel to permit easy demonstration of the functions of circuits and parts.

To demonstrate the effect of faulty circuits, switches have been located on the back of the panel which is shown in photo B. These switches enable the instructor to simulate certain failures. The students then trace the signal on its

(Continued to page 234)

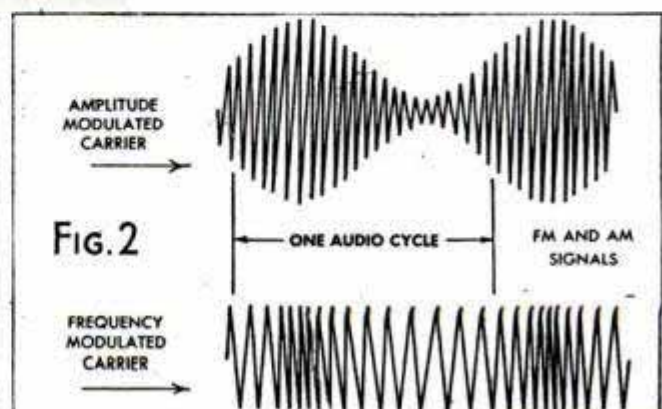
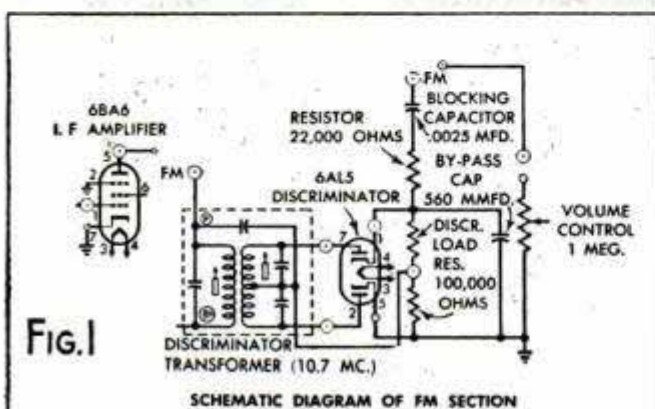
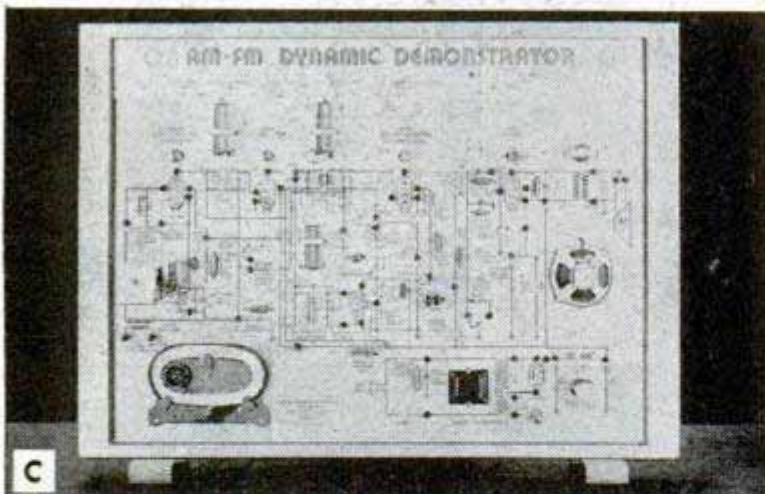
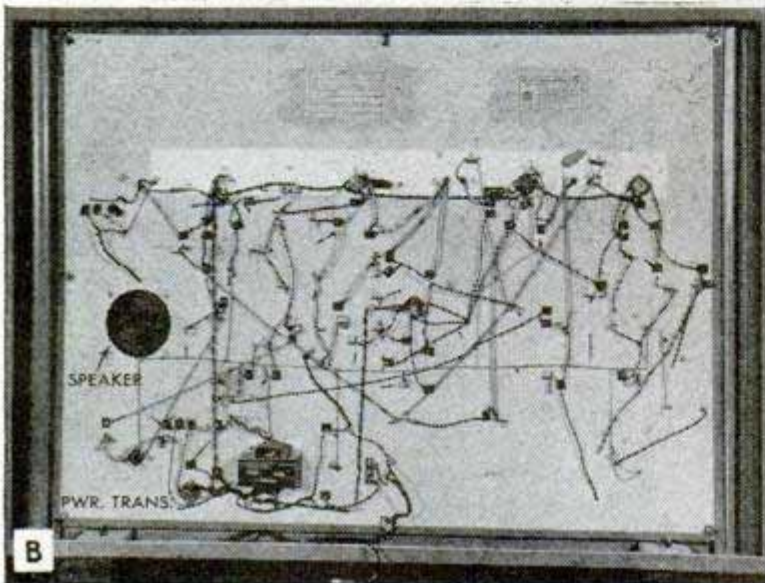
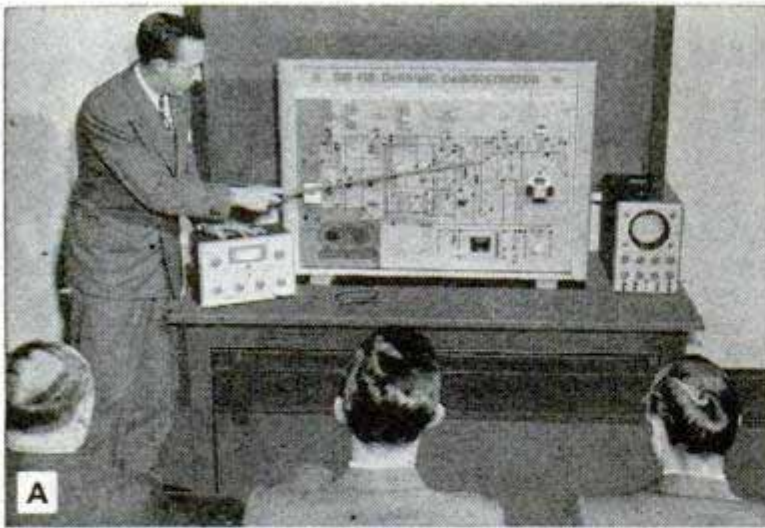



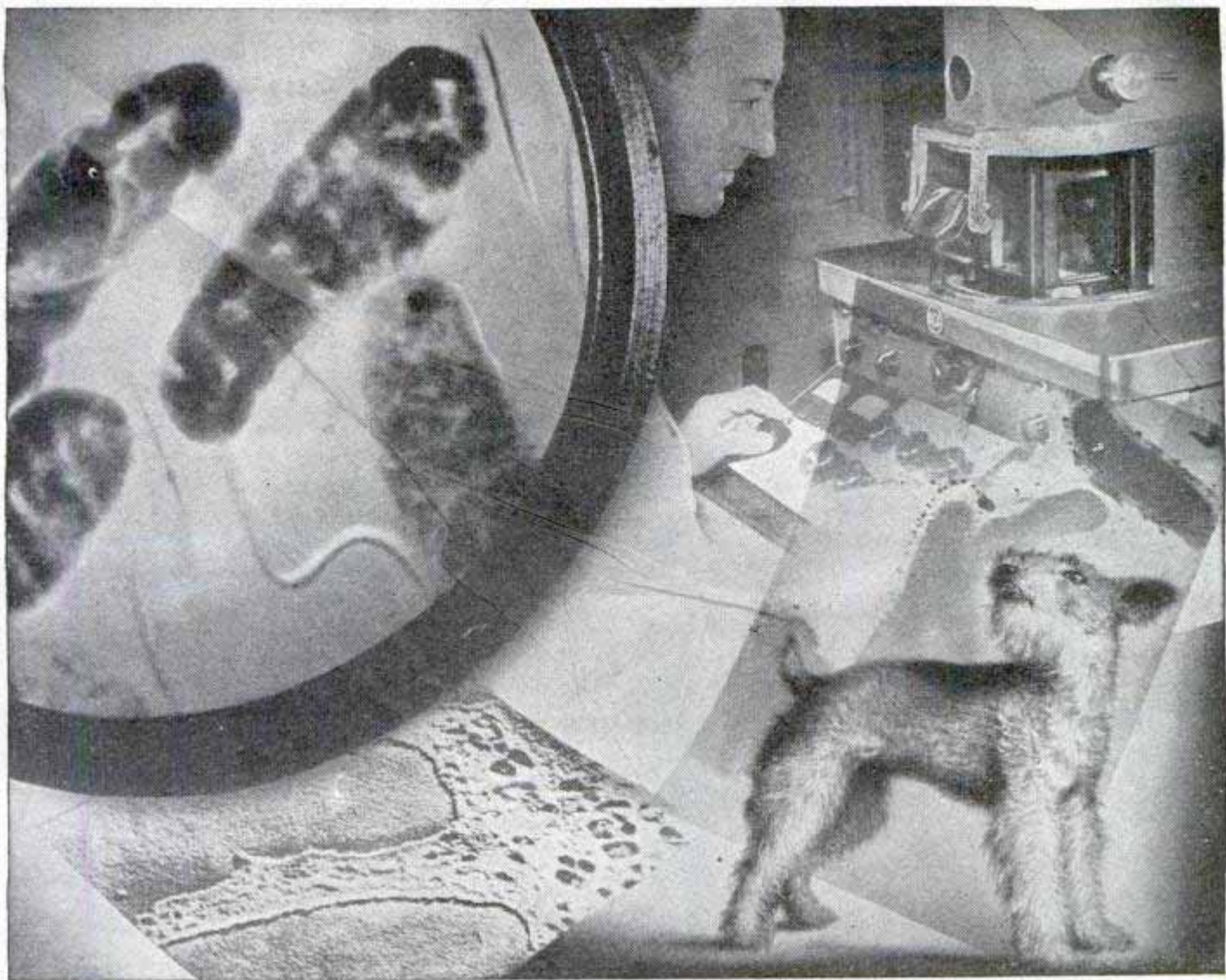

*Electron microscope, perfected at RCA Laboratories, reveals hitherto hidden facts about the structure of bacteria.*

## ***Bacteria bigger than a Terrier***

Once scientists, exploring the invisible, worked relatively "blind." Few microscopes magnified more than 1500 diameters. Many bacteria, and most viruses, remained invisible.

Then RCA scientists opened new windows into a hidden world—with the first commercially practical electron microscope. In the laboratory it has reached magnifications of 200,000 diameters and over. 100,000 is commonplace...

To understand such figures,

picture this: A man magnified 200,000 times could lie with his head in Washington, D. C., and his feet in New York... A hair similarly magnified would appear as large as the Washington monument.

Scientists see both bacteria, and viruses—and have even photographed a molecule! Specialists in other fields—such as industry, mining, agriculture, forestry—have learned unsuspected truths about natural resources.

Development of the electron microscope as a practical tool of science and industry is another example of RCA research at work. This leadership is part of all instruments bearing the names RCA, and RCA Victor.

*When in Radio City, New York, you are cordially invited to see the radio, television and electronic wonders at RCA Exhibition Hall, 36 West 49th Street. Free admission. Radio Corporation of America, RCA Building, Radio City, New York 20.*



**RADIO CORPORATION of AMERICA**



*Twice the  
Wear  
from every pair*

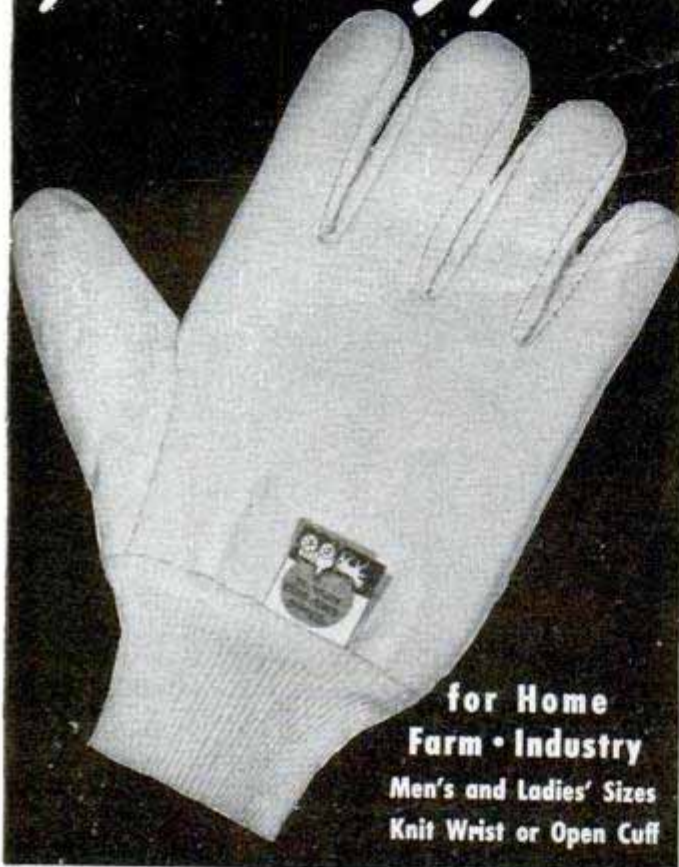

**for Home  
Farm • Industry**  
Men's and Ladies' Sizes  
Knit Wrist or Open Cuff

There's twice the wear in every pair of Riegel's REVERSIBLE Work Gloves...Strong, comfortable gloves that you can switch from one hand to the other when they finally begin to wear out. Made of special flannel-backed canvas, soft finish inside, in either knit wrist or open cuff styles.

### **OTHER STYLES FOR EVERY NEED**

canvas, jersey, leather...knit wrist, band top, gauntlet...double palm, reversible, quilted. Ask for the Riegel brand wherever work gloves are sold. Write for FREE catalog on business letterhead.

**Riegel Textile Corp.**  
342 Madison Avenue  
New York 17, N. Y.



**"THIS TRADE MARK IS YOUR GUARANTEE OF VALUE"**

## **AM-FM Dynamic Demonstrator Simplifies Radio Teaching**

*(Continued from page 232)*

path through the circuits from the time it enters the receiver at the loop or antenna post until it energizes the speaker shown on the right of the panel in photo C. The demonstrator is further designed to operate from an input signal of 550 to 1600 kc. from a signal generator. The FM i.f. section, Fig. 1, will operate on a 10.7 mc. signal from an FM sweep generator. This FM portion of the dynamic demonstrator is designed to enable the user to understand the chief difference between a conventional AM receiver and the FM receiver.

An amplitude-modulated (AM) signal is one in which the amplitude of the carrier is varied in accordance with the information being transmitted; the carrier frequency remains constant. A frequency-modulated (FM) wave is one in which the carrier frequency is varied in accordance with the information being transmitted. The amplitude of the signal in this case is kept constant. Fig. 2 illustrates the FM and AM signals. The circuits preceding the second detector in the FM receiver are essentially the same as those found in the more familiar AM unit, the main difference being the band-pass characteristic required.

Contained in a gray metal frame with removable feet, the demonstrator stands upright on any table or it can be hung on a wall. It weighs 25 pounds and is portable.

## **How to Convert Your Receiver Into a Wire-Recorder Combination**

*(Continued from page 231)*

Experimenters who wish to assemble their own combination either in an old console cabinet or modern built-in wall cabinet will find excellent FM-AM-broadcast-receiver units available in complete chassis form with matching PM speaker. A typical receiver of this description is the Lafayette-Concord chassis shown in photos F and G. The chassis layout appears in Fig. 4; the phono-input provision and extra a.c. outlet into which the wire-recorder line cord may be plugged make it ideal for the new combination installation. With the wire-recorder unit listed at \$99.50 and the chassis and speaker at about \$77.00, the handy experimenter can assemble his own high-grade combination with very little effort. In making the wire-recorder-cable connections in the receiver, it will be noted that the B-supply lead is cut at X and X in Fig. 3 for the B-positive

*(Continued to page 236)*



Dependable

# CHAMPION

America's Favorite Spark Plug



The Christmas tree harvest is on, bringing with it all that is implied by "Christmas spirit." Our Christmas spirit extends to the vast public we serve, for it is they who have made Champion America's Favorite Spark Plug. This preferred position is, we feel, due above all to Champion's inherent and traditional dependability, outstanding quality and value—marks which we pledge will always distinguish every spark plug to bear the name CHAMPION. Champion Spark Plug Company, Toledo 1, Ohio.

***FOLLOW THE EXPERTS***

**DEMAND NEW DEPENDABLE CHAMPIONS FOR YOUR CAR**

Listen to the CHAMPION ROLL CALL . . . Harry Wismer's fast sportscast every Friday night, over the ABC network



# HANDEE

## Homecrafters' Choice

This is it—the famous Tool of 1001 Uses — first tool of this type and today's finest. It's the tool for you whether you're an eager beginner or an expert.

GRINDS  
DRILLS  
CARVES  
SANDS  
SAWS  
SHARPENS  
POLISHES  
ENGRAVES

There's Only One  
GENUINE HANDEE

FREE  
64-Page  
Manual



### FOR PLEASURE OR PROFIT

You'll enjoy making ship, train and plane models, puppets, costume jewelry, wood carvings, bookends. You'll engrave monograms on glassware, tool leather billfolds, handbags, etc. And it's a dandy for all kinds of repairs. Used by industry for exacting production jobs — preferred by craftsmen and mechanics.

**EASY TO USE** as a pencil. Fits your hand comfortably. Lightweight, only 12 oz.

**WORKS ON ANY MATERIAL.** Metal, alloy, glass, plastics, wood, horn, bone, leather, etc.

**PACKED WITH POWER AND SPEED.** Runs at a cool 25,000 r.p.m. AC or DC current.

**DESIGNED RIGHT** in every detail—result of 50 years' experience. Close-fitting motor, non-breakable housing, 7-segment commutator, interchangeable spring collet clutch. Every part triple-tested to make Handee the perfect tool. With 7 accessories \$20.50. In carrying case with 40 accessories \$27.50.

**PLASTIC-CRAFT KIT.** All materials needed for internal carving (Handee not included) \$6.95.

**500 ACCESSORIES.** Start with a few, add more as needed.

With its Attachments and Accessories, Handee Performs More Operations with Greater Accuracy than any other Tool of this Type.

**GET AT STORES OR SENT POSTPAID**

CHICAGO WHEEL & MFG. CO.  
1101 W. Monroe St., Dept. PM, Chicago 7, Ill.

Send  Handee Kit  Handee Tool  Plastic-Craft Kit  
 C.O.D.  Remittance enclosed  Send Manual

Name \_\_\_\_\_

Address \_\_\_\_\_

switch leads indicated in Fig. 2. Conductor A in Fig. 2 and its shielded lead, B, are connected across the volume control at A and B, as shown. This places the signal from the wire recorder in the audio section for reproducing through the set speaker. The same position is used also to take phonograph pickup or radio signal from the receiver for the purpose of recording it on the wire. The reason for doing this is that when the proper push button is pressed for

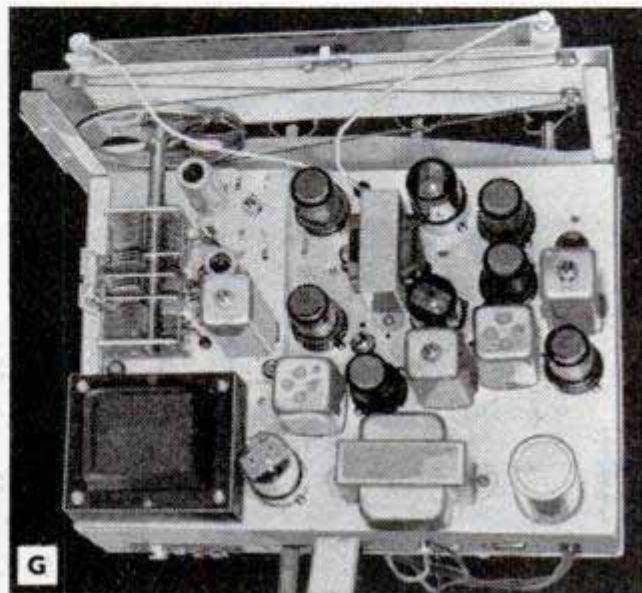

reproducing the wire recording it automatically cuts off radio reception so that the wire recording is heard without radio or other background. When any of the other buttons on the recorder unit is pressed, this circuit is restored so that radio reception is possible. As a suggestion for accurate editing on the wire recorder, a small piece of paper may be ruled as shown in photo H and glued to the plastic recording-head cap. By counting the strokes as the recording head moves up and down, the exact place on the wire to be erased and changed can be observed so that the control lever may be thrown to stop the recorder in position for editing.





# How to focus your Camera for Photoflash Pictures

Here's another of the dozens of photography jobs your flashlight, packed with "Eveready" batteries, does for you.

When you're taking photoflash pictures, it isn't easy to focus—or get good composition—in dim light. Prop your "Eveready" flashlight pointing at the subject to be photographed. Or, if somebody's around to help, have him hold it. Of course, once your picture is set, the flashlight should be turned off.



## How to get longer life and brighter light in your flashlight



- Reload with "Eveready" batteries—they last longer, give brighter light—and they're the largest-selling flashlight batteries in the world!

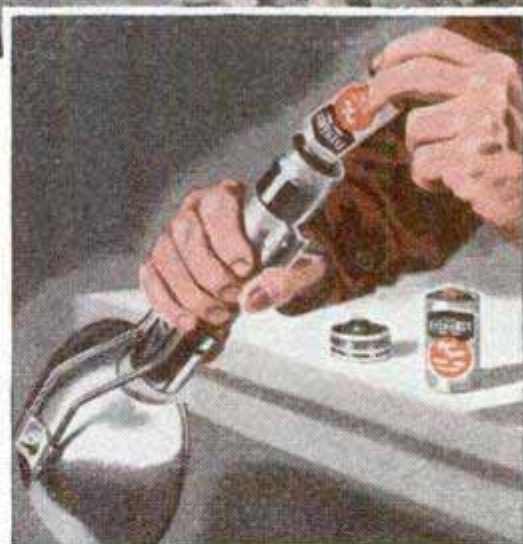

IN THE PHOTOFLASH itself, be sure to use "Eveready" No. 950 flashlight batteries.

## "EVEREADY" FLASHLIGHT BATTERIES

The trade-mark "Eveready" distinguishes products of **NATIONAL CARBON COMPANY, INC.**

30 East 42nd Street, New York 17, N. Y.

Unit of Union Carbide  and Carbon Corporation



You see it -  
with a **LORRAINE**

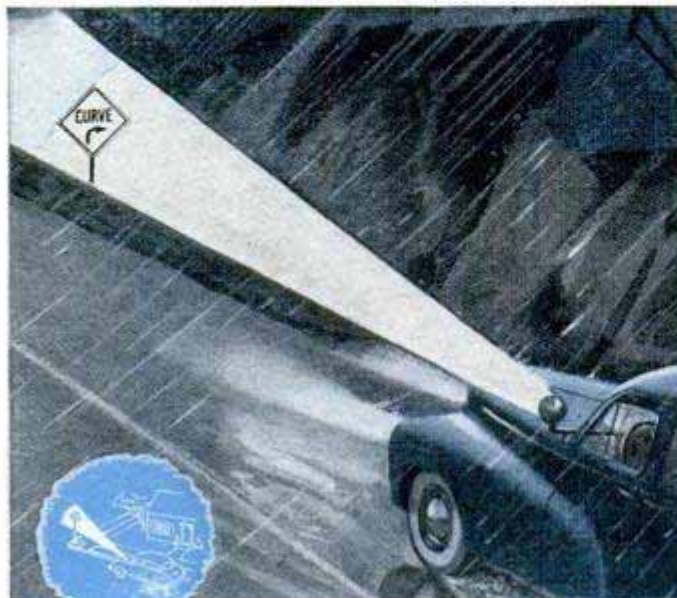

Street Signs

## WORLD'S FINEST DRIVING LIGHT

Sharp curve ahead! But you've got a Lorraine and you're ready for it. The sealed beam spotlight unit in your powerful Lorraine casts a concentrated, glareless ray over a range of half a mile.

Lorraine wireless construction prevents shorts. Machined bronze bevel gears assure lasting wear. Why is it called the World's Finest Driving Light? Ask your nearest Lorraine Dealer today.

**APPLETON ELECTRIC COMPANY**  
1713 Wellington Ave. • Chicago 13, Illinois

Manufacturers of Lorraine and  
Appleton Driving Lights.

Easily Installed;  
Complete  
Instructions  
Included

**DRESS UP  
HIS CAR FOR  
CHRISTMAS**

**FITS ANY CAR OR TRUCK**

## Clearing the Range for Beef

(Continued from page 172)

selective and will destroy native grasses in the area, but it is effective on all brush.

Best results with chemicals have been obtained by compounds of 2,4-D. Mixtures of 2,4-D and Diesel oil get good kills on larger trees. The heavy stalk cutter and brush beater knock down the deadened brush the second and third years after applying the chemicals.

Disposal of the felled brush goes one of three routes on the Red Plains. It is worked into a mulch and subsequently returns minerals to the soil as occurs when the stalk cutter is used, or it is piled into gullies for erosion control. Some brush is burned.

A power-lift buck rake capable of lifting and transporting half a ton of brush and operating over rough terrain and in close quarters was designed and built at the Guthrie station to reduce the man hours required for assembling and piling the brush. An acre of brush can be cleared in 2½ hours by using a tractor-saw and buck-rake combination.

Adaptable for use on any tractor with an adjustable power lift, the rake head is five feet two inches wide, with teeth four feet six inches long. The teeth are spaced 12 inches, center-to-center, and are made of two-inch pipe instead of wood so they will bend or give without breaking if they strike a stump or stone.

Costs of clearing vary. Saws for portable operation cost about \$400 each, while those for tractor mounting range from \$700 upwards. Complete brush bars for tractor-drawn mowers recently were quoted at \$30 by major farm-machinery manufacturers. The brush beater can be built for approximately \$300, exclusive of labor, and the brush cutter is quoted at \$890 for two 7-foot cutter sections. Costs of poisoning with chemicals vary from \$15 to \$25 per acre.

Interest in the brush-removal program is evidenced by the increase in numbers of brush-removing contractors and the attendance at field days where farmers and livestockmen view results of the work and see the equipment operate under actual conditions. This year, more than 3100 farmers and ranchers attended the event at Guthrie.

Last year, a bit of drama was added to the station's brush-removal program when Herman Morton, a flying farmer from Grandfield, Okla., landed his light plane on a 40-acre pasture at Guthrie. His smooth landing was made on a tract which was producing over 60 pounds of beef per acre. Ten years earlier, the area was covered with brush and other undesirable growths.



IN THOUSANDS OF HOME WORKSHOPS...

# 5-IN-1 SHOPSMITH DOES BIG JOBS

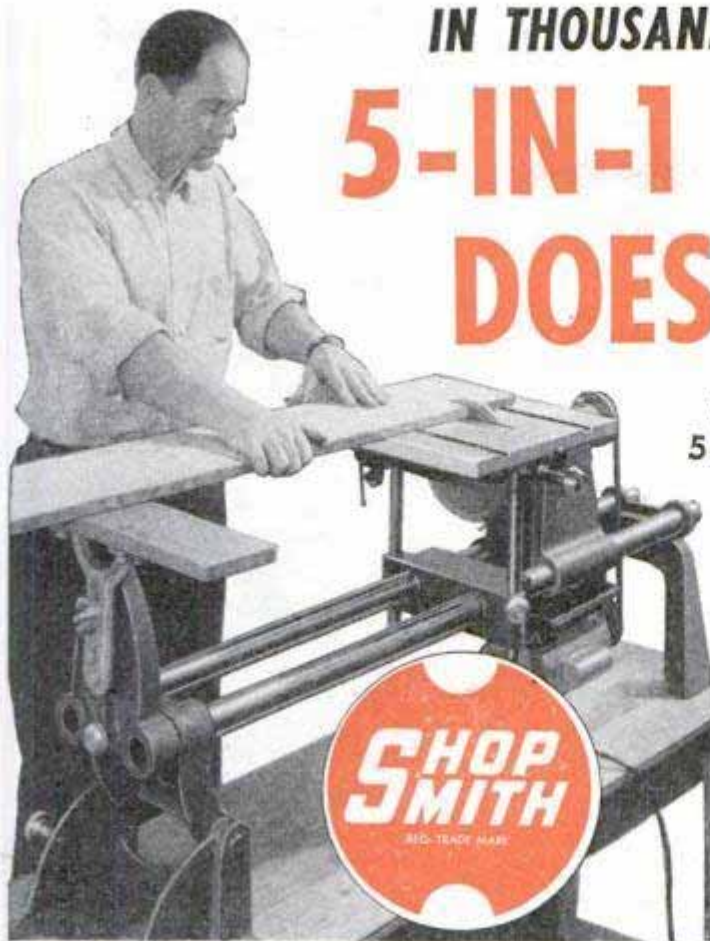

COMPLETE 5-IN-1 TOOL **\$159<sup>50</sup>** With special 1/2 H. P. ball bearing motor \$195.50

Do your present power tools balk at big stock? Do they hold you back from the jobs you really want to do?

Then take a look at *SHOPSMITH* — the new, big capacity circular saw, wood lathe, disc sander, vertical and horizontal drill press all in one. Each has big capacity . . . built to husky specifications. And see what big jobs *SHOPSMITH* does in limited home workshop space.

With all its big capacity and rugged construction *SHOPSMITH* stands just 59" long by 18" wide.

Check *SHOPSMITH* against your wood-working needs. See it demonstrated. For name of nearest *SHOPSMITH* dealer, and free folder, write Department M, Magna Engineering Corporation, 465 California Street, San Francisco 4, California.

**1. SHOP SMITH AS CIRCULAR SAW** Has 8" saw blade; depth of cut 2 1/4"; 14 1/2" x 17" table, with extension 54" x 17"; up to 46" between blade and fence . . . so you can cut to center of 92" board. Table tilts to any angle — positive lock. Takes work on either side of blade. New principle provides micro-adjustment of distance between fence and saw blade.

*Includes:* 8" combination saw blade and arbor. Table extension. Mitre gauge. Rip fence. Saw guard. And in less than one minute you can change from saw to lathe, disc sander or drill press!

**2. SHOP SMITH AS WOOD LATHE**

Has 34" between centers. Fifteen-inch swing. Also turns light metals, plastics. No wrench needed for setup. Finger-tip pressure slides tool rest which locks in position. Variable speeds. Quill feed 4 1/4".

*Includes:* Tool rest, Drive center, Cup center. *SHOPSMITH* is precision-machined, factory-tested for accurate work.

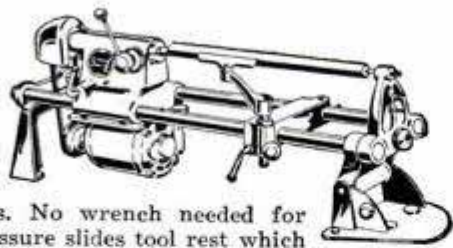

**3. SHOP SMITH AS DISC SANDER**

Has 12" disc; 14 1/2" x 17" tilting table . . . supplies more work support than single-purpose sander. Adjustable mitre gauge and rip fence assure accuracy in squaring, mitering, finishing. *SHOPSMITH* discs can be removed and replaced in seconds . . . so you can sand a job with various grits.

*Includes:* 12" disc; balanced dynamically and statically. Mitre gauge. *SHOPSMITH* is sturdily constructed . . . will take all the wear and tear you would ever give it.

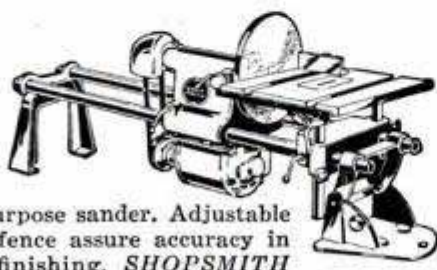

**4. SHOP SMITH AS VERTICAL DRILL PRESS**

Drills to center of 15" circle. Has 27" table-to-chuck clearance. Drills big stock. Has 4 grease-sealed Fafnir ball bearings. Quill can be fed from left or right side. Spindle: 5/8" Dia., 6 spline, hardened tip. Spindle feed: 4 1/4". Variable speeds. *Includes:* 1/2" Jacobs key chuck. Fence.

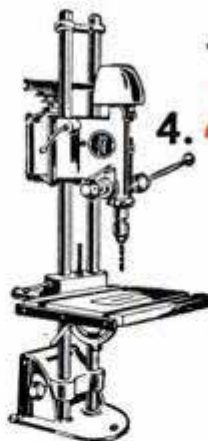

**5. SHOP SMITH AS HORIZONTAL DRILL PRESS**

For the first time in the power tool field, *SHOPSMITH* makes available a horizontal drill press. Has 14 1/2" x 17" table; extends to 34 1/2" x 17". Provides accurate method of drilling for doweling. And the only limit to length of work is size of your shop. *Includes:* 1/2" Jacobs key chuck. Mitre gauge. Table extension. *SHOPSMITH* is also convertible to grinder, buffer, router, drum sander, shaper, scratch brusher.

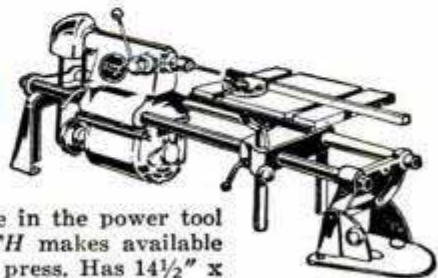



# Clinic



## for Homemakers

As a service to our readers in solving the hundreds of problems pertaining to a home—inside or out—the editors of *Popular Mechanics* invite you to present your problems to The Clinic Editor for help and advice. Address your questions to The Clinic Editor, *Popular Mechanics Magazine*, 200 East Ontario Street, Chicago 11, Ill.

### Garage Doors of Knotty Pine

**Q**—I would like my garage doors to be built of knotty pine in board-and-creak construction and finished in the natural color like interior woodwork. However, my carpenter does not recommend this; he says doors of this type and finish will soon warp and be difficult to open and close. Is he right? Or is there some finish that will prevent this?  
M.E., St. Paul, Minn.

**A**—We are inclined to agree with your carpenter, although it is true that natural-finished garage doors of knotty pine are now quite widely used.

If sound, well-seasoned stock is obtained and if the doors can be built and the finish applied immediately to protect the wood from undue moisture absorption, then it is probable that doors of this construction would be satisfactory. A door built up from a number of narrow strips of 1 3/8-in. stock, doweled and edge-glued with waterproof glue, would, we think, prove more durable than one of board-and-creak construction. The wood should be stained lightly to bring out the grain and knots and should be finished all over—top, bottom, edges and both sides—with at least two coats of spar varnish.

### Painting Wooden Cabinet Doors

**Q**—My linen closet has flush doors of fir plywood. I recently enameled the doors with two coats of good-quality enamel. I sanded the doors before applying the enamel, and also between coats, but the grain still shows on each door. What can I do to hide the grain?  
B.W., Brooklyn, N.Y.



**A**—Certain kinds of wood used in facing plywood have a mixed hard and soft grain. The hard grain is built up during the latter part of the growing season, while the soft portions are formed during the early-season period of rapid growth. The soft grain absorbs the paint, but the paint film builds up a thickness on the hard grain. The best method of getting a smooth enamel finish on such surfaces is to coat the bare wood with a sealer. Sand the sealer, when dry, with medium-grit sandpaper, then follow with two applications of enamel undercoater and only one finishing coat of enamel. Smooth the second coat of undercoater and also the enamel coat lightly with fine sandpaper. Then rub the enamel coat with rottenstone mixed to a thin paste with either rubbing oil or water.

(Continued to page 242)



THE GIFT I REALLY WANT!

The World's Greatest Hand Tool!

- Most POWERFUL
- Most USEFUL
- Most COMPLETE



Every man will be thrilled to receive a gift of the New Model VISE-GRIP! For never before has so much USEFULNESS been packed into a single hand tool. Wonderful for a thousand jobs about the home, shop, factory, farm, and for the sportsman. Does those "impossible" jobs. Adjusts to plier action or LOCKS to the work with Ton-Grip! The New VISE-GRIP has **added**, important features: **INVOLUTE JAW CURVE** gives even greater gripping power, all shapes. **KNURLED JAW TIPS** hold to the very tip. Powerful **WIRE CUTTER** cuts wire and small bolts. **THIN NOSE** gets into close quarters. Opens easier from locked position. Made of finest alloy steel. Nickel plated. Guaranteed. Get yours now.

If your dealer doesn't have it, order direct.  
Postage paid if price accompanies order.

PETERSEN MFG. CO., Dept. M-12, DeWitt, Nebr.



The Perfect Gift for HIM!

NEW VISE-GRIP WRENCH

WITH Cutter: 7", \$2.25; 10", \$2.50  
WITHOUT Cutter: 7", \$1.85; 10", \$2.25



# NEW GILBERT CHEMISTRY LABS

put hundreds  
of thrilling  
experiments  
at your  
finger tips



**No. 6 Senior Laboratory**—Big, three compartment blue metal cabinet crammed with chemicals and apparatus. Large manual describes 389 experiments. \$7.95. Price Denver and West slightly higher.

## WIN FAME AND BIG AWARDS WITH A GILBERT CHEMISTRY SET



V. Rasicci, Jr.

Here are three of the 168 boys who have won fame and important cash awards with Gilbert Chemistry Labs. You have an opportunity to do the same. But be sure to start right—with a genuine Gilbert Chemistry Lab.



R. T. Whitaker



F. C. Menenko

The New Gilbert Labs have all these advanced features.

- NEW**—All metal cabinet—rugged, easy to carry.
- NEW**—Each section designed as complete laboratory with trays and racks.
- NEW**—Tip racks for test tubes, for easier handling.
- NEW**—Brown, light-proof bottles.
- NEW**—Rectangular shaped bottles and shelf spaces, holding bottles with label side out.
- NEW**—Postwar chemistry book. 144 big pages, illustrated, stay-open binding. Edited by Prof. Treat B. Johnson, famous Yale scientist.

THIS  
EXCITING  
BOOK WILL  
HOLD YOU  
SPELLBOUND  
!!



Copyright, 1948,  
National Com.,  
Publishers, Inc.

The new Gilbert Chemistry Labs are far more than "toy" labs. Range of chemicals and apparatus are based on real laboratory technique. Make strange chemicals change color. Transform a liquid into a gas—then into a solid—finally to a liquid again. Write messages in invisible ink or fire ink. Make a chemical weather flag. Do fingerprinting. Turn a salt cellar into a miniature gas volcano. Hundreds of spectacular experiments in organic, inorganic and electro chemistry.

**\$200.00 IN ANNUAL AWARDS** To the boy doing what, in my opinion, is the most important research in Chemistry, Microscopy or Electricity in 1949, I will award \$100.00 in cash. To the ten boys doing the next most important research, I will award \$10.00 each. Applicants must not be over 17 years old and must send me a full description of their experiments by May 1, 1949.

*A.C. Gilbert*

Founder of the Gilbert Hall of Science

## FREE! SUPERMAN!

shows you the wonders of the Gilbert Hall of Science

This 32-page book—illustrated in full color—tells you all about it. Mail coupon today.

Gilbert Hall of Science  
500 Erector Square, New Haven, Conn.  
Rush free book "With Superman at the Gilbert Hall of Science."

Name.....  
Street.....  
City.....State.....

(This offer good only in the U. S. A.)



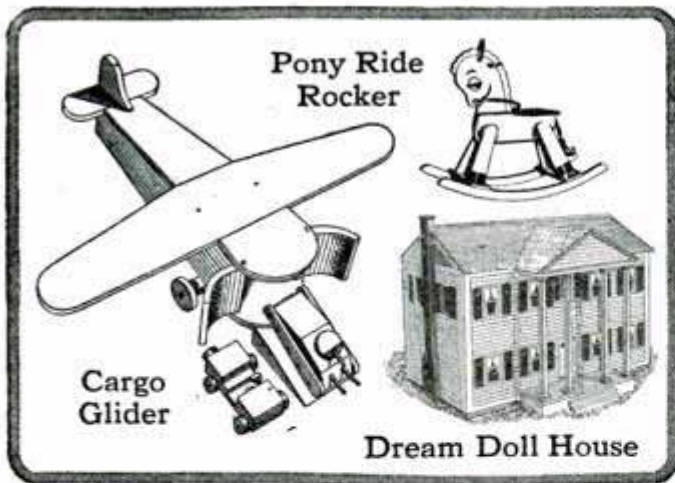

## HAVE FUN! SAVE MONEY! BUILD TOYS WITH EASI-BILD\* Full-Size Patterns

Here's your chance to give the kids a real "toy" Christmas without breaking open their piggy banks to do it. You can build the toys shown above and many more for half the store cost and, it's easy—you simply trace the full-size pattern on wood; saw, and assemble with Cascamite, described below.

\*Reg. U. S. Pat. Off. by Easi-Bild Pattern Co.

### How to choose a glue!

Follow these directions and solve all your gluing problems:



**For boats, outdoor furniture, sports equipment**—joints that must withstand outdoor exposure—**CASCOPHEN** (Resorcin Resin Glue). The first completely durable glue available to homecraftsmen!



**For furniture, toys, heavy-duty home repairs**—strong, stain-free, moldproof, highly water-resistant **CASCAMITE** (Urea Resin Glue). Mixes quickly with cold water!



**For models, photo prints, labeling**—general home, school, or office gluing, use the new, clean, white, fast-setting **CASCOREZ** (Polyvinyl Resin Glue). Liquid ready to use!

Send Coupon for Toy Patterns to

Casco Pattern Dept. PM-128  
P. O. Box 215, Pleasantville, N. Y.

Enclosed is \_\_\_\_\_¢ for patterns checked below.

- ( ) Dream Doll House, Pattern #33-50¢  
 ( ) Pony Ride Rocker, Pattern #53-35¢  
 ( ) Cargo Glider, Pattern #70-25¢  
 ( ) 32-page Pattern Book illustrating 94 pattern projects—20¢

Name \_\_\_\_\_

Address \_\_\_\_\_

City \_\_\_\_\_ Zone \_\_\_\_\_ State \_\_\_\_\_

**THE BORDEN CO. • CHEMICAL DIVISION**  
Makers of Casco Glues

### Removing Paint Mildew From Window Sash

**Q**—Windows in my kitchen steam over, or "sweat," in the winter and the water running down the glass has stained the enamel on the sash rails a dirty-brown color. In some places, the enamel has peeled, exposing the bare wood. How can I remove this stain preparatory to repainting?  
P.R., Waterloo, Iowa.

**A**—The condition you describe is the result of a fungus growth which stops when the wood and paint dry out. To remove the stain, use an ordinary paint cleaner or a few drops of household ammonia on a cloth. In repainting you can use a mildew-proof paint, but the better way is to remove the cause of the condensation by reducing the humidity in the room and installing tight-fitting storm sash. In installing the storm sash, line the edges of the stiles and rails with felt strips and use metal turn buttons rather than hangers to fasten the sash in place.

### Stopping Floor Squeaks

**Q**—I have oak floors in my living and dining rooms. The floors in both rooms squeak when walked on, not just in certain areas, but all over the floor. In many places the top floor seems to be springy but the floor boards are in good condition and all joints are tight. How can I remedy this trouble?  
H.B., Rochester, N.Y.



**A**—You do not say whether the house is old or new, nor do you give the thickness of the flooring. If the floor has been laid a number of years, it is probable that the nails holding the bridging between the joists have loosened, permitting the floor to spring irregularly as you walk through the room. This has the effect of loosening the nails holding the top floor to the subfloor. Slight movements between the two floors produce most of the squeaks. Raise the floor slightly with screw jacks and wooden extensions placed under the joists. Tighten the bridging, driving in additional nails if necessary. Then drill a line of small holes midway between each pair of floor joists, spacing the holes about 6 in. apart and taking care not to drill through the top floor. Select flat-headed screws of a size to fit these holes and of a length that will enter the floor board but will not go through. Drive screws in all holes and draw them uniformly tight. If the finish is worn, the floors then should be sanded, filled and varnished.

### Repairing Damaged Brick Wall

**Q**—My house is about 15 years old and of brick-veneer construction. There are two cracks in the wall on one corner running diagonally upward to the cornice. In the basement there is a crack in each wall and also plaster cracks in the room directly above. How do I repair the damage? J.M., Springfield, Ill.



**A**—Your description makes this sound like a major repair. One very probable cause is an artificial fill under the foundation footing at the corner. This could be cinders, loose stone, broken concrete and possibly even wood that has rotted. Another possibility is that water from an underground spring has filtered into the area under the corner of the foundation. If we interpret your description correctly, it will be necessary to excavate under the old footing and put in a new fill, a new, wider footing and a new section of foundation wall. It probably will be necessary to rebuild the brickwork. The wall should be rigidly supported while the work is being done.



# Who makes the Plymouth so safe?



## YOU DO :

When you drive carefully—observe all traffic laws—keep your car in good running condition—you make the most important contribution to your Plymouth's safety.

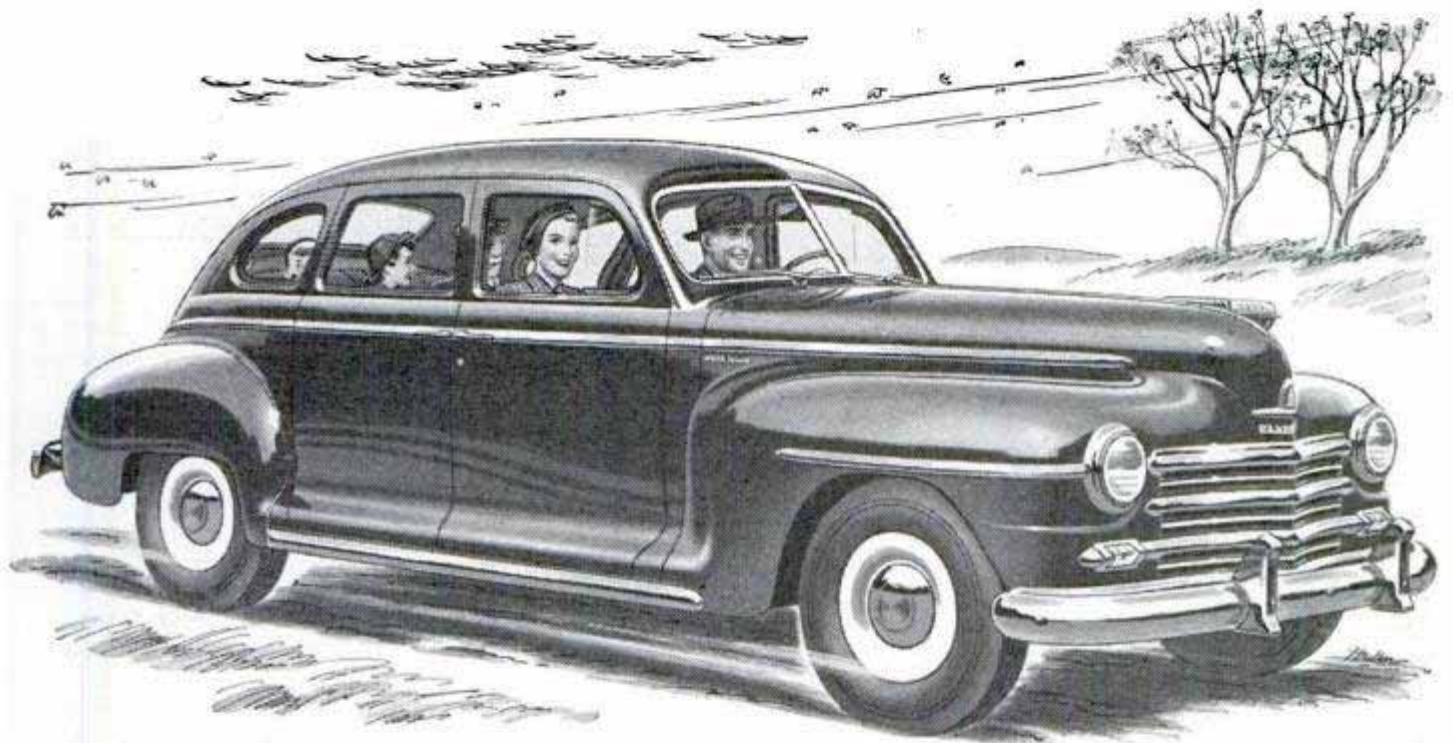

## WE DO :



**Plymouth Builds Great Cars . . .  
Good Service Keeps Them Great.**

Your nearby Plymouth dealer will provide the service and factory-engineered parts to keep your present car in good condition while you're waiting for your new Plymouth.

PLYMOUTH Division of  
CHRYSLER CORPORATION,  
Detroit 31, Michigan.

Built into your Plymouth is a combination of safety features you find in no other car in the lowest-priced field.

Plymouth gives you *Super-Cushion Tires* as standard equipment at no extra cost. These bigger, softer tires run cooler, are less likely to blow out. If the unexpected should happen—even at high speeds—Plymouth's *Safety-Rim Wheels* enable you to slow to a sure, safe stop.

Plymouth also gives you quicker, smoother stops with *Safe-Guard Hydraulic Brakes*. Plymouth's *Safety-Steel Body*—welded into a rugged, single unit—offers added protection.

Even in minor details, Plymouth engineers keep your safety first. The improved *Safety-Signal Speedometer* helps you maintain safe speeds for night driving. The running boards are floor-level so you can't trip. There are safety catches on the rear doors which can be set to guard against accidental opening. The luggage compartment lid lifts and lowers with finger-touch ease and is so counter-balanced it *can't* fall.

These features—and many more like them—are the reasons why in safety, too, *there's a lot of difference in low-priced cars—and it's Plymouth that makes the difference!*



More people choose

**PLUMB**

than all  
others  
combined

Every group of tool users, homecraftsmen, farmers, artisans, prefer Plumb over all others. Independent surveys have brought out this fact many times.

Plumb tools are made better. Special analysis steel is used in the one-piece head. The handles are made of tested, shock-absorbing hickory. The real reason for Plumb's popularity, however, is that Plumb tools do jobs faster and better.

Fayette R. Plumb, Inc., Philadelphia 37, Pa.

The red handle with the black head  
—exclusively Plumb

**PLUMB**

HAMMERS • HATCHETS • AXES • FILES

## Don't Bet Against a Cow Pony

(Continued from page 141)

TipTop is still coming to a stop. Shields runs forward to tie the calf's legs together and the horse meanwhile backs up to keep the rope tight in order to prevent the calf from struggling. It's fast split-second action all the way through, with man and horse working as a perfect team to do the job expertly and in record time.

Many of the big ranches of the cattle country maintain their own racing stables. Ranch boys are trained as jockeys and some owners employ professional jockeys who wear the ranch colors. The race-type quarter horses are smaller and more slender than the big bulldog type, which is favored for rodeo work.

Because of the emphasis on quick starts and early speed, some of the races are for distances of only 50 or 100 yards, though distances of 220 and 440 yards are much more common.

Quarter-horse racing is a widespread sport all through the Southwest from eastern Texas to the Pacific. Some of the race meets are completely informal, some are highly organized and have all the glamour and thrills of big-time thoroughbred racing. A well-advertised meet attracts thousands of spectators.

Typical of the big meets are the races held by the Del Rio Livestock Association, a nonprofit organization made up of 100 ranchers in western Texas. The Del Rio track has a covered concrete grandstand, judges' stand, a mechanical starting gate, and photo-finish apparatus. It is a small edition of such famous tracks as Churchill Downs or Santa Anita.

At Del Rio, the quarter horses race for purses that are made up of the entry fees plus portions of the gate receipts. Owners who have gotten into arguments as to which owns the fastest horse may put up special purses amounting to \$10,000 or so, winner take all, for special match races that are inserted in the regular racing programs. Sometimes, too, they make side bets as to which horse will break first from the gate, which will lead at 10 yards, and which will be in the lead at 50 yards.

The outstanding difference between the quarter-horse races and ordinary thoroughbred races is that all commercial gambling is unknown at the short-horse tracks. No pari mutuels or formal betting facilities are present. Friends who are watching a race may arrange a wager on the outcome between themselves and that's as far as it goes. Modern quarter-horse racing follows the amateur traditions of early colonial times.



**THE SMOOTHEST RIDE  
ON TWO WHEELS!**



**1949**

**HARLEY-DAVIDSON**  
with the New *HYDRA-GLIDE* FORK

- ① NEW Hydra-Glide Fork irons out bumps like magic!
- ② NEW powerful front brake takes hold at a touch!
- ③ NEW sealed ray headlight turns night into day!
- ④ NEW air flow fenders for streamlined beauty.

SMOOTH is the word for it . . . comfortably smooth, even on rough roads! Remarkably stable and easier than ever to handle. Takes off like a "jet-job" . . . amazing new performance! All this and more is yours in the New Harley-Davidson with the Hydra-Glide Fork. You'll ride with new road-hugging security, steer with new effortless ease, stop at a touch of the brakes, enjoy the great sport of motorcycling as never before! You'll enter a new world of motorcycling performance, as you thrill to the "flying-feel" of your Harley-Davidson wheeling you swiftly, securely and comfortably to exciting race meets, hillclimbs, endurance runs, sightseeing tours and faraway places. See your Harley-Davidson dealer today. Take a ride. Mail coupon now.

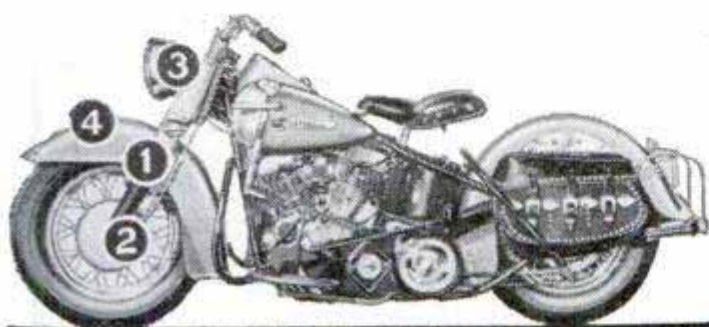

Harley-Davidson Motor Co.,  
Dept. P, Milwaukee 1, Wis.  
Send literature on 1949 models, also  
free copy of ENTHUSIAST Maga-  
zine filled with motorcycle action  
pictures and stories.

Name.....

Address.....

City..... State.....

Copyright 1948, Harley-Davidson Motor Co.



Here's "before and after"

proof why **You**  
**Should Simoniz**  
**Your Car!**

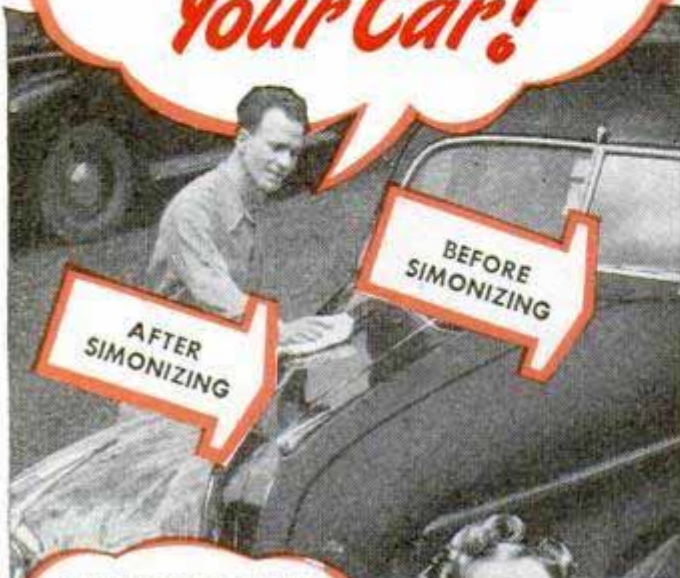

GIVES TWICE THE  
SHINE IN 1/2 THE  
TIME!



KEEPS COLORS  
FROM FADING!



### Simoniz Kleener makes dull cars look new again

Nothing equals wonderful Simoniz Kleener—for safely cleaning the finish and making cars look really new again. Anyone can do a professional job of Simonizing without a buffer—just inexpensive Simoniz and Simoniz Kleener. Use Liquid Kleener for a "quickie slick-up" or before applying Simoniz. Extremely dull cars require Paste Kleener. To protect the finish and make it last longer—follow up with famous Simoniz!

THE SIMONIZ COMPANY, CHICAGO 16, ILL.



MOTORISTS WISE  
**SIMONIZ**

T. M. REG. U. S. PAT. OFF.

MAKES THE FINISH LAST LONGER

## Building the Parade of Flowers

(Continued from page 104)

down a proposed flower-decorated helicopter that would cruise along at the standard parade speed of three miles per hour while hovering four or five feet off the ground.

No float is permitted in the parade until the float-construction committee has approved its strength and safety. Tires, ignition system, battery and other mechanical parts are scrutinized to make sure that no avoidable breakdown will occur. Each float must be equipped with a built-in tow bar so that it can be removed from the line of march in case of failure.

Early on the morning of the parade, the floats are assembled into divisions on side streets that lead into Orange Grove Avenue. When the parade begins, the leading division moves out into Orange Grove Avenue, proceeds along it for a few blocks, and turns on Colorado Boulevard, Pasadena's main thoroughfare, leading the other divisions as they move through the city. The parade lasts for about 2½ hours.

Pasadena has a population of 106,000 people and yet, for a few hours each year, it becomes one of the largest cities in the United States. In addition to the 1,500,000 million spectators at the parade, another 200,000 visit the post-parade area where the floats are on display for the balance of New Year's Day. Meanwhile, the Rose Bowl game in the afternoon draws 99,000 spectators and the Santa Anita races at adjoining Arcadia attract about 70,000 people.

All these events in a few hours create the world's greatest traffic problem. The regular Pasadena police force of 400 men is augmented by 1100 additional officers recruited mostly from the Los Angeles force and the county sheriff's department.

All the highways leading to Pasadena are turned into one-way streets in the early morning to accommodate the incoming crowd; the flow is reversed when the parade ends. Clarence Morris, chief of police of Pasadena, spends the day in a blimp spotting traffic jams as they occur.

The history of the parade goes back to 1890, when residents of Pasadena decorated their surreys and wagons with garlands of roses on New Year's morning and drove out to a picnic area for an afternoon of games. With the years, the drive to the picnic grounds evolved into a formal parade and the afternoon of games developed into the Rose Bowl football classic.

These days the parade is sponsored and staged by the Tournament of Roses Association, a nonprofit community group of about 1000 members and 30 committees.



# TOMMY GETS A TARGETEER FOR CHRISTMAS!

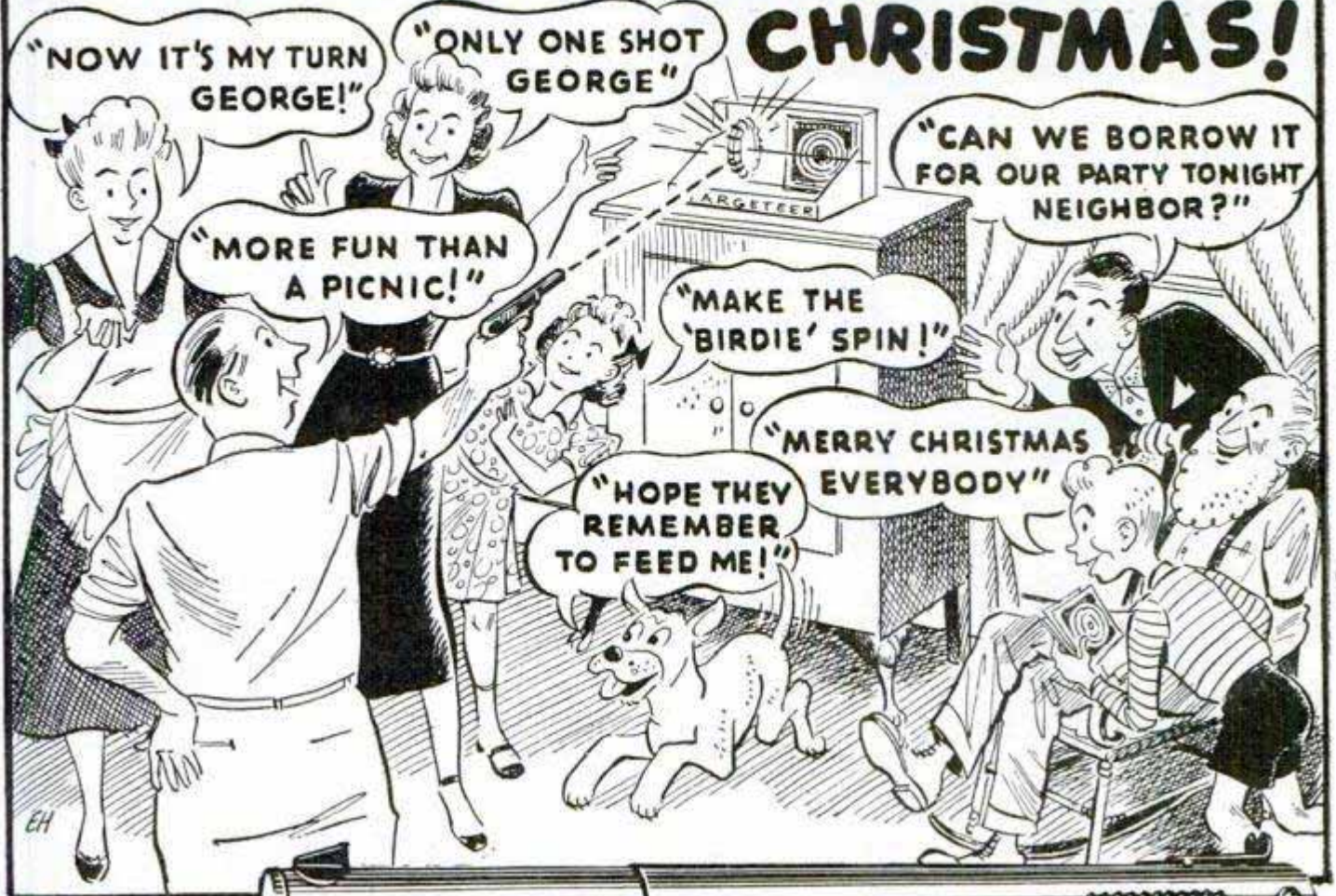

## DAISY'S SAFE FAMILY FUN GUN!



Daisy Targeteer Target Pistol Outfit offers harmless, exciting shooting fun for all the family! Complete Outfit includes: TARGETEER—famous, low velocity, blued steel air pistol—big, balanced and very accurate at short range; 500 rounds special .118 calibre ammunition (tiny B-B's); 2 metal spinning "birdie" targets; target cards; backstop.

Buy Targeteer AT SPORTING GOODS and TOY DEPARTMENTS

Only  
**\$2<sup>95</sup>**

No. 118

**WANT A DAISY FOR CHRISTMAS? TRY THIS:**

**DAISY AIR RIFLES CATALOG** - FEATURING THE DAISY 1000 SHOT RED RYDER COWBOY CARBINE



See New Daisy B-B Guns, Targeteer, in Catalog Section of Handbook No. 2

My Handbook May Help You Get a Daisy!



128 PAGES

LICENSED BY STEPHEN GLENNER, INC. N.Y.

(All prices higher in Mont., Wyo., Colo., N.M., Texas and West. Duty added in Canada.)

Send for Daisy Handbook No. 2 with latest Daisy Air Rifle, Targeteer Catalog bound in! Show Catalog to the person most likely to get you a Daisy for Christmas or anytime! Also enjoy reading 128 pages of comic strips, jokes, cowboy lore, camp tips, etc. in this handy, thick, pocket-size Handbook. Rush only one thin dime (10c), unused 3c stamp—we'll send Handbook No. 2 postpaid!



No. 25 DAISY PUMP GUN \$6<sup>95</sup>

No. 111 DAISY'S RED RYDER CARBINE \$4<sup>95</sup>

**DAISY AIR RIFLES**

DAISY MANUFACTURING CO., 1898 UNION ST., PLYMOUTH, MICHIGAN

Do not order air rifles or Targeteer direct from the factory, please. See your dealer.



*The Christmas  
he'll remember!*

**Model  
TOYS**

SCALED FROM MACHINES  
YOUR CHILD HAS SEEN ...  
AND BUILT TO LAST ... AND LAST!



**Model ROAD GRADER**

\*Other **Model** Toys Shown Below

As real to your child as the original Adams Road Grader! Sturdily-built of heavy gauge steel, electrically welded. Adjustable scraper blade and steering wheel; double-action axles; six Goodyear-tired wheels! **Model** Toys are quality... designed for hard usage, years of constructive fun, indoors and outdoors!

## **Model Toys**

*well worth the difference!*

THE CHARLES WM. DOEPKE MFG. CO., ROSSMOYNE, OHIO



**Model** BUCKET LOADER



**Model** CONCRETE MIXER



**Model** EARTH HAULER

**AT STORES WHEREVER TOYS ARE SOLD**



### HULL AUTOMOBILE COMPASSES

FIND THEIR WAY

- To Discriminating Gift Lists
- To Any Destination

BEACONLITE ILLUMINATED \$5.95

STREAMLINE STANDARD \$3.95

At your Dealer's.

HULL MFG. CO. P. O. Box 246-D12  
Warren, Ohio

## We Drove to Alaska

(Continued from page 149)

would be uncomfortably cold. You won't have to worry about heavy traffic from the states—we saw only 35 U. S. license plates from Dawson Creek to Fairbanks.

Fairbanks was busier and more modern than we expected. With 8500 residents, it is Alaska's second-largest community in a total population of between 90,000 and 94,000. Paved streets, theaters, auto showrooms, two radio stations, two newspapers, well-stocked shops and a railway to Anchorage quickly dispel any notion you had about seeing a typical frontier town.

Winters are dark and cold, with the thermometer plunging to 50 degrees or more below zero for long periods. Summers are warm, with an average maximum of 72 degrees for July, when it is light 20 hours a day. Light-sleeping visitors cover bedroom windows with blankets.

Meal prices were not excessive by U. S. standards and many articles, like tires, cost about the same as in Chicago. Housing is scarce and you should confirm hotel reservations in advance if you expect to spend much time in Fairbanks. Large U. S. Air Force bases nearby, at Ladd and Eielson, put an added strain on the eating and housing facilities. Homesteading, one of the pioneer touches in this wilderness country, still hasn't attracted as many takers as the government hoped.

Two of the most interesting local attractions are a display of Alaskan natural history at the University of Alaska and large-scale gold-dredging operations, both short distances north of Fairbanks.

Between Fairbanks and Anchorage is 20,300-foot Mt. McKinley, highest peak in North America, in the center of a national park with 112 species of birds and 34 kinds of animals. It is open from mid-June to mid-September.

All these things, plus firsthand experience in one of the few great wildernesses left in the world, are yours to enjoy if you follow our lead along the Alaska Highway.

## Radio Programs for Bus Riders

Bus riders in Cincinnati, Ohio, are entertained, as they ride, by radio programs picked up on FM receivers. The installation on Cincinnati buses was made at the expense of a broadcasting company to increase its listening audience during commuting and shopping hours. In a recent poll, 96 percent of the riders said they enjoyed listening to the programs while riding the buses.



# Men... Get into the Television Business in a Big Way!

Assemble and Sell Transvision TV Kits and Cabinets—Make Big Money!

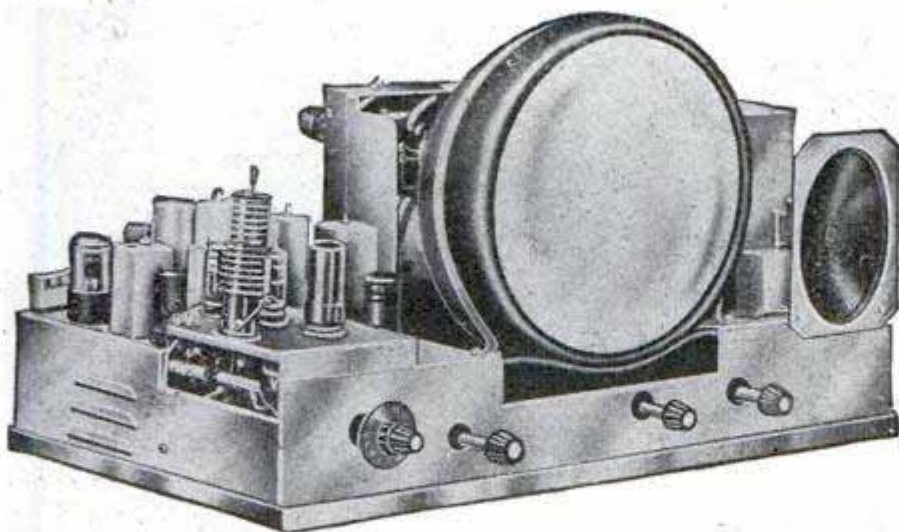

## TRANSVISION

offers ambitious men an opportunity to get into Television now, and make big money.

Here's our 3-Point DEALER PLAN:

1. Sell high-quality television sets constructed by you from our TV kits, at competition-beating prices.
2. Feature our beautiful line of exclusive custom-built cabinets, designed and finished to your customers' specifications.
3. Make profits from resale of the nationally advertised Transvision line of TV Kits and Accessories.

Write for Dealer Folder No. D-1, or see your distributor.

## New... Transvision 10" TV Kit (Model 10A)—a Sensational Value!

Gives Bright, Stable 52 Sq. In. Picture—Continuous Tuning  
EASY TO ASSEMBLE — SAVES YOU 1/2 THE COST!

Want a television set for yourself? Want to assemble them for resale at a profit? The new Transvision Model 10A electromagnetic Television Kit (illustrated above) is ideal: Gives a bright, stable 52 sq. in. picture. Has 10" picture tube, and **CONTINUOUS TUNING** on all 12 channels. Its high sensitivity makes for improved long-distance reception; especially good on high channels. Comes complete with all-channel double-folded dipole antenna and 60 ft. of lead-in wire.

Transvision **MODEL 10A TV KIT**, less cabinet.....Net \$199.00

Transvision **MODEL 12A TV KIT**, same as above, but has a 12" picture tube.....Net \$263.00

**NEW STREAMLINED CABINETS** for Transvision Model 10A or 12A TV Kit. Made of select grain walnut with beautiful rubbed finish. Fully drilled, ready for installation of assembled receiver.

Walnut Cabinet for 10A or 12A (Specify).....Net \$44.95  
Mahogany and Blonde slightly higher.

### NO TECHNICAL KNOWLEDGE REQUIRED FOR ASSEMBLY!

Transvision's simple step-by-step Instruction Sheet makes assembling a Television Kit a pleasure. Each kit comes complete with all-channel double-folded dipole antenna and 60 ft. of lead-in wire.

Nothing else to buy!

## FREE 162 p. Transvision TELEVISION COURSE with purchase of any Transvision TV Kit.

You don't need this course to assemble a Transvision TV Kit, because the job is easy enough and our instruction sheet is simple and clear. BUT, if you want a good introduction to television fundamentals as a basis for further study, the Transvision Television Home-Study Course is ideal. Remember, you pay nothing extra for this course. Ask your distributor.

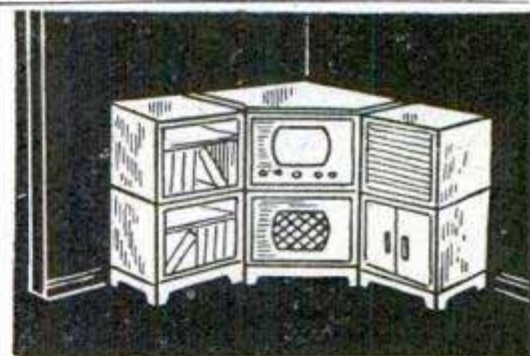

## NOW... A Complete Line of "MODULAR" KNOCKDOWN, UNPAINTED CABINETS

that you can assemble and paint in a jiffy!

Transvision's "MODULAR" Cabinets come in knockdown, unpainted units, offering an unlimited range of combinations, including even a bar. Finish them off to suit any living room, den, office, etc. The units are simple and practical in design, and require as little as 1/2 hour per unit for assembly.

Corner piece, shown above, has room for Television, Phono, Record Storage, and Open Book Case... COMPLETE Net \$84.00. For other units and prices, write for "Modular" Catalog.

All Transvision Prices are fair traded; subject to change without notice. Prices 5% higher west of the Mississippi.

**TRANSVISION, INC., Dept. PM, NEW ROCHELLE, N. Y.**

For FREE 20 p. TV BOOKLET, Dealer Folder D-1, and Catalog, See Your Distributor!

### NEW YORK, N. Y.

BEACON TELEVISION, INC.  
785 Third Ave.  
FEDERATED PURCHASER  
80 Park Place

### BRONX, N. Y.

NATIONAL RADIO DIST.  
899 Southern Blvd.

### BROOKLYN, N. Y.

BENRAY DISTRIBUTING CO.  
506 Coney Island Ave.

### STATEN ISLAND, N. Y.

B. & D. DISTRIB. CO.  
Staten Island 5

### LONG ISLAND, N. Y.

ELECTRONIC SUPPLY CO.  
40-14 Greenpoint Ave.  
Long Island City, N. Y.  
ISLAND RADIO DIST. CO.  
412 Fulton Ave.  
Hempstead, L. I., N. Y.

### WESTCHESTER, N. Y.

RADIOMART  
149 Riverdale Ave.  
Yonkers, N. Y.

### NEW JERSEY

NIDISCO JERSEY CITY  
713 Newark Ave.  
Jersey City, N. J.; also:—  
Cliffside, Passaic, Trenton

### VARIETY ELECTRIC CO.

601 Broad St.  
Newark, N. J.

### BOSTON, MASS.

BEACON TELEVISION  
1306 Boylston St.

### PHILADELPHIA, PA.

TRANSVISION OF PHILA.  
235 N. Broad St.

### WASHINGTON, D. C.

STAR RADIO  
409 11th St., N.W.

### CHICAGO, ILL.

TRANSVISION OF CHICAGO  
1002 S. Michigan Ave.

### HOLLYWOOD, CALIF.

TRANSVISION OF CALIFORNIA  
8572 Santa Monica Blvd.



## Our 70-Group Air Force Emerges

(Continued from page 95)

fully assembled. When used as an ambulance plane, the C-119 will have room for 36 litter patients with attendants.

The Boeing C-97, a cargo version of the B-29, can carry 40,000 pounds of cargo 4000 miles at speeds in excess of 300 miles per hour. As a troop transport, it carries 134 fully equipped troops; as an ambulance plane, it holds 83 litter patients and 4 attendants.

The Douglas C-124 is a new aircraft developed from the C-74. It can be converted into a two-decker for 222 fully equipped troops. Fifty-thousand pounds of cargo can be carried, including tanks, guns and fully loaded trucks. The C-99, a cargo version of the B-36, has been completed, and is under test. This giant plane has a range of 8100 miles and a cargo capacity of over 100,000 pounds, or 400 fully equipped troops, or 335 litter patients.

### SPECIALIZED SQUADRONS

The 22 specialized squadrons will have aircraft designed to perform functions such as liaison and rescue. Helicopters will be used to some extent for both purposes, but other planes are being developed. Some rescue aircraft will continue to be

Simulating troops, 400 employees of Consolidated-Vultee line up to show passenger capacity of their company's big XC-99. The transport version of the world's largest bomber, the B-36, it has six pusher-type engines

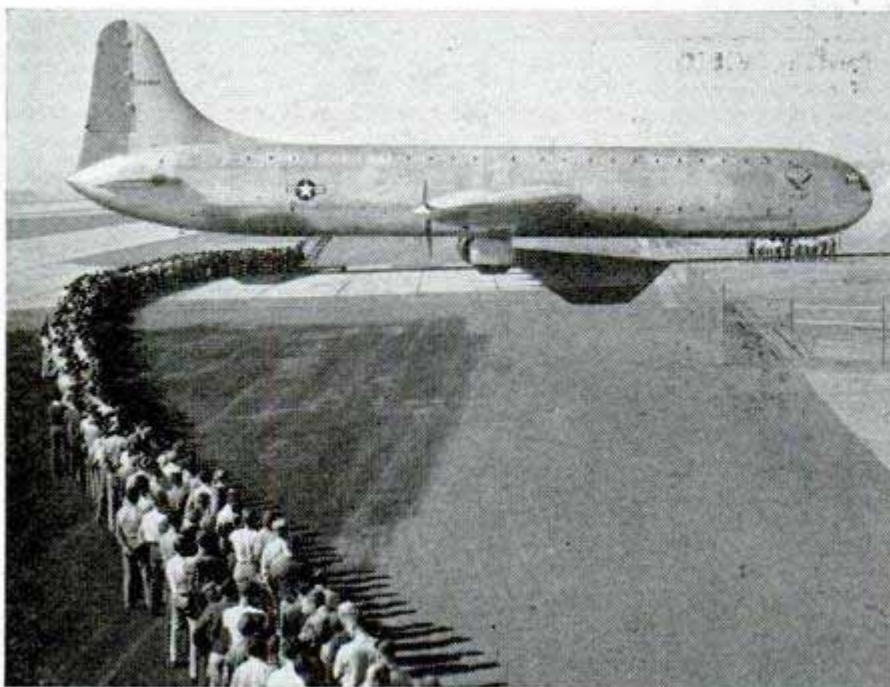

World's largest helicopter, the Piasecki XH-16 will function as a troop or cargo carrier. It will be approximately the size of a Douglas C-54. It features a quickly detachable capsule which about doubles its load

modified tactical planes, designed to carry equipment, such as lifeboats, and para-rescue teams, necessary for their mission.

### RESEARCH AIRCRAFT

Research is constant in the Air Force as we seek to extend the horizon of flight for man and machine, and assure the United States of the best aerial weapons in the world. We now have four research aircraft designed to explore the realm of supersonic speed. The Bell X-1 has already paid dividends by piercing the sonic barrier many times at speeds hundreds of miles greater than that of sound. It is designed for speeds of 1700 miles an hour at 80,000 feet. The Bell X-2 is also a research and development laboratory to explore the problems of transsonic and supersonic flight. Like the X-1, it is rocket-powered but has a swept-back wing and is designed for greater speeds.

The Douglas X-3 is directed toward the development of a design capable of speeds three times that of sound and at altitudes of 200,000 to 300,000 feet. Over 60 different design studies have been made, ranging from a stubby, blunt-nosed model to a long, slender fuselage that comes to a sharp, bulletlike point in the front and rear. Ramjet, pulsejet, and turbojet propulsive units, singly and in combination, have been studied as possible propellants.

The Northrop X-4, newest of the group, is similar to their XB-35

(Continued to page 252)



# GENIUS at WORK



12" DRILL PRESS



12" BAND SAW



## SHOPMASTER TOOLS

**gives ease of operation  
with professional results**

Whatever it is you make, a simple stool or an elaborate cabinet, it will contain that indefinable extra craft touch only you can put into it.

Most Americans have this ability to design and make things. They like to work with their hands. They know and take pride in good tools.

Shopmaster Tools have been designed to meet the needs of American craftsmen, both amateur and professional. Expertly engineered to give precise results with ease of operation, they have the rugged construction necessary for long years of service. And, best of all, they are priced within the reach of all.

See Shopmaster Tools at your dealer, or for free catalog, illustrated in full color, write to:

**SHOPMASTER, INC.**

1214 Third St. South, Minneapolis 15, Minn.

LATHE



8" TILTING ARBOR SAW



15" JIG SAW



SABER SAW



8" TABLE SAW



6" JOINTER-PLANER

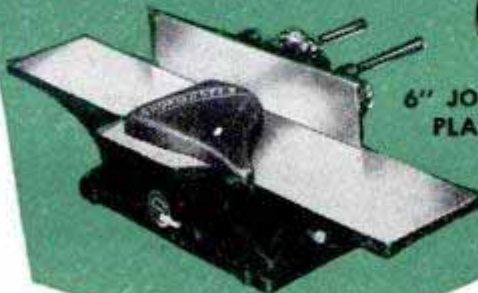

*P.S. Christmas is coming. Leave this ad where the rest of the family can take the hint.*



PERFORMANCE GOES UP IN SMOKE . . .

*"You haven't missed  
the boat, MATE*

... IT'S A CAR THAT NEEDS  
**FEDERAL-MOGUL  
ENGINE BEARINGS"**



**WORN CONNECTING ROD BEARINGS  
CAUSE OIL PUMPING**

Smoky exhaust means oil pumping. Don't miss the boat! When having your engine overhauled, make sure the connecting rod and main bearings are checked. Worn bearings let excess oil reach combustion chambers. It burns to carbon on plugs, rings, pistons, valves—steals power. Replace with Federal-Mogul Oil-Control Bearings to restore power, pep, economy!

**FEDERAL-MOGUL SERVICE**  
(DIVISION OF FEDERAL-MOGUL CORPORATION)  
COLDWATER, MICHIGAN

Replace in Sets with Genuine  
**FEDERAL-MOGUL**  
Oil-Control Bearings  
in your car



and the B-49 Flying Wing. It is one of the smallest planes built for the Air Force in recent years, being approximately 20 feet long with wingspan of 25 feet. The X-4 is designed to explore characteristics of aircraft of different designs and power plants in the high-subsonic, transsonic and supersonic ranges.

**PERSONNEL**

The 70-group *air-force-in-being* will require 502,000 men, with training as modern as the planes they fly, maintain and command. Rapid demobilization after



Transport sister ship of the B-29, the Boeing C-97 will move loads of about 40,000 pounds at 300 m.p.h.

World War II depleted our ranks of specialists and we have been faced ever since with the problem of plugging those gaps.

Approximately 50 percent of the men in the Air Force must be technically trained, and this training covers more than 100 specialties. At present 18,000 technical trainees can be handled annually. This number, however, must be increased to meet our minimum requirements. Technical training has been changed from the wartime



Fairchild C-119 Packets carry 42 troops with gear. Track-type gear permits landings on rough fields

policy, which necessitated a high degree of specialization, to that of providing the individual with a broad technical background, giving him a greater usefulness in a variety of assignments. Specialization is accomplished in on-the-job training.

(Continued to page 254)



**A HOME YOU'LL REALLY ENJOY!**  
**ROYAL** *Super Fine* Coaches



It's Royals plan and purpose to build America's most satisfying trailers. Continual search for perfection in manufacturing methods and materials gives you a coach of unusual quality and beauty. A Royal abounds with conveniences for extra home comfort and more enjoyable living. Live the modern way in a completely furnished Royal. They are surprisingly low priced. Send for free literature. Dept. PM.

**ROYAL COACH CO. INC., Hastings, Michigan**



**NONE BETTER! SUPER DRILL GRINDER**



Sharpens round shank drills from 3/32" to 1/2" in diameter, up to 6" long. Grinds old drills like new in 4 different point angles, using hand or power grinding wheels. Money-back guarantee.

Price only \$2.95

At Dealers or Postpaid

**CRANDALL MFG. CO. 1512 W. Slauson, Dept. FA-36, Los Angeles 44, Calif.**

WRITE NOW FOR FREE CATALOG NO. M



**FOSTER MFG. CO., M KINSEY AVE., BUFFALO 17, N. Y.**

**LIQUID MARBLE**

Mold, Brush, Trowel, Spray It!



material makes \$1 seller. Make Marbleized floors, Tile Walls. Colorful, glossy, amazing! Easily learned; start in garage or basement. Particulars free.

**MARBLEIZING SERVICE, Dept. 10-F, Edwardsville, Ill.**

**COMPOSITION FLOORS**

**FLEXIBLE MOLDS**

Mold Novelties, Statuary, Art Goods in Flexible Plastic Molds; 5c material makes \$1 seller. Make Marbleized floors, Tile Walls. Colorful, glossy, amazing! Easily learned; start in garage or basement. Particulars free.

**BUILD YOUR OWN TILTING ARBOR SAW!**



**SAVE \$50 OR MORE**

- 27x28 in. table stays level. Blade tilts full 45 degrees
- 10 in. blade cuts 3 3/4 in. deep, jackscrew depth adjustment
- Floor model, 34 in. table height

- New Departure ball bearing arbor, 3/4 in. precision shaft, ready to run, 5/8 in. bore blades
- Quick-positioning, self-aligning rip fence guide
- Sturdy wood, steel and aluminum construction
- No machining—Build easily with hand tools only
- Capacity and performance of floor saws selling for \$150.00 and up!

GIL-BILT Step-by-Step Plans—pictorial drawings, full size patterns, actual photographs \$ 1.00

GIL-BILT Metal Parts Kit—includes Plans, ball bearing arbor, cast aluminum miter gauge, rip fence guide, jackscrew with 4 1/2 in. handwheel, and all other metal parts. . . . . 20.95  
 Same kit with 10" combination blade. . . . . 25.95  
 Same kit with 8" combination blade. . . . . 24.95

**GILLIOM POWER TOOLS** P.O. Box 1-PN, Lambert Field St. Louis 21, Missouri

**THIS EASY WAY to SCREEN YOUR HOME**

*-costs dollars less\**



wash windows without removing screens

**DURALL**

WITH

**ALUMINUM TENSION SCREENS**  
**A FULL-LENGTH SCREEN FOR DOUBLE-HUNG WINDOWS**

YOU SAVE up to dollars per screen on the price alone with Durall!\*

YOU GET a good looking, top quality, all metal screen . . . It's aluminum—never rusts, stains or needs painting. Tension design prevents sagging.

YOU CAN install Durall easily from inside your house . . . it's light, flexible—has no side frames! Just snap a catch here, turn a thumbscrew there and it's in, taut and trim. No outside ladders to climb, no cutting, no fitting.

YOU ENJOY lifelong freedom from maintenance troubles with Durall. Wipe it off with a damp cloth or toss it in a tub for cleaning. Leave it up the year round or roll it up for compact storage—it will stay attractive!

\*The popular 28" x 54" size retails at only

**\$4.35**

SEE DURALL at your dealer's or write us for folder.

NEW YORK WIRE CLOTH CO., 445 Park Ave., New York 22, N. Y.

Please send me your DURALL folder

PM-12

Name \_\_\_\_\_

Street address \_\_\_\_\_

City \_\_\_\_\_ State \_\_\_\_\_



Pilot training was virtually suspended in 1946 and present training rates are approximately only one half that required. But by the middle of 1949, the Air Force expects to be training an input of 3000 pilots annually.

The functions of bombardier, navigator and radar observer—insofar as practicable—are being consolidated in the modern aircrew, so that one man can perform all three. At present, navigators and bombardiers are being cross-trained in the other specialties. The training rate is being increased to meet the requirement of 70 groups.

Operational training is a constant process. Units of the Strategic Air Command are rotated for training in the overseas theaters to acquaint them with varying problems. The Tactical Air Command participates in joint maneuvers with the Army and Navy to develop tactics and techniques of cooperative action. The Air Defense Command conducts training exercises in the air defense of the continental United States and coordinates the training of civilian air components.

The education of officers has an important place in the Air Force program. Selected air officers attend schools and colleges of the Air University, such as the Air War College, the Air Command and

Staff School, the Air Tactical School, the Air Special Staff School, and the Aviation School of Medicine. There is an educational program under which officers are sent to civilian universities and technical schools for graduate and undergraduate training. Specific courses of instruction are selected and the student is monitored throughout his schooling.

The Air Force is organized as a team with the Air Defense Command, the Strategic Air Command, the Tactical Air Command and the Military Air Transport Service, performing special missions, but coordinated so that the over-all mission may be accomplished in the shortest possible time and with the greatest economy of manpower, natural resources and wealth.

The continental commands, the Air Training Command, the Air Materiel Command, the Air Proving Ground, and the Air University are organized to furnish the combat commands with the trained personnel and the best planes and equipment required by them to discharge their missions.

The planes we build, the airmen we train and educate, and the organization we develop are designed to assure security of the United States and to discharge our responsibilities to world peace.

*"Company's more fun . . .  
since Paw glued his chair to the door with Weldwood Glue"*

When you want a wood-to-wood bond that will really hold . . . remember Weldwood Glue. It's quick to mix . . . easy to use . . . tremendously strong . . . stain-free . . . rot-proof . . . and permanent. At hardware stores, lumber yards, chain stores, in 15¢, 35¢, 65¢, 95¢ and larger sizes.



**WELDWOOD**  
PLASTIC RESIN GLUE

United States Plywood Corporation, New York 18, N. Y.



**DELTA  
MILWAUKEE**

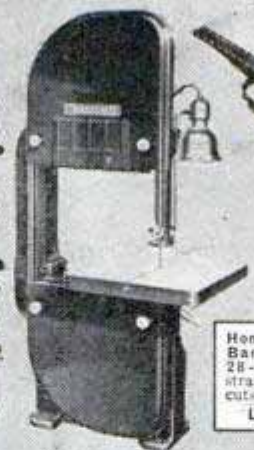

Homecraft 4-in. Jointer, No. 37-110 — for forming straight, true edges without the drudgery of hand planing...\$32.95

Homecraft 10-in. Band Saw, No. 28-110 — for straight or curved cuts...\$39.95  
Lamp extra.

Homecraft 11-in. Drill Press, No. 11-120 — 7 tools in 1. For drilling, shaping, routing, carving, sanding, grinding, mortising...\$43.95  
Motor Extra.

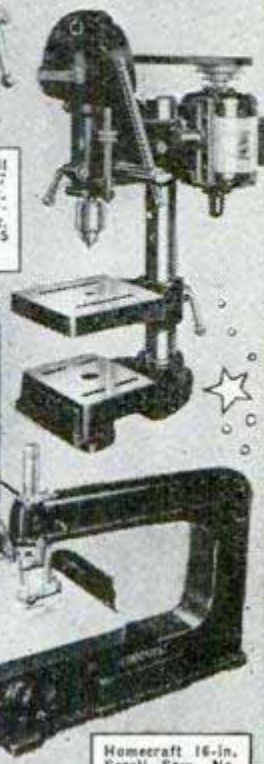

Homecraft 16-in. Scroll Saw, No. 40-110 — for all curved sawing, in making toys, shelves, etc. Also for filing and sanding...\$41.95  
Motor, belt, and lamp attachment extra.

**THE Gift of Happiness:**  
**HOMECRAFT® POWER TOOLS**  
(Made by Delta)

It's sure to thrill him (or her) — your gift of one or more Homecraft Power Tools. It's a gift that provides years of fun and healthful relaxation.

These popular tools are easy to use. And the range of jobs you can do on them is truly amazing—especially when you add the many attachments that only Delta offers in complete variety.

Homecraft Power Tools are designed and built specifically for off-and-on use in the home shop — which explains their low cost. Yet they're "a lot of tool for the money" — as thousands of Homecraft users can testify.

Look over the selection of Homecraft Power Tools at your dealer's store — and ask about the time-payment plan. ...This Christmas, put happiness in his (or her) hands.

**Hinting Season Is Here**  
If you happen to read this ad first, leave it around where the right people will see it.

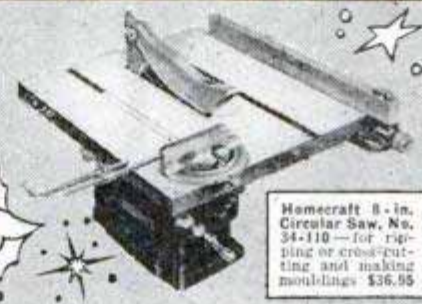

Homecraft 8-in. Circular Saw, No. 34-110 — for ripping or cross-cutting and making mouldings \$36.95

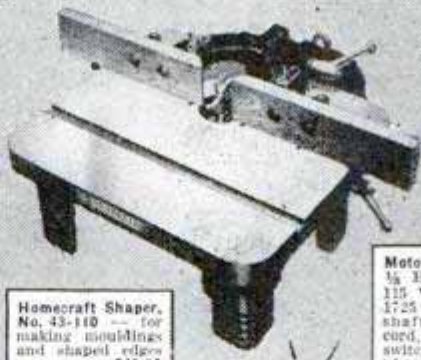

Homecraft Shaper, No. 43-110 — for making mouldings and shaped edges...\$49.95



Homecraft Buffing Head and Grinder — for sharpening tools and knives, polishing household metals. Complete with attachments as shown...\$9.80



Motor No. 60-030 — 1/2 H.P. Single Phase, 115 V., 60 cycle, A.C., 1725 r.p.m., 1/2" single shaft, complete with cord, plug, and toggle switch. This is a split phase sleeve-bearing motor for light use \$16.45



Homecraft 10-in. Lathe, No. 46-110 — for spindle and faceplate turning to make lamps, toys, etc...\$36.95

**DELTA MANUFACTURING DIVISION**  
ROCKWELL MANUFACTURING COMPANY  
MILWAUKEE 1 WISCONSIN  
General Sales Office • 4 NORTH MICHIGAN AVENUE CHICAGO 3, ILLINOIS

**HOMECRAFT®  
POWER TOOLS**

All tool prices shown are without motors and lamp attachments. Prices subject to change without notice.



Send 10¢ . . .  
— for woodworking handbook and catalog of Homecraft Power Tools.

\*Trade Mark Reg. U. S. Pat. Off.

**Made by Delta**  
Homecraft Power Tools are made by the world's leading manufacturer of light power tools, the same company that makes the famous Delta® Power Tools. Delta tools are famous for quality, dependability, and safety. They are widely used in industrial plants, schools, and in home shops of people who want the best in heavy-duty quality.

**TEAR OUT COUPON AND MAIL TODAY!**

**DELTA MANUFACTURING DIVISION**  
681N E. Vienna Ave., Milwaukee 1, Wis.  
Enclosed is 10¢. Send me copy of new Homecraft Catalog HC-1.

Name.....  
Address.....  
City..... State.....



# ALADDIN ANNOUNCES . . .

A sensational new line of

## LOW-COST WOODWORKING TOOLS

for home and industry!

Now, at amazingly low cost, you can get heavy duty wood-working tools that outperform much more expensive tools! Look over the models below—compare the quality, the price, and the sound, safe design. Then order the model best suited to your needs and watch for further announcements of new wood-working tools by Aladdin.

Exclusive! On many Aladdin drill press tools, there's an exclusive new feature—a pilot bearing that eliminates dangerous side thrust, chatter and vibration. Pilot bearing feature assures same smooth cutting action you'd only expect to find in shapers selling for several hundred dollars.

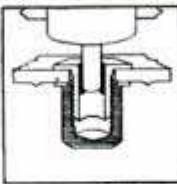

### ALADDIN Wood Shapers for your Drill Press



U. S. Pat. Pend.

MODEL #60—Originally designed for heavy industrial use, now priced for home workshop. Can be attached directly in chuck of your drill press. Exclusive pilot bearing eliminates side thrust, chatter and vibration—assures smooth cutting action. Blades can't come out—set screws hold them securely. Complete, with your choice of any 6 pair double-ground blades shown below, only \$12.95.



U. S. Pat. Pend.

MODEL #50—Same as Model #60, but without exclusive pilot bearing. Designed for intermittent shaping. Cuts rabbets and joints, planes wood with blade P-810. Adjustable hole-cutter with blade H-911, adjustable wheel-cutter with blade W-910—together, cuts holes and wheels at same time. Over 100 different shapes can be cut. Complete, with any 6 blades of your choice shown below, only \$8.95.

### ALADDIN Wood Shaper for your Circle Saw

MODEL SA-10—Heavy-duty, industrial-type shaper of solid steel, now priced in home workshop range. Absolutely safe—blades locked in position with set screws all the way through. When ordering, state diameter of shaft. Complete with arbor and any 6 pair of ready-ground blades shown below, only \$14.95.



U. S. Pat. Pend.

### ALADDIN Wood-Shaping Blades

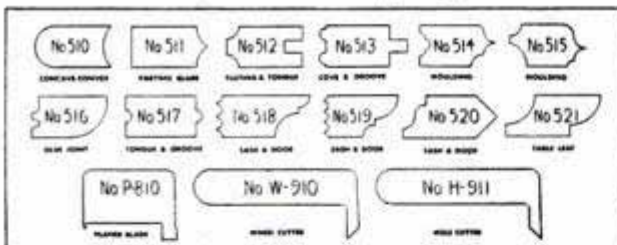

Specify by number the six blades you want when ordering ALADDIN Wood Shapers. Additional blades—\$1.50 ea.

### NEW! Model SDS-8 Three-In-One Drum Sander



U. S. Pat. Pend. sleeves, medium, fine or coarse, 1 x 3, 20c ea.; 2 x 3, 25c ea.; 3 x 3, 30c ea.

Here's a one-inch, two-inch, and three-inch drum sander *all in one!* Now you no longer need to hunt for the right diameter—just slip the telescoping diameters on or off till you have the diameter you want. Diameters can be changed in a matter of seconds. Comes with pilot bearing that eliminates side thrust, chatter and vibration. Complete with a sandpaper sleeve for each diameter, only \$6.95. Extra sanding

#### HERE'S HOW TO ORDER

Be sure to specify Model No. of Aladdin tool you want. When ordering wood-shapers also specify 6 blades by number. When ordering blades only, specify whether to be used with drill press or circle saw. When ordering shaper for circle saw, specify diameter of shaft.

All Aladdin tools are *guaranteed*. Postage prepaid with all cash orders. C.O.D. plus postage. GET YOUR ORDER IN TODAY.

### ALADDIN MFG. CO., INC.

3121 Main St. Kansas City, Mo.

Dealers Write Today

## Warning: Earthquake Ahead

(Continued from page 127)

full-size buildings to artificial earthquakes to learn their vibration periods. To create the needed vibration they use a machine, consisting of two heavy metal disks, deliberately out of balance, that are rotated in unison by an electric motor. The push-pull effect of the whirling disks vibrates the structure to which the machine is attached. The vibrations are recorded by seismographs placed at carefully selected locations in other parts of the building.

Disks that weigh 10 pounds, spun by a 1/3-horsepower motor, will vibrate a 10-story office building when the machine is clamped to a low point on the building. A big 200-pound model, operated by the Coast and Geodetic Survey, has been used to vibrate and test several of the West's large dams, including Hoover Dam. The motion of a big dam when vibrated by the machine is sometimes strong enough to ripple the surface of the water in the reservoir behind the dam.

All large buildings should have two-fold mass-rigidity symmetry to avoid the destructive twisting effects that may occur to odd-shaped buildings. A structure of rectangular shape will experience minimum damage while an L-shaped or U-shaped building tends to twist when subjected to vibration, increasing the damage. Unsymmetrical buildings should be especially strong or be built as several units, each symmetrical in itself.

Earthquake engineers try to minimize the damage a quake will cause but they don't try to avoid it entirely. Minor cracks and scaling are considered unavoidable. What the engineers try to prevent is the collapse of structures and walls, even the falling of a single brick. They design stairways with extra strength and insist on vertical steel reinforcements in chimneys to prevent their falling over.

The ability of a structure to withstand a shock depends on the quality of the workmanship. Tests of damaged and undamaged buildings after the Long Beach earthquake showed that good workmanship could make one building 16 times stronger than another. This was found true in the recent Japanese earthquake.

Fire is always an immediate threat after a destructive quake. One precaution being taken is the requirement that all new chimneys be lined with fire-clay materials. Schools and public buildings should have earthquake valves that immediately shut off the flow of gas from the mains when a

(Continued to page 258)



# Snap-on

# Bench Grinders

With the famous **Blue-Point** Trade Mark

... have the construction features that guarantee smoother, more powerful operation



**GRINDING WHEELS**  
of natural aluminous oxide abrasive . . . fully vitrified. From 60 grit for fine grinding to 24 grit for heavy work.



**WIRE WHEEL BRUSHES**  
High quality wire and metal, bound to prevent chips flying loose. Crimped bristles cannot bend or break.



**WHEEL DRESSER**  
Quickly trues, cleans grinding wheels. Protective hood over cutters. Includes extra set of easily inserted cutter wheels.



**EYE SHIELDS**  
Thick safety glass for clear vision, protection. Sturdy aluminum frame. Easily attached to grinder.

**COMPLETELY ENCLOSED MOTOR:** Super powered, precision balanced motors enclosed to prevent dirt, grit, etc. from entering.

**BALL BEARING CONSTRUCTION:** Oversize grease sealed ball bearings used throughout, assure smooth, motor operation.

**LARGE RUGGED BASE:** Rubber feet provides solid mounting free from vibration. Recessed bolt openings for permanent mounting.

**INDUCTION RUN MOTOR:** Develops less heat in the windings — more desirable for continuous operation.

**LARGE WHEEL GUARDS:** Allow use of special shape grinding wheels or wire brushes. Guards fitted with chip breakers.

**BELL TYPE CONSTRUCTION:** Provides full clearance so that long straight pieces may be ground across the face of the machine.

**STURDY TOOL RESTS:** Adjustable for any type of work with ample take-up for wheel wear.

**CAPACITOR START MOTOR:** Uses low starting current . . . actually less than 15 amps. is consumed.

**VOLTAGE:** Standard models of the 1/3 H.P. and 1/2 H.P. grinder require 110 Volts, 50/60 cycle AC current. Standard 1 H.P. grinder takes 220 Volts, 50 or 60 cycle AC current.

## SNAP-ON TOOLS CORPORATION

8062-L 28th AVENUE • KENOSHA, WISCONSIN

International Division: Kenosha, Wis., U. S. A.



### SNAP-ON TOOLS CORPORATION

8062-L 28th Ave., Kenosha, Wisconsin

Please send catalog containing Bench Grinder details.

Name.....

Position.....

Company.....

Address.....

City..... (.....) State.....



# Sure as Shootin'!



**MERCURY**  
**OUTBOARD MOTORS**  
 are built the way you  
 Engineers and Mechanics  
 know they should be!



Ball and Roller Bearings Throughout.

Proved  
**FULL JEWELLED**  
**POWER\***

You can stop hunting for that "dream" outboard now . . . Kiekhaefer Engineers have applied the sound, modern proved principles of ball and roller bearings, into a portable power plant that gives you the advantages of anti-friction performance, in a light, easy to handle, highly maneuverable outboard motor of matchless versatility. The Full-Jeweled construction\* throughout the modern Mercury gives moving parts a ride on ball and roller bearings so Mercury's parts stay younger, perform smoother. Let your dealer show you the Mercury. You'll find the type of engineering you've always wanted in an Outboard Motor . . . with those who know mechanics . . . Mercury's Miles Ahead.

Write for Brochure Kiekhaefer Corporation, Cedarburg, Wis. U.S.A.

NAME \_\_\_\_\_  
 ADDRESS \_\_\_\_\_  
 CITY \_\_\_\_\_ STATE \_\_\_\_\_



quake occurs. One type of valve consists of a heavy metal ball balanced on top of a needlelike pedestal. Dislodged by the shock, it falls from the pedestal and into a seat where it seals off the flow of gas.

It is estimated that 90 percent of the seismic activity in the United States occurs in the California-Nevada region. Southern California alone, including Owens Valley, has about one half of one percent of the seismic activity of the entire globe. Hundreds of shocks strong enough to be felt, all local in nature, occur every year.

Earthquakes are measured by a scale in which the numeral 2 corresponds to the smallest shocks ordinarily reported, the numeral 6 corresponds to moderately destructive earthquakes and the numeral 12 corresponds to the largest recorded earthquakes. On this basis, eight quakes of a magnitude of around 7 to 8, roughly equal in intensity to the Long Beach quake, have occurred in southern California in the last 15 years. Fortunately these took place in the mountains, desert or offshore and little damage was done. In the last hundred years four great quakes of a magnitude of 9 or greater have taken place in California and Nevada.

One phase on which more information is desired is the actual motions that occur near the epicenter of a quake and especially the motions that occur in buildings near the epicenter. Ordinary seismographs can't give a true picture of these motions.

To find out more about what happens at the epicenter, the Coast and Geodetic Survey has installed a number of "strong motion" accelerographs at locations along the West Coast where earthquakes may be expected. Insensitive to minor shocks, the accelerographs make a record of the east-west, north-south and up-down motions that occur when a strong quake sets them in operation. Displacement meters also have been installed at various places to aid in this important research.

Recently the Coast and Geodetic Survey asked a number of engineers, university research people and other earthquake experts to serve as a committee that would make recommendations concerning future earthquake studies. The committee is creating an Earthquake Engineering Research Institute that will coordinate and centralize much of the research on the effects of earthquakes on structures. To be located in California, the institute's findings will help designers and engineers to design buildings that are even more resistant to earthquakes than the best of today.



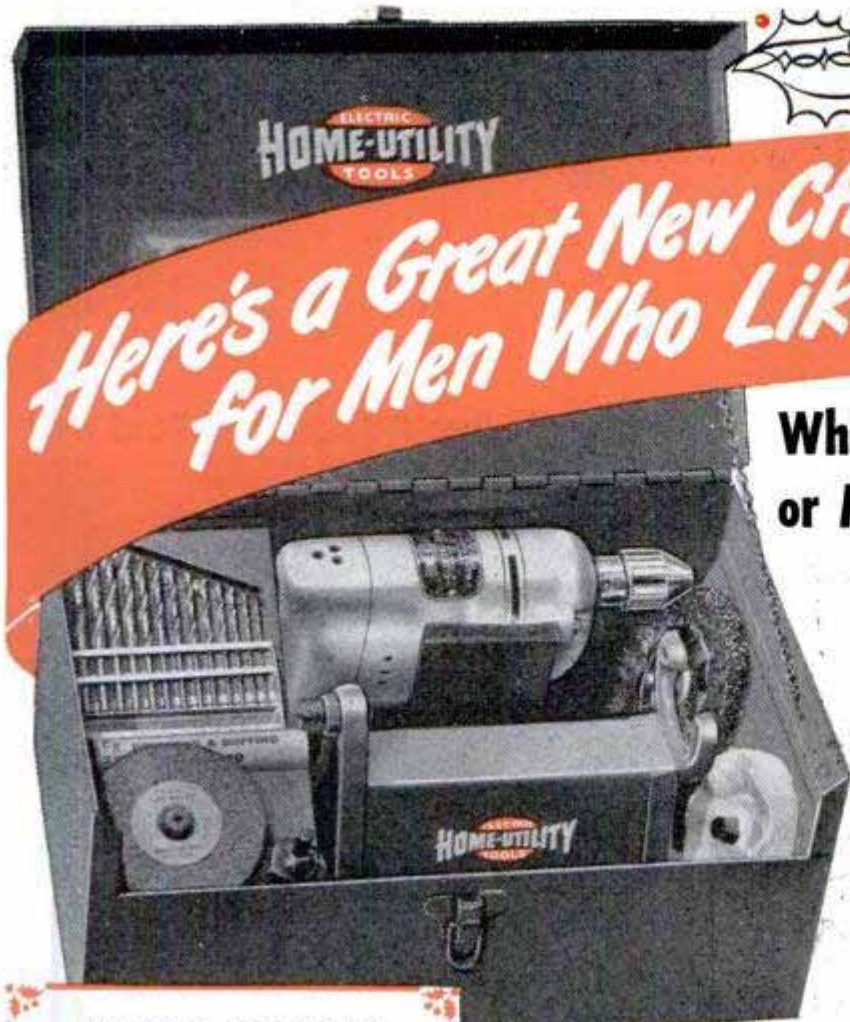

**Here's a Great New CHRISTMAS GIFT  
for Men Who Like TOOLS!**

**Whether You're on the Giving  
or Receiving End . . .**

Looking for the ideal gift for someone who likes to build or repair things around the house? Passing out hints for your own present? In either case, this versatile Home-Utility Electric Drill Kit is a *natural!* It's the handiest collection of tools you've ever seen for drilling holes, sharpening cutlery and tools, removing rust and old paint, buffing and polishing and a 100-and-1 other jobs. It features a husky, well-built Home-Utility 1/4" Drill . . . plus a handy Horizontal Stand, twist drills, grinding and buffing wheels, an arbor and buffing compound . . . all in a sturdy steel kit. A real value at \$39.95! Built by BLACK & DECKER, world's largest maker of quality electric tools, with 27 Factory Branches to give speedy, nationwide repair service! At your hardware, electrical or implement dealer. Products of The Black & Decker Mfg. Co., Dept. H12M, Towson 4, Maryland.

*P. S.—A swell idea, too, if you're giving yourself a Christmas present!*

**HOME-UTILITY  
Electric Tool KIT  
ONLY \$39.95  
FOR ALL THIS!**

1/4" Home-Utility  
Electric Drill

Horizontal Stand

13 High-Speed  
Twist Drills (1/16" to 1/4")

3" Grinding Wheel,  
3" Buffing Wheel; 4" Wire  
Wheel Brush with Arbor

Buffing Compound

DRILLS—GRINDS—SHARPENS  
WIRE BRUSHES—BUFFS—POLISHES

**Here's what  
HOME-UTILITY  
Owners Say . . .**



"It's amazing how my Home-Utility 1/4" Drill speeds up so many jobs. Drilling, sanding, grinding . . . it does them all!"



"Dad says good tools really make a workshop. I know he's right every time I use my Home-Utility Drill."



"My Home-Utility Drill is mighty handy when one of my farm machines comes down with a broken bolt."

**SEE YOUR HARDWARE, ELECTRICAL OR IMPLEMENT DEALER**

**ELECTRIC  
HOME-UTILITY  
TOOLS**

**FOR HOMES • HOBBY SHOPS • FARMS • TOOL KITS**

**These Other HOME-UTILITY Tools Make Ideal Christmas Gifts, Too!**

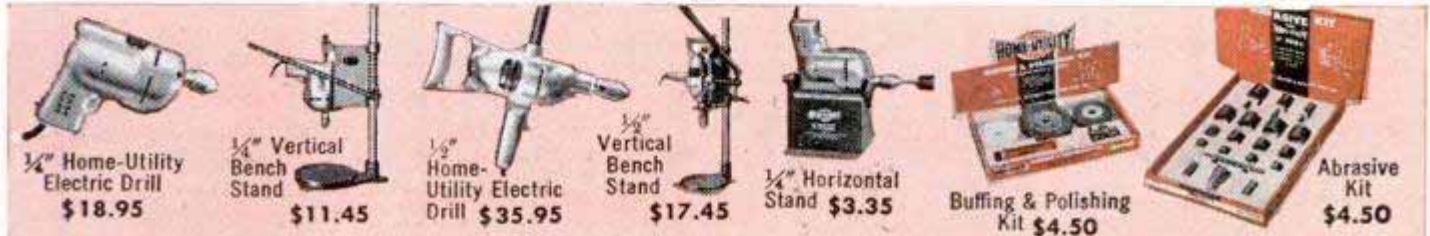



**INSTANTLY CONVERTS  
LINEAR FEET  
TO BOARD FEET**



**Solves many other  
woodworking problems  
in seconds**  
only **10¢**

Easy to use. Fast . . . simply set dial of GREENLEE Handy Calculator to get measurements; slope per foot in degrees; comparative hardness, weights and workability of various woods; bit sizes; nail specifications; tool sharpening hints. 6" diameter heavy varnished cardboard. Special offer by maker of famous GREENLEE tools. Send 10¢ to Greenlee Tool Co., 2112 Columbia Avenue, Rockford, Illinois.



## Yellow Powder Gives Off Oxygen To Sustain Human Life

Man now can carry his atmosphere with him in the form of a yellow powder that gives off life-sustaining oxygen. The powder, a potassium oxide, was developed by chemists at the Naval Research Laboratory. It may be used for fire fighting, high-altitude flying, in submarines and to supply oxygen in a mask.

## Electric De-Icer Attached to Roof Melts Snow Along the Edge



Electric heating cable can prevent damage to homes from snow and ice on the roof. Often the snow forms "dams" which prevent water from running off the roof when the snow begins to melt. The water then may back up under shingles and eaves causing damage to walls and ceilings by seepage. According to General Electric engineers, the cable melts the snow along the edges, permitting the water to run off. Easy to install, the cable is placed along the eaves in a saw-tooth pattern. It can be plugged into an ordinary home outlet; a 60-foot length uses about a penny's worth of electricity per hour. The current need be turned on only during a snowstorm or immediately afterward. The same cable also can be used to heat soil in greenhouses, warm poultry houses and clear driveways of ice and snow.



# LAFAYETTE CONCORD KIT-QUARTERS FOR 500,000 BEGINNERS HAMS and PROFESSIONALS AMERICA'S GREATEST RADIO VALUES

You still have time to order Xmas gifts from Lafayette, if you don't delay. Rush the handy order coupon to the mail order center nearest you (Chicago—New York—Atlanta). We'll give you same-day service! Or shop in person at any one of our outlets, listed below. You'll save plenty either way.



**THIS IS IT!**  
FM-AM CHASSIS & SPEAKER  
Save at least \$25!

PROFESSIONAL  
TYPE HIGH  
FIDELITY

The set you've been reading so much about! Fine 12 tube plus rectifier high fidelity chassis of advanced design, for your custom installation. Covers the 88-108 MC FM band, as well as the 550-1600 KC AM standard broadcast band. Large 12" Alnico V PM speaker for outstanding tone quality. Tone control, automatic volume control. Phono selection switch and phono input. Modernize your present radio, or build a new custom job you'll be proud of with this remarkable value. Chassis dimensions: 11" deep x 13 1/2" wide x 7" high. Operate on 105-125 volts, 60 cycles AC. Complete with tubes, 12" speaker and antenna. No. 1N1300P. Shipping weight 23 lbs. .... \$7750

## NEW! DRAFTING MACHINE AN EXCEPTIONAL BUY!

Eliminates use of T-square, protractor, and triangles. Makes sharp, accurate drawings up to 16" x 22". Combination 90° angle, calibrated scale moves at any angle to any point on the masonite board. Includes 17 1/2" x 23 1/2" x 3/4" board, steel arms, fittings, rubber feet. No. 1N15092P. Ship wt. 8 lbs. ... \$663



FOR MECHANICS, DRAFTSMEN,  
DESIGNERS, INVENTORS, ETC.



## A DIFFERENT GIFT! BEDLAMP RADIO

Here's a Christmas gift that shows imagination and good sense too! It's a beautifully-designed Bed Lamp & Radio combination. Enables her to read under light that's kind to her eyes—while she listens to her favorite band. Superhet circuit. Built-in "air-magnet" Complete broadcast band coverage. AC or DC. Lamp has frosted lens for glareless light. Lamp and radio operate separately or together, as desired. Streamlined walnut bakelite. Brackets fit any type of bed. It's a \$29.95 value! No. 1-533P. Ship. wt. 9 lbs. ... \$2195



# LAFAYETTE-CONCORD

world's largest radio supply organization

100 SIXTH AVE., NEW YORK 13

901 W. JACKSON BLVD., CHICAGO 7 • 24 CENTRAL AVE., NEWARK 2  
229 W. MADISON ST., CHICAGO 6 • 265 PEACHTREE ST., ATLANTA 3  
110 FEDERAL ST., BOSTON 10 • 542 E. FORDHAM RD., BRONX 58

## AMAZING, MULTI-PURPOSE SHAFT TOOL IT'S FLEXIBLE! TRY ONE!

For engraving, buffing, grinding, polishing. Precision balanced 1/20 HP motor, 15,000 rpm at handpiece—with power to spare when using any of the 10 standard tools included. Pencil-size handpiece permits professional workmanship. Takes any standard 3/32" or 1/8" shank tool. 3' flexible shaft, plastic-covered or oil-free operation. Complete with accessory tools, 2 wrenches, shaft, motor, motor bracket. No. 18N15645P — in blonde wood cabinet—wt. 7 lbs. .... \$1595



## WONDER GUN



FOR  
BETTER HIGH  
SPEED SOLDERING

No waiting for iron to heat—merely pull the trigger. Heats and cools in 5 seconds. New pistol-type grip is easy to hold, easy to handle, even in tight corners. Built-in spotlight prevents "dark-spot" errors. Tips stay tinned, solder easily, bend by hand. 100 watts on 115 V., 60 c. AC. A new low price. No. 18N15183P—3 lbs. Only ..... \$1269  
No. 18N15181P—Extra Long Life Tips—2 oz.—6 for 50c

## ELECTRIC SAW



MOTOR-DRIVEN VALUE  
Lightning fast—safe as a hand saw. Electrically operated—just guide it! 7200 strokes per min. Saws the most intricate patterns, cuts at any angle—side-ways, back and forth. Automatic switch in handle instantly stops, starts motor. 50/60 c., AC. With cord, plug. No. 18N15352P—with 3 blades—2 lbs. .... \$585  
No. 18N15353P—Extra blades—12 for 60c

## BUILD YOUR OWN FILING CABINET



### STEEL DRAWERS

each  
40c

Convenient, economical storage for fittings, small parts—no more confusion, wasted time. Each drawer interlocks with others at top, bottom or side. May be fitted to existing fixtures to save space. Each drawer has handy pull and holder for contents card. Steel two-tone green. 2 1/2" x 2 1/4" x 5". No. 18N22381P—10 oz. 10 for ..... \$360

## 8" PM SPEAKER BARGAIN

High quality PM speaker at a money saving low price. Excellent replacement unit for hi fidelity radios and Public Address systems. 21 ounce magnet is capable of handling 10-12 watts output. Voice coil impedance 8 ohms. No. 99N7018P—Shgg. wt. 4 lbs. .... \$395  
10" PM SPEAKER, NO. 99N7019R ..... \$3.46



## IT'S FREE! BIG 180-PAGE CATALOG Cuts your costs on radio, television, electronics, and tools

"Why didn't I look in the Lafayette-Concord catalog first?" That's what you'll say when you get your copy of this famous Money Saver! It's the new 1949 edition, just out. 180 pages crammed with tens of thousands of real bargains. Latest developments in TV, Hi-Fi, Ham, AM & FM Radios, P.A., Test Equipment, Parts, Kits, Tools, etc. All the well-known brands, including our own Lafayette-Concord make. Rock bottom prices, made possible by the purchasing power of the largest radio-electronics supply organization in the world! The sooner you send for this catalog, the more you save.



### RUSH THIS COUPON TODAY

LAFAYETTE-CONCORD Dept. LL-8  
901 W. Jackson Blvd., Chicago 7  
100 Sixth Avenue, New York 13  
265 Peachtree St., Atlanta 3

- Please send me Free Catalog No. 89
- Please fill the following order:  No. 18N22381P ..... 40c each  
 No. 1N1300P ..... \$77.50  No. 18N15181P ..... 6 for 50c  
 No. 18N15092P ..... 6.63  No. 18N15352P ..... \$5.85  
 No. 1533P ..... 21.95  No. 18N15353P ..... 12 for 60c  
 No. 18N15645P ..... 15.95  No. 18N22381P ..... 10 for \$3.60  
 No. 18N15183P ..... 12.69  No. 99N7018P ..... \$3.95  
 No. 99N7019R ..... \$3.46

for which I enclose \$\_\_\_\_\_ in postal note, money order, or check. I will remit few cents postage when order is received.

NAME \_\_\_\_\_  
ADDRESS \_\_\_\_\_  
CITY \_\_\_\_\_ ZONE \_\_\_\_\_ STATE \_\_\_\_\_

USE COUPON FOR  
ORDERING AND FOR  
FREE CATALOG



## Fish With Acute Sense of Smell May Prevent "Chlorine Taste"

Keen-nosed minnows, trained for the job, may be the best means of keeping the objectionable "chlorine taste" out of urban drinking water. It results when phenols, dumped into natural waters as waste products by many industries, combine with chlorine. Purification plants aren't able to detect small amounts of phenols in water until it is too late—when users complain. Two sets of bluntnose minnows have been trained at the University of Wisconsin in an effort to find a solution. They detect phenol long before it reaches concentrations humans can taste. One group has been conditioned to rush to a food trough whenever they smell phenols in the water. The others have been trained to fear an electric shock if they venture near the trough when the phenol smell is prevalent. If water samples put into an aquarium containing the trained fish have phenols, the behavior of the minnows instantly indicates its presence.

## Mildew Preventive Saves Linens

Linens last 60 percent longer when a new process for locking a mildew-preventing chemical into the fabric is used in

laundering. Several hundred pounds of laundry can be treated for a few cents. A modification of an old method for fireproofing textiles, the process consists of adding eight ounces of a 30-percent solution of sodium pentachlorophenate to about 40 gallons of water, in which the clothes to be treated are rinsed for five minutes. This "souring" rinse converts a chemical in the fibers into a fixed mildew inhibitor. It lasts until the fabric is re-washed, when sudsing redissolves the chemical.

## Mosquitoes "Fly" Glued to Wire

In an experiment to study wing motions during flight, live mosquitoes recently were glued to the ends of slender brass wires without harming the insects. Prof. Marshall Laird of Victoria University College, New Zealand, developed the technique in order to make the insects fly "in place" before the lens of an ultra-high-speed camera. Wing motions then were studied by projecting the film. The mosquitoes first were lightly anesthetized, then attached to the wires with a touch of quick-setting glue on the backs of their chest regions. When the photos had been taken, the insects were released by sharp taps on the wire.

# SCREW DRIVER TIPS

Choose a screw driver just as carefully as you pick a plane, chisel or other fine tool. And don't try to make one screw driver do for all jobs. The best costs so little, it's a real economy to have a full range of sizes and styles . . . long ones for more powerful driving, short ones for close-quarter work and the correct tip width to fit all sizes of screws. Blades tempered entire length. Stanley makes them all the Stanley way.

Coupon brings you two books . . . one FREE, the other the popular workshop textbook, clothbound, illustrated, just \$1.



NO. 2702 . . . . .  
for Nos. 5 to 9  
Phillips Screws.  
Blade secured  
by swaged ears.

NO. 25 . . . . .  
3" up to 12"  
blades. Bolster  
construction  
locks blade in  
wood handle.

THE TOOL BOX OF THE WORLD

# STANLEY

Reg. U.S. Pat. Off.

HARDWARE · HAND TOOLS · ELECTRIC TOOLS

Stanley Tools,  
1128 Elm St.,  
New Britain, Conn.

Please send me by return mail:  FREE booklet, "The Joy of Accomplishment".  
 188-page book, "How to Work with Tools and Wood". \$1.00 enclosed.  
(In Canada: send order to Stanley Tool Co. of Canada, Ltd., Roxton Pond, Quebec)

NAME \_\_\_\_\_

ADDRESS \_\_\_\_\_

CITY \_\_\_\_\_

STATE \_\_\_\_\_



NO. 1009 . . . . .  
handy for tight  
places. Blade 1 1/2"  
long. Unbreakable  
composition handle.



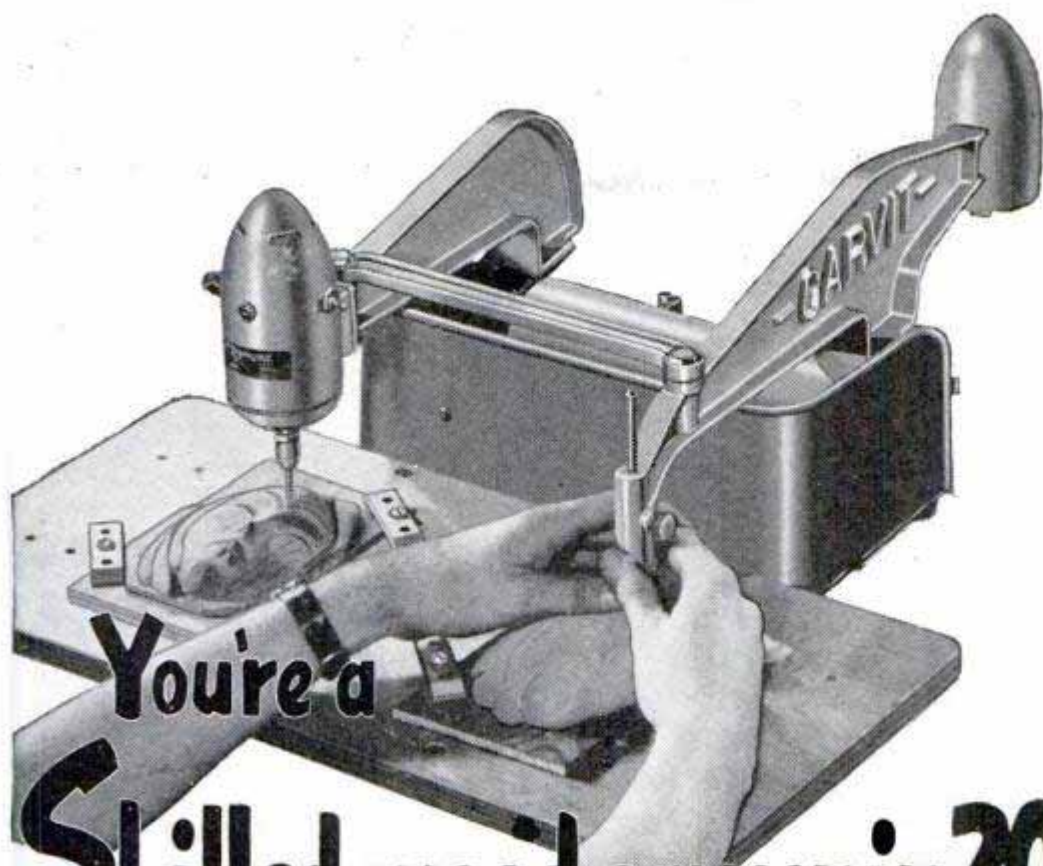

# You're a Skilled wood carver in 20 minutes

## ... with a Dumore Carvit

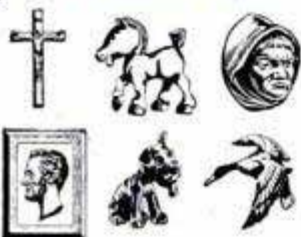

Woodcarving is great fun with the Carvit, a delightful hobby complete in one tool! It's simple, too. Even a child can make fine carvings with a Carvit. And experienced craftsmen say it's just the thing to give their wood-working projects a professional touch with carved ornamentation. With a Carvit, you make beautiful copies

of low-cost objects. You can find dozens of models in any dime store or gift shop. Reproduce them in mahogany, walnut, and other fine woods on your Carvit. Your carvings are many times more beautiful and valuable than the originals. And it's so easy! Your friends are amazed at the perfection of your first carving. Try it and see!

**New!**

Attachment makes your Carvit a Flexible-Shaft Machine.

### No skill or training needed

Hundreds of Carvit owners find hours of happiness and profit in wood carving. They carve useful ornaments for the home, distinctive gifts, fine carvings that sell.

You can do the same. Here's how the Carvit works: You clamp a model below the tracer pin, and a block of wood below the cutter. Then you trace the model. The

Carvit makes an exact duplicate for you. With an index attachment, you can carve statuettes and busts the same way. Simple, isn't it?

The Carvit is an ideal gift for every hobby fan — and for anyone with an artistic flair. See the Carvit at your local hardware store today — or mail the coupon below.



### Flexible-Shaft Chucks Right into Carvit Motor

— converting it to a tool of 1001 uses for work in wood, metal and plastic: sanding, filing, grinding, cleaning, polishing, routing, etc. \$6.25.

*Tear out this coupon and mail it today!*

The Dumore Company, Dept. 51M, Racine, Wis.

- Please send complete information on the Carvit.
- Please send one Carvit. \$48.50 enclosed.
- Please send one Carvit with Index Attachment. \$58.25 enclosed.
- Please send Flexible-Shaft attachment for Carvit. \$6.25 enclosed. Shipping charges C.O.D.

H-21

Name.....

Address.....

City.....(.....) State.....

Satisfaction guaranteed or your money back in 10 days!



*Announcing*

THE  
REVOLUTIONARY  
NEW  
BOICE-CRANE



## FRICTION-MATIC WET TOOL GRINDER

**SIMPLIFIED SELF-ADJUSTING FRICTION ROLL DRIVE.** No countershaft or extra belt. **PERIPHERAL SPEED REMAINS CONSTANT AS WHEEL WEARS.** Exclusive feature. **NO WATER THROWN ON OPERATOR.**

Has "controlled-water action". **PERMITS PROPER PRESSURE CONTROL.** Operator takes a comfortable standing position and works on top of the wheel. **LARGER TOOL REST (2½" x 5").** Perfect for long, slim knives, wide tools.

**ACCURATE CONTROLS FOR GRINDING ANGLES FROM ZERO TO 30°.** First tool rest with adequate adjustment.

**8" DIAMETER and 1½" FACE SANDSTONE WHEEL.** 135 r.p.m. increasing as wheel wears to maintain peripheral speed of approximately 280 feet per minute.

**GRAY ENAMELLED STEEL CASE.** 16 gauge. Weight 14 lbs. net; 17 lbs. packed.

**Only \$16.50**

Order today from  
Power Tool Dealers Everywhere.

**BOICE-CRANE COMPANY**  
943 CENTRAL AVENUE • TOLEDO 6, OHIO

THICKNESS PLANERS • SPINDLE SHAPERS • SAW-JOINTERS • LATHES • TILTING-ARBOR SAWS • BELT SANDERS • SPINDLE SANDERS • BAND SAWS • JIG SAWS • DRILL PRESSES



### Rock Salt Embedded in Recap Tread Forms Pores for Traction on Ice

Tires can now be salted for safer winter driving by means of a new recap tread. The tread contains thousands of pieces of rock salt which, as the tread wears down, are released to form surface pores. These pores give the tire more traction on ice and hard-packed snow. Tests conducted on clear lake ice show that the salted tread stops cars up to 30 percent quicker than new tires with conventional treads.

### Automatic Wind-Data Recorder

Wind velocity and direction are recorded by a portable electric instrument which can be left unattended in isolated places a month at a time. The instrument was developed for the Army Signal Corps. It records the data on a moving roll of paper which is long enough to make an 800-hour recording. Moving arms connected to a conventional velocity-measuring instrument and to a weather vane mark sensitized paper by sending sparks through it. The instrument can register wind velocities up to 150 miles an hour and direction within 1.5 degrees.

### Television Crew for Football Outnumbers Players on Field

More men are needed to televise a football game than to play it. Station WMAL-TV of Washington, D.C., uses 27 men, five more than there are on the football field. Eighteen are required at the scene of the game and nine are needed to operate equipment at the studio.



# Now Available...

## Amazing New P&H AC Arc Welder with Dial-lectric Control



### Makes sound welds easier, faster, and at lower cost

These industrial and commercial arc-welding jobs are easier to do and cost less when you use a P&H Dial-lectric AC Arc Welder:

- All types of industrial welding
- Sub-contracting work for large manufacturers
- Air conditioning
- Home heating
- Truck body building
- Trailer building
- Automotive repairs { blocks fenders frames
- Fuel-oil tanks
- Contractors' welding
- Bridge work
- Construction equipment repairs { excavators tractors graders ditchers, etc.
- Kitchen equipment
- Cabinet work
- Fabricated housing
- Fabricated garages
- Cast iron repairs for foundries
- Maintenance work for industrial plants
- Ventilating systems
- Bicycle repairs
- Stainless steel bar equipment
- Ornamental iron work
- Fabricating equipment of your own design

Built for heavy industrial use, with welding service range from 20-275 amps. Also ideal for automotive, general repair, job welding, and machine shops; foundries; schools; etc.

#### The only welder with easy-to-use Dial-lectric Control

Anyone can quickly learn to use the new P&H Dial-lectric welder. There is only one control — the dial is clearly marked and a ¼ turn of the radio-like knob covers the entire welding range. There are no plug-ins to make, no wheels or levers to crank or adjust — welding is just plain easy with a P&H Dial-lectric machine. A clearly illustrated, easily understood welding manual is supplied with each machine so that beginners can learn to weld in an extremely short time. Old hands may pick up some new tricks, too.

#### No maintenance is needed

Dial-lectric control eliminates all moving parts. That is why P&H AC Welders require no attention or maintenance — why operating costs are lower — why so many industrial users are switching to this new welder. Also, NEMA rating assures you of long life and dependable operation.

#### You produce sounder, better-looking welds in a shorter time

The P&H remote control feature permits proper heat selection at the job. You waste no time or energy walking back and forth to the machine to make adjustments. There is no temptation to skimp — remote control lets you use the right heat. Welds are sound and better looking. Work is done faster. Additional features that make for better, faster welding are: Easy quick-start arc. High-low welding range. Elimination of arc blow.

#### Requires only 2¼ feet of floor space

You can put a Dial-lectric welder most any place — it is connectible for 220 or 440 volts. Despite its weight of 307 lbs., it is remarkably compact. The Dial-lectric is easy to move around, too — it's mounted on wheels, you handle it just like a hand truck.

#### A complete electrode service is provided by convenient P&H Shop Packs

P&H Shop Packs contain eight different packages of electrodes. Detailed instructions are printed on each individual package so that you can use the right electrode for every

job. Guesswork is eliminated. Welds are stronger, better-looking. You can weld anything made of steel, alloy or stainless steel, sheet metal, cast iron. You can put hard, protective, long-life coatings on new parts, or build up worn parts better than new. The cost of all 8 types, individually packaged and labeled for your convenience, is only \$11.75.

It pays to use P&H electrodes. No matter what make of welder you have, order a P&H shop pack today from your nearby P&H distributor.

#### Reduce welding costs in your plant or business

If you are connected with, or are interested in welding, use your influence to bring in a P&H Dial-lectric AC Welder. A comparison of its performance with that of other units quickly shows that a Dial-lectric improves the quality of the welds, speeds the work, and reduces costs.

A P&H Dial-lectric AC arc welder can be purchased for as little as \$209.75. Also get P&H Shop Pack electrodes (\$11.75). You will want to standardize on these weld rods after you have checked their speed, quality, easy manipulation, and great variety of uses. Contact your nearby P&H distributor, or send in coupon below, clipped to your business letterhead.



Manufacturers of America's Most Complete Welding Service

TEAR OUT COUPON, ATTACH TO YOUR BUSINESS LETTERHEAD, AND MAIL TODAY

HARNISCHFEGER CORPORATION  
4673 W. National Avenue, Milwaukee 14, Wisconsin

Yes, I'm interested in the new P&H AC Arc Welder with revolutionary Dial-lectric control, and money-saving P&H electrodes. I would like information on the items that I have checked below.

- P&H AC Welders  Send address of distributor
- P&H "Shop Pack" Electrodes  Send representative
- Send Free Book, "Simplified Welding"

Name.....  
Position..... Company.....  
Address.....  Home  Business  
City..... State.....



What a Christmas Gift!

NOW...SANDING IS FUN!



## Amazing MOTO-SANDER AND POLISHER

Saves Time - Saves Elbow Grease!

Here's an inexpensive Sander and Polisher so easy to handle that a child can use it. All you do is guide it! **Moto-Sander** delivers 7,200 strokes a minute... does a magically smooth job... gets into places other sanders can't reach. Has only two moving parts... never needs oiling or adjustment. Uses 110-120 volt, 60 cycle A.C. electric current. Has 8 ft. (Underwriters' Approved) rubber cord. Furnished with 8 sheets assorted grade Garnet paper for sanding, plus 1/8" thick felt pad and sheepskin pad for wax polishing.

Only  
**\$14.85**  
POSTPAID

### FINE FINISHES - FAST!

Use **Moto-Sander** to get satin smooth sanded finish on woodwork, stairways, doors, furniture; ideal for finish sanding of boats, painted walls, bird houses or scale models. Use it also for speedy, effortless polishing of waxed furniture, automobiles and other surfaces, simply by removing sandpaper and clamping on polishing pad. **Moto-Sander** is the highest, most practical electric sander on the market, and is patented.

### MONEY-BACK GUARANTEE

See **Dremel Moto-Sander** at your dealer's. If he cannot supply you, use coupon below to order on 5-day trial, money-back guarantee. **Moto-Sander** will be sent complete and postpaid for \$14.85 (check or money order in full). Or, send only \$2 with order and pay postman balance plus postage upon C.O.D. delivery. Remember, **YOUR MONEY BACK** if not delighted after 5 days' trial.

### DREMEL MFG. CO.

DEPT. SP-118-M • RACINE, WIS.  
MANUFACTURERS OF THE FAMOUS  
MOTO-TOOL AND MOTO-SAW



EASY FOR  
AWKWARD PLACES



SANDS FLAT  
SURFACES EVENLY



GETS INTO  
TIGHT CORNERS



ROUNDS CORNERS  
LIKE MAGIC



GREAT FOR  
AUTO POLISHING



## Hill-Climbing Spikes on Skis Close Flush With Underside

Skiing uphill is no problem when your skis are equipped with wide spikes that hinge to the underside of each ski directly under the footplate. For ski-running on down slopes, the spike closes flush so it doesn't interfere with forward motion. When open, the spike digs into the snow to prevent backsliding on uphill climbs.

## Rubber Powder Mixed in Asphalt Improves Wear and Is Less Slippery

Mixing rubber powder with asphalt makes road surface longer-lived, more wear-resistant and improves its anti-skid qualities, according to the British Rubber Development Board. Experimental stretches of road in the Netherlands, after 10 years of use including heavy wartime traffic, are in first-class condition compared with stretches of rubberless asphalt. The rubber makes the asphalt more elastic and reduces its tendency to flow.

## Recipe for Synthetic Glycerine Calls for Salt and Petroleum

Synthetic glycerine is being made from three simple raw materials—salt, water and petroleum—at a plant in Houston, Tex. The process was developed by the Shell Development Company. Glycerine is used in manufacturing paints, high explosives, Cellophane, lacquers and foods.

IF YOUR DEALER CANNOT SUPPLY YOU  
USE THIS COUPON TO ORDER

DREMEL MFG. CO. • DEPT. SP-118-M • RACINE, WIS.

- Enclosed find \$14.85 (Check or money order in full). Ship **Moto-Sander** at once Postpaid.
- Enclosed find \$2 00 as part payment on **Moto-Sander**. I will pay postman balance plus postage upon C.O.D. delivery.
- Please send Free Catalog of Dremel Tools and Equipment.

NAME \_\_\_\_\_  
ADDRESS \_\_\_\_\_  
CITY \_\_\_\_\_ ZONE \_\_\_\_\_ STATE \_\_\_\_\_





# Moto-Tool

THE "POCKET-SIZE  
MACHINE SHOP"

THE GIFT  
HE'LL LIKE BEST  
AND USE  
LONGEST



Grinds, Routs,  
Drills, Carves,  
Engraves, Cleans,  
Polishes, Finishes.

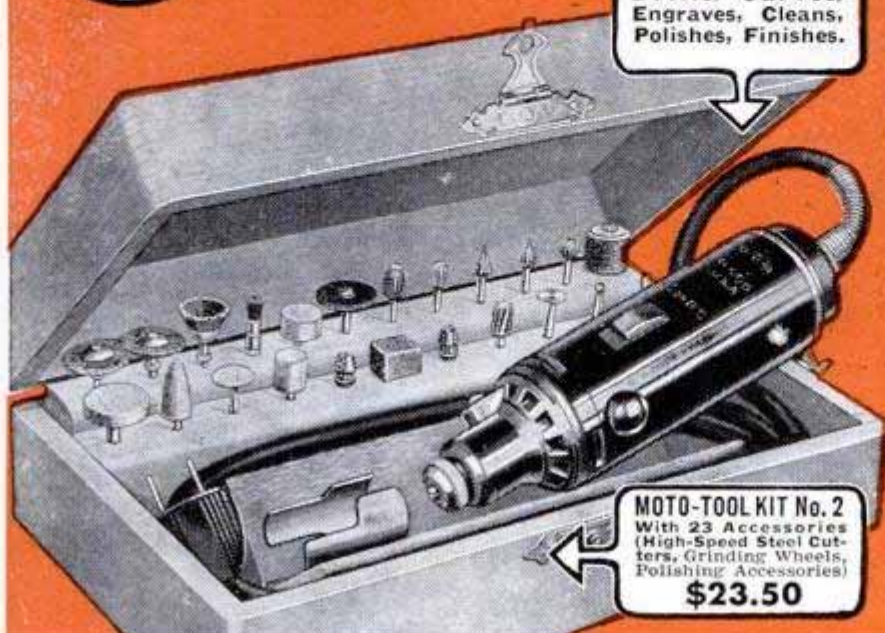

MOTO-TOOL KIT No. 2  
With 23 Accessories  
(High-Speed Steel Cut-  
ters, Grinding Wheels,  
Polishing Accessories)  
**\$23.50**



APPROX.  
27,000 R.P.M.



Great for  
Hobbyists

Saves Time  
and Labor

## A SHOP TESTED TOOL

Moto-Tool is backed by over 12 years of industrial use . . . packs years of extra pleasure . . . yet, due to increased production, pre-war prices still prevail!

### LOOK FOR THESE MOTO-TOOL FEATURES

Oil-less, sealed bearings • Patented automatic chuck lock pin • Oversize armature shaft; hardened, ground, polished • Shock-proof, bakelite housing • Dust filtered air cooling system • Dynamically balanced for vibrationless operation • Exclusive hanger hook • Weight only 13 oz.

# MOTO-SAW

THE AMAZING ELECTRIC SCROLL SAW

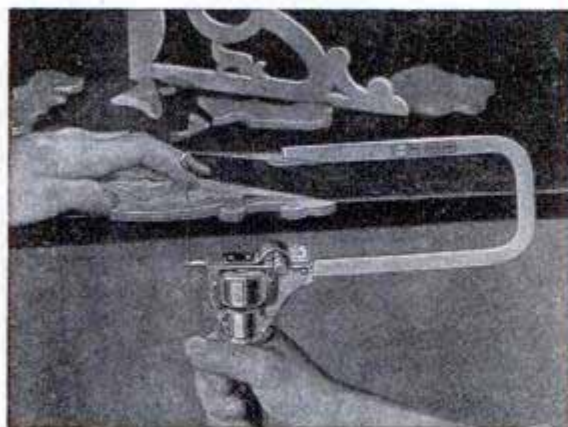

This electric coping saw works like magic! Easily cuts intricate scroll designs in medium-hard wood up to 3/4" thick. Runs 7,200 strokes a minute . . . just guide it! Has only two moving parts . . . never needs oiling. Operates on 110-120 volt, 50 or 60 cycle A.C. electric current. As safe as a handsaw . . . thousands of satisfied users. Comes complete with 3 saw blades, at only... **\$5.85**

## New DRILL PRESS

ONLY **\$9.95**

(Less Moto-Tool)

Only Dremel offers you a portable, precision drill press at such an amazingly low price. Just the thing for creating costume jewelry, model making, wood carving, routing, etc. Utilizes Model No. 2 Moto-Tool, which can be raised or lowered, swung in any direction, or quickly removed for off-hand use. Drill Press stands 12" high. Base is 6 3/4" x 4". Weighs approximately 3 1/2 pounds.



### MONEY-BACK GUARANTEE

Buy Dremel Tools from your dealer. If he cannot supply you, use coupon below to order desired items on 5-day trial, money-back guarantee. Items checked will be sent complete and postpaid for check or money order in full. Or, send only \$2 with order, and pay postman balance plus postage upon C.O.D. delivery. Remember, YOUR MONEY BACK if not delighted after 5 days' trial.

**DREMEL MFG. CO.**

DEPT. T-118M • RACINE, WIS.

Here's  
**BIG VALUE!**



MODEL No. 1  
**MOTO-TOOL KIT**  
ONLY **\$17.50**

This highly popular Kit contains lighter Model No. 1 Moto-Tool and 34 practical accessories in attractive, lacquer-finish wood box. It's the biggest bargain in the field.

## USE THIS COUPON TO ORDER

IF YOUR DEALER CANNOT SUPPLY YOU WITH DREMEL TOOLS

**DREMEL MFG. CO., Dept. T-118M • RACINE, WISCONSIN**

- Enclosed find \$\_\_\_\_\_ (Check or money order in full). Ship items checked below at once Postpaid.
- Enclosed find \$2.00 as part payment on items checked. I will pay postman balance plus postage upon C.O.D. delivery.
- Moto-Tool Kit No. 2, \$23.50     Moto-Saw, with 3 blades, \$5.85
- Moto-Tool Kit No. 1, \$17.50     \_\_\_\_\_dozen blades (60c per doz.)
- Drill Press (Less Moto-Tool), \$9.95     Free catalog of Dremel Tools and Equip.

NAME \_\_\_\_\_ ADDRESS \_\_\_\_\_

CITY \_\_\_\_\_ ZONE \_\_\_\_\_ STATE \_\_\_\_\_





## OWN YOUR BUSINESS

### Start in Spare Time with a FOLEY SAW FILER

Here is a steady repeat CASH business you can start at home in your basement or garage, while you are working at your regular job. No experience is necessary to turn out perfect cutting saws—"the first saw I sharpened came out 100%. I think the Foley Saw Filer is a marvel of perfection," writes C.E.P. Every saw you sharpen will bring you new customers. You will find you can make up to \$2 or \$3 an hour—\$20 to \$30 a week in your spare time as a starter.

With a Foley Saw Filer you can file all hand saws, also band and cross-cut circular saws. It is easy to operate—simple adjustments—no eye-strain. Patented jointing principle evens up all irregular teeth and make an old saw cut just like new.

#### This Free Book Shows How to Start

"INDEPENDENCE AFTER 40!" shows you how to get plenty of saws to file without canvassing, and how you can develop into a general repair shop that will be your own business. This is a helpful, practical book that tells just what to do—send for your free copy today.



Send For **FREE BOOK**

**FOLEY MFG. CO., 1216-8 Foley Bldg., Minneapolis 18, Minn.**

Send me free book "INDEPENDENCE AFTER 40!"

Name \_\_\_\_\_

Address \_\_\_\_\_

SAY YOU SAW IT IN POPULAR MECHANICS

ASSEMBLE

*King Midget*



45 MILES AN HOUR

90 MILES A GALLON

New, low cost transportation. Practical. Safe. A pleasure to drive. Home assembly keeps cost low. Just bolt together our factory built units. Immediate delivery. Send 25c for detailed circular with large picture, 4-view drawings, price of all parts. Or send for actual Assembly Book with 42 photographs, blueprints, drawings, sketches AND above literature—all for \$1 (refunded first order).

**MIDGET MOTORS MFG. CO., Athens, Ohio**

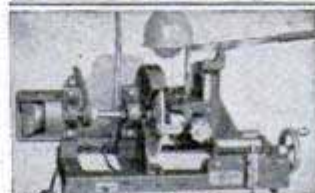

Pat. applied for

Start a **NEW BUSINESS**  
Or Add to Your Present  
Repair Business  
**Sharpen Dull Pipe Wrenches**  
**Pipe Taps & Dies**  
**"Gum" Circular Saws**  
Write for information.

**J. C. MOORE INDUSTRIES** P.O. Drawer 276  
FREDONIA, PA.

**LAW**

STUDY AT HOME for Business 'Success and LARGER PERSONAL EARNINGS. 39 years expert instruction—over 114,000 students enrolled. LL.B. Degree awarded. All text material furnished. Easy payment plan. Send for **FREE BOOK**—"Law and Executive Guidance," NOW!

**AMERICAN EXTENSION SCHOOL OF LAW**  
Dept. 96-PM 646 N. Michigan Ave. Chicago 11, Ill.

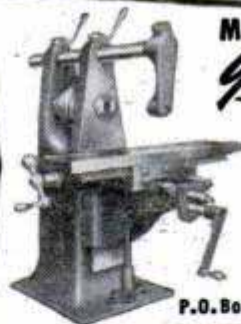

Make This **MILLING MACHINE** Yourself From low-cost **LEWIS CASTINGS!**

**MILLS SLOTS, keyways, dovetail, flat surfaces, etc., in all types of metals. Castings sold rough or semi-finished. Comparable to similar commercially-built machines in quality and capacity. WRITE FOR FREE CATALOG describing many LEWIS Power Tool Castings and Projects!**

**LEWIS MACHINE TOOL COMPANY**  
P.O. Box 7446, Sta. 1, Dept. M, Los Angeles 23, Calif.

**SAVE OIL... SAVE MONEY**  
**ADD COMFORT**

with  wall thermostat

Conversion top connects to manual control... Complete with Transformer and Accessories.



ONLY \$22.97 pre-paid. "Pays for itself in Savings."

An A-P AUTOMATIC Temperature Control Set on your present Oil Burning Heater can save up to 10% on oil consumption. Provides more healthful, comfortable, steadier room temperatures — at the mere touch of a Thermostat dial. Easy to install.



For **FREE Booklet** "3 Times More Comfort" Write

**AUTOMATIC PRODUCTS CO.**  
2522 N. 32nd St., Milwaukee 10, Wis.



★ SCIENTISTS ★ HOBBYISTS  
★ FARMERS ★ STUDENTS

## Use the VICTOR RAIN-GAGE

Be weatherwise! Use this scientific instrument that accurately measures up to 6" of rainfall. Designed by a meteorologist. Not a toy but a real rain measuring device. Simple, easy to read. Rustproof and unbreakable. Instructions and 11-year record book included. Makes an ideal gift. Satisfaction guaranteed.

If your dealer can't supply you, order direct, giving dealer's name. Send no money. Pay postman \$2.40 plus COD charges, or send check or money order for postpaid delivery. Ask about other weather instruments.

**VICTOR RAIN-GAGE CO.**  
AIRPORT P. O. ★ WICHITA, KANSAS



Only  
**\$2.40**

## \$4.95 REAL ENGINE VALUE



A miniature gas engine that really operates. Thousands of Buzz "B" gasoline engines have been sold at twice the price. Now is your chance to buy a real 1/6 H.P. gas engine for only \$4.95. Turns up over 8,000 r.p.m. For Boats, planes, midget cars, etc. Guaranteed and ready to run. Includes Champion spark plug and tank. Send only \$1.00, engine shipped collect for balance, same day.

WRITE FOR FREE CATALOG OR  
SEND 10c FOR NEW MAMMOTH ILLUSTRATED  
CATALOG OF THOUSANDS OF HOBBY ITEMS.

America's Hobby Center, Inc., Dept. B-128, 156 West 22nd St., N. Y. 11

### MOVIE MAKERS' FAVORITE SINCE 1937

SATISFACTION GUARANTEED  
Solar Type 12-Film (Weston 12 Outdoor) **\$1.59**

Orino, Non-Halo, Fine Grain  
16MM 50 Ft. **\$1.90** • 16MM 100 Ft. **\$3.30** **DOUBLE 8mm**

**24-HOUR FREE PROCESSING SERVICE**

Order now. Send cash and save shipping cost or \$1.00 deposit on C.O.D. Illinois residents add 2% sales tax.

**SOLAR CINE PRODUCTS, INC.**

4247 So. Kedzie Dept. PM12 Chicago 32, Illinois

Write For Circular

**15-SHOT AUTOMATIC**  
**De Luxe at POPULAR PRICE**

WILL SHOOT AS YOU THE AS FAST CAN PULL TRIGGER

Model #151M  
.22 cal.  
automatic  
**\$30.90**  
[\$31.70 West of Rockies]

#4M4 Scope with Internal Adjustment feature **\$9.95**

Perfect result of Mossberg research. Handles without change .22 cal. regular or high speed Long Rifle cartridges, lubricated or dry. Complete action instantly removable without tools. Has Mossberg's finest sights—front, sporting rear and micro-click prep. Receiver grooved for Mossberg #4M4 scope sight, giving sturdiest mount ever.

**SEE IT AT YOUR DEALER'S**  
Descriptive folder free on request.  
No Sales at Factory.

**O.F. Mossberg**  
C. SONS, INC.

86512 St. John St., New Haven 5, Conn.

SAY YOU SAW IT IN POPULAR MECHANICS

# NEW DIE CAST ALUMINUM LEVEL

## Here's new Value!

Celebrating 80 years of Toolmaking



No. 624 — 24" die cast aluminum level

**\$6.30**

Slightly higher in the west  
(others 18" to 30" — \$5.50 to \$7.20)



A level's a level until you look into its quality, durability, utility, design. Then — a level can be a thing of beauty, a tool to help you project your own skill to the precision work you turn out.

Take a new Millers Falls die cast aluminum level in hand. Feel its keen balance and highly polished, accurately ground faces. Note the superb visibility of its white vial wells — how well they're protected with solidly set glasses. Think of the convenience of the two level vials and four plumb vials . . . how long the smooth aluminum die cast frame will last.

Make you want one? Your hardware dealer has plenty! See him today.



# Millers Falls Tools

GREENFIELD • MASSACHUSETTS



the striking new  
**Crosley**  
station wagon

Smart • Fashionable • Sleek



- ★ Lowest priced
- ★ 35 to 50 miles per gallon of gasoline
- ★ All-steel throughout
- ★ Range of colors
- ★ 4 cyl. Crosley Cobra liquid-cooled engine



**CROSLLEY**  
a FINE car

For beautiful catalog write:  
Crosley Motors, Inc., 2532-HT Spring Grove Ave.  
Cincinnati 14, Ohio

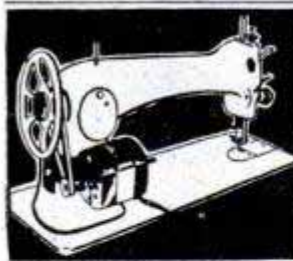

**SEWING MACHINE  
MOTOR KIT...**

How to Convert Your Old Model Sewing Machine into a Modern All-Electric Machine—in a few minutes. Save up to \$175 over cost of an Electrical-Machine! Send for free folder.

**BROWNELL CO., PM-12**  
308 CANAL ST., NEW YORK 13, N. Y.

**FINE TOOLS  
NEED  
FINE OIL!**



• Lubricates



• Prevents Rust

• Cleans • Polishes

SOLD EVERYWHERE!

**3-IN-ONE Oil**

**RUPTURED?**

HERE'S COMFORTABLE, SAFE RELIEF!



Made of molded rubber, soft and pliable, this form-fitting truss is bringing new comfort, with safe protection, to thousands. Based on nature's way, WEB Truss gives strong support without painful pressure. Has no springs or leather, is completely washable. Under money-back guarantee of satisfaction, you run no risk. Write today for FREE illustrated literature.

**WEB TRUSS CO. Dept. M-8 Hagerstown, Md.**

**GOOD MONEY IN WEAVING**

Earn money at home weaving rugs, carpets, etc. from old rags or new yarn—in your community! No experience necessary. 31,000 doing it with easy running Union Looms costing less than \$50.00! Send for our free booklet today.

**UNION LOOM WORKS • 458 Post St. • BOONVILLE, N. Y.**

Only **\$16.95** **DUAL PURPOSE SPRAY GUN**



USES ONLY 25 LBS. AIR PRESSURE  
**FLOCKS AND SANDBLASTS**

AT HOME: You can refinish Lamps, Radios, Book Ends, Statues and hundreds of things with lovely colorful flocking. ETCH GLASS: Many designs and initials can be sandblasted on shower doors, ash trays, glassware. AUTO INTERIORS: Transform ugly dirty auto interiors to "new car beauty" with a BLASTO DUAL PURPOSE SPRAY GUN. Merely spray flock similar to Velvet, Plush, Suede and Mohair inside your car. ANTIQUE WOOD... REMOVE PAINT. MAKE EXTRA MONEY by doing any or all the above for profit. BLASTO is highest quality and carries a 5 day money-back guarantee. Operates on small air compressor. Send \$16.95 cash, check or money order for postpaid delivery. Write for free information. Full line of Flocking Supplies.

**BLASTO SPRAY GUN MFG.** Dept. PM-12, 7007 Haas Avenue  
Los Angeles 44, California

SAY YOU SAW IT IN POPULAR MECHANICS

The Chief

**WORK BENCH**

*Built to Last a Lifetime!*

With Bottom Shelf and 18" Sq. Drawer. 2"x6", Solid Plank, Grooved and Dovetailed Top and 1"x8" Back Rail, Shellacked to a Smooth, Satiny Finish.

MOHAWK LUMBER CO. Dept. 33  
14525 W. Chicago Blvd. Detroit 27, Mich.  
Enclosed  Check  Money Order for \$.....  
Ship..... CHIEF WORK BENCHES at  
Quantity.....  
\$16.95 each, F.O.B. Detroit, Mich.  
 Send C.O.D., \$5 Deposit Enclosed.

NAME.....  
ADDRESS.....  
CITY..... STATE.....  
No Priority Necessary!

• 6 Ft. Long • 34" High • 26" Deep. Shipped Knock-down, with Bolts, Nuts and Screws and ABC Chart for Quick, Simple Assembly.

Prompt Delivery  
**MOHAWK LUMBER CO.**  
14525 W. Chicago Boulevard  
DETROIT 27, MICHIGAN



**\$16.95**  
F.O.B. DETROIT

Send Check or Money Order, or Will Ship C. O. D. (\$5 Deposit)



**NOW** PRECISION METALWORKING  
AT LOW COST!

**Atlas 6" LATHE**

**\$113<sup>50</sup>\***

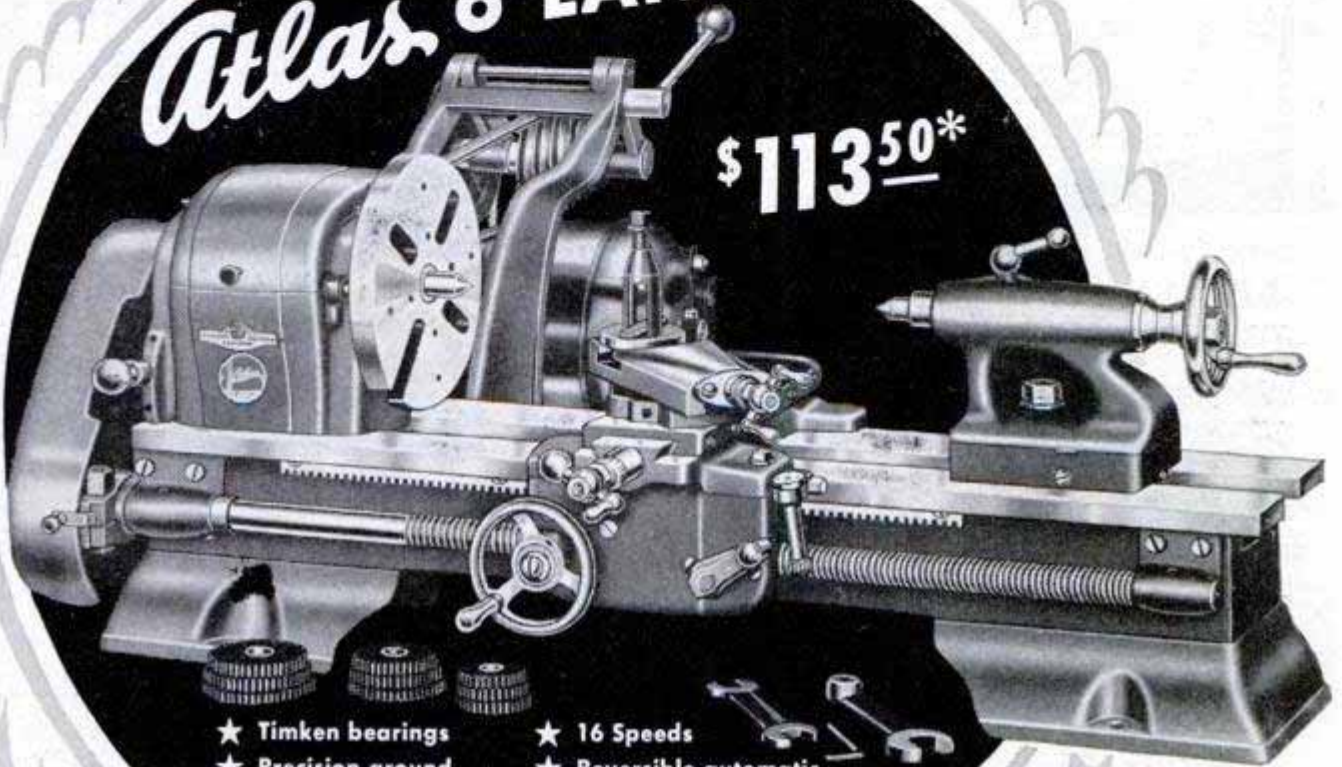

- ★ Timken bearings
- ★ Precision ground bed ways
- ★ V-belt drive
- ★ 16 Speeds
- ★ Reversible automatic longitudinal power feed
- ★ Back gears
- ★ Cuts 8 to 96 threads per inch

\*F. O. B. Kalamazoo less motor



**Today's Greatest Lathe Value**

Precision lathe work for your home or commercial shop or garage comes at its lowest cost with an Atlas 6" lathe. You can't beat its value no matter where you look! Timken bearings... 16 speeds... 18" between centers... back gears for extra power on heavy cuts... low cost attachments for milling, boring, cutting tapers, mica undercutting, coil winding, collet work... precision capabilities to thousandths... practically all the performance features of big lathes costing several times more are yours with this Atlas 6" lathe — ready for immediate delivery. Send a postcard for new catalog — just off the press — and name of nearest dealer.

**Turns METALS, WOODS, PLASTICS**

The wide speed range of the Atlas — from 54 to 3225 RPM — plus Timken bearings to assure smooth running and long wear, give you complete versatility in working all kinds of materials with this lathe.

Standard equipment includes Reversible Automatic Power Longitudinal Feed; Graduated Compound Rest; Tool Post, Ring and Rocker, 3/8" Tool Bit; Complete set of Change Gears to cut standard threads between 8 and 96 per inch; Threading Chart, Threading Dial; Rapid Lever Countershaft; Complete V-belt drive; Motor Pulley for 1/2" motor shaft (prices for other sizes on request); 60-Hole Indexing Mechanism; 5/4" Combination Metal and Woodworking Face Plate; Two 60° Lathe Centers — No. 2 MT for headstock, No. 1 MT for tailstock; 3 wrenches; Atlas Manual of Lathe Operation.

**NEW FREE**

**ATLAS PRESS Company**

1243 N. Pitcher St. • Kalamazoo, Mich.



**MATCHED PRECISION TOOLS FOR WOODWORKING AND METALWORKING**



**FREE**

*get it now*

**ALLIED'S NEW 1949  
RADIO CATALOG!**

**180  
Value-Packed  
Pages**



**EVERYTHING  
IN RADIO AT  
LOWEST PRICES**



**TELEVISION AND  
NEW HOME RADIOS**



**SERVICE SUPPLIES  
BUILDERS' SUPPLIES**



**AMATEUR GEAR**



**SOUND SYSTEMS**

**Radio's Great Buying Guide**

Send today for your **FREE** copy of Radio's Leading Catalog! It's the preferred Buying Guide for Servicemen, Dealers, Engineers, Soundmen, Amateurs, Builders and Experimenters. You'll find everything you want in Radio and Electronic Equipment—all the newest releases—complete, highest quality stocks at low prices that save you money on every purchase!

**Save on Everything!**

Get *everything* you need from the world's largest stocks—new Television receivers, latest home radios and radio-phonos (with new Dual-Speed Changers), Amateur receivers and station gear, test instruments, public address and sound equipment, new builders' kits—plus thousands of parts, tubes, tools, radio books and diagrams. Get the speedy reliable service and expert help you want from **ALLIED—Radio's Largest Supply House**. Write today for your **FREE** copy of the new 180-page **ALLIED Radio Buying Guide!**

**ALLIED RADIO**

**ALLIED RADIO CORP.,  
833 W. Jackson Blvd., Dept. 5-M-8  
Chicago 7, Illinois**

**FREE  
CATALOG**

Rush **FREE** 1949 **ALLIED** Catalog.

Name.....

Address.....

City.....Zone.....State.....

THOUSANDS OF SUFFERERS USE  
**BREATHEASY**  
FOR  
**ASTHMA**  
CARRY IT WITH YOU  
USE IT ANYWHERE  
*Sold on Money-Back  
Guarantee*

Write To Dept. PM  
**BREATHEASY DISTRIBUTORS, INC.**  
65 CEDAR STREET  
SEATTLE 1 WASHINGTON

*New* **MILLING ATTACHMENT**

**SIZES FOR 8" to 16" METAL LATHES**  
Build it yourself from our sets of semi-machined castings and save \$8. Can be finished on your lathe alone. Complete drawings and instructions furnished with castings.

Mill keyways, slots, splines, dovetails, flutes for reamers, special cutters. Produce gears, ratchets, racks; bore, face, etc. with this precision attachment.

**FREE** Illustrated folder and price list of castings, milling cutters, etc. Write today. Mention your lathe.

**HURON MACHINE AND TOOL CO.**  
YALE 4, MICHIGAN

**LOOK!**  
**FIN-DER SAX-SLING**  
NEVER SLIP OR KINK  
HIGH SPEED ADJUSTING  
BALLBEARING

**\$1.00**

AT ALL GOOD DEALERS  
OR ORDER DIRECT  
**NEW!**

FIN-DER 1251 • 4th Avenue, San Diego 1, Calif.

**KODACHROME PRINTS  
and ENLARGEMENTS**  
up to 11x14...from your color transparencies  
Order through your Kodak dealer  
**EASTMAN KODAK CO., Rochester 4, N. Y.**

**BOATS! ASSEMBLE YOUR OWN  
PACKAGED BOAT**

16 models of outstanding design—8 to 18 ft.—prices from \$34.50 up. These complete plywood kits save you 50% or more. Assembly is simple, all parts pre-cut—frames pre-assembled. Send 25c (coin) for complete, illustrated literature. (Literature plus booklet, "How to Build Plywood Boats," send \$1.00.)

**MARINE MART**  
BUFFALO 7-B NEW YORK

**INBOARD**  
**OUTBOARD**  
**UTILITY**

**SKIFF**  
**PRAM**  
**KAYACK**



**BUILD IT! - FIX IT!**  
WITH... MULTI-PURPOSE AMBROID  
"IT STAYS STUCK"



For a quick job with permanent results use multi-purpose, fast drying Ambroid Liquid Cement. For home workshop, household, or factory. A quality leader for 38 years. Ready-to-use Ambroid is waterproof, transparent, quick drying, extra strong, flexible, heat and corrosion resistant. For assembling, repairing, or mending jobs, keep Ambroid handy. At your dealers or send 25c for a big 2 oz. tube postpaid. Money back guarantee.

Also 50¢ 4-oz. tube. Pts., qts., gals., for industrial use.

**AMBROID**

303 Franklin St., Boston 10. Mass.

**ELECTRONIC EDUCATIONAL KITS  
THE ELECTRIC EYE**



This is not a toy but rather a skillfully engineered kit ready for assembly. The parts furnished are commercial parts used in the best electronic equipment. This unit assembled, will be adaptable to uses such as opening garage doors, counting, burglar alarm, etc. Ideal for the beginner as well as the highly developed engineer. Worth \$25.00 but priced to sell at only \$9.95. Unit completely assembled \$14.95. KINDLY NOTE: CASH WITH ORDER OR \$3.00 DOWN, BALANCE C.O.D.

**ELECTRONIC PRODUCTS, 6516 Foster Ave., Chicago**

**EASY PROFIT IN PAINT SPRAYING**



Paints walls, ceilings, screens, furniture and machinery faster, better. All complete as shown less motor. Carry anywhere. Fully guaranteed. Could be used with 1/4 H.P. motor or less. Price \$35.00 less motor F.O.B. Chicago. \$5.00 deposit balance C.O.D. or see your dealer. With motor \$55.00.

**IDEAL AUTOMATIC PUMP CO., Dept. P.M. 8  
Chicago 7, Ill.**

801 W. Washington Blvd.

**Send For This Automatic Shut-Off  
for your gas water heater**



Installed in a few minutes with ordinary tools. Complete, simple instructions. Just replace regular gas-cock with ERIE TIME-O-GAS. Set knob to burn from 2 to 55 minutes. . . . Device shuts off automatically! Works on manufactured, natural, mixed gas. Use with or without pilot. Pilot lighter included free with each unit. Described in October Popular Mechanics, page 121. Send \$8.95 for postpaid ERIE TIME-O-GAS; or C.O.D. plus postage, or write for free information. Models for incinerators and other gas appliances also available.

**ERIE MFG. CO., Dept. P-2  
300 N. 8th St. MILWAUKEE 3, WIS.**

**HOBBY CATALOG**

**CRAFT CATALOG**

NEW 1949 edition, 84 pages crammed with big selection of tools and materials for plastics, ceramics, hand power tools, plans, etc., etc. A gold mine of hard-to-find items such as foam rubber, kits, books and "How To" information. Every crafter should have a copy. Send 25c now to

**JACKSON, Dept. 73  
5440 N. Shoreland Ave., Milwaukee 11, Wis.**

ORIGINALLY \$30 to \$55

**MEN'S FULLY GUARANTEED NEW 15-JEWEL WRIST WATCH \$13.95 PLUS TAX**



Sacrificed because they're post-war surplus

**WATER PROOF — SHOCK PROOF**

Luminous dial . . . sweep second hand . . . anti-magnetic . . . imported Swiss precision movement and case. You get them now for a small fraction of original prices. Don't delay! Order now . . . while they last. Send only \$1 down payment with order. Pay balance to postman on arrival, plus postage. Or we pay postage if you enclose \$13.95 plus \$1.39 Fed. Tax. Receive handsome expansion band FREE with prepaid order. Money back in 5 days if not delighted. Order now.

**MARYLAND DISTRIBUTORS, Dept. 112  
501 E. Baltimore St. Baltimore 2, Md.**

**\$54.95**  
In U.S.A.  
(Saw Only)



**You Can do More**

with **Mall** Hobbyist Tools  
REG. U.S. PAT. OFF.



**\$22.50**  
In U.S.A.  
(Drill Only)

**1/4" HOBBYIST**

**Mall Drill**

**EASILY CONVERTED TO 10 OTHER TOOLS**



This handy electric MallDrill can be equipped for sanding, wire brushing, grinding, rotary filing, sawing wood or metal, counter-sinking, shearing metal and hole sawing as well as drilling wood, metal and plastics. A sturdy drill stand converts it to a drill press. 1/4" and 1/2" models.

**\$17.50**  
In U.S.A.  
(Stand Only)

Disc Sanding  
Drilling Masonry

**MODEL 60-2" CAPACITY**

**Mall Saw**

**CUTS EVERYTHING FROM WOOD TO STEEL**



Interchangeable saw blades, abrasive discs and other accessories — plus a handy lightweight table stand, complete with rip fence and miter guide — equip the Model 60 MallSaw for cross-cutting, ripping, table sawing, shaping, sanding, grooving, grinding, wire brushing and countless other uses.

**\$32.50**  
In U.S.A.  
(Stand only)

Cutting Lumber  
Cutting Concrete  
Equipped as a Table Saw

The Mall Dealer nearest you is listed in your Classified Telephone Directory. Visit him TODAY or write direct for FREE Booklet.

**Preferred by Master Craftsmen**

**MALL TOOL COMPANY**  
7805 South Chicago Ave., Chicago 19, Ill.





the perfect  
christmas gift!



6

TOOLS IN ONE!

LOW COST!

Duo Sander-Polisher (only).....\$ 36.50  
Set of 21 Accessories.....\$ 12.50  
Duo with Complete set of 21 Accessories.....\$ 49.00

F. O. B. Muskegon, Michigan



**SANDS!** Accessories: 3" pad assembly, 3 grades each of 3" and 5" abrasive discs.



**DRILLS!** Accessories: Drill chuck and adapter for drills up to 1/4" (drills supplied by dealer).



**GRINDS!** Accessories: Drum and cone adapter assemblies, 3 grades each of drum and cone abrasive sleeves.



**POLISHES!** Accessories: Two lamb's wool bonnets.



**BUFFS!** Accessory: 5" wool buffing pad.



**WIRE BRUSHES!** Accessory: 1/2" steel wire brush.

The All-Purpose Tool! The Clarke Duo sands, polishes, drills, grinds, buffs and wire brushes. Has hundreds of uses in the home, on autos, trailers and boats. Ideal for hobby-crafters, "handy" men and mechanical-minded boys. Indispensable for the farm. Use it for all types of refinishing, repair and building. Anyone can quickly interchange accessories. Lightweight, powerful, easy to operate. Approved by Underwriters' Laboratories. AC-DC. Get it at your dealer's or order by coupon below.

A Multitude of Uses for the Duo! Buff to apply polish and wax on surfaces. Polish cars, home and office furniture. Grind various shaped surfaces and narrow openings. Sand desks, cabinets and boats, remove paint and smooth plaster. Drill holes up to 1/4 inch in metal, composition and wood. Wire brush to clean small spaces and to remove rust and other materials.

**Clarke Sanding Machine Company**  
4512 Clay Avenue, Muskegon, Michigan

Send  Clarke Duo Sander-Polisher (only), \$36.50.  Complete Set of accessories, \$12.50.  Clarke Duo Machine complete with all accessories, \$49.00.  Enclosed money order for \$\_\_\_\_\_.  
 Ship C.O.D. (I pay postage).  Package for Christmas Gift.

NAME \_\_\_\_\_

ADDRESS \_\_\_\_\_

CITY \_\_\_\_\_ ZONE \_\_\_\_\_ STATE \_\_\_\_\_

CLARKE . . . PIONEER AND LEADER IN FLOOR  
SANDING, POLISHING AND MAINTENANCE MACHINES

SAY YOU SAW IT IN POPULAR MECHANICS

274

## BUILD YOUR OWN POWER LAWN MOWER

WHY BREAK YOUR BACK  
MOWING FIELD OR LAWN?

**FREE**  
Write for  
Building  
Instructions

The Rite-Way  
Mower  
Attachment  
Ball Bearing

**SAVE MONEY  
SAVE TIME**

Now anyone can save time and effort mowing field or lawn by building their own whirl type power mower. Build according to your own ideas and needs at small cost. Cut close to fences, walks, buildings, etc. Build in short time with parts and instructions we furnish. Save hours of time and back breaking labor. Write today for FREE information.



IT'S FUN TO BUILD

T & H MFG. Co., Dept. MP-18  
811 E. 31. Kan. City 3, Mo.

## LUMBER

A BOARD OR A CARLOAD

Harold Hunt wants to send you big, new No. 15-B Catalog. Over 148 pages of woodworking ideas. 12 pages of rare woods in colors. UNEQUALLED BARGAINS in imported and American woods, supplies, hard-to-find hardware. Send only 15c to cover postage and handling.

CRAFTSMAN WOOD SERVICE CO.  
2729 S. Mary St. Dept. A-100 Chicago 8, Ill.

TOP  
GRADE  
KILN-  
DRIED  
WALNUT  
MAHOG.  
CHERRY  
WHITE  
HARD  
MAPLE  
POPLAR  
OAK  
AROMATIC  
RED CEDAR



**FREE for Trailer Builders**

*Safety-Engineered*

• TORQ-LESS AXLES • BULL DOG HITCHES  
AND PARKING JACK LITERATURE

**HAMMER BLOW TOOL CO.**

Dept. 129 • WAUSAU, WIS.

FREE . . . WRITE TODAY!



**DRAINS CELLARS, WASH TRAYS  
CIRCULATES OIL**

Pumps 1800 GPH 300 gal.  
30' high, use 1/8 to 1/2 HP **\$6.50**  
motor. Will not clog.

Postpaid if cash with order.  
(Add 50c for west of the Mississippi.)

Thousands in use since 1936

LABAWCO PUMPS, BELLE MEAD 7, N. J.



**BUILD YOUR OWN ZEOLITE  
WATER SOFTENER**

You can do it inexpensively with only a wrench and a little spare time. Famous Zeolite process as used by leading manufacturers. Send \$1 for easy-to-follow directions and list of materials. (Materials available locally or from us.) Or inquire about factory-built LARCO Softeners \$45.75 up. LAKE REGION MFG. CO., INC., 3920-A Lynn Ave., Minneapolis 16, Minn.

**BINOCULARS, 6 x 30 Universal,** \$42.50  
used, good condition.....  
**BINOCULARS** \$95.00  
U. S. Navy 7 x 50.....  
**BINOCULARS** \$57.50  
U. S. Army 6 x 30. New, with Case.....  
5 Power Ranger.....  
**TELESCOPES** \$2.00  
Engineers Metal Army Type and.....  
**SIGHTING LEVELS** \$2.00  
**SURPLUS GOVT. TRIPODS** for Level.....  
Transit, Cameras, etc. Used. Good Condition. \$5.95  
**NEW TRIPODS** for Transits, Levels, etc. \$13.50  
Value \$75.00. Special.....  
**TRANSFORMERS, Western Elec-** **CANVAS SAFETY BELTS, Metal**  
tric, 5 volt to 650, \$4.95 Snaps, New, \$3.00  
New..... 75c  
Val.....

4th Edition Annual Gun Digest together with our  
Catalog \$1.50.

**Public Sport Shops**

11 S. 16th St., Phila. 2, Pa. No COD'S

POPULAR MECHANICS



# 100 Fireplace Ideas FREE

For Home, Playroom, Cottage, or Camp



**If You're Building Your Own Fireplace HERE'S AN EASIER FOOL-PROOF WAY TO DO IT**  
Choose a design that will look well with the materials you have available. Prepare a concrete or brick slab the size of your fireplace. Center your FYRO-PLACE, the warm-air circulating form, on the base, and build round it. You will have a well-engineered, successful fireplace. You can't fail.



**WRITE FOR BOOK TODAY**  
Small Book 4 1/4 x 5 1/2 sent free. Larger Book, 8 1/2 x 11, beautifully illustrated, 25c  
Ask for Free Data on Outdoor Fireplaces

**PRICE FIREPLACE HEATER & TANK CORP.**  
72 Austin Street, Buffalo 7, New York

## Make your own Gems 29.50 F.O.B.

All necessary lapidary equipment is furnished, including a super-charged diamond blade for sawing, and all wheels for grinding, shaping and polishing; also complete instructions. The complete equipment as shown, less motor and belt, for only \$29.50, f.o.b., Burlington, Wisconsin. Write today for information and literature.

**B & I MANUFACTURING CO.**

Dept. S Burlington, Wis.

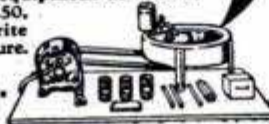

## Universal Tool Block

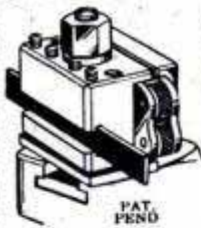

PAT. PEND.

Replaces tool post and nine standard tool holders. Rigidly supports turning, boring, threading, and cut-off tool bits. Rotatable. Has self-aligning knurling head. Precision adjustment for tool height. No re-adjustment required when replacing tools. Adaptable to some other lathes. Write for dimension sheet.

Lathe Size	Price
9"	\$11.80
10"	12.50
13"	14.50
14-1/2"	16.50
16"	17.00
16/24"	17.00

f.o.b. factory

**SOUTH BEND LATHE WORKS**  
455A E. Madison St.  
South Bend 22, Indiana

**MAGNETS OF ALL TYPES—10c UP**  
AMAZINGLY POWERFUL!  
4 oz. Alnico Magnet, lifts 10 lbs., \$1.00. Our Leader, 15 oz. Magnet, lifts 40 lbs. \$2.50. New alloy—will not weaken! Useful for lifting valuables from tanks, lakes, or rivers easily! 7 small magnets \$1.00 with list of many shop and home uses. Satisfaction guaranteed.  
R. EYRICH, 2566 N. 49TH ST., MILWAUKEE 10, WIS.

Plastic Coasters and Tiles

## EMBED REAL FLOWERS in NEW Magic PLASTIC



Now create many lovely and unusual things like the distinctive pansy coaster shown—made by embedding real pansies in Castolite—the "magic" liquid casting plastic. Comes crystal clear, or may be dyed to produce gorgeous color effects. Make really different jewelry, book ends, picture frames, candle sticks, figurines. Embed butterflies, coins, medals, photos, for novel plaques, paper weights, tiles, other art objects. Use only home utensils. Follow simple step by step method. New pleasure, fine profits are possible. Send 25c for exciting new Home Project Manual showing how to get started. Write today! **The Castolite Company, Dept. P-1, Box 391, Woodstock, Ill.**

MANUAL 25c

## A profitable business of your own—

comes easily with this  
**5 KW POWER**  
plus  
**ARC WELDING**



You Get all three

**a.** This 200 amp. gas driven AC welder becomes a 5 KW AC power unit by flipping a switch.

### YOU CAN START AT ONCE

With one machine, you are ready to start doing business. Lots of highly paid work—repair, construction, maintenance—is waiting for you and arc welding.

### OUTSIDE JOBS PAY EXTRA

Ability to operate independent of power lines prompts calls for work in the field. This adds to income from regular jobs people bring to your shop.

### A BUSINESS WITH A FUTURE

Your business is sure to grow and you'll want to be able to handle all the big pay jobs. Hobart builds a complete line for all types of arc welding.

### BUILD WITH RIGHT FOUNDATION

Make certain of success. Use Hobart. Mail coupon today.

Hobart Bros. Co., Box M-128, Troy, O.  
"One of the World's Largest Builders of Arc Welders"



**d.** Build Your Own" Welder



**c.** Industrial Type AC



**a.** Shop Type AC Welder



**e.** Gas Drive Welder with DC Power



**f.** Electric Drive

## Hobart School of Welding

Enroll Now! Learn arc welding by doing. Expert instructors give individual attention.

## HOBART

It's Better to Buy A Hobart than to wish you had

Fill in Coupon and Mail Now!  
HOBART BROTHERS CO., BOX M-128, TROY, OHIO

Send me the Free Book, and also information on the items I've checked below:

(a.) (b.) (c.) (d.) (e.) (f.)

Tell me more about the Hobart Trade School

My work now is \_\_\_\_\_

NAME \_\_\_\_\_

ADDRESS \_\_\_\_\_

CITY \_\_\_\_\_

STATE \_\_\_\_\_

Free!

Vest Pocket Guide to Better Welding, With charts, symbols, etc.





# SANDEE Specials

SANDEE MUFFLERS  
V-8  
DUALS  
& SINGLES



## MUFFLERS Steels & Aluminums with a MELLOW Motorboat Tone

SINGLES, Chev., V-8, Plymouth, Steels \$5.50, Aluminum \$7.00, Chry., Olds., Buicks, etc., Steels \$7.50, Aluminum \$9.00. V-8 and MERCURY DUALS, Steel \$17.50, Aluminum \$21.00. Split Manifold Sets, Steels \$35.00, Aluminum \$45.00. '49 Ford Duals, \$2.50 extra.

SANDEE ALUMINUMS ARE GUARANTEED FOR LIFE OF YOUR CAR

## Streamline Your Car with SANDEE FENDER SKIRTS... \$17.20 pr.

Sparkling beauty you'll like. Constructed of heavy gauge body steel, finished in prime perfect fit.



For Ford, Chev., (except Fleetline), Merc., Plym., De Soto, Chry., Dodge, Kaiser, Frazer, Buick (except 42-48 Super), Olds. Series 60 & 70 1937-40, Pont. 6 1939-40.

Beautify your car... bring out the flowing lines inherently designed there.

for AMAZING acceleration

## DIXIE-WESTERN DUAL INTAKE MANIFOLDS for V-8 FORDS AND MERCURYS \$15.00

Gas Line and Throttle Kit \$2.50 extra. Chrome Plated Velocity Stacks \$3.00 pair.

By test: Increased acceleration by 26%—increased power and speed by 11%.

All DIXIE WESTERN manifolds are brightly polished cast aluminum.

ATTENTION service station men, garage men, and auto parts store owners; we have a profitable dealer's discount on quantity orders of any of the above merchandise.

SANDEE MUFFLER COMPANY  
Box 296 LoTij Station  
Los Angeles 43, California

WE SHIP C.O.D.

Please ship— Mufflers, Dual Set  Single;   
Fender Skirts;  Dixie Western Manifold .

Make of Car \_\_\_\_\_ Model \_\_\_\_\_ Year \_\_\_\_\_

Name \_\_\_\_\_

Address \_\_\_\_\_

City \_\_\_\_\_ State \_\_\_\_\_

Check Enclosed \$ \_\_\_\_\_ Ship C.O.D. \$ \_\_\_\_\_

## SANDEE MUFFLER CO.

Factory Address

5643 Corryne Place Culver City, California



## NOW YOU CAN SHAVE IN YOUR CAR!

Just plug this conversion Unit into your dash cigarette lighter receptacle—and connect your AC-DC electric shaver to unit! Presto! You're all set to shave right in your car anytime. Fast—simple—compact—durable—very low current drain. 6 Volt DC input. Unit is also ideal for operating 3-way portable radios in car. Unit is complete with cord and plugs. Order MF 102. Price: Only **\$7.95** post paid



## ELECTRIC MOTORS

Left—6 or 12 Volt AC or DC Motor. Powerful, heavy-duty, reversible type. Can be used for heater, fan, pumps, power-tools, etc. 1/2" shaft, 5/16" dia.

Order MH 103. **\$3.50**  
Price ... postpaid

Right—110 Volts AC Fractional HP Motor. Heavy-duty construction, ball bearings, 4000 RPM. Ideal for power tools, fans, models, blowers, etc. Order MH 102. Price..... **\$3.95** postpaid



## Motor Control RHEOSTAT

Shown at left—Heavy-duty, wire wound control for regulating speed of AC or DC motors, toy trains, etc. 150 Watt, 8.28 ohms., 5 amps. Order MR 104. Price..... **\$1.95** postpaid

ADDRESS: DEPT. M-12—No C.O.D. orders—Shipments postpaid in U.S.

**FAIR RADIO SALES**  
132 SOUTH MAIN ST. LIMA, OHIO

## Get that NEW-CAR FEEL again! SEALED POWER PISTON RINGS The only ring with the Full-Flow Spring! SEALED POWER CORP., DEPT. G-12, MUSKEGON, MICH.



## INSTALL Metal Tile YOURSELF and save \$\$\$

MODERNIZE YOUR KITCHEN, BATHROOM, OR PLAYROOM—save on repainting. Permanent—will not crack, chip or peel. Beautiful colors... Peach, White, Light Green, Light Blue, Yellow and Ivory. Choice of colors for trim. With our complete instructions, you can easily install it yourself on any wall. Only 59c sq. ft.—We ship anywhere.

SEND FOR FREE SAMPLE, CATALOG AND ESTIMATE. Measure walls and send along diagram. Specify colors desired.

ROSSELL SALES CO.

Dept. PM-12—5764 West Pico Blvd. Los Angeles 35, Calif.

DEALERS WANTED



## BOAT PATTERNS • BLUEPRINTS

70 Modern plywood designs by leading naval architects. Large scale, fully detailed blueprints, full size paper patterns available. Kayaks to cruisers, row—power—sail. (6 to 30 ft.). Send 25c (coin) for Design Catalog, or \$1.00 for Catalog plus booklet, "How to Build Plywood Boats."

MARINE MART, Buffalo 7-B, New York



## Powell SETS THE PACE

DEALER INQUIRIES  
INVITED

- 7 H.P. Motorcycle-type Engine
- Faster pick-up than a car
- Automatic clutch
- Smooth, simplified control

- Solid steel frame
- Highway cruising speed of 45 miles per hour
- Chrome-plated fenders,

- handlebars, and sport muffler—looks like a custom job
- Costs no more than ordinary scooters

## Powell MANUFACTURING COMPANY

DEPT. PM-8  
COMPTON, CALIF.

Write for FREE FOLDER and address of nearest dealer



# LOOK at the EXTRA-VALUE Features of this POWER KING 8" Tilt/Arbor Saw

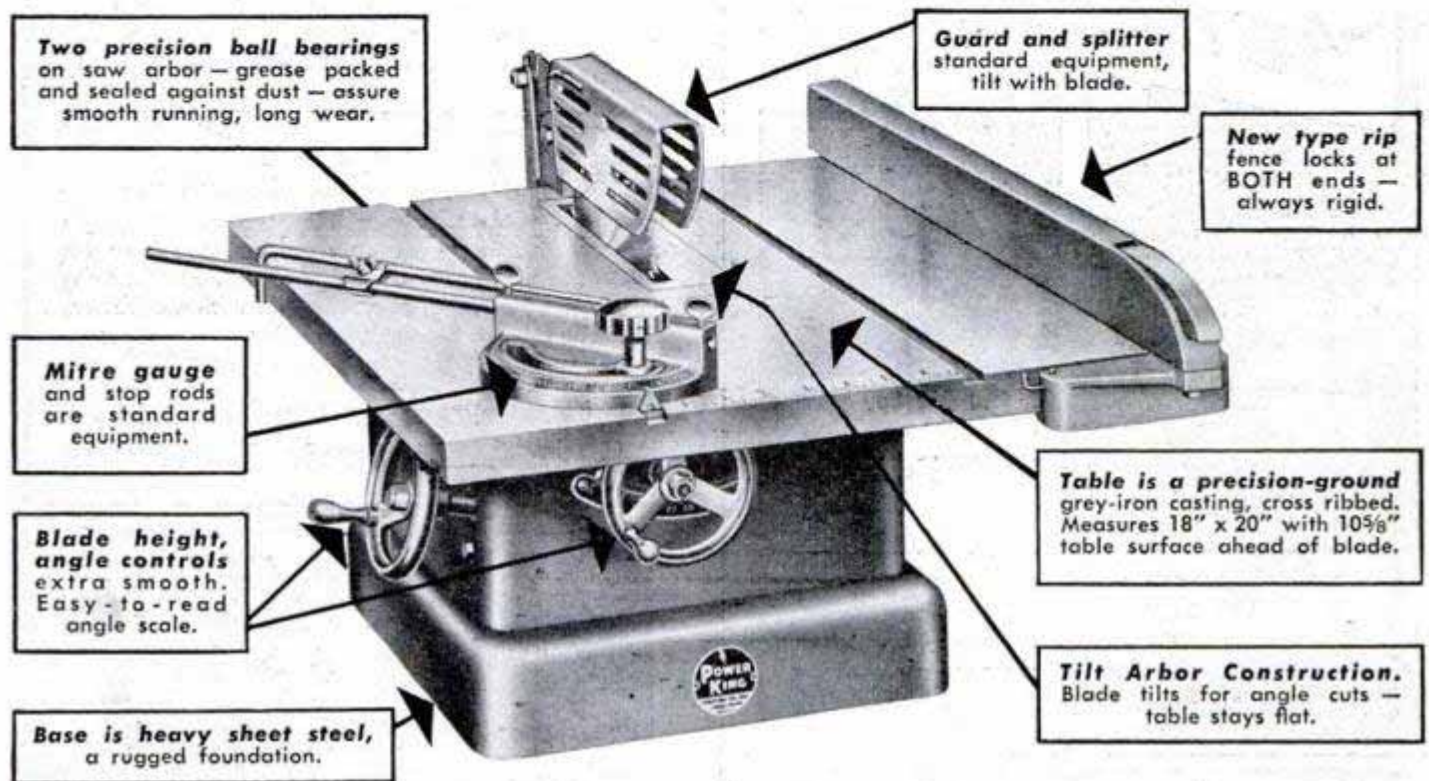

## Use It To Save Many Dollars This Year

It beats hand sawing a mile — makes your workshop time doubly productive — to install a fast accurate tilt/arbor saw. Tables, chairs, cabinets, cupboards, shelves... the list is almost endless of the ways you can save money with your home shop.

But it takes a good saw to make the greatest savings — one whose accuracy can always be depended upon — one that's built to help you do a "professional" job on every project and give you a lifetime of service. You'll see for yourself that Power King is such a saw when you compare it with other 8" saws.

First, notice the bigger table and its precision-ground grey-iron surface. Work slides smoother on it. Note the rugged full-size base. And on the Power King the saw blade tilts for angle sawing. The table is always flat in the safest position for use. The blade cuts 2 $\frac{5}{8}$ " deep.

Take particular notice of the new type rip fence. It's an accuracy feature and time-saver you'll always appreciate — extends clear across the table, locks securely at both ends, releases instantly to lift off or position.

The bearing construction also adds to Power King's extra-value. The saw arbor runs on two precision ball bearings, grease-packed and sealed against dust and dirt. Such wear-resisting construction assures long accurate service with a Power King.

Yes, in every way, the Power King 8" saw can do a better job for you in your shop, and it's a low cost tool. Send a postcard for full construction details and the name of your nearest Power King dealer.



**NEW! FREE CATALOG SHOWS  
ALL 8 POWER KING TOOLS**

Send a Postcard



**ATLAS PRESS Company**

1235 N. Pitcher St., Kalamazoo, Michigan



**MATCHED PRECISION TOOLS FOR  
WOODWORKING AND METALWORKING**



**ONLY** *Royalton* 

# FILTERWELL

*has All Three*

- 1 Economy Price **\$1**
- 2 Ajustomatic\* Stem
- 3 Imported Briar

*All Royalton Pipes have the Ajustomatic Stem*

\* Patented

ADJUSTOMATIC STEM NEVER LOCKS OUT OF LINE

FILTER ABSORBS TARS & JUICES

Before you buy your next pipe check all features of the Royalton Filterwell: patented Ajustomatic screw-stem, plus fine imported briar in a filter pipe at \$1.00... Luxury smoking at amazingly low price!

At leading stores. If unavailable locally write to  
**HENRY LEONARD & THOMAS, INC. OZONE PARK 17, N. Y.**

## NOW, YOU TOO CAN WELD!

IT'S EASY—WITH THE

High in PERFORMANCE  
—LOW IN COST!



**miller**  
*"Hobby Arc"*  
HOME WELDER  
110 VOLTS

Designed and built by the men who make the Miller industrial welders. Compact, light in weight, low in cost yet able to do a man sized welding job with electrodes up to 1/8". Operates on AC current on a 30 ampere fuse. Shipped complete with electrodes, electrode holder, helmet and cables.

TRY IT IN YOUR WORKSHOP

**miller** ELECTRIC MANUFACTURING CO.  
APPLETON, WISCONSIN

## BOYS! Have fun with CHEMCRAFT!



**FREE-**

*This exciting new book*



Send today for new, FREE Chemcraft Chemistry book—"The Wonders of Chemistry". Shows how to amaze friends and family with chemical magic. Describes many fascinating home experiments like making perfume, windshield cleaner, soap, etc. Loads of fun, thrills, excitement and adventure await boys who start now to obtain knowledge of Chemistry. Act now! Send for FREE Chemcraft Chemistry book—TODAY!

REG U S PAT OFF

# CHEMCRAFT

*America's Leading Chemistry Outfits*



Sold in the best stores all over the country. Address below for your FREE copy of "THE WONDERS OF CHEMISTRY."

**THE PORTER CHEMICAL COMPANY**  
83 Prospect Avenue • Hagerstown, Md.

SAY YOU SAW IT IN POPULAR MECHANICS

**safe**  
FOR FAST BATTERY CHARGING...



Model K  
\$149.50  
F. O. B.

**H&H**

• FAST BATTERY CHARGER & COMPRESSOR

GUARANTEED not to harm batteries. Users all over the world say "Wouldn't be without it!" SIMPLE-FAST and SAFE TOO! Starts motors and inflates tires QUICKLY. Charges in 30-45 min. Model GKN gas powered for farm use, Model SN, charger only. See your dealer or write factory. VALUABLE TERR. OPEN FOR SPECIALTY SALESMEN AND DISTRIBUTORS, WRITE NOW. Mfr'd & GUARANTEED by

**H&H PRODUCTS MFG. CO.**  
DEPT. M 306 BOYD STREET-LOS ANGELES 13, CALIFORNIA

## AUTOMATIC FLOOR LIGHT

FOR FORD AND MERCURY CARS  
1941 THRU 1948 MODELS

OPERATES WHEN DOOR IS OPEN  
Brightly Illuminates Floor and Running Board for Safety and Convenience.

Simple Installation — No Holes to Drill  
**\$3.00 PAIR — POSTPAID**  
Send Postal Money Order — No C.O.D.

**AIRCRAFT METAL PROD.**  
4012 Richmond N.W., Grand Rapids 4, Mich.

**GENUINE DIAMOND SCRIBER!**



WRITES ON GLASS, METALS, PLASTICS

Never before at this price! Finest diamonds specially selected for cutting qualities. Set in hexagonal aluminum handle 6" long, by patented "Perma-Grip" method. Scribes or etches on glass, metals, plastics. Every scriber tested. Money back guarantee. Made by Clipper, foremost New York diamond tool manufacturer.

No C.O.D.'s. Send cash, M.O., or check.

**\$ 2 0 0**  
Postpaid

Agent and dealer inquiries invited.

**CLIPPER DIAMOND TOOL CO., INC.**  
21-B WEST 46 STREET, NEW YORK 19





**Outstanding  
Manufacturing  
Opportunity**



*More Local Duntile Plants  
Must Be Installed*

Amazing demand for DUNTILE—World's Most Beautiful Roof—opens up new manufacturing opportunities for men of modest capital, backed by vision and aggressiveness. Ties in with the great building industry, now starting its biggest period in history. Duntile is masonry—strong, safe, enduring. Smart design, in choice of many select colors. Has pride-appeal to every home owner. Definitely economical. With these advantages it has unlimited market possibilities. Manufacturing is easy; we supply all equipment for automatic, low-cost production. Excellent profits—100%-125% mark-up on basic costs. Write immediately for literature and Manufacturing Analysis. Get into this business NOW!



**W. E. Dunn Mfg. Co.**  
619 W. 24th St., Holland, Mich.

**DUNTILE**

**WOODWORKERS... Get this**  
CONSTANTINE MASTER MANUAL

**Get the Most Fun From Your Hobby**

Indispensable to woodworkers. Newest, biggest edition, more pages, more color, helpful how-to-do-it articles, pre-war and new items, more bargains. Send 25c today and we will include **FREE! FULL YRS. SUBSCRIPTION** to Chips and Chats, published bi-monthly. Keeps you up-to-date on everything in woodworking, offers big money-saving bargains. Send now.

ALBERT CONSTANTINE & SON, Inc.  
791-H 135th Street, New York 54, N. Y.



**THIS 1 RULE DOES ALL 3**

**On the level!** The minute you see it you know you must have it! A lot for your money because it does a lot: measures, levels, plumbs. All-in-one! Hardwood; precision-made; a practical working tool for home, office, shop, factory. Has horizontal and perpendicular levels smartly set off in red. A great year-round gift—for yourself or friends. Send \$1 today for your 3-in-1 Rule-Level. Money back if not satisfied! **RULE-LEVEL, INC., 105 E. California Street, Glendale, California.**

**MEASURES  
LEVELS  
PLUMBS**  
**\$1** postpaid  
Money-Back  
Guarantee

**FIX SEWING MACHINES**

**BIG MONEY.** Spare or full time. Open your own neighborhood shop. Thousands need repairs. Send for complete Service Manual—only \$1.95 postpaid. Money back guarantee.  
**SEWING MACHINE SERVICE CO., Hamilton 25-HH, Ohio**

**2 Tons Cutting Power!**  
**IT'S THE NEW  
MANCO JR.**

**No Workshop  
Complete  
Without  
It**

**Does More  
COSTS LESS  
\$3.50**  
List Price



Compound leverage provides fast, easy cutting of mild steel bolts up to 1/4" . . . screws, rivets, nails, fencing of any material up to the hardness of heat treated steel. Nickel plated with alloy tool steel jaws. Convenient tool box size. Ideal for farm, automotive and home workshops. See your dealer or order direct. Dealer and jobber inquiries invited.

**MANCO MFG. CO., DEPT. 2, BRADLEY, ILLINOIS**  
Gentlemen: Please rush me C.O.D. \_\_\_\_\_ Manco Jr.  
Cutters @ \$3.50 each plus postage.

Name \_\_\_\_\_  
Street \_\_\_\_\_  
City \_\_\_\_\_ State \_\_\_\_\_

**ORDER  
YOUR  
MANCO  
JR.  
NOW!**



**THE GIFT  
THEY ALL  
WILL USE!**

Dad will use SYNCRO for intricate scroll work, what-nots, book ends, other useful articles. Mom will use it to make lapel pins, saw frozen meat, etc. Here is the PERFECT family Gift! Ask your favorite dealer today for SYNCRO Safe Power Saw!



So SAFE children may use to make models, toys, cardboard cut-outs, etc.

**SYNCRO**  
ELECTRIC  
**SAFE POWER SAW**



**ONLY  
\$17.50**  
COMPLETE WITH BUILT-IN MOTOR!

**R.A. JONES**  
*Lives Here*

Phone **532** Ladies



**JOHN SMITH**

Yes, here's the ONLY power saw in the world EVERY member of the family can SAFELY use . . . whether they're "making things" for personal pleasure or to sell for extra income! Syncro is used in schools, hospitals, and thousands of apartments, houses in towns, on farms. NO MOTOR TO BUY! Plug into any 50-60 cycle, 110-120 volt A.C. only outlet—and saw! Portable. Cleanly cuts wood, thin metal, plastics. Arm adjusts to cut any length material. New Off-On switch. Quiet operating. Enjoy a Free Trial at dealers near. Still only \$17.50 (\$18.50 direct from factory, postpaid, if no Syncro dealer near.) Full-size Pattern No. 74 (for House Numbers, Name Plates, Signs) FREE with your SYNCRO. (For Pattern No. 74 only, send 25c to Syncro Pattern Division, Dept. H-128, Box 216, Pleasantville, N. Y.) Or rush post-card to factory for Free Syncro Circular!

**SYNCRO CORPORATION**  
DEPT. H-128 ROCHESTER, MICHIGAN

**MAKE CUT-OUT FREE AT DEALERS!**

Paste figure of "Miss Syncro" (or any snapshot) on 1/4" plywood or 1/2" soft wood, take to nearest Syncro dealer, present Coupon below, and cut out a wooden silhouette FREE—take home for mantel, dresser display.  
(DEALERS! Write, wire for "Special Dealer" Offer!)

**FREE TRIAL COUPON**

MR. SYNCRO DEALER: This entitles bearer to saw out, on your SYNCRO SAW, FREE, one snapshot or picture bearer has pasted on 1/4" plywood or 1/2" softwood—or personally try SYNCRO at store using material you furnish.

**SYNCRO CORPORATION, Rochester, Michigan**



**SAVE TIME!  
AND WORK!**

**MAKE EXTRA!  
MONEY!**

**EASY TO  
OPERATE**



**SHAW  
"DU-ALL"**  
and **"PEPPY PAL"**  
GARDEN TRACTORS

**PLOW**

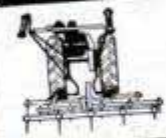

**HARROW**



**CULTIVATE**



**MOW**

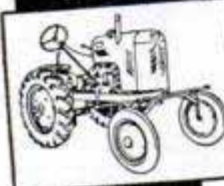

**RIDE**

RW-2

**SHAW  
MFG. CO.**

These sturdy walking and riding tractors ideal for dozens of uses around the farm, orchard, garden, golf course, estate and poultry farm.

**DO DOZENS OF JOBS**

Shaw Du-All or Peppy-Pal tractors do many jobs quickly and easily. Plow, cultivate, harrow, mow, disk, bulldoze, spray, grind, haul and saw wood. New uses discovered every day.

**BUILT FOR RUGGED WORK**

Sturdy, extra-strength construction means low upkeep, long life. Patented tool control allows quick shift for crooked rows. Attachments easy to change with improved "Jiffy Hitch."

**CHEAP TO OPERATE**

Operates on a few cents an hour. Soon pays for itself in time and labor-saving plus low initial and operating costs.

**LOW FACTORY PRICES**

Buy direct or through your dealer! Almost anyone who has a garden can afford a Shaw Du-All or Peppy-Pal. Full year's guarantee.

**RIDING TRACTORS**

Four models, from 5 to 12 1/2 H. P., 68 in. wheelbase, 36 in. wide, 24 in. plant clearance. Hand or electric starter. Improved steering device, brakes enclosed in differential housing shaft. Standard hitch for trailers and wagons. Plow, harrow, cultivator, cutter bar, snow plow, bulldozer available.

**PROMPT SHIPMENT** No waiting — order now for immediate delivery.

**FREE:** Illustrated folders giving complete details and price lists. Write today:

4512 Front St., GALESBURG, KAN.  
668-G North 4th St., COLUMBUS, O.

**WIND ELECTRIC MOTORS**

like GE., Westinghouse and others do

**WITH OUR STATOR HOLDERS  
ADJUSTABLE ARMATURE HORSES  
SKEIN WINDERS - DEREELERS ETC.**

If you want to start a shop of your own—write us

SEND FOR CATALOG

**MOTORCRAFT, BOX 470, MUNCIE, IND.**



**Original  
HOLLYWOOD WOLF WHISTLE**

**CAR HORN**



Give the  
**WOLF CALL**



You, too, can become a Hollywood Wolf. Give the wolf call and make other weird noises with the original HOLLYWOOD WOLF WHISTLE on your car. Precision made. Works off the intake manifold. Easily installed in 15 minutes.

Works in trucks, motorcycles, motor boats, outboard motors, too. Guaranteed. If your dealer cannot yet supply you, order direct, giving us your dealer's name. No COD's or stamps. No individual foreign orders. AUTOMOTIVE DEALERS & JOBBERS write for information on this fast selling, proved item.

**YODER MFG. COMPANY**

2403-21P East 103rd St., Los Angeles 2, California

**DESCRIPTIVE  
LITERATURE  
ON  
REQUEST**

Sand Casting — Forging — Heat Treating — Case Hardening

**BRONZE FOUNDRY**



In your own workshop allows you to design and build your own GASOLINE ENGINES, STEAM ENGINES, STATUARY, ART OBJECTS, SPECIAL TOOLS, NEW INVENTIONS, ETC. You can also make forgings and case harden steel. Your shop is not complete without a FOUNDRYETTE. Three sizes are available capable of making bronze castings of 1 1/2, 3 and 6 pounds weight, aluminum, copper, brass, etc., \$22.50, \$29.50, \$42.00 f.o.b. Kansas City. Domestic gas supply and 110 volt AC or DC energy required for operation. Write for circular.

**KANSAS CITY SPECIALTIES CO.**

Box 6022, Dept. P-11

Kansas City, Mo.

**SADDLE HORSES**

LEARN HORSE TRAINING AND MANAGEMENT

SUBSCRIBE  
FOR

The **"EXPERT HORSEMAN"**



**FREE BOOK**—You will also receive a booklet that tells how you can learn to Break Colts, Gait Show Horses, Train Race, Stock, and Race Horses, Break Bad Habits, Handle any horse, Train Circus Trick Horses.

**ONLY  
\$1.00  
YEAR**  
1st COPY  
MAILED  
AT ONCE

**ANIMAL LOVERS ASSOCIATION**

BOX KA-111

TARZANA, CALIFORNIA

**MOTORISTS! NOW EASE THAT TIRED  
ACHING LEG WHILE DRIVING**



Tall or short, fat or thin motorists get instant relief from tired aching leg muscles with the new "LEG-EEZ" Gas Pedal Extension. Provides many changes of position of leg and foot while driving. Adjustable. Fits all models of foot accelerators. Installed in 5 min. Guaranteed. Send check or M.O. for \$1.65 ea. postpaid U. S. Dealers and Agents Wanted. Write:

**McDONALD ENTERPRISES •**

520 "E" St.

DEPT. PM

San Diego 12, Calif.

**"Does Same Work as High Priced Machines"**

... so says L. E. Puterbaugh, Dayton, Ohio. YOU MUST SEE this amazing 5-in-1 EMRICK to fully realize what a wonderful bargain we offer. Handles big, heavy jobs. Tools quickly interchangeable — 83 operations. Needs only ONE motor (1/4 to 1/2 h.p.). Equals in performance equipment costing up to 8 times more. Dandy for man or boy — do home repairs; make scores of articles from wood, metals or plastic. Use it for operating profitable spare-time business. Thousands of satisfied users. Don't squander hard-earned money on high-priced outfits — GET AN EMRICK!

Mail coupon now, or write us.

**FREE 10-DAY  
OFFER**

EMRICK, INC., 1742 Clinton, Kalamazoo, Mich.

I enclose \$18.00. Ship Emrick Workshop (complete less motor and saw blade) on balance c.o.d. basis. Unless completely satisfied, I may return within 10 days and get my money back.

Name \_\_\_\_\_ (PLEASE PRINT)  Send FREE catalog.  
Street \_\_\_\_\_  
City \_\_\_\_\_ State \_\_\_\_\_

**Look - ONLY \$39.95  
for This 5-in 1 Machine**

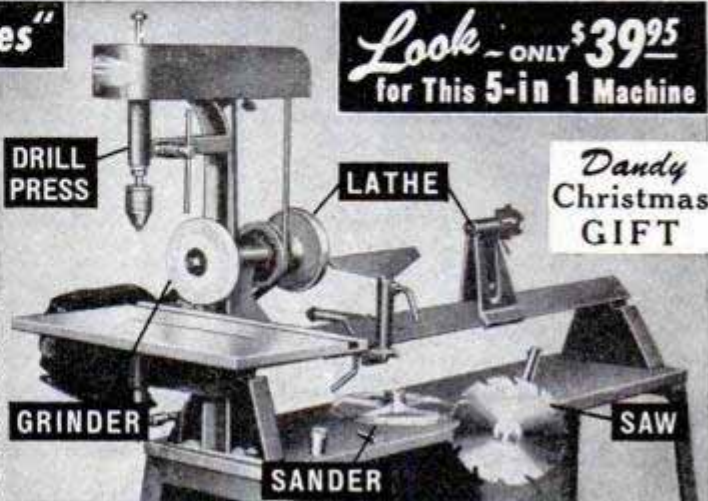

**Dandy  
Christmas  
GIFT**



# You Can Be a Local COLORCRETOR



You can build a profitable, lifetime business with Colorcrete. Large waiting market. Work is easy and interesting. Moderate investment; high return. Large waiting market. Full instructions and liberal cooperation.

## Sprayed-On Beauty

Colorcrete is modern beauty treatment for masonry surfaces — exterior and interior. Fuses to concrete, stucco, etc. Applied by air pressure. Range of many smart colors. Proven by 20 years of use on all kinds of buildings. Write or wire for Opportunity Book.

**Colorcrete Industries, Inc.**  
570 Ottawa Ave., Holland, Mich.

**Outstanding  
Business  
Opportunity**



## BRASS NAME PLATES OR KEY TAGS

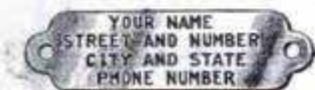

Half actual size

(Individual Stamping)

40c each

3 for \$1.00

Duplicate plates or key tags (same stamping on the lot) 8 for \$2—15 for \$3—24 for \$4—50 for \$6. Larger quantities on request.

For quick identification, always use TAGCO enduring tags in brass or nickel silver. Our latest circular illustrates a large variety of tags of all sizes, also blanks. Prices reasonable. Send for it and booklet "A Name for your dog." Both Free.

DEALERS WANTED

STAMPING EQUIPMENT

**TAGCO, BOX 38X, WINGDALE, N. Y.**

## STOPS FOGGY WINDSHIELDS NEW Chemical Mitt



**Amazing Discovery!** Autoists will discover new "NO-FOG" Windshield Cleaner. Simply glide over windshield chemically-treated Mitt—at once glass sparkles crystal clear. Cloudy haze, mist, dust, grime disappear like magic. Stops fogging. *Sell like wild!*

**SAMPLES FOR AGENTS** Sample offer sent immediately to all who send name at once. A penny postal will do. **SEND NO MONEY—just your name.** KRISTEE CO., 694 Bar Street, AKRON, OHIO

## ALL THE THRILLS OF REAL FOOTBALL



## PASS 'N PUNT

Miniature football game

Amazing table football game uses miniature men in game played like real football. No other like it. A GAME OF SKILL — no dice or spinner. The ball is actually kicked and passed. The miniature men carry the ball in line bucks — end runs — trick plays. The real game of football is all here with forward and lateral passes — field goals — touchdowns, etc. Acclaimed by football coaches. Standard football rules understandingly applied. Learn and play the game with real football strategy. As exciting to watch as it is to play. Miniature men finished in brilliant oil colors.

Remittance with order — \$4.95 postpaid

C.O.D. orders... \$5.50

**ARNOLD SPECIALTY COMPANY**

Dept. 12A Box 469

Burbank, Calif.

# The Truth about DEAFNESS

## AND HEARING AIDS



**A**RE YOU hard of hearing? Do you fear the complete loss of your hearing — yet find yourself confused about which way to turn, because of so many conflicting claims?

Well, if you want the truth about deafness and hearing aids, let us send you a free copy of the booklet, "I'm Deaf, But I Won't Stop Hearing."

In this booklet, a well-known author tells about his experience with 20 years of deafness — his many efforts to secure satisfactory hearing, and how he finally solved his problem.

With this fact-packed booklet we will send full details about the sensational, new single-unit Zenith† "75" Hearing Aid — how you can try it for 10 days without risk\* — how you can buy it on easy terms, if you like.

So write today and start yourself on a new road to happiness! Address Zenith Radio Corporation, Hearing Aid Division, Dept. PM-128, 5801 Dickens Avenue, Chicago 39, Illinois.

\*Available on direct sales by Zenith Radio Corp. or its subsidiaries.

## NEW ZENITH RADIONIC† HEARING AID

By the Makers of the World-Famous Zenith Radios

Look only to your doctor for  
advice on your ears and hearing



This is all you wear!  
\$75 Complete



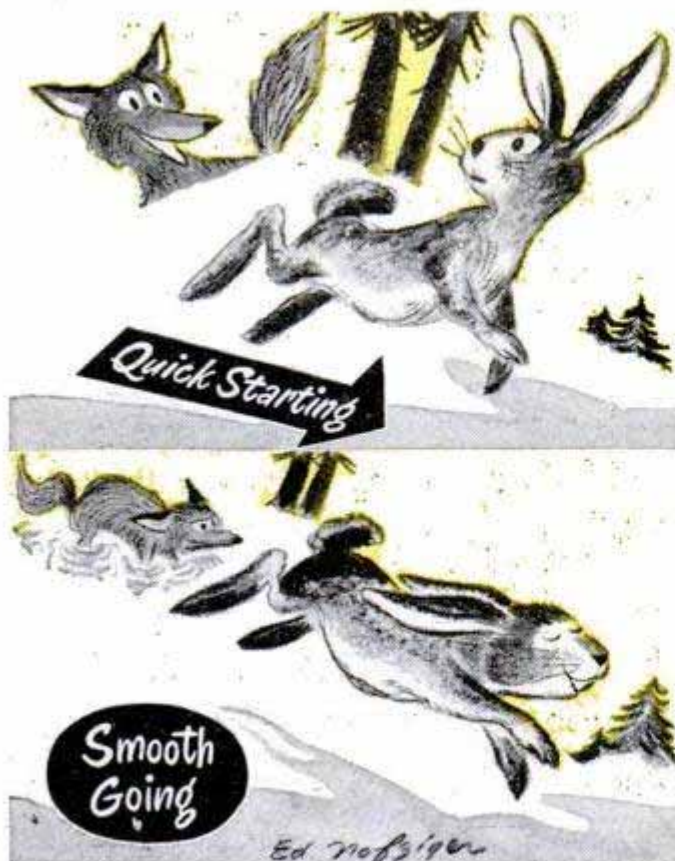

### ... with Casite in Your Car

● Casite gives you quick, snappy starts, right on time, every time. No matter how cold the weather, Casite retards congealing of oil, lets your motor spin and go.

And Casite keeps you going smoothly, steadily, powerfully—without spit or sputter, jerking or jumping.

You'll know a new thrill, a new satisfaction from your car. You'll know, too, your engine's getting extra protection, improved lubrication, and longer, brisker life—with Casite in the crankcase.

THE CASITE CORPORATION, HASTINGS, MICHIGAN  
Casite Division, Hastings Ltd., Toronto

75¢ a pint

95¢ in  
Canada



### Windshield Scraper Made of Plastic

Ice can be scraped off car windshields and windows without scratching the glass with a small scraper made of Plexiglas. The scraper's blade is two inches wide and has a handle shaped to fit the fingers. A miniature compass is mounted in the center of the scraper and a key chain is looped through a hole in the handle. The scraper is decorated with an engraved initial.

### Scientists Record Chewing by Moth

Preserved on a phonograph record, the sound of a moth chewing a piece of cloth sounds like someone eating corn flakes, according to a scientist at Cornell University where the recording was made. By sewing the larva inside a tiny cloth sack, the scientists were able to make it chew its way out. The sound of the chewing was picked up by a supersensitive microphone and recorded. Last year, the scientists produced an album of 72 bird songs and they have just completed an album featuring the calls of 26 varieties of frogs and toads. The moth-chewing record was made at the request of a moth-ball manufacturer.

### Rival for Stainless Steel

Titanium metal, used only for laboratory research in the past, now is being produced for commercial development. The metal is similar to stainless steel in strength and corrosion resistance but weighs only a little more than half as much. It probably will be used where a high ratio of strength to weight is needed, such as in the production of high-speed planes. A Du Pont pilot plant is turning out 100 pounds daily and the output is expected to increase as new uses are found for the metal. Although titanium is the ninth most common element in the earth's crust, it is very difficult to separate in pure form from its ores.



# Inseparable

GOOD CRAFTSMANSHIP...GOOD TOOLS

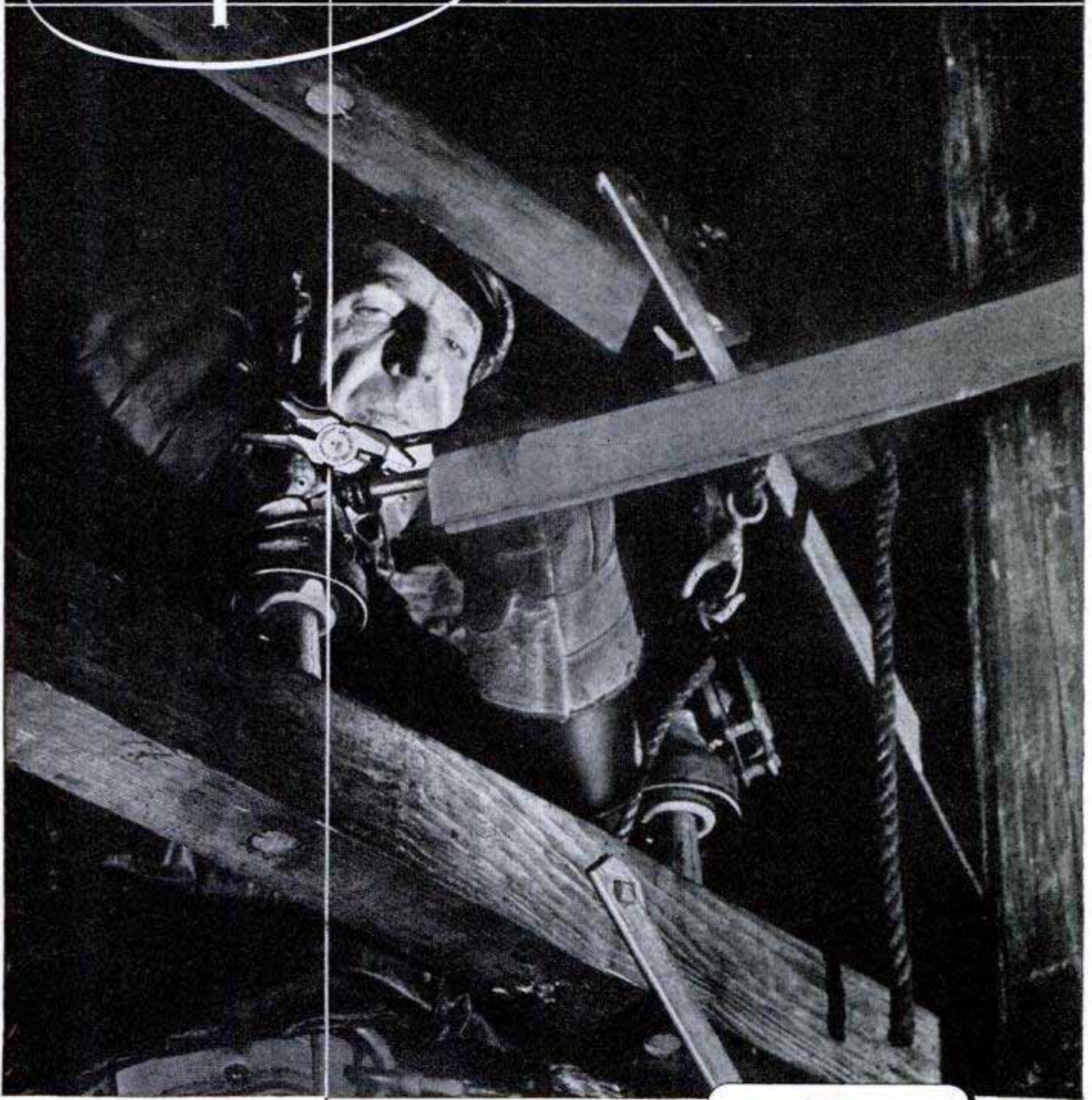

"CRESCENT" is our trade-mark registered in the United States and foreign countries for wrenches and other tools. "Crescent" tools are made only by Crescent Tool Company of Jamestown, N. Y., and are sold by leading distributors everywhere.

**CRESCENT TOOL COMPANY**  
Jamestown, N. Y.

## CRESCENT TOOLS



*Sign of the Artisan  
Symbol of Excellence*



# Amazing NEW TOY GUN

**"Shoots" Like a Real Gun**

**ONLY \$1.00**

**INCLUDES 10,000 SHOTS**

### COMPLETELY SAFE

Here is the gun that will thrill every boy. When you pull the trigger, it cracks out like a real gun and smoke puffs out of the muzzle. The American Rangers Automatic is a quick acting, repeating pistol that never misses. It shoots 60 to 75 shots without re-loading. Looks like a real gun. Absolutely SAFE. Contains no explosives. Each gun comes boxed with 10,000 shots of smoke powder or enough ammunition to last a full year. This smoke powder is harmless. Will not hurt the eyes and may even be eaten. Only \$1.00 each or 3 guns for \$2.00. Only limited quantity available. Write for yours NOW.

### SEND NO MONEY Try 10 Days - At Our Risk

Just send name and address. On arrival deposit only \$1.00 plus C.O.D. postage for one gun or \$2.00 plus C.O.D. postage for three guns. If not completely satisfied return and your money refunded. Save money. If you send cash with order, we pay postage. Write TODAY. No foreign orders accepted.

**SPECIALTIES MFG. CO., Dept. 508**  
1367 N. Sedgwick Chicago 10, Ill.

# DO YOU WAKE UP STIFF?



When muscles are stiff and sore from unusual exercise or strain, use HEET®, the liniment that's strong yet does not burn the skin. Wonderful relief from muscular soreness comes as comforting HEET quickly starts to penetrate. Just brush it on with the applicator. HEET starts at once to ease muscular pain and keeps on working for hours. Ask your druggist for HEET liniment.

SAY YOU SAW IT IN POPULAR MECHANICS

## SAVE HEATING FUEL COST WITH THE STRICKLAND FUEL SAVING FURNACE BLOWER FOR GRAVITY TYPE HOT AIR FURNACE SYSTEMS

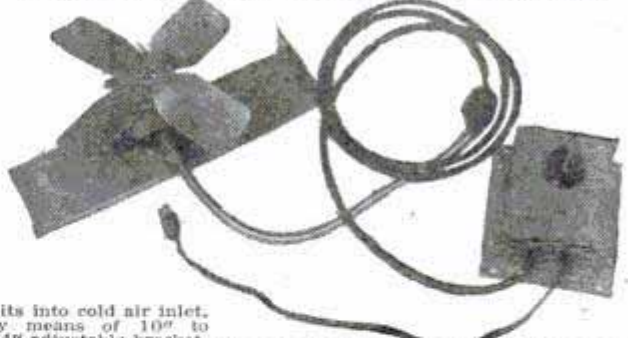

Fits into cold air inlet, by means of 10" to 24" adjustable bracket, to make efficient blower type heating systems out of old inefficient gravity systems by blowing hot air out of the furnace into desired spaces. Helps to heat upstairs rooms instead of over-heating basements. Greatly reduces fuel consumption at a time most desirable. May be used in summer to help reduce house temperature. Variable Speed Control gives wide range of air volume. Flexible conduit covered cord for protection at cold air grill. Operates in any position. May be used in connection with thermostats or thermostatic furnace switches. Guaranteed against defects in material and workmanship for one year. Price complete as shown, \*\$28.50. Without Speed Control and its wiring, for single speed operation, \*\$18.50. Sold on 5 days free trial. Shipped prepaid to points within U.S.A., if remittance is enclosed with order, or shipped COD for balance and charges upon receipt of \$3.

**STRICKLAND ELECTRIC COMPANY**  
1427 E. 18th AVE. Section PM-12 COLUMBUS 11, OHIO  
\*Prices subject to 3% Sales Tax if shipped to points within Ohio.

## MAXIM AUTO POWERED BUZZ SAW

Let your car saw wood—in back-yard or woodlot—carry this outfit anywhere in your car—quick and easy to set up—no careful alignment necessary. Sold as complete outfit or power unit, etc., separately.



Send for FREE catalog

**MAXIM SILENCER CO., 99 Homestead Ave., Hartford 1, Conn.**

## REAL PRECISION AT GREAT SAVINGS!



You can still get a fine Scherr micrometer at a low price—and with .0001 vernier in the 1" and 2" sizes. But you must hurry. Order now or write for our illustrated folder or for details of our shop agent plan.

**\$8.75**  
IN 1" SIZE AS SHOWN

**GEO. SCHERR CO., INC.** 202 Lafayette St. New York 12, N. Y.

## Mail Order Season \$\$\$\$ is here again!

NOW is the time to get started on this terrific money-making business. There is big money to be made this fall, winter and spring—why not CASH IN ON IT? Amazing particulars FREE! Send card today to—

**E. A. MEDVED COMPANY, Dept. P**  
210 Fifth Avenue New York, N. Y.

## WITH MOLLY YOU CAN FASTEN ANYTHING

and do it quickly, neatly and safely. MOLLY will hold fixtures securely to floors, ceilings or any hollow wall construction... Simple to install, all you need is a screw driver. Sold by leading hardware stores everywhere.

Write for Free Descriptive Folder

PLACE FIXTURE WHERE SCREWS WON'T HOLD — USE MOLLYS

**MOLLY CORP.**  
522 COURT STREET  
READING, PA.



Phenomenal Value • Treasured Lifetime Gift

INCABLOC  
Shock  
Resistant  
Feature

17 JEWEL • 2 PUSH BUTTON  
**CHRONOGRAPH**

"4-in-1" Precision Instrument

- WRIST WATCH • TELEMETER
- STOP WATCH • TACHOMETER

Sweep second hand • Anti-magnetic • Radium dial  
Stainless steel back • Un-breakable crystal. IDEAL  
for use in sports,  
sciences, engineer-  
ing, medicine, photo-  
graphy, radio,  
aviation.

**\$29.75**  
plus  
10% tax  
(formerly  
\$71.50)

OUR FAMOUS  
GUARANTEE  
MONEY BACK  
in 10 DAYS  
If not satisfied  
for any reason



Also  
available  
in 18K  
Gold Case  
**\$64.50**  
plus 10% tax  
(formerly \$125)

Mail orders promptly  
filled. Shipped C.O.D.  
or send check or money  
order. Address all mail orders  
to: **ADLEW JEWELERS,**  
152 W. 42 St. N.Y. 18 (Dept. 117)

**Adlew  
JEWELERS**  
117 W. 42nd St., New York 18

**RUPTURE!**

An amazing Air-Cushion  
Invention allows body  
freedom at work or play.  
Light, neat, cool, sanitary.



Durable, cheap. Day and night protection helps  
Nature support weakened muscles gently but surely.  
No risk. Sent on Trial! Write NOW for free Booklet and  
Proof of Results. All correspondence confidential.

**Brooks Company, 161-D State St., Marshall, Mich.**

**RACING CAR EQUIPMENT**  
FOR ALL CARS

Engines, Racing Heads, Manifolds, Carburetors, Mufflers, etc. Speed  
Instructions and literature \$1.00—refunded first order.

**LEE MOTORCRAFT CO.**

1412 Great Northern Bldg.

Chicago, Ill.

**Build YOUR OWN BOAT**



Complete parts cut to exact size—ready  
to assemble. Marine waterproof plywood,  
rustproof oarlocks. Ideal for car top.  
Also models with laminated frames; ma-  
hogany decked runabouts. Build for sale at attractive  
profit. Exclusive franchise to local builders. Send  
10 cents (dime) for illustrated literature.

**\$39.50**  
and  
up

**OZARKA**

724 WASHINGTON AVE.

WOODSTOCK, ILL.

**PLASTICATED "GI" CLOTHS**

WATERPROOF, LIGHTWEIGHT, 8 X 10 foot, 1001 uses as painter's  
dropcloth, lawn, furniture, machinery, merchandise cover, beach  
blanket, or shelter. Many uses camping, fishing, or picnic trips.

Send one dollar, and we will ship one cloth prepaid—

**SAX-ON • Dept. M-12 • 3840 Fullerton • Chicago 47, Ill.**

**DIE-LESS  
DUPLICATING**

Many small parts can be formed without  
dies, to duplicated accuracy of .001" with  
DI-ACRO Precision Machines. — Benders,  
Brakes, Shears. Save die expense and time  
delay. Ideal for experimental  
and research work, making  
samples, models, etc., as well  
as regular production runs.  
Write for descriptive literature.

**O'Neill-Irwin Mfg. Company**

341 8th Ave.  
Lake City, Minnesota



**RUST REMOVAL** with wire brush at-  
tachment for electric drill. For those  
hard-to-get-at places and large, awk-  
ward metal objects, your electric drill  
fitted with a wire brush as shown will do  
the job nicely.

**Extra  
Uses  
For Your  
Electric  
Drill!**

Yes, there are plenty of *extra* jobs your electric  
drill can do for you because its tight-gripping  
**JACOBS CHUCK** will hold a variety of attach-  
ments with tremendous gripping power. Your own  
imagination is the only limiting factor in your  
drill's usefulness.

**AND FOR YOUR OTHER WORK SHOP  
EQUIPMENT . . .** Jacobs new Rubber-Flex  
Collet Chucks are available to multiply the use-  
fulness of your present power tools. These amaz-  
ing new chucks give greater gripping power . . .  
better accuracy . . . longer life.

Exclusive, bonded rubber-and-steel construc-  
tion . . . no loose jaws . . . no springs . . . not  
harmed by oils or coolants. Real precision chucks  
at popular prices. See them at your local hardware  
dealer's.

**IF IT'S A JACOBS . . . IT HOLDS**



**HEX-KEY CHUCK** . . . fits drill press spindles  
— motor shafts — jack shafts. With  
Morse taper arbor, fits lathe headstock,  
tailstock. 4 models, capacities to 1/2"; fits  
1/2" or 3/8" shafts.



**HAND-TITE CHUCK** . . . fits all hand  
tools and power tools with threaded spin-  
dles . . . used on polishing heads, bench  
grinders, flexible shafts, etc. 3 sizes . . .  
capacities to 1/2". Models to fit 3/8-24,  
1/2-20 and 1/2-24 threaded spindles.

**ONLY**

**Jacobs Chucks**

**Have The Rubber-Flex Collet.  
Its Parallel Bite Holds True and Tight.  
GET THIS BOOK OF UNUSUAL DRILL  
PRESS AND LATHE TRICKS . . .**

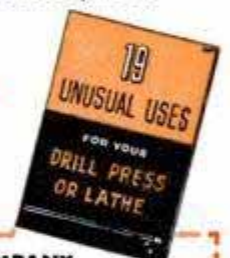

**THE JACOBS MANUFACTURING COMPANY**  
150 JACOBS ROAD, HARTFORD 2, CONN.

Please send me a copy of "19 Unusual Uses For Your Drill  
Press And Lathe". I enclose 10¢ for handling.

NAME .....

STREET .....

CITY.....ZONE.....STATE.....



**a Crosman** ... for **Christmas**



• Year-round pleasure for the whole family with either air-powered Crosman pellet pistol or rifle. Tops in accuracy and power. The Crosman performs anywhere... indoors or out. Uses safe, low-cost ammunition. No flash, smoke or recoil. At home, fine for parties and family fun. Outside, perfect target and light game gun.

THE CROSMAN RIFLE, available in .177 and .22 caliber, single and 20-shot magazine models, rifled barrel, adjustable sights, adjustable power.

The CROSMAN PISTOL, also .177 and .22 caliber, is long barreled with wide land rifling for accuracy. Has adjustable power, safety, adjustable sights.

If not available at your dealers send for literature

**Crosman Arms Co., Inc.**  
3 Henrietta Street Rochester 7, N. Y.

**You Too. Can Fire Rockets**

There's a new thrill coming as you watch one of these rockets soar up into the blue... With speed and action just like a full size rocket. You can have fun or experiment seriously with this model.



**V-2 ROCKET**

May be used over and over. Charge capsules are available everywhere. Complete unit consists of a V-2 Rocket, launching device, and a generous supply of capsules for only \$1.98. When payment is sent with order, we pay postage. Or send no money and pay postman \$1.98 plus mailing costs.

**\$1.98**

Walsh Products, Inc., 209 N. Maple Ave., East Orange, N.J.

SOARS OVER 200 FEET IN THE AIR

Rocket being fired at Wendover Field, Utah.

**PAINTERS' STRIPING TOOL** A TOOL... NOT A BRUSH

**NEW, IMPROVED**



Modern—streamlined—fits the hand like a fountain pen! Easy to use as a pencil. Draws parallel lines—straight, curve or circular. Does expert job on autos, furniture, toys, bikes, model planes, signs, bulletins, linoleum. (Makes wall board look like tile.) Every printer and craftsman needs one! Type "M" MASTER Painters' Striping Tool complete with tip for 1/16" stripe, \$1.00. Tool with choice of 1/64", 1/32", 3/64", 5/64", 3/32", 1/8" tip—\$1.50... all tips 75c ea. Tool with complete set of 7 tips \$5.00. (COD's postage collect.) Paint dealers, write!

**EASY AS USING A PENCIL!**

**\$1.00 POST PAID**

**WENDELL MFG. CO.**  
4234-B Lincoln Ave., Chicago 18, Illinois

**SPEED AND POWER HANDBOOK**



Very latest methods! Construct your own Superchargers, "Water Injectors," Hi-Compression Heads, Fuel Saving Devices—easily. Save many dollars! Get racing speed, acceleration, dynamic power increases from any automobile! Build fast stock cars! California roadsters! Hotrods! Get ingenious formulas! Speed secrets! Illustrations! Conversion ideas! Also "Economy Information"—Mileage tricks! Tuning techniques! Instructions! Picture catalogues. Including "California Restyling Ideas"—Glossy photographs! Drawings! Model revising! Customizing! Streamlining! Leatherlike bound—\$1.98 complete.

Newhouse Automotive Industries, 5941-84 Hereford, Los Angeles 22, Calif.

**EASY WAY TO REMOVE PAINT**

**Wonder-Paste Remover** quickly softens up the toughest paint, varnish, enamel, etc. Apply with brush; allow time for penetration—then remove with a putty knife. At paint and hardware stores.

**WILSON-IMPERIAL CO., 119 Chestnut Street, Newark 5, N.J.**

**MARCOT KEY MACHINE**



Immediate Delivery

MARCOT No. 8 KEY MACHINE, mounted on Cabinet, less motor, \$95.00  
Auto Code Book and Auto Depth Keys..... 12.50  
100 Dz. Popular Cylinder Key..... 60.00  
Blanks.....  
Set—Key File, Follow-Through Rods, Lock Picks, Bit Key Gauge, Thimble, Pins, Springs..... 10.50  
"Locksmith Trade Books":..... 6.75  
How to Open Locks without Keys or Picks; Secret of Locksmithing; How to Make Keys by the Impression Method; Master Key Systems.

**TOTAL COST.....\$184.75**

**A. J. MARCOTTE CO.,** 1200 N. Kedzie Ave. Dept. PM. Chicago 51, Ill.

**DUAL TAIL PIPE EXTENSION**



Fits all cars—chrome plated  
**DEEP TONE**  
produced by 2 1/2 inch outlets **\$2.95**  
Postage free on prepaid orders  
DEALER INQUIRIES INVITED

**LYONS PRODUCTS COMPANY**  
PAT. PEND. 2426 So. LaBrea Ave., Dept. PM-12, Los Angeles 16, Calif.

**Now CHEAP OIL BURNER**

FOR HEATING AND COOKING STOVES—FURNACES  
HEAT YOUR HOME, COOK YOUR MEALS WITH CHEAP FURNACE OIL



NO MORE SHOVELING COAL OR ASHES. Sensational Fuelizer Starter Vaporizing System turns Cheap No. 1 Furnace Oil, also Range, Heater, Tractor Distillate, Kerosene and like oils into oil heat—one of the quickest, hottest fires known. LIFETIME GUARANTEE. \$1.00 Bonus Offer for Testing. We will let you try it in your own stove or furnace for one month. Get yours for introducing. Big profits QUICK. Be first. Send in your name today for details and cash in on the tremendous demand for this Amazing Invention.

**NORTHWEST MFG. CO., 608-P, Mitchell, S. Dak.**



## GIVES YOU 2 DRILLS IN 1

Converts any 1/4 inch Electric Drill to 1/2 inch capacity. Reduction gears reduce speed 5 to 1, the average speed of 1/2 inch Drill thereby increasing power.

Jobbers write Price **\$11.95**  
for proposition

M.O. or check with order

**G. M. CO. MANUFACTURING, INC.**  
1308 43rd Avenue  
Long Island City 1, New York



*It's  
NORTHLAND  
SKI  
Time!*

**THE TIME OF THE YEAR**  
*for the time of your life!*

Pack the season with thrills. Race your favorite slope with the sure-footed control of perfectly matched, hand-crafted Northland Skis. Northlands are ideal to own, ideal to give. Send 15c for the famous Northland Ski Manual, or, write for free pamphlet.

**NORTHLAND SKI MFG. CO.**

Supplier to the U.S. Olympic Ski Team

95 MERRIAM PARK • ST. PAUL 4, MINNESOTA

*Save Money-Make Money*  
with **LARSON Leathercraft**

For gifts or for sale—make easy-to-assemble leather items. Complete stock leathers, tools, accessories.

Send ten cents for new catalog of 101 money-making ideas.

**J. C. LARSON CO.** 824 S. Tripp Ave.  
Chicago 24, Illinois

## THERE'S PROFIT in ELECTRICITY—LEARN from PRACTICAL ELECTRICS, \$1.00



Whether you want to enter the electrical field as a profession — or whether you want to know more about fixing electrical gadgets around the house, you will find Practical Electrics a profitable investment. You can find the right answers quickly. It gives you the

fundamentals of electricity, electrical circuits, motors, transformers, electrical symbols, trouble shooting, etc. —all in plain, simple, understandable language. Send \$1.00 today for a copy of Practical Electrics, the ready reference book of electricity.

**AUTOPOWER, INC., 918 SOUTH THERESA, ST. LOUIS 3, MISSOURI**

## ONLY WRIGHT OFFERS THESE OUTSTANDING FEATURES AT THESE PRICES



**\$112<sup>50</sup>**  
less  
motor

### The WRIGHT 6-inch jointer



**\$63<sup>95</sup>**

Complete with AC motor 3/4 HP, 3450 RPM, 110-220 V 60 cycle, 8 ft. cord and plug, 2V drive and driven pulleys and 2V belts, \$185.00

**Wright 10-in. tilting arbor saw**  
Improved, simple rip fence for maximum rigidity.

Machined trunnions for tilt-arbor mechanism for accuracy, long life. 5/8" spindle turns in ball bearings grease-sealed for life.

Under-table space designed for double V pulley for positive power transmission, 45° arbor tilt; 3 1/4" depth of cut; table height 12"; size 30" x 24". Generous use of carefully machined aluminum alloy castings.

The Wright Saw and Jointer will add capacity and speed to your shop, and increase the accuracy of your work. Investigate these new, rugged, precision tools now.

CHOICE DEALERSHIPS ALSO OPEN

**Wright Engineering & Supply Co.**

1300 So. Bannock St. • Estab. 1918 • Denver 10, Colorado

Improved lock knobs with exclusive instant-locking features for setting fence quickly.  
Exclusive safety plate on back of fence covers knives when fence is extended for rabbeting.  
Easy removability of guard for rabbeting.  
Full 45° fence tilt—balanced cutter head—tool steel knives.  
Precision-machined durable lightweight aluminum alloy castings.

Paste coupon on postcard or mail check TODAY!

WRIGHT ENGINEERING

1300 So. Bannock St., Denver 10, Colorado

Please send me further information on the 10" tilt-arbor saw ( ) 6" jointer ( )

Please ship prepaid one saw without motor ( ) with motor ( ) one jointer ( )

I enclose check ( ) money order ( ). I understand that if I am not completely satisfied with my purchase, I may return the saw or jointer in 10 days and get my money back.

Name \_\_\_\_\_

Address \_\_\_\_\_

City \_\_\_\_\_ Zone \_\_\_\_\_ State \_\_\_\_\_



Another GREAT NECK First!

ALL NEW!

REVOLUTIONARY  
MAXIMUM-GRIP  
PLASTIC HANDLE  
SCREW DRIVER

★ Unbreakable!  
★ Twistproof!  
★ Modern Design!

Blade  
lengths  
from  
4"  
to  
10"



GREAT NECK—leader in tool design—offers the new, handsome maximum-grip screw driver you've been waiting for! Richly colored unbreakable plastic handle is slip-proof, non-explosive, non-absorbent to grease or oils. Entire blade is of specially hardened and oil tempered quality alloy tool steel, highly mirror-polished. Bit is precision-ground to exact size. Blade is deeply embedded and twistproof. Here is a beautiful engineered tool to give good service for many years!

THE QUALITY TOOL FOR CRAFTSMEN,  
MECHANICS, HOBBYISTS—EVERYONE!

ASK FOR GREAT NECK TOOLS BY NAME

NOW AT HARDWARE COUNTERS

GREAT NECK SAW MFRS., INC. • MINEOLA, N. Y.

Now for EVERY WORK SHOP!

NEW Invention Electroplates by BRUSH

Easy to Plate CHROMIUM  
GOLD, SILVER, NICKEL, COPPER

... For Pleasure and Profit!

If you have a workshop—at home or in business—you need this new Warner Electroplater. At the stroke of an electrified brush, you can electroplate models and projects—you can replate worn articles, faucets, tools, fixtures, silverware, etc. with a durable, sparkling coat of metal... Gold, Silver, Chromium, Nickel, Copper or Cadmium. Method is easy, simple, quick. Everything furnished—equipment complete, ready for use. By doing a bit of work for others, your machine can pay for itself within a week. So make your shop complete by getting a Warner Electroplater right away. Send today for FREE SAMPLE and illustrated literature. ACT AT ONCE! Mail Coupon.  
WARNER ELECTRIC CO., DEPT. W-9  
1512 Jarvis Avenue, Chicago 26, Ill.

FREE Details & Sample!

WARNER ELECTRIC CO., 1512 Jarvis Avenue, Chicago 26, Dept. W-9

Gentlemen: Send Free Sample and Details to:

Name \_\_\_\_\_  
Address \_\_\_\_\_  
City \_\_\_\_\_ State \_\_\_\_\_



Why Pay More?

TUBE GIVEN WITH EVERY TIRE  
Send this AD with Order  
Slightly Used  
High Original Treads  
★ BUY IN CONFIDENCE ★  
Safe! Dependable! Standard Brands  
GUARANTEED to give A-1 Service  
Positively Not Re-caps!

600-16	\$4.82	700-15	\$4.92
650-15	4.32	700-16	5.22
650-16	4.82	750-16	6.12
900-16	\$7.02	900-20	\$13.32
650-20	8.02	1000-20	15.52
700-20	10.72	1100-20	15.52
750-20HD	12.52	32x6 (8)	9.82
825-20	13.32	32x6 (10)	11.42

750-20 MILITARY 8 PLY \$10.82

Thousands of tires shipped to satisfied customers. Trial will convince you. Orders Shipped Freight or Express. SEND MONEY ORDER OR CHECK.

STANDARD  
834 N. Broad St. Phila. 30, Pa.

BUILD YOUR OWN POWER TOOLS

BALL BEARING ARBORS \$6.95

Reliable Guarantee

Rugged aluminum alloy housing, heavy duty sealed ball bearings, precision steel shaft 1/2", 5/8" or 3/4". Right or left hand thread.

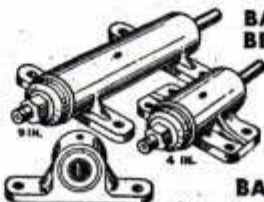

Housing	Overall	Price
2 1/4 x 4"	7 1/2	\$6.95
2 3/4 x 9"	13	7.95

BALL BEARING PILLOW BLOCKS

Same bearings as Arbors. Sizes 5/8" and 3/4". \$3.00 Shipped Immediately Postpaid. Order today, you will be pleased.

O. V. HAWTHORNE TOOL CO., Dept. M, OTSEGO, MICH.

ENSHRINE THEIR MEMORIES WITH

U.S. MONUMENTS

Erected. Freight paid.

There is none better. Our free catalog is ready for you. Write today. A-18, U. S. Marble & Granite Co., Oneco, Fla.

MILITARY TRUCK PARTS



Every part for every G.I. type vehicle from jeep to 20-ton prime mover 6x6 40% to 80% below list.

NORTHWESTERN AUTO PARTS CO.

834 NORTH SEVENTH ST. • MINNEAPOLIS 11, MINN.

COMPASS SAW KIT \$3.69

Postpaid or from your dealer. No C.O.D. orders



Every home craftsman should have one. Contains cast aluminum handle and 4 blades for cutting wood, metal, lath, plaster, BX cable, etc.

Spartan Saw Works, Springfield 7, Mass.





# Here are Real **WAR SURPLUS BARGAINS!**



## HI-SPEED GRINDER

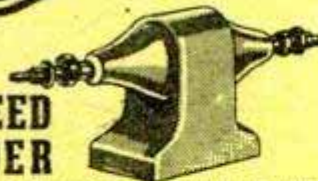

Heavy duty, ball bearing with heavy aluminum casting. 2 step pulley driven thru the rear or base. Precision spindle, 17" long by 3/4" or 3/8" shaft (Specify size desired). 6" from base to center of spindle. Ship. Wt. 12 **\$1395** lbs. Stock #328. NEW, only.

## BALL BEARING ARBOR

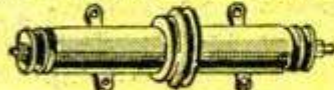

Grinding and saw arbor. Has 1/2" double end shaft, 10" long with 2" center pulley. New Departure double roll precision aircraft ball bearings. Right and left hand thread. Self-aligning Dodge pillow block. 10,000 RPM. Bearings alone list at \$10.00. Complete arbor NEW only. **\$495**

DELUXE version of above arbor—has 2 and 3 inch center step pulley and 2 1/2 in. heavy cast aluminum pillow block **\$695**

## Electric Rubber Cable (ALL NEW)



### CORD SETS

Extension cords, 100 ft. heavy duty. Plug, socket and guard. Number 16 wire. Worth at least \$10. **\$535**

Same as above—50 ft. length. (Stock #311). **\$385**

### HEAVY DUTY ELECTRIC CABLE

3 wire #10 submarine cable and lugs—can be placed underwater, underground or overhead. Also for portable tools. Will carry 40 amps. Stock #312

50 ft. **\$12.00** 100 ft. **\$20.00** 250 ft. **\$45.00** 500 ft. **\$85.00**

## RUBBER CABLE

150 ft. reels, 3 wire #6 with 4, 60 amp Crouse & Hines connectors—2 male & 2 female. Perfect for welders, hay loaders, saws, electric ranges, etc. List price **\$65.00** \$190. per reel. OUR PRICE **\$65.00** (Stock #313)

## JARVIS GRINDERS



2 HP, 60 cycle, 220-440 volt, 3450 RPM. Totally enclosed G.E. motor with 6 ft. flexible shaft. List price **\$285.00**. Used—like new. **\$85.00** (Stock #326)

AS ABOVE with 1 1/2 HP motor **\$75.00** (Stock #330)

AS ABOVE with 1 HP motor **\$65.00** (Stock #331)



## All Bronze GEAR PUMP

All bronze corrosion resistant gear pump. Will lift water 25 ft. Will deliver 1020 gal. per hour at 1200 RPM. Develops 110 lbs. pressure or 250 ft. head. Self-locking packing nuts, drain cock, reversible head. Will pump brine, salt water, oil, vinegar, gasoline, etc. Dimensions: 10" L x 7" H x 5 1/2" W. Base holes 1 3/4" x 3". Shaft 1 1/16", 1" x 1" inlet & outlet. Wt. 24 lbs. Mfg. by Sherwood Brass Works. Requires 1/2 to 3 HP motor. \$80. value for only **\$2495** now (Stock #314)

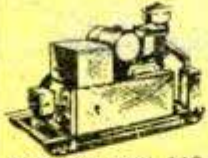

## AC ARMY LIGHT PLANTS

New 750 watt 110 volt 60 cy. light plant with Briggs-Stratton model AP gas engine. (Stock #315) **\$145.00**

New 1000 watt 110 volt 60 cy. light plant with Briggs-Stratton model BP gas engine. (Stock #316) **\$175.00**

New 2500 watt 110 volt 60 cy. light plant Briggs-Stratton model Z 6 HP gas engine. (Stock #317) **\$265.00**

Rebuilt 5000 watt 110 volt 60 cy. light plant with automatic remote control. Powered by Jeep 4 cyl. gas engine. Rebuilt like new and guaranteed. (Stock #318) **\$625.00**

10,000 watt 110 and 220 volt 60 cy. light plant with automatic remote control. Powered by Jeep 4 cyl. gas engine. Rebuilt like new and guaranteed. (Stock #319) **\$725.00**

## PORTABLE DC LIGHT PLANT

3000 watt 110 volt DC powered by new 6 HP Briggs-Stratton model ZXP gas engine. Rebuilt generator. Generator alone lists at \$243.00. Has volt meter, rheostat, 4 female plugs, and ball bearing 2.75 x 10 rubber wheels. Guaranteed. (Stock #320) **\$165.00**

## GENERATORS

DC—3000 watt, 110 volt. Has voltmeter, rheostat & 4 female plugs. Lists at \$243.00. (Stock #321). OUR PRICE **\$60.00**

AC—750 watt 110 volt 60 cycle with voltmeter, rheostat, 3/4" shaft. Dimensions: 9"H x 12"W x 13"L. Wt. 52 lbs. Shielded to prevent radio interference. Mfg. by Eicor. \$125.00 value. **\$49.50** OUR PRICE, new (Stock #322)

DC—300 watt, 12 volt, 2000 RPM. Heavy duty, with current cut-out relay, high and low switch, 30 amp meter, charge and discharge, Mfg. for the Army by the Marathon Elect. Co. Can be used for boats, trucks, tractors, light plant, wind mills, cabins. 3/4 HP gas or 1/2 HP electric motor will drive it. Sleeve bearings. Dimensions: 11 1/2"L x 10 1/2"W x 7"H. Base holes 4 3/4" long, 6" wide. Can be bought less shaft and base to be used direct mounted to Briggs-Stratton 1 HP engine. (Stock #323) **\$7.00** new Complete with base, shaft and bearing. (Stock #324) **\$15.95** new

## POWER WINCH

Ideal for Contractors Farmers Elevators Movers RR Car Movers Well Drillers Mines, etc.

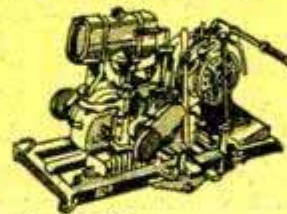

Stock #303

New two cyl. gasoline driven hoists, powered by 11 HP, two cyl. Waukesha air cooled gas engine. Gear shift, 2 speed with twin disc clutch, throttle and hydraulic brake. Capacity on single line approx. 4,000 lbs. Dimensions: 36" wide, 60" long, 30" high. Mfg. Benson Winch Co. Comes with complete repair kit tools and box. Can also be used as a hand winch. In original **\$325.00** crate.....only

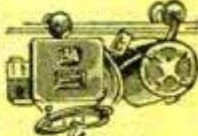

## Electro-Lift HOIST

500 lb. Electro-Lift Hoist. 17 ft. of cable—up and down button and trolley. 3 phase, 220 or 440 volt, 60 cycle. Used, in A-1 shape. List price **\$185.00**. OUR PRICE **\$90.00** (Stock #301) Specify 220 or 440 volt

## Briggs-Stratton GAS ENGINES

Rope start, 1750 RPM. All brand new and guaranteed. 2 1/2 HP model AP... list price \$102.10. OUR PRICE **\$77.00** (Stock #307)

3 1/2 HP model BP... list price \$86.00. OUR PRICE **\$111.50** (Stock #308)

5 to 7 HP model ZXP... list price \$102.00. OUR PRICE **\$137.00** (Stock #309)

## ROTARY PUMP

Heavy duty, designed to pump water, oil, gas, lime, etc. Will pump 35 gal. per min. Also used as vacuum pump. 3/4" outlet and inlet on bottom. Dimensions: 7 1/2"W x 5"D x 7"H. Compact and sturdy. Four mounting holes in base. Can be used with 1/4, 1/3, or 1/2 HP motors. Ship. wt. 17 lbs. (Stock #325) only. **\$16.95** new



## HORNS and HOWLERS



Motor driven (not a vibrator). Heavy duty with great power and long life. Adjustable for high, medium or low tone. 110 volt AC current. Weather proof. For alarm or signal horn on boats, school yards, factories, etc. List price **\$47.00**. OUR PRICE, **\$9.45** new.

9 ft. of cord & switch for horn. **\$1.00**

## Automatic AIR COMPRESSOR

Complete. Piston type with 10 gal. tank, 1/2 HP capacitor type, AC, 110 and 220 volt 60 cycle motor. Will develop 75 lb. pressure—approx. 2 cu. ft. Brand new. **\$79.50** (Stock #340).....only AS ABOVE—unassembled. **\$69.50** (Stock #341).....only

## HEAVY DUTY WAGON



Not war surplus—not a toy. Double the cu. ft. of the average coaster and built to carry 1200 to 1400 lbs. Body measures 24" x 42" with sides 6" high, made of heavy 3/16" plate aluminum. Ball bearing wheels with 2.75 x 10 Goodrich tires and 3/8" axle. Tremendously strong yet weighs only 75 lbs. Ideal for newsboys, grocers, farms, factories, etc. Built to last for years... nothing like it **\$39.50** now on the market. (Stock #332).....

**ALL ITEMS GUARANTEED AS REPRESENTED C & H ELECTRIC Co.**  
434 W. JUNEAU AVE.  
MILWAUKEE 3, WISCONSIN

All prices F.O.B. Milwaukee. 25% deposit required on all C.O.D. orders. No C.O.D.'s under \$10.00. Use stock number when ordering. Many other bargain items not listed—write for our free circulars.





**STOP  
AIR LEAKS**  
in Your Furnace  
or Heater, and  
**CUT  
FUEL BILLS**

**L**OOSE, warped doors or door frames in your furnace or heater cause wasteful air leaks. Use Smooth-On No. 1 Iron Cement to seal such leaks. Use it, too, to seal cracks and leaks in boilers, piping, flues and radiators. You use Smooth-On like putty — no heat needed. It hardens like metal and stays tight, for it expands a little as it sets. Buy Smooth-On No. 1 in 1 1/4-oz., 7-oz. or 1-lb. size at your hardware store. If they haven't it, write us.

**FREE Repair Handbook**

40 pages 170 illustrations. Clear, simple directions for many time-saving, money-saving home repairs. Write for YOUR free copy today.

**SMOOTH-ON MFG. CO., Dept. 37M**  
570 Communipaw Ave., Jersey City 4, N.J.

80-306



*Do it with*

**SMOOTH-ON**

THE IRON CEMENT OF 1 000 USES

**EARN BIG MONEY  
AND BE YOUR OWN BOSS**  
*Sharpening Lawn Mowers*

**THE UNIVERSAL GRINDER  
PUTS YOU INTO BUSINESS  
WITH SMALL INVESTMENT**

Earn as much as \$400.00 a month in your basement or garage. Mr. Felber of Ind., writes, "MY UNIVERSAL GRINDER is faster and more accurate than any other grinder. Its efficiency enabled me to sharpen 450 mowers in 4 1/2 months. More than paid for itself the first month. Every customer satisfied." Mr. Hardy of Mississippi writes, "Received my Universal Grinder the first part of May and by August 18 had sharpened over 1000 mowers." Mr. Bacon of California writes, "The lawn mower business, with my Universal Grinder, has been a gold mine these last two years."



Only on the UNIVERSAL GRINDER can the inside face, the edge of the stationary blade, and the reel blades, be ground to proper clearance ALL IN ONE SET-UP WITHOUT REMOVING ANY BLADE FROM THE MOWER  
Free Folder

**Rogers Mfg. Co., Dept. M-128, Lindsey, Ohio**

**SEND TODAY FOR FULL DETAILS**

**ROGERS MFG. CO., Dept. M-128, Lindsey, Ohio**  
Please send me without obligation complete details about how I can earn BIG Money with the Universal Grinder.

Name \_\_\_\_\_  
Address \_\_\_\_\_  
City \_\_\_\_\_ Zone \_\_\_\_\_ State \_\_\_\_\_

**AUTOMATIC RETOOTHER**

MAKES NEW PROFITS

for **HAND SAWS**

Cuts new teeth in 50 seconds — any size 4 to 16 points. Old teeth fall off as chips. Easy to operate. A perfect job.

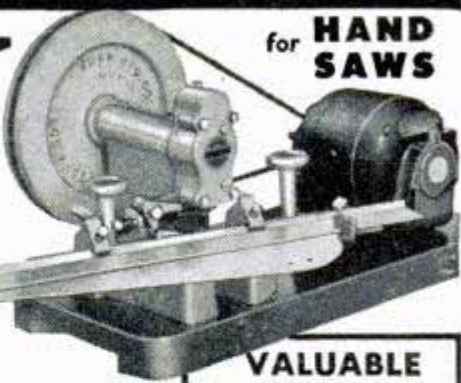

IMMEDIATE DELIVERY

VALUABLE BOOK

**BURR MFG. CO.**  
8933-Y VENICE BLVD.  
LOS ANGELES 34, CALIFORNIA

Order Burr's Blue Book of Coast to Coast prices for saw shop services. **25c**

**BUILD HEAVY DUTY MACHINES**

**SAVE UP TO 90%** — You can build, using our practical, easy-to-read plans, all kinds of machines, for home, farm or shop — scooters, portable sawmills, metal working machines, concrete machinery of all kinds, printing equipment, woodworking machines, midget autos, dish washers, farm equipment, freezers, tractors.

**FREE CATALOG HANDBOOK**  
183 SETS OF PLANS  
VALUABLE INFORMATION

**NICHOLS EQUIPMENT COMPANY**  
D-1710 PURVIS, MISS.

**Turret Tool Block**

Square turret indexes within .0005". Rocker adjustments provided for tools. Mounts on cross slide of current models of South Bend Lathes, adaptable to others. Write for dimension sheet.



Size Lathe	Size Sq.	Takes Tools	Prices *	Prices **
9"	3"	3/8" x 3/8"	\$42	\$48
10"	3"	3/8" x 3/8"	—	53
13"	3"	3/8" x 3/8"	—	75
14 1/2"	4"	3/8" x 3/8"	—	80
16"	4"	3/8" x 3/8"	—	80

HOLDS 4 TOOLS PAT. PEND.

\* Double Tool Cross Slide Model  
\*\* Compound Rest Cross Slide Model

**SOUTH BEND LATHE WORKS**

455A E. Madison St.  
South Bend 22, Indiana

**LAWN ORNAMENT-NOVELTY PATTERNS**

28 Lawn Ornament Patterns, 25c. Other patterns: 15-20" high; Dutch Girl, Dutch Boy, Pirate, Bull Terrier, Mexican Girl, Mexican Boy, Dwarf, Penguin, Flower Girl, 10c each. 25 Novelty Patterns, 30c. All 62 Full Size Patterns, \$1.00 Postpaid. Strother Pattern Service, Dept. AT-8, Box 383, Belington, W. Va.

**"Makes Arithmetic Interesting"**

NEW ABACUS of beautiful aluminum, the fastest and handiest little adding machine ever invented! Guaranteed to save time and money in any business. Ideal for children to learn arithmetic like a game. With illustrated instructions, \$3.50. Send for FREE lesson and details. Discounts to schools. **LOY'S CHINESE CALCULATOR**, Dept. 89-M, 1317 R. I. Ave. N.E., Washington 18, D. C. Exclusive Dealers Wanted.

**30" SHEET METAL BRAKE**

Forms angles, channels, vees, flanges, locks, zees. Handles 26 gage sheet steel, heavier gages of aluminum, copper, plastic, etc. Portable. Can be held in a bench vise, or bolted down. All steel. Wt. 40 lbs. Shipped exp. collect, \$34.50.  
**12" BRAKE.** Fits in vise to form difficult and compound bends, up to 20 gage steel 12" wide, \$12.50.  
**18" CURVE FORMER.** Handles 16 gage steel 2" to 30" dia., \$10.00 PP.  
**WISE IRON BENDER.** Forms rings, hooks, eyelets, etc. in 1/2" round or square; 1/2" up to 2" wide in bar iron. Price \$10.00 PP.  
**SHEET METAL PLIERS.** 2 1/2" wide, \$2.00; 5" can also be used as a hand vise and welder's clamp, \$3.50. 20 page instruction booklet, 50c. Immediate delivery. Order direct, cash or C.O.D., or send for folder.  
**WISE BRAKE MFG. CO.**  
1116 So. 27th St. Dept. P12 Omaha 5, Nebr.





# URAC "185" NOW AVAILABLE...

IN SMALL CONTAINERS

URAC-RESIN  
ADHESIVE  
WITH  
HARDENER  
185-



Best bonding agent for gluing structures: furniture, toys, bows, arrows, plastic table tops, phenolic and melamine laminates, masonite, Etc.

Easy to Mix . . . Easy to Use . . . Water Resistant . . . Rot Proof . . . Stain Proof. Allows for lower pressures and heavier glue lines. Joints are stronger than wood itself.

This wartime development a must for quality production . . . Ideal for the Hobbyist.

Pts. \$1.50; Qts. \$2.25; Gal. \$5.50 and 5-gal. \$23.75 including Hardener.

Send Payment and Save postage and C. O. D. FEES.

TRADE NAME REGISTERED BY AMERICAN CYANAMID CO., MFR.

**THE NELSON COMPANY**  
IRON MOUNTAIN - MICHIGAN

## CURIOUS?

ABOUT A  
SHIP-IN-A-BOTTLE

Here is the secret plus all of the material less bottle. See your dealer first. Catalog 10c.



Postpaid in U.S.A. **75c**

BRAUN-CRAFT, 1232 Etowah, Dept. PM-12, Royal Oak, Mich.

## SOLID CHROME INITIALS

ED  
BOB  
FRED

Personalize your auto, bicycle, motorcycle, rifle, Christmas and other gifts, with these eye catching initials. Easily applied. No glue necessary. Will not rust, tarnish, wash off or injure surface. Simple instructions enclosed. RUSH ORDER NOW, 25c each letter, minimum 4 letters. Pay postman price plus postage or send payment with order and we pay postage.

A. J. R. PRODUCTS CO., Dept. C15  
96 Warren St. New York 7, N. Y.

"the *Finest* precision writing instrument of its kind in the world"

You will marvel at the ease, speed and durability of this truly fine typewriter . . . direct descendant of "the first successful portable"



Plus these 5 big typing aids!

1. TOUCH SELECTOR
2. VARIABLE LINE SPACER
3. FLOATING SHIFT
4. ONE STROKE RIBBON REVERSE
5. TYPEBAR SPEED BOOSTER

**Smith-Corona**  
PORTABLE TYPEWRITERS

## FOR FUN AND PROFIT You need a **GRAFLEX!**

Pacemaker  
SPEED GRAPHIC



Whether it's a *Pacemaker SPEED GRAPHIC* (left) or a *Super D Graflex* (right) . . . or any other camera in the fine line made by Graflex . . . you're sure to get the best in the field. And that means *great pictures* . . . pictures that are sparkling clear, that are *salesworthy!* Be like the press photographers, professionals and serious amateurs everywhere who depend on Graflex cameras for truly *great pictures.*

See your local Graflex dealer today! *Graflex, Inc., Rochester 8, N. Y.*

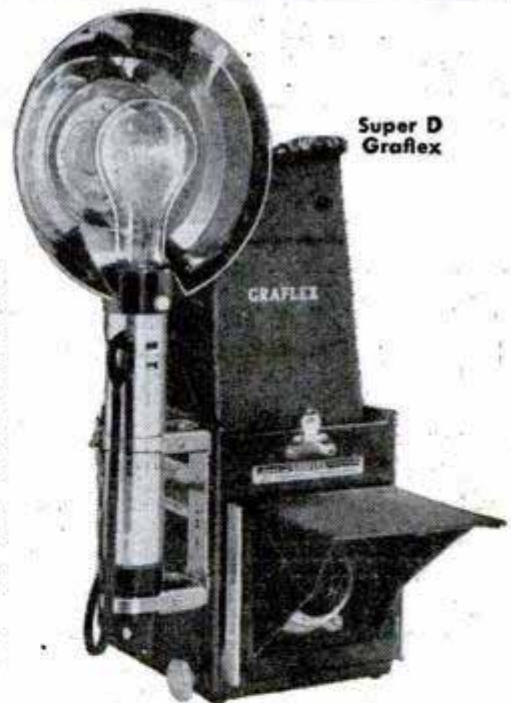

Super D  
Graflex



**GRAFLEX**  
*Prize-Winning Cameras*

Western Division: 3045 Wilshire Blvd., Los Angeles 5, California

DECEMBER 1948



## A REMARKABLE NEW LINE!

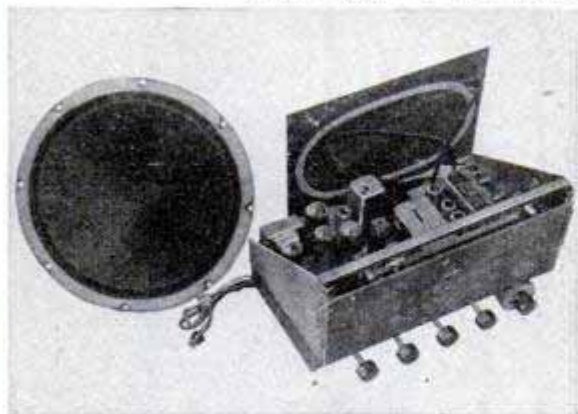

### High QUALITY—High POWER Custom-Built AM-FM Chassis

You need no longer hesitate to replace your outmoded radio receiver with a modern, low priced, powerful ESPEY replacement chassis. The Model 511 (illustrated) is typical of the complete ESPEY line, and features 12 tubes plus Rectifier and Tuning Indicator. This high quality AM-FM receiver, drift compensated, is supplied complete with 25 watt speaker, both antennas and all necessary hardware. It's your best bet! Consult your nearest radio service-dealer for full details, or write to Dept. D-12 today.

**ESPEY MFG. CO., INC.**

528 East 72nd St. New York 21, N. Y.  
"Established — 1928"

## START A BUSINESS OF YOUR OWN

Like John Lehman, Who Says:

"The complete Fyr-Fyter extinguisher line gives me a steady income and real independence."



Yes, capable men like John Lehman will find an outstanding opportunity with Fyr-Fyter. You can be your own boss . . . operate in your own town and vicinity . . . build a permanent, steady income. No capital needed. We carry accounts, make deliveries, pay profits weekly. Thousands of prospects due to the vast need for fire protection.

### Write for FREE BOOK

Get details on Fyr-Fyter's famous sales kit . . . facts on the complete, Underwriters' approved Fyr-Fyter line . . . how you earn while you learn. Write today! No obligation.

**Fine Business  
for men past 40.**



FYR-FYTER CO. Dept. 90-48, Dayton, Ohio

## AMAZING MYSTERY BUTTON

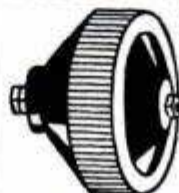

Startles Everybody. With this *Electronic Button* you can make your own Telephone — Amplifier—Detectiphones. Attach this button to piece of cardboard—transmit conversation to another room. Music also transmitted to distant places. Most interesting electrical apparatus ever discovered. Enables you to perform hundreds of experiments. So tiny it can be concealed in dozens of places. A Pre-War Product. *Electronic Button* including 5000 word instruction booklet with 50 illustrated experiments. postpaid. only. **\$1.00**  
Electronic Products Company, Saint Charles 6, Ill.

## S AGENTS 300% Profit SIGN LETTERS

For Store Fronts and Office Windows. Anyone can put them on. Free Samples. Liberal Offer to General Agents.

METALLIC LETTER CO., 430 N. Clark, Chicago 10



## TYPEWRITERS!

ALL MAKES — REBUILT LIKE NEW

For School, Business or Home Use

Write for Information

M. & M. TYPEWRITER CO.

84 W. Washington St. Chicago, Ill.

## Do a Better Job WITH ONE OF THESE EMPIRE LEVELS

Smallest, most handy and accurate Level made. "Cigar-shaped"—no sharp corners to tear pocket. Aluminum stock. Only 3 oz. wgt. 9" long. Has Level, Plumb, 45° Vials. No. 26 .....\$2.00



### ALUMINUM LEVEL — No. 151

Cast and Machined, a Beautiful Tool, with Patented, Removable Level and Vial. With 2 Plumb, 2 Levels, 2 — 45° Vials. 18" .....\$6.00  
24" .....\$6.50 28" .....\$7.00

Order EMPIRE LEVELS from your local dealer.  
Write direct for literature.

### EMPIRE LEVEL MFG. CO.

BOX 97, DEPT. P-255 MILWAUKEE 13, WISCONSIN



DO IT

*Yourself!*

### Change over to overhead door convenience

Here's just what you've been wanting—modern, new Garage Door Hardware, specially designed for quick, economical conversion to overhead door convenience. Balanced . . . smooth . . . quiet. Made by Richards-Wilcox, acknowledged leader in Door Hardware, the new R-W 999 Garage Door Hardware is adaptable to a single piece door, or two doors fastened together to form a single piece door. Comes complete, with everything needed for installation and operation.

MAIL  
COUPON  
FOR  
FREE  
FOLDER

Richards-Wilcox Mfg. Company  
Aurora, Illinois-PM-8

Gentlemen: Please send me literature and information on your R-W 999 Garage Door Hardware.

Name.....

Street.....

City.....State.....

My Dealer is.....

**Richards-Wilcox Mfg. Co.**

AURORA, ILLINOIS, U.S.A.

LEADERS IN DOOR HARDWARE FOR 68 YEARS



**WORLD'S**

# LOWEST PRICED ADDING MACHINE

**VEST POCKET SIZE**

**NEW!**

Fits vest pocket or purse. Guaranteed accurate. Operated as easily, and as reliable, as machines costing many times as much. **NOT A TOY OR GADGET.** Precision made—very durable. Guaranteed for life against defects in construction. Beautiful looking, modernized design. Finished in silver with black numbers and red slides. You positively can't buy a Calculator of equal quality for as little money. **ACCEPTED AS THE FINEST LOW PRICED CALCULATOR FOR OVER 35 YEARS!** Now completely redesigned and improved. **BETTER THAN EVER BEFORE!** Operates with a flick of your finger. Adds, subtracts, multiplies, divides—counts up to one billion. Pays for itself over and over in mistakes avoided and time saved.

**MAKES IDEAL GIFT**

Baby Calculator makes an ideal gift — for every Gift occasion. Birthday—Graduation—Christmas—Anniversaries. For men, women, children, teachers, business people, home or shop use. **COMES PACKED READY FOR GIFT WRAPPING.**

**TEN DAY TRIAL**

**Money Back Guarantee**

Because we know that our machine is the very best Calculator to be obtained at this low price, we make this 10 Day Trial Offer, on a positive money back guarantee! Don't buy ANY Calculator without this guarantee! Send only name and address, pay postman \$2.95 plus postage (if cash is sent, we pay postage—you save up to 40c). (Send full cash if outside U.S.) Money back within 10 days if not delighted.



**IDEAL XMAS GIFT**

**FREE TRIAL ONLY**

**\$2.95**

**AGENTS WANTED**

**SEND NO MONEY**

**FREE!!**

Each Baby Calculator enclosed in beautiful, rich-looking simulated Leather Case — at no extra cost.

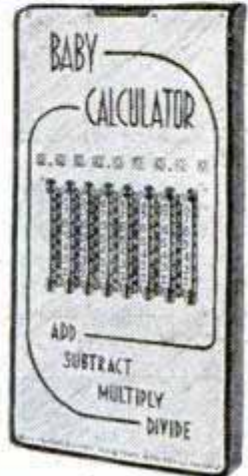

**CALCULATOR Machine Co. (Mfrs.)**

Dept. 209, P. O. Box 248, GLENVIEW, ILL.

**USE COUPON**

**CALCULATOR MACHINE CO. (Mfrs.)**

P. O. Box 248, Dept. 209, Glenview, Ill.

Your Calculator is just what I've been looking for. Send one at once (C.O.D.) or (I am enclosing \$2.95).

Name \_\_\_\_\_  
 Address \_\_\_\_\_  
 City \_\_\_\_\_ State \_\_\_\_\_

**BIG BARGAIN! .22 CAL. RIFLE & PISTOL**



**CLEANING ROD KITS**

All-brass, famous make, pocket-size in waterproof cloth case, with adaptor for other makes. **98c**  
 22-27 Cal. only. Also, 30-45 Cal. same price.  
 12, 16, 20 Ga. Shotgun Kits with brush, patch tip, handle. **ONLY \$1.19** (Specify Ga.).

Sorry—No C.O.D.'s  
**FRANKAY OF CALIFORNIA**

P. O. Box 126, Dept. OS, San Gabriel, Calif.



**NOW! FILE YOUR OWN SAWS**

Do expert saw filing at home. Precision filing easy without experience. Two simple adjustments. Keeps any hand saw extra sharp and true-cutting. Complete with file. Money back guarantee. Cash with order, prepaid. (COD postage extra.) Order today.

**\$2.95 EACH**

**THE SPEED CORP., Dept. PM1**  
 2025 N. E. Sandy, Portland 12, Oregon

**FREE CATALOG**

**F O R** (HOBBYISTS WATCHMAKERS MODEL MAKERS HOME CRAFTERS)

100 PAGES

MONEY SAVING PRICES



Ask for Cat. # 7P

● **TOOLS**

Twoeers, pliers, screwdrivers, lathes, motors, Saws, Drills, etc.

● **MATERIALS**

Watch Parts, Solder, Gold Wire, Bead Clamps, Spring Rings, etc.

● **SUPPLIES**

Oils, Cements, Polishing Materials, Cleaning Solutions, etc.

**BURTON M. REID SONS INC.**

1st and Wash "The House of Friendly Service" Springfield, Ill.

**PROTECT YOURSELF**  
 in case you enter a hospital on account of **SICKNESS or ACCIDENT**



The New Family Mutual Hospitalization Plan gives you protection that is high in value but low in cost—only \$1.00 per month for each adult, 50c per month for each child.

**FOR SICKNESS OR ACCIDENT**

Hospital Room and Board up to **\$6.00** a day for 30 days  
 Operating Room up to **\$10.00**  
 X-Ray Examinations up to **\$10.00**  
 Laboratory Examinations up to **\$10.00**

**FOR ACCIDENT**

Ambulance up to **\$10.00**  
 Emergency Accident—Dispensary up to **\$6.00**  
 Loss of Limbs, sight, etc., or loss of life up to **\$300.00**  
 Maternity Indemnity up to **\$35.00**

The policy provides indemnities for actual expense incurred at the time of hospitalization but will in no case exceed the amounts shown above.

Be protected against hospital bills, in case sickness or accident strikes you, by allowing the Family Mutual Life Insurance Company to aid you in meeting your hospital expenses. You may choose any hospital. Benefits for children are one-half those paid to adults.

**DON'T DELAY—MAIL THE COUPON TODAY**

**FAMILY MUTUAL LIFE INSURANCE CO., WILMINGTON 99, DEL**

Family Mutual Life Insurance Co. Dept. P-3  
 601 Shipley St., Wilmington 99, Del.  
 Please send me, without obligation, complete information on your Economical Hospitalization Plan.  
 NAME \_\_\_\_\_  
 ADDRESS \_\_\_\_\_  
 CITY \_\_\_\_\_ STATE \_\_\_\_\_

**SAY YOU SAW IT IN POPULAR MECHANICS**



# A SENSATION with CRAFTSMEN EVERYWHERE!



THIS AMAZING, NEW, LOW-PRICED OSCILLATING, SANDER AND POLISHER!

**\$14<sup>95</sup>**  
DU-FAST ATTACHMENT ONLY

**CRAFTSMEN!** . . . Here's the new, remarkably efficient oscillating Sander and Polisher attachment for Black & Decker Home Utility 1/4" Electric Drill.

Now, in a fraction of the time, and with far less "elbow grease", the DU-FAST SANDER AND POLISHER\* gives you certain, superior finishes every time . . . plus a definite saving in time and money!

- ATTACHED AND DETACHED IN A JIFFY
- WEIGHS ONLY 5 LBS. (with drill) — ELIMINATES FATIGUE
- EASY TO USE IN CORNERS, ON OPEN STOCK, AND ON CURVED SURFACES

If you use a B & D Home Utility 1/4" drill . . . you'll want the Du-Fast Oscillating Sander and Polisher attachment. In any case, don't fail to see it and try it at any hardware dealer who carries B & D Home Utility Tools.

\*PAT. APPLIED FOR

MANUFACTURED BY **DU-FAST, Inc.**  
32 EAST FOURTH STREET, NEW YORK 3, N. Y.

Available only at hardware dealers carrying Black & Decker Home Utility Tools. Stop at one today!

## ELECTRICITY Anywhere

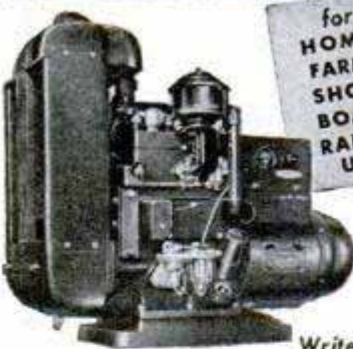

for HOMES FARMES SHOPS BOATS RADIO USE

● Onan gasoline-engine-driven Electric Plants supply reliable, economical electric service for any use. Portable, stationary or stand-by models. Water or air-cooled, compact and rugged.

A.C.: 350 to 35,000 watts in all standard voltages and frequencies. D.C.: 600 to 10,000 watts, 115 and 230 volts. BATTERY CHARGERS: 500 to 3,500 watts; 6, 12, 24, 32 volts.

Write for folder

**D. W. ONAN & SONS INC.**  
2548 Royalston Ave., Minneapolis 5, Minn.



# WANTED MAN WITH CAR



No Time Like Now to Get In **McNess Business**

It's no trick to make good money when you use your car as a McNess "Store on Wheels." Farmers buy everything they can from McNess Men because McNess Products are tops in quality, represent extra values. Attractive business-getting prizes and premiums; also money-saving deals to customers make selling McNess daily necessities a snap.

Use Your CAR to Raise Your PAY

**We Supply Capital—Start Now!**

There's no better work anywhere. Pays well, permanent, need no experience to start, and we supply capital to help you get started quick. You begin making money first day. Write at once for McNess Dealer Book. It's FREE. Tells all—no obligation. (1)

**THE McNESS CO., 680 Adams St., Freeport, Ill.**



## ACCURATE SLIDE RULE FOR ONLY \$1.00

For engineers, salesmen, draftsmen, machinists, students, hobbyists. Seven scales will compute multiplication, division, squares, square roots, cubes, cube roots, reciprocals, proportions. Laminated construction on long-life dimensionally stable plastic. Diameter 4 1/4". Complete instruction booklet and heavy storage envelope. Send \$1.00—Post Paid. Money back guarantee.

**Allegheny Plastics, Inc., 306 Chestnut Rd. Sewickley, Pa.**

**MICROSCOPES SUPPLIES-ACCESSORIES & SCIENTIFIC INSTRUMENTS**  
BEL SPENCER NEW & USED LEITZ ZEISS BOUGHT- SOLD- EXCHANGED- REPAIRED MEDICAL INDUSTRIAL AMATEUR  
Send for FREE LIST  
NATIONAL SCIENTIFIC INSTRUMENT CO. 119 CHAMBERS ST. N.Y.

## EXTRA PROFITS FOR SAW SHOPS

WITH **BEMACO RAPID SAW SET**

IT'S AUTOMATIC  
Sets hand saw teeth in 60 seconds—Approx. 400 band saw teeth. 4 1/2 to 12 points with one adjustment. Hammer and anvil action does precision job. Every tooth alike—no breakage.

IMMEDIATE DELIVERY  
WRITE TODAY

802A South Isis Avenue, Inglewood, California

**BEAVER MFG. CO.**

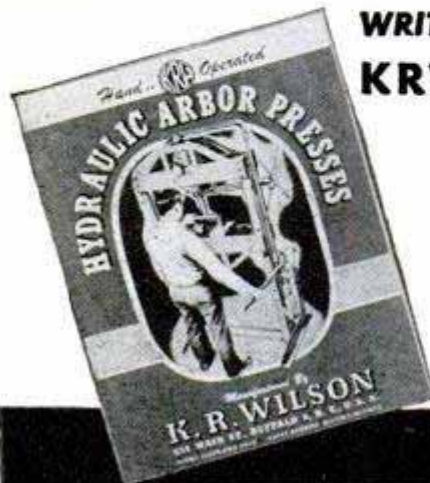

## WRITE FOR YOUR FREE COPY OF THE NEW KRW HYDRAULIC PRESS BOOK

Describes all manner of Production and Shop Work on KRW Hydraulic and Bench Type Presses. 32 pages illustrating the new KRW Hand-operated, Electric-operated and Air-operated Hydraulic Presses. 25 to 100-ton capacities.

Write for your copy today.



**K. R. WILSON, DEPT. 17, 215 MAIN ST., BUFFALO 3, N. Y.**



## MACHINE SHOP EQUIPMENT



The 1949 edition of the famous Center Tool Co. Catalog is now ready! Every workshop owner should have a copy. 240 pages full of illustrations, descriptions, and prices of the latest tools made by best known manufacturers in U. S. You pay the cost of printing—50c. **We refund your 50c with your first order of \$10.00 or more.** Prompt delivery on most tools. Send check or money order today!

**CENTER TOOL CO., 153 Centre Street, Dept. C, New York 13**

### THE PERFECT LATHE TOOL HOLDER

for home workshop, jobshop and light industrial use

Unique cam-locking jaws hold three sizes of tool bits—3/16", 1/4" and 5/16"—in four positions: R. H. Offset, L. H. Offset and Straight Holder all in one. Also holds straight boring bars. Camming lock prevents chatter. Available in several sizes.



Only  
**\$6.00**

**Edward Blake Company**  
437 Cherry St., West Newton, Mass.

postpaid if  
cash with order

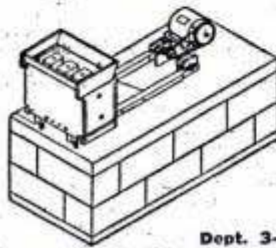

### BUILD THIS CONCRETE BLOCK MACHINE

Sell blocks; or build your home, garage, barn at 1/3 cost by making and laying your own blocks. This simple machine which you can build yourself at a cost of about \$15 (excluding motor) will make a block in 30 seconds using only one form. 2 to 4 forms can be used on each vibrator. Power driven concrete mixer plans also. Write for further information. No obligation.

#### U-BUILD-IT SERVICE

Dept. 3-A, 206 West Wilder Ave., Tampa 3, Fla.

SAY YOU SAW IT IN POPULAR MECHANICS

# No More Aching Backs! FOR EASY LIFTING

## Get this husky low-priced Hoist



The Chester Differential Hoist is ideal for garages, farms, stores, and shops. Handy, light and portable, this dependable hoist holds the load at any point; will not self-lower. Smooth, free operation assured by accurately made sheave wheels, high tensile malleable iron frames, drop-forged heat-treated hooks, best quality hoist chain. It's amazing how many uses you can find for this handy hoist. No need to break your back lifting heavy loads.

**1/4 ton, 6-foot lift, only \$18 complete**  
Freight allowed east of Rockies. Larger sizes at proportionately low prices. Satisfaction guaranteed. *Order now for immediate delivery.*

**THE NATIONAL SCREW & MFG. CO.**  
Chester Hoist Division, Dept. D., Lisbon, Ohio

# PALTE VODU V VAŠOM VOZE! QUEMEN AGUA EN SU COCHE! BRAEND VAND I DERES BIL! All Over The World They're Saying It: BURN WATER IN YOUR CAR!

The new OCTA-GANE Injector is designed to give your car the utmost in overall superior performance from any fuel. It will measurably increase power and mileage. It will keep your engine internally clean. It will completely eliminate detonation or "ping." It will give premium performance from low grade fuels. The OCTA-GANE is a well constructed unit, engineered to last for the life of your car. It comes complete with a solid bronze water injecting carburetor, a stainless steel tank, and all fittings and brackets necessary for its simple installation. A one year guarantee is enclosed with each unit. It is priced at only \$24.95 delivered. If you are interested in giving your car a new lease on life, then please drop us a post card and we will be pleased to send you full descriptive literature.



**COMMONWEALTH CARBURETOR CORP.**  
SUCCESSORS TO CONTINENTAL CARBURETOR CO.  
DIV. 128, 1478 UNIVERSITY AVENUE, BERKELEY, CAL.  
*Inquiries invited from established automotive dealers.*

Mail this coupon today!

**COMMONWEALTH CARBURETOR CORP.**  
DIV. 128, 1478 UNIVERSITY AVENUE, BERKELEY, CAL.

SIRS: PLEASE SHIP TO ME IMMEDIATELY ONE COMPLETE OCTA-GANE WATER INJECTOR UNDER THE PLAN CHECKED BELOW.

- \$1.00 ENCLOSED. PAY POSTMAN BALANCE C.O.D.
  - \$24.95 ENCLOSED. SHIP FULLY PREPAID.
- (PLEASE PRINT PLAINLY)

NAME: \_\_\_\_\_  
STREET: \_\_\_\_\_  
CITY: \_\_\_\_\_ STATE: \_\_\_\_\_  
MAKE & YEAR OF CAR: \_\_\_\_\_  
MODEL: \_\_\_\_\_ NUMBER OF CYLINDERS: \_\_\_\_\_



**BE THE LIFE OF THE PARTY**

*with* **TRICKS  
JOKES-MAGIC**



**JOKES:**

- No. 669 Hand Shocker..... 69c
- No. 609 Squirt Ring..... 69c
- No. 720 Plate Lifter..... 69c
- No. 582 Dribble Glass..... 49c
- No. 564 Crazy Mirror..... 29c
- No. 644 Jumping Candy..... 19c
- No. 583 Itching Powder..... 15c
- No. 537 Imitation Roaches..... 15c
- No. 512 Pepper Gum..... 15c
- No. 721 "Light-Up" Bow Tie.... \$1.98
- No. 554 Whirring Letter..... 29c
- No. 528 Rubber Point Pencil.... 15c
- No. 556 Dirty Soap..... 19c
- No. 579 Hole in One Gum..... 19c
- No. 505 Glow in Dark Paint..... \$1.00
- No. 601 Hot Tooth Picks..... 19c

**MAGIC:**

- No. 707 Nail Thru Finger..... 19c
- No. 591 Throw Your Voice (Ventri-  
trillo)..... 15c
- No. 90 Magic Cards (Read from  
Back)..... \$1.49
- No. 652 Vanishers..... 49c

**NOVELTIES:**

- No. 762 Juke Box Bank  
(Lights Up)..... \$1.98
- No. 641 Radio Mike (Talk Thru  
Own Radio)..... \$1.49
- No. 587 Realistic Snake..... 39c
- No. 630 Big Fake Diamond Ring . 39c

**SEND NO MONEY**

Just send name, address and tricks wanted. When package arrives pay postman cost plus C.O.D. postage. (Minimum order \$1.) If cash is sent with order, we pay postage.

**HOLLISTER WHITE CO.,**

Dept. 610, 4th Fl., 215 N. Michigan, Chicago 1, Ill.

**RUPTURED?**

**Get Relief This Proven Way**

Why try to worry along with trusses that gouge your flesh—press heavily on hips and spine—enlarge opening—fall to hold rupture? You need the Cluthe. No leg-straps or cutting belts. Automatic adjustable pad holds at real opening—follows every body movement with instant increased support in case of strain. Cannot slip whether at work or play. Light. Waterproof. Can be worn in bath. Send for amazing FREE book, "Advice To Ruptured," and details of liberal truthful 60-day trial offer. Also endorsements from grateful users in your neighborhood. Write:

**CLUTHE SONS, Dept. 31, Bloomfield, New Jersey**

**STEADY PROFITS**

**YOUR OWN  
BUSINESS WITH  
CORADIO**

*The Coin Operated Radio*

Place these specially built radios that play 1 or 2 hours for 25c in the thousands of available hotel rooms, tourists courts, etc. They yield immediate profits and steady income. Install Coradio, the finest made. Limited capital required. Send for further information. Write today.

**CORADIO Coin Operated Radio  
DEPT. C**

212 Broadway, Phone: BEekman 3-0038-9  
NEW YORK 7, N. Y.

**REAL DIESEL ENGINE**

**\$2.95**

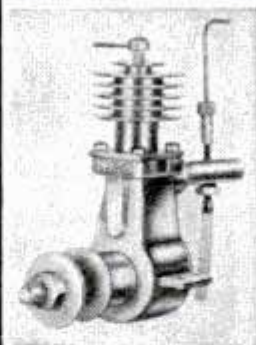

**WE'RE CRAZY**, they tell us, giving away a real diesel engine, complete with cylinder and piston, carburetor, crankshaft and connecting rod. All parts completely machined, ready for easy assembly. **ONLY \$2.95**. How do we do it? We're selling thousands of **DEEZILS**. So production's up; costs tumble down. **DEEZIL** is a precision engine. Actually runs at 7500 RPM. Produces 1/7 HP. Ideal for planes, boats, midget cars. Send \$2.95 plus 15c postage today.

**GOTHAM HOBBY CORP.**

107 East 126th Street New York 35, N. Y. Dept. "P"

**BUILD FOR ONE-HALF PRICE**



with composition cement and cheap wood. Good 3-room house for \$250; barns low as \$50.00. 100 illustrations and 100 money and labor saving suggestions. Get this newly revised and enlarged, guaranteed book before you build. **\$1.00**, postpaid. **SHEET METAL COTTAGES** and other buildings. Several new methods. Illustrated instructions, 50c. **FURNITURE OF COMPOSITION**. Cement, sawdust, asbestos, etc., scrap wood, metal, etc. Illus. 50c. **SHOP MACHINES FROM OLD AUTO PARTS**: Over 60 described, 50c. **HOME MFG. ENTERPRISE**. 50 home shop projects, Ills., 50c. Special: All five booklets described above, \$2.00 postpaid.

**HOME INDUSTRIES, 1116 So. 27th St., Dept. P12, Omaha 5, Nebr.**

**ONE-MAN SAWMILL LESS THAN \$225.00**  
**Easy To Turn Trees Into Money**

Makes lumber, ties, shingles, crates, lath, studding, siding.



**Belsaw Models** in 10 to 24 foot sawing lengths. **MECHANICAL FEED**, accurate set works and positive dogs. Use tractor or old auto engine for low cost power. Thousands used for commercial sawing. Pays for itself quickly. Send post card today for FREE booklet, "How To Make Lumber" and Catalog of Woodworking Equipment. **BELSAW MACHINERY CO., 8111 Field Bldg. 315 Westport Road Kansas City 2, Mo.**

**EVINRUDE Catalog Free**



Describes complete line of 1948 Evinrude Outboard Motors—sensational new "Sportwin" model — 2 models with revolutionary "Weedless Drive" — 3 thrilling four-cylinder models. Gives helpful information on boats, speeds, etc. Profusely illustrated. Write

**EVINRUDE MOTORS**  
5689 N. 27th St., Milwaukee 9, Wis.

**BRUSH PLATING OUTFITS**

● for re-plating articles in the home and shop. No tanks necessary. Free particulars. ●  
**GUNMETAL CO., AVE. M, DECATUR, ILLINOIS**

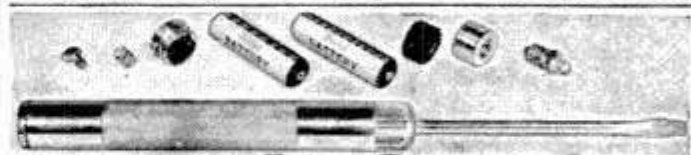

**SCREWDRIVER WITH BUILT-IN LIGHT**

OPERATES ON TWO PEN LIGHT BATTERIES  
All metal. Shockproof. Throws bright light around screwhead. Use it anywhere day or night. An excellent tool, an ideal gift. Overall length 10". Cadmium-plated steel blade, 3/16" tip. Send cash or money order. \$1.50 each, less batteries, postpaid.  
**H. H. WHITLOCK, 210 Douglas Bldg., Windsor, Ontario, Canada**

**SAY YOU SAW IT IN POPULAR MECHANICS**

**RED GARDEN TRACTOR**  
NO BELTS • NO CHAINS  
POWER TURNING

**E** FLOW, DISC, HARROW, CULTIVATE and FLOW SNOW  
3-4.5 H.P.  
Easy to Operate • Economical

BUY DIRECT from FACTORY at FACTORY DISCOUNT write for BIG, FREE CATALOG

RED-E IS DIRECT DRIVE-ALL GEARS ENCLOSED.

RED-E TRACTOR CO.  
230 Fond du Lac Rd., RICHFIELD, WIS.



**WILLARD 1 1/2 VOLT BATTERY**



Rechargeable, wet plate battery. Brand new. Battery is shipped dry but fully charged—any battery station will add acid. Use singly or in multiples for radio sets, bell circuits, alarm systems, etc. Measures 3 1/2 x 4 1/2 x 1 1/2 inches. Full floats indicate condition of charge. Shp. Wgt. 4 lbs. Stock No. 297—**\$2.95** Each Only.....

**CLINOMETER SHOWS DEGREE OF INCLINE**



The pendulum acts as a plumb bob. It swings back and forth over a calibrated scale that shows you the degree of incline. Use on ships to show amount of roll—may be used for any purpose where it is desired to determine the degree of incline. Plastic body 12 x 7 inches. Brass pendulum in black finish. Shipping weight 3 lbs. Stock No. 393. Each only..... **\$3.95**

**RUBBER OVERBOARD SUIT**



Here is a buy! Fits over your regular clothes and shoes. Can be cut apart for waist high waders, hip high or knee high boots, also arm length rubber gloves. Heavy gum rubber over fabric. Fine for commercial fishermen, sewer diggers, etc. Use it as is or cut it up for waders. All brand new! Wgt. 14 lbs. **\$4.95** No. 183, Each. Please include 75c for postage.

**TRAILER UNDER-CARRIAGE**



**OVERSIZE TIRES**

Build your own trailer for boat, camping gear or delivery service. Fitted with 26 x 2.125 U.S. Royal Tires. Motorcycle type wheels. Solid steel axle, leaf type springs and body mounting brackets. All brand new! Hitch not included. Folds to fit trunk of car. Shipped express collect only. **\$18.95** No. 199, Ea.....

**AVIATION CABLE**



Flexible 133 strand wire cable, 5/32 in. diam., 3300 lb. break test. Lengths up to 450 ft. Use for tow rope, guy wire, clothes line, etc. Wgt. per 100 ft. 4 lbs. Specify length wanted. No. 421—**4c** Per Ft. ....

**ARMY BANDO-LEERS**



Of fine heavy khaki. Big roomy pockets with snap button fasteners. Fine for hunters, campers, boy scouts, etc., also for shop work in carrying small parts, etc. Material alone is worth this price. Shp. wt. 1 lb. 11 Pocket Type No. 129 Each **49c** | 5 Pocket Type No. 128 Each **29c**

**U.S. Govt. BOLO KNIFE**



Extra heavy. For farm, home or jungle use. Blade of Govt. formula cutting steel. Walnut riveted handle. 3 1/2 inch hilt, 10 1/2 inch blade. You'll find hundreds of uses for a bolo knife. Blade will take and hold a keen cutting edge. Wt. 2 lbs. A112—**\$4.95** with Army Sheath

**WIRE CUTTER**



Heavy duty, compound leverage. Cuts up to 1/4 inch wire. Upper jaw acts as feeder to cutting edges. Insulated handles. Ideal for farm fence work and shop use. Shp. Wgt. 2 lbs. Stock No. 392—Each **\$1.95**

**Heavy Duty RUBBER GLOVES BRAND NEW**



Extra heavy—extra long. Brand new, high quality gum rubber for softness and ease in use. Designed for heavy duty industrial services—protection in handling chemicals, acids, etc. A real bargain at this low price. Stock No. 295—Per Pair, Only **79c**

**AMMUNITION BOX**



Used for 50mm ammunition. Heavy, all metal design with latching top and folding handle. Provides safe, fire-proof storage for valuables, etc. Measures 12x6x7 1/2 inches. Used but in new condition. Shp. Wgt. 8 lbs. No. 338—Each **79c**

**CAVALRY SPURS**



Genuine wishbone type cavalry spurs. Nickeled brass A102, **98c** Pair..... A103 Spur straps per set of four..... **50c**

# WAR SURPLUS AND HUNDREDS OF OTHER BARGAINS

**STIRRUP PUMP**



Works with any pail or bucket. Shoots a high pressure stream up to 30 feet. Use it for spraying garden and trees, for whitewashing, fire fighting, drainage, etc. Complete with 10 foot flexible hose. All brand new. Regular \$3.80 value. No. 244—**\$1.49** Each.....

**MEDICAL STERILIZER**



Consists of alcohol burner and sterilizing tray in hinged metal case 1 1/8 x 1 1/8 x 2 3/4 inches. Burner may be used separately. Bright nickel finish. All brand new. A125—Ea. **98c**

**VEEDER ROOT COUNTING MACHINE**



Five wheel type—counts to 99,999 and repeat. Nickel finish case. Has 1/4 inch round shank. Use it for any counting job. Brand new. Shp. Wgt. 1 lb. No. 241—Each **98c**

**POPULAR RECORD ASSORTMENT**



Fifty records of modern dance, race, blues and hillbilly selections. No two alike. Famous name bands and artists included. Used in juke boxes, but guar. perfect. Shipped exp. collect only—no exchanges or refunds. Wgt. 28 lbs. No. A303—50 records ..... **\$9.64**

No. A300—25 Records. All Dance. Wgt. 14 lbs. .... <b>\$4.88</b>	No. A301—25 Records. Hillbilly, Race and Blues. Wgt. 14 lbs. Set... <b>\$4.88</b>	No. 302—25 Records. All Hillbilly numbers. Wgt. 14 lbs. Set... <b>\$4.88</b>
---	---	--

**ELECTRIC MOTOR**



Small but powerful. Shaded pole type, designed for fan application. 115 V. 60 cycle. Has 1/4 inch shaft, one inch long. Operates at 3150 RPM under no load, 2000 RPM under 2.33 oz. inches load. Full load current .6 amp. Ideal for use on toys, window displays, etc. Shp. Wgt. 1 1/2 lb. Stock No. 555—Each **\$1.95** only.....

**MCCLELLAN SADDLE**



Brand new! Top grade cowhide. 12 inch seat. Hair girth. Has straps for blanket roll and knapsack. Gun boot and sabre loops. Shipping weight 15 lbs. Stock No. A145. Each. .... **\$16.95**

**BAYONET BLADE**

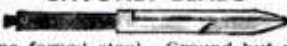

Fine forged steel. Ground but not polished. May be made into throwing or hunting knife or spear. Blade 6 3/4 x 1 1/2 inches, 1 1/4 inches overall. Will take and hold a fine edge. Shp. wt. 1 lb. No. 664-R—Each..... **49c**

**7 LB. EXPERIMENTER PARTS ASSORT. KIT**



A "gold mine" for the radio serviceman. Hundreds of valuable radio parts, new radar and electronic parts and sub-assemblies, coils, resistors, trimming condensers—worth many times this low price. **\$1.79** A130R—7 lbs. ....

**RAIN SUITS**



New 2 piece rain suits. Of durable wear resisting water and wind repellent OD fabric. Bib style pants, zipper fly. Jacket has parka attached. Guaranteed 100% weatherproof. Small, medium and large sizes. Shp. Wgt. 3 lbs. No. R549—**\$4.95** Ea.....

**Officers Watch Compass**



Brand new gov't. surplus. Army-Navy model. Single jewel mounted needle. Silver colored dial. A splendid value. Shp. Wgt. 1 lb. A174—Each... **98c**

**OXYGEN TANK**



Loaded with aviator's breathing type oxygen at 1800 pounds pressure. Tank measures 13 1/2 x 5 1/2 inches with rounded ends. Tank is of solid metal fitted with brass release valve at top. Brand new! Loaded—ready for all types of emergency use. Shp. Wgt. 13 pounds. Ship exp. only. Stock No. 390—Each, **\$3.50** only.....

**AVIATOR'S OXYGEN**



Ball out type. Consists of all metal tank, release valve, gauge and breather hose, all enclosed in khaki colored cloth bag. These tanks are loaded with oxygen at 1800 pressure. Ideal for use as reserve oxygen supply for all types of emergency use. Shipping weight 4 pounds. All brand new. Stock No. 391—Each..... **\$4.95**

**ORDER DIRECT FROM THIS AD**

Values galore! Hundreds of hard-to-find items for home, shop and outdoor use. Make remittances by money-order, bank draft or personal check. Send 25% deposit on C.O.D. orders. No C.O.D.'s on orders for less than \$5.00. Include sufficient postage on parcel-post orders—any overage will be promptly refunded. All quotations F.O.B. Chicago. Used items and materials are guaranteed serviceable and as described. Your money back if not more than satisfied.

**NEW CATALOG Now Ready—Send 10c To Cover Postage and Mailing**

**STARK'S** Dept. PM12  
509 So. State St. CHICAGO 5, ILL.

**STERNO STOVE**



Complete Sterno outfit with folding stove having 6x6 inch top. Also special vaporizer and inhaler for medical use. Special sterilizing tray 3x2x1 inch. Heat intensifier with handle. One can Sterno canned heat, flame snuffer and can opener. Ideal for boy scouts, hunters, hikers, etc. Ship Wgt. 3 lbs. No. 425. Each only..... **\$2.95**



THE GREATEST  
THING

IN  
PLASTICS!

# PLASTICAST



## A NEW HOME INDUSTRY AND HOBBY!

**PLASTICAST** is a transparent liquid plastic: can be poured into ANY kind of mold or container. Hardens in a few minutes into a transparent solid, clear-as-glass, tough as steel plastic! No tools machinery or skill required. IDEAL for inbedding pretty flowers, butterflies, photos, medals, souvenirs, biological specimens, etc. Makes a PERMANENT and ATTRACTIVE display. Make attractive jewelry, gems, lenses, knick-knacks, novelties. Easily cast into sheets, rods, blocks, ANY color, ANY shape! EVERYTHING furnished, including molds, for making about \$50.00 worth of unusual novelties! **PLASTICAST OUTFIT, Complete \$3.50** with 3 molds.....

**PLASTIDUR** . . . (LIQUID IVORY). Ideal for casting all OPAQUE articles. Hardens in a few minutes into an extremely hard IVORY-like plastic! May be dyed any color or cast into any shape. Works in EVERY type of mold! Non-inflammable, waterproof. DURable. Ideal for statuary, novelties, figurines, toys, gadgets, tools, knobs, bases . . . a million useful applications! Outfit comes complete with molds, dyes, accessories, instructions, etc. for making about \$100.00 worth of attractive jewelry, etc! **\$5.00**

**PLASTIDUR OUTFIT, Complete with 3 molds**.....  
Our Casting Plastics are as easy to use as pouring water out of a glass!

**TERMS:** We pay the postage (U.S.A. & Canada only) if full cash accompanies your order. C.O.D. accepted (U.S.A. only) if \$1.00 deposit is included for each item ordered. C.O.D. orders not postpaid.

**FREE** A very attractive and useful novelty made with one of our plastics given absolutely free with every one of our catalogs! Catalog lists many new materials for making **MOLDS and CASTINGS** with Liquid Plastics, Liquid Marble, Latex, Elastex, Castwood, Wax, Metals, Plaster, Shellcraft, Internal Carving, Molds, Moulage, etc. Price of catalog only 10c.

**DEALERS: WRITE FOR ATTRACTIVE WHOLESALE PRICE LISTS**  
**PLASTICAST CO. (Dept. C)**  
5961 Madison St. Chicago 44, Illinois (Order by mail only) P. O. Box 987 Palo Alto, Calif.

## NEWEST OTTAWA LOG SAW

**SELF-PROPELLED - MOVES ANYWHERE on OWN POWER**

World's fastest Log Saw. Powerful 6 H-P air-cooled motor. Attachments for sawing down trees, buzzing limbs, post hole digging and pulley for belt jobs. Big demand for wood, pulp, posts. Make big money sawing wood this easy way. Low factory-to-user prices. Nothing like it. **FREE** details. **OTTAWA MFG. CO., 7-827 Pine St., Ottawa, Kansas**



### BARGAINS FROM WORLD WAR II

Thousands of Bargains in Military, Outdoor & Sport Goods for Hunter, Farmer, Scout. Send 10c for NEW 32-page catalog, just issued, returned with first order.

**A and N SUPPLY CO.**

4720 LESTER ST. RICHMOND 15, VA.

Say You Saw It in  
**POPULAR MECHANICS**

## An Outstanding METAL HAND PUNCH with unusual performance

Needed by every  
Mechanic in every  
Shop . . . . .



No. 5 Jr. HAND PUNCH  
CAPACITY—1/4" THRU 16  
Ga. Mild Steel. 3/32" —  
1/8" — 5/32" — 3/16" —  
7/32" — 1/4" — 9/32" —  
Punches and Dies Furnished.

**THROAT  
DEPTH  
2 inches**

Weights  
2 3/4 lbs.

only **\$8.75**

**ORDER YOURS TODAY!**

Write for **FREE** Catalog on other tools.

**WHITNEY METAL TOOL CO., Dept. P, Rockford, Ill.**

Postpaid in  
U.S.A.



**WAKE UP YOUR Scalp**  
WITH THE NEW  
ELECTRIC-AUTOMATIC  
**Vitabrush**

**BE FAIR TO YOUR HAIR** Want better looking hair? Embarrassed by falling dandruff, itching scalp? Get the new VITABRUSH, the electric-automatic brush with built-in brush head motor. . . gives scalp and hair an invigorating "workout" in just 3 minutes. Cleans scalp, stimulates blood supply, distributes the natural oils. Fun to use—relaxing. Write for satisfaction-guaranteed offer—today. Hershey Mfg. Co., 3755 Field Bldg., Chicago 3.

# WANTED

Any quantity Hayes Brake Blocks No. B27-166  
or B27-105

**GROSSO & GROSSO, 7502 Wheatland Ave., Roscoe, Calif.**

## BUMPER RE-NU

Renew bumpers yourself in a few minutes with our chrome-lak finish. This amazing, revolutionary discovery is a result of many years of laboratory research. No electricity—no special equipment needed. A child can do a perfect job. This is not a paint, not a polish, but an entirely new application. Creates a durable finish which can be used on hundreds of different surfaces. Sold with money back guarantee. Receive your Bumper Re-Nu by return mail by sending \$1 today to:

**JACK ERMAN, BOX 147, HAMTRACCK 12, MICHIGAN**

\$1 post pd.

## IMPORTED SWEDISH STEEL FEELER GAUGE

Tough! Accurate! Durable markings

26-3 1/2 inch blades  
.015 to .025 size range

**SPECIAL**  
**\$2.65**  
post paid

Order today — check, C.O.D. or money order to

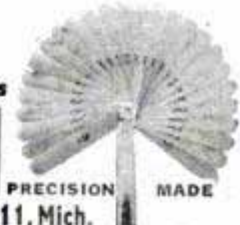

PRECISION MADE

**Chap Associates, 2042 E. Milwaukee, Def. 11, Mich.**

## PROTECT THE LIFELINE OF YOUR CAR!

with

### KLER-LINE VALVE

- Keeps fuel line clear!
- No need to disconnect gas line!
- Permanent, once installed!



each **1.25**  
post-paid

COMPLETE WITH INSTRUCTIONS

**EVERY CAR OWNER NEEDS IT!**

**EASILY INSTALLED! NEEDS ONLY AIR PRESSURE!**

Apply ordinary air line used to inflate tires—and KLER-LINE VALVE eliminates harmful dirt, sediment, condensation, ice and vapors that clog the intake line to the fuel pump! Keep gas line open for higher motor efficiency! IT'S PERMANENT, ONCE INSTALLED — READY FOR INSTANT USE.

**Beat the cold snap with year 'round KLER-LINE VALVE!**

**AT YOUR DEALER — OR ORDER DIRECT!**

**SEND \$1.25 NOW — WE PAY POSTAGE!**

**KLER-LINE VALVE CORP., 11 W. 42 ST., N.Y. 18**



# 7 x 50 BINOCULARS

Made to Rigid Military Specifications



Actual  
Photograph  
Ht. 7"  
Wt. 39 oz.

Brand New  
**\$44**

With  
COATED  
Lenses & Prisms  
**\$54**

These magnificent 7x50 prism binoculars were obtained through the Supreme Commander of the Allied Powers. They have the brilliant luminosity, precise clarity, and wide, undistorted field of view obtainable only with a good large glass. Because 7x50 glasses give the highest performance obtainable they are now the official choice of the Army, Navy and Marine Corps. This is your opportunity to purchase a brand new 7x50 AT 1/3 OF THE USUAL COST. Lifetime construction. Lightweight aluminum body. Ultra-precise optics, sealed against moisture and dust. Unsurpassed by any other binoculars, regardless of price. Sold with a guarantee of complete satisfaction or money refunded.

Price Without Case		Price With Richly Finished Case & Straps	
7x50 Uncoated	7x50 Coated	7x50 Uncoated	7x50 Coated
\$44*	\$54*	\$48*	\$58*

\*Plus 20% Federal Tax  
WE PAY THE SHIPPING COST

**BROWSCOPE CO.**

Dept. 12M, 24 West 45th St., New York 19, N. Y.

# JIFFY METAL CABINET

with  
ALUMINUM or CARDBOARD DRAWERS



32 DRAWER  
MODEL PICTURED  
ONLY  
**\$5.95**  
POST PAID

SO HANDY  
FOR SO MANY USES

AT HOME, SHOP AND OFFICE

HANDY WAY TO KEEP SMALL PARTS, NUTS, WASHERS, BOLTS, NAILS, SCREWS, STAMPS, PHOTO SUPPLIES, HOBBYIST'S NEEDS, ETC.

Smart way to keep small items at home, office or at your work bench—The Jiffy metal cabinet: holds 32 or 64 spacious drawers (aluminum or heavy weight cardboard) that put small parts at your fingertips. Spot welded steel cabinet, enamel finish—metal flange drawer guides. Why fumble? With a Jiffy you know where it is. Order today for yourself or gift giving. Send check or money order—no C. O. D.'s please—prices listed below. Add 3% sales tax for Ohio orders.

### WITH RUSTPROOF ALUMINUM DRAWERS

Solid one piece drawers—long service life. Satin finish. Ideal for shop and work bench needs.

32 DRAWER UNIT  
**\$8.95** POST PAID

64 DRAWER UNIT  
**\$15.95** POST PAID

### SPECIFICATIONS

6" DEEP  
12 3/4" WIDE  
15 1/4" HIGH

### DRAWER SIZE

1 1/4" DEEP  
2 3/4" WIDE  
6" LONG

6" DEEP  
25 1/2" WIDE  
15 1/4" HIGH

### DRAWER SIZE

1 1/4" DEEP  
2 3/4" WIDE  
6" LONG

32 DRAWER UNIT  
**\$5.95** POST PAID

64 DRAWER UNIT  
**\$9.95** POST PAID

### WITH HEAVYWEIGHT CARDBOARD DRAWERS

Suitable for most home uses. Heavy reinforced cardboard with kraft covering. Metal drawer pulls.

**KAYTEE PRODUCTS**

DEPT. M BOX 588 CANTON, OHIO

## A 10-Ton Press at Low Cost

Pressing, separating, bending, and straightening jobs in your shop are easy with this press. Ten-ton capacity provides ample pressure. Adjustable table takes work up to 18 inches wide and 11 1/2 inches high. Send for free bulletin showing press and wide variety of accessories.

UT-10A Press f.o.b. factory \$31.00



**DAKE ENGINE COMPANY**

624 Seventh Street, Grand Haven, Michigan

# INVENTORS

Whether an invention is patentable can be substantially determined by a search of the U. S. Patent records. Without obligation, write for information explaining the steps you should take to secure a patent.

**JOHN N. RANDOLPH**

Registered Patent Attorney

201 Columbian Building, Washington 1, D. C.



**SAW-HORSE WORK-BENCH** has many uses. You may now have a saw horse, work bench with clamp, tool box, step ladder and scaffold—ALL IN ONE.

28" high 9" wide 4' long. Light enough to carry, wide top provides excellent sawing space. Divided top with clamps holds boards for planing, chiseling, and vice work; holds regulation size doors firmly in end.

Lower shelf with rail makes convenient open tool box; six trays store nails, screws and small tools. Standing-scaffold to reach 9 1/2 feet high; additional height easily obtained by extensions in clamp, solid place to stand while sawing, painting, papering and nailing. More convenient than step ladder. Satisfaction guaranteed. Shipped with legs K. D. Send \$5.00 with order, balance C.O.D.

R. B. FLEMING MANUFACTURING CO., P. O. Box 9647, Dallas, Texas





for  
**SOCKET SETS**

There's a Billings Set for every home, workshop, garage or industrial use. See the Billings Ratchet Wrench, deep wall sockets, speeders and many other handy pieces in these sets . . . Write for Socket Set Catalog W48.

**BETTER BUY BILLINGS**

Socket Sets in 3/8" - 1/2" - 3/4" drive selected to give maximum service with minimum of pieces. Sturdy metal boxes with carrying handle and snap fasteners . . . See your Billings Dealer.

**BILLINGS**  
WRENCHES

Buy them at Your  
Hardware Store

The Billings & Spencer Company, Hartford 1, Conn.

**Made \$2,600  
LAST SEASON**



"Last year we sharpened and repaired about 1000 lawn mowers for a net profit of \$2600," says E.G. "In 1939 I bought a Foley Lawn Mower Sharpener," writes W.T.J., "the best investment I ever made. I have made a good living for my wife and self, and have put money in the bank besides."

**99c Profit On Each Dollar**

It costs less than 1c for electricity and material. The Foley sharpens all blades and cutter bar together just like lawn mower manufacturers do it. Build a steady, repeat CASH business. Start in spare time in basement or garage.

**SEND FOR FREE PLAN**

Tells you how to start — no canvassing. The Foley sharpens 3 or 4 mowers an hour without removing handle. Available now. Mail coupon today.

**FOLEY LAWN MOWER SHARPENER**

FOLEY MFG. CO., 1207-8 Foley Bldg., Minneapolis 18, Minn.  
Send FREE PLAN on the Foley Lawn Mower Sharpening business.

Name \_\_\_\_\_

Address \_\_\_\_\_

**Sensational Value!**  
**PAINT SPRAYER**  
WITH ELECTRIC MOTOR

**Best Results Say Thousands of Satisfied Users**

Complete Only  
**\$19.95**

Shipped Anywhere

Does all Ordinary Paint Spray Jobs. Uses Paints, Lacquers, Varnishes, Etc.

Positively unheard of 'til now—an electric powered sprayer outfit at such a low price. Not a toy! Not a makeshift. It's a real, practical all-purpose sprayer outfit complete with compressor, 110 volt A.C. or D.C. electric motor, suction type, continuous flow spray gun, paint container, 10 ft. air hose, 6 ft. electric cord and plug. Use it for home shop, auto and 'round the house jobs, and do a good job—quick. Rush order today. Only \$19.95 complete. Send check or M.O. If C.O.D. send a five dollar bill for deposit. Outside U. S.—Remittance with order—\$21.95



Weights Only 8 lbs. Portable. Use it Anywhere.

**HOME SHOP PRODUCTS CO.**  
DEPT. 19, 4821 SHERIDAN ROAD CHICAGO 40

**ELECTRIC METERS**



Measure current on motors, tools, lights, appliances . . . sub-meter to tenants . . . install in your trailer! Same nationally famous 5-amp. 2-wire 110-v rebuilt meters that are sold to utilities. Accurately calibrated, guaranteed for full year. Cash orders sent prepaid to any point in U. S.

**\$4.95 each.** For higher capacities, write for prices.

**REBUILT METER CO.** 759 NORTH MILWAUKEE STREET MILWAUKEE 2, WISCONSIN

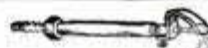

**MACK'S GAS TORCH AND SOLDERING IRON**  
6,000 B.T.U. attaches to any gas hose; furnished with 2 jets for natural and bottled gas; equipped with adjustment set screw. **\$2.00** Postpaid



**Mack's GAS BURNER**  
Jet Power, Self-Acting (Pat. pending), 24,000 B.T.U. for natural and bottled gas, industrial and home use. **\$2.00** Postpaid

**Mack's Automatic Water Heater**

Approx. 20 gal. capacity and larger for home and industry. Easily installed. Amazingly low-priced. Guaranteed. **\$32.50** Del.



**McDaniel MANUFACTURING CO., INC.**  
10214 POKHATTAN ST. • DALLAS 2, TEX.

**OVER 250 SURPLUS BARGAINS**

Write for FREE Catalog PM-7 TODAY!

**FISLER SALES CO.** 721 Walnut Kansas City 6, Mo.

**New "THERMO-SAW" (CUTS WITH HEAT)**  
**MAKE THINGS FOR THE HOME or FOR SALE**

• Any Child Can Use It!

- NO NOISE
- NO VIBRATION
- NO SAWDUST

CUTS RAPIDLY AND CLEANLY THROUGH WOOD AND OTHER MATERIALS . . . AN IDEAL GIFT!

Difficult patterns are made QUICK and EASY . . . No turning of work . . . Cuts in every direction . . . Cuts plywood 1/2" or 3/4" . . . Cuts 14"x36" board . . . Special Transformer produces high frequency current in a "tough steel wire blade" from ordinary Alternating (AC) current. No radio interference. IMMEDIATE DELIVERY!

NOTE:  
Operates on 110 volt Alternating Current: 50 to 60 cycle.



Machine Measures 11x4x3 1/2" High. Throat 7" Deep. PATTERN FREE. Postpaid **ONLY \$4.95**

COMPLETE SAW outfit as illustrated with transformer and 12 spare blades. READY TO USE.

**BOISSELIER MFG. CO., Dept. P-12, GLEN ELLYN, ILL.**



# Bargains FOR HOBBYISTS AND EXPERIMENTERS

ALL QUANTITIES LIMITED SUBJECT TO PRIOR SALES

## HEATHKIT 3 TUBE ALL WAVE RADIO KIT

No. K1. An Ideal Beginners Radio Kit covers 550 to 6000 KC including Broadcast, police, aircraft, amateur marine, and foreign broadcasts. All parts including 3 tubes supplied. 110V 60 cy AC. Transformer operated, calibrated dial complete instructions for assembly. Operates loud speaker (not included). Excellent boy's gift. Ship. wt. 3 lbs. Loud speaker 2½" PM (extra)..... \$1.95 Headphones (extra)..... \$1.00



**\$8.75**

## BC 645 GENERAL ELECTRIC TRANSCEIVER



No. 201. Complete 15 tube transmitter receiver. Ideal for new citizens band 460 Mc for communication between office and car, home, boat, etc. Conversion

article in August ELECTRONICS Magazine. Brand new in original G.E. cartons with tubes. Add postage for 25 lbs.

**\$19.50 . . . . 2 FOR \$35.00**

## ACCESSORIES FOR BC 645

PE 101C Dynamotor 110V 60 cycle power supply for car use.... \$3.95  
 110V 60 cycle power supply for home or office use.... \$14.50

## HOME WORKSHOP GRINDER KIT

No. 230. Easily assembled 110V AC or DC ball bearing fully enclosed motor from Army surplus dynamotor. Purchaser to make simple changes and shaft extensions, detailed instructions and all parts supplied. Motor approximately 5,000 R.P.M. Ideal for tool-post grinder, flexible shaft tool, model drill press, saw. Shipping weight 6 lbs.



**\$3.95**

## ARMY ELECTRONIC ALTIMETER



No. 200. Brand new 14 tube army transmitter receiver radar unit with indication in feet. Many applications such as electronic burglar alarm, radar set, etc. Complete with 14 tubes, controls, plugs, antennas and instruction manual. Shipping wt. 87 lbs.

**\$34.50**

## TANK TRANSMITTER POWER SUPPLY

No. 223. Army PE125 power supply provides 500 volts at 160 MA from 12 or 24 Volt storage battery. Heavy duty unit with filters starting relays, fuses, tubes, and diagram. Shipping wt. 73 lbs.



**\$12.95**

## T 32 TABLE MICROPHONE



No. 210. One of the Army's best. Built by Kellogg, ideal for factory call system, public address, amateur use. Brand new in original cartons. Add postage for 5 lbs..... \$2.95

## INTERPHONE 2 WAY CALL SYSTEM KIT

No. 1P1. Saves many steps between house and barn, tenant house, workshops, etc.; can be used to watch baby from neighbors. Uses 2 wires and will operate up to 1-5 mile. More than one remote can be used. Kit is complete with tubes, one master, one remote speaker and detailed instructions. Shipping weight 5 lbs.



**\$14.50**

## ASTROGRAPHS WITH CASE



**Only \$3.95**

No. 259. New B29 navigation instrument which can easily be used to make a good contact printer, strip map holder, etc. The plywood case 14½" x 11" x 10" high is perfect as a tool kit, camera, projector case or for building a portable phonograph picnic kit, make up case, etc., has leather handle reinforced covers, 8 covered compartments in bottom. Cost Gov't \$125.00. Add postage for 20 lbs.

## GN 58

## GENERATOR

No. 275. Makes excellent home lighting plant, operated by wind propeller, waterfall, gas engine, or hand crank. Reduction gear allows full output at slow speed, supplies 6 volts at 2.45 amp., 425 volts at .115 amp. New. Add postage for 28 lbs.



**\$7.95**



**\$1.00**

## BC 746 TUNING UNIT

No. 257. Transmitter Receiver Tuning Unit from Army Walkie Talkie. Containing coils tuning condenser, transmitter crystal sockets, etc., excellent for building amateur station. Shipping wt. 1 lb.

## METER SPECIAL

No. 237. Beautiful Dejur 3" Square Precision Milliampmeter 0-800 MA range. 0-10 MA basic movement. Probably the best buy ever offered in a war surplus meter. Shipping wt. 1 lb.



**\$2.95**



**\$9.95**

## BENDIX DIRECTION FINDER LOOP

No. 219. Brand new loop excellent for aircraft or boat direction finder. Also useful as radio aerial to eliminate local interference. Rugged army construction. Shipping wt. 8 lbs.

## G.E. 50 AMP CIRCUIT BREAKER

No. 204. New General Electric 50 Amp. 220 Volt AC circuit breakers. 100 Amp. when used on 110V. Add postage for 4 lbs. \$2.95, 3 for \$7.50



## MINIATURE ELECTRIC MOTOR



**\$2.95**

No. 211. Tiny Delco motor only 1" x 1¼" x 2" 10,000 RPM. Operates from 6 to 24V. Excellent for models. Add postage for 1 lb.

## HEATHKIT HIGH FIDELITY AMPLIFIER KIT

No. A2. A truly fine 110V 60 cy transformer operated High Fidelity Amplifier Kit. Ideal for reproducing quality music at home, churches, mortuaries, outdoor gatherings etc. Output over 10 Watts. Complete with all tubes (push pull circuit) transformers, punched chassis and detailed assembly instructions. Shipping weight 20 lbs. High Fidelity 12" P.M. Speaker for above \$6.95 Mahogany speaker cabinet size 14½" x 14½" x 8" for above speaker..... \$8.75



**\$14.95**

## BC375 TRANSMITTER TUNING UNIT



**\$2.49**

No. 203. A beautiful Army Tuner containing 3 precision variable condensers, tank coils, switches, vernier dials, worth over \$30.00. The best buy in surplus. Shipping wt. over 20 lbs.

## FM PUSH BUTTON TUNER

No. 224. Brand new ten push button tuning assembly from Army FM receiver. Contains 4 gang 100 MMF silver plated tuning condenser. Add postage for 10 lbs.



**\$2.50**

## G.E. 1000 VOLT 350 MA DYNAMOTOR

No. 213. An ideal dynamotor for mobile operation in taxicabs, police cars, sound systems and amateur stations. Supplies above voltage from 12 Volts or 500V. at 350 MA from 6 Volts. Complete with starting relay, and fuses. New. Our Dynamotor A. Shipping Weight 72 lbs.



**\$5.95**

## DM-36 DYNAMOTOR

No. 215. Western Electric 24 Volt input, 220V at 60 MA out. With filter assembly. Ship. weight, 6 lbs.



**\$2.95**

## POWER TRANSFORMER - SPECIAL

No. 226. Primary 117V. 60 cycle. Secondaries supply 746 V.C.T at 220 MA, 6.3V. at 4.5A., and 5V. at 4A. Will handle 13 tube radio receivers. Supply is limited, order early. Shipping Weight 11 lbs. each.



**\$3.95**

**3 FOR \$9.95**

## HEARING AID HEADPHONES

No. 216. Hearing aid type, comfortable, keeps out outside noise, one of the Army's best types. Add postage for 2 lbs..... \$1.00



## THE NEW 1943 HEATHKIT 5" KIT OSCILLOSCOPE

No. 03. Complete kit to build a beautiful 5" oscilloscope. Ideal for studying and servicing television and FM radio. 6 tubes including 5BP1 cathode ray tube. 1500-Volt power supply operates from 110-V 60 cy A.C. Has compensated vertical and horizontal amplifiers and 15 cy to 30 KC sweep generator. Detailed instructions make assembly easy. Shipping weight 35 lbs. Nothing else to buy.

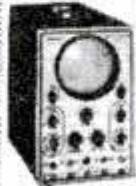

**\$39.50**

## HOW TO ORDER

Give part number and description. Add postage for weight shown. No orders under \$2.00. We will ship C.O.D.

# HEATH COMPANY BENTON HARBOR 17, MICHIGAN



Check these  
**SMASHING  
BARGAINS**

# WAR Surplus

Listed here are a few samples of the unusual bargains that are being offered in both War Surplus and other merchandise. Take advantage of these super-specials and order from this ad.

## NAVY STYLE FIELD SHOES

NEW. Rugged, comfortable. Reversed uppers, full oak leather inner sole, extra composition outer sole. Add 22c post.



67012

## BOMBER JACKET

13.99

B-15  
STYLE



SIZES  
34  
to  
46

NEW. Water repel. Mountain cloth outside, full pile lining incl. sleeves, 4 pockets. Wool knit wristlets and waistband. Gen. mouton collar. Add 35c postage.

## SPECIALS

O. D. Wool Serge  
Shirts 13-15 2.79  
Pants 28-34 2.95

Used, perfect condition. Cleaned and pressed by the Q. M. Corp. - 100% wool serge. Add 10c post.

Dust Masks  
NEW. \$1.50 value. Ideal for millers, farmers, paint and insecticide spraying. Add 6c post. **33c**

Khaki Surtan  
Shirts 14-17 2.99  
Pants 29-42 3.88

NEW. Made of genuine S.2 khaki chino material. Trousers with cuffs. Add 10c post.

Navy T-Shirts  
NEW. Full cut. White only. Fine combed yarn. Add 6c post. **69c**



## ARMY STYLE COMBAT BOOTS

NEW. For sportsmen and outdoor wear, 10" high. Reversed uppers, full oak leather sole, with composition outer sole. Add 27c post.

6 TO 12



77 EACH  
Surplus  
50% WOOL  
SHIRTS  
DRAWERS

NEW. Shirts: long sleeves, crew neck. Drawers: ankle length. Medium weight, 50% wool, O. D. color. Add 10c post.



## Genuine NYLON

PARACHUTE CORD PER HANK  
NEW. Ideal for clotheslines, drapery, venetian blind cords, etc. 550 lbs. tensile strength. 3/16" diameter. Add 7c post. **59c**  
50 FT.



OFFICER STYLE OXFORDS  
6.95  
NEW. Finest quality uppers, best quality oak bend leather outer sole. Half leather lined. Add 20c post. •BROWN •BLACK

## MAIL ORDERS

Please remit with order. Be sure to include postage. Satisfaction or money back.

**SIoux FALLS SURPLUS STORE**  
SIoux FALLS, S. D.

SEND FOR  
**FREE**  
Surplus  
CIRCULAR

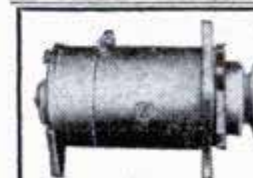

## Rebuilt GENERATORS

Chevrolet—Ford—Plymouth  
exchange price  
F.O.B. Chi. **\$6.95** guaranteed  
Generators rebuilt by factory-trained experts. Also hard-to-get parts for every car. STARTERS, TRANSMISSIONS and rear ends at tremendous savings.

WORLD AUTO PARTS CO.  
2200 N. Ashland

ORDER from one of the nation's largest replacement dealers  
Chicago 14, Ill.

## PRINT YOUR OWN POST CARDS

COMPLETE OUTFIT  
only  
**\$7.50**



Amazing results in sales, inquiries and contacts... saves time and money... very easy to use GEM STENCIL DUPLICATOR is ideal for Advertising, Announcements, Notices, Labels, Forms, Price Lists—hundreds of uses for every type of business and organization. Comes complete with all supplies, instructions and 60-page Book of Ideas.

FREE TRIAL OFFER: Try it before you buy it! Write and a GEM OUTFIT will be sent you postpaid. After 10 days, send only \$7.50 or return the GEM, no questions asked. The GEM must sell itself; you be the judge.

BOND EQUIPMENT CO. • Dept. 135  
6633 Enright • St. Louis 5, Mo.

SEND NO MONEY • FREE TRIAL OFFER



## SHARPEN SIRCULAR SAWS LIKE AN EXPERT

With SURE-SHARP you can precision file your own saws for the home workshop. No experience necessary. Adjustable for any pitch or angle. Makes blades true and sharp. Complete with file and instructions. Money back guarantee. Cash with order, prepaid. Order Now!

SURE-SHARP MFG. CO. BOX 24, SANTA ANA 1 CALIFORNIA

## NOW YOU TOO CAN BUILD 15 RADIOS



Absolutely No Knowledge of Radio Necessary

You Need NO Additional Parts

The PROGRESSIVE RADIO KIT is THE ONLY COMPLETE KIT. Contains everything you need. Instruction Book, Metal Chassis, Tubes, Condensers, Resistors and all Radio parts. The 36-Page Book written by Expert Radio Instructors teaches you to build radios in a Professional Manner. You start with a 1-tube receiver. Before you are done with this kit, you will have built 11 Receivers, 1 Public Address System and 3 Transmitters.

### SPECIAL FREE OFFER!

Electrical and Radio Tester sent absolutely FREE with each Progressive Radio Kit. PLUS FREE membership in Progressive Radio Club. Entitles you to free expert advice and consultation service with licensed radio technicians.

Write for further information, or ORDER your KIT **\$14.75**

NOW! ONLY... Postage prepaid with check or money order (Postage not prepaid with C.O.D. orders)

PROGRESSIVE ELECTRONICS CO., Dept. PM-17  
497 Union Avenue Brooklyn 11, N. Y.



## GERSTNER Tool Chests

A greater degree of perfection built into genuine GERSTNER chests always pleases good machinists and toolmakers. Free catalog.

GERSTNER TOOL CHESTS  
448 Columbia St. Dayton 7, Ohio

## Say You Saw It in POPULAR MECHANICS



## ROLLER BEARING WHEELS

IDEAL for home use: garden and shopping carts, wheelbarrows, coasters, wagons, racers, etc. Heavy cushion rubber treaded tires. Baked cream enamel steel discs 10" x 1.25". 3 1/2 lbs. SATISFACTION GUARANTEED.

Send Check or Money Order \$1.85 ea.  
Set of Two \$3.55 Set of Four \$6.95

Postage Prepaid

## COLSON EQUIPMENT & SUPPLY CO.

1321 Willow St. Los Angeles 13, Calif.

POPULAR MECHANICS



## EMERGENCY SUPPLY TANK



Fill at any gas station, 150 lbs. airs 5 flat tires. Inflates rubber boats. Use for touch-up spray jobs, tire service truck, air horns, dust out motors, machinery, etc.

Shatterproof 12"x24" stainless steel tank with carry handle, check valve, two feet \$7.95

hose and tire filling chuck. Only.....

Tank only 12"x24", tapped each end 1/4 pipe thread, 500 lb. pressure. Build your own. Ideal for paint spray, air receivers, net floats, buoys, etc. Each.....\$4.75

Small size tank, 6"x24". Only.....\$2.98

## BRIGGS-STRATTON ENGINES

### 1 1/2 HP MODEL N—GOVT. SURPLUS

In good operating condition with 30 day written guarantee **\$39.50**

PRICES FOB, K. C. NO COD'S

Write For Our New Catalog  
Hundreds of Values

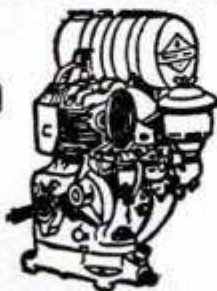

## MIDWEST SURPLUS SALES CO.

2533-P-INDIANA KANSAS CITY 1, MO.

## SPECIAL OFFER!

LOCK-STITCH SEWING AWL

**\$1.**

Postpaid



Famous, patented lock-stitch sewing awl complete with needles, waxed thread and direction folder. Hundred uses — sewing, repairing leather goods, canvas, belting, harness, saddles, gun cases, awnings, golf bags. Extra needles and thread available. Satisfaction guaranteed or money back. Send currency, check or money order. Yates Mfg. Co., 611-H Main St., Lake Geneva, Wisconsin

## BUILD YOUR POWER TOOLS

WITH POLY BALL BEARING ARBORS Model D-12 Pictured  
**HEAVY DUTY GRINDER**

3/4" x 17 1/2" precision spindle, self-lubricating ball bearings, heavy casting, V belt, 2 step pulley driven through rear or base.

ONLY **\$18.25**

Ship. wt. 13 pounds

**POLY BALL BEARING ARBORS**  
C4-1/2 x 12 1/2 spindle, housing 2x8, \$7.95 pp.  
C5-5/8 x 12 1/2 spindle, housing 2x8, \$8.45 pp.  
C6-3/4 x 12 1/2 spindle, housing 2 1/2 x 8, \$9.45 pp.  
D8-1 x 17 1/2 spindle, housing 2 5/8 x 11, \$18.75 pp.  
SHAPER ARBORS 3 inches between collars, C4-1/2 \$14.25, C5-5/8 \$14.25, C6-3/4 \$15.25, D8-1 \$23.00, B25-1 1/2 x 2" capflange mounts \$5.95.  
PILLOW BLOCKS—Ball Bearing, 1/2 \$3.50, 5/8 \$3.50, 3/4 \$4.25.

FREE!  
Write for POLY Illustrated literature.

C4-1/2 Pictured

SHAPER ARBORS

PILLOW BLOCKS

Ball Bearing

1/2 \$3.50

5/8 \$3.50

3/4 \$4.25

2 1/2 x 8 \$9.45 pp.

2 5/8 x 11 \$18.75 pp.

3 inches between collars

C4-1/2 \$14.25

C5-5/8 \$14.25

C6-3/4 \$15.25

D8-1 \$23.00

B25-1 1/2 x 2" capflange mounts \$5.95

Ball Bearing

1/2 \$3.50

5/8 \$3.50

3/4 \$4.25

2 1/2 x 8 \$9.45 pp.

2 5/8 x 11 \$18.75 pp.

3 inches between collars

C4-1/2 \$14.25

C5-5/8 \$14.25

C6-3/4 \$15.25

D8-1 \$23.00

B25-1 1/2 x 2" capflange mounts \$5.95

Ball Bearing

1/2 \$3.50

5/8 \$3.50

3/4 \$4.25

2 1/2 x 8 \$9.45 pp.

2 5/8 x 11 \$18.75 pp.

3 inches between collars

C4-1/2 \$14.25

C5-5/8 \$14.25

C6-3/4 \$15.25

D8-1 \$23.00

B25-1 1/2 x 2" capflange mounts \$5.95

Ball Bearing

1/2 \$3.50

5/8 \$3.50

3/4 \$4.25

2 1/2 x 8 \$9.45 pp.

2 5/8 x 11 \$18.75 pp.

3 inches between collars

C4-1/2 \$14.25

C5-5/8 \$14.25

C6-3/4 \$15.25

D8-1 \$23.00

B25-1 1/2 x 2" capflange mounts \$5.95

Ball Bearing

1/2 \$3.50

5/8 \$3.50

3/4 \$4.25

2 1/2 x 8 \$9.45 pp.

2 5/8 x 11 \$18.75 pp.

3 inches between collars

C4-1/2 \$14.25

C5-5/8 \$14.25

C6-3/4 \$15.25

D8-1 \$23.00

B25-1 1/2 x 2" capflange mounts \$5.95

Ball Bearing

1/2 \$3.50

5/8 \$3.50

3/4 \$4.25

2 1/2 x 8 \$9.45 pp.

2 5/8 x 11 \$18.75 pp.

3 inches between collars

C4-1/2 \$14.25

C5-5/8 \$14.25

C6-3/4 \$15.25

D8-1 \$23.00

B25-1 1/2 x 2" capflange mounts \$5.95

Ball Bearing

1/2 \$3.50

5/8 \$3.50

3/4 \$4.25

2 1/2 x 8 \$9.45 pp.

2 5/8 x 11 \$18.75 pp.

3 inches between collars

C4-1/2 \$14.25

C5-5/8 \$14.25

C6-3/4 \$15.25

D8-1 \$23.00

B25-1 1/2 x 2" capflange mounts \$5.95

Ball Bearing

1/2 \$3.50

5/8 \$3.50

3/4 \$4.25

2 1/2 x 8 \$9.45 pp.

2 5/8 x 11 \$18.75 pp.

3 inches between collars

C4-1/2 \$14.25

C5-5/8 \$14.25

C6-3/4 \$15.25

D8-1 \$23.00

B25-1 1/2 x 2" capflange mounts \$5.95

Ball Bearing

1/2 \$3.50

5/8 \$3.50

3/4 \$4.25

2 1/2 x 8 \$9.45 pp.

2 5/8 x 11 \$18.75 pp.

3 inches between collars

C4-1/2 \$14.25

C5-5/8 \$14.25

C6-3/4 \$15.25

D8-1 \$23.00

B25-1 1/2 x 2" capflange mounts \$5.95

Ball Bearing

1/2 \$3.50

5/8 \$3.50

3/4 \$4.25

2 1/2 x 8 \$9.45 pp.

2 5/8 x 11 \$18.75 pp.

3 inches between collars

C4-1/2 \$14.25

C5-5/8 \$14.25

C6-3/4 \$15.25

D8-1 \$23.00

B25-1 1/2 x 2" capflange mounts \$5.95

Ball Bearing

1/2 \$3.50

5/8 \$3.50

3/4 \$4.25

2 1/2 x 8 \$9.45 pp.

2 5/8 x 11 \$18.75 pp.

3 inches between collars

C4-1/2 \$14.25

C5-5/8 \$14.25

C6-3/4 \$15.25

D8-1 \$23.00

B25-1 1/2 x 2" capflange mounts \$5.95

Ball Bearing

1/2 \$3.50

5/8 \$3.50

3/4 \$4.25

2 1/2 x 8 \$9.45 pp.

2 5/8 x 11 \$18.75 pp.

3 inches between collars

C4-1/2 \$14.25

C5-5/8 \$14.25

C6-3/4 \$15.25

D8-1 \$23.00

B25-1 1/2 x 2" capflange mounts \$5.95

Ball Bearing

1/2 \$3.50

5/8 \$3.50

3/4 \$4.25

2 1/2 x 8 \$9.45 pp.

2 5/8 x 11 \$18.75 pp.

3 inches between collars

C4-1/2 \$14.25

C5-5/8 \$14.25

C6-3/4 \$15.25

D8-1 \$23.00

B25-1 1/2 x 2" capflange mounts \$5.95

Ball Bearing

1/2 \$3.50

5/8 \$3.50

3/4 \$4.25

2 1/2 x 8 \$9.45 pp.

2 5/8 x 11 \$18.75 pp.

3 inches between collars

C4-1/2 \$14.25

C5-5/8 \$14.25

C6-3/4 \$15.25

D8-1 \$23.00

B25-1 1/2 x 2" capflange mounts \$5.95

Ball Bearing

1/2 \$3.50

5/8 \$3.50

3/4 \$4.25

2 1/2 x 8 \$9.45 pp.

2 5/8 x 11 \$18.75 pp.

3 inches between collars

C4-1/2 \$14.25

C5-5/8 \$14.25

C6-3/4 \$15.25

D8-1 \$23.00

B25-1 1/2 x 2" capflange mounts \$5.95

Ball Bearing

1/2 \$3.50

5/8 \$3.50

3/4 \$4.25

2 1/2 x 8 \$9.45 pp.

2 5/8 x 11 \$18.75 pp.

3 inches between collars

C4-1/2 \$14.25

C5-5/8 \$14.25

C6-3/4 \$15.25

D8-1 \$23.00

B25-1 1/2 x 2" capflange mounts \$5.95

Ball Bearing

1/2 \$3.50

5/8 \$3.50

3/4 \$4.25

2 1/2 x 8 \$9.45 pp.

2 5/8 x 11 \$18.75 pp.

3 inches between collars

C4-1/2 \$14.25

C5-5/8 \$14.25

C6-3/4 \$15.25

D8-1 \$23.00

B25-1 1/2 x 2" capflange mounts \$5.95

Ball Bearing

1/2 \$3.50

5/8 \$3.50

3/4 \$4.25

2 1/2 x 8 \$9.45 pp.

2 5/8 x 11 \$18.75 pp.

3 inches between collars

C4-1/2 \$14.25

C5-5/8 \$14.25

C6-3/4 \$15.25

D8-1 \$23.00

B25-1 1/2 x 2" capflange mounts \$5.95

Ball Bearing

1/2 \$3



# Supreme HOMESHOP

## BAND and CIRCULAR SAWS

**HAIRLINE CONTROL • LESS RESHARPENING  
FASTER, SMOOTHER CUTTING • LONGER LIFE**

NOW—for your home shop! Famous SUPREME Band and Circular Saws nationally used by industry—now available in the SUPREME HOMESHOP Line to fit any size or make of home power tool! Special Nickel Alloy Steel. Free from kinks and other imperfections. SUPREME HOMESHOP SAWS are precision-engineered for highest cutting efficiency under heaviest punishment. End saw troubles, cut costs, speed your best work.

**SUPREME BAND SAWS**  
6' 6"—\$1.00    7' 9-1/2"—\$1.10    9' 6-3/4"—\$1.30  
in any of the following widths: 1/8, 3/16, 1/4, 3/8",  
8" Flat-Ground Combination Circular Saw—\$3.65

**IMMEDIATE DELIVERY—ALL STANDARD SIZES**

**ACT TODAY! ORDER DIRECT, stating  
Size, Make and Model. Or at your  
dealer. Write for Free Illustrated Circular.**

**THE SAW & KNIFE SPECIALTY CO.**  
6526 CARNEGIE AVENUE • CLEVELAND 3, OHIO

### HEAVY CAST ALUMINUM DOUBLE EXHAUST BLOWER

ONLY **\$16.85**

Excellent for Coal Furnace Blower. Use cheap Buckwheat, Rice coal instead of expensive Stove coal. Gives hotter water, faster... Removes gas fumes from garages. Install it yourself with any household tools. Double intake and exhaust from 2 balanced wheels. Flanges for attachment to ducts. Cont. duty motor, 110 V., A.C. 50-60 cycles. **SINGLE EXHAUST BLOWER—** Delivers App. 100 CU. FT. AIR per MINUTE—\$11.25. Add 50¢ handling; \$1 west of Miss. Send check. M.O. Money Back Guarantee. Free lit. Universal Yonkers Corp., (M-12), 137 Alexander St., Yonkers 2, N.Y.



**SAY YOU SAW IT IN POPULAR MECHANICS**

### ELECTRIC HAND GRINDER OUTFIT

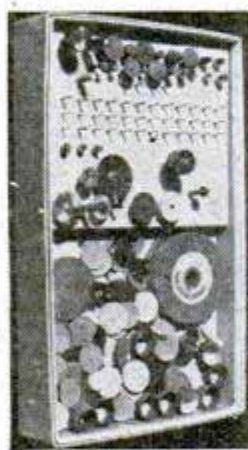

Compact container. Special rack for drills. Over 260 tools and items.

for cutting wood, metal or plastic.  
**MASTER \$9.75 \$45 Value  
KIT Only Postpaid in U.S.A.**

- 115 Grinding, Cutting and Polishing WHEELS PLUS 150 assorted tools most useful for Home or Shop.
  - 3 Grinding Wheels from 1" to 3" dia.
  - 1 Rotary File, High Speed Steel.
  - 3 Rotary Cutters 1/8" Shank.
  - 6 Rotary Cutters 3/32" Shank.
  - 6 Mounted Grind. Wheels 1/8" Shank.
  - 6 Mounted Wheels 3/32" & 1/4" Shk.
  - 3 Rubber Wheels.
  - 4 Speed Drills 3/32" Shank.
  - 30 Rotary Cutting Burs 3/32" Shank.
  - 2 Mandrels 3/32" Shank.
  - 1 Mandrel 1/8" Shank.
  - 1 Screw Type Mandrel 3/32" Shank.
  - 3 Rotary Bristle Brushes 3/32" Shank
  - 1 Rotary Wire Wheel Brush.
  - 1 Circular Saw
  - 1 Mandrel for Circular Saw 1/8" Shank.
  - 2 Rubber Cylinders and Mandrel 3/32"
  - 10 Cut-off Discs and grinding wheels.
  - 1 Rotary Drum Sander 1/8" Shank.
  - 15 Bands for Rotary Drum Sander.
  - 15 Rotary Felt Wheels 1" dia.
- The right attachment for every job. **ORDER TODAY.** Send check or send \$2.00 deposit with C.O.D. order.

**SPECIAL • 100 PIECES • \$1.00 Postpaid**  
Grinding Wheels, Cut-off Wheels, Sanding Discs, Mounted Stones, Sharpening and Honing Stones, Rotary Cutting Burs, Abrasive Cartridges and many other items.

**SCHUPACK SUPPLY COMPANY**  
7331 Cottage Grove Ave., Dept. PM-12 Chicago 19, Ill.

Clean YOUR SHOTGUN  
Faster, Easier  
WITH THE

### New COX TELESCOPING GUN ROD

← **P-U-L-L** →  
—it's fully extended, ready to use!

→ **PUSH** ←  
—it telescopes for easy carrying or storage!

2 SIZES AT  
**\$3.00**  
Each, Postpaid

No. 3 for 12-16-20-28 gauge shotguns.  
No. 4 for 28 and .410 gauge shotguns.

The new Cox Gun Cleaning Rod is what you've been wanting... it's fully rigid when extended—no "wobble" or buckle. Aluminum tip has standard thread, is interchangeable with special cleaning tips. No joint threads to "jimmy," no separate sections to lose or misplace. Finely made of brass tube, aluminum handle... light weight (only 6 oz.) telescopes to 15". It's the perfect gift for your hunting partner. Handsomely packaged in a miniature gun case of fleecelined suede.

Shipped postpaid. Send your order with check or money order today! State gauge of gun.

**COX MACHINE TOOL CO.**  
1010 So. Industrial Blvd., Dallas 8, Texas



### GEIGER COUNTERS FOR LOCATING RADIOACTIVE MINERALS • FOR HOSPITAL AND INDUSTRIAL USE.

Write for Details and Prices  
**OMAHA SCIENTIFIC SUPPLY CORP.**  
Dept. D, 3623 LAKE ST., OMAHA 4, NEBR.

### OTTAWA Buzz Master



A faster brush cutter and wood sawing machine. Propels itself while cutting saplings and brush. 7 H-P motor. Many outstanding and exclusive features. Available attachments: sickle bar, rotary tiller, sprayer, air compressor, snow plow and pulley for belt work. Thousands in use. Send for FREE booklet.

**OTTAWA MFG. CO., 1-827 Brush Ave., Ottawa, Kansas**



### AC's NEW "RECORD BREAKER" SPARK PLUGS FOR ALL MODEL ENGINES

More Speed Longer Life No Heat Failure

Users say these new AC's outperform any other spark or glow plug. AC's patented, aircraft type insulator, copper glass seal, tapered electrodes, make the difference. New engineering throughout. Hot and cold type in each of three thread sizes.

AC SPARK PLUG DIVISION • GENERAL MOTORS CORPORATION  
Flint 3, Michigan

**75c** AT YOUR HOBBY DEALER



POPULAR MECHANICS



## 3/4" BLACK & DECKER HOME UTILITY DRILL KIT



**PRICE**  
**\$39.95** Shipped Prepaid in U.S.A.

We also stock the 1/4" Home Utility Drill separately. Price \$18.95. 1/2" Home Utility Drill \$35.95.

## NEW — IMPROVED ELECTRIC DRILL KIT

22 Pc. 1/4" Capacity



22 Ga. Steel Carrying Case — Size 3 1/4" x 5 3/4" x 10 1/2" ONLY

**\$19.95**  
Shipped Prepaid in U.S.A.

### FAIRCHILD 1/4" LIGHT-DUTY DRILL

New Streamlined Design, Fast, Modern Electric Drill Suitable for Hobbyist, Mechanic and Farmer.

Fairchild universal type motor—housing made of 2 piece precision cast aluminum alloy—improved sturdy keyless 3 jaw chuck—Saw grip handle gives perfect balance and makes drilling easier. Lacquer sprayed with hard finish that will not peel. Factory Guaranteed for 90 days.

## WOOD BITS

The only drills expressly made to drill holes up to 1/2" Dia. in wood with 1/4" electric drills.

### SET W-5

Contains 5 Wood Bits with 1/4" round shank, sizes 1/4", 5/16", 3/8", 7/16", and 1/2", packed in cardboard box.

set **\$3.95**

## An Excellent Gift Combination Package

We would like to suggest the M-12 Hi-Speed Drill and Wood Bit Set and Tool Box, the 1/4" Black & Decker Home Utility Drill, and the New 7" Flex-Sander and Polisher.

All 3 for **\$33.50**

## XMAS SUGGESTIONS from THE ELECTRIC DRILL KING

Complete Distributors of Electric Drills and Accessories  
SORRY, NO C.O.D.'S ACCEPTED WITHOUT 25% DEPOSIT  
All goods shipped Parcel Post prepaid in U.S.A.

Mail Orders to

## The Electric Drill King

Mail Order Div. of Prehler Bros. Hdw.  
1627-29 N. DAMEN AVE.  
CHICAGO 47, ILLINOIS

CENTURY'S NEW

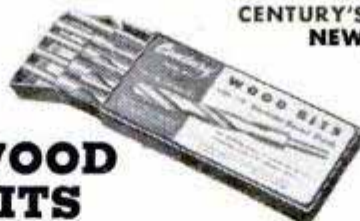

## Hi-Speed Drill and Wood Bit Set with Tool Box



Set No. M-12 ONLY

**\$9.90**

complete

M-12 includes:  
7 HI-SPEED TWIST DRILLS  
5 WOOD BITS WITH 1/4" SHANK

Sizes 1/16" to 1/4" Drill rack provides holes for 6 intermediate 64th sizes.

For Iron, Steel, Wood, Plastic, Etc.

For Use in Wood Only Designed especially for use in 1/4" capacity portable electric drills.

### ALL-METAL TOOL BOX

Compartment designed to hold all popular priced 1/4" electric drills.

## New Prehler 7" Flex Sander and Polisher

ONLY **\$4.95**

COMPLETE  
Bends  
Polishes  
Bufs



1/4" Shank for use in Lathes, Electric Drills, Drill Press, Flexible Shaft tools on AC or DC motors.

We have tested many sanders, some cost more, some less, but consider, in our estimation, this 7" Flex-Sander and Polisher to be today's best value — The Electric Drill King.



## GENUINE WAR SURPLUS

### Release of Pocket Watch Compass! Genuine Navy Flashlight!

**COMPASS**—hunting watch-type case in gold, silver finish; metal dial with black markings on silver background. Needle mounted on a jewel; locks automatically when case is closed. For hunters, fishermen, autoists, boy and girl scouts, etc.

**FLASHLIGHT**—one cell "Delta" with attaching Pin; for boats, trailers, bikes, etc. Used by Navy on life boats.

**ORDER NOW**—Limited supply. Enclose \$1 each for Compass, \$1 for 2 Flashlights sent postpaid. Excellent gifts. Satisfaction guaranteed or money refunded.

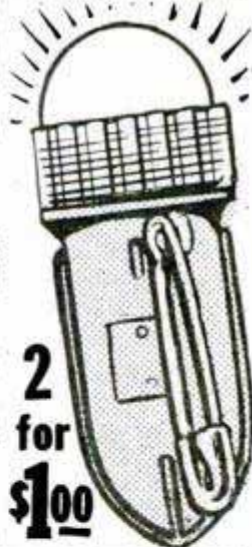

2 for **\$1.00**

**A & T SALES CO., Inc.**

2476 LINCOLN AVE.  
CHICAGO, ILL., DEPT. PM

## PARKA COAT

New Army Air Force Type B-11 Finger tip length. Fully alpaca lined with mouton fur parka hood. Zipper and button front.  
Sizes 36 thru 46

**24.95**  
PLUS 35¢ FOR MAILING

## SHEEPLINED FLIGHT PANTS

Reissue, excellent condition. All leather. Sizes small, med., large

**4.98**  
PLUS 35¢ FOR MAILING

Money Back Guarantee

## WAR SURPLUS VALUES

### AVIATORS' JACKET

Brand new. Air Corps Type B-15. Fully alpaca lined, including sleeves. Zipper front. Large mouton fur collar.  
Sizes 34 thru 44

**14.95**  
PLUS 35¢ FOR MAILING

### NAVY JACKET

Brand new. Navy N-1 Jacket. Fully alpaca lined. Zipper and button front.  
Sizes 36 thru 44

**13.88**  
PLUS 35¢ FOR MAILING

## NATIONAL JOBBING CO.

1703 No. 24th St. Dept. N-5 Omaha, Nebr.

## OFFICERS' PINKS

Brand new. Fine quality officers' elastique trousers.  
Sizes 29 thru 42. Reg. \$17.95 value.  
plus 35¢ for mailing.

**11.50**

## NAVY KNIFE

Brand new. Tempered steel 5 1/2 inch "Parkerized" blade. Laminated leather handle. Complete with sheath.

**98c**

Send for FREE CATALOG



**BUILD**  
*You can plan Your*  
**DREAM HOUSE**  
 MADE OF COLORFUL PLASTIC  
 SAVE MONEY-HAVE FUN



**NO TOOLS**  
**EASY TO ASSEMBLE**  
**USE OVER AND OVER AGAIN**  
**SIMPLE DIRECTIONS**  
**COLORFUL PLASTIC**  
**PREVENT BUILDING MISTAKES**

Make your "dreams" live by constructing a table size model of your Dream Home. It's so simple a child can do it. No tools—No fuss. Just follow the easy directions. Hundreds of floor plans can be created to fit your own taste.

Making changes on a scale model helps save expensive mistakes when you build your real home. Furniture cutouts to scale, enable you to plan your decorating scheme and electrical outlets.

**FREE:** "How To Plan The Home You Want" 32 pages (WITH SET) full of helpful home building hints.

**ONLY \$5.00**—Send check or money order and we pay postage. CODs you pay postage plus COD charge.  
 Add 2% Tax in N. Y. C.

**BUILD-A-PLAN, INC., Dept. PM**  
 1150 BROADWAY, N. Y. 1, N. Y.

**WAR SURPLUS AND OTHER BARGAINS**  
**TRANSFORMER**

Jefferson Electric step up or step down transformer. Input, primary 110-117 Volts A.C. Output, from 5 Volts to 650 Volts. Suitable for use with war surplus gadgets, heater relays, radio test filaments, electric trains, house chimes, etc. Weight 10 lbs. . . . . New \$7.95 Each.



**SEND CHECK, MONEY ORDER or CASH**

**FANCY BRIAR PIPES**  
 We have been awarded 100,000 fancy briar pipes by Quartermaster Corps. Assorted shapes and sizes. All popular makes. Buy now for Christmas Gifts . . . . . Set of 7, \$3.50

**25% DEPOSIT REQUIRED ON C.O.D. ORDERS**

**SHIP'S BELL:** U. S. Navy Surplus. Solid Brass with smooth polished finish. 5" diameter. Great for Patios, Doorways, in Dens, Ranches, etc. Matching solid brass wall bracket included. An unusual Xmas gift. Weight 3 1/4 Lbs. All new . . . . . \$5.95 Each

**ALL PRICES F.O.B. CULVER CITY, CALIF.**

**CLAMPS**—Adel Aluminum Co., Rubber lined, hundreds of uses in any shop. Assorted sizes, all new . . . . . 5 Doz. \$1 — 500 \$5

**AIRBORNE SALES CO., INC.** DEPT. PM 12-B CULVER CITY, CALIF.

**MICROMETER**  
 Chrome plated, precision engineered and carefully tooled to give long life . . .  
 all new. 0-1" capacity, \$2.25.  
 1-2" capacity, \$3.50 Each.

**HIGH SPEED DRILL BITS**  
 Like new! Original value over \$16.00.  
 25 assorted sizes & lengths \$2.50.

**POCKET-MITE PORTABLE PACKS AMAZING POWER!**  
 Tiny enough to easily slip into pocket and featuring hearing-aid midget tubes and new long-life midget batteries all contained within beautiful plastic case. No ground or outside antenna needed for strong reception within 50 miles radius. Stations over 2,000 miles distance received with plug-in antenna. Complete set of finished midget parts including tubes and beginners picture diagram direct from lab to you. Ready to wire as shown. Only \$6.99 P.P. Foreign orders \$8.00 U.S. Cash.  
**ELECTRONIC RESEARCH LABS., Dept. A**  
 1216 PARK ROW BLDG. NEW YORK CITY 7

**MAKE YOUR STOP LIGHT SHOUT**  
**AMAZING STOP LIGHT FLASHER**  
 Makes Your Stop Light Flash 115 Times Per Min. A SENSATION! Automatic, instant acting when foot brake applied. Non-rusting, Dust, Oil, Vapor & Waterproof. Used by Police & Fire Depts. Attach in 5 min. to any model car or truck. Approved by safety engineers. FREE BOOKLET with order. Tells how to SAVE MONEY ON YOUR CAR. ORDER NOW if dealer can't supply. SEND NO MONEY. Pay postman \$3.00 plus postage. Send \$3.00 we pay postage. Satisfaction or money back.  
**DEALERS & AGENTS WANTED**  
 MACCHI & CO., 927 Larkin St., Dept. MO, San Francisco, Calif.

**BUILD YOUR OWN BOAT—ONLY \$35**  
**NEW Guaranteed, Complete KIT**

Includes all PRE-CUT marine wood parts, screws, glue, hardware, building jig. Easy to build in few spare hours. Aircraft shell design gives amazingly tough, 65 lb. boat for hunters, fishermen, yachtsmen, boys 8 to 80.

FREE DETAILS. Write Dept. P.M.  
**PRITCHARDSONS'** 2744 W. 37TH PL. CHICAGO 32, ILL.

**OTTAWA TRACTOR SAW**

350 Cuts Per Minute—cuts them down, saws them up, one man operates. Thousands in use, stiff heavy blade, built to last, safety clutch control, uses power take-off any tractor. Low price.  
**OTTAWA MFG. CO., 2-827 Forest Avenue, OTTAWA, KANSAS**

**A BUSINESS OF YOUR OWN**

Make HOLLYWOOD STYLE cement pottery, birdbaths, mantels, miniature castles, benches; without moulds. Washing-wells, stucco-rock walls, fountains, rustic walks, tile tables. Dime brings chemically colored sample, amazing pictures.  
**HOLLYWOOD CEMENTCRAFT**  
 8527-A WONDERLAND AVE. HOLLYWOOD 46, CALIF.

**SAY YOU SAW IT IN POPULAR MECHANICS**  
**MORE POWERFUL PORTABLE**

**BENCH GRINDER—\$13.50** DELIVERED

FULL 1/12 H.P. MOTOR AT 3450 R.P.M. BY DYNAMOMETER TEST  
 With adjustable tool rests and removable cast wheel guards for buffing. Diamond-trued 4" x 1/2" coarse and fine wheels . . . dust proof bearings . . . off-on switch . . . 6 ft. rubber cord . . . baked hammertone finish . . . 110-120 volts a.c., 60 cycle . . . guaranteed one year against defective workmanship or materials. Send check or money order, we prepay postage.  
**ALHAMBRA PRODUCTS, BOX 328, ALHAMBRA, CALIF.**



**NOW FOR THE FIRST TIME**

# SPINGRIT\*

**Makes small radius sanding a pleasure!**

A sanding spindle set in 1/4", 1/2", 3/4", and 1" dias. with WRAP AROUND abrasive strips that stay put.—



Inexpensive straight strips of abrasive in a wide range of grits quickly wrapped (Barber-pole style) and securely locked at both ends, making a fine precision tool for inside or outside CONTOUR SANDING and GRINDING.

SPINGRITS chuck into any drill press, flexible shaft, lathe head or electric drill and at about one-tenth the cost make obsolete costly, hard-to-get preformed abrasive sleeves.

**COMPLETE SET OF SPINGRITS** — ALL 4 SIZES IN POLISHED WOOD CASE, sample strips and instructions..... **\$12.50**

ORDER TODAY—Shipped prepaid when cash accompanies order. \$1.00 deposit required on C.O.D. orders. FOR A LIMITED TIME ONLY we will include 48 assorted abrasive strips (a \$2.00 value) at no extra charge.

**THE SPINGRIT CO.**  
16550 Greenfield Road, Detroit 27, Michigan

\*PAT. PENDING

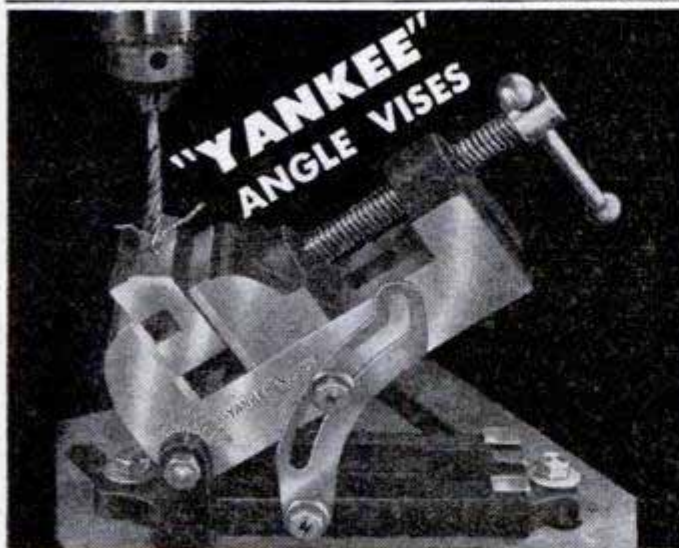

**1-minute angle set-ups!** Tilt it for the angle and lock it. You're set up for any operation, machine or bench. Two sizes, 2" and 2 3/4" jaws, with or without swivel base. Write for Vise

Folder and "Yankee" Tool Book.

YANKEE TOOLS NOW PART OF

**STANLEY**

THE TOOL BOX OF THE WORLD  
NORTH BROS. MFG. CO.  
Philadelphia 33, Pa.

# NOW ! Porter Designed & BUILT DUAL-TONE AND MELLOW-TONE MUFFLER SETS

## PORTER DUAL-TONE

Dual sets, scoop design, "Thru-Type", left hand tail pipe, 2 mufflers and brackets, Ford and Mercury

1935 to 1948.

ONLY  
**\$17<sup>50</sup>**

ORDER NOW FOR  
PROMPT DELIVERY



## PORTER MELLOW-TONE

Construction - 16 gauge steel. Cannot burn out or blow out.

1935-48. Ford and Mercury.

ONLY  
**\$23<sup>00</sup>**

"Steel-Pack" Muffler Sets,



LIFE-TIME  
GUARANTEE

'49 Ford and  
Mercury  
\$25.00

25% Deposit on C.O.D.

## PORTER' CHROME STATION WAGON STACKS



Specify year and model, also specify RIGHT or LEFT. Ford and Mercury '42 thru '48 complete with bracket . . . \$14.95 each

Dealer Inquiries Invited All Prices F.O.B., Hollywood

## PORTER MUFFLER MFG. CO., INC.

5401 Sunset Blvd.

Hollywood 27, California

Porter Muffler Manufacturing Co., Inc.  
5401 Sunset Blvd. Dept. PM-1  
Hollywood 27, California  
Gentlemen:

**ALL PORTER Mufflers reduce back pressure 50% thus increasing power and gas economy.**

Enclosed is 25c. Please send me your complete catalog on Porter dual tone and Porter "Life Time" mellow tone mufflers.

Name \_\_\_\_\_

Address \_\_\_\_\_

City \_\_\_\_\_ Zone \_\_\_\_\_ State \_\_\_\_\_



# Flex-O-Shaft

HANDLES LIKE  
A PEN\*

**\$35<sup>00</sup>**



Flex-O-Shaft is an improved all-purpose machine for homes, schools, shops, or factories. The slender, light-weight aluminum hand piece is ideal for grinding, drilling, sawing, buffing, scoring, etching, polishing, and scores of other uses. There is no bulky, throbbing, pulling motor in your hand. The light-weight motor can hang on the wall, or can be set down on working table. Speed is controlled by foot-operated rheostat, leaving hands free. This precision ball-bearing tool is as easily guided as a pen, speeding up operation because of ease in handling. It is a wonderful, compact, power house for making all kinds of objects. This unit consisting of Flex-O-Shaft with 6-ft. cord, 1/16 H. P. Motor, Rheostat with cord and plug, all for \$35.00. Send for complete information today! Use coupon below. Men will appreciate this unique Tool Kit as a Christmas gift.

Flex-O-Shaft and complete Tool Kit with 66 accessories only

**\$50<sup>00</sup>**



**FLEX-O-SHAFT SALES CO. (Dept. C)**  
Prairieview, Illinois

- Please send complete information on the Flex-O-Shaft Kit.
- Please send one Flex-O-Shaft Kit. \$50.00 enclosed. Shipping charges C.O.D.

Name \_\_\_\_\_

Address \_\_\_\_\_

City \_\_\_\_\_ Zone \_\_\_\_\_ State \_\_\_\_\_

**Say You Saw It in Popular Mechanics**

HOW FAR  
WILL THE OLD  
CAR GO?



Truck and Fleet Owners Stretch Car Miles, Prolong Motor Life, Cut Engine Repairs and Save Gas and Oil with

**VACU-VENT** The perfect Crank Case Ventilator Fume Filter - Motor Miser.

NOW YOU CAN HAVE Their Secret - Install VACU-VENT on Your Car, Your Boat or any Gasoline Engine. Installation is simple. Send for Free Descriptive Folder.

Dept. P. MOTOR ECONOMY PRODUCTS, Inc. 407 W. 36 St. N. Y. C. 18



PRICE  
**\$2<sup>80</sup>**

The Original **E-Z**  
DRILL SHARPENING FIXTURE  
(PAT. NO. 2,411,609)

Sharpens drills 3/32" to 1 1/2" dia. to factory precision in 30 seconds. Made of cold rolled steel (no pot metal). Aluminum protractor. Production or home workshop.

**E-Z MFG. CO.** 4406 San Fernando Rd. Glendale 4, Calif.

## SHARP-TUNER A completely new, really efficient RADIO RECEIVER



The best signal-powered set ever offered. Single control actually separates stations, even in large cities! New circuit developed by leading electronics company. Costly precision parts—Germanium detector, Leitz coil, modern capacitors. Beautiful durable enclosed cabinet 2 1/2" long! Uses no batteries or electricity—lasts indefinitely—reception guaranteed. Set alone with leads and directions, \$3.60. Trim single headset included \$1.00 more. Foreign orders 10% extra, prepaid only.

**CARING PRODUCTS** Dept. AJ, Box No. 1308 Chicago 90, Ill.

## SPECIAL OFFER ON ELECTRIC MOTORS

1/15 HP capacitor induction type motors available now complete with cord, plug, condenser, and mounting plate. This 115 volt, 60 cycle, single-phase motor develops 1600 RPM. Mfg. by Eastern Air Devices. Price: 1 to 12 motors, \$5.75. 12 or more, \$5.25 each. Take advantage of this special offer! FOB Los Angeles. Send cash, check, or money order. No C.O.D.



**MOTIONAIR INC.** 208 EAST 59th ST., LOS ANGELES 11, CALIF.

## DUAL CROSS and ROTARY FEED

**PALMGREN** ROTARY, INDEX, MILLING TABLE

Has 8" table, 360° movement and 4" cross feed travel. Adjusting wheels and dials graduated in degrees and thousands. Slotted for bolting to table. No. 83 Priced \$49.50. No. 82 without rotary feed \$39.75.

Write for Circular No. 10  
**CHICAGO TOOL and ENGINEERING CO.**  
8365 South Chicago Ave., Chicago 17, Ill.



# See the IMPROVED SALSBURY MOTOR SCOOTER

Dependable—6 H. P. Engine  
Easy to Drive—Automatic Shift  
65 or more miles to the gallon

Write for Free Folder

**SALSBURY MOTORS, INC.**  
DEPT. PM-12 POMONA, CALIFORNIA







SANDING

The only attachment for angle-head electric drilling.

POLISHING

**Why Pay More and Get Less? Only the BULL BUFFER**

*Has everything you want in a polisher-sander!*

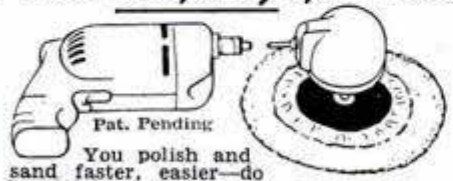

You polish and sand faster, easier—do beautiful, professional work—with this amazing attachment for your electric drill. (You can also drill up to 1/2" with your 1/4" drill and at right angles never before possible!) Bull Buffer more than pays for itself the very first time you make your car, floors, woodwork, furniture gleam like new. It's built of lifetime materials and *guaranteed*. Thousands and thousands of satisfied users. At your dealer or send cash, check or money order for your Bull Buffer, complete as pictured. Only

**\$9.95**

1. Fits any chuck on an electric drill or flexible shaft—no extra power unit to buy!
2. Only Bull Buffer has gear reduction—the power to do any job without injury to your electric drill!
3. Only Bull Buffer has *swivel action*—turns in complete circle when drill is stationary!
4. Only Bull Buffer has *angle head* for electric drill—gets to all hard-to-reach surfaces, curved or flat!
5. Only Bull Buffer has 3 speeds\*—“same as,” 1/2-speed, or twice speed of your drill!

\*See description under photo of Bull Buffer kit.

*Special priority given Christmas orders—just let us know.*

**BERTRAM H. ENGINEERING CO.**  
3121 MAIN ST. Dealers Write for Information KANSAS CITY, MO.



Bull Buffer comes complete with sheepskin bonnet and two sanding discs, only \$9.95. Bull Buffer alone cuts drill speed 1/2; for direct drive (or “same as”) drill speed, order Adapter A with Bull Buffer; for twice drill speed, order Adapter B.

**ORDER THESE ACCESSORIES FOR YOUR BULL BUFFER**

1/2" Jacobs No. 6425 key chuck; increases 1/4" drill to 1/2" capacity—reduces speed, increases power.....	\$5.00
Extra sanding discs (000-00-0-1-2 1/2-3-4) each .....	.10
2 1/2" cup wire brush for removing paint, rust, scale, etc.....	1.75
Extra sheepskin bonnet.....	1.25
Adapter A—for direct drive at “same as” drill speed.....	1.00
Adapter B Set—for sanding at twice drill speed.....	2.00
Bull Buffer car cleaner.....	.50
Bull Buffer car polish.....	1.00

**PRESSURE PRINCESS**

*Makes every job EASIER*

**Y**OU have never seen a single cylinder portable air compressor that packs so much power as this one. Built by the makers of the famous 4 cylinder Pressure Queen, the Princess will do any job, from inflating tires to painting buildings. Compact, simple and rugged, it will last your lifetime and pay for itself over and over again.

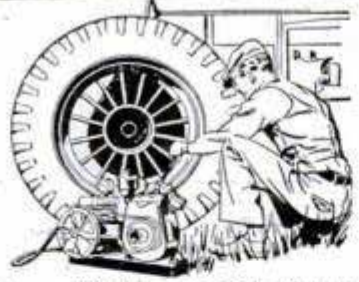

Powered by electric motor or gas engine.

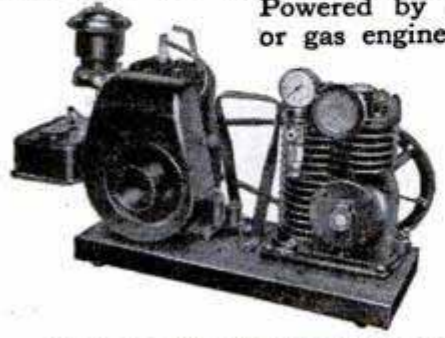

*Write for Literature and Prices*

**THE CAMPBELL-HAUSFELD CO.**  
1046 Railroad Avenue Harrison, Ohio

SAY YOU SAW IT IN POPULAR MECHANICS

**No More Stalling on Icy Streets!**



**GET GOING QUICK WITH AMAZING NEW**

**MAGIC ICE CARPET**

4-PLY KNITTED GALVANIZED STEEL WIRE



**Grips the road! Gives your spinning wheels traction! Save time and expensive towing charges. Just slip a strip of MAGIC ICE CARPET in track of each of your rear wheels—and get rolling in a jiffy!**

**ICE ON THE WAY—DON'T DELAY!**

**EASY TO USE, AGAIN AND AGAIN!**

*An Ideal Xmas Gift!*

Only **\$1** per pair

LETRAW MFG. CO. Dept. P 229 W. Illinois St., Chicago 10 Add 25c for postage and handling.

Rush me.....pairs of amazing MAGIC ICE CARPET at \$1.00 per pair, (No C.O.D. orders, please).

Name.....

Address.....

City..... Zone..... State.....



## FARMERS: Get these Answers to Your Tillage Problems... for Higher Yields at Lower Cost!

Write for our latest illustrated Seaman Tiller Bulletin NST. It tells, in Seaman users own words, how they have increased crop yields, cut costs and increased profits with the help of SEAMAN ROTARY TILLAGE. It tells how the Seaman Tiller prepares an ideal seedbed . . . to fit your crop and soil conditions . . . providing fine pulverization, coarse, or "in between." Learn, also, how you can use this machine for soil aeration, conserving and holding moisture in the seedbed, weed and pest control, pasture renovation, erosion control mixing-in cover crops and fertilizer for more effective plant utilization, etc. Seaman farm-size Rotary Tillers are available in 20 different models, (gas- or diesel-powered and power take-off types), in 3 ft. to 7 ft. tillage widths. Write for Bulletin NST today!

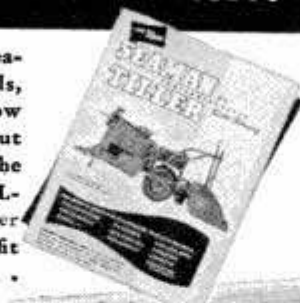

**SEAMAN MOTORS, Inc.** 364 N. 25th Street Milwaukee 3, Wis.

## Learn to MOUNT Birds and Animals



### FUN • PROFITS

#### Send Today for Free Book

Old reliable school (250,000 students) will teach you **AT HOME** to Mount **BIRDS, ANIMAL HEADS, FISH** and **TAN SKINS** and **FURS**. Write now—at once.

**SPORTSMEN:** Save your trophies. Game is growing scarcer—every **Specimen** is valuable. Keep them—save them—mount them. Decorate your den. Fun and fascination. Profits, too.

**TAN** heavy and light skins and furs. Make real **HARNESSES, LEATHER, BUCK SOLE LACE, ETC.** Best method known, but easy and simple. Don't sell those hides cheap. Tan them for your own use. Make leather vests, belts, gloves, etc. **TAN FOR OTHERS.**

**FUR-WORK** for men and women. Tan and make up scarfs, capees, coats, muffs, mitts, trimmings. Quickly, easily learned.

**EXTRA MONEY** \$40 to \$80 a month, even more. Big demand for **TAXIDERMISTS, TANNING AND FUR-WORK.** A real spare-time business—good in every community. If you need extra money, **WRITE!**

### FREE BOOK

48 pages, 100 beautiful pictures, tells **ALL** about Taxidermy, Tanning, Fur-Work. Write **Today**—this minute for this **STRANGE, MARVELOUS FREE BOOK.** A postal will do. State **AGE.**

**N. W. School of Taxidermy, 2512 Elwood Bldg., Omaha, Neb.**



## Prices are DOWN!

### 1/4" AIR HOSE (B. F. GOODRICH)

**\$1.98** per 24 ft. length

New Government surplus. Resistant to oil, gas, grease. Two-ply, made to exact government specifications. Superior even to highest grade air hose. Can be coupled to any desired lengths. Complete with standard fittings — \$2.57.

### AIR COMPRESSORS

as low as **\$59.50**

Bendix-Westinghouse with all accessories — for home or commercial use. Built to rigid government specifications.

### AIR & LIQUID TANKS

**\$3.59**

Non-rusting stainless steel; 12" diameter, 24" length; 10 gallons liquid capacity; holds up to 400 lbs. safe air pressure. Write for description of hundreds of uses and list of accessories.

All prices f.o.b. Kansas City, Mo.

**WRITE FOR FREE LITERATURE DESCRIBING THESE AND HUNDREDS OF OTHER BARGAINS**

### The original MID-WEST BUY-ANYTHING CO.

Not Connected with Firms of Similar Names

Dept. M, 1520 Locust

Kansas City, Mo.

## CARBURETOR TOO RICH MAKES MOTORIST TOO POOR



Car owners who are wasting money and not getting proper gas mileage due to over-rich mixtures will be pleased to learn how to save gasoline by **VACU-MATING** over-rich mixtures. **VACU-MATIC** fits all cars, trucks and tractors. It is **automatic** and operates on the supercharge principle. Easily installed in a few minutes.

### SALEMEN WANTED! Big Profits!

Send name, address on penny postcard for free particulars and how to get yours for introducing.

**VACU-MATIC CO., 7617-1418 W. State St., WAUWATOSA, WIS.**

## Superette Dual Vacuum Auto Horns



### The Voice of Authority on The Highway

One blast and those "road hogs" really move over. Superette Horns compare favorably to air horns costing \$75 to \$100. Can

be installed under hood or on front fender. Beautiful lacquer finish. Operates from intake manifold of your car. No tank needed. Cost is only \$8.95 complete with all necessary fittings, control valve and simple installation instructions. Send check or money order today or order C. O. D. - Adds much to your car.

**THE PROTECTUOD COMPANY Dept. 153, 4033 Windsor Road, Youngstown 7, Ohio**

## BUILD THIS SMART AND COLORFUL TRAWLER MODEL

Kit contains carved hull and complete set of fittings. Send today for kit #1225 which will be sent postpaid for \$15.00. Our 40 page illustrated catalog mailed on receipt of 25c.

**A. J. FISHER**

1002 Etowah Ave., Dept. M Royal Oak, Mich.



## PLASTIC TOPS

smooth sparkling surfaces



NOW . . . the Home Worker can cover his Sinks — Counters — Tables and Bars with colorful hardwearing decorative Laminates.

## EASY TO APPLY

This tough, durable plastic comes in panels 1/16" thick and is the same superlative surface you have seen on modern kitchen tables, cabinets, and in high-class restaurants. Ideal for splash panels in bath rooms and kitchens. Countless other uses. This plastic top is washable—color fast—highly resistant to stains, alcohol, abrasion and cigarette burns.

**10 BEAUTIFUL COLORS**—Linen: tan, red, blue, green. Patterns: bleached mahogany, mother of pearl. **Solid Colors:** red, green, blue, yellow, black.

Instructions for easy application included.

Shipped prepaid east of the Mississippi; west of the Mississippi add 90c per panel. Send check or money order.

Price for 30" x 48" panel

**\$7.79**

**BANDT, INC.** Dept. M-1

37-17 33rd Street

Long Island City 1, N. Y.



# BALL BEARING STEEL WHEELS

Complete With Wheels, Tires & Bearings Made To Outwear Other Type Wheels

SIZE	TIRE	BEARINGS	LOAD Lbs.	ONE	TWO	FOUR
6" x2"	Solid	Ball 1/2", 5/8"	300	\$ 3.25	\$ 6.25	\$12.00
8" x2"	Solid	Ball 1/2", 5/8"	250	\$ 4.25	\$ 8.00	\$15.50
10" x1 3/4"	Semi-Pneu.	Ball 1/2", 5/8"	125	\$ 3.00	\$ 5.50	\$10.50
10" x2 1/2"	Semi-Pneu.	Ball 5/8"	250	\$ 5.50	\$10.00	\$19.00
12" x2 1/2"	Semi-Pneu.	Ball 1/2", 5/8"	150	\$ 5.50	\$10.50	\$20.00
12" x2 3/4"	Semi-Pneu.	Ball 1/2", 5/8"	225	\$ 5.75	\$11.00	\$21.00
12" x3"	Semi-Pneu.	Ball 1/2", 5/8"	340	\$ 8.50	\$16.00	\$31.00
16"(4.00x8)	Pneumatic	Roller 3/4"	520	\$12.50	\$24.50	\$48.00
16"(5.00x8)	Pneumatic	Ball 3/4"	375	\$13.00	\$25.50	\$50.00

NOTE: Other wheels from 3" dia. to 23" with loads from 100 lbs to 1700 lbs. in fibre, solid rubber, semi-pneu., pneumatic 2 to 8 ply, axles to match.

**ORDER NOW** Add 10% for Prepaid Shipment in U.S.A. 25% DEPOSIT ON C.O.D. ORDERS

Descriptive Circulars and Lists of our products will be mailed promptly if you enclose 10 cents in your letter.

**OSBORN WHEEL COMPANY, 115 So. Main St., Dept. P-12, Doylestown, Penn. Now Make Him Real Happy**

## The New 1949 Model "E" CHASSIS

• TWO PASSENGER •  
36" Wide x 76" Long

COMPLETELY ASSEMBLED with 14" Steering Wheel and Dual Brakes  
**READY TO RIDE**

12" x 3" Wheels Semi-Pneumatic Tires  
**Built-In . . . Spillproof and Roadability . . .**

Complete as Shown ONLY \$99.50 (Plus \$6.50 crating) F.O.B. Doylestown  
Model "E" Gift Kit . . . Same as Above Unassembled . . . ONLY \$79.50 (Plus \$4.50 crating)  
**FOR ADULTS or CHILDREN . . . A Splendid Father and Son Project.** Can be purchased with Pneumatic High Speed Wheels. Also complete Model "D" 40" x 90" with 7.7 H.P. Engine.



**340 lb. Load Per Wheel**

Arranged For Chain Drive With Sprocket Attached. Will take up to 4 H.P. Engine.

## HOME WORKSHOP BARGAIN



**1/2 H.P. Cap.**  
INCLUDES ALL THE WORKING FEATURES AND SAFETY FACTORS NECESSARY FOR AN IDEAL HOME WORKSHOP MOTOR

**ONLY \$35.00**  
Reg. Sold \$49.50

- Double 5/8" Shafts
- Sealed Ball Bearings
- High Starting Torque
- 3 Pole Reverse SW.
- Overload Protected
- Rubber Cord and Plug

GUARANTEED FOR ONE YEAR. ON NON-CONTINUOUS DUTY

Tool Jobs Rated 1 hour 55 C. 115 V. 60 C., A.C., 1750 or 3450 RPM

**Here's a Real Boys Christmas Gift**  
**A GENUINE TRAINING REPLICAS**  
of the U. S. ARMY'S OFFICERS CARBINE RIFLE



**ONLY \$2.50**  
Two for \$4.00  
No C.O.D.

**CANAL ELECTRIC CO.**

310 Canal St., Dept. PM 12, N. Y. C. 13, N. Y.

## Metal CASTING!

**Profits!**  
**Make Over 100 SOLDIERS and TOYS an Hour!**

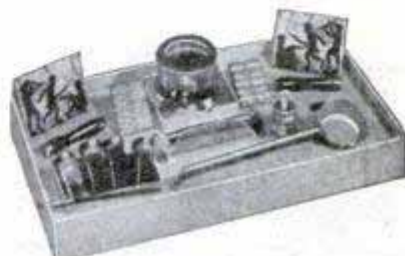

COMPLETE ELECTRIC CASTING SET — Start earning profits right away. Fascinating hobbycraft. Produce PERFECT MACHINE CASTS in lead! At home, in your spare-time create small, going business. Big demand for toy soldiers, other lead-cast toys right in your neighborhood. Set includes Electric Melting Stove, Ladle, Casting Metal, Molds Machine-fitted for 3 Figures, 4 Color Finishes . . . everything you need to start immediately. No experience required. Easy and simple to learn. Clear step-by-step instructions. Gift-packaged, only \$5, postpaid. ORDER now!

## ETCH WOOD, LEATHER *Electrically*



Wonder Pen. Etches beautiful figures, faces, designs. Turn out hand-crafted merchandise, popular, profitable . . . racks, plaques, frames, toys, furniture, belts, bags, wallets, knick-knacks. 7 patterns plywood Plaques. Rack pieces, Sandpaper, paint, brush. Plug Wonder Pen into AC or DC—develop skill rapidly. Underwriter's approved. Guaranteed! Complete outfit in Gift Box, only \$3, postpaid. Write today!

**RAPAPORT BROS.** 1826 S. Washtenaw Ave. Dept. PMD, Chicago 8, Ill.

# FREE Sample Of New PLASTIC Shows How To Make Leather and Leatherette LIKE NEW!

**Magically Changes Cloth To Imitation Leather**

**SAVE MONEY - TIME AND EFFORT** by renewing Luggage — Leather Covered Furniture — Golf Bags — Auto Seat Covers—Restaurant Furniture, Booths or any Leather or Leatherette item with new plastic discovery called Leather-New. Coat cloth or cloth covered items such as Gilder Cushions, Tarpaulins, Couch Furniture, Etc. and make them look and wear like they were leather. Spreads easily with brush or spray gun—leaves NO BRUSH MARKS. Simple Acids, Caustics and Alcohols do not stain this finish—It is sun and mildew proof. Stays Fresh and Clean as long as real leather. Comes in all standard colors. Just mail coupon for Free sample of Leather-New coated material which shows effects.

**OWN A PROFITABLE LIFETIME BUSINESS**

Cash in on big profits to be made in this new business—Profits up to \$700.00 monthly possible, renewing booths and furniture for bars, restaurants, grills, movie houses, etc. Mail name and address on 1c postcard—I'll show you how. Jack Edwards, Sales Mgr.

**JUST MAIL COUPON**

**No Obligation**

LEATHER-NEW PRODUCTS  
6082 Sunneslope, Kansas City, Missouri

Name \_\_\_\_\_

Address \_\_\_\_\_

City \_\_\_\_\_ State \_\_\_\_\_

Fill Out—Mail Today

**LEATHER-NEW PRODUCTS • 6082 Sunneslope • Kansas City, Missouri**



# SpeedWay

BLUE LINE TOOLS



No. 69  
1/4" Drill  
\$11.80



G. A. KIT  
\$13.95

Not only the home craftsman, mechanic and builder, but every home owner needs these basic SpeedWay power tools for general repairing and installing and maintaining household fixtures and equipment.

Write for circular and name of local dealer.



No. 117  
Grinder \$14.95

**SPEEDWAY MANUFACTURING CO.**  
1863 S. 52nd Ave., Cicero, Ill.



★ ROUTE MEN!  
★ SPORTSMEN!  
★ CYCLISTS!  
★ FARMERS!

Keep Warm and Comfortable in an

## "Outdoorsman" Fur Cap



Warm... comfortable... weatherproof! Handsomely made of water repellent tan tackle twill with genuine Beaver shade Mouton fur ear flaps, neck warmer and peak. Ideal for all your winter outdoor activities. Also available in red Mouton for hunters. State size when ordering.

ONLY  
**\$5.95**  
Post Paid

**MONEY BACK GUARANTEE**

Order today - Use coupon below

MID STATES FUR CO.  
Dept. M, Box 1377  
Shorewood 1, Wisconsin

Name \_\_\_\_\_  
Address \_\_\_\_\_  
City \_\_\_\_\_ Zone \_\_\_\_\_ State \_\_\_\_\_  
Size \_\_\_\_\_ Check \_\_\_\_\_ Money Order \_\_\_\_\_

## Electrically Welded Endless Paramount

**BAND  
SAW  
BLADES**



Made in widths from 1/8" to 1-3/4"

Make your band saw do more work for you. The proper width of blade will extend the scope of this important machine. Burrill's Paramount Blades are made from tough Nickel Alloy Steel properly tempered. Teeth accurately set and filed, and all saws carefully straightened. Send order and check today. Delivery will be made as promptly as conditions permit, from a few days to a week or two. You can obtain these saws at the following prices:

1/8"-3/16"-1/4"-3/8" wide, 5'6" long.....\$1.04 each  
3/8"-3/16"-1/4"-3/8" wide, 6'6" long.....\$1.16 each  
3/8"-3/16"-1/4"-3/8" wide, 7'6" long.....\$1.27 each

Other sizes at proportional prices

**NO C.O.D. SHIPMENTS ACCEPTED**

State Make of Machine

Your satisfaction is guaranteed

**BURRILL SAW & TOOL WORKS**

407 E. Main St., Ilion, N.Y.

## LINOLEUM TILE

SAVE 1/2-PLACE DOWN TILES YOURSELF!

Ugly, old, worn floors like NEW - at a price you can afford. Lay beautiful, durable, genuine inlaid LIN-O-BLOX linoleum tile. Nothing to it - an evening or two. No waste. Heavy weight. Distinctive, modern colors, patterns. All famous brand linoleum. Most efficient floor. Easy to clean. **FREE 4-COLOR BOOK**, simple laying instructions, and 10 actual tile **SAMPLES!** Write for yours today! No obligation.



**CASSIDY TILE COMPANY, Dept. 9**  
5657 N. Lincoln Ave. Chicago 45, Ill.

## BE SAFE afoot in Night-Time TRAFFIC!



Carry a **SAFE-T-FLECTOR**. Made especially for pedestrians by **MONADNOCK MILLS**, Subsidiary of U.C.F. Corp. - Easy to carry in pocket, purse or wallet - weighs less than 1/2 ounce. **NEW, SENSATIONAL MATERIAL** - GUARANTEED positive night-time reflection FROM ANY ANGLE. WHY TAKE CHANCES. Order one or more today - Sent **POSTPAID** for \$1.00. **DO IT NOW!!** Write to:

**PRODEX CO.** Dept. M-7275 Franklin Ave.  
Hollywood 46, Calif.



## BUILD FINE GRANDFATHER CLOCK NOW

The simple sensible Red-i-Kut way as thousands have - **SAVE HALF. SHOP TESTED PLANS "SPIRIT OF THE CENTURY"** - Narrow waist 83" tall or stately **"SPIRIT OF AMERICA"** - straight side model with pictures. **EASY-TO-FOLLOW PLANS** tell all - plus **BROCHURE** of fine brass weight Westminster, tube chime, movements, dials and mahogany case kits. Send **\$1.00** today - Both Plans **\$1.50 NOW**. **KUEMPEL CHIME CLOCK CO.**, #10 Kuempel Bldg., Minneapolis 16, Minn.

## MAKE YEAR 'ROUND PROFIT WITH YOUR IDEAL SHARPENER

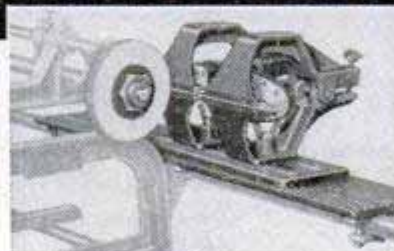

Sharpen  
Skates

WITH IDEAL  
SKATE GRINDING  
ATTACHMENT

Ideal Lawn Mower Sharpener Owners: Make extra profits this winter by adding No. 160 Skate Grinding Attachment to your Ideal Sharpener. Hollow-grinds all types of ice skates. Quickly and easily attaches to your Ideal Lawnmower Sharpener. Shipping wt. 60 lbs., Price \$15.00 FOB Plymouth, Ohio. Order Now.

**THE FATE-ROOT-HEATH CO.** • Dept. D-3, Plymouth, Ohio



## BE YOUR OWN BOSS WITH A **WOODBOS**



**THIRTY SEVEN  
POUNDS OF  
CUTTING  
MAGIC**



FALLING



BUCKING

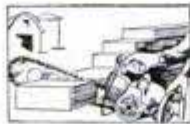

SAWING TIMBERS

Hundreds of case histories prove that a man with a Woodboss Saw is always in demand. You and Woodboss can earn \$200 to \$300 a week! Contract logging or sawing for city, county or construction companies; contract falling and bucking, cutting cordwood, to mention a few. *Be your own boss with a WOODBOSS*

Dept. M Write for free booklet and full particulars.

**WOODBOS, INC.** 2712 N. Mississippi Ave., Portland 12, Ore.

In Canada: POWER MACHINERY, LTD., 148 E. 3rd Ave., VANCOUVER, BRITISH COLUMBIA

## Now ROTARY DRILL CONCRETE Easily!

CONCRETE • BRICK  
ASPHALT • SLATE  
WALLBOARD  
and most other  
construction  
materials

SLIP A CARBOLOY MASONRY DRILL INTO  
YOUR ROTARY DRILL, HAND BRACE OR  
DRILL PRESS AND WATCH IT GO—AND  
GO FAST!



- DRILLS 4 TIMES FASTER!
- STAYS SHARP 50 TIMES LONGER!
- CUTS CLEAN, TRUE-SIZED HOLES!



Tipped with  
CARBOLOY Ce-  
mented Car-  
bide—harder  
than the hard-  
est steel.

Goodbye to back-breaking masonry drill-  
ing! Carboley Masonry Drills — round  
shank for shallow holes, fluted for all-  
purpose drilling—cut through masonry  
jiffy-quick! Priced as low as \$1.40. Ask  
about Economy 6-Drill Set, 3/16", 1/4",  
5/16", 3/8", 1/2" and 5/8", in canvas kit,  
\$10.40 postpaid or C.O.D., from your  
dealer or direct. Ask for leaflet SA236.  
CARBOLEY COMPANY, INC.

11185 E. 8 Mile St., Detroit 32, Mich.

## GET FISHING'S GREATEST THRILLS!

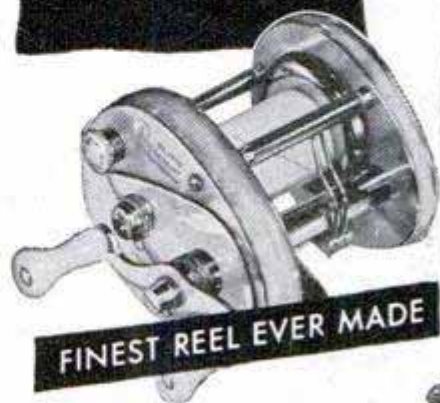

**FINEST REEL EVER MADE**



with the New *Shakespeare*  
**PRESIDENT REEL**

**NO OTHER REEL GIVES YOU ALL 9  
BETTER FISHING FEATURES**

When you own a PRESIDENT Reel, you get the greatest thrills in fishing, fun like you've never had before. And what a better job of fishing you'll do, with the PRESIDENT'S instant response to your every cast, its whisper-quiet, smooth operation.

Nine better fishing features have been *custom-crafted* into this amazing reel—new type gears, carboley spool pivot bushings, adjustable casting drag and balanced teardrop design, to mention a few. Own the PRESIDENT. You'll be the envy of your fishermen friends. At your Sports Store.

**FREE 1949 TACKLE BOOK**  
and pocket fishing calendar. Newest in Reels, Rods,  
Lines, Accessories, Fishing Tips. Write Shakespeare  
Co., Dept. 812, Kalamazoo 2, Michigan.

*Shakespeare*  
**FINE FISHING TACKLE**  
HONOR BUILT FOR OVER 50 YEARS

SAY YOU SAW IT IN POPULAR MECHANICS

## **MP** QUALITY TILTING TABLE SAW

TABLE INCLUDING EXTENSION 18" x 14"

**\$24.95**

Complete as shown  
F.O.B.  
Royersford, Pa.



TAKES

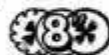

BLADE

Send for catalogue showing complete line of Tilting  
Table and Tilting Arbor Saws, from \$24.95 to \$87.50  
**AMERICAN MACHINE & TOOL CO., Inc.**  
ROYERSFORD, PA. DEPT. 111

**IMMEDIATE  
DELIVERY**



**WAR SURPLUS BARGAINS**

**Outstanding MECHANICAL, ELECTRONIC Buys!**

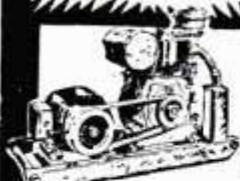

• Power Plants. Nearly new and perfect. 110-volt, 60-cycle, 2500-watt units. Well known make. Pine for farm, cabin etc. Original Cost \$535.00 **SALE \$229.80**



• Same as above except NEW and complete with tools and spare parts. Sale **\$266.80**

• Gas Engines. Nearly new and perfect. Briggs ZZ 6.5 h.p. Useful tractor, elevators, pumps, scooters, buzz saws, etc. A real value. Original Cost \$140.00 **SALE \$86.90**



• Rotary Gear Pump. New. High vacuum and pressure. Hundreds of uses. 1/2 inch drive shaft. Original Cost \$38.65 **SALE \$3.95**



• A-C Motor. New. Reduction gear with four shafts. Speeds of 8, 32, 320 and 4000 r.p.m. Useful buffers, grinders, drills, etc. 110-volt, 60-cycle. An experimental wonder. Original Cost \$38.75 **SALE \$8.75**



• Electrical Room Heater. New 110-volt, 60-cycle, 1600-watts. Latest Chromalox highly efficient elements. A top flight heater. Original Cost \$29.60 **SALE \$12.80**



• Electrical-Electronic experimental kit. Permits hundreds of experiments. Eaves-dropping, private telephone, electrical theory, radio set, burglar alarm, etc., etc. Ideal for boys Xmas present. Full instructions. Educational — fascinating — scientific. Parts Cost \$15.00 **SALE \$4.77**

We pay all freight and postage charges in the U.S.A. Order direct from ad or send for catalog giving full description of our many bargains. We accept personal checks. Our references—NATIONAL BANK OF COMMERCE.

**LECO ENGINEERING CO.**

BOX 908-PM12

LINCOLN, NEBR.

**Drive Relaxed! with HANDE-FEED Finger-Tip GAS CONTROL**



Fits steering post of any car. Connects to carburetor. Simply lift lever to increase engine speed; when released, engine idles. Pivots for use with right or left hand. Does not interfere with gear shift or steering, or cut out foot accelerator. Hand buffed chrome finish. Easy to install. Instructions furnished. Send coupon below.

**\$795 POSTPAID**

**Protection from Burning Sun TUCK-A-WAY AUTO AWNING ASK YOUR DEALER OR ORDER DIRECT**

Made of green and white striped waterproof duck. Steel brackets. Screw on top of door yourself. No holes to drill. Theft proof when doors are locked. Folds up for storage in glove compartment. Adjustable for sedans, coaches and coupes. **\$495 PAIR POSTPAID**

TRANS-CONTINENTAL, Inc. DEPT. 8 BOX 3812, St. Louis, Mo.

HANDE-FEED      Send me \_\_\_\_\_ each of items checked.  
 AUTO AWNING  
 I'm enclosing      Name \_\_\_\_\_  
 CHECK:  M. O.      Street \_\_\_\_\_  
 SHIP C. O. D. PLUS      POSTAGE  
 FREE CIRCULAR      City \_\_\_\_\_ State \_\_\_\_\_

**Save 75% on Brand New Portable POWER WINCH**

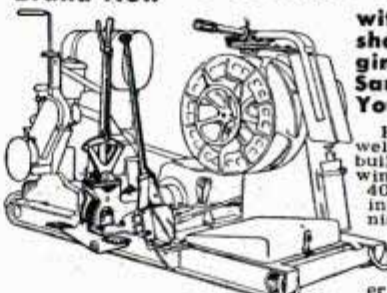

with 2 cyl. 11 H.P. Waukesha Gasoline Engine. Cost Uncle Sam \$1150 each, **Your Price . . . . . \$320**

For building contractors, water well drillers, coal mines, tank builders, farmers—wherever a real winch is needed. Drum carries 400' of 3/4" cable or equivalent in other sizes (cable not furnished). In low gear will handle 2000-2500 lbs. at 167' per minute, 5000-6000 lbs. at 50 ft. per min., or 3000# at 100 ft. per min. or lighter loads much faster. Free wheeling drum. Hydraulic brake. Standard automotive parts and other available parts from winch manufacturer. Motor alone worth \$180. Will last for years. Similar winches sell now for \$1600. Save 75% or more. Guaranteed brand new with tools, parts list, 32 accessories in all. Ready to ship, \$320 FOB Cincinnati. Net wt. 1070 lbs. Shipping wt. 1650 lbs. Net size about 41"x42"x64". Use, or resell them at nice profit. You need to act! Send 25% deposit. Bal. COD subject to inspection. These will sell fast! Folder on request.

**SOUTHWESTERN CO.** 303-5 N. Harvey St., Dept. M12  
 Pho. 2-1115 Okla. City, Okla.—"Since 1902"

**Ideal Gift For The Craftsman: COMPLETE SANDING & POLISHING KIT**



Order Now! We pay all mailing charges with Money Order or Check. Postage extra with C.O.D. **NEDRO SALES CO., Dept. L1, 102 N. 11th Street, Phila. 7, Pa**

**Amazing New ELECTROMOTIVE DE-RUSTER REMOVES CAR RADIATOR RUST & SCALE!**

Quickly, efficiently, cleans by Electrolytic action. No moving parts, no interference with circulation system. Install in radiator cap neck in 15 seconds. Money back guarantee, for 30,000 miles. Send check or money order, stating car model and make Prompt shipment. Order today. **ONLY \$3.95 POSTPAID**

CURTIS COMPANY, BOX 51, ANCHORAGE KY.

**ORDER BY MAIL for huge savings in Automatic AIR COMPRESSORS**



Complete piston type air compressor with 10 gal. tank. 1/2 HP capacitor type, AC, 110 and 220 volt 60 cycle motor, V-belt drive. Has automatic pressure switch, check valve, drain cock, 20 ft. cord, hose, pop-off valve, stop cock, gauge, belt, pulleys — etc. Will develop 75 lb. pressure — approx. 2 cu. ft. Brand new. . . . . **ONLY \$79.50**

**SAME AS ABOVE . . . unassembled. (Stock #340) . . . . . only \$69.50**

**SAME AS ABOVE, with 1/2 HP motor and Westinghouse T-1, 2 cyl. compressor. Will develop 3 cu. ft., 75 lb. pressure. Completely assembled. (Stock #341) . . . . . only \$109.50**

**AS ABOVE, unassembled. (Stock #342) . . . . . only \$99.50**

**COMPRESSOR ONLY: 2 cyl. Westinghouse model T-1. Brand new. (Stock #343) . . . . . only \$22.50**

All items guaranteed to be as advertised. All prices F.O.B. Milwaukee. Send 25% deposit, balance C.O.D. Write for our free circulars.

**C & H ELECTRIC CO.** 1208 N. 5th St. Milwaukee 3, Wis.



## SHOPMASTER TOOLS

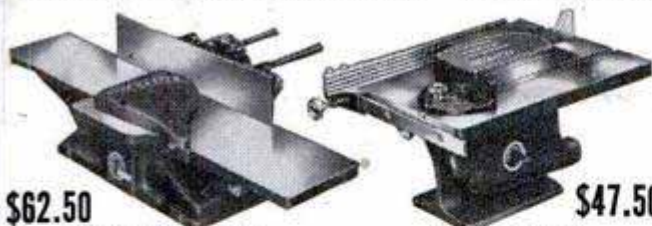

\$62.50

### 6" JOINTER-PLANER

Sealed for life ball bearings—New design fence—Requires no wrenches. Maximum protection guard—High speed steel blades. Requires 1/3 or 1/2 HP motor.

\$47.50

### 8" TABLE SAW

Tilting table—Cuts up to 2 1/4-inch wood—Sealed for life ball bearings. 14 inch x 18 inch table—Complete with blade, mitre gauge, rip fence and guard. Requires 1/2 HP motor.

## SPEEDY PAINT SPRAYERS



\$4.85



Delivers 2 cu. ft. free air per minute at 30 to 40 lbs. pressure—ample for every material. Operated by any 1/4 H.P., 1750 R.P.M. Motor with 1/2" shaft. Without Motor..... \$29.95

### AUTO POWER SPRAYER

SPEEDY JR. comes ready to use with:  
 • Sturdy plastic spray gun • 6 oz. cup  
 • Pump • Spark plug adapters • Tire adapters • 18 foot hose • Instruction Manual

15" Jigsaw .....\$19.95 1/4 HP Motor .....\$14.95  
 12" Bandsaw ..... 62.50 1/3 HP Motor ..... 16.95  
 12" Drill Press ..... 42.50 1/2 HP Motor ..... 29.95

Electric Drills, Spray Guns, Tools, Etc.  
 Send Check or M.O.—C.O.D. 25% Deposit

INDIANA APPLIANCE CO. 20 E. SYCAMORE EVANSVILLE, IND.

## BRAND NEW SURPLUS BARGAINS



### Pistol Grip Drills

1/4" 110 V. AC-DC Heavy Duty  
 Clark 2000 RPM 1/4" Chuck  
 Thor 2500 RPM 1/2" Chuck  
 Thor 3750 RPM 1/2" Chuck

Specify type desired..... \$17.95

### PISTOL GRIP AIR DRILL

1/4" w/ Jacobs Chuck, 10 ft. hose. \$12.50  
 Used, perfect condition. Each.....

### CLEVELAND AIR RIVETER

Type E-3. 7 inches long. Used. \$7.50  
 Guaranteed .....



### New Precision Bilt MICROMETERS

Chrome finished nationally known makes. Gives a lifetime of accurate detailed service. Individually boxed.

1" Central .....\$3.50 4" Central .....\$6.25  
 1" Tubular .....\$3.75 4" Slocomb .....\$6.95  
 1" Reed .....\$4.00 5" Reed .....\$7.25  
 2" Central .....\$4.95 6" Central .....\$7.75  
 2" Reed .....\$5.25 6" Slocomb .....\$8.50

### REAL FIRE PROTECTION! NEW FIRE EXTINGUISHERS

Approved by Underwriters. 1 gal. capacity fully charged, ready to use. Anyone can operate them. Carbon-tetrachloride is non-conductor—will not freeze; stored pressure type shoots 40 foot stream; height 23", diameter 5". Ideal for home, office, garage, boats, workshop, summer cabins, etc. Lists for approx. \$65.00. Our price..... \$14.95

Prices FOB, Kansas City, Mo. No COD's.  
 Write for our new Catalog

ATLAS EQUIPMENT & SALVAGE CO.

229 S. W. Blvd.

Kansas City, Mo.

## Here's DC POWER for

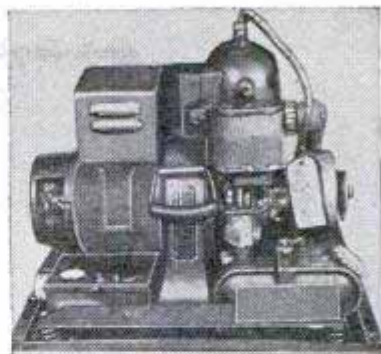

- Auxiliary Lighting
- Amateur Radio
- Battery Charging
- Starting Plane Engines
- Running Farm Implements

### 28-32 v. Gasoline Generator (HRU-28)

It's the famous, war-tested PUTT-PUTT, at this terrifically low price! Single cylinder, 2-cycle gasoline engine with generator rated at 2,000 watts DC, 70 amps. 1001 uses—operates practically everything. More literature on request.

\$74.50

## POLICALARM FM RADIO—

152 mc to 162 mc

\$39.50



Ideal table or desk model radio that covers police, fire dept., radio telephone, interurban telephone and taxi 2-way radio. Fine for monitoring.

## BABY SITTER INTER-COM

\$19.95



Price includes master station, one remote, and 50' of wire. Rig it up as a baby-sitter, with pick-up at baby's crib so you can hear him if he cries; useful in office, or for instant contact with basement, garage, attic, kitchen. Simple to install—just plug in to 110 v. AC or DC socket.

## Combination Broadcasting Receiver & INTERCOM SYSTEM \$29.95

(Includes master station, 1 remote and 50' of wire)  
 6-tube superhet standard broadcast receiver plus home or office intercom system; walnut finish; uses one to four remotes. Any station can call master while radio plays; call can be returned to any remote. 115 v. AC; original list \$84.50 (with 4 remotes). Additional remote stations, \$3.95.

All equipment shipped F.O.B. Save C.O.D. charges by remitting in full with order. Please don't send money for postage; we ship "trans. charges collect."

# R&M RADIO COMPANY

1426 N. QUINCY ST. DEPT. PM128  
 ARLINGTON, VA.



Older folks  
say it's  
common  
sense...



## ALL-VEGETABLE LAXATIVE

NATURE'S REMEDY (NR) TABLETS—A purely vegetable laxative to relieve constipation without the usual griping, sickening, perturbing sensations, and does not cause a rash. Try NR—you will see the difference. Uncoated or candy coated—their action is dependable, thorough, yet gentle as millions of NR's have proved. Get a 25c box and use as directed.

*Nature's Remedy*  
NR TO-NIGHT TOMORROW  
ALRIGHT

FUSSY STOMACH?

RELIEF FOR ACID  
INDIGESTION,  
GAS AND  
HEARTBURN



EAT LIKE CANDY  
**TUMS**<sup>10¢</sup>  
STOMACH DISTRESS  
FOR  
THE TUMMY!

## 3 CLINTON ENGINES

- Reliably Built • Priced Right
- Service Anywhere



No. 500      No. 700      No. 1100  
3/4 to 1.2 H.P. • 1 1/2 to 2 H.P. • 2 1/2 to 3 H.P.

Clinton engineers have designed these 3 quick-starting engines to give sturdy, dependable service in whatever fields their horsepower ranges are needed. Sold world-wide (service anywhere) Clinton Engines are performing daily in many versatile capacities. Uses include installations for tractors, generators, refrigeration-compressors, grain augers, elevators, pumps, small boats, construction and concrete machinery, mowers, scooters, etc. Some desirable wholesale distributor territories are available. Also, some counties still open for authorized service stations.

For full information write Dept. 102PM

4 CYCLE • AIR COOLED

It's Powered BEST When CLINTON Powered  
**CLINTON MACHINE CO.** CLINTON MICHIGAN



Now  
ONLY \$1.98\*

### THIS HANDY AUTO & UTILITY KIT WITH INTERCHANGEABLE DRIVERS

Heat-treated and plated alloy steel drivers are contained in hollow plastic handle. Kit is ideal for repair and maintenance.

Send Money Order, Check or Cash. No C. O. D. orders accepted. Domestic postage prepaid.

*An Ideal Xmas Gift*

KIT	DRIVERS IN KIT	PRICE
*REGULAR	#1 Phillips, #2 Phillips, 5/32" Clutch Head, 1/8" Clutch Head, Tapered Reamer, 1/4" Flat, 3/32" Flat	\$1.98
EXTRA LARGE	#2 Phillips, #3 Phillips, 1/8" Clutch Head, 1/4" Clutch Head, Tapered Reamer, 1/8" Flat, 3/16" Flat	\$2.48
BOTH TOGETHER \$4.28		

**STANDARD PRESSED STEEL CO.**

POST OFFICE BOX No. 184, WYNCOTE, PA.

## WHAT TO MAKE SERIES

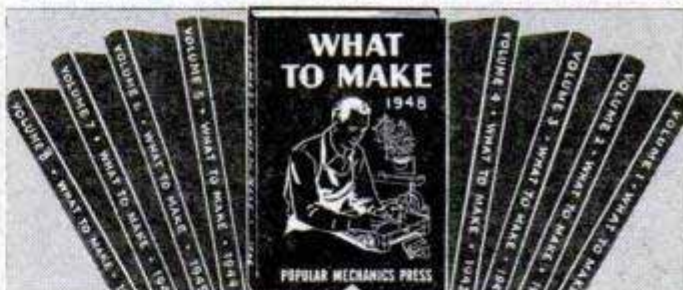

Send for your copy of the new 1948 clothbound edition now! Keep your set up to date. This is the 9th in this famous series of Home Workshop and Hobby Guides. If you do not have the earlier volumes you are missing a wonderful source of inspiration for making fascinating things at home. Every book is different... contains material not in the other volumes.

POPULAR  
MECHANICS  
1948  
EDITION

Partial contents: Birdhouses, sideboards, benches, furniture, book ends, chairs, toys, games, photo equipment, Dutch windmill, leathercraft, bookbinding, ship and yacht models, rearing chairs, fruit baskets, bobbed hamper, garden furniture, log cabins, porch furniture, tables, hostess trays, footstools, desks, lamps, fireplace screens, bookcases, wall cabinets.

### PACKED WITH FUN AND PROFIT FOR EVERY HOME CRAFTSMAN

Nine big books.....1900 pages, 4000 pictures  
\$1.75 a volume.....\$14.00 for set of nine

POPULAR MECHANICS PRESS, 200 E. Ontario St., Chicago 11, Ill.

Please send What to Make books as checked below, I will pay postman price and few cents postage. It is understood my money will be refunded if I'm not satisfied.

What to Make Vol. 9.....\$1.75  
What to Make Library (9 vols.).....\$14.00  
Postage paid if remittance accompanies order.  
Outside U.S.A. 15% additional.

Name.....  
Street and No.....  
City..... Zone..... State.....



# Wellworth" Sensational Offer! WESTINGHOUSE AIR COMPRESSOR

plus Pressure Tank, Safety Valve } 5 Items \$29.75

Air Regulator, and Gauge } ALL for

IDEAL for  
**HOME — FARM — FACTORY**  
Wherever Compressed Air is Needed

A fortunate purchase from the Government enables us to offer you this amazing buy at a small fraction of its original cost. All brand new. You get the compressor, pressure tank, air regulator and gauge, safety valve all for \$29.75. Shipping weight 58 lbs.

Designed for automotive truck or tractor mounting. Can be run off fan belt or power takeoff, or mounted horizontally. Comes with automatic clutch. Can be installed for use on: farm trucks, jeeps, tractors, tire or garage service trucks, contractor or road building machinery, pneumatic devices, etc.

Can be operated with 1/2 H.P. or more electric motor or equivalent portable gas engine.

Piston Type, 2-cylinder, 2 inch bore, 1 1/2" Stroke, Ball Bearing. **AUTOMATIC CLUTCH. OIL FREE AIR. 3.27 C.F.M. at 600 R.P.M. 6.54 at 1200.**

Suggested operating pressure, 75 P.S.I. **DIMENSIONS: 9" wide, 11 7/8" high, 6 5/8" deep. Wt. 23 lbs.**

8 inches x 42 inches with 4 openings suitable for 100 lbs. Pressure. Safety valve, Air regulator, Gauge, Regulates Pressure 0 to 75 lbs.

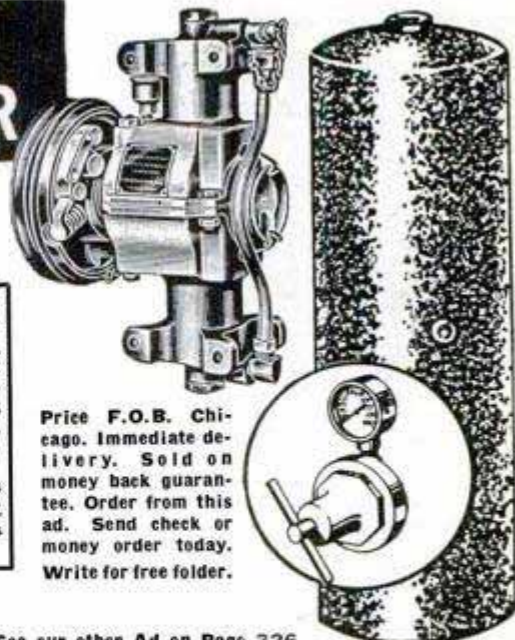

Price F.O.B. Chicago. Immediate delivery. Sold on money back guarantee. Order from this ad. Send check or money order today. Write for free folder.

**WELLWORTH TRADING CO.**

MERGED WITH C & M EQUIPMENT CO.

1831 S. STATE ST., DEPT. D-12, CHICAGO 16, ILL.

See our other Ad on Page 326

**TOOLS** at Mechanics' "NET" Prices



Send 10c for literature and price lists on "Nationally known" mechanics hand and specialty tools mfd. by Plomb, Utica, Channel-Lock, Herbrand, Vichok, Zim, S-K, Vim, etc.

**GIZMO TOOL CO. SAN FRANCISCO, CALIF.**

BOX 656

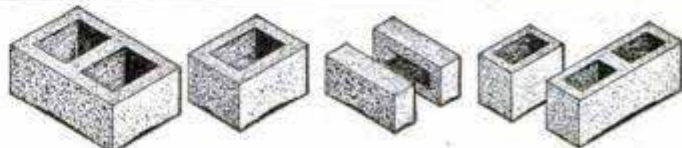

## Make Concrete Blocks and Bricks

New superior method makes square, true, easy-to-lay units which will pass any building code. Small investment, high production, big profits. One \$30.00 machine will make four 5"x8"x12" blocks per minute—1000 per day. Pays for itself in a few days. Sell blocks or save 2/3 building cost by making and laying your own.

POST CARD BRINGS FREE FOLDER

**Economy Manufacturing Company**  
Dept. P Stone Mountain, Georgia

## 40 POWER TELESCOPE



Coated Lenses  
**\$42.50** post-paid  
40X—WONDERFUL for Astronomy  
30X—SUPERB for Long Distances  
20X—EXCELLENT Spotting Scope  
10X—FINE for Close Study

FOUR TELESCOPES in One because of Adjustable Power Eyepiece. Precision American made Telescope. Magnesium-fluoride Hard Coated Lenses. Achromatic Objective lens 2 1/8" diameter. Length closed 9 1/2", open 27 1/2". Genuine Leather covering. Weight 28 ozs.

### ACHROMATIC TELESCOPE OBJECTIVES

Perfect Magnesium Fluoride Coated and cemented government surplus achromats. Made of finest Crown and Flint optical glass; are fully corrected and have tremendous resolving power. Guaranteed well suited for Astronomical Telescopes, Spotting Scopes, etc.

48m/m (1-7/8")	Dia. 600m/m (23 1/2")	F.L. ea. \$10.75
73m/m (2-7/8")	Dia. 876m/m (34 1/2")	F.L. ea. 25.00
76m/m (3")	Dia. 381m/m (15")	F.L. ea. 19.00
81m/m (3-3/16")	Dia. 622m/m (24 1/2")	F.L. ea. 22.50

### 6-POWER MONOCULAR



Army used, but optically perfect, light weight, approximately one lb., 30 mm objective, focusing eyepiece. Small, compact, easily carried in pocket. Ideal for Bird Study, Sports, etc. Postpaid \$15.00.

### 3X ELBOW TELESCOPE



Ideal for Bird Study, etc. Brand new, has 1" Achromatic Objective, Amici Prism Erecting System, 1 3/8" Achromatic Eye and Field Lens. Small, compact, light weight. 2 lbs. Govt. Cost \$200. **\$6.50**  
Our Price .....

"MILLIONS" of Lenses, etc. Send stamp for "Bargain" List.

**A. JAEGER'S**

93-08P 95th AVE.  
OZONE PARK 16, N. Y.



# This Christmas

MAKE YOUR "STARS" SHINE

with a



**SCREEN**

The perfect gift for every family who projects pictures. Da-Lite's finer picture surface, made by the originators of the Crystal-Beaded screen, makes movies and slides "come to life" with sparkling brilliance. Backed by 39 years experience in screen making. Write for FREE sample of fabric and 16 page book on Da-Lite screens.

### DA-LITE CHALLENGER

Most popular portable model for homes, schools, churches, industry. Quickest set-up. Handsome blue octagon case. Lightest weight.

"World's Largest Selling Screens Since 1909"

**DA-LITE SCREEN COMPANY, INC.**  
2721 North Pulaski Road, Chicago 39, Illinois



# NEW FOREDOM Model #99 at an Amazing LOW PRICE

**FLEXIBLE SHAFT  
MACHINE  
with PENCIL-SIZE  
HANDPIECE**

**\$15.95  
COMPLETE  
WITH  
MOTOR**



35"  
FLEXIBLE  
SHAFT

USES  
HUNDREDS OF  
ACCESSORIES

PENCIL-SIZE  
HANDPIECE

**Grinds, Polishes, Cleans,  
Sharpens, Mills, Carves,  
Engraves, Etches on Metal  
Wood, Glass and Plastic**

**5 REASONS WHY  
FOREDOMS ARE TOPS:**  
1. Extra power and longer motor life because motor not dwarfed to fit hand. 2. Correct handpiece size for deft, sensitive, fingertip control. 3. No obstructed view of your work. 4. Freedom from gyroscopic action—hence better work. 5. Small handpiece size lets you get into hard-to-reach places.

**Hundreds of Uses**

Foredoms handle hundreds of tasks. Use them for pleasure or profit, for tinkering or expert craftsmanship. Their versatility is unlimited. Use them to grind, polish, mill, engrave, sharpen, slot, rout, saw, carve, clean, sand, etch, cut, etc. Ideal for internal carving of plastics, the astounding new craft. You can work on wood, glass, plastic and all metals with a Foredom. No. 25 Accessory Set (A truly versatile assortment) only \$5.50 extra.

Over 70,000 Foredoms now in use



← YOUR MOTOR

**Foredom PRESTO-FLEX  
with  
PENCIL-SIZE Handpiece \$5.95**

Now turn your old motor, drill press, or electric drill into a Flexible Shaft Tool. Simply attach to your electric drill, drill press or motor. Presto—a flexible shaft machine! Off again in a jiffy! Pencil size handpiece gives you finger-tip control. Gets into tight places you can't reach with any other tool. Handy 35" overall length. And—only \$5.95 complete! Not to be confused with inferior imitations. Precision made, backed by 1/4 century experience in this field. All parts replaceable. Order NOW. If ordered for use on motor, specify motor shaft diameter and add 50¢ for coupling. (Available for 1/4", 5/16", 3/8", and 1/2" shafts.) No. 50 Accessory Set Available \$1.50 extra. Order TODAY.

**SEND NO MONEY**

**FOREDOM ELECTRIC CO., Dept. B1112** Mail Coupon  
27 Park Place, New York 7, N. Y. Now!

Please send me FOREDOMS checked below on 10 day trial.

- Presto-Flex Tool (\$5.95)
- Motor Coupling (50¢)
- Flexible Shaft Machine (\$15.95)
- No. 50 Accessory Set (\$1.50)
- No. 25 Accessory Set (\$5.50)
- Catalog on request

Send C.O.D. plus postage. I will pay postman.  
 I enclose payment. Send postpaid.  
(Money back either way if not delighted)

Name \_\_\_\_\_  
Address \_\_\_\_\_  
City \_\_\_\_\_ Zone \_\_\_\_\_ State \_\_\_\_\_

Say You Saw It in  
**POPULAR MECHANICS**

**WINDMILL--RAINBOW--FLASHER  
SPINNING AUTO LIGHT**  
Spins with the wind. The most beautiful light in the world. Red, White and Blue. Everybody wants one. Easily put on auto, Airplane or Boat. Pay Mailman \$2 plus postage or send \$2 and we pay postage. Be First.  
**Agents Wanted.  
SPIN LIGHT CO.  
373F BELMONT AVE. PATERSON, N. J.**

# UTILITY GRINDERS



Lifetime lubricated ball bearings. Two 6 x 3/4 inch wheels, one coarse, one fine. 115 V., single phase, 60 cycle—3450 rpm. Bright red glossy finish.

1/4 hp—\$25.00 net  
1/3 hp—\$27.50 net

Lad Products Are Guaranteed for One Year

# HOME WORKSHOP MOTORS

Capacitor type, sealed ball bearings, 1725 rpm, standardized mounting, with cord, plug, switch and double shaft extension.

1/4 hp—\$22.50 net  
1/3 hp—\$25.00 net  
1/2 hp—\$33.00 net

SEND CHECK OR MONEY ORDER. WE PAY FREIGHT EXCEPT FOR SLIGHT CHARGE WEST OF MISSISSIPPI RIVER.

WRITE TO **LAD, INC.** DEALERS' IN-  
DEPT. PM-12 QUIRIES INVITED  
161 W. Wisconsin Ave. Milwaukee 3, Wis.

# A HANDY-DANDY for every-day use

# GAGETEER TOOL KIT

So ideal for fishermen, hunters, householders, mechanics, professional men, etc. . . .

A "Quickee," compact, handy Tool Kit, always ready, to serve in so many everyday needs . . . It's 5 inches long and rust-proofed. Made of hardened steel . . .

**MAKES AN ORIGINAL  
XMAS GIFT . . .**

Sent postpaid upon receipt of  
**\$1.00**

No COD'S or postage stamps. . . . Money cheerfully refunded if not satisfied.

**THE McINTYRE CO.**  
Dept. P-1168  
209 S. La Salle St., CHICAGO 4, ILL.

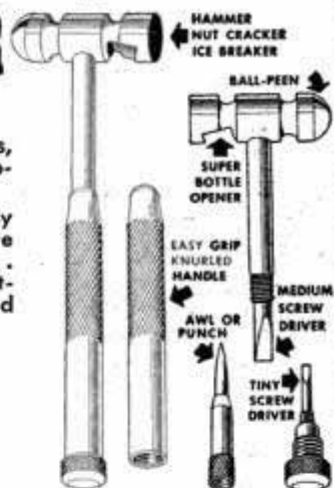

**GIVE YOUR FORD OR MERCURY THAT CUSTOM LOOK**  
Install a pair of our Polished Aluminum Head Covers. Fits all 24 stud motors from 1938-1948—10 minute installation—  
Only **\$3.95** pair  
**TARZIAN AUTOMOTIVE**  
730 ELLIS STREET SAN FRANCISCO, CALIF.

**BUILD OR BUY A Rotary SNOW-PLOW**  
**No More Strenuous Snow Shoveling!** PLAN 35¢  
Clean off your snow the easy LeJay Way. It is easy to build your own Snow Plow. Operates from small gas engine or electric motor. Cleans an 18 inch path. Swirls the snow to either side. Plan is thorough and easy to follow. Enjoy making one of these Snow Plows from new or used parts. Mail 35¢ today for complete plans and catalog.  
**LEJAY MFG.**  
247 LeJay Bldg. Minneapolis 8, Minn.



Carries the Same 90 DAY GUARANTEE As a New Motor Assy.

## Our Finest Precision REBUILT MOTOR BLOCK ASSEMBLIES

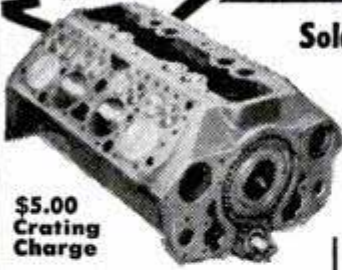

\$5.00 Crating Charge

### Sold Outright or Exchange

Rebuilt by skilled mechanics. Assembly has Reborn Block with New Pistons, Pins, Rings, Reground Crankshaft, all New Bearings. Guaranteed 90 Days. Allowance on Old Motor We ship at outright price. Send your motor prepaid, must be suitable for rebuilding. Send in notarized bill of sale showing title number if any. We refund difference when we receive your motor.

<b>BUICK</b>	Outright	Exch.
34-47 8 cyl.	\$219.00	\$175.00
<b>CHEVROLET</b>	Outr.	Exch.
29-47 6 cyl.	135.00	105.00
<b>CHRYSLER</b>	Outright	Exch.
34-47 6 cyl.	174.50	142.00
35-47 8 cyl.	219.00	175.00
<b>DE SOTO</b>	Outright	Exch.
34-47 6 cyl.	174.50	142.00
<b>DODGE</b> —3 1/4" bore	Exch.	
33-47 6 cyl.	165.00	130.00
3 3/8" bore	Outright	Exch.
34-47 6 cyl.	174.50	142.00
<b>FORD</b>	Outright	Exch.
28-31 4 cyl.	129.00	97.00
32-34 V8	149.00	119.00
35-47 V8	169.00	119.00
37-39 60 HP.	169.00	119.00

<b>HUDSON-TERRA</b>	Outright	Exch.
35-36 6 cyl.	\$191.00	\$147.00
37-42 6 cyl.	209.50	159.50
<b>LINCOLN-ZEPHYR</b>	Outr.	Exch.
36-37 also fits 38-39	252.00	202.00
39-40	394.00	244.00
<b>MERCURY</b>	Outright	Exch.
39-47 V8	169.00	119.00
<b>Oldsmobile</b>	Outright	Exch.
37-47 6 cyl.	187.50	147.50
35-47 8 cyl.	219.00	175.00
<b>PLYMOUTH</b>	Outr.	Exch.
1932 4 cyl.	149.00	124.00
33-47 6 cyl.	160.00	130.00
<b>PONTIAC</b>	Outright	Exch.
37-47 6 cyl.	187.50	147.50
35-47 8 cyl.	219.00	175.00
<b>Studebaker</b>	Outright	Exch.
35-47 Comm.	191.50	147.50
39-46 Cham.	169.50	136.50
35-47 8 cyl.	219.00	175.00

### 60 HP. JEEP Engines



\$5.00 Crating Charge

Reconditioned, Tested and Guaranteed in perfect running order and ready to run. Every part is checked to be perfect and carries a 90 Day Guarantee same as a new engine.

**COMPLETE** with . . . Generator, Starter, Distributor, Coil, Fan and Fan Belt, Water Pump, Fuel Pump, Intake and Exhaust Manifolds, Carburetor, Oil Filter, Spark Plugs, Flywheel, Clutch and Pressure Plate, Wiring.

Outright, PG58R-003, Ea. **\$179.50**

SEND 25% CASH WITH ORDER, BALANCE C.O.D.

### JEEP FRONT FLOOR MATS

Rubber with Felt Back. For all Jeeps. Ea. **\$3.95**

**J.C. WHITNEY & Co.**  
1917 Archer Ave. Chicago 16, Ill.

1935-48 FORD V8 & 1939-48 MERCURY

### DUAL MUFFLERS

Increases power. Reduces back pressure. Saves gas. MD20N-208—Complete Set **\$17.95**

## NEW CONVERTIBLE TOPS

Choice of Black or Tan. All Tops Tailor Made for Easy Installation. Instructions for Simple Installation with Each Top

As Low as **\$24.95**



### "ZIPPER TYPE" REAR CURTAIN

Each top packed complete and consists of main top proper, rear curtain and all needed binding and fittings. (Glass is not supplied—use glass from top being replaced). Best quality, laboratory tested—equal to or better than the original. All metal parts are of heavy bright chrome plated rust resistant. Tops are heavily stitched with treated thread and sewed for durability and appearance.

Car	Year	Price	Car	Year	Price
BUICK	1936-48	\$41.75	Hudson also		
CADILLAC	1936-48	41.75	Terra. to '38	1936-40	\$39.95
CHEVROLET	1936-48	39.50	HUDSON	1941-47	46.95
CHRYSLER	1935-38	33.00	LASALLE	1936-40	41.75
CHRYSLER	1940-48	39.50	MERCURY	1939-42	37.95
DE SOTO	1938-38	33.00	MERCURY	1946-49	39.95
DE SOTO	1940-48	39.50	NASH & LAFAYETTE	1937-41	39.95
DODGE	1935-38	33.00	OLDSMOBILE	1936-48	41.75
DODGE	1940-48	39.50	PACKARD	1936-48	45.95
FORD			PLYMOUTH	1935-39	33.00
1928-31 Roadster & Cpe.	24.95		PLYMOUTH	1940-48	39.50
1933-39-Rdstr. & 2 pas. Cpe.	33.00		PONTIAC	1936-48	41.75
1928-39-Phaet. & Sedan	42.95		STUDEBAKER 1948		44.15
1936-42-5 Pas. Cib. Cpe.	37.95				
1946-48-6 Pas. Cib. Cpe.	39.95				

NOTE: Specify color wanted also Model or Series. Body Style, Year & Make when ordering.

### FENDER SKIRTS for Modern Beauty

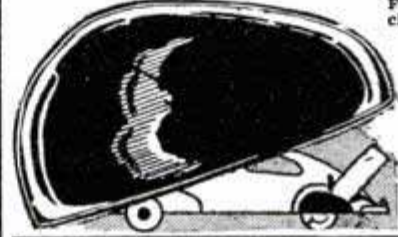

For most makes of cars including '49 Ford & Mercury. Made of all metal, prime finish, with Rubber beading to prevent rattle. Easy to Install.

MC31N-9  
Per Pair **\$12.95**  
Be sure to specify year, make & model of car.

### GUTTED MUFFLERS FOR ALL CARS



Gives that Motorboat Tone  
MD20N-210  
Universal type to fit all cars. **\$4.95** ea.

Say You Saw It in POPULAR MECHANICS

## BUILT TO LAST HANDSOME RUGGED

Your Third Driving Eye! Wide View of Rear Traffic

Send For It TODAY!

**SUPER-VU \$1.95**

### Side View Mirror

Beautiful, durable, theft proof. Four way swivel adjustment; ball joint fully weathersealed; mirror has polished stainless steel back for protection against rust. Clamp will not mar, holds arm rigid. 5" dia.



- A. Non-glare glass sealed against moisture.
- B. Extra large tripod base. Full theft protection.

**ORDER NOW: E. M. DIETRICH**  
13619 Maple Ridge Detroit 5, Mich.  
Postage prepaid with check or money order

Say You Saw It in POPULAR MECHANICS

## Ball-Bearing SPEED WHEELS



### JUVENILE WHEELS

(No bearing, solid tires)

4"	45c	6"	65c
7"		7"	75c

(Semi-pneumatic tire, ball bearing)

6x1	1.65	8x2	2.20
8x1.25	1.85	10x1.25	2.20
8x1.75	1.95	10x1.75	2.30
12x1.75	3.45		

### INDUSTRIAL WHEELS FOR HEAVY LOADS

6x2 Welded	3.45	10x2.75 HC.	5.70
6x2 Bolted	4.35	10x2.75 Pne.	7.60
8x1	5.25	12x2.00	6.90
8x2.00	5.20	12x3.00	10.60
8x2.50	5.40	4.00x8-2	14.70
10x2.00	6.10	4.00x8-4	15.85
16x4.00	15.15		

DEALERS, JOBBERS, AND MANUFACTURERS! OUR NEW PRICES WILL INTEREST YOU.

WRITE US NOW FOR COMPLETE NEW CATALOG  
Send check with order. No C.O.D.

**JIM BROWN TOY COMPANY**  
1097 Home Ave. Akron 10, Ohio



**FOR X-MAS DELIVERY—ORDER AIRMAIL!**



**ELECTRIC HOME-UTILITY TOOLS**

PRODUCTS OF BLACK & DECKER

**NEW ELECTRIC DRILL KIT \$39.95 in U. S. A. (HU-1004)**

Here's what you get with this big kit: 1—Home-Utility 1/4" Electric Drill (HU 1) A.C.-D.C., 110 Volt, Jacobs hex key-type chuck. Weighs only 3 1/4 lbs. Fine for wood, plastics and steel. 1—1/4" Horizontal Stand, 13—High-Speed Drill Bits, 1/16" to 1/4" inclusive, 1—4" Wire Wheel Brush, 1—3" General Purpose Grinding Wheel, 1—3" Cotton Buffing Wheel, 1—Tube of Polishing and Buffing Compound, 1—Wheel Arbor (1/2" Diam., 1/4" Shank), 1—Steel Kit Box with supports to hold all of the above items in place.

**HU-1—1/4" AC-DC DRILL, \$18.95 in U. S. A.**  
**HU-2302, HORIZONTAL STAND ONLY, \$3.35 in U. S. A.**  
**HU-20—1/2" AC-DC DRILL, \$35.95 in U. S. A.**  
**HU-2301—1/2" STAND ONLY, \$17.45 in U. S. A.**



**HU-1—1/4" AC-DC DRILL, \$18.95 in U. S. A.**

**HU-2302, HORIZONTAL STAND ONLY, \$3.35 in U. S. A.**

**HU-20—1/2" AC-DC DRILL, \$35.95 in U. S. A.**



This is the most practical "all-purpose" Electric Drill for all kinds of drilling—in all kinds of material—in all sizes from 1/8" to 1/2" in steel. It drives wood-augurs up to 7/8"; Hole Saws up to 2 1/2". 110 Volt. 375 RPM Jacobs Chuck.

**HU-2301—1/2" STAND ONLY, \$17.45 in U. S. A.**



"DUFAST" Sander attachment for HU-1—1/4" "Home-Utility" Drills No. BDHU-1, \$14.95 in USA. SANDS, BUFFS, POLISHES.

**SANDING AND POLISHING SET—Fits any Drill—\$2.95 Set in USA.** 1—5" Rubber sanding pad with lamb's wool bonnet. 3—Sanding discs. POLISHES CARS, FURNITURE, ETC.



**ORDER TODAY—We'll pay postage in USA if you send full amount, or send \$2.00 now and pay postman balance plus postage.**

**SATISFACTION GUARANTEED**

HEALE'S, 5605 East Beverly Blvd. • PM 12-8, Los Angeles 22, California  
 Gentlemen: Enclosed is \$..... for which please send me  
 Complete Electric Drill Kit  1/4" Electric Drill  Horizontal Stand only  1/2" Electric Drill  1/2" Stand only  Sander attachment  Sanding and Polishing Set .

NAME \_\_\_\_\_

STREET \_\_\_\_\_ ZONE \_\_\_\_\_

CITY \_\_\_\_\_ STATE \_\_\_\_\_

**SAY YOU SAW IT IN POPULAR MECHANICS**

**It's EASY!  
ECONOMICAL!**

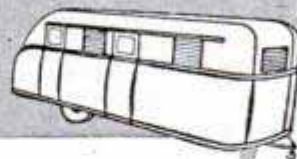

**Build Your Own Trailer with NATIONAL'S Simplified Plans**

Beat the housing shortage with a full-size house on wheels or add new pleasure to your vacations and week-ends with a sleek sport trailer. Step-by-step instructions and complete bill of materials with every plan. *Three different models.*

**NATIONAL MODEL 27: A 27-ft. luxury liner with 3 rooms, lavatory, sleeping space for six. Plans \$1.00**

**NATIONAL MODEL 28: A 20-ft. cabin-trailer that's good-looking and sturdy, with beds for four. Plans \$1.00**

**NATIONAL CAMPER: The sport trailer you've wanted for hunting, fishing, vacations. Sleeps two. Plans .50**

**ORDER ALL THREE—AND GET ONE FREE Complete set \$2.00**

**Big parts catalog FREE with any order!**

**NATIONAL TRAILER STORES**  
 Dept. 51 • Box 2353 Terminal Annex • Los Angeles 54, Calif.

**W. S. W. Auto Curb Signals**



At last—positive protection against curb damage. No more damaged fenders, dented hub caps, scraped tires from curbs. Make parking a pleasure and a dead cinch. Two flexible, coiled chrome springs attached to front and back fenders touch curb when you park and sound buzzer under dash. Fits all makes of cars and is easily and quickly installed. Factory guarantee. Price only \$4.95. Postpaid for cash or sent C.O.D. Not only beautifies your car but adds many times their cost to its value.

**THE PROTECTUROD COMPANY Dept. 152**  
 4033 Windsor Road, Youngstown 7, Ohio

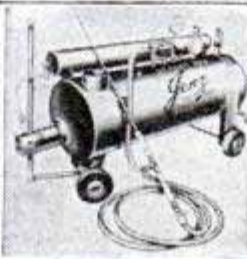

**LOW PRICED STEAM CLEANER**

**Jenz Super Chief**

Portable—No moving parts—Cleans anything—Motors—Chassis—Machinery—Floors—Buildings—Remove wallpaper—Dairy & Creamery—Oil Rigs etc. Oil fired—Economic—fully tested and warranted. 75± Steam in less than 10 min. Model 70, Complete as illustrated. **\$276.50**

F.O.B. factory.  
**HI-PURE LABORATORIES EVANSVILLE, IND.**

**AMATEUR ASTRONOMERS AND SURVEYORS**



The ideal "star-spotter" for the amateur astronomer. Gives altitude and bearing at same time. Easy to operate—no conversion. Divides circle in 6400 parts, making triangulation problems easy to solve. Originally used for aiming artillery. Has precision mounted telescope and comes with leather case. Excellent for simple surveying and map-making. Good condition.

**AIMING CIRCLE, with case, FOB Chicago, each \$12.95**

**THE MART, 11 E. Harrison St., Chicago**

**The "GRAB ALL" TOOL The Most Useful Tool in the World!**



**Precision Work On Objects Too Small to Hold in Hands**



**Recovering That Nut That Always Falls Into the Pan**

Truly the Tool of a 1000 uses. Mechanics, Radio and Appliance Repair Men, Hobbyists, Electricians, Machinists, Handy Men—Yes, even housewives say: "Wouldn't be without it." Precision-made of steel. Picks up any-shaped object from hard-to-reach places. Flexible—to work at any angle, around corners, any direction, even S turns. Grips and holds securely by tempered-spring action. Almost a million in use.

Mfg'd Since 1908



**The "GRAB ALL" is guaranteed against ANY Mechanical Defect—with reasonable care it will last a lifetime.**

**ONLY 75c**

If your dealer can't supply you, SEND 75c DIRECT TO FACTORY—WE WILL SEND POSTPAID. C.O.D. ACCEPTED.

**DEALERS**  
 Here is a BIG PROFIT DEAL—write for complete information.

**IN THE HOME**



**Fishing Object From Sink**



**Getting Things Within Reach In the Oven**

**GRAB ALL TOOL CO., 11703 South Main St., Los Angeles 3, Calif.**



**AN IDEAL AND PRACTICAL GIFT FOR ANY MAN!**

*The New Improved  
All-Purpose*

**DYNAMIC Super Charged ARC WELDER**

Industrial Transformer Type

ONLY  
**\$28.50**  
COMPLETE



**IDEAL FOR AUTO HOME APPLIANCE AND FARM IMPLEMENT REPAIRS**  
WORKS ON IRON, STEEL and other metals. Does work you'd expect from a larger costlier machine. Portable, easily carried. OPERATES from any properly wired 110 Volt Line. Also available for 220 volt current at slight additional cost.

**IT WELDS • IT BRAZES • IT SOLDERS**

EASY TO OPERATE TRANSFORMER TYPE WELDER. If inexperienced you can learn to do professional work by following the SIMPLIFIED WELDING and OPERATING INSTRUCTIONS FURNISHED—comes complete ready to operate with helmet, rods, cable, instructions. SAVE TIME and MONEY—Do your own welding. Just a few repair jobs will pay for this machine. A practical and profitable machine tool for any workshop. Make money doing repair work for others. Write today for full particulars.

**DYNAMIC WELDER CO., Dept. 128-S, 15 E. 23rd St., Chicago 16, Ill.**

**SPECIAL GIFT OFFER! ARC TORCH WORTH \$6.80 YOURS at NO EXTRA COST!**

**TWIN CARBON TORCH** (illustrated) for use with DYNAMIC is unsurpassed for brazing, soldering, pre-heating and cutting iron, steel, brass, bronze and other metals. With it you greatly increase profitable uses of your welder. Does work of oxy-acetylene torch. Comes complete with instructions, carbons and cables. For LIMITED TIME ONLY we are giving a

Twin Carbon Electric Arc Torch worth \$6.80 with every DYNAMIC WELDER. Act now to get this valuable premium at the single low price of welder alone.



**—Mail Coupon FOR FREE FACTS—**

**10-DAY TRIAL OFFER**

DYNAMIC WELDER CO., Dept. 128-S, 15 E. 23rd St., Chicago 16, Ill. Send me FREE details of your ELECTRIC Arc Torch Gift Offer and Dynamic Welder 10-Day TRIAL OFFER.

NAME \_\_\_\_\_  
ADDRESS \_\_\_\_\_  
CITY \_\_\_\_\_ ZONE \_\_\_\_\_ STATE \_\_\_\_\_

**STOPS LEAKS PERMANENTLY**

Cut your fixture replacement, water and fuel bills with Economy Renewable Seats. Make economical, permanent repairs quickly and easily with the Junior Kit (illus.). Repair bathroom, kitchen and laundry fixtures. Everything you need incased in steel box. This is a natural for the "Fixit" shops—get extra income from making permanent repairs on your customers' faucets.

Senior Master Kit also available—repairs faucets and valves up to 1" pipe. At Better Jobbers and Hardware Stores . . . or Write Direct

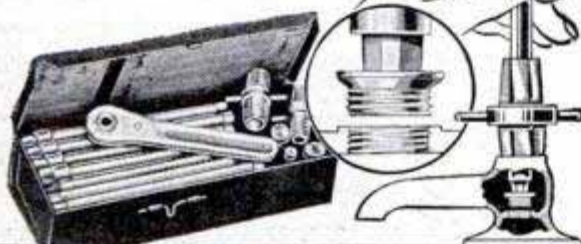

**ECONOMY VALVE SEAT CO.**

3122 N. California Ave. Chicago 18, Ill.

**FASTEST PLANER in the WORLD at this Low Price... \$215.00**

**BELSAW Multi-Duty Planer**

Speed up production! Increase your profits! BELSAW power self-feeds at 24 feet per minute... The lowest-priced surfacer that will handle 12 x 6 in. stock. Planes green or dry sawed lumber into smooth, worked forms. Three high-speed steel knives make 42 cuts per inch. Multi-duty BELSAW takes inexpensive attachments for all planing mill operations—Jointing, Rabbeting, Grooving, Matching. BELSAW is the only 12 in. planer providing attachments for jointing and grinding its own knives. Start planning NOW for BIGGER VALUE and BETTER PERFORMANCE, with BELSAW. Write for FREE specifications, illustrations and low prices.



● LARGER CAPACITY ● FASTER OUTPUT ● KNIFE SHARPENING ATTACHMENT  
**BELSAW MACHINERY CO.**  
B1012 Field Bldg., 315 Westport Rd. Kansas City, Mo.

**MASTER HOBBY ARBOR TOOL KIT AT THE GIVE-AWAY PRICE \$5.95**

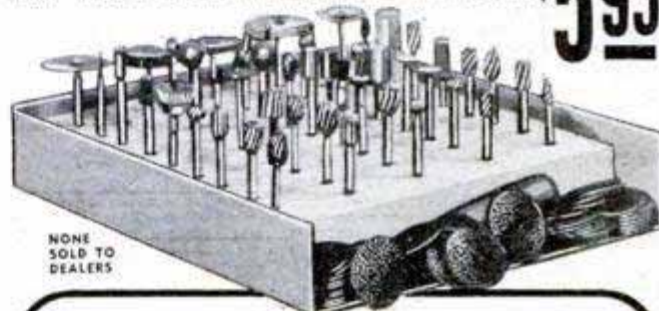

NONE SOLD TO DEALERS

3/32nd 1/8 shanks—the best gift you can give to the hobby worker. We give you saws, drills, routers, carvers, emery disks, polishing compound, reamers, borers, shapers, stone polishers, stone points, grinding points. Over 150 pieces that we want out and priced in other stores for over \$20.00 for half of what we sell for \$5.95. After receiving set, if you don't think it is worth at least \$20.00, send it back. Your money refunded.

Send C. O. D., check, cash or money order.

**GENERAL AIRE CO.**

447 W. NORRIS ST. • Dept. PM • PHILA. 22, PA.

**START—BUILD 23' CRUISER**

Cut-to-Fit for Quick Home Assembly. Everything Complete Plus Illus. Instructions. No Experience Necessary. Simple as A, B, C.

**ALSO 18 FT. RUNABOUTS, OUTBOARDS, INBOARDS, ROWBOATS & DINGHIES.**



SEND 25c (COIN) FOR ALL COLORFUL ILLUSTRATED CATALOGS SHOWING '49 MODELS

**KAYAK BOAT CO.**  
U-MAK-IT MARINE PRODUCTS

703P WHITTIER ST. NEW YORK 59, N. Y.

**M-SCOPE TREASURE-MINERAL LOCATORS**

WRITE FOR FREE, ILLUSTRATED 16-PAGE BOOKLET

M-SCOPE TREASURE-MINERAL LOCATORS. Low priced, unsurpassed efficiency, lightweight models. Factory guaranteed. Immediate shipment. Credit plan available. Write for free 16-page booklet.

GEIGER COUNTERS for finding Uranium ores. Several models. Simple operation. Low priced. Immediate shipment. Interesting free literature.



**URANIUM**

**FISHER RESEARCH LAB., INC., PALO ALTO, CALIF.**

**GOLD**



Thousands of Parts  
For Military

# TRUCKS

We have for immediate delivery genuine parts for all makes and models, 4x2 - 4x4 - 6x4 and 6x6. All models from 1/4 ton to 20 tons. All makes: Autocar, Biederman, Brockway, Chevrolet, Diamond T, Dodge, Federal, Ford, GMC, International, Mack, Oshkosh, Reo, Studebaker, White, Willys and Jeeps. We have parts lists available on some models. Write stating model of Truck.



## TRAILER AXLE

Heavy duty trailer axle suitable for many types of trailer construction. Also excellent for building of heavy farm trailers and wagons. It is a 15,000 lb. capacity square type straight

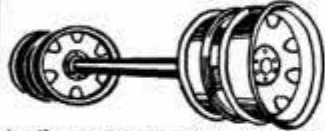

trailer axle complete with Timken roller bearings, hubs, and 6 hole 750 x 20 Budd Wheels. Without brakes. Axle is 2 1/2 inches square and 70 inches between wheel mounting flanges. Std. width. AN EXCELLENT BUY.

With Single Wheels. \$59.50 With Dual Wheels. \$69.50

## NEW POWER WINCHES

Govt. Surplus. All are Brand New and Suitable for front or rear mounting.

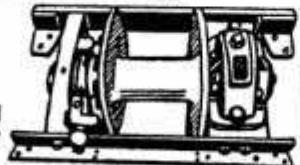

WINCH CABLE—With Chain and hook. 1/2" in diameter. 200 ft. length.

**\$2500**

New WINCH, GARWOOD OR HEIL—15,000 lb. capacity.

**\$15000**

A 25,000 lb. Winch with 3 speed power take-off, shafts, joints and attaching parts for International TD-9 and TD-14. For Front only. Shipping weight 1700 lbs. Only.

**\$25000**

Above Winch adaptable to front or rear of H. D. Trucks. Available cables, power-take-offs, shafts and joints reasonable

New All Purpose

## WINCH

3,000 LBS. RATED CAPACITY  
— IDEAL FOR JEEP

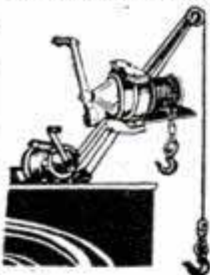

Spur gear type winch complete with crank, 50 ft. 1/4 inch cable and hook and 89 inch boom with pulley. Ideal for lifting or pulling. Winch bracket can be mounted on truck or at material location. Plenty of power. 27 to 1 ratio. Weight of entire unit unpacked 142 lbs., boxed 238 lbs. Special, each....

**\$59.50**

## Austin Pintle Hooks

For all Trucks and Trailers. 25,000 lbs. capacity, shipping wght. 30 lbs. List price \$47.50. Single ea. only \$8.95. Lots of 12, each only

**\$7.50**

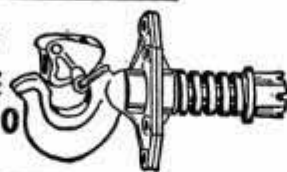

All prices quoted are FOB, Kansas City. 25% deposit required on COD orders.

**American AUTO PARTS CO.**

1830 LOCUST — DEPT. PM  
KANSAS CITY, MISSOURI.



Say You Saw It in  
POPULAR MECHANICS

## HIGH QUALITY SURPLUS LENS KIT



Assemble your own telescope, 6 precision ground lenses

LARGE FIELD  
HIGH ILLUMINATION

HIGH MAGNIFICATION

Has been assembled to give up to 40 power. Lenses range from 1 1/2" to 2 1/4" dia. Complete assembly about 30" over-all length. LENSES ONLY, PER KIT.

**\$22.50**

Instructions furnished — free surplus list. Satisfaction guaranteed or your money back.

DICK ROSE—ERECO, 2912 Hewitt Ave., Everett 21, Wash.

# PROFITS AND SPEED

## THE MODERN LAWN MOWER SHARPENER

PRICE  
**\$241.50**  
LESS  
MOTOR

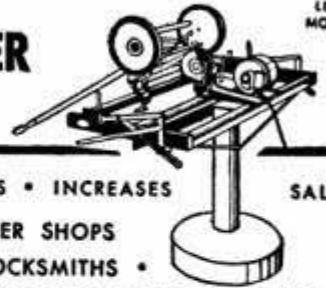

INCREASES PROFITS • INCREASES SALES!

FOR LAWN MOWER SHOPS  
FIXIT SHOPS • LOCKSMITHS •  
HARDWARE STORES • GOLF COURSES • SCHOOLS  
PARKS • PLAYGROUNDS • INSTITUTIONS •  
CEMETERIES • AND ALERT INDIVIDUALS!

Sharpens All Reel Type Mowers • Hand, Power or  
Gang • 10 to 20 Minutes • No Dismantling  
No Extra Attachments Needed

All reel type mowers, from 5-inch edgers to 36-inch power mowers, are quickly sharpened to extreme ends of both left and right twist reel blades. Handle, wheels, roller and motor remain in place when sharpening is in process. Bed knife is sharpened in same brackets that hold mower in grinding position. No extra attachments required. One lever puts mower or bed knife in grinding position. 100% steel construction. Grinding head rides on five ball bearing races. Small, compact, easy to operate. Sharpens wood chisels, joiner knives and planer blades without extra attachments.

ORDER  
NOW  
Immediate  
Delivery

Skate Sharpener Attachment Available

Send For Free Bulletin No. 10B

MODERN MFG. CO. 160 N. FAIR OAKS AVE.  
PASADENA, CALIFORNIA

## Power it with **POWER-PAK**

### AIR COOLED GASOLINE ENGINE



Rugged, powerful, easy-to-start, smooth running, light weight (26 lbs.). 2 cycle. Single Cylinder. 2 H.P. at 4000 RPM. Only 15-5/16" high. Automatic governor.

MANY USES: Garden Tractor, Lawn Mowers, Scooters, Pumps, Mixers, Motor Boats, Spray Equipment, etc.

Immediate delivery. Send only 25% deposit with order. Balance C.O.D. Shipped complete with guarantee.

**\$89.00**

ORDER TODAY

PROPULSION ENGINE CORP., Dept. 204  
7th & White Eagle Rd., Kansas City, Kansas

**CANVAS COVERS** Waterproof tarpaulins, war surplus (Used), perfect condition. Originally made for tents. Approx. 5'x8'. Two buttoned together make approx. 80 sq. ft. Complete with buttons attached. Suitable for use as canvas dams, hay covers, truck covers, machinery and equipment covers, etc. Packed in bales of 30, priced 30 covers, \$1.25 ea.; 15 covers, \$1.50 ea. Less than 15, \$1.75 ea. All FOB, Kansas City.

AMERICAN SUPPLY CO.

329 W. 5th

DEPT. PM

KANSAS CITY, MO.



STOP

## GENERATOR and BATTERY TROUBLE!

KNOW the condition of your Generator  
the condition of your Battery

SEE—how you can manually control and correct each, while driving your car.

LEARN all about the sensational GEN-O-BATT.  
Get the FREE particulars NOW . . . Write Today.

GEN-O-BATT Generator Co., Dept. P-12, 1136 Dodge Av., Evanston, Ill.



# IF IT'S MADE BY LIONEL, YOU CAN GET IT AT MADISON HARDWARE



No. 3462 **\$9.50**

**OPERATING MILK CAR WITH PLATFORM**  
7 miniature cans load through a roof hatch, and at each touch of the remote control button, door opens and milkman pops out to deliver a milk can to the platform. Car is 9" long, handsomely finished in white enamel. Platform of heavy gauge steel.

**Brand New!**  
**LIONEL STEAM-TYPE SWITCHER LOCO & TENDER**  
**\$25.00**



Real railroad-type knuckle couplers at front and rear make this handsome loco the work-horse of your layout! Goes forward or backward by remote control. Tender has thermostatically controlled bell; rear back-up light. Powerful headlight, realistic valve gear, jewelled running lights, stainless steel handrails. For all gauges.

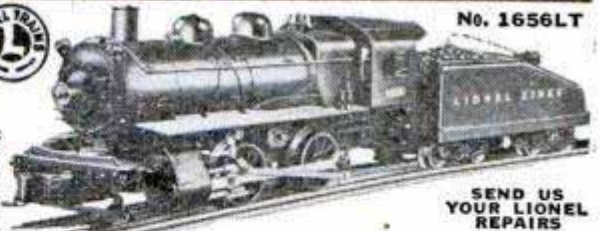

No. 1656LT  
SEND US YOUR LIONEL REPAIRS

Madison has been World Headquarters for Lionel since 1909. We offer a complete line of Lionel Train Sets, Cars and Accessories. Write for big Train folder — it's FREE.

We pay postage on cash orders. C.O.D.'s accepted.

MADISON HARDWARE CO., 103 E. 23rd St., New York 10

Please ship Quantity \_\_\_\_\_ Switcher Loco & Tender @ \$25.00 each  
Milk Car with Platform @ \$9.50 each

Send me FREE Big Train Folder.

Name \_\_\_\_\_  
Address \_\_\_\_\_  
City \_\_\_\_\_ Zone \_\_\_\_\_ State \_\_\_\_\_  
 Cash  M.O.  Check  C.O.D.

MADISON HARDWARE CO., 103 EAST 23rd ST., N. Y. 10, N. Y.

## CHRISTMAS SPECIALS

Address: Photocon Research Products  
Dept. PM-12  
1062 No. Allen Ave.  
Pasadena 7, California  
(Please enclose check, cash or money order)



**G.S.A.P. Gun Camera**  
converted, f3.5 lens, viewfinder, exposure calculator, handle, battery case; uses 50-foot standard 16mm magazine.  
**ONLY \$49.00**  
postpaid



**PHOTOFASH CAPACITOR**  
25.5 mfd at 2,000 V.D.C.; G.E. 25 F454 Pyranol Capacitor, 3 1/4 x 3 3/4 x 6 1/2.  
**ONLY \$10.50**  
postpaid

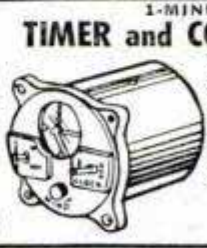

**1-MINUTE TIMER and CONTACTOR**  
BC 608 contactor unit, spring-wound clock assembly with 1-minute phosphorescent sweep-hand and contactor mechanism.  
**ONLY \$3.00**  
postpaid

## NOTHING ELSE LIKE IT...



Get this **REVERSIBLE 2-in-1 Screw Driver**  
(Stock No. DU2)  
Combines a standard size Phillips (No. 1) Cross Point and regular (3/8") bit in ONE driver. Ends the hunt for that missing tool! Break and shock-proof plastic handle... oil tempered chrome vanadium steel blade. Precision-built throughout... no play or wobble. Fully Guaranteed. Finest tool you ever owned! Only 75¢



**5-in-1 Screw Driver Kit**  
(Stock No. ZB50)  
Consists of leatherette tool roll, 1 break and shock-proof plastic handle, and 5 interchangeable oil tempered, chrome vanadium steel blades: 1/8", 3/16", and 1/4" regular; No. 1 and No. 2 Phillips. Fits easily into back pocket. An ideal all-purpose screw drive kit. Fully Guaranteed. Price, only \$2.50

**Gift Packaged Screw Driver Set**  
(Stock No. A6)  
A beautiful assortment of 6 famous Amberyl handled screw drivers in a blue enameled steel box. Very finest quality throughout! A set every man will be proud to own... the ideal gift. Square, round, stub and ignition size blades ranging from 3/8" to 1/2". Fully Guaranteed. Price, only \$4.50



See your Dealer, or send check or money order direct. We Pay Postage.

**VACO PRODUCTS COMPANY**  
317 EAST ONTARIO STREET, CHICAGO 11, ILLINOIS

## MILL IT...ON YOUR LATHE!

# PALMGREN

## MILLING ATTACHMENT

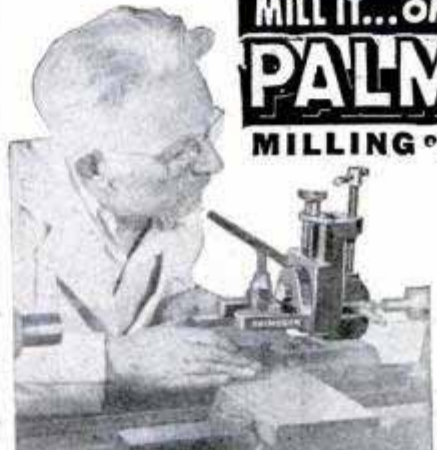

**3 SIZES**  
No. 250 Illustrated

2 1/2" JAW **\$24.75**  
Only

**CONVERT LATHE IN 10 SECONDS**

Now you can Mill, Slot, Grind, Groove, Square Shafts, Saw at Angles, Recess and many other important jobs. SAVE TIME and MONEY! Why send work out or use costly methods when a PALMGREN MILLING ATTACHMENT will solve your problem. Precision built, it has accurate graduations for rotary angle adjustments, also graduated vertical feed screw. Fits South Bend, Atlas, Craftsman, Logan, Sheldon and all other lathes. Thousands now in use in small and large machine shops, repair shops, railroads, schools, home work shops, etc. ORDER SIZE NEEDED TODAY!—it will quickly pay for itself.

IMMEDIATE DELIVERY

Nos.	Width Jaws	Depth Jaws	Jaws Open	Weight Pounds	Fits Tool Post	Price F.O.B. Factory
150	1 1/2"	1"	1 5/8"	6 1/2	1" Dia.	\$18.75
250	2 1/2"	1 7/16"	2 1/2"	11	1 1/4" Dia.	24.75
400	4"	1 1/2"	4"	25	2" Dia.	39.75

Order From Your Dealer or Jobber: Write for Circular No. 351  
Mfrs. of PALMGREN PRODUCTS Since 1915  
**CHICAGO TOOL and ENGINEERING CO.**  
8365 South Chicago Ave. Chicago 17, Ill.

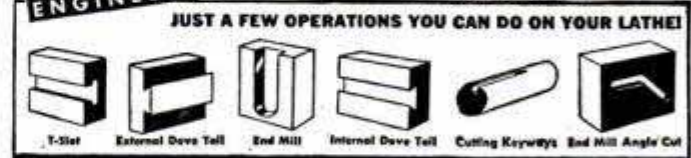

## DUST-O-VAC THE DUST COLLECTOR ENGINEERED FOR HOME WORKSHOPS...

**DUST-O-VAC** sucks up wood and metal dust, wood shavings and chips—blows them into a dust bag (supplied free).  
**DUST-O-VAC** attaches to any circular saw, planer, band saw, grinder, belt or disc sander, shaper, drill press with shaper or sander attachment, spindle shaper, wood lathe or jig saw. COMPLETE MOUNTING INSTRUCTIONS INCLUDED.  
**DUST-O-VAC** has solid cast alum. housing. Cont. duty motor. 110V., A.C., D.C. WRITE FOR FREE LIT.

**UNIVERSAL YONKERS CORP.** 137 Alexander St., M-12 Yonkers 2, New York

**\$19.95**

Free shipping east of Miss. West of Miss., add \$1. Send check, money order.



# 15 ESSENTIAL OPERATIONS ON ANY DRILL PRESS WITH BARRON Workshop TOOLS

You can plane woods and plastics, rabbet, tenon, panel, groove, bead, contour, rout, mortise, surface sand, drum sand, cut moldings, shape, dovetail, grind and drill with Barron's time-tested and proved precision workshop tools. They save time, money, broaden your workshop technique. A full line of drill press spindle adapters and 1/2" Dovetail cutter also available. All tools sold on 10 day money back guarantee.



**ROTARY WOOD PLANER**

3" dia. safety planer fits any drill press. Over 100,000 now in use.  
**\$7.50 Complete**



**2 1/2 x 3" DRUM SANDER**

A "must" for sanding contours and straight edges. Also available in 1" dia. at **\$2.10**  
**\$3.95 With 5 Sleeves**



**ROTARY SURFACE SANDER**

4" dia. aluminum housing and heavy rubber pad. A perfect finishing sander.  
**\$5.95 With 20 Discs**



**AUXILIARY DRILL PRESS TABLE**

Fits any drill press. Has 234 sq. inch working surface for holding work pieces flat and true. Equipped with adjustable steel fence.  
**\$9.85 F.O.B. Detroit**



**ALL-METAL SHAPER FENCE**

Ideal for shaping and molding operations, other uses. All metal, nothing to warp. A real buy at **\$7.95 F.O.B. Detroit**



**ROUTER & ROUND END MORTISING BITS**

New type hi-speed steel spiral flute bits. Available in individual sizes or sets of 6 attractively packaged from 1/8" to 1/2" at **\$9.50**



**WRITE FOR FREE WORKSHOP GUIDE**



**SAFETY SHAPER & MOLDING CUTTER**

New, patented design eliminates set screw. More versatile than any other similar design on market. **\$9.00** with 3 Sets Standard Blades

See Your Dealer . . . Or Write Direct

**BARRON TOOL CO., INC.**  
569 Architects Bldg., Detroit 1, Mich.

## BARRON PRECISION WORKSHOP TOOLS

### BROADCASTS to Your Own Radio NO WIRES or Hookups

COMPLETE MINIATURE TRANSMITTING STATION. Electronic wonder—MICRO-VOX. Beams voice right thru ether . . . to any RADIO WITHIN 75 FEET tuned to MICRO-VOX. Amazing precision instrument. NOT JUST A MICROPHONE. SELF-CONTAINED. Portable Transmitter—Tube & Batteries. CLEAR, LIFE-LIKE fidelity. EASY TO OPERATE. HUNDREDS OF USES with your Radio—Inter-Com! Public Address! "Baby Listening" Nurse! Pleasure! Parties! Meetings! Gags! Sing, play instruments, produce sound effects, shows. Practice public speaking, make records.

**FREE 24-HR. TRIAL!** Send no money. \$6.95 C.O.D., plus charges. Or remit \$7—we pay postage. Test MICRO-VOX 24 hours! If not delighted, money refunded. ORDER NOW.

**\$6.95 Complete**  
MICRO-VOX, Inc., Dept. 59, 130 N. Wells St., Chicago 6, Ill.

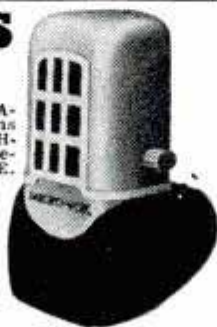

## NEW UNIVERSAL DOG-VISE

is man's best friend!



**JAW UNIT**



**BASE**

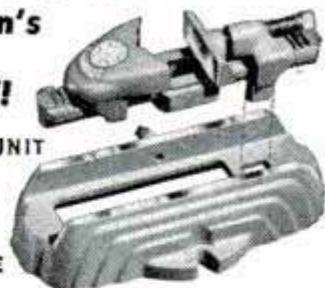

### HANDIEST TOOL YOU'VE EVER SEEN!

1. Jaw unit removable from base, giving adjustable lathe dog with 1/4" to 3" range. 2. Holds any work, any position properly in your vise. 3. Complete unit is useful vise for drill press, milling machine, bench; ideal holder for those who carve, drill, chisel, grind, sand or model—metal, wood, or plastic. \$8.45 post-paid or sent C.O.D. with \$3.00 deposit. Cast iron, precision machined. Send for folder. Pat. Pending.

**DEROY PRODUCTS, INC.**

300 W. GORGAS ST. LOUISVILLE OHIO  
Ohio Residents Add 26c Each Sales Tax

## ARC WELDING FOR PROFIT OR PLEASURE

**60 LBS. OF READY MADE PARTS**

Only \$24.95

### EASY TO ASSEMBLE!

Easy to Operate. Now you can do all-around welding on Steel, Cast Iron and other Metals. Earn BIG PROFITS. Repair AUTO, HOME or FARM EQUIPMENT. This HEAVY-DUTY Welder gives 100% penetration. OPERATES ON 110 OR 220 AC current.

Complete with Instruction Manual. You Can Do Expert Welding in a Few Hours. Sold on 30 Day Money-Back Guarantee

**FREE:** WRITE TODAY FOR FULLY ILLUSTRATED BOOKLET P-12.

**ATOMIC ARC WELDER CO.**  
1037 So. 19th St., OMAHA, NEBR.

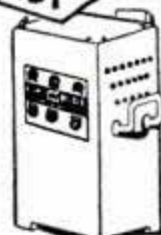

## SHATTERLESS "ALL PURPOSE" STEEL BOTTLE

Use For All Types of Liquids, Gases, Chemicals, etc.



May Be Used For Air Pressure Up to 500 Lbs.

### STAINLESS STEEL TYPE

Formerly used by the AAF for oxygen storage. Shatterless design permits internal pressures up to 500 lbs. They may be used as air pressure tanks for inflating tires, operating horns, air motors, etc. May also be used as a buoy or float or for water supply storage on boats, trailers, trucks, etc. Makes an ideal shipping container for gases, chemicals and other liquids. Made of stainless steel through-out with threaded plug at each end. Approximate size 12x22 inches. Guaranteed brand new! Each only.....

**\$5.95**

You pay transit charges. Mail orders promptly filled. Send check or money order. Satisfaction guaranteed.

### REGULAR STEEL BOTTLES

Made of regular steel—shatterless—500 P.S.I. working pressure. Internal volume approx. 9 quarts. Measures 24x6 inches. Brand new! Order today.

**\$2.95**

**AERO PARTS SUPPLY, Dept. PM 12**  
MUNICIPAL AIRPORT HOUSTON 17, TEXAS



### OWN THIS FINE 8 PC. COMB. BOX AND OPEN END WRENCH SET

in transparent leatherette roll. Made of hi-grade alloy steel and heat treated. 9 sizes 13/64 to 7/16. At your local dealer.

**PRICES** Retail \$3.00 per set Dealer \$24.00 per doz. sets DISTRIBUTORS WANTED

Send \$2.00 only for sample set postpaid.

**STEPHENS TOOL WORKS**  
Box 306, La Tijera 5th., L.A. 43, Calif.



# RADIOMEN'S HEADQUARTERS \* WORLD WIDE MAIL ORDER SERVICE!

## COMPRESSED AIR INSTANTLY, Anywhere!!

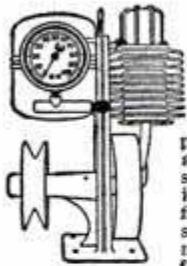

Portable Air Compressor and storage tank. Ruggedly built of best materials using lifetime lubricated ball-bearing on connecting rod and oil impregnated main bearing on shaft. Unusual design forever eliminates valve trouble, the most common fault in air compressors. **PATENTED** unique air intake system increases efficiency tremendously over other compressors so that air output is much greater than that from larger compressors powered by heavier motors. Will deliver approx. 3500 cu. in. air per min. at maintained pressure of 30 lbs., or will inflate a 90 lb. truck tire in less than 1 min. Complete with 100 lb. gauge, fingertip adjustment allows setting of output pressure at any value, which will automatically be maintained. Works from any 1/4 H.P. motor. Useful for spraying paints or lacquers, disinfectants, insecticides, annealing or brazing with natural gas, inflating tires, etc. Price \$14.50 postage prepaid anywhere in U.S. Efficient, adjustable syphon type spray gun complete with 12 ft. of 100 lb. tested hose for only \$7.75 with pint container, also prepaid. 25% required on C.O.D. orders. Send for free catalogs of radio parts and surplus items.

**Terrific Value ONLY**  
**\$20.95**



Equipped with 1/4" Jacobs Geared Chuck and Key  
**PORTABLE ELECTRIC DRILL**  
(Sold at less than established factory price so we cannot mention brand name)

Not an intermittent duty drill, but a full size rugged tool. Most convenient type switch, natural grip handle, and balance like a six shooter. Precision cut gears—turbine type cooling blower—extra long brushes. No stalling under heaviest pressure because of powerful 110 Volt AC or DC motor and multiple ball bearing thrust. Other bearings self-aligning lifetime-lubricated Ollite type. Made for toughest year-in and year-out service in plant or on construction jobs. Amazing perpetual factory guarantee assures you of a lifetime of trouble-free use.

Full refund (you pay transportation) if not pleased with drill after trial.

## HEAT GUN

Streamlined pistol grip heat gun in vivid red housing, that delivers a powerful 20 Cubic Ft. per minute blast of hot air at 160° Fahrenheit. Ordinary blowers have small fan motors, but this has a lifetime-lubricated AC-DC motor of the rugged vacuum cleaner type, that produces a hurricane of either hot or cold air. Perfect for blowing out dirt or dust, drying out ignition systems, warming up carburetors, drying paint, thawing out radiators, etc. Warning:—Keep this away from your wife, or she will be using it to dry her hair because it will do it in half the time of her ordinary hair dryer, to say nothing of her using it to dry stockings or clothing, or defrost the refrigerator instantly. Only \$12.95. Satisfaction guaranteed or money refunded if returned prepaid within 5 days.

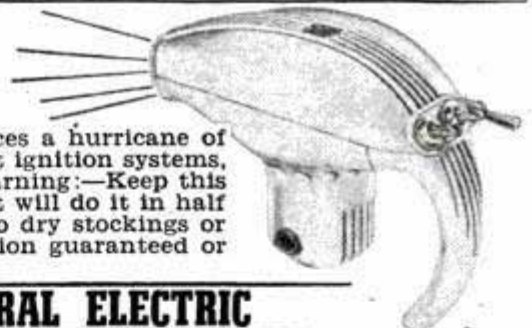

## Sensational Value in AC-DC Pocket Tester

This analyzer, featuring a sensitive repulsion type meter housed in a bakelite case, represents the culmination of 15 years achievement in the instrument field by a large company specializing in electronic test equipment.

Specifications of the AC-DC Model Volt-Ohm-Milliammeter:

AC Volts—0-25,50,125,250  
DC Volts—0-25,50,125,250  
Milliamperes AC—0 to 50  
DC Milliamperes—0 to 50  
Ohms Full Scale—100,000  
Ohms Center Scale—2400  
Capacity—.05 to 15 Mfd.



Total Price, prepaid anywhere in the USA—\$7.00  
Similar DC Meter, lacking the AC operated ranges of above, \$5.50 prepaid.

## GENERAL ELECTRIC 15-TUBE TRANSMITTER AND RECEIVER SET

This brand new 15 tube transmitter-receiver was designed for mobile service on 12 volts, and will operate in the "Citizens' Band," where no amateur license to transmit is necessary. It's a cinch for any experimenter to connect this unit for 110 VAC operation by following the instructions and diagrams supplied, which cover numerous applications, including television. For those intending to use on car or boat, a new dynamotor, exactly as originally supplied, costs only \$15.00. Don't fail to write for FREE descriptive bulletin. Order our RT-1248 for only \$29.95, or two for \$53.90.

**RT-1655 — 11 tube crystal controlled SUPERHETERODYNE RECEIVER** that covers the FM band. The ultra modern circuit uses the latest types of tubes. Beautiful chassis and aluminum cabinet. Tubes and schematic supplied—\$14.95.

World renowned 700 page tenth edition of the **RADIO HANDBOOK** in cloth binding and hard cover at the sensational reduced price, for a limited time only, \$1.49.

## \$5.95 Takes Both BIG BARGAINS

**1. ALUMINUM GEAR BOX 18x8x7** that contains two powerful electric motors and two matched gear trains. 62 gears in all varying in size from 1/2 to 4 inches in diameter. This unit is readily converted to rotate a beam antenna or any other similar use.....\$3.00

**2. SENSATIONAL, FASCINATING, AMAZING SELSYNS.** Brand new selsyns made by G. E. Co. Two or more connected together work perfectly on 110 VAC. Any rotation of the shaft of one selsyn and all others connected to it will rotate exactly as many degrees in the same direction, following unerringly as if the units were connected together by shafting instead of wires. This is true whether you twist the shaft of the master unit a fraction of a revolution or many revolutions. Useful for indicating the direction of weather vanes, rotating directional antennas, or controlling innumerable operations from a distance. Complete with diagram and instructions. Per matched pair.....\$4.95

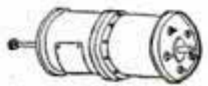

## GENERAL ELECTRIC 150 WATT TRANSMITTER

## GENERAL ELECTRIC 150 WATT TRANSMITTER

Cost the Government \$1800.00 —  
Cost to You — Brand New — \$100.00

The most famous of all surplus transmitters. Was used by air force ground stations and bombers during the war. Will work on all important bands or frequencies. Complete with power supply. Send for free descriptive literature. Quantity limited.

## RADIO SET SCOOP

Product of a famous aircraft radio manufacturer who has abandoned the manufacture of home radios because of the flood of new government orders. All in 5 ply genuine mahogany cabinets, both regular and bleached. 6-tube models have tone control. Original list price given first—then your cost. Sensational discounts.

5-tube Mah. or Blonde.....\$ 34.95 \$ 16.97  
6-tube Mah. or Blonde.....\$ 44.95 \$ 21.97  
6-tube Console with Record Changer:  
Blonde only.....\$215.00 \$105.00

## Our PE-109 Direct Current Power Plant

This power plant consists of a gasoline engine that is coupled to a 2000 watt 32 volt DC generator. This unit is ideal for use in locations that are not serviced by commercial power or to run many of the surplus items that require 24-32v DC for operation. The price of this power plant tested and in good condition is only \$79.95 F. O. B. Buffalo, or we can supply strictly "as is" condition for \$58.95 F. O. B. New York City. These latter are exactly as received, in heavy steel-strapped gov't cases, and we are unable to determine if the individual units are new, used or what the condition is if used, while the \$79.95 are some of the same that we have brought to Buffalo for testing and repair if necessary. We do not recommend gambling on the "as is" condition, except for quantity purchasers. We can also supply a converter that will supply 110V AC from the above unit or from any 32V DC source for \$12.95.

Each of the PE-109 power plants that we sell has been actually run and tested for output by us before shipment.

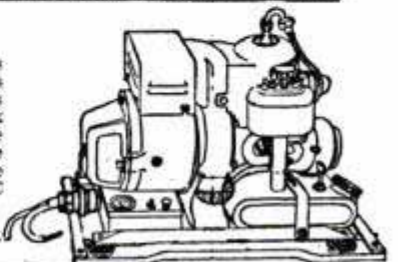

**BUFFALO RADIO SUPPLY, 219-221 Genesee St., Dept. PM, BUFFALO 3, N. Y.**



# "WELLWORTH" Amazing BARGAINS

SAVE \$30.00 ON THIS "WELLWORTH" PORTABLE SPRAY OUTFIT

1/3 H.P.

ELECTRIC MOTOR DRIVEN

Complete With Base



\$79.50 Value

Well balanced Portable Spray Painting Outfit for use where painting job requires a larger quantity of material. Sprays all types of average viscosity paints, enamels, lacquers, varnishes, etc. Piston type, single cylinder air compressor has 2 in. bore by 1 3/4 in. stroke. Displacement 2.86 C.F.M.; maximum working pressure 40 lbs. Mounted on sturdy wood base with rubber feet attached. Pulsation chamber is equipped with safety valve, drain cock. 1/3 H.p. G-E motor, 110-volt AC, with cord and plug; 20 ft. air hose and fittings. Spray Gun is pressure feed type, internal atomizing, with one quart metal cup. Fan and round spray nozzle furnished. Shipping Wt. 50 lbs.

Price only  
**\$49.95**

## PNEUMATIC AIR TOOLS

SAVE \$64.00 AND UP

Ideal fender and bumping hammers, and for riveting brake lining, concrete breaking and many other uses. Like new. At these unheard of low prices it pays to order a good supply.



CHICAGO PNEUMATIC RIVETER & CHIPPING HAMMER

CP4X Pistol grip handle, with air control. Takes up to 3/16" rivet. Weight 6 lbs. List price \$73.00. SPECIAL PRICE..... **\$8.95**

Size CP3 — Takes 5/32" Rivet — \$7.95  
IR-AVC11 — Takes 5/32" Rivet — \$7.95

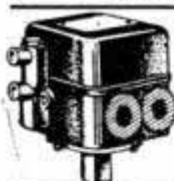

Automatic Pressure Switch with Unloader

Double pole, with 2 way release valve. Set at 125 to 150 lbs. pressure. For use on compressor units 1/2 to 3 H.P. Pressure range 20 to 200 lbs. Weight 4 lbs. only **\$10.25**

WATER PRESSURE SWITCH

Double Pole, double break. Range 5 to 60 lbs. Set 20 to 40 lbs. Wt. 2 lbs. Special at **\$5.50**



"Wellworth" 1/4" REDUCING VALVE & GAUGE

Oil resistant, pressure 0-to-200 lb. Reduced pressure 0 to 75 lb.; 3 outlets 1/4". Wt. 2 lbs. **\$5.75**

"WELLWORTH" CHECK VALVES

Dash pot check valve. Prevents leakage after pressure stops. 1/4" air check valve ..\$2.75  
1/2" air check valve ..\$4.50



WELLWORTH PRESSURE TANK

8" x 42" Welded Steel. 3/4" opening on each end. 1/4" and 3/8" openings at centers. Convex Head and Bottom; 100 lbs. working pressure. Shipping Wt. 35 lbs. SPECIAL **\$875** PRICE only .....

ORDER FROM THIS AD

All items advertised are brand new unless otherwise stated. Sold on money back guarantee. Terms F.O.B. Chicago. Send check or money order. Prompt shipments.

**WELLWORTH TRADING CO.**

MERGED WITH C & M EQUIPMENT CO.

1831 S. State St.

Dept. D-12

Chicago 16, Ill.

See our other ad on page 317

"Wellworth" PISTON TYPE AIR COMPRESSOR

Piston type, size 2 x 1 3/4, head in valves, bronze bearings, splash lubrication, "V" Belt drive, Intake muffler and cleaner. Capacity 2.8 c.f.m. at 100 lbs. continuous pressure or 150 lbs. Intermittent, with 1/2 HP motor. Can be used with 1/4 HP or 1/3 HP at lower speed. Weight 14 lbs. Operating instructions furnished.

only **\$17.95**

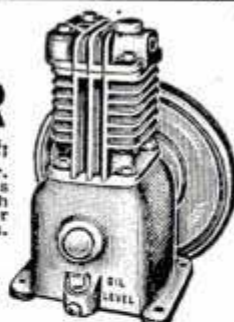

ONAN LIGHT PLANT

1 K.W. 110 volt AC Air cooled engine. Rope start. Shipping wt. 275 lbs. Regular Price \$295.00. SPECIAL PRICE **\$195.00**

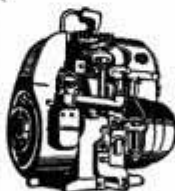

Save \$15.00 on an ESSEX LUBRICATOR

Automatic Sight feed. All brass. Oil Chamber, 3 1/2". Pipe thread 3/8". Regular price, \$20.00. Wt. 4 lbs. SPECIAL — ONLY **\$4.95**

HEAVY DUTY ELECTRIC MOTORS

Ball Bearing 110/220 volts—1 phase—60 cycle—1750 R.P.M.—Continuous duty, 300% full load starting Torque, outlet box, operates clockwise or counter-clockwise, carries one year guarantee against mechanical defects. Also in 3450 R.P.M. at same price.  
1/2 HP Wt. 36 lbs. ....\$33.50  
3/4 HP Wt. 50 lbs. .... 42.00  
1 HP Wt. 80 lbs. .... 54.00  
1 1/2 HP Wt. 80 lbs. .... 56.00  
Note: 1 1/2 h.p. in 3450 r.p.m. only.



G. E. MOTORS

1 h. p.—115 Vt. DC, 1725 RPM Comp. shunt wound, 1 h.p. Wound. B. Bearing, at 1750 RPM. B. Bearing, 40° cont. List price \$132.00. Special **\$67.50**  
2-SPEED 115 V. DC, shunt wound, 1 h.p. at 1750 RPM. B. Bearing, 40° cont. Wt. 225 lbs. List price, \$325.00. Special **\$87.50**

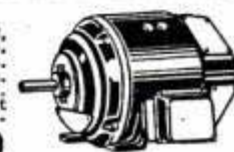

BALANCE TYPE POSTAL SCALE

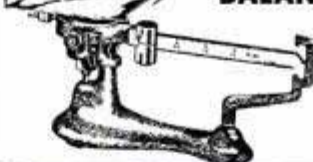

"DETECTO" Nationally known. Weighs every 1/2 ounce, up to 4 lbs. Regular Price \$20.00. Special Price. Wt. 20 lbs. **\$5.95**

4 for \$20.00



Wellworth Air Gauge —2 1/2" 0 to 200 lb. Pressure **\$1.75**

AIR GAUGE — Same as above, 0 to 160 lbs. back connection..... **\$1.75**



POP TYPE VALVES 150 lbs. pressure. Has a close range of closing after pop-off pressure is reached. 1/4" pipe thread. **\$1.50**

AIR REGULATOR & GAUGE

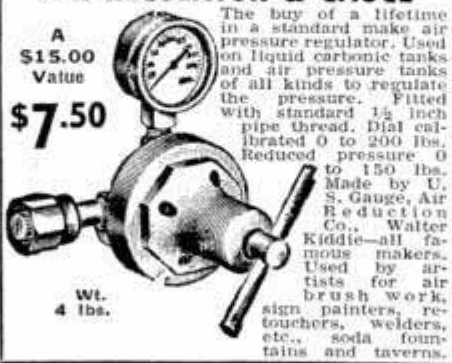

The buy of a lifetime in a standard make air pressure regulator. Used on liquid carbonic tanks and air pressure tanks of all kinds to regulate the pressure. Fitted with standard 1/2 inch pipe thread. Dial calibrated 0 to 200 lbs. Reduced pressure 0 to 150 lbs. Made by U. S. Gauge, Air Reduction Co., Walter Kiddie—all famous makers. Used by artists for air brush work, sign painters, restorers, welders, etc., soda fountains and taverns. A \$15.00 Value **\$7.50**  
Wt. 4 lbs.

6 FT. STOW FLEXIBLE SHAFT

Heavy Duty, 3/8" Core. Best piano wire. Ball bearing handle and arbor, rubber covered housing; for 1/2" motor shaft; for 1/4" bore wheels. Operates on 1/4 H.P. Motor at 1725 or 3450 R.P.M. \$29.00 Value, only **\$16.50**. Wt. 8 lbs.



Only \$16.50



MOTOR BARGAIN

1/30 HP 24 volt DC motor 2450 R.P.M. .95 amps **\$2.45**  
3/4" shaft size overall 3" x4", Weight 3 lbs.

USE AS 6 VOLT GENERATOR—Generate your own power. Can be operated on your bicycle wheel. Furnishes sufficient power for two 6 volt bulbs. Resistor furnished free with each motor enables you to maintain constant voltage. Special Price \$2.45, or 4 for \$7.50. Lots of 24 for \$36.00



# SAVE UP TO 85% IN WAR SURPLUS-SENSATIONAL VALUES

at "GADGETEER'S HEAVEN" IN MANY ITEMS WE HAVE THE WORLD'S LARGEST SUPPLY

HERE'S AN AD FULL OF XMAS GIFTS

### NEW HYDRAULIC CYLINDERS, VALVES, PUMPS, FITTINGS, HOSE & TANKS

51 sizes & types. World's Largest Supply

1001 Labor Saving Adaptations for pulling, pushing, lifting operations. Finest precision workmanship and materials. Liquid and air operation, developing terrific power.

20,000 Available WRITE FOR CATALOGUE PRICED TO SELL AT 15% GOV'T. COST.

### PUMPS NEW HYDRAULIC VACUUM AIR

For every purpose at 15% of Value.

#### P.V.-1

May be used as air or fuel pump for pressure or vacuum. Will pump 1 1/2 gals. oil at 300 R. P. M. Builds air pressure 30 lbs. per sq. in. at 1500 R.P.M. Vacuum draws 28 in. Hg. at 1500 R. P. M.

**\$9.49**

### ROMECH FUEL

800 GPH at 30 PSI. can also be used as hydraulic for 4 GPM at 400 PSI. or for Vacuum drawing 15 in. mercury at 1500 RPM.

**\$6.29 ea.**

### NEW PRESSURE TANKS

Stainless steel - Shaver proof. Rustless. 16,000 available in 6 different sizes. 2001 models.

C-1 2 1/2 x 24 inches	Capacity 25 cu. in.	\$4.75
D-2 3 1/2 x 24 in.	300 Cu. in. capacity	\$2.49
F-1 10" x 18" 1000 Cu. in. Capacity	Cu. in. capacity	\$3.95
F-2 8" x 48 in.	1000 Cu. in. capacity	\$3.95
A-4 5" x 8" 164 cu. in. Capacity		\$1.35
A-8 5 1/2" x 15" 380 cu. in. Capacity		\$1.95

Excellent portable tanks for carrying air in car or trailer. Ideal for painting, cooking, spraying, steam, bores, underwater fishing or diving.

MOB-1 Oxygen Regulator with 500 lb. queue will fit all tanks **\$1.39**

### DC GENERATOR NEW 140 AMP

Direct Current Generator. especially suited for adaptation to homemade welding unit.

A fast moving item at **\$17.95**

P-1 GENERATOR 200 AMP **\$22.50 ea.**

K-1 GENERATOR 75 AMPS. **\$14.50 ea.**

### GADGET MIX

Especially prepared for the MOBBIEST. Rivets, Spacers, Bolt, Screws, Nuts, Gear, etc. A gold mine.

#104. 1 LB. **\$1.19**

### BEARING MIX

Roller, Ball & Roller Bearings in excellent assortment. Sizes from 1/2" to 2". One of our "BEST SELLERS".

15 BEARINGS #170. 1 LB. ONLY **\$2.95**

### HINGE MIX

32 pieces of steel and brass hinges. Sizes 1" x 1" to 1 1/2" x 4" in length to 8" strap.

#170H. A \$3.00 Value FOR ONLY **\$1.09**

### ABRASIVE AND GRINDING WHEEL MIX

38 Pieces including honing stone, pencil rolls, wheels, Abrasive sheets, etc. A real sharp value.

#170AG. **99c**

### SPRING MIX

Torsion Compression & Tension Springs, ass'd. sizes.

A treasure house for every mechanic. #208. 1 LB. ONLY **89c**

### COMBO-MIX

Combination of all above, all in one package deal. At special introductory price **\$5.79**

### WINCH HOIST

now equipped with mounting frame, handle, cable, etc. complete. Thousands of Satisfied Users! Hundreds have written, telling us it's the most wonderful tool in the world!

Capacity 2500 lbs. 20-1 ratio. Bronze Worm Gear. Ideal for Garages, Truck Loading, Machine Shops, Boat Builders, etc.

\$100 Value for ONLY **\$18.99**

### TINY MITE WINCH HOIST

1000 lb. Capacity, with 30 to 1 Bronze worm gear, 4"x1 1/4" Cable drum. Ratchet on handle, safety factor to hold load, with pin release lowering loads, tightening lances, etc.

**\$7.49 ea.**

### Continental Gas Engine

Genuine Red Seal 4 Cycle Air Cooled L head standard equipment inc. Mesh type air cleaner, flywheel, magneto, float type carburetor, blower housing, muffler, fuel tank, fuel filter with shut off valve, starter pulley, etc. The ideal power package for light tractors, lighting plants, compressors, boats, lawn mowers, etc. And cost your eyes at this price A \$75.00 VALUE While they Last. Net weight 63 lbs. for only **\$48.49**

### FIRE EXTINGUISHER

Kidde Lux Col Type. Built to Gov't spec. windshield shatterproof Heavy Case. Fully recharged 2 1/2 lb. 28" x 4" Tanker control with hose 478 in. #421A **\$13.25**

3 lb. Col type #421A Value **\$11.75**

10 lb. Charged with brass Col #421A Value **\$25.75**

15 lb. Break Disc type New #421A Value **\$29.75**

11 lb. Wheel Control #421B Value **\$32.95**

15 lb. Squeeze grip. New #421C Value **\$39.95**

All above Col type fully charged and with hose. Indispensable for small or large planes, Trucks, Auto, Home, Factory, Etc.

### New Electric Motors

#500 new 1/2 H.P. 27 Volt D. C. 24 Volt A. C. This motor can be readily adapted to 110 A. C. by the simple method of rearranging armature brush leads. We furnish free diagram of instructions with each order. A Sensational Value @ **\$5.95**

### NEW FLEXIBLE GOOSENECK LAMP

110 V. A. C. 13 ft. wire with socket, switch and plug. In mounting bracket suitable for home or workshop. Wire alone worth our price of **99c each.**

### Vickers Hydric Transmission

VT-1 Self contained, 2 H. P. constant torque of all speeds with variable volume reversible piston pump (controlled by outside lever) supplying piston hydraulic motor. Automatic pressure, dash pot for smooth control. Power output R. P. M. .O to 1/2 input R. P. M. in both directions. Input R. P. M. 1800 continuous 4000 intermittent. Dash pot can be removed for greater R. P. M. Ideal for Lathes, Duplicator Setup on Mills, Conveyors, Small Cars, Drives, Gearing, Etc.

COST GOVERNMENT APP. \$400.00 You'll Chortle when you get it for ONLY **\$19.50**

### GREENLEE - HAND TUBE BENDER

Designed for fast, free action, in bending steel, copper, brass, aluminum tubing. Fits in std. vise up to 180 degree bend, makes smooth, small radius bends, free of kinks, scratches, etc. Available in the following sizes:

1/4" @ \$4.50, 5/16" @ \$4.95, 3/8" @ \$6.95, 1/2" @ \$8.25, 5/8" @ \$9.75, 3/4" @ \$11.25

Comp. Set of 6 Benders **\$43.95**

### PLASTIC PARALLEL STRAIGHT EDGE

with ends and rubber pads for use alligator on work surface. A must for navigators, mechanics, draftsmen, engineers. . . You'll never see 'em at **97c ea.**

### PNEUMATIC AND AIR TOOLS

10,000 in various popular makes, sizes, types. Cleco, Aero, Ingersoll Rand, Chicago, Pneumatic, Buckeye, etc.

### RIVET GUNS

Pistol & Goose-neck Type. 101 Gas Chipping, 102 Gas Chipping, 103 Breaking cement and auto body work.

Chicago Pneumatic, Cleco, Ingersoll Rand Makes. E3, E2, 3X, 2X, OY. \$55 Value **\$8.95**

#186 Squeezer **\$15.95**

### AIR DRILLS OR MOTOR SPECIAL

with 1/4" JCB Chuck

THOR #210R Model 4526 REVERSIBLE AIR DRILL 1000 R.P.M. Xlnt. for Tapping **\$19.95**

### PNEUMATIC ANGLE DRILL

With Terry Adapter ea. **\$12.50**

### CHI. PNU. IMPACT WRENCH

Model 337rs 3/8" sq. dr. hwd. & sevsrs. 6 spd. catfl. **\$19.50**

Send for Catalogue and List of Other Sizes, Types of Pneumatic Tools.

### HIGH PRESSURE OXYGEN BOTTLE

New. Will hold up to 3,000 lbs. PSI. with Co2 used as tire inflator or fire extinguisher, with oxygen for sick room or deep-water diving, etc. Completely equipped with brass valve, 3/8" hose, dial gauge, & canvas bag **\$2.29 ea.**

### TANK

Capacity 21.7 gallons. Aluminum 4 threaded parts. Filler Capacity. Size 7" x 28" x 28". Ideal for Water or Gas Tank on Auto, Boat, Truck, Tractor, Etc. New. #126 **\$5.29**

### PIANO HINGE

Overall Width	Length	Price
1 1/4" (3/4" side)	72" alum.	\$1.00 ea.
2" (1" side)	72" alum.	\$1.13 ea.
1 1/2" (3/4" side)	53" cad. steel	.75 ea.
2 1/2" (1 1/2" side)	33" steel	\$1.00 ea.

### AIRCRAFT CABLE

Alloyed steel, rust resistant. 3/16" dia. 18 ft. long, with turnbuckle ends. 99c

On reels in any length

1/16" 3c ft.	5/32" 5c ft.
3/32" 4c ft.	3/16" 8c ft.
1/8" 4 1/2c ft.	9/32" 8c ft.

### RUBBER GOODS

NEOPRENE SHEET RUBBER

Thick.	Price per sq. yd.
#325 .020"	1.64
#325 .032"	1.72
#325 .125"	1.88

Item #323 is laminated rubber sheet with cloth center. Flexible but very firm for heavy work. Rubberized Hoop, or Bed Shts. **\$2.29**

54"x72" \$10.00 Value Only

### ELECTRIC SOLDERING IRON

#198 110 Volt A. C. Vulcan **\$8.50 Value**

#198 200 Watt **\$3.95**

#198A 100 Watt **\$2.95**

**PALLEY THE LARGEST FIRM OF ITS TYPE SUPPLY CO. IN THE WORLD**

Order from this Ad. All sales final. All Prices F. O. B. Los Angeles. Pay by M. O. or Check. P. O.'s Accepted. from D & B firms. 1/2 deposit with C. O. D's. FREE LARGE ILLUSTRATED CATALOG

DEPT. P. M. 128 - 6321 SAN FERNANDO RD GLENDALE 1, CALIF.

We wish each and everyone of you a Merry Xmas and a Happy, Peaceful New Year.



#### FOUR PRECISION BALL BEARINGS

Two on spindle, two on drive sleeve. Pre-lubricated and sealed precision type, no oiling required.

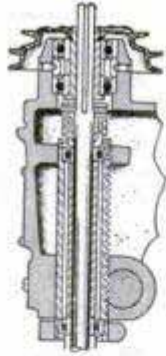

#### ADJUSTABLE QUILL RETURN SPRING

Retracts quill instantly upon release of feed lever. Tension of spring adjustable.



#### DEPTH GAUGE

Controls feed depth, length of return stroke, or locks spindle in any position. 16th graduations.



#### BELT TENSION RELEASE

Flip of lever removes tension from belt for easy speed changes. Proper belt tension maintained.

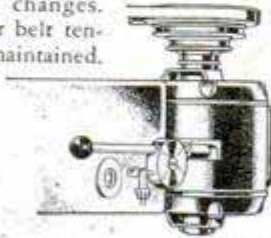

#### BUILT-IN LIGHT

Provides shielded, shadowless illumination on work area. Independent on-off switch is built-in.

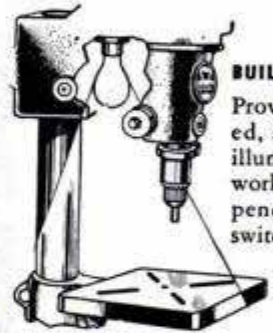

# NEW!

**SOUTH BEND**  
**14" Drill Press**



#### INTERCHANGEABLE SPINDLES

Spindles available to take No. 2 Morse taper shank tools, and for 1/2" straight shank tools, router bits, shaper cutters, etc.



#### TABLE LOCK

Double-plug binder securely locks table to column. Eliminates misalignment. Column bearing is NOT split.

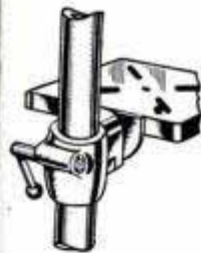

#### FREE-FLOATING SPINDLE

Design prevents misalignment, side thrust and whip. Precision splines in spindle and sleeve.

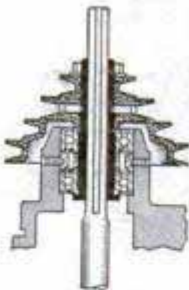

#### QUILL BEARING ADJUSTMENT

Shoe-type take-up provides feather-touch tension and secure locking. Quill bearing is NOT split.



#### CAPACITIES — SPECIFICATIONS

##### CAPACITY

Maximum drill size in iron or steel—1/2". Drills to center of 1 3/4" circle.

##### CHUCK

Capacity—0 to 1/2"

##### SPINDLE

Regular drill chuck type supplied. Travel..... 4"

##### CHUCK TO BASE DISTANCE

Bench Model—17" Floor Model—46 1/2"

##### SPINDLE SPEEDS

Four—655 to 4530 r. p. m.

##### TABLE SIZE

10" x 10". Tilts to any angle.

Bench Model **\$129<sup>30</sup>**

Floor Model **\$144<sup>30</sup>**

Prices, f.o.b. factory, include drill chuck and 1/2" b. p., 115 or 230 v., 1 pb., 60 cycle motor and switch.

#### ONE-PIECE HEAD CASTING

Insures perfect alignment. Double-plug binder locks the head to column. Column bearing is NOT split.



# SOUTH BEND LATHE WORKS

BUILDING BETTER TOOLS SINCE 1906 • 455 EAST MADISON ST., SOUTH BEND 22, INDIANA

Printed by Popular Mechanics Company, Chicago, Ill., U. S. A.



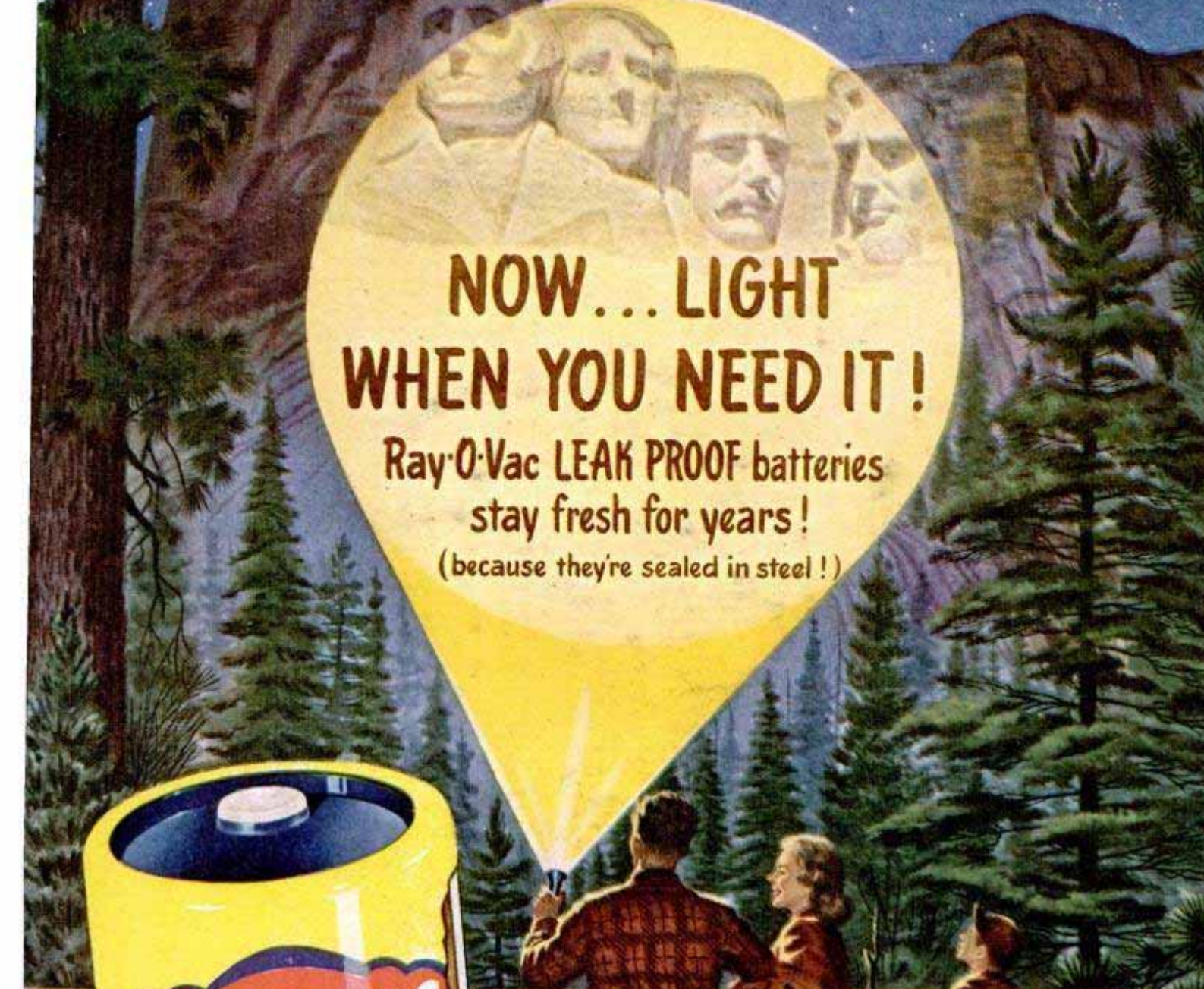

**NOW... LIGHT  
WHEN YOU NEED IT!**

**Ray-O-Vac LEAK PROOF batteries  
stay fresh for years!**

**(because they're sealed in steel!)**

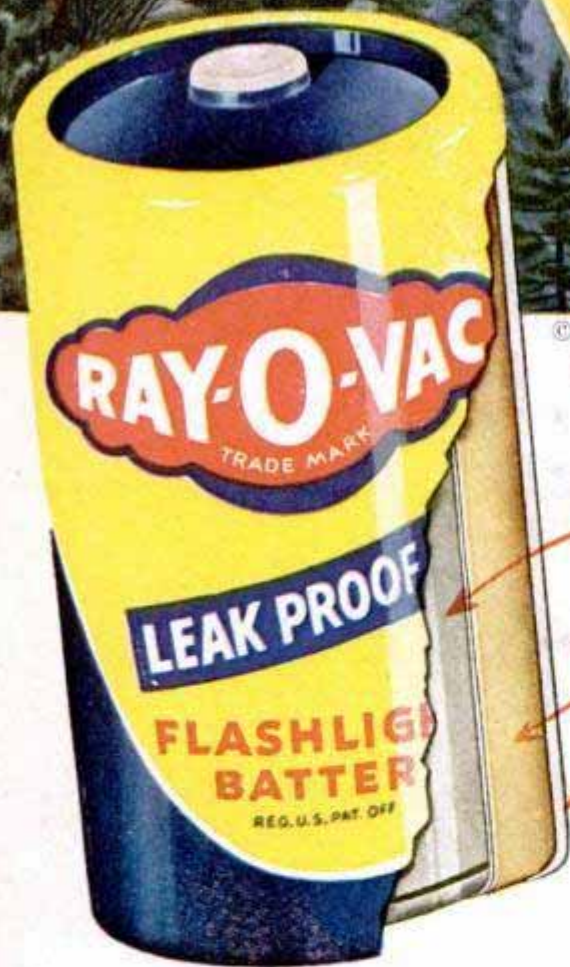

© 1948 BY RAY-O-VAC COMPANY, MADISON, WIS. RAY-O-VAC, CANADA LTD., WINNIPEG, MAN.

### See how much more you get

in these truly modern batteries. Each Ray-O-Vac Leak Proof starts with a powerful, well made battery. Then . . .

1. Steel bottom is added.
2. And a steel top.
3. Next—multiple insulation. Nine layers of protection against corrosion.
4. Last—a steel jacket. This completes an air-tight seal, to stop corrosion and keep the battery fresh and powerful. Only Ray-O-Vac builds batteries with all four of these safeguards.

**GUARANTEE** on every Ray-O-Vac Leak Proof: "If your flashlight is damaged by corrosion, leakage or swelling of this battery, send it to us with the batteries and we will give you **FREE** a new, comparable flashlight with batteries."

*Ask for Ray-O-Vac Leak Proofs*

**Buy Spares... they stay fresh**



# BLUEPRINT OF THE PERFECT GIFT FOR HER!

Beauty \_\_\_\_\_  
 Utility \_\_\_\_\_  
 Individuality \_\_\_\_\_  
 Superior Quality \_\_\_\_\_  
 Pride of Possession \_\_\_\_\_  
 Desirability \_\_\_\_\_  
 Value \_\_\_\_\_

OK  
 OK  
 OK  
 OK  
 OK  
 OK  
 OK



Crest DeLuxe Tuckaway Threesome. Gold filled caps richly chased. Truly distinctive! Pen, \$17.50 — Pencil, \$6.00 — Stratowriter, \$12.50. Complete Set, \$36.00; plus fed. tax.



Sentinel DeLuxe Tuckaway Threesome. Mirror finish—caps strikingly chased. An outstanding gift. Pen, \$15.00 — Pencil, \$5.00 — Stratowriter, \$10.00 — Complete Set, \$30.00; no fed. tax.



Stratowriter Tuckaway—Gold filled. America's most dependable ball-tip writer. Slip-on cap — tucks in purse or pocket! \$15.00 fed. tax included.



Tuckaway Ensemble. Smart distinctive colors — Persian Blue—Burnt Umber Brown—Aristocratic Black. Pen, \$10.00—Pencil, \$4.00—Complete Set \$14.00; no fed. tax.



A GIFT MEANS MUCH MORE WHEN IT'S MADE BY SHEAFFER



"Triumph" Desk Set shown \$17.50. Sheaffer Desk Sets available with pen—pen and pencil—pen, pencil and stratowriter. From \$10.00 to \$108.00.

Every Sheaffer Writing Instrument, handsomely boxed, individually or in sets, makes a magnificent gift. For sale at all good dealers throughout

the United States and Canada.