

NOVEMBER 1944

35 CENTS

ANC



# POPULAR MECHANICS

## MAGAZINE

WRITTEN SO YOU CAN UNDERSTAND IT

REG. TRADE MARK GREAT BRITAIN NO. 40426

REG. U.S. PAT. OFF.



**NORTH POLE WEATHER RUN**  
— Page 97

If safety's a must with you

it's "PRESTONE"  
ANTI-FREEZE



1 FIREMEN, DOCTORS, TOW-CAR DRIVERS—people who drive in emergencies—rely on "Prestone" anti-freeze. They use "Prestone" anti-freeze... then they're *safe* and they *know* it!



2 EMERGENCIES—LIKE RUSHING to the hospital in zero weather—can happen to any driver! It pays to play it safe. One shot of "Prestone" brand anti-freeze keeps your car safe from freeze-ups all winter!



3 WHETHER IT'S DRIVING to work, to the station, to the shopping center, your car is a most important factor in your everyday life. Give it the same protection emergency drivers give theirs—"Prestone," far and away America's Number One brand.

NO RUST • NO FOAM  
NO FREEZE • NO FAILURE

*One shot lasts all winter!*

"Prestone" anti-freeze is America's Number One brand. Year after year, more motorists depend on it than on all other brands of all-winter anti-freezes combined. There is nothing else like it!

**GUARANTEED!** Ask your dealer to show you the guarantee. It's your assurance of all-winter safety.

**\$3.50** PER GAL.

**PRESTONE**  
TRADE-MARK

*Anti-Freeze*



The registered trade-marks "Prestone" and "Eveready" distinguish products of

NATIONAL CARBON COMPANY, INC.

30 East 42nd St., New York 17, N. Y. Unit of Union Carbide and Carbon Corporation

# B.F. Goodrich

## FIRST IN RUBBER

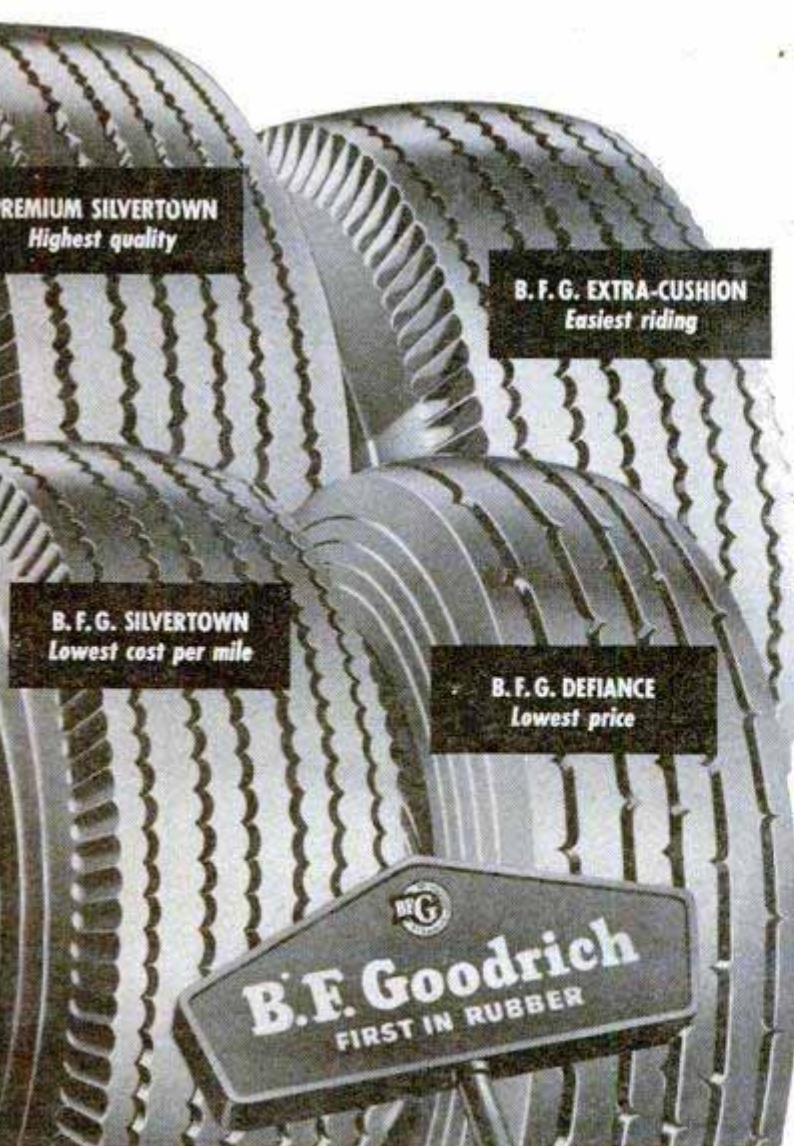

**PREMIUM SILVERTOWN**  
Highest quality

**B. F. G. EXTRA-CUSHION**  
Easiest riding

**B. F. G. SILVERTOWN**  
Lowest cost per mile

**B. F. G. DEFIANCE**  
Lowest price

**B.F. Goodrich**  
FIRST IN RUBBER



**MORE MILES!** With 26,000 miles on his B. F. Goodrich tires, F. R. Helms of Birmingham, Ala., writes, "I can reasonably expect another 20,000".



**MORE MILES!** Safety Patrolman John Olson, Everett Wash., after driving 33,527 miles on B. F. Goodrich tires, calls them "finest ... on the road".

**And more COMFORT! And more SAFETY!**

**U**SERS agree **MORE MILES!** Riding tests prove **MORE COMFORT**—



prove B. F. Goodrich regular tires *ride smoother* than regular tires of other makes! They give you **MORE SAFETY**, too, with a stronger cord body, plus a wider, road-hugging tread!

And for a floating, "velvet pillow" ride, with *super safety*, there's the B. F. G. Premium Silvertown.

Whichever B. F. G. tire you choose, you get **MORE** for your money—because B. F. Goodrich leads in research. And that research is now backed by a great, new B. F. Goodrich development—the world's finest rubber research center.



# Pipe Circuits

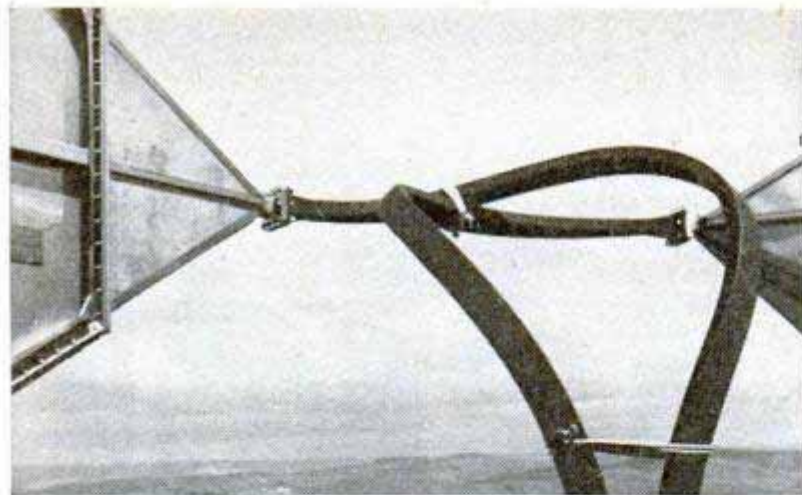

**3** The waveguide connects with antennas, which are oriented in azimuth with antennas at next station. At right is complete repeater station.

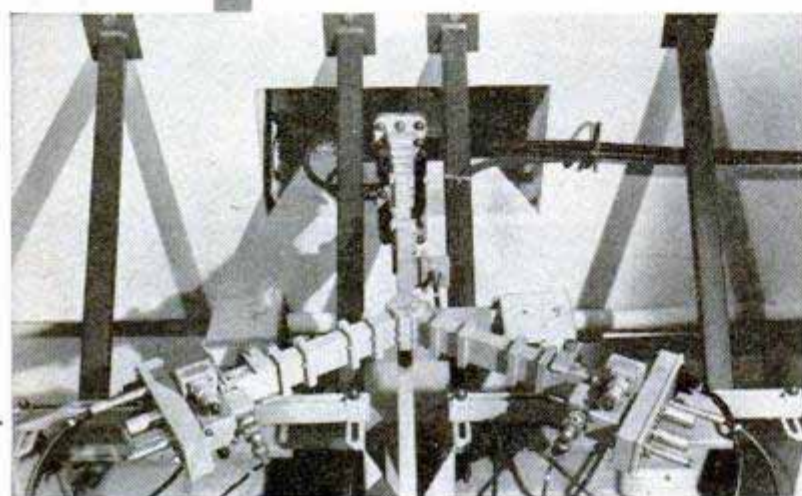

**2** The waveguide continues upward through the roof of the station toward the antennas.

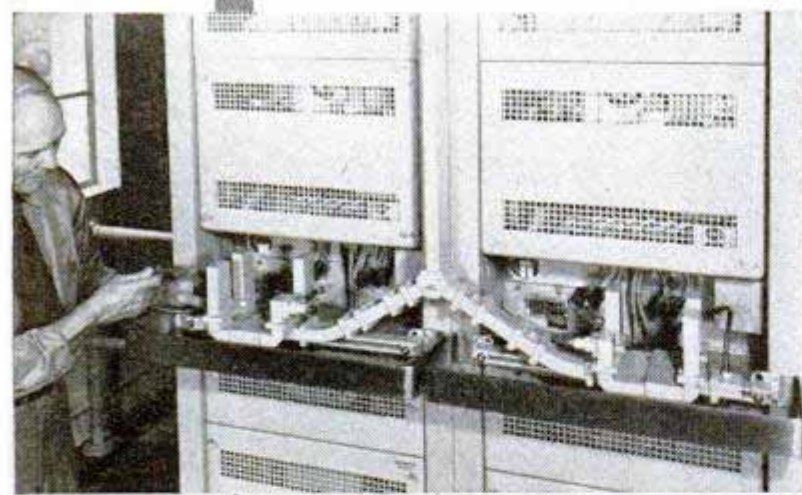

**1** Base of a waveguide circuit in a repeater station of the New York-Boston radio relay system.

**U**NLIKE radio broadcast waves, microwaves are too short to be handled effectively in wire circuits. So, for carrying microwaves to and from antennas, Bell Laboratories scientists have developed circuits in "pipes," or waveguides.

Although the waves travel in the space within the waveguides, still they are influenced by those characteristics which are common to wire circuits, such as capacitance and inductance. A screw through the guide wall acts like a capacitor; a rod across the inside, like an inductance coil. Thus transformers, wave filters, resonant circuits—all have their counterpart in waveguide fittings. Such fittings, together with the connection sections of waveguide, constitute a waveguide circuit.

From Bell Laboratories research came the waveguide circuits which carry radio waves between apparatus and antennas of the New York-Boston radio relay system. As in long distance wire communication, the aim is to transmit wide frequency bands with high efficiency—band widths which some day can be expanded to carry thousands of telephone conversations and many television pictures.

Practical aspects of waveguides were demonstrated by Bell Telephone Laboratories back in 1932. Steady exploration in new fields, years ahead of commercial use, continues to keep your telephone system the most advanced in the world.

## BELL TELEPHONE LABORATORIES

EXPLORING AND INVENTING, DEVISING AND PERFECTING FOR CONTINUED IMPROVEMENTS AND ECONOMIES IN TELEPHONE SERVICE.



# Popular Mechanics Magazine

Registered in U. S. Patent Office and Canada

H. H. WINDSOR, Founder

H. H. WINDSOR, Jr., Editor and Publisher

## To Our Readers

It is with much regret that I tell you that all costs that go into the production of our magazine have made it necessary for us to raise the newsstand price of Popular Mechanics from 25c to 35c per copy. We will make no advance in subscription rates until January 1, 1949, when the annual rate will be \$3.50. As soon as costs come down and we are able to reduce the price, we will do so.

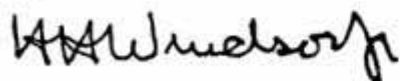

Editor and Publisher

★ ★ ★

## Next Month

EARTHQUAKE experts may be able to predict the "big shakes" in the distant future, but until then the best man can do is to prepare for them. Some of the ingenious ways of protecting everything from buildings to heirlooms are told in a December feature. Another story, "Now They're Weaving Houses," tells about a new and time-saving type of construction. Also in December is the story behind the floats seen in Pasadena's amazing Tournament of Roses.

CRAFTSMEN who like "hand crafts" which can be turned out in a few minutes will welcome the article on gimp braiding next month. Another how-to-do-it feature which will find a wide audience concerns shooting a photo record of the baby in your home. Why not start with the baby's first Christmas? This can grow into a hobby that is easy to master and a lot of fun. Next month's shop feature tells how to build a bandsaw with an 18-inch swing.

HOW to convert your receiver into a wire recorder combination is a December Radio feature.

Volume 90 NOVEMBER 1948 Number 5

Managing Editor.....Roderick M. Grant  
Assistant Managing Editor.....Wayne Whittaker  
Shop Notes and Crafts Editor.....James R. Ward  
Radio and Electronics Editor.....Frank L. Brittin  
Aviation Editor.....Aubrey O. Cookman, Jr.  
Associate Editor.....Clifford B. Hicks  
Eastern Editor.....Bill Reiche  
Western Editor.....Thomas E. Stimson, Jr.  
Art Director.....Frank Beatty

### Assistant Editors

Donald R. Brooks Arthur R. Railton

### Assistant Editors, Shop Notes and Crafts

W. Clyde Lammey Wayne C. Leckey Frank N. Stephany A. E. Youngquist

## In This Issue

Top of the World Weather Run	-	97
Down in the Sea for Oil	- - -	108
Debut for the '49 Nash	- - -	115
Trainer of Champions	- - -	120
Television, Navy's Schoolteacher	-	125
Ride 'im, Dude!	- - - - -	129
Pearl Harbor's Secret Caverns	-	134
We Drove to Alaska—Part II	- -	145
Canada Hunts Minerals	- - -	156
Mystery of the "Hand Animals"		162
What's New for Your Home	- -	172
Junior Foresters	- - - - -	178

## For the Craftsman

Ten Firing Hints	- - - - -	194
Rings of Light	- - - - -	198
Weather-Strip for Economy	- -	205
Stretch Your Gasoline Dollar—		
Part I	- - - - -	210
Two Power Sanders Fill All Needs		226
Modernize Home Wiring	- - -	232
Radio and Electronics	- - -	237
Clinic for Homemakers	- - -	248

*Table of Contents continued on page 8*

Published monthly by POPULAR MECHANICS COMPANY, 200 East Ontario Street, Chicago 11, Ill. H. H. Windsor, Jr., president; Paul H. Dunakin, vice president and general manager; D. F. Windsor, vice president and secretary-treasurer; William Harrison Fetridge, vice president and assistant to the publisher; Clover L. Perkins, advertising manager; Alan M. Deyoe, circulation manager. Single copy in the United States and Canada, 35 cents; subscription rates in United States and possessions, Canada, Philippines and countries of the Pan-American Postal Union, 1 year, \$2.50; 2 years, \$4.50; 3 years, \$6.00. To all other countries add \$1.00 a year over United States prices for overseas postage. If you plan to move, notify us at least 30 days in advance so you will not miss an issue. Give both old and new addresses. Entered as Second Class Matter, September 15, 1903, at the Post Office at Chicago, Illinois, under Act of March 3, 1879. Entered as Second Class Matter at Post Office Dept., Canada. Copyright 1948 by Popular Mechanics Company. Copyright under International Copyright Union. Copyright in France. All rights reserved under Pan-American Copyright Union. Printed in the United States of America.

# **FREE TRAINING** in **Auto Mechanics Plus good pay while learning**



Become a first-class automotive mechanic and you're set for life... sure of a good job or able to run a shop of your own. Here's your chance to learn this valuable trade and the training won't cost you a penny. In addition, you'll get good pay while learning.

The United States Army is offering this outstanding opportunity to a limited number of young men who have high school diplomas, or state certificates to show equivalent education. Under the new Army plan, you can sign up for the automotive school and be *sure* of enrollment immediately after basic training.

In the Army trade schools you'll be taught by experts, with equipment that

is the very latest in the automotive field. These schools are the finest in the world. So good that many colleges and trade schools give credit for work done in them.

Your pay starts immediately. You'll get \$75 a month, plus free food and housing... free clothing and equipment... free medical and dental care... free retirement plan... low-cost insurance. In all, the pay is equal to \$211.50 in civilian life.

You owe it to your future to get details on this opportunity today.

You can get the facts, without obligation, at the nearest U. S. Army Recruiting station.

## **INTERESTED IN SOME OTHER TRADE?**

*Automotive Mechanics is only one of more than 60 U. S. Army trade schools open to qualified young men. Ask your Recruiting Officer about any trade in which you are interested. Chances are he can offer you what you want.*



**PEACE IS AMERICA'S  
MOST IMPORTANT BUSINESS**

The new peacetime Army and Air Force offer young men...

- ★ WIDEST CHOICE OF CAREER JOBS
- ★ BEST OPPORTUNITY FOR ADVANCEMENT
- ★ UNUSUAL RETIREMENT BENEFITS

**U.S. ARMY and U.S. AIR FORCE  
RECRUITING SERVICE**



**NEAT**

This resilient mount is a neat, workmanlike job of die casting, with precision-fit rubber insert. It plainly shows "engineered efficiency"—the reason why Hoover Motors run so smooth, so quiet, so cool even in continuous operation. New resilient and rigid units meet NEMA mounting dimensions. If you need a motor in your shop, you need a Hoover Motor. Order today from your nearest dealer.

Hoover Motors are made in ratings of  $\frac{1}{4}$  hp up to 1 hp by the makers of the world-famous Hoover Cleaners.



# **HOOVER MOTORS**

Electric Motor Division . . . The Hoover Company . . . North Canton, Ohio

NOVEMBER 1948

This One



L910-KPA-NDZT

5

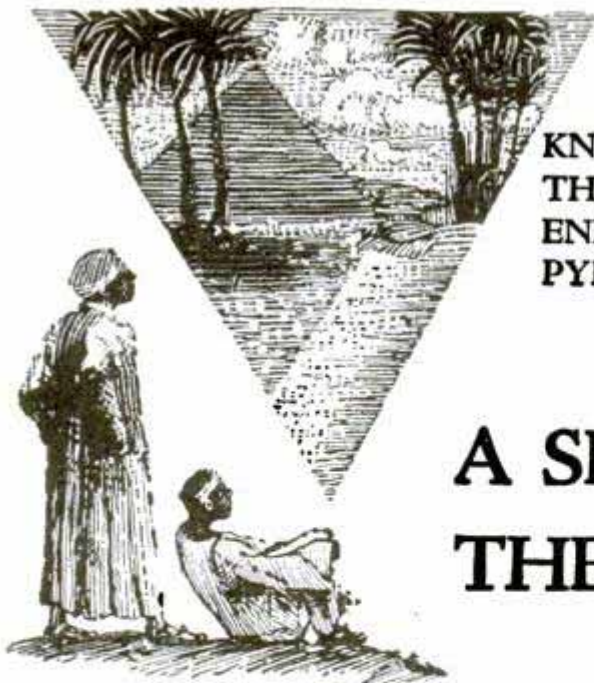

KNOWLEDGE  
THAT HAS  
ENDURED WITH THE  
PYRAMIDS

## A SECRET METHOD FOR THE MASTERY OF LIFE

**W**HENCE came the knowledge that built the Pyramids and the mighty Temples of the Pharaohs? Civilization began in the Nile Valley centuries ago. Where did its first builders acquire their astounding wisdom that started man on his upward climb? Beginning with naught they overcame nature's forces and gave the world its first sciences and arts. Did their knowledge come from a race now submerged beneath the sea, or were they touched with Infinite inspiration? From what concealed source came the wisdom that produced such characters as Amenhotep IV, Leonardo da Vinci, Isaac Newton, and a host of others? Today it is known that they discovered and learned to interpret certain *Secret Methods* for the development of their inner power of mind. They learned to command the inner forces within their own beings, and to master life. This secret art of living has been preserved and handed down throughout the ages. Today it is extended to those who dare to use its profound principles to meet and solve the problems of life in these complex times.

### This Sealed Book—FREE

Has life brought you that personal satisfaction, the sense of achievement and happiness that you desire? If not, it is your duty to yourself to learn about this rational method of applying natural laws for the mastery of life. To the thoughtful person it is obvious that everyone cannot be entrusted with an intimate knowledge of the mysteries of life, for everyone is not capable of properly using it. But if you are one of those possessed of a true desire to forge ahead and wish to make use of the subtle influences of life, the Rosicrucians (not a religious organization) will send you *A Sealed Book* of explanation without obligation. This *Sealed Book* tells how you, in the privacy of your own home, without interference with your personal affairs or manner of living, may receive these secret teachings. Not weird or strange practices, but a rational application of the basic laws of life. Use the coupon, and obtain your complimentary copy.

## The ROSICRUCIANS

SAN JOSE

(AMORC)

CALIFORNIA



AMENHOTEP IV  
Founder of Egypt's  
Mystery Schools

Use this  
coupon for  
**FREE**  
copy of book

-----  
SCRIBE E. Q. A.  
The Rosicrucians (AMORC)  
San Jose, California

Please send free copy of *Sealed Book*,  
which I shall read as directed.

NAME.....

ADDRESS.....

CITY.....



# Why be a BOOKKEEPER?

... When Accountancy offers more Money and Success...

If you are a bookkeeper, you are right on the threshold of a profession that pays far above average—where there's real opportunity to get ahead and move up fast.

Why not step UP from bookkeeping—be an accountant—make real money!

You can learn Accountancy by the interesting LaSalle Problem Method—in your convenient spare time, at home, without losing a day from your work. You learn by *doing* . . . you study Accounting principles and solve Accounting problems under the clear guidance of experienced C.P.A.'s. You cover Accountancy from the basic principles right up through Accounting Systems and Income Tax Procedure—to advanced training for the C.P.A. degree if you so desire. And as you go along step-by-step, you master the principles of auditing, business law, statistical control, cost accounting, organization, management, finance, etc.

You go as fast or as slowly as you choose. And you may start "cashing in" on your new ability long before you complete the training—as thousands of others have proved. Many advance quickly to better positions, even before they are half way through. And that is only the *beginning* of a growing and continuing success for the rest of your business life.

Why remain "just a bookkeeper" when Accountancy holds so much for you? Our free 48-page booklet, "ACCOUNTANCY, THE PROFESSION THAT PAYS," tells you what you must know to be an Accountant, and how you can prepare in your

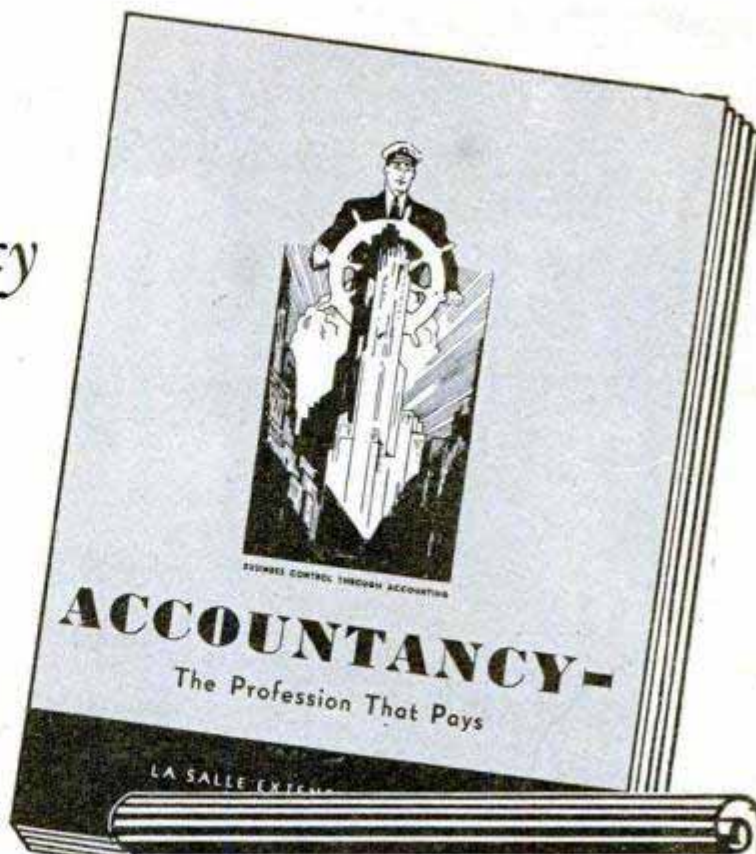

## LASALLE Extension University

*A Correspondence Institution*

Dept. 1164-HR • 417 S. Dearborn • Chicago 5, Ill.

Send me your free 48-page booklet, "Accountancy, the Profession That Pays"—plus "Ten Years' Promotion in One"—a book which has helped many men.

Higher Accountancy

### Other LaSalle opportunities:

- |  |  |
|--|--|
| <input type="checkbox"/> C.P.A. Coaching     | <input type="checkbox"/> Traffic Management            |
| <input type="checkbox"/> Bookkeeping         | <input type="checkbox"/> Foremanship                   |
| <input type="checkbox"/> Law: LL.B. Degree   | <input type="checkbox"/> Industrial Management         |
| <input type="checkbox"/> Business Management | <input type="checkbox"/> Stenotypy (Machine Shorthand) |
| <input type="checkbox"/> Salesmanship        |  |

Name..... Age.....

Address .....

City, Zone, State.....

**LASALLE EXTENSION UNIVERSITY**

*A Correspondence Institution*

Dept. **1164-HR** 417 S. Dearborn St.

Chicago 5, Illinois

leisure time, at moderate cost and on easy terms.

Send the coupon today and we'll include "Ten Years' Promotion in One"—a book which has helped many men. Get all the facts and judge for yourself. There is no obligation. You are already started in this field . . . find out how you can rapidly go to the top! Mail coupon NOW!

# When you change to Winter Oil---

YOU NEED

# PYROIL

MORE THAN EVER!

The winter oil you put in your crankcase is low viscosity oil. It is necessary for cold weather starting. But the operating temperature of the motor is much the same in winter as in summer. When you stop your car, turn off the ignition, the low viscosity oil quickly drains off cylinder walls. *Unprotected*, they are subject to corrosion. *Dry*, the cylinder walls are subject to wear upon starting. *Pyroil gives oil the property of clinging to cylinder walls.* The famous Pyroil film stays there, protecting them from corrosion and wear.

Whenever you add oil — add PYROIL — and add miles to your car.

### Pyroil For Aircraft Engines

Use Aircraft Pyroil B for lubricating oil, Aircraft Pyroil A for gasoline.

## GIVEN!

An attractive Pyroil metal savings bank — takes coins up to 50c pieces — is yours for the asking — sent postage paid.

Manufactured and Guaranteed by  
Pyroil Company, 85 Pyroil Bldg.,  
La Crosse, Wisconsin.

Canadian Distributors:  
Central Purchasing Agencies, Ltd.,  
Toronto, Ontario



**PYROIL COMPANY**  
85 Pyroil Bldg., La Crosse, Wisconsin

I want my car to last and run properly. Please tell me more about Pyroil and how it can accomplish this for me.

Name \_\_\_\_\_

Address \_\_\_\_\_

City or Town \_\_\_\_\_ State \_\_\_\_\_



## TABLE OF CONTENTS (Continued)

### AUTOMOTIVE

Body lifts up to enter doorless bubble car.....	103
Car is 40 inches high.....	105
Auto-seat bed for two-door or four-door cars.....	124
Brake ends stop-light creep and acts as hill-holder.....	132
"Vicinity" car.....	168
Dashboard indicator shows oil level.....	177
Antiglare visor for car has clear-vision area.....	181

### AVIATION

Test lab for jets.....	105
Plane wing pivots in flight.....	107
Helicopter prospects for oil.....	119
Radio for light planes weighs nine pounds.....	119
Corrugated wing designed for speedy repairs.....	144
Fuel-control panel aids Navy pilots.....	151
Elevators in wing of Swiss glider.....	151
Huge transport can carry two buses and 56 men.....	165

### ELECTRICAL

Fittings for electric conduit cut their own threads.....	141
Old clock with wooden gears converted to electricity.....	176
High-voltage arc removes broken studs.....	181
Miniature racer is run by remote control.....	184

### HOUSE AND HOME

Kit contains precut hardwood parts for tea wagon.....	103
Cushions without springs used in home-designed furniture.....	128
Nozzle extension makes garden hose more useful.....	132
Glass-top popper has trick shaker.....	132
Ivy-planted blocks end lawn erosion.....	183

### INDUSTRY

400,000-pound tamper smooths ground for runways.....	140
A house is poured.....	152
Reel holds 300 feet of heavy cable for easy carrying.....	161
Nylon cover for wire cable has many potentialities.....	184

### MACHINES AND TOOLS

Cam-action grip locks pliers.....	102
Portable-saw mount.....	107
Flywheel wrench.....	107
Meter "prods" big machines to record vibrations.....	113
Guide gives varying letters from same template.....	139
Lightweight pipe wrench.....	141
Holders make one motor serve many machines.....	154
Replaceable table insert converts bench saw into shaper.....	161
Crane moves snow.....	168
Portable bench saw can be powered by auto wheel.....	183
Versatile tool for carpenters.....	184

### MEDICAL

Electric exerciser for paralytics.....	106
Human bone bank would aid medicines.....	139
Germ-killing chemical is derived from organisms in soil.....	140
Artificial fingers.....	151
X-rays sent by telephone for expert interpretation.....	181

### MODELS, NOVELTIES AND TOYS

Lighting engineers are modern Gullivers along Lilliput lane.....	104
Horizontal swing rolls on cables.....	113
Picket-boat model measures nine feet.....	119
Jet models on wires race between cars.....	124
Toy automobile is steered by remote control.....	144
Smoke climbs pipe-stem "stairs".....	161
Wave-driven boat.....	177

### PHOTOGRAPHY

15-inch camera lens.....	170
Shells fired through studio wall are "stopped" by camera.....	182
Portable enlarger packs inside case.....	182

### RECREATION AND HANDIWORK

Plastic centers repair records.....	102
Folding chair for bleachers.....	106
Reflector oven for open fires.....	114
Casting with rubber by coagulation-control liquid.....	133
Football place-kick tee.....	141
A robot sets 'em up.....	142
Skate sharpener is small enough to go along to the rink.....	154
Sponge sculpture with a razor.....	160
Spear fishermen stalk the big ones.....	171
Lure has interchangeable hooks.....	176

### TRANSPORTATION

Sedan-type trailer towed by bicycle.....	139
All seats "reserved" on Paris buses.....	139
Inside-out train door.....	141
All the comforts of home in trailer only 10 feet long.....	155
Homemade three-wheeler travels 55 m.p.h.....	170
Cleaning up Chicago's underground.....	184

### MISCELLANEOUS

Sighting level for farm use.....	102
Radar reflector marks life raft.....	102
Pilofilm aids plant breeding.....	106
Metal television tube.....	113
Lightning bolts strike car and plane in lab tests.....	114
Lid converts paint can to spray container.....	128
Wire winder fits on tractor.....	133
Paddle-wheel boat is pedaled, steered just like a bicycle.....	154
Crank-operated oar.....	160
Vertical lift bridge goes up and down like an elevator.....	165
Science goes duck hunting.....	168
Theater of the atom.....	169
Telegraph office fits on desk.....	170
Plywood wheelbarrow carries meteor detector.....	177

(Continued to page 10)

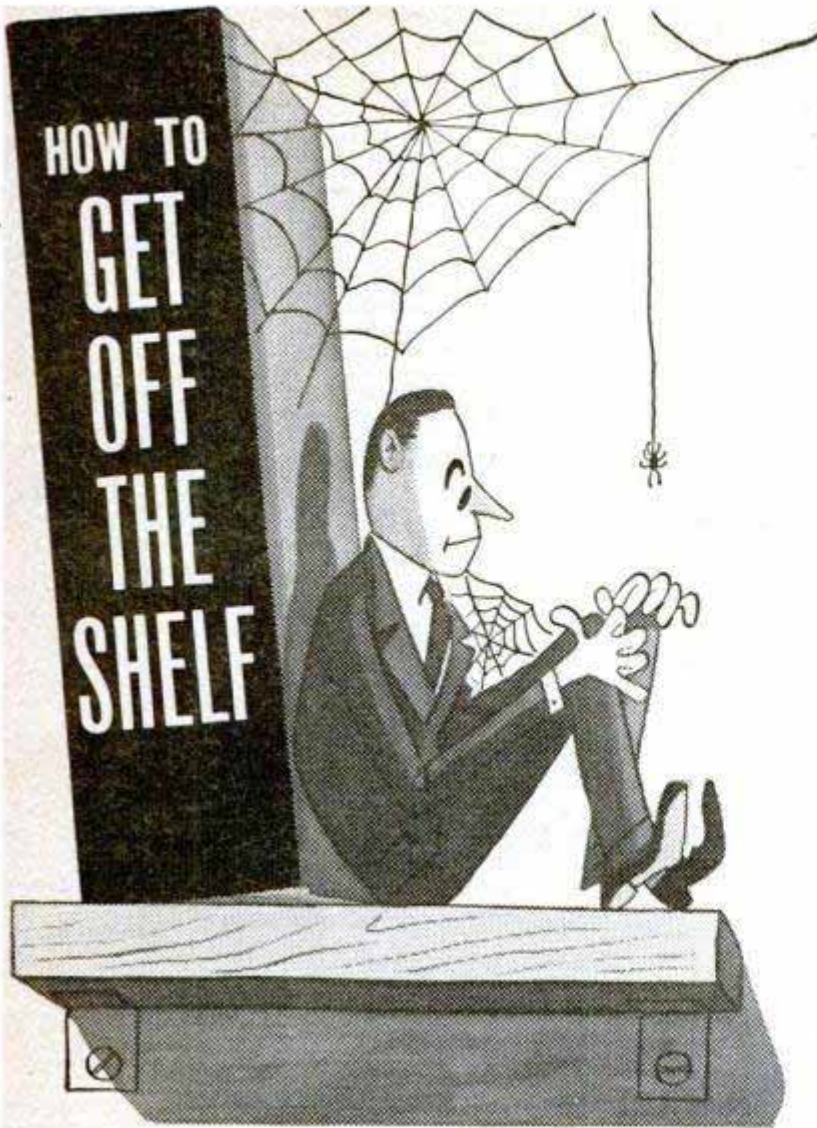

ONE or two promotions . . . several pay raises . . . and then that long, long stretch "on the shelf." You want to keep on climbing. You want to feel that you are getting somewhere. But how?

I. C. S. can show you. A little more training could be all you need to get back in the *upswing*. An advanced course or a "refresher"—studied in your spare time—will help prepare you for the next step, will show that you are ready to handle more responsibility, a better job.

Trained men get the "breaks"! That's a fact proved over and over again by the records of former I. C. S. students.

You don't want to bog down in your job. You don't want to remain "on the shelf" with the untrained. Mail the coupon today for complete information on how you can join the steady climbers.

## INTERNATIONAL CORRESPONDENCE SCHOOLS



BOX 5639-K, SCRANTON 9, PENNA.

Without cost or obligation, please send me full particulars about the course BEFORE which I have marked X:

- |   |  |   |   |
|---|--|---|---|
| <p><b>Business and Academic Courses</b></p> <input type="checkbox"/> Accounting <input type="checkbox"/> Advertising<br><input type="checkbox"/> Bookkeeping<br><input type="checkbox"/> Business Administration<br><input type="checkbox"/> Business Correspondence<br><input type="checkbox"/> Certified Public Accounting<br><input type="checkbox"/> Commercial<br><input type="checkbox"/> Commercial Art<br><input type="checkbox"/> Cost Accounting<br><input type="checkbox"/> Federal Tax<br><input type="checkbox"/> First Year College<br><input type="checkbox"/> Foremanship<br><input type="checkbox"/> Good English<br><input type="checkbox"/> Higher Mathematics<br><input type="checkbox"/> Motor Traffic<br><input type="checkbox"/> Retailing<br><input type="checkbox"/> Retail Store Management<br><input type="checkbox"/> Salesmanship<br><input type="checkbox"/> Sign Lettering<br><input type="checkbox"/> Spanish<br><input type="checkbox"/> Traffic Management<br><p><b>Air Conditioning and Plumbing Courses</b></p> <input type="checkbox"/> Air Conditioning<br><input type="checkbox"/> Heating<br><input type="checkbox"/> Refrigeration | <p><b>Chemistry Courses</b></p> <input type="checkbox"/> Chemical Engineering<br><input type="checkbox"/> Chemistry, Analytical<br><input type="checkbox"/> Chemistry, Industrial<br><input type="checkbox"/> Chemistry, Mfg. Iron & Steel<br><input type="checkbox"/> Petroleum Refining <input type="checkbox"/> Plastics<br><input type="checkbox"/> Pulp and Paper Making<br><p><b>Civil Engineering, Architectural and Mining Courses</b></p> <input type="checkbox"/> Architecture<br><input type="checkbox"/> Architectural Drafting<br><input type="checkbox"/> Building Estimating<br><input type="checkbox"/> Civil Engineering <input type="checkbox"/> Coal Mining<br><input type="checkbox"/> Contracting and Building<br><input type="checkbox"/> Highway Engineering<br><input type="checkbox"/> Lumber Dealer<br><input type="checkbox"/> Reading Structural Blueprints<br><input type="checkbox"/> Sanitary Engineering<br><input type="checkbox"/> Structural Drafting<br><input type="checkbox"/> Structural Engineering<br><input type="checkbox"/> Surveying and Mapping<br><p><b>Communications Courses</b></p> <input type="checkbox"/> Electronics<br><input type="checkbox"/> Practical Telephony<br><input type="checkbox"/> Radio, General <input type="checkbox"/> Radio Operating<br><input type="checkbox"/> Radio Servicing | <p><input type="checkbox"/> Telegraph Engineering</p> <p><b>Electrical Courses</b></p> <input type="checkbox"/> Electrical Drafting<br><input type="checkbox"/> Electrical Engineering<br><input type="checkbox"/> Electric Light and Power<br><input type="checkbox"/> Lighting Technician<br><input type="checkbox"/> Practical Electrician<br><input type="checkbox"/> Power House Electric<br><input type="checkbox"/> Ship Electrician<br><p><b>Internal Combustion Engines Courses</b></p> <input type="checkbox"/> Auto Technician<br><input type="checkbox"/> Diesel-Electric<br><input type="checkbox"/> Diesel Engines <input type="checkbox"/> Aviation<br><input type="checkbox"/> Gas Engines<br><p><b>Mechanical Courses</b></p> <input type="checkbox"/> Aeronautical Engineer's, Jr.<br><input type="checkbox"/> Aircraft Drafting <input type="checkbox"/> Flight Engineer<br><input type="checkbox"/> Forging <input type="checkbox"/> Foundry Work<br><input type="checkbox"/> Heat Treatment of Metals<br><input type="checkbox"/> Industrial Engineering<br><input type="checkbox"/> Industrial Metallurgy<br><input type="checkbox"/> Machine Shop<br><input type="checkbox"/> Machine Shop Inspection<br><input type="checkbox"/> Mechanical Drafting<br><input type="checkbox"/> Mechanical Engineering | <p><input type="checkbox"/> Mold-Loft Work<br/> <input type="checkbox"/> Patternmaking—Wood, Metal<br/> <input type="checkbox"/> Reading Shop Blueprints<br/> <input type="checkbox"/> Sheet-Metal Drafting<br/> <input type="checkbox"/> Sheet-Metal Worker<br/> <input type="checkbox"/> Ship Drafting    <input type="checkbox"/> Ship Fitting<br/> <input type="checkbox"/> Tool Designing    <input type="checkbox"/> Toolmaking<br/> <input type="checkbox"/> Welding—Gas and Electric<br/> <input type="checkbox"/> Welding Engineering</p> <p><b>Railroad Courses</b></p> <input type="checkbox"/> Air Brake <input type="checkbox"/> Car Inspector<br><input type="checkbox"/> Diesel Locomotive<br><input type="checkbox"/> Locomotive Engineer<br><input type="checkbox"/> Locomotive Fireman<br><input type="checkbox"/> Locomotive Machinist<br><input type="checkbox"/> Railroad Section Foreman<br><p><b>Steam Engineering Courses</b></p> <input type="checkbox"/> Boilermaking<br><input type="checkbox"/> Combustion Engineering<br><input type="checkbox"/> Engine Running<br><input type="checkbox"/> Marine Engineering<br><input type="checkbox"/> Steam Electric <input type="checkbox"/> Steam Engineer<br><p><b>Textile Courses</b></p> <input type="checkbox"/> Cotton Manufacturing <input type="checkbox"/> Loom Fixing<br><input type="checkbox"/> Rayon Weaving <input type="checkbox"/> Textile Designing<br><input type="checkbox"/> Woolen Manufacturing |
|---|--|---|---|

Name \_\_\_\_\_ Age \_\_\_\_\_ Home Address \_\_\_\_\_  
 City \_\_\_\_\_ State \_\_\_\_\_ Working Hours \_\_\_\_\_ A.M. to \_\_\_\_\_ P.M.  
 Present Position \_\_\_\_\_ Employed by \_\_\_\_\_

Special tuition rates to members of the Armed Forces. Enrollment under G.I. Bill and P.L. 16 approved for World War II Veterans.  
 Canadian residents send coupon to International Correspondence Schools Canadian, Ltd., Montreal, Canada.

AMAZING OFFER TO

# EVERY MAN WHO SHAVES!

COMPLETE Mennen SHAVE KIT ONLY **15¢**



● These famous Mennen shavers' necessities are offered almost as a gift, solely to introduce you to Mennen. Only 15¢ for the complete Shave Kit, mailed postpaid to your door. Offer limited. Closes midnight, March 31, 1949. Hurry! Fill in and mail the coupon today!

THE MENNEN COMPANY  
Department PM-118  
52 West Houston Street  
New York 12, N. Y.

● Please send me \_\_\_\_\_ of your Mennen Shave Kits. I enclose 15¢ in coin for each Kit ordered.

NAME \_\_\_\_\_ (PLEASE PRINT)

ADDRESS \_\_\_\_\_

CITY \_\_\_\_\_ ZONE (IF ANY) \_\_\_\_\_ STATE \_\_\_\_\_  
OFFER GOOD ONLY IN U. S. A.

(Continued from page 8)

## Craftsman and Shop Notes Index

<b>AUTOMOTIVE</b>	
Emergency hose clamp .....	202
Preserving polish on car hood .....	204
Sand-filled pail provides cushion when removing hub-caps .....	214
Tire chains wrapped in burlap .....	220
Beveling clutch-plate splines aids mounting transmission .....	224
Hairpin makes emergency repair for broken rotor brush .....	229
<b>FARM</b>	
Heavy tractor weights of concrete cast in flat-rimmed wheels .....	222
Laying-nest unit has hinged bottom to permit rapid cleaning .....	224
Winterizing stock tank .....	230
Corncob tied to hen's leg discourages brooding .....	230
<b>FURNITURE</b>	
File cabinet forms pedestal base for a desk .....	193
Baby's bath-o-chest .....	203
Record-player cabinet simulates bookcase to supply ample storage space for albums .....	209
<b>HOUSE AND HOME</b>	
Preventing draintile obstruction due to tree-root growth .....	188
Solving home problems .....	190
Thumbtacks keep picture level .....	192
10 firing hints that help you save coal .....	194
Recess cut in porch floor keeps door mat in place .....	196
Support for heavy pictures installed during construction .....	202
<b>OFFICE, SHOP AND STORE</b>	
Steel wool plugs pipe ends .....	192
Name-plate or card holders cut from curtain rod .....	196
Conserving carbon paper .....	209
Comb rack files shop data .....	214
Clipping papers to spindle facilitates handling .....	222
Identifying diameter of tubing .....	224
Sheet plastic simulates water for show window .....	230
<b>PAINT AND PAINTING</b>	
Preserving shape of paintbrush .....	192
Nails in legs elevate furniture to simplify painting .....	220
Magnetized sheet-metal masks speed spray painting .....	222
<b>PHOTOGRAPHY</b>	
Developer stored quickly with gravity tank .....	204
Contact printer .....	216
Rubber glove filled with ice cools photo solutions .....	218
Tape identifies print tongs .....	218
Emergency flash-bulb reflector made from paper plate .....	218
Darkroom timer preset by rubber-band stop .....	218
Cord substitutes for tripod .....	218
Dimmer switch controls photo flood lighting .....	219
Negatives dried on clothespin rack .....	219
<b>RADIO AND ELECTRONICS</b>	
Eight-band transmitter .....	237
Hi-quality four-tube amplifier .....	238
Television today .....	240
<b>RECREATION</b>	
Marking hockey-rink boundaries .....	192
Turkey hunt .....	197
Igniting damp matches outdoors .....	204
<b>TOOLS, JIGS AND MACHINES</b>	
Notched block holds door rigid for installing lock .....	188
Removing headless nails .....	186
Hose sections form tool rack .....	196
Measuring taper-turning setover .....	202
Folding rule transfers angles .....	204
Beveled putty knife speeds glazing .....	214
Caliper for inside measurements from clothespin and sticks .....	215
Tenon jig slides in table slot .....	221
Wall cabinet contains stepped drill rack .....	223
Collet chuck compressed by knurled cap instead of draw rod .....	223
V-block adapts lathe dog for small work .....	224
Transmission operates variable-speed hoist .....	225
Tape seals hole in grinder spindle to keep out dust .....	225
Vise equipped with hardwood die serves as sheet-metal brake .....	229
Adjustable stops in T-slots position angle-plate bolts .....	230
Small screw jack .....	231
<b>TOYS AND NOVELTIES</b>	
Desk set from plastic .....	186
China plate fitted with handle forms novel tidbit server .....	187
Intriguing cigarette box has cantilever trays .....	189
Colorful table lamp from bottle gourd .....	193
Toy derrick equipped with bell magnets lifts metal cargo .....	209
Piepan provides steering wheel for homemade racer .....	220
<b>MISCELLANEOUS</b>	
Wire mesh anchors chinking .....	188
Increasing length of boards .....	188
Door latch closed by spring is operated from both sides .....	189
Installing roll-type roofing to prevent leakage .....	192
Cleaning checkered pistol grips .....	192
Lubricating slide fasteners .....	196
Potato moistens postage stamps .....	202
Spot rings in garments avoided .....	204
Pendant for pull-chain socket improvised from pencil eraser .....	214
Thumbtack seals glue tube .....	214
Replacing knob-insulator washers .....	214
Weight of Christmas tree locks novel stand .....	215
Lighter fluid aids igniting candles .....	215
Slipping of glued wood prevented .....	220
Stairway on storage-tank pipe facilitates operating valve .....	224

**IMPORTANT NOTICE**—It is the intention of this magazine to provide its readers with information regarding the latest developments in the mechanical arts. We take no responsibility as to whether the disclosures contained in our articles are covered by patents and advise readers to investigate this subject before making, using, or selling any of the products, machines, or processes described in order to avoid possible liability for patent infringements.

**AUDELS CARPENTERS & BUILDERS GUIDES—(4 Book Set).....\$6**

A practical illustrated trade assistant on modern construction for carpenters, joiners, builders, mechanics and all woodworkers. 4 vols., 1600 pages, 3700 illustrations. Fully indexed, flexible covers. Each volume sold separately \$1.50 a vol.

**AUDELS PLUMBERS & STEAMFITTERS GUIDES—(4 Book Set).....\$6**

A Practical Trade Assistant & Ready Reference. Explains in plain language & by clear illustrations, diagrams, charts, graphs, pictures principles of modern plumbing practice including Marine Pipe Fitting and Air Conditioning. 4 Vols.—1670 Pages—3642 Diagrams & Illustrations. Each Vol. Sold Separately \$1.50 a Vol.

**AUDELS OIL BURNER GUIDE.....\$1**

384 Pages Covering Installation, Servicing & Repairs All Types Domestic & Industrial Burners. Illustrated. Highly Endorsed.

**AUDELS HOUSE HEATING GUIDE.....\$4**

1000 Pages Covering Working Principles, Installation, Service of All Modern House Heating, Ventilating & Air Conditioning Systems. Explains New Radiant Heating. Fully Illustrated & Indexed.

**AUDELS REFRIGERATION & AIR CONDITIONING GUIDE.....\$4**

New from Cover to Cover—1280 Pages, Fully Illus. Covering basic principles, servicing, operation & repair of household, commercial & industrial refrigeration & air conditioning. A gold mine of essential important facts for engineers, servicemen, users.

**AUDELS SHEETMETAL WORKERS HANDY BOOK.....\$1**

Practical inside information. Fundamentals of Sheet Metal Work. 388 pages. Illustrated. 11 sections. Clearly written. Essential & important facts, figures, pointers in everyday language. Ref. Index.

**AUDELS SHEETMETAL PATTERN LAYOUTS.....\$4**

Developed by Experts for Sheet Metal Workers, Layout Men & Mechanics. A Practical Encyclopedia in 10 Sections, size 7 x 10 x 2—1125 Pages—350 Layouts—1600 Illustrations. 1001 Key Facts. Fully indexed for ready reference in answering your layout problems. Covers all phases of sheet metal work including Pattern Cutting, Pattern Development & Shop Procedure.

**AUDELS BLUE PRINT READING.....\$2**

For Mechanics & Builders. Covers all types of blue print reading including ship & airplane. 416 pages, fully illustrated.

**AUDELS MATHEMATICS & CALCULATIONS FOR MECHANICS \$2**

Mathematics for home study or reference. 700 pages, 550 illus. Practical mathematics from beginning. How to figure correctly. Easy, correct methods covering complete review. Illus. & Indexed.

**AUDELS AUTOMOBILE GUIDE.....\$4**

A practical quick ready reference book for auto mechanics, service men, operators & owners. Explains theory, construction & servicing of modern motor cars, trucks, buses & auto type Diesel engines. 1790 pages, fully illustrated. 55 chapters. Indexed. A standard book for mechanics. New Hydraulic drive covered.

**AUDELS DIESEL ENGINE MANUAL...\$2**

A practical, concise treatise with questions and answers on the theory, operation and maintenance of modern diesel engines. Over 400 pages, fully illus. All details plainly brought out, this book is of extreme value to engineers, operators & students.

**AUDELS WELDERS GUIDE.....\$1**

A concise, practical text on operation & maintenance of all welding machines for all mechanics. Over 400 pages, illustrated. Covers all methods of electric and acetylene welding including airplane work.

**AUDELS MACHINIST & TOOLMAKERS HANDY BOOK.....\$4**

Covers modern machine shop practice in all its branches. Tells how to set up & operate lathes, screw and milling machines, shapers, drill presses & all other machine & hand tools. 1600 pages, fully illustrated. Indexed. 5 sections. 1—Modern Machine Shop Practice. 2—Blue Print Reading & How to Draw. 3—Calculations & Mathematics for Machinists. 4—Shop Physics. 5—How to Use the Slide Rule. 60 chapters. Easy to read and understand. A shop companion that answers your questions.

**AUDELS ELECTRIC MOTOR GUIDE \$4**

Practical Information Covering Construction, Control, Maintenance & Wiring Hookups of All Types Electric Motors also Armature Winding. 1000 Pages Fully Illustrated & Indexed.

**AUDELS ELEC. WIRING DIAGRAMS \$1**

210 Pages, Illustrated. Gives practical facts on wiring of electrical apparatus. It shows clearly how to wire apparatus for practically all fields of electricity. Each diagram is complete & self-explanatory. Highly Endorsed Pocket Companion.

**AUDELS PRACTICAL ELECTRICITY \$4**

A key to a practical understanding of Electricity. For maintenance engineers, electricians & all electrical workers. 1440 Pages, 2600 Illus. Covers important electrical information in handy form—including wiring for Light & Power. Indexed.

**AUDELS RADIOMANS GUIDE.....\$4**

A key to the practical understanding of radio including Frequency Modulation, Television, etc., Aircraft & Marine Radio. For radio engineers, servicemen, amateurs, 914 Pages, 633 Illustrations & Diagrams. Photos. Review Questions & Answers. Reference Index.

**AUDEL, Publishers, 49 W. 23 St., N.Y. 10**

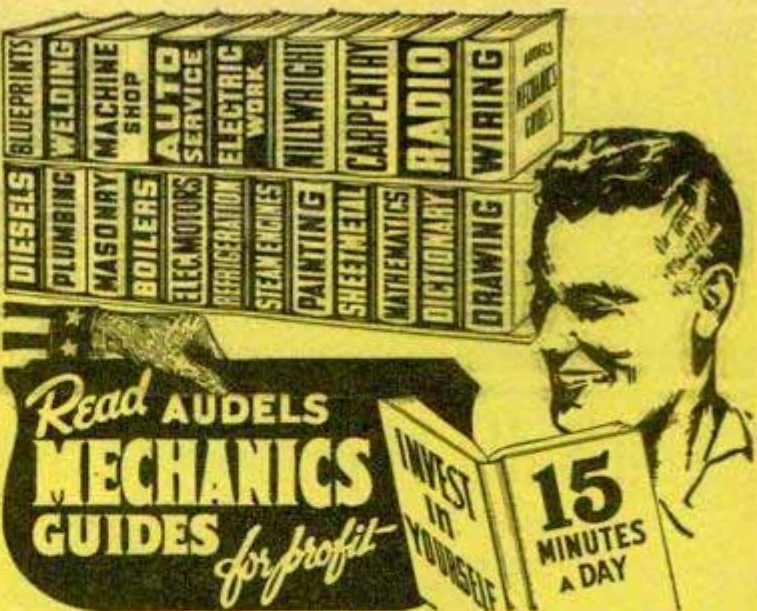

**AN AUDEL GUIDE IS A GOOD FRIEND!**  
Step Up Your Own Skill with the Practical Facts and Figures of Your Trade. Save time and money with right methods, short cuts, labor saving ideas. CHECK NOW! You can look over any Audel Guide in your home. Start the Easy Payments if satisfied.

**--- CUT HERE ---  
MAIL ORDER**

AUDEL, Publishers, 49 W. 23 St., New York 10, N. Y.

Please mail me for 7 days' free examination the books marked (X) below. I agree to mail \$1 in 7 days on each book or set ordered, and to further mail \$1 a month on each book or set ordered until I have paid the purchase price. If I am not satisfied with Guides I will return them.

- AUTOMOBILE GUIDE, 1700 Pages . . . . . \$4
- DIESEL ENGINE MANUAL, 400 Pages . . . . . 2
- WELDERS GUIDE, 400 Pages . . . . . 1
- CARPENTERS & Builders Guides (4 Book Set) . . . . . 6
- PLUMBERS & Steamfitters Guides (4 Book Set) . . . . . 6
- MASONS and Builders Guides (4 Book Set) . . . . . 6
- BLUE PRINT READING, 416 Pages . . . . . 2
- MASTER PAINTER & Decorator, 320 Pages . . . . . 2
- GARDENERS & GROWERS GUIDES (4 Book Set) . . . . . 6
- OIL BURNER GUIDE, 384 Pages . . . . . 1
- HOUSE HEATING GUIDE, 1000 Pages . . . . . 4
- REFRIGERATION & Air Conditioning Guide, 1280 Pages . . . . . 4
- SHEET METAL WORKERS Handy Book, 388 Pages . . . . . 1
- SHEET METAL PATTERN LAYOUTS, 1100 Pages . . . . . 4
- AIRCRAFT WORKER, 240 Pages . . . . . 1
- MECHANICAL DRAWING GUIDE, 160 Pages . . . . . 1
- MECHANICAL DRAWING & DESIGN, 480 Pages . . . . . 2
- MATHEMATICS and CALCULATIONS, 700 Pages . . . . . 2
- MECHANICAL DICTIONARY, 968 Pages . . . . . 4
- MACHINISTS & Toolmakers Handy Book, 1600 Pages . . . . . 4
- MILLWRIGHTS & Mechanics Guide, 1200 Pages . . . . . 4
- POWER PLANT ENGINEERS GUIDE, 1500 Pages . . . . . 4
- ENGINEERS & FIREMANS EXAMINATIONS, 528 Pages . . . . . 1
- PUMPS, HYDRAULICS & Air Compressors, 1658 Pages . . . . . 4
- MARINE ENGINEERS Handy Book, 1280 Pages . . . . . 4
- ENGINEERS and Mechanics Guides (8 Book Set) . . . . . 12
- Answers on Practical ENGINEERING, 254 Pages . . . . . 1
- ELECTRIC WIRING DIAGRAMS, 210 Pages . . . . . 1
- ELECTRICIANS EXAMINATIONS, 250 Pages . . . . . 1
- ELECTRIC DICTIONARY, 9000 Terms . . . . . 2
- ELECTRIC MOTOR GUIDE, 1000 Pages . . . . . 4
- PRACTICAL ELECTRICITY Handy Book, 1440 Pages . . . . . 4
- ELECTRICAL POWER CALCULATIONS, 425 Pages . . . . . 2
- RADIOMANS GUIDE, 914 Pages . . . . . 4
- ELECTRONIC DEVICES, 216 Pages . . . . . 2
- NEW ELECTRIC LIBRARY, 7000 Pages (12 Book Set) . . . . . 18

Name.....  
Address.....  
Occupation.....  
Employed by.....

I Will  
Show You  
How to

# Learn RADIO

## You Build This Modern Superheterodyne Receiver

As part of my Course, I send you the Speaker, Tubes, Chassis, Transformer, Loop Antenna—EVERYTHING you need to build this modern, powerful Radio Receiver. You also get parts to build many other real Radio circuits like those pictured here. Mail coupon for complete information.

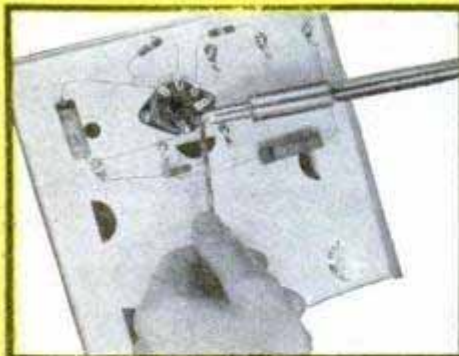
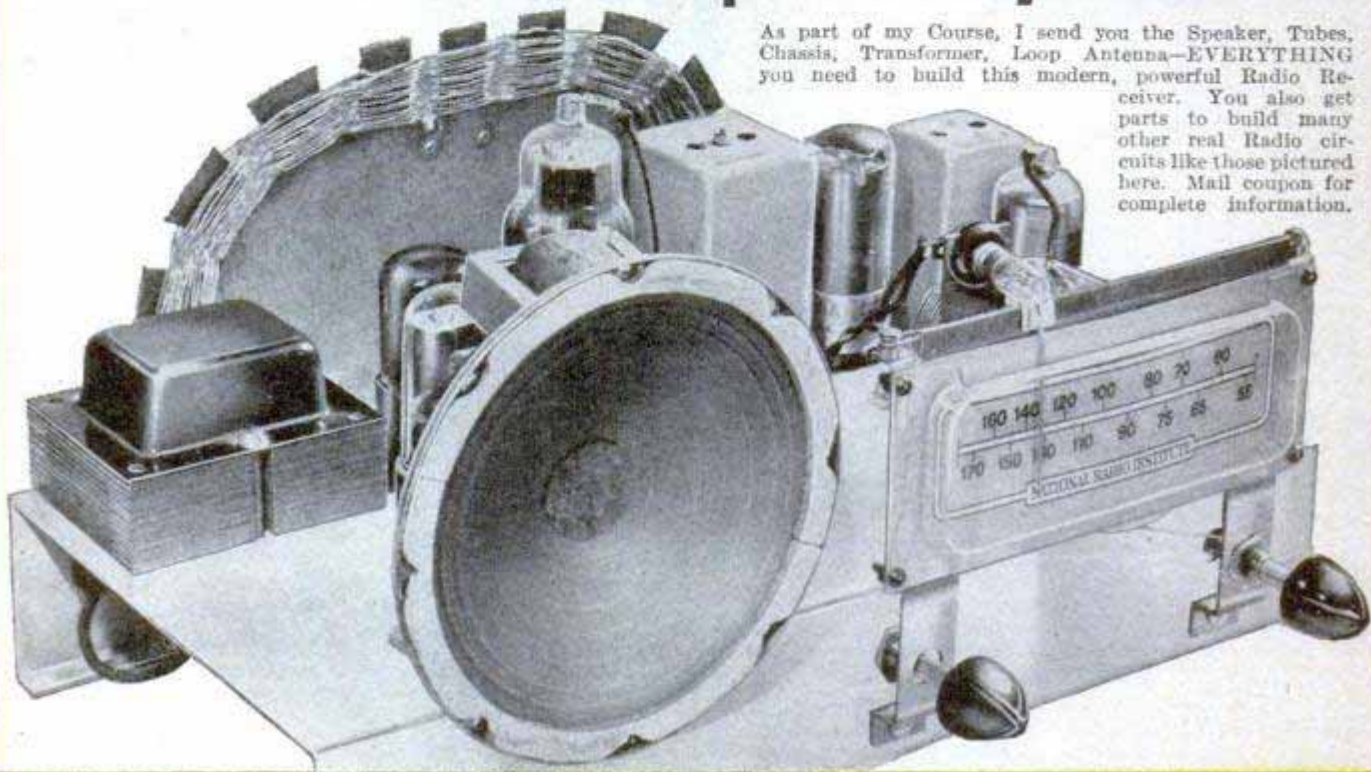

**YOU PRACTICE** Radio soldering with Soldering Equipment and Radio Parts I send you. Get practical experience mounting and connecting parts.

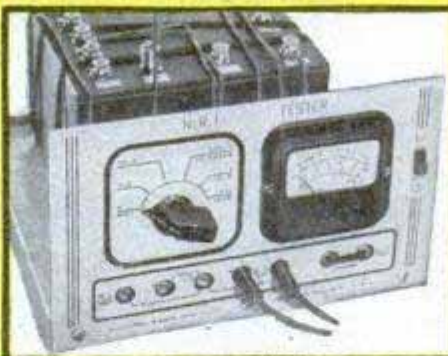

**YOU BUILD** this Tester with parts N. R. I. sends early in course. Soon helps you fix neighbors' Radios and **EARN EXTRA MONEY** in spare time.

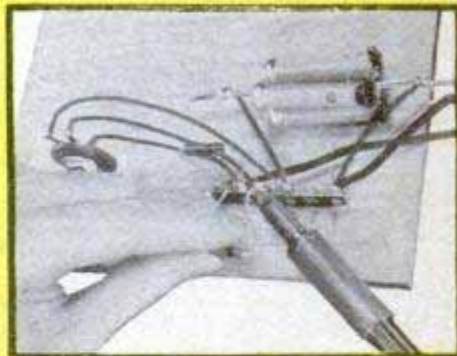

**YOU TEST** Radio Circuits like this built with parts I send. Build special circuits; learn how to locate and repair circuit defects.

## MEN I TRAIN AT HOME GET GOOD JOBS LIKE THESE

### MADE \$1500 WHILE LEARNING

"By the time I finished my NRI training I had made \$1500. When I started the Course I did not know a resistor from a condenser. I have bought my home. My income from Radio work, etc., is about \$3,000 a year." — **WILLIAM THOMAS**, Baldwin, Mississippi.



### ASSISTANT TO CHIEF ENGINEER AT STATION WHJB

"Have been employed for the past two years as assistant to the chief engineer at Radio Station WHJB. Knew nothing about Radio when I enrolled for the NRI Course." — **CECIL J. GIUNIPERO**, Greensburg, Pennsylvania.



### KNEW NOTHING ABOUT RADIO

"I knew nothing about Radio when I enrolled. At present I am doing spare time work. I have more than paid for my Course and I have about \$300 worth of equipment which has paid for itself." — **RAYMOND HOLT-CAMP**, Vandalia, Illinois.



### FULL-TIME JOB BEFORE FINISHING COURSE

"After completing about two-thirds of my Course I entered a Radio Repair shop. Later I branched out for myself and opened a shop in my own home. I am much pleased with the work I had during my first year of business." — **A. H. AYERS**, Washington 10, D. C.



# by Practicing in Spare Time

I Send You  
Big Kits  
of Radio Parts



## KNOW RADIO *Win Success* I Will Train You at Home

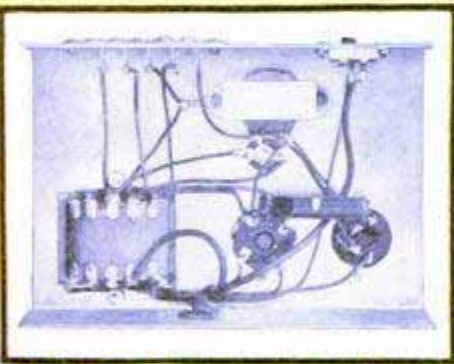

**YOU BUILD** Vacuum Tube Power Pack; make changes which give you experience with packs of many kinds. Learn how to correct Power Pack troubles.



**YOU BUILD** this A. M. Signal Generator for more valuable experience. It provides amplitude-modulated signals for many tests and experiments.

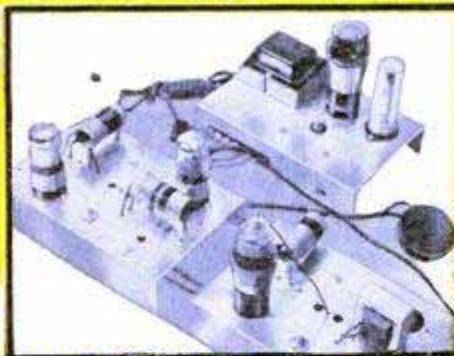

**YOU PRACTICE FM** (Frequency Modulation) experiments, get more experience with this Superheterodyne Receiver Circuit you build with parts I send.

Want a good-pay job in the fast-growing Radio and Television-Electronics industries? Want to be boss of your own money-making Radio shop? I've trained hundreds of men with *no previous experience* to be Radio technicians. I can do the same for you! My train-at-home method gives you practical experience with **BIG KITS OF PARTS** I send. You get Radio and Television principles from easy illustrated lessons. All equipment yours to keep.

### VETERANS

You Can Get  
This Training  
Under  
G. I. Bill.  
Mail Coupon.

#### Make EXTRA MONEY In Spare Time

The day you enroll, I send **EXTRA MONEY** booklets. Use your know-how to make **EXTRA MONEY** fixing Radios in spare time. The next step is your own Radio shop or a good-pay Radio job.

#### N.R.I.—Trained Men Face Bright Future

Think of money-making opportunities in Police, Aviation, Marine Radio, Broadcasting, Radio Manufacturing, Radio Repairing, Public Address work . . . think of even greater opportunities in booming Television, FM, Electronic fields!

*Our 34th Year of Training  
Men for Success in Radio*

#### See What N.R.I. Can Do For You

My special **DOUBLE FREE OFFER** gives you actual lesson on Radio repairing short-cuts absolutely free. You also get my 64-page book, "HOW TO BE A SUCCESS IN RADIO-TELEVISION-ELECTRONICS." See how quickly, easily you can get started. Send **NOW!** J. E. SMITH, Pres., Dept. 8MP, National Radio Institute, Pioneer Home Study Radio School, Washington 9, D. C.

**Good for Both—FREE**

**MR. J. E. SMITH, Pres., Dept. 8MP**  
National Radio Institute, Washington 9, D. C.

Mail me **FREE**, your Sample Lesson and 64-page book. (No salesman will call. Please write plainly.)

Name.....Age.....

Address.....

City.....Zone.....State.....

Check If Veteran

**SAMPLE LESSON  
FREE**

Gives hints on Receiver servicing, locating defects, repair of Loudspeaker, I. F. Transformer, Gang Turner, Condenser, etc. Mail coupon.

**My Radio Course Includes  
TELEVISION • ELECTRONICS  
FREQUENCY MODULATION**

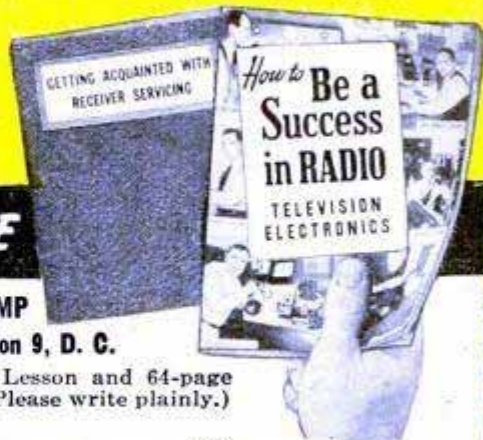

**Approved for Training under GI Bill**

For Greater Income

# LEARN A TRADE



- ✓ Auto Mechanics
- ✓ Body-Fender Repair
- ✓ Diesel Engines
- ✓ Building Construction

- ✓ Refrigeration Air Conditioning
- ✓ Electricity Electronics
- ✓ Radio Servicing
- ✓ Television
- ✓ Drafting

The years ahead are going to be big. Grow with them. Prepare now to get into a great, growing industry. Train with C.T.I. — a Nationally Known School. Get the benefits of our efficient Placement Service whether you want a better job or business of your own. You can come directly to our big, well equipped shops, located only a block from the shores of Lake Michigan — or you can begin your training at home by C.T.I.'s SHOP-PROVED HOME TRAINING METHODS. Fill out coupon — mail it today for big, illustrated FREE booklet.

## FILL OUT · CUT OUT · MAIL TODAY!

### FACTS FREE FOR MEN WHO WANT TO GET AHEAD

COMMERCIAL TRADES INSTITUTE, Dept. E2-11  
1400 W. Greenleaf, Chicago 26, Ill.

Send free illustrated Brochures and other information about the field I have checked below.

- |  |                                      |   |
|--|--------------------------------------|---|
| <input type="checkbox"/> Body and Fender Repairing | <input type="checkbox"/> Radio       | <input type="checkbox"/> Building                           |
| <input type="checkbox"/> Automotive Mechanics      | <input type="checkbox"/> Television  | <input type="checkbox"/> Drafting                           |
| <input type="checkbox"/> Diesel Mechanics          | <input type="checkbox"/> Electricity | <input type="checkbox"/> Refrigeration and Air Conditioning |

Name \_\_\_\_\_

Address \_\_\_\_\_

City \_\_\_\_\_ State \_\_\_\_\_

- Veteran       Non-Veteran



## VETERANS!

C.T.I. courses are approved under the G.I. Bill. Just Mail Coupon, we will handle all details. (Low tuition, easy terms if you are not a veteran.)

### Commercial Trades Institute

Dept. E2-11

1400 W. GREENLEAF  
CHICAGO 26, ILL.



# VETERANS Learn WATCHMAKING

## JEWELRY ENGRAVING

Above Average Pay  
No Age or Physical Limitation

In One of the Most Highly Respected Careers

Trained Men Always in Demand

Trades with Greater Security

Learn by our Advanced Training Method . . . Only Latest Scientific Equipment and Facilities.

Write Today for Complete Information and Catalog



Approved G. I. Training

## KANSAS CITY SCHOOL OF WATCHMAKING

America's Most Progressive Horological School

617-621 Wyandotte St.      Kansas City 6, Mo.

## NEW YORK SCHOOL of MECHANICAL DENTISTRY

SINCE 1920—The outstanding Training Center for all phases of Dental Laboratory Technology.  
Licensed by New York and New Jersey States  
Approved for Veterans G.I. BILL & P.L. 16  
Visitors Welcome.      Ask for Free Bulletin "P."

### NEW YORK SCHOOL OF MECHANICAL DENTISTRY

America's Oldest School of Dental Technology  
138 Washington St.      NEWARK 2, NEW JERSEY  
Also: 125 W. 31 Street      NEW YORK 1, N. Y.  
Immediate Enrollment — Day and Evening

THOUSANDS OF SUFFERERS USE

# BREATHEASY

FOR

# ASTHMA

CARRY IT WITH YOU  
USE IT ANYWHERE

Sold on Money-Back Guarantee

Write To Dept. PM

BREATHEASY DISTRIBUTORS, INC.  
65 CEDAR STREET  
SEATTLE 1      WASHINGTON





# INVENTORS



Learn how to protect your invention. The U. S. Patent Laws provide that any new and useful art, machine, article of manufacture, or composition of matter, or any new and useful improvement thereof, may be patented if the act of invention is involved. Therefore, every inventor with a valuable invention should take advantage of the Patent Laws and proceed for patent protection in order to safeguard his rights.

A patent gives the inventor the exclusive right to prevent others from making, using, or selling the invention claimed in the patent for a period of seventeen years.

The Patent Laws were enacted for the benefit of the inventor to give him protection for the features of his invention which are patentable. These features must be properly and concisely set forth and claimed in a formal application for patent, in order to comply with the requirements of the Patent Laws. For that reason, unless the inventor is familiar with patent matters, he should engage a competent registered patent attorney or agent to represent him. We are registered to practice before the U. S. Patent Office and are prepared to serve you in the handling of your patent matters.

A specially prepared booklet entitled "Patent Guide for the Inventor", containing detailed information with respect to patent protection and procedure, together with a "Record of Invention" form will be promptly forwarded to you without obligation upon request.

## CLARENCE A. O'BRIEN & HARVEY JACOBSON

*Registered Patent Attorneys*

81-L DISTRICT NATIONAL BUILDING • WASHINGTON 5, D. C.

*Patents*  
*Trademarks*  
*Copyrights*

CLARENCE A. O'BRIEN & HARVEY JACOBSON  
Registered Patent Attorneys

81-L District National Bldg., Washington 5, D. C.

Please send me copy of "Patent Guide for the Inventor" and also "Record of Invention" form. This request does not obligate me.

Name \_\_\_\_\_

Address \_\_\_\_\_

City \_\_\_\_\_ State \_\_\_\_\_

(Please write or print plainly.)

HOW TO MAKE MONEY  
in  
RADIO  
ELECTRONICS  
TELEVISION

HOW TO READ  
RADIO DIAGRAMS  
AND SYMBOLS

SPRAYBERRY  
P. O. BOX 40

SPRAYBERRY  
ACADEMY  
OF RADIO

GET THESE 2 BIG BOOKS  
**FREE.**

IF YOU  
WANT TO LEARN

**RADIO!**

I Train You RIGHT by Sending You 8 BIG KITS of Radio Equipment  
including A POWERFUL 6 TUBE SUPERHET  
RECEIVER and 16 RANGE TEST METER!

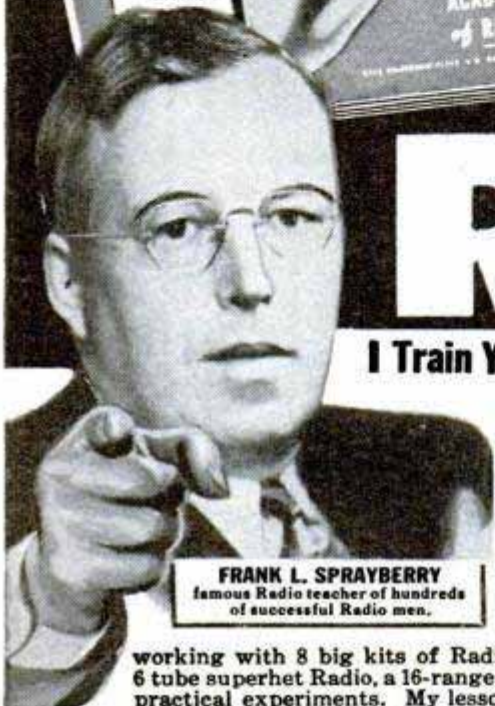

**FRANK L. SPRAYBERRY**  
famous Radio teacher of hundreds  
of successful Radio men.

working with 8 big kits of Radio parts I supply. You build a powerful  
6 tube superhet Radio, a 16-range test meter, perform over 175 interesting,  
practical experiments. My lessons are easy and interesting... you need

no previous experience in Radio. My  
famous *Business Builders* help you  
earn EXTRA CASH getting and doing  
neighborhood, Radio Service jobs while  
learning. You couldn't pick a better time  
to get into Radio. Good Radio Service and  
Repair Shops are needed everywhere as  
millions of new sets are in use. Trained  
men are wanted for opportunities in  
Police, Aviation and Marine Radio, F.M.,  
Standard Broadcasting and Television.  
Mail coupon today for my FREE Books.

LEARN HOW TO BUILD-TEST-REPAIR RADIOS By Working with YOUR HANDS!



I give you a fine, moving  
coil type Meter—with parts  
for a complete analyzer and  
Circuit Continuity Tester.  
"Trouble-shoot" with pro-  
fessional accuracy.

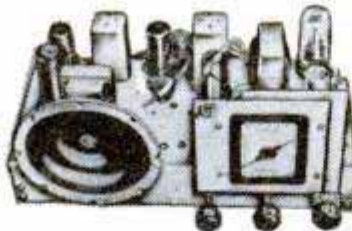

You really learn Radio the PRAC-  
TICAL way... when you build this  
big, powerful 6-tube Superhet  
Radio from parts I send you.

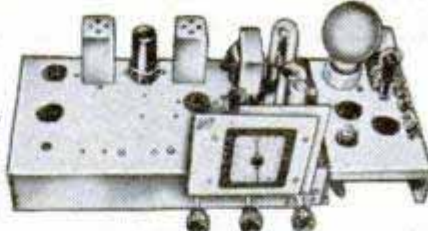

You don't have to buy expensive  
ready-made equipment. You get  
valuable experience building this Signal  
Generator and Multi-purpose Tester.

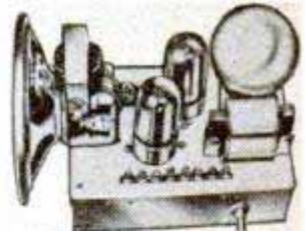

You construct this rec-  
tifier, filter, resistor and con-  
denser tester, and really get on  
the Practical end of Radio.

**LOW COST RADIO TRAINING STUDY AT HOME IN SPARE HOURS**

**RUSH COUPON Today!**

**SPRAYBERRY ACADEMY OF RADIO**  
F. L. SPRAYBERRY, President  
Room 10118, Sprayberry Bldg., Pueblo, Colorado  
Please rush my FREE copies of "How To Make Money  
In Radio, Electronics and Television" and "How To Read  
Radio Diagrams and Symbols." No salesman will call.

Name..... Age.....

Address.....

City and Zone..... State.....

CHECK HERE IF A VETERAN  
(Mail in an Envelope or Paste on Penny Postcard)

Easy monthly payments, if desired. Every-  
thing you need is furnished—nothing else  
to buy. The equipment I send you is yours  
"for keeps"—to use in your business or job.  
I have trained hundreds of successful Ra-  
dio men—and I can help you, too. Get the  
facts about Sprayberry Training—it's your  
first step to success, security and a bigger  
income. Fill out and mail coupon today. I'll  
rush my 2 Free books to you by return mail.

**VETERANS:** Approved for G. I. Training  
under Public Laws 16 and 346.

**SPRAYBERRY ACADEMY of RADIO**

F. L. SPRAYBERRY, President

Room 10118, Sprayberry Bldg., Pueblo, Colorado



Trained Radio men can step into their  
own profitable Radio Service Shop—or



New developments constantly open  
new big pay job opportunities in Radio.

# INVENTORS

Patent laws encourage the development of inventions.

We recommend that an inventor employ a registered Patent Attorney or agent, if the inventor is not familiar with patent matters. This is because the value of a patent depends largely upon the skillful preparation of the specification and claims in the patent application.

The firm of McMorrow, Berman and Davidson is registered to practice before the United States Patent Office. Additionally it engages patent attorneys able to readily understand inventors' disclosures, to advise concerning patentability, and to prepare appropriate specifications and claims.

If an inventor believes he has an invention, a search of the most pertinent prior U. S. patents should be made and a report obtained relative to its patentability. Where such report indicates that the invention appears patentable, in order to secure protection, diligence should be exercised in making application for a patent.

Send for a copy of Patent Booklet entitled "How To Protect Your Invention." This booklet contains information on patent protection and procedure. You will also receive an "Invention Record" blank. This will be promptly forwarded to you upon request—no obligation.

## McMORROW, BERMAN & DAVIDSON

*Registered Patent Attorneys*

PATENTS • TRADE MARKS • COPYRIGHTS

135-S VICTOR BUILDING, WASHINGTON 1, D. C.

### McMORROW, BERMAN & DAVIDSON

*Registered Patent Attorneys*

135-S Victor Building, Washington 1, D. C.

Send me your Patent Booklet, "How To Protect Your Invention", and also "Invention Record" form at once. I understand this request does not obligate me.

Name.....

Address.....

City.....

(WRITE OR PRINT NAME CLEARLY)

# And to think they used to call me SKINNY!

Give Me 15 Minutes a Day and I'll Give You a NEW BODY

PEOPLE used to laugh at my skinny 97 lb. body. I was ashamed to strip for sports or for a swim. Girls made fun of me behind my back. THEN I discovered my muscle-building system—"Dynamic Tension." It turned me into such a complete specimen of MANHOOD that today I hold the title "THE WORLD'S MOST PERFECTLY DEVELOPED MAN."

That's how I traded in my "bag of bones" for a barrel of muscle! And I felt so much on top of the world in my big new, husky body that I decided to devote my life to helping other fellows change themselves into "perfectly developed men."

## What's My Secret?

When you look in the mirror and see a healthy, husky, strapping fellow smiling back at you—then you'll be astonished at how short a time it takes "Dynamic Tension" to GET RESULTS! "Dynamic Tension" is the easy, NATURAL method you can practice in the privacy of your own room—JUST 15 MINUTES EACH DAY—while your scrawny shoulder muscles begin to swell . . . those spindly arms and legs of yours bulge . . . and your whole body starts to feel "alive," full of zip and go!

Thousands are becoming marvelous physical specimens—my way. I give you no gadgets or contraptions to fool with. With "Dynamic Tension" you simply utilize the dormant muscle-power in your own body—watch it increase and multiply into real, solid LIVE MUSCLE.

## FREE Book

Mail coupon right now for my illustrated book, "Everlasting Health and Strength." Tells all about my "Dynamic Tension" method. Shows actual photos of men I've made into Atlas Champions. It's a valuable book—and it's FREE. Mail coupon to me personally. CHARLES ATLAS, Dept. 8L, 115 East 23rd St., New York 10, N. Y.



CHARLES ATLAS, Dept. 8L  
115 East 23rd Street, New York 10, N. Y.

I want the proof that "Dynamic Tension" will help make a new man of me—give me a healthy, husky body and big muscle development. Send me your free book, "Everlasting Health and Strength."

Name \_\_\_\_\_ Age \_\_\_\_\_  
(Please print or write plainly)

Address \_\_\_\_\_

City \_\_\_\_\_ State \_\_\_\_\_

## A Better Way TO BUY LIFE INSURANCE

Newly developed Policy Selector enables you to quickly determine the best life insurance policy for your particular needs. Shows you how to buy it right. Enables you to get more protection for your insurance dollar.

SENT FREE.... The Service "SELECT-A-POLICY" insurance planner is yours for the asking. No cost. No obligation. Sent BY MAIL! No agent will call. Just write—  
DEPT. 643



Write For FREE "POLICY SELECTOR"

The SERVICE LIFE INSURANCE CO. Omaha 2, Nebr.

## LEARN MEAT CUTTING



through actual practice. Profitable Meat Cutting and Successful Meat Merchandising taught easily, quickly. LEARN BY DOING at Toledo in just six short weeks under actual market conditions. For beginners or men with experience. All subjects taught thoroughly and completely. Diploma. Job help. Get store of own. People must eat. School in operation nearly 25 years. Approved for GI training. Send today for FREE illustrated catalog. No obligation. NATIONAL SCHOOL OF MEAT CUTTING, Dept. 50-G, Toledo 4, Ohio

## FREE BARGAIN CATALOG of BOOKS

25,000 books of all publishers listed in our 54th Annual Bargain Catalog of 320 pages. Old-time favorites—latest "best sellers." Reference, Fiction, Juvenile, History, Scientific, etc. Supplying schools, colleges, libraries and thousands of individual customers. Send postcard today for our new 1949 catalog, "Bargains in Books."

THE BOOK SUPPLY COMPANY, DEPT. 139  
564-566 West Monroe St. Chicago 6, Ill.

## LEARN MONEY-MAKING CARTOONING

IN SPARE TIME — by Easy Picture Chart Method  
Same Simplified Method that has helped train creators of "Terry & Pirates," "Freckles," "Out Our Way," "Winnie Winkle," "Regular Fellers," "Strange As It Seems," "The Neighbors," and many others. Earn while learning. Send 10c for Picture Chart (to test your ability), and full details. (State age.)  
THE LONDON SCHOOL, 4811 Cleve. Transit Bldg., Cleveland, O.

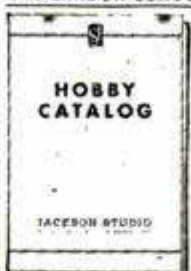

## CRAFT CATALOG

NEW 1949 edition, 84 pages crammed with big selection of tools and materials for plastics, ceramics, hand power tools, plans, etc., etc. A gold mine of hard-to-find items such as foam rubber, kits, books and "How To" information. Every crafter should have a copy. Send 25c now to

JACKSON, Dept. 72  
5440 N. Shoreland Ave., Milwaukee 11, Wis.

## Photography for PLEASURE or PROFIT



Learn at home. Spare time. Practical basic training. Long-established school. Many have earned while learning. Send coupon below for free booklet, "Opportunities in Modern Photography" and full particulars.

AMERICAN SCHOOL OF PHOTOGRAPHY  
1315 Michigan Avenue Dept. 1358 Chicago 5, Illinois  
Send booklet, "Opportunities in Modern Photography," full particulars and requirements. No salesman will call.

Name \_\_\_\_\_ Age \_\_\_\_\_  
Address \_\_\_\_\_  
City \_\_\_\_\_ Zone \_\_\_\_\_ State \_\_\_\_\_

Training is essential to advancement in any field—and it's important to have it on record.

International Correspondence Schools' sound and practical training goes on record—and counts in the record. I. C. S. regularly reports the progress of its students to their employers, regularly receives letters expressing appreciation for this service.

A typical employer communication notes: "I have every I. C. S. report on my men filed with their personal records, the records which help to determine any action taken in regard to those men."\*

YOU want your record to show you have *trained* for promotion.

YOU want your employer to know that you have *prepared* yourself for larger responsibilities. Then *act* now to obtain that training.

I. C. S. Courses cover more than 400 business and technical subjects. The coupon brings full information.

\*Name furnished on request



## INTERNATIONAL CORRESPONDENCE SCHOOLS



BOX 5640-K, SCRANTON 9, PENNA.

Without cost or obligation, please send me full particulars about the course BEFORE which I have marked X:

- |  |   |  |  |
|--|---|--|--|
| <p><b>Air Conditioning and Plumbing Courses</b></p> <ul style="list-style-type: none"> <li><input type="checkbox"/> Air Conditioning</li> <li><input type="checkbox"/> Heating</li> <li><input type="checkbox"/> Refrigeration</li> <li><input type="checkbox"/> Chemistry Courses</li> <li><input type="checkbox"/> Chemical Engineering</li> <li><input type="checkbox"/> Chemistry, Analytical</li> <li><input type="checkbox"/> Chemistry, Industrial</li> <li><input type="checkbox"/> Chemistry, Mfg. Iron &amp; Steel</li> <li><input type="checkbox"/> Petroleum Refining</li> <li><input type="checkbox"/> Pulp and Paper Making</li> <li><input type="checkbox"/> Civil Engineering, Architectural and Mining Courses</li> <li><input type="checkbox"/> Architecture</li> <li><input type="checkbox"/> Architectural Drafting</li> <li><input type="checkbox"/> Bridge and Building Foreman</li> <li><input type="checkbox"/> Building Estimating</li> <li><input type="checkbox"/> Civil Engineering</li> <li><input type="checkbox"/> Coal Mining</li> <li><input type="checkbox"/> Contracting and Building</li> <li><input type="checkbox"/> Highway Engineering</li> <li><input type="checkbox"/> Lumber Dealer</li> <li><input type="checkbox"/> Reading Structural Blueprints</li> <li><input type="checkbox"/> Sanitary Engineering</li> <li><input type="checkbox"/> Structural Drafting</li> </ul> | <ul style="list-style-type: none"> <li><input type="checkbox"/> Plumbing</li> <li><input type="checkbox"/> Steam Fitting</li> <li><input type="checkbox"/> Plastics</li> <li><input type="checkbox"/> Architecture</li> <li><input type="checkbox"/> Aviation</li> <li><input type="checkbox"/> Gas Engines</li> </ul> <p><b>Structural Engineering</b></p> <ul style="list-style-type: none"> <li><input type="checkbox"/> Structural Engineering</li> <li><input type="checkbox"/> Surveying and Mapping</li> </ul> <p><b>Communications Courses</b></p> <ul style="list-style-type: none"> <li><input type="checkbox"/> Electronics</li> <li><input type="checkbox"/> Practical Telephony</li> <li><input type="checkbox"/> Radio, General</li> <li><input type="checkbox"/> Radio Operating</li> <li><input type="checkbox"/> Radio Servicing</li> <li><input type="checkbox"/> Telegraph Engineering</li> </ul> <p><b>Electrical Courses</b></p> <ul style="list-style-type: none"> <li><input type="checkbox"/> Electrical Drafting</li> <li><input type="checkbox"/> Electrical Engineering</li> <li><input type="checkbox"/> Electric Light and Power</li> <li><input type="checkbox"/> Lighting Technician</li> <li><input type="checkbox"/> Practical Electrician</li> </ul> <p><b>Internal Combustion Engines Courses</b></p> <ul style="list-style-type: none"> <li><input type="checkbox"/> Auto Technician</li> <li><input type="checkbox"/> Diesel-Electric</li> <li><input type="checkbox"/> Diesel Engines</li> </ul> <p><b>Mechanical Courses</b></p> <ul style="list-style-type: none"> <li><input type="checkbox"/> Aeronautical Engineer's, Jr.</li> <li><input type="checkbox"/> Aircraft Drafting</li> <li><input type="checkbox"/> Forging</li> <li><input type="checkbox"/> Heat Treatment of Metals</li> <li><input type="checkbox"/> Industrial Engineering</li> </ul> | <ul style="list-style-type: none"> <li><input type="checkbox"/> Industrial Metallurgy</li> <li><input type="checkbox"/> Machine Shop</li> <li><input type="checkbox"/> Mechanical Drafting</li> <li><input type="checkbox"/> Mechanical Engineering</li> <li><input type="checkbox"/> Mold-Loft Work</li> <li><input type="checkbox"/> Patternmaking—Wood, Metal</li> <li><input type="checkbox"/> Reading Shop Blueprints</li> <li><input type="checkbox"/> Sheet-Metal Drafting</li> <li><input type="checkbox"/> Sheet-Metal Worker</li> <li><input type="checkbox"/> Ship Drafting</li> <li><input type="checkbox"/> Tool Designing</li> <li><input type="checkbox"/> Welding Engineering</li> <li><input type="checkbox"/> Welding—Gas and Electric</li> </ul> <p><b>Railroad Courses</b></p> <ul style="list-style-type: none"> <li><input type="checkbox"/> Air Brake</li> <li><input type="checkbox"/> Diesel Locomotive</li> <li><input type="checkbox"/> Locomotive Engineer</li> <li><input type="checkbox"/> Locomotive Fireman</li> <li><input type="checkbox"/> Locomotive Machinist</li> <li><input type="checkbox"/> Railroad Section Foreman</li> </ul> <p><b>Steam Engineering Courses</b></p> <ul style="list-style-type: none"> <li><input type="checkbox"/> Boilermaking</li> <li><input type="checkbox"/> Combustion Engineering</li> <li><input type="checkbox"/> Engine Running</li> <li><input type="checkbox"/> Marine Engineering</li> <li><input type="checkbox"/> Steam Electric</li> </ul> | <p><b>Textile Courses</b></p> <ul style="list-style-type: none"> <li><input type="checkbox"/> Cotton Manufacturing</li> <li><input type="checkbox"/> Loom Fixing</li> <li><input type="checkbox"/> Textile Designing</li> <li><input type="checkbox"/> Woolen Manufacturing</li> </ul> <p><b>Business and Academic Courses</b></p> <ul style="list-style-type: none"> <li><input type="checkbox"/> Accounting</li> <li><input type="checkbox"/> Bookkeeping</li> <li><input type="checkbox"/> Business Administration</li> <li><input type="checkbox"/> Business Correspondence</li> <li><input type="checkbox"/> Certified Public Accounting</li> <li><input type="checkbox"/> Commercial</li> <li><input type="checkbox"/> Cost Accounting</li> <li><input type="checkbox"/> Federal Tax</li> <li><input type="checkbox"/> Foremanship</li> <li><input type="checkbox"/> Good English</li> <li><input type="checkbox"/> Higher Mathematics</li> <li><input type="checkbox"/> Motor Traffic</li> <li><input type="checkbox"/> Retailing</li> <li><input type="checkbox"/> Retail Store Management</li> <li><input type="checkbox"/> Salesmanship</li> <li><input type="checkbox"/> Sign Lettering</li> <li><input type="checkbox"/> Spanish</li> <li><input type="checkbox"/> Traffic Management</li> </ul> |
|--|---|--|--|

Name \_\_\_\_\_ Age \_\_\_\_\_ Home Address \_\_\_\_\_  
 City \_\_\_\_\_ State \_\_\_\_\_ Working Hours \_\_\_\_\_ A.M. to \_\_\_\_\_ P.M.  
 Present Position \_\_\_\_\_ Employed by \_\_\_\_\_

Special tuition rates to members of the Armed Forces. Enrollment under G.I. Bill and P.L. 16 approved for World War II Veterans. Canadian residents send coupon to International Correspondence Schools Canadian, Ltd., Montreal, Canada.

# INVENTORS

A patent is a valuable right. On the basis of a constitutional provision Congress has established a system under which inventors may secure the exclusive right to prevent the unauthorized use, manufacture and sale of their inventions for periods of seventeen years. The inventor secures this protection by obtaining a patent.

Unless an inventor is thoroughly familiar with such matters, he is advised to employ a competent registered patent attorney, as the value of patents depends largely upon the skillful preparation of the specification and claims.

We recommend that you authorize us to conduct a search through the United States patents pertinent to your invention and to submit a report setting forth our opinion with respect to its patentability.

This firm is registered to practice before the U. S. Patent Office and is available to assist inventors in the preparation and prosecution of their cases. Detailed information and the preliminary steps to take to obtain patent protection will be furnished upon request. *Form below for mailing convenience.*

**VICTOR J. EVANS & CO.** • *Merlin M. Evans*  
REGISTERED PATENT ATTORNEY  
330-M MERLIN BUILDING, WASHINGTON 6, D. C.

**VICTOR J. EVANS & CO.** • **Merlin M. Evans**  
*Registered Patent Attorney*  
330-M Merlin Building, Washington 6, D. C.

*Please send me without obligation a copy of your booklet "Patent Protection For Inventors" together with your convenient "Evidence of Invention" form.*

Name.....

Address.....

City and State.....

PATENTS

TRADEMARKS

COPYRIGHTS

These Men are Learning

# ELECTRICITY

ON REAL EQUIPMENT  
in the GREAT SHOPS of COYNE



**Why Spend Years Preparing for a Good Job?  
Train Quickly at COYNE—Be Making Real  
Money While Others are Still Puttering Along!**



**B.W. COOKE**

Yes, you can get ready for Good Pay—a Big Future in **ELECTRICITY**—by coming to **COYNE** in Chicago to train on actual equipment! Here you work on real motors, armatures, switchboards—do actual wiring and trouble-shooting—get the "all-around" training you need.

**Not a "Home-Study" Course**

We do not teach by mail. All training is given in our Great Shops, plus necessary theory. Expert instructors guide you. No advanced education or previous experience needed.

**EARN WHILE LEARNING**

If you need part-time work to help out with living expenses while at Coyne, we'll help you get it. Don't be held back by lack of money.

**Electrical Refrigeration Included**

Added training now included in great new field of Electric Refrigeration—Industrial Electronics also included. Both mean added opportunities.

**GI Approved—Finance Plan for Non-Vets**

COYNE is authorized to train men under the G.I. Bill. Non-veterans may enroll now, pay most of tuition after graduation. Special plan for men of draft age. Coupon brings details.

**GET THE FACTS!**

**BIG FREE BOOK** tells all about your future in Electricity and how you can get ready quickly at COYNE. Dozens of pictures. Rush coupon today!

**PREPARE FOR PERMANENT  
JOBS LIKE THESE**

Light and Power Wiring  
Power Plant Work  
Armature Winding  
Substation Operator  
Maintenance Electrician  
Electrical Testing  
Signal Maintenance  
Industrial Electronics  
Electric Refrigeration  
and many others  
Our Employment Bureau for graduates gives **FREE Lifetime Job Service.**

**FREE  
BOOK**



**B. W. COOKE, Pres.  
COYNE ELECTRICAL  
AND RADIO SCHOOL, Dept. 88-72  
500 S. Paulina St., Chicago, 12, Ill.**

Send me your big **FREE BOOK** on **ELECTRICITY** and Special plan for men of draft age. This does not obligate me in any way and **no salesman will call on me.**

**COYNE ELECTRICAL AND RADIO SCHOOL**

**500 S. Paulina St., Dept. 88-72, Chicago 12**

This modern fireproof building is occupied entirely by COYNE. Located in Chicago, the Electrical Center of the World,  
**FOUNDED 1899**



**MAIL  
NOW**

NAME.....

ADDRESS.....

CITY..... STATE.....

**NOW-YOU CAN GET**

# BIG MONEY FOR LITTLE IDEAS

## CRYING NEED FOR 2100 INVENTIONS

**B**IG money waiting for people with ideas for new inventions, improvements, novelties! Thousands of manufacturers looking for new products to meet hundreds of post-war demands. YOU can cash in—if you KNOW which inventions are really needed!

It's often the *littlest* things that make the *biggest* money! The rubber pencil tip, ordinary paper clip, clamp fruit-jar top made fortunes for their inventors. The Kiddie Kar brought a cool million. A 70-year-old grandmother made \$350,000 with an overall buckle idea.

### This Book Will Get You Started

Don't waste time and work on something nobody wants! The big secret is in *knowing WHAT to invent!* That's just what this book gives you. Its author, Raymond F. Yates, noted science editor and inventor, lists and describes over 2100 PRACTICAL, money-making ideas that are crying aloud to be invented!

These 2100 needed inventions are the things *most needed and surest to make money in EVERY* field. For quick reference, you get them under 34 different headings: Electrical, Radio, Automotive, Agricultural, Mechanical, Building, Household, Clothing, Food, Toys, Time-Savers, etc., etc.

This book ALSO tells how to think inventively; how to PROTECT your ideas; how to develop an invention STEP-BY-STEP; the most needed inventions in *everyday* life, etc.

### FREE EXAMINATION OFFER

See for yourself what this amazing book can do for you. It doesn't cost a penny to find out! Simply mail coupon below without money—now. The book will be sent to you for 5 days' FREE examination. If you're not convinced that it's jam-packed with money-making ideas for YOU, return it in 5 days, pay nothing. Otherwise send only \$2.50, plus few cents actual postage, as payment in full.

Would YOU like a slice of the \$280,000,000 in royalties that is paid out to American inventors every year? Then you owe it to yourself to get started with this book NOW! Don't break your heart working on things that there's no eagerly-waiting market for! Any ONE of the 2100 "self-starting" ideas fully described in this great book will bring somebody a fortune—and it may as well be YOU! So mail coupon at once! **WILFRED FUNK, Inc., Publishers, Dept. T4911, 227 East 44 Street, New York 17, N. Y.**



### FREE 5-DAY EXAMINATION

**WILFRED FUNK, Inc., Publishers, Dept. T4911  
227 East 44 Street, New York 17, N. Y.**

Please send me 2100 NEEDED INVENTIONS for FREE EXAMINATION. If I keep the book I will send you \$2.50 plus few cents actual postage. Otherwise I will return it within 5 days, without further obligation.

Name \_\_\_\_\_

Address \_\_\_\_\_

City \_\_\_\_\_ Zone No. \_\_\_\_\_ State \_\_\_\_\_ (if any)

Check here if enclosing \$2.50 WITH this coupon, and we will pay all postage charges. Same 5-day return privilege, for full refund, applies. (Canadian Orders—25c extra for carrying charges. Only U. S. currency accepted.)

SAY YOU SAW IT IN POPULAR MECHANICS

## Have an OFFICE of YOUR OWN!

**LEARN NEW PROFITABLE PROFESSION**  
At Home in 60 Days, Men & Women, 18 to 70!

Be Your Own Boss and the Boss of Others. Be Respected. Meet Interesting People.

Earnings of men and women in this profession run as high as \$5,000-\$15,000 yearly. Others make good money in spare time. Little money needed to start. A business where your earnings begin sooner. Easy to learn. No selling or goods to buy. No experience necessary. A depression-proof business. A course of action to guide you step by step as you earn. All 53 lessons sent at once to use as operating manuals. Easy terms. Diploma. Money-back agreement. Write for FREE BULLETIN.



**FRANKLIN CREDIT SCHOOL**  
Dept. 75-M ROANOKE 7, VIRGINIA

BY MAIL in Easy Lessons

## LEARN TO WRITE a Good Hand!

FOR BUSINESS AND SOCIAL SUCCESS!

Easy to improve your handwriting at home quickly with my new instruction books just off the press. Master all the secrets of better penmanship. Simple and easy, fully illustrated, highly endorsed. Begin today. Write for:  New Free Book, "How to Become a Good Penman," or check books wanted, \$1.00 each.  Business Writing  Artistic Writing  Card Writing  Engrossing Alphabets  Bird and Design Flourishing  Complete Set \$4.50  Enclose 10c for your name beautifully written and special penpoint for shaded writing.

S. A. Ziller, President, TAMBLYN SCHOOL OF PENMANSHIP  
441 Ridge Bldg. In Business Over 52 Years Kansas City, Mo., U.S.A.

## LEARN WATCH REPAIRING



**AT HOME.** By our modern and original system of instruction you can learn every part of the WATCH REPAIRING TRADE AT HOME. Prepare yourself for a well-paying position or start in business after completing our course of instruction. Good watch repairers are in demand and generally earn very good salaries. For particulars apply to the Wisconsin School of Watch Repairing 759 North Milwaukee St., Milwaukee 2, Wis.

## SADDLE HORSES

LEARN HORSE TRAINING AND MANAGEMENT

SUBSCRIBE FOR The "EXPERT HORSEMAN" ONLY \$1.00 PER YEAR



FREE BOOK—You will also receive a booklet that tells how you can learn to Break Colts, Gait Show Horses, Train Rodeo, Stock, and Race Horses, Break Bad Habits, Handle any horse, Train Circus Trick Horses.

**ANIMAL LOVERS ASSOCIATION**  
BOX KA-111 TARZANA, CALIFORNIA

## 500 TRICKS MAGIC TRICKS

It's FUN to do MAGIC

Be popular! Amaze—mystify—entertain! For 30 years Douglas has satisfied customers all over the world. Now you can enjoy this fascinating hobby. Only 10c brings our new 1949 Catalog 500 Tricks, containing brand new tricks for pocket, parlor, stage. Join in the fun—send 10c today!

Douglas Magicland, Dept. C, Dallas, Texas

## ANALYZE Handwriting

Uncrowded, fascinating field. Gratifying earnings reported by graduates in Employment, Credit, Social Service, Police and Entertainment fields. Others have developed profitable private practice, full or spare time, as Personal Problem and Vocational Counselors. Send for 3000 word TEST LESSON and Grapho Analyst FREE.

A. I. G. A. Inc.

Witholt Bldg., Dept. 120 Springfield, Mo.



## MONEY for MEN ALL DATA FREE

THE PLASTEX Industry needs manufacturers on small scale and for big production of Lamp and Clock Stands, Art Goods and Novelties in Plastex and Marble imitation. Experience unnecessary, 1/2c material makes regular 10c store sellers. Rubber molds furnished for speed production. Small investment brings good returns. Big chain store orders now being placed. Ambitious men have chance for real prosperity. Our Free booklet will interest and benefit you.

PLASTEX INDUSTRIES, Dept. A  
3400 Third Ave. New York 56, N. Y.



# WHICH OF THESE *Opportunities* INTERESTS *You* MOST?

Accounting  
Air Conditioning  
Architecture & Building  
Automotive Engineering  
Aviation—Practical  
Aviation Drafting & Design  
Better Foremanship  
Bookkeeping  
Business Management

Contracting  
Diesel Engineering  
Drafting & Design  
Electrical Engineering  
Electricity—Practical  
Electronics, Industrial  
High School Courses  
Machine Shop Operations  
Mechanical Engineering

Plastics Engineering  
Plumbing—Practical  
Private Secretary  
Radio Operating & Servicing  
Railway Training  
Refrigeration  
Sheet Metal Pattern Drafting  
Shop Management  
Tool Making

## THINK! LOOK FORWARD!

Business is making big, new plans

Men and Women are preparing for the future

### WHAT ARE YOU DOING ABOUT YOUR TOMORROWS?

● *Today*, choose the job you want—and prepare for it. Or if you are already engaged in the work you like best, start training *now* for quicker promotion. Acquire the knowledge that will help you to get ahead faster, make more money and have greater security.

Invest part of your spare time in more rapid progress. Start training now, in spare time in your own home. Be ready to grasp your opportunity and step out ahead of those who lack the ability you have attained.

American School, founded in 1897 as an educational institution *not for profit*, can help you to reach your goal just as it has helped others during the past fifty-one years. Give serious thought to the list above. Pick one or more subjects that interest you. Then check the coupon at right, add your name and address and mail it at once. The school will send you details on its training plan and outline of study prepared by specialists. There is no charge, no obligation, so send the coupon immediately.

PRACTICAL, EFFECTIVE HOME - STUDY TRAINING SINCE 1897

Take This First Easy Step

**CHECK, CLIP AND MAIL COUPON NOW**

AMERICAN SCHOOL, Dept. G845, Drexel at 58th, Chicago 37, Ill.  
Without obligation, Please send FREE and postpaid, bulletin and details of the Subject checked.

- |  |  |  |
|--|--|--|
| <input type="checkbox"/> PLASTICS ENG'R            | <input type="checkbox"/> Accounting            | <input type="checkbox"/> Drafting and Design for Men and Women |
| <input type="checkbox"/> Refrigeration             | <input type="checkbox"/> Electrical Engr.      | <input type="checkbox"/> Radio                                 |
| <input type="checkbox"/> Architecture and Building | <input type="checkbox"/> Electricity-Pract.    | <input type="checkbox"/> High School                           |
| <input type="checkbox"/> Contracting               | <input type="checkbox"/> Electronics, Industr. | <input type="checkbox"/> Air Conditioning                      |
| <input type="checkbox"/> Practical Plumbing        | <input type="checkbox"/> Bookkeeping           | <input type="checkbox"/> Mechanical Eng.                       |
| <input type="checkbox"/> Automotive Engineering    | <input type="checkbox"/> Private Secretary     | <input type="checkbox"/> Shop Management                       |
| <input type="checkbox"/> Aviation Drafting         | <input type="checkbox"/> Diesel Engineering    | <input type="checkbox"/> Tool Making                           |
| <input type="checkbox"/> Aviation                  | <input type="checkbox"/> Sheet Metal           | <input type="checkbox"/> Better Foremanship                    |
| <input type="checkbox"/> Business Mgmtment         | <input type="checkbox"/> Pattern Drafting      | <input type="checkbox"/> Machine Shop Operations               |
| <input type="checkbox"/> Railway Training          |  |  |

Name..... Occupation.....

Address..... Age.....

City..... State.....

**AMERICAN SCHOOL**

Dept. G845, Drexel at 58th Street, Chicago 37

# Draw Your Way to Happiness-



## ART FOR PLEASURE AND PROFIT

Learn to Draw in Spare Time—at Home!  
**TRAINED ARTISTS** are capable of earning \$60, \$75 AND MORE A WEEK

Prepare yourself for a pleasant, profitable Art career. **COMMERCIAL ART, DESIGNING, CARTOONING**—all in one complete home study course. Enjoy a career with no age or physical limitations. Many pleasant art positions available in this great field. You can become your own boss, work at home and on your own time. Many students earn extra money while learning by designing posters, rendering signs, lettering, etc. W. S. A. is now in its 34th successful year of training men and women. No previous art experience necessary, we teach you step-by-step and prepare you for good jobs. **TWO ART OUTFITS** and other features included with training. Write for **FREE BOOK**, "Art for Pleasure & Profit"—tells about our course, instruction service and commercial opportunities for you.

APPROVED FOR VETERANS UNDER G. I. BILL

### FREE BOOK gives details

**WASHINGTON SCHOOL OF ART**, Studio 1211M  
 1115—15th St., N.W., Washington 5, D. C.  
 Please send me full information and your Free Book, "Art for Pleasure and Profit."

Name \_\_\_\_\_ AGE \_\_\_\_\_  
 Street \_\_\_\_\_  
 City \_\_\_\_\_ Zone \_\_\_\_\_ State \_\_\_\_\_  
 I am entitled to training under the GI Bill



## HIGH PAY JOBS



## FOR MEN WHO QUALIFY IN DIESEL

**ASSURE YOUR FUTURE.** Steady, big pay jobs await men qualified in Diesel, Tractor and Heavy Equipment. Can you take advantage of Diesel job and advancement opportunities in this fast-growing field?

### COMPLETE DIESEL COURSE AVAILABLE

If you are ambitious and want to get ahead in this lucrative field, you'll want to know about the complete training in Diesel provided by Interstate. Trains you at home in spare time. Does not interfere with your present job. Covers all phases of operation. Up to the minute. Revised regularly to cover new developments. Free placement advisory service.

### YOU OWE IT TO YOURSELF

to investigate I.T.S. home Diesel training. Thousands of students agree it has helped them to better jobs... better pay. It can do the same for you!

### SEND FOR FREE BOOK TODAY!

We'll gladly send you our big 24-page book "Getting Ahead In Diesel" FREE! Paste coupon on penny card and mail to

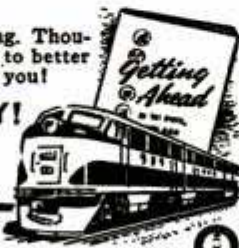

**INTERSTATE TRAINING SERVICE**  
 4035 N. E. Sandy, Portland 13, Ore.  
 Please see that I receive FREE BOOK "Getting Ahead In Diesel":

Name \_\_\_\_\_ Age \_\_\_\_\_  
 Address \_\_\_\_\_  
 City \_\_\_\_\_ Zone \_\_\_\_\_ State \_\_\_\_\_ M-3

## PROTECT LIVES and PROPERTY with these

### LOW COST FIRE EXTINGUISHERS

A little foresight now may save LIVES and PROPERTY later. Equip your home, your garage, your office, your boat with **AutoFYRstop**, the modern fire extinguisher and alarm that is setting new records... Write for **FREE** literature today.



**KILLS FIRE BY ITSELF**



**MONEY MAKING OPPORTUNITY**

We have openings for high grade salesmen in choice territories. If interested in outstanding money-making opportunity, write for plan TODAY!

**AUTOFYRSTOP CO., Dept. PM-1148**  
 2035 Washington Ave., Philadelphia 46, Pa.

# CHEMISTRY

**LEARN AT HOME...** Chemical knowledge is essential for thousands of good jobs in industry, business, science. IPC enables you to master practical chemistry. It's the **ONLY** home study chemistry course which enables you to learn by performing actual experiments—using chemicals and apparatus supplied with the course—in addition to your IPC textbook studies. Compares with recognized college courses in General Chemistry. Write today for free descriptive booklet.

**INSTITUTE OF PRACTICAL CHEMISTRY**  
 3 PROSPECT AVENUE, HAGERSTOWN, MD.

## LAW FREE BOOK



Your **FREE** copy of "The Law-Trained Man" shows how to gain prestige and greater earnings through Blackstone home law study. All instruction material furnished including 18-volume Law Library written by 65 well-known law authorities. Lawyers, judges among our graduates. L.L.B. degree. Low cost; easy terms. Write today.

**BLACKSTONE COLLEGE OF LAW** Dept. 58, Chicago 1, Ill.  
 A Correspondence Institution Founded in 1890

*Learn to Write at Home in spare time*

You can become a good Business and Artistic Penman at home in spare moments by my Simplified Method. Write for my **FREE BOOK**, "How to Become an Expert Penman," which shows that others have learned. Send 10c for Special Penpoint and your name with a flourished bird written on a card. Write TODAY.

J.M. Lewis, Box 25K, Chillicothe, Mo.

## TRI-STATE COLLEGE

B. S. Degree in 27 months in Civil, Electrical, Mechanical, Chemical, Aeronautical, Radio Engineering; Bus. Admin., Acc't and Sec. Science. Graduates successful. 65th year. Enter Jan., March, June, Sept. Catalog. 4118 College Ave., Angola, Ind.

**PLAY GUITAR LIKE THE COWBOYS DO... 8 1/2 A LESSON**

Just out—very latest guaranteed, simple, easy method. Play cowboy songs the Western way in a few minutes by ear. Surprise and amaze your friends. Be in big demand at parties, camps, public entertainments, on the radio, etc. 12 Complete Lessons. **SEND NO MONEY**. Pay postman only \$1.00 charges, or send \$1.00 and get EXTRA SONGS all postpaid. (Canada, \$1.25 money order only.) Nothing else to buy. Positive money back guarantee. Rush order today.

**WESTERN RANGER STUDIO, Dept. 1511, Hutchinson, Kan.**

# 10 Reasons Why...

## D.T.I. IS ONE OF YOUR BEST BUYS

- 1 You profit from our 17 years of "Know-how" in preparing men for real opportunities in the Radio-Electronics field.
- 2 A faculty of more than 60 skilled residential and 15 extension instructors to guide students in their training.
- 3 You may learn at home or in our new, modern laboratories in Chicago.
- 4 Home Movies, an exclusive D.T.I. feature, help you learn faster... easier at home.
- 5 You receive many shipments of commercial-type equipment which give you practical "on-the-job" experience in your own home. You keep all of this equipment — working about 180 experiments, including a permanent 6-tube Radio Receiver the entire family will enjoy.
- 6 You build and keep modern-type test equipment which you can regularly use for analyzing, checking and testing purposes.
- 7 You also get lessons with many illustrations and schematic drawings that make electronic circuits easier to understand.
- 8 The only training of its kind to be awarded the Certificate of Merit by the New York Museum of Science and Industry.
- 9 EFFECTIVE EMPLOYMENT SERVICE is available when you complete your training to help you get started.
- 10 Consultation Service. After you have completed your training, you are privileged to write for additional information to help you with "on-the-job" problems.

## D.T.I. can prepare you for a profitable future in TELEVISION Radio - Electronics

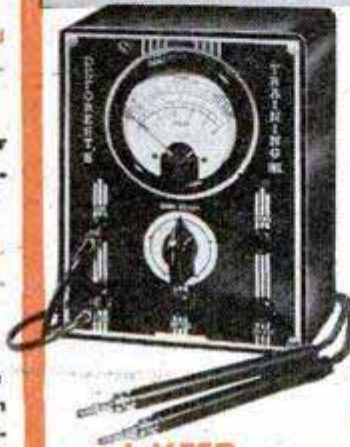

**You BUILD and KEEP** this jewel bearing MULTI-METER (above) and 6-tube "Super-Het" Receiver (below) giving you practical experience at home in ASSEMBLY... WIRING... SOLDERING... TESTING... TROUBLE SHOOTING!



See how DeForest's Training, Inc. can start preparing you now for the opportunities ahead in TELEVISION... RADIO... ELECTRONICS. We provide practical training in your own home to help you gain the confidence and "know-how" to fit you for a responsible, well-paying job or your own business. D.T.I. trains you rapidly, thoroughly, by using modern instruction methods and equipment. Write today for free facts on how you, too, may get started toward a profitable, exciting career.

### NO EXPERIENCE NECESSARY

D.T.I. sends every major aid to speed your home training. In addition to the many shipments of Radio-Electronics parts and assemblies, you receive well illustrated, loose-leaf lessons, prepared in clear, simple language to help you learn faster, easier.

### YOU ALSO USE HOME MOVIES

Only D.T.I. provides you with this all important home training aid that makes Radio-Electronics principles remarkably clear and easier to understand. We lend you a 16 mm. projector and many reels of information-packed film.

### EMPLOYMENT SERVICE

When you complete your training, our Employment Service will help you get started. Mail coupon today for full details.

### MAIL THIS OPPORTUNITY COUPON NOW!

DeForest's Training, Inc.  
2533 N. Ashland Ave. Dept. PM-E11  
Chicago 14, Illinois

Send me complete details, showing how I may make my start in Radio-Electronics-Television. No obligation.

Name ..... Age.....

Address ..... Apt.....

City ..... Zone ..... State .....

If under 16, check here for special information  If a discharged veteran of World War II, check here.

## DeFOREST'S TRAINING, INC.

CHICAGO, ILLINOIS

Associated with the DeVry Corporation,  
Builders of Electronic and Movie Equipment



## Satisfied with my JOB and PAY? NOT ME!!

"Some day I'll really get a break and go right on to the top." That's wishful thinking.

You know that the "breaks" go to the man or woman who is prepared to take advantage of them—to the person who can fill the better job and is worth more money. He makes the "breaks" instead of waiting for them.

You can influence your own future by preparing now for the step forward—so that openings come because you are equipped for them—not as the result of luck.

Why not take the road that thousands of ambitious men and women have taken to help them to better jobs and more money.

Prepare now. Send the coupon below—check the business field of your choice and we'll send you without obligation our FREE 48-page book describing the opportunities and complete information on that field—plus "Ten Years' Promotion in One"—a book which has helped many men.

Send the coupon Now. It may be the turning point in your life to that better job and more money.

**LASALLE Extension University**  
A Correspondence Institution  
Dept. 1164-R Chicago 5, Ill.

### LASALLE Extension University A Correspondence Institution

417 S. Dearborn St., Dept. 1164-R, Chicago 5, Ill.

I want to make my own "breaks" by preparing for a better job. Send free 48-page book on the subject I have checked.

- |  |  |
|--|--|
| <input type="checkbox"/> Higher Accountancy  | <input type="checkbox"/> Salesmanship                  |
| <input type="checkbox"/> C.P.A. Coaching     | <input type="checkbox"/> Traffic Management            |
| <input type="checkbox"/> Bookkeeping         | <input type="checkbox"/> Foremanship                   |
| <input type="checkbox"/> Law: LL.B. Degree   | <input type="checkbox"/> Industrial Management         |
| <input type="checkbox"/> Business Management | <input type="checkbox"/> Stenotypy (Machine Shorthand) |

Name ..... Age .....

Address .....

City ..... Zone ..... State .....

Please Mention Popular Mechanics When Answering Ads

# FREE HOBBY BOOK

For MEN and BOYS  
TELLS HOW TO LEARN TO  
MOUNT BIRDS

and animals, fish, pets, and all game. Learn to TAN SKINS with wonderful Krome-Tan. Simple as ABC. Many earn big PROFITS in spare time mounting for others. Great FUN. Wild game not needed. Over 500,000 students since 1903. RUSH postal TODAY for STRANGE BOOK, over 100 game pictures. FREE. No obligation. State AGE! N. W. School of Taxidermy, 2571 Elwood Bldg., Omaha 2, Neb.



## WATCH REPAIRING

Be a Master Watchmaker! Graduates earn big money—many in business for themselves. The famous Sweazey System of Instruction teaches you quickly and easily. Our 41st year.

Write today for free information.

**CHICAGO SCHOOL OF WATCHMAKING**  
Dept. 1118, 1608 Milwaukee Ave. Chicago 47, Ill.

**"How to Make Money with Simple Cartoons"**  
A book everyone who likes to draw should have. It is free; no obligation. Simply address **FREE BOOK**

**CARTOONISTS' EXCHANGE**  
Dept. 911-D Pleasant Hill, Ohio

## WATCHMAKING

### JEWELRY ENGRAVING AND REPAIR

Enter this high-paying, time-honored profession, or prepare for a business of your own. Watchmakers in great demand. More jobs than qualified workers. Study under expert instructors in a long-established, nationally recognized school. Receive recognized diploma and certificate. Placement service. Approved under G. I. Bill. Write for FREE booklet.



**The Baronian School, Inc.**

2116 WALNUT ST. (DEPT. C) PHILA. 3, PA.

## INVENTING

**—FOR PROFIT!** If you have an inventive turn of mind, write for free 28-page booklet explaining how the Institute of American Inventors is helping inventors pre-test the profit possibilities of proposed devices to fill today's unprecedented demand for useful new inventions.

**INSTITUTE OF AMERICAN INVENTORS**  
Dept. 4, 1926 Eye St., NW, Washington 6, D. C.

## BAKING

**— a Sound Trade or Business**



Baking is one of America's high industries in wages. Not seasonal, but year 'round good field for trained and experienced men. Thorough basic spare time home study course lays solid foundation. If you have aptitude for this type of work, send coupon below for FREE Booklet, "Opportunities in Commercial Baking."

**NATIONAL BAKING SCHOOL**  
1315 S. Michigan Ave., Dept. 1358, Chicago 5, Ill.  
Send free booklet "Opportunities in the Baking Industry" and full particulars.

Name .....  
Address .....  
City ..... State .....



**1 FIRST:** You get vital basic knowledge at home—during spare hours. Train as fast or as leisurely as you like.



**2 THEN:** You come to ITI's giant shops in Chicago—for a Full Four Weeks of practical instruction and actual work on newest, most modern equipment.



**REFRIGERATION**—Trained men needed to handle service and repair jobs.



**AIR CONDITIONING**—Plenty of opportunity in this great industry for trained men.

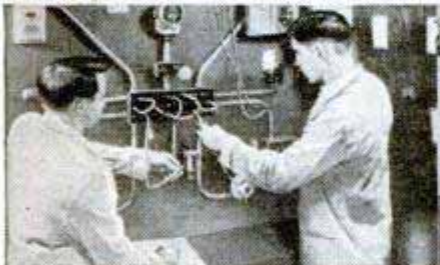

**HEATING**—ITI trains you in this big pay field to handle essential service work.



**INDUSTRIAL TRAINING INSTITUTE**  
Formerly the L. L. Cooke School of Electricity & Refrigeration & Air Conditioning Institute  
Dept. L-1, 2150 LAWRENCE AVE., CHICAGO 25, ILL.

Prepare **NOW**—Start Training in Spare Time for a **BETTER JOB** in

# REFRIGERATION AIR CONDITIONING

Good Practical Training Pays Rich Rewards in **BIGGER PAY** and Steady Advancement

## AMERICA'S FOREMOST SCHOOL of PRACTICAL TRAINING preparing ambitious men for greater opportunities since 1916

••• Now is the time to lay your plans for a better job at better pay! Get the facts about your future in the amazingly FAST GROWING field of Refrigeration, Air Conditioning and Heating! Men who know how to install, repair, rebuild and maintain this equipment are going ahead FAST! But many more fine jobs are open NOW in this rapidly expanding industry in both the home and commercial equipment fields. Experts say the opportunities are almost unlimited... BUT ONLY THE PROPERLY TRAINED MEN CAN QUALIFY!

### Train at Home and in ITI's Huge Shops

Investigate the Industrial Training Institute's 2-Way Course in Refrigeration, Air Conditioning AND Heating. In a few months this training gives you solid, practical, down-to-earth knowledge and experience you need. You don't have to leave home or give up your present job. Then you come to the huge ITI shops in Chicago for FOUR FULL WEEKS of action-packed practical experience!

### Interesting, Practical Course

You don't need any special schooling or experience to master the ITI course. Just a desire to learn and advance. Useless theory and dull mathematics have been reduced to a minimum. ITI lesson Work Sheets are easy to read, interesting and 100% practical. The ITI trained man is ready to handle any practical job in the industry. And ITI helps you find your job!

### VETERANS:

ITI Residence Training is fully approved under the G. I. Bill.

ITI also trains ambitious men for good pay jobs in . . .

- Electricity & Industrial Electronics
- Machine Drafting & Design
- Precision Instruments

### TRAINING MEN FOR INDUSTRY SINCE 1916!

ITI Training is backed by more than 30 years of success and experience. We have given training to over 400,000 men since 1916. Today thousands of ITI graduates hold down top paying jobs. ITI occupies five large buildings, with over \$500,000.00 invested in shops and training facilities. Instruction staff of more than 150 men. ITI is recognized as the world's foremost school of practical training!

### Mail Coupon for FREE Facts!

Find out about ITI Training. See for yourself how easy and simple it is to start at home, in your spare time, and prepare yourself for a fine job with a real future. It's all in ITI's fascinating, illustrated FREE book, "Your Future in Refrigeration & Air Conditioning." Just fill out and mail the coupon below NOW! Take this first step toward success TODAY!

MAIL COUPON TODAY FOR  
**FREE BOOK!**

Mr. C. H. Smith, President,  
INDUSTRIAL TRAINING INSTITUTE  
2150 Lawrence Ave.,  
Dept. L-1, Chicago 25, Ill.

Please send me FREE the ITI book, "Your Future in Refrigeration and Air Conditioning" and information about the opportunities for trained men in this fast growing field. I understand I'm under no obligation.

NAME \_\_\_\_\_ AGE \_\_\_\_\_

ADDRESS \_\_\_\_\_

CITY \_\_\_\_\_ ZONE \_\_\_\_\_ STATE \_\_\_\_\_

ARE YOU A VETERAN? \_\_\_\_\_



# 9 BIG BUILDING BOOKS

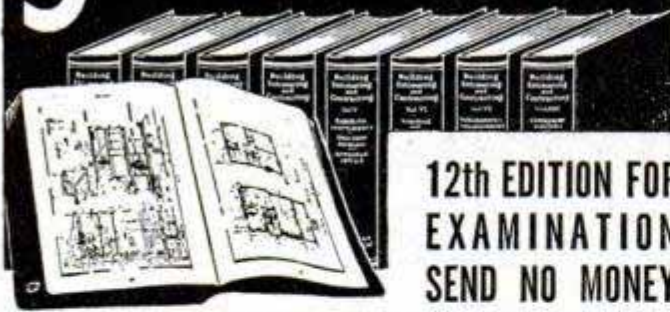

**12th EDITION FOR EXAMINATION SEND NO MONEY**

Learn to draw plans, estimate, be a live-wire builder, do remodeling, contracting. These 9 practical, profusely illustrated books cover subjects that will help you to get more work and make more money. Masonry, concrete forms, carpentry, steel square, roof framing, construction, plumbing, heating, painting, decorating and many other subjects. More than 4000 pages—2750 illustrations.

## BETTER JOBS — BETTER PAY

A nationwide building boom is in full swing and trained men are needed. Big opportunities are always for **MEN WHO KNOW HOW**. These books supply quick, easily understood training and handy, permanent reference information that helps solve building problems.

## UP-TO-DATE EDITION

These books are the most up-to-date and complete we have ever published on these many subjects.

## Coupon Brings Nine Big Books for Examination

**AMERICAN TECHNICAL SOCIETY—Publishers since 1898**  
Dept. G819 Drexel at 58th Street Chicago 37, Ill.

You may ship me the Up-to-Date edition of your nine big books, "Building, Estimating and Contracting," without any obligation to buy. I will pay the delivery charges only, and if fully satisfied in ten days, I will send you \$2.00, and after that only \$3.00 a month, until the total price of \$34.80 is paid. I am not obligated in any way unless I keep the books.

Name.....

Address.....

City.....State.....

Please attach a letter stating your age, occupation, employer's name and address, and name and address of at least one business man as a reference. Men in service, also please give home address.

## The Steady Pay Profession Good Times or Bad!

### SCIENTIFIC CRIME DETECTION

FOLLOW THIS MAN

Operator No. 38



### It Is Easy to Learn!

I will teach you this fascinating science during your spare time at home. It pays to be an expert in Finger Printing, Firearms Identification, Police Photography and Criminal Investigation. I have trained hundreds of men and women now successfully serving in identification bureaus throughout America. You, too, may quickly prepare yourself to become a well-paid valued officer of the law, often sharing in the generous rewards offered for wanted criminals.

**FREE! OVER 800**

### "BLUE BOOK OF CRIME"

This book is full of exciting information on scientific crime detection. It will show how you can get started in a grand career. Now, at amazingly low cost. Clip coupon now...Mail it today.

of all Identification Bureaus in the U. S. employ students and graduates of I. A. S. A majority of these men are heads of Bureaus. Many of them knew nothing about crime detection before training with me. Now they have steady jobs, good salaries and a fine future. Write today for full particulars and free book. Give age.

### INSTITUTE OF APPLIED SCIENCE

1920 Sunnyside Ave., Dept. 1358, Chicago 40, Ill.

**INSTITUTE OF APPLIED SCIENCE**  
1920 Sunnyside Ave., Dept. 1358, Chicago 40

Gentlemen: Without any obligation on my part, send me the "Blue Book of Crime," and complete list of Identification Bureaus employing your students or graduates, together with your low prices and Easy Terms Offer. (Literature will be sent ONLY to persons stating their age.)

Name..... Age.....

Address.....

RFD or Zone..... State.....



## For Trained men in the uncrowded field of Wood production Engineering

The steps to top positions in the wood working industry, through resident study and training in Grand Rapids, or correspondence home study course are all described when you Write Now and

## GET THIS FREE BOOK

Veterans make wood working your vocation. You can study and train FREE under G. I. Bill. State preference for resident or correspondence course, with Name, Age, occupation, and if veteran Write now to

**KLOK INSTITUTE**  
LOUIS ST. N.W.  
GRAND RAPIDS 2, MICH.



## GENERAL LEATHERCRAFT

You can make attractive leather articles easily when you follow the simple instructions in Raymond Cherry's book "GENERAL LEATHERCRAFT." One of the finest books ever published. Includes 78 "show how" illustrations as well as designs and complete directions for making 35 useful articles—for personal use, gifts or sale. At Craft stores or direct only \$1.20 postpaid. Or sent COD plus postage. Order today. McKNIGHT & McKNIGHT, 136 W. Market St., Bloomington, Ill. Clip this.



## LABORATORY TECHNICIAN

BE A LABORATORY SPECIALIST; complete course. Big demand from hospitals, doctors, clinics. We teach all branches of medical laboratory work, including Medical and Dental X-Ray.

Approved by American College of Medical Technologists  
Co-educational Free Placement Bureau  
Free Catalog

Accredited for "veteran" training  
**CHICAGO COLLEGE OF LABORATORY TECHNIQUE**  
Dept. P.M., 431 S. Wabash Ave. Chicago 5, Illinois

## ARTISTS MAKE MONEY

Do you like to draw? Send name, address, age and occupation for FREE ART TEST, to find out your ability.

**ART INSTRUCTION, Inc.**  
11138 ART INSTRUCTION BLDG., MINNEAPOLIS 15, MINN.

# If Ruptured Try This Out

**Modern Protection Provides Great Comfort and Holding Security Without Torturous Truss Wearing**

An "eye-opening" revelation in sensible and comfortable reducible rupture protection may be yours for the asking, without cost or obligation. Simply send name and address to William S. Rice, Inc., Dept. 32-C, Adams, N. Y., and full details of the new and different Rice Method will be sent you Free. Without hard flesh-gouging pads or tormenting pressure, here's a Support that has brought joy and comfort to thousands — by releasing them from Trusses with springs and straps that bind and cut. Designed to securely hold a rupture up and in where it belongs and yet give freedom of body and genuine comfort. For full information—write today!



# GET INTO DRAFTING

The Draftsman Plays a most  
Important Part in INDUSTRY

## DRAWING OUTFIT INCLUDED with Drafting courses

All the tools you need including folding drawing table. With them you can put your ideas on paper quickly and with accuracy. With training you are all set to master Drafting in months, — not years — at home.

### Learn in Spare Time—At Home!

(or at the College in Chicago)

A few hours of pleasant home study every week — that's all. With Chicago Tech's help, you train yourself step by step. This tested method — developed over 44 years of C.T.C. progress — prepares men for good positions in industry.



Practically everything that's built or manufactured these days is constructed from blue print drawings prepared by the draftsman. He is the KEY man in industry. No new machines can be built, no bridges erected, no buildings constructed until the draftsman has completed his work.

Drafting is clean, interesting, professional-type work. The draftsman is paid well to start. And he has real opportunities for advancement to high-pay jobs in Engineering. The tremendous production programs ahead in industry will require more draftsmen than ever before.

Send today for free information. See what this training has done for others, what it can do for you. Simply MAIL COUPON TODAY in an envelope or use a penny postcard.

## MAIL COUPON NOW

Chicago Technical College  
P-211 Tech Bldg., 2000 So. Michigan Ave.  
Chicago 16, Illinois

Mail me FREE Drafting Lesson with information about big opportunities in DRAFTING and how I can train at home.

- Architectural Drafting       Electrical Drafting  
 Machine Drafting           Structural Drafting  
 Builders' Course

Name \_\_\_\_\_ Age \_\_\_\_\_

Address \_\_\_\_\_

City \_\_\_\_\_ Zone \_\_\_\_\_ State \_\_\_\_\_

**CHICAGO  
TECHNICAL COLLEGE**  
P-211 Tech Building, 2000 South Michigan Ave.  
Chicago 16, Illinois

## Get this Great Catalog of MAGIC



Amazing tricks, mystifying and spooky stage and party illusions. Easy to do—no skill—perfect instructions. Fool your friends. Loads of fun. Add "life" to any party. 350 pages. 600 illustrations. Mail \$1.00 for catalog, credited on your first order for \$5.00 or more.

**NATIONAL MAGIC COMPANY**  
119 S. State St., Dept. P-11  
Chicago 3, Ill.

## LEARN TRIG QUICKLY—EASILY

BY COMPETITIVE TESTS

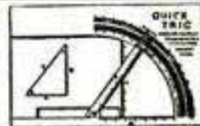

It was found that QUICK TRIG gave answers faster to one with a slight knowledge of trig than to an expert on trig with a slide rule. Simply set the slides and read the answers for all three sides and angles of a triangle. Also gives degrees, sines, cosines and tangents of angles. Entirely automatic. Easy instructions included FREE. We mail C.O.D. plus postage or enclose \$1.00, the full price, and we will mail postpaid. Send now for your QUICK TRIG, to

**REED MFG. CO., 11350-D Burbank Blvd., N. Hollywood, Calif.**

# LEARN MEAT CUTTING EASILY - QUICKLY At Home - In Spare Time



The steady, dependable trade of Meat Cutting taught easily, quickly by improved HOME METHOD. National School, established over 25 years, has organized its famous "Learn By Doing" Classroom, Cutting room and Retail Market training system into sound, practical HOME STUDY form.

Now, by the miracle of this EXTENSION TRAINING you can prepare in Your Spare Time At Home, for a better job, bigger responsibilities or success and security in a store of your own. Remember, PEOPLE MUST EAT!

Buying, cutting, percentage, pricing, advertising, selling— a complete meat education. For beginner or men with ex-

perience. Thousands of successful graduates. Send coupon for FREE Bulletin NOW!

## MAIL THIS COUPON TODAY FOR FREE BULLETIN

National School of Meat Cutting Div. U-99, Toledo 4, Ohio

Send me your FREE Bulletin on Meat Cutting and Meat Merchandising. No obligation. No Salesman will call.

Name \_\_\_\_\_

Street \_\_\_\_\_

City \_\_\_\_\_ State \_\_\_\_\_

# Do you want

- ..to go to College?
- ..or to enter a Profession?
- ..or get an Office Position?

(Such as Accounting, Architecture, Nursing, Dentistry, Teaching, Social Work, Osteopathy, Beauty Culture, Optometry, Embalming, Chiropractic, Law, Medicine, etc.)

To get anywhere, you practically **MUST** finish High School **FIRST**. You can complete our simplified High School Course in **SPARE** time at home, as **FAST** as your time and abilities permit. Equivalent to resident school work—prepares you for college, pre-professional examinations, business, industry. Standard texts furnished. Diploma. Credit for H. S. subjects already completed. Single subjects if desired. Low tuition, easy terms. American School, Chicago, est. 1897—endorsed by educators. Finish your high school education **NOW**, Write **TODAY!**

## High School Course at Home Many Finish in 2 Years

American School, Dept. H845, Drexel Ave. at 58th St., Chicago 37, Ill.

Gentlemen: Send me **FREE** information covering special training in subjects checked below. No obligation on my part.

- |  |  |
|--|--|
| <input type="checkbox"/> High School Course          | <input type="checkbox"/> Diesel Engineering                  |
| <input type="checkbox"/> Architecture and Building   | <input type="checkbox"/> Drafting and Design for Men & Women |
| <input type="checkbox"/> Automotive Engineering      | <input type="checkbox"/> Plastics                            |
| <input type="checkbox"/> Business Management         | <input type="checkbox"/> Private Secretary                   |
| <input type="checkbox"/> Electrical Engineering      | <input type="checkbox"/> Mechanical Engineering              |
| <input type="checkbox"/> Elec. and Gas Refrigeration | <input type="checkbox"/> Aviation                            |
| <input type="checkbox"/> Air Conditioning            | <input type="checkbox"/> Salesmanship                        |
| <input type="checkbox"/> Railway Training            | <input type="checkbox"/> Radio                               |
| <input type="checkbox"/> Electronics, Industrial     |  |

Name.....

Address.....

→ LEARN ←

# AVIATION

AN ESSENTIAL INDUSTRY IN PEACE OR WAR  
**MAXIMUM TRAINING IN MINIMUM TIME**

for 19 years Cal-Aero Technical Institute has specialized in....

## ✓ AERONAUTICAL ENGINEERING

2 year course — kept abreast of new research and scientific development.

## ✓ MASTER AVIATION MECHANICS

1 year course — C. A. A. approved for Airplane and Engine License.

Modern "live" training equipment, including helicopters, jets, rockets, wind tunnel... Classes start monthly—Room and board available on our airport... Cal-Aero Tech Training is carefully designed for just one thing—**TO MAKE MORE MONEY FOR YOU**. More than 7000 successful graduates in addition to 26,000 pilots and 7500 mechanics trained for Army & Navy Air Forces, prove that our career training is unsurpassed. **APPROVED FOR VETERANS**



GRAND CENTRAL AIR TERMINAL  
 GLENDALE 1, CALIFORNIA  
 LOS ANGELES COUNTY

### MAIL THIS COUPON TODAY!

Please send full information on Aviation Training **FREE**—without obligation.

Name..... Birth Date.....

Street..... Zone.....

City..... State.....

CHECK ONE  VETERAN  NON-VETERAN PM-11

## SEND FOR FREE CATALOG!

*Out of Pawn!*

# GENUINE DIAMONDS



**Direct to You**—Save up to 50% and more on fine quality, Genuine Diamonds, reset in beautiful modern mountings, styled for Ladies and Men—Sold with an Iron-Clad Money-Back Guarantee. Over 100,000 satisfied customers. Order now from this ad. Write us for **FREE ILLUSTRATED CATALOG** of other Unredeemed Diamond Pledges from \$5.00 to \$5000. Send today. Reference: Any Bank or any Mercantile Agency.

1/5 CARAT  
 \$125 Value

**\$49**  
 Tax incl.

1/2 CARAT  
 \$200 Value

**\$95**  
 Tax incl.

### BERMAN'S COLLATERAL LOAN BANK

Dept., P.M., 636-38 W. Balto. St.,

Baltimore 1, Md.

## BE A MAGICIAN

*Learn this fascinating hobby by mail*

You can amuse and mystify your friends from the first instructions. Learn magic secrets the easy way. Send 10c for full details, illustrated magic catalogue, and your first trick.

### CALIFORNIA MAGIC DEPOT

Dept. M, 2491 Telegraph Ave.

Berkeley, California

## Be an INVESTIGATOR

**JAMES S. BOLAN**, FORMER POLICE COMMISSIONER OF NEW YORK CITY offers **MEN & WOMEN** an attractive opportunity to prepare for a future in *Investigation & Criminology* by comprehensive Home Study Course. Free placement service assists graduates to obtain jobs. **APPROVED UNDER G. I. BILL OF RIGHTS.**

Write for Free Booklet PM.

### THE BOLAN ACADEMY, INC.

EMPIRE STATE BLDG., NEW YORK 1, N. Y.

## THERE'S MONEY IN CARTOONS!

**RAYE BURNS** will teach you **HOW** to **CREATE ORIGINAL CARTOONS** at home that you may **SELL!** Course contains 26 lessons and over 600 illustrations. All for **Only...**

**\$2.85**

Send name and address for free details.

**RAYE BURNS SCHOOL**, Dept. M, Box 3583, CLEVELAND, OHIO

NATION'S  
 LARGEST  
 EXCLUSIVE  
 ELECTRICAL  
 SCHOOL

"LEARN-BY-DOING"

# ELECTRICITY

PRACTICAL TRAINING  
 NOT "HOME STUDY"

**G.I. APPROVED** Get actual experience in great shops of M.T.I. Learn all phases Practical Electricity; Housewiring, Motors, Const., Maintenance, etc. Living arrangements, Part-time jobs, etc.

Send coupon **TODAY**.

**MICHIGAN TECHNICAL INSTITUTE**  Veteran  
 2281 W. Fort St., Detroit, Mich., Dept. PM-11

Name.....

Street.....

City..... State.....





# Learn RADIO

## TELEVISION, ELECTRONICS

by

### SHOP METHOD HOME TRAINING

Let NATIONAL SCHOOLS, of Los Angeles, a practical Technical Resident Trade School for almost 50 years, train you for today's unlimited opportunities in Radio

You receive all parts, including tubes, for building this fine, modern Superheterodyne Receiver. This and other valuable standard equipment becomes your property.

these two **FREE** books will tell you how

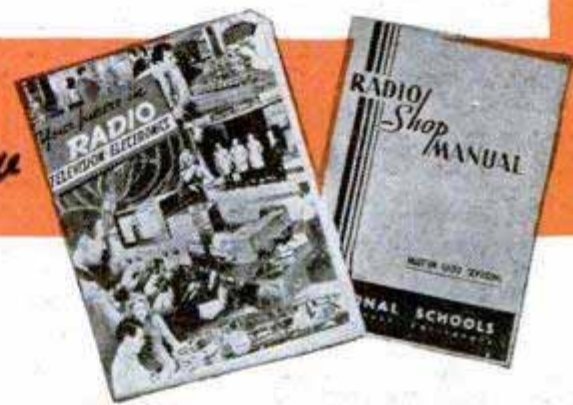

### Good Jobs Await the Trained Radio Technician

You are needed in the great, modern Radio, Television and Electronics industry! Trained Radio technicians are in constant and growing demand at excellent pay—in Broadcasting, Communications, Television, Radar, Research Laboratories, Home Radio Service, etc. National Schools Master Shop Method Home Study Course, with newly added lessons and equipment, can train you in your spare time, *right in your own home*, for these exciting opportunities. Our method has been proved by the remarkable success of National Schools-trained men all over the world.

### You Learn by Building Equipment with Standard Radio Parts We Send You

Your National Schools Course includes not only basic theory, but practical training as well—you learn by doing. We send you complete standard equipment of professional quality for building various experimental and test units. You advance step by step until you are able to build the modern superheterodyne receiver shown above, which is yours to keep and enjoy. You perform more than 100 experiments—build many types of circuits, signal generator, low power radio transmitter, audio oscillator, and other units. The Free Books shown above tell you more about it—send for them today!



### NOW! NEW PROFESSIONAL MULTITESTER INCLUDED



This versatile testing instrument is portable and complete with test leads and batteries. Simple to operate, accurate and dependable. You will be able to quickly locate trouble and adjust the most delicate circuits. You can use the Multitester at home or on service calls. It is designed to measure AC and DC volts, current, resistance and decibels. You will be proud to own and use this valuable professional instrument.

GET THE DETAILS—SEND THE COUPON

### LESSONS AND INSTRUCTION MATERIAL ARE UP-TO-DATE, PRACTICAL, INTERESTING

National Schools Master Shop Method Home Training gives you basic and advanced instruction in all phases of Radio, Television and Electronics. Each lesson is made easy to understand by numerous illustrations and diagrams. All instruction material has been developed and tested in our own shops and laboratories, under the supervision of our own engineers and instructors. A free sample lesson is yours upon request—use the coupon below.

- Here's Just a Few of the Interesting Facts you Learn with the **FREE MANUAL**
1. Routine for diagnosing Radio Troubles.
  2. Preliminary inspection of Receivers.
  3. How to Test and Measure Voltages.
  4. How to Test Speaker in Audio Stages.
  5. How to Trace the Circuit and Prepare Skeleton Diagram.
  6. Complete Reference Table for Quickly Locating Receiver Troubles.

Both Resident and Home Study Courses Offered

**APPROVED FOR VETERANS CHECK COUPON**

**NATIONAL SCHOOLS**  
LOS ANGELES 37, CALIF. • EST. 1905

### MAIL OPPORTUNITY COUPON FOR QUICK ACTION

National Schools, Dept. PM-11  
4000 South Figueroa Street  
Los Angeles 37, California

(Mail in envelope or paste on penny postcard.)

Mail me **FREE** the books mentioned in your ad including a sample lesson of your course. I understand no salesman will call on me.

NAME \_\_\_\_\_ AGE \_\_\_\_\_

ADDRESS \_\_\_\_\_

CITY \_\_\_\_\_ ZONE \_\_\_\_\_ STATE \_\_\_\_\_

Check here if veteran of World War II

# Learn **RADIO** -TELEVISION F.M.-ELECTRONICS



## in the GREAT SHOPS OF **COYNE**

Get ready for a better job, bigger pay NOW in Radio. Cash in with "All-around" knowledge of Radio—Television. Train on actual equipment. You learn easily at COYNE because it's real shop training. Thousands of graduates in Industry.

### Not a "Home-Study" Course!

You get actual shop work on full-size equipment plus necessary theory. Whether you had previous experience or not makes no difference at Coyne.

### Easy To Start Own Shop

Right along with our course, we include special training on how to operate your own Radio Shop.

GI Approved—Finance Plan for Non-Vets  
Special Plan for Men of Draft Age

If you need part-time work to help out with living expenses while at Coyne we'll help you get it. Don't be held back by lack of money. Free employment service to graduates.

### SEND FOR FREE BOOK

Get the facts! BIG FREE BOOK tells about your future in Radio and Television and how you can prepare at Coyne. Dozens of pictures. No obligation—no salesmen will call.

Established 1899

### MAIL COUPON TODAY!

B.W. COOKE, President  
COYNE Electrical and Radio School  
500 S. Paulina St., Dept. 88-3H, Chicago 12, Ill.

Please send me your Big Free Radio and Television Book and all facts, including plan for men of draft age.

NAME.....

STREET.....

CITY..... STATE.....

### COYNE

Gives You All-Around Shop Training in:

**RADIO  
ELECTRONICS  
TELEVISION  
FREQUENCY  
MODULATION (FM)  
RADIO SERVICE  
(Your own shop)  
SOUND SYSTEMS**



### COMPLETELY SAFE

Here is the gun that will thrill every boy. When you pull the trigger, it cracks out like a real gun and smoke puffs out of the muzzle. The American Rangers Automatic is a quick acting, repeating pistol that never misses. It shoots 60 to 75 shots without re-loading. Looks like a real gun. Absolutely SAFE. Contains no explosives. Each gun comes boxed with 10,000 shots of smoke powder or enough ammunition to last a full year. This smoke powder is harmless. Will not hurt the eyes and may even be eaten. Only \$1.00 each or 3 guns for \$2.00. Only limited quantity available. Write for yours NOW.

### SEND NO MONEY

### Try 10 Days - At Our Risk

Just send name and address. On arrival deposit only \$1.00 plus C.O.D. postage for one gun or \$2.00 plus C.O.D. postage for three guns. If not completely satisfied return and your money refunded. Save money. If you send cash with order, we pay postage. Write TODAY. No foreign orders accepted.

**SPECIALTIES MFG. CO., Dept. 508**

1367 N. Sedgwick

Chicago 10, Ill.

### BOYS-IT'S FREE!

This exciting book "THE WONDERS OF CHEMISTRY"

Shows how to amaze your friends with chemical magic, describes many fascinating home experiments, tells of fun, thrills, adventure and big future opportunities for boys who know chemistry. Send today!

**THE PORTER CHEMICAL COMPANY**  
33 Prospect Avenue Hagerstown, Md.



**FREE BOOK**  
TELLS HOW TO BE AN...

*Accountant  
Salesman  
Secretary  
Stenographer*

### SECURED FUTURE... FREE EMPLOYMENT SERVICE

Enter one of the "substantial earnings" fields through Hill's "Success Plan" training. A lifetime opportunity to join thousands of successful graduates in positions secured through our nation-wide employment service. No matter where you live, what you are doing now, Hill's can train you by study at home or in the resident school. Big Free book shows you the way to substantial earnings and an assured future. G. I. Approved.

Hill's Extension School & Business University  
Dept. PM-11, 619 W. Main St., Oklahoma City 2, Okla.  
Please send your free book, "Through Hill's to Success."

NAME.....

ADDRESS.....

CITY..... STATE.....

Check here if eligible under G.I. Bill.

MAIL THIS

EASY-TO-USE COUPON TODAY

# Famous Artists Course

prepares you at home for a career in commercial art



**ALBERT DORNE**, brilliant artist. President of the Institute of Commercial Art.



**FRED LUDEKENS**, versatile illustrator, famed art director, Vice-President.



**NORMAN ROCKWELL**, popular American artist, famed for his *Post* covers.

America's Foremost commercial artists and illustrators join in bringing you an exciting **NEW** and **MODERN** method of art instruction.



**AL PARKER**, artist for *Ladies' Home Journal*, *Good Housekeeping*, etc.



**BEN STAHL**, outstanding illustrator of magazine stories and advertisements.



**JON WHITCOMB**, whose glamour girl illustrations symbolize youth.



**STEVAN DOHANOS**, whose colorful *Post* covers are familiar to millions.



**ROBERT FAWCETT**, famed for masterful drawing, superb craftsmanship.



**PETER HELCK**, creator of heroic compositions of industrial America.



**GILBERT BUNDY**, illustrator of the younger set for stories, advertising.



**AUSTIN BRIGGS**, one of the great newcomers among American artists.



**HAROLD VON SCHMIDT**, best known for his exciting western pictures.



**JOHN ATHERTON**, famed for *Post* covers, and for fine art paintings.

Now, by an entirely new and unique spare-time, home-study method, you can prepare for a money-making career in commercial art. Now, for the first time, you can learn the modern methods used by the most successful, highest paid artists and illustrators. The famous artists whose pictures appear here bring you this opportunity through their Famous Artists Course in Commercial Art and Illustration.

**More Good Artists Urgently Needed.** Never was there such a demand for good artists as now. Magazines, newspapers, advertising agencies, art serv-

ices, retail stores, printers, direct mail firms—all are looking for trained artists with fresh, new ideas. But you must know modern methods. Times have changed. To be a successful commercial artist today, you must know today's techniques—the techniques the famous artists know so well and use in their own work in America's leading magazines.

**Today's Methods Made Easy for You.** The Famous Artists Course teaches these modern methods in a modern way. It is excitingly different from any course you ever have seen or heard of. It is

made amazingly simple through step-by-step directions and more than 4,000 drawings and sketches made by the famous artists especially for this course. Your progress should be rapid. In your very first lesson you begin to make pictures.

**Get the Full Story.** If you have even a little art talent, really want to be a successful commercial artist and can arrange for the modest tuition (about \$200, on monthly payments if you wish) by all means send the coupon or write at once for full information about the Famous Artists Course.

## Institute of Commercial Art, INC. Westport, Conn.



INSTITUTE OF COMMERCIAL ART, INC., BOX L-6, WESTPORT, CONN.

Please send me the book telling all about the Famous Artists Course in Commercial Art and Illustration.

NAME \_\_\_\_\_ AGE \_\_\_\_\_  
 STREET \_\_\_\_\_  
 CITY \_\_\_\_\_ ZONE \_\_\_\_\_ STATE \_\_\_\_\_

BE A **WINNER** AT ANYTHING YOU TACKLE WITH **PROGRESSIVE POWER** Now **ALL 5 FAMOUS JOWETT COURSES** in 1 Volume for only **25c**

DARLING, THAT BRILLY WON'T PICK ON YOU AGAIN.

JOE YOUR NEW ENERGY AND APPEARANCE SURE DO A GOOD JOB YOU EARNED YOUR PROMOTION.

WHAM

"The Jowett System is the greatest in the world!" says R. F. Kelly, Physical Director.

Atlantic City

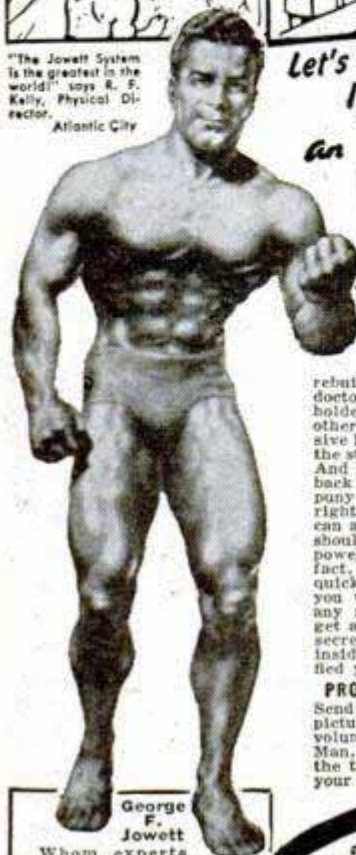

George F. Jowett

Whom experts call "Champion of Champions"

- World's wrestling and weight lifting champ at 17 and 19.
- World's Strongest Arms. 4 times World's Perfect Body — plus other records.

**10 DAY TRIAL!** Think of it—all five of these famous courses now in one picture-packed muscle-building volume for only 25c. If you don't actually FEEL results within ONE WEEK, send it back and your money will be promptly refunded! Photo Book of Famous Strong Men!

**FREE!**

Photos that inspire you to might and muscle. Free with order.

Let's Go, Pal! I'll prove I can make YOU an **"ALL-AROUND" HE-MAN**

FAST — OR NO COST! says George F. Jowett World's Greatest Body Builder

Enjoy My "Progressive Power" Strength Secrets! Give Me 10 Easy Minutes a Day — Without Strain! I'll teach you the "Progressive Power Method" through which I rebuilt myself from a physical wreck the doctors condemned to die at 15, to the holder of more strength records than any other living athlete or teacher! "Progressive Power" has proven its ability to build the strongest, handsomest men in the world. And I stand ready to show you on a money back basis—that no matter how lanky or puny you are I can do the same for you right in your own home. Let me prove I can add inches to your arms, broaden your shoulders, give you a man-sized chest, powerful legs and a Rock-like back—in fact, power pack your whole body so quickly it will amaze you! Yes, I'll jam you with power and confidence to master any situation—to win popularity—and to get ahead on the job! Through my proven secrets I bring to life new power in you inside and out, until YOU are fully satisfied you are the man you want to be.

**PROVE IT TO YOURSELF IN ONE NIGHT** Send only 25c for my 5 easy-to-follow, picture-packed courses now in 1 complete volume "How to Become a Muscular He-Man." Try it for one night! Experience the thrilling strength that surges through your muscles.

I am making a drive for thousands of new friends fast—REGARD-LESS OF COST!

**SO GET NOW MY 5 Muscle Building COURSES** (Valued at \$5 each)

**All in 1 Great Complete Volume Packed With How-To-Do-It Pictures!**

Now, this "get-acquainted," extremely low price of only 25c is your chance to build a body you'll be proud of! Follow Jowett's easy method of muscle building NOW!

For **25c** Only



**FREE GIFT COUPON!**

Jowett Institute of Physical Culture Dept. PM-811  
230 Fifth Avenue, New York 1, N. Y.

Dear George:—Please send by return mail, prepaid, **FREE** Jowett's Photo Book of Strong Men, along with all 5 Muscle Building Courses: 1. Molding a Mighty Chest, 2. Molding a Mighty Arm, 3. Molding a Mighty Grip, 4. Molding a Mighty Back, 5. Molding Mighty Legs—Now all in One Volume "How to Become a Muscular He-Man." Enclosed find 25c. NO C.O.D.'S.

George F. Jowett  
Champion of Champions

NAME \_\_\_\_\_ AGE \_\_\_\_\_

(Please Print Plainly, Include Zone Number)

ADDRESS \_\_\_\_\_

WE THINK IN WORDS

**LEXIPOWER**

THOUGHT IS POWER

Acquiring a superior **VOCABULARY** is basic training for a top position in any profession, trade or business. To get in the upper brackets financially and socially, develop a masterful **VOCABULARY** through the fascinating, entertaining and profitable new science of **LEXIPOWER**. You are judged and rated by every sentence you utter. Executive ability and professional capacity are demonstrated by what you say — not by what your hands do. More **POWER** to you through **LEXIPOWER**. Benefit at once! You start using the **POWER** of **LEXIPOWER** after the first Lesson. Write **NOW** for **FREE** details about **LEXIPOWER Dime-a-Day LESSON CLUB**.

**LEXIPOWER LESSON CLUB**

517-N W. Deming Place

Chicago 14, Ill.



**BE AN ARTIST**

Send for interesting picture book "BUILDING A FUTURE"

Explains the unique position of the professional artist in American life. Gives examples of huge professional income. Tells definitely how YOU can acquire **PROFESSIONAL SKILL—AND PROFESSIONAL INCOME—within one year**—in spare time at home. No obligation. Book is free. Write name, address and age on penny postcard and mail TODAY to:

**GRANT SCHOOL OF ART**

Dept. 188, 53 W. Jackson Blvd., Chicago 4, Ill.

**ENGINEERING DEGREE IN 27 MONTHS**

**INDIANA TECHNICAL COLLEGE**

Aeronautical, Chemical, Civil, Electrical, Mechanical, and Radio Engineering (inc. television). Drafting, 1-yr. Gov't approved for G.I.'s. Low rate. Earn board. Large industrial center. Students from 48 states, 18 countries. Demand for graduates. Enter December, March, June, September. Catalog.

5118 E. Washington Blvd., Ft. Wayne 2, Ind.

**WATCHMAKING**

Millions of watches and clocks need repairing. Start your training now for a better paying job or own profitable business. Qualified watchmakers in demand. Outstanding training by experts. Write for free catalog. Approved for veterans.

**SCIENTIFIC SCHOOL OF WATCHMAKING, Dept. PM-11**  
3923 San Fernando Road Glendale 4, Calif.

**NEW! LOW COST! RESPIRATOR**

Wear when sanding, grinding, paint spraying, sweeping, dusting, furnace cleaning, etc. Handy as a pair of glasses. Just keep mouth closed and breathe through nose as all you do to operate. Protects against nuisance dusts, lint, coal, cement, grain dust, hay fever pollen. Has 9 sq. in. filter. For **27c** protection against paint spray, dusts, gases, fumes, smoke, order our Fog-Proof Rubber GOGGLES ..... \$2.00 p.p.



Order Today \$1.00 POST PAID

**JERRY BRYANT, Dept. PM**  
919 N. Michigan Ave. Chicago 11, Ill.

FREE BOOK

**RAISE HAMSTERS**



The new wonder animals from Syria. Often called Toy Bears. Delightful pets. Everyone wants them. Laboratories need thousands. Clean, odorless. Raise anywhere. A profitable and interesting hobby or business. We furnish breeding stock with manual of instructions.

Write today for free illustrated literature.

**GULF HAMSTERY, 1536 BASIL, MOBILE, ALA.**

**FALSE TEETH**

**KLUTCH holds them tighter**

**KLUTCH** forms a comfort cushion; holds dental plates so much firmer and snugger that one can eat and talk with greater comfort and security; in many cases almost as well as with natural teeth. **KLUTCH** lessens the constant fear of a dropping, rocking, chafing plate. 25c and 50c at druggists . . . If your druggist hasn't it, **don't waste money on substitutes**, but send us 10c and we will mail you a generous trial box. © I. P. INC.

**KLUTCH CO.**

Box 4893-K

ELMIRA, N. Y.

# OIL BURNER

INFORMATION IN A HANDY FORM

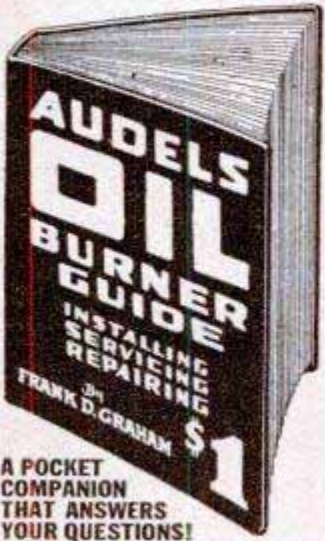

## AUDELS OIL BURNER GUIDE

- A new practical, concise treatise, 384 pages-31 Chapters - 321 Diagrams and Illustrations - covering Domestic and Industrial Oil Burners.

New from Cover to Cover, for mechanics interested in Oil Burners. Gives practical inside working knowledge of theory, construction, installation, operation, testing, servicing and repair of all types of oil burners. Includes electrical hook-ups and wiring diagrams of automatic control systems.

PRICE \$1 POSTPAID  
Get this information for yourself. Mail coupon today. No obligation unless satisfied.

ASK TO SEE IT

A POCKET COMPANION THAT ANSWERS YOUR QUESTIONS!

AUDEL, Publishers, 49 W. 23rd St., New York 10, N. Y.

Please mail AUDELS OIL BURNER GUIDE (Price \$1). If satisfactory, I will remit \$1 on its safe arrival, otherwise I will return the book.

Name \_\_\_\_\_  
Address \_\_\_\_\_  
Occupation \_\_\_\_\_  
Employed by \_\_\_\_\_ PM

# PRACTICAL AUTO INFORMATION

Keeps Cars Rolling by Making Repairs and Adjustments Easy!

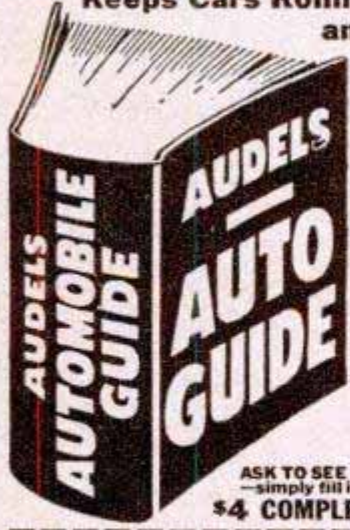

**AUDELS AUTO GUIDE**  
For Every Mechanic, Driver, Owner and Repair Shop.

**Sent on 7 Days Approval**  
Shows How to Tune Up—Keep Brakes Safe—Batteries Powerful—Tire Mileage Up—Save Gas—Lubricate Correctly.

**ANSWERS YOUR QUESTIONS**  
Contains all you need to know about 1—Construction, 2—Operation, 3—Service, 4—Repair of Modern Motor Cars, Trucks, Buses & Diesel Engines in every detail.

**NEW FLUID DRIVE TREATED**  
Easy to understand—1540 Pages, 1540 Illustrations. Gives definite directions on How to handle service jobs.

ASK TO SEE IT—Get this information for yourself—simply fill in and mail coupon today.

**\$4 COMPLETE • PAY ONLY \$1 A MO.**

AUDEL, Publishers, 49 West 23rd St., New York  
Mail AUDELS AUTOMOBILE GUIDE (\$4) for free examination. If O. K., I will send you \$1 in 7 days; then remit \$1 monthly until \$4 is paid. Otherwise, I will return book promptly.

Name \_\_\_\_\_  
Address \_\_\_\_\_  
Occupation \_\_\_\_\_  
Employed by \_\_\_\_\_ PM



A 1000 PAGE BOOK WORTH HAVING

For Heating, Ventilating and Air Conditioning Engineers, Plumbers, Maintenance Men, Contractors, Building Superintendents and Mechanics seeking practical, authentic information on Heating, Ventilating, Air Conditioning. 1000 Pages—910 Illustrations—57 Chapters explaining the working principles of all Modern House Heating, Ventilation and Air Conditioning systems. Fully illustrated and indexed. This up to date book of reference gives answers to 1001 questions on Heating, Ventilating, Air Conditioning & Radiant Heating.

**\$4 COMPLETE • PAY ONLY \$1 A MONTH**

To get this assistance for yourself, fill in and

**MAIL ORDER**

AUDEL, Publishers, 49 W. 23rd St., New York 10, N. Y.  
MAIL AUDELS HOUSE HEATING GUIDE for free examination. If O. K. I will send you \$1 in 7 days; then remit \$1 monthly until price of \$4 is paid. —Otherwise, I will return it.

Name \_\_\_\_\_  
Address \_\_\_\_\_  
Occupation \_\_\_\_\_  
Employed by \_\_\_\_\_ PM

# AUDELS Carpenters and Builders Guides

4 vols. \$6



**Inside Trade Information**  
for Carpenters, Builders, Joiners, Building Mechanics and all Woodworkers. These Guides give you the short-cut instructions that you want—including new methods, ideas, solutions, plans, systems and money saving suggestions. An easy progressive course for the apprentice and student. A practical daily helper and Quick Reference for the master worker. Carpenters everywhere are using these Guides as a Helping Hand to Easier Work, Better Work and Better Pay. To get this assistance for yourself, simply fill in and mail the FREE COUPON below.

**Inside Trade Information On:**  
How to use the steel square—How to file and set saws—How to build furniture—How to use a mitre box—How to use the chalk line—How to use rules and scales—How to make joints—Carpenters arithmetic—Solving mensuration problems—Estimating strength of timbers—How to set girders and sills—How to frame houses and roofs—How to estimate costs—How to build houses, barns, garages, bungalows, etc.—How to read and draw plans—Drawing up specifications—How to excavate—How to use settings 12, 13 and 17 on the steel square—How to build hoists and scaffolds—skylights—How to build stairs—How to put on interior trim—How to hang doors—How to lath—lay floors—How to paint



AUDEL, Publishers, 49 W. 23rd St., New York 10, N. Y.

Mail AUDELS Carpenters and Builders Guides, 4 vols., on 7 days free trial. If O. K. I will remit \$1 in 7 days and \$1 monthly until \$6 is paid. Otherwise I will return them. No obligation unless I am satisfied.

Name \_\_\_\_\_  
Address \_\_\_\_\_  
Occupation \_\_\_\_\_  
Employed by \_\_\_\_\_ PM

**Bigger Opportunities  
Than Ever in . . .**



**AUTO  
BODY  
AND  
FENDER  
REPAIR**

● **THE FIELD IS STILL GROWING** after more than 40 years . . . expanding with the giant auto industry! Millions of new cars are getting to market, millions of old ones are still on the road—**THE NEED for MAN-POWER** in the service field is **INCREASING!**

**TRAIN NOW . . . FOR THE OPPORTUNITIES AHEAD!**

Don't be stuck in a low-pay job! Opportunity here is big enough for thousands to find big-pay work either in a reliable job or in their own shops. UEI teaches Auto Body & Fender Repairing the *easy* way. No special education or experience needed . . . you can start in your spare time, right at home . . . keep your job while you learn. Then, when home study is finished, you continue at the well-equipped UEI shops getting practical experience. Fix and refinish damage, replace panels and tops. Learn up-to-date methods in use of tools, spray painting, welding, metal work—all under expert supervision.

**GET THE FACTS . . . FREE!**

UEI HAS TRAINED THOUSANDS for opportunity fields, and students are making good. If you want to get ahead, send coupon today for free facts on **AUTO BODY AND FENDER REPAIRING**. Don't delay!

**AUTOCRAFTS DIVISION  
UTILITIES ENGINEERING  
INSTITUTE**

2523 Sheffield Ave. Dept. 1118-X  
Chicago 14, Illinois

Approved for  
training under  
G. I. Bill

Founded  
1927



**FILL OUT AND MAIL . . . TODAY!**

Autocrafts Division  
Utilities Engineering Institute, Dept. 1118-X  
2523 Sheffield Ave., Chicago 14, Ill.  
Yes, I'm interested! Send me those Free Facts about  
Auto Body and Fender Repairing.

NAME \_\_\_\_\_ Age \_\_\_\_\_

ADDRESS \_\_\_\_\_

CITY \_\_\_\_\_ Zone or  
County \_\_\_\_\_ STATE \_\_\_\_\_

Check here for Special Information if under 17.

*Learn* **ELECTRICAL  
APPLIANCE  
REPAIRING**  
IN YOUR SPARE TIME!



S. T. Christensen  
President

**HERE'S BIG  
MONEY and  
INDEPENDENCE**

**\$5.00 TO \$6.00 PER HOUR!**

This fascinating lifetime opportunity can be yours if you are mechanically inclined (can hold and use tools). It is not unusual for appliance repairmen to charge on this basis of \$5.00 to \$6.00 per hour.

**NO PREVIOUS EXPERIENCE NEEDED!**

Think of going to a friend's or your neighbor's home. Picking up and carrying back to your work bench their Sewing Machine, Vacuum Cleaner, Iron or other appliance. Then using your Christy Course and Christy Electronic Kit to help you locate the trouble and easily repairing the appliance from the clear instructions given. I will help you . . . by showing you exactly how much **PROFIT** to charge for each repair job.

**CHRISTY APPLIANCE COURSE &  
ELECTRONIC KIT . . . SENT TO YOU**

Rush your name and address by the next mail and I will send to you our special form where you can get our complete course and electronic Kit on our simple, easy payment plan. Pay me later with your **EARNINGS WHILE LEARNING**.

**WRITE ME TODAY!**

Mr. S. T. Christensen, Pres.

Christy Supply Co., Dept. D-6303  
2835 N. Central Ave., Chicago 34, Ill.

**WHY DON'T YOU WRITE?**

Writing short stories, articles on business, sports, homemaking, gardening, shop crafts, local and club activities, etc., will enable you to earn extra money. In your own home, on your own time, the New York Copy Desk Method teaches you how to write—the way newspaper men learn, by writing. Our unique "Writing Aptitude Test" tells whether you possess the fundamental qualities essential to successful writing. You'll enjoy this test. Write for it, without cost or obligation.

**Veterans: This course approved for Veterans' Training.**

**NEWSPAPER INSTITUTE OF AMERICA**  
SUITE 5598-T, ONE PARK AVENUE, NEW YORK 16, N. Y.

*New*  
**Advertising  
Machine**



**PRINTS and  
ILLUSTRATES  
1¢ POST CARDS**

Send  
Coupon

**CARDMASTER CO., 4546 Ravenswood  
DEPT. 1311, CHICAGO 40, ILL.**

**FREE!**

Send **FREE** Illustrated Book\* and complete, unique advertising plans and money making ideas for my business.

\* Shows HOW thousands of business men in every line are boosting sales in spite of conditions with 1c messages printed and illustrated in few minutes on gov't post cards—with amazing, new, patented **CARDMASTER**. Your "today's" ideas, read by your prospects next morning. Not a toy, but a sturdy advertising machine built to last years. Sold direct at low price. Guaranteed five years. **SEND NAME TODAY. All FREE!**

NAME \_\_\_\_\_

ADDRESS \_\_\_\_\_

CITY \_\_\_\_\_ ZONE \_\_\_\_\_ STATE \_\_\_\_\_

**FREE**  
7-DAY TRIAL  
JUST MAIL COUPON

# HOW TO BUILD A BETTER HOME

If You Are Undecided Whether You Should Build or Buy—  
If You Are Leery of 'Cheap' Building, Shoddy Work or Poor Design—  
If You Are Fed-Up With DREAMING About Your New House and  
Want to Get STARTED—Then This Will Prove a GOD-SEND to YOU!

HERE is the answer to how to build your own home. Here is the WORKS—how to plan, how to construct, how to supervise—simply, clearly explained step-by-step. Jam-packed with everything you need to know about building your own home yourself, or having a contractor build it for you. Hundreds of clear-cut, complete diagrams. You will be able to build a home that will amaze everyone!

Everything You Need to Know to Get Started

### Some of the Things This Book Explains:

Here at your fingertips are the secrets that produce fine small homes—completely revealed in this great—easy—reference book!

- HOW TO decide on home ownership.
- HOW TO fit your house to your income.
- HOW TO choose among types (prefabs, bungalows, one story, two story).
- HOW TO get started.
- HOW TO select professional services: real estate dealer; bank; attorney; contractor; insurance broker.
- HOW TO select a good building lot.
- HOW TO finance your home.
- HOW TO draw contracts.
- HOW TO use comparative costs in deciding—size, plan, design, material, finish and equipment.
- HOW TO prevent termites, cracks, leaks, decay and corrosion.
- HOW TO locate house on lot.
- HOW TO excavate.
- HOW TO get good masonry construction—foundations, piers, basement walls, chimneys and fireplaces, walks, driveways and terraces.
- HOW TO waterproof.
- HOW TO select good lumber.
- HOW TO frame.
- HOW TO roof.
- HOW TO select and install heating.
- HOW TO plan and install electric wiring.
- HOW TO insulate.
- HOW TO install plumbing.
- HOW TO lath, tile and plaster.
- HOW TO get and install good millwork and finished carpentry.
- HOW TO specify sheet metal work.
- HOW TO paint and finish.
- HOW TO grade.

This complete book contains over 500 "How to do it" drawings and illustrations. It explains what you should do and what you should not do. It covers every phase of home ownership. No detail is missing. For example, it lists 46 things you should consider before you even buy a lot.

Hundreds of references to publications on related subjects are given, such as home equipment, landscaping, stock plans, decorating. Over one hundred of these publications may be had free.

Nothing Like It Before! One Simple Fact May Repay you a HUNDRED Times its Small Cost. A Book You Will Refer to for Years to Come!

### Read What Great Building Authorities Say About This Amazing Book (names on request)

Excerpts from typical letters of praise:  
"... the best book on the subject that has been published to date." "was thrilled!" "valuable information for the new home-builder." "an excellent piece of work" "helped us decide our building plans" "well worth price." "very much impressed... an excellent reference book."  
"... the writing is clear and compact... complete and unbiased information."  
"... most interesting and complete." "You are to be congratulated. Contains more information than any volume seen... Everything you said."  
"... One of the best works of its kind I have ever seen. Send me 10 more for presents."  
And from an amateur:  
"From this book I did the plans myself! Had never done anything like it before... A neighboring architect said I was an up-and-coming designer and he found not one fault with my plans... The building is now finished and everyone says it's beautiful!... I saved \$1000!"

Provides you with all the facts. Whether you are going to spend \$2,000 or \$20,000 for your home—whether you are going to employ an architect or use stock plans—or whether you are going to buy a house instead of building, this book will help you. Before you build you should know the difference between good and bad construction. Now—in these days of shortages—just one of the hundreds of diagrams can save you hundreds of dollars. You will get a thrill out of being "in the know," being "wise" to the game, being able to talk to building people in their own language. You'll be respected, admired, and get better workmanship on your home. You'll get a feeling of pride as your friends admire the home being built. Here, in one clear-cut volume is all the basic information you will need!

### Where to Begin

No matter what your building problem may be, you will find the answer in this amazing volume. No truth is kept from you. You are told the disadvantages of home ownership as well as the advantages. You are told of the precautions you will need to safeguard your investment. You are shown how to select a lending institution, a lawyer, a real estate dealer, an architect, a contractor. Your questions on methods of buying are fully answered. Just a quick glance at the partial table of contents on this page will show you some of the thousands of facts on building which this complete volume contains. Those who have bought a copy write that they have never seen so thorough a work on this subject for any price, anywhere!

### Hundreds of Construction Details

Explains all the "mysteries" of permits, contract forms, and construction. Tells you how to build the right kind of home, how to avoid "cheap," cracker-box construction, how to get a house that is suitably located, beautiful to look at and priced within your means—a house you will be proud to call your home.

### How to Build—from Plans to Paint

Not one important step is missing from this volume. See for yourself. Every conceivable thing you would want to know about building will be found in this wonderful new book!

## SEND NO MONEY

Examine It for 7 Days FREE!

You don't even risk a cent to examine "How to Build a Better Home." Just mail coupon. Study book for a week, FREE! See how easy it is to supervise or build a better home, YOURSELF—even if you know nothing about construction NOW! Then, if you are THRILLED with this amazing volume, send only \$3.98 plus postage. If you are not thrilled, return book and pay nothing! This is your chance to build not just a house, but a BETTER HOME! Mail FREE EXAMINATION COUPON NOW to The Westport Publishing Company, Dept. PM-11, Westport, Conn.

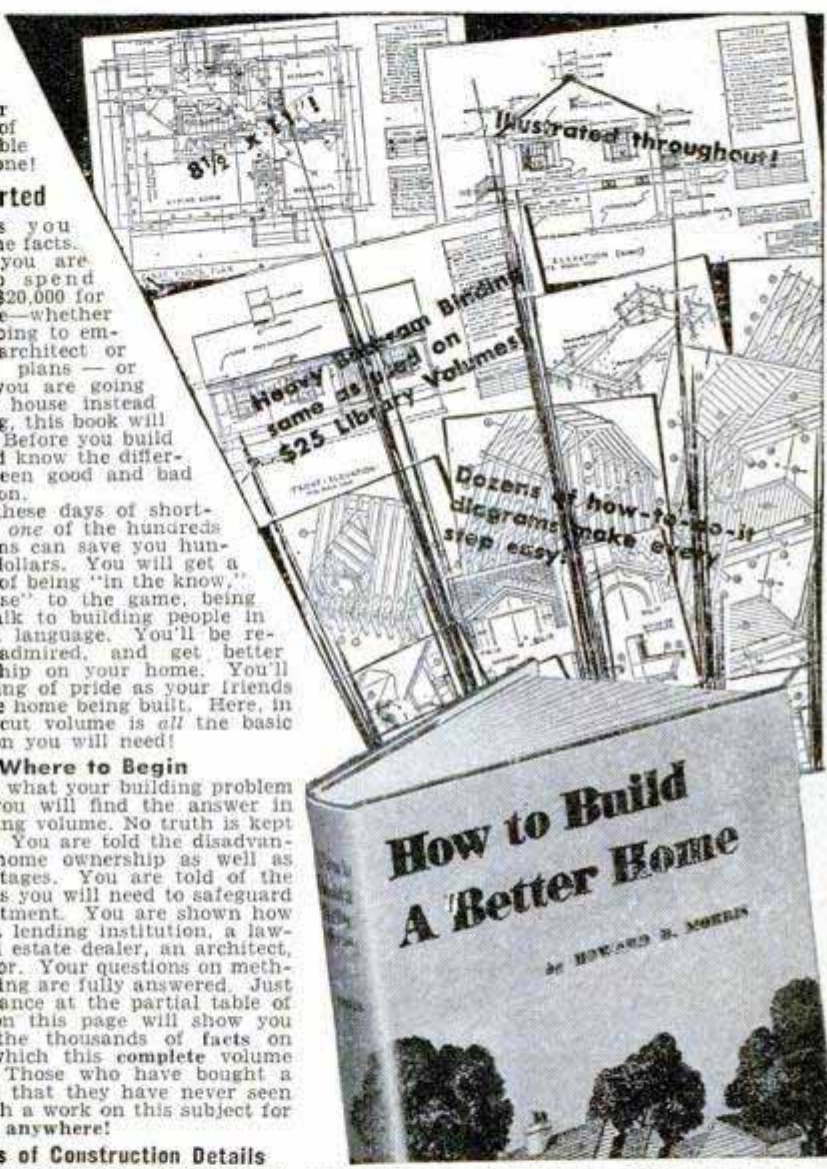

## FREE Examination Coupon—Mail Now

The Westport Publishing Company, "Books of Merit," Dept. PM-11, Westport, Conn.

Please send me, for one week's FREE EXAMINATION, a copy of "How to Build a Better Home." After 7 days I will either return this book and owe you nothing, or I will keep it and send you \$3.98 (plus shipping charges).

Name \_\_\_\_\_ Age \_\_\_\_\_  
(please print)

Address \_\_\_\_\_

City & Zone \_\_\_\_\_ State \_\_\_\_\_

Save postage. Check here if you enclose full payment of \$3.98 (check or money order) WITH coupon. WE will then pay shipping charges. If not thrilled with book, return it and we will refund your money by AIR MAIL! Foreign Orders \$4.50 Cash with order.

## Increasing your hold on your job and giving yourself a chance for advancement

Few men deliberately plan to work persistently on self-improvement. If progress comes naturally, they're happy; if it doesn't, they worry or ignore the situation. Yet it is possible to pay attention to self-improvement with considerable hope of success. A noticeable degree of advancement is practically assured any one who will make an intelligent and persistent effort. Thousands of men have proved this for themselves, with:



### The Croft Library of Practical Electricity

The Croft Library is a complete electrical educator. It is founded on practice—on 20 years of shirt-sleeve experience—on work as it is actually done. It is jammed from cover to cover with the kind of hard-headed facts you want. Written so that the beginner can easily understand it, yet so sound, so thorough, that it is the daily guide of 50,000 highly paid electrical workers and engineers. Croft tells you the things you need to know about motors, generators, armatures, commutators, transformers, circuits, switchboards, distribution systems—electrical machinery of every type—wiring for light and power—wiring of finished buildings—underwriters and municipal requirements—illumination in its every phase—the most improved methods of lighting lamps—and lamp effects, etc.—how to do a complete job, from planning it, to completion.

#### No money down — easy payments

Fill in and mail the coupon attached and we will send you the entire set of seven volumes for ten days' examination on approval. We take all the risk—you assume no obligation. If you decide to keep the books, send \$3.50 in ten days and the balance at the rate of \$4.00 a month. Send the coupon NOW and see the books for yourself.

McGraw-Hill Book Co., 330 W. 42nd St., New York 18, N. Y.  
Send me for ten days' examination on approval the Croft Library of Practical Electricity, 7 vols. If satisfactory I will send you \$3.50 in 10 days and \$4.00 monthly until the price of \$19.50 is paid. If not wanted, I will return the books postpaid.

Name \_\_\_\_\_  
Home Address \_\_\_\_\_  
City and State \_\_\_\_\_  
Company \_\_\_\_\_  
Position \_\_\_\_\_

PM-11-48

## PROTECT YOURSELF in case you enter a hospital on account of SICKNESS or ACCIDENT

The New Family Mutual Hospitalization Plan gives you protection that is high in value but low in cost—only \$1.00 per month for each adult, 50c per month for each child.



#### FOR SICKNESS OR ACCIDENT

Hospital Room and Board up to . . . . .	\$6.00
Operating Room up to . . . . .	\$10.00
X-Ray Examinations up to . . . . .	\$10.00
Laboratory Examinations up to . . . . .	\$10.00

#### FOR ACCIDENT

Ambulance up to . . . . .	\$10.00
Emergency Accident—Dispensary up to . . . . .	\$6.00
Loss of Limbs, sight, etc., or loss of life up to . . . . .	\$500.00
Maternity Indemnity up to . . . . .	\$35.00

The policy provides indemnities for actual expense incurred at the time of hospitalization but will in no case exceed the amounts shown above.

Be protected against hospital bills, in case sickness or accident strikes you, by allowing the Family Mutual Life Insurance Company to aid you in meeting your hospital expenses. You may choose any hospital. Benefits for children are one-half those paid to adults.

DON'T DELAY—MAIL THE COUPON TODAY

FAMILY MUTUAL LIFE INSURANCE CO., WILMINGTON 99, DEL.

Family Mutual Life Insurance Co. Dept. P-2  
601 Shipley St., Wilmington 99, Del.  
Please send me, without obligation, complete information on your Economical Hospitalization Plan.  
NAME \_\_\_\_\_  
ADDRESS \_\_\_\_\_  
CITY \_\_\_\_\_ STATE \_\_\_\_\_



# FREE BOOK TELLS HOW YOU CAN LEARN TO

## MOUNT BIRDS and ANIMALS

BE A TAXIDERMIST—Learn by Mail

Easy home lessons teach you quickly how to MOUNT BIRDS, ANIMALS, GAME-HEADS, FISH—TO TAN LEATHER, FURS. Save your hunting trophies. Have a home museum. It's thrilling! Taxidermy is wonderful, FUN, A PLEASURE HOBBY AND A MONEY MAKER.—Investigate! Get this strange FREE BOOK. EXTRA MONEY:—Earn in your spare time. Sell your mounts; and do work for other sportsmen. Students report \$30 to \$75 and more per month. Big demand. Fine prices. If you want REAL PROFIT from spare time WRITE TODAY. FREE BOOK —with 100 photos of wild game. Tells about Taxidermy and how YOU can learn, easily, quickly. Old reliable school. 275,000 students. — STOP this minute and TEAR OUT THIS AD NOW as a reminder; then write; get the free book. You will be delighted, AMAZED, RUSH postal or letter and learn how to have more FUN, FASCINATION, PROFIT. State your AGE. Northwestern School of Taxidermy, Dept. 2511 Omaha, Neb.

Game is growing scarcer—every specimen valuable!

## SHORTHAND in 6 Weeks at Home

Famous Speedwriting system. No signs; no symbols; no machines; uses ABC's. Easy to learn; easy to write and transcribe. Fast preparation for a job. Surprisingly low cost. 100,000 taught by mail. Used in leading offices and Civil Service. Write for free booklet. SPEEDWRITING, Dept. 1511-8, 55 W. 42 St., New York 18

## LAW

STUDY AT HOME for Business Success and LARGER PERSONAL EARNINGS. 39 years expert instruction—over 114,000 students enrolled. LL.B. Degree awarded. All text material furnished. Easy payment plan. Send for FREE BOOK — "Law and Executive Guidance."

AMERICAN EXTENSION SCHOOL OF LAW  
Dept. 95-PM 646 N. Michigan Ave. Chicago 11, Ill.

## APTITUDE TESTS

discover the kind of work or studies best for your success! You get a personal report—a guide for life—more happiness—more prosperity. For men, women, boys and girls. Write for complete facts.

VOCATIONAL COUNSELING INSTITUTE  
956 Maccabees Bldg., Detroit 2, Michigan

## STAMMER ?

This new 128-page book, "Stammering, Its Cause and Correction," describes the Bogue Unit Method for scientific correction of stammering and stuttering—successful for 47 years. Benj. N. Bogue, Dept. 4824, Circle Tower, Indianapolis 4, Ind.

GET THIS FREE BOOK!

LEESE  
CORRESPONDENCE COURSES IN RADIO and ELECTRICAL ENGINEERING  
Tuition \$25  
ELECTRICAL ENGINEERING. Get good grasp of wide electrical field. Modern, Very understandable. Theory made easy. RADIO ENGINEERING. Extra fine course in radio, public address, photo-electric work. Trains you to be super-service man, real vacuum tube technician. Tuition ONLY \$25, either course. Deferred payment plan. Servicemen needed badly. FREE Write for free copies of school catalogs, student magazines, etc. LINCOLN ENGINEERING SCHOOL, Box 931-P119, Lincoln, Nebr.

## HOW TO CUT RAFTERS

New vest pocket book gives lengths, side cuts, plumb cuts, deductions. For all rafters for any building from one inch to forty feet wide. Gives numbers to cut on square. Also degrees for same cuts for Radial Saws. All standard pitches from 1/8 to 3/4. Just open book to pitch page and there are your lengths, side cuts, etc. Anyone who knows what a jack rafter is can frame a roof if he has this great book. Price \$1.50. (\$2.00 in Canada). Builders' Topics, Dept. M, Lock Box 828, Seattle, Washington. CARPENTERS, PLUMBERS, PLASTERERS, ELEC. TRICIANS, ETC., subscribe for Builders' Topics, the monthly magazine for HE-MAN CONSTRUCTION WORKERS. Only \$1.50 per year, (In Canada—\$2.00). Sample copies 25c.



# IMAGINE THEIR JOY

## WHEN THEY FOUND THEY COULD PLAY

This easy as A.B.C. way!



### LEARNED QUICKLY AT HOME

"I didn't dream I could actually learn to play without a teacher. You can imagine my surprise when after 3 or 4 weeks I found I could play real tunes. Now, when I play for people they hardly believe that I learned to play so well in so short a time."  
\*H. C. S., Calif.

### INVESTMENT PAID BACK A THOUSAND FOLD

"Anyone with musical ability should make good with your course. My little investment paid back a thousand fold. I have been playing for 4 years now. Today I play in one of our top bands."  
\*J. M., San Juan, P. R.



### TAKES THIRD COURSE

"The piano course is the third course with your school. Some years ago I took saxophone and clarinet. Since then I've played a lot of dance jobs."  
\*E. A., Lake View, Iowa.



### FUN TO LEARN

"Your lessons are everything you said they would be. Never before have I seen such an easy way to learn music. It's easy, encouraging and fun. I thank you with all my heart for introducing me to your wonderful course."  
\*G. M., Berlin, N. H.

### PLAYS AT DANCES

"I have completed your course and your lessons have been most satisfactory. I can play all of the popular songs. I have also earned money playing at dances."  
\*E. N. J., New York.

## Thousands Have Learned to Play Quickly, Easily At Home

WHAT instrument would you like to play? We'll show you how you can learn to play it—quickly, easily, in spare time at home for only a FEW CENTS A DAY! Never mind if you don't know one note of music from another—don't worry about "special talent."

The truth of the matter is that thousands now play who never thought they could! Yes, men and women everywhere are enjoying the thrilling satisfaction of playing the piano, violin, guitar, saxophone or other favorite instrument. Some of them are playing in orchestras and over the radio; others are teaching music, making

money in spare or full time. And thousands are playing for their own enjoyment and the entertainment of their friends.

It all came about when they wrote to the U. S. School of Music for the Free Booklet that shows you how EASY it is to learn music at home this modern way. No tedious scales, no tiresome exercises. You learn to play by playing—start right in almost at once with the melody of a simple tune! It takes only a few minutes a day and the cost is trifling; you save the expense of a private teacher. Mail coupon and get FREE PROOF! (Instruments supplied when needed, cash or credit.) U. S. School of Music, 711 Brunswick Bldg., New York 10, N. Y. (Est. 1898—50th Anniversary)

### NOTICE

Prices of our courses have not gone up. Music lessons still cost only a few cents a day. Remember, we don't teach music "by ear" or by numbers. We teach you to play standard notes.

### SEND TODAY → FOR COMPLETE DETAILS

● You'll open your eyes when you find how quickly and easily you can learn to play your favorite instrument. Don't doubt; don't hesitate. Send for the fascinating illustrated booklet that answers all your questions; let the free Print and Picture Sample show you how this method actually works. If interested, mail the coupon NOW.

\*Actual pupils' names on request. Pictures by professional models.

### FREE! Print and Picture Sample

#### U. S. SCHOOL OF MUSIC

711 Brunswick Bldg., New York 10, N. Y.

I am interested in music study, particularly in the instrument checked below. Please send me your free illustrated booklet, "How to Learn Music at Home."

<input type="checkbox"/> Piano	<input type="checkbox"/> Saxophone	<input type="checkbox"/> Modern Elementary
<input type="checkbox"/> Guitar	<input type="checkbox"/> Trumpet, Cornet	<input type="checkbox"/> Harmony
<input type="checkbox"/> Hawaiian Guitar	<input type="checkbox"/> Reed Organ	<input type="checkbox"/> Clarinet
<input type="checkbox"/> Violin	<input type="checkbox"/> Tenor Banjo	<input type="checkbox"/> Practical Finger Control
<input type="checkbox"/> Piano Accordion	<input type="checkbox"/> Mandolin	<input type="checkbox"/> Other Instrument

Have you Instrument? \_\_\_\_\_

Name \_\_\_\_\_  
(Please Print)

Address \_\_\_\_\_

City \_\_\_\_\_ State \_\_\_\_\_

NOTE: If you are under 16 years parent must sign coupon.

Save 2c—Stick coupon on penny postcard.

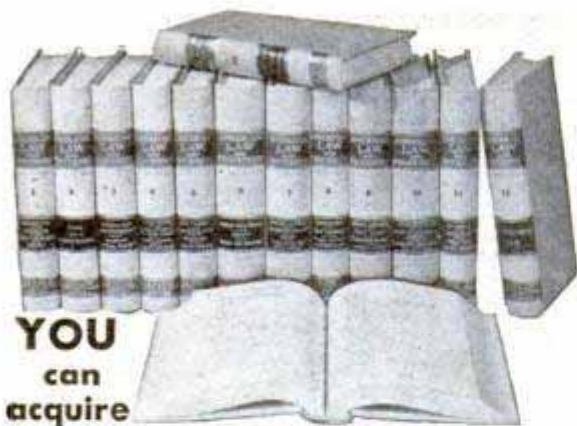

YOU  
can  
acquire

## LAW NIGHTS AT HOME! L. L. B. DEGREE

LaSalle's famous Law Library—used as reference in many Law libraries and Law offices—has enabled thousands to master Law surprisingly fast, in spare hours at home, for business and professional advancement.

These 14 remarkable volumes, compiled by leading professors and lawyers, cover the whole basic field of Law in condensed, orderly, simplified manner.

You advance rapidly with this great library, plus special lectures furnished. We guide you step-by-step with personalized Problem Method of instruction . . . you learn by doing—handling legal problems—not by memorizing rules.

Send for two FREE 48-page booklets, "Law Training for Leadership," and "Evidence," answering questions about Law and its value to you, and telling how LaSalle Law graduates are winning rapid advancement in business and public life. Mail coupon below. No obligation.

### LA SALLE EXTENSION UNIVERSITY

A Correspondence Institution

417 S. Dearborn St. Dept. 1164-L Chicago 5, ILL.

Send me your two FREE booklets described above; without obligation.

Name..... Age.....

Street.....

City, Zone & State.....

SAY YOU SAW IT IN POPULAR MECHANICS

AIR  
RIFLES

**BENJAMIN**

AIR  
PISTOLS

PIONEERS - LEADERS

SEND FOR FREE FOLDER OF LATEST MODELS TODAY  
If you want a REAL GUN for PRACTICAL USE inside or outdoors get a SAFE - CLEAN - ECONOMICAL - BENJAMIN with Adjustable Power and Amazing Accuracy. For BEST RESULTS use BENJAMIN H-C PELLETS. WRITE AT ONCE. BENJAMIN AIR RIFLE CO., 812 MARION ST., ST. LOUIS 4, MO.



**WAR  
SURPLUS  
NYLON  
THREAD**

Amazing Strong  
Thread used to  
sew Parachutes

NOW AVAILABLE  
For Home Use...

This genuine Du Pont Nylon thread is practically unbreakable. What every hobbyist, sportsman, sailor, camper wants. Used in model making, sail mending, tent repairing, bow and arrow winding, bamboo rod wrapping, kite flying and repairing, and many other uses. Used by Air Force on parachutes because of its amazing strength and dependability. Here is your chance to get a giant spool of 5000 feet—almost a mile of Nylon thread at the sensational low war surplus close-out price of only \$1.69. Black or white. Order TODAY.

GIANT SPOOL  
only  
**\$1.69**  
BLACK or WHITE  
APPROX 5000  
FEET

**SEND NO MONEY, TEST AT OUR RISK**

Just send your name and address. Specify white or black or two giant spools for only \$3.29. On arrival, deposit only \$1.69 per spool (\$3.29 for two spools) plus C.O.D. postage on our guarantee if you are not delighted, you can return in 10 days and your money back. Cash with order, we pay postage. Limited Supply. Write Today.

**LEEWARD PRODUCTS**

Dept. F49P, 189 W. Madison St., Chicago 2, Illinois

## Learn RADIO-TELEVISION

In Your Own HOME WORKSHOP

Build interesting Radio Circuits, acquire real experience, do scores of practical experiments—all through RTA's complete balanced training plus 10 BIG KITS of parts which RTA GIVES YOU! Get finest instruction direct from Hollywood, nerve-center of broadcasting, television and radio activities.

**FREE BOOK**  
Send postal for complete details plus FREE BOOK "How to Make Good in Radio-Television."

**RADIO TRAINING ASSOCIATION OF AMERICA**

5620 Hollywood Blvd. Dept. PMK Hollywood 28, Calif.

**GET THIS FINE SUIT NO MONEY TO PAY!**



**BIG CASH EARNINGS, TOO!**

Big news! This fine tailored suit yours without paying one cent—and big cash earnings, too! It's easy! Just take a few orders. Earn up to \$10 in a day and get your own suit as extra bonus. Dozens of rich new fabrics, superbly tailored in latest styles, at low prices produce orders on sight. Money-back guarantee.

**FREE SAMPLES!** Write today giving name, address, age, etc. for big complete outfit of actual samples and details of amazing new **BONUS SUIT** and money-making plan—All Sent Free! No experience. **SEND NO MONEY!** W. Z. GIBSON, Inc. 500 S. Throop, Dept. L-516, Chicago 7, Ill.

**GLOWS IN THE DARK**

5



Write for **Free Sample!**

**AN EASY WAY TO MAKE BIG MONEY**

Be the first to sell sensational luminous house numbers, light switch plates, wall protectors, cord pulls, etc. Also luminous pictures, statues, decals, and a host of religious, nursery and other objects THAT GLOW IN THE DARK. Sell on sight. GET INTO THIS NEW AND GROWING INDUSTRY. ENORMOUS DEMAND... NO COMPETITION... BIG PROFITS. Represent a large manufacturer, established over 34 years. WRITE AT ONCE for liberal MONEY-MAKING offer and FREE SAMPLE to show you how they GLOW IN THE DARK. MADISON MILLS, 303 Fourth Ave., Dept. L-4, New York 10, N.Y.

# Now YOU-TOO-Can Be a "WHIZ" on ANY AUTO REPAIR JOB!



"Motor's Manual paid for itself on the first 2 jobs, and saved me valuable time by eliminating guess work."—W. SCHROP, Ohio



"Instructions so clear, have no trouble learning anything about any car. Now working as mechanic in big plant."—SAM. ORDONEZ, Cal.



"Fixed motor another mechanic had worked on half a day. With your Manual, I did it in 30 minutes!"—C. AUBERRY, Tenn.



"So complete, easy to understand—have done jobs with Manual I would not have attempted without it."—C. L. VAN-ERSTROM, Mich.

**MoToR's AUTO REPAIR MANUAL Is Showing Thousands of Men How to Handle ANY Job on ANY Car—Faster and Easier! Now Let It Go To Work For YOU!**

## FREE-7 Day Offer

HERE'S the book YOU need to "Whiz through" every auto repair job—including those "ornery," extra-hard ones that give other mechanics such a "headache"!

THOUSANDS of men like the four above are letting MoToR's AUTO REPAIR MANUAL help them "lick" even the toughest repair problems—in LESS TIME, with LESS work and MORE profits than ever before!

Complete "How-To-Do-It" Now let these 200,000 factory-correct instructions and facts, 1700 "how-to-do-it" pictures, 200 "quick-check" charts and tables, go to work for YOU! With them you

can repair anything from carburetor to rear end, Ford to Cadillac, shaky '35 model to shining '48—quickly, easily, right!

Just look up make, model, job in quick index; then let official instructions, "boiled down" from 150 auto manufacturers' factory shop manuals, show you how, step-by-step! Sturdy binding, 8½ x 11 inches, over 700 pages.

### SEND NO MONEY

Find out for yourself how this book can pay for itself first few days you use it. Try it FREE 7 days! Just mail coupon. Pay postman nothing. Put Manual to actual test. Then, if not entirely satisfied with it, return book in 7 days, pay nothing. Mail coupon today! MoToR Book Dept., Desk 1N, 572 Madison Ave., New York 22, New York.

### Every Job on Every Car Built Since 1935!

Nearly 200,000 service and repair facts on:  
American Bantam • Auburn • Austin • Buick • Cadillac • Chevrolet • Chrysler • Cord • Crosley • DeSoto • Dodge • Ford • Frazer • Graham • Hudson • Hupmobile • Kaiser • Lafayette • LaSalle • Lincoln • Lincoln Zephyr • Mercury • Nash • Oldsmobile • Packard • Pierce Arrow • Plymouth • Pontiac • Reo • Studebaker • Terraplane • Willys.

700 big pages; including 70 pages of carburetor text, charts, illustrations covering all models. Over 200 charts, tables: Tune-up Chart; Valve Measurements; Torque Wrench Reading; Starting Motor; Engine Clearances; Generator; Body Service; Dash Gauges; Brake Specifications; Front End Measurements, etc., Engines; Electric, Fuel,

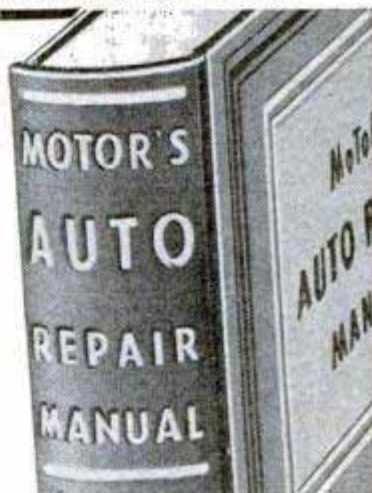

Cooling, Lubricating Systems; Transmissions; Universals; Front Ends; Wheels; Rear Ends, etc.

MoToR Published by MoToR, The Leading Automotive Business Magazine. MoToR's manuals assure high standards of repair work.

### MAIL COUPON NOW FOR 7-DAY FREE TRIAL

MoToR Book Dept., Desk 1N, 572 Madison Ave., N. Y. 22  
Rush to me at once: (Check box opposite book you want)

- MoToR's AUTO REPAIR MANUAL. If O.K. I will remit \$1 in 7 days, (plus 35c delivery charge), then \$2 monthly for 2 months, and a final payment of 95c a month later. (Foreign price, remit \$8 cash with order).
- MoToR's TRUCK REPAIR MANUAL. (Described at left.) If O.K. I will remit \$2 in 7 days, and \$2 monthly for 3 months, plus 35c delivery charge with final payment. Otherwise I will return book postpaid in 7 days. (Foreign price, remit \$10 cash with order.)

Print Name.....Age.....  
Print Address.....  
City..... Zone No. (if any).....  
State..... Occupation.....

Check box and SAVE 35c delivery charge by enclosing WITH COUPON entire payment of \$5.95 for Auto Repair Manual (or \$8.00 for Truck Repair Manual). Same 7-day return-refund privilege applies.

### Same FREE 7-Day Offer Applies on MoToR's Truck Repair Manual

For mechanics, truck specialists, service stations, fleet owners. Covers EVERY job on EVERY truck made since 1936! 1400 pictures, 952 pages, 300,000 facts. Used by Armed Forces. Warranted to contain every essential fact you need to know. Strong binding size 8½ x 11. Covers all types Gasoline Engines; Diesels and Hesselmans. Fuel Sys-

tems, Governors, Lubrication Systems, Ignition Systems, Starters, Generators, Clutches, Transmissions, Axles, Torque Dividers, Transfer Cases, Brakes, Steering, etc., etc. Also services buses, farm and industrial tractors, contractor, and road building equipment, stationary power machinery, etc. (on all parts described in Manual.) Offered on same FREE 7-Day examination as Auto Repair Manual. Check box in coupon at right.



# AUTO BOOKS ON APPROVAL



**SEND NO MONEY.** Just mail the coupon for a complete set of 4 Big, Thick Auto Books. 20th Edition. Over 2700 Pages! Whether you are a mechanic or helper, expert or apprentice, auto owner or driver, take immediate advantage of this **FREE EXAMINATION OFFER.**

### MAKE GOOD MONEY NOW HOLD A PERMANENT JOB

America wants its automobiles kept in good repair. Men with "know how" are in demand, at big pay. These books will help you get and hold an important job, or give you a chance to go into business for yourself now or later. Any man who half tries to improve himself can learn auto servicing and repairing by this quick reference method. Use the **JEFFY INDEX** to find easily understood answer to any auto problem. These wonder books prepared by eleven of America's great automobile engineers. Many hundreds of valuable illustrations. Send the coupon **TODAY.**

**A year's consulting privileges with our engineers now given with these books without extra charge.**

*Publishers Since 1898*

### CAN YOU FIX IT?

These wonder books tell step by step **HOW** to make difficult repairs and adjustments, how to keep a car at maximum efficiency, including latest improvements in car design and operation. Engine troubles and how to correct them well covered.

### 4 BIG, THICK VOLUMES

Over 2700 pages, 2000 illustrations, wiring diagrams, etc., including Diesel engines. Beautiful modernistic, washable cloth binding.

### AMERICAN TECHNICAL SOCIETY, Dept. A819

Drexel Ave. at 58th St., Chicago 37, Ill.

I would like to examine your 4-Volume Set of Auto Books. I will pay the delivery charges only, but if I choose I may return them express collect. If after 10 days' use I prefer to keep them, I will send you \$2 and pay the balance at the rate of only \$3 a month until \$24.80 has been paid. Include consulting service as offered above.

Name \_\_\_\_\_

Address \_\_\_\_\_

City \_\_\_\_\_ State \_\_\_\_\_

Please attach letter stating age, occupation, employer's name and address and name and address of at least one business man as reference. Men in service, also please give home address.

## Now for EVERY WORK SHOP!

# NEW Invention Electroplates by BRUSH



### Easy to Plate CHROMIUM GOLD, SILVER, NICKEL, COPPER ... For Pleasure and Profit!

If you have a workshop—at home or in business—you need this new Warner Electroplater. At the stroke of an electrified brush, you can electroplate models and projects—you can replating worn articles, faucets, tools, fixtures, silverware, etc. with a durable, sparkling coat of metal... Gold, Silver, Chromium, Nickel, Copper or Cadmium. Method is easy, simple, quick. Everything furnished—equipment complete, ready for use. *By doing a bit of work for others, your machine can pay for itself within a week.* So make your shop complete by getting a Warner Electroplater right away. Send today for **FREE SAMPLE** and illustrated literature. **ACT AT ONCE! Mail Coupon.**

**WARNER ELECTRIC CO., DEPT. W-8  
1512 Jarvis Avenue, Chicago 26, Ill.**

## FREE Details & Sample!

**WARNER ELECTRIC CO., 1512 Jarvis Avenue, Chicago 26, Dept. W-8**

Gentlemen: Send Free Sample and Details to:

Name \_\_\_\_\_  
Address \_\_\_\_\_  
City \_\_\_\_\_ State \_\_\_\_\_

STATEMENT OF THE OWNERSHIP, MANAGEMENT, CIRCULATION, ETC., REQUIRED BY THE ACT OF CONGRESS OF AUGUST 24, 1912, AS AMENDED BY THE ACTS OF MARCH 3, 1933, AND JULY 2, 1946, of Popular Mechanics Magazine, published monthly at Chicago, Illinois, for October 1, 1948.

State of Illinois, County of Cook, ss.  
Before me, a Notary Public in and for the State and county aforesaid, personally appeared H. H. Windsor, Jr., who, having been duly sworn according to law, deposes and says that he is the Editor of the Popular Mechanics Magazine, and that the following is, to the best of his knowledge and belief, a true statement of the ownership, management (and if a daily, weekly, semiweekly or triweekly newspaper, the circulation), etc., of the aforesaid publication for the date shown in the above caption, required by the Act of August 24, 1912, as amended by the acts of March 3, 1933, and July 2, 1946 (section 537, Postal Laws and Regulations), (printed on the reverse of this form to wit: First. That the names and addresses of the publisher, editor, managing editor, and business managers are: Publisher, Popular Mechanics Company, 200 E. Ontario St., Chicago, Ill.; Editor, H. H. Windsor, Jr., 200 E. Ontario St., Chicago, Ill.; Managing Editor, R. M. Grant, 200 E. Ontario St., Chicago, Ill.; Business Manager, P. H. Dunakin, 200 E. Ontario St., Chicago, Ill. Second. That the owner is: (if owned by a corporation, its name and address must be stated and also immediately thereunder the names and addresses of stockholders owning or holding one percent or more of total amount of stock. If not owned by a corporation, the names and addresses of the individual owners must be given. If owned by a firm, company, or other unincorporated concern, its name and address, as well as those of each individual member, must be given.) Popular Mechanics Company, 200 E. Ontario St., Chicago, Ill.; H. H. Windsor, Jr., 200 E. Ontario St., Chicago, Ill.; H. H. Windsor, Jr., Trustee for H. H. Windsor III and Wm. T. Windsor, 200 E. Ontario St., Chicago, Ill. Third. That the known bondholders, mortgagees, and other security holders owning or holding 1 percent or more of total amount of bonds, mortgages, or other securities are: (if there are none, so state.) The Equitable Life Assurance Society of the United States, 29 S. LaSalle St., Chicago, Ill. Fourth. That the two paragraphs next above, giving the names of the owners, stockholders, and security holders, if any, contain not only the list of stockholders and security holders as they appear upon the books of the company but also, in cases where the stockholder or security holder appears upon the books of the company as trustee or in any other fiduciary relation, the name of the person or corporation for whom such trustee is acting, is given; also that the said two paragraphs contain statements embracing affiant's full knowledge and belief as to the circumstances and conditions under which stockholders and security holders who do not appear upon the books of the company as trustees, hold stock and securities in a capacity other than that of a bona fide owner; and this affiant has no reason to believe that any other person, association, or corporation has any interest direct or indirect in the said stock, bonds, or securities than as so stated by him. Fifth. That the average number of copies of each issue of this publication sold or distributed, through the mails or otherwise, to paid subscribers during the twelve months preceding the date shown above is (not daily publication). (This information is required from daily, weekly, semiweekly, and triweekly newspapers only.) H. H. Windsor, Jr., Editor. Sworn to and subscribed before me this 14th day of September, 1948. Vera L. Freehill, Notary Public. (My commission expires July 17, 1950.)

### X.L. RUBBER MOLDS

will realize you great profits quickly!

## GREAT PROFITS

MAKE YOUR OWN RUBBER MOLDS

SEND FOR FREE FACTS

WRITE FOR NEW FREE CATALOG

YOU can EASILY learn to cast thousands of perfect plaques, book ends, figurines, ash trays, etc. IT'S EASY, FUN, PROFITABLE!

X.L. Rubber, Pts. \$2.00; X.L. \$3.50; Galins \$8.00; Models and enough rubber for 3 molds \$1.00—Foreign \$1.50.

PLASTIC ARTS STUDIO • Route 2 • Dept. 2 / Muncie, Ind.

## Free Book

MOUNT BIRDS, ANIMALS, FISH

Yes, FREE. Explains Taxidermy. Tells how to learn at home by mail to mount birds, animals, heads... to TAN skins and furs. Great for MEN and BOYS. Pua! Also earn money in spare time. **WRITE TODAY—NOW—** for free book containing 100 game pictures. State AGE. N.W. School of Taxidermy, Dept. 2591, Omaha, Neb.

MAIL Postal Today

## ELECTRICIANS' SCHOOL

HOUSE AND COMMERCIAL WIRING • MOTOR REPAIR AND REWINDING • ELECTRIC REFRIGERATION

Approved for Veterans Training

PENNSYLVANIA INSTITUTE SCHOOL OF ELECTRICITY

42nd and SPRUCE STS. PHILADELPHIA 4, PENNA.

## RUPTURED?

### Get Relief This Proven Way

Why try to worry along with trusses that gouge your flesh—press heavily on hips and spine—enlarge opening—fail to hold rupture? You need the Cluthe. No leg-straps or cutting belts. Automatic adjustable pad holds at real opening—follows every body movement with instant increased support in case of strain. Cannot slip whether at work or play. Light. Waterproof. Can be worn in bath. Send for amazing **FREE** book, "Advice To Ruptured," and details of liberal truthful 60-day trial offer. Also endorsements from grateful users in your neighborhood. Write:

CLUTHE SONS, Dept. 31, Bloomfield, New Jersey



# Learn ELECTRIC APPLIANCE

## Service & Repair

### AT HOME IN YOUR SPARE TIME

We teach you this interesting, good-paying business from A to Z—at home. Our practical, thorough, shop-method course qualifies you to take a job at once, or start in for yourself. A grade school education is all you need. This is an ideal time for men of all ages (up to 60) to get into this active, constantly expanding field, for every year sees millions of new homes wired for electricity . . . and multiple millions of new electric appliances produced. Everyone, literally, is a customer for the man who knows how to service and repair electric devices.

This business is particularly suited to the man who is handy with tools, and likes to keep busy with his hands . . . the men who are the makers, builders, and servicers of life. If you are not completely happy in your present work, there is a WIDE-OPEN OPPORTUNITY for you in this field . . . which is getting bigger and better every day.

#### YOU LEARN

How To Repair  
Washing Machines  
Vacuum Cleaners  
Electric Ranges  
Lamps, Motors,  
Irons, etc.  
REFRIGERATION  
and  
House Wiring

**This  
ELECTRICAL  
APPLIANCE  
TESTER  
and a  
BIG KIT OF TOOLS  
INCLUDED  
at No Extra Cost!**

### Earn While You Learn

You can actually start earning before your course is finished with the Kit of Tools and Tester we send you. With your first set of lessons, I show you easy jobs that can be done in your spare time, at home. And remember—just one good repair job can pay for the complete cost of the course. A business can be started in your garage or basement—expanding from there, as you grow. Let's talk it over by mail.

Make it a point to get posted about our course by sending TODAY—without obligation—for our free booklet telling the entire story.

### OPEN YOUR OWN SHOP Be Independent and Secure

No new-fangled machine can ever take your place in this work . . . as it calls for trained hands to service appliances—so your job is safe, even in a depression. If you open your own shop, you not only enjoy security and independence . . . and can have others work for you . . . it's just a step to a prosperous appliance business where the **BIG PROFITS LIE**. There's no satisfaction like being your own boss, and here's a real opportunity to make that a reality. Or, of course, you can take a well paid job in this active line, as trained men are needed. Remember, this is AN ELECTRICAL AGE. Getting into this field now is to ride the tide of progress.



**Send  
for this  
FREE  
BOOKLET**



**No Salesman Will Call**

### MAIL COUPON TODAY

PACIFIC TRAINING SCHOOL — Dept. P-811  
7217 So. Broadway, Los Angeles 3, Calif.

Please send me your FREE BOOKLET:  
"Today's Big Opportunity — Appliance Servicing"

NAME \_\_\_\_\_ AGE \_\_\_\_\_

ADDRESS \_\_\_\_\_ ZONE \_\_\_\_\_

CITY \_\_\_\_\_ STATE \_\_\_\_\_

Please print plainly

# MAKE BIG MONEY FAST



**STEVINSON TRAINED  
AUTO and ELECTRICAL EXPERTS  
GET TOP MONEY**

Our 26 years of Successful Training of men in chosen careers in automotive, air-conditioning, refrigeration, and electrical appliance industries, has perfected the famous **Stevinson classroom-shop system** of instruction... a technical, plus practical experience method... which speeds your progress... assures quick qualification for top incomes.

**APPROVED FOR CIVILIAN AND VETERANS TRAINING**  
The steady work, backed by proved time-saving methods of Stevinson training and experience has won approval from civilians and veterans alike. If you are a qualified G I, don't delay a day. Write today. Approved under laws 346 and 16.

**EARN WHILE YOU LEARN**  
No wasted time. Be an expert in latest modern methods... you work with most advanced new equipment. We help you arrange part-time work... help you get best jobs or set up your own business on graduating. Don't limit yourself. Get on the quick road to success with a solid Stevinson foundation.

**WITH STEVINSON TRAINING**

## GET FULL FACTS FREE. MAIL COUPON NOW!

Stevinson Auto & Electrical School,  
Dept. P, 2008 Main St., Kansas City 8, Mo.

Common sense tells me the practical 26 years success of Stevinson classroom-shop training means faster earning of big money for me. Send me full facts on the training courses I have checked, at no cost or obligation:

- |  |   |
|--|---|
| <input type="checkbox"/> Auto                          | <input type="checkbox"/> Air Conditioning     |
| <input type="checkbox"/> Refrigeration                 | <input type="checkbox"/> Electrical Appliance |
| <input type="checkbox"/> Auto Body & Fender Rebuilding |   |

Name \_\_\_\_\_

Street \_\_\_\_\_

Town \_\_\_\_\_ State \_\_\_\_\_

# How to Write

The demand for writers is creating great new opportunities for people with an urge to write. It's not as hard to succeed as you may imagine. Most famous authors come from ordinary walks of life. At home, you too may learn fiction writing, the best basis for all fields—short stories, features, articles, technical, mechanical and business items. Palmer Institute's Home Study Training (Established 1917) is en-

# MAKE YOUR OWN!

WITH

## Griffin READYCUT LEATHER PROJECTS

Over 100 KITS in every kind of Tooling and Carving Leather, accurately cut, all parts included. Only Top Grade Leathers used. You do the choosing You do the tooling, carving, stamping, the punching and assembling.



SEND FOR COMPLETE CATALOG It's free to leather workers. A postal card will do

SINCE 1924

OUT OF THE WEST, THE HOME OF LEATHER CARVING

**Griffin Craft Supplies**

Dept. PM 5515-21 GROVE STREET OAKLAND 9 CALIFORNIA

### EVERYTHING FOR THE LEATHER WORKER

Largest, most complete stock of Leathercraft Tools and Accessories in U.S.A.



HIDES AND SKINS of Craft Leathers of every kind if you prefer to cut your own.

# EXPERT PHOTOGRAPHY MADE EASY

## LEARN PHOTOGRAPHY NOW

—for both a sound and secure future and immediate opportunities. Ever-increasing demand for trained men and women. Excellent earnings. Resident or home study. 39th year. Write for full details.

### NEW YORK INSTITUTE OF PHOTOGRAPHY

Dept. "49," 10 West 33 Street New York 1, New York

# BE A NOTARY PUBLIC

Largest notary supply house equips you for \$16.97, guarantees your appointment by governor. Honor, prestige. You certify legal papers, collect fees. Easy. At home, office, anywhere. You use official seal made with your name. Notaries needed everywhere. Be one.

Write STATIONERS EXCHANGE, Helotes 17, Texas

# LEARN MOVIE PROJECTION THEATRE MANAGEMENT



The Motion Picture Theatre Business offers big opportunities for trained men. Get into a fascinating field with a promising future. Train at home in spare time. Free Catalog. Established 20 years.

THEATRE SCHOOL, 370 Washington St., Elmira, New York

# Short Stories, Mysteries, Novels, Articles—at home in spare time

dorsed by Rupert Hughes, Gertrude Atherton, Keith Monroe and other famous authors and by scores of successful graduates. Complete instruction material, professional coaching develop your own style. FREE book shows how you may enjoy an ideal part time or full time career. Write today (no salesman will call). Veterans: advise us if you are eligible for G.I. Training.

PALMER INSTITUTE OF AUTHORSHIP • Desk T-118 • 1680 N. Sycamore • Hollywood 28, Calif.

# Sensational New Electric ① WELDER ② CUTTER!



WELDER UNIT



CUTTER UNIT

Uses 110-115 AC or DC • INSTRUCTIONS INCLUDED  
WELD - BRAZE - CUT - MELT - SOLDER - HEAT TREAT

The WELDRITE combination—tested and proven by countless commercial and amateur users, is now offered direct to you at the amazingly low price of only \$12.00. No Gas—No Gauges—No Spark Lighter needed. Always ready for immediate use—Just plug WELDRITE into 110-115 AC or DC outlet. Uses standard welding and brazing materials available at all welding supply stores. WELDRITE furnished complete with Converter Unit, #1 Single Holder with attached Alligator clip, for welding metal up to 3/16" thickness, using up to 3/32" rod, and #2 Double Holder with Copper Coated Dual Carbon Electrodes for Cutting, Brazing, Heat Treating, Soldering, etc. Starting welding materials and instructions included.

Ideal for home workshop. Invaluable for body

and fender shops, garages, repair and machine shops, manufacturers, etc.

### SEND NO MONEY! 10 DAY TRIAL OFFER

Order your WELDRITE Electric WELDER-CUTTER C.O.D. today. Pay postman \$12 plus postage charges (wt. 4 lbs.) or send \$12 and we pay postage. Either way, if not satisfied, return WELDRITE in 10 days, and money will be refunded. WELDER HOOD—Approved lens found in hoods costing to \$10—only \$3.95. California orders please add 2 1/2% sales tax.

### CALIFORNIA TECHNICAL PRODUCTS CO.

448 So. Hill St., Los Angeles 13, Calif. Dept. A-11

**BOTH only \$12**  
LOWEST PRICE IN HISTORY!



# Learn BUILDING

AT HOME • All Blue Print Building Plans, Specifications, Lessons Furnished

## FIND OUT ABOUT TRAINING AND OPPORTUNITIES FOR YOU IN BUILDING

Established in 1904, Chicago Technical College offers you thorough, practical training in Building, by home-study. Mail coupon for free information. See what this Course has done for others, what it can do for you. Read what Chicago Tech graduates say about their work, earnings, success. Learn the rewards awaiting you as a trained builder — and how quickly, easily you can get started. Simply MAIL COUPON TODAY in an envelope or paste on a penny postcard.



**CHICAGO TECHNICAL COLLEGE**  
P-152, Tech Building, 2000 South Michigan Ave.  
Chicago 16, Illinois

## MAIL COUPON NOW

**CHICAGO TECHNICAL COLLEGE**  
P-152, Tech Bldg., 2000 So. Michigan Ave.  
Chicago 16, Illinois

Mail me FREE building Lesson with information about big opportunities in BUILDING and how I can train at home.

Name \_\_\_\_\_ Age \_\_\_\_\_  
Address \_\_\_\_\_  
City \_\_\_\_\_ Zone \_\_\_\_\_ State \_\_\_\_\_

# PLASTICS

## OFFERS YOU A GREAT FUTURE!

BECAUSE MORE AND MORE PRODUCTS ARE BEING MADE OF PLASTICS!

LOOK AT THESE INDUSTRIES!

- AUTOMOBILE
- CONSTRUCTION
- ELECTRICAL
- TEXTILE
- SPORTING GOODS
- RUBBER COMPOUNDS
- LEATHER
- MARINE
- GENERAL MANUFACTURING

ON AND ON — through industry after industry — thousands of useful, practical, every-day products made BETTER and CHEAPER from some kind of PLASTIC. That's why men and women trained in Plastics can qualify for a great future. YOU CAN GET THIS TRAINING NOW AT PLASTICS INSTITUTE, the world's largest and finest school devoted exclusively to Plastics.

You can enroll for Plastics Institute's famous Home Study Course which prepares you for a career in plastics while you carry on your present activities. Or come to California for Resident Training in P.I.T.I. shops and laboratories. **START YOUR TRAINING NOW**—Mail coupon below for complete details of Plastics Institute's training developed under guidance of industry leaders. No wasted time or padded lessons. You learn quickly, easily.

**YOU MAKE THINGS**—Home study students get practical kit materials. You make handsome, useful articles. You farm, dye, decorate, cast and laminate various types of plastics. You get experience designing and developing your own ideas.

**STUDY AT HOME**

or **AT PLASTICS INSTITUTE'S RESIDENT SCHOOL IN LOS ANGELES, CALIFORNIA**

**APPROVED For Veterans**

**AVAILABLE For Non-Veterans**

## PLASTICS INDUSTRIES TECHNICAL INSTITUTE

• NEW YORK • CHICAGO • LOS ANGELES •

Plastics Industries Technical Institute,  
1601 S. Western Ave., Los Angeles 6, Calif. PM1 1-R  
Gentlemen: Please send me literature and information on your  
Resident School Courses  Home Training Courses

Name ..... Age ..  
Street ..... Zone ..  
City ..... State ..  
Veteran ..... Non-Veteran ..... Previous Education .....

# OWN a Nationally Advertised Business

Now, we are appointing dealers in U.S.A., Canada, Mexico and foreign countries . . . in territories still open. If you are capable, co-operative and willing to work to enjoy success, we'll establish you in your own business and arrange easy terms to help you get started. Gross profits up to \$15 and \$20 a day on each of your service men. No experience needed.

## Clean Rugs and Upholstery

Duraclean Dealers' businesses are built upon the solid foundation of a national organization with 18 years of Proven Success. Duraclean Service was established to improve cleaning methods for rugs and upholstery . . . to eliminate harsh machine scrubbing . . . to prevent shrinkage from soaking. Instead of floating surface soil down into upholstery and rugs, this amazing process actually removes it!

## Protects Against Moths

Here is another year 'round service rendered right in the home, office, or business building—without removing furnishings. Duraproof protects carpets, upholstery, furs, clothing, piano felts and auto interiors from damage by moths or carpet beetles. Guards against mildew, too. To our knowledge, Duraproof is the only mothproof service backed by a National Money-Back 4-YEAR WARRANTY.

## Voluntary and Repeat Orders

Customers are not merely satisfied—many are enthused with results and tell friends and neighbors. Duraclean is recommended by America's foremost furniture and department stores. Services are NATIONALLY ADVERTISED in Quality Magazines to help create still more demand for you and to explain the superior merits of YOUR modern processes and to develop confidence in your service.

## No Overhead Expense

Shop is optional! At the start you may want to render service yourself from your own home, on a part time basis. It's easy to learn. Almost every building in your territory houses a potential customer needing one or both services. Even auto dealers buy your Duraclean Service to revive upholstery in used cars.

## Two-Way Profit

You enjoy unusual profits on both materials and labor after paying service men and salesmen. Mr. E. Schalchin reported, "Have on hand 5 orders totaling over \$500, obtained from recommendations of customers." J. Dalton says, "Business previous four weeks was \$1,600."

## FREE Booklet

If you are interested in an opportunity like this, fill out the coupon today! A letter and 16 page illustrated booklet will explain everything. We furnish electric machines, advertising matter, store cards, introduction slips, sales portfolios, demonstrators and enough materials to return your TOTAL investment. You can have YOUR OWN business operating within a week after equipment arrives. Mail coupon NOW and discover for yourself. No obligation. Easy Terms!



1/4 PAGE

Better Homes and Gardens

## "OWN a Business" Coupon

### Duraclean Co.

Division of HOME SERVICE CO.  
16-N Ct., Deerfield, Illinois

With no obligation to me, send booklet and letter giving full details. Tell me how I can OWN a growing business of my own built upon satisfied customers.

Name \_\_\_\_\_ Age \_\_\_\_\_

Address \_\_\_\_\_

City \_\_\_\_\_ State \_\_\_\_\_

SAY YOU SAW IT IN POPULAR MECHANICS

THE ONLY GENUINE WEBSTER IS THE

# Merriam-Webster



A century ago, G. & C.

Merriam Company acquired the rights to publish Webster's Dictionary. Through the years, with each new edition, Merriam has constantly enlarged the scope and usefulness of Noah Webster's original work, until today the names MERRIAM and WEBSTER are equally important in identifying "The Supreme Authority." Ask for WEBSTER'S NEW INTERNATIONAL DICTIONARY, Second Edition—the great unabridged Merriam-Webster.

G. & C. MERRIAM CO., Dept. 821, Springfield 2, Mass.

Buy Give-a-Book Certificates at Your Bookseller

"THE SUPREME AUTHORITY"

## ELECTRICAL TRAINING

Intensive 32 weeks' residence course in fundamentals of industrial electrical engineering, including radio, electronics. Prepares for technician, engineering aides. Approved for veteran training. 54th year. Enter November 22, April 4. Catalog.

## BLISS ELECTRICAL SCHOOL

7644 TAKOMA AVENUE  
WASHINGTON 12, D. C.

## BIG 3 1/2" POWER BINOCULARS only 2.98

Quality plus—yet priced to beat all competition. All metal with adjustable focusing wheel and shoulder strap. Tubes extend for sharp, instant view of distant objects. SEND NO MONEY! Clip ad and mail. We'll ship C.O.D. Check here to get handsome Carry Case only 50c extra.  Illinois Merchandise Mart, Dept. 2227-A 1227 Loyola Ave., Chicago 26, Ill.



## Is Your Rupture HERE?

Why continue to suffer with an uncomfortable truss if we can help you? Relief GUARANTEED or it costs you nothing. Send for the facts about my perfected truss invention—the Brooks Appliance for reducible rupture—with the patented AIR-CUSHION support that works silently with Nature to give protection. Thousands bought by doctors.

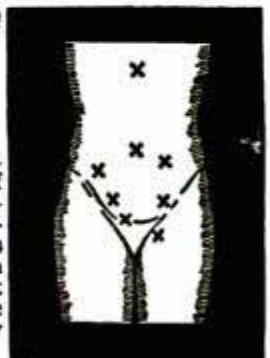

Sent on Trial—Made-to-measure, individual fitting for man, woman or child. Low-priced, sanitary, durable. No obnoxious springs or hard pads; no metal girdle to rust. Light weight, neat and comfortable. Not sold through stores or agents—beware of imitations. Write today for full information sent free in plain sealed envelope.

**BROOKS APPLIANCE CO.** 161-C State St. Marshall, Mich.



It's Amazing! It's Sensational! It's Exclusive!

# "The New Arthur Murray Way"

**makes learning to dance easier than ever!**

Even if you never danced before you can become a popular partner in a fraction of the usual time "The New Arthur Murray Way"

Take Arthur Murray's short-cut to good times. Find the self-confidence and popularity you've always wanted.

Only a few hours at any Arthur Murray Studio will transform you into an expert dancer. His unique methods make learning easy and fast! The key to all new dances is Arthur Murray's basic discovery — the

"First Step to Popularity." Like magic you find yourself leading or following a smart new Fox Trot, Rumba, Samba. You can actually go out dancing after one hour even if you've never danced before.

### Stop Passing Up Good Times

Only at an Arthur Murray Studio can you get that wonder-working combination of his new, improved exclusive methods and the trained skill of his teachers. You'll be a joy to dance with, a pleasure to watch. Get a dance analysis *free* at any Arthur Murray Studio. Come in or phone *now*.

### PROOF You can dance after 1 lesson!

See how quickly you can learn to dance "The New Arthur Murray Way." Send for the "Murray-Go-Round" today! It contains instructions on the Fox Trot, Waltz and all dances. Consult your telephone directory and **MAIL THIS COUPON TO YOUR NEAREST ARTHUR MURRAY STUDIO**; or send it to Arthur Murray (Studio 9), 11 East 43rd St., New York 17, N.Y.

Copyright 1948—Arthur Murray Inc.



ONLY **25¢** 44 PAGE DANCE MAGAZINE

**ARTHUR MURRAY STUDIOS:** Please send me your magazine, "Murray-Go-Round," 44 pages of pictures and instructions on the latest ballroom dances, Fox Trot, Waltz, Rumba, Samba, etc. I enclose 25c.

NAME \_\_\_\_\_

ADDRESS \_\_\_\_\_

CITY \_\_\_\_\_ ZONE \_\_\_\_\_ STATE \_\_\_\_\_

PM—NOV.

## ARTHUR MURRAY

DANCE STUDIOS FROM COAST-TO-COAST

Visit the one nearest you for  
a FREE dance analysis

# Paint Your Car!

AND 1001  
OTHER ITEMS

AMAZING  
NEW

# "Super" CARONIZE

FACTORY-FINISH TYPE

## AUTO ENAMEL

One Quart Covers! One Hour to Apply! One Hour to Dry!

*Just Wipe it on!*

Handy  
Applicator



Makes Your Old Car  
Gleam Like New!

INCLUDED AT NO EXTRA COST

Now you can quickly and easily make your old car look almost NEW! Just give it a speedy coat of new "SUPER" CARONIZE. With "SUPER" CARONIZE all back-breaking labor is eliminated... NO BRUSHING, SPRAYING, MASKING, BUFFING OR SCRAPING is necessary. Simply clean car and WIPE ON this sensational new fast-drying paint. In just a short time, your car will GLEAM with a mirror-bright finish that LASTS FOR YEARS. "SUPER" CARONIZE won't peel, crack, chip in spite of rain, snow or sun.

THE RESULT OF MONTHS OF LABORATORY RESEARCH!

"Super" Caronize smoothly covers your car because it contains genuine THERMOREZ, the very same type synthetic resin as is used in finishing newest cars. If you are getting a new car, a brilliant "Super" Caronize finish may increase your trade-in value \$100 and more.

*Guaranteed*  
3 FULL YEARS

The only wipe-on enamel in America that gives you a 3-year WRITTEN guarantee against chipping, cracking or peeling when applied according to directions.

## 16 CHOICE OF BEAUTIFUL NEW COLORS

Black • Maroon • "Fiery" (Bright)  
Red • Cloud Grey • "Washington"  
(Dark) Blue • Brewster (Dark) Green  
Monticello (Light) Blue • Jewel  
(Light) Green • Orange • "Lettuce"  
(Very Light) Green • Light Yellow • Tan  
Ivory • Chrome • Clear • White

"Super" Caronize White is absolutely non-yellowing

Use coupon below. Send us your color choice today! Pay postman only \$2.95 plus postage. Or send cash and we pay postage.

SEND NO MONEY

RUSH ORDER TODAY!

Fill Out and Mail This Coupon Today! Send No Money!

Please send me ..... qts. of  
"Super" Caronize at \$2.95 per qt.

COLORS:

NAME .....  
(Please Print)

ADDRESS .....

CITY.....STATE.....

Send Postpaid,  
remittance enclosed

Send C. O. D.  
plus postal charges

ONLY  
\$ 2.95  
Enough  
to Paint  
Almost  
Any Auto

AMAZING FOR AUTOS and  
1001 OTHER PAINT USES

### AT HOME

Caronize colors are wonderful for all refrigerators, gas stoves, furniture. All porcelain, metal and wood surfaces. "Super" Caronize Clear gives a durable coating to floors, linoleum and all household woodwork.

### OUTDOORS

Perfect for all lawn furniture, swings, bird-baths and other items of this type. Also recommended for boats, canoes, etc.

### ON THE FARM

Durable for tractors and all other kinds of farm implements, dairy and utensil uses.

### STORES AND OFFICES

Excellent for desks, table tops, files and 1001 other uses in stores, shops, taverns, beauty parlors, offices, etc.



## CARONIZE, INC.

DEPT. 1801 Singleton Ave.  
PM-11 St. Louis 3, Mo.

AGENTS AND DISTRIBUTORS  
Write for Free Information

**WORLD'S  
BEST  
WANT AD  
MEDIUM**

# CLASSIFIED Advertisements



Advertisements in this section 75 cents per word, each insertion, minimum 10 words, payable in advance  
To be inserted under proper classification, copy must be in our office the 22nd of the  
second month preceding date of issue

F. W. Johnson, Manager, Classified Advertising

Popular Mechanics Magazine, 200 East Ontario Street, Chicago 11, Illinois

**1241**

**CLASSIFIED  
ADVERTISEMENTS**

**1241**

**OPPORTUNITIES  
FOR YOU**

## AUTOMOBILES, MIDGET CARS

**DUALTONE** Crystalline packed California mufflers for all automobiles. Large chrome tailpipe extensions. Chromed carburetors, fuel pumps, long shackles, dual manifolds, hi-compression heads, flywheels, camshafts, fender skirts, plexitops. Send 20c illustrated catalogue, deduct from first order. Streamlining Manual \$1.00. Dualtone Mufflers, 2636C India Street, San Diego 1, Calif.

**"SPEED & Mileage"** Manual—Easily obtain greater speed, mileage, racing performance from any automobile! Famous (original) book shows soup up methods; speed tuning; mileage secrets; racing tricks! "Customizing ideas!" Photographs! Instructions on building inexpensive speed equipment! Economizers! "Hot-Rods!" Speedsters! Fast conversions! Engines! Superchargers! "Water injectors!" Mufflers! All about "Economy Tuning," compression, manifolds, ignition, lubricants, cams, fuels! Latest "Hollywood Stylizing;" streamlining; sports car conversions! Plans: "Fascinating Pictorial Supplement;" catalogues; charts; parts lists! Deluxe enlarged edition, \$1.98. (Guaranteed). Almquist Engineering, Milford 41, Pennsylvania.

**CUSTOMIZE** Your car! Authentic California restyling plans galore! Working sketches, specific model changes. Comprehensive; complete! 130 photographs! Plus accessory catalog! Largest, finest, or refund! \$2 postpaid. Post Publications, Box 723-ZE, Arcadia, California.

**HOT Rod** racing book, 90 photographs, illustrations famous record holders used California Dry Lakes. Contains hotrod tips, closeup action shots, specifications, 8 beautiful drawings suitable framing, \$1.50 postpaid. Clymer, Dept. A-11V, 1268 So. Alvarado, Los Angeles 6, Calif.

**"CUSTOM Styling"** Manual—Quickly make car look Hollywoodized, custom, ultra-beautiful by easy, inexpensive methods! 100 photographs, instructions on customizing, restyling, streamlining; new and old cars! Thrilling sport changes! Latest custom, sportster, convertible, speed, model conversions; accessories; mufflers; engine "soup up" specifications! (Custom car catalog included). Most complete book \$2. Almquist Engineering, Milford 41, Pennsylvania.

**INSTANT Starting!** Save gas! 1949 "Lektron" atomic coil booster. Easily installed. Only \$2.00. Money-back guarantee! Specify car. Electronic Industries, Cleveland 11, Ohio.

**MODEL "A"** and **"T"** Ford book, 572 pages, complete information repairing, maintenance, servicing both models and Fordson tractor. \$3.50. Model "A" book only \$1.00 postpaid. Clymer, Dept. A-ATA, 1268 So. Alvarado, Los Angeles 6, Calif.

**"RACING Book"**—Just out! Photo packed with data on roadsters, midgets, dirt, championship cars; drivers! How to speed up passenger cars, build 145 m.p.h. racers! Hotrods! Sport cars! Stock conversions! Power equipment! All about speed tuning, streamlining, superchargers, fuels, valves, speed tricks! Racing secrets! Records! Formulas! Drawings! Action pictures! Sensational \$1.98. Almquist Engineering, Milford 41, Pennsylvania.

**MERCEDES**, Pioneer of an industry. Profusely illustrated history of development of gasoline engine and thrilling early races. Send \$2.00. Alec Ulmann, Riverside, Connecticut.

**MAKE** Your car go! Hot-Rod Manual, \$1.50, speed parts list 25c. Hollywood Hot-Rod, Box 9626P, Hollywood 27, Calif.

**CLYMER'S** Test reports on post-war Kaiser-Frazer, Studebaker, 1949 Mercury, 1949 Ford, give impartial, uncensored report 3000-mile economy, speed, record tests. Part-by-part equipment analysis. 3000 owner tabulations in each book, 200 owner letters. Good, bad comments about each make, no punches pulled. Learn the truth. Specify make car interested in. \$1.50 postpaid, Clymer, Dept. A-TR, 1268 So. Alvarado, Los Angeles 6, Calif.

**SANDEE Mufflers**—Singles, duals. Echo pipes, skirts, velocity stacks, wheel discs. Charles Hohenrath, 36 Main St., Port Washington, New York.

**"SPEED Up, customize your car!"** Famous racing, speed equipment, beautifying accessories, mufflers, dual manifolds, heads, Hollywood discs, "streamliners," skirts, "superchargers," hotrod, custom supplies. Low factory prices! Beautiful "Handbook Catalog" 20c (refundable). Almquist Engineering, Milford 41, Pennsylvania.

**DIRECT** From California—Speed equipment for all passenger automobiles! We pay shipping costs! Beautiful dress-up accessories! Picture-Catalogues 25c. Newhouse Automotive Industries, 5941-B3 Hereford, Los Angeles 22.

**FORD V-8** Gas saver carburetor balancer. Install yourself \$1. Ray Bachelder, 605-42 St., Oakland 9, Calif.

**PHOTOGRAPHS**, World's finest automobiles. List, sample, 10c. Box 1028, Minneapolis, Minnesota.

**"HI-SPEED"** Compression heads for your V-8. Famous "Hotton-Sullivan" racing design guarantees up to 25% power increase! Amazing acceleration, economy, speedway performance! Now only \$45.00 pair. Circular free. Almquist Engineering, Milford 41, Pennsylvania.

**USED-CAR Buyer's** handbook. Includes authoritative specific late model evaluations! Complete tests, dealers' tricks, graphic photographs! \$1 postpaid. Post Publications, Box 723-TE, Arcadia, California.

**STUDEBAKER** Champion 135", 140", 160", 184" racing engines. Power equipment for stock cars. Frank Morgan, Studebaker Dealer, Marysville, California.

**CLYMER'S** 1948 Indianapolis Race Year Book. Complete information, 100 photographs, charts, drawings, cartoons. \$1.50. Deluxe fabrikoid bound \$2.50 postpaid. Clymer, Dept. A-548, 1268 So. Alvarado, Los Angeles 6, Calif.

**FORD** Fuel pumps can't fail with my fixture. \$1.00 postpaid. Guaranteed. Hooper System, 13191 Gridley, San Fernando, Calif.

**"SUPERCHARGER"** Needle valve—Increases speed, power, pep! Starting! 10% more mileage guaranteed! Free trial! Quickly replaces idling jet. Specify car, \$1.50. (Eight's take 2, six's 1). Almquist Engineering, Milford 41, Pennsylvania.

**SEE** Our ad under motorscooters for midget car bargains. Midget Motors Directory, Athens, Ohio.

**CALIFORNIA** Custom accessory headquarters. Buy direct from original designers and save. Solid hood sides, grille panels, lowering blocks, fender skirts, mufflers, speed equipment. Picture catalogue with scores of items, 25c. Eastern Auto Supply, 3319L South-Grand, Los Angeles 7, Calif.

**"SPEED And Power"** Handbook—Very latest methods! Construct your own superchargers, "water injectors," hi-compression heads, fuel saving devices—easily. Save many dollars! Get racing speed, acceleration, dynamic power increases from any automobile! Build fast stock cars! California roadsters! Hotrods! Get ingenious formulas! Speed secrets! Illustrations! Conversion ideas! Also "Economy Information"—mileage tricks! Tuning techniques! Instructions! Picture catalogues, including "California Restyling Ideas"—glossy photographs! Drawings! Model revising! Customizing! Streamlining! Leatherlike bound—\$1.98 complete. Newhouse Automotive Industries, 5941-B3 Hereford, Los Angeles 22.

**HOT Rod** builders! We chrome plate cylinder heads, generator housings, carburetors and other parts. Send parts in for free estimate. Master Silverplaters, 2158 Gratiot, Detroit, Michigan.

**CALLAIR** Snowcar for dependable winter transportation. \$1700 to \$2250. Working drawings \$10.00. Complete machine or any part. Callair, Afton, Wyoming.

**"VAPO-STEAMATIC"** Water injection. Easily constructed (for less than \$1.00). Finest automatic "moist-humidity" system. Engineering triumph—gets up to 33 miles per gallon. Tremendously increases horsepower! Eliminates ping, carbon, overheating. Reduces wear—lengthens engine life! Copyrighted "Installation Handbook"—(illustrated)—including "Mileage Information" Parts lists, picture catalogues, etc. \$1.00 complete. Newhouse Automotive Industries, 5941-B1 Hereford, Los Angeles 22.

**FORD-MERCURY** Owners. Attention! Supertone dual exhaust systems reduce back pressure 50%. Increase mileage, beautiful tone. Leaf or coil springs weak or flat? Free spring and muffler catalog; all cars. Trucks 1 ton or less. Supertone Mufflers, 2470 E. Slauson, Huntington Park 3, Calif.

**NEW** Sensational seat cover. Mono, #545 Santa Monica Blvd., Hollywood, California.

**CHEVROLET** Speed manual now available to discriminating Chevrolet owners who desire real "hotrod" performance from their 1937 to 1948 Chevrolets. Filled with photographs, complete information, proven methods showing you how to make your road car into a genuine 110 m.p.h. job, or how to build 134.52 m.p.h. Chevrolet hotrod. Every page worth the purchase price of only \$2.00 postpaid. California Bill, Box L-1, Eaglerock, Los Angeles 41, Calif.

**MAKE** Your Model "A" do 100 m.p.h. Lightning acceleration, breath-taking top speed. Complete details, photographs, \$1 postpaid. Four Barrel, Box L-1, Eaglerock, Los Angeles 41, Calif.

**FROM** Speedway to roadway! Track-proved hi-speed heads and manifolds now available for your passenger car! No special tools needed! Increase horsepower 25%! Astounding getaway! Free illustrated catalog. Speedsport, 6215AA Diversey, Chicago 39.

**INSTALL** V-8 engine in your Model A for extreme acceleration, more top speed, smoother performance. Complete details, photographs, \$1 postpaid. A-V-8, Box L-1, Eaglerock, Los Angeles 41, Calif.

**MAKE Your Ford fast!** Complete details, photographs. How to construct 120 m.p.h. Hotrod. \$1 postpaid. California Bill, Box L-1 Eaglerock, Los Angeles 41, Calif.

WE Sell direct to customers over 200 speed equipment parts manufactured by us. Ford A-B-V8-6-4 (Ferguson), Studebaker Champion, Chevrolets and Willys. Cylinder heads, dual intake manifolds, lynch flywheels, oversize valves, compound springs, camshafts and other supplies. Complete engines ready for race for cars, boats and midgets. \$1.00 to cover illustrated literature and price sheet. R & R Mfg. Co., Robert M. Roof, Box 546, Anderson, Indiana.

**BUILD** Speedy midget track racer from castoff parts! Plans, specifications, construction information, \$1.00. Motor Supply, Box CS-1682, Toledo, Ohio.

**AUTOMOBILE** Racing, Sixth Edition. 100 illustrations. Working drawings with building instructions for Ford-60 midget, California roadster, Offenhauser racer. Details on racer parts. Sample entrance blank. World's record 158.5 m.p.h. rear engine four-wheel drive car. Interesting information for fans, drivers, mechanics. \$2.00 postpaid; \$2.25 c.o.d. Ray Kuns, Department 63, Cincinnati 27, Ohio.

**AUTOMOBILE** Racing book, fifth edition, well illustrated. Instructions on building bodies, frames, engines. Ford A and B conversions. Plans. AAA rules, specifications. Roadster racing. Indianapolis cars. \$1.00 postpaid, \$1.30 C.O.D. Ray Kuns, Dept. 47, Madisonville, Cincinnati 27, Ohio.

**EASILY** Built professional midget racer, motorscooter, midget roadster, or midget motorcycle from cast off parts. Plans, specifications for all four contained in illustrated handbook, 25 cents. Directory of bargain priced used parts and motors included free! Midwest, 3839 Drummond, Toledo, Ohio.

**SPECIAL!** Until December 1st only! Speed Age, motor racing magazine, yearly subscription half price. Regularly \$3.00. Now \$1.50. Give subscriptions for Christmas. P.O. Box 237M Hyattsville, Maryland.

#### **AUTO SUPPLIES AND EQUIPMENT**

**GENUINE** Ford parts mailed c.o.d. anywhere by America's original mail-order parts specialist. Speedy service. No catalog. Baker Corp., Brookline 46, Mass. Authorized Ford dealer for 25 years.

**SHABBY** Automobile? Apply one application of the revolutionary new discovery, KP-Clear, and make your old, dull, chalky automobile finish like new. Not a wax or polish. Deposits a brilliant, transparent plastic coating which dries in one hour. Enough KP-Clear for one automobile, including applicator, \$2.00. Shipped c.o.d. or send \$2.00 and save charges. Kimball Products, Dept. 102, 26970 Princeton, Inkster, Michigan.

**BATTERY** Weld stick! Repairs cracked batteries. Free sample for letterhead. Northlako, Peoria 4, Ill.

**GRILLES** For all cars. 1939 Plymouth shells; 1940 Plymouth shells. Wagner Grille Co., Route 2, Bernville, Penna.

**MORE** Gasoline mileage. Free descriptive, illustrated, instructions. Neher Industries, La Verne, California.

**WATER** Injection, former top military aviation secret for fighter-craft airplane engines, increases horsepower and speed; decreases fuel consumption, keeps engines cooler, cleaner, more carbon free; now available for cars and trucks in the Octa-Gane water injecting carburetor. Complete with tank \$24.25 (without tank \$17.50). Specify car model. Mail postcard for literature. H & F Products, Box 144, Linden, N. J.

**NEW.** Used, immediate shipment, transmissions, rear ends. State needs. North Auto Parts, 1601 Clybourne Ave., Chicago 14.

**HYDRAULIC** Jack repair kits. Repair your own. Send for prices. Beerman Precision Machine Works, 2000 So. Claiborne, New Orleans 13, La.

**DRIVERS.** Protect yourself against front and rear headlight glare with Saf-T-Aids. Set \$3.25 postpaid. Brookmyre, 4924-P State Road, Drexel Hill, Penna.

**WELDING** Bodies, blocks; repairing fenders, bumpers easy with Hobart welders. Low cost, adds \$\$\$ to your profits. Catalog free. Write Hobartweld, Box M-1182, Troy, Ohio.

**MOTORISTS**—Save gasoline by Vacuumating overrich mixtures. Fits all cars. For free particulars write Vacuumatic, Dept. 1410, Wauwatosa, Wis.

**PUSHIN** Dispenser loaded with 3 lbs. grease for autos, trucks, tractors, \$1.00. Pushin, 1601 Clybourne, Chicago 14.

**CONVERTIBLE** Tops—Completely sewn. Easily installed. Reasonable prices. Free literature. Rio Top Company, 1370 Roanoke, Newport News 18, Virginia.

**SKID-CHAIN** Mounting tool. Solid brass. Mounts full chains like magic. Prepaid \$1.00. Distributor's opportunity. Wildon Manufacturing Company, Box 87, Nutley 10, N. J.

**AUTO** Parts—New, used or rebuilt. Anything for engine or body. Any model car or truck. Reasonable prices. Immediate shipments. What do you need? Write: Brown & Baker Motors (Parts Division), 5254 West Pico Blvd., Los Angeles 25, California.

**THE ABC** of water injection. Complete information free. Advanced Automotive Products, 563-12 Lake Road, Webster, N. Y.

**REPAIR** Your car. Motor parts for all engines, chassis parts, ignition and carburetor parts, etc.; new replacement parts. Genuine and highest quality at manufacturers' retail prices. Orders receive priority over inquiries. Briggs Automotive Engineering, Box 3454, Merchandise Mart, P.O. Chicago 54, Ill.

**SEAT** Covers, front or rear. C. Page, Franklinville, New York.

**AUTOMOBILE** Shatterproof glass! Direct savings! Write requirements. Cooper's, 3135 Lawrence, Chicago 25.

**GOVERNMENT** Surplus. Low voltage circuit tester in steel box. Cost \$202.00. Our price \$27.50. Will test batteries, starters, generators, voltage regulators, grounds, short circuits. Wilt Electrical Company, 7829 S. Racine Ave., Chicago 20, Ill.

**NEW** And used automobile and truck parts. Lowest prices. Complete stock. Prompt reply. Babbitt Auto Parts, 2833 W. Chicago Ave., Chicago 22.

**BRUSH** Plating outfits connect to a battery. No tanks or shop required. Free particulars. Gunmetal Co., Avenue J, Decatur, Illinois.

**SAVE** 6c Per gallon with Gane Air-Flow Needles. Shipped C.O.D. \$1.50 (8 cyl. cars take 2). Advanced Automotive Products, 563-18 Lake Road, Webster, N. Y.

**SMITH'S** Sport muffler for Ford V-8, 1942 to 1948, \$5.95 each. Bucks Auto Parts, Box 1296H, Merced 1, California.

**SEAL** Cracked batteries! Cement \$1.00 can. Guaranteed! Postpaid! Batteryman, Grand Junction, Colorado.

**AUTO** Parts—All kinds; prices upon request; no catalog. Meyer's Auto Parts, 820 Dryades, New Orleans, La.

**CAR** Trouble? Million new, used parts. Describe needs. Automotive, 2928A North Western, Chicago 18.

**AUTO** Parts. Buy direct. Get dealers' prices. Represent us in your territory. Write requirements. Specify car make. Mechanics Auto Parts, Factory Warehouse, 3807-PM N. Ashland, Chicago 13.

**AUTO** Parts for all cars, transmissions, motors, differentials, fenders, carburetors. Security Auto Parts, 1923-PM Grace, Chicago 13.

#### **AUTO TRAILERS**

**BUILD** Folding camp unit. Attaches to box trailer, sleeps four. Simple compact design, easily constructed. Plans, parts, kits. Write for free information. C. W. Gray, 600 Sixteenth St., Oakland 12, California.

**TRAILER** Book. Plans, drawings, instructions, parts list to build five different trailers to 30 ft. \$2.00. New circulars 20c. Craftsmann Books, Box 1153, Milwaukee 1, Wisconsin.

**TRAILER** Plan catalog—All types, house, camp, boat, etc.; including complete line trailer parts and accessories, plus booklet, "Trailer Building;" send \$1.00. Marine Mart, Buffalo 7-B, New York.

**TORKSPRING** Axle assures low center gravity, swayless action. Install on new or old trailer. S. H. Edwards, Inc., Richmond, California.

**BUILD** Your own trailer! Save money! Have every feature you want! Plans for house, sport, camp and utility trailers. Catalog describing 9 models 10c. 15c in Canada and overseas. Jim Dandy, Box 125-A, Wausau, Wisconsin.

#### **MOTORCYCLES, BICYCLES, MOTORSCOOTERS AND SUPPLIES**

**MODERN** Motorcycle Mechanics Manual—Latest third edition 600 pages 275 illustrations, covers all British and American motorcycles, most complete motorcycle book available; \$3.65 postpaid. Nicholson Bros., Saskatoon, Canada.

**1948** WHIZZERS On heavy duty Schwinn bike with automatic clutch, front wheel brakes, spring action fork, oversized tires and wheels, \$223.50 prepaid. Complete line of Whizzer parts, bicycles, supplies and accessories. All orders shipped in 24 hours. Curtis Jones, 4131 Maryland, St. Louis 8, Mo.

**MOTORCYCLE** News, monthly. Yearly subscription \$1.00. Latest worldwide information. Sample 15c. Motorcycle News, 5424-A Sawyer, Chicago 25.

**JET** Propelled bicycle. Assemble your own. Photo and instructions \$1.00. Refunded on engine purchase. Rush order. Maupin, Tipp City 5, Ohio.

**1937** MOTORSCOOTER Complete \$35; 1931 Harley \$20, poor engine; Whizzer motorbike motor \$25; Harley single engine \$4; Maytag \$3; over 6300 small tires \$1 up; plenty brand new Regal motorscooters \$37.50 less motors; plenty new midget cars. Send 25c for Big War-Bargain Catalogue Number 27, just out, listing these and hundreds of other bargains in motorscooters, midget racers, outboards, power mowers, engines etc. (35c by first class mail). Midget Motors Directory, Athens, Ohio.

**BICYCLE** Supplies. Wholesale, retail list 10c. Universal, 4713 Virginia, St. Louis, Missouri.

**NOW** Available for all 1945-46-47 American Moto-Scoots. Bendix generator, sealed beam headlight with attachments. Give model number when ordering. Send 25 cents in coin or stamps for illustrated parts catalog and parts price list. Genuine Moto-Scoot parts in stock. American Moto-Scoot Co., 1323 West Carroll Ave., Chicago, Ill.

**MOTORCYCLE** Pistons and parts, new, used. Harley, Indian, Henderson, Super-X. List 10c. Ballak, 811 N. 9th, St. Louis 1, Missouri.

**MIDGET** Car, factory built \$40. 1½ h.p. Clinton motor \$30. Factory built scooter \$75. Briggs model Y engine \$25. Used scooters such as Cushman, Comet, Gest, Hiawatha, Powell, etc. Motorbikes, motorcycles, race cars and many more bargains listed in the Exchange Bulletin. Mail order only. 25c in coin, first class mail 35c. Behnke's, Dept. B, 5721 Leland, Chicago 30, Ill.

**NEW** Bicycles \$29.95. Wholesale. Retail. Bulletin 10c. Century Cycle, 3447 Lawrence, Chicago.

**MOTOR** Scooters, bicycle engines. 120 miles gallon. Dime for catalog. Clymer, Desk A-115, 1268 So. Alvarado, Los Angeles 6, Calif.

**WHIZZER** Engines, parts, accessories. Catalogue twenty-five cents. Raycycle Company, 3322 So. Grand, St. Louis 18, Missouri.

**COMPLETE** One Stop Harley Davidson Sales Service, 813 Ohio Street, Wichita Falls, Texas.

**RECONDITIONED** Motorcycles and motors. Chromium accessories. Complete stock Indian parts. Expert rebuilding. Fast service. Indian Motorcycle Sales, Kansas City 1, Mo.

**HARLEY-DAVIDSON** Parts, accessories, oil, expert service. Tires all sizes. Rebuilt 45" motors. Send \$2.25 for Army 45 Motorcycle Manual. 25c for accessory catalog and bulletins. Knuth's (Harley-Davidson Dealers), 2491 Fondulac, Milwaukee, Wis.

**WHEELS!** Build wagons, scooters, mowers, trailers, wheelbarrows, grocery carts, baby carts, play pens, baby carriages. 4" to 16". Free list. Truilen Mfg. Co., 811 E. 31, Kansas City, Mo.

**MOTO-SCOOT** \$35. Midget racer \$15. Indian motorcycle \$30. Cushman motorscooter with extra tire \$20, motors \$3 and up, homemade motorscooter \$10. Send 25c for new catalog listing these and many other sensational bargains in used motors, wheels, tires, motorscooters, midget cars, motorbikes, etc. Associated, Box 1764-CS, Toledo, Ohio.

**MIDGET** Car with three-speed transmission \$35. Cushman motorscooter \$15. Shaw bicycle motor \$15. Harley-Davidson motorcycle \$15. motorbike outfit \$15. Rush 25 cents for special new catalog listing amazing bargains in motorscooters, used motors, tires, parts, midget cars, etc. Gail, 538 Erie, Toledo, Ohio.

**TIRES** And industrial wheels, suitable for scooters, wheelbarrows, farm equipment, etc. All sizes. Bicycles and accessories. Largest assortment in America. Send dime for list. Cycle Transport Company, 1241 So. Michigan Ave., Chicago 5, Illinois.

**HARLEY-DAVIDSON** Parts, accessories, batteries, and tires, 24 hour service. Authorized factory dealer. Philadelphia Harley-Davidson Company, 857 North Broad Street, Philadelphia 23, Penna.

### AVIATION

**FAMOUS "Zweng"** books include Mechanic's Ratings \$3.00; Flight Engineer \$4.00; Flight Dispatcher \$4.00; surplus Fairchild sextants \$12.50; aerial cameras \$77.50. (Free catalog). Pan American Navigation Service, 12021-C Ventura Blvd., North Hollywood, Calif.

**PROPELLERS**—2-3 Blade. Sleds, air-drive boats. Standard Aircraft, Box 387, Ft. Worth, Texas.

**PROPELLERS**, Plans for ice sleds, snow sleds, air boats. Catalog 10c. Banks-Maxwell, Ft. Worth.

**LIGHTPLANE** Blueprints. Circular designs, motors, 20c. Craftsmann Books, Box 1153, Milwaukee 1, Wisconsin.

### BATTERIES, GENERATORS

**EDISON** Non-Acid lifetime storage batteries for home lighting, motors, industrial uses, radios, etc. Free interesting literature. Hawley Smith Co., Croton Falls 1, N. Y.

### ELECTRICAL SUPPLIES

**ELECTRIC** Pencil: Engraves all metals. \$1.00. Beyer Mfg., 10511 Springfield, Chicago 43.

**CHRISTMAS** Tree light sets and bulbs. Jeannette Electric, 159 West 23rd St., New York 11, N. Y.

**"CONSTAVOLT"** Selenium rectifiers! Full voltage at full load. New! Automatic! Free booklet. Lectralabs-3, Wakefield, Rhode Island.

**ARMATURES**—Rewind exchange. Send armature. Price return mail. Modern, Box 659, Tulare, Calif.

**ELECTRIC** Eye kit. Send for details. Gelbrook Products, 9508 Queens Blvd., Rego Park, Long Island, N. Y.

**LAMPS**—Build own originals, parts wholesale any amounts. Catalogue 10c. Brown Lamp Co., Box 501, Wellston, St. Louis 12, Mo.

**WAR** Surplus automatic gun chargers, brand new, complete. Includes ball-bearing fractional h.p. motor, 1½"x4½", a.c.-d.c., variable voltage, speed regulator, 120 r.p.m. from geared head or 12,000 direct. Makes handy diemaker's grinder, power screwdriver, etc. Also 10 amp micro switches, solenoids, springs, etc. Instructions for 110 v. use. \$2.95 complete, c.o.d. or express collect. Aero Manufacturing Company, Lincoln 3, Nebraska.

**LAMPS**—If you build or repair, send 10c for 36 page, illustrated catalog showing every part necessary. If dealer send business card for quantity discount. Gyro Lamps, 5416P Clark, Chicago 40.

**OIL** Lamps—Make money converting to electric. All parts shown in illustrated catalog 10c. Speedy 24 hour service from largest stock in country. Gyro Lamps, 5402P Clark, Chicago 40.

**TWO** Alnico (V) magnets, booklet, literature, 25c. Terry Sales Company, 1915-23 Nebraska, Toledo 1, Ohio.

**LAMP** Parts wholesale. Large variety available for building, repairing, or remodeling. Order in any quantity. New 1948 catalog 10c. Gearon Company, 27 South Desplaines, Chicago.

**LELAND** Electric generators, 2.5 kva, 120 volt, 60 cycle, single phase with radio filter. Turns at 1800 r.p.m., producing 2500 watts. \$125.00 freight prepaid. Hopper & Company, 3124 East 14th Street, Oakland, California.

**FREE** Catalog—Rotary snow plows, scooters, bicycle motor attachments, home freezers, motors, welders, generators, many other items. LeJay Company, Minneapolis, Minnesota.

### REFRIGERATION

**REFRIGERATION** Graduates; booklet helps you earn more money. Send for free details. Refrigeration Advisory Service, 3155 Chippewa, St. Louis 18, Mo.

### WELDING, SOLDERING, PLATING

**WELDROD** Electric. Approximately 50% less list price. Send for descriptive literature. P.O. Box 70, Lucas, Ohio.

**ACETYLENE** Welding outfits, new, \$54.50; arcwelders, Eagle Welding, Dept. PM, 5085 Broadway, Chicago 40, Ill. Distributors wanted.

**WELDERS!**—New portable Champion special transformer welder; 110/120 volts, a.c.; develops to 75 amps. 9 heat stages. Welds, brazes, solders, cuts all metals. Complete with electrode holder, helmet, rods, carbons, fluxes, cables. Also special flame weld torch. Easy to use. Full directions. Splendid for shop, farm and home repairs. Guaranteed. Only \$27.50. Also other models. Magic Welder Co., 239 MP11 Canal St., New York, N. Y.

**WELDERS** 110v. Welds ½" steel \$32.50. Morris Welding Service, 1850A State, Schenectady 4, N. Y.

**BUY** Direct from factory. Welding outfit, \$48.36. Soldering outfits \$7.76 to \$10.16 complete prepaid. Box 331, Hamilton, Ohio.

**"BUILD-UR-OWN"** Portable arc welder. Save \$300. Easy with Hobart Generator plus auto engine. D.C. welders, or A.C. welder—A.C. power plant combination. Free instruction book. Write Hobartweld, Box M-1183, Troy, Ohio.

**WELDERS**—For all requirements. Free catalog. Write Hobartweld, Box M-1184, Troy, Ohio.

**WELDING**—A profitable trade. Demand for trained men. Learn quickly at best equipped school in U. S. G.I. approved. Free catalog. Write Hobart Welding School, Box M-1185, Troy, Ohio.

**RADIATOR** Repairing, cleaning, explained. How to equip the shop at low cost. Supply sources, trade secrets told. Instruction system \$2. Radiator Service & Supply, McBain, Michigan.

**RECTIFIERS:** Ramyr Selenium platers, 10, 30, 50, 100 amp. sizes. Immediate shipment. Complete line of bronze baby shoe mounts. Write for list. Hollywood Bronze Supply, 1770 N. Vermont, Hollywood 27, Calif.

**OXY-ACETYLENE** Welding outfit—New. Includes everything: two full oxygen and acetylene cylinders, torches, goggles, lighter, regulators, hose, welding rod, and carrying case. Only \$89.75. Cylinders refilled anywhere. Ideal for hobbyists, garages, repair shops. Guaranteed. Burdett Oxy-Weld Co., 3397 Lakeside Ave., Cleveland 14, Ohio. Welding supplies since 1923.

**OWN** Mirror shop. Resilver mirrors. Glass sign making. Electroplating. Supply prices. John Sprinkle, V55, Marion, Indiana.

### MACHINERY, TOOLS, SUPPLIES

**ELECTRIC** Motors and drills. Albert Schantz, Baden, St. Louis 15, Mo.

**EMERGENCY** Screw driver and wrench, 25c. Coyle, 38 Fritz, Bloomfield, N. J.

**INDEX** Heads for sale. Very inexpensive. Sixty two different divisions. Used on lathes, drill press, milling machines, etc. Very accurate and durable. Not a toy. Every shop owner should have one. Write for free folder. Long's Index Heads, Box 537, Torrington, Wyoming.

**POWER** Tools. Build your own with Lewis castings. Save up to 80%! Complete castings, materials and blueprints supplied for 23 woodworking and metalworking tools. Free catalog. Write today. Lewis Machine Tool Co., 3217 Union Pacific Avenue, Dept. M, Los Angeles 23, Calif.

**"REPAIR** Leaks without tools!" Patented clamps! Combination set fits ¾" to 2½" pipes. Prepaid \$2.00. Lincoln Equipment, 10-A South 18th, Philadelphia 3.

**BARGAINS** In war surplus hydraulic transmissions, switches, motors, geared speed reducers, aviation instruments, etc. Delta Sales, P.O. Box 968, Shreveport, Louisiana.

**FIRE** Extinguishers, C-O-2, others. Repairing, recharges, parts. Fess-Co., 98 Vermont, Newark 6, New Jersey.

**BAND** Saw—Special \$14.95. Ideal for hobbyists and home workshop. Circular free. Woodcraft Tools Inc., 147 E. Lake, Minneapolis, Minn.

**POWER** Tools, motors all makes. Co-operative plan. Homecrafters Co-operative, Grand Rapids 6, Michigan.

**10" BANDSAW**, \$29.95; \$45.00 Value! Guaranteed. Investigate. Free circular. Raymond Tools, 1305 Glenwood, Minneapolis 5, Minnesota. Dept. PM-20.

**BANDSAW**—\$17.95! "World's lowest-priced!" Self-lubricating bearings. Modern, enclosed mechanism. Blade included. Literature free. Accromatic, 4610 Alaska, Saint Louis 11, Missouri.

**MACHINE** Tools for wood and metal. We specialize in small machinery. Tell us your needs, we will quote. Kandler, Kalamazoo 12, Michigan.

**TUNGSTEN** Carbide tipped lathe and cutting tools. High speed boring tools. Grinding wheels. Used high speed drills, etc. Free circular. Tool Supply Co., 3370 N. 53 St., Milwaukee 10, Wis.

**BACK** Geared metal and wood cutting 12" band saw, 6" jointer, ball bearing, 47" long. Ball bearing spindle shaper, 15" x 20" table. 8" tilting table, ball bearing, bench saw. Lowest priced line of high grade tools on market. Free catalog. Dealers include. Backus Machine Co., Boyd, Wisconsin.

**SMALL** Parts sorting boxes. Sturdy, plastic 3½" x 2½" x ¾" friction slipover covers. Eight boxes; assorted colors; dollar postal note. Stampade, 1221 Huron, Cleveland 15, Ohio.

**QUICK** Change sander, fits any electric drill \$1.95. Circular, Wasco Manufacturing, Box 111, Blue Island, Illinois.

**CHUCKS**, (Genuine Westcott) Independent, Universal, threaded 1½"-8 for South Bend, Atlas, Logan, Clausing, Craftsman lathes. Also other chucks to 16". Top value. Free literature. Westcott Chuck Co., 3600 Walnut, Oneida, N. Y.

**HOME** Lathe owners—Build your own attachments. Send for picture, sample of work and list of blueprints. Cut gears, ratchets, etc. Make neat screws easy way. The Home Shop, 415 Raymond Ave., Glendale 1, Calif.

**CONCRETE** Block machines \$39.50 up. Catalog free. Concrete Machine Company, 5466 Gravois, St. Louis 16, Missouri.

### BOATS, OUTBOARD MOTORS

**MARINE** Compasses \$31.50; Astro compasses \$12.50; marine lanterns \$7.50; deck clocks \$37.50; navy barometers \$17.50. (Free catalog). Pan American Navigation Service, 12021-C, Ventura Blvd., North Hollywood, Calif.

**P-38** BELLY Tank speed boat. Complete plans and instructions \$1.00. Twintank Boat Company, 1032 62nd Street, Oakland, Calif.

**KERMATH** Engine, 150 h.p., \$315.00. Many others. Bargain catalog marine supplies free. Lind Supply Company, Coldwater, Michigan.

**MARINE** Conversions and reverse gears for all Ford and Jeep engines. Catalog 25c. Dept. P. Arthur Gershel, 51 Chambers St., New York 7.

**CANVAS** Covers, war surplus, all sizes; tents, clothing, paints, camping equipment. Morsan, 10-15G 50th Ave., Long Island City 1, N. Y.

**TWENTY** Plywood boat plans 10c. Catalog boat building plans 10c. The Rudder, 15 Murray Street, New York 7.

**150** RECONDITIONED Marine and outboard motors. Also propellers and boat fittings. Write "Dept. J" for free list. W. L. Masters & Son, Inc., 210 W. Chicago Ave., Chicago 10, Ill.

**MARINE** Supply catalog—Thousands of deliverable items; priced and beautifully illustrated. Send \$1. Arthur Gershel, 51 Chambers St., New York 7.

**KNOCK** Down boat kits. Outboards, inboards, sail, racing. Send dime for literature and prices. Brooks Boat Company, Carrollton, Michigan.

**MARINE** Reverse gears and air-cooled motors, propellers, shafts, etc. Complete kits or separately. Rowboats, outboards, inboards 14", 16" reasonable. Special discounts dealers and liveries. Free literature. Steffy Screw Products, New Baltimore, Michigan.

**BARGAIN** \$20. Make your own boat now with readymade streamlined laminated one piece hull as developed for Navy. Light, sturdy, leakproof. Anyone can convert into dinghy, outboard scooter, cartopper, other craft. 9' x 4'. Write Warwood, 480 Lexington, New York 17.

**MARINE** Plywood sheets (fir, mahogany, etc.) and boat building lumber. Send 25c (coin) for "Plywood Hints" with stock list. Marine Mart, Buffalo 7, N. Y.

**CONVERSION** Kits for Ford, Willys, etc. Also air cooled engines, clutches, vee drives and stern drives. Send 50c (coin) for catalog and booklet. "Conversion Hints," Marine Mart, Buffalo 7, N. Y.

BOAT Plans, kits. See display ads, pages 288 and 294. Marine Mart, Buffalo 7-B, New York.

**BUILD** Your own boat by the Welch System, ready cut parts. No experience necessary. Save 2/3 cost. Rowboats to cruisers. Illustrated catalog 25c. Midwest Boat Company, Menomonee Falls, Wis.

**MARINE** Fittings, accessories. Thousands of items (pictured, prices). Prompt delivery. Catalog \$1.00. Marine Mart, Buffalo 7-B, New York.

**OUTBOARD** Motors—Good values, used motors. Also used parts for most makes and models. Crandall-Hicks Co., 911 Commonwealth, Boston, Mass.

**MARINE** Conversions for Ford and Jeep engines. Catalog 10c. Lehman Manufacturing Company, Department D, Newark 2, New Jersey.

**NEW**, Used, rebuilt marine motors. Marine conversions, fittings. Free catalog. Stokes Marine Supply, Dept. 24, Coldwater, Michigan.

**OUTBOARD** Motor parts. New-used, all makes. New pistons (standard, oversize). Cylinders rebored. Outboard Motor Mart, 309 Atlantic Ave., Boston 10, Mass.

**P-38 BELLY** Tanks. New, steel, 10 foot or 6 foot size, \$9.95. Anzio Boat Company, 89H, Merced 9, Calif.

**BOAT** Plans by graduate naval architects. Send specific requirements for free suggestions. Westlawn Associates, Montville 5, N. J.

### ENGINES, MOTORS, DYNAMOS

**WELDING** Generators, 150 ampere \$47.50. 1/2 horse, 1750 r.p.m. motors \$19.75. 3/4 horse, 3450 r.p.m. \$22.50. 1 horse, \$28.50. Compressors \$17.50. Butler, 1885 Milwaukee, Chicago.

**WIZZ** Electric motor: (3" x 1 3/4"). Flashlight cell operates. Parts complete plus instructions 30c postpaid. Eltro, Deer Park, N. Y.

**"POWER-WELDER"**—New a.c. welder—a.c. power plant. Portable. Gives you welding, plus power for tools, lights, motors; anywhere, independent of power lines. "Build-ur-own" and save \$300. Free instruction book. Write Hobartweld, Box M-1186, Troy, Ohio.

**NEW** General Electric, all purpose 1/2 horsepower motors, 115 volts, 60 cycles, splitphase, speed 1725. \$12.50. Plenge, 114 Elliot Place, Bronx, New York.

**WINDING** Data, listing 225 motors, single and three phase, \$1.00. Motor Data Co., Box 7631, Kansas City 3, Mo.

**MOTORS!** 1/2 H.P. D.C. converted to A.C. All new. High speed 110 volt, 25 or 60 cycle, ball bearing motors. Actual value about \$75.00. Now \$15.00 each or 3 for \$40.00. With forward and reverse switch \$19.50, 3 for \$50.00. Countless uses for home mechanics. Can be used in any position. Order today! Immediate delivery! No c.o.d. orders. "Amazing Bachman's." 27 Herman Street, Rochester 5, New York.

**MOTOR** Repair men, send for bulletins on motor winding tester and a.c. motor winder. Motor Industries, Quincy, Illinois.

### ATHLETIC EQUIPMENT, BODY BUILDING COURSES

**BARBELLS**, Olympic types, stamp for folders. Jackson Barbells, Springfield, N. J.

**BARBELLS!** 95 Pound set \$10.80; extra plates 10c pound. Send for free course and catalog. Bur Barbell Co., Lyndhurst, N. J.

**THE** Worlds strongest men are built by: The Key Institute of Physical Culture, Titusville, Florida.

**DEADLY** Judo—Fiercest fighting technique. Trick knockouts. (200 photographs, plus illustrations.) Expert instructions, three volumes. Complete \$2.25. Variety House, Box 46-B, Wall Station, New York 5.

**BARBELLS**, Exercise equipment. Courses. Free booklet. Good Barbell Co., Reading, Penna.

### SPORTING GOODS, GUNS, FISHING TACKLE, ARCHERY, TRAPPING

**TRAPPERS!** Lures for all animals. \$1.00 a bottle. Female mink urine, \$1.50 a bottle. Hayward Newlon, Grafton, W. Va.

**180** PAGES Antique and modern pistol, sword, etc. values. 50c. Robert Abels, A860 Lexington Ave., New York 21.

**NYLON** 3/16" Braided cord. 550 lb. test. Will not mildew or rot. Marvellous durability. A must for campers, hunters and fishermen. Ideal for tennis, tarpaulins, packs, decoys, trolling, trot line and a thousand other purposes. 75-ft. hank \$1.00, postpaid. All multiple hanks connected. White or khaki. Sorry no c.o.d. Beebe Cordage Company, Inc., Dept. 2, Cranford, N. J.

**NINE** Guns in one—With a Poly-Choke on your favorite shotgun. Over 20,000 installed by us. Satisfaction guaranteed. New ventilated model \$18.75; Standard Poly-Choke \$14.75, installed. 3-day service. Write for new fall catalog. Andy Anderson's Sporting Goods Co., 120 W. Grand, Oklahoma City 2, Okla.

**SHOTGUNS:** Remington automatics \$99.00, M12, M37, M31 \$83.50 each. Rifle and pistol ammo. Jeff Trader, Pocomoque City, Maryland.

**WONDER-ALL** The new action bouncing stick. Entertainment for the entire family. 35c. 3 all different, one dollar. Agrillo, 33 West 6th St., Gilroy 1, Calif.

**AMMUNITION**—Most complete stock in Middle West. Dime for list. Central Sports, Delphos 5, Ohio.

**SHOTGUNS**, Rifles, revolvers, over 500 modern, obsolete. Also cartridges, list 10c coin. Ed Howe, 52 Main, Coopers Mills, Maine.

**SHOOTERS:** Handload your own ammunition. For full information send 60c for a copy of the B & M book "Handloading Ammunition." Circular free. Belding & Mull, Box 428B, Phillipsburg, Penna.

**SHOTGUNS**, Rifles, handarms, ammunition, rods, reels. List 10c. Rudolph's, Atchison, Kansas.

**5000** BARGAINS. Firearms, binoculars, war relics. Catalog 40c. Smith Firearms, Runnemede, New Jersey.

**BOWS**—Arrows, write headquarters for archery equipment. Quality products. Popular prices, catalog 10c. Large illustrated handbook instructions, aiming and shooting, 50c. Archery, 617-B So. State, Chicago 5.

### TAXIDERMY

**FINEST** Glass eyes; taxidermy supplies. Catalog free. Elwood Company, Department 234, Omaha 2, Nebr.

### BINOCULARS, TELESCOPES, MICROSCOPES, MAGNIFIERS

**REFRACTING** Telescopes, accessories; highest quality workmanship. Catalog 10c. Janan Instrument Company, 76 Interhaven Avenue, Plainfield, N. J.

**"TERRIFIC"** Bargains—Government surplus telescopes, binoculars. Send \$1.00 for 10 piece hobbyist lens set. Contains magnifying and reducing lenses. Send stamp for "bargain" list. H. Jaegers, 93-08 95th Ave., Ozone Park 16, N. Y.

**6x30** NEW Bausch and Lomb. U.S.N. Lightweight. Coated. With case, straps. \$65.00. Add 20% tax. New telescopes (no tax). 10x23, \$13.95; 15x31, \$22.95; 30x53, \$29.50. Money back guarantee. United, 7941 So. Halsted, ARF-708, Chicago 20.

**ALUMINIZED** Reflecting telescope mirrors; 3" diameter with diagonal \$3.00. 4" \$6.00. 5" \$10.00. 6" \$18.00. 6" ready polish \$6.00. Postcard brings plans, list outstanding optical values. Pfelegor Optical Co., PM-12, Sunbury, Penna.

**POWERFUL** Astronomical refracting telescope, equatorially mounted, all metal, two eyepieces, \$16.50. Bluhm Optical Lab., 4213 Gifford Ave., Cleveland 9, Ohio.

**POCKET** Magnifiers—Metal case, powerful 18 diopter lens, precision ground, ideal for experimenters, jewelers, engineers, chemists, all precision work. Wonderful gift, only \$2.95 postpaid, money back guarantee. Bestin Mdse., 4606 Clark, Chicago 40.

**GIANT** Astronomical telescope 100 diameters magnification, with tripod. Full power, clear vision. \$15.00. Suffolk Science Service, Manorville, N. Y.

**POWERFUL** Astronomical telescopes easily made. Perfect lenses and instructions; 100X \$3.00. 100X and 200X \$4.00. 100X, 200X and 400X \$6.00. Clear vision, full power guaranteed. Instructions alone 10c. Suffolk Science Service, Manorville, N. Y.

**BINOCULARS**, Telescopes, watches, guns. Buy, sell, trade. Schweer's, Donnellson, Iowa.

**ASTRONOMICAL** Telescopes, binoculars, microscopes; bought, sold repaired. Books. Lists 10c. Rasmussen-Reece, Amsterdam, N. Y.

**TELESCOPES**, Binoculars, microscopes, big bargain catalog free. Brownsong Company, 24 West 45th Street, New York.

### DOGS, PETS, BIRDS, RABBITS

**ST. BERNARD** Puppies! Details, delightful pictures free! Manitou Kennels, Watrous, Sask., Canada.

**BEAUTIFUL** Pure white pedigreed police puppies. Ansonia Kennels, Mose, North Dakota.

**ZOOLOGICAL** And pet animals for sale. Illustrated catalogue, literature. 25c. Trails End Zoo-5, St. Stephen, S. C.

**RAISE** Guinea pigs. Make money at home. Big demand. Booklet free. Taylor, Box 426A, Hapeville, Georgia.

**REPTILE** Bulletin 5c. Hobby catalogue 10c. Pair golden hamsters \$2.75. Baby alligator \$2.50. Chameleon 25c. Quivira Specialties, Topeka, Kansas.

**LEARN** To raise any kind of a pet. Minimum 68 pages monthly. Sample 25c; \$2.00 year. All-Pets Magazine, Fond du Lac 3, Wisconsin.

**MINK** Raising information free. Complete. Lake Superior Mink Farm, Superior, EE1, Wisconsin.

**MAKE** Extra cash. Raise giant chinchilla rabbits. Waters Rabbit Farm, Glennville, Ga.

**RAISE** Chinchilla rabbits. Year-round money-makers from furs, meat, breeders. Experience unnecessary. Folder 25c. Willow Farm, Sellersville 15, Penna.

**RAISE** "White Satin" rabbits, meat and fur. "Golden Hamsters" pets and laboratories. Free information. Pem's Rabbitry and Hamstery, 3010 10th Ave. No., St. Petersburg 6, Fla.

**\$250.00** MONTHLY Raising angora rabbits. Particulars free. White's Rabbitry, Newark, Ohio.

**\$50.00** WEEKLY Raising Angoras for us. Free literature. Angoraville, 1215-34th Northeast, Cedar Rapids, Iowa.

**MINK** Raising amazingly profitable. Free folder gives inside "secrets" on feed; care. Lawrence Molgard, Brigham City 12, Utah.

**RAISING** Rabbits, cavies, hamsters, chinchillas is profitable. Big demand. Magazine 10c. Instruction book and magazine 25c. Book and magazine (monthly) one year, \$1. Address, Small Stock Farmer, Fairlawn 2, New Jersey.

**INCREASE** Your income by raising domestic rabbits. Small space needed. Ready market for delicious meat, fur and wool. Largest magazine in the industry tells you how. \$1.50 per year. Sample 15 cents. No stamps. Small Stock Magazine, Lamoni 20, Iowa.

**\$3000** YEARLY Raising Angora rabbits. We buy your output. Contract particulars free. Kise's Enterprises, St. Paul 8, Minn.

**RAISE** Rabbits, market provided. Breeding stock furnished on production pay plan. Literature 25c, with hutch plans \$1. Hansen's Rabbit Institute, 1347 Miller Avenue, Salt Lake City 6, Utah.

### PLANTS, SEEDS, NURSERY AND GARDEN SUPPLIES

**GLADIOLUS**—New varieties, novelties, list. Robinson, Box 31, Sebastopol, Calif.

### FARMS, FARM LANDS, REAL ESTATE

**650** FARMS, Ranches, water frontage properties. Free descriptive folders, price lists. Splendid opportunities, Washington, Idaho, Montana, Dakotas, Upper Michigan, Wisconsin, central corn belt. Information regarding Columbia and Missouri River Basin irrigation projects. L. H. Robbins, Milwaukee Railroad, 736K Union Station, Chicago 6, Illinois.

**UNITED'S** Winter catalog—Just off press, bargains galore! Farms, ranches, groves, businesses, homes. Exciting free catalog of up-to-the-minute values Midwest, famous Ozarks, California, many states. America's biggest bargains. Write for free copy today! United Farm Agency, 1408-PM Consumers Bldg., Chicago 4, Ill.

**FREE** Farm lands available in sunny Florida. Details, method of application, only 25c. Century Publications, 5803 1/2 Central, Tampa, Florida.

**STROUT'S** Fall-Winter farm catalog—Free! Red cover. Chock-full of bargains, coast-to-coast. Eqpd. and uneqpd. farms, groves, retirement places, etc., etc. Write today for your free copy. Strout Realty, 255-P 4th Ave., New York 10, N. Y. 20 W. 9th St., Kansas City 6, Mo. 453 S. Spring, Los Angeles 13, Calif.

**FARMS** Acreage, beach sites. Exceptional crop, livestock, poultry production. Good markets and transportation. All year pleasant climate, rainfall averages sixty inches annually, productive soils, reasonable prices. Salt and fresh water fishing, boating, hunting and other sports. Wonderful locations for retired persons. Choice of the gulf coastal sections of northwest Florida, south Alabama or south Mississippi. Write for illustrated information, specify preferred state and purpose for which land is wanted. E. J. Hoddy, Desk 2, Room 108, General Office Building, Louisville & Nashville Railroad, Louisville 1, Ky.

**DON'T** Worry about the future. Be secure. Buy virgin land now; \$5 monthly. Free list with home buyers helps. Write Mr. Armstrong, Shook, Mo.

**OZARK** Magazine, Eureka Springs 11, Arkansas. For homeseekers, tourists. Year, \$1.50.

**GOVERNMENT** Lands \$2.00 acre up. Information all states twenty-five cents. National Tax Service, 834-A Majestic Bldg., Detroit.

**\$5.00 MONTHLY** Buys 40 acres, near town. Price \$200.00. Free list. Box 425-P, Carthage, Mo.

**LOTS \$300**—Convenient payments. California's finest garden section. On Morro Bay's scenic shores. Wonderful fishing, hunting, boating, bathing. Fertile soil, softest water, temperate climate, congenial community. Free literature, Richard Otto, Department M, San Luis Obispo, California.

**GOOD Farms**—Ranches, Washington, Minnesota, Montana, Idaho, Oregon, North Dakota. Dependable crops, favorable climate. Write for literature, lists describing typical farm opportunities. Specify which state. J. W. Haw, 119 Northern Pacific Ry., St. Paul 1, Minn.

**OZARK** Lands for all purposes. Actual river frontages, 5 acres \$90.00 and upwards. Free list and literature, Hubbard, 424-I Minnesota Ave., Kansas City 4, Kansas.

### POULTRY, FARM SUPPLIES

**RAISE** Turkeys the new way. Write for free information explaining how to make up to \$3000.00 in your own backyard. Address National Turkey Institute, Dept. 3, Columbus, Kansas.

**EARN \$4 To \$12** hourly. Chick sexing, culling and caponizing, G.I. approved. Pilch's School, Box PM, Thompsonville, Connecticut.

**FARMERS!** Make money with poultry in 1949. Big demand, higher prices. Our editors will help you. Mail \$1.00 today 24-month trial subscription. Poultry Tribune, Dept. 16, Mount Morris, Illinois.

**RAISE** Fryers new easy way. One man home plant earns \$500 monthly. Details free. Fortune Fryer Farm, Box A, Simi, California.

**KNOW** How to raise poultry for profit. Read Northeastern Poultryman. Every issue packed with helpful hints and practical suggestions. Latest articles on breeding, feeding and management. Subscribe now. 1 year 65c. 2 years one dollar, foreign subscriptions \$1.00 a year. Northeastern Poultryman, Dept. P.M., 376 Boylston St., Boston 16, Mass.

### PROFITABLE OCCUPATIONS

**LOOK** Here! Wanted—Men to start in business on our capital. Sell some 200 farm-home products. Thousands our dealers now make quick sales, big profits. For particulars write Rawleigh's, Dept. K-192-PPM, Freeport, Ill.

**WORLD** Wide construction job listings published monthly for overseas and U.S.A. \$1.00 postpaid. Global Reports, P.O. Box 883-DX, Hollywood 28, Calif.

**EXCELLENT** Profits. Make, sell holiday flowers, novelties. Literature free. Velva Artcrafts, 324-M East 14, New York 3, N. Y.

**"FROG-RAISING"**—New book explains everything! Marlboro, 1035 Marlborough, Detroit 15, Michigan.

**\$50.00 WEEKLY** And more, selling neckties to friends and neighbors in spare time. Fine quality lined ties sell for \$1.50 each. Cost you only \$10.80 dozen. Unlimited market. A Christmas "natural." We guarantee quality. Send \$1.00 for sample tie and let us prove it. Your money back instantly if not completely satisfied. American Novelty Company, P.O. Box 2641, New Orleans 16, La.

**MAKE** Big profits installing weather-stripping to save fuel. Double Seal Co., 2725 Ross, Waco, Texas.

**"MOST Everybody likes candy."** Learn to make in a professional manner. (Our 38th year.) Ragsdale Candies, D6, East Orange, New Jersey.

**MUSHROOMS** Grown. Boxes, Barrels. Instructions 50c. Spawn \$1.00. Manureless composting process \$2.95. Gordons, 553 William, Winnipeg, Manitoba.

**FREE** Particulars. 100 cleaners, soaps. Easily made at home. Brown, 9111-R Hoyne, Chicago 20.

**MAKE** Novelty candies for big profits! Details free. Robins, E. Sylvan Lake, Mundelein, Illinois.

**\$46** FROM Square foot plywood; jigsaw necessary. Write, Woodarts, P-38, Bridgewater, Mass.

**VENEZUELA.** Sensational information about great opportunities for everybody. \$3. H. W. Bardt, Edificio Washington, Apartemento 70, Caracas.

**WANTED**—Purchasing agents. No money or experience required. Write Dept. C, Purchasing Manager, 2719 Lawrence, Chicago, Ill.

**FIX** Typewriters, full or part time. Inexpensive copyrighted home study course quickly trains you for high earnings. Factory methods cover all phases with drawings and illustrations. No curiosity seekers. Typewriter Repair, 1015 Corbet, Tarentum, Pennsylvania.

**START** Cement painting business. Make wonder cement paint 2c pound. Enormous profits. Bryan, Box 702, Cincinnati 1.

**FOREIGN** Employment? List of 100 firms with overseas projects, and sample letter of application. COD \$1.30 or \$1.00 cash. Foreign Service Institute, Box 3934, Miami 24, Fla.

**PERFUME** Handbook. Secrets of making, selling, perfumes, cosmetics. \$1.00 postpaid. Edward Lawson, 10-21 Joiner Street, St. Augustine, Florida.

**START** Lamp business in your home, basement, garage. Profitable, fascinating, easy to learn. Illustrated course teaches you. General instructions and wholesale catalog. \$1.00. Gearon Company, 27-F South Desplaines, Chicago.

**LOCKSMITHING** Secrets—Key fitting, lock opening, repairing, prices to charge, supply sources. Illustrated book only \$1.00. Wechsler Supply, 7 W. 36, New York City.

**WOULD** You pay 3%—first \$350 made? Color-illustrated book "505 Odd, Successful Enterprises" free! Some offer occasional "day off." Work home. Expect something odd! Pacific, Oceanside, Calif.

**\$40.00 WEEKLY** Made growing mushrooms, fresh, dried. Dominion patent 331583. Free spawn. North American, 169P Yonge, Toronto, Canada.

**OWN** Mirror shop. Resilver mirrors. Glass sign making. Electroplating. Supply prices. John Sprinkle, V50, Marion, Ind.

**BE** The Popular Mechanics representative in your neighborhood and earn big profits in your spare time. Write Popular Mechanics Magazine, Room 408M, 200 E. Ontario St., Chicago, Ill.

**INTERESTED** In Latin American and foreign employment? \$1.00 brings Foreign Service Directory listing exporters and importers, oil, construction, mining, aviation companies. Hot tips for applications. Global Reports, Box 883-M, Hollywood 28, Calif.

**OPERATE** A letter shop. Unlimited opportunity. Send for free prospectus. Dougherty, 255 Washington, Phillipsburg, N. J.

**HYDROPONICS.** Soilless vegetables, cheap chemicals. Free information, Box 57B, Bristol, Virginia.

**ALASKA**—The Last Frontier offers unlimited opportunities. \$1 brings government map and directory listing firms in fishing, construction, mining, aviation, fish and game rules, homestead data. Alaska Opportunist, Box 883-M, Hollywood 28, Calif.

**TYPISTS**—Profitable business at home. Complete copyrighted information, 50c. Gaunt, 3521A Broadway, Chicago 13, Ill.

### BOOKS, PERIODICALS, PICTURES, POSTCARDS

**WE** Can supply you with almost any book. (Magazine subscriptions). House of Kilroy, (Booksellers), Box 772, Detroit 31, Mich.

**TRAVEL** Graphs for motorists, 20c each. Columbia Graphs, Columbia, Connecticut.

**BACK** Number magazines, used books. Reasonable. Reedmore, 240 East 9th, New York 3, N. Y.

**EASY** Profits taking magazine subscriptions, handling greeting cards. Full details free! Cassell Publishers, Westfield, N. J.

**BOOKS.** Hard-to-find. Out-of-print. Banker Book Co., Dept. 11, Sherman Oaks, Calif.

**SWAP**—Send four hobby, opportunity, business, instruction books. We will return four different books on subjects you desire. Send or pay postman \$1 plus charges. Only books in excellent condition accepted. Wotring Co., Catasaqua 1, Penna.

**STARTLING** Revelations! Read "Prophetic Years 1947-1953." Free literature. Progress Company, 4033 Chown, Minneapolis 10, Minn.

**BOOKFINDERS!** (Scarce, out-of-print, unusual books). Quickly supplied. Send wants. Clifton, Box 1377-PM, Beverly Hills, Calif.

**AFRICA!** Scenic wonderland. Lions. Big game. Zulu warriors. Dusky maidens. Gold, diamonds. Victoria Falls. Big packet postcards \$1.00. Gibbons, Box 39, Simonstown, Cape, South Africa.

**SELF-EXPLAINING** Bible; illustrated circular free. Box 446-P, Minneapolis, Minn.

**PLEASURE** Profit book list free. Johnson, Box 49, Astoria Station, Long Island City, N. Y.

**EXCITING** And strange books. Send 25c (coin) for catalog and private collector list. Rare Book Co., 1219 1/2 North La Brea Ave., Hollywood 38, California.

**MAKE** Extra cash taking friends' magazine subscriptions at home and office. Details and confidential wholesale price list #10 free. General Circulation Co., Inc., 1311 Widener Bldg., Philadelphia 7, Penna.

**BOOKS** For sportsmen. Hunting, fishing, all sports, games. Lists free. Kennedy Publishing Co., 15 East 40th St., New York, N. Y.

**BOOKHUNTERS!** All subjects. Send wants! Jaher Book Service, 620-P East 178 Street, New York 57.

### GAMES, ENTERTAINMENT

**ENTERTAIN** Friends with Emcee. Entertainer's handbook, 25c. Frankel, 3505A Adams, Chicago 24.

**CHRISTMAS** Gift for young and old a delightful game. Special introductory price 50c. Satisfaction guaranteed or money refunded. Hix Novelty Works, 1568 East 22nd Street, Los Angeles 11, California.

### MAGIC TRICKS, PUZZLES, JOKER NOVELTIES

**PROFESSIONAL** Catalog. 124 pages, 25c. Williams, 900 Plymouth, Ellwood City, Penna.

**279** MAGIC Tricks book 25c. illustrated. Not a catalog. Garvey, 44-2 Bates Road, Brockton 11, Mass.

**500** TRICKS. New 1949 edition. Send 10c for Douglas famous catalog showing best in good magic, lowest prices, fastest same-day service. 30 years in business. Douglas Magicland, Dept. 1, Dallas, Texas.

**BOOK** "84 Card Tricks" magazine "Magic Is Fun." catalog 500 tricks, all only 50c. Robbins Co., 152-P West 42nd Street, New York.

**FREE** Catalog. Magic tricks, jokes, puzzles, novelties. Laramie Sales, 4800 S. Laramie Ave., Chicago, Ill.

**SQUIRTING** Rings, turtles, chocolates, 25c. Water pistol, 150 shot, \$1.00. Aggressive, Box 148, Kenosha, Wisconsin.

**FREE** Trick with illustrated magic catalogue 25c. Hall Magic, 345 John R, Detroit 26, Michigan.

**HOWARD** Thurston's card tricks only 50c. Specialty House, Box 542, Danville, Illinois.

**WIZARD** Aviator cards. Ten illustrated tricks. Send one dollar. John Swenke, 1139 North Kedvale Avenue, Chicago 51.

**4** POPULAR Card tricks 25c. Stivers, 40 Salem, Medford, Mass.

**EARN** Big money! Learn easily how to be a magician. For complete information write Stallard Enterprises, 1888 Richmond Drive, Louisville 5, Kentucky.

**VENTRILOQUISM** Taught. 3c stamp bring particulars. Smith, 801 Bigelow, Peoria 5, Ill.

**WORLD'S Largest professional magic shop,** keeps you in touch with latest tricks. To receive mailings, send 50c for new catalog. Holden's, M220 West 42nd St., New York.

**MAGIC Tricks, puzzles, books, cards, punch boards.** Catalog 10c. Specialty, Box 671, St. Louis 1, Mo.

**BE A magician.** Large professional magic catalog of latest tricks, 35c. Ireland, C-109 North Dearborn, Chicago 2.

**LARGE Catalogue of the best magic for professionals and amateurs.** Send 25c. Mazda Magic Co., 1135 Westgate Ave., Oak Park, Ill.

**MAGICIANS' Headquarters.** 400-page professional catalogue, pocket, parlor stage tricks. World's finest magic. Send \$1.00 for catalogue (refunded first \$5.00 order). Kanter's, M-1311 Walnut, Philadelphia 7, Penna.

**LEARN Magic, ventriloquism, mind-reading.** Write for particulars. Quackenbush, Big Flats, N. Y.

**BIG Magic magazine, trick and price lists—25c.** Lloyd M. Jones, 4064 39th Avenue, Oakland 2, California.

**VANISHING Half dollar trick and catalog 25c.** Sterling Magic Co., Royal Oak, Mich.

**200 ELECTRIC Stunts, 110 volts, \$1.00.** Kutting Sons, Campbell, Calif.

**TRICKS, Secrets, cards, punchboards, etc. explained.** Big illustrated circular free. Mack, Box 1278-E, San Francisco.

### COINS, TOKENS, CURRENCY

**10 DIFFERENT Coins** including old United States 50c. Other selections on approval. Bishop, Box 2201, Kansas City, Mo.

**SO You want to be a millionaire.** Monthly course on coin collecting. Write for particulars. Alwick, 5437 Nagel, St. Louis 9, Mo.

**FREE Coin, banknote, lists.** Reynolds Stamp-Coin Shop, Flint 3, Michigan.

**OLD Money wanted.** Do you know that coin collectors pay up to \$100.00 for certain U. S. cents? And high premiums for all rare coins? We buy all kinds. Send 4c for large coin folder. May mean much profit to you. Numismatic Co., Dept. 20, Fort Worth, Texas.

**FOREIGN Bills—10 different, 15c.** Bills and coins, lists. Oliver Arnold, Macon, Mo.

**BARGAINS—Large \$1.00 bill \$1.60; large \$2.00 bill \$3.40; 3-legged buffalo nickel \$1.25; 20 different Indian cents \$1.00; 4 Whitman coin folders \$1.00, handbook 75c; 254 page guidebook \$1.50.** Large retail catalogue 15c. Bebee Coin Company, 1180 East 63rd, Chicago 37, Illinois.

**BARGAINS! Rare collection** contains United States large cent over 90 years old. Flying Eagle cent, white Indian cent, 1890 cent, 1909VDB cent, 1923 S cent, 2c piece, 3c silver, 3c nickel, half dime, shield nickel, 1883 nickel, 1913 nickel, dime before 1838, Liberty seated dime, Liberty seated quarter, Civil War cent, Confederate bill, broken bank bill, foreign coin, foreign bill and our complete buying-selling catalogue all for \$3.00. Catalogue alone 25c. 25 different later Indian cents \$1.00. 40 assorted \$1.00, colonial coin before 1790 75c, half cent before 1858 50c, 50c before 1840 \$1.00. Worthy Coin Corporation, 294 Washington, Boston, Mass.

**MONTHLY Price list** for collectors who wish to buy U. S. and foreign coins. Sample copy 15c. Six months 75c. James Randall, 116 South Michigan Avenue, Chicago 3, Illinois. Chicago's Oldest Dealer.

**U. S., Foreign. Free lists.** Slikes, 1831 E. Allegheny, Philadelphia 34, Penna.

**35 WORLD Coins \$1.00.** Harry Elsholz, Box 9014, Pittsburgh 24, Penna.

**4 WHITMAN Folders \$1.00,** complete stock. Foreign coin included with bargain price list, 10c. Little, 337 North Menard, Chicago 44.

**100 COINS And bills, \$1.00.** Oddehon, Box 482, St. Louis, Mo.

**COINS Wanted.** will pay up to \$2000 for certain coins, send 25c for catalogue. Burton's, 111 So. Third, Columbus, Ohio.

**GET Profit and pleasure** in collecting old coins. Send 10c for 56 page illustrated coin catalog. You'll be delighted with it. Send for it now. B. Max Mehl, 370 Mehl Bldg., Fort Worth, Texas. Largest rare coin establishment in U. S. Established 48 years.

**FREE! Foreign coin, banknote and coin collectors** illustrated catalog to approval service applicants. Send 3c postage. Tatham Coinco, Springfield-125, Mass.

**COMMEMORATIVE \$1/2,** Oregon, Texas, Kentucky, Cleveland, Long Island, \$2.00 ea. Illustrated catalogue 25c. Norman Shultz, Salt Lake 9, Utah.

**4-IN-1 Special \$1.00 bargain offer:** (1) United States 1893 Columbian world's fair half dollar; (2) album for holding coins; (3) large 56 page coin catalog; (4) genuine wooden nickel. Yes! All four items for only \$1.00. Order today. Money back if not pleased. Ben's Coin Company, 72 W. Washington, Chicago 2, Illinois.

**WANTED: Certain coins.** Will pay up to \$2,000. Send 50c for illustrated catalogue. The Central Coin Exchange, 504 So. Yale Ave., Columbus, Ohio.

### STAMP COLLECTING

**1946 SARAWAK "White Rajah"** commemorative, plus Eastern Rumelia, Italian East Africa, Cilicia, Southwest Africa, Kwangchowan. Everything 3c with approvals. Viking, 130-ZZ Clinton St., Brooklyn, N. Y.

**15,000 DIFFERENT Stamps 2c each!** Gordon Davison, Box 1019B, Manchester, N. H.

**UNITED States bargain price list.** Send 3c postage. Chassy, 38-P Park Row, New York 7.

**STAMPS of the world.** Try a selection of Canada and Newfoundland. Dan Hayden, Box 703, Bloomington, Illinois.

**RUSSIA, 20 Different, 10c.** Approvals. Reidenbach, Lexington Ave., Troy, New York.

**FREE! Canadian sets, royal visit, George VI, George V, coronation, jubilee, others, to approval applicants.** Ensign, Box 118-M, South Orange, N. J.

**ILLUSTRATED List free.** Peter Weterquist, 1635-13th Ave., Rockford, Ill.

**FREE—Famous Americans set, plus Flag Set, plus the National Parks Set, plus the Presidential Set to the \$5.** A total of 90 stamps absolutely free to customers for our unsurpassed U. S. or foreign selections. Send 3c postage for 15 of the above mentioned stamps and full particulars. Triboro Stamp Company, 145 Nassau St., Dept. 111, New York.

**35 DIFFERENT Greece or 100 different world, 10c.** Approvals 1/2c up. Kingman, Highbridge Box 42, New York 52.

**1000 PEELABLE Hinges and 25 different Canada 10c** with approvals. Jaydee, 218 Dickinson S.W., Grand Rapids 7, Mich.

**AMAZING! Free! 25 different Switzerland** to approval applicants. Eric Kardell, 1175-M Clay, San Francisco 8, California.

**5 DIFFERENT United States \$5.00 stamps 5c** to approval applicants. Mohawk, Box 524, Albany, New York.

**350 WORLDWIDE Stamps 10c.** Approvals. Free lists. Klondike, Harrisburg, Illinois.

**COMPLETE Outfit 5c.** Stamps cataloging over \$1, plus hinges, gauge, book for 200 stamps. Approvals, Moulblow, 740 Hegnay, Bronx 56.

**"SHARE The Profit" plan.** Insured approvals. Miami Stamp Company, Box 2437, Miami 14, Florida.

**BRITISH Colonials on approval; mostly half catalog.** Ostrow, Box 121B, Elizabeth, N. J.

**SENSATIONAL! Set Capejuby, Brunei, Perak, Honduras, Paraguay, Nigeria, and over 100 different others.** Everything 10c with approvals. D. O'Keefe, 7517 Merrill Ave., Chicago, Ill.

**FREE! 200 Commemoratives, flags, airmails; including error; \$2.50 value!** Approvals. National, Box 42A, Passaic, N. J.

**ENORMOUS Collection of 3c U. S. mint commemorative blocks of 4 being sacrificed.** 5 different blocks \$1.00, 10-\$2.00, 15-\$3.00. Rakusin, 505 Avenue C, Brooklyn 18, N. Y.

**10 MINT French Colonials 5c** with approvals. Rukenbrod, 1053 Second N.E., Massillon, Ohio.

**ILLUSTRATED U. S. 30 page list.** Send 10c for mailing. Pomeroy Stamps, Pomeroy Building, Minneapolis.

**ILLUSTRATED Price lists, free!** Patrick Agencies, 3650A Central, Indianapolis, Indiana.

**25 DIFF. Argentine stamps; 10 cents** with approvals. Karl Scheerer, P.O. Box 301, Pottsville, Penna.

**DOLLAR Specials: 1200 U. S.; 1500 foreign; approvals when requested.** Seiden, 1331-M Intervale, New York 59.

**FREE! St. Helena pictorial, and surprise packet of triangles, airmails, to approval applicants.** Pioneer, Box 414, Pasadena 18, California.

**350 DIFFERENT Stamps to serious approval applicants 10c.** 15 different Indian pennies 65c. Superior Coin & Stamp, 6908 Zoeter, Cleveland 3, Ohio.

**SWAP Duplicates—Send 50 stamps** with 10c and a stamped envelope. We send 150 different. Lou D'Milia, 72 Schole Street, Brooklyn 6.

**66 DIFFERENT Stamps, including U. S. battleships 6c.** World wide approvals. Telic-Arts, Devon, Conn.

**BRAZIL Diamonds shaped set, 10c** with approvals. Vargo Stamps, 6044 South Fairfield, Chicago 29, Illinois.

**SURPRISE Packet 3c; approvals.** Schmidie, 721 S.E. 139, Portland 16, Oregon.

**Fiji Included! Stamps from 40 countries, 10c.** Elsea, Bowling Green, Ohio.

**ABSOLUTELY Free! 25 different mint Chinese new issues, with approvals.** Barton, Box 488P, Elizabeth, N. J.

**FREE—25 Different with approvals.** Bolin Stamp Service, Holliston, Mass.

**300 DIFFERENT Including airm, commemoratives 50c.** Penny approvals. Engelter, Ashton, Ill.

**GIFT Southern Rhodesia royal visit set** to approval applicants. Deane Stamps, Box 87, Miami 35, Florida.

**\$50.00 CATALOG Value.** 2000 mixed stamps from over 21 countries and a surprise packet for only \$1.00 to approval applicants. Alfred Fahsing, Dept. PM, Box 181, Topanga, California.

**GLOBULAR Collection! 50 countries** represented. 3c to approval applicants. Eastern Company, Box 1295, Grand Central Station, New York 17.

**TRIANGLES! Diamonds! 25 different 50c.** U.S.A.—200 different \$1.00. Approvals. Hiawatha Lane, Fergus Falls, Minnesota.

**50 MINT Hitler heads \$1.00.** Peters, Box 308, Hemet, Calif.

**POSITIVELY Greatest free offer—Rare octagonal (eight sided) stamp, gorgeous diamond, giant triangle, also mammoth and midget stamps, total value \$2.00,** all free to approval buyers. Plus free, Scott's International \$6.00 album and latest stamp catalogues. Odd Stamps, P.O. Box 1700, San Francisco, California.

**FREE! Negro Triangle; Cayman; Dakar; Guinea; Palestine; "Fairy Tale," Pirate Chart, Map, Ship, Sea Lion and Snake stamps; French, British, Portuguese Colonies, etc.** Free for 3c postage. Approvals. Potomac Stamps, Washington 10, D. C.

**U. S. Price list.** Send postage. State Stamp Service, 1225 Park Building, Pittsburgh 22, Penna.

**GIANT Approvals—1 to 5c.** Bargains galore. References. Collanders, 905 5th Avenue, Moline, Ill.

**RUSSIA, Colombia, Hungary packet.** free. Approvals. Martin, Box 1128, Miami Beach, Fla.

**FREE! Africa, Asia, Europe packet.** Approvals. Standard, Box 43 West Farms, New York 60, New York.

**200 DIFFERENT.** Catalog \$5.00, only 10c with approvals. Bert Soika, Box 146-M, Jackson Heights, N. Y.

**ILLUSTRATED U. S. Catalog free!** Jarr, Box 217-M Madison Square, New York 10.

**GIBRALTAR Packet free—Nice collection** Gibraltar, New Zealand Centennial, British Uganda, French Colonials, early British Colonial, West Indies, South American, war stamps plus Philatopie Monthly Magazine. All for 5c postage. Empire Stamp Company, Dept. PM, Toronto 5, Canada.

**COLLECTION of 50 different countries, including Roosevelts, triangles, airmails and many more pictorials, 25c** to approval applicants. Fields, 1939 E. 85, Cleveland 6, Ohio.

**CIPEX Sheet, commemorating 100th anniversary 1847 issue** with 30 different U. S. containing early issues, commemorative, airmail, envelope, revenue. Catalog value exceeds 50c; all for 10c to approval applicants only. Curhan Stamp, Gloucester, Mass.

**WORLDWIDE Packet 50 stamps 5c** with approvals. Carlins Approval Service, Box 307, Fresno, Calif.

**200 DIFFERENT Including Roosevelt triangle, 5c** to approval applicants. M. Avalon Stamp Company, Springfield, Mass.



**MURDER!** Heydrich the Nazi hangman (Bohemia-Moravia #B20 black cataloging 40c) sent to you for 3c. Special offer made strictly to introduce general approvals. Act now! Eisenmac, 3518 Cummings, Cleveland 18, Ohio.

50 DIFFERENT Stamps, triangle, airmails, etc., 5c with approvals. Carlton's, 10243 Silverton, Tujunga, California.

SPANISH Air set free. Approval applicants. Flamingo, Box 4038, Pinewood Station, Miami 38, Florida.

\$5.00 PRESIDENTIAL Exchanged for 125 large commemoratives. George Hyde, Chico, California.

"WHERE The heck is that" countries are our specialty. Send 5c for surprise packet and swell approvals. Pikes Peak Stamps, 117 Nevada, Colorado Springs, Colorado.

U. S. And foreign want-lists promptly filled. Approvals sent upon request. Henry Thompson, R.F.D. #1, Lowell, Mass.

COLLECTION Builder approvals. Henry Jay Service, 15 Park Row, New York 7, N. Y.

GIANT Bicolored royal visits, Malta pictorials, gorgeous Guianas, Goose airmail, Scandinavian packet and illustrated stamp publication, 10 cents with approvals. Crown Stamps, Box 331, Toronto, Canada.

\$440.00 FACE Value Chinese airmails. Free to approval applicants. Andrew Peck, Box 114A, Battle Creek, Michigan.

77 DIFFERENT U. S. 17c. Approval applicants only. Standard, 3817 Sackett, Cleveland 9, Ohio.

LOOK At this! 50 different Norway only 10c to approval applicants. Floyd Frederick, 513 1/2 Green Street, Lancaster, Penna.

100 DIFF. Foreign mint \$1.00. Burg, 58 East 97th, New York 29.

CENTENNIAL First Day! And three early U. S. covers 10c. Sea Horse, 1311 Lincoln Place, Brooklyn 13, N. Y.

LOOK! Beautiful Vatican City set, picturing various Cardinals, 14 different 10c. Approvals. Powell, 619 Franklin, Lynchburg, Virginia.

FREE Illustrated list. Elbe dealer. "Treasure Hunt" penny approvals on request. Reed Company, Box 80, Chicago 90, Illinois.

NATIVE Icons. Four new, unusual, Belgian East African mint pictorials. Special! 5c to approval applicants only. GeeKay, 13-A Overlea Ave., Baltimore 6, Md.

UNITED States. Anything, everything on approval. Legend Stamps, East Troy, Wisconsin.

CHINA: Mixtures: 1000 modern, \$1; 300 large pictorials, \$1. Send cheque or currency registered. J. Y. Chow Co., Box 1075, Shanghai.

100 ALL Different from China! Includes airmails! High values! Mint sets! Others! Only 10c to approval applicants. Star Stamp Company, Jamestown, New York.

BADEN—Hard to get local issue set of six sent to approval applicants only 5c. Supply limited. Don Rob Stamp Company, 3507 Troost, Kansas City, Missouri.

200 WORLD Wide 27c. Pacific, P.O. Box 5704, Los Angeles, Calif.

STAMP Buyers' Guide (Box 1649P, Oakland 4, California), plus 50 different Chinese stamps, for 10c.

TREMENDOUS Values and a whole of fun. Magic penny approvals. Resch Stamps, 3739 North Wilton, Chicago 13.

500 MIXED Stamps from all parts of the world, 10 cents to approval applicants. Daniel W. Menge, 2466 Littitz Avenue, Neffsville, Penna.

BETTER U. S. Approvals, used or mint. Panther Stamp Service, Dorchester 24, Mass.

VERY Fine U. S. mint sets. Flags 85c. National parks \$1.00. Approvals. Quinn, 570, Madison 1, Wis.

CROATIA Set complete free, approvals. Thode, 14302L 119 Avenue, So. Ozone Park 20, N. Y.

STAMP Magazine—Copy free! "Stamp Post." Station A, Pasadena, Calif.

GENUINE "Goya Nude" set complete 35c. Approvals. Royal Stamp Company, Tamaqua, Penna.

50 U. S. Airmails, commemoratives, 25c. Norwood Exchange, 4005 Ivanhoe, Norwood, Ohio.

FREE—25c Worth of stamps to U.S. approval applicants. Village Stamp Co., 90-39P 214 St., Queens Village 8, N. Y.

APPROVALS! 1/2c Up. Premiums! Mar-Jay's, Box 14 Brevort, Brooklyn 16, N. Y.

SOUVENIR Of Hollywood—25 covers from foreign countries, addressed to famous stars, direct from film studios. \$1.00. P.O. Box 1443, Philadelphia 5, Penna.

DIFFERENT. 25 Canada, 25 Denmark, 25 Finland, 25 U. S. 3c with approvals. Alatalo, Maynard 14, Massachusetts.

INTRODUCTORY Packet 10c. Free lists. Schneider, Box 441, Route 3, McHenry, Illinois.

ELEGANT Offer! Includes Norfolk, Brunel, Kedah, Nigeria, Cook, etc. 10c to approval applicants. Val Stamps, 16 Powell, Evansville 9, Indiana.

1/2c UP Low and medium priced approvals by countries. Hurt & Fosse, Blue Ridge, Virginia.

U. S. Price list free. S. Stone, Box 52-P, Dorchester 24, Mass.

500 DIFF. Penny approvals. Roscoe Stamp, 1321 Roscoe St., Chicago 13, Ill.

UNPICKED: 5000 U. S. \$2.00; 5000 foreign \$3.00; 1000 British Colonials \$2.00. Kuhn, 81-10 Broadway, Elmhurst, New York.

ALBUMS. Used, new, 25c up. Lists 3c. Alatalo, Maynard 14, Massachusetts.

FREE—United States commemorative price list. Historical Stamps, 1280 Ocean Ave., Brooklyn 30, N. Y.

EXCHANGE Stamps universe. Particulars free. "Exchangers," Bry 126, Seine, France.

FREE: China Confucius issue to collectors requesting foreign approvals. Modern Stamp Service, Box 12, Wakefield Station, N. Y.

250 MIXED Stamps 10c with approvals. Robert Hovell, 209 Maple Ave., Lansdowne 3, Penna.

WHAT A collection! 500 different stamps from all over the world \$1.50. Beautiful 1c approvals. Free premium! Atlantic Stamp Agency, 298 Pearl Street, New York 7.

SPECIAL! Bicolor Vatican set 3c. Catalogs 90c. Approvals. Rostamps, 1921 Schiller, Little Rock, Ark.

U. S. Foreign lists free. Slikes, 1831 E. Allegheny, Philadelphia 34, Penna.

307 ALL Different 10c. You will find scores of new varieties here for your collection! Big and little stamps, bisected stamp, commemoratives, triangles, high values! Bicolored beauties! Strange countries! Every stamp is different. All for only 10c to approval applicants. Write today and receive special Ionian Island stamp extra. Garcelon Stamp Company, Box 400, Calais, Maine.

25 UNUSED Stamps. Pictorials, airmail, triangle, etc., only 3c with approvals. Paul Bauer, 31 Wilkshire, Lancaster, N. Y.

20 U. S. Commemorative stamps, 10c. Ideal. Box 179, Park Ridge, Ill.

YOUR Choice! Complete Greek Roosevelt memorials or wind gods airmails, only five cents! (Both for ten cents) with approvals. Charles Ernest, 64 Wayne Terrace, Staten Island 10, New York.

GREAT "\$5.00 Catalog price for 10c" offer! (1) Big collection of 112 all different genuine stamps from Africa, South America, South Sea Islands, etc. Includes airmails, triangle and animal stamps; many others. (2) Four scarce unused United States, catalog price 40c. (3) Fine packet 25 different British Colonies—Burma, Hong Kong, Solomon Islands, etc. (4) U. S. \$5.00 high value. Total catalog price over \$5.00! Everything for only 10c to approval applicants! Big lists of other bargains given. Crystal Stamp Co., Littleton 16, N. H.

COLORFUL Chinese "victory" set, complete, mint, catalogs \$2.30, only 10c with approvals. Kalumet Stamps, 523 Detroit, Hammond, Ind.

A WORLD Of stamps for 10c! To obtain 1000 new customers for our approval service, we offer this stupendous bargain, stamps from every part of the world, airmails, pictorials, commems, etc. A fine lot of stamps for only 10c. Send your dime with your request for our bargain approvals now. Cosmopolitan Stamp Co., 1457 Broadway, New York City 18.

300 DIFFERENT Given free with approvals. Postage 3c. Windsor Stamps, 1435 East 67th Place, Chicago 37.

BREAKING Up large collections. Reasonable and unusual approvals. Strecker, 5725F Chester, Philadelphia 43, Penna.

ILLUSTRATED Stamp magazine, 26 weeks 25c. Stamp Journal, Kalamazoo, Michigan.

CANADA, Bell, citizen, princess 10c with attractive approvals. Rheaume, 8949 Routhier, Montreal 12, Canada.

WEIRD—Fantastic. African carved images, leopards, etc., included in big packet Belgium and colonies stamps. 5c if you request approvals. Frazer, Box 4600, Portland 2, Oregon.

GOYA Nude (2) 5c. Approvals, Han-nay's, 310 Quail, Albany 3, N. Y.

128-PAGE United States catalog—1000 illustrations, 10c. Harris & Co., 202 Transit Bldg., Boston.

GORGEOUS Worldwide sets on approval. Gehling, 1834 Fuller, Philadelphia 15, Penna.

AMAZING Bargain, 25 Vaticans only 10c. Wilhelms, 14646 58th Road, Flushing, N. Y.

REQUEST Free copy Southern Philatelist, stamps newspaper, 3240 NW 27th Avenue, Miami, Fla. 37.

MIXTURES. Worldwide, 1,500, \$1.00. Missions Outlet, Reverend Marshall, Paterson 1, New Jersey.

VALUABLE Pocket stamp wallet free with approvals. Granada, 4891 Southwest 5th Street, Miami 34, Florida.

FREE! Crystal-mount samples! Har-risco, 202 Transit Bldg., Boston.

ATTRACTIVE Sets on approval! Zampino, 2337 Bath Avenue, Brooklyn 14, N. Y.

WORLDWIDE Different. 200, 25c; 500, 50c; 1000, \$1.25; 2000, \$3.25; 5000, \$15.00. Beacon Sales, Maynard 2, Mass.

KEEP Up-to-date, monthly illustrated price list, free. Frances Reese, Box F30, Martinsville, Indiana.

UNION South Africa. Thirty different 25c, forty different 50c with approvals. Douglas, Hawkesbury, Ontario.

POSITIVELY Your money's worth! Seychelles, Djibouti, Angola, Chinese hunger stamps, together with 100 different others, 10c to approval applicants. Atlas Stamps, 4220 West 16th, Little Rock, Ark.

100 ASSORTED U. S. old and new, 25c. Weatherby, Medina, Ohio.

100 U. S. including commemoratives, airm, 10c. 300, 25c. Box 457, Newark 1, N. J.

FREE! Famous Formosa map set! Complete, unused, commemorative. Request approvals. Riedell, Greensburg, Pennsylvania.

UNITED States unused, Complete set 13 flag stamps plus 5c China commemorative only \$1.00. Fine approvals. Willett Stamps, Box 507, Port Chester, N. Y.

BINGO! Jackpot collection! Triangles, maps, animals, midgets. All for 5c to approval applicants only. Southwest Stamps, Box 117, Long Beach 1, California.

200 BRITISH Empire stamps; only 3c. Kenmore Stamp Co., Arlington 7c, Massachusetts.

FREE—Illustrated catalog! Kenmore Stamp Co., Arlington 7c, Massachusetts.

"UNITED-STATES" Collection. Thirty-seven different unused commemoratives, including Columbians 1893-1943 issues only. Price \$1.00 approval applicants only. "Stamps." Box 87M, Albany 1, New York.

YOU'LL Like our American and British Colonial approvals. Write now. Chesapeake Stamps, 748 Overbrook, Baltimore 12, Maryland.

FREE. Irish commemorative collection, including rebellion issue with approvals. Raymax, 123-Z William St., New York City 7.

FREE U. S. price list, postage 3c. Mark Hanna, 335 5th Ave., Pittsburgh 22, Penna.

FREE! U. S. monthly lists. Cole, 43-A Rinewalt, Buffalo 21, N. Y. Precancels also available!

FREE, Triangle, Roosevelt, Vatican, Ethiopia, Hitler heads. Request approvals. Florida Stamp Company, Box 807, Miami 5, Fla.

WORLD—500 Diff. 50c, 1000 \$1.25, 75 Canada 25c, approvals, lists. Victoria Stamp Co., London 4, Canada.

10 DIFFERENT Iraq 5c to approval applicants, Jeffery Stamp Co., 9726 Chappel, Chicago 17, Illinois.

200 DIFFERENT Stamps—Cataloging up to 15c each, only 3c to approval applicants! Littleton Stampco, Littleton 42, N. H.

WORLD'S Largest stamp (7 1/2 x 14 inches). A real curiosity! Retail for 50c, only 3c to approval applicants. Tatham Stamp Co., Springfield 30, Mass.

FLAG Stamp free with U. S. approvals. Wenigman, 929 Oakdale, Chicago.

25 ALL Different stamps 10c. Tunis. Wakeman Ave., Newark 4, New Jersey.

**ZOWIE-E!** A barrel of fun for only a dime. 500 United States stamps—absolutely unpicked and unsorted—just as received from church missions. Many varieties, including large commemoratives, airmails, high denominations up to \$5.00! Stampdom's biggest package of fun—and you might find something really valuable! Price only 10c to serious approval service applicants. Money back if not delighted. Illustrated bargain lists with each order. Mystic Stamp Company, Dept. 80, Camden, New York.

**WOW!** \$10.00 Worth of fun. Only 10c! What a treasure hunt! Big package 500 foreign stamps from foreign missions, other sources. Includes stamps from Africa, South America, Free French, Somalia, Palestine, etc. Includes airmails, commemoratives and stamps worth up to 50c. This offer sent for 10c to approval applicants only. Jamestown Stamp Co., Dept. 22, Jamestown, N. Y.

**DANDY** United States approvals. Write immediately. Sullivan, Endicott Building, St. Paul, Minnesota.

50 DIFFERENT United States 10c. No approvals. Seidenberg, Cassopolis, Mich.

**FREE!** 100 Worldwide different stamps to approval buyers. Big U.S. and illustrated bargain lists sent with approvals. Bookman, Maplewood, N. J.

**BRITISH**, Spanish and French Colonies. Vatican, Hitler heads, and airmail packet free with approvals. Pan-American Stamp Co., Box 145, New York 33, N. Y.

**STAMP** Collections wanted. Complete collections, duplicate lots, surplus stock, mint and used. Prefer trade for printing or other items, buy outright if priced right. What have you, what's wanted? Vanroy Shirk, Lebanon, Penna.

**DEALERS**—Wholesale list. Postage 3c. Frank, 5031 Queensberry, Baltimore 15, Md.

**FIRST** Day covers on approval. Knobel, 1918 S.W. 12th Street, Miami 35, Florida.

U. S. Price list. Send postage. Stanley Gibbons, 38-P Park Row, New York.

**UNITED** States approvals complete coverage, fine quality, attractive prices. Seminoe Stamps, Box 1138-P, Coral Gables, Florida.

**WHOOPIE!** Wow! 25c worth of stamps free to buyers. Write M & N Co., 742A Sheffield Ave., Brooklyn, N. Y.

**OLD** Scarce U. S. seconds on approval. Slightly defective, bargain prices. Hermsfield, Clintonhill Station, Newark 8, N. J.

**START** Your own stamp business. Write for free circular. Donald Shepard, Box 5139, Chicago.

**POUND** Stamps containing thousands \$1.00. Longacre Shop, 108 West 42nd, New York 18.

**BERLIN** Bears, complete set of eight and 100 different stamps only 10c to approval applicants. Reich Stamp Co., 4647 Kenmore, Chicago 40, Ill., Dept. M11.

**NICARAGUA** "Tin Pan Alley" diamond, Ecuador showing George Washington, and American flag in natural colors, Fezzan, Trieste, "American Army" stamp, first U. S. commemorative, \$100.00 Shanghai, Corsica, Anzac, Antique, others. All 5c. Approvals. Capital Stamp Co., Dept. 2, Little Rock, Ark.

**TRIANGLES!** Diamonds! Octagons! Midgets! Giants! Roosevelts! Hitlers! U.S. \$1.00-\$5.00 stamps! Stamp Magazine! Everything 10c with approvals! Thrifty Stamps, Silver Spring, Maryland.

**COLLECTORS** Possessing valuable extra stamps may exchange them through this club. Particulars for stamp. McPherson, Branch, Michigan, U. S. A.

### PRECIOUS STONES, MINERALS

**PACIFIC** Ocean water and sand, 25c. "Souvenir," Box 138, San Clemente, Calif.

**GEMSTONES**, Rough, polished. Crystallized specimens. Every variety, lowest prices. List free. Plummer's 5068 Brighton, San Diego 7, California.

**METAL** Detectors. The very latest circuit. Free literature. Hedden Metal Detectors, 3329 Liberty Avenue, Pittsburgh 1, Penna.

**BEAUTIFUL** Arizona agates, polished samples and listings \$2.00. Unpolished samples \$1.00. Arizona Agate Mines, Cave Creek, Arizona.

### HOBBIES AND COLLECTIONS

**TOOLRAK** For hand tools; interchangeable holders. Free folder. Davis Development Co., Colorado Springs, Colo.

**COPY** of All-Hobby magazine, 10c. Hobby Digest, Postoffice Box 52, Detroit 21, Mich.

**WANTED** Old cigarette cards. Write Charles Bray, East Bangor, Penna.

**UNUSED** Matchbook covers; 100 different \$1.00; free catalog. Charles Edelman, 1311C East 84, Cleveland 3, Ohio.

**INVENTING** Can be an interesting and profitable hobby. Write for complete particulars. Institute of American Inventors, Dept. 40-E, 1926-Eye St. N. W., Washington 6, D. C.

50 DIFFERENT Army embroidered patches \$1. Other bargains. Insignia Mart, 703A Broadway, New York 3, N. Y.

### CAMERAS, PHOTO SUPPLIES

**YOUR** Prized negatives make beautiful photo enlargements easily, economically with the new Precise Photo Enlarger, only \$22.20 complete, nothing else to buy. Send postcard for details. Tam Products, CM-11, 3814 Wrightwood, Chicago 47.

**YOUR** Every requirement met by the new Precise All Metal Enlarging Easel, only \$7.50 complete. Nothing finer at any price. Send postcard for details. Tam Products, EM11, 3814 Wrightwood, Chicago 47.

**EXPERT** Camera repair. Advance Camera Supply, 1626 Lunt, Chicago 26, Illinois.

**PROJECTORS**, Cameras, photographic bargain list free. Selco, PM11, Danvers, Massachusetts.

**BASS** Says! At the sign of the old "Horse Trader," 38th year. Thousands of satisfied customers everywhere! Finest brands including Kodak, Bell & Howell, Argus, Zeiss, Leitz, etc. Satisfaction always guaranteed, or your money back! Bass buys 'em, sells 'em, trades 'em. Write or wire. Bass Camera Company, Dept. AG, 179 W. Madison St., Chicago 2.

**FREE!** 116-Page illustrated photographic catalog, send 3c stamp. Bloom's Camera Center, 1657 Main, P.M., Springfield, Mass.

**200X TELEPHOTO** Camera easily made. Trifling cost. Telephoto lens and instructions \$3.00. Instructions alone 10c. Suffolk Science Service, Box 208, Manorville, N. Y.

### PHOTO FINISHING

**PHOTOGRAPHIC** Christmas card sample, 5c. Send negatives only. Roll developed 8 Velox prints 25c. Superior Finishers, Box 5610, Dallas 2, Texas.

**EXPERT** Finishing. Roll developed and 8 prints 30c. Rancho Photo, Dept. P, Ontario, Calif.

**COSTUME** Button photo brooches and earrings! You can make them yourself from photos from your negatives at only few cents cost. No equipment needed. You just mount selected part of photo in beautifully styled clear Lucite costume button (1-7/16 inch diameter, for brooch). Cement clear Lucite window (1-1/16 inch diameter) into button over photo. Cement pin to button. Photo earrings made by similar method. Sell at good profits. Wonderful items for Christmas presents. Sample large costume button with clear window, and metal pin to assemble as brooch, 40c postpaid—no stamps. Write for wholesale prices. William E. Moore, Costume Button Jewelry, Box 546, Winnemucca, Nevada.

**YOUR** Photograph reproduced. Any size. Wholesale prices any amount. Linden Agency, P.O. Box 753, Hamilton, Ohio.

**BIGGEST** Bargain yet! 8x10 enlargements, your negative, 35c, 3 for \$1.00. 24 hour service. Graphic Labs, 827 North Charles, Baltimore 1, Maryland.

**THIS** Ad is valuable. Send this ad and only 29c with 8 exposure roll or 8 negatives and receive 8 sparkling prints complete in album; regular price 35c; only once to a customer; also free "library enlargement" coupon. Album Photo Service, Dept. 131-A, Drawer 220, Regina, Saskatchewan or Box 280, Toronto, Ontario.

**ROLLS** Developed and printed in newest continuous strip. 8 exposures—35c; 12 to 16—50c. Hitone A, Box 2426, E. Cleveland, Ohio.

**ENLARGEMENTS**, Process flexibility permits individual perfection: 5"x7", send negative, 15c; 8"x10", 25c. Brandt Photo, Box 222D, Kenilworth, Illinois.

**SENSATIONAL** Introductory offer! Send snapshot or negative, this ad and 10c. We'll send you a beautiful 7x5" enlargement! Or, Kodak roll developed and printed (with free coupon) only 25c; or 8 giant prints from roll, 30c. Reprints from negatives, any quantity, regular size, 3c; Giant size 4c. Candid rolls—36 exp. 35mm. developed, vaporated, enlarged to 3x4, \$1.00, 18 exp. 50c. Free mailers. Free premium offers sent on request. American Studios, Dept. 364, La Crosse, Wisconsin.

**DEVELOPING** And printing. New electronic process. 8 oversize prints, deckle edged in fanfold, 35c. 12 exposures, 45c. Write for other sizes and prices. Pittsburgh Photo Lab, Box 9665, Pittsburgh 26, Penna.

**ROLLS** Developed—8 prints, one 5x7 enlargement, 35 years in business. Sterling, Box 2442 A, E. Cleveland, Ohio.

**NEW** Negative from your valuable picture and a 5x7 enlargement \$1.00. C.O.D. accepted. Photo-Craft, 12310-M West Dixie Highway, North Miami, Florida.

**WHY** Not pay a little more and get the best? Automatic machine development. Electronic exposed prints in album form, 8 exposure rolls, 50c—over 8 add 5c per exposure. 35 years in business. Hifoto A, Box 2133, Cleveland 8, Ohio.

**PHOTOS** "Cello sealed"—Mail your favorite photo and 25c. We seal it permanently in glasslike plastic. Makes a beautiful, indestructible, lifetime keepsake. Cello Seal Co., 3959 W. Ogden Ave., Chicago 23.

**YOUR** Portrait or enlargement oil colored 50c. Rochester Artist, Box 813, Rochester, N. Y.

**PHOTO** Christmas cards, only \$1.00 for 25 beauties with envelopes (your negative returned). For 3 different samples with your photo, send 15c with favorite negative. Photo Finish Studio F, Box 1268, Fresno, California.

**TWO** Beautiful prints from each picture on roll 30c. Twenty-seven years of satisfied customers. Quick service. Lens Photos, Dept. J4, Janesville, Wis.

**BEAUTIFUL** Enlargement from each picture on roll 30c. Cut Rate Photos, Dept. B4, Janesville, Wis.

**8 HOUR** Service, Box 468, San Francisco. Your 8 exposure roll printed jumbo or regular size 30c; 12 exposures 35c; 16 exposures 50c; 36 exposures \$1.00. Reprints, jumbo or regular 3c. Regular prints deckled. Fine grain developing. Send for free mailers. Quality Photo Service, Box 468, San Francisco 1, Calif.

**ROLLS** Developed and enlarged 2 to 6 times larger. 8 exposures 25c coin, 12 exposures 35c. 16 exposures 50c. Enlarged reprints 3c each. Alden Photos, 94-3 Astor Station, Boston, Mass.

**8 BEAUTIFUL** Double size pictures and roll developed 30c. 8 hour service. Free mailers. Pacific Photo Service, Box 666, San Francisco, Calif.

**2 BEAUTIFUL** Hi-Gloss prints each good negative and enlarging coupon with each 8 exposure roll developed 28c. Free mailers. Owlphoto Co., Weatherford, Oklahoma.

**ENLARGEMENTS!** 5x7, 15c; 8x10, 25c, glossy or dull. Gorgeously oil colored, 50c extra. Negatives made from your favorite photos, 50c. Rolls developed, printed, 25c. L R, Box 1476-c, Milwaukee 1, Wisconsin.

**24-HOUR** Film service, 8 exposures 25c. Quality prints mailed within 24 hours after film received. York Photo Finishing Service, Box 1469, York, Penna.

**OVERSIZE** Prints; overnight service; 35c. Films developed and 8 prints near postcard, only 35c. Electronic process, non-fade, glossy pictures. Write for free mailers. Peachtree Photo Finishers, Dept. PM, P.O. Box 4324, Atlanta, Georgia.

**YOU'LL** Be delighted. Eight Never-fade prints now only 25c. Two prints each only 35c. Free mailers and price list showing other services. Write today. Hammond Sales Co., Hannibal, Mo.

**NEW** Process developing and printing. 8 exposure rolls 35c. Mayfair Photo Service, Box 261K, Toledo, Ohio.

**8 PRINTS** All enlarged to nearly postcard size from your roll or negatives 25c; 16-50c. (Trial offer). Willard Studios, Box 3535A, Cleveland, Ohio.

**16 DECKLEDGE** Prints from any standard 8 exposure roll 25c. Quick service. Professional work. Skrudland, Lake Geneva, Wis.

**FREE** Price list on quality developing, printing, enlarging. Write for it today. Bryan's Photo Shop, Dept. M, Panama City, Florida.

**PORTRAIT** Quality 5x7 enlargements 15c, 2 for 25c. NuTone Fotos., Box 228, Pottstown, Penna.

**JUMBO** Or photo pack prints, 8 exp. roll 35c. 16 exp. roll 65c. NuTone Fotos., Box 228, Pottstown, Penna.

### MOTION PICTURES AND SOUND EQUIPMENT

"MISS America of 1948" 8mm., 50 ft. Kodachrome, \$7.50, (black-white, \$2.00), 16mm., 100 ft. Kodachrome, silent, \$14.75, (black-white, \$4.00). Big movie catalog, 25c. World in Color Productions, Elmira, N. Y.

**EXCLUSIVE** Movies, sports, slide films, viewers, projectors, screens. Free catalog. Home Pix, 1674 Broadway, New York 19, N. Y.

**UNUSUAL** Home movies. Free lists. Loja, Box 74B, Brevoort, Brooklyn 16.

**MUSICALS** 16MM. Sound, big name bands, 100 feet complete (reverse titles) Eddie Howard, Spike Jones, etc. Only \$1.95 each, 1500 different titles. Send check or money order today while stock is complete. National Photo Supply, 4724 Packard, Cudahy, Wisconsin.

**FINEST** Movie screen paint, used on all screens, literature. Snow White Screen Company, Danville, Illinois.

**VICTOR** 40B 16MM. sound projector. \$275. Bell & Howell 138, \$325. Movie Mite, \$225. All excellent condition. Robert Salmon, 3558 So. 11th East, Salt Lake City, Utah.

**8MM CINEX** Projectors, 100-150 W.; new, \$22.50. Becco, Box 675, Charleston, South Carolina.

**16 35MM.** Silent sound films, Bedner, 5300 So. Talman, Chicago.

**BARGAINS** In good used 16mm. sound films. Complete one reel subjects often available at \$2.95. List for stamp. Blackhawk Films, Davenport, Iowa.

**35c 50 FT., 8MM.** movie exchange. Lists 5c. Filmland, 3530-A Osceola, Chicago 34.

**SAVINGS!** Movie equipment! Bargain bulletins, 10c. Towers, 935 North 40th, Philadelphia 4.

**MOVIE Film—Hi-Speed.** 8mm., \$2.25; 16mm. mag. \$3.50; 16mm. 100 ft. \$5.95; processed free; free price list. Hollywoodland Studios, South Gate 3, Calif.

**MOVIE** Film, machine processing service, bulk film, free literature. Atlantic Films, Reading, Penna.

**16MM.** Sound features and shorts. Outright sale. Tom Gillespie, 6 Hospital Drive, Logan, W. Va.

**USED** Movie equipment, films. 3c stamp. L. Orluske, Lakefield, Minnesota.

**FILM—Movetone** is back. It's Weston 12 nonhalation. Free processing 100 ft. 16mm. \$3.25. 25 ft. double 8mm. \$1.50. Bulk film without processing 100 ft. 16mm. \$2.25, double 8mm. \$2.45. Free circulars. Fromader Genera, Davenport 4, Iowa.

**COMPLETE** Stocks always of Castle, Official, Pictorial films, 8mm., 16 mm., sound, Musicals, soundies, free catalogs. We exchange your films and equipment, or buy them for cash. Frank Lane, 5 Little Bldg., Boston, Mass.

**TITLE** Making, amateurs free booklet. Westwood Company, 635 Victoria Street, San Francisco 12, California.

"THE World's Greatest Passion Play." 8mm. 16mm. and 35mm. Specify silent or sound. Rent or purchase. Hemenway Film Co., 33-F Melrose St., Boston 16, Mass.

**COLOR** Movie film now available. 8mm. Ansco color, daylight roll type, and 16mm. 50' magazine type film. Ansco color, daylight. Brand new fresh stock fully guaranteed. Write immediately for prices. Immediate shipment. Indiana's largest camera store. Capitol Camera Co., Inc., 201 W. Washington Street, Indianapolis 4, Indiana.

**WESTERNS:** Three headliners: Abbott and Costello, "No Indians Please," "Stampede," "Cowboy Justice" 16mm. (also toy projectors) \$2.79 each; 8mm. \$1.79 postpaid. M.O. or check. B & C, 263 State, Elmira, N. Y.

**8-16 MM.** Movie film in bulk for home processing. Big free catalog—bargains in film, processing equipment, supplies. Superior, 105B S. Wells, Chicago 6.

**RENT** 16mm. sound films 50c reel. Large selection, free catalog. Film Service, 128 Chestnut St., Roselle Park, N. J.

**HOME** Movies since 1929. No.wat-ka, 257 Main Ave., Passaic, N. J.

**FREE** Movie list. Superior Film Service, Box 713, Troy, N. Y.

**FREE** Movie catalog; sample films, 10c. Goodwill Company, Jackson, Tennessee.

**8MM.** Sound projector for the price of a silent machine. Write Standard Sales, Box 7525, North Kansas City, Missouri.

**BASS** Says! 38 years of leadership means satisfaction to you! Finest equipment, 8 and 16 mm., sound cameras, sound projectors. Bass buys 'em, sells 'em, trades 'em. Satisfaction always guaranteed, or your money back! Bass Camera Company, Dept. A, 179 W. Madison St., Chicago 2.

**SOUND** Features shipped, rental \$3.95. 1,600' shorts, \$2. Free catalog. National Cinema Service, 71 Dey Street, New York City.

**I BUY,** exchange, swap movies. What have you? What do you want? Lowest exchange rates in world. Catalogue \$1.00. Refundable. Harvey Iris, Box 539, Brockton, Mass.

**GUARANTEED** Fresh anti-halo outdoor movie film! Weston 12! Daylight loading! Processing free! Three spools double 8 mm. \$3.45! Six single 8 mm. for Univex, \$4.60! Postpaid! Catalog. Eso-S, 47th Holly, Kansas City 2, Missouri.

**8-16MM.** Silent-sound films. Complete rental library. All latest subjects. Free catalogue. (sample film 10c). Garden Film, 317 West 50th, New York 19.

**LEARN** Professional motion picture technique at home. Approved for veteran training under G.I. Bill. Free catalog. Motion Picture Institute, Birmingham 4, Mich.

**LEARN** Movie projection, management. Free catalog. Theatre Institute, Elmira, N. Y.

**BRAND** New 16mm. sound projectors \$129.50. Send 10c for 1948 photographic catalogue. Sterling's, 679 Northampton, Easton, Pennsylvania.

**WE** Buy, sell, rent, exchange home movies. Details for dime. Midland, Box 429, Oak Park 4, Ill.

**8-16MM.** Film specialties. Catalog dime. Warrington Films, 1418 Knecht Ave., Halthorpe 27, Maryland.

**PROCESS** Own movie film. Free literature. Duro Products, 1519 Eggert, Buffalo 21, N. Y.

### MUSIC AND MUSICAL INSTRUMENTS

**RIGHTHANDED** Pianists—Left hand is easy. No exercises. Complete system \$2. Sample and song 25c. Musicraft Hall, 239-55th Street, Brooklyn 20, N. Y.

**POEMS** Wanted for musical setting. Send poems for free examination. Five Star Music Masters, 630 Beacon Bldg., Boston, Mass.

**REAL** Composer of music will co-operate with lyric writers in song production. Fine publication proposition. National distribution of publication. C. Isabel Mayer, Box 3896, Portland 8, Ore.

**HILLBILLY** Western records, late numbers 29c. Catalog 3c. P-L Shop, Box 19-L, New York 35, N. Y.

**SONGWRITERS!** Outstanding ethical offer. Hibbler, C5, 2157 N. Avers, Chicago 47.

**STREAMLINE** Accordions below wholesale. Circular. Metro, 44 North Albany, Chicago.

**ACCORDIONISTS—**Play better, sooner with Visuaid. Improve technique, sight-reading, transposing. \$2.00. Arkay, Box 5772, Cleveland 13, Ohio.

**ACCORDIONISTS:** Sensational automatic chord, scale finders, enable immediate performance any chord, scale. \$1.00. Free: catalogue accordion music, accessories. Carol, Box 21, Lefferts, Brooklyn 25, N. Y.

**POEMS** Wanted for musical setting. Send poem for immediate consideration and free rhyming dictionary. Richard Brothers, 24 Woods Building, Chicago.

**AUTOMATIC** Chord-changers for Hawaiian guitars. Complete 40 lessons \$8.95. "By ear" Spanish guitar picture method \$2.00. Guitar Headquarters, Box 886, Ventura, California.

**LEARN** To play piano by music, in one lesson. \$1.00. Miner Chart System, 931 13th Avenue B, Seattle 23, Wash.

**SONGWRITERS** Attention! The amazing demand for phonograph records, accelerated by countless juke-boxes, warrants your immediate investigation. We are offering new writers the rare opportunity of having celebrated "hit" composer furnish music on reduced percentage basis for any likely poems received this month. The Petrillo ban does not affect us. Recola Records, Hollywood 28, Calif.

**POEMS** Wanted for musical setting. Send poems for free examination. Hamann Service, 614 Manhattan Building, Milwaukee, Wisconsin.

**AMPLIFY** Your accordion with our new mike \$22.50. Sounds like organ. Installed in minute. Use any amplifier. Amplifier and mike \$72.50. Write Del Principe, 307 So. Wabash Ave., Chicago.

**SONGWRITERS—**Protect your songs. Get the facts first. Free booklet, attractive offer. Song Service, 331-C West 46th, New York.

**POEMS** Wanted to be set to music. Free examination. Send poems. McNeil, Master of Music, 510-PM S. Alexandria, Los Angeles, California.

**SONGWRITERS:** Send poems for free examination and outstanding offer. United Music Service, 150, Salem, Indiana.

**WRITE** Songs. Big money and reputation. Write for information. J. Gordon Pub. Co., 201 N. Hoyne Ave., Chicago.

**ACCORDIONS—**Guitars, trumpets and all musical instruments, new and used. Direct from national distributors, cash and terms. Save money. Del Principe, 307 So. Wabash Ave., Chicago.

### RADIOS, SUPPLIES, INSTRUCTION

**MAKE** Crystal radio "boosters." Free instructions. Radio Leader, LaVerne, California.

**ONE** Tube loud speaker set. Plan 25 cents. Dey, 216, Jamaica, N. Y.

**26 YEARS** Experience radio repairing at your fingertips. I've repaired 45,000 radios. Have perfected simple system you can follow step by step. No calculations or formulas. Total price \$2.00 postpaid or COD. Moneyback guarantee. Ross Radio, 14615-M Grandriver, Detroit 27, Michigan.

**MAKE** "Loudest" crystal radios. Instructions, loudest crystal, catalog: 25c. Amorose, Route Four, Richmond, Virginia.

**EXPERIMENTERS,** Beginners. 3 issues "Radiobuilder"—25c. Laboratories, Eye-c, San Carlos, California.

**RADIO** Tubes, parts. Send order. "Radio," Box 138, San Clemente, Calif.

**FREE** Lists. Radios, television, records, appliances. Bargain prices. Mail post card today. J.M.A.D. Company, 122 Clinton St., Buffalo 3, N. Y.

**RADAR** Crystals. Supersensitive. Free details. Communications, 110-P University, Seattle 1, Wash.

**RADIO** Tubes, surplus radio equipment, bargains. Ask for list. Kay Electronics, Box 25, Hollis, New York.

**FREE** Radio and television catalog! Money saving prices on radios, hard-to-get-parts, record changers, wire and disc recorders, amplifier systems, tubes, books, amateur and test equipment. Write today! Radionic Equipment Co., Dept. 2011, 170 Nassau Street, New York 7, N. Y.

**BUY** Everything at wholesale prices! Radio parts, equipment for the amateur, service man and experimenter. Lowest prices anywhere. Write Mid America, Dept. CE-10, 2412 S. Michigan, Chicago 16, Ill.

**HERE** It is. What you been waiting for. "Squeeze crystal." \$1.00. Nevadium Company, Elko, Nevada.

**MAKE** Simple, tubeless, batteryless, distance-getting crystal radios. Crystal and illustrated instructions 25c postpaid. Allen, 427-P, Clinton, Missouri.

### BUSINESS OPPORTUNITIES

**START** Your own business on our capital. Always your own boss. Hundreds average \$6,000 to \$25,000 annual sales year after year. We supply stocks, equipment on credit. 200 home necessities. Selling experience unnecessary to start. Wonderful opportunity to own pleasant, profitable business backed by world-wide industry. Write Rawleigh's, Dept. K-U-PPM, Freeport, Ill.

**MAKE** Money this easy way at home. Make your own costume jewelry. Pleasant, interesting. No experience needed. We supply settings and sparkling rhinestones at wholesale prices. Steady profits. Write for details now. Sparkle Mart, Dept. B, 475 Fifth Ave., New York.

**ANNOUNCING** Home study course in commercial baking. Practical basic training. Good field for those with aptitude. Nearly depression proof. Send for free booklet. "Opportunities in Baking Industry." National Baking School, 1315 Michigan Ave., Dept. 3438, Chicago 5, Ill.

**YOUR Own plastic business at home.** Produce costume jewelry, novelties, statuettes. Liquid plastic, liquid marble. Flexible molds. Write for free book. American Trades, Box 1473-A, Cincinnati 1, Ohio.

**"COLLECT And grow rich"** is a free booklet that's yours for the asking. Learn of this opportunity for a lifetime, spare or full-time office business of your own, where you can make a profit on the work of thousands of others. T. J. Surface, Pres., Dept. 230-M, Roanoke 4, Virginia.

**SEALTEC** Collection money making plans. Local—mail order. Sixth edition. Particulars free. Flasco Sales, 2505VN 150 St., Flushing, New York.

**ORCHIDS Metallized!** Real flowers preserved! Inexpensive to start. New field. Details free. Write, R. O. Morgan, 6230 Myrtle Avenue, Long Beach 5, California.

**MORE Money—Easier!** Revolutionary new method makes public bookkeeping easy interesting way to earn \$5.00-\$10.00 hourly, full or spare time. Simple, complete instructions! Start earning after 30 days. Success-revealing information free! Auditax Systems, 4515-S Sunset, Los Angeles 27.

**GET It** for them wholesale. Be neighborhood buyer nationally-known merchandise; radios, appliances, etc. Start spare time. This pleasant easy work can earn \$5,000 year. Free information. Cox, Saugus 10, Massachusetts.

**ENORMOUS Opportunity** developing inventive ideas. List of eleven ideas free. Jack Kester, Deckerville, Michigan.

**PERFUME—Make it yourself.** Profitable sparetime home business for men and women. Free information tells how. Write "International," 6347 Parnell-X-7, Chicago 21, Illinois.

**METAL.** Onyx, plastic mountings for bronzed baby shoes, 20 styles. Hardening solution. Wholesale. Box 2095, Wichita, Kansas.

**MAKE Liquid marble,** artificial marble flooring, flexible molds, statuary, art goods, novelties. Complete formulas, instructions \$1.00. Kemico, Park Ridge 5, Ill.

**TRADE Magazines** help you get ahead. Latest single copies. Over 1000 covering every trade, business and interest available through our easy-to-get-acquainted service. Full particulars and price-list free. Commercial Engraving Publishing Co., 34C North Ritter, Indianapolis 19, Indiana.

**3,000,000 ARTICLES Wholesale!** Where, how, save, make money. Valuable information. Also new angel-food pie recipe, small gift. All for \$1.00. Details free. Lane, Box 907, Broderick, Calif.

**HOW To sell** by mail spare time. Write Mileson, 1818 Tyler Pkwy, Louisville, Ky.

**NOW Subscribe** to weekly "Surplus Reporter." Tipp City 3, Ohio. Seven weeks trial \$1.00. Rush order.

**HALF Million articles** wholesale. Directory 25c (refundable). Publisher's, Box 1302-P11, Detroit 31.

**PROFITS Selling** office supplies by mail to business firms. Particulars free. Glenn Snyder, 5-B Spring, Beachwood, New Jersey.

**BE A real estate broker.** Pays big. I made \$1283.79 in September 1948 on 2 easy deals. Write for free literature. W. B. Schulte, Realtor, Box 2983, Houston 1, Texas.

**LIQUID Marble—Make in any color.** Soundproof plastic flooring. Flexible molds. Cast novelties, plaques, statuary. Big money, your own business. Catalog free. Write, Bing Products, 88-A11A Broad Street, Boston 10, Mass.

**PLENTY Extra money.** Exclusive territory. No investment. Cover-Nu, 1911-N, Lubbock, Texas.

**GOODYEAR—Has natural Malaya 75%** heavy brushing rubber. For molds. Trial half pint 50c. Write for full particulars. Goodyear, Lake Geneva, Wis.

**BEAUTIFUL Figurines,** plaques, bookends, unpainted. Cochranes, 1536 W. 7th St., St. Paul 2, Minn.

**MAKE Money** making new greaseless doughnuts at home on electric machine. Wholesale to grocers, drug stores, cafes, hamburger shops. Send for free recipes and plans. M. Ray Company, 3605 South 15 Ave., Minneapolis 7, Minnesota.

**TAX-CONTROL Bookkeeping** prevents income tax overpayments. Free details. Box 33, Forest Hills, N. Y.

**THOUSANDS Articles** wholesale. "Supply Source Directory" 10c. Ideal Service, Park Ridge 40, Illinois.

**MAKE Tough,** hard plastic 1c pound. Makes durable floors, walls, mantels, roofs, 101 uses. Build attractive home yourself. Material cost \$150 room. Bays Laboratory, Oklahoma City 9.

**816 WHOLESALE Manufacturing sources** \$1.00. Buy direct. Dancer, Mansfield, Ohio.

**MAKE Hollywood style** cement pottery, birdbaths, mantels, miniature castles; without moulds. Washing-wells, stucco-rock walls, fountains. Dime brings colored sample, amazing pictures. Hollywood Cementcraft, 8527-R Wonderland, Hollywood 46, Calif.

**LEARN To metallize** baby shoes. Instructions \$1.00. Don Brady, 1618 Sage, Topeka, Kans.

**OPERATE Vending machines.** 10 new ball gum vendors low as \$11.00 new, or \$7.50 reconditioned. 3/8" TOT brand gum, 3,500 to case \$8.75. Circulars free. T. O. Thomas Co., 1572 Jefferson, Paducah, Ky.

**PAYING Mail order** business, at home. Write, Dean, 2319-H Thomas, Fresno, Calif.

**BRONZING Baby shoes** pays enormous profits full or spare time. Start your business for \$3.95 total cost of materials and instructions. No equipment required, particulars free. Metaloids, Box 2095, Wichita, Kansas.

**MAKE Money!** Sell hand painted neckties by mail. Rehling Neckties, 415 44th Street, Rock Island, Ill.

**YOUR Own business.** Shortage, wide demand bring amazing profits! Concrete drain tile machine (\$67.50). Ceeten Products, Cornelia, Ga.

**VARIETY Stores** are profitable. I help you start. Fred Carpenter, Hamlin, Texas.

**INCOME From local information.** No selling. Neher Company, LaVerne, Calif.

**OPERATE Profitable** mail order business. Splendid opportunity. Details free. Capital Sales, 502 B Street, Lincoln, Nebraska.

**MONEY Making** plans, ideas. Leo Dahm, 758 Broadway, Buffalo 12, N. Y.

**SELL Cigars—Double your money.** Send \$3.30 for 100 sample cigars and details. Stanley-Allen Cigar Manufacturers, Box 127, Brookline, Massachusetts.

**TRIAL Subscription** Dixie Business Quarterly Magazine \$2 year. Winter issue features "South's Man of Year." Classified advertising 15c word. Sample copy 50c. Hubert Lee, Editor, Stone Mountain, Georgia.

**START Home manufacturing** business making Cleaning Compounds, Soaps, Insecticides, Cosmetics, Polishes, Food Flavors. No machinery. Literature free. Kemix, Park Ridge, Ill.

**BIG Money in vending machines.** Smallest capital start brings immediate profits that build permanent profitable business. Starting instructions free. Becker Vendors, 105-A Dewey, Brillion, Wis.

**LIQUID Rubber.** Make flexible molds. Free sample. Chaney, 1130 E. 16th St., Jacksonville 6, Fla.

**FREE Metal finishing** and plating booklet. Money making plans for chromium, nickel, gold and silver plating. Send postcard for your copy. Highly paid, interesting, uncrowded field. M. Hyde, 412 West Sixth Street, Room 209, Los Angeles 14, California.

**"HARNESSING The Earthworm."** Author will mail valuable free booklet: "Successful Earthworm Breeding." Thomas J. Barrett, Dept. 14-E, Box 488, Roseco, Calif.

**MAKE Ornamental products—Urns,** bird baths, boxes, benches for low cost concrete. Sell at big profits! We supply molds. Also, money-making automatic drain tile machines. Prepare now for spring, summer business. Free literature. Concrete Machinery Company, Hickory, North Carolina.

**NEW Industrial hand cleaner.** Free manufacturing-distributing plans. Unusual money-making proposition. "Acro-Sol-Ex," 623 West 14th Ave., Denver 4, Colorado.

**DOLL Hospital instruction.** Very profitable. Information. Box 755, Southkent Br., Grand Rapids, Michigan.

**FREE Colorful book** "372 Unusual Worldwide Business Adventures"! Photos! Pictures! True; successful. Australia, Africa, South America, New Zealand, Mexico! Not hokum. Operate, some at home. Refreshingly "different" plans. Publishers, 1199 Oak, Carlsbad, Calif.

**NEW Mail order manual** tells how, what, where to sell. Details free. Everett, 542A Barclay, Naperville, Illinois.

**MECHANICALLY Inclined?** Resurface butcher blocks. Lifetime business. Roy Crawford, Keyport, New Jersey.

**MAKE Money** addressing envelopes. Our instructions reveal how. Glen Glenway, 5713 Euclid, Cleveland 3, Ohio.

**I MAKE Big money** in the mail-order business. You can do the same at home with copyrighted system. Write me. I'll tell you how. F. Little, R.D. #1, Glenshaw, Penna.

**ENVELOPES Addressed** accurately, reasonably. Fast service. We have capable addressers in your city. Glenway System, 5713-Y Euclid, Cleveland 3, Ohio.

**A WONDERFUL Business** for today and the future. Easy fascinating work at home. Amazing profits. 3,000 word treatise, 25c. Austin, 206-A, R1, Roanoke, Virginia.

**EXCELLENT Manufacturing** propositions. Request circular. Richards, 44 North Albany, Chicago.

**CAST Metal, plaster, plastic products.** Pricopoulos, 761 Worthington, Springfield 5, Massachusetts.

**LEARN Piano tuning** and repairing at home. Write Karl Bartenbach, 1001H Wells St., Lafayette, Ind.

**METALLIZE Baby shoes.** Excellent profits. New system assures success. Free details. Treasures Forever, 89 Henry Ave., Lynn, Mass.

**MAIL Order jobber.** Protected franchise. Operate part time from home. Send \$3.00 for ten day trial examination. Everything furnished. Tom Turnipseed, Inc., Box 681, St. Louis, Mo.

**NICE Profits** selling costume jewelry. Home of "Nadine" pearls—direct to you. Free catalog. Master Makers, P.O. 207, DuBois, Penna.

**BOOKKEEPERS—Operate** own bookkeeping and tax service. Part or full time. Free course. "How to Operate a Contract Bookkeeping Service." A. J. Hawthorne, Public Accountant, Decatur, Ala.

**PROFITS Unlimited!** Make cleaners, soaps, etc., in home or garage without machinery. Easy instruction booklet, formulas (including waterless hand cleaner). \$1.00. Brown, 9111-k Hoyne, Chicago 20.

**WATCHES.** All kinds, new, used; retail \$3.65—\$345.00; big discounts; show catalogue, get orders. Brookins, B-1975AL, Little Rock, Ark.

**STATE And local distributors** wanted for complete line guaranteed paints. Full or part time, two-way plan; straight commission paid with order, no investment; or start retail store on small capital. High year-round income. Standard Industrial Products, Dept. PM-11, Evansville 4, Indiana.

**BEST Gift item** on market. Beautiful Mexican bird pictures. Hand made of real feathers. Sample, \$1.50. Mielak, 172-14 89th Ave., Jamaica, N. Y.

**MAKE Your own rubber molds.** Easy. We supply liquid rubber and full information. Prices low. Write Renflex, Box 74B, Queens Village, N. Y.

**SELL By mail!** Ideas galore! Join Mail Selling Opportunities Club! Details free! E. Wehner, Box 142-A, Roxbury 19, Mass.

**SAWDUST.** Turn it into cash. Six methods. Instructions 25c. Charles, 12-BN, Norwood, Ohio.

**CAST Novelties for profit!** Genuine Latex molds supplied! Fast sellers! Low cost! Catalog free! Castcraft Studios, 2027-P Fulton St., Brooklyn 33, N. Y.

**MAKE Metallic sign letters.** Free literature. Your name in 4 1/2 inch gold or silver color \$1.00. Art. Box 352, New Westminster, B.C., Canada.

**BIG Money in established** mail-order business. Our experience can start you successfully. Ray-Bar, 4501 Oakmont St., Philadelphia 36, Penna.

**EARN Money** at home. Many others do. Free lesson. Werts Shellcraft, Sharp Park, Calif.

**READ "Advance"—The voice** of mail order. Offers money-making opportunities, sources of supply, personal guidance, etc. Issued monthly. Sample copy 25c. Yearly subscription \$2.00. Advance Publishing Company, 313 East 21st Street, Suite 450, New York 10, N. Y.

**START Real estate** business. America's finest profession spare time. Details free. Educational Book Co., 2907 Berwick Ave., Baltimore 14, Md.

**FOR Sound, sensible,** proven successful mail order methods, write for free details to P.O. Box 1207, Glendale, Calif.

**MOLD-MAKERS.** Finest quality natural latex. Sample and instructions on request, also latex for casting rubber articles in plaster molds. Foam latex. Lowest prices. Major Chemical Co., 131 Inman St., Cambridge 39, Mass.

**BELTS!** Make 'em and make money. No tools! Sample 50c. Artinc Leather, 411 Joseph Ave., Rochester 5, N. Y.

**"PANTOGRAVER"**—"Handee," "Dremel," "Craftsman" motor tool attachment. Engraves plastic signs, nameplates. Sample engraving, details 25c. Desco Products Distributors, 6334-C Sepulveda, Van Nuys, Calif.

**BE Independent**—Operate America's lowest price penny vending machine. Big profits. Immediate shipments. Write for bulletin and prices. Fielding Mfg. Co., Desk 118, Jackson, Mich.

**FREE Literature** on money making ideas. Write: Lighthouse, 1023 Hamilton Street, Lockport, Illinois.

**FREE**—Wholesale catalog casting, finishing, mold making materials. Plastic Products, 2351-3W Southport, Chicago.

**BUSINESSMEN** Pay good commission for certain prospects. Excellent idea, no canvassing. Small capital needed. Particulars free. Wm. Kutzke, 1021 Prospect Ave., Toledo, Ohio.

**START Home business** making statuettes, plaques, artificial marble flooring, liquid marble, rubber molds, metalizing baby shoes. Amazing profits. Folder free. Creative, 236-L, Winnetka, Illinois.

**MAKE \$100 Per week** or more in a full or spare time baby shoe metalizing business of your own. Write now for free literature on this easy to learn, highly profitable business. Joseph B. Kushner, Metal Finishing Engineer, Stroudsburg 2, Penna.

**MAKE At home** beautiful jewelry, gifts, novelties, from sea shells, plastics. No tools or experience needed. 60-page beautifully photographed instruction course \$1.00. Beginner's 6-piece jewelry kit \$3.00 (foreign \$4.00). Information free. House of Gifts, Box 4550-XM, Coral Gables, Fla.

**CANDY Manufacturing** and marketing, complete course \$6.00, information free. Box 670, Kissimmee, Florida.

**"WATERLESS Hand Cleaner."** Make, sell. No machinery. Build profitable business. Complete formula \$1.00. Ideal Service, Park Ridge 2, Illinois.

**START Sewing machine** business by electrifying and converting to portables. Free details. Pasaak, P.O. Box 153, Canal Street Station, New York 13, N. Y.

**CO-PUBLISH** Mail order magazine. Details free. Feather Specialties, Chippewa Falls, Wis.

**BE A used car dealer,** guaranteed plan \$1.00. Edw. Smith, 17A Rockland, Yonkers, N. Y.

**EARN More money.** Read "Dollars and Sense," picture trade magazine. Sample dime. Martin, 57 Hart, New Britain PM, Connecticut.

**INFORMATION**—Supply sources, trade secrets, ideas, money making facts. Be your own boss! 24 page booklet tells how. \$1.00. Tip-Top, Box 9083PM, Dallas, Texas.

**OPERATE** Community merchandise club. Hold weekly drawings. Give away many kinds household utility merchandise. Easy, fascinating work. Amazing profits up to \$600 month. Details free. Fast action necessary. Kraft, Aurora 3, Missouri.

**METALIZE** Baby shoes and other non-metallic articles. Fascinating work. Big profits. Shuplate, Box 1388, Lawton, Okla.

**MAKE Money** selling quilt pieces by mail. One man ran \$200 into quarter million. Write Lovell, 2166 South Shore, Erie, Pennsylvania.

**A BUSINESS** In your own home! Our chemicals, plus free water and cheap "grocery store" materials can bring you over \$500 monthly earnings. Plans and formulas free. Chemica Division, 1269 S. Norton, Los Angeles 6.

**WRITE** For details to sell tablets by mail. Large profits; small investment. NuAid Co., 608 W. Union, Bethlehem, Penna.

**A FACTORY** In your home garage! Mfg. and sales rights, mechanics' waterless hand cleaner. \$500-\$800 monthly. No special equipment necessary. Formula free. Western Aircraft Mfg., Dept. D, Los Angeles 6, Calif.

**SELL \$2.** Fire extinguishers. Mailorder, locally. Lorrac Products, Albany 1, N. Y.

**HOME Workers** wanted to hand-spin Angora wool. Either sex. House of Angora, Springfield, Ill.

**BUY** The new Concession popcorn machine. Biggest low priced popper on market. \$100 puts you in business, complete. Also caramel corn, candy floss, candy pullers, kettles, heating equipment. Write for new catalog. Concession, Dept. A, Toledo 6, Ohio.

**PROFITABLE** Mail order opportunities. Details 10c. Brown, 18 Gracie Station, New York 28.

**WHOLESALE** Supply sources and money making plans offer security, success, in your own business. Details free. Reynard Publications, Smithfield 3, Ohio.

**MAKE** Just 90c profit on every dollar received. Circulars free. Carl Bohman, Saratoga Springs, New York.

**MAKE** Beautiful vari-colored, highly glazed concrete pottery. Amazing profits. Small capital starts. Write for details. Ozark Enterprises, Box 273, St. Charles, Mo.

**MAKE Money** by mail. Howard, 1778A Hamburg St., Schenectady 4, N. Y.

**BABY Shoe** metallizing. Trade secrets never before revealed. Everything you need to know. Amazing offer. Send card. Schoettle, Friendship, Ohio.

**NEW Products** deserve modern package-molded plastic boxes. 3 1/2" x 2 1/2" x 5/8". Friction slipover cover. Eight boxes. Assorted colors, dollar postal note. Stampade, 1220 Huron, Cleveland 15, Ohio.

**USE** Your home as magazine subscription station. Represent all magazines. Liberal commissions—we supply everything. Big Christmas business ahead. Catalog, full details, free. McGregor Magazine Agency, Dept. 22, Mount Morris, Ill.

**DOLLAR'S** in personalized baby record books; sell by mail; use same literature we do. No-Co-Ro, Oakland 6-M, California.

**LEARN Import-export!** Represent manufacturers! Sell-buy abroad, make 1000% profit. Send \$1 for two bulletins, supplying hundreds of overseas addresses seeking connections. Money refunded if unsatisfied. Benko, 246-P Fifth Ave., New York 1.

**UNPAINTED** Bookends, plaques, statues, figurines. List. Haverty Products, 1219 8th Ave., Altoona, Penna.

**MAIL Order** offers increased income, independence, unlimited possibilities. Free literature. Manhattan House, 126L, Lexington, New York 16.

**START** Bottled natural gas business. New, amazing opportunity. Demand enormous. Pays big profits. Literature free. Enco, Pasadena 16, California.

**INCORPORATE** Your business, free details. Tax Research Bureau, Inc., Delaware Trust Building, Wilmington, Delaware.

**LEARN** Piano tuning, repairing, at home. Tremendous field! Piano parts, tools furnished. Established 1935. Empire School of Piano Tuning, 606-B East University Ave., Champaign, Ill.

**NEW Method** of casting metal toys and novelties opens opportunity for full or spare time business and profits. Latest 1948 scale model autos, original ashtrays, savings banks, water pistols, etc., easily cast with bronze moulds. Enormous wholesale and chain store Xmas demand keeps manufacturers busy. No experience or special place necessary. Write for details and illustrations of patterns needed. Metal Cast Products Co., Dept. A, 1696 Boston Road, New York 60, N. Y.

**NATURAL** Molding Latex. Extra thick. Free sample. W. Wooley, 115-A Donald, Peoria, Ill.

**CASH** For your idea. 280 manufacturers need inventions, patented or unpatented. List free. Invention Bureau, 208M Clinton, Oak Park, Illinois.

**MAKE Money** sharpening saws at home on electric machine. No experience necessary. Hardware dealers act as your agents to secure work. Send for free book "Independence After 40" shows complete plan for starting in spare time. Foley Mfg. Co., 47 Foley Bldg., Minneapolis 18, Minn.

**RUBBER!** White liquid rubber! America's finest flexible moulding rubber! New! Extra heavy viscosity! Quick drying! Ideal for home, classroom, or industry. Only \$7.95 per gallon, \$2.95 per quart, and \$1.00 per half-pint sample. Parcel post prepaid! Plastercraft Supply Company, 3051 St. Clair Avenue, Cleveland 14, Ohio.

**MAIL Dealers!** Information guide, 10c. Live mailing lists, 200 names \$1.50. Leese, 4718 N. Laverne, Chicago 30.

**YOUR Own** mail order business at home. New, illustrated course. Free booklet. Registrar, 7219 South Broadway, Los Angeles 3.

**VENDING Machines** earn big money! An investment as low as \$10.50 will start you in this fascinating, profitable business that can lead you to the road of success and independence. Routes can be established and operated in either full or spare time with no experience needed. Write for full details and our free catalog illustrating our nut, candy, gum and stamp vendors; also slot machines, amusement games, etc. Parkway Machine Corporation, 623 W. North Avenue, Dept. 7, Baltimore 17, Maryland.

**NO Selling,** operate vendors, amazing profits, details free. Silver-King, 622 Diversey, Chicago 14, Ill.

**SPECIAL** Rubber for making molds. Literature and sample free. Universal, Box 1076-A, Peoria, Ill.

**HOW** And where to obtain capital. Small and large loans. Free particulars. Star Service, Wapakoneta, Ohio.

**OWN** Mirror shop. Resilver mirrors. Glass sign making. Electroplating. Supply prices. John Sprinkle, V60, Marion, Indiana.

**BRONZED** Baby shoe mountings and supplies. All metal bronze bookends, picture frames, ash trays, etc. Onyx ash trays, desk sets, plaques. Hardening solution, 30-amp. plating rectifiers with powerstat control, \$85.00. Geared motors for agitation \$20.00. Lead lined tanks. Write for list. Hollywood Bronze Supply, 1770 N. Vermont, Hollywood 27, Calif.

**QUICK** Money. "Repairing car batteries." At home! Easy too! Batteryman, Grand Junction, Colorado.

**WANTED** Unused U. S. postage stamps, small discount. Advance Stamp Company, 24 East 23rd Street, New York.

**POPCORN** Machines. Potato chip outfits. Long Eakins Company, 4860 Hi Street, Springfield 99, Ohio.

**\$46 FROM** Square foot plywood. Jigsaw necessary. Write, Woodarts, X-38, Bridgewater, Mass.

**OPERATE** Profitable mail order business. Write Walter Service, 4159-A East 112th, Cleveland 5, Ohio.

**RECAST** Old batteries into new. Latest achievements. Battery Laboratories, Minneapolis.

**RE-NEW** Leather and leatherette—Make cloth into imitation leather with plastic discovery called Leather-New. Opportunity to make real profits taking care of sales resulting from national advertising. Write for free sample of Leather-New covered material and complete deal. 4723A Troost, Kansas City, Missouri.

**COLORGLAZED** Concrete pottery made without molds. Patented method. Cemetery products, novelties, tiles. Basement leak-sealing. Money-making projects. Booklet, details free. Men only. National Potteries Company, Grand Rapids, Minnesota.

**START** Mailorder bookshop—Everything furnished. 25c brings booklet, samples, exciting ideas. General Publications, Ossining, N. Y.

**SPECIALTY** Manufacturing, the big money business that can be operated anywhere, start on a very small capital; we supply dependable formulas and complete instructions; get interesting free booklet, "Money-making Opportunities in Specialty Manufacturing." Howard Robinson, Ph.G., 1300-A South Ohio Street, Sedalia, Mo.

**\$25 WEEKLY** Working two hours daily. No canvassing. No manufacturing. Lycke, Box 2471, Cleveland 12, Ohio.

**137 WAYS** To make money, in home or office, business of your own. Full particulars free. Elite Co., 220 Grand St., New York 13.

**BRUSH** Plating outfits connect to a battery. No tanks necessary. Good paying business at home plating autoparts, bathroom fixtures, bicycles, reflectors, silvering mirrors. No shop or experience required. Outfits furnished. Free booklet. Gunmetal Co., Ave. H, Decatur, Ill.

**WOULD** You pay 3%—first \$350 made? Color-illustrated book "505 Odd, Successful Enterprises" free! Some offer occasional "day off." Work home. Expect something odd! Pacific, Oceanside, Calif.

**MAILING** Postcards selling repeat merchandise is profitable. Everything supplied. Details free. Gordan Publishers, Box 23, Pawtucket, R. I.

**RUBBER** Molds, natural liquid rubber, flock filler (for making sectional molds), statuary plasters, felt finishes for novelties. Catalog and "Plastercraft" course free. Blue Rapids Supply, Blue Rapids, Kansas.

**CO-PUBLISH** And advertise in The Central Mail Advertiser. Sample copy for stamp. Low rates. Large circulation. Bagby Printing Co., Georgetown, Ohio.

**MAIL** Order opportunities. Full or spare time. Hundreds of chances. No charge. Postal brings copy. Blackstone Press, Somerville, New Jersey.

**START** Home plaster novelty business. Amazing course tells how. Literature free. Kemo-Courses, Dept. A, 4882 Catalpa, Chicago 30, Ill.

**MAKE** Rubber stamps. Metalize baby shoes, silver mirrors, make plaster novelties. Catalogue of "20 Ideas" free. Universal, Box 1076-A, Peoria, Ill.

**50 BUSINESSES** You can start with \$10 and make \$10 per week! Complete—detailed! Copy, \$1.00. Literature free. Carey, 25-P, Waverly Place, Melrose 76, Mass.

**OWN**—Operate bull gum, nut, cigarette vending machines. Amazing profits, no selling. Write for free details. Cameo Vending, Dept. P, 432 West 42nd, New York.

**EARN** \$200 Weekly installing new amazing "Styron" plastic wall tile in homes, offices. Easily applied. Tile your own kitchen, bathroom, too. Instructions, everything furnished. Literature free. U. S. Tile Co., 30 W. Washington St., Chicago 2, Ill.

**\$10.00-\$20.00 WEEKLY**, Spare-time. Amazing opportunity. Free literature. Teepee Co., Cleveland 3, Ohio.

**COPUBLISH** Leading m.o. paper. Latest copy Mail Sale Advertiser and proposition, dime. Vanroy W. Shirk, Lebanon, Penna.

### MONEYMAKING OPPORTUNITIES

**OPERATE** Successful mail business with our tested plans. Free details. Reynolds, Box 103Y, McAlester, Penna.

**WANT** Pleasant outdoor work in a business of your own? Good profits selling over 200 widely advertised Rawleigh home/farm necessities. Pays better than most occupations. Hundreds in business 5 to 20 years or more! Products—equipment on credit. No experience needed to start. We teach you how. Write today for full particulars. Rawleigh's, Dept. H-145-PPM, Freeport, Ill.

**EARN** \$25 Distributing 50 boxes of greeting cards. Over 20 different top quality assortments for Xmas, birthday plus deluxe boxed stationery. Also make extra money taking magazine subscriptions. Details free! Cassell Co., 11-D Elm St., Westfield, N. J.

**SELL** Novelties. Locally or by mail. 4 different samples 25c. Lewis Davis, 3431 Campbell, Lynchburg, Virginia.

**WIN** Cash, cars in prize contests! Write for copy filled with current contests, winning hints and tips. Send only 25c. Wright Contest Digest, Dept. 17-M, P.O. Box 2266, St. Louis 9, Missouri.

**BOYS** Start earning Christmas money by selling this mystery toy of the year. No springs, no wires yet they dance and move about. Retail for \$1.00, costs you 50c. No stamps or c.o.d. please. Omer Marceau, 916 E. Third, Royal Oak, Mich.

**GOOD** Profits, showing fast moving items to men and women. Sells on sight. "Adams," 1143 Oley St., Reading, Penna.

**MEN, Women**—"Most everybody likes candy." Learn to make in a professional manner. (Our 38th year). Ragsdale Candies, D4, East Orange, New Jersey.

**METALLIZE** Baby shoes. Further information 3c stamp. Metal Crafts, Box 125-R5, Tampa 4, Florida.

**START** Your own business! Big money manufacturing novelties, plaques, statuary. Free catalog. Write Bing Products, 88-A11B Broad Street, Boston 10, Mass.

**EARN** Up to \$520 month part or full time keeping books for small firms. Simplified system. Write Tax-Saver System, Dept. M, Ft. Worth, Texas.

**\$50.00 WEEKLY** Mailing postcards. Write, Lynch, 402-4 Hazlett, Baltimore 29, Md.

**EXTRA** Money. Thrilling. Sensational toys. Information free. Kolinski, 759 South 25th, Milwaukee 4, Wisconsin.

**EARN** Money evenings, copying and duplicating comic cartoons for advertisers. Adservice, Argyle 1, Wisconsin.

**MAKE** 100%. Internally hand carved flowers in Plexiglas pins or earrings \$1.00. Winston Sprague, 817 Genesee Pk. Blvd., Rochester 11, N. Y.

**YOU** Can make money raising Golden Hamsters. New tiny animal. Profitably raised basement or garage. Write for details. Hudson Hamstery, R.P.D. #1, Newfoundland, New Jersey.

**WHOLESALE** Catalog, 10c (illustrated). Bargains galore. Stafford, Box 5211-Z, Indianapolis 1, Indiana.

**FINE** Opportunity to have pleasant outside business of your own. Supply every home with food products, flavors, washing preparations, and scores of other daily used items. Work part or full time. Many dealers with us for from five to twenty years. Exclusive territory assigned. No age limit. Selling experience unnecessary. Don't delay. Every day counts. Write now for details. C. I. Tognstad Co., Dept. PM-11, Kokomo, Ind.

**READ** "Advance"—The voice of mail order. Offers money-making opportunities, sources of supply, personal guidance, etc. Issued monthly. Sample copy 25c. Yearly subscription \$2.00. Advance Publishing Company, 313 East 21st Street, Suite 450, New York 10, N. Y.

**BIGGEST** Profit selling our gift novelties. Free catalogue. Aabalon's, New York 18.

**START** Profitable business on \$25.00 capital; like I did, instructions 25c. Alan, Box 2587, West Palm Beach, Florida.

**RESILVER** Mirrors at home. Formula 25c. Ideal Service, Park Ridge 6, Illinois.

**LEARN** Year round air conditioning at home. Free information. Don Nelson, Warner Robins 2, Georgia.

**MONEY-MAKING** Service. Particulars free. BC Company, 760 North Main St., Fall River, Mass.

**MONEY** Making plans. Send dime for magazine. James Carter, Rocky Mount, Virginia.

**\$12.00 PROFIT** On 25c investment. Free folder. Suproco, Ogema 5, Wisconsin.

**BABY** Shoes preserved. Formulas, instructions \$1.00. Supplies and bases. Novelty Bronzing, Box 58, Hyde Park 36, Mass.

**EARN** \$3.00 Hour! Service aquariums! Professional booklet \$1.00. Aquarium Assembling Service, Box 47, Cathedral Station, New York 25.

**\$3.41 PROFIT** Per hour interest you? Easy, amazing process velvetizes interiors, signs, novelties, radios, lamps at low cost. Free sample. Sparks, 1145 Queen Anne, Los Angeles 6.

**PRIZE** Contest bulletin gives various contests now operating, and valuable hints. 3c stamp. National Contest Bulletin, Box 2685P, Miami, Florida.

**WIN** Contest money. General Contest Magazine gives hundreds of tips. Lists current contests and rules. Sample 25c. General Contests, 1609 1/2 East 5th, Duluth, Minn.

**WOULD** You pay 3%—first \$350 made? Color-illustrated book "505 Odd Successful Enterprises" free! Proven! Work at home, office. Expect something odd! Pacific, Oceanside, Calif.

**PUBLISH** Your own magazine. Handsome 52 page format, well edited, illustrated. Cost low as \$1.00 month. Brings you prestige, profits. 25c brings sample. details. National Ord. Nebr.

**FREE** Booklet "How To Raise Worms For Bait." Tells how to propagate, package, sell. Send postcard. El Sobrante Earthworm Farm, 749-A Rincon Road, El Sobrante, California.

**INCREASE** Your earnings: Local business opportunities; mail order information; wholesale supply sources; valuable money-making tips; information, free details, rush name. Wilkin Company, Hillsboro, Ohio.

**SCHOOL** Seniors—Sell classmates America's most beautiful graduation name cards. Largest selection. 40% commission. Outsells all others. Free sample kit. Printercraft, Dept. M, 1425 E. Elm St., Scranton 5, Penna.

### FORMULAS, PLANS, ETC.

**10,000 FORMULAS** And trade secrets. Free literature. Stillman, 555 Kingston Ave., Brooklyn 3, N. Y.

**FORTY** Fast selling formulas and catalog \$1.00. Co-operative Service, 7 W. Madison, Chicago.

**YOU** Name it! We'll airmail formula. \$1.00. Satisfaction or refund. Brown, 9111B Hoyne, Chicago 20.

**FORMULAS**. Processes, analysis. Free literature. Pricopoulos, 761 Worthington, Springfield 5, Massachusetts.

**PRIVATE** Label cosmetic directory. 25c copy. Chaumont Sales, Box 228, Nyack, New York.

**FREE** Formula catalog, including automobile specialties. Anything analyzed \$20.00. Western Chemical, Salem, Oregon.

**MAKE**—Sell cleaners, soaps, polishes, flavors, cosmetics. No machinery. Formula literature free. Kemico, Park Ridge 16, Illinois.

**\$1.00 GETS** You 21 money-making popcorn, candy apple formulas. We supply equipment. Concession Supply Company, Dept. A, Station "B," Toledo, Ohio.

**TESTED** Formulas. Interesting descriptive booklet free. Pont, Box 635-PM, Terre Haute, Indiana.

**SAWDUST** Principal ingredient of product universally used. Easily manufactured in cellar or garage. Manufacturer's formula \$2.00. Hoyt, 344 Broadway, So. Portland 7, Maine.

**REAL** Manufacturing formulas. List free. Cummings, Chemist, Gordon Av., Syracuse 4, N. Y.

### PLASTICS

**NEW** Crystal clear liquid casting plastic for hobbycraft and industrial users. "Astrolite" R-250 was developed for biological embedment work at leading university. Exceptional clarity, quick setting, ideal for all casting applications. Send \$2.95 (U.S.A.) for introductory shipment (plastic, hardener, instructions). No c.o.d. orders. Whether you cast for money or fun "Astrolite" will amaze you. Consult our technical staff on all problems relative to plastics. Associated Plastics Laboratories, Dept. B, 3324 Park Blvd., Oakland 10, Calif.

**MAKE** Your own Christmas gift jewelry. Internally carved flowers beautifully colored in Plexiglas ready for assemblage. Kit contains earrings, brooch, and pendant, with silver-plated bow-knot pin. Complete with findings, cement, and instructions \$3.95. Pilot Plastics Co., 69 Beekman St., New York City 7.

**PRACTICAL** Plastics, fabrication—internal carving. New classes now forming. Approved G. I. bill PL 346 & 16. Write Dept. PM, Enterprise School of Plastics, 81 Willoughby Street, Brooklyn 1, N. Y.

**PLEXIGLAS** Sheets, masked. Good assortment \$1.00. Douglas Crowe, Bristol, Tenn.

**INTERNAL** Carvings, drills, dyes, jewelry findings, tools. Plexiglas masked sheets, 12"x12" 1/16" \$1.00, 1/8" \$1.25, 3/16" \$1.55, 1/4" \$1.85. Include 10% postage. Rods, tubes, dyes, cements, buffing compounds. Free listings. Craft Plastics, Somerville, New Jersey.

**PLASTIC** Kits ideal training for hobbyists. Complete instructions, templates and lucite to make ten beautiful useful gifts, picture frames, candle holders, dishes, etc. All for \$2.00 prepaid. Plastics. Lawrence, Michigan.

**AMAZING** Liquid plastic pours cold, hardens in half hour. Clear, colors. Expensive equipment unnecessary. Embed photographs, coins, flowers, seashells. Complete kit only \$3.25. Kristalon Plastics, Dept. A-11, Box 29, Wilmette, Ill.

**PLEXIGLAS**, Lucite, acetate, sheets, rods, tubes, jewelry findings, craft supplies, over 1700 items. 25c which brings catalog internal carving folder, information on fabricating plastics, deducted from first order. Plastic Parts, Dept. H-2118, 1157 S. Kingshighway, St. Louis, Mo.

**SAVE**. Plastics directory lists "right" sources for materials, molds, equipment, incidentals. \$1. Circular free. Plastics Digest, 2917-B Michigan, Kansas City 3, Mo.

**PLASTICS**—Sheets, rods, tubing, coatings. Shells, findings, dyes, craft supplies. Lucite scrap 25-65c pound. Illustrated fabricating manual, price list, 10c. Lucite sample, 35c. Courtesy to dealers. Gem-O-Lite, 5350F Riverton, North Hollywood, Calif.

**DON'T** Throw away broken plastic articles. Use WestCol plastic cement. 40c postpaid. WestCol Mfg. Co., 108 North 3rd, Grand Junction, Colorado.

**INTERNAL** Carved roses, orchids, swans, goldfish, butterflies, etc. Jewelry and gifts. Crystal Floral Novelty Co., Somerville, New Jersey.

**RENEW** Leather and leatherette—Make cloth into imitation leather with plastic discovery called Leather-New. Opportunity to make real profits taking care of sales resulting from national advertising. Write for free sample of Leather-New covered material and complete deal. 4723B Troost, Kansas City, Missouri.

**PLASTIC** Injection machine. Flexiglas, jewelry findings, sequins, dyes, cements, tools, drills. Catalog. G. Baker Company, River Edge, New Jersey.

**BARGAINS** In plastics. Lucite, Plexiglas, Catalin. Many colors and sizes. Details free. George Plastics, 6938A George St., Chicago 34, Ill.

**PLASTIC** Materials and supplies for your hobby or business. Catalog and internal carving instructions free. Art Plastics of Calif., 8125 East 14th Street, Oakland 3, Calif.

**LUCITE, Plexiglas.** Any size sheets. Cost square foot (12"x12") 1/16" 96c; 1/8" \$1.25; 3/16" \$1.52; 1/4" \$1.80; 100-\$1.14. Include 10% postage. Almac Plastics, 1150 Broadway, New York 1, N. Y.

## CHEMISTRY

**NEW** Laboratory supply catalog of chemicals and apparatus. Contains many thousands of items with illustrations. Send 25c. Standard Science Supply Company, 1232 N. Paulina St., Chicago 22, Ill.

**LABORATORY** Supplies at wholesale prices. Catalogue chemicals, apparatus, etc. 15c. Microscopic stains 20c. Both for 25c. National Scientific Company, 2204 W. North Ave., Chicago 47, Ill.

**CHEMICALS** And apparatus for industrial, analytical, and private laboratories. Catalog 10c. Dept. M-26. Biological Supply Co., 1176 Mt. Hope Ave., Rochester 1, N. Y.

**LEARN** Chemistry at home, from the house of Winn. Home of supplies for student chemists. New idea chemical and apparatus outfits for home experimenting. Photographic scales, semi-professional microscopes and accessories. Send 15c for retail catalogue. Established 1931. John H. Winn, 124A West 23 Street, New York 11, N. Y.

**FREE** Catalog: Chemistry, mineralogy, physics, biology. Tracey Laboratories, Evanston, Illinois.

**HANDBOOK** For chemical experimenters, illustrated, hundreds of experiments, 50c. Experiment booklet 15c. Supply catalog 5c. Reading Scientific Company, Reading, Penna.

**LABORATORY** Chemicals, apparatus, books. Catalog 10c. Fleischer's Laboratories, Everett 49, Mass.

## HELP WANTED

**ACT.** Sell new Xmas photo greeting folders. Big profits, we deliver, free kit. Spooner, 115 Chauncy, Boston, Mass.

## AGENTS WANTED

**RELIABLE** Man take care store route. Distribute, collect; new product, protected territory. Earn excellent weekly income. B. and W. Nut Co., St. Paul 1, Minn.

**BIG** Money—fast. Sell quality plastic tablecloth (from \$4 doz.), aprons, curtains, etc. Factory prices! Free samples! Durever, 314 C-Albany Ave., Brooklyn 13, N. Y.

**MAKE** Big weekly commissions selling nationally advertised aluminumware, silverware, pressure cookers, canners and gift items. No investment required. Simply take orders, collect commissions, we do the rest. Complete sales kit free. Write Ury Co., Dept. 12C, 222 - 4th Ave., New York 3.

**STRANGE** "Dry" window cleaner. Sells like wild. Replaces messy rags, liquids. Simply glide over glass. Samples sent on trial. Kristee 127, Akron, Ohio.

**\$5.00 CASH** Advance commission every sale 38-piece "Lady Ann" silverware. Guaranteed quality, value bring sales galore. Also varied line of other silverware and housewares. Write for sure-fire sales outfit. Dexter Silver Co., Dept. PM-11, 303 Fifth Ave., New York 16.

**SPOT** Remover sensation. Removes food, grease, perspiration stains overnight. Lip-stick stain. Special price to sales agents. Retail for 15c. Write for details. D. R. Mackenzie Co., Lincoln Bldg, New York 17, N. Y.

**LOOK** Here! Wanted—men to start in business on our capital. Sell some 200 farm-home products. Thousands our dealers now make quick sales, big profits. For particulars write Rawleigh's, Dept. K-192A-PPM, Freeport, Ill.

**\$1 STARTS** You in business. Sell lined ties, 100% wool interlining. Costs you only \$7 per dozen, you make \$5.00 dozen. Send \$1.00 for special introductory offer two ties. Catalog complete line free. Philip's Neckwear, 20 West 22nd St., Dept. K-29, New York 10.

**AMAZING** Profits selling advertising coasters. Single order paid \$108.00 commission. Sales outfit containing pencils, plastic, leather and metal specialties post-paid \$1.10. Refundable first order. Eric Howlett, Huntington, N. Y.

**PLASTIC** Tablecloth covers, curtains, drapes, baby pants, bowl covers and other plastic articles selling like wildfire! Make big money now! Free details. Write L & M Co., Dept. 58-M, 510 St. Charles, St. Louis, Mo.

**100% PROFIT**—75c Seller—Knife and scissors sharpener. Homes, hardware, department stores. Exclusive territory open. Sample 25c coin. Keenway, 185 Barbee, Fontana, Calif.

**BIG** Earnings easy when you sell nationally advertised products. Write for free catalog to: F. J. Savarese, 26-39 29th St., Long Island City 2, N. Y.

**IT'S** New, sample 25c (Crystal-Flex) in beautiful reflecting colors. Store and Bible text mottoes. Also colored tinselled holiday signs. Special Kut Signs, Dept. N. Sidney, Ohio.

**SELL** Ultra-blue stock signs to stores. 1000 slogans, comedy, general, religious. "7x11" cost 6c, sells 35c. Make money. 15 samples ultra-blue signs "7x11" \$1.00 postpaid. Lowy, 8 West Broadway, Dept. 424, New York City 70.

**POCKET** Pal: replaces pocket knives, new, safe, beautiful. Always razor sharp. 50c seller. 321% profit. \$15.00 or more daily. Agents, salesmen, distributors. Sample 10c. Nelson Mfg. Co., 222 W. Kellogg, St. Paul 2, Minn.

**LONG** Needed invention. Established company. Every home, factory, store, farm a prospect. Low price, long profit. Exclusive. Fine outfit. No deposit. Local territory. Write 237 R. C. Building, Red Comet, Inc., Littleton, Colorado.

**MAKE** 100% Profit selling name imprinted Christmas cards and \$1.00 assortments. Personalized napkins and stationery. Request samples. Dunbar, Sanford 2, Florida.

**RAT-SNAP.** No odor, rats dry up. Sells 35c, cost you \$1.50 doz. Sells dealers \$2.50. Allen Co., Pittstown, N. J.

**AGENTS** House to house. Valuable premiums or cash commission. Write today for particulars. Benwood Laboratory Inc., Dept. B, 317 No. Memorial Drive, St. Louis 2, Mo.

**DIRECT** From factory. Make \$100.00 weekly selling watches. Advertised brands with guarantee. Free catalogue. Ergim Watch, 833 Columbus Ave., New York.

**AGENTS**—Garage, gas station contacts! Sell King McCoy spark plug checkers. Most accurate on market, simple guaranteed, fast seller. \$4.95 less 50% to agents. Write King McCoy Inc., 101 Pine St., Dayton, Ohio.

**SELL** Mexican bird pictures, hand made of real feathers in beautiful colors. Sample 8x10, \$2.50; 10x12, \$3.00. Each with frame. Importer C. Staff, 14660 Evanston, Detroit 24, Michigan.

**SCHOOL** Seniors! Your postal will bring our wonder. Kwick-Sell Cardalog of popular graduation name cards. Biggest profits! Only firm giving free souvenir chest and card case. Don't miss out! Hurry that postal! Craftcards, Box 235-L, Pittsburgh 30, Pennsylvania.

**YOUR** Own business, \$100 weekly. Fast selling plastic furniture covers. Floral table covers, aprons, etc. 100% profit. Free sample. Carwell, 330-PF South Wells, Chicago.

**MUSIC** Greeting cards. All occasions. Dorby Music Card, P. O. Box 738, Morrisstown, New Jersey.

**EARN** Big money year 'round. Be a one-person-department-store. Take orders for shirts, ties, hosiery, lingerie. Household linens, etc. For information, Corporate Merchandisers, Dept. PM-8, 110 West 34 Street, New York City 1.

**SPECTACULAR** Guarantees, popular prices, make selling easy. Biggest steady repeat profits selling Colt's famous men's, women's guaranteed shoes, hosiery. Experience unnecessary. Free selling outfit. Colt Shoes, 601-J11 Atlantic, Boston 10, Mass.

**QUICK** Money: 100% profit. Show Xmas cards, stationery to friends, coworkers. No experience. Approval samples. Torres Co., 373 Fulton St., Brooklyn 1.

**FREE** Sample. Profitable fast seller. Salesmen, distributors, mail dealers write Flinson, Box 4333-B-C, Kansas City 1, Mo.

**BUY** Thousands of nationally advertised products direct from manufacturers. Write for "Buy Direct and Save." Consumers Assn., 287-A Lebanon Ave., Mt. Lebanon, Penna.

**FREE** Nylons given if Kendex hosiery runs or snags! World's only women's hosiery sold with a written guarantee that amazes everybody. Mere words could not possibly express the almost unbelievable opportunity you now have to make money. Fantastic and "impossible" earnings now become a reality. Can you imagine a guarantee that replaces hosiery regardless if damage is due to use or abuse and regardless whether it is the fault of the hose or the wearer? Here is sales dynamite that will blast your earnings to the sky! Even if you never sold a thing in your life, three magic words: "guaranteed against everything" will open doors for you—will make women listen and will pour money in your pocket. Kendex stockings are not sold in stores, so you have no competition. Complete line includes beautiful sheer nylons; long wearing, durable service nylons; three different lengths; genuine outside nylons; latest shades; choice of full fashioned with seams or seamless; lowest priced rayons. Also separate complete line of men's hosiery including nylon, lisle, rayon, cotton, mixtures etc.; plain and fancy; long and short. Thousands of pairs shipped daily. No money or experience needed. Nothing to invest or risk. No samples to buy. Nothing to pay, now or later! Simply write orders. We deliver and collect. Liberal advance cash plus huge cash bonus. Write orders spare or full time; exclusively or as a side line. Become a manager and appoint others to sell for you with steady income on their sales! Complete money-making outfit, including salesbooks in color, samples cut from actual hose, instructions, order blanks etc. furnished free and prepaid. Rush name and address on postcard and start making money next week. Kendex Co., Babylon 186, New York.

**MAKE** Sensational profits! New, sell-on-sight plastic line: Tablecloths, aprons; many other splendid fast-selling items, novelties. Postal brings free details, special deals. Hurry! Royalty, Box K-748, Passaic, N. J.

**SILVER** Plating liquid (NuSilver). Apply with cloth. Durable, guaranteed, genuine, silver finish. Renews silverplated ware, articles, pieces. Silverplates brass, copper. NuProcess Products, Aurora, Ill.

**AGENTS**—Something new in house numbers. Illuminated number and door bell push-button combination. Write for sample and particulars. Nitenumber Co., Box 5150, Cleveland, Ohio.

**GUARANTEED** Tire patch. Sell garages, filling stations. Protected territory. Economy Rubber Co., Riverdale Station, Box 552-D, Dayton 5, Ohio.

**POSITIVELY** New. 100% profit. Heavy repeat sales. Fast selling, two sided, reversible neckties. Free details. Farrell Company, Dept. 35, 1377 Galbraith, Cincinnati 31, Ohio.

**BIG** Profits. Sell nationally famous guaranteed Dans wrist watches. Illustrated circular. Brooks, B120M, Arkansasaw, Wis.

**PHOTO**-Salesmen-agents. Sell beautiful hand-colored plastic enlargements. Collect deposit, we deliver. Profitable sideline. Send card, for free sample kit. Novel Portrait Co., 3343 North Ave., Chicago, Ill.

**AGGRESSIVE** Agents wanted to demonstrate guaranteed Copper-Cote ironing pad and cover sets. Endorsed by housewives everywhere. Sure-fire sales plan helps you get started. Generous commissions. Protected territories for producers. Real deal for live wires. The Sheldon Company, Box 1347, Milwaukee, Wisconsin.

**GUARANTEED** Product in protected territory, if you are now selling or intend to sell house-to-house. For full 1 qt. sample amazing High Shine Windsor No Rubbing Wax, send only 25c covering handling and postage. (Sells for \$1.25.) Windsor Wax Co., Inc., Dept. P.M.-2, Hoboken, N. J.

**I'LL** Put a "shoe store business" in your pocket! Nation's leader trains you to make big money! Fit men, women. Free sample outfit, write today! Consolidated Shoe System, Dept. S-139, Chippewa Falls, Wis.

**SELL** The famous \$3 "Fire-Killer" extinguisher with bracket, wholesale or direct; exclusive territory. Demonstrating sample \$2; refilled free. "Fire-Killer," Syracuse 1, N. Y.

**BIG** Money selling cast iron and aluminum cooking utensils direct to consumer, exclusive designs. Free illustrations. Jones Machine & Foundry Co., Chattanooga 2, Tenn.

## EDUCATIONAL AND INSTRUCTION

**SQUARE-ROOT.** Easy short cut, 15c. Prof. Lineback, College Station, Stillwater, Oklahoma.

**FOR An extremely profitable lifetime business operate a collection agency—credit bureau. Easily learned. Free folder. Cole & Associates, Syracuse 2, N. Y.**

**NEW Profession. Pedemetry—Foot correction. Unlimited field. Learn at home. Write Registrar, American Foot Health Institute, 55 East Washington, Chicago, Ill.**

**U. S. Gov't Jobs. Start high as \$3,351. Men-women. Quality at home for secure positions. 40-page book, sample tests—free. Write Franklin Institute, Dept. H24, Rochester, N. Y.**

**LAW Students! Finish your law correspondence course with our expert coaching. Low cost. Write today, stating your course and how far advanced for free particulars. Glenn Squires, Lock Box 5375, Van Buren Station, Chicago 7, Ill.**

**LEARN Auctioneering by mail. Sample lesson free. Nelson Auction School, Renville, Minnesota.**

**BECOME A Doctor of Psychology or Metaphysics. Teach secret of contentment, happiness. Win degree of Ps.D. or MsD. Solve mental worries. Free book. College of Universal Truth, 5153-C North Clark, Chicago.**

**GOOD Jobs and a sound substantial future await you in hotel and institutional field. Men and women, all ages, needed for well-paid positions that offer color, excitement, ever-new and fascinating duties. Record breaking travel means even greater opportunities for trained men and women in hotels, clubs and institutions. Lewis School receiving calls for managers, assistant managers, stewards, hostesses, purchasing agents and 55 other types of important positions! From coast to coast there are important positions that offer splendid opportunities for advancement in a business where you are not dropped because you are over 40. Previous experience proved unnecessary! No need to leave your job to qualify. A good grade school education, plus Lewis Training qualifies you at home, in spare time. Our National Placement Bureau helps to place you; and our amazing Certified Job Plan actually certifies you will "make good" when placed. Write today for free book! Course approved for Veteran's training. Lewis Hotel Training School, Room NW-368, Washington 7, D.C. (First and only school of its kind—now in its 33rd year.)**

**NOW You can have an office. Many earn up to \$5,000-\$15,000 annually in the collection business. Learn by home study course. Experience unnecessary. Write for free bulletin. No obligation. Franklin Credit School, Dept. 228-M, Roanoke 7, Virginia.**

**BE A Notary Public. Largest notary supply house equips you for \$16.97, guarantees your appointment by governor. Honor, prestige. You certify legal papers, collect fees. Easy. At home, office, any where. You use official seal made with your name. Notaries needed everywhere. Be one. Write Stationers Exchange, Helotes 18, Texas.**

**WRITE For pay! New guide helps you get started. Complete, \$1.00. Charles Cox, 821-B East Linwood, Kansas City, Mo.**

**CORRESPONDENCE Courses. Used International. Many subjects. Satisfaction guaranteed. Write today. Baker, 3509 Winthrop, Chicago 40.**

**"HOW To Break and Train Horses"—A book every farmer and horseman should have. It is free, no obligation. Simply address, Beery School of Horsemanship, Dept. 11011, Pleasant Hill, Ohio.**

**MAKE Up to \$30-\$40 week as a trained practical nurse! Learn quickly at home. Booklet free. Chicago School of Nursing, Dept. M-11, Chicago.**

**BE A real estate broker through home study or classroom instruction. Write for free book. Approved for veterans. Weaver School of Real Estate, 15 E. Pershing Rd., Box CP-1, Kansas City 8, Mo.**

**STUDY Dental technician trade at home. Ten complete lessons \$5.00. Grant Laboratory S, Los Angeles 14, Calif.**

**PRACTICAL Course—Automobile radiators, repairing, recoring, cleaning. Ralph Hendry, Galt, Canada.**

**MATHEMATICS, Arithmetic; algebra, geometry, trigonometry, calculus, physics, radio and business math, drafting, architectural, mechanical, electrical, structural, building estimating. Approved for veterans. Mondell, 230 West 41st, New York.**

**INTRODUCTORY Offer: mail \$2.00 for cologne and perfumes retailing \$6.60. Not samples! Tremendous market—Huge profits. Beau-Belle Creations, 3740M North Paulina, Chicago 13.**

**ADVERTISING Book matches—Cash in on big demand; sell union label matches. Cuts for all businesses and political parties. Free powerhouse selling kit, low prices, protection guaranteed on repeat orders. Cash commissions. Superior Match Co., Dept. M-118, 7530 Greenwood, Chicago.**

**BARBECUE Picnic sets. Lawn-sickle mowers. Engines. Motors. Farmco, M-2001, Excelsior Springs, Mo.**

**MAKE \$15.00 To \$25.00 per day. Joe Louis' and Marva Louis' (his wife) toilet articles, cosmetics and other products for men and women are sensational. White people like them; colored people buy on sight. Perfumes, powders, pomades, creams, brown creams, flavors, remedies, and many other fast sellers are our features, \$3.95 buys \$10.03 (23 items) retail deal—send \$1.00, pay postman balance. Be first in your community to offer this new line and you will be happy. Joe Louis Products Company, 6 E. Garfield Blvd., Dept. PM-11, Chicago 15, Illinois.**

**SELL Delicious candies, nuts, gum. Immediate delivery. Write Casterline, 3031-PN Sunnyside, Chicago 25, Illinois.**

**BIG Money selling tooth powder. Write today. James Walker, 633 Plymouth Ct., Chicago, Ill., Dept. 3.**

**STOP! Read carefully! Today's rapid-fire money maker. Only complete giant volume World War II. Profits to distributors already over \$2,000,000. Surface only scratched. Sells on sight. Over 20,000,000 prospects—every home, shop, school, office. Don't miss these landslide profits. Write quick! Universal House, 1024-B Arch Street, Philadelphia, Penna.**

**AUTOMATIC Fire extinguishers, it really sells. Guaranteed top profits. Exclusive territory available. Red Ball Inc., Box 1552, Salt Lake City, Utah.**

**IF Punchboards are allowed in your territory, we have the hottest thing this side of the Mississippi. You will say you never made money any easier or faster. Wico Products, Logansport, Ind.**

**HOBBY Books. Latest titles. Catalog free. Popular Mechanics Press, (C-43), 200 E. Ontario, Chicago.**

**OLD Cars run like new! Stops vibration, rattle, shimmy. Lox-It Safety Clamps are designed and proven to save lives from car-truck wrecks caused by tie rod-drag link failure. Give make and model. Prepaid on receipt of \$1.50. Best investment and cheapest insurance you ever made. Agents make \$3.00 per dozen selling service stations. Good salesmen make \$200 to \$400 a week. Advertising matter free. Lox-It Manuf. Co., Clarksdale, Miss.**

**SALESMEN—Put yourself in line for big money and real future. Keep stores supplied with 5c-10c counter goods. Nationally advertised merchandise. Top profits for you and merchants. Liberal deals boost sales. Sideline or full time. World's Products, Dept. 10-K, Spencer, Ind.**

**CHRISTMAS Balloons wholesale. Twistee animals. Complete rubber toy line plastic balls, dolls, 12 samples 25c. Ellswood's, LaJunta, Colorado.**

**BIG Money quickly and easily taking orders for complete line personalized initialed buckles, belts, cap badges, 2,000 emblems. Fast repeats. Write today. Hook-Fast Company, Box 480-PM, Roanoke, Virginia**

**JOBS Open in selling! Send name, address for free copy Opportunity Magazine, listing hundreds of companies who need men now, full or spare time. Experience not essential. Opportunity, 28 E. Jackson, Dept. 17, Chicago 4, Ill.**

**BIG Money taking orders. Shirts, ties, Sox, pants, jackets, sweaters, shoes, uniforms, etc. Sales equipment free. Experience unnecessary. Nimrod, 4922-AN Lincoln, Chicago.**

**MAKE \$2,000 Next 60 days. New invention cleans clogged drains in jiffy. No chemicals. Nothing like it! Prospects everywhere. Commissions advanced. We deliver. Free sample offer. Campbell Co., Rochelle 3, Illinois.**

**QUICK Sure money selling Annie Blaine flavors. Highland Park 1, New Jersey.**

**BE The Popular Mechanics representative in your neighborhood and earn big profits in your spare time. Write Popular Mechanics Magazine, Room 408C, 200 E. Ontario St., Chicago 11.**

**USE Your home as magazine subscription station. Represent all magazines. Liberal commissions, we supply everything. Big Christmas business ahead. Catalog, full details, free. McGregor Magazine Agency, Dept. 12, Mount Morris, Illinois.**

**BIG Bargains for big profits. Over 100 sensational wholesale values. Men's used suits \$2, pants 35c, topcoats \$1.25, overcoats \$2, shoes 20c. Experience unnecessary. Free catalog. Superior, 1250-A Jefferson, Chicago 7.**

**FREE Sample! Big profit opportunity with amazing Glow-in-the-Dark house numbers, switch plates, pictures, decals, religious articles. Represent large manufacturer. Madison Mills, 303 Fourth Avenue, New York 10, N. Y.**

**PLASTIC Christmas cards. Exclusive new plastic, sachet, panoramic and carols Christmas assortments. Five leading 21 card \$1.00 feature assortments. Six portfolios of personal cards. All this plus America's fastest imprint service. Free samples. Elmcraft Card Co., 5930 South Western, Chicago 36, Illinois.**

**MAKE More money selling personal initialed individualized belts, buckles, cap badges, tie holders, name plates, 2,000 emblems to choose. Big profits, whole or part time. Write today: special outfit offer. Hookfast Specialties, Box 1425, Dept. 6, Providence, Rhode Island.**

**FREE Water and our concentrates, makes flavors, lotions, shampoos, 72 products, labels, bottles furnished. Qualco, E-20030 Russell, Detroit.**

**MAGIC Cleaner—Laundry soap deal. Hotter than a firecracker. Big profits. Sample free. Bestco, 4642 No. Central, Chicago.**

**AGENTS: Stamping names on pocket-key protectors. Sample check with your name, address, 25c. Stamping outfits. Emblem checks, check-fobs, name plates. Hart Mfg. Co., 303 Degraw St., Brooklyn, N. Y.**

**INFORMATION—Wholesale supply sources. Moneymaking plans. Increase your income! Write Reynard Service, Smithfield 3, Ohio.**

**GOLD Lacquered window sign letters. Large sizes penny each. New foils. Absolutely beautiful. Free samples. Atlas, 544 W. 79th, Chicago 20.**

**EXCELLENT Sideline for printing and advertising salesmen. Decalomania name plates in small quantities. Great demand. Also, make money with our line of automobile initials and sign letters. Free samples. "Ralco" XL-Roxbury, Boston 19, Mass.**

**AGENTS—300% Profit selling genuine gold window letters; stores and offices. Free samples. Metallic Letter Co., 438-B North Clark, Chicago.**

**CHRISTMAS Cards! Jobbers' prices! Fifty different items from 18c to 38c per box. Gift wraps, seals, Christmas tree windows, books, letterheads. Illustrated catalog free! Fantus, 436 North Wells, Chicago.**

**GREETING Card agents! Double your income with profitable sidelines. Write today! Mosher's, Vinyard Haven, Mass.**

**SCHOOL Seniors—Earn 40% commission selling classmates America's most beautiful graduation name cards. Largest selection. Outsell all others. Free sample kit. Printeraft, Dept. M, 1425 E. Elm St., Scranton 5, Penna.**

**SELL Books by mail. Mammoth sales and huge profits. Everything furnished. 3c stamp brings complete particulars. Box 177, Madison Square Station, New York 10.**

**\$1 STARTS You in business. Write, Successful Income Builders, 508, Hollywood 28, California.**

## HIGH-GRADE SALESMEN

**START Your own business on our capital. Always your own boss. Hundreds average \$6,000 to \$25,000 annual sales year after year. We supply stocks, equipment on credit. 200 home necessities. Selling experience unnecessary to start. Wonderful opportunity to own pleasant, profitable business backed by world-wide industry. Write Rawleigh's, Dept. K-U1-PPM, Freeport, Ill.**

**MAKE \$500.00 A week! Be first with "Neo-Fluorescent." Revolutionary invention! New type fluorescent sign replacing neon. Fantastic virgin market with dealers, mfgs., distrib. nets fabulous profits. Free sample offer. Rose Co., 539-WW So. Franklin, Chicago.**



**SUPERMEMORY** Makes data stick like burrs! Write Thor Books, CM-11, Box 1210, Chicago.

**EDUCATED** Memory develops alertness, confidence and success. "Memorology" science of memory simplified, will enable you to amaze your friends and employer. Literature free. Memorology Club, 2016 Sunnyside Ave., Chicago 25, Illinois.

**INVESTIGATOR** Training, other. Scientific crime detection courses. Free literature. Write today! State age. Institute of Scientific Criminology, Dept. J. 1324 West Broadway, Spokane, Washington.

**RADIO** Announcing. Train for this interesting, profitable profession at home in spare time! Details free. Radio Arts Center, 2912 South Salina Street, Syracuse, N. Y.

**MAKE** Money in bookkeeping! Introductory lesson 35c; 15 lesson course \$5. Bernard Buchalter, 1280 Ocean Ave., Brooklyn 30, N. Y.

**PIANO** Tuning pays. Learn this profitable profession at home. Our Tonometer and mechanical aids make learning easy. No knowledge music necessary. Diploma granted. Largest and oldest school—50th year. G.I. approved. Write for booklet. Niles Bryant School, 78 Bryant Bldg., Washington 16, D.C.

**TECO** Motor kit—Complete parts for small low voltage a.c.-d.c. motor. Quality product for electrical students in high school, industrial, vocational, and home laboratories. Arranged for demonstrating squirrel cage and wound rotor, series, shunt and compound connections, brush settings, air gaps, and other salient technical points pertaining to electric motor operation. (Not merely a toy). Write Teco Incorporated, P.O. Box 127, Boonton, New Jersey.

**VETERANS**—Send for free 36-page colored photo book. World's Largest Watchmaking School, Desk 40, 808 Ridge Ave., Pittsburgh, Penna., "Workshop of the World."

**HOME** Bible course. Simple, helpful, instructive. Total cost \$4.00 includes textbooks, stationery, examinations, certificate. \$1.00 starts you, or simply request prospectus. The Bible Study School, 378 Van Houten Street, Paterson 1, N. J.

**MEDICAL** Laboratory technicians in great demand. We train you in your own home, in your spare time. Also home study course in general chemistry. Free catalogue. Imperial Technical Institute, Box 973-J, Austin, Texas.

**INVESTIGATOR** Training. Phillips Secret Service, 1917B North Kenneth, Chicago 39, Illinois.

**BOOKKEEPERS!** Increase your earnings! Operate your own simplified "dollar-a-week" bookkeeping and tax service. Full or spare time. Details free. No obligation. Ellis, Box 200, Cedar Grove, North Carolina.

**USED** Correspondence courses and books bought, sold, rented and exchanged. Catalog free. Lee Mountain, Pisgah, Alabama.

**LINGUAPHONE** Makes languages easy. At home learn to speak Spanish, Portuguese, Italian, French, German, Russian, by quick, easy Linguaphone Conversational Method. Save time, work, money. Linguaphone correspondence courses are available to veterans under G.I. bill of rights. Send for free book. State if G.I. Linguaphone Institute, 83 RCA Bldg., New York, 20, N. Y.

**LEARN** Photo-engraving at home or in oldest, largest school in America. Work for newspaper or establish own profitable business. New Tasope' Photo-Engraving equipment available soon. Write for information. Veterans ask about G.I. training. The Aurora School of Photo-Engraving, Tasope' Bldg., Aurora, Mo.

**SECRET** Investigation. Experience unnecessary. Investigators particulars free. George Wagner, M 125 West 86th, New York.

**USED** Correspondence courses and educational books bought, sold, rented. Catalog free. Educational Exchange, Summerville, Ga.

### PLAYS, STORIES, MANUSCRIPTS

**NEW** Writers make good money from start. Experience unnecessary. Particulars free. Howard Snyder, Canton, Mississippi.

**I WANT** New writers to cash hundreds of checks for \$1 to \$100, offered each month. The easiest way to write for pay. No previous experience necessary. Send for free details. No obligation. Saunders M. Cummings, 467-M Independence Bldg., Colorado Springs, Colo.

### BUSINESS SERVICE

**MAILING** Lists revised before posting \$7.50 a 1000. Sheriff Specialty, 700 Washington, Albany 6, California.

**REMAILING**, Daytona. Five for dollar. Box 94, Flagler Beach, Fla.

**CALIFORNIA** Mail address. Prominent building. \$2.00 monthly. P.O. Box 1291, Main Office, Los Angeles 53.

**CHICAGO** Mail address. Business or personal. Receiving, forwarding. Confidential service. \$1 monthly. Faultless, 3439-P Michigan, Chicago 16.

**WE** Receive, reforward letters; \$3.00 monthly or 25c each. "Hawkins," 1300 Taylors, Washington 11, D. C.

### SPECIAL SERVICES

**PHOTOSTATIC** Copies. Write for prices. Hamy, 214 Robinson, Hudson, N. Y.

**MAIL** Forwarded from New York, 25c letter. Rakusin, 505 Avenue C, Brooklyn 18.

**LET** Us solve your mathematics problems. Consultation free. Solutions guaranteed or no fee. Mathematics Associates, Box 852, Lancaster, Penna.

**HOUSEBUILDERS** Construction drawings from your sketches. McDonald Realty, Austin, Texas.

**HOSIERY** (Firsts, imperfects), handkerchiefs, shirts! Wholesalers, distributors, write for prices. Spartan Hosiery Company, Spartanburg, South Carolina.

### INFORMATION

**DOES** Sunny California interest you? We supply facts, figures and dependable information about housing, jobs, etc. \$1.00. Pomeroy Service, 1926-PM Wilshire, Los Angeles 25, California.

**FOREIGN** Employment for you. Excellent permanent job opportunities for U. S. citizens. Wages at least 20% higher, less taxation, lower living costs. Improved social position. Transportation and housing furnished. Choice of climate and location. South and Central America, Far East, China, Alaska, Africa. Send \$1.00 for copyrighted Digest showing oil, shipping construction, mining, etc. Companies working and hiring. Includes sample application letter, advice on wages, tips, etc. World Wide Company, Dept. PM-11, Madison 1, Wisconsin.

**CALIFORNIA'S** Famous San Fernando Valley. Send one dollar for any information to San Fernando Valley Business Bureau, Box #175, Encino, California.

### ADVERTISING AGENCIES, LETTER WRITERS, FOR ADVERTISERS

**CHOICE** Mailing lists. E. J. Eller, Broker, 1000 Sutter Street, San Francisco 9, Calif.

**ADVERTISE:** 24 Words, 40 newspapers \$3.50. Lists free. Advertising Bureau, 10511-C Springfield, Chicago 43.

**SELL** Anything by mail. Dynamic ads, prospectus, letters written. Classified lists. Millions. Teachers, students, investors, stockholders, agents, etc. Faultless Advertisers, P-3439 Michigan, Chicago 16.

**24 WORDS** In 50 weeklies, \$4.96. J. Darnell, 730 Hays, Jackson, Tennessee.

**SELLING** By mail? Planning to? Want to? You need "Mail Sellers' Handbook." Copy 10c. National, Box 88P, Dorchester, Mass.

**EARN** Money in your spare time. Progressive Mail Trade tells you how. Large 64 page magazine for a dime. Progressive Mail Trade, 822 Center Ave., Sheboygan, Wisconsin.

**ADVERTISERS!** Reach nearly 18,000,000 readers. 25 Sunday national key newspapers, 18 words, \$47.75. "Terrific pullers." 20 popular newspapers, \$9.75. "Free booklet." Special—One inch display 2,-821,198 circulation, \$42.00. Newmark's Advertising Agency, (Established 1893) 217-7th Ave., New York 11.

**ADS** Placed in out of town newspapers and magazines. Low rates. Catalogue free. Ideas that pay. Baker Advertising Agency, Successors Ankrum Agency, 189 W. Madison, Chicago 2.

**MAILING** Lists, certified, productive, inexpensive, \$5.00 1000. Homeworkers, agents, buyers, etc. Write Dixie Service, King, N. C.

**ADVERTISING** Sensation! Reach 2,100,000 families, \$32.90 inch. Display, classified, ratebook (newspapers, magazines, mailing lists), advertising assistance, free. Chicago Advertising Agency, 20-PM West Jackson, Chicago 4.

**FREE!** 1948 Advertisers Rate and Data Directory. 52 pages! E. H. Brown Advertising Agency, 20 N. Wacker, Chicago 6.

### CARTOONING, COMMERCIAL ART, SHOWCARD WRITING, SIGN PAINTING

**LEARN** Cartooning, illustrating, showcard writing, photo coloring, etc., quickly with our new, easy methods. Catalog free. National Artists Bureau, Box 4248-W, Dallas 8, Texas.

**"HOW To Make Money With Simple Cartoons"**—a book everyone who likes to draw should have. It is free; no obligation. Simply address Cartoonists' Exchange, Dept. 911-C, Pleasant Hill, Ohio.

**SIGNS** Made easily. Instructions and ten sets modern alphabets, numerals, patterns. Sizes up to eight inches. All for \$1.00. Co-operative Business, 7 West Madison, Chicago 2.

**EARN** Money evenings, copying and duplicating comic cartoons for advertisers. Adservice, Argyle 1-B, Wisconsin.

**SIGN** Painting taught at home. Test lesson free. Ben Kerns Studios, Box 812, Greenville, S. C.

**9 ALPHABET** 3 Numeral pattern sets and catalog, \$1.00. Sign Letter Distributors, P.O. Box 101, Mineola, N. Y.

**FIGURE** Drawings by French artist Lalire. Over hundred female poses, body details, \$1.00. Art Headquarters, 1160 25th Avenue North, St. Petersburg, Florida.

**CARTOONS** Printed. Write School of Cartoons, P.O. Box 3291, San Francisco 19, Calif.

**CHALK** Talks. Laugh producing program, \$1.00. Catalog 10c. Balda The Cartoonist, Oshkosh, Wisconsin.

### TYPEWRITERS, DUPLICATORS, OFFICE DEVICES

**TYPEWRITER** Platen resurfacing fluid, \$1.00 prepaid. Dowd, 2021 Pecan, San Angelo, Texas.

**SIMPLEX** Typewriters \$5.00. Jewelry samples \$10.00. Dimeo, #64 Elmwood, Providence, R. I.

**STANDARD** Typewriters \$25.00; duplicators \$12.50; adders \$12.50; Ship anywhere. "Typewritery," 118 Spruce, Wichita, Kansas.

**NEW** Portable typewriters. Big discounts, send stamp. Dupligrapp, River Grove, Illinois.

**TYPEWRITERS**—Portables, office models. Free price sheet. Ray George, 3322 South Grand, St. Louis 18, Missouri.

**PHOTOCOPY** Anything—Papers, books. No darkroom. \$6.95 complete. Fotoflek, 4801 Yarmouth Place, Cincinnati 29, Ohio.

**"PRINTOMATIC"** Selffeeding post card stencil printing duplicators \$9.50 up. Office size duplicators, Speedoprints, Hilcos, Excellographs \$33.41 up. Literature free. Pittsburgh Typewriter Supply, 336-WK Fourth Avenue, Pittsburgh 22, Penna.

**RECONDITIONED** Typewriters, mimeograph, multigraph printing devices, appliances, supplies. Catalog. Dixiegraph Service, King, N. Carolina.

### RUBBER STAMPS AND OFFICE SUPPLIES

**3 LINES** 45c; Cushioned, indexed, 55c. Pads 35c. Stampright, Wauwatosa, Wis.

**RUBBER** Stamps. Send for catalog. Excello, Box 500, Shreveport, Louisiana.

**LINE** 20c; 2-35c; 3-50c. Stamp Works, Auburn, Nebraska.

### PRINTING, MULTIGRAPHING, MIMEOGRAPHING, GUMMED LABELS

**150 SHEETS**, 75 Envelopes printed \$1.75 prepaid. Miller Stamp, Highland Avenue, Malden 48, Massachusetts.

**BUSINESS**, Personal stationery. State requirements. Samples. Mero Products, 100 Morrison, Punxsutawney, Penna.

**1000 BUSINESS** Cards (embossed) \$2.95 postpaid. Zephyr Printing, Box 312pmm, Venice, California.

**PENCILS** Imprinted. Any name on 20 pencils \$1.00. Andrews, 275 Bittersweet, Berea, Ohio.

**PRINTED**, 150 8½x11 Letterheads, 100 envelopes, \$1.89. Postpaid. Casazza, Box 206A, San Bruno, Calif.

**GLO-BRITE** Letterheads "Impress" customers. Beautiful combination colors. Samples free. M. Rienzi Press, 24 North 7th Street, Newark 7, New Jersey.

**1949 CALENDAR** Novelties. Samples, printing prices for stamp. Cassel, R4, Middletown, N. Y.

**BUSINESS**, Personal stationery. State requirements. Samples, pricelists free. How Printing Company, 721-23 Eunice, Webster Groves 19, Missouri.

**ENVELOPES** Printed, 1,000 6<sup>3</sup>/<sub>4</sub>—\$3.85, #10—\$5.25. F.O.B. Cusack Press, Fulton, New York.

**24 HOUR** Printing service. Samples free. Mango, 555-M South 20th, Newark 3, N. J.

**100 8<sup>1</sup>/<sub>2</sub>x11 HAMMERMILL** Letterheads, 100 envelopes, (5 lines) \$2.00. R. Cook, (Dept. 2118), 730 West Gift, Peoria 5, Illinois.

**DISTINCTIVE** Printing that's different. Reasonable. Samples. Highspire Press, Highspire 2A, Penna.

**PRINTING** And mimeographing layout kit, 10c. You design it, we print it. D'Yarmett Printing, Newark, Ohio.

**100 GOVT.** Stamped postals mimeographed, \$2.00. Leming Service, Russellville, Ark.

**FINE** Printed letterheads; envelopes; 100 either \$1.00. Benneville, Box 1931, Pittsburgh 30, Penna.

**1,000 CARDS.** Blotters \$2.50 postpaid, samples. Box 174, Niagara Falls, New York.

**500 LETTERHEADS** and envelopes \$8.00. Prompt service, prepaid. Sumar Press, 81 W. Van Buren Street, Chicago, Ill.

**LETTERHEADS.** Envelopes, circulars. Small, large quantities. H.M.G. Company, Mecca, Indiana.

**WRITE** For samples, prices attractive letterheads, cards, circulars. Journal Printing Co., Newark, Arkansas.

**500 3/4x2 1/4 FOUR** Line gummed stickers 35c; red border 50c. Moritz Printery, Saginaw, Mich.

**1000 BUSINESS** Cards, \$2.50, prepaid. Samples free. Reliable Print Shop, 905 E. Jefferson, Louisville 6, Ky.

**SEND** 10c Now, for our 48 page 1948 price list—refunded first order. McCall Press, 1326 South 27th, Omaha, Nebraska.

**QUALITY** Printing—Reasonable prices. Fast service on catalogs, folders, publications. Write for prices. Bagby Printing Co., Georgetown, Ohio.

**MIMEOGRAPHING**—Letters, pricelists, formulas, instructions. Lowest prices. Lem's Letter Shop, 5710 Stanton, Detroit 8.

**DISTINCTIVE** Printing, lower cost. Price list free. Walter H. Kane, Woburn, Mass.

## PRINTING OUTFITS AND SUPPLIES

**BARGAINS**—Hand presses, supplies. Catalogs 10c. Customprint, 211-N, Springfield, Missouri.

**PLASTIC** Printing outs. Make your own. New Plexiplat process. Plexiservice, Argyle 1, Wisconsin.

**PRINTING** Equipment, type, supplies. Catalog 10c. Wilson, 809 Flint, Fort Worth 10, Texas.

**PRINTERS** Supply catalog free. Brighton's, 4234-M South Mozart, Chicago 32, Illinois.

**PRINTING** Presses, type, supplies. Lists 3c. Turnbaugh Service, Loysville, Penna.

**PRINTING** Presses, type, supplies. Send dime for complete illustrated printer's supply book, details and press samples. Kelsey, Inc., A-11, Meriden, Connecticut.

**INEXPENSIVE** Home-made printing press. Details free. Novelty Shop, Downsville, Louisiana.

## PATENT ATTORNEYS

**IF** An inventor believes he has an invention, a search of the most pertinent prior U. S. patents should be made and a report obtained relative to its patentability. Write for further particulars as to patent protection and procedure and "Invention Record" form at once. No obligation. McMorro, Berman & Davidson, Registered Patent Attorneys, 134-T Victor Building, Washington 1, D. C.

**PATENTS.** Trade marks. Sanders, 6430 Evans, Chicago. Registered U. S. Patent Office.

**PATENT** Protection—Unless an inventor is thoroughly familiar with such matters, he is advised to employ a competent registered Patent Attorney as the value of a patent depends largely upon the skillful preparation of the specification and claims. Send for booklet, "Patent Protection for Inventors," outlining preliminary steps to take to obtain patent protection. Victor J. Evans & Co., 331-M Meriin Building, Washington 6, D. C.

**GUSTAVE Miller**—Patents and trade marks, 118A Warner Building, Washington 4, D.C. Registered Patent Attorney, Associate Patent Examiner, U. S. Patent Office 1922-1929.

**INVENTORS:** Learn how to protect your invention. Unless the inventor is familiar with patent matters, he should engage a competent registered patent attorney or agent to represent him. We are registered to practise before the U.S. Patent Office and prepared to serve you in handling your patent matters. "Patent Guide for the Inventor" containing detailed information concerning patent protection and procedure with "Record of Invention" form will be forwarded to you upon request—without obligation. Clarence A. O'Brien & Harvey Jacobson, Registered Patent Attorneys, 81B-K District National Building, Washington, D. C.

**C. A. SNOW & Co.**—M-427, Snow Building, Washington 1, D. C. Registered Patent Attorneys. Write for information.

**PATENTS**—Trade marks, Irving L. McCathran, 315 McLachlen Bldg., Washington 1, D. C. Registered Patent Attorney.

**INVENTORS:** For "Record of Invention" form, contact Carl Miller, Registered Patent Attorney, Woolworth Building, New York.

**INVENTORS:** Without obligation, write for information explaining the steps you should take to secure a patent. John N. Randolph, Registered Patent Attorney, 203 Columbian Bldg., Washington 1, D. C.

**"INVENTOR'S Guide"** free on request. Frank Ledermann, Registered Patent Attorney, 154 Nassau St., New York 7, N. Y.

**PATENT** Practice before U. S. Patent Office. Validity and infringement investigations and opinions. Booklet and form "Evidence of Conception" forwarded upon request. Lancaster, Allwine & Rommel, Registered Patent Attorneys, Suite 411, 815-15th Street, N.W., Washington 5, D. C.

**PATENTS.** "Proof of Invention" folder mailed without obligation. E. E. Vrooman, Registered Patent Attorney, 871 Woodward Building, Washington 5, D. C.

**INVENTORS:** Write for free brochure "Evidence of Invention." Labiner, World Building, New York 7.

**INVENTORS:** When you are satisfied that you have invented something of value write me, without obligation, for information as to what steps you should take to secure a patent. Write Patrick D. Beavers (Formerly Randolph & Beavers) Registered Patent Atty., 935 Columbian Bldg., Washington 1, D. C.

## FOR INVENTORS

**INVENTORS'** Financial assistance. Investment Development Company, Box 1462, Amarillo, Texas.

**IDEAS** Are worth money. Free booklet. Elo Development Company, Long Island City 1.

**PATENTED.** Unpatented, inventions promoted. M. Joyce Humphries, 1424 Landtitle, Philadelphia 10, Penna.

**YOUR** Invention objectively evaluated by the patent engineer of a large corporation, for only \$2. Jack Cafarelli, 2137 Lindsay Road, Pittsburgh 21, Penna.

**IF** An Inventor believes he has an invention, a search of the most pertinent prior U. S. patents should be made and a report obtained relative to its patentability. Write for further particulars as to patent protection and procedure and "Invention Record" form at once. No obligation. McMorro, Berman & Davidson, Registered Patent Attorneys, 134-S Victor Building, Washington 1, D. C.

**INVENTORS**—This firm is registered to practice before the U. S. Patent Office and is available to assist inventors in the preparation and prosecution of their cases. "Patent Protection for Inventors" booklet containing detailed information and steps to take toward patent protection will be sent upon request. No obligation. Victor J. Evans & Co., 332-M Meriin Building, Washington 6, D. C.

**INVENTORS!** Have you good, patentable ideas? Write Patent Agent Metzler, 11 West 42nd, New York.

**PATENT** Searches \$6.00; trade-mark searches \$5.00; progress reports on pending applications for patent \$5.00. Invention protection forms free. Write Miss Ann Hastings, Patent Searcher, P.O. Box 176, Washington 4, D. C.

**BEWILDERED** Inventors? Too many schemes? My book will guide you to success. Details free. McLoughlin, 1101 Meade Ave., Scranton 8, Penna.

**RELIABLE** Patent searches \$6.00. Invention protection forms free. Write Raymond L. Smith, Patent Searcher, 410-M Bond Building, Washington 5, D. C. (Former U. S. Patent Office employee).

**INVENTORS:** Learn how to protect your invention. Unless the inventor is familiar with patent matters, he should engage a competent registered patent attorney or agent to represent him. We are registered to practise before the U.S. Patent Office and prepared to serve you in handling your patent matters. "Patent Guide for the Inventor" containing detailed information concerning patent protection and procedure with "Record of Invention" form will be forwarded to you upon request—without obligation. Clarence A. O'Brien & Harvey Jacobson, Registered Patent Attorneys, 81A-K District National Building, Washington, D. C.

**INVENTORS**—Possibly I can help you. Many years experience. Charles A. Scott, 773 Garson Avenue, Rochester 9, N. Y.

**"INVENTOR'S Guide"** free on request. Frank Ledermann, Registered Patent Attorney, 154 Nassau St., New York 7, N. Y.

**INVENTORS:** If you have an invention for sale, patented or unpatented, write Institute of American Inventors, Dept. 40A, 1926 Eye St. N.W., Washington 6, D. C.

**INVENTORS:** Without obligation, write for information explaining the steps you should take to secure a patent on your invention. John N. Randolph, Registered Patent Attorney, 202 Columbian Bldg., Washington 1, D. C.

**CASH** For your idea. 280 manufacturers need inventions, patented or unpatented. List free. Invention Bureau, 208M Clinton, Oak Park, Illinois.

**INVENTORS:** The usual first step is to have a search of the U. S. Patents conducted, so I can report on patentability. Write, without obligation, Patrick D. Beavers (Formerly Randolph & Beavers) Registered Patent Atty., 936 Columbian Bldg., Washington 1, D. C.

**PATENT** Searches; reliable, efficient, air-mail service; \$6.00. Write for free invention protection form. Patent Research Service, 703P Albee Bldg., Washington 5, D. C.

**YOUR** Invention worth \$2.95 to protect it? Buy "Patent Law for the Executive and Engineer" from Research Press, Inc., Dept. H, Dayton, Ohio.

**BOOKS**—All Kinds—Homecraft, Radio, Plastics, Boat Building, Photography, Model Building. Catalog free. Popular Mechanics Press, 200 E. Ontario St., Chicago 11, Ill.

## INVENTIONS WANTED

**WE** Sell patents. Submit details. Universal Guaranty Company, Lakewood, New York.

**ATTENTION!** Sell your inventions yourself. Send \$2.00 for directory listing manufacturers buying various inventions. Free. "Protective Assignment Contract." Invention Market Research, 342-PMA Madison Ave., New York 17.

**HIGHEST** Royalties—Cash. Official U. S. I. R. C. certification. Request free Booklet "M", Universal Marketing Co., 354 South Spring St., Los Angeles 13, Calif.

**INVENTORS**—What have you, patented, patent pending to offer manufacturers? Submit details or request free booklet, information. Direct Market Contacts, 11106-A2 Longwood, Chicago 43.

**CASH** For your idea, 280 manufacturers need inventions, patented or unpatented. List free. Invention Bureau, 208M Clinton, Oak Park, Illinois.

**INVENTORS:** Hundreds of manufacturers have requested our assistance in locating marketable new products. Complete information, free. Institute of American Inventors, Dept. 40-D, 1926-Eye St. N.W., Washington 6, D. C.

**SMALL** Inventions wanted by manufacturers. I'll help you sell your invention. Write for circular. Stanley Hull, 7829 Euclid, Cleveland, Ohio.

**INVENTIONS** Wanted. Patented or pending only. Inventors' Exchange-3, Hartford 1, Conn.

## PATENTS FOR SALE

**FLUORESCENT Lamp.** U. S. patent just allowed. Simple, efficient, starterless. Independent manufacturers may license. U. S. and foreign. Clarence Farris, Hot Springs, New Mexico.

**INVENTORS:** Test the commercial value of your patented or unpatented inventions, quickly and inexpensively. Write for free information. Institute of American Inventors, Dept. 40-B, 1926-Eye St. N.W., Washington 5, D. C.

## MANUFACTURING

**PERMANENT Moulds** for plastics, aluminum castings. Unamit Mould & Machine Company, Bunker Hill, Ill.

**COMPLETE Design, model, light manufacturing facilities.** Jones Sporting Goods Manufacturing Co., Banning, Calif.

**CASTINGS.** Aluminum, brass, bronze, small quantities solicited. Lehnert Company, Norwood 4, N. J.

**PLASTIC Moulds,** progressive stamping, production, tools and dies. Steffey Screw Products, New Baltimore, Michigan.

**MODELS.** Tools, dies, experimental work; large and small lot manufacturing. Van-Ess Specialties Company, 212 W. 14th Street, Covington, Ky.

**MODELS**—Small lot manufacturing. Metals, plastics, etc. Milburn, Burlington, Kentucky.

**SMALL Lot production wanted.** Aluminum castings; stampings; screw machine; plastics. J and M Company, Burlington, Kentucky.

## MODELS, MODEL SUPPLIES

**LEATHERCRAFT**—Silversmith. Tools, dies, engravers. Made to order. Belt toppers, billfolds, key cases. Louis Jones, 1405 Throckmorton, Ft. Worth, Texas.

**MODEL Plastic buildings** for that Xmas gift train. Two kits \$1. Johnson, 366 Freeman, Long Beach 14, Calif.

**DOWMETAL Magnesium** for all model makers. Rod, bar, sheet and scale structural shapes. The Craftsmen, 15427 Robson, Detroit 27, Michigan.

**BROWNING Machine gun kit,** 40 machined parts, only \$1.00. Vancraft, 17792 Northrop, Detroit 19, Mich.

**TINY Power steam engines, boilers,** locomotives finished ready-to-run. Also castings, prints. New catalog 25c. Chas. Arnold, Philomath, Oregon.

**EXPERIMENTAL Work** and models for inventors and designers. Free estimates. Steffey Products, New Baltimore, Michigan 13.

**SHIP Model kits.** Send 15c for 1949 catalog. Model Shipways, Folio 60, 476 Main Street, Fort Lee, New Jersey.

**RAILROADERS**—50c Gets new 1949 catalog reference manual. State O or HO gauge. Walthers, 247 Erie, Milwaukee 2, Wis.

**POWER Models**—Steam and gasoline engines, steam traction engine, metals, tools. Catalog 35c. Chas. Cole, Ventura, Calif.

**MINIATURE Racing cars** scale models, famous Millers, Offenhausers, etc. Kits or complete cars. Catalogue 25c. AAECO, Box 874, Inglewood, Calif.

**LARGE Illustrated catalog** Lionel trains and accessories, 10c. Bens Hobby Shop, 72 West Washington, Chicago 2.

**THE Speed King steam engine,** casting kits, water tube boilers. Literature 5c. H & P Machine Co., 1617 Fulton, Kalamazoo 25, Mich.

**SHIP And yacht model supplies, fittings.** Catalogue 25c. Welcher, Fulton, N. Y.

**200 SHIPS Drawings, clippers** to landing barges, shipfittings, engines. List dime. Gullmars, Westhill, Ontario.

**STEAM Engines, boilers, castings.** Catalog 25c. Anton Bohaboy, 2297 Price, Rahway, New Jersey.

**MINIATURE Steam locomotives,** 1/4", 1/2", 3/4" scales. Castings, parts, rail, steam fittings! Thorough drawings with instructions. Catalog 25c. Little Engines, Wilmington, Calif.

**SHIP Models and yacht supplies** complete. Large 64 page catalogue 30c. Bill Wild's, 510 East 11 St., New York City 9.

**LANDLOCKED Sailors!** Here's a beautiful, richly illustrated, fully descriptive catalogue of famous model ships—whalers, slavers, corvettes, etc.—authentic in every detail. Send for it today. Only 25c. Halesite Yacht Service, Inc., Halesite, Huntington, N. Y.

**SHIP And yacht model fittings; blueprints.** Send 25c for illustrated catalog No. 21—listing hundreds of items. A. J. Fisher, 1002-1 Etowah Ave., Royal Oak, Mich.

**MODEL Railroads exclusively**—Complete stock scale; Lionel, American Flyer. Send for catalog, 15c, state gauge. Eric Fuchs, 26 Tremont Street, Boston 8, Mass.

**BUILD Historic ship models,** complete kits 39c to \$8.50; send 10c for catalog. Ideal Models, 19 West 18th Street, New York 11, N. Y.

**KEEP In touch** with the activities of the British model-making fraternity. Send a dollar bill for year's subscription (4 issues) Modelcraft Magazine and list, 77 Grosvenor Road, London, S. W. 1.

## HOME CRAFTSMEN

**PLYWOOD Cabinet kitchen plans** 25c. Playnecabinets, 4617 Johnson Avenue, Western Springs, Illinois.

**COSTUME Jewelry supplies.** Low prices. Myles-Herber, 1360-A Hicks, New York 67.

**SHELLCRAFT! Make beautiful seashell jewelry.** Income or hobby! Large illustrated catalog! Supplies, instructions, 10c postage. (Buy direct from manufacturer.) Pace's, Box 279M, Bradenton, Florida.

**SHELLCRAFT.** For pleasure and profit. Make beautiful shell jewelry at home full or spare time. Free illustrated booklet. \$1.00 brings you 450 rare Caribbean shells with findings and instruction book for making \$6.00 worth (necklaces or brooches). State choice. Shell Co., 302-B, Chamber Commerce Building, Miami, Fla.

**OREGON Myrtlewood prices** on request. M. Weaver, 3923 SE Tibbetts, Portland 2, Oregon.

**FLOCKING Kit:** 6 packages different colored flock, brush, adhesive, designs, instructions. \$1.00 postpaid. A & M Crafts, 672-C East 91 Street, Brooklyn 12, N. Y.

**LAWN Chairs, garden figures, furniture, novelties, toys** etc., 68 popular plans with full size patterns, \$1.00. Mastercraft 11M, 7041 Olcott, Chicago 31, Illinois.

**LEATHERCRAFT Supplies**—Begin making beautiful Christmas gifts now. Send \$1.30 for complete instruction book. Continental Leather Co., 201 1/2 West Magnolia, Fort Worth, Texas.

**MAKE Jewelry and other items,** everything furnished. Free circular. Leisure Hour, 416 Rose Street, West Hazleton, Penna.

**PROFITS** From small bits of wood. Dollhouse Novelties, Saugus 3, Massachusetts.

**LEATHERCRAFT Catalogue** and textbook, America's finest. The leatherworker's bible. Mail postcard for details. Artcraft Leather, Dept. PM-11, 271 Twelfth St., Oakland 7, California.

**OVER 100 New machined and fabricated parts** of plastic, bronze, steel, stainless steel, etc., including springs, knobs, shafts, matched gears, etc. \$3.00. Dobrin, 855 East 175 St., Bronx, New York.

**UNPAINTED Figurines,** illustrated list free. Oman, 642-P, Broadway, St. Paul 1, Minn.

**UNPAINTED Plaster ornaments,** easily decorated with water colors or oil paints. Profit or hobby. These are good. Free illustrations and lists. Midwest Novelty Manufacturers, 524-A E. Park, Anaconda, Montana.

**SHELLS Plastics, findings.** Beginner's kit \$3.00. Free catalog. Stelle's, Box 502, Apopka, Florida.

**LEATHER Designs, Tooling, carving.** Handbags, Belts, Billfolds. Miscellaneous designs. \$1.00 each. Any three \$2.50. Lampkin Artcrafts, Box 641-MN, Culver City, Calif.

**SURPLUS.** Electrical, mechanical devices. List free. Siefke, Box 18, Station E, Buffalo 11, N. Y.

**COMPLETE Line** of leather-craft supplies. Quality leather, tools and accessories. Write for latest catalog. Dept. 48PM. Wilder-Craft, 1038 Crosby St., Chicago 10, Illinois.

**LEATHERCRAFTERS:** Free! 6 designs with latest catalogue, send 25c handling charge. Leather Specialties, 358 East Broadway, Long Beach 2, California.

**MAKE Your own jewelry!** All types of findings, metal and plastic; cameos, beads, shell kits, illustrated catalog. 20c. Hobby Art, P.O.B. 276, Dept. 7, New York 18, N. Y.

**SHELLCRAFTERS:** Nuflox finishes novelties. Cut price, shells, findings. (Stamp) catalogue. Dixie Shell Service, Lakeland, Fla.

**KLONDIKE!** For jewelry makers! Novelty jewelry findings swept from manufacturers' tables. Parts for bracelets, pins, earrings, finished and unfinished chains, rings, stones, clips, beads, many others. Sample pound assortment \$2.00, 5 pound lots \$7.50. Also, unset stones, for rings, jewelry; all colors, sizes, designs, 1,000 assortment \$5.00, sample 100 assortment \$1.50. Also, beads, assorted colors, sizes, 5 pound lots, \$4.00, sample pound, \$1.00. Prepaid only. Merchandise Distributing, 19 East 16th Street, New York 3.

**SHELLS, Plastics, findings.** Lowest prices. Free catalog. Frances Jones, Box 251, Sarasota, Fla.

**HOBBYISTS:** Send 25c for biggest value in hobby catalogs, 64 pages, 500 illustrations. Materials, books, tools, kits for 26 hobbies. Jar Hobby Mart, Dept. C6, Box 137, Iselin, N. J.

**SWISS Music units,** Xmas and popular tunes \$3.50. Double tunes \$4.50. Irv Meyers, 126 Lexington Ave., New York 16, New York.

**MASONITE Mill ends** 10# \$1.00 plus postage. Carl Signs, Wooster, Ohio.

**PROJECT Deal** for Christmas. Table, lamp, etc. Designs and lumber. Veneer deals. Sedlo Company, PO Box 7161, New Orleans, Louisiana.

**50 PATTERNS Toy furniture, action toys, etc.,** \$1.00. Continental Homecrafters, 907 Birch, Eau Claire 3, Wisconsin.

**LEATHERCRAFT Lace bargains!** Francis Byrd, 3406 Montrose Ave., Richmond, Va.

**CATALOG:** Patterns plywood novelty furniture, lawn ornaments, letters, numerals, plaques, frames, silhouettes, weathervanes, toys. Decal transfers. Over 100 other items. 200 articles illustrated. 25c. refunded first order. (No stamps please). Wo-Met Shop, Box 167, Ashburn, Georgia.

**BUSY-WORK Velcoat kit,** with which you can give any surface a soft, velvet-like finish in six exciting colors. Each color in individual gun; ready for use. Matching adhesives, brush, designs, work booth and instruction book \$4.95. Free samples and literature. Busy-Work Shops, Box 8715, Pittsburgh 21, Penna.

**JEWELRY Making** is simple with our metal, plastic, and sterling findings, wire, chain; chemicals, kits, rosary parts. Everything. Lowest prices. Catalog 25c (refunded first order). Pittshire, Box 90-E, Pittsfield, Mass.

**BANDSAWS, Jigsaws,** earn amazing profits. Nu-Art, 33 Rosemont, Weymouth 91, Massachusetts.

**TORTOISE Shell** makes beautiful custom jewelry. Bracelet, earrings and pin blanks. All 4 \$1.00 unpolished. Sam Patchett, 5053 Cristobal, Canal Zone.

**LEATHER.** Retail, mail orders, catalog, tools, lacing, supplies. National Handicraft Co., 30 Frankfort St., New York City 7.

**PLASTIC Jewelry supplies.** Free catalog. J & M Novelties, Box 464P, Griffith, Indiana.

**KNOCKDOWN Cedar chests,** Lumber and veneers. Free price list. Giles & Kendall Company, Huntsville, Ala.

**LEATHERCRAFT!** Complete stocks of leathers, tools, supplies. Immediate shipment. Free catalog. Kit Kraft, 3203 W. Washington Blvd., Los Angeles 16, California.

**CERAMIC Jewelry supplies,** bar pins, ear screws, for ceramic and woodworkers; also glass and seashell assemblers. Free catalog. Philadelphia Badge Co., Dept. B-1, 1007 Filbert St., Philadelphia, Penna.

**LEATHERCRAFTERS:** Belt kits, projects, leather, supplies. Free catalog. Art Leather, 411 Joseph Ave., Rochester 5, N. Y.

**COPPER And brass materials.** Complete line for craftsmen and workshops. Catalog A free. Groundmaster Company, Boulder, Colorado.

**SEA Shells.** Interested in making shell jewelry, lamps, novelties. We have all supplies at wholesale. Write for price list. Sea Shells, 269 W. Flagler Street, Miami, Fla.

**SHELLCRAFT Jewelry kit** \$1.69 postpaid. Free instructions, catalogue. Shell-Art Novelty, Fifth and Moore, Philadelphia 48, Penna.

**SHELL Jewelry supplies.** Wholesale only. McFarland Plastic Co., Sarasota, Fla.

**BEAUTIFUL Texas ebony.** Large piece. \$1. Sample, dime. Particulars, stamp. Many other hardwoods. StarCraft (1), Edinburg, Texas.

**SPECIAL Offer:** 80 full size toy, novelty, and lawn ornament patterns only \$1.00 postpaid. Lynds, Box 193D, Medway, Mass.

**SHELLCRAFTERS.** Write for catalog. Tropicrafts, P.O. Box 1951-P, Fort Myers, Florida.

### MAKE IT YOURSELF

**ANYONE** Can build heavy duty garden tractor from old auto and junk parts obtainable anywhere. Send \$1.00 for plans, easy instructions. Ellsworth Tractor Co., Dept. A, Camptonville, California.

**BUILD** Versatile tilting table circular saw. Details free. Ward Manufacturing Co., Walsenburg, Colo.

**MAKE** Your own power lawn mower with our easy to assemble kit, only \$9.95. Free folder. Arthur Gershel, 51 Chambers St., New York 7.

**MAKE** It yourself book of handicrafts \$1.00. Free catalogue interesting books. A. Fuller Company, 201 Dewey Street, Newark 8, New Jersey.

**BUILT-IN** Kitchen cabinets. \$1.00 brings detailed plans and specifications showing construction methods. Will fit any kitchen. Thombert Co., Box 447M, Newton, Iowa.

**SOLAR** Water heater systems efficient any locality. Standard materials, low cost and easily built. Free facts. Solar Water Company, Box 175, Coral Gables, Florida.

**BUILD** Concrete block machine. Inexpensive. Practical. Motor vibrator or hand. Free details. Clyde Lee, Dept. A, Mountain View, Okla.

**"CONCRETE** Block homes." 32 page booklet; drawings, instructions on how to build. \$1.00. H. C. Lightfoot, Civil Engineer, Richboro 1, Penna.

**ZEOLITE** Home water softener. Plans for building your own \$1. Materials available from us. Lake Region Mfg. Co., Inc., 3920-J Lynn Ave., Minneapolis 16, Minn.

**MAKE** Your own handy lightweight concrete blocks quickly with new block-maker. Circular stamp. Manual 25c. Peerless, New Lenox, Illinois.

### WATCHES, OLD GOLD, JEWELRY

**COSTUME** Jewelry findings and supplies. Conner, Box 188, National Park, N. J.

**GOLD** \$35.00 Ounce—Mail old gold teeth, jewelry, watches, diamonds—receive cash by return mail. Satisfaction guaranteed. Free information. Dr. Weisberg's Gold Refining Company, 1500-Q Hennepin, Minneapolis, Minn.

**HIGHEST** Prices paid for old gold, silver, platinum, diamonds, watches, gold teeth, old jewelry. Send now. Cash immediately. Goods returned if offer is not satisfactory. United Smelting Works, (The Old Reliable), 39-B South State, Chicago 3.

**"HOW** To buy and sell old gold, silver, platinum, etc." National jewelry syndicate. Short practical, money-making course. Only \$1.49 complete. Satisfaction guaranteed. Nelson Company, Dept. 2L02, Chicago 5.

**NEW** York's Leading pawnbroker offers out-of-towners bargains in unredeemed, ladies' and gentlemen's wrist watches. Bulova, Benrus, Elgin, Waltham. Fifteen jewels, \$15.00; 17 jewels, \$19.50. Send money order. State first and second choice. Kaskel's, Established 1882, Dept. PM-11, 9 Columbus Avenue, New York 23, N. Y.

**ELGIN!** Waltham! Bulova! Pocket, wrist watches; wholesale. Box 1874, Chicago 90, Illinois.

**SEND** Your discarded jewelry, watches, crowns, bridges, spectacles, silver, etc., for cash offer. Goods returned promptly if offer unsatisfactory. Old State Metal Co., P.O. Box 1054, Houston 1, Texas.

**STUN** Your friends with genuine, sparkling, brilliant-white zircons. Cut, polished, mounted just like diamonds. Amazing diamond-like appearance. Top-quality. Hard for even experts to tell the difference. Beautiful settings 14K gold. Over 100 gorgeous latest-style rings to choose from. Attractive low prices. Send for big free catalog. U. S. Zircon Syndicate, 139 N. Clark, Dept. 15, Chicago 2.

**HIGHEST** Cash for old, broken jewelry. Mail gold teeth, watches, rings, silverware, diamonds, spectacles. Satisfaction guaranteed. Free information. Rose Smelting Co., 29-A East Madison, Chicago.

**LIBERAL** Cash for diamonds and old gold. Any condition. Federal Traders, Box 2075, Boston 5, Mass.

**GEMS.** Precious and semi-precious, all genuine, from world wide sources. Deal direct, no overhead, save money. Catalog 10c. Hill Co., Route 7, Salem, Oregon.

### TOBACCO, SMOKERS' SUPPLIES

**IMPORTED** Virgin briar pipes. Unvarnished. Unstained. \$7.50 seconds only 98c. Free catalog trial offer. Sidney Ram, 156 N. Franklin, Chicago 6, Illinois.

**CIGARS** Direct from manufacturer: full size "Club House" smokers blended with Havana, \$2.50 box of fifty, satisfaction guaranteed. Eastern Penn Cigar Company, 129 No. Penn Street, York 15, Penna.

**GENUINE** Imported briar pipe, 60 cleaners, complete. Prepaid \$1.00. Splendid value. Ideal gift. Lincoln, 10-A South 18th, Philadelphia 3.

**FREE**—For greater pipe satisfaction tell us your brand of tobacco and get package Green River free. Pete Moberly, Box 791, Owensboro, Kentucky.

**SECONDS** \$5.00 Pipes, 2 for \$1.00. Pipe making kits 75c. Literature free. Carvapipe, 2829-G Dixie, Hamilton, Ohio.

**PIPE** Lovers magazine, Long Beach 12, California, contains pictures, articles, gadgets, ideas. Sample 10c.

### FOR THE HOME

**EXPERT** Advice on plumbing problems. 50c per question. Save 25% of fuel heating domestic hot water. Proven plan \$1.00. Evergreen, Dept. PM, Box 37, Brooklyn 22, New York.

**STAZ** Kleen. Brush-on plastic wallpaper coating. Permanent protection from grease, dirt. Pint \$1.00 postpaid. Agents wanted. Manson Chemical, 8106 Merion, Upper Darby, Penna.

### FOR SALE — MISCELLANEOUS

**WAR** Surplus, aircraft items, shop equipment, machinery and a million other items. Free catalog. Atlas Equipment, 229 Southwest Blvd., Kansas City 8, Mo.

**USED** Army raincoats—Good serviceable condition. Satisfaction guaranteed. Pay when received. Our best grade, excellent quality, some practically new, medium weight, \$2.50. Buford Butts, Sharon, Tenn.

**WAR** Surplus clothing; men's, women's. Amazing bargains. Free catalog. N. Y. Clothing Co., 2079A Second Ave., New York 29.

**USED** Dresses 89c, skirts 59c, blouses 49c, ties 7½c. Suits, O'coats. List free. Calumet Sales, 4719 Kennedy Ave., East Chicago, Indiana.

### WANTED—MISCELLANEOUS

**CASH** Paid for home workshop products. Details free. Home Workshop Sales Bureau, Dept. M-2, Farnsworth, Great Lakes, Ill.

**WILL** Pay up to \$5,000 for certain old books. Catalog 10c. Ohio Historical Publishing Co., PMN, Columbus 1, Ohio.

**WANTED** To purchase fix-it shop. Any location. Give price, details. Write S. Schwartz, Box 132, Park Ridge, Ill.

**ANYTHING** Of value. Robert, 207 North 5th Street, Springfield, Illinois.

**SINGER** Sewing machine dropheads wanted. \$15 for long bobbin model, \$25 round bobbin model. Write serial number and model. Dept. M, Box 129, New York 16, N. Y.

**QUICKSILVER** (Mercury) urgently needed! Immediate payment. Wholesale Terminal, Norwood, Massachusetts.

### PERSONAL

**CREATIVE** Psychology can change your world as you would wish to have it. New, different—gets results. Thrilling details free. Beacom, Box 177, New Brighton, Penna.

**MEXICAN** Law. General Practice Attorney, 1203 Arizona Street, El Paso, Texas.

**LOSING** Hair? Have dandruff? Write for free, confidential booklet on care of scalp and hair. Eugene Burt, 1928 State Ave., Kansas City, Kansas.

**FEET** Hurt? Wear adjustable cuboid foot easers. Three dollars pair. Any size. Free literature. Write, Stemmons Mfg. Co., Kansas City 5, Mo.

**PHOTOGRAPHS** Copied—Dollar for 100. Dey, 216, Jamaica, N. Y.

**GLOBAL** Vieward selection; worldwide remaining service. Free particulars. Travelpost, Box 5453, Tucson, Arizona.

**RECEIVE** "Interesting Mails"—25c keeps your name on preferred mailing list for six months. Bentz, Jr., Chatawa 24, Mississippi.

**EVERLAST** Ball pen. Longer wear. Sample 25c. Four, dollar. Capener, 849 Almaden, San Jose, California.

**NEW** York Postmark. Letters remailed 25c. Gem, 471 Fourth Avenue, New York.

**LOS** Angeles Postmark! Fool your friends. Letters remailed 25c. "Shockey", 1638 LeMoynne, Los Angeles 26, Calif.

**MEXICAN** Mailing service. Letters received, forwarded 20c. Photographic postcards 15c. Retailed free. Remit stamps. Tillotson, Apartado 1405, Guadalupe, Jalisco, Mexico.

**SEND** Seven ties and \$1.00, receive seven cleaned ties. Mail Me Ties, Box 4411-A, Philadelphia 40, Penna.

**HOW** You can find out! Information discreetly developed, any matter, person, problem, anywhere. Personal-business assignments, representations undertaken. Nation-wide. Officially licensed, bonded service established 1922. Reasonable. Confidential. William Herman, 170 Broadway, New York.

**HAIR** Falling? Dandruff? Write Trichologist, 137 Lewis St., Phillipsburg, N. J.

**RUPTURED?** Positive comfort, no undertraps, no steel, no elastic. Write Smith Manufacturing Company, Preston, Ontario.

### MISCELLANEOUS

**DARNDDEST** Gadget! Moneyback guarantee of family entertainment! Five real movies and 8mm. viewer \$2.00 postpaid. Limpro Company, 612 North Sweetzer, Hollywood 36, California.

**MINIATURE** Cones for the holiday season. Order now. Bertha Hamaker, Horse Creek, California.

**FREE** Oranges! Bushel delicious tree-ripened fruit free for sending orders for four bushels oranges: Soar's Sweet (best early orange) \$4.00, select standard varieties \$3.00, field run oranges and grapefruit \$2.50 per bushel, f.o.b. Pomona Nurseries, R.D. 2, Dade City, Florida.

**NAME** Pin of beautiful Spanish olive wood. Any name, \$1.00. Shook's Novelties, Summit, San Bernardino County, California.

**METAL** Mountings for bronzed baby shoes. Urbans, 2806 Holliday, Wichita Falls, Texas.

**CAMEO** Oval lucite pendants. Choker. Colors, \$1.00. Iamarino, 2375½ N.W. 28th St., Miami, Fla.

**LEVELING**—New \$3.00 device does all kinds; details. Aqua-Level, Taylorsville 6, Calif.

**INFORMATION.** Any subject. The Roxbys, 747 S. New Hampshire, Los Angeles 5.

**VENETIAN** Blind tape 25c yard, cord 5c. All colors. Moore, Box 461, Kittanning, Penna.

**ARTIFICIAL** Eyes—Assortments mailed you from world's largest; finest selection imported glass and all-plastic unbreakable eyes. Write for free booklet and color chart. Established 1906. Denver Optic Company, 1101 University Bldg., Denver 2, Colo.

**PANNING** GOLD—Free instruction booklet. Catalogue mining books; supplies. Old Prospector, B-187, Dutch Flat, Calif.

**WALLET** Photos, cards sealed in plastic. 25c each. Quick service. Dura-seal, Laminating Dept., Box 1384, Baltimore 3, Md.

**FOR** Big men only—Quality shoes sizes 10-16, Widths AA-EEE. Dress, work shoes, loafers, wing tips, moccasins, hitops, sox. Guaranteed. Write for free catalog. King-size, 696, Brockton, Mass.

**CESSPOOL** Trouble cured by the new Septic Bend Co., Rockland, Mass.

**SHOE** Shining simplified. 3c postage for circular. Preferred Merchandise, Box 923, New York 17, N. Y.

**GIFT** Animal ashtray. Unusual 75c. 1601 Clybourne, Chicago 14.

**GROW** Colorful metallic gardens. Formula 50c. Marshall, Box 5356, Chicago, Illinois.

**STANDARDIZED** Home made fruit cake, \$1.40 per pound. Mrs. Erich Bogusch, Grit, Tex.

**BRITISH Magazine subscriptions—**  
**Punch** (famous British humor weekly) \$7.50 year; **Picture Post** (leading newspaper weekly) \$4.50 year; **World Review** (monthly) \$4.50 year; postpaid direct from England. Price list other magazines free. Order from **Thomas & Co., Blackpool, England**, or American Representative **Charles Cassell, 545 Lawrence Ave., Westfield, New Jersey.**

**EARTHWORM Castings** make the best fertilizer for house plants or germination of seeds. One pound for one dollar, postpaid; instructions included. **Pennsylvania Earthworm Farm, Warrendale, Penna.**

**DANDY Gift item, stationery humorously designed for "golfers," "fishermen," "homemakers," "office gals."** Each box, \$1.00 postpaid. Specify boxes desired. **Gebo Stationery, 2345 N. W. Marshall, Portland 10, Ore.**

**PRIZE-WINNING 100% Wool handloomed rugs.** Beautiful colors. Washable. Imagine—3 large sizes from \$2.85 to \$4.33. Repeat seller 20 years. Write **R. & M. Dauphin, 17 Garrison St., Suite 8, Boston, Mass.**

**RECEIVE Free magazines, catalogues, moneymaking opportunities, mails galore.** Three years "surefire" listing and free gift \$1.00. One year 50c. 4 months 25c. **Howards, 126 Lexington, New York 16.**

**BRAZILIAN Orchids, Palm leaves, Uva flowers, etc.** Informations with **Orquidario Catarinense, Exporters, Corupa, Santa Catarina, Brazil.**

**COMPASSES, Officers wrist or pocket models.** New, choice \$1.00 postpaid. **Central Sports, Delphos 5, Ohio.**

**CHRISTMAS Price list and leather cards samples 25c.** **Mexican Products Co., 126 No. Main, Tulsa 3, Okla.**

**"RECEIVE Mail." Moneymaking offers, opportunities, catalogs.** Name listed 10c. **Ideal Service, Park Ridge 10, Ill.**

**AMAZING Bargain catalog: Save up to 75%.** Watches, clothing, sporting goods, novelties, etc. 25c (refunded first order). **Tip-Top, Box 9083PM, Dallas, Texas.**

**TI-TRADE.** Send 6 ties and \$1.00. Receive 6 equal quality cleaned. Color preferences. **Box 6065, Washington 5, D. C.**

**PERSONALIZED Pencils—Individual or firm name.** Dozen 60c, gross \$4.80. Cash delivered. **Pencil Market, 611 15th St., Knoxville 16, Tenn.**

**"DID Moses Write Pentateuch?"** 10c. **Christian Evidence League, Malverne, N. Y.**

**MEDICAL Laboratory technicians** in great demand. We train you in your own home, in your spare time. Also home study course in general chemistry. Free catalogue. **Imperial Technical Institute, Box 973-J, Austin, Texas.**

**TATTOOING Machines, outfits.** Free catalogue. **Jensen, 120 West 83rd Street, Los Angeles 3.**

**LUCITE Bar, name pin, safety clasp.** Price \$2.00. Made to order. **Nightingale Pin Co., P. O. Box 1772, West Palm Beach, Florida.**

**TREASURE Finders! Goldak's new 11 pound lightweight, gold, silver and mineral locator, money-back guaranteed superior any other device.** Free information. **The Goldak Co., 1542 West Glenoaks Blvd., Glendale 1, Calif.**

**M-SCOPE Metal, mineral locators** sensational new electronic lightweight models, immediate shipment. **Fisher Research Laboratory, Inc., manufactures some of the finest metal locators for the U. S. Army.** Built for Arctic, Tropic use. Unsurpassed efficiency, low prices. Time-payment plan available. Send for free 16-page illustrated booklet. **Fisher Research Laboratory, Inc., Palo Alto, Calif.**

**TATTOOING Outfits, supplies.** Illustrated list free. **Zeis, 728 Lesley, Rockford, Illinois.**

**70 BIBLE Lessons, 25c.** Bulletin. **Box 87, Cathedral Station, New York 25.**

**WHEELS, Semi-pneumatic ball bearing—**3x1.75, \$1.65; 8x2, \$1.76; 10x1.75, \$1.92; 1 1/2", 10x2.75, \$4.63—3/8"; 10x1.75 hubless oilite bearing, 1/2", \$2.19. C.O.D. plus postage. **Wheelhouse, 4439 W. State, Milwaukee 8, Wis.**

**NOW Ready: New, amazing Classified Advertising Record Book—**prepared especially for classified advertisers. Here is a book that tells you instantly whether or not your advertising in any publication is paying you real results. You can tell immediately how many inquiries each publication produced—how much cash received from every ad. Spaces are provided for the name and address of the publication, date of issue, space used, rate, cost of ad, key number, etc. You have a complete record of each publication right before your eyes. Plenty of space to keep accurate record of 28 separate publications. You can have a copy by sending only 10c to cover postage and handling. Send for your copy now. **W. F. Johnson, Classified Adv. Mgr., Popular Mechanics Magazine, 200 E. Ontario Street, Chicago 11, Illinois.**

**NEW! EASY!** **EARN BIG MONEY!** **RIGHT IN YOUR OWN HOME FULL OR SPARE TIME**

**PUT YOURSELF IN THE SUCCESS PICTURE! a few cents worth of material... BRINGS YOU DOLLARS!!**

Yes, 18th profits are waiting to be tapped in this new field. New **MIRACLE** finish gives a velvety, luxurious surface to radios, toys, lamps, signs, store displays, figurines—Makes old objects beautiful and saleable—Makes new things worth much more. Learn in a few days—it is easy to become an expert and establish yourself in a successful lifetime business. Start earning **BIG MONEY—\$500 to \$1,000 per month** full time—up to \$75 per week spare time. Everything furnished—including complete, simple-to-understand instructions on this **NEW** method that is **EASY** to learn. Send **NO** money—a post card will do—it's too good to miss! Write now for details. **FREE** sample of **ELO-KRAFT** covered material, and hundreds of useful and profitable **IDEAS.** Do it now—be first!

**COAST INDUSTRIES, 1507-11 West Manchester, Los Angeles 44, California**

**Now Easy to Start A BIG BUSINESS in Spare Time**

**Metalizing BABY SHOES AND OTHER KEEPSAKES**

**MAIL COUPON TODAY for NO RISK OFFER of COMPLETE PLAN**

**DO YOU** want extra money right away in a business you can run from your house with no house-to-house selling? Do you want to start small—the easy, inexpensive way—and watch how our guidance jumps you into bigger and bigger profits every week? Do you want a business that the whole family can help with—a business that is stable, permanent, steady—with a lifetime certainty of good income?

**DON'T WASTE A MINUTE GET THE FACTS ON METALIZING**

My own shop does big business by same methods I will reveal to you. Exclusive Warner Electroplating Process—trade secrets available for first time—puts coating of actual metal (22K Gold, Genuine Silver, or Bronze) on Baby Shoes or other keepsakes. Amazing results, yet so simple and easy by my plan that you can become an Expert Metalizer in a few days.

**SEND NO MONEY Just Your Name—but Quick**

Find out fast how the love every mother has for her baby's first shoes can be turned into quick cash—big profits—a permanent lifetime business for you. Complete step-by-step Business System sent to you on no risk trial—costs nothing if you return it. But get the Free facts first. Then decide. Send penny postcard or coupon today. Time is precious!

**WE SHOW YOU**

- How to start at home in spare time
- How to Metalize the easy Warner way
- How to bring in the business
- How to start at low cost
- How to pyramid profits

**WE FURNISH EVERYTHING**

All supplies and mountings from one source, for quick shipment, keeps investment low!

**Ray Brandell, Mgr., Warner Electric Co., 1512 Jarvis Ave., Dept. 311, Chicago 26, Ill.**

Don't send the PLAN. First send all facts free. I'll decide after I investigate. Everything you send now is **FREE.** No obligation.

Name \_\_\_\_\_

Address \_\_\_\_\_

City \_\_\_\_\_ Zone \_\_\_\_\_ State \_\_\_\_\_

**3¢ MAY START A FORTUNE**



**E. J. SWEENEY**  
87,675 men have  
come to E. J.  
Sweeney Schools  
—WHY?



**DO  
IT  
NOW**

## Get Ready Quick for a TOP PAY JOB AUTO BODY, FENDER and PAINT MEN

Let me show you how to get ready—fast—for high pay and a steady job with a real future in auto body and fender work. My new Free literature tells how you can learn this specialized trade quickly and easily by the Sweeney System of Practical Experience. See actual photos of up-to-date modern equipment and big roomy shops. For a real opportunity to make good money, get in auto, body and fender work. Send for the facts today. **1054** Want Ads in newspapers in one state in one month alone show the amazing demand for trained men. Here is actual proof that there is opportunity for you today in this big field. Read the complete story on opportunities today in my Free literature. Mail a post card for yours today.

APPROVED FOR VETERANS TRAINING

**SWEENEY AUTO SCHOOL, Inc.**  
Dept. 23, 2901 East 14th St., Kansas City 1, Mo.

**FREE  
LITERATURE  
POSTPAID**

MAIL COUPON FOR DETAILS

E. J. Sweeney, President  
Sweeney Auto School, Inc.  
Dept. 23, 2901 East 14th St.  
Kansas City 1, Mo.

Name \_\_\_\_\_

Address or RFD \_\_\_\_\_

City \_\_\_\_\_

State \_\_\_\_\_

Veteran

Non-Veteran



**ARE YOU ON THE ROAD  
TO A SECURE FUTURE?**  
Or are you just plugging along in a blind alley job, getting nowhere? Check your opportunity in drafting. A job in drafting means bigger pay, better working conditions, better living and, most of all—**SECURITY**.

Charles N. Zelenko  
Director

# DRAFTING

**EASY TO LEARN  
AT HOME IN YOUR SPARE  
TIME — THE C.E.I. WAY!**

You can learn to be a skilled draftsman in your spare time at home, and I guarantee you will enjoy every minute of it. You will get FREE a complete set of drafting instruments. You'll learn to use them at the drafting board. Everything practical, to the point. There's no quicker way to learn, and you won't forget. Mail coupon NOW.

CLEVELAND ENGINEERING INSTITUTE  
PM-11, 2325 Chester Ave., Cleveland 14, Ohio  
Send me a FREE drafting lesson and your Success Book, showing opportunities in drafting.

NAME \_\_\_\_\_

ADDRESS \_\_\_\_\_

CITY \_\_\_\_\_

STATE \_\_\_\_\_

Veteran  Non-Veteran. Hours you work \_\_\_\_\_  
NO OBLIGATION

**GET  
FREE  
BOOK**

## Lathe Collets



Precision Steel and Brass Collets for South Bend Lathes or other makes of lathes or machines that they will fit.

Collet No.	3	2	4	5
Max. Cap. In.	1/2	11/16	3/4	1
Thread Dia. In.	.850	.855	.950	1.250
Thread Lgth. In.	3/4	13/16	13/16	3/4
Threads Per In.	26	20	20	20
Body Dia. In.	.6495	.8595	.9495	1.2495
Collet Lgth. In.	2-11/16	3-5/16	3	3-9/32
Head Dia. In.	.852	1.095	1.150	1.452
Head Taper Deg.	12	15	10	10
Prices	Steel \$3.75	\$4.00	\$4.25	\$4.75
Postpaid	Brass \$2.00	\$2.25	\$2.35	\$2.50

**SOUTH BEND LATHE WORKS**  
455A E. Madison St.  
South Bend 22, Indiana

**SUCCEED IN THE  
POULTRY BUSINESS!**



Poultry is providing many trained men and women with a good, comfortable living, either part or full time. For 27 years our Home Study Course has been helping thousands obtain training and "know how" that means extra income from the start. Don't delay — Write today for prospectus describing courses, methods, service, opportunities.

DEPT. 50 NATIONAL POULTRY INSTITUTE  
ADAMS CENTER, N. Y.

**PATENTS  
AND TRADE MARKS**  
**C. A. SNOW & CO.**  
REGISTERED PATENT ATTORNEYS  
WRITE FOR INFORMATION TO  
428 SNOW BUILDING, WASHINGTON 1, D. C.



## TRIM YOUR OWN

**TRIM HAIR AT HOME—SAVE BARBER BILLS**  
Trims hair as it combs! Easy! Quick! Keeps men's, women's, children's hair trim, neat, freshly-cut looking all the time! Trims, tapers, thins out uneven hair. Use like ordinary comb. Safe. Simple. No experience required. Fine for legs, underarms! *Sells Like Wild!*

### SAMPLES FOR AGENTS

Sample offer sent immediately to all who send name at once. Penny postal will do. SEND NO MONEY. Just your name. **KRISTEE CO.**  
693 BAR ST., AKRON, OHIO



**INVENTORS**  
HIGHEST  
**ROYALTIES and CASH**  
FOR YOUR INVENTIONS  
INVENTION MARKETING SERVICE "UNPARALLELED" BY ANY  
OTHER AGENCY IN THE WORLD  
Write for FREE booklet without obligation  
**UNIVERSAL MARKETING CO.**  
354 South Spring St. (Suite M) Los Angeles 13, Calif.

**TRADE MAGAZINES** Help You Get Ahead  
Latest single copies. More than 1000 different periodicals covering every trade, business or interest available through our easy-to-get acquainted service. Write now for full particulars and price-list.  
**COMMERCIAL ENGRAVING PUB. CO., 348 No. Ritter, Indianapolis 19, Ind.**

Say You Saw It In  
**POPULAR MECHANICS**  
**ACCOUNTING**  
STUDY AT HOME for C.P.A. and BIG PAY Accounting opportunities with 44 year old school. No previous training needed. Texts furnished. EASY PAYMENTS. Send for FREE BOOK, G. I. Approved.  
**MACCORMAC EXTENSION SCHOOL**  
Dept. M 1170 E. 63rd St. Chicago 37, Ill.



# STUDY AT HOME

With An Educational Institution

Men with specialized training win higher positions, insure larger earnings, and are bigger successes in business and public life. Opportunities NOW greater than ever before. Send for our Catalog.

## ARTS and SCIENCES

Courses in Philosophy; Education; Letters; Public Health; Medical Jurisprudence; Psychology; Sociology; Physics; Chemistry; Plastics; Geology; Political Science; Theology; Business and Commerce; Accounting; Mathematics; Statistics; Agriculture.

## ENGINEERING

Courses in Electrical, Civil, Mechanical, Drafting, Architectural, Steam, Aeronautical, Radio, Structural, Mining, Industrial, Petroleum, Marine, Chemical, Diesel, Automobile, Refrigeration, and Air Conditioning Engineering.

## LAW

Complete Professional Law Course includes 18 Hornbook Series college grade textbooks. Courses also in Commercial Law, Patent Law and Medical Jurisprudence.

McKinley-Roosevelt Incorporated, 4610-K, Sheridan Rd., Chicago 40, Ill.

# INVENTORS

IF YOU WISH TO PROTECT YOUR INVENTION, You should take steps to protect it by a U. S. Patent. Write me for "Record of Invention" form.

**CARL MILLER**  
REGISTERED PATENT ATTORNEY

Woolworth Bldg., 35th Floor, Dept. 118-A, New York City  
Please send me "Record of Invention" form.

NAME \_\_\_\_\_

ADDRESS \_\_\_\_\_

# INVENTORS

When you are satisfied that you have invented a matter of value—write me, without obligation, for full information as to what steps you should take to secure a Patent.

The usual first step is to have a search of the prior U. S. Patents conducted, so that I can report to you on the question of Patentability.

**PATRICK D. BEAVERS**

(Formerly RANDOLPH & BEAVERS)

Registered Patent Attorney

934 Columbian Building Washington 1, D. C.

**PATRICK D. BEAVERS, Registered Patent Atty.**  
934 Columbian Bldg., Washington 1, D. C.

Please send me full information on how to secure Patent Protection and Trademark Registration.

Name \_\_\_\_\_

Street \_\_\_\_\_

City \_\_\_\_\_ State \_\_\_\_\_

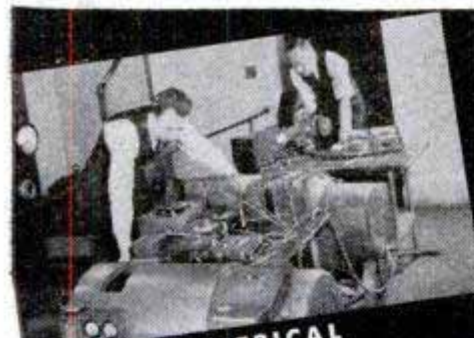

**ELECTRICAL ENGINEERING**



**ELECTRONICS**



**REFRIGERATION AND AIR CONDITIONING**

**SPECIALIZE**  
In 6 Months to 3 Years  
**COURSES**

**SERVICE**

- 6 to 12 Months
- Electricity
- Welding
- Refrigeration
- Heating

**TECHNICIAN**

- 1 to 2 Years
- Electrotechnics
- Radio and Television
- Electronics
- Refrigeration, Heat- ing, and Air Con- ditioning

**PROFESSIONAL**

- 3 Years
- Electrical Engineering Bachelor of Science Degree
- Major in Machinery or Electronics



## PRACTICAL TECHNICAL TRAINING

Train for a substantial career in industry . . . or a business of your own. Our time-tested Concentric System enables you to build your career step by step. Each 6-month course is complete in itself, yet prepares you for advanced courses. Stay as long as circumstances permit, until you reach the top step in your technical training. More than 1,538 students now enrolled from 48 states and 13 overseas countries. Faculty of 72 specialists. World-wide alumni counselor committee. Terms start January, April, July and September. SEND COUPON TODAY!

**MILWAUKEE SCHOOL OF ENGINEERING**  
"A Technical Institute - Founded 1903"

Milwaukee School of Engineering  
Dept. PM-1148, N. Broadway and E. State, Milwaukee, Wis.  
Without obligation send me free booklet "Career Building" and more details on course in \_\_\_\_\_

Name \_\_\_\_\_ Age \_\_\_\_\_

Address \_\_\_\_\_

City \_\_\_\_\_ State \_\_\_\_\_

# SAVE MONEY

on Costly Electrical Jobs

## PRACTICAL RESIDENTIAL WIRING

by John F. Nowak

Instructor, Electrical Installation and Practice—  
Teacher Trainer, New York City

Here at last is a truly authoritative book that tells you everything you need to know in order to do your own electrical work, from the smallest repairs to the largest installations. It begins by showing you how to read and draw electrical diagrams, starting with the simplest of all problems, the wiring of a single light, and proceeding step-by-step through every type of installation up to the layout of an entire home. Then the author shows you exactly how to do the actual work. He furnishes hundreds of hands-at-work photographs, with full explanations, on the use of all the tools in carrying out and testing every operation. The National Electrical Code is clearly applied at each crucial point, insuring that everything you do fulfills Code requirements. See for yourself how completely this book covers every detail of planning and installation, repair and maintenance of any house wiring system. Mail the coupon today, for a free 10-day examination of this money-saving book!



### MAIL THIS COUPON

D. Van Nostrand Company, Inc.  
250 Fourth Avenue, N. Y. 3, N. Y.

Please send me "Practical Residential Wiring" on approval. Within 10 days I will either return the book without obligation or send you \$1.95, plus a few cents postage, and \$2.00 per month for 2 months thereafter. (If you send the entire amount of \$5.95 with this coupon, we will pay the postage. Same return privilege and refund guarantee.)

Name \_\_\_\_\_

Address \_\_\_\_\_

City \_\_\_\_\_ Zone \_\_\_\_\_ State \_\_\_\_\_ PM-11/48

## Learn this Profitable Profession



IN 90 DAYS AT HOME

## Money-Making Career Open to Men and Women, 18 to 50

Hundreds of men and women between 18 and 50 make \$10 to \$20 in a single day giving scientific Swedish Massage and Hydro-Therapy treatments. There is big demand from doctors, hospitals, sanatoriums and clubs. Graduates earn large full time incomes from these or in private practice in their own offices. Others make good money from home treatments given in spare time. Learn this interesting, money-making profession in your own home, through our home study course. Same instructors as in our nationally known resident school. You can win independence and prepare for future security by qualifying for your Diploma. Course can be completed in 3 to 4 months. Many earn while they learn. Begin your training at once.



### Anatomy Charts & Booklet FREE

Enroll now and we will include, at no extra cost, many needed supplies. Fit yourself to help meet growing demand for Scientific Swedish Massage. Send the coupon at once for complete details. Anatomy Charts and 32-Page Illustrated Booklet, FREE, postpaid.

#### THE COLLEGE OF SWEDISH MASSAGE

Dept. 864-P, 41 E. Pearson, Chicago 11, Illinois

Please send me FREE and postpaid, Anatomy Charts, 32-page Booklet and complete details on Home Training.

Name \_\_\_\_\_ Age \_\_\_\_\_

Address \_\_\_\_\_

City \_\_\_\_\_ State \_\_\_\_\_

# CARTOONING

Taught by 9 Professionals



Here's a new idea in cartooning schools—45 Lessons created by NINE Famous Professionals: Boltinoff, Liarz, Nofziger, Roit, Ross, Roth, Salo, Schus and Wolfe. Over 2000 Instruction Drawings! Complete course includes: COMIC STRIPS • MAGAZINE CARTOONING • SPORT CARTOONS • POLITICALS • ANIMALS • ADVERTISING COMICS • BOOK ILLUSTRATION • CUTE GIRLS, etc.

Learn the modern way! Your homework personally criticized by all 9 famous teachers. Up to 2 years to finish. Approved as a Correspondence School under the laws of the State of New York. Approved for Veterans. For literature write to:

The PROFESSIONAL SCHOOL OF CARTOONING, Inc.  
Dept. PM-1, 505 Fifth Avenue • New York 17, N. Y.

## Aviation NEEDS YOU NOW!

Urgent demand for Embry-Riddle mechanic and flight graduates -- for proof and information on training, write: Registrar Dept. 89A



## PRACTICAL MATHEMATICS 4 BOOKS IN ONE! SAVE HALF PRICE!

Easy self-instruction in 25 branches by college experts—all in one volume! Helps you qualify for a better job. 1280 pages, 600 illustrations. Sent for free trial. Only \$1.00 down, \$1.00 a month; total \$4.95 plus postage. (Cash price \$5.00 postpaid) 160-page Logarithm book free with order. National Educational Alliance, Inc., Dept. 5611, 37 West 47th St., New York 19, N. Y.

## RADIO ENGINEERING, Broadcasting, Television, FM, Servicing, Electronics, Aviation, Marine & Police Radio taught thoroughly.

Engineering course equivalent to 3 years' college radio work. Approved Veteran Training. Catalog free.

VALPARAISO TECHNICAL INSTITUTE, Dept. D, Valparaiso, Ind.



## There's No "Mystery" in Watchmaking! YOU CAN LEARN THIS PROFITABLE SKILL!

For 300 years, watchmakers' skills have been closely-guarded secrets. Now, you can learn skilled watchmaking in scenic, mile-high Denver. I'll give you everything in practical benchwork from hair-spring manipulation to position adjustment. Nationally accredited, veteran approved. Write Orville R. Hagans for information, no obligation. No salesman will call. FREE BOOKLET.

AMERICAN ACADEMY INC. SCHOOL OF HOROLOGY  
1549 Lawrence St., Dept. B, Denver 2, Colo.

### SAY YOU SAW IT IN POPULAR MECHANICS

## DEVELOP MUSCLES LIKE MINE

Says Dan Lurie "America's Most Muscular Man"



Learn how I built a powerful body. Find new strength, pep, vitality. Have the build you've always wanted, simply by following my amazing new course. It's easy and it's fun. Easy-to-understand, over 75 how-to-do-it pictures. Every Mr. America and the best built men in the world have used this proven method. Complete course only 50c postpaid. Do not send stamps please. INCLUDED FREE—4-11" x 22" illustrated wall charts to help you to learn.

START IN AT ONCE — SEND FOR YOUR COURSE TODAY!

Write to DAN LURIE, Personal, Dept. 159  
1729 Rockaway Parkway Brooklyn 12, N. Y.





# Drafting PAYS BIG

Learn in Spare Time — At Home or at Allied School in Chicago

## KEY POSITIONS OPEN IN INDUSTRY

- Mechanical Drafting
  - Structural Drafting
  - Aircraft Drafting
  - Tool and Die Making
  - Tool and Die Designing
  - Machinist Trade
  - Product Designing
  - Product Illustrating
- Approved for Civilians and Veterans . . .

## Train Now!

In Nationally Known, Fully Approved School and Endorsed by Industry . . .

Established in 1928

FREE EMPLOYMENT SERVICE

• • • Write For Catalog — A 1c Postcard will do

### ALLIED SCHOOL OF MECHANICAL TRADES

1338-1340-1342 So. Michigan Ave.

4211 Allied Bldg. CHICAGO 5, ILL.

## DON'T BE A JOB SLAVE! LEARN WATCH REPAIRING AT HOME



### WITH OUR SELF TRAINING KIT

Get started NOW in this uncrowded field! EASY to learn! BIG MONEY! SECURE FUTURE! Earn while you learn! Even as a sideline you can make \$50 and up each week. — Our new PRACTICAL SELF-TRAINING KIT is all you need. Contains set of PROFESSIONAL TOOLS: (Loupe, 3-4 power; complete set of 6 special screw drivers—finest tempered steel blades; Tweezer AA; Plastic Material tray) and

COMPLETE BOOK on Modern Watch Repairing. Fully illustrated, easy to understand, shows every step in repair, adjustment and use of tools. Now only \$6.25 Post (if C.O.D., plus charges.) Money Back Guarantee.

If ordered separately: book \$3.25; set of tools, \$3.50. MODERN TECHNICAL BOOK & TOOL CO. Dept. MMC, 55 W. 42nd Street, New York 18, N. Y.

JUST OUT! New All-Inclusive Tool, Material Catalog Revised and Enlarged for Watch-Clockmakers, Jewelers, Tool-Instrument Makers, Handicrafters. Over 600 ILLUSTRATIONS and IDENTIFICATION CHART. NEW REDUCED PRICES. All books in these fields: write for literature. SEND 25c for catalog — FREE with order.



## LEARN TO REPAIR AND SERVICE

Sewing Machines, Motors, Bicycles, Refrigerators, Lawn Mowers, Etc. Start with a few common tools. Build equipment or buy at cost from directory of many jobbers. No complicated study of electricity or blueprints. Men with a little mechanical ability earn up to \$6 an hour. Free advisory service.

Send postal for details. 5 days free examination. REPAIRMAN'S SERVICE, Complete course, 222-P.4th Ave., Janesville, Wis. \$4.75 postpaid.

## GET INTO PHOTO OFFSET PRINTING!

BIG DEMAND • UNCROWDED FIELD • LEARN AT HOME BUILD YOUR OWN SIMPLE EQUIPMENT

Write today for interesting details

JOHN L. MOON, PUBLISHER • Box 1775 • Spokane, Wash.



## \$\$ SQUABS MAKE MONEY!

FREE Book tells how. Easily raised any climate. Full, spare time. Sell 25 days. Waiting year round market. Easy! PROFITABLE! No experience needed. PORCH FARM, Midlothian 8, Ill.



## WAR SURPLUS BARGAINS

\$500,000.00 INVENTORY for QUICK LIQUIDATION

U. S. Gov't. surplus and other items for home, shop, factory, farm and outdoors. New, used and reconditioned. Tremendous savings! All priced for quick sale.

Send 10c to cover cost and mailing for this big illustrated bargain catalog. Write today!

STARK'S Dept. 509 So. STATE STREET CHICAGO 5, ILLINOIS



## START AS HIGH AS \$3,351 YEAR Prepare NOW for 1949 Examinations

### Railway Postal Clerks

Railway Postal Clerks get \$2,750 the first year of regular employment, being paid on the first and fifteenth of each month. (\$114.60 each pay day.) Their pay is automatically increased yearly to \$3,850 and \$4,050 in larger organizations. Advance may be had to Chief Clerk at \$5,850 a year. (\$243.80 each pay day.) Male veterans only.



### RAILWAY POSTAL CLERKS

### 3 Days On—3 Days Off—Full Pay

Railway Postal Clerks on long runs usually work 3 days and have 3 days off duty or in the same proportion. During this off duty their pay continues just as though they were working. They travel on a pass when on business. When they grow old, they are retired with a pension.

### City Mail Carriers, Post Office Clerks

Clerks and Carriers now get \$2,550 the first year of regular employment and automatically increase \$100 a year to \$3,550. Open to men—women 18 to 50.



### Patrol Inspectors

Men 21 to 35. Entrance salary \$3,351 year. Appointments to positions along the nation's borders are made from this examination.

### Many Other Positions

Many other positions are obtainable. Those wishing these positions should prepare at once.

### Get Free List of Positions

Fill out the following coupon. Tear it off and mail it today—now, at once.

Although not government sponsored, this can be the first step in your getting a big-paid government job.

FRANKLIN INSTITUTE, Dept. H85, Rochester 4, N. Y.

Rush to me, entirely free of charge (1) a full description of U. S. Government Jobs; (2) Free copy of illustrated 40-page book, "How to Get a U. S. Government Job"; (3) List of U. S. Government Jobs; (4) Tell me what to do to prepare for one.

Name \_\_\_\_\_

Address \_\_\_\_\_

Vet. \_\_\_\_\_

Use This Coupon Before You Mislaid It. Write or Print Plainly.

# Here's how to prepare for GOOD PAY, a STEADY JOB in AUTO MECHANICS

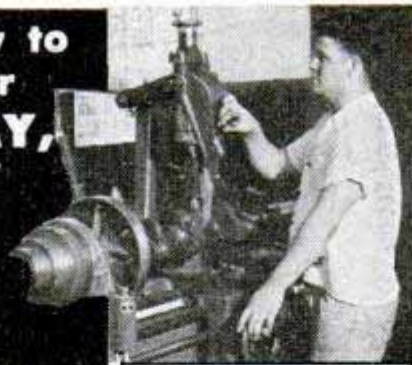

**AUTO MACHINIST**  
Student in engine rebuilding learning to operate a crankshaft grinder. Specialized training puts you in line for better jobs and higher pay.

Earn more money in Auto Mechanics when you choose one type of work and specialize in it. Get ready for a top pay job with security and a real future. New FREE booklet tells how to get specialized training and what to learn to move ahead faster. Get the full facts on opportunities today. See why trained men get the best jobs. Write for your Free copy today.

## ENGINE REBUILDING

Up-to-date practical training on latest equipment. You learn machine shop, auto electricity, carburetion, trouble shooting, motor tune-up and transmissions.

## GENERAL AUTO MECHANICS

Practical training for general garage work. Engine overhaul, auto electricity and many other subjects. See shops and equipment in our FREE booklet.

**VETERANS:** American Trade School is G. I. Approved. Please state if Veteran.

**WRITE TODAY FOR FREE BOOKLET**

**AMERICAN TRADE SCHOOL**  
2417 McGee, Kansas City, Mo.

PLANNING YOUR FUTURE IN AUTO MECHANICS



**WANT TO EARN \$3000-\$7500 A YEAR IN RADIO-TELEVISION?**

## Empire's Spare Time Home Study Course Can Prepare You for an FCC License in 15 Months or Less!

Will you join scores of Empire students now headed for bright futures as FCC-licensed engineers and technicians in radio-television-electronics? The Empire Course provides exactly the complete, basic, resident-school type training needed. The cost is surprisingly small . . . the opportunities great. You have everything to gain, nothing to lose, so investigate NOW. The Empire Radio School is approved as a Correspondence School under New York State Law.

**THE EMPIRE RADIO COURSE GIVES YOU**  
60 Comprehensive Lessons . . . 20 Periodic Examinations . . . 3 Standard Text Books . . . Student Note Book . . . Radio Receiver Construction Kit . . . Personal Review of Papers . . . Helpful Suggestions.

APPROVED for VETERAN TRAINING

SEND FOR FREE BOOKLET TODAY

**EMPIRE RADIO SCHOOL**  
Box 1170, Rochester 3, N. Y.

Without obligation, please send me your booklet, free and postpaid. (Please Print Name, Etc., Below)

Name .....

Address .....

City ..... Zone ..... State .....



# INVENTORS



**NO PATENT PROTECTION ... NO PROFITS.** Authoritative book on patent law, already bought by thousands of **INVENTORS, ENGINEERS & EXECUTIVES** will pay for itself . . . You **CAN'T AFFORD TO BE WITHOUT IT.** Learn simply and easily how protected inventions can make money for you; how to deal with your attorney . . . **A MUST FOR INVENTORS, MECHANICS, ENGINEERS,** who have money making patentable ideas . . . Easy to read and understand, only \$2.95. **FREE:** for cash or money order with your order, we will send a set of 8 1/2 x 11 invention records. Check or money order only.

**RESEARCH PRESS, 139 N. Perry St., Dayton 2, Ohio**

Send me "Patent Law for the Executive and Engineer."  
—Check or Money Order enclosed (You pay postage and send FREE complete set of Invention Records).  
—Five days approval. I'll remit \$2.95 plus postage or return the book in five days.

Name..... Title.....

Address.....

City..... Zone..... State..... PM10

## MOVIE MAKERS' FAVORITE SINCE 1937

**SATISFACTION GUARANTEED**  
Solar Type 12-Film (Weston 12 Outdoor) **\$1.59**  
Ortho, Non-Halo, Fine Grain

16MM **\$1.90** • 16MM **\$3.30**  
50 Ft. 100 Ft. **DOUBLE 8mm**

**24-HOUR FREE PROCESSING SERVICE**

Order now. Send cash and save shipping cost of \$1.00 deposit on C.O.D. Illinois residents add 2% sales tax.

**SOLAR CINE PRODUCTS, INC.**

4247 So. Kedzie Dept. PM11 Chicago 32, Illinois



**TALK-SING thru your own radio with RADIO MICROPHONE**

Be the life of the party. Put on your own broadcasts at home. Talk-Sing make announcements from any room. Wonderful voice practice. Microphone easily attached to any radio. Follow enclosed instructions. **SEND NO MONEY**—pay postman \$1.98 plus postage. Send Money Order or check and save postage.

**EMPIRE RADIO & TELEVISION CO.** (Dept. M4) 1521 Bedford Ave. Brooklyn 16, N. Y.

## AIR FORCE FLIGHT BOOTS

Genuine A-6. Will keep your feet warm and dry in the coldest weather. Genuine shearing fully lined. Rubber soles and zipper closure. Reconditioned like new. State shoe size when ordering. No C.O.D.'s.

**\$7.95**



**SURPLUS MERCHANDISE DEALERS, Dept. P. M. 38 WEST 30th ST. NEW YORK, N. Y.**

## SHOE SHINE KIT

The E-Z Shine Aluminum Shoeholder has toe pieces for men's, women's, children's shoes, both left and right. Demountable. \$2.50. Check or postal remittance. Postage added to C.O.D.'s. Money Back Guarantee. New self-polishing shoe-cloth 10¢ additional.



**\$2.50**

**WAYNE Mfg. Co.**

Dept. M. X., WAYNE, PA.



**Free!**  
7-Day Trial  
Just Mail Coupon NOW

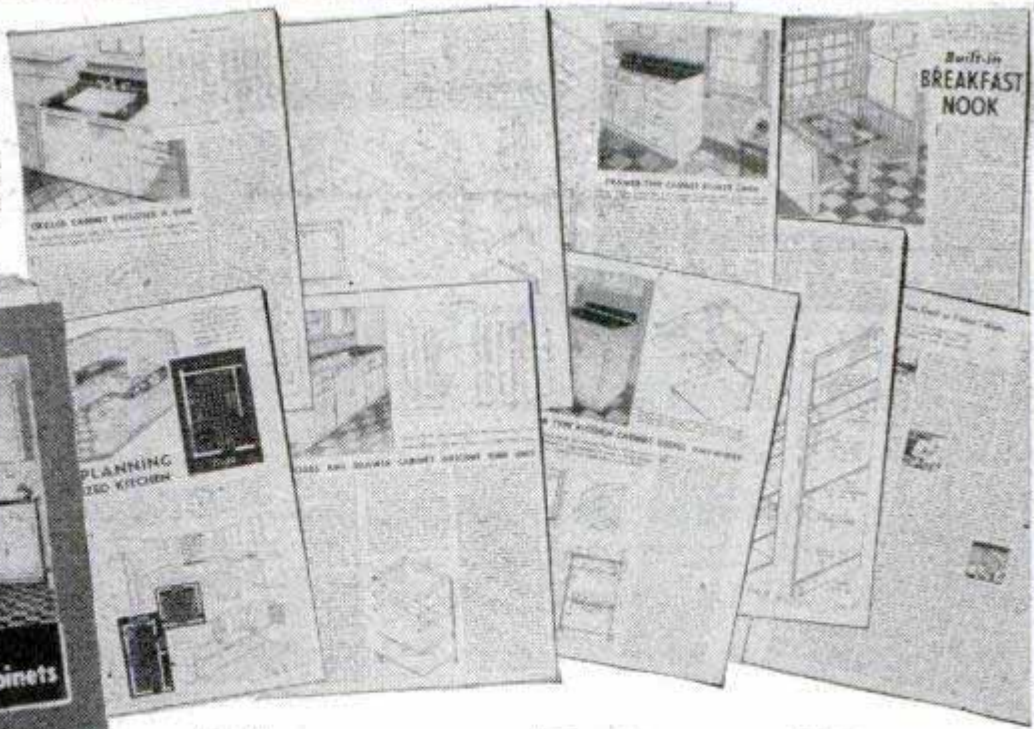
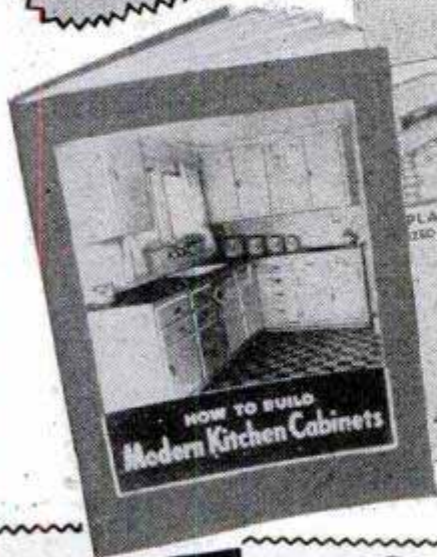

Which of these  
**MODERN  
KITCHENS**  
do YOU want?



TYPICAL kitchen schemes shown here are but a few of many, many combinations you can have by selecting cabinets for your own special needs and in widths that fit your available space



PLAN A is a suggested arrangement if you have two adjacent walls for cabinets. PLAN B gets a wide variety of cabinets into compact space along one wall. PLAN C has broom closet



PLAN D has cabinets along one wall and efficient corner for convenient dinette. PLAN E is laid out on the efficient U principle around three walls. Built-in breakfast nook included



Wide Variety of Floor and Wall Models

- 1—Sink. 2—Drawer and cupboard.
  - 3—Single door. 4—All drawer.
  - 5—Double door. 6 & 9—Corner.
  - 7—Double door wall unit. 8—Single-door wall. 10—Broom closet or storage. 11—Desk and storage.
- EVERY STYLE CABINET!

# How to Bring Your Kitchen Up-to-Date—

## How to Plan the Space—Build the Cabinets Install and Finish Like a Professional

"How to Build Modern Kitchen Cabinets" makes your dream kitchen come true. Only book of its kind. Amazing! Helps you select best cabinets for special needs. Guides you every step. Then shows how to install, finish for a perfect job! Best of all, it is yours on free trial if you act at once. Just fill in and mail coupon.

### Save Money Building Your Own!

Shows you how to build one cabinet, at a time, or combination. A style for every purpose, a size for every kitchen. When you're ready, simply measure space, refer to "Modern Kitchen Cabinets" complete lumber list of sizes. Easy as that! Simplified so that you find all the help you need. Units designed to be assembled in workshop and brought to kitchen ready to install.

### Secrets of Planning Revealed

Should cabinets be near door? Sink? Work counters? Where should dishes be kept? Answers are in your copy of "Modern Kitchen Cabinets." An architect works with the same facts you find here. Read chapter on "Secret of Planning a Modernized Kitchen"

and you'll learn fundamentals. Then select the RIGHT CABINETS and locate them to save steps. You'll pick the best combination to fit your space. Be sure of work-counters where needed! To save time and error, the designer has prepared a cutting list in chart form. There's a chart for each cabinet, complete for whatever size you choose. This alone cuts work in HALF. All you do is cut single pieces of wood to sizes given. When all are ready, assemble into a finished cabinet!

### Gives You the Answer to Every Problem

Every step, every operation fully described. Every detail clearly shown. How to cut joints, what size to cut every piece in every style. Nothing missing! Plywood or solid wood; plastic or metal moulding. Reveals types, how to install hardware. How to hang cabinet. How to cement linoleum to tops. How to insert grilles. How to ventilate. Special drawer-runner construction. Beautiful, lifetime hard-cover binding.

### Mail Free Examination Coupon Now

Will be sent for 7 days' free trial. Now you can build the kitchen cabinets you need. You can plan your own kitchen. Why delay? Why be old-fashioned? Get started now.

**SEND NO MONEY JUST MAIL COUPON**

Pay postman only \$1.50 plus postage, or send \$1.50 (check or money order) and WE pay postage. Read and study it for 7 days at our risk. If not delighted—if not worth every penny of \$1.50 to you, send it back at our expense. We will refund your \$1.50 by AIR MAIL.

"HOW TO BUILD MODERN KITCHEN CABINETS" was compiled by the Editors of CRAFTSMAN PUBLISHING.

CRAFTSMAN PUBLISHING  
115 Worth Street, Dept. PM11  
New York 13, N. Y.

### What Enthusiastic Readers Say:

"I have made quite a few from plans. I received 15 more orders."  
—M. P., New Jersey  
"I am in the midst of making a complete set using the plans which I find excellent. You have set them forth in such complete detail — greatly appreciated."  
—W. J. R., Absecon, N. J.

CRAFTSMAN PUBLISHING, Dept. PM11  
115 Worth St. New York 13, N. Y.

Send me "How to Build Modern Kitchen Cabinets" on 7 days' Free Trial. If I am not delighted, you will refund my \$1.50 at once.

Name \_\_\_\_\_

Address \_\_\_\_\_

City \_\_\_\_\_ Zone \_\_\_\_\_ State \_\_\_\_\_

- I enclose \$1.50. Send postpaid.
- Send C.O.D. I will pay postman \$1.50 plus postage.



# DIESEL OPERATING ENGINEERS and MECHANICS ARE in DEMAND

Train at Home in Spare Time

OR in HEMPHILL SCHOOL'S  
shops in New York, Memphis  
and Los Angeles



Get your copy of the book  
"MARCH  
OF DIESEL"

It shows you in pictures and  
words the great and growing  
Diesel Industry with its many  
opportunities for trained men.

## HEMPHILL TRAINED MEN KNOW DIESEL

America's oldest and largest Diesel schools have many graduates successfully employed or in own businesses. In construction, farming, marine, oil, power plant and other industries using Diesel engines, you'll find Hemphill trained men.



## GET INTO DIESEL

REMEMBER—In a national emergency, trained Diesel men, and those in training, will be in a favored position to render an important service to our nation.

APPROVED FOR VETERANS—NON-VETERANS  
CLIP AND MAIL COUPON TODAY!

HEMPHILL DIESEL AND AUTOMOTIVE SCHOOLS  
1601 S. WESTERN AVE., DEPT. PM11-8, LOS ANGELES 6, CALIF.

Gentlemen: Please send me FREE BOOKLET and information on your Diesel Courses. Home Study  Shop Training  at New York (31-28 Queens Blvd., L. I. City, N. Y.)

Memphis, Tenn. (311 S. Main St.)  Los Angeles

NAME \_\_\_\_\_ AGE \_\_\_\_\_

STREET \_\_\_\_\_ ZONE \_\_\_\_\_

CITY \_\_\_\_\_ STATE \_\_\_\_\_

VETERAN \_\_\_\_\_ NON-VETERAN \_\_\_\_\_

SAY YOU SAW IT IN POPULAR MECHANICS

*What a Gift!*  
CHRISTMAS WRAPPED  
BEAUTIFULLY CHROME-PLATED



### Lenk Gun Grip electric SOLDERING IRON

For the home owner, the workshop hobbyist, the mechanic, or the novice! Has 4 special-use tips for heavy or fine work. Cool plastic gun-grip. AC-DC. UL approved. Gift packaged in handsome box, Christmas wrapped. \$4.95 post-paid, includes free booklet, Soldering Instructions. Check or money order. No C. O. D.'s.

**S. STEVENS CO., INC.**  
199 WASHINGTON STREET R 801 BOSTON 8, MASS.

BINOCULARS	
U. S. Navy 7 x 50.....	\$95.00
BINOCULARS	
U. S. Army 6 x 30.....	\$57.50
5 Power Ranger	\$2.00
TELESCOPES	
Engineers Metal Army Type and	\$2.00
SIGHTING LEVELS	
SURPLUS GOVT. TRIPODS for Level,	\$5.95
Transit, Cameras, etc. Used. Good Condition.	
NEW TRIPODS for Transits, Levels, etc.	\$13.50
Value \$75.00. Special.....	
TRANSFORMERS, Western Elec-	
tric, 5 volt to 650, \$4.95	
NEW	
CANVAS SAFETY BELTS, Metal	
Snaps, New, \$3.00	
Val.....	75c

## Public Sport Shops

11 S. 16th St., Phila. 2, Pa. No COD'S

## SHOE REPAIR OFFERS BIG INCOME

LEARN IN 12 WEEKS TIME

You can own your own shop or earn big income as skilled shoe repairman. Growing demand everywhere at top wages for men who know how. We teach you quickly by actually working on shoes and modern machines. Costs nothing under G. I. Bill of Rights. School open to all from 18 to 60 years of age. FREE BIG 16 PAGE BOOK explains everything. Send for your copy today.

MODERN SHOE REBUILDING SCHOOL

Established 1927

2937 Belmont Ave., Chicago, Ill. Rush Postcard Today.  
4577 Hollywood Blvd., Los Angeles 27, Calif.

## HOME and OFFICE Security SAFE!



with 3 TUMBLER COMBINATION  
Electrical welded steel plates. Furnace  
Tested. Fire-Burglar resistant. Insu-  
lated. (Key lock if preferred.)

ONLY \$28.45  
Ideal for: Bonds, Insurance,  
Stocks, Deeds, Valuables.  
SEND NO MONEY. Pay Ex-  
pressman on delivery, plus  
shipping and COD charge. If  
not satisfied return within 5  
days for complete refund.

EMILEEN CO., 33 West 42 St., N. Y. C.

## UNITED STATES

MONUMENTS AND MARKERS are good. We erect any-  
where. Write for FREE Catalog. U. S. MARBLE &  
GRANITE CO., Onecc. 18, Florida.

Plastic Coasters  
and Tiles

## EMBED REAL FLOWERS in NEW Magic PLASTIC

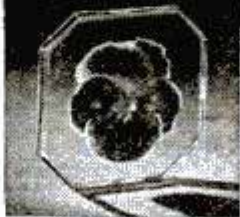

Now create many lovely and unusual things like the distinctive pansy coaster shown—made by embedding real pansies in Castolite—the "magic" liquid casting plastic. Comes crystal clear, or may be dyed to produce gorgeous color effects. Make really different jewelry, book ends, picture frames, candle sticks, figurines. Embed butterflies, coins,

medals, photos, for novel plaques, paper weights, tiles, other art objects. Use only home utensils. Follow simple step by step method. New pleasure, fine profits are possible. Send 25c for exciting new Home Project Manual showing how to get started. Write today! The Castolite Company, Dept. m-1, Box 391, Woodstock, Ill.

MANUAL  
25c

# DO ANY JOB EASIER MAKE MORE MONEY

Used by Army, Navy, Other Government  
Depts., 200 Schools and Industrial Firms.

Mail Coupon

**FREE TRIAL** in Your Home.  
Send No Money!  
We Ship C.O.D. in U.S.  
and Will Refund Money  
if Not Satisfied.



# Get Ready for BIGGER OPPORTUNITIES and BEST PAYING JOBS

Do it now! Get the better pay that goes to men with specialized knowledge. Get into one of these big opportunity fields. Big money and many other advantages await you if you prepare now. Here is the help you need—EASY—QUICK—AT LOW COST. Thousands of men have already used these famous books. Beginners and experienced men alike have doubled and tripled their earnings with this help. You too, can now get the special knowledge you need for top pay, better jobs, or a business of your own. This is your **GOLDEN OPPORTUNITY**.

## AIR CONDITIONING

Big air conditioning boom interrupted by war now bigger than ever and alive with new opportunities! Get this non-technical book by international authority and be ready for your share of millions to be spent. Covers whole field. 450 pages. Illustrated. \$4.00.

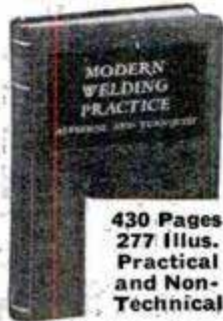

## MODERN WELDING PRACTICE

Newest book on all types of welding and heat treatment of metals. Written by recognized specialists in training men for production jobs. Practical and Non-Technical.

430 Pages  
277 illus.  
Practical and Non-Technical

Covers everything you need to know. Prepare for best pay jobs now. Price \$4.00.

## SHEET METAL LAYOUT

Makes sheet metal layout work so simple that anyone can learn. Get this new instructor and get into the easiest, cleanest and best paying part of all sheet metal work. 143 jobs worked out in drawings and carefully explained. Gives standard for all sheet metal fittings. \$3.50.



## AUTO BODY and FENDER REPAIR

Opens the Door to One of the Big Opportunity Fields of the Day

THE LOW COST, EASY WAY TO A GOOD PROFITABLE BUSINESS OF YOUR OWN

Owners will spend big money to keep their good older cars looking like the new ones coming out. This is a practical money-making guide, ideal for shop owners and every man who wants a share of the millions to be spent in keeping old cars looking new. Tells how to get a good job or start business of your own with small capital. Covers everything including tools, methods and materials. Only book of its kind. 325 pages, 232 illustrations. \$3.50.

## HOUSE WIRING LATEST EDITION

Get this sixth edition of this standard and practical electrical wiring book. It gives complete practical instruction on every phase of house wiring in one handy volume. Goes further than most books on subject. Hand-book style. Gives National Electric Code. 400 pages, 669 illustrations. Electrical work will reach a new high with millions of new homes to be built. Get started now. \$3.00.

## DYKE'S FAMOUS CARBURETOR BOOK

This famous book has been the standard guide in the best paying auto work for a generation. It has helped thousands of men make money. New edition covers engine tune-up, compression, ignition, carburetion, fuel pump valves, etc. Use this book to specialize in this big field. 244 pages, 549 illustrations. \$3.50.

## Modern Gas and Electric REFRIGERATION

New Printing—Almost 1000 Pages,  
408 Pictures, 17 Diagrams in Colors

The Book of the Hour

Thousands of Refrigerators need repairs! Owners will pay big for competent service. Get this non-technical guide to all types of refrigerators and get your share of this new profit. Get a job or start your own service business. This book will help you make money anywhere. Price \$5.00.

Make Big Money  
Keeping Old Cars  
Looking New. Get  
This Book Today!

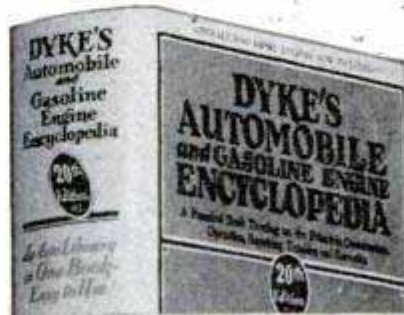

**BIG 20th EDITION**  
Leading Auto Book for Over 36 Years

## World's Greatest AUTO BOOK

New Material on Transmissions, Trucks, Tractors, Diesels, Aircraft and Auto Engines

Now with millions of cars needing repairs and thousands of men needed to do the work, you need the famous DYKE Auto Book more than ever before. This big 20th Edition covers all principles, construction, repair, adjustments, testing, troubles and remedies of all cars. Over a half million copies of 20 editions of Dyke's have been sold. Gives specifications of old and newer cars. World's biggest book value, \$7.00. This big book, a complete auto library in one volume, has 1483 pages—4600 illustrations and diagrams—weighs 6 lbs.—equal to 4 ordinary books.

## BAILEY'S HANDBOOK For Engineers and Firemen

World famous handbook of universal questions and answers for Stationary, Marine and DIESEL engineers and firemen. Prepares for any license examination. This is the one book that men should have if they want to reach the top in installation, maintenance and operation of Diesel and steam plants. Pocket size, \$2.00.

Goodheart-Willcox Co., Inc.  
1321 S. Michigan Ave., Dept. 18, Chicago 5, Ill.

**SEND NO MONEY! Mail Coupon**

GOODHEART-WILCOX CO.,

1321 S. Michigan Ave., Dept. 18, Chicago 5, Ill.

Send books checked, C.O.D. I will pay postman, plus few cents charges. If not satisfactory I will return books in 5 days and you will refund money paid. (Outside U.S. or possessions remit with order.)

- |  |  |
|--|--|
| <input type="checkbox"/> Gas & Electric Refrigeration . . . . . \$5.00 | <input type="checkbox"/> Air Conditioning . . . . . \$4.00 |
| <input type="checkbox"/> Dyke's Auto Book . . . . . \$7.00             | <input type="checkbox"/> Engineers Handbook . . . \$2.00   |
| <input type="checkbox"/> Dyke's Carburetor Book \$3.50                 | <input type="checkbox"/> Body and Fender Repair \$3.50     |
| <input type="checkbox"/> Modern Welding . . . . . \$4.00               | <input type="checkbox"/> Shop Math. (2 vols.) . . . \$3.00 |
| <input type="checkbox"/> Airplane Welding . . . . . \$3.50             | <input type="checkbox"/> House Wiring . . . . . \$3.00     |
| <input type="checkbox"/> Sheet Metal Layout . . . \$3.50               | <input type="checkbox"/> A.C. Power Wiring . . . \$4.00    |
|  | <input type="checkbox"/> D.C. Power Wiring . . . \$4.00    |

If remittance accompanies order we will pay all postage charges under same return privilege.

Name \_\_\_\_\_  
Address \_\_\_\_\_  
City \_\_\_\_\_ State \_\_\_\_\_

# Don't Envy The PLUMBER-Be One

**Make \$15 to \$50 a Day**  
(and work every day)

Every skilled workman will tell you Plumbers have the best of it. WINTER and SUMMER the Plumber is busy at top wages. No skilled Plumber is ever out of a job . . . compare his opportunities with any trade, and decide where your opportunity is.



## Own Your Own PLUMBING BUSINESS

No other business offers you the opportunity of starting in your own business, and making good profits, with little investment other than Universal's training and a kit of tools.

## JOURNEYMAN PLUMBER Gets Good Salary

Master Plumbers own their own shop. A Journeyman works for a Master. With Universal's training a journeyman can depend on high wages from the start.

## FREE

**DETAILS SHOW YOU HOW TO START**

You can start now to success as a plumber by simply filling out the coupon and mailing it . . . or just write Universal Plumbing School, 815 Holmes, Kansas City, Mo. FREE details showing how will be sent by return mail.

Plumbing, to the man with know how, means profit. Investigate Universal's unique "Shop Method" system . . . This system, developed over a quarter century ago by a master plumber, offers you the opportunity to quickly get into the plumbing business. This is not a "war born school" . . . but a plumbing school developed and operated by plumbers since 1923.

## BE A PLUMBER In Just 32 Weeks

Now, just 32 weeks of intensive training equips you to be a plumber. No need ever serve an apprenticeship. Don't envy the plumber's big profits . . . enjoy them.

### System Shows How With Tools . . . Not Books

Universal's highly developed method makes plumbers by a special developed system showing how to use plumbing tools . . . not books. Every instructor is a Licensed Master Plumber capable of showing every trick of the trade . . . Lead Work . . . Blueprint for plan reading, etc. This business offers a wonderful opportunity for the man who likes to work with tools.

### Over 7,000 Successful Plumbers Recommend This School

This system has made more than 7,000 plumbers. Each will testify it was the Universal Plumbing School that started him on the road to profits. Investigate our past performance . . . then decide. Universal is the largest and only school in America devoted exclusively to plumbing. It was established in 1923 under a system developed by a plumber and is owned and operated by licensed plumbers.

Don't waste your time looking over "war born schools" . . . investigate this system . . . then get into the profitable plumbing business.

## JUST MAIL COUPON

Send me FREE details about the plumbing business and tell me how to make profits as a plumber . . . I understand there is no obligation.

Name \_\_\_\_\_  
Address \_\_\_\_\_  
City \_\_\_\_\_ State \_\_\_\_\_

G. I. Approved. Established 1923

**UNIVERSAL PLUMBING SCHOOL**

815 HOLMES KANSAS CITY, MO.

SAY YOU SAW IT IN POPULAR MECHANICS

## EXTRA MONEY FOR YOU!

### ORDERS GALORE for Lucky Pennies

From every kind of business. Men! Make big extra money showing how lucky penny key chains stimulate business. You can earn \$100.00 to \$150.00 a week in spare time. Contains brand new copper penny and customer's ad stamped on back. Write for details and new catalog.

HOUSE OF MEINHARDT  
4138 SHERIDAN, DEPT. M-11 CHICAGO 13



**NEW CHEMICAL MITT**  
Sensational! DRY Window Cleaner! Uses no water, no messy liquids. Chemically Treated. Simply glide over windows; leaves glass sparkling clear. No heating water, no heavy buckets to carry. No rags, powders, sponges, chemicals. No mess or muss. No red chapped hands. Dust, dirt, grime, fog disappear like magic. Wonderful for auto windows, windshield!  
**SAMPLES FOR AGENTS** Sample offer sent immediately to all who send name at once. A penny postal will do. SEND NO MONEY—just your name, KRISTEE CO., 692 Bar Street, AKRON, OHIO.

## INSTANT NICKEL NO CURRENT OR BATTERIES USED

JUST PATENTED — Now everybody can NICKEL PLATE. No equipment, electricity or copper plating needed. Just rub. A BLESSING to Doctors, Hobbyists, Auto, Machinery and Home Owners and practically everybody. NO POISONOUS CYANIDES OR QUICKSILVER. It will plate to a practical thickness. Steel, Iron, Copper, Brass, etc. It's NEW, DIFFERENT, PRACTICAL, ECONOMIC! —By following easy directions a matte or brilliant "CHROMIUM LIKE" finish is obtainable—fascinating hobby—piste for neighbors and friends. MONEY-BACK GUARANTEE. C.O.D.'s few cents extra.

INSTANT PLATING PRODUCTS, Dept. G-2, 3439 So. Michigan, Chicago 16, Ill.

COMPLETE \$2.50 PAID 1948 PATENT AGENTS WANTED

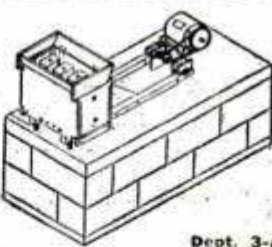

## BUILD THIS CONCRETE BLOCK MACHINE

Sell blocks; or build your home, garage, barn at 1/3 cost by making and laying your own blocks. This simple machine which you can build yourself at a cost of about \$15 (excluding motor) will make a block in 30 seconds using only one form. 2 to 4 forms can be used on each vibrator. Power driven concrete mixer plans also. Write for further information. No obligation.

**U-BUILD-IT SERVICE**  
Dept. 3-A, 206 West Wilder Ave., Tampa 3, Fla.



Balance 4" x 9" Base. With either Metric or Avoirdupois Weights . . . \$8.00  
Catalog with 3000 Illustrations of laboratory apparatus, and over 10,000 prices sent for \$1.50.  
LABORATORY MATERIALS CO.  
7321 Vincennes Ave., Chicago 21, Ill.

## SAVE with WAR SURPLUS

NAVY OVERALL  
**PANTS**

Wool blanket lined, with storm tabs on bottom of legs. Water repellent cloth, in a bib-top suspender style, with button and zipper front. Gov't. cost \$10.00.

**4.88**

BRAND NEW

MAIL CHECK MONEY ORDERS OR C.O.D.'S TO

**MONEY-BACK GUARANTEE**

**WORLD WAR SURPLUS STORES**  
841 S. BLUE ISLAND AVE. CHICAGO 7, ILL. Dept. P.M.

Add 25c per item for Postage and Handling.  
Illinois Residents add 2% Tax. Send for Free Catalog.

# START A BUSINESS AT HOME...

Like John Lehman, Who Says:

"The complete Fyr-Fyter extinguisher line gives me a steady income and real independence."



Yes, capable men like John Lehman will find an outstanding opportunity with Fyr-Fyter. You can be your own boss... operate in your own town and vicinity... build a permanent, steady income. No capital needed. We carry accounts, make deliveries, pay profits weekly. Thousands of prospects due to the vast need for fire protection.

## Write for FREE BOOK

Get details on Fyr-Fyter's famous sales kit... facts on the complete, Underwriters' approved Fyr-Fyter line... how you earn while you learn. Write today! No obligation.

**Fine Business for men past 40**

FYR-FYTER CO. Dept. 90-47, Dayton, Ohio

## ACCURATE SLIDE RULE FOR ONLY \$1.00

For engineers, salesmen, draftsmen, machinists, students, hobbyists. Seven scales will compute multiplication, division, squares, square roots, cubes, cube roots, reciprocals, proportions. Laminated construction on long-life dimensionally stable plastic. Diameter 4 1/4". Complete instruction booklet and heavy storage envelope. Send \$1.00—Post Paid. Money back guarantee.

Allegheny Plastics, Inc., 306 Chestnut Rd. Sewickley, Pa.

# PLASTI-LINER

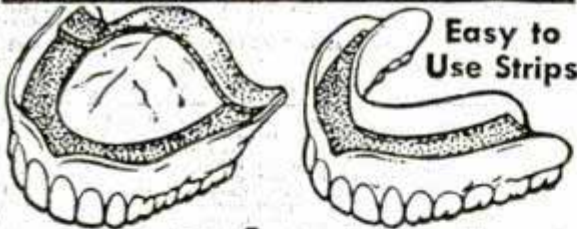

Easy to Use Strips

## Makes False Teeth Fit For the Life of Your Plates

If your plates are loose and slip or hurt, use this amazing, pliable, non-porous strip to refit them yourself, for instant and permanent comfort. It's easy. Just lay the strip on your upper plate or lower plate, then bite and it molds perfectly. Hardens for lasting fit and comfort. Helps stop the embarrassment of slipping, rocking plates or the misery of sore gums. Eat anything and talk freely without fear your teeth will loosen. Ends forever the mess and bother of temporary applications that last only a few hours or months.

## Easy to Re-Fit and Tighten False Teeth

PLASTI-LINER is tasteless and odorless. Won't injure your plate. Guaranteed to give satisfaction or your money back. Removable as per directions. Users say: "Until I used Plasti-Liner I used several kinds of liners without success. Now I can eat anything." H. H. M. "My plates are now better fitting than new." E. H. C.

**SEND NO MONEY:** Just order a \$2.25 package of PLASTI-LINER to reline both upper and lower plates, or \$1.25 to reline one plate. Deposit money with your postman when he delivers. Or send the money now, and save C.O.D. charges. Generous sample of special plate cleaner supplied free.

PLASTI-LINER CO., Dept. 43F, Buffalo 2, N. Y.

# Get This Free Booklet...

Learn what it means to have Northrop training in AERONAUTICAL ENGINEERING

The Northrop Engineering Graduate and His Qualifications



This brochure has been placed in the hands of 750 top executives of aircraft manufacturing firms and air transport companies by the Graduate Placement Department of Northrop Aeronautical Institute—to inform them of the Northrop-trained man's superior qualifications. It will tell YOU the important advantages YOU can enjoy during your training, upon entering Aviation, and throughout your career.

Here are the answers to: why the Northrop-trained man is in demand—why Northrop graduates hold important positions with many leading aviation firms throughout the world—how Northrop training prepares men for better starting jobs, more rapid advancement, and successful careers.

Read this description of training at a technical institute that is part of a famous aircraft company, a school in the midst of important research, development, engineering, manufacturing, and maintenance activities—where you get many advantages that make your first job simply a continuation of the practical duties in which you gained experience during your Northrop training.

You will want to read this booklet... if you are interested in Aviation... if you want to make the most of Aviation's big opportunities. Send the coupon for your free copy.



# NORTHROP AERONAUTICAL INSTITUTE

Division of Northrop Aircraft, Inc.  
James L. McKinley, Managing Director  
1527 E. Broadway, Hawthorne, Los Angeles County, Calif.  
APPROVED FOR VETERANS

NORTHROP AERONAUTICAL INSTITUTE  
1527 E. Broadway, Hawthorne, Los Angeles County, Calif.

Please send my free copy of "The Northrop Engineering Graduate and His Qualifications," also the Institute catalog and complete information on Northrop training, including starting dates of classes. I am interested in:

Aeronautical Engineering       Aircraft and Engine Mechanics

Name \_\_\_\_\_

Address \_\_\_\_\_ Age \_\_\_\_\_

City \_\_\_\_\_ Zone \_\_\_\_\_ State \_\_\_\_\_

Check one:  Veteran       Non-Veteran

Make \$15 to \$25 *extra*  
each week!



MR. C. H. MARTIN  
Princeton, Illinois  
A successful salesman with this plan, who averages over \$200.00 per week.

Be your own Boss

Go into business for yourself. Use your spare time working out of your home evenings, Saturdays and Sundays. You can make \$15 to \$25 and more extra money each week.

Make \$100 to \$200 per wk.

After you have proven to yourself that you can sell, then drop your present job and put in full time. Others make \$100 to \$200 per week or more on full time. You'll be running your own agency.

We train you

Our state or district men will come to your home to train you. They'll go out and work with you evenings or weekends until you are ready to take over on your own. You should succeed . . . You will be a representative of a well established business that is over 65 years old and has \$150,000,000 in assets.

Modern Woodmen of America Sales Opportunity Office  
Rock Island, 12, Illinois

Mail this coupon to-day!

MODERN WOODMEN OF AMERICA  
Sales Opportunity Office  
Rock Island 12, Illinois

Please send full information (without obligation) about your new free training plan and explain further my opportunity to make more money.

NAME \_\_\_\_\_

STREET \_\_\_\_\_

CITY \_\_\_\_\_

## Draw Your Own PLANS

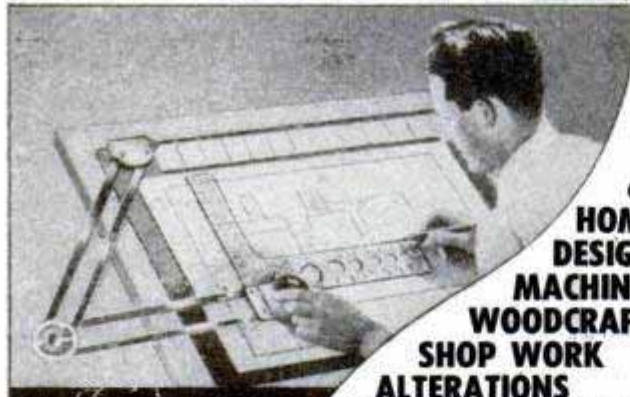

of  
HOMES  
DESIGNS  
MACHINES  
WOODCRAFT  
SHOP WORK  
ALTERATIONS  
LAYOUTS—LETTERING

Accurate to Scale—101 Different Uses

Here is a new mechanical drawing board every home worker, hobbyist, machinist, artist, or student will want. It incorporates modern drafting principles used by professionals. The combination one-piece 90° angle and calibrated scale moves at any angle to any point on board in quick, smooth movements. Makes drawings up to 16" x 22" without T-square, triangles, protractor or ruler. Table of decimal equivalents, etc. mounted on board.

SEND COUPON TODAY! MONEY BACK GUARANTEED. Special Cash Offer for limited time—Only \$9.95 Postpaid. If not fully satisfied—return in 10 days and we will cheerfully refund purchase price.

REPLOGLE, Inc., Dept. PM-11  
317 No. Hoyne Ave.  
Chicago 12, Ill.

Please send me Mechanical Drawing Board #1 Only \$9.95 postpaid. Enclosed find check or Money Order.

Please send C.O.D. for \$9.95 plus postage

NAME \_\_\_\_\_

ADDRESS \_\_\_\_\_

CITY \_\_\_\_\_ STATE \_\_\_\_\_



Remodeling



Tool design



Interior decoration



Patterns

EXCLUSIVE TERRITORIES OPEN!  
Write for Full Details Today.

—AN ARTMOORE PRODUCT—  
Cut Housework in Half  
with NEW ART CLEANER

WRINGS  
LIKE  
THIS



REFILLS  
EASILY  
REPLACED

Again available with genuine Latex sponge rubber head! Over a million in use—doing a better, faster, *easier* job of scrubbing dusting, waxing floors. 10 inches wide. Self-wringing, self-cleaning—48-in. hardwood handle means no kneeling, no stretching. If agent hasn't called, **\$5.95** write direct. Postpaid

**ARTMOORE CO.**

Dept. PM-118, 1319 N. 3rd, Milwaukee 12, Wis.

## SPEED AND POWER HANDBOOK



Very latest methods! Construct your own Superchargers, "Water Injectors," Hi-Compression Heads, Fuel Saving Devices—easily. Save many dollars! Get racing speed, acceleration, dynamic power increases from any automobile! Build fast stock cars! California roadsters! Hotrods! Get ingenious formulas! Speed secrets! Illustrations! Conversion ideas! Also "Economy Information"—Mileage tricks! Tuning techniques! Instructions! Picture catalogues. Including "California Restyling Ideas"—Glossy photographs! Drawings! Model revising! Customizing! Streamlining! Leatherlike bound—\$1.98 complete.

Newhouse Automotive Industries, 5941-84 Hereford, Los Angeles 22, Calif.

## A BUSINESS OF YOUR OWN

Make HOLLYWOOD STYLE cement pottery, birdbaths, mantels, miniature castles, benches: without moulds. Washing-wells, stucco-rock walls, fountains, rustic walks, tile tables. Dime brings chemically colored sample, amazing pictures.

HOLLYWOOD CEMENTCRAFT  
8527-A WONDERLAND AVE.  
HOLLYWOOD 46, CALIF.

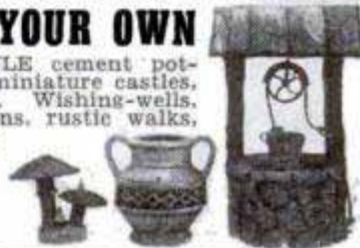

SAY YOU SAW IT IN POPULAR MECHANICS

## HAMSTERS!



Get the unique Golden Hamster today. Profitable, Pro-life, Educational, friendly. 1000's needed by labs and pet shops. Raised anywhere. No experience required. Send 10c for literature or \$5 for pair and literature.

Azalea City Hamstery, 1412 East Linwood Dr., Dept. F, Mobile 18, Alabama



## ITALIAN ACCORDIONS

Hand Made. Very Best. Lowest Prices. Buy Direct from Factory Representative and Save Money. Send Name and Address for FREE catalog.

ITALIAN ACCORDION MFG. CO.  
7600 Cottage Grove Ave., Dept. PM-11, Chicago, Ill.



**BE FAIR TO YOUR HAIR** Want better looking hair? Embarrassed by falling dandruff, itching scalp? Get the new VITABRUSH, the electric-automatic brush with built-in brush head motor. . . gives scalp and hair an invigorating "workout" in just 3 minutes. Cleans scalp, stimulates blood supply, distributes the natural oils. Fun to use—relaxing. Write for satisfaction-guaranteed offer—today. Hershey Mfg. Co., 3735 Field Bldg., Chicago 3.



Learn to  
Use the

# SLIDE RULE

**EASY! QUICK! NEW LOW COST!**

Newly Revised and Simplified Step by Step Method

**10 in. SLIDE RULE  
and Famous  
Book Both for Only \$2.98**

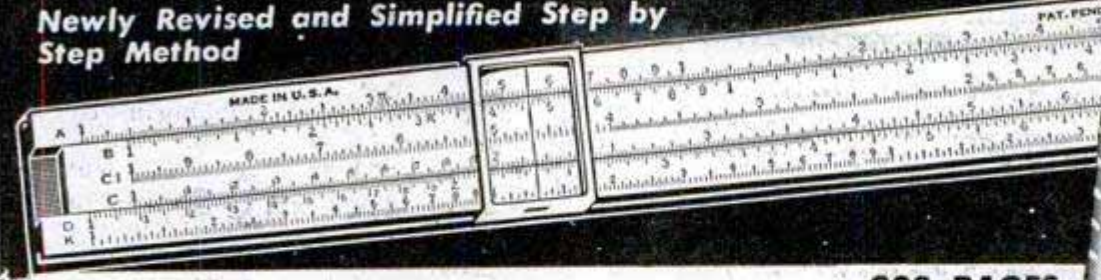

**Practical Help for Bigger Pay — Better Jobs — for Mechanics, Draftsmen, Shop Men, Accountants — All Who Use Figures**

Get this new revised and simplified edition of the "Slide Rule and How to Use It." Thousands of older editions sold at much higher price. Now — a more simplified book at a lower price with genuine full-size Mannheim type beginner's Slide Rule included at no extra cost. Do all kinds of figure work. Stop wasted time. Stop pencil errors. Learn quickly to multiply, divide, extract roots, find ratios and percentages, squares, areas of circles, radii, volume, etc. Do it in a flash and learn now with this book and slide rule combination.

**Practical Step by Step Guidance**

No other book like it. Contains complete instruction and removable work sheets that make the slide rule simple as A,B,C. Also Five Place Logarithm Table, Tables of Trigonometric Functions of Angles, review of Mathematics from simple arithmetic through calculus, and with complete answers to check yourself on every problem. It can easily be worth hundreds of dollars to you in promotions, better pay, saving time and error. It's a book for students, mechanics, business men—everyone should learn to use the slide rule, now that it is so easy.

**Learn in a Few Hours to Do Many Calculations**

There is nothing mysterious about the slide rule and its use. Just read the book and follow the rules. You'll be amazed at the problems you can solve in just a few hours. Mail the coupon now. Book and slide rule will be sent at once. Use them for 5 days, then if you are not satisfied in every way, return them and your money will be refunded without delay. Use the coupon. Mail now.

**208 PAGES  
LOG TABLES  
Helpful Review  
of Mathematics**

*Mail Coupon*  
Money Back if  
Not Satisfied

**Austin Publishing Co., Dept. 18  
165 N. Pine Ave., Chicago 44, Ill.**

Send me "The Slide Rule and How To Use It" and 10" full size Mannheim type beginner's Slide Rule. Total cost for both \$2.98. I understand you will refund amount paid you if I return them in 5 days.

- Remittance Enclosed
- Send C.O.D. Postage and Charges Extra

Name \_\_\_\_\_

Address \_\_\_\_\_

City \_\_\_\_\_ State \_\_\_\_\_

**AUSTIN PUBLISHING CO., Dept. 18, 165 N. Pine Ave., Chicago 44, Ill.**

*Profit and Fun*

**CARVING LEATHER**

New Device makes it possible for beginners to improve overnight. Now is the time to cash-in on this Big Paying business—year round profits are easy if you follow new method of instruction to be found only in Baird's home study course. Big sale for bill folds, wallets, belts, purses gun holsters, saddles, and other leather articles. Make up to \$50.00 per week spare time or up to \$500.00 or more monthly full time.

*at home spare time full time*

Start your own business. Make Xmas presents and other gifts. The Baird Course is **Complete**. Full instructions — Tools and equipment — including new device that makes learning easy. Write for full details and interesting catalog — containing many profitable suggestions — **sent free** — **Write Now. DEPT. F**

**BAIRD SCHOOL OF LEATHER CARVING • 221 Manitou Ave., Manitou Springs, Colorado**

**Get Ready for Big Opportunities!**  
*Business Role*

**TOOLS AND EQUIPMENT SENT WHEN YOU START**

Get a better job with more pay and pleasant working conditions. Get into Drafting — where all products start. I will train you at home — give you experience — on the same kind of jobs you will do with the best paying firms. I furnish instruments and all equipment when you start. Write today for vital facts and FREE book. Give age.

**ENGINEER DOBE • Dept. 18 • Libertyville, Ill.**

*I Will Train You at Home Until You Get a*

**GOOD PAY JOB in DRAFTING**

**Learn ORNAMENTAL HORTICULTURE**

A thorough, constructive home-training for employment or advancement in Nursery Operations, Park Supervision or maintenance, Landscape Designing or Landscape Gardening. My 3 way Plan shows you how to start your own business, get a better job, or earn extra money in spare time. Send for Free Book. APPROVED FOR VETERANS.

**NATIONAL LANDSCAPE INSTITUTE**  
Dept. P-12, 310 So. Robertson Los Angeles 36, California

**Train Now for Big Pay Open to**

## Carpenters & Brick Masons

**IN A FEW SHORT MONTHS IN MODERN WELL EQUIPPED Midwest Shops**

**Approved for Veterans. Non-veterans may pay tuition by the month. MAIL COUPON TODAY FOR FREE INFORMATION.**

Get into the billion dollar building trades. Demand widespread, check your own neighborhood for shortages of carpenters and brick masons. Our graduates are actively employed in the Building Trades, stepping directly from school into jobs or business of their own in various parts of the country. Many of our students supplement their income with part time earnings while attending school. Pleasant inexpensive living quarters in beautiful, healthful surroundings. Enroll now. Limited classes. MSBT teaches building trades only. If you prefer, you can begin your training at home.

**MIDWEST SCHOOL OF BUILDING TRADES, Dept. PM-11**  
411 N. Center Street, Bloomington, Ill.

Please send me free information about training in the field I have checked:

Carpentry                       Masonry

Name \_\_\_\_\_

Address \_\_\_\_\_

City \_\_\_\_\_ State \_\_\_\_\_

Are you a veteran?  Yes  No

# LINGUAPHONE



is your *Passport*  
to the World

In your own home, alone or in a group, you can now learn to speak

**SPANISH • PORTUGUESE  
FRENCH • RUSSIAN  
ITALIAN • GERMAN**

or any of 23 other languages by the world-famous

## LINGUAPHONE Conversational METHOD

You learn the new language by listening to voices of native teachers. It is amazingly simple; thousands have succeeded. Educators hail Linguaphone as a notable advance in simplifying the mastery of languages. That is why so many Linguaphone Sets are used in schools, colleges, universities, as an aid to fluent speaking.

### Fun and Profit

Taking up a language by Linguaphone is actually a pleasure and entertainment. Every difficulty has been foreseen and removed. You begin to speak the new language so quickly that you not only amaze your friends but derive personal pleasure from your new accomplishment. Tens of thousands have proved this for themselves.

Available to Veterans under  
**G I BILL OF RIGHTS**

SEND FOR FREE BOOK  
**LINGUAPHONE INSTITUTE**  
98 RCA BUILDING, NEW YORK 20, N. Y.

**LINGUAPHONE INSTITUTE**  
98 RCA Bldg., New York 20, N. Y.  
Send me the FREE Linguaphone Book.  
I am , am not  a World War II Veteran  
I want to learn.....language.  
Name .....  
Address..... City.....

SAY YOU SAW IT IN POPULAR MECHANICS

# TRAVEL FOR "UNCLE SAM"!

AS HIGH AS \$3,351 FIRST YEAR

**RAILWAY POSTAL  
CLERKS**

**Veterans Get  
Special Preference**



Many other Government  
Jobs, City and Rural Car-  
riers — Postoffice Clerks —  
Meat Inspectors — Storekeeper  
— Gaugers — Stenographers —  
Typists — etc. Prepare now for  
1949 Examinations.



FUN  
FOR  
THE  
WHOLE  
FAMILY

Make Your Own Figurines  
— With —

Ready to Use Rubber Molds

Molds from .....25c

Kits from .....\$1.00

Write today for 20 page 8½x11  
inch catalog in color with direc-  
tions and dealer's name.

Dept. N X 48

Monmouth, Illinois



## RUPTURE-EASER

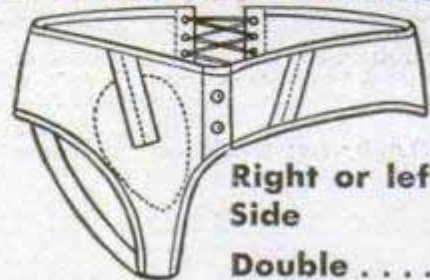

Right or left \$3.95  
Side

Double .....\$4.95

A strong, form fitting, washable support. Back lacing adjustable. Snaps up in front. Adjustable leg strap. Soft, flat groin pad. No steel or leather bands. Unexcelled for comfort. Also used as after operation support. For men or women. Mail orders give measure around the lowest part of the abdomen. Specify right or left side or double.

**PIPER BRACE CO.**

308 E. 12th DEPT. PM-11 KANSAS CITY 6, MO.

## LIQUID MARBLE

COMPOSITION FLOORS  
FLEXIBLE MOLDS  
MOLD Novelties, Statu-  
ary, Art Goods in Flex-  
ible Plastic Molds; 5c  
material makes \$1. matter. Make Marbleized floors,  
Tile Walls. Colorful, glossy, amazing! Easily learned;  
start in garage or basement. Particulars free.  
MARBLEIZING SERVICE, Dept. 10-F, Edwardsville, Ill.



## FIX SEWING MACHINES

BIG MONEY. Spare or full time. Open your own neighborhood shop. Thousands need repairs. Send for complete Service Manual—only \$1.98 postpaid. Money back guarantee.  
SEWING MACHINE SERVICE CO., Hamilton 25-06, Ohio



## GET A SECRET RINGUN NOW!

Makes a loud bang like a real gun... this secret ring is adjustable to fit any finger... it shoots paper caps. (Safe and harmless.) Your friends won't guess just how you do it. Secret RINGUN is yours for only 35c in stamps or coin. Send to:

**HARRY C. BJORKLUND** 3207 Girard N.  
Mpls. 12, Minn.

Name.....  
Address..... Vet?.....

POPULAR MECHANICS

# START A BUSINESS at HOME...

others make **BIG MONEY**

**DOES THE WORK OF 6 TOOLS IN 1**  
Holds 20 times its weight in water



Hands Never Touch The Water .. Can Be Put In Boiling Water

"Enclosed find 56 orders representing 9 1/2 hours work on Monday and Tuesday." "Enclosed are 12 orders secured after supper this p.m."

**Housewives Pleased**  
Everyone that sees this outstanding CELL-U-MOP immediately want one... That's the reason our distributors are so successful... For MOPPING, WAXING, WALLS, WINDOWS, AUTOs and CLEANING RUGS. Sells quick to Taverns, Clubs, Hotels, Hospitals, Stores, Restaurants, Homes, etc. Drain Bracket squeezes out water thoroughly.

Write for FREE particulars

CLOSED CELL-U-MOP CO., Dept. P-11 FREEPORT, ILL.

# LAWNMOWER SHARPENING IS NOT SEASONAL!

With The **PEERLESS GRINDER!**

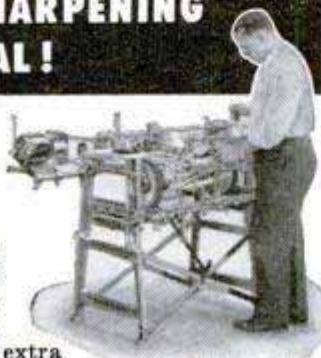

Send for Free Catalog

Golf clubs, parks, and cemeteries are now ready to turn over their mowing equipment for overhaul. With a PEERLESS GRINDER you cash in on this year 'round business. Earn extra money!

# The FATE-ROOT-HEATH CO.

DEPT. D-3 — PLYMOUTH, OHIO

# BUILD and ENJOY YOUR OWN BOAT!



ASSEMBLED IN 8 HOURS

WITH A **Plywood Boat Kit**

LIGHTWEIGHT, 12-FEET LONG

READY CUT — needs no forms nor special tools to assemble. Kit includes all hardware, paint, etc. (less oars).

**ONLY \$54.00**

(Freight paid)

Send for Free Folder

**TAFT MARINE WOODCRAFT**

Dept. M, 636 39th Ave. N.E.

Minneapolis 18, Minn.

# WAR SURPLUS OPTICAL BARGAINS

ASSEMBLE YOUR OWN BINOCULARS!

Save More Than 1/2 Regular Cost



## GOVERNMENT'S 7X50 BINOCULARS

Complete Optics!  
Complete Metal Parts!

We supply full instructions

**METAL PARTS**—Set includes all Metal Parts—completely finished—for assembly of 7 X 50 Binoculars. No machining required. Bodies have been factory hinged and covered. A sturdy Binocular Carrying Case is optional with each set of Metal Parts.

Stock # 842-H ..... \$39.40  
Postpaid, plus \$4.80 for Case—Total ..... \$44.20

**OPTICS**—Set includes all Lenses and Prisms you need for assembling 7 X 50 Binoculars. These are in excellent condition—perfect or near-perfect—and have new low reflection coating.

Stock # 5102-H ..... \$25.00 Postpaid  
(These are standard American made parts... not Japanese, French or German.)

**NOTICE!** If you buy both Binocular Optics and Binocular Metal Parts, add 20% Federal Excise Tax to above prices.

## ARMY'S 6x30 BINOCULARS

**COMPLETE OPTICS & METAL PARTS**—Model M-13A1, 6 X 30 Binoculars. (Waterproof Model). Everything you need—ready for assembly. When finished will look like a regular factory job costing \$102. to \$120. The Optics are new, in perfect or near-perfect condition. Have new low reflection coating. Metal Parts are new and perfect, all completely finished. No machining required. Bodies factory hinged and covered. Complete assembly instructions included.

Stock # 830-H ..... \$40.00 Postpaid  
plus \$8.00 tax—Total—\$48.00

**20X PRISM SPOTTING SCOPE SET**—Consists of all lenses and prisms (slightly chipped) you need to make a good, standard 20X Spotting Scope. Low reflection coated. 57 mm. dia. Achromatic objective. Direction sheet included.

Stock # 5145-H ..... \$22.00 Postpaid  
(Also surplus Riflescopes — Write for Bulletin 18-H)

**SLIDE PROJECTOR SETS**—Consist of all unmounted lenses you need to make the following size projectors:

Stock # 4038-H—2 1/4"x2 1/4" ..... \$3.35 Postpaid  
Stock # 4039-H—2 1/2"x3 1/2" ..... \$3.35 Postpaid  
Stock # 4029-H—35 mm. .... \$2.85 Postpaid

**6 POWER GALILEAN TELESCOPE**—(Commercial Surplus) 28mm dia. Achromatic Objective Lens. Sturdily constructed of Aluminum. 7" long, extends to 9". Complete with carrying case.

Stock # 941-H ..... \$3.00 Postpaid

● ANNOUNCING! 1948 Annual Gadget Contest. ●  
IT'S FUN! IT'S EASY! BIG CASH PRIZES for Optical Gadget IDEAS! Write for Entry BLANK and Details!

We have literally millions of war surplus lenses and prisms for sale at bargain prices ranging 10c and up. Write for Catalog "H" — Sent Free!

Order by Stock No.

Satisfaction Guaranteed

# EDMUND SALVAGE COMPANY

P. O. AUDUBON, NEW JERSEY

SAY YOU SAW IT IN POPULAR MECHANICS

New Method...

# BIG PROFITS!

Can be Yours...  
Right in Your Own Home

## No Experience Needed

At last a way to get in on the Big Money made every day in Copper Art—Plaques—Bowls—Trays—Gifts—Souvenirs of all kinds. No art talent necessary—our NEW METHOD makes it so easy, even a child can do it. Big Markets waiting. Anyone can learn quickly—you start making money right from the start. Don't miss this opportunity to cash in at once on this big-paying easy to operate business. Be your own boss. SEND NO MONEY—act NOW to get all the free details—just send your name on a penny postcard today—Do it Now! Write today—



No Selling Money-Back Guarantee

7266 Sunset Boulevard  
Hollywood 46, California

**HOLLYWOOD COPPER ART STUDIO Dept. M2**

# LOOK! NEW 1949 ELECTROCAR with 3 real speed shifts

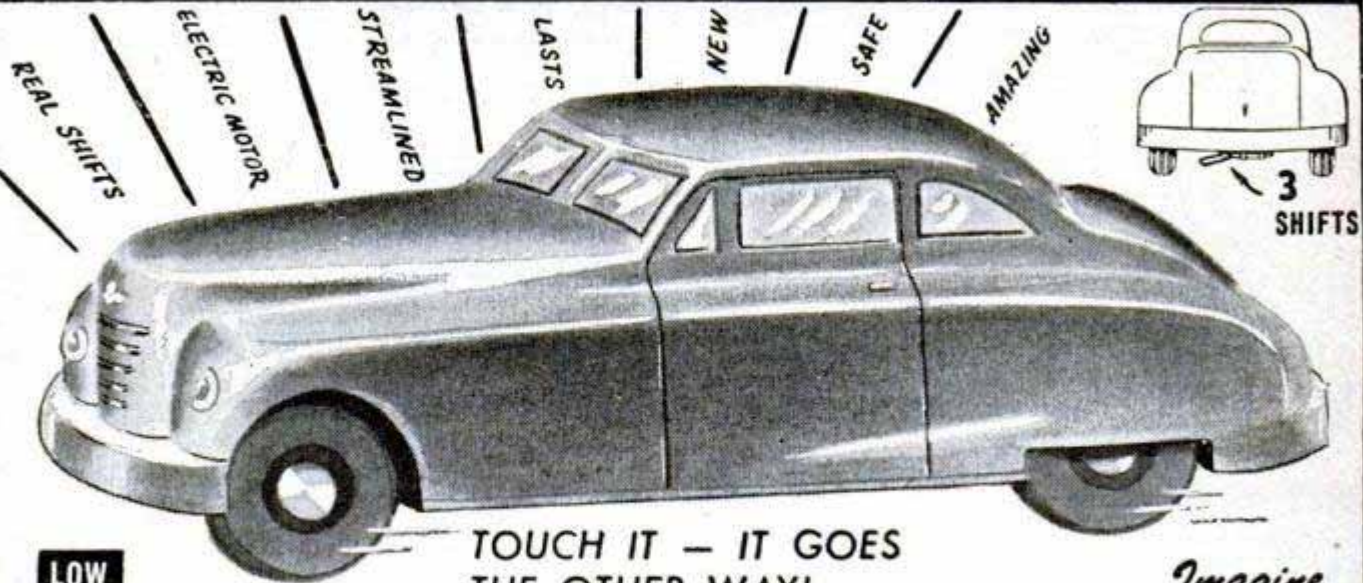

**LOW**  
**SECOND**  
**HIGH**  
**REVERSE**

**TOUCH IT — IT GOES  
THE OTHER WAY!**

Here is the sensationally new scale-model car that captivates every child (and mommy and daddy, too.) One flick of the magic gear lever and off it goes — in low, second, high — or reverse. Runs for hours. Driven by an electric motor, powered by two flashlight batteries — safe, economical — easily replaced. Over 10 inches long — comes completely assembled with batteries, headlights, balloon-type rubber tires — in shiny red durable plastic body. Lasts forever. RUSH ORDER TODAY!

SEND NO MONEY (C.O.D. you pay postage. Remit with order, we pay postage.)

Imagine  
only **2<sup>98</sup>**  
Complete

**ELECTROCAR CO., 59 East 8th St. N. Y. 3 Dept. P.M.2**

## Learn A Trade NOW! PRACTICAL SHOP TRAINING!

### In Our Chicago Shops

- |   |  |
|---|--|
| <input type="checkbox"/> AUTO MECHANICS   | <input type="checkbox"/> WELDING—ARC and GAS |
| <input type="checkbox"/> DIESEL MECHANICS | <input type="checkbox"/> MACHINIST           |
| <input type="checkbox"/> REFRIGERATION    | <input type="checkbox"/> PIANO TUNING        |
| Above Approved For G. I.'s and Civilians  |  |
| <input type="checkbox"/> BODY-FENDER      |  |

One of America's Leading Practical Schools  
7 Floors of Fully Equipped Shops  
Over 48,000 Successful Graduates  
Expert Individual Instruction  
Learn by Doing—Low Living Expense  
Established 1902—Day and Evening Classes

### Also the following Home Study Courses

- |                                  |  |                                 |
|----------------------------------|--|---------------------------------|
| <input type="checkbox"/> PLASTIC | <input type="checkbox"/> REFRIGERATION | <input type="checkbox"/> DIESEL |
|----------------------------------|--|---------------------------------|

— CALL IN PERSON OR MAIL THIS AD TO —  
**GREER SHOP TRAINING**

(Dept. PM-28) 460 South State St., Chicago 5, Ill.  
Please send without obligation free information regarding trade checked above. (Specify whether you are a Veteran  or Civilian )

Name \_\_\_\_\_ Age \_\_\_\_\_  
Address \_\_\_\_\_  
City \_\_\_\_\_ State \_\_\_\_\_

SAY YOU SAW IT IN POPULAR MECHANICS



## CARTOONING

HAVE FUN! MAKE MONEY! Cash in on your sense of humor AT HOME—BY MAIL. No experience needed to start. Write today FOR FREE TRIAL LESSON and full particulars.  
Moon Gag Cartoon School, Dept. M; Fall Creek, Wis.



## MAKE MAGIC YOUR HOBBY

BE A MAGICIAN FOR FUN OR PROFIT!  
Rush 50c for large catalogue of magic apparatus and we will include FREE a copy of "MAGIC IS FUN" the magician's magazine and book of "84 E-Z CARD TRICKS." D. Robbins & Co., Dept. A-19, 152 W. 42 St., N. Y. 18, N. Y.

## MONEY IN GOLD STAMPING

Now you can set up a business in your home and print in gold, silver, or any color, on billfolds, pen and pencils, book matches, and hundreds of other items, by the hot stamping process. There is a big demand for personalized items even among your friends and neighbors. More extra dollars printing on advertising novelties for any business. Our table model machine will pay for itself in no time at all! You'll be surprised at the extremely low price. Send for free circular now!

NATIONAL EMBOSING CO., 17369 Riopelle, Detroit 3, Michigan

## RID YOUR DOG OF WORMS



USE

**NEMA**

**WORM  
CAPSULES**

Dependable, easy to give, scientifically prepared and low in cost, NEMA Worm Capsules effectively remove large round worms and hookworms in dogs and cats.

FREE! Send for illustrated, helpful worm booklet.  
**PARKE, DAVIS & CO., DETROIT 32, MICH.**  
**DRUG STORES SELL PARKE-DAVIS PRODUCTS**

POPULAR MECHANICS

**LOW  
FACTORY  
PRICES!**

# ... on the Sensationally **NEW 1949** **MIDWEST RADIOS**

**NEW  
SERIES 16  
SUPER DE LUXE  
AM-FM  
CHASSIS**

**30 DAYS TRIAL**



Here is the last word in radio engineering . . . a powerful, world-ranging, magnificently-toned radio that is unsurpassed for performance, selectivity, sensitivity, and advanced engineering features. Uses these latest-type tubes, rectifier and tuning indicator: three 7A7, three 7A4, two 7C5, one 7A6, one 7Q7, one 6BA6, one 6BE6, one 6C4, one 6AL5, one 5U4, one 6U5. Comes complete with satin stripe copper finish front panel attached, Magna-Tenna Loop Aerial and giant 14 1/2" Electro-Dynamic Panasonic Speaker. Requires only a few minutes to install, plug in and play. **LOW FACTORY PRICES . . . EASY TERMS . . . 30 DAYS TRIAL.** Send TODAY for FREE 1949 Midwest Radio Catalog of separate Chassis and beautiful Console and Table models.

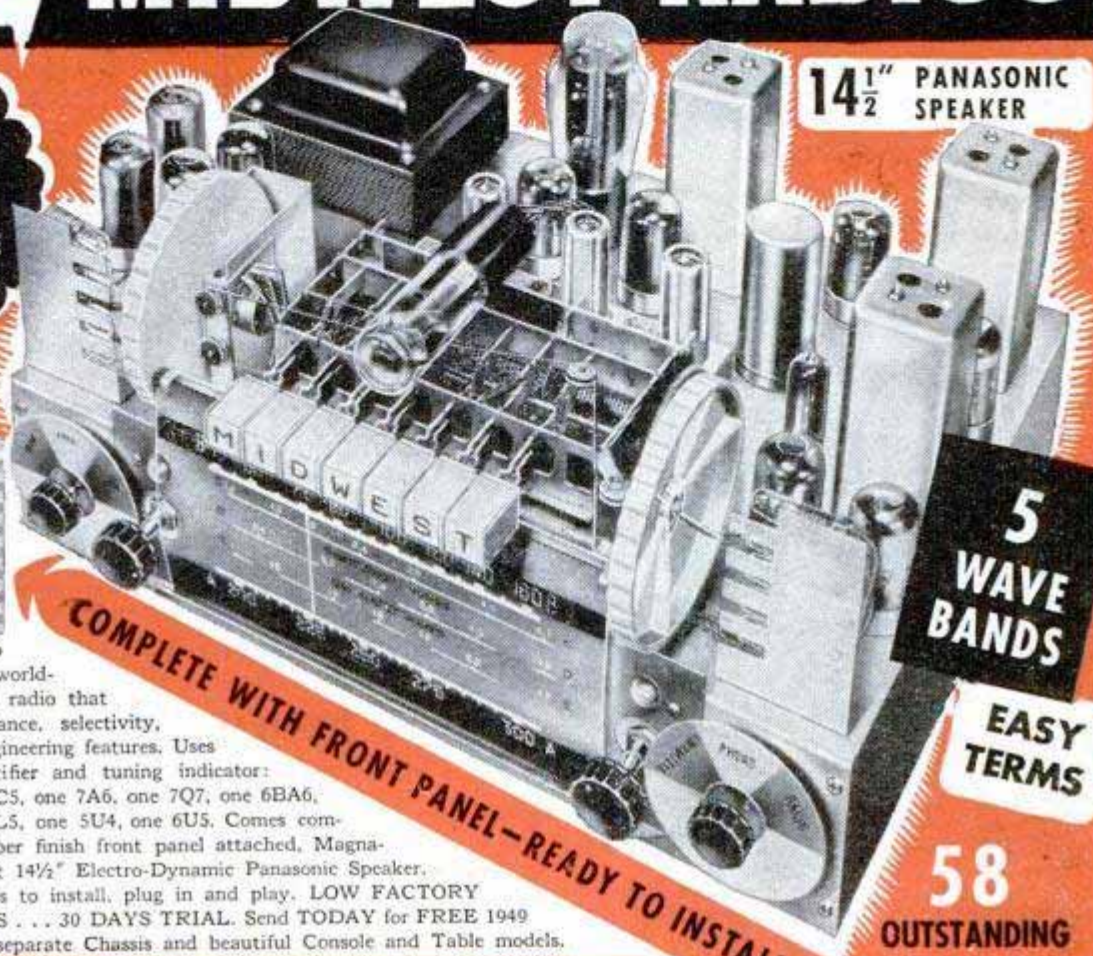

**14 1/2" PANASONIC  
SPEAKER**

**5  
WAVE  
BANDS**

**EASY  
TERMS**

**58  
OUTSTANDING  
FEATURES**

- Including the Exclusive Midwest*
- FLASH-O-MATIC Volume and Band Indication
  - TELEVISION Audio Switch-Over
  - FIDEL-A-STAT Color-Ray Tone Selection
  - TRI-MAGNADYNE Coil System
  - ...Plus NO-DRIFT FM and many other features

**A Complete Line of FINE RADIOS and RADIO-PHONOGRAPHS . . . Available in SEPARATE CHASSIS Like the POWERFUL SERIES 16 AM-FM Model above or in COMPLETE CONSOLES like this...**



## **Beautiful SYMPHONY GRAND AM-FM Radio-Phonograph with TELEVISION Audio Switch-Over and NEW Intermix AUTOMATIC RECORD CHANGER**

A Magnificent musical instrument and a masterpiece of cabinet design—the finest Midwest Radio in 29 years of manufacture. Offers world-ranging radio reception and newest automatic Intermix Record Changing Phonograph. Uses Series 16 Super DeLuxe AM-FM Chassis. Giant 14 1/2" Panasonic Speaker; Tri-Magnadyne Coil System; Built-In Loop Antenna. Other luxurious console and table model cabinets available with Series 16, 12, and 8 chassis—on Easy Terms and 30 Days Free Trial.

**Rush for Free Catalog!**

FILL IN COUPON AND MAIL TODAY OR JUST SEND NAME AND ADDRESS ON 1c POSTCARD

**MIDWEST RADIO & TELEVISION CORP.**  
Dept. 254, 909 Broadway, Cincinnati 2, Ohio  
Please send me your new FREE 1949 Catalog.

NAME \_\_\_\_\_  
ADDRESS \_\_\_\_\_  
CITY \_\_\_\_\_ ZONE \_\_\_\_\_ STATE \_\_\_\_\_

**BUY DIRECT FROM FACTORY and SAVE!**

**MIDWEST RADIO & TELEVISION CORP.**

Dept. 254 909 Broadway, CINCINNATI 2, OHIO

MEN and  
WOMEN



**Learn EXPORT**  
**HIGH INCOME**  
**TRAVEL • ADVENTURE**

... await in World Trade. Work for others or start your own full or part time business in this big-money industry. Your home can be your office. Buy and sell world-wide without capital by mail order as I have. My practical low cost home study course teaches you quickly at home. World Trade is a common sense business which I teach you in a common sense way, based on *my own twenty-five years' practical experience*. Simple words - clear instruction. No need to know or learn a foreign language. No previous special experience or schooling needed. World Trade Certificate awarded. Authorities predict that the *Marshall Plan will expand U. S. Exports* to \$60 BILLION over the next five years; also billions in Imports will result. World Trade now offers the biggest opportunities in history for newcomers. Send today for **FREE INFORMATION**. Airmail reaches me overnight.

**MAIL FOR FREE DETAILS**

**B. L. MELLINGER, Director, The Mellinger Co.**  
**1422-BZ WESTWOOD BLVD • LOS ANGELES 24, CALIF.**  
SEND FREE LITERATURE ABOUT MY OPPORTUNITIES IN WORLD TRADE

NAME \_\_\_\_\_  
ADDRESS \_\_\_\_\_  
CITY \_\_\_\_\_ STATE \_\_\_\_\_  
VETERAN? \_\_\_\_\_ OCCUPATION? \_\_\_\_\_ AGE? \_\_\_\_\_

**AUTHENTIC MODEL KITS**



- Stage Coach Kit \$150**  
Plus 15c postage
- Covered Wagon Kit \$150**  
Plus 15c postage
- Army Truck Kit \$100**  
Plus 15c postage
- ALL 3 for Only \$375**  
Plus 25c postage

Pleasant leisure hours spent in building these realistic miniature replicas pay off in satisfaction and the pride of displaying your craftsmanship. Wells Fargo Stage Coach revives memories of the Old West; Conestoga Covered Wagon just like the Pioneers'; 2 1/2 ton Army Cargo Truck is backbone of U. S. Army combat supply service. Covered Wagon and Stage Coach 1/2" scale; Army Truck 1/2" scale. You'll enjoy working with precision parts, die-cut from white pine and plywood, for simple, accurate assembly: free-rolling wheels, real metal fittings, formed ribs, leather springs, etc., full size plans.

**HOLLYWOOD MODELS** POST OFFICE BOX 389  
BURBANK, CALIFORNIA

**NAVY FOUL WEATHER JACKET**



**THE GENUINE NAVY N-1 JACKET**  
**MADE TO NAVY SPECIFICATIONS**

A rough weather jacket. It has everything! Made of durable Mountain Cloth. **BRAND NEW!** Has Alpacalined body and sleeves. 2 slash pockets. Zipper front with outside button fly. Draw String bottom. Full 26" length! Zelon water repellent throughout. We offer this exact quality jacket at a tremendous cash saving. Sizes 34 to 46. Save \$7.00. Now only \$15.95! A Xmas gift that would be appreciated. Rush your order TODAY!

**LEONARDS & LEE**  
**SURPLUS SALES**  
Dept. NJ 111  
69-71-73 E. 75th St., Chicago 19



**FULLY AUTOMATIC**

**BUBBLE-MATIC**

YOU "SHOOT" THOUSANDS OF HARMLESS, STAINLESS BUBBLES without reloading

**ORDER NOW FOR CHRISTMAS!**

Youngsters everywhere love this gift! Made of strong, light aluminum, this new automatic gun "shoots" thousands of stainless, harmless bubbles at a loading. Easy to operate. Fun galore! But safe fun! Shipped anywhere in U. S., with 6 refill "cartridges", \$2.98 postpaid. Extra refills, 6 for 30c. Send check or money order. Add 3% sales tax to Ohio orders. P. S.—Get Dad one, too, today!

**\$2.98 COMPLETE**

**NOVELTY PRODUCTS** Dept. LM  
22 W. Seventh St. Cincinnati 2, Ohio

**NOW! you can Enjoy a Clean, Cool, Pleasant Smoke . . .**

**FROM ANY ONE OF YOUR OLD PIPES**

Without a doubt here is the answer to your **SMOKING PLEASURE**. CLEAN it right and **TAMP** it tobacco right and notice the big difference from the same pipe. Always carry the **DENNY PIPER** with you. A REAL TREAT for you and your friends . . . 4 cost you only \$1 Postpaid.

**USE THE 6 inch DENNY PIPER NO MORE SCORCHED or SOILED FINGERS**

**TRY IT ONLY 25c Postpaid**

**AN IDEAL XMAS GIFT** at tobacco counters or **MAIL ORDER TODAY**

**THE DENISTON CO.**  
4852 SO. WESTERN AVE.  
DEPT. P-11 CHICAGO 9

**Original HOLLYWOOD WOLF WHISTLE**

**CAR HORN**

Give the **WOLF CALL**

**\$4.00**

You, too, can become a Hollywood Wolf. Give the wolf call and make other weird noises with the original **HOLLYWOOD WOLF WHISTLE** on your car. Precision made. Works off the intake manifold. Easily installed in 15 minutes.

Works in trucks, motorcycles, motor boats, outboard motors, too. Guaranteed. If your dealer cannot yet supply you, order direct, giving us your dealer's name. No COD's or stamps. No individual foreign orders. **AUTOMOTIVE DEALERS & JOBBERS** write for information on this fast selling, proved item.

**YODER MFG. COMPANY**  
2403-21M East 103rd St., Los Angeles 2, California

**DESCRIPTIVE LITERATURE ON REQUEST**

## Famous BAILEY TECHNICAL SCHOOLS

OFFER THE FOLLOWING COURSES:  
**PRACTICAL DIESEL ENGINEERING**  
**REFRIGERATION-AIR CONDITIONING**  
**COMMERCIAL ELECTRICITY**  
**RADIO-TELEVISION MECHANICS**

Your future success depends largely on the reputation of the school you attend. Don't take chances! Train at America's foremost school of mechanical specialization. Bailey is recognized and approved by industry. Bailey graduates get the top pay jobs! G.I. Approved. Send for FREE Catalog.

**BAILEY TECHNICAL SCHOOLS**  
 1655 So. Grand Blvd., St. Louis, Mo.

## New Easy Way TO MAKE BIG MONEY!

AT HOME

FULL OR SPARE TIME



Permanently METALLIZED BABY SHOES

Costs You Only 5¢-You Get \$6.00

Now is the time to cash in on this big-paying, easy-to-operate year 'round business, and you need no experience! With actual illustrations and step by step instructions, YOU can start earning money in only one week—up to \$1000 per month full time, or \$50 to \$75 per week spare time . . . at \$5.00 per hour. Working only a few hours you can make more money than most people make working an entire week.

### LARGEST NUMBER OF SUCCESSFUL BUSINESSMEN

Our course has the largest number of successful businessmen in this field today! They are all men and women who acted and are making money. This course is guaranteed—your money will be fully refunded if you are not more than satisfied. There is nothing to lose, so act at once.

- Money Back Guarantee
- Most Successful Name in Metallizing
- Big Income
- Huge Demand
- Sales Plans
- Future Security
- Your Own Boss

### IMMEDIATE RESULTS

This tested and proven method shows you complete details, so that you may start at once, metallizing Baby Shoes, with real GOLD, SILVER or BRONZE. They will last forever, retaining every priceless detail of the natural shoes; something for which there are 5 million new customers waiting to buy every year.

### BEGIN AT HOME

Don't pass up this real opportunity to start your own business on a shoestring right at home. ACT NOW! We will send you all the details absolutely free.



**FREE!**

Two actual metallized Baby Shoes guaranteed to be the most attractive on the market—or a pair of your own Baby Shoes metallized if you prefer.

Name \_\_\_\_\_  
 Address \_\_\_\_\_  
 City \_\_\_\_\_ State \_\_\_\_\_

USE THIS COUPON  
**SEND NO MONEY**

**KIKTAVI**  
 Company Dept. P-5  
 2111 W. Manchester  
 Los Angeles 44, California

Rush me FREE full particulars at once.

## AUTO RIFLE MECHANISMS SMALL ARMS DESIGN

You'll find them both in **Book of the GARAND**

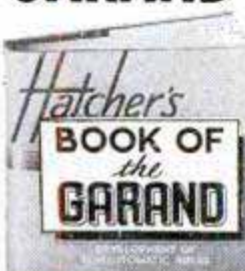

• Gen. Julian Hatcher, world's top expert on small arms design, covers the whole development of the Garand (M-1) rifle, from the first primer-actuated model of the 20's to the sniper's model of World War II. Photos and diagrams make the operation of the Garand crystal-clear—special notes and added diagrams cover every other well-known automatic rifle, including the once top-secret Pedersen. \$6.00

Recommended by THE AMERICAN RIFLEMAN

Order Direct from  
**THE SPORTSMAN'S PRESS**  
 Dept. P-1, 1115 Seventeenth St., N. W.  
 Washington 6, D. C.

## Be a PIANO STYLIST the Professional Way—at Home!

Piano Playing is Fun — It's Easy, Too  
**COMPLETE TRAINING — POPULAR MUSIC!**

Beginners, Medium, Advanced—it makes no difference—anyone can learn to play JAZZ—SWING—BOOGIE. It's different from them all . . . this complete, easy to follow instruction. Valuable material in the big, new, 150 page CAVANAUGH BOOK! Piano secrets revealed. You actually learn HOW to add notes, chords, basses, breaks, fillers, tricks, hot licks to popular songs. Hundreds have been thrilled and have learned to play with this successful method. Not Ear or Correspondence. It's all in one big book which took 10 years to compile. Decide NOW to play modern music.

Get all the facts—FREE! Send postcard for FREE folder giving full details about this new Piano Book. See how you can learn Piano the easy way! Amaze your friends with your Piano Styles. Don't wait—Write today!

### CAVANAUGH PIANO SCHOOLS

Dept. P 475 Fifth Ave. New York 17, N. Y.

### FIBRE ARMS AND LEGS!

Light, correctly fitted, strong and comfortable. Natural appearance. Braces for all deformities. Scientific design. Fair Terms. BUCHSTEIN-MEDCALF 223 S. 6th St., Minneapolis, Minn.

Say You Saw It in Popular Mechanics

## Make Money With MAGIC—



### PARLOR or STAGE TRICKS—I'll Show You How!

• WORLD'S FINEST MAGIC •

SPECIAL! . . . Most Perfect Playing Card Trick Deck; using standard deck of cards . . . No sleight of hand, long practicing, or awkward moves. Do tricks like the professionals . . . Name any chosen card AMUSE instantly. And many other tricks (no YOUR marked cards) . . . Cards can be thoroughly shuffled. . . .

Established Over 38 Years CATALOG ONLY 35¢  
 ONLY \$1.00 Postpaid

CHICAGO MAGIC CO., Dept. P-11, 2300 No. Mason Av., CHICAGO 39

# ETCH Electrically

## in Wood, Leather. Wonder Craft!

Use on  
**RACKS**  
**PLAQUES**  
**FRAMES**  
**TOYS**  
**FURNITURE**

**BELTS**  
**BAGS**  
**WALLETS**

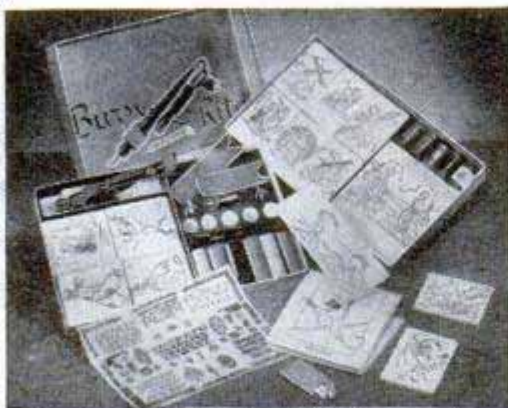

Do it with Wonder Pen. Etches beautiful figures, faces, designs. Use all tones from delicate browns to near-black. Work wonders on wooden knick-knacks, tie-racks, wall plaques, letter racks, what-nots, outdoor furniture. Produce handsome leather belts, handbags, wallets . . . other Craft Beauties.

**MAKE MONEY.** Get this complete outfit. Develop your skill rapidly, easily. Turn out Hand Craft merchandise . . . popular, profitable.

**ELECTRIC WONDER PEN.** Just plug in AC or DC. Comfort-cool finger grip, scientific balance, multi-purpose Etching Tip and Faces, of special heat resistant brass. Compact heat unit. Cord and plug. Underwriters approved. Guaranteed.

**OTHER MATERIALS, TOO!** 7 Patterns printed on 7 bass plywood Plaques. Rack pieces. Sandpaper. Paints. Brush. All you need to start out immediately in fascinating, profitable Craft for the Gift trade. Write now. Complete outfit, in individual Gift Box shipped fully postpaid, only \$3.

**RAPAPORT BROS.** 1826 S. Washtenaw Ave. Dept. PM, Chicago 8, Ill.

## MACHINE SHOP MEN

*Needed Now!*

Learn to set up and run ANY kind of machine: **MAKE MORE MONEY NOW** by learning quickly **HOW TO DO THINGS** which usually take years of study and practice. The demand for **SKILLED** men offers excellent opportunities for men with "know how."

**Bigger Pay** Don't miss this chance to qualify for promotion, don't miss this Big Opportunity which is yours almost for the asking. Eight Big Books, 14th Edition, chockful of important mechanical facts told simply and clearly. Over 3000 pages, nearly 3000 illustrations cover every subject fully, including Tool Making, Pattern Making, Foundry Work, Mechanical Drawing, Forging, Machine Shop Practice and Management, and hundreds of other subjects. A big help to G. I. trainees and other ambitious men.

### 8 BIG BOOKS ON APPROVAL

With them we send a **Big Binder** of nearly 900 pages with 293 shop tickets and over 1300 illustrations. These show, step by step, how to set up and run almost any kind of job and are in addition to the 8 books. Note their great **MONEY MAKING** value, then, if you want to keep them, pay on the easiest kind of payments. A year's consulting privileges with our engineers now given with these books without extra charge.

**AMERICAN TECHNICAL SOCIETY, PUBLISHERS SINCE 1898**

American Technical Society, Dept. 5819, Drexel at 58th St., Chicago 37  
 You may send me the 8 big books and binder of shop tickets on approval. I will pay the delivery charges only, unless I decide to keep them in which case I will send \$2.00 in ten days and \$3.00 per month until the total price of only \$34.80 is paid. If I return them in 10 days I will owe you nothing. You also agree to send me a certificate entitling me to consulting privileges with your experts for one year without extra charge.

Name \_\_\_\_\_

Address \_\_\_\_\_

Please attach a letter stating age, occupation, employer's name and address and name and address of at least one business man as reference. Men in service, also please give home address.

ASSEMBLE

*King Midget*



45 MILES AN HOUR

90 MILES A GALLON

New, low cost transportation. Practical. Safe. A pleasure to drive. Home assembly keeps cost low. Just bolt together our factory built units. Immediate delivery. Send 25c for detailed circular with large picture, 4-view drawings, price of all parts. Or send for actual Assembly Book with 42 photographs, blueprints, drawings, sketches AND above literature — all for \$1 (refunded first order).

**MIDGET MOTORS MFG. CO.** Athens, Ohio

## FIND UNDERGROUND MINERALS and METALS with M-SCOPE

New sensational lightweight models, unsurpassed efficiency  
 Low prices. Time-payment plan. Write for free 16 page booklet.

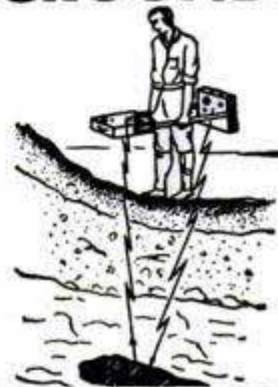

**FISHER RESEARCH LABORATORY, INC.**  
 PALO ALTO CALIFORNIA

## CARBURETOR TOO RICH • MAKES MOTORIST TOO POOR



Car owners who are wasting money and not getting proper gas mileage due to over-rich mixtures will be pleased to learn how to save gasoline by **VACU-MATING** over-rich mixtures. **VACU-MATIC** fits all cars, trucks and tractors. It is automatic and operates on the supercharge principle. Easily installed in a few minutes.

**SALESMEN WANTED! Big Profits!** Send name, address on penny postcard for free particulars and how to get yours for introducing.

**VACU-MATIC CO., 7617-1407 W. State St., WAUWATOSA, WIS.**

## AGENTS 300% Profit SIGN LETTERS

For Store Fronts and Office Windows. Anyone can put them on. Free Samples. Liberal Offer to General Agents.  
**METALLIC LETTER CO., 430 N. Clark, Chicago 10**

## BOMBER JACKET \$14.95



**ALPACA-LINED — WIND-PROOFED**

**\$14.95 = B-15**

This is the genuine **ARMY AIR FORCE B-15** jacket—not an imitation. **BRAND NEW!** Has fine lustrous genuine mouton collar and storm tab. 2 outside snap-fastened pockets. Full zipper front with wind-proof flap. Knit cuffs and bottom. Sizes 36 to 46. Made of sturdy Mountain Cloth (9 oz. Sateen) in O.D. shade. Formerly sold for \$20.00. Now only \$14.95! An ideal Christmas gift. **SEND NO MONEY!** Just name, address, size. Pay postman only \$14.95 plus charges on delivery. Cash orders sent postpaid.

**LEONARDS & LEE SURPLUS SALES**

69-71-73 E. 75th St., Dept. BJ-116, Chicago 19



**\$350** IN A SINGLE WEEK **GROSS**



IN MY OWN BUSINESS

Some Make More, Some Less... Start This Business for **YOUR OWN**

**FREE BOOK! MAIL COUPON**

VON SCHRADER MFG. CO.  
B-81, Racine, Wisconsin

Send at once (no obligation) your FREE booklet containing information about your Electric Upholstery Cleaner and how I can own my own permanent, profitable business.

Name \_\_\_\_\_  
Address \_\_\_\_\_  
City \_\_\_\_\_ Zone \_\_\_\_\_ State \_\_\_\_\_

George Held earned \$350 in one week with

**ELECTRIC UPHOLSTERY CLEANER**

Here's YOUR chance to start a money-making, year-round business of your own and make the success you've dreamed about. R. O. Donnley took in \$40 in seven hours. O. W. Ware landed a \$750 hotel job and made a fine profit. J. S. Corbit grossed \$279.50 his first month. P. D. Ash cleaned 23 auto seats at \$5 each in one week. And so it goes. Homes, hotels, offices, clubs, all places where furniture is used, offer you big profit possibilities. Auto seats and interiors, also.

**NO SHOP OR OFFICE NECESSARY**

You clean furniture on customers' premises. No hauling costs. No high rents. Supplies are in-

expensive and you operate, at low cost, from your home. What you take in is mostly profit. Surely YOU will want to investigate an opportunity like that—right away. Own your own business. Be your own boss. If you are ambitious, honest and courteous, we will help you to start and succeed.

**FULL INFORMATION FREE MAIL COUPON TODAY**

Send the coupon or write for Furniture Cleaner Booklet. It tells all about this electric cleaner—how to start YOUR business—how to make a profitable success. Don't delay. It's your BIG opportunity.



MAIL COUPON TO

**VON SCHRADER MFG. CO., B-81, RACINE, WIS.**

THESE 5 TRADES ASSURE YOU

**HIGH PAY • Future Security**

- **PLUMBING** Every phase of plumbing: Pipe-Cutting and Threading, Lead-Wiping, Rough-in Projects on Installations, Completed Installations of entire plumbing systems, Blueprint reading, Estimating.
- **DRAFTING** College-level courses in General Machine and Architectural Drafting, with fundamentals in Drafting Mathematics—all under graduate engineers.
- **SHOE REPAIRING** From simplest repairs on boots and shoes to the finest details of reconditioning and rebuilding, under expert craftsmen.
- **ELECTRICAL** Technical and shop training include Basic Electricity, Residential Wiring, Industrial Wiring, General Testing and Trouble Shooting, and Appliance Repair.
- **AUTOMOTIVE & TRACTOR** Applied training on latest model automobiles and tractors, including engine overhaul, transmission and differentials, carburetion, generator and ignition systems, engine tune up, Hydramatic and Vacamatic Transmissions, and general service.

Choose One of these 5 Essential Trades

Our complete courses of thorough training prepare you to go right into the field as a Qualified Tradesman at High Pay in only 34 weeks (39 in Shoe Repair). All courses under especially trained instructors with practical experience. 6 Hour Classes 5 Days a Week. Our Employment Department helps you.

**VETERANS** "Approved for veterans' training by the State Department of Education under Public Law 346." "Approved for veterans' training by the Veterans' Administration under Law 16."

Send Coupon for Free Information Now

"There's Always a Demand for the Man who KNOWS!"

**CHOOSE ONE OF THESE 5 LEADING TRADES**

Get Out of that Rut... Be a Skilled Tradesman! Have a Lifetime Career... Own Your Own Business and Be Secure in Your Old Age.

**NOW** while Enrollment is still open, send for FREE information.

THE 5 DIVISIONS OF

**NATIONAL TRADE SCHOOL**

2610 Grand Ave., Kansas City 8, Mo.

- \_\_\_ ● Plumbing
- \_\_\_ ● Shoe Repairing
- \_\_\_ ● Drafting
- \_\_\_ ● Electrical
- \_\_\_ ● Automotive & Tractor

NAME \_\_\_\_\_  
ADDRESS \_\_\_\_\_  
CITY \_\_\_\_\_ STATE \_\_\_\_\_  
VETERAN \_\_\_\_\_ OCCUPATION \_\_\_\_\_

# FREE "SCREEN TEST"

shows amazing improvement in your pictures!



Project your pictures on Free Sample of Radiant's new "Million Mirror" screen fabric—and see for yourself the remarkable difference it makes!

See how millions of tiny glass mirrors, firmly imbedded in the pure white screen surface, make your pictures fairly glow with life! See what happens when light is reflected instead of absorbed! You will enjoy clearer, sharper black and whites—richer, brighter, more brilliant colors. Here is projection as real as life itself! The new 1949 Radiant Screens have many unusual and exclusive features. See them at your dealer today!

Write today and get absolutely FREE a sample of the new Radiant "Million Mirror" Screen Fabric ALSO a copy of the Basic Film Source Directory your guide to film sources.

**RADIANT MANUFACTURING CORP.**  
1257 South Talman Avenue Chicago 8, Illinois

## GRAND FOR CHRISTMAS GIVING

Order This Educational, Entertaining WORLD DIE CASTER today!



More than a toy! Makes clever, colorful clay figures, plaques, party favors. Play-tested for boys, girls 5 to 12. Provides hours of entertainment. Develops creative ability. Set includes die caster, dies, 4 extrusion dies, clay, water colors, modeling tool, instruction book. Circus box package. Only \$4.95 postpaid. Send check or M.O.

TAYLOR SALES, INC., 1213 S. Akard St., Dallas, Texas

WOULD YOU LIKE TO MAKE ... \$100 a week ... in your own

### ELECTROPLATING BUSINESS

FULL OR SPARE TIME

Write NOW for FREE illustrated booklet that will start you on the road to financial independence!

**JOSEPH B. KUSHNER**

Metal Finishing Engineer Stroudsburg 12, Penna.



## FIN-DER SAX-SLING

NEVER SLIP OR KINK  
HIGH SPEED ADJUSTING  
BALLBEARING

AT ALL GOOD DEALERS OR ORDER DIRECT

FIN-DER 1251 - 4th Avenue, San Diego 1, Calif.

NEW!

## LOCKSMITHING & Key Making



PRACTICAL UP-TO-DATE COURSE—ONLY \$3.95

Easy-to-learn modern information for self-instruction. How to work on locks, de-code, make master-keys, repair, install, service, etc. For every handyman, home owner, carpenter, mechanic, service station operator, fix-it shop, hardware dealer, gunsmith. 53 plain illustrated lessons. FULL PRICE ONLY \$3.95. SEND NO MONEY. Just pay postman plus C.O.D. postage. Or send \$3.95 with order, we'll ship postpaid. Satisfaction guaranteed or refund. NELSON-HALL CO., 1139 S. Wabash Ave., Dept. L-02, Chicago 5, Ill.

## PATENTS "Proof of Invention"

Folder mailed without obligation.

**E. E. VROOMAN, Registered Patent Atty.**  
871 Woodward Building, Washington 5, D.C.

## STRENGTHEN Your VOICE!

YES—you can now build yourself a powerful speaking and singing voice with this amazing new scientifically sound tested method. Self-training . . . no music or piano required. Results GUARANTEED. Just send your name for the sensational details. FREE chart of your vocal mechanism included! PERFECT VOICE STUDIOS, Studio L-10, Kimball Hall Building, Chicago 4, Ill

# Amazing "MAGIC LETTERS" Make 1000 Display Signs from Single Kit!

**NO "HOUSE TO HOUSE" FREE!** Business men buy on sight. Don't send a penny for Actual Sample of "MAGIC LETTER" you can use to demonstrate. Kit contains everything needed to make beautiful, eye-catching ADVERTISING DISPLAY SIGNS. Saves hundreds of dollars for owners of Stores, Restaurants, Taverns, Bars, Grills, etc. Sells on sight. Big profits in every territory—small towns or big city . . . Nothing else like "MAGIC LETTERS". Stick to glass, porcelain, plastic, or any smooth surface without glue, gum, paste or cement, yet peel off quick as a wink! Can be used over and over again! Be first in your territory to show amazing "MAGIC LETTERS". Rush coupon today for facts, and actual sample of mystifying "MAGIC LETTERS" absolutely FREE.

**MAXILUME CO., 125 W. Hubbard St., Dept. 811, Chicago 10, Ill.**

**SAMPLE LETTER FREE! SEND NAME!**

**LETTERS STICK WITHOUT CEMENT, GLUE, PASTE, OR GUM!**

**MAXILUME CO.**  
125 W. Hubbard, Dept. 811  
Chicago 10, Ill.

Rush actual sample of mysterious "MAGIC KIT" Letters absolutely FREE and complete selling outfit so I can take orders for the MAGIC KITS at once. No cost to me.

NAME \_\_\_\_\_  
ADDRESS \_\_\_\_\_  
CITY \_\_\_\_\_ Zone \_\_\_\_\_ STATE \_\_\_\_\_





# Here are Real **WAR SURPLUS BARGAINS!**



## Electro-Lift HOIST



500 lb. Electro-Lift Hoist, 17 ft. of cable—up and down button and trolley. 3 phase, 220 or 440 volt, 60 cycle. Used, in A-1 shape. List price \$185.00. **OUR PRICE..... \$75.00**

Stock #301 Specify 220 or 440 volt

## U. S. Surplus HORNS and HOWLERS



Motor driven (not a vibrator). Heavy duty with great power and long life. Adjustable for high, medium or low tone, 110 volt AC current. Weather proof. For alarm or signal horn on boats, school yards, factories, etc. List price \$47.00. **OUR PRICE..... \$9.45**

new..... \$1.00

5 ft. of cord & switch for horn..... \$1.00

## POWER WINCH

Ideal for  
Contractors  
Farmers  
Elevators  
Movers  
RR Car  
Movers  
Well  
Drillers  
Mines, etc.

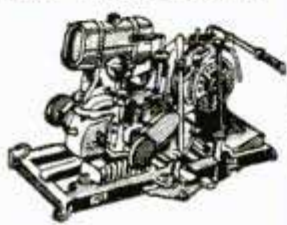

Stock #303

New two cyl. gasoline driven hoists, powered by 11 HP, two cyl. Waukesha air cooled gas engine. Gear shift, 2 speed with twin disc clutch, throttle and hydraulic brake. Capacity on single line approx. 4,000 lbs. Dimensions: 36" wide, 60" long, 36" high. Mfg. Benson Winch Co. Comes with complete repair kit tools and box. Can also be used as a hand winch. In original crate.....only **\$325.00**



## PORTABLE AIR COMPRESSOR

Hand truck job with Quincy 1 cyl. compressor, 4 gal. tank, automatic pressure switch, pop-off drain, stop cock, 25 ft. hose, blow gun, "V" drive, air gauge, 25 ft. cord, 10" ball bearing puncture proof Goodrich Silver-town tires, 75 lb. pressure, 1/2 HP **\$125.00** electric motor. NEW only.....

Stock #304

## SEPARATE PARTS FOR ABOVE COMPRESSOR

- Piston type air compressor: size 2 x 1 3/4, head in valves, bronze bearings, splash lubrication, "V" belt drive. Capacity 2.8 c.f.m. at 75 lbs. continuous pressure or 100 lbs. intermittent with 1/2 HP motor. Can be used with 1/4 or 1/3 HP. **\$17.50**
- 1/4" Reducing valve & gauge: oil resistant, pressure 0 to 150 lbs. .... **\$5.50**
- Pop-off Valves.....ea. **\$1.40**
- Check Valves: prevent leakage .....1/4 in. **\$2.35**
- 1/2 in. **\$4.00**
- Pressure Switch (without unloader) 80 to 110 lbs. from 1/4 to 2 HP..... **\$6.50**
- Pressure Switch (automatic with unloader) 125 to 150 lbs. Can be used in 1/2 to 5 HP unit..... **\$8.50**
- Motor—1/2 HP. Capacitor type, 110 volt AC, 60 cycle..... **\$26.00**
- Tank—4 gal. capacity..... **\$4.95**
- Mounting base with handle..... **\$3.00**
- Truck: 2 wheel hand truck with 10" ball bearing rubber wheels..... **\$12.80**



## BALL BEARING ARBOR

Grinding and saw arbor. Has 1 1/2" double end shaft, 10" long with 2" center pulley. New Departure double roll precision aircraft ball bearings. Right and left hand thread. Self-aligning Dodge pillow block, 10,000 RPM. Bearings alone list at \$10.00. Complete arbor NEW only..... **\$4.95**

Stock #305  
DELUXE version of above arbor—has 2 and 3 inch center step pulley and 2 1/2 in. heavy cast aluminum pillow block **\$6.95**

Stock #306

## Briggs-Stratton GAS ENGINES

Save \$25

Rope start, 1750 RPM. All brand new and guaranteed. 2 1/2 HP model AP... list price \$102.10. **OUR PRICE..... \$77.00**

Stock #307  
3 1/2 HP model BP... list price \$86.00 **\$111.50. OUR PRICE.....**

Stock #308  
5 to 7 HP model ZEP... list **\$102.00** price \$137.00. **OUR PRICE.....**

Stock #309



## Electric Rubber Cable (ALL NEW) CORD SETS

Extension cords, 100 ft. heavy duty. Plug, socket and guard. Number 16 wire. Worth at least \$10. **\$5.35**

OUR PRICE.....

(Stock #310)  
Same as above—50 ft. length. (Stock #311)..... **\$3.85**

HEAVY DUTY ELECTRIC CABLE  
3 wire #10 submarine cable and lugs—can be placed underwater, underground or overhead. Also for portable tools. Will carry 40 amps. Stock #312

50 ft.	100 ft.	250 ft.	500 ft.
\$12.00	\$20.00	\$45.00	\$85.00

## RUBBER CABLE

150 ft. reels, 3 wire #6 with 4, 60 amp Crouse & Hines connectors—2 male & 2 female. Perfect for welders, hay loaders, saws, electric ranges, etc. List price **\$65.00** \$190. per reel. **OUR PRICE.....**

(Stock #313)



## All Bronze GEAR PUMP

All bronze corrosion resistant gear pump. Will lift water 25 ft. Will deliver 100 gal. per hour at 1200 RPM. Develops 110 lbs. pressure or 250 ft. head. Self-locking packing nuts, drain cock, reversible head. Will pump brine, salt water, oil, vinegar, gasoline, etc. Dimensions: 10" L x 7" H x 5 1/2" W. Base holes 1 3/4" x 3". Shaft 1 1/16", 1" x 1" inlet & outlet. Wt. 24 lbs. Mfg. by Sherwood Brass Works. Requires 1/2 to 3/4 HP motor. \$80. value for only **\$24.95** new (Stock #314)

## ALL ITEMS GUARANTEED AS REPRESENTED

Order at once!—Surplus merchandise is subject to prior sale.

All prices F.O.B. Milwaukee, 25% deposit required on all C.O.D. orders. No C.O.D.'s under \$10.00. Use stock number when ordering. Many other bargain items not listed—write for our free circulars.

**C & H ELECTRIC COMPANY**  
CLARK & HENKE, Owners  
Dept. M-11, 436 W. Juneau Ave.  
Milwaukee 3, Wisconsin

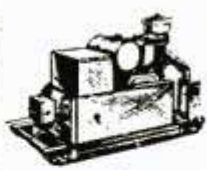

## AC ARMY LIGHT PLANTS

New 750 watt 110 volt 60 cy. light plant with Briggs-Stratton model AP gas engine. (Stock #315)..... **\$135.00**

New 1000 watt 110 volt 60 cy. light plant with Briggs-Stratton model BP gas engine. (Stock #316)..... **\$165.00**

New 2500 watt 110 volt 60 cy. light plant Briggs-Stratton model Z 6 HP gas engine. (Stock #317) **\$245.00**

Rebuilt 5000 watt 110 volt 60 cy. light plant with automatic remote control. Powered by Jeep 4 cyl gas engine. Rebuilt like new and guaranteed. (Stock #318)..... **\$625.00**

10,000 watt 110 and 220 volt 60 cy. light plant with automatic remote control. Powered by Jeep 4 cyl. gas engine. Rebuilt like new and guaranteed. (Stock #319)..... **\$725.00**

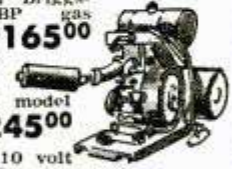

## PORTABLE

## DC LIGHT PLANT

3000 watt 110 volt DC powered by new 6 HP Briggs-Stratton model ZEP gas engine. Rebuilt generator. Generator alone lists at \$243.00. Has volt meter, rheostat, 4 female plugs, and ball bearing 2.75 x 10 rubber wheels. Guaranteed. **\$165.00** (Stock #320).....only

## GENERATORS

DC—3000 watt, 110 volt. Has voltmeter, rheostat & 4 female plugs. Lists at \$243.00. (Stock #321). **OUR PRICE \$60.00**

AC—750 watt 110 volt 60 cycle with voltmeter, rheostat, 3/4" shaft. Dimensions: 9"H x 12"W x 13"L. Wt. 52 lbs. Shielded to prevent radio interference. Mfg. by Eicor. \$125.00 value. **\$49.50** OUR PRICE, new



(Stock #322)

DC—300 watt, 12 volt, 2900 RPM. Heavy duty, with current cut-out relay, high and low switch, 30 amp meter, charge and discharge, Mfg. for the Army by the Marathon Elect. Co. Can be used for boats, trucks, tractors, light plant, wind mills, cabins. 3/4 HP gas or 1/2 HP electric motor will drive it. Sleeve bearings. Dimensions: 11 1/2" L x 10 1/2" W x 7" H. Base holes 4 3/4" long, 6" wide. Can be bought less shaft and base to be used direct mounted to Briggs-Stratton 1 HP engine. (Stock #323) **\$70** new

Complete with base, shaft and bearing. (Stock #324)..... **\$15.95** new

## JARVIS GRINDERS



2 HP, 60 cycle, 220-440 volt. 3450 RPM. Totally enclosed G.E. motor with shaft. List price \$250. Used— **\$75.00** like new. (Stock #326).....

## ROTARY PUMP

Heavy duty, designed to pump water, oil, gasoline, etc. Will pump 35 gal. per min. Also used as vacuum pump. 3/4" outlet and inlet on bottom. Dimensions: 7 1/2" W x 5" D x 7" H. Compact and sturdy. Four mounting holes in base. Can be used with 1/4, 1/3, or 1/2 HP motors. Ship. wt. 17 lbs. (Stock #325) only.. **\$16.95** new



**Electricians! Maintenance Men!**

**I Want You To Use  
COYNE'S Big NEW Electrical  
TROUBLE-SHOOTING  
MANUAL For 7 Days  
FREE!**



**SPECIAL INTRODUCTORY OFFER**

Here's a SPECIAL "try it yourself" offer on America's newest and most complete Electrical Trouble Shooting Manual. The ONLY BOOK OF ITS KIND—Just Off The Press. It has over 600 large, 8 1/2 x 11 inch, wiring diagrams. Easy, short-cut, tested methods show you how to locate troubles on motors, appliances, and all types of electrical apparatus and circuits. A book every electrical worker can use.

**ACT NOW—SEND NO MONEY**

Fill in and mail coupon below. SEND NO MONEY. Brand new COYNE ELECTRICAL TROUBLE SHOOTING MANUAL will be rushed to you postage paid. Try it out any way you want to. If it isn't the most practical electrical book you've ever used on the job, send it back in 7 days and you owe nothing. If you keep Manual send either \$6.95 cash, or \$3 after 7 days and \$3 per month until \$7.50 is paid. This "try it" offer is limited so ACT NOW—Send Coupon today.

THIS BIG BOOK HAS 660 pages on Motors, Plant and Home Wiring; Lighting, Refrigeration, Industrial Electronics, etc. — COMPLETE—NEW—AUTHENTIC

**FREE TRIAL COUPON — Mail Now!**

B. W. Cooke, President  
COYNE ELECTRICAL & RADIO SCHOOL, Dept. 88-R6,  
500 S. Paulina St., Chicago 12, Illinois  
YES! Rush the NEW COYNE ELECTRICAL TROUBLE SHOOTING MANUAL Postage paid as per your free "try it" offer.

NAME \_\_\_\_\_ AGE \_\_\_\_\_  
ADDRESS \_\_\_\_\_  
TOWN \_\_\_\_\_ ZONE \_\_\_\_\_ STATE \_\_\_\_\_

WHERE EMPLOYED \_\_\_\_\_  
 Check here if you want Manual sent COD. You pay postman \$6.95 when delivered. YOUR MONEY BACK IF NOT 100% SATISFIED.

**SHEEPSKIN LEATHER JACKET**

NAVY J4 FLYING TYPE—SIZES 36-46—CONVERTED  
Now you can get a WELL TAILORED, LONGER LASTING, WARM jacket at absolute minimum cost because you are buying direct from the Manufacturer. Check These Special Features: Length 27", Monton Collar, By-swing Sleeve, Full Cut, Heavy-duty Talon Zipper, Double Lined Leather Cuffs and Wristlets, Extra Leather Reinforcement on Top Sleeve, Leather Windbreaker.  
Take advantage of this amazing value now! Complete Money Back Guarantee if not satisfied. **\$18.95**  
Renovate Your Jacket  
Lengthen the life of your leather jackets at manufacturer's wholesale rates. Send for FREE descriptive circular and price list today.  
Prepaid orders shipped postage free. C.O.D. orders — you pay postage.  
**Berlew Mfg. Co., Inc.**  
Dept. M  
Merrick, New York

**LEARN CODE**  
TWO DOTS MAKE LETTER "i"  
EASY PICTURE WAY  
MEMORY METHOD. COMPLETE ALPHABET & LESSONS SEND ONE DOLLAR — OTTO LUTHER, NEW PRESTON, CONN.

**SAY YOU SAW IT IN POPULAR MECHANICS**



Learn .....  
**WATCH REPAIRING**

**TRAINED WATCH MAKERS ALWAYS IN DEMAND**  
The need for trained Watch Makers everywhere is increasing daily with increased watch production. Watch Repairing is a big pay profession—steady the year around. No dull seasons. Work for others or start your own shop!

From The LARGEST APPROVED SCHOOL of its kind

just as ambitious men and women are doing right now. As an expert Watchmaker you can enter an uncrowded field with big pay possibilities and an assured future. No previous mechanical experience needed.

**ACTUAL WATCH REPAIRING** is taught you with each Lesson. All necessary tools and watch is furnished for actual, professional watch repairing use. We teach you how to take any watch apart and make all repairs and part replacements. You EARN AS YOU LEARN with actual repair jobs, with a Diploma issued upon completion of our highly practical Course.

**ILLINOIS SCHOOL of WATCH REPAIRING**

2870-DE ELSTON AVE.

**In Your SPARE TIME At Home**

**BIG PAY IN AN UNCROWDED FIELD**

Now—without loss of time from your present work you may learn the fascinating art of WATCH REPAIRING in your spare time right in your home . . .

CHICAGO 18, ILLINOIS



**Free Leathercraft instructions**

All materials for making easy-to-assemble leather goods. Free instructions included. No experience necessary.

**MAKE AS GIFTS—OR TO SELL**



Belts, gloves, purses, wool-skin toys and mittens, 100 other practical, money-making items. Largest complete stock of leather and leathercraft supplies in America. Immediate delivery.

Send 10 cents for new catalog of gift suggestions and profitable ideas. Write today.

**J. C. LARSON COMPANY**

824 S. Tripp Avenue, CHICAGO 24, ILL.

**A GIFT THAT "CLICKS" AT XMAS**  
**ASSEMBLE THIS CLOCK for ONLY \$3.95**  
IT'S EASY — IT'S FUN — IT'S INSTRUCTIVE  
(A small screwdriver is the only tool required.)  
Complete, Ready to Assemble—Accurate—Lasts for Years  
Exquisite Design—Ebony Black Plastic Case  
See what makes a clock "tick." See how smart you are mechanically by timing yourself as you assemble this beautiful, weight driven pendulum clock which you can't buy in finished form in stores for twice the price.  
You save all assembly costs. Makes ideal Xmas gift, remembered always.  
**WILCOX, INC.** Dept. P-11, 971 Goodrich Blvd. Los Angeles 22, Calif.

**WHITE BLANKET \$12.95**  
ALL WOOL — DOUBLE SIZE!  
A real economy buy! All wool, full double bed size, downy soft, springy wool blankets for cozy wintertime sleeping. Guaranteed to keep you toasty warm. Lasts give years of hard wear. Have gleaming, lovely satin bindings. You save when you buy from our large Army and Navy Surplus Sales Stock. A tremendous value! You will want one for every bed in the house. Supply limited. Rush order today—only \$12.95. Come Christmas wrapped if requested. SEND NO MONEY. Just name and address. Pay postman only \$12.95 plus charges on delivery. Cash orders sent postpaid.  
**LEONARDS & LEE SURPLUS SALES**  
69-71-73 E. 75th St. Dept. B-106 Chicago 19.

**WAR SURPLUS**  
Lathes, Milling Machines, Drill Presses, Sawing equipment, Motors and thousands of miscellaneous items. Also information on Helicopters, Sleeper Trailers, Garden Tractors, Power Lawn Mowers, Welders, Jet Impulsion for Cars and Tractors etc. Rush name for free literature.  
**THE WAYNE ENGINEERING CO., DEPT. 101, ELKINS, W. VA.**

**NOW! GET MORE POWER**  
*Out of YOUR CAR!*

Old or New Car... Amazing **NEW Gasoline Injector** Peps Up Motor for Peak Power Demands, Gives You...

- **QUICKER STARTING**
- **FASTER PICK-UP**
- **BETTER MILEAGE**

**Remarr Automatic Gasoline Injector**  
**Works on Low Manifold Vacuum...**

**NO WATER OR CHEMICALS TO ADD... INSTALL AND FORGET**

NOW you can thrill to improved engine performance in your car by installing **REMARR AUTOMATIC GASOLINE INJECTOR**. You can feel the difference the first time you step down on the gas. Old or new car... you get **SNAPPIER GETAWAY**... no "dead spot" or sputter! **MORE POWER** on hills, reduces knock, less shifting! **QUICKER STARTING** in any weather... with practically no choking, no drain on battery! It's amazingly simple and efficient... engineered to *instantly and automatically* inject atomized fuel into the engine when needed! It **SAVES GAS**... delivers 14 to 4 miles more per gallon! Uses no water or special fluids, and is adaptable to **ALL** cars and light trucks. Once installed, requires no further adjustments.

**Dynamometer Tests** have proved up to 19% **MORE H.P.** at 40 M.P.H. (depending on condition of engine).

**DEALER INQUIRIES INVITED!**

**Read What User Says:** "Remarr Automatic Gasoline Injector has given my car faster acceleration, greater power; also gives better fuel economy." **ED. NORMI, Petaluma, Cal.**

- **IMPROVES MOTOR PERFORMANCE**
- **QUICKER STARTING**
- **FASTER PICK-UP**
- **BETTER MILEAGE**
- **LESS CHOKING**
- **LESS CARBON**
- **ELIMINATES MOTOR SPUTTER**
- **LONGER MOTOR LIFE**
- **No More Vapor Lock**

**Adaptable to ALL Cars & Light Trucks**

If your dealer does not have a supply of Remarr Automatic Gasoline Injectors, send \$19.95 with coupon, and give make, model, and year of your car. Kits include all parts and fittings you need to install. Easy instructions furnished. (Average installation costs about . . . \$2.50)



Low intake manifold vacuum automatically opens check valve for injection of needed fuel.

**\$19.95**

**KIT COMPLETE**

Available thru independent and chain auto supply stores, repair shops, garages.

Product & Development Co., St. Louis 1, Mo.

**NIPPLE CONNECTS TO ADAPTOR**  
**BALL CHECK VALVE**  
 In drawing below, Adaptor (A) fits between carburetor and intake manifold. Check Valve (B) must be in horizontal position.

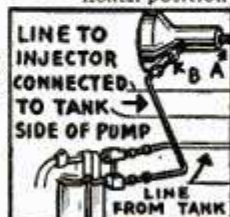

**CLIP THIS COUPON TO ORDER DIRECT!**

Product & Development Co.  
 705 Olive St., St. Louis 1, Mo. PM-1

Send \_\_\_\_\_ Remarr Injector at \$19.95 ppd. I'm enclosing  
 check     M. O.     Send C. O. D. plus postage.

Make \_\_\_\_\_ Model \_\_\_\_\_ Year \_\_\_\_\_

Name \_\_\_\_\_

Street \_\_\_\_\_

City \_\_\_\_\_ State \_\_\_\_\_

**NEW POWERFUL (PENCIL TYPE) MICROSCOPE**

**"An Ideal Christmas Gift"**  
*Fits the Pocket like a Pencil!*

for: **PROFESSIONALS AMATEURS - STUDENTS**

The **EDERSCOPE** offers distinct advantages over many magnifiers because of its adaptability, instantly, for the purpose. No tripod or other support required. Finest adjustment for proper focusing. Precision and polished optical lenses of the finest quality. Excellent in **GEOLOGY, CHEMISTRY, CRYSTALLOGY, ZOOLOGY, ENTOMOLOGY, BIOLOGY, DERMATOLOGY, BOTANY, METALLURGY**, etc. Also for Printing & Engraving, Stamps & Coins, Gem-Polishing, Textiles, Paper Products, Tools & Dies, Inspection and many others. **POSITIVELY HIGHEST QUALITY GUARANTEED!**



**EASILY AND QUICKLY FOCUSED**  
 Common Salt Magnified

**MORE THAN 25 Power Magnification**

**SHARP DEFINITION**

**NO DISTORTION**

**LONG WORKING DISTANCE advantage over magnifiers and loupes.**

**ONLY \$10.00**

**Postage Paid SEND NO MONEY**

Pay postman on delivery only \$10 plus C.O.D. postage, or send \$10 with order and we pay postage. **GENUINE LEATHER CASE FREE.**

Order Yours Today  
 Dealers Invited  
 Streamline Design  
 5 inches long



**EDER INSTRUMENT CO.**

Manufacturers & Developers of Optical Instruments  
 1849 No. Halsted St. CHICAGO 14, ILL.

**PRACTICAL BOOKS for the HOME CRAFTSMAN**

**For Extra Pleasure and Profit From Your Leisure Hours!**

**WOOD FINISHING AND PAINTING MADE EASY.** By **Ralph G. Waring**

Just like an encyclopedia—everything you want to know about the selection and application of suitable finishes to wood and metal. All facts about such subjects as wood stains, fillers, fast-drying finishes, spray-guns. Give your work that professional finish! **\$3.50**

**50 POPULAR WOODWORKING PROJECTS.** By **Joseph J. Lukowitz**

You have been looking for these original new designs. Anyone can make the clever door stops, beautiful wall shelves and plaques, ship model, birdhouses, toboggan, etc., described here in such simple detail. **\$1.50**

**PRACTICAL SIGN PAINTING.** By **Robert E. Owen**

You can make money in sign painting. This is the only book on this important subject, covering every angle for both beginner and professional. Includes Silk Screen work, Brush Lettering, Sign Alphabets, Layout, Color Harmony, Sign backgrounds, etc. **\$3.00**



**MAIL COUPON TODAY**

**THE BRUCE PUBLISHING COMPANY**  
 1311 Montgomery Bldg., Milwaukee 1, Wis.

Gentlemen: Please send me the following books on five days' approval.

Wood Finishing and Painting Made Easy — \$3.50  
 50 Popular Woodworking Projects — \$1.50  
 Practical Sign Painting — \$3.00

I am enclosing \$\_\_\_\_\_ Send C.O.D. and I will also pay postage.

Name \_\_\_\_\_

Address \_\_\_\_\_

City \_\_\_\_\_ Zone \_\_\_\_\_ State \_\_\_\_\_

Save Money  
Enjoy the  
Fun

DO EVERY  
**HOME JOB**  
YOURSELF!

Save Hundreds of Dollars Every Year!

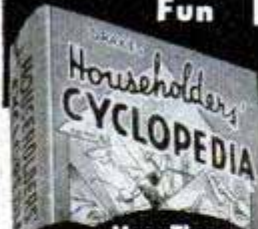

More Than  
**700 Jobs Explained**  
and Illustrated!  
**1000 PICTURES**  
**640 PAGES**

Tells Everything—Shows Every-  
thing—Repairing, Remodeling,  
Modernizing, Carpentry, Paint-  
ing, Decorating, Plumbing,  
Heating, Electric Wiring and  
Appliance Repairs, Furniture  
Repairs, Etc.

Written in plain English. 1000  
pictures make everything sim-  
ple as A.B.C. This book can  
save you hundreds of dollars  
every year.

Get This Amazing Book  
Today. Mail Coupon

This is a real HOW-TO-DO-IT book  
that gives step by step instructions,  
explaining the simplest and least  
costly, effective methods for hun-  
dreds of regular jobs around the  
home which require only ordinary  
materials and simple hand tools.

Use it to improve your home in  
many ways, to make alterations, ex-  
tensions and repairs—use it to repair  
electrical appliances, do electric wir-  
ing, plumbing, etc. Use it to re-  
juvenate and modernize your equip-  
ment and furnishings and to make  
your home the delightful, liveable  
place you have always wanted, with-  
out having to worry about the cost.  
With the Householders Cyclopeda  
to guide you all repairs, alterations  
and improvements can easily be yours.

MAIL COUPON

Get this helpful book now. Turn  
spare hours into the things you  
want and save money besides. Mail  
the coupon below for quick delivery  
right to your home.

FREDERICK J. DRAKE & CO., Dept. 18  
117 Green Bay Road, Wilmette, Ill. (Suburb of Chicago)

Rush Drake's Householders Cyclopeda, price \$3.00. If not  
pleased with this book I will return it in 5 days and you will  
refund my money.

- Remittance enclosed. Send fully prepaid.
- Send C.O.D. I will pay postman plus postage and C.O.D.  
charges.

Name \_\_\_\_\_

Address \_\_\_\_\_

City \_\_\_\_\_

State \_\_\_\_\_

GET INTO **DIESEL-AUTO**  
**MECHANICS** MASTER  
**ALL PHASES**

SHOP METHOD  
**HOME TRAINING**

by an Established Resident School  
prepares you for **Many Good Jobs!**

Get Complete Training

Diesel-Automotive Industry  
needs trained men, to install,  
maintain and repair all types  
Diesel and Automotive en-  
gines — AND allied equip-  
ment. Now, National Schools  
offers you practical, proved  
home study training cover-

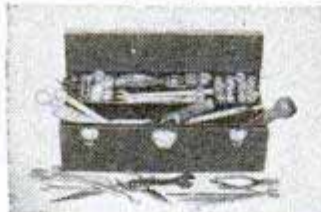

You Receive Tools and Equipment  
as Part of Your Course.

ing **ALL** phases. Basic instruction and  
specialization in field of your choice. All-  
embracing instruction. Valuable, large  
engine manual —  
**TOOLS and EQUIP-**  
**MENT** included.  
Earn while you learn.  
**INVESTIGATE**—get  
full information.

Big Book  
and  
Sample  
Lesson  
FREE

APPROVED  
FOR VETERANS

**NATIONAL SCHOOLS**

LOS ANGELES 37, CALIF. • EST. 1905



FIND OUT NOW... MAIL COUPON TODAY

NATIONAL SCHOOL, Dept. PMD-11  
4000 South Figueroa Street  
Los Angeles 37, California

(Mail in envelope  
or paste on penny  
postcard)

Mail me **FREE** the book, **YOUR FUTURE IN DIESEL**, to-  
gether with the Sample Lesson. I understand I may keep and  
use the information with no obligation.

Name \_\_\_\_\_

Age \_\_\_\_\_

Address \_\_\_\_\_

City \_\_\_\_\_

Zone \_\_\_\_\_

State \_\_\_\_\_

Check here if Veteran of World War II

Take along  
**COMFORT and SAFETY**

For Every Hour in the Open

**MARBLE'S** OUTING  
EQUIPMENT



Marble's Water-  
proof Match Box  
Keeps matches dry,  
even under water.  
Price 75c

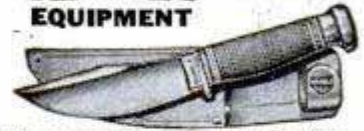

Marble's Woodcraft No. 49.  
Beautiful leather handle. Extra keen  
4½ in. forged steel blade, with sheath.  
Price . . \$3.00



Marble's Expert No. 545  
Hunters' and Trappers' favorite. 5 in.  
blade. With sheath. Price . . . \$3.50



Marble's  
Compasses  
Pin-on, Pocket and  
Wrist models, No.  
082 Pin-on shown  
Price \$2.00



Marble's Ideal No. 45  
All-purpose for field, forest and camp.  
Extra sturdy. With sheath, 5 in. blade,  
\$3.50; 6 in. blade, \$4.00.

Ask your Dealer, or write for Catalog (SEE)  
**Marble Arms & Mfg. Co.** 578 Delta Ave.  
Gladstone, Mich., U.S.A.

SAY YOU SAW IT IN POPULAR MECHANICS

**Bar Bells**  
Buy Direct From Factory **\$8.95**  
up  
Write for free booklet  
and price list  
INDEPENDENT IRON WORKS  
2416 East 23rd Street, Dept. B  
Los Angeles 11, Calif.

**PRICES SLASHED! ALUMINUM PIPES**  
\$4.50 pipe for \$1.00. Im-  
ported briar bowl, hard  
rubber stem, air cooled  
aluminum shank, straight  
or curved. No filters required.  
A perfect Xmas gift. Send check  
or money order, we pay postage.  
C.O.D. orders filled on request. Write  
for **FREE** catalog of pipes and cigars.  
Satisfaction Guaranteed or Your  
Money Back

**Eddie THE CIGAR MAN**  
Dept. M-7, 1096 Bedford Ave., Brooklyn 5, N. Y.

**NOW YOU TOO CAN BUILD  
15 RADIOS** COMPLETE KIT \$14.75

Absolutely No Knowledge  
of Radio Necessary  
You Need **NO** Additional Parts

The **PROGRESSIVE RADIO KIT**  
is THE ONLY COMPLETE KIT. Con-  
tains everything you need. Instruction  
Book, Metal Chassis, Tubes, Condens-  
ers, Resistors and all Radio parts.  
The 36-Page Book written by Expert Radio  
Instructors teaches you to build radios in a Professional Manner.  
You start with a 1-tube receiver. Before you are done with this  
kit, you will have built 11 Receivers, 1 Public Address System  
and 3 Transmitters.

**SPECIAL FREE OFFER!**  
Electrical and Radio Tester sent absolutely **FREE** with each Pro-  
gressive Radio Kit. **PLUS FREE** membership in Progressive Radio  
Club. Entitles you to free expert advice and consultation service  
with licensed radio technicians.  
Write for further information, or **ORDER** your KIT **\$14.75**  
**NOW! ONLY** . . . . .  
Postage prepaid with check or money order  
(Postage not prepaid with C.O.D. orders)

**PROGRESSIVE ELECTRONICS CO., Dept. PM-16**  
497 Union Avenue Brooklyn 11, N. Y.

# Build your own Novelty Lamps, Stand's - etc.

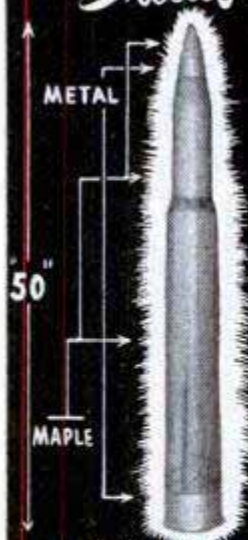

All kinds of ways to make clever household furniture from these dummy five-inch, hollow center, shells assembled in five parts. Number 1 natural maple, will take a high polish, lending itself to hundreds of home workshop ideas. Wt. 28 lbs. \$7.50 each F. O. B. Reno. Write

## Hill Equipment Co.

Post Office Box 643, Reno, Nevada.

### SAVE with WAR SURPLUS SHOE PACS



**388**  
pair

- 12" Waterproof Cowhide Uppers!
- Thick Rubber Soles
- Weathered
- Perfect Condition

• Gov't. Cost \$10  
SIZES 8-9-10-11-12

MAIL CHECK  
MONEY  
ORDERS OR  
C.O.D.'S TO

#### MONEY-BACK GUARANTEE!

#### WORLD WAR SURPLUS STORES

841 S. BLUE ISLAND AVE., Dept. P.M.  
CHICAGO 7, ILL.

Add 25c per item for Postage and Handling.  
Illinois Residents add 2% Tax. Send for Free Catalog

### CUBIC-INCHER RADIO SET \$2.39

SIGNAL-POWERED  
NO ELECTRICITY



Entire set less than one cubic inch in size, rests in bowl of teaspoon! Radar 1N34 detector, world's best for crystal sets. Works anywhere—never wears out—costs nothing to operate. Safe and foolproof. Reception is guaranteed. With connecting leads and complete directions. \$2.39 postpaid without phone. \$3.19 postpaid with phone. Foreign orders 10% extra, prepaid only.

CARING PRODUCTS Dept. M-6, Box 1308  
Chicago 90, Ill.

### BUILD YOUR OWN BOAT—ONLY \$35

#### NEW Guaranteed, Complete KIT

Includes all PRE-CUT marine wood parts, screws, glue, hardware, building jig. Easy to build in few spare hours. Aircraft shell design gives amazingly tough, 65 lb. boat for hunters, fishermen, yachtsmen, boys 8 to 80.

FREE DETAILS. Write Dept. P.M.

**PRITCHARDSONS'** 2744 W. 37TH PL.  
CHICAGO 32, ILL.

### WINDMILL--RAINBOW--FLASHER

SPINNING AUTO LIGHT



Spins with the wind. The most beautiful light in the world. Red, White and Blue. Everybody wants one. Easily put on auto, Bicycle, Airplane or Boat. Pay Mailman \$2 plus postage or send \$2 and we pay postage. Be First.

Agents Wanted.

SPIN LIGHT CO.

373 1/2 BELMONT AVE. PATERSON, N. J.

## New SUN RAY Aristocrat ENLARGER

GIVES YOU  
TOP FLIGHT  
ENLARGEMENTS

ONLY  
**\$14.95**  
COMPLETE

MADE & GUARANTEED BY  
ONE OF AMERICA'S LARG-  
EST AND OLDEST M'F'G'S OF  
QUALITY ENLARGERS

Here's the greatest opportunity ever for beginners in photography to get exciting new thrills out of making fine, beautiful enlargements . . . AND AT LOW COST. Whether you want to make a career or gain in skill and knowledge, the ARISTOCRAT 2 1/4 x 3 1/4 enlarger will give you smart, crisp, snappy professional looking enlargements. The ARISTOCRAT not only fits into your budget but fits equally well into small space and can be used effectively in a closet or small room, where space is an important factor. Hollywood prints are within your grasp . . . as you become familiar with this new enlarger sensation. The moment you start using it you will see how easy and simple it is to make fine large prints of your negatives. Simple "how-to-do" instruction book accompanies each enlarger. The ARISTOCRAT will give splendid performance and at a low cost.



AN  
UNUSUAL  
GIFT  
ITEM



TUCK-A-WAY  
CARRYING  
CARTON  
INCLUDED

#### START NOW TO MAKE GOOD ENLARGEMENTS

See it. Try it.  
You will be  
amazed at its  
remarkable re-  
sults . . . all

for only  
**\$14.95**

Complete  
Send your  
order NOW

The ARISTOCRAT is compact, portable, rugged . . . yet it has all of the features necessary for making fine enlargements. It accommodates all negatives from 35 mm up to 2 1/2 x 3 1/2. It contains bulb, diffusing glass and is wired for use on AC or DC. The lens is fitted into a precision focusing mount from which pin-point accuracy and sharpness is assured. Supplied with a durable, heavy, double fibre negative holder . . . easily accessible "in or out" of the enlarger's special "Open Jaw" arrangement. Its telescoping upright shaft fitted into a metal baseboard is collapsible so that the entire unit can be stored away in small space.

PHOTO HOBBY INC., 489 FIFTH AVE., DEPT. P.M., NEW YORK 17, N.Y.

Gentlemen: — Please send at once the ARISTOCRAT enlarger so that I can get started on my career as a photographer. I am enclosing check  money order  for \$14.95 Postpaid. (See note below).

Name \_\_\_\_\_

Address \_\_\_\_\_

City \_\_\_\_\_

State \_\_\_\_\_

NOTE: Should you want the ARISTOCRAT sent C.O.D. plus postage please indicate same by checking here .

# YOU CAN MAKE THESE WITH POPULAR MECHANICS PLANS AND BLUEPRINTS

- 501—Colonial Grandfather's Clock. 25c
- 507-508—Doll-House, 5-Rooms, Open staircase, fireplace. . . . . 50c
- 526—Queen Anne Coffee Table: True replica of antique. . . . . 25c
- 528—Duncan Phyfe Console Table: 30 in. high. . . . . 25c
- 529—Lawn Chair: Southern style. . . . . 75c
- 593—Three Attractive Corner Shelves: Scroll-sawed. . . . . 25c
- 596—Three Hanging Type Shelves: Hold books, china, etc. . . . . 25c
- 661—Rocking Horse: Scroll-sawed from plywood. . . . . 25c
- 707—12 Ft. Rowboat: Flat-bottom, four seats. . . . . 25c
- 795—Two Handsome Cedar Chests. 25c
- 811-812—16 Ft. Canoe: Canadian type, cedar planking. . . . . 50c
- 813-814—Pops Outboard Racers: 10 ft. long, stepped bottom. . . . . 50c
- 828-835—Sovereign of the Seas: English warship model. . . . . \$2.00
- Sovereign of the Seas: Instruction Book. . . . . \$1.00
- 836—12 in. Bandsaw: Uses plywood, cuts two in. stock. . . . . 25c
- 839—Melrose Corner Cabinet: Old Colonial design. . . . . 25c
- 846-848—Governor Winthrop Desk: True copy of original. . . . . 75c
- 896-897—Three Easily Made Workbenches—Simplified construction. 25c
- 906-909—Midget Auto: 58 in. wheelbase, 1/2 to 3/4 h.p. . . . . \$1.00
- 910—Circular Saw Table: Hardwood, 24" x 36", Stationary. . . . . 25c
- 917—Outdoor Fireplaces: Several simple but practical. . . . . 25c
- 920-922—Lawn and Garden Furniture: Swings, arbors, tree seat. . . . . 75c
- 923—Indoor Fireplaces: Standard Sizes. . . . . 25c
- 926-927—Venetian Blinds: Three different styles. . . . . 50c
- 930—Hooked Rug Frame. . . . . 25c
- 933—Cape Cod Cupboard: 4 ft. wide, 5 ft. 8 in. high. . . . . 25c
- 935—Knee-Hole Desk: 40 in. long, 30 in. high, 31 1/2 in. wide. . . . . 25c
- 936—Modern Coffee Table: 24 in. long, 15 in. wide. . . . . 25c
- 952—Child's Crib in Maple. . . . . 25c
- 958—Colonial Corner Cupboard: 6 ft. 8 in. high. . . . . 25c
- 961—Hanging China Cabinet: 38 in. long, 40 in. high. . . . . 25c
- 969—Combined Chest and Writing Desk: 35 1/4 in. high. . . . . 25c
- 970—Modern Clothes Chest: Built of Plywood. . . . . 25c
- 977—Bookcase in Chippendale Style: 47 in. high, 10 in. wide. 25c
- 978—Lawn Chair on Wheels: Lightweight easy to wheel. . . . . 25c
- 981—Colonial Wall-Shelf: 30 in. high, 19 in. wide. . . . . 25c
- 984—Duncan-Phyfe Drop-Leaf Table: Reproduction of historic piece. 25c
- 986-987—Utility Trailers: Built of old auto parts. . . . . 50c
- 989-990—Speedy Motor Scooter: Gas engine, 40 to 60 miles on gal. of gas. . . . . 50c
- 991—Gun Cabinet: Handy cabinet includes rack for rifles. . . . . 25c
- 993—Twin-Deck Beds: 6 ft. 4 in. long, 31 1/2 ft. wide. . . . . 25c
- 1106-1112—SEACRAFT—25 FT. CABIN CRUISER: Adaptable as sport fisher, express cruiser, or utility boat. Cruises at 15 knots with marine engine or converted auto engine. Cabin sleeps four, Galley has fresh-water tank, sink, and cook stove. Set of seven large-sized blueprints scaled 1 in. per ft. plus 40-page two-color illustrated booklet, only. . . . . \$10.00
- 1011—Fireplace Fittings: Andirons, log rack, etc. . . . . 25c
- 1080-1081—Banta: 12 Ft. Plywood Runabout: Vee-Bottom, 3-passenger. . . . . 50c
- 1086—Black Forest Corner Shelf: Scroll-sawed. . . . . 25c
- 1089-1090—Home-Constructed Freezing Unit: reaches 30 degree temp. . . . . 50c
- 1091-1096—17 ft. trailer, 7 ft. wide. Steel chassis. . . . . \$1.50
- 1102-1105—Midget Trailer: "Tear-drop" body. Sleeping quarters for two. . . . . \$1.00
- 1113-1114—Gold Rush of '47: The A.M.A. Open Class B Record Holder Plane Model. . . . . \$1.00

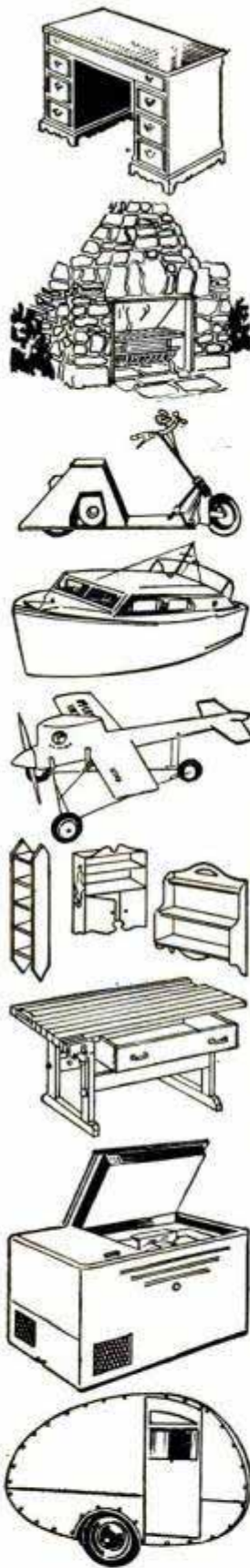

## FILL OUT AND MAIL THIS COUPON NOW

POPULAR MECHANICS CO.  
200 E. Ontario St., Chicago 11

Please send the following plans.

\_\_\_\_\_ I am enclosing \$ \_\_\_\_\_

Name \_\_\_\_\_

Address \_\_\_\_\_

*A Thousand and One  
Ideas You Can  
Use on the Farm!*



# POPULAR MECHANICS FARM MANUAL

Use it to Step up Farm Efficiency — Increase Production — Improve Farm Appearance — Save Time, Labor, Money!

**A Must for Every Farm Family! Saves Money for City Homeowners Too!**

Here is the experience of hundreds of successful farm operators brought together in one handy, easy-to-read, easy-to-use, working handbook by the editors of Popular Mechanics. It is brimful of short cuts, labor-saving ideas, ingenious apparatus and methods that will simplify the day's work and lighten some of the more tedious chores, make money and save money for you.

## HELPS IN THE FIELD — IN THE BARN — IN THE HOME

Every department of the farm is covered in the Farm Manual. Every member of the family will find in it something that he or she can use to tremendous advantage in farm operation, maintenance and improvement, from the building and care of equipment to painting the farm home and fast freezing fruits and vegetables. It covers farm buildings, the farmhouse and other homes and is of interest equally to the woman looking for home improvement, beauty and convenience and the man striving for easier and more profitable operation.

## ORDER TODAY — FOR YOURSELF — FOR A GIFT

Use the coupon below. Mail it today. Book will be sent at once, postpaid if you include payment with your order. If you don't think the Farm Manual is worth even more than you paid for it after five days' use, send it back by mail and your money will be refunded. This may be the best investment you ever made. Rush coupon today.



**284**  
**FACT-PACKED PAGES**  
•  
**Hundreds of Illustrations**

Popular Mechanics Farm Manual is packed with practical ideas and usable information that can easily be worth hundreds of dollars to farm families and homeowners everywhere.

**Farm Machinery and Implements**  
How to make and get the most out of farm implements.

**Farm Workshop Equipment and Repairs**  
Ideas that can save hundreds of dollars.

**Poultry and Livestock**  
How to build equipment, gadgets. Care of farm animals and poultry.

**Vegetable Storage—Processing**  
Winter storage, home freezing tips, make your own freezer.

**Farm Home Improvement**  
Fencing, repairing electrical appliances, plumbing, electrical wiring, saving coal, painting, curing leaky basements, banking wall paper, making garden tools, garages, working with concrete, painting, etc.

**Farm Hints and Kinks**  
Forty pages of illustrated, practical ideas, short cuts, etc., that will save time, labor and money.

## MAIL COUPON • Money Back if Not Satisfied

POPULAR MECHANICS PRESS, Dept. 665  
200 East Ontario St., Chicago 11, Ill.

Send \_\_\_\_\_ copies of the Farm Manual at once.  
 Remittance (\$3.00 each) enclosed. Send postpaid. Add 15% if outside U.S.A.  
 Send C.O.D. (\$3.00 each) plus delivery charges. U.S.A. only.  
 If sent as a gift to another, send name and address on separate sheet.

Name \_\_\_\_\_

Address \_\_\_\_\_

City \_\_\_\_\_ Zone or Route \_\_\_\_\_ State \_\_\_\_\_



# SPEECH DEFECTS

... overcome in the privacy  
of your own home!

Your money back if our system  
fails to correct your stuttering,  
stammering, lisping.

Send for this FREE booklet today →

It contains a valuable Analy-  
sis Chart and all details.



## VOCALON Institute

264 W. 40th St., New York 18, N. Y.

# BE A REAL ESTATE BROKER

**PAYS BIG!** EASY TO LEARN—Start and  
run your own business quickly.

Many graduates report making up to \$1000 a month. Course  
of study covers Sales, Property Management, Appraising,  
Loans, Mortgages and hundreds of related subjects. Course  
in home study or classroom instruction in leading  
cities. Big new illustrated catalog from this  
nationally known school. G. I. Approved. Send  
a Post Card Today.

**WEAVER SCHOOL OF REAL ESTATE** (Estab. 1936)  
15 E. Pershing Road Dept. PM-1 Kansas City, Mo.



## For a Shipshape Shop!

Popular Mechanics SHOP NOTES 1949 is the  
book you need. 240 interest-packed pages for  
mechanic, painter, carpenter, auto-worker, elec-  
trician, welder, farmer, plumber and home crafts-  
man. Whether it's ball bearings or shotgun  
gauges, painting a car or mounting motors, the  
best and latest methods are here.

Hundreds of articles. Hundreds of ideas!  
See your news dealer or order direct from  
**POPULAR MECHANICS PRESS** . . . \$1.00  
200 E. ONTARIO ST. CHICAGO 11

## Handy Mail Order List

Little Library of Useful INFORMATION

5 for \$1.00  
12 for \$2.00  
25¢ Each

Here at amazingly low cost is the practical  
help and information you have always wanted.  
Articles in previous issues of Popular Me-  
chanics have been classified according to sub-  
ject and are now available in these handy  
reprint booklets.

- How to Use Measuring Tools—  
Micrometers, Calipers, etc.—  
106.
- Power Driven Saws—74.
- Drill Presses, Grinders, Etc.—79.
- Wood, Metal Turning Lathes—81.
- Filing Machine, Hacksaw, Cutoff  
Wheel, Shaper—82.
- Lathe Tools You Can Make—101.
- Workbenches—Tool Cabinets—47.
- Spray Painting—94.
- From Pattern to Casting—91.
- Tool and Saw Sharpening—92.
- Sharpening Drills, Wood Bits—  
90.
- Successful Wood Turning—32.
- How to Read Blueprint—71.
- Metal Turning Lathe Kinks—99.
- Operating a Metal Lathe—100.
- Heat Treating, Hardening—102.
- Working With Glass—103.
- Servicing Elec. Motors—75.
- Electromagnets & Solenoids—44.
- Transformer Construction—41.
- The Boy Electrician—43.
- Soldering and Brazing—17.
- Arc and Spot Welders—5.
- Electroplating With Nickel, Chro-  
mium, Cadmium, Etc.—86.
- Plating Leather, Wood, etc.—87.
- Lower Your Fuel Costs—31.
- Curing Leaky Basements—45.
- Fitting Home Game Room—55.
- Indoor & Outdoor Fireplaces—88.
- Backyard Gardening—39.
- Lawn and Garden Novelties—72.
- Trellises, Pergolas, Fences—76.
- Lawn and Garden Furniture—77.
- Playground Equipment—73.
- How to Use Your Drill Press—125
- Making Servicing Trays—53.
- Knits and Ropowork—105.

- Working With Plastics—61
- Simple Home Improvements—104
- Ridding Home of Insect Pests—107
- Children's Room Furniture—51.
- Jigsawed Novelties—57.
- Doll House & Doll Furniture—60.
- 25 Shelves You Can Make—64.
- Novelties Turned on Lathe—62.
- Inlay Pictures—Veneering—63.
- Wood, Soap Carving—65.
- Windmills & Weathervanes—68.
- Lamos from Wood, Metal—69.
- Rustic Furniture—18.
- Wood Finishing—40.
- How to Fix Electrical  
Appliances—111
- Painting Your House—117
- Build Your Own Relays—123
- Rowboats, Small Dinghy—83.
- Small Sail Boats—84.
- Two Outboard Runabouts—85.
- Build Own Canoe, Kayak—30.
- Build Class-E Ice Yacht—22.
- Auto Kinks, Shortcuts—10.
- Lawn and Garden Equip-  
ment—124
- Motor-Driven Midget Cars—34.
- Stop Auto Elect. Troubles—95.
- Photo Printers and Dryers—25.
- Photo Darkroom Equipment—96.
- Trick and Table Top Photos—97.
- Home Movie Equipment—118
- Poultry Houses—108.
- Guns and Decoys—109.
- Re-Silvering Mirrors—70.
- Chemical Experiments—93.
- Log Cabins, Tourist Houses—14.
- Using Basic Tools—120
- Farm and Garden Tractors—8.
- Building Extra Attic Rooms—23.
- Attractive Basement Rooms—24.

- Sanders—80.
- House Wiring—89.
- Hanging Wallpaper  
—38.
- Built-in Fixtures—78.
- Bird Houses—7.
- Magazine Racks—49.
- Clock Cases—50.
- Book Ends—52.

- Small Tables—54.
- Smoking Stands—56.
- Desks—58.
- Book Cases—59.
- Action Toys—66.
- High Flying Kites  
—67.
- Telescopes—20.
- Metal Craft—28.
- Small Looms—37.

- Gem Cutting—42.
- Photo Enlargers—1.
- Photo Kinks—98.
- Cleaning Formulas  
—11.
- Taxidermy—9.
- Photo Lighting—119
- Training Dogs—35.
- Small Furnaces—36.

Check Titles Wanted, Clip, Mail with Remittance to

POPULAR MECHANICS PRESS, Dept. 635, 200 E. Ontario, Chicago 11

for the newest in

## RADIO AND TELEVISION

# FREE



## 1949 NEWARK CATALOG

a value-packed listing of  
more than 20,000 standard  
brand items including

- Radio kits for beginners and professionals
- Television components and kits for hobbyists
- Electronic and laboratory test equipment
- Sound systems • Technical literature

IF IT'S IN RADIO & TELEVISION... NEWARK HAS IT!  
ONE YEAR TO PAY WHILE USING EQUIPMENT

### 3 GREAT STORES

at 115 West 45th Street, and  
212 Fulton Street, NEW YORK  
323 West Madison St., CHICAGO

### MAIL ORDER DIVISIONS

242 W. 55th St., N. Y. 19, N. Y.  
323 W. Madison St., Chi. 6, Ill.

24-hr. mail-order service

MAIL COUPON TODAY



Newark Electric Co., Dept. 14  
242 W. 55th St., N. Y. 19

Please send me FREE the Newark 1949 Catalog

MY NAME \_\_\_\_\_  
ADDRESS \_\_\_\_\_ CITY \_\_\_\_\_ STATE \_\_\_\_\_

## LEARN WATCH MAKING

JEWELRY REPAIR

Engraving

G. I. APPROVED



Prepare NOW! Our Master  
Course covers everything  
needed for high-salaried  
positions in Jewelry Field.  
Latest equipment makes  
learning a pleasure. High  
percentage of graduates  
successfully placed. Housing  
available. (Schools in  
Warren, O. and P'gh, Pa.).  
Catalog FREE.

A. W. THACKER ACADEMY FOR JEWELERS  
Dept. P • 423 Federal St. • Pittsburgh 12, Penna.



## AMAZING NEW HOLLYWOOD PLAN

Yes, YOU can draw GIRLS, CARS,  
FRIENDS and even MAGAZINE  
COVERS. It's so simple, no mat-  
ter what your age. Many artists  
make more than \$150.00 per week  
in advertising and cartoons. Be  
your own boss, draw for money  
anywhere. Our Commercial Art-  
ists will teach you the secrets  
from HOLLYWOOD. Drawing  
materials furnished. Be a suc-  
cess. Write NOW for free details

## HOLLYWOOD SCHOOL OF ART

DIVISION OF AXELSON STUDIOS

6533 Hollywood Blvd.  
Hollywood 28, Calif.

Name \_\_\_\_\_

Address \_\_\_\_\_

City \_\_\_\_\_ Zone \_\_\_\_\_ State \_\_\_\_\_

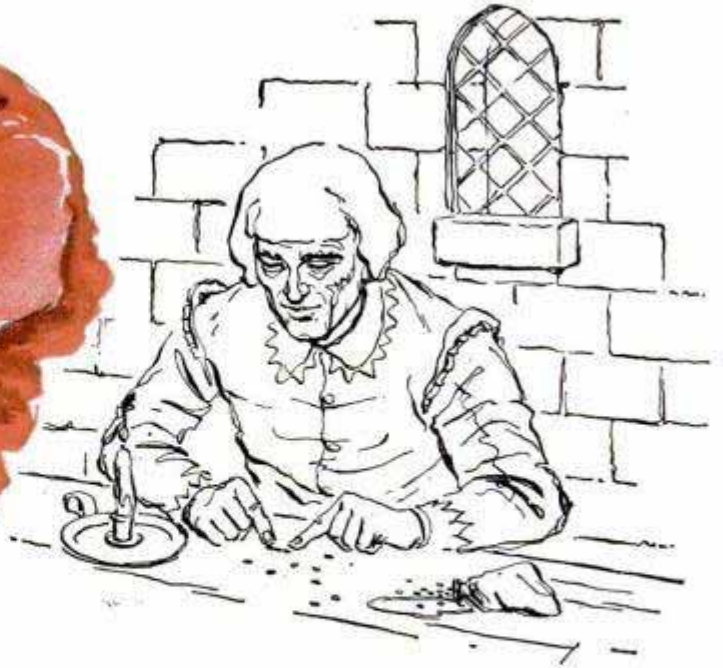
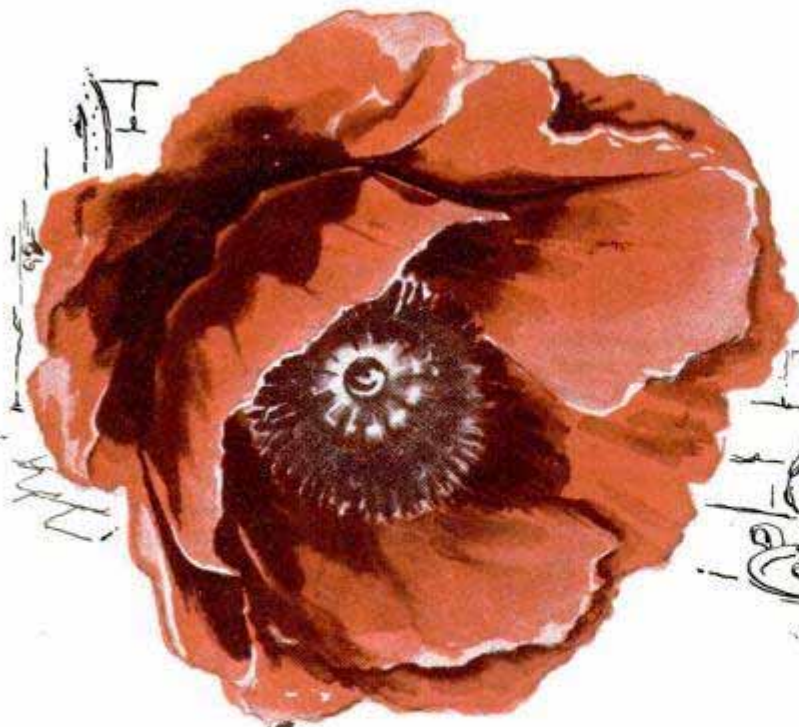

## The Birth of Precision

12 HAIRBREADTHS = 1 POPPY SEED  
4 POPPY SEEDS = 1 BARLEY CORN  
3 BARLEY CORNS, END TO END = 1 INCH  
*(First used in England, early 16th Century)*

● Out of a single poppy seed, a 16th Century device first used in England to measure 12 hairbreadths, came man's quest for accuracy of measurement. It was the birth of precision.

Down through the centuries, man has learned the importance and economic value of accuracy. It is imperative in industry and in the fabrication of all materials.

In highway construction, oil fields, on the farm, in the building trades, in the shops of industry . . . at sea, on the rails and in the air . . . in forests, mines and mills, in homes and stores, in class rooms . . . measuring instruments are essential, indispensable to good workmanship.

The tape, the rule, the precision tool are instruments of accuracy. Their dependability is governed by the inviolate standards of the men who make them. Lufkin's unending search for ever-finer quality is reflected in products of longer life, greater accuracy and exclusive features which aid today's skilled craftsmen in their all-important work.

For 65 years Lufkin has dedicated its resources and facilities to the production of better measuring instruments. Wherever precision is a creed . . . wherever man seeks the truth in dimensions the name of Lufkin is recognized as a symbol of undeniable accuracy—a tribute to precision.

PRECISION TOOLS

**LUFKIN**

TAPES • RULES

*Accuracy of Measurement is the Key to Precision*

THE LUFKIN RULE COMPANY • SAGINAW, MICHIGAN



# Top of the World Weather Run

U. S. Air Force photo

Far out over the Arctic Ocean, a B-29 wings its way toward the North Pole. Right, round-trip course of polar run, which can be flown in either direction

By Aubrey O. Cookman, Jr.

**S**HUTTILING between Alaska and the North Pole on a timetable schedule, Air Force B-29s are seeking an answer to that simple question so vital to picnickers, generals and farmers—"What's the weather next week?"

Minus fanfare and plugging along routinely over a hazardous route with monotonous safety, the Superfortress weather men are laying the foundations for long-range forecasting for North America. From total experience—and over 110 missions have already flown the 3290-nautical-mile track successfully—the Air Force hopes to uncover much of the unknown about the arctic-born blasts that sweep across Canada and the United States.

There has been practically no information available on weather north of 70 degrees latitude. Until recently, only a few widely spaced expeditions had ever reached the pole, and their findings were

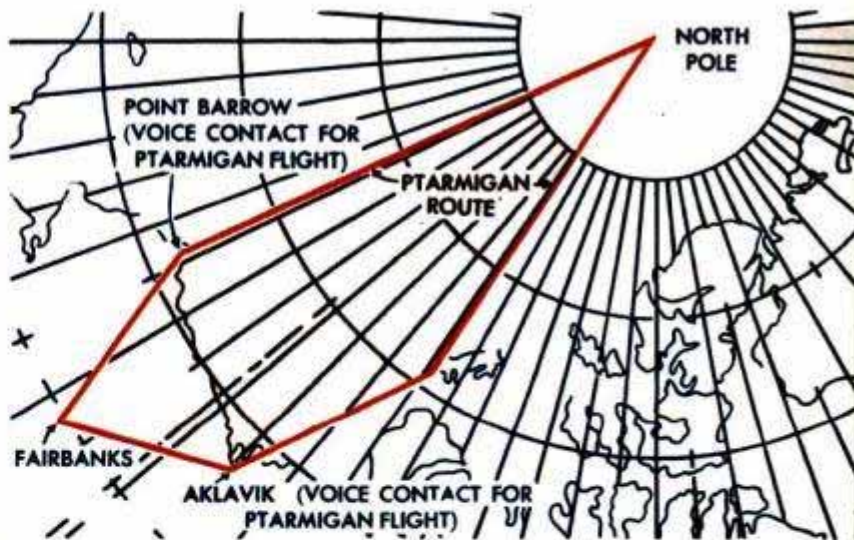

meager. Ground reporting stations on the arctic icecap were an impossibility. Meteorologists had early recognized the potentialities of aircraft, but the "top of the world" was beyond prewar-aircraft range.

Out of the war, where accurate weather reconnaissance was vital to victory, came the big, fast, long-range aircraft meteorologists had dreamed about as a tool to unlock the Arctic's weather secrets. By

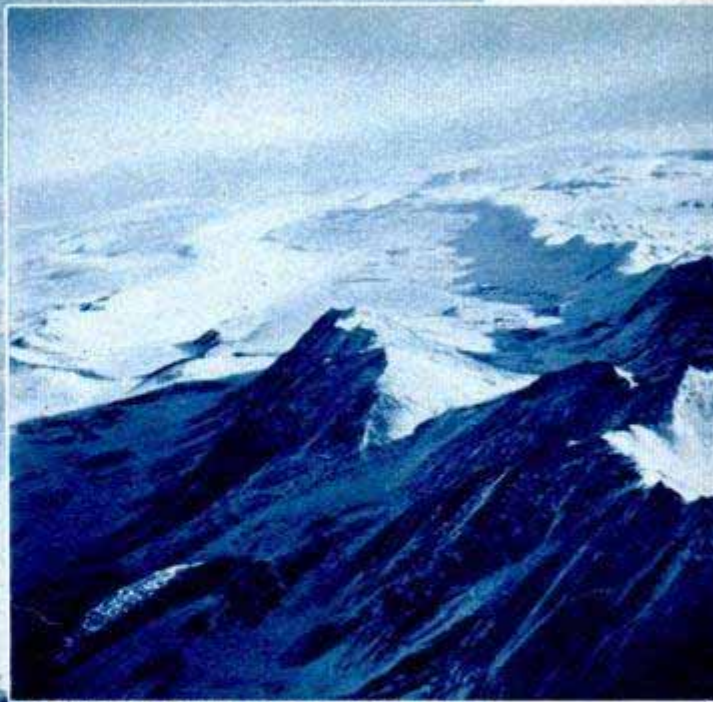

Heavily loaded with gasoline, the weather planes gain altitude slowly. Right, Brooks Range, over which they fly

March, 1947, long months of preparation ended and the first over-the-pole airline was ready for business.

Selected to fly the Ptarmigan missions, so called after an arctic bird, was the 375th Reconnaissance Squadron, commanded by Lt. Col. Karl T. Rauk. Veterans of the Biki tests, the squadron's "home office" is

Ladd Air Force Base at Fairbanks, Alaska. With all the surface casualness of young fellows taking a quiet ride in the country, the crews roar north from there every other day for 15 to 19 hours' work over one of the bleakest routes in the world, two thirds of it over an ice-choked ocean.

The normal 11-man crew consists of a

Turning the props through for an early take-off at Ladd. They were over the pole and back in 16 hours







Above, drawing equipment after the preflight briefing. During winter missions, 35 pounds of clothing are carried or worn by each man. Below, an oddity of polar flying. Illustration shows sun's position during mission March 16, when crew witnessed two sunrises and two sunsets during course of 16-hour flight

gloves (nylon, wool and leather), heavy wool underwear, shirt, pants, sweater and a muffler, covered by a wool flying suit with fleece-lined pants and a parka. On their feet are several pairs of socks, felt innerliners, inner soles and a pair of mukluks.

At 4:35 one late summer morning, our typical mission, piloted by Lt. David Laughman of Hanover, Pa., got off the ground. The big B-29s are gasoline-heavy, loading 8000 gallons—at about six pounds per gallon—for the trip, and they use every inch of the runway on take-off. Burning fuel at the rate of approximately 350 gallons per hour, they can expect to arrive

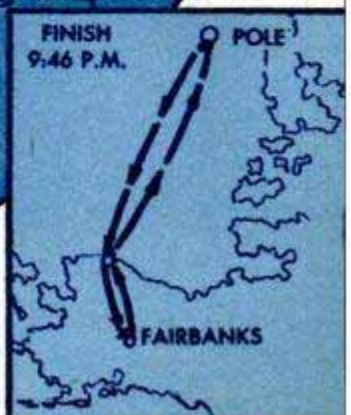
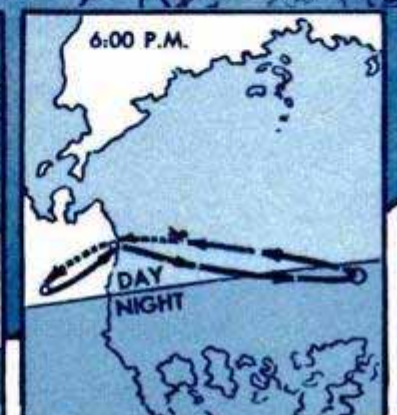
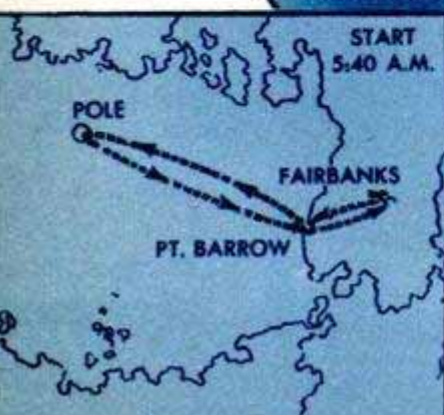
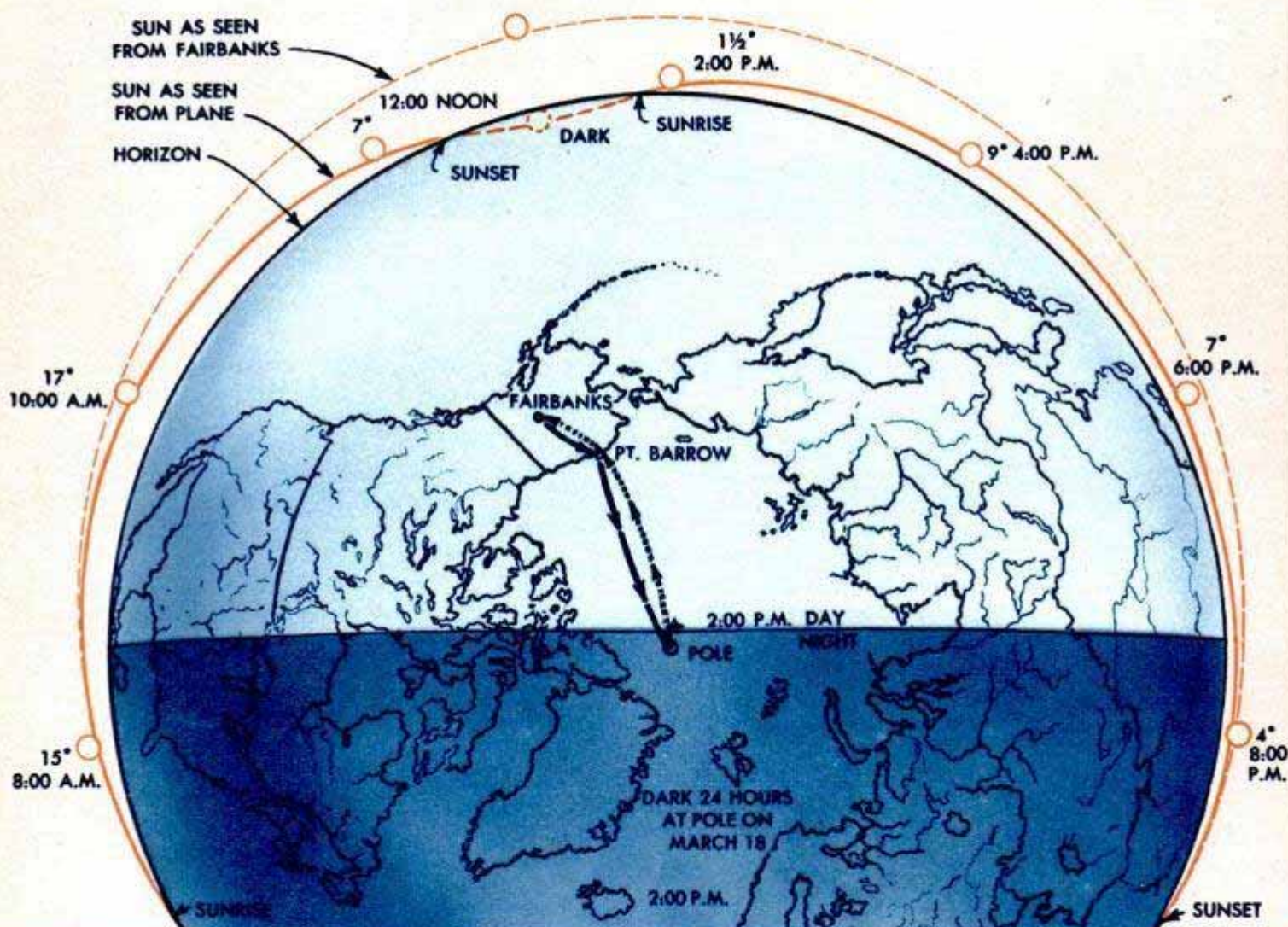

back at Ladd with a safe margin of about 1500 to 2000 gallons.

The missions followed a "synoptic" or fixed track, since regular observations from the same locations and at the same altitude are of more value to forecasters than those from scattered points and at different heights. In effect, it creates a chain of fixed weather stations at places from which reports would otherwise be unobtainable.

Technical meteorological observations are taken every half hour, except when existing conditions warrant additional checks. Less than a half hour after each observation starts, the complete information has been radioed back to Ladd, checked there for transmission errors by the meteorologist from the previous mission, and sent along on a Teletype for international use. It is made available to every nation in the world. Hour by hour, the procedure is repeated during the entire flight.

Depending on the wind, the five-legged course is flown either clockwise or counterclockwise at 18,000 feet. Laughman headed counterclockwise, making his first check point Aklavik, near the northern tip of Canada, then veered up toward his second check station at Prince Patrick Island.

Upsetting a conventional notion, airmen report ice formations in the water below are generally tightest at about 80 degrees latitude, gradually loosening up as they head north.

At 12:07 Alaska time, 8½ hours after take-off, Laughman's plane turned around the North Pole and headed home. The first southbound leg, from the pole to Point Barrow, longest of the mission, required

(Continued to page 262)



Above, pilot traces route of next day's mission on briefing map. Wind predictions favored a counterclockwise course. Lower left, light beam from this ceilometer determines cloud heights at Point Barrow check point. Below, weather reports from flight are checked at Ladd for transmission flaws before relay

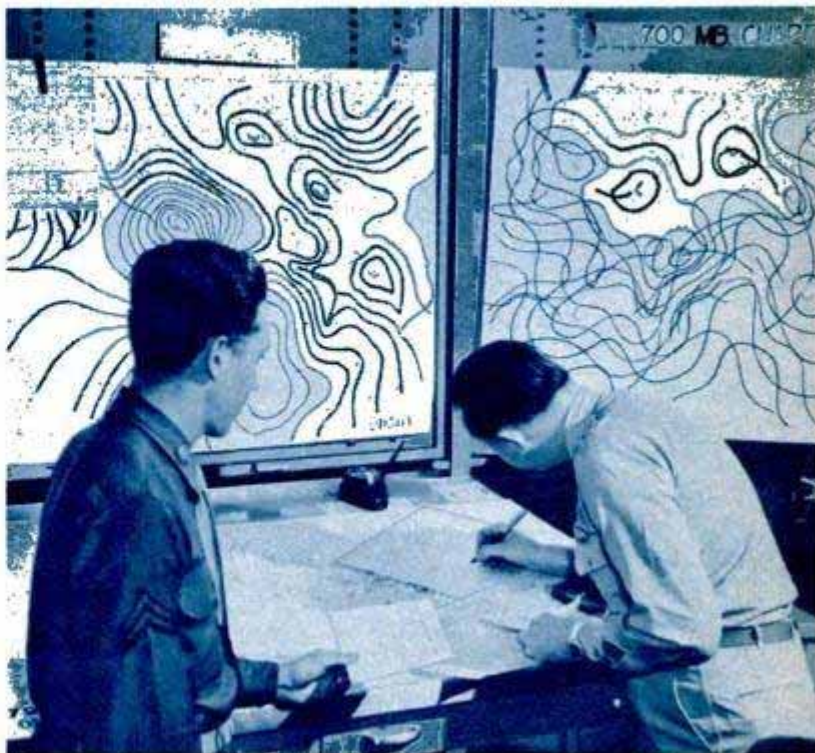

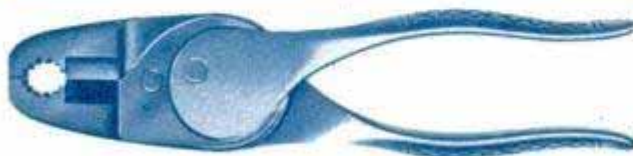
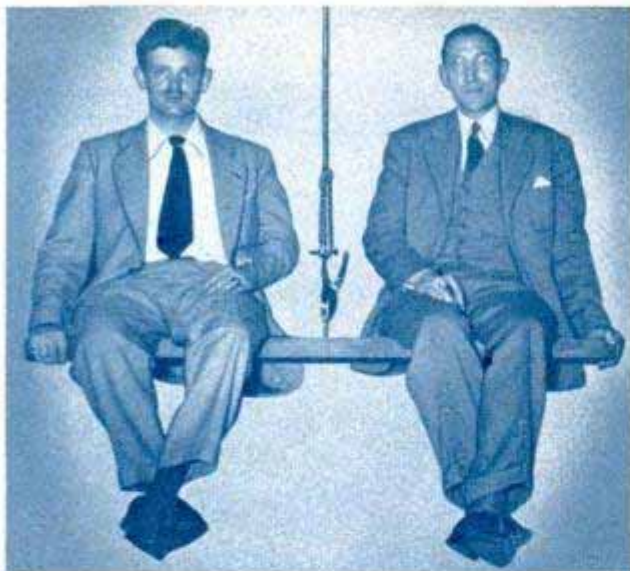

### Cam-Action Grip Locks Pliers

Locked with normal hand pressure, a pair of pliers with a cam-action grip holds so tightly that it can support the weight of two men. The pliers will lock on an object up to  $\frac{1}{16}$  inch in diameter and can be used as wire pullers, bolt cutters, wire cutters and linemen's pliers. They will cut 30-penny spikes and  $\frac{1}{4}$ -inch annealed bolts.

### Sighting Level for Farm Use

Terraces, contours and irrigation ditches are laid out accurately by a leveling device that mounts on a sturdy tripod. Two built-in vials are used to level a square formed by a continuous string wound around posts on the four arms. By sighting across any two sides of this square, a level line of sight is provided. A 10-foot slip rod and target are used with the level.

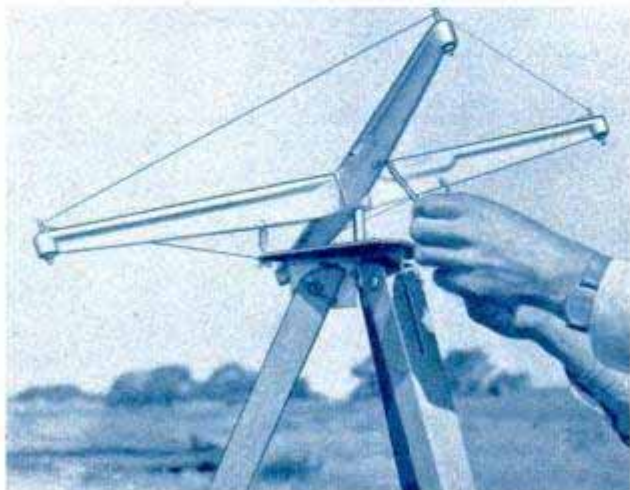

### Plastic Centers Repair Records

When your record changer damages the pivot holes in your favorite recordings, you don't have to throw them away. You can easily repair the damage by cementing a Vinylite plastic disk around the center of the record. The new center hole in the plastic disk then enables the record changer to operate smoothly.

### Radar Reflector Marks Life Raft

Men afloat on a new-type life raft may be rescued more quickly through a radar reflector on the mast. The float was developed for the British Royal Navy. The reflector bounces radio beams back to any radar station within range, thereby enabling the life raft to be located on the ocean. Made of rubber, the raft holds 10 men, has a fabric floor and is covered by a tent. It contains food and water, a bailer, sponge, paddles and a bellows for inflating the cushions. It is inflated initially by pulling a lanyard which releases carbon dioxide.





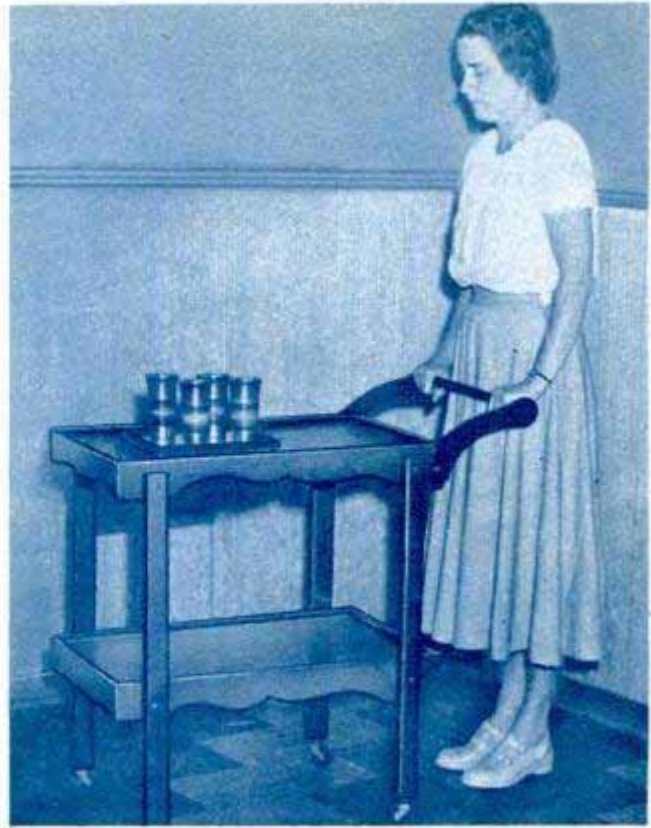

### Kit Contains Precut Hardwood Parts for Tea Wagon

With parts precut and ready for assembly, a tea wagon in kit form can be built in five minutes. The wagon, equipped with casters, has two trays. The parts are

held together with bolts and wing nuts. Made of hardwood, the wagon is delivered unfinished, or finished in mahogany, maple, Chinese red, green, canary or black lacquer.

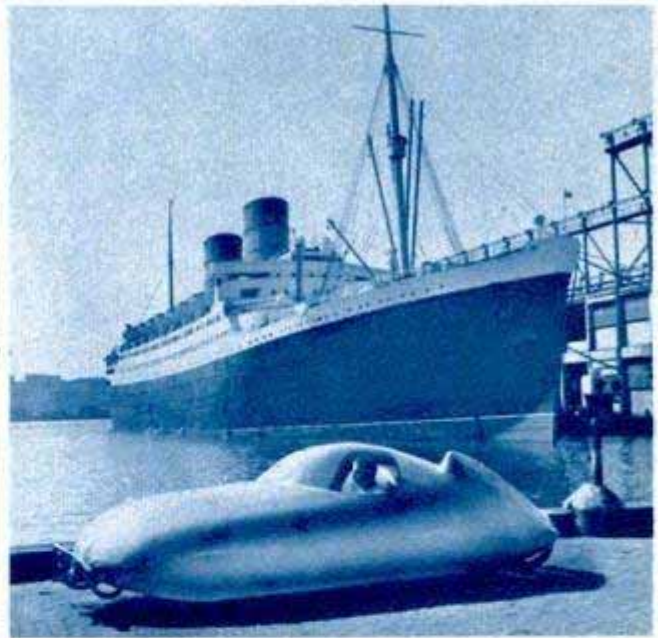

### Body Lifts Up for Access to Doorless Bubble Car

When Russ Case of New York couldn't find a new car that suited his tastes, he decided to build his own. Eighteen months and \$15,022 later, he brought out a creation unlike anything else on the highway. Case's car is low-slung with a glittering aluminum body. A large Plexiglas bubble

serves as roof and windows. There are no doors; Case merely presses a button and the whole body casing swings into the air to reveal the single, four-passenger seat and the engine. The car is built around a jeep chassis. The steering wheel came from an A-20 fighter-bomber.

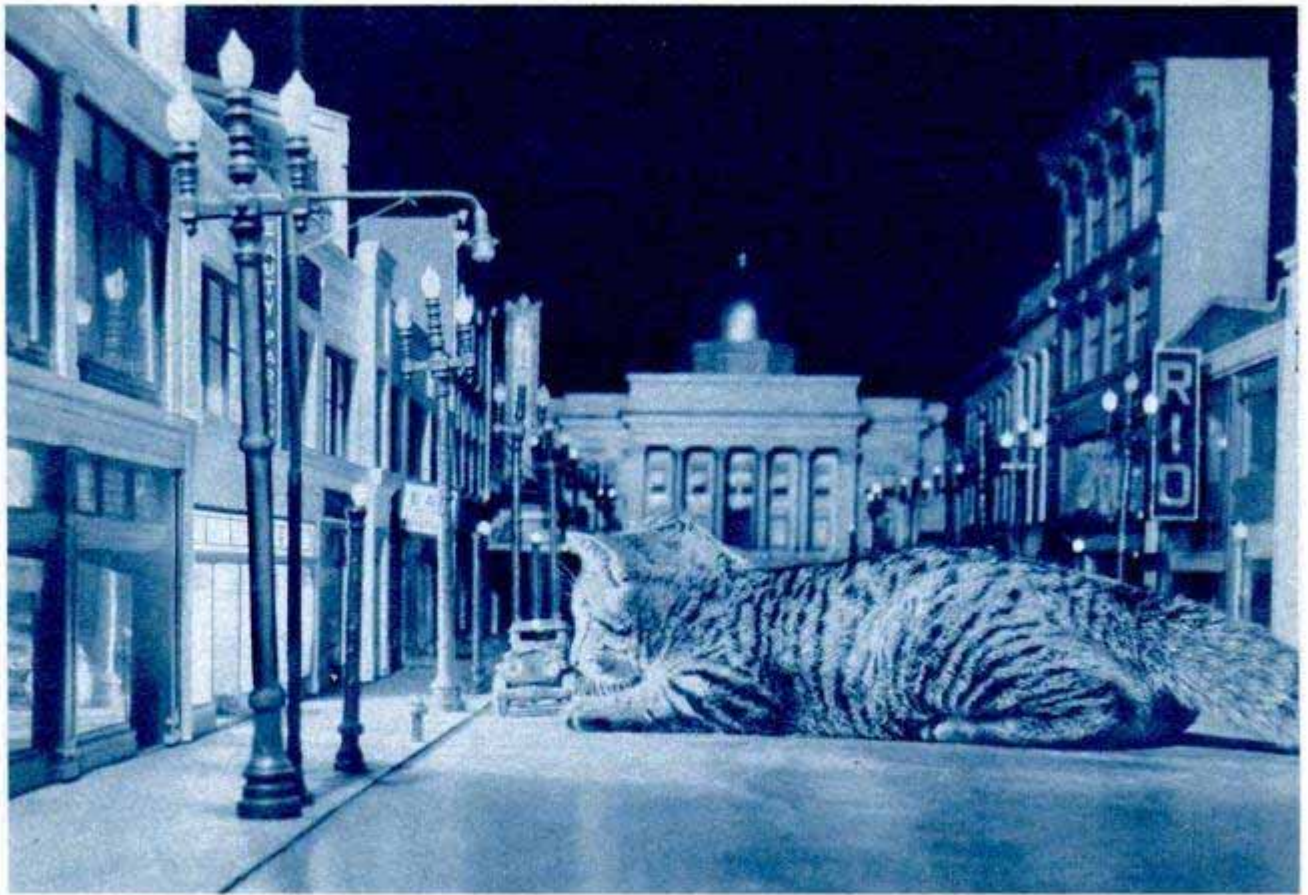

Stretched out in front of Lilliput Lane's beauty parlor, Tabbie the cat looks like a dangerous jungle giant

## Lighting Engineers Are Modern Gullivers Along Lilliput Lane

Gulliver's travels didn't take him to Schenectady, N. Y., but if they had, that fictional wanderer would have felt right at home in one section of the General Electric Laboratory. Designed for testing the effects of various street lamps on pedestrian and driver visibility, a scale-model business district, called Lilliput Lane, is complete in every detail except inhabitants. Along its miniature street are automobile sales

rooms, restaurants, a bank, movie theater, beauty shop and other business establishments. A master switchboard at one end of the street enables the engineers to control the lights and to measure illumination qualities. By experimenting on this pint-size shopping district, lighting experts are able to determine the efficiency of new street-lighting fixtures prior to putting them into production.

Below left, looking down the miniature street from the control booth as an engineer turns on the city's lights. Right, a six-year-old visitor plays the role of a modern Gulliver in front of Lilliput's Capitol





## Car Is 40 Inches High

Built from a 1941 Cadillac coupe with parts from other cars, a sports roadster stands only three feet four inches high. A mechanic of Burbank, Calif., scrapped the original body and designed and built a new one around a pair of 1942 Buick front fenders and two 1942 Cadillac rear fenders. The chassis is standard with full-spring suspension. Engine-operated vacuum units raise the hood and radio antenna. The doors are opened by special solenoids operated by push buttons under the instrument board. Baggage is carried under a canvas cover behind the seat. The car was built in six months and is valued at \$12,500.



Top, with its low, sweeping lines, the custom-built auto stands only three feet four inches high. Above, dashboard push buttons raise the vacuum-operated hood and radio antenna



## Test Lab for Jets

Jet engines for airplanes are tested under flight conditions in a \$25,000,000 center built by General Electric at Lynn, Mass. Scale models of new designs are laboratory-tested for altitudes up to 70,000 feet and at temperatures from 70 degrees below zero to 150 degrees above in large test stands inside which the atmosphere is precisely controlled. While major component jet parts, such as the turbine and compressor, are tested in the laboratory, the full-size engine is tested under altitude conditions aboard a B-29 flying laboratory.

You may wish to obtain additional information about new products described each month in Popular Mechanics. If you want to know the name and address of the manufacturer or distributor, just write to Bureau of Information, Popular Mechanics Magazine, 200 East Ontario Street, Chicago 11, Illinois.

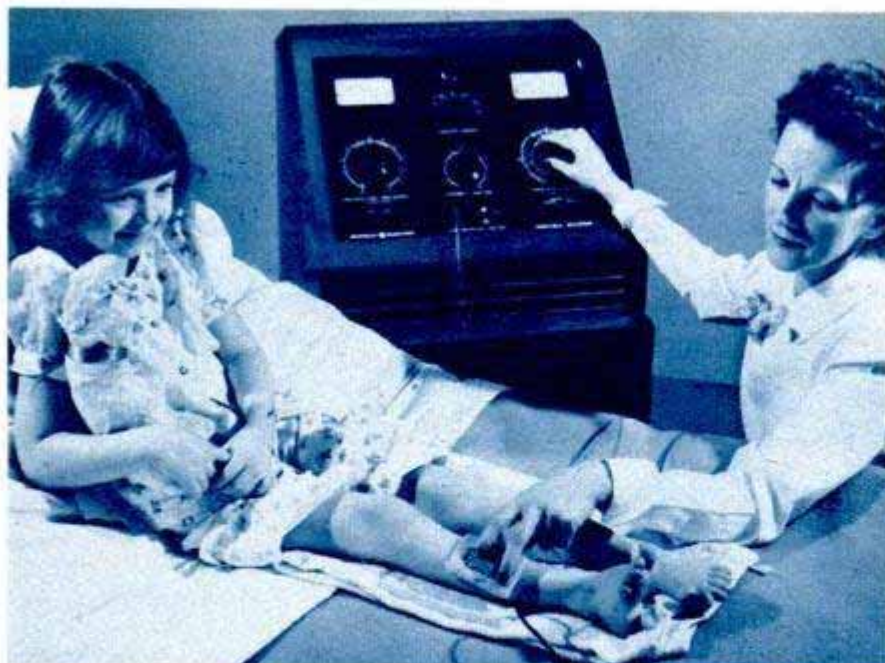

### Electric Exerciser For Paralytics

Stimulating paralyzed muscles with electric current, a variable-frequency wave generator prevents the muscles from wasting away through disuse. Electric current from the instrument alternately contracts and relaxes the muscles 24 times a minute, thus giving them exercise without effort on the part of the patient. The treatment causes practically no discomfort to the patient and can be used to treat almost any type of paralysis.

### Pliofilm Aids Plant Breeding

Pliofilm is bound tightly around the wound of a parent plant in a new method of propagation developed by William R. Grove of Laurel, Fla. The process eliminates the necessity of watering the parent plant and insures an exact reproduction in the new plant. Grove wounds the stem or branch all the way around, then packs the wound with wet sphagnum moss and dirt. Instead of binding the moist mass with burlap, which is customary, he uses Pliofilm bound tightly to the branch with a rubber band. When the roots are sufficiently grown, they can be seen through the bandage. The plant then is transplanted.

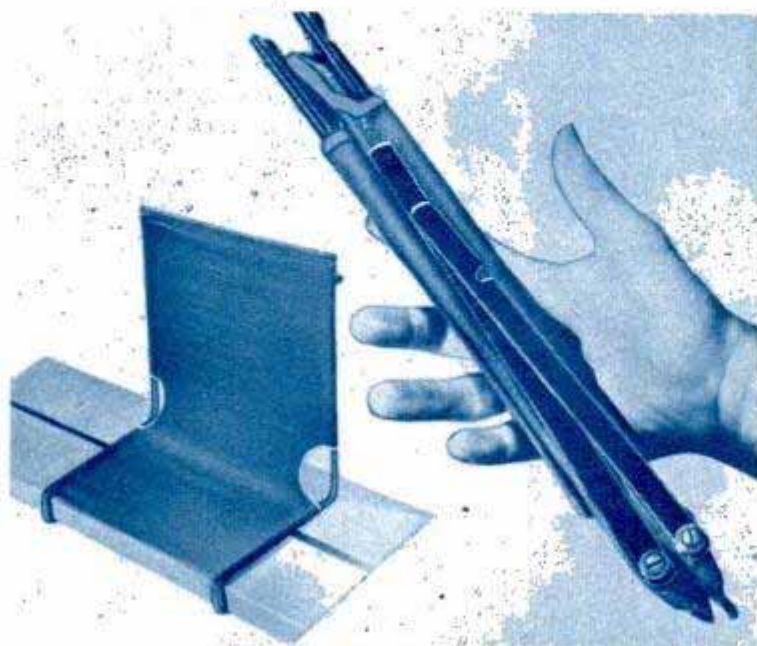

### Folding Chair for Bleachers

Bleacher spectators at ball games and other outdoor events can enjoy full back support with a folding chair that hooks over any bench board. The seat is made of steel covered with heavy canvas. When not in use, it can be collapsed into a small roll. It is instantly attached by hooking it over the edge of a board such as a picnic bench, rowboat seat or bleachers.

☐ A Montana man has patented a locomotive headlight that "looks around curves," a pendulum arrangement swinging the light so that it follows the rails as the locomotive takes a banked curve.



Official British photo

## Plane Wing Pivots in Flight

Pivoting at its roots, the wing of a new British amphibian can be tilted in flight for either quick climbing or level cruising. The

wings can also be folded mechanically for storage on aircraft carriers. Built by Vickers-Armstrong, the Seagull is powered by a Rolls-Royce Griffon engine and has contrarotating propellers.

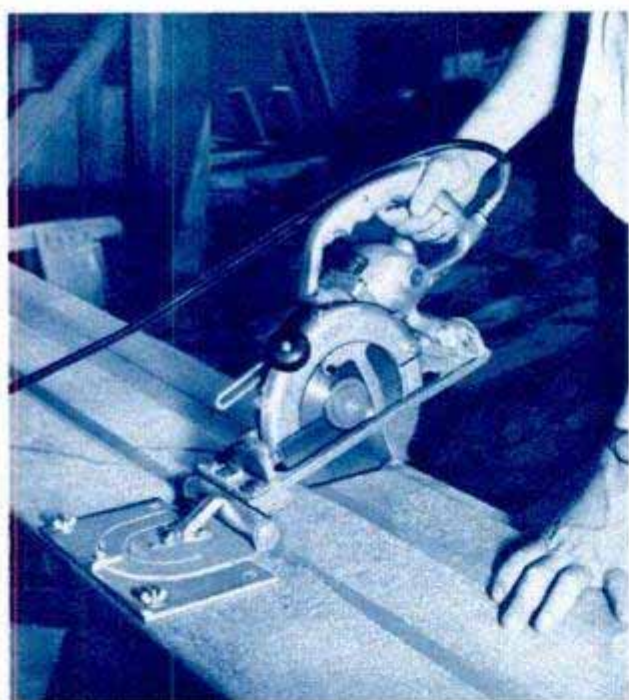

## Portable-Saw Mount

Electric handsaws are converted into rigid precision tools for making cuts at any angle by a mount that fastens to the workbench. Boring two holes in the saw's base plate is all that is necessary to attach the mount. An indicator scale is marked for standard rafter cuts and for angles up to 45 degrees right or left. When the operator releases the saw after the cut, a spring in the mount lifts the saw above the work, leaving both hands free to move the stock. The mount will fit any 6 to 12-inch portable electric saw now on the market.

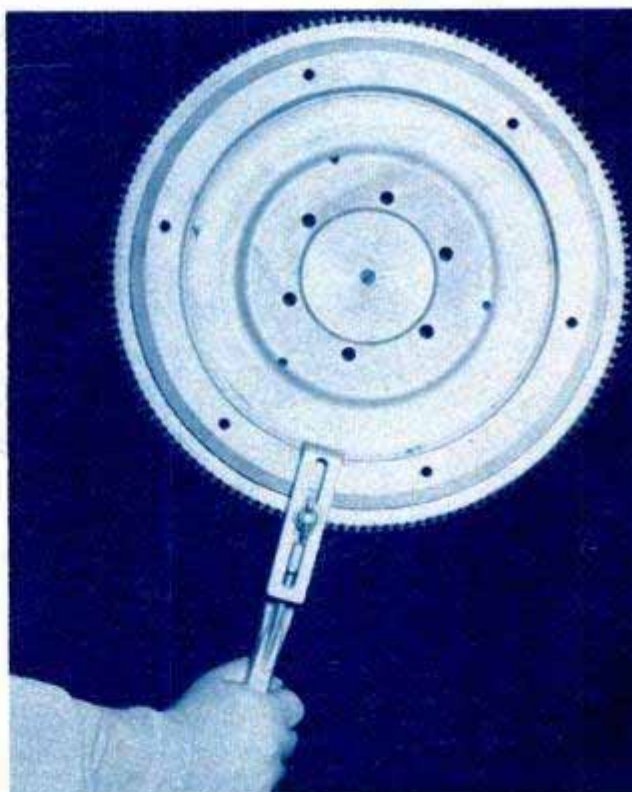

## Flywheel Wrench

With a wrench that locks firmly on the rim of the flywheel, mechanics can turn over the engine to any desired position without danger of cutting or bruising knuckles. Adjustable notches in the wrench prevent slipping, even on worn and greasy flywheel teeth. The wrench, designed to avoid lost motion between tool and flywheel, also enables mechanics to detect drag when fitting new bearings.



By Gorman McMullen

AMERICA'S oil industry has gone to sea—not for the salt air, but to tap a treasure chest of five billion barrels of oil which lie under the warm waters of the Gulf of Mexico. Mammoth steel frames the height of a 10-story building are rising up out of 50 feet of surging salt water eight miles from shore. Converted LSTs, teeming with roughnecks who a few months ago were landlubbers, are defying hurricanes to rush drilling. Men work in shifts around the clock.

That's the scene as the nation's oil industry opens up a new frontier of exploration in an almost desperate effort to find new oil supplies to feed the machines of our modern industrial world.

Drilling in water is not new, not even in salt water. Wells were drilled off the California coast almost 50 years ago. And for many years wells have been drilled in

Man-made island on stilts eight miles off Louisiana shore serves as a platform for the drilling derrick

**DOWN  
IN THE SEA  
FOR OIL**

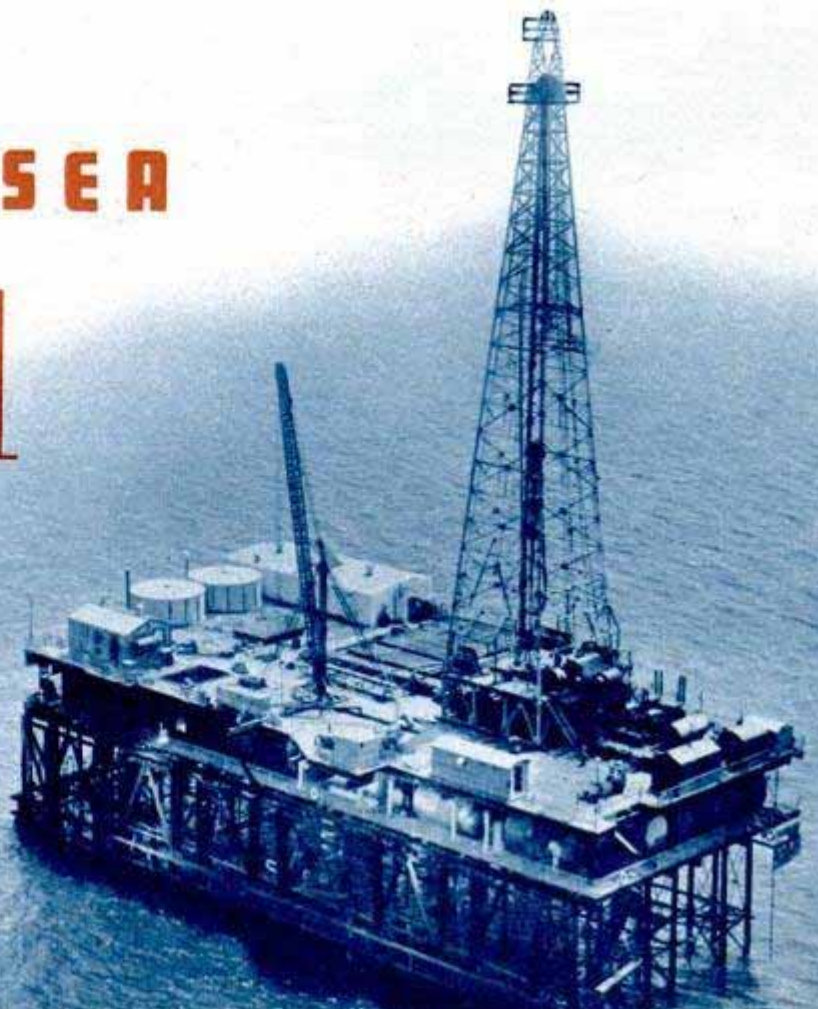



Dots on the map show the locations of offshore operations. The largest single installation is the Grand Isle platform, from which six wells can be drilled by shifting one derrick

water as deep as 100 feet in Lake Maracaibo, Venezuela. In the salt-water marshes along the Louisiana and Texas coasts, new techniques have been discovered to conquer nature and bring out petroleum. Oil was discovered offshore in the Gulf in 1938, a mile off Louisiana in 14 feet of water.

But real deep-water drilling in the open ocean is definitely something new. The largest single installation is Humble Oil & Refining Company's \$1,200,000 drilling platform eight miles off the shore of Grand Isle, La., near New Orleans.

Imagine the framework of a 10-story building plunked down in 50 feet of restless green water. Imagine two platform decks in this network of steel; the lower deck carrying complete living quarters for 54 men, tons of modern drilling equipment and roomy storage facilities; the top deck towering 46 feet above the water and supporting a regular drilling derrick, the same tremendous structure you have seen safely rooted on land. That's how Humble's man-made island, almost out of sight of land, stacks up.

This structure would be quite a feat even in calm water. Built to withstand the unceasing pressure of tons of shifting ocean water, plus the occasional 35-foot waves and 100-mile winds that come with the twice-yearly hurricane seasons, it is an engineering marvel. Engineers drove steel pilings

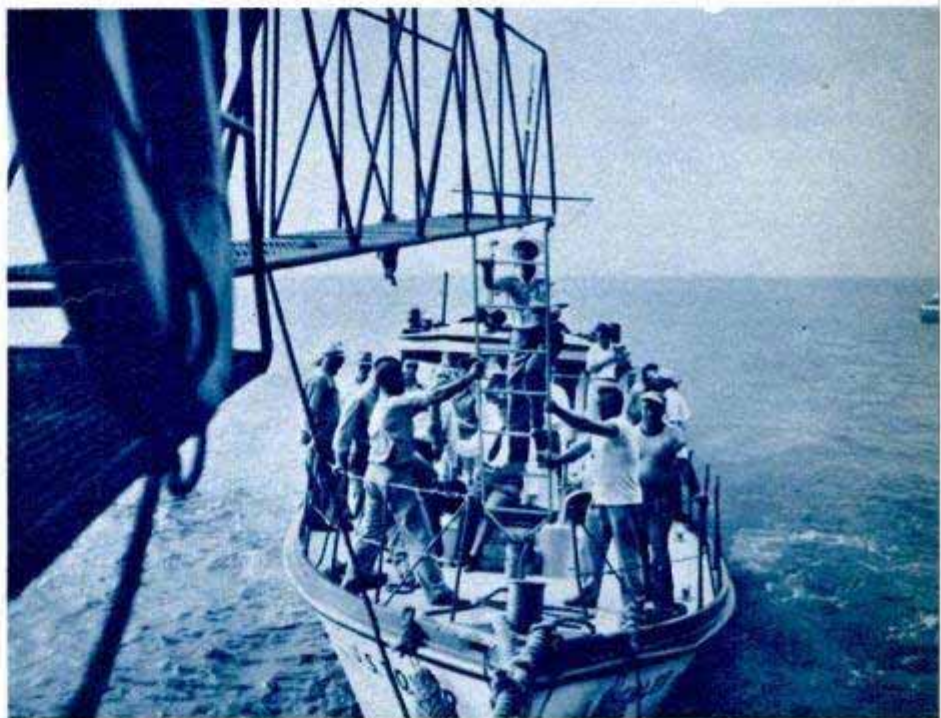

Swinging catwalk with a ladder at the end is the answer to the problem of boarding the platform during rough weather. Catwalk is hinged and pivoted to move in any direction. Bottom of ladder connects with boat through a socket joint

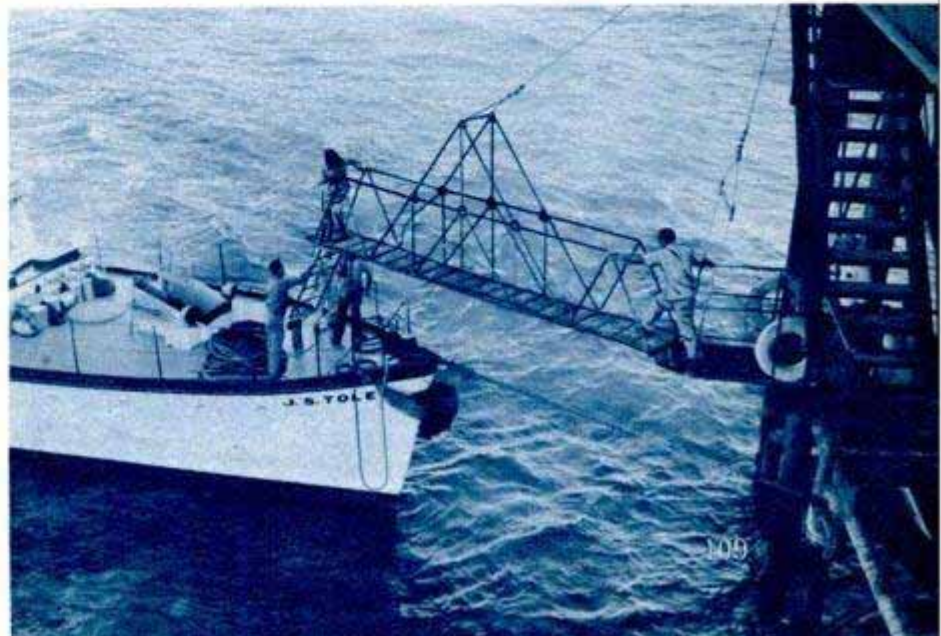



Welders secure the pilings which will support more than an acre of working space. The pilings are driven to an average penetration of 200 feet

nearly 200 feet into the floor of the Gulf to anchor this drilling platform. The two platform decks are each 100 by 206 feet. More than 5,000,000 pounds of steel were used in the structure. It was built in about 100 days, days which ranged from glassy calm weather to near-hurricane winds.

Difficult as the platform was to build, it was only the first of many headaches for Humble's engineering staff. How would you unload a five-ton storage tank from a boat to the drilling structure when waves are running 15 feet high? How could the workers, who labor in shifts around the clock, climb from a bobbing 60-foot tug in high waves onto a ladder in the platform without injury? How about the super-safety precautions necessary on such an isolated post? The company met and solved these problems.

The matter of transferring personnel from a boat to the platform, which might appear simple to the uninitiated, turned

out to have many complications. A number of schemes were considered and dropped. The simple-appearing arrangement which solved the problem consists of a catwalk extending out from the platform, with a ladder hinged to the outer end of the catwalk and dropping down toward the water.

On the platform end, the catwalk is hinged for vertical motion and pivoted for horizontal motion. A boat coming up to the platform connects the boarding ladder with a ball-and-socket device mounted on the boat's bow. The boarding ladder is hinged for vertical motion, and the ball-and-socket device allows horizontal motion. A pulley-and-counterweight rig keep the catwalk up and level when not in use.

One of these catwalk-and-ladder rigs has been provided on each of the platform's four sides to meet all conditions of wind and tide.

Unloading heavy equipment is a problem that wasn't solved with any one rig. The roughnecks learned a bit of seamanship to add to their experience in handling

heavy weights ashore. With this know-how, they have managed to cope with what the sea has had to offer.

Safety is a word that never leaves the minds of the platform's supervisors. No gasoline-driven machinery is used, either on the platform or on the boats. Diesel oil, used instead of the customary steam to power the drilling equipment, is handled with extreme care. Drilling work is done with a seasoned crew with the greatest caution, and no injury taking a man from his work has yet occurred.

And the first wildcat test is being drilled. Six wells can be drilled from this one rig, by shifting the derrick to different spots on the top deck. The equipment is capable of drilling to a depth of 15,000 feet. The first test has been made and encouraging indications of oil-bearing earth were found.

Future open-ocean drilling platforms are likely to be somewhat smaller because of the cost. Humble is now working on two



smaller structures in the same area, one 50 by 150 feet and another 33 by 66 feet. These platforms will carry only the well machinery, while the crews and materials will be stationed alongside in converted Navy LSTs. This will greatly reduce the cost. Most other oil companies conducting deep offshore operations are using converted landing craft to house personnel and carry a part of the drilling equipment. The Ohio Oil Company plans a unique arrangement for its drilling in 50 feet of water, six miles offshore from Freeport, Tex. There will be one platform to carry all equipment, while another platform, joined by a catwalk, will contain quarters for workers.

Wildcat drilling often has been done ashore on nothing more than a hunch. Where a million-dollar platform has to be built before the drilling bit can dig one foot into the under-ocean ground, such a method is out of the question. Months of work by crews of expert geologists preceded the choice of location for Humble's offshore experiment. Using radar-equipped former Navy submarine chasers, these crews groped their way through fog, high winds and choppy seas to make seismographic tests to locate promising areas.

The seismographic technique consists of dropping small explosives in water and recording the results of the blast. This technique is based on the fact that salt earth, in

which most oil in the Gulf coast area is found, reflects sound in a different manner from the regular ocean floor.

Nor did the planners forget the human element, the 54 men who handle the tools which probe the underwater earth, searching for oil. These men work five days on the platform and then are taken ashore for two days off. While off shift but still on the platform, they have a recreation room in which to while away the hours. Radios, games, books and magazines are provided.

The know-how which has made Humble's million-dollar experiment possible was gained in years of shallow-water drilling in the marshes and swamps of Louisiana and Texas. Producing wells now dot these once almost inaccessible areas. Most shallow-water drilling has been done from ingeniously rigged barges. Some barges are submergible, sinking down as much as 10 feet to put the drilling rig directly in touch with the earth. Latest method is to use two

↓ Crane swings a template into place. A network of 25 of these templates forms foundation for platform. Right, pilings are inserted into templates and then sunk deep into the ocean floor to give firm support

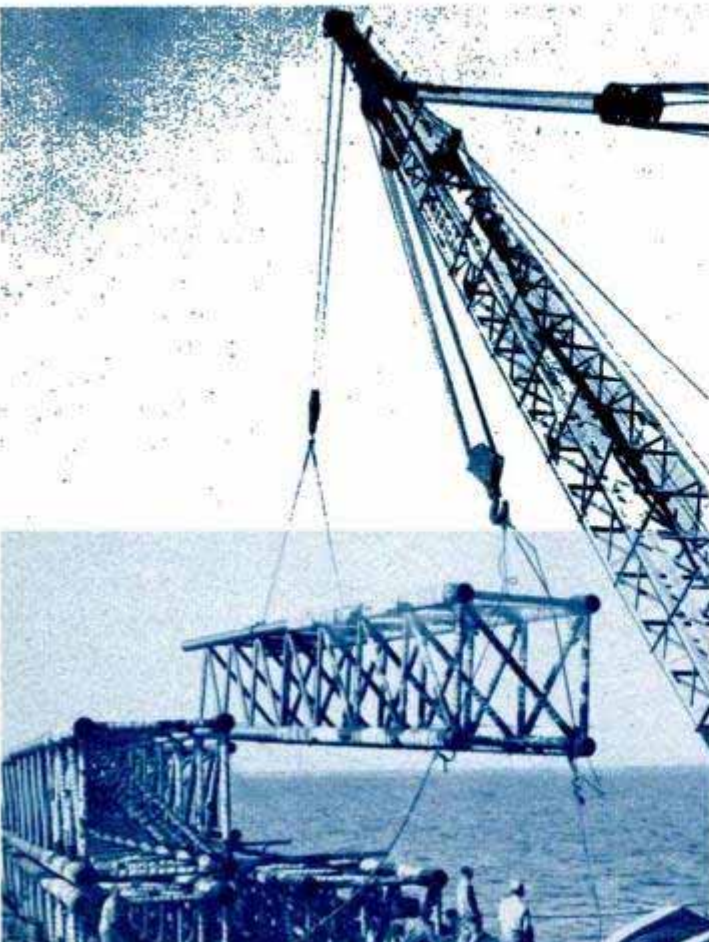



Crane lifts equipment and supplies aboard the platform. The tanks in the foreground hold fresh water

Drawing shows completed platform. Top deck is for drilling operations, lower deck for accommodations

OVER-ALL WIDTH, 110½ FEET  
OVER-ALL LENGTH, 206 FEET

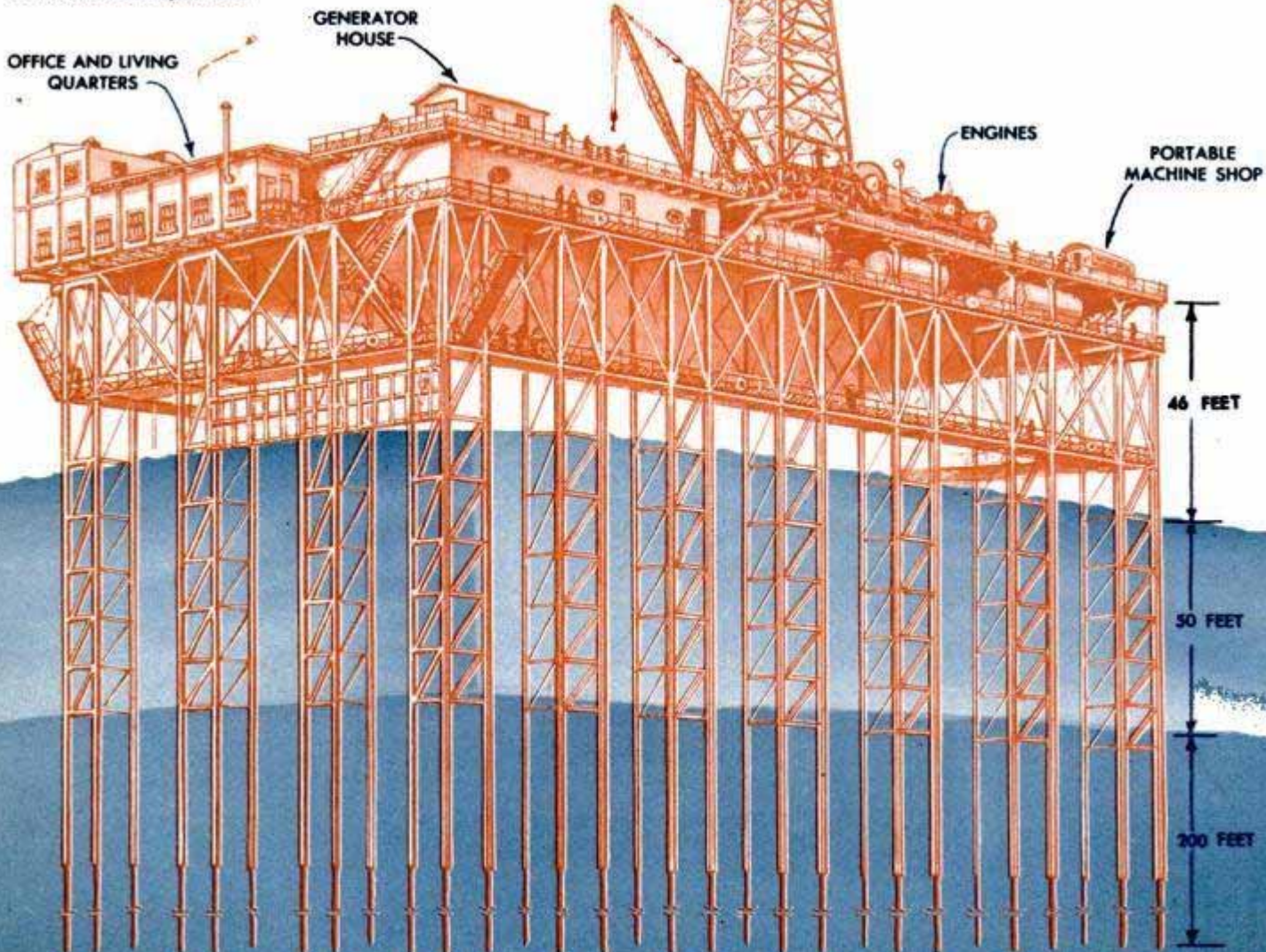

conventional barges with the drilling derrick lying between them supported partly by each barge.

Current interest in deep-water open-ocean drilling is concentrated in Louisiana and Texas. Louisiana at last count had nearly 30 offshore drilling efforts under way or about to be started. Texas has four such operations. The gently sloping Gulf coastal terrain, which means comparatively shallow water out to distances of as much as 30 miles, offers a fertile field for oil exploration. These operations would not be possible any distance off the West Coast, for example, where the ocean jumps to a depth of several hundred feet within a mile.

Oil-industry scientists think that 50 to 60 feet is the greatest depth in which wells can be drilled with present methods. With improvements, perhaps this could be extended to nearly 150 feet.

Will any greater depth ever be possible for drilling? Perhaps, scientists say. A submarine drilling shelf dropped to the ocean floor but operated by controls at the surface might someday make possible drilling at any depth.

Necessity is the mother of invention, these scientists say. And the ever-increasing demand for oil provides necessity aplenty.



### Meter "Prods" Big Machines To Record Vibrations

Called a recording vibrometer, a small instrument measures and records on a paper tape the frequency and amount of vibrations set up by large machinery. A short metal prod, which protrudes from the side of the vibrometer, is held against the vibrating object. Vibrations are transmitted through the prod, magnified 12 times by a spring, and passed to the moving sapphire point that rests on the waxed-paper tape. An electric motor moves tape under the point as it draws curves showing frequency and amount of vibration.



### Metal Television Tube

Television tubes made largely of metal provide a larger picture than all-glass tubes of the same diameter. The metal tube "scans" without distortion almost to the outer edge of the picture screen, while pictures on conventional tubes are frequently distorted by the curve of the glass. The new tube consists of a cone of spun chrome-steel alloy. Only the screen and the stem are made of glass which is sealed to the metal. The 16-inch tube is lighter in weight than an all-glass tube and offers more shielding against stray light and other interference.

### Horizontal Swing Rolls on Cables

There are no ups and downs on a swing that rolls horizontally along a frame staying at the same level from the ground. Suspended from overhead cables, the chains of the swing are attached to two rollers that ride on the cables. It was invented by a Nashville man and is a favorite with the youngsters.

Recently discovered White Dwarf stars are so dense that a cubic inch of their matter would weigh from one to one thousand tons on the earth.

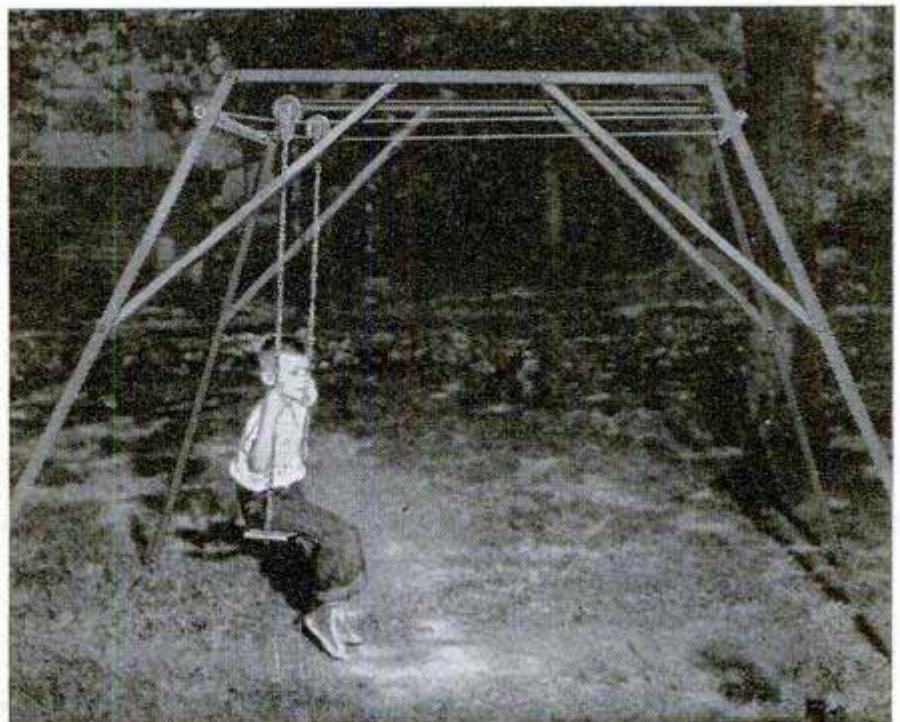



## Lightning Bolts Strike Car and Plane in Lab Tests

In a "lightning laboratory" at Trafford, Pa., scientists are producing their own lightning to test protective devices for homes and factories, and to find out how safe planes and cars are during electrical storms. In one test conducted by the Westinghouse scientists, a 3,000,000-volt lightning stroke, produced by a giant generator, was fired at a rain-swept automobile with a driver inside. The car acted as a cage and the lightning passed harmlessly into

the ground. The driver felt nothing because there was no difference in voltage across his body to produce a shock, even though the voltage of the car and his body rose to about 200,000 volts. In another test, a model of an airplane was struck with a tremendous lightning bolt which hit the plane at the nearest surface, a propeller tip, traveled along the outside of the plane to the lowest surface and then streaked toward the ground.



## Reflector Oven For Open Fires

Made almost entirely of aluminum for light weight and efficient reflection of heat, a collapsible reflector enables the camper to bake biscuits in front of an open fire. Knocked down, the reflector is only one inch thick. Opened, it will take any standard biscuit, pie or cake pan. There are no loose parts to misplace since its sections are permanently fastened together.

☐ Havana has 33 radio stations, more than any other city in the world.

# DEBUT for the '49 NASH



By Wayne Whittaker

AS THE POSTWAR PARADE of U. S. automobiles swings along the boulevards, country highways and Main Streets late this fall, there's a newcomer getting a cheer from the crowds. It is the five-foot-two 1949 Nash, a wallflower of last season, but now all dolled up in a postwar design and getting lots of admiring whistles.

The whistles are followed by some laments that the automotive glamour girls all look too much alike. Did all the automobile-body designers go to the same school? Or was there a government decree that all postwar cars must be wide, low, fenderless and with straight-flowing lines?

Well, Nash has gone one step beyond the rest in the general campaign to make an automobile look like a Great Lakes cabin cruiser. Its fenderless steel siding completely encloses the front wheels. Maybe this is the automotive version of the "new look." To make the long-skirt enclosure of the front wheels possible, the front tread was narrowed by 2½ inches.

The forward fenders, by the way, are bolted on—which mechanics will be happy to hear. Along with the grille, the fenders can be removed in about an hour for major engine repairs.

Strictly postwar in design, the streamlined Nash is first with fenders enclosing the front wheels

Below: A—Air intake. B—Defrosting motor and blower. C—Cover plate for fresh-air filter. D—Air intake to carburetor redesigned to get under low hood. E—Oil filter is in front of the carburetor air cleaner. F—Battery in fan blast. G—Grille allows ample air flow

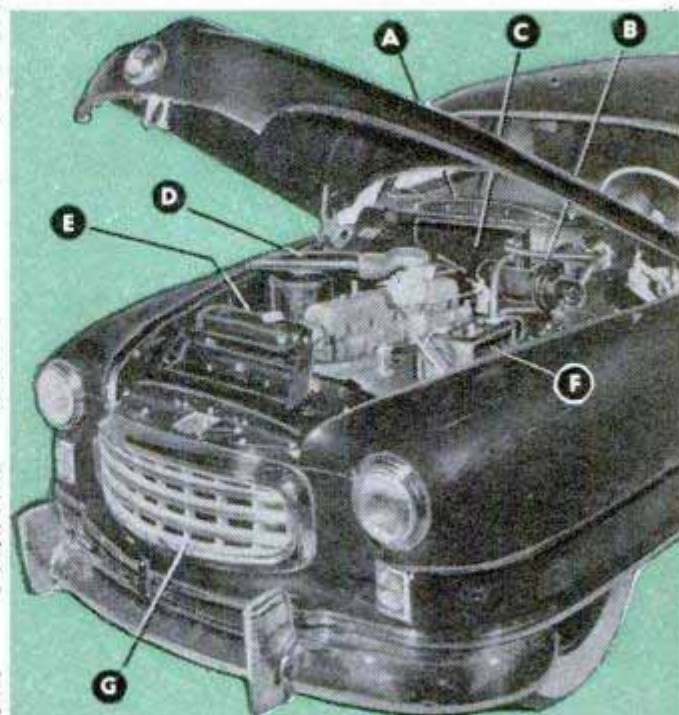

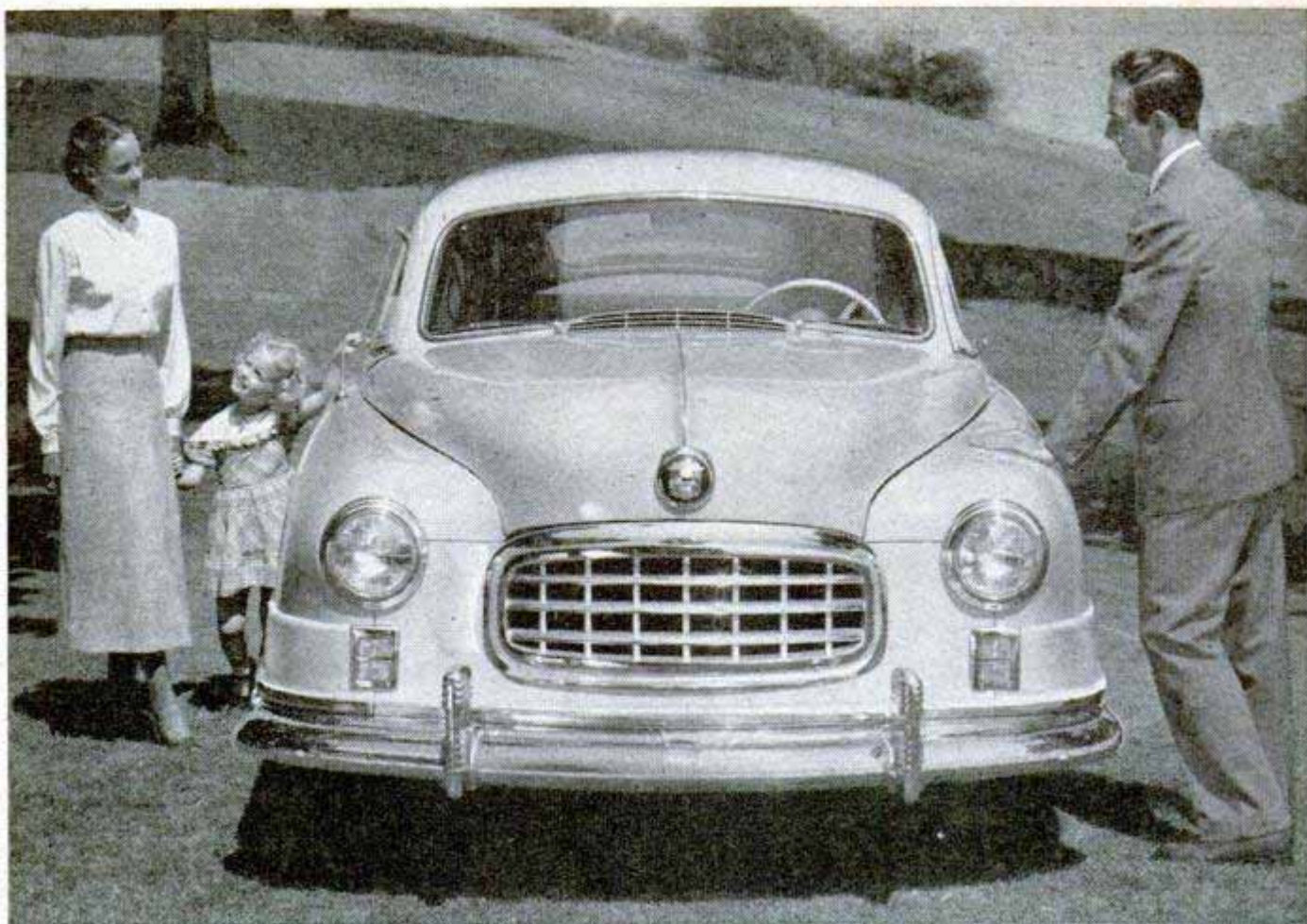

The '49 Nash is wide and low (62 inches) with good visibility. Air vent below windshield is always open

The beautiful '49 Nash is following the trend of Studebaker, Kaiser-Frazer, Hudson and Ford. This will probably start an argument with Nash engineers, who point out that the new Nash Ambassador and "600" models are so drastically changed that all body dies and major assembly-line equipment used in turning out the old models had to be scrapped. But who's comparing the car to a '48 Nash?

After the first approving look at the newest postwar beauty, Mr. and Mrs. Public want to know in the same breath if it has an automatic transmission. The answer is—not yet. Nash has been experimenting with various types of automatic transmissions—in fact tests are now being conducted on 100 cars—but no transmission has been found to satisfy the three-fold Nash requirements. Their engineers insist on a



Left, mounted on massive steering column is cockpit-type instrument group. Below, pickup pump on carburetor acts to smooth fuel flow with engine demand

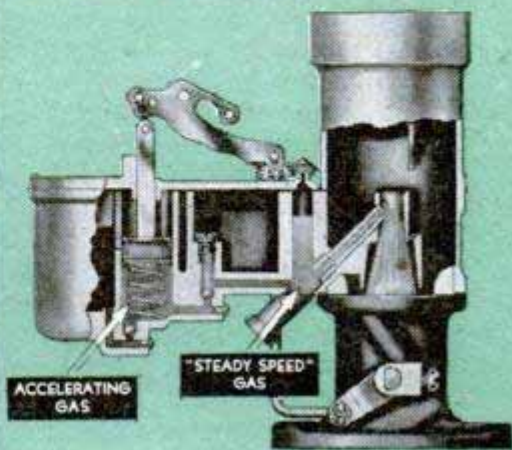

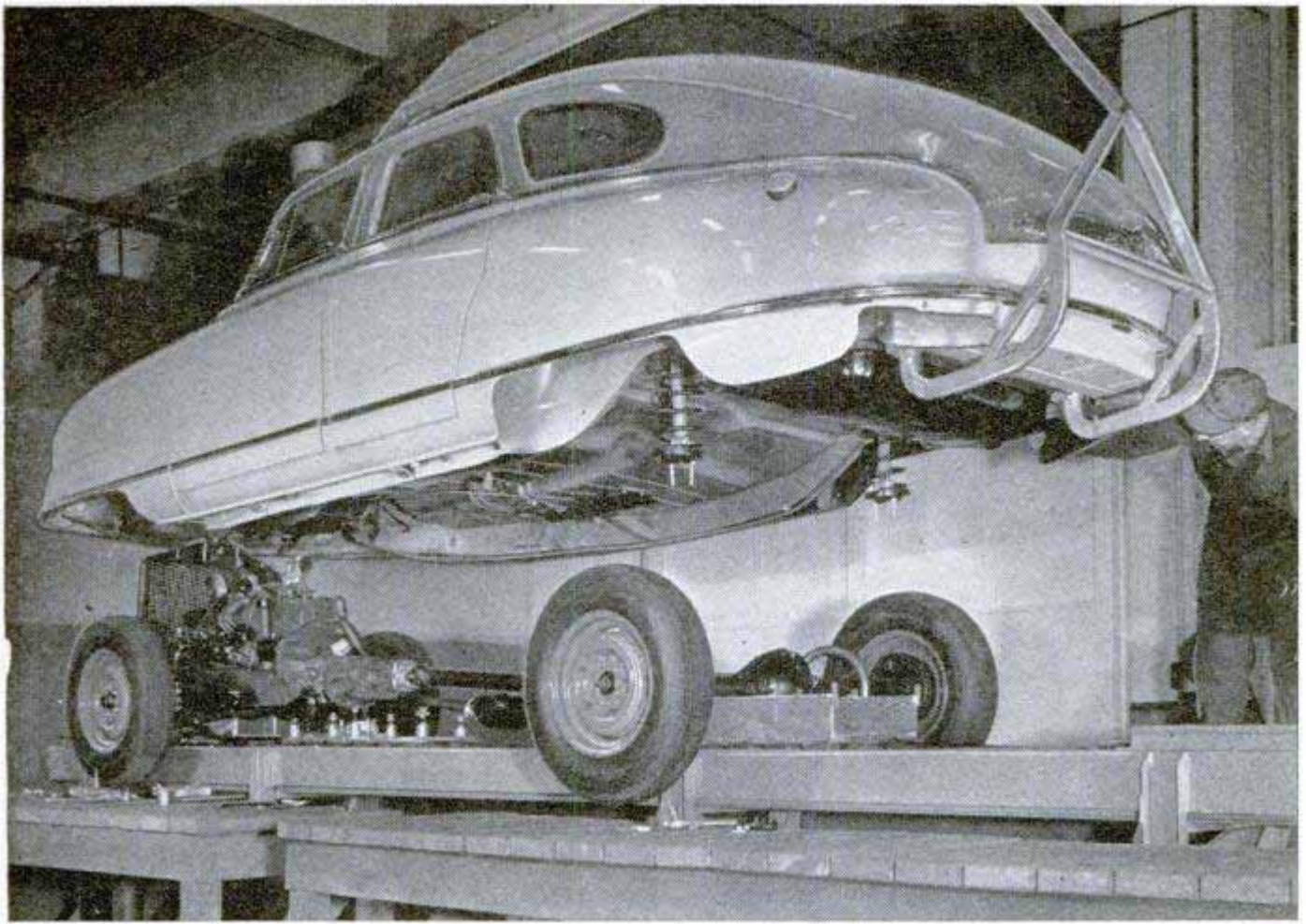

**Nash body built as single unit including frame is dropped on what remains of chassis on test assembly line**

transmission that will be inexpensive (probably less than \$100), fully automatic, and economical in operation.

That last factor—economy—is high on the Nash list of “musts” and something very close to the heart of George Mason, president of the company. For years Nash has stressed the economy of operation of the “600”—more than 25 miles to the gallon of gasoline at average highway speeds.

**A handy feature on the '49 Nash is this magazine or map rack on back of front seat. It's about 2½" deep**



That proud boast—which test drivers vouch for—is made again this year for the '49 models.

“We could up that mileage figure a bit and still be safe,” said one of the engineers, “with our new Uniflo-jet carburetor. In road tests the new carburetor gives from 1½ to 2½ miles per hour better fuel economy up to 50 miles an hour.”

This new carburetor, developed by Nash, has a special feed system which smooths out the fuel delivery when you “step on it.” The accelerator pump discharges extra gasoline into the passages between the main jet and the high-speed nozzle. This eliminates the abrupt shot of extra gasoline through a separate nozzle and conserves fuel without sacrificing performance.

As in the cases of Hudson and Studebaker, the Nash engines in both new models have been “improved” rather than redesigned. The six-cylinder engines which have proved their worth are the Ambassador's overhead-valve 112-horsepower engine and the “600's” L-head type 82-horsepower engine. The “600” has a



Divided front seat drops back to form single or "twin" bed arrangement without disturbing the luggage space

heavier crankshaft with additional counterweighting to provide smoother operation. The Ambassador crankshaft still has seven bearings—more than any other U. S. car now in production. Incidentally, a shaft of this type was found necessary in the super-high-compression Kettering engine now being tested by General Motors.

Other engineering changes include oil-saving four-ring pistons for the "600" and torque-tube drive for both models. The Ambassador formerly had the Hotchkiss drive but switched to the torque tube in the '49 in order to use coil springs at the rear as well as in front. Now both models have coil springs all around.

On the Nash proving grounds near Bur-

lington, Wis., the '49 Nash received grueling tests long before it was introduced to the public. As you slip behind the wheel of a shiny new sedan, the first thing you notice is the absence of instruments on the conventional panel. These instruments are grouped directly in front of the driver on what is called the Uniscope, mounted on the steering column. Here are the speedometer, oil, fuel and temperature gauges. What, no ammeter? In place of the ammeter, which Nash engineers say is the least needed and least used of all panel instruments, is a dot which glows when the battery is discharging.

If you are accustomed to glancing at a large speedometer, you will find yourself squinting at the small Uniscope. Perhaps familiarity with it will make its use easier. The "dashboard" is vacant, except for radio; the designers considered padding this panel as a safety feature to protect the vulnerable passenger beside the driver, but the extra cost was deemed greater than the public would pay.

In regard to visibility, the Nash is excellent to the front with the single-paned curved windshield that pushes the posts back. There are still blind spots at either side of the rear windows, although the distance between each rear and side window

(Continued to page 264)

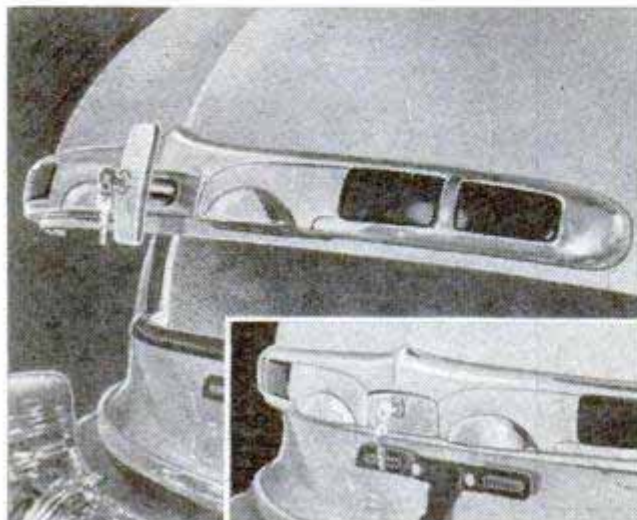

Rear lights are mounted in the trunk lid which has trick lock. Tamperproof handle springs out to open



## Picket-Boat Model Measures Nine Feet

Almost big enough to carry a passenger is a nine-foot model picket boat which was built by a Navy trade-shop group at the Puget Sound Navy Yard, Bremerton, Wash. The hull is made of laminated fir, with the superstructure laminated mahogany. Plexiglas windows have been installed and the top of the main cabin is made of the same material. The engine is not a working model but is a replica in wood. These boats are used for patrol and target pickup work.

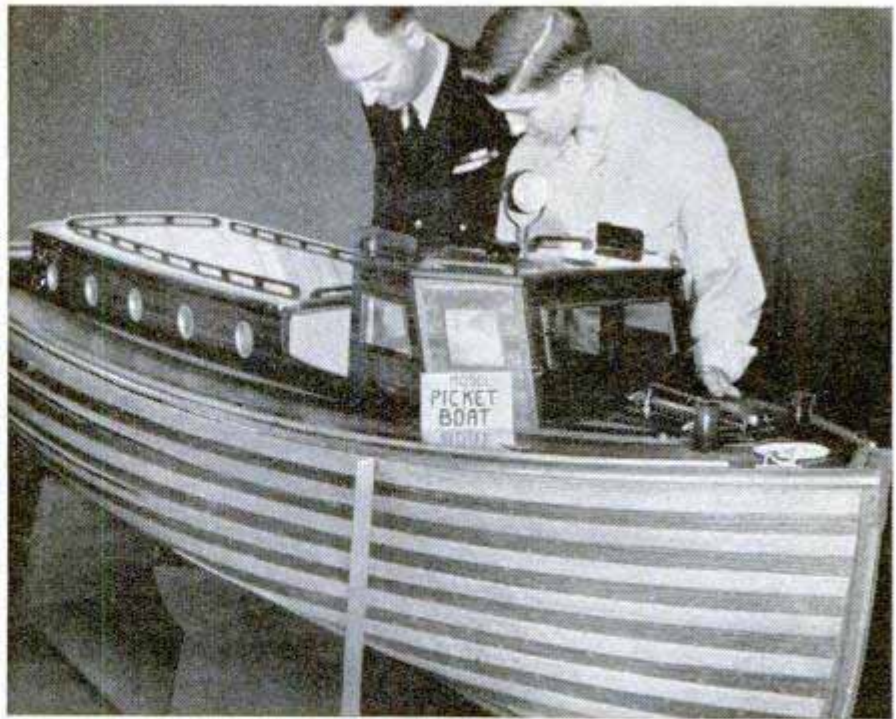

## Helicopter Prospects for Oil

Oil prospectors recently completed a survey of Louisiana swamp country with the aid of a helicopter. The wingless plane set crew members down at almost any point in the bayous and water-soaked marshes which are virtually impassable on foot because of the high reeds. The downdraft of the rotor blades flattened the weeds wherever the helicopter landed. The plane carried a gravity meter, which helps locate possible pools of oil by measuring minute differences in the pull of gravity. To facilitate operation, the instrument extended through the floor of the helicopter.

## Radio for Light Planes Weighs Nine Pounds

So compact it can be mounted behind the instrument panel, a light-plane radio transceiver (transmitter-receiver) provides the pilot with all essential radio communication and navigation facilities. Weighing nine pounds, the radio gives the following services: tower communications, four course ranges, marker beacons, standard broadcast frequencies, loop direction finding and six VHF transmitting channels, in addition to a cabin intercom system.

☐ Alaska's first dial telephone system is now in operation on Kodiak Island.

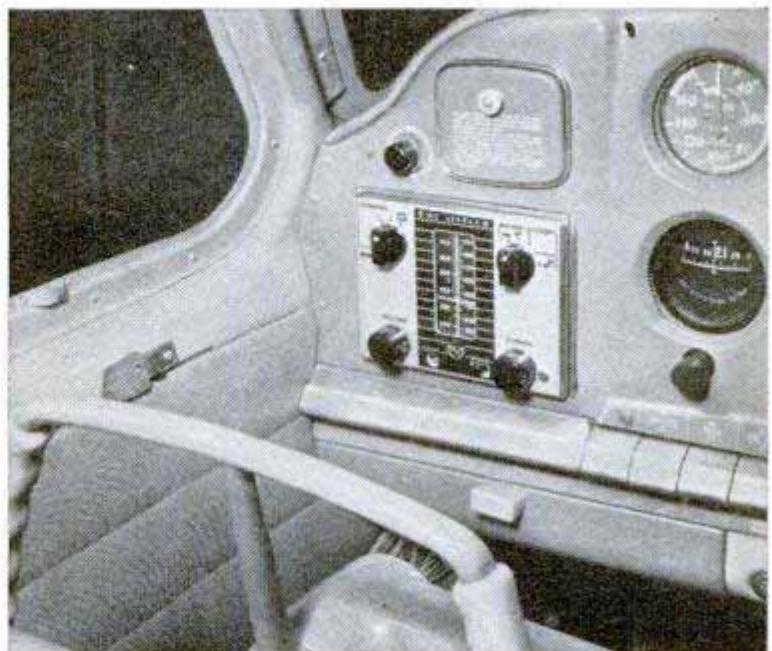

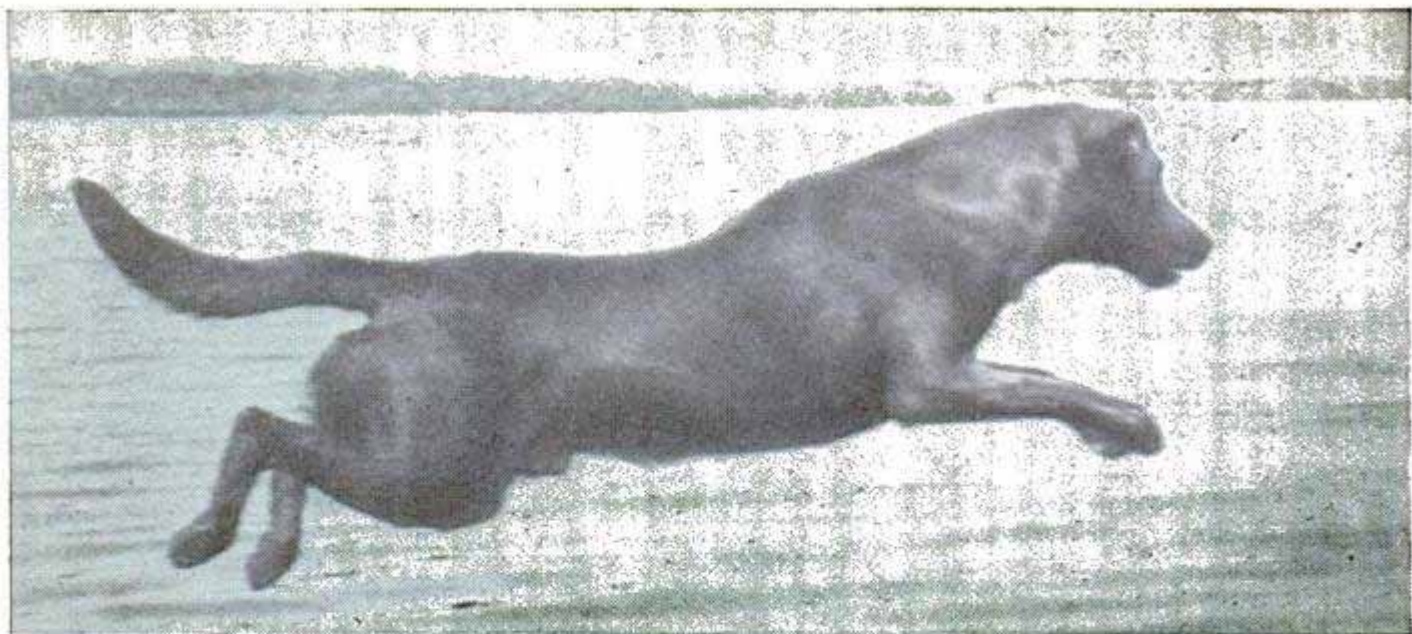

# ***Trainer of Champions***

Bill Walker, whose Labradors consistently cop prizes, says anyone can train a pup to be a top-notch retriever. Just guide the dog's instincts and soon you will be receiving wild fowl by special delivery

Big role in conservation is played by retrievers that locate and bring in wild fowl the hunter can't find. These Labradors are among the best

By Clifford B. Hicks

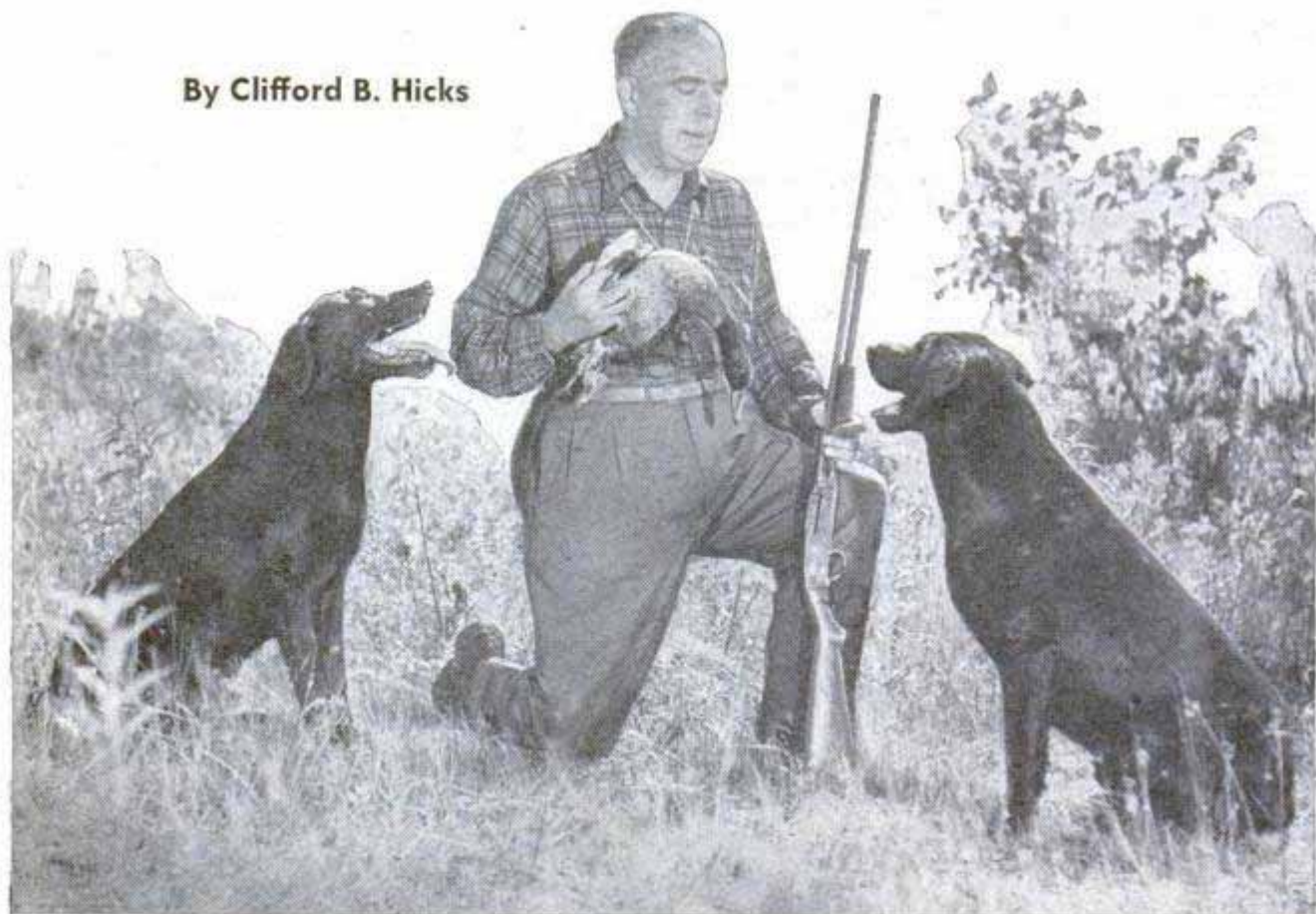



After a running dive, Nick, Walker's champ, swims to crippled duck, grasps it tenderly and returns to shore

**S**PECTATORS at a sportsmen's show in Chicago watched as gun dogs plunged into a huge canvas tank in a demonstration of wild-fowl retrieves. One man was so thrilled at the sight that he leaned too far over the edge of the tank, tottered a moment, and suddenly disappeared with a splash. There was a streak of black as a big Labrador, without a word of command, dived into the tank, swam to the sputtering man, grasped him by the arm and hauled him to safety. If the dog had been strong enough he would have deposited the bedraggled spectator gently in the hands of his master, Bill Walker.

The dog was Tyke of Barrington, and he's only one of the big Labradors of championship qualities whom Walker has owned or handled.

Walker is not a professional trainer—he's a sportsman who loves hunting and gun dogs. And he has a word of encouragement for any dog owner. "You don't need to be a trainer to teach your dog to be a good hunting companion. A trainer might get results faster, but any man with patience and a respect for his dog can bring it to the same peak of performance."

Tyke's record is outstanding. He won 64 field trials before he died a few years ago. Tyke seemed to know exactly what Walker wanted, even without commands. Just for the thrill, Walker once entered Tyke in a springer spaniel trial—a test in which the dogs flush game as well as retrieve it. Tyke won easily without any training in this type of field work. The big Labrador was considered by authorities to be one of the greatest retrievers that ever lived, even though he was not rated national champ because one of his great-grandfathers was not a pure-bred.



Without ruffling the duck's feathers, Nick presents it to his master. He knows canine courtesy and will back away before shaking the water from his body

Another of Walker's dogs, Nick of Rockingel, has never failed to place in more than 75 field trials in which he has competed with the finest retrievers in the country. But he's not only a show dog, he's a top-flight performer at his everyday job of finding and returning wild fowl to Walker. In four seasons of hunting, the sportsman has lost only one duck. "And that," he says proudly, "was my fault and not the dog's." The sportsman once turned down a \$3000 offer for Nick, whom he regards as his closest friend.

Walker now is working only two dogs, Nick and a one-year-old named Sin-Jin Tim, a pup the sportsman bought for his wife who also is a master at training retrievers. According to Walker, Tim will be the finest retriever in the country in a few years, but he hasn't yet developed the style that marks Nick as a retriever of real championship qualities.

Nick lives for those few moments in the field when he can bring in the waterfowl Walker shoots down. The signal given, he bounds forward in a great dive that takes him eight feet into the water, and hits with the splash of a ship being launched. He swims fast and for great distances—he'll go a half-mile from shore to pick up a duck. He'll nose through reeds or any other obstacles to find the bird. On the return trip, he carries the game as tenderly as a mother holding a child, and deposits it gently in Walker's hand. Then, courteously, he backs away from Walker before shaking the water from his body.

Walker is interested in hunting dogs—especially retrievers—because he feels they can do more for wild-fowl conservation than any other single force. He cites figures. "The hunter has a right to bring home his limit. Yet the toll of killed and crippled wild fowl, downed but never found, is one cause of the big drop in the game birds in this country. Statistics show that the average hunter picks up scarcely 60 percent of the game he shoots—unless

he has a trained dog to bring in the birds for him. If the hunter's limit is eight ducks, and he shoots down 12 or 13 in order to bring home his limit, then he has needlessly killed four or five birds. Figure this destruction over a season's shooting and you'll see that lost birds could well produce nearly 40 percent more ducks for the next season. Every hunter is morally responsible to bring home the game he shoots down. If he can't do this without a dog, then he never should go to the field without a retriever."

Nick, the champion Labrador, performs his job with a mastery and dignity that would thrill any sportsman. "Much of it is instinct," says Walker. "Educating a gun dog is not a matter of teaching him tricks. It's a program to develop the dog's own instincts, not for use by the dog but by the hunter."

Walker points out that even an eight-week-old Labrador pup will waddle after a tossed object and bring it back to the person who threw it. Many generations of breeding for working qualities have brought Labradors to a point where it's just plain natural for them to search out a bird and bring it to their master. A common mistake in training such a dog, according to Walker, is to expect too much too fast—to teach the dog more than he can absorb in one lesson.

"The trainer must know exactly what he expects the dog to do, and must insist on a

With two training "bundles" out, Nick switches from one to the other on gestured command during retrieve



proper performance. Training is based on obedience, so the trainer must have complete control at all times. This doesn't mean he should severely punish the dog for mistakes. If a dog likes you and knows that you are displeased, he'll make every effort to correct his errors. Thus a sharp word often will hurt a dog more than harsh physical punishment. Companionship means a great deal to a dog. The amateur owner who treats his dog as a hunting companion is more likely to produce a superlative field dog than the professional trainer."

He suggests that very little training be given a retriever until the puppy is about six months old. By that time the dog should recognize his name and probably will come whenever his master calls. The first few lessons are similar to those given any good dog: teach him to sit by speaking the word and pushing down on his back; teach him to heel by holding him with a collar; and teach him to "steady" by picking him up and returning him to

**Walker's wife trains one-year-old Tim to grasp a dummy bird solidly but gently. A top-notch retriever won't break the skin or bones of a bird**



**Tyke, one of the greatest retrievers that ever lived, leaps a fence with a pheasant in his mouth. This dog won 64 field trials during his life**

his former position every time he moves.

About this time, according to Walker, the retriever becomes "gamey"—that is, he is fascinated by birds. The trainer encourages this trait by teaching him to retrieve a "bundle" which simulates a bird. Walker uses a small boat bumper covered with canvas, which is about the same weight as a duck and has about the same resistance

to a dog's teeth. Even a dummy made of rags will be satisfactory. Teaching the dog to return the bundle is no trick—instantly he will mark its fall, run to the spot and rush back with it. The principal danger is that he will develop "hard mouth"—grasp the bundle so tightly between his teeth that he would injure it if it were a real bird. A trainer's patience may overcome such a tendency—patience in holding the bundle and insisting that the dog clasp it firmly but gently between his jaws.

Breaking the dog to retrieve live game is the next step, and usually is accomplished with little trouble. Pigeons are good training birds. Their wings are tied together with a bit of cloth as close

(Continued to page 268)

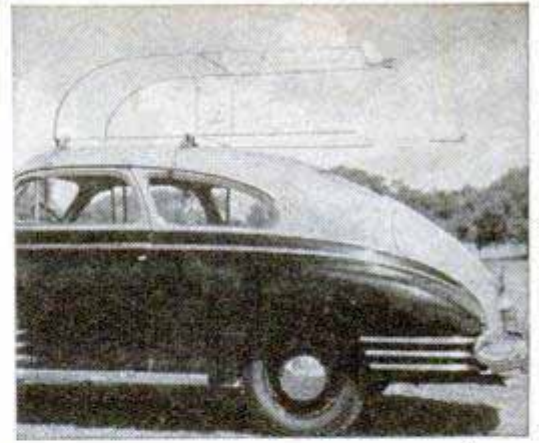
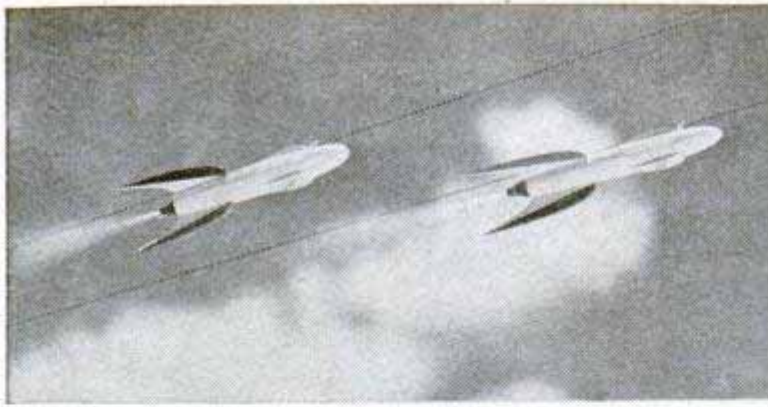

Left, young jet fans ready to start the models racing along wires. Top left, a pair of racers in flight. Above, rubber bands stop models at end of race. Photos show two systems of hanging guide wires

## Jet Models on Wires Race Between Cars

Looking like rocket ships on their way to some distant planet, jet-propelled models hit speeds of more than 125 miles an hour on steel wires stretched between two parked automobiles. Several types of guide-wire hangers are used, some stretching the wires side by side, others support-

ing one wire above the other. Springs keep the wires taut and rubber bands stretched across the wires stop the rockets without damage at the end of the race. The models are propelled by carbon-dioxide cartridges which are punctured by a spring-loaded needle when the starting gun is fired.

## Auto-Seat Bed Can Be Installed in Any Two-Door or Four-Door Car

Hotel space in your own automobile is provided by an auto-seat bed designed by a St. Petersburg, Fla., war veteran. Easily made up for sleeping, the three-cushion bed can be installed in any two-door or four-door car. Without leaving the automobile, the driver can give a fingertip pull on a cord and the back of the front seat

falls backward to align with the rear seat as a comfortable couch or bed. The front seat moves downward and forward beneath the steering wheel, allowing adequate space for reclining without interfering with the wheel. The bed works on a ball-bearing, wheel-and-track principle akin to that of the roll-up garage door.

Below left, a cord between the cushions releases the front seat. Right, the three cushions make a roomy bed



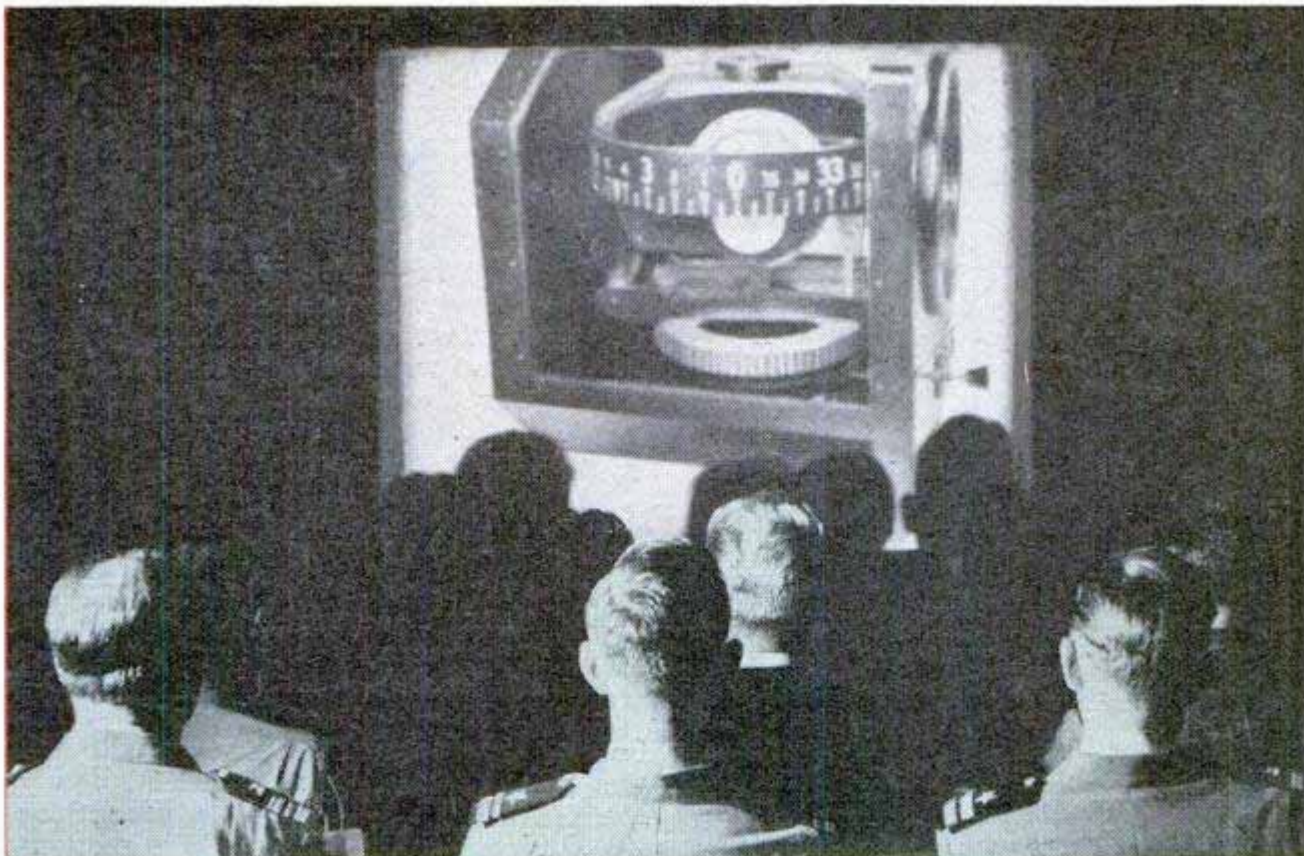

Navy officers in experimental "studio classroom" get a close-up of a directional gyro on television screen

## is the navy's

**By Bill Reiche**

**N**OW HEAR THIS," the Navy's classic call for attention, may soon be heard by thousands of gobs simultaneously in widely separated bases. How? By making television serve as schoolteacher.

Almost since the day the first image flickered faintly on a Kinescope, video has been touted as a possible medium to train a scattered audience. Its advantages are numerous: a single gifted instructor can reach an infinite number of students; for demonstration it can employ people, scale models, pictures, drawings, charts and movies (including the animated variety); it's alive—unedited and up-to-the-minute.

Project 15U2, being conducted by the Special Devices Center of the Office of Naval Re-

search at Sands Point, N. Y., is launching a three-pronged attack—technical, pedagogical and psychological—to find out whether an excellent theory can be transformed into acceptable practice.

Designed for the enormous training demands encountered in wartime, training by television can do yeoman service in the

View from the rear control room of the Navy studios at Sands Point, N. Y.





E. A. Hungerford, director of research at Sands Point, takes a part in one of his own television programs during Navy tests

days of peace—both with active officers and men and with reservists.

The idea was born after Pearl Harbor, when the best military minds looked for an air raid on the continental United States and probably aimed at the No. 1 prestige target, New York City. Air-raid wardens

were trained by a series of television lessons.

The link that carried the idea forward was E. A. Hungerford, Jr., then an NBC television production executive, who shortly afterward went into the Navy where he was assistant head of the radar section of the Special Devices Division.

Two years ago, after consultation with the Chief of Naval Operations, the Bureau of Personnel and the Bureau of Ships, he drew up a prospectus which has blossomed into Project 15U2. Hungerford and his project television producer, Peter L. Barker, realize they are pioneering and must keep their eyes on the goal of the best teaching to the most men at the least cost.

The laboratory studio at the Special Devices Center has two studio and two mobile cameras and was completely equipped by General Electric, except for the Du Mont mobile units. Three motion-picture projectors are installed so that any one may immediately be cut into the program. The set also includes two 35-mm.

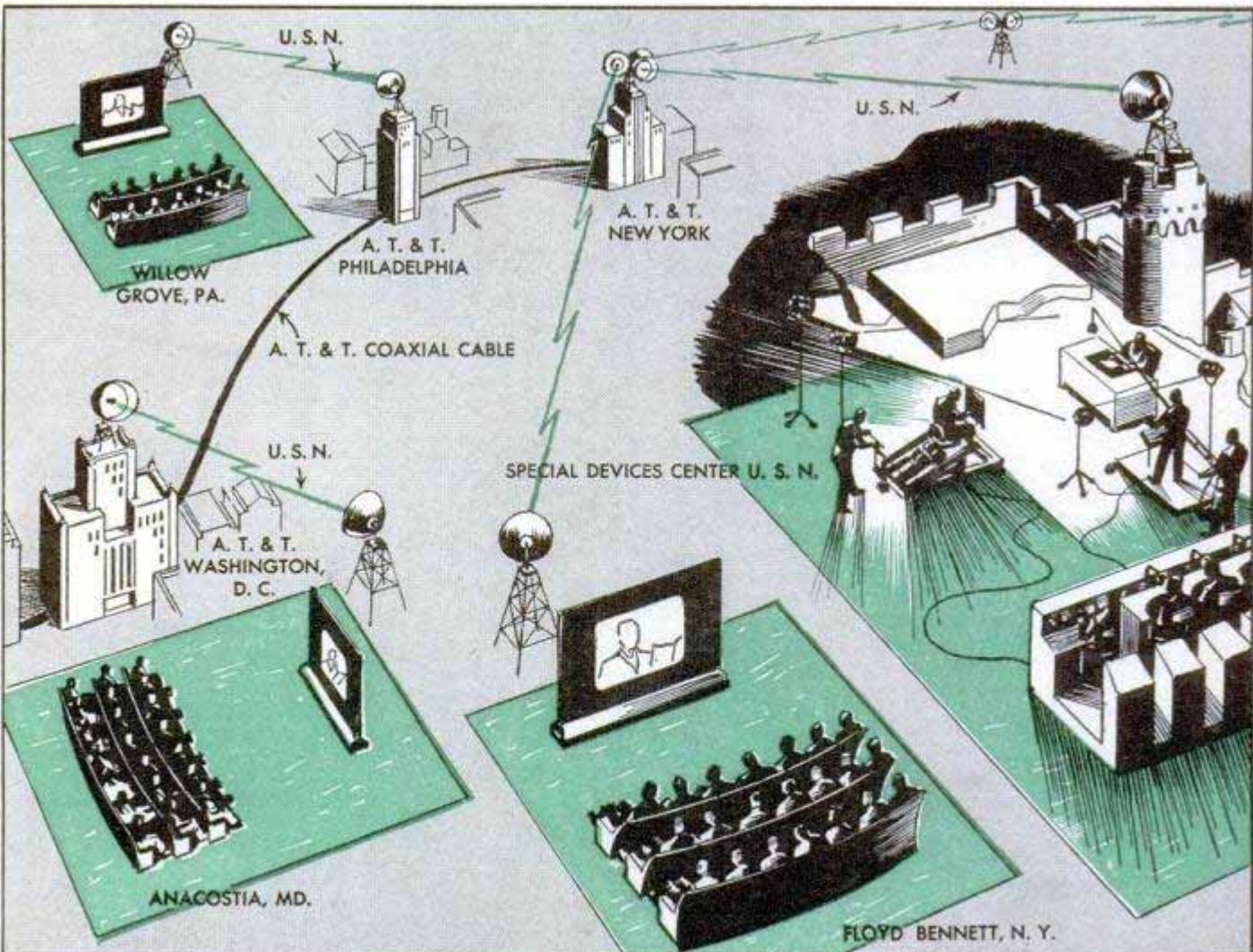



slide units. Two new techniques are being developed in the use of films. One is in making animated sequences, where the accepted Hollywood practice is now to make them slowly and at great expense. The SDC men, instead of making the "movement" very slight from frame to frame, which results in a smooth sequence but a long and costly job, will increase the movement and bridge the gap by carrying the eye from spot to spot by using air-brushing on intervening frames.

A field gun in the studio can be superimposed on a battlefield background by filming the gun against a black background and then piping the image twice into the camera line which is carrying the battlefield. The first time it is brought in, the gun will "cut a hole" in the background to its exact outlines and the second time the gun fills the hole.

It is expected that television centers will be situated in strategic regional locations, taking into account transmission facilities

(Continued to page 270)

Sketch below shows how one instructor at Navy Special Devices Center, Sands Point, N. Y., can reach thousands of students. Micro links connect with Boston and the coaxial cable to Philadelphia and Washington reaches the local naval training centers

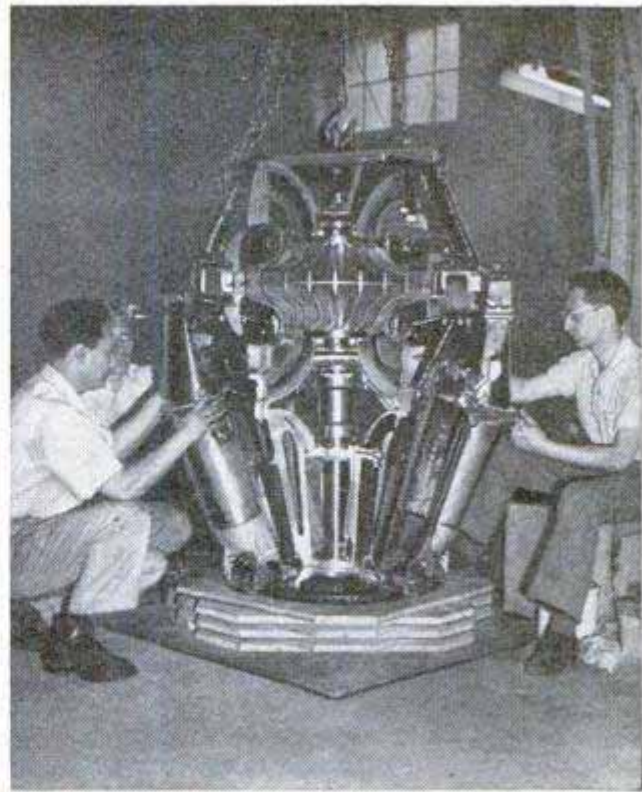
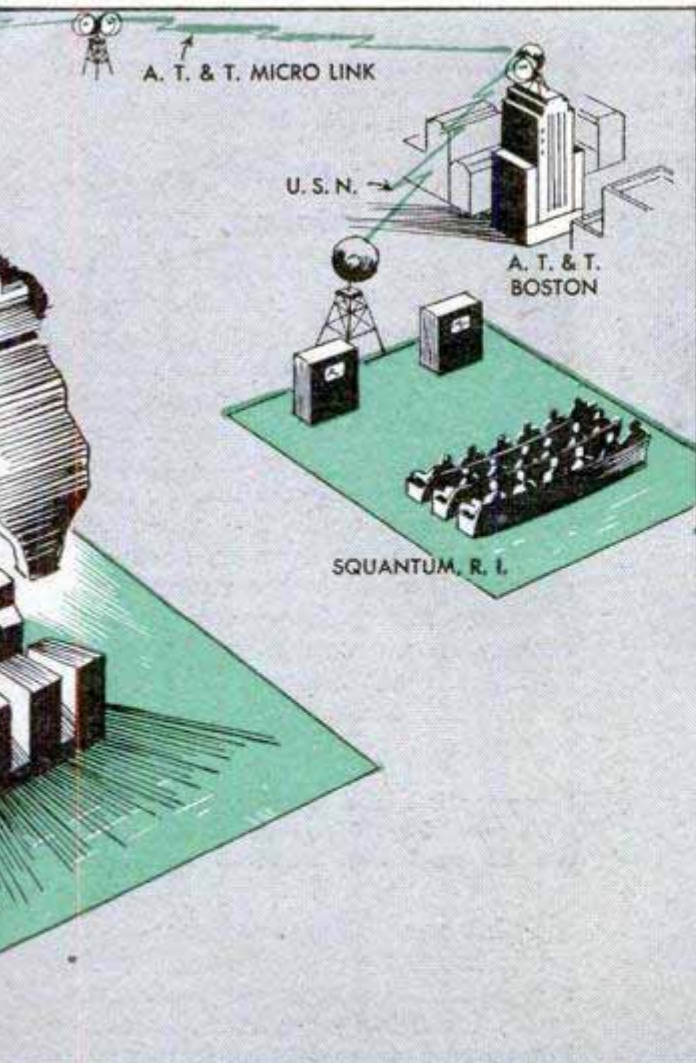

A J-33 jet aircraft engine is rushed from assembly line to television studio for Navy class. Below, a technician readies projection equipment in studio. Bottom, studio craftsmen construct model of a Waterbury speed gear used to elevate guns on a warship

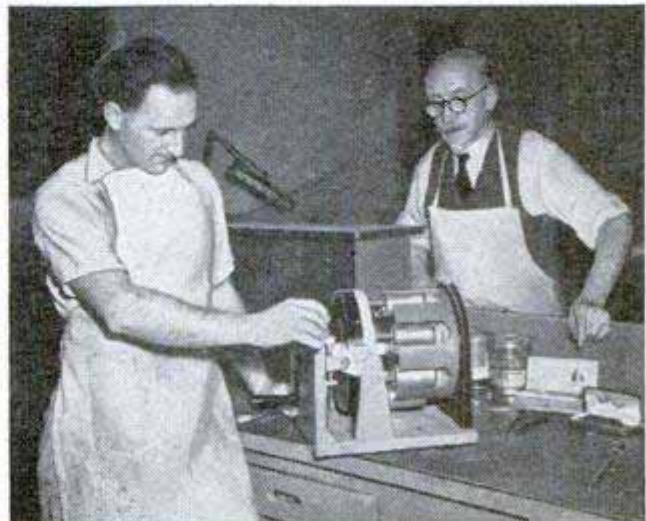
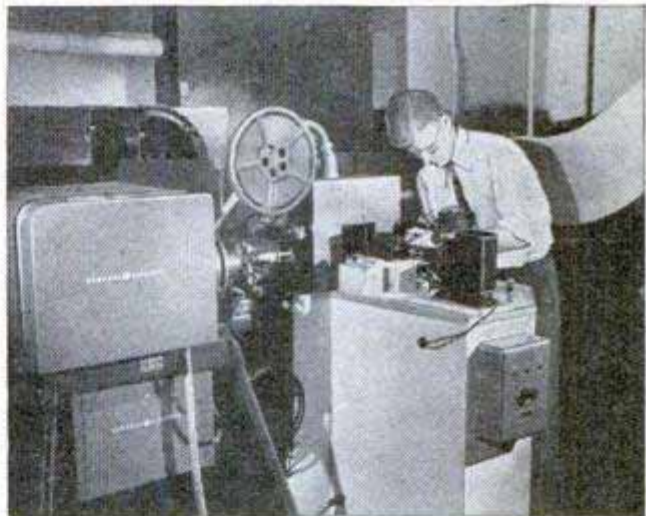

## Cushions Without Springs Can Be Used in Home-Designed Furniture

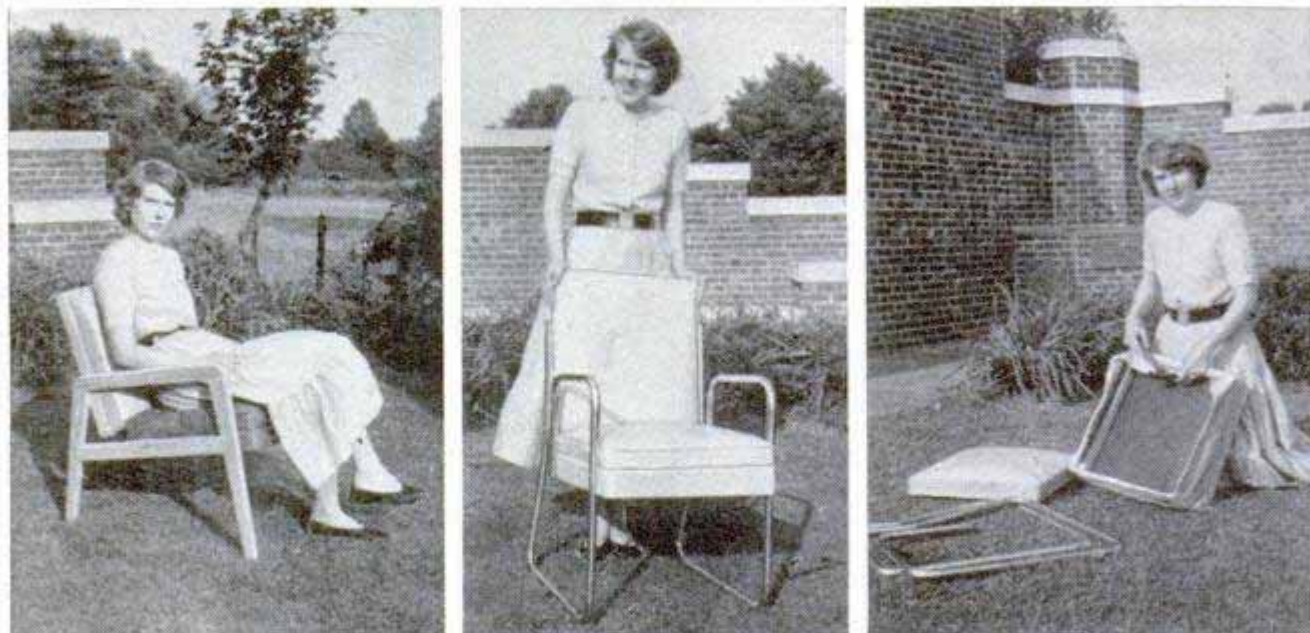

Left, furniture designed by the home craftsman can be built around these cushions. Center, cushions have no springs, but are soft and retain their shape. Right, skirt on cushion is tacked to the frame for a seat

Soft furniture cushions, made without springs, can be used by the home craftsman in building chairs of his own design. The cushions are cut from plastic sheeting with a leather grain. They are filled with kapok, which unites with the air to form a soft, fluffy material that retains its shape without the use of springs. In one model, the cushion is airtight and has a valve

which automatically fluffs up the stuffing. The home craftsman can tack the skirt extending from the lower edge of the cushion to the seat, and design and build a frame of his own. Only a fraction of the usual time and skill spent on upholstery is required. The cushions are suitable for porch and lawn furniture because they are watertight.



### Lid Converts Paint Can To Spray Container

Paint can be sprayed directly from the original container with a special cover that fits any can. The adapter eliminates the loss of paint in transfer from the original can to the spray container. It consists of top and bottom plates made of cast aluminum. A neoprene gasket seals the container when three wing nuts are screwed down. Attached to the cover plate are a brass regulator valve, a dial gauge, an automatic safety valve and brass air fittings. The paint outlets fit standard spraying equipment.

Spray top is sealed to the paint can with wing nuts. Inset shows air fittings, which can be used with standard equipment

Paint made from tobacco-seed oil is more flexible than linseed-oil paint, although it remains tacky for a longer period, according to two scientists of India.

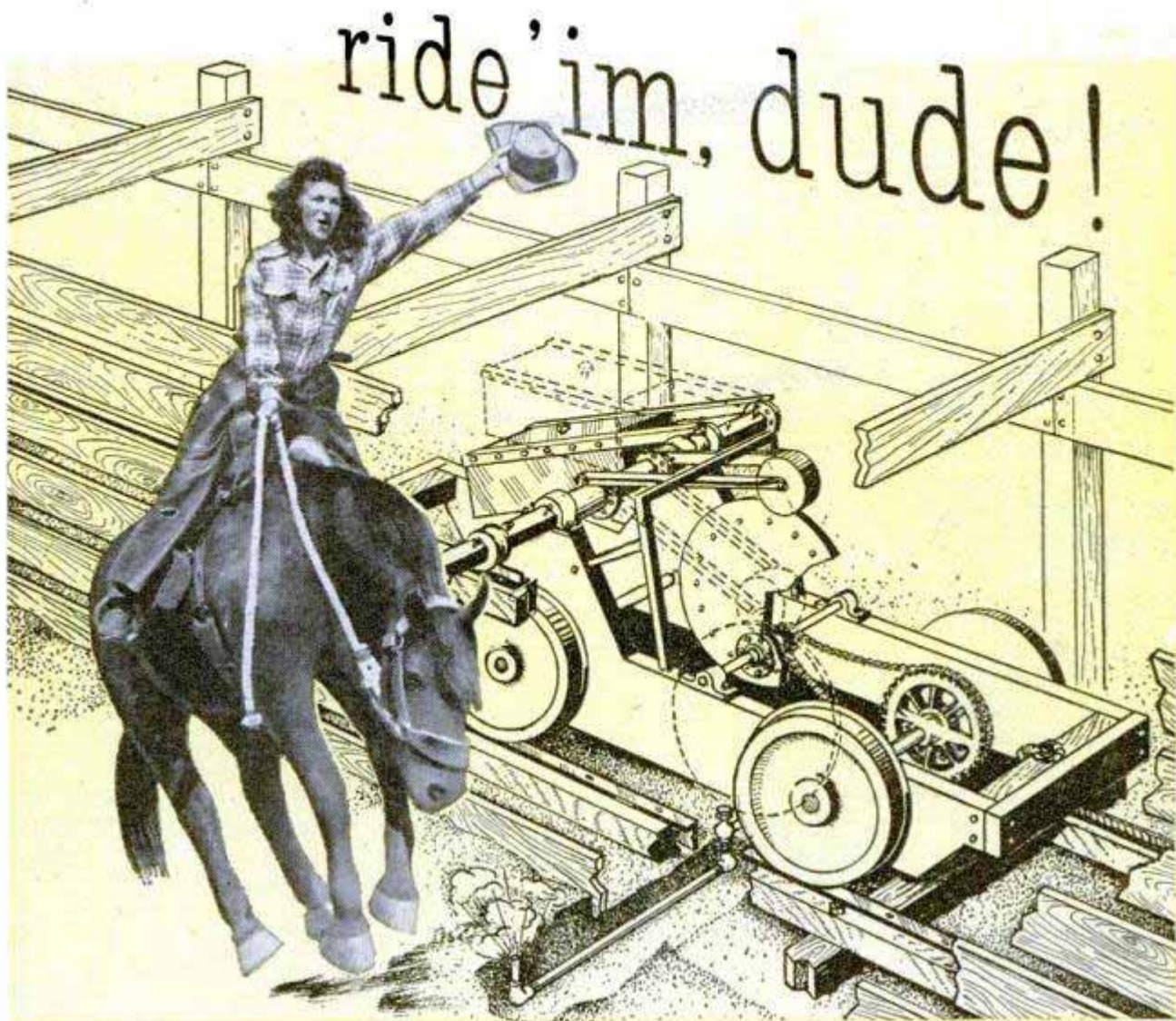

**T**HE GATE OPENS and Gunpowder, the bucking bronco, comes out of the chute plunging and pitching, dust spurring from under his feet. With head lowered, he charges alongside a high corral fence, his rider hanging on for dear life! And yet this is the gentlest horse in captivity. A child of three can ride him, and so can his grandmother. In fact, he will not even switch at a fly. He is a mechanical horse and every move he makes is controlled by an operator.

This man-made horse charges out of a chute and bucks the length of a fence 120 feet long. He can buck twice a second or once a minute. Though he is not supposed to

Bronco-busting is safe when you're riding this mechanical horse that is driven by a machine behind the fence. Even dust clouds are provided

**By Howard D. Clark**

Backstage view of the man-made horse and the machine that makes it buck

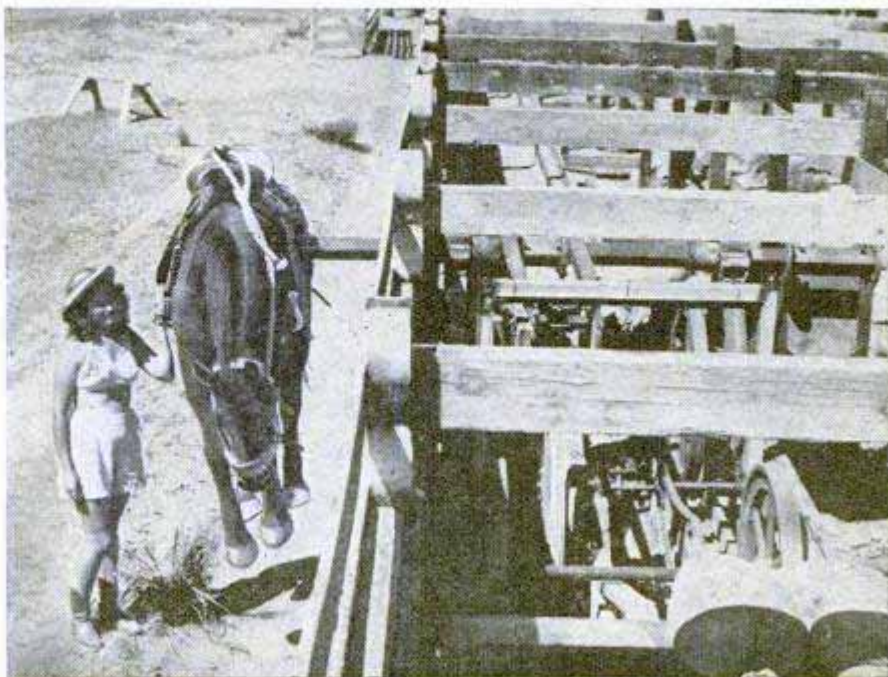

throw the rider, no doubt this horse could, if the question arose, offer the severest test of sticking ability that a rodeo rider would care to meet.

Gunpowder's creator, Bill Pace of Buckin' Horse Ranch, Yucca Valley, Calif., knows horses. As a master horseman and skilled mechanic, he constructed the horse, and designed and built the mechanism that makes it travel and buck at his bidding.

Pace grew up with horses in the Southwest, riding all kinds and breaking his share of broncs. He once saw a taxidermist's horse hanging from a post and realized that if he could make that horse buck he'd really have something. So he made a model on a scale of three inches to the foot and designed a mechanical bucking machine. For his full-size model, a taxidermist's horse wouldn't do because it wouldn't stand the wear of "rodeo" action.

So Pace set about making his own bronco. He made a cast of a dead horse with one-day cement. With this as a guide, he sculptured his bronco in fighting pose, using paper, muslin, glue and steel reinforcing. Its rayon-flock hair would fool its own mother. The bronc has steel eyelashes, rubber ears and natural mane and tail. In styling the tensed form, neck and features, Pace modeled his steed after the quarter horse. It took about four months to make it, but he now has a cast so he can repro-

duce it in four weeks. In all, the animal cost \$1600 and the bucking mechanism represents an additional outlay of \$7000.

In its bucking action the horse does not touch the ground, but it seems to do so to the spectator who can see no support. It is suspended on a steel bar extending through the fence to a wheeled chassis which runs on a track behind the fence. The chassis carries the bucking mechanism. When the car moves the horse forward, the bar travels along an opening between the fence planks. The two upper planks of the fence above this opening are supported from the rear. To strengthen the illusion, rubber flaps that are pushed aside as the bar moves along simulate fence posts making the fence look like one piece.

A 5-horsepower electric motor and a 1½-horsepower compressor provide the power that drives the mechanical bronc. The chassis is pulled along the fence by a rope attached to each end of the car and wound around a windlass at one end and a pulley at the other. As the car moves, a chain, driven by a sprocket wheel on the axle, turns an eccentrically mounted cam which raises and lowers the bucking arm by a roller arrangement. This roller is held against the cam by a weight, set to balance the weight of the rider. When he dismounts, the weight raises the roller, stopping the bucking action.

**Speed and vigor of the action are controlled by the operator seated near the entrance with other spectators**

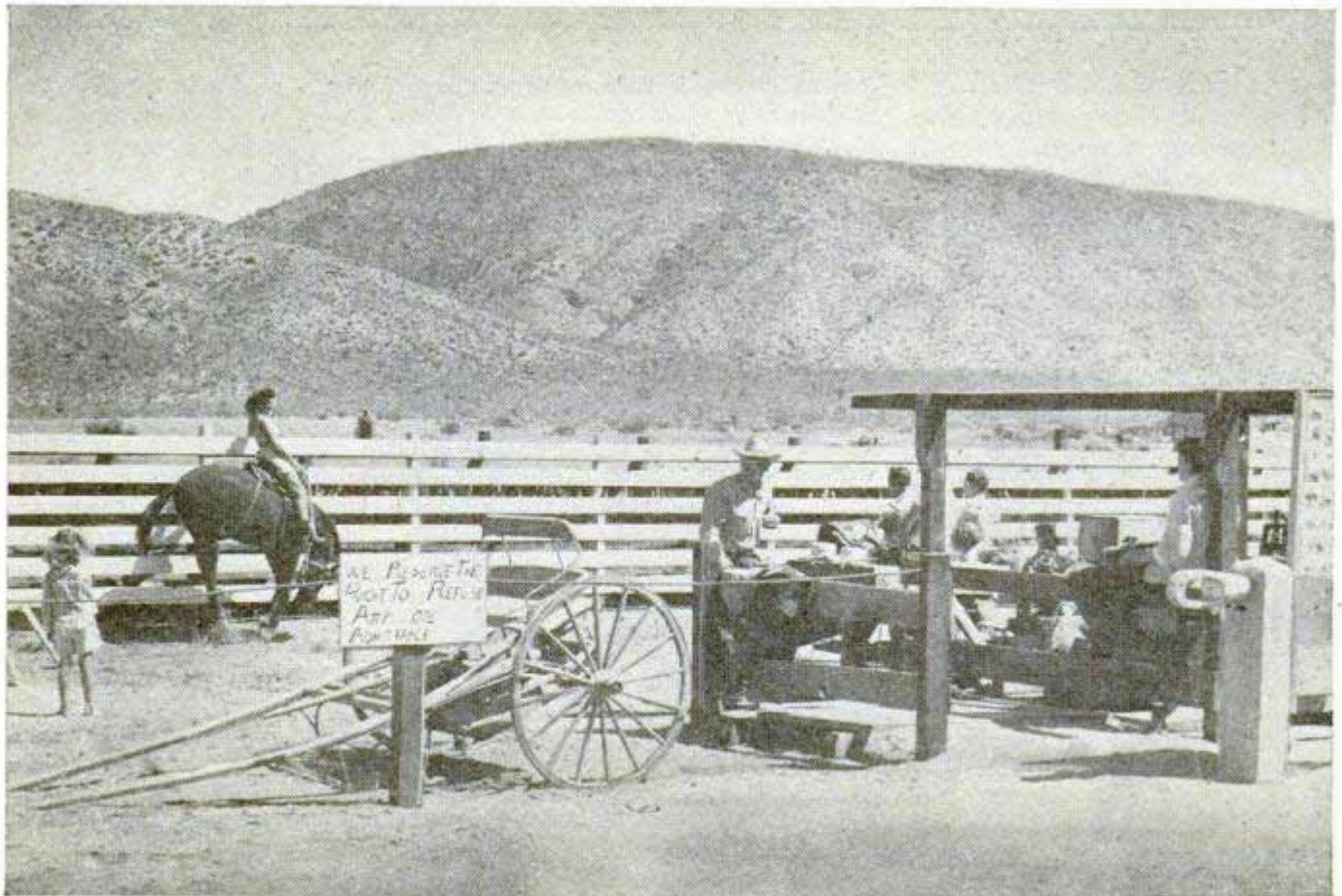

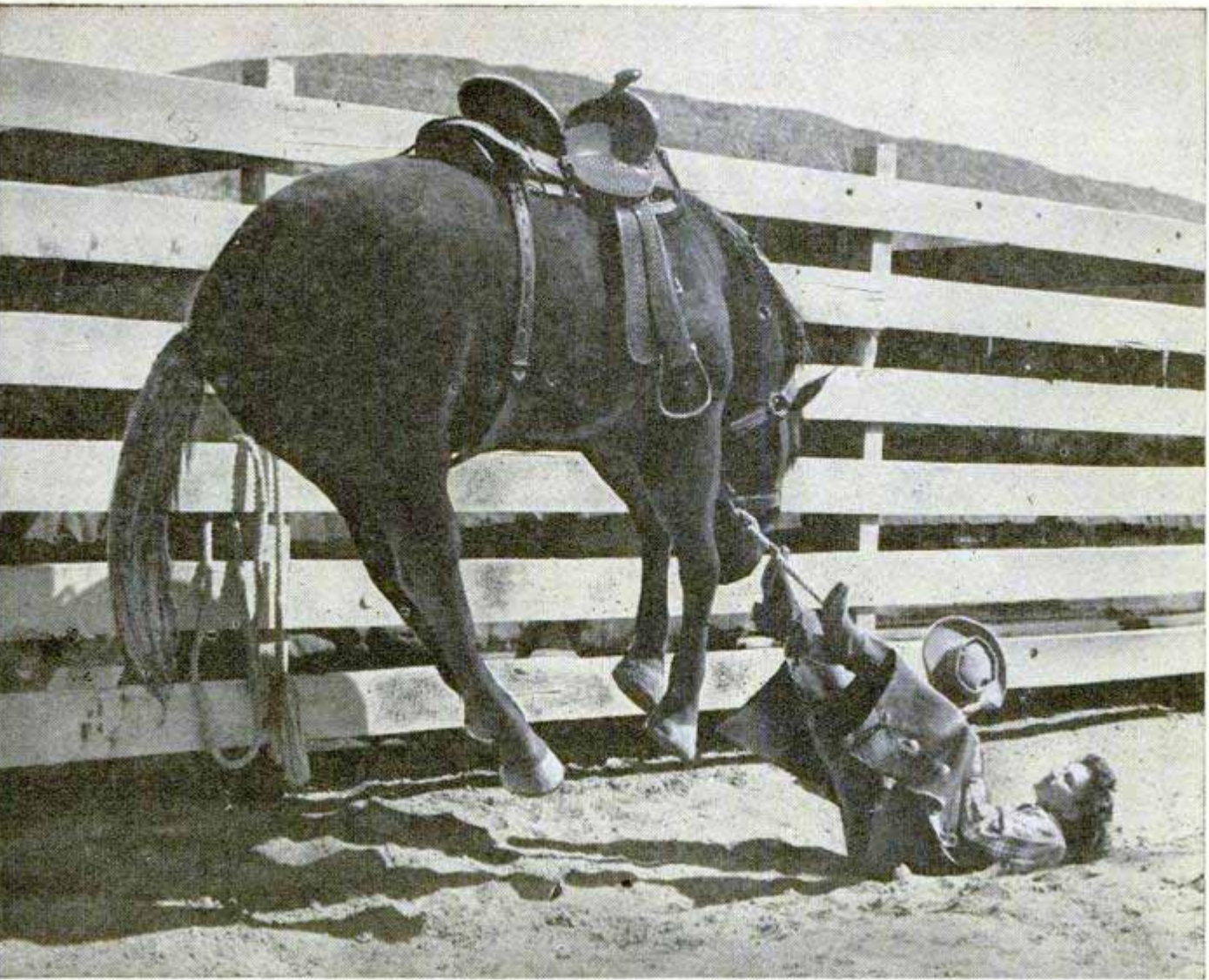

Action shots, like this one of a tossed rider, can be faked. Break in the fence post can be detected here

A favorite with the dudes, the mechanical horse is a safe way for them to be photographed by either movie or still cameras in thrilling poses. When these pictures get back home, they look like exciting rodeo scenes. Pace says his idea germinated at Merced, Calif., during 20 years of giving curious tourists a safe taste of riding that approximated rodeo style.

A leaf spring on the bucking bracket recessed inside the horse takes out jars and shocks, providing life-like resilience. The horse makes a vertical rise of 20 inches during a 3½-foot jump. This, plus the spring action, gives the rider as much thrill as the average dude wants. With added speed it could be made to toss him high in the air, but that never happens. If he does fall off, the automatic mechanism stops the bucking at once and the horse, as any bronc

would, rises and floats over the grounded rider with the greatest of ease. The steed then backs quietly into the chute.

Ever the perfectionist, Pace couldn't overlook the inevitable cloud of dust. A buried air line with outlet pipes spaced to match each rotation of the cam takes care of that. As the horse moves along, the cam engages a valve releasing a quick blast of air from each of a series of pipes under the dirt just as the bucking horse seems to hit the ground.

After building and testing the complete rig at Merced, Pace installed it at his roadside Buckin' Horse Ranch at Yucca Valley. Judging by customer reaction, the bronc would be the hit of the show, anywhere from Coney Island to Golden Gate Park.

**Inventor Bill Pace walks away from his animal after putting a bucking surcingle around it**





## Nozzle Extension Makes Garden Hose More Useful

Designed to make your garden hose three times as useful, a nozzle extension saves you work when washing your car, flushing down your driveway or watering delicate plants. A mop head attaches to the bent extension tube for washing the car or the

windows of the house. To sweep sidewalks and driveways with water, a high-pressure nozzle is used. A pressure-breaker attachment is provided for gently irrigating soil around the bases of plants without spraying leaves, resulting in a saving of water.

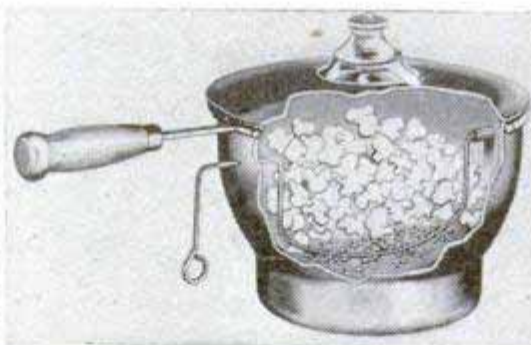

## Glass-Top Popper Has Trick Shaker

You can see the corn exploding in a glass-topped corn popper that features a pendulum-type agitator. Instead of the usual flat bottom, the popper has a popping chamber shaped like a half ball. The pendulum agitator, curved to fit the bottom, keeps unpopped kernels on the area of greatest heat and moves the popped corn up so it won't burn. The glass cover is heatproof and enables you to see when the kernels are all popped. The agitator is operated by an extension arm.

## Automatic Brake Ends Stop-Light Creep and Acts as Hill-Holder

Fully automatic, a braking device locks the hydraulic brakes on when a car comes to a complete stop. There are no buttons to push or other driver-operated controls. By a combination of automatic switches, the braking device holds hydraulic pressure in the brake cylinders as long as the car is motionless, the ignition switch turned on

and the accelerator released. When the accelerator is pushed to resume motion, the braking device releases automatically. The unit does not go into operation again until the car comes to a complete stop. It is especially designed for hill-holding and to prevent creeping by automatic-transmission cars.



### Casting With Rubber Is Simplified By Coagulation-Control Liquid

Making molds and castings with latex solution is much easier and faster when a newly developed material, which speeds the rate of coagulation, is added to the latex. By adding more or less of this liquid, the rate of coagulation can be controlled. When used for dipping, as in the production of rubber gloves, the latex will produce a film up to  $\frac{1}{10}$  inch thick in a single dip. Without this material, it would require about 20 dips to produce the same thickness. The new material also makes it possible to cast solid rubber articles in one-piece molds. The elasticity of the latex permits removal of the casting from the mold without breaking either. Molds made with the material can be used also for casting liquid plastic, plaster and other materials.



Above left, latex mixed with new material is poured over model, which is easily removed (right) when the latex coagulates. Top, the rubber molds and castings. Center mold made the plastic figures in front of it

### Winder for Tractor Keeps Wire Taut While Rolling it on Spool

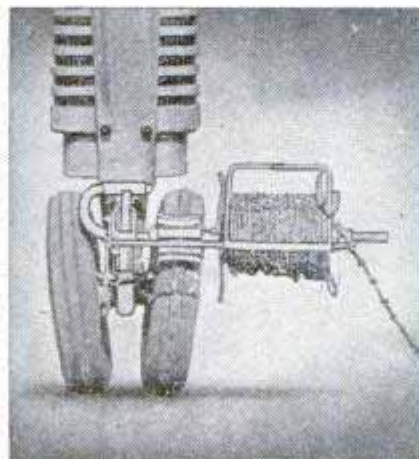
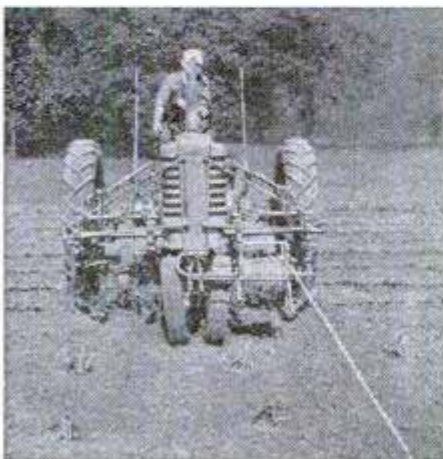

Barbed wire can be rolled or unrolled at a rate of 80 rods every three minutes with a winding attachment for a tractor. The winder is friction-powered by the front wheel and is geared to keep the wire taut while winding it on the spool. The wire is picked up and rolled at the same time, eliminating snarling and backlash.

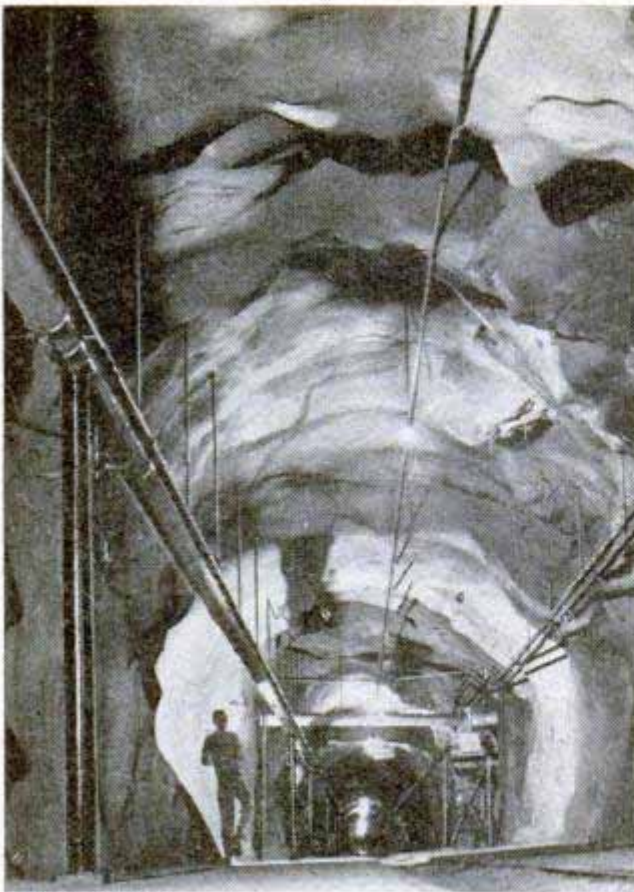

U. S. Navy photos

Five hundred feet underground, battery-driven train runs through rough-hewn tunnel with fuel lines along sides. Below, steel ladder leads straight up to dome of each tank where visitors look down inside a tank (if empty) to a depth of 300 feet. See sketch, right

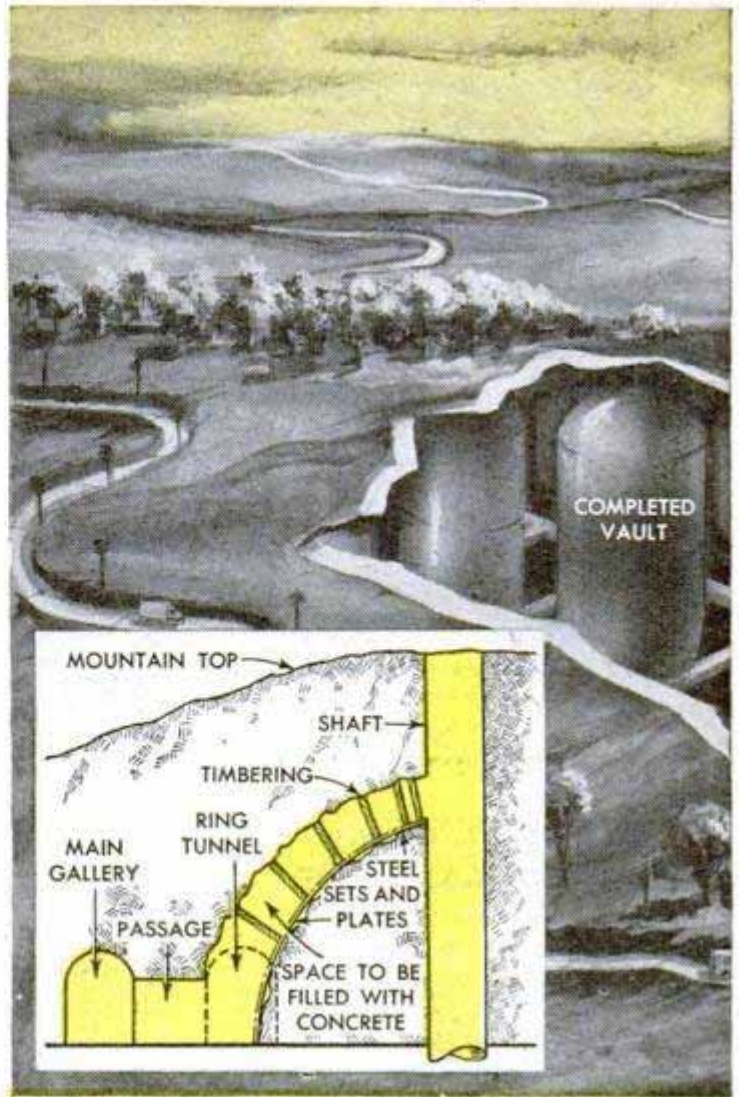

**This is one of the biggest "now it can be told" stories of World War II — far below Pearl Harbor are fabulous underground caverns holding oil for the fleet**

**O**NE OF THE NAVY'S most closely guarded "top secrets" during World War II was the fabulous underground oil-storage tanks hidden hundreds of feet deep in a mountain back of Pearl Harbor, Hawaii. These fuel-storage tanks, considered among the greatest engineering feats of all times, are so huge that a 30-story building could be dropped inside each tank with room to spare. The 20 underground tanks hold 4,000,000 barrels of precious oil for the Pacific fleet—enough fuel to carry a cargo ship 500 times around the world!

Threatening gestures of the Japanese fleet back in 1940 made necessary this 42-million-dollar project at Red Hill. At that time the Navy realized if war occurred in the Pacific the above-ground fuel tanks would be inadequate and highly vulnerable. Inadequate because not enough fuel could be stored to take care of the Pacific



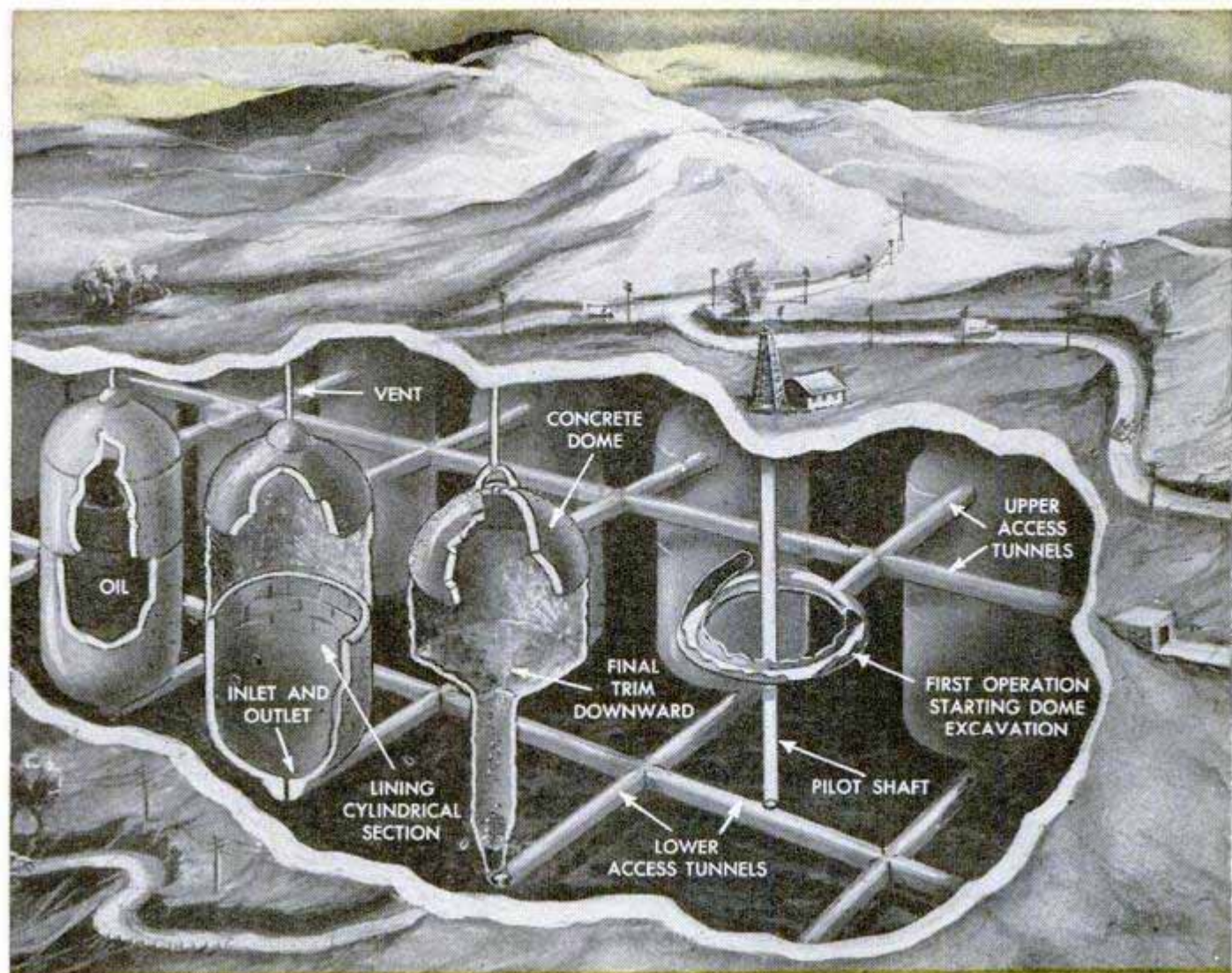

Adapted from drawings by Lill Rethi and Louis Ruyl from the book "Builders for Battle" by David O. Woodbury

## Inside Pearl Harbor's Secret Caverns...

By Richard M. Botts

fleet's vast wartime needs, and vulnerable because these tanks could be wrecked easily by a few well-aimed enemy bombs.

To take care of this situation, the Navy decided to embark on a daring, untried and gigantic experiment. The experiment would be the building of an underground oil-storage area so deep in the earth that not even bombs or earthquakes could menace the fleet's lifeblood.

At first, the civilian engineers planned to store the oil in horizontal tunnels. But this would require much heavy equipment and men all working in narrow, cramped quarters. With the Navy's consent, the engineers decided to build something entirely without precedent—vertical underground tanks, side by side, 200 feet apart and connected by underground tunnels. By carving the tanks out in vertical fashion, beginning at the dome of the tank, most of

the rock and earth could be disposed of by gravity. In this manner, the engineers figured, they would save much time, money and machinery.

To make the tanks bombproof, construction of the tank's dome began 100 feet underground. But, before actual construction of the storage area could begin, two horizontal tunnels had to be driven through the mountain—one at the 150-foot level, the other somewhat below the 400-foot level.

While the tunnels were in progress, a vertical shaft was dug over 400 feet deep bisecting both tunnels. As soon as these two operations were completed, construction of the tanks began. Miners were lowered 100 feet down the shaft to begin building the dome of the tank. It was hot and dark. No light penetrated from the outside and, although blowers were used, the heat sometimes ran to 130 degrees.

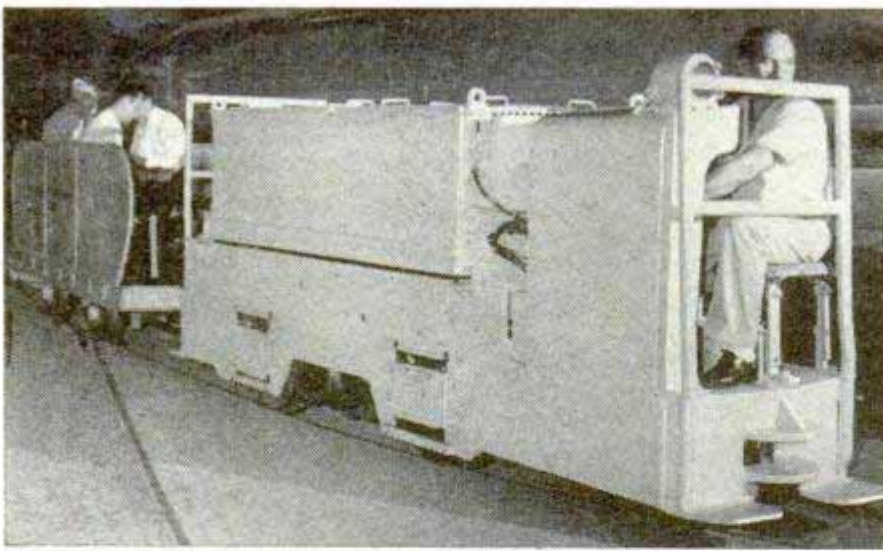

"Fuel Line Special" makes three-mile trip through tunnel in 30 minutes

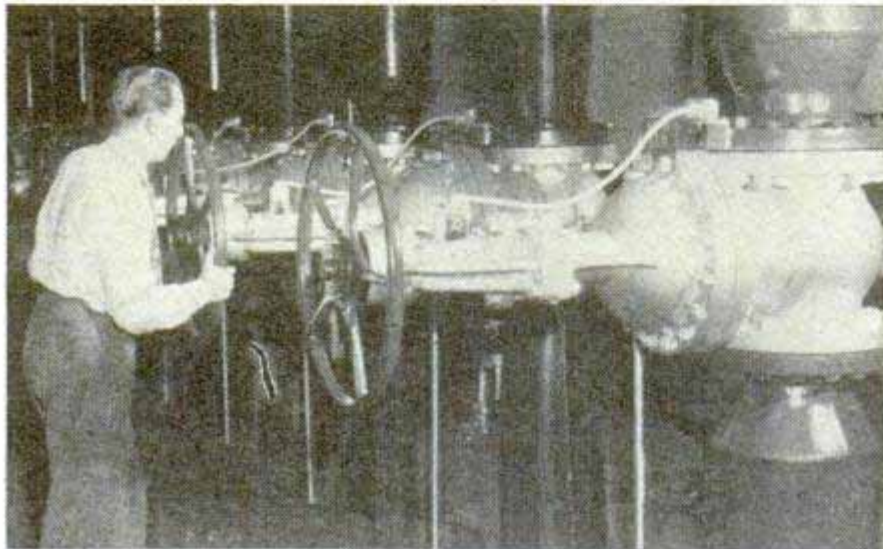

In the main pump room (above and below) huge pumps force the oil from Pearl Harbor up into the tanks three miles away. The room itself is half the size of a city block. In case of power failure from Honolulu, the farsighted Navy has built a special room for emergency generators

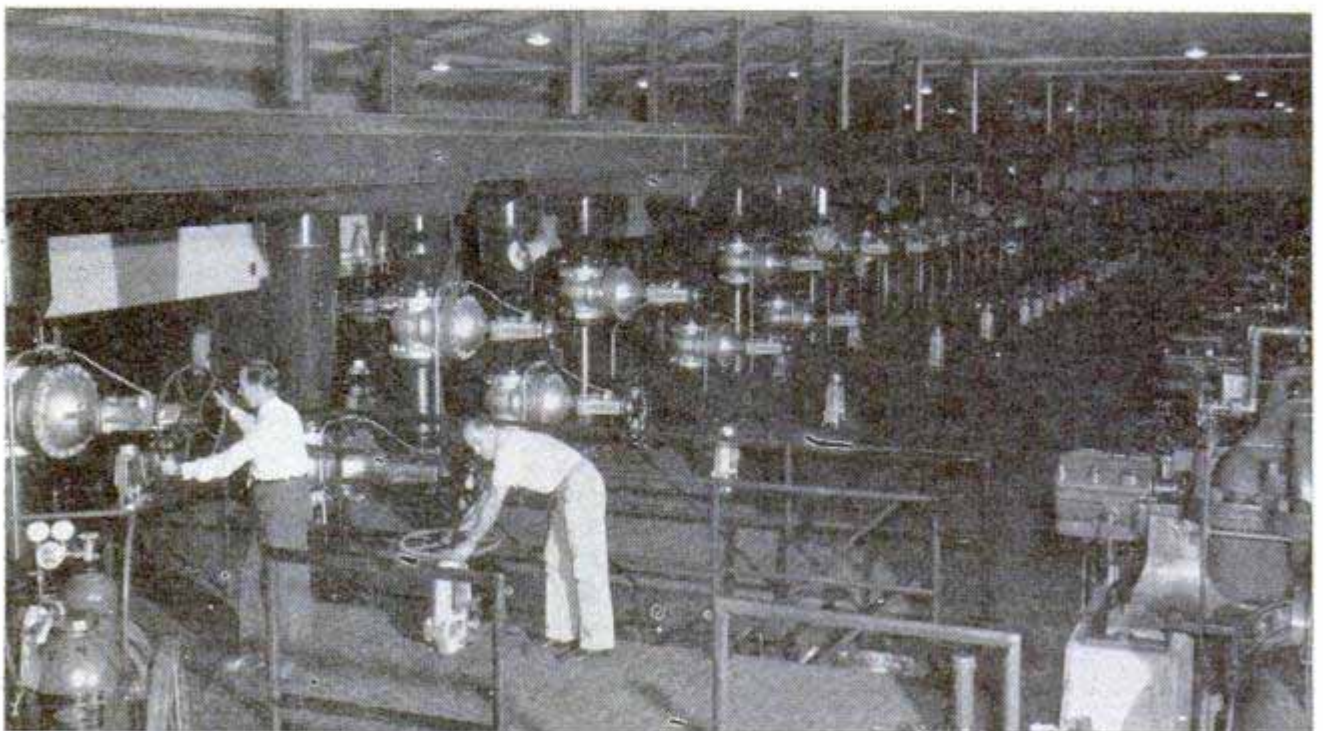

Building the dome of the tank required excavating an annular space which was timbered and then steel plates set against the inside rim. When the steel plates were completely welded together the timbering was removed and concrete shot down specially designed chutes to fill the space completely.

Once the concrete had hardened, the really hard and dangerous work began. The miners then began excavating the tanks from the inside out. As the miners dug the rock loose they simply let it fall down the 300-foot shaft to the bottom where it broke up and landed on a conveyor belt. The belt then carried the rock outside without a hand touching it from the time the rock was dislodged from the miner's pick until it arrived outdoors. The conveyor belt consisted of loops of rubber and fabric belt running over rollers driven by electric motors. On miles of this conveyor belt the muck was quickly and easily eliminated.

Begun the day after Christmas, 1940, the Red

Hill underground storage tanks were finally completed in late 1943.

Today, from his offices close to the entrance to the storage tanks at Pearl Harbor, Lt. Comdr. K. A. Beede and his small group of naval and civilian employees run the underground "show." Entrance to the still closely guarded storage cave is obtained by entering a mammoth concrete structure resembling a Quonset hut at Pearl Harbor. The only indication that this leads to the fabulous underground is a sign in the concrete wall reading "Station F."

Once through the steel zigzag door, the visitor must walk 100 feet inside the tunnel to the main entrance door. A ring of the bell at the side of the door brings a guard who cautiously peers through a thin slit in the steel door, views every corner of the tunnel from a large reflection mirror, examines all credentials, passes, and when satisfied that everything is in order, slides a bolt and a gargantuan two-foot-thick steel door swings gently outward and the visitor is passed into the underground wonderland.

The main control room lies right beyond this door. Here are the master controls for all the tanks. A large board indicates which valves are open, which closed, amount of fuel in each tank, the pressure in the tanks, the temperature and the number of feet of fuel in each tank.

Adjoining the main control room is the pump room. About half the size of a city block, these pumps are powerful enough to pump fuel from Pearl Harbor to the tanks three miles distant. Just in case of power shortage from Honolulu there is a special room for emergency generators to supply the power to keep the operation working continuously.

Beyond the pump room, a battery-driven train known as the "Portuguese Jeep" or "Fuel

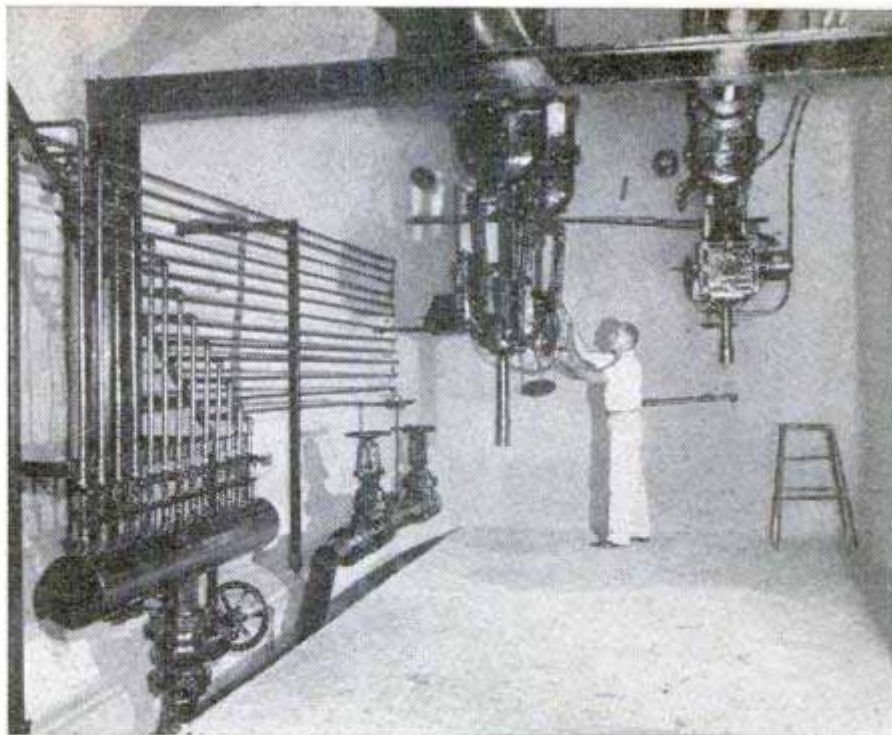

Below each tank is a leak locator, operated automatically or manually. In case of a leak in one of the tanks, oil is drained out immediately

Line Special" awaits the visitor. It is the only transportation between the pumping station and the tanks, three miles away and 500 feet beneath the earth.

The train makes the three-mile trip in about 30 minutes. All along the side of the tunnel are 16, 18 and 32-inch fuel lines. There are no above-ground fuel lines. Lights glow eerily every 50 feet or so which makes the whole route a reminder of a carnival "tunnel of love."

The "Fuel Line Special" stops at the

Main control board shows pressure, number of feet of oil, temperature, and whether there is a leak in any one of the 20 underground fuel tanks

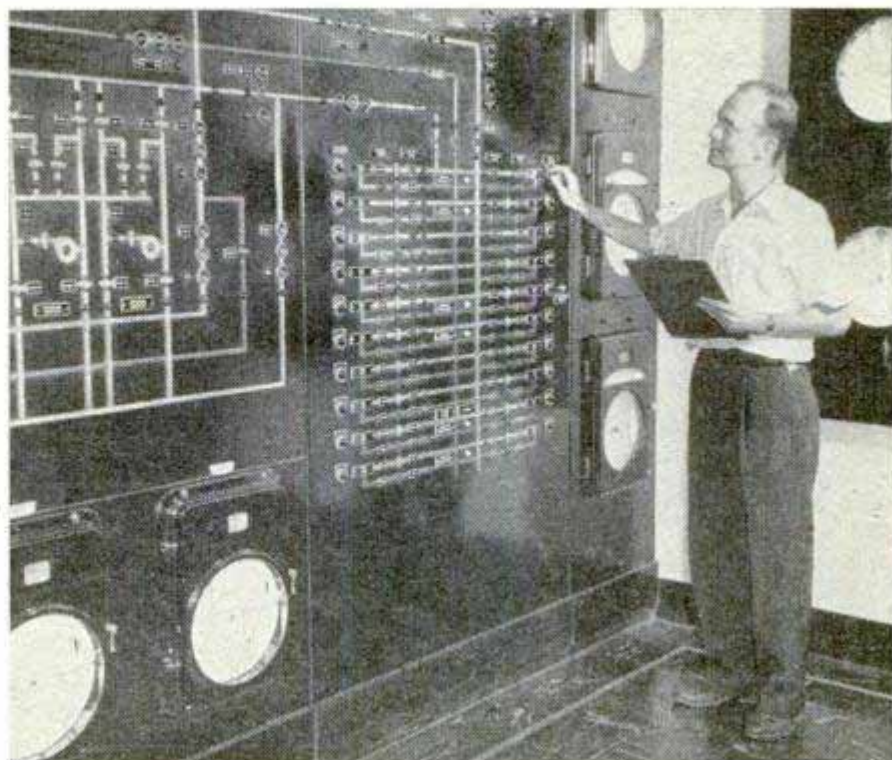

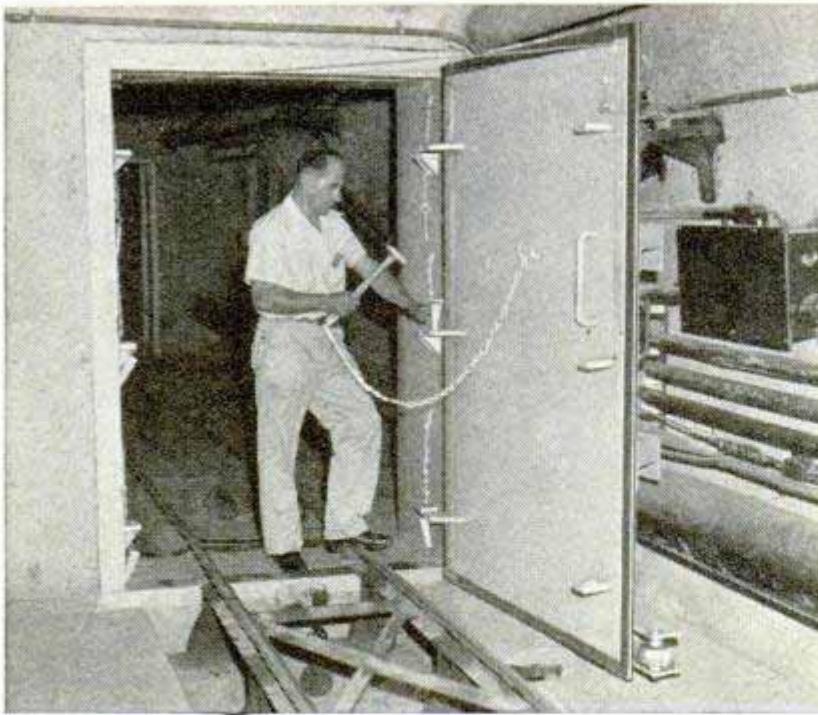

In case of oil flood the track drops into a pit permitting the oil-tight safety door to close automatically

main lower gallery. Here the visitor is 500 feet underground. Above his head are tons of oil. The cavernous lower gallery is built without smoothing the walls and the rough-hewn caverns are sprayed with a mushy pearl-gray Gunitite.

At the base of each tank is a leak locator. This indicator tells automatically if there is a leak in that particular tank. If there is, the oil is drained out, the tank filled with water to the point of leak and a rowboat lowered. Welders repair the leak hundreds of feet underground.

To view the inside of the tank, the visitor must go up an elevator to the main upper gallery. Here he walks into another huge tunnel and climbs a vertical steel ladder about 100 feet. At the top of the dome he may peer down a manhole 300 feet to the bottom of an empty tank.

Of the 4000 to 5000 men who built the tanks, the great majority were Americans of Japanese ancestry!

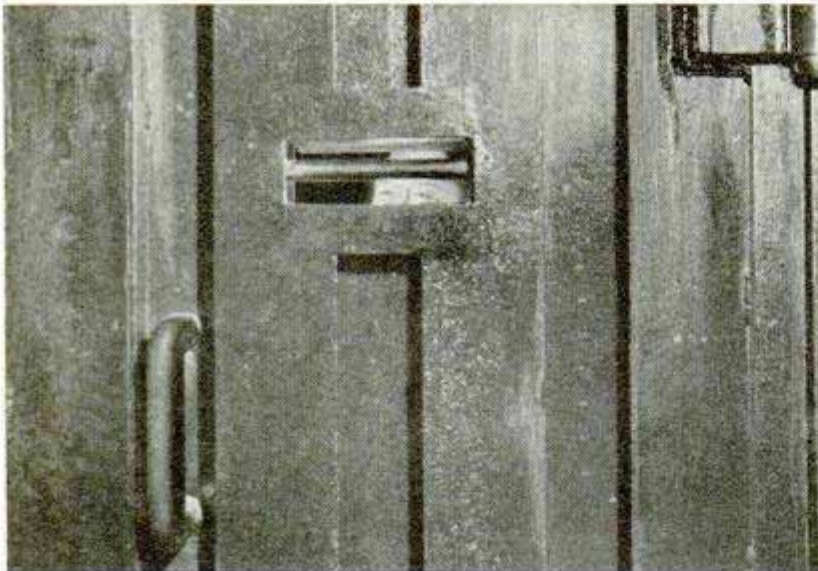

Through slot in inner main-entrance door (left) all visitors are carefully inspected. The Pearl Harbor entrance (below) resembles a huge Quonset hut made of solid concrete

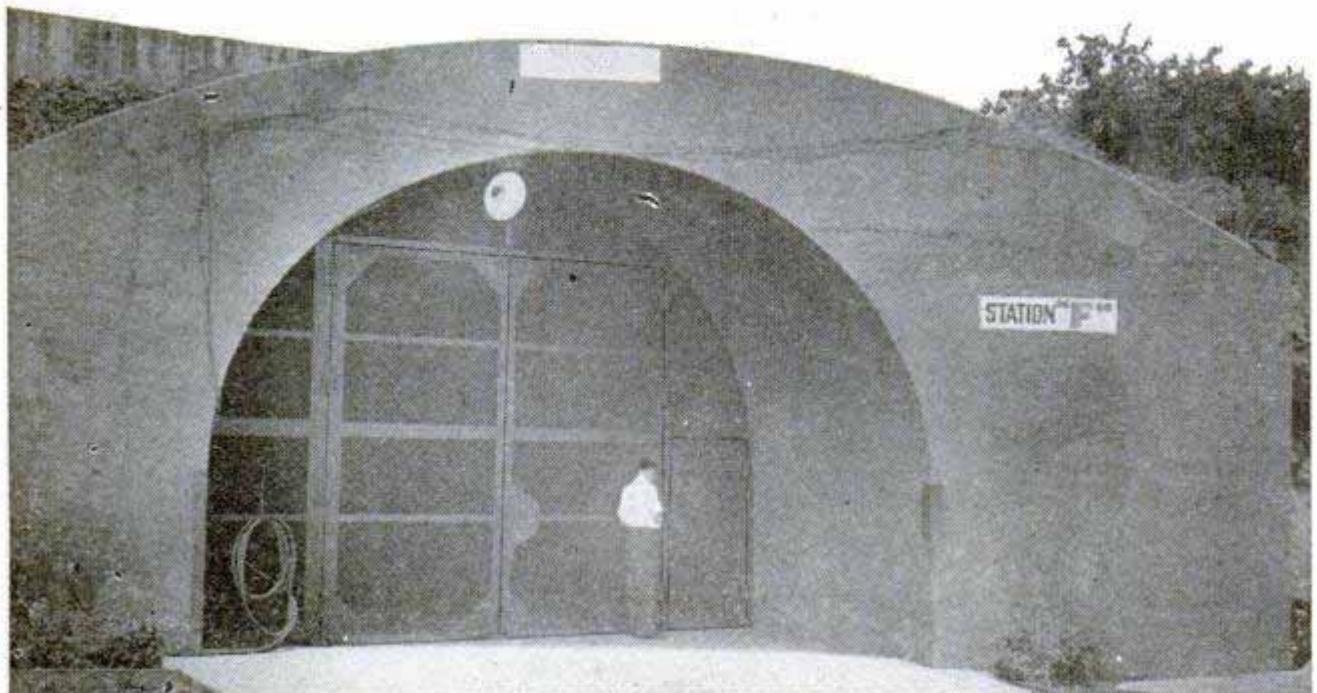

## All Seats "Reserved" On Paris Buses

Bus passengers in Paris are assured they can board a vehicle when it's their turn without being pushed aside. The passenger pulls a numbered ticket out of a dispensing machine at the bus stop. Passengers then board the bus according to the numbers they hold.

## Human Bone Bank Would Aid Medics

Human bone can be preserved indefinitely at temperatures of minus 20 to 30 degrees Centigrade, according to medical research conducted on the possibility of setting up bone banks to provide a constant supply for hospitals. By means of such bone banks, large quantities of bone, needed in

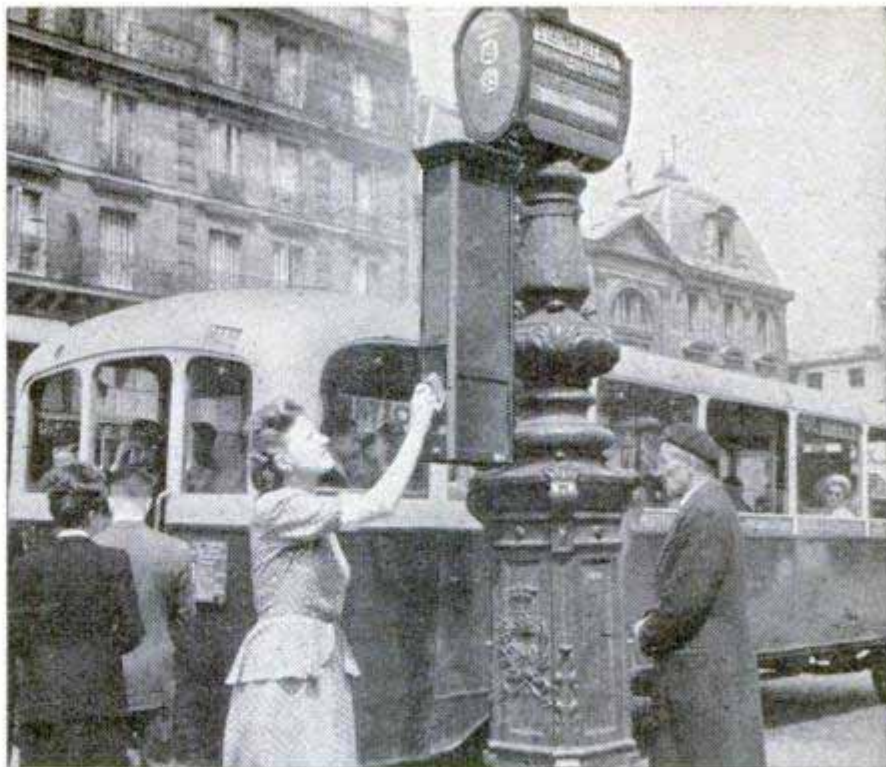

certain spinal operations and in the correction of bone defects, would be available at all times.

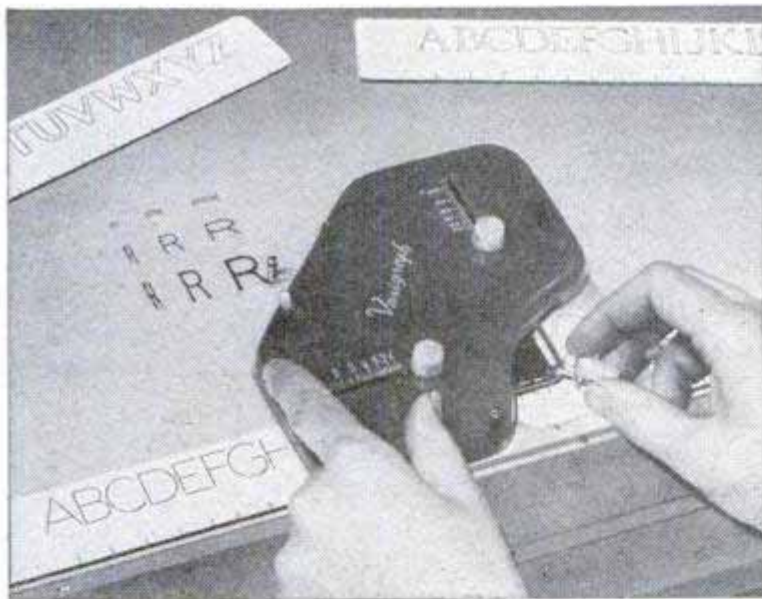

## Guide Gives Varying Letters From Same Template

Letters varying in height and width can be traced from the same template with the aid of an adjustable lettering instrument. The device slides along a straightedge and the template moves left or right beneath the finger-operated point so that the proper letter can be positioned. To reproduce a letter the point is guided along the grooves in the template. The width and height of the letters are controlled by two knobs which can be quickly adjusted to afford variation in sizes from .075 inch to .750 inch.

## Sedan-Type Trailer Towed by Bicycle

Mounted on the bed of a small child's wagon, a bicycle trailer was built entirely of discarded scraps of plywood. Extremely lightweight, the two-wheeled trailer is easily towed by the bicycle. Large openings on all sides give the four-year-old passenger an excellent view.



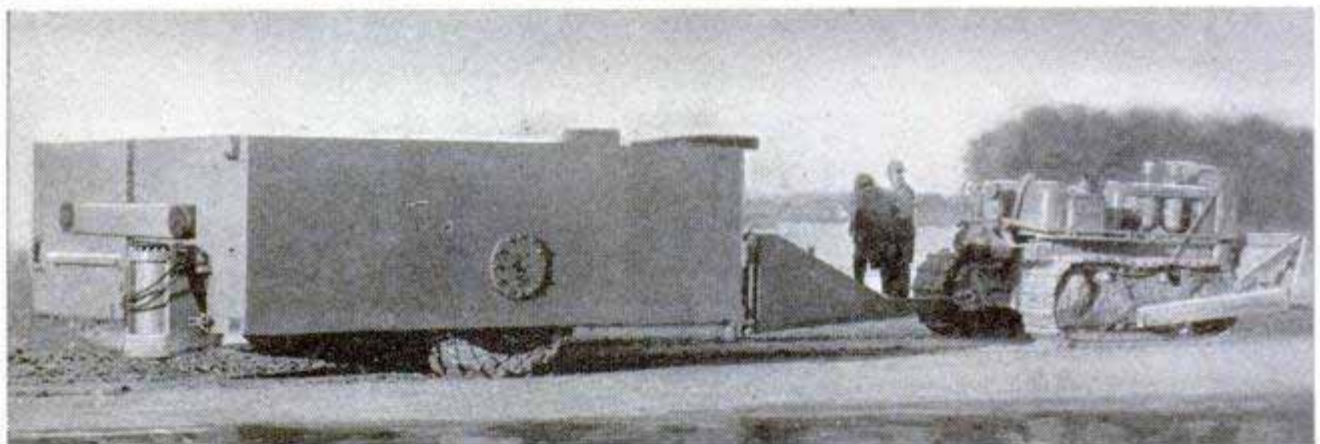
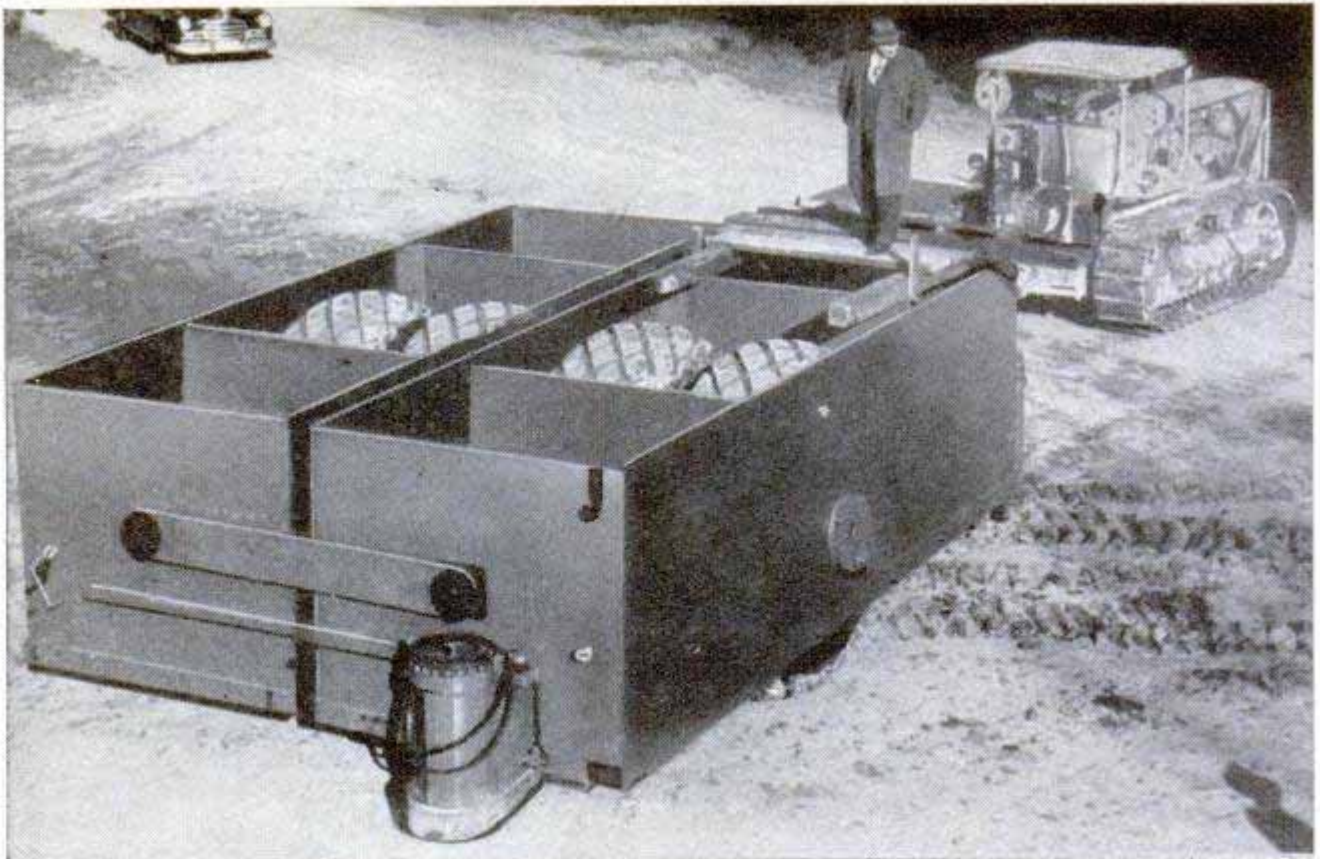

## 400,000-Pound Tamper Smooths Ground for Runways

Runway foundations prepared with a 400,000-pound roller will permit thinner concrete paving. The giant tamper is pulled by a tractor and exerts a pressure of 9600 pounds per square foot. It consists of a pair of two-wheeled boxes for scrap-iron ballast, each 20 feet long, over seven feet wide

and six feet high. Steel bars hold them together and all four wheels are on a single axle. The 60-ply tires, eight feet high and weighing nearly a ton, have a 30-inch tread. A hydraulic jack at the rear is used for making pressure tests of the subgrade and for lifting the boxes for tire changes.

## Germ-Killing Chemical Is Derived From Organisms in Soil

Derived from a bacillus commonly found in soil and water, a new antigerm chemical, polymyxin, is 25 times more effective than streptomycin in treating one severe skin infection. The new germ killer may replace streptomycin in treatments of some serious diseases. It is under trial at the Johns Hopkins Hospital in Baltimore. Polymyxin is given by hypodermic injection into the muscles every three hours at

present, but further study may lead to less frequent use. Some diseases that may be fought with the new chemical are plague, undulant fever, certain types of meningitis, typhoid fever, blood poisoning and other infections.

☐ Saw timber in our forests is currently being consumed at a rate  $1\frac{1}{2}$  times the rate of growth.

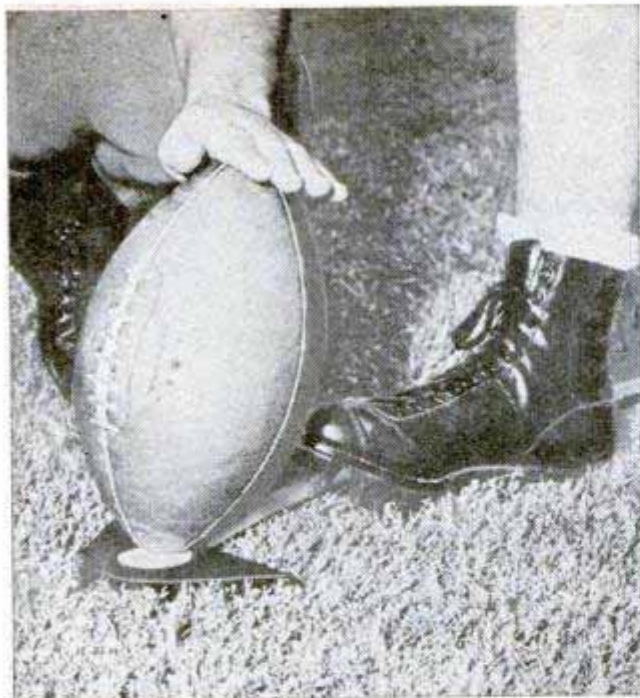

### Football Place-Kick Tee

Higher, quicker and truer place kicks can be made with a tee officially approved for use in college football games this season. It elevates the ball one inch off the ground. A six-foot-long hard-rubber tape extending from the tee gives the kicker a straight, line-of-sight approach to the ball.

### Fittings for Electric Conduit Cut Their Own Threads

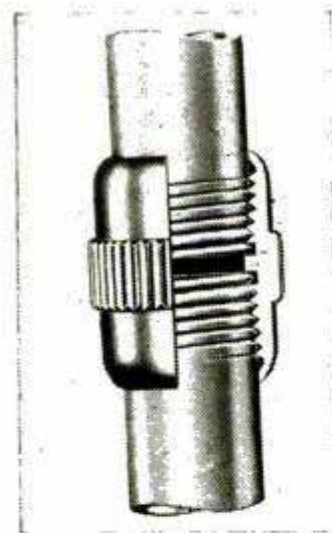

Cutting their own threads, one-piece steel fittings for thin-wall electric conduits save time and energy during installation and, at the same time, insure rain-tight joints. You merely push the conduit into the coupling, give it two turns with a pair of pliers and the tapered thread inside the connector acts as a die, cutting a tight thread. Although designed to permit repeated usage, their principal advantage is in initial installation.

Our WHERE-TO-FIND-IT index, listing names and addresses of manufacturers and sources of further information for products and articles in this issue, is available free upon request. This index is one of the many services offered to Popular Mechanics readers by the Bureau of Information. For your copy, just write Bureau of Information, Popular Mechanics, 200 E. Ontario St., Chicago 11

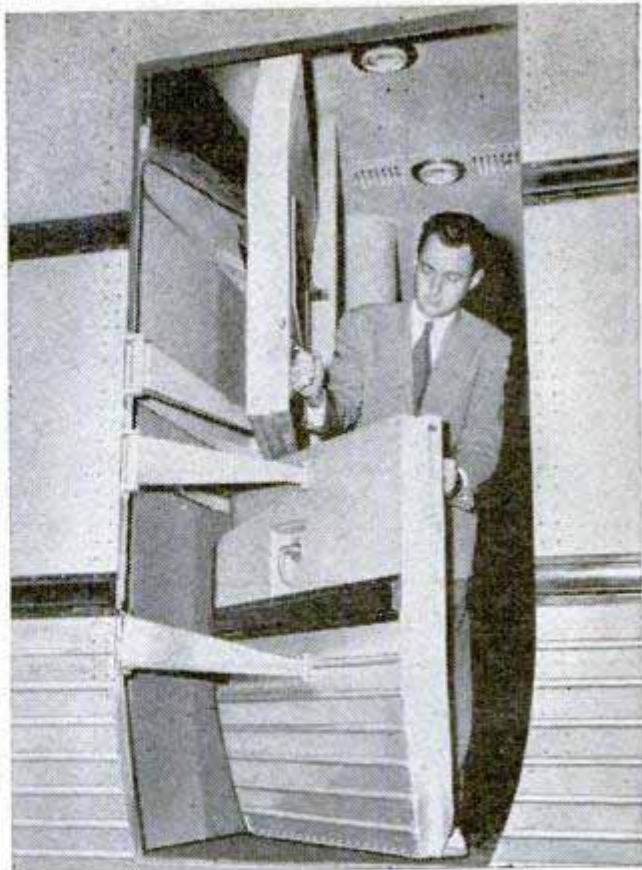

### Inside-Out Train Door

Passengers won't soil their hands or clothing on the vestibule doors of "Train X," a 150-mile-per-hour train designed for the Chesapeake and Ohio Railway. Inside-out doors for the new train have been exhibited at the Railroad Fair in Chicago. The doors pull in on special hinges that expose the inside surface to the passengers and hide outside surfaces which may become dirty. A test model of the new low-slung train is expected to be on the rails by 1950.

### Lightweight Pipe Wrench

Pipe wrenches made of aluminum are so light that a girl can easily lift the largest size with one hand. The wrenches weigh less than half as much as their steel counterparts, yet meet government specifications for steel wrenches. In tests, the new wrenches have withstood a pressure of 13,500 inch-pounds, which is the equivalent of 900 pounds of load pressure applied 15 inches from jaws.



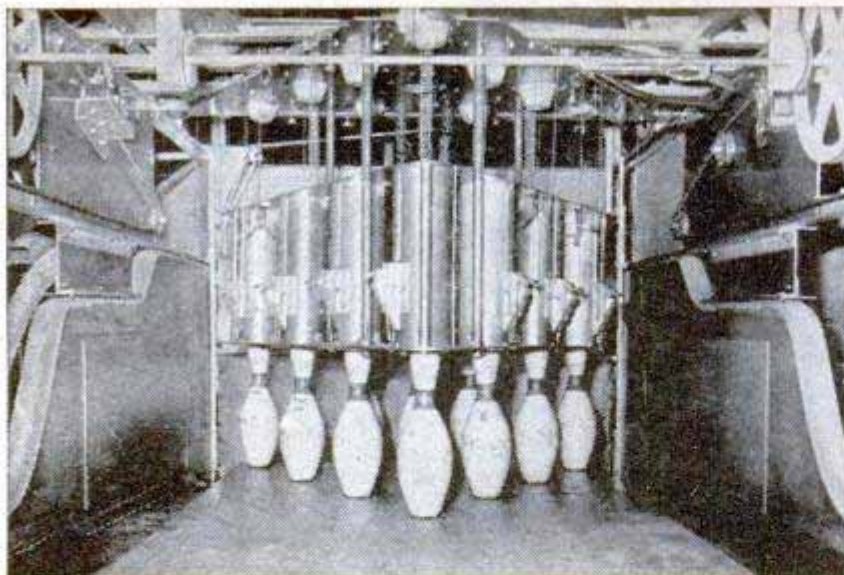

Front view of automatic spotter, after pins have dropped into place. Right, sweeper shoving pins off alley

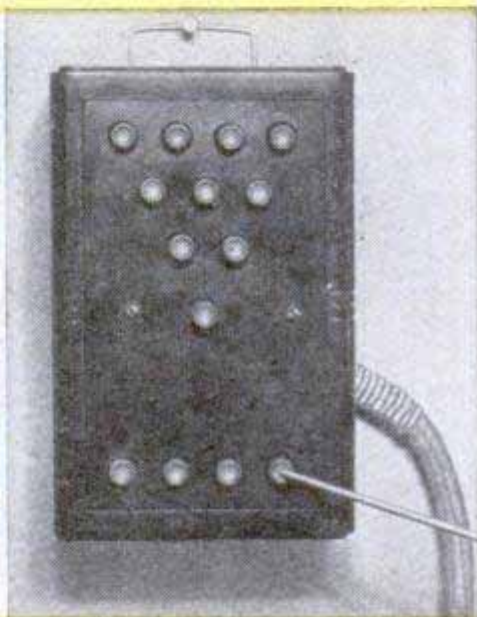
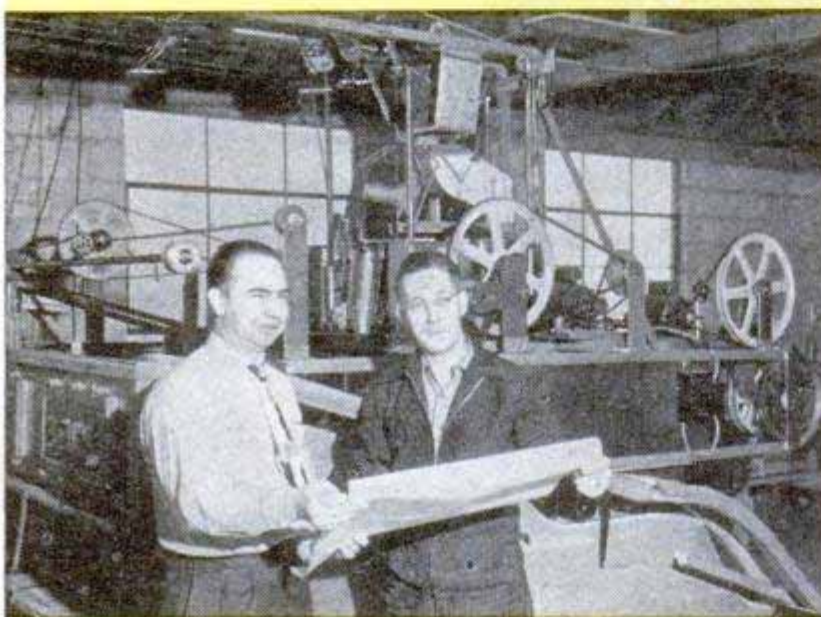

Two of the Ogden, Utah, inventors of the machine standing before test model of their device. Right, bowler-operated control panel. Pointer is on correction button, used to cancel out button-pushing errors

Below left, pit tray moving up with pins and ball toward trap, at rear, from which pins will be carried to distributing racks. Right, catwalk used by attendants when reaching for "dead" wood around off-spot pins

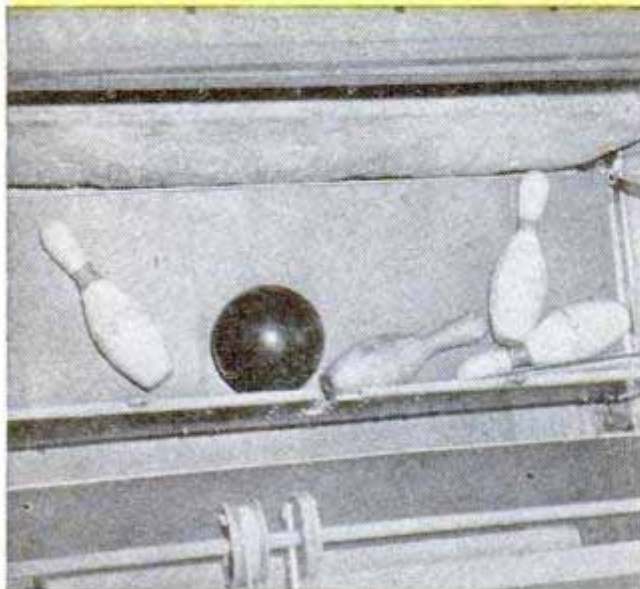



# a Robot Sets 'em Up

COMPLETE bowler-control is a unique feature of an automatic pin-setting machine currently being tested. Pressing buttons on a control panel sets from one to ten pins in any combination desired.

The machine can be used both during regulation games and for practicing difficult shots. It will repeatedly set individual pins for hard-to-make "leaves" like the 5-7, 5-10, "baby" splits and even "big fours." The present model is the sixth the inventors, John L. Parker, Dr. Leslie Foutz, William J. Wood and Henry W. Leavitt, all of Ogden, Utah, have made during six years of experimentation. They built most of the parts themselves.

Pushing one button sets in motion gears, chains, wheels and automatic levers that bring down a sweeper to clear pins off the alley. The sweeper then returns forward to shield the machine from balls accidentally delivered before the setting operation is completed.

Meanwhile, the swept-off pins are elevated by a pit tray onto a pair of parallel rods and dropped into a trap at the rear. The ball, too wide to drop between the rods with the pins, is rolled onto the return groove as the tray lowers. Gravity takes it back to the bowler in the usual manner.

In the pin trap are two chain-driven equalizing conveyors, running in opposite directions and synchronized with two rotating disks or hoppers on either side be-

low. The equalizers divide the number of pins so that both disks are kept busy, thus speeding the handling.

Each disk has a specially formed pin pocket and an arm. As the pins turn in the disk pocket, the arm pushes one at a time into a loader trap, head up.

A revolving chain with loops every three feet picks pins up from the trap and carries them forward to an overhead reserve rack, where the lassoed pins are released and distributed to 10 different positions. After they are in place, the upper rack in turn fills vacancies in a lower rack, which is then lowered to one inch above the alley. From that position, the pins are dropped the remaining inch and spotted accurately.

The machine operates with a.c., d.c. or three-phase motors and fits standard alleys without alteration. It is set to the speed of average bowlers and works on 18-second cycles, but it can be made to run faster or slower. At average speed, the automatic setter is faster than a pin boy and spots seven to eight games an hour.

When a pin is left standing off spot after the first roll, attendants remove "dead" wood from the alley with a specially designed stick, leaving the off-spot pin or pins untouched. A catwalk spanning the collecting disks at the rear gives them easy access to the pins. This is the only instance, in sanctioned league or tournament play, where human aid is needed.

Cutaway view of automatic pin spotter, showing sequence of events during its 18-second cycle of operation

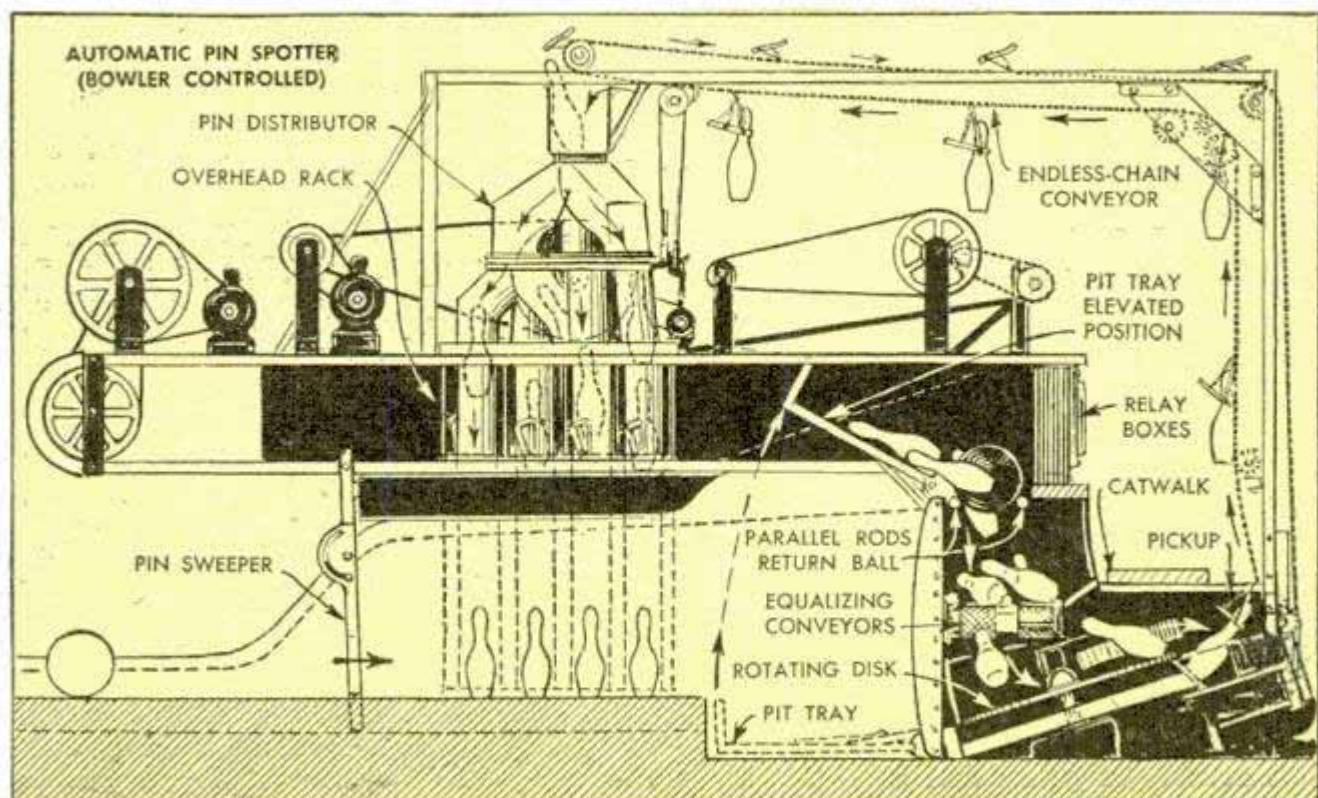

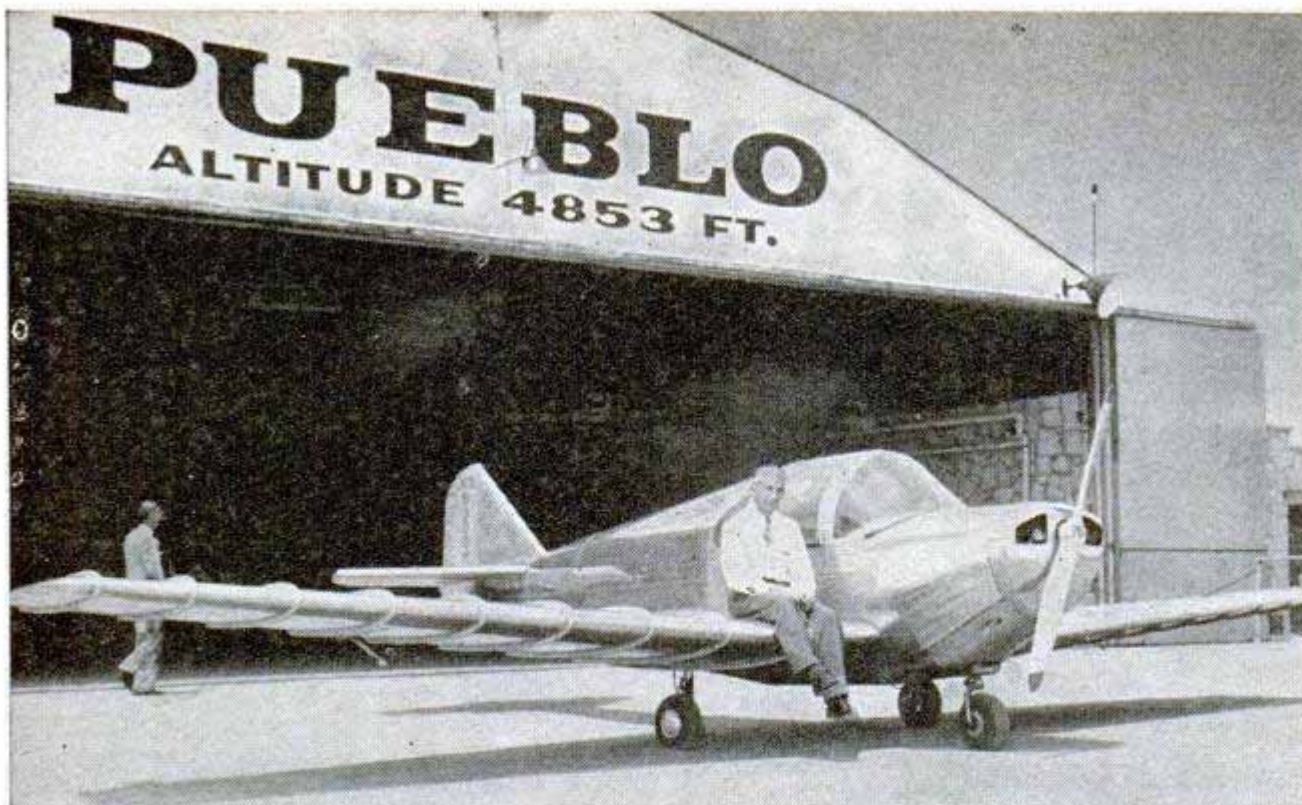

## Corrugated Wing Designed for Speedy Repairs

With wings that appear corrugated, a new low-wing monoplane looks a little like the canvas-covered wood-ribbed planes of earlier days. But the new, all-metal model has many advantages. Wing tips are built in separate pieces so they can be replaced

easily without taking the wings apart if they should be damaged. The sections of both wings are identical and can be used on either side of the fuselage. Part of the internal framework of the wings is covered by the corrugations.

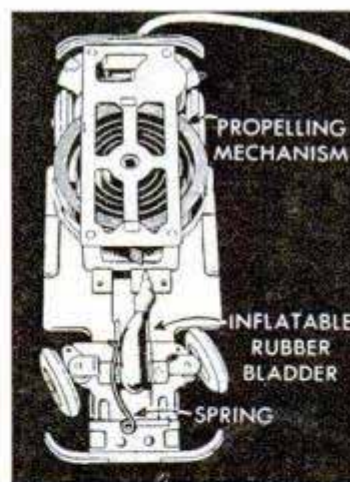
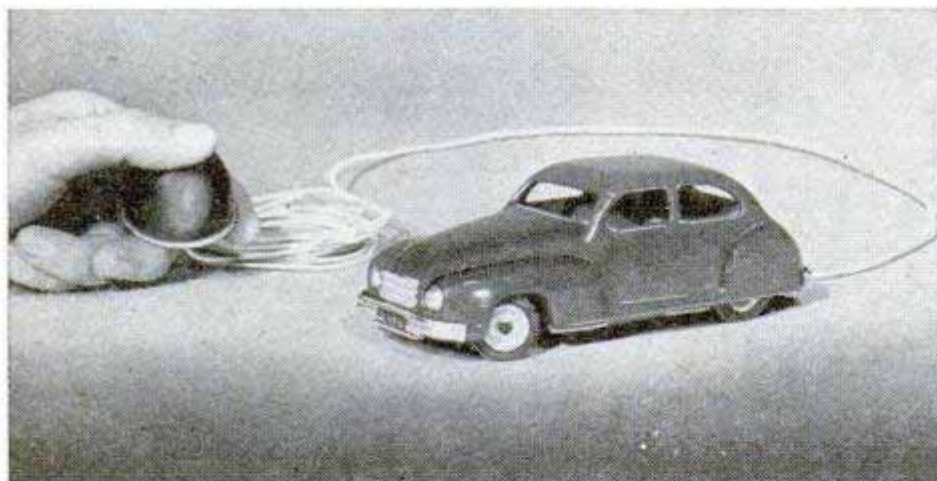

## Toy Automobile Is Steered by Remote Control

Both Dad and the children will enjoy playing with a toy car that is steered by remote control. Spring-driven, the car can be made to turn circles, swing around obstacles or run straight ahead. The steering apparatus is operated by air pressure created when the operator squeezes a rubber bulb attached to the end of a long air line. A spring keeps the front wheels turned toward the right until the bulb is squeezed. This action pumps air into a bladder be-

tween the wheels and, by a mechanical linkage, turns the wheels toward the left. The harder the bulb is squeezed, the farther the wheels turn. When the pressure is relaxed, the wheels swing back toward the right. Made in England, the car is available in this country.

☐ Insects cause four billion dollars' worth of damage to American crops each year, according to the Department of Agriculture.



WE DROVE

TO

# Alaska

PART TWO

By Aubrey O. Cookman, Jr.

Photos by Frank Fritz

**D**RIVING across Canada to Alaska was rougher going, compared with the 1700 miles in the U. S. described last month.

Most of our difficulty hinged around poor road conditions, which slowed progress and made driving hard work, especially in wet weather. Dirt roads made into long stretches of slime by downpours are not pretty pictures to face, even in the best of automobiles.

To Canada's credit, it is a problem that should be greatly minimized by next spring for drivers en route to Alaska. Road construction crews were busy at most of the sorest

Start of Alaska Highway, above, at Dawson Creek, B.C. Below, swift-flowing rivers bordering the road provide excellent "sink" for those who draw dishwashing chores





Above, anglers on the Toad River at Mile 457. Hundreds of good fishing haunts adjoin the highway all the way to Fairbanks. Washouts and slides, like the one below, keep maintenance crews constantly on the move. May until mid-June is busiest period

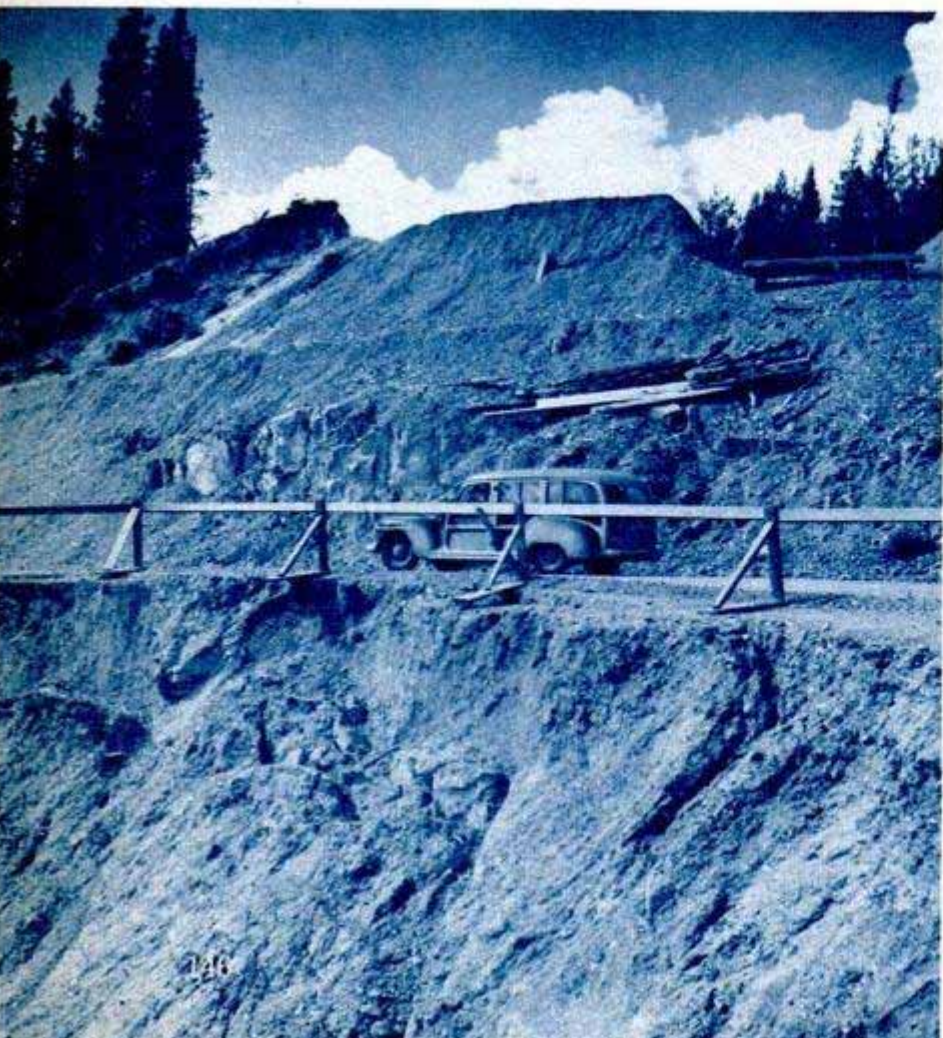

spots, evidence that the Province of Alberta was moving ahead vigorously with its 15-million-dollar highway program for 1948. In some places, entirely new roads were being laid parallel with present routes. At others, as a lesson from this year's floods, the size of culverts was being doubled to handle the drain-off.

Overnight accommodations were excellent and generally less expensive than we had found in the United States. At Calgary and Edmonton we stayed in neat tourist cabins with shower baths, complete cooking facilities and separate beds, at \$5.00 a night for both of us. Farther along, at Fort Nelson, where prices were generally higher, we paid only \$3.00 for a two-bed hotel room.

Tourist-cabin hunting is simplified in Alberta by a government order alphabetically grading cabins according to completeness of their facilities. Using one of these graded lists, it is a good idea to phone ahead in the morning for overnight reservations after you've decided how far you'll drive that day. We found most experienced long-distance travelers starting off very early and halting in the late afternoon, in plenty of time for a leisurely dinner and a full night's sleep.

After 17 miles of rutted road north from the United States border, our Plymouth station wagon reached Cardston. At one of the town's several banks we converted some cash to Canadian money and a larger amount to Canadian travelers' checks, both as a safeguard against loss and for simpler handling. Until you are able to make the conversion, your U. S. dollar will be accepted at par for small purchases.

Poor road marking out of Cardston misled us into lurching and twisting over 12 miles of rough clay before a helpful Canadian advised us that it wasn't Alberta Route 2. Retreating, we picked up the path to McLeod and finally reached High River. It wasn't until there, about 130 miles from the border, that we again traveled on a hard surface comparable to what we used in the United States.

En route we had telephoned a tourist camp in Calgary for a reservation, on the strength of the

motor club's description, and it turned out to be an excellent choice. Phoning ahead early was also fortunate, because the "No Vacancy" sign was already turning away latecomers when we drove up.

Dinner that night in Calgary, first big Canadian city on our route, affords a sidelight on the often-exaggerated meal prices. For two large, five-course steak dinners, at a restaurant singled out for us as one of the three best available, we paid less than four dollars. On the basis of pre-trip scare stories, that was what we had expected to pay for sandwiches and coffee.

There is nothing scenic about the 191 miles from Calgary to Edmonton, capital of the province and reputed to be Canada's fastest growing city. A new road paralleling the present one much of the way will probably be open for use shortly. Just before reaching Edmonton, Alberta Highway 2 skirts the new, rich Le Duc oil field, site of a runaway well that was spurting 14,000 barrels of petroleum daily over nearby farmland. Using the phoning-in-advance technique again, we lined up a good cabin for the second night in a row.

From Edmonton we followed temporary detours for a while, finally getting back on Alberta 2 in time to experience our first puncture en route at Clyde. Filling our gas tank there reminded us of one of the trip's rising-cost items. Gasoline at 44 cents a gallon, though in the imperial measure that is about one fifth larger than the U. S. version, was on the march up to the 65 cents we paid later on the Alaska Highway. Practically the full increase reflects the cost of trucking fuel long distances from the nearest rail facility. The government tax, in British Columbia, for example, is 10 cents a gallon. Food prices likewise mirror the distance from rail or water transportation.

It isn't until you are more than a hundred miles north of



Staff photographer Frank Fritz appears puzzled, above, by the galaxy of signs left behind by tourists eager to boost their home towns



This tent came in handy when hotels were hard to find. It was easy to put up and is shown pitched at camping ground near Watson Lake. Below, the Popular Mechanics travelers found their cooking equipment an asset in regions where eating places were few and far between





His survey of the highway completed for the American Automobile Association, field reporter F. C. Durkin, center, swaps opinions with the author

Edmonton that the real flavor of the wilderness trip begins to appear. From there on, settlements are smaller and more widely spaced, lakes and streams begin to border the roadway and log houses become the rule rather than architectural oddities.

Just beyond High Prairie you temporarily abandon Alberta 2 for Alberta 34 and approach what is becoming a landmark for Alaska-bound travelers—the Little Smoky Inn. It is a small restaurant and store run by a young Waukegan, Ill., couple, Mr. and Mrs. Dick Strazer. Like many others, they set out for Alaska a year ago in an old car that finally wheezed its last not far from their present location.

After young Strazer helped out the local blacksmith for a while, long enough for them to decide they wanted to stay, they located an unused log cabin and set up an inn. Their fare is already attracting a steady stream of loggers, trappers and hungry tourists.

At Little Smoky we also met Henry Bucher, a 20-year-old mining student, chugging along in a 1923 Reo, the most decrepit-looking car seen on the trip. Henry had converted his back seat into a bed and installed a small pantry and hot grill in the space between the back and front seats, virtually qualifying his jalopy as a traveling kitchenette apartment. He

wore coveralls and drove barefoot.

To make room for larger, present-day tires to replace the original bicycle-size set, Henry had to cut the forward sections off both front fenders. Strapped to the top was a washtub, and a collection of oil, gas and water cans rode along in the luggage carrier. A good mechanic, he had coaxed his \$200 car all the way from Missouri and, when last seen at Whitehorse, was still headed north.

We took advantage of our first good locale for camping out at Little Smoky. And, less pleasantly, it was also the setting for the repair of puncture number two,

apparently caused by the sharp gravel and rutted road.

The remainder of Alberta 34, and Alberta 2 all the way to Dawson Creek, was a graveled surface that kept speeds below the 45-mile-an-hour mark. The rolling wheat country was beginning to give way to stands of poplar, birch and pine trees.

To avoid the possibility of delay, it is well to plan your trip so that you don't reach the Big Smoky River about mid-June. Then, or a little later, mountain thaws set in and send trees rushing along in the swift current so fast that they sometimes put the government-operated car ferry out of action for days.

Dawson Creek, B. C., jump-off point for the Alaska Highway, has only a few thousand residents but it looms large when you

Scene of the worst single washout during 1948, the wooden-pile bridge over the Rancheria River had just been restored when this was taken



head north. There the railroad ends and you get your last look at a community of any size for nearly 1000 miles of wilderness. It has eight standard-make automobile agencies and service stations. If your car isn't running smoothly, if the tires have gone bad or you need supplies, Dawson Creek represents your last good chance for help for many days.

Prudent travelers stop at Dawson Creek's provincial police office to register their firearms and to get permits to kindle fires along the highway. For the safety of motorists, no hunting is permitted for one mile on each side of the highway, but big-game parties break off at Trutch and elsewhere to head for the main range of the Rockies. Fishing is good

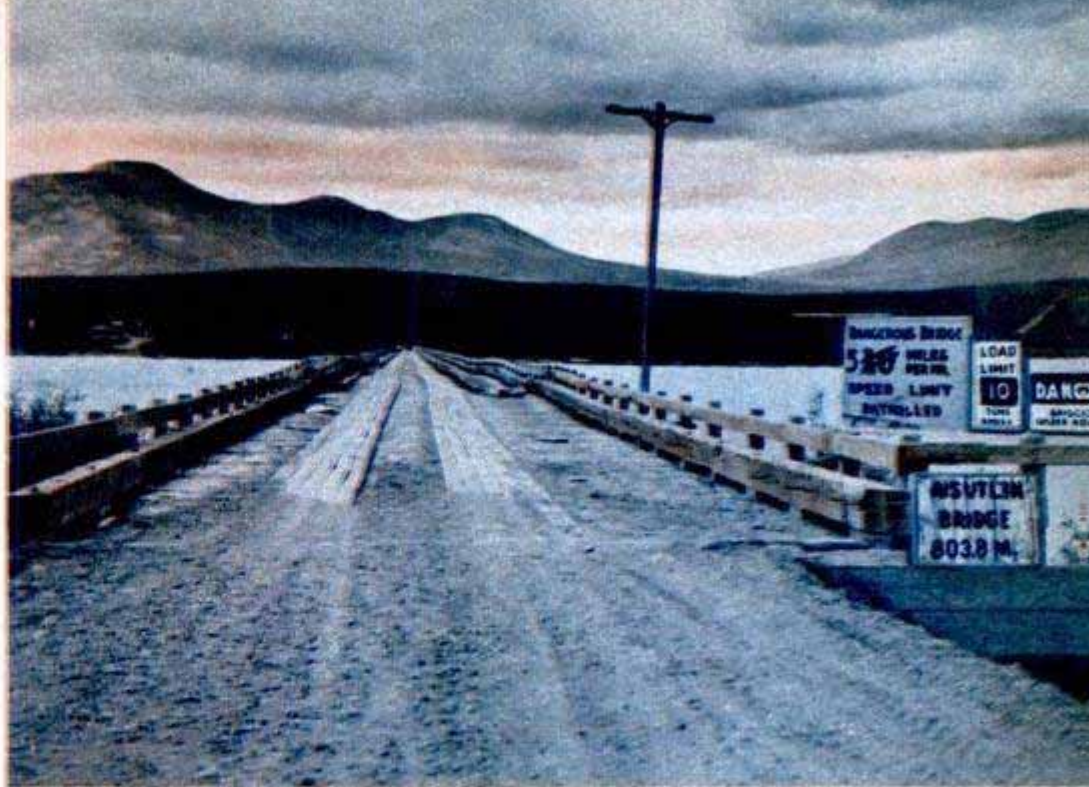

Longest bridge on the highway is the wooden structure over a section of Teslin Lake, at Mile 803. Steel bridges in time will replace most of the wooden ones. Stampede during 1898 Klondike gold rush passed nearby

One of the Yukon River's picturesque sternwheelers, the Klondike was built to carry concentrates from the silver and lead mines at Mayo. Like its sister steamers on the river, it burns four-foot-long cords of wood

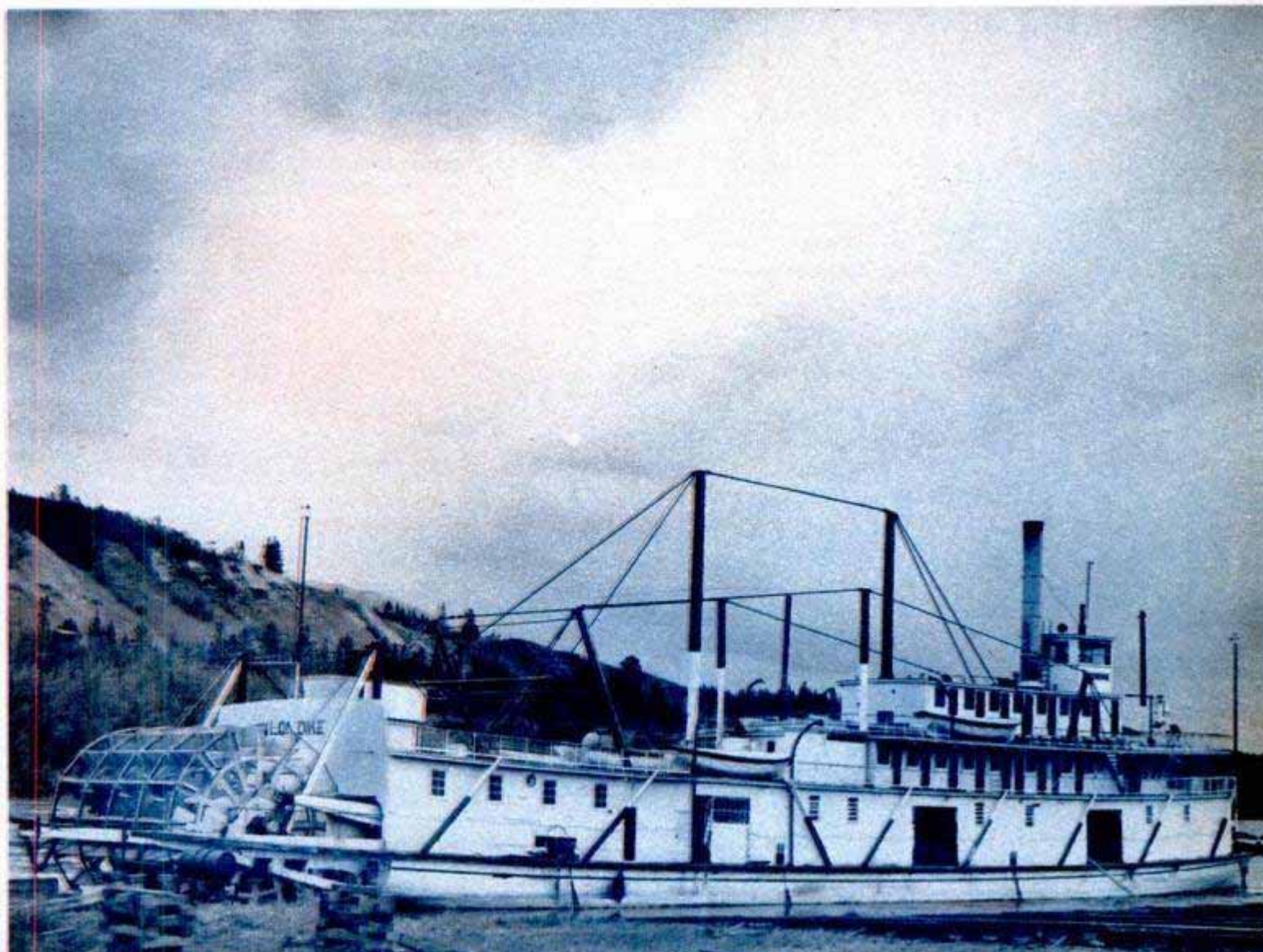

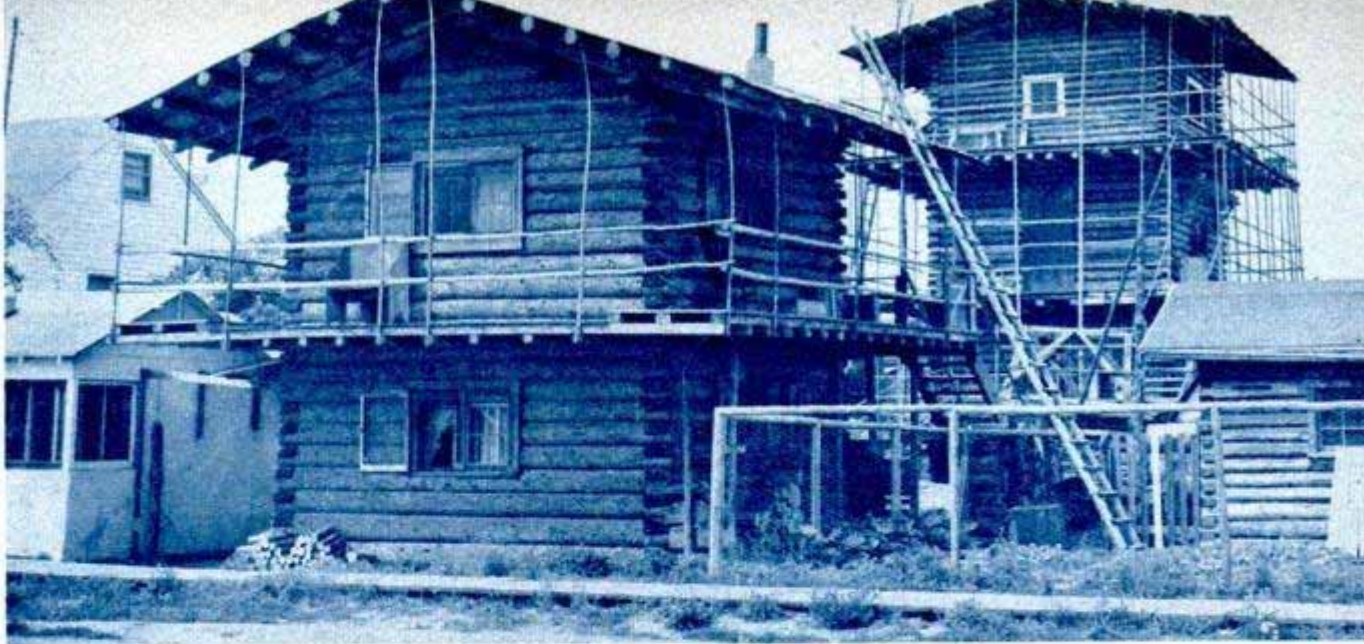

Double and triple-deck log apartments distinguish Whitehorse, Y.T., which also has a 100-room hotel

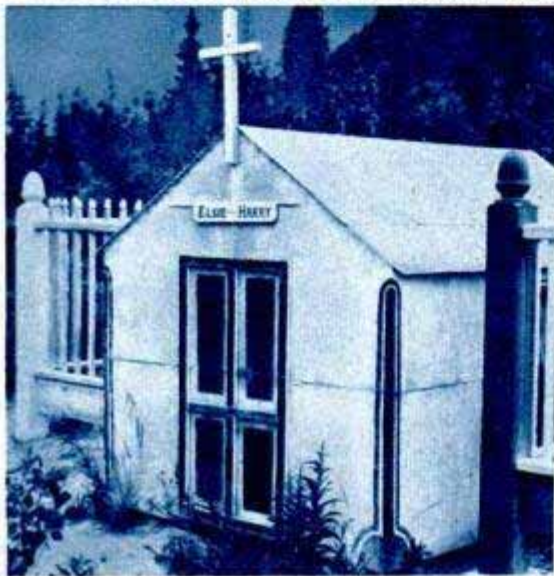

Above, tiny buildings and tents cover graves at Indian cemetery in Whitehorse. Below, air view of Whitehorse, by far the largest town between the start and end of the Alaska road

all the way to Alaska, of course, so go prepared if you are an angler.

At first glance, what impressed us most about the Alaska Highway was its width and smoothness. It is 26 feet from edge to edge, nearly four car widths, and there is room alongside the well-kept gravel surface for emergencies. It is perfectly flat all across, without a trace of ruts.

Mileage markers stretching along the east side of the road are another unique feature. Since most en-route stopping places and historic sites are designated by mile number rather than name, you quickly grow dependent on the neat wooden signs.

At Mile 35 you cross Peace River Bridge, a 2130-foot steel suspension span that is the most impressive single structure along the entire road. Between there and Whitehorse, Mile 918, the scenery resembles that of Colorado and Montana. Snow-capped mountains are in sight most of the way, although the road itself never rises very high, 4256 feet at Summit Lake, Mile

(Continued to page 260)





## Artificial Fingers

Fitted with fingers which not only resemble the human hand but function like it, an artificial hand developed by a British prosthetics manufacturer has been engineered to make possible a great variety of work or play for the handicapped. A demonstrator for the company showed the Royal College of Surgeons that he could shave with the hand, use a typewriter and take shorthand, pick up a pin, work in the garden, tie knots, play golf—and even darn his socks.



## Elevators in Wing Of Swiss Glider

With an unusually large wing area, a Swiss glider has no elevators in the tail. Instead, the elevators are mounted on the trailing edge of the wing near the tips. The ailerons are between the elevators and the fuselage. The glider is a two-seater with the passenger riding amidships. The wide wing is swept back to make up for lack of horizontal tail surfaces.

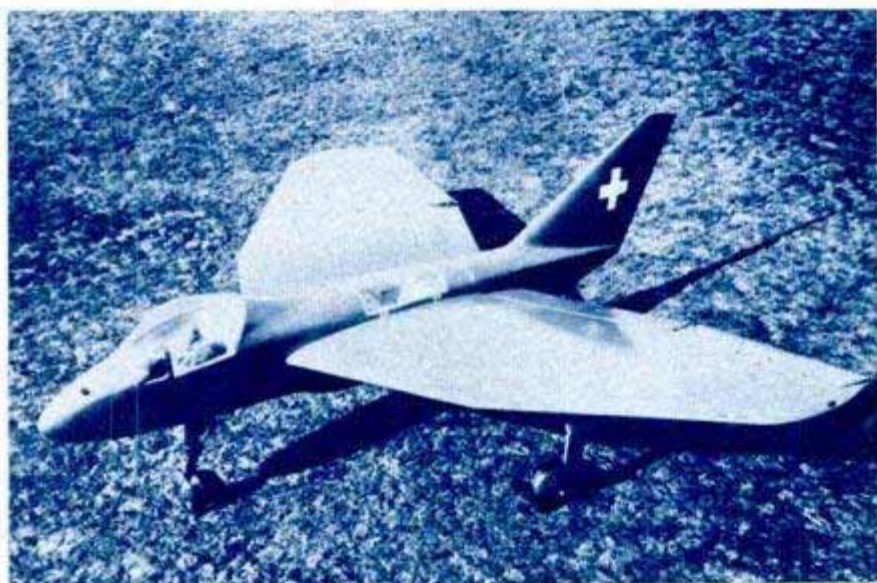

## Fuel-Control Panel Aids Navy Pilots

Navy pilots can read their fuel situation at a glance with a plastic control panel which has illuminated fuel paths. The panel is installed in the Martin P4M Mercator patrol planes which have eight gas tanks with fuel lines leading to any one of four engines. Control knobs are designed so they do not break the light path when turned to the "on" position. This system eliminates any confusion in controlling and selecting fuel flow. The panel is located forward of the throttles.



Lighted paths on plastic panel show at a glance the flow of fuel from any one of eight tanks to any of the four engines — two jet and two propeller-driven. Panel is mounted in front of the throttle quadrant

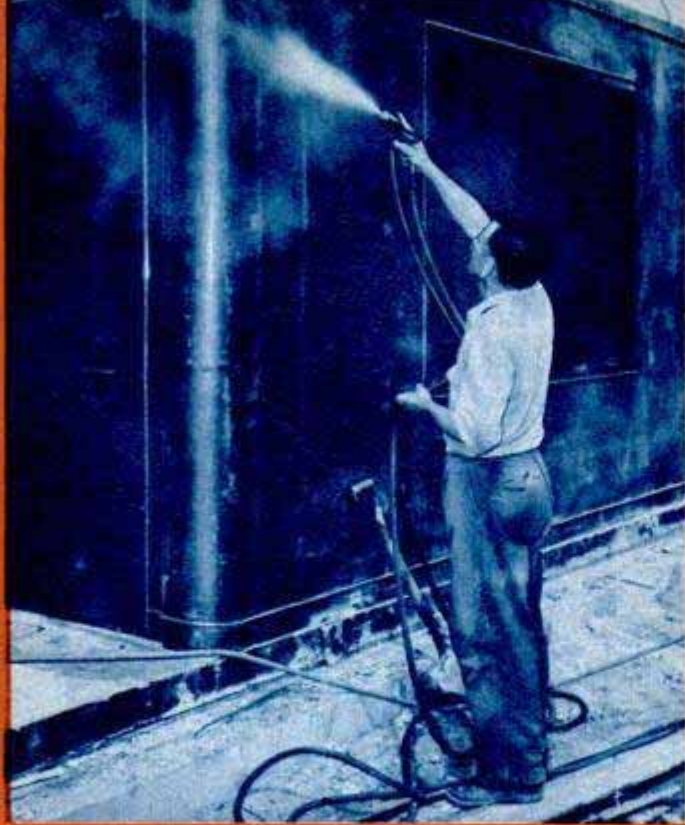

Left, a coating of oil is sprayed on the steel forms to insure a smooth wall surface and also to prevent sticking when the forms are removed

Below, floor plan of the poured house. It has a floor space of 900 square feet without garage. The attic stairway is finished, making it easier to add two upstairs bedrooms as the family grows

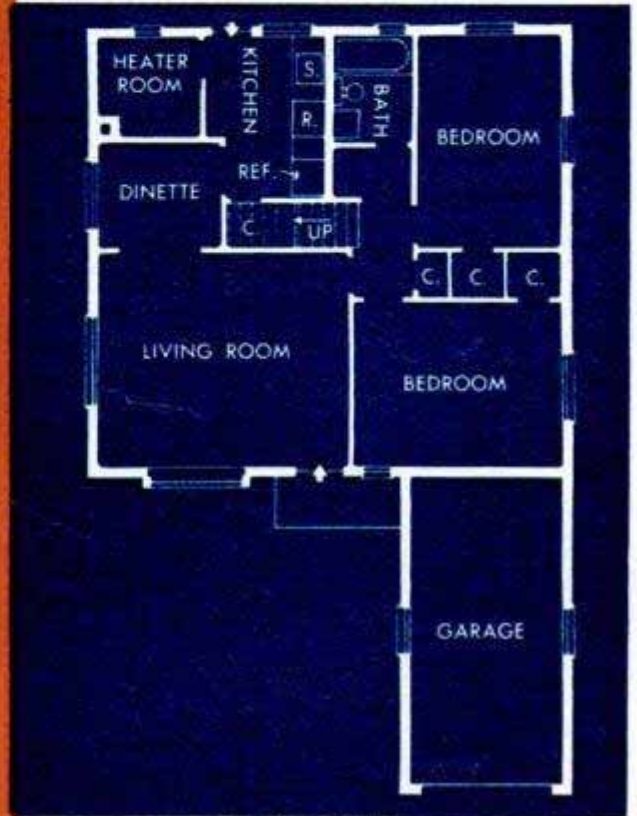

# A HOUSE IS Poured

Steel form for the gable is lifted away by the crane after the concrete has set. Outer forms for the lower wall are still in place

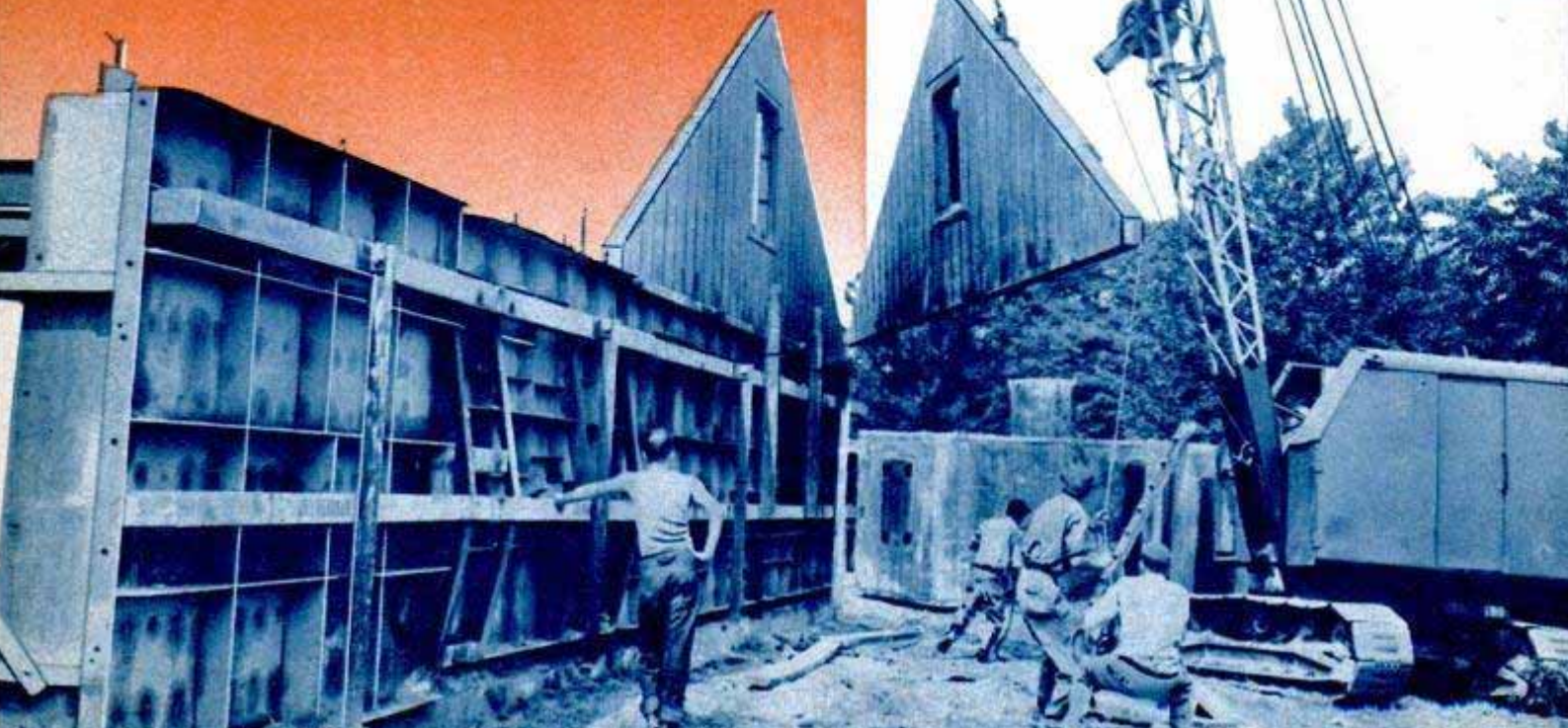

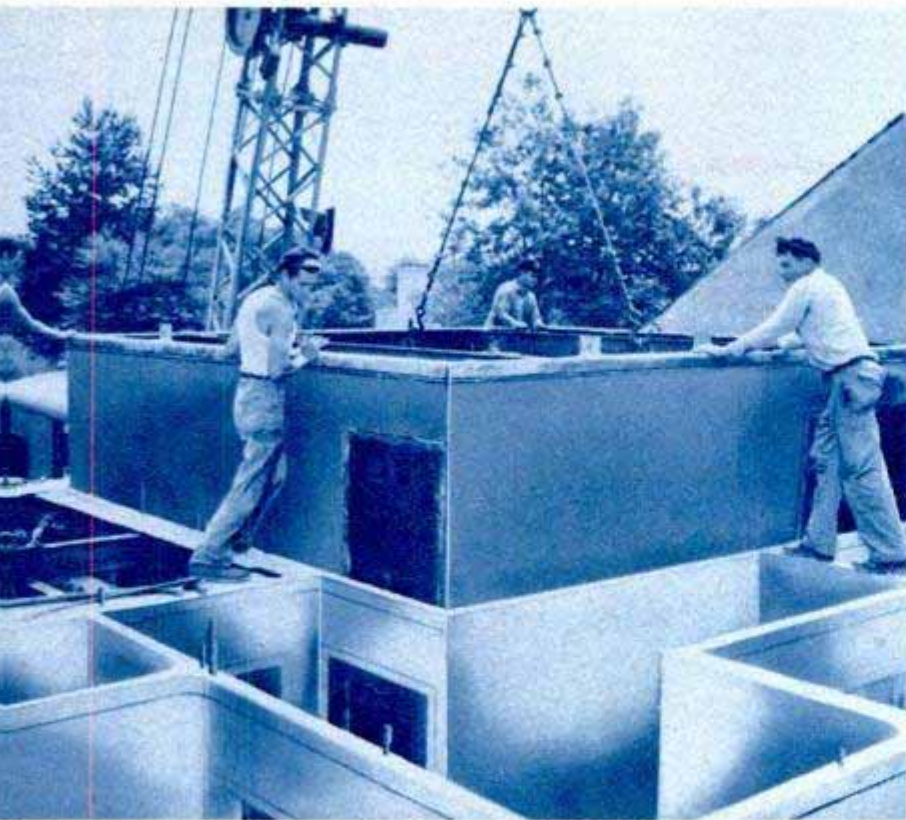

Left, removing the interior form from the living room. Right, collapsible forms are used for the windows

**CONCRETE** houses are built in six days by means of huge steel forms that are moved in and out of position by a crane. Individual forms are used for each room and all walls are completed at one pouring. Exterior-wall forms mark the concrete to simulate planking, brick or stone. To pre-

vent condensation, walls have two layers separated by insulation and vapor barriers. The house has no basement. A radiant heating system of copper tubing is embedded in the concrete subfloor. Priced at \$11,900 with all utilities, the house is one of 150 being built on Long Island, N. Y.

The completed house looks like a frame cottage because of the horizontal grooves that give the effect of wide planks. Brick and stone finishes can also be simulated





Four passengers don't make a crowd on water cycle. Left, no skill is needed. You just pedal and steer as on a bike

## Paddle-Wheel Boat Is Pedaled, Steered Just Like a Bicycle

Pedaled and steered like a bicycle, a pontoon-equipped water cycle moves forward and backward at about walking speed. Its broad base provides stability and, being extremely buoyant, it can operate on less

than a foot of water. An eight-bladed paddle wheel is driven by a stainless-steel shaft connected to the pedals. The water cycle will support several persons safely and it is said to be capsizproof.

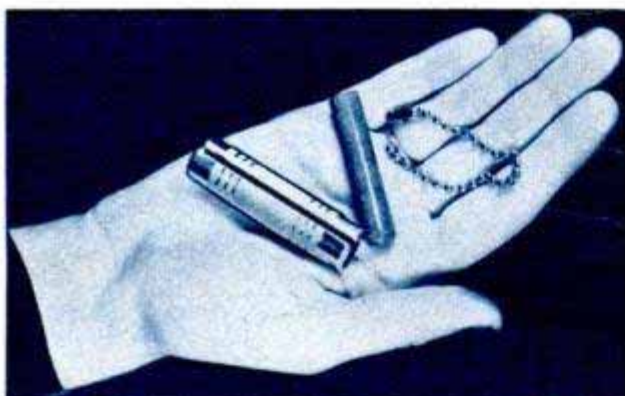

**SKATE SHARPENER** is small enough to be carried in the pocket on a key chain. With it you can sharpen your skates without taking them off. A slot along the case holds the stone in the proper position on the blade. The stone, made of aluminum oxide, is removable and can be replaced when worn. Weighing two ounces, the sharpener has an attached chain

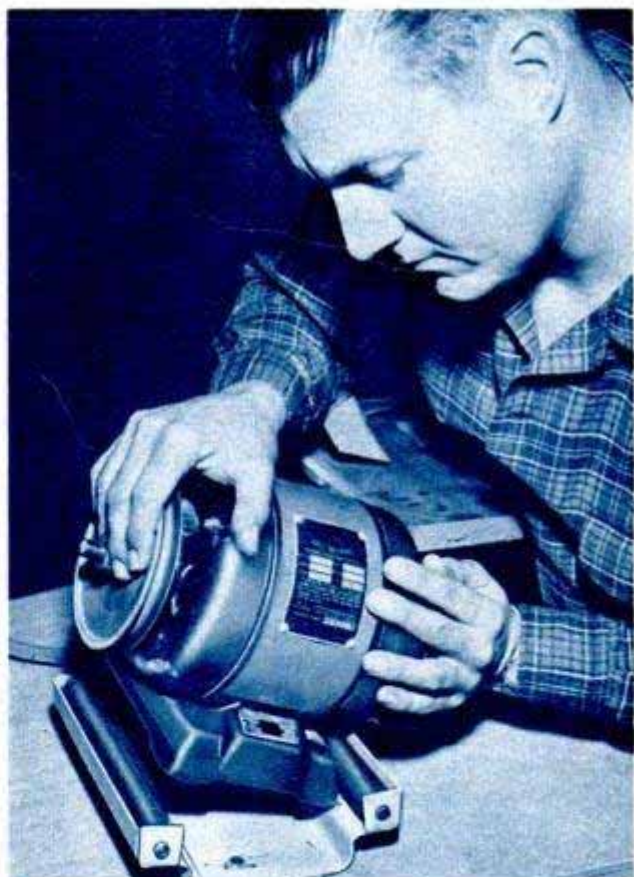

**MOTOR HOLDERS** make it easy to run all the power tools in your workshop with one motor. You just mount a holder alongside each tool and then transfer the motor from one to the other easily. Holders have two rubber-covered rails that clamp the motor securely when you press it down into the mount. Adjustable, they hold any motor up to one horsepower



Even a scooter can tow this tiny trailer that has everything you'll need, including a roomy dinette (top)

## ALL THE COMFORTS OF HOME IN TRAILER ONLY 10 FEET LONG

Below, cutaway shows ingenious use of space in trailer. Hinged door closes off "bathroom" area. Note the gun rack for sportsmen

You'll find everything, including the kitchen sink, in a compact trailer only 10 feet long and 7 feet wide. Designed to sleep four adults, the aluminum trailer has a bathtub, flush toilet, Pullman-type washstand and a complete kitchen. The dining nook seats four and the table lowers to bench level, forming a double bed. The bathtub is concealed beneath the davenport which becomes a double-decked bunk when the rear cushion is swung up horizontally. A septic tank under the floor takes care of sewage disposal. During cool weather, a gas fireplace heats the trailer. Both gas and electric lighting systems are provided.

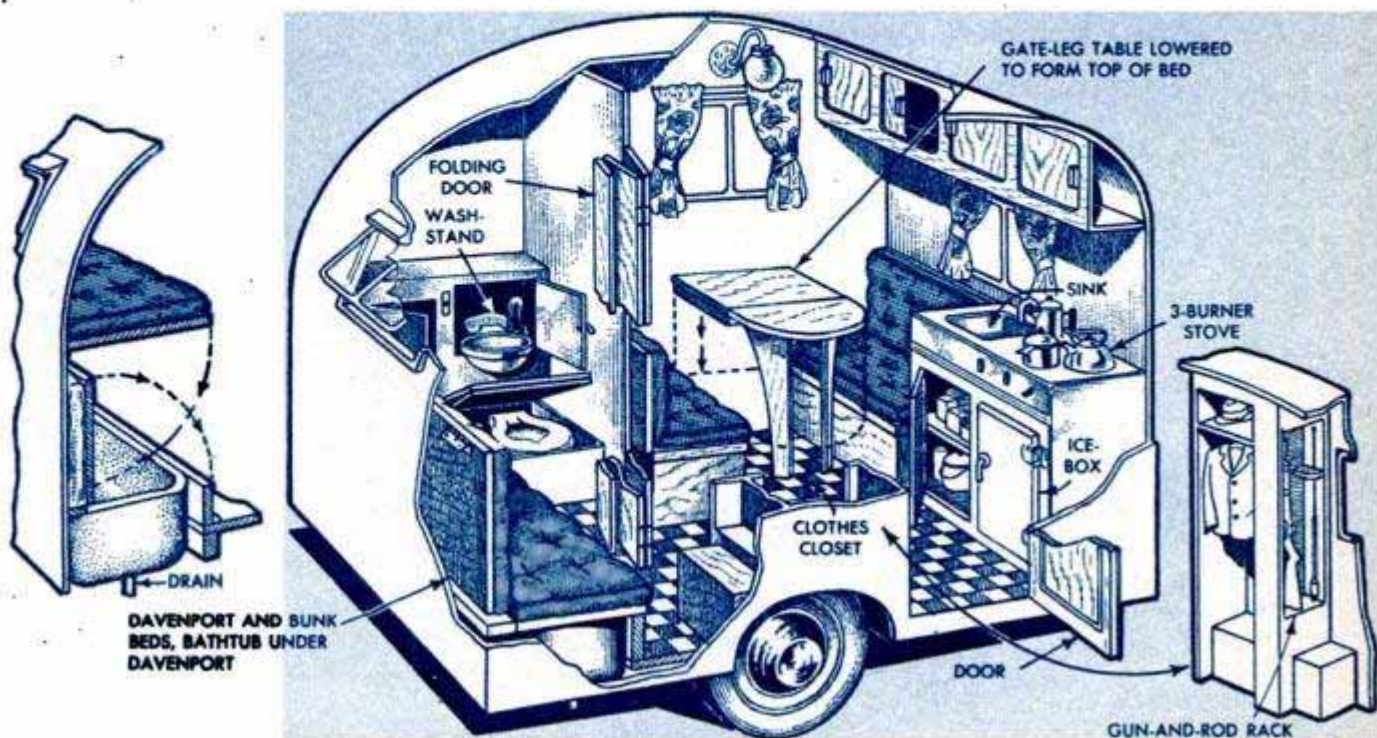



Geological Survey of Canada photos

↑ Canoe-borne field party in search of new ore deposits in Canada's rugged terrain portages around a waterfall

# Canada Hunts Minerals

↓ Geologist from a university prospects with a Geiger counter, which detects radioactive ore deposits





Royal Canadian Air Force photo

Gasoline must be flown to the isolated bases from which the photo planes operate during the search for ore

**S**cientific prospectors are conducting the greatest search in Canada's history — a search for mineral wealth from the International Boundary to the islands of the Arctic Sea and from British Columbia to Cape Breton and Prince Edward Island. Combing the mountains and valleys of Canada are 117 separate field parties equipped with modern instruments from aerial cameras to Geiger counters.

By Harry Chapin Plummer

But other metals are not forgotten — investigators

are running down new sources of gold, silver, copper, tin, lead, manganese, fluor spar, nickel, vanadium, zinc, mica, chromite, tungsten and barite. Even sand, gravel and stone, sorely needed for building materials, are on the schedule for investigation.

The parties are searching for minerals and ores that will make Canada less dependent on importations. Heading the list are pitchblende and other radioactive ores of which Canada is now the world's second source (the Belgian Congo is the first).

Teaming up for the search are students of mining schools and universities, pilots of the Royal Canadian Air Force and scientists and officials of several government agencies. The field parties began this season's work in April. Most of them already have been forced to return from their expeditions because of cold, snow and ice.

↓ Scientist and pilot check the recording instrument of the magnetometer, which detects presence of ores from the air. Below right, the magnetometer itself is mounted beneath the tail of the amphibian plane

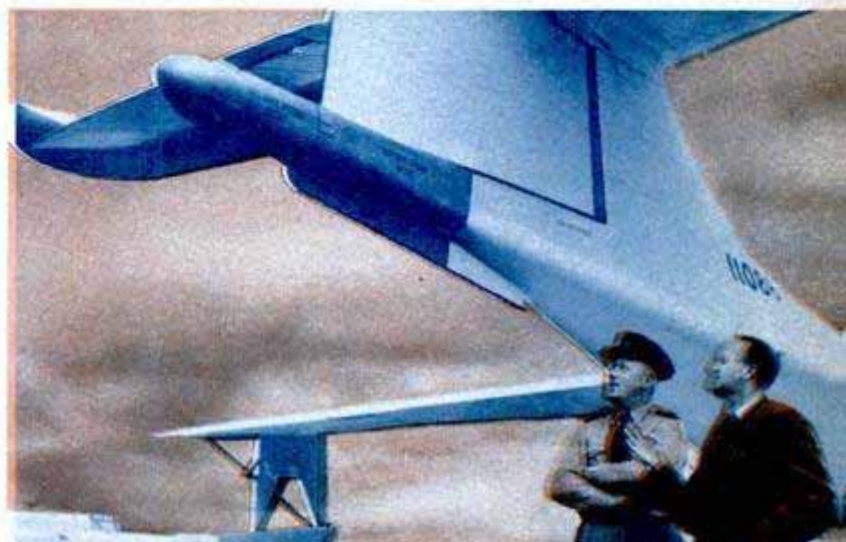

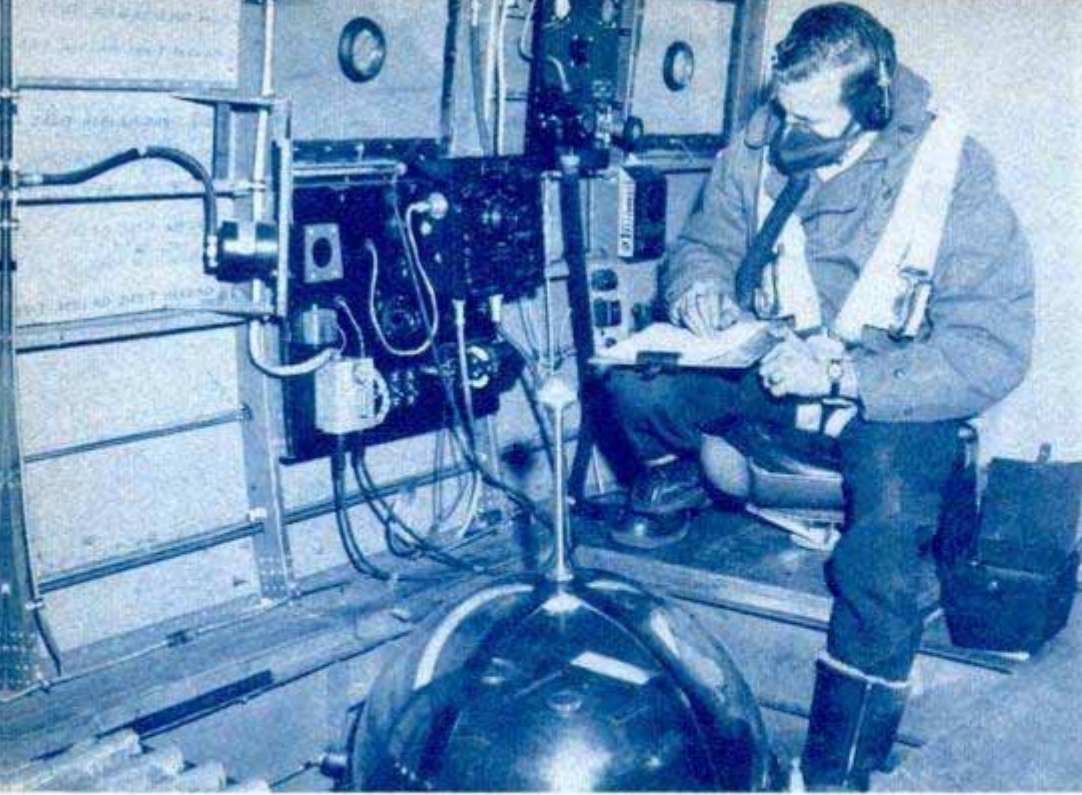

Planes climb to high altitudes to get large-area photos, and personnel must wear oxygen masks

essential before accurate maps can be made from the aerial photographs. Missions carry the planes as far north as bleak Baffinland, well within the Arctic Circle. Experiments are being made with shoran-controlled aerial photography, which accurately establishes the position of each aerial photo, thereby simplifying the making of maps.

The Dominion Department of Mines and Resources has control over all the survey work on behalf of the government. The RCAF provides

Photography, both ground and air, has played a dominant role in this search for mineral wealth. From aerial photos, geologists can spot areas likely to yield ores of strategic importance.

Sixteen planes—four of them long-range Lancasters—are flying photographic missions. In addition, Air Force amphibians are flying the Geodetic Survey crews who “shoot” the stars to fix points that are

planes, crews and equipment. Negatives are taken to Ottawa where they are developed and printed. Eventually, they are turned over to Mines and Resources, the army or other departments to guide in the drawing of maps.

Aircraft are sent out in detachments with each group assigned one or more areas. In some cases, they operate from isolated bases where ground crews service

Vertical pictures taken in sequence are mounted to show the junction of the MacKenzie River with the Nahanni

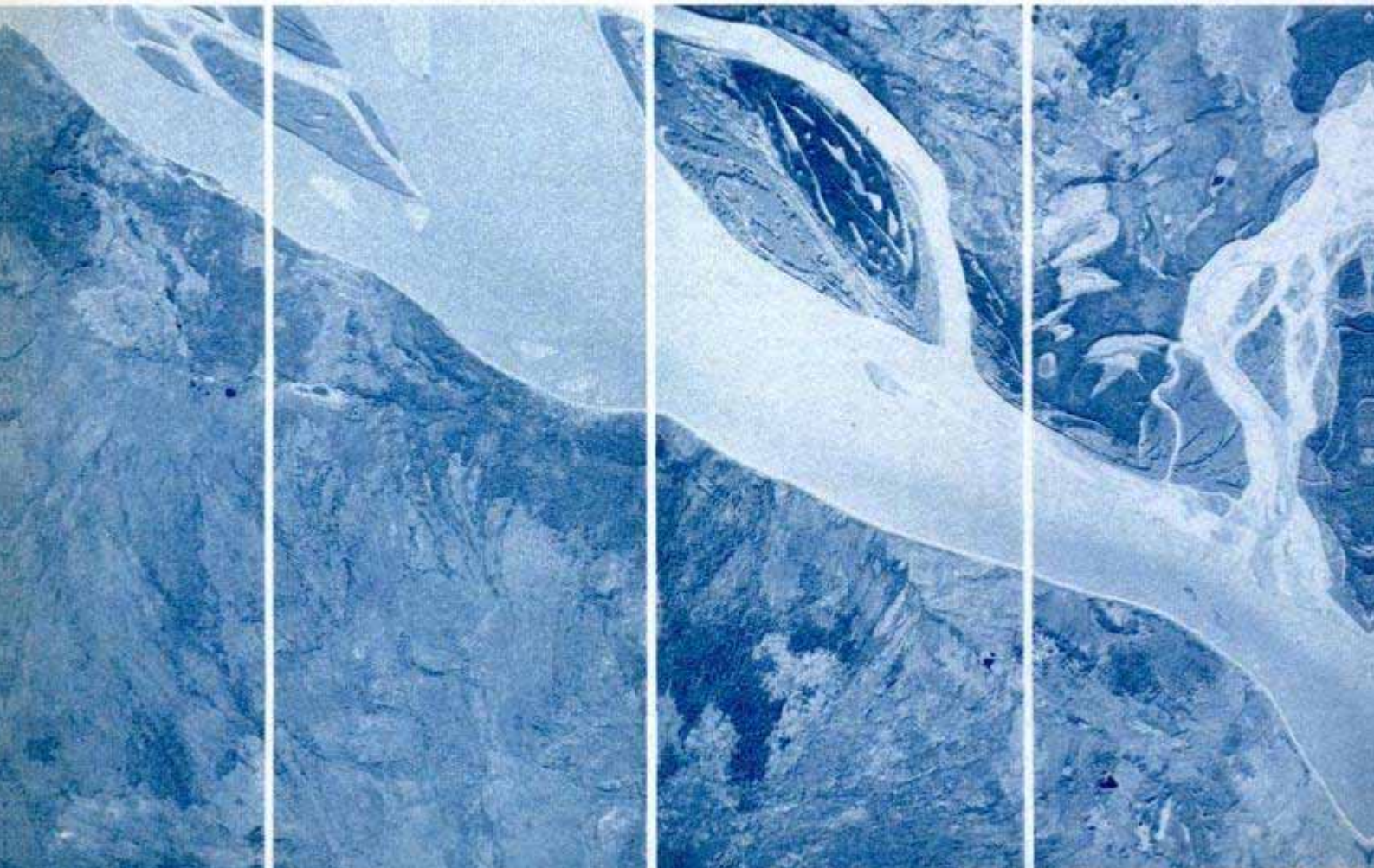





Men of the field parties conquer all kinds of terrain. Here a group of prospectors wades up the Athabaska River

the survey planes throughout the season.

Photographing the terrain is a constant battle between aircraft crews and the weather. Areas to be photographed must be free of ice and snow. In early season flights the retreating winter is followed northward and the photos taken as soon as the snow and ice melt. In some areas convection clouds form as the land warms, and it is not unusual for the crews to find only a few days during the entire season when the weather is suitable for photography.

Vertical photography is done at 10,000 to 18,000 feet, and tri-camera work is carried out at 20,000 feet, requiring a sky free from low-lying clouds. Even patchy clouds above or below the aircraft may blur or

spot photographs so much they are useless.

Improved navigational and photographic equipment has enabled the RCAF to extend its coverage. During the 1947 season two photo squadrons covered more than 400,000 square miles. Survey workers hoped to cover 550,000 square miles this year.

One plane has been fitted with an airborne laboratory including magnetic detection apparatus, a control room which contains a panel of altimeter and magnetic recorders, and a well-equipped observer's station in the nose, where flight lines are calculated and the plane's course directed. The magnetometer makes possible the coverage of mining areas at a rate of 250 square miles a day. Furthermore, it permits the tracing of geological formations that are covered by glaciers, thus providing information that would be impossible to obtain from the ground without extensive drilling.

When the plane's observer gives a signal, all recording apparatus is placed in operation. A record is made on the magnetic and altitude recorders as well as on a strip film. The camera is mounted in the tail and takes continuous photos. When

(Continued to page 256)

Flotilla of scows carries a field party and its equipment across Great Slave Lake



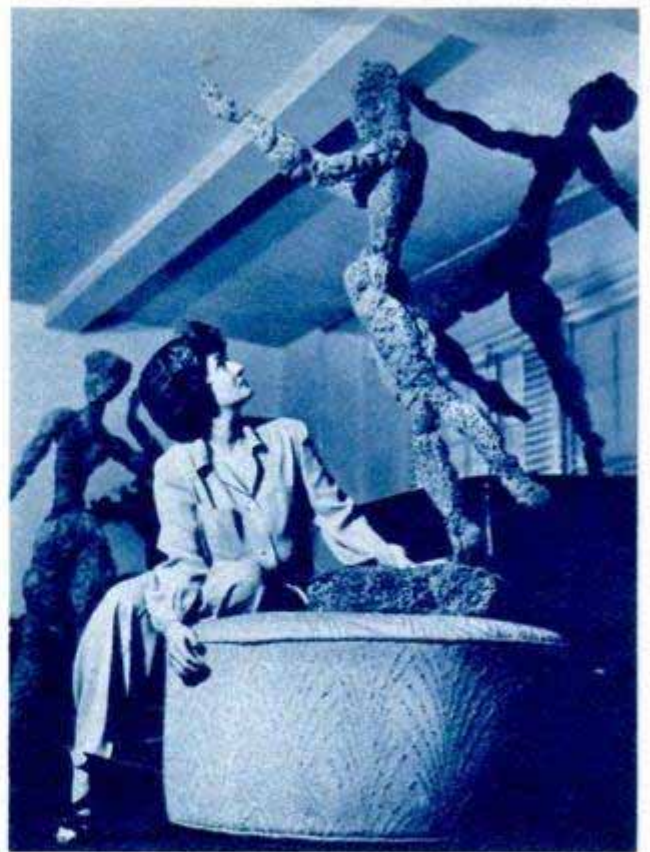

### Sponge Sculpture With a Razor

Sponges become sculptured figures under the talented fingers of Arline Wingate of New York. Miss Wingate recently decided to find a new material for sculpture. At first she tried pine cones, which bruised her fingers. She then hit on sponges as a

pliant material that could be cut easily. She uses brown Mediterranean sponges from 9 to 12 inches in length, bleaching them to a pale yellow. They can be cut easily with a straight razor and trimmed with a pair of scissors. The sculptress first builds up a frame of wire, which she covers with sponges to form the figure.



### Crank-Operated Oar

Clamped at the stern, a single paddle propels a boat through the water at speeds up to four miles an hour. The paddle, invented by Roy Croach of Little Rock, Ark., has a crank-type handle. Rotating the handle imparts a "fishtail" motion to the paddle to move the boat. When not in use, the paddle can be placed in a locked position out of the water. It can be used in water only one foot deep.



Information, including the names and addresses of manufacturers or distributors, concerning products described in this issue may be obtained by writing Bureau of Information, Popular Mechanics Magazine, 200 East Ontario Street, Chicago 11

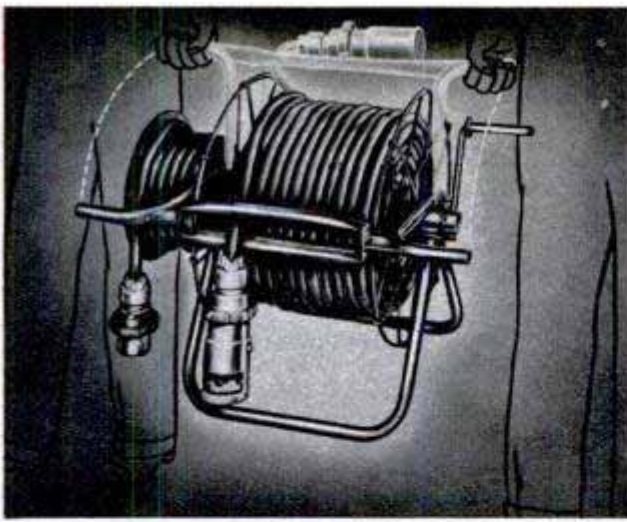

### Reel Holds 300 Feet of Heavy Cable For Easy Carrying by Two Men

Long lengths of heavy electric cable are easily transported by hand with a portable reel that holds up to 300 feet of  $\frac{3}{4}$ -inch, four-conductor cable. Twin handles permit two-man carrying and the tubular supports that form the base act as runners to facilitate passing the reel in and out of trucks. Empty, the reel weighs only 21 pounds. It has adjustable flanges to vary its width and a free-running crank handle to make rewinding easy. The reel can be used, of course, for smaller-diameter cables and with them much greater lengths can be accommodated.

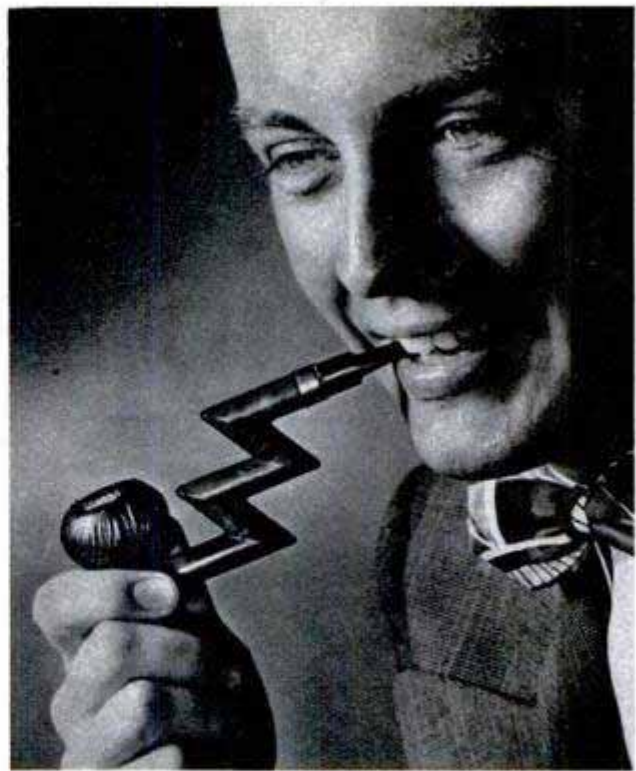

### Smoke Climbs Pipe-Stem "Stairs"

Looking like something out of the comic strips, a pipe with a zigzag stem is said to provide a cool, dry smoke. The stem, molded of Tenite plastic, prevents tobacco tars from draining into the hard-rubber mouthpiece. Fitted with Italian-briar bowls, the stems come in mottled colors.

### Replaceable Table Insert Converts Bench Saw Into Shaper

Ordinary bench saws can be converted into shapers with an attachment invented by Roswell Bearup of Colorado Springs, Colo. The attachment was one of the top prize winners at a recent inventors' congress held in Pueblo, Colo. It fits as a unit on the saw, replacing the table insert. The saw blade is removed and a cone-shaped steel disk bolted in its place. The lower part of the attachment also is shaped like a

cone and is backed by a rubber grommet. An ordinary molding-head cutter is fastened to the attachment. Friction between the two cones drives the cutter, and the rubber acts as a cushion for sudden shocks. Other top prizes at the inventors' show were awarded to E. L. Wilkins of Las Animas, Colo., for a beet harvester and Elmer Lundvall of Greeley, Colo., for a cooling attachment for milking machines.

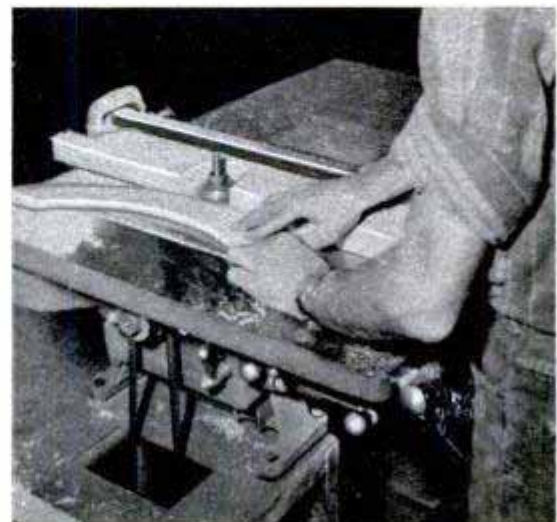
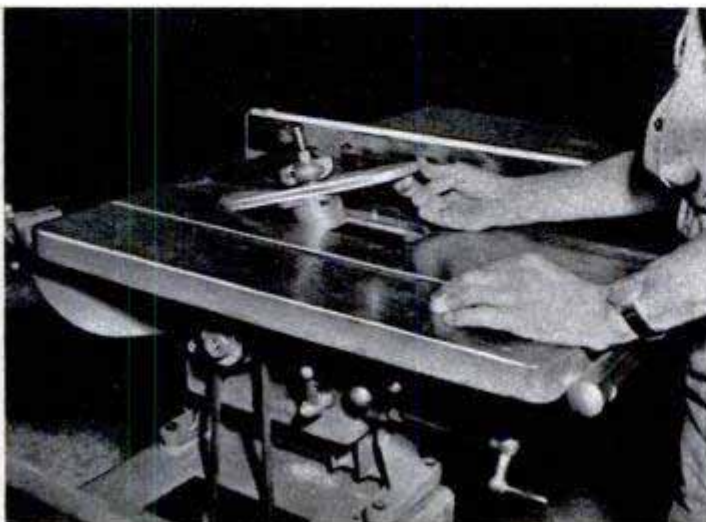

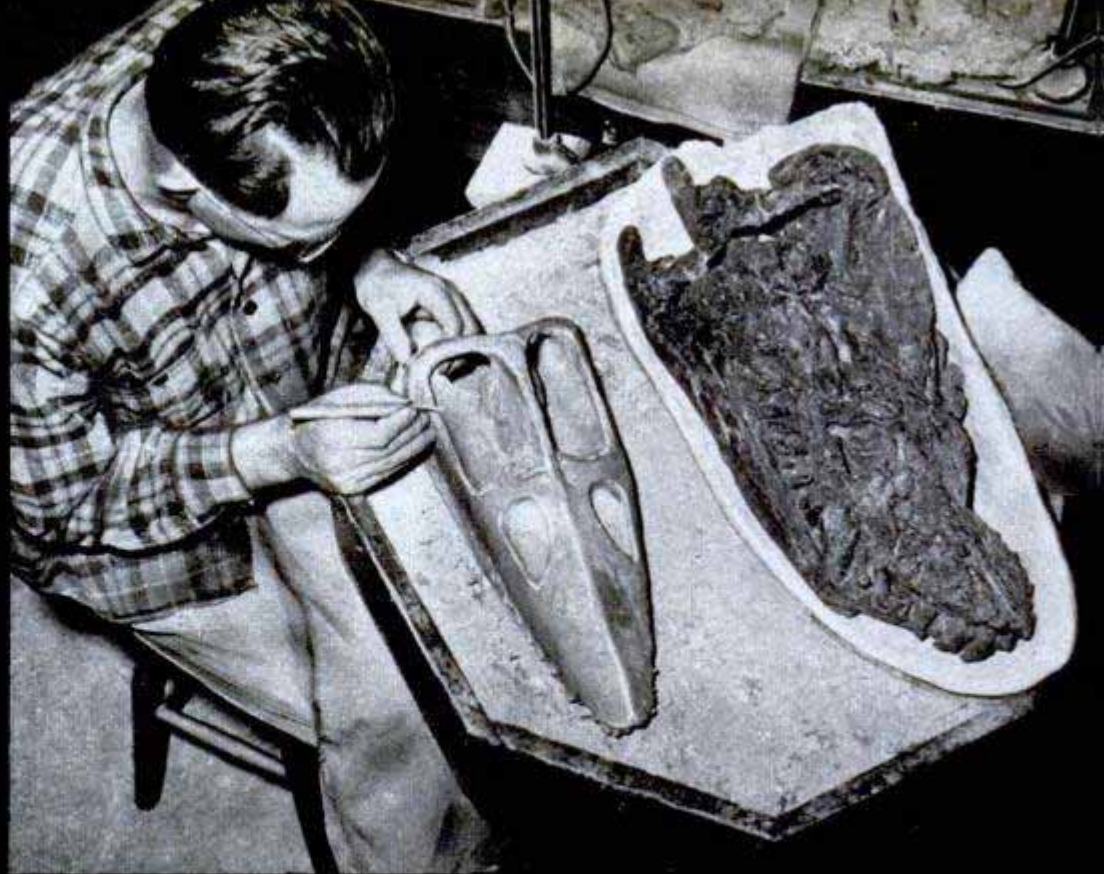

Panels at left of page show two slabs of sandstone found near Cameron, Ariz., and on which sharp images of the "hand animal's" footprints are visible in relief. Above, aim of paleontologists is to be able to reconstruct the hand animal as this scientist is doing with skull of an ancient sea serpent, using fossilized evidence found in Colorado



## the mystery of the "HAND ANIMALS"

America's hand animals roamed the area covered by this map. They left footprints behind them as evidence and sand formations have preserved these fossil remains for scientists trying to solve the mystery



Right, scientists clear earth away from rock slab which has prints of the mystery animal on underside. The arrow points to Meteor Crater on the skyline



Bottom sketch shows impression made by the handlike hind foot of one species of hand animal. Upper drawings show prints made by hind foot and smaller front foot as another species of the mystery animal walked across a prehistoric mud flat

**F**OR MORE THAN a century in different parts of Europe people have talked about the mysterious monster whose handlike tracks occasionally are found impressed on the rock slabs of quarries.

Resembling the print of a grotesque human hand, the marks seem to have been made by four fingers and a thumb, tipped with powerful claws and coated with a scaly skin.

Possibly a great prehistoric ape, some thought, or a giant opossumlike marsupial had roamed across Europe, leaving this record behind. Others suggested that the tracks were those of some strange amphibious creature. Curiously, every print showed the thumb on the outside of the track instead of inside where it seemed to belong. To explain this oddity one early scientist created in his imagination an evolutionary absurdity, a froglike beast that shuffled along cross-legged.

Gradually European paleontologists came to the conclusion that the tracks were those of a reptile that preceded the dinosaurs. The thumbprint, it was decided, wasn't made by a thumb, but by a little toe or finger which served as a crude prop for the foot.

The creatures were given the name of *Chirotherium* or "hand animal." A few conclusions about probable size and appearance were reached but, with no evidence available except a few tracks, the hand animal remained one of the unsolved mysteries of the past.

Then, a few years ago, the town of Cameron in northern Arizona provided a new clue. Visiting Cameron, Major L. F. Brady of the Museum of Northern Arizona was amazed to see handlike markings on slabs of red sandstone used by a fellow Arizonan to build his fireplace. They were typical *Chirotherium* tracks and Brady learned that the slabs had been excavated from a nearby hillside.

Large areas of northern Arizona, including the Cameron region, are virtual storehouses of the remains of prehistoric life. Fossilized skulls and other bones as well as "trackways" abound. Erosion has cut cliffs into the sedimentary strata and sometimes a paleontologist makes a rare find by walking along the base of a cliff and inspecting its surface. Prospecting for fossils by automobile is even possible for once a scientist found the tracks of prehistoric beasts

By Thomas E. Stimson, Jr.

Photos from paper by Dr. F. E. Peabody, Univ. of Calif. Pubs., Bul. of Dept. of Geol. Sci., 1948



Power tool is used by paleontologist as he removes rock from the fossilized skull of prehistoric creature



Above, photo of hand-animal track and scientist's drawing of details. Below, early conception of the appearance of mystery animal. Bottom, this model of hand animal is based on currently accepted ideas



by glancing out his car window at some rocks that had been heaved up when a telephone pole was set in the ground.

The Triassic beds of the Arizona plateau were laid down during the age of reptiles. The Appalachian Mountains had just appeared and the Rockies and the Pacific Coast ranges were far in the future. At that time, the Arizona region was fairly flat, close to sea level, and was inhabited by giant land reptiles and water-living amphibians. Today, their fossilized bones—in some cases almost entire skeletons—are dug out of the rocks and preserved by paleontologists.

Preservation of the tracks of these creatures has been largely a matter of accident, beginning aeons ago when repeated floods carried fine sand over dried mud flats across which the animals had recently walked. The sand filled in the tracks and, with the passage of time, the layer of sand gradually changed into sandstone. When this stone is turned over today its underside is an exact cast of the original mud surface, including the cracks in the prehistoric mud and any footprints that had been pressed into it. The cast is easier to study and photograph, but if the original form is desired, the paleontologist makes a plaster cast of the rock surface.

The discovery of tracks of the hand animal at Cameron proved that the *Chirotherium* had ranged over much if not all of the Northern Hemisphere and was not exclusively European. A search was made for more prints and, when these were found, some shrewd detective work led to a fairly clear picture of the animal.

Nearly all that science knows about the *Chirotherium* has been deduced from footprints the animals made while walking across muddy ground some 200 million years ago. Only a few unrelated bones of the creatures have been found and in some cases there is a question as to whether they can be those of *Chirotherium* at all.

After the Cameron discovery, the Museum of Paleontology of the University of California sent a number

(Continued to page 254)

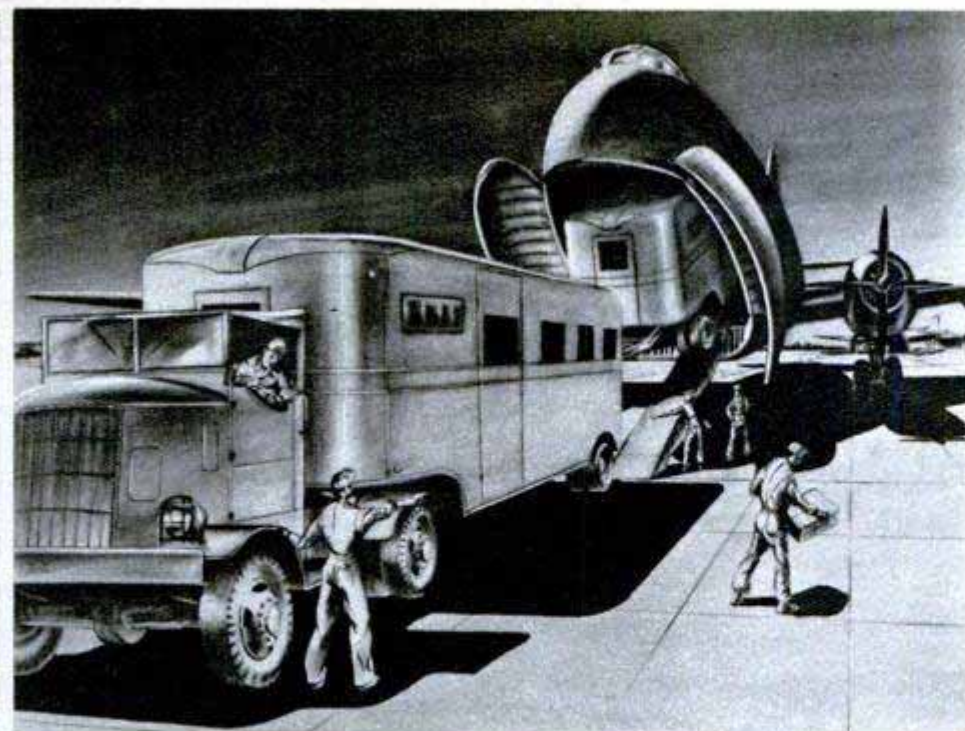

### Huge Transport Can Carry Two Buses and 56 Men

Big enough to haul two full-size city buses and 56 fully equipped troops, the Air Force's new heavy-duty transport, the Douglas C-124, has a range equal to that of heavy bombers. An unusual feature of

the plane is the large clamshell nose opening through which heavy trailers and other large vehicles are backed into the plane. Its speed has not been announced, but it is described as a high-speed transport.

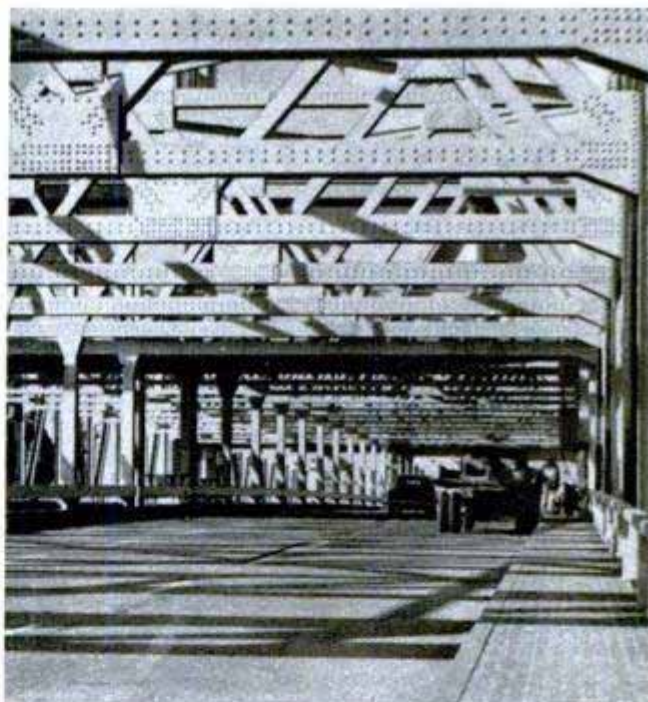

### Vertical Lift Bridge Goes Up and Down Like an Elevator

Although it weighs 1,700,000 pounds, a vertical lift bridge in California is raised to the top of its 224-foot towers by four 100-horsepower electric motors. In fact, it is so well counterbalanced that in an emergency it can be raised by just two motors. The bridge spans a man-made channel between Wilmington and Terminal Island, Calif. Cables in each of the four corners hoist the

bridge to the raised position. The pulleys over which the cables run are 14 feet in diameter. Length of the movable span is 240 feet, while the total length of the bridge, including approaches, is three quarters of a mile. The roadway is six lanes wide. Raising the span to its full height, which gives a 175-foot clearance, takes 2 minutes and 15 seconds.

NET FOLDED READY FOR USE

HIDDEN BEHIND A MOUND OR IN TRENCH

GROUND SHEET

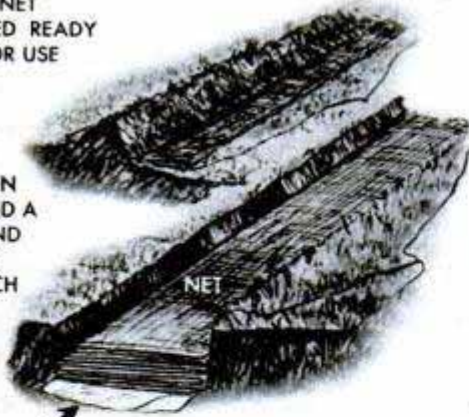

WATCHERS ABOUT TO RELEASE THE NET, AS LEADING BIRDS GET WITHIN 4 OR 5 YARDS OF TRENCH

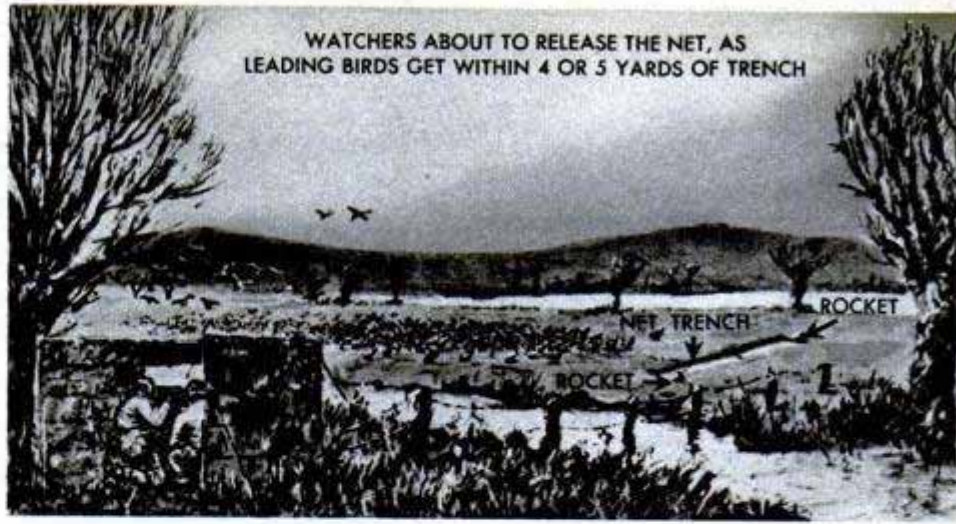

THE MOMENT AFTER FIRING ROCKETS

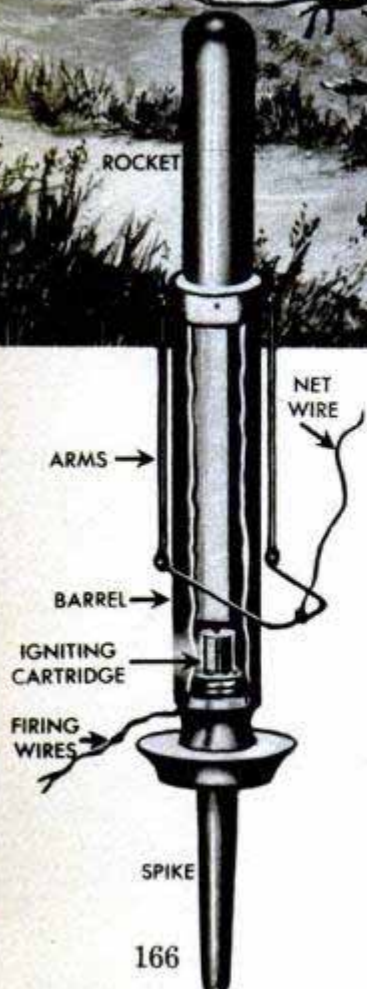
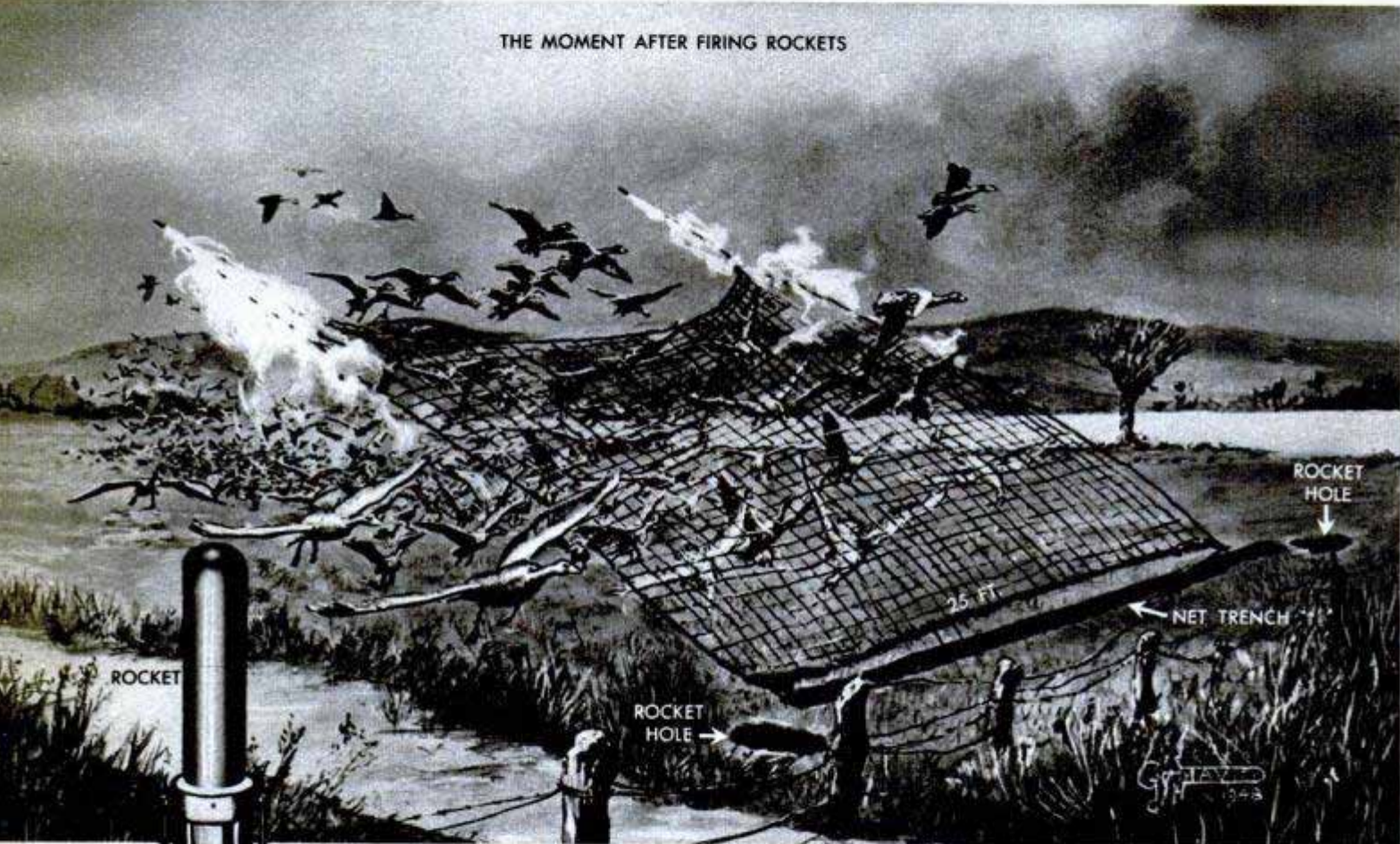

To net wild geese, the British conservationists use a rocket-thrown net. Top left, the net is folded and hidden behind a mound or stacked in a shallow trench. Top right, "hunters" in blind prepare to fire rockets as geese approach edge of net. Above, this is what takes place as the rockets go off. The net is pulled up and over the fowl. Being anchored to the ground at two corners, it falls to earth, netting many of the birds. They are then picked up and banded. Left, the type of rocket used to spread the net. It is fired remotely from the blind. Right, once banded, the bird is freed



RELEASING A RINGED GOOSE





Driving wild ducks into small end of the mesh tunnel where they will be removed and banded

## SCIENCE GOES DUCK HUNTING

HUNTING wildfowl with rockets and nets may not sound like sport, but that's what British conservationists are doing as they seek ways to stop the steady decrease in bird population due to the spread of civilization. They bag scores of birds at a time with rocket-thrown nets and narrowing mesh tunnels into which wildfowl are lured

by tame birds. Once caught, the birds are banded with metal rings bearing identification numbers and released. The numbers are recorded and whenever the birds are recaptured the scientists are able to plot their movements. The program, carried out by the Severn Wildfowl Trust, is providing data about habits of wildfowl.

Wild ducks start up mesh tunnel. Tame ducks follow trained dog at left and their wild brothers tag along

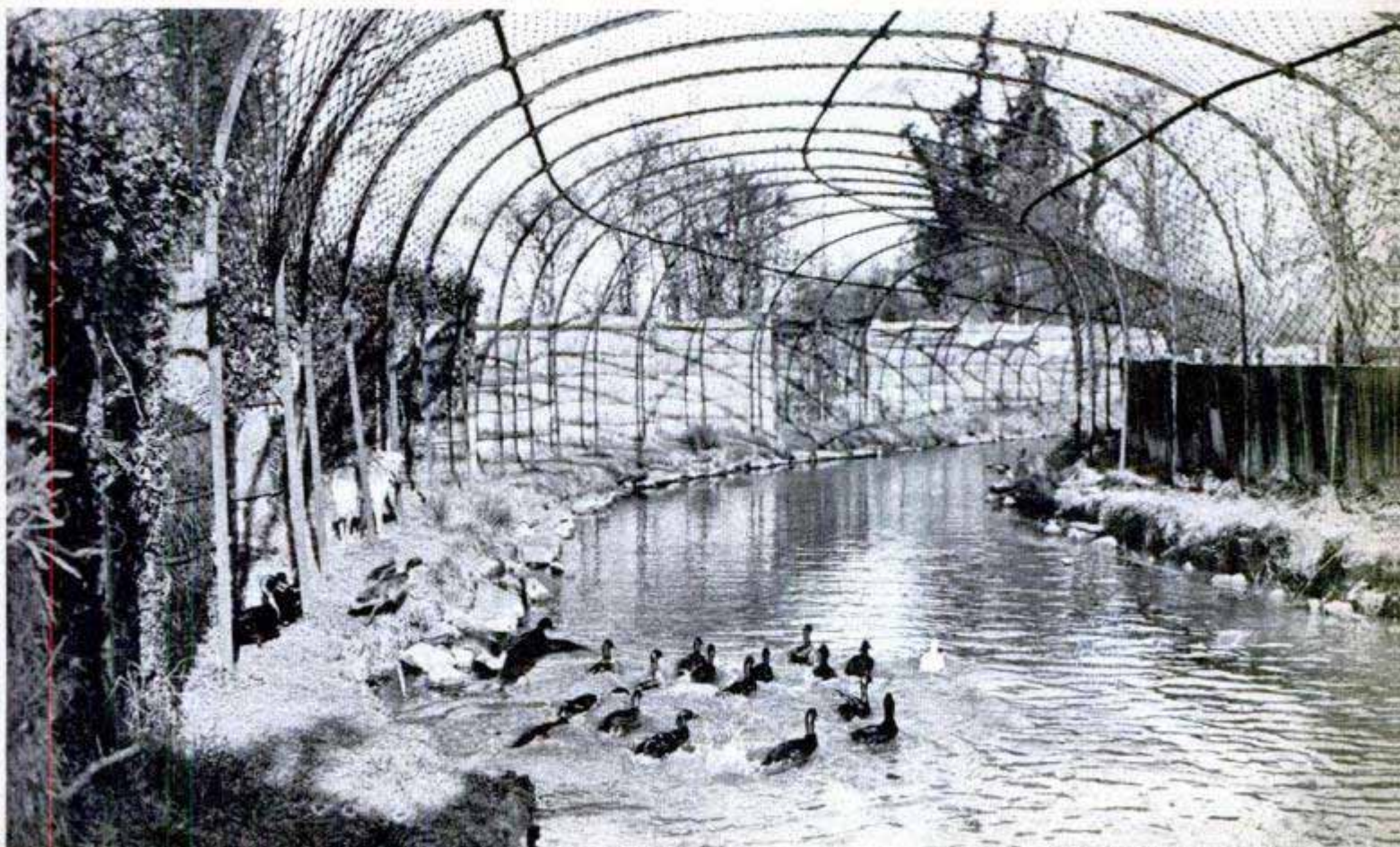



### "Vicinity" Car

Almost as large as conventional autos, a new low-cost car, the Airway, travels 50 miles per gallon of fuel. The car, designed as "vicinity" transportation for shoppers and commuters, is expected to sell in the \$500 to \$750 price range. With a wheelbase of 100 inches and a 50-inch tread, the car seats three in the front. Extra seats may be installed in the rear if desired, or the space may be used for carrying packages. The experimental models, made of aluminum, weigh only 600 pounds. Production models will be made of plastic combined with aluminum. A 10-horsepower



engine drives the car 50 miles an hour. Mounted in the rear, it weighs only 120 pounds. The auto is equipped with fluid drive, plus a low gear for steep grades.



### Crane Moves Snow

Snow removal and grading have been added to a crane's chores by an ingenious operator who detached the boom and added a bulldozer blade. A hook attachment, normally used with the boom, maneuvers the bulldozer blade. The crane had previously been used only for loading machinery and unloading coal.

Scientists at Brookhaven National Laboratory have produced a variety of field corn that grows only six feet tall, short enough to simplify hand or machine harvesting.

To dramatize chain reaction of the A-bomb, 50 mouse-traps are used. Two corks, representing neutrons, are placed on each trap and when a cork neutron is dropped among the traps (at right), the "bomb" explodes (below) by a chain reaction. As each trap goes off, corks fly around, tripping others



# THEATER OF THE ATOM

Combining science with entertainment, an unusual "vaudeville" show dramatizes atomic power in a truly hair-raising manner (see photo below). The show uses an assortment of interest-holding stage props to portray the story of atomic knowledge from its beginning as a laboratory curiosity down to the present. Sponsored by Westinghouse, it is touring the country, bringing better understanding of the atom to Mr. and Mrs. America.

Below left, a simplified atom motor. From the miniature atom smasher at left, a 200,000-volt charge of electricity leaps across a gap, giving each of the copper spheres a similar charge. Like charges repel, driving the spheres away and spinning the wheel. Center, a model atom shows the cluster of particles in the center nucleus and the electrons on the rim. Right, this hair-raising act is not magic. It is what takes place when you sit down on 200,000 volts

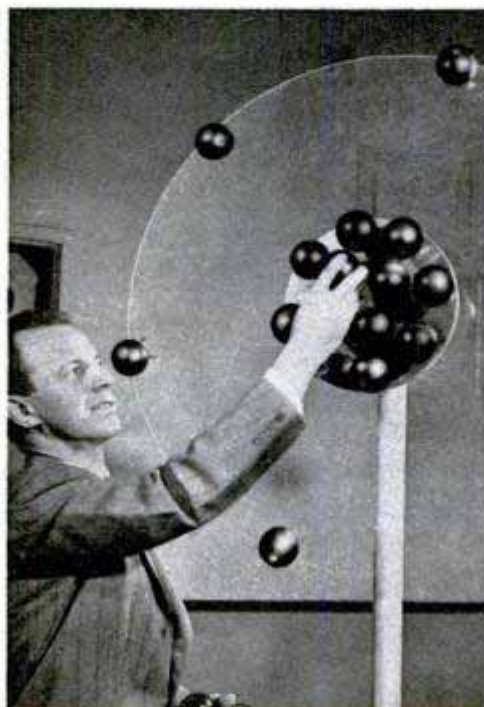

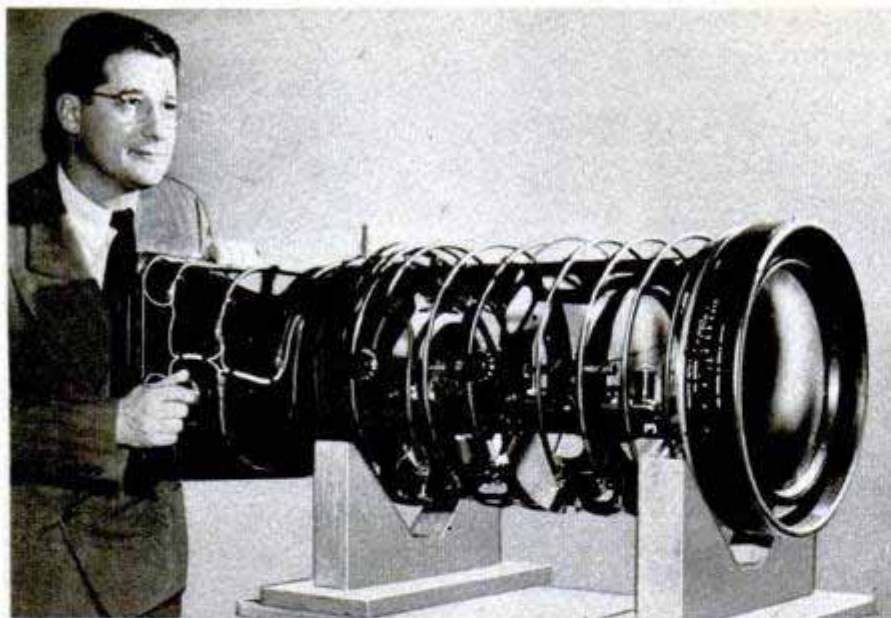

### 15-Inch Camera Lens

Measuring 15 inches in diameter and nearly 4 feet in length, a giant telephoto lens recently was completed for use by the Air Force in aerial reconnaissance photography. Built by Eastman, the lens consists of five pieces of glass. The f:6.0 lens has a focal length of 60 inches. Tubes containing electric heating elements surround the lens to keep the temperature constant, as variations would affect the focus. The lens will be used with the K-34 aerial camera, which takes pictures on 9 by 18-inch film at altitudes up to 10 miles. Haze is reduced by interchangeable filters.

### Telegraph Office Fits on Desk

Miniature facsimile machines for desk use bring telegraph service within arm's reach of the user. Eventually, the machines will be installed in transportation terminals, offices, hotels and telegraph agencies. Developed by Western Union, the machines save the time of picking up and delivering telegrams by messenger. The sender merely places the message on a cylinder and presses a button. As a stylus passes over the message, electrical impulses are created which flash over the wire to the receiving machine where they are converted back into words by the stylus. Each office machine

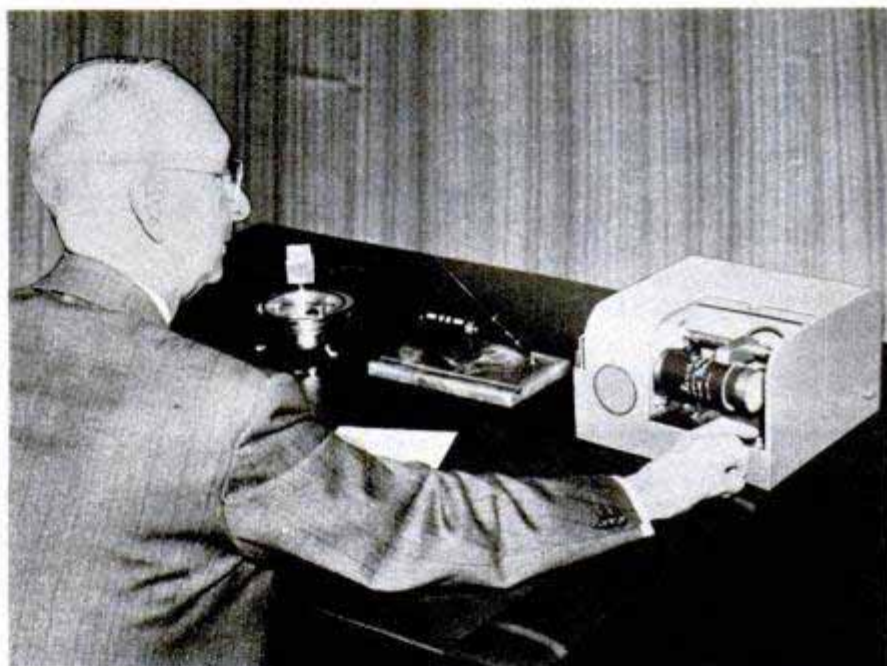

automatically becomes a receiver when the central office signals that it wishes to transmit a message.

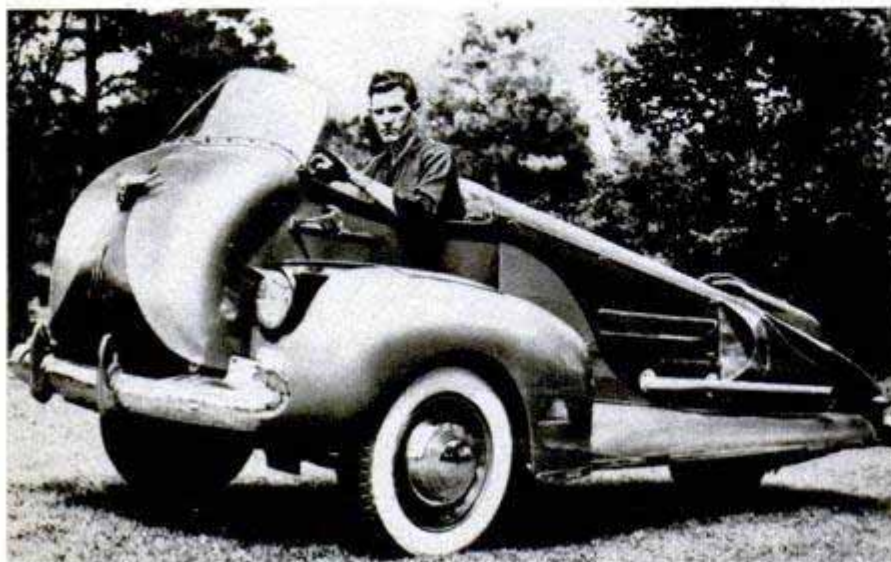

### Homemade Three-Wheeler Travels 55 M.P.H.

In order to beat the car shortage, Frank Mayes, a farmer who lives near Fayetteville, Ark., built a luxury car himself. The car has only three wheels and is constructed mainly of Ford and Chevrolet parts. Both the driving and the braking are applied to the front wheels, while the single back wheel rolls free. The farmer-mechanic completed the car in 22 months. In trial runs the unique auto has rolled along the highway at speeds up to 55 miles an hour.

## SPEAR FISHERMEN STALK THE BIG ONES

FISHERMEN of Miami's Five Fathom Club are too impatient to wait for the fish to bite—they roam the ocean floor hunting for their game. Weapons used are several varieties of spears, some of them adapted from surplus war implements. One gas gun fires a harpoon with such power that it will pass entirely through a fish four feet thick. Standard equipment for the anglers includes a face goggle, webbed fins made of rubber and an arm lung that gives the wearer an extra two minutes of underwater activity.



† Angler-inventor demonstrates his rebreather lung which gives him an extra two minutes underwater in case he's speared a big one. Right, equipment includes the lung, goggles and rubber fins for rapid movement through the water. A larger lung permits angler to stay 1½ hours underwater at a depth of 60 feet



† Club member adjusts a gas gun which is used on bigger fish. It fires a five-foot spear with a harpoon head by means of compressed gas. Below, underwater anglers land a 235-pound jewfish with aid of boat tenders



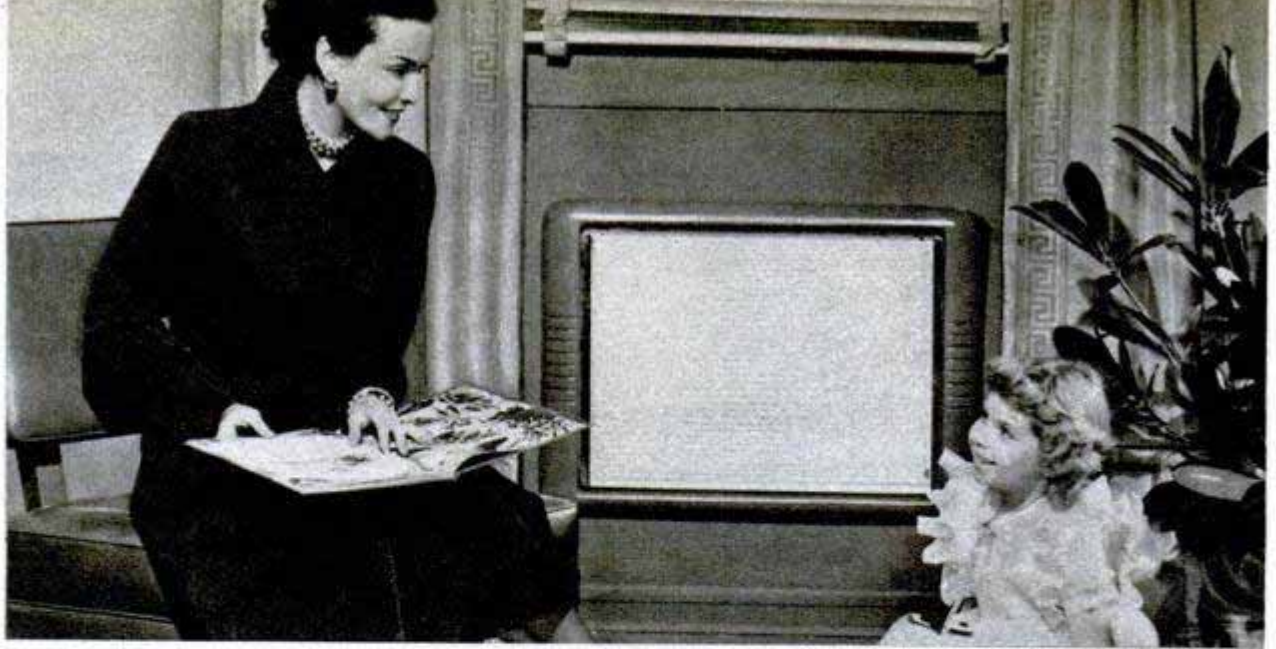

**RADIANT-HEATING PANEL** uses an electrically heated glass plate into which an aluminum element has been fused. Thermostatically controlled, it can be installed in new or old homes to provide comfortable radiant heat. The panels operate on 110 or 220 volts and each one will heat a room of 1400 cubic feet

# WHAT'S NEW *For Your Home*

**A four-page "shopping section" dedicated to modern homemakers**

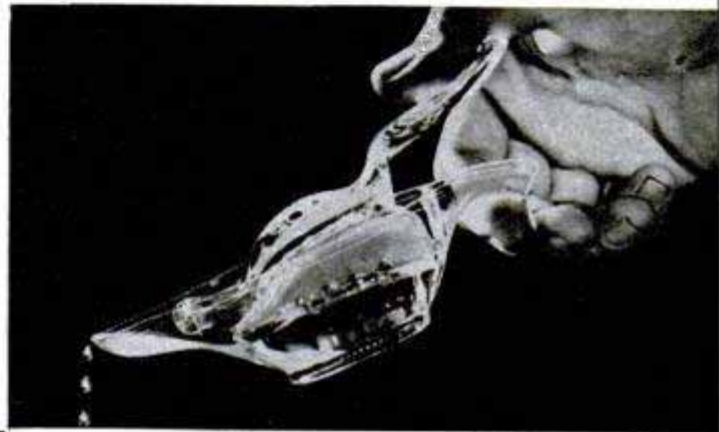

↑ **LEMON SQUEEZER** keeps juice out of your eye as you squeeze small amounts for flavoring. Made of Lucite, it has a removable plastic strainer

← **FLEXIBLE SCREENS** don't have to be taken down for window washing. They are aluminum mesh and can be put up and taken down from the inside

**SERVING DISH** (below left) keeps foods cold or hot for hours. It has a three-quart capacity

**CAN OPENER** (below right) opens strip-sealed cans. Ejector discards strip when can is opened





**FIREPLACE SCREEN** (left) has plate-glass louvers that control draft. Closed, below, it prevents loss of room heat up the chimney

**FLOOR POLISHER** (right) fits on vacuum cleaner and consists of a revolving brush that brings out a high luster on wood or linoleum

**BALL CASTER** (below center) is easy to push in any direction. It has a ball-bearing roller. Three prongs attach it to the furniture

**POLLEN REMOVER** (below right) brings relief for victims of hay fever. It removes pollen by washing room air six times every hour

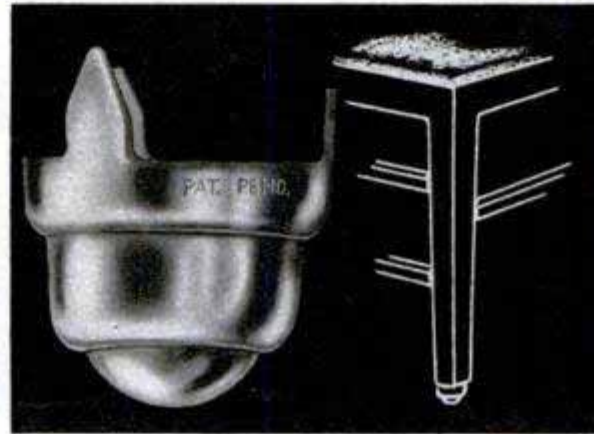
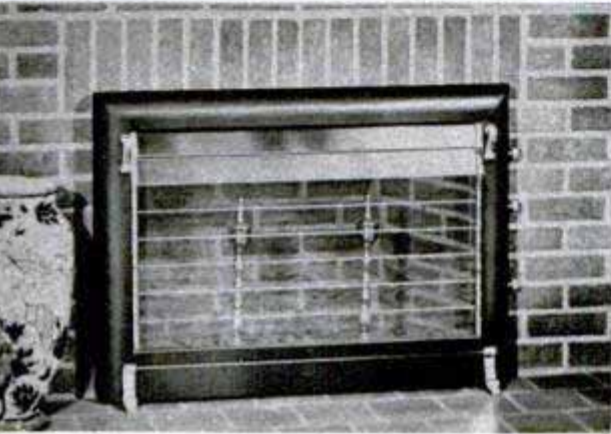

**MOUNTED MIRROR** (below left) can be adjusted to convenient height or tilted to any angle. It is two-faced, one side being a magnifying mirror, the other a flat mirror. The stand, which has rubber-capped feet, telescopes to 24 inches for traveling

**ADJUSTABLE MATTRESS** (below) enables you to select the right amount of softness to assure sound slumber. By pulling on cords strung through buttons on the side, you make the mattress harder. You can make part of it hard, the rest soft, if you desire





**TAILOR TACKS** are made without stitching by a two-armed marking device that chalks both sides of the cloth with a single twist of the knurled knob

## WHAT'S NEW *For Your Home*

Continued from preceding page

*Sources of supply for these products may be obtained from Bureau of Information, Popular Mechanics Magazine*

**HOSE BASKET** keeps hose connected to tap. It saves time and the hose is ready for use if fire breaks out

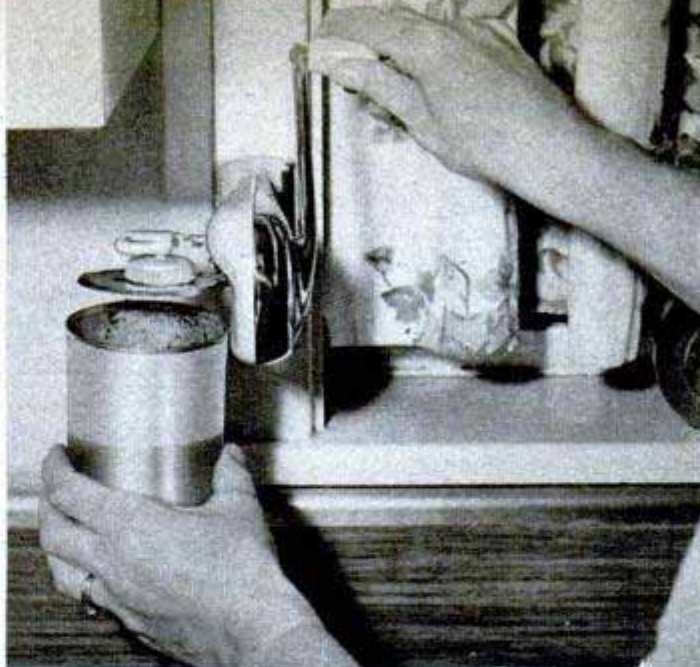
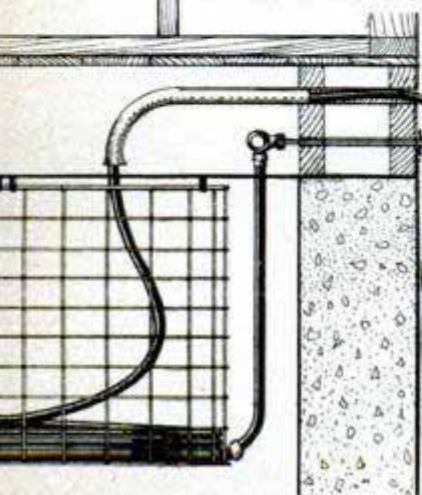

**MAGNETIC "THIRD HAND"** for housewives prevents the lid from dropping inside the can as it is being opened. Magnet is a feature of new can opener

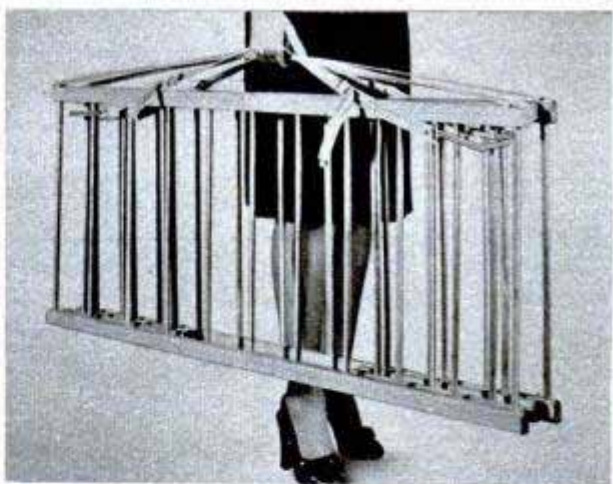

↑ **STRAP-ON CRIB** can be taken with you when you go visiting. It converts any bed into a safe crib

↓ **DISPENSING CAPS** for milk bottles keep milk sanitary. To open the cap, you merely press handle







**FOLDING SCREENS** made of a plastic mesh are translucent but give privacy in small homes. Accordion doors use the same material, called Celanese Vimlite

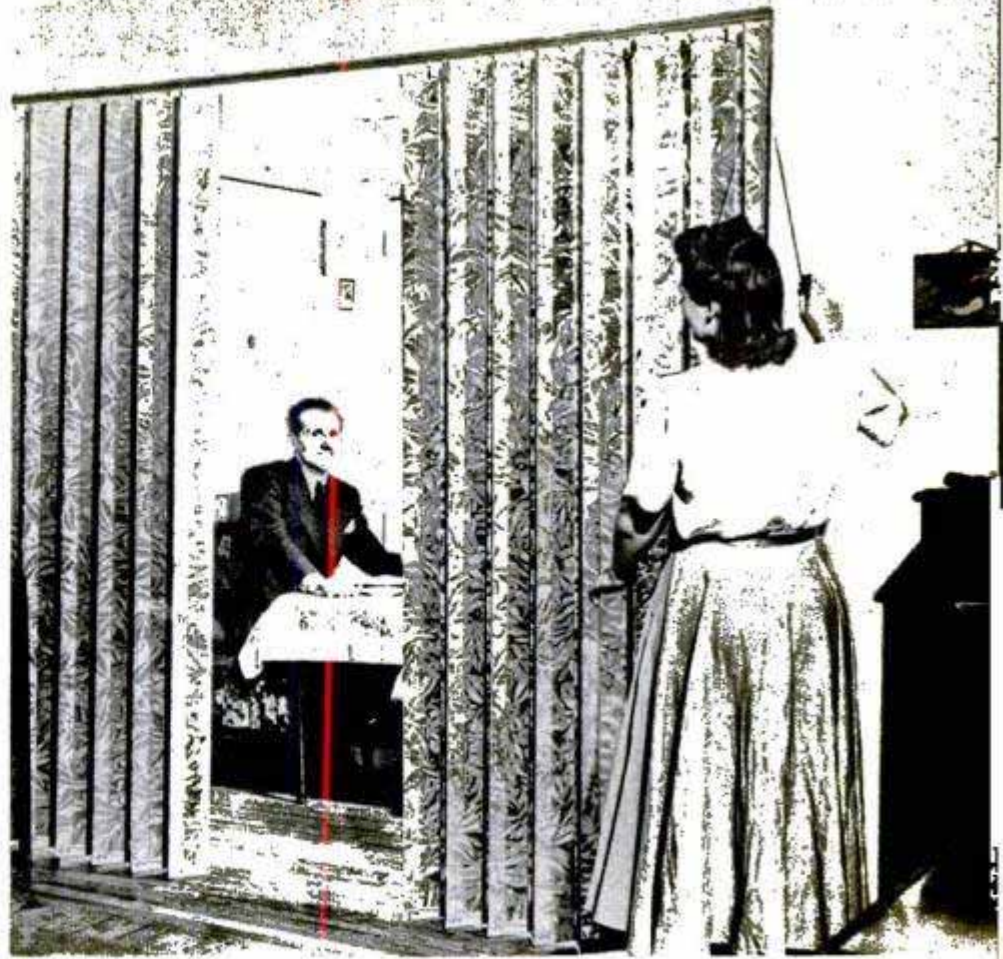

**STEEL LEGS** (right) convert any steel spring into a studio couch or day bed. Rubber-tipped, they attach to the angle iron near each of the corners

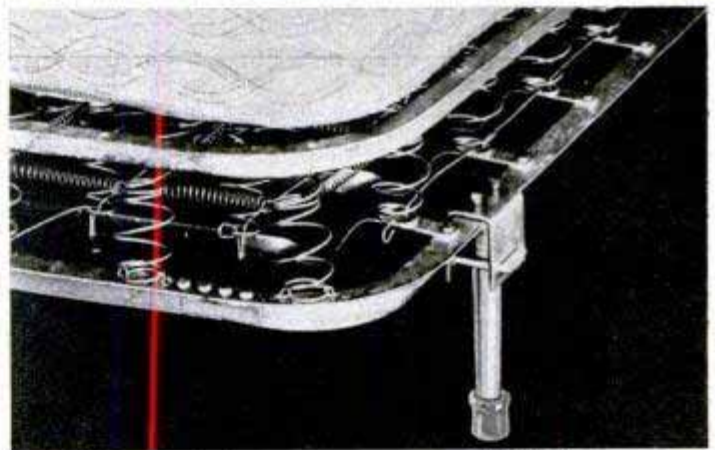

**THREE-DECKER TABLE** (below) provides storage space for large kitchen appliances. It is mounted on casters so that it can be wheeled around easily

**MECHANICAL TOOTHBRUSH** (below right) takes the place of the bristle type. Two rubber brushes spin as you turn the crank, cleaning the teeth and massaging the gums. It's used with powder or paste



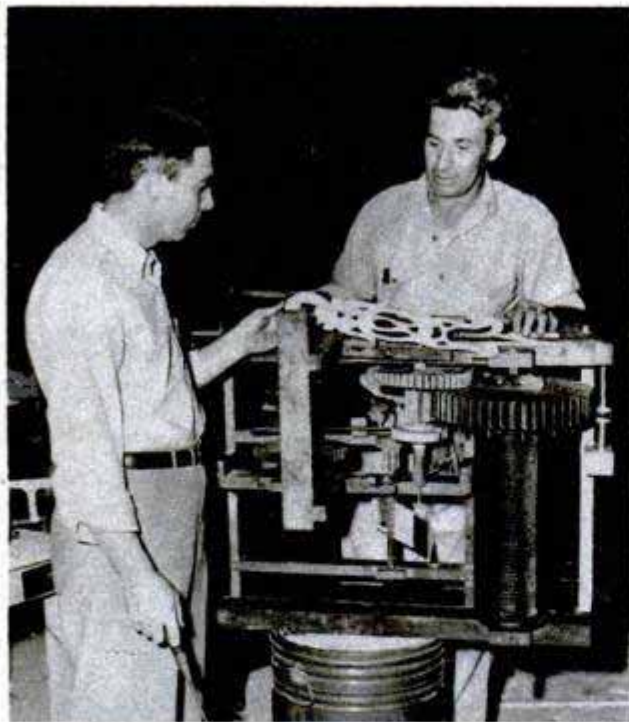

## Old Clock With Wooden Gears Converted to Electricity

Above, paper pattern is cut for new hands. Note large gears in old clockworks. Above right, converted clock is installed in tower. Right, wooden cog is sawed out

Students, a retired college president, a professor and a maintenance man recently converted to electricity a 96-year-old, wooden-gear clock. The clock is housed in a tower on the campus of Marietta College, Marietta, Ohio. Draper T. Schoonover, the retired president of the college, suggested the electrification. He had often cut new wooden gears for the ancient clock in his workshop. He and one of the professors made new cogs for the gears behind each of the four faces. One of the maintenance men cut new hands from plywood and students installed them with collars made from a used automobile-engine head. A special striking mechanism driven by a  $\frac{1}{4}$ -horsepower electric motor was installed. Students wired the clock and once more it tolled out the time, this time driven by an electric motor.

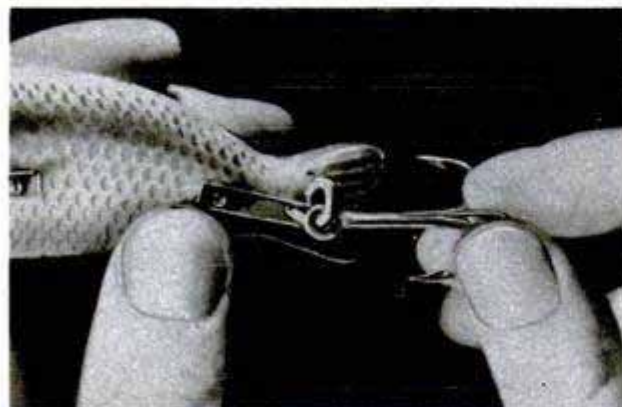
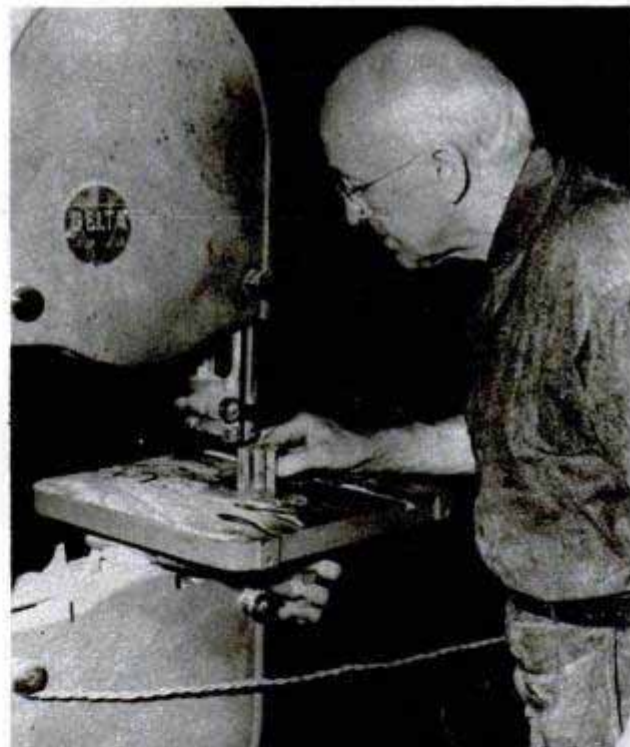

## ← Lure Has Interchangeable Hooks

Fishhooks that are damaged or are the wrong size can be removed from a new fishing plug and other hooks substituted in a few seconds. The plug has an open-end eye held in a closed position by a spring piece. When the piece is raised, the fisherman can rotate the eye to an open position, remove the hook and put on another. With the hooks removed, the angler can carry the plugs in his pocket. The plugs are available in several types.

## Wave-Driven Boat

Tired of continually winding his daughter's spring-driven boat, Walter A. Anderson of Omaha, Neb., invented a way for the waves to propel the craft. Now it moves so fast that even in a light chop it passes a rowboat and then has to be captured by a powered craft. Anderson, a civil engineer, first built a balsa hull three feet long. About 18 inches below the hull he fastened an aluminum framework with fins pivoted on their leading edge. As the boat rises to a wave's crest, the fins open 45 degrees, providing forward propulsion. When the boat plunges down

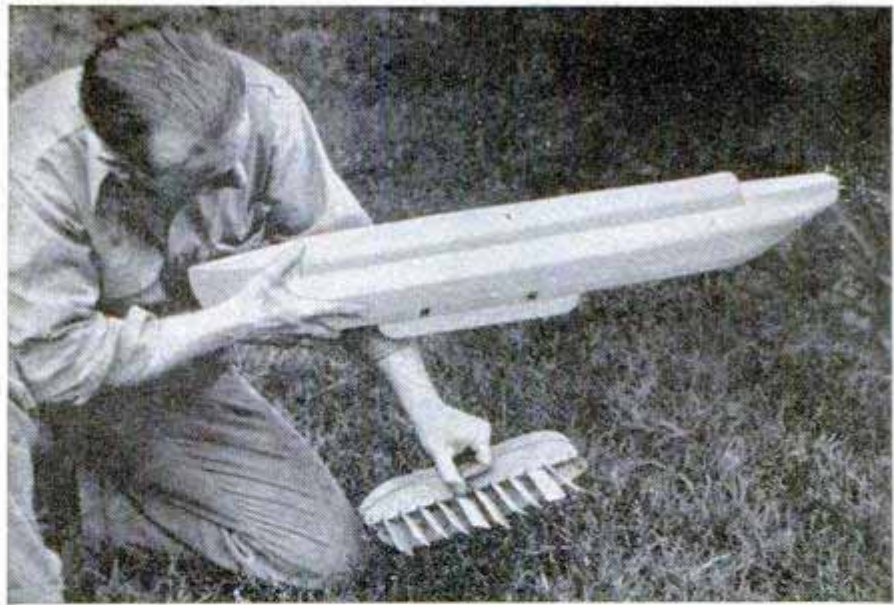

into the trough between waves, the fins close, and their inclined surface continues the forward propulsion.

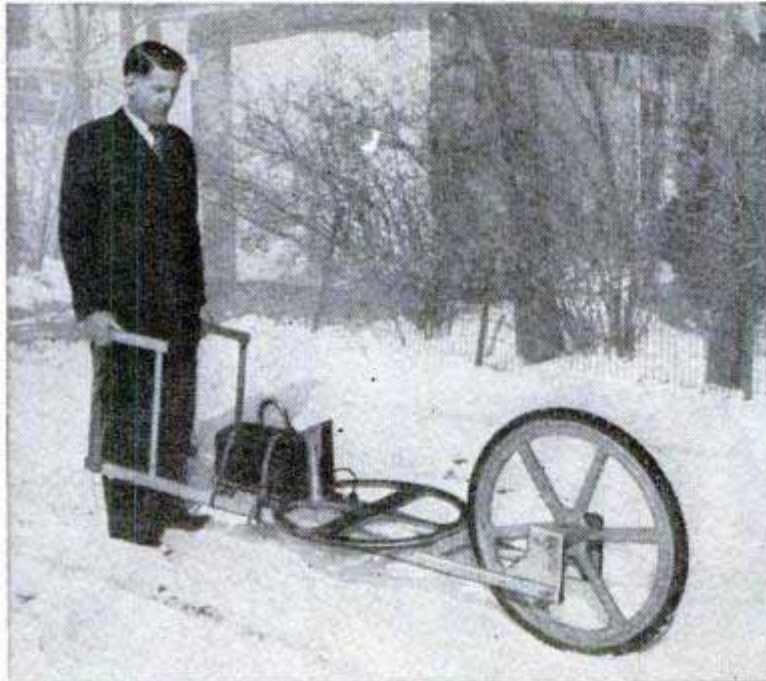

## Plywood Wheelbarrow Carries Meteor Detector

Pushing a plywood wheelbarrow, H. O. Stockwell is prospecting fields near Norton, Kans., for the fragments of a meteor reported to have exploded in mid-air in that area. The unusual wheelbarrow carries an electronic metal detector. Since last year, Stockwell has unearthed four meteor fragments in the Kansas area, the largest weighing 740 pounds.

☐ In the Bell Telephone network today there are 113 million miles of wire, three-fifths of this total being underground and 95 percent of it being rugged cables.

## Dashboard Indicator Shows Oil Level

Motorists can tell at a glance whether their oil is low with an indicator that lights up when the supply drops to the danger point. A plug unit is installed in the oil pan in place of the regular drain plug and connected to the dashboard with a cable. The weight of oil in the pan is transmitted through the plug to a diaphragm, which sets off an electrical current flow as soon as the oil supply goes down. When one quart of oil is needed, an amber light flashes on

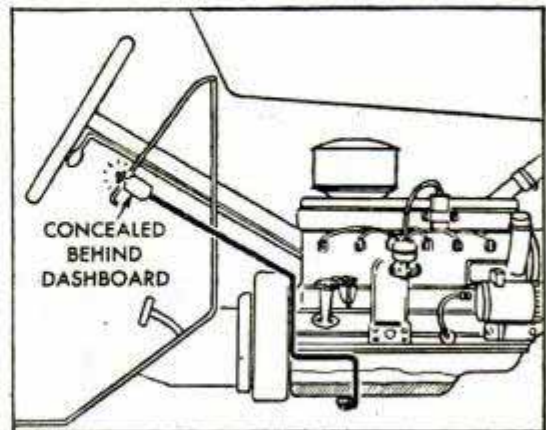
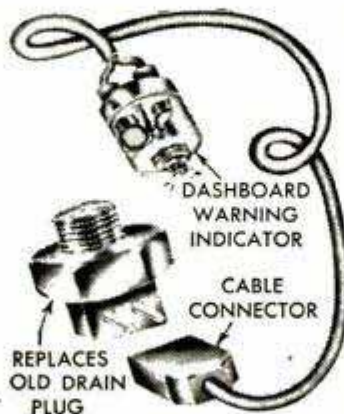

to warn the driver. When the oil supply is down two quarts, a red bulb lights up. The indicator operates whenever the ignition switch is on.



Junior Foresters have planted more than 10,000 trees in Omaha. Here a youngster uproots a nursery tree prior to planting it on a city street

Young foresters bore holes in an old stump and drive rotted wood into them. If wood is well watered, the stump will rot out in about a year



**A** 12-YEAR-OLD boy stood defiantly in front of the superintendent of an Omaha housing project. He had been caught deliberately hacking a young tree in the project with a knife.

"You are guilty of a crime not only against this city but against life itself," said the superintendent. "Under the circumstances, I am determined to report your action to the juvenile authorities."

A small man stepped forward and stood beside the boy. He was F. J. Pipal, City Forester of Omaha. "Would you be willing to follow my recommendations in dealing with this boy?"

"Yes, Mr. Pipal. This crime was committed in your department. You may punish him in any way you wish."

# Junior Foresters



Border of about 75 young elm trees was planted along a boulevard in a city park by the Junior Foresters

"Then I propose that we give the damaged tree to this boy. He'll own it. But if the tree dies while in his care, he will return to you for full punishment."

Less than 10 minutes later the boy appeared at Pipal's office begging for advice on how to save his tree. Pipal showed him the techniques of tree surgery, how to remove the damaged portions and bind the wounds.

Months later, with the tree thriving, the boy was an enthusiastic member of a unique organization, Omaha's Junior Foresters. The excitement of planting, protecting and performing surgery on growing trees had captured his imagination in the same way this kind of work has appealed to hundreds of other Omaha children.

The Junior Foresters are dedicated to providing more and better trees for Omaha. More than 1800 members keep sharp young eyes on watch for damage to the city's trees, and in the past seven years the youngsters have planted about 10,000 trees within the city limits. By legal action they are officers of the city. They have received authority from the City Council to intervene with any citizen on questions of public or private trees. Each forester's badge is registered by number in the city hall. The pint-sized arborists are constantly jolting middle-aged residents into action on behalf of

the trees, and frequently they correct the elders' mistakes.

In 1941, shortly after Pipal started work as Omaha's City Forester, he decided that something should be done to make the city children conscious of tree damage. He inaugurated a school contest with prizes for the best essays on the city's trees. Winner of that original contest was a girl who stated in her essay that she was "president of a club whose motto is 'More and Better

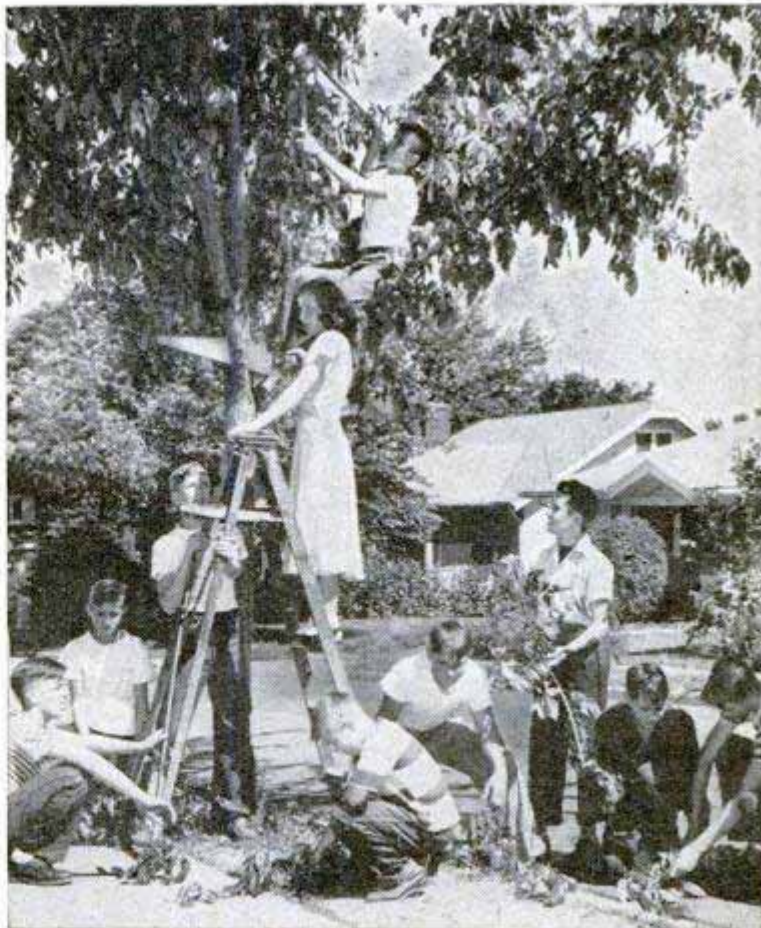

Youngsters enthusiastically prune trees surrounding their school in practice work

Omaha World-Herald photo



Junior Foresters cleaned out a cavity in this tree, then filled it with cement. Black paint finished the project until they decided to camouflage their work by painting bark on the cement. Below, boys wield shovels to plant one of their 10,000 trees



Trees for Omaha.' Pipal, in reporting to the girl's mother that the girl had won first prize, asked about the club. "Mildred has a wild imagination," said the mother in resignation. "She's never even heard of a tree club." There was only one thing to do; with the help of Mrs. Mayme Carpenter, a teacher, Pipal started such an organization—the Junior Foresters.

Clubs are organized by schools to include pupils in the sixth and seventh grades, and in some cases the fifth and eighth. The youngsters are in complete charge of each organization. Pipal has taken on the job of guidance and teaching and provides each member with a booklet for study. The clubs and their work form a definite part of the school curriculum.

In the first lesson for each club—how a tree grows—Pipal brings to the classroom a tree eight feet tall, complete with roots and artificial leaves. About one third of the trunk is sliced off lengthwise to show the location of the cambium, inner bark and other parts. Later in the course, the students learn to prune trees, the fundamentals of tree surgery, how to plant trees and kill the insects that may attack them. Much of the work is done on trees in the school yard. The young foresters became so enthused with their surgery on one tree that after they had filled the cavity they spent hours "camouflaging" the cement by painting bark on top of it.

In their eagerness to display their knowledge, the youngsters are lavish in their advice to elders. "For chewing insects, poison their food; for sucking insects, use a contact spray, and for borers keep the tree in such good health that the borers can't get in."

Pipal had no idea when he started the organization that it would prove so exciting to the students. Now he scarcely has time to visit each club and carry on his regular duties. Kids swarm into his office after school. At any time his phone may ring and a voice pipe up, "Mr. Pipal, this is your dendrologist of Bancroft School. I have found a total of 127 species for you." A dendrologist, Mr. Pipal explains, is a person who makes a scientific study of trees.

(Continued to page 252)

## High-Voltage Arc Removes Broken Studs Without Heating Casting

Taps, studs or reamers that break off inside a casting are removed in a few minutes with an automatic steel disintegrator without distorting or heating the casting. Electrodes direct the high voltage into the broken piece, disintegrating it electrically. The machine can be used in any position and the electrodes are self-feeding. Once adjusted, the machine operates itself. An ordinary  $\frac{1}{2}$ -inch tap is removed in about eight minutes.

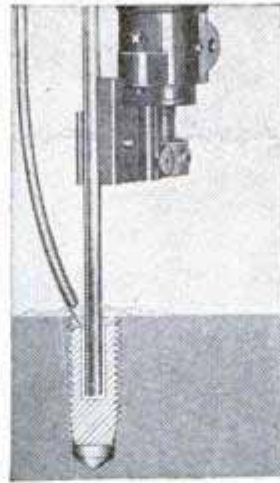

## X-Rays Sent by Telephone For Expert Interpretation

X-ray pictures now can be sent by telephone, a technique that may save the lives of accident victims. Many small hospitals do not have competent radiologists who can interpret X-ray pictures after they have been taken. In the new system, the hospital technician puts the picture on a transmitting machine and "phones" it over the regular lines to a receiver in the office of a specialist, who then interprets the picture for the patient's physician. The process takes about three minutes. The facsimile transmission is similar

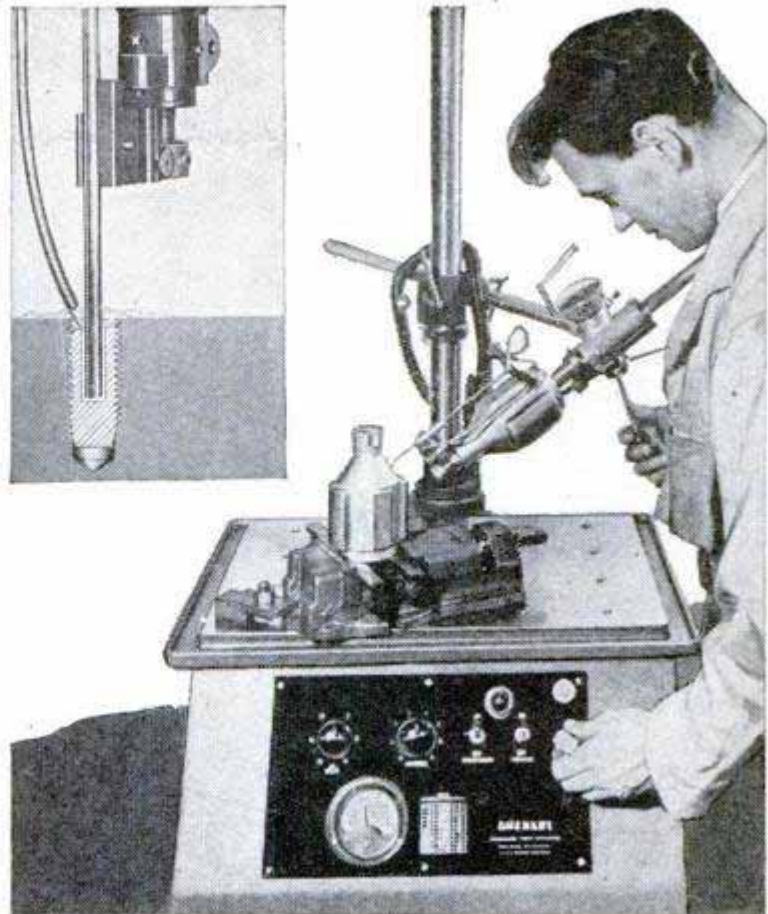

to that used in sending newspaper photographs. With the use of radio instead of telephone, it could serve ships at sea.

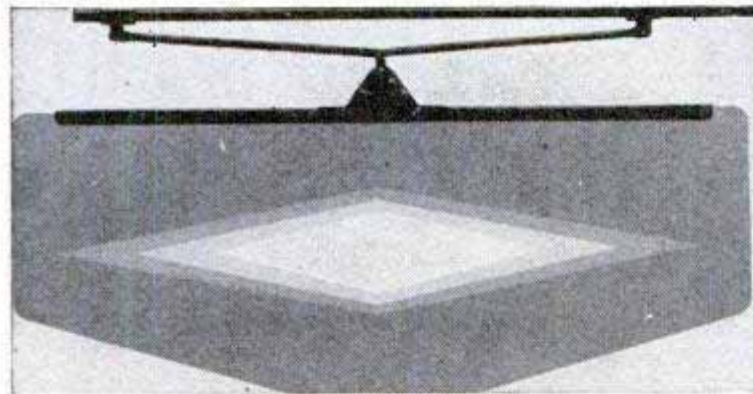

## Antiglare Visor for Car Has Clear-Vision Area

With a clear center section in the shape of an elongated diamond, an automobile visor with graduated color densities provides the driver with glare protection without obstructing his view. Made of transparent plastic, the blue-green color density gradually increases from the clear area to the outer edges. The viewing area in the center is designed to hold back a large percentage of vertical light, thus diminishing glare. The color graduations prevent a sharp contrast between light and dark areas and absorb dangerous light reflections. The visor, which can also be used for night driving, was invented by an optometrist.

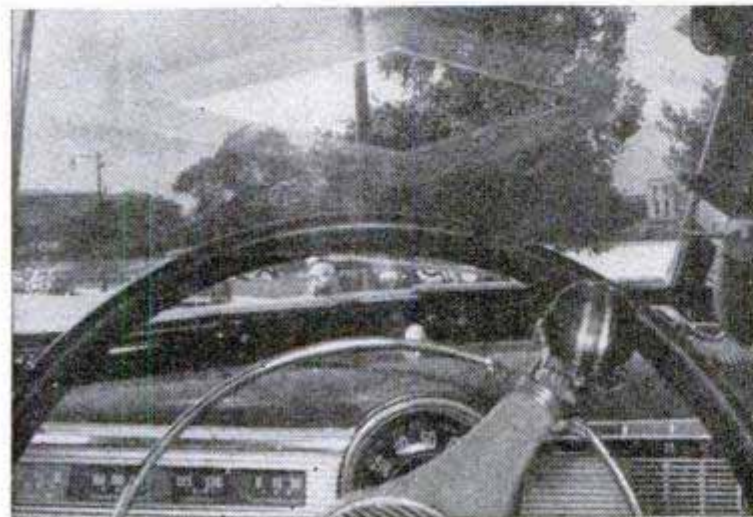

☐ Bathroom mirrors and car windshields are kept free of annoying condensation by wiping the glass with a chemically-treated cloth now on the market.

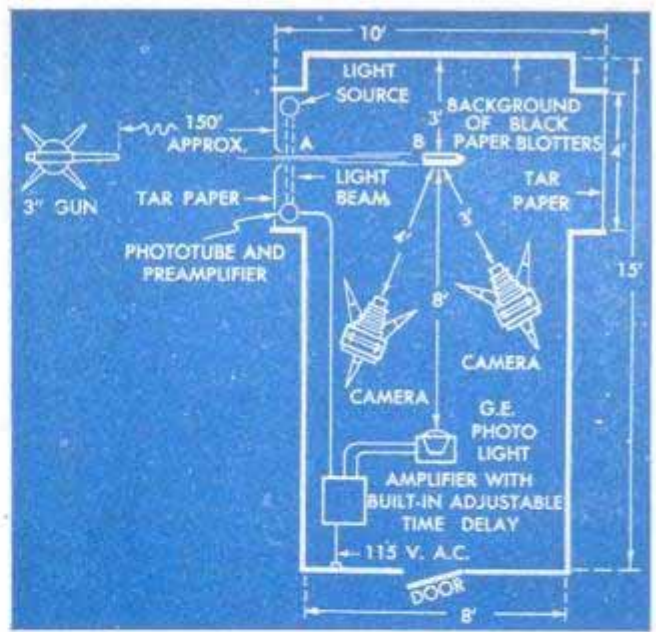

## Shells Fired Through Studio Wall Are "Stopped" by Camera

Naval shells moving at 1842 miles an hour, more than twice the speed of sound, are "stopped" in their flight by high-speed photographic equipment developed by General Electric. The camera, a press model with a remote-controlled shutter release, is placed in a dark room that has two tar-paper walls through which the shell is fired. The camera is focused and the shutter cocked prior to the firing of the shell. When the gun is fired, the camera shutter, operated remotely, is opened for one-second exposure. As the shell bursts through the tar paper into the dark room it crosses a light beam, setting a timer in operation. After a precalculated delay, the high-intensity flash unit is discharged automatically, producing a light that lasts only two-millionths of a second and exposing the film.

Top left, photographer adjusts amplifier that fires flash (rear) lasting two-millionths of a second. Above, plan of the picture-taking room showing setup of equipment. Below, photo of a shell going 1842 m.p.h.

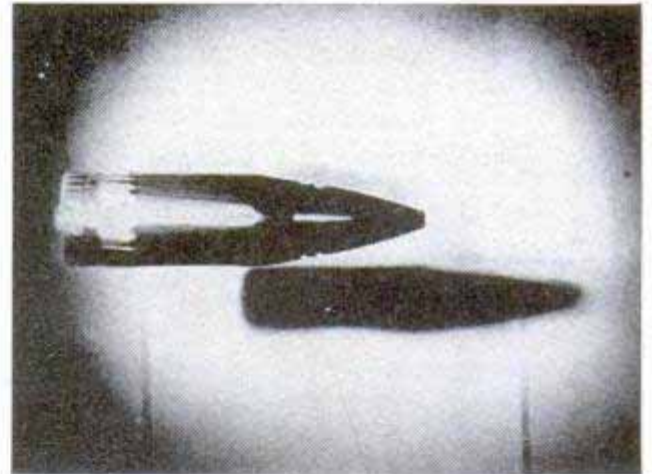

## Portable Enlarger Packs Inside Case

For the photographer with limited space, an enlarger now available can be dismantled and stored in a handy carrying case. The case measures only 6 by 16½ by 19 inches and stores in a small space. Handling all miniature negatives up to 2¼ by 3¼ inches, the enlarger is equipped with a highly corrected three-element lens with a 6.3 opening. Although the enlarger can be easily dismantled, it is a sturdy instrument made of reinforced steel.



## Ivy-Planted Blocks End Lawn Erosion

One resident of Alhambra, Calif., saved himself about \$450 by covering his lawn with concrete blocks instead of building a costly retaining wall. He used 250 of the large, hollow-type blocks and planted the open spaces with English ivy to stop erosion. The job cost him \$60 and in time he expects the ivy to spread and completely cover the blocks, producing an erosionproof "lawn."

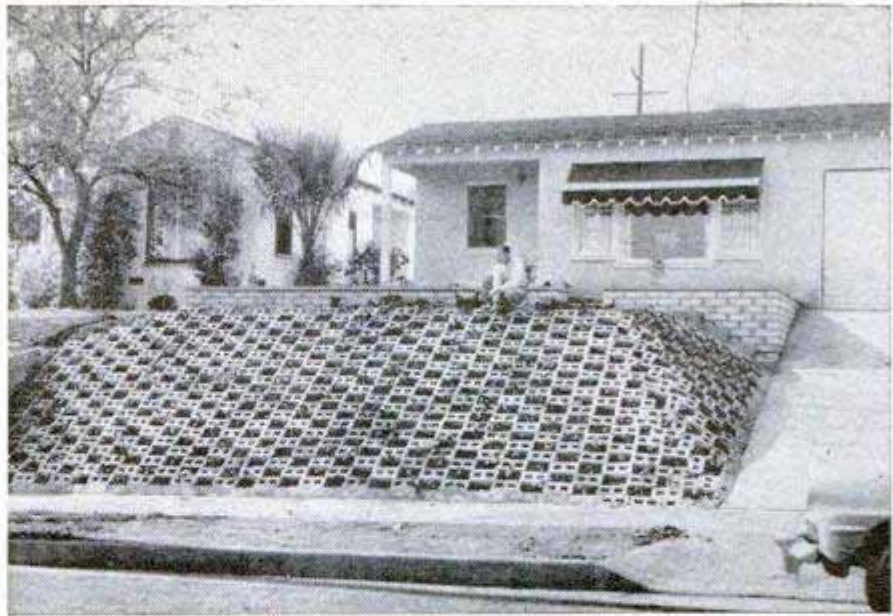

## Portable Bench Saw Can Be Powered by Auto Wheel

Lightweight and small enough when knocked down to fit in the trunk of a car, an all-purpose bench saw can be carried right to the job. With six points of adjust-

ment, the versatile tool can be used for routing, dadoing, shaping, sanding and other operations as well as sawing. A flexible shaft transmits the power from the pulley under the table to the blade. If electricity is not available, the saw can be driven by an automobile wheel, concrete mixer or tractor. The eight-inch blade cuts to three inches and can be turned for ripping and angle cuts, tilted to cut bevels, raised and lowered for depth cuts, and moved along the horizontal arm for cutting action or location.

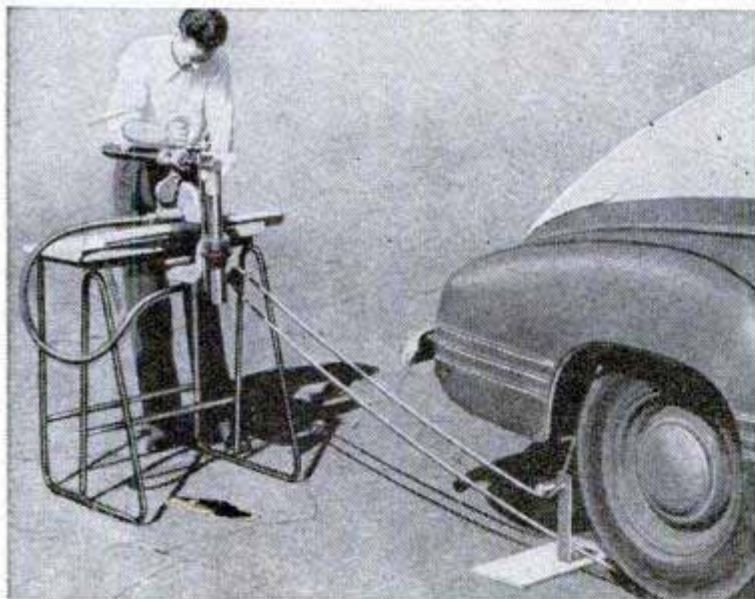

Left, when used in the field, the saw is driven by a belt wrapped around the rear wheel of a car. Lower left, blade tilts for bevel cuts. Below, the complete unit

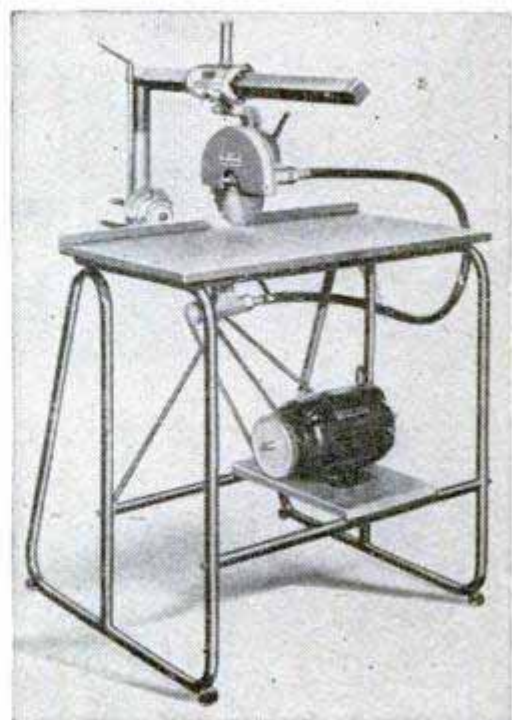
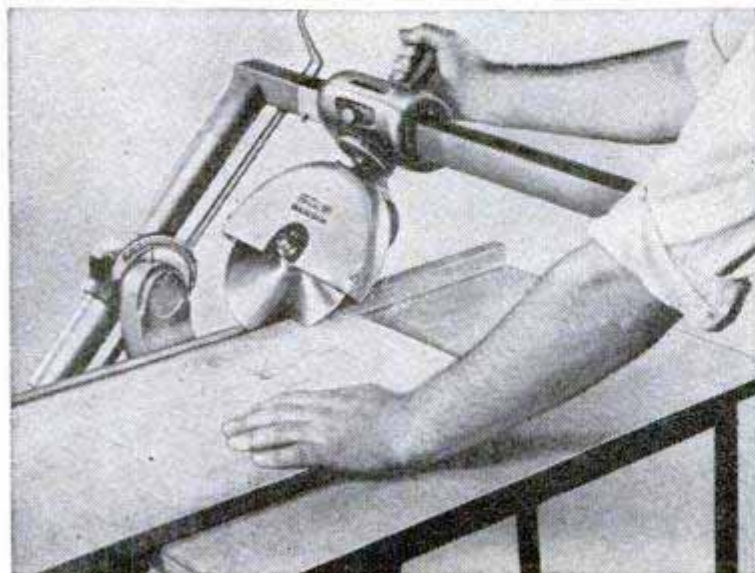



← **REMOTE-CONTROL** racer can be run forward and backward and steered on the end of a 100-foot wire. A knob on the control box regulates the speed of the model, which will go up to 40 miles an hour. The control operates on less than 30 volts and is said to be safe even for children

↓ **NYLON "HOSE"** covers wire cable to make it stronger and more durable. Chemically similar to the nylon used in hosiery, the covering completely surrounds the cable. The coated wire is expected to have many uses ranging from dog leashes to cables for power shovels and elevators

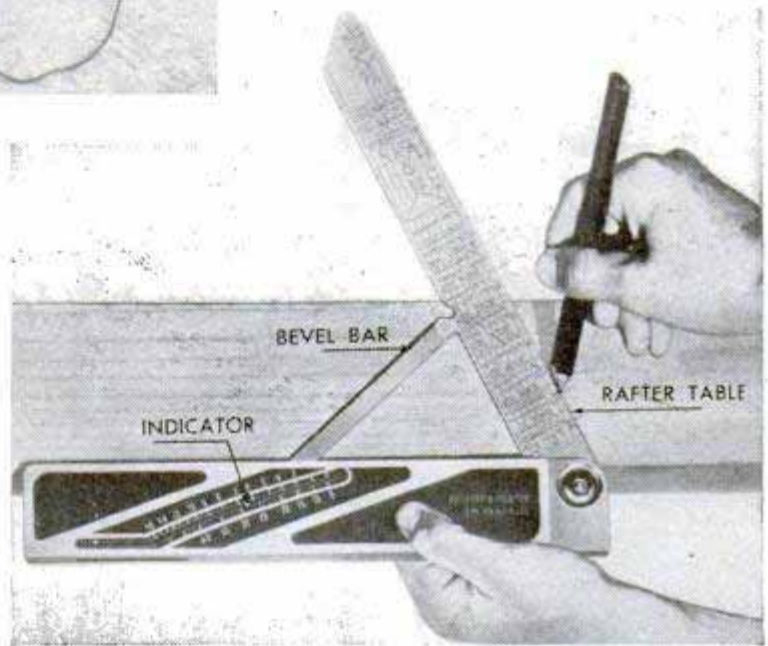
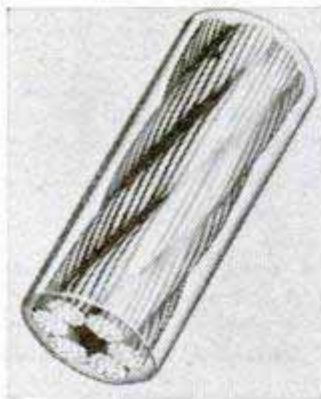

↑ **ROOFING TOOL**, a combined framing square and slide rule, quickly gives carpenters the "pitch" on roofing problems. The tool automatically yields framing figures and at the same time provides a blade for marking cuts. A rafter table enables the carpenter to determine rise per foot run and the length of rafter

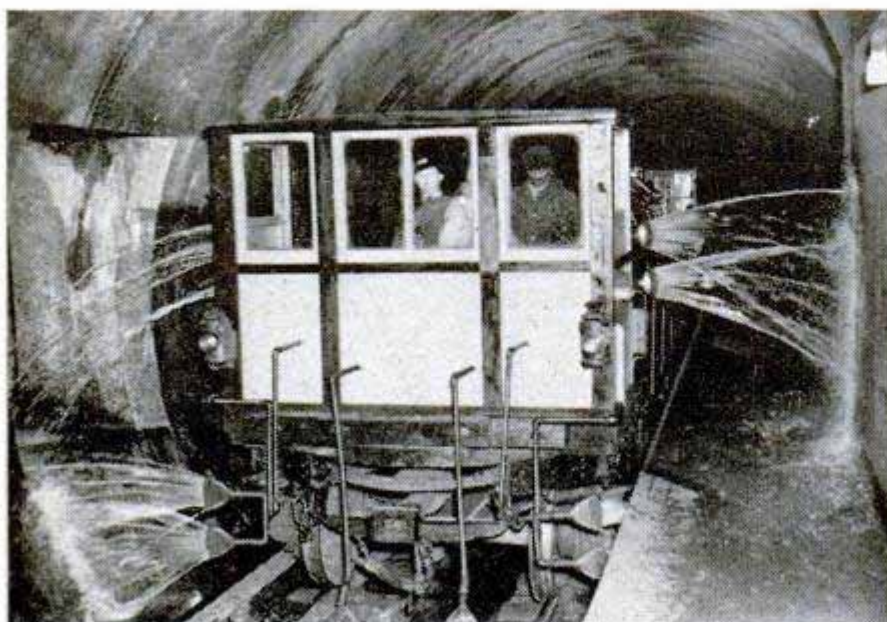

← **SUBWAY SHOWER** cleans up Chicago's underground railway system. A special tank car winds through the tunnels squirting water from nozzles on both sides

# The CRAFTSMAN

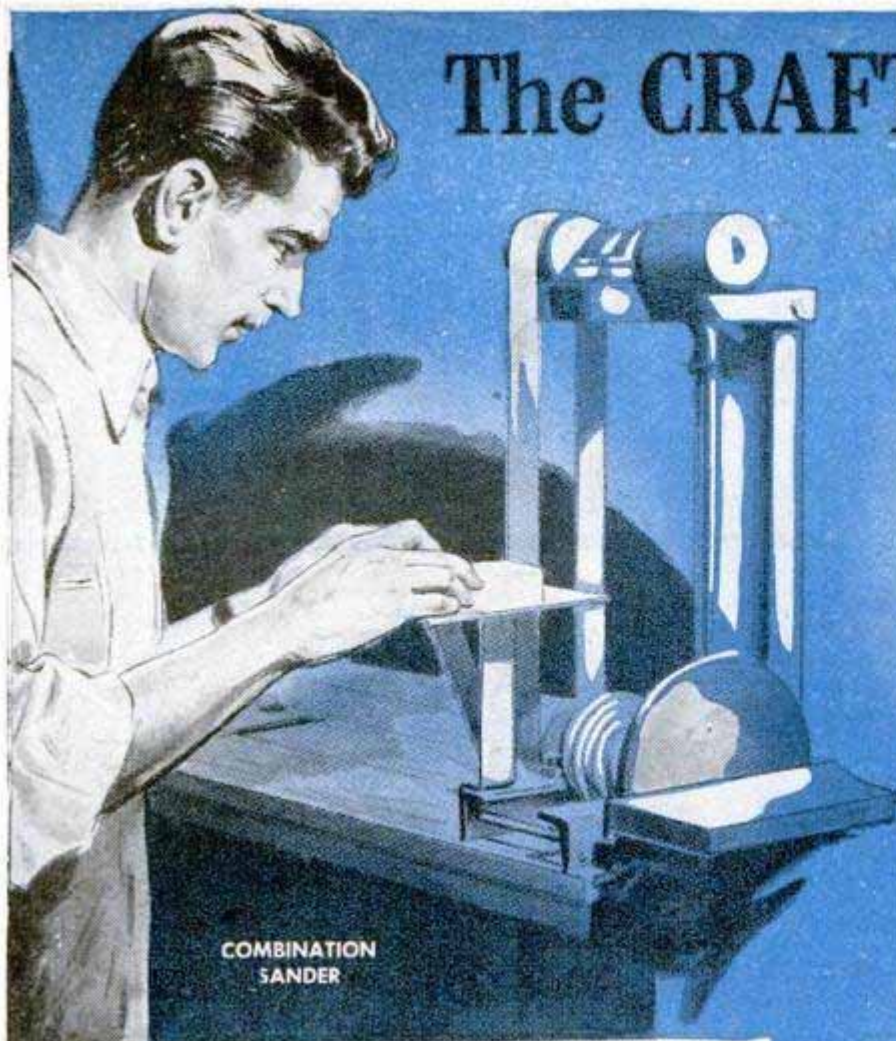

COMBINATION SANDER



WEATHER STRIPPING

★ Why bother with the tedious job of hand-sanding when it's so easy to build power-driven sanders that will turn out work of professional quality? On page 226 we've detailed two machines. One combines a bandsander with a disk and drum in a single unit designed especially for finishing small parts, while the other is a table-top belt type for smoothing large flat surfaces. With the proper abrasives, these machines also can be used to finish metal parts.

★ Weather-stripping doors and windows will cut heat losses as much as 20 percent, besides helping to prevent cold drafts near the floors and outside walls. A practical article on page 205 describes common types of weather stripping and details the methods of installation.

★ Another timely feature, page 194, which will be of special interest to homeowners with hand-fired heating plants, pictures 10 ways to save coal. The trick in economical hand-firing is to set up a routine of furnace tending that can be changed easily to suit variations in outside temperature, without forcing or banking the fire for long periods of time. The procedure outlined results in a uniform rate of burning that reduces heat loss to the minimum.

★ Attractive fixtures for circular fluorescent lamps are very simple to build and install without any changes in the house wiring. An article on page 198 gives complete instructions.



FIRING HINTS



CIRCULAR FLUORESCENT LAMPS

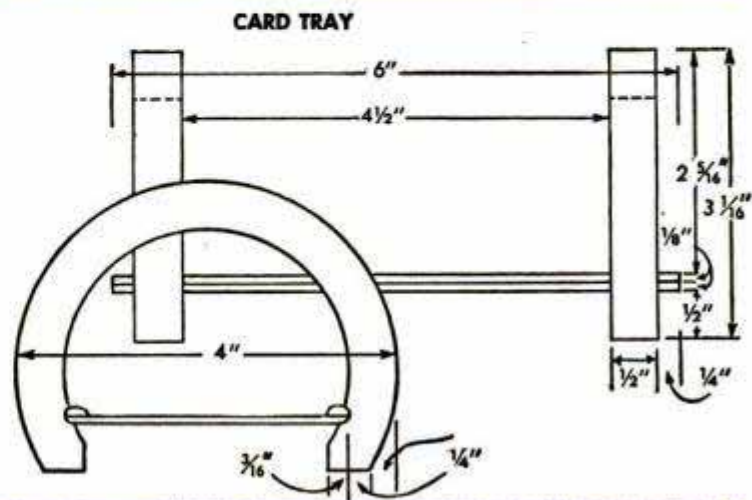
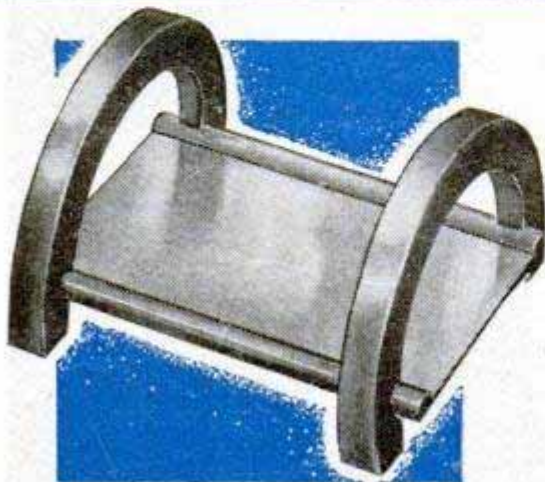
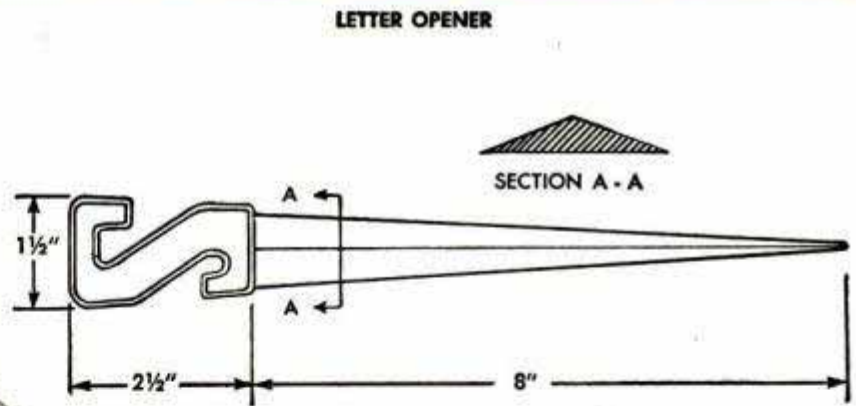
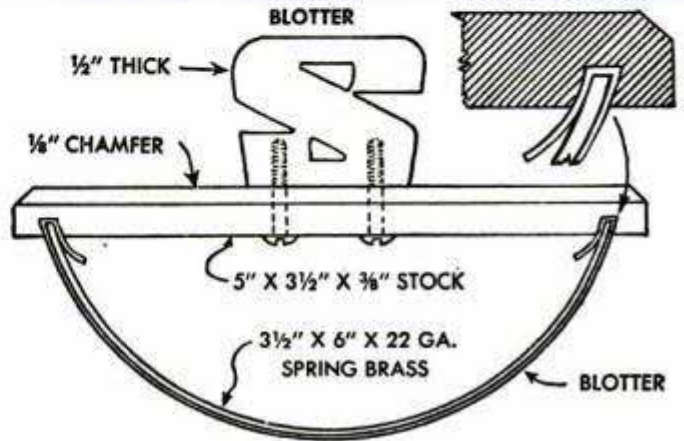
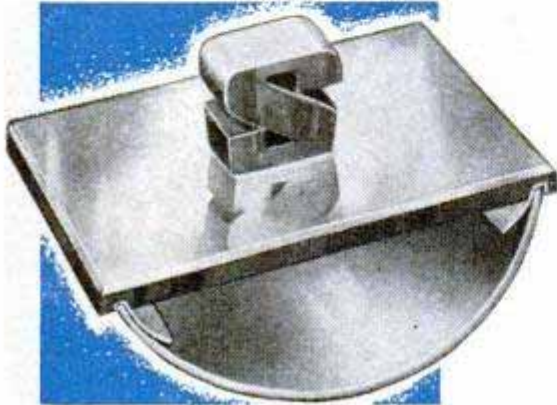
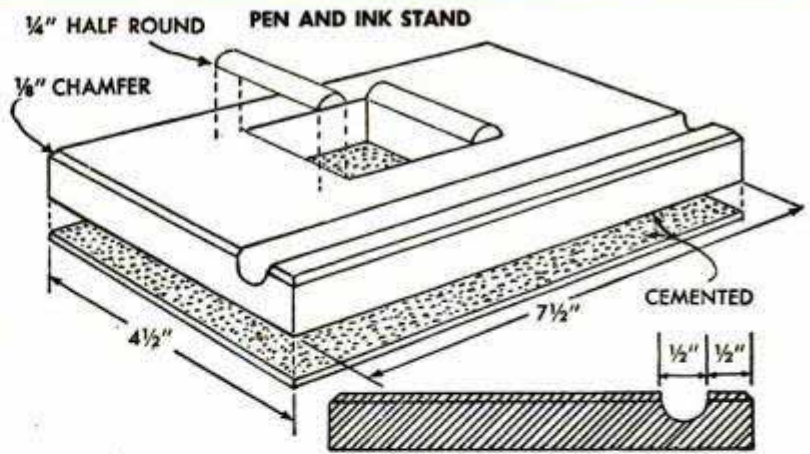
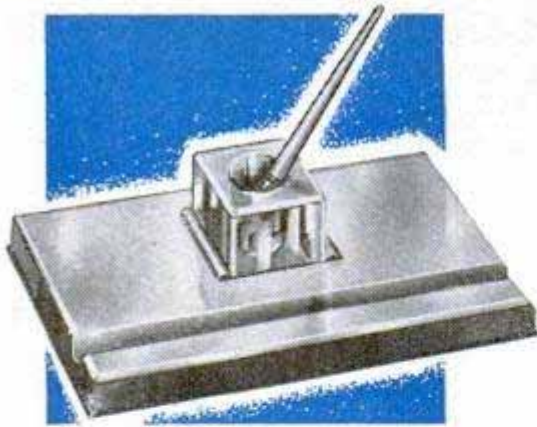

# DESK SET from PLASTIC

Plastics in harmonious color combinations can be used for each unit of this set. Letter initials in color provide handles

*By S. S. Palestrant*



HERE ARE four unusual projects which are very useful and attractive either when used individually or combined to make a distinctive, initialed desk set. All pieces are made from plastic, the sheet, rod and tubular forms being required if all projects are made. Although the colored plastic used can be any of those available that suit your fancy, combinations of red and green, and blue and yellow are especially attractive. Details give the general design and approximate sizes of the parts. Base pieces of the inkstand and the blotter are made from  $\frac{1}{2}$ -in. and  $\frac{3}{8}$ -in.-thick plastic respectively. The letter "S" shown is typical of the style of letter used for the initial which personalizes the roller blotter and letter opener. Angle slots cut in the base of the blotter take the ends of a piece of flat spring brass which forms a backing for the blotting paper as indicated in the

sectional view. The brass backing should be buffed to a high polish and lacquered to prevent tarnishing. Circular grooves, such as those in the inkstand and card tray, are rough-cut with a fine round file and finished smooth with 8-0 sandpaper. Then they are polished by charging a cloth buffing wheel with rouge. Cement green felt to the bottom of the inkstand to prevent scratching the furniture. Letters are cut to the rough form with a jigsaw or coping saw and are finished with a fine file. A nail file is just right for this job. The sawed edges are chamfered and polished, care being taken first to remove all saw and file marks. The letter, which forms a handle, is attached to the back of the blotter with screws rather than cement. If the letter opener is made from plastic of two colors, the initial must be cemented to the blade. Otherwise, both are formed from one piece.

## China Plate Fitted With Wooden Handle Forms Novel Tidbit Server

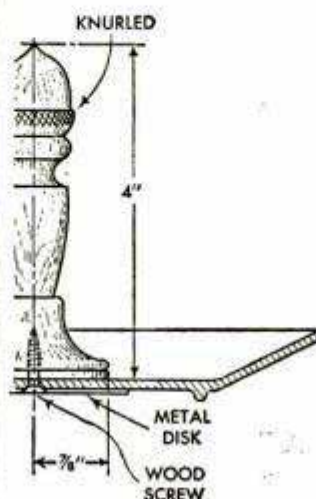

A decorative china plate fitted with a hardwood handle makes an attractive tidbit server. The handle is attached to the plate with a wood screw, the head of which is countersunk in a sheet-metal disk. A hole for the screw can be drilled through the plate with a small brass rod chucked in a drill press or hand drill. A putty dam, built around the hole area, retains an abrasive mixture of silicon carbide and water.

## Preventing Drain-tile Obstruction Due to Tree-Root Growth



Tree roots were obstructing the drain-tile leading from my house as the tile was installed without copper root-stop rings. However, I found a way to correct this difficulty without the expense of digging up the tile, merely by running a length of No. 18 copper wire from the floor drain to the spot where the root obstructions were encountered and allowing it to remain in the tile. The wire, being fairly stiff, was easy to push into the tile and its end was looped through the floor-drain cover. The slow corrosion of this wire produces the copper salts necessary to prevent root growth but does not harm the tree in any way.—John A. Lerch, Cleveland, Ohio.

## Increasing Length of Boards

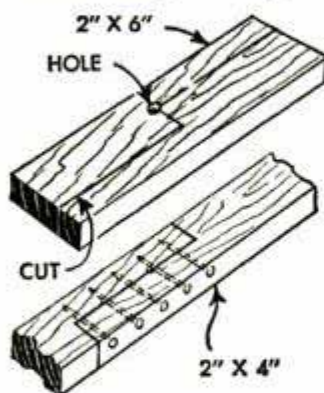

Recently, while making a minor repair, the only board I had for the purpose was a 2 by 6, which was too short. Not wishing to purchase a piece, and as the width of it did not matter, I hit upon the idea of making the 2 by 6 do by ripping it as shown and splicing the 2 pieces together to increase its length. To do this, first divide the length of the board in half and draw a line. Next, divide the board crosswise into 3 equal parts and draw a line lengthwise from the center mark to

one end of the board, locating it a distance from the edge equal to  $\frac{1}{3}$  the width of the board. Do the same on the other side of the center mark and along the opposite edge of the board so that it will be marked as shown in the upper detail. To cut the board into 2 pieces, rip it from each end and stop at the center mark. Then bore a hole as indicated to take the point of a key-hole saw and cut along the center mark. Finally, the 2 pieces are spliced and spiked together which will make a board approximating the size of a standard 2 by 4.

Herbert E. Fey, New Braunfels, Tex.

## Wire Mesh Anchors Chinking

Concrete mortar used as a seal or chinking between the logs in a cabin wall will give better and longer service if the chinking is anchored with heavy wire mesh instead of the usual wooden blocks. The mesh is cut into strips and bent so that the top of the strip touches the upper log. The edges of the strip are nailed to the lower log and the concrete mortar is troweled in place. To assure a good bond, press the mortar firmly between the logs.

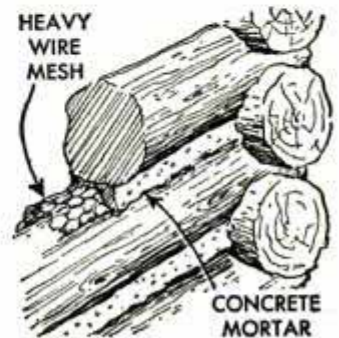

Charles F. Dillingham, Nashville, Tenn.

## Notched Block Holds Door Rigid For Installing Lock

The job of installing a new lock in a door already hung is much easier if both hands are left free to work. This can be accomplished by notching a block of wood to fit over the edge of the door. Then, by placing the block on the floor and slipping the notch over the door edge, the door can be held securely in any position by resting one foot on the block. By covering the underside of the block with a piece of inner tube or rubber matting, less foot pressure will be required to keep the board from sliding.



Victor H. Lamoy, Upper Jay, N. Y.

# Intriguing Cigarette Box Has Cantilever Trays

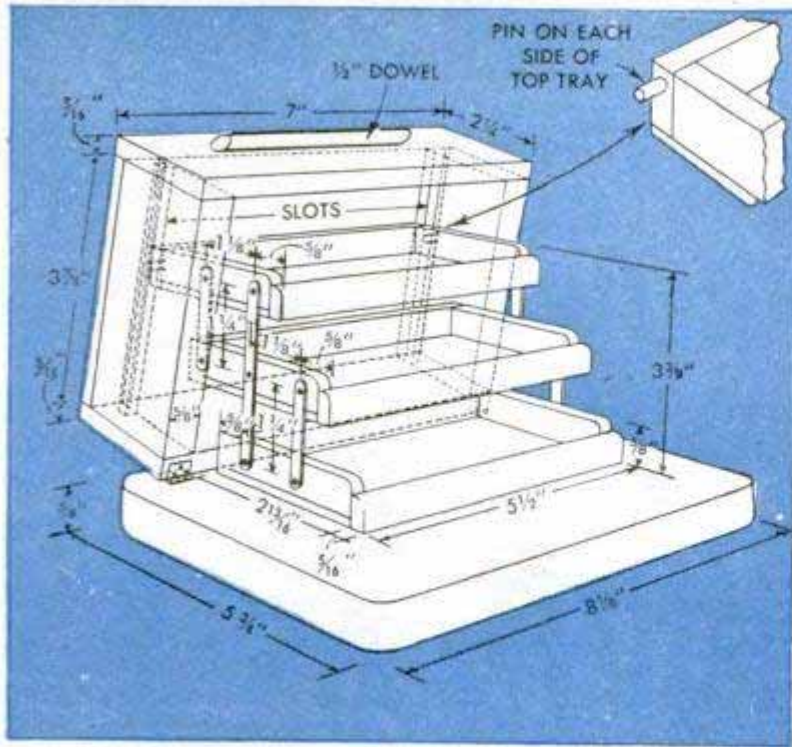

As this unusual cigarette box is opened, the 2 top trays rise and move backward in stair-step fashion, leaving all three trays exposed for easy access to the cigarettes. Made of fine wood in its natural finish or of more common wood\* appropriately painted, the box blends attractively with the living-room furnishings. The trays are linked together with metal strips pivoted loosely with screws, and the bottom tray is glued to the base. The back of the lid is mortise-hinged and 2 small pins at the rear corners of the top tray ride in slots cut in

the inside of the lid endpieces. The pins can be made by driving screws into the tray and cutting or grinding off their heads. A length of 1/2-in. dowel with its ends angle-cut provides an ornamental handle for the lid front. When assembling the box, do not attach the frontpiece until the trays and lid have been aligned and the bottom tray glued in place. For the best results, check all the parts for proper fit before final assembly and finish or paint them individually. Glue felt to the bottom.

R. W. Madden, Palatine, Ill.

## Door Latch Closed by Bamboo Spring Is Operated From Both Sides

Here's a spring-actuated door latch that can be operated from both sides of a door or gate. Its handle, consisting of a piece of dowel, extends through the latch bar and through a slot in the door. The slot also serves as a stop for the latch. Both bar and brackets are made from hardwood and a strip of bamboo provides a spring which actuates the latch bar. The spring is formed in a U-shape so that, under tension, one end engages a hole drilled in the underside of the latch bar, while the other end is fastened to the inner bracket through which the bar slides. The striker plate, which receives the beveled end of the bar, is a duplicate of the 2 brackets.



☐ A small amount of liquid wax rubbed on refrigerator shelves will retard rusting. However, make sure that the surface is thoroughly dry before applying wax.

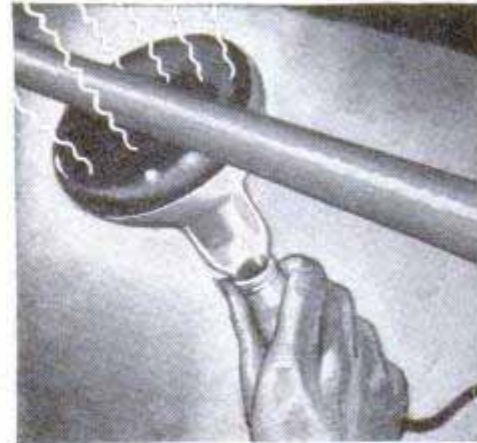

**REMOVING ICE** from a wire clothesline, above center, is done in a jiffy when the comb from a safety razor is fastened to the clothes pole and used as a scraper. Comb engages wire as pole is pulled

**THAWING WATER PIPES**, above, where it is not advisable to use a blowtorch can be done safely with the heat from an infrared bulb. Be careful in using it that the hand does not touch the unguarded bulb

**IN-A-DOOR BOOKCASE**, left, built in the recess of a shallow clothes closet found in some older homes, modernizes opening and puts it to practical use. Shelves rest on flat side of screw eyes turned into jambs

**WATERPROOFING TREATMENT** for boots and shoes consists of applying hot ski wax to the leather and rubbing it briskly with a stiff brush. Rub with a cloth after wax hardens

**HOT POKER** hung up after firing will not scorch wall if a wooden block is placed a little below the nail on which it hangs to hold the hot end of poker away from wall

**TOASTING ONE SLICE** at a time in a door-type toaster is done faster if the element on one side is covered with asbestos to direct the heat to the opposite side

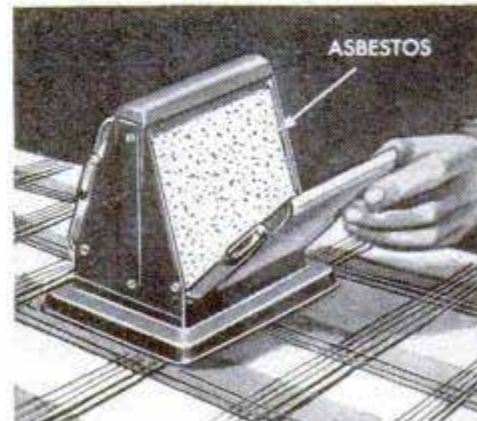
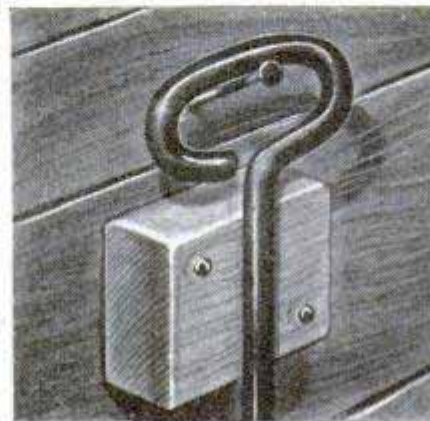



# HOME PROBLEMS

**RAG RUGS** in front of a sink or stove usually bunch up and never lie flat. A simple way to overcome this is to stiffen the edges with wire. The wire is threaded through long way of rug on back side. The small amount of wire exposed on the top side is inconspicuous. Use a soft but fairly stiff iron wire

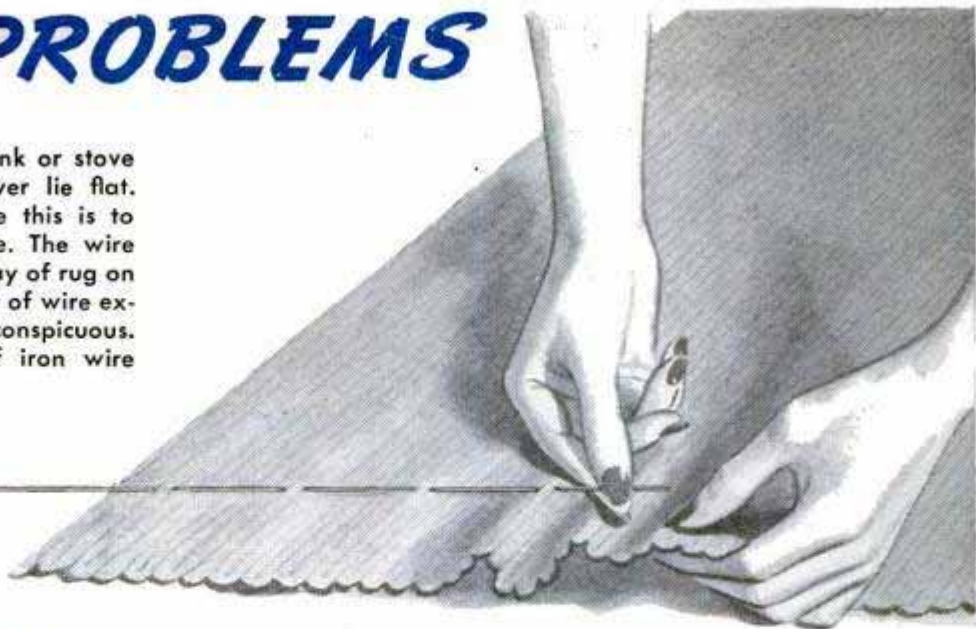

**FLOWER FROG** for narrow-neck vase, right, is improvised from the top of a scouring-powder can. Leave about  $\frac{1}{4}$  in. of the cardboard container attached to the metal top to center and hold the frog in neck of vase



**STERILIZING CORK** of a vacuum bottle, left, requires that it be submerged. A good way to do this is to impale the cork on end of ice pick. Besides keeping the cork submerged, a handle is had to retrieve the cork

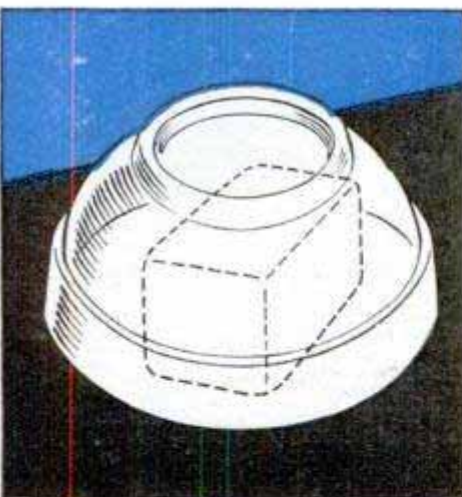

**SOFTENING BUTTER** taken from the refrigerator, above, can be done quickly and without waste due to melting if a bowl is heated and then placed over the butter for a short time

**EGG CARTON** in drawer of child's chest, right, provides individual storage compartments for socks. In addition to keeping them together in an orderly manner, idea promotes tidiness



## Installing Roll-Type Roofing To Prevent Leakage

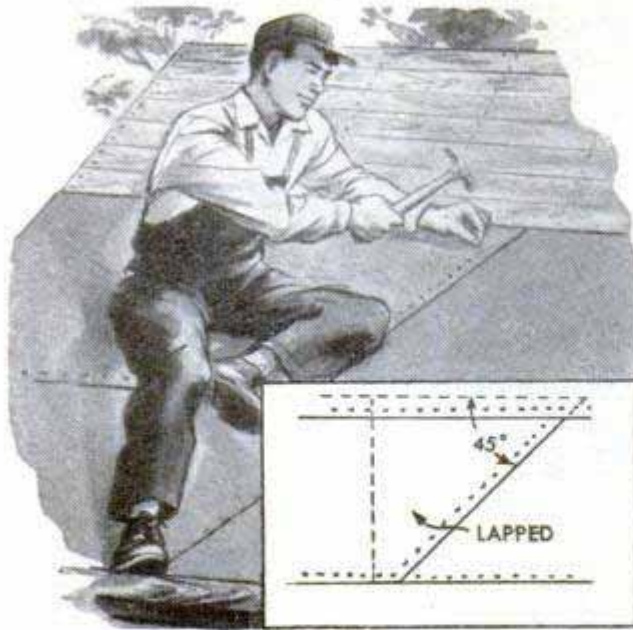

A roof that leaked considerably during a driving rain prompted one man to devise a way of fastening roll-type roofing which he found to be completely waterproof. When lapping the joints, he cut the end of the roll at a 45-deg. angle and fastened the roofing in the regular manner, lapping the lower edge of the strip about 8 in. In this way, the water flows freely over the joints and there is no chance of its seeping between them. The angle joint also can be used when applying a patch or when finishing a job with small pieces of roofing.

## Thumbtacks Keep Picture Level

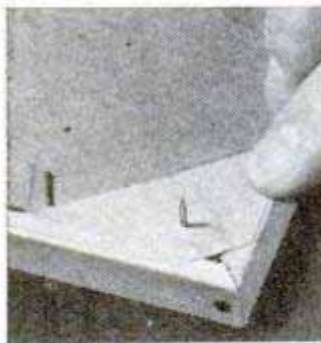

Wall. If this is done carefully, the tacks will not leave noticeable marks on the wall surface.—R. E. Donovan, Jersey City, N. J.

Taping a thumbtack to each of the bottom corners of a picture frame will keep it from tilting due to vibration. After the frame has been properly positioned, the thumbtacks are pressed lightly into the

## Marking Hockey-Rink Boundaries

It's a difficult problem to mark the boundaries of an ice-hockey rink with lines that last as long as the ice. One solution is to mix equal proportions of table salt and methyl-blue powder in a tin can. Then bend the can to form a spout and sprinkle the mixture on the ice. The salt

will melt the ice temporarily, freezing the color in. If another and contrasting boundary line is desired, use red-ocher powder. Powdered household dyes also are suitable for this purpose.

Edwin Leet, Bethlehem, Pa.

## Preserving Shape of Paintbrush

When paintbrushes are stored, some means should be provided so that they will hold their shape. One inexpensive method of doing this is to store each brush in a cardboard milk carton. To do this, just punch a hole through the bottom of the carton for the handle, insert the brush so the handle projects and then fold the open end of the carton over the bristles, creasing it at the end of the bristles. The folded carton will keep the brush shaped correctly and maintain its chisel edge.

N. P. Smith, New York City.



## Cleaning Checkered Pistol Grips

Checkered grips on pistols and rifles often become stained from perspiration and lose their original luster. However, it is easy to keep them clean and shiny by lightly scrubbing them occasionally with a few drops of carbon tetrachloride sprinkled on a suede shoe brush. This type of brush has fine brass bristles which will get into the crevices of the grip without scratching the surface.

D. J. Bachner, Jackson Heights, N. Y.



## Steel Wool Plugs Pipe Ends

Before storing lengths of pipe, it's a good idea to plug the open ends to keep out dirt, insects and rodents. Fine steel wool, dipped in oil and then pressed tightly in the pipe, will exclude all foreign matter.

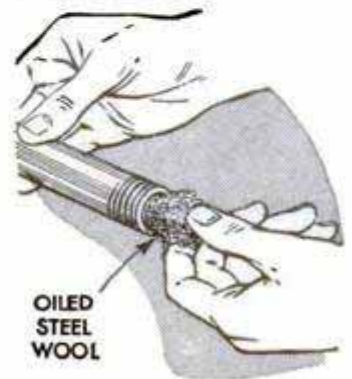

# File Cabinet Forms Pedestal Base for a Desk

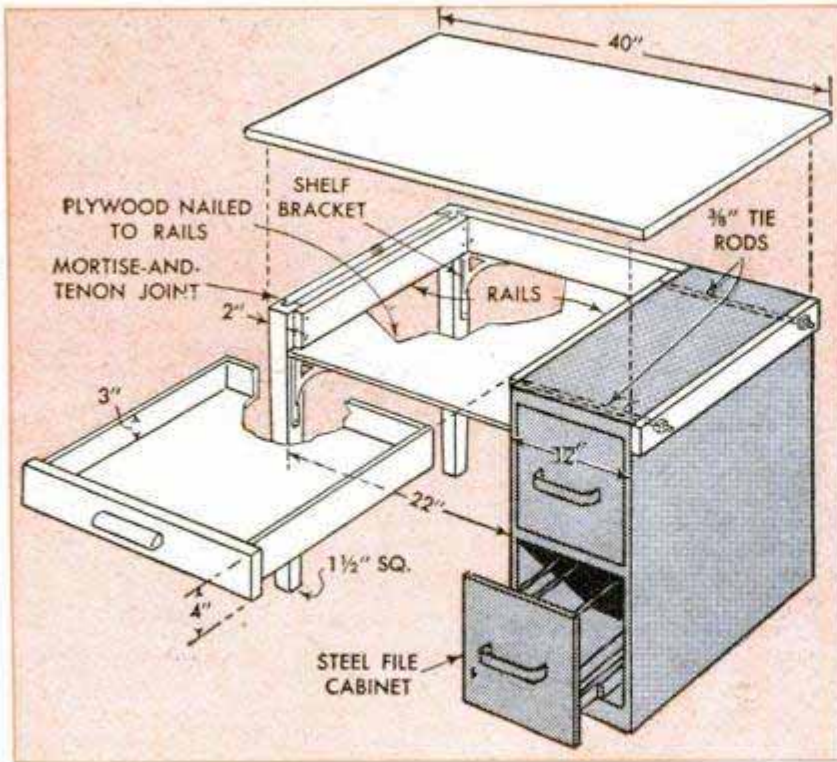

An old two-drawer file cabinet of either wood or metal serves as the pedestal for this student desk. With the file cabinet at hand, the job is more than half done as the most involved part of the cabinet work is ready-made. The rest is simple. Drill holes through both sides of the file cabinet near the top. These are for tie rods to hold wooden rails to which the balance of the parts can be securely attached with screws and nails. The two legs are tapered from 2 in. to 1½ in. square at the lower ends and are joined to rails at the side and back with mortise-and-tenon joints. Attach the inner end of the back rail and the plywood bot-

tom of the drawer compartment to the wooden strip on the file cabinet. Use ordinary metal shelf brackets to brace the legs. Cut the top from ¾-in. walnut plywood and note that only the length of the top is given. The width is determined by depth of the file cabinet. The center drawer can be made in the conventional way with the bottom fitted into grooves cut in the sides and front, or the drawer can be assembled with simple nailed butt joints. The plywood bottom may be nailed to the bottom edges of the sides and back. Stain or paint the wooden parts to match the cabinet.

E. A. Rerucha, Franklin Park, Ill.

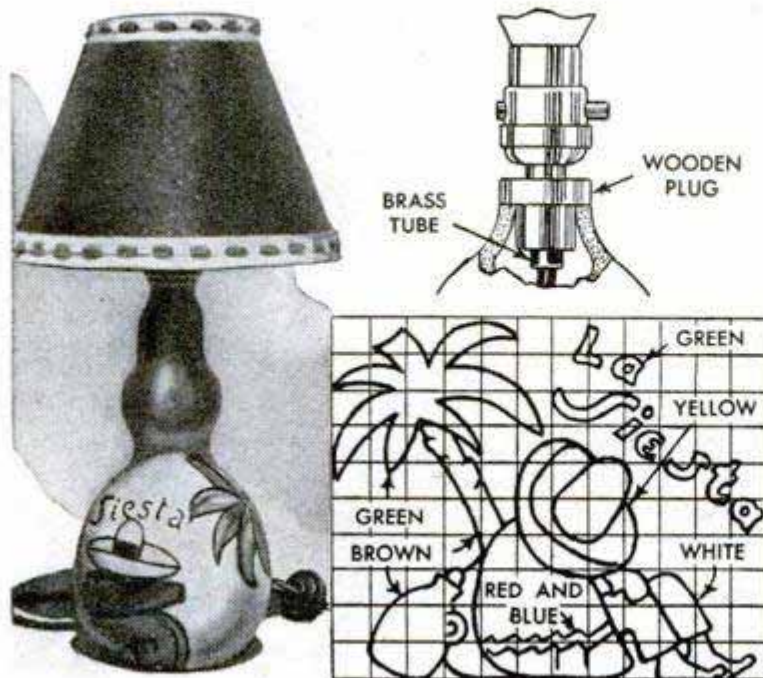

## Colorful Table Lamp From Bottle Gourd

A colorful Mexican scene painted on a dried bottle gourd provides an unusual and attractive base for a small table lamp. To make the lamp, cut off the top of the gourd and turn a wooden plug as shown to fit in the neck of the gourd. The shoulder should be flush with the outside. Then drill the plug to take a piece of brass tubing and wire a lamp socket, running the cord through the tubing and a hole drilled near the bottom of the gourd. Weight the gourd with gravel or sand and secure the plug to the neck with adhesive tape. A brightly colored shade completes the lamp.



**DON'T BANK THE FIRE BED** with ashes. This only tends to produce clinkers which cause inefficient burning and waste of coal. It is better to keep a deep fuel bed and to regulate the fire with the controls

**DON'T LET ASHES ACCUMULATE** in the ashpit. Make it a practice to remove them each morning after shaking down the fire. A clean ashpit assures proper combustion and prolongs the life of the furnace grates



Certain information courtesy  
Chicago Coal Merchants Association

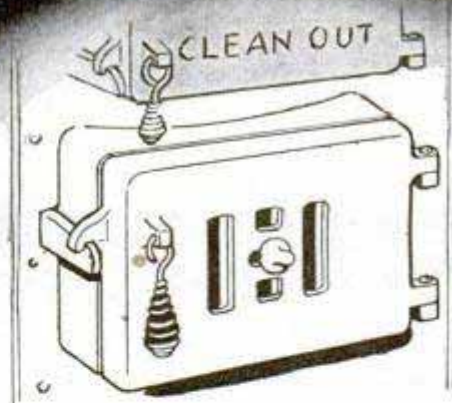

**DON'T NEGLECT TO CLOSE FIRE DOOR** after firing. Leaving it open cools fire and wastes fuel. Keep the slide open in the fire door. Air through opening aids combustion in most heating plants

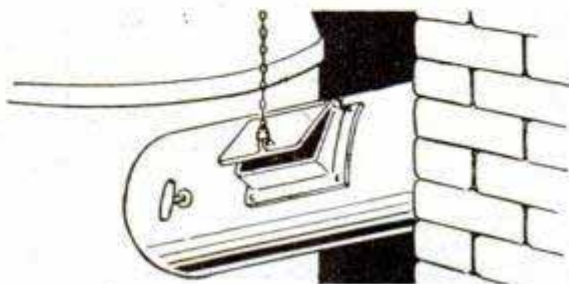

**DON'T FORGET THE CHECK DAMPER** if the furnace is not equipped with a thermostat. Open it when you want less heat, close it when you want more

**DON'T RAM THE POKER INTO THE GRATES.** Ashes mixed with fire cause clinkers. Bend poker as indicated and use sparingly to break up top crust

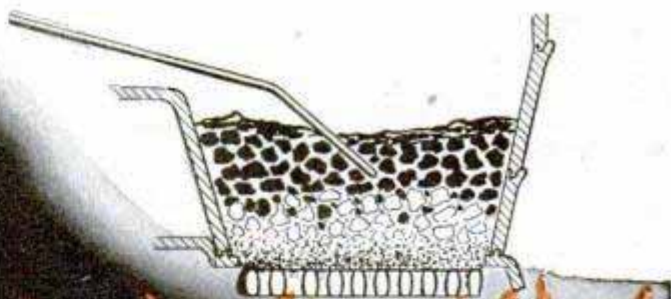

**COAL**, when properly fired, provides greater heat value per dollar than any other fuel. But it is estimated that 10 percent of the coal used to heat the average home is wasted through improper hand-firing and

# 10 FIRING HINTS THAT



**DON'T REGULATE FIRE BY ASHPIT DOOR** itself; use the draft damper in front. Operate this and check damper simultaneously. When you want more heat, open draft damper and close the check



**DON'T LET HEAT ESCAPE** up the chimney. Use the turn damper to control chimney draft by keeping damper as nearly closed as possible without smoke emerging from the fire door. This operation is important

**DON'T SHAKE GRATES** AT NIGHT unless deep ash bed takes room needed for fresh coal. Shake gently and stop when red glow appears in ashpit. Shaking every other day should be often enough in mild weather

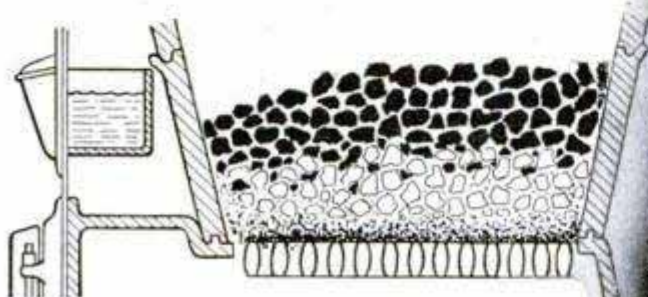

**DON'T SHAKE LIVE COALS** INTO ASHPIT. Keeping grates covered with thin ash layer in the cold weather helps hold fire, keeps it burning evenly

**DON'T LET SOOT ACCUMULATE.** Make it a habit to throw rock salt on a hot fire periodically to keep the furnace and the smoke pipe free of soot

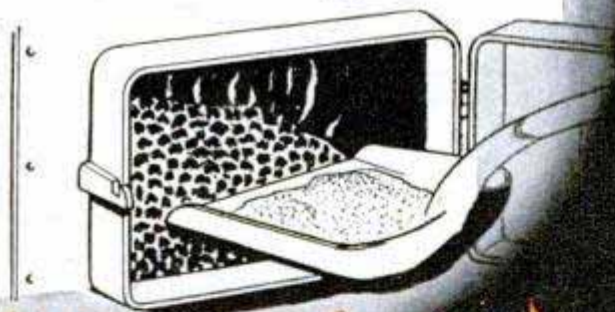

furnace regulation. While there are many factors to consider in arriving at the correct method in each case, these 10 hints on how *not* to fire will reduce waste, minimize smoke and lessen furnace attention.

By Wayne C. Leckey

**HELP YOU SAVE COAL**

## Recess Cut in Porch Floor Keeps Door Mat in Place

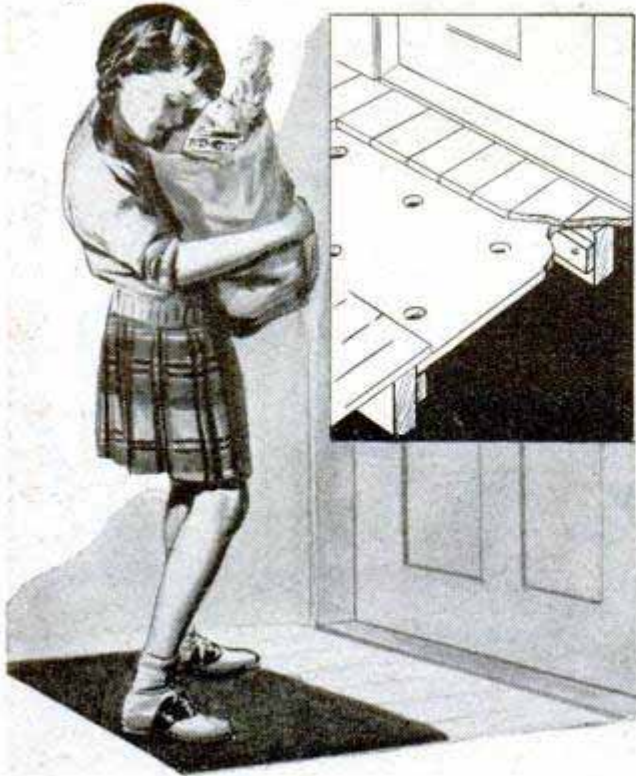

Recessed nearly flush with the floor of a sheltered porch, a fiber door mat takes on real value. It can't be tripped over and stays in place right in front of the door where guests and youngsters will find it ready to use. It is merely lifted out of the recess for cleaning and does not interfere with washing the porch. The cutaway detail shows how the recess is made. Exact location of it is dependent to some extent on the position of the floor joists. If they run parallel with the door, forming the recess is a matter of simply sawing an opening between them slightly larger than the mat and then nailing cleats to the face of the joists to support a board which forms a bottom for the recess. If the direction of the joists is at right angles to the door, it will be necessary to notch out a portion of one joist the required depth. Note that drain holes are made in the bottom of the recess to facilitate washing.

## Hose Sections Form Tool Rack

In order to keep his small tools neatly and conveniently at hand, one home-workshop enthusiast used sections of garden hose to hold tools such as screwdrivers, chisels, etc. The hose sections

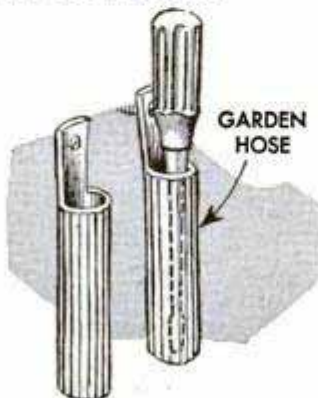

should be cut long enough to cover the lower ends of the tools completely and should have ears formed at the upper ends to take screws with which they are attached to a wall or other mounting. The idea of using garden-hose sections for this purpose is especially convenient for the man who does not want to build a cabinet or who does not have sufficient tools to warrant installing regular racks.

Roger Woodbury, Atkinson, N. H.

## Name-Plate or Card Holders Cut From Curtain Rod

Name-plate holders of a practical size are provided by sections cut from flat, telescoping curtain rods. Sections of curtain rod also will serve as index-card holders for filing cabinets

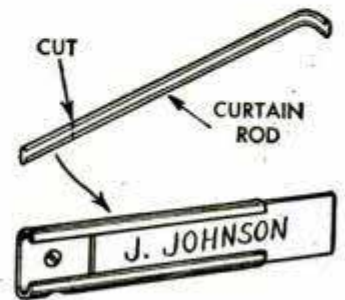

or for various other uses in the shop or office. The holders may be soldered to metal surfaces if desired.

## Removing Headless Nails



Nails from which the heads have been broken are difficult to remove, especially if they have been driven into hardwood. However, they can be withdrawn with little

difficulty if the end of the nail is gripped with a pair of pliers and a claw hammer is used to lift both pliers and nail, as shown.

Henry Hanscom, Elmhurst, Ill.

## Lubricating Slide Fasteners

When slide fasteners on overshoes or garments begin to bind and become difficult to operate, lubricate them with graphite. A small amount of graphite applied to the zipper will eliminate the binding. Rubbing it with a soft-lead pencil will do. — Richard Hanscom, Elmhurst, Ill.



# TURKEY HUNT

## AN EXCITING DART GAME

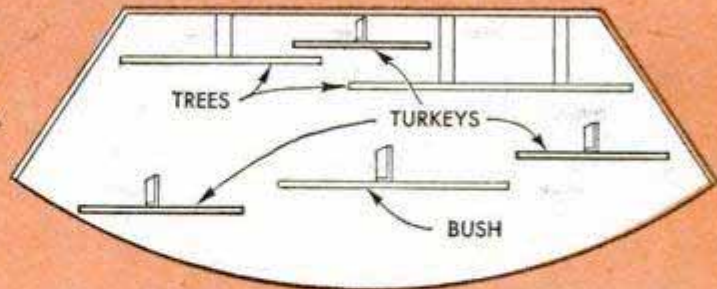
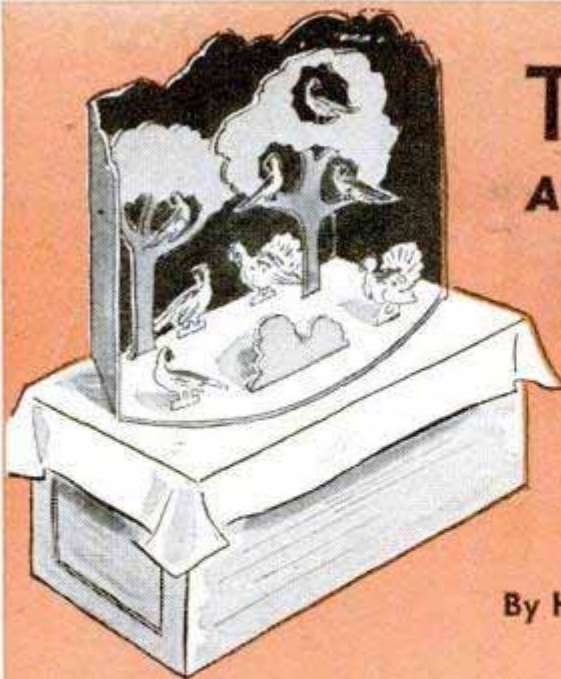

By Hi Sibley

Bag a turkey if you will, but the consequence written on its back may have you scouring the town for a red horsehair or walking upstairs on your hands. The game can be a riot at a party, depending on the originality of the penalties. One turkey wins a prize, but the players don't know which one. The backstop is made of stiff cardboard and painted to represent sky and landscape. The trees and turkeys also can be made of cardboard, but they will be more durable if jigsawed from thin plywood. Standards are fitted to the various targets, while tabs permit some of the birds to roost in the trees. A bow is shaped from a piece of bamboo fish pole and strung with a length of fishline. Darts are made of  $\frac{1}{8}$ -in. dowel, tipped with a cartridge shell. Feathers are lashed to the opposite end with silk thread and cement

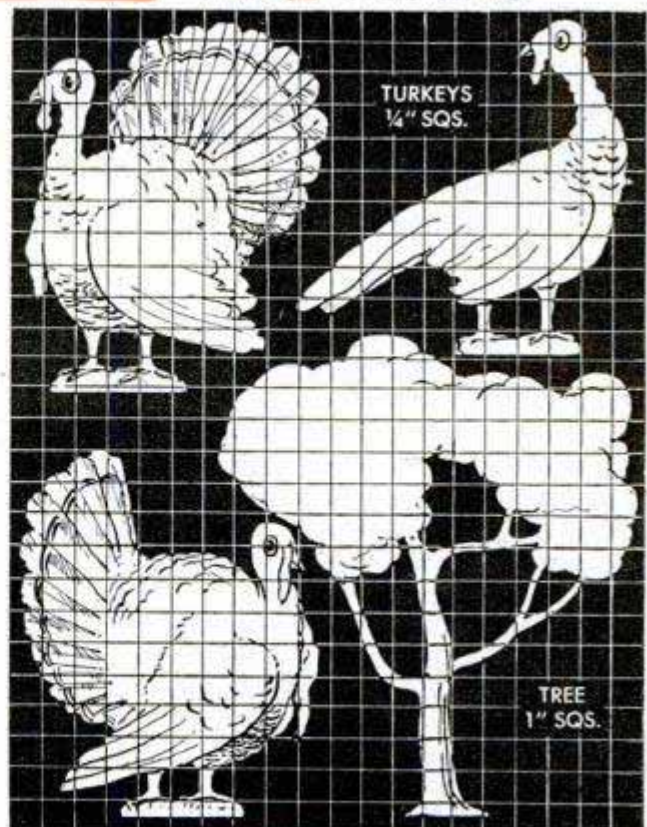
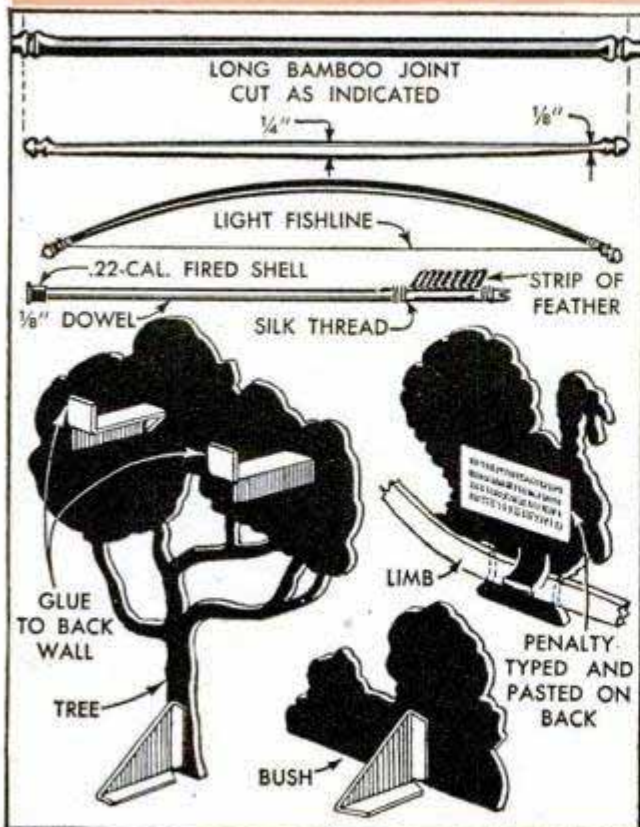
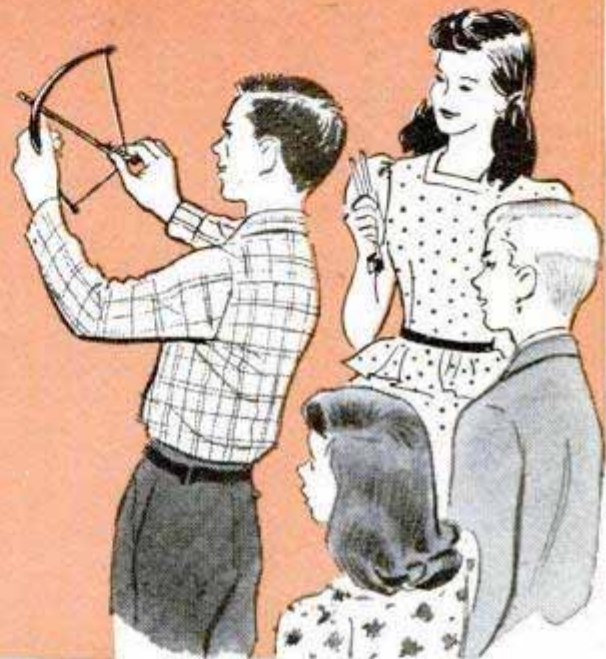

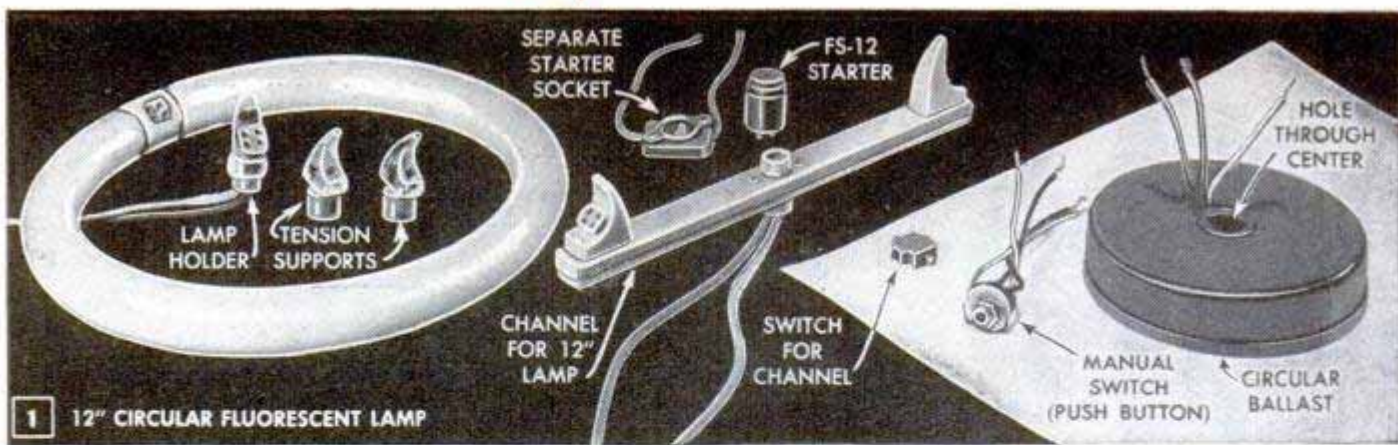

1 12" CIRCULAR FLUORESCENT LAMP



2 FITTING THE BACK

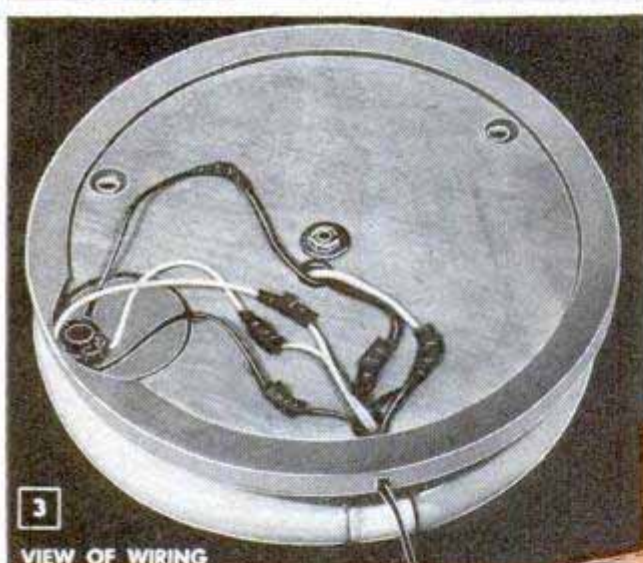

3 VIEW OF WIRING

# RINGS OF

By Sam Brown

CIRCULAR fluorescent lamps offer new possibilities for making special fixtures in more compact and attractive designs than was possible with the long, tubular lamps. Although a complete range of sizes of the new circular lamps is not yet available, simple ceiling and wall fixtures for the small and medium-size lamps can be made by any craftsman.

Circular lamps can be used for large, illuminated magnifiers or opaque projectors, and are excellent, too, for house-number lights, merchandise-display fixtures and illumination for certain power tools. The square ballast can be housed in most ceiling fixtures and is considerably cheaper than the circular type. The mirror style of fixture is excellent for close work like

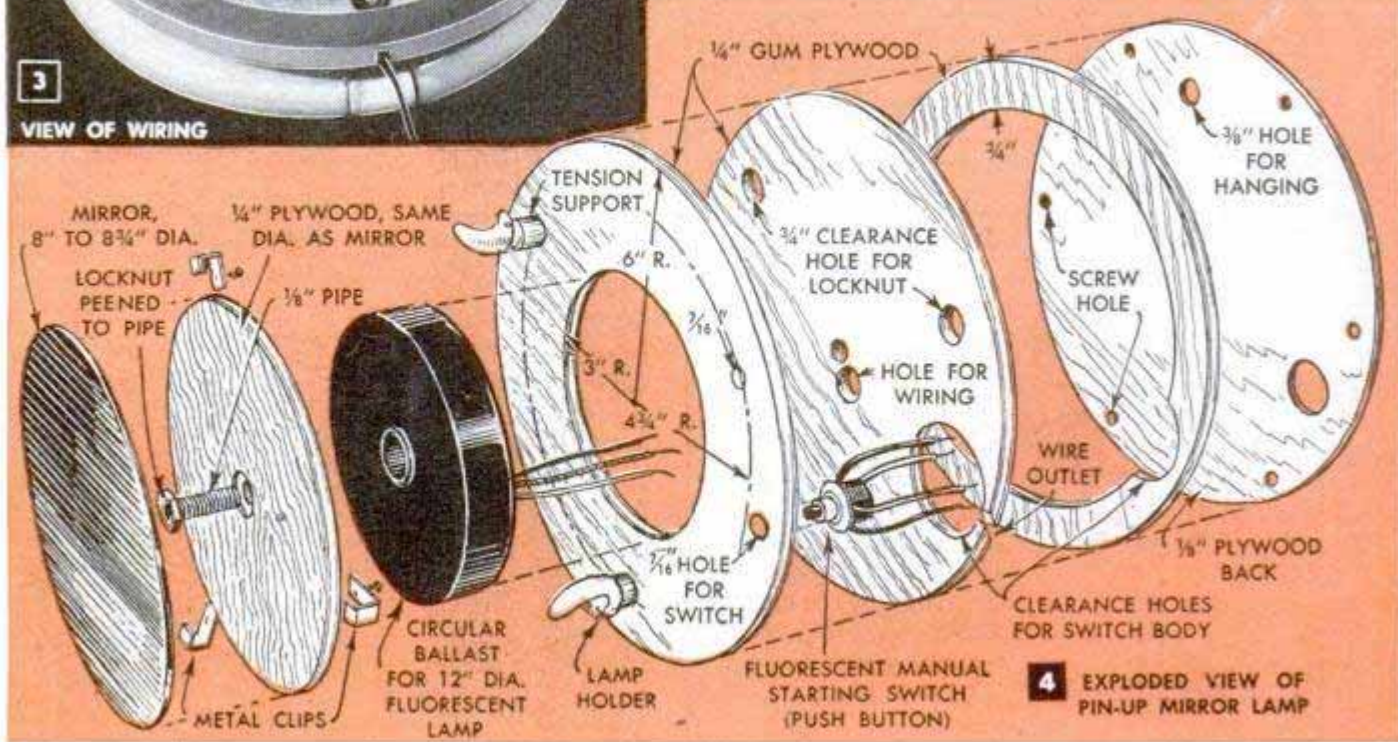

4 EXPLODED VIEW OF PIN-UP MIRROR LAMP



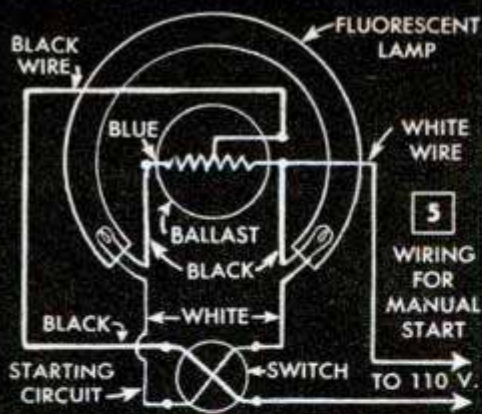

# LIGHT

applying make-up. However, it should not be employed as a general long-view mirror unless a special reflector is used, because illumination blacks out the mirror except at close range. Lamps of three sizes nest one within the other, offering scope for added illumination. Single ballasts are available to work these combinations. Lamps also can be arranged in a double deck. Although only three simple fixtures are shown here, anyone can adapt these or design others to fit individual needs, even to using the circular lamps in floor and table units. Study the details carefully and notice how the various parts fit together to form a neat, compact unit.

**Parts:** Other than lamps, the special parts needed are shown in Fig. 1. The supporting or mounting members for the lamp consist of a fixed lamp holder with four wire leads, and two spring-actuated tension supports. A second type of mounting is the channel, which has one fixed lamp holder and one tension support. A special starter, FS-12, is needed for all fixtures using automatic starting. All units require a special size of ballast, which can be obtained in either the rectangular or circular type. Other parts, such as manual switches and starter sockets, are standard fluorescent-lamp equipment.

**Pin-Up Mirror Lamp:** Construction of this unit, which is pictured in Fig. 6, is shown in Fig. 4. The unit uses a 12-in. circular lamp. The body or base consists of three rings of  $\frac{1}{4}$ -in. plywood, which are glued together after the various openings required have been cut or drilled. Fig. 7 shows how the lamp looks in section, the circular ballast projecting forward and serving as a base for the plywood-backed mirror: Note that the mirror is attached to the plywood backing by means of small metal clips, Fig. 4. These are exposed in the finished fixture so care should be taken to space them equally. The backing piece is counterbored to take a standard  $\frac{1}{8}$ -in. locknut which is peened to a  $\frac{1}{8}$ -in. pipe nipple. This nipple passes through the plywood backing plate, the circular ballast unit and also the third spacing disk, Fig. 7. In assembling, a locknut turned



6 12" LAMP EXCELLENT FOR MAKE-UP MIRROR

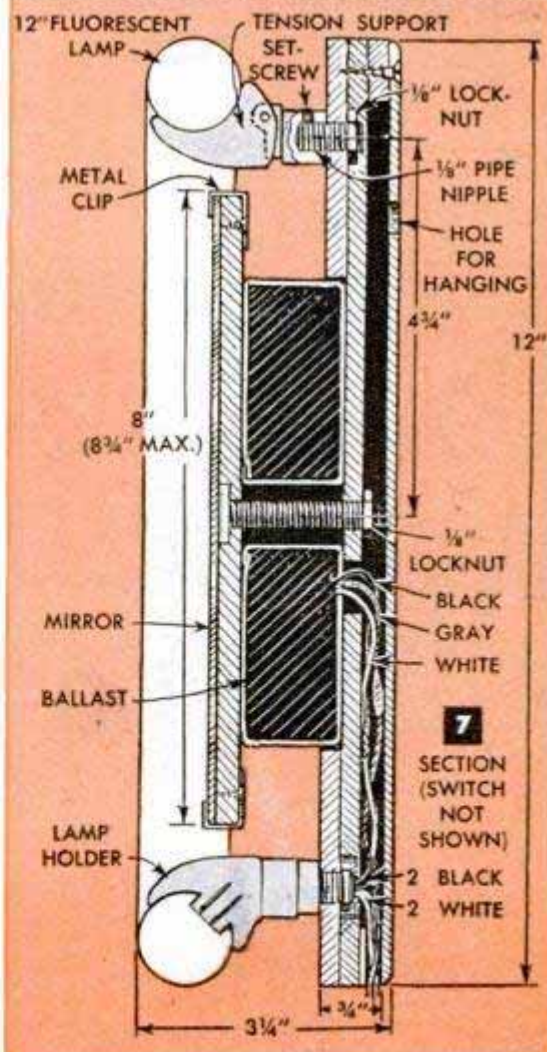



8 SIMPLE CEILING FIXTURE IS EASY TO MAKE

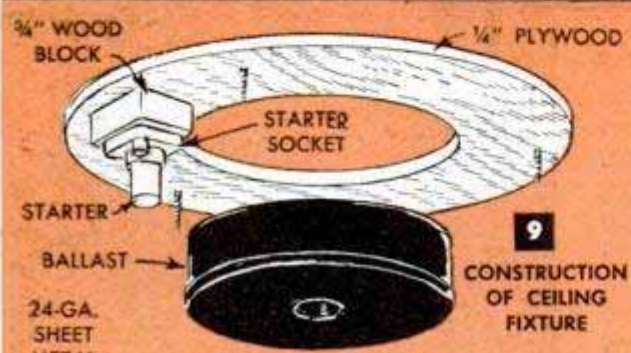

9 CONSTRUCTION OF CEILING FIXTURE

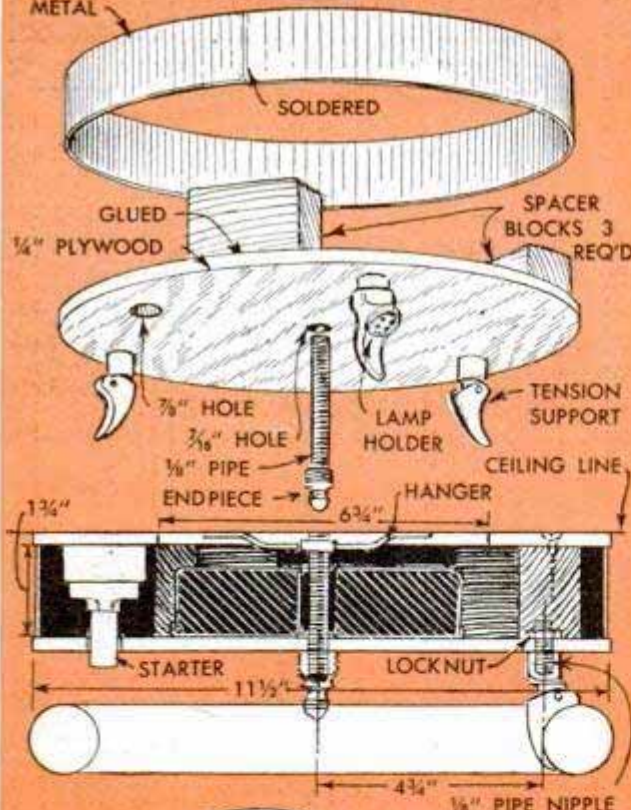

10 SECTIONAL VIEW

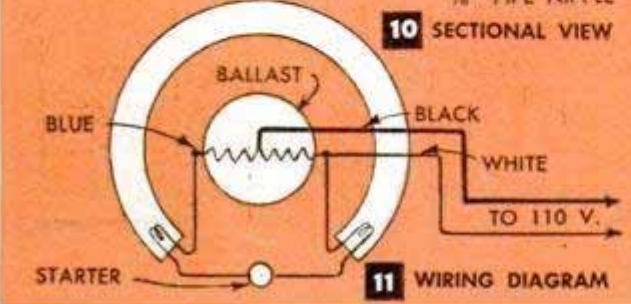

11 WIRING DIAGRAM

onto the projecting end of the nipple draws the parts tightly together ready for gluing and screwing to the mounting disk and spacer. Finish the edges of the plywood smooth to provide a good base for enamel. The lamp holder and tension supports are spaced equally around a circle having a radius of  $4\frac{3}{4}$  in., mounting being made by means of a pipe nipple and locknut. Fig. 2 shows how the back is fitted. The whole unit is easy to make despite its complex appearance in the drawings. The finish should be white or a pastel shade of enamel. Lamp temperature is about 110 deg. so there is no danger of heat discoloring the finish or causing the

wooden parts to catch fire.

**Wiring:** The wiring diagram for the pin-up lamp is shown in Fig. 5. The view of the wiring shown in Fig. 3 looks involved, but it really is simple as the various units have colored lead wires. If the small,  $8\frac{1}{4}$ -in. circular lamp is used, its low-voltage rating permits it to be used with a simple, series type of ballast. This has two leads, and wiring is just a matter of cutting the ballast into one wire of the power line. Medium and large circular lamps require an auto-transformer type of ballast which has three lead wires.

**Ceiling Fixture:** A basic type of ceiling fixture consists of a circular mounting frame or body with a 12-in. circular lamp supported by a three-point mounting. Fig. 8 shows a typical unit, excellent for kitchen or game room. This unit employs the automatic starter, and is constructed as indicated in Figs. 9, 10 and 11. Instead of using a sheet-metal rim to enclose the unit, as specified in Fig. 9, the rim of the fixture can be made a solid-wood turning as suggested by the two left-hand details of Fig. 15. Ornamentation of the rim can be done by fluting, turning or carving. If fluting or turning is used, a hardwood that will harmonize with other wood finishes in the room is best but, if the rim is to be carved, it should be made of softwood to simplify the carving job. If desired, you could use aluminum or stainless steel and corrugate or otherwise ornament it. However, the simple base unit shown, with a gleaming

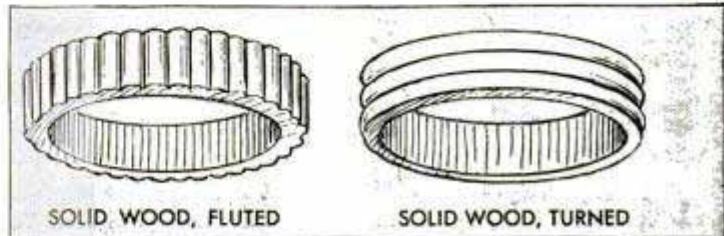

white finish, is nice enough for almost any location. This fixture can be flush-mounted, as shown in Fig. 10, or it can be dropped down from the ceiling by using a standard ceiling outlet box as a spacer.

**Shelf Fixture:** This fixture, shown in Figs. 12, 13 and 14, illustrates a neat idea in a whatnot shelf, and also serves to show the wiring for the medium and large circular lamps when the ballast is mounted some distance from the fixture. As indicated in Fig. 14, three wires run from the fixture to the ballast. With average lamp cord, the ballast can be installed a distance up to 50 ft. from the fixture without any danger. Advantages of this mounting are a more compact fixture, freedom to use the less expensive square or rectangular ballast instead of the circular form, and no ballast hum. With a good ballast, hum is reduced to the minimum. Note in this unit that only two lamp supports are used, this mounting being practical in all cases except where the lamp hangs straight down from the supports. Also note how the over-all extension from the wall is decreased a little by recessing the supports into the base. The plastic shelf is in the form of a full, half circle, cut either from clear plastic or from colored plastic in blue or yellow. The curved edge is highly polished. The shelf is edge-screwed to the wooden backing disk. Take care in drilling and tapping the plastic for the screws, making the diameter of the holes very slightly smaller than the screws. If the screws fit too tightly, they may crack the plastic when driven into it. If they are too small, any weight on the shelf may strip the threads. Do not pull the screws up too tightly as this also may strip them.

**Channel Mounting:** The channel mounting shown in Fig. 1 is not illustrated with a specific fixture application. This mounting has central connections on both sides for  $\frac{1}{8}$ -in. pipe. In combination with the small  $8\frac{1}{4}$ -in. lamp, fixture-making with the channel mounting is almost as simple as making one for a filament-bulb lamp. The ballast is cut into the power line, or a plug-in type of ballast is used.

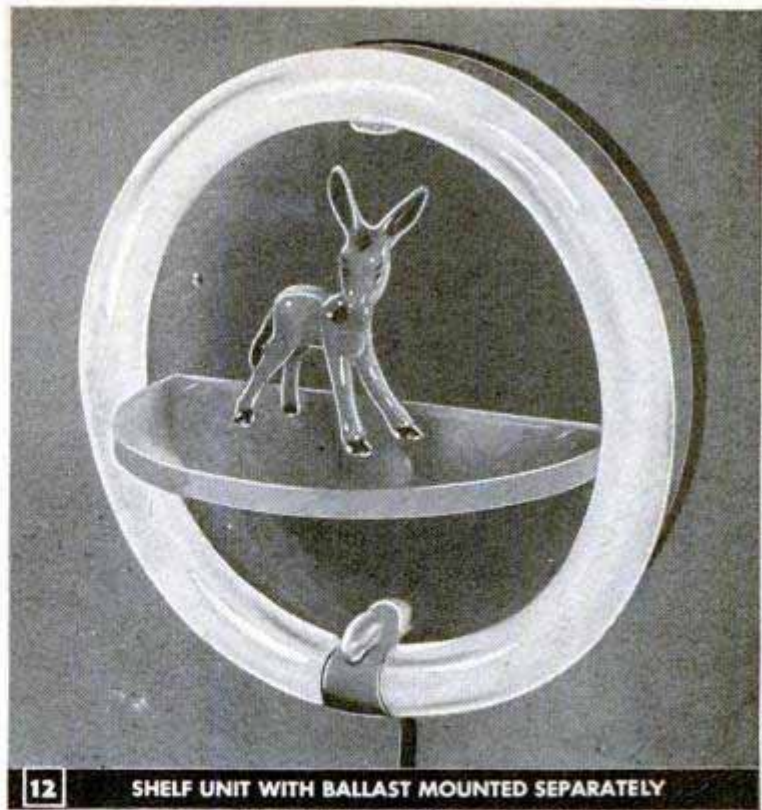

12 SHELF UNIT WITH BALLAST MOUNTED SEPARATELY



13 BACK OF  $\frac{3}{8}$ " THICK BASE IS ROUTED FOR WIRING

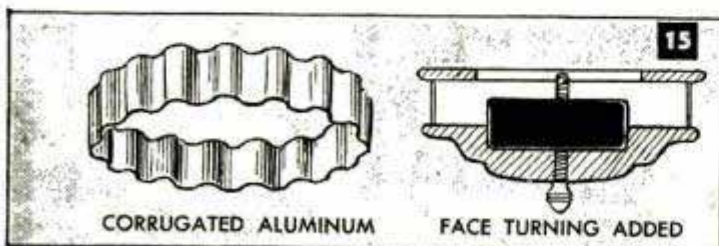
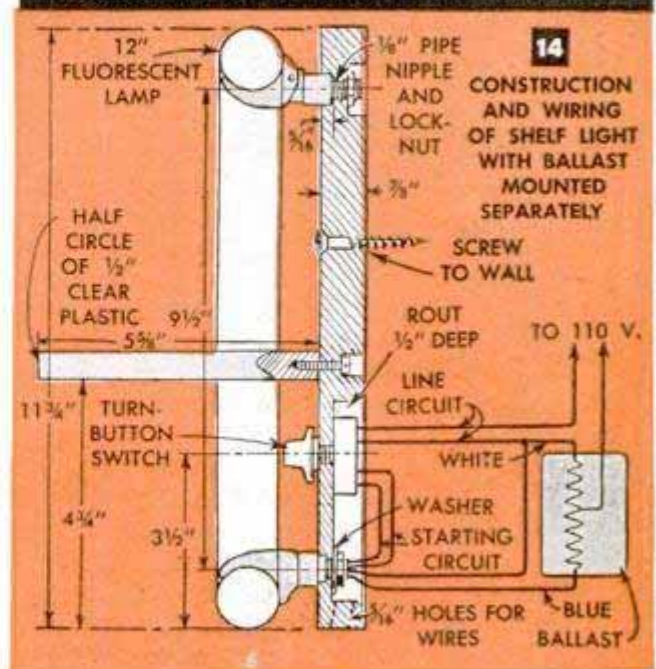

## Built-in Support for Heavy Pictures Installed During Construction



There'll be no need to search for studs from which to hang heavy pictures or mirrors if wooden supports are built into the walls before plastering. If your home is in the planning stage or under construction, decide now where you intend to hang these items. Pieces of 2 by 6 or 2 by 10, nailed to cleats between the studs at the desired points, will provide sturdy mounting bases and also allow sufficient leeway to position the picture or mirror properly. To eliminate guesswork, it's a good idea to make a record of the location of each support before the walls are lathed and plastered.

Neal W. Houlahan, Glenshaw, Pa.

## Emergency Hose Clamp



RADIATOR HOSE

All that is needed to get home or to a garage when a hose clamp breaks on your car is a short piece of wire and a small bolt. Just loop the wire around the bolt head, wrap it around the hose once and twist the loose ends together.

After starting the nut on the bolt, bring the twisted end of the wire over the nut and tighten the nut with a wrench or pliers.

This draws the ends of the wire together and fastens the hose until a new hose clamp is obtained.

## Potato Moistens Postage Stamps

When sending out greeting cards or invitations, one way to avoid the unpleasant task of licking postage stamps is to moisten them with a potato. To do this, simply cut the potato in half and impale one of the halves on a nail driven through a board. As a potato contains considerable water, one half usually will be sufficient for the job.

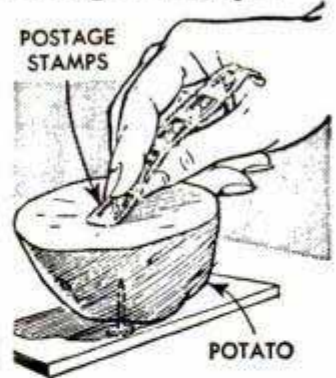

## Measuring Taper-Turning Setover

Setover between the live and dead centers of a lathe can be measured easily and accurately by clamping a narrow rule, marked on both sides, in the tool holder. The rule is clamped between the holder and the cutoff tool, Fig. 1, thereby relieving all pressure on the rule but still affording a rigid mounting. Then, the lathe centers are moved together, Fig. 2, the tailstock quill is locked and the rule is adjusted for height by means of the rocking wedge on the tool post. A standard chart gives the setover for a specific taper.

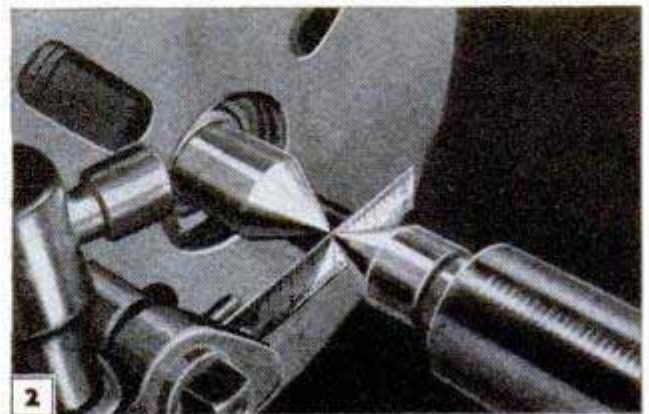

# Baby's BATH-O-CHEST

SWUNG open, this novel chest with its nesting trays affords convenient access to baby's clothes—everything being within easy reach for dressing an infant. The chest is made in 2 separate units hinged together at a rear corner. Four of the 2-piece legs are 29 in. long and the others are 24 in. Short pieces of the leg stock are fastened to the exposed corners of the trays to make the short legs appear full length when the chest is closed. The legs are fastened to the trays with long screws in the manner shown in the circular detail. The interior of each tray and the underside of the lid are lined with quilted satin or rayon which is formed around cardboard and glued in place after the chest is painted to match the nursery.— Charles and Bertram Brownold, Cedarhurst, N. Y.

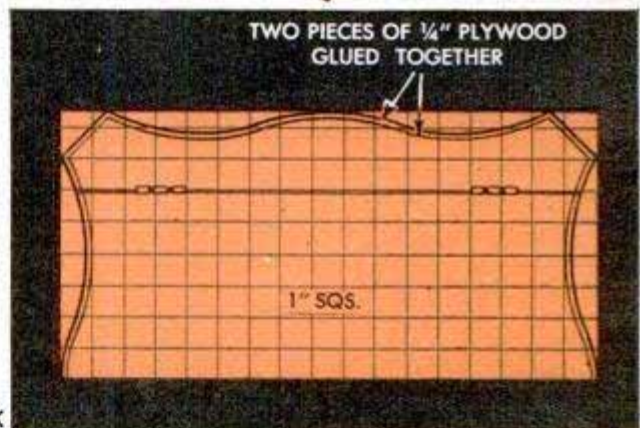
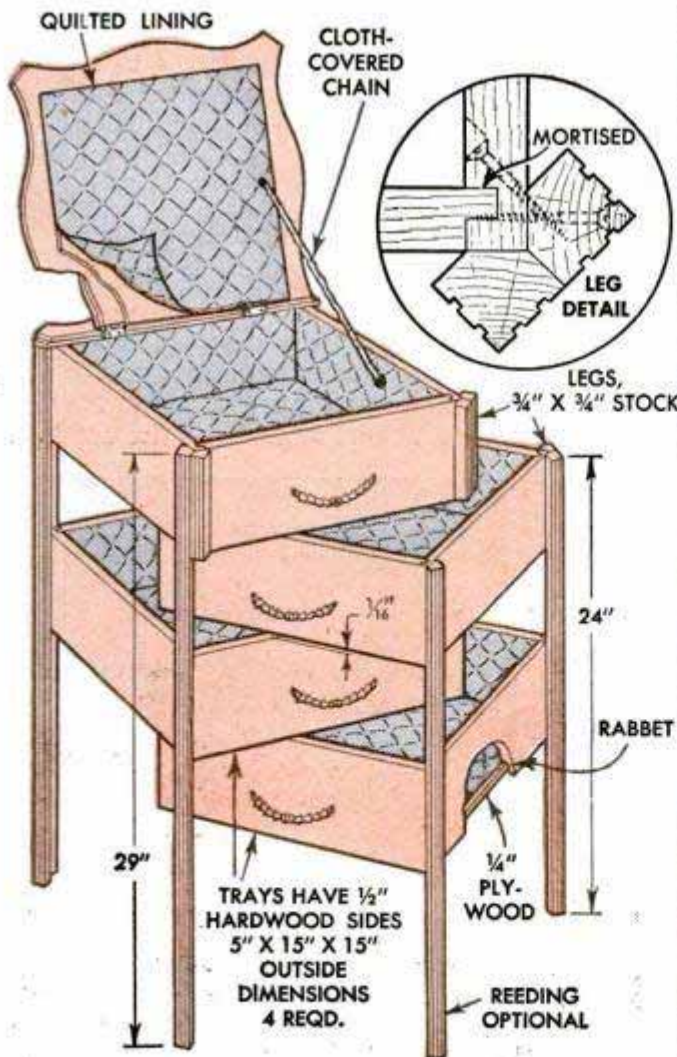
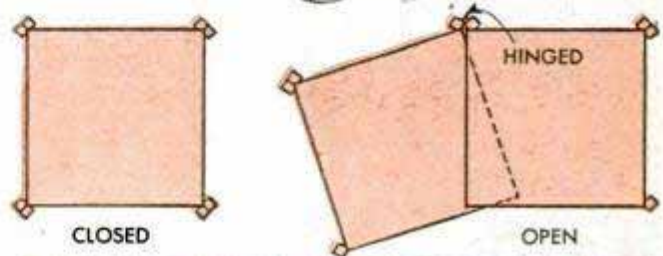

## Developer Stored Quickly With Gravity Tank

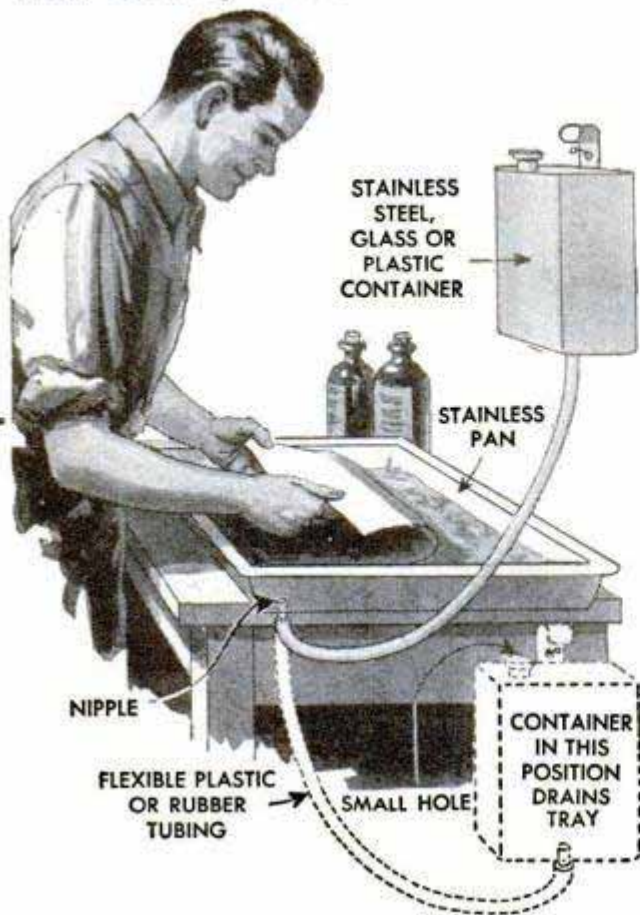

Photostat developer often is allowed to remain in open trays when not in use, resulting in discoloration and loss of strength. One drafting department discouraged this practice and conserved developer by rigging up a simple device to eliminate the bothersome job of pouring the liquid back into the bottle after each use. The device consists of a noncorrodible tank, a cork and a rubber hose. One end of the hose is connected to the bottom of the tank and the other to a drain hole in the developing tray. The hose connections are made by forcing the ends of the tubing over 2 brass nipples, one brazed to the bottom of the tank and the other to the bottom of the tray. Then the inside of the nipples are coated with rubber-base paint. A small vent hole is made in the top of the tank, after which the tank is filled with developer and hung on the wall above the tray. To fill the tray, the cork is merely removed from the drain hole. To drain the tray, the tank is taken from the wall and hung in a position below the tray, as indicated.

C. L. Meehan, Lakeview, Ont., Can.

## Preserving Polish on Car Hood

To keep the hood looking as new as the rest of the car without additional polishing, simply apply a coat of aluminum paint to the underside of the hood. The paint will

deflect much of the heat which ordinarily causes the wax to melt. Be sure to clean the metal surface before painting it.

Jeff Sterns, New Bedford, Mass.

## Igniting Damp Matches Outdoors

When the wooden matches I usually carry on hunting and fishing trips become damp and difficult to ignite, I use the following method: First, I pick out a rock with a smooth, dry surface and rub the match back and forth across it several times, inclining the match so that both the head and tip contact the surface. Friction dries out a small portion of the head and tip, and a final sweep of the match causes it to ignite.



Jack Bronte, Surf, Calif.

## Spot Rings in Garments Avoided

The formation of spot rings on the cloth when removing stains from garments can be avoided by placing a felt-covered furniture floor cup under the spot before applying the cleaning fluid. In addition to preventing a ring from forming, the brush-like fibers of the felt also keep the material from slipping when the spot is rubbed.

G. E. Hendrickson, Argyle, Wis.

## Folding Rule Transfers Angles

If you do not have a sliding T-bevel to determine the angle of work to be duplicated, a common zigzag rule will serve as a substitute where the measurement is not too critical. In transferring the angle to the work, be careful not to disturb the setting.

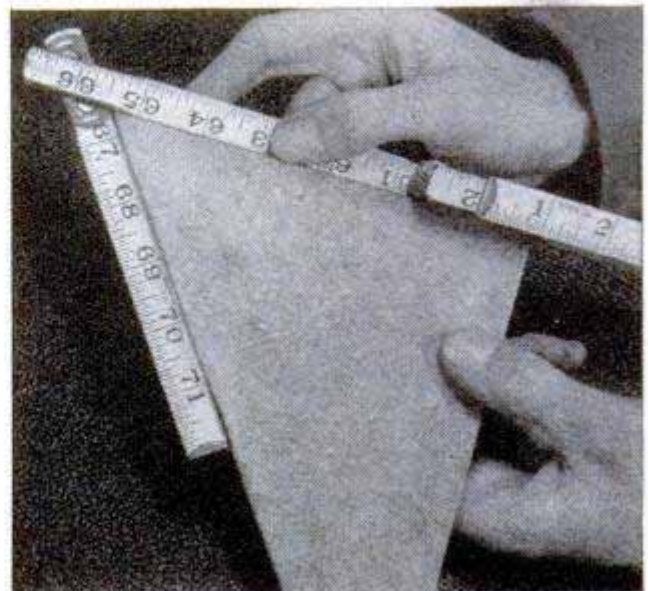

# WEATHER-STRIP



By E. J. Lucas

WHEN sharp wintry winds reach full velocity and temperatures drop below freezing, the unsealed doors and windows of your home may account for as much as 40 percent of the total heat loss during an average day. Weather stripping alone can reduce this loss as much as 20 percent, even without the addition of storm sash and storm doors. There are many kinds of weather stripping, some designed only for temporary use, such as plain felt strips, felt strips with a wood or metal backing, and rubber-coated fabrics. The interlocking types made from bronze, brass or other rustproof metals are designed for permanent installations. The interlocking types are, of course, the best in the long run as they do not require a friction contact to form an effective seal. Doors and windows fitted with these types open and close as easily as before stripping, while the friction-seal stripping makes window sash somewhat harder to raise and lower and doors a bit more difficult to close. Both types, however, make a very effective seal against heat loss.

Except along the bottom edge, a door can be weather-stripped with the interlocking type, cut and bent to the shape shown in detail A of the series of detail illustrations A to K inclusive. If this material is not available from local hardware, lumber, or building-materials dealers, a sheet-metal shop can prepare it at small cost. Zinc is quite commonly used as it is easy to work, but any other corrosion-resistant metal, soft enough to be formed to the desired shape, may be used. A splice is made by snipping a tongue out of the sheet metal

One way to test a weather-stripped door for air leaks is by moving a lighted match along opening between door and jamb. Flame flickers if air is entering

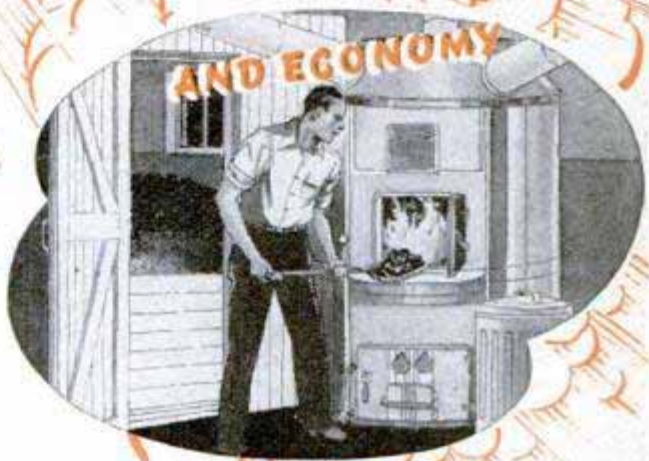



Before weather-stripping a door, true it up to assure uniform clearance between door and jamb. Be sure to plane edges square

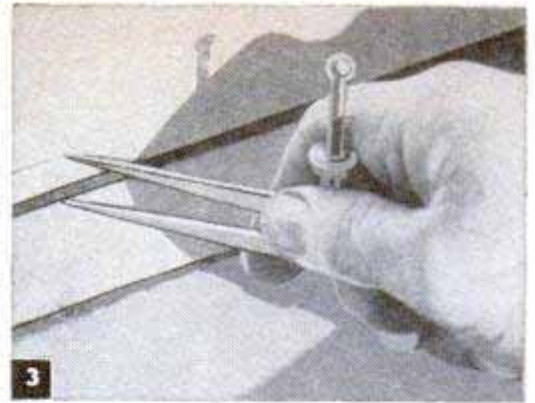

as in detail B and inserting it in the folded flange of the other piece. Rustproof nails should be used.

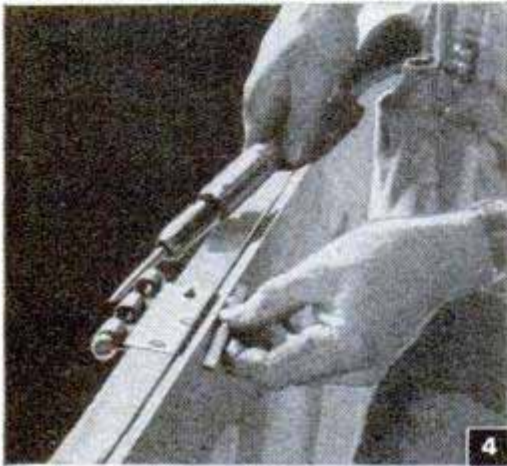

The first step before removing the door is to see that it is hung properly. It may be necessary to plane off some high spots, as in Fig. 2, or to shim up one of the hinges. If the wooden threshold is worn down in places, plane it level. Then, with dividers, scribe a line along the bottom of the door as in Fig. 3, using the threshold as a guide for the lower point of the dividers. These should be set so that the bottom of the door, when sawed along the scribed line, will clear by  $\frac{1}{16}$  in. the top of the brass threshold to be installed, Fig. 10. After marking the bottom of the door, remove the door from the frame, block it on the floor with the hinged edge up, and remove the hinge butts. Using a rabbet plane or an electric hand plane such as shown in Fig. 7, cut a  $\frac{1}{8}$  by  $\frac{3}{8}$  in. rabbet the entire length of the door. With a hacksaw, cut a piece from the outside edge of each hinge

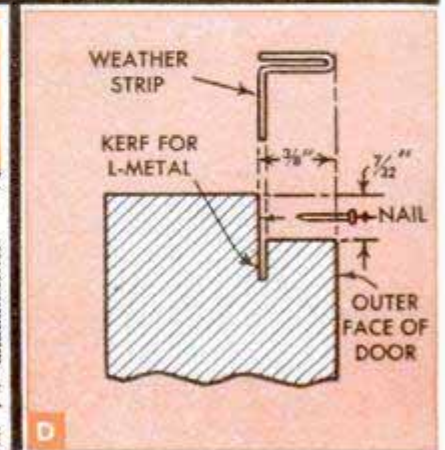
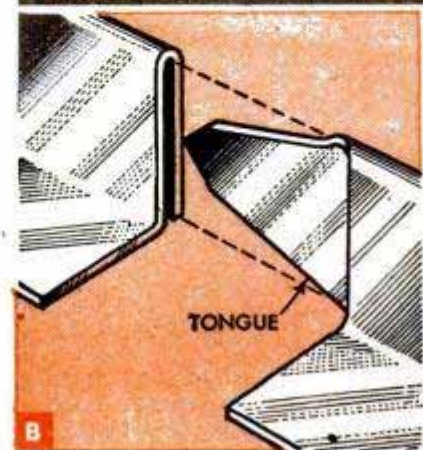
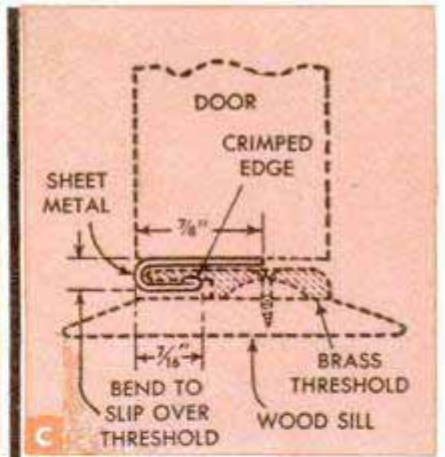
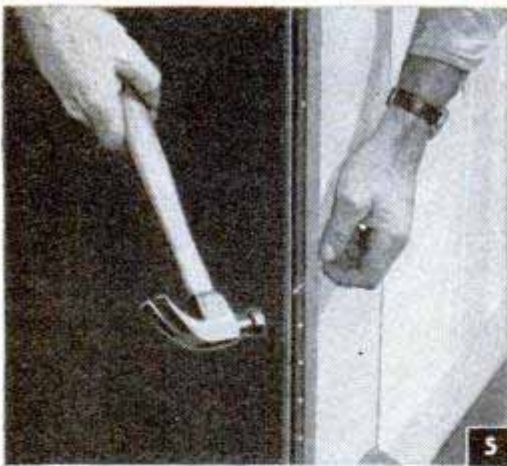



butt just wide enough so that, when the butt is replaced on the door, it will clear the rabbet, Fig. 4.

Now, following the line scribed near the bottom of the door, saw off just enough to clear the brass threshold. If a felt door bottom is to be used, this can be nailed or screwed to the door after rehanging; but if the metal threshold is of the interlocking type with overhanging lip, then be sure that allowance is made for the interlocking bottom strip which is nailed to the bottom of the door, as in detail C, to interlock with the threshold lip. This can be bent to the dimensions given from the same material as the weather strip used on the rest of the door, unless, of course, a similar strip is purchased ready-made. Attach the strip, as shown, with the back of the hook flush with the inside face of the door.

As the lock side and the top of the door are weather-stripped in the same manner, rabbet the outside edge of each as in detail D. Dimensions should be maintained closely so that the edge of the weather strip will not extend beyond the outside face of the door, Fig. 8, as the strip which later is installed on the jamb must be fitted to interlock closely without binding. A suitable kerfing tool to cut the groove for the metal edge can be made from a piece of steel, with a cutting point filed or ground as in detail E. A short length of saw blade not less than  $\frac{1}{2}$  in. wide and bolted to a handle, also will serve this purpose. If there is sufficient clearance between the striker plate and the edge of the door, the weather

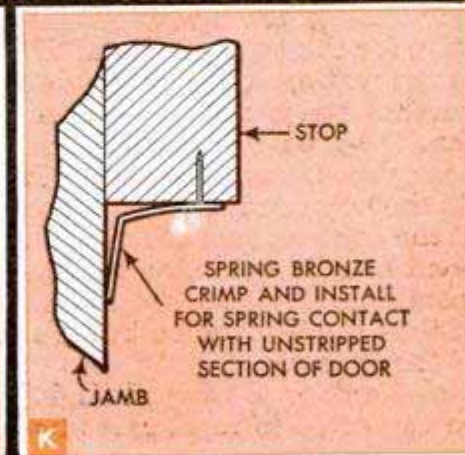
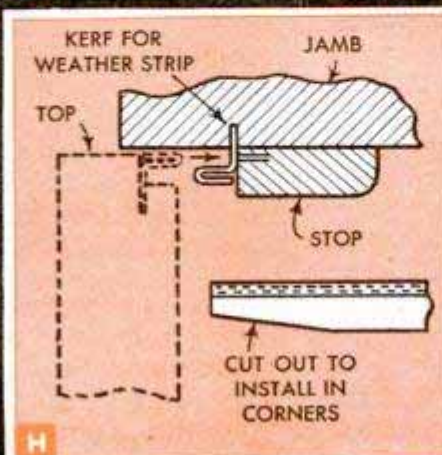
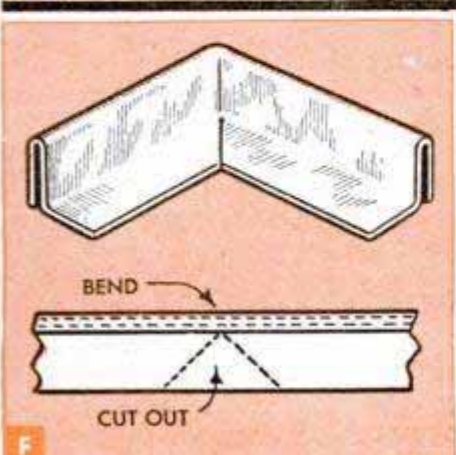
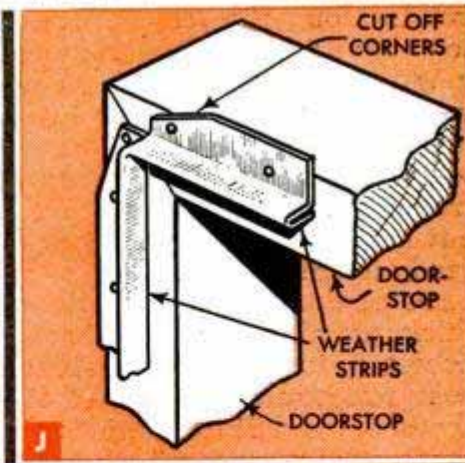
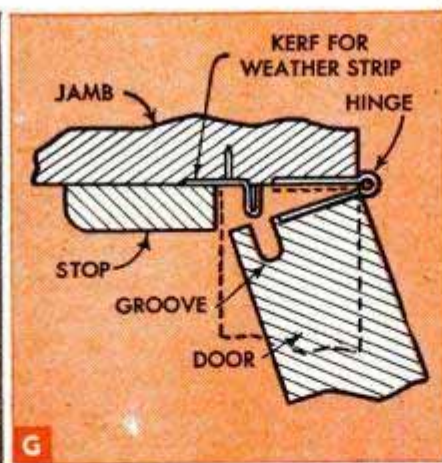
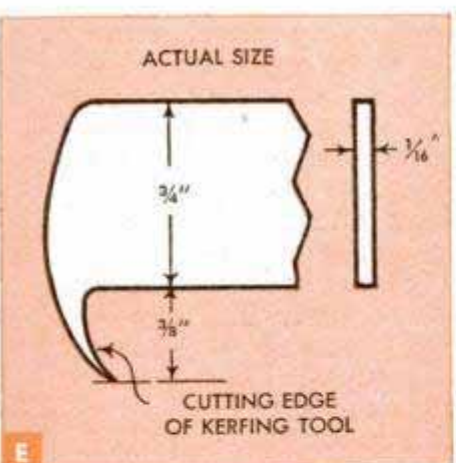
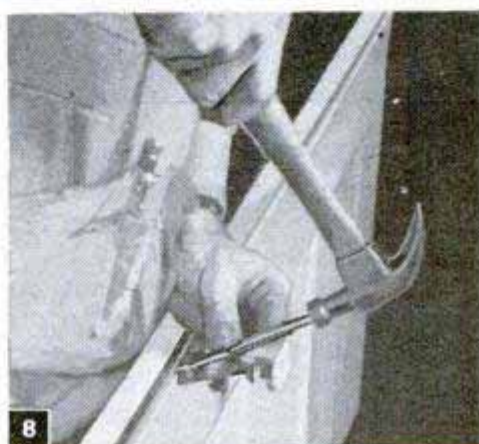
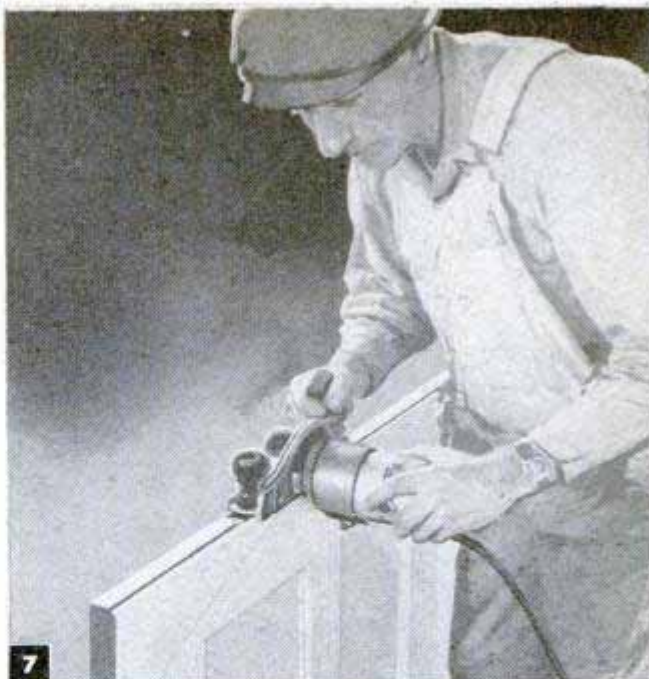



strip can be installed for the entire length of this side. Otherwise, cut the rabbet up to the striker plate and then taper the cut with a chisel as in Fig. 6.

The metal strip now can be nailed in place as in Fig. 5, with the outside edge flush with the edge of the door. Fit the strip at the corner by snipping out a vee and bending around the corner as shown in detail F. When necessary to join at other points along the length, pieces are fitted together with a tongue as in detail B.

With work on the door completed, the weather stripping is now installed on the jamb. Detail G shows one method used when installing the strip on a new door frame, the strip being nailed in a groove cut in the jamb. If the door frame is already installed, cut a shallow rabbet in the back of the stop to a depth equal to the thickness of the strip. In this way, it is unnecessary to groove the jamb. In either case, best procedure usually is to install the threshold and fit the metal top strip first, as the two sides are more easily fitted to these later. Install the threshold and the weather strip for the top as in detail H, fitting both to the mating strips on the door. Then the vertical strips are installed, making sure that the groove in the hinged edge of the door closes over the metal without binding. As the kerf cannot be cut to sufficient depth at the corners, snip the metal so that a neat bend can be made, as in detail J, before installing. The metal strip on the lock side of the door is installed in the same manner as the top strip.

If the door is warped slightly, this may be corrected in most cases by planing the



Above, on old door frames a metal threshold is carefully installed so that door will close without binding. Left, when installing metal stripping, space back of striker plate is closed with spring bronze

stop to make uniform contact with the outer edge of the door before installing the metal strip. Where the stop on the lock side of the door is planed to fit the warped door, it will be necessary to relocate the striker plate so that the door can be closed securely without rattling. Finally, crimp a strip of spring bronze and nail to the stop, as in detail K and Fig. 9, to close the gap at the striker plate. One way of testing a weather-stripped door for leaks is to move a lighted match slowly along the opening between the door and the jamb as in Fig. 1. If air is leaking in at any point the flame will flicker. Generally, the leak can be stopped by springing the strip slightly.

Methods of applying the interlocking weather strip to windows are essentially the same as those used in fitting it to doors. When the stripping is purchased ready-made, specially formed strips usually are furnished for the meeting rails of ordinary double-hung windows, and also for casement sash. Spring-bronze weather strip of the contact type is usually furnished in rolls from which the required lengths are cut with tin snips. It is one of the easiest of all to apply as it is supplied in uniform widths with adjustable contact edges and a perforated nailing flange. This type of stripping is fitted to both doors and windows in much the same way. To simplify installation, the contact strip often is applied only to the sides and top of the door frame and a metal-reinforced felt door bottom is screwed to the inside bottom edge of the door. Felt weather stripping, with or without metal reinforcing, is a more or less temporary installation.

☐ An emergency highway flare is a handy item to have in the car at all times. One is made by rolling a strip of corrugated cardboard and inserting it in a tin can. Melted paraffin is poured over the cardboard.

Built of plywood and partitioned to meet individual requirements, this unusual cabinet provides compact storage space for both loose records and albums in addition to housing a portable record player. The front panel of the record-player compartment is faced with brightly colored book jackets. These jackets are glued separately to a number of wooden blocks which are rounded on one face and fastened side by side to the panel. If the phonograph is to be played through a table radio, the partitioning of the cabinet can be varied so that the radio will fit in the center compartment. A piece of plywood which is cut to fit over the top of the record player provides a shelf for accessories and needle cups which are recessed flush. — George Radbourn, Ottawa, Ont., Can.

## Record-Player Cabinet Simulates Bookcase To Supply Ample Storage Space for Albums

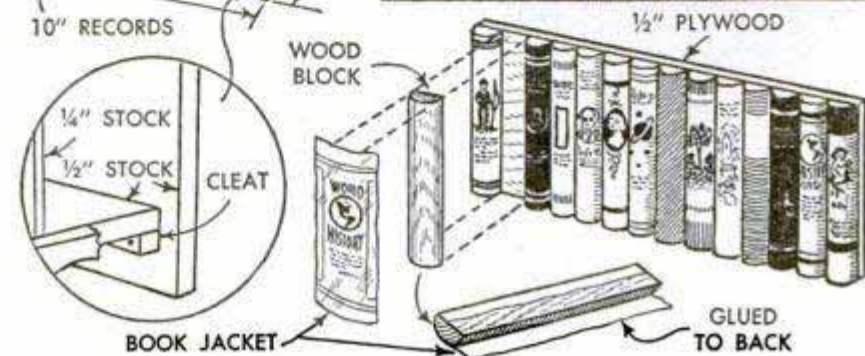
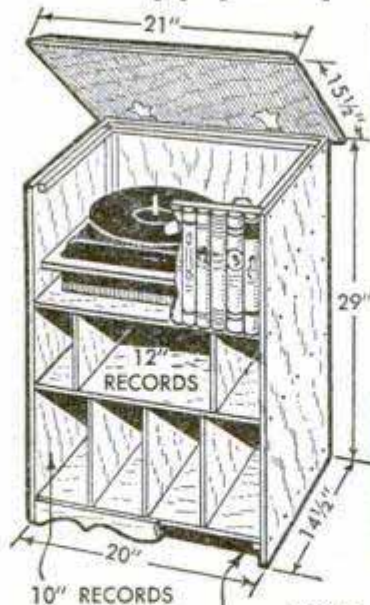

## Homemade Toy Derrick Equipped With Bell Magnets Lifts Metal Cargo

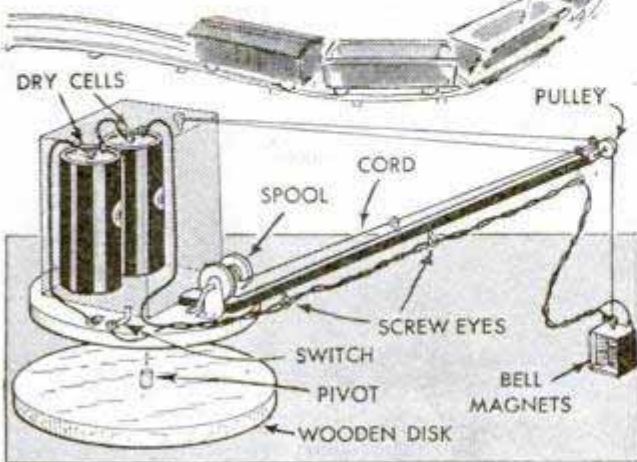

Unloading a carload of metal parts with the electromagnet of this toy crane gives the small boy the thrill of operating a life-size machine. The arm of the crane is a piece of wood nailed to a wooden disk pivoted on another disk which serves as a base. Bell magnets, tied to a length of cord wound on a sewing-thread spool, are wired through a simple switch to 2 dry cells. The latter are enclosed in a realistically painted cab of cardboard or cigar-box wood. The switch may consist of a brass strip loosely attached to the rotating base with a brass screw so that it can be swung to contact another brass screw.

## Conserving Carbon Paper

A sheet of typewriter carbon paper need not be discarded when worn, as it still can be used a number of times if about  $\frac{1}{8}$  in. is clipped from each end of the sheet. Thus, when the paper is lined up for insertion in the typewriter, the unused portions of the carbon that originally were between the typed lines are moved opposite the type.

☞ Adding a little vinegar to water used for washing windows will help prevent the glass from streaking and make it shine.

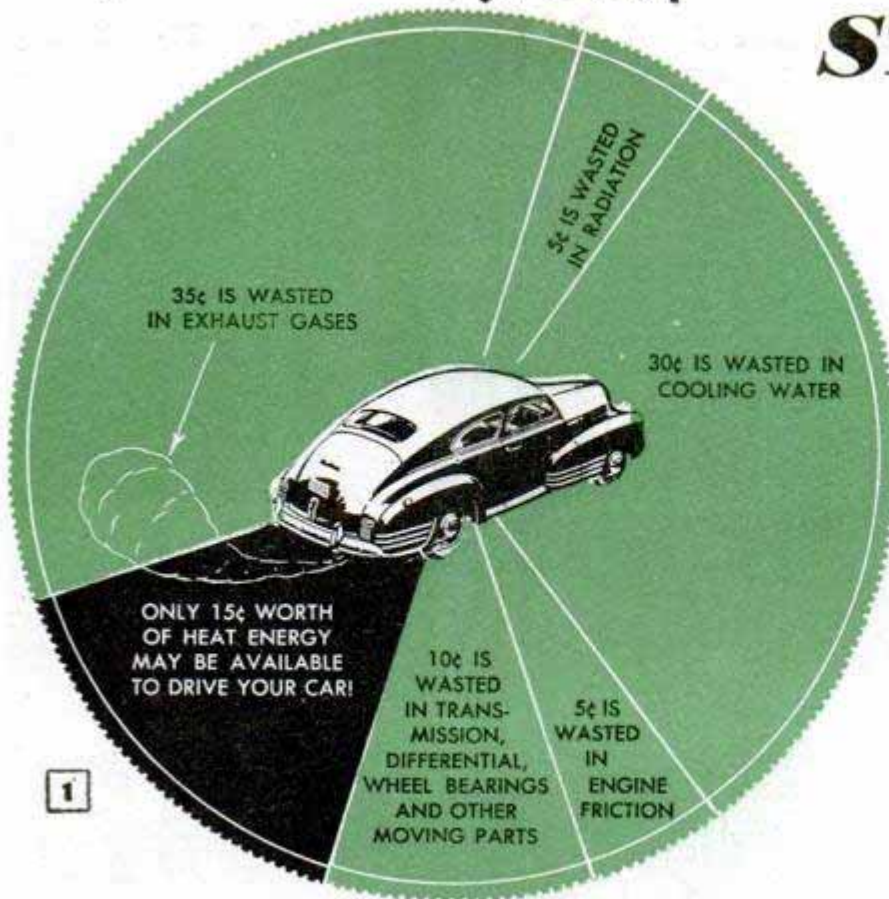

The miles per gallon of fuel your car delivers depends not only on your driving habits, but more on how well you keep all parts of the car adjusted. That is why it is important to keep the ignition and fuel systems at peak operating efficiency, and to check the brakes, lubrication and wheel alignment to reduce rolling resistance to the minimum

## Part I

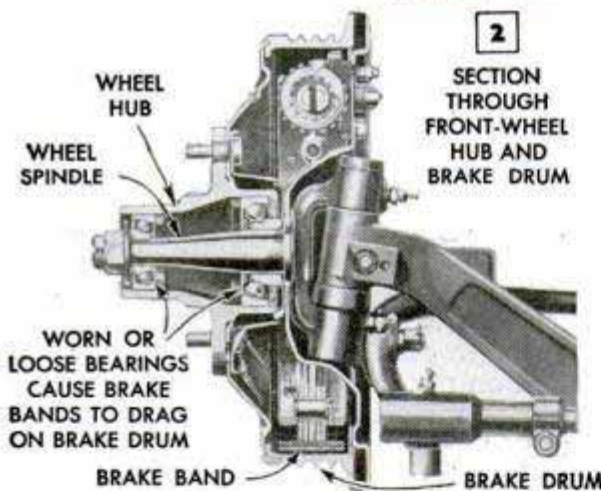

Loose wheel bearings can be the cause of dragging brakes. Brake shoe contacts bottom of drum

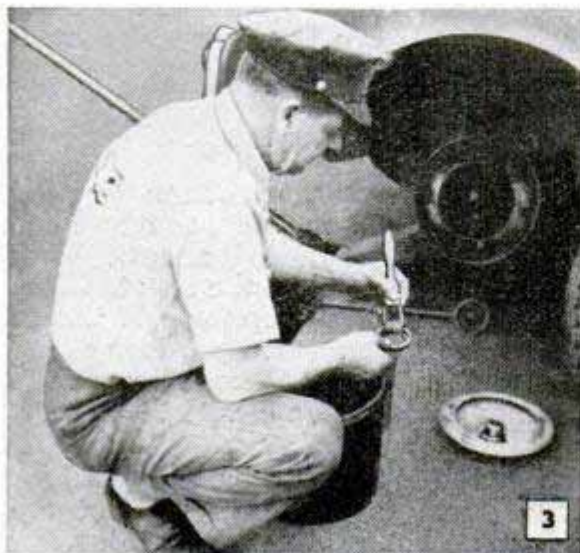

**D**O YOU KNOW that only 15 cents' worth of gasoline out of every dollar spent for car fuel actually reaches the wheels in the form of power to propel the car? The remaining part of your dollar's worth of fuel is expended in friction, exhaust gases, heat radiation and cooling water. A careful study of the diagram in Fig. 1 will show how important it is to fuel economy to keep all parts of the car adjusted to give peak performance.

In this two-part story, C. Edward Packer, a former Service Instructor of the Ford Motor Co., will describe numerous ways the motorist can conserve gasoline by simply keeping the ignition and fuel systems adjusted correctly, and by keeping a careful check on brakes, lubrication, wheel alignment and other friction-producing parts of the car.

Normally, about 10 percent of the engine's power is consumed in the train of power-transmitting parts. Any condition which tends to increase frictional drag in any of the parts will increase the power loss proportionally. Also, a tight or loose wheel bearing, a dented hydraulic-brake line, worn brake-shoe pivots and wheel misalignment, even though slight, can cut gasoline mileage appreciably. If a wheel bearing is sufficiently loose, the bearing slack may cause the bottom brake shoe to drag on the lower part of the drum as in Fig. 2. A slight drag on all four wheels is not apparent in the operation of the car, but it can cut fuel mileage considerably. Bearings that are too tight may heat and develop sufficient drag to affect fuel economy. A flying stone thrown by the wheels or a carelessly handled jack can

# your **GASOLINE DOLLAR**

dent hydraulic-brake lines. Such a dent may prevent the brake shoes from releasing fully after application. A dent in any of the lines indicated by the letter D in Fig. 4 will affect only the brake connected to that particular line, but a dent at point F would act equally on both front brakes. Similarly, a dent in the line at R would act equally on both rear brakes.

In most cases, such dents only partially impede the flow of hydraulic fluid and do not noticeably interfere with application of the brakes. But when the pressure on the pedal is released, the tension of the brake-shoe retracting spring, Fig. 4, S, is not sufficient to immediately free the brake shoes completely from contact with the drum. The release is slow, due to the greatly restricted flow of the brake fluid. During this time, the car can be rolled by hand on the level only with great difficulty. Another condition in the brake system that cuts deeply into gasoline mileage is due to dirt clogging the bleeder hole in the master hydraulic cylinder, Fig. 4. With the brake in the released position, the rubber cup on the end of the master-cylinder brake piston uncovers this hole. Then, as the car is driven and expansion of the hydraulic

fluid takes place due to rising temperature, fluid moves out of the brake system and into the master-cylinder chamber above the piston. As the brakes are applied, this bleeder hole is covered as soon as the master piston moves. If the bleeder hole becomes partially clogged, all four brakes will drag on release, perhaps not enough to affect noticeably the performance of the car, but sufficient to cause a considerable loss of power. Similarly, rusted brake-shoe bolts or pivot pins, A in Fig. 4, can prevent the quick and free release of the shoes. Failure of the shoes to release also may be due to weak, broken or missing brake-shoe springs. If a car gives poor gas mileage, these are possible causes to keep in mind as they usually are overlooked when checking a car to improve mileage.

Front-wheel bearings should be washed and relubricated in the spring and fall, Fig. 3. Avoid packing the bearings with too much grease as they will be difficult to adjust correctly. When the bearing is reinstalled, the castle nut should be drawn up until the wheel begins to bind. Then the nut is backed off slowly until the wheel spins with only a very slight drag. If correctly made, this adjustment permits the

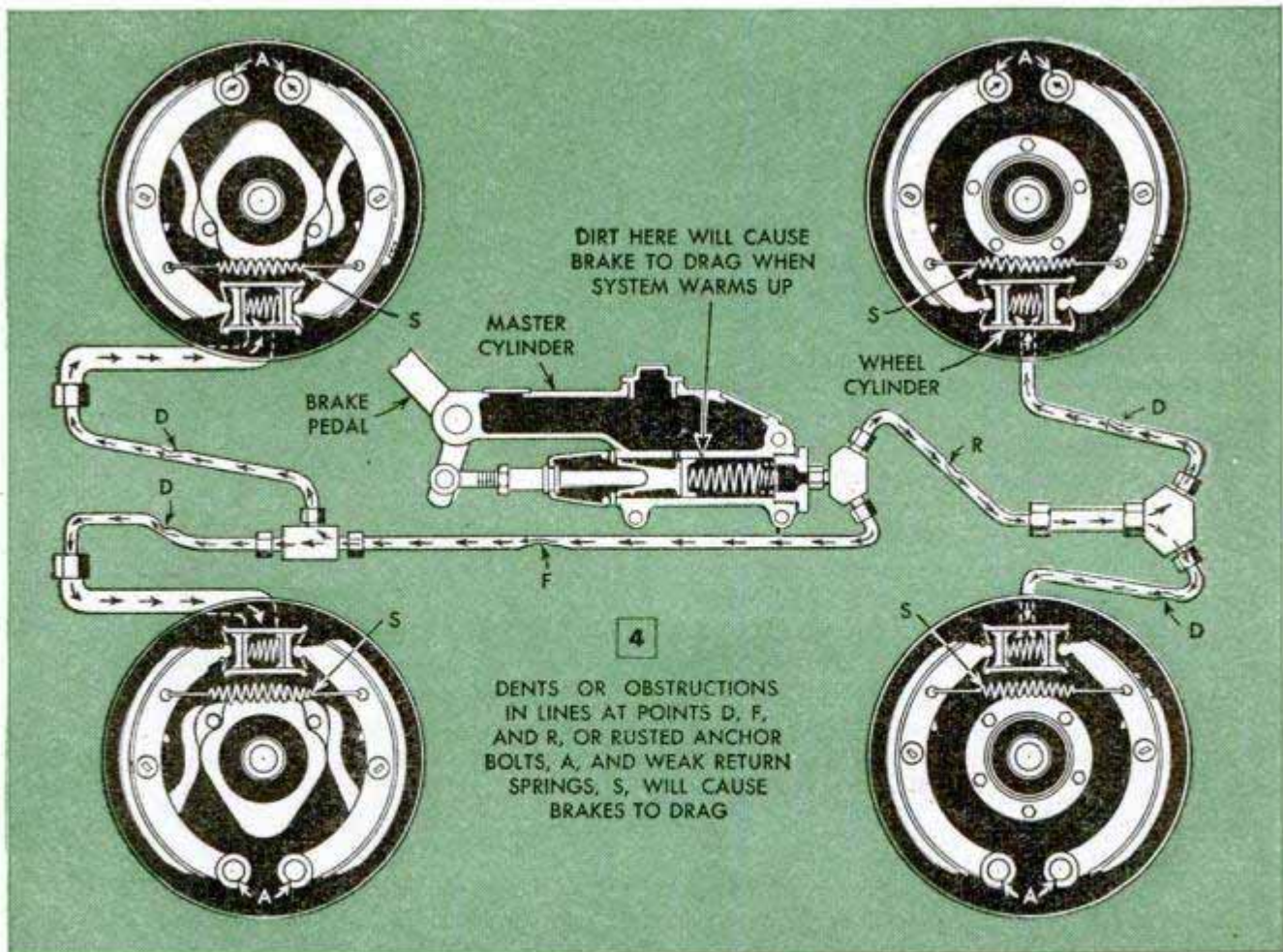

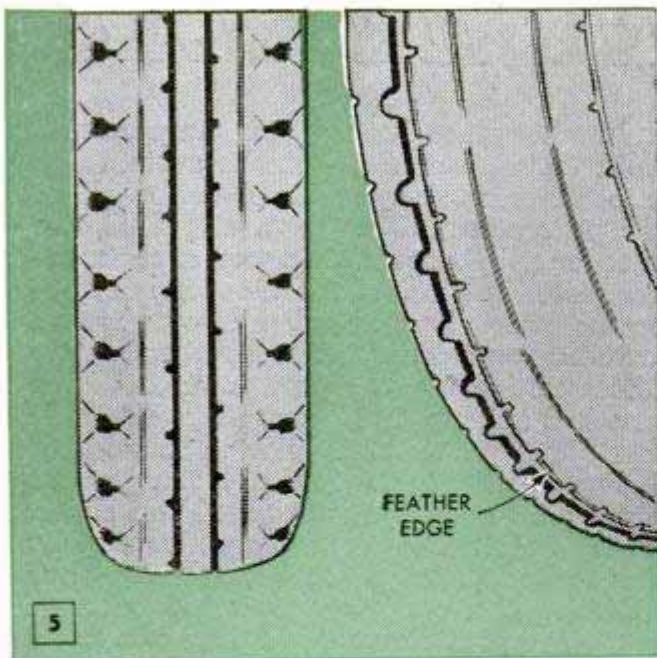

Misalignment of the front wheels causes rapid tire wear. Abnormal road friction requires more power

wheel to run with no noticeable looseness. Rear wheels, if provided with adjustable bearings, should be set up for free running with no measurable looseness. If the bearings are of the straight roller type, any up-and-down play should be corrected by replacing worn parts. Where brakes are of the hydraulic type, care must be taken when brake drums are removed not to depress the brake pedal, as this may drive the wheel pistons out of their cylinders.

Condition of the tires will reveal certain mechanical faults to a practiced eye. For example, a flat spot at only one place on a tire usually indicates a brake drum worn out of round. This can mean that the brake shoe is riding the drum at some point at each turn of the wheel. Proper adjustment of the brakes cannot be made if the drums are out of round or badly scored. Most defective drums can be restored to full usefulness on a brake-drum lathe, Fig. 6. After truing the braking surface of the drum, the shoes must be relined, either with an oversize lining or regular lining applied over a suitable shim to compensate for the enlarged diameter of the drum. After the lining is securely riveted or cemented to the metal shoe, it is ground to the exact radius of the drum as in Fig. 7. When installing the repaired parts, renew the brake-shoe pivot pins and retracting springs if these parts are damaged or weakened by rust.

When feather edges develop along a front-tire tread as in Fig. 5, it indicates either too much toe-in or toe-out, depending on which side of the tire the excessive wear develops. The tire is not only rolling forward, but is being scuffed sideways as well. This takes a lot of power by adding

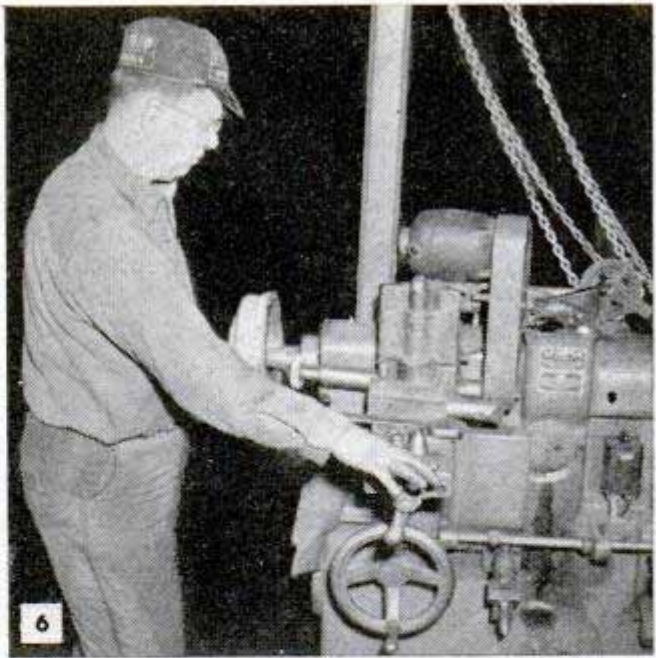

It's good economy to true up any defective brake drums; otherwise brakes cannot be properly adjusted

to the rolling resistance. Wheel alignment should be checked periodically to avoid fuel waste and excessive wear on the tires. Driving with the tires underinflated likewise results in lowered tire and fuel mileage. Soft tires make the car ride easier, but the added road friction consumes extra fuel. The tires flatten under the load and the undue flexing of the side walls eventually breaks down the fabric on each side of the tread. Underinflated tires also heat excessively when driven at high speeds. This greatly accelerates side-wall wear. The new low-pressure tires, designed to run on 24 lbs. of air pressure, present more square inches of tread to the road, and thus carry the load at reduced pressure. However, these tires should not be used underinflated.

Wheels that dance and bounce due to the poor snubbing action of defective shock absorbers consume extra power. It is comparatively simple to keep these parts in good condition at a minimum cost by regular inspection and servicing.

Incorrect lubricants can almost double the fuel energy required to deliver power through a transmission such as that shown in Fig. 10. Relatively the same losses from this cause can also occur in the rear axle. It is true economy on the part of the car owner to see that the chassis lubricants are adapted to the car and to the change in the seasons. When refilling both the transmission and rear axle with lubricant, follow the manufacturer's recommendations.

Check the clutch-pedal clearance. The pedal should have at least  $\frac{3}{4}$  in. of free movement to assure full engagement. A simple check any driver can make, Fig. 9, will show quite accurately the condition of



After relining, brake shoes should be ground down to the exact radius of the drum to prevent chatter

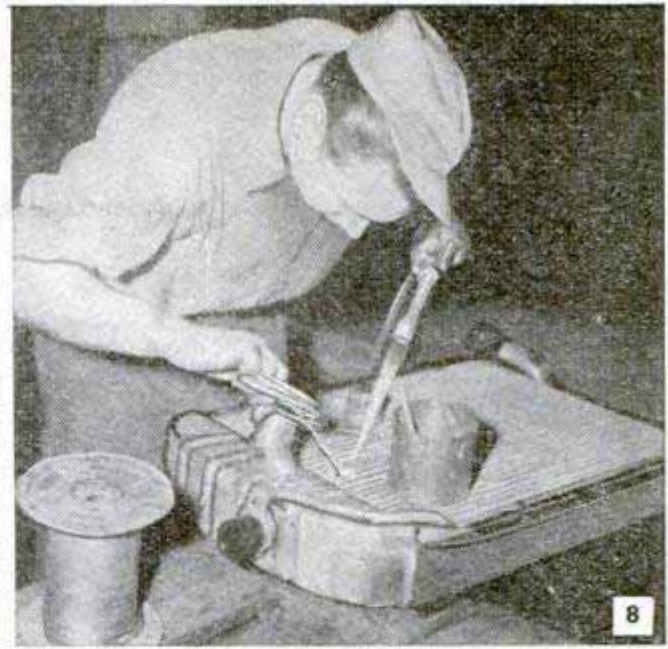

If the engine tends to overheat, clean the cooling system and solder any leaks that show under test

the clutch. Drive at 15 m.p.h. on a straight road in high gear and apply both the brake and the accelerator at the same time. Try to balance the pressure on brake and accelerator so that the car continues to run at 15 to 16 m.p.h. If, under this combined braking and acceleration, the engine suddenly breaks loose and races, it indicates that the clutch is slipping badly. If the clutch is in good condition, this procedure will kill the engine, even though the driver continues acceleration. A slipping clutch not only wastes gas, but it soon burns so that the facing has to be replaced.

If the engine temperature stays slightly above normal for any length of time, clean the cooling system. Use a good commercial cleaner and, if the car has been in use two or more years, have the radiator back-flushed after the cleaner has been removed. If this is not done, loosened particles of lime and rust may clog the small water passages in the radiator. Small leaks sometimes show up in a radiator after cleaning and should be closed by soldering as in Fig. 8. A leaky radiator may cause overheating and waste expensive antifreeze solutions.

(Continued next month)

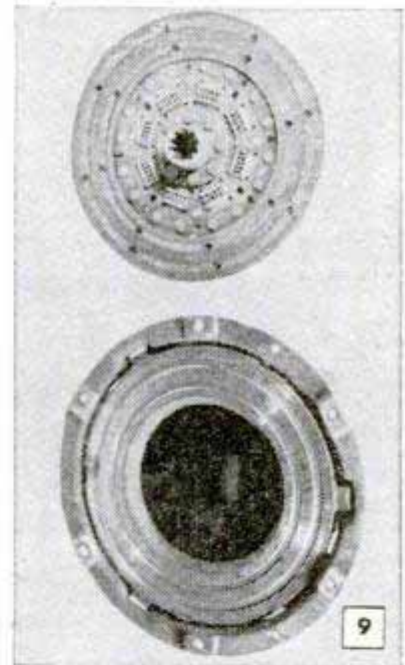

Below, improper lubricants in the transmission and, center, a slipping clutch can cause high power losses

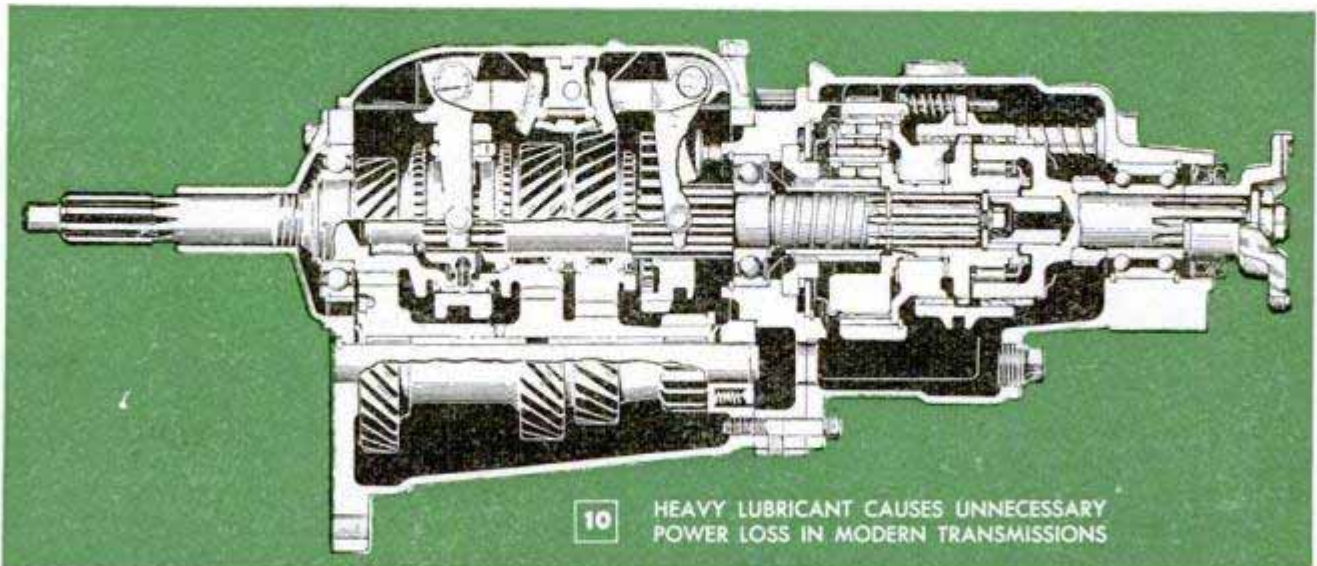

HEAVY LUBRICANT CAUSES UNNECESSARY POWER LOSS IN MODERN TRANSMISSIONS

## Sand-Filled Pail Provides Cushion When Removing Hub-Cap Dents



Should you want to hammer out the dents in a hub cap, you will find that a pail filled with dry sand provides the cushion needed to do a good job. A piece of heavy cloth placed over the top of the pail protects the hub cap from scratches.

## Comb Rack Files Shop Data

A handy card index for shop data can be made easily from 2 coarse-toothed combs and a block of wood. Drill 2 holes in each of the combs and fasten them with roundheaded screws and washers to opposite sides of the block. Then insert the reference material between the teeth of the combs.

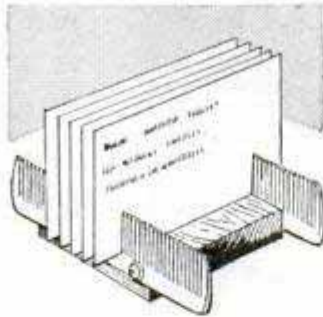

## Beveled Putty Knife Speeds Glazing

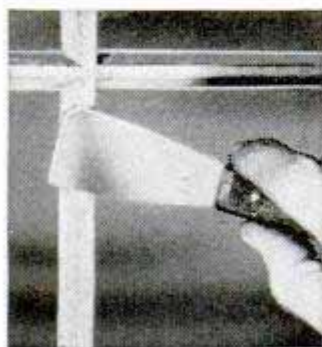

Faster, neater jobs of window glazing can be done with a putty knife ground to a 45-deg. bevel at one corner of the blade. The bevel permits scraping off just the right amount of excess

putty and serves as a gauge to keep the angle of the putty uniform. The bevel also is useful when working in the corners of the pane, as it allows the knife to fit against the putty already in place in the adjacent rabbet of the sash.

## Replacing Knob-Insulator Washers

When the leather shock washers used to cushion the nailhead on knob insulators become worn, rubber faucet washers make good substitutes. Being thicker than the leather ones, the rubber washers better protect the knobs from being cracked or chipped when nailing them in place. Also, the rubber has more resiliency, thus providing a tighter grip on the top of the insulator.

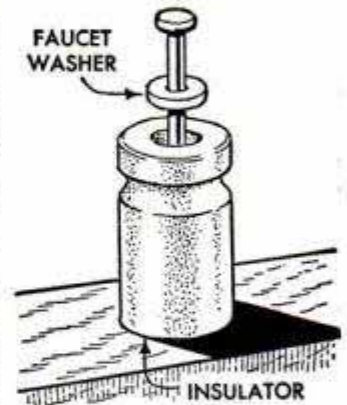

W. H. McClay, Pasadena, Calif.

## Pendant for Pull-Chain Socket Improvised From Pencil Eraser

If the small metal pendant on a pull-chain socket escapes your grasp, a better grip is provided by using a slip-on pencil eraser at the end of the chain. Besides affording a larger object to grasp, the eraser makes a neat pendant. To attach it to the chain, simply slit the eraser lengthwise on one side, open it up and place it around the metal pendant.

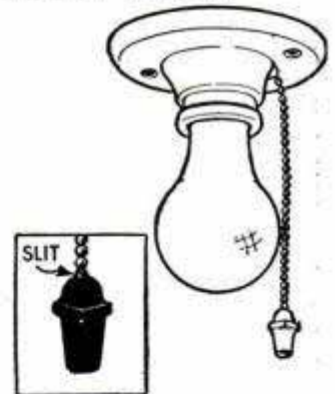

## Thumbtack Seals Glue Tube

Tubes of cement or glue from which the screw-type plugs have been lost, can be capped by inserting a thumbtack in the tube opening. As the head of the thumbtack is easy to grip and the tack does not have to be turned into the tube, it is removed and replaced more quickly than the original plug.





# Weight of Christmas Tree Locks Novel Stand

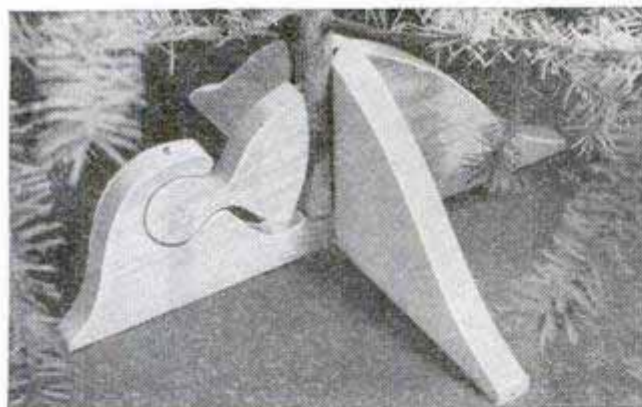

The unusual clamping-dog arrangement of this wooden stand securely holds Christmas trees of any size likely to be used in the home. The weight of the tree causes the dog to grip the trunk tightly, and a V-groove in one side of the crosspiece prevents the tree from slipping sideways. The dog is slotted, and a nail is driven through the curved arm of the frame to hold the dog in place without interfering with the hinging action.

Benj. Nielsen, Aurora, Neb.

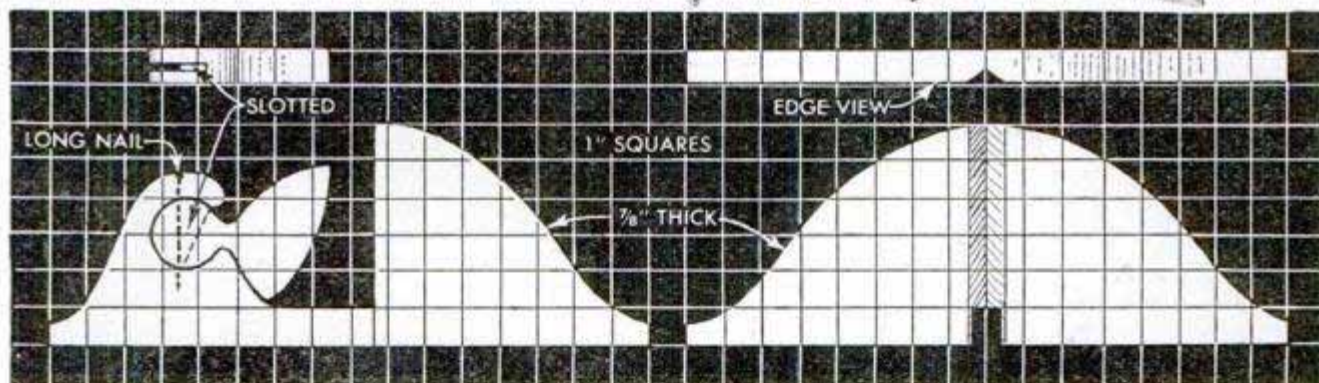

# Caliper for Inside Measurements Made From Clothespin and Sticks

Needing a measuring tool to determine the exact width of a linen closet so that shelves could be cut to fit, I devised this three-piece sliding caliper. It's made from a clothespin and two flat sticks, the latter being thin enough to slide snugly, on edge, through the slot of the clothespin. A small pin keeps the two sticks in the slot and stop pins in the edges of the

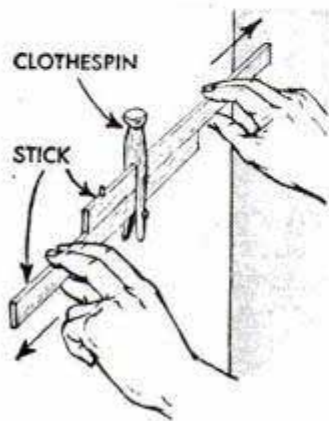

sticks prevent them from being pulled all the way out. In use, the tool is extended between the walls of the cabinet until the ends of the caliper touch the sides. Then, without disturbing the setting, the caliper is removed and laid on the work.

Edward Rivard, Leonminster, Mass.

# Lighter Fluid Aids Igniting Candles

Lighter fluid applied to the wicks of ceremonial candles overcomes difficulty in lighting them. Within an hour or so of the ceremony, light each candle, allow it to burn a short time, blow it out, and then pour three or four drops of lighter fluid over the wick. The fluid will run into the molten wax where it is retained.

# CONTACT

By George R. Cryder



**F**EATUREING a lightproof drawer for printing paper, this easy-to-build contact printer will be one of your favorite pieces of photographic equipment. It handles negatives up to 4 by 5 in. and offers all the refinements of the commercial product at exceptionally low cost. The novel printing-paper drawer, Fig. 2, will save you considerable time and effort by eliminating the need for opening the envelope each time a sheet of paper is needed. Of course, the printer can be built without the drawer if you wish. It also can be made to take larger-size negatives simply by increasing the dimensions and lights proportionately.

Construction of the printer is detailed in Fig. 3. The drawer and the sides and top of the cabinet are of  $\frac{1}{4}$ -in. plywood, while the bottom and the false bottom above the drawer are of 1-in. solid stock. Cleats of 1 by 1-in. material around the upper edge of the cabinet support the top. A pressure handle, made as shown, is hinged to the top of the cabinet and raised by a small steel spring.

The unit is fitted with five lamp sockets and a snap switch, wired as indicated in the wiring diagram, Fig. 3. A red,  $7\frac{1}{2}$ -w. safelight is inserted in the center receptacle and 10-w. lamps in the four others for even distribution of light. The switch controls the printing lamps but does not break the safelight circuit, allowing it to remain on until the plug is disconnected. Opal glass is preferred for diffusing the light but, if it is not available, a suitable substitute can be made by sandwiching a piece of tracing paper between two pieces of clear glass.

Although the platen and glass from a manufactured printing frame were used on the original printer, a platen can be made from two pieces of plywood. Ordinary window glass may be used for the printing-frame glass which is countersunk flush with the top of the cabinet. The bottom of the platen should be covered with felt and the two wooden sections joined with a piano hinge or two small butt hinges. Standard masks were fitted to the printer as shown in Fig. 1. However, if you wish to make your own masks, either very thin sheet metal or col-

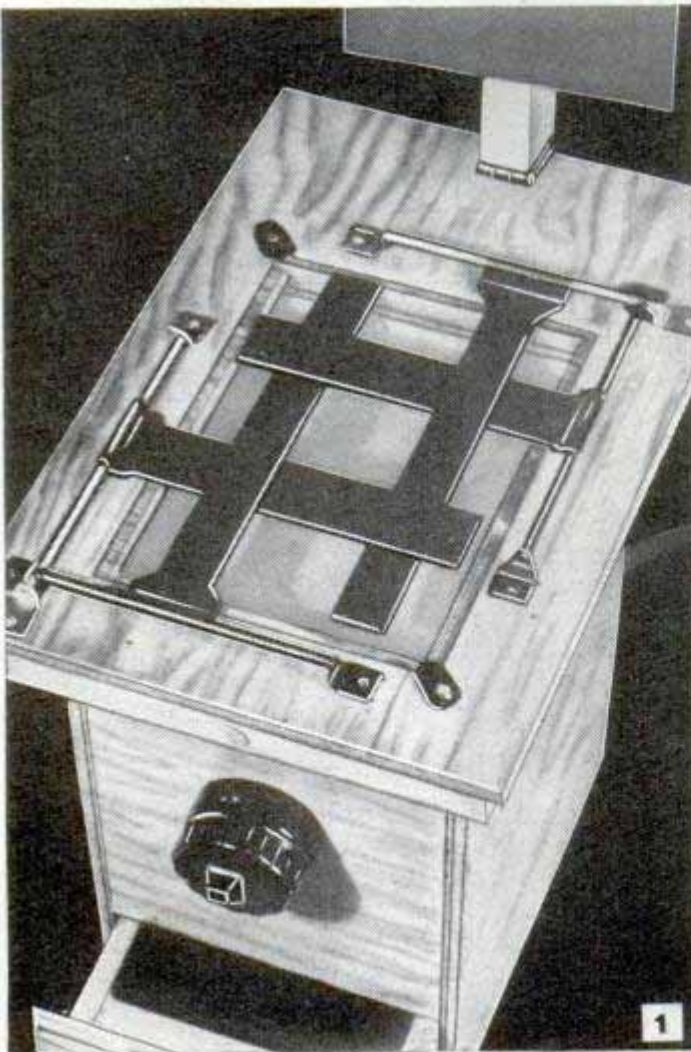

# PRINTER

ored celluloid (red or black) will suffice. Should you make them, keep in mind that the strips should be as thin as possible so the edges of the prints will be in focus.

When assembling the printer, make sure that all parts are a tight fit to prevent light leakage. The edges of the cabinet should be glued as well as nailed together for maximum strength. Better light reflection will be had if the inside of the printer is painted a glossy white. Black paper from a printing-paper envelope serves as a lightproof lining for the drawer.

In mounting the printing-frame glass in the top of the unit, be sure that the rabbeted edges of the opening will bring the glass flush with the top. After the printer has been assembled, sand the outside wooden surfaces and stain or paint as desired.

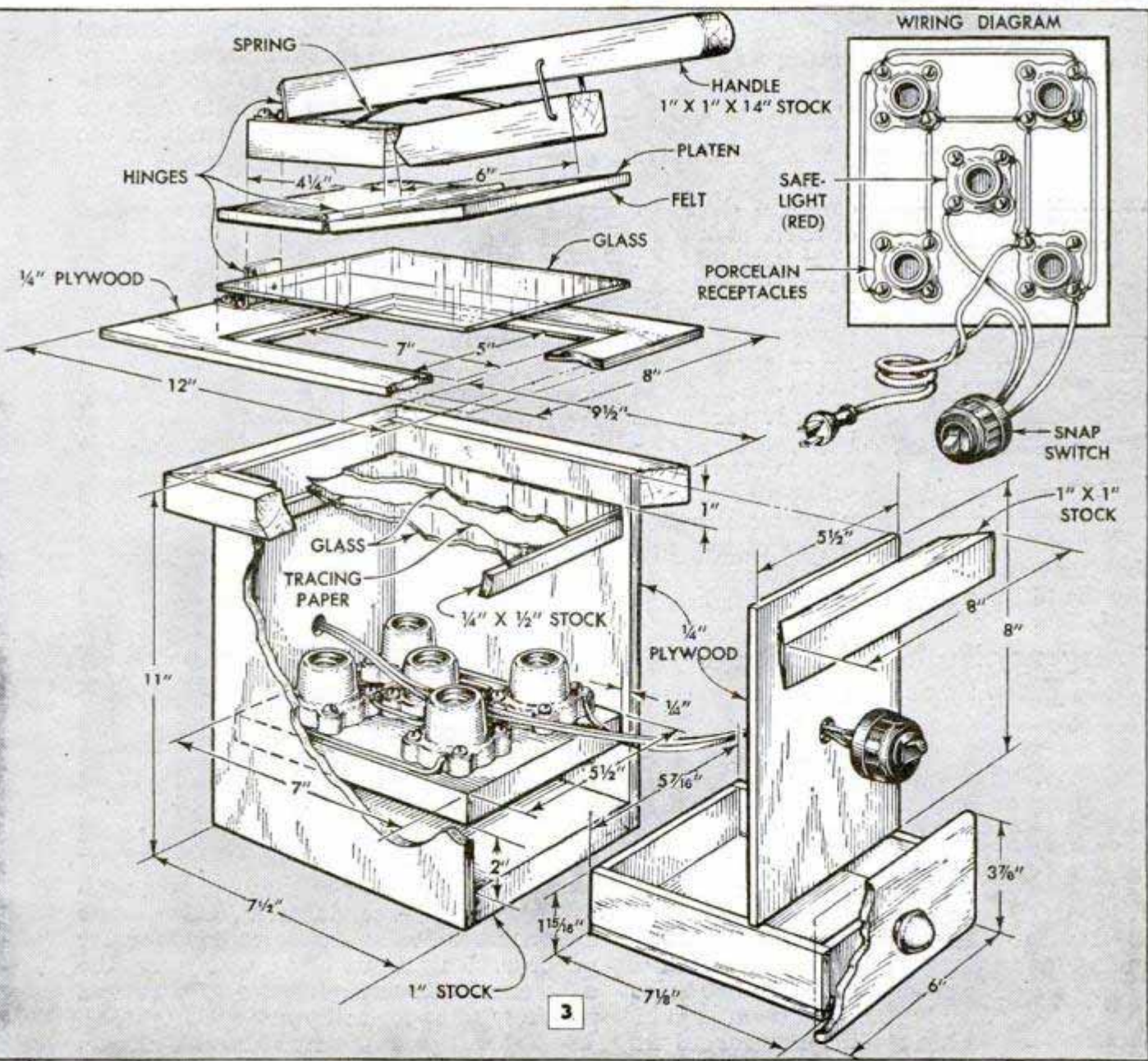
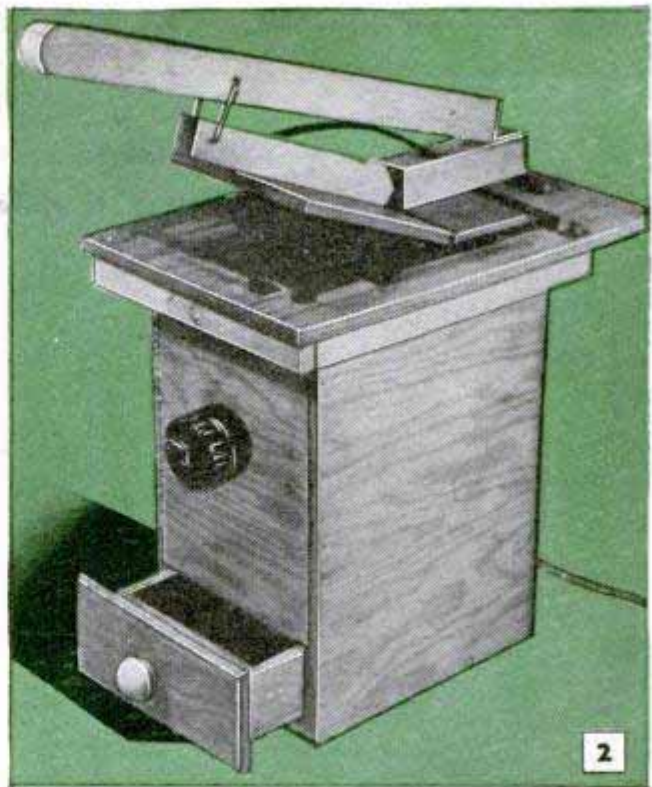

## Rubber Glove Filled With Ice Cools Photo Solutions

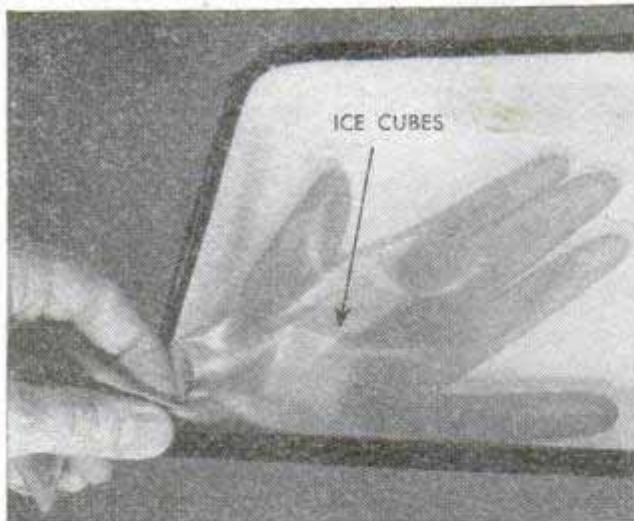

An excellent way to cool photo solutions is to place a rubber glove, partly filled with ice, in the tray. The glove will hold several ice cubes and the rubber prevents the solution from becoming diluted. The open end of the glove can be held closed with a rubber band or tied with string.

## Tape Identifies Print Tongs



tape around a leg of one pair of tongs so that his thumb would contact it and identify the tongs readily even in dim light.

Unlike plastic print tongs, which come in different colors, stainless-steel tongs used in developer are easily mixed with those used in hypo. As it is important not to contaminate developer with hypo, one dark-room worker wrapped water-

proof adhesive

## Emergency Flash-Bulb Reflector Made From Paper Plate



A flash-bulb reflector for emergency use can be made from a paper plate. To make the reflector, cut a wedge-shaped segment from the plate and join the edges to form a shallow cone. Then cut a hole in the center to fit

around the base of the bulb. The reflector is held together with staples or paper clips. If desired, you can apply aluminum paint to the inside of the plate, or a good reflecting surface can be had by pasting tin foil to the paper, smoothing out the wrinkles.

## Darkroom Timer Preset By Rubber-Band Stop

Photo timers not equipped with a starting lever, which permits them to be set for a certain interval and later started in total darkness, can be made pre-setting by snapping two or three rubber bands



and the dial pointer as shown. To use, set the timer for the desired interval in light and wrap enough loops of the bands around the pointer to hold it at the proper setting. Then, when you are ready to time the development, all you have to do to start the timer is feel for the rubber bands in the dark and slip them off the pointer.

## Cord Substitutes for Tripod

As an exposure greater than  $\frac{1}{25}$  sec. frequently produces blurred pictures when a camera is held by hand, I use a length of strong cord as a tripod to steady the camera against body movement. The cord is tied in a loop long enough to pass under the feet and over the bed of the camera as shown. Thus, by pulling up on the camera, the tension of the cord helps to steady it while snapping the picture. In this



way, I am able to take sharp photos with exposures of  $\frac{1}{2}$ -sec. duration. Carpenter's chalk line provides excellent cord for the purpose. This stunt often will mean the difference between getting a picture and missing the opportunity altogether.

Bob Hurst, Chicago.

# Dimmer Switch Controls Photoflood Lighting

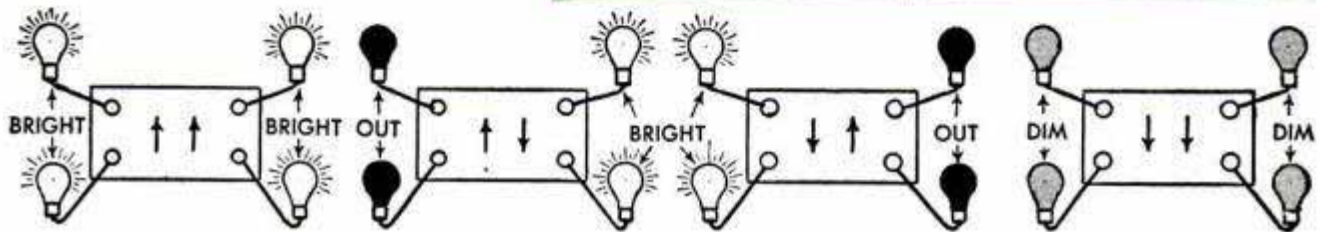
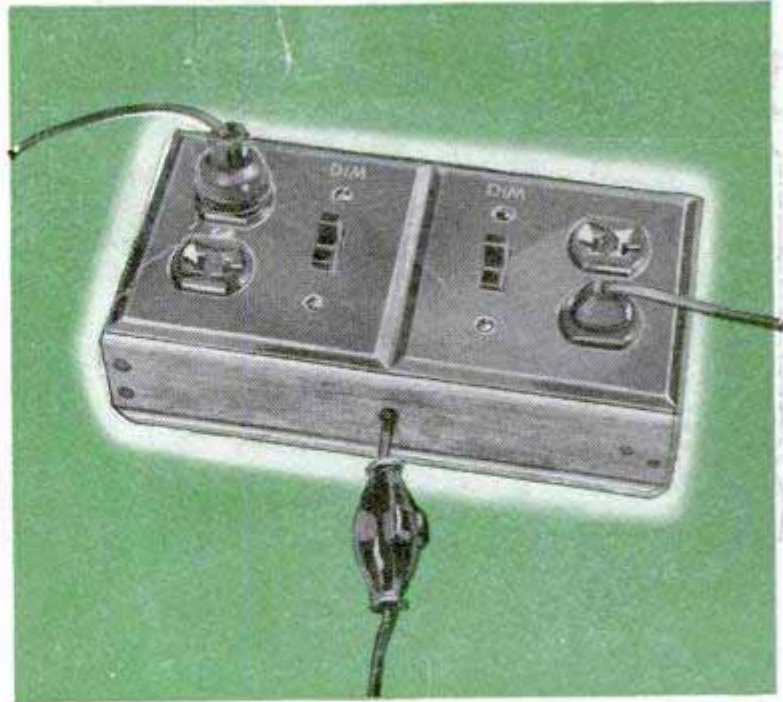
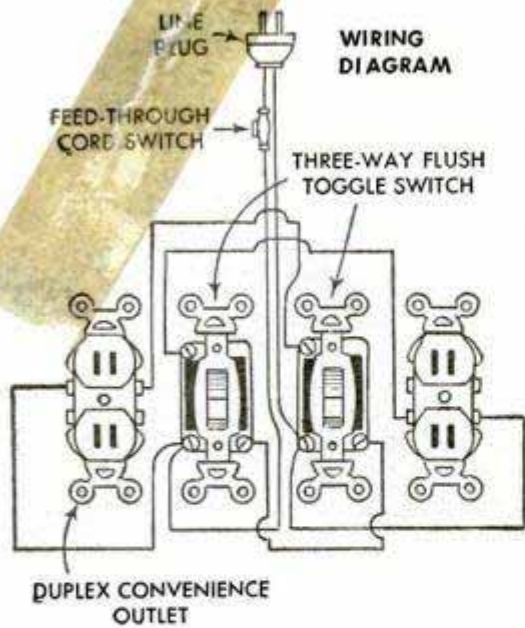

Better indoor shots and more of them can be had from your photofloods if you control the lamps with this handy dimmer switch. Besides lengthening the life of the lamps by dimming them for focusing purposes, the switch makes balancing the light convenient when using lamps for both front and back lighting. Being wired to light the lamps separately or simultaneously, in addition to dimming them, the switch permits a light reading to be taken with either the front lights or the back lights on. The dimming feature also adds to the comfort of your model. The unit

consists of two 3-way, flush-type toggle switches, two duplex convenience outlets, two wall plates and a feed-through switch in the line. The switches and outlets are wired side by side, following the wiring diagram, and are enclosed in a wooden case. The unit will handle four photoflood lamps, but do not use this many simultaneously unless you are sure that the circuit will carry the load. Most house circuits, fused for 15 amp., will safely handle four No. 1 photoflood lamps. If you need more than four lamps or ones of greater size, connect them to two or more circuits.

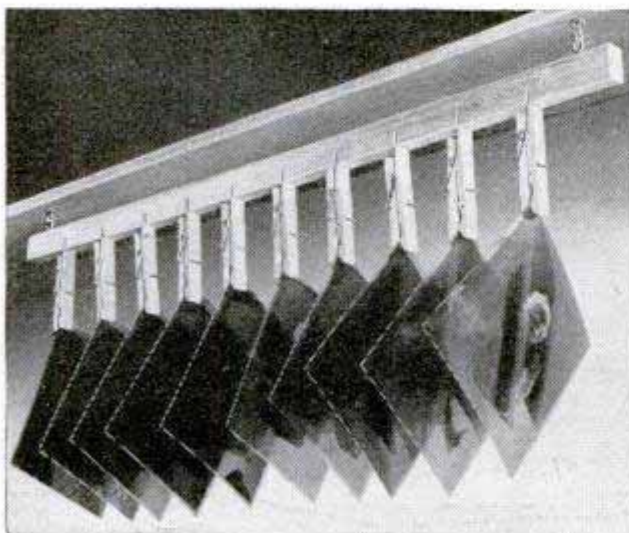

## Negatives Dried on Clothespin Rack

Several spring clothespins and a strip of wood  $\frac{5}{8}$  in. square furnish the material for an excellent negative drying rack. To make the rack, cut one of the legs of each clothespin  $\frac{5}{8}$  in. shorter than the other. Then cut slots about 2 in. apart and  $\frac{1}{2}$  in. deep in one edge of the wooden strip, making them wide enough to take the longer clothespin leg. Finishing nails hold the clothespins in the slots. Two screw eyes turned into the side of the strip opposite the clothespins and near each end complete the unit. It is suspended under a shelf or cabinet by means of small hooks.

Madison Devlin, San Francisco, Calif.

## Nails in Legs Elevate Furniture To Simplify Painting

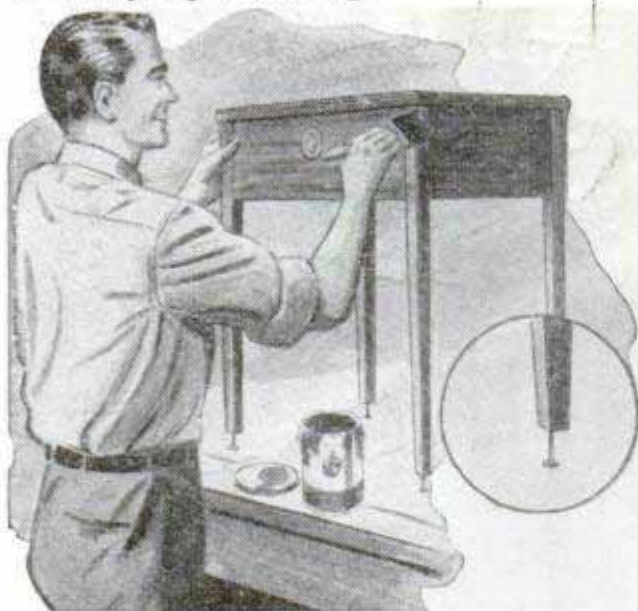

To do a better job of painting or varnishing chairs, occasional tables and other lightweight furniture, try driving a nail into the bottom of each leg to raise the piece above the bench top. This makes it easier to brush the finish down to the ends of the legs and keeps paper used to cover the bench top from sticking.

## Tire Chains Wrapped in Burlap

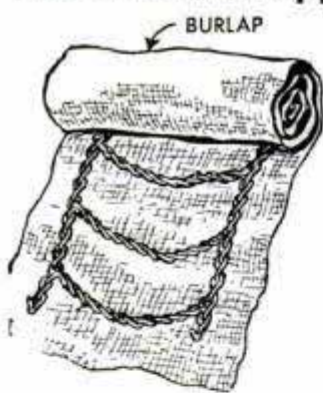

Not only will wrapping tire chains in burlap prevent them from becoming tangled, but it also eliminates the annoying rattle of loose chains in the trunk. Cut a strip of burlap or heavy cloth for each chain, making it

slightly wider and longer than the chain itself. Then, laying the chain flat on the burlap, roll the two together.

Edward J. Monroe, Schuyler Lake, N. Y.

## Slipping of Glued Wood Prevented



Nailing together 2 pieces of wood being glued to keep them from slipping when clamps are applied is undesirable because it mars the work. However, it is not necessary to nail

the pieces together if a few grains of sand are sprinkled on the glue. As pressure is applied, the sand will be embedded in the wood and prevent slipping and displacement of the parts. The sand should be sprinkled near the center of the work away from edges that will be machined.

## Piepan Provides Steering Wheel For Homemade Racer

In addition to being sturdy and good looking, this easily built steering wheel for a homemade racer costs very little to make. It consists of an 8-in. piepan and a 7-in. disk of hard-pressed board or plywood fastened to a  $\frac{3}{4}$ -in. pipe flange with 4 bolts. These parts are bolted together loosely and a  $\frac{1}{2}$ -in. rubber hose is cut to length to fit in the groove formed by the piepan and disk. Next, a length of heavy wire (coat-hanger wire will do) is threaded through the hose and its ends are twisted to draw the ends of the hose tightly together. After the ends of the wire have been cut short and tucked into the hose, the piepan and disk are dismantled. Then, bicycle rim cement is spread around the sloping edge of the piepan and the unit is reassembled with the hose in place between the piepan and disk. This time, the parts are bolted tightly to the flange. A length of  $\frac{3}{4}$ -in. pipe provides a steering column, and before the wheel is mounted a locknut is turned on the pipe threads. When the wheel has been screwed on the pipe, the locknut is tightened against the flange to prevent the wheel from backing off as it is turned to the left.

Thos. W. Benson, Philadelphia, Pa.

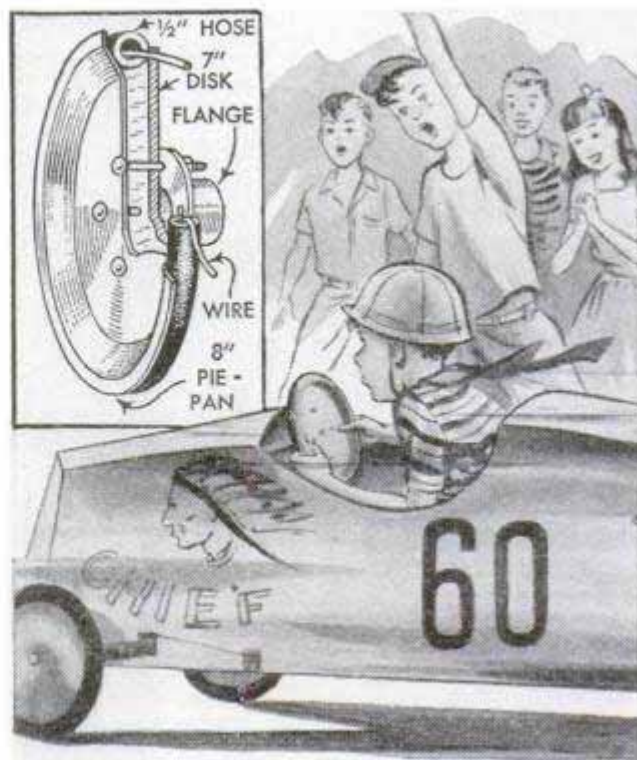



# Shop Notes

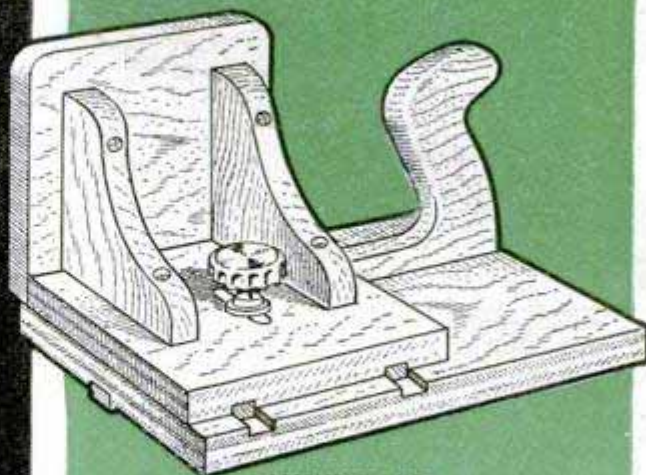
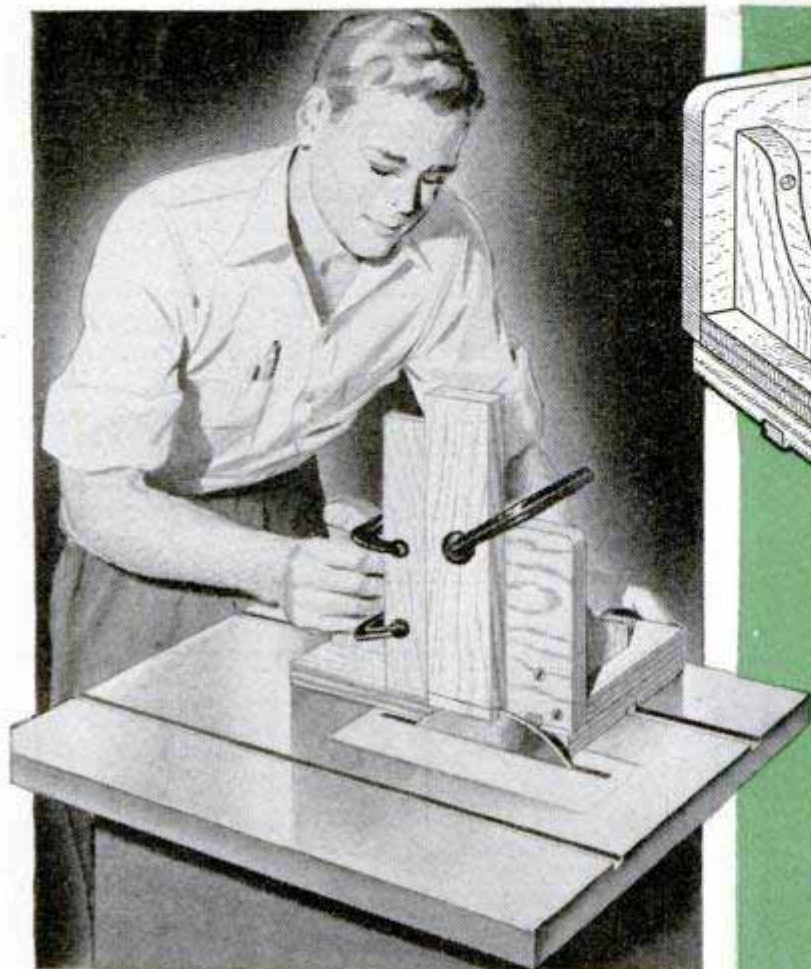

ASSEMBLED JIG

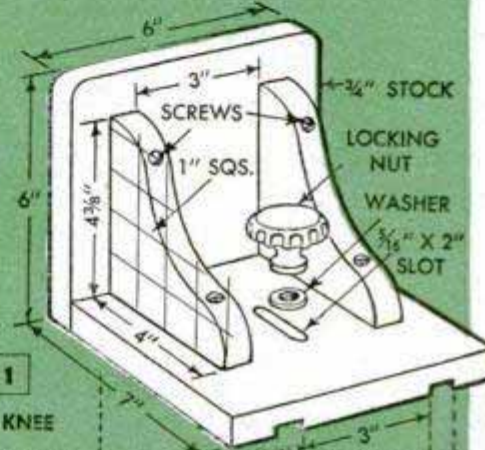

1

KNEE

3/8" X 1/2" X 7" HARDWOOD KEYS, PRESS-FIT IN SLOTS

3/4" PLYWOOD HANDLE

HANDLE

1" SQS.

3/16" X 2" BOLT

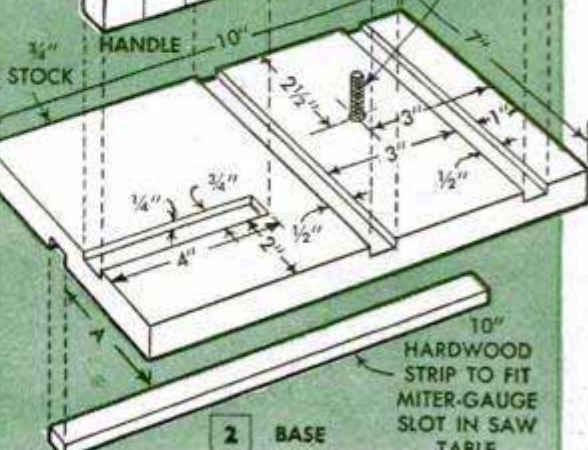

2

BASE

10" HARDWOOD STRIP TO FIT MITER-GAUGE SLOT IN SAW TABLE

## TENON JIG SLIDES IN TABLE SLOT

NOT ONLY is this wooden jig invaluable when sawing the cheek cuts of tenons, but it is a saw attachment that should be in every home workshop because it affords maximum safety in cutting tenons of small size. The jig is designed to slide in the table groove provided for the crosscut guide, and when its handle is grasped and pushed forward like a hand plane, the jig feeds the work parallel with the blade. Thus, with the work clamped to the jig and the hand away from the blade, the chance of injury is remote when cutting even the smallest tenon.

By using two saw blades spaced with a collar equal to the thickness of the desired tenon, both cheek cuts can be made at one time, after which the shoulder cuts are made in the usual way. In addition to speeding the operation, the jig permits cutting an accurate tenon of uniform width regardless of

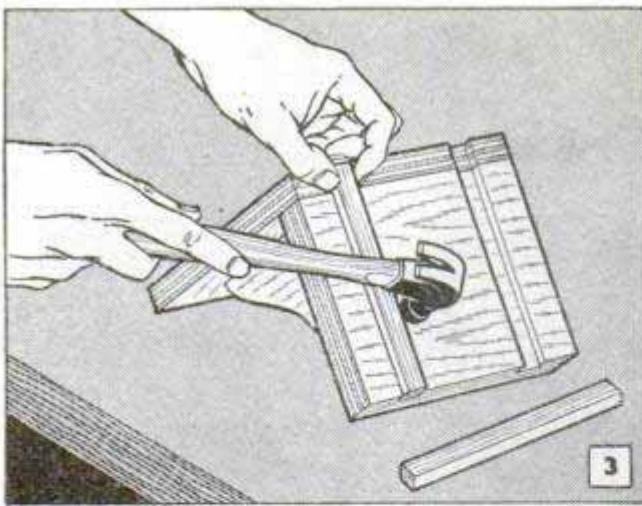

the irregular thickness of work being cut.

The original jig was made in two separate parts: the knee against which the face of the work is placed, and the base which has a runner on the bottom to fit the table groove. Figs. 1 and 2 detail these parts respectively. The knee has runners on the underside, Fig. 3, that engage grooves in

the top side of the base, so that the former is adjustable laterally to suit the thickness of the work. The knee is locked in position with a handwheel.

In running the dados for the knee runners, cut corresponding grooves in both pieces at the same fence setting. That is, set the saw fence 1 in. from the blade and run a dado in the knee and one also in the base. Then move the fence for the second cut. In this way, corresponding dados will align perfectly. It is important that the dados be cut exactly at right angles to the base as the face against which the work is clamped must be parallel with the blade. A shoulder or stop for the work is clamped to the face of the knee to suit the end of the work. If the tenons are to be cut on work having square ends, the stop, which is simply a wooden block, is clamped perpendicular to the surface of the saw table. If a miter tenon is to be cut, the stop is clamped in a 45-deg. position or at whatever angle is required. Thus, the stop is used to position the work in relation to its end.

## Heavy Tractor Weights of Concrete Cast in Flat-Rimmed Wheels

Permanent forms for casting concrete weights for rubber-tired tractors are improvised from discarded tractor front wheels having flat rims. Such wheels usually can be picked up in a junk yard. Remove the spokes from the wheels, leaving only short stubs at the rim end to embed in the concrete. Any can of suitable size will provide an inner form for the hub opening. Bolts may be embedded in the concrete and spaced to span the tractor-wheel spokes, or the concrete can be cored to take U-bolts. If regular bolts are used, metal plates are needed to center the weight on the wheel.

A. M. Wettach, Mt. Pleasant, Iowa.



## Clipping Papers to Spindle Facilitates Handling

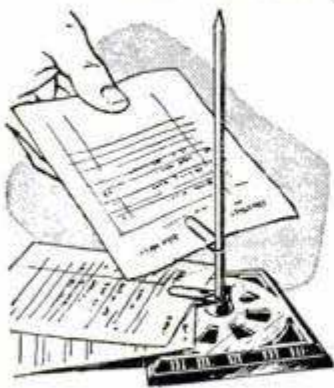

Shipping orders, invoices, etc., will not be punctured or torn if they are attached to a spindle with paper clips. In addition, this method permits a particular paper to be taken from the spindle without tearing it off or removing

the papers above it. Also, papers can be filed in any desired order by first placing a number of clips on the spindle and then attaching the papers to the clips.

H. Klein, Pittsburgh, Pa.

## Magnetized Sheet-Metal Masks Speed Spray Painting

In our sheet-metal shop we use lightweight metal jigs to mask the finished pieces for production paint spraying. However, the jigs had a tendency to lift up when the spray gun was passed over them, thus spoiling the paint job. I corrected this trouble merely by magnetizing the jigs so that they would hold fast to the work. In this way, we saved much time and extra work.

L. Justin Basher, Lancaster, N. Y.



# Wall Cabinet Contains Stepped Drill Rack

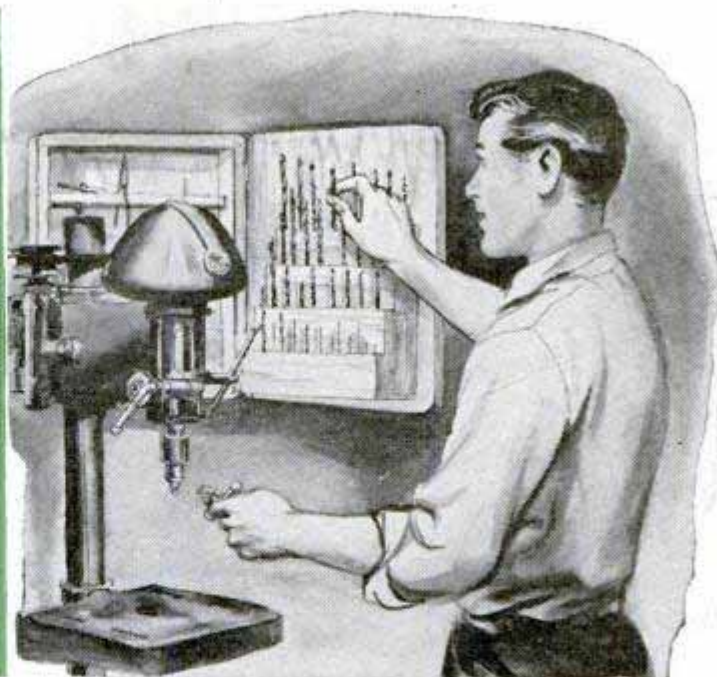
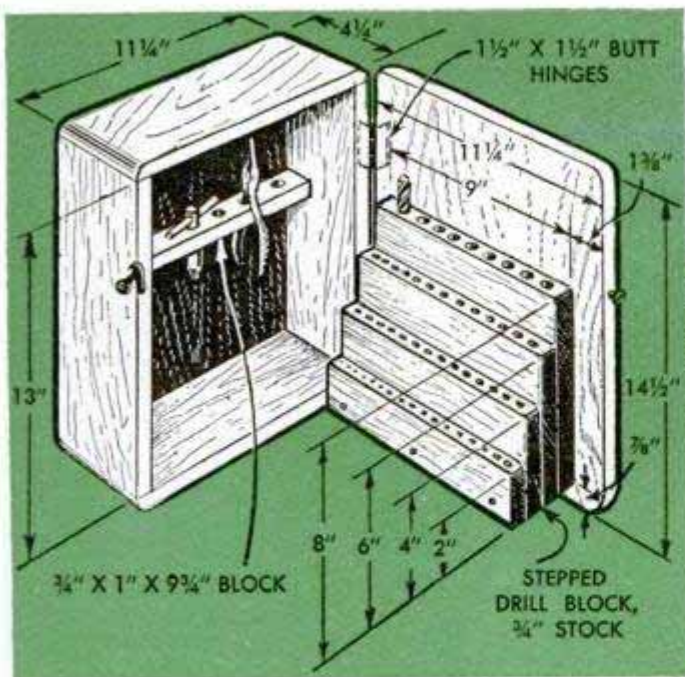

Mounted within easy reach of the drill press, this handy wall cabinet keeps an entire set of drills available for immediate selection. Both cabinet and drill rack are made of  $\frac{3}{4}$ -in. white pine, the rack consisting of four blocks of wood of increasing width fastened to the inside of the cabinet door. A shelf across the back of the cabinet holds wrenches, micrometer and other necessary tools. The drills are stored upright in blind holes drilled in a row along

the top edge of each block, each hole being made with a drill of the next size larger than the one the hole is to retain. After the blocks have been drilled, the holes are labeled appropriately and the blocks are nailed and glued together as shown. Then they are attached to the cabinet door in the same manner. The door is hung on butt hinges and is held closed with a hook or with a hasp and padlock.

Dick Hutchinson, Alhambra, Calif.

## Collet Chuck Is Compressed by Knurled Cap Instead of Draw Rod

Here's a collet chuck that differs from the draw-in type in that a knurled cap instead of the draw rod usually employed compresses the collet. It also has the fea-

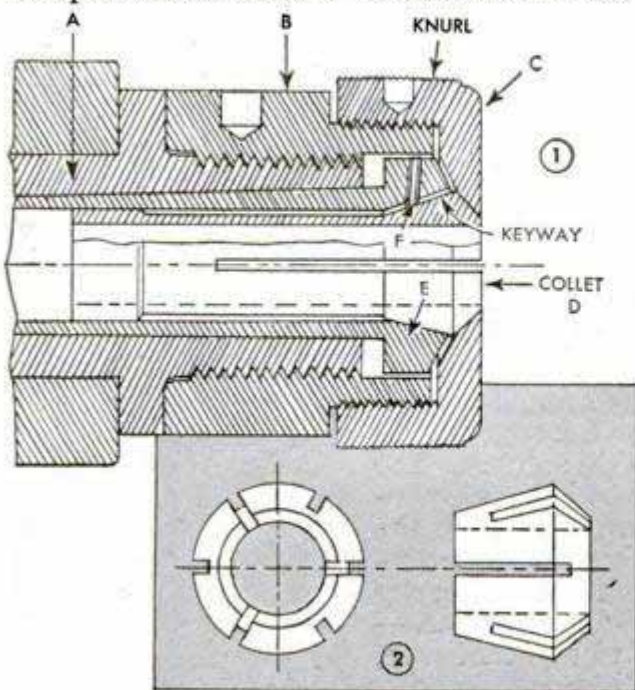

ture of admitting larger collets. The lathe spindle, part A, first is fitted with a hardened and ground taper sleeve, part E. Next, part B is machined and threaded to fit the lathe spindle, after which the part is drawn up tightly against the shoulder of the spindle with a spanner wrench. The outer end of part B has a fine thread for a knurled cap, part C. Note that the hole in the cap is beveled on the inside to match the taper on the front end of the collet, Fig. 1. Pressure at this point, when the cap is tightened, causes the collet to grip the work. A pin, part F, pressed into part E, prevents the collet, D, from turning. If a lathe does not have a hollow spindle, the chuck can be adapted for use by lengthening part B and using the short collet shown in Fig. 2. In this case, of course, only short work could be held in the chuck.

Wm. E. Helsel, Grand Rapids, Mich.

☐ Pipe-threading compound brushed on the teeth of a hacksaw increases the cutting speed of the blade and prolongs its life.

## Laying-Nest Unit Has Hinged Bottom To Permit Rapid Cleaning

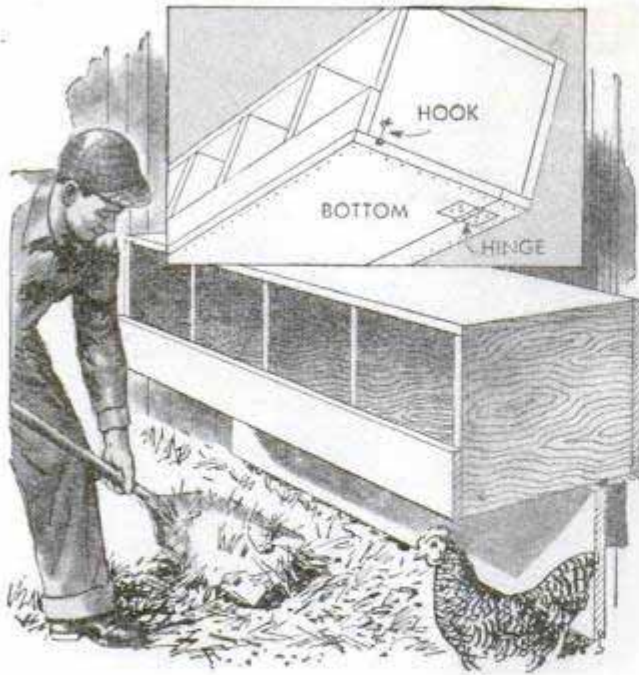

When constructing a laying-nest unit, one poultryman found that he could simplify cleaning the unit by hinging the bottom. A hook and eye at each end of the nest holds the bottom in the closed position.  
Opie Read, Jr., Chicago.

## Stairway on Storage-Tank Pipe Facilitates Operating Valve

This steel stairway welded to the inlet pipe of a huge storage tank provides easy access to the valve and a sure footing for the operator. The steps and platform are made from steel floor plates, the steps being cut to fit the curvature of the pipe. A

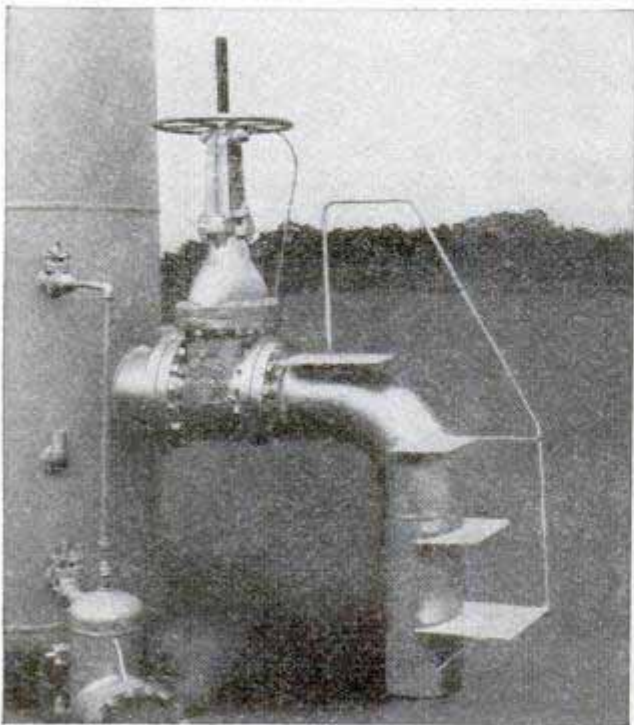

handrail of  $\frac{1}{2}$ -in. rod is an additional safeguard. Painted aluminum, the stairway requires little or no maintenance and does not interfere with changing or working on the valve.—Elton Sterrett, Houston, Tex.

## V-Block Adapts Lathe Dog For Small Work

Where only one lathe dog is at hand and the clamping screw does not advance far enough to handle small-diameter work, the dog can be adapted for this purpose by fitting it with a V-block insert. The insert is made by tracing the inside contour of the dog on a piece of flat brass  $\frac{3}{8}$  in. thick. Then, this is cut and filed to shape and notched to form the V-block.



## Identifying Diameter of Tubing

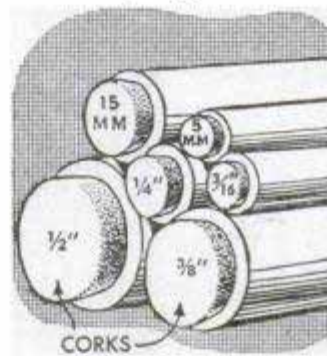

If small quantities of tubing or pipe of various sizes are stored together in one rack, here's a way you can tell at a glance the diameter of each piece. Simply insert a cork in one end of each length of

tubing and print the size of the tubing on the face of the cork. If the tubing is cut from the end opposite the cork, the piece will be identified permanently.

Jo Ro Jung, Jr., New Orleans, La.

## Beveling Clutch-Plate Splines Aids Mounting Transmission

Guiding the transmission shaft into the splines of the clutch-plate hub is simplified by filing a bevel on the edges of the hub splines. The beveled edges permit the end of the shaft to center itself and be easily slid into place.—Erwin S. Plavec, Chicago.

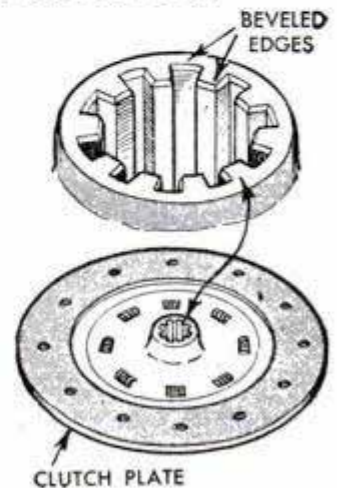

# Transmission Operates Variable-Speed Hoist

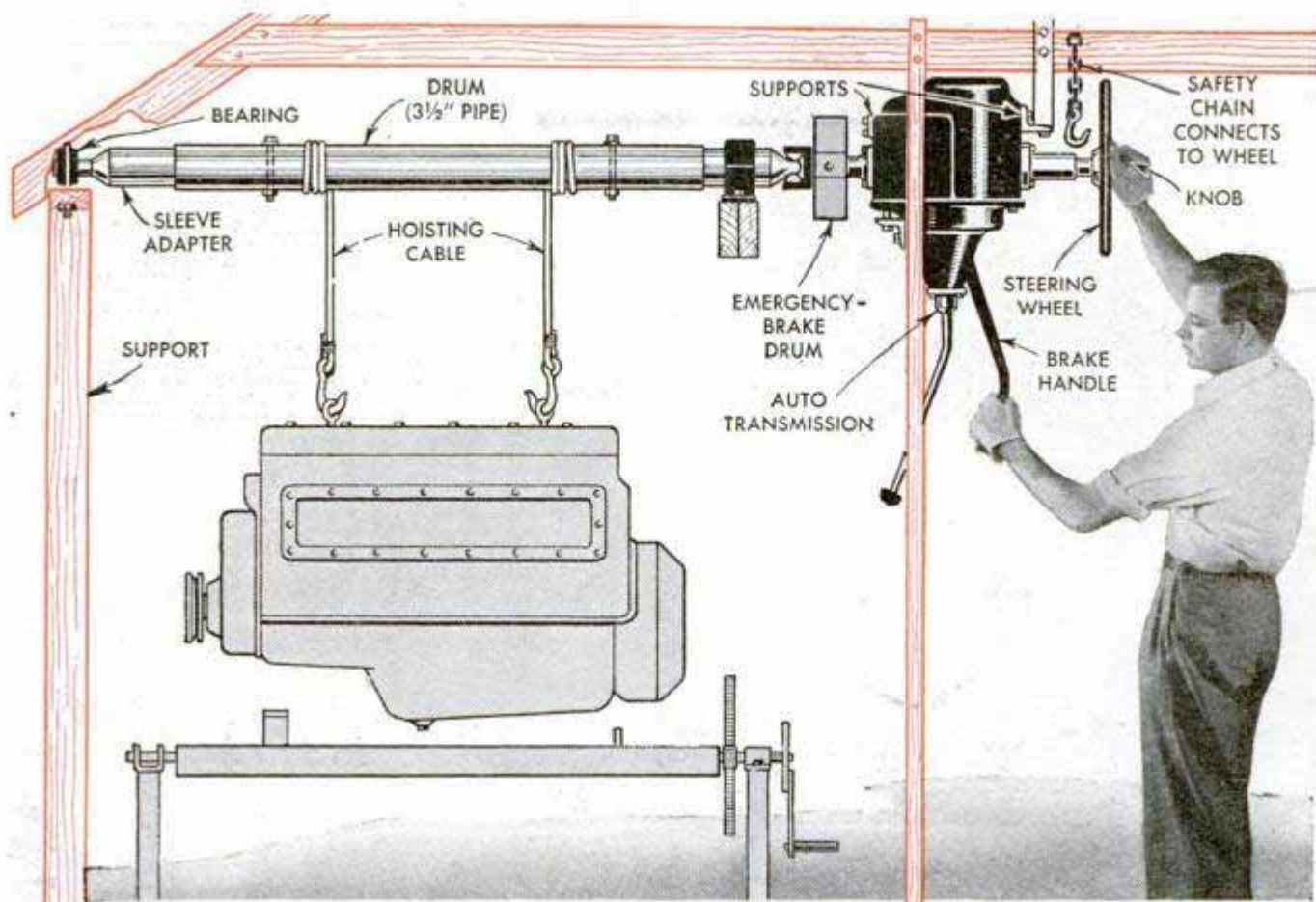

By utilizing an old auto transmission of the type having the emergency brake mounted on the drive shaft at the rear of the housing, you can build a powerful hoist for use either on the farm or in the garage. The detail above shows a typical installation with the transmission mounted upside down so that both the shift lever and the emergency-brake lever can be reached easily. The hoist is operated by an auto steering wheel attached to the forward drive shaft of the transmission. A chain with a small hook at one end is attached to the supporting framework so that when a load is raised the chain can be hooked to a

spoke of the handwheel. The drum is a length of 3 1/2-in. pipe which is slipped over the auto drive shaft and centered by means of sleeve adapters. After fitting, the parts are welded in place for maximum strength. The inner and outer ends of the drum shaft are supported in pillow-block bearings as shown. If regular pillow blocks are not available, suitable bearings can be made by cutting short lengths of pipe of the correct inside diameter and welding to lengths of flat iron to form bases. Drill the flat-iron bases so that the bearings can be attached to the frame with bolts.

Peter P. Ruppe, East Detroit, Mich.

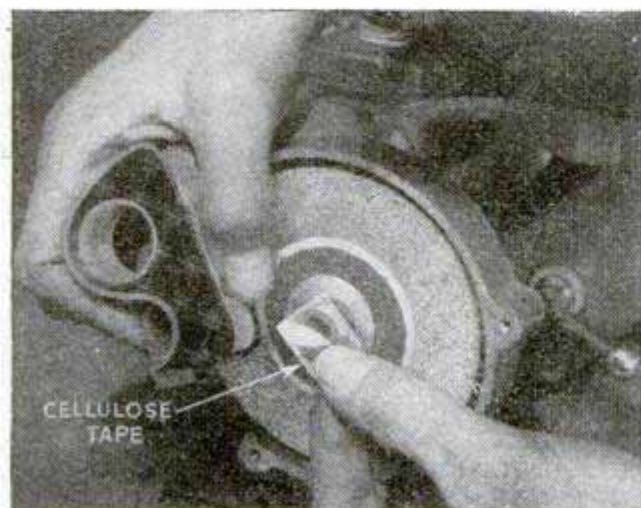

## Tape Seals Hole in Grinder Spindle To Keep Out Abrasive Dust

When using a tool-post grinder for external work, it's a good idea to seal the hole in the tapered spindle with a piece of cellulose tape. This will keep abrasive dust from entering the taper and preventing the internal grinding quills from seating properly. The cellulose tape is removed quickly when the spindle is to be used.

¶ Duplicator stencils, which are used and kept on hand for future use, produce better copies if they are rubbed on both sides with a little light machine oil before storing.

# TWO POWER SANDERS

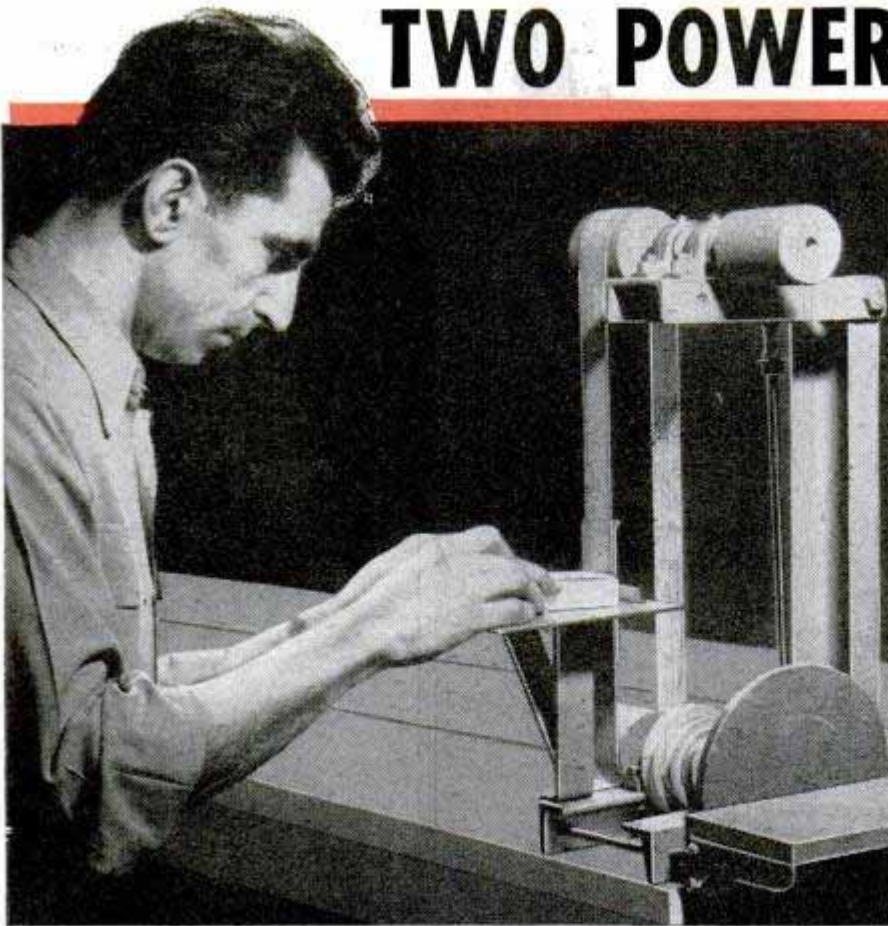

One model combines three sanders in one machine driven by a single motor. The other, a 6-in. belt sander, employs standard shaft hangers for bearings, and features positive tension adjustment. Both machines can be built at nominal cost from scrap parts

By  
**R. Barsamian**

**H**ERE ARE TWO homemade sanders that will handle practically every sanding job in the home shop. One is a combination band, disk and drum sander, while the other is a conventional 6-in. belt sander. Both can be made inexpensively, using standard parts along with odds and ends.

**Band Sander:** Figs. 1 and 2 picture and detail the construction of the combination sander. The framework is assembled from pieces of channel iron, the upright being 3-in. channel welded to a 6-in. channel base. Note that the upright is located 2 in. from one edge of the base and that a 3 by 8-in. opening is cut in the base to permit belting and driving the machine from below. The dimensions given for the frame accommodate a 45-in. standard belt. If a longer one is used, the upright must be lengthened. Holes are drilled in the top surface of the base for mounting two ball-bearing pillow blocks. These carry the drive pulley and double-end shaft which drive the sanding belt and the disk. The arm, which carries the upper bearings, also is a length of 3-in. channel iron with the web cut out at one end, as shown, and the flanges spread apart to fit over the flanges of the channel upright. The arm is drilled and pivoted to the upright with a 1/2-in. bolt, after first being drilled for two bronze-bushed pillow-block bearings and a tensional rod. In drilling the mounting holes for the pillow blocks, extra care must be taken to assure perfect alignment of both upper and lower bearings. This is important, as there is no provision for adjustment of sanding-belt trackage other than the use of shims under the pillow blocks. It is also important that the holes for the tensional rod in both base and arm be aligned accurately to avoid the necessity of shimming the pillow blocks. The hole for the rod in the arm must be elongated slightly with a round file to provide clearance. The rod, which is threaded at each end, is anchored to the base by two nuts and a lock washer. A washer and nut on the upper end provide a shoulder for the end of a 3/8-in. i.d. compression spring which bears against

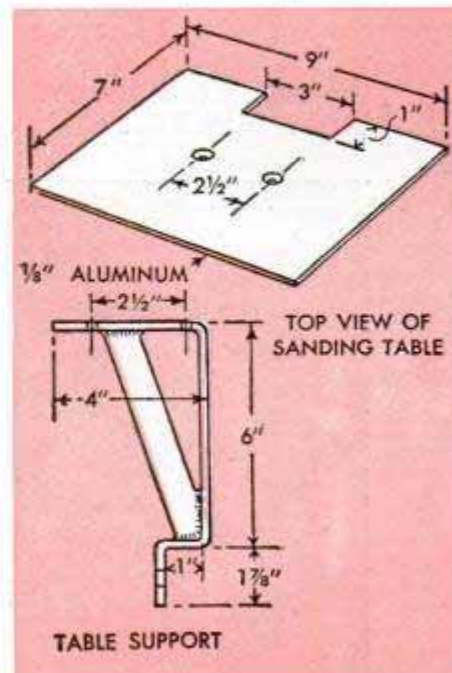
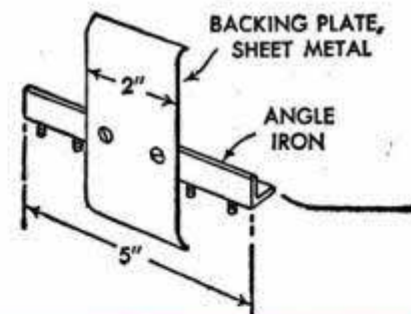

# FILL ALL NEEDS

the underside of the arm. The location of the nut and washer must suit the spring used and tension desired. The end of the rod is capped with a handwheel, which is tightened or loosened to regulate belt tension. The flanges of the channel-iron base are drilled for three studs on which the swivel blocks and table bracket are mounted. Two of the studs are formed by a single rod, one end being threaded before tack-welding the rod in position.

The idler and driving drums for the belt sander are turned to size and balanced right on their shafts. This is done by drilling a 1/2-in. hole in the end grain of hardwood blocks and pinning each block to its shaft with a nail driven crosswise through an undersize hole in both drum and shaft. Note that the drums are crowned 1/16 in. The sanding-belt table, which can be either metal or wood, is supported by a 90-deg. bracket bent and welded from 1 1/4-in. flat iron. This bracket is mounted on the threaded base stud. Note that the table is

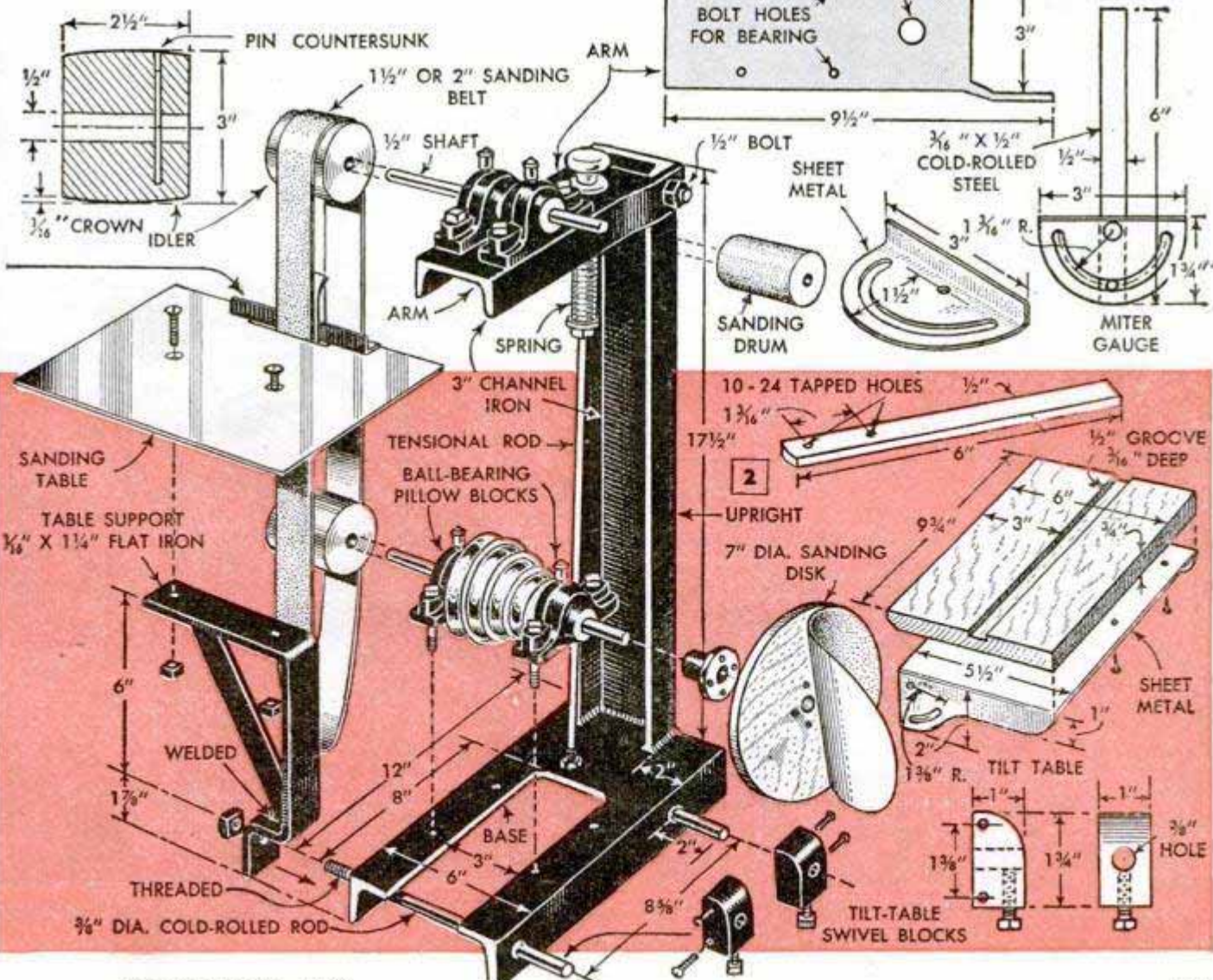
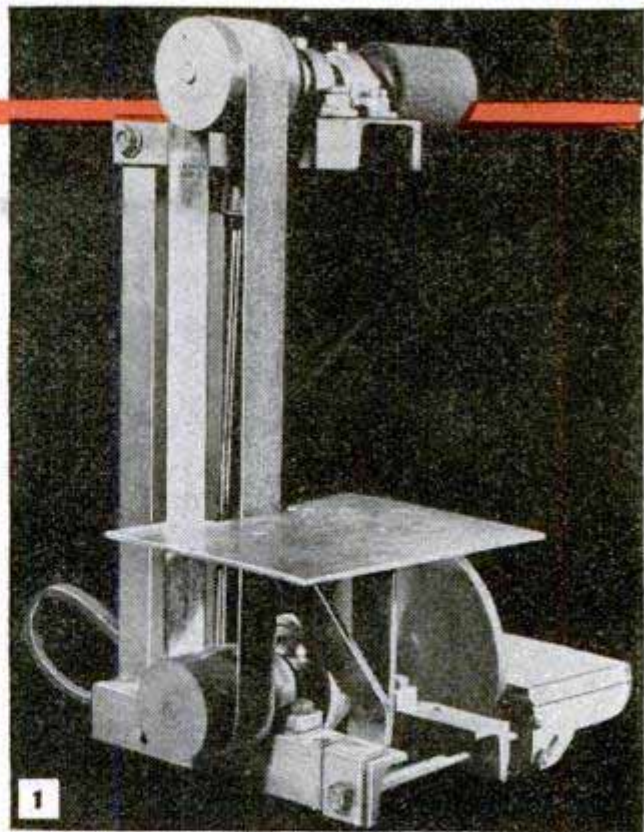

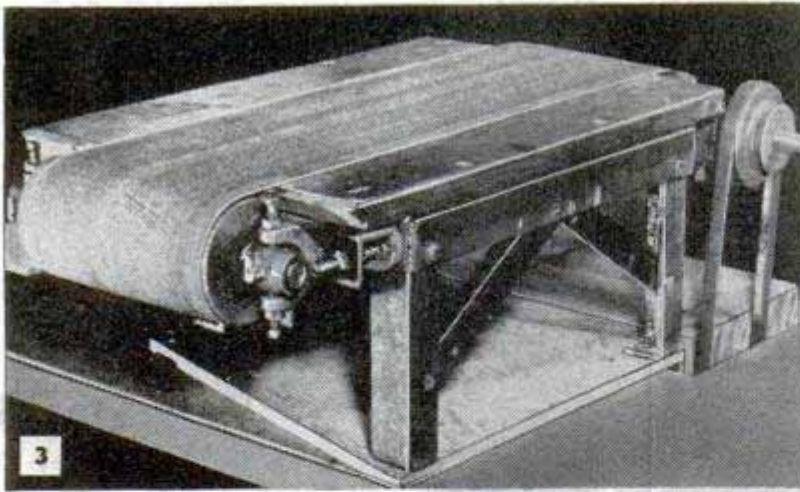

notched at the rear edge to take a backing-plate fixture for the belt. This fixture is installed after the belt is on the drums.

The sanding disk features a tilting table which accommodates a miter gauge. Swivel blocks for the table are cut from 1-in.-square bar stock, drilled to fit over the studs on the base. The top edges of the blocks are rounded to give proper clearance. Note that setscrews are provided to lock the blocks to the studs and that two small machine screws are fitted in tapped holes in the outer faces of the blocks. These screws are for the one-piece trunnion fixture which is bent from sheet metal and faced with a hardwood table, the latter being grooved to take a commercial miter gauge or a homemade one as detailed. The

front edge of the wooden table is beveled 45 deg. The sanding disk is a piece of plywood faced with sandpaper and mounted on the shaft by means of a small faceplate. A regular metal sanding disk can be purchased if you wish. Likewise, a commercial unit can be used for the drum on the idler shaft.

**Belt Sander:** This sander uses standard  $\frac{1}{2}$ -in. shaft hangers and a 6-in. endless sanding belt. The base parts of the hangers are bolted to the ends of a metal framework that is shaped and

braced as shown in Fig. 4. The top part, to which a wooden table is bolted, is bent from one piece of angle iron by drilling a small hole at the point of bend and then cutting out a 90 deg. segment or gusset as indicated in the detail. Welding the mitered corners, as well as the two rear legs, to the frame, makes an exceptionally sturdy assembly. However, the parts can be bolted together. Note that the front leg pivots to permit mounting and removing the sanding belt.

The idler and driving drums are balanced by pinning and turning them on their shafts. Belt tension and tracking adjustment are provided by a piece of angle iron drilled and tapped at each end for a  $\frac{1}{4}$ -in. adjusting screw and locknut. This piece

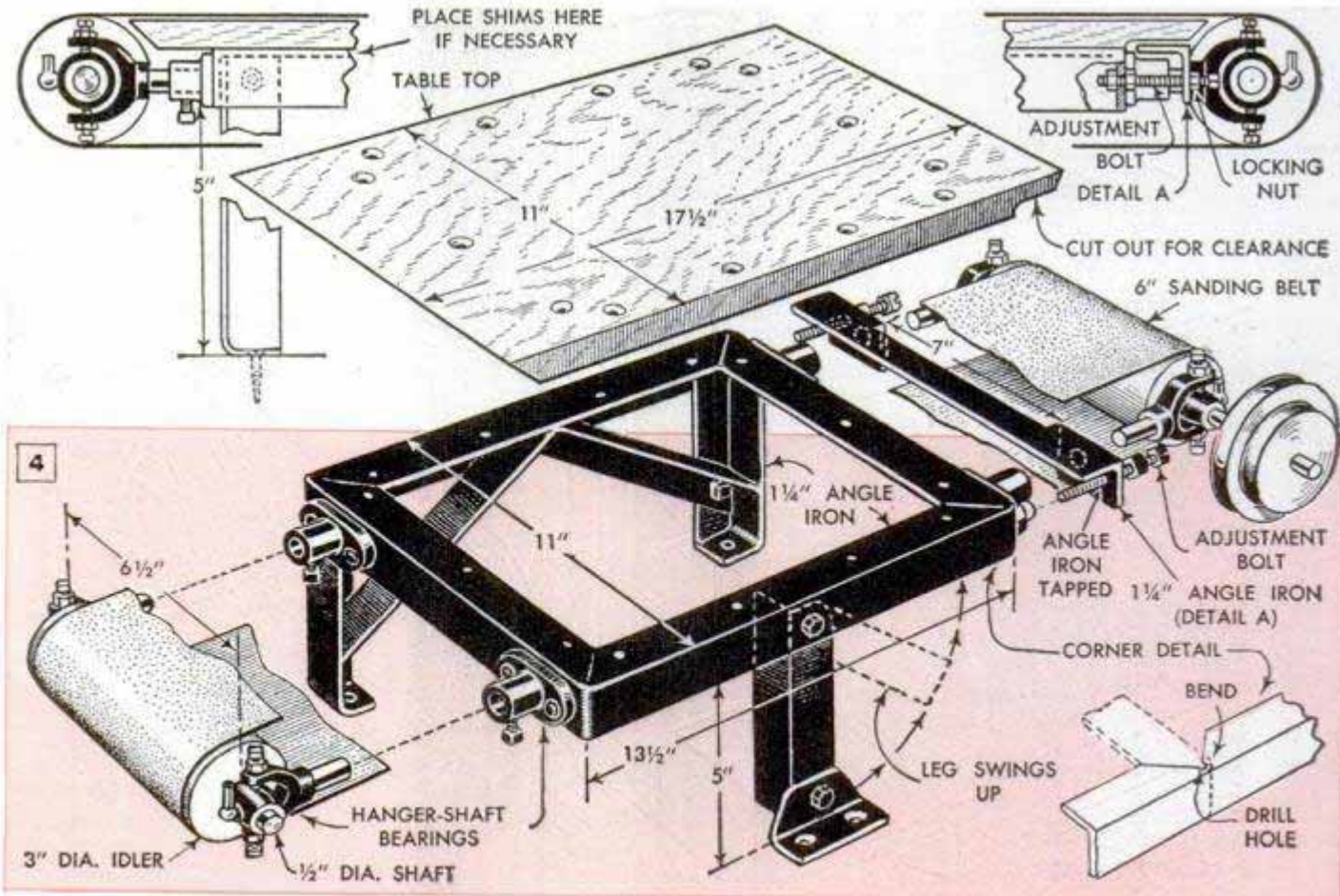

also is drilled at each end to slip loosely over the post of each hanger. It may be necessary to cut out a 7-in. section of the angle iron to give clearance for the driving drum. Belt tension and tracking are maintained simply by turning in or backing out the adjusting screws, as the ends of the screws bear against the frame and force the hangers inward or outward. You may find it necessary to rabbet the underside of the wooden table to provide clearance for the tension fixture. Also, shims may be required between the frame and wooden table to bring the surface flush with the sanding drums. While the sander is shown without a fence in Figs. 3 and 5, one can be made by clamping angle-iron supports to the rear legs of the machine and fastening a hardwood fence to them to overhang and clear the sanding belt.

Note that the pillow-block bearings of the band sander, Fig. 2, and the shaft-hanger bearings of the belt sander, Fig. 4, are fitted with either oil cups or grease fittings. A ¼-hp. motor is sufficient to operate the band sander. How-

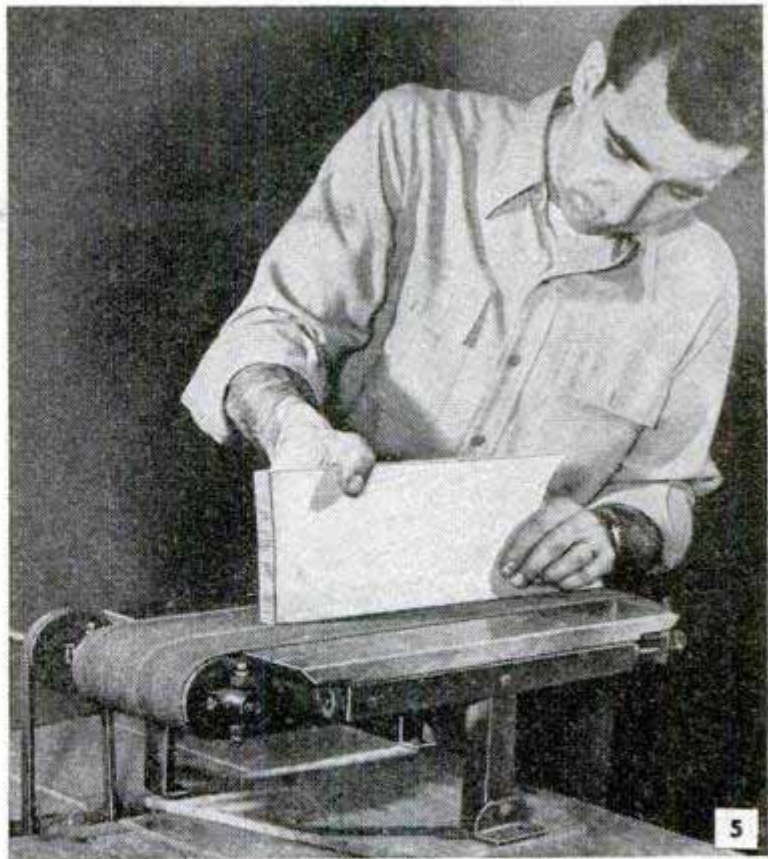

ever, the belt sander should be driven by a motor of at least ⅓ or ½ hp., especially when coarse sanding belts are used.

## Vise Equipped With Hardwood Die Serves as Sheet-Metal Brake

Sheet metal of light gauge can be formed without marring its surface by using a brake which consists of a block of hardwood cut into two parts so that the pieces come together at the desired angle. The metal is placed between the two parts of the block and a vise is used to force the pieces together. Because of the natural "spring back" tendency of most metals, cut

the block apart at an angle greater than the bend required so the metal will be bent slightly more than the desired angle. Also, flatten the corners of the block which rest against the vise jaws to keep the block from slipping when pressure is applied.

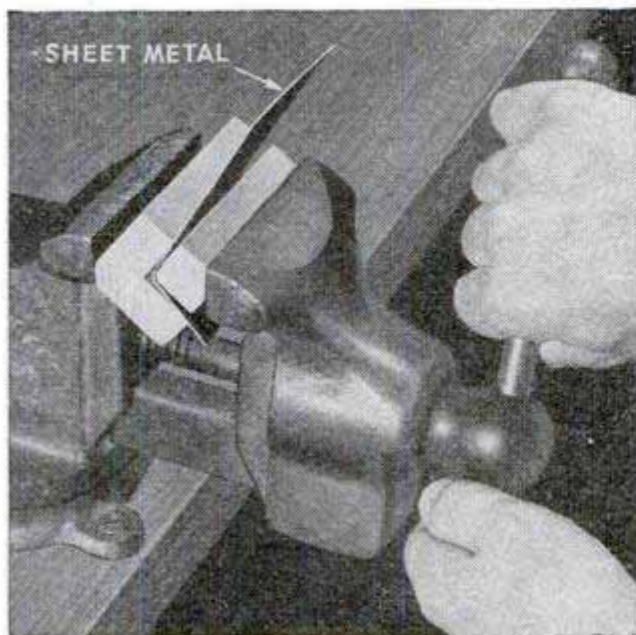

## Hairpin Makes Emergency Repair For Broken Rotor Contact Brush

Motorists caught on the road with a broken distributor-rotor brush will profit by remembering this simple emergency repair. It can be made with any bit of wire, even a hairpin, by twisting the wire around the remaining part of the brush and forming the free end of the wire into an eye.

The eye is bent upward to make contact with the center terminal of the distributor cap. While this is only a temporary repair, it will permit driving to a garage.

John Krill, Youngstown, Ohio.

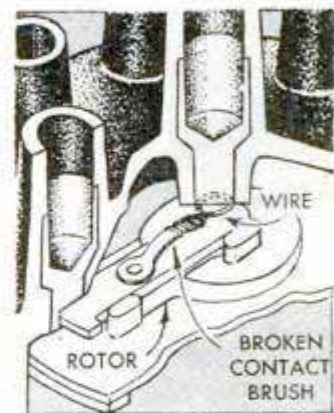

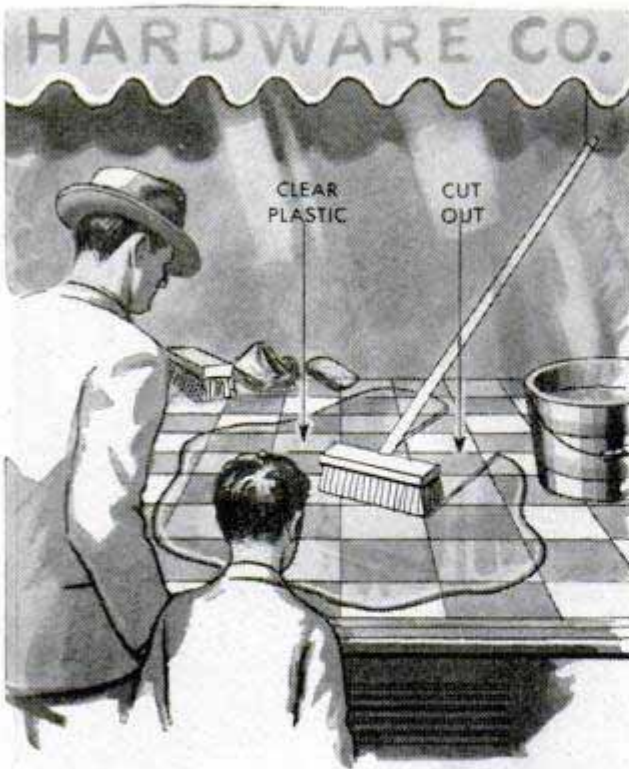

### Sheet Plastic Simulates Water For Show Window

An enterprising hardware dealer added an interesting touch to his window display of mops and scrub brushes by using a sheet of clear plastic to simulate water. He trimmed the edges of the sheet to an irregular shape and cut away a portion of the center to give the appearance that a long-handled brush had been pushed partially through the "puddle." The brush was held in the normal working position by a piece of string suspended from the ceiling and tied to the end of the handle.

### Adjustable Stops in T-Slots Position Angle-Plate Bolts

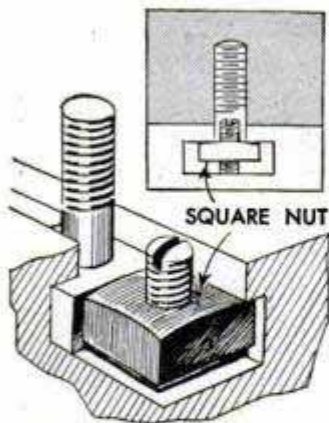

Attaching duplicate work to the angle plate of a milling machine is easier and faster if the bolts which anchor the work to the plate are held in position with stops. Thus, when the work is removed, the bolts will not slide down in the T-slot.

Where it is required that the anchor bolts do not slide in either direction, a stop is placed on each side of the bolt head. The stops are held in the T-slot with headless setscrews, which, when tightened, cause the stops to bear against the underside of the slot overhang. To make a stop, select a

bolt having a square nut of a size that will slide freely in the T-slot. Then make the setscrew by sawing off a short length of the bolt and slotting one end.

W. F. Schaphorst, Newark, N. J.

### Winterizing Stock Tank

Insulating a stock watering tank reduces considerably the amount of fuel oil necessary to heat the water to keep it from freezing in extremely cold weather. This is done by banking the tank with partly-rotted straw and fitting the top with a hinged wooden cover. A wooden baffle which extends below the surface of the water is fitted to the cover at the point where it is hinged. The baffle prevents cold air from circulating over the entire surface of the water in the tank when the cover is raised. Thus, heat loss is reduced and the tank heater burns less fuel.

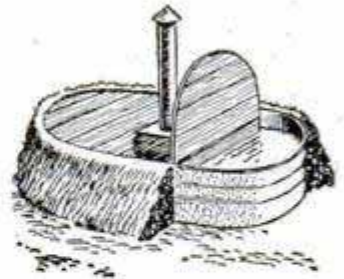

### Corncob Tied to Hen's Leg Discourages Brooding

One poultryman discouraged the brooding habit of some of his hens by tying a piece of corncob to one leg of each hen. The corncob distracts the hen's attention from her desire to brood and also makes her position in the nest uncomfortable. A hole punched through the center of the corncob permits fastening it to the hen's leg with a strip of tape or cloth.

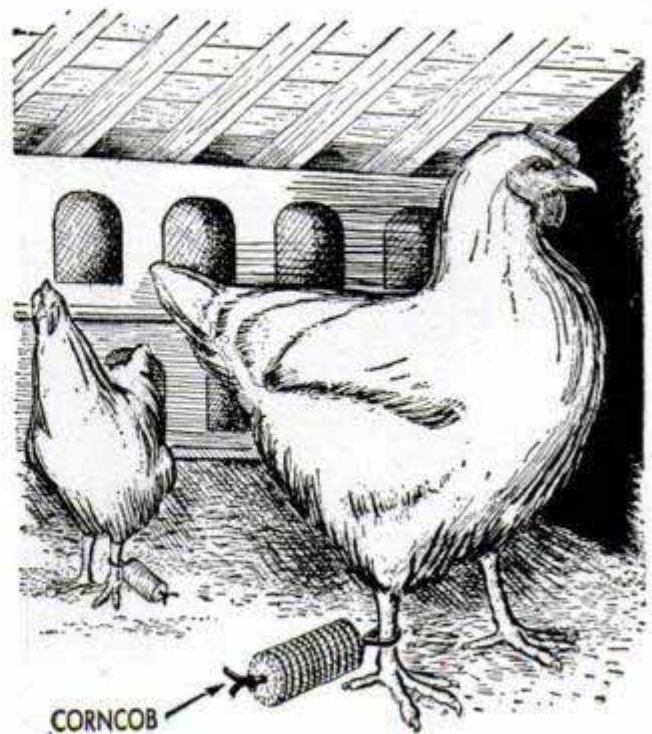



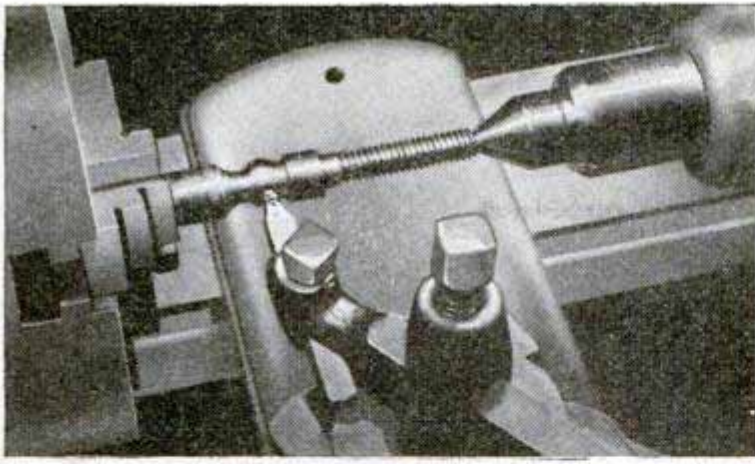

## SMALL SCREW JACK *a metal-turning project*

By Walter E. Burton

This little screw jack is really a jack-of-all-trades around the shop. The machinist will find it useful for leveling, internal-clamping operations in machine-tool setups and in assembly work. The jack consists of only 6 parts and the necessary machining operations make it an excellent lathe project. The curved screw handle can be folded down against the body of the jack and a clamping arrangement permits the jack-screw to be locked without disturbing its position. The body of the original jack was made from a piece of 1-in. hexagon aluminum bar, although it can be turned from steel or brass. Other parts are of cold-rolled or hardenable tool steel, the latter being preferred for durability.

Begin making the jack by turning the body to the shape indicated, leaving a ridge about  $\frac{5}{16}$  in. long for the locking lugs. Next, drill and tap a hole through the body for the jackscrew, and slot the lug side of the body for at least half its length. Then shape and drill the lugs, reaming out one of them and tapping the other. After this, make the locking screw and drill a hole transversely through its unthreaded end to take a handle which is made from a nail or  $\frac{3}{32}$ -in. steel wire. Silver-solder beads keep the handle from slipping out of the hole.

The jackscrew is turned and threaded as indicated and an elongated hole for the screw handle is made through the portion of the jackscrew just below the ball. The cap is machined and then recessed with a  $\frac{7}{16}$ -in. twist drill. After completion of the parts, the ball is oiled and the joint assembled by hammering the cap edge around the ball or by spinning, that is, forcing the flat tip of a screwdriver against the edge while turning the assembly in the lathe. The cap should be able to tilt about 10 deg. from the vertical in all directions. The screw handle is made in the same way as the locking handle and V-grooves are filed or milled across the top of the cap to keep round work from slipping.

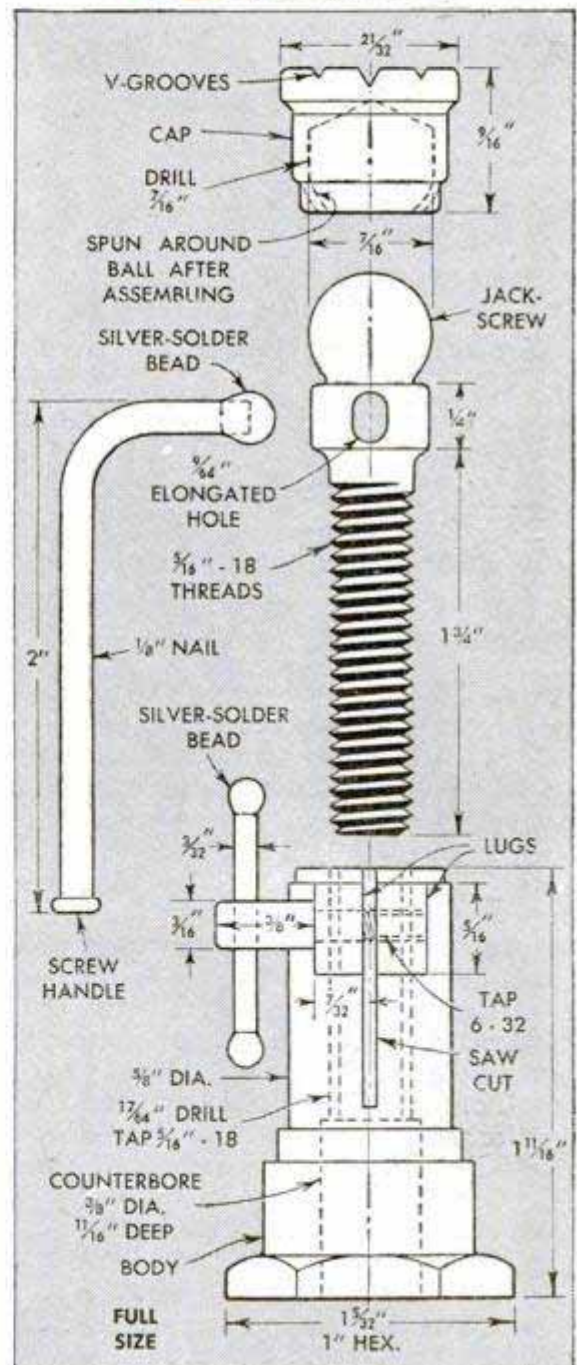
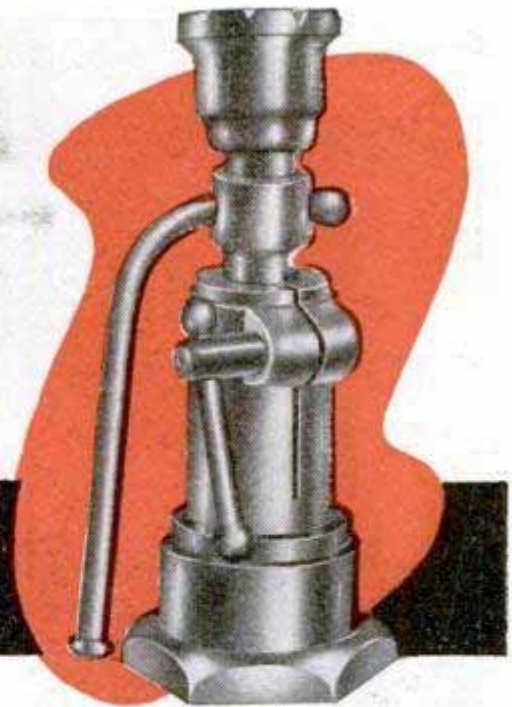

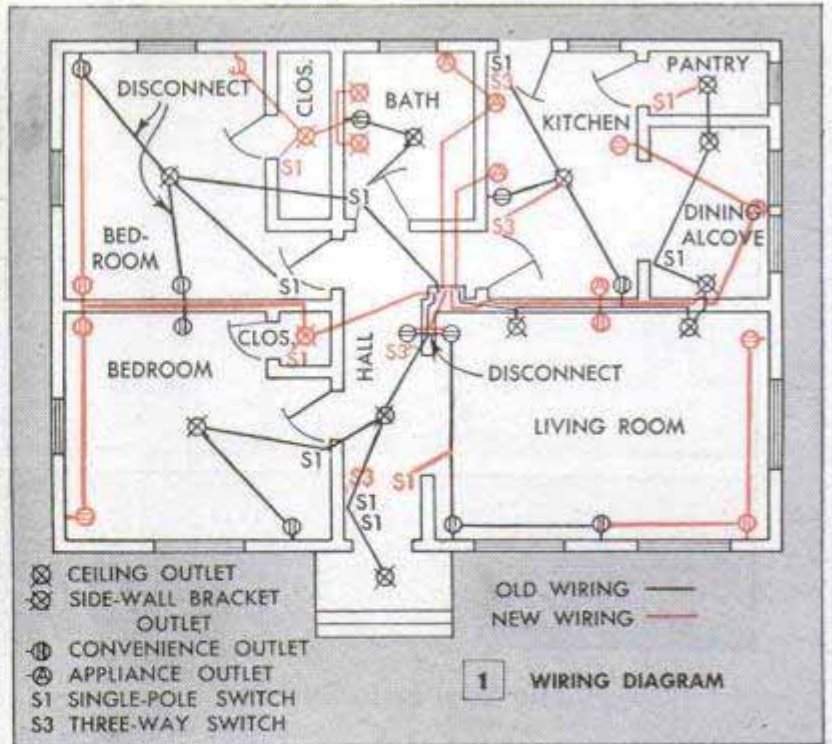

# REWIRE YOUR HOME FOR

**If your home is more than 10 years old, it probably is not wired adequately to enable you to enjoy fully the convenience of modern electrical appliances**

*By Thomas Trail*

**O**LDER homes usually are not wired to make full use of all electrical conveniences now available or being developed. In many houses, the wiring is not of approved sizes to carry modern appliance loads; there are too few switches for control of the lights and an insufficient number of convenience outlets. Rewiring a home to take care of present and possible future requirements is quite simple to do. While most localities have no regulations prohibiting a homeowner from doing his own wiring, it generally is required that the completed job be inspected by a competent electrician for compliance with both the national and local electrical codes. Therefore, before going ahead with a wiring job, the homeowner should study all the local ordinances and codes and should be familiar with the requirements of the national electrical code.

A rewiring job requires careful planning, so the first thing to do is make rough pencil sketches of the present wiring, as shown in black lines on the wiring diagram, Fig. 1. Make a separate diagram for each floor of

the house. If there is a garage or other building wired for electricity, include this on the ground-floor sketch. On each sketch, simply mark the approximate location of each lighting fixture, wall switch, convenience outlet, etc. Next, make pencil notes of the various conveniences and appliances desired. Among those that may be needed are fluorescent lighting, combination receptacles for radio power, aerial and ground, Fig. 4, and switches that permit lights to be turned on and off from any entrance to a room or from the top or bottom of a stairway. Other modern conveniences include door switches in all clothes closets, Fig. 5, that turn on the lights when the doors are opened, and outlets that provide plug-in receptacles easily reached from any part of the room. Locate separate outlets for the kitchen clock, mantel clock, electric iron, washing machine, dishwasher, garbage-disposal unit and a ventilating fan. Any other special lighting problems should be considered and provided for in the rough plan.

If wires are not large enough to handle maximum current requirements, lights and appliances will not deliver their rated output. The national code recommends No. 12 wire as the smallest size to be used on branch circuits. Furthermore, the code specifies that wiring capacity be sufficient to provide at least 2 watts of lighting for every square foot of floor area in the house,

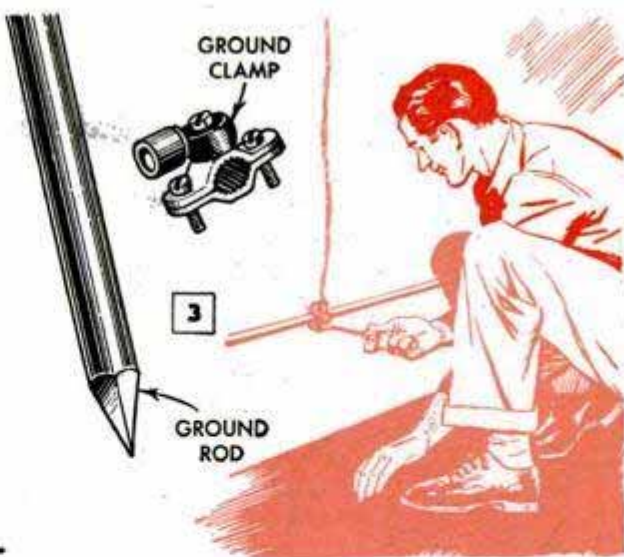
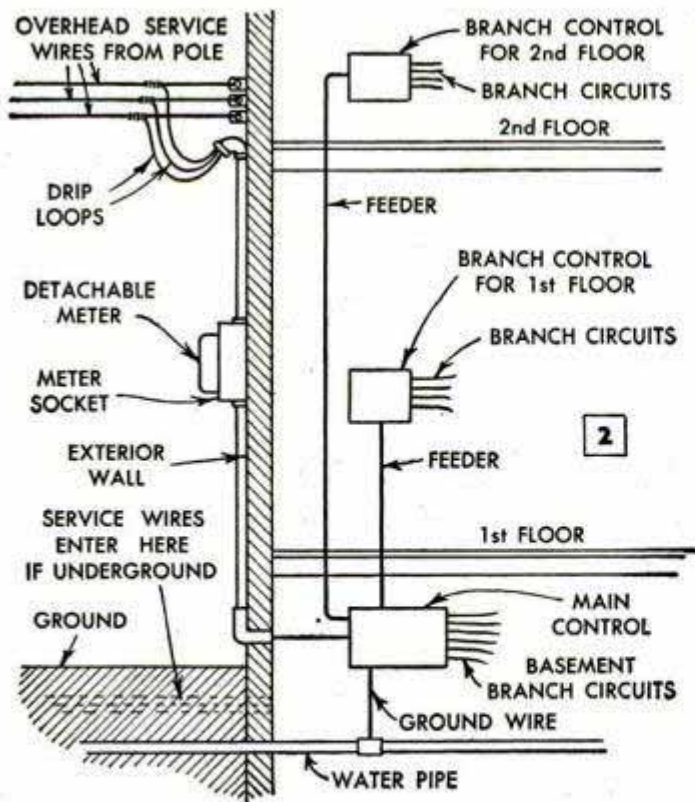

Grounding of neutral wire at service entrance is accomplished by connecting to water pipe with clamp shown above. If water pipe is not available, ground wire is connected to rod driven into ground

# MODERN LIVING

excluding unfinished areas such as the basement and attic unless these require special lighting.

In addition to lighting requirements, capacity for 1500 watts of appliance load must be provided on circuits separate from the lighting and convenience-receptacle circuits. Appliance circuits usually are provided for the kitchen, dining room, utility room and laundry, or whichever of these are on the floor plan. If a total of more than six receptacles is required in these locations, two or more circuits are provided. When planning appliance circuits, remember that other heavy-load appliances such as a home freezer, clothes drier and perhaps a room-type air conditioner may be added in the future. If you are considering these extra units, plan one or more extra circuits or provide sufficient capacity in the branch control center and feeders to take care of the requirements.

In deciding on the location of convenience outlets and circuits, the following suggestions may be helpful as they follow approved procedure: Place a receptacle in each usable wall space 3 ft. or more in width. Have a receptacle located within 6 ft. (at the floor line) of any location in any usable wall space. Provide receptacles on enclosed porches. All outdoor receptacles must be of the weatherproof type. Receptacles for television sets should be located so that the set can be placed where light from windows will not strike the screen directly. Place at least one receptacle at each work space in the kitchen, workshop, garage and utility room. Locate separate receptacles for fixed appliances such as the garbage eliminator, dishwasher, ventilating fan and bathroom heater. Workshop motors should be on the

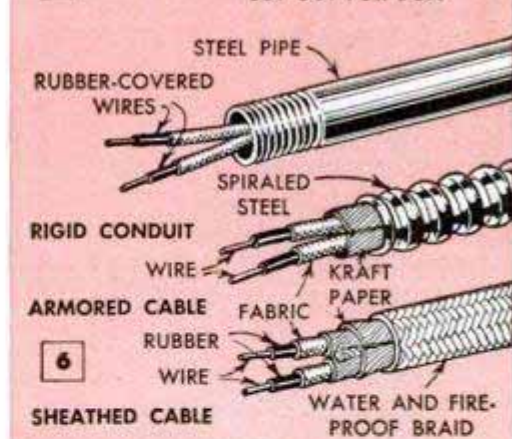
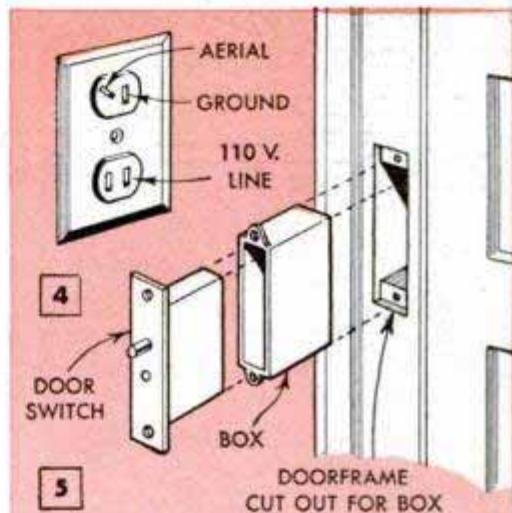

**7 CURRENT CAPACITIES OF WIRES**

Size	Size
14-15 amperes	4-70 amperes
12-20 "	3-80 "
10-30 "	2-95 "
8-40 "	1-110 "
6-55 "	

These are Code capacities. The sizes mentioned throughout this article are one size larger to compensate for voltage drop. For feeders use one size larger than table

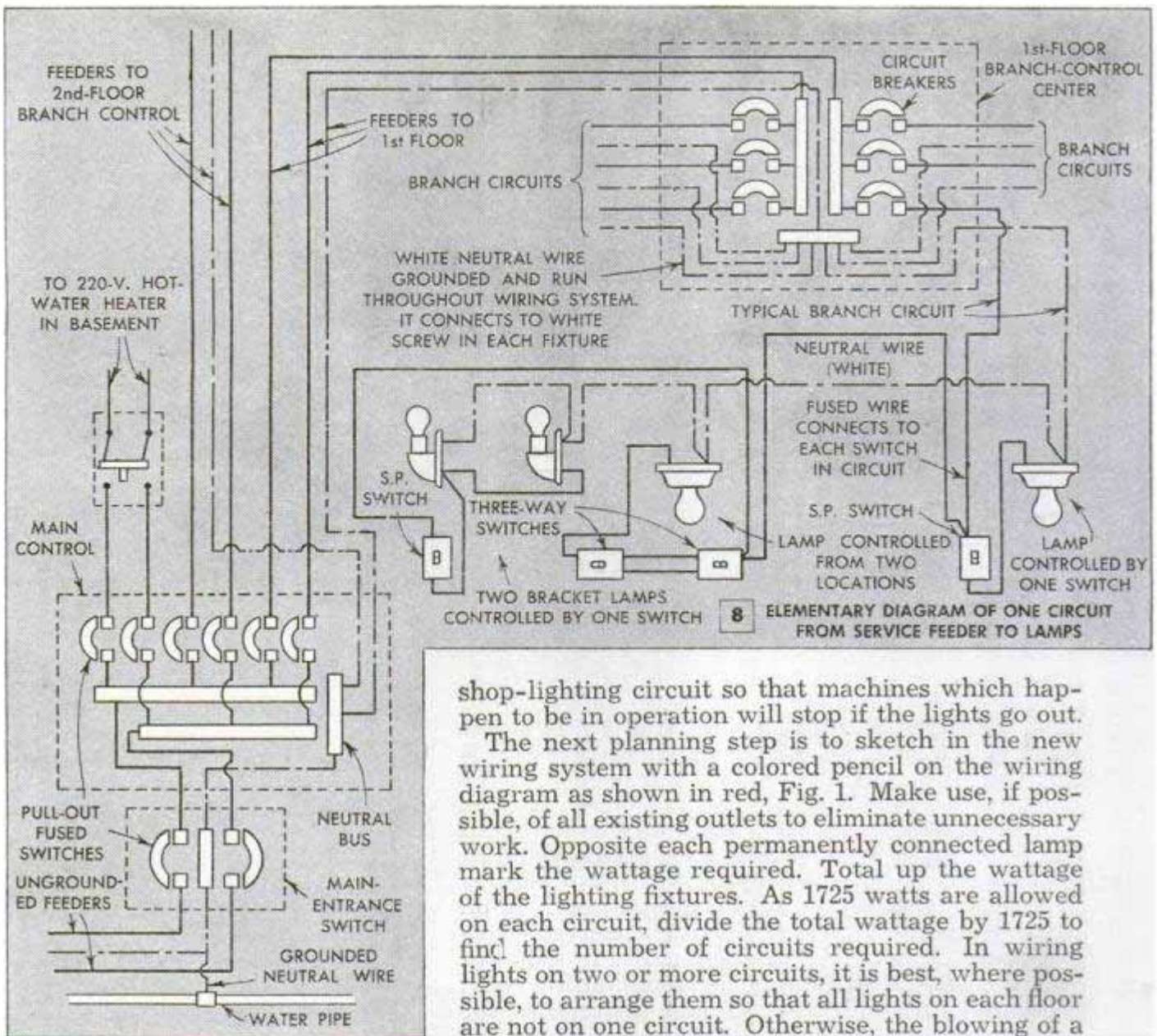

8 ELEMENTARY DIAGRAM OF ONE CIRCUIT FROM SERVICE FEEDER TO LAMPS

shop-lighting circuit so that machines which happen to be in operation will stop if the lights go out.

The next planning step is to sketch in the new wiring system with a colored pencil on the wiring diagram as shown in red, Fig. 1. Make use, if possible, of all existing outlets to eliminate unnecessary work. Opposite each permanently connected lamp mark the wattage required. Total up the wattage of the lighting fixtures. As 1725 watts are allowed on each circuit, divide the total wattage by 1725 to find the number of circuits required. In wiring lights on two or more circuits, it is best, where possible, to arrange them so that all lights on each floor are not on one circuit. Otherwise, the blowing of a fuse will cause all the lights on that floor to go out. To figure the number of receptacle circuits required (other than the special ones feeding kitchen, laundry, etc.) allow one circuit for each six or seven receptacles. As in Fig. 2, it is best to provide a branch control center for each floor in the house. These branch control centers are fed from a main control center located near the point where the service feeder from the power lines enters the house.

When the number of lighting and convenience-receptacle circuits have been calculated for each floor, mark this information on the sketch. Branch circuits should be of No. 12 wire, each circuit being rated at 15 amp. The rated amperage of all the circuits in a branch control center added together will give the total amperage required for that control center. This will apply where two-wire feeders are used between the branch control centers and the main control center. However, three-wire service lately has come into common use in new installations. With three-wire feeders, the amperage will be halved. The correct size of wire required for each branch feeder can be determined easily from the table in Fig. 7. The feeder circuits remaining to be calculated are the individual branch circuits

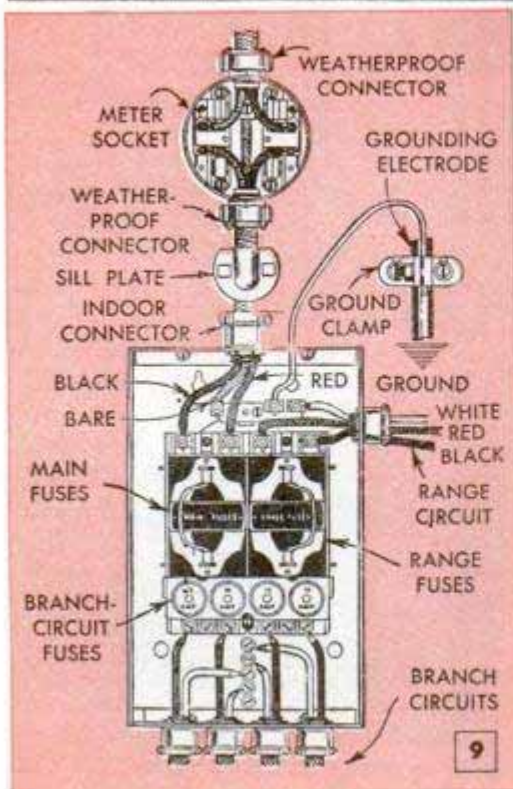

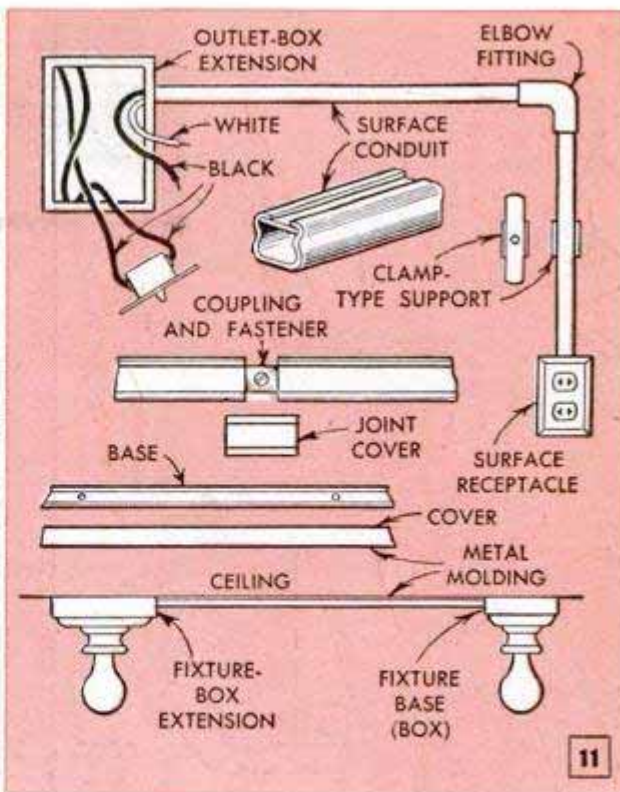
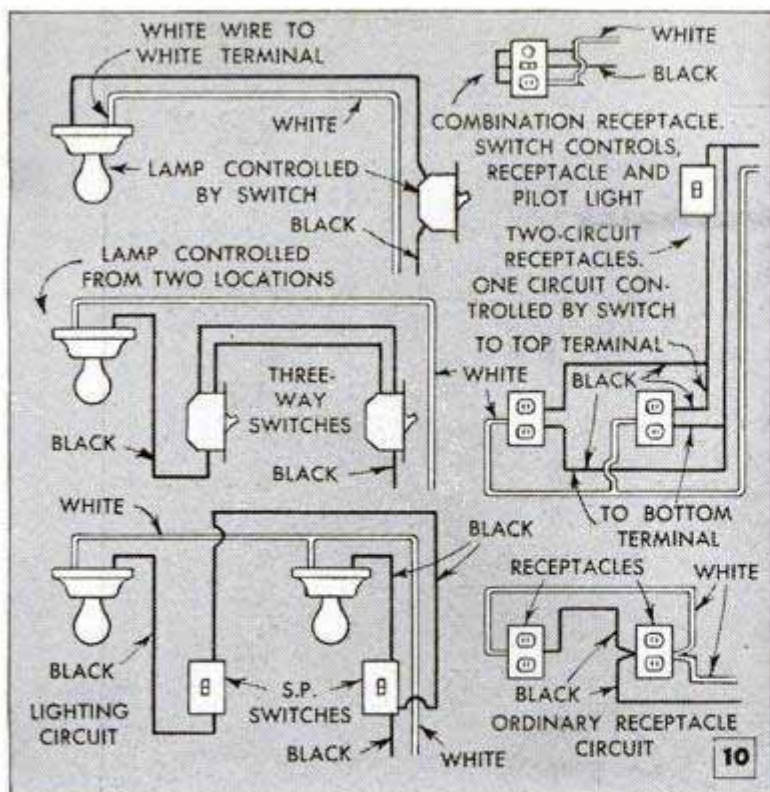

which feed directly to heavy-load appliances such as a water heater or range. If the power company does not require a separate meter on the water-heater circuit, both the heater and the range may be connected to the same branch circuit. To calculate the size of the feeders required, simply divide the wattage of each appliance by the voltage. This will give the amperage required. For example, a water heater consuming 3000 watts at 230 volts will require 13 amp. (3000 divided by 230). Use No. 10 wire for this load. The range load is calculated in the same manner. While ranges usually operate on both 115 and 230 volts, depending upon how many burners are in use at a time, only the 230 voltage is used to calculate the amperage. For a range rated at 7000 watts, the load would be 30.4 amp. Use a three-wire feeder of No. 16 wire.

Branch control centers may be arranged in three ways. They may consist of only 15-amp. circuits for lamps and convenience receptacles. Secondly, they may contain one or more 15-amp. circuits and one or more 20-amp. appliance circuits. Or, they may contain only 20-amp. circuits. A fuse or circuit breaker protects each circuit, but the fuse or breaker must be of no greater capacity than the circuit. The main control center will contain two fuses or a double-pole circuit breaker for each feeder from the branch control center and for each feeder from the appliance branch-circuit feeder where three-wire feeders are used. These overload devices must have a rating no higher than the carrying capacity of the wires they feed. If two-wire feeders are

used, only one fuse is required. The grounded wire, Fig. 3, is not fused.

After the calculations have been made, mark this information on the rough sketch of the circuits and control centers of the new system. The installation of new conduit runs is not difficult. Some local codes permit only thin-wall conduit to be used in certain locations. Check before making the installation. In all conduit work, whether using rigid or flexible metal conduit, Fig. 6, the structure of the house determines to some extent the procedure to be followed. Usually, there is a way to feed flexible conduit either through or around ordinary obstructions, but sometimes it will be found impossible to run conduit to certain locations. Such outlets may have to be relocated or surface conduit, called metal molding, may have to be used as in Fig. 11. A suitable box should be installed in the basement or utility room to contain the doorbell transformer, which should be connected to a branch lighting circuit and protected with fuses.

Of course, rewiring an old house is more involved than wiring a new one. Service will have to be maintained to some lights while other circuits are being installed. Start by installing the service-entrance wires and equipment, as shown in Figs. 8 and 9. The service switch shown in Fig. 9 is ideal for a house utility room where all the rooms are on one floor. Next, run the branch-circuit feeders and the individual appliance circuits. The latter should terminate in suitable receptacles or switch boxes to which the appliances are to be connected. Follow this by removing all the

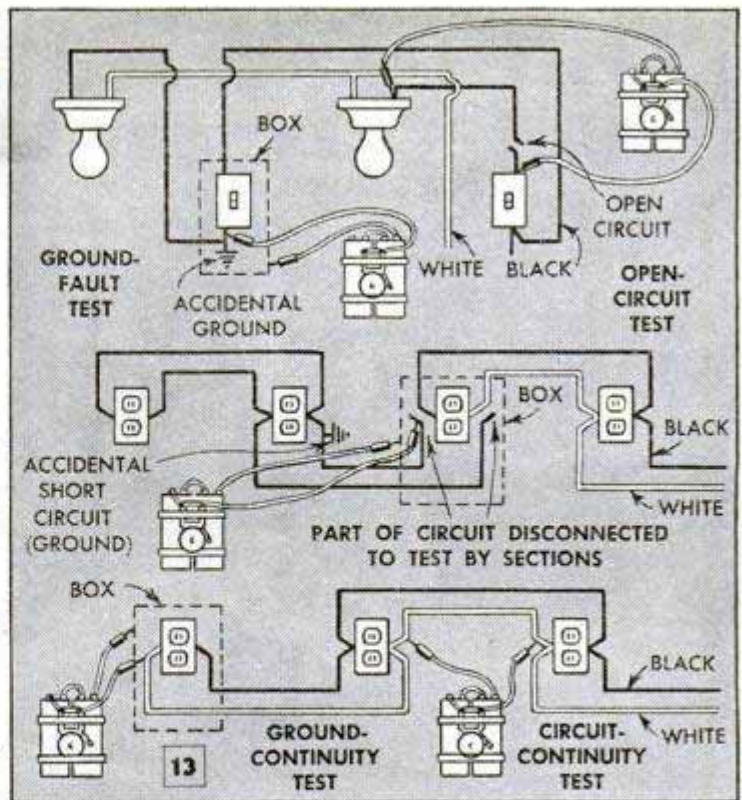
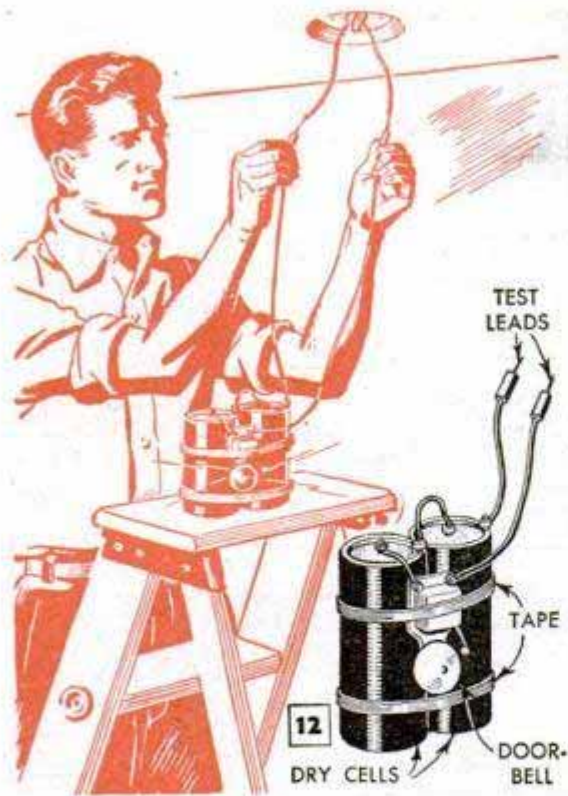

existing wires from one circuit at a time and installing new, larger-capacity wires. Where armored cable, nonmetallic cable or knob-and-tube wiring is to be replaced, remove all the old wiring. Next, fish in the new armored cable or flexible metal conduit and attach to the boxes. Larger-capacity armored cable may be installed, or three-wire armored cable substituted and the outlets divided evenly between the two circuits.

If rigid conduit is merely to be rewired, pull out the old wires and replace them with larger-capacity wiring of the new S.N. type having a smaller diameter. This can only be used for rewiring of existing conduits or metal molding. Either the same number of wires of larger capacity can be used, or the circuit can be split into two parts and two circuits installed, using three or four wires of the same capacity. Where three-wire branch circuits are used, they must be considered as two separate circuits. Each ungrounded wire is protected at the branch control center by a single-pole breaker or by a fuse, Fig. 8.

As each circuit is completed and the connections made, it is tested and connected temporarily to the old distribution fuses. Figs. 8 and 10 show how various devices and fixtures are connected to circuits. In splicing wires in outlet boxes, solder the joints and cover with rubber tape and friction tape, or use approved solderless connectors. When all the new circuits are finished they may be disconnected from the old fuses and connected to the new branch control centers, or main control center, as the case may be. The feeders are then con-

nected and the branch control centers are mounted in their proper location. Then the feeders are connected to the main control center, but all circuit breakers are left in open-circuit position until the feeders and circuits have been tested. To feed individual branch circuits, appliance circuits, feeders and service feeders, a simple test set is assembled from a doorbell, two dry cells and test prods as in Fig. 12. Fig. 13 shows how to test the various circuits.

If a ground shows up, check all boxes through which the circuit feeds for the cause of the trouble. It may be caused by the end of a bare wire touching some metal part of an outlet box, or the insulation may have been cut on a wire where it enters a box. If the defective circuit can be tested in sections, this may save considerable time in locating the trouble. The same general procedure is followed in searching for an open circuit, except that in the case of an open circuit a defective splice or broken wire usually is the cause of the fault. If all circuits test free of grounds and show complete circuit continuity, then test for ground continuity at each outlet. Sometimes paint will prevent a good ground connection between a box and the conduit or cable attached to it. To insure against defects in the wiring, be sure to tighten all wire-terminal screws, cable clamps, lock-nuts and bushings in boxes. Insulate splices carefully and use fiber bushings in the ends of flexible metal cable. Fasten all switches, outlets and fixtures securely.

☐ Alum melted in an iron container forms a strong cement for joining glass and metal.

## EIGHT-BAND TRANSMITTER

**A**LTHOUGH no larger than an ordinary table-model receiver, this flexible general-purpose phone and CW transmitter is capable of delivering r.f. power on all amateur frequencies from 3.5 megacycles to and including 148 megacycles. It may be used with any power-supply unit delivering plate voltage up to 450 volts. The tube heaters may be operated from either 6 or 12 volts. Dynamotor power-supply units are available for portable-mobile operation in cars or boats if desired. For fixed-station operation, the tube heaters can be supplied from a 6-volt a.c. transformer winding in the power unit.

This transmitter is 13¼ in. high, 9¼ in. wide and 8½ in. deep; it weighs only 17 pounds. A type 6AQ5 tube is used as an oscillator/multiplier; a second 6AQ5 is employed as a multiplier. The final amplifier in this Harvey-Wells transmitter consists of the well-known and very popular 807 tube. Two 6L6 glass-type tubes are employed as modulators. The output coupling is a simplified pi-type designed for feeders between 50 ohms and 500 ohms. The front panel controls shown in photo A are labeled as follows: Left to right top row, "drive" for adjusting the grid excitation to the 807 tube; "plate" for the 807 plate tank; "load" for antenna loading. In the second row are the "power/off" switch and "transmit/standby." This last switch may be wired to control the output of the power supply. In the third row at left is the "CW/Phone" switch and, at right, the "grid/plate" switch for shifting the meter to read grid or plate current. The large rotary switch at lower left selects the bands

(Continued to page 246)

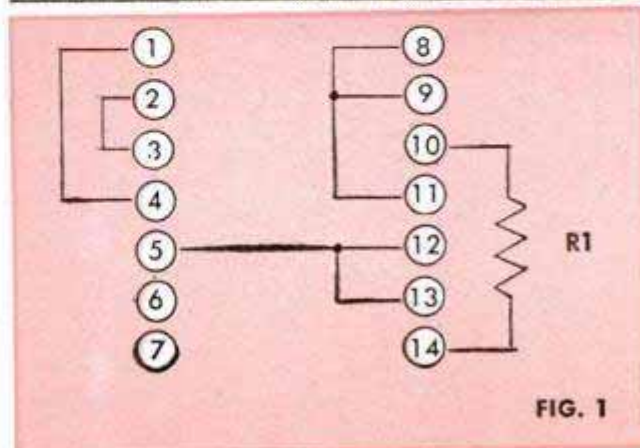
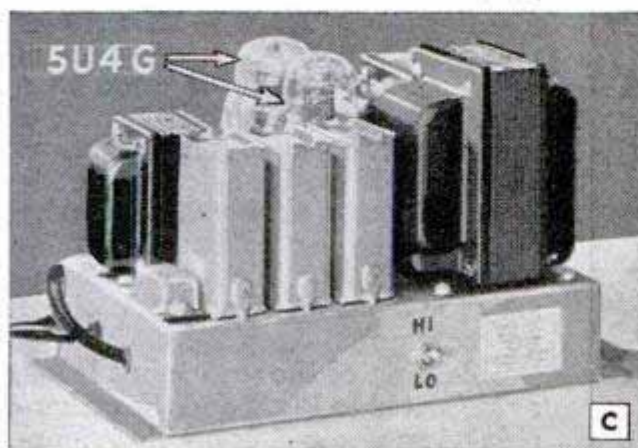
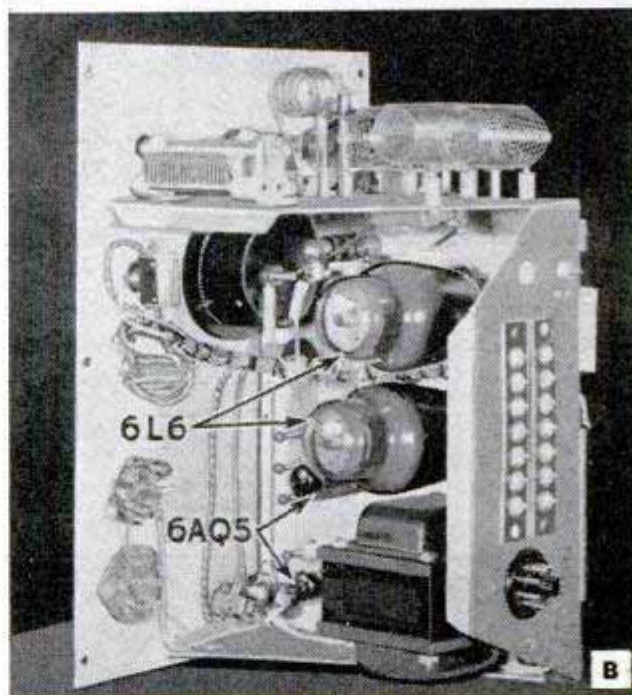

# COMPACT HI-QUALITY MULTI-PURPOSE

By Edward Drabek

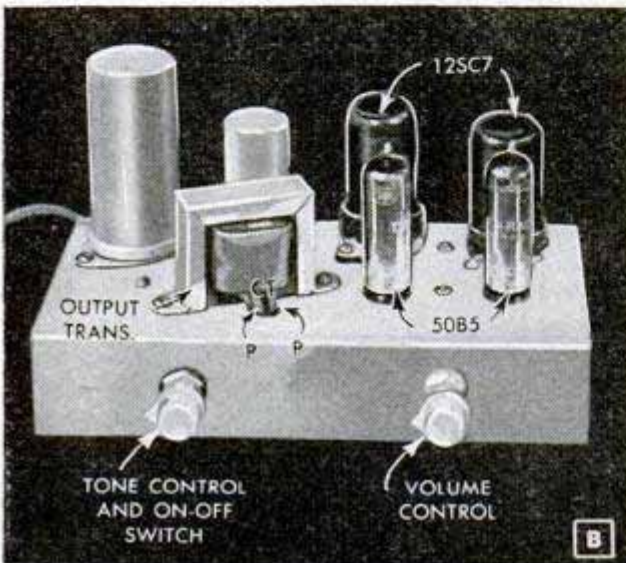

## RESISTORS

- |   |  |
|---|--|
| 3 Carbon type 6800-ohm 1/2-watt, R1, R2 and R3  | 2 Carbon type 33,000-ohm 1/2-watt, R14 and R15 |
| 2 Carbon type 3.3-megohm 1/2-watt, R4 and R5    | 2 Carbon type 10,000-ohm 1/2-watt, R16 and R17 |
| 1 Carbon type 180,000-ohm 1/2-watt, R6          | 1 Carbon type 150,000-ohm 1/2-watt, R18        |
| 1 Carbon type 220,000-ohm 1/2-watt, R7          | 1 Carbon type 100-ohm 2-watt, R19              |
| 1 Carbon type 27,000-ohm 1/2-watt, R8           | 1 Wire-wound 100-ohm 5-watt, R20               |
| 2 Carbon type 330,000-ohm 1/2-watt, R9 and R10  | 1 Carbon type 22,000 ohm 1/2-watt, R21         |
| 1 Carbon type 1000-ohm 1/2-watt, R11            | 1 500,000-ohm tone control (and switch), R22   |
| 2 Carbon type 100,000-ohm 1/2-watt, R12 and R13 | 1 500,000-ohm volume control, R23              |
- Note—R22 and R23 are audio-taper types

TRULY a mighty midget is this four-tube a.c.-d.c. reluctance or magnetic-type pickup amplifier. It can be used in conjunction with any reluctance or magnetic pickup with an output of as low as 2.5 millivolts since the preamplifier is incorporated in the unit. Built-in equalization circuits eliminate a surprising amount of experimenting with matching networks after the unit is completed. Two inputs are provided, one for the GE variable-reluctance or magnetic-type pickup, and the other for a crystal pickup or an AM or FM tuner. It also makes an ideal amplifier for the four-tube super a.c.-d.c. AM broadcast tuner that was described in the May 1948 issue of this magazine. When used with the variable-reluctance-type pickup for high-quality record reproduction, it gives a frequency response and fidelity limited only by the record itself.

Ample power output is obtained with a pair of 50B5 miniature tubes in push-pull, exceeding an output of 4 watts. Phase inversion in the output stage eliminates the usual bulky driver transformer to provide high-frequency response well over 12,000 cycles. The power supply consists of two selenium rectifiers used in a voltage-doubler circuit, thus eliminating a rectifier tube and providing long, trouble-free operation.

Unusually compact for a versatile unit of this type, it permits the constructor to adapt the amplifier easily to any existing equipment. Photo A shows the amplifier unit used with an FM tuner; operation in conjunction with an automatic record player using a GE reluctance-type pickup is illustrated in photo C. Photos B, D and E show various views of the completed unit. Complete details for the simple chassis base are given in Fig. 1. Any standard base about 4 x 8 x 1 1/2-in. may be used. The one shown was made by bending 1/16-in. sheet metal between two blocks of wood in a vise. All holes may be cut before the metal sheet is bent to shape. When mounting the selenium rectifiers, be sure to observe the polarity as shown in the schematic circuit diagram, Fig. 2. This is very necessary for the proper operation of the power supply.

Shielding of the grid input leads, as indicated in Fig. 2 and the underside-view photo E, is highly impor-

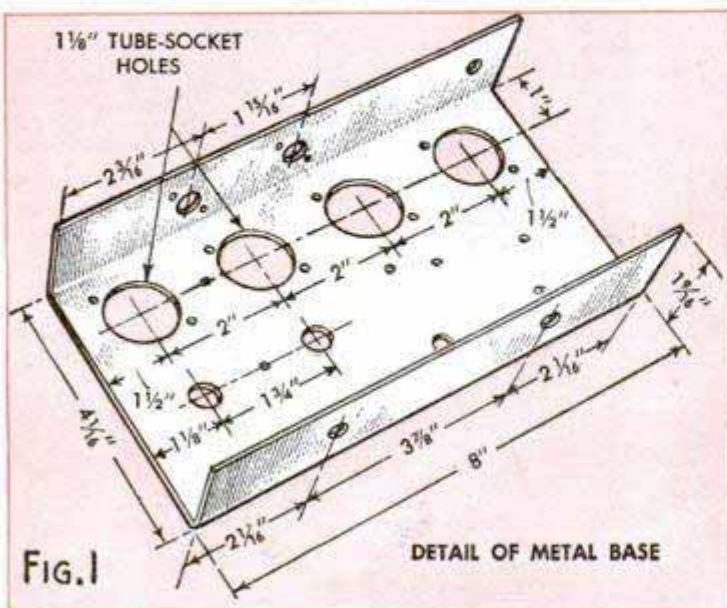



# FOUR-TUBE A.C.-D.C. AMPLIFIER

tant to reduce hum pickup due to the high gain of the preamplifier stage. Please note that the speaker output transformer is mounted on the top of the chassis base and the voice-coil leads run directly from this transformer to the speaker which is a permanent-magnet type with an 8-ohm voice coil. The speaker may be any size from 6 to 12 in. If desired, the speaker output transformer may be mounted directly on the speaker, which is housed in the separate cabinet shown in the photos. When wiring the circuit, use rosin-core wire solder and be sure that all connections are carefully made. All tube connections should be as short as possible, and keep all grid and plate leads well separated to eliminate oscillations. The input 12SC7 tube socket should be mounted on soft-rubber bushings, or grommets, to prevent microphonic noises. The mounting will be noted in top-view photo D.

As this is an a.c.-d.c. amplifier unit, care must be taken in handling it while making tests; one side of the power line is grounded and should not be brought in contact with any external ground. Any possibility of shock may be eliminated by tying all of the negative-B leads together and isolating them from the chassis by means of a .01-mfd. 400-volt tubular paper by-pass condenser. The condenser is merely connected between all negative-B leads and the metal

(Continued to page 244)

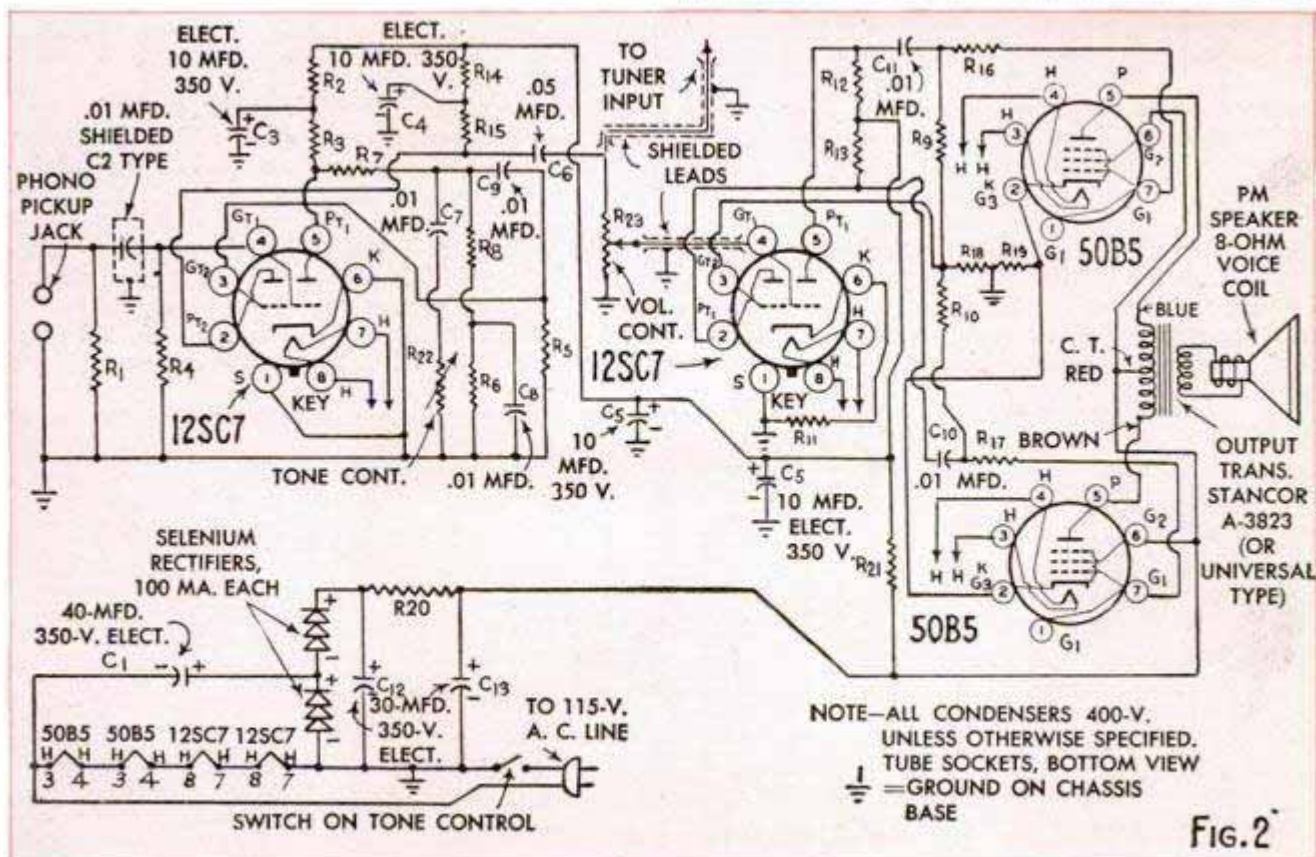
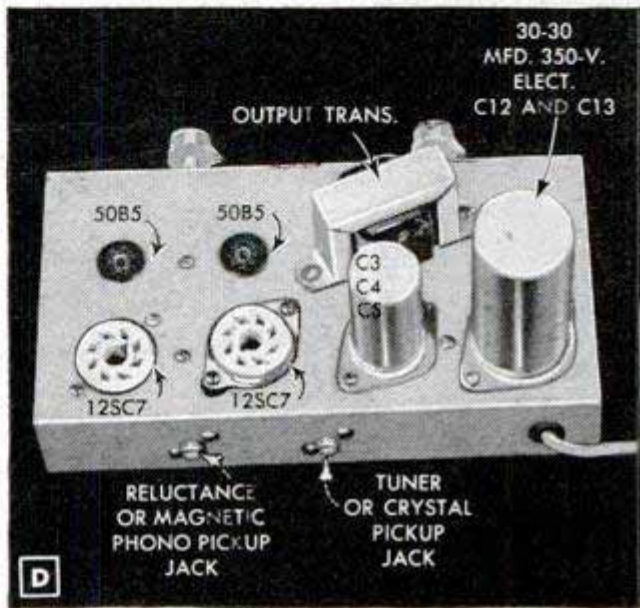

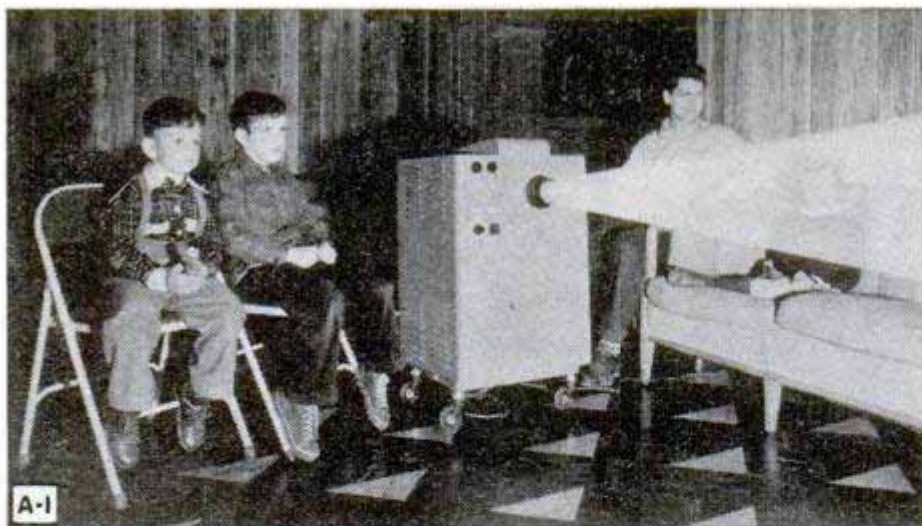

# TELEVISION TODAY

A-1—Life-size television for the rumpus room, restaurants, schools, industrial plants and churches is now possible by means of this mobile projection-type TV receiver that requires no permanent installation. It is capable of throwing a video image varying in size from several inches up to 6 by 8 ft. Photo A-2 shows the wall screen in position

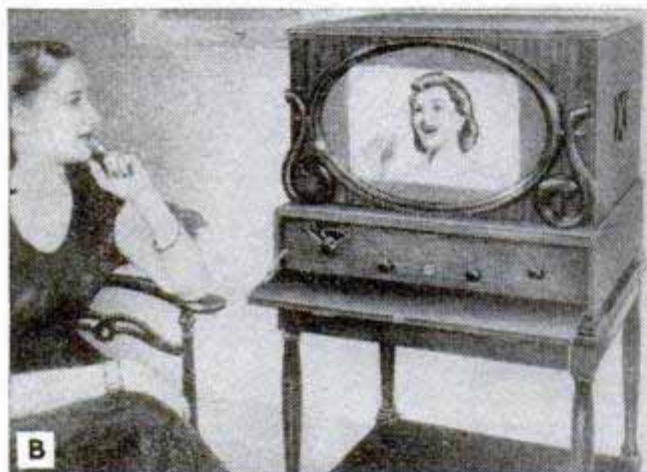

B—Featuring a dual-purpose Polaroid filter screen, which also serves as a mirror in a period-styled cabinet, this TV set employs a 15-in. picture tube

C—Recently announced table-model projection-type television receiver provides a large video image on a built-in screen. The picture is 13½ by 18 in.

D—What appears to be an attractively framed picture on the wall is really a built-in TV set with speaker. The controls for both sound and picture are concealed behind the gold-leaf frame surrounding the screen.  
 E—Inexpensive portable television receiver produces a "candid size" TV picture 2 by 3 in. It may be moved from room to room; a carrying case is available for travel purposes. It covers 13 channels; weighs 15 lbs.  
 F—Chimney-mount antenna base designed to cut time and costs in erecting television and FM antenna systems

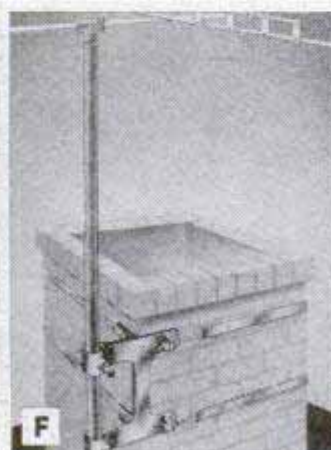
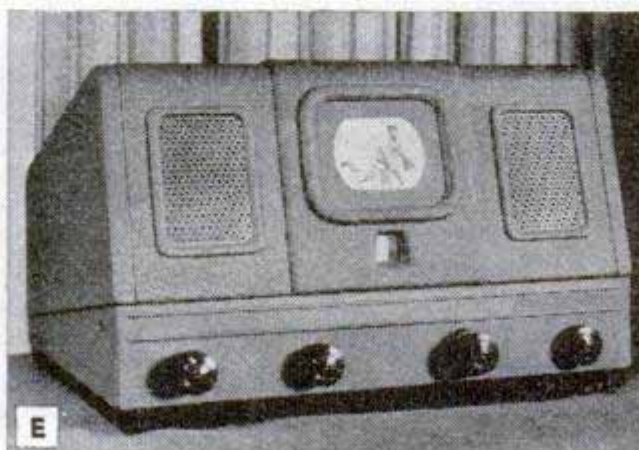



## Two Majestic New Diesels featured by **LIONEL TRAINS**

Two big, powerful LIONEL Diesels, just like the kind that have been shattering speed records for the *New York Central* and *Santa Fe* railroads! Patterned after the famous General Motors F3 type, these mighty Locomotives measure 26½ inches long and are powered by TWO motors!

Other LIONEL TRAINS puff SMOKE and blow a realistic WHISTLE.

Send for the new Catalog and Special 25¢ Offer now—it tells all about the Electronic Control train, new rolling stock, LIONEL Construction Kit and many other features.

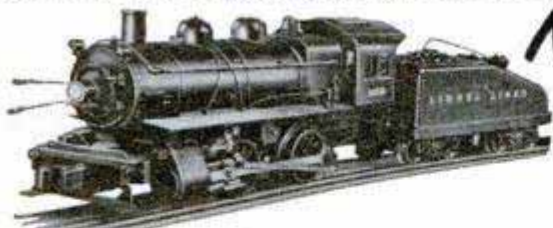

### *New Switcher for 1948*

Every model railroad fan will want this powerful little "yard goat" for his pike! Modeled after ladder-back type used by major lines in U. S. Has automatic built-in bell and back-up light.

### *Special Offer:*

- 1 This is what you get: beautiful 36-page full color LIONEL TRAIN Catalog.
- 2 Set of 3-Dimensional views of LIONEL TRAINS in Action.
- 3 Pair of Stereopticon Eyeglasses for viewing scenes.
- 4 Special Kit of 6 cut-out colorful buildings to create realism for your train layout.

Enclose 25¢ with coupon!

**SEND FOR IT AT ONCE!**



LIONEL TRAINS, P. O. BOX 331  
Madison Square Station, New York 10, N. Y.

I enclose 25¢. Please send me Special Offer of 36-page full color Catalog, Stereopticon views of LIONEL TRAINS, Stereopticon Eyeglasses, and Kit of 6 building cut-outs.

NAME \_\_\_\_\_

ADDRESS \_\_\_\_\_

CITY \_\_\_\_\_ ZONE \_\_\_\_\_ STATE \_\_\_\_\_

# THE KODAK LINE-UP HAS A

# Special

Better pictures  
with  
the right camera



2

1

**1 KODAK REFLEX CAMERA**—Twin lenses—4-element  $f/3.5$  for speed, *Lumenized* for brilliance, superbly corrected for sharpness, for beautiful color.  $1/200$  Flash Kodamatic Shutter. Black-and-white pictures,  $2\frac{1}{4} \times 2\frac{1}{4}$ ; Kodacolor snaps, about  $3 \times 3$ . With field case, \$120; Flashholder, \$9.50.

**2 KODAK 35 CAMERA WITH RANGE FINDER**—*Lumenized*  $f/3.5$  lens yields superb color transparencies and prints, sharp black-and-whites for big enlargements. Coupled range finder.  $1/200$  Flash Kodamatic Shutter. Automatic shutter cocking, double-exposure prevention. \$75; Flashholder, \$9.50.



3

**3 KODAK TOURIST CAMERA**—Finest folding model yet. Hard-coated  $f/4.5$  lens,  $1/200$  shutter. Built-in exposure computer. Efficient new-type shutter release on bed of camera. Black-and-white pictures,  $2\frac{1}{4} \times 3\frac{1}{4}$ ; color snaps, about  $3 \times 4\frac{1}{2}$ . \$61.50; also lower-priced models. Flashholder, \$9.50.

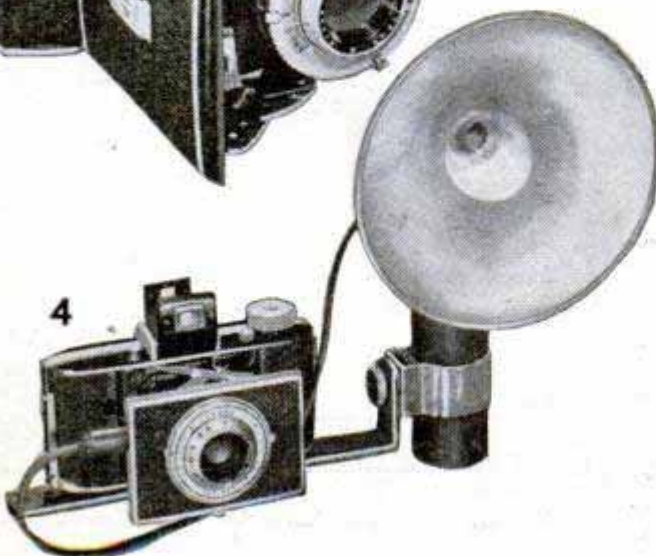

4

**4 KODAK FLASH BANTAM CAMERA  $f/4.5$** —Small, light, moderately priced. Makes sharp black-and-white negatives; also full-color Kodachrome transparencies for projection on the home screen and for Kodachrome Prints and Enlargements. *Lumenized*  $f/4.5$  lens,  $1/200$ -second shutter. \$50; Flashholder, \$9.50.

**EASTMAN KODAK CO.**

"Kodak" is a trade-mark

# Gift

## FOR YOUR FAVORITE FAN

**5 KODASLIDE TABLE VIEWER**—entirely new type of projection viewer for 2x2 cardboard or glass slides, or a combination of both. Superb for small group shows, editing, and quick viewing. 7½x7½-inch Kodak Day-View Screen gives brilliant image in lighted room. Has *Lumenized* f/3.5 lens (Kodak Ektanon), slide changer, cooling system, focusing lever. \$95.

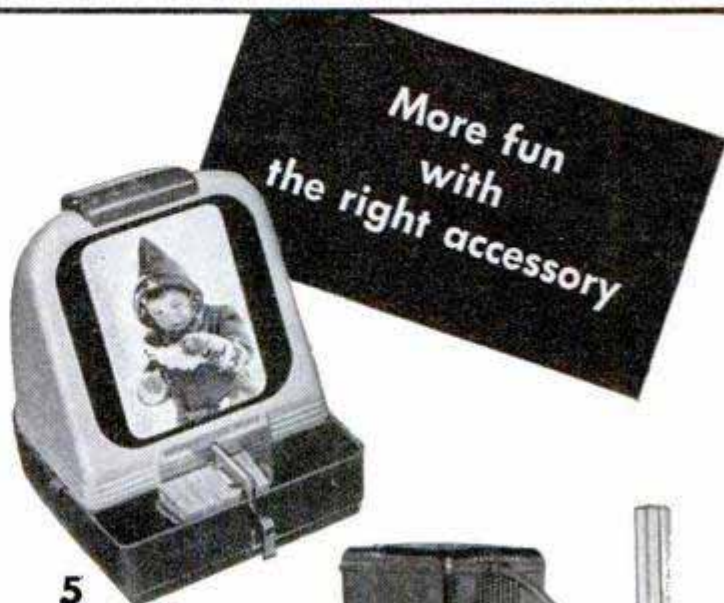

**6 KODASLIDE PROJECTOR, MODEL 1A**—takes 2 x 2 cardboard or glass slides. Projects big, bright images up to 84 inches wide. Sharp focusing with the Kodak Projection Ektanon Lens, 4-inch f/3.5. *Lumenized* optical system increases screen brilliance 50%. \$27.50.

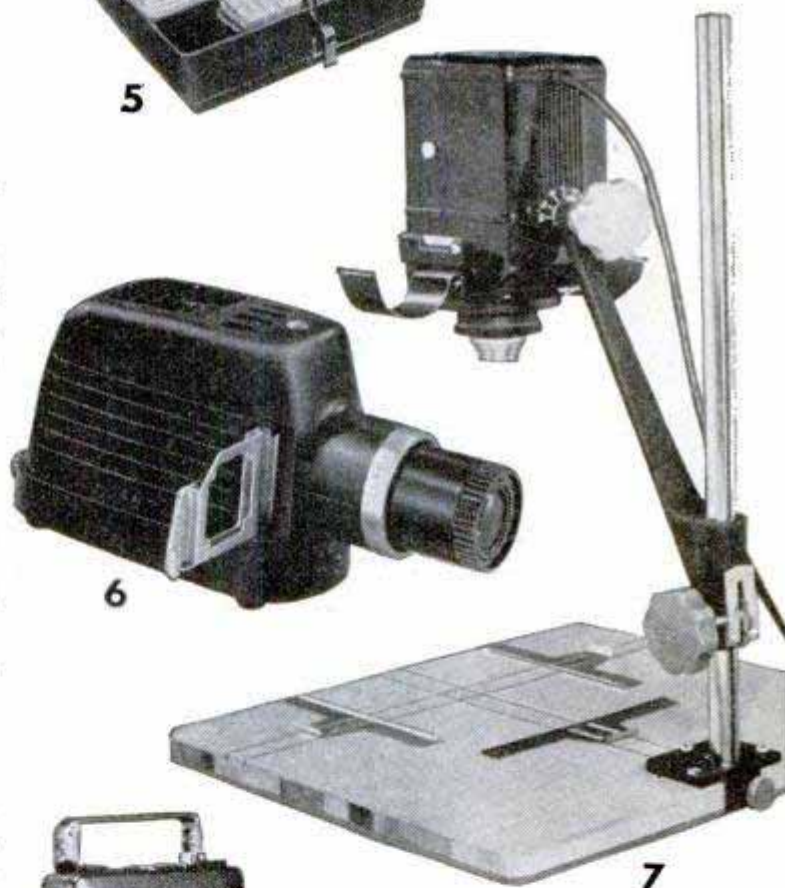

**7 KODAK PORTABLE MINIATURE ENLARGER**—blows up 35mm. or Bantam negatives. Three-lens condenser system, heat-absorbing glass, 50-watt lamp insure high-quality prints. Price, \$48.50. Pack-All Case is ideal storage place... handy for trips. \$15.

**8 KODAK TRIPODS**—all types of camera supports for movie or still cameras—for all-round better pictures. Wide price range. Visit your nearest Kodak dealer for a complete review of the Kodak line-up.

*(Prices, subject to change without notice, do not include tax where applicable.)*

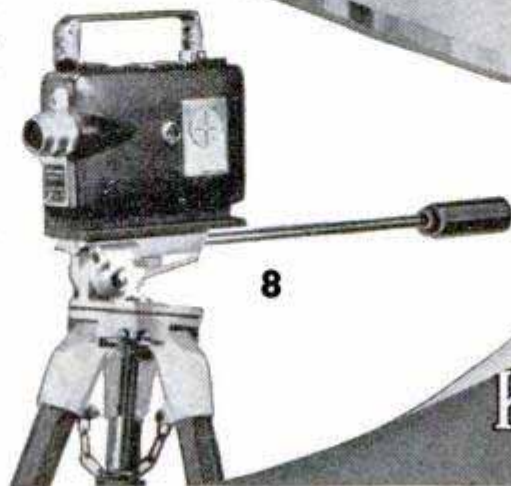

ROCHESTER 4, N. Y.

Kodak

# introducing the JOLLY TAR



*New*  
**RIEDEL WORK GLOVE**  
for Home  
Farm · Industry  
Men's and Ladies' Sizes

For greater comfort when you work...and for lots of extra wear...try Riegel's new "JOLLY TAR" Work Glove. Elastic back strap keeps glove on comfortably...permits circulation of air so hands won't become sweaty. Made of special flannel-backed canvas, soft finish inside, with safety cuff for greater protection.

## OTHER STYLES FOR EVERY NEED

canvas, jersey, leather...knit wrist, band top, gauntlet...double palm, reversible, quilted. Ask for the Riegel brand wherever work gloves are sold. Free catalog if requested on business letterhead.

**Riegel Textile Corp.**  
342 Madison Avenue  
New York 17, N. Y.



"THIS TRADE MARK IS YOUR GUARANTEE OF VALUE"

## Hi-Quality Four-Tube Amplifier

(Continued from page 239)

chassis base. When used with a variable-reluctance-type pickup, surface noises are minimized in record reproduction. These improved pickups will fit practically any standard pickup arm without alteration, and they actually transform old-style record reproduction into full, rich, mellow tones. Like any high-fidelity, high-quality microphone, the output of this type of pickup is low, and a preamplifier is needed between the pickup and the phono input.

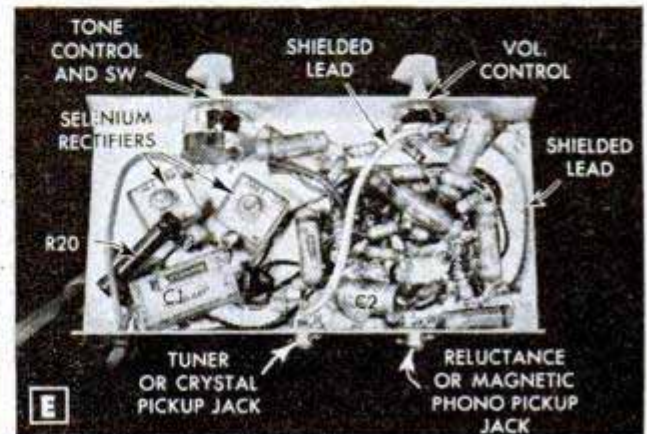

Therefore, the necessary preamplifier is built into this versatile multi-purpose amplifier unit.

The General Electric reluctance-type pickup consists of a natural-sapphire stylus mounted on the end of a small cantilever spring. A lateral motion of the cantilever directs the magnetic flux alternately through the cores of two coils which are connected in push-pull. As the stylus is driven laterally in the record groove, the cantilever moves correspondingly with respect to the pole pieces. Thus, the output voltage generated in the coils is directly proportional to the rate of change of flux. Therefore, the pickup responds accurately to a constant-velocity signal when proper equalization is provided. As the output voltage is generated directly by the motion of the stylus mounting device, there are no long couplings and losses are low. The needle scratch is extremely low with this pickup as it responds only to vibrations in a lateral direction. As there is no vertical response, the usual frictional noises are not transmitted from the record surface.

As the four-tube amplifier chassis is quite small, it may be mounted in the average record-player case, or it may be housed in a separate wooden cabinet of suitable size. Detailed student material list R-372 is available from Popular Mechanics Radio and Electronics department upon receipt of ordinary letter postage.

# BEST WAY TO SOLDER WIRE



**1** Be sure current is disconnected. Then, take your flashlight, powered with "Eveready" batteries, and find the broken wire. Next, prop up your flashlight so that it will shine brilliantly on your work.



**2** Make sure wire ends are clean and bright... twist wires to form a joint that is mechanically strong enough to be self-supporting. (It's a common mistake to let solder serve as a strength binder.)

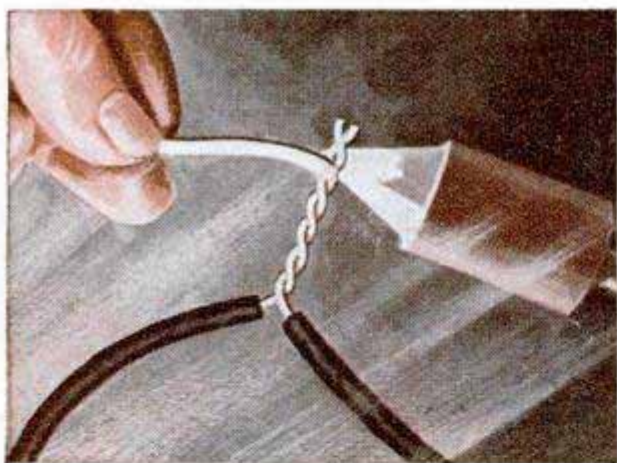

**3** Use a hot iron with the copper tip well tinned. Don't drip the solder on the joint—apply the soldering iron *underneath* the joint and heat the wires until they melt the solder. Apply a moderate amount of solder. After it has flowed freely through the wire strands, remove the iron.

## BEST WAY TO LOAD YOUR FLASHLIGHT

For fixing your radio . . . car wiring . . . any job requiring portable light . . . be sure to load your flashlight with long-life "Eveready" batteries.



## "EVEREADY" FLASHLIGHT BATTERIES

The trade-mark "Eveready" distinguishes products of  
**NATIONAL CARBON COMPANY, INC.**

30 East 42nd Street, New York 17, N. Y.

Unit of Union Carbide  and Carbon Corporation

# ATKINS

FOR THE SATISFACTION  
OF BETTER WORK

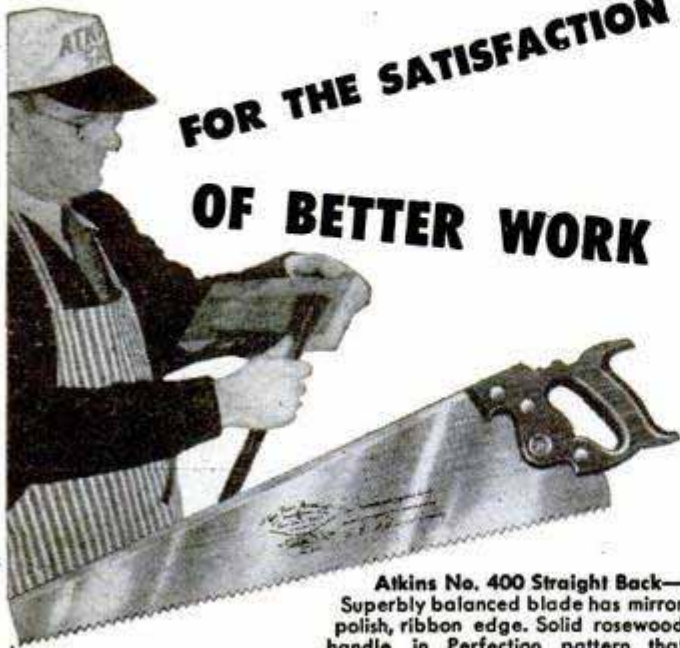

**Atkins No. 400 Straight Back**—Superbly balanced blade has mirror polish, ribbon edge. Solid rosewood handle in Perfection pattern that prevents wrist strain. Segment ground 5 gauges for easy clearance. Carefully hardened and tempered. Filed and set ready for use. Ship-point pattern.

It's easier to achieve the fine workmanship that doubles the pleasure you get from your home workshop if you use Atkins Saws. Atkins have the balance and design that make them handle better—the extra keenness that means faster, cleaner cutting. Because they are made of "Silver Steel"—Atkins' special saw steel that takes a keener edge and holds it longer—it takes fewer sharpenings to keep an Atkins cutting smoothly for longer periods. There's an Atkins for every workshop need. To get the most in sawing satisfaction, get Atkins.

## 4 FAVORITES FROM THE COMPLETE ATKINS LINE

**No. 65 Straight Back**—Fine quality suited to general carpentry. Segment ground, Damascus polish blade, filed and set for use. Carved apple handle. Ship pattern.



**No. 2000 Straight Back**—Light but stiff tempered blade, segment ground, polished and etched. New "Perfect-Grip" apple handle is close to blade for easy handling. Ship pattern.



**No. 37 Compass Saw**—17 x 18 gauge hardened, tempered and polished. 8 points per in. Filed and set. Plastic handle.



**No. 39 Keyhole Saw**—Ground 18 x 19 gauge for easy clearance with minimum set. 10 points per inch. Uniform temper. Filed and set. Plastic handle.



**E. C. ATKINS AND COMPANY**  
INDIANAPOLIS 9, INDIANA

## Eight-Band Amateur Transmitter

(Continued from page 237)

which are as follows: 3.5; 7; 14; 21; 27; 28; 50 and 144 megacycles. The band limits and crystals required appear on the center chart. Crystal sockets are placed at lower right for both  $\frac{3}{32}$ -in.-dia. pins on  $\frac{1}{2}$ -in. centers, or  $\frac{1}{8}$ -in.-dia. pins on  $\frac{3}{4}$ -in. centers. Two views of the upright chassis are shown. Photo B shows the arrangement of the oscillator, multiplier and modulator tubes. It will be noted that there is very little exposed wiring on this side of the chassis. Photo D shows the remarkably compact arrangement of parts and wiring on the opposite side of the chassis. There are two terminal strips provided at the rear

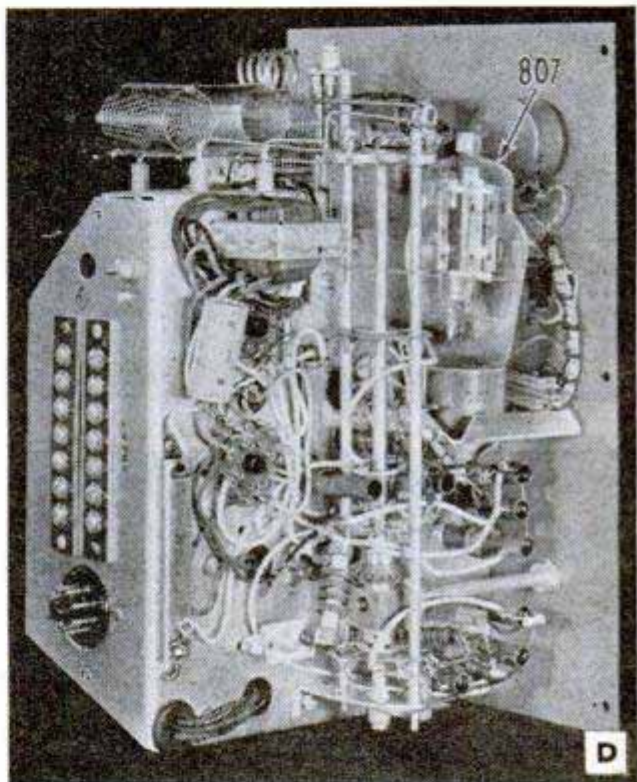

of the chassis so that connections can be made to cover a wide variety of operating conditions. The terminals are numbered as indicated in Fig. 1. With the connections shown for normal phone or CW operation with a 300-volt power supply and 6 volts on the tube heaters, the value of the resistor R1, connected between terminals 10 and 14, is 4700 ohms  $\frac{1}{2}$  watt. Diagrams are also supplied for 400-volt operation with 12 volts on the heaters, and also for exciter service with modulation removed from the 807 plate.

The special power-supply unit, photo C, is available from the manufacturer or a similar unit can be built from diagrams and specifications furnished with the transmitter unit. Complete data is also included for several types of antenna systems.



*Used on  
more new cars  
-sold by more  
dealers!*



replace with a  
**DELCO**  
BATTERY

**DELCO-REMY WHEREVER WHEELS TURN OR PROPELLERS SPIN**

# HANDY ALL-PURPOSE SHELVING



**SURPRISE YOUR HUSBAND!**

Assemble Hines-Shelves yourself—  
two Regular Units measure 68 in. high,  
36 in. wide—6 shelves, 18 sq. ft. of shelf space—**\$15<sup>00</sup>**

What a boon to housewives! Handy, strong Hines-Shelves will solve your home storage problems. Bolted assembly—clear pine frame with Masonite presdwood shelves go together with no nailing or sawing. Shelf height is just right for mason jars, canned goods or books. Satisfaction guaranteed.

#### STORAGE SET-UP

Set up at right is made up of 2 Regular Units and 2 Extension Units. This set-up measures 6 ft. wide and 68 in. high—gives you 36 sq. ft. of shelf space—only **\$28.**

**REGULAR UNITS** (illus. below at left)—3 ft. wide, 34 in. high, 11½ in. deep—3 shelves give you 9 sq. ft. of shelf area. Can be set one over the other as in illustration, only **\$7.50** each.



**EXTENSION UNIT** (illustrated at left)—For making long lines of continuous shelving. Same size as Regular Unit—packaged, ready for assembly. Only **\$6.50** each.

**EDWARD HINES LUMBER CO.**  
2431 So. WOLCOTT AVE. • CHICAGO, ILL.

#### FREE DELIVERY COUPON

Please send me, delivery charges prepaid,..... Regular Units @ \$7.50 each,..... Extension Units @ \$6.50 each.

NAME.....

ADDRESS.....

CITY..... STATE.....

## Clinic



## for Homemakers

As a service to our readers in solving the hundreds of problems pertaining to a home—inside or out—the editors of *Popular Mechanics* invite you to present your problems to The Clinic Editor for help and advice. Address your questions to The Clinic Editor, *Popular Mechanics Magazine*, 200 East Ontario Street, Chicago 11, Ill.

#### Winter Protection for Climbing Rose

**Q**—I have a climbing rose which has nearly covered a large wooden trellis. During the last year much of the growth died out. The trellis is located at the northwest corner of the house and is exposed to severe winter winds. Is the exposure the cause of the canes dying, or is it due to disease?

**B.W.**—Minneapolis, Minn.

**A**—Ordinarily, the climbers are quite hardy, especially those with small blooms in clusters such as the ramblers. In very severe winters they may be damaged somewhat but if the plant is not diseased it will renew itself in a season or two. The large-flowered climbers generally are less hardy. It is possible that the rose disease known as "black spot" has so weakened the plant that it is unusually susceptible to winter injury. The disease can be controlled by spraying with a prepared rose spray during the growing season. In localities where the winters are severe, many gardeners remove the canes from the trellis late in the fall and tie them in a loose bundle. This is laid on the ground and covered with a layer of small twigs. Finally, leaves or coarse straw is used to cover the bundle. Ordinarily, this is sufficient protection.

#### Renewing Finish On Old Piano

**Q**—I have an old upright piano on which the original finish is checked. The checks are fine and run irregularly over all the finished surfaces. I believe the wood is mahogany. Is there any method of renewing the old finish?

**J.M.**—Lima, Ohio.



**A**—If you are sure the wood is mahogany and that the finish is not a grained finish over some other wood, then it is possible to do a fairly good job of renewing the original finish provided the checks are merely surface checks and do not go clear through to the wood. One way is to mix fine pumice stone and rubbing oil to a thick paste, place a small quantity in the center of a square of soft cloth and then fold the corners of the cloth over to form a pad. Rub the checked surfaces, first with a circular motion then with a straight back-and-forth stroke. Continue this procedure until the checks are removed, then polish with rottenstone and oil on a pad in the same manner.

(Continued to page 250)



The **BEST** costs you **LESS** at these  
**FACTORY-TO-YOU SAVINGS**

# Get De Luxe SEAT COVERS

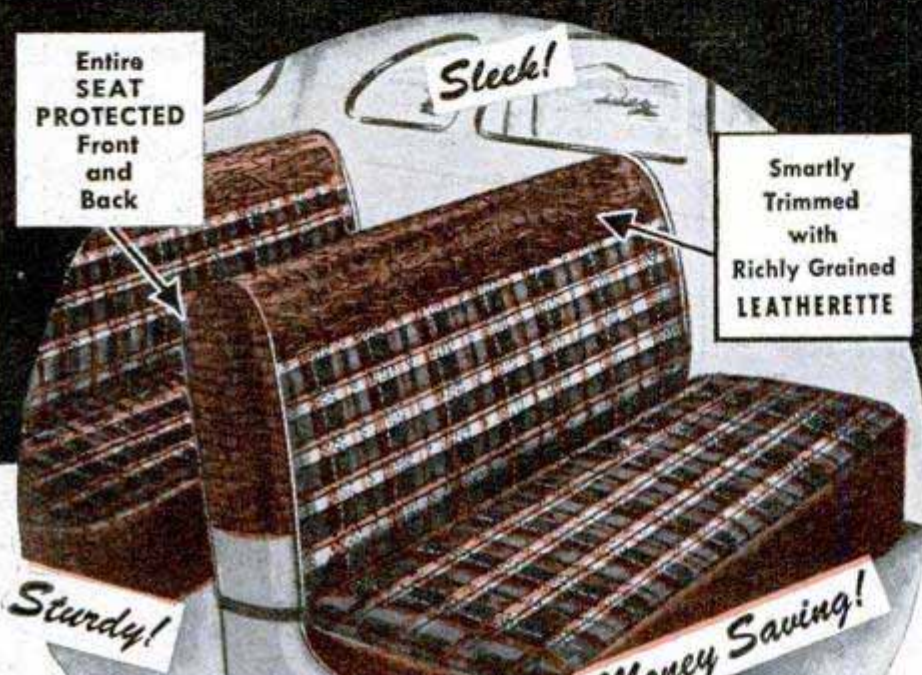

*Way  
Below  
Retail!*

**ACTUALLY THE VERY SAME MATERIAL USED IN COVERS SELLING UP TO \$25!**

Our direct-factory prices offer you tremendous savings. Richer! Stronger! More Luxurious! GAYLARK'S New Auto Seat Covers are TOPS in quality, smart styling and value. Stunning plaid designs in softly harmonious multi-color weaves.

Every GAYLARK FIBRE Auto Seat Cover is carefully finished with elasticized slip-over sides for snug, smooth fit. Just the handsome, thoroughbred accent of elegance your car deserves.

**MONEY-BACK GUARANTEE**

We insist—you must be entirely 100% satisfied, or your money will be cheerfully refunded at once.

**JUST NAME THE CAR — WE HAVE THE COVERS**

To Fit Every Popular Make Auto—New or Old Models

- |          |            |            |
|----------|------------|------------|
| FORD     | PACKARD    | STUDEBAKER |
| PLYMOUTH | FRAZER     | OLDSMOBILE |
| DODGE    | CADILLAC   | BUICK      |
| CHRYSLER | LA SALLE   | HUDSON     |
| PONTIAC  | CHEVROLET  | KAISER     |
| MERCURY  | DeSOTO     | LINCOLN    |
| WILLYS   | NASH       | LAFAYETTE  |
|          | TERRAPLANE |            |

**EASY TO INSTALL—on all types and makes of cars!**

Be sure to specify which type covers you wish when you order. Note styles illustrated below:



1. Solid back for 4-door sedan—front or rear. Rear for coach or coupe



2. Divided back, solid seat for front coupe or coach



3. Individual seats or bucket type for divided back and seat

**\$398** FOR COUPE OR FRONT SEAT  
**\$795** COMPLETE SET OF COVERS FOR SEDAN OR COACH



**BUY DIRECT AND SAVE BY MAIL**

Our Factory-to-You Prices Mean Guaranteed Savings

**SEND NO MONEY**

**GAYLARK PRODUCTS, Dept. DA**  
615 N. Aberdeen, Chicago 22, Ill.

Gentlemen: Please rush Gaylark Seat Covers on 5-day money-back guarantee.

- complete front & back covers, \$7.95 My car is a 19..... Make.....
- front seat cover only ..... 3.98  2-door  4-door
- back seat cover only ..... 3.98  Type 1  Type 2  Type 3
- Rush postpaid...\$.....enclosed  Send C.O.D. plus postage

Name \_\_\_\_\_  
(please print)  
Address \_\_\_\_\_  
City \_\_\_\_\_ Zone \_\_\_\_\_ State \_\_\_\_\_

- Please include one pair Fibre Door Protectors to match, at \$1.00 per set
- Wedge cushion to match, \$1.00

**GAYLARK PRODUCTS** 615 N. Aberdeen, Chicago 22, Ill.

# FOR Building AND Repairing CHRISTMAS TOYS



use **PLASTIC WOOD**

You can get a professional finish on those jobs for the kids! For a slick, smooth finish that takes paint, lacquer or varnish perfectly, use Plastic Wood as your filler. Repairs such as cracks, gouges or loose joints are quickly mended and the toy is back in apple-pie order! Handles like putty—hardens into wood!

... dozens of other uses

- |                        |                    |
|------------------------|--------------------|
| FOR FILLING ...        | FOR REPAIRING ..   |
| • Countersunk screws   | • Loose casters    |
| • Chipped furniture    | • Broken balusters |
| • Nail and screw holes | • Broken furniture |

- You'll want Plastic Wood SOLVENT, too. Get both at one time. It is made especially to control the consistency of Plastic Wood... useful also in removing dried Plastic Wood from tools and fingers.

T. M. Reg. U. S. Pat. Off.

At all Hardware,  
Paint and 10c Stores



## PLASTIC WOOD

Tube or Can

A CELLULOSE FIBRE FILLER

### Metal Weather Strip for Storm Sash

**Q**—I recently purchased an old house and want to fit storm sash all around to conserve heat. Some of the window frames seem to be warped or pulled out of square. On several, the sills are curved upward at the center, making it almost impossible to get a tight fit of the storm sash. Can you suggest a remedy?

**B.R.**—Waterloo, Iowa.

**A**—Use metal weather strip of the spring-contact type. This will add to the cost of installation but the fuel savings will more than offset the extra initial cost. Measure the window frames carefully and cut the storm sash to fit with an allowance of about 3/16 to 1/4 in. all around. Then nail the metal strip to the edges of the storm-sash frame with the nailing flange flush with the inside corner of both rails and stiles. Apply the weather strip in this manner to the top and bottom rails and to the stiles. When installing the storm sash, use turn buttons rather than hangers for fastening.

### Simulated Wrought-Iron Finish

**Q**—Cabinets in my kitchen are finished in natural pine and are fitted with wrought-iron hardware. Due to hard use, the cabinets and hardware are badly scratched and need refinishing. Is there a way to renew the dull black finish of the hardware?

**A.D.**—Scranton, Pa.

**A**—Remove the hardware and clean it first with a paint cleaner and then by wiping lightly with a cloth dipped in lacquer thinner. Coat the hardware and screws with a flat-black brushing lacquer, using a small brush with fine bristles and taking care to apply a uniform coating to both sides of hinges and latches. This will give a flat, dull finish which closely resembles the original. If the doors of the cabinets are to be refinished, be sure that the finishing material is thoroughly dry before the hardware is replaced.



### Chain Loosens Soot in Chimney

**Q**—My three chimneys are old, unlined and, I suspect, badly coated with soot. One chimney is about 30 ft. high; the other two 18 or 20 ft. high. Only the taller one has a cleanout door. Is there any easy way of removing the soot from these chimneys?

**G.H.**—Rome, N. Y.

**A**—One way of loosening the soot in a tall chimney is to lower a chain into the flue from the top. The chain should be long enough to reach nearly to the bottom of the chimney. A light wire chain is best, although any chain will do. After lowering the chain into the flue, swing it with a quick circular movement to give a whipping motion. This will cause the chain to strike the sides of the flue all along its length. The action of the chain will loosen the soot very effectively. Cleanouts should, of course, be installed in the two shorter chimneys.



### Control of Snow Mold on Lawn

**Q**—Early last spring, when raking up the few remaining leaves from the previous fall, I noticed several patches on my lawn which appeared a peculiar whitish gray color just after the snow melted. What is the cause of this? **G.R.**—Milwaukee, Wis.

**A**—Judging from your description, the open patches in your lawn were caused by snow mold, a fungus disease favored by deep snow and ice coatings and especially by any mulch such as wet leaves. It can be controlled to some extent by applying mercuric chloride in the fall at the rate of about 3 oz. per 1000 sq. ft.

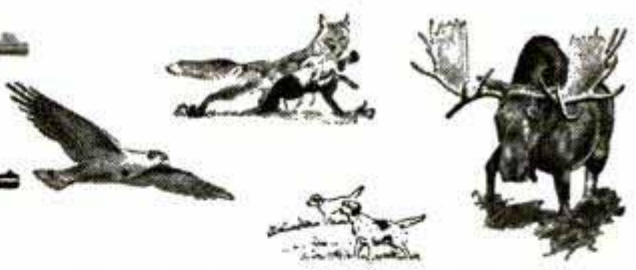

First in the Field • in Values • New Models



## Rifles and Shotguns ... for every Shooter and every kind of Shooting

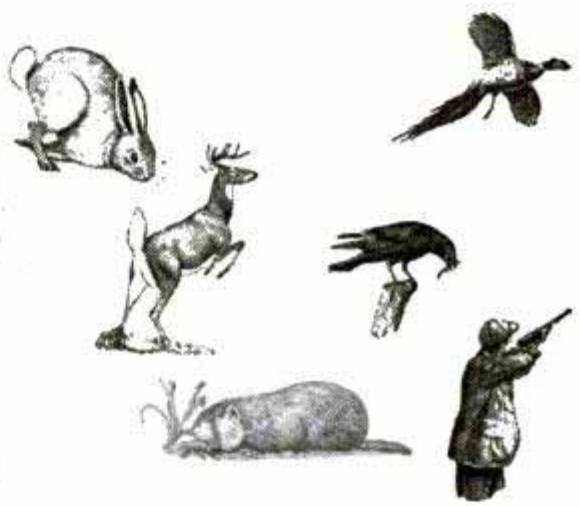

SAVAGE ARMS CORPORATION      Firearms Division      CHICOPEE FALLS, MASSACHUSETTS

(A) SAVAGE Model 99—Hi-Power, Lever Action Repeating Rifle—chambered for the hi-power, flat shooting, Savage-developed .300 and Savage .250-3000 cartridges. Famous for its "smashing power", streamlined design and lightning-fast handling.

(B) SAVAGE Model 745—Lightweight Auto-Loading Shotgun—12 gauge. "Faster because it's pounds lighter." For upland game and skeet. Model 720 (standard weight). 12 and 16 gauge. For water fowl shooting with heavy loads.

(C) STEVEN'S Model 620—Slide Action Repeating Shotgun. 12, 16 and 20 gauge. Hammerless, take-down. A fast handling, smooth operating model for the shooter who prefers a "pump gun."

(D) STEVEN'S Model 325—Hi-Power Bolt Action Rifle. Chambered for the ever popular .30-30 cartridge. A lightweight, accurate, carbine-type rifle that's priced "within the reach of all."

(E) STEVEN'S Model 124—Repeating Shotgun. 12 gauge, 3-shot. Featured by a compactly efficient, fast, simple to operate cross-bolt action design. This latest addition to the Savage line brings the shooter new design and sensational new value in the repeating shotgun field.

(F) STEVEN'S Double and Single Barrel Shotguns—Available in 12, 16, 20 and .410 gauge. Model 530 Double Barrel Shotgun. Hammerless . . . coil springs . . . barrels of forged steel. Checkered American walnut stock and forearm, full pistol grip. Model 107 Single Barrel Shotgun. Hammer style . . . automatic ejector . . . takedown . . . case hardened frame . . . walnut stock. Models 311 Double and 94 Single—same as above but with stocks and forearms of beautiful, durable, practical TENITE.

(G) STEVEN'S Model 59—Bolt Action, Tubular Magazine, 6-shot Repeating Shotgun. .410 gauge. A lightweight, well balanced gun, attractively priced.

(H) STEVEN'S Model 22-410—Over-and-Under. Upper barrel shoots .22 long rifle, long or .22 short cartridges. Under barrel chambered for .410 shot shells—2 1/2" or 3". One of the most popular, practical guns ever made.

(J) STEVEN'S Model 87—.22 Cal. Auto-Loading Rifle. As auto-loader—15 shots as fast as you can pull the trigger. Also, instantly adjustable as single shot or bolt action repeater, shooting .22 long rifle, long or .22 short cartridges.

(K) STEVEN'S Model 84—.22 Cal. Bolt Action, Clip Magazine, Repeating Rifle. Nicely stocked, accurate. For small game hunting or informal target shooting.

(L) STEVEN'S Model 15—.22 Cal. Bolt Action Single Shot Rifle. An accurate, well balanced rifle particularly suited for the younger shooter. Shoots .22 long rifle, long or .22 short cartridges.

SEE THESE MODELS AT YOUR DEALER'S—WRITE FOR FREE CATALOG

# 44 new ideas for your bathroom!



Here's the grand new *illustrated* booklet that shows you *how* to plan the perfect bathroom for your new home . . . or how to lend new charm and utility to your present bathroom!



Its smart *new* ideas are based on more than 25 years of leading the way with modern improvements in bathroom cabinet design, convenience and construction! Mirrors, crystal glass shelves, towel racks, accessories . . . see how to arrange them perfectly!



Let your bathroom reflect your own individuality and good taste. This booklet is full of wonderful suggestions!



mail this coupon today!

**MIAMI**  
*Carey*

Miami Cabinet Division  
The Philip Carey Mfg. Company  
Cincinnati 15, Ohio

Dept. PM-11

I am enclosing 10c. Please send me the booklet,  
"44 Ideas For Your Bathroom."

NAME \_\_\_\_\_

ADDRESS \_\_\_\_\_

CITY \_\_\_\_\_ ZONE \_\_\_\_\_ STATE \_\_\_\_\_

## Junior Foresters

(Continued from page 180)

Students learn to remove a stump by infecting it with a piece of rotten wood and then encouraging the rot to grow. They learn the life cycle of trees, the history of species in this country and the story of arborist movements in America.

Junior Foresters are especially proud that J. Sterling Morton, who founded Arbor Day in 1872, was a resident of Nebraska.

Recently, some of the youngsters wrote letters of invitation to Mrs. Joseph M. Cudahy, granddaughter of the founder of Arbor Day and Chairman of the Board of Trustees of the Morton Arboretum at Lisle, Ill. After a visit to the Omaha organization, Mrs. Cudahy said the youngsters are far ahead of most adults in their knowledge, and she proposed that the organization be made nationwide.

Letters requesting information on the Junior Foresters have poured into Pipal's office from city officials in most states, state foresters, teachers and organizations in other countries. He received one letter from a Hindu nobleman who wanted to start a similar movement in India.

Pipal is amazed by the way his students apply his suggestions. Youngsters of one club ruthlessly ordered him off the school lawn which they had relandscaped and reseeded under his direction. He tells of one of his favorite Junior Foresters, Ronnie, who carried a badge of his devotion to the cause for weeks. One day Ronnie found the neighborhood bully in the top of a tree breaking off the branches. Ronnie insisted that the boy stop. The bully promptly rewarded him with a pair of the blackest eyes in Omaha history. Asked if he was discouraged, Ronnie gazed through puffed eyelids and replied, "I'm going to work even harder now that I can see that these trees really need protection."

Once Pipal described to a club the way leaves of plants take in carbon dioxide and give off oxygen by photosynthesis. Later, four boys asked him a question that stumped him, so he suggested they take the problem to a scientist at Creighton University. Here is the theoretical question the boys pitched at the professor:

"Thirty children 12 years old are in a room with a snake plant. The room is 36 by 28 by 10 feet and the children have enough food to last several days. The temperature of the room is 72 degrees Fahrenheit and it is sealed so no outside air can get in. The leaves of the plant measure 1 by 4 $\frac{1}{8}$  inches. Now, how long can the children stay alive?"

The professor was stumped too.

Amazing New Utility —  
with sanding attachment  
for Dumore Duplex

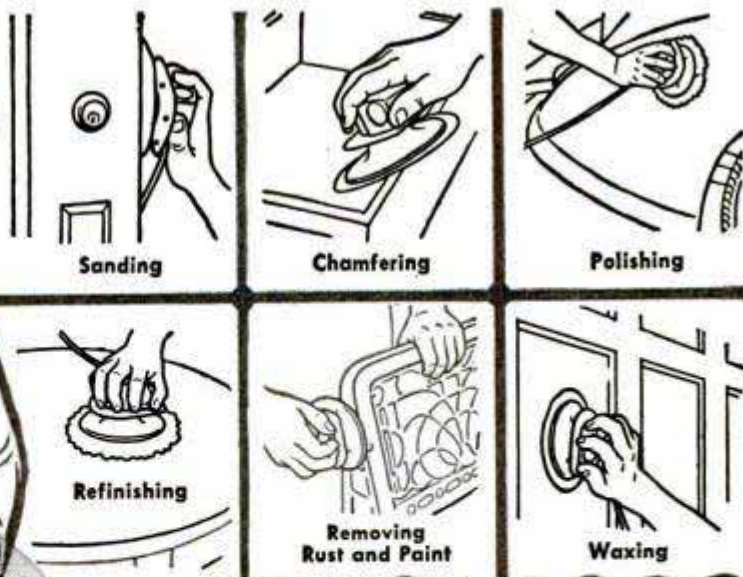
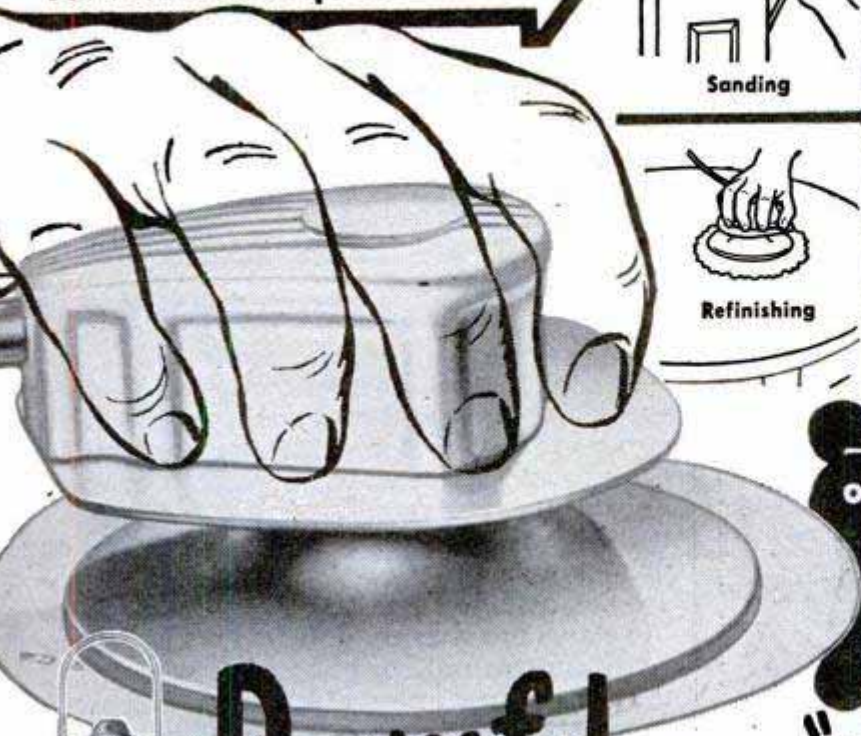

— do these and dozens of  
other jobs with Dumore's  
Handy Sandy  
sanding  
attachment  
... only **\$9.95**

# Powerful new "Handy Sandy"

(sanding and polishing attachment)

**makes Dumore Duplex the most useful tool in your shop!**

Here's a low-priced sander and polisher that *really does a job for you!* It's a powerful, practical tool — not just a toy. The rugged 1/14 HP Duplex Grinder motor gives it the punch *you want* on man-sized jobs.

Attached to the end of the Duplex flexible

shaft, the Dumore Handy Sandy is a light-weight, maneuverable sander. It fits your hand, and fills the bill for rough clean-up work or sensitive finishing operations. Get a Handy Sandy for your shop today. It makes tough work in wood and metal a pleasure.

## More Power, More Capacity for Easier Work

That's what you get from a Dumore Duplex — the grinder that takes 3/32", 1/8", and 1/4" tools for a wide range of work. Deluxe Kit (as illustrated) with 27 accessories, \$27.50; Standard Kit with 9 accessories, \$19.75. Attachments extra. See it at your dealer's, or order direct today!



The Dumore Handy Sandy fits right onto the flexible shaft attachment of your Dumore Duplex Grinder.

**Tear out this coupon and mail today —**  
for complete information on the Handy Sandy,  
Dumore Duplex, and other Duplex attachments.

The Dumore Co., Dept. L-51, Racine, Wis.

Please send me the items checked:

- "Handy Sandy" attachment complete with 5 1/2" rubber disk, sheepskin polishing pad, two sanding disks, and wrench, \$9.95 enclosed.
- Duplex Deluxe Kit with 27 accessories, \$27.50 enclosed.
- Duplex Standard Kit with 9 accessories, \$19.75 enclosed.
- Flexible Shaft for Duplex Grinder, \$6.25 enclosed.
- Information on the Duplex Grinder and attachments. Shipping charges C.O.D.

Name.....

Address.....

City.....(.....) State.....

H-22

when you  
think of pliers...

think of  
**CHANNELLOCK**

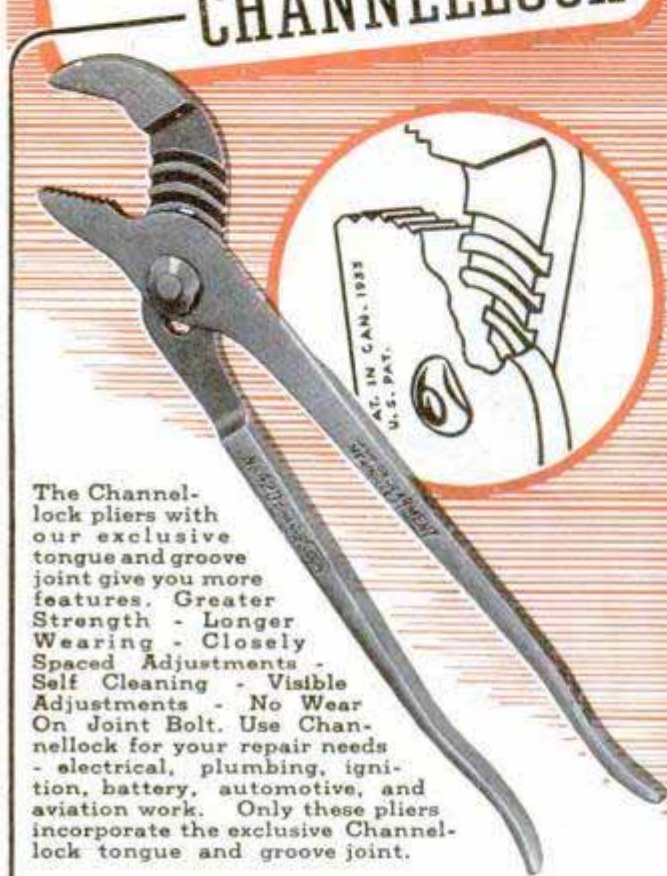

The Channellock pliers with our exclusive tongue and groove joint give you more features. Greater Strength - Longer Wearing - Closely Spaced Adjustments - Self Cleaning - Visible Adjustments - No Wear On Joint Bolt. Use Channellock for your repair needs - electrical, plumbing, ignition, battery, automotive, and aviation work. Only these pliers incorporate the exclusive Channellock tongue and groove joint.



There is a line of standard pattern pliers, too, with Channellock quality construction . . . including diagonal cutters, needlenose pliers, linemen's and electricians' pliers, battery and standard slip-joint pliers.

Choose the pliers that fit your needs . . . Choose Channellock.

**CHAMPION DEARMENT TOOL CO.**  
MEADVILLE, PA.

Only Champion DeArment makes

**CHANNEL LOCK**

## The Mystery of the "Hand Animals"

(Continued from page 164)

of field parties into the area. Most of the researchers specialized in seeking bones of animals, but one member of the group, Dr. Frank E. Peabody, was concerned mainly with trackways. Many of these contained prints of the hand animals.

Recently completed, Doctor Peabody's studies of the *Chirotherium* have confirmed or corrected earlier deductions about the creature and have contributed additional information. Much of the field work was done within sight of Meteor Crater in what are known as the Moenkopi strata of the Triassic age.

Doctor Peabody found evidence of eight species of the hand animals, two of which appear to be identical with species found in Europe and six of which appear to be new. Footprints of one small type suggest a creature about the size of a cat while other prints, over a foot long, indicate that some species attained giant size. In some cases, the claws are sharply outlined while others are blunt and almost hooflike, suggesting that the hand animals included herbivorous as well as carnivorous species.

One important discovery was the finding of marks such as would be made by a tail that intermittently touched the ground as the creature moved along. This confirmed earlier conclusions that the hand animal did indeed have a long tail similar to that of the later dinosaurs.

Some *Chirotherium* tracks show front feet almost half as large as the hind feet. Others show the front feet to be considerably smaller. But all tracks of *Chirotherium* show that the animal was essentially quadrupedal. The conclusion is that *Chirotherium* started out as a fully quadrupedal animal, advanced to an incipient bipedal stage with a tendency to walk on the two hind feet alone, and then, over a period of many centuries, gave up the attempt. However, it retained the small front feet to the end of its history on earth.

Usually, a layer of shale rock is found under a sandstone slab that contains tracks. This shale is the ancient dried-out mud. In one rare example, the mud layer was found just as it was when it was deposited 200 million years ago. Peabody collected samples of the mud, wet it and spread it out to dry. The mud broke up into the same patterns of cracks that had been preserved by the sandstone overburden. Small salamanders were induced to walk across the soft mud and their tracks were reproduced with the same fidelity as were footprints of the hand animals.

(Continued to page 256)





*Coming your way -*  
**SUPER-SMOOTH RIDING!**

# 1949 HARLEY-DAVIDSON

with the new *HYDRA-GLIDE* FORK!

- NEW** "flight-smooth" comfort that irons out bumps like magic!
- NEW** "road-hug" stability that makes handling easy and sure!
- NEW** "effortless" steering that gives positive control at all speeds!
- NEW** "feather-touch" braking that provides stopping power to spare!
- NEW** "speed look" that makes people stop, look, and *envy!*
- NEW** unmatched performance for greatest fun and thrills!

You'll think you've got wings . . . when you take off down the highway on this jet-like streamliner! It's so smooth, so comfortable! It handles so easily, hugs the highway so securely, stops so quickly! Amazing Hydra-Glide Fork irons out bumps like magic, gives you effortless steering ease, new riding stability even on roughest roads. Faster-action, oversize front brake gives you increased stopping power. Sealed ray headlight makes night riding a pleasure. These and other features of the 1949 Harley-Davidson bring you new thrills, more fun, more enjoyment than ever before as you take in race meets, hillclimbs, endurance runs, gypsy tours, sightseeing trips. See your dealer today and mail the coupon now.



**HARLEY-DAVIDSON MOTOR CO., Dept. P, Milwaukee 1, Wis.**

Send literature on 1949 models, also free copy of **ENTHUSIAST** Magazine filled with motorcycle action pictures and stories.

Name.....

Address.....

City..... State.....

Copyright 1948, Harley-Davidson Motor Co.

# Complete New SUPER POWER TOOL KIT



Built  
by  
DURO

**America's  
Greatest Power  
Tool Value!**

Hobbyists, home craftsmen—this is the power tool kit for you! Heavy duty DURO super power unit does cutting, grinding, polishing, engraving, carving and scores of other operations. Smooth, vibrationless in operation... this DURO power unit runs at 20,000 RPM—develops 42 watts output. Complete power tool kit contains the power unit with cord, 5 abrasive points and cutting burrs and full operating instructions—for only \$19.95.

ONLY  
**\$19.95**  
Complete With Power Unit, 5  
Accessories. Sturdy Case  
and Full Instructions



## FLEXIBLE SHAFT MEANS ADDED UTILITY!

New DURO flexible shaft with ball bearing hand piece makes engraving, free hand carving, sanding, easier, lots more fun. Double the utility of your DURO Super Power Tool Kit with this useful flexible shaft for only **\$13.95**

### You can start with this LOW COST Power Tool Kit ... and BUILD A COMPLETE HOME WORKSHOP

One DURO super power unit is used on all of these home workshop tools! You may buy them singly—or in a group.

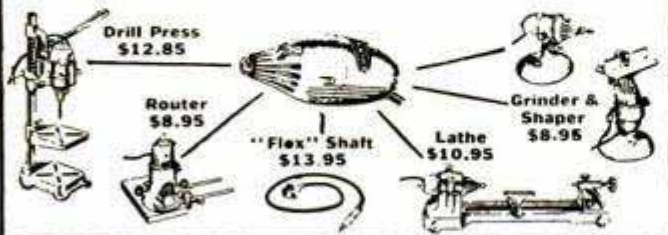

WRITE FOR FREE CIRCULAR giving full details on the Super Power Tool Kit and the new, low cost home workshop units.

**DURO METAL PRODUCTS CO.**  
2677 N. KILDARE AVE., CHICAGO 39, ILL.

In studying Chirotherium, Peabody made a number of lizards walk across a prepared mud surface. Comparative studies of the tracks with the skeleton of the lizard provided a kind of equation by which more information about the hand animals was gathered from the tracks that these creatures made.

All in all, the composite picture of the hand animal, confirmed and amplified by Peabody, reveals a large, awkward reptile that resembled somewhat the great bipedal dinosaurs of a later age. In fact, Chirotherium is judged to be part of the family that gave rise to these dinosaurs.

The mystery of the hand animal will not be finally solved until a fairly complete skeleton of the creature is found. The uncovering of a set of foot bones would be a most important discovery for then it would be possible to study the actual bones of the foot that made the curious footprints. There is a good chance that such a skeleton may be unearthed in Arizona.

Expeditions from various universities and museums, exploring portions of the Moenkopi formation each summer, are keeping a sharp lookout for any object that might be a bone of the hand animal. Discovery of one bone may in turn lead to discovery of an entire skeleton and to the final unraveling of the mystery which has been puzzling scientists for years.

## Canada Hunts Minerals

(Continued from page 159)

the flight is finished, all the information can be correlated to give a true picture of the mineral possibilities and the terrain features of the area that has been covered.

At Great Bear Lake and the more recently discovered Ontario uranium ore fields, scientists use both air and ground photos as tools for the recovery of radioactive minerals. The latest technique is to identify mineral specimens by employing a special desensitized film. It distinguishes between uranium and thorium by the relative intensity of the image.

One of the simplest ways of detecting radiation from minerals is to place the specimen on ordinary photographic film in a light-tight box and allow it to remain undisturbed for 36 to 48 hours. The developed negative then will show a distinct image if uranium or thorium is present. The intensity of the image is a rough measure of the degree of radioactivity and thus of the amount of the mineral present.

Radioactivity is detected without photography by a scintilloscope, an instrument

(Continued to page 258)

# Ingenious New Technical Methods

To Help You  
Increase Efficiency

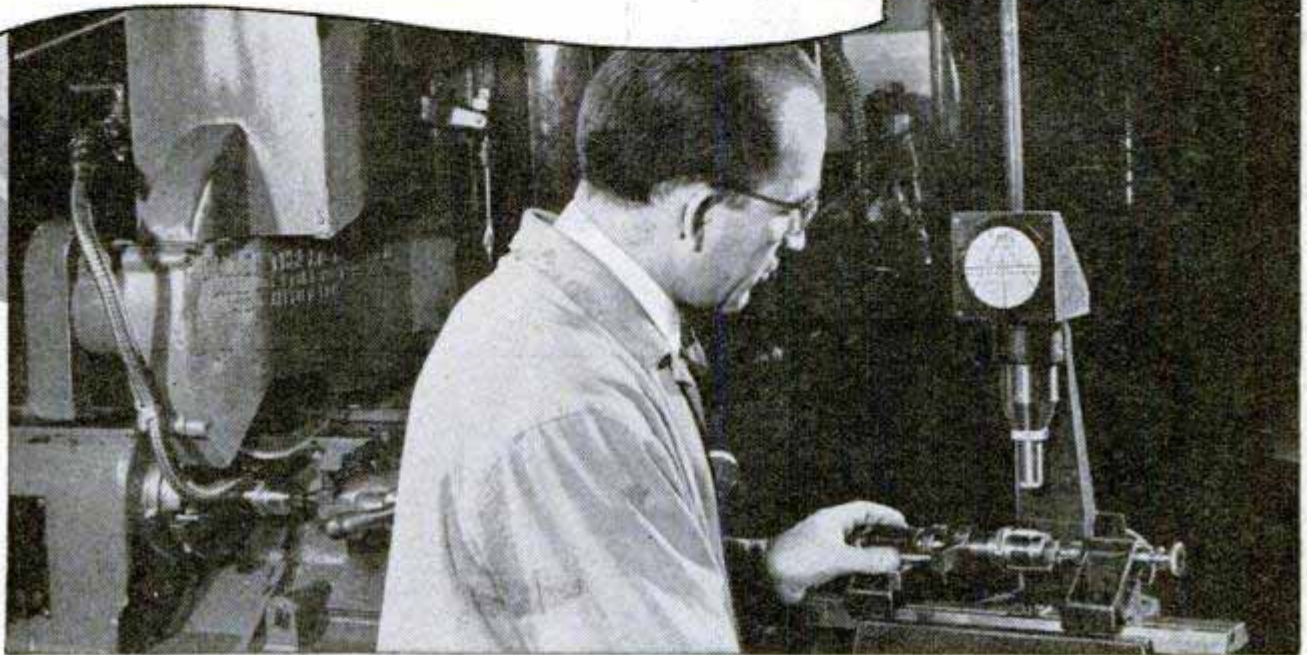

## Light Projector Increases Thread Grinding Production

Production of thread grinding machines can now be increased through the use of a light projecting device called the Thread Pick-up Projector. The thread profile appears in a viewing screen, magnified 20 times, thereby permitting accurate visual adjustments.

In operation the Thread Pick-up Projector is placed alongside the thread grinding machine. A Dalzen Thread Grinder, Model No. 1, is shown above. While the machine is grinding the thread, the operator, using the Light Pick-up Projector, adjusts a "dog" on the next piece to be ground. When the "dog" and piece are then placed in the thread grinder the thread profile is automatically in location and ready for grinding immediately.

Even the most inexperienced personnel can "pick up the thread" using this instrument after only a few minutes demonstration. Grinding is also done more accurately and the viewer permits measurements of reliefs, notches, etc. to .0005 inch.

Efficiency of Production can also be increased through the use of chewing gum. The act of chewing helps relieve nervous tension and seems to make the work go easier and faster. For these reasons, Wrigley's Spearmint Chewing Gum is being made available more and more by plant owners everywhere.

Complete details may be obtained from  
Acme Scientific Company  
1457 West Randolph, Chicago 7, Illinois



Thread Pick-up Projector



AC-79

# Speed Sweep

**+ Arbitrin**



Speed Sweep, the brush with the steel back, is designed to sweep cleaner, faster, easier, and to outlast ordinary brushes 3 to 1. Arbitrin sweeping fluid, sprayed on the floor before sweeping, disinfects, deodorizes, and removes stains in the process of sweeping. These, plus many more advantages (16 in all) have proved to be the perfect answer to effective, low cost floor sanitation in over 60,000 factories, offices, schools, and stores. Mail coupon for complete facts. *Milwaukee Dustless Brush Co., 530 N. 22nd St., Milwaukee 3, Wis.*

**Milwaukee Dustless Brush Co.**  
530 North 22nd St. • Milwaukee 3, Wis.

We are interested in complete information about Speed Sweep brushes and Arbitrin sweeping fluid.

Name .....  
Address .....  
City ..... Zone ..... State .....

that consists of a short brass tube ending in a cap which holds a magnifying lens. A minute glass prism, with its lower surface coated with zinc-sulphate powder, is cemented below the lens. When a radioactive mineral is held close to the coated surface, some of the radioactive particles strike the grains of powder and cause a succession of momentary flashes that can be seen through the lens.

Still another instrument in use in the great Canadian mineral search is the gold-leaf electroscope. Radioactive ores release the electrical charge on two small strips of gold leaf through ionization of the air. By measuring the rate of discharge, scientists are able to make a reasonably close and rapid estimate of the degree of activity and therefore the uranium content of the test sample. Through such instruments they are saving a great deal of time at the mills and refineries which produce and treat uranium ores such as those at Port Hope and Chalk River, Ontario, where the ores recovered at Eldorado Mines on Great Bear Lake are processed.

Geiger counters in a variety of forms are used to discover and evaluate new fields of uranium. Portable models of the telltale instruments are carried into the field and indicate the presence of ore deposits. Others used in the laboratory measure the amounts of uranium and thorium that are present in samples.

The Canadian Parliament, in 1840, passed the Survey Code which provides help for geology students in carrying out graduate studies. Men from various schools and universities are assigned to field parties and are given an opportunity to continue research work in various geological fields. The plan helps the students in their studies and aids the government not only in its survey work but also by providing a backlog of trained geologists for future work in the discovery and processing of important radioactive ores.

## Announcing **CHAMPION** V-Glow Plugs

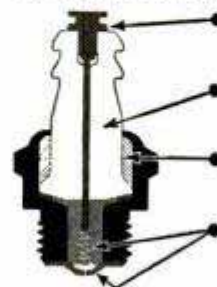

- **CHAMPION TERMINAL**—assures better center electrode seal and provides sturdier electrical connection.
- **CHAMPION-CERAMIC INSULATORS**—proved dependable in millions of Champion Spark Plugs.
- **CHAMPION SILLMENT SEAL**—prevents excessive compression leakage between insulator and shell.
- **CHAMPION "THERM-O-FLEX" CONSTRUCTION**—longer element life, more dependable performance.

Follow recommendations of plug types and fuels approved by engine manufacturer.

**CHAMPION**

SPARK PLUG COMPANY, TOLEDO 1, OHIO

Dependable

# CHAMPION

America's Favorite Spark Plug



Weather-wise ducks are flying south, and weather-wise motorists are installing new dependable Champion Spark Plugs. It's the best, most economical insurance of snappy winter engine performance if new ones are needed. New Champions insure quick starts, minimum battery drain, and better gas mileage

all winter long, when gas consumption is usually up. Insist on dependable Champions—America's Favorite Spark Plug—because they're tops in quality, value, performance and dependability. A quacking duck poster will remind you—"HERE COMES WINTER!" Champion Spark Plug Company, Toledo 1, Ohio.

***FOLLOW THE EXPERTS***

**DEMAND NEW DEPENDABLE CHAMPIONS FOR YOUR CAR**

Listen to the CHAMPION ROLL CALL . . . Harry Wisner's fast sportscast every Friday night, over the ABC network

## We Drove to Alaska

(Continued from page 150)

392, being the peak point along the entire distance.

The population thins out sharply. Though the distance between habitation points as small as gas stations averages about 37 miles for 1000 miles, at two places it is more than 90 miles. It is wise to take on oil and gas often, particularly if you plan to drive any distance at night. Making frequent service stops enabled us to complete the trip without once using gas carried along in an emergency container.

Our Plymouth station wagon performed beautifully throughout, but four punctures in 600 miles, with brand-new 6-ply tires, taught us that high-speed driving was poor time economy. Averaging about 40 miles an hour, we didn't have another puncture all the way to Fairbanks.

Food prices increased as we drove north, comparable meals at Fort Nelson running about twice the rate at Dawson Creek. If you have cooking and camping equipment along, you'll find the Alaska Highway's first 1000 miles a good opportunity to make use of them.

North country mosquitoes, earlier described to us as slightly smaller than fighter planes and almost as deadly,

reached their meanest during this stage of the trip. Their size and individual ferocity is greatly overrated, but in numbers they can easily overwhelm the traveler who doesn't carry insecticide bombs, a skin repellent and netting for protection at night.

At Mile 803 the road passes over part of Teslin Lake on a 2300-foot wooden-pile bridge and a little later on, at Mile 837, spans the Teslin River over a half-million-dollar structure.

Before reaching Whitehorse, we talked with Francis C. Durkin, a field reporter for the American Automobile Association. Durkin was returning from Alaska after completing his organization's first official survey of the highway. He was very favorably impressed with the road's condition but recommended holding the absolute top speed well under 50 miles an hour. His inspection over the road's full length had revealed both tourist and car-service facilities, though sparse, to be reasonably good according to U. S. standards.

(Continued next month)

☞ Dandelions, not bad weather, are responsible for small sets of apples, says E. J. Rasmussen of the University of New Hampshire, because the bumblebees, attracted by the flowers, neglect the apple blossoms.

## IS THE MAIL CARRYING YOUR PICTURES?



Have you seen your local Graflex Dealer for entry forms? Or if you haven't a Graflex-made camera, have you asked your dealer to show you the famous Pace-maker *SPEED* and *Crown GRAPHICS*, the RB Series B (the lowest priced) . . . the Super D Graflex with Automatic Diaphragm? Don't wait. There's no obligation . . . so take the first big step to consistently outstanding pictures! Stop in today!

**GET ENTRY FORMS FROM YOUR GRAFLEX DEALER!!**

# 62 PRIZES TOTALING \$5,000.00

A (Teen-Agers)	Action Division	Feature Division
1st	\$150.00	\$150.00
2nd	100.00	100.00
3rd	50.00	50.00
10 Honor Awards (5 in each division)—\$10.00 each		
B (Non-professionals)		
1st	350.00	350.00
2nd	200.00	200.00
3rd	100.00	100.00
10 Honor Awards (5 in each division)—\$25.00 each		
C (Professionals)		
1st	350.00	350.00
2nd	200.00	200.00
3rd	100.00	100.00
10 Honor Awards (5 in each division)—\$25.00 each		
COLOR		
1st	350.00	(Open to all three groups of contestants.)
2nd	200.00	
3rd	100.00	
10 Honor Awards—\$25.00 each		
<b>Special Press Award—\$300.00</b> —open to all groups. Enter any photo published in a newspaper or general magazine between Oct. 1, 1947 and Dec. 1, 1948.		
<b>NOTE:</b> Only pictures made within the above dates, with a GRAPHIC, Graflex, Crown or Century camera, anywhere in the world are eligible in the contest. Contest extends from Sept. 1 to Dec. 1, 1948.		

**GRAFLEX INC. ROCHESTER 8  
NEW YORK**  
Western Division, 3045 Wilshire Blvd., Los Angeles, California  
New York Sales and Service Offices, 50 Rockefeller Plaza

# Craftsmen! Hobbyists! Tool of 1001 uses! Bargain-priced! An ideal Christmas Gift! Buy it NOW!

Look at ALL  
these Tools!



FOR  
WOOD  
METALS  
GLASS  
PLASTICS  
LEATHER  
ETC.

52-piece  
Set, complete in Case  
FOR ONLY \$19.95\*  
Postpaid

Until  
DEC. 31, 1948  
in the  
United States  
only

## **CRAFTSMAN** Deluxe Rotary Electric Tool

**Complete! . . . Handy! . . . Priced amazingly low!**

Now a sensational "buy" . . . for yourself or as a gift! Truly a whole shopful of tools-in-one . . . this superb CRAFTSMAN Deluxe Rotary Electric Tool will help you turn out all kinds of fine work quickly, easily, accurately . . . for pleasure or profit! Perfect for home or shop, hobby or professional work . . . for maintenance, toolroom, and light industrial production . . . and for scores of other jobs!

Notice all these quality features! Precision-built throughout! Powerful, 18,000 R.P.M. universal motor for 110-120-volt, 25-60-cycle, A.C. or D.C., has improved fan-cooling system; grease-packed precision ball bearing in front; self-aligning rear bronze bearing. Large size brushes, replaceable from outside. Balanced armature and built-up commutator. Built-in condenser reduces radio static. Positive-break on-off switch.

1000-volt tested. Entire tool — not just cord and plug — approved by Underwriters' Labs., Inc. Removable finger-rest over chuck for close, accurate work. Removable pistol-grip handle. Accurate collet chuck assures solid locking of accessories. 5½-ft. heavy rubber-covered cord and unbreakable plug. Over-all length of tool, 7 inches. Weighs only 1¾ lbs., less cord. In handsome, simulated leather-covered case. Buy it NOW at your nearest SEARS RETAIL STORE, or order direct from your nearest SEARS MAIL ORDER HOUSE, using coupon below.

### A complete 52-piece Set . . . with every tool you'll need!

ALL these Accessories (shown at left): 7 Steel Cutters; 1 Mounted Saw, ¾-in.; 1 Saw, ¼-in.; 3 High Speed Drills; 3 Brushes; 8 Mounted Emery Wheels; 1 Cloth Buffing Wheel; 1 Felt Buffer; 2 Rubber Polishing Wheels; 1 Sanding Drum Assembly, with Sleeve; 4 Extra Sleeves; 4 Abrasive Discs; 2 Mandrels (Washer, and Screw-on types). PLUS these Accessories (not shown): 2 Collet Inserts, 3/32 and ¼-in. cap.; 2 Chuck Wrenches; 1 Socket Wrench; 1 Rip Guide; 1 Emery Wheel Dresser; 5 Extra Mandrels (on Saw and Wheels); 1 Set of Motor Replacement Brushes . . . with Rotary Electric Tool, Collet Chuck, cord and plug, in sturdy Workshop Case.

Look what  
it can do!

GRINDS  
SHARPENS  
DRILLS  
SAWS  
CUTS  
CARVES  
ENGRAVES  
ETCHES  
ROUTS  
SANDS  
POLISHES  
BIFFS  
BRUSHES  
SMOOTHS  
CLEANS  
and many  
other uses!

**ACT NOW!** Mail this coupon **TODAY** to your nearest SEARS, ROEBUCK AND CO. MAIL ORDER HOUSE, as listed below: Chicago 7, Ill.; Philadelphia 32, Pa.; Boston 15, Mass.; Kansas City 14, Mo.; Minneapolis 1, Minn.; Atlanta, Ga.; Memphis 2, Tenn.; Dallas 2, Texas; Greensboro, No. Carolina; Seattle 4, Wash.; or Los Angeles 54, Calif.

Please send me the CRAFTSMAN Deluxe Rotary Electric Tool Set, No. 9 C 2652, offered in the United States only, at your special price of \$19.95\*.

I enclose check or money order for \$19.95\*.

\*PLUS additional correct amount for Tax on Sales, if required by your State or City.

Name \_\_\_\_\_

Address \_\_\_\_\_

City and State \_\_\_\_\_

Please Print

PM 11

**CRAFTSMAN** Hand and Power Tools by SEARS, ROEBUCK AND CO.  
Famous for their Top Quality and Extra Value!

## Top of the World Weather Run

(Continued from page 101)

little more than six hours. Another two hours and the weary crew climbed down to familiar ground at Ladd Air Force Base, mission completed.

From countless flights like that of Laughman and his crew, the Air Force is learning about polar weather, valuable knowledge for war or peacetime purposes. Flyers discovered the weather generally looked worse than it was. The air, they found, was mostly stable, with fog, snow and ice haze the main hindrances.

Contrary to previous conceptions, it was found that both lows and highs are constantly moving across the region. The lows were found to be more intense than those to the south, but the resulting weather was not as severe. Experience soon established the prevalence of propeller-icing hazards and the extraordinary tenacity of rime-ice formations.

The missions recognize no "no flying" time, though the twilight transition periods early in the spring and fall present the greatest difficulty. Then the navigators plan flights to concur with phases and positions of the moon or the brighter planets, Venus, Jupiter or Saturn. During this time, there is a 40-minute leeway each

way, during which the flights have to go or be canceled.

Use of the astro-compass in conjunction with a recently devised new form of navigation, called grid navigation, instead of the magnetic compass, eliminates the shifting North Magnetic Pole as a navigational problem. When possible, navigators prefer to work with the sun because it requires fewer corrections.

During the beginning of the twilight transition periods, when the sun is just a glow on the horizon to the south, missions fly out with the sun. They move through about two hours of twilight as they near the pole, depending on the automatic pilot and the directional gyros to hold a correct heading. Then they fly back through the darkness on the other side of the twilight band after the turn at the pole.

On March 16 this year, just prior to the vernal equinox, one crew had the odd experience of seeing two sunrises and two sunsets during a normal length flight. The sun didn't appear until they were on their way, set when they were almost at the pole, reappeared as they headed south and had set again by the time they landed at Fairbanks.

The science of weather is still relatively

(Continued to page 264)



*"We needed some extra rooms in a hurry,  
so when we found out that Weldwood Glue is so strong . . ."*

When you want a wood-to-wood bond that will really hold . . . remember Weldwood Glue. It's quick to mix . . . easy to use . . . tremendously strong . . . stain-free . . . rot-proof . . . and permanent. At hardware stores, lumber yards, chain stores, in 15¢, 35¢, 65¢, 95¢ and larger sizes.



**WELDWOOD**  
PLASTIC RESIN GLUE

United States Plywood Corporation, New York 18, N. Y.





# A LOT OF POWER TOOL IN A LITTLE SPACE

**SHOP SMITH AS CIRCULAR SAW** Has maximum distance of 46" between blade and fence. Tilts to any angle—positive lock. New principle provides micro-adjustment of distance between fence and saw blade. *Specifications:* Saw Blade: 8" Dia. Depth of cut 2 1/4". Table: 14 1/2" x 17"; with extension, 54" x 17". *Equipment:* 8" saw blade and arbor. Table extension. Mitre gauge. Rip fence. Saw guard.

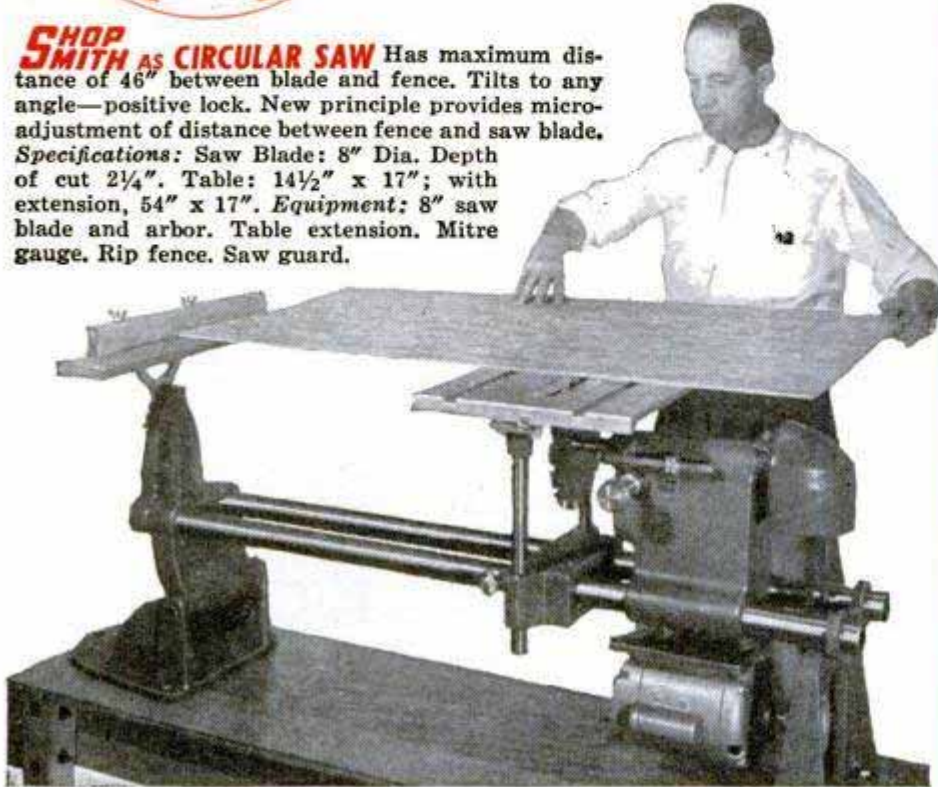

**Complete 5-in-1 SHOPSMITH — 59" Long  
By 18" Wide — Only \$159<sup>50</sup>. With Special  
1/2 H.P. Ball Bearing Motor, \$195<sup>50</sup>**

You're looking at a new kind of power tool. It's **SHOPSMITH**—a circular saw, wood lathe, disc sander, vertical and horizontal drill press *all in one*. For the first time, a multi-purpose power tool with full usefulness in all five positions . . . and convertible to grinder, buffer, router, drum sander, shaper, scratch brusher. And just 59" long by 18" wide. Yes, **SHOPSMITH** outworks single purpose tools of comparable size . . . and you can change from tool to tool in less than one minute.

**BUILT RUGGED**

**SHOPSMITH** has cast iron head-

stock and carriage. Centerless ground and polished steel ways. Heavily reinforced aluminum table. Four life-long grease-sealed Fafnir ball bearings. Weighs over 200 pounds.

**PRECISION MACHINED**

Each **SHOPSMITH** part is precision-machined, factory-tested. Carriage is precision-bored and gauged. Gives cutting tool and work support constant relationship. *You can work more accurately with SHOPSMITH.* Have **SHOPSMITH** demonstrated for you in-the-store. Write for name of nearest dealer and free descriptive folder.

**Magna Engineering Corporation  
465 California Street, San Francisco 3**



**SHOP SMITH AS VERTICAL DRILL PRESS**

*Capacity:* Drills to center of 15" circle. Clearance: Table to chuck — 27" max. Spindle: 5/8" Dia., 6 spline, hardened tip. Spindle Feed: 4 1/4". 4 grease-sealed Fafnir ball bearings. Variable speeds. Table: 14 1/2" x 17". *Equipment:* 1/2" Jacobs key chuck. Fence.

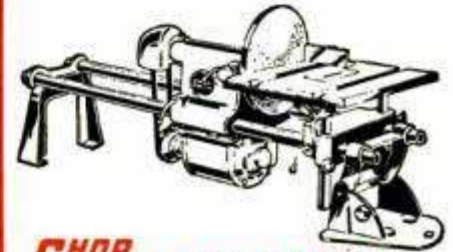

**SHOP SMITH AS DISC SANDER**

Disc Diameter: 12". Table Dimensions: 14 1/2" x 17". Tilting Table. *Equipment:* 12" disc. Mitre gauge.

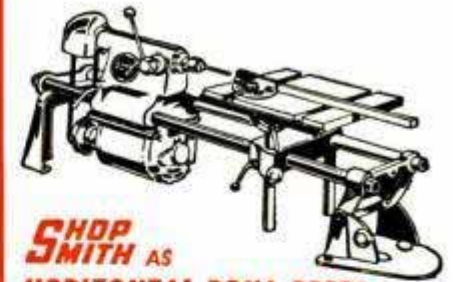

**SHOP SMITH AS HORIZONTAL DRILL PRESS**

Only **SHOPSMITH** performs this highly useful function. No limit to length of work. Provides accurate method of drilling for doweling, etc.

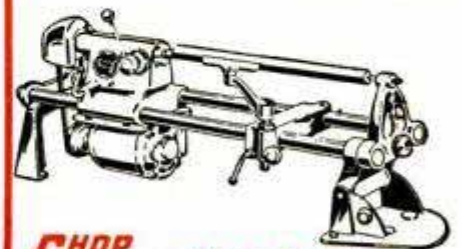

**SHOP SMITH AS WOOD LATHE**

34" between centers. Swing: 15". Variable speeds. Quill Feed: 4 1/4". *Equipment:* Tool rest. Drive center. Cup center.

# See the NEW TRIPLE TOOL

only \$48.75



Complete with following accessories:

- 3-5" Sanding discs (fine, medium, coarse)
- 1-5" Lamb's wool bonnet
- 1-5" Backing pad
- 1-7B Jacobs chuck with key and patented key holder

## SANDER-POLISHER-DRILL

Here's the portable power tool you've always wanted. Ideal for hundreds of jobs around home and workshop. New Triple Tool is a 5" disc sander, 5" polisher and 1/4" drill combined! **Three tools for the price of one!** Triple Tool converts from sander-polisher to drill by removing backing pad and attaching 7B Jacobs chuck to spindle. Drills 1/4" in steel; 1/2" in hardwood.

It's light (6 lbs.)—rugged—compact—powerful. Built by manufacturers of famous Bradford Metalmaster Toolroom Lathes. Has all ball bearings with sealed-in lubrication. Helical-cut hardened gears. Push-button spindle lock. Removable side handle. Powerful 115 volt AC/DC motor drives disc at 2300 rpm free speed; 1400 rpm under normal load.

See the Triple Tool in action at your Bradford distributor, or write for catalog sheet giving complete specifications. The Bradford Triple Tool is available for immediate delivery. 25% deposit with order, balance C.O.D.

Dealers: Write for our sales proposition.

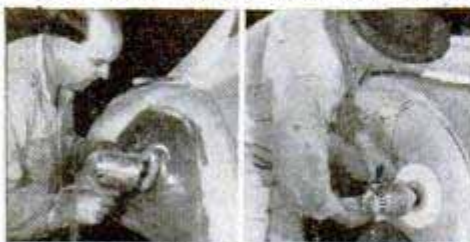

**SANDS  
POLISHES  
DRILLS**

WOOD • METAL • PLASTICS

**THE BRADFORD  
MACHINE TOOL CO.**

671 Evans St., Cincinnati 4, Ohio  
Precision Since 1840



unexplored. As knowledge of the upper atmosphere increases, the forecasters' requirements change. More study is constantly being directed toward factors such as atmospheric electricity, radiation and ozone measurements, water-drop size and pollen count.

Some of these factors may hold the key to virtually exact weather forecasting, or even to the control of weather, as some confidently believe. But the first big step has been taken now and the USAF's "commuter runs" over the pole are taking the mystery out of arctic weather.

## Debut for the '49 Nash

(Continued from page 118)

has been decreased three inches on the '49.

To start a Nash you step on the clutch. This long-time Nash safety feature has been retained in the '49. It's impossible to start this car in gear. As the motor begins to purr and you move down the bumpy road toward the high-speed track, you are impressed with the comfortable ride.

The Ambassador we tested advanced from 0 to 30 m.p.h. in 6 seconds; 0 to 40, 10

### NASH SPECIFICATIONS

	Ambassador	"600"
Engine.....	6 cyl. over-head valve	6-cyl. L-head
Horsepower.....	112	82
Wheelbase.....	121"	112"
Over-all length.....	208-9/16"	199-9/16"
Height.....	62"	62"
Brakes.....	Hydraulic	Hydraulic
Springs.....	Coil (front and rear)	
Drive.....	Torque tube	
Width of front seat...	5' 3"	5' 3"
Width of rear seat....	5' 1"	5' 1"
Tires (super-cushion)...	7:10x15	6:40x15
Luggage compartment.	28 cubic feet	
Models.....	4-door sedan, 2-door sedan, brougham	

seconds; 0 to 50, 14 seconds; 0 to 60, 20 seconds. Tests starting at 10 m.p.h. with the Ambassador resulted as follows: 10 to 30, 7 seconds; 10 to 40, 12 seconds; 10 to 50, 15 seconds; 10 to 60, 22 seconds.

The new Nash holds the road firmly on curves. This is due to better suspension, redistribution of weight and lowered center of gravity. The car stands only 62 inches high—six inches lower than the '48 Nash and only two inches taller than the new

(Continued to page 266)

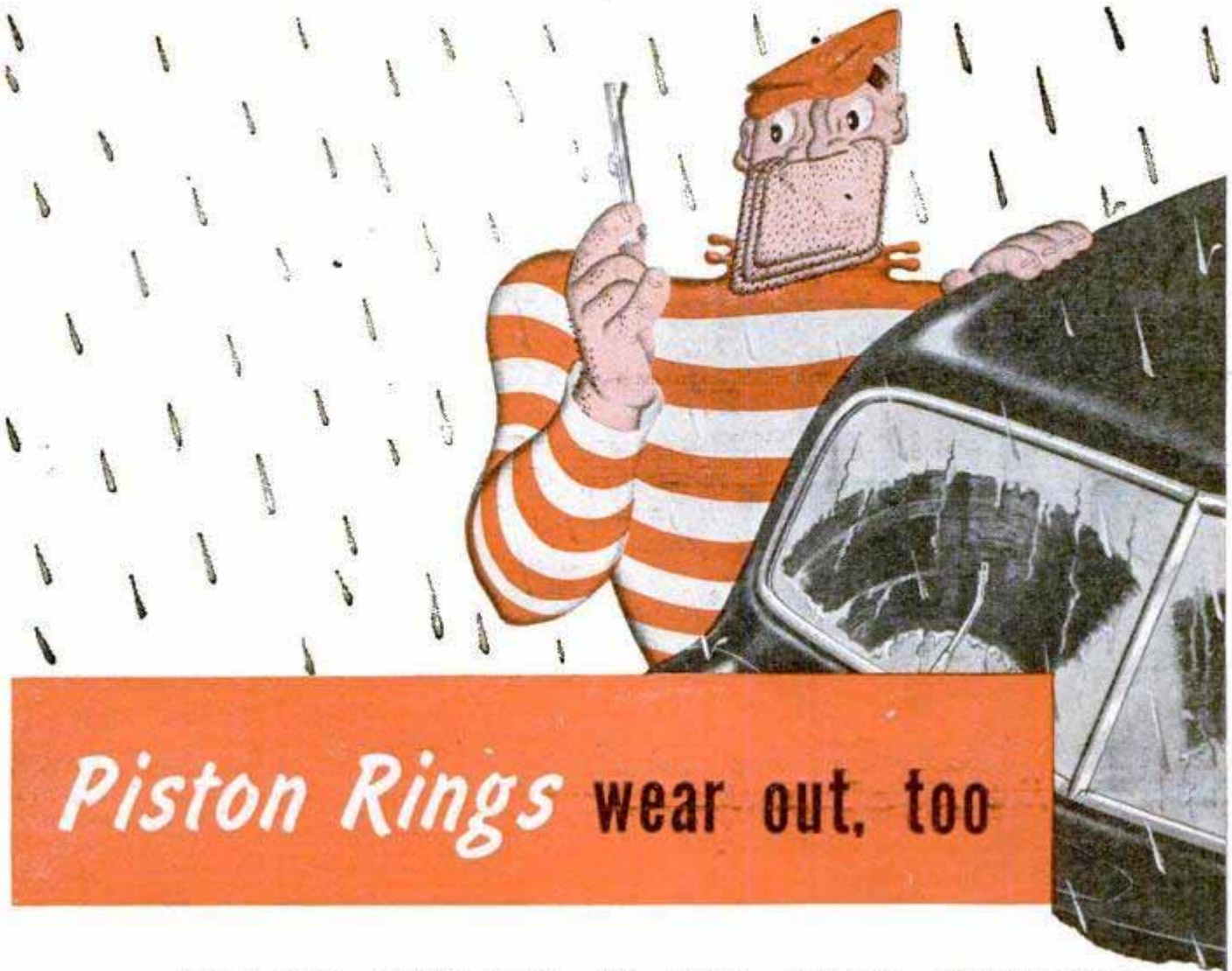

## *Piston Rings* wear out, too

### ...AND OIL PUMPING IS THE FIRST SYMPTOM

If you ignore worn-out piston rings you'll wind up with a lot of needless trouble and expense.

So, at the first sign of ring wear—oil pumping, exhaust smoke or loss of power—take your car to a good mechanic.

If he suggests new piston rings it will pay you to get Hastings Steel-Vents. They *stop* oil pumping, *check* cylinder wear, *restore* engine performance. It's the best money you can spend on your car.

## HASTINGS *Steel-Vent* PISTON RINGS

 GET AN EXPERT CHECK-UP...WITHOUT OBLIGATION

There's good common sense in having your motor checked over now and then—especially now, when so many repairmen are set up to give a Hastings Spot Check without charge or obligation. Drive in to your repairman, and ask for it.

HASTINGS MANUFACTURING COMPANY • HASTINGS, MICH.  
HASTINGS LTD., TORONTO

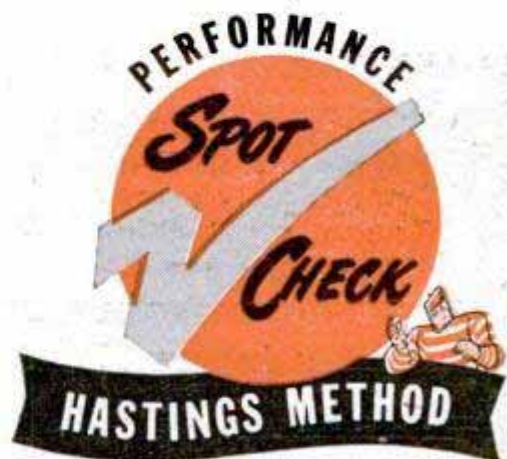

What Science  
now knows  
may help you...

## HEAR BETTER



Get the answers to your questions—plus many interesting and encouraging facts about your hearing—in a new booklet now available to you without cost, called "Modern Science and Your Hearing." Prepared with the help of scientists at Bell Telephone Laboratories, it is published by Western Electric. Mail coupon for your free copy.

**MAIL COUPON TODAY**

**Western Electric** Dept. 380-PM11

195 Broadway, New York 7, N. Y.

Send free copy of "Modern Science and Your Hearing." Also booklet on two new all-in-one Western Electric Hearing Aids.

Name \_\_\_\_\_

Address \_\_\_\_\_

City \_\_\_\_\_ State \_\_\_\_\_

low-slung Hudson. It has ample headroom.

Former Nash owners will be pleased to discover that the Weather Eye ventilation system has been retained with some improvements. The Weather Eye supplies a continuous flow of fresh filtered air. Improvements include better heating at low speeds, a main circulation fan and a more effective water shedder. The vent on top of the hood is never closed. This vent is placed high to avoid highway fumes and dust. The position of this vent should be appreciated by one company which is being sued by the widow of a driver who was asphyxiated. He was parked, according to the suit, behind a taxi with his sedan windows closed and vent open. Exhaust from the taxi entered the low forward vent and filled the sedan with deadly fumes.

Back in the garage after the test run, enthusiastic workmen gather around to point out highlights of the new Nash. These men refute the old theory about no man being a hero to his valet. The fellows who build, service and test the '49 Nash are its biggest boosters. They point out that the '49 retains its "unitized" body construction with the frame built as an integral part of the body. Nash pioneered this type of body construction and their engineers consider the word "chassis" an antique expression.

Another Nash feature which has been improved on the '49 is the bed which is now a twin. This optional equipment, available on all two and four-door sedan models, is easily operated. Each half of the divided front seat can be dropped back, singly or together, to form sleeping space. Two single mattresses fit over the seat cushions. This arrangement provides a single bed while the car is under way.

The Nash engineers have taken a free hand with the luggage compartment. Including four cubic feet for the tire in a vertical position on the right side, the compartment affords 28 cubic feet of storage space. All the rear lights are installed in the trunk lid, a novelty with both good and bad features. When it is lifted at night the lights are hidden from an approaching car. However, a small red warning light shines inside the trunk. The ingenious tamper-proof lock on the trunk has a T-handle which fits flush with the lid. When unlocked, the handle snaps out under spring pressure.

Body styles for both models of the Nash include the four-door sedan, two-door sedan and the brougham. The brougham has two wide single seats in the rear separated by a large triangular armrest. The seats are angled slightly to face toward center.



SWIVEL  
JAW

**NEW!**

SEYMOUR SMITH  
**"Snap-Lock"**  
PLIER-WRENCH

**3**  
**NEW**  
**Features**

1. Swivel Jaw holds odd-shaped pieces.
2. Capacity Indicator pre-sets jaw spread.
3. Release unlocks jaws instantly by a touch of the finger.

Tremendous grip. Use as a plier or, when locked closed, for holding articles to be drilled, welded, ground, etc. 1000's of uses around home, farm, garage, shop. No. 2607, 7", \$1.75; No. 2610, 10", \$2.25. At your dealer or write direct. Free circular.

CAPACITY  
INDICATOR



INSTANT  
LOCK  
RELEASE

SEYMOUR SMITH & SON, INC.  
900M Main St., Oakville, Conn.

**BUILD IT, FIX IT**

WITH

**AMBROID**

**"IT STAYS STUCK!"**



For a quick job with permanent results use multi purpose, fast drying Ambroid liquid cement. For home workshop, household or factory. A quality leader for 38 years. Ready-to-use Ambroid is waterproof, transparent, quick drying, extra strong, flexible, heat and corrosion resistant. For assembling, repairing or mending jobs, keep Ambroid handy. At your dealer's or send 25c for a big 2 oz. tube postpaid. Money back guarantee.

Also 50¢ 4-oz. tube. Pts., qts., gals., for industrial use.

**AMBROID**

303 Franklin St., Boston 10, Mass.

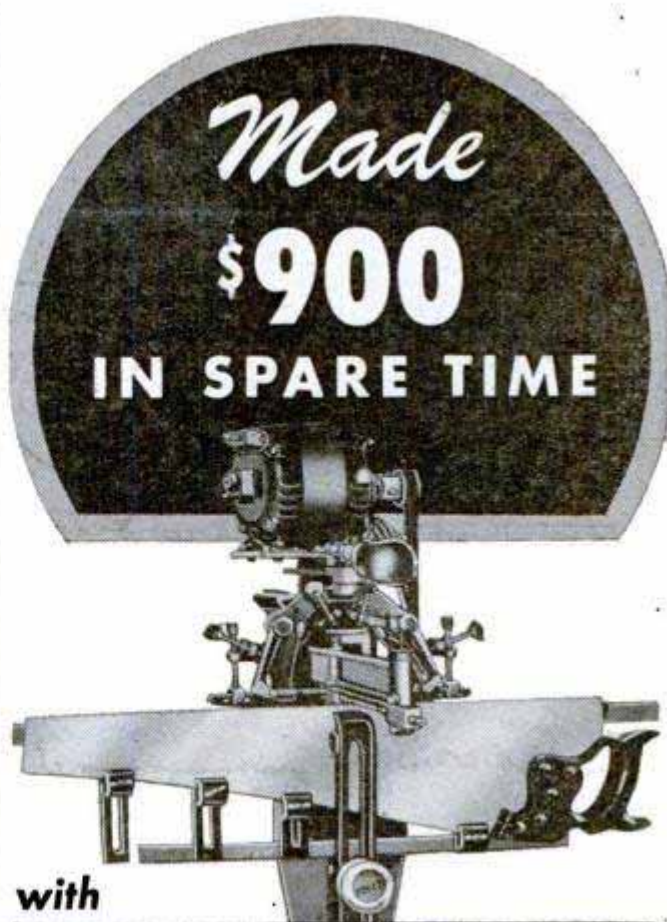

with

**FOLEY\* automatic SAW FILER**

\*Trade Mark Reg. U. S. Pat. Off.

"I did very well last year with my Foley equipment, about 950 saws and 240 lawn mowers, in my spare time. About \$900 for me." L.H.M., New York. A.G.W. in Mass. says: "I have filed over 5000 saws in 8 years and find the Foley Automatic Saw Filer very satisfactory."

Make up to \$2 or \$3 an hour in Spare Time. With the high prices of food, clothing and everything else, just think what you could do with extra money every week! With a Foley Automatic Saw Filer you can file hand, band and circular saws better than the most expert hand filer. "The first saw I sharpened with my Foley Filer came out 100%"—writes C.E.P. Every saw you sharpen with the machine accuracy of the Foley Saw Filer is an ad that brings you more customers. Cash business, no canvassing. No eyestrain, no experience needed.

**FREE BOOK**

**INDEPENDENCE AFTER 40!**

Shows just how you can start at home in spare time in your basement or garage. Just think—with a small investment, no overhead, no stock of goods to carry, you can get right into a cash business—and later on develop into a full-time repair shop. Send coupon today for this practical plan.



**Send Coupon for FREE BOOK**

FOLEY MFG. CO., 1116-8 Foley Bldg., Minneapolis 18, Minn.  
Send FREE BOOK—"Independence After 40."

Name \_\_\_\_\_

Address \_\_\_\_\_

What a Christmas Gift!

NOW...SANDING IS FUN!



## Amazing MOTO-SANDER AND POLISHER

**Saves Time - Saves Elbow Grease!** Here's an inexpensive Sander and Polisher so easy to handle that a child can use it. All you do is guide it! **Moto-Sander** delivers 7,200 strokes a minute... does a magically smooth job... gets into places other sanders can't reach. Has only two moving parts... never needs oiling or adjustment. Uses 110-120 volt, 60 cycle A.C. electric current. Has 8 ft. (Underwriters' Approved) rubber cord. Furnished with 6 sheets assorted grade Garnet paper for sanding, plus 1/8" thick felt pad and sheepskin pad for wax polishing.

Only **\$14.85**  
POSTPAID

### FINE FINISHES - FAST!

Use **Moto-Sander** to get satin smooth sanded finish on woodwork, stairways, doors, furniture: ideal for finish sanding of boats, painted walls, bird houses or scale models. Use it also for speedy, effortless polishing of waxed furniture, automobiles and other surfaces, simply by removing sandpaper and clamping on polishing pad. **Moto-Sander** is the lightest, most practical electric sander on the market, and is patented.

### MONEY-BACK GUARANTEE

See **Dremel Moto-Sander** at your dealer's. If he cannot supply you, use coupon below to order on 5-day trial, money-back guarantee. **Moto-Sander** will be sent complete and post-paid for \$14.85 (check or money order in full). Or, send only \$2 with order and pay postman balance plus postage upon C.O.D. delivery. Remember, **YOUR MONEY BACK** if not delighted after 5 days' trial.

**DREMEL MFG. CO.**  
DEPT. SP118-L • RACINE, WIS.  
MANUFACTURERS OF THE FAMOUS  
MOTO-TOOL AND MOTO-SAW

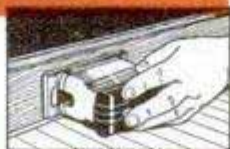

EASY FOR  
AWKWARD PLACES



SANDS FLAT  
SURFACES EVENLY



GETS INTO  
TIGHT CORNERS



ROUNDS CORNERS  
LIKE MAGIC



GREAT FOR  
AUTO POLISHING

IF YOUR DEALER CANNOT SUPPLY YOU

### USE THIS COUPON TO ORDER

DREMEL MFG. CO. • DEPT. SP118-L • RACINE, WIS.

- Enclosed find \$14.85 (Check or money order in full). Ship **Moto-Sander** at once Postpaid.  
 Enclosed find \$2.00 as part payment on **Moto-Sander**. I will pay postman balance plus postage upon C.O.D. delivery.  
 Please send Free Catalog of Dremel Tools and Equipment.

NAME \_\_\_\_\_

ADDRESS \_\_\_\_\_

CITY \_\_\_\_\_ ZONE \_\_\_\_\_ STATE \_\_\_\_\_

## Trainer of Champions

(Continued from page 123)

to the body as possible. An assistant drops the pigeon some distance from the dog. After holding the dog steady for a moment, the trainer signals him forward and the dog makes the retrieve. Nick can return a live pigeon all day without even ruffling the bird's feathers.

At any advanced point in the training, Walker switches his dogs to whistle signals so they will be easier to handle in the field. This is done simply by uttering the command word and then immediately blowing the corresponding blast on the whistle. The dog quickly associates the two, and soon will work by whistle signal alone while in the field.

The trainer maintains that holding a dog steady when a shotgun is fired is no particular problem. Most good retrievers soon will learn to associate the report of the gun with the fall of a bird and will be eager to make a retrieve.

By the time the dog is a year old, Walker says, he should be trained well enough to work as a partner in the field. At three or four years of age he will reach his peak in performance and will remain a top-notch worker for several years.

Walker has taught his dogs refinements that have made them known throughout the country. For example, he can put out six pigeons in tall grass a great distance from Nick. On command, the dog will bring back any chosen bird, switch from one to another or retrieve all six in succession. Thus, when Nick accompanies a large hunting party, he can make retrieves for every Nimrod who brings down a bird, working only on Walker's signals.

Nick also has an exceptional eye for marking the fall of a fowl. This is a trait that cannot be taught—either a dog has the knack of running or swimming straight to the fallen bird, regardless of obstacles in his path, or he must hunt the bird for some time. A good retriever, if he can't find the bird immediately, will make long "casts" in a pattern determined by the terrain, searching every inch of the ground to pick up the scent.

Nick is fearless. He will dive from a high bank far out into the water, will jump a six-foot fence with a pheasant in his mouth and has been known to crash repeatedly against even higher fences with the full force of his body in an effort to break his way through.

According to Walker, Nick is afraid of only one thing—making a mistake. That has always been the mark of a champion.



# Moto-Tool

THE "POCKET-SIZE  
MACHINE SHOP"

THE GIFT  
HE'LL LIKE BEST  
AND USE  
LONGEST



Grinds, Routs,  
Drills, Carves,  
Engraves, Cleans,  
Polishes, Finishes.

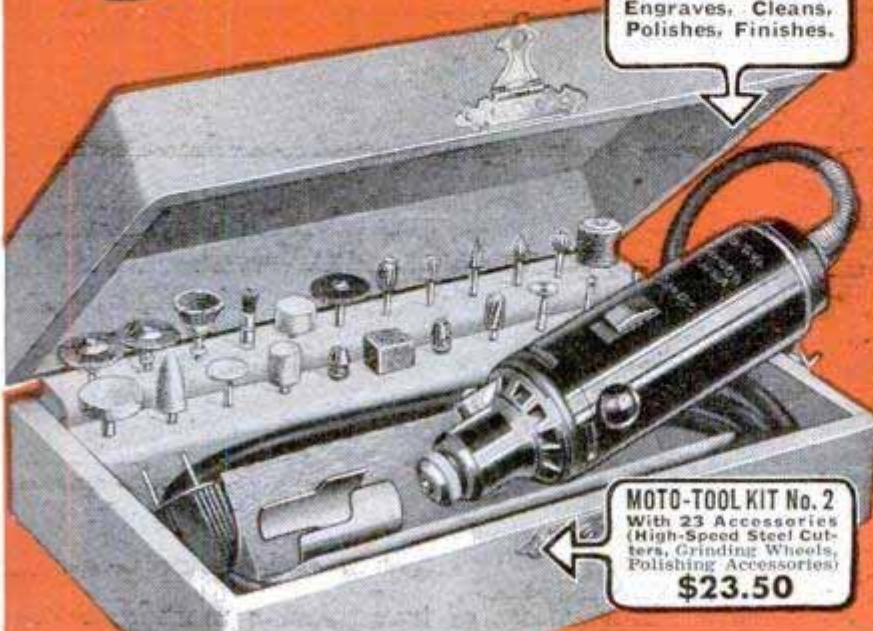

**MOTO-TOOL KIT No. 2**  
With 23 Accessories  
(High-Speed Steel Cut-  
ters, Grinding Wheels,  
Polishing Accessories)  
**\$23.50**



APPROX.  
27,000 R.P.M.



Great for  
Hobbyists



Saves Time  
and Labor

## A SHOP TESTED TOOL

Moto-Tool is backed by over 12 years of industrial use . . . packs years of extra pleasure . . . yet, due to increased production, pre-war prices still prevail!

### LOOK FOR THESE MOTO-TOOL FEATURES

Oil-less, sealed bearings • Patented automatic chuck lock pin • Oversize armature shaft; hardened, ground, polished • Shock-proof, bakelite housing • Dust filtered air cooling system • Dynamically balanced for vibrationless operation • Exclusive hanger hook • Weight only 13 oz.

## New DRILL PRESS

ONLY **\$9.95**

(Less  
Moto-Tool)

Only Dremel offers you a portable, precision drill press at such an amazingly low price. Just the thing for creating costume jewelry, model making, wood carving, routing, etc. Utilizes Model No. 2 Moto-Tool, which can be raised or lowered, swung in any direction, or quickly removed for off-hand use. Drill Press stands 12" high. Base is 6 3/4" x 4". Weighs approximately 3 1/2 pounds.



### MONEY-BACK GUARANTEE

Buy Dremel Tools from your dealer. If he cannot supply you, use coupon below to order desired items on 5-day trial, money-back guarantee. Items checked will be sent complete and postpaid for check or money order in full. Or, send only \$2 with order, and pay postman balance plus postage upon C.O.D. delivery. Remember, **YOUR MONEY BACK** if not delighted after 5 days' trial.

**DREMEL MFG. CO.**

DEPT. T118-L • RACINE, WIS.

Here's  
**BIG VALUE!**



MODEL No. 1  
**MOTO-TOOL KIT**  
ONLY **\$17.50**

This highly popular Kit contains lighter Model No. 1 Moto-Tool and 34 practical accessories in attractive, lacquer-finish wood box. It's the biggest bargain in the field.

# MOTO-SAW

THE AMAZING ELECTRIC SCROLL SAW

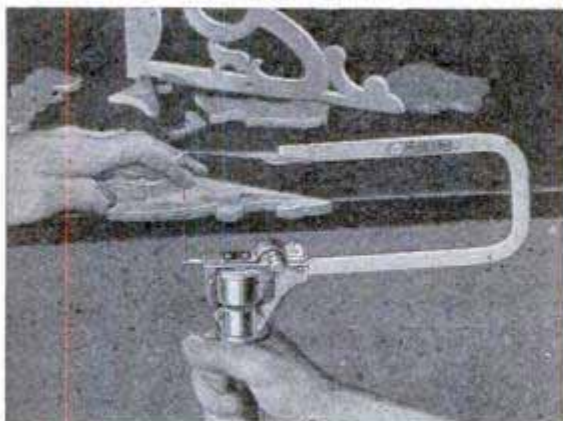

This electric coping saw works like magic! Easily cuts intricate scroll designs in medium-hard wood up to 3/4" thick. Runs 7,200 strokes a minute . . . just guide it! Has only two moving parts . . . never needs oiling. Operates on 110-120 volt, 50 or 60 cycle A.C. electric current. As safe as a handsaw . . . thousands of satisfied users. Comes complete with 3 saw blades, at only... **\$5.85**

## USE THIS COUPON TO ORDER

IF YOUR DEALER CANNOT SUPPLY YOU WITH DREMEL TOOLS

**DREMEL MFG. CO., Dept. T118-L • RACINE, WISCONSIN**

- Enclosed find \$\_\_\_\_\_ (Check or money order in full). Ship items checked below at once Postpaid.
- Enclosed find \$2.00 as part payment on items checked. I will pay postman balance plus postage upon C.O.D. delivery.
- Moto-Tool Kit No. 2, \$23.50     Moto-Saw, with 3 blades, \$5.85
- Moto-Tool Kit No. 1, \$17.50     \_\_\_\_\_dozen blades (60c per doz.)
- Drill Press (Less Moto-Tool), \$9.95     Free catalog of Dremel Tools and Equip.

NAME \_\_\_\_\_ ADDRESS \_\_\_\_\_

CITY \_\_\_\_\_ ZONE \_\_\_\_\_ STATE \_\_\_\_\_



If a gift for some man has you worried remember nothing could be more appreciated than fine tools. Perfect for use on the job or at home, they will please the most particular male — whether he's 6 or 96. Singly or in sets, Proto Tools are fun to give and a joy to receive. See your dealer today. Write for catalog to Plomb Tool Company, 2255C Santa Fe Avenue, Los Angeles 54, California.

**Long-Lasting,  
Appreciated!**



Set No.  
9900 D

4891

**PROTO TOOLS**  
Reg. U. S. Pat. Off.

*First in Quality*

MFD. IN U.S.A. BY  
**PLOMB TOOL CO.**

## Television Is the Navy's Schoolteacher

(Continued from page 127)

via coaxial cable or micro-wave relay and the location of the student body. Regions, somewhat in the order of their probable activation, might be: East Coast; Chicago-St. Louis-Detroit; West Coast; Florida and Texas.

The network covering the East by radio relay from Boston to New York and by coaxial cable from New York to Richmond, Va., could cover a multitude of service personnel and this group could be heavily increased if this web were extended to include Norfolk, Va., and Cherry Point, N. C. Transmission time could be acquired by the usual commercial means and could, if necessary, be drafted in emergencies.

A possible alternative to the coax-relay combination might be the Westinghouse Stratovision scheme, whereby airplanes at four miles altitude pick up and relay TV signals from a ground station, making it possible almost to cover the country by eight planes.

Regardless of transmission method, security could be maintained by possible introduction of coded interference in the video and audio signals at the source and filtering them out at the receivers at the various bases.

The Navy plans to keep the class groups small, probably not more than 30, to maintain the intimacy and feeling of personal contact with the instructor. The picture will be projected and the image will not be smaller than three feet by four feet and may be twice that large. The picture must be large enough to show details and not so large that the instructor on the screen overpowers the students.

Instructors will be able to ask questions of any group and receive answers via a parabolic mike in each classroom. In addition, a rater system will enable him to know just how well he has made a certain point by polling the entire group, wherever situated. To a given question he will show four answers and ask the men to push the one button of four on their desks which indicates their choice. The aggregate answers for the whole group will appear in the studio along with the answers from each group and each classroom will have a board indicating its own answers.

After each lesson there will be a question period. Each student will have a mike on his desk connected with the instructor's assistant at the center. The student presses a button on the mike and asks his

(Continued to page 272)



Harvey E. Whitman  
Jackson, Mich.  
Senior 1st Award  
\$4,000 Scholarship



Howard Eichen  
San Francisco, Calif.  
Senior 2nd Award  
\$3,000 Scholarship



Leon Levand  
Washington, D. C.  
Senior 3rd Award  
\$2,000 Scholarship



Howard K. Graves  
South Bend, Ind.  
Senior 4th Award  
\$1,000 Scholarship



Ronald Johnson  
Portland, Ore.  
Junior 1st Award  
\$4,000 Scholarship



Tom Goad  
Birmingham, Mich.  
Junior  
Dup. 1st Award  
\$4,000 Scholarship



## Major Award Winners 1948 Competition

# BOYS! \$65,000 IN AWARDS

Build model cars for the 1949 Fisher Body Craftsman's Guild Competition — 734 awards — university scholarships worth up to \$4,000 each — cash — trips — tool chests!



Harold L. Simon  
San Antonio, Tex.  
Junior 2nd Award  
\$3,000 Scholarship

Paul E. Jaquish, II  
Saginaw, Mich.  
Junior 3rd Award  
\$2,000 Scholarship



Richard A. Norton  
Chicago, Ill.  
Junior 4th Award  
\$1,000 Scholarship

Any boy 12 years old or over and not yet 20 on September 1, 1948, may enter the competition to design and build a model car. Junior and Senior Divisions with identical awards let you compete with boys of your own age. No dues or entrance fees. Awards include Model Builders' Tool Chests, cash, all-expense trips to the Guild Convention, and 8 university scholarships worth \$1,000 to \$4,000 each. (Duplicate awards are given if sons of General Motors employes win.) Judges include deans or presidents of 10 leading technical schools and universities.

Write for free membership. Each new member receives a membership card and button, a full set of plans and instructions, *all free*. Competition closes at midnight July 1, 1949. You can win one of these awards! Mail the coupon NOW and get started.

### FISHER BODY CRAFTSMAN'S GUILD

Sponsored by: Fisher Body Division of General Motors  
General Motors Bldg., Detroit 2, Michigan

Gentlemen: Enroll me in the Fisher Body Craftsman's Guild 1949 Model Car Competition. Send me full instructions without charge.

Name \_\_\_\_\_

Address \_\_\_\_\_

City \_\_\_\_\_ Zone \_\_\_\_\_ State \_\_\_\_\_

I was born on the \_\_\_\_\_ day of \_\_\_\_\_, 19\_\_\_\_

Parent or guardian \_\_\_\_\_

Name of school \_\_\_\_\_

City \_\_\_\_\_ State \_\_\_\_\_ Dept. 2 \_\_\_\_\_



## When Your Radiator Springs a Leak...

Keep Smooth-On No. 1 Iron Cement handy for emergency auto repairs. Use it to stop radiator leaks; seal cracks in water jackets, crank or gear cases; tighten loose door hinges, handles, etc. You can save time and money making these repairs yourself. And they'll STAY TIGHT, for Smooth-On expands a little as it hardens. Buy Smooth-On in 1 1/4-oz., 7-oz. or 1-lb. size at your hardware store. If they haven't Smooth-On, write us.

### FREE Repair Handbook

This famous 40-page book shows, as well as the above repairs, many other useful ones you can make around the house. 170 pictures. Send postcard for YOUR free copy today.

SMOOTH-ON MFG. CO., Dept. 37L  
570 Communipaw Ave., Jersey City 4, N. J.

Do it with

# SMOOTH-ON

THE IRON CEMENT OF 1 000 USES



## A NEW KIND OF MOTORCYCLING WITH

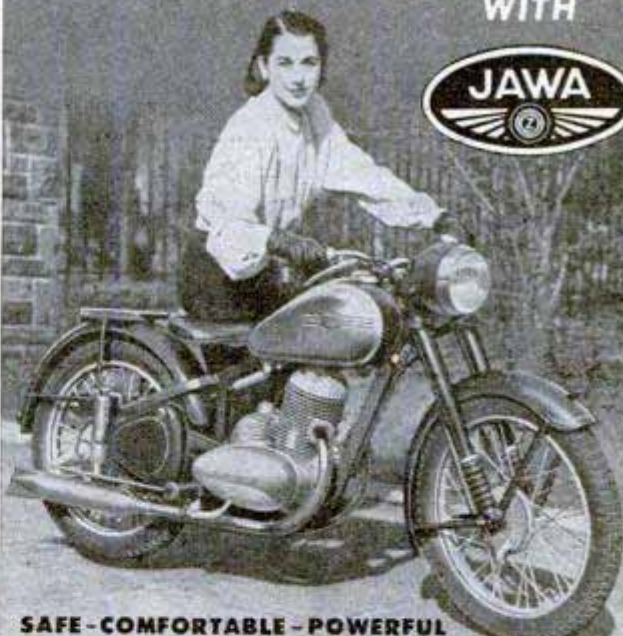

### SAFE - COMFORTABLE - POWERFUL

Automatic Clutch. Telefloat Spring Suspension.  
Foot Gear Shift. 95 miles per gallon. 70 Miles per hour.  
See and drive it at your nearest JAWA DEALER or write for free folder.

## JAWA MOTORCYCLE CO.

Dept. M

460 FOURTH AVE., NEW YORK 16, N. Y.

DEALER INQUIRIES INVITED

the perfect  
christmas gift!



6

TOOLS IN ONE!

LOW COST!

Duo Sander-Polisher (only).....\$ 36.50  
Set of 21 Accessories.....\$ 12.50  
Duo with Complete set of 21 Accessories.....\$ 49.00

F. O. B. Muskegon, Michigan



**SANDS!** Accessories: 3" pad assembly, 3 grades each of 3" and 5" abrasive discs.



**DRILLS!** Accessories: Drill chuck and adapter for drills up to 1/4" drills supplied by dealer.



**GRINDS!** Accessories: Drum and cone adapter assemblies, 3 grades each of drum and cone abrasive sleeves.



**POLISHES!** Accessories: Two lamb's wool bonnets.



**BUFFS!** Accessory: 5" wool buffing pad.



**WIRE BRUSHES!** Accessory: 1/2" steel wire brush.

The All-Purpose Tool! The Clarke Duo sands, polishes, drills, grinds, buffs and wire brushes. Has hundreds of uses in the home, on autos, trailers and boats. Ideal for hobby-crafters, "handy" men and mechanical-minded boys. Indispensable for the farm. Use it for all types of refinishing, repair and building. Anyone can quickly interchange accessories. Lightweight, powerful, easy to operate. Approved by Underwriters' Laboratories. AC-DC. Get it at your dealer's or order by coupon below.

A Multitude of Uses for the Duo! Buff to apply polish and wax on surfaces. Polish cars, home and office furniture. Grind various shaped surfaces and narrow openings. Sand desks, cabinets and boats, remove paint and smooth plaster. Drill holes up to 1/4 inch in metal, composition and wood. Wire brush to clean small spaces and to remove rust and other materials.

**Clarke Sanding Machine Company**  
4511 Clay Avenue, Muskegon, Michigan

Send  Clarke Duo Sander-Polisher (only), \$36.50.  Complete Set of accessories, \$12.50.  Clarke Duo Machine complete with all accessories, \$49.00.  Enclosed money order for \$\_\_\_\_\_  Ship C.O.D. (I pay postage).  Package for Christmas Gift.

NAME \_\_\_\_\_

ADDRESS \_\_\_\_\_

CITY \_\_\_\_\_ ZONE \_\_\_\_\_ STATE \_\_\_\_\_

CLARKE . . . PIONEER AND LEADER IN FLOOR  
SANDING, POLISHING AND MAINTENANCE MACHINES

question, which either goes to the assistant personally, or if he is busy, to an automatically activated wire recorder, which will repeat the question to the assistant as soon as his line is clear. The questions can then be combined, to bring out all the salient points, and sent on to the instructor.

The trial operation of the project is now being held with 50 second-class men of the Merchant Marine Academy at Kings Point, N. Y., being used as guinea pigs. They are being instructed by television in a Naval ROTC course, the nearest thing on their schedule to actual Navy instruction, while their 250 classmates are taking the same course by the usual means.

The Kings Point men are considered an ideal test group since they are of high intelligence—their entrance examination is the same as that for Annapolis. They will be observed carefully by three-month periods and it's expected that after the initial period the novelty factor can be safely discounted. The course ends next June 1, when comparative results will be known.

It is hoped that an operational course for organized Naval air reservists on a six-hour-a-week basis may soon be started. Via the TV East Coast network this would reach Squantum Naval Base near Boston; Floyd Bennett in New York City; Willow Grove, outside Philadelphia; and Anacostia, near Washington. Such a course could be used to keep officers on inactive status up to the minute on the latest equipment and techniques.

If the project is accepted by the Navy Department, and indications are that it will be, it is expected that either the TV University might be enlarged to include Army and Air Force training or that these branches of the service might set up their own Kinescope Colleges.

## Rare Gas Aids Fluorescent Lamps

With the addition of a rare gas, known but little used for 50 years, lighting engineers have boosted the efficiency of fluorescent lamps. The gas is krypton, one of nature's rarest elements. A new 85-watt lamp containing krypton provides as much light as a 100-watt lamp filled with argon, saving the user 17 percent in electricity costs without lowering the lighting level. The 85-watt lamp, built by Westinghouse, is interchangeable with the present 100-watt fluorescent lamp. Most fluorescent lamps this large are used industrially.

ⓄTire tubes that will hold air four times as long as ordinary tubes have been developed for military and commercial aircraft by Firestone.

**LAFAYETTE  
CONCORD  
KIT-QUARTERS  
FOR  
RADIO BEGINNERS  
HAMS and PROFESSIONALS  
AMERICA'S GREATEST RADIO VALUES**



**here's a swell gift:  
ELECTRIC HAND DRILL  
KIT ONLY \$19<sup>95</sup>**

Kit contains 1/4" capacity drill with universal type 110-120 V. AC-DC motor. Free chuck speed 1100 rpm. Balanced saw grip handle puts "in line" pressure on drill for fewer breakages. Thumb control switch located on top of handle. Metal case holds drill and 20 "mechanic's length" high grade steel twist drills, sizes up to 1/4". 10 for steel and iron, 10 for wood. No. 18N15765P. 8 lbs. **\$19<sup>95</sup>**



**6 tube, 2 band kit  
BUILD IT YOURSELF**

Has a freq. range from 550-1600 kc and s.w. band from 7-16 mc. Two band dial. Three controls. Circuit includes untuned stage of RF amplification. 12SK7 as RF amplifier, a 12SA7 oscillator-converter, a 12SK7 IF amplifier, a 12SQ7 as a det., AVC, 1st Audio Amplifier, 35L6GT power output, and a 35Z5 rectifier. Kit includes all parts and cabinet except tubes, wire and solder. No. 32N24542P-AC-DC. **\$17<sup>95</sup>**

**NEW MICRO-GROOVE  
LP PICKUP**

For the new long-playing records, crystal phono pickup for reproduction of lateral cut long playing microgroove records at 33 1/3 rpm. Excellent frequency response for voice and music. Output volt. approx. 1 volt. Low tracking force. No. 99N3577P Wt. 12 oz. **\$4<sup>95</sup>**



**idea of the year... PORTABLE BICYCLE RADIO  
for only \$19<sup>95</sup>**



Battery operated. Can be easily mounted or carried as a personal. Supplied complete with all bicycle mounting hardware and telescopic antenna which plugs into radio. Slide rule dial. Vernier tuning. Full size Alnico #5 speaker. Operates on inexpensive flashlight cells and standard 67 1/2 volt "B" battery. Attached handle. Lightweight. Case beautifully finished. Anti-theft feature. Size: 7 1/4 x 4 1/4 x 3 1/2". 3 lbs. 3 ounces. Battery kit \$1.84 No. 1N420P **\$19<sup>95</sup>**

**LAFAYETTE-CONCORD**

100 Sixth Avenue, New York      229 W. Madison St., Chicago  
901 W. Jackson Blvd., Chicago      265 Peachtree St., Atlanta  
110 Federal St., Boston      24 Central Ave., Newark  
542 E. Fordham Rd., Bronx

**here's your chance to get a professional  
JIG SAW at only \$13<sup>45</sup>**

Highly-polished, rust-proof, extra-strong aluminum construction. Only 1/4 the weight of the usual cast-iron power tool. Includes many expensive machine features: "Oillite" bronze bearings; roller bearing saw guide; built-in blower; sturdy, accurate protractor to set or reset table to any desired angle quickly. Blade may be turned to any angle for ripping. 14" throat will cut work up to 2" thick on



table 9"x12". 720 strokes. No. 18N15736P-Wt. 12 1/2 lbs. **\$13<sup>45</sup>**

**BEST SPEAKER BUY EVER**

Grab up a couple at this amazingly low price. They're top quality 10" PM speakers. 4.8 oz. Alnico V magnet. Voice coil impedance 3.2 ohms. Up to a booming 8 watt capacity. Ideal for radios, etc. No. 99N7019P.



**10" P M  
\$3<sup>45</sup>**



**ELECTRIC MOTOR KIT  
motorize your models**

A complete set of precision-made parts for building a swell electric motor. Simple, vividly illustrated instruction book with 25 pages of "whys" and "hows" of electricity, television, radar and atomic energy. Hours of fun. No. 32N24455P **\$2<sup>95</sup>** complete, everything including two batteries. Only

**FREE  
BIGGEST BOOK  
IN RADIO  
180 PAGES**



Listen - how would you feel if you opened your mail box this A.M. and found an envelope stuffed with crisp new fives and tens? That's how veteran bargain hunters react when they open their copies of the giant new Lafayette-Concord 1949 Catalog, now in the mails! It's the next best thing to a bankbook: 180 pages crammed with sensational "buys," made possible by the purchasing power of the largest radio supply organization in the world-plus everything in famous brands! There's hardly a page without some real "find" in TV, Hi-Fi, Ham, AM & FM Radios, P.A., Test Equipment, Parts, Tools, etc. If you want the best there is, shop from this catalog, or drop into one of our stores.

**RUSH THIS COUPON AT ONCE**

LAFAYETTE-CONCORD, DEPT. LK-8  
100 Sixth Ave., New York 13  
901 W. Jackson Blvd., Chicago 7  
265 Peachtree St., Atlanta 3

**MAIL THE COUPON NOW**

Please rush FREE catalog No. 89.  
 Send Free Xmas Gift Catalog  
 I enclose \$..... Please fill attached order.  
Shipping charges extra.

Name.....  
Address.....  
City..... Zone..... State.....

**ONLY** *Royalton* 

# FILTERWELL

*has All Three*



- 1 Economy Price** **\$1**
- 2 Ajustomatic\* Stem**
- 3 Imported Briar**

*All Royalton Pipes have the Ajustomatic Stem*

\*Patented

**AJUSTOMATIC STEM NEVER LOCKS OUT OF LINE**

**FILTER ABSORBS TARS & JUICES**

Before you buy your next pipe check all features of the Royalton Filterwell: patented Ajustomatic screw-stem, plus fine imported briar in a filter pipe at \$1.00... Luxury smoking at amazingly low price!

*At leading stores. If unavailable locally write to*  
**HENRY LEONARD & THOMAS, INC. OZONE PARK 17, N. Y.**

## The **NEWEST** Thing in **VISORS**

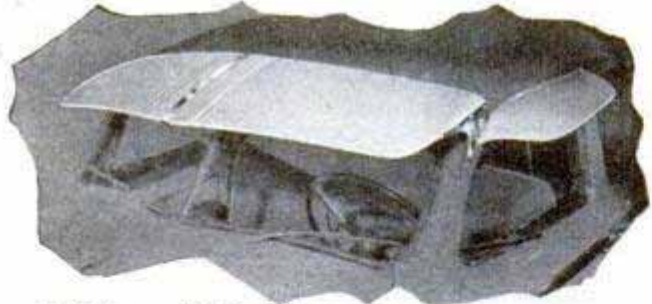

### AiRite ALL WEATHER SHIELDS

For the first time, a pair of smartly tailored side visors has been matched with a front visor providing a real new look for today's cars. It's "the fringe on the top of the surrey." For the first time, complete protection from sun and glare, snow, rain and sleet is possible — on each side of the car as well as the front. AiRite offers this assembly of precision die stampings, bonderized, spray-painted and baked, easily and quickly installed, to give you the clear vision so essential to safe driving.

- |  |   |
|--|---|
| <b>FRONT VISORS</b><br>(fitting most cars) | <b>SIDE VISORS</b><br>(fitting any 4-door cars) |
| <b>\$24.95</b> (Full chrome Brackets)      | <b>\$12.00</b> (pair)                           |
| <b>\$22.50</b> (Painted Brackets)          |   |

Visors come to you with prime paint ready for color match with your car. If your Dealer cannot supply you, send check or money order for immediate direct factory shipment.

**AiRite MANUFACTURING COMPANY**  
 5515 Telegraph Road Toledo 12, Ohio

## WORLD'S LOWEST PRICED ADDING MACHINE

### VEST POCKET SIZE THE IDEAL XMAS GIFT!

FREE TRIAL  
**ONLY \$2.95**  
 TOTAL COST  
 SEND NO MONEY

Fits vest pocket or purse. Guaranteed accurate. Operated as easily, and as reliable, as machines costing many times as much. Not a toy. Precision made, very durable—guaranteed for life against defects in construction. You positively can't buy a calculator of equal quality for as little money. **ACCEPTED AS THE FINEST LOW PRICED CALCULATOR FOR OVER 35 YEARS!** Operates with a flick of your finger. Adds, subtracts, multiplies, divides—counts up to one billion. Pays for itself over and over in mistakes avoided, and time saved.

**FREE!!**  
 Each Baby Calculator in Beautiful, rich-looking Leatherette case—at no extra cost.



**MAKES IDEAL GIFT**  
 Sold on a positive money back guarantee. Send only \$2.95. Calculator sent postpaid, or send name and address and pay postman \$2.95 plus postage. **MONEY BACK IN 10 DAYS IF NOT DELIGHTED!** (If outside U. S., send \$3.50.)

**AGENTS WANTED**  
**CALCULATOR MACHINE CO., (Mfrs.)**  
 Dept. 208, P. O. Box 248, Glenview, Illinois

## Masonry Drilling is Easy...



### with the super-hard Kennadrill

Kennametal (carbide) tipped masonry drills make the toughest masonry drill easy. They drill up to 5 times as fast and stay sharp up to 100 times longer than steel. Hard diamond-like cutting edges pierce smooth surfaces instantly. Holes are true, sharp edged. Use the drill that gives contractors, electricians, wiremen, pest control operators, hobbyists, these results: "100 holes in cement, 2 hours," "1 inch holes in limestone, 3 1/2 seconds," "50 holes in glazed tile, 33 minutes." Use in hand braces, drill presses, rotary drills.

Write for bulletin MK on the KENNADRILL now.  
 Available in Hardware Stores Everywhere  
**KENNAMETAL Inc., LATROBE, PA.**

### Send For This Automatic Shut-Off for your gas water heater



Installed in a few minutes with ordinary tools. Complete, simple instructions. Just replace regular gas-cock with ERIE TIME-O-GAS. Set knob to burn from 2 to 55 minutes... Device shuts off automatically! Works on manufactured, natural, mixed gas. Use with or without pilot. Pilot lighter included free with each unit. Described in October Popular Mechanics, page 121. Send \$8.95 for postpaid ERIE TIME-O-GAS; or C.O.D. plus postage, or write for free information. Models for incinerators and other gas appliances also available.

**ERIE MFG. CO., Dept. P-1**  
 300 N. 8th St. MILWAUKEE 3, WIS.

## Build YOUR OWN BOAT



Complete parts cut to exact size—ready to assemble. Marine water-proof plywood, rustproof oarlocks. Ideal for car top. Also models with laminated frames; mahogany decked runabouts. Build for sale at attractive profit. Exclusive franchise to local builders. Send 10 cents (dime) for illustrated literature.

**\$39.50**  
 and up

**OZARKA** 723 WASHINGTON AVE.  
 WOODSTOCK, ILL.



10" LATHE

Saber Saw Blades and Files. Blades six to an envelope. Files in set of 12 different shapes.



SABER SAW



Lathe Turning Tools. Single Tools and sets of 5 and 8. Made of tempered tool steel, with hardwood handles.



15" JIG SAW

Chucks for Lathe—either Jacobs or 3" and 4" four-jaw chucks.



Rip Fence Assembly. Make your Band Saw do more work. Makes straight line sawing far easier.



Jig Saw Blades—six to an envelope. 7 sizes for all types of sawing.

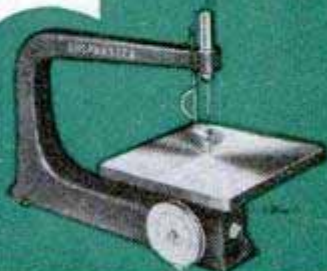
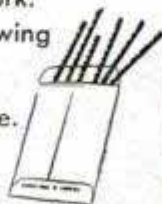

12" DRILL PRESS



12" BAND SAW

## ASK YOUR DEALER FOR Genuine SHOPMASTER Accessories

DO MORE WORK WITH YOUR POWER TOOLS,  
AND DO IT EASIER

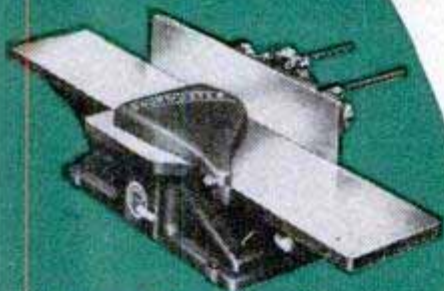

6" JOINTER-PLANER



Mortising Kit complete with chisel holder, fence, hold-down, chisel and bit. Drill square holes and mortises with Drill Press, 1/4", 3/8" and 1/2" sizes.

Sanding Drum—2" diameter, for all types of sanding with your Drill Press.



8" Circle Saw Blades, crosscut, rip and combination, and for very fine sawing, hollow-ground combination blades.

Dado Sets—high grade blades plus chip-pers. A "must" for all circle saw owners.



In addition Shopmaster offers Jack Shaft Assemblies, Adjustable Stands, Motors and other equipment. See this complete line at your dealer or, for catalog giving complete details, write:

SHOPMASTER, INC.  
1214 THIRD STREET SO., MINNEAPOLIS 15, MINN.



8" TILTING ARBOR SAW



8" BENCH SAW

*P.S. Christmas is coming. Leave this ad where the rest of the family can take the hint.*



**SHOPMASTER INC.**  
MINNEAPOLIS, MINN.

**For Faster Drilling--  
Finer Workmanship...**



HOME-UTILITY \$18.95  
1/4" DRILL

## This Husky Drill Tops 'em All!

From the first time you pull its trigger switch, this Home-Utility 1/4" Drill will click with you! You'll turn out better work, faster—drilling holes, driving abrasive attachments—for everything from building furniture to repairing appliances. It's a *real buy* at \$18.95, with ample motor, husky housings, full-size gears and bearings. And it's well-built by **BLACK & DECKER**, world's leading maker of quality electric tools for 38 years! Order all Home-Utility Tools from your hardware, electrical or implement dealer.

**ELECTRIC  
HOME-UTILITY  
TOOLS**

Products of THE BLACK & DECKER MFG. CO.  
Dept. H11M, Towson 4, Maryland

**MAKE YOUR  
OWN TABLES!**



FREE! "How-to-do-it" Woodworking Plans. Complete instructions and diagrams for easy-to-make handsome end tables, hamper, sewing cabinets, etc., for your home, for gifts. A full size jar of famous Rogers "Gorilla Grip" Glue included. Same as used by cabinetmakers. Makes furniture, toys last a lifetime.

Take advantage of this special offer . . . send 10c today to Rogers Isinglass & Glue Co., Gloucester, Mass.

**ROGERS**

the best LIQUID FISH GLUE  
GLOUCESTER, MASS.



**PAINT  
COMES OFF  
without hard scraping!**



Cracked or peeling paint, varnish, enamel, shellac, or lacquer must be removed before the surface can be refinished properly. Wonder-Paste Remover makes this job easy. Simply apply Wonder-Paste with a paint brush directly over the old finish. It will not run! When penetration is complete, the old finish is reduced to a soft sludge that slides off like wet snow.

Write for Literature

We'll be glad to advise you on your particular removing problem, and to send you literature on Wonder-Paste . . . At paint and hardware stores.

**WONDER-PASTE**

Wilson-Imperial Company, 119 Chestnut Street, Newark 5, N. J.

Only **\$16.95** Complete **DUAL PURPOSE SPRAY GUN**  
USES ONLY 25 LBS. AIR PRESSURE  
FLOCKS AND SANDBLASTS



AT HOME: You can refinish Lamps, Radios, Book Ends, Statues and hundreds of things with lovely colorful flocking. ETCH GLASS: Many designs and initials can be sandblasted on shower doors, ash trays, glassware. AUTO INTERIORS: Transform ugly dirty auto interiors to "new car beauty" with a BLASTO DUAL PURPOSE SPRAY GUN. Makes reflectorized signs too. Merely spray flock similar to Velvet, Plush, Suede and Mohair inside your car. ANTIQUE WOOD . . . REMOVE PAINT. MAKE EXTRA MONEY by doing any or all the above for profit. BLASTO is highest quality and carries a 5 day money-back guarantee. Operates on small air compressor. Send \$16.95 cash, check or money order for postpaid delivery. Write for free information. Full line of Flocking Supplies.

**BLASTO SPRAY GUN MFG.** Dept. PM-11, 7007 Maas Avenue  
Los Angeles 44, California

SAY YOU SAW IT IN POPULAR MECHANICS

**The Chief** **WORK BENCH**

*Built to Last a Lifetime!*

With Bottom Shelf and 18" Sq. Drawer. 2"x6", Solid Plank, Grooved and Dovetailed Top and 1"x8" Back Rail, Shellacked to a Smooth, Satiny Finish.

• 6 Ft. Long • 34" High • 26" Deep. Shipped Knock-down, with Bolts, Nuts and Screws and ABC Chart for Quick, Simple Assembly.

MOHAWK LUMBER CO. Dept. 33  
14525 W. Chicago Blvd. Detroit 27, Mich.  
Enclosed  Check  Money Order for \$  
Ship..... CHIEF WORK BENCHES at  
Quantity  
\$16.95 each, F.O.B. Detroit, Mich.  
 Send C.O.D., \$5 Deposit Enclosed.

NAME.....  
ADDRESS.....  
CITY..... STATE.....  
No Priority Necessary!

*Prompt Delivery*  
**MOHAWK LUMBER CO.**  
14525 W. Chicago Boulevard  
DETROIT 27, MICHIGAN



• CHRISTMAS PRESENT  
HE'D APPRECIATE

**\$16.95**  
F.O.B. DETROIT

Send Check or Money  
Order, or Will Ship  
C. O. D. (\$5 Deposit)

# The Truth about DEAFNESS AND HEARING AIDS



ARE YOU hard of hearing? Do you fear the complete loss of your hearing—yet find yourself confused about which way to turn, because of so many conflicting claims?

Well, if you want the truth about deafness and hearing aids, let us send you a free copy of the booklet, "I'm Deaf, But I Won't Stop Hearing."

In this booklet, a well-known author tells about his experience with 20 years of deafness—his many efforts to secure satisfactory hear-

ing, and how he finally solved his problem.

With this fact-packed booklet we will send full details about the sensational, new single-unit Zenith "75" Hearing Aid—how you can try it for 10 days without risk\*—how you can buy it on easy terms, if you like.

So write today and start yourself on a new road to happiness! Address Zenith Radio Corporation, Hearing Aid Division, Dept. PM-118, 5801 Dickens Avenue, Chicago 39, Illinois.

\*Available on direct sales by Zenith Radio Corporation or its subsidiaries.



NEW **ZENITH**

**RADIONIC HEARING AID**

BY THE MAKERS OF WORLD-FAMOUS ZENITH RADIOS

Look only to your doctor for advice on your ears and hearing



## THERE'S PROFIT in ELECTRICITY—LEARN from PRACTICAL ELECTRICS, \$1.00



Whether you want to enter the electrical field as a profession—or whether you want to know more about fixing electrical gadgets around the house, you will find Practical Electrics a profitable investment. You can find the right answers quickly. It gives you the

fundamentals of electricity, electrical circuits, motors, transformers, electrical symbols, trouble shooting, etc.—all in plain, simple, understandable language. Send \$1.00 today for a copy of Practical Electrics, the ready reference book of electricity.

**AUTOPOWER, INC., 918 SOUTH THERESA, ST. LOUIS 3, MISSOURI**



## Powell SETS THE PACE

DEALER INQUIRIES INVITED

- 7 H.P. Motorcycle-type Engine
- Faster pick-up than a car
- Automatic clutch
- Smooth, simplified control

- Solid steel frame
- Highway cruising speed of 45 miles per hour
- Chrome-plated fenders,

- handlebars, and sport muffler—looks like a custom job
- Costs no more than ordinary scooters

Write for FREE FOLDER and address of nearest dealer

**Powell MANUFACTURING COMPANY**

DEPT. PM-8  
COMPTON, CALIF.

# Atlas

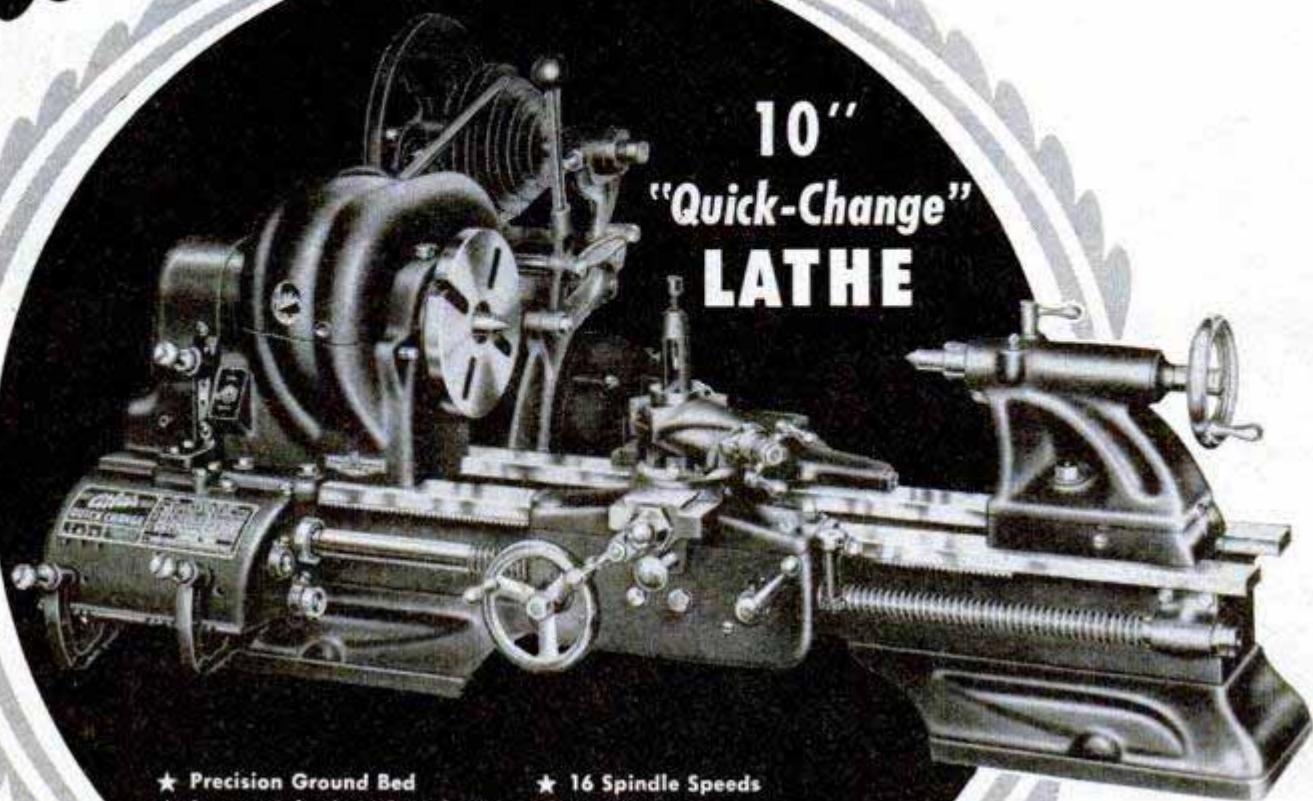

## 10" "Quick-Change" LATHE

- ★ Precision Ground Bed
- ★ Instant Selection of 54 threads or feeds
- ★ Instantly Reversible Power Cross and Longitudinal Feeds
- ★ Timken Tapered Roller Bearings
- ★ 16 Spindle Speeds
- ★ V-Belt Drive
- ★ Back Gears for Extra Power

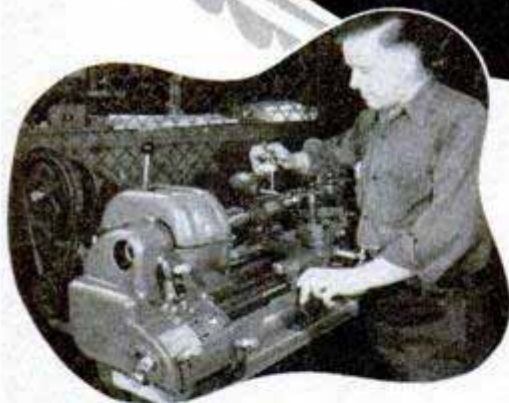

Atlas 10" Lathes with standard change gears, and Atlas 6" Metalworking Lathes also available.

## Best Buy For Your Metalworking Shop

Thousands of commercial and home shop owners from coast to coast confirm this fact—America's greatest compact metalworking lathe value today is the Atlas 10" "Quick-Change" lathe. Your own comparison—feature by feature—quickly shows you why. In *speed range, bearings, versatility, dependable lasting precision, and economical price*—it has no equal!

Atlas Timken tapered roller bearings enable you to do wood-turning, metal spinning, and plastics machining as well as work at normal speeds. An Atlas gives you precision to ten thousandths on standard machining jobs . . . saves you time and money in home or commercial shop, garage, or industrial plant. Ask your Atlas distributor for full details, or send for the new free catalog.



**MATCHED PRECISION TOOLS**



# NEW *Atlas* BIG-CAPACITY WOODWORKING TOOLS

## 10" TILT/ARBOR BENCH SAW

Now any-size project can be handled in your shop with this big new saw. No. 3070 (one extension) gives you capacity for ripping 4' panels between blade and fence, 12 $\frac{3}{4}$ " table surface ahead of blade. Cuts 3 $\frac{1}{4}$ " deep. Precision-ground grey-iron table. SKF ball bearings.



**NEW**

## 24" JIG SAW

The 14" x 14" table gives you an idea of its massiveness. 4 speeds. Cuts 2 $\frac{1}{4}$ ". Chuck takes blades and sabres to 5/16" wide, files to 1/4" shank. Table tilts 45°R, 15°L. SKF ball bearings.



**NEW**

## WOOD SHAPER

The real aid to "professional" workmanship — panels, reeds, flutes, grooves, bevels, planes, tongues, etc. Has 15" x 21" table which raises and lowers 2". Stationary spindle on SKF ball bearings for lasting accuracy, smooth cutting. Takes all cutters with 1/2" bore.

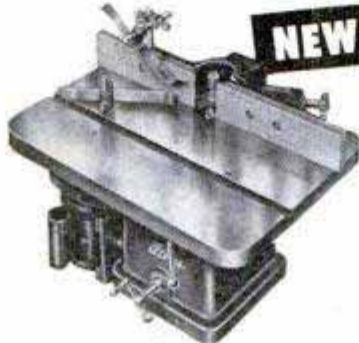

**NEW**

## BELT and DISC SANDER

Takes all the hard work, and inaccuracy, out of hand sanding. Gives you a "professional" finish in a matter of seconds. 10" diam. disc, 4" wide belt sand any width boards, angles, curves — metals, plastics, Table tilts 45°, both ways. SKF ball bearings,

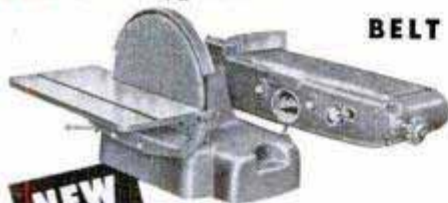

**NEW**

boards, angles, curves — metals, plastics, Table tilts 45°, both ways. SKF ball bearings,

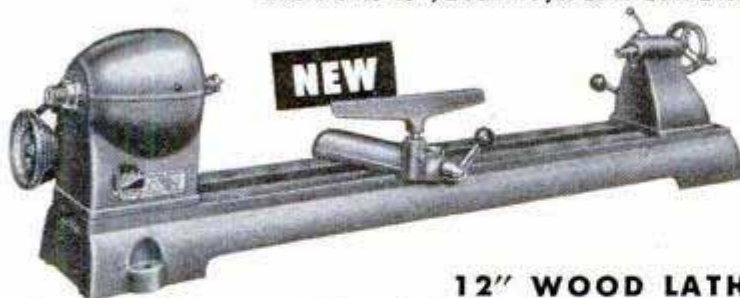

**NEW**

## 12" WOOD LATHE

The last word in a smooth, dependable wood lathe for your shop. It's built with extra-heavy bed, head, and tailstock. Has 12" tool rest. Both tailstock and tool rest have instant lock-levers for quick positioning. No wrenches needed. Handles outboard and inboard turning. SKF ball bearings plus many other new and useful features. Be sure to see it.

Send  
Postcard  
FOR LATEST CATALOG

## To Complete Your Metalworking Shop

*Atlas*

### DRILL PRESSES

For pleasure or profit, or both, you can't beat an Atlas drill press for fast accurate drilling and tapping. And with low cost attachments it mortises, routs, sands, carves, shapes. 7 TOOLS IN 1. Bench and floor sizes take drills to 1/2". Exclusive "floating-drive" spindles.

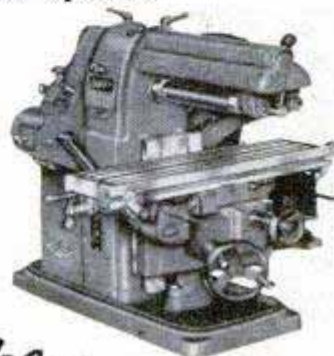

### *Atlas* MILLING MACHINE

Gives you the full range of milling operations — slabbing and facing cuts, end milling, keyways, boring, layout work. Timken bearings. 8 spindle speeds. Operates from 1/2 HP motor.

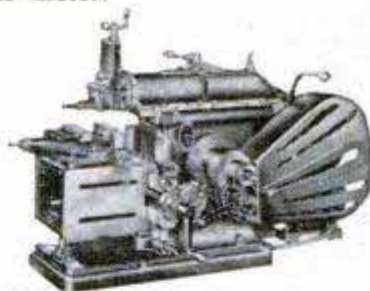

### *Atlas* 7" SHAPER

Handles all shaping operations within a 7" stroke — dovetailing, keyseating, vertical and angular cuts, gear cutting. Heavily built. Crank type ram drive. Timken bearings. 4 speeds. 5 cross feeds. See catalog for full details.

## ATLAS PRESS Company

1143 N. Pitcher St.,  
Kalamazoo, Mich.

FOR METALWORKING AND WOODWORKING

# You Can Do 'Most Everything with Mall Hobbyist Tools

• IMMEDIATE DELIVERY

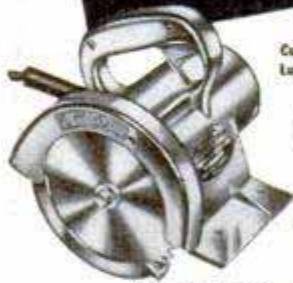

Cutting Lumber



Cutting Concrete

Equipped as Table Saw



\$54.95  
in U.S.A.  
(Saw Only)

\$32.50  
in U.S.A.  
(Table Only)

## MODEL 60 Mall Saw

### Cuts Everything From Wood To Steel

This powerful, lightweight electric hand saw cross-cuts, rips and angle cuts wood up to 2" thick, cuts metal with a friction blade—hardened steel, glass, porcelain or concrete with an abrasive disc, grooves mortar joints, scores tile and other compositions. When placed in a special Floor Stand, it serves as a table saw—complete with rip fence and miter guide. Other attachments equip it for shaping, grinding, sanding or wire brushing.



Wire Brushing

As a Drill Press

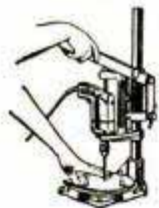

\$17.50  
in U.S.A.  
(Stand Only)



Polishing Shoes



Sharpening Tools

\$22.50  
in U.S.A.  
(Drill Only)



1/4" HOBBYIST

## Mall Drill

Can Be Converted into 10 Other Tools

Interchangeable attachments now available convert this handy Mall-Drill into a drill press, sander, metal shears, hole saw, grinder, wire brush, rotary file, paint stirrer, saw for wood or metal and counter-sinker. 1/4" Model drills wood, metal, plastics,

masonry and concrete. 1/2" Model can also be equipped as a polisher.

See Your Classified Telephone Directory for Nearest Mall Dealer. FREE Book "Mall Portable Power Tools" sent upon request. Write TODAY.



## MALL TOOL COMPANY

7805 South Chicago Avenue • Chicago 19, Illinois  
Preferred by Master Craftsmen

## PISTON TYPE AIR COMPRESSOR

Piston type, size 2 x 1 3/4, head in valves, bronze bearings, splash lubrication, "V" Belt drive. Intake muffler and cleaner. Capacity 2.8 c.f.m. at 100 lbs. continuous pressure or 150 lbs. Intermittent, with 1/2 HP motor. Can be used with 1/4 HP or 1/8 HP at lower speed. Weight 14 lbs. Operating instructions furnished.

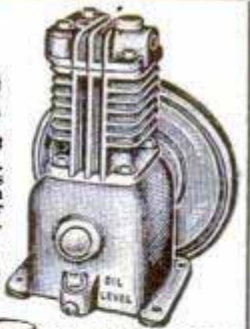

Immediate delivery **\$17.95**  
Price only



### 1/4" REDUCING VALVE & GAUGE

Oil resistant, pressure 0-to-200 lb. Reduced pressure 0-to-75 lb.; 3 outlets 1/4".  
Wt. 2 lbs. **\$5.75**



### POP TYPE VALVES

Has a close range of closing after pop-off pressure is reached. 1/4" pipe thread. Only..... **\$1.50**

### Check Valves

Prevent leakage after compressor stops.  
1/4" .....\$2.75  
1/2" .....\$4.75



Only **\$8.95**



**AUTOMATIC PRESSURE SWITCH WITH UNLOADER**  
125-150 lb. pressure. Uses 1/4 to 5 H.P. unit  
Only **\$8.95**



**Air Gauge**  
—2 1/2".  
0 to 200 lb. Pressure  
**\$1.75**

**Heavy Duty MOTORS**  
1/4 to 1 1/2 H.P.

**C & M EQUIPMENT COMPANY**  
1831 S. State St.,  
Dept. D-11, Chicago 16, Ill.

**SOLD ON MONEY BACK GUARANTEE.** Send check or money order today. Write for free folder.



**HIDE GLUE**  
best for all  
**WOOD WORK**

**NO ODOR  
NO MIXING  
NO HEATING  
NO CHILLED JOINTS**

**15¢**  
At Your  
**HARDWARE**

Used by leading furniture manufacturers, craftsmen, schools. If your dealer cannot supply you, send 20c (including postage and wrapping) to THE FRANKLIN GLUE CO., COLUMBUS, 15, O.

## BRASS NAME PLATES OR KEY TAGS

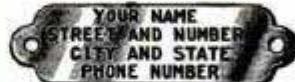

(Individual Stamping)

**40c each  
3 for \$1.00**

Duplicate plates or key tags (same stamping on the lot) 8 for \$2—15 for \$3—24 for \$4—50 for \$6. Larger quantities on request.

For quick identification, always use TAGCO enduring tags in brass or nickel silver. Our latest circular illustrates a large variety of tags of all sizes, also blanks. Prices reasonable. Send for it and booklet "A Name for your dog." Both Free.

**DEALERS WANTED STAMPING EQUIPMENT TAGCO, BOX 38X, WINGDALE, N. Y.**

**MAGNETS** OF ALL TYPES—10c UP  
AMAZINGLY POWERFUL!  
4 oz. Alnico Magnet, lifts 10 lbs. \$1.00. Our Leader, 15 oz. Magnet, lifts 40 lbs. \$2.50. New alloy—will not weaken! Useful for lifting valuables from tanks, lakes, or rivers easily! 7 small magnets \$1.00 with list of many shop and home uses. Satisfaction guaranteed.  
R. EYRICH, 2566 N. 49TH ST., MILWAUKEE 10, WIS.

**QUVAS**

**Photo-Electronic Kit**



A LIGHT METER FOR BETTER PRINTS



ELECTRIC-EYE TRAIN CONTROLS



BUILD BURGLAR & FIRE ALARMS



FOR EXPERIMENTS AND TESTING



MEASURE LIGHT FOR BETTER SIGHT

MODEL 11

THE IDEAL GIFT FOR BOYS - IT'S EASY TO BUILD

- Train Controls
- Burglar Alarms
- Radio Test Meters
- Fire Alarms
- Headlight Tester
- Enlarging Meter
- Home Light Meters
- Exposure Meters
- And Many Other Devices

MODEL 5, Basic Kit, \$5.95 MODEL 11 Deluxe Kit has additional chemical, optical and electrical experiments. \$8.95

At Leading Hobby, Toy & Dept. Stores, or Direct, Post Paid. Send Check or Money Order.

QUVAS PRODUCTS, INC. 47 DOGWOOD RD. WEST ORANGE, N. J.

Sand Casting — Forging — Heat Treating — Case Hardening

**BRONZE FOUNDRY**



In your own workshop allows you to design and build your own GASOLINE ENGINES, STEAM ENGINES, STATUARY, ART OBJECTS, SPECIAL TOOLS, NEW INVENTIONS, ETC. You can also make forgings and case harden steel. Your shop is not complete without a FOUNDRYETTE. Three sizes are available capable of making bronze castings of 1 1/2, 3 and 6 pounds weight, aluminum, copper, brass, etc., \$22.50, \$29.50, \$42.00 f.o.b. Kansas City. Domestic gas supply and 110 volt AC or DC energy required for operation. Write for circular.

KANSAS CITY SPECIALTIES CO. Box 6022, Dept. P-10 Kansas City, Mo.

**Genuine Snap-on Tools**

Available Only Through Snap-on's Direct-To-User Tool Service

WRITE FOR INFORMATION SNAP-ON TOOLS CORP. • Kenosha, Wisconsin

Get that NEW-CAR FEEL again!  
**SEALED POWER PISTON RINGS**

The only ring with the Full-Flow Spring!

SEALED POWER CORP., DEPT. G-11, MUSKEGON, MICH.

**HOLD-E-ZEE**

*Automatic Grip*

**SCREWDRIVERS**

... not only tools of finest quality, with chrome-vanadium blades, hand-ground bits, insulating, unbreakable handles ... but possessing the exclusive Gripper which holds, starts, and sets up screws in unhandy places. At leading dealers everywhere. Upson Bros., Inc., 86 Exchange St., Rochester, N.Y.

QUALITY UNSURPASSED • CONVENIENCE UNEQUALLED

NOVEMBER 1948

**AMAZING NEW CAR LIGHTER!**



**VIS-O-LITE**

NOW MAKES IT EASIER FOR YOU TO LIGHT-UP WHILE DRIVING AT NIGHT!

Press it in—VIS-O-LITE automatically pops out when ready! Illuminated lighter well glows softly—guides your hand back. Why fumble? ... why scratch your dashboard? Install a VIS-O-LITE—built by Casco, originators of the pop-out lighter that's standard equipment on 9 out of 10 new cars! Featured at Car Dealers, Auto Stores, Garages & Service Stations ...

only **\$2.75**

- VIS-O-LITE illuminated well assembly (minus pop-out unit) (uses your original pop-out unit) ..... \$1.25
- Replacement pop-out unit ..... \$1.50
- Replacement element only ..... \$1.00

**CASCO Necessities**  
FOR CAR AND HOME!

**COMPLETE POWER WORKSHOP**  
LOWEST PRICED AT \$14.95



- It drills
- It saws
- It carves
- It sands
- It sharpens
- It polishes
- It grinds
- It cleans
- It cuts

PRECISION-BUILT FOR HOBBY-CRAFT!  
IDEAL GIFT—SAVES MONEY ON HOME REPAIRS!

Only Casco puts a complete shopful of tools in your hands for an unbeatable low \$14.95! Perfect gift for father and son! Works on metal, wood, fibre, glass, plastics. Comes complete with 20,000 RPM, AC-DC precision-built power head, and all accessories in sturdy tool box. 36-page Project book included! On sale now at Department, Hardware, Auto Supply and Appliance Stores ... and bargain-priced at **\$14.95!**

**CASCO**

CASCO PRODUCTS CORPORATION  
Bridgeport 2, Conn.

Say You Saw It in Popular Mechanics

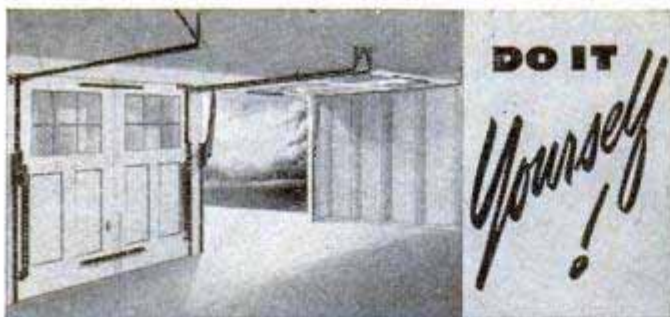

## Change over to overhead door convenience

Here's just what you've been wanting—modern, new Garage Door Hardware, specially designed for quick, economical conversion to overhead door convenience. Balanced... smooth... quiet. Made by Richards-Wilcox, acknowledged leader in Door Hardware, the new R-W 999 Garage Door Hardware is adaptable to a single piece door, or two doors fastened together to form a single piece door. Comes complete, with everything needed for installation and operation.

**MAIL  
COUPON  
FOR  
FREE  
FOLDER**

Richards-Wilcox Mfg. Company  
Aurora, Illinois-PM-8

Gentlemen: Please send me literature and information on your R-W 999 Garage Door Hardware.

Name.....  
Street.....  
City.....State.....  
My Dealer is.....

## Richards-Wilcox Mfg. Co.

AURORA, ILLINOIS, U.S.A.

LEADERS IN DOOR HARDWARE FOR 68 YEARS

It's Wise To Go

# WHIZZER

America's Thriftiest Power  
Transportation



With all necessary  
attachments  
**\$109.97**  
Fed. Tax Incl.  
F. O. B.  
Pontiac,  
Mich.

Save money every day with the new '48 Whizzer Bike Motor—ride 5 miles for a penny. Precision made in every part... Twist-Grip controls... steel cable core notched V-belt drive... Quick-Start ignition... auto-type carburetor... 4-cycle design... deluxe chrome trim... 2½ rugged horsepower. It's America's finest bike motor!

**RIDE ONE AND YOU'LL BUY ONE!**

See your Whizzer Dealer—or write Whizzer Motor Co., Pontiac, Mich. For 10 years—world's largest bike motor builder.

## New TELEPHONE SECRETARY

*An Ideal Gift*

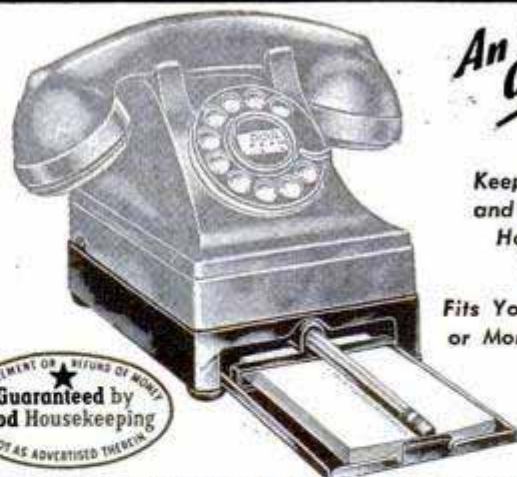

Keeps Pad  
and Pencil  
Handy

Fits Your Phone  
or Money Back



**ORDER DIRECT—ONLY \$2.65 POSTPAID** Tel-Sec keeps pad and pencil at your finger tips—in handy, rigid, pull-out drawer. Ideal for home, office, shop, store. All metal. Non-breakable. (Not plastic.) Beautiful enamel finish matches phone. Installed instantly—simply snap into place. No more hunting for paper or pencil—or writing on wall—uses ordinary pad and pencil. This is the original, all-metal Tel-Sec, with over 100,000 enthusiastic users. Order yours today!

**COMPLETE SATISFACTION OR MONEY BACK** 5x7½ oblong, \$2.65; 5x6 oval and 5½ round, \$2.95; 5½x9, \$3.95. Extra refill pads, 20 for \$1.00. No C.O.D.'s. Dealers and agents invited.

**LANKO INDUSTRIES SALES DIVISION** (Exclusive Nat'l Distributor)  
6774 TAFT DEPT. X-11 DETROIT 8, MICH.

## Surface Plate, Angle Plate, V-Blocks

**SURFACE PLATE** for laying out, etc. Precision ground to .001". 12" x 17" x 3", top ¾" thick... **\$37.50**

**ANGLE PLATE.** Precision ground. 3-1/4" x 3-1/4" x 4-1/4"... **\$20**

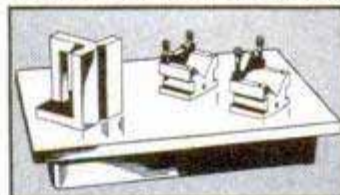

**V-BLOCKS** for holding cylindrical parts. Precision ground. 1-15/16" x 2-15/16" x 2-1/4". Cap. 1/4" to 2" round. Per matched pair **\$32**  
Prices f. o. b. factory

**SOUTH BEND LATHE WORKS**  
455A E. Madison St.  
South Bend 22, Indiana



# CEMENT TILE

## Today's Big Manufacturing Opportunity

The market for drain tile is HUGE. Demand is increasing much faster than supply. Farmers urgently need it to increase soil fertility and crop productivity—and have the money to buy. More Champion cement drain tile plants are needed—badly—throughout the country. At least one in every farming community.

Manufacturing is easy. Market opportunities are unlimited. Profits are generous. Champion Drain Tile Machine makes the finest tile ever developed—strong, dense, perfectly shaped. All sizes up to 12" diameter. Better than clay tile yet can be sold for less without penalizing profits. Made in local plants, of local materials, by local labor for local market. Requires only a moderate investment. Write for literature.

**CONCRETE EQUIPMENT COMPANY**

522 Ottawa Avenue

Holland, Mich.

**BOYS!**

Look at all  
the  
Spectacular  
Buzz-With-  
Action

Models you can build with  
**ERECTOR**<sup>®</sup>

Developed at the GILBERT HALL OF SCIENCE

ERECTOR  
HAS GIRDERS OF  
STEEL—TO  
BUILD LIKE REAL!



LOOK! HE'S MADE OF METAL!  
HE HAS ELECTRIC EYES! HE  
WALKS BY REMOTE CONTROL!  
HE'S THE MYSTERIOUS  
ERECTOR WALKING GIANT!

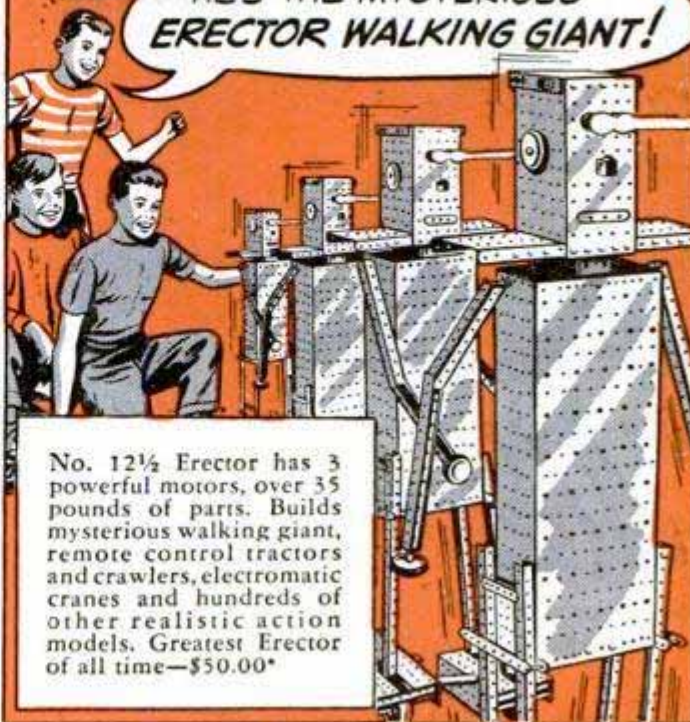

No. 12½ Erector has 3 powerful motors, over 35 pounds of parts. Builds mysterious walking giant, remote control tractors and crawlers, electromatic cranes and hundreds of other realistic action models. Greatest Erector of all time—\$50.00\*

THIS GIANT FERRIS WHEEL HAS  
ELECTRIC LIGHTS, REVERSING  
ELECTRIC ENGINE...OPERATES IT IN  
BOTH DIRECTIONS  
AT HIGH OR LOW  
SPEED!



Built with No. 8½ Erector—the All-Electric Set. Most complete engineering outfit Dad can buy for \$19.95\*



GOSH...THAT ERECTOR  
ELECTRIC ENGINE HAS  
REAL POWER! IT MAKES  
MODELS BUZZ  
WITH ACTION!



AIRPLANE RIDE BUILT WITH SENSATIONAL NO. 6½ ERECTOR.  
Loads of fun at the sensational low price of \$10.00\*

Fun with Erector starts the moment you open the big box and start to assemble girders, wheels, gears and other parts. Erector parts have equi-distant holes, so that you just count the holes to put them together. No other construction set builds the square girder with interlocking edges and contains so many parts. Curved, straight and giant steel girders. Metal base plates. Real engineering bolts and nuts. 5 kinds of gears. Electric engine. Electro-magnet. Electric lights. Engineer's shack. Boiler shells. Giant flywheel parts. Automobile wheels. See the new Erectors wherever toys are sold.

\*Denver and west, prices slightly higher

THIS  
EXCITING  
BOOK WILL  
HOLD YOU  
SPELLBOUND  
!!



Copr. 1948.  
Nat'l Com.  
Pub. Inc.

**FREE! SUPERMAN!**

shows you the wonders of the Gilbert Hall of Science

What did Superman see with his x-ray vision at the Gilbert Hall of Science? This 32-page book—cramped with color pictures—tells you all. Mail coupon or post card today.

Gilbert Hall of Science  
409 Erector Square, New Haven, Conn.  
Rush free book "With Superman at the Gilbert Hall of Science."

Name.....

Street.....

City.....State.....

(This offer good only in U. S. A.)

WHEN IN NEW YORK, VISIT THE GILBERT HALL OF SCIENCE, FIFTH AVE. AND 25<sup>TH</sup> ST. ADMISSION FREE!

**PLOWS CLEAN THROUGH  
3 DAYS'  
BEARD!**



New,  
Improved



ONLY  
**\$12.95**

# Whisker

ELECTRIC SHAVER  
... the Shaver That Shaves Any Beard

Here's a precision made, close-cutting electric shaver at a pleasing price. The *Whisker*, utilizing a long tested hair-clipper principle, shaves *any* beard . . . even 3 days' growth . . . effortlessly, quickly and cleanly. It's built to last . . . has no gears, brushes, bearings. Powerful, magnetic-type motor for 110 v., 60 cycle AC, is quiet operating. No radio interference. If your Barber, Beautician, or Dealer does not yet have the *Whisker*, use coupon to order. Money back if not delighted. ELECTRO TOOL CORP., DEPT. 528-L, RACINE, WISCONSIN

If Your Dealer Cannot Supply You  
**MAIL THIS COUPON**

**ELECTRO TOOL CORP.**  
Dept. 528-L, Racine, Wis.

I enclose (check, money order) for \$12.95, for which please send me a Whisker Shaver postpaid on 5 day trial.

Name \_\_\_\_\_

Address \_\_\_\_\_

City \_\_\_\_\_ State \_\_\_\_\_

## 10 SHELF PLANS

NEW FULL SIZE

New, full size, easily built, beautiful wall shelf plans ready to trace on lumber, cut out and assemble. Corner and wall racks with 1 to 3 shelves. Stores charge about \$75.00 for these shelves. Make money selling them. Finest selection available. PLUS BONUS of 48 other novel cut-outs, Dutch Boys, Girls, Toys, etc., etc. PLUS FREE new 1949 Handicraft Catalog. Send only \$1 to



**JACKSON, Dept. 62**  
5440 N. Shoreland Ave.  
Milwaukee 11, Wis.



## SPRAY PAINTING OUTFIT

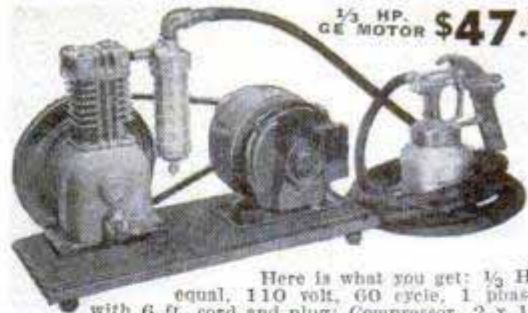

1/3 HP. GE MOTOR **\$47.50** COMPLETE LESS BASE

**2.8 C. F. M.**  
Displacement  
Compact  
Power Plus  
Complete as shown, less base

Here is what you get: 1/3 HP. GE motor or equal, 110 volt, 60 cycle, 1 phase, 1750 RPM, with 6 ft. cord and plug; Compressor, 2 x 1 1/4 piston type; Spray gun with qt. cup, 2 nozzles, round-fan spray, oil and water trap, 20 ft. hose and fittings; belt and pulley. All bolts necessary for mounting on base. We pass the big saving in labor on to you. All you have to do is mount on base as shown. Complete operating instructions furnished. Weight 50 lbs. Special Price . . . . . **\$47.50**

### ALSO SOLD SEPARATELY:

Spray Gun, 2 nozzles, 20 ft. hose, weight 6 lbs. . . . . \$ 9.45  
Air Compressor with oil and water trap, weight 15 lbs. 19.95  
1/3 H.P. G.E. Motor, weight 26 lbs. . . . . 14.50

PRICES ARE F.O.B. CHICAGO. Immediate delivery. **SOLD ON MONEY BACK GUARANTEE.** Send check or money order today. **WRITE FOR FREE FOLDER.**

**C & M EQUIPMENT COMPANY** 1831 S. State St., Dept. D-11, Chicago 16, Ill.

## NEW SOUND POWER TELEPHONES

LEATHER CASE # E. E. 108

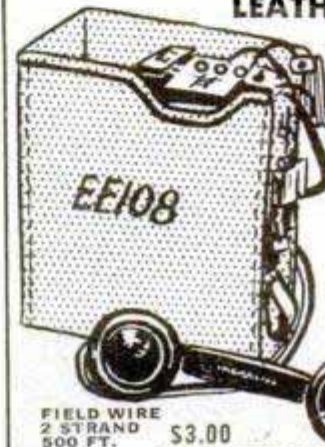

**NO BATTERIES REQUIRED**

Available NOW For Scores of Applications:

- |            |                |
|------------|----------------|
| Farms      | Construction   |
| Warehouses | Industrial     |
| Garages    | Mines          |
| Nurseries  | Schools        |
| Workshops  | Firing Ranges  |
| Camps      | Mills          |
|            | Hunting Lodges |

Anyone can install this handy, dependable telephone! Just hook up terminals to any Two-strand wire; several phones on same line if desired.

Performance Equals Present-Day Commercial Telephones. Up to 5 Miles.

PAIR **\$45.00** SINGLE **\$25.00**

FIELD WIRE  
2 STRAND  
500 FT. **\$3.00**

F.O.B. NEW YORK • NO C. O. D.

**COLUMBO TRADING CO., INC.**

304 Canal St., Dept. PM

New York 13, N. Y.

## POCKET-MITE PORTABLE

**PACKS AMAZING POWER!**

Tiny enough to easily slip into pocket and featuring hearing-aid midget tubes and new long-life midget batteries all contained within beautiful plastic case. No ground or outside antenna needed for strong reception within 50 miles radius. Stations over 2,000 miles distance received with plug-in antenna. Complete set of finished midget parts including tubes and beginners picture diagram direct from lab to you. Ready to wire as shown. Only \$6.99 P.P. Foreign orders \$8.00 U.S. Cash.



**ELECTRONIC RESEARCH LABS., Dept. A**  
1216 PARK ROW BLDG. NEW YORK CITY 7

SAY YOU SAW IT IN POPULAR MECHANICS

**make your own Gems** **29.50** F.O.B.

All necessary lapidary equipment is furnished, including a super-charged diamond blade for sawing, and all wheels for grinding, shaping and polishing; also complete instructions. The complete equipment as shown, less motor and belt, for only \$29.50. F.o.b., Burlington, Wisconsin. Write today for information and literature.

**B&I MANUFACTURING CO.**  
Dept. S Burlington, Wis.



This Delta Shaper stands up under constant use, turning out furniture parts fast and accurately.

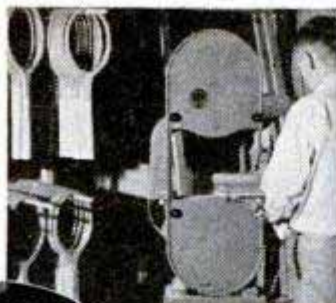

A Delta 14" Wood-cutting Band Saw sawing tennis racket frames. (Metal-cutting model available, also.)



A Delta Unisaw\* at the job-site saves time and cuts costs for this builder.



A Delta 12" Lathe helps this pattern maker do a better job with greater economy.



Above: This Delta Sander cuts costs for finishing, mitering, and squaring of moulded plastic products.



Many companies use Delta-Milwaukee Machine Tools to build and repair these and other products:

- Accordions
- Adding Machines
- Advertising Displays
- Air Conditioners
- Aluminum Products
- Archery Supplies
- Artificial Limbs
- Asbestos Products
- Athletic Goods
- Bar Fixtures
- Barn Equipment
- Batteries
- Bicycles
- Boats
- Coin Machines
- Da'ry Supplies
- Doors
- Electrical Equipment
- Farm Implements
- Furniture
- Hardware
- Interior Woodwork
- Kitchen Cabinets
- Laundry Equipment
- Lighting Fixtures
- Metal Specialties
- Millwork
- Mouldings
- Musical Instruments
- Novelties
- Organs
- Ornamental Bronze
- Outboard Motors
- Picture Frames
- Pipes
- Plastic Products
- Plumbing Supplies
- Rubber Goods
- Sash and Trim
- Screens
- Sheet Metal Products
- Signs
- Stairs
- Store Fixtures
- Storm Sash
- Tavern Equipment
- Toys
- Truck Bodies
- Venetian Blinds
- Woodenware

Profitably used by

- Blacksmiths
- Boat Builders
- Body Shops
- Cabinet Makers
- Carpenters
- Contractors
- Coppersmiths
- Die Makers
- Display Companies
- Garages
- Model Builders
- Pattern Makers
- Sign Shops
- Tool Makers
- Upholsterers
- Wood Turners
- Hobbyists

—and many others.

## The flexibility and low cost of DELTA-MILWAUKEE® MACHINE TOOLS save you time and money

—in working hardwood, softwood, plywood, builders board, plastic, non-ferrous metals

They cost less to buy! You save money, because Delta mass-produces a large volume of standard models.

They cost less to run! You save money on power — and on replacement parts.

They're compact and portable! You can put Delta-Milwaukee Power Tools *where* you need them, *when* you need them.

Delta-Milwaukee Machine Tools are safe, accurate, and dependable. That's why they're the choice of many businesses (of schools and home shops, too). Have your nearby Delta distributor show you the complete line and explain the advantages *you* can enjoy.

Look for the name of your Delta distributor under "Tools" in the classified section of your telephone directory.



Above: This Delta-Saw-Jointer Combination saves space, time, and money for a manufacturer of store fixtures — both in the shop and out of it on installation jobs.

Below: This Delta Scroll Saw is used for airplane maintenance work.

1001 uses in maintenance departments of:

- Apartments
- Airports
- Hotels
- Theatres
- Hospitals
- Schools
- Department Stores
- Office Buildings
- Public Buildings

**TEAR OUT COUPON AND MAIL TODAY!**

Send for free catalog!



DELTA MANUFACTURING DIVISION  
ROCKWELL MANUFACTURING CO.  
681M E. Vienna Avenue  
Milwaukee 1, Wisconsin

Send me free copy of Delta-Milwaukee Catalog B-48.

Name.....  
 Title.....  
 Company.....  
 Address.....  
 City..... (.....) State.....

\*Trade Mark Reg. U. S. Pat. Off.

HM-62



**Panic-Proof  
Randolph  
EXTINGUISHER**

Even a child can operate the *Trigger-Touch* Randolph. Instantly smothers the fire in snowy clouds of CO<sub>2</sub>. Dry, odorless, stainless, harmless—even to food. Vanishes without a trace. Thousands now in use on farms, in homes, stores, garages, factories, Armed Services, hospitals, hotels. Be prepared—before fire strikes!

At your dealer, or order direct. Underwriters' Laboratories approved. Randolph "2", \$22.00; transportation collect.

**DEALER  
SALEMEN**  
Territories open—  
Write for plan.

**RANDOLPH Laboratories**  
6 E. Kinzie Street ● Chicago 11, Illinois

**The SEAMAN ROTARY TILLER  
is a Many-Job Farm Machine!**



You can use a Seaman Tiller for:

- Complete Seedbed Preparation
- Pasture Renovation
- Aerating Soil
- Weed Eradication
- Mixing in Cover Crops
- Orchard Cultivation
- Mixing in Fertilizer
- Light Brush Removal
- Working Sod
- Erosion Control
- Nursery Work
- Better Moisture Control

In addition, the motorized models can now be adapted to Irrigation Service simply by attaching a Centrifugal Pump to the Tiller Power-take-off. Belt Pulley Attachment for motorized models also available for year-round power service. Ask your dealer about SEAMAN ROTARY TILLERS, and write for your copy of Bulletin NST, just off the press! It tells about many interesting farm service applications and new, outstanding improvements. Motorized and power-take-off models, 3-ft. to 7-ft. tillage widths.

**SEAMAN MOTORS, INC.**  
364 NO. 25TH ST., ● MILWAUKEE 3, WISCONSIN

**NOW, YOU TOO CAN WELD!  
IT'S EASY—WITH THE**

HIGH IN  
PERFORMANCE  
—LOW IN  
COST!



**miller**  
*"Hobby  
Arc"*  
HOME  
WELDER  
110 VOLTS

Designed and built by the men who make the Miller industrial welders. Compact, light in weight, low in cost yet able to do a man sized welding job with electrodes up to 1/8". Operates on AC current on a 30 ampere fuse. Shipped complete with electrodes, electrode holder, helmet and cables.

TRY IT IN YOUR WORKSHOP

**miller** ELECTRIC MANUFACTURING CO.  
APPLETON, WISCONSIN

**PAINTERS'  
STRIPING  
TOOL**

A TOOL...  
NOT A BRUSH

**NEW, IMPROVED**

Modern—streamlined—fits the hand like a fountain pen! Easy to use as a pencil. Draws parallel lines—straight, curve or circular. Does expert job on autos, furniture, toys, bikes, model planes, signs, bulletins, linoleum. (Makes wall board look like tile.) Every painter and craftsman needs one! Type "M" MASTER Painters' Striping Tool complete with tip for 1/16" stripe, \$1.00. Tool with 1/64", 1/32", 3/64", 5/64", 3/32", 1/8"—\$1.50... all tips 75c each. Tool with complete set of 7 tips \$5.00. (C.O.D.'s postage collect.) Paint dealers, write!

**\$1.00**  
POST  
PAID

**EASY AS  
USING A  
PENCIL!**



**WENDELL MFG. CO.**  
4234-B Lincoln Ave., Chicago 18, Illinois

**Make your Oil Heater an  
AUTOMATIC Heating Plant...**



Add an A-P THERMOSTATIC HEAT REGULATOR SET. Save up to 10% on oil, get greater comfort, avoid overheating. Easy to install on any oil heater using an A-P Manual Control. Ask your dealer. (Mention heater name and control model number.) . . . ONLY \$22.97.

For FREE Booklet—"3 Times More Comfort" write  
**AUTOMATIC PRODUCTS CO.**  
2522 N. 32nd Street, Milwaukee 10, Wisconsin

Say You Saw It in Popular Mechanics

**RACING CAR EQUIPMENT  
FOR ALL CARS**

Engines, Racing Heads, Manifolds, Carburetors, Mufflers, etc. Speed Instructions and literature \$1.00—refunded first order.

**LEE MOTORCRAFT CO.**  
1412 Great Northern Bldg. Chicago, Ill.



# POWER-UP with POWER KING TOOLS

Save hundreds of dollars this year!



*Build It Yourself!*

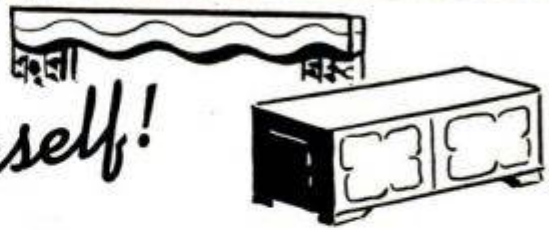

Mechanize your home shop . . . make it a real money-saver for you during these days of high prices. Shelves, cupboards, cabinets, tables, desks, beds, storm sash . . . you can make them — expertly and easily — with accurate Power King tools to speed your work. Power King tools are heavily built, with SKF ball bearings for smooth operation and lasting accuracy. They are America's outstanding low-cost tools!

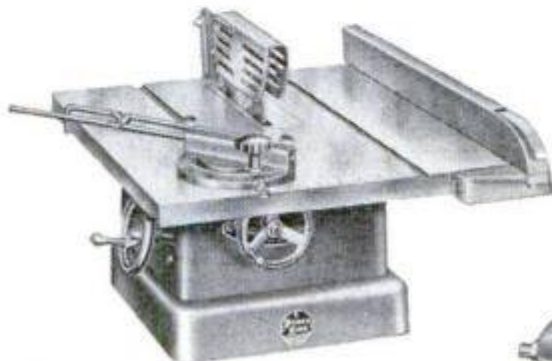

**8" TILT/ARBOR SAW**

Basic tool for your shop is this 8" Tilt/Arbor Saw. Its 18" x 20" precision-ground table has 8 1/4" between blade and fence—10 3/8" area ahead of blade, which cuts 2 3/8" deep. Blade tilts 45°. Table is always flat so your work can't slide into saw on angle cuts. New type rigid fence locks at both ends, releases instantly for positioning. Table graduated in 1/16ths. Arbor runs on SKF ball bearings for long lived accuracy. An exceptional bargain . . . **\$6175**

Price F.O.B. Kalamazoo, less motor

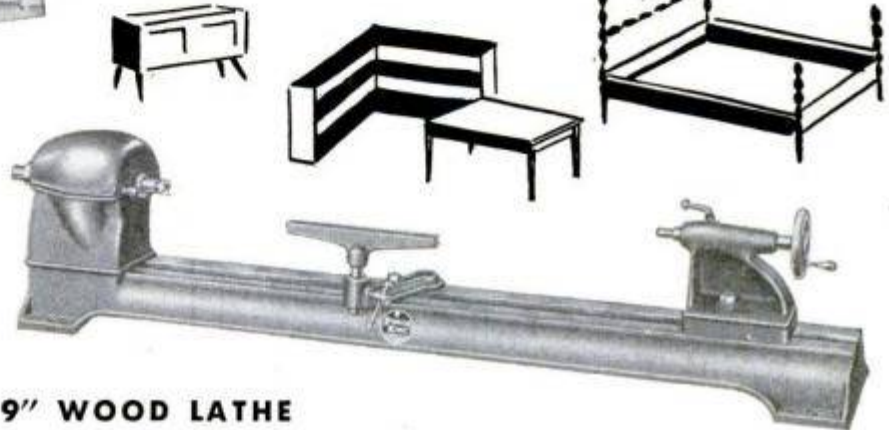

**9" WOOD LATHE**

Typical of Power King engineering is this new 9" wood lathe. It has the rigidity to handle your most exacting work. Bed is a heavy cross-braced semi-steel grey-iron casting. Headstock and tailstock are also grey-iron castings. Takes 30" between centers. Handles inboard and outboard turning. You'll find no better value anywhere at its low price — **\$3975**

Price F.O.B. Kalamazoo, Michigan, less motor . . . . .



**4 1/2" JOINTER-PLANER**



**18" JIG SAW**

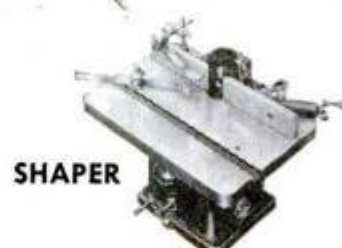

**SHAPER**



**12" BAND SAW**



**BELT AND DISC SANDER**



**11 1/4" DRILL PRESS**



**NEW FREE CATALOG!**

Send today for illustrated catalog of new low-cost Power King tools. Your name and address on a penny post-card will bring it.

**ATLAS PRESS CO.**

1135 North Pitcher Street  
KALAMAZOO, MICHIGAN



**MATCHED PRECISION TOOLS FOR WOODWORKING AND METALWORKING**

*Announcing*

THE  
REVOLUTIONARY  
NEW  
BOICE-CRANE



## FRICTION-MATIC WET TOOL GRINDER

SIMPLIFIED SELF-ADJUSTING FRICTION ROLL DRIVE. No countershaft or extra belt. PERIPHERAL SPEED REMAINS CONSTANT AS WHEEL WEARS. Exclusive feature. NO WATER THROWN ON OPERATOR. Has "controlled-water action". PERMITS PROPER PRESSURE CONTROL. Operator takes a comfortable standing position and works on top of the wheel. LARGER TOOL REST (2½" x 5"). Perfect for long, slim knives, wide tools. ACCURATE CONTROLS FOR GRINDING ANGLES FROM ZERO TO 30°. First tool rest with adequate adjustment. 8" DIAMETER and 1½" FACE SANDSTONE WHEEL. 135 r.p.m. increasing as wheel wears to maintain peripheral speed of approximately 280 feet per minute. GRAY ENAMELLED STEEL CASE. 16 gauge. Weight 14 lbs. net; 17 lbs. packed.

Only \$14.95

Order today from  
Power Tool Dealers Everywhere.

**BOICE-CRANE COMPANY**  
943 CENTRAL AVENUE • TOLEDO 6, OHIO

THICKNESS PLANERS • SPINDLE SHAPERS • SAW-JOINTERS • LATHES • TILTING-ARBOR SAWS • BELT SANDERS • SPINDLE SANDERS • BAND SAWS • JIG SAWS • DRILL PRESSES

## AUTOMATIC RETOOTHER

MAKES NEW PROFITS

Cuts new teeth in 50 seconds! Any size 4 to 16 points. Old teeth fall off as chips. Easy to operate. A perfect job.

IMMEDIATE DELIVERY

INCREASE SAW SHOP PROFITS

Sharpen circular saws. Accurately—Quickly—Safely. Any size 6" to 60". With an Acme Circular Saw Sharpener. Write today!

**BURR MFG. COMPANY** 8933-X Venice Blvd. Los Angeles 34, Calif.

FOR HAND SAWS

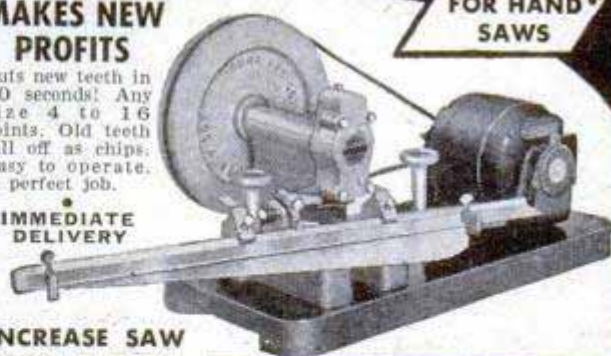

VALUABLE BOOK  
ORDER BURR'S BLUE BOOK OF COAST TO COAST PRICES FOR SAW SHOP SERVICES. **25c**

## OTTAWA TRACTOR SAW

350 SAW STROKES PER MINUTE



## THOUSANDS IN USE

Falls trees quick—no lifting, pulled by tractor—easily swung into position. Saws large and small logs. Safety Friction Clutch. The most useful, low-priced tractor saw ever built. Thousands in use—NEW improvements making more useful than ever. Saw your wood lot into Cash while prices are high. Make your tractor pay bigger dividends. Lowest direct-to-user prices. Fully guaranteed. Send for Free details.

Costs Too Little To Do Without

**OTTAWA MFG. CO., 4-827 Forest Ave., Ottawa, Kansas**

## WHIPS THE DARK!

800 foot spot, or handy floodlight. Dozens of uses! Stands, hangs at any angle. 80-100 hrs. on 6-volt battery. A genuine Delta. At hdwe., sport, elec. stores: Less battery **\$4.65**



**Delta ELECTRIC CO.**  
MARION, INDIANA

**POWERlite** 2-LITE ELECTRIC LANTERN

## BOATS! ASSEMBLE YOUR OWN PACKAGED BOAT



16 models of outstanding design—8 to 18 ft.—prices from \$34.50 up. These complete plywood kits save you 50% or more. Assembly is simple, all parts pre-cut—frames pre-assembled. Send 25c (coin) for complete, illustrated literature.



**MARINE MART**  
BUFFALO 7-B NEW YORK

# You Too, Can Fire Rockets

There's a new thrill coming as you watch one of these rockets soar up into the blue . . . With speed and action just like a full size rocket. You can have fun or experiment seriously with this model.

## V-2 ROCKET

May be used over and over. Charge capsules are available everywhere. Complete unit consists of a V-2 Rocket, launching device, and a generous supply of capsules for only \$1.98. When payment is sent with order, we pay postage. Or send no money and pay postman \$1.98 plus mailing costs.



Rocket being fired at Wendover Field, Utah.

**SOARS  
OVER  
200  
FEET  
IN  
THE  
AIR**

**\$1.98**

Walsh Products, Inc., 209 N. Maple Ave., East Orange, N.J.

**ALL THE THRILLS OF REAL FOOTBALL**



## PASS 'N PUNT

TRADE MARK  
Miniature football game

Amazing table football game uses miniature men in game played like real football. No other like it. **A GAME OF SKILL** — no dice or spinner. The ball is actually kicked and passed. The miniature men carry the ball in line bucks — end runs — trick plays. The real game of football is all here with forward and lateral passes — field goals — touchdowns, etc. Acclaimed by football coaches. Standard football rules understandingly applied. Learn and play the game with real football strategy. As exciting to watch as it is to play. Miniature men finished in brilliant oil colors.

Remittance with order — **\$4.95 postpaid**  
C. O. D. orders . . . \$5.50

**ARNOLD SPECIALTY COMPANY**  
Dept. 11A. Box 469  
Burbank, Calif.

## REYNOLDS CIRCULAR SAW GRINDER

SAWS  
5"-30"



**FOR JOINTING  
GUMMING • SHARPENING  
ALL TYPES OF CIRCULAR SAWS**  
WRITE FOR CIRCULAR  
**PROVIDENCE SAW & KNIFE  
COMPANY**  
Reynolds Machinery Co. Bldg.  
305 Eddy St. Providence 3, R. I.



**FREE for Trailer Builders**

*Safety-Engineered*

• TORQ-LESS AXLES • BULL DOG HITCHES  
AND PARKING JACK LITERATURE

**HAMMER BLOW TOOL CO.**

Dept. 128 • WAUSAU, WIS.

**FREE . . . WRITE TODAY!**



**Create a new  
mechanical toy**

*Win  
an Income  
for Life!*

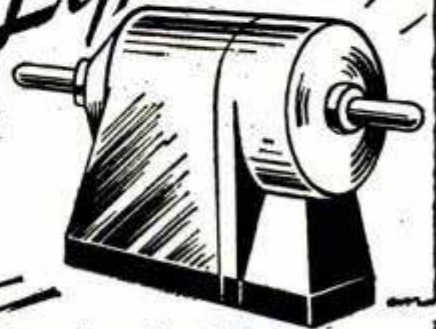

Test your wits and your hands. You can earn big money if you design a new or different motor driven toy, powered by the mighty MINI MOTOR.

The manufacturer of the MINI MOTOR (also the famous "75" water pistol and "500" machine water gun) offers you a 5% royalty for the rest of your life on all sales of your "brain-child," if it is manufacturable.

Used to operate toy airplanes, racing cars, speed boats or whatever you may design, the MINI MOTOR (flashlight battery operated, wgt. 2 oz.) is light as a feather, built with hairbreadth precision and is powerful enough to run a toy bulldozer. You may find unexplored uses for this wonder motor which costs only \$2, yet may make you rich.

Fill in the coupon below and mail it with your check or money order for \$2. You will receive your motor by return mail with full instructions and suggestions to help you get started in this toy award plan, and also a contract for your protection. Nationally known engineers and scientists will judge the designs. Don't tell us your ideas until you receive your contract.

You have three months to work — so get in line early and be a winner.

**ARPIN PRODUCTS, INC.**

**422 ALDEN STREET  
ORANGE, N. J.**

Enclosed money order  check  for \$2.  
Please send the MINI MOTOR and my contract to me at once with full details on how I may earn an income for life.

Name . . . . .

Address . . . . .

City . . . . . Zone . . . . . State . . . . .

Dept. P

**SAVE TIME!  
AND WORK!**

**MAKE EXTRA!  
MONEY!**

**EASY TO  
OPERATE**



**SHAW  
"DU-ALL"**  
and "PEPPY PAL"  
GARDEN TRACTORS

**PLOW**



**HARROW**



**CULTIVATE**



**MOW**



**RIDE**

These sturdy walking and riding tractors ideal for dozens of uses around the farm, orchard, garden, golf course, estate and poultry farm.

**DO DOZENS OF JOBS**

Shaw Du-All or Peppy-Pal tractors do many jobs quickly and easily. Plow, cultivate, harrow, mow, disk, bulldoze, spray, grind, haul and saw wood. New uses discovered every day.

**BUILT FOR RUGGED WORK**

Sturdy, extra-strength construction means low upkeep, long life. Patented tool control allows quick shift for crooked rows. Attachments easy to change with improved "Jiffy Hitch."

**CHEAP TO OPERATE**

Operates on a few cents an hour. Soon pays for itself in time and labor-saving plus low initial and operating costs.

**LOW FACTORY PRICES**

Buy direct or through your dealer! Almost anyone who has a garden can afford a Shaw Du-All or Peppy-Pal. Full year's guarantee.

**RIDING TRACTORS**

Four models, from 5 to 12 1/2 H. P., 58 in. wheelbase, 36 in. wide, 24 in. plant clearance. Hand or electric starter. Improved steering device, brakes enclosed in differential housing shaft. Standard hitch for trailers and wagons. Plow, harrow, cultivator, cutter bar, snow plow, bulldozer available.

**PROMPT SHIPMENT** No waiting — order now for immediate delivery.

**FREE:** Illustrated folders giving complete details and price lists. Write today:

4511 Front St., GALESBURG, KAN.  
668-G North 4th St., COLUMBUS, O.

**SHAW  
MFG. CO.**

There is **MONEY**  
in **LAMPS**



Easy to get your share. No experience necessary. Start lamp business in your home, attic, basement or garage. Highly profitable. Fascinating. Illustrated instructions and wholesale catalog \$2. Simple as A.B.C. Write TODAY.

THE GEARON COMPANY, Dept. PM2  
27 S. Desplaines Chicago 6, Illinois

**URAC "185"  
NOW AVAILABLE...**  
IN SMALL CONTAINERS

**URAC\*RESIN  
ADHESIVE  
WITH  
HARDENER  
185-**



Best bonding agent for gluing structures: furniture, toys, bows, arrows, plastic table tops, phenolic and melamine laminates, masonite, Etc.

Easy to Mix . . . Easy to Use . . . Water Resistant . . . Rot Proof . . . Stain Proof. Allows for lower pressures and heavier glue lines. Joints are stronger than wood itself.

This wartime development a must for quality production . . . Ideal for the Hobbyist.

Pts. \$1.50; Qts. \$2.25; Gal. \$5.50 and 5-gal. \$23.75 including Hardener.

Send Payment and Save postage and C. O. D. FEES.

\*TRADE NAME REGISTERED BY AMERICAN CYANAMID CO., MFR.

**THE NELSON COMPANY**  
IRON MOUNTAIN - MICHIGAN



**NOW YOU CAN  
SHAVE  
IN YOUR CAR!**

Just plug this conversion Unit into your dash cigarette lighter receptacle—and connect your AC-DC electric shaver to unit! Presto! You're all set to shave right in your car anytime. Fast—simple—compact—durable—very low current drain. 6 Volt DC input. Unit is also ideal for operating 3-way portable radios in car. Unit is complete with cord and plugs. Order MF 102. Price: Only **\$7.95** post paid



**ELECTRIC MOTORS**

Left—6 or 12 Volt AC or DC Motor. Powerful, heavy-duty, reversible type. Can be used for heater, fan, pumps, power-tools, etc. 1/2" shaft, 5/16" dia.

Order **MH 103. \$3.50**

Price . . . postpaid

Right—110 Volts AC Fractional HP Motor. Heavy-duty construction, ball bearings, 4000 RPM.

Ideal for power tools, fans, models, blowers, etc. Order **MH 102. Price . . . \$3.95**

postpaid

**Motor Control  
RHEOSTAT**



Shown at left—Heavy-duty, wire wound control for regulating speed of AC or DC motors, toy trains, etc. 150 Watt, 8.28 ohms., 5 amps. Order **MR 104. Price . . . \$1.95**

postpaid

ADDRESS: DEPT. M-11—No C.O.D. orders—Shipments postpaid in U.S.

**FAIR RADIO SALES**  
132 SOUTH MAIN ST. LIMA, OHIO

**Electrify MOTHER'S OR WIFE'S  
SEWING MACHINE!**

**MAKES SEWING  
A PLEASURE!**

**COMPLETE  
WITH  
SEWING LIGHT  
\$15.95**  
PLUS POSTAGE  
WT. 6 LBS.



**ANYONE CAN  
INSTALL**

**OUTFIT CAN  
BE USED FOR  
HOBBY WORK,  
SHOP, ETC.**

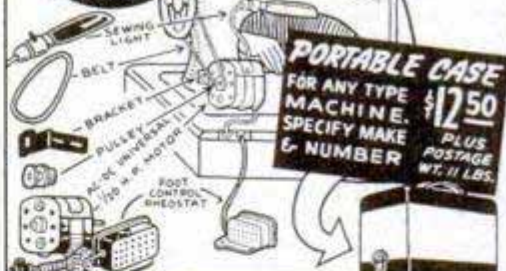

**PORTABLE CASE  
FOR ANY TYPE  
MACHINE.  
SPECIFY MAKE  
& NUMBER**  
PLUS POSTAGE  
WT. 11 LBS.

**PASAAK'S** DEPT. PM 343 CANAL ST.,  
NEW YORK 13, N. Y.

Say You Saw It in  
**POPULAR MECHANICS**

**FOOLISH TO PAY MORE — DANGEROUS TO PAY LESS**



**OUT-OF-TOWN FOLKS—TAKE 10%  
ORIGINAL TIRES NOT  
98% NON-SKID TIRES RECAPS**

Factory Adjustments, Worn Slightly.  
U. S., Goodyear, Firestone and Others.  
**GOLDEN-RULE 14 MO. GUAR.**

450-21	\$6.00	600-16	\$5.55	600-20	\$9.00
475-19	6.25	650-16	5.90	650-20	9.00
525-18	6.65	700-16	6.00	700-20	12.00
550-16	5.55	750-16	8.00	825-20	14.50
550-19	7.75	800-16	8.00	900-20	14.50
		850-15	5.00	32x6 (8)	11.00
		850-17	7.00	32x6 (10)	12.80

**750-20 "MILITARY" TREAD (Fits 32-6 and 700-20)**  
Standard Grade, Guaranteed 14 months. . . . \$12.00  
Super Grade, Guaranteed 24 months. . . . \$14.00  
900-16 Military-Super, Guar. 24 mos. \$8.00

Hundreds of thousands of folks we've never met, send us their remittance in advance to save the C.O.D. charges. Send Ck. or M.O. and this ad. 31 yrs. of "know-how" in our triple inspection.

**BLATT** COR. GIRARD & LANCASTER STS., DEPT. E  
BLATT BUILDING, PHILADELPHIA 31, PA.

# QUALITY TILTING TABLE SAW

TABLE INCLUDING EXTENSION 18" x 14"

**\$24.95**

Complete as shown  
F.O.B.  
Royersford, Pa.

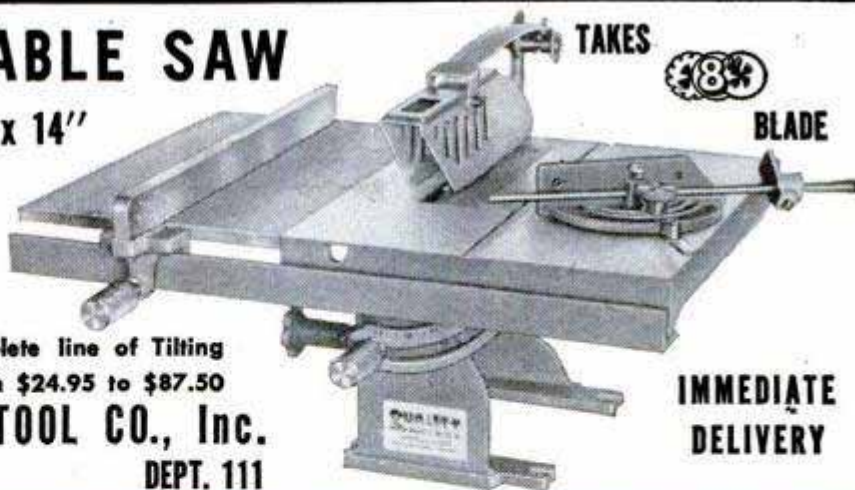

IMMEDIATE  
DELIVERY

Send for catalogue showing complete line of Tilting  
Table and Tilting Arbor Saws, from \$24.95 to \$87.50  
**AMERICAN MACHINE & TOOL CO., Inc.**  
ROYERSFORD, PA. DEPT. 111

Carries  
the Same  
**90 DAY  
GUARANTEE**  
As a New  
Motor Assy.

## Our Finest Precision REBUILT MOTOR BLOCK ASSEMBLIES

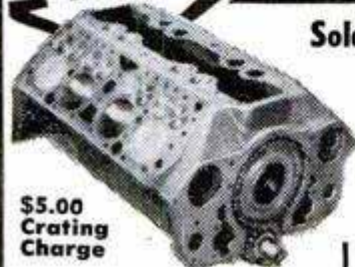

\$5.00  
Crating  
Charge

**Sold Outright or Exchange**

Rebuilt by skilled mechanics. Assembly has Rebor'd Block with New Pistons, Pins, Rings, Reground Crankshaft, all New Bearings. Guaranteed 90 Days. **Allowance on Old Motor** We ship at outright price. Send your motor prepaid, must be suitable for rebuilding. Send in notarized bill of sale showing title number if any. We refund difference when we receive your motor.

<b>BUICK</b>	Outright	Exch.
34-47 8 cyl.	\$209.00	\$170.00
<b>CHEVROLET</b>	Outr't.	Exch.
29-47 6 cyl.	127.50	97.50
<b>CHRYSLER</b>	Outright	Exch.
34-47 6 cyl.	172.50	140.00
35-47 8 cyl.	209.00	170.00
<b>DE SOTO</b>	Outright	Exch.
34-47 6 cyl.	172.50	140.00
<b>DODGE—3 1/4" bore</b>		Exch.
35-47 6 cyl.	154.00	119.00
<b>3 3/8" bore</b>		Exch.
34-47 6 cyl.	172.50	140.00
<b>FORD</b>	Outright	Exch.
28-31 4 cyl.	119.00	87.00

<b>FORD</b>	Outright	Exch.
32-34 V8	\$149.00	\$109.00
35-47 V8	159.00	109.00
<b>HUDSON- TERRA.</b>	Outright	Exch.
35-47 6 cyl.	195.00	155.00
<b>MERCURY</b>	Outright	Exch.
39-47 V8	159.00	109.00
<b>Oldsmobile</b>	Outright	Exch.
37-47 6 cyl.	185.00	145.00
35-47 8 cyl.	209.00	170.00
<b>PLYMOUTH</b>	Outr't.	Exch.
35-47 6 cyl.	149.00	119.00
<b>PONTIAC</b>	Outright	Exch.
37-47 6 cyl.	185.00	145.00
35-47 8 cyl.	209.00	170.00
<b>Studebaker</b>	Outright	Exch.
35-47 6 cyl.	185.00	145.00
35-47 8 cyl.	209.00	170.00



\$5.00  
Crating  
Charge

## 60 HP. JEEP Engines

Reconditioned, Tested and Guaranteed in perfect running order and ready to run. Every part is checked to be perfect and carries a 90 Day Guarantee same as a new engine.

**COMPLETE** with . . . Generator, Starter, Distributor, Coil, Fan and Fan Belt, Water Pump, Fuel Pump, Intake and Exhaust Manifolds, Carburetor, Oil Filter, Spark Plugs, Flywheel, Clutch and Pressure Plate, Wiring.

Outright,  
PG58R-003. Ea. **\$179.50**

1935-48 FORD V8 &  
1939-48 MERCURY  
**DUAL MUFFLERS**  
Increases power. Reduces back  
pressure. Saves Gas.  
MD20N-208-  
Complete Set **\$16.95**



SEND 25% CASH WITH ORDER, BALANCE C.O.D.

## NEW CONVERTIBLE TOPS

Choice of Black or Tan. All Tops  
Tailor Made for Easy Installation.

Instructions for  
Simple Installation  
with Each Top

As Low as  
**\$24.95**

"ZIPPER TYPE"  
REAR CURTAIN

Each top packed complete and consists of main top proper, rear curtain and all needed binding and fittings. (Glass is not supplied—use glass from top being replaced). Best quality, laboratory tested—equal to or better than the original. All metal parts are of heavy bright chrome plated rust resistant. Tops are heavily stitched with treated thread and sewed for durability and appearance.



Car	Year	Price	Car	Year	Price
BUICK	1936-48	\$41.75	Hudson also		
CADILLAC	1936-48	41.75	Terra, to '38	1936-40	\$39.95
CHEVROLET	1936-48	39.50	HUDSON	1941-47	46.95
CHRYSLER	1935-38	33.00	LASALLE	1936-40	41.75
CHRYSLER	1940-48	39.50	MERCURY	1939-42	37.95
DE SOTO	1935-38	33.00	MERCURY	1946-49	39.95
DE SOTO	1940-48	39.50	NASH & LAFAYETTE	1937-41	39.95
DODGE	1935-38	33.00	OLDSMOBILE	1936-48	41.75
DODGE	1940-48	39.50	PACKARD	1936-48	45.95
FORD			PLYMOUTH	1935-39	33.00
1928-31 Roadster & Cpe.	24.95		PLYMOUTH	1940-48	39.50
1933-39 Rdstr. & 2 pas.	33.00		PONTIAC	1936-48	41.75
Cpe.	33.00		STUDEBAKER	1948	44.15
1928-39 Phaet. & Sedan	42.95				
1936-42-5 Pas. Clb. Cpe.	37.95				
1946-48-6 Pas. Clb. Cpe.	39.95				

NOTE: Specify color wanted also Model or Series, Body Style, Year & Make when ordering.

## FENDER SKIRTS for Modern Beauty

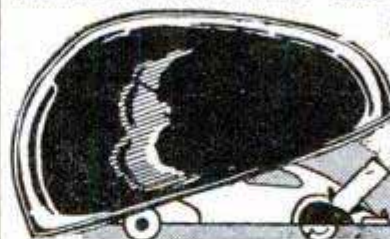

For most makes of cars including '49 Ford & Mercury. Made of all metal, prime finish, with Rubber beading to prevent rattle. Easy to Install.

MC31N-9

**\$12.95**

Per Pair

Be sure to specify year, make & model of car.

**JEEP FRONT FLOOR MATS** Rubber with Felt Back. For all Jeeps. Ea. **\$3.95**

## GUTTED MUFFLERS FOR ALL CARS

MUFFLERS that give that Motorboat tone

Made of high quality steel For:

FORD DeSoto  
Plymouth Chrysler  
Chevrolet BUICK  
DODGE Pontiac

Also Universal type to fit all other cars. Specify year, make & model when ordering.

MD20N-210  
**\$4.95**  
ea.

**RADIATORS**  
FOR ALL CARS & TRUCKS  
Write in for Our Low Prices.  
Give year, make & model.

**J.C. WHITNEY & Co.**  
1917 Archer Ave. Chicago 16, Ill.

**REPLACEMENT GRILLES**  
For Most Cars  
Write in for Our Low Prices.  
Give year, make & model.

**SEND ONLY \$1.00**  
and get a  
**Genie**



## Built-in Can Opener

GENIE, the only built-in can opener, fits flush with the wall and is easily installed in tile, plaster, wood or any wall finishing, in either new or old homes. GENIE shears lid from can directly under rim, prevents lid or metal shreds from dropping in food. Streamlined in appearance and made of finest grade steel, with front and opener heavily chrome-plated, built-in box of white baked enamel, GENIE adds beauty to any kitchen.

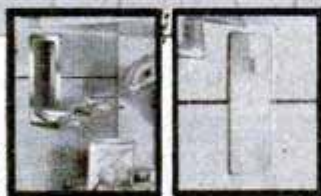

Pull knob...it's ready to use. Closes up when not in use.



**MONEY BACK GUARANTEE**  
Send only \$1.00 and we will ship you a GENIE Can Opener C.O.D. You pay postman balance of \$6.50 plus postage. Or shipped postpaid for payment in full (\$7.50); send check or money order.

**ORDER TODAY!**

Robert H. Clark Company

9330 SANTA MONICA BLVD. • BEVERLY HILLS, CALIFORNIA

**A SENSATION WITH CRAFTSMEN EVERYWHERE!**



**THIS AMAZING, NEW, LOW-PRICED OSCILLATING, SANDER AND POLISHER!**

**CRAFTSMEN!** . . . Here's the new, remarkably efficient oscillating Sander and Polisher attachment for Black & Decker Home Utility 1/4" Electric Drill.

Now, in a fraction of the time, and with far less "elbow grease", the DU-FAST SANDER AND POLISHER\* gives you certain, superior finishes every time. . . plus a definite saving in time and money!

- ATTACHED AND DETACHED IN A JIFFY
- DURABLE — NOTHING TO GET OUT OF ORDER
- WEIGHS ONLY 3 LBS. (with drill) — ELIMINATES FATIGUE
- PERFECTLY BALANCED — ALL VIBRATION IS IN THE PLATEN
- EASY TO USE IN CORNERS, ON OPEN STOCK, AND ON CURVED SURFACES
- PRICED LOW — EVERY CRAFTSMAN CAN (and should) OWN ONE.

If you use a B & D Home Utility 1/4" drill . . . you'll want the Du-Fast Oscillating Sander and Polisher attachment. In any case, don't fail to see it and try it at any hardware dealer who carries B & D Home Utility Tools.

ONLY **\$14<sup>95</sup>** COMPLETE  
(DU-FAST ATTACHMENT)

\*PAT. APPLIED FOR

Available only at hardware dealers carrying Black & Decker Home Utility Tools. Stop at one today!

MANUFACTURED BY  
**DU-FAST, Inc.**

32 EAST FOURTH STREET, NEW YORK 13 N. Y.

## A Manufacturing Opportunity Open to YOU!

Your big years are right ahead! You can tie in with the great building industry, yet develop your own business manufacturing concrete block, drain tile, brick, roof tile, etc. We'll start you right in the



## Modern Masonry Products

business and help you put it over. We supply complete equipment, built and developed through forty years of dealing with men like you. Helps you build for local market, using local materials and labor. High income potentials. Our line of modern machinery enables you to start small and grow big.

Write for catalog. Gives prices and full information.

**CONCRETE EQUIPMENT CO.**

512 Ottawa Ave., Holland, Mich.

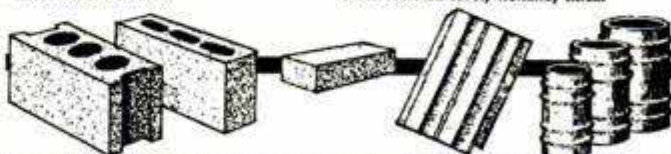

**Cutter Bit Grinding Gauge**



This gauge eliminates guesswork when grinding cutter bits. Every necessary angle, including rake can be checked. Made of stainless steel. Size 1-7/8" x 2" x 1/16".

PRICE **50¢** POSTPAID

**SOUTH BEND LATHE WORKS**  
455A E. Madison St.  
South Bend 22, Indiana

**SLOW POWERFUL ELECTRIC MOTOR**  
*Brand New Surplus! Guaranteed!*

For Rotating Ham, FM, Television Antennas; Barbecue Spits, Min. RR Turntables, Telescopes  
● Operates on 110V AC, 60-Cycles (Requires only 12 MFD Condenser) ● Appr. 3/4 RPM—Hi-Torque ● Self-Locking Clutch ● Reversible ● Quiet ● Easy to mount ● Instructions.

\$1 Dep. **\$5.95** Postpaid in Cont. U.S.A.  
Bal. C.O.D. Gov't. Cost \$40

**ALVARADIO, Dept. P-2**  
907 S. Alvarado Los Angeles 6, Calif.



**GIVES YOU 2 DRILLS IN 1**



Converts any 1/4 inch Electric Drill to 1/2 inch capacity. Reduction gears reduce speed 5 to 1, the average speed of 1/2 inch Drill thereby increasing power.

Jobbers write for proposition Price **\$11.95**  
M.O. or check with order

**G. M. CO. MANUFACTURING, INC.**  
1308 43rd Avenue  
Long Island City 1, New York

# Bargains FOR HOBBYISTS AND EXPERIMENTERS

ALL QUANTITIES LIMITED SUBJECT TO PRIOR SALES

## HEATHKIT 3 TUBE ALL WAVE RADIO KIT

No. K1. An Ideal Beginners Radio Kit covers 550 to 6000 KC including Broadcast, police, aircraft, amateur marine, and foreign broadcasts. All parts including 3 tubes supplied. 110V 60 cy AC. Transformer operated, calibrated dial complete instructions for assembly. Operates loud speaker (not included). Excellent boy's gift. Ship. wt. 3 lbs. Loud speaker 2½" PM (extra).....\$1.95 Headphones (extra).....\$1.00



**\$8.75**

## BC 645 GENERAL ELECTRIC TRANSCEIVER

No. 201. Complete 15 tube transmitter receiver. Ideal for new citizens band 460 Mc for communication between office and car, home, boat, etc. Conversion article in August ELECTRONICS Magazine. Brand new in original G.E. cartons with tubes. Add postage for 25 lbs.

**\$19.50 . . . . 2 FOR \$35.00**

### ACCESSORIES FOR BC 645

PE 101C Dynamotor 110V 60 cycle power supply for home or office use. . . . \$3.95

## HOME WORKSHOP GRINDER KIT

No. 230. Easily assembled 110V AC or DC ball bearing fully enclosed motor from Army surplus dynamotor. Purchaser to make simple changes and shaft extensions, detailed instructions and all parts supplied. Motor approximately 5,000 R.P.M. Ideal for tool-post grinder, flexible shaft tool, model drill press, saw. Shipping weight 6 lbs.



**\$3.95**

## ARMY ELECTRONIC ALTIMETER

No. 200. Brand new 14 tube army transmitter receiver radar unit with indication in feet. Many applications such as electronic burglar alarm, radar set, etc. Complete with 14 tubes, controls, plugs, antennas and instruction manual. Shipping wt. 87 lbs.

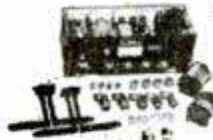

**\$34.50**

## TANK TRANSMITTER POWER SUPPLY

No. 223. Army PE125 power supply provides 500 volts at 160 MA from 12 or 24 Volt storage battery. Heavy duty unit with filters starting relays, fuses, tubes, and diagram. Shipping wt. 73 lbs.



**\$12.95**

## T 32 TABLE MICROPHONE

No. 210. One of the Army's best. Built by Kellogg, ideal for factory call system, public address, amateur use. Brand new in original cartons. Add postage for 5 lbs. . . . . \$2.95



## INTERPHONE 2 WAY CALL SYSTEM KIT

No. 1P1. Saves many steps between house and barn, tenant house, workshops, etc.; can be used to watch baby from neighbors. Uses 2 wires and will operate up to 1-5 mile. More than one remote can be used. Kit is complete with tubes, one master, one remote speaker and detailed instructions. Shipping weight 5 lbs.



**\$14.50**

## ASTROGRAPHS WITH CASE



**Only \$3.95**

No. 259. New B29 navigation instrument which can easily be used to make a good contact printer, strip map holder, etc. The plywood case 14½" x 11" x 10" high is perfect as a tool kit, camera, projector case or for building a portable photograph picnic kit, make up case, etc., has leather handle reinforced covers, 8 covered compartments in bottom. Cost Gov't \$125.00. Add postage for 20 lbs.

GN 58

## GENERATOR

No. 275. Makes excellent home lighting plant, operated by wind propeller, waterfall, gas engine, or hand crank. Reduction gear allows full output at slow speed, supplies 6 volts at 2.45 amp., 425 volts at .115 amp. New. Add postage for 28 lbs.



**\$7.95**

## BC 746 TUNING UNIT

No. 274. Transmitter Receiver Tuning Unit from Army Walkie Talkie. Containing coils tuning condenser, transmitter crystal sockets, etc., excellent for building amateur station. Shipping wt. 1 lb.



**\$1.00**

## METER SPECIAL

No. 237. Beautiful Dejur 3" Square Precision Milliampmeter 0-800 MA range, 0-10 MA basic movement. Probably the best buy ever offered in a war surplus meter. Shipping wt. 1 lb.



**\$2.95**

## BENDIX DIRECTION FINDER LOOP

No. 219. Brand new loop excellent for aircraft or boat direction finder. Also useful as radio aerial to eliminate local interference. Rugged army construction. Shipping wt. 8 lbs.



**\$9.95**

## G.E. 50 AMP CIRCUIT BREAKER

No. 204. New General Electric 50 Amp. 220 Volt AC circuit breakers. 100 Amp. when used on 110V. Add postage for 4 lbs. \$2.95, 3 for \$7.50



**\$2.95**

## MINIATURE ELECTRIC MOTOR

No. 211. Tiny Delco motor only 1" x 1¼" x 2" 10,000 RPM. Operates from 6 to 24V. Excellent for models. Add postage for 1 lb.

## HEATHKIT HIGH FIDELITY AMPLIFIER KIT

No. A2. A truly fine 110V 60 cy transformer operated High Fidelity Amplifier Kit. Ideal for reproducing quality music at home, churches, mortuaries, outdoor gatherings etc. Output over 10 Watts. Complete with all tubes (push pull circuit) transformers, punched chassis and detailed assembly instructions. Shipping weight 20 lbs. High Fidelity 12" P.M. Speaker for above \$6.95 Mahogany speaker cabinet size 14½" x 14½" x 8" for above speaker. . . . . \$8.75



**\$14.95**

## BC375 TRANSMITTER TUNING UNIT

No. 203. A beautiful Army Tuner containing 3 precision variable condensers, tank coils, switches, vernier dials, worth over \$30.00. The best buy in surplus. Shipping wt. over 20 lbs.



**\$2.49**

## FM PUSH BUTTON TUNER

No. 224. Brand new ten push button tuning assembly from Army FM receiver. Contains 4 gang 100 MMF silver plated tuning condenser. Add postage for 10 lbs.



**\$2.50**

## G.E. 1000 VOLT 350 MA DYNAMOTOR

No. 213. An ideal dynamotor for mobile operation in taxicabs, police cars, sound systems and amateur stations. Supplies above voltage from 12 Volts or 500V. at 350 MA from 6 Volts. Complete with starting relay, and fuses. New. Our Dynamotor A. Shipping Weight 72 lbs.



**\$5.95**

## DM-36 DYNAMOTOR

No. 215. Western Electric 24 Volt input, 220V at 60 MA out. With filter assembly. Ship. weight, 6 lbs.



**\$2.95**

## POWER TRANSFORMER - SPECIAL

No. 226. Primary 117V. 60 cycle. Secondaries supply 746 V.C.T at 220 MA, 6.3V. at 4.5A., and 5V. at 4A. Will handle 13 tube radio receivers. Supply is limited, order early. Shipping 3 FOR \$9.95 Weight 11 lbs. each.



**\$3.95**

## HEARING AID HEADPHONES

No. 216. Hearing aid type, comfortable, keeps out outside noise, one of the Army's best types. Add postage for 2 lbs. . . . . \$1.00



## THE NEW 1948 HEATHKIT 5" KIT OSCILLOSCOPE

No. 03. Complete kit to build a beautiful 5" oscilloscope. Ideal for studying and servicing television and FM radio. 6 tubes including 5BP1 cathode ray tube. 1500-Volt power supply operates from 110-V 60 cy AC. Has compensated vertical and horizontal amplifiers and 15 cy to 30 KC sweep generator. Detailed instructions make assembly easy. Shipping weight 35 lbs. Nothing else to buy.



**\$39.50**

## HOW TO ORDER

Give part number and description. Add postage for weight shown. No orders under \$2.00. We will ship C.O.D.

# HEATH COMPANY BENTON HARBOR 17, MICHIGAN

**"FINEST** precision writing instrument of its kind in the world"

Regular  
84 character  
keyboard  
same as on  
big office  
machines



**5 BIG MACHINE AIDS**

1. TOUCH SELECTOR
2. VARIABLE LINE SPACER
3. FLOATING SHIFT
4. ONE STROKE RIBBON REVERSE
5. TYPEBAR SPEED BOOSTER

Ask dealer for demonstration

ASK ABOUT BUDGET PLAN

**Smith-Corona**  
PORTABLE TYPEWRITERS

**Supreme HOMESHOP**  
BAND and CIRCULAR  
**SAWS**



**HAIRLINE CONTROL • LESS RESHARPENING FASTER, SMOOTHER CUTTING • LONGER LIFE**  
NOW—for your home shop! Famous SUPREME Band and Circular Saws nationally used by industry—now available in the SUPREME HOMESHOP Line to fit any size or make of home power tool! Special Nickel Alloy Steel. Free from kinks and other imperfections. SUPREME HOMESHOP SAWS are precision-engineered for highest cutting efficiency under heaviest punishment. End saw troubles, cut costs, speed your best work.

**SUPREME BAND SAWS**  
6' 6" — \$1.00    7' 9-1/2" — \$1.10    9' 6-3/4" — \$1.30  
in any of the following widths: 1/8, 3/16, 1/4, 3/8".  
8" Flat-Ground Combination Circular Saw — \$3.65  
**IMMEDIATE DELIVERY — ALL STANDARD SIZES**

**ACT TODAY! ORDER DIRECT**, stating Size, Make and Model. Or at your dealer. Write for Free Illustrated Circular.

**THE SAW & KNIFE SPECIALTY CO.**  
6526 CARNEGIE AVENUE • CLEVELAND 3, OHIO



**How TIP-TOP LIQUID SOLDER Saved My Hunting Trip**

Last Fall, on my first day of deer hunting in the Rockies, I broke the mount of my telescopic rifle sight. No repairs were available for several hundred miles so I fixed the break with Tip-Top Liquid Solder. Despite the terrific recoil from my 30-30 rifle, the joint held throughout the hunt.

Mr. T. M. — Iowa

Sportsmen, keep a tube of Tip-Top handy in your kit. It's perfect for emergency repairs on all kinds of sports equipment. This amazing Liquid Solder forms a perfect joint in metal, wood, glass and fabric. Tip-Top is water and gasoline proof . . . sticks where others fail.

Keep Tip-Top handy at home, too. It licks hundreds of home mending problems. Buy Tip-Top at your hardware dealer's today, or write Tip-Top Products, Omaha, Nebraska. Insist on Tip-Top, the original and superior Liquid Solder.



**MACHINE STEEL AND BRASS?**

**YES! WE'VE GOT IT!**

- GROUND AND POLISHED DRILL ROD ROUNDS
- COLD FINISHED STEEL ROUNDS
- COLD FINISHED STEEL SQUARES
- COLD FINISHED STEEL FLATS
- COLD FINISHED STEEL HEXAGONS
- FREE CUTTING BRASS ROUNDS
- FREE CUTTING BRASS HEXAGONS

**WRITE FOR FREE STOCK LIST**

Get all the details now. Write for Free Stock List today. No obligation. Learn about special introductory offer—handsome automatic lead pencil free with your first order for \$5.00.

**CHESTERFIELD STEEL SERVICE CO.**  
DEPT. PM-11 P.O. BOX 3056 CLEVELAND 17, OHIO



**BINOCULARS  
TELESCOPES  
MICROSCOPES**

Write for  
**BIG BARGAIN  
CATALOG**

It's FREE

**BROWNSCOPE CO.**  
Dept. 11M    24 West 45th St.    New York 19, N. Y.

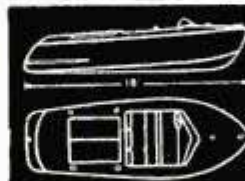

**BOAT PATTERNS • BLUEPRINTS**

70 Modern plywood designs by leading naval architects. Large scale, fully detailed blueprints, full size paper patterns available. Kayaks to cruisers, row-power-sail, (6 to 30 ft.). Send 25c (coin) for Design Catalog, or \$1.00 for Catalog plus booklet, "How to Build Plywood Boats."

MARINE MART, Buffalo 7-B, New York

**MAXIM AUTO POWERED BUZZ SAW**

Let your car saw wood—in backyard or woodlot—carry this outfit anywhere in your car—quick and easy to set up—no careful alignment necessary. Sold as complete outfit or power unit, etc., separately.

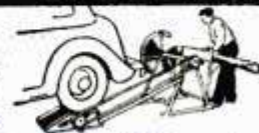

Send for FREE catalog

**MAXIM SILENCER CO.** 99 Homestead Ave., Hartford 1, Conn.



Phenomenal Value • Treasured Lifetime Gift

INCABLOC  
Shock  
Resistant  
Feature

17 JEWEL • 2 PUSH BUTTON  
**CHRONOGRAPH**

"4-in-1" Precision Instrument

- WRIST WATCH • TELEMETER
- STOP WATCH • TACHOMETER

Sweep second hand • Anti-magnetic • Radium dial  
Stainless steel back • Un-breakable crystal. **IDEAL**  
for use in sports, sciences, engineering, medicine, photography, radio, aviation.

**\$29<sup>75</sup>**

plus  
10% tax  
(formerly  
\$71.50)

OUR FAMOUS  
GUARANTEE  
**MONEY BACK**  
in 10 DAYS  
If not satisfied  
for any reason



Also  
available  
in 18K  
Gold Case  
**\$64.50**  
plus 10% tax  
(formerly \$125)

Mail orders promptly  
filled. Shipped C.O.D.  
or send check or money  
order. Address all mail orders  
to: **ADLEW JEWELERS**,  
152 W. 42 St. N. Y. 18 (Dept. 117)

**Adlew  
JEWELERS**  
117 W. 42nd St., New York 18

World's finest and  
Strongest Folding Rule!

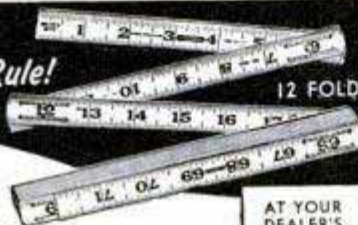

**GENERAL**

No. 900 Inside Markings  
No. 901 Outside Markings

**6 Foot DURALUMIN FOLDING RULE**

• Made of DURALUMIN, the toughest aluminum alloy. Won't warp, shrink or stretch. 100% rustproof. Left and right hand graduations in 16ths readable in any position. Black numerals permanently etched against bright satin finish. Will last a lifetime. **Money-back guarantee!**

AT YOUR  
DEALER'S  
Or Direct  
**\$2.25**  
PREPAID  
(\$2.50 west  
of Rockies  
higher in  
Canada)  
Check or  
m. o. No  
C O D'S,  
please.

GENERAL HARDWARE MFG. CO., Inc., 117 Duane St., New York 7

**CANVAS COVERS** Waterproof tarpaulins, war surplus (Used), perfect condition. Originally made for tents. Approx. 5'x8'. Two buttoned together make approx. 80 sq. ft. Complete with buttons attached. Suitable for use as canvas dams, hay covers, truck covers, machinery and equipment covers, etc. Packed in bales of 30, priced 30 covers, \$1.25 ea.; 15 covers, \$1.50 ea. Less than 15, \$1.75 ea. - All FOB, Kansas City.

329 W. 5th Dept. PM Kansas City, Mo.

"Build Your Own"  
AC welder & power plant

Save \$200 to \$300  
Produce your own AC electric power to do arc welding or operate lights, tools, appliances, etc., with this one compact AC-AC generator. Connect to a good used gas engine, tractor, truck or line shaft and belt. Simply move the switch on the side to "welder" or "A.C. Power" as desired and use in hundreds of ways.



Check HOBART  
coupon for  
more details

FREE "Build-Your-Own"  
booklet... Write for it.

**HOBART**

Hobart Bros. Co., Box M-1181, Troy, Ohio  
"World's Largest Builders of Arc Welders"

Make **BIG MONEY**  
Arc Welding!

Combination  
A.C. arc welder  
plus...  
A.C. power

for lights, small  
tools, motors, etc.

You get all these  
**EXTRA ADVANTAGES**  
in one machine



Think how you can increase your income by doing an unlimited variety of welding jobs in the shop, in the field, or anywhere. With this gas engine drive unit, you weld, operate lights, run small tools and do hundreds of big-profit jobs, independent of power lines.

**A Money-Making Workshop**

Use arc welding to build a profitable business of your own. Be sure of success with a Hobart made to fit your plans. There's a size and type to fit every welding need.

**A.C. (alternating current) transformer welder**

Ideal for shop work. Lets you do repair work and fabricate metal products that sell at a profit. Easy to operate, makes better welds. Highly efficient. Made in 180 to 500 ampere sizes.

**It's Easy to Learn Arc Welding**

Let HOBART train you in a short time at low cost. Individual instruction by expert instructors. Qualified under G. I. Bill. Check coupon.

HOBART BROS. CO., Box M-118, TROY, OHIO



Gas Drive Welder



Welder with D.C. Power

**HOBART**

"World's Largest Builders  
of Arc Welders"

HOBART BROS. CO., Box M-118, TROY, OHIO  
Without obligation send me complete information on the items I've checked.

- A.C. Welder—A.C. Power
- Electric Drive Portable
- A.C. Transformer Welder
- Welder with D.C. Power

- Generator Only
- Gas Drive Welder
- Build Your Own AC-AC

free a book  
of information  
for all welders.

free  
Check here for  
Pocket guide.

NAME \_\_\_\_\_

ADDRESS \_\_\_\_\_

CITY \_\_\_\_\_ STATE \_\_\_\_\_

# NOW

## THE JIFFY METAL CABINET WITH RUSTPROOF ALUMINUM DRAWERS

32  
DRAWER  
UNIT  
**\$8.95**

POSTAGE PAID

64  
DRAWER  
UNIT  
**\$15.95**

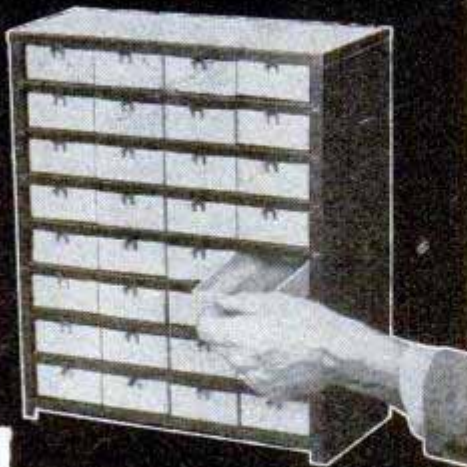

APPROXIMATE  
SIZES  
DRAWER  
1 1/4" Deep  
2 3/4" Wide  
6" Long

32 DRAWER UNIT  
6" Deep  
12 3/4" Wide  
15 1/4" High

64 DRAWER UNIT  
6" Deep  
25 1/2" Wide  
15 1/4" High

for home or shop,  
the handy way to  
keep small parts,  
washers, nuts, bolts,  
nails, screws, etc.

AND  
STILL  
AVAILABLE

32  
DRAWER  
UNIT  
**\$5.95**

POSTAGE PAID

64  
DRAWER  
UNIT  
**\$9.95**

Solid one-piece aluminum drawers for greater strength and long life—and still at low cost. So handy to keep office, shop, work bench, household and hobbyist needs at your fingertips. Spot welded steel cabinet, enamel finish, and metal flange drawer guides.

32-Drawer Unit—\$8.95. 64-Drawer Unit—\$15.95. Postage Paid. Send check or money order. No C. O. D.'s, please. Add 3% sales tax for Ohio orders.

## THE JIFFY METAL CABINET WITH LAMINATED FIBREBOARD DRAWERS

Same steel cabinet as above with covered fibreboard drawers. Suitable for most home needs. Thousands in use. 32-Drawer unit—\$5.95. 64-Drawer unit—\$9.95. Postage Paid. Check or money order. No C.O.D.'s. Add 3% sales tax for Ohio orders.

**KAYTEE PRODUCTS**  
DEPT. M • BOX 588 • CANTON, OHIO



## BUILD YOUR OWN 2500 WATT ELECTRIC LIGHT PLANT

All you need is an electric generator; a small engine to drive generator at proper speed; 2 dual sheaves; 2 V-belts; and a welded angle iron base. No wiring is involved, and you do not need to know anything about electricity to make this assembly.

Start out by buying the 2.5 KVA Leland Alternator shown above. It is a 120 volt, 60 cycle, single phase, A.C. generator, complete with radio filter box, and self regulating voltage. It must turn at 1800 r.p.m. for bright, even lighting. Requires 3 3/4 H.P. to turn generator at full load—so buy an engine of at least 6 H.P. to have plenty of reserve.

We will ship you the GENERATOR ONLY, without pulley or belts, for \$125.00 freight prepaid. If your needs are urgent, we will assemble your set, using above generator and a 6 H.P. Salsbury gasoline engine, manually started, governor controlled, and ship to you \$297.00 freight prepaid. Same unit but with Ensign conversion to run on natural gas \$347.50 freight prepaid.

To eliminate time lapse for personal checks to clear, we suggest remittance by bank draft or cashiers check.

**HOPFER & COMPANY**  
3124 EAST 14TH STREET, OAKLAND, CALIFORNIA

Plastic Coasters  
and Tiles

## EMBED REAL FLOWERS in NEW Magic PLASTIC



Now, create many unusual things like the distinctive pansy coaster shown—made by embedding real pansies in Castolite—the "magic" liquid plastic that "pours like honey . . . sets like glass." Crystal-clear or may be dyed for brilliant color effects. Embed coins, medals, stamps, etc. Preserve treasured photos against "Time" in unique wall plaques, paper-weights, photo-lampshades. Embedded autumn leaves retain glorious color and natural appearance.

## POUR GORGEOUS BOOKENDS



Castolite makes it easy to cast exquisite bookends, too, like the one shown. Make duplicates of hundreds of art objects, figurines, candlesticks, etc. Use only home utensils. No artistic ability needed. With new, easy-to-use Casto-Mold compound, you can make your own molds in minutes. Follow simple step-by-step method. New pleasure, fine profits are possible. Send 25c for exciting new Home Project Manual showing how to get started. Write today! The Castolite Co., Dept. TMI Box 391, Woodstock, Ill.

MANUAL  
25¢

## How to Make Liquid Marble

Make amazing Liquid Synthetic Marble at home in your kitchen, basement or garage. Terrific demand! BIG PROFIT! No heat, pressure or machinery needed. No experience necessary. MOLD, TROWEL or BRUSH—make in almost any color.

**FLEXIBLE MOLDS:** Valuable information for novelty casting. 3c material makes \$1.00 item. PERMA-TEX Plastic Flooring: Make lifetime floors in any color or shade. Can be laid over wood, concrete, brick, etc. Work out beautiful patterns in contrasting and harmonious colors. **WRITE FOR FREE CATALOG!**

**BING PRODUCTS** Dept. PM-118  
88 Broad St., Boston 10, Mass.

# THE BULL BUFFER

PAT. PEND.

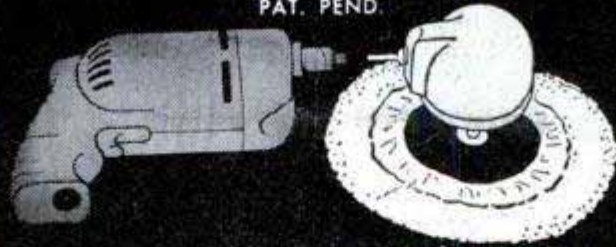
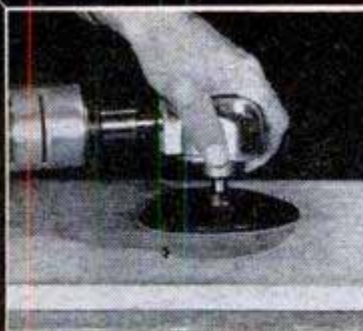

You polish and sand faster, easier — do beautiful, professional work—with this amazing new attachment for your hand drill. And it more than pays for itself the very first time you polish and sand your car, floors, woodwork, furniture. The Bull Buffer fits any chuck on an electric drill

(or flexible shaft). It's the only buffer you can turn in a complete circle while you hold your hand drill stationary. Reaches all curved and flat surfaces. It's packed with power, built of lifetime materials and *guaranteed*.

If your dealer doesn't stock, send cash, check, or money order for your Bull Buffer, complete as pictured below, each..... **\$9.95**

## ORDER THESE ACCESSORIES FOR YOUR BULL BUFFER:



Cup wire brush attachment for removing paint, rust, scale, etc. \$1.75



Jacobs key chuck increases 1/4" drill to 1/2" capacity—reduces speed, increases power. \$5.00

- Bull Buffer car cleaner ..... \$ .50
- Bull Buffer car polish ..... 1.00
- Extra sheepskin bonnet ..... 1.25
- Extra sanding discs (000-00-0-1-2 1/2-3-4) each ..... .10
- 1/2" Jacobs No. 6425 key chuck (see photo) .. 5.00
- 2 1/2" cup wire brush (see photo) ..... 1.75

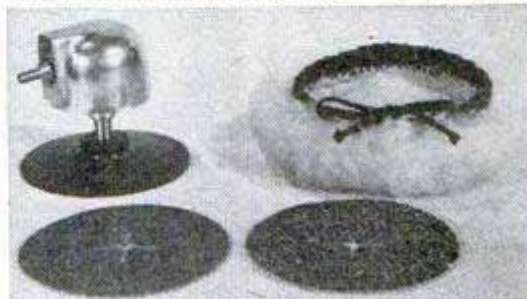

Bull Buffer comes complete with 5-inch rubber disc, sheepskin bonnet, and 2 sanding discs, only \$9.95.

**BERTRAM G. ENGINEERING COMPANY**  
 3121 MAIN ST. Dealers write for information **KANSAS CITY, MO.**

"I'LL TAKE THE WHITE ONE EVERY TIME!"



**WYTEFACE**  
 TRADE MARK  
**STEEL MEASURING TAPES**



**KEUFFEL & ESSER CO.**

## GIVE YOUR CAR THE "WOLF CALL" of Deep Tone DUAL MUFFLERS



The rich, low, mellow sound of "straight thru" ADVANCE mufflers is something all your friends will admire.

Also greater power, speed, and economy result from the reduced back pressure of this scientific design. Rugged steel tube throughout (no aluminum); blowout-proof.

**SIMPLE TO INSTALL.** No welding, cutting, or holes to drill. Complete with rubber mounted clamps (no rattle) and all necessary fittings.

ADVANCE MUFFLERS, 6800 S. Vermont Ave., Dept. PM11-8, Los Angeles 44, Calif. Send Check, Money Order, or we will mail C.O.D. You pay postage upon receipt.

Dual Muffler Set (Ford, Mercury only) \$20.00  Single Muffler (other makes) \$5.50   
 Single Muffler (Ford, Chev., Plym.) 4.86  2 1/2" Chrome tail pipe tips 1.75

Car make \_\_\_\_\_ Year \_\_\_\_\_ Model \_\_\_\_\_

Name \_\_\_\_\_

Address \_\_\_\_\_ City \_\_\_\_\_ State \_\_\_\_\_

**ADVANCE MUFFLERS**

6800 S. Vermont Ave., Los Angeles 44, Cal.

# Make a DRILL PRESS Your Most Versatile Workshop Tool

● You can plane woods and plastics, rabbet, tenon, panel, groove, bead, contour, rout, mortise, surface sand, drum sand, cut moldings, shape, dovetail, grind and drill with Barron's time-tested and proved precision workshop tools. They save time, money, broaden your workshop technique. A full line of drill press spindle adapters and 1/2" Dovetail cutter also available. All tools sold on 10 day money back guarantee.



**ROTARY WOOD  
PLANER**

3" dia. safety planer fits any drill press. Over 100,000 now in use.  
**\$7.50 Complete**



**2 1/2 x 3" DRUM  
SANDER**

A "must" for sanding contours and straight edges. Also available in 1" dia. at \$2.10  
**\$3.95 With 5 Sleeves**



**ROTARY SURFACE  
SANDER**

4" dia. aluminum housing and heavy rubber pad. A perfect finishing sander.  
**\$5.95 With 20 Discs**



**AUXILIARY  
DRILL PRESS TABLE**

Fits any drill press. Has 234 sq. inch working surface for holding work pieces flat and true. Equipped with adjustable steel fence.  
**\$9.85 F.O.B. Detroit**



**ALL-METAL  
SHAPER FENCE**

Ideal for shaping and molding operations, other uses. All metal, nothing to warp. A real buy at  
**\$7.95 F.O.B. Detroit**



**ROUTER & ROUND END  
MORTISING BITS**

New type hi-speed steel spiral flute bits. Available in individual sizes or sets of 6 attractively packaged from 1/8" to 1/2" at \$9.50



**WRITE  
FOR  
FREE  
WORKSHOP  
GUIDE**



**SAFETY SHAPER &  
MOLDING CUTTER**

New, patented design eliminates set screw. More versatile than any other similar design on market. \$9.00 with 3 Sets Standard Blades

See Your Dealer . . . Or Write Direct

**BARRON TOOL CO., INC.**  
569 Architects Bldg., Detroit 1, Mich.

## BARRON PRECISION WORK SHOP TOOLS

### NEW 30" SHEET METAL BRAKE

Forms angles, channels, vees, flanges, locks, zees. Handles 26 gage sheet steel, heavier gages of aluminum, copper, plastic, etc. Portable. Can be held in a bench vise, or bolted down. All steel. Wt. 40 lbs. Shipped exp. collect, \$24.50.

**12" BRAKE.** Fits in vise to form difficult and compound bends, up to 20" gage steel 12" wide. \$12.50.

**18" CURVE FORMER.** Handles 16 gage steel 2" to 30" dia., \$10.00 PP.

**VISE IRON BENDER.** Forms rings, hooks, eyelets, etc. in 1/2" round or square; 1/4" up to 2" wide in bar iron. Price \$10.00 PP., with attachment to bend 1/2" pipe, \$12.50.

**SHEAR.** Cuts 16 gage steel any length and width, \$12.50.

**SHEET METAL PLIERS.** 2 1/4" wide, \$2.00; 5" \$3.50. 20 page instruction booklet, 50c.

Immediate delivery. Order direct, cash or C.O.D., or send for folder.

**VISE BRAKE MFG. CO.**  
1116 So. 27th St. Dept. P11 Omaha 5, Nebr.



*Why Pay More?*

**TUBE GIVEN WITH EVERY TIRE**  
Send this AD with Order  
Slightly Used  
High Original Treads  
★ BUY IN CONFIDENCE ★  
Safe! Dependable! Standard Brands  
**GUARANTEED to give A-1 Service**  
Positively Not Re-caps!

600-16 .. \$5.72	700-15 .. \$5.92
650-15 .. 5.12	700-16 .. 6.22
650-16 .. 5.80	750-16 .. 7.22
900-16 \$8.52	900-20 \$15.52
650-20 9.52	1000-20 15.52
700-20 12.52	1100-20 15.52
750-20HD 12.52	32x6(8) 11.82
825-20 15.52	32x6(10) 13.82
<b>750-20 MILITARY 8 PLY \$13.52</b>	

1/2 million tires shipped to satisfied customers.  
Trial will convince you. Orders Rushed. SEND  
MONEY ORDER OR CHECK.

**STANDARD**  
834 N. Broad St. Phila. 30, Pa.

## PRINT YOUR OWN POST CARDS

**COMPLETE  
OUTFIT  
only  
\$7.50**



Amazing results in sales, inquiries and contacts . . . saves time and money . . . very easy to use **GEM STENCIL DUPLICATOR** is ideal for Advertising, Announcements, Notices, Labels, Forms, Price Lists—hundreds of uses for every type of business and organization. Comes complete with all supplies, instructions and 60-page Book of Ideas.  
**FREE TRIAL OFFER:** Try it before you buy it! Write and a GEM OUTFIT will be sent you postpaid. After 10 days, send only \$7.50 or return the GEM, no questions asked. The GEM must sell itself; you be the judge.

**BOND EQUIPMENT CO. • Dept. 135**  
513 Olive St. • St. Louis 1, Mo.

**SEND NO MONEY • FREE TRIAL OFFER**



**SAVE on High Quality  
Dress  
GABARDINE Trousers**

**WARM FOR WINTER**

Huge direct-to-you volume enables us to give exceptional value! Fully guaranteed. Genuine virgin wool and fine-spun rayon blended. Warm. Twill weave resists wrinkles, holds crease, gives amazing wear. Expert fashion tailored for perfect fit. Zipper front. Roomy pockets. Blue, Tan, Sand, Lt. or Dk. Brown, Blue-Gray. WAIST: 28-38 pleated or 28-50 plain.

**Send Only \$1** with name, waist size, 1st and 2nd color selection. Pay postman balance plus C.O.D. Or, send entire amount, save C.O.D. Money back within 10 days if you're not pleased.

**LINCOLN TAILORS** DEPT. PM-11  
LINCOLN, NEBR.

## ELECTRIC WELDER



**AC or DC 110 Volts**  
Pre-war type—All metal—No chemical—5 year written guarantee. Welds 1/8" thick metal or money back. Repairs tanks, tools, fenders, machine parts, etc. Comes complete with rods, unit directions and eye shield.  
On C.O.D. mailing charges extra.

**\$645  
COMPLETE**

**ESSAY MFG. CO., INC., Dept. P.M., Quincy 69, Mass.**

# MAKE \$ MORE MONEY

Applying or Selling

## CORKSTONE

A General Purpose Magnesium Oxychloride Flooring

THE MODERN PLASTIC FLOORING

### EASY TO APPLY

Here's your opportunity to get into business for yourself applying or selling Corkstone, the economical, top-grade plastic flooring. Plenty of profit Act without delay!

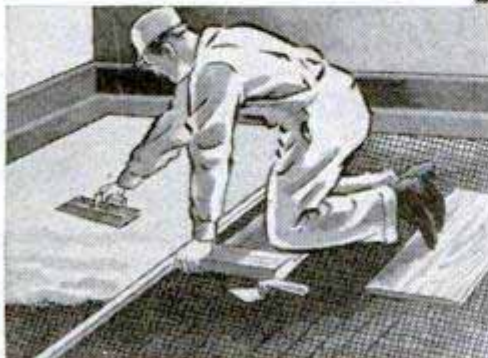

Dealers & Agents Wanted

WRITE FOR DETAILS

LASTING PRODUCTS COMPANY

Franklinton Road Plant,

Baltimore 23, Md.

One Year Written Guarantee!

ARMY AIR CORPS 16 JEWEL

# ELGIN

## \$19.95



Made for Pilots and Navigators of the U. S. Army Air Forces. They had to be good. Sturdy 16 Jewel Elgin men's wrist watches. Shock resistant. Sweep second hand. Luminous hands and dial. Stainless steel back. Unbreakable crystal. Water repellent. Made by ELGIN one of America's outstanding watch manufacturers. Fully reconditioned. One year written guarantee sent with each watch. Supply limited! **SEND NO MONEY.** Simply pay postman \$19.95 plus 10% tax and postage on delivery. Cash orders sent postpaid. **UNITED PRODUCTS CO.,** 7941 S. Halsted, Dept. RES-1209, Chicago 20.

This Christmas  
Give him a...  
**Nimrod PIPELITER**



**\$3.50**  
AT YOUR DEALER

Unconditionally Guaranteed

- CHIMNEY-ACTION
- DOWN-DRAFT
- WINDPROOF
- LIGHTWEIGHT
- LARGE FLAME

Ashley F. Ward, Inc., Dept. 35-M, 2968 Jessamine St., Cincinnati 25, Ohio

# NEW FOREDOM Model #99

at an Amazing LOW PRICE

## FLEXIBLE SHAFT MACHINE

with PENCIL-SIZE HANDPIECE

# \$15.95

COMPLETE WITH MOTOR



35" FLEXIBLE SHAFT

USES HUNDREDS OF ACCESSORIES

PENCIL-SIZE HANDPIECE

Grinds, Polishes, Cleans, Sharpens, Mills, Carves, Engraves, Etches on Metal Wood, Glass and Plastic

5 REASONS WHY FOREDOMS ARE TOPS:

1. Extra power and longer motor life because motor not dwarfed to fit hand.
2. Correct handpiece size for deft, sensitive, fingertip control.
3. No obstructed view of your work.
4. Freedom from gyroscopic action—hence better work.
5. Small handpiece size lets you get into hard-to-reach places.

Hundreds of Uses

Foredoms handle hundreds of tasks. Use them for pleasure or profit, for tinkering or expert craftsmanship. Their versatility is unlimited. Use them to grind, polish, mill, engrave, sharpen, slot, rout, saw, carve, clean, sand, etch, cut, etc. Ideal for internal carving of plastics, the astounding new craft. You can work on wood, glass, plastic and all metals with a Foredom. No. 25 Accessory Set (A truly versatile assortment) only \$5.50 extra.

Over 70,000 Foredoms now in use

← YOUR MOTOR

## Foredom PRESTO-FLEX

with PENCIL-SIZE Handpiece

# \$5.95



- Now turn your old motor, drill press, or electric drill into a Flexible Shaft Tool. Simply attach to your electric drill, drill press or motor. Presto—a flexible shaft machine! Off again in a jiffy! Pencil size handpiece gives you fingertip control. Gets into tight places you can't reach with any other tool. Handy 35" overall length. And—only \$5.95 complete! Not to be confused with inferior imitations. Precision made, backed by 1/4 century experience in this field. All parts replaceable. Order NOW. If ordered for use on motor, specify motor shaft diameter and add 50c for coupling. (Available for 1/4", 5/16", 3/8", and 1/2" shafts.) No. 50 Accessory Set Available \$1.50 extra. Order TODAY.

— SEND NO MONEY —

**FOREDOM ELECTRIC CO., Dept. B1111** Mail Coupon  
27 Park Place, New York 7, N. Y. Now!

Please send me FOREDOMS checked below on 10 day trial.

- |   |  |
|---|--|
| <input type="checkbox"/> Presto-Flex Tool (\$5.95)        | <input type="checkbox"/> No. 50 Accessory Set (\$1.50) |
| <input type="checkbox"/> Motor Coupling (50c)             | <input type="checkbox"/> No. 25 Accessory Set (\$5.50) |
| Specify motor shaft diameter . . .                        | <input type="checkbox"/> Catalog on request            |
| <input type="checkbox"/> Flexible Shaft Machine (\$15.95) |  |

Send C.O.D. plus postage. I will pay postman.

I enclose payment. Send postpaid.

(Money back either way if not delighted)

Name \_\_\_\_\_

Address \_\_\_\_\_

City \_\_\_\_\_

Zone \_\_\_\_\_

State \_\_\_\_\_

SAY YOU SAW IT IN POPULAR MECHANICS

# 30 Early American Designs

New designs . . . Early American pieces adapted to modern living . . . in 2 series, A and B. Each packet contains 15 sheets, 8 1/2 x 11", with photos and working drawings. Easy to make Christmas gifts . . . cricket, napkin holder, candle stand, etc. Each packet 25c postpaid. Send for both packets. Stanley Tools, 1118 Elm St., New Britain, Conn.

**25c**  
a packet of  
15 plans



**STANLEY**

Reg. U.S. Pat. Off.

THE TOOL BOX OF THE WORLD

# WAR SURPLUS AND OTHER BARGAINS

## TRANSFORMER

Jefferson Electric step up or step down transformer. Input, primary 110-117 Volts A.C. Output, from 5 Volts to 650 Volts. Suitable for use with war surplus gadgets, heater relays, radio test filaments, electric trains, house chimes, etc. Weight 10 Lbs. New \$7.95 Each



SEND CHECK, MONEY ORDER or CASH

**FANCY BRIAR PIPES**  
We have been awarded 100,000 fancy briar pipes by Quartermaster Corps. Assorted shapes and sizes. All popular makes. Buy now for Christmas Gifts. Set of 7, \$3.50



**MICROMETER**  
Chrome plated, precision engineered and carefully tooled to give long life ...  
all new. 0-1" capacity, \$2.25.  
1-2" capacity, \$3.50 Each.



## WILLARD WET PLATE BATTERY

This extra long life rechargeable battery is ideal for portable radios, mobile units, bell circuits, alarm systems, rural telephones, Strobe bulbs, etc. 2 V 20 Amps. Only 5" high. Visible ball float hydrometer built in Lucite case. Shipped dry. Any battery service will supply standard battery electrolyte. Used singly or in multiples. Shipping Wgt. 3 1/2 lbs. All new. \$2.75 each



25% DEPOSIT REQUIRED ON C.O.D. ORDERS

**WEATHERSTRIPPING ADHESIVE FELT**  
Dutch Brand, made by Van Cleef Bros. 3/4" wide, 3/16" thick. Adheres with strong grip to any surface in any climate. No nailing required. 101 different uses, in aircraft, autos, boats, trailers, etc. Linen backed. 50 Ft. Rolls \$1.50 per roll



**MICROSWITCH**  
Type Z - 2"x1"x 1/2". Used open or closed. For automatic contacting-light, sound, model train systems, chimes, etc. New. 3 for \$1.



ALL PRICES F.O.B. CULVER CITY, CALIF.

**4 in 1 SCREWDRIVER:**  
3 smaller sizes fit into 6" overall size. Fine steel bits. Solid brass handles. All New. Each \$1.



**HIGH SPEED DRILL BITS**  
Like new! Original value over \$16.00. 25 assorted sizes & lengths \$2.50.



**CLAMPS**—Adel Aluminum Co., Rubber lined, hundreds of uses in any shop. Assorted sizes, all new. 5 Doz. \$1 - 500 \$5

**AIRBORNE SALES CO., INC.** DEPT. PM 11-8 CULVER CITY, CALIF.

Say You Saw It in POPULAR MECHANICS

# MEAD AIR PRESS



**—FOR GREATER PRODUCTION!**  
For greater production at less cost, use Mead Air Press. Hundreds of industrial plants now employ them for staking, crimping, assembly and similar operations. Large model delivers 1200 lbs. pressure on 100 PSI, 7 1/2" clearance — small model delivers 400 lbs. pressure on 100 PSI, 4" clearance. With foot control these presses speed up countless bench jobs, save muscular effort. Write for Free MEAD AIR POWER CATALOG of Air Presses, Air Vises, Air Collets, etc.

**MEAD SPECIALTIES CO.**  
4114 No. Knox Avenue, Dept. PM-118  
Chicago 41, Illinois

## SAVINGS ON SURPLUS BARGAINS

**RUBBER SHEETING** Brand new, 68" x 80". Heavy weight with Grommets. Used as bed mattress cover, hunter and campers tent bottoms, etc. Original government cost over \$12.00 each. Packed 15 to a case. Minimum \$395 order one case. Each.....

**PUP TENTS** Perfect—2 man size for scouting, camping, etc. Without pole \$295

**SQUAD TENTS** 16'x32'6" with 6'6" door, fire and mildew resistant, heavy duck OD color. Excellent for storage of machinery, equipment, truck covers, etc. Original cost \$4800 \$172.00. Our price.....



**PYRAMIDAL TENTS**  
16'x16', 8 man tent. Reconditioned, perfect, fire and mildew resistant, of heavy duck. Complete with tie ropes. Cost Govt. over \$100.00. Our sale price..... \$2650

**WALL TENT** 9'x9' waterproof canvas, front and back windows, 3'6" wall. Ends 8' high. Only..... \$1995

**PLYWOOD TRUNK TYPE LOCKER**  
Galvanized sheet steel cover, size 29" long x 17 1/2" high x 18" wide. Reinforced at all corners and edges. Complete with two clamp down fasteners. Trunk type latch lock, O. D. color. Perfect condition. Our price... \$795

**FLASHLIGHT**  
**INSPECTION LAMP ASSEMBLY**  
NEW—Govt. surplus. Lights up the "Hard-to-get-at" places. Fine for the home, mechanics, electricians, etc. Plastic 12" extension. Adjustable to any angle. Each..... \$129  
Send check or M. O. Add 10% for handling and mailing.



**AMERICAN SUPPLY COMPANY**  
329 W. 5th STREET DEPT. PM KANSAS CITY, MO.

**FASTER... SAFER**  
**SHAPER & Planer \$4.00**  
FITS ANY DRILL PRESS POSTPAID PAT. PEND.

**ORDER TODAY**  
EASY TO USE  
NO CHIPS TO BIND

**MONEY BACK PLANES**  
... IF NOT SATISFIED **RABBETS**  
**ROUTES**  
Machined and balanced — simple to operate — ideal for all precision woodworking. Comes complete with 3 Planer Knives. Set of 3 Moulding Knives — \$1.00 extra.



**LIGHTNING TOOL CO.**  
SOUTHWICK, MASS. DEPT. 3

## CRESCENT TOOLS

Give Wings to Work

ASK YOUR HARDWARE DEALER

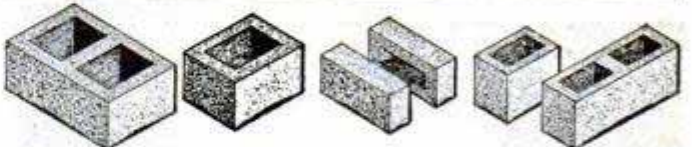

## Make Concrete Blocks and Bricks

New superior method makes square, true, easy-to-lay units which will pass any building code. Small investment, high production, big profits. One \$30.00 machine will make four 5"x8"x12" blocks per minute—1000 per day. Pays for itself in a few days. Sell blocks or save 2/3 building cost by making and laying your own.

POST CARD BRINGS FREE FOLDER

**Economy Manufacturing Company**  
Dept. P Stone Mountain, Georgia

# SERVICE STATION OWNERS



**Don't let this happen to you!**

## USE "SAFETY-FILL" NOZZLE WITH AUTOMATIC CUT-OFF

Follow the thousands operating service stations who are purchasing their own. Investigate! You will find many already in service in your locality. The same nozzle as advertised in Saturday Evening Post and other publications.

Customers are beginning to demand "SAFETY-FILL" service. It sells more fill-ups because:

**CUTS OFF AUTOMATICALLY WHEN TANK IS FILLED**

**NO SPILLING. WASTING GASOLINE**

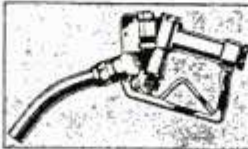

Underwriters approved. Mail your order today. Price \$15.22. Prepaid nearest RR station. Send \$3.00 for each nozzle ordered. Balance C.O.D. **SALES AGENTS WANTED**

### RICHMOND OIL EQUIPMENT CO., INC.

1419-21-23 E. MAIN ST.

RICHMOND 19, VA.

- ★ SCIENTISTS    ★ HOBBYISTS
- ★ FARMERS       ★ STUDENTS

## Use the VICTOR RAIN-GAGE

Be weatherwise! Use this scientific instrument that accurately measures up to 6" of rainfall. Designed by a meteorologist. Not a toy but a real rain measuring device. Simple, easy to read. Rustproof and unbreakable. Instructions and 11-year record book included. Makes an ideal gift. Satisfaction guaranteed.

If your dealer can't supply you, order direct, giving dealer's name. Send no money. Pay postman \$2.40 plus COD charges, or send check or money order for postpaid delivery. Ask about other weather instruments.



Only \$240

### VICTOR RAIN-GAGE CO.

AIRPORT P. O. ★ WICHITA, KANSAS

## Amazing Invention! GUARDS AGAINST EXPENSIVE DAMAGE

- PROTECT YOUR CAR ●

The **MAGIC BRAIN** of your car! Read about it in Sept. issue of Popular Mechanics on Page 167 . . . New Improved Model **SAVES YOUR** Generator, Battery, Starter, Coil, Distributor, Points, Regulator, etc. You can install the **GEN-O-BATT** in 12 minutes without tools.

GEN-O-BATT Generator Co., Dept. P-11, 1136 Dodge Av., Evanston, Ill.

CONTROLS ENTIRE ELECTRICAL SYSTEM OF YOUR CAR

WARNS OF TROUBLE THE INSTANT IT OCCURS  
**Write for FREE information**



## TYPEWRITERS!

ALL MAKES — REBUILT LIKE NEW

For School, Business or Home Use

Write for Information

**M. & M. TYPEWRITER CO.**

84 W. Washington St.

Chicago, Ill.



A man likes a gift that's unique . . . different! And that's *Taykit*, the new *pocket-size* camp stove! *Taykit* is perfect for outdoor cooking . . . for home workshop use, too! It's the world's smallest gasoline stove . . . fits pocket or glove compartment. Sets up in seconds. Pressurized blue flame needs no pumping or priming! Made of gleaming Monel — and guaranteed for a lifetime!



# Taykit

## POCKET STOVE

At hardware and sporting goods dealers, or write:

**TRAVELERS EQUIPMENT COMPANY**

342 Keeler Bldg.

Grand Rapids, Mich.

Say You Saw It in Popular Mechanics



## WHEELS AT BARGAIN PRICES

- ... 4" wheel & tire, 5/16" sleeve bearing .50 ea.
- ... 5" wheel 5/8" solid tire 5/16" shaft hole .65 ea.
- ... 6" wheel 5/8" solid tire 5/16" shaft hole .75 ea.
- ... 7" wheel 3/4" solid tire 3/8" shaft hole .85 ea.
- ... 8" wheel 1" solid tire 1/2" sleeve bearing 1.25 ea.
- ... 8x2" wheel, semi-pneumatic tire 7/16" ball bearing . . . . . 2.50 ea.
- ... 10x1.75 wheel semi-pneumatic tire 7/16" or 1/2" ball bearing . . . . . 3.25 ea.
- ... 12x1.75 wheel semi-pneumatic tire 1/2" bronze bearing . . . . . 4.00 ea.
- ... 10x2.50 wheel semi-pneumatic 1/2" ball bearing . . . . . 4.50 ea.
- ... 6x2" wheel 5/8" ball bearing, solid tires . . . . . 2.95 ea.

**BUILD YOUR OWN**—Wagons—Scooters—Soap Box Racers—Welding Carts—Baby Pens—Etc. To order above wheels write number wheels wanted in space provided, tear out and mail this ad with check or money order and your name and address. If other sizes are wanted write for **FREE LIST**.

**TRULSON MFG. CO., 811 E. 31 St., Dept. PM-17, Kansas City, Mo.**

Check these  
**SMASHING  
BARGAINS**

# WAR Surplus

Listed here are a few samples of the unusual bargains that are being offered in both War Surplus and other merchandise. Take advantage of these specials and order from this ad.

**NAVY STYLE FIELD SHOES**  
NEW. Rugged, comfortable. Reversed uppers, full oak leather inner sole, extra composition outer sole. Add 22c post.

**4.99**

6 TO 12

## SPECIALS

**O. D. Wool Serge**  
**Shirts** 13-15 **2.79**  
**Pants** 28-34 **2.95**

Used, perfect condition. Cleaned and pressed by the Q. M. Corp. 100% wool serge. Add 10c post.

• **Dust Masks**  
NEW. \$1.50 value. Ideal for millers, farmers, paint and insecticide spraying. Add 6c post. **33c**

• **Khaki Suntan**  
**Shirts** 14-17 **2.99**  
**Pants** 29-42 **3.88**

NEW. Made of genuine 8.2 khaki chino material. Trousers with cuffs. Add 10c post.

• **Navy T-Shirts**  
NEW. Full cut. White only. Fine combed yarn. Add 6c post. **69c**

**BOMBER JACKET** **13.99**

**B-15 STYLE**

NEW. Water repel. Mountain cloth outside, full pile lining incl. sleeves, 4 pockets. Wool knit wristlets and waistband. Gen. mouton collar. Add 35c postage.

SIZES 34 TO 46

**ARMY STYLE COMBAT BOOTS**  
**6.88**

NEW. For sportsmen and outdoor wear, 10" high. Reversed uppers, full oak leather sole, with composition outer sole. Add 27c post.

6 TO 12

**77** EACH

**Surplus**

**50% WOOL SHIRTS DRAWERS**

NEW. Shirts: long sleeves, crew neck. Drawers: ankle length. Medium weight, 50% wool, O. D. color. Add 10c post.

**Genuine NYLON**

**PARACHUTE CORD PER HANK**  
**59c**

NEW. Ideal for clotheslines, drapery, venetian blind cords, etc. 550 lbs. tensile strength, 3/16" diameter. Add 7c post.

**50 FT.**

**OFFICER STYLE OXFORDS**  
**6.95**

NEW. Finest quality uppers, best quality oak bend leather outer sole. Half leather lined. Add 20c post.

• BROWN  
• BLACK

**MAIL ORDERS**  
Please remit with order. Be sure to include postage. Satisfaction or money back.

**SIoux FALLS SURPLUS STORE**  
SIoux FALLS, S. D.

**EASY PROFIT IN PAINT SPRAYING**

Paints walls, ceilings, screens, furniture and machinery faster, better. All complete as shown less motor. Carry anywhere. Fully guaranteed. Could be used with 1/4 H.P. motor or less. Price \$35.00 less motor F.O.B. Chicago. \$5.00 deposit balance C.O.D. or see your dealer. With motor \$55.00.

**IDEAL AUTOMATIC PUMP CO., Dept. P.M. 8**  
Chicago 7, Ill.

601 W. Washington Blvd.

# 100 Fireplace Ideas FREE

For Home, Playroom, Cottage, or Camp



If You're Building Your Own Fireplace HERE'S AN EASIER FOOL-PROOF WAY TO DO IT

Choose a design that will look well with the materials you have available. Prepare a concrete or brick slab the size of your fireplace. Center your FYRO-PLACE, the warm-air circulating form, on the base, and build round it. You will have a well-engineered, successful fireplace. You can't fail.



WRITE FOR BOOK TODAY  
Small Book 4 1/4 x 5 1/2 sent free. Larger Book, 8 1/2 x 11, beautifully illustrated, 25c

Ask for Free Data on Outdoor Fireplaces

**PRICE FIREPLACE HEATER & TANK CORP.**  
68 Austin Street, Buffalo 7, New York

## BUILD YOUR POWER TOOLS

WITH OUR GUARANTEED INDUSTRIAL POLY BALL BEARING ARBORS

New Departure Self Lubricating Bearings 10,000 R.P.M.

(No extra charge for left hand threads)

C4—1 1/2" Pictured

B33—\$5.45 PP. C4—1 1/2 x 1 1/2 spindle, housing 2x8... \$7.95 PP.  
5/8 x 4 1/2 Spindle C5—5/8 x 1 1/2 spindle, housing 2x8... \$8.45 PP.  
B15 Plain Spindle C6—3/4 x 1 1/2 spindle, housing 2 1/2 x 8... \$9.45 PP.  
\$3.95 PP. D8—1 x 1 1/2 spindle, housing 2 1/2 x 11... \$18.75 PP.

1 INCH BETWEEN WASHER AND COLLAR

SHAPER ARBORS 3 inches between collars, C4-1 1/2 \$14.25, C5-3/8 \$14.25, C6-3/4 \$15.25, D8-1 \$23.00, B25—1 1/2 x 2" cap, flange mount \$5.95.

PILLOW BLOCKS—Ball Bearing, 1/2 \$3.50, 3/4 \$3.50, 3/4 \$4.25.

**POLY PRODUCTS, 2032-A E. Walnut, Pasadena 8, Calif.**

## Sensational NEW Rejuvenator PORTABLE RADIO

• AC-DC BATTERY SET •

The "Playmate" operates on battery or AC-DC current with built-in Battery Rejuvenator. With 4 tubes and instant operating lifetime Selenium Rectifier. No heating time required for either operation. 3-Position Selector Switch instantly connects the radio for AC-DC power, Battery, or charging. Unusual life from batteries. Wonderful reception. THE IDEAL XMAS GIFT. Take orders among your friends... Profitable.

**MONEY BACK GUARANTEE**

WE PREPAY POSTAGE when remittance in full accompanies the order. WE SHIP C.O.D. plus postage. \$2.00 deposit must accompany order. Unusual proposition is offered to DEALERS... Write Today.

ONLY \$34.45 Including Batteries Postpaid

AMERICAN PRODUCTS CO., 3556 W. Ogden Ave., Dept. P, Chicago 23

SAY YOU SAW IT IN POPULAR MECHANICS

**L\* M CARBIDE SCRIBER**  
NON-MAGNETIC

Tungsten Carbide — carefully ground on diamond laps, brazed into stainless steel 6" handle for marking steel and other metals — for etching, marking, cutting glass. In plastic case with pocket clip.

**\$2.00**  
PRICE POST PAID

**PRICK PUNCH**  
Tungsten carbide tip, silver brazed into 3 1/2" heat treated steel body.

with Carbide Tip... **\$1.50**  
Price Post Paid

**LUCAS-MILHAUPT ENGINEERING CO.**  
5053 SOUTH LAKE DRIVE • CUDAHY, WISCONSIN



**GENUINE SWISS**  
2-Push-Button  
**CHRONOGRAPH**  
**WRIST WATCH**



ONLY... **\$7.95**

A Sensationally low price for such a precision time-piece... A **WRIST WATCH** and **STOP WATCH** in one!

**IT HAS EVERYTHING!**

Note These Features...

- It's a **TIMEKEEPER!**
- It's a **STOP WATCH!**
- It **MEASURES DISTANCE!**
- It **MEASURES SPEED** of Airplanes, Cars, Race Horses, etc.

It has Sweep Second Hand, Chrome Case, Precision Workmanship.

**EXPANSION BRACELET** of matching stainless steel 49c additional.

**SEND NO MONEY!**

Rush order today. Pay postman only **\$7.95** plus 10% tax and postage. Satisfaction guaranteed or money refunded if returned within 10 days.

**HARVEY SALES, Dept. 120**

4916 N. Albany Ave. Chicago 25, Ill.

**MACHINE SHOP EQUIPMENT**



The 1949 edition of the famous Center Tool Co. Catalog is now ready! Every workshop owner should have a copy. 240 pages full of illustrations, descriptions, and prices of the latest tools made by best known manufacturers in U. S. You pay the cost of printing—50c. **We refund your 50c with your first order of \$10.00 or more.** Prompt delivery on most tools. Send check or money order today!

**CENTER TOOL CO., 153 Centre Street, Dept. C, New York 13**

**STOP! Burning Out Your EMERGENCY BRAKES**

**USE — The MUTH "BRAKE\*-SAVER"**

**LIGHT ON DASH WARNS YOU EACH TIME YOU USE THE EMERGENCY BRAKE... KEEP YOUR EMERGENCY BRAKE IN PERFECT WORKING ORDER FOR ANY EMERGENCY**

No more burned out emergency brakes! If your hand brake is set, a **WARNING SIGNAL LIGHT** on your dashboard reminds you the instant you turn on your ignition key... It flashes a steady amber beam as a **WARNING**... The light blinks out **ONLY** when brake is released... You just can't forget the emergency brake with the **MUTH "BRAKE\*-SAVER"** attached to your car... It **SAFEGUARDS THE LIFE OF YOUR EMERGENCY BRAKE!**... Worth many times its low cost for your **COMFORT** and **SAFETY** on hills and inclines, while driving or parking... A few blocks with your **EMERGENCY BRAKE ON** may ruin your brakes entirely and cause costly replacement. **EASILY INSTALLED BY ANYONE.** **AN IDEAL XMAS GIFT**

**Fits All Cars Or Trucks**

**COMPLETE WITH SIMPLE INSTALLATION INSTRUCTIONS**



**ONLY \$2.49**

**TECHTMANN INDUSTRIES** Postpaid in U.S.A.  
Dept. P-11, 714 West Wisconsin Ave., MILWAUKEE 1, WISC.

**SAY YOU SAW IT IN POPULAR MECHANICS**

**BUILD AN ARC WELDER FROM OLD GENERATOR**

For Light or Heavy Work. 75-200 amps. No previous experience needed. Complete **PLANS** and valuable Catalog 35c.

**LEJAY MANUFACTURING CO.**  
1347 LeJay Bldg., Minneapolis 8, Minn.



**SANTA SAYS!**  
**"A WONDERFUL HOBBY WORKSHOP GIFT!"**

*Just dial* **ANY WIDTH CUT ON YOUR SAW**



WITH **DADO SAWING WASHERS**

**Warren**

Cut clean, accurate, parallel grooves—12 widths, any angle. No chatter, burning, chewing—or sanding! No more blade vibration—no screws to fuss with—just four balanced washers. Simply dial desired width with Micromatic adjustment. Can be left on blade for straight cuts. 5 sizes fit any arbor— $\frac{1}{2}$ ",  $\frac{3}{4}$ ",  $\frac{5}{8}$ ", 1",  $1\frac{1}{8}$ ". A perfect gift for woodworkers. See your dealer or use coupon below!

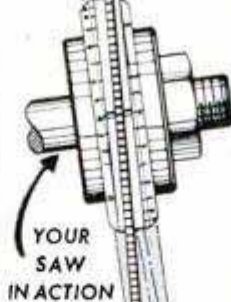

YOUR SAW IN ACTION

**\$4.95 SET**

**DEALERS, ORDER DIRECT!**

**WARREN WASHERS CO., DEPT. 31**  
70 Medbury, Detroit 2, Mich.  
Enclosed \$4.95 for one set of Warren Washers, postpaid.

MY ARBOR SIZE \_\_\_\_\_

NAME \_\_\_\_\_

ADDRESS \_\_\_\_\_

CITY \_\_\_\_\_ STATE \_\_\_\_\_

# GIFT OF THE YEAR for a photographer

the meter with a  
**MEMORY!**

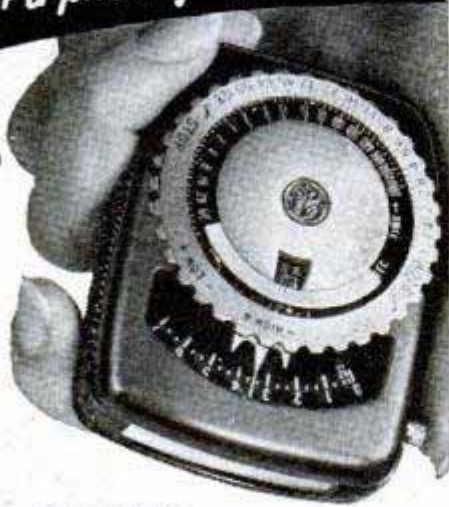

the new



## exposure **METER**

Versatile! Complete. Good for movies and stills, incident or reflected light. And so easy to use! Give the new G-E photographic exposure meter for a thrilling Christmas! Type PR-1, \$32.50\*. General Electric, Schenectady 5, New York.



Also famous Type DW-58 . . . \$19.95\* and \$21.95\*  
\*Fair Trade price. Fed. tax inc.

## GENERAL ELECTRIC

806-47K

### SMALL VERTICAL SPEED REDUCER

Just the thing for Home and Shop Bench work, Animated and Revolving Displays, Revolving Antennae, Light Production work. Sturdy, compact, (see dimensions), efficient. Case of aluminum, gears of specially selected nickel bronze; worm of hardened steel. Roller bearings throughout. Torque capacity, 25 to 150 inch lbs. Available in 4 different assemblies (see below) and in any one of these standard ratios:

4-1	25-1	64-1	200-1
8-1	30-1	75-1	300-1
10-1	40-1	80-1	400-1
16-1	50-1	100-1	600-1
20-1	60-1	150-1	800-1
1600-1			

When ordering be sure to specify assembly and ratio required. Shipping weight in carton 8 1/2 lbs. Prompt delivery. Full Money Back Guarantee.

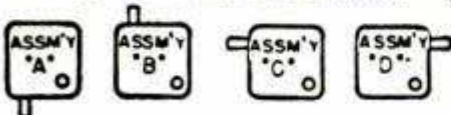

### THE OHIO GEAR CO.

1411 EAST 179th ST. • CLEVELAND 10, OHIO



**\$26.75**

WEST OF ROCKIES

**\$27.50**

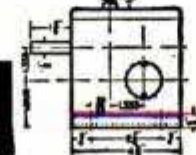
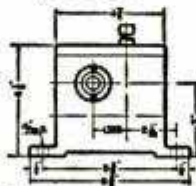

## GIGANTIC SURPLUS SAVINGS



**Semi-Pneumatic  
TIRED WHEEL**  
10 x 1.75, New, perfect, shop worn.  
Only . . . . . **\$1.75**

### WIRE ROPE CABLE

New Aircraft, flexible with high breaking strength. For tow rope, guy wire, clothes line, etc.  
1/16" . . . . . 2c per ft. 1/4" . . . . . 9c per ft.  
3/32" . . . . . 3c per ft. 5/16" . . . . . 11c per ft.  
1/8" . . . . . 4 1/2c per ft. 3/8" . . . . . 14c per ft.  
5/32" . . . . . 6c per ft. 3/4" . . . . . 20c per ft.  
Minimum 100 ft.

### WORK TABLE LAMP

Overall dimensions, 37 1/2", weight 1 lb. Has 4 flexible ball joints. 110 volt, Less plug and bulb. Real surplus bargain.



ONLY  
**\$2.95**

### WORK TABLE LAMP

Same as above. 25" long. Has 3 flexible ball joints. Less plug and bulb. Only . . . . . \$2.75  
BULB for above 30 amps. . . . . 38c

PRICES FOB. KANSAS CITY. NO COD'S.  
WRITE FOR OUR FREE CATALOG.

## ATLAS EQUIPMENT & SALVAGE CO.

229 SOUTHWEST BLVD. KANSAS CITY, MO.

### New MILLING ATTACHMENT



**SIZES FOR 8" to 16" METAL LATHES**  
Build it yourself from our sets of semi-machined castings and save \$5. Can be finished on your lathe alone. Complete drawings and instructions furnished with castings.  
Mill keyways, slots, splines, dovetails, flutes for reamers, special cutters. Produce gears, ratchets, racks; bore, face, etc. with this precision attachment.

**FREE** Illustrated folder and price list of castings, milling cutters, etc. Write today. Mention your lathe.

HURON MACHINE AND TOOL CO.  
YALE 4, MICHIGAN

## BRUSH PLATING OUTFITS

for re-plating articles in the home and shop. No tanks necessary. Free particulars.

GUNMETAL CO., AVE. M, DECATUR, ILLINOIS



### GERSTNER Tool Chests

Strong, durable chests, attractively finished, will please the better machinist and toolmaker. Free catalog.

GERSTNER TOOL CHESTS  
448 Columbia St. Dayton 7, Ohio

## ACE

LATHE TOOL SET



Be permanently toolled-up for every operation on your Metal Cutting Lathe

The ACE Set is complete—there's nothing more to buy. Drop forged by the manufacturers of cutting tools used by 96 per cent of the plants and shops in industry they are correctly designed, are of special steel, are finely finished, are stronger—will last a lifetime. You can cut easier, faster and more accurately with ACE TOOLS.  
At your Hardware Store—

ARMSTRONG BROS. TOOL CO.

"The Tool Holder People"

5268 W. Armstrong Ave., Chicago 30, U.S.A.

## MAKE MONEY MAKING DOUGHNUTS

Make new greaseless doughnuts at home on electric machine. Sell for cash to grocers, cafes, drug stores, etc. No exp. nec. Good profits. Small investment. Send for free recipes and plans.

MART RAY CO. • 3605 S. 15 Ave. • Minneapolis 7, Minn.

# OVER 250 SURPLUS BARGAINS

Write for FREE Catalog  
PM-11 Today!

TYPE  
B-3

## FLYING JACKETS

Genuine Air Force issue! Fine quality seal brown leather, adjustable waist and collar straps, sheep lined, zipper closure. Reconditioned. Sizes 36-46. A \$30.00 value! Only



TYPE D-1 JACKET. Similar to type B-3 but lighter in weight. Zip front, long wearing. Reconditioned State size . . . \$9.88

**\$15.95**

## GENUINE ARMY BLANKETS

Finest 100% wool blankets issued! Soft, soil resistant nap. Olive drab, cleaned, guaranteed perfect. This quality in civilian colors sells for \$12.50. Wgt. 4 lbs. **\$3.88** 2 for \$7.50



BRAND NEW O. D. ARMY BLANKETS Right out of orig. govt. cases. Size 68" x 86". 4 lbs. **\$4.88** 2 for 9.50

## TYPE A-10 FLYING GLOVE

NEW!



Soft, brown pony leather, wool lined. Knit wrist. A \$5.00 value! Sizes 8 to 10.

**\$2.50**

## GENUINE US NAVY LAST OXFORDS

The most comfortable shoe made! Finest quality leather. Fits like a glove, outlasts ordinary shoes, ask any Navy man. Now! in all widths, B-C-D-E. **\$6.88**



## BROWN ARMY OXFORDS—\$6.88

Same fine quality as Navy oxford, top grain calf, all widths, B-C-D-E.

## NEW! TYPE B-3A FLYING GLOVE



A real beauty. Soft, fine supple brown leather. Fits like your own skin. Brown separate liner for extra warmth. Sizes 8-9-10-11. Leather gloves with rayon liners. Both complete for only \$2.88.

Only

**\$2.88**

## AIR FORCE FLYING TROUSERS

LEATHER • SHEEP LINED! Brand New! The Navy's finest! Zippers entire length of pant. Suspenders included. All sizes. Government cost over \$20.00. State waist size and length. **\$8.88**



## AAF ALPACA LINED PANTS

ALPACA LINED THRU-OUT! Weatherproof poplin outer. Complete with pockets, zippers and suspenders. Warm, light weight. **\$6** State waist size.

## A-9 FLYING GLOVES

\$10.00 wouldn't buy a better mitt. Warm, fleecelined, soft deer-skin. New! Large only. **\$4.98**



## FAMOUS A2-N JACKET

Front quarter horsehide, handsome, long wearing. Sateen lining, shoulder straps.

With fur collar **\$21.95**

With horsehide collar **\$19.95**



Snaps on pockets, collar. Concealed zipper. Wool knit at cuff and waist. A \$30.00 value.

## A-2 JACKET

Select capeskin leather, same design as jacket above, but in capeskin. Choice of fur or leather collar. Fur collar . . . **\$18.88** Leather collar **\$16.88**

- TENTS, Army issued, perfect cond. 9x9 ft. **\$19.50**. 16x16 ft. **\$29.50**. 16x32 ft. **\$49.50**. Shipped freight collect, with ropes, etc. Poles addit.
- 8.95 ARMY COMBAT BOOTS, all sizes **\$6.90**
- 12.50 PARATROOPER BOOTS, Double sole **\$8.90**
- 10.00 A-6 SHEEPLINED BOOTS, reconditioned. (new \$12.50) **\$6.95**
- 35.00 AAF PARKA COAT, quilt or alpaca lined! fur parka! **\$24.44**

- 19.50 NAVY DECK JACKET, alpaca lined throughout **\$14.88**
- 18.75 B-15 TYPE JACKET, alpaca lined throughout, fur collar. **\$14.88**
- 17.50 NAVY PEA COATS, 100% wool regulation type **\$12.88**
- 18.00 OFFICERS "PINKS", smartly tailored, zip fly **\$10.88**
- 4.95 WOOL ARMY SLEEPING BAGS, zipper mummy type **\$2.88**

## JACKET—SHEEPLINED TYPE AN-J4

Genuine Air Force issue! The Air Corp's finest jacket. Top grade leathers, trimmed at cuff and waist. Ex. lge. sheeplined collar. Adj. tabs at side, zip front. Reconditioned. **\$42.50** value. Med. sizes only. **\$19.50**



B-2 FLYING CAP. New, all leather cap, square visor, sheeplined, turn-up flaps. \$5.00 value. State size. **\$2.50**

# FISLER SALES CO. 723 Walnut St. Kansas City 6, Mo.

Mail orders add 10% or include sufficient postage. Any overage will be promptly refunded. Complete satisfaction guaranteed.

## BUILD YOUR OWN FAST FREEZER

PLANS \$1

It's easy to build this household appliance with LeJay Plans. Made from new or used parts. Save up to 75%. No expert knowledge needed. Plans show 5 sizes and are easy to follow. All details clearly explained. Enjoy making one of these freezers. Mail \$1 for set of plans and catalog. LEJAY MFG. CO., 447 LeJay Bldg., Minneapolis 8, Minnesota



SAY YOU SAW IT IN POPULAR MECHANICS

# MAKE MONEY WITH YOUR CAR

## EARN A SWELL LIVING THE EASY McNESS WAY

Use your car as a McNess Store On Wheels. Sell things farmers need and consume. Serve same families year after year. Everything guaranteed. Big demand already exists, as farmers know only best quality products carry McNess name. You start right in making money the first day. No selling experience necessary. Advertising—premiums—offers—sales know-how supplied.



USE OUR CAPITAL—Get started at once. Write today for FREE Book that explains all. Tell what county and state you wish to serve. No obligation.

THE McNESS CO., 679 Adams St., Freeport, Ill.

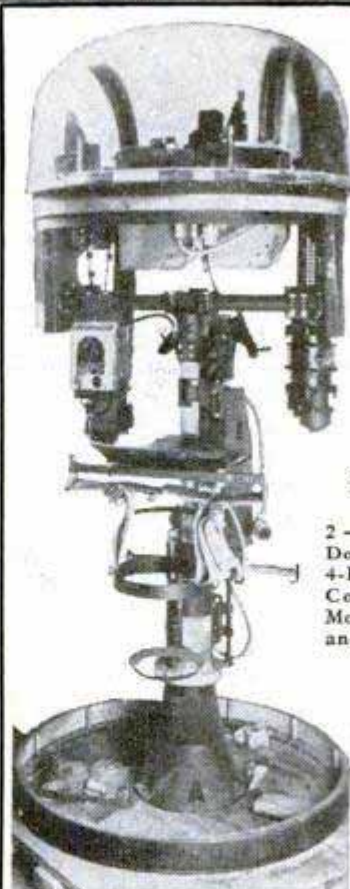

A \$2500 PIECE OF Electrical and Mechanical Equipment for

**\$25.00** GOVERNMENT SURPLUS

# PILOT Trainer

# TURRET

3 1/2 ft. in diameter  
6 1/2 ft. high

Chuck full of all kinds of gadgets, including:

- 2 — 1 H.P. Motors — Plexiglas Dome — Motorcycle Saddle — 4-Lens Gunsight — Pistol Grip Controls — Oscillating Gun Mounts—Electric Trouble Lamp and 100 other attachments.

WHILE THEY LAST

**\$25.00** EACH

Approximate shipping weight — 500 lbs.

IMMEDIATE SHIPMENT

Send Cash, Check, or Money Order to:

## JOSEPH STERN

610 West Court Street, Dept. 5 Cincinnati 2, Ohio



**COMMON SENSE..**  
*proved thousands upon  
 thousands of times!*  
**ALL-VEGETABLE  
 LAXATIVE**

**NATURE'S REMEDY (NR) TABLETS**  
 —A purely vegetable laxative to relieve constipation without the usual griping, sickening, perturbing sensations, and does not cause a rash. Try NR—you will see the difference. Uncoated or candy coated—their action is dependable, thorough, yet gentle as millions of NR's have proved. Get a 25c box and use as directed.



**FUSSY STOMACH?**  
 RELIEF FOR ACID  
 INDIGESTION,  
 GAS AND  
 HEARTBURN



Say You Saw It in  
**POPULAR MECHANICS**

## It's Kester for Real Soldering Efficiency



**Kester Cored Solders** —  
 Acid and Rosin Core—are  
 the choice of all home and  
 hobby craft workers for  
 clean, fast, and efficient  
 soldering.

**KESTER SOLDER COMPANY**  
 4251 Wrightwood Ave., Chicago 39, Illinois  
 Factories Also at  
 Newark, New Jersey • Brantford, Canada



# K-R-O KILLS RATS

• Comes in **POWDER** and **BIS-KIT** form. Both contain *red squill*; are safer around farm animals and pets. **POWDER**, 75¢; **BIS-KITS**, 35¢ and \$1.00. If unavailable from your druggist or seedsman, order direct; adding 15¢ for mailing and handling. Money-back guarantee. *The K-R-O Company, Springfield, Ohio.*

**TERRIFIC FOR THE HOLIDAYS**

Clip-write  
**TIE-CLASP PENCIL**



This is a high class item. Gold plated — Sells on sight for \$1.50 plus tax. For men's neckties and women's handbags. Ideal for Xmas gifts and commercial premiums. Send 75c for sample.

**CLIP-WRITE COMPANY**  
 270 LAFAYETTE ST. NEW YORK 12

## LOOK! Famous AAF N3C Sight

CONTAINS EXCELLENT F2.5 LENS having 51.5" focal length, front-surface optical mirror, reticle and 24-volt bulb. FREE instructions included for converting to projector, telescopic gun sight, telescope, telephoto lens for movie or 35-mm camera, projection pointer, and many other valuable items. New, in original cartons. AAF cost nearly 20 times this value. Send check, money order or C.O.D. instructions. Prepaid orders sent postpaid.



**\$2.49**

**MICRONICS CO.** • 1818 W. Foster Ave. • Chicago 40, Ill.

### NEW PRICES

## Ball-Bearing **SPEED WHEELS**

### JUVENILE WHEELS

(No bearing, solid tires)

4".....45c 6".....65c  
 7".....75c

(Semi-pneumatic tire, ball bearing)

6x1 .....1.65 8x2 .....2.20  
 8x1.25 .....1.85 10x1.25 .....2.20  
 8x1.75 .....1.95 10x1.75 .....2.30  
 12x1.75 .....3.45

### INDUSTRIAL WHEELS FOR HEAVY LOADS

6x2 Welded ..3.45 10x2.75 HC.. 5.70  
 6x2 Bolted ..4.35 10x2.75 Pne. 7.90  
 8x1 .....5.25 12x2.00 .....6.90  
 8x2.00 .....5.20 12x3.00 .....10.80  
 8x2.50 .....5.40 4.00x8-2 .....14.70  
 10x2.00 .....6.10 4.00x8-4 .....15.85  
 16x4.00 .....15.15

**DEALERS, JOBBERS,  
 AND MANUFACTURERS!**  
 OUR NEW PRICES WILL  
 INTEREST YOU.

**WRITE US NOW FOR COMPLETE  
 NEW CATALOG**  
 Send check with order. No C.O.D.

**JIM BROWN TOY COMPANY**  
 1097 Home Ave. Akron 10, Ohio

# THE NEW **MP** QUALITY WOODWORKER DOES EVERYTHING!



SPINDLES DESIGNED FOR JACOBS CHUCK

CAREFULLY MACHINED SEMI-STEEL CASTINGS

BED CAN BE LENGTHENED TO ANY SIZE

IMMEDIATE DELIVERY!

**\$2275** F. O. B. Royersford, Pa.  
(As Shown)

**BALL BEARING THRUST—BRONZE BEARINGS**  
PROFESSIONAL TYPE, 2 x 4 x 48" HARDWOOD BED

Jacobs chuck #6426 1/2" capacity \$4... #508 ground cast iron table for sawing or sanding, tilts to 50°, accurate scales show degrees, takes 8" blade, cuts 2 1/2" deep, screw regulates depth of cut \$11.95... Miter gauge #540, cast iron, accurate scale shows degrees \$3.75... Combination extension and fence #556, screw adjustment \$3.75... Arbor #500, 5/8" dia. for saw blade, buff or grinding wheel \$1.50... Sanding disc #503, 10" aluminum \$3.50... Disston-made saw blade 8" dia., 5/8" hole, combination, rip or crosscut \$3.50 ea. ... Face plate #505, 5 3/4" dia. \$3.75... G. E. Motor 3/8 H. P. 110 V. A. C. \$13.95... All prices F. O. B. Royersford, Pa.

Write for free illustrated literature

Sanding

Outboard Turning (face plate #505) Grinding or Buffing

Cutting Large Workpiece with Extension #556

Drilling with Jacobs Chuck

Cutting compound angle

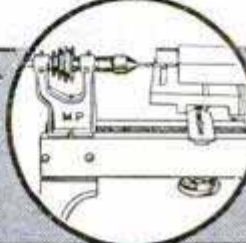
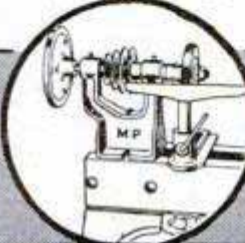

AMERICAN MACHINE & TOOL CO., INC., DEPT. 15, ROYERSFORD, PA.

## WRITE FOR YOUR **FREE** COPY OF THE NEW **KRW HYDRAULIC PRESS BOOK**

Describes all manner of Production and Shop Work on KRW Hydraulic and Bench Type Arbor Presses. 32 pages illustrating the new KRW Hand-operated, Electric-operated and Air-operated Hydraulic Presses. Write for your copy today.

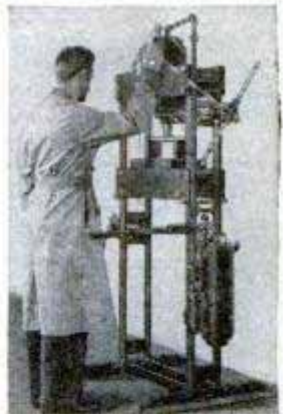
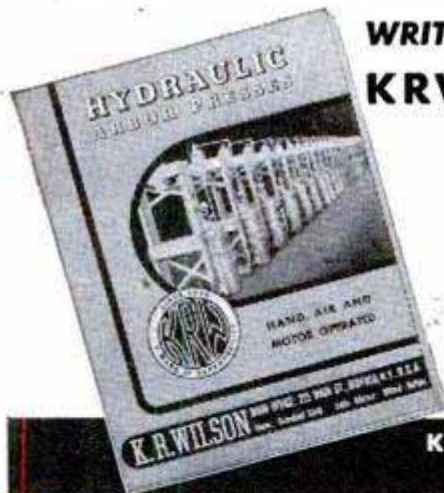

K. R. WILSON, DEPT. 17, 215 MAIN ST., BUFFALO 3, N. Y.  
Builders of Shop Equipment for Ford Dealers Since 1916

## FREE Sample Of New **PLASTIC** Shows How To Make **Leather and Leatherette** LIKE NEW!

**Magically Changes Cloth To Imitation Leather**

**SAVE MONEY - TIME AND EFFORT** by renewing Luggage - Leather Covered Furniture - Golf Bags - Auto Seat Covers - Restaurant Furniture, Booths or any Leather or Leatherette item with new plastic discovery called **Leather-New**. Coat cloth or cloth covered items such as Glider Cushions, Tarpaulins, Porch Furniture, Etc. and make them look and wear like they were leather. Spreads easily with brush or spray gun—leaves **NO BRUSH MARKS**. Simple Acids, Caustics and Alcohols do not stain this finish—It is sun and mildew proof. Stays Fresh and Clean as long as real leather. Comes in all standard colors. Just mail coupon for Free sample of **Leather-New** coated material which shows effects.

**OWN A PROFITABLE LIFETIME BUSINESS**

Cash in on big profits to be made in this new business—Profits up to \$700.00 monthly possible, renewing booths and furniture for bars, restaurants, grills, movie houses, etc. Mail name and address on 1c postcard—I'll show you how. Jack Edwards, Sales Mgr.

**JUST MAIL COUPON**

No Obligation

LEATHER-NEW PRODUCTS  
4723-AN Troost, Kansas City, Missouri

Name \_\_\_\_\_

Address \_\_\_\_\_

City \_\_\_\_\_ State \_\_\_\_\_

Fill Out—Mail Today

LEATHER-NEW PRODUCTS • 4723 Troost, Dept. AN • Kansas City, Missouri

## REAL SURPLUS VALUES EMERGENCY SUPPLY TANK



Fill at any gas station. 150 lbs. airs 5 flat tires. Inflates rubber boats. Use for touch-up spray jobs, tire service truck, air horns, dust out motors, machinery, etc.

Shatterproof 12"x24" stainless steel tank with carry handle, check valve, two feet

hose and tire filling chuck. Only **\$7.95**  
 Tank only 12"x24", tapped each end 1/4 pipe thread, 500 lb. pressure. Build your own. Ideal for paint spray, air receivers, net floats, buoys, etc. Each **\$4.75**  
 Small size tank, 6"x24", Only **\$2.98**

## Portable SPOT-LITE



### PISTOL GRIP SPOT AND EMERGENCY LIGHT

For police cars, auto wreck trucks, cars, boats, etc. Red, green, amber and blue snap-on lenses free.

4 1/2 inch spot with 26 volt sealed beam lamp **\$1.95**  
 With 6 volt, sealed beam lamp **\$2.49**  
 6 inch spot with 26 volt lamp **\$2.95**  
 With 6 volt lamp **\$3.95**  
 26 volt replacement bulb **49c**  
 6 volt sealed beam **\$1.23**

## BRIGGS-STRATTON ENGINES

### 1 1/2 HP MODEL N— GOVT. SURPLUS

In good operating condition with 30 day written guarantee **\$39.50**

Engines will develop almost 2 Hp at 3600 RPM. Hurry, don't wait, buy now while limited supply lasts. Suitable for lawn mowers, garden tractors, motor bicycles and scooters, midjet cars, etc. Will power many kinds of machinery.

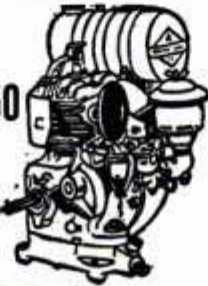

"Bull Buffer" **SANDER & POLISHER** **\$9.95**  
 Attachment fits any chuck on Electric Drill or Flex Shaft. Only

## HOME SHOP POWER TOOLS

"Darrah-James." Lathes, sanders, bench saws, band saws, drill presses. Complete line.

PRICES FOB, K. C. NO COD'S

**MIDWEST SURPLUS SALES CO.**  
 2533-P-INDIANA  
 KANSAS CITY 1, MO.

SEND FOR  
**FREE CATALOG**  
 HUNDREDS OF VALUES



Say You Saw It in Popular Mechanics

## MAGIC RADIO-MIKE BROADCAST THRU YOUR RADIO WITHOUT WIRE

Without wires, lets you broadcast through your own radio. Simply turn on radio and tune to any clear channel between 1250 and 1700KC, talk into the mike and you'll hear through your own radio up to 75 feet away. For home, office, restaurants, nurseries. COMPLETELY SELF-CONTAINED: comes complete with tube and batteries. No hookups or connections needed; ideal for parties, gatherings, etc.

**ONLY \$6.95 COMPLETE**



**SEND NO MONEY** Send us your name and address and we'll ship you your MICRO-VOX RADIO-MIKE C.O.D. plus postage. Or send us \$7.00 and we ship postpaid. Order today.

**MICRO-VOX, Inc., Dept. M**  
 130 N. WELLS ST. CHICAGO, ILLINOIS

# Don't Risk Engine Overheating

Keep cooling systems  
**ALWAYS up to par**  
 with regular

**Warner** care



### Warner Liquid Solder (Non-Metallic)

• Deposits tiny fibers to repair leaks anywhere in the cooling system.

### Warner Radiator Cleaner

• Thoroughly cleans cooling system of rust, oil muck and grease.

### Warner Cooling System Protector

• Prevents rust, scale and corrosion.

No delays—just pour in and keep on driving. Do it yourself, or ask your service man.



Warner-Patterson Co., 920 S. Michigan Ave., Chicago 5

## EASY TO BUILD

**U-MAK-IT BOAT KITS** for Home Assembly. Complete with Illustrated Instructions. No Experience Necessary. SEND 25c Postage (Coin) Today for 3 Money Saving Illus. Catalogs Showing all '48 Models & Construction Details.

**KAYAK BOAT CO.**  
 703P-WHITTIER ST., N. Y. 59, N. Y.

**KAYAKS<sup>TM</sup>**  
 INBOARDS  
 OUTBOARDS  
 ROWBOATS  
 RUNABOUTS  
 DINGHIES  
 V23 CRUISER



## ALL PURPOSE FOLDAWAY

### TABLE or BENCH LEGS

Make sturdy folding tables, benches or work borses with these steel channel, riveted folding legs. Black enameled and rubber tipped. 30" high for table tops 5.98 pr.; 24" high for benches or work horses 4.98 pr. Send for free circular.

**THE DIAMOND MFG. CO.**  
 1100 ALTAMONT AVE. SCHENECTADY 7, NEW YORK



**\$4.98**  
 (LEGS ONLY)



## GEIGER COUNTERS

FOR LOCATING RADIOACTIVE MINERALS - FOR HOSPITAL AND INDUSTRIAL USE.

Write for Details and Prices  
**OMAHA SCIENTIFIC SUPPLY CORP.**  
 Dept. N, 3623 LAKE ST., OMAHA 4, NEBR.



## MOHAWK CHIEF

**Glow Plug Model** Less Plug **\$7.50**

• The highest quality miniature gas engine in the low-priced field. Now in either Spark Plug or Glow Plug models as priced above. Real steel 1-piece cylinder with deep flut, 1-piece crankshaft. Aluminum crankcase. Other outstanding features. For B-class—299 dia, 2-12,000 RPM, .760 bore, .669 Stroke, Wt. 7 oz. At your dealer's or order direct, adding 25c to above prices for handling. Or send \$1.00 and pay balance C.O.D. Every engine **BLOCK TESTED & GUARANTEED.**



### SPITFIRE Coil and Lead — ONLY \$1.50

High output matched unit for Mohawk Chief Spark Ignition Engine.

MOHAWK ENGINEERING CO., 1511 Michigan St., Mohawk, N. Y.

# Stucco Spraying Earns High Incomes

It's today's biggest business opportunity in the building field. High returns from a low investment. Easy, fascinating work. Large waiting market because Colorcrete is applied over all kinds of old and new masonry surfaces — exterior and interior.



## Beautifies and Protects All Types of Buildings

Pneumatic pressure sprays plastic-like Colorcrete to give enduring beauty and water-resistant values. Range of 30 gleaming colors; many textures. Easy to wash. Smartly modern. Write or wire today for Opportunity Portfolio.

**COLORCRETE** COLORCRETE INDUSTRIES, INC.  
570 OTTAWA AVE., HOLLAND, MICH.

# CURIOUS?

ABOUT A

## SHIP-IN-A-BOTTLE

Here is the secret plus all of the material less bottle. See your dealer first. Catalog 10c.



Postpaid in U.S.A. **75c**

BRAUN-CRAFT, 1232 Etowah, Dept. PM-11, Royal Oak, Mich.



## BUILD FINE GRANDFATHER CLOCK NOW

The simple sensible Red-i-Kut way as thousands have—SAVE HALF. SHOP TESTED PLANS "SPIRIT OF THE CENTURY" Narrow waist 83" tall or stately "SPIRIT OF AMERICA" straight side model with pictures. EASY-TO-FOLLOW PLANS tell all—plus BROCHURE of fine brass weight Westminster, tube chime, movements, dials and mahogany case kits. Send \$1.00 today—Both Plans \$1.50 NOW. KUEMPEL CHIME CLOCK CO., 110 Kuempel Bldg., Minneapolis 16, Minn.

SAY YOU SAW IT IN POPULAR MECHANICS

# IMMEDIATE DELIVERY ON NEW HEAVY DUTY CERWECO BENDING BRAKES



Heavy steel-plated welded construction. Ideal machine for sheet metal shop and short run production jobs. Easy and simple to set up. One man handles easily. Quick independent clamping of sheets. Quick set screw adjustment for upper clamping plate. Well balanced bending apron. Renewable bending edge bars. Apron arranged for various forming molds. 4 ft. model illustrated—up to 16 gauge mild steel capacity.

LOW AS

4 Ft. Model—\$185.00, F.O.B. St. Louis, Mo. 25% cash with order, balance C.O.D.  
DEALERS WANTED: Write for information on complete line of brakes.

**\$185.00**

**CERTIFIED WELDING & ENGR. CO.**

4506-PM-11 Delmar

Forest 6522

St. Louis 8, Mo.

# Siegler PATENTED OIL HEATER

TWICE THE HEAT  
WITH LESS OIL  
IN YOUR HOME

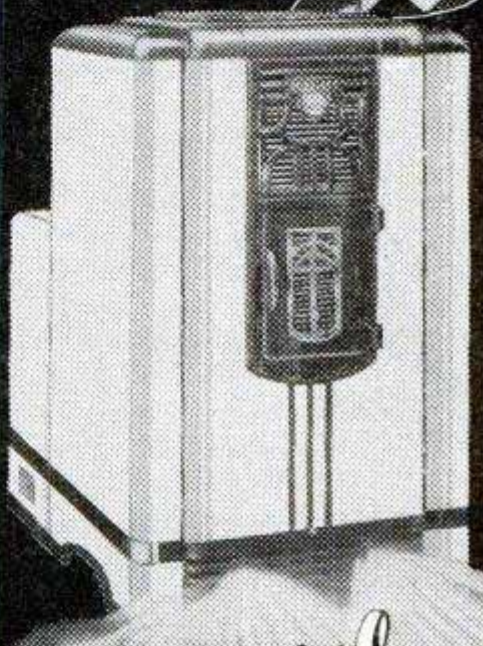

FORCED  
HEAT  
*Tropical  
Floor Heat*

GETS TO THE BOTTOM OF THE  
COLD FLOOR PROBLEM

See Your Furniture, Hardware or Appliance Dealer

MAIL THIS COUPON TODAY TO  
SIEGLER'S, Dept. PM-11  
BOX 111, CENTRALIA, ILL.

For FREE Information and the name of your  
Siegler dealer.

NAME \_\_\_\_\_  
ADDRESS \_\_\_\_\_  
CITY \_\_\_\_\_ STATE \_\_\_\_\_

TRADE NOW AND SEE HOW SIEGLER  
SAVES AS IT PAYS FOR ITSELF



## TRAILER BUILDERS' SUPPLIES! TO BUILD, REPAIR OR MODERNIZE!

And save money. You must have our big Catalog. We are the largest and most complete trailer supply house in the States. Our new large 1948 catalog 10c; blue prints and building instructions, 25c.  
NATIONAL TRAILER EQUIPMENT CO., 1007 N. Water St., Milwaukee 2, Wis.

# Gifts Supreme BY Lenk

**THE HOME OWNER, THE HOBBYIST, THE MECHANIC**

Here's the very best in home workshop equipment. These and other superior quality Lenk items hand-somely gift-wrapped, ready at your dealer's:

- LENK GUN-GRIP ELECTRIC SOLDERING IRON . . . . \$5.00
- LENK WORKSHOP KIT (soldering iron, bltorch, solder) 4.00
- LENK SELF-GENERATING BLOTORCH (ALCOHOL TYPE 3.25)  
GASOLINE TYPE 3.00

If your dealer is out of stock, send check or money order to us (mention dealer's name).

**THE Lenk MFG. COMPANY** \*\*\*  
30-38 CUMMINGTON ST., BOSTON 15, MASS.



YES, DEAR, WITH A HULL AUTOMOBILE COMPASS I WOULDN'T HAVE TO GO THIS FAR TO TELL A WRONG TURN!

AT YOUR DEALER'S. WRITE FOR CIRCULAR.

Beaconlite (illustrated) \$5.95

Streamline \$3.95



HULL MFG. CO., P.O. Box 246-D11, Warren, Ohio

**SAY YOU SAW IT IN POPULAR MECHANICS**



- 750' 2-PLY NYLON 25 lb. T
- 150' 3-PLY NYLON 85 lb. T
- 250' 3-PLY NYLON 45 lb. T
- 300' SILK LINE 30 lb. T
- 500' 3-Ply Nylon 35 lb. T
- 500' Linen Line 32 lb. T
- 3 Ply Nylon Rope 1/4" dia.
- 6c Ft. Braided Nylon Line

Koller Lite Wght. Fly Reel 1/16 dia. 250 lb. T 2c ft. Pachner & 3c ft. All lines available in longer lengths. Send Check, M.O., no C.O.D.'s. **MAC-MILLS** Dept. 11 Pleasant Valley, New York, N. Y.

## Water Cooled PIPE FOR THE SMOKE OF YOUR LIFE

**IT'S NEW** **IT'S COOL** **IT'S DIFFERENT!**

- Water filtered tobacco flavor
- Eliminates soggy heel & goo
- Water reservoir traps tars, resins
- Smoke cooled & cleaned

Size: 7 1/2" long 4" high

Also available in Natural Smooth Finish. **\$3.50**

Remit with order, postage paid or C.O.D. plus postage.

**PORTER PRODUCTS, Dept. 14** 1472 Broadway, New York 18, N. Y.

## FREE CATALOG FOR HOBBYISTS WATCHMAKERS MODEL MAKERS HOME CRAFTERS

100 PAGES MONEY SAVING PRICES

- **TOOLS**  
Tweezers, pliers, screwdrivers, lathes, motors, Saws, Drills, etc.
- **MATERIALS**  
Watch Parts, Solder, Gold Wire, Bead Clamps, Spring Rings, etc.
- **SUPPLIES**  
Oils, Cements, Polishing Materials, Cleaning Solutions, etc.

Ask for Cat. # 7P

**BURTON M. REID SONS INC.**  
1st and Wash "The House of Friendly Service" Springfield, Ill.

## Rebuilt GENERATORS

Chevrolet—Ford—Plymouth

exchange price **\$6.95** guaranteed

F.O.B. Chi.

Generators rebuilt by factory-trained experts. Also hard-to-get parts for every car. **STARTERS, TRANSMISSIONS** and rear ends at tremendous savings.

**WORLD AUTO PARTS CO.** 2200 N. Ashland Chicago 14, Ill. **ORDER** from one of the nation's largest replacement dealers

# BURN WATER IN YOUR CAR!

**THE NEW OCTA-GANE WATER INJECTING CARBURETOR GIVES YOU BETTER MILEAGE & PICK-UP MORE POWER & MORE PEP CLEANER & COOLER MOTOR**

*New OCTA-GANE is the only water injecting carburetor engineered on the Venturi Principle. Only \$24.25 complete with tank. Send only \$1.00 down with special offer coupon at right. Send today! Mail postcard for particulars.*

**CONTINENTAL CARBURETION CO.**  
Div. 11-B, 1478 UNIVERSITY AVE., BERKELEY, CAL.

Sirs: Please ship me immediately one complete OCTA-GANE assembly under the plan checked below.

\$1.00 enclosed, pay postman balance c.o.d.  
 \$24.25 enclosed, ship fully prepaid.

(PLEASE PRINT)

Name \_\_\_\_\_  
Address \_\_\_\_\_  
City \_\_\_\_\_ State \_\_\_\_\_  
Make, Year & Model Car \_\_\_\_\_

**DEALERS:** Write on your letterhead for discounts.



# You Can Be the Local Manufacturer



More local plants are badly needed to make Dunbrik-Dunstone—America's finest masonry. Smart—modern—colorful. Yet costs less than lumber. Millions used annually for homes, stores, factories, public buildings, etc.

Write for portfolio "Blueprints for Profit"



With Dunbrik-Dunstone you can ride the tide of the biggest building cycle in history. Local plant—local materials—local labor. Equipment costs moderate. Liberal sponsor co-operation. 100%—150% mark-up on basic costs. Write at once.

**W. E. DUNN MFG. CO.**  
600 W. 24th St., Holland, Michigan

## DUNBRIK DUNSTONE

### FURNACES FOR HOME AND SHOP



COAL—LP—GAS—OIL. Fittings, pipes and registers. Water heaters, Ranges and floor furnaces. BLOWERS with motors. Get the parts you need and modernize your own heating system. Wholesale & Retail. Lowest prices.

FREE BOOKLET

**PEERLESS SALES & SUPPLY**  
4318 Sheridan Lincoln 6, Nebr.

## OWN A Printing Business



Cards, Tickets, Stationery, etc. Good profit in spare time. PRINT YOUR OWN greeting cards, movie titles, church work, etc. Save money. Easy rules supplied. Raised printing like engraving too. Have home shop. Sold direct from factory only. Send dime for supply book, suggested outfits, all details and advice on your needs. No obligation. **KELSEY, INC., C-37, MERIDEN, CONN.**

## SPECIAL OFFER!

LOCK-STITCH SEWING AWL

\$1.00

Postpaid

Famous, patented lock-stitch sewing awl complete with needles, waxed thread and direction folder. Hundred uses—sewing, repairing leather goods, canvas, belting, harness, saddles, gun cases, awnings, golf bags. Extra needles and thread available. Satisfaction guaranteed or money back. Send currency, check or money order. Yates Mfg. Co., 611-H Main St., Lake Geneva, Wisconsin

SAY YOU SAW IT IN POPULAR MECHANICS

ORIGINALLY sold up to \$55

**MENS FULLY GUARANTEED NEW 15-JEWEL WRIST WATCH \$13.95 PLUS TAX**

Sacrificed because they're post-war surplus

### WATER PROOF—SHOCK PROOF

Luminous dial . . . sweep second hand . . . anti-magnetic . . . imported Swiss precision movement and case. You get them now for a small fraction of original prices. Don't delay! Order now . . . while they last. Send only \$1 down payment with order. Pay balance to postman on arrival, plus postage. Or we pay postage if you enclose \$13.95 plus \$1.39 Fed. Tax. Receive Reg. \$2 expansion band FREE with prepaid order. Money back in 5 days if not delighted. Order now.



**MARYLAND DISTRIBUTORS, Dept. 111**  
501 E. Baltimore St. Baltimore 2, Md.

# SANDEE Specials



## MUFFLERS Steels & Aluminums with a MELLOW Motorboat Tone

SINGLES, Chev., V-8, Plymouth, Steels \$5.50, Aluminum \$7.00. Chry., Olds., Buicks, etc., Steels \$7.50, Aluminum \$9.00. V-8 and MERCURY DUALS, Steel \$17.50, Aluminum \$21.00. Split Manifold Sets, Steels \$35.00, Aluminum \$45.00. '49 Ford Duals, \$2.50 extra.

SANDEE ALUMINUMS ARE GUARANTEED FOR LIFE OF YOUR CAR

## Streamline Your Car with SANDEE FENDER SKIRTS . . . \$17.20 pr.

Sparkling beauty you'll like. Constructed of heavy gauge body steel, finished in prime perfect fit.

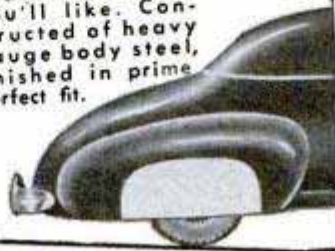

For Ford, Chev., (except Fleetline), Merc., Plym., De Soto, Chry., Dodge, Kaiser, Frazer, Buick (except 42-48 Super), Olds. Series 60 & 70 1937-40, Pont. 6 1939-40.

Beautify your car . . . bring out the flowing lines inherently designed there.



## DIXIE-WESTERN DUAL INTAKE MANIFOLDS for V-8 FORDS AND MERCURYS \$15.00

Gas Line and Throttle Kit \$2.50 extra. Chrome Plated Velocity Stacks \$3.00 pair.

By test: Increased acceleration by 26%—increased power and speed by 11%.

All DIXIE WESTERN manifolds are brightly polished cast aluminum.

ATTENTION service station men, garage men, and auto parts store owners; we have a profitable dealer's discount on quantity orders of any of the above merchandise.

SANDEE MUFFLER COMPANY  
Box 296 LaTij Station  
Los Angeles 43, California

WE SHIP C.O.D.

Please ship— Mufflers, Dual Set  Single;  Fender Skirts;  Dixie Western Manifold .

Make of Car \_\_\_\_\_ Model \_\_\_\_\_ Year \_\_\_\_\_

Name \_\_\_\_\_

Address \_\_\_\_\_

City \_\_\_\_\_ State \_\_\_\_\_

Check Enclosed \$ \_\_\_\_\_ Ship C.O.D. \$ \_\_\_\_\_

## SANDEE MUFFLER CO.

Factory Address

5643 Corryne Place Culver City, California



# HEATERS

Gasoline, burning 40,000 B.T.U., built by Stewart Warner for USAAF as cabin and engine heaters. Brand new and in original cases. Small modification makes ideal installation in trucks, buses, trailers, boats, small buildings, etc. No exposed flame. Crated shipping wt. 40 lbs. A bargain at \$28.50 ea. FOB Wash., D. C.

## MICHEHL INDUSTRIES

930 F ST. N.W.

WASHINGTON 4, D. C.

# BALL BEARING STEEL WHEELS

Complete With Wheels, Tires & Bearings Made To Outwear Other Type Wheels

SIZE	TIRE	BEARINGS	LOAD Lbs.	ONE	TWO	FOUR
6" x 2"	Solid	Ball 1/2", 5/8"	300	\$ 3.25	\$ 6.25	\$12.00
8" x 2"	Solid	Ball 1/2", 5/8"	250	\$ 4.25	\$ 8.00	\$15.50
10" x 1 3/4"	Semi-Pneu.	Ball 1/2", 5/8"	125	\$ 3.00	\$ 5.50	\$10.50
10" x 2 1/2"	Semi-Pneu.	Ball 5/8"	250	\$ 5.50	\$10.00	\$19.00
12" x 2 1/2"	Semi-Pneu.	Ball 1/2", 5/8"	150	\$ 5.50	\$10.50	\$20.00
12" x 3"	Semi-Pneu.	Ball 1/2", 5/8"	225	\$ 5.75	\$11.00	\$21.00
12" x 3"	Semi-Pneu.	Ball 1/2", 5/8"	340	\$ 8.50	\$16.00	\$31.00
16" (4.00x8)	Pneumatic	Roller 3/4"	520	\$12.50	\$24.50	\$48.00
16" (5.00x8)	Pneumatic	Ball 3/4"	375	\$13.00	\$25.50	\$50.00

NOTE: Other wheels from 3" dia. to 23" with loads from 100 lbs to 1700 lbs. In fibre, solid rubber, semi-pneu., pneumatic 2 to 8 ply, axles to match.

**ORDER NOW** Add 10% for Prepaid Shipment in U.S.A. 25% DEPOSIT ON C.O.D. ORDERS

Descriptive Circulars and Lists of our products will be mailed promptly if you enclose 10 cents in your letter.

**OSBORN WHEEL COMPANY, 115 So. Main St., Dept. P-11, Doylestown, Penn.**

The New 1949 Model "D" RACER

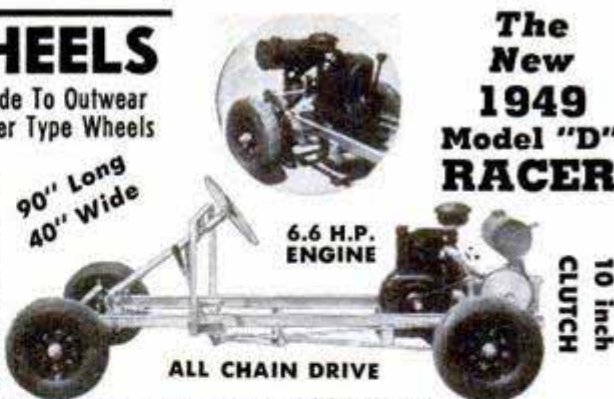

Complete as Shown ONLY \$299.50 (Plus \$7.50 crating) As Shown Less Engine, Jack Shaft and Clutch ONLY \$159.50 F.O.B. (Plus \$7.50 crating)

Pulls Up Hills With Ease. Runs as low as 2 miles per hour or UP TO 35 MILES PER HOUR. Safe and Easy to Operate for Work or Play. ANY AGE. Equipped with 4.00 x 8 High Speed Wheels and Many Other Features.

Ride Around in Your Own Car

## SAVE HANDS SAVE TIME



with Steel-Grip Gloves

The best opportunity for lower costs lies in speeding production. Keep materials moving with Steel-Grip chrome tanned cowhide gloves. Steel ribbons over tough leather strips; palm and fingers reinforced, for utmost wear. Handle rough, heavy, sharp materials with speed and safety and sureness. Or what's your problem? Steel-Grip safeguards may give you an immediate answer. Used by big industrials since 1910. Write for catalog or state your need today.

**INDUSTRIAL GLOVES CO.**  
1403 Garfield, Danville, Illinois  
(In Canada: Safety Supply Co., Toronto)

## LUMBER

A BOARD OR A CARLOAD

Harold Hunt wants to send you big, new No. 15-B Catalog. Over 148 pages of woodworking ideas. 12 pages of rare woods in colors. UNEQUALLED BARGAINS in imported and American woods, supplies, hard-to-find hardware. Send only 15c to cover postage and handling.

**CRAFTSMAN WOOD SERVICE CO.**  
2729 S. Mary St. Dept. A-99 Chicago 8, Ill. AROMATIC RED CEDAR

TOP GRADE KILN-DRIED WALNUT MAHO. CHERRY WHITE HARD MAPLE POPLAR OAK

## AUTOMATIC FLOOR LIGHT FOR FORD AND MERCURY CARS

1941 THRU 1948 MODELS

OPERATES WHEN DOOR IS OPEN  
Brightly Illuminates Floor and Running Board for Safety and Convenience.

Simple Installation — No Holes to Drill

\$3.00 PAIR — POSTPAID

Send Postal Money Order — No C.O.D.

**AIRCRAFT METAL PROD.**

4012 Richmond N.W., Grand Rapids 4, Mich.



## ROSS RENCHPLIERS \$3.95

They Grip—They Lock—They Release with a Twist of the Wrist Postpaid in U.S.A. No C.O.D.



The removable parallel jaw and the fast shift lever adjustment make it possible, in the matter of seconds, to grip squarely or to lock onto nut, bolt, or other article. Jaws always parallel. Won't mar brass fittings or plating. Can lock and un-lock in very small space. Do not have to pull handles apart—just turn adjusting nut to release jaws. Prevents skinned knuckles. Capacity of jaws 1 1/4"—total length of tool 10 1/4"—compound leverage is forty-to-one. All working parts hardened.

## MASTER MECHANICS CO.

1601 S. Hill St.

Los Angeles 15, Calif.

6 handy tools in ONE!

- 1 MITERING GUIDE
- 2 DIAMETER GAGE
- 3 ACCURATE SQUARE
- 4 MARKING GAGE
- 5 CENTER FINDER
- 6 CONVENIENT RULER

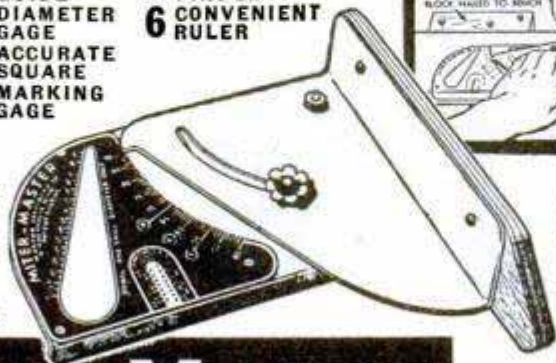

Miter Master takes the place of an expensive miter box accurately set to any angle. Scale marked for mitering 5, 6, and 8-sided frames. Steel construction. Built to last a lifetime. If your dealer can't supply you we will send it postpaid anywhere in the U. S. for \$2.00. (Foreign \$2.25.) Unconditional guarantee. If not satisfied within ten days for any reason whatsoever, your money will be refunded.

\$2.00 POSTPAID

## MITER-MASTER

**MASTER SPECIALTY COMPANY**  
3018 EAST LAKE STREET • MINNEAPOLIS 6, MINN.

**NOW! USE YOUR ELECTRIC DRILL for  
POLISHING!  
GRINDING!  
SANDING!**

**Work on curved  
or flat  
surfaces**

You can use it to fix bodies, fenders; wax; polish cars, floors, linoleum; re-finish furniture, wood, metal surfaces; smooth, re-duce welds, etc.

**FITS ANY 1/4 IN. CHUCK or DRILL,  
FLEXIBLE SHAFT, MOTOR, etc.**

Designed and engineered for high speed sanding, polishing, finishing, etc. Full 6 1/2 inch rubber face plate bends into curved surface. New clamp arrangement mounts sanding discs instantly—no cementing. Draw-string lamb's wool bonnet slips on for high speed polishing, finishing, etc. Outfit includes 6 1/2" flexible rubber disc with 1/4" metal shank, fibre backed sanding disc and heavy lamb's wool polisher. Equals \$75.00 outfits in performance. You'll find hundreds of time saving uses for it. Fully guaranteed. Shp. wgt. 2 lbs. F.O.B. Chicago. Complete, only

**\$4.95**

At your favorite hardware store or direct.

**PREHLER PROVED PRODUCTS**

Division Norbert Prehler & Co.

Dept. PM-11 — 1623-25 Milwaukee Ave. Chicago 47, Illinois



On Flat Surface

Bends To Take Curved Surfaces

On Curved Surface

Polishes

**Comfort  
FOR YEARS**



**THREE-YEAR  
MAINTENANCE  
WARRANTY**

**ENGINEERED  
INSULATION...  
FORCED-AIR  
HEATING**

**COMPLETELY  
PRIVATE  
BEDROOMS**

**EXTRA-HIGH,  
WIDE DOORS**

**BUILT-IN  
EQUIPMENT**

● A Schult Trailer Coach is today's outstanding value... for years of comfortable living or extended travel. Behind this warranted, quality product lie more than a decade of Schult customer research and able engineering, plus latest, accurate, machine construction methods.

Inspect for yourself the many plus-values a Schult offers, for comfort, living convenience, and long-term satisfaction. Let a Schult dealer show you why you should "Buy Wisely... Buy Schult." Or write Schult Corporation, Dept. 3211, Elkhart, Indiana. In Canada: John Inglis Co., Ltd., Toronto.



Smartly-furnished living rooms and amazing storage space await you in any luxurious Schult model.

Write for free illustrated book on trailer coach living and the latest, easy-trailing Schult models.

**SCHULT Trailer Coaches**

**PRECISION MADE SWISS WATCH**

Fully Guaranteed **SPECIALLY PRICED \$23.75**

For sportsmen, men who like activity, this watch can really take it! The 17 jewel Swiss movement is a model of accuracy. Chrome case with a stainless steel back. For the man who sometimes forgets, this model is absolutely waterproof, shockproof and anti-magnetic. Radium dial that glows in the dark and a sweep-second hand for perfect visibility. For long, faithful, uninterrupted service this smart watch is unexcelled.



**FREE BONUS FOR PROMPTNESS!** A fine stainless steel expansion band to match this watch. Order yours early! Remit with order and save C.O.D. charges. \$5.00 deposit required on C.O.D.s. **SATISFACTION GUARANTEED OR YOUR MONEY REFUNDED.** REGISTERED JEWELERS

172 1/2 Canal Street Dept. PM-11 New York 13, N. Y.

**DUAL TAIL PIPE EXTENSION**

Fits all cars — chrome plated  
**DEEP TONE**

produced by 2 1/2 inch outlets **\$2.95**

Postage free on prepaid orders  
DEALER INQUIRIES INVITED

**LYONS PRODUCTS COMPANY**

PAT. PEND. 2426 So. LaBrea Ave., Dept. PM-11, Los Angeles 16, Calif.

**BUILD THIS SMART AND COLORFUL TRAWLER MODEL**

Kit contains carved hull and complete set of fittings. Send today for kit #1225 which will be sent post-paid for \$15.00. Our 40 page illustrated catalog mailed on receipt of 25c.

**A. J. FISHER**

1002 Etowah Ave., Dept. M Royal Oak, Mich.



**A SURE CURE for Cold Weather Starting...  
the new SHUR-HETE Motor Water Heater**

Install a Shur-Hete unit on your engine—plug it into a 110 volt A.C. outlet and your car will start easily and quickly, even on the coldest mornings. Why? Because the water around the sealed electric element is heated, causing automatic circulation which keeps the entire engine block warm; therefore the oil in the crankcase and around the cylinder walls is always free-flowing.

Easy to install—Any garage mechanic can install a Shur-Hete in a short time. 1/4" connections into head block and into drain plug opening are all that are necessary. Fittings included—nothing else to buy.



**Dealerships Open!**

**JOHANSON MOTOR HEATER CO.  
817 W. Webster St. Chicago 14, Ill.**

for All Autos, Trucks, Tractors  
Pat'd and Pat. Pend.

**Save Time and Money  
with Shur-Hete!**

Eliminate run-down batteries... towing charges... needless engine wear... and wasted gas.  
Uses only 1/3 to 1/2c electric power per hour.  
Safe to use with any standard anti-freeze.  
Will not overheat engine or burn out.

**GUARANTEED!**  
Shur-Hete Outfits for Autos  
only \$12.50  
Truck and Tractor Outfits—  
\$13.50

Important: Give make and year of auto, truck or tractor. Shipped parcel post prepaid if remittance is enclosed; otherwise COD with postage added.

# NEW 16-page FOLDER

It's NEW and it's FREE! This colorful 16-page folder is packed with information on how Garden-All can save you time and effort on all your lawn and gardening work! It explains in detail the functions of each attachment! It describes Garden-All's many outstanding features including Instant Tool Attachment and Exclusive Depth Control! Get your copy now by writing for it today!



**Garden-All**  
LAWN and GARDEN TRACTOR

WRITE FOR  
YOURS NOW!

**ORDER YOUR  
Garden-All NOW!**

The increased demand for this quality, versatile equipment keeps Garden-All on the hard-to-get list. With materials becoming more difficult to obtain production may not meet demand. So we suggest that you order your Garden-All NOW—in advance of the time you expect delivery.

**GARDEN-ALL TRACTOR, INC.**  
Dept. P, 110 W. UNION STREET, LIBERTY, INDIANA

**EARN BIG MONEY**  
AND BE YOUR OWN BOSS  
*Sharpening Lawn Mowers*

**THE UNIVERSAL GRINDER**  
PUTS YOU INTO BUSINESS  
WITH SMALL INVESTMENT

Earn as much as \$400.00 a month in your basement or garage. Mr. Felber of Ind., writes, "MY UNIVERSAL GRINDER is faster and more accurate than any other grinder. Its efficiency enabled me to sharpen 450 mowers in 4 1/2 months. More than paid for itself the first month. Every customer satisfied." Mr. Hardy of Mississippi writes, "Received my Universal Grinder the first part of May and by August 18 had sharpened over 1000 mowers." Mr. Bacon of California writes, "The lawn mower business, with my Universal Grinder, has been a gold mine these last two years."



Only on the UNIVERSAL GRINDER can the inside face, the edge of the stationary blade, and the reel blades, be ground to proper clearance ALL IN ONE SET-UP WITHOUT REMOVING ANY BLADE FROM THE MOWER  
Free Folder

Rogers Mfg. Co., Dept. M-118, Lindsey, Ohio

**SEND TODAY FOR FULL DETAILS**

ROGERS MFG. CO., Dept. M-118, Lindsey, Ohio  
Please send me without obligation complete details about how I can earn BIG Money with the Universal Grinder.

Name \_\_\_\_\_  
Address \_\_\_\_\_  
City \_\_\_\_\_ Zone \_\_\_\_\_ State \_\_\_\_\_

# THE MITER KING

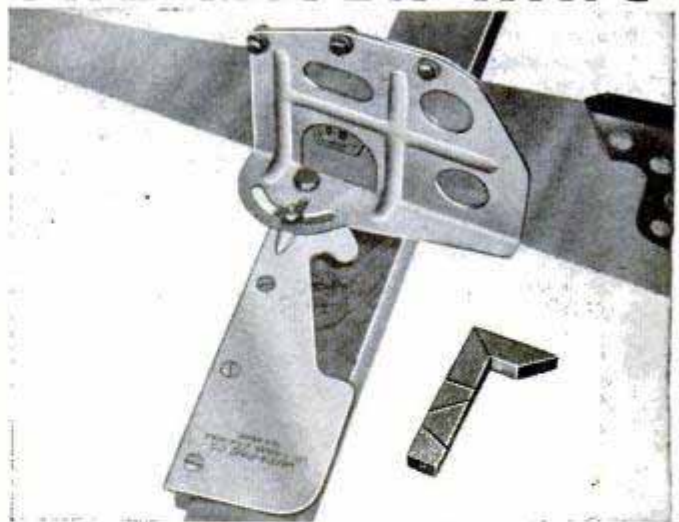

**IT'S REVOLUTIONARY**

Carpenters' most versatile "mitering" and timber squaring precision built tool. Price \$7.00 post paid in U. S. Send check or money order or ask for folder, won't you please?

**MITER KING CO.** 4124 LONG BEACH AVE. LOS ANGELES 11, CALIFORNIA

## REMOTE INDICATORS



\$3.95  
PAIR

Selects remote position indicators. When small of one unit is turned, remote unit shall follow in same position. Operates any distance with only simple electrical connections in between. For remote indication of weather vane, tank liquid level, television or ham antenna direction, camera lens focus, film footage and hundreds of other applications. Complete with instructions and capacitor for 115 Volt AC house current operation.

ADD 30c FOR POSTAGE & HANDLING

**DUBIN ELECTRONICS CO., INC.** Dept. P5 10  
103-02 NORTHERN BLVD., CORONA, N. Y.



**ASSEMBLE THIS FOREIGN RACING CAR POWERED BY WORLD'S SMALLEST, LIGHTEST D. C. MOTOR!**

You'll thrill to the speed and perfect detail of this new English-made racing car that you assemble yourself. And you'll marvel at the Electrotor—the world's smallest, lightest D.C. motor. Tiny as a spool, the amazing Electrotor hooked to 6-volt battery enables car to attain scale speed of 190 m.p.h.!

Grand Prix car is 5 in. long. Runs in 2-6 ft. radius, requires no elaborate track. Complete kit of finished parts with everything you need for assembly and operation, including Electrotor and detailed instructions, only \$9.95. (Does not include battery). Supply of these imported cars is limited—send cash, check or M.O. today for \$9.95. Satisfaction guaranteed.

LITERATURE ON REQUEST  
**BAIRD - WHITMER**

431 ALAMEDA RD. KANSAS CITY, MO.

# UTICA TOOLS

FOR MORE TOOL MILEAGE



No 91—4", 6", 8", 10", 12"  
Adjustable Steel Wrench

**UTICA DROP FORGE & TOOL CORPORATION**  
UTICA 4, NEW YORK

# THE OPPORTUNITY of a LIFETIME to Establish Yourself in a NEW BIG MONEY MAKING BUSINESS!

Set a Detector in Every Room, Basement, Attic, Barn, Factory or Wherever a Fire Can Start . . .

"Wak-Em" Fire Alarm installed, to WARN YOU from the spot . . . WHERE THE FIRE IS STARTING . . . because the Detector SETS OFF THE ALARM and WARNS YOU . . . A continuous "watch dog" DAY and NIGHT . . . The kind of protection NEEDED IN EVERY HOME IN THE CITY or THE FARM.

FIRE takes a tremendous toll of LIVES and PROPERTY every day . . . in every locality . . . Why not catch it WHEN IT STARTS! . . . Before it makes headway! . . . That's what "Wak-Em" Fire Alarm does . . . a SUPER SENSITIVE Thermostat that SETS OFF THE ALARM at the spot WHERE THE FIRE IS STARTING . . . Many times a pail of water will put out a fire at the start . . . BUT . . . give it time and THEN IT IS TOO LATE for anybody to stop destruction. NOW it is possible, with the "Wak-Em" Fire Alarm, to WARN YOU from the spot . . . WHERE THE FIRE IS STARTING . . . because the Detector SETS OFF THE ALARM and WARNS YOU . . . A continuous "watch dog" DAY and NIGHT . . . The kind of protection NEEDED IN EVERY HOME IN THE CITY or THE FARM.

EVERY HOME, STORE, FACTORY, etc. — Sales Are Everywhere . . .

SIMPLE, COMPACT . . . BUT EFFECTIVE and EASILY INSTALLED BY ANYONE with a screw driver to the home current . . . That's all, and once installed it is the faithful servant to WARN AGAINST FIRE DESTRUCTION. It makes no difference what you have or have not sold here is a REAL OPPORTUNITY.

WANTED—DISTRIBUTORS—AGENTS—EVERYWHERE

Write or Wire Today

Dept. P.M. 11

Wak-Em Fire Alarm, PLANO, ILL.

THIS could be YOUR HOME...



CATCH the fire WHEN and WHERE SAVES LIVES and PROPERTY IT STARTS



THE BEST Type of Fire Protection AT LOWEST COST

3 Detector Set with 4" Bell Alarm ONLY \$6.75 Postpaid

## NOW YOU CAN OWN A GENUINE CALIFORNIA



Ideal STAINLESS STEEL WATCH BAND

FOR \$1.00 ONLY FULL PRICE

Flexible • Secure  
Sanitary • Comfortable  
Closely Adjustable

Used by ENGINEERS MACHINISTS • FARMERS SPORTSMEN • FLYERS  
Order Yours Today!

Fits any wrist up to 8-in. Ends of band at watch 3/8" wide. If your dealer cannot supply you, send \$1 cash or money order. Band sent at once postpaid.

MARQUARDT MFG. CO. 1825 N. MAIN STREET LOS ANGELES 31, CALIF.



LOW PRICED STEAM CLEANER

Jenz Super Chief

Portable—No moving parts—Cleans anything—Motors—Chassis—Machinery—Floors—Buildings—Remove wallpaper—Dairy & Creamery—Oil Rigs etc. Oil fired—Economical—fully tested and warranted. 75# Steam in less than 10 min. Model 70, Complete as illustrated. . . . . \$276.50

P.O.B. factory. HI-PURE LABORATORIES EVANSVILLE, IND.

## BACK ACHE?



## SORE MUSCLES?

When muscles are stiff and sore from unusual exercise or strain, use HEET®, the liniment that's strong yet does not burn the skin. Wonderful relief from muscular soreness comes as comforting HEET quickly starts to penetrate. Just brush it on with the applicator. HEET starts at once to ease muscular pain and keeps on working for hours. Ask your druggist for HEET liniment.

## WOODWORKERS... Get this

CONSTANTINE MASTER MANUAL

Get the Most Fun From Your Hobby Indispensable to woodworkers. Newest, biggest edition, more pages, more color, helpful how-to-do-it articles, pre-war and new items, more bargains. Send 25c today and we will include FREE! FULL YRS. SUBSCRIPTION to Chips and Chats, published bi-monthly. Keeps you up-to-date on everything in woodworking, offers big money-saving bargains. Send now.

ALBERT CONSTANTINE & SON, Inc. 791-G 135th Street, New York 54, N. Y.



## IT'S NEW THE PUTTY MASTER

PLACES GLAZIERS SKILL IN YOUR HANDS

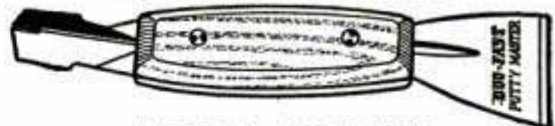

IT'S EASY

A putty knife with the patented shaper that anyone can operate—packs, shapes and trims putty perfectly with one stroke and allows only the right amount of putty to be applied—a time and money saving item that will more than pay for itself.

Only \$1.00 Postpaid anywhere in the United States.

I am enclosing \$1.00—please send me one Duo-Fast Putty Master.

PUTTY MASTER

864 Fletcher Street, Chicago 14, Illinois

Name \_\_\_\_\_

Address \_\_\_\_\_

City and State \_\_\_\_\_

# Keep Brushes like New

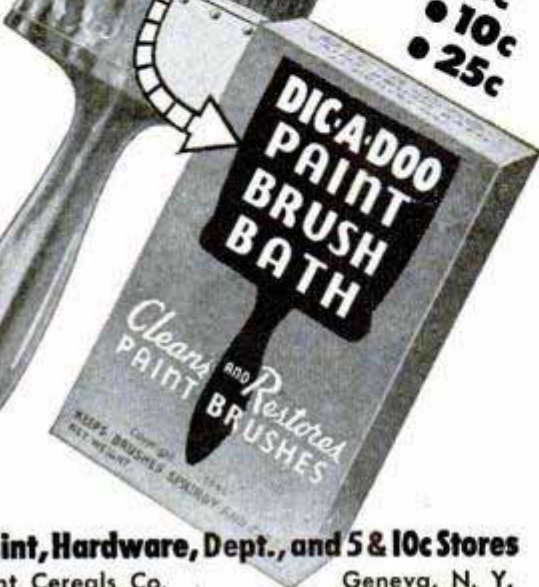
**BEFORE**  **AFTER** 

• 5c  
• 10c  
• 25c

**DICA-DOO PAINT BRUSH BATH**

Clean and Restore PAINT BRUSHES

At Paint, Hardware, Dept., and 5 & 10c Stores  
Patent Cereals Co. Geneva, N. Y.

**CASH IN ON THE BUILDING BOOM!**

**MAKE BUILDING BLOCKS RIGHT IN YOUR OWN BACKYARD AMAZING GENERAL BLOCK MACHINE**

CAPACITY 1000 BLOCKS PER DAY

**\$199** LESS MOTOR  
ONLY F.O.B. PLANT  
SHIPPING WEIGHT 400 lbs.

Cinder and Concrete Blocks in big demand. Sell all you produce, to contractors and builder supply yards, at 15c to 25c each. Easy to start your own profitable business.

GENERAL BLOCK MACHINE can be operated indoors or out, in floor space 9 ft. x 10 ft. All steel construction. Vibrator mounted in sealed ball bearings. Simple to run. Powered by 1/2 H.P. electric motor or 1 H.P. gas engine. Produces up to 1,000 8x8x16 blocks in 8 hour day. Superior 3 core type, meeting all building code requirements. Produces 4x8x16, 8x8x16, 17x8x16 blocks. Material for blocks, cinders; cement; and sand; obtainable anywhere. Full instructions and mixing formulas with each machine. Immediate Delivery. Mail coupon at once for full details, sent free without obligation.

**HOW TO BUILD YOUR OWN CONCRETE BLOCK HOME**  
Only \$1 Prepaid

Wonderful book written and illustrated by our staff of experts.

## GENERAL ENGINES CO.

(EASTERN DIVISION) DEPT. M—DREXEL BLDG., PHILA. 6, PA.

Shows you 8 ways to save money and how to make and lay blocks, laying out building lines, mixing your own concrete, building steps, porches and concrete floors, includes floor plans for 6 beautiful easy to construct concrete block bungalows. Mail coupon at once with \$1.

Name .....

Address .....

City..... Zone... State.....

# STOP CHANGING MOTOR OIL!

End this needless waste and expense forever with **RECLAIMO** Today's Most Advanced Oil RE-REFINING Filter

Continuously cleans and RE-REFINES motor oil as you drive (by utilizing motor heat)—keeps oil in high grade lubricating quality at all times—reduces motor wear to a minimum! Proves conclusively that "Oil Does Not Wear Out Mechanically" as stated by U. S. Bureau of Standards, (Bulletin 86).

- "RECLAIMO"**
- REMOVES SOLIDS (by filtration)
  - REMOVES WATER (by distillation)
  - PREVENTS Excess Fuel Dilution
  - PREVENTS Acid and Sludge Formation

**MAINTAINS** Stable Viscosity **ELIMINATES** All Oil Changes  
**CAR • TRUCK • TRACTOR OWNERS!**

You'll want to know more about Reclamo's Oil, Motor and Money-Saving Features. **FREE 40-PAGE BOOK "OIL FACTS"** gives you the complete "Reclamo" story plus details about our **New 90-Day No Risk-No Cost TRIAL OFFER!** WRITE for YOUR COPY TODAY!

**RECLAIMO MFG. CO.**

5083 ELSTON AVE., Dept. 84, CHICAGO 30, ILL.



**NEW ADDED FEATURE!**  
Gas - Moisture Vapor Injector  
Increases Mileage with Smoother Performance



**LAW** STUDY AT HOME for Business Success and LARGER PERSONAL EARNINGS. 39 years expert instruction—over 114,000 students enrolled. LL.B. Degree awarded. All text material furnished. Easy payment plan. Send for **FREE BOOK** — "Law and Executive Guidance."

**AMERICAN EXTENSION SCHOOL OF LAW**  
Dept. 95-PM 646 N. Michigan Ave. Chicago 11, Ill.

**MARCOT KEY MACHINES**

MARCOT No. 8 KEY MACHINE, mounted on Cabinet	\$ 95.00
Auto Code Book and Auto Depth Keys	12.50
100 Dz. Popular Cylinder Key Blanks	60.00
Set — Key File, Follow-Through	
Roads, Lock Picks, Bit Key Gauge, Thimble, Pins, Springs..	10.50
"Locksmith Trade Books"	6.75
How to Open Locks without Keys or Picks; Secret of Locksmithing; How to Make Keys by the Impression Method; Master Key Systems.	TOTAL COST \$184.75
The \$60.00 cost of the Key Blanks would return approximately \$350.00. This would more than pay for your entire KEY MACHINE OUTFIT. IMMEDIATE DELIVERY—Motors available with Key Machine Orders.	

**A. J. MARCOTTE CO.** 1200 N. KEDZIE AVE. DEPT. PM, CHICAGO 51, ILL.

## STATION WAGON CABS AND BODIES FOR ALL JEEPS—SMART MAPLE—OAK WOODS

Year around comfort for Jeep owners. Kiln dried hardwoods, safety glass. Finest hardware, varnishes, top materials. Full opening rear door, locks.

**CABS \$144.50** Plus Tax

FOB Cleveland. Complete, semi-assembled. Full bodies slightly higher. Send 25% with order, balance COD.

**STATION WAGONS, INC. (PM)**  
6619 Euclid Avenue, Cleveland, O.

**BARGAINS FROM WORLD WAR II**

Thousands of Bargains in Military, Outdoor & Sport Goods for Hunter, Farmer, Scout. Send 10c for NEW 32-page catalog, just issued, returned with first order.

**A and N SUPPLY CO.**  
4720 LESTER ST. RICHMOND 15, VA.

## PRECISION JEWELERS SCREW DRIVERS

Complete Set of 8 for Every "Hobbyist"

At last—a complete set of precision screw drivers to meet the needs of every model builder. Not a miniature but the same type set used by U. S. Navy for precision instruments and watches during the war. Brass knurled handles, hexagon heads, finest tempered steel blades. Sizes 2-9. Never before a set of this quality and precision at such a low price. Your money back if not satisfied.

**For Every Hobbyist**  
C.O.D. \$2.00 plus postage or send \$2.00 and we pay postage.

**PINE WATCH CO., Rm. 40A, 29 Eldridge St., New York 2, N. Y.**

# UTILITY GRINDERS



1/4 hp — \$25.00 net  
1/3 hp — \$27.50 net

Lifetime lubricated ball bearings. Two 6 x 3/4 inch wheels, one coarse, one fine. 115 V., single phase, 60 cycle—3450 rpm. Bright red glossy finish.

## HOME WORKSHOP MOTORS

Capacitor type, sealed ball bearings, 1725 rpm. Standardized mounting, with cord, plug and switch.

1/4 hp—\$22.50 net  
1/3 hp—\$25.00 net  
1/2 hp—\$33.00 net

FOB Milwaukee. Send check or money order.

### LAD, INC.

DEPT. PM-11

161 W. Wisconsin Ave.

Milwaukee 3, Wis.

## EVINRUDE Catalog Free



Describes complete line of 1948 Evinrude Outboard Motors—sensational new "Sportwin" model — 2 models with revolutionary "Weedless Drive" — 3 thrilling four-cylinder models. Gives helpful information on boats, speeds, etc. Profusely illustrated. Write

**EVINRUDE MOTORS**  
5689 N. 27th St., Milwaukee 9, Wis.

## CAR OWNERS

Overcome your winter starting troubles by installing the **IDEAL ELECTRIC ENGINE BLOCK HEATER**. Easily attached. Heats block in 20 minutes in zero temperatures. Plug into any electric outlet. Complete with extension cord and instructions \$5.95 postpaid. Year's guarantee. **IDEAL SPECIALTY CO.**, Route 2, Box 45, Royal Oak, Mich.

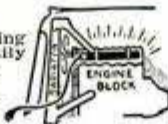

Pat. applied for

**Start a NEW BUSINESS**  
Or Add to Your Present  
Repair Business  
**Sharpen Dull Pipe Wrenches**  
**Pipe Taps & Dies**  
**"Gum" Circular Saws**

Write for information.

**J. C. MOORE INDUSTRIES** P. O. Drawer 276  
FREDONIA, PA.

## New STREAMLINED Electric Drills



"500" SERIES

1/2-Inch Electric Drill  
Model 500 (with Jacobs Hex-Key Chuck) . . . \$2965  
Model 510 (with Jacobs Gear Chuck) . . . \$3465

**MODEL 25C**  
Full 1/4-inch Capacity \$1995  
with Jacobs key type chuck

In its capacity range, each model represents an advancement in the combination of high power, quality and refinement in construction, long-life performance, and unusual handling ease and convenience. See these new **Electric Drills** at your hardware dealer, or write—

**PORTABLE ELECTRIC TOOLS, INC.**  
255-59 W. 79th Street, Chicago 20, Ill.

# Nu-WAY

## WEATHER STRIP FOR WINDOWS AND DOORS

### KEEPS COLD OUT • HEAT IN

Easiest strip in the world to put on. Can be used on any type door or window. 100% all-wool felt, reinforced with white metal.

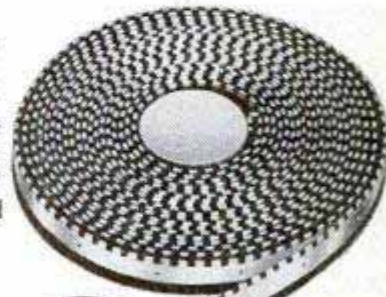

Macklanburg-Duncan Co.  
Oklahoma City 1, Oklahoma



AT LEADING LUMBER YARDS AND HARDWARE STORES

## QUALITY TILTING ARBOR SAW

FULL BALL-BEARING

TAKES



BLADE

**\$59.50**

F.O.B. Royersford, Pa.



IMMEDIATE DELIVERY

### SAW BLADE TILTS • TABLE STAYS LEVEL

Send for catalogue showing complete line of Tilting Table and Tilting Arbor Saws, from \$24.95 to \$87.50

**AMERICAN MACHINE & TOOL CO., Inc.**  
ROYERSFORD, PA. DEPT. 100



# MILL IT... ON YOUR LATHE!

## PALMGREN

### MILLING ATTACHMENT

**3 SIZES**  
No. 250 Illustrated  
**2 1/2" JAW** **\$24.75**  
Only  
**CONVERT LATHE IN 10 SECONDS**

Now you can Mill, Slot, Grind, Groove, Square Shafts, Saw at Angles, Recess and many other important jobs. **SAVE TIME and MONEY!** Why send work out or use costly methods when a **PALMGREN MILLING ATTACHMENT** will solve your problem. Precision built, it has accurate graduations for rotary angle adjustments, also graduated vertical feed screw. Fits South Bend, Atlas, Craftsman, Logan, Sheldon and all other lathes. Thousands now in use in small and large machine shops, repair shops, railroads, schools, home work shops, etc. **ORDER SIZE NEEDED TODAY!**—it will quickly pay for itself.

**IMMEDIATE DELIVERY**

No.	Width Jaws	Depth Jaws	Jaws Open	Weight Pounds	Fits Tool Post	Price F.O.B. Factory
150	1 1/2"	1"	1 5/8"	6 1/2	1" Dia.	\$18.75
250	2 1/2"	1 7/16"	2 1/2"	11	1 1/4" Dia.	24.75
400	4"	1 1/2"	4"	25	2" Dia.	39.75

Order From Your Dealer or Jobber: Write for Circular No. 351  
Mfrs. of **PALMGREN PRODUCTS** Since 1915  
**CHICAGO TOOL and ENGINEERING CO.** 8365 South Chicago Ave. Chicago 17, Ill.

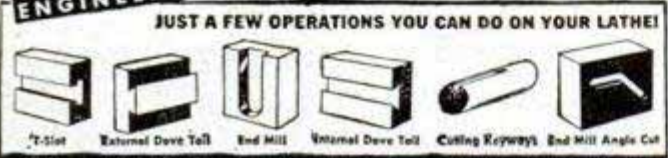

## ORDER IT...GET IT NOW



**\$2.95, POLISHER-SANDER KIT**  
5" lambs wool buffer (perfect for car and furniture polishing)  
Also 3 sanding discs.

**\$18.95, 1/4" PORTABLE ELECTRIC DRILL (HU1)**  
A.C.—D.C., 110 Volt, Jacobs hex key-type chuck. Weighs only 3 1/4 lbs. Fine for wood, plastics and steel.

Other Accessories Available

Send only \$18.95 (add \$2.95 for Buffer-Sander kit). We'll pay postage in U.S.A. or send \$2.00 now and pay postman balance plus postage

**ORDER TODAY FOR PRE-CHRISTMAS DELIVERY**  
Satisfaction Guaranteed

NEALE'S, 5605 East Beverly Blvd., Los Angeles 22, Calif.

Gentlemen: Enclosed is \$\_\_\_\_\_ for which please send me a Portable Electric Drill  and Polisher-Sander kit

NAME \_\_\_\_\_  
STREET \_\_\_\_\_ ZONE \_\_\_\_\_  
CITY \_\_\_\_\_ STATE \_\_\_\_\_

# U-BUILD-IT TRAILER COMPANY

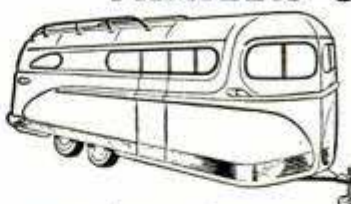

supplies all parts to size for quick, easy assembly of complete metal trailer body—Roof Caps, Roof Bows, Doors, Complete Chassis, Roof Corners, Roof Ends. Build this modern

streamlined design economically yourself.

*Write* for complete working plans showing detailed construction, location of parts for 12 ft., 16 ft., 20 ft., 24 ft. and 28 ft. lengths. Only **\$100**  
**U-BUILD-IT Trailer Co.**  
Dept. B P.O. Box 611 Elkhart, Ind.

## MAIL THIS COUPON FOR TWO FREE BOOKLETS That Offer Helpful Hints on Car Care

**BURD PISTON RING CO., DEPT. 118-L**  
Rockford, Illinois  
I'd like copies of your "Servicemen's Handy Handbook" which tells how to keep my car in good working order, and the booklet "No Job For a Dub."  
Name.....  
Address.....  
City..... State.....



Burd "Graf-Flox" Piston Rings are made from electric furnace iron to exacting specifications. They're available in "Engineered for Results" Combination sets for any make and model car, truck, tractor... in fact, for any internal combustion engine.  
**BURD PISTON RING COMPANY**  
ROCKFORD, ILLINOIS

## MORE POWER FOR YOUR WHIZZER

**WEBER'S CAST ALUMINUM CYLINDER HEAD FOR WHIZZER BICYCLE MOTORS**  
• PROVIDES INCREASED POWER • SAVES GASOLINE  
• ELIMINATES GASKET TROUBLE • SMOOTH COMBUSTION  
WEBER'S Hi-Compression Cylinder Head is designed with an unrestricted gas chamber, and machined for perfect seating thus eliminating all gasket complications.  
SEND YOUR ORDER TODAY  
**\$5.95**  
C.O.D. OR CASH WITH ORDER  
**WEBER TOOL COMPANY • 4200 WHITESIDE • LOS ANGELES 33, CALIF.**



## "Makes Arithmetic Interesting"

NEW ABACUS of beautiful aluminum, the fastest and handiest little adding machine ever invented! Guaranteed to save time and money in any business. Ideal for children to learn arithmetic like a game. With illustrated instructions, \$3.50. Send for FREE lesson and details. Discounts to schools. **LOY'S CHINESE CALCULATOR**, Dept. 87-M, 1317 R. I. Ave. N.E., Washington 18, D. C. Exclusive Dealers Wanted.



**GENUINE DIAMOND SCRIBER!**  
WRITES ON GLASS, METALS, PLASTICS

Never before at this price! Finest diamonds specially selected for cutting qualities. Set in hexagonal aluminum handle 6" long, by patented "Perma-Grip" method. Scribes or etches on glass, metals, plastics. Every scriber tested. Money back guarantee. Made by Clipper, foremost New York diamond tool manufacturer.

No C.O.D.'s. Send cash, M.O., or check.

**\$ 2 0 0**  
Postpaid

Agent and dealer inquiries invited.  
**CLIPPER DIAMOND TOOL CO., INC.**  
21-B WEST 46 STREET, NEW YORK 19





# SOLDER IN 6 SECONDS



WITH *Flash*  
CONTROLLED HEAT

**Instant Heat.** Solder in 6 seconds after pressing trigger. **Finger Control** keeps tip at exactly the right heat. **Pistol grip**—built to stay cool; light weight; only 6 ounces. **Operates** on 6-12 V-D.C. or 110V-A.C. through Flash HD-520 stepdown transformer—price \$6.20; or from Std. Car Btry.

Interchangeable Tips

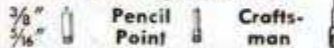

**\$4.75**  
List Price

Model SF-100

**Phillips Manufacturing Co., Inc.**  
2818 Aldrich Avenue South Minneapolis, Minn.

MORE POWERFUL PORTABLE

## BENCH GRINDER—\$13.50 DELIVERED

FULL 1/12 H.P. MOTOR  
AT 3450 R.P.M. BY  
DYNAMOMETER TEST



With adjustable tool rests and removable cast wheel guards for buffing. Diamond-trueed 4" x 1/2" coarse and fine wheels . . . dust proof bearings . . . off-on switch . . . 6 ft. rubber cord . . . baked hammertone finish . . . 110-120 volts a.c., 60 cycle . . . guarantee one year against defective workmanship or materials. Send check or money order, we prepay postage.

ALHAMBRA PRODUCTS, BOX 328, ALHAMBRA, CALIF.



## NOW! FILE YOUR OWN SAWS

Do expert saw filing at home. Precision filing easy without experience. Two simple adjustments. Keeps any hand saw extra sharp and true-cutting. Complete with file. Money back guarantee. Cash with order, prepaid. (COD postage extra.) Order today.

THE SPEED CORP., Dept. PM1  
2025 N. E. Sandy, Portland 12, Oregon

## USED BUT REBUILT IN CLEAN, GOOD CONDITION! ARMY SHOES \$2.59 A Pair

Now you can wear these sturdy, all weather Army Shoes. Will last and stand up under the toughest wear. Fits comfortably, thick soled, strong leather. Russet tan color only. All sizes. Valued about \$5 a pair. Now only \$2.59 a pair. Also higher top Combat Boots only \$3.75. Special: Both Army Shoes and Combat Boots \$5.98. Send shoe size and width, name and address. SEND NO MONEY! Pay postman on delivery price plus postage. Money Back Guaranteed. Order Now! Also send for our free catalog of shoes, hats, suits, army clothes, etc.



EUNICE MAIL ORDER HOUSE  
STATION B. P.O. BOX 101, DEPT. PM-N. N.Y.C.

## Thousands of Parts For Military TRUCKS

We have for immediate delivery genuine parts for all makes and models, 4x2 - 4x4 - 6x4 and 6x6. All models from 1/4 ton to 20 tons. All makes: Auto-car, Biederman, Brockway, Chevrolet, Diamond T, Dodge, Federal, Ford, GMC, International, Mack, Oshkosh, Reo, Studebaker, White, Willys and Jeeps. We have parts lists available on some models. Write stating model of Truck.

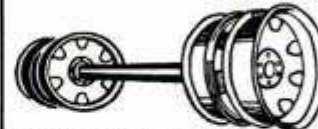

### TRAILER AXLE

Heavy duty trailer axle suitable for many types of trailer construction. Also excellent for building of heavy farm trailers and wagons. It is a 15,000 lb. capacity square type straight trailer axle complete with Timken roller bearings, hubs, and 6 hole 750 x 20 Budd Wheels. Without brakes. Axle is 2 1/2 inches square and 70 inches between wheel mounting flanges. Std. width. AN EXCELLENT BUY. With Single Wheels. \$59.50 With Dual Wheels. \$69.50

## NEW POWER WINCHES

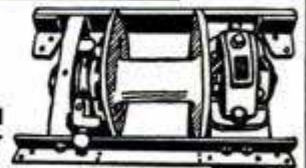

Govt. Surplus. All are Brand New and Suitable for front or rear mounting.

BRADEN WINCH—5,000 lb. cap. For 1/2, 3/4 and 1 ton trucks. . . . .	<b>\$95.00</b>	GARWOOD WINCH—12,000 lb. capacity. . . . .	<b>\$125.00</b>
WINCH, GARWOOD OR HEIL—15,000 lb. capacity. . . . .	<b>\$150.00</b>	GARWOOD WINCH—25,000 lb. capacity. . . . .	<b>\$200.00</b>

## New All Purpose WINCH



3,000 LBS. RATED CAPACITY — IDEAL FOR JEEP

Spur gear type winch complete with crank, 50 ft. 1/4 inch cable and hook and 89 inch boom with pulley. Ideal for lifting or pulling. Winch bracket can be mounted on truck or at material location. Plenty of power, 27 to 1 ratio. Weight of entire unit unpacked 142 lbs., boxed 238 lbs. Special, each. . . . .

**\$59.50**

WINCH CABLE With Chain and Hook, 1/2" in diam. 200 ft. length. New. . . . . **\$25.00**

AUSTIN PINTLE HOOKS For All Trucks and Trailers, 25,000 lbs. capacity, shipping wgt. 30 lbs. List price \$47.50. Single ea. only \$8.95. Lots of 12, each only. . . . . **\$7.50**

## New Gasoline Engine Driven GENERATOR

Complete with built-in air cooled gasoline engine fuel tank and ammeter. This is a HOMELITE Model HRUH-28 Generator, 30 volts, DC 50 amps, 1500 Watts. Will operate 32 volt bulbs and equipment. Ideal for farms or cabins. Will charge 5 batteries at one time when used as battery charger. Limited supply. Each. . . . . **\$59.50**

All prices quoted are FOB, Kansas City. 25% deposit required on COD orders.

**American AUTO PARTS CO.**  
1830 LOCUST — DEPT. PM  
KANSAS CITY, MISSOURI.



SAY YOU SAW IT IN POPULAR MECHANICS

## AMAZING INVENTION—Saves Time, Effort and Does Job Better MECHANICS "Mir-R-Lite" — for all Craftsmen and Mechanics — SEE THE SPOT LIGHT & BRIGHT

13 inches Long  
2 Sections  
Adjustable Mirror

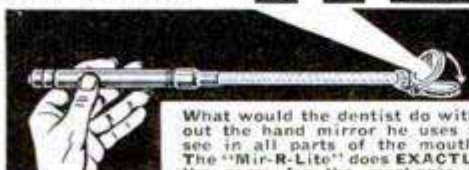

Consists of Chrome-plated flashlight with 6" Lucite Rod which transmits the light to 1" hinge-mounted mirror. Plastic mirror housing PREVENTS SHOCKS or SHORTS. Locking switch allows one-hand operation, leaving other hand free. No tool kit is complete without the "Mir-R-Lite." A new experience for any mechanic.

What would the dentist do without the hand mirror he uses to see in all parts of the mouth? The "Mir-R-Lite" does EXACTLY the same for the mechanic in places he can't locate or see clearly.

Without a doubt here is the best item for the benefit of any mechanic or craftsman to do BETTER WORK and DO IT QUICKER. Why Work in the Dark?

• IDEAL XMAS GIFT •  
COMPLETE WITH BATTERIES only **\$249**

• ORDER YOURS TODAY •  
PAUL GOUGELMAN CO., 30 No. Michigan Ave., Dept. P, CHICAGO 2

Light and Reflection RIGHT WHERE YOU WANT IT!  
LIGHTS DOWN, UNDER and AROUND. For Hard-To-Get-At Places and Delicate Work.



Give a **VISE-GRIP**  
The World's Most  
**POWERFUL**  
**USEFUL**  
**COMPLETE**  
Hand Tool!

**NEW**  
**VISE-GRIP**

**WRENCH**

Dad, Hubby, Brother or Son will sure appreciate this gift! For never before was so much **USEFULNESS** packed into a single hand tool! Adjusts to ratchet action or **LOCKS** to the work with **Ton-Grip!** Besides, **Involute Jaw Curve** gives powerful gripping, all shapes. Powerful **Wire Cutter** cuts wire and small bolts. **Thin Nose** gets into close quarters. **Knurled Jaw Tips** hold to the very tip. **WITH Cutter-7", \$2.25; 10", \$2.50. WITHOUT Cutter-7", \$1.85; 10", \$2.25.**

If your dealer hasn't it, order direct.

Postage prepaid if price accompanies order.

**PETERSEN MFG. CO., Dept. M-11, DeWitt, Nebr.**



It's **EASY!**  
**ECONOMICAL!**

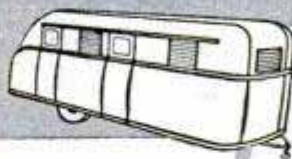

**Build Your Own Trailer with NATIONAL'S Simplified Plans**

Beat the housing shortage with a full-size house on wheels or add new pleasure to your vacations and week-ends with a sleek sport trailer. Step-by-step instructions and complete bill of materials with every plan. *Three different models.*

**NATIONAL MODEL 27:** A 27-ft. luxury liner with 3 rooms, lavatory, sleeping space for six. Plans . . . . . **\$1.00**

**NATIONAL MODEL 28:** A 20-ft. cabin trailer that's good-looking and sturdy, with beds for four. Plans . . . . . **\$1.00**

**NATIONAL CAMPER:** The sport trailer you've wanted for hunting, fishing, vacations. Sleeps two. Plans . . . . . **.50**

**ORDER ALL THREE - AND GET ONE FREE**  
Complete set \$2.00

Big parts catalog **FREE!**  
FREE with any order!

**NATIONAL TRAILER STORES**

Dept. 51 • Box 2353 Terminal Annex • Los Angeles 54, Calif.



**ROLLER BEARING WHEELS**

**IDEAL** for home use: garden and shopping carts, wheelbarrows, coasters, wagons, racers, etc. Heavy cushion rubber treaded tires. Baked cream enamel steel discs 10" x 1.25". 3 1/2 lbs.  
**SATISFACTION GUARANTEED.**

Send Check or Money Order **\$1.85 ea.**  
Set of Two **\$3.55** Set of Four **\$6.95**



Postage Prepaid

**COLSON EQUIPMENT & SUPPLY CO.**

1321 Willow St. Los Angeles 13, Calif.

**NEWEST OTTAWA LOG SAW**

**SELF-PROPELLED - MOVES ANYWHERE on OWN POWER**

World's fastest Log Saw. Powerful 6 H-P air-cooled motor. Attachments for sawing down trees, buzzing limbs, post hole digging and pulley for belt jobs. Big demand for wood, pulp, posts. Make big money sawing wood this easy way. Low factory-to-user prices. Nothing like it. **FREE details.**  
**OTTAWA MFG. CO., 7-827 Pine St., Ottawa, Kansas**



**SAY YOU SAW IT IN POPULAR MECHANICS**

**LAWN ORNAMENT-NOVELTY PATTERNS**

28 Lawn Ornament Patterns, 25c. Other patterns: 15-20" high; Dutch Girl, Dutch Boy, Pirate, Bull Terrier, Mexican Girl, Mexican Boy, Dwarf, Penguin, Flower Girl, 10c each. 25 Novelty Patterns, 30c. All 62 Full Size Patterns, \$1.00 Postpaid. Strother Pattern Service, Dept. AS-8, Box 383, Belington, W. Va.



**Save 80%**  
Buy Only  
**NECESSARY PARTS**

**BY ASSEMBLING YOUR OWN ARC WELDER**

**NOW!**

**BUILD YOUR OWN ARC WELDER**

**IDEAL FOR ALL PURPOSE HEAVY DUTY WELDING!**

TAKES UP TO 1/8" ELECTRODES  
PLUG INTO ANY 110 OR 220 A.C. LINE  
60 LBS. OF READY-MADE PARTS . . . **only \$24.95**

**FREE**

**WRITE TODAY BOOKLET P-23 FREE**

**ATOMIC ARC WELDER**

1038 SO. 19TH ST. OMAHA, NEBR.

**540 MILES for \$3.27**



All-steel Crosley Station Wagon seats 4, or 2 with 1/4 ton load. Priced \$600 to \$700 less than any other station wagon, costs about 1/2 as much to run. Typical owner's report:

J. L. Chambers, 600 Tucker St., Chattanooga, Tenn., drove his Crosley 540 miles, averaging 45 miles per gallon of gasoline. Total cost, \$3.27. Four other smart Crosley models to choose from.

**CROSLLEY**  
a **FINE** car

For beautiful, full-color catalog, write: Crosley Motors, Inc., 2532-NS Spring Grove Ave., Cin'tl 14, Ohio

# AN OUTSTANDING VALUE

READY TO USE SPRAYING OUTFIT  
AT THIS SENSATIONAL LOW PRICE

COMPLETE  
WITH  
MOTOR  
110 V.  
A.C. OR D.C.

**\$19.95**

Shipped  
Prepaid  
in U.S.A. Proper



This is positively not a toy. You will, like us, have to use it to believe it can do the job. It is a compact, portable, efficient paint spraying outfit. This unit even in the hands of an inexperienced operator will successfully spray lacquers, enamels, shellacs, varnishes, insecticides, disinfectants, and mothproofing solutions. Ideal for use in painting furniture, screens, radiators, car fenders, etc., etc. It has a vacuum type spray gun with paint container, 10' air hose, 6' electric cord, compressor, and motor. All mounted on sturdy metal base with 4 rubber feet. Weight complete only 8 lbs.

\$5.00 Deposit Required on C.O.D. Orders  
\$1.00 Additional for All Orders Outside U.S.A. Proper  
MAIL ORDERS TO

## THE ELECTRIC DRILL KING

1627-29 N. Damen Ave. Telephone ARmitage 6-2518  
Chicago 47, Illinois, U.S.A.

## Now CHEAP OIL BURNER

FOR HEATING AND COOKING STOVES-FURNACES  
HEAT YOUR HOME, COOK YOUR MEALS  
WITH CHEAP FURNACE OIL

NO MORE SHOVELING COAL OR ASHES. Sensational Fuelizer Starter Vaporizing System turns Cheap No. 1 Furnace Oil, also Range, Heater, Tractor Distillate, Kerosene and like oils into oil heat—one of the quickest, hottest fires known. LIFETIME GUARANTEE. \$1.00 Bonus Offer for Testing. We will let you try it in your own stove or furnace for one month. Get yours for introducing. Big profits QUICK. Be first. Send in your name today for details and cash in on the tremendous demand for this Amazing Invention.

NORTHWEST MFG. CO., 608-N, Mitchell, S. Dak.

## IMPORTED SWEDISH STEEL FEELER GAUGE

Tough! Accurate! Durable markings

26-3 1/2 inch blades

.015 to .025 size range

Order today — check, C.O.D. or money order to

SPECIAL  
**\$2.65**  
post  
paid

PRECISION MADE

Chap Associates, 2042 E. Milwaukee, Del. 11, Mich.



## HONE and WHETSTONE

HUNTER'S and FISHERMAN'S SPECIAL! ALSO  
FOR HOME WORKSHOP and MACHINE SHOP

Fine quality, high-grade knife, fish-hook, tool and hand-axe sharpener and polisher. U S Government surplus. Light weight (weight less than 1 ounce). Size, 1/2 inch wide x 4 inches long. One-half of instrument is finest possible whetstone and other half is cork rust remover and polisher. Any trapper, hunter, fisherman, hobbyist or machinist cannot afford to pass up this bargain.



ORDER  
NOW

3  
for  
**\$1.00**

Mailed  
postpaid

AMERICAN SURPLUS PRODUCTS CO.  
140 W. NEW YORK ST. INDIANAPOLIS, INDIANA

NOVEMBER 1948

## ALADDIN ANNOUNCES . . .

### A sensational new line of LOW-COST WOODWORKING TOOLS

for home and industry!

Now, at amazingly low cost, you can get heavy duty wood-working tools that outperform much more expensive tools! Look over the models below—compare the quality, the price, and the sound, safe design. Then order the model best suited to your needs and watch for further announcements of new wood-working tools by Aladdin.

Exclusive! On many Aladdin drill press tools, there's an exclusive new feature—a pilot bearing that eliminates dangerous side thrust, chatter and vibration. Pilot bearing feature assures same smooth cutting action you'd only expect to find in shapers selling for several hundred dollars.

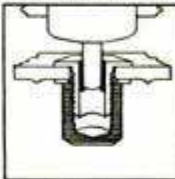

### ALADDIN Wood Shapers for your Drill Press



U. S. Pat. Pend.

MODEL #60—Originally designed for heavy industrial use, now priced for home workshop. Can be attached directly in chuck of your drill press. Exclusive pilot bearing eliminates side thrust, chatter and vibration—assures smooth cutting action. Blades can't come out—set screws hold them securely. Complete, with your choice of any 6 pair double-ground blades shown below, only \$12.95.



U. S. Pat. Pend.

MODEL #50—Same as Model #60, but without exclusive pilot bearing. Designed for intermittent shaping. Cuts rabbets and joints, planes wood with blade P-810. Adjustable hole-cutter with blade H-911, adjustable wheel-cutter with blade W-910—together, cuts holes and wheels at same time. Over 100 different shapes can be cut. Complete, with any 6 blades of your choice shown below, only \$8.95.

### ALADDIN Wood Shaper for your Circle Saw

MODEL SA-10—Heavy-duty, industrial-type shaper of solid steel, now priced in home workshop range. Absolutely safe—blades locked in position with set screws all the way through. When ordering, state diameter of shaft. Complete with arbor and any 6 pair of ready-ground blades shown below, only \$14.95.



U. S. Pat. Pend.

### ALADDIN Wood-Shaping Blades

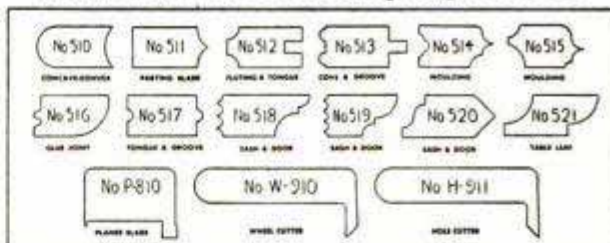

Specify by number the six blades you want when ordering ALADDIN Wood Shapers. Additional blades — \$1.50 ea.

### NEW! Model SDS-8 Three-In-One Drum Sander



U. S. Pat. Pend.

sleeves, medium, fine or coarse, 1 x 3, 20c ea.; 2 x 3, 25c ea.; 3 x 3, 30c ea.

Here's a one-inch, two-inch, and three-inch drum sander *all in one!* Now you no longer need to hunt for the right diameter—just slip the telescoping diameters on or off till you have the diameter you want. Diameters can be changed in a matter of seconds. Comes with pilot bearing that eliminates side thrust, chatter and vibration. Complete with a sandpaper sleeve for each diameter, only \$6.95. Extra sanding

#### HERE'S HOW TO ORDER

Be sure to specify Model No. of Aladdin tool you want. When ordering wood-shapers also specify 6 blades by number. When ordering blades only, specify whether to be used with drill press or circle saw. When ordering shaper for circle saw, specify diameter of shaft.

All Aladdin tools are guaranteed. Postage prepaid with all cash orders. C.O.D. plus postage. GET YOUR ORDER IN TODAY.

### ALADDIN MFG. CO., INC.

3121 Main St.

Dealers Write Today

Kansas City, Mo.

SAY YOU SAW IT IN POPULAR MECHANICS

# SURPLUS AIRPLANE ENGINES

175 H.P. BRAND NEW

TYPE  
L440-1

RANGER  
6 CYLINDER  
AIR COOLED  
TYPE



## A REAL BARGAIN AT THIS LOW PRICE

With the bottom of the "surplus barrel" in sight, bargains like this won't last long. These are genuine Ranger Type L440-1 six cylinder in line, 175 H.P. aircooled engines. Perfect for use on air driven boats, catamarines, barges, etc. by use of air propeller for propulsion. May also be used for ground power stations if proper cooling is provided. These motors are preserved in original factory cases measuring 28x41x62 inches—shipping weight 700 lbs. Army corrosion and protective controls have been applied. Shipped less carburetor but with 2 magnetos, tool kit, plugs, etc. Original cost many times more.

SHIPPED MOTOR OR RAIL FREIGHT  
SEND \$100.00 DEPOSIT ON C.O.D.  
COMPLETE AS DESCRIBED, ONLY **\$495.00**

WAR SURPLUS  
HYDRAULIC  
PRESSURE  
ASSEMBLY  
**\$49.50**  
COMPLETE UNIT

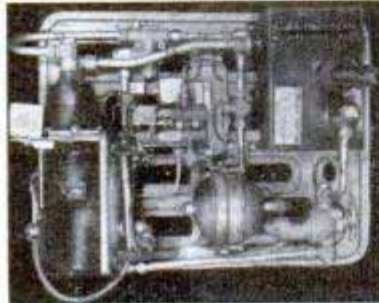

Complete to the last detail—and at a price that you couldn't begin to buy half of the parts for. It is completely equipped ready to go—just add the oil and put it to work. Unit is mounted on an alloy rack and contains the following high quality components: hydraulic reservoir 5 x 10 x 9 inches; large Purupulator filter; hydraulic pressure accumulator; pressure relief valves; hydraulic pressure control unit; solenoids; genuine Pesco valves; Pesco hydraulic gear type pump of 1000 lbs. per sq. in. pressure at 1750 R.P.M. (motor turns at 4000 R.P.M.); full 2 1/2 horse power Pesco elec. motor, AC or DC 24 volts, 4000 R.P.M. (will run on 110 AC by use of transformer); all connectors, tubing, fittings, etc. are included. Unit measures 24 x 18 x 6 inches overall. Just add the hydraulic oil and you can put the system to work on any type of hydraulic power action. Has hundreds of uses. For cash with order will include full gallon high grade hydraulic oil plus hydraulic control valve and send shipping charges collect. Shipping wgt. approx. 60 lbs. Guaranteed perfect. Price complete, only..... **\$49.50**

24 VOLT, 200 AMP GENERATOR. Will operate above hydraulic unit. Just add pulley and motor to turn the generator. Good used condition. Approx ship. wgt. 50 lbs. **\$22.50**  
Each only.....

SHATTERLESS "ALL PURPOSE" STEEL BOTTLE  
HAS HUNDREDS OF  
USES \*FOR LIQUIDS,  
GASES, STORAGE,  
AIR PRESSURE, ETC.



Formerly used by AAF for oxygen storage. You can use it now as an air pressure tank for inflating tires, operating horns, air motors, etc. May also be used as a buoy or float or for water supply storage on boats, trailers and trucks. Ideal as shipping container for gases, chemicals, etc. Bottle is non-shatterable with working pressure up to 500 lbs. psi., and weighs only 5 lbs. when empty. Internal volume 500 cu. in. (approx. 9 qts.). Has 3/8 in. pipe thread at each end. Approx. size 24 x 6 in. They won't last long at this low price. Order now!  
Similar to above, but of stainless steel and larger, approx. size 12x22 ins. Each only..... **\$5.95**

## ALL PURPOSE GENERATOR



Aviation type generator, ideal for use on boats, trucks, light and power plants, welders, water wheels, etc. Rated 24 volts, 25 amps at 2500 RPM. Has 7/8 inch shaft. Measures 10 x 5 inches overall. Highest quality aviation design. Actual weight 2 1/2 lbs. Two for \$30.00. **\$17.50**  
Each.....

Send stamp for FREE CATALOG. All prices F.O.B. Houston. Mail orders promptly filled. Send check or money order.

AERO INSTRUMENT COMPANY, Dept. PM11  
MUNICIPAL AIRPORT HOUSTON 17, TEXAS

Now  
ONLY **\$1.98\***

## FOR THIS SOCKET WRENCH KIT

Pocket-size and rugged. Interchangeable heat-treated alloy steel tools in hollow plastic handle. Send Money Order, Check or Cash. No C. O. D. orders accepted. Domestic postage prepaid.

An Ideal  
Xmas Gift



KIT	SIZE OF SOCKET OPENING	DRIVE	PRICE
★ REGULAR	1/4", 5/16", 11/32", 3/8" and 7/16"	1/4"	<b>\$1.98</b>
EXTRA LARGE	3/8", 7/16", 1/2", 9/16", 5/8" and 3/4"	3/8"	<b>\$2.48</b>
<b>BOTH TOGETHER \$4.28</b>			

STANDARD PRESSED STEEL CO.

POST OFFICE BOX No. 184 WYNCOTE, PA.



ONLY  
**\$3.75**  
POSTPAID

THE IDEAL WIRE STRIPPING TOOL FOR CRAFTSMEN; RADIO, IGNITION MEN; ELECTRICIANS. STRIPS ALL TYPES INSULATION. ALL SIZES WIRE. Handy pocket tool makes it easy to strip insulation from all types of wires and cables, such as ignition wires, household wires, cords, etc. A very fast operating, easy to use, and sturdy tool. ORDER TODAY AND SAVE ON THIS PRODUCTION SPEED TOOL. Regular Model No. 733 strips No. 12 to No. 20 Wires.

WOOD SPECIALTY MFG. CO., ROCKFORD, ILL., U.S.A.



## E-Z THREAD QUICK CHANGE GEAR BOX

To fit CRAFTSMAN, SOUTH BEND 9" and 13", POWR-KRAFT, LOGAN 9" and 10", CLAUSING and SHELDON Lathes. Aluminum alloy casting, Torrington needle bearings and steel cut gears. Will cut 78 threads. Easily installed. Price — **\$69.50 F.O.B.**

MONGE MACHINE SHOP  
NORTH CHICAGO, ILL.

## 3 CLINTON ENGINES 4 CYCLE AIR COOLED

• Reliably Built • Priced Right  
• Service Anywhere

No. 500  
3/4 to  
1.2 H.P.

No. 700  
1 1/2 to  
2 H.P.

No. 1100  
2 1/2 to  
3 H.P.



These 3 quick-starting Clinton Engines are performing daily on tractors, generators, refrigeration-compressors, grain augers, elevators, pumps, small boats, construction and concrete machinery, mowers, scooters, etc.

It's Powered BEST When CLINTON Powered  
For full information write Dept. 102 PM

CLINTON MACHINE CO. CLINTON MICHIGAN

## SHOPMASTER TOOLS



\$62.50

\$47.50

### 6" JOINTER-PLANER

Sealed for life ball bearings—New design fence—Requires no wrenches. Maximum protection guard—High speed steel blades. Requires 1/3 or 1/2 HP motor.

### 8" TABLE SAW

Tilting table—Cuts up to 2 1/4 inch wood—Sealed for life ball bearings. 14 inch x 18 inch table—Complete with blade, mitre gauge, rip fence and guard. Requires 1/2 HP motor.

## SPEEDY PAINT SPRAYERS



Delivers 2 cu. ft. free air per minute at 30 to 40 lbs. pressure—ample for every material. Operated by any 1/4 H.P. 1750 R.P.M. Motor with 1 1/2" shaft. Without \$29.95 Motor.....

### AUTO POWER SPRAYER

SPEEDY JR. comes ready to use with:  
 • Sturdy plastic spray gun • 6 oz. cup • Pump • Spark plug adapters • Tire adapters • 18 foot hose • Instruction Manual

\$4.85

15" Jigsaw .....\$19.95 1/4 HP Motor .....\$14.95  
 12" Bandsaw ..... 62.50 1/3 HP Motor ..... 16.95  
 12" Drill Press ..... 42.50 1/2 HP Motor ..... 29.95

Electric Drills, Spray Guns, Tools, Etc.  
 Send Check or M.O.—C.O.D. 25% Deposit  
 Dept. P-1148

INDIANA APPLIANCE CO. 20 E. SYCAMORE EVANSVILLE, IND.

## 100 PRACTICAL USES Glider Model FLAME GUN

**KILL WEEDS**, crab grass, Canada thistle, — stalks, seeds and roots. Destroy brush, caterpillar nests, diseased trees, grasshoppers, chinch bugs, etc. Clear irrigation ditches, split rocks, burn tree stumps. Sterilize poultry houses, kennels, barns. Use as portable home forge. Melt ice, thaw pipes. Safe, inexpensive. Burns only 6% kerosene —94% Air! Thousands satisfied users. Write for **FREE CATALOG**.....

HAUCK MFG. CO., 79 Tenth St., Brooklyn 15, N.Y.

## ONE-MAN SAWMILL LESS THAN \$225.00

**Easy To Turn Trees Into Money**  
 Makes lumber, ties, shingles, crates, lath, studding, siding.  
 Belsaw Models in 10 to 24 foot sawing lengths. MECHANICAL FEED, accurate set works and positive dogs. Use tractor or old auto engine for low cost power. Thousands used for commercial sawing. Pays for itself quickly. Send post card today for **FREE** booklet, "How To Make Lumber" and Catalog of Woodworking Equipment.  
**BELSAW MACHINERY CO., 811K Field Bldg.**  
 315 Westport Road Kansas City 2, Mo.

## NEW BAND SAW BRAZER

**SAVES TIME AND MONEY ...**  
 better than welding—easy to use—operates on 60 cycle lighting circuit. Complete kit includes resistance brazer, silver solder, flux, and instructions  
**Introductory price \$18.50**  
**THE ERWOOD COMPANY**  
 214 WOODSTOCK STREET  
 CRYSTAL LAKE, ILLINOIS  
 Send Your Order to DEPT. PM11

# HANDEE Homecrafters' Choice

This is it—the famous Tool of 1001 Uses — first tool of this type and today's finest. It's the tool for you whether you're an eager beginner or an expert.

GRINDS  
 DRILLS  
 CARVES  
 SANDS  
 SAWS  
 SHARPENS  
 POLISHES  
 ENGRAVES



FREE 64-Page Manual

There's Only One GENUINE HANDEE

## FOR PLEASURE OR PROFIT

You'll enjoy making ship, train and plane models, puppets, costume jewelry, wood carvings, bookends. You'll engrave monograms on glassware, tool leather billfolds, handbags, etc. And it's a dandy for all kinds of repairs. Used by industry for exacting production jobs — preferred by craftsmen and mechanics.

**EASY TO USE** as a pencil. Fits your hand comfortably. Lightweight, only 12 oz.

**WORKS ON ANY MATERIAL.** Metal, alloy, glass, plastics, wood, horn, bone, leather, etc.

**PACKED WITH POWER AND SPEED.** Runs at a cool 25,000 r.p.m. AC or DC current.

**DESIGNED RIGHT** in every detail—result of 50 years' experience. Close-fitting motor, non-breakable housing, 7-segment commutator, interchangeable spring collet clutch. Every part triple-tested to make Handee the perfect tool. With 7 accessories \$20.50. In carrying case with 40 accessories \$27.50.

**PLASTIC-CRAFT KIT.** All materials needed for internal carving (Handee not included) \$6.95.

**500 ACCESSORIES.** Start with a few, add more as needed.

**GET AT STORES OR SENT POSTPAID**

CHICAGO WHEEL & MFG. CO.  
 1101 W. Monroe St., Dept. PM, Chicago 7, Ill.

Send  Handee Kit  Handee Tool  Plastic-Craft Kit  
 C.O.D.  Remittance enclosed  Send Manual

Name \_\_\_\_\_  
 Address \_\_\_\_\_

SAY YOU SAW IT IN POPULAR MECHANICS

**Luther** **JIFFY JR.** **GRINDERS**  
 HAND AND POWER GRINDERS • KNIFE • SCISSORS • UTILITY

**Xmas Gift Suggestion**  
 Anyone can do an expert sharpening job with the Luther Jiffy Jr. Knife blades are sharpened in tapered groove between two Silicon Carbide wheels. No marring of sides of blade. Grinds only cutting edge. No further honing necessary. Easy, quick, sure.

If your dealer hasn't this household grinder of many uses, order direct. Immediate shipment. Only **\$2.95** post paid. Write today.

Scissors properly pitched by steel guide.

Ice picks, awls pointed in raised flange.

**LUTHER GRINDER & TOOL CO.**  
 (Established 1896) Sheboygan, Wisconsin

**BUILD YOUR OWN POWER TOOLS**

**BALL BEARING ARBORS \$6.95**  
 Reliable Guarantee

Rugged aluminum alloy housing, heavy duty sealed ball bearings, precision steel shaft 1/2", 3/8" or 3/4".

Housing	Overall	Price
2 1/4 x 4"	7 1/2"	\$6.95
2 1/4 x 9"	13"	7.95

**BALL BEARING PILLOW BLOCKS**  
 Same bearings as Arbors. Sizes 3/8" and 3/4". \$3.00 Shipped immediately Postpaid. Order today, you will be pleased.

**O. V. HAWTHORNE TOOL CO., Dept. M, OTSEGO, MICH.**

**NEW!**  
**HANDY, FLEXIBLE SHAFT**  
 Converts Any Motor, Drill Press, Electric Drill, Electric Fan Into A Handy Rotary Tool

**ONLY \$2.95**

**OLD FAN MOTOR**  
**YOUR ELECTRIC MOTOR**  
**VACUUM CLEANER MOTOR**

Attach ROTA-SHAFT in a Jiffy. Can Be Used for Grinding, Polishing, Sharpening, Cleaning, Engraving, Marking Tools, Carving, On Metal, Plastic, Wood, Glass.

Yes! Only \$2.95 and ROTA-SHAFT turns your old motor, drill press, electric drill or electric fan (10 inch or larger) with blades removed, into an efficient, versatile Flexible Shaft Tool for doing hundreds of grinding, polishing, sharpening jobs, especially in hard-to-get-at places. Attaches to motor shaft or in chuck. Convenient handlepiece for ease of handling. Generous 40-inch overall length. Comes complete with buff and sanding disc ready to use in a drill press chuck. Order today.

**SEND NO MONEY!** Just mail order. Pay postman only \$2.95 plus postage on delivery, or send \$2.95 and we pay postage. Try 10 Days — if not delighted return for money-back.

If you order Rota-Shaft for use on motor add 35c for Special Coupling and State Shaft Diameter. **MAIL ORDER NOW!**

**STRADER PRODUCTS CO., Dept. G-101**  
 259 Strader Ave. Cincinnati 26, Ohio

**AMAZING SCREWLESS VISE**

The new Heinrich "Grip-Master" is a SCREWLESS vise. Operates effortlessly . . . avoids tiresome winding . . . saves time. Movable jaw adjusted in a jiffy . . . locked securely by easy press on locking lever. Design permits drilling clear thru work. Jaws have built-in parallels . . . extra loading capacity. Bars and locking mechanism hardened and ground. The "Grip-Master" is the most revolutionary advancement in 100 years of vise manufacture.

**Money Back Guarantee**  
 If your dealer does not have the "Grip-Master," we will ship postpaid for cash with order. Model 3-SV (3" jaw), \$16.50; 4-SV (4" jaw), \$27.50. Larger sizes also available. Folder on request.

**HEINRICH Grip-Master**  
 NATIONAL MACHINE TOOL CO. • Dept. 158-L • RACINE, WIS.

**SAY YOU SAW IT IN POPULAR MECHANICS**

**1/4" SURPLUS HEAVY DUTY ELECTRIC DRILLS**  
**THOR — VAN DORN — CLARK**  
 NEW JACOBS CHUCK WITH KEY  
 NEW HEAVY DUTY 8' CORD  
 110 V. 3500 & 3750 RPM

These drills are used but in A-1 condition and are sold with money-back guarantee. If you buy 12 drills, one drill will be sent you free. These drills are of much finer quality and durability than the home utility type drills. Choice of drill brand will be observed as much as possible. All drills priced f.o.b. Tulsa, Oklahoma. Send money order, check, cashier's check or 25% deposit if drills are shipped C.O.D.

**ONLY \$13.98**  
 ORIGINAL COST \$38.00

**MIKE A. TRAVIS**  
 101 West Archer Tulsa, Oklahoma

# WHY PAY MORE? . . .

Amazing **5-in-1** Shop  
ONLY \$39.95 COMPLETE

*Wonderful Christmas Gift*

Yes, you get a Lathe, Saw, Drill Press, Grinder and Sander, when you buy an Emrick 5-in-1 Shop. All tools quickly interchangeable. All capable of big, heavy-duty work.

The Emrick machine takes 1/4 to 1/2 h.p. motor—equals in performance equipment costing up to 8 times more. Ideal for handling home repairs, running a money-making business. You can work in wood, metals or plastics. Thousands of satisfied customers . . . our 50th year.

Give an Emrick this Christmas—make someone very happy. Buy one for your own pleasure and profit. Use coupon now, or write us.



**LATHE**—excellent power tool; handles big, heavy work; 30" between centers; 10" swing; bronze replaceable bearings; wide speed range.



**DRILL PRESS**—heavy-duty performance; pulls 1/2" drill in steel; 2" travel.



**SAW**—handles heavy ripping and cutting; takes 6, 7 or 8" dia. blade.



**SANDER**—gives your work professional finish; swell for shaping plastic; 8" dia. disc.



**GRINDER**—for sharpening your tools; grinding metal; polishing; 5" dia. wheel.

## MONEY-BACK GUARANTEE

EMRICK, INC., 1741 Clinton, Kalamazoo, Mich.

I enclose \$18.00. Ship Emrick Workshop (complete less motor and saw blade) on balance c.o.d. basis. Unless completely satisfied, I may return within 10 days and get my money back.

Name \_\_\_\_\_ (PLEASE PRINT)  Send FREE catalog.  
Street \_\_\_\_\_  
City \_\_\_\_\_ State \_\_\_\_\_

## 3-Pc PAINT STRIPE SET Only \$1.00



3 SEPARATE TOOLS—Each makes different width

Stripe perfect lines—straight, curved, with any paint, lacquer, enamel, easy as drawing lines with ruler! Beautify furniture, toys, autos; make signs and imitation tile. Simple instructions included.

SEND NO MONEY. Mail order. Pay postman only \$1.00 plus postage. If not delighted return in 5 days for money back. Order Now.

STRADER MFG. CO.  
259 Strader Ave. Dept. D-351  
Cincinnati 26, Ohio



## AC's NEW "RECORD BREAKER" SPARK PLUGS FOR ALL MODEL ENGINES

More Speed Longer Life No Heat Failure

Users say these new AC's outperform any other spark or glow plug. AC's patented, aircraft type insulator, copper glass seal, tapered electrodes, make the difference. Now engineering throughout. Hot and cold type in each of three thread sizes.

AC SPARK PLUG DIVISION • GENERAL MOTORS CORPORATION  
Flint 3, Michigan

75c AT YOUR HOBBY DEALER



## Talk AS FAR AS 17 MILES WITH ARMY FIELD TELEPHONES

Amazingly simple to install and operate. Just hook up terminals of two or more phones to any two-strand wire and you are ready to talk! Powered by standard flashlight batteries. Compact . . . rugged . . . portable.

Hundreds of uses for quick, low-cost, dependable 2-way communication around home, shop, farm, industry. Performance equals present-day commercial telephones. Up to six phones can be used efficiently on a single line, making a complete telephone system. No maintenance required. Each phone complete with self-contained hand-operated ringer. Every phone checked for perfect operation and fully guaranteed. Originally cost government \$39.90 each.

USED—good, serviceable condition . . . \$ 7.45 ea.  
USED—excellent condition . . . 8.95 ea.  
RECONDITIONED—(by U. S. Signal Corps) . . . 10.75 ea.  
LIKE NEW, slightly used . . . 12.95 ea.

## ARMY FIELD TELEPHONE WIRE

Weatherproof-Durable  
2-conductor, twisted, 3 copper and 4 steel strands, tinned, insulated.

On Original Steel Reels

W-110B Unused, new, but stored in open. Half-mile reels (2500 to 2750 feet). Wt. 85 lbs. \$14.25  
Each . . . . .  
500-foot coil (14 lbs.) . . . \$3.50  
1000-foot coil (28 lbs.) . . . 6.50  
W-130 LIGHT WEIGHT AS-SALT WIRE. Weighs only 16 lbs. New, half-mile reels (2600 feet). Each. \$15.00

All prices FOB Sacramento. No COD. California residents add 2 1/2% for sales tax.

WRITE FOR FREE FOLDER!

SEND CHECK OR MONEY ORDER **LORIS SALES**  
P. O. Box 1896-B-11 Sacramento, California

WRITE NOW FOR FREE CATALOG NO. M-3

## THE FOSTER LINE POWER TOOLS

FOSTER MFG. CO., M-3 KINSEY AVE., BUFFALO 17, N. Y.

SAY YOU SAW IT IN POPULAR MECHANICS

## STOP THIS LEAK SOMETHING NEW!

1—Adjustable Collar  
2—Improved Guide Rod  
3—New Rubber Ball  
4—Press-On Solid Brass Seat

Just The Thing To Stop These Leaks

INSTALL IT YOURSELF  
Any man, woman or child can install this NEW UNIT in less than 3 MINUTES. No tools or skill needed. 3 KITS \$1.60 EACH . . . 6 KITS \$1.50 EACH . . . 12 KITS ONLY \$1.25 EACH.

ORDER YOUR SUPPLY TODAY

COMPLETE KIT ONLY \$1.79  
Postpaid in U.S.A.

Gee Co., Dept. L-11, 2600 West 79th St., CHICAGO 29

Now Your  
Dream Home  
Comes True!

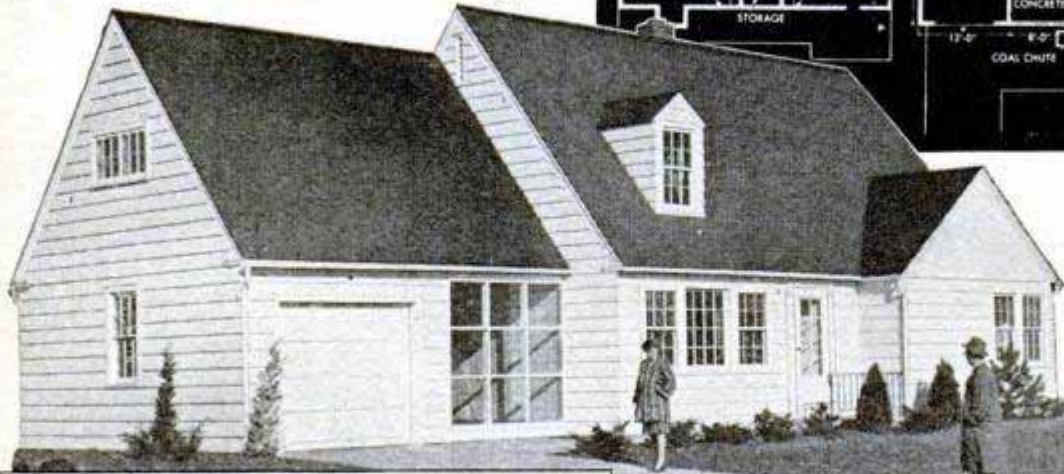
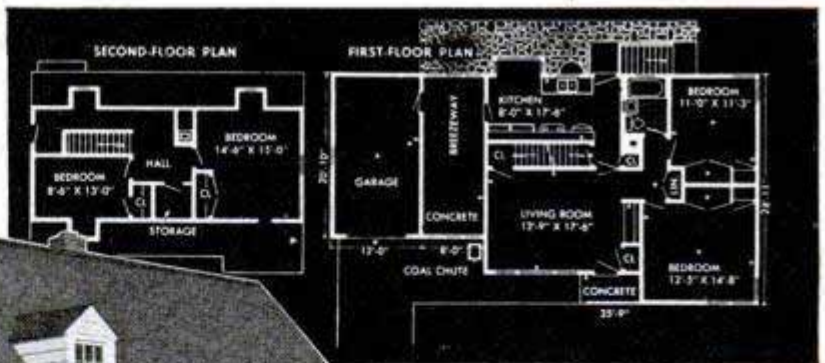

**The House That  
Jack Built**

From actual photograph of Build-It-Yourself House with breezeway and garage as built by Jack Brownson, Aurora, Illinois, a twenty-three-year-old veteran.

**YOU CAN BUILD  
THIS HOUSE  
YOURSELF!**

**MAIL COUPON FOR BIG NEW BOOK  
AND PLANS • BUILD IT YOURSELF  
OR HAVE IT BUILT AT A BIG SAVING!**

**GET THE BOOK NOW!  
STUDY THE PLANS NOW!**

*Start Building When You Can*

You can get "Your Home and How to Build It Yourself" and complete plans by mailing the coupon below. Book is plastic bound and contains 100 pages, size 8½ x 11 inches. Three-fifths of the book consists of photographs and drawings. Several sections are printed in extra colors and a four-page, four-color insert shows just how your own house will look in actual colors. Every detail of the house and its construction are discussed in this book with minute details of Build-It-Yourself instruction that will guide you in every step.

**PLANS YOU CAN READ  
AND FOLLOW**

Plans consist of ten working size blueprints, giving floor plans, elevations, notes on construction, framing, lumber list, millwork list, specifications, plumbing and wiring diagrams. Every measurement is marked, every detail made as clear as A-B-C. With the book to guide you and the plans to follow, any handyman who can use simple tools can build this remarkable house and enjoy every minute of the work while saving thousands of dollars.



Can you use a hammer—saw a board straight—use common, everyday tools as well as the average *Popular Mechanics* reader? Then, startling as it may at first seem, you too, can build this modern house in any of its five designs, and do it easily and quickly, at a tremendous saving. *Popular Mechanics* and a famous firm of architects have designed it and worked out every detail so you can do every part of the job yourself, even though you have no experience whatever.

**SPACE FOR LIVING AND  
FAMILY GROWTH**

Illustrated is the *Popular Mechanics* "build-it-yourself" house Jack Brownson built from our plans, in Aurora, Illinois, with one inexperienced helper. This beautiful, modern house is 1½ stories, with basement, living room, kitchen, dining nook, two bedrooms, bath, plenty of closets and space for 2 additional bedrooms on the second floor. The house itself is 35'-9" x 28'-11"; breezeway 20'-10" x 8'; garage 20'-10" x 12 feet.

**THE HOUSE THAT HAS  
EVERYTHING**

The big, basic idea behind the design is ease of construction and the most living space and the most useful space, at the least cost, considering attractiveness and suitability for any neighborhood and most income groups. On top of this is its adaptability to other types of architecture, such as modified Dutch Colonial, modified Cape Cod, plain gable roof house without dormer windows, or the house as pictured, but without garage and breezeway.

**USE CONVENIENT ORDER  
COUPON**

You may never have thought about actually building your own house, but you can do it. And now that building restrictions have been lifted, it's easier than you think. So send for the big new book—Your Home and How to Build It Yourself, and set of construction plans, today. Even if you engage a contractor or builder to build this house for you, you will need the plans. Then too, you will certainly want the book, which can easily save you countless hundreds of dollars whether you build this house or any other house of your choosing

**100 Pages  
52 in Color  
60% Illus.  
8½"x11"**

**MAIL COUPON FOR BOOK AND PLANS**

Popular Mechanics Press,  
200 E. Ontario Street, Chicago 11.

I enclose \$\_\_\_\_\_ Send me the items checked at once.

- Your Home and How to Build It Yourself . . . . . \$ 3.00
- Complete set of plans for Popular Mechanics Home . . . . . 12.50
- Book and Plans at reduced price . . . . . 14.00
- Duplicate sets of plans . . . . . 5.00

Name \_\_\_\_\_  
Address \_\_\_\_\_ Zone \_\_\_\_\_  
City \_\_\_\_\_ State \_\_\_\_\_



# "SEA CRAFT" BLUEPRINTS READY NOW!

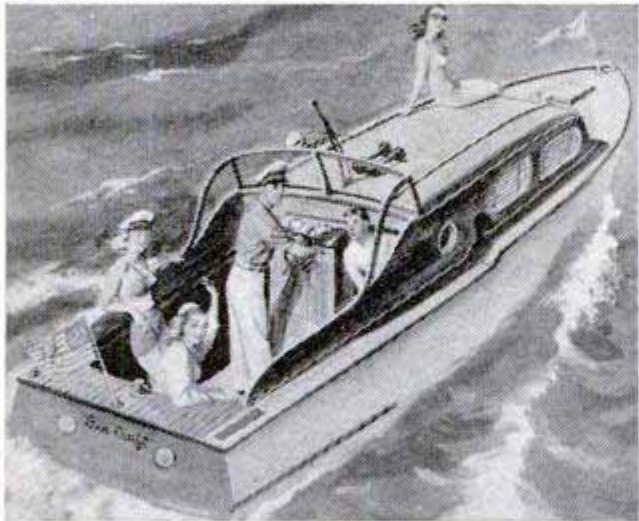

Build this luxurious cabin cruiser yourself and save money. What a beauty it is! A 25-foot boat readily adaptable as a sport fisher, express cruiser, or utility boat. Cruises effortlessly at 15 knots with a marine engine or converted auto motor. Its spacious cabin sleeps four and has a galley complete with fresh-water tank, sink, and cook stove. Has open cockpit large enough for fishing, lounging, etc.

During war the Coast Guard used "Sea Craft" for ship-to-shore travel. Order today your complete set of seven large-size blueprints scaled 1 inch to the foot. These, plus a 40-page two-color illustrated booklet giving step-by-step instructions, only \$10.00.

**POPULAR MECHANICS PRESS**

200 EAST ONTARIO ST.

CHICAGO 11, ILL.



## BUILD A BOAT

Row Boat—12 Foot  
Dinghy—8 Foot  
Dinghy—14 Foot Sailing  
Training Ship—6 Foot  
Sea Sled—9 Foot  
Outboard—12 Foot  
Outboard—18 Foot  
Cruiser—Kayak  
Bicycle Boat—Sectional  
Row Boat—Sailing  
Dinghy—Sailing  
Canoe—16 Foot  
Sailing—12 Foot  
Outboard—12 Foot  
Outboard—Runsabout  
Pontoon Ice Yacht

### FOR PLEASURE OR PROFIT DESCRIBES 17 LOW COST BOATS

Get this outstanding book and build a boat at home for your own use or to sell at a profit. You can do it. Just the boat you've always wanted—power, sail or row boat—17 different kinds and sizes.

Order BUILD A BOAT on postal card and pay only \$1.50 plus postage on delivery. Return in 5 days if not pleased and get money back. Or send \$1.50 with order and we'll pay postage. (Outside U. S. \$1.70 with order.) Order today.

**POPULAR MECHANICS PRESS**  
Dept. 598, 200 E. Ontario, Chicago 11

## HELPFUL BOOKS

Send post card asking for FREE catalog

Popular Mechanics Press, 200 E. Ontario, Dept. 601, Chicago 11



**POPULAR MECHANICS**

### Outdoor Sports Manual!

All sportsmen, attention! Here are 156 pages of helpful hints for the Hunter, Fisherman, Trapper, Camper, Archer, and Boatman. How to make your own decoys, recondition your fishing rod, outwit the fur bearers, make an insect and vermin proof tent, shoot a modern crossbow, and service your outboard motor. These and a pack bag full of other articles for outdoor men. Your News Dealer has it in the 60c paper edition and we can supply the beautifully bound \$2.00 library edition.

**Popular Mechanics Press**

200 E. ONTARIO ST.

CHICAGO 11

# PAY RAISING—EXTRA MONEY BOOKS

supplying outstanding self-help books for our FREE catalog.

**Outdoor Sports Manual**  
Hunters, Fishermen, Trappers, Campers, Archers, Boatmen, here is your book!...\$2.00

**Shop Notes Library**  
3 Vols.—1948, 47, 44 (No Dup. Mat.)...\$2.00

**Painting, Furniture Finishing and Repairing**...\$1.50

**Rewinding and Servicing Electric Motors (No. 75)**... 25c

**Elementary School Subjects for Home Study**

Covers high points of grammar, spelling, arithmetic, history, science, geography, etc. 635 pages...\$1.89

**High School Self Taught**

Covers 25 subjects with study guide and self-testing quizzes. Completely revised and enlarged edition, 1280 pages, 300 illustrations...\$3.95

**Garden Book**

Build own trellises, lawn furniture, fireplaces, ornaments, etc. ....\$1.00

**Diving, Cutting and Welding in Underwater Salvage Operations**  
Only book of its kind...\$2.00

**Picture Framing**

Modern methods for making and painting picture frames. Fully illustrated...\$2.75

**Frog Industry**

Breeding, feeding, dressing and marketing...\$2.00

**New Fields for the Writer**

Television, radio, film, drama...\$1.00

**Everyday Mathematics**

Businessmen, tradesmen, executives and secretaries applaud this arithmetical brush-up... 50c

**Breaking into Advertising**...\$1.00

**Into the Freezer and Out**

A complete handbook on the home freezing of foods...\$2.50

**Concrete Handbook**

New book on using concrete around home, garden, farm...\$1.50

**Zero Storage in Your Home**

How to prepare, store and freeze food properly...\$2.50

**This Way Up**

The successful philosophy of practical business men...\$2.00

**Welding, Brazing and Soldering**

How to build own equipment and how to use it effectively...\$1.25

**Modern Refrigeration**

Electric, Gas, Ice service expert...\$5.00

**Dyke's Auto Ency. (includes Diesels, airplane engines)**

New 20th Ed. World's greatest book for mechanics...\$7.00

**Household Mechanics**

The "fix-it" book to end all "fix-it" books. Covers electric appliances, painting, carpentry, etc...\$2.75

**Oil Burner Handbook**...\$2.50

**Build Your Own Boat**

Describes 17 popular boats—rowboats, sailboats, plywood outboard, etc. 192 pages...\$1.50

**House Wiring (No. 89)**... 25c

**Turn Scrap Into Money**

Convert old auto generators into motors, welders, etc...\$1.00

**Popular Mechanics Farm Manual**

Packed with practical ideas and usable information that can easily be worth hundreds of dollars to every farm family and to homeowners everywhere. Send for free descriptive folder giving complete contents!...\$3.00

**Woodworking for Every-body**...\$2.75

**Sheet Metal Work**...\$3.00

**Tool and Saw Sharpening (No. 92)**... 25c

**Forging Practice**...\$1.50

**Action Toys (No. 66)**  
Plans for 21 easy-to-make toys... 25c

**Pattern Making**...\$2.25

**Foundry Work**...\$2.25

**Wood, metal**...\$2.25

**Forty Power Tools**

Build own saw, drill, lathe, sander, etc., from scraps—save money...\$1.25

**Carpentry**...\$2.50

**The Young Craftsman**

Over 450 things boys can make...\$1.50

**Five Acres and Independence**

How to make money on small farm...\$2.50

**Your Home and How to Build It Yourself**

Step by step construction of the famous POPULAR MECHANICS house. Wonderfully illustrated...\$3.00

**Everyday Law**

A lawyer tells laymen about negotiable instruments, partnerships, contracts, real estate and wills...50c

**Motorist's Handbook**

Popular Mechanics scores again. A 160 page guide to automotive happiness...\$2.00

**Knots, Ties and Splices**

For everyone who uses rope...\$1.25

**What to Make for Children**

Junior tough on toys? Build him playthings that will last...\$2.00

**LeJay Manual of Homemade Electric Equipment**

How to construct 100 items that are scarce and valuable...\$1.50

**How to Estimate for the Building Trades: Material and labor costs for masonry, plumbing, electricity, carpentry, heating, hardware, painting, etc. 629 pp.**...\$5.50

**Pay Dirt**

How to make soil fertile by obeying Nature's laws...\$3.00

**Rabbits for Food and Fur**...\$2.50

**Tool Making**...\$4.50

**Tool Design**...\$4.50

**Plumbing Installation & Repair**...\$2.00

**Ropp's Calculator**

Figuring made easy... 75c

**Slide Rule Simplified**...\$2.75

**Drake's Refrigeration Service Manual**...\$2.00

**Primer for Home Builders**

All the information you need to know in building a house...\$2.50

**Oxy-Acetylene Welding and Cutting**

Up-to-date handbook on gas welding and cutting...\$2.75

**Toys You Can Make of Wood**...\$2.50

**A.B.C. of Poultry Raising**...\$2.50

**Ice Cream for Small Plants**

Some technical formulas for ice cream, ices and frozen desserts on a commercial scale...\$2.50

**Furniture Joinery**...\$2.50

**Essentials of Upholstery**...\$3.25

**Radio Physics Course**

A thorough training in radio fundamentals...\$5.00

**Modern Home Medical Adviser**

How to recognize diseases, practice proper hygiene, and know what to do in medical emergencies. 900 pages, 136 illustrations...\$2.49

## MAIL THIS COUPON TODAY

Check the books you want, write your name and address below, and mail this advertisement with money order or check. Outside U. S. A. include 15% additional for shipping charges.

Books selected will be mailed promptly on our "money back if you're not entirely satisfied" guarantee.

Name \_\_\_\_\_

Address \_\_\_\_\_

City \_\_\_\_\_ State \_\_\_\_\_

Mail to **POPULAR MECHANICS PRESS**

Dept. 651—200 East Ontario St., Chicago 11, Ill.

**IT COST ME MONEY  
TO FORGET!**

...This Doesn't Happen  
If You Use *Memindex*



**MEMINDEX**—the famous memory method and personal systematizer, is credited by thousands of successful persons with speeding their rise to the top. Memindex keeps all data on handy, cleverly indexed and dated cards—today's always visible. Fine leather **POCKET CASE** organizes your daily memos—handsome **DESK UNIT** keeps permanent records for you. No transcribing. Worth 1000 times its small cost to salesmen, businessmen and professional men, hobbyists and social leaders. Outfits \$5.75 and up.



**IDEAL  
XMAS  
GIFT**

**FREE** Dated Cards for balance of 1948 with your 1949 Memindex. Write for Catalog describing complete line of reminder specialties.

**WILSON MEMINDEX CO.**  
Dept. L  
249 Carter St. Rochester 5, N. Y.

**HOME CRAFTSMEN BUY DIRECT**

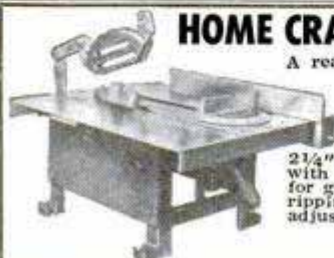

A real machine, mirror polished table 12" x 15". Table hinged to base for oiling & blade changes. Base of Steel & Aluminum Alloys enamel finished. Bronze bearings, 2" of bearing length. Saw blade adjustable—0 to 2 1/4" cut. Uses 6 or 7" Saw Blades, with 1/2" hole. Fitted for Dado Saws for grooving. Aluminum saw guard and ripping fence. Calibrated Cut Off Slide adjustable to any angle.

Complete With Blade

Only . . . . **\$19.95**

**TINKER CRAFT SALES CO.**  
428 New York Bldg.  
St. Paul, Minn.

**SAVE ON BLADES** SAE 1075 Steel  
6" dia. \$2.00 Combination 2.15  
7" dia. 2.25 Combination 2.40  
8" dia. 2.54 Combination 2.70  
8 Piece Dado Head SAE 1075 Steel  
5 15/16x3/8. From 1/8" to 3/8" in  
1/16 variations \$5.60.



**NEW PLAN CATALOG**

Send postcard today for FREE catalog of up-to-the-minute workshop projects—home bars, poker table, kitchen cabinets, workbenches, outdoor fireplaces, power tools, novelties, things to make for children, etc.

**CRAFTPLANS, 7241 Madison, Dept. 131, Kansas City 5, Mo.**



**SAW-HORSE WORK-BENCH** has many uses  
You may now have a saw horse, work bench with clamp, tool box, step ladder and scaffold—ALL IN ONE.

28" high 9" wide 4' long. Light enough to carry, wide top provides excellent sawing space. Divided top with clamps holds boards for planing, chiseling, and vise work; holds regulation size doors firmly in end. Lower shelf with rail makes convenient open tool box; six trays store nails, screws and small tools. Standing-scaffold to reach 9 1/2 feet high additional height easily obtained by extensions in clamps, solid place to stand while sawing, painting, papering and nailing. More convenient than step ladder. Satisfaction guaranteed. Shipped with legs K. D. Send \$5.00 with order, balance C.O.D.

**R. B. FLEMING MANUFACTURING CO., P. O. Box 9647, Dallas, Texas**

**2 Tons Cutting Power!**

IT'S THE NEW  
**MANCO JR.**

No Workshop  
Complete  
Without  
It



Does More  
COSTS LESS  
**\$3.50**  
List Price

Compound leverage provides fast, easy cutting of mild steel bolts up to 1/4" . . . screws, rivets, nails, fencing of any material up to the hardness of heat treated steel. Nickel plated with alloy tool steel jaws. Convenient tool box size. See your dealer or order direct. Dealer and jobber inquiries invited.

**MANCO MFG. CO., BRADLEY, ILLINOIS**

Gentlemen: Please rush me C.O.D. \_\_\_\_\_ Manco Jr. Cutters @ \$3.50 each plus postage.

Name \_\_\_\_\_

Street \_\_\_\_\_

City \_\_\_\_\_

State \_\_\_\_\_

**ORDER  
YOUR  
MANCO  
JR.  
NOW!**

**DELCO MOTORS**



A REAL BUY! Delco motor with blade for heating and ventilating purposes. All are factory tested and guaranteed. Quiet operation. Triple rubber mountings. Horseshoe stand. 1/75 H.P., 110 Volt A.C., 50-60 Cy., 900 R.P.M. 6 blade fan 7 1/2"—stand 6 1/4", 4 1/2" wide. Complete as shown. Shp. Wt. 5 lbs.

No. P7014 Suction Type  
No. P9272 Blower Type . . . EACH **\$5.25** plus postage  
Lots of 10, ea. \$4.90. Lots of 50, ea. \$4.75

**FREE**—Send for new G & E Appliance and Parts Catalog  
**G. & E. EQUIPMENT SUPPLY COMPANY**  
Ogden at Fulton Chicago 7, Illinois

**MILITARY TRUCK PARTS**



Every part for every G.I. type vehicle from jeep to 20-ton prime mover 6x6 40% to 80% below list.

**NORTHWESTERN AUTO PARTS CO.**  
834 NORTH SEVENTH ST. • MINNEAPOLIS 11, MINN.

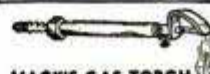

**MACK'S GAS TORCH AND SOLDERING IRON**  
6,000 B.T.U. attaches to any gas hose; furnished with 3 jets for natural and bottled gas; equipped with adjustment \$2.00 set screw. Postpaid



**Mack's GAS BURNER**  
Jet Power, Self-Acting (Pat. pending), 34,000 B.T.U. for natural and bottled gas, industrial and home use. Guaranteed. \$2.00 Postpaid

**Mack's Automatic Water Heater**  
Approx. 20 gal. capacity and larger for home and industry. Easily installed. Amazingly low-priced. Guaranteed. \$32.50 Del.



Prompt Delivery • Order Now • Factory Service • Send Check or Money Order

*McDaniel*

**MANUFACTURING CO., INC.**  
1812 1/2 POWHATAN ST. • DALLAS 2, TEX.

**DRAINS CELLARS, WASH TRAYS  
CIRCULATES OIL**



Pumps 1800 GPH 300 gal. 30' high, use 1/8 to 1/2 HP **\$6.50**  
motor. Will not clog.

Postpaid if cash with order.  
(Add 50c for west of the Mississippi.)

Thousands in use since 1936

**LABAWCO PUMPS, BELLE MEAD 7, N. J.**

**NEW! ROTARY SANDER**

FOR DRILL PRESS OR ELECTRIC DRILL

No Gluing — No Special Discs

Uses 3" square of any paper. Change in one minute without messy gluing. 3/8" shank for drill press. 1/4" shank for electric drill. Specify size. Lamb's wool polishing bonnet \$1 extra. Write for literature on other time-saving tools.

**MASTERCRAFT** 60 SOUTH ST. BOSTON, MASS.



**BUILD YOUR OWN ZEOLITE  
WATER SOFTENER**



You can do it inexpensively with only a wrench and a little spare time. Famous Zeolite process as used by leading manufacturers. Send \$1 for easy-to-follow directions and list of materials. (Materials available locally or from us.) Or inquire about factory-built LARCO Softeners \$55.20 up. **LAKE REGION MFG. CO., INC., 3920-A Lynn Ave., Minneapolis 16, Minn.**



**Thrilling Work COLORING PHOTOS**

Fascinating vocation learned at home by those with aptitude. Thrilling pastime. National method brings out life-like colors. Free booklet.  
**NATIONAL PHOTO COLORING SCHOOL**  
1315 S. Michigan, Dept. 1358, Chicago 5

## PNEUMATIC AIR TOOLS

SAVE \$64.00 AND UP

Ideal fender and bumping hammers, and for riveting brake lining, concrete breaking and many other uses. Like new. At these unheard of low prices it pays to order a good supply.



**CHICAGO PNEUMATIC RIVETER & CHIPPING HAMMER**

CP4X Pistol grip handle, with air control. Takes up to 3/16" rivet. Weight 6 lbs. List price \$73.00. **SPECIAL PRICE..... \$8.95**

Size CP3 — Takes 5/32" Rivet.... \$ 7.95  
PRS-A5 — Squeezer ..... \$17.95

Prices are F.O.B. Chicago. Immediate delivery. **SOLD ON MONEY BACK GUARANTEE.** Send check or money order today. Write For Free Folder on Air Compressors and Equipment.

**C & M EQUIPMENT COMPANY** 1831 S. State St., Dept. D-11 Chicago 16, Ill.

## OTTAWA Buzz Master

A faster brush cutter and wood sawing machine. Propels itself while cutting saplings and brush. 7 H-P motor. Many outstanding and exclusive features. Available attachments: sickle bar, rotary tiller, sprayer, air compressor, snow plow and pulley for belt work. Thousands in use. Send for FREE booklet.



No Other Like It!

**OTTAWA MFG. CO., 1-827 Brush Ave., Ottawa, Kansas**

## DO LATHE JOBS on DRILL PRESS with DRILLATHE

**\$2.50** Postpaid

A rugged tool that converts drill press into lathe. Precision made of cast aluminum. Comes complete with high speed tool bit. Money back guarantee. Send \$2.50—we pay postage.

**Surface or Bench Plate only \$3.50**

6" square—C.I.—weighs 6 lbs., surface ground to .001 flatness. Money back guarantee. Send \$3.50, postage collect.

**BRAEMER PRODUCTS • Box 2636 • Lakewood, Ohio**

## BUILD YOUR OWN ENLARGER

Enjoy Photography's most fascinating hobby at a fraction of usual cost. With simple step-by-step instructions and diagrams plus a screwdriver and pliers you assemble your own Enlarger and Save! Get all features of more expensive Enlargers: precision machined aluminum alloy castings, 90° tilt for wall projection of prints, spherical aluminum lamphouse, helical rack and pinion focusing with extra large knobs, unconditional guarantee. For 35mm to 2 1/4 x 3 1/4 negatives. Time payment plan.

Write Today for Free Illustrated Folder  
**CALIFORNIA TECHNICAL PRODUCTS CO.**  
448 S. Hill, Dept. M-11, Los Angeles 13, Calif.

## BIG BARGAIN! .22 CAL. RIFLE & PISTOL CLEANING ROD KITS

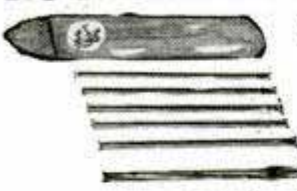

All-brass, famous make, pocket-size in waterproof cloth case, with adaptor for other makes. 22-27 Cal. only. Also, 30-45 Cal. same price. **98c**  
12, 16, 20 Ga. Shotgun Kits with brush, patch tip, handle. **ONLY \$1.19** (Specify Ga.)  
Sorry—No C.O.D.'s

**FRANKAY OF CALIFORNIA**  
P. O. Box 126, Dept. OS, San Gabriel, Calif.

**safe**  
FOR FAST BATTERY CHARGING...



## FAST BATTERY CHARGER & COMPRESSOR

**GUARANTEED**—not to harm batteries. Users all over the world say "Wouldn't be without it!" **SIMPLE-FAST and SAFE TOO!** Starts motors and inflates tires **QUICKLY.** Charges in 30-45 min. Model GKN gas powered for farm use. Model SN, charger only. See your dealer or write factory. **VALUABLE TERR. OPEN FOR SPECIALTY SALESMEN AND DISTRIBUTORS. WRITE NOW. Mfr'd & GUARANTEED by**



Model K \$149.50 F. O. B.

**H&H PRODUCTS MFG. CO.**

DEPT. M 306 BOYD STREET-LOS ANGELES 13, CALIFORNIA

## "TERRIFIC" WAR SURPLUS BARGAINS

### ACHROMATIC TELESCOPE OBJECTIVES



Perfect Magnesium Fluoride Coated and cemented government surplus achromats. Made of finest Crown and Flint optical glass; are fully corrected and have tremendous resolving power. Guaranteed well suited for Astronomical Telescopes, Spotting Scopes, etc.  
48m/m (1-7/8" ) Dia. 600m/m (23 1/2") F.L. ea. \$10.75  
73m/m (2-7/8" ) Dia. 876m/m (34 1/2") F.L. ea. 25.00  
76m/m (3" ) Dia. 381m/m (15" ) F.L. ea. 19.00  
81m/m (3-3/16" ) Dia. 622m/m (24 1/2") F.L. ea. 22.50

### 6-POWER MONOCULAR



Army used, but optically perfect, light weight, approximately one lb., 30 mm objective, focusing eyepiece. Small, compact, easily carried in pocket. Ideal for Bird Study, Sports, etc. **Postpaid \$15.00.**

### KODACHROME PROJECTOR LENS SET

for 35m/m slides: includes 2 Achromatic Lenses, Condensers, Heat Absorbing Glass and Instructions.....ea. **\$3.10**

### SPOTTING SCOPE or MONOCULAR LENS SETS

Consists of cemented Achromatic objective, 2 prisms, eye and field lens and diagram. Buy 2 sets to construct a High Power Binocular.

8 Power Set...ea. **\$5.25** 13 Power Set...ea. **\$ 7.75**  
11 Power Set...ea. **6.00** 27 Power Set...ea. **11.85**

## SPECIALS!!!

7X50 Binocular Objectives, Coated and Cemented...ea. **\$3.75**  
6X30 Binocular Prisms.....ea. **1.00**  
7X50 Binocular Prisms, Coated.....ea. **2.00**  
Kellner Eyepiece Lens Set, 22m/m F.L.....ea. **2.50**  
Polaroid Filters 60m/m dia.....ea. **1.25**  
Tank Prisms, Silvered 5 3/4" long (Seconds).....ea. **1.00**  
10 Assorted Lenses (Hobbyist Set).....ea. **1.00**

500,000 Lenses and Prisms  
Send 3c stamp for "Bargain" List

**A. JAEGER'S** 93-08P 95th AVE. OZONE PARK 16, N. Y.

## WAR SURPLUS BARGAINS

## Outstanding MECHANICAL, ELECTRONIC Buys!

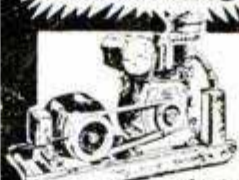

• Power Plants. Nearly new and perfect. 110-volt, 60-cycle, 2500-watt units. Well known make. Fine for farm, cabin etc. **Original Cost \$535.00 SALE \$229.80**

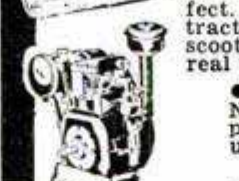

• Gas Engines. Nearly new and perfect. Briggs ZZ 6.5 h.p. Useful tractor, elevators, pumps, scooters, buzz saws, etc. **A real value. Original Cost \$140.00 SALE \$86.90**



• Rotary Gear Pump. New. High vacuum and pressure. Hundreds of uses. 1/2 inch drive shaft. **Original Cost \$38.65 SALE \$3.95**

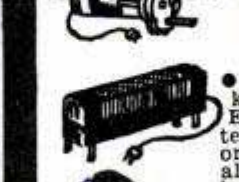

• A-C Motor. New. Reduction gear with four shafts. Speeds of 8, 32, 320 and 4000 r.p.m. Useful buffers, grinders, drills, etc. 110-volt, 60-cycle. An experimental wonder. **Original Cost \$38.75 SALE \$8.75**



• Electrical Room Heater. New 110-volt, 60-cycle, 1600-watts. Latest Chromalox highly efficient elements. A top flight heater. **Original Cost \$29.60 SALE \$12.80**

• Electrical-Electronic experimental kit. Permits hundreds of experiments. Eaves-dropping, private telephone, electrical theory, radio set, burglar alarm, etc., etc. Ideal for boys Xmas present. Full instructions. Educational — fascinating — scientific. **Parts Cost \$15.00 SALE \$4.77**

We pay all freight and postage charges in the U.S.A. Order direct from ad or send for catalog giving full description of our many bargains. We accept personal checks. Our references—NATIONAL BANK OF COMMERCE.

**LECO ENGINEERING CO.**

BOX 908-PM11

LINCOLN, NEBR.

# Christmas Specials IDEAL GIFTS

**Centrifugal Mercury Clutch** (3/8-inch shaft). Suitable for motor scooter, garden tractor, lawn mower or other units powered by electric motor or gas engine. Use as replacement or spare. Special purchase stock, each unit perfect and in original package. A \$28.50 value—your price, only \$7.95, postpaid. Not Warranted. Send check or M. O.



**Head and Tail-Light Combination** . . . for bike or scooter, or as auxiliary on truck, car, tractor, motorcycle. Special 6-volt bulbs, suitable for generator or battery. Every set in perfect condition. A \$2.75 value; your price, only \$1.49, postpaid. Send check or M. O.

**WEISHOR CORPORATION**

1029 N. 7th St., Milwaukee, Wis.



★ **ROUTE MEN!**  
★ **SPORTSMEN!**  
★ **CYCLISTS!**  
★ **FARMERS!**

Keep Warm and Comfortable in an  
**"Outdoorsman" Fur Cap**



Warm . . . comfortable . . . weatherproof! Handsomely made of water repellent tan tackle twill with genuine Beaver shade Mouton fur ear flaps, neck warmer and peak. Ideal for all your winter outdoor activities. Also available in red Mouton for hunters. State size when ordering.

ONLY  
**\$5.95** Post Paid

**MONEY BACK GUARANTEE**

— Order today — Use coupon below —

**MID STATES FUR CO.**  
Dept. M, Box 1377  
Shorewood 1, Wisconsin

Name \_\_\_\_\_  
Address \_\_\_\_\_  
City \_\_\_\_\_ Zone \_\_\_\_\_ State \_\_\_\_\_  
Size \_\_\_\_\_ Check \_\_\_\_\_ Money Order \_\_\_\_\_

# BUILD THIS HOUSE Yourself



Designed by Popular Mechanics and Famous Architects. Every Detail Simplified and Explained. No Previous Experience Needed!

Can you use everyday tools as well as the average Popular Mechanics reader? Then you, too, can easily build this modern house in any of its five designs, doing every part of the job yourself. The new Popular Mechanics Book, "Your Home—How to Build It Yourself" will show you how.

### Space for Living and Family Growth

This beautiful, modern house is 1½ stories, with basement, living room, kitchen, dining nook, two bedrooms, bath, plenty of closets and space for two additional bedrooms on second floor. The house itself is 35' 9"x28' 11"; breezeway 20' 10"x8'; garage 20' 10"x12'.

### The House That Has Everything

Designed for easy construction and the most living space for the least cost, the Build-It-Yourself House is also most attractive and suitable for any community and most income groups. The basic plan is adaptable to four other exterior designs.

### Get Book and Plans Now—Build When You Can

You may never have thought about actually building a house yourself, but now that building restrictions have been lifted, it is easier than you think. So order book and plans today. Even if you engage a contractor to build for you, you will need the plans. And you certainly will want the book which can easily save you hundreds of dollars, whether you build this or any other house.

## MAIL COUPON FOR BOOK AND PLANS

**POPULAR MECHANICS PRESS**

200 E. Ontario St., Chicago 11

I enclose \$\_\_\_\_\_ Send me the items checked at once.

- Your Home and How to Build It Yourself . . . . . \$ 3.00  
 Complete set of plans for Popular Mechanics Home . . . 12.50  
 Book and plans at reduced price . . . . . 14.00  
 Duplicate sets of plans . . . . . 5.00

Name \_\_\_\_\_  
Address \_\_\_\_\_  
City \_\_\_\_\_ Zone \_\_\_\_\_ State \_\_\_\_\_

## The Famous Popular Mechanics House

The picture below is from an actual photograph of the Build-It-Yourself House with breezeway and garage, as built by Jack Brownson, 23-year-old veteran, in Aurora, Illinois.

## Mail Coupon for New Book and Plans!

Build It Yourself or Have It Built—Save Hundreds of Dollars!

### PLANS YOU CAN READ AND FOLLOW

Plans consist of ten working-size blueprints—floor plans, elevations, construction notes, framing, joints, lumber and mill list, specifications, plumbing and wiring diagrams. Every measurement is marked—every detail made clear as ABC. Book has 100 pages—three-fifths are photographs and drawings. Some sections in colors, showing just how your house will look when finished.

**BIG BOOK**  
8½x11 inches



## • 2 BIG UTILITY ITEMS •

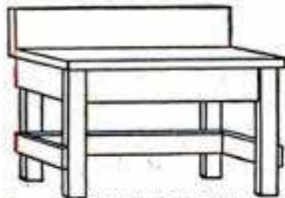

### WORK BENCH

An outstanding value. In a few minutes you have a real work bench. 71 inches Long.

ONLY \$8.50  
35 inches High and 20 inches Wide.  
fob Chicago (weight 71 lbs.)

at Big Savings  
Pre-cut and READY TO ASSEMBLE. Made of Kiln dried pine. For the Home Mechanic or Craftsman.

JAR STORAGE  
Every housewife appreciates this jar storage space. Holds 90 quarts or 130 pints. Ideal for Basement or Closet. 24" Wide, 48" High and 12" deep. ONLY \$5.65  
fob Chicago (weight 34 lbs.)

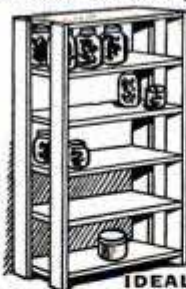

IDEAL XMAS GIFT

### GEE LUMBER CO.

Dept. K-11, 2600 West 79th St., CHICAGO 29

## \$4.95 REAL ENGINE VALUE

A miniature gas engine that really operates.

Thousands of Buzz "B" gasoline engines have been sold at twice the price. Now is your chance to buy a real 1/6 H.P. gas engine for only \$4.95. Turns up over 8,000 r.p.m. For boats, planes, midget cars, etc. Guaranteed and ready to run. Includes Champion spark plug and tank. Send only \$1.00, engine shipped collect for balance, same day.

WRITE FOR FREE CATALOG OR SEND 10c FOR NEW MAMMOTH ILLUSTRATED CATALOG OF THOUSANDS OF HOBBY ITEMS.

America's Hobby Center, Inc., Dept. B-118, 156 West 22nd St., N. Y. 11

## HEAVY CAST ALUMINUM BLOWER ONLY \$11.25

SINGLE EXHAUST BLOWER DELIVERS APP. 100 CU. FT. AIR PER MINUTE. Excellent for Coal Furnace Blower. Gives hotter water, faster . . . Removes gas fumes from garages. Install it yourself with any household tools. 110 V., A.C., 50-60 cycles. Cont. duty motor.

DOUBLE EXHAUST BLOWER. 2 heavy cast alum. housings. Double intake and exhaust. \$16.85. Add 50c handling; \$1 west of Miss.

Send check, M.O. Money-Back Guar. Free Lit.

UNIVERSAL YONKERS CORP.  
137 Alexander St. (M-11) Yonkers 2, N. Y.

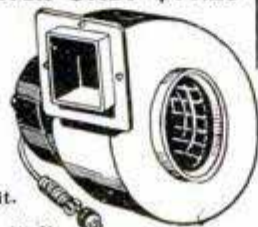

# INVENTORS

Whether an invention is patentable can be substantially determined by a search of the U. S. Patent records. Without obligation, write for information explaining the steps you should take to secure a patent.

## JOHN N. RANDOLPH

Registered Patent Attorney

201 Columbian Building, Washington 1, D. C.

## WHEELS + WHEELS

5-in. disc wheel, 5/8-in. tire, 5/16-3/8 sleeve . . . . . \$ .30  
6-in. disc wheel, 5/8-in. tire, 5/16-3/8 sleeve . . . . . \$ .35  
7-in. disc wheel, molded tire, 3/8-in. sleeve . . . . . \$ .45  
8-in. disc wheel, 1 1/2 tire, 1/2-in. sleeve . . . . . \$ .70  
7-in. disc wheel, 1-in. tire, 1/2-in. B.B. . . . . \$ .80  
8-in. disc wheel, 1 1/2 tire, 1/2-in. B.B. . . . . \$1.00  
10-in. disc wheel, semi-pneumatic 1 3/4 tire, 1/2-in. B.B. . . \$1.50  
Above wheels painted red.

10-in. alum. wheel, semi-pneumatic 2 3/4 tire, 5/8-in. B.B. . . \$4.50  
Hub caps for 5", 6", 7" wheels \$.03 extra. Plus Postage

UNITED WHEEL STAMPING CO., 2756 W. 115th St., Chicago, Ill.

## FASTEST PLANER in the WORLD at this Low Price... \$215.00

### BELSAW Multi-Duty Planer

Speed up production! Increase your profits! BELSAW power self-feeds at 24 feet per minute. . . The lowest-priced surfacer that will handle 12 x 6 in. stock. Planes green or dry sawed lumber into smooth, worked forms. Three high-speed steel knives make 42 cuts per inch. Multi-duty BELSAW takes inexpensive attachments for all planing mill operations — Jointing, Rabbling, Grooving, Matching. BELSAW is the only 12 in. planer providing attachments for jointing and grinding its own knives. Start planning NOW for BIGGER VALUE and BETTER PERFORMANCE, with BELSAW. Write for FREE specifications, illustrations and low prices.



● LARGER CAPACITY ● FASTER OUTPUT ● KNIFE SHARPENING ATTACHMENT

BELSAW MACHINERY CO B1011 Field Bldg., 315 Westport Rd., Kansas City, Mo.



ARCHITECTS! DRAFTSMEN!  
ENGINEERS! STUDENTS!  
YOU NEED THESE C-THRU  
TIME SAVERS...

## C-THRU ADJUSTABLE TRIANGLE... ONLY \$4.00

A sturdy clear plastic adjustable triangle — will save you hours each week. Plot angles from 0° to 90° in a jiffy. Accurate angular scale set quickly by a twist of brass thumb screw. You'll discover many other valuable features when you own a C-THRU Adjustable Triangle . . . get yours today.



## C-THRU 12" SPEE-DOTTER... \$1.50

Draw dotted lines with one stroke of your pencil or pen. Clear plastic . . . may be used for drawing accurate parallel lines or as metric or inch ruler. Interchangeable templates produce evenly spaced sharp (a) dotted lines (b) dash and dot lines (c) dash and two dot lines as illustrated:



(a)----- (b)----- (c)-----  
Your Dealer Has C-THRU Drawing Supplies . . . or order from:

C-THRU Ruler Co.

WINDSOR STREET, HARTFORD, CONN., U.S.A.



# REPAIRS

FURNITURE, LUGGAGE, ETC.

It's transparent, water-proof, flexible and durable.



# DUCO CEMENT

REG. U. S. PAT. OFF.

See You Saw It in Popular Mechanics

# "DANGDEST THING YOU EVER SAW!"

## Flex-O-Pic

An Amazing Convenience around  
AUTOS  
RADIO SHOPS  
AIRPLANES  
BOATS  
ALL HOME WORKSHOPS

WORKS  
AROUND  
CORNERS!

### A Specialty Tool for HARD-TO-REACH PARTS AND PLACES

Specially invented for tricky service jobs. Expanding and retracting fingers in flexible housing reach in anywhere and grab ahold of anything. Works around corners, S-turns, etc. 100 different uses around the home or shop. Mother will like it too. Try it on a 5-day money-back guarantee. Send name and address for C.O.D. delivery, or send \$1.00 now, and we ship prepaid. Descriptive circular free.

NOW ONLY \$1.00

#### DEALERS:

This is a terrific item! Write for complete details.

### EMCO ENTERPRISES, Inc.

6750 Stony Island Dept. PM-11 Chicago 49, Ill.

NONE BETTER!

## SUPER DRILL GRINDER

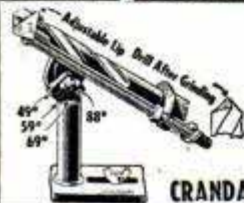

Sharpens round shank drills from 3/32" to 1/2" in diameter, up to 6" long. Grinds old drills like new in 4 different point angles, using hand or power grinding wheels. Money-back guarantee.

Price only \$2.95  
At Dealers or Postpaid

CRANDALL MFG. CO. 1512 W. Slauson, Dept. FA-35, Los Angeles 44, Calif.

## ELECTRICITY Anywhere



for HOMES FARM SHOPS BOATS RADIO USE

Onan gasoline-engine-driven Electric Plants supply reliable, economical electric service for any use. Portable, stationary or standby models. Water or air-cooled, compact and rugged.

A.C.: 350 to 35,000 watts in all standard voltages and frequencies. D.C.: 600 to 10,000 watts. 115 and 230 volts. BATTERY CHARGERS: 500 to 3,500 watts; 6, 12, 24, 32 volts.

Write for folder

D. W. ONAN & SONS INC.  
2547 Royalston Ave., Minneapolis 5, Minn.



### WORLD'S MOST POWERFUL

Completely Different Than Any Other!

## HY-SCORE

### AIR PISTOL

Famed HY-SCORE used by experts. Expensively made. Looks and feels like a Luger. Revolutionary mechanism blasts pellets at close-to-firearm speed. EXTREMELY ACCURATE. Cal. .177 or .22. \$19.85 including 500 HY-SCORE pellets (pellet value \$1.49 for cal. .177, \$1.88 for cal. .22). Also sample dart.

If your dealer cannot supply, write for free booklet, Dept. PM-11

HY-SCORE ARMS CORP. • BROOKLYN 1, N.Y.



### A GREAT SURPLUS BARGAIN

## AIR REGULATOR and GAUGE

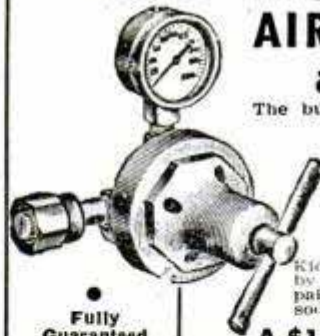

The buy of a lifetime in a standard make air pressure regulator. Used on liquid carbonic tanks and air pressure tanks of all kinds to regulate the pressure. Fitted with standard 1/2 inch pipe thread. Dial calibrated 0 to 200 lbs. Reduced pressure 0 to 150 lbs. Made by U. S. Gauge, Air Reduction Co., Walter Riddle—all famous makers. Used by artists for air brush work, sign painters, retouchers, welders, etc., soda fountains and taverns.

• Fully Guaranteed  
• All Brand New and in Perfect Condition

A \$15.00 VALUE \$5.95 (Wt. 4 lbs.)

Price F. O. B. Chicago. Immediate delivery. Sold on money back guarantee. Send check or money order today. Write for free folder.

C & M EQUIPMENT CO.

1831 S. State St., Dept. D-11, Chicago 16, Ill.

## AIR AND LIQUID TANKS



at New Low Prices \$3.59

WHY PAY MORE! f.o.b. K. C., Mo.  
Non-rusting stainless steel; 10 gallons liquid capacity; 12" diameter, 24" length. Holds up to 400 pounds safe air pressure. Ideal for water supply in home trailers, bottled gas, air horns and brakes, floating rafts, buoys, compressed air. No operating cost; fill free at any filling station. Price list of accessories (air hose, gauge, fittings) on request.

The Original

### MIDWEST BUY-ANYTHING CO.

Not Connected with Firms of Similar Names

Dept. M, 1520 Locust

Kansas City, Mo.

## HOME EMBOSSING KIT

For Raised Letter Writing

Now you can emboss Xmas and Greeting Cards, Stationery, etc., and earn extra money. Enough for 1000 signatures. Simple instructions. Send only \$1.00 today.  
BARRY SERVICE CO., 3107 George St., Chicago 18, Ill.

## WHAT TO MAKE SERIES



Send for your copy of the new 1948 clothbound edition now! Keep your set up to date. This is the 9th in this famous series of Home Workshop and Hobby Guides. If you do not have the earlier volumes you are missing a wonderful source of inspiration for making fascinating things at home. Every book is different... contains material not in the other volumes.

POPULAR MECHANICS  
1948  
EDITION

Partial contents: Birdhouses, sideboards, benches, furniture, book ends, chairs, toys, games, photo equipment, Dutch windmill, leathercraft, bookbinding, ship and yacht models, recaning chairs, fruit baskets, bob-sled, hamper, garden furniture, log cabins, porch furniture, tables, hostess trays, footstools, desks, lamps, fireplace screens, bookcases, wall cabinets.

### PACKED WITH FUN AND PROFIT FOR EVERY HOME CRAFTSMAN

Nine big books.....1900 pages, 4000 pictures  
\$1.75 a volume.....\$14.00 for set of nine

POPULAR MECHANICS PRESS, 200 E. Ontario St., Chicago 11, Ill.

Please send What to Make books as checked below. I will pay postman price and few cents postage. It is understood my money will be refunded if I'm not satisfied.

What to Make Vol. 9.....\$1.75  
What to Make Library (9 vols.).....\$14.00  
Postage paid if remittance accompanies order.  
Outside U.S.A. 15% additional.

Name \_\_\_\_\_  
Street and No. \_\_\_\_\_  
City \_\_\_\_\_ Zone \_\_\_\_\_ State \_\_\_\_\_

# Quick Strip

ONLY 79¢ Prepaid

**AMAZING NEW WIRE STRIPPER**  
Simple, fast, easy. Strips insulation from wire sizes Nos. 12 to 22. Hardened, ground blade contains 3 calibrated stripping slots, 1 wire cleaning slot. Also will remove braided metal shielding. Small, sturdy, compact, useful in close quarters. Blade may be sharpened or easily replaced. Colorful plastic handle. Invaluable for radio and television men, auto mechanics, electricians, home handy men and hobbyists. If your radio or hardware store can't supply you, send order direct to us. **JACO PRODUCTS CO., Dept. PM, 6408 Euclid Avenue, Cleveland, Ohio.**

## NEW SAW EASY HANDLING BIG POWER

New American Portable Electric Saw saves time, labor and money in production work. Not a hobby tool. One hand operation. Cuts any angle. 8" blade. Write... give occupation.

**AMERICAN**  
FLOOR SURFACING MACHINE COMPANY  
535 So. St. Clair St. Toledo 3, Ohio

## \$295 REAL DIESEL ENGINE

DEEZIL'S so popular we're selling thousands. So—production's up... cost to you is way down for a real diesel engine. **LOWEST PRICE ON THE MARKET. DEEZIL is a precision engine.** An carefully machine-tooled, a giant Army motor. Actually runs at 7500 RPM. Produces 1.7 HP. Send for your DEEZIL KIT TODAY \$2.95 plus 15c postage.

Ideal for planes, boats, midget cars.  
**GOTHAM HOBBY CORP.**  
107 East 126th Street Dept. P New York 35, N. Y.

## INVENTION SALES SERVICE

If you have a good invention or an idea for one, send for our free list of inventions wanted by manufacturers, plus details about our sales service.

**MANUFACTURERS INQUIRIES INVITED**  
We service about 200 firms with new inventions, and can service many more in nearly every conceivable line. Write, telling us your requirements in complete detail for best results.  
**INVENTORS SALES BUREAU**  
208M CLINTON OAK PARK, ILL.

## EASY-TO-BUILD PEDAL TRACTOR

Note to Dads: If you want to build Sonny something that will make him the envy of all the kids stop right here—this is it! Novel, easy to make in home workshop. For complete plans send 50c to **CRAFTPLANS, Dept. 130, 7241 Madison, Kansas City 5, Mo.**

## Individual Bench Legs—Steel or Aluminum

Make any size Table, Work Bench, or Power Tool Stand, EASILY, with four of these STURDY Steel or Aluminum legs, Wood Top of any desired size, and Wood shelf. Quickly attached, with only three wood screws or stove bolts per corner. Two heights: 28" for table saw, jointer, belt sander, or band saw; and 32" for lathe, jig saw, or drill press. Packed four legs with brackets attached in corrugated carton. Price, \$5.95 for 28" height; \$6.45 for 32" height. Rubber feet, 85c extra per set 4 feet. POSTPAID on receipt P.O. Money Order or Check.

Dealers Write Illustrated Circular Free  
**J. N. MACKENZIE**  
194 Christiana St. N. Tonawanda, N. Y.

## STAR UNIVERSAL NO-LEAK TESTER

AT THE BENCH AT THE JOB  
TEST LAMP SHOWS CONTINUITY  
Test CONTINUITY ON THE SPOT, anywhere, in factory or home. No batteries. Just plug into any 110 volt receptacle. Locate open circuits, dangerous grounds in motors, fixtures, etc. Vest pocket size—wt. 2 1/2 oz. Also unexcelled for line testing, 110 to 600 volts.  
**A NECESSITY for Electricians, Maintenance Men, Home Owners**  
No-leak neon lamp in one test prod shows definitely what is wrong... and where. At \$2.50 most dealers, or direct from us postpaid.  
**A Mighty Useful Xmas Gift**  
Order NOW. Address Dept. M

**STAR FUSE CO., 233 Canal St., New York 13, N. Y.**

## THE GREATEST THING IN PLASTICS!

# PLASTICAST



## A NEW HOME INDUSTRY AND HOBBY!

**PLASTICAST** is a transparent liquid plastic; can be poured into ANY kind of mold or container. Hardens in a few minutes into a transparent solid, clear-as-glass, tough as steel plastic! No tools machinery or skill required. IDEAL for imbedding pretty flowers, butterflies, photos, medals, souvenirs, biological specimens, etc. Makes a PERMANENT and ATTRACTIVE display. Make attractive jewelry, gems, lenses, knick-knacks, novelties. Easily cast into sheets, rods, blocks, ANY color, ANY shape! EVERYTHING furnished, including molds, for making about \$50.00 worth of unusual novelties! **PLASTICAST OUTFIT, Complete with 3 molds... \$3.50**

**PLASTICAST OUTFIT MAKES UNFORGETTABLE TREASURED CHRISTMAS GIFT! WE WILL ENCLOSE YOUR CARD.**

**PLASTIDUR... (LIQUID IVORY).** Ideal for casting all OPAQUE articles. Hardens in a few minutes into an extremely hard IVORY-like plastic! May be dyed any color or cast into any shape. Works in EVERY type of mold! Non-inflammable, waterproof, DURABLE. Ideal for statuary, novelties, figurines, toys, gadgets, tools, knobs, bases... a million useful applications! Outfit comes complete with molds, dyes, accessories, instructions, etc. for making about \$100.00 worth of attractive jewelry, etc! **\$5.00**

**PLASTIDUR OUTFIT, Complete with 3 molds... \$5.00**  
Our Casting Plastics are as easy to use as pouring water out of a glass!  
**TERMS:** We pay the postage (U.S.A. & Canada only) if full cash accompanies your order. C.O.D. accepted (U.S.A. only) if \$1.00 deposit is included for each item ordered. C.O.D. orders not postpaid.

**FREE** A very attractive and useful novelty made with one of our plastics given absolutely free with every one of our catalogs! Catalog lists many new materials for making **MOLDS and CASTINGS** with Liquid Plastics, Liquid Marble, Latex, Elastex, Castwood, Wax, Metals, Plaster, Shellcraft, Internal Carving, Molds, Moulage, etc. Price of catalog only 10c.  
**DEALERS: WRITE FOR ATTRACTIVE WHOLESALE PRICE LISTS**  
**PLASTICAST CO. (Dept. C)**  
5961 Madison St. Chicago 44, Illinois (Order by mail only) P. O. Box 987 Palo Alto, Calif.

## Liquid Live Rubber

Turn spare time into extra dollars with our Rub-er-spra. Make genuine rubber molds that cost only a few cents each and cast thousands of fast selling novelties. Send 25c in coin for catalog.  
**KEN-DOR STUDIO (formerly Stewarts Studio)**  
949 George St. Lake Geneva, Wis.

## SAY YOU SAW IT IN POPULAR MECHANICS

## PAINT SPRAYER WITH ELECTRIC MOTOR

Sensational Value!  
**Complete Only \$19.95**

**DOES ALL ORDINARY PAINT SPRAY JOBS**  
Positively unheard of 'til now—an electric powered sprayer outfit at such a low price. Not a toy! Not a makeshift. It's a real, practical all-purpose sprayer outfit complete with compressor, 110 volt A.C. or D.C. electric motor, suction type, continuous flow spray gun, paint container, 10 ft. air hose, 6 ft. electric cord and plug. Use it for home shop, auto and 'round the house jobs, and do a good job—quick. Rush order today. Only \$19.95 complete. Send check or M.O. If C.O.D. send a five dollar bill for deposit.  
Uses Lacquers, Varnishes, Paints, Etc.  
Weights Only 8 lbs. Portable. Use it Anywhere.

**HOME SHOP PRODUCTS CO.**  
DEPT. 18, 4821 SHERIDAN ROAD CHICAGO 40

# BUILD YOUR OWN TILTING ARBOR SAW!

Exclusive GIL-BILT Build-It-Yourself Features

- \* No machining—build easily with hand tools only
- \* No blueprint reading—step-by-step pictorial plans, full scale patterns, actual photographs
- \* Sturdy wood, aluminum, and steel construction

SAVE \$50 OR MORE

## GIL-BILT 10 INCH TILTING ARBOR SAW



- 27x28 in. table, 13 1/2 in. capacity in front of blade
- 10 in. blade cuts 3 1/4 in. deep, tilts full 45 degrees
- Floor model, 34" high table always stays level
- New Departure ball bearing arbor, 3/4 in. precision shaft, ready to run
- Jackscrew and 4 1/2 in. dia. handwheel lowers and raises blade
- Cast aluminum miter gauge and self-aligning rip fence guide

GIL-BILT Metal Parts Kit includes Plans, Ball Bearing Arbor, Miter Gauge and Bar, Rip Fence Guide, Machined Lock Knobs, Jackscrew Mechanism and Handwheel, and All Other Metal Parts (less blade).....\$20.95  
Same Kit with 10" comb. blade..... 25.90  
Same Kit with 8" comb. blade..... 24.90

## GIL-BILT 8 INCH TILTING TABLE SAW



- 21x27 in. table tilts full 45 degrees, 13 in. capacity in front of blade
- 8 in. blade cuts from 0 to 2 1/2 inches
- New Departure ball bearing arbor, 5/8 in. precision shaft, ready to run
- Cast aluminum miter gauge and self-aligning rip fence guide (same as above)

GIL-BILT Metal Parts Kit includes Plans, Ball Bearing Arbor, Miter Gauge and Bar, Rip Fence Guide, Machined Lock Knobs, Tilt Support Segments, and All Other Metal Parts (less blade).....\$15.95  
Same Kit with 8" Combination Blade..... 19.90

## GIL-BILT 12 INCH BAND SAW



- Cuts to center of 24 in. circle
- Handles stock up to 6 in. thick
- Fully enclosed mechanism for utmost safety
- Wheels turn on heavy 5/8 in. shafts, four Oilite bronze bearings
- 18x18 in. table tilts 45 degrees
- Upper wheel tension and tilt mechanism of cast aluminum; completely assembled
- Two blade guides, each has ball thrust bearing, self-lub bronze jaws
- Rubber tired wheels. Choice of cast alum. or make-your-own wood wheels on metal hubs
- Uses standard 78 in. blades up to 3/8 in. wide
- GIL-BILT Metal Parts Kit includes Plans, rubber tires, 3/16" blade, hubs for wood wheels, bearings, shafts, tilt mechanism, guides, tilt support segments, and all other metal parts.....\$16.95  
Same kit with two ready-to-install 12" cast aluminum wheels 20.95

NO DEALERS—ONE LOW PRICE! Prices include postage up to 500 miles. Send cash, check or money order for complete kit, or send \$1.00 for Step-by-Step Plans and Order kit later less cost of Plans. Plans sent postpaid anywhere in the world.

## GILLIOM POWER TOOLS

Box 1-PM, Lambert Field, St. Louis 21, Missouri

COMPLETE PLANS only \$1.00

## LIGHT PLANTS

110/AC Volts — 2500 Watts

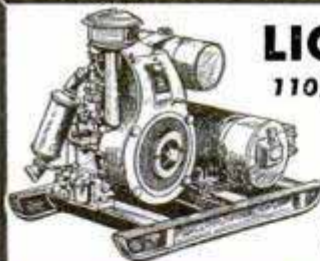

Powered by Briggs-Stratton 1-cylinder air-cooled engine. Very economical to operate; used; original cost, approx. \$480—

Sale Price . . . \$249.50

The Original  
MIDWEST BUY ANYTHING CO.  
DEPT. M,  
1520 Locust, Kansas City, Mo.

Write for FREE Illustrated Circular—Hundreds of \$\$\$-Saving Bargains

## SPEEDWAY 1/4" AC-DC DRILL

Put a sparkling finish on your car, boat, furniture, silverware, leather goods, etc. Simoniz your car in half the usual time!



## POLISHER & SANDER

High Pile Lambwood Bonnet with 7" polishing surface on heavy-duty flexible rubber disc. Also includes sandpaper disc . . . . .

\$1.95

## SPECIAL COMBINATION OFFER!

### DRILL & POLISHER only \$1265

10 pc. high-grade drill set from 1/16" to 1/4" with metal stand—\$2.25 extra. Complete Prepaid

## SPEEDWAY BENCH GRINDER



One of the most popular grinders built! Check all these specifications: Speed 3400 RPM, Rating 1/15 Horsepower, Intermittent Duty, Motor Shaded Pole AC, Grinding Wheels 4 1/2" x 3 1/2" x 3/8", Voltage 110-120 AC, Length 8", Height 6". Self-aligning Bronze Bearings. Beautifully finished in blue crackle, complete with 2 grinding wheels, built-in thumb switch—installed near base, and 6 ft. rubber covered cord with unbreakable plug. . . . . \$1498

WE PAY POSTAGE — Send Check or Money Order Today — MONEY BACK GUARANTEE



FREE!

SPECIAL GIFT!

7 piece Slip-On Socket Set . . . sizes 1/4" to 7/16" . . . with the purchase of either the Bench Grinder or Grinder Kit. Regular Price \$1.50.

## SPEEDWAY GRINDER KIT

Ideal for home craftsmen, mechanics, handy men, model makers, etc. Consists of powerful, all-purpose Speedway Grinder, with collets for 3/32" and for 1/4" arbors, and 16 selected rotary files, mounted stones, discs, brushes and wheels. It cuts, grinds, cleans and polishes . . . works in wood, metals, bone and plastics. Complete kit, encased in beautiful, sturdy simulated leather box. Excellent for gifts!



only \$13.98 complete

## THE ORDER MART, Dept. Q

62 Warren Street, N. Y. C. 7 - WO 4-3497



The Modern PLASTIC for lasting Home Repairs

PERMANENTLY mends cracks or holes in wood, tile, stone or plaster. Sticks and stays put—Does not chip, shrink or fall out. Easy to use. Economical. Mold it, chisel it, polish or paint it. If unobtainable from your lumber, paint or hardware dealer, the big 4-lb. can will be sent you postpaid (in U.S.) for only \$1. Full money-back guarantee, order now.

DONALD DURHAM CO.  
Box 804-W, Des Moines, Ia.



## Ask Your Hardware Store for FULLER'S Unbreakable Amber Handle SCREW DRIVERS

America's most popular line of moderately-priced screw drivers! Wide range of sizes. FULLER TOOL CO., Inc. 911 Faile St. New York 59 World's largest makers of Amber-Handle Tools

## DUAL CROSS and ROTARY FEED

### PALMGREN ROTARY, INDEX, MILLING TABLE No. 83

Has 8" table, 360° movement and 4" cross feed travel. Adjusting wheels and dials graduated in degrees and thousands. Slotted for bolting to table. No. 83 Priced \$49.50. No. 82 without rotary feed \$39.75. Write for Circular No. 10 CHICAGO TOOL AND ENGINEERING CO. 8365 South Chicago Ave., Chicago 17, Ill.

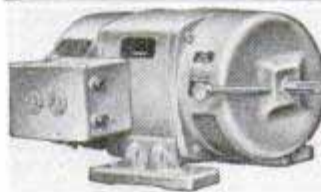

## LELAND ELECTRIC GENERATOR

2.5 KVA, 120 volt, 60 cycle, 1 phase, AC. Any comparable new generator will cost you twice our price.

Remit by Bank Draft HOPFER & COMPANY 3124-A E. 14th St., Oakland, Cal.



## OWN THIS FINE 8 PC. COMB. BOX AND OPEN END WRENCH SET

in transparent leatherette roll. Made of hi-grade alloy steel and heat treated. 8 sizes 13/64 to 7/16. At your local dealer.

PRICES Retail \$3.00 per set Dealer \$24.00 per doz. sets DISTRIBUTORS WANTED

Send \$2.00 only for sample set postpaid.

STEPHENS TOOL WORKS Box 306, LaTiferaSta., L.A. 43, Calif.



**SENSATIONAL!... HARMIC'S**  
**New Alcohol Blow Torch**  
**with 1800° flame**

ONLY  
**\$2.00**

POSTPAID

Highest quality brass, triple-plated chrome finish. Extra heavy case. No moving parts — no adjustment — just fill with denatured alcohol and light. Absolutely safe.

Its 1800° F. flame is just the thing for preheating work . . . improving the quality of your soldering . . . bending glass tubing. Hundreds of uses in every home workshop.

Thousands of satisfied users. Order today. Send \$2.00 — cash or money order. We ship postpaid. No C.O.D. Money-back guarantee.

ORDER 2 — GIVE ONE FOR XMAS

TRINITY PRODUCTS

949 Commonwealth Ave., Boston 15, Mass.



**WAR SURPLUS**  
**TERRIFIC BARGAINS**

**ELECTRIC MOTOR** 1/2 H.P. 27 V.D.C. R.P.M. 4000 No. 750. FOR INTERMITTENT OR CONTINUOUS DUTY. 5/8" SHAFT. VARIABLE SPEED MOTOR. Can readily be adapted to 110 V.A.C. or R.E.A. line by simple method of rearranging armature brush leads. UNUSED. Instructions incl. Ea. **\$5.50**

**VALUABLE GEARS BARGAINS.** SELSYN CONTROL TRANS-Speed Reducer G.E. 10 to 1 or 5 to 1 ratio, 90 degree angle. Shaft Driven. 1/2" Spline Shaft with 3 mounting holes 5/16". **\$3.50** Ea. **SELSYN CONTROL TRANSFORMERS** Model #2J1G1. 57.5 Volts, 400 cycle. Can be used on 110 V. 60 cycles. Instructions incl. **\$1.00** ea. New.

**LUBE PUMP.** Brand new precision Gear Impeller pump. Pumps liquid up to 3 G.P.M. Pressure up to 200 lbs. per sq. in. For high vacuum, air pressure, operating Hydraulic units, etc. S.U'd. 1/2" threaded and keyed **\$3.50** Ea. Shaft Instructions Incl.

**PESCO GEAR TYPE UTILITY HYDRAULIC PUMP.** At 1750. exerts 1000 P.S.I. Hydraulic pressure and pumps over 2 gal per minute. Brand new. Ea. **\$7.50**

**VICKERS PUMP.** High Pressure Hydraulic pump. Use it for any type liquid pumping job. 400 gal. per hr. at 3750 R.P.M. rated 1000 P.S.I. Brand New. Only... **\$7.50**

**BRAND NEW WONDERFUL RATOR MOTOR.** For rotating Ham. FM Antennas, Turntables, Telescopes, etc. Operates directly on 110 V. A.C. 60 cycles (requires only 12 MFD Condenser) 3/4 R.P.M. Fine for operating Ventilating Louvers such as used with Attic Fans, Furnace Dampers or check drafts. Complete instructions incl. Ea. **\$3.95**

**SEXTANTS SURPLUS BARGAIN CLOSEOUTS.** Fairchild type A-10 army air force bubble sextant averaging type includes light system for night readings. Used but in good condition. Wood case includes accessories and instructions. **\$7.50** Ea.

**DYNAMOTORS. GREATEST VALUE IN YEARS.** All brand new G.E. Input 27 V. D.C. 485 KVA. Output 115 V. A.C. Wt. 16 lbs. Ea. **\$4.50**

**DYN. New Model PE-73-CM. G.E.** Input 28 V. A19, Output 1000 V. D.C. at 350 MA. Wt. 38 lbs. Ea. **\$4.95**

**DYN. New Model DY-22/ARC.** Input 28 V. D.C. Output 210 V. D.C. Cont. Duty. Ea. **\$1.50**

**DYN. New Model #23350.** Input 27 V. D.C. Output 285 V. D.C. Ea. **\$1.35**

**NEW CUNO OIL FILTER** aircraft type keeps oil clean without cartridge replacement. For all AUTOS, TRUCKS and TRACTORS. Install at home in a few minutes. STOP CHANGING MOTOR OIL. Instructions incl. Ea. **\$4.95**

SEND CHECK OR MONEY ORDER. NO C.O.D.'s. PRICES F.O.B. K.C.

**GENERAL SALVAGE COMPANY**

Dept. 61, 2920 E. 27th St. Kansas City, Mo.

**3000 WATT POWER PLANTS**

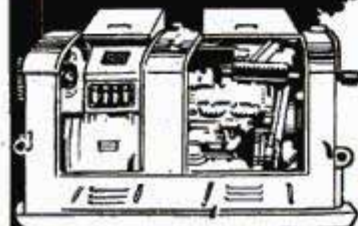

**AC 50 or 60 CYCLE SINGLE or 3 PHASE**

Famous Army M-5 Generator Power Unit. Save over \$100! Ideal for Camps, Mines, Farms, Resorts, etc. Just press a button and get electricity for every requirement! Single (3-1,000 watt circuits) or 3 phase (3-KVA units). 4 cylinder Hercules motor with complete instrument panel, self-starter and generator. Compact, portable, versatile. Built to endure. Guaranteed to give service comparable to brand new units. Only difference is in outward appearance. For quick clearance, reduced to only \$295.00 F.O.B.

**\$295.00 F.O.B.**

LEONARDS & LEE SURPLUS SALES

69-71-73 E. 75TH ST. DEPT. P-101 CHICAGO 19.

**SHINE and SAVE**

SHOE SHINES are easy with **HOME VALET**



Hammered finish cast aluminum. Fits all shoes. Demountable when not in use. If C.O.D., send \$1.00; pay postman balance \$1.75 plus postage. Money back guarantee.

**\$2.75** postpaid

ADD 15¢ for postage. **PREFERRED MERCHANDISE CO.** Box 923, Dept. D-1, Grand Central Station, New York 17, N.Y.

**MIRACLE "BENCH KING"**

The Revolutionary Vise in Solid Bronze . . . With Fingers . . . GIVES YOU AN EXTRA HAND! Comp. WITH ACCESSORIES . . . \$14.95

NOW . . . Our new model #65. For hobbyist or professional. Less Accessories . . .

**6.50**

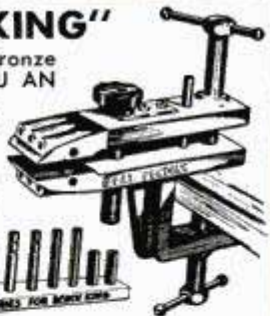

FREE! Our new catalogue describing "BENCH KING." Dealer's inquiries invited. Send check or M.O. with order. We prepay postage.

**BENJ. UYDESS & SONS, INC.**

964 E. 167th Street Bronx 59, N. Y.

**IF IT'S MADE BY LIONEL, YOU CAN GET IT AT MADISON HARDWARE**

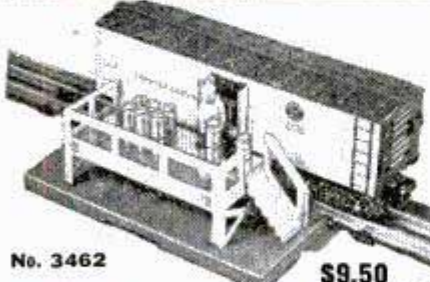

No. 3462 **\$9.50**

**OPERATING MILK CAR WITH PLATFORM** 7 miniature cans load through a roof hatch, and at each touch of the remote control button, door opens and milkman pops out to deliver a milk can to the platform. Car is 9" long, handsomely finished in white enamel. Platform of heavy gauge steel.

**Brand New!**  
**LIONEL STEAM-TYPE SWITCHER LOCO & TENDER**  
**\$25.00**



Real railroad-type knuckle couplers at front and rear make this handsome loco the workhorse of your layout! Goes forward or backward by remote control. Tender has thermostatically controlled bell; rear back-up light. Powerful headlight, realistic valve gear. Jewelled running lights, stainless steel handrails. For all gauges.

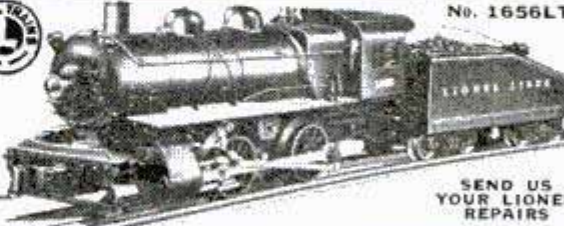

No. 1656LT

SEND US YOUR LIONEL REPAIRS

Madison has been World Headquarters for Lionel since 1909. We offer a complete line of Lionel Train Sets, Cars and Accessories. Write for big Train folder — it's FREE.

We pay postage on cash orders. C.O.D.'s accepted.

**MADISON HARDWARE CO., 103 E. 23rd St., New York 10**  
 Please ship \_\_\_\_\_  
 Quantity \_\_\_\_\_ Switcher Loco & Tender @ **\$25.00** each  
 \_\_\_\_\_ Milk Car with Platform @ **\$9.50** each  
 Send me **FREE** Big Train Folder.  
 Name \_\_\_\_\_  
 Address \_\_\_\_\_  
 City \_\_\_\_\_ Zone \_\_\_\_\_ State \_\_\_\_\_  
 Cash  M.O.  Check  C.O.D.

**MADISON HARDWARE CO., 103 EAST 23rd ST., N. Y. 10, N. Y.**

## NOTHING ELSE LIKE IT...

### Get this **REVERSIBLE** **2-in-1 Screw Driver**

(Stock No. DU2)

Combines a standard size Phillips (No. 1) Cross Point and regular ( $\frac{3}{16}$ " ) bit in ONE driver. Ends the hunt for that missing tool! Break and shock-proof plastic handle... oil tempered chrome vanadium steel blade. Precision-built throughout... no play or wobble. Fully Guaranteed. Finest tool you ever owned! Only 75¢



### 5-in-1 Screw Driver Kit

(Stock No. Z850)

Consists of leatherette tool roll, 1 break and shock-proof plastic handle, and 5 interchangeable oil tempered, chrome vanadium steel blades:  $\frac{1}{8}$ ",  $\frac{3}{16}$ ", and  $\frac{1}{4}$ " regular; No. 1 and No. 2 Phillips. Fits easily into back pocket. An ideal all-purpose screw drive kit. Fully Guaranteed. Price, only . . . \$2.50

### Gift Packaged Screw Driver Set

(Stock No. A6)

A beautiful assortment of 6 famous Amberly handled screw drivers in a blue enameled steel box. Very finest quality throughout! A set every man will be proud to own... the ideal gift. Square, round, stub and ignition size blades ranging from  $\frac{3}{16}$ " to  $\frac{1}{2}$ ". Fully Guaranteed. Price, only . . . \$4.50



See your Dealer, or send check or money order direct.  
We Pay Postage.

## VACO PRODUCTS COMPANY

317 EAST ONTARIO STREET, CHICAGO 11, ILLINOIS

## PROFITS AND SPEED

### THE **MODERN** LAWN MOWER **SHARPENER**

PRICE  
**\$241<sup>50</sup>**  
LESS  
MOTOR

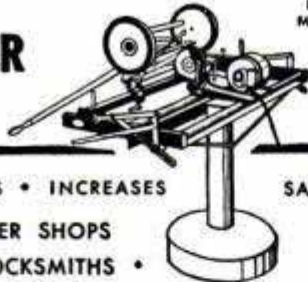

INCREASES PROFITS • INCREASES SALES!

FOR LAWN MOWER SHOPS  
FIXIT SHOPS • LOCKSMITHS •  
HARDWARE STORES • GOLF COURSES • SCHOOLS  
PARKS • PLAYGROUNDS • INSTITUTIONS •  
CEMETERIES • AND ALERT INDIVIDUALS!

Sharpens All Reel Type Mowers • Hand, Power or  
Gang • 10 to 20 Minutes • No Dismantling  
No Extra Attachments Needed

All reel type mowers, from 5-inch edgers to 36-inch power mowers, are quickly sharpened to extreme ends of both left and right twist reel blades. Handle, wheels, roller and motor remain in place when sharpening is in process. Bed knife is sharpened in same brackets that hold mower in grinding position. No extra attachments required. One lever puts mower or bed knife in grinding position. 100% steel construction. Grinding head rides on five ball bearing races. Small, compact, easy to operate. Sharpens wood chisels, joiner knives and planer blades without extra attachments.

Skate Sharpener Attachment Available

Send For Free Bulletin No. 10B

**ORDER  
NOW**  
Immediate  
Delivery

**MODERN MFG. CO.** 160 N. FAIR OAKS AVE.  
PASADENA, CALIFORNIA

## Air Pressure Transfers Liquids

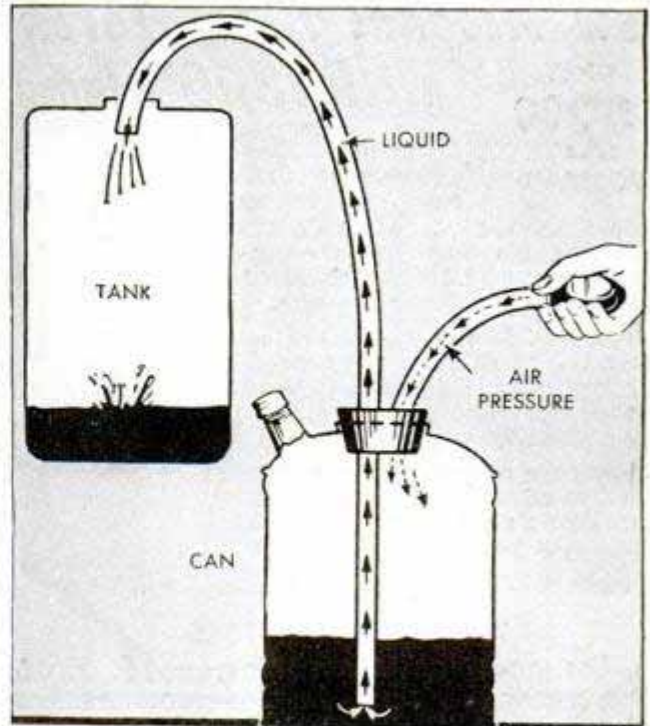

Liquids such as gasoline and kerosene are transferred from a container to a tank without spilling by a simple air-pressure device. It consists of a tapered plug that fits any standard can, two flexible tubes and a bulb. All parts are made of oil-resistant synthetic rubber. When the bulb is squeezed, air is forced into the first container forcing the liquid through the long tube, which has a built-in filter, and into the tank or container to be filled. It can also be used to start a siphon when the first container is higher than the second.

## Want to Live a Long Time? Then Move to Nebraska

If you want to live to a ripe, old age, your best bet is to move to Nebraska, according to a statistical survey worked out by a large insurance company. The survey, which covers only members of the white population, shows that people live longer in Nebraska than in any other state. The West North Central states, Minnesota, the Dakotas, Nebraska, Iowa, Kansas and Missouri, rank highest in the sectional compilation. There, women live to be more than 69 years old, while men average over 65. Shortest length of life is in the Mountain states: Idaho, Montana, Wyoming, Colorado, Utah, Nevada, Arizona and New Mexico. In that section, women average 66.03 years and men 60.98 years. Generally, the white population of the North has the longest average length of life, followed by the South and West in that order.

AN IDEAL AND PRACTICAL GIFT FOR ANY MAN!

The New Improved  
All-Purpose

# DYNAMIC Super Charged ARC WELDER

Industrial Transformer Type

**IT WELDS • IT BRAZES • IT SOLDERS**

**IDEAL FOR AUTO—HOME APPLIANCE AND FARM REPAIRS.** This portable, industrial transformer type welder easily carried right to the job can be operated from any convenient properly wired 110 Volt 60 Cycle Line. Can also be supplied for 220 volt 60 cycle operation and other voltages and cycles at slight additional cost. **EASY-TO-OPERATE.** If inexperienced you can easily learn to do a variety of high grade welding jobs by following the practical, simplified welding and operating instructions furnished. Once you see the **DYNAMIC WELDER** in operation you won't want to be without it. Its simplicity will amaze you. In a year the **DYNAMIC** only costs you about 7c a day. **COMES COMPLETE READY TO OPERATE WITH HELMET, RODS, CABLES, HOLDER, OPERATING AND WELDING INSTRUCTIONS, ETC.**

**SAVES YOU VALUABLE TIME AND MONEY!**

**DESIGNED TO DO HIGH GRADE WELDING** inexpensively—Maintenance Men, Farmers, Mechanics, Machine Shops, Foundries, Auto, General Repair and Job Welding Shops, all using the **DYNAMIC** find it so indispensable and useful that they can't afford to be without it. **WORKS ON IRON, STEEL, BRASS, BRONZE AND OTHER METALS.** Has 8 metallic and carbon arc heat stages. **DOES WORK YOU WOULD THINK ONLY POSSIBLE WITH A LARGER, MORE EXPENSIVE MACHINE.**  
**DYNAMIC WELDER CO., Dept. 118-R, 15 East 23rd St., CHICAGO 16, ILL.**

ONLY

**\$2850** COMPLETE

**Do Your Own Welding**

Just a few repair jobs will pay for this machine. A practical and profitable machine tool for any workshop... Make money doing repair work for others.

Write Today for Particulars

**GET DETAILS** on our 10 day Trial Offer.

Member Chicago Association of Commerce.



**SPECIAL GIFT OFFER! ELECTRIC ARC TORCH ATTACHMENT WORTH \$6.80**

**THIS TWIN CARBON TORCH** illustrated below for use with the **DYNAMIC** is unsurpassed for brazing, soldering, pre-heating and cutting on iron, steel, brass, bronze and other metals. With it you can greatly increase the profitable uses of your welder. Comes complete with instructions, carbons & cables. Does work of an Oxy-Acetylene Torch.

**MAIL COUPON FOR FREE DETAILS**

**10-DAY TRIAL OFFER**

**DYNAMIC WELDER CO., Dept. 118-R**

**15 EAST 23rd STREET, CHICAGO 16, ILL.**

Send me FREE details of your ELECTRIC Arc Torch Gift Offer and Dynamic Welder 10-Day Trial Offer.

NAME \_\_\_\_\_

ADDRESS \_\_\_\_\_

CITY \_\_\_\_\_ Zone \_\_\_\_\_ STATE \_\_\_\_\_

**Yours at No Extra Cost!**

For a limited time only we are giving away a Twin Carbon Electric Arc Torch worth \$6.80 with every **DYNAMIC WELDER**. This valuable premium is yours at the single low price of welder alone if you act now.

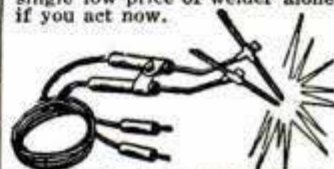

**BUILD HEAVY DUTY MACHINES**

**SAVE UP TO 90%**— You can build, using our practical, easy-to-read plans, all kinds of machines, for home, farm or shop—scooters, portable sawmills, metal working machines, concrete machinery of all kinds, printing equipment, woodworking machines, midget autos, dish washers, farm equipment, freezers, tractors.

**FREE CATALOG HANDBOOK NO. 13**  
**183 SETS OF PLANS**  
**VALUABLE INFORMATION**

**NICHOLS EQUIPMENT COMPANY**  
D-1610 PURVIS, MISS.

**SHARPEN CIRCULAR SAWS LIKE AN EXPERT**

With **SURE-SHARP** you can precision file your own saws for the home work shop. No experience necessary. Adjustable for any pitch or angle. Makes blades true and sharp. Complete with file and instructions. Money back guarantee. Cash with order, prepaid. Order Now!

**\$6.95**

**SURE-SHARP MFG. CO.** BOX 24, SANTA ANA 1 CALIFORNIA

**TUBULAR STEEL AXLES \$6.95**

**BUILD YOUR OWN TRAILER OR UTILITY FARM WAGON**

**FORGED COUPLER BALLS**  
2 in. dia.  
**90c**  
incl. Nut and washer

**58" tread width axle—1 ton capacity**  
**Fits Ford V8 or Plymouth wheels**

Higher tonnage axles and special tread widths available at reasonable prices. Axle also adaptable to Chevrolet wheels. Write for folder today. A post card brings complete details.

**C.A.R. PRODUCTS CORPORATION**  
1811 6th St. Wyandotte, Mich.

**GEIGER COUNTERS**

PORTABLE, RUGGED, COMPACT, LIGHTWEIGHT

Goldak, famous for its metal detectors, now brings you a new radioactive mineral locator, complete with meter, phones, batteries and tubes. Write for complete information.

**THE GOLDAK CO., 1544 W. Glenoaks, Glendale 1, California**

**Free Booklet on FLEX-O-SHAFT**

illustrating this all-purpose power machine with hand-piece that handles as easily as a pen. Motor with switch, foot-operated rheostat, and 66 accessories at special low price. Write

**FLEX-O-SHAFT SALES CO.**  
Dept. C Prairieview, Illinois.

**MODEL BUILDERS! HOME MECHANICS**

Send for the Handy All-Purpose, Lightweight 1 1/4 lb. **EASY TO CARRY!**

**WISE • \$1.95**

Strong, efficient, compact, for home or laboratory; machine or wood shop; dentists, jewelers. Extremely solid, accurately machined. Jaws offset to hold long pieces. Soft jaws will not mar. Flat anvil. Height 6", width of jaw 2". Max. jaw opening 2 1/2".

**ORDER NOW: E. M. DIETRICH**  
13619 Mapleridge Detroit 5, Mich.  
Postage prepaid with check or money order



# Announcing the NEW HURRICANE '48 Model PORTABLE ROUTER and Shaper

**Motor:** Universal, 110 volt AC-DC, 1 1/4 HP. Speed, 18,000 r.p.m. 30 load. Weight 11 1/4 lb., height 9 inches, diameter 4 inches. Switch conveniently located on body of motor with plug-in cable.

**Cooling:** Air cooled, by turbine type wheel.

**Bearings:** New Departure sealed ball bearings.

**Finish:** Outer housing all highly polished.

**Template Guide:** One 5/8" furnished with machine.

**Gauges:** Straight and circular of aluminum.



**124.50**

F.O.B.  
Chicago

A beautifully constructed precision machine for professional use. ORDER NOW at your dealer or direct. Firms not rated, 25% deposit required. Bal. C.O.D.

**HURRICANE MACHINE WORKS**

6316 WENTWORTH AVE. CHICAGO 21, ILLINOIS

**Outstanding Surplus Value!**

**BRAND NEW - GUARANTEED**

**GRINDING WHEEL KITS**

HUNDREDS OF ASSORTED ITEMS - A \$50 VALUE



FOR CUTTING,  
SHAPING,  
GRINDING,  
& POLISHING  
WOOD, METAL  
OR PLASTIC.

While supply  
still lasts, only

**\$8.95**

Per  
Complete  
Kit

F.O.B. Chicago

SET INCLUDES OVER 300 ITEMS

Here is the list.

- 35 Grinding and cut-off wheels, sizes 1 to 5 inches, 1/8 to 3/4 hole
- 10 Mounted stones—3/32", 1/8", 1/4"
- 3 Steel cutters 1/8"
- 5 Steel cutters 3/32"
- 1 Steel circular saw mounted on mandrel
- 1 Drum sander 1/2" mounted on 3/32" mandrel
- 6 Cut-off Wheels on 1/8" mandrel
- 1 One inch buff on 1/8" mandrel
- 1 One inch felt wheel on 1/8" mandrel
- 1 7/8" rubber wheel on 1/8" mandrel
- 2 High speed rotary files 1/4" shank
- 100 3/4" cloth butterfly abrasive discs
- 1 One inch wire wheel 5/8" hole, brass center
- 10 Cloth abrasive discs
- 3 Sheets crocus cloth 9 x 11
- 1 Box paper discs—100
- 1 Bristle brush 3", 5/8"
- 1 Roughing stone 1 hole, brass center
- 1 Rag wheel—4 inch

In sturdy compact container 13 1/4 x 9 1/4 x 2 1/2", weight 8 1/2 pounds; with installed rack for all drills.

**Satisfaction Guaranteed**

- 2 Leather wheels
- 10 Sanding rolls
- 6 Sanding sleeves
- 1 Roughing stone
- 3 Honing stones
- 2 Felt bobs

I enclose \$8.95  Check  M. O.  Send C. O. D.

Name \_\_\_\_\_

Address \_\_\_\_\_

City \_\_\_\_\_ Zone \_\_\_\_\_ State \_\_\_\_\_

**GROBAN SUPPLY CO.** 1522 So. Michigan Ave. Dep't. PM-2, Chicago 5, Ill.

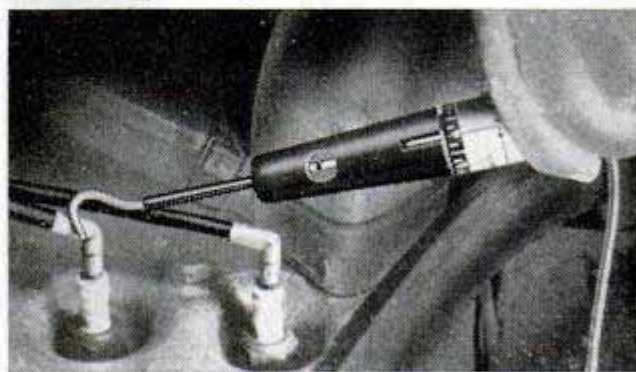
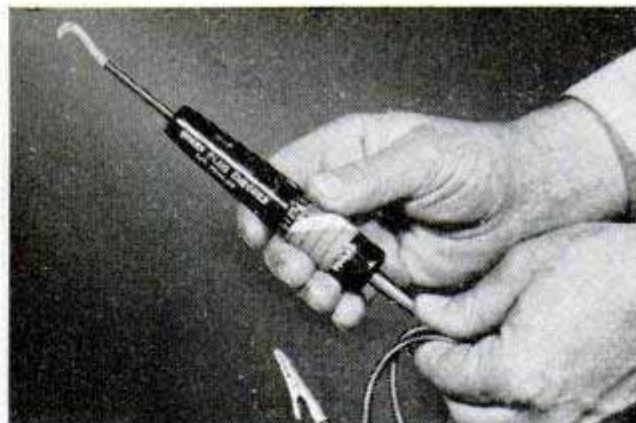

## Spark Plugs Tested in Two Minutes With Engine Left Running

Spark plugs can now be checked quickly under actual operating conditions without removing them and with the engine running. A new tester determines fouled plugs and indicates if they should be replaced. It also measures spark loss because of leakage or defective insulation. Only two minutes are required to make the check which is done by simply attaching the tester clip to a good ground and measuring the coil output and then checking the condition of the plug.

## Numbers Tattooed on Rattlesnakes Aid Study of Migration Habits

Tattooing rattlesnakes is probably, to most people, about as inviting an occupation as going over Niagara Falls in a barrel, but Prof. Angus M. Woodbury of Salt Lake City thinks nothing at all of the dangerous-sounding work. In the past 10 years he has tattooed identification numbers on 777 rattlesnakes and 529 nonpoisonous snakes so that they can be identified and their movements traced if they are picked up subsequently. He uses a homemade outfit consisting of six fine needles vibrated by an old doorbell mechanism. To tattoo a snake, he holds it down with his foot and applies the identification number on the underside of the body just behind the head, according to an article in the zoological journal, Copeia.

**ALLIED'S NEW FREE**

**1949 RADIO CATALOG**

**180 VALUE-PACKED PAGES**

*Send for it now!*



## The Preferred Radio Buying Guide

It's ready for you—the new 1949 ALLIED Radio Catalog! Get the Radio Buying Guide that's the first choice of thousands of expert service technicians, engineers, soundmen, Amateurs, builders and experimenters. The new ALLIED Catalog—Radio's largest and most complete—brings you 180 pages packed with the widest selections of the newest and finest equipment, at today's lowest, money-saving prices! Here's everything in radio for everyone in radio: new Television and home receivers; radio-phonos with new Dual-Speed Changers; packaged Sound Systems, high-fidelity sound components and P. A. equipment; latest Amateur receivers and station gear; test instruments; builders' kits; thousands of parts, tubes, tools, books—the world's largest and finest stocks of nationally known equipment. Take advantage of ALLIED's speedy, expert shipment and the personal attention of seasoned old-time radio men. Get the details, too, of radio's most liberal Time Payment Plan. Write today for your FREE copy of ALLIED's newest and greatest Catalog—the preferred Radio Buying Guide!

**LARGEST STOCKS • QUICK, EXPERT SERVICE**

**Send for your FREE copy of  
Radio's Most Complete Catalog.  
Use the coupon below—NOW!**



### WORLD'S LARGEST STOCKS

Everything in radio for everyone in radio! ALLIED's huge stocks are the world's largest, including complete lines of all leading makes of parts and equipment. Get everything you need from one dependable centralized source—ALLIED RADIO!

### TELEVISION & HOME RADIOS

See ALLIED'S outstanding selection of new Television sets, new table model radios, FM-AM combinations with new Dual-Speed Automatic Changers. Save on these radio models—the choice of experts!

### AMATEUR STATION GEAR

You'll find everything you need for your shack in the new ALLIED Catalog. See all the latest releases in receivers, transmitters, parts, station equipment—the biggest and most complete listings in Ham radio!

### NEW SOUND EQUIPMENT

Packaged, ready-to-use Sound Systems; amplifiers guaranteed for one full year; high-fidelity sound components; everything in speakers, mikes, P. A. accessories, intercom and recording equipment—headquarters for Soundmen!

**Radio's Leading  
Buying Guide . . .**



ALLIED RADIO CORP.  
833 W. Jackson Blvd., Dept. 5-L-8  
Chicago 7, Illinois

Send FREE New 1949 ALLIED Catalog.

Name.....

Address.....

City.....Zone.....State.....

**THE WORLD'S  
LARGEST  
RADIO  
SUPPLY  
HOUSE . . .**

**★ ALLIED  
RADIO**  
*Everything in Radio  
and Electronics*

## Tool Rips Open Sheath On Nonmetallic Cable



Braided or plastic sheathing on electric cables is ripped open without scoring the conductors by a ripping tool that works on both small and large-diameter cables. The ripper consists of two hinged parts between which the cable is laid. When the top is closed, a blade cuts through the sheath between the conductors. Then, as

the tool is pulled forward it slices open the cable. The insulation can then be stripped off quickly.

## Electricity Passed Through Glass Produces Heat Which Melts It

Flawless glass is produced by an electrical heating process developed by General Electric. Electric current, passed through the glass, is converted into heat by the resistance of the material. Used in Europe for a number of years, the technique frequently produced discolored and faulty glass. The American process has overcome this difficulty and the resulting glass is of the highest quality.

## High-Frequency Sound Waves Detect Flaws in Metal

Small flaws in metal pieces are discovered by an ultrasonic instrument that shoots sound waves through the metal at a frequency of one million cycles a second. The metal is immersed in oil, since these waves will not travel through air, and the waves transmitted through the metal to a receiver. The receiver plots the incoming waves on a graph and any flaws in the metal show up as dips in the graph curve.

## GROBAN'S - WAR SURPLUS BARGAINS

SHOP BY MAIL and SAVE  
*Better buys • Satisfaction guaranteed*

### ALL-PURPOSE WATER PUMP

Mfd. by PACKARD  
MOTOR CAR CO.

Ready for use on  
any pumping need

Use it for:  
DRAINING  
BASEMENTS

HOME WATER  
SYSTEMS

FIRE PROTECTION

PRESSURE BOOSTER

IRRIGATION

DRAINING PONDS,  
TANKS, etc.

SPRINKLING  
SYSTEMS

STOCK WATERING

INDUSTRIAL  
PUMPING

Complete with pulley  
and mounting brackets,  
ready for use.

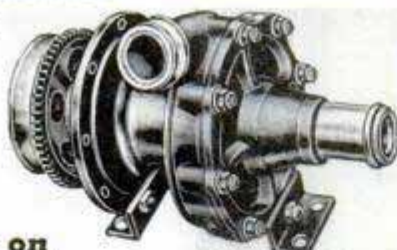

Brand New

### Belt Driven — Centrifugal Pump

An extraordinary value for all types of intermittent or continuous pumping in the home . . . farm . . . factory. Built to exact specifications of Packard Motor Car Co. for use in Rolls-Royce Merlin Aircraft Engines. May be run with electric motor, gas engine or power take-off on tractor. Delivers up to 25 gallons a minute with 1/4 H.P. motor; 80 gal. a min. with one H.P. motor. Will deliver up to 44 ft. head or 25 ft. suction. Use 1" outlet hose; 1" or 1 1/2" inlet hose (recommended).

COMPLETE ENGINEERING REPORTS AND  
OPERATING INSTRUCTIONS FREE  
WITH PUMP

Has cast aluminum housing, accurately machined 5" bronze impeller; 3 1/2" V belt pulley and mounting brackets. Shaft rotates on ball bearing; has grease gun fitting.

Original cost approx.  
\$88.00. Shipping weight  
10 lbs. A REAL BUY.

**\$21.50**

F.O.B. Chicago

## WESTINGHOUSE AIR COMPRESSOR

BRAND NEW

### WAR SURPLUS BARGAIN

2-Cylinder Piston Type

Ideal for:

- Paint Spraying
- Industrial Uses
- Tire Inflating
- Spraying Insecticide
- Operating Air Tools

For the:

### HOME... FARM... FACTORY

Designed for automotive truck or tractor mounting. Can be run off fan belt or power takeoff. Comes with automatic clutch. Can be installed for use on: farm trucks, jeeps, tractors, tire or garage service trucks, contractor or road building machinery, pneumatic devices, etc.

Can be operated with 1/2 H.P. or more electric motor or equivalent portable gas engine.

Light weight, compact and versatile unit . . . delivers "oil free air" . . . simple in operation; requires minimum of maintenance; operates under all climatic conditions; suggested operating pressure 75 P.S.I.; equally efficient operation in either direction of rotation; approx. displacement 3.27 CFM at 600 RPM, 6.54 CFM displacement at 1200 RPM. Has 2 inch bore—1 1/2 inch stroke. Overall dimensions: width 9", height 11 7/8", depth 6 5/8"; approx. wt. 23 lbs.

A REAL BUY . . .  
worth many times  
this price

**\$26.95**

F.O.B. CHICAGO

ORDER DIRECT FROM AD SATISFACTION GUARANTEED  
Send payment or purchase order today

WRITE FOR OUR FREE CATALOG!

**GROBAN SUPPLY CO.**  
1507 S. MICHIGAN AVE., Chicago 5, Dept. PM-11

# GROBAN'S—WAR SURPLUS BARGAINS

SHOP BY MAIL  
and SAVE  
Better buys • Satisfaction guaranteed

## Self-Priming BRONZE PUMP

Positive Displacement

Gerotor Type

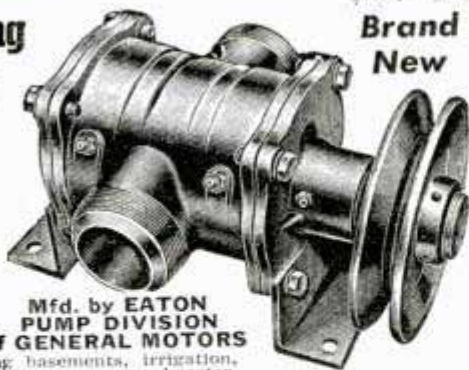

Brand New

Mfd. by EATON PUMP DIVISION of GENERAL MOTORS

Perfect for draining basements, irrigation, fire fighting, sprinkling, pressure booster, insecticide and other spraying, fuel transfer, stock watering, industrial pumping, deep well jet pumping and home water systems. Rated 25 ft. suction and 100 ft. head pressure at 65 gallons a minute with 1725 RPM at one H.P.

Complete engineering report and instructions FREE with pump

**\$32.50**

Supplied with mounting brackets and 6" V belt pulley, ready for instant use. Standard 1 1/2" inlet and outlet pipe thread. Dimensions: 9 1/2" x 7 1/4" x 4 1/4". Ship, wt. 18 lbs. A \$142.00 value...

F.O.B. Chicago

## Self-Priming ELECTRIC PUMP

APPLICATIONS: oil burners, aquariums, fluid metering, fuel pump, tool post grinder, coolant pump, pressure lubricating pump, general industrial, etc.



Compact — BRAND NEW

MOTOR MFD. BY BLACK & DECKER: double ball bearing series wound, continuous duty, 1/30 H.P. electric motor, rated 12,000 R.P.M. Transformer included for use on 110 VAC current. Also applicable for 24-32 VDC.

PUMP MFD. BY WELDON TOOL CO. with standard 1/4" tubing ports; rated 2 G.P.M.; remove pump and use motor as high speed grinder.

**\$12.95**  
postpaid

## Brand New Three-in-One MULTI-PURPOSE PUMP

Three independent pump sections running off of one shaft, for single or multiple pumping. Use one as a vacuum pump capable of drawing 25 inches of mercury. Use one or two as a liquid pump for hydraulics, insecticide spraying, pond and basement draining, stock watering, aeration, etc.



Supplied with 4" V belt pulley. Inlets and outlets 3/8". Easy to use — foot mounting. Constructed of bronze and aluminum to exacting ordnance specifications. Dimensions: 6" x 5" x 4 3/8". Ship, wt. 10 lbs. Government acquisition cost \$74.00. YOUR PRICE.....

**\$19.75**

F.O.B. Chicago

BRAND NEW

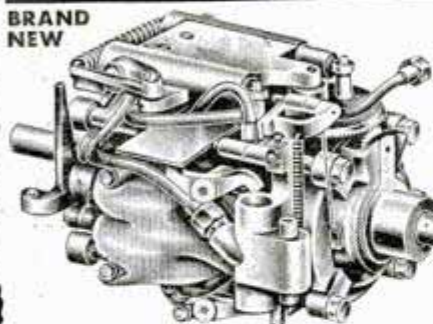

## WESTINGHOUSE HYDRAULIC TRANSMISSION

Gov't. Acquisition cost..... \$300.00

Use it on chain saws, midget autos, lathes, drills, power machinery, chucking machines, farm machinery, potters' wheels, tractors, trucks, etc. Ideal as hydraulic torque converter. Contains hydraulic pump and hydraulic motor; has reversing

**\$18.95**

F.O.B. Chicago

## BRAND NEW



## AIR OR OIL HYDRAULICS

Use hydraulics on arbor presses, hydraulic presses, hay lifts, manure loaders, lift trucks — push or pull, tilt or turn, press or squeeze, open or close, lift or lower — and other hydraulic and industrial applications. Use with either air or oil... of finest precision workmanship.

1. Double action, 1 1/2" bore, 5" stroke, will lift 1760 lbs. in one second with Vickers MF6 Pump. \$8.95  
Wt. 3 lbs. A \$35.00 value..... postpaid
2. Double action, 1 1/2" bore, 9" stroke, will lift 1760 lbs. in one second with Vickers MF6 Pump. \$10.95  
Wt. 4 lbs. A \$45.00 value..... postpaid
3. Use these cylinders on farm trucks, bulldozers, hay lifts, manure loaders, etc. Double action, 1 1/2" bore, 27" stroke. (Will lift 1760 lbs. in 2 seconds with Vickers Pump.) Wt. 8 lbs. A \$55.00 \$12.95  
hydraulic cylinder value for only..... postpaid
4. Double action, 2 3/4" bore, 8" stroke. (Will lift 4400 lbs. in one second with Vickers Pump.) Will withstand 1500 P.S.I. against wall. Wt. 7 lbs. \$14.50  
A \$65.00 value..... postpaid
5. Double action, 3" bore, 12" stroke. All steel hydraulic cylinder, will lift up to 12,000 lbs. (7000 lbs. in 3 seconds with Vickers Pump.) Complete with fittings. Wt. 12 lbs. \$19.50  
A \$78.00 value..... postpaid
6. Double action, 3 1/2" bore, 11" stroke. (Will lift 9600 lbs. in 7 seconds using Vickers MF6 Pump.) Complete with fittings. Wt. 15 lbs. A \$22.50 \$22.50  
\$92.00 value..... postpaid

## Hydraulic Control Valves

Brand New



Outlets are standard 1/4" pipe thread and inlet takes standard 1/4" copper tubing fitting.

1. Four-way control valve for use with double action hydraulic cylinder, may be used with 1500 P.S.I. hydraulic system to open and close hydraulic cylinders. Brand new. Ship, wt. 4 lbs. A \$38.00 value..... postpaid \$7.95
2. Four-way control valve for use with two hydraulic double action cylinders. Each cylinder may be operated independently of the other or in conjunction with the other. Oil may be locked in any of the cylinders to hold the piston at any required position. Brand New. Ship, Wt. 6 lbs. \$10.95  
A \$60.00 value..... postpaid
3. A two cylinder double action valve with a unique arrangement, allowing the operator to raise both cylinders simultaneously, to lower them simultaneously or to raise one and lower the other at any predetermined rate and speed. Brand New. \$14.95  
Ship, Wt. 8 lbs. A \$75.00 value..... postpaid

## Vickers MF6 Hydraulic PUMP or MOTOR

Compact, powerful, rated 1,000 P.S.I., .507 cu. in. per revolution, 8 gal. per min. at 3750 r.p.m. Change rotation by reversing flow. Delivers up to 6 H.P. BRAND NEW. \$14.95  
Wt. 4 1/2 lbs., \$60.00 value for... Postpaid



Brand New CHECK and RELIEF VALVE. Adjustable for any pressure..... \$2.95 post-paid

## VICKERS HEAVY DUTY HYDRAULIC PUMP BRAND NEW



For tractors, bull-dozers, construction machinery, lift trucks, industrial applications, etc. Used on Ross carriers. Delivers 18 gal. per minute at 1000 P.S.I. at 1200 R.P.M. using 10 H.P. Has 1 1/2" intake; 1 1/4" outlet; threaded and keyed 3/4" shaft for direct or pulley drive. Wt. 40 lbs. Dimensions: 5 3/4" diameter, 7 1/2" high. Original value \$148.00. NOW..... \$39.50  
F.O.B. Chicago

WRITE FOR OUR FREE CATALOG!

ORDER DIRECT FROM AD  
Send payment or purchase order today  
SATISFACTION GUARANTEED

## GROBAN SUPPLY CO.

1507 SOUTH MICHIGAN AVE.  
Chicago 5, Ill. Dept. PM-11

## ELECTRIC HAND GRINDER OUTFIT

for cutting wood, metal or plastic.

MASTER **\$9.75** \$45 Value  
KIT Only **Postpaid in U.S.A.**



Compact container. Special rack for drills. Over 260 tools and items.

- 115 Grinding, Cutting and Polishing WHEELS PLUS 150 assorted tools most useful for Home or Shop.**
- 3 Grinding Wheels from 1" to 3" dia.
  - 1 Rotary File, High Speed Steel.
  - 3 Rotary Cutters 1/4" Shank.
  - 6 Rotary Cutters 3/32" Shank.
  - 6 Mounted Grind. Wheels 1/4" Shank.
  - 6 Mounted Wheels 3/32" & 1/4" Shk.
  - 3 Rubber Wheels.
  - 4 Speed Drills 3/32" Shank.
  - 30 Rotary Cutting Burs 3/32" Shank.
  - 2 Mandrels 3/32" Shank.
  - 1 Mandrel 1/4" Shank.
  - 1 Screw Type Mandrel 3/32" Shank.
  - 3 Rotary Bristle Brushes 3/32" Shank.
  - 1 Rotary Wire Wheel Brush.
  - 1 Circular Saw
  - 1 Mandrel for Circular Saw 1/4" Shank.
  - 2 Rubber Cylinders and Mandrel 3/32"
  - 10 Cut-off Discs and grinding wheels.
  - 1 Rotary Drum Sander 1/4" Shank.
  - 15 Bands for Rotary Drum Sander.
  - 15 Rotary Felt Wheels 1" dia.

● The right attachment for every job.  
**ORDER TODAY.** Send check or send \$2.00 deposit with C.O.D. order.

### 18 ROTARY CUTTERS

Ass't Sizes 1/8" or 3/32" Shk. Will fit all electric hand grinders. Ideal for cutting wood, metal or plastic.

\$13.50 Val.

ONLY **\$5.85**

\$2.00 with COD orders **post-paid in U.S.A.**

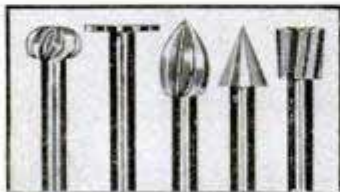

### SPECIAL • 100 PIECES • \$1.00 Postpaid

Grinding Wheels, Cut-off Wheels, Sanding Discs, Mounted Stones, Sharpening and Honing Stones, Rotary Cutting Burs, Abrasive Cartridges and many other items.

### SCHUPACK SUPPLY COMPANY

7331 Cottage Grove Ave., Dept. PM-11 Chicago 19, Ill.



### Personal Alarm

Thugs and thieves may be frightened away by a personal alarm slightly larger than a cigarette case. The alarm can be carried by women walking alone at night, bank messengers and pay-roll carriers, or can be placed on a bedside table. The alarm requires no batteries or electric current. It operates on a clock spring, emitting a piercing siren sound for 35 seconds and cannot be shut off until it has run down.

### Rat-Repellent Plywood

Rats can't gnaw through a new plywood that is made from hardwood veneer and impregnated fiber. The board is designed for use in poultry houses, storage bins and other farm structures holding food that is attacked by rats. It is moisture resistant, lightweight, pliable and can be painted. The paneling is available in sheets four by eight feet and 3/32 inch thick.

### Typewriter Copies Without Carbons

Eliminating the need for carbon paper, a ribbon attachment for typewriters permits the making of one to five copies of letters at the same time. The attachment, which can be installed in three minutes, feeds ribbons between the sheets of paper to make extra copies. A flip of the wrist inserts or removes the ribbons, once the attachment is installed. In erasing, no backing sheets are necessary as the ribbons will not smudge. The extra ribbons last about twice as long as ordinary ribbons because the paper cushions them from the keys.

## PROTECT YOUR PAINT BRUSHES

With the

# NEW CLIP-ON PAINT BRUSH HOLDER

A sure, easy way to care for your paint brushes Before, During and After painting.

- Fits standard 10 and 12 qt. Galvanized pails.
- Removable clips keep brushes suspended in liquid to proper depth.
- Holds 6 brushes — any size.
- Light weight — all metal construction.

Begin now to give your brushes Better Care for Longer Wear!

Order your CLIP-ON PAINT BRUSH HOLDER Today!

ONLY **\$1.00** POST-PAID

Complete with Instruction Sheet — "Care Of Your Brushes"

**MONEY-BACK GUARANTEE!**

Dealer Inquiries Invited

**ANDAR MFG. CO.**  
1959 N. Prospect, Milwaukee 2, Wis.  
Enclosed find One Dollar for 1 Clip-On Paint Brush Holder. (No C.O.D.'s, please.)

Name \_\_\_\_\_  
Address \_\_\_\_\_  
City \_\_\_\_\_ Zone \_\_\_\_\_ State \_\_\_\_\_



**COMPRESSED AIR  
INSTANTLY, Anywhere!!**

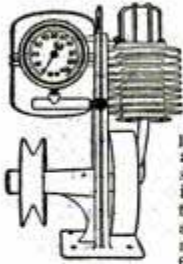

Portable Air Compressor and storage tank. Ruggedly built of best materials using lifetime lubricated ball-bearing on connecting rod and oil impregnated main bearing on shaft. Unusual design forever eliminates valve trouble, the most common fault in air compressors. **PATENTED** unique air intake system increases efficiency tremendously over other compressors so that air output is much greater than that from larger compressors powered by heavier motors. Will deliver appr. 3500 cu. in. air per min. at maintained pressure of 30 lbs., or will inflate a 90 lb. truck tire in less than 1 min. Complete with 100 lb. gauge, fingertip adjustment allows setting of output pressure at any value, which will automatically be maintained. Works from any 1/4 H.P. motor. Useful for spraying paints or lacquers, disinfectants, insecticides, annealing or brazing with natural gas, inflating tires, etc. Price \$14.50 postage prepaid anywhere in U.S. Efficient, adjustable syphon type spray gun complete with 12 ft. of 100 lb. tested hose for only \$7.75 with pint container, also prepaid. 25% required on C.O.D. orders.

Inflating tires, etc. Price \$14.50 postage prepaid anywhere in U.S. Efficient, adjustable syphon type spray gun complete with 12 ft. of 100 lb. tested hose for only \$7.75 with pint container, also prepaid. 25% required on C.O.D. orders.

**Terrific Value**

ONLY

**\$20.95**

Equipped with 1/4" Jacobs Geared Chuck and Key



**PORTABLE ELECTRIC DRILL**

(Sold at less than established factory price so we cannot mention brand name)

Not an intermittent duty drill, but a full size rugged tool. Most convenient type switch, natural grip handle, and balance like a six shooter. Precision cut gears—turbine type cooling blower—extra long brushes. No stalling under heaviest pressure because of powerful 110 Volt AC or DC motor and multiple ball bearing thrust. Other bearings self-aligning lifetime-lubricated Oilite type. Made for toughest year-in and year-out service in plant or on construction jobs. Amazing perpetual factory guarantee assures you of a lifetime of trouble-free use.

Full refund (you pay transportation) if not pleased with drill after trial.

**HEAT GUN**

Streamlined pistol grip heat gun in vivid red housing, that delivers a powerful 20 Cubic Ft. per minute blast of hot air at 160° Fahrenheit. Ordinary blowers have small fan motors, but this has a lifetime-lubricated AC-DC motor of the rugged vacuum cleaner type, that produces a hurricane of either hot or cold air. Perfect for blowing out dirt or dust, drying out ignition systems, warming up carburetors, drying paint, thawing out radiators, etc. Warning:—Keep this away from your wife, or she will be using it to dry her hair because it will do it in half the time of her ordinary hair dryer, to say nothing of her using it to dry stockings or clothing, or defrost the refrigerator instantly. Only \$12.95. Satisfaction guaranteed or money refunded if returned prepaid within 5 days.



**Sensational Value in  
AC-DC Pocket Tester**

This analyzer, featuring a sensitive repulsion type meter housed in a bakelite case, represents the culmination of 15 years achievement in the instrument field by a large company specializing in electronic test equipment.

Specifications of the AC-DC Model Volt-Ohm-Milliammeter:

- AC Volts—0-25,50,125,250
- DC Volts—0-25,50,125,250
- Milliamperes AC—0 to 50
- DC Milliamperes—0 to 50
- Ohms Full Scale—100,000
- Ohms Center Scale—2400
- Capacity—.05 to 15 Mfd.



Total Price, prepaid anywhere in the USA—\$7.00  
Similar DC Meter, lacking the AC operated ranges of above, \$5.50 prepaid.

**RT-1248 INTERCOMMUNICATION TRANSCEIVER**

This brand new 15 tube transmitter-receiver was designed for mobile service on 12 volts, and will operate in the "Citizens' Band," where no gov't. license to transmit is necessary. It's a cinch for any experimenter to connect this unit for 110 VAC operation by following the instructions and diagrams supplied, which cover numerous applications, including television. For those intending to use on car or boat, a new dynamotor, exactly as originally supplied, costs only \$15.00. Don't fail to write for FREE descriptive bulletin. RT 1248 transceivers only \$29.95 each, or two for \$53.90.

**RADAGER\***

\*Combination Auto Radio-Battery Charger

Nationally advertised brand 1949 car radio that will fit practically any car. These car radios have plenty of eye appeal plus a host of other features that no other radio regardless of cost can offer.

Built in battery charger that will charge a car battery. The unique circuit of this radio steps up the 6 v input to 110v, that is available in a convenient outlet, for operation of an electric shaver or similar electrical appliance.

The radio is a powerful 6 tube superheterodyne that has a three gang condenser and a stage of radio frequency amplification for increased sensitivity. The radio, complete with built in battery charger and power outlet, is a single compact unit that is easily installed. Sample—\$39.95; Dealer price, \$37.47 each in lots of two or more.

**RT-1655 — 11 tube crystal controlled SUPER-HETERODYNE RECEIVER** that covers the FM band. The ultra modern circuit uses the latest types of tubes including 7 miniature 6AJ5's. Beautiful chassis and aluminum cabinet. Tubes and schematic supplied—\$14.95.

World renowned 700 page tenth edition of the **RADIO HANDBOOK** in cloth binding and hard cover at the sensational reduced price, for a limited time only, \$1.49.

**\$5.95 Takes Both  
BIG BARGAINS**

**1. ALUMINUM GEAR BOX** 18x8x7 that contains two powerful electric motors and two matched gear trains, 62 gears in all varying in size from 1/2 to 4 inches in diameter. This unit is readily converted to rotate a beam antenna or any other similar use.....\$3.00

**2. SENSATIONAL, FASCINATING, AMAZING SELSYNS.** Brand new selsyns made by G. E. Co. Two or more connected together work perfectly on 110 VAC. Any rotation of the shaft of one selsyn and all others connected to it will rotate exactly as many degrees in the same direction, following unerringly as if the units were connected together by shafting instead of wires. This is true whether you twist the shaft of the master unit a fraction of a revolution or many revolutions. Useful for indicating the direction of weather vanes, rotating directional antennas, or controlling innumerable operations from a distance. Complete with diagram and instructions. Per matched pair.....\$4.95



**BUFFALO RADIO SUPPLY** PM  
219-221 Genesee Street  
Buffalo 3, New York  
Please send 1949 Bargain Catalog.

Name \_\_\_\_\_  
Address \_\_\_\_\_  
City \_\_\_\_\_ Zone \_\_\_\_\_ State \_\_\_\_\_

CABLE ADDRESS BUFRAD

Minimum order \$3.00—All prices subject to change—25% deposit with C.O.D. orders.

**BUFFALO RADIO SUPPLY, 219-221 Genesee St., Dept. PM, BUFFALO 3, N. Y.**

**UP TO**  
**SAVE 85%**

**in WAR SURPLUS... SENSATIONAL VALUES**  
at "GADGETEER'S HEAVEN"  
IN MANY ITEMS WE HAVE THE WORLD'S LARGEST SUPPLY

**B-15 STYLE JACKET**  
A Garment You'll be PROUD TO WEAR! Water repellent, wind resistant, nice green, sateen, genuine Zealand Sanforized Poplin, full zipper front with slash pockets and large genuine Mouton Fur Collar. Heavy Alpaca lined for Warmth. Sleeves also lined with Heavy Rayon Rib-knit cuff and bottom.  
Sizes 34 through 48.  
**LOOK AT THE PRICE! \$11.95**



**Navy Melton Cossack Style Jacket**  
NEW All Wool, Sturdy, Warm Zipper front 2 slash pockets, Taped Collar. Wonderful Buy For Utility and long lasting Qualities.  
Sizes 34 thru. 46  
**\$5.69**



**HUNTING KNIFE**  
6" chrome vanadium blade handle, leather grip. In leather sheath.  
\$5.98 Value For Only **\$1.79**

Like above but black Parkered Finish. #307A **\$1.49**

**BOLO KNIFE**  
10" x 2" Parkered Blade 5" Gripped Handle. Weight 1 1/2 lbs. Ideal for Hunting, Clearing Brush, or Trails **\$1.19 ea.**



**MACKINAW**  
Made of heavy water repellent poplin cover. Wool blanket lined, thigh length, sleeve flap for adjustment. An ideal coat for the outdoor man, truck driver, hunter, farmer. Sizes 34 thru 48 **\$7.95**



**MESS TRAY** 6 compartments, rustless, stainless steel. Barbecue, outdoor cooking, save dish-washing. Hospital, Restaurant, Home, or touting. #311 New **83c ea.**  
#311A Used but in Fine Serviceable Condition **59c ea.**



**SLEEPING BAG**  
NEW! 100% wool. Heavy type Heavy duty 38" zipper. Grey. Cost \$22.00. \$1.95, extra for used water repellent cover. Sold only with Sleeping Bag **\$3.95**



**FLYING HELMET**  
#407 Fleets or Chamois lined winter type. Ideal for cycle drivers, racers, sportsman. Used, but in excellent condition. **\$1.59 ea.**

**CANVAS HELMET**  
Used #407 A - Summer weight **69c**



**COMPASS**  
Matchbox type, jewel floating dial **39c ea.** #152  
#154 Wrist strap type A True Hunting Pal **69c ea.**



**SHARPSITE. NIGHT DRIVING GLASSES**  
With 57 mm yellow amber lenses. These lenses are 6 base especially PRECISION Grad. and Polished to reduce Glare of headlights from on coming cars, also to focus objects sharply and more clearly during night driving. Absolutely one of the greatest boons for Safe Night Driving, or during stormy, murky weather. Highway Patrolmen, Truck Drivers swear by them. A must for your Vacation or Nite Driving.



**TELEVISION!** These glasses help wonderfully! SHARPEN FOCUS. Aid in eliminating Glare. DISCOVER GREAT-ER ENJOYMENT.  
INTRODUCTORY OFFER ND-1 **\$14 VALUE \$5.89**  
In Men's size or Ladies Harlequin style. SAME GLASSES but clip on. Fit-over style without temple bars **\$4.59**



**HERE ARE PLASTIC KITS**  
UNSURPASSED VALUES for ARTISTICALLY INCLINED HOME HOBBYIST!

Start planning Naval Xmas gifts Now! Kit #1 contains 1 Do. Plexiglas & Lucite sheets in various shapes, 1 ea. bottle of clear cement, 1 ea. bottle color set cement and 4 bottles of colors in Orange, Red, Yellow, Peach, etc. Also a Plastic Handbook of uses and instructions. This set easily worth \$3.95. Our Price **\$2.19**

Kit #2 contains 1 1/2 lbs. of plastic sheet, 1 ea. bottle of clear cement, and the Plastic Handbook. A \$3.50 Value for ONLY **99c**



**TEAR SHAPED PLEXI DOME**  
Overall length 2 1/2" width at widest point 1 1/2" at base 4" 5" deep. #70-1A **\$1.39 ea.**



**Plexiglass Windows**  
in Alum. Frames, for your trailer, boat, or home ornamental use. Priced at the value of the sheet alone.  
#703A - 18 1/2" x 15 1/2" x 3/16" thick **\$2.95**  
#704A 12" x 9" x 3/16" **\$1.59**



**Signal Corp Control Unit**  
Standard Back Panel 17" x 5 1/2" x 1 1/2" Case size 5 1/4" x 17" x 1 1/2" with numerous relays, condensers, 4 bay switches, 4 bay plugs, jacks, resistors, transformers, etc. Enclosed in Parkered steel case. Parts alone worth more than our asking Price of ONLY **\$2.69**



**Radio ANTENNA Reel**  
Just the thing for tuning beam antennas. Powered by 1/2 hr. 24v. G. E. Motor. Removable 6" Reel. Unit Switch - Can Warn gears. Best of gear. Spinnoid clutch.  
Many engaged in heat reduction only when electrical contact made. Operates in either direction. Ideal for auxiliary power take-off, opening and closing doors, etc. **\$4.29**



**RADIO HEAD SET**  
AN-BH-1  
A Wonderful Buy **\$1.**



**FOLDING STEEL COTS**  
With Tubular Metalworks and sturdy double heavy wire twin springs. A Lite line buy. **\$2.95 Ea.**

**NAVY BUNK BED**  
With steel angle hand-stands, steel frame spring made of twisted heavy gauge wire reinforced with lateral slingers. Can be used as single bed or joined together to serve as double bunk bed. Specially suited to hard wear, cruise children, dormitory, camps, etc. Simple. **\$3.95**  
In sets of two **\$7.75**



**MATTRESS** for above cot or bed. Cotton top, local motor height for shipping cost due to 100lb. net. mattress shown below can be included in our extra ship. cost.  
In sets of two **\$6.95**

**ME-1 PILLOWS** Curled Chicken Feathers. 25" x 17". Blue & white Ticking **.99c** Each  
Both Mattress and Pillows are reconditioned and sterilized in accordance with laws of Calif. and Gov's.



**GENUINE Aviators (AN-6530) Windproof & Dustproof GOGGLES**  
Go-41 Sponge and leather grained frame with ground lens in clear, amber and green. Clear lens in replaceable metal frame with blinged nose bar. Ideal for Motorcycling, etc. **\$1.69 ea.**

**SUNGLASSES** HERE'S THE REAL McCoy!  
ARMY AIR FORCE & base. Precision Polished and Ground. Glare-Free lens with leather case that can be attached to belt. Gold plated adjustable frame. Pearlized crown and pads. A real Pulley **\$17.50 Value for Only \$3.95**



**ARMY AIR FORCE TYPE SUNGLASSES**  
4 lens, polished and ground lens. 3 1/2" Ultra Violet Ray, less gold plated frame, genuine leather & pads. leatherette case. Our price **\$2.39**



**NEW AIRCRAFT ALUMINUM BUCKET SEAT**  
Use for boats, jeeps, tractor seats, etc. 17" x 18" seat, 18" x 24" back. Rib reinforced. Adjustable height tube mounting. Wide, high back gives excellent support. Easily installed. Shipped in original carton. You'll appreciate the buy at **\$4.95**



**CUSHIONS** Mid. for above Bucket seat, but can be used in trucks, autos, boats, tractors. Made to Gov't. Spec. of finest imitation leather, yellow pigskin col. filled with kapok. Will float. Same as shown in LIFE magazine saving a man from drowning.  
New Back Rest, 22" x 16" x 1 1/2" thick **\$2.95**  
Used Back Rest, 22" x 16" x 1 1/2" thick **\$1.35**  
SEAT, New, 17" x 16" x 3" thick **\$3.49**  
SEAT, Used, 17" x 16" x 3" thick **\$2.29**



**AT REAL VALUES!**  
3 1/2" dia. 3 strand, cotton .01 ft. **1/4**" dia. Treated Navy layard. in 300 ft. rolls **\$1.95**  
3/8" dia. 3 strand, treated jute **.02 ft.**  
3/8" dia. 3 strand, jute **.07 ft.**  
3/8" dia. 3 strand, sisal **.08 ft.**  
3/8" dia. 3 strand, sisal **.08 ft.**  
These prices speak for themselves, we also have other types and larger sizes in stock. We welcome your inquiry. No sales under \$1.00



**VINYLLITE TUBING**  
Capable of insulating up to 3000 volts. This Plastic tubing used for protecting wire, decorative purposes, water or other fluid hose.  
Price per ft.  
1", Black, Clear, Red **.15**  
1/2", Clear, Red **.12**  
1/2", Grey, White **.10c**  
3/16", White **.02**  
3/16", Clear **.02**  
No Sale Under \$1.00  
Above sizes are only a sample of the stock we carry, should you desire other sizes or types please send us your inquiry.



**AIR CORPS FLEECE LINED JACKET**  
D-1 TYPE  
These have been reconditioned, cleaned, and brushed. If you want a warm, rugged, full sheepskin felt, fleece lined collar, zippered front, leather jacket that has lots of outdoor wear left in it, that you can't heat for value **\$7.95 ea.** at this close-out price. You'd better write in fast, before they are all gone.  
Ideal for Hunters, Farmers, Garage Mechanics, etc. Large Size Only.



**NEW 100% ALL WOOL BLANKET**  
7 x 7 ft. Extra heavy. Also Double warmth. Fits Wood's Robe sleeping bag. **\$4.65**



**COMFO RESPIRATOR**  
dual-disc, Style BM-2101, with 10 extra filters, a \$3.50 value. **\$1.59 each**



**NEW TARPS - HEAVY CANVAS**  
Mildew & Flame Resistant. Cheap Outside Storage. They are Really Moving at These Prices.  
5' x 7' **\$3.95**  
15' x 22' **\$29.95**  
8' x 10' **\$8.50**  
16' x 22' **\$20.95**



Rubberized Linen 7' x 11" NEW **\$5.95**  
Only 3 lb. light weight yet waterproof ideal for outside car storage.



**Waltham 8 Day U. S. Navy Airplane Clock**  
Runs 8 days without re-winding. 15 jewels, adjusted for temperature & up-right position. Watch type escapement. Dial registers 24 hr. day in hr. min. & sec. Also days of the month. Used but guaranteed Reconditioned. A \$50. VALUE FOR ONLY **\$13.95**



'Twas Made for the Air Force THE BEST  
**Loose Leaf BINDER**  
You ever saw - 3 metal pins. Cylindrical locking heavy duty 2 1/8" interlocking bonded covers. End identification window. Ideal for price books, telephone directories, photo albums, students, publications, reference books, artist sketch books, etc. Will hold 50 sheets. 8 1/2" x 11". A \$3.00 Value for Only **59c**  
50 Page Binder. Bond. Filler for 25c Extra.



**For THE FOOTBALL SEASON**  
and for those cold, hard stadium seats RUBBERIZED HAIR CUSHIONS  
#RC1 14" dia. x 1 1/2" **69c ea.**  
#RC2 21" x 12" **69c ea.**  
#RC3 22" x 16" **\$1.19 ea.**  
#RC4 25" x 18" **\$1.19 ea.**  
These cushions are used in many places and are in very good condition.



**LEATHERETTE**  
Heavy Hodge Brown color. With Heavy Backing. Recover your outdoor furniture or your Auto, Truck, Boat or Tractor Seats at a fraction of what you would otherwise pay.  
In 29" Widths, Running Yard **95c**



**PALLEY SUPPLY CO.**  
THE LARGEST FIRM OF ITS TYPE IN THE WORLD  
Order from this Ad. All sales final. All Prices F. O. B. Los Angeles. Pay by M. O. or Check. P. O's. Accepted. from D & S firms. 1/2 deposit with C. O. D's. FREE LARGE ILLUSTRATED CATALOG  
DEPT. P. M. 118 - 6321 SAN FERNANDO RD. GLENDALE 1, CALIFORNIA

# SOUTH BEND

## Precision

# MACHINE TOOLS



### NEW 13" & 14½" — 1" COLLET LATHES

The 13" and 14½" swing South Bend Lathes are now available with larger headstock spindles having 1⅜" bore, which permits using the No. 5 South Bend Collet which has 1" maximum capacity. Except for the increased capacity through the spindle and collet, these lathes are the same as the regular 13" and 14½" lathes shown on the following pages.

Prices include 3 ph. motor and control.

Lgth. of Bed Feet	13"—1" Collet Lathes				14½"—1" Collet Lathes			
	Quick Change		Toolroom		Quick Change		Toolroom	
	Cat. No.	Price	Cat. No.	Price	Cat. No.	Price	Cat. No.	Price
4	145-A	\$1294.25	.....	.....	.....	.....	.....	.....
5	145-B	1332.25	8145-B	\$1694.25	185-B	\$1581.25	8185-B	\$1963.25
6	145-C	1370.25	8145-C	1734.25	185-C	1621.25	8185-C	2008.25
7	145-D	1408.25	8145-D	1774.25	185-D	1661.25	8185-D	2053.25
8	.....	.....	.....	.....	185-E	1701.25	8185-E	2098.25

### NEW 14 INCH DRILL PRESS

A ruggedly built tool unsurpassed for accuracy, ease of operation and dependable performance. Features free-floating spindle, precision ball bearings, quick-acting belt tension release, etc. Has built-in light for illumination of work. Drill capacity is ½" in steel. Prices include ⅓ h.p. single ph., 60 cycle, 115 V. motor and switch.

Bench Model.. \$129.30  
Floor Model... 144.30



### NEW 7" BENCH SHAPER

The South Bend 7" Precision Bench Shaper has been developed to meet toolroom and industrial demands for an accurate, compact bench shaper that is precision engineered and sturdily constructed.

Ram has 0" to 7" stroke. Tool head has 3" feed and swivel clapper box. Table is 5⅞" x 5" x 6" deep, has 13" horizontal travel, 5" vertical travel. Has power cross feed. Vise opens to 4" and has graduated swivel base.

Prices Quoted  
on Request.



All prices in this catalog are net f.o.b. factory unless otherwise stated



## SOUTH BEND LATHE WORKS

BUILDING BETTER TOOLS SINCE 1906

543 EAST MADISON STREET, SOUTH BEND 22, INDIANA., U.S.A.

# SOUTH BEND

## 16", 14½", and 13" Quick Change Gear Lathes

South Bend 16" x 6'  
Quick Change  
Gear Lathe  
**\$1729.25**

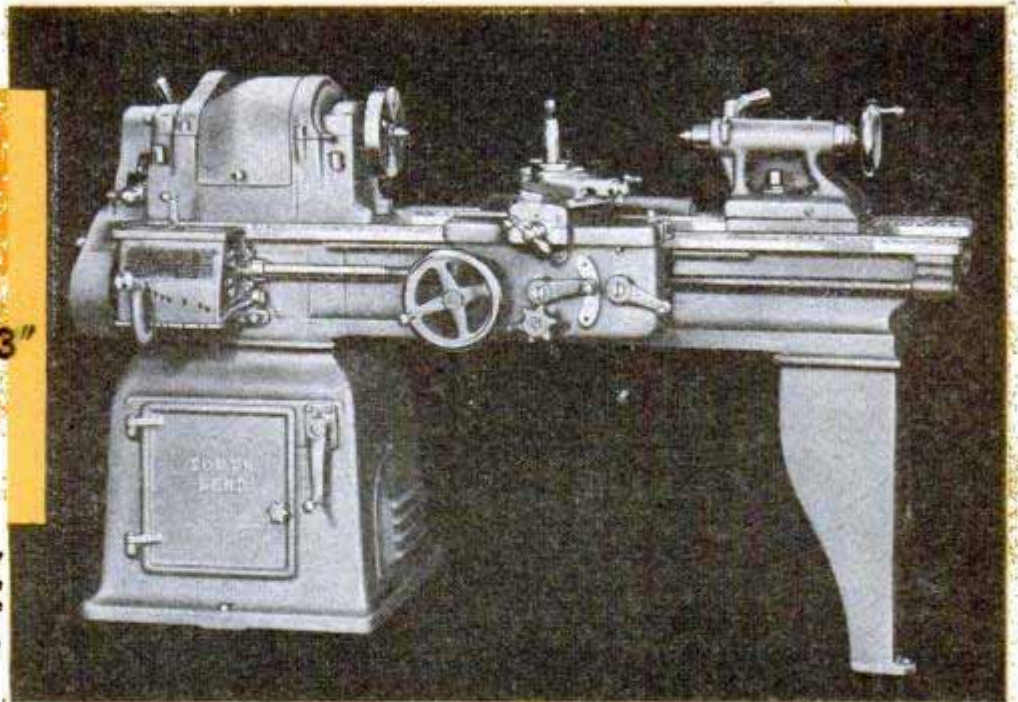

SPECIFICATIONS	16-INCH	14½-INCH	13-INCH
Swing over bed and saddle wings.....	16¼"	14⅝"	13⅞"
Swing over saddle, chip guard removed	11⅞"	10¼"	8¾"
Swing over saddle with chip guard....	9⅞"	8¾"	7¾"
Spindle speeds.....	26 to 885 r.p.m.	27 to 800 r.p.m.	34 to 875 r.p.m.
Thread cutting range.....	4 to 224 R.H. or L.H.	4 to 224 R.H. or L.H.	4 to 224 R.H. or L.H.
Power longitudinal feeds.....	.0015" to .0841"	.0015" to .0841"	.0015" to .0841"
Power cross-feeds.....	.0006" to .0312"	.0006" to .0312"	.0006" to .0312"
Hole thru spindle.....	1⅜"	1⅞"	1"
Collet capacity.....	1"	¾"	11/16"
Spindle centers.....	No. 3 Morse Taper	No. 3 Morse Taper	No. 3 Morse Taper
Size motor.....	1½ h.p.	1½ h.p.	1 h.p.

South Bend Quick Change Gear Lathes are equally efficient on precision toolroom work or close tolerance manufacturing operations. Hundreds of nationally known manufacturers select them when streamlining their shop equipment to meet present day needs. Substantial savings in capital investment, power consumption, floor space, and labor costs have resulted from their installation. They will give you the same efficient service.

The Underneath Motor Drive provides an unusually wide range of spindle speeds. The belt drive to the spindle is silent in operation and develops smooth, steady power entirely free from gear vibration.

Price includes 3 ph., 60 cy., 220 v. A.C. motor and drum control, and regular lathe equipment such as belts, centers, face plates, tool post, etc. Chucks and tools are extra. See following pages.

**TIME  
PAYMENT  
TERMS**

25% down, balance 12 mos., moderate finance charge (unless federal law requires otherwise)

### Quick Change Gear Underneath Motor Driven Lathes

Catalog Number	Swing Over Bed Inches	Length of Bed Feet	Distance Between Centers Inches	Approx. Shipping Weight Pounds	Price f.o.b. Factory
<b>16" QUICK CHANGE GEAR LATHES</b>					
117-C	16¼	6	33½	2300	\$1729.25
117-D	16¼	7	45½	2380	1769.25
117-E	16¼	8	57½	2460	1809.25
117-G	16¼	10	81½	2620	1924.25
117-H	16¼	12	105½	2850	2039.25
<b>14½" QUICK CHANGE GEAR LATHES</b>					
183-B	14⅝	5	24½	1995	\$1466.25
183-C	14⅝	6	36½	2070	1506.25
183-D	14⅝	7	48½	2145	1546.25
183-E	14⅝	8	60½	2225	1586.25
<b>13" QUICK CHANGE GEAR LATHES</b>					
113-A	13⅞	4	16	1460	\$1189.25
113-B	13⅞	5	28	1510	1227.25
113-C	13⅞	6	40	1560	1265.25
113-D	13⅞	7	52	1615	1303.25

**SOUTH BEND LATHE WORKS, 543 E. Madison Street, South Bend 22, Indiana, U.S.A.**

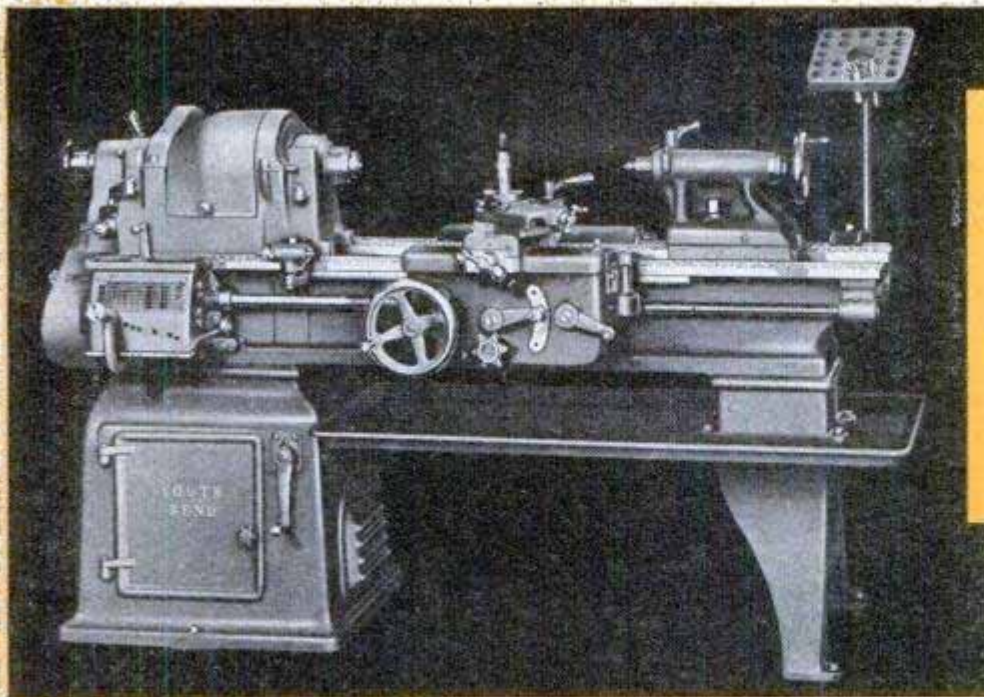

# SOUTH BEND

16", 14½", and 13"  
Toolroom  
Lathes

South Bend 16" x 6'  
Toolroom Lathe  
**\$2145.25**

## SPECIFICATIONS

	16-INCH	14½-INCH	13-INCH
Swing over bed and saddle wings...	16¼"	14⅝"	13⅜"
Swing over saddle cross slide.....	9⅝"	8-15/16"	8"
Spindle speeds.....	26 to 885 r.p.m.	27 to 800 r.p.m.	34 to 875 r.p.m.
Thread cutting range.....	4 to 224 R.H. or L.H.	4 to 224 R.H. or L.H.	4 to 224 R.H. or L.H.
Power longitudinal feeds.....	.0015" to .0841"	.0015" to .0841"	.0015" to .0841"
Power cross-feeds.....	.0006" to .0312"	.0006" to .0312"	.0006" to .0312"
Hole thru spindle.....	1⅝"	1⅝"	1"
Collet capacity.....	1"	¾"	11/16"
Spindle centers.....	No. 3 Morse Taper	No. 3 Morse Taper	No. 3 Morse Taper
Size motor.....	1½ h.p.	1½ h.p.	1 h.p.

## Toolroom Underneath Motor Driven Lathes

Catalog Number	Swing Over Bed Inches	Length of Bed Feet	Distance Between Centers Inches	Approx. Shipping Weight Pounds	Price f.o.b. Factory
<b>16-INCH TOOLROOM UNDERNEATH BELT MOTOR DRIVEN LATHES</b>					
8117-C	16¼	6	33½	2525	\$2145.25
8117-D	16¼	7	45½	2605	2191.25
8117-E	16¼	8	57½	2685	2237.25
<b>14½-INCH TOOLROOM UNDERNEATH BELT MOTOR DRIVEN LATHES</b>					
8183-B	14⅝	5	24½	2180	\$1843.25
8183-C	14⅝	6	36½	2255	1888.25
8183-D	14⅝	7	48½	2330	1933.25
8183-E	14⅝	8	60½	2405	1978.25
<b>13-INCH TOOLROOM UNDERNEATH BELT MOTOR DRIVEN LATHES</b>					
8113-B	13⅜	5	28	1665	\$1577.25
8113-C	13⅜	6	40	1715	1617.25
8113-D	13⅜	7	52	1770	1657.25

South Bend Toolroom Lathes are equally efficient on precision toolroom work or close tolerance manufacturing operations. Their versatility reduces set-up time to a minimum. Smooth, vibration-free operation permits finish turning or boring with such precision that subsequent machine operations can often be eliminated. A convenient arrangement of controls makes for an ease of operation which reduces fatigue and lowers the probability of error. A wide range of spindle speeds permits machining work with maximum tool efficiency.

Improved Features include: alloy steel headstock spindle; replaceable headstock bearings; double wall apron; quick change gear box for threads and feeds; and semi-steel lathe bed.

In Addition to 3-ph., 60 cy., 220 v., A.C. motor and drum control, and all equipment supplied with quick change gear lathe (see preceding page) the following toolroom attachments are included in price of lathe: handwheel type draw-in collet chuck attachment; collet rack; telescopic taper attachment; thread dial indicator; chip pan; and micrometer carriage stop. Chucks, tools, and collets are extra.

**SOUTH BEND LATHE WORKS, 543 E. Madison Street, South Bend 22, Indiana, U.S.A.**

# SOUTH BEND

## 10"-1" Collet Lathes

### SPECIFICATIONS

- Swing over bed and saddle wings.....10 $\frac{1}{8}$ "
- Swing over saddle cross slide.....5 $\frac{3}{8}$ "
- Spindle speeds (12).....50 to 1357 r.p.m.
- Thread cutting range....4 to 224 R.H. or L.H.
- Power longitudinal feeds.... .0015" to .0836"
- Power cross-feeds..... .0006" to .0309"
- Hole thru spindle.....1 $\frac{3}{8}$ "
- Collet capacity.....1"
- Spindle centers.....No. 2 Morse Taper
- Cross slide travel.....5 $\frac{7}{8}$ "
- Compound rest top slide travel.....2"
- Size motor..... $\frac{3}{4}$  h.p.



10-inch Swing South Bend Precision Lathes are capable of the most exacting operations on both tool and production work. This accuracy, together with their speed and versatility, contribute to lower machining costs. They contain all the design features that make the larger models so dependable.

Price includes 3 ph., 60 cy., 220 v., A.C. motor; drum control, and regular lathe equipment such as belts, centers, face plates, tool post, etc. Chucks and tools are extra. Toolroom Lathes also include: handwheel type draw-in collet attachment (without collets); collet rack; telescopic taper attachment; thread dial indicator; and micrometer carriage stop.

### TIME PAYMENT TERMS

25% down, balance 12 mos., moderate finance charge (unless federal law requires otherwise)

Bench is included in price of bench lathe.

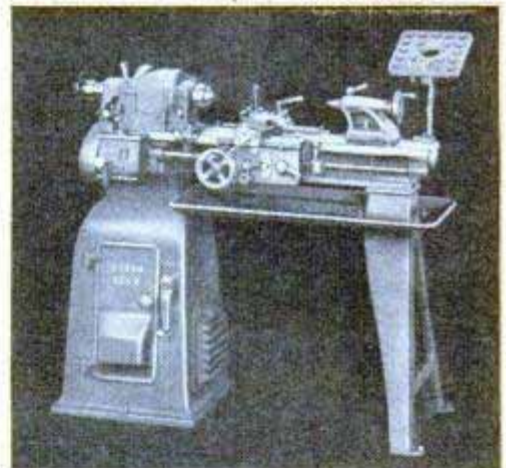

South Bend 10" x 3 $\frac{1}{2}$ ', 1" Collet Toolroom Lathe \$1249.35

### 10"-1" Collet Quick Change Gear and Toolroom Lathes

Catalog Number	Swing Over Bed Inches	Length of Bed Feet	Between Centers Inches	Shipping Weight Pounds	Price f.o.b. Factory	Catalog Number	Swing Over Bed Inches	Length of Bed Feet	Between Centers Inches	Shipping Weight Pounds	Price f.o.b. Factory
<b>QUICK CHANGE GEAR BENCH LATHES</b>						<b>TOOLROOM BENCH LATHES</b>					
187-YS	10 $\frac{1}{8}$	3	14 $\frac{3}{4}$	850	\$ 994.35	8187-YS	10 $\frac{1}{8}$	3	14 $\frac{3}{4}$	960	\$1272.35
187-ZS	10 $\frac{1}{8}$	3 $\frac{1}{2}$	20 $\frac{3}{4}$	880	1011.35	8187-ZS	10 $\frac{1}{8}$	3 $\frac{1}{2}$	20 $\frac{3}{4}$	990	1289.35
187-AS	10 $\frac{1}{8}$	4	26 $\frac{3}{4}$	950	1038.35	8187-AS	10 $\frac{1}{8}$	4	26 $\frac{3}{4}$	1060	1316.35
187-RS	10 $\frac{1}{8}$	4 $\frac{1}{2}$	32 $\frac{3}{4}$	980	1062.35						
<b>QUICK CHANGE GEAR LATHES WITH FLOOR LEGS</b>						<b>TOOLROOM LATHES WITH FLOOR LEGS</b>					
187-Y	10 $\frac{1}{8}$	3	14 $\frac{3}{4}$	810	\$924.35	8187-Y	10 $\frac{1}{8}$	3	14 $\frac{3}{4}$	935	\$1231.35
187-Z	10 $\frac{1}{8}$	3 $\frac{1}{2}$	20 $\frac{3}{4}$	835	941.35	8187-Z	10 $\frac{1}{8}$	3 $\frac{1}{2}$	20 $\frac{3}{4}$	960	1249.35
187-A	10 $\frac{1}{8}$	4	26 $\frac{3}{4}$	860	958.35	8187-A	10 $\frac{1}{8}$	4	26 $\frac{3}{4}$	985	1267.35
187-R	10 $\frac{1}{8}$	4 $\frac{1}{2}$	32 $\frac{3}{4}$	885	982.35						

**SOUTH BEND LATHE WORKS, 543 E. Madison Street, South Bend 22, Indiana, U. S. A.**

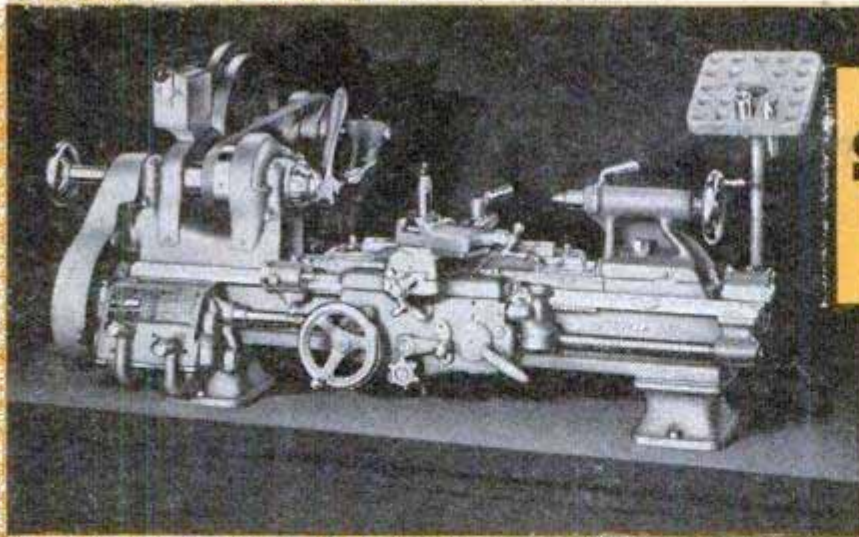

South Bend 9" x 3' Toolroom Bench Lathe **\$521.45**



South Bend 9" x 3' Model C Bench Lathe

## SOUTH BEND

### 9-Inch Bench Lathes

#### SPECIFICATIONS

- Swing over saddle wings..... 9 1/4"
- Swing over chip guard..... 5 1/2"
- Spindle speeds:
  - 6 speed drive..... 41 to 658 r.p.m.
  - 12 speed drive..... 41 to 1270 r.p.m.
- Thread cutting range:
  - Model A..... 48 pitches R.H. or L.H. 4 to 224 per inch
  - Models B & C... 45 pitches R.H. or L.H. 4 to 160 per inch
- Power longitudinal feeds:
  - Model A..... .48—.0015" to .0853"
  - Model B..... .26—.0021" to .0155"
  - Model C..... .14—.0021" to .0156"
- Power cross feeds:
  - Model A..... .48—.0004" to .0252"
  - Model B..... .23—.001" to .0046"
- Belt, width of pulley step for..... 1"
- Centers, Morse taper..... No. 2
- Collet capacity, maximum..... 1/2"
- Headstock spindle hole..... 3/4"
- Lead screw 29° Acme Thread..... 3/4"—8
- Motor, size required:
  - For 6-speed drive..... 1/4 h.p.
  - For 12-speed drive..... 1/2 h.p.
- Spindle nose threads..... 1 1/2"—8
- Tailstock top set over..... 5/8"
- Tool holder cutter bit..... 3/4" sq.
- Tool holder shank..... 3/8" x 13/16"
- Approx. shipping weights:
  - 3 ft. bed lathe..... 355 lbs.
  - 3 1/2 ft. bed lathe..... 380 lbs.
  - 4 ft. bed lathe..... 405 lbs.
  - 4 1/2 ft. bed lathe..... 430 lbs.

Model A 9-inch Lathes have heat-treated alloy steel spindle, quick change gear box, and friction clutch worm drive for power longitudinal feeds and power cross-feeds.

Model B 9-inch Lathes are same as Model A Lathes except that they have independent change gears, instead of the quick change gear box, for threads and feeds.

Model C 9-inch Lathes are same as Model B Lathes except they do not have the worm drive for power feeds. The cross-feed is hand-operated, and

longitudinal feeds are obtained by engaging half-nuts with the lead screw.

Toolroom 9-inch Lathes are same as Model A Lathes except that they have the following toolroom attachments: collet chuck; collet rack; taper attachment; thread dial; and micrometer carriage stop.

Price includes 1 ph., 60 cy., 115 v., A.C. instant reversing motor, drum control, and regular lathe equipment such as belts, centers, small face plate, tool post, etc. Chucks, collets, and tools are extra.

### 9-Inch Swing Horizontal Motor Driven South Bend Precision Bench Lathes

Length Bed Feet	Be- tween Cent- ers Inches	9" TOOLROOM LATHES		9" MODEL A LATHES				9" MODEL B LATHES				9" MODEL C LATHES			
				6-speed drive		12-speed drive		6-speed drive		12-speed drive		6-speed drive		12-speed drive	
		Cat. No.	Price	Cat. No.	Price	Cat. No.	Price	Cat. No.	Price	Cat. No.	Price	Cat. No.	Price	Cat. No.	Price
3	16	8644-Y	\$521.45	444-Y	\$298.35	644-Y	\$340.45	477-Y	\$240.35	677-Y	\$282.45	415-YC	\$187.35	615-YC	\$229.45
3 1/2	22	8644-Z	537.45	444-Z	314.35	644-Z	356.45	477-Z	256.35	677-Z	298.45	415-ZC	203.35	615-ZC	245.45
4	28	8644-A	553.45	444-A	330.35	644-A	372.45	477-A	272.35	677-A	314.45	415-AC	219.35	615-AC	261.45
4 1/2	34	.....	.....	444-R	353.35	644-R	395.45	477-R	295.35	677-R	337.45	415-RC	242.35	615-RC	284.45

**SOUTH BEND LATHE WORKS, 543 E. Madison Street, South Bend 22, Indiana, U.S.A.**

# 9" SOUTH BEND V-Belt Horizontal Motor Driven Bench Lathes

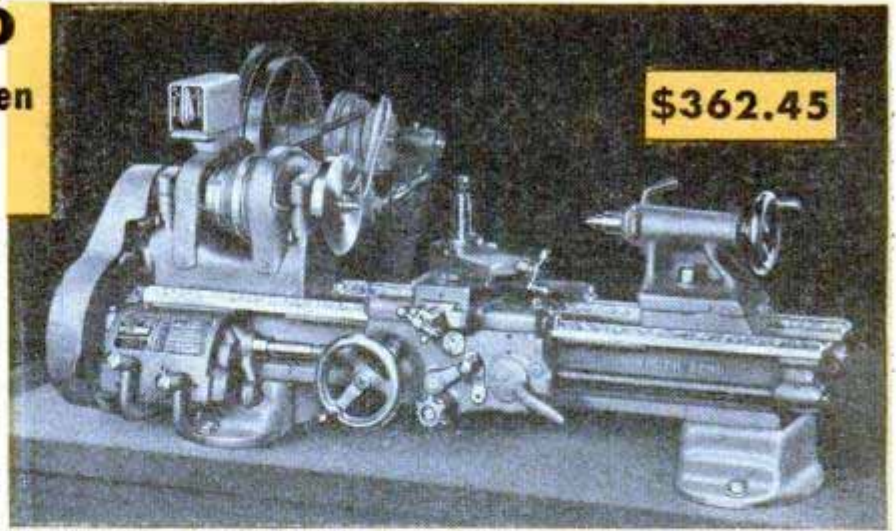

The 9" Bench Lathes with 8-speed and 16-speed V-belt horizontal motor drives offer more spindle speeds—an advantage when surface speeds are critical. These lathes are identical in all other respects to those described on the preceding page.

Price includes 1 ph., 60 cy., 115 v., A.C. motor, drum control, and regular lathe equipment such as belt, centers, small face plate, tool post, etc. Chucks, collets, tools, and bench are extra.

### TIME PAYMENT TERMS

25% down,  
balance 12 mos.,  
moderate finance  
charge (unless  
federal law re-  
quires otherwise)

### SPECIFICATIONS

Swing over saddle wings.....9 1/4"  
Swing over chip guard.....5 1/2"  
Hole thru spindle.....3/4"  
Collet capacity.....1/2"  
Spindle speeds  
8 speed drive....46 to 609 r.p.m.  
16 speed drive....46 to 1176 r.p.m.  
Thread cutting range:  
Model A.....48 pitches R.H. or L.H.  
4 to 224 per inch.  
Models B & C.45 pitches R.H. or L.H.  
4 to 160 per inch.

Power longitudinal feeds  
Model A......48—.0015" to .0853"  
Model B......26—.0021" to .0155"  
Model C......14—.0021" to .0156"  
Power cross-feeds  
Model A......48—.0004" to .0252"  
Model B......23—.001" to .0046"  
Spindle centers.....No. 2 Morse Taper  
Size motors  
8 speed drive.....1/4 h.p.  
16 speed drive.....1/2 h.p.

### 9-Inch Bench Lathes with V-Belt Horizontal Motor Drive

Length Bed Feet	Between Centers Inches	Ship. Wt. Crated Pounds	MODEL A		MODEL B		MODEL C	
			8-speed drive	16-speed drive	8-speed drive	16-speed drive	8-speed drive	16-speed drive
			Cat. No.	Price	Cat. No.	Price	Cat. No.	Price
3	16	355	544-Y \$321.35	744-Y \$362.45	577-Y \$263.35	777-Y \$304.45	515-YC \$210.35	715-YC \$251.45
3 1/2	22	380	544-Z 337.35	744-Z 378.45	577-Z 279.35	777-Z 320.45	515-ZC 226.35	715-ZC 267.45
4	28	405	544-A 353.35	744-A 394.45	577-A 295.35	777-A 336.45	515-AC 242.35	715-AC 283.45
4 1/2	34	430	544-R 376.35	744-R 417.45	577-R 318.35	777-R 359.45	515-RC 265.35	715-RC 306.45

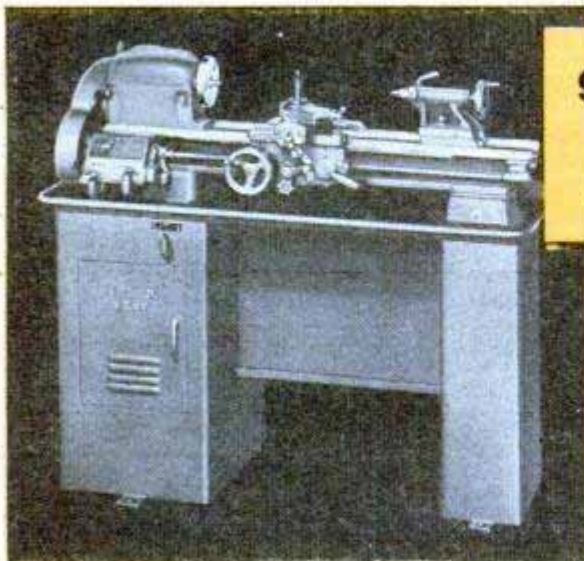

## 9" SOUTH BEND Underneath Motor Driven Lathe

Capable of machining work to the most exacting tolerances, this lathe is recommended for precision work in the toolroom, laboratory, or machine shop. Fully enclosed motor drive unit provides twelve spindle speeds, 41 to 1270 r.p.m. See above for other specifications. Price includes 1 ph., 60 cy., 115 v., A.C. motor, drum control, and regular lathe equipment. Chucks, collets, and tools are extra.

### 9" Underneath Motor Driven Lathes

Catalog Number	Model	Length of Bed Feet	Between Centers Inches	Weight Crated Pounds	Price f.o.b. Factory
344-ZN	A	3 1/2	22	570	\$512.45
377-ZN	B	3 1/2	22	560	454.45
8344-ZN	Toolroom	3 1/2	22	630	693.45

**SOUTH BEND LATHE WORKS, 543 E. Madison Street, South Bend 22, Indiana, U.S.A.**



SPECIFICATIONS	SERIES 900	SERIES 1000	SERIES 2-H
Collet capacity.....	1/2"	1"	1"
Hole thru spindle.....	3/4"	1 1/4"	1 1/4"
Swing over bed and saddle wings.....	9 1/4"	10 1/4"	16 1/4"
Swing over double tool-slide.....	3-9/16"	3-9/16"	6 7/8"
Swing over compound slide.....	5 1/2"	5 3/4"	6 1/8"
Turret tool feed.....	4"	4"	6 1/8"
Turret face to spindle distance, max.....	20 3/8"	19 3/8"	6' bed—28 1/4"
Double tool slide cross travel.....	3 3/8"	3 3/8"	9 3/4"
Thread cutting range, 48..	4—224 per in.	4—224 per in.	4—224 per in.
Spindle speeds, 12.....	41-1270 r.p.m.	50—1357 r.p.m.	16-880 r.p.m.
Carriage power feeds:			
Longitudinal, 48.....	.0015"—.0853"	.0015"—.0836"	.0015"—.0841"
Transverse, 48.....	.0004"—.0252"	.0006"—.0309"	.0006"—.0312"
Carriage longitudinal travel.....	18"	16"	6' bed—22 1/2"
Turret power feeds.....	.....	.....	.0001"—.0148"
Turret indexing tolerance at 4" from turret face.....	.0005"	.0005"	.0005"
Size motor.....	1/2 h.p.	3/4 h.p.	2-1 h.p.

# SOUTH BEND

## Precision Turret Lathes

**Series 900.** This turret lathe is specifically designed for second operations on small, precision parts. Its accuracy, and speed of handling and machining produce appreciable economies in manufacturing that are not possible with heavy turret lathes. Price includes 1 ph., 60 cy., 115 v.,

A.C. motor, drum control, power feed universal carriage, handlever bed turret, handlever cross slide, compound rest cross slide, coolant return assembly, and metal column base with built-in oil pan.

**Series 1000.** Designed for the same types of applications as the Series 900, these turret lathes with their larger capacities are ideal for machining a wide variety of precision parts. Numerous choices of spindle speeds, power longitudinal and transverse carriage feeds, and thread cutting feeds keep production efficient. Price includes 3 ph., 60 cy., 220 v., A.C. motor, drum control, power feed universal carriage, handlever bed turret, handlever cross slide, compound rest cross slide, oil pan, and coolant return assembly.

**Series 2-H.** The production of precision duplicate parts in both machine shops and toolrooms is simplified with 2-H Turret Lathes. They are especially suited for exacting second operations on large work because of their accuracy and ease of operation. Price includes 2-speed, 3 ph., 60 cy., 220 v., A.C. motor, drum control, power feed universal carriage with screw feed double tool slide having front and rear tool blocks, power feed ram-type turret, and oil pan.

*Prices do not include coolant pump, splash pan or collet equipment.*

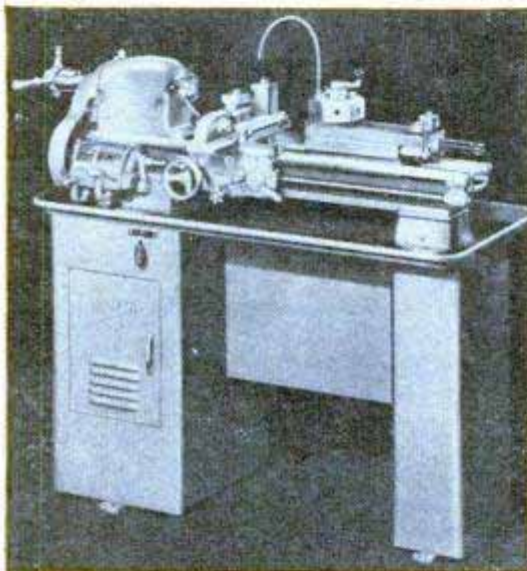

Ser. 900, Cat. No. 930-Z Turret Lathe \$805.45

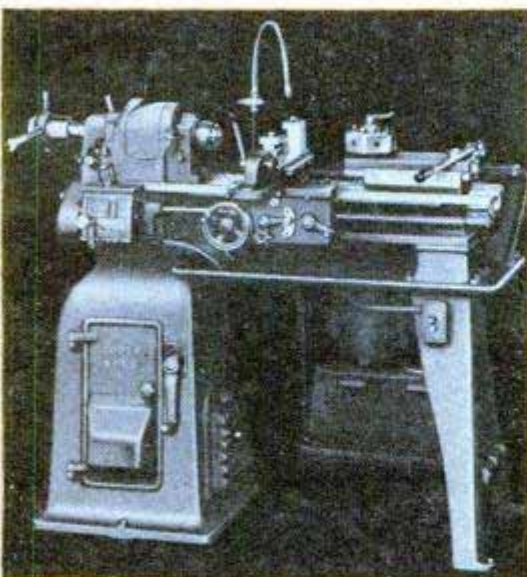

Ser. 1000, Cat. No. 1006-Z Turret Lathe \$1279.35

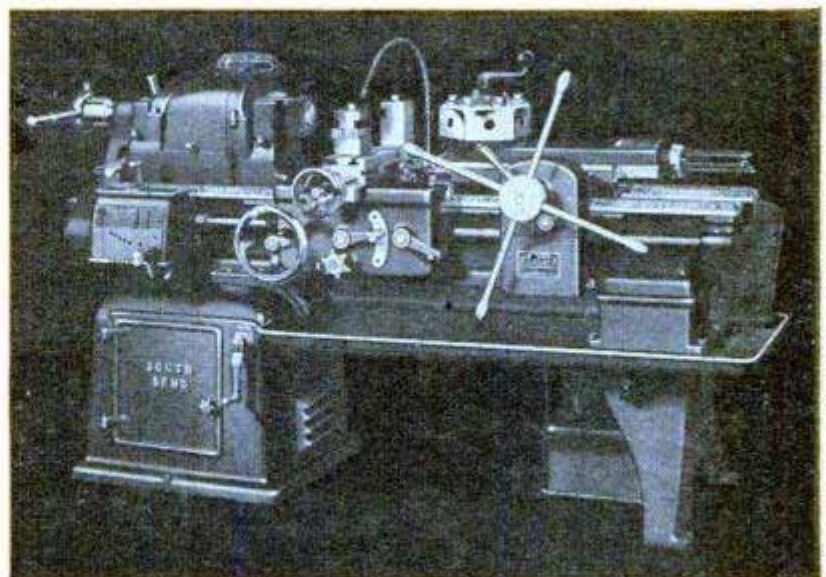

Series 2-H, Cat. No. 2-CT Turret Lathe (6' bed) \$2692.35

**SOUTH BEND LATHE WORKS, 543 E. Madison Street, South Bend 22, Indiana, U.S.A.**

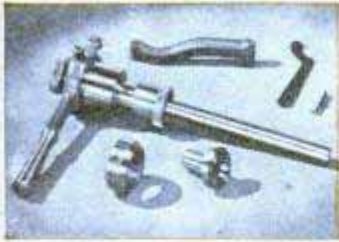

**HANDLEVER  
COLLET ATTACHMENT**

The Handlever Collet Attachment is an aid to rapid production work. Stock can be released and fed through the collet without stopping the lathe.

**Collet  
Attachment**

**HANDWHEEL TYPE**

The Handwheel Collet Attachment is a very accurate type of chuck. It is used for precision toolroom work and for the manufacture of small parts, or wherever extremely close tolerances are required. Bar and tube stock can be fed through the hollow draw-bar that operates the collet. Equipment includes draw-bar, spindle nose cap, spanner wrench, and closing sleeve. Collets are not included.

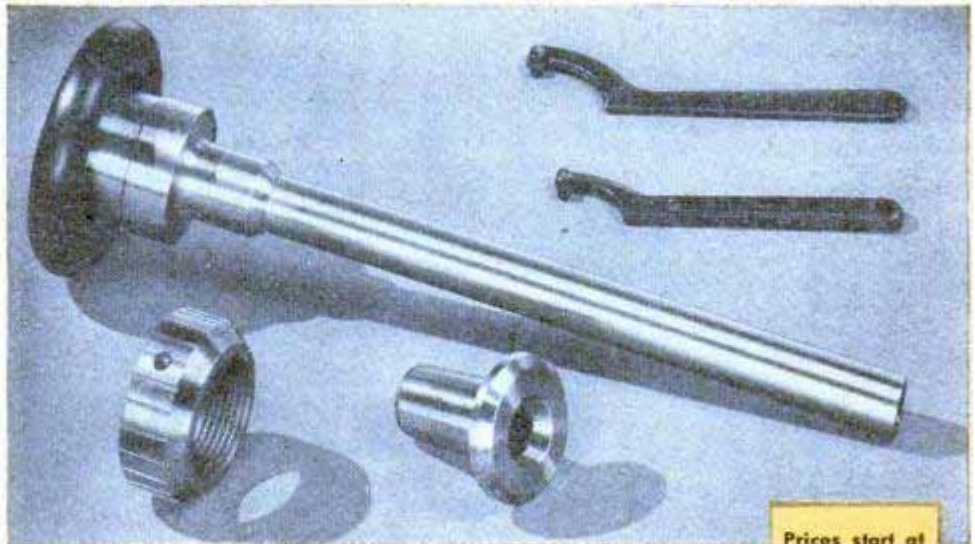

Handwheel Draw-in Collet Attachment

Prices start at

**\$26**

**DRAW-IN COLLET ATTACHMENTS**

Size of Lathe	Collet Required	Max. Collet Cap.	Handwheel Type		Handlever Type	
			Catalog Number	Price	Catalog Number	Price
9" and Series 900.....	No. 3	1/2"	4306-W	\$26	5206-W	\$ 89
10"-11/16" Collet.....	No. 2	11/16"	4310	42	5210	126
10"-1" Col. & Series 1000.	No. 5	1"	4312	52	5219	158
13"-11/16" Collet.....	No. 2	11/16"	4313	42	5213	126
13"-1" Collet.....	No. 5	1"	4313-Q	52	5213-Q	158
14 1/2"-3/4" Collet.....	No. 4	3/4"	4314	47	5214	147
14 1/2"-1" Collet.....	No. 5	1"	4314-M	52	5214-M	158
16", 16/24", & No. 2-H.....	No. 5	1"	4316	52	5216	158

**Collet Rack and Collet Chest**

Collet Rack No. 1770-W holds 19 collets, all others hold 17 collets. Collets are not included.

**COLLET RACKS**

Catalog Number	Size of Lathe	Price
1770-W	9" and 900	\$13
1752	10"-11/16" Col.	16
1753	10"-1" C & 1000	18
1772	13"-11/16" Col.	16
1772-Q	13"-1" Col.	18
1791	14 1/2"-3/4" Col.	18
1774	14 1/2", 16" & 16/24"	18

No. 2225—Collet Chest only, for holding handwheel collet attachment and collets for 9" lathe. Collet attachment and collets not included. Price: \$7.50.

No. 2220—Collet Chest, 9" handwheel collet attachment and 29 steel collets for round work, 1/16" to 1/2" by 64ths. Complete: \$123.00.

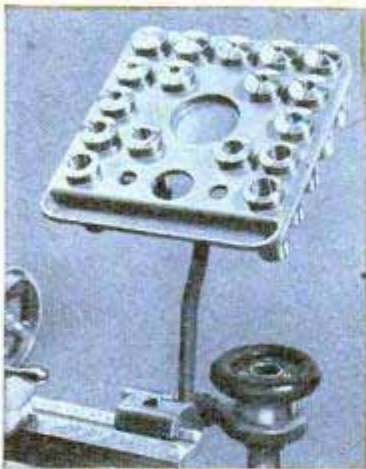

**COLLET RACK**

Holds collets, centers, spindle sleeve, draw-bar, spindle nose cap, wrench, etc.

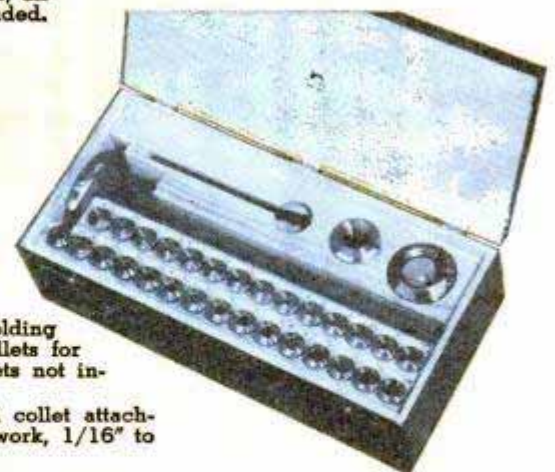

**COLLET CHEST**

Holds handwheel collet attachment and 29 collets. Well constructed of wood.

**TIME  
PAYMENT  
TERMS**

When order includes lathe, 25% down, balance 12 mos., moderate finance charge (unless federal law requires otherwise)

**SOUTH BEND LATHE WORKS, 543 E. Madison Street, South Bend 22, Indiana, U. S. A.**

# Collets and Collet Sets

South Bend Collets, manufactured with the same exacting care as South Bend Lathes, deliver long, dependable service on precision work. Each collet is carefully inspected and tested, and packed in substantial plastic box with transparent lid through which the size can be read for easy selection.

Steel Collets are carefully heat-treated for maximum service and are precision ground to exceedingly close tolerances.

Brass Collets, a South Bend innovation, have many practical applications.

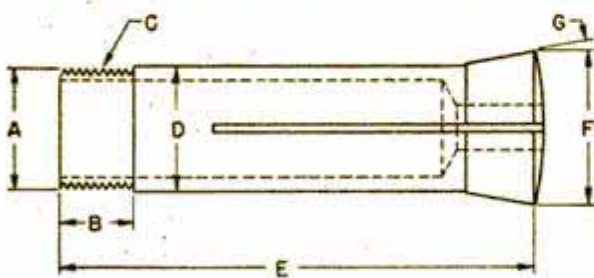

Their low cost makes them desirable for odd sizes that are used only occasionally. They can be readily machined on the job for holding tapered or irregular shapes. When worn, they can be rebored to larger diameters.



Steel Collet



Brass Collet



Collet Packaged in Plastic Box

## Specifications of Steel and Brass Collets

Collet Number	For South Bend Lathes	A Thread Diameter Inches	B Thread Length Inches	C Threads Per Inch	D Body Diameter Inches	E Collet Length Inches	F Head Diameter Inches	G Head Angle Degrees
3	9" and Series 900	.650	3/4	26	.6495	2-11/16	.852	12
2	10" and 13"—11/16" Collet	.855	13/16	20	.8595	3-5/16	1.095	15
5	10", 13", 14 1/2", 16"—1" Collet	1.250	3/4	20	1.2495	3-9/32	1.452	10
4	14 1/2"—3/4" Collet	.950	13/16	20	.9495	3	1.150	10

\*Collets can also be used on any other lathe or machine which they will fit.

## South Bend Collets and Collet Sets

Collet	Description	Steel Collets		Brass Collets	
		Cat. No.	Price	Cat. No.	Price
No. 3	1 Collet, any standard size 1/16" to 1/2" in 64ths.....	609-W	\$ 3.75	1696	\$ 2.00
	Set of 8 Collets in 16ths, 1/16" to 1/2".....	2047	27.00	2235	15.00
	Set of 7 Collets in odd 32nds, 3/32" to 15/32".....	2476	24.00	2534	13.00
	Set of 14 Collets in odd 64ths, 5/64" to 31/64".....	2477	46.00	2535	24.00
	Decimal Collets (.0625" to .500") each.....	769-W	4.00	1856	2.15
	Metric Collets (1.5 mm to 12.5 mm) each.....	773-W	4.00	1702	2.15
No. 2	1 Collet, any standard size 1/16" to 11/16" in 64ths.....	1721	4.00	1697	2.25
	Set of 11 Collets in 16ths, 1/16" to 11/16".....	2432	39.00	2238	23.00
	Set of 10 Collets in odd 32nds, 3/32" to 21/32".....	2478	36.00	2536	21.00
	Set of 20 Collets in odd 64ths, 5/64" to 43/64".....	2479	71.00	2537	40.00
	Decimal Collets (.0625" to .6875") each.....	769-N	4.25	1857	2.40
	Metric Collets (1.5 mm to 17.0 mm) each.....	773-N	4.25	1703	2.40
No. 5	1 Collet, any standard size 1/16" to 1" in 64ths.....	1722	4.75	1698	2.50
	Set of 16 Collets in 16ths, 1/16" to 1".....	2435	68.00	2241	37.00
	Set of 15 Collets in odd 32nds, 3/32" to 31/32".....	2482	64.00	2540	35.00
	Set of 30 Collets in odd 64ths, 5/64" to 63/64".....	2483	127.00	2541	65.00
	Decimal Collets (.0625" to 1.000") each.....	769-R	5.00	1858	2.65
	Metric Collets (1.5 mm to 25.0 mm) each.....	773-R	5.00	1704	2.65
No. 4	1 Collet, any standard size 1/16" to 3/4" in 64ths.....	1713	4.25	1699	2.35
	Set of 12 Collets in 16ths, 1/16" to 3/4".....	2438	46.00	2244	26.00
	Set of 11 Collets in odd 32nds, 3/32" to 23/32".....	2480	42.00	2538	24.00
	Set of 22 Collets in odd 64ths, 5/64" to 47/64".....	2481	81.00	2539	45.00
	Decimal Collets (.0625 to .7500") each.....	769-K	4.50	1859	2.50
	Metric Collets (1.5 mm to 19.0 mm) each.....	773-K	4.50	1705	2.50

**SOUTH BEND LATHE WORKS, 543 E. Madison Street, South Bend 22, Indiana, U.S.A.**

## Chuck and Tool Assortments

The chucks and tools in the assortments shown are recommended for use with the various South Bend Lathes. This is the basic equipment required for the average shop for general machine work, such as turning, boring, drilling, cutting-off, chucking, etc. A 3-jaw Universal chuck can be substituted for the 4-jaw Independent at additional cost.

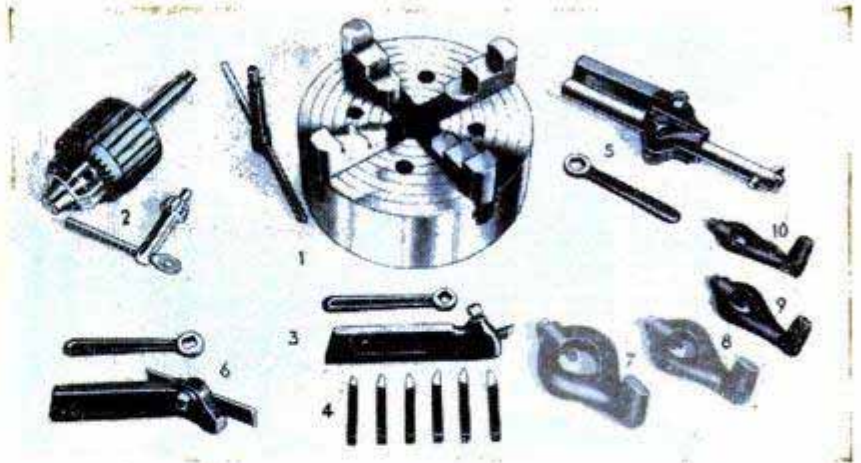

### Contents of Assortment

- 4-Jaw Independent Lathe Chuck fitted to lathe. Sizes: 6 in. on 9" and 10" Lathes; 7½ in. on 13" Lathe; 9 in. on 14½" Lathe; 10 in. on 16" and 16/24" Lathes.
- Jacobs 3-Jaw Drill Chuck. Sizes: ½ in. on 9" and 10" Lathes; ¾ in. on 13" and 14½" Lathes; 1 in. on 16" and 16/24" Lathes.
- Arbor Fitted to Above Drill Chuck.
- Straight Shank Tool Holder.
- 6 Ground Cutter Bits for Tool Holder.
- Boring Tool Holder, Style "B." 9" Lathes take Style "D."
- Cutting-Off Tool Holder, Right-Hand.
- 4 Malleable Lathe Dogs. Sizes: ½", ¾", 1", and 1¼" on 9" and 10" Lathes; ½", ¾", 1", and 1½" on all others.

### Prices of Complete Assortments

Size of Lathe	Catalog No.	Price
9" & 900.....	105-WT	\$53.89
10"—11/16" Collet.....	110-T	92.72
10"—1" Collet & 1000...	110-L	93.72
13"—11/16" Collet.....	113-T	109.41
13"—1" Collet.....	113-TQ	110.41
14 ½"—¾" Collet.....	114-T	123.28
14 ½"—1" Collet.....	114-TM	136.28
16" & 16/24".....	116-T	144.28

### Wood Turning Rest

Mounts on compound rest base to convert lathe for wood turning. See page 14 for wood turning centers.

Price includes socket and two T-rests, 4" and 12" wide.

Prices Start At \$10

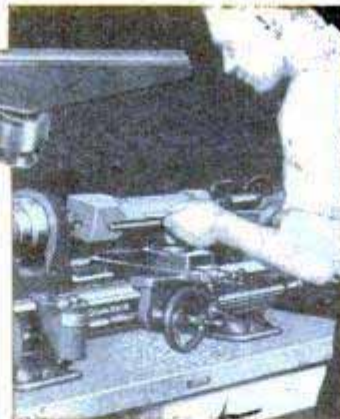

Size of Lathe	Catalog No.	Price
9".....	896-W	\$10
10".....	1069	13
13".....	1073	15
14 ½".....	1165	19
16" and 16/24".....	1075	19

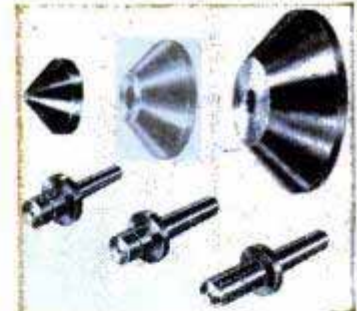

### Pipe Centers

Cat. No.	Takes Pipe	Requires Shank	Price
2160	½" to 3"	2172-NR	\$4.75
2161	3" to 5"	2172-TH	6.50
2162	5" to 8"	2173-TH	9.75

### Pipe Center Shanks

Cat. No.	Taper	Price
2172-NR	No. 2	\$4.75
2172-TH	No. 3	4.75
2173-TH	No. 3	8.00

**TIME  
PAYMENT  
TERMS**

When order includes lathe 25% down balance 12 mos., moderate finance charge (unless federal law requires otherwise)

### Chip Pans and Oil Pans

Oil Pans, Splash Pans, and Chip Pans can be supplied for all South Bend Lathes. Oil Pans should be factory-installed for proper fit. Complete information and prices will be supplied on request.

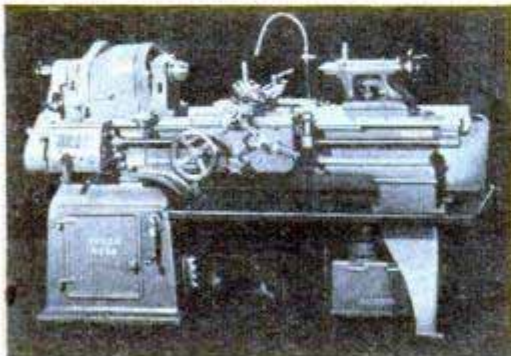

**SOUTH BEND LATHE WORKS, 543 E. Madison Street, South Bend 22, Indiana, U.S.A.**

## Milling and Keyway Cutting Attachment

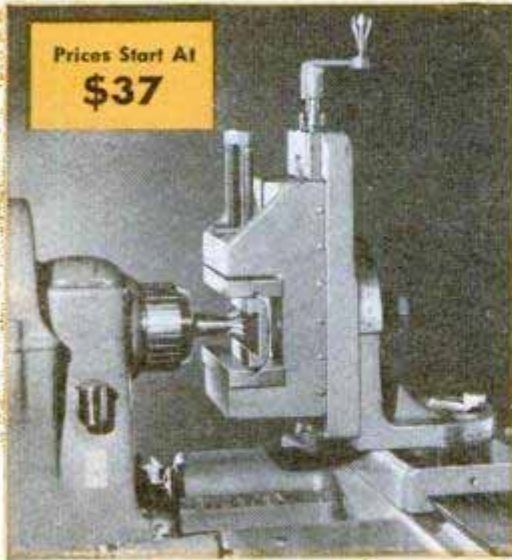

Milling and Keyway Cutting Attachment

This useful attachment is ideal for shops not having enough of this work to justify a milling machine. Mounts on compound rest base of lathe, permitting the power cross and longitudinal feeds to be used for milling, boring and keyway cutting operations on work held in the milling attachment vise. Vise swivels in any direction, 180° horizontal and vertical graduations. Vertical slide adjusting screw equipped with micrometer graduated collar.

Size Lathe	Cat. No.	Vise Cap.	Price
9" & 900	9-W	1 1/2"	\$37
10" & 1000	1-N	1 3/4"	47
13"	3	2 3/8"	58
14 1/2"	4-K	4"	68
16", 16/24"	5	4"	79

### Arbors for Milling Cutters



Holds cutters with 1" holes. Capacity between nut and shoulder, 1 1/8". 3 spacing collars furnished. All shanks No. 3 Morse Taper.

Lathe Size	Catalog No.	Price
9" & 900	109-NH	\$7.50
10" & 1000	109-NH	7.50
13"	109-NH	7.50
14 1/2"	109-NH	7.50
16", 16/24"	109-NH	7.50

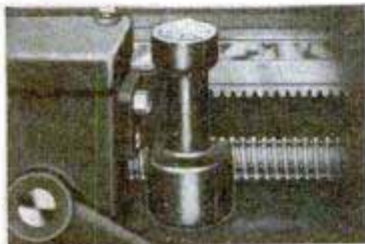

### Thread Dial Indicator

Eliminates reversing of lathe spindle when cutting threads. Dial is numbered and graduated to show when to close half-nuts on lead screw to catch the thread on the next successive cut, after returning carriage to starting point.

Lathe Size	Catalog No.	Price
9" & 900	810-W	\$ 9
10" & 1000	1588	14
13"	813	16
14 1/2"	813	16
16", 16/24", 2-H	813	16

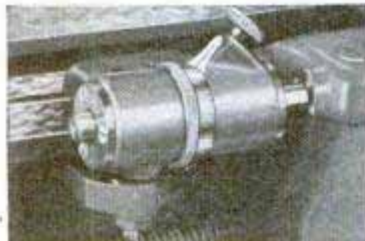

### Micrometer Carriage Stop

Locates the carriage at any point along the bed for accurate facing, turning, boring, etc. Has accurately graduated micrometer collar. Stop is hardened on both ends for use on either side of carriage. Can be locked for duplicate work.

Size of Lathe	Catalog No.	Price
9" & 900	968-W	\$16
10" & 1000	1518	17
13"	973	19
14 1/2"	975-FH	20
16", 16/24", 2-H	975-FH	20



### Follower Rest

Supports long, slender shafts being machined between centers. Attaches to, and travels with, the carriage. Adjusting screws and lock screws are provided for setting the jaws in position. Slots in bottom of follower rest permit quick attachment or removal.

Size of Lathe	Catalog No.	Capacity		Price
		Max.	Min.	
9" & 900	34-W	2"	3/16"	\$5.00
10" & 1000	1353	2 1/2"	3/16"	7.50
13"	376	3 1/4"	3/16"	8.50
14 1/2"	1351	4 1/4"	3/16"	10.00
16"	730	4 1/4"	3/16"	11.00
16/24"	1352	4 1/4"	3/16"	16.00

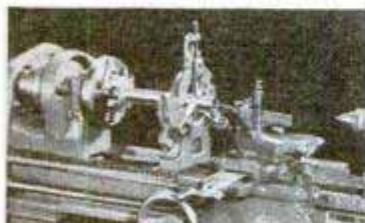

### Center Rest

Clamps on inside ways of lathe bed and is used for supporting long shafts, boring spindles, etc. The 3 jaws are adjustable, and are made of cast iron. Top of center rest is hinged to facilitate inserting and removing shafts.

Size of Lathe	Catalog No.	Capacity		Price
		Max.	Min.	
9" & 900	125-W	3"	1/4"	\$7.50
10" & 1000	1177	3"	1/4"	11.00
13"	341	3 3/4"	3/8"	14.00
14 1/2"	1174	4 3/4"	3/8"	17.00
16"	720	4 3/4"	3/8"	19.00
16/24"	1175	4 3/4"	3/8"	26.00

**SOUTH BEND LATHE WORKS, 543 E. Madison Street, South Bend 22, Indiana, U.S.A.**

## Taper Attachments

Telescopic and Plain

Taper turning and boring are as easily accomplished as straight turning on lathes equipped with South Bend Taper Attachments. The Taper Attachments are permanently mounted on the lathe carriages, and must be fitted at the factory. Accuracy and smooth operation are assured by their practical design and rugged construction. The swivel bar is graduated in both degrees and taper per foot.

Telescopic Taper Attachments are used only on 10" and larger lathes. A telescopic cross-feed screw eliminates the necessity of disconnecting the cross-feed nut when tapers are machined. The Plain Taper Attachment used on 9" Lathes requires the disconnecting of the cross-feed screw and nut.

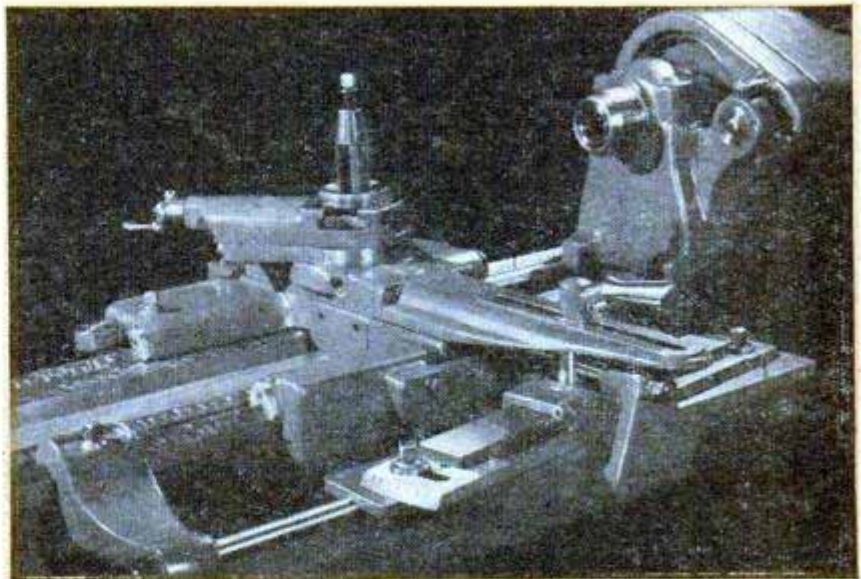

Telescopic Taper Attachment

### TIME PAYMENT TERMS

When order includes lathe 25% down, balance 12 mos., moderate finance charge (unless federal law requires otherwise)

Size of Lathe	Catalog Number	Max. Length at One Setting	Max. Taper per Foot	Max. Taper in Degrees	Price
9" and 900....	428-W	7"	3 1/2"	16 1/2°	\$ 80
10" & 1000....	1545	8 1/2"	3 1/2"	16 1/2°	145
13".....	379	9 1/4"	3 1/2"	16 1/2°	165
14 1/2".....	309	9 1/4"	3 1/2"	16 1/2°	177
16" & 16/24"..	381	11 1/2"	3 1/2"	16 1/2°	198

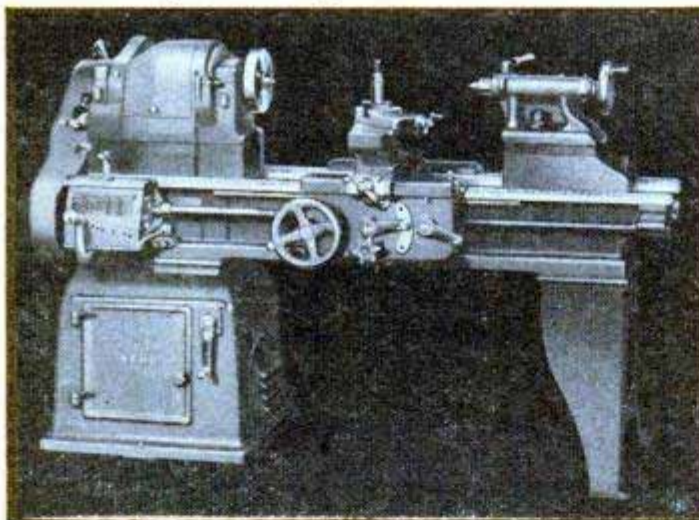

## 16/24" Quick Change Gear Lathe

This lathe has ample capacity for large, awkward jobs such as wheels, fly wheels, brake drums, etc.; yet, it is not too heavy or cumbersome for efficient operation on small parts. Takes 24 1/4" over bed and 18 3/4" over saddle cross slide. Other specifications are same as for 16" lathes on page 2.

Cat. No. 198-E—16/24" x 8' Quick Change Gear Lathe with 3 ph., 60 cy., 220 v. A.C. motor and drum switch..... \$2028.25

Prices of same lathe with 6', 7', 10', or 12' bed on request.

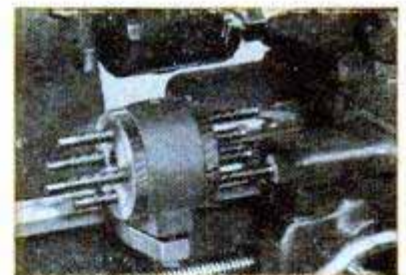

## Four Position Carriage Stop

Used to position cutting tools for repetitive operations. Has four stop screws. Each may be set for a different tool position. Especially useful with a square turret tool block carrying four cutting tools. Clamps to bed on either side of lathe carriage.

Cat. No.	Size of Lathe	Price
2185-N	9".....	\$18
2185-R	10".....	20
2185-T	13".....	21
2185-F	14 1/2".....	22
2185-H	16", 16/24", 2-H..	23

**SOUTH BEND LATHE WORKS, 543 E. Madison Street, South Bend 22, Indiana, U.S.A.**

## Universal Tool Block

The new Universal Tool Block replaces the conventional tool post and various tool holders ordinarily used for general lathe work. It provides rigid support for turning, boring, threading, and cut-off tool bits. In addition, it is equipped with a self-aligning knurling head. Screw adjustments for tool height are easily made, and they stay put. No re-adjustment is required when replacing tools. This tool block can be adapted to fit other makes of lathes.

Size of Lathe	Cat. No.	Price
9".....	1413-N	\$11.80
10".....	1413-R	12.50
13".....	1413-T	14.50
14 1/4".....	1413-F	16.50
16" & 16/24"	1413-H	17.00

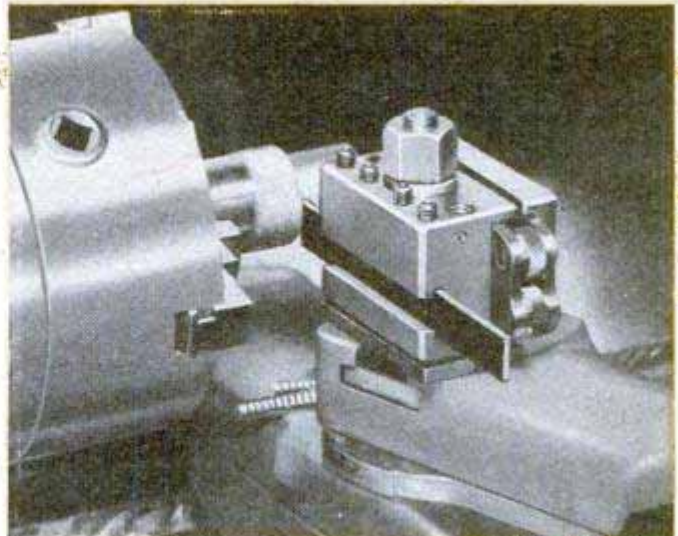

Universal Tool Block Patent Pending

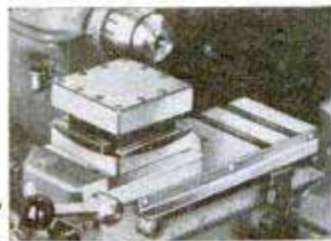

### Square Turret Tool Block

for Double Tool Cross Slide

The turret indexes within .0005", permitting each of four tools to be used in sequence for rough turning, finish turning, facing, boring, cutting-off, or other

operations as required. A quick-acting lever locks the turret securely in each of the four positions. Rocker adjustment is provided for adjusting height of each tool. For use on the double tool cross slides of South Bend Lathes, but can be adapted for use on other makes.

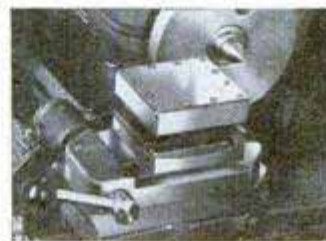

### Square Turret Tool Block

for Compound Cross Slide

Used on compound cross slides for same purpose as tool block described at left. Turret indexes within .0005" to each of four positions and locks by means of lever. Rocker adjustments provided for tools. Ruggedly constructed. This tool block is for use on compound rest cross slides of South Bend Lathes but can be adapted for use on other makes.

Patent Pending

### Tool Blocks for Double Tool Cross Slides

Size of Lathe	Catalog Number	Size Square	Takes Tools	Price
9" & 900.....	41-ND	3"	3/8" x 3/8"	\$42
10" & 1000.....	41-ND	3"	3/8" x 3/8"	42
16".....	42-ND	4"	5/8" x 5/8"	75

### Tool Blocks for Compound Cross Slides

Size of Lathe	Catalog Number	Size Square	Takes Tools	Price
9" & 900.....	40-NC	3"	3/8" x 3/8"	\$48
10" & 1000.....	41-NC	3"	3/8" x 3/8"	48
13".....	43-NC	3"	3/8" x 3/8"	53
14 1/2".....	44-NC	4"	3/8" x 3/8"	75
16" & 16/24".....	42-NC	4"	5/8" x 5/8"	80



### Handlever Double Tool Cross Slide

Ideal for increasing production on repetitive operations. Three 7/16" square cutter bits can be used—two in front tool block, one in rear tool block. Mounts on saddle cross slide in place of compound rest. Can be operated by handlever or power cross-feed.



### Handlever Bed Turret

Turret head indexes automatically when lever is moved to extreme right. Each turret face has independently adjustable feed stop screw which accurately regulates length of cut. Effective feed of turret slide 4". Turret indexes within .0005" four inches from turret face.

Size of Lathe	Catalog Number	Swing over Slide	Price
9" & 900...	2030-W	3-9/16"	\$79
10" & 1000.	2031	3-9/16"	95

Size of Lathe	Cat. No.	Price
9" & 900.....	1611-W	\$210
10" & 1000....	1612	220
13".....	1613	237

**SOUTH BEND LATHE WORKS, 543 E. Madison Street, South Bend 22, Indiana, U.S.A.**

## Standard and Safety Lathe Dogs

Lathe dogs should correspond in capacity to the diameter of the work if the work is to be held securely. These lathe dogs are made of heavy malleable iron and are properly designed for maximum strength and long service. The Standard Lathe Dog has square head alloy steel set screw. The Safety Lathe Dog has a headless alloy steel set screw.



## Lathe Dogs for 13" and Larger Lathes

Cap. In.	STANDARD		SAFETY		
	Cat. No.	Price	Cat. No.	Wrench Required	Price
1/2	3843	\$0.85	3826	2385	\$0.85
3/4	3844	1.00	3827	2386	1.00
1	3845	1.10	3828	2387	1.10
1 1/4	3846	1.25	3829	2388	1.25
1 1/2	3847	1.50	3830	2389	1.50
1 3/4	3848	1.65	3831	2389	1.65
2	3849	1.80	3832	2389	1.80
2 1/2	3850	2.05	3833	2390	2.05
3	3851	2.30	3834	2390	2.30
3 1/2	3852	3.15	3835	2390	3.15
4	3853	4.25	3836	2390	4.25

## Lathe Dogs for 9" and 10" Lathes

Cap. In.	STANDARD		SAFETY		
	Cat. No.	Price	Cat. No.	Wrench Required	Price
3/8	3837	\$0.75	3820	2385	\$0.75
1/2	3838	.80	3821	2385	.80
3/4	3839	.95	3822	2386	.95
1	3840	1.05	3823	2387	1.05
1 1/4	3841	1.15	3824	2388	1.15
1 1/2	3842	1.45	3825	2388	1.45

A complete set of lathe dogs is a must in any shop.

## Lathe Centers and Drill Pads

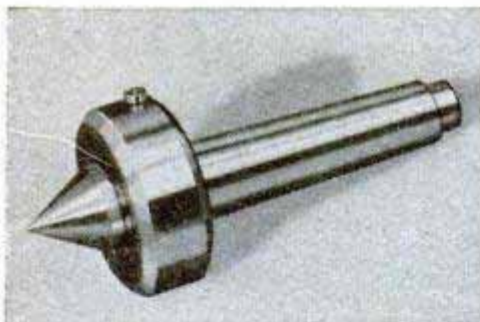

Patent Pending

### Ball Bearing Live Center

Designed for maximum strength and rigidity, the Ball Bearing Live Center is recommended for high speeds, heavy roughing cuts, etc. 60° point runs in substantial precision ball bearing which is easily replaceable.

Catalog No.	Shank Taper	Price
3900	No. 2	\$13.75
3901	No. 3	16.25

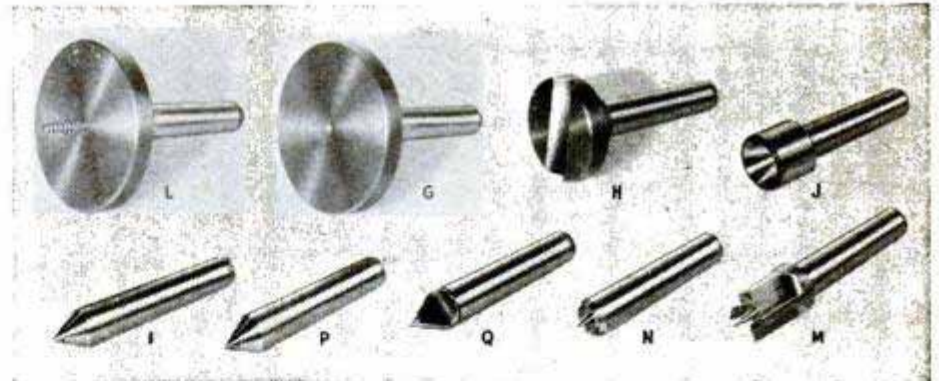

L—Screw Center for wood turning. G—Drill Pad to support flat work for drilling. H—Crotch Center supports round work for cross drilling. J—Hollow Center for supporting centerless shafts up to 3/8" dia. I—60° Center. P—Carbide Center. Q—Half Center. N—Cup Center. M—Spur Center, for all wood turning operations.

Description	No. 2 Taper for 9" and 10" Lathes		No. 3 Taper for 13", 14 1/2", & 16"	
	Cat. No.	Price	Cat. No.	Price
L—Screw Center.....	731-NR	\$3.15	731-TH	\$3.50
G—Drill Pad.....	727-NR	2.65	727-TH	2.90
H—Crotch Center.....	728-NR	2.65	728-TH	3.50
J—Hollow Center.....	1896-NR	2.15	1896-TH	2.90
I—60° Center.....	726-NR	2.40	726-TH	3.15
P—Carbide Center.....	1889	4.75	1890	8.50
Q—Half Center.....	926-NR	2.40	926-TH	3.15
N—Cup Center.....	733-NR	2.15	733-TH	2.90
M—Spur Center.....	732-NR	3.15	732-TH	3.50

**TIME  
PAYMENT  
TERMS**

When order includes lathe 25% down, balance 12 mos., moderate finance charge (unless federal law requires otherwise)

**SOUTH BEND LATHE WORKS, 543 E. Madison Street, South Bend 22, Indiana, U.S.A.**



## Grinding Attachment

This powerful and efficient grinding attachment is recommended for external grinding. Designed to fit the various sizes of South Bend Lathes, it is easily adaptable for use on milling machines, shapers, planers, or other makes of lathes. The spindle revolves on pre-lubricated, precision ball bearings which are sealed to protect them from damage by dust, grit, and metal particles produced when grinding. Supplied with  $\frac{1}{4}$  h.p., 1725 r.p.m., 115 v., 60 cy., 1 ph. motor and 4" x  $\frac{1}{2}$ " grinding wheel.

Prices with other motors quoted on request.



External Grinding Attachment

Catalog No.	Size of Lathe	Price
301-BN	9" & Series 900.....	\$52
301-BR	10" & Series 1000.....	52
301-BT	13".....	52
301-BF	14 $\frac{1}{2}$ ".....	52
301-BH	16" & 16/24".....	52

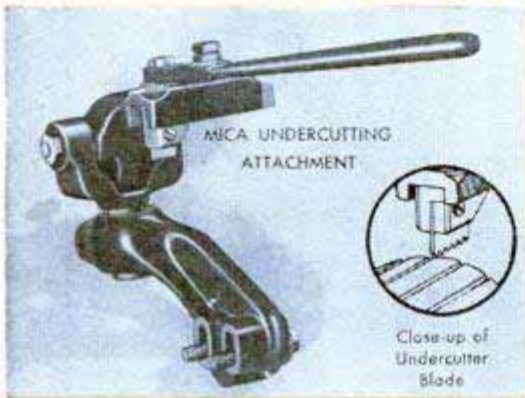

Patented

## Mica Undercutting Attachment

Any shop that repairs armatures for motors, generators or starters will have a lot of use for this practical attachment. It attaches to the saddle of the lathe which insures rigidity and alignment. The blade travels parallel to the commutator bars which insures clean, straight cutting. Upper portion is hinged so the blade holder can be swung back so it does not interfere with turning the commutator.

Price includes one blade .020" thick. Extra cutter blades .020" and .015" thick are available as listed below.

Size of Lathe Description	9"		10"		13"		14 $\frac{1}{2}$ "		16"	
	Cat. No.	Price	Cat. No.	Price	Cat. No.	Price	Cat. No.	Price	Cat. No.	Price
Mica Undercutting Attachment.....	675-N	\$19.00	675-R	\$19.00	675-T	\$20.00	675-F	\$21.00	675-H	\$22.00
Extra Blade, .015".....	2028	.20	2028	.20	2028	.20	2028	.20	2028	.20
Extra Blade, .020".....	2029	.30	2029	.30	2029	.30	2029	.30	2029	.30

## Adjustable Collet Bushing Chuck

The adjustable collet bushing chuck provides an extremely accurate, but inexpensive equipment for mounting centerless armature shafts, and similar parts, in the lathe. Can be used in either head or tail spindle of lathe. Collets are made of brass, and may be adjusted for either running fit or driving fit on shaft.

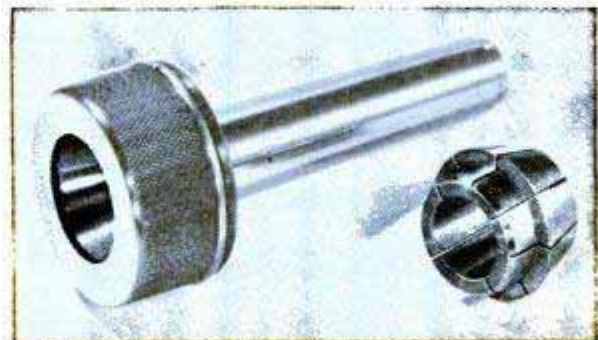

Description	Cat. No.	Shank	Price
Adjustable Collet Bushing Chuck	1615-NR	No. 2	\$6.60
Only.....	1615-TH	No. 3	7.15
Adjustable Collet Bushing Chuck with set of 3 collets, 9/16", 5/8" and .637" capacity for popular armatures.....	1608-NR	No. 2	9.45
	1608-TH	No. 3	9.95

Cat. No. 1659, Extra Collets for round work, any capacity  $\frac{1}{4}$ " to 1" round by 16ths, price each \$1.10.

**SOUTH BEND LATHE WORKS, 543 E. Madison Street, South Bend 22, Indiana, U. S. A.**

# SOUTH BEND LATHE ATTACHMENTS

## Accessories for South Bend Lathes

DESCRIPTION	9"	10"	13"	14½"	16"
Bench, angle iron with 26" x 60" wood top, no drawers...	\$32.75	\$.....	\$.....	\$.....	\$.....
Bench Drawer, 20" x 14" x 3⅜", for above bench.....	6.25	.....	.....	.....	.....
Bench, tubular steel with 27" x 51½" top and six drawers..	135.00	.....	.....	.....	.....
Center Knock-out Bar, with knurled handle and brass tip..	2.65	3.25*	4.75*	4.75*	4.75
Chuck, face plate type, with four jaws.....	15.75	20.00*	.....	.....	.....
Chuck, ⅛" to ⅝" Hollow Threaded for holding auto. valves.	15.00	.....	.....	.....	.....
Chuck, ⅜" to ¾" Hollow Threaded for holding auto. valves.	18.00	.....	.....	.....	.....
Chuck, 6" Independent 4-jaw, medium pattern.....	32.50	38.50*	.....	.....	.....
Chuck, 6" Independent 4-jaw, regular pattern.....	60.00	66.00*	66.00*	.....	.....
Chuck, 7½" Independent 4-jaw regular pattern.....	.....	73.00*	73.00*	74.00*	74.00
Chuck, 9" Independent 4-jaw, regular pattern.....	.....	.....	80.00*	81.00*	81.00
Chuck, 10" Independent 4-jaw, regular pattern.....	.....	.....	.....	93.00*	93.00
Chuck, 12" Independent 4-jaw, regular pattern.....	.....	.....	.....	.....	107.00
Chuck, 5" Universal 3-jaw med. pattern, with two sets jaws.	47.22	53.22*	.....	.....	.....
Chuck, 5" Universal 3-jaw, reg. pattern, with two sets jaws.	75.00	81.00*	81.00*	82.00*	82.00
Chuck, 6" Universal 3-jaw, reg. pattern, with two sets jaws.	.....	84.00*	84.00*	85.00*	85.00
Chuck, 7½" Universal 3-jaw, reg. pattern, with two sets jaws	.....	.....	96.00*	97.00*	97.00
Chuck, 9" Universal 3-jaw, reg. pattern, with two sets jaws..	.....	.....	.....	.....	125.00
Chuck, 0 to ⅜" Jacobs Drill, with No. 2 Morse Taper arbor..	6.40	6.40	.....	.....	.....
Chuck, 0 to ½" Jacobs Drill, with No. 2 Morse Taper arbor..	7.74	7.74	.....	.....	.....
Chuck, ⅜" to ¾" Jacobs Drill, with No. 2 Morse Taper arbor	12.90	12.90	.....	.....	.....
Chuck, ⅜" to 1" Jacobs Drill, with No. 2 Morse Taper arbor.	20.90	20.90	.....	.....	.....
Chuck, 0 to ⅜" Jacobs Drill, with No. 3 Morse Taper arbor..	.....	.....	6.85	6.85	6.85
Chuck, 0 to ½" Jacobs Drill, with No. 3 Morse Taper arbor..	.....	.....	8.19	8.19	8.19
Chuck, ⅜" to ¾" Jacobs Drill, with No. 3 Morse Taper arbor	.....	.....	13.35	13.35	13.35
Chuck, ⅜" to 1" Jacobs Drill, with No. 3 Morse Taper arbor.	.....	.....	21.35	21.35	21.35
Cutter Bits, high speed steel, to fit turning tool holders.....	.25	.25	.35	.55	.55
Diamond Dresser and holder for truing grinding wheels....	13.25	13.25	14.25	14.25	15.25
Die Holder with No. 2 M. T. shank, for 1½" round dies....	4.25	4.25	.....	.....	.....
Die Holder with No. 3 M. T. shank, for 1½" round dies....	.....	.....	4.75	4.75	4.75
Double Tool Cross Slide, screw feed type.....	.....	.....	.....	.....	131.00
Gauge, for grinding lathe tool cutter bits.....	.50	.50	.50	.50	.50
Metric Transposing attachment, Quick Change Gear Lathe.	11.00	42.00	47.00	53.00	58.00
Metric Transposing attach., Standard Change Gear Lathe.	13.00	.....	.....	.....	.....
Reamer and cutter grinding stops, for use with grind. attach.	16.00	17.00	19.00	21.00	21.00
Tailstock, handlever type, in addition to regular T. S.....	84.00	100.00	.....	.....	.....
Tailstock, handlever type, in lieu of regular T. S.....	63.00	74.00	.....	.....	.....
Tool, boring, style "B" with sleeve bar and two cutter bits..	6.53	6.53	7.73	10.20	10.20
Tool, boring, style "D" with solid boring bar.....	4.13	4.13	4.80	6.00	6.00
Tool, left hand turning, with cutter bit and wrench.....	1.67	3.80	4.33	5.33	5.33
Tool, right hand turning, with cutter bit and wrench.....	1.67	3.80	4.33	5.33	5.33
Tool, straight shank turning, with cutter bit and wrench...	1.67	3.80	4.33	5.33	5.33
Tool, knurling, with medium diamond knurls.....	4.00	7.53	9.00	10.66	10.66
Tool, left hand cut-off, with cutter blade and wrench.....	.....	3.80	4.80	6.00	6.00
Tool, right hand cut-off, with cutter blade and wrench.....	2.00	3.80	4.80	6.00	6.00
Tool, straight shank cut-off, with cutter blade and wrench..	2.00	3.80	4.80	6.00	6.00
Tool, threading, with 60° formed cutter.....	3.33	5.53	6.67	8.53	8.53
Turret, turnstyle operated, for lathe bed.....	.....	.....	.....	.....	525.00

\*These prices are for 1" Collet Lathes. Prices for regular lathes are slightly less.

**SOUTH BEND LATHE WORKS, 543 E. Madison Street, South Bend 22, Indiana, U. S. A.**

# MAKE YOUR GIFTS

... SAVE MONEY or START A  
SPARE TIME, PROFITABLE BUSINESS  
with THIS AMAZING, NEW, SAFE  
**SYNCRO** POWER SAW!  
ELECTRIC



The Name Plates, House Numbers and Signs illustrated to right, make unusual, appreciated Christmas Gifts for your friends and family. Or sell them at a profit. All you need is a SYNCRO Power Saw and Pattern No. 74. Just trace full-size pattern on wood, SYNCRO SAW IT, assemble. No. 74 Pattern comes FREE with every SYNCRO, or send 25c to: SYNCRO PAT-TERN DIVISION, Dept. H-118, Box 215, Pleasantville, N. Y.



**The Gift They All Will Use!**



The really amazing feature about SYNCRO Safe POWER SAW is this—it is the ONLY safe jig saw on the market and is so safe small children may use—yet so powerful, versatile, every adult craftsman needs it! By getting a SYNCRO for Christmas, you give something practical that can be used by every member of the family! It's economical—no motor to buy! Just plug into any 50-60 cycle, 110-120 volt A. C. only outlet—and saw! Cuts 1/4" hardwood and 1/2" softwood, also thin metals, plastics—clean and smooth—no sanding necessary! Portable—use anywhere in home, on farm, for pleasure or profit. New adjustable arm permits sawing ANY length material. New Off-On switch. Quieter operating. Sold on 10 Days Money Back Trial to prove it's the best, lasting gift to give or get. TRY IT FREE NOW. Read below!



**Make this Cut-Out FREE**  
**AT YOUR HARDWARE STORE!**

(Take To Your Dealer Today)

### FREE TRIAL COUPON

**MR. SYNCRO DEALER:** This entitles bearer to saw out, on your SYNCRO SAW, FREE, one snapshot or picture bearer has pasted on 1/4" plywood or 1/2" softwood—or personally try SYNCRO at store using material you furnish.

SYNCRO CORPORATION, Rochester, Michigan

3. RESULT—a realistic photo "cut-out" suitable for mantel, desk, dresser use or as a "gift"



1. PASTE GIRL ON WOOD



2. SAW AROUND GIRL



If there is no SYNCRO Dealer near you, do this: Send only \$17.50 (plus \$1 for shipping cost) direct to factory with name, address of your favorite hardware store—we'll ship saw to you POSTPAID on 10 Days Money Back Trial AND include FREE full-size Pattern No. 74 enabling you to make Name Plates, House Numbers, Signs for personal use, Christmas Gifts, or extra cash. Or rush postcard for full details. (Dealers: write for Special Introductory Deal Offer.) Hurry. Address:

**SYNCRO CORPORATION**

Dept. H-118 ROCHESTER, MICHIGAN

"World's Largest Makers of Electric Jig Saw"

# LION ON THE LOOSE!



Zoo Curator Clyde Gordon finds EXPERIENCE IS THE BEST TEACHER—in handling "big cats" ...and in choosing a cigarette, too!



**EXPERIENCE IS THE BEST TEACHER\***  
LONG EXPERIENCE HAS TAUGHT CLYDE GORDON NEVER TO SHOW FEAR TO AN ANIMAL. HE STANDS HIS GROUND... SPEAKING SOFTLY, INSISTENTLY... WHILE DIVERTING HER ATTENTION WITH BROOM HANDLE.



\* TRUE, TOO, IN CHOOSING A CIGARETTE! WITH SMOKER AFTER SMOKER WHO TRIED AND COMPARED—CAMELS ARE THE "CHOICE OF EXPERIENCE"!



R. J. Reynolds Tobacco Co., Winston-Salem, N. C.



Let your "T-Zone" tell you why!



T for Taste...  
T for Throat... that's your proving ground for any cigarette. See if Camels don't suit your "T-Zone" to a "T."

Zoo Curator Clyde Gordon says:

I'VE LEARNED FROM EXPERIENCE THAT MILD, FULL-FLAVORED CAMELS SUIT ME TO A 'T'!

*Clyde Gordon*

General Curator and Director  
Staten Island Zoo



According to a Nationwide survey:  
**MORE DOCTORS SMOKE CAMELS THAN ANY OTHER CIGARETTE**

When 113,597 doctors were asked by three independent research organizations to name the cigarette they smoked, more doctors named Camel than any other brand!



**CAMELS—the Choice of Experience!**