

ANC



POPULAR MECHANICS

MAGAZINE

WRITTEN SO YOU CAN UNDERSTAND IT

REG. TRADE MARK GREAT BRITAIN No. 40428



RUNNING ROPES

— Page 121

NOW... LIGHT
WHEN YOU NEED IT!

Ray-O-Vac LEAK PROOF batteries
stay fresh for years!

(because they're sealed in steel!)



© 1948 BY RAY-O-VAC COMPANY, MADISON, WIS. RAY-O-VAC, CANADA LTD., WINNIPEG, MAN.

See how much more you get

in these truly modern batteries. Each Ray-O-Vac Leak Proof starts with a powerful, well made battery. Then . . .

1. Steel bottom is added.
2. And a steel top.
3. Next—multiple insulation. Nine layers of protection against corrosion.
4. Last—a steel jacket. This completes an air-tight seal, to stop corrosion and keep the battery fresh and powerful. Only Ray-O-Vac builds batteries with all four of these safeguards.

GUARANTEE on every Ray-O-Vac Leak Proof:
"If your flashlight is damaged by corrosion, leakage or swelling of this battery, send it to us with the batteries and we will give you FREE a new, comparable flashlight with batteries."

Ask for Ray-O-Vac Leak Proofs

Buy Spares... *they stay fresh*



5 B.F.G. TIRE, with over 30,000 miles
t, "looks to be good for as many
e": F. H. Neely, Columbia, Tenn.



26,007 MILES on this B. F. Goodrich tire
... "and still plenty of good tread left,"
reports Dr. H.C. Baumann, Pottstown, Pa.



63,479 MILES on this B. F. Goodrich tire.
"Need you ask if I'm satisfied?" writes
J. C. Hinrichs, Jr., Waterbury, Conn.

Users get more miles because **RESEARCH KEEPS**

B.F.

Goodrich

FIRST IN RUBBER

you get more comfort, too!

Users agree **MORE MILES!**
Experience shows **MORE**
SAFETY! Riding tests prove
MORE COMFORT—prove
B. F. Goodrich regular tires *ride smoother* than
like tires of other makes! And for *super-*
comfort there's the B. F. Goodrich Extra-
cushion tire. You get *more* with B. F. G. tires,
regardless of price, because research—now
backed by the world's greatest rubber research
center, recently opened at Brecksville, Ohio—
keeps B. F. Goodrich First In Rubber.



PREMIUM SILVERTOWN
Highest quality

B. F. G. EXTRA-CUSHION
Easiest riding

B. F. G. SILVERTOWN
Lowest cost per mile

B. F. G. DEFIANCE
Lowest price

ALWAYS LOOK FOR THIS SIGN



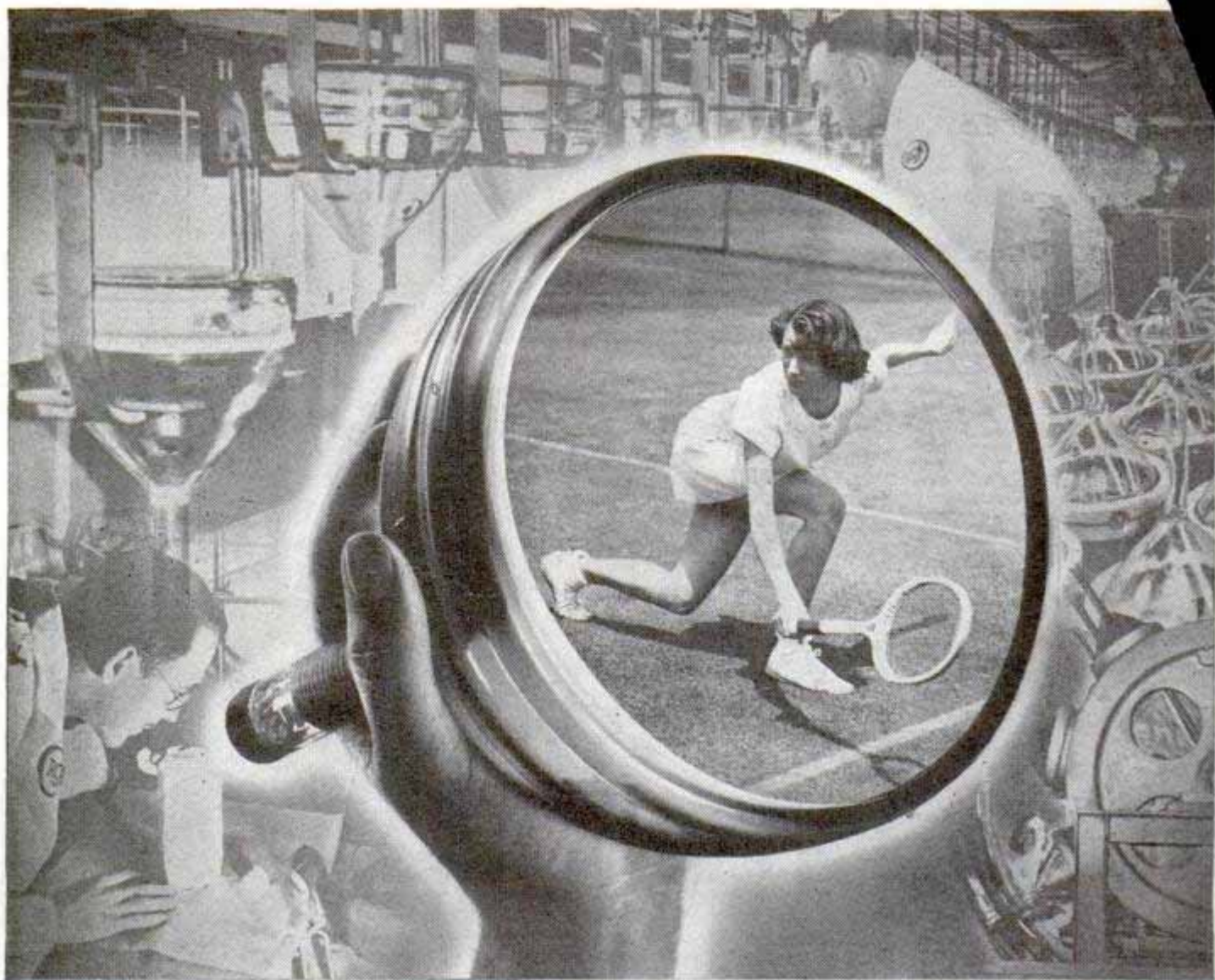

Machines in RCA's Lancaster Tube Plant are designed for mass production of Kinescopes—television picture tubes—at lowest possible cost.

Behind the magic of a Television Tube

Every morning, 14 tons of glass "bulbs" go down to the production lines at the RCA Tube Plant in Lancaster, Pa.

By evening, the bulbs are television picture tubes, their luminescent faces ready to glow—in television homes everywhere—with news, sports, entertainment, education, politics.

Born of glass, metals, chemicals, the picture tube comes to life through flame and heat. Its face

is coated with fluorescent material—forming a screen on which an electron gun "paints" moving images.

Each step is so delicately handled that, although RCA craftsmen are working with fragile glass, breakage is less than 1%.

Water, twice-distilled, floats the fluorescent material into place on the face of the tube, where it clings by molecular attraction—as

a uniform and perfect coating.

Every phase of manufacture conforms to scientific specifications established by RCA Laboratories. **Result:** Television tubes of highest perfection—assuring sharp, clear pictures on the screens of RCA Victor home television receivers.

When in Radio City, New York, be sure to see the radio, television and electronic wonders at RCA Exhibition Hall, 36 West 49th Street. Free admission. Radio Corporation of America, RCA Building, Radio City, New York 20.



RADIO CORPORATION of AMERICA

Popular Mechanics Magazine

Registered in U. S. Patent Office and Canada

H. H. WINDSOR, Founder

H. H. WINDSOR, Jr., Editor and Publisher

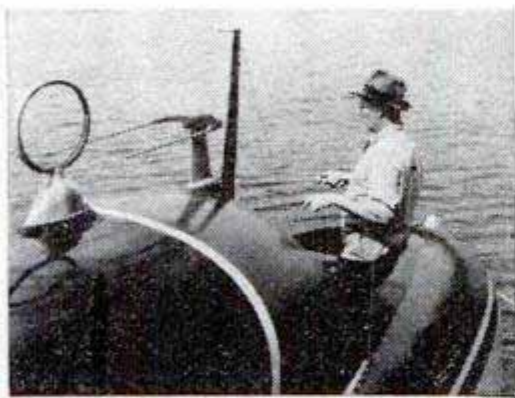

DR. SAMUEL EDDY is one lucky fisherman who had a chance to prove his story (page 114). A couple of our staff men took Doctor Eddy along to a northern lake to get photos to illustrate his article. Doctor Eddy, who teaches a class in fishing at the University of Minnesota, was given an "A" by our staff when he caught a big northern pike by simply practicing what he preaches.

NEXT MONTH'S bill of fare includes a story on the "Top-of-the-World Weather Run." Air Force pilots cruise to the pole three weekly to spot the kind of weather that may strike this country many days later. Another feature takes you through Pearl Harbor's secret caverns, where oil is stored in tanks so huge that each could hold a 30-story building. On the November "must" list is Aubrey Cookman's second installment of "We Drove to Alaska."

POURING MONEY out the window? Winter heat loss through windows and doors ranges up to 40 percent of total heat loss. A Craftsman feature next month tells how to weather-strip to plug the leaks. The first of two articles on "57 Ways to Save Gasoline" appears next month. Another practical feature tells how to build two sanders.

RADIO experimenters will find a phono amplifier for the new reluctance, or magnetic-type, pickups next month.

Volume 90 OCTOBER 1948 Number 4

Managing Editor.....Roderick M. Grant
Assistant Managing Editor.....Wayne Whittaker
Shop Notes and Crafts Editor.....James R. Ward
Radio and Electronics Editor.....Frank L. Brittin
Aviation Editor.....Aubrey O. Cookman, Jr.
Associate Editor.....Clifford B. Hicks
Eastern Editor.....Bill Reiche
Western Editor.....Thomas E. Stimson, Jr.
Art Director.....Frank Beatty

Assistant Editors

Donald R. Brooks

Arthur R. Railton

Assistant Editors, Shop Notes and Crafts

W. Clyde Lammey Wayne C. Lecky Frank N. Stephany A. E. Youngquist

In This Issue

We Drove to Alaska—Part I	- -	89
Workshop Wizard on the Stage	-	100
Television Covers the Game	- -	105
School for Fishermen	- - -	114
Gauges—the Guide to Perfection	-	122
How to Watch a Football Game	-	130
Sculpture for Fun	- - -	137
More Food From Light	- - -	148
Firing the Battleship's Big Guns	-	153
Exploring the Ocean Bottom	- -	164
Revolution in Weaving	- - -	170

For the Craftsman

It's Easy to Cement Plastics	- -	186
Christmas Workshopping	- -	190
Dry Walls	- - -	197
Lick Cold-Weather Starting	- -	201
To Make or Repair a Briar Pipe	-	208
Electric Arc Welder—Part II	-	213
More Power for "One Lungers"	-	222
Radio and Electronics	- - -	229
Clinic for Homemakers	- - -	240

Table of Contents continued on page 8

Published monthly by POPULAR MECHANICS COMPANY, 200 East Ontario Street, Chicago 11, Ill. H. H. Windsor, Jr., president; Paul H. Dunakin, vice president and general manager; D. F. Windsor, vice president and secretary-treasurer; William Harrison Petridge, vice president and assistant to the publisher; Clover L. Perkins, advertising manager; Alan M. Deyoe, circulation manager. Single copy in the United States and Canada, 25 cents; subscription rates in United States and possessions, Canada, Philippines and countries of the Pan-American Postal Union, 1 year, \$2.50; 2 years, \$4.50; 3 years, \$6.00. To all other countries add \$1.00 a year over United States prices for overseas postage. If you plan to move, notify us at least 30 days in advance so you will not miss an issue. Give both old and new addresses. Entered as Second Class Matter, September 15, 1903, at the Post Office at Chicago, Illinois, under Act of March 3, 1879. Entered as Second Class Matter at Post Office Dept., Canada. Copyright 1948 by Popular Mechanics Company. Copyright under International Copyright Union. Copyright in France. All rights reserved under Pan-American Copyright Union. Printed in the United States of America.

Inseparable

GOOD CRAFTSMANSHIP... GOOD TOOLS

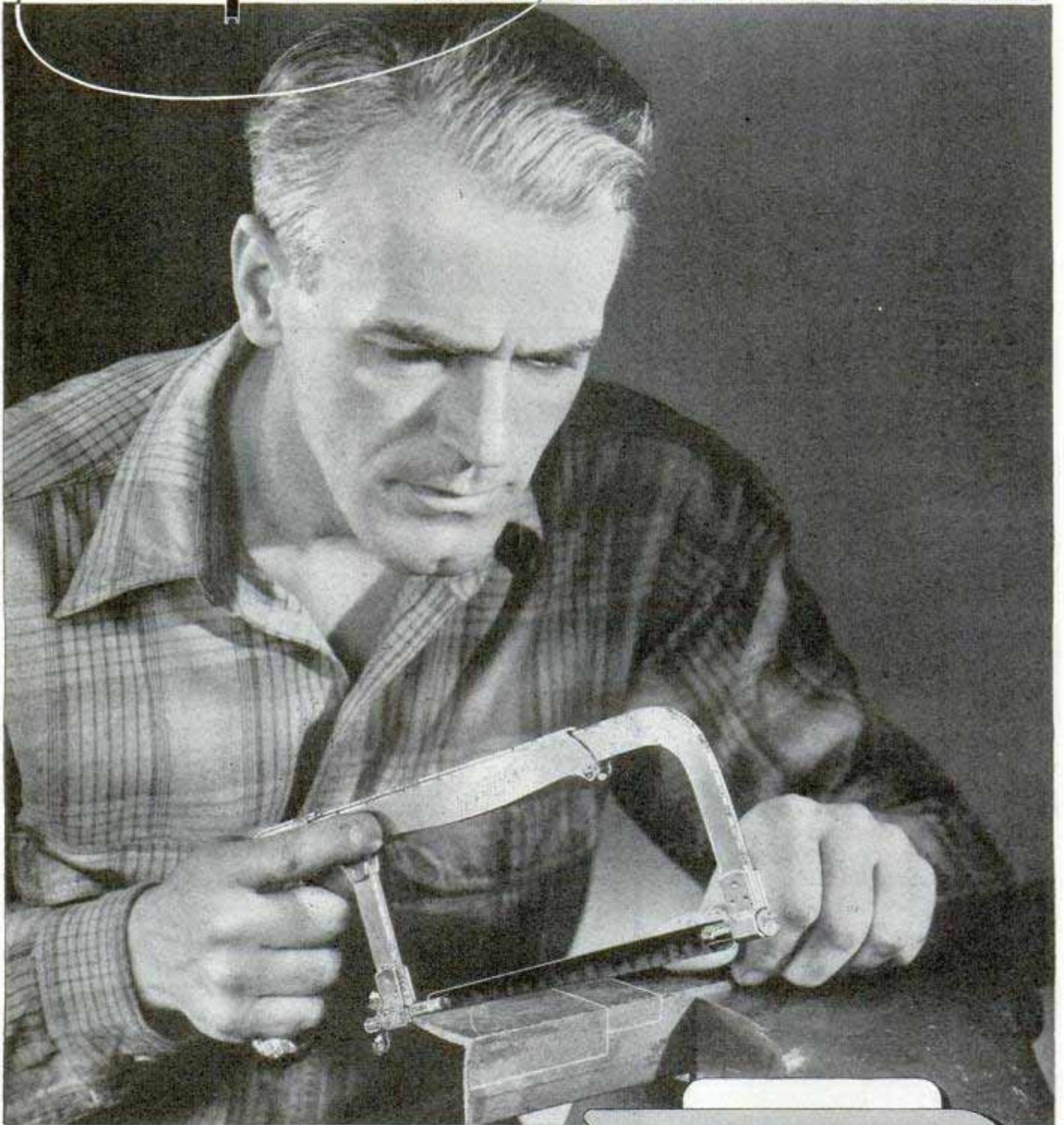

"CRESCENT" is our trade-mark registered in the United States and foreign countries for wrenches and other tools. "Crescent" tools are made only by Crescent Tool Company of Jamestown, N. Y., and are sold by leading distributors everywhere.

CRESCENT TOOLS



*Sign of the Artisan
Symbol of Excellence*

In addition to greater comfort, this new oil heater will give you

BIG FUEL SAVINGS THIS WINTER!



Automatic! Light it in the Fall... relax!

Your new thermostatically-controlled Perfection Heater creates comfort without supervision. No jumping to adjust fire for every weather change. Fire automatically cuts back from high or low flame to fuel saving pilot when room is warm enough... returns to higher fire automatically when needed.



Quiet "Floor-Flo" Blower for Floor Level Comfort!

Far corners are more easily heated and circulation improved, thanks to Perfection's specially designed blower (not just a fan). "Floor-Flo" action delivers large volume of warm air at floor level, helps keep heat where you need it. Quiet as a summer breeze.



"Multi-Heat" Burner with "Midget" Pilot Saves Money!

No other heater has Perfection's "Multi-Heat" burner with the new "Midget" Pilot. A tiny separate burner within the main burner provides a real pilot, not just a low fire. Fed fuel "by the drop", the pilot burns hours for a penny. No other burner can match its low consumption. It alternates with high or low fire to balance economy with comfort in any weather.



"Heat Extractor" Chamber Gives More Heat Per Gallon

The Perfection "Heat Extractor" catches heat that would otherwise go up the chimney. Makes it heat your home—adds to your comfort! Saves money by getting the most possible value from each gallon of fuel.

There's nothing better than the

new **PERFECTION** *Oil Heater* **"More-comfort-per-gallon"**

PERFECTION STOVE COMPANY, 7036-C Platt Ave., Cleveland 4, Ohio

Manufacturers of Oil Ranges and Cook Stoves, Oil Heaters, Oil Water Heaters, Oil and Gas Winter Air-Conditioning Furnaces.

ATLANTA • CLEVELAND • CHICAGO • JERSEY CITY • KANSAS CITY • OAKLAND • ST. PAUL

OCTOBER 1948



T9DY-N64-KKQ3

ARE YOU LOSING YOUR HAIR?

READ THESE CERTIFIED FACTS!



Left—Carl Brandenfels before using his home course. Right—Carl as he looks today.



Eldon Beerbower, 2905 N. Portland Blvd., Portland, Ore., was completely bald. Left, Eldon after 8 weeks use and right, Eldon getting his first haircut since total baldness.



Mrs. Amy Clevenger, Central Point, Ore., age 62, says, "I was completely bald for 2 years. Now I have almost all my hair back."



Left, O. K. Nulton, Olympa, Wash., age 65—"My hair was falling out by handfuls. Now my head is almost covered with hair." Right, Rev. L. C. Elliott, 2033 S.E. 51st Ave., Portland, Ore., age 70—"I purchased on advice of my barber and I got results."

WHAT MAKES HAIR GROW?

Scientists agree that hair will continue to grow as long as the hair follicle remains undamaged and as long as a sufficient supply of blood reaches the follicle. If the hair follicle is completely dead there is no way known to bring it back to life.

Carl Brandenfels of St. Helens, Oregon, believes that in many bald or partially bald people, the hair follicles are still alive even though no hair is growing from them. Carl also believes that proper use of his formulas and massage will, in many cases, bring about a condition which will help nature allow hair to grow.

RESULTS SPEAK FOR THEMSELVES

Back in 1929 Carl Brandenfels began to search for the causes of baldness. In 1945 he developed two formulas and a unique pressure massage. Recently, certified public accountants made an impartial audit of the result letters in Carl's files.

By this certified count, Carl Brandenfels has received 11,236 letters from users who report from one to all of the following results after using Brandenfels' Scalp and Hair Applications and Massage:

- Renewed Hair Growth**
- No More Excessive Falling Hair**
- Relief From Dandruff Scale**
- Improved Scalp Condition**

These letters came from every state in the Union and from people in every walk of life. They were from youngsters in their teens and from oldsters

in their 80's. They were from men and from women. Some users had been totally bald and some had just begun to lose their hair.

A RECOMMENDATION

Carl Brandenfels sincerely recommends his home course to men and women who are bald or who are losing their hair. Carl does not classify his formulas and massage with the so-called "hair-growers" nor does he guarantee to promote new hair growth for every user. Carl does believe he has solved some of the problems of baldness, and he is genuinely proud of the results obtained by users of his formulas and massage.

APPLIED AT HOME

Brandenfels' Scalp and Hair Applications and Massage are applied in the privacy of your own home. One of Carl's formulas contains the important agent lanolin. The other contains a small percentage of sulfanilamide. Carl's home course is designed to bring about a more healthy condition of the scalp, to soften the scalp, and to increase the blood supply to the scalp area.

Carl's formulas are not sticky and will not rub off on hat bands, clothing or bed linens. Directions are easy to follow. A five-week home course costs \$15 plus \$3 Fed. tax, and orders should be sent to Carl Brandenfels, St. Helens, Oregon.

DO A FRIEND A FAVOR...

Cut out this page and send this story to a friend who needs it.



SEND THIS ORDER TODAY

CARL BRANDENFELS, St. Helens, Oregon

Please send me—in a plain wrapper—a 5-week supply of Brandenfels Scalp and Hair Applications and Massage with directions for use in my own home.

- Cash—I enclose \$15 plus 20% Fed Tax (\$3) total \$18 (Cash orders shipped postpaid)
- C.O.D.—I agree to pay postman \$18 plus postal charges

Name.....

Address.....

City..... Zone..... State.....

If you are still skeptical, contact any of the above people direct.

NONE GENUINE WITHOUT THIS SIGNATURE



Brandenfels'

SCALP AND HAIR APPLICATIONS AND MASSAGE

THE ONLY APPLICATIONS AND MASSAGE OF THEIR KIND IN AMERICA



IF you're that man, here's something that will interest you.

Not a magic formula—not a get-rich-quick scheme—but something more substantial, more practical.

Of course, you need something more than just the desire to be an accountant. You've got to pay the price—be willing to study earnestly, thoroughly.

Still, wouldn't it be worth your while to sacrifice some of your leisure in favor of interesting home study—over a comparatively brief period? Always provided that the rewards were good—a salary of \$3,000 to \$10,000?

An accountant's duties are interesting, varied and of real worth to his employers. He has *standing!*

Do you feel that such things aren't for you? Well, don't be too sure. Very possibly they *can* be!

Why not, like so many before you, investigate LaSalle's modern Problem Method of training for an accountancy position?

Just suppose you were permitted to work in a large accounting house under the personal supervision of an expert accountant. Suppose, with his aid, you studied accounting principles and solved problems day by day—easy ones at first—then more difficult ones. If you could do this—and could turn to him for advice as the problems became complex—soon you'd master them all.

That's the training you follow in principle under the LaSalle Problem Method.

You cover accountancy from the basic Principles right up through Accountancy Systems and Income Tax Procedure. Then you add C. P. A. Training and prepare for the C. P. A. examinations.

As you go along, you absorb the principles of Auditing, Cost Accounting, Business Law, Statistical Control, Organization, Management and Finance.

Your progress is as speedy as you care to make it—depending on your own eagerness to learn and the time you spend in study.

Will recognition come? The only answer, as you know, is that success *does* come to the man who is really *trained*. It's possible your employers will notice your improvement in a very few weeks or months. Indeed, many LaSalle graduates have paid for their training—with increased earnings—before they have completed it! For accountants, who are trained in organization and management, are the executives of the future.

Write For This Free Book

For your own good, don't put off investigation of *all* the facts. Write for our free 48-page book, "Accountancy, The Profession That Pays." It'll prove that accountancy offers brilliant futures to those who aren't afraid of serious home study. We'll also include "Ten Years' Promotion in One"—a book which has helped many men. Send us the coupon *now*.

**LASALLE EXTENSION
CHICAGO 5, ILL.**

Over 2800 Certified
Public Accountants among
LaSalle alumni

Other LaSalle Opportunities

- Higher Accountancy
- C.P.A. Coaching
- Bookkeeping
- Law: LL.B. Degree
- Business Management
- Salesmanship
- Traffic Management
- Foremanship
- Industr'l Management
- Stenotypy
(Machine Shorthand)

LASALLE EXTENSION UNIVERSITY A CORRESPONDENCE INSTITUTION

417 S. Dearborn St. Dept. 1064-HR Chicago 5, Ill.

I want to be an accountant. Send me without obligation, "Accountancy, the Profession that Pays" training program—also "Ten Years' Promotion in One."

Name.....Age.....

Address.....

City, Zone & State.....



How much did your car wear out last night?--or do you protect it with Pyroil?

Yes, automobiles do wear out even while they are standing still. When you put your car in the garage for the night, the oil drains from the cylinder walls and permits rust and corrosion to start. When you step on the starter the next morning, metal rubs against metal before a coating of oil is built up to stop wear.

Pyroil's protective film cannot drain off! It gives oil the *property of clinging to metal surfaces*. It prevents rust, corrosion and serious wear of "dry starts." Give your car added protection—simply ask your gas station attendant to *add Pyroil*—and add miles to your car.

Pyroil For Aircraft Engines

Use Aircraft Pyroil B for lubricating oil, Aircraft Pyroil A for gasoline.

GIVEN! An attractive Pyroil metal savings bank—takes coins up to 50c pieces—is yours for the asking—sent postage paid.

Manufactured and Guaranteed by Pyroil Company, 84 Pyroil Bldg., La Crosse, Wisconsin.

Canadian Distributors:
Central Purchasing Agencies, Ltd.,
Toronto, Ontario



PYROIL COMPANY
84 Pyroil Bldg., La Crosse, Wisconsin

I want my car to last and run properly. Please tell me more about Pyroil and how it can accomplish this for me.

Name _____

Address _____

City or Town _____ State _____



TABLE OF CONTENTS (Continued)

ATOMICS AND AVIATION

The atomic pile.....	96
Fold-up plane can be converted into an automobile.....	96
Atomic superbomb.....	111
Two-place helicopter.....	121
Navy tests longer hull to make flying-boat landings safer.....	159
Avalon seadrome made from barge.....	159
"Horace"—Britain's uncomplaining test pilot.....	162

AUTOMOTIVE

British model racer is diesel-powered.....	95
Car quiz.....	112
1949 Kaiser.....	121
Simplified hydraulic brake has 50 percent fewer parts.....	135
Auto desk swings out of way.....	142
Battery plug shows water level.....	142
Tester for truck lights.....	146
Convertible-top cover.....	146
Jack raises car sideways.....	146
100,000,000 U. S. motor vehicles.....	163
Portable garage designed to solve parking problem.....	168
Car trouble light has warning "flare".....	174

FARM

Wire-fence suspension bridge is practically floodproof.....	128
Side-delivery rake reduces excess leaf shatter.....	175
Disks are ground without dismantling.....	176
Rear-engine tractor.....	176

HOUSE AND HOME

Death wagon for weeds.....	95
Timer turns off water heater.....	121
"Trailer" unit powers lawn mower.....	142
What's new for your home.....	160
War-surplus glider becomes trailer home.....	169
Two-brush polisher also scrubs and waxes.....	174

INDUSTRY

Motor-driven chart shows 2000 items.....	104
Giant pipe bender.....	111
Hand truck moves paper rolls.....	136
Hydraulic jet drives work boat.....	144
"Snow jeep" tows 1500-pound load across drifts at 30 m.p.h.	158
Waste anthracite silt may provide gasoline.....	158

NOVELTIES

Shadow box in kit form depicts Chinese scene.....	120
Outboard motor for model boats.....	128
Giant frying pan.....	146
Musical toys from planes.....	147
Pipe with jointed stem can be tilted in any direction.....	169

PHOTOGRAPHY

Reptile snaps own picture with flick of the tongue.....	99
Photo triangulator.....	104
Lens shade and filter holder attached to camera.....	143
Borderless easels are poured from a can.....	143
Photoelectric cell fires flash bulb.....	143

RADIO AND ELECTRICAL

Radio operates turrets and guns of model warship.....	98
Remote control for yard light.....	111
Hearing-aid battery "breathes" as used.....	135
Walking robot has radio controls.....	136
142-ton transformer serves city of 200,000.....	158

TOOLS AND DETECTORS

Hand torch burns seven hours for less than a nickel.....	95
Daggerlike tool opens boxes.....	142
Sound you can't hear detects light you can't see.....	162
Detector guards workers against beryllium particles.....	168

MISCELLANEOUS

"Eggplant" scares tropical lizards.....	104
Three-way gear system for outboard motor boats.....	120
"Handful" generator.....	120
Luminous flashlight.....	120
Lightweight motorcycles.....	129
Opener pries lids from all jars.....	136
Coded recordings.....	175
Portable cooker stands on tripod.....	178

Craftsman and Shop Notes Index

AUTOMOTIVE

Water helps to remove tires.....	217
Oil-gauge stick readily located by white enamel on handle.....	218
Removing broken head bolts from engine block.....	226
Radius arms kept tight on knee-action car.....	228

(Continued to page 10)

What's ahead?

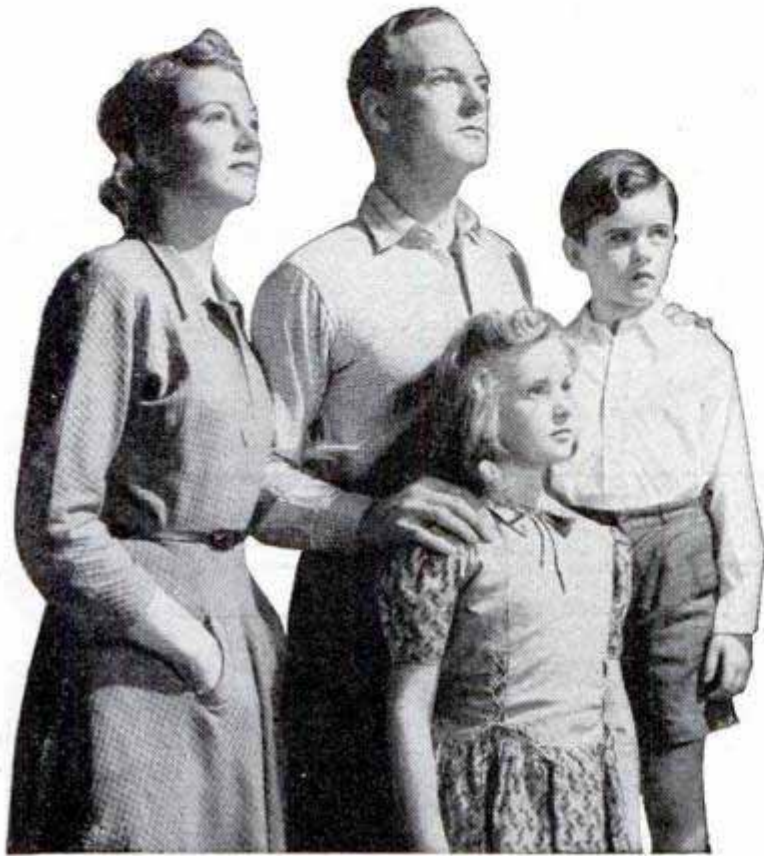

A world of rapid changes and new economic problems, that's certain. Just as surely, however, there's *one* thing that will be unchanged. In the near future and the long future, the important positions will be held by *trained men*.

You want security for your family . . . freedom from financial worry . . . your own home . . . perhaps your own business. The surest route to them is specialized *training* that pays out in promotions and increased income.

Thousands of I. C. S. graduates have proved the truth of this. In a single 30-day period, these famous Schools have received as many as 635 student letters reporting advancements in salary and position. In a period of 120 days, we've recorded 1,920 such reports.

The few dollars these men and women paid for I. C. S. *training* have proved to be the best investments of their lives. You have the same opportunity. Act *now* to prepare for the future. Mail the coupon for full information on practical, authoritative *training* in any one of more than 400 business and technical subjects.

INTERNATIONAL CORRESPONDENCE SCHOOLS



BOX 5637-K, SCRANTON 9, PENNA.

Without cost or obligation, please send me full particulars about the course BEFORE which I have marked X:

- | | | | |
|--|--|--|---|
| <p>Air Conditioning and Plumbing Courses</p> <p><input type="checkbox"/> Air Conditioning
<input type="checkbox"/> Heating
<input type="checkbox"/> Refrigeration
<input type="checkbox"/> Plumbing
<input type="checkbox"/> Steam Fitting</p> <p>Chemistry Courses</p> <p><input type="checkbox"/> Chemical Engineering
<input type="checkbox"/> Chemistry, Analytical
<input type="checkbox"/> Chemistry, Industrial
<input type="checkbox"/> Chemistry, Mfg. Iron & Steel
<input type="checkbox"/> Petroleum Refining
<input type="checkbox"/> Plastics
<input type="checkbox"/> Pulp and Paper Making</p> <p>Civil Engineering, Architectural and Mining Courses</p> <p><input type="checkbox"/> Architecture
<input type="checkbox"/> Architectural Drafting
<input type="checkbox"/> Bridge and Building Foreman
<input type="checkbox"/> Building Estimating
<input type="checkbox"/> Civil Engineering
<input type="checkbox"/> Coal Mining
<input type="checkbox"/> Contracting and Building
<input type="checkbox"/> Highway Engineering
<input type="checkbox"/> Lumber Dealer
<input type="checkbox"/> Reading Structural Blueprints
<input type="checkbox"/> Sanitary Engineering
<input type="checkbox"/> Structural Drafting</p> | <p><input type="checkbox"/> Structural Engineering
<input type="checkbox"/> Surveying and Mapping</p> <p>Communications Courses</p> <p><input type="checkbox"/> Electronics
<input type="checkbox"/> Practical Telephony
<input type="checkbox"/> Radio, General
<input type="checkbox"/> Radio Operating
<input type="checkbox"/> Radio Servicing
<input type="checkbox"/> Telegraph Engineering</p> <p>Electrical Courses</p> <p><input type="checkbox"/> Electrical Drafting
<input type="checkbox"/> Electrical Engineering
<input type="checkbox"/> Electric Light and Power
<input type="checkbox"/> Lighting Technician
<input type="checkbox"/> Practical Electrician</p> <p>Internal Combustion Engines Courses</p> <p><input type="checkbox"/> Auto Technician
<input type="checkbox"/> Diesel-Electric
<input type="checkbox"/> Diesel Engines
<input type="checkbox"/> Gas Engines
<input type="checkbox"/> Aviation</p> <p>Mechanical Courses</p> <p><input type="checkbox"/> Aeronautical Engineer's, Jr.
<input type="checkbox"/> Aircraft Drafting
<input type="checkbox"/> Flight Engineer
<input type="checkbox"/> Forging
<input type="checkbox"/> Foundry Work
<input type="checkbox"/> Heat Treatment of Metals
<input type="checkbox"/> Industrial Engineering</p> | <p><input type="checkbox"/> Industrial Metallurgy
<input type="checkbox"/> Machine Shop
<input type="checkbox"/> Mechanical Drafting
<input type="checkbox"/> Mechanical Engineering
<input type="checkbox"/> Mold-Loft Work
<input type="checkbox"/> Patternmaking—Wood, Metal
<input type="checkbox"/> Reading Shop Blueprints
<input type="checkbox"/> Sheet-Metal Drafting
<input type="checkbox"/> Sheet-Metal Worker
<input type="checkbox"/> Ship Drafting
<input type="checkbox"/> Tool Designing
<input type="checkbox"/> Toolmaking
<input type="checkbox"/> Welding Engineering
<input type="checkbox"/> Welding—Gas and Electric</p> <p>Railroad Courses</p> <p><input type="checkbox"/> Air Brake
<input type="checkbox"/> Diesel Locomotive
<input type="checkbox"/> Locomotive Engineer
<input type="checkbox"/> Locomotive Fireman
<input type="checkbox"/> Locomotive Machinist
<input type="checkbox"/> Railroad Section Foreman
<input type="checkbox"/> Car Inspector</p> <p>Steam Engineering Courses</p> <p><input type="checkbox"/> Boilermaking
<input type="checkbox"/> Combustion Engineering
<input type="checkbox"/> Engine Running
<input type="checkbox"/> Marine Engineering
<input type="checkbox"/> Steam Electric
<input type="checkbox"/> Steam Engr.</p> | <p>Textile Courses</p> <p><input type="checkbox"/> Cotton Manufacturing
<input type="checkbox"/> Loom Fixing
<input type="checkbox"/> Textile Designing
<input type="checkbox"/> Rayon Weaving
<input type="checkbox"/> Woolen Manufacturing</p> <p>Business and Academic Courses</p> <p><input type="checkbox"/> Accounting
<input type="checkbox"/> Advertising
<input type="checkbox"/> Bookkeeping
<input type="checkbox"/> Business Administration
<input type="checkbox"/> Business Correspondence
<input type="checkbox"/> Certified Public Accounting
<input type="checkbox"/> Commercial
<input type="checkbox"/> Commercial Art
<input type="checkbox"/> Cost Accounting
<input type="checkbox"/> Federal Tax
<input type="checkbox"/> Foremanship
<input type="checkbox"/> Good English
<input type="checkbox"/> Higher Mathematics
<input type="checkbox"/> Motor Traffic
<input type="checkbox"/> Postal Civil Service
<input type="checkbox"/> Retailing
<input type="checkbox"/> Retail Store Management
<input type="checkbox"/> Salesmanship
<input type="checkbox"/> Sign Lettering
<input type="checkbox"/> Spanish
<input type="checkbox"/> Stenography
<input type="checkbox"/> Traffic Management</p> |
|--|--|--|---|

Name _____ Age _____ Home Address _____
 City _____ State _____ Working Hours _____ A.M. to _____ P.M.
 Present Position _____ Employed by _____

Special tuition rates to members of the Armed Forces. Enrollment under G.I. Bill and P.L. 16 approved for World War II Veterans.
 Canadian residents send coupon to International Correspondence Schools Canadian, Ltd., Montreal, Canada.

FREE

get it now

ALLIED'S NEW 1949 RADIO CATALOG!

180
Value-Packed
Pages



EVERYTHING
IN RADIO AT
LOWEST PRICES



TELEVISION AND
NEW HOME RADIOS



SERVICE SUPPLIES
BUILDERS' SUPPLIES



AMATEUR GEAR



SOUND SYSTEMS

Radio's Great Buying Guide

Send today for your FREE copy of Radio's Leading Catalog! It's the preferred Buying Guide for Servicemen, Dealers, Engineers, Soundmen, Amateurs, Builders and Experimenters. You'll find everything you want in Radio and Electronic Equipment—all the newest releases—complete, highest quality stocks at low prices that save you money on every purchase!

Save on Everything!

Get everything you need from the world's largest stocks—new Television receivers, latest home radios and radio-phonos (with new Dual-Speed Changers), Amateur receivers and station gear, test instruments, public address and sound equipment, new builders' kits—plus thousands of parts, tubes, tools, radio books and diagrams. Get the speedy reliable service and expert help you want from ALLIED—Radio's Largest Supply House. Write today for your FREE copy of the new 180-page ALLIED Radio Buying Guide!

ALLIED RADIO

ALLIED RADIO CORP.,
833 W. Jackson Blvd., Dept. 5-K-8
Chicago 7, Illinois

Rush FREE 1949 ALLIED Catalog.

Name.....

Address.....

City..... Zone..... State.....

FREE
CATALOG

(Continued from page 8)

ELECTRICAL

Extension-cord connector.....	195
Toggle bolts anchor outlet box in soft wallboard.....	228
Polarity tester for electric current.....	228

HOUSE AND HOME

Steel wool strains water when bathing dog in tub.....	180
Keeping brick fireplaces clean.....	180
Solving home problems.....	182
Heat lamp of many uses made from spare parts.....	184
Storm sash opens when window is raised.....	185
An ice-skating rink in your back yard is inexpensive and fun for everyone.....	189
Tumblers stored on wooden pegs conserve space.....	196
Catch basin in eaves trough collects leaves and twigs.....	200
Fan circulates warm air through stove-heated home.....	200
Separating steam-boiler sections.....	200
Cork-plugged vents in storm sash regulate amount of air.....	212
Freezing saves leftover food.....	212

PHOTOGRAPHY

Shock absorber of elastic tape safeguards exposure meter.....	204
Funnel aids filling film tank.....	204
Ferrotone polish lubricates reel.....	204
Determining correct exposure when using filters.....	204
Spotting prints with eyebrow pencil.....	204
Detergent cleans condensing lens.....	204
Controlled enlarging light.....	205
Foot switch for enlarger or printer made from auto parts.....	206
Pan-head "tripod" made of hardwood or pipe utilizes compression spring for swivel joint.....	207
Iodine bleaches pinhole spots on photo negatives.....	207
Making slow exposures.....	207
Test strips are easier to handle when left in sheet form.....	207

RADIO AND ELECTRONICS

Dual-speaker TV set.....	229
Low-cost phone system also serves as electronic nurse.....	230
Improving television reception in fringe areas.....	232
Television-receiver construction.....	238

TOOLS

Quick-change mounting block for home-workshop motor.....	180
Garden rake makes tool rack.....	180
Wood-burning pen provides light.....	184
Gas burner preheats blowtorch.....	184
Smudge from candle flame speeds filing a handsaw.....	212
Lathe dog holds rods for cutting.....	217
Clamp positions work for welding angle-iron corners.....	218
Simplified method to cut keyway in large pulley or gear.....	218
True holes in light metal.....	219
Tools permanently magnetized with battery and wire.....	220
Collar prevents chattering of boring bit.....	220
Sickle section bolted to handle forms handy bundie cutter.....	220
Circle-cutting jig slides in saw-table groove.....	221
Bars from potato-grading unit used to make hand tools.....	221
Marker for threading chart reduces possibility of error.....	226
Stub boring bar fits lathe spindle.....	226
Muffin-pan rack keeps small parts handy.....	227
Modifying 45-deg. triangle increases its usefulness.....	227
Lathe pinch-hits for special machine when marking calibrations on cylindrical work.....	227
Socket-head wrenches adapted to ratchet end wrench.....	228

TOYS AND NOVELTIES

Halloween "pumpkin" delights children by blinking one eye.....	179
Keyboard art.....	181
Rotating base for construction set provided by throw-out bearing from automobile clutch.....	196

WOODWORKING

Picture carving in relief.....	178
Improved veneer-taping method.....	184
Cutting hard-pressed board.....	212

MISCELLANEOUS

Oilcan loads air rifle.....	180
Steaming brightens illustrations drawn with indelible pencil.....	184
Shirt fitted with game pocket worn during warm weather.....	189
Pipe loosens steel tent pegs.....	196
Reinforcing document corners.....	200
Fore-finger provides reading glass in an emergency.....	212
Photograph of window display aids customer's selection.....	217
Portable poultry feeder.....	218
Repairing lawn-mower gears.....	220
Outlining with glass cutter aids amateur sign painter.....	228

IMPORTANT NOTICE—It is the intention of this magazine to provide its readers with information regarding the latest developments in the mechanical arts. We take no responsibility as to whether the disclosures contained in our articles are covered by patents and advise readers to investigate this subject before making, using, or selling any of the products, machines, or processes described in order to avoid possible liability for patent infringements.

AUDELS CARPENTERS & BUILDERS GUIDES—(4 Book Set).....\$6

A practical illustrated trade assistant on modern construction for carpenters, joiners, builders, mechanics and all woodworkers. 4 vols., 1600 pages, 3700 illustrations. Fully indexed, flexible covers. Each volume sold separately \$1.50 a vol.

AUDELS PLUMBERS & STEAMFITTERS GUIDES—(4 Book Set).....\$6

A Practical Trade Assistant & Ready Reference. Explains in plain language & by clear illustrations, diagrams, charts, graphs, pictures principles of modern plumbing practice including Marine Pipe Fitting and Air Conditioning. 4 Vols.—1670 Pages—3042 Diagrams & Illustrations. Each Vol. Sold Separately \$1.50 a Vol.

AUDELS OIL BURNER GUIDE.....\$1

384 Pages Covering Installation, Servicing & Repairs All Types Domestic & Industrial Burners. Illustrated. Highly Endorsed.

AUDELS HOUSE HEATING GUIDE.....\$4

1000 Pages Covering Working Principles, Installation, Service of All Modern House Heating, Ventilating & Air Conditioning Systems. Explains New Radiant Heating. Fully Illustrated & Indexed.

AUDELS REFRIGERATION & AIR CONDITIONING GUIDE.....\$4

New from Cover to Cover—1280 Pages, Fully Illus. Covering basic principles, servicing, operation & repair of household, commercial & industrial refrigeration & air conditioning. A gold mine of essential important facts for engineers, servicemen, users.

AUDELS SHEETMETAL WORKERS HANDY BOOK.....\$1

Practical inside information. Fundamentals of Sheet Metal Work. 388 pages. Illustrated. 11 sections. Clearly written. Essential & important facts, figures, pointers in everyday language. Ref. Index.

AUDELS SHEETMETAL PATTERN LAYOUTS.....\$4

Developed by Experts for Sheet Metal Workers, Layout Men & Mechanics. A Practical Encyclopedia in 10 Sections, size 7 x 10 x 2—1125 Pages—350 Layouts—1600 Illustrations. 1001 Key Facts. Fully indexed for ready reference in answering your layout problems. Covers all phases of sheet metal work including Pattern Cutting, Pattern Development & Shop Procedure.

AUDELS BLUE PRINT READING.....\$2

For Mechanics & Builders. Covers all types of blue print reading including ship & airplanes. 416 pages, fully illustrated.

AUDELS MATHEMATICS & CALCULATIONS FOR MECHANICS \$2

Mathematics for home study or reference. 700 pages, 550 illus. Practical mathematics from beginning. How to figure correctly. Easy, correct methods covering complete review. Illus. & Indexed.

AUDELS AUTOMOBILE GUIDE.....\$4

A practical quick ready reference book for auto mechanics, service men, operators & owners. Explains theory, construction & servicing of modern motor cars, trucks, buses & auto type Diesel engines. 1700 pages, fully illustrated. 55 chapters. Indexed. A standard book for mechanics. New Hydraulic drive covered.

AUDELS DIESEL ENGINE MANUAL....\$2

A practical, concise treatise with questions and answers on the theory, operation and maintenance of modern diesel engines. Over 400 pages, fully illus. All details plainly brought out, this book is of extreme value to engineers, operators & students.

AUDELS WELDERS GUIDE.....\$1

A concise, practical text on operation & maintenance of all welding machines for all mechanics. Over 400 pages, illustrated. Covers all methods of electric and acetylene welding including airplane work.

AUDELS MACHINIST & TOOLMAKERS HANDY BOOK.....\$4

Covers modern machine shop practice in all its branches. Tells how to set up & operate lathes, screw and milling machines, shapers, drill presses & all other machine & hand tools. 1600 pages, fully illustrated. Indexed. 5 sections. 1—Modern Machine Shop Practice. 2—Blue Print Reading & How to Draw. 3—Calculations & Mathematics for Machinists. 4—Shop Physics. 5—How to Use the Slide Rule. 60 chapters. Easy to read and understand. A shop companion that answers your questions.

AUDELS ELECTRIC MOTOR GUIDE \$4

Practical Information Covering Construction, Control, Maintenance & Wiring Hookups of All Types Electric Motors also Armature Winding. 1000 Pages Fully Illustrated & Indexed.

AUDELS ELEC. WIRING DIAGRAMS \$1

210 Pages. Illustrated. Gives practical facts on wiring of electrical apparatus. It shows clearly how to wire apparatus for practically all fields of electricity. Each diagram is complete & self-explanatory. Highly Endorsed Pocket Companion.

AUDELS PRACTICAL ELECTRICITY \$4

A key to a practical understanding of Electricity. For maintenance engineers, electricians & all electrical workers. 1440 Pages, 2600 illus. Covers important electrical information in handy form—including wiring for Light & Power. Indexed.

AUDELS RADIOMANS GUIDE.....\$4

A key to the practical understanding of radio including Frequency Modulation, Television, etc., Aircraft & Marine Radio. For radio engineers, servicemen, amateurs, 614 Pages, 633 Illustrations & Diagrams. Photos. Review Questions & Answers, Reference Index.

AUDELS, Publishers, 49 W. 23 St., N.Y. 10

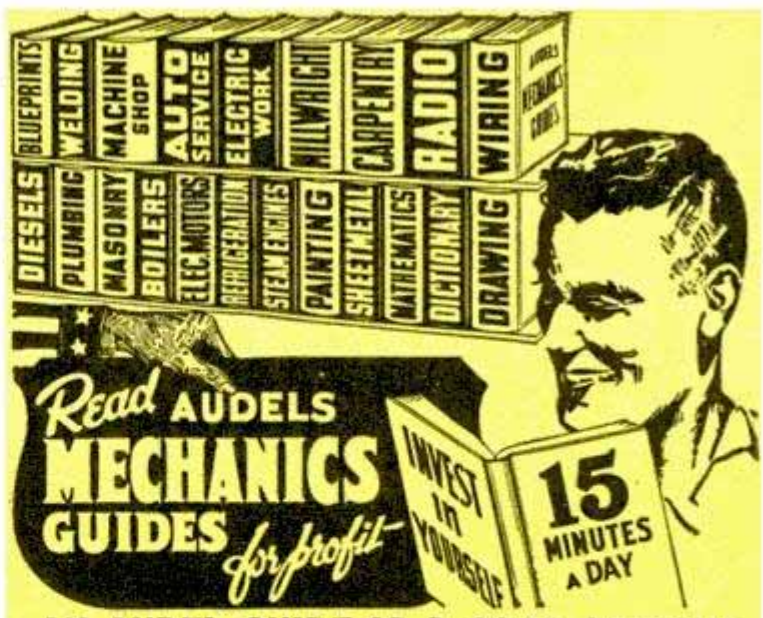

AN AUDEL GUIDE IS A GOOD FRIEND!

Step Up Your Own Skill with the Practical Facts and Figures of Your Trade. Save time and money with right methods, short cuts, labor saving ideas. CHECK NOW! You can look over any Audel Guide in your home. Start the Easy Payments if satisfied.

— — — CUT HERE — — — MAIL ORDER

AUDEL, Publishers, 49 W. 23 St., New York 10, N. Y.

Please mail me for 7 days' free examination the books marked (X) below. I agree to mail \$1 in 7 days on each book or set ordered, and to further mail \$1 a month on each book or set ordered until I have paid the purchase price.

If I am not satisfied with Guides I will return them.

- AUTOMOBILE GUIDE, 1700 Pages \$4
- DIESEL ENGINE MANUAL, 400 Pages 2
- WELDERS GUIDE, 400 Pages 1
- CARPENTERS & Builders Guides (4 Book Set) 6
- PLUMBERS & Steamfitters Guides (4 Book Set) 6
- MASONS and Builders Guides (4 Book Set) 6
- BLUE PRINT READING, 416 Pages 2
- MASTER PAINTER & Decorator, 320 Pages 2
- GARDENERS & GROWERS GUIDES (4 Book Set) 6
- OIL BURNER GUIDE, 384 Pages 1
- HOUSE HEATING GUIDE, 1000 Pages 4
- REFRIGERATION & Air Conditioning Guide, 1280 Pages 4
- SHEET METAL WORKERS Handy Book, 388 Pages 1
- SHEET METAL PATTERN LAYOUTS, 1100 Pages 4
- AIRCRAFT WORKER, 240 Pages 1
- MECHANICAL DRAWING GUIDE, 160 Pages 1
- MECHANICAL DRAWING & DESIGN, 480 Pages 2
- MATHEMATICS and CALCULATIONS, 700 Pages 2
- MECHANICAL DICTIONARY, 968 Pages 4
- MACHINISTS & Toolmakers Handy Book, 1600 Pages 4
- MILLWRIGHTS & Mechanics Guide, 1200 Pages 4
- POWER PLANT ENGINEERS GUIDE, 1500 Pages 4
- ENGINEERS & FIREMANS EXAMINATIONS, 528 Pages 1
- PUMPS, HYDRAULICS & Air Compressors, 1658 Pages 4
- MARINE ENGINEERS Handy Book, 1280 Pages 4
- ENGINEERS and Mechanics Guides (8 Book Set) 12
- Answers on Practical ENGINEERING, 254 Pages 1
- ELECTRIC WIRING DIAGRAMS, 210 Pages 1
- ELECTRICIANS EXAMINATIONS, 250 Pages 1
- ELECTRIC DICTIONARY, 9000 Terms 2
- ELECTRIC MOTOR GUIDE, 1000 Pages 4
- PRACTICAL ELECTRICITY Handy Book, 1440 Pages 4
- ELECTRICAL POWER CALCULATIONS, 425 Pages 2
- RADIOMANS GUIDE, 914 Pages 4
- ELECTRONIC DEVICES, 216 Pages 2
- NEW ELECTRIC LIBRARY, 7000 Pages (12 Book Set). 18

Vols. I, II, III, IV, V, VI, VII, VIII, IX, X, XI, XII—\$1.50 Each

Name _____
 Address _____
 Occupation _____
 Employed by _____



MAKE EXTRA MONEY WHILE LEARNING
 Early in my Course I show you how
 to earn cash by fixing
 neighbors' Radios
 in spare time.

Be a RADIO Learn by Practicing

**MY
 COURSE INCLUDES
 TELEVISION
 FM - ELECTRONICS**

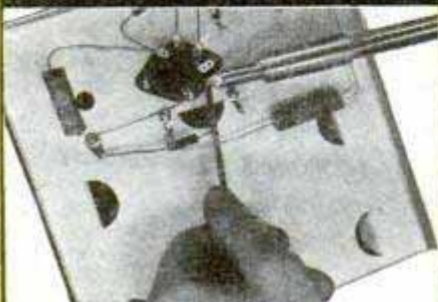

YOU PRACTICE Radio Soldering with Soldering Equipment and Radio Parts I send you. Get practical experience mounting and connecting parts.



YOU BUILD this Tester with parts N. R. I. sends early in course. Soon helps you fix neighbors' Radios and **EARN EXTRA MONEY** in spare time.

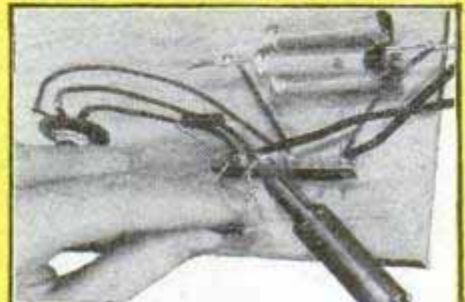

YOU TEST Radio Circuits like this built with parts I send. Build special circuits; learn how to locate and repair circuit defects.

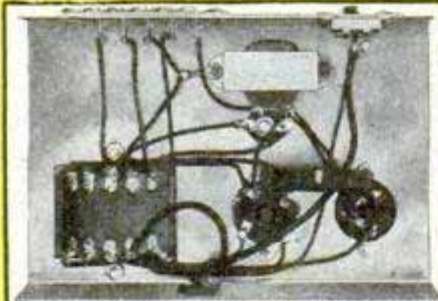

YOU BUILD Vacuum Tube Power Pack; make changes which give you experience with packs of many kinds. Learn how to correct Power Pack troubles.

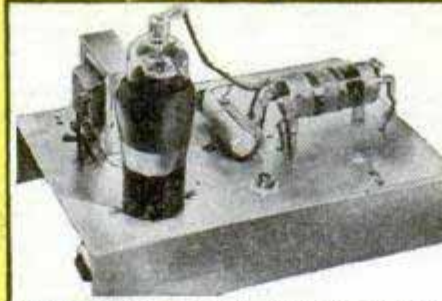

YOU BUILD this A. M. Signal Generator for more valuable experience. It provides amplitude-modulated signals for many tests and experiments.

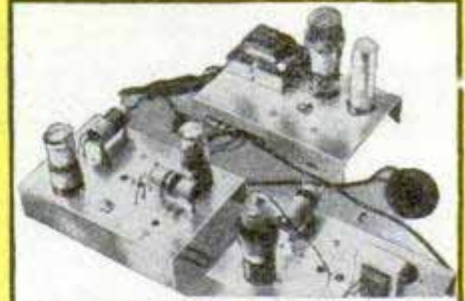

YOU PRACTICE FM (Frequency Modulation) experiments, get more experience with this Superheterodyne Receiver Circuit you build with parts I send.

I TRAINED THESE MEN FOR GOOD PAY JOBS

Now My Own Boss



"N. R. I. trained my brother and me. We now have our own shop and more business than we can handle."—**JERRY McCARTHY**, Washington, D. C.

Extra Cash in Spare Time



"For the past five years I have averaged \$15 and up a week in my spare time."—**STANLEY GENTON**, Cincinnati, Ohio.

Radio Station Pays



"Am Broadcast Engineer for Station KROP. Fundamentals of Radio learned in N. R. I. training; invaluable."—**JERRY G. COLLETT**, Brawley, Cal.

Makes Extra Cash

"Service Radios three or four hours an evening and my monthly average is \$75."—**R. E. HAMRIOK**, Houston, Texas.



Good Job in Radio Station

"Am Chief Engineer of Station WORD, in charge of four men. Owe all I know about Radio to N. R. I."—**CLYDE J. BURDETTE**, Spartanburg, S. C.



Has Own Radio Business

"After finishing course, opened my own Radio shop. Can't praise your training too high. It's the best!"—**ERNEST T. SLATE**, Corsicana, Texas.



VETERANS You Can Get This Training Under G. I. Bill

TECHNICIAN

at Home in Spare Time

I Send You
BIG KITS
of Parts



**You Build This
MODERN RADIO**

As part of your training . . . to give you practical experience . . . N. R. I. sends you the speaker, tubes, chassis, transformer, sockets, loop antenna, etc., to build this powerful receiver.

KNOW RADIO-Win Success I Train You at Home

**ACTUAL
LESSON
FREE**



J. E. SMITH, President
National Radio Institute

Want a good-pay job in the fast-growing Radio and Television Industries? Want to be boss of your own money-making Radio shop? I've trained hundreds of men with no previous experience to be Radio technicians. I can do the same for you! My train-

at-home method gives you practical experience with **BIG KITS OF PARTS** I send. All equipment yours to keep. You learn Radio and Television principles from easy, illustrated lessons.

Make Extra Money In Spare Time

The day you enroll, I send **EXTRA MONEY** booklets. Use your *know-how* to make **EXTRA MONEY** fixing Radios in spare time. The next step is your own Radio shop or a good-pay Radio job.

N. R. I. Trained Men Face Bright Future

Think of money-making opportunities in Police, Aviation, Marine Radio, Broadcasting,

Radio Manufacturing, Radio Repairing, Public Address Work . . . think of even greater opportunities in fast-growing Television, FM and Electronics.

My special **DOUBLE FREE OFFER** gives you actual lesson on Radio repairing short-cuts absolutely free. You also get my 64-page book, "HOW TO BE A SUCCESS IN RADIO-TELEVISION-ELECTRONICS." See how quickly, easily you can get started. Send NOW! J. E. SMITH, President, Dept. 8KP, National Radio Institute, Pioneer Home Study Radio School, Washington 9, D. C.

Tells Radio repair short-cuts. Same coupon also entitles you to my 64-page book, "HOW TO BE A SUCCESS IN RADIO-TELEVISION - ELECTRONICS." Send NOW!

Get Both **FREE**

MR. J. E. SMITH, Pres., Dept. 8KP
National Radio Institute, Washington 9, D. C.
Mail me **FREE** Sample Lesson and 64-page book about how to win success in Radio and Television—Electronics. (No salesman will call. Please write plainly.)

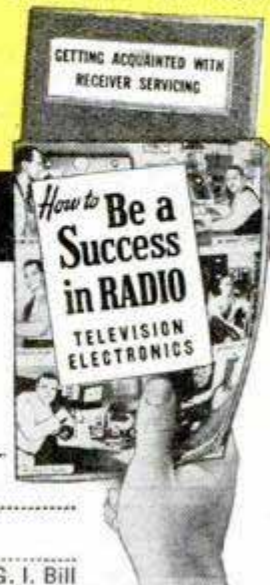

Name..... Age.....

Address.....

City..... Zone..... State.....

Check if Veteran Approved For Training Under G. I. Bill

Mail Coupon

HERE IS YOUR JOB in AVIATION



We have hundreds of urgent requests for Embry-Riddle ground and flight graduates -- 40 times the graduates we had available could have been placed in the last 3 months. Never has there been such opportunity for you in aviation. Begin your career now. A few short months at Embry-Riddle and you're ready for a good job with best pay.

EMBRY-RIDDLE OFFERS

Complete training in minimum time for A&E Mechanics and all fundamental flight, specialist and technical positions • Modern airline-size hangars, classrooms, shops and airplanes • Experience gained over a quarter-century of aviation training • Living facilities on the airport.

INDUSTRY NEEDS

Mechanics, technicians, specialists, engineers, pilots--many, many more men than all aviation schools together can supply. The shortage of trained personnel is becoming more acute. Get in on the ground floor... Embry-Riddle students are spoken for well ahead of graduation. Don't delay. Write for proof of job opportunities TODAY. Begin your aviation career at Embry-Riddle NOW.

Authorized training under the G. I. Bill of Rights

Please rush me complete information on Embry-Riddle training and details of job opportunities for Embry-Riddle graduates.

Dean of Enrollments - Dept. 89
Embry-Riddle School of Aviation
Miami 30, Florida

Name _____ Age _____

Address _____

City _____ State _____

CHECK ONE:

Veteran

Non-Veteran



TRAIN IN MIAMI -- AIR CAPITAL OF THE WORLD



INVENTORS



Learn how to protect your invention. The U. S. Patent Laws provide that any new and useful art, machine, article of manufacture, or composition of matter, or any new and useful improvement thereof, may be patented if the act of invention is involved. Therefore, every inventor with a valuable invention should take advantage of the Patent Laws and proceed for patent protection in order to safeguard his rights.

A patent gives the inventor the exclusive right to prevent others from making, using, or selling the invention claimed in the patent for a period of seventeen years.

The Patent Laws were enacted for the benefit of the inventor to give him protection for the features of his invention which are patentable. These features must be properly and concisely set forth and claimed in a formal application for patent, in order to comply with the requirements of the Patent Laws. For that reason, unless the inventor is familiar with patent matters, he should engage a competent registered patent attorney or agent to represent him. We are registered to practice before the U. S. Patent Office and are prepared to serve you in the handling of your patent matters.

A specially prepared booklet entitled "Patent Guide for the Inventor", containing detailed information with respect to patent protection and procedure, together with a "Record of Invention" form will be promptly forwarded to you without obligation upon request.

CLARENCE A. O'BRIEN & HARVEY JACOBSON

Registered Patent Attorneys

81-K DISTRICT NATIONAL BUILDING • WASHINGTON 5, D. C.

Patents
Trademarks
Copyrights

CLARENCE A. O'BRIEN & HARVEY JACOBSON
Registered Patent Attorneys
81-K District National Bldg., Washington 5, D. C.
Please send me copy of "Patent Guide for the Inventor" and also
"Record of Invention" form. This request does not obligate me.

Name _____

Address _____

City _____ State _____

(Please write or print plainly.)



**I Put You to Work with Your Hands to LEARN RADIO!
You Build Receivers! You Make Typical Defects Occur
and Make Tests to Prove the Theory!**

**YOU GET
8 BIG KITS OF RADIO
PARTS & EQUIPMENT
including
2-BAND SUPER
RECEIVER!
and 16 RANGE METER
FOR TESTING**

F. L. SPRAYBERRY, PRES-
IDENT of the SPRAYBERRY
ACADEMY OF RADIO. This
is the man who directs
your study. His years of
experience and Radio
"know-how" assure you of
the finest in home Radio
Training!

**LEARN RADIO
to MAKE MONEY!**

LOW COST TRAINING — EASY PAYMENT PLAN!

**You Learn at Home How to
Build and Test Dozens and
Dozens of Circuits — Simple
and Complex!**

**YOU DO
OVER 175
INSTRUCTIVE
EXPERIMENTS**



**YOU BUILD
ALL THESE TESTERS
..... AND MORE!**

I give you a fine,
moving-coil type
Meter Instrument on
Jewel Bearings — with parts for a
complete Analyzer
Circuit Continuity
Tester. You learn
how to check and
correct Receiver
defects with professional speed and
accuracy.



You'll get
valuable experi-
ence and
practice
building this
Signal Gener-
ator and mul-
ti-
purpose
Tester. Makes a
breeze out of fixing Radios and you
don't have to spend money on ready-
made Equipment.

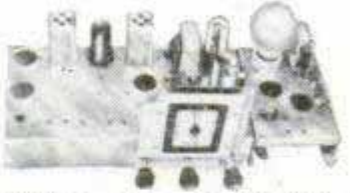
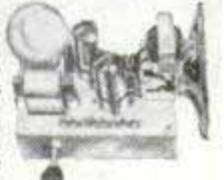

Soldering, wiring, connecting Radio
parts . . . building circuits with your
own hands — you can't beat this
method of learning. When you con-
struct this Rectifier and Filter, Res-
istor and Condenser Tester, etc., you
get a really practical slant on Radio
that leads to a money-making future.

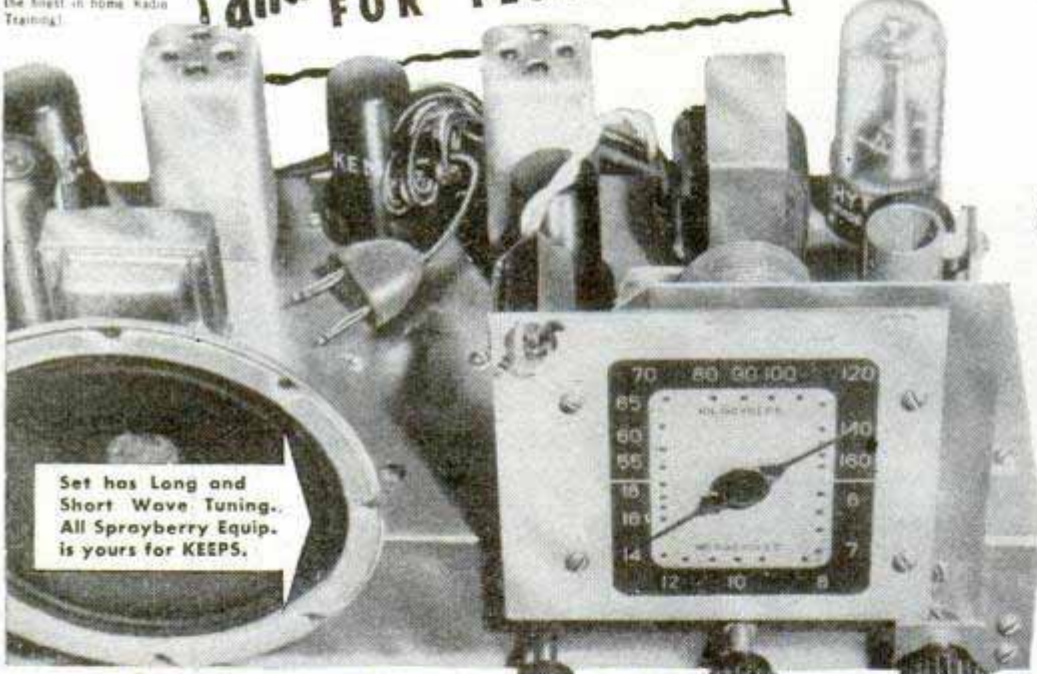

Set has Long and
Short Wave Tuning.
All Sprayberry Equip.
is yours for KEEPS.

SPRAYBERRY HOME TRAINING is PLANNED to MAKE MONEY for you FAST!

I train you with regular professional Radio Equip-
ment. I tell you exactly what to do . . . how to do
it. You handle Radio Parts, see them operate,
learn what they're for. With the fine Kits I supply,
you learn how to build Radio Circuits, construct
your own Test Equipment. I'll show you how to
cause typical Radio defects so you can watch and
see how they act. You learn the latest methods for
trouble-shooting and repair. All this adds up to

the finest kind of "bench" experience. And you get
it right in your own home. In no time at all, you'll
be ready for a business of your own or a good job
in Radio, FM, Television,
Radar, Industrial Elec-
tronics, etc. Now's
the time to get
started!



VETERANS!

**Approved for
G. I. Training
Under Public
Laws 16 and 346**

**SEND FOR MY
VALUABLE
FREE BOOKS!**

"How To Read Radio Diagrams and Symbols"
A wonderfully complete new book, which ex-
plains in simple English how to read and
understand any Radio Set Diagram. Includes
translation of all Radio symbols. Send for
this volume at once! It's free! With it I'll
send you another Big Free Book, describing
in detail my Radio Electronic Training!

SPRAYBERRY ACADEMY OF RADIO

F. L. Sprayberry, President
10108 Sprayberry Building, Pueblo, Colorado

Please rush my FREE copies of "How to MAKE MONEY in
RADIO, ELECTRONICS and TELEVISION" and "How to READ
RADIO DIAGRAMS and SYMBOLS."

Name _____ Age _____
Address _____
City _____ State _____
 Check here if a veteran.

(Mail in envelope or paste on penny postcard)

INVENTORS

Patent laws encourage the development of inventions.

We recommend that an inventor employ a registered Patent Attorney or agent, if the inventor is not familiar with patent matters. This is because the value of a patent depends largely upon the skillful preparation of the specification and claims in the patent application.

The firm of McMorrow, Berman and Davidson is registered to practice before the United States Patent Office. Additionally it engages patent attorneys able to readily understand inventors' disclosures, to advise concerning patentability, and to prepare appropriate specifications and claims.

If an inventor believes he has an invention, a search of the most pertinent prior U. S. patents should be made and a report obtained relative to its patentability. Where such report indicates that the invention appears patentable, in order to secure protection, diligence should be exercised in making application for a patent.

Send for a copy of Patent Booklet entitled "How To Protect Your Invention." This booklet contains information on patent protection and procedure. You will also receive an "Invention Record" blank. This will be promptly forwarded to you upon request—no obligation.

McMORROW, BERMAN & DAVIDSON

Registered Patent Attorneys

PATENTS • TRADE MARKS • COPYRIGHTS

135-R VICTOR BUILDING, WASHINGTON 1, D. C.

McMORROW, BERMAN & DAVIDSON

Registered Patent Attorneys

135-R Victor Building, Washington 1, D. C.

Send me your Patent Booklet, "How To Protect Your Invention", and also "Invention Record" form at once. I understand this request does not obligate me.

Name.....

Address.....

City.....

(WRITE OR PRINT NAME CLEARLY)

Will You Let Me PROVE I Can Make YOU a New Man?

LET ME START SHOWING RESULTS FOR YOU



"Did weigh 141. Now 170." T.K., N.Y.



"Recommend you for quick results!"—W.G., N.J.



"Have put 3 1/2 in. on chest."—F.S., New York

I COULD fill this whole magazine with enthusiastic reports from OTHERS. But what you want to know is—"What can Atlas do for ME?"

15 MINUTES A DAY

Just give me 15 minutes of your spare time daily. That's all I ask. And even in that short time I'll start giving RESULTS. And it will be the kind of RESULTS that you (and anyone else) can SEE, FEEL, MEASURE with a tape.

FREE BOOK

I myself was once a 97-pound weakling—sickly, half-alive. Then I discovered "Dynamic Tension." And I won the title, "The World's Most Perfectly Developed Man!"

"Dynamic Tension" has done so much for other fellows that I simply ask you to let me prove that it can make a New Man of YOU—that it can start new inches of power pushing out your chest—build up your shoulders to champion huskiness—put new, hard, firm muscles on your biceps—make those stomach muscles of yours hard ridges!

Why not risk a postage stamp? Send coupon for my 48-page illustrated FREE BOOK AT ONCE! Address me personally: Charles Atlas, Dept. 8K, 115 East 23rd Street, New York 10, N. Y.



**CHARLES ATLAS, Dept. 8K,
115 East 23rd Street, New York 10, N. Y.**

I want the proof that your system of "Dynamic Tension" will help make a New Man of me—give me a healthy, husky body and big muscle development. Send me your free book, "Everlasting Health and Strength."

Name _____ Age _____
(Please print or write plainly)
Address _____
City _____ State _____

THIS FREE BOOK

Tells how we can teach you QUICKLY & EASILY



TO MOUNT BIRDS AND ANIMALS

GAME HEADS, FISH
Send at once for this fascinating free book which tells how you can learn to be a taxidermy artist. Save and preserve your beautiful hunting trophies. Decorate your den. A grand hobby for sportsmen, hunters, anglers—both men and boys! **DOUBLE your fun** from hunting and fishing. We teach you this marvelous art right in your own home, by mail, in your spare time. Also, we teach you to make strong, useful **GENUINE LEATHER** from hides. **Act RIGHT NOW.**

FREE BOOK

SEND TODAY! Rush a letter or penny postcard for the beautifully illustrated 68-page **FREE BOOK.** Full of fascinating game pictures. Learn about this old reliable school for outdoorsmen, 43 years in business. More than 400,000 students. No cost or obligation for the book. **BE SURE TO STATE YOUR AGE!**
NORTHWESTERN SCHOOL OF TAXIDERMY
2510 Elwood Building • OMAHA 2, NEBRASKA



LEARN MONEY-MAKING CARTOONING

IN SPARE TIME — by Easy Picture Chart Method
Same Simplified Method that has helped train creators of "Terry & Pirates," "Freckles," "Out Our Way," "Winnie Winkle," "Reg'lar Fellers," "Strange As It Seems," "The Neighbors," and many others. Earn while learning. Send 10c for Picture Chart (to test your ability, and full details. (State age.)



THE LONDON SCHOOL, 4810 Clevel. Transit Bldg., Cleveland, O.

INVENTING

—FOR PROFIT! If you have an inventive turn of mind, write for free 28-page booklet explaining how the Institute of American Inventors is helping inventors pre-test the profit possibilities of proposed devices to fill today's unprecedented demand for useful new inventions.

INSTITUTE of AMERICAN INVENTORS

Dept. 4, 1926 Eye St., NW, Washington 6, D. C.

LEARN WATCH REPAIRING



AT HOME. By our modern and original system of instruction you can learn every part of the **WATCH REPAIRING TRADE AT HOME.** Prepare yourself for a well-paying position or start in business after completing our course of instruction. Good watch repairers are in demand and generally earn very good salaries. For particulars apply to the **Wisconsin School of Watch Repairing** 759 North Milwaukee St., Milwaukee 2, Wis.

ACCOUNTING

STUDY AT HOME for C.P.A. and **HIG PAY** Accounting opportunities with 44 year old school. No previous training needed. Texts furnished. **EASY PAYMENTS.** Send for **FREE BOOK.** G. I. Approved.

MACCORMAC EXTENSION SCHOOL
Dept. M 1170 E. 63rd St. Chicago 37, Ill.

NEW! LOW COST! RESPIRATOR

Wear when sanding, grinding, paint spraying, sweeping, dusting, furnace cleaning, etc. Handy as a pair of glasses. Just keep mouth closed and breathe through nose is all you do to operate. Protects against nuisance dusts, lint, coal, cement, grain dust, hay fever pollen. Has 9 sq. in. filter. For **EYE** protection against paint spray, dusts, gases, fumes, smoke, order our **Fog-Proof Rubber GOGGLES** \$2.00 p.p.



JERRY BRYANT, Dept. PM
919 N. Michigan Ave. Chicago 11, Ill.

Order Today \$1.00 POST PAID

There's **BIG MONEY** in

PLASTICS

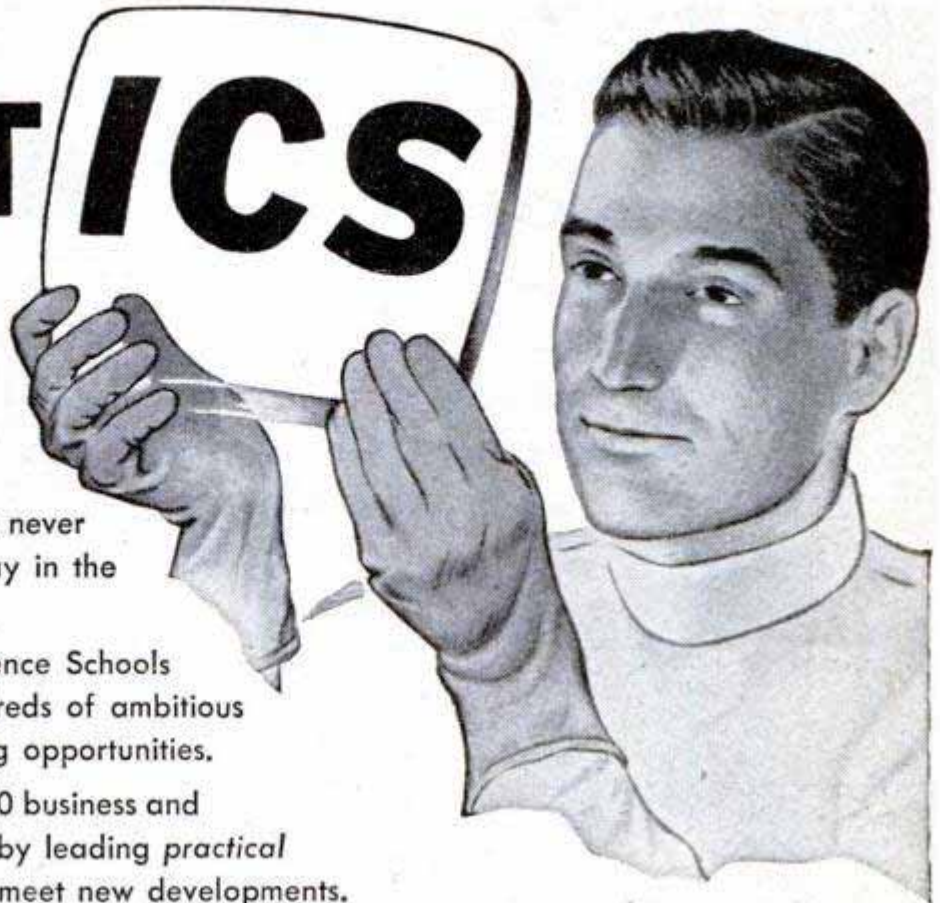

- Your chances for success have never been greater than they are today in the field of plastics.
- The International Correspondence Schools Course in Plastics is fitting hundreds of ambitious men for these great and growing opportunities.
- All I.C.S. Courses (covering 400 business and technical subjects) are prepared by leading practical authorities, constantly revised to meet new developments. Yet the cost of I.C.S. training is surprisingly low.

Inspecting a plastic lens similar to type used to magnify television images.

- Join the men who will be tomorrow's leaders. Mail this coupon today!

INTERNATIONAL CORRESPONDENCE SCHOOLS



BOX 5638-K, SCRANTON 9, PENNA.

Without cost or obligation, please send me full particulars about the course BEFORE which I have marked X:

- | | | | | |
|--|--|--|--|---|
| <input type="checkbox"/> PLASTICS | <input type="checkbox"/> Structural Engineering | <input type="checkbox"/> Industrial Engineering | <input type="checkbox"/> Steam Electric | <input type="checkbox"/> Steam Engineer |
| <input type="checkbox"/> Air Conditioning and Plumbing Courses | <input type="checkbox"/> Surveying and Mapping | <input type="checkbox"/> Industrial Metallurgy | <input type="checkbox"/> Textile Courses | |
| <input type="checkbox"/> Air Conditioning | <input type="checkbox"/> Communications Courses | <input type="checkbox"/> Machine Shop | <input type="checkbox"/> Cotton Manufacturing | <input type="checkbox"/> Loom Fixing |
| <input type="checkbox"/> Heating | <input type="checkbox"/> Electronics | <input type="checkbox"/> Mechanical Drafting | <input type="checkbox"/> Rayon Weaving | |
| <input type="checkbox"/> Refrigeration | <input type="checkbox"/> Practical Telephony | <input type="checkbox"/> Mechanical Engineering | <input type="checkbox"/> Textile Designing | |
| <input type="checkbox"/> Plumbing | <input type="checkbox"/> Radio, General | <input type="checkbox"/> Mold-Loft Work | <input type="checkbox"/> Woolen Manufacturing | |
| <input type="checkbox"/> Steam Fitting | <input type="checkbox"/> Radio Operating | <input type="checkbox"/> Patternmaking—Wood, Metal | <input type="checkbox"/> Business and Academic Courses | |
| <input type="checkbox"/> Chemistry Courses | <input type="checkbox"/> Radio Servicing | <input type="checkbox"/> Reading Shop Blueprints | <input type="checkbox"/> Accounting | <input type="checkbox"/> Advertising |
| <input type="checkbox"/> Chemical Engineering | <input type="checkbox"/> Telegraph Engineering | <input type="checkbox"/> Sheet-Metal Drafting | <input type="checkbox"/> Bookkeeping | |
| <input type="checkbox"/> Chemistry, Analytical | <input type="checkbox"/> Electrical Courses | <input type="checkbox"/> Sheet-Metal Worker | <input type="checkbox"/> Business Administration | |
| <input type="checkbox"/> Chemistry, Industrial | <input type="checkbox"/> Electrical Drafting | <input type="checkbox"/> Ship Drafting | <input type="checkbox"/> Business Correspondence | |
| <input type="checkbox"/> Chemistry, Mfg. Iron & Steel | <input type="checkbox"/> Electrical Engineering | <input type="checkbox"/> Tool Designing | <input type="checkbox"/> Certified Public Accounting | |
| <input type="checkbox"/> Petroleum Refining | <input type="checkbox"/> Electric Light and Power | <input type="checkbox"/> Welding Engineering | <input type="checkbox"/> Commercial | <input type="checkbox"/> Commercial Art |
| <input type="checkbox"/> Pulp and Paper Making | <input type="checkbox"/> Lighting Technician | <input type="checkbox"/> Welding—Gas and Electric | <input type="checkbox"/> Cost Accounting | <input type="checkbox"/> Federal Tax |
| <input type="checkbox"/> Civil Engineering, Architectural and Mining Courses | <input type="checkbox"/> Practical Electrician | <input type="checkbox"/> Railroad Courses | <input type="checkbox"/> First Year College | |
| <input type="checkbox"/> Architecture | <input type="checkbox"/> Internal Combustion Engines Courses | <input type="checkbox"/> Air Brake | <input type="checkbox"/> Foremanship | <input type="checkbox"/> French |
| <input type="checkbox"/> Architectural Drafting | <input type="checkbox"/> Auto Technician | <input type="checkbox"/> Diesel Locomotive | <input type="checkbox"/> Good English | <input type="checkbox"/> High School |
| <input type="checkbox"/> Bridge and Building Foreman | <input type="checkbox"/> Diesel-Electric | <input type="checkbox"/> Locomotive Engineer | <input type="checkbox"/> Higher Mathematics | |
| <input type="checkbox"/> Building Estimating | <input type="checkbox"/> Diesel Engines | <input type="checkbox"/> Locomotive Fireman | <input type="checkbox"/> Motor Traffic | <input type="checkbox"/> Postal Service |
| <input type="checkbox"/> Civil Engineering | <input type="checkbox"/> Gas Engines | <input type="checkbox"/> Locomotive Machinist | <input type="checkbox"/> Retailing | |
| <input type="checkbox"/> Coal Mining | <input type="checkbox"/> Mechanical Courses | <input type="checkbox"/> Railroad Section Foreman | <input type="checkbox"/> Retail Store Management | |
| <input type="checkbox"/> Contracting and Building | <input type="checkbox"/> Aeronautical Engineer's, Jr. | <input type="checkbox"/> Steam Engineering Courses | <input type="checkbox"/> Salesmanship | <input type="checkbox"/> Secretarial |
| <input type="checkbox"/> Highway Engineering | <input type="checkbox"/> Aircraft Drafting | <input type="checkbox"/> Boilermaking | <input type="checkbox"/> Sign Lettering | |
| <input type="checkbox"/> Reading Structural Blueprints | <input type="checkbox"/> Flight Engineer | <input type="checkbox"/> Combustion Engineering | <input type="checkbox"/> Spanish | <input type="checkbox"/> Stenography |
| <input type="checkbox"/> Sanitary Engineering | <input type="checkbox"/> Forging | <input type="checkbox"/> Engine Running | <input type="checkbox"/> Traffic Management | |
| <input type="checkbox"/> Structural Drafting | <input type="checkbox"/> Foundry Work | <input type="checkbox"/> Marine Engineering | | |
| | <input type="checkbox"/> Heat Treatment of Metals | | | |

Name _____ Age _____ Home Address _____
 City _____ State _____ Present Position _____
 Employed by _____ Working Hours _____ A.M. to _____ P.M.

Special tuition rates to members of the Armed Forces. Enrollment under G.I. Bill and P.L. 16 approved for World War II Veterans.
 Canadian residents send coupon to International Correspondence Schools Canadian, Ltd., Montreal, Canada.

I N V E N T O R S

A Patent is a Valuable Right. On the basis of a provision in the Constitution of the United States, Congress has established a system under which inventors may secure the exclusive right to prevent the unauthorized use, manufacture and sale of their inventions for periods of seventeen years. The inventor secures this protection for his invention by obtaining a United States Patent.

*T*his firm is registered to practice before the U. S. Patent Office and is available to assist inventors in the preparation and prosecution of their cases. Detailed information and the steps to be taken in obtaining patent protection will be furnished upon request.

Form below for mailing convenience

VICTOR J. EVANS & Co. *Merlin M. Evans*
REGISTERED PATENT ATTORNEY

330-L MERLIN BUILDING, WASHINGTON 6, D. C.

Please send me without obligation a copy of your booklet "Patent Protection For Inventors" together with your convenient "Evidence of Invention" form.

Name.....

Address.....

City and State.....

PATENTS TRADEMARKS COPYRIGHTS

These Men are Learning

ELECTRICITY

in the Great SHOPS of COYNE

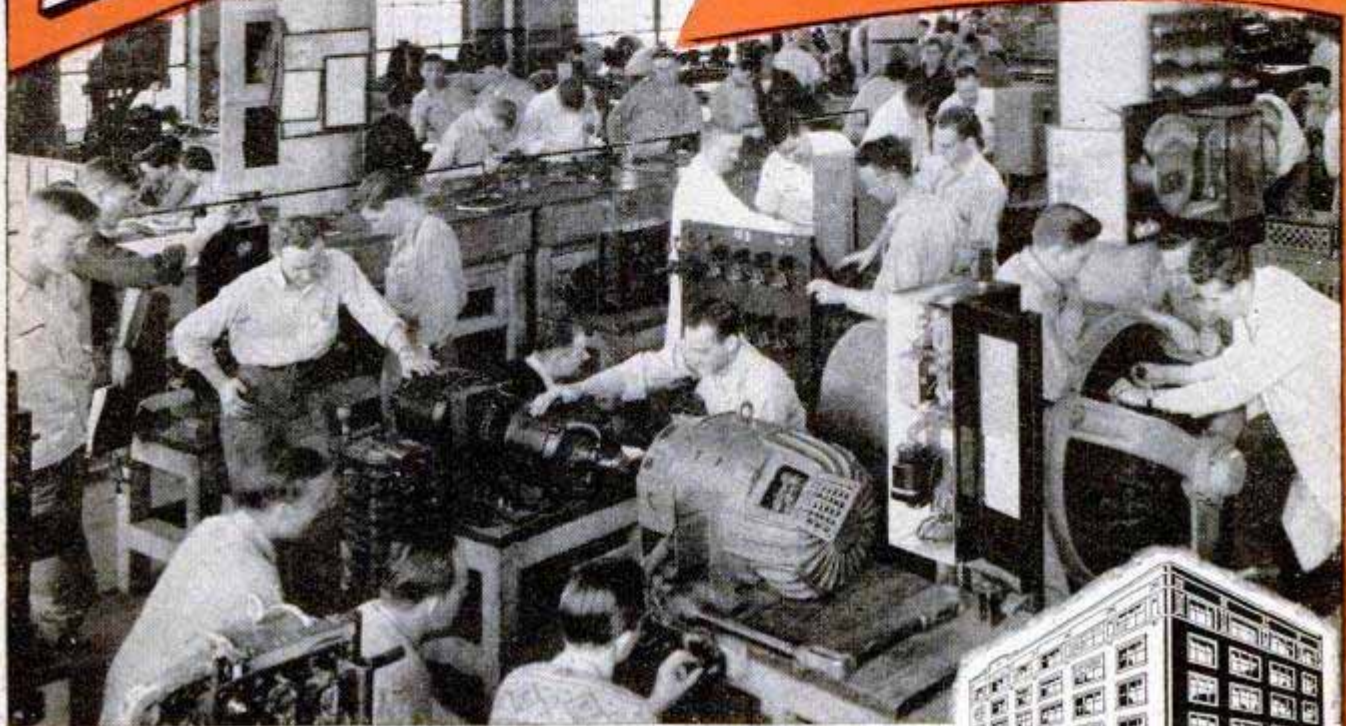

ESTABLISHED 1899
Oldest, Largest, Best
Equipped School of
Its Kind in U. S.

Why Spend Years Preparing for a Good Job?
Train Quickly at COYNE—Be Making Real
Money While Others are Still Puttering Along!

Learn on Real Equipment

Do as these fellows are doing! Get ready for Good Pay—a Big Future in ELECTRICITY—by training in the Great Shops of COYNE. Here you work on real motors, armatures, switchboards; do actual wiring and trouble shooting; get "all-around" training for dozens of well-paid job opportunities. Mail coupon today!

Not a "Home-Study" Course

We do not teach by mail. All training plus necessary theory is given in our Great Shops. Expert instructors guide you. No advanced education or previous experience needed.

EARN WHILE LEARNING

If you need part-time work to help out with living expenses while at Coyne, we'll help you get it. Don't be held back by lack of money.

GI Approved—Finance Plan for Non-Vets

COYNE is authorized to train men under the G. I. Bill. Non-veterans may enroll now, pay most of tuition after graduation. Whatever your problem, COYNE can help you! Coupon brings details.

Electrical Refrigeration Included

Added training now included in great new field of Electric Refrigeration—also Industrial Electronics. Both mean added opportunities for you.

B. W. COOKE, President

COYNE ELECTRICAL AND RADIO SCHOOL

500 S. Paulina St., Dept. 78-72
CHICAGO 12, ILLINOIS

Get This Free Book!

See what COYNE offers in quick, pay-raising training. Send coupon for Big FREE BOOK, filled with pictures of our great shops and all the facts to help you. No obligation. No salesman will call. Rush coupon now!



B. W. COOKE, Pres.
COYNE ELECTRICAL AND RADIO SCHOOL, 500 S. Paulina St., Dept. 78-72, Chicago 12, Illinois.

Send me your big FREE BOOK on ELECTRICITY. This does not obligate me in any way and no salesman will call on me.

NAME.....

ADDRESS.....

CITY.....STATE.....

PREPARE
AT COYNE
FOR REAL
FUTURE
in Jobs
Like These



Switchboards
House Wiring
Power Wiring
Maintenance
Electric Mfg.
Refrigeration
Signal Work
FREE Lifetime Job Service to COYNE Graduates.

Motor Testing
Armature Work
Industrial
Electronics
Power Plants
Substations
Your Own Shop

MAIL NOW!



Satisfied with my JOB and PAY? NOT ME!!

"Some day I'll really get a break and go right on to the top." That's wishful thinking.

You know that the "breaks" go to the man or woman who is prepared to take advantage of them—to the person who can fill the better job and is worth more money. He makes the "breaks" instead of waiting for them.

You can influence your own future by preparing now for the step forward—so that openings come because you are equipped for them—not as the result of luck.

Why not take the road that thousands of ambitious men and women have taken to help them to better jobs and more money.

Prepare now. Send the coupon below—check the business field of your choice and we'll send you without obligation our FREE 48-page book describing the opportunities and complete information on that field—plus "Ten Years' Promotion in One"—a book which has helped many men.

Send the coupon Now. It may be the turning point in your life to that better job and more money.

LASALLE Extension University
A Correspondence Institution
Dept. 1064-R Chicago 5, Ill.

LASALLE Extension University
A Correspondence Institution

417 S. Dearborn St., Dept. 1064-R, Chicago 5, Ill.

I want to make my own "breaks" by preparing for a better job. Send free 48-page book on the subject I have checked.

- | | |
|--|--|
| <input type="checkbox"/> Higher Accountancy | <input type="checkbox"/> Salesmanship |
| <input type="checkbox"/> C.P.A. Coaching | <input type="checkbox"/> Traffic Management |
| <input type="checkbox"/> Bookkeeping | <input type="checkbox"/> Foremanship |
| <input type="checkbox"/> Law: LL.B. Degree | <input type="checkbox"/> Industrial Management |
| <input type="checkbox"/> Business Management | <input type="checkbox"/> Stenotypy (Machine Shorthand) |

Name Age

Address

City Zone State

LEARN AT HOME TO MOUNT BIRDS



Animals, Heads, Fishes, Pets; to TAN. Be a Taxidermist. Profit and FUN.

Hunters, save your valuable TROPHIES. Mount ducks, squirrels, everything. Learn to TAN for leather and furs. Wonderful HOBBY Have a HOME MUSEUM.—BIG PROFITS mounting for others. INVESTIGATE NOW.

FREE BOOK With 100 fine game pictures. NOW absolutely FREE. Write TODAY.

Send Postal TODAY for FREE BOOK. State AGE. N.W. SCHOOL OF TAXIDERMY, Dept. 2570, Omaha, Neb.



WATCHMAKING

JEWELRY ENGRAVING AND REPAIR

Enter this high-paying, time-honored profession, or prepare for a business of your own. Watchmakers in great demand. More jobs than qualified workers. Study under expert instructors in a long-established, nationally recognized school. Receive recognized diploma and certificate. Placement service. Approved under G. I. Bill. Write for FREE booklet.



The Baronian School, Inc.

2116 WALNUT ST. (DEPT. C) PHILA. 3, PA.

BE A REAL ESTATE BROKER

PAYS BIG! EASY TO LEARN—Start and run your own business quickly. Many graduates report making up to \$1000 a month. Course of study covers Sales, Property Management, Appraising, Loans, Mortgages and hundreds of related subjects. Course in home study or classroom instruction in leading cities. Big new illustrated catalog from this nationally known school. G. I. Approved. Send a Post Card Today.

WEAVER SCHOOL OF REAL ESTATE (Estab. 1936)
15 E. Pershing Road Dept. PM-1 Kansas City, Mo.



STAMMER?

This new 128-page book, "Stammering, Its Cause and Correction," describes the Bogue Unit Method for scientific correction of stammering and stuttering—successful for 47 years. Benj. N. Bogue, Dept. 4824, Circle Tower, Indianapolis 4, Ind.



SHOE REPAIR OFFERS BIG INCOME

LEARN IN 12 WEEKS TIME

You can own your own shop or earn big income as skilled shoe repairman. Growing demand everywhere at top wages for men who know how. We teach you quickly by actually working on shoes and modern machines. Costs nothing under G.I. Bill of Rights. School open to all from 18 to 60 years of age. FREE BIG 16 PAGE BOOK explains everything. Send for your copy today.

MODERN SHOE REBUILDING SCHOOL

Established 1927
2937 Belmont Ave., Chicago, Ill. Rush Postcard Today.
4577 Hollywood Blvd., Los Angeles 27, Calif.

make MONEY CASTING AT HOME

Make your own rubber molds quickly, cheaply with X.L. RUBBER. Cast thousands of perfect figurines, book ends, plaques, ornaments, ash trays, etc. GREAT PROFITS!

Write for NEW Catalog.
X.L. Rubber, Pts. \$2.00; Qts. \$3.50; Gallons \$8.95; Models and enough rubber for 3 molds \$1.00—Foreign \$1.50.

PLASTIC ARTS STUDIO Route 2 • Dept. 2 • Muncie Ind.

SUCCEED IN THE POULTRY BUSINESS!



Poultry is providing many trained men and women with a good, comfortable living, either part or full time. For 27 years our Home Study Course has been helping thousands obtain training and "know how" that means extra income from the start. Don't delay—Write today for prospectus describing courses, methods, service, opportunities.

NATIONAL POULTRY INSTITUTE
DEPT. 50 ADAMS CENTER, N. Y.

WHICH OF THESE *Opportunities* INTERESTS *You* MOST?

Accounting
Air Conditioning
Architecture & Building
Automotive Engineering
Aviation—Practical
Aviation Drafting & Design
Better Foremanship
Bookkeeping
Business Management

Contracting
Diesel Engineering
Drafting & Design
Electrical Engineering
Electricity—Practical
Electronics, Industrial
High School Courses
Machine Shop Operations
Mechanical Engineering

Plastics Engineering
Plumbing—Practical
Private Secretary
Radio Operating & Servicing
Railway Training
Refrigeration
Sheet Metal Pattern Drafting
Shop Management
Tool Making

THINK! LOOK FORWARD!

Business is making big, new plans

Men and Women are preparing for the future

WHAT ARE YOU DOING ABOUT YOUR TOMORROWS?

● *Today*, choose the job you want—and prepare for it. Or if you are already engaged in the work you like best, start training *now* for quicker promotion. Acquire the knowledge that will help you to get ahead faster, make more money and have greater security.

Invest part of your spare time in more rapid progress. Start training now, in spare time in your own home. Be ready to grasp your opportunity and step out ahead of those who lack the ability you have attained.

American School, founded in 1897 as an educational institution *not for profit*, can help you to reach your goal just as it has helped others during the past fifty-one years. Give serious thought to the list above. Pick one or more subjects that interest you. Then check the coupon at right, add your name and address and mail it at once. The school will send you details on its training plan and outline of study prepared by specialists. There is no charge, no obligation, so send the coupon immediately.

PRACTICAL, EFFECTIVE HOME - STUDY TRAINING SINCE 1897

Take This First Easy Step

CHECK, CLIP AND MAIL COUPON NOW

AMERICAN SCHOOL, Dept. G745, Drexel at 58th, Chicago 37, Ill.
Without obligation, Please send FREE and postpaid, bulletin and details of the Subject checked.

- | | | |
|--|--|--|
| <input type="checkbox"/> PLASTICS ENG'R | <input type="checkbox"/> Accounting | <input type="checkbox"/> Drafting and Design for Men and Women |
| <input type="checkbox"/> Refrigeration | <input type="checkbox"/> Electrical Engr. | <input type="checkbox"/> Radio |
| <input type="checkbox"/> Architecture and Building | <input type="checkbox"/> Electricity-Pract. | <input type="checkbox"/> High School |
| <input type="checkbox"/> Contracting | <input type="checkbox"/> Electronics, Industr. | <input type="checkbox"/> Air Conditioning |
| <input type="checkbox"/> Practical Plumbing | <input type="checkbox"/> Bookkeeping | <input type="checkbox"/> Mechanical Eng. |
| <input type="checkbox"/> Automotive Engineering | <input type="checkbox"/> Private Secretary | <input type="checkbox"/> Shop Management |
| <input type="checkbox"/> Aviation Drafting | <input type="checkbox"/> Diesel Engineering | <input type="checkbox"/> Tool Making |
| <input type="checkbox"/> Aviation | <input type="checkbox"/> Sheet Metal | <input type="checkbox"/> Better Foremanship |
| <input type="checkbox"/> Business Mgmt | <input type="checkbox"/> Pattern Drafting | <input type="checkbox"/> Machine Shop Operations |
| <input type="checkbox"/> Railway Training | | |

Name..... Occupation.....

Address..... Age.....

City..... State.....

AMERICAN SCHOOL

Dept. G745, Drexel at 58th Street, Chicago 37

Here's how to prepare for GOOD PAY, a STEADY JOB in AUTO MECHANICS

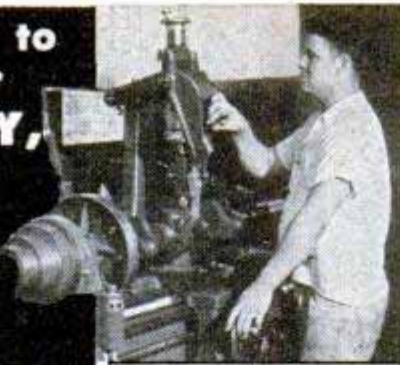

AUTO MACHINIST

Student in engine rebuilding learning to operate a crankshaft grinder. Specialized training puts you in line for better jobs and higher pay.

Earn more money in Auto Mechanics when you choose one type of work and specialize in it. Get ready for a top pay job with security and a real future. New FREE booklet tells how to get specialized training and what to learn to move ahead faster. Get the full facts on opportunities today. See why trained men get the best jobs. Write for your Free copy today.

ENGINE REBUILDING

Up-to-date practical training on latest equipment. You learn machine shop, auto electricity, carburetion, trouble shooting, motor tune-up and transmissions.

GENERAL AUTO MECHANICS

Practical training for general garage work. Engine overhaul, auto electricity and many other subjects. See shops and equipment in our FREE booklet.

VETERANS: American Trade School is G. I. Approved.

WRITE TODAY FOR FREE BOOKLET

AMERICAN TRADE SCHOOL
2417 McGee, Kansas City, Mo.



Do you want

- ➔ ..to go to College?
- ➔ ..or to enter a Profession?
- (Such as Accounting, Architecture, Nursing, Dentistry, Teaching, Social Work, Osteopathy, Beauty Culture, Optometry, Embalming, Chiropody, Law, Medicine, etc.)
- ➔ ..or get an Office Position?

To get anywhere, you practically **MUST** finish High School **FIRST**. You can complete our simplified High School Course in **SPARE** time at home, as **FAST** as your time and abilities permit. Equivalent to resident school work—prepares you for college, pre-professional examinations, business, industry. Standard texts furnished. Diploma. Credit for H. S. subjects already completed. Single subjects if desired. Low tuition, easy terms. American School, Chicago, est. 1897—endorsed by educators. Finish your high school education **NOW**, Write **TODAY!**

High School Course at Home Many Finish in 2 Years

American School, Dept. H745, Drexel Ave. at 58th St., Chicago 37, Ill.

Gentlemen: Send me **FREE** information covering special training in subjects checked below. No obligation on my part.

- | | |
|--|--|
| <input type="checkbox"/> High School Course | <input type="checkbox"/> Diesel Engineering |
| <input type="checkbox"/> Architecture and Building | <input type="checkbox"/> Drafting and Design for Men & Women |
| <input type="checkbox"/> Automotive Engineering | <input type="checkbox"/> Plastics |
| <input type="checkbox"/> Business Management | <input type="checkbox"/> Private Secretary |
| <input type="checkbox"/> Electrical Engineering | <input type="checkbox"/> Mechanical Engineering |
| <input type="checkbox"/> Elec. and Gas Refrigeration | <input type="checkbox"/> Aviation |
| <input type="checkbox"/> Air Conditioning | <input type="checkbox"/> Salesmanship |
| <input type="checkbox"/> Railway Training | <input type="checkbox"/> Radio |
| <input type="checkbox"/> Electronics, Industrial | |

Name.....

Address.....

Say You Saw It in Popular Mechanics

STUDY AT HOME

With An Educational Institution

Men with specialized training win higher positions, insure larger earnings, and are bigger successes in business and public life. Opportunities **NOW** greater than ever before. Send for our Catalog.

ARTS and SCIENCES

Courses in Philosophy; Education; Letters; Public Health; Medical Jurisprudence; Psychology; Sociology; Physics; Chemistry; Plastics; Geology; Political Science; Theology; Business and Commerce; Accounting; Mathematics; Statistics; Agriculture.

ENGINEERING

Courses in Electrical, Civil, Mechanical, Drafting, Architectural, Steam, Aeronautical, Radio, Structural, Mining, Industrial, Petroleum, Marine, Chemical, Diesel, Automobile, Refrigeration, and Air Conditioning Engineering.

LAW

Complete Professional Law Course includes 18 Hornbook Series college grade textbooks. Courses also in Commercial Law, Patent Law and Medical Jurisprudence.

McKinley-Roosevelt Incorporated, 4610-K, Sheridan Rd., Chicago 40, Ill.

ELECTRICIANS' SCHOOL

HOUSE AND COMMERCIAL WIRING • MOTOR REPAIR AND REWINDING • ELECTRIC REFRIGERATION

Approved for Veterans Training

PENNSYLVANIA INSTITUTE SCHOOL OF ELECTRICITY

42nd and SPRUCE STS.

PHILADELPHIA 4, PENNA.

RADIO ENGINEERING

Broadcasting, Television, FM, Servicing, Electronics, Aviation, Marine & Police Radio taught thoroughly. Engineering course equivalent to 3 years' college radio work. Approved Veteran Training. Catalog free.

VALPARAISO TECHNICAL INSTITUTE, Dept. D, Valparaiso, Ind.

Be an INVESTIGATOR

JAMES S. BOLAN, FORMER POLICE COMMISSIONER OF NEW YORK CITY offers MEN & WOMEN an attractive opportunity to prepare for a future in *Investigation & Criminology* by comprehensive Home Study Course. Free placement service assists graduates to obtain jobs. APPROVED UNDER G. I. BILL OF RIGHTS.

Write for Free Booklet PM.

THE BOLAN ACADEMY, INC.
EMPIRE STATE BLDG., NEW YORK 1, N. Y.

An ASSURED FUTURE for You Learn Profitable WATCH REPAIRING

BIG MONEY WHILE LEARNING
Study at Home — or at Our Accredited School

Complete Home Correspondence Course or G. I. Approved Residence School Plan. Also, Post-Graduate Plan at school for correspondence students.

Write Today for **COMPLETE DETAILS** to
American Institute of Specialized Watch Repair

Dept. No. 100 270-76 East Building Grand Rapids, Michigan



Bar Bells

Buy Direct From Factory

Write for free booklet and price list

\$8⁹⁵
up

INDEPENDENT IRON WORKS
2416 East 23rd Street, Dept. B
Los Angeles 11, Calif.

Here's Our **GREATEST** Combination of Training Advantages IN 17 YEARS to Help YOU...

Learn RADIO and TELEVISION

YOU KEEP *this* **EQUIPMENT**

Here's good news . . . **BIG** news . . . our **BIGGEST NEWS** in 17 years. Now, **AT HOME**, you can get one of today's most effective combinations of Radio-Electronic training aids . . . and you **KEEP ALL EQUIPMENT**.

Mail coupon **TODAY!** Get **FREE FACTS** about **D.T.I.'s** amazing new home training. See how effectively **D.T.I.** prepares you to earn good money . . . do interesting work . . . enjoy a grand future in America's thrilling Radio-Television-Electronics fields.

You BUILD and KEEP this 6-tube "SUPER" RADIO RECEIVER . . .

. . . as one of your many "Learn-By-Doing" projects to help you get valuable "on-the-job" experience in **ASSEMBLY . . . WIRING . . . SOLDERING . . . ALIGNING . . . TESTING . . . and TROUBLE SHOOTING.**

A Jewel-Bearing, Self Powered **MULTI-METER**

You also receive the necessary parts from which you construct and keep this valuable, commercial-type test meter, which can help you earn while you learn.

Build **200** Experiments from these **RADIO PARTS**

D.T.I. sends you many Radio-Electronic parts which you mount on bases with spring clip terminals for quick assembly . . . ideal for experimenting. Build and operate 8 different Radio Receiver Circuits . . . Radio Telephone . . . PA System . . . Electric Eye . . . and many other fascinating projects.

Effective EMPLOYMENT SERVICE helps you get started! Upon completing your training you can get the same effective employment service that has helped many D.T.I. graduates get started in the field.

USE HOME MOVIES

. . . a **D. T. I. Exclusive!**

You also receive the loan of a 16 mm. Movie Projector and many reels of instructive, "Learn-By-Seeing" film to help you grasp basic points faster, easier. It's like a teacher in your home, giving you an **EXTRA** advantage many say is worth the cost of the entire training.

Modern CHICAGO LABORATORIES

If you prefer, you can get all your preparation in one of the nation's outstanding new training laboratories. If you come to Chicago, living quarters will be found for you.



DeFOREST'S TRAINING, Inc.

CHICAGO, ILLINOIS

Associated with the DeVry Corporation, Builders of Electronic and Movie Equipment.

MAIL TODAY

DeForest's Training, Inc.
2533 N. Ashland Ave., Dept. PM-E10
Chicago 14, Illinois

Send me complete details showing how I may make my start in Radio-Electronics-Television. No obligation.

Name Age

Address Apt.

City Zone State

If under 16, check here. If a discharged veteran for special information. If a discharged veteran of WWII, check here.

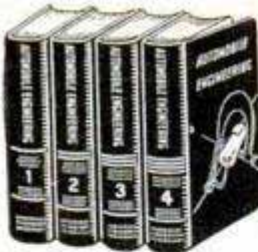

AUTO BOOKS ON APPROVAL



SEND NO MONEY. Just mail the coupon for a complete set of 4 Big, Thick Auto Books. 20th Edition. Over 2700 Pages! Whether you are a mechanic or helper, expert or apprentice, auto owner or driver, take immediate advantage of this **FREE EXAMINATION OFFER.**

MAKE GOOD MONEY NOW HOLD A PERMANENT JOB

America wants its automobiles kept in good repair. Men with "know how" are in demand, at big pay. These books will help you get and hold an important job, or give you a chance to go into business for yourself now or later. Any man who half tries to improve himself can learn auto servicing and repairing by this quick reference method. Use the **JIFFY INDEX** to find easily understood answer to any auto problem. These wonder books prepared by eleven of America's great automobile engineers. Many hundreds of valuable illustrations. Send the coupon **TODAY.**

A year's consulting privileges with our engineers now given with these books without extra charge.

Publishers Since 1898

CAN YOU FIX IT? These wonder books tell step by step **HOW** to make difficult repairs and adjustments, how to keep a car at maximum efficiency, including latest improvements in car design and operation. Engine troubles and how to correct them well covered. **4 BIG, THICK VOLUMES** Over 2700 pages, 2000 illustrations, wiring diagrams, etc., including Diesel engines. Beautiful modernistic, washable cloth binding.

AMERICAN TECHNICAL SOCIETY, Dept. A719
Drexel Ave. at 58th St., Chicago 37, Ill.

I would like to examine your 4-Volume Set of Auto Books. I will pay the delivery charges only, but if I choose I may return them express collect. If after 10 days' use I prefer to keep them, I will send you \$2 and pay the balance at the rate of only \$3 a month until \$24.80 has been paid. Include consulting service as offered above.

Name _____
Address _____
City _____ State _____
Please attach letter stating age, occupation, employer's name and address and name and address of at least one business man as reference. Men in service, also please give home address.

Learn this Profitable Profession



IN 90 DAYS AT HOME

Money-Making Career Open to Men and Women, 18 to 50

Hundreds of men and women between 18 and 50 make \$10 to \$20 in a single day giving scientific Swedish Massage and Hydro-Therapy treatments. There is big demand from doctors, hospitals, sanatoriums and clubs. Graduates earn large full time incomes from these or in private practice in their own offices. Others make good money from home treatments given in spare time. Learn this interesting, money-making profession in your own home, through our home study course. Same instructors as in our nationally known resident school. You can win independence and prepare for future security by qualifying for your Diploma. Course can be completed in 3 to 4 months. Many earn while they learn. Begin your training at once.



Anatomy Charts & Booklet FREE

Enroll now and we will include, at no extra cost, many needed supplies. Fit yourself to help meet growing demand for Scientific Swedish Massage. Send the coupon at once for complete details. Anatomy Charts and 32-Page Illustrated Booklet, **FREE**, postpaid.

THE COLLEGE OF SWEDISH MASSAGE
Dept. 864-M, 41 E. Pearson, Chicago 11, Illinois

Please send me **FREE** and postpaid, Anatomy Charts, 32-page Booklet and complete details on Home Training.

Name _____
Address _____
City _____ State _____

SAY YOU SAW IT IN POPULAR MECHANICS



There's No "Mystery" in Watchmaking! YOU CAN LEARN THIS PROFITABLE SKILL!

For 300 years, watchmakers' skills have been closely-guarded secrets. Now, you can learn skilled watchmaking in scenic, mile-high Denver. I'll give you everything in practical benchwork from hair-spring manipulation to position adjustment. Nationally accredited, veteran approved. Write Orville R. Hagans for information, no obligation. No salesman will call. **FREE BOOKLET.**

AMERICAN ACADEMY INC.
SCHOOL OF HOROLOGY
1549 Lawrence St., Dept. B, Denver 2, Colo.



FREE BOOK RAISE HAMSTERS

The new wonder animals from Syria. Often called Toy Bears. Delightful pets. Everyone wants them. Laboratories need thousands. Clean, odorless. Raise anywhere. A profitable and interesting hobby or business. We furnish breeding stock with manual of instructions.

Write today for free illustrated literature.
GULF HAMSTERY, 1536 BASIL, MOBILE, ALA.

LEARN TO WRITE a Good Hand!

FOR BUSINESS AND SOCIAL SUCCESS!
Easy to improve your handwriting at home quickly with my new instruction books just off the press. Master all the secrets of better penmanship. Simple and easy, fully illustrated, highly endorsed. Begin today. Write for: New Free Book, "How to Become a Good Penman," or check books wanted, \$1.00 each. Business Writing; Artistic Writing; Card Writing; Engraving Alphabets; Bird and Design Flourishing; Complete Set \$4.50 Enclose 10c for your name beautifully written and special penpoint for shaded writing.
S. A. Ziller, President, **TAMBLYN SCHOOL OF PENMANSHIP**
441 Ridge Bldg. In Business Over 52 Years Kansas City, Mo., U.S.A.

DO YOU LOVE HORSES?

• ARE YOU INTERESTED IN HORSE TRAINING AND MANAGEMENT?
SUBSCRIBE FOR The "EXPERT HORSEMAN" 2 YEARS \$7.00
FREE BOOK—You will also receive a booklet that tells how you can learn to break colts, gait show horses, train rodeo, stock, and race horses, break bad habits, handle any horse and train circus trick horses. **SEND \$1.00 TODAY**
ANIMAL LOVERS ASSOCIATION
Box No. KA111, TARZANA, CALIFORNIA

AVIATION TRAINING

AERONAUTICAL ENGINEERING AIRCRAFT and ENGINE MECHANICS (A & E)
Train on famous Northrop Field—New classes starting soon.
Write for illustrated catalog.
Northrop Aeronautical Institute
1527 E. BROADWAY Division of Northrop Aircraft, Inc. LOS ANGELES COUNTY HAWTHORNE CALIFORNIA
APPROVED FOR VETERANS

THERE'S MONEY IN CARTOONS!

RAYE BURNS will teach you **HOW** to **CREATE ORIGINAL CARTOONS** at home that you may **SELL!** Course contains 26 lessons and over 600 illustrations. All for Only... **\$2.85**
Send name and address for free details.

RAYE BURNS SCHOOL, Dept. M, Box 3583, CLEVELAND, OHIO



LABORATORY TECHNICIAN

BE A LABORATORY SPECIALIST; complete course. Big demand from hospitals, doctors, clinics. We teach all branches of medical laboratory work, including **Medical and Dental X-Ray.**
Approved by **American College of Medical Technologists**
Co-educational **Free Placement Bureau**
Free Catalog

Accredited for "veteran" training
CHICAGO COLLEGE OF LABORATORY TECHNIQUE
Dept. P.M., 431 S. Wabash Ave. Chicago 5, Illinois

LEARN RADIO BROADCASTING

THIS PROFESSIONAL WAY—ACTUAL BROADCASTING MATERIALS SUPPLIED YOU IN YOUR OWN HOME
AM — FM — Television
Train with America's foremost school of broadcasting. Fascinating field, good pay. Training in preparation for professional productions, and for teachers, club members. Broadcast stations need qualified people. You receive actual equipment in own home including microphone, recordings, scripts, etc. You may follow home study with instruction in our Chicago Studios. Send for **FREE FACTS** today. No Obligation.
BROADCAST PRODUCTIONS
Dept. PM-10 25 E. Jackson Blvd. Chicago, Ill.
POPULAR MECHANICS

AMERICA'S
FOREMOST SCHOOL OF
PRACTICAL TRAINING
**IS READY TO
PREPARE YOU
NOW FOR A
GOOD JOB IN—**

REFRIGERATION AIR CONDITIONING

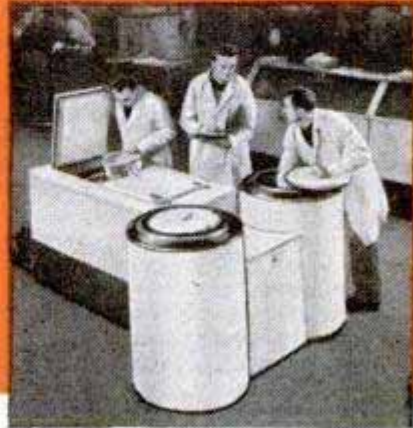
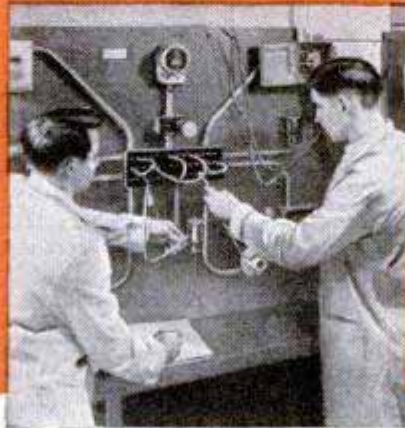

TRAIN BOTH AT HOME



AND IN ITI'S BIG SHOPS



What's YOUR ambition? Better pay? An interesting job? Your own business? They're all waiting for you **right now** in Refrigeration and Air Conditioning! The tremendous growth of this great industry is almost unbelievable . . . and a growing industry needs trained men. If you're mechanically inclined and like to work with tools . . . Refrigeration and Air Conditioning offers you a bright future. In a few short months Industrial Training Institute . . . America's foremost school of practical training—will prepare you to step into a good paying job with plenty of opportunity to advance.

Home and Shop Training

Under the famous ITI 2-Way Plan you get all the fundamentals of Refrigeration and Air Conditioning at home . . . during spare hours. Keep your present job and income while training. Upon completion of your ITI Home Study you come to Chicago, with transportation paid, for a FULL FOUR WEEKS of practical training in our great shops. You actually work with the same kind of equipment you'll meet on the job.

WARM AIR HEATING INCLUDED

ITI Training is best for you because it's really complete . . . including the huge field of Warm Air Heating to boost your income. You learn both the "how" and the "why" of servicing, repairing, installing and rebuilding both home and commercial equipment. The ITI graduate is qualified to handle any practical job in the industry.

AN OLD ESTABLISHED SCHOOL

Established in 1916, ITI has given training to over 400,000 men. Thousands of its graduates hold key jobs at top income. This great school, occupying five large buildings with over \$500,000.00 invested in training equipment and facilities, offers you the training you need for a flying start to success.

ITI TRAINING 100% PRACTICAL

You need no special schooling or experience. ITI training is easy to grasp, simple, 100% practical. No dull mathematics or complicated theory. ITI lesson Work Sheets are written in simple English. **After graduation, ITI's Job Placement Help Department will help you find the job you want.**

GET THE FACTS NOW—Mail Coupon!

Find out what's ahead for you in Refrigeration and Air Conditioning. See how simple it is to study at home and prepare yourself for a fine job with a splendid future. It's all in our fascinating, illustrated FREE book, "Your Future in Refrigeration and Air Conditioning." Just fill out and mail the coupon for your FREE copy. Take this first step today.

VETERANS:

ITI Residence Training is fully approved under the G. I. Bill.

ITI also TRAINS AMBITIOUS MEN for GOOD JOBS in . . .

- Electricity and Industrial Electronics
- Machine Drafting & Design
- Precision Instruments

MAIL COUPON TODAY FOR

FREE BOOK!

Mr. C. H. Smith, President,
INDUSTRIAL TRAINING INSTITUTE
2150 Lawrence Ave.,
Dept. K-1, Chicago 25, Ill.

Please send me FREE the ITI book, "Your Future in Refrigeration and Air Conditioning" and information about the opportunities for trained men in this fast growing field. I understand I'm under no obligation.

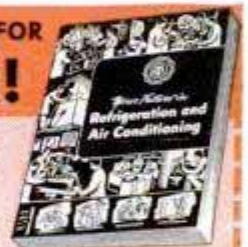

NAME _____ AGE _____

ADDRESS _____

CITY _____ ZONE _____ STATE _____

ARE YOU A VETERAN? _____



INDUSTRIAL TRAINING INSTITUTE

Formerly the L. L. Cooke School of Electricity & Refrigeration & Air Conditioning Institute
Dept. K-1, 2150 LAWRENCE AVE., CHICAGO 25, ILL.

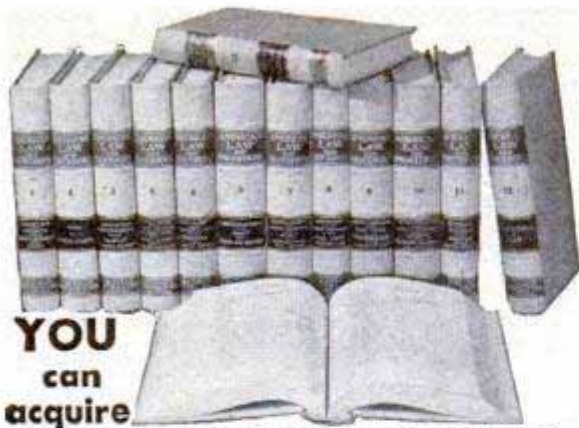

**YOU
can
acquire**

**LAW NIGHTS AT HOME!
L. B. DEGREE**

LaSalle's famous Law Library—used as reference in many Law libraries and Law offices—has enabled thousands to master Law surprisingly fast, in spare hours at home, for business and professional advancement.

These 14 remarkable volumes, compiled by leading professors and lawyers, cover the whole basic field of Law in condensed, orderly, simplified manner.

You advance rapidly with this great library, plus special lectures furnished. We guide you step-by-step with personalized Problem Method of instruction . . . you learn by doing—handling legal problems—not by memorizing rules.

Send for two FREE 48-page booklets, "Law Training for Leadership," and "Evidence," answering questions about Law and its value to you, and telling how LaSalle Law graduates are winning rapid advancement in business and public life. Mail coupon below. No obligation.

LA SALLE EXTENSION UNIVERSITY

A Correspondence Institution

417 S. Dearborn St. Dept. 1064-L Chicago 5, ILL.

Send me your two FREE booklets described above; without obligation.

Name _____ Age _____

Street _____

City, Zone & State _____

ELECTRICAL TRAINING

Intensive 32 weeks' residence course in fundamentals of industrial electrical engineering, including radio, electronics. Prepares for technician, engineering aides. Approved for veteran training. 54th year. Enter November 22, April 4. Catalog.

BLISS ELECTRICAL SCHOOL
7642 TAKOMA AVENUE
WASHINGTON 12, D. C.



Photography
for 



PLEASURE or PROFIT

Learn at home. Spare time. Practical basic training. Long-established school. Many have earned while learning. Send coupon below for free booklet, "Opportunities in Modern Photography" and full particulars.

AMERICAN SCHOOL OF PHOTOGRAPHY

1315 Michigan Avenue Dept. 1357 Chicago 5, Illinois
Send booklet, "Opportunities in Modern Photography," full particulars and requirements. No salesman will call.

Name _____ Age _____

Address _____

City _____ Zone _____ State _____

10 SHELF PLANS
NEW FULL SIZE

New, full size, easily built, beautiful wall shelf plans ready to trace on lumber, cut out and assemble. Corner and wall racks with 1 to 3 shelves. Stores charge about \$75.00 for these shelves. Make money selling them. Finest selection available. PLUS BONUS of 48 other novel cut-outs, Dutch Boys, Girls, Toys, etc., etc. PLUS FREE new 1949 Handicraft Catalog. Send only \$1 to



\$1



JACKSON, Dept. 61

5440 N. Shoreland Ave.
Milwaukee 11, Wis.

Have an **OFFICE of YOUR OWN!**

LEARN NEW PROFITABLE PROFESSION
At Home in 60 Days, Men & Women, 18 to 70!

Be Your Own Boss and the Boss of Others. Be Respected. Meet Interesting People.

Earnings of men and women in this profession run as high as \$5,000-\$15,000 yearly. Others make good money in spare time. Little money needed to start. A business where your earnings begin sooner. Easy to learn. No selling or goods to buy. No experience necessary. A depression-proof business. A course of action to guide you step by step as you earn. All 53 lessons sent at once to use as operating manuals. Easy terms. Diploma. Money-back agreement. Write for FREE BULLETIN.



FRANKLIN CREDIT SCHOOL

Dept. 75-K ROANOKE 7, VIRGINIA

BY MAIL in Easy Lessons

'How to Make Money with Simple Cartoons'



A book everyone who likes to draw should have. It is free; no obligation. Simply address

FREE BOOK

CARTOONISTS' EXCHANGE

Dept. 910-D Pleasant Hill, Ohio

WANTED—PURCHASING AGENTS

NO MONEY OR EXPERIENCE REQUIRED

Write — **PURCHASING MANAGER, Dept. C**

2719 Lawrence Ave. Chicago 25, Ill.

ANY BOOK IN PRINT



Delivered at your door. We pay postage. Standard authors, new books, popular editions, fiction, reference, medical, mechanical, children's books, etc. Guaranteed savings. Send for Clarkson's 1949 catalog.

FREE Write for our great illustrated book catalog. A short course in literature. The buying guide of 300,000 book lovers. The answer to your Christmas gift problem. Free if you write now—today!

CLARKSON PUBLISHING COMPANY

Dept. PM8, 1257 So. Wabash Ave., Chicago, Ill.

ENGINEERING DEGREE IN 27 MONTHS

INDIANA TECHNICAL COLLEGE

Aeronautical, Chemical, Civil, Electrical, Mechanical, and Radio Engineering (inc. television). Drafting, 1-yr. Gov't approved for G.I.'s. Low rate. Earn board. Large industrial center. Students from 48 states, 18 countries. Demand for graduates. Enter December, March, June, September. Catalog.

5108 E. Washington Blvd., Ft. Wayne 2, Ind.

SAY YOU SAW IT IN POPULAR MECHANICS

FIBRE ARMS AND LEGS!



Light, correctly fitted, strong and comfortable. Natural appearance. Braces for all deformities. Scientific design. Fair Terms.

BUCHSTEIN-MEDCALF

223 S. 6th St., Minneapolis, Minn.



ELECTRICAL ENGINEERING



RADIO AND ELECTRONICS

**Choose
Your
Career**

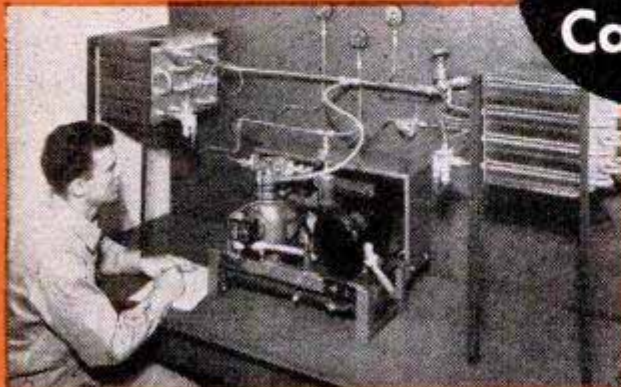

REFRIGERATION & AIR CONDITIONING



GAS AND ARC WELDING

PRACTICAL TECHNICAL TRAINING

prepares you in 6 months to 3 years

CONCENTRIC CURRICULUM



Our time-tested CONCENTRIC SYSTEM enables you to build your career step by step. Each 6-month course is complete in itself. Stay as long as circumstances permit — until you reach your desired occupational objective.

COURSES

SERVICE . . . 6 Months to 12 Months

- Practical Electricity
- Practical Welding
- Refrigeration Service
- Heating Service

TECHNICIAN . . . 1 to 2 Years

- Electro Technician
- Radio Technician
- Electronics Technician
- Refrigeration, Heating, and Air Conditioning Technician

PROFESSIONAL . . . 3 Years

- Electrical Engineering
- Bachelor of Science Degree—Major in Machinery or Electronics



Training men for specific and substantial careers in industry has been the primary purpose of the Milwaukee School of Engineering since its founding 44 years ago. More than 35,000 former students in industries the world over attest the school's career-building value. Exceptional facilities in laboratories, comprehensive technical courses, plus a faculty of 72 specialists account for this outstanding record. At present there are 1,538 students enrolled from 48 states and 13 overseas countries. Terms start in January, April, July and September. **SEND COUPON TODAY!**

MILWAUKEE SCHOOL OF ENGINEERING

A Technical Institute Founded 1903

MILWAUKEE,

WISCONSIN

Milwaukee School of Engineering,
Dept. PM-1048, N. Broadway and E. State, Milwaukee, Wis.

Without obligation, send me free booklet "Career Building" and more details on course in _____

Name _____ Age _____

Address _____

City _____ State _____

9 BIG BUILDING BOOKS

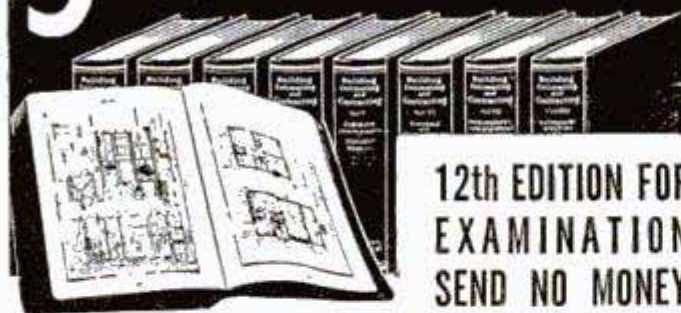

12th EDITION FOR EXAMINATION SEND NO MONEY

Learn to draw plans, estimate, be a live-wire builder, do remodeling, contracting. These 9 practical, profusely illustrated books cover subjects that will help you to get more work and make more money. Masonry, concrete forms, carpentry, steel square, roof framing, construction, plumbing, heating, painting, decorating and many other subjects. More than 4000 pages — 2750 illustrations.

BETTER JOBS — BETTER PAY UP-TO-DATE EDITION

A nationwide building boom is in full swing and trained men are needed. Big opportunities are always for MEN WHO KNOW HOW. These books supply quick, easily understood training and handy, permanent reference information that helps solve building problems.

These books are the most up-to-date and complete we have ever published on these many subjects.

Coupon Brings Nine Big Books for Examination

AMERICAN TECHNICAL SOCIETY—Publishers since 1898
Dept. G-719 Drexel at 58th Street Chicago 37, Ill.

You may ship me the Up-to-Date edition of your nine big books, "Building, Estimating and Contracting," without any obligation to buy. I will pay the delivery charges only, and if fully satisfied in ten days, I will send you \$2.00, and after that only \$3.00 a month, until the total price of only \$34.80 is paid. I am not obligated in any way unless I keep the books.

Name _____

Address _____

City _____ State _____

Please attach a letter stating your age, occupation, employer's name and address, and name and address of at least one business man as a reference. Men in service, also please give home address.

Draw Your Way to Happiness—



ART FOR PLEASURE AND PROFIT

Learn to Draw in Spare Time—at Home! TRAINED ARTISTS are capable of earning \$60, \$75 AND MORE A WEEK

Prepare yourself for a pleasant, profitable Art career. COMMERCIAL ART, DESIGNING, CARTOONING—all in one complete home study course. Enjoy a career with no age or physical limitations. Many pleasant art positions available in this great field. You can become your own boss, work at home and on your own time. Many students earn extra money while learning by designing posters, rendering signs, lettering, etc. W. S. A. is now in its 34th successful year of training men and women. No previous art experience necessary, we teach you step-by-step and prepare you for good jobs. TWO ART OUTFITS and other features included with training. Write for FREE BOOK, "Art for Pleasure & Profit"—tells about our course, instruction service and commercial opportunities for you.

APPROVED FOR VETERANS UNDER G. I. BILL

FREE BOOK gives details

WASHINGTON SCHOOL OF ART, Studio 1210M

1115—15th St., N.W., Washington 5, D. C.

Please send me full information and your Free Book, "Art for Pleasure and Profit."

Name _____ AGE _____

Street _____

City _____ Zone _____ State _____

I am entitled to training under the GI Bill



LAW

STUDY AT HOME for Personal Success and LARGER EARNINGS. 39 years expert instruction—over 114,000 students enrolled. LL.B. Degree awarded. All text material furnished. Easy payment plan. Send for FREE BOOK—"Law and Executive Guidance."

AMERICAN EXTENSION SCHOOL OF LAW
Dept. 94-PM 646 N. Michigan Ave. Chicago 11, Ill.

WATCH REPAIRING

Be a Master Watchmaker! Graduates earn big money—many in business for themselves. The famous Sweazey System of Instruction teaches you quickly and easily. Our 41st year.

Write today for free information.

CHICAGO SCHOOL OF WATCHMAKING
Dept. 1108, 1608 Milwaukee Ave. Chicago 47, Ill.



SEND FOR THIS FREE!

Make money. Know how to break and train horses. Write today for this book FREE, together with special offer of a course in Animal Breeding. If you are interested in Gaiting and Riding the saddle horse, check here () Do it today—now.

BEERY SCHOOL OF HORSEMANSHIP
Dept. 11010D Pleasant Hill, Ohio

WANTED PRACTICAL RADIOMEN

Your FCC license is the next Step Up!

Better radio jobs require FCC license. We train and coach you to get it, but you must have some practical experience or be graduate of basic home study or resident radio course. Send outline of your radio experience to get Free Book, "How to Pass FCC License Exams."

CLEVE. INSTITUTE RADIO-ELECTRONICS
PM-10, 513 Terminal Tower Cleveland 13, Ohio

Become a Doctor of PSYCHOLOGY

Win the degree of Ps.D. Teach the secret of contentment, happiness. Solve mental worries. Experience the revelation of truth. Chartered college. Individual help. Write for FREE book. COLLEGE OF UNIVERSAL TRUTH, 5153-B North Clark St., Chicago.



LEARN MEAT CUTTING

through actual practice. Profitable Meat Cutting and Successful Meat Merchandising taught easily, quickly. LEARN BY DOING at Toledo in just six short weeks under actual market conditions. For beginners or men with experience. All subjects taught thoroughly and completely. Diploma. Job help. Get store of own. People must eat. School in operation nearly 25 years. Approved for GI training. Send today for FREE illustrated catalog. No obligation. NATIONAL SCHOOL OF MEAT CUTTING, Dept. 50-F, Toledo 4, Ohio

SHORTHAND in 6 Weeks at Home

Famous Speedwriting system. No signs; no symbols; no machines; uses ABC's. Easy to learn; easy to write and transcribe. Fast preparation for a job. Surprisingly low cost. 100,000 taught by mail. Used in leading offices and Civil Service. Write for free booklet. SPEEDWRITING, Dept. 1510-8, 55 W. 42 St., New York 18

SAY YOU SAW IT IN POPULAR MECHANICS

FREE BARGAIN CATALOG of BOOKS

25,000 books of all publishers listed in our 54th Annual Bargain Catalog of 320 pages. Old-time favorites—latest "best sellers." Reference, Fiction, Juvenile, History, Scientific, etc. Supplying schools, colleges, libraries and thousands of individual customers. Send postcard today for our new 1949 catalog, "Bargains in Books."

THE BOOK SUPPLY COMPANY, DEPT. 138
564-566 West Monroe St. Chicago 6, Ill.

THOUSANDS NOW PLAY

who never thought they could!



Thrilled by Playing

I've had my lessons just a week. I think your course is super. I was more thrilled than words can express when I found I could actually play America, The Merry Widow Waltz and the others.

*J. T., Mancelona, Mich.



Wouldn't Take \$1000 for Course

The lessons are so simple that anyone can understand them. I have learned to play by note in a little more than a month. I wouldn't take a thousand dollars for my course.

*S. E. A., Kansas City, Mo.



Shares Course With Sister

The teaching is so interesting and the pieces so beautiful I couldn't ask for anything better. I recommend your course highly. My sister shares it with me and feels the same way.

*D. E. G., Wausau, Wisc.



Finding New Joy

I am finding a new joy that I never experienced before, for I have always wanted to play, but had given up hope until I heard of your course.

*C. S., Lucien, Okla.



Plays After 2 Months

I hesitated before sending for your course because of an earlier experience I had with a course by ear from another company. I am playing pieces now I never dreamed I would play after only two months.

*E. T., Prichard, Ala.

*Actual pupils' names on request. Pictures by professional models.

You, too, can play any instrument By this EASY A-B-C Method

YOU think it's difficult to learn music? That's what thousands of others have thought! Just like you, they long to play some instrument—the piano, violin, guitar, saxophone or other favorites. But they denied themselves the pleasure—because they thought it took months and years of tedious study to learn.

Learn in Spare Time at Home

And then they made an amazing discovery! They learned about a wonderful way to learn music at home—without a private teacher—without tedious study—and in a surprisingly short time. They wrote to the U. S. School of Music for the facts about this remarkable short-cut method. And the facts opened their eyes! They were amazed to find how easy it was to learn.

The result? Over 850,000 men and women have studied music at home this simple, A-B-C way. Now, all over the world, enthusiastic music-lovers are enjoying the thrilling satisfaction of creating their own music. They have found the key to good time, popularity and profit.

Costs Only Few Cents a Day

And that's what you can do, right now. Get the proof that you, too, can learn to play your favorite instrument—quickly, easily, in spare

time at home for only a few cents a day. Never mind if you have no musical knowledge, training or talent. Just read the fascinating booklet and Print and Picture sample that fully explain all about the famous U. S. School method. Instruments supplied when needed, cash or credit. If interested tear out the coupon now, before you turn the page. U. S. School of Music, 710 Brunswick Bldg., New York 10, N. Y. (50th year)

FREE!

Print and Picture
Sample



NOTICE

Prices of our courses have not gone up. Music lessons still cost only a few cents a day. Remember, we don't teach music "by ear" or by numbers. We teach you to play by standard notes.

U. S. SCHOOL OF MUSIC,
710 Brunswick Bldg., New York 10, N. Y.

I am interested in music study, particularly in the instrument checked below. Please send me your free illustrated booklet "How to Learn Music at Home," and your free Print and Picture Sample. (Instrument supplied when needed, cash or credit.)

Piano	Saxophone	Clarinet	Practical
Guitar	Trumpet, Cornet	Trombone	Finger
Hawaiian	Reed Organ	Flute	Control
Guitar	Tenor Banjo	Modern	Piccolo
Violin	Ukulele	Elementary	Mandolin
Piano Accordion		Harmony	

Name _____ Have you _____
(Please print) Instrument? _____

Address _____

City _____ State _____

NOTE: If you are under 16 years of age, parent must sign coupon.

SAVE 2c — STICK COUPON ON PENNY POSTCARD

Learn **RADIO** -TELEVISION



in the GREAT SHOPS OF **COYNE**

Get ready for a better job, bigger pay NOW in Radio. Cash in with "All-around" knowledge of Radio—Television. Train on actual equipment. You learn easily at COYNE because it's real shop training. Thousands of graduates in Industry.

Not a "Home-Study" Course!

You get actual shop work on full-size equipment plus necessary theory. Whether you had previous experience or not makes no difference at Coyne.

Easy To Start Own Shop

Right along with our course, we include special training on how to operate your own Radio Shop.

GI Approved—Finance Plan for Non-Vets EARN WHILE LEARNING

If you need part-time work to help out with living expenses while at Coyne we'll help you get it. Don't be held back by lack of money. Free employment service to graduates.

SEND FOR FREE BOOK

Get the facts! BIG FREE BOOK tells about your future in Radio and Television and how you can prepare at Coyne. Dozens of pictures. No obligation—no salesmen will call.

Established 1899

MAIL COUPON TODAY!

B.W. COOKE, President
COYNE Electrical and Radio School
500 S. Paulina St., Dept. 78-3H, Chicago 12, Ill.

Please send me your Big Free Radio and Television Book and all the facts.

NAME.....

STREET.....

CITY..... STATE.....

COYNE
Gives You All-around
Training
RADIO MFG.
TELEVISION
FREQUENCY
MODULATION (FM)
RADIO SERVICE
(Your own shop)
SOUND SYSTEMS



Do You Make These Mistakes in English?

MANY persons say "between you and I" instead of "between you and me"—or use "who" for "whom"—or don't know whether to spell certain words with one or two "c's" or "m's" or "r's," or with "ie" or "ei," etc. Every time you speak or write you show what you are. Mistakes in English reveal lack of education, refinement. Lack of language power prevents you from presenting your thoughts in the strongest way. Real command of English will help you reach ANY goal. Stop making mistakes in spelling, punctuation, pronunciation, grammar. Increase your vocabulary.



Sherwin Cody

WONDERFUL INVENTION

Only 15 minutes a day with Sherwin Cody's new invention—and you can actually SEE your English improve. It teaches by HABIT—makes it easier to do the RIGHT way. Wonderful self-correcting lessons.

FREE BOOK ON ENGLISH Lack of language power may be costing you friendships, income, every year. See what Mr. Cody's method can do for you; it costs nothing to find out. Write today for free book, "How You Can Master Good English in 15 Minutes a Day." It will prove a revelation. WRITE NOW. **SHERWIN CODY COURSE IN ENGLISH, 510 B & O Bldg., Rochester 4, N. Y.**

Be a PIANO SYLIST the Professional Way—at Home!

Piano Playing is Fun — It's Easy, Too COMPLETE TRAINING — POPULAR MUSIC!

Beginners, Medium, Advanced—it makes no difference—anyone can learn to play JAZZ—SWING—BOOGIE. It's different from them all... this complete, easy to follow instruction. Valuable material in the big, new, 150 page **CAVANAUGH BOOK!** Piano secrets revealed. You actually learn HOW to add notes, chords, basses, breaks, fillers, tricks, hot licks to popular songs. Hundreds have been thrilled and have learned to play with this successful method. Not Ear or Correspondence. It's all in one big book which took 10 years to compile. Decide NOW to play modern music. Get all the facts—FREE! Send postcard for FREE folder giving full details about this new Piano Book. See how you can learn Piano the easy way! Amaze your friends with your Piano Styles. Don't wait—Write today!

CAVANAUGH PIANO SCHOOLS

Dept. P 475 Fifth Ave. New York 17, N. Y.

Learn MASONRY CARPENTRY



Big money in the building trades. Learn now while opportunities are greatest. Train in our completely equipped shops under expert instructors, or by Home Study. Vets attending school entitled to G.I. benefits.

MIDWEST SCHOOL OF BUILDING TRADES

Dept. PM-10 411 N. Center Street Bloomington, Ill.

ANALYZE Handwriting

Uncrowded, fascinating field. Gratifying earnings reported by graduates in Employment, Credit, Social Service, Police and Entertainment fields. Others have developed profitable private practice, full or spare time, as Personal Problem and Vocational Counselors. Send for 3000 word TEST LESSON and Grapho Analyst FREE.

A.I.G.A. Inc.

Withoit Bldg., Dept. 120 Springfield, Mo.



NEW YORK SCHOOL of MECHANICAL DENTISTRY

SINCE 1920—The outstanding Training Center for all phases of Dental Laboratory Technology.

Licensed by New York and New Jersey States
Approved for Veterans P.L. 346 and P.L. 16
Visitors Welcome. Ask for Free Bulletin "P."

NEW YORK SCHOOL OF MECHANICAL DENTISTRY

America's Oldest School of Dental Technology
138 Washington St. NEWARK 2, NEW JERSEY
Also: 125 W. 31 Street NEW YORK 1, N. Y.
Immediate Enrollment — Day and Evening

SAY YOU SAW IT IN POPULAR MECHANICS

NEW HELP FOR RUPTURE

is the amazing Treatise which explains simple, inexpensive, easy, proven way for curbing your rupture, right at home. This proven, reliable way is NOT a truss. Many rupture sufferers being helped quickly. So don't let your rupture get worse. Send for FREE details today. Mailed to you in plain, sealed envelope. No obligation.

BRADNER PUBLISHING COMPANY (Established 1933)
Dept. H-5, Dixon, Ill.

FREE
7-DAY TRIAL
JUST MAIL COUPON

HOW TO BUILD A BETTER HOME

If You Are Undecided Whether You Should Build or Buy—
If You Are Leery of 'Cheap' Building, Shoddy Work or Poor Design—
If You Are Fed-Up With DREAMING About Your New House and
Want to Get STARTED—Then This Will Prove a GOD-SEND to YOU!

HERE is the answer to how to build your own home. Here is the WORKS—how to plan, how to construct, how to supervise—simply, clearly explained step-by-step. Jam-packed with everything you need to know about building your own home yourself, or having a contractor build it for you. Hundreds of clear-cut, complete diagrams. You will be able to build a home that will amaze everyone!

Everything You Need to Know to Get Started

Some of the Things This Book Explains:

Here at Your Fingertips, the Secrets that Produce Fine Small Homes — Completely Revealed in this Great Easy-Reference Book!
How to Get Started; Deciding Upon Home Ownership; How to Select Professional Service; How to Finance Your Home; How to Select a Building Lot; How to Plan the Home; Where to Get Stock Plans; Taxes, Insurance, Interest, Maintenance, Assessments; How to Choose a Bank, Real Estate Dealer, Contractor; Locating House on Lot, Tax Searches, Comparative Costs, Designs; Prefabricated Houses; How to Fill Out Contract Documents; How to Obtain Good Construction; How to Prevent Termites; How to Prevent Decay; How to Prevent Corrosion; How to Lay Out Building, Excavate, Grade; Monolithic Concrete Construction; Masonry Construction; Footings for Foundation Walls, Chimneys, Piers; How to Build Piers; Foundation Walls; Basement Construction; How to Waterproof Basements and Foundation Walls; How to Build Chimneys and Fireplaces; How to Select the Proper Species and Grades of Wood; House Framing Methods and Details; Finish Carpentry and Millwork; How to Insulate; Sheet-Metal Work, Roofing, Stucco, Lath and Plaster; How to Paint and Finish; Tile Work, Electrical Work, Plumbing, Heating; List of Over 100 Free Publications for the Home Builder; Bungalows, List of Usual Mistakes; Architectural "Don'ts" and over 300 additional paragraphs of important information.

QUICK REFERENCE INDEX TO SPECIAL PAGE-SIZE PLATES (HUNDREDS OF ILLUSTRATIONS)

Footings — foundation walls — basements; Garage floor, footings, etc. — septic tank—grease trap—area for basement window; Concrete porches, steps, automobile runways and driveways and walks; Brick steps, walks and terraces; Brick, tile and stone wall details—flagstone and stepping stone walls; Masonry dwellings—brick veneer walls; Chimney and fireplace details; Balloon framing — details (minimum-shrinkage type); Balloon framing details (box sill type); Roof framing details; Basement columns and girders—framing of openings—bridging; Miscellaneous framing details; Watertables—exterior sidewalls of siding or shingles—cornices—porch columns; Double-hung wood window details; Door frame details—points for millwork—stock doors and windows—sash details; Paneling — stairwork — wainscoting details; Termite shields—miscellaneous flashings; Flashing details; Gutters and leaders (downspouts); Roofing details.

Nothing Like It Before! One Simple Fact May Repay you a HUNDRED Times its Small Cost. A Book You Will Refer to for Years to Come!

Read What Great Building Authorities Say about This Amazing Book (names on request)

Excerpts from typical letters of praise:
"... the best book on the subject that has been published to date." ... "was thrilled" ... "valuable information for the new home-builder."
"... an excellent piece of work" ... "helped us decide our building plans" ... "well worth price."
"... very much impressed" ... "an excellent reference book."
"... the writing is clear and compact ... complete and unbiased information."
"... most interesting and complete." "You are to be congratulated. Contains more information than any volume seen ... Everything you said."
"... One of the best works of its kind I have ever seen. Send me 10 more for presents."
"And from an amateur:
"From this book I did the plans myself! Had never done anything like it before ... A neighboring architect said I was an up-and-coming designer and he found not one fault with my plans. The building is now finished and everyone says it's beautiful! ... I saved \$100!"

Provides you with all the facts. Whether you are going to spend \$2,000 or \$20,000 for your home—whether you are going to employ an architect or use stock plans — or whether you are going to buy a house instead of building, this book will help you. Before you build you should know the difference between good and bad construction.

Now—in these days of shortages—just one of the hundreds of diagrams can save you hundreds of dollars. You will get a thrill out of being "in the know," being "wise" to the game, being able to talk to building people in their own language. You'll be respected, admired, and get better workmanship on your home. You'll get a feeling of pride as your friends admire the home being built. Here, in one clear-cut volume is all the basic information you will need!

Where to Begin

No matter what your building problem may be, you will find the answer in this amazing volume. No truth is kept from you. You are told the disadvantages of home ownership as well as the advantages. You are told of the precautions you will need to safeguard your investment. You are shown how to select a lending institution, a lawyer, a real estate dealer, an architect, a contractor. Your questions on methods of buying are fully answered. Just a quick glance at the partial table of contents on this page will show you some of the thousands of facts on building which this complete volume contains. Those who have bought a copy write that they have never seen so thorough a work on this subject for any price, anywhere!

Hundreds of Construction Details

Explains all the "mysteries" of permits, contract forms, and construction. Tells you how to build the right kind of home, how to avoid "cheap," cracker-box construction, how to get a house that is suitably located, beautiful to look at and priced within your means—a house you will be proud to call your home.

How to Build—from Plans to Paint

Not one important step is missing from this volume. See for yourself. Every conceivable thing you would want to know about building will be found in this wonderful new book!

SEND NO MONEY Examine It for 7 Days FREE!

You don't even risk a cent to examine "How to Build a Better Home." Just mail coupon. Study book for a week, FREE! See how easy it is to supervise or build a better home, YOURSELF — even if you know nothing about construction NOW! Then, if you are THRILLED with this amazing volume, send only \$3.98 (plus postage). If you are not thrilled, return book and pay nothing! This is your chance to build not just a house, but a BETTER HOME! Mail FREE EXAMINATION COUPON NOW to The Westport Publishing Company, Dept. PM10, Westport, Conn.

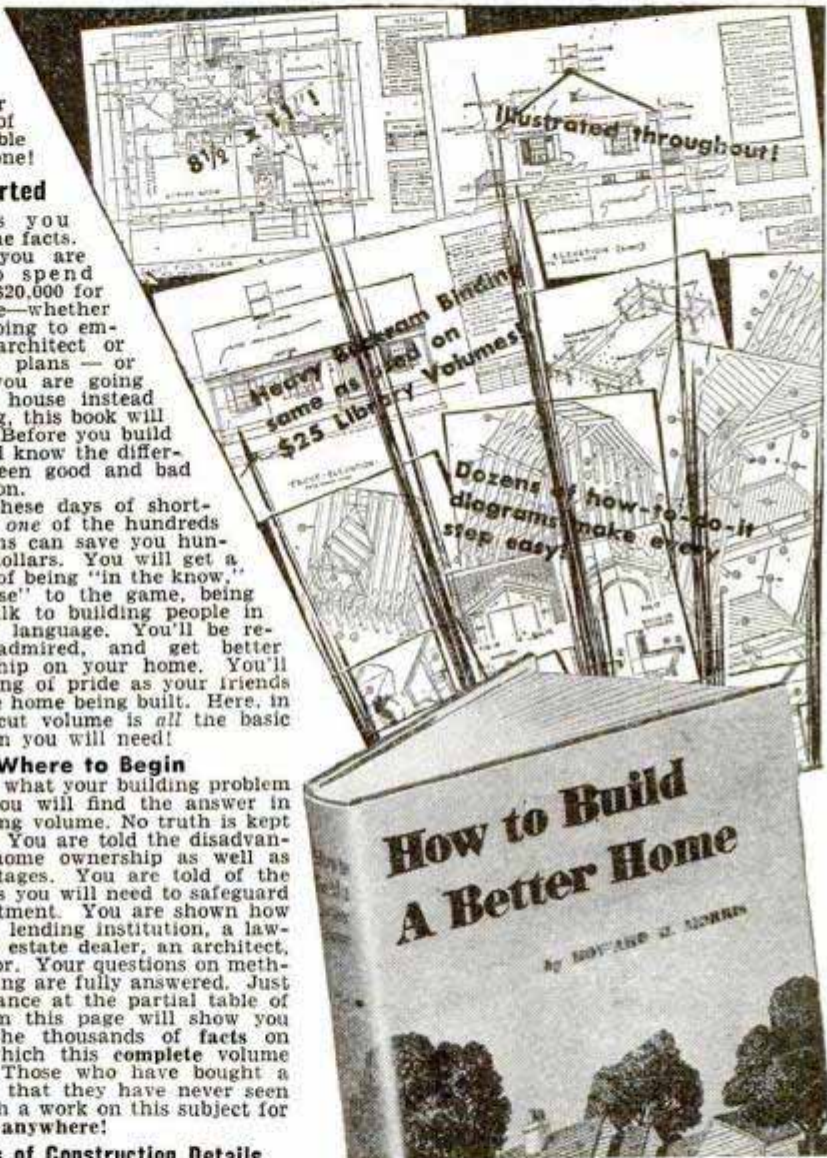

How to Build A Better Home
By ROY AND E. MORRIS

FREE Examination Coupon—Mail Now

The Westport Publishing Company, "Books of Merit," Dept. PM-10, Westport, Conn. Please send me, for one week's FREE EXAMINATION, a copy of "How to Build a Better Home." After 7 days I will either return this book and owe you nothing, or I will keep it and send you \$3.98 (plus shipping charges).

Name _____ Age _____
(please print)

Address _____

City & Zone _____ State _____

Save postage. Check here if you enclose full payment of \$3.98 (check or money order) WITH coupon. WE will then pay shipping charges. If not thrilled with book, return it and we will refund your money by AIR MAIL! Foreign Orders \$4.50 Cash.

Play a Saw

Quickly produce saw music of amazing, voice-like beauty. Without knowing one note from another, without using music, soon play such songs as "Long, Long Trail," "Till We Meet Again," and other favorites old and new. No notes to read, no dreary practice—success guaranteed.



The Musical Saw

entertainments, everywhere.

Since 1921, thousands of our students have amazed themselves and friends . . . many have starred in shows and broadcasting orchestras. This is your opportunity to gain quick popularity, and to make money entertaining at parties, dances, lodges, clubs, church enter-



You Play or NO PAY!

5 DAYS TRIAL

If you can sing, whistle or hum a tune then you can play the Musical Saw. To prove how quickly and easily you can learn, we allow you **FIVE DAYS TRIAL** Play at the next party! Write TODAY for details to . . .

MUSSEHL & WESTPHAL
Musical Saws to the Profession since 1921
14 Fort Street
Fort Atkinson, Wis.

Be a Writer

of Short Stories, Mysteries, Articles. **FREE** Book Shows How You Learn at Home for Extra Income or Full-Time Career

The demand for writers is creating great new opportunities for people with an urge to write. It's not as hard to succeed as you may imagine. At home, you too may learn fiction writing, the best basis for all fields—short stories, articles, radio scripts—technical, mechanical and business items. Palmer Institute's Home Study Training (Estab-

lished 1917) is endorsed by Rupert Hughes, Keith Monroe and other famous authors and by scores of successful graduates. Complete instruction material, professional coaching develop your own style. **FREE** book shows how you may enjoy an ideal part time or full time career. Write today (no salesman will call). Veterans: advise us if you are eligible for G.I. Training.

PALMER INSTITUTE OF AUTHORSHIP • Desk T-108 • 1680 N. Sycamore • Hollywood 28, Calif.

LEARN WELDING

Learn a profitable trade now at America's oldest established school devoted exclusively to teaching of welding. For over 25 years we have trained welders. Both Electric Arc and Acetylene Gas courses. Why spend years "picking-up" a trade when you can get the benefit of years of experience under capable and competent instructors. Immediate enrollment for both Day and Evening courses. Approved for Veteran Training. Write for **FREE CATALOGUE**.

DEPT. A Kalix Trade School, 439 N. 11th Street, Phila. 23, Pa.

Listen to this Record!



SPEAK SPANISH

FRENCH, GERMAN OR ITALIAN

Big opportunities awaiting Americans who speak Spanish. Learn as a child learns—"by listening" to these brand-new CORTINA recordings.

Only 15 Minutes a Day

Learn to Speak Spanish like a Native! The Cortinaphone Method famous for 65 years teaches you—right in your own home, relaxed and at ease. Thousands have found it the most fascinating, most satisfactory method. Here is the quick, easy way to learn Spanish for Pleasure and Business. Investigate!

Sent on 5 Days' Approval

"The Cortina Short-Cut" tells just what you want to know. Interesting. It's Free! Get it!

Write today—NOW!

Spanish Course Available Under **G. I. BILL OF RIGHTS**

CORTINA ACADEMY (Language Specialists for 65 Years)
SUITE 6410, 105 WEST 40th ST., NEW YORK 18, N. Y.

Please send me—without obligation—your free booklet. I am interested in (mark):

- SPANISH FRENCH ITALIAN GERMAN

Name _____

Address _____

Check here if you are a Veteran

SAY YOU SAW IT IN POPULAR MECHANICS

LEARN MOVIE PROJECTION THEATRE MANAGEMENT

The Motion Picture Theatre Business offers big opportunities for trained men. Get into a fascinating field with a promising future. Train at home in spare time. Free Catalog. Established 20 years.

THEATRE SCHOOL, 370 Washington St., Elmira, New York

CAUGHT BY THEIR FINGER PRINTS



YOU
Can Train for **CRIMINAL INVESTIGATION and IDENTIFICATION WORK AT HOME!**

Send Now for **"BLUE BOOK OF CRIME"**

Thrilling, inspiring, helpful. Be sure to state your age when sending for book. **FREE!**

INSTITUTE OF APPLIED SCIENCE

Dept. 1357 1920 Sunnyside Ave., Chicago 40, Ill.

During the past 30 years the I. A. S. has trained hundreds of men at home to fill positions of responsibility and steady pay as finger print experts. This fascinating, profitable profession can be learned at home during spare time. More than 800 American Identification Bureaus employ I. A. S. graduates or students. Write today for complete list of these Bureaus.

Learn CARTOONING

HAVE FUN! MAKE MONEY! Cash in on your sense of humor at HOME—BY MAIL. No experience needed to start. Write today FOR **FREE TRIAL LESSON** and full particulars.

Moon Gag Cartoon School, Dept. M, Fall Creek, Wis.

WATCHMAKING

Millions of watches and clocks need repairing. Start your training now for a better paying job or own profitable business. Qualified watch makers in demand. Outstanding training by experts. Write for free catalog. Approved for veterans.

SCIENTIFIC SCHOOL OF WATCHMAKING, Dept. PM-10, 3923 San Fernando Road, Glendale 4, Calif.

Thrilling Work COLORING PHOTOS

Fascinating vocation learned at home by those with aptitude. Thrilling pastime. National method brings out life-like colors. Free booklet.

NATIONAL PHOTO COLORING SCHOOL, 1315 S. Michigan, Dept. 1357, Chicago 5

POPULAR MECHANICS

OIL BURNER

INFORMATION IN A HANDY FORM



AUDELS OIL BURNER GUIDE

A new practical, concise treatise, 384 pages—31 Chapters—321 Diagrams and Illustrations—covering Domestic and Industrial Oil Burners.

New from Cover to Cover, for mechanics interested in Oil Burners. Gives practical inside working knowledge of theory, construction, installation, operation, testing, servicing and repair of all types of oil burners. Includes electrical hook-ups and wiring diagrams of automatic control systems.

PRICE \$1 POSTPAID

Get this information for yourself. Mail coupon today. No obligation unless satisfied.

ASK TO SEE IT

A POCKET COMPANION THAT ANSWERS YOUR QUESTIONS!

AUDEL, Publishers, 49 W. 23rd St., New York 10, N. Y.

Please mail AUDELS OIL BURNER GUIDE (Price \$1). If satisfactory, I will remit \$1 on its safe arrival, otherwise I will return the book.

Name _____
 Address _____
 Occupation _____
 Employed by _____ PM

PRACTICAL AUTO INFORMATION

Keeps Cars Rolling by Making Repairs and Adjustments Easy!

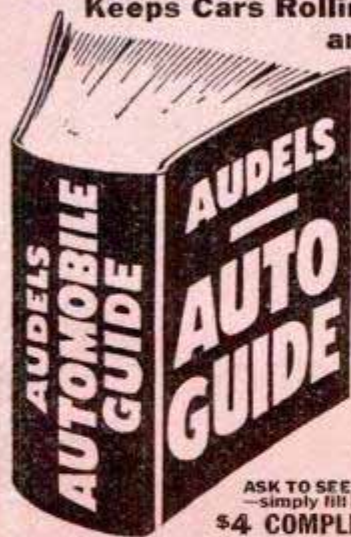

AUDELS AUTO GUIDE
 For Every Mechanic, Driver, Owner and Repair Shop.

Sent on 7 Days Approval
 Shows How to Tune Up—Keep Brakes Safe—Batteries Powerful—Tire Mileage Up—Save Gas—Lubricate Correctly.

ANSWERS YOUR QUESTIONS
 Contains all you need to know about 1—Construction, 2—Operation, 3—Service, 4—Repair of Modern Motor Cars, Trucks, Buses & Diesel Engines in every detail.

NEW FLUID DRIVE TREATED
 Easy to understand—1540 Pages, 1540 Illustrations. Gives definite directions on How to handle service jobs.

ASK TO SEE IT—Get this information for yourself—simply fill in and mail coupon today.

\$4 COMPLETE • PAY ONLY \$1 A MO.

AUDEL, Publishers, 49 West 23rd St., New York
 Mail AUDELS AUTOMOBILE GUIDE (\$4) for free examination. If O. K., I will send you \$1 in 7 days; then remit \$1 monthly until \$4 is paid. Otherwise, I will return book promptly.

Name _____
 Address _____
 Occupation _____
 Employed by _____ PM

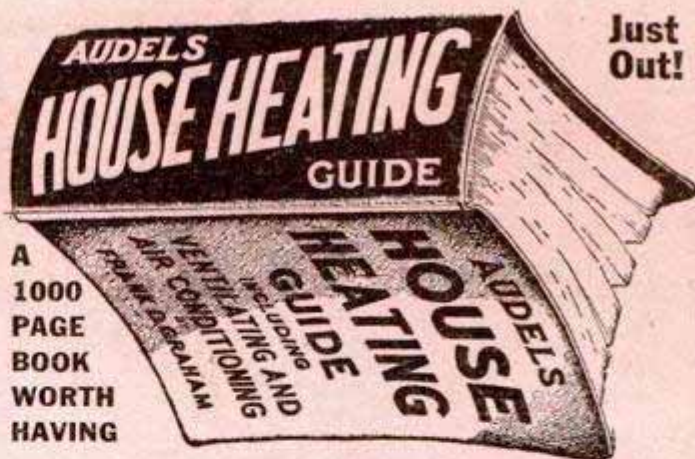

Just Out!

A 1000 PAGE BOOK WORTH HAVING

For Heating, Ventilating and Air Conditioning Engineers, Plumbers, Maintenance Men, Contractors, Building Superintendents and Mechanics seeking practical, authentic information on Heating, Ventilating, Air Conditioning. 1000 Pages—910 Illustrations—57 Chapters explaining the working principles of all Modern House Heating, Ventilation and Air Conditioning systems. Fully illustrated and indexed. This up to date book of reference gives answers to 1001 questions on Heating, Ventilating, Air Conditioning & Radiant Heating.

\$4 COMPLETE • PAY ONLY \$1 A MONTH

To get this assistance for yourself, fill in and

MAIL ORDER

AUDEL, Publishers, 49 W. 23rd St., New York 10, N. Y.
 MAIL AUDELS HOUSE HEATING GUIDE for free examination. If O. K. I will send you \$1 in 7 days; then remit \$1 monthly until price of \$4 is paid. Otherwise, I will return it.

Name _____
 Address _____
 Occupation _____
 Employed by _____ PM

AUDELS Carpenters and Builders Guides

4 vols. \$6

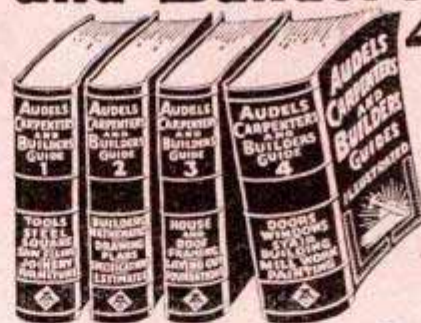

Inside Trade Information
 for Carpenters, Builders, Joiners, Building Mechanics and all Woodworkers. These Guides give you the short-cut instructions that you want—Including new methods, ideas, solutions, plans, systems and money saving suggestions. An easy progressive course for the apprentice and student. A practical daily helper and Quick Reference for the master worker. Carpenters everywhere are using these Guides as a Helping Hand to Easier Work, Better Work and Better Pay. To get this assistance for yourself, simply fill in and mail the FREE COUPON below.

Inside Trade Information On:

How to use the steel square—How to file and set saws—How to build furniture—How to use a mitre box—How to use the chalk line—How to use rules and scales—How to make joints—Carpenters arithmetic—Solving mensuration problems—Estimating strength of timbers—How to set girders and sills—How to frame houses and roofs—How to estimate costs—How to build houses, barns, garages, bungalows, etc.—How to read and draw plans—Drawing up specifications—How to excavate—How to use settings 12, 13 and 17 on the steel square—How to build hoists and scaffolds—skylights—How to build stairs—How to put on interior trim—How to hang doors—How to lath-lay floors—How to paint



AUDEL, Publishers, 49 W. 23rd St., New York 10, N. Y.

Mail AUDELS Carpenters and Builders Guides, 4 vols., on 7 days free trial. If O. K. I will remit \$1 in 7 days and \$1 monthly until \$6 is paid. Otherwise I will return them. No obligation unless I am satisfied.

Name _____
 Address _____
 Occupation _____
 Employed by _____ PM



Now **ALL 5 FAMOUS JOWETT COURSES** in 1 Volume For only **25c**

"The Jowett System is the greatest in the world!" says R. F. Kelly, Physical Director. Atlantic City



THEY "PUSH ME AROUND"

says George F. Jowett... World's Strongest Man. I'll prove I can make YOU. too, a **HUSKY He-Man** FAST—or it won't cost you a cent!

Enjoy My "Progressive Power" Strength Secrets! Give Me 10 Easy Minutes a Day—Without Strain! I'll teach you the "Progressive Power Method" through which I rebuilt myself from a physical wreck the doctors condemned to die at 15, to the holder of more strength records than any other living athlete or teacher! "Progressive Power" has proven its ability to build the strongest, handsomest men in the world. And I stand ready to show you on a money back basis—that no matter how flabby or puny you are I can do the same for you right in your own home. Let me prove I can add inches to your arms, broaden your shoulders, give you a man-sized chest, powerful legs and a Rock-like back—in fact, power pack your whole body so quickly it will amaze you! Yes, I'll jam you with power and confidence to master any situation—to win popularity—and to get ahead on the job! Through my proven secrets I bring to life new power in you inside and out, until YOU are fully satisfied you are the man you want to be.

PROVE IT TO YOURSELF IN ONE NIGHT
Send only 25c for my 5 easy-to-follow, picture-packed courses now in 1 complete volume "How to Become a Muscular He-Man." Try it for one night! Experience the thrilling strength that surges through your muscles.

George F. Jowett
Whom experts call "Champion of Champions"
● World's wrestling and weight lifting champ at 11 and 18.
● World's Strongest Arms. ● 4 times World's Perfect Body—plus other records.

10 DAY TRIAL!
Think of it—all five of these famous courses now in one picture-packed muscle-building volume for only 25c. If you don't actually FEEL results within ONE WEEK, send it back and your money will be promptly refunded! Photo Book of Famous Strong Men!

I am making a drive for thousands of new friends fast—REGARDLESS OF COST!
SO GET NOW MY 5 Muscle Building COURSES (Valued at \$5 each)
All in 1 Great Complete Volume Packed With How-To-Do-It Pictures!
Now, this "get-acquainted," extremely low price of only 25c is your chance to build a body you'll be proud of! Follow Jowett's easy method of muscle building NOW!
For only 25c



FREE!
Photos that inspire you to might and muscle. Free with order.



FREE GIFT COUPON!

George F. Jowett
Champion of Champions

Jowett Institute of Physical Culture Dept. PM-810
230 Fifth Avenue, New York 1, N. Y.
Dear George:—Please send by return mail, prepaid, **FREE** Jowett's Photo Book of Strong Men, along with all 5 Muscle Building Courses. 1. Molding a Mighty Chest. 2. Molding a Mighty Arm. 3. Molding a Mighty Grip. 4. Molding a Mighty Back. 5. Molding a Mighty Leg—Now all in One Volume "How to Become a Muscular He-Man." Enclosed find 25c. NO C.O.D.'S.

NAME _____ AGE _____
(Please Print Plainly, Include Zone Number)
ADDRESS _____

BE AN EXPERT REPAIRMAN OF MUSICAL INSTRUMENTS



MANY JOBS NOW OPEN FOR TRAINED MEN... BIG OPPORTUNITIES!

Over 3,000,000 amateur and professional musicians are potential customers. You can make good money twelve months of the year... even start your own business. We'll train you. Course approved by U. S. Veterans Administration. Get complete information NOW, without obligation.

SEND FOR **FREE SCHOOL CATALOG F-31**

CONN VOCATIONAL SCHOOL
127-129 S. Main St., Elkhart, Indiana, Div. of C. G. Conn Ltd.

WHY DON'T YOU WRITE?

Writing short stories, articles on business, sports, homemaking, veterans' affairs, shop crafts, local and club activities, etc., will enable you to earn extra money. In your own home, on your own time, the New York Copy Desk Method teaches you how to write—the way newspaper men learn, by writing. Our unique "Writing Aptitude Test" tells whether you possess the fundamental qualities essential to successful writing. You'll enjoy this test. Write for it, without cost or obligation.

Veterans: This course approved for Veterans' Training.

NEWSPAPER INSTITUTE OF AMERICA
SUITE 5598-S ONE PARK AVENUE NEW YORK 16, N. Y.



BE AN ARTIST

Send for interesting picture book "BUILDING A FUTURE!" Explains the unique position of the professional artist in American life. Gives examples of huge professional income. Tells definitely how YOU can acquire PROFESSIONAL skill—AND PROFESSIONAL INCOME—within one year—in spare time at home. No obligation. Book is free. Write name, address and age on penny postcard and mail TODAY to:

GRANT SCHOOL OF ART
Dept. 178, 53 W. Jackson Blvd., Chicago 4, Ill.

Learn about Earning Opportunities in THE BUILDING TRADES

FREE—Important Information Telling How to Get Started. Do you want to be on the inside in the building boom—where big money is made? This is your chance now. HOME TRAINING prepares you for these big opportunities. Course recognized by Building Industry. (Approved for Veterans.) Write today—no obligation.
COMMERCIAL TRADES INSTITUTE, Dept. D2-10
1400 W. Greenleaf Chicago 26, Ill.

EXPERT PHOTOGRAPHY MADE EASY LEARN PHOTOGRAPHY NOW

—for both a sound and secure future and immediate opportunities. Ever-increasing demand for trained men and women. Excellent earnings. Resident or home study. 38th year. Write for full details.
NEW YORK INSTITUTE OF PHOTOGRAPHY
Dept. "49," 10 West 33 Street New York 1, New York

Learn ORNAMENTAL HORTICULTURE

A thorough, constructive home training for employment or advancement in Nursery Operations, Park Supervision or maintenance, Landscape Designing or Landscape Gardening. My 3 way Plan shows you how to start your own business, get a better job, or earn extra money in spare time. Send for Free Book. APPROVED FOR VETERANS.

NATIONAL LANDSCAPE INSTITUTE
Dept. P-10, 310 So. Robertson Los Angeles 36, California
SAY YOU SAW IT IN POPULAR MECHANICS

CORRESPONDENCE COURSES IN RADIO and ELECTRICAL ENGINEERING Tuition \$25
ELECTRICAL ENGINEERING. Get good grasp of wide electrical field. Modern. Very understandable. Theory made easy.
RADIO ENGINEERING. Extra fine course in radio, public address, photo-electric work. Trains you to be super-service man, real vacuum tube technician. Tuition ONLY \$25, either course. Deferred payment plan. Service men needed badly.
FREE Write for free copy of school catalogs, student magazines, etc.
FREE LINCOLN ENGINEERING SCHOOL, Box 931-P118, Lincoln, Nebr.

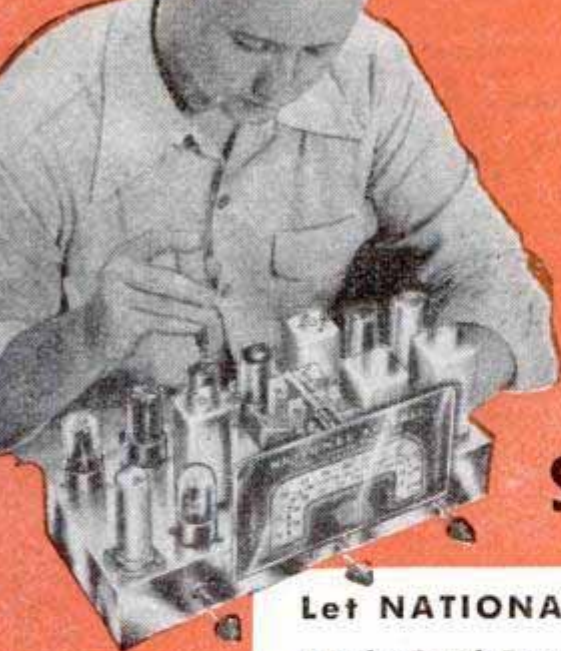

You receive all parts, including tubes, for building this fine, modern Superheterodyne Receiver. This and other valuable standard equipment becomes your property.

Learn RADIO TELEVISION, ELECTRONICS *by* SHOP METHOD HOME TRAINING

Let NATIONAL SCHOOLS, of Los Angeles, a practical Technical Resident Trade School for almost 50 years, train you for today's unlimited opportunities in Radio

these two FREE books will tell you how

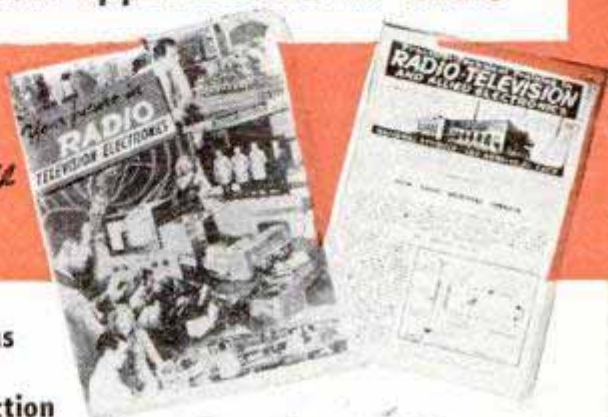

GOOD JOBS AWAIT THE TRAINED RADIO TECHNICIAN

You are needed in the great, modern Radio, Television and Electronics industry! Trained Radio technicians are in constant and growing demand at excellent pay—in Broadcasting, Communications, Television, Radar, Research Laboratories, Home Radio Service, etc. National Schools Master Shop Method Home Study Course, with newly added lessons and equipment, can train you in your spare time, *right in your own home*, for these exciting opportunities. Our method has been proved by the remarkable success of National Schools-trained men all over the world.

You Learn by Building Equipment with Standard Radio Parts We Send You

Your National Schools Course includes not only basic theory, but *practical* training as well—you learn by doing. We send you complete standard equipment of professional quality for building various experimental and test units. You advance step by step until you are able to build the modern superheterodyne receiver shown above, which is yours to keep and enjoy. You perform more than 100 experiments—build many types of circuits, signal generator, low power radio transmitter, audio oscillator, and other units. The Free Books shown above tell you more about it—send for them today!

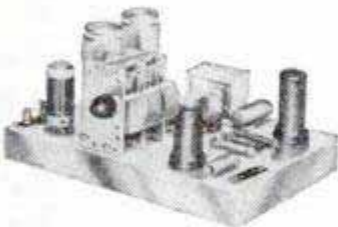

NOW! NEW PROFESSIONAL MULTITESTER INCLUDED

This versatile testing instrument is portable and complete with test leads and batteries. Simple to operate, accurate and dependable. You will be able to quickly locate trouble and adjust the most delicate circuits. You can use the Multitester at home or on service calls. It is designed to measure AC and DC volts, current, resistance and decibels. You will be proud to own and use this valuable professional instrument.



Lessons and Instruction

Material Are Up-to-Date, Practical, Interesting

National Schools Master Shop Method Home Training gives you basic and advanced instruction in all phases of Radio, Television and Electronics. Each lesson is made easy to understand by numerous illustrations and diagrams. All instruction material has been developed and tested in our own shops and laboratories, under the supervision of our own engineers and instructors.

A free sample lesson is yours upon request—use the coupon below.

YOU GET THIS AND OTHER VALUABLE INFORMATION IN THE FREE SAMPLE LESSON:

1. Basic Receiver Circuits and How They are Used.
2. Construction of the Antenna Circuit.
3. How Energy is Picked Up by the Aerial.
4. How Signal Currents are Converted into Sound.
5. How the Tuning Condenser Operates.
6. How the R-F Transformer Handles the Signal, and other data, with diagrams and illustrations.

Both Resident and Home Study Courses Offered

APPROVED FOR VETERANS
CHECK COUPON

NATIONAL SCHOOLS

LOS ANGELES 37, CALIFORNIA EST. 1905



MAIL OPPORTUNITY COUPON FOR QUICK ACTION

National Schools, Dept. PM-10
4000 South Figueroa Street
Los Angeles 37, California

(Mail in envelope or paste on penny postcard.)

Mail me FREE the books mentioned in your ad including a sample lesson of your course. I understand no salesman will call on me.

NAME _____ AGE _____

ADDRESS _____

CITY _____ ZONE _____ STATE _____

Check here if veteran of World War II

Learn Neon Tube Bending and neon sign fabrication

The Demand for Our Well-trained Men Continues to Exceed the Supply

A HIGH PERCENTAGE OF OUR GRADUATES HAVE BEEN EARNING

\$100⁰⁰ PER WK. OR MORE FOR MANY WEEKS

Not one single student satisfactorily completing one of our neon courses, failed to qualify or hold, a good pay job in the industry, because — our

G.I. APPROVED — 15 MONTH RESIDENT COURSES

are designed for those who seriously desire to become COMPETENT MECHANICS and who are willing to devote enough time to proper training to assure satisfactory development.

When Writing for Information, Please State if You are Veteran or Non-Veteran.

GENERAL INDUSTRIAL TRAINING INSTITUTE

125 N. Seventh Street

Stuebenville, Ohio

INVENTORS

When you are satisfied that you have invented a matter of value—write me, without obligation, for full information as to what steps you should take to secure a Patent.

The usual first step is to have a search of the prior U. S. Patents conducted, so that I can report to you on the question of Patentability.

PATRICK D. BEAVERS

(Formerly RANDOLPH & BEAVERS)

Registered Patent Attorney

934 Columbian Building Washington 1, D. C.

PATRICK D. BEAVERS, Registered Patent Atty.
934 Columbian Bldg., Washington 1, D. C.

Please send me full information on how to secure Patent Protection and Trademark Registration.

Name _____

Street _____

City _____ State _____

AUTO BODY & FENDER REBUILDING

Tired of Working for the Other Fellow?

Be Your Own Boss

A Big Field for Your Future

Body & Fender Rebuilding is one of the best paid branches of the automobile industry. Go into business for yourself or prepare for good job opportunities. Train at home or in our big shops. Approved for Veterans. (Non-Veterans inquire about our Low Payment Plan and

Pay After Graduation Plan.) Send for FREE Booklet and full information. No obligation.

COMMERCIAL TRADES INSTITUTE, Dept. F 2-10

1400 W. Greenleaf Avenue, Chicago 26, Ill.

LOCKSMITHING & Key Making

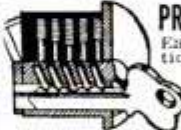

PRACTICAL UP-TO-DATE COURSE—ONLY \$3.95

Easy-to-learn modern information for self-instruction. How to work on locks, de-code, make master-keys, repair, install, service, etc. For every handyman, home owner, carpenter, mechanic, service station operator, fix-it shop, hardware dealer, gunsmith. 53 plain illustrated lessons.

Just pay postman plus C.O.D. postage. Or send \$3.95 with order, we'll ship postpaid. Satisfaction guaranteed or refund. **FULL PRICE ONLY \$3.95. SEND NO MONEY.**
NELSON-HALL CO., 1139 S. Wabash Ave., Dept. K-02, Chicago 5, Ill.

PRACTICAL MATHEMATICS 4 BOOKS IN ONE! SAVE HALF PRICE!

Easy self-instruction in 25 branches by college experts—all in one volume! Helps you qualify for a better job. 1280 pages, 600 illustrations. Sent for free trial. Only \$1.00 down, \$1.00 a month; total \$4.95 plus postage. (Cash price \$5.00 postpaid) 160-page Logarithm book free with order. National Educational Alliance, Inc., Dept. 5610, 37 West 47th St., New York 19, N. Y.

\$ AGENTS 300% Profit SIGN LETTERS

For Store Fronts and Office Windows. Anyone can put them on. Free Samples. Liberal Offer to General Agents.

METALLIC LETTER CO., 430 N. Clark, Chicago 10

APTITUDE TESTS

discover the kind of work or studies best for your success! You get a personal report—a guide for life—more happiness—more prosperity. For men, women, boys and girls. Write for complete facts.

VOCATIONAL COUNSELING INSTITUTE
956 Maccabees Bldg., Detroit 2, Michigan

INVENTORS

IF YOU WISH TO PROTECT YOUR INVENTION, You should take steps to protect it by a U. S. Patent. Write me for "Record of Invention" form.

CARL MILLER

REGISTERED PATENT ATTORNEY

Woolworth Bldg., 35th Floor, Dept. 108A, New York City
Please send me "Record of Invention" form.

NAME _____

ADDRESS _____

PATENTS

AND TRADE MARKS

C. A. SNOW & CO.

REGISTERED PATENT ATTORNEYS

WRITE FOR INFORMATION TO

428 SNOW BUILDING, WASHINGTON 1, D. C.

PATENTS

"Proof of Invention"
Folder mailed without obligation.

E. E. VROOMAN, Registered Patent Atty.

871 Woodward Building, Washington 5, D. C.

Learn BAKING At Home

Baking is one of America's high industries in wages. Nearly depression-proof. Thorough basic home course lays sound foundation. If you have aptitude, write for FREE BOOKLET, "Opportunities in Commercial Baking."

National Baking School, 1315 Mich. Ave., Dept. 1357, Chicago 5

MEN IN DEMAND!

Trained Men Are Needed
NOW, And No End To This
Need Is IN SIGHT In The Tre-
mendously Growing Billion \$

AIR CONDITIONING and Refrigeration INDUSTRY



By Your Own Initiative — NOW — TODAY

You can start the training program that will make you a valuable SPECIALIST in the profitable, fast multiplying industry which Air Conditioning and Refrigeration has become. TOO FEW ambitious men have taken advantage of the unlimited opportunities for big-paying jobs and steady promotions WAITING FOR YOU in all parts of the United States.

GRADUATE... ...SUCCESSSES

"My A.C.T.C. training is the best investment I ever made. When I finished lesson 33, I started doing service work for a dealer here. I made enough to pay for my training even before I completed it, and my earnings are ever increasing." A.A., Jr.
"When I reached the 25th lesson, I started doing spare time service work in the evenings and made about \$200.00 in that way. So far my total earnings in this field have amounted to \$2,274.00. This spring I had six or seven offers to change jobs. I consider your course the best investment I ever made." O.M.S.
"I started doing spare time work for dealers and individuals immediately after beginning my course with you. My work was on both commercial and domestic equipment. Most of my work was done in the evenings and I made around \$2,000.00." J.F.K.

- **WHERE YOUR FUTURE LIES.** Two big fields are open to you after you have completed the practical, low-cost and complete training course established by Air Conditioning Training Company. You may enter industrial air conditioning and refrigeration. Scores of big companies installing equipment in factories, hotels, department stores, restaurants, and homes need men with training... training that YOU can obtain in your spare time. AND you may build your own business around maintenance and repair of home refrigerators, air conditioning units. It is estimated that over 16,000,000 service calls are needed every year on these units in private homes alone, not to mention stores and all other types of business establishments.
- **KEEP YOUR PRESENT JOB—TRAIN AT HOME.** You can master the Air Conditioning Training Company course at home in your spare time, take as long or as short a time as you wish. You learn HOW TO DO IT quickly and simply. No previous schooling (such as mathematics, etc.) is necessary. This course is designed by experts in the field to give you FACTS and KNOW-HOW.
- **WHEN HOME TRAINING IS COMPLETED** you are brought to Youngstown, Ohio, for two weeks of intensive, practical experience on actual equipment in our complete, modern laboratories. Your transportation to and from Youngstown is included in A.C.T.C.'s plan. Also board and lodging during the intensive training period. When you have completed the A.C.T.C. course you are eminently fitted to your own valuable position in this interesting, exciting new industry.



Send for this
Free
Information

containing FACTS about the air conditioning industry and the one school that concentrates on fitting you for a lifetime good-paying career in this field. Send this coupon today. Remember, Air conditioning Training specializes in AIR CONDITIONING and REFRIGERATION ONLY!



AIR CONDITIONING TRAINING CO.
789-791 Wick Avenue—Dept. PM-24
Youngstown, Ohio

Gentlemen:

Please send me, with no obligation, complete information on how I can train in my spare time for a good future in Air Conditioning and Refrigeration.

NAME _____

ADDRESS _____

CITY _____ STATE _____

AIR CONDITIONING TRAINING CO.

Dept. PM-24 • 789-791 WICK AVENUE • Youngstown, Ohio
One of America's Finest Practical Training Institutes

Learn DIESEL

AUTOMOTIVE AND ALLIED MECHANICS
at Home in Spare Time



Good Pay and Interesting
Job Opportunities In the
Diesel Industry!

These two
FREE BOOKS
will tell you how

Diesel engines are used in locomotives, tractors, farm machinery, stationary and portable power plants, oil pipeline pumping stations, Diesel trucks and buses, power shovels, excavating machinery and many other applications. Trained Diesel and automotive mechanics are in steady and growing demand to install, maintain and repair Diesel, semi-Diesel, and gasoline engines in these and other fields. Or you can operate your own service shop or commercial garage!

YOU CAN QUALIFY FOR THESE OPPORTUNITIES WITH NATIONAL SCHOOLS' MASTER SHOP METHOD HOME TRAINING!

You learn not only basic Diesel engine principles, construction and repair, but the more specialized fields of Diesel fuel injection, automotive carburetion, ignition and motor tune-up. You receive practical assignments covering actual Engine Repair, Installation Operation and Maintenance Service on all types of Diesel and Automotive equipment. Your instruction material is interesting, well illustrated, easy to understand . . . and complete!

EARN WHILE YOU LEARN

With our Master Shop Method Home Training, you study at home in your spare time. You need not interrupt your present job. You receive Spare Time Work Lessons which enable you to earn while you learn!

Send the coupon today for a Free Sample Lesson and big illustrated book, "Your Future in Diesel."

Home Study and Resident Training Offered

Check Coupon Below

**APPROVED FOR
VETERANS**

NATIONAL SCHOOLS

LOS ANGELES 37, CALIF. • EST. 1905



MAIL OPPORTUNITY COUPON FOR QUICK ACTION

NATIONAL SCHOOLS, Dept. PMD-10
4000 South Figueroa Street
Los Angeles 37, California

(Mail in envelope
or paste on penny
postcard)

Mail me **FREE** the book, **YOUR FUTURE IN DIESEL**, together with the Sample Lesson. I understand I may keep and use the information with no obligation.

Name _____ Age _____

Address _____

City _____ Zone _____ State _____

Check here if Veteran of World War II

DRAFTING

Plan for a **TOP PAY JOB** · Drafting Outfit Included
SEND FOR FREE LESSON

Here is a modern practical way to learn Drafting right in your own home. You are furnished all the instruments and supplies you need to actually do the assignments, and the entire Drafting Outfit is included at no extra cost. Visual aid instruction helps you learn quickly, easily—you receive projector and slides. Draftsman has Key Job in industry—many executives advanced to present top positions with aid of a knowledge of Drafting. Find out about this up-to-date C.T.I. training program in Drafting. Write today for **FREE** lesson and full information. No obligation.

COMMERCIAL TRADES INSTITUTE, Dept. J2-10
1400 W. Greenleaf Chicago 26, Ill.

Be A MASTER PLUMBER

Earn \$15 To \$50 A Day

DON'T ENVY THE PLUMBER — BE ONE

Every skilled workman will tell you that Plumbers have the best of it. WINTER and SUMMER the Plumber is busy at top wages. No skilled Plumber is ever out of a job—compare his opportunities with any trade, plus the opportunities of having your own shop.

We teach you Plumbing with **TOOLS** (not books) under Licensed Master **PLUMBERS** in one of the finest equipped schools in America. We make you a Plumber, every branch is taught thoroughly—Lead Work—Blueprint for plan reading—all other tricks.

LEARN IN 30 WEEKS WITHOUT PREVIOUS EXPERIENCE

If you like to work with tools you owe it to yourself to investigate. No need to ever work as an apprentice. Get free bulletin. Write now! **G.I. APPROVED.** Our 24th year.

UNIVERSAL PLUMBING SCHOOL
815 HOLMES STREET KANSAS CITY, MO.

SAY YOU SAW IT IN POPULAR MECHANICS

→ LEARN ←

AVIATION

AN ESSENTIAL INDUSTRY IN PEACE OR WAR
MAXIMUM TRAINING IN MINIMUM TIME

For 19 years Cal-Aero Technical Institute has specialized in . . .

✓ **AERONAUTICAL ENGINEERING**

2 year course — kept abreast of new research and scientific development.

✓ **MASTER AVIATION MECHANICS**

1 year course — C. A. A. approved for Airplane and Engine License.

Modern "live" training equipment, including helicopters, jets, rockets, wind tunnel . . . Classes start monthly — Room and board available on our airport. . . Cal-Aero Tech Training is carefully designed for just one thing — **TO MAKE MORE MONEY FOR YOU.** More than 7000 successful graduates in addition to 26,000 pilots and 7500 mechanics trained for Army & Navy Air Forces, prove that our career training is unsurpassed. **APPROVED FOR VETERANS**



CAL-ACRO
TECHNICAL INSTITUTE

GRAND CENTRAL AIR TERMINAL
GLENDALE 1, CALIFORNIA
LOS ANGELES COUNTY

MAIL THIS COUPON TODAY!

Please send full information on Aviation Training **FREE**—without obligation.

Name _____ Birth Date _____

Street _____ Zone _____

City _____ State _____

CHECK ONE VETERAN NON-VETERAN PM-10

Free!
7-Day Trial
 Just Mail Coupon NOW

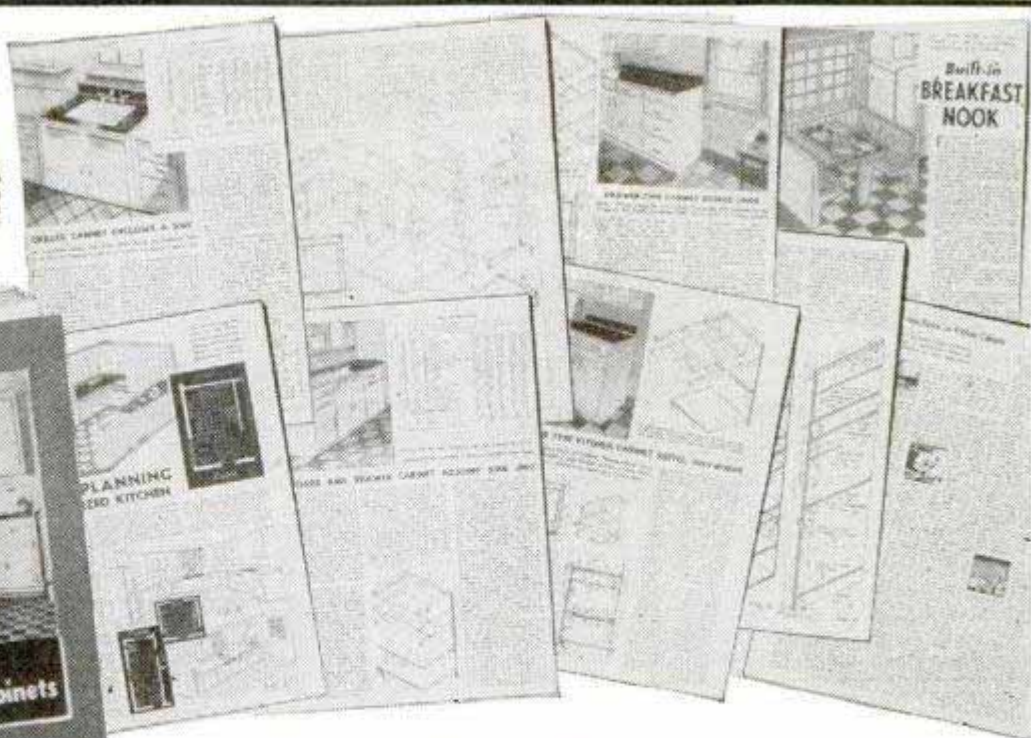
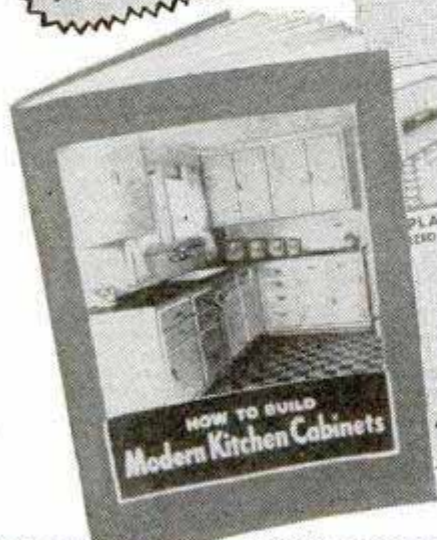

Which of these
**MODERN
 KITCHENS**
 do YOU want?



TYPICAL kitchen schemes shown here are but a few of many, many combinations you can have by selecting cabinets for your own special needs and in widths that fit your available space



PLAN A is a suggested arrangement if you have two adjacent walls for cabinets. PLAN B gets a wide variety of cabinets into compact space along one wall. PLAN C has broom closet



PLAN D has cabinets along one wall and utilizes corner for convenient dinette. PLAN E is laid out on the efficient U principle around three walls. Built-in breakfast nook included

How to Bring Your Kitchen Up-to-Date-

How to Plan the Space—Build the Cabinets Install and Finish Like a Professional

"How to Build Modern Kitchen Cabinets" makes your dream kitchen come true. Only book of its kind. Amazing! Helps you select best cabinets for special needs. Guides you every step. Then shows how to install, finish for a perfect job! Best of all, it is yours on free trial if you act at once. Just fill in and mail coupon.

Save Money Building Your Own!

Shows you how to build one cabinet, at a time, or combination. A style for every purpose, a size for every kitchen. When you're ready, simply measure space, refer to "Modern Kitchen Cabinets" complete lumber list of sizes. Easy as that! Simplified so that you find all the help you need. Units designed to be assembled in workshop and brought to kitchen ready to install.

Secrets of Planning Revealed

Should cabinets be near door? Sink? Work counters? Where should dishes be kept? Answers are in your copy of "Modern Kitchen Cabinets." An architect works with the same facts you find here. Read chapter on "Secret of Planning a Modernized Kitchen"

and you'll learn fundamentals. Then select the RIGHT CABINETS and locate them to save steps. You'll pick the best combination to fit your space. Be sure of work-counters where needed!

To save time and error, the designer has prepared a cutting list in chart form. There's a chart for each cabinet, complete for whatever size you choose. This alone cuts work in HALF. All you do is cut single pieces of wood to sizes given. When all are ready, assemble into a finished cabinet!

Gives You the Answer to Every Problem

Every step, every operation fully described. Every detail clearly shown. How to cut joints, what size to cut every piece in every style. Nothing missing! Plywood or solid wood; plastic or metal moulding. Reveals types, how to install hardware. How to hang cabinet. How to cement linoleum to tops. How to insert grilles. How to ventilate. Special drawer-runner construction. Beautiful, lifetime hard-cover binding.

Mail Free Examination Coupon Now

Will be sent for 7 days' free trial. Now you can build the kitchen cabinets you need. You can plan your own kitchen. Why delay? Why be old-fashioned? Get started now.

SEND NO MONEY JUST MAIL COUPON

Pay postman only \$1.50 plus postage, or send \$1.50 (check or money order) and WE pay postage. Read and study it for 7 days at our risk. If not delighted—if not worth every penny of \$1.50 to you, send it back at our expense. We will refund you \$1.50 by AIR MAIL.

"HOW TO BUILD MODERN KITCHEN CABINETS" was compiled by the Editors of CRAFTSMAN PUBLISHING.

CRAFTSMAN PUBLISHING
 115 Worth Street, Dept. B
 New York 13, N. Y.

What Enthusiastic Readers Say:

"I have made quite a few from plans. I received 15 more orders."
 —M. F., New Jersey
 "I am in the midst of making a complete set using the plans which I find excellent. You have set them forth in such complete detail — greatly appreciated."
 —W. J. R., Absecon, N. J.

CRAFTSMAN PUBLISHING, Dept. B

115 Worth St. New York 13, N. Y.
 Send me "How to Build Modern Kitchen Cabinets" on 7 days' Free Trial. If I am not delighted, you will refund my \$1.50 at once.

Name _____
 Address _____
 City _____ Zone _____ State _____
 I enclose \$1.50. Send postpaid.
 Send C.O.D. I will pay postman \$1.50 plus postage.

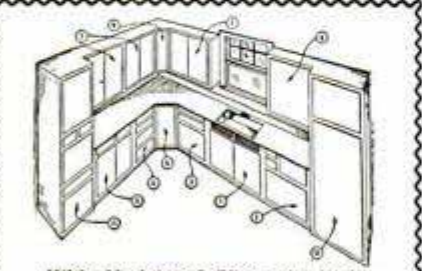

Wide Variety of Floor and Wall Models

- 1—Sink. 2—Drawer and cupboard.
- 3—Single door. 4—All drawer.
- 5—Double door. 6 & 9—Corner.
- 7—Double door wall unit. 8—Single-door wall. 10—Broom closet or storage. 11—Desk and storage.

EVERY STYLE CABINET!

THE OPPORTUNITY OF A LIFETIME



For the electrical man who is prepared for advancement

WAS there ever such an opportunity to get started in electrical maintenance and repair—and at top-notch wages? Are you ready—with experience and ability—to cash in on it? Others are getting just the sort of background needed—quick! practical!—to handle the great variety of electrical maintenance and repair work TODAY—from this well-known electrical library. You can too!

THE LIBRARY OF ELECTRICAL MAINTENANCE AND REPAIR

5 vols., 1826 pages, 1724 illustrations

Gives you the "know-how" to tackle any wiring or motor job. Five books show you HOW—to install all types of motor and generator units—to inspect and repair motor starters and generators—to diagnose motor and generator troubles—to figure new windings for old cores—DC and AC windings—to test armature windings—test induction motors, etc., etc. One book is full of trouble-shooting charts that show quickly symptoms, causes, specific remedies, etc.

Take the first step toward improving YOUR future—Mail this coupon TODAY

No money down—special price—easy payments—FREE trial

McGraw-Hill Book Co., 330 W. 42 St., New York 18, N. Y.

Send me for ten days' free examination the Electrical Maintenance and Repair Library. If satisfactory I will send you \$2.50 in 10 days and \$3.00 monthly until the price of \$17.50 is paid. If not wanted I will return books postpaid.

Name _____
 Home Address _____
 City _____ Zone _____ State _____
 Company _____
 Position _____ PM-10-48

HIGH PAY JOBS FOR MEN WHO QUALIFY IN DIESEL

ASSURE YOUR FUTURE. Steady, big pay jobs await men qualified in Diesel, Tractor and Heavy Equipment. Can you take advantage of Diesel job and advancement opportunities in this fast-growing field?

COMPLETE DIESEL COURSE AVAILABLE

If you are ambitious and want to get ahead in this lucrative field, you'll want to know about the complete training in Diesel provided by Interstate. Trains you at home in spare time. Does not interfere with your present job. Covers all phases of operation. Up to the minute. Revised regularly to cover new developments. Free placement advisory service.

YOU OWE IT TO YOURSELF

to investigate I.T.S. home Diesel training. Thousands of students agree it has helped them to better jobs... better pay. It can do the same for you!

SEND FOR FREE BOOK TODAY!

We'll gladly send you our big 24-page book "Getting Ahead In Diesel" FREE! Paste coupon on penny card and mail to



INTERSTATE TRAINING SERVICE
 4035 N. E. Sandy, Portland 13, Ore.

Please see that I receive FREE BOOK "Getting Ahead In Diesel":

Name _____ Age _____
 Address _____
 City _____ Zone _____ State _____ K-3

Drafting PAYS BIG

Learn in Spare Time — At Home or at Allied School in Chicago

KEY POSITIONS OPEN IN INDUSTRY

- Mechanical Drafting
- Tool and Die Making
- Tool Design and Engineering
- Machinist Trade
- Product Design and Illustration

Train Now!
 In Nationally Known, Fully Approved School and Endorsed by Industry . . .

Established in 1928
 FREE EMPLOYMENT SERVICE

Approved for Civilians and Veterans . . .

• • • Write For Catalog — A 1c Postcard will do

ALLIED SCHOOL OF MECHANICAL TRADES
 1338-1340-1342 So. Michigan Ave.
 4210 Allied Bldg. CHICAGO 5, ILL.

REFRIGERATION

AIR CONDITIONING—Trained men paid well to service, install, maintain, repair, rebuild household and commercial refrigerators. Opportunity for full time, spare time earnings. Train at home or in our big shops. Approved for Veterans. (Non-Veterans inquire about our Low Payment Plan and Pay After Graduation Plan.) Send for FREE BOOKLET AND FULL INFORMATION. No obligation.

COMMERCIAL TRADES INSTITUTE, Dept. A2-10
 1400 W. Greenleaf Chicago 26, Illinois

LAW FREE BOOK

Your FREE copy of "The Law-Trained Man" shows how to gain prestige and greater earnings through Blackstone home law study. All instruction material furnished including 18-volume Law Library written by 65 well-known law authorities, Lawyers, Judges among our graduates. LL.B. degree. Low cost; easy terms. Write today.

BLACKSTONE COLLEGE OF LAW 225 N. Michigan Ave.
 Dept. 57, Chicago 1, Ill.
 A Correspondence Institution Founded in 1890

TRI-STATE COLLEGE

B. S. Degree in 27 months in Civil, Electrical, Mechanical, Chemical, Aeronautical, Radio Engineering; Bus. Admin., Acc't and Sec. Science. Graduates successful. 65th year. Enter Jan., March, June, Sept. Catalog. 4108 College Ave., Angola, Ind.

BE A NOTARY PUBLIC

Largest notary supply house equips you for \$16.97, guarantees your appointment by governor. Honor, prestige. You certify legal papers, collect fees. Easy. At home, office, anywhere. You use official seal made with your name. Notaries needed everywhere. Be one.

Write **STATIONERS EXCHANGE, Helotes 11, Texas**

Write Like This

STRANGE DISCOVERY! Corrects poor penmanship in few days—big improvement in 3 hours. No failures! Now it's fun to become an expert penman. **TEN DAYS' TRIAL ALLOWED!** Write, INVENTOR OZMENT, 34-T, St. Louis, Mo.

YOU can draw!

AMAZING NEW HOLLYWOOD PLAN
 Yes, YOU can draw **GIRLS, CARS, FRIENDS** and even **MAGAZINE COVERS**. It's so simple, no matter what your age. Many artists make more than \$150.00 per week in advertising and cartoons. Be your own boss, draw for money anywhere. Our Commercial Artists will teach you the secrets from **HOLLYWOOD**. Drawing materials furnished. Be a success. Write NOW for free details

HOLLYWOOD SCHOOL OF ART
 DIVISION OF AXELSON STUDIOS

6533 Hollywood Blvd.
 Hollywood 28, Calif.

Name _____
 Address _____
 City _____ Zone _____ State _____



Learn BUILDING

AT HOME • All Blue Print Building Plans, Specifications, Lessons Furnished

FIND OUT ABOUT TRAINING AND OPPORTUNITIES FOR YOU IN BUILDING

Established in 1904, Chicago Technical College offers you thorough, practical training in Building, by home-study. Mail coupon for free information. See what this Course has done for others, what it can do for you. Read what Chicago Tech graduates say about their work, earnings, success. Learn the rewards awaiting you as a trained builder — and how quickly, easily you can get started. Simply MAIL COUPON TODAY in an envelope or paste on a penny postcard.



CHICAGO TECHNICAL COLLEGE
N-152, Tech Building, 2000 South Michigan Ave.
Chicago 16, Illinois

MAIL COUPON NOW

CHICAGO TECHNICAL COLLEGE
N-152, Tech Bldg., 2000 So. Michigan Ave.
Chicago 16, Illinois

Mail me FREE building Lesson with information about big opportunities in BUILDING and how I can train at home.

Name _____ Age _____

Address _____

City _____ Zone _____ State _____

THESE 5 TRADES ASSURE YOU HIGH PAY • Future Security

- **PLUMBING** Every phase of plumbing: Pipe-Cutting and Installations, Completed Installations of entire plumbing systems, Threading, Lead-Wiping, Rough-in Projects on Blueprint reading, Estimating.
- **DRAFTING** College-level courses in General Machine and Architectural Drafting, with fundamentals in Drafting Mathematics—all under graduate engineers.
- **SHOE REPAIRING** From simplest repairs on boots and shoes to the finest details of reconditioning and rebuilding, under expert craftsmen.
- **ELECTRICAL** Technical and shop training include Basic Electricity, Residential Wiring, Industrial Wiring, General Testing and Trouble Shooting, and Appliance Repair.
- **AUTOMOTIVE & TRACTOR** Applied training on latest model automobiles and tractors, including engine overhaul, transmission and differentials, carburetion, generator and ignition systems, engine tune up, Hydramatic and Vacamatic Transmissions, and general service.

"There's Always a Demand for the Man who KNOWS!"

CHOOSE ONE OF THESE 5 LEADING TRADES

Get Out of that Rut... Be a Skilled Tradesman! Have a Lifetime Career... Own Your Own Business and Be Secure in Your Old Age.

NOW while Enrollment is still open, send for FREE information.

THE 5 DIVISIONS OF

NATIONAL TRADE SCHOOL

2610 Grand Ave., Kansas City 8, Mo.

___ ● Plumbing ___ ● Drafting

___ ● Shoe Repairing ___ ● Electrical

___ ● Automotive & Tractor

NAME _____

ADDRESS _____

CITY _____ STATE _____

VETERAN _____ OCCUPATION _____

Choose One of these 5 Essential Trades

Our complete courses of thorough training prepare you to go right into the field as a Qualified Tradesman at High Pay in only 34 weeks (39 in Shoe Repair). All courses under especially trained instructors with practical experience. 6 Hour Classes 5 Days a Week. Our Employment Department helps you.

VETERANS "Approved for veterans' training by the State Department of Education under Public Law 346."
"Approved for veterans' training by the Veterans' Administration under Law 16."

Send Coupon for Free Information Now

EARN MORE

\$\$\$\$\$



SEND FOR THIS FREE BOOK NOW!

• Increase your earning power. Become thoroughly trained in a well-paid profession. Without obligation, find out about the opportunities in Electrical, Mechanical, Plastics, Civil, Mining and other engineering fields. Our free 118-page handbook, lists details of home study courses, compiled by world authorities. See for yourself how you can soon earn more dollars. Write today, to: Canadian Institute of Science and Technology, Ltd., 463 Century Building, 412, 5th Street, N.W., Washington, D. C.

Special discounts for Veterans and Servicemen

MAIL THIS COUPON NOW

Canadian Institute of Science & Technology, Ltd.,
463 Century Building, 412, 5th Street N.W.,
Washington, D. C.

Please forward free of cost or obligation of any kind your 118-page handbook "Engineering Opportunities".

Name..... Age.....

Address.....

CANADIAN ENQUIRIES: 219 Bay Street, Toronto 1.

Sensational
New Electric

① WELDER
② CUTTER!

NOW!
10 DAY TRIAL
BOTH only \$12

INSTRUCTIONS INCLUDED

The WELDRITE combination—tested and proven by countless commercial and amateur users, is now offered direct to you at the amazingly low price of only \$12.00. No Gas—No Gauges—No Spark Lighter needed. Always ready for immediate use—Just plug WELDRITE into 110-115 AC or DC outlet. Uses standard welding and brazing materials available at all welding supply stores.

WELDER HOOD
With Wilson Weld Lens No. 10, approved by American Optical Company. Used in Hoods costing to \$10, only..... **3 95**

Uses 110-115 AC or DC
WELD - BRAZE - CUT
MELT - SOLDER - HEAT TREAT

WELDRITE furnished complete with Converter Unit, #1 Single Holder with attached Alligator clip, for welding metal up to 3/16" thickness, using up to 3/32" rod, and #2 Double Holder with Copper Coated Dual Carbon Electrodes for Cutting, Brazing, Heat Treating, Soldering, etc. Starting welding materials and instructions included.

Ideal for home workshop. Invaluable for body and fender shops, garages, repair and machine shops, manufacturers, etc.

NAME.....

ADDRESS.....

SEND NO MONEY! 10 DAY TRIAL OFFER

Order your WELDRITE Electric WELDER-CUTTER C.O.D. today. Pay postman \$12 plus postage charges (wt. 4 lbs.) or send \$12 and we pay postage. Either way, if not satisfied, return WELDRITE in 10 days, and money will be refunded. WELDER HOOD—Approved lens found in hoods costing to \$10—only \$3.95.

California orders please add 2% sales tax.

CALIFORNIA TECHNICAL PRODUCTS CO.
448 So. Hill St., Los Angeles 13, Calif. Dept. CA-10

- Send Weldrite C.O.D. \$12 plus P.O. charges.
- Send Weldrite & Hood C.O.D. \$15.95 plus chgs.
- Send Weldrite postpaid, I enclose \$12.
- Send Weldrite & Hood postpd. I enclose \$15.95 Same 10 day Trial Offer
- Send Free Folder.



Acquiring a superior VOCABULARY is basic training for a top position in any profession, trade or business. To get in the upper brackets financially and socially, develop a masterful VOCABULARY through the fascinating, entertaining and profitable new science of LEXIPOWER. You are judged and rated by every sentence you utter. Executive ability and professional capacity are demonstrated by what you say—not by what your hands do. More POWER to you through LEXIPOWER. Benefit at once! You start using the POWER of LEXIPOWER after the first Lesson. Write NOW for FREE details about LEXIPOWER Dime-a-Day LESSON CLUB.

LEXIPOWER LESSON CLUB

517-M W. Deming Place

Chicago 14, Ill.

DON'T BE A JOB SLAVE! LEARN WATCH REPAIRING AT HOME

WITH OUR SELF TRAINING KIT
Get started NOW in this uncrowded field! EASY to learn! BIG MONEY! SECURE FUTURE! Earn while you learn! Even as a sideline you can make \$50 and up each week. —Our new PRACTICAL SELF-TRAINING KIT is all you need. Contains set of PROFESSIONAL TOOLS: (Loupe, 3-4 power; complete set of 6 special screw drivers—finest tempered steel blades; Tweezer AA; Plastic Material tray) and COMPLETE BOOK on Modern Watch Repairing. Fully illustrated, easy to understand, shows every step in repair, adjustment and use of tools. Now only \$6.25 Post Paid (If C.O.D., plus charges.) Money Back Guarantee. If ordered separately; book \$3.25; set of tools, \$3.50. MODERN TECHNICAL BOOK & TOOL CO. Dept. MMC, 55 W. 42nd Street, New York 18, N. Y.

JUST OUT! New All-Inclusive Tool, Material Catalog
Revised and Enlarged for Watch-Clockmakers, Jewelers, Tool-Instrument Makers, Handicrafters. Over 600 ILLUSTRATIONS and IDENTIFICATION CHART. NEW REDUCED PRICES. All books in these fields; write for literature. SEND 25c for catalog — FREE with order.



Learn to Write at Home in spare time
You can become a good Business and Artistic Penman at home in spare moments by my Simplified Method. Write for my FREE BOOK, "How to Become an Expert Penman," which shows that others have learned. Send 10c for Special Penpoint and your name with a flourished bird written on a card. Write TODAY.

J.M. Travis, Box 25K, Chillicothe, Mo.

RADIO MADE EASY!

Here is a METHOD of radio repairing that can be LEARNED QUICKLY—Begin repairing immediately. The electronic field is wide open. Prepare yourself for a GOOD INCOME NOW! Send for the JRI Home Trainer TODAY. \$2.00 postpaid or plus c.o.d. charge. Satisfaction guaranteed. THE JRI TRAINERS, P.O. Box 2091, Dept. 930, Chicago 9, Ill.

SAY YOU SAW IT IN POPULAR MECHANICS

ARTISTS MAKE MONEY

Do you like to draw? Send name, address, age and occupation for FREE ART TEST, to find out your ability.

ART INSTRUCTION, Inc.
10138 ART INSTRUCTION BLDG., MINNEAPOLIS 15, MINN.

HAVE YOU AN APTITUDE FOR WRITING?

Storycrafters Guild determines your writing potentialities with a FREE APTITUDE TEST, then teaches you fundamentals of ALL creative writing. You study current material editors have bought and published. You learn how to write Stories, Articles, Radio, Motion-Picture, Novels, "Fillers"; specialty writing of all kinds under personal direction of Frederick Palmer. EARN WHILE YOU LEARN through Storycrafters Guild Manuscript Sales Service. Send for FREE APTITUDE TEST today!

STORYCRAFTERS GUILD, Dept. 122
5617 Hollywood Blvd., Hollywood 28, Calif.
Send FREE APTITUDE TEST and details of Home-Study Course in Creative Writing.
Mr. Mrs. Miss.....
Address.....
City..... State.....

Now! NO AUTO REPAIR JOB IS TOO TOUGH FOR YOU!

Let this New Short-Cut Save You Time and Work!

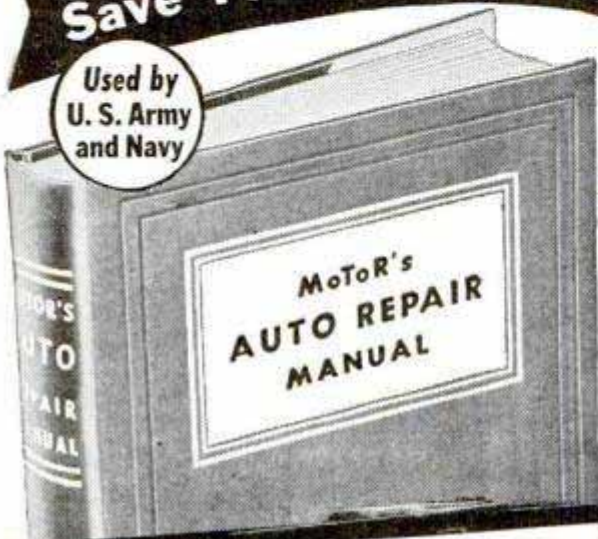

Whether you do auto repairs either as full-time or as part-time work, no service or repair job can "throw" you when you've got MoToR's AUTO REPAIR MANUAL! Just look up make, model, and the job in the streamlined index—and you're ready to lick ANY job from carburetor to rear end, faster, easier, better!

Try it FREE for 7 Days!

MoToR's AUTO REPAIR MANUAL Shows You How to Service and Repair ANY Part of ANY Car Built Since 1935!

Nearly 200,000 service and repair facts on all 32 makes. Over 700 big pages; including 70 pages of carburetor text, charts, illustrations, covering all models. Over 200 charts, tables; Tune-up Chart; Valve Measurements; Torque Wrench Reading; Starting Motor; Engine Clearances; Generator; Body Service; Dash Gauges; Brake Specifications; Front End Measurements, etc. Engines; Electric; Fuel, Cooling, Lubricating Systems; Transmissions; Universals, Front Ends; Wheels; Rear Ends, etc.

Covers All These Makes!

American	Cresley	Lafayette	Packard
Bantam	De Soto	La Salle	Pierce Arrow
Auburn	Dodge	Lincoln	Plymouth
Austin	Ford	Lincoln	Pontiac
Buick	Frazier	Zephyr	Reo
Cadillac	Graham	Mercury	Studebaker
Chevrolet	Hudson	Nash	Terraplane
Chrysler	Hupmobile	Oldsmobile	Willys
Cord	Kaiser		

Try this great book for 7 days FREE! It's "headquarters" for 200,000 facts about service, repair, adjustment, replacement, and tune-up — on every car built from 1935 to 1948! The engineer-editors of MoToR Magazine built this Manual for YOU, by collecting and organizing all the vital information from over 150 official factory shop manuals. Then they put ALL the facts into this ONE amazing workbook.

Army, Navy, trade and technical schools, thousands of auto servicemen and handymen everywhere! No wonder we're willing to have YOU try it, FREE, for 7 days! Once you use it—and see for yourself how much valuable time and hard work it saves—you'll never again want to be without it!

More Than 1,700 Pictures!

MoToR's AUTO REPAIR MANUAL not only TELLS you clearly what to do. It SHOWS you, too—in over 1,700 cut-away photos, diagrams, drawings. Over 700 BIG pages (8½x11 inches) put the complete "know-how" right at your fingertips! And the fabric binding is strong; built for years of day-in-day-out service!

SEND NO MONEY

7-Day Free Examination

Don't send any cash — unless you wish to do so in order to save postage charges! Simply mail coupon NOW. When postman brings your book, pay him nothing. First make the book show you what it does for you! Unless convinced it's the greatest time-saver and work-saver you've ever seen—return book in 7 days, pay nothing. Mail coupon NOW! Address: MoToR Book Dept., Desk 1M, 572 Madison Avenue, New York 22, N. Y.

No wonder it is used by the U. S.

Same FREE 7-Day Offer Applies on MoToR's TRUCK REPAIR MANUAL

For mechanics, truck specialists, service stations, fleet owners. Covers EVERY job on EVERY truck made since 1936! 1400 pictures, 952 pages, 300,000 facts. Used by Armed Forces.

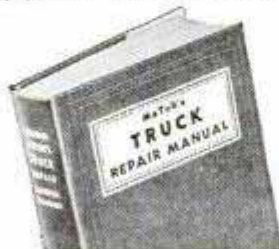

All types Gasoline Engines, Diesels, Hesselman, Fuel Systems, Governors, Lubrication Systems, Ignition Systems, Starters, Generators, Clutches, Transmissions, Axles, Torque Dividers, Transfer Cases, Brakes, Steering, etc.

ALSO SERVICES many buses, farm and industrial tractors, contractor and road building equipment, stationary power machinery, etc. (on all parts described in Manual.) Check box in coupon at right.

Published by MoToR, The Leading Automotive Business Magazine. MoToR's manuals assure high standards of repair work.

MAIL COUPON NOW FOR 7-DAY FREE TRIAL

MoToR Book Dept., Desk 1M, 572 Madison Ave., New York 22, N.Y. Rush to me at once: (check box opposite book you want).

- MoToR's AUTO REPAIR MANUAL. If O.K., I will remit \$1 in 7 days, (plus 35c delivery charge), then \$2 monthly for 2 months, and a final payment of 95c a month later. (Foreign price, remit \$8 cash with order).
- MoToR's TRUCK REPAIR MANUAL. (Described at left.) If O.K., I will remit \$2 in 7 days, and \$2 monthly for 3 months, plus 35c delivery charges with final payment. Otherwise I will return book postpaid in 7 days. (Foreign price, remit \$10 cash with order).

Print Name _____ Age _____

Print Address _____

City _____ Zone No. _____ (if any)

State _____ Occupation _____

Check box and SAVE 35c delivery charge by enclosing WITH COUPON entire payment of \$5.95 for Auto Repair Manual (or \$8.00 for Truck Repair Manual). Same 7-day refund privilege applies.

Helps you solve today's toughest CONSTRUCTION PROBLEMS



6 vols., 3763 pp., illus.
10 DAYS' FREE TRIAL

Here are the facts you need on every problem concerned with the design and construction of civil engineering structures. These books give you the most complete compilation of structural engineering data ever published—bring you genuine professional information from records of actual practice. Written by 63 recognized engineering specialists, these six volumes are a complete reference on each aspect of structural engineering.

STRUCTURAL ENGINEERS' HANDBOOK LIBRARY

Covers the how and why of foundation and substructure design and construction, general theory of structural members and detailed design of such members—explains the principles of statics, reactions, moments and shears in beams and trusses, influence lines, methods of computing stresses in lateral trusses—gives details of design and construction of steel, timber and concrete structures, etc., etc.

See coupon for Special Price and Terms

McGraw-Hill Book Co., 330 W. 42 St., New York 18, N. Y.

Send me for ten days' free examination the Structural Engineers' Handbook Library. If satisfactory I will send you \$4.75 in 10 days and \$5.00 monthly until the price of \$29.75 is paid. If not wanted I will return books postpaid. (To insure prompt shipment write plainly and fill in all lines.)

Name _____
Home Address _____
City _____ Zone _____ State _____
Company _____
Position _____ PM-10-48

ELECTRICAL BOOKS

shipped for EXAMINATION



8 BIG BOOKS

SEND NO MONEY
MODERN
ELECTRICITY
INCLUDING RADIO
AND REFRIGERATION

Here's great news for anyone interested in Electricity. NEW, up-to-date 19th Edition of Applied Electricity with new subjects fully covered, including blueprint reading, electronics, F. M. radio, fluorescent lighting, 8 Big Books sent for examination!

NEW Edition for Beginners and Experts

Over 3700 pages, 2700 illustrations and 134 tables in most complete electrical work we have published. Dynamos, motors, diesel plants, power stations, transmission—everything explained for easy understanding.

BIG FIELD! Big Demand! Big Pay!

Men who understand electricity are needed now in all kinds of industries. Practically every business depends on electrical knowledge, and men who know this subject make big money. Learn easily with these new, interesting books. Send coupon for a set of books on approval. See how they will help you to get ahead faster.

SEND NOW

A year's consulting privileges with our engineers now given to all buyers of this famous Cyclopaedia of Electricity.

AMERICAN TECHNICAL SOCIETY
Vocational Publishers Since 1898

American Technical Society, Dept E719, Drexel at 58th St., Chicago 37
Send for 10 days' free use, 8 volume set of New 19th Edition, Applied Electricity, including a certificate entitling me to consulting privileges for one year. I will pay the delivery charges only on the books. If I wish I may return them in 10 days and owe you nothing, but if I keep them, I will send \$2.00 after 10 days, then \$3.00 a month until the total price of only \$34.80 is paid.

ADDRESS _____
NAME _____
CITY _____ STATE _____

Please attach letter stating age, occupation, employer's name and address, and name and address of at least one business man as reference. Men in service, also please give home address.

SAY YOU SAW IT IN POPULAR MECHANICS

Famous BAILEY DIESEL SCHOOLS Now Accepting CIVILIAN STUDENTS!

Bailey has a national reputation for "finest training methods." Bailey teaches you fundamentals, plus the practical application of theory in plenty of actual shop work. Bailey is approved by industry. Bailey graduates get the jobs!

Civilian men and boys over 17 who are ambitious to get ahead will act now. Send for FREE catalog. No salesman will call.

BAILEY TECHNICAL SCHOOLS
1655 So. Grand Blvd., St. Louis, Mo.

Learn RADIO-TELEVISION In Your Own HOME WORKSHOP

Build interesting Radio Circuits, acquire real experience, do scores of practical experiments—all through RTA's complete balanced training plus 10 BIG KITS of parts which RTA GIVES YOU! Get finest instruction direct from Hollywood, nerve-center of broadcasting, television and radio activities.

FREE BOOK
Send postal for complete details plus FREE BOOK "How to Make Good in Radio-Television."

RADIO TRAINING ASSOCIATION OF AMERICA
5620 Hollywood Blvd., Dept. PMJ Hollywood 28, Calif.

BOYS-IT'S FREE!

Exciting, new book tells about "ATOMIC ENERGY" and "THE WONDERS OF CHEMISTRY"

Also shows how to amaze friends with Chemcraft magic and do many exciting home experiments. Free. Send today!



THE PORTER CHEMICAL CO., 59 Prospect Ave., Hagerstown, Md.

MONOGRAMS - INITIALS

Beautiful gold decals. App. 1 inch square for automobile doors, bicycles, luggage, etc. Easily applied to any surface. Instructions included. State letters wanted. 6 for \$1.00, 3 for 50c, postpaid.

KESSLER AUTO SUPPLIES, Centreville, Maryland

FREE BOOK TELLS HOW TO BE AN...

Accountant
Salesman
Secretary
Stenographer

SECURED FUTURE... FREE EMPLOYMENT SERVICE

Enter one of the "substantial earnings" fields through Hill's "Success Plan" training. A lifetime opportunity to join thousands of successful graduates in positions secured through our nation-wide employment service. No matter where you live, what you are doing now, Hill's can train you by study at home or in the resident school. Big Free book shows you the way to substantial earnings and an assured future. G. I. Approved.

Hill's Extension School & Business University
Dept. PM10, 619 W. Main St., Oklahoma City 2, Okla.
Please send your free book, "Through Hill's to Success."

NAME _____
ADDRESS _____
CITY _____ STATE _____

Check here if eligible under G.I. Bill.

MAIL THIS EASY-TO-USE COUPON TODAY

EASY-TO-USE COUPON TODAY



GET INTO DRAFTING

The Draftsman Plays a most Important Part in INDUSTRY

DRAWING OUTFIT INCLUDED with Drafting courses

All the tools you need including folding drawing table. With them you can put your ideas on paper quickly and with accuracy. With training you are all set to master Drafting in months, — not years — at home.

Learn in Spare Time—At Home!
(or at the College in Chicago)

A few hours of pleasant home study every week — that's all. With Chicago Tech's help, you train yourself step by step. This tested method — developed over 44 years of C.T.C. progress — prepares men for good positions in industry.



**CHICAGO
TECHNICAL COLLEGE**
N-211 Tech Building, 2000 South Michigan Ave.
Chicago 16, Illinois

MAIL COUPON NOW

Chicago Technical College
N-211 Tech Bldg., 2000 So. Michigan Ave.
Chicago 16, Illinois

Mail me FREE Drafting Lesson with information about big opportunities in DRAFTING and how I can train at home.

- Architectural Drafting Electrical Drafting
 Machine Drafting Structural Drafting
 Builders' Course

Name _____ Age _____

Address _____

City _____ Zone _____ State _____

*Find your future
Success*

in DIESEL

LEARN at HOME in Spare Time, the Famous HEMPHILL way
... the **QUICK, EASY** way!



Trained Diesel men are in demand throughout the world. Many of the skilled men now on interesting, well-paying Diesel jobs are Hemphill trained. Wherever Diesels are used the name "Hemphill" stands for men who "know Diesel." Diesel operating engineers and mechanics have a wide variety of interesting career possibilities—Diesel engines in trains, ships, trucks, drilling rigs, sawmills, construction equipment, etc., all require trained men to service and maintain them. Prepare yourself for this great swing to Diesel power. Get complete details of Hemphill Diesel training now!

Learn Diesel AT HOME in spare time, without interfering with your present activities. Prepare for a bigger future. Mail the coupon below for complete details or take

SHOP TRAINING IN DIESEL AT

NEW YORK 31-28 Queens Blvd. LOS ANGELES 1601 S. Western Ave. MEMPHIS 311 S. Main Street
Long Island City 1, New York Los Angeles 6, California Memphis 3, Tennessee

Automotive Tune-Up Specialist Training at Los Angeles

**JUST OFF THE PRESS...
the NEW
March of Diesel
MAIL COUPON FOR
YOUR FREE COPY**



HEMPHILL DIESEL AND AUTOMOTIVE SCHOOLS Dept. PM 10-8
Administrative Office: 1601 South Western Ave., Los Angeles 6, California
Gentlemen: Please send me FREE BOOKLET and information on job opportunities. I am interested in Home Study Shop Training at New York Memphis Los Angeles (Check school desired) Auto Tune-up L. A.

Name _____ Age _____

Street _____ Zone _____

City _____ State _____

Veteran _____ Non-Veteran _____

Approved for Veterans
Available for Non-Veterans

Paint Your Car!

AND 1001
OTHER ITEMS

AMAZING
NEW

"Super" CARONIZE

FACTORY-FINISH TYPE

AUTO ENAMEL

One Quart Covers! One Hour to Apply! One Hour to Dry!

Just Wipe it on!

Handy
Applicator



INCLUDED AT NO EXTRA COST

Makes Your Old Car
Gleam Like New!



Now you can quickly and easily make your old car look almost NEW! Just give it a speedy coat of new "SUPER" CARONIZE. With "SUPER" CARONIZE all back-breaking labor is eliminated... NO BRUSHING, SPRAYING, MASKING, BUFFING OR SCRAPING is necessary. Simply clean car and WIPE ON this sensational new fast-drying paint. In just a short time, your car will GLEAM with a mirror-bright finish that LASTS FOR YEARS. "SUPER" CARONIZE won't peel, crack, chip in spite of rain, snow or sun.

THE RESULT OF MONTHS OF LABORATORY RESEARCH!

"Super" Caronize smoothly covers your car because it contains genuine THERMOREZ, the very same type synthetic resin as is used in finishing newest cars. If you are getting a new car, a brilliant "Super" Caronize finish may increase your trade-in value \$100 and more.

Guaranteed
3 FULL YEARS

The only wipe-on enamel in America that gives you a 3-year WRITTEN guarantee against chipping, cracking or peeling when applied according to directions.

16 BEAUTIFUL NEW COLORS

Black • Maroon • "Fiery" (Bright) Red • Cloud Grey • "Washington" (Dark) Blue • Brewster (Dark) Green Monticello (Light) Blue • Jewel (Light) Green • Orange • "Lettuce" (Very Light) Green • Light Yellow • Tan Ivory • Chrome • Clear • White

"Super" Caronize White is absolutely non-yellowing

Use coupon below. Send us your color choice today! Pay postman only \$2.95 plus postage. Or send cash and we pay postage.

SEND NO MONEY

RUSH ORDER TODAY!

Fill Out and Mail This Coupon Today! Send No Money!

Please send me qts. of
"Super" Caronize at \$2.95 per qt.

COLORS:

NAME
(Please Print)

ADDRESS

CITY.....STATE.....

Send Postpaid,
remittance enclosed

Send C. O. D.
plus postal charges

ONLY
\$2.95
Enough
to Paint
Almost
Any Auto

AMAZING FOR AUTOS and
1001 OTHER PAINT USES

AT HOME

Caronize colors are wonderful for all refrigerators, gas stoves, furniture. All porcelain, metal and wood surfaces. "Super" Caronize Clear gives a durable coating to floors, linoleum and all household woodwork.

OUTDOORS

Perfect for all lawn furniture, swings, bird-baths and other items of this type. Also recommended for boats, canoes, etc.

ON THE FARM

Durable for tractors and all other kinds of farm implements, dairy and utensil uses.

STORES AND OFFICES

Excellent for desks, table tops, files and 1001 other uses in stores, shops, taverns, beauty parlors, offices, etc.



CARONIZE, INC.

DEPT. PM10 1801 Singleton Ave.
St. Louis 3, Mo.

AGENTS AND DISTRIBUTORS
Write for Free Information

**WORLD'S
BEST
WANT AD
MEDIUM**

CLASSIFIED Advertisements



Advertisements in this section 75 cents per word, each insertion, minimum 10 words, payable in advance
To be inserted under proper classification, copy must be in our office the 22nd of the
second month preceding date of issue

F. W. Johnson, Manager, Classified Advertising
Popular Mechanics Magazine, 200 East Ontario Street, Chicago 11, Illinois

1216

**CLASSIFIED
ADVERTISEMENTS**

1216

**OPPORTUNITIES
FOR YOU**

AUTOMOBILES, MIDGET CARS

CLYMER'S 1948 Indianapolis Race Year Book. Complete information, 100 photographs, charts, drawings, cartoons. \$1.50. Deluxe fabrikoid bound \$2.50 postpaid. Clymer, Dept. A-548, 1268 So. Alvarado, Los Angeles 6, Calif.

FORD Racing manifolds. The famous Columbia Ford racing manifolds, increased speed and efficiency for '60-'65 Fords and Mercurys. Now only \$32.50 for '65' Fords and Mercurys. \$27.50 for '60' Fords. Write for free circular. P.O. Box 2372, Portland, Oregon. Dealers invited.

"SPEED And Mileage" manual—Easily obtain greater speed, mileage, racing performance from any automobile! Famous (original) book shows soup up methods; speed tuning; mileage secrets; racing tricks! Photographs! Instructions on building inexpensive speed equipment! Economizers! Sporty accessories! "Hotrods!" Speedsters! Fast conversions! Engines! Superchargers! "Water injectors!" Mufflers! All about "economy tuning," compression, manifolds, ignition, lubricants, cams, fuels! Latest "Hollywood customizing," streamlining; simplified sport conversions! Plans; charts; fascinating pictorial supplement; catalogues; parts lists! Guaranteed most complete. \$1.98. Alquist Engineering, Milford 39, Pennsylvania.

MODEL "A" and "T" Ford book. 572 pages, complete information re: repairing, maintenance, servicing both models and Fordson tractor. \$3.50. Model "A" book only \$1.00 postpaid. Clymer, Dept. A-ATA, 1268 So. Alvarado, Los Angeles 6, Calif.

"SPEED And Power" Handbook—very latest methods! Construct your own superchargers, water injectors; compression heads, fuel saving devices; easily, practically without cost. Get racing speed, acceleration, dynamic power increases from any automobile! Build stock conversions! Fast roadsters! Hotrods! Get ingenious formulas! Speed secrets! Also "Economy Information," tuning techniques! Ignition. Carburetion. Fuels. Mileage tricks! Illustrations! Catalogues. Including "California Re-styling Ideas," Glossy photographs! Drawings! Model revising! Customizing! Streamlining! Sport changes! Leatherlike bound. \$1.98 complete. Newhouse Automotive Industries, 5941-B2 Hereford, Los Angeles 22.

SPEED Up, customize your automobile! Famous racing; speed equipment; beautifying accessories; Hollywood "streamliners;" hotrod; custom supplies. Low factory prices! Beautiful "Handbook Catalog" 20c (refundable). Alquist Engineering, Milford 39, Pennsylvania.

BRITISH Racing cars. Illustrations, photographs, historical information on British racers, Sunbeam, Bentley, M.G., Riley, Lagonda, Austin, others. Just published. \$1.50 postpaid. Clymer, Dept. A10L, 1268 So. Alvarado, Los Angeles 6, Calif.

BRITISH Auto magazines. Yearly rates: Autocar \$7.00, Motor \$7.00, Motorcycling \$5.00. Motorcycling \$5.00. Postpaid weekly from England. Illustrated general price list free. Order from Thomas & Co., Blackpool, England; or American representative, Cassell, 545 Lawrence Avenue, Westfield, New Jersey.

USED-CAR Buyer's handbook. Includes authoritative specific late model evaluations! Complete tests, dealers' tricks, graphic photographs! \$1 postpaid. Post Publications, Box 723-TE, Arcadia, California.

CUSTOMIZE Your car! Authentic California restyling plans galore! Working sketches, specific model changes. Comprehensive; complete! 130 photographs! Largest, finest, or refund! \$2 postpaid. Post Publications, Box 723-BE, Arcadia, California.

CUSTOM "Hi-speed" compression heads for your V-8. Famous finned-aluminum racing design guarantees up to 20% power increase! Amazing acceleration; economy; speedway performance! Now only \$45.00 pair. Circular free. Alquist Engineering, Milford 39, Pennsylvania.

HOT Rod builders! We chrome plate cylinder heads, generator housings, carburetors and other parts. Send parts in for free estimate. Master Silverplaters, 2158 Gratiot Avenue, Detroit 7, Michigan.

CLYMERTONE, Twin muffler sets, beautiful sound, complete with necessary welded pipes, E-Z installation. Ford V-8, \$20.00. Chevrolet set with split manifolds, \$37.50. Specify car model. Clymer, Dept. A-104, 1268 So. Alvarado, Los Angeles 6, Calif.

RACING Book — Just out! Photo packed with data on hotrods, midget, dirt, championship cars; drivers! How to speed up passenger cars; build 145 m.p.h. racers! Hotrods! Sport cars! Stock conversions! Power equipment! All about speed tuning, streamlining, superchargers, fuels, cams, racing secrets! Records! Formulas! Drawings! Action pictures! Sensational! \$1.98. Alquist Engineering, Milford 39, Pennsylvania.

CUSTOM California speed equipment. Dual-single mufflers, heads, cams, manifolds. Chrome supplies. Latest catalog 25c. Save freight. Midwest warehouse. Von Esser's, 2840 No. Kedzie, Chicago 18, Ill.

STUDEBAKER Champion power and racing equipment. Engines 135 to 177 inch. Engineering help and list free. Frank Morgan, Studebaker Dealer, Marysville, California.

"VAPO-STEAMATIC" Water injection. Easily constructed (for less than \$1.00). Finest automatic "moist-humidity" system. Engineering triumph—gets up to 33 miles per gallon. Increases horsepower! Eliminates ping, carbon, overheating. Reduces wear. Lengthens engine life! Copyrighted "quick installation handbook" (illustrated) including "mileage information" parts lists, picture catalogues, etc. \$1.00 complete. Newhouse Automotive Industries, 5941-B1 Hereford, Los Angeles 22.

STEAM Automobile books. Clymer's Steam Scrapbook, 224 pages; 100 steam cars illustrated, described, \$2.00. Modern Steam Car book \$2.00. Original catalog reprints Stanley, White, Doble \$1.00 each postpaid. Specify title wanted. Clymer, Dept. A-SS, 1268 So. Alvarado, Los Angeles 6, Calif.

"MIDGET Car" book—Complete plans for easily building inexpensive midget racers, two passenger highway runabouts, streamlined roadsters, 3-wheel cars, scooters, etc. Motor data, supply sources, 75 photographs, blueprints! Instruction kit! \$1.98. Alquist Engineering, Milford 39, Pennsylvania.

FORD-MERCURY Owners. Attention! Supertone dual exhaust systems reduce back pressure 50%. Increase mileage, beautiful tone. Leaf or coil springs weak or flat? Free spring and muffler catalog; all cars. Trucks 1 ton or less. Supertone Mufflers, 2470 E. Slauson, Huntington Park 3, Calif.

INTERCHANGEABLE Parts book. New book tells every automobile part that interchanges with others. Same parts many times vary 100% in price. This book enables garages, mechanics, dealers, owners to buy under cheapest listing. Tremendous savings for users. \$15.50 postpaid. Clymer, Dept. A-IP, 1268 So. Alvarado, Los Angeles 6, Calif.

1948 SUPERIGNITIONITER Starting, pep, mileage. \$4.85 dealers. EG Mfg., Elmsford, N. Y.

HIGH Compression heads, V-8. More speed, acceleration, power. Offenhauser or Edlebrock \$75.00 complete set. Dual manifolds complete with throttle kit, fuel lines, Edlebrock \$49.00. Offenhauser \$55.00. Give make, model V-8. Catalog 10c. Clymer, Dept. A-103, 1268 So. Alvarado, Los Angeles 6, Calif.

SEE Our ad under motorscooters for midget car bargains. Midget Motors Directory, Athens, Ohio.

RACING Car builder book. 22 drawings. Racing rules. Contains information on cams, compression, balance, midgets, big cars, roadsters, V-8 speed data. \$2.00 postpaid. Clymer, Dept. A-RB, 1268 So. Alvarado, Los Angeles 6, Calif.

NEW Sensational seat cover. Mono. \$545 Santa Monica Blvd., Hollywood, California.

HOT Rod Racing Book. 90 photographs, illustrations famous record holders used California Dry Lakes. Contains hotrod tips, closeup action shots, specifications, 8 beautiful drawings suitable framing. \$1.50 postpaid. Clymer, Dept. A-10V, 1268 So. Alvarado, Los Angeles 6, Calif.

PHOTOGRAPHS. World's finest automobiles! List, sample, 10c. Box 1028, Minneapolis, Minnesota.

ALUMINUM Welding—Castings repaired or fabricated for hot rods or motorcycles. Gene Thompson, 937 32nd St., South Bend, Indiana.

FAMOUS Car catalog reprints. Duesenberg, Italian Maserati racing and new sport car, Mercedes-Benz, new rear-engined Isotta-Fraschini V-8, Rolls-Royce "Silver Wraith," Miller race cars, Cord, Rayfield Cyclocar, V-8 Chevrolet, Stanley steamer, Doble steamer. Specify catalog desired. \$1.00 each postpaid. Clymer, Dept. A-10X, 1268 So. Alvarado, Los Angeles 6, Calif.

CLEAN Or repair any radiator. Easily tin rusty metal. Complete instruction system \$2. Radiator Service and Supply, McBain, Mich.

"HOW To Be An Expert Car Buyer." Book exposes 36 tricks used to defraud used and new car buyers. \$1.10 postpaid. Rand's, 1231 Cass, Detroit 26, Michigan.

MINIATURE Racing cars scale models, famous Millers, Offenhausers, etc. Kits or complete cars. Catalogue 25c. AAECO, Box 874, Inglewood, Calif.

CLYMER'S Test Reports on post-war Kaiser-Frazer, Studebaker, 1949 Ford, 1949 Mercury, give impartial, uncensored report 3000-mile economy, speed, record tests. Part-by-part equipment analysis. 3000 owner tabulations in each book. 200 owner letters. Good, bad comments about each make, no punches pulled. Learn the truth. Specify make car interested in. \$1.50 postpaid. Clymer, Dept. A-TR, 1268 So. Alvarado, Los Angeles 6, Calif.

"CUSTOM Styling" manual—Quickly make car look Hollywoodized, custom, ultra-beautiful by easy, inexpensive methods! 100 photographs, instructions on customizing, restyling, streamlining; new and old cars! Thrilling sport changes! Latest custom, foreign, convertible, speed, model conversions; accessories; mufflers; engine "soup up" specifications! (Custom car catalog included.) Most complete book \$2. Alquist Engineering, Milford 39, Pennsylvania.

CALIFORNIA Steelpacked mufflers. Deep, mellow, tone. Easily installed, complete with fittings. Ford, Mercury, \$17.95 set. Deaptone singles, Chevrolet, Plymouth, Ford, \$4.95. Specify make, year. Eastern Auto Supply, 3319G South Grand, Los Angeles 7, Calif.

DUALTONE Crystalline packed California mufflers for all automobiles. Large chrome tailpipe extensions, chromed carburetors, fuel pumps, long shackles, dual manifolds, hi-compression heads, flywheels, camshafts, fender skirts, Plexiglas tops. Send 20c illustrated catalogue, deduct from first order. Dualtone Mufflers, 2636C India St., San Diego 1, California.

CHEVROLET Speed manual now available to discriminating Chevrolet owners who desire real "hotrod" performance from their 1937 to 1948 Chevrolets. Filled with photographs, complete information, proven methods showing you how to make your road car into a genuine 110 m.p.h. job, or how to build 134.52 m.p.h. Chevrolet hotrod. Every page worth the purchase price of only \$2.00 postpaid. California Bill, Box L-1, Eaglerock, Los Angeles 41, Calif.

MAKE Your Model "A" do 100 m.p.h. Lightning acceleration, breath-taking top speed. Complete details, photographs. \$1 postpaid. Four Barrel, Box L-1, Eaglerock, Los Angeles 41, Calif.

FROM Speedway to roadway! Track-proved hi-speed heads and manifolds now available for your passenger car! No special tools needed! Increase horsepower 25%! Astounding getaway! Free illustrated catalog. Speedsport, 6215AA Diversey, Chicago 39.

INSTALL V-8 engine in your Model A for extreme acceleration, more top speed, smoother performance. Complete details, photographs. \$1 postpaid. A-V-8, Box L-1, Eaglerock, Los Angeles 41, Calif.

HOT-ROD Manual, fast Fords, photos, instructions, \$1.50. Airmailed \$1.75. Racing parts list 25c. Hollywood Hot-Rod, Los Feliz, Box 9626P, Hollywood 27, California.

MAKE Your Ford fast! Complete details, photographs. How to construct 120 m.p.h. Hotrod. \$1 postpaid. California Bill, Box L-1 Eaglerock, Los Angeles 41, Calif.

WE Sell direct to customers over 200 speed equipment parts manufactured by us. Ford A-B-V8-6-4 (Ferguson). Studebaker Champion, Chevrolets and Willys. Cylinder heads, dual intake manifolds, lynite flywheels, oversize valves, compound springs, camshafts and other supplies. Complete engines ready for race for cars, boats and midgets. \$1.00 to cover illustrated literature and price sheet. R & R Mfg. Co., Robert M. Roof, Box 546, Anderson, Indiana.

BUILD Speedy midget track racer from castoff parts! Plans, specifications, construction information, \$1.00. Motor Supply, Box CS-1682, Toledo, Ohio.

AUTOMOBILE Racing, Sixth Edition. 100 illustrations. Working drawings with building instructions for Ford-60 midget, California roadster, Offenhauser racer. Details on racer parts. Sample entrance blank. World's record 158.5 m.p.h. rear engine four-wheel drive car. Interesting information for fans, drivers, mechanics. \$2.00 postpaid; \$2.25 c.o.d. Ray Kuns, Department 63, Cincinnati 27, Ohio.

AUTOMOBILE Racing book, fifth edition, well illustrated. Instructions on building bodies, frames, engines. Ford A and B conversions. Plans AAA rules, specifications. Roadster racing. Indianapolis cars. \$1.00 postpaid, \$1.30 C.O.D. Ray Kuns, Dept. 47, Madisonville, Cincinnati 27, Ohio.

EASILY Built professional midget racer, motorscooter, midget roadster, or midget motorcycle from cast off parts. Plans, specifications for all four contained in illustrated handbook, 25 cents. Directory of bargain priced used parts and motors included free! Midwest, 3839 Drummond, Toledo, Ohio.

AUTO SUPPLIES AND EQUIPMENT

BUICK Parts. We stock a complete line of new parts and engines. Immediate shipment anywhere. Write today. Robertson Buick Co., 1001 S. Wabash, Chicago 5, Ill.

AUTO Parts—New, used or rebuilt. Anything for engine or body. Any model car or truck. Reasonable prices. Immediate shipments. What do you need? Write: Brown & Baker Motors (Parts Division), 5254 West Pico Blvd., Los Angeles 35, California.

THE ABC of water injection. Complete information free. Advanced Automotive Products, 563-12 Lake Road, Webster, N. Y.

REPAIR Your car. Motor parts for all engines, chassis parts, ignition and carburetor parts, etc.; new replacement parts. Genuine and highest quality at manufacturers' retail prices. Orders receive priority over inquiries. Briggs Automotive Engineering, Box 3454, Merchandise Mart, P.O. Chicago 54, Ill.

SEAT Covers, front or rear. C. Page, Franklinville, New York.

FILCOOLATOR—Filters and cools oil. Patented, practical, guaranteed. \$14.50 complete. Filcoolorator, Inc., 703 South Palm Avenue, Alhambra, California.

AMAZING New scientific anti-glare car visor attachment. Reduces 80% of glare day or night driving. Guaranteed. Only \$5.98 postpaid. Jewel Industries, Inc., Dept. C, P.O. Box 889, Canton, Ohio.

AUTOMOBILE Shatterproof glass! Direct savings! Write requirements. Cooper's, 3135 Lawrence, Chicago 25.

GRILLES For all cars. 1939 Plymouth shells; 1940 Plymouth shells. Wagner Grille Co., Route 2, Bernville, Penna.

DUAL Vacuum horns—Doll up your car, fellows! Beautiful chrome finish for fender mounting \$29.50; lacquer \$23.75. We'll ship c.o.d. immediately. Protectorud Company, 4033 Windsor, Dept. 1, Youngstown 7, Ohio.

WINTER Is coming. 70% of car batteries fail because of sulfation. New product removes sulfation, restores full power. Protect your battery before failure. Easily applied. Non-injurious. Guaranteed. Lloyds of London. \$2.00 postpaid. Santa Cruz Battery Service, 110 Doyle, Santa Cruz, California.

GOVERNMENT Surplus. Low voltage circuit tester in steel box. Cost \$202.00. Our price \$27.50. Will test batteries, starters, generators, voltage regulators, grounds, short circuits. Wilt Electrical Company, 7829 S. Racine Ave., Chicago 20, Ill.

NEW And used automobile and truck parts. Lowest prices. Complete stock. Prompt reply. Babbitt Auto Parts, 2833 W. Chicago Ave., Chicago 22.

BRUSH Plating outfits connect to a battery. No tanks or shop required. Free particulars. Gunmetal Co., Avenue J, Decatur, Illinois.

GASOLINE Saver. Indicates how to drive automobile for maximum mileage. Small attractive instrument. Mounts on windshield frame, connects to vacuum system. \$5. Associated Manufacturing Company, Thompson Building, Tulsa, Oklahoma.

SAVE 6c Per gallon with Gane Air-Flow Needles. Shipped C.O.D. \$1.50 (8 cyl. cars take 2). Advanced Automotive Products, 563-18 Lake Road, Webster, N. Y.

MOTORISTS Save gasoline by Vacuumating overrich mixtures. Fits all cars. For free particulars write Vacuumatic, Dept. 1400, Wauwatosa, Wis.

WELDING Bodies, blocks, fenders—easy with Hobart welders. Low cost, adds profits. Catalog free. Write Hobartweld, Box M-1082, Troy, Ohio.

SMITHY'S Sport muffler for Ford V-8, 1942 to 1948, \$5.95 each. Bucks Auto Parts, Box 1296H, Merced 1, California.

MORE Gasoline mileage. Free descriptive, illustrated, instructions. Neher Industries, La Verne, California.

SAP-T-VIEW Automobile mirror. A knockout. Complete inside fingertip control like spotlight. Chromed. Fits any car. Easily installed. Specify make. \$8.25 postpaid. Clymer, Dept. A-SAP, 1268 So. Alvarado, Los Angeles 6, Calif.

WATER Injector. New hydro-jet automatic control unit. Improves performance. Easily installed any make. Complete with tank, all fittings, \$22.50 postpaid. Specify car make, model. Clymer, Dept. A-HJ, 1268 So. Alvarado, Los Angeles 6, Calif.

SEAL Cracked batteries! Cement \$1.00 can. Guaranteed! Postpaid! Batteryman, Grand Junction, Colorado.

HYDRAULIC Jack repair kits. Repair your own. Send for price list. Beerman Precision Machine Works, 2000 So. Claiborne Avenue, New Orleans 13, Louisiana.

CONVERTIBLE Tops—Completely sewn. Easily installed. Reasonable prices. Free literature. Rio Top Company, 1370 Roanoke, Newport News 16, Virginia.

AUTO Parts. Any part for any make car; new, used. Auto Parts Service, 111 Sunset Ave., Fairfield, Conn.

ELECTRIC Pencil—Writes, engraves all metals. \$2.95 postpaid. Reb Industries, Elmhurst 4, Illinois.

SAVE Gas! Instant starting. "Lektron" spark intensifier. Guaranteed! Easily installed. \$1.25 cash, or c.o.d. State make car. Electronic Industries, Cleveland 11, Ohio.

AMAZING New invention! "Magic brain" master generator output control unit X-rays entire electrical system while driving. Instantly indicates any electrical trouble. Quick-charges battery. Sensational low price! Write quick for free demonstrator offer! Gen-O-Batt, 1136A Dodge, Evanston, Ill.

AUTO Parts—All kinds; prices upon request; no catalog. Meyer's Auto Parts, 820 Dryades, New Orleans, La.

AIR Horns—"Strombos" most powerful of all signals! Complete passenger car kits; all cars. Models available for boats, trucks, buses, and diesel locomotives. For the "right of way" right away! Buy Strombos. Illustrated bulletins on request. Strombos Company, 4525 Twelfth, Detroit 8, Michigan.

CAR Trouble? Million new, used parts. Describe needs. Automotive, 2928A North Western, Chicago 18.

AUTO Parts. Buy direct. Get dealers' prices. Represent us in your territory. Write requirements. Specify car make. Mechanics Auto Parts, Factory Warehouse, 3807-PM N. Ashland, Chicago 13.

AUTO Parts for all cars, transmissions, motors, differentials, fenders, carburetors. Security Auto Parts, 1923-PM Grace, Chicago 13.

AUTO TRAILERS

AIRPLANE Wheels for trailers! New surplus 19" (overall) tire, tube, wheel; bearings; 1" axle size. \$17.95, four sets for \$59.95. No C.O.D.'s. Aero Parts Supply, Municipal Airport, Houston, Texas.

BUILD Folding camp unit. Compact, neat, sleeps four. Attaches to box trailer or pick-up truck. Plans \$1.00, or write for information on kits. C. W. Gray, 600 16th Street, Oakland 12, California.

TRAILER Book. Plans, drawings, instructions, parts list to build five different trailers to 30 ft. \$2.00. New circulars 20c. Craftsmann Books, Box 1153, Milwaukee 1, Wisconsin.

TRAILER Plan catalog—All types, house, camp, boat, etc.; including complete line trailer parts and accessories, plus booklet, "Trailer Building;" send \$1.00. Marine Mart, Buffalo 7-B, New York.

ACTUAL Photographs and plans for 12' camp and travel trailer \$1.00. Exceptionally roomy. Trails perfectly. Ed Christensen, Box 687, Thief River Falls, Minn.

TORKSPRING Axle assures low center gravity, swayless action. Install on new or old trailer. S. H. Edwards, Inc., Richmond, California.

BUILD Your own trailer! Save money! Have every feature you want!—Plans for house, sport, camp and utility trailers. Catalog describing 9 models 10c. 15c in Canada and overseas. Jim Dandy, Box 125-A, Wausau, Wisconsin.

MOTORCYCLES, BICYCLES, MOTORSCOOTERS AND SUPPLIES

NOW Available for all 1945-46-47 American Moto-Scoots, Bendix generator, sealed beam headlight with attachments. Give model when ordering. Genuine Moto-Scoot parts also in stock. American Moto-Scoot Co., 1323 W. Carroll Ave., Chicago 7, Ill.

1937 **MOTORSCOOTER** Complete \$35; 1931 Harley \$20, poor engine; Whizzer motorbike motor \$25; Harley single engine \$4; Maytag \$3; over 6300 small tires \$1 up; plenty brand new Regal motorscooters \$37.50 less motors; plenty new midget cars. Send 25c for Big War-Bargain Catalogue Number 27, just out, listing these and hundreds of other bargains in motorscooters, midget racers, outboards, power mowers, engines, etc. (35c by first class mail). Midget Motors Directory, Athens, Ohio.

SIX H.P. Fairbanks engine \$40.00. Three speed motorcycle transmission \$12.50. Factory built scooter, \$75. 1 1/2 h.p. Clinton motor \$30.00. Professional race cars and many other bargains. Send 25c in coin for bulletin. Behnke's, Dept. B, 5721 Leland, Chicago 30, Ill.

RECONDITIONED Motorcycles and motors. Chromium accessories. Complete stock Indian parts. Expert rebuilding. Fast service. Indian Motorcycle Sales, Kansas City 1, Mo.

JET Propelled bicycle. Assemble your own. Photo and instructions \$1.00. Refunded on engine purchase. Rush order. Maupin, Tipp City 5, Ohio.

BICYCLES, New \$29.95. Chains, Bulletin 10c. Century, 3447 Lawrence, Chicago.

MOTOR Scooters, bicycle engines. 120 miles gallon. Dime for catalog. Clymer, Desk A-105, 1268 So. Alvarado, Los Angeles 6, Calif.

BOYS—All bicycle repair secrets revealed. Illustrated "Bicycle Repair Manual," \$1.00. Klausner Cycles, Shelbyville, Illinois.

HARLEY-DAVIDSON Parts, accessories, oil, expert service. Tires all sizes. Rebuilt 45" motors. Send \$2.25 for Army 45 Motorcycle Manual. 25c for accessory catalog and bulletins. Knuth's (Harley-Davidson Dealers), 2491 Fondulac, Milwaukee, Wis.

WHEELS! Build wagons, scooters, mowers, trailers, wheelbarrows, grocery carts, baby carts, play pens, baby carriages. 4" to 16". Free list. Trulsen Mfg. Co., 811 E. 31, Kansas City, Mo.

BICYCLE Supplies wholesale, retail. List 10c. Universal, 4713 Virginia, St. Louis, Missouri.

MOTO-SCOOT \$35. Midget racer \$15. Indian motorcycle \$30. Cushman motor-scooter with extra tire \$20, motors \$3 and up, homemade motorscooter \$10. Send 25c for new catalog listing these and many other sensational bargains in used motors, wheels, tires, motorscooters, midget cars, motorbikes, etc. Associated, Box 1764-CS, Toledo, Ohio.

MIDGET Car with three-speed transmission \$35. Cushman motorscooter \$15. Shaw bicycle motor \$15. Harley-Davidson motorcycle \$15, motorbike outfit \$15. Rush 25 cents for special new catalog listing amazing bargains in motorscooters, used motors, tires, parts, midget cars, etc. Gall, 538 Erie, Toledo, Ohio.

MOTORCYCLE News, monthly. Yearly subscription \$1.00. Latest worldwide information. Motorcycle News, 5424-A Sawyer, Chicago 25.

TIRES And industrial wheels, suitable for scooters, wheelbarrows, farm equipment, etc. All sizes. Bicycles and accessories. Largest assortment in America. Send dime for list. Cycle Transport Company, 1241 So. Michigan Ave., Chicago 5, Illinois.

HARLEY-DAVIDSON Parts, accessories, batteries, and tires, 24 hour service. Authorized factory dealer. Philadelphia Harley-Davidson Company, 857 North Broad Street, Philadelphia 23, Penna.

AVIATION

PROPELLERS—2-3 Blade. Sleds, air-drive boats. Standard Aircraft, Box 387, Ft. Worth, Texas.

STEEL Tubing for snow sleds. Turnbuckles. Big discounts. Karl Ort, York, Penna.

PROPELLERS, Plans for ice sleds, snow sleds, air boats, Catalog 10c. Banks-Maxwell, Ft. Worth.

LIGHTPLANE Blueprints. Circular designs, motors, 20c. Craftsman Books, Box 1153, Milwaukee 1, Wisconsin.

VETERANS: Flight training under the G. I. Bill. Tuition paid. Private, commercial, flight instruction, instrument and multi-engine ratings. Opportunities to work for living expenses or tuition, if not a veteran. Write Gottschalk School of Aeronautics, Adrian, Mich.

FAMOUS "Zweng" books include Mechanic's Ratings \$3.00; Flight Engineer \$4.00; Flight Dispatcher \$4.00; War Surplus releases; Fairchild Sextants \$12.50; Link Sextants \$17.50; Astro compasses \$7.50; F8 aerial cameras \$139.00. (Free catalog). Pan American Navigation Service, 12021-C, Ventura Blvd., N. Hollywood, Calif.

ELECTRICAL SUPPLIES

OIL Lamps—Make money converting to electric. All parts shown in illustrated catalog 10c. Speedy 24 hour service from largest stock in country. Gyro Lamps, 6416P Clark, Chicago 40.

LAMPS—Build own originals, parts wholesale any amounts. Catalogue 10c. Brown Lamp Co., Box 501, Weiston, St. Louis 12, Mo.

TWO Alnico (V) magnets, booklet, literature, 25c. Terry Sales Company, 1915-23 Nebraska, Toledo 1, Ohio.

ELECTRIC Pencil: Engraves all metals. \$1.00. Beyer Mfg., 229-H Dixon, Uniontown, Penna.

"CONSTAVOLT" Selenium rectifiers! Full voltage at full load. New! Automatic! Free booklet. Lectralabs-3, Wakefield, Rhode Island.

ELECTRIC Pencil—Writes, engraves all metals, 110 volts. \$2.95 postpaid. Battery model \$1.00. Reb Industries, Elmhurst 4, Illinois.

FREE Catalog—Motors, welders, welding supplies, generators, fencers, electric mowers, freezers, other electrical items. LeJay Company, Minneapolis, Minn.

WESTINGHOUSE, General Electric, dynamotors. D.C. input 28 volts; D.C. output 575. Each \$4.75. Wilt, 7829 S. Racine Ave., Chicago 20, Illinois.

LAMP Parts wholesale. Large variety available for building, repairing, or remodeling. Order in any quantity. New 1948 catalog 10c. Gearon Company, 27 South Desplaines, Chicago.

LELAND Electric generators, 2.5 kva, 120 volt, 60 cycle, single phase with radio filter. Turns at 1800 r.p.m., producing 2500 watts, \$125.00 freight prepaid. Hopper & Company, 3124 East 14th Street, Oakland, California.

WATTHOUR Meters. Reconditioned G.E., West., 115 v. \$2.95. T. Price, 310 14th, Raymond, Wash.

WELDING, SOLDERING, PLATING

WELD! Do your own work. Save time and money. Make money. WC-25 professional-type, portable Gasweld welding outfit for home, farm and shop jobs. Complete \$72.00. Handles any gas welding operation. Includes: 24-oz. gooseneck torch, four tips, oxygen regulator, acetylene regulator, goggles, hose, safety spark lighter, combination wrench, instruction book. Money back guarantee. WC-20 cutting attachment, \$20.00 extra. Order now. Wall Chemicals Division, The Liquid Carbonic Corporation, Dept. PM, 3110 South Kedzie Avenue, Chicago 23, Illinois.

WELDERS 110V. Welds 1/2" steel \$32.50. Morris Welding Service, 1850A State, Schenectady 4, N. Y.

ACETYLENE Welding outfits, new, \$54.50; arcwelders, Eagle Welding, Dept. PM, 5085 Broadway, Chicago 40, Ill. Distributors wanted.

WELDERS!—New portable Champion special transformer welder; 110/120 volts, a.c. 8 heat stages. Welds, brazes, solders, cuts all metals. Complete with electrode holder, helmet, rods, carbons, fluxes, cables. Also special flame weld torch. Easy to use. Full directions. Splendid for shop, farm and home repairs. Guaranteed. Only \$27.50. Also resistor model, now \$14.95. Magic Welder Co., 239 MP Canal St., New York, N. Y.

BUILD Your own arc welder—Save money. Welder transformer parts kit only \$16.95. Easy to assemble and operate. Simplified instructions furnished. 75 ampere capacity from 110 volt line. Build or repair auto, home appliance and farm implements for yourself and others. Does brazing, soldering, welding, cutting. Write for free particulars. Order today. Money refunded if not satisfied in 30 days. Dynamic Welder Co., 17 E. 23rd St., TY Chicago 16, Ill.

NEW U. S. Navy surplus regulators. Harris 2 gauge polished brass oxygen regulator \$10.95 each. Milburn 2 gauge polished brass acetylene regulators \$10.95 each. Trindl 125 amp. combination 110-220 v. electric welder with accessories \$62.50 ea. 50 ft. lengths 1/4" twin welding hose with connections \$11.95 ea. 25 ft. lengths 1/4" twin welding hose with connections, \$5.95 ea. Satisfaction guaranteed! Universal Machinery Co., 1120 W. Jackson Blvd., Chicago.

OXY-ACETYLENE Small cylinders for farm use sold by largest Linde mail-order distributor of Purox welding and cutting apparatus & Oxweld supplies. Freight prepaid in U. S. Free literature. A-A Welding Supply Company, Dept. E, 9228 South Ada Street, Chicago 20, Illinois.

RECTIFIERS: Ramyr Selenium platers, 10, 30, 50, 100 amp. sizes. Immediate shipment. Complete line of bronze baby shoe mounts. Write for list. Hollywood Bronze Supply, 1770 N. Vermont, Hollywood 27, Calif.

WELDING—A profitable trade. Demand for trained men. Learn quickly at best equipped school in U. S. G.I. approved. Free catalog. Write Hobart Welding School, Box M-1085, Troy, Ohio.

"BUILD-UR-OWN" Portable arc welder. Save \$350. Easy with Hobart generator plus auto engine. Free instruction book. Write Hobart Welders, Box M-1084, Troy, Ohio.

OXY-ACETYLENE Welding outfit—New. Includes everything: two full oxygen and acetylene cylinders, torches, goggles, lighter, regulators, hose, welding rod, and carrying case. Only \$89.75. Cylinders refilled anywhere. Ideal for hobbyists, garages, repair shops. Guaranteed. Burdett Oxy-Weld Co., 3397 Lakeside Ave., Cleveland 14, Ohio. Welding supplies since 1923.

OWN Mirror shop. Resilver mirrors. Glass sign making. Electroplating. Supply prices. John Sprinkle, V55, Marion, Indiana.

MACHINERY, TOOLS, SUPPLIES

BACK Geared metal and wood cutting 12" band saw. 6" jointer, ball bearing, 47" long. Ball bearing spindle shaper, 15" x 20" table. 8" tilting table, ball bearing, bench saw. Lowest priced line of high grade tools on market. Free catalog. Dealers wanted. Backus Machine Co., Boyd, Wisconsin.

SANDING Belts, 6" x 54 1/2", new; for wood, plastics, metals, 37c. Ranix, 5736 Calmont, Ft. Worth 7, Texas.

FIRE Extinguisher, C-O-2; new 15-lb. hoses, 36"-1 1/4"-1 1/4" females; sample \$2, dozen \$20. Fess-Co., 98 Vermont, Newark 6, New Jersey.

16" AND 26" Size jigsaws. Ten dollars and fourteen dollars. Mail money order. Shellington Machinery, 2055 W. Hunting Park Avenue, Philadelphia 40, Penna.

SAW Jointer—Perfection without file 50c. Simple, Route 7, Palestine, Texas.

WAR Surplus in small tools for machine shop. Send 15c for bulletin. Travers Tool Co., Dept. P, 5 Court Square, Long Island City 1, N. Y.

SMALL Parts sorting boxes. Sturdy, plastic 3 1/2" x 2 1/2" x 3/8" friction slipover covers. Eight boxes; assorted colors; dollar postal note. Stampade, 1221 Huron, Cleveland 15, Ohio.

BUY Tools, equipment, supplies, wholesale. Lists free. Homecrafters Co-operative, Grand Rapids 6, Michigan.

ATLAS Lathe, \$45. Miller, \$35. Cutters, 25c. Machinery, Newfane 2, Vermont.

GLASS, Ceramic hand drill 1/8, 1/4, 3/8. \$1.00 each. Special fluid provided. Make vases into lamps, mount mirrors, glass, dishes, fixtures. Dealers invited. Lavern's Tools, Box 7, Caldwell, New Jersey.

BALL Bearings one-fourth list price. Free list. Burgess, Box 168, Ferguson, Mo.

10" BANDSAW, \$17.95! "World's lowest-priced!" Designed for hobbyists, home craftsmen. Many highest-priced features. Investigate! Free illustrated literature. Acro, 4610 Alaska, St. Louis 11, Missouri.

QUICK Change sander, fits any electric drill \$1.95. Circular, Wasco Manufacturing, Box 111, Blue Island, Illinois.

FOOTSWITCH—Operates all power tools. \$3.95; two for \$6.50 postpaid. Reb Industries, Elmhurst 4, Illinois.

YOUR Own machine shop will save time and money on your repairs. Your neighbors work will pay you \$2-\$3 per hour. Our surplus machines are accurate, low-priced and delivered at once. Screw-cutting engine lathes \$150 and up. Powerful upright drill press from \$110. Milling machines \$150, some higher. Shapers, welders, band saws, grinders. Our guarantee: Satisfaction or your money back. Conversion Parts Co., 278 Adams St., Boston 22, Mass., U. S. A.

DRILL Grinder for twist drills, \$3.95. See ad on page 306.

INSTRUCTIONS For perfect tapping, simple, saves time and taps. 25c. Chas. Carvo, 6080 Dequindre, Rochester, Mich.

\$2.85 POSTPAID. Big box, over 2000 mixed steel cadmium plated machine screws, nuts, washers, etc. Meltz Aircraft. New Brunswick, N. J.

CHUCKS. (Genuine Westcott) Independent, Universal, threaded 1 1/2"-8 for South Bend, Atlas, Logan, Clausing, Craftsman lathes. Also other chucks to 16". Top value. Free literature. Westcott Chuck Co., 3600 Walnut, Oneida, N. Y.

HOME Lathe owners—Build your own attachments. Send for picture, sample of work and list of blueprints. Cut gears, ratchets, etc. Make neat screws easy way. The Home Shop, 415 Raymond Ave., Glendale 1, Calif.

CONCRETE Block machines \$39.50 up. Catalog free. Concrete Machine Company, 5466 Gravois, St. Louis 16, Missouri.

10" BAND Saw; latest design; cast aluminum; guaranteed. Only \$29.95. Send for free circular. Raymond Tools, 1305 Glenwood, Minneapolis 5, Minnesota, Dept. PM-10.

BOATS, OUTBOARD MOTORS

BUILD Your boat now. Knock down kits. Save time and money. Simple and enjoyable. Outboards, inboards, sail, racing. Send dime for literature. Brooks Boat Company, Carrollton, Michigan.

TWENTY Plywood boat plans 10c. Catalog boat building plans 10c. The Rudder, 15 Murray Street, New York 7.

MARINE Fir plywood for boat building. Send 10c today for complete stock and price list. Trans-Marco Corporation, 70 East 45th Street, New York, N. Y.

CANVAS Covers, war surplus, all sizes; tents, clothing, paints, camping equipment. Morsan, 10-15G 50th Ave., Long Island City 1, N. Y.

BARGAIN Catalog free. Marine supplies. New, rebuilt engines. Lind Supply Company, Coldwater, Michigan.

MARINE Reverse gears and air-cooled motors, propellers, shafts, etc. Complete kits or separately. Rowboats, outboards, inboards 14', 16' reasonable. Special discounts dealers and liveries. Free literature. Steffy Screw Products, New Baltimore, Michigan.

BARGAIN \$20. Make your own boat now with readymade streamlined laminated one piece hull as developed for Navy. Light, sturdy, leakproof. Anyone can convert into dinghy, outboard scooter, cartopper, other craft. 9' x 4'. Write Warwood, 480 Lexington, New York 17.

BOAT Steer wheels, windshield brackets \$8.95. Modern hardware kits, bargains galore. Folder. Marine, Box 681, Mendota, Minnesota.

OUTBOARD Motorboating handbook. 252 pages, 89 charts, drawings. Complete service information every make outboard. Greatest outboard book ever. Just published. \$3.50 postpaid. Clymer, Dept. A-OM, 1268 So. Alvarado, Los Angeles 6, Calif.

MARINE Plywood sheets (fir, mahogany, etc.) and boat building lumber. Send 25c (coin) for "Plywood Hints" with stock list. Marine Mart, Buffalo 7, N. Y.

CONVERSION Kits for Ford, Willys, etc. Also air cooled engines, clutches, vee drives and stern drives. Send 50c (coin) for catalog and booklet. "Conversion Hints." Marine Mart, Buffalo 7, N. Y.

BOAT Plans, kits. See display ads, pages 294 and 306. Marine Mart, Buffalo 7-B, New York.

BUILD Your own boat by the Welch System, ready cut parts. No experience necessary. Save 3/4 cost. Rowboats to cruisers. Illustrated catalog 25c. Midwest Boat Company, Menomonee Falls, Wis.

MARINE Fittings, accessories. Thousands of items (pictured, prices). Prompt delivery. Catalog \$1.00. Marine Mart, Buffalo 7-B, New York.

OUTBOARD Motors—Good values, used motors. Also used parts for most makes and models. Crandall-Hicks Co., 911 Commonwealth, Boston, Mass.

MARINE Conversions for Ford and Jeep engines. Catalog 10c. Lehman Manufacturing Company, Department D, Newark 2, New Jersey.

NEW, Used, rebuilt marine motors. Marine conversions, fittings. Free catalog. Stokes Marine Supply, Dept. 24, Coldwater, Michigan.

OUTBOARD Motor parts. New-used, all makes. New pistons (standard, oversize). Cylinders rebored. Outboard Motor Mart, 369 Atlantic Ave., Boston 10, Mass.

P-38 BELL Tanks. New, steel. 10 foot or 6 foot size, \$9.95. Anzio Boat Company, 89H, Merced 9, Calif.

P-38 BELL Tank speed boat, complete plans, instructions \$1.00. Twintank Boat Company, 1032 62nd St., Oakland 8, Calif.

BOAT Plans by graduate naval architects. Send specific requirements for free suggestions. Westlawn Associates, Montville 5, N. J.

BUILD Your own 25 ft. cruiser Sea Craft. Adaptable as a sport fisher, express cruiser or utility boat. Sleeps four. Has fresh-water tank, sink, galley. Set of 7 complete blueprints and descriptive booklet. The boat you have always wanted to build. \$10.00. Popular Mechanics Press, 200 East Ontario Street, Chicago 11, Illinois.

ENGINES, MOTORS, DYNAMOS

"BUILD-UR-OWN" AC welder and a.c. power unit combination. Welding, plus power to run tools, lights, motors, anywhere. Save \$350. Easy with Hobart generator plus auto engine. Free instruction book. Write Hobart Welders, Box M-1083, Troy, Ohio.

BARGAINS In war surplus hydraulic transmissions, switches, motors, geared speed reducers, aviation instruments, etc. Delta Sales, P.O. Box 968, Shreveport, Louisiana.

NEW General Electric, all purpose 1/2 horsepower motors, 115 volts, 60 cycles, splitphase, speed 1725, \$12.50. Plenge, 114 Elliot Place, Bronx, New York.

WINDING Data, listing 225 motors, single and three phase, \$1.00. Motor Data Co., Box 7631, Kansas City 3, Mo.

MOTORS! 1/2 H.P. D.C. converted to A.C. All new. High speed 110 volt, 25 or 60 cycle, ball bearing motors. Actual value about \$75.00. Now \$15.00 each or 3 for \$40.00. With forward and reverse switch \$19.50, 3 for \$50.00. Countless uses for home mechanics. Can be used in any position. Order today! Immediate delivery! No c.o.d. orders. "Amazing Bachman's," 27 Herman Street, Rochester 5, New York.

MOTOR Repair men, send for bulletins on motor winding tester and a.c. motor winder. Motor Industries, Quincy, Illinois.

ATHLETIC EQUIPMENT, BODY BUILDING COURSES

BARBELLS! 95 Pound set \$10.80; extra plates 10c pound. Send for free course and catalog. Bur Barbell Co., Lyndhurst, N. J.

THE Worlds strongest men are built by: The Key Institute of Physical Culture, Titusville, Florida.

DEADLY Judo—Fiercest fighting technique. Trick knockouts. (200 photographs, plus illustrations.) Expert instructions, three volumes. Complete \$2.25. Variety House, Box 46-B, Wall Station, New York 5.

BARBELLS, Exercise equipment. Courses. Free booklet. Good Barbell Co., Reading, Penna.

SPORTING GOODS, GUNS, FISHING TACKLE, ARCHERY, TRAPPING

NYLON 3/16" Braided cord 550 lb. test. Will not mildew or rot. Marvelous durability. A must for campers, hunters and fishermen. Ideal for tents, tarpaulins, packs, decoys, trolling, trot line and a thousand other purposes. 75-ft. hank \$1.00, postpaid. All multiple hanks connected. White or khaki. Sorry no C.O.D. Beebe Cordage Company, Inc., Dept. 2, Cranford, N. J.

NINE Guns in one—With a Poly-Choke on your favorite shotgun. More than 15,000 installed by us. Satisfaction guaranteed. New ventilated model \$18.75; standard Poly-Choke \$14.75, installed. 3-day service. Write for new fall catalog. Andy Anderson's Sporting Goods Co., 120 W. Grand, Oklahoma City 2, Okla.

180 PAGES Antique and modern pistol, sword, etc. values, 50c. Robert Abels, A860 Lexington Ave., New York 21.

SEND For new Fall sports catalog of hunting, fishing and gift suggestions for sportsmen. Andy Anderson's Sporting Goods Co., 120 W. Grand, Oklahoma City 2, Oklahoma.

AMMUNITION—Most complete stock in Middle West. Dime for list. Central Sports, Delphos 5, Ohio.

SEND 10c For list 100 used guns. Frayseth's. Willmar, Minn.

GOLF Clubs, new, 5 irons, 2 woods, bag, \$34.50. Turnipseed, Inc., Box 681, St. Louis, Mo.

FELT Letters anyone can sew on athletic uniforms. Adhesive backed. Sample. Modern Embroidery & Felt Lettering Co., 815 1/2 N. 8th, St. Louis 1, Mo.

SHOTGUNS, Rifles, revolvers, over 500 modern, obsolete. Also cartridges, list 10c coin. Ed Howe, 52 Main, Coopers Mills, Maine.

SHOOTERS: Handload your own ammunition. For full information send 50c for a copy of the B & M book "Handloading Ammunition." Circular free. Belding & Mull, Box 428B, Philipsburg, Penna.

SHOTGUNS, Rifles, handarms, ammunition, rods, reels. List 10c. Rudolph's, Atchison, Kansas.

5000 BARGAINS, Firearms, binoculars, war relics. Catalog 40c. Smith Firearms, Runnemede, New Jersey.

BOWS—Arrows, write headquarters for archery equipment. Quality products. Popular prices, catalog 10c. Large illustrated handbook instructions, aiming and shooting, 50c. Archery, 617-B So. State, Chicago 5.

TAXIDERMY

FINEST Glass eyes; taxidermy supplies. Catalog free. Elwood Company, Department 234, Omaha 2, Nebr.

BINOCULARS, TELESCOPES, MICROSCOPES, MAGNIFIERS

TELESCOPES And binoculars—Saturn, coated 20x telescopes, \$25.00, guaranteed. Tinsley Laboratories, Department 40, Berkeley 4, California.

GOVERNMENT Surplus. Terrific bargains, telescopes, binoculars, lenses, prisms, send stamp for catalogue. H. Jaegers, 123-26 Rockaway Boulevard, South Ozone Park 20, New York.

BUILD Extraordinary reflecting telescope. Principle of 200" Mount Palomar. Complete optical parts including fully polished and aluminized mirror, eyepiece lenses and flap. 3" (40 power) \$6.00; 4" (60 power) \$10.00; 5" (80 power) \$15.00. Simple instructions. Sharp, clear definition guaranteed. Also spotting and bird use. Thousands satisfied makers. Do not confuse with inferior items offered at any price. Bulletin 10c. Ross, Section C, 68 West Broadway, New York, N. Y.

BINOCULARS, Gun scopes, spotting scopes, camera lenses, 20% to 50% increased visibility by hard coating your optics. Eyeglass and custom coating. Binoculars, gun scopes, bought, sold, exchanged, condition unimportant. Write for details. Optical Coating Laboratory, Inc., Dept. 4, 711 Eighth N.W., Washington 1, D. C.

GIANT Astronomical telescope 100 diameters magnification, with tripod. Full power, clear vision. \$15.00. Suffolk Science Service, Manorsville, N. Y.

POWERFUL Astronomical telescopes easily made. Perfect lenses and instructions; 100X \$3.00, 100X and 200X \$4.00, 100X, 200X and 400X \$6.00. Clear vision, full power guaranteed. Instructions alone 10c. Suffolk Science Service, Manorsville, N. Y.

BINOCULARS, Telescopes, watches, guns. Buy, sell, trade. Schweer's, Donnellson, Iowa.

ASTRONOMICAL Telescopes, binoculars, microscopes; bought, sold, repaired. Books. Lists 10c. Rasmussen-Reece, Amsterdam, N. Y.

TELESCOPES, Binoculars, microscopes, big bargain catalog free. Brownscope Company, 24 West 45th Street, New York.

DOGS, PETS, BIRDS, RABBITS

MINK Raising information free. Complete. Lake Superior Mink Farm, Superior, E.E.I. Wisconsin.

BEAUTIFUL, Pure white pedigreed police puppies. Ansonia Kennels, Mose, N. Dak.

MAKE Extra cash. Raise giant chinchilla rabbits. Waters Rabbit Farm, Glennville, Ga.

RAISE Guinea pigs. Make money at home. Big demand. Booklet free. Taylor, Box 426A, Hapeville, Georgia.

REPTILE Bulletin 5c. New catalogue: pets, hobbies, supplies, 10c. Chameleon 25c. Quivira Specialties, Topeka, Kansas.

RAISE Chinchilla rabbits. Year-round money-makers from furs, meat, breeders. Experience unnecessary. Folder 25c. Willow Farm, Sellersville 15, Penna.

RAISE "White Satin" rabbits, meat and fur. "Golden Hamsters" pets and laboratories. Free information. Pem's Rabbitry and Hamstery, 3010 10th Ave. No., St. Petersburg 6, Fla.

GOLDEN Hamsters, profitable, interesting, adult trio \$7.00. Robert Probert, Box 315, Valdosta, Georgia.

\$250.00 MONTHLY Raising angora rabbits. Particulars free. White's Rabbitry, Newark, Ohio.

ANGORAS, Giant Chinchillas, White Giants. World's most profitable rabbits. Finest pedigree, heavy-producing, prize-winners. Literature free. Grinsteads, Edwardsville, Illinois.

\$50.00 WEEKLY Raising Angoras for us. Free literature. Angoraville, 1215-34th Northeast, Cedar Rapids, Iowa.

MINK Raising amazingly profitable. Free folder gives inside "secrets" on feed; care. Lawrence Moigard, Brigham City 12, Utah.

RAISING Rabbits, cavies, hamsters, chinchillas is profitable. Big demand. Magazine 10c. Instruction book and magazine 25c. Book and magazine (monthly) one year, \$1. Address. Small Stock Farmer, Fairlawn 2, New Jersey.

INCREASE Your income by raising domestic rabbits. Small space needed. Ready market for delicious meat, fur and wool. Largest magazine in the industry tells you how. \$1.50 per year. Sample 15 cents. No stamps. Small Stock Magazine, Lamoni 20, Iowa.

\$3000 YEARLY Raising Angora rabbits. We buy your output. Contract particulars free. Kise's Enterprises, St. Paul 8, Minn.

PLANTS, SEEDS, NURSERY AND GARDEN SUPPLIES

GLADIOLUS—New varieties, novelties, list. Robinson, Box 31, Sebastopol, Calif.

FREE Cacti; three different rare blooming size dwarf cacti, including Mexican two-colored cactus. Send 25c for mailing and handling. Cactus Tex., Edinburg, Texas.

FARMS, FARM LANDS, REAL ESTATE

UNITED'S Fall catalog—Bargains galore! Farms, ranches, groves, businesses, homes. Exciting, free catalog of up-to-the-minute values. Great Lakes, midwest, famous Ozarks, to California. America's biggest bargains. Write for free copy today. United Farm Agency, 1408-PM Consumers Bldg., Chicago 4, Ill.

WEST'S New picture catalogue, describes 1000 farm and business bargains. Free. West's Farm Agency, HE-19, Pittsburgh 17, Pennsylvania.

CHEAP Homes: Stock, dairy, garden, fruit, poultry farms, for retiring strong, sick, folks, for hunting, fishing, long life, health, happiness, in scenic, mild, Ozarks, write G. W. Starr, Ozono, Ark.

FREE Farm lands now available in sunny Florida. Only 25c brings full details, including method of application. Century Publications, 5803½ Central Avenue, Tampa, Florida.

OZARK Magazine, Eureka Springs 11, Arkansas. For homeseekers, tourists. Year, \$1.50.

650 FARMS, Ranches, water frontage properties. Free descriptive folders, price lists. Splendid opportunities. Washington, Idaho, Montana, Dakotas, Upper Michigan, Wisconsin, central corn belt. Information regarding Columbia and Missouri River basin irrigation projects. L. H. Robbins, Milwaukee Railroad, 736K Union Station, Chicago 6, Illinois.

GOVERNMENT Lands \$2.00 acre up. Information all states twenty-five cents. National Tax Service, 834-A Majestic Bldg., Detroit.

JUST Out! Strout's new fall-winter farm catalog—Free! Red cover. Chock full of bargains coast-to-coast. Eqp'd. and uneqp'd. farms, groves, retirement places, etc., etc. Write today for your free copy. Strout Realty, 255-P 4th Ave., New York 10, N. Y. 20 W. 9th St., Kansas City 6, Mo. 453 S. Spring, Los Angeles 13, Calif.

\$5.00 MONTHLY Buys 40 acres, near town. Price \$200.00. Free list. Box 425-P, Carthage, Mo.

LOTS \$300—Convenient payments. California's finest garden section. On Morro Bay's scenic shores. Wonderful fishing, hunting, boating, bathing. Fertile soil, softest water, temperate climate, congenial community. Free literature. Richard Otto, Department M, San Luis Obispo, California.

GOOD Farms—Ranches, Washington, Minnesota, Montana, Idaho, Oregon, North Dakota. Dependable crops, favorable climate. Write for literature, lists describing typical farm opportunities. Specify which state. J. W. Haw, 119 Northern Pacific Ry., St. Paul 1, Minn.

OZARK Lands for all purposes. Actual river frontages. 5 acres \$90.00 and upwards. Free list and literature. Hubbard, 424-I Minnesota Ave., Kansas City 4, Kansas.

POULTRY, FARM SUPPLIES

RAISE Fryers new easy way. One man home plant earns \$500 monthly. Details free. Fortune Fryer Farm, Box A, Simi, California.

EARN \$4 To \$12 hourly. Chick and turkey sexing, culling and caponizing—G.I. approved. Pilch's School, Box P.M., Thompsonville, Connecticut.

KNOW How to raise poultry for profit. Read Northeastern Poultryman. Every issue packed with helpful hints and practical suggestions. Latest articles on breeding, feeding and management. Subscribe now. 1 year 65c. 2 years one dollar, foreign subscriptions \$1.00 a year. Northeastern Poultryman, Dept. P.M., 376 Boylston St., Boston 16, Mass.

PROFITABLE OCCUPATIONS

PERFUME Handbook. Secrets of making, selling, perfumes, cosmetics. \$1.00 postpaid. Edward Lawson, 10-21 Joiner Street, St. Augustine, Florida.

YOU Can make real money raising Golden Hamsters, the new amazing tiny animal. Food costs less than 10c month per animal. Breeds in 18 days! Easily raised in basement, attic, garage, barn, or shed. Write for convincing details. Hudson Hamstery, R.F.D. #1, Newfoundland, N. J.

START Lamp business in your home, basement, garage. Profitable, fascinating, easy to learn. Illustrated course teaches you. General instructions and wholesale catalog, \$1.00. Gearon Company, 27-F South Desplaines, Chicago.

MAKE Liquid marble, artificial marble flooring, flexible molds, statuary, art goods, novelties. Literature free. Kemico, Park Ridge 50, Ill.

PROFITABLE Business making and building with easy-laying interlocking building blocks. Rex Products, Dept. 10, Piqua, Ohio.

START Your own business on our capital. Always your own boss. Hundreds average \$6,000 to \$25,000 annual sales year after year. We supply stocks, equipment on credit, 200 home necessities. Selling experience unnecessary to start. Wonderful opportunity to own pleasant, profitable business backed by world-wide industry. Write Rawleigh's, Dept. J-U-PPM, Freeport, Ill.

NOVELTY Manufacturing at home pays big profits. Excellent opportunity, orders waiting. Plastex Products, 711 Laguna, San Francisco.

EXTRA Money at home casting silver rings? Free details. Lauckner, 624-2A SW., Gt. Falls, Mont.

MUSHROOMS Grown. Boxes. Barrels. Instructions 50c. Spawn \$1.00. Manureless composting process \$2.95. Gordons, 553 William, Winnipeg, Manitoba.

JUNK Is gold. Start own scrap yard. Profitable exclusive franchises available. Small capital. Write Scrapco, Box 32, Rock Island, Ill.

MAKE Money raising bees. Wonderful spare time hobby explained in 96-page booklet "How to Succeed with Bees." Illustrated. Only \$1.00. Popular Mechanics Press, 200 East Ontario Street, Chicago 11, Illinois.

FREE Particulars on 100 easily made cleaners and soaps. Brown, 9111-m Hoyne, Chicago 20.

AUSTRALIA! Opportunities, wages, prices, etc. Latest, complete authentic report by Ex-G.I. migrants, \$2.00. Box 1360, San Francisco, Calif.

VENETIAN Blinds! Easy, profitable, full or spare time business. Small capital. Construction blueprints, instructions, supply sources \$1.00! Hunter, 2172 Green, Cleveland 21, Ohio.

FIX Typewriters, full or part time. Inexpensive copyrighted home study course quickly trains you for high earnings. Factory methods cover all phases with drawings and illustrations. No curiosity seekers. Typewriter Repair, 9915 Corbet, Tarentum, Pennsylvania.

LOCKSMITHING Secrets—Key fitting, lock opening, repairing, prices to charge, supply sources. Illustrated book only \$1.00. Wechsler Supply, 7 W. 36, New York City.

WOULD You pay 3%—first \$350 made? Color-illustrated book "505 Odd, Successful Enterprises" free! Some offer occasional "day off." Work home. Expect something odd! Pacific, Oceanside, Calif.

\$40.00 WEEKLY Made growing mushrooms, fresh, dried. Dominion patent 331583. Free spawn. North American, 169P Yonge, Toronto, Canada.

OWN Mirror shop. Resilver mirrors. Glass sign making. Electroplating. Supply prices. John Sprinkle, V50, Marion, Ind.

BE The Popular Mechanics representative in your neighborhood and earn big profits in your spare time. Write Popular Mechanics Magazine, Room 408M, 200 E. Ontario St., Chicago, Ill.

INTERESTED in Latin American and foreign employment? \$1.00 brings Foreign Service Directory listing exporters and importers, oil, construction, mining, aviation companies. Hot tips for applications. Global Reports, Box 883-M, Hollywood 28, Calif.

OPERATE A letter shop. Unlimited opportunity. Send for free prospectus. Dougherty, 255 Washington, Phillipsburg, N. J.

HYDROPONICS, Soilless vegetables, cheap chemicals. Free information, Box 57B, Bristol, Virginia.

ALASKA—The Last Frontier offers unlimited opportunities. \$1 brings government map and directory listing firms in fishing, construction, mining, aviation, fish and game rules, homestead data. Alaska Opportunist, Box 883-M, Hollywood 28, Calif.

TYPISTS—Profitable business at home. Complete copyrighted information, 50c. Gaunt, 3521A Broadway, Chicago 13, Ill.

BOOKS, PERIODICALS, PICTURES, POSTCARDS

FREE Folder describes special offering six exquisite, colorful bird, flower and fashion prints. Mail postcard now. The Oxford Company, Gramercy Place, San Antonio 6, Texas.

SELF-EXPLAINING Bible: illustrated circular free. Box 446-P, Minneapolis, Minn.

BOOKS—Out-of-print. Rare. Hard-to-find. Banker Book Co., Dept. 4, 13518 Contour Dr., Sherman Oaks, Calif.

BACK-DATE Magazines. Books. Specific issues; years. Arkell's, Tarzana 1, Calif.

PLEASURE Profit book list free. Johnson, Box 49, Astoria Station, Long Island City, N. Y.

WE Can supply you with almost any book. (Magazine subscriptions). House of Kilroy (Booksellers), Box 772, Detroit 31, Mich.

EASY Profits taking magazine subscriptions, handling greeting cards. Full details free! Cassell Publishers, Westfield, N. J.

EXCITING And strange books. Send 25c (coin) for catalog and private collector list. Rare Book Co., 1219½ North La Brea Ave., Hollywood 38, California.

BOOKS On health, religion, science, writing, salesmanship, education, romance. Catalogue of 150 hard to get books free. Davis, 607 Rialto, Venice, Calif.

MAKE Extra cash taking friends' magazine subscriptions at home and office. Details and confidential wholesale price-list #10 free. General Circulation Co., Inc., 1311 Widener Bldg., Philadelphia 7, Penna.

BE Your own long range weather forecaster 50c. W. C. Ewert, 4411 Greenview Ave., Chicago 40, Illinois.

BOOKS For sportsmen. Hunting, fishing, all sports, games. Lists free. Kennedy Publishing Co., 15 East 40th St., New York, N. Y.

ARCHITECTURAL, Building, art, handicraft books, catalog 10 cents. Artcraft, 6827, Baltimore 4, Maryland.

NOW You can "borrow and prosper!"—Amazing, truthful "money-secrets" that brought happiness to 13,000 typical families. 68 pages, by H. L. Edsall, \$1.00 postpaid. Box 115, Verona, New Jersey.

BARGAINS In old and rare American biography, history, misc. literature, etc. Free lists. Bookman, Box 3366, Grand Central Sta., Glendale, Calif.

BOOK Lovers! Send six fictions, good condition, with \$1. We return six different fictions. Robert Miller, 20 Kelly Pl., Springfield 4, Mass.

BOOKHUNTERS! All subjects. Send wants! Jaher Book Service, 620-P East 178 Street, New York 57.

BOOKS—All Kinds—Homecraft, Radio, Plastics, Boat Building, Photography, Model Building. Catalog free. Popular Mechanics Press, 200 E. Ontario St., Chicago 11, Ill.

GAMES, ENTERTAINMENT

FOOTBALL Fans! Enjoy "Gridplay," fascinating new game for adults and teen-agers. Simulates practically every situation of real football. You call your "team's" plays, match your football strategy against opponent's grid tactics. Satisfaction guaranteed. Send \$2.00 to Russell Oakes, Producer, Waukesha, Wisconsin.

MAGIC TRICKS, PUZZLES, JOKER NOVELTIES

FREE Trick with illustrated magic catalogue, 25c. Hall Magic, 345 John R. Detroit 26, Michigan.

TRICKS, Joke novelties of all kinds. Illustrated literature free. Rone's, Box 97, Katonah, New York.

HOWARD Thurston's card tricks only 50c. Specialty House, Box 542, Danville, Illinois.

WIZARD Aviator cards. Ten illustrated tricks. Send one dollar. John Swenick, 1139 North Kedvale Avenue, Chicago 51.

MAGIC Vanisher, booklet, catalog. All 10c. Wade Magic, 1423 Palou, San Francisco 24, Calif.

STAMP Brings free joker's novelty. Ideal Sales Co., P.O. Box 105, St. Johns, Brooklyn 13, N. Y.

4 POPULAR Card tricks 25c. Stivers, 40 Salem, Medford, Mass.

MAGIC Monthly, Year 25c. Sample and big magic catalogue free. Rubber banana \$1.50; rubber egg \$2; rubber light bulb \$2. Eagle Magic, Minneapolis 2, Minn.

EARN Big money! Learn easily how to be a magician. For complete information write Stallard Enterprises, 1888 Richmond Drive, Louisville 5, Kentucky.

ILLUSTRATED Catalogue 10c. Penny changes to dime 50c. DeLux Magic Studio, Box 2606, New Orleans, La.

COMPASSION Card is latest, funniest—but practical! Give to friends and enemies. Illustrated. Always appropriate. Carry several, wallet-size. Sample 25c. Box 2707, Paterson, New Jersey.

WORLD'S Largest professional magic shop, keeps you in touch with latest tricks. To receive mailings, send 50c for new catalog. Holden's, M220 West 42nd St., New York.

SNEEZING, Itching, powders. Eighteen other tricks free with joker's catalog 25c. 2404-N Fifteenth, Philadelphia.

VENTRILOQUISM Taught. 3c stamp bring particulars. Smith, 801 Bigelow, Peoria 5, Ill.

MAGIC Tricks, puzzles, books, cards, punch boards. Catalog 10c. Specialty, Box 671, St. Louis 1, Mo.

500 TRICKS. Send only 10c for Douglas' famous 112-page catalog 500 tricks. New magic for amateur, professional. America's fastest service for 25 years. Douglas Magicland, Dept. 1, Dallas, Texas.

BE A magician. Large professional magic catalog of latest tricks, 35c. Ireland, C-109 North Dearborn, Chicago 2.

LARGE Catalogue of the best magic for professionals and amateurs. Send 25c. Mazda Magic Co., 1135 Westgate Ave., Oak Park, Ill.

"VENTRILLO," Professional voice throwing instrument and "unusual" catalog 25c. POB-971, Philadelphia.

MAGICIANS' Headquarters. 400-page professional catalogue, pocket, parlor, stage tricks. World's finest magic. Send \$1.00 for catalogue (refunded first \$5.00 order). Kanter's, M-1311 Walnut, Philadelphia 7, Penna.

LEARN Magic, ventriloquism, mind-reading. Write for particulars. Quackenbus, Big Flats, N. Y.

BIG Magic magazine, trick and price lists—25c. Lloyd M. Jones, 4064 39th Avenue, Oakland 2, California.

DOLLAR Magic set free with Mammoth catalog 25c. "Mysto," 4462-PM Germantown, Philadelphia.

VANISHING Half dollar trick and catalog 25c. Sterling Magic Co., Royal Oak, Mich.

MAGIC List free. "Marean" Magic Shop, Box 551-R, Hopewell, Virginia.

200 ELECTRIC Stunts, 110 volts, \$1.00. Kutting Sons, Campbell, Calif.

TRICKS, Secrets, cards, punchboards, etc. explained. Big illustrated circular free. Mack, Box 1278-E, San Francisco.

COINS, TOKENS, CURRENCY

MONTHLY Price list for collectors who wish to buy \$rce and rare coins. Sample copy 15c. \$1.50 annually. James Randall, 116 South Michigan Avenue, Chicago 3, Illinois.

OLD Money wanted. Will pay fifty dollars for nickel of 1913 with Liberty head (no buffalo). We pay cash premiums for all rare coins. Send 4c for large coin folder. May mean much profit to you. Numismatic Co., Dept. 20, Fort Worth, Texas.

15 DIFFERENT African coins \$3.00; Rhodesian set \$3.00. Send dues in dollar bills, registered mail. Burnman, Kitwe, Northern Rhodesia, Africa.

FREE! Bus token with each 50c coin book. Bill the Coin Man, Elkhart, Indiana.

INDIAN Penny with catalog 10c. (Refunded.) Brunk Coins, 3530 Osceola, Chicago 34, Illinois.

35 WORLD Coins \$1.00. Harry Elsholz, Box 9014, Pittsburgh 24, Penna.

100 FOREIGN Coins \$4.00, postpaid. Parker, 1254 Market, San Francisco 2, Calif.

4 WHITMAN Folders \$1.00, complete stock. Foreign coin included with bargain price list, 10c. Little, 337 North Menard, Chicago 44.

100 COINS And bills, \$1.00. Oddehon, Box 482, St. Louis, Mo.

"SO You want to be a millionaire," course on coin collecting. Send \$1.00 for first lesson. Returnable. Alwick, 5437 Nagel, St. Louis 9, Mo.

FOREIGN Coins, 10 different 25c. Lists. Oliver Arnold, Macon, Mo.

20 DIFFERENT Indian head cents \$1.00. 4 Whitman coin albums \$1.00; handbook 75c; 254 page guidebook \$1.50. Our large retail catalogue 15c. Bebee Coin Company, 1180 East 63rd, Chicago 37, Illinois.

COINS Wanted, will pay up to \$2000 for certain coins, send 25c for catalogue. Burton's, 111 So. Third, Columbus, Ohio.

GET Profit and pleasure in collecting old coins. Send 10c for 56 page illustrated coin catalog. You'll be delighted with it. Send for it now. B. Max Mehl, 370 Mehl Bldg., Fort Worth, Texas. Largest rare coin establishment in U. S. Established 48 years.

FREE! Foreign coin, banknote and coin collectors illustrated catalog to approval service applicants. Send 3c postage. Tatham Coinco, Springfield-125, Mass.

COMMEMORATIVE \$1.25. Oregon, Texas, Kentucky, Cleveland, Long Island, \$2.00 ea. Illustrated catalogue 25c. Norman Shultz, Salt Lake 9, Utah.

4-IN-1 Special \$1.00 bargain offer: (1) United States 1893 Columbian world's fair half dollar; (2) album for holding coins; (3) large 56 page coin catalog; (4) genuine wooden nickel. Yes! All four items for only \$1.00. Order today. Money back if not pleased. Ben's Coin Company, 72 W. Washington, Chicago 2, Illinois.

STAMP COLLECTING

307 ALL Different 10c. You will find scores of new varieties here for your collection! Big and little stamps, bisected stamp, commemoratives, triangles, high values! Bicolored beauties! Strange countries! Every stamp is different. All for only 10c to approval applicants. Write today and receive special Ionian Island stamp extra. Garcelon Stamp Company, Box 400, Calais, Maine.

25 UNUSED Stamps, Pictorials, airmail, triangle, etc., only 3c with approvals. Paul Bauer, 31 Wilkshire, Lancaster, N. Y.

U. S. Price list free. S. Stone, Box 52-P, Dorchester 24, Mass.

66 DIFFERENT Stamps, including U. S. battleships, 6c. World wide approvals. Telic-Arts, Devon, Connecticut.

FLAG Set free; request approvals. Bill, 43 Lake Hunter, Lakeland, Florida.

20 U. S. Commemorative stamps, 10c. Ideal, Box 179, Park Ridge, Ill.

YOUR Choice! Complete Greek Roosevelt memorials or wind gods airmails, only five cents! (Both for ten cents) with approvals. Charles Ernest, 64 Wayne Terrace, Staten Island 10, New York.

FREE—Famous Americans set, plus Flag Set, plus the National Parks Set, plus the Presidential Set to the \$5. A total of 90 stamps absolutely free to customers for our unsurpassed U. S. or foreign selections. Send 3c postage for 15 of the above mentioned stamps and full particulars. Triboro Stamp Company, 145 Nassau St., Dept. 110, New York.

GREAT "\$5.00 Catalog price for 10c" offer! (1) Big collection of 112 all different genuine stamps from Africa, South America, South Sea Islands, etc. Includes airmails, triangle and animal stamps; many others. (2) Four scarce unused United States, catalog price 40c. (3) Fine packet 25 different British Colonies—Burma, Hong Kong, Solomon Islands, etc. (4) U. S. \$5.00 high value. Total catalog price over \$5.00! Everything for only 10c to approval applicants! Big lists of other bargains given. Crystal Stamp Co., Littleton 16, N. H.

LOOK! Nepal, idol, Soruth, lion, Borneo, oxen, Nauru, ship, San Marino, Roosevelt; scarce stamps from hard-to-get countries, plus 50 other good stamps. 5c to new approval applicants. Moulblow, 740 Hegway, Bronx 56, N. Y.

COLORFUL Chinese "victory" set, complete, mint, catalogs \$2.30, only 0c with approvals. Kalumet Stamps, 523 Detroit, Hammond, Ind.

VICTORY Packet free—Includes stamps from Tanganyika, British Cayman Islands, animal, scarce babyhead, Coronation, early Victorian, airmail, map stamps. Including big illustrated catalogue. Send 5c for postage. Gray Stamp Company, Dept. PM, Toronto, Canada.

FREE! Complete Balkan aviation set with approvals. Beaman, Leeds, Alabama.

A WORLD Of stamps for 10c! To obtain 1000 new customers for our approval service, we offer this stupendous bargain, stamps from every part of the world, airmails, pictorials, commems, etc. A fine lot of stamps for only 10c. Send your dime with your request for our bargain approvals now. Cosmopolitan Stamp Co., 1457 Broadway, New York City 18.

FREE! Mint British colonies from Solomon Islands, Caymans, Grenada, Dominica, Turks Caicos. Absolutely free to new approval applicants. Viking, 130-Z Clinton St., Brooklyn, N. Y.

AMAZING Stamp bargains build your collection. Sent on approval. Fast airmail service. N. H. Philatelic Ass'n., Inc., Deerfield 8, N. H.

SENSATIONAL! Set Capejuby, Brunel, Perak, Honduras, Paraguay, Nigeria, and over 100 different others. Everything 10c with approvals. D. O'Keefe, 7517 Merrill Ave., Chicago, Ill.

UNUSUAL Foreign first day covers. Wide selection of foreign covers from all nations. What are your interests? Sample selection of 3 diff. exotic foreign FD covers, \$1.00. Clyde J. Sarzin, 855 West End Ave., New York City 25, N. Y., U.S.A.

WEIRD—Pantastic. African carved images, leopards, etc., included in big packet Belgium and colonies stamps. 5c if you request approvals. Frazer, Box 4600, Portland 2, Oregon.

FIVE Large mint pictorials free to approval applicants. Postage paid both ways. Rush postcard to Phipps, 10993-M Wellworth, Los Angeles 24, Calif.

"PRISONERS Of war" set cataloging 60c for 25c. Approvals. Barricks, 247-A Langfield Drive, Buffalo 15, N. Y.

LIBERAL Premiums with carefully selected approvals. Wayne Bosley, Broken Bow, Nebraska.

GOYA Nude (2) 5c. Approvals. Hanay's, 310 Quail, Albany 3, N. Y.

35 DIFFERENT Greece or 100 different world, 10c. Reasonable approvals. Kingman, Highbridge Box 42, New York 52.

SEND 125 Different clean stamps for 125 all different. Job-Oyd's, 476 Metairie Road, New Orleans 20, La.

BREAKING Collections; medium, advanced super approvals. McWhorter, 6435 Green, Chicago 21.

GIANT Approvals, 500 penny stamps, 40 stamps 1 1/2c up. Beautiful sets. Wahl's Stamp Exchange, 7008P Farragut, Chicago 31, Ill.

300 DIFFERENT Given free with approvals. Postage 3c. Windsor Stamps, 1435 East 67th Place, Chicago 37.

AMERICAN Flags in colors on 3 gigantic 5-color airmails 5c. Townsend, 2036 S. 59th St., Philadelphia, Penna.

PENNY Approvals and sets. You'll like them. Stockers, Groton, Mass.

BREAKING Up large collections. Reasonable and unusual approvals. Strecker, 5725F Chester, Philadelphia 43, Penna.

ILLUSTRATED Stamp magazine, 26 weeks 25c. Stamp Journal, Kalamazoo, Michigan.

CANADA, Bell, citizen, princess 10c with attractive approvals. Rheaume, 8949 Routhier, Montreal 12, Canada.

STAMP Buyers' guide (Box 1649P, Oakland 4, California), plus 50 different Chinese stamps, for 10c.

128-PAGE United States catalog—1000 illustrations, 10c. Harris & Co., 202 Transit Bldg., Boston.

GORGEOUS Worldwide sets on approval. Gehling, 1834 Fuller, Philadelphia 15, Penna.

MARJAY'S Approvals! 1/2c up. Premiums! Box 14, Brevort, Brooklyn 16, N. Y.

U. S. Or foreign price list free. Slikes, 1831 E. Allegheny, Philadelphia 34, Penna.

REQUEST Free copy Southern Philatelist, stamps newspaper, 3240 NW 27th Avenue, Miami, Fla. 37.

MIXTURES. Worldwide. 1,500, \$1.00. Missions Outlet, Reverend Marshall, Paterson 1, New Jersey.

500 MIXTURE Stamps with prize set. 10c to approval applicants. Morrell Stamps, 203 Fenimore St., Brooklyn 26, N. Y.

AMAZING Bargain, 25 Vaticans only 10c. Wilhelms, 14646 58th Road, Flushing, N. Y.

AIRMAIL Cataloging \$1.25 with approvals 15c. Atlas, 3500 Fillmore Avenue, Brooklyn 10, New York.

50 U. S. And approvals, 5c. Scioto Stamp Shoppe, 1141 2nd St., Portsmouth, Ohio.

VALUABLE Pocket stamp wallet free with approvals. Granada, 4891 Southwest 5th Street, Miami 34, Florida.

MOZAMBIQUE, Abyssinia, Philippines, others, 6c. Approvals. Burgett Stamps, Lima, Ohio.

FREE! Crystal-mount samples! Har-risco, 202 Transit Bldg., Boston.

LOOK! Beautiful Vatican City set, picturing various cardinals, 14 different 10c. Approvals. Powell, 619 Franklin, Lynchburg, Virginia.

500 DIFF. Penny approvals. Roscoe Stamp, 1321 Roscoe, Chicago 13, Ill.

FREE! Tiny Chinese "midjet" war set. Approvals. Seminole, Leeds, Alabama.

PENNY Approval bargains. Write Department PM, 1267 Tutwiler, Memphis 7, Tennessee.

FREE! Asia, Africa, Europe packet. Approvals. Standard, Box 43 West Farms, New York 60, New York.

BICOLOR Vatican set 3c! Catalogs 90c. Approvals. Rostamps, 1921 Schiller, Little Rock, Ark.

154 U. S. Commemoratives, etc., 10c. Worldwide approvals. Dorenbusch, 501 Ridgeway, Cincinnati 29, Ohio.

FREE! St. Pierre Miquelon set, mint, approvals. Martin, Box 1128, Miami Beach, Fla.

DIFFERENT. 25 Canada, 25 Denmark, 25 Finland, 25 U. S. 3c with approvals. Alatalo, Maynard 14, Massachusetts.

ATTRACTIVE Sets on approval! Zampino, 2337 Bath Avenue, Brooklyn 14, N. Y.

FREE. China airmail set. 5 large pictorials with our attractive worldwide approvals. Fields, 1939 E. 85, Cleveland 6, Ohio.

WORLDWIDE Different. 200, 25c; 500, 50c; 1000, \$1.25; 2000, \$3.25; 5000, \$15.00. Beacon Sales, Maynard 2, Mass.

NEWFOUNDLAND 75 Unsorted 25c. Real value. Mayfair, Regal Rd., Toronto 10, Canada.

SNAPPY United States approvals that please. Premiums that satisfy. Jarr Stamps, Box 217-X, Madison Square, New York 10.

MOZAMBIQUE Triangles, unused. Set 10c with approvals. Vargo Stamps, 6044 South Fairfield, Chicago 29, Illinois.

KEEP Up-to-date, monthly illustrated price list, free. Frances Reese, Box F30, Martinsville, Indiana.

GOOD U. S. approvals reasonably priced. Panther Stamp Service, Dorchester 24, Mass.

PANORAMA! 20 Different mint U. S. commemorative \$1. Historical Covers, 1280 (MP) Ocean Ave., Brooklyn 30, N. Y.

PICTORIAL Set. Six 10c. Ten other sets free. Newstamps, Alexandria, Ont.

PENNY Approvals. Dazzling quality, high-cataloging. Atlas-M, 3210 Republic, Racine, Wisconsin.

UNION South Africa. Thirty different 25c, forty different 50c with approvals. Douglas, Hawkesbury, Ontario.

PHILIPPINES On approval. Over half catalog discount. References. Afran Stamp, Box 1338, San Francisco, Calif.

POSITIVELY Your money's worth! Seychelles, Djibouti, Angola, Chinese hunger stamps, together with 100 different others, 10c to approval applicants. Atlas Stamps, 4220 West 16th, Little Rock, Ark.

FINE U. S. Washington bicentennial set. Used. 10c. Approvals. Quinn, 570, Madison 1, Wis.

FREE, 25c Worth of stamps to U. S. approval applicants. Village Stamp Co., 90-39P 214 St., Queens Village 8, N. Y.

MAGNIFICENT! United States Civil and Spanish war revenues. 50 to 87 years old. 10 different, 5c to approval applicants. AAA Stamp Company, St. Louis 1, Mo.

WORLD 200 Different, packet price list 25c. Box 23, New York 53, N. Y.

GIANT Bicolored royal visits, Malta pictorials, gorgeous Guianas, Goose airmail, Scandinavian packet and illustrated stamp publication, 10 cents with approvals. Crown Stamps, Box 331, Toronto, Canada.

ABSOLUTELY Free! 25 different mint Chinese new issues with approvals. Barton, Box 488P, Elizabeth, N. J.

NEW U. S. illustrated album; \$1 post-paid, plus packet of stamps, Burg, 58 East 97th, New York 29.

SIAM—Complete set uncanceled \$5.00. Postcards airmailed anywhere \$1.00 each. R. W. Miller, c/o PAA, Bangkok, Siam.

50 U. S. Airmails, commemoratives 25c. Norwood Exchange, 4005 Ivanhoe, Norwood, Ohio.

GERMANY, "Nazi army issue"; ships, planes, (13) free to approval customers. William Deems, Ravenswood, W. Va.

100 ASSORTED U. S. old and new. 25c. Weatherby, Medina, Ohio.

BONGO! Bongo! Stamps from the Congo. Four beautiful, new, mint pictorials. Special 5c to approval applicants only. GeeKay, 13-b Overlea Ave., Baltimore 6, Md.

SAN Marino—Set of six beautiful Roosevelt commemoratives 10c. Keller, 304 Belonda, Pittsburgh 11, Penna.

100 U. S. including commemoratives, airm, 10c. 300, 25c. Box 457, Newark 1, N. J.

FREE! Fifty different worldwide with approvals. Additional fifty not over 1,000, 10c per fifty. Jack Dudak, 150-B-10, Streator, Illinois.

EXOTIC Pictorial collection—Djibouti, Fezzan Ghadames, Togo, Sakalava chieftain, Andorra Reunion, Algeria, St. Pierre Miquelon, Devils Island, Tunisia, Monaco, Guadeloupe, Martinique, many others. Everything 5c. Imperial, Drawer 1491, Tampa, Florida.

FREE! High value airmails! Unusual. Mint. Large! Premiums. Absolutely free! With low price approvals! National, Box 42, Passaic 1, New Jersey.

\$5000 STAMP Included in this fascinating collection of 100 all different from China! Only 10c to approval applicants. Star Stamp Company, Jamestown, New York.

FIFTY Stamps from 50 countries, 10c. Garrow, 84-M, Montevista, Chula Vista, Calif.

U. S. stamps. Clean, clear design, used older issues on approval. Sophus Jensen, Coupeville, Washington.

IMAGINE Three valuable old U. S. covers only 10c. Sea Horse, 1311 Lincoln Place, Brooklyn 13, N. Y.

EXTRA Quality blended U. S. mixture. 2 pounds \$1.25. 5 pounds \$2.65. 10 pounds \$5.00. Halay, 132A West 63rd, New York 23.

1/2c UP Low priced approvals by countries. Hurt & Fosse, Blue Ridge, Virginia.

FREE! Famous Formosa map set! Complete, unused, commemorative. Request approvals. Riedell, Greensburg, Pennsylvania.

UNITED States unused. Complete set 13 flag stamps plus 5c China commemorative only \$1.00. Fine approvals. Willett Stamps, Box 507, Port Chester, N. Y.

FREE! St. Helena pictorial, and surprise packet of triangles, airmails, to approval applicants. Pioneer, Box 414, Pasadena 18, California.

200 WORLD Wide 27c. Pacific, Metro Box 5704, Los Angeles, Calif.

BINGO! Jackpot collection! Triangles, maps, animals, midjets. All for 5c to approval applicants only. Southwest Stamps, Box 117, Long Beach 1, California.

HUGE Roosevelt, Bolivia music set, free with approvals. Stone Stamps, Box 604, Miami 34, Florida.

BELGIAN Mixture—1 lb. including two sets catalogued \$2.50. Send \$2.00 bills. Approval applicants. Henry Loufs, (PMI), Wetteren, Belgium.

200 BRITISH Empire stamps; only 3c. Kenmore Stamp Co., Arlington 74c, Massachusetts.

FREE—Illustrated catalog! Kenmore Stamp Co., Arlington 74c, Massachusetts.

"UNITED-STATES" Collection. Thirty-seven different unused commemoratives, including Columbians 1893-1943 issues only. Price \$1.00 approval applicants only. "Stamps," Box 87M, Albany 1, New York.

YOU'LL Like our American and British Colonial approvals. Write now. Chesapeake Stamps, 748 Overbrook, Baltimore 12, Maryland.

FIJI Included! Stamps from 40 countries 10c. No approvals. Elsea, Bowling Green, Ohio.

MAGIC Bag penny approvals. Resch Stamps, 3739 North Wilton, Chicago.

SPAIN'S "Goya Nude" set complete 35c. Approvals. Royal Stamp Company, Tamaqua, Penna.

FREE. Irish commemorative collection, including rebellion issue with approvals. Raymax, 123-Z William St., New York City 7.

FREE U. S. price list, postage 3c. Mark Hanna, 335 5th Ave., Pittsburgh 22, Penna.

FREE! U. S. monthly lists. Cole, 43-A Rinewalt, Buffalo 21, N. Y. Precancels also available!

FREE. Triangle, Roosevelt, Vatican, Ethiopia, Hitler heads. Request approvals. Florida Stamp Company, Box 807, Miami 5, Fla.

SPANISH Air set free to approval applicants. Flamingo Stamp Company, Box 4038, Pinewood Station, Miami 38, Florida.

FREE Monthly illustrated bulletin showing recent issues. Penny approvals on request. Reed Company, Box 980, Chicago 90, Illinois.

WORLD—500 Diff. 50c, 1000 \$1.25, 75 Canada 25c, approvals, lists. Victoria Stamp Co., London 4, Canada.

PENNY Approvals that satisfy. Neff Gronberg, Box 5441-P, Philadelphia 43, Penna.

10 DIFFERENT Iraq 5c to approval applicants. Jeffery Stamp Co., 9728 Chappel, Chicago 17, Illinois.

200 DIFFERENT Stamps—Cataloging up to 15c each, only 3c to approval applicants! Littleton Stampco, Littleton 42, N. H.

200 DIFFERENT. Including Roosevelt triangle, 5c to approval applicants. H. Avalon Stamp Co., Springfield, Mass.

WORLD'S Largest stamp (7 1/2 x 14 inches). A real curiosity! Retail for 50c, only 3c to approval applicants. Tatham Stamp Co., Springfield 30, Mass.

FLAG Stamp free with U. S. approvals. Wenigman, 929 Oakdale, Chicago.

25 ALL Different stamps 10c. Tunis, Wakeman Ave., Newark 4, New Jersey.

ZOWIE-E! A barrel of fun for only a dime. 500 United States stamps—absolutely unpicked and unsorted—just as received from church missions. Many varieties, including large commemoratives, airmails, high denominations up to \$5.00! Stampdom's biggest package of fun—and you might find something really valuable! Price only 10c to serious approval service applicants. Money back if not delighted. Illustrated bargain lists with each order. Mystic Stamp Company, Dept. 80, Camden, New York.

WOW! \$10.00 Worth of fun. Only 10c! What a treasure hunt! Big package 500 foreign stamps from foreign missions, other sources. Includes stamps from Africa, South America, Free French, Somali, Palestine, etc. Includes airmails, commemoratives and stamps worth up to 50c. This offer sent for 10c to approval applicants only. Jamestown Stamp Co., Dept. 22, Jamestown, N. Y.

DANDY United States approvals. Write immediately. Sullivan, Endicott Building, St. Paul, Minnesota.

50 DIFFERENT United States 10c. No approvals. Seidenberg, Cassopolis, Mich.

FREE! 100 Worldwide different stamps to approval buyers. Big U.S. and illustrated bargain lists sent with approvals. Bookman, Maplewood, N. J.

BRITISH, Spanish and French Colonies Vatican, Hitler heads, and airmail packet free with approvals. Pan-American Stampco, Box 145, New York 33, N. Y.

STAMP Collections wanted. Complete collections, duplicate lots, surplus stock, mint and used. Prefer trade for printing or other items, buy outright if priced right. What have you, what's wanted? Vanroy Shirk, Lebanon, Penna.

DEALERS—Wholesale list. Postage 3c. Frank, 5031 Queensberry, Baltimore 15, Md.

FIRST Day covers on approval. Knobel, 1918 S.W. 12th Street, Miami 35, Florida.

U. S. Price list. Send postage. Stanley Gibbons, 38-P Park Row, New York.

UNITED States approvals complete coverage, fine quality, attractive prices. Seminoles Stamps, Box 1138-P, Coral Gables, Florida.

FREE Beautiful airmails. Commemoratives, pictorials, eight countries. Approvals enclosed. Green and Company, Norwood 12, Ohio.

WHOOPIE! Wow! 25c worth of stamps free to buyers. Write M & N Co., 742A Sheffield Ave., Brooklyn, N. Y.

OLD Scarce U. S. seconds on approval. Slightly defective, bargain prices. Hernefield, Clintonhill Station, Newark 8, N. J.

SURPRISE Packet 3c; approvals. Schmidie, 721 S.E. 139, Portland 16, Oregon.

START Your own stamp business. Write for free circular. Donald Shepard, Box 5139, Chicago.

COLLECTION Builder approvals. Henry Jay Service, 15 Park Row, New York 7, N. Y.

15,000 DIFFERENT Stamps 2c each! In books of 100 to 1,000. Gordon Davison, Box 1019B, Manchester, N. H.

POUND Stamps containing thousands \$1.00. Longacre Shop, 108 West 42nd, New York 18.

BERLIN Bears, complete set of eight and 100 different stamps only 10c to approval applicants. Reich Stamp Co., 4647 Kenmore, Chicago 40, Ill., Dept. M11.

NICARAGUA "Tin Pan Alley" diamond, Ecuador showing George Washington, and American flag in natural colors, Fezzan, Trieste, "American Army" stamp, first U. S. commemorative, \$100.00 Shanghai, Corsica, Anzac, Antique, others. All 5c. Approvals. Capital Stamp Co., Dept. 2, Little Rock, Ark.

TRIANGLES! Diamonds! Octagons! Midgets! Giants! Roosevelts! Hitlers! U.S. \$1.00-\$5.00 stamps! Stamp Magazine! Everything 10c with approvals! Thrifty Stamps, Silver Spring, Maryland.

FINE U. S. foreign approvals. Rossom, 218 West 59th St., Chicago 21, Ill.

COLLECTORS Possessing valuable extra stamps may exchange them through this club. Particulars for stamp, McPherson, Branch, Michigan, U. S. A.

POSITIVELY Greatest free offer—Rare octagonal (eight sided) stamp, gorgeous diamond, giant triangle, also mammoth and midget stamps, total value \$2.00. All free to approval buyers. Plus free, Scott's International \$6.00 album and latest stamp catalogues. Odd Stamps, P.O. Box 510, Bell, California.

HOBBIES AND COLLECTIONS

CASH From hobbies! Send stamp. "E-Z", 3215 Merrimack, Dayton 5, Ohio.

WANTED Old cigarette cards. Write Charles Bray, East Bangor, Penna.

BIG Campaign ribbon packet, illustrated book \$1.00. Brown, 236-28th Ave. N.W., Calgary, Canada.

COLLECT Minerals and gems as a hobby. Free list. Elbert McMacken, Box 1, Escondido, Calif.

UNUSED Matchbook covers; 100 different \$1.00; free catalog. Charles Edelman, 1311C East 84, Cleveland 3, Ohio.

INVENTING Can be an interesting and profitable hobby. Write for complete particulars. Institute of American Inventors, Dept. 40-E, 1926-Eye St. N. W., Washington 6, D. C.

50 DIFFERENT Army embroidered patches \$1. Other bargains. Insignia Mart, 703A Broadway, New York 3, N. Y.

PRECIOUS STONES, MINERALS

GEMSTONES. Rough, polished. Crystallized specimens. Every variety, lowest prices. List free. Plummer's 5068 Brighton, San Diego 7, California.

"GENUINE" Deep red Arizona rubies (garnets). Send quarter for packet. Mineral Specimens Company, Box 2651, Phoenix, Arizona.

ZIRCONS, Sapphires, rubies, others. Best quality; lowest prices. Free colored catalogue. Imhusex, Box 232, White Plains, N. Y. Agents wanted.

METAL Detectors. The very latest circuit. Free literature. Hedden Metal Detectors, 3329 Liberty Avenue, Pittsburgh 1, Penna.

BEAUTIFUL Arizona agates, polished samples and listings \$2.00. Unpolished samples \$1.00. Arizona Agate Mines, Cave Creek, Arizona.

ANTIQUES, RELICS, INDIAN GOODS, CURIOS

4 FINE Tiny ancient bird arrowheads \$1.00. List free. Lear's, Kirby, Arkansas.

CAMERAS, PHOTO SUPPLIES

YOUR Prized negatives make beautiful photo enlargements easily, economically with the new Precise Photo Enlarger, only \$22.20 complete, nothing else to buy. Send postcard for details. Tam Products, CM-10, 3814 Wrightwood, Chicago 47.

ENLARGER? Build your own cheap. We show you how. Complete plans \$1.00. Somerset Specialties, 10514 Somerset, Detroit 24, Mich.

CAMERAS, Projectors, Photographic bargain list free. Selco PM10, Danvers, Massachusetts.

BASS Says! At the sign of the old "Horse Trader," 38th year. Thousands of satisfied customers everywhere! Finest brands including Kodak, Bell & Howell, Argus, Zeiss, Leitz, etc. Satisfaction always guaranteed, or your money back! Bass buys 'em, sells 'em, trades 'em. Write or wire. Bass Camera Company, Dept. AG, 179 W. Madison St., Chicago 2.

PHOTOGRAPHY For pleasure or profit. Learn at home. Practical basic training. Long established school. Write for booklet. American School of Photography, 1315 Michigan, Dept. 3432, Chicago 5.

FREE! 116-Page illustrated photographic catalog, send 3c stamp. Bloom's Camera Center, 1657 Main, P.M., Springfield, Mass.

200X TELEPHOTO Camera easily made. Trifling cost. Telephoto lens and instructions \$3.00. Instructions alone 10c. Suffolk Science Service, Box 208, Manorville, N. Y.

K-21 AAF Aerial combat cameras, manufactured by Graflex; motor driven, with flexible shaft; 24 volt operation; including step-down transformer to 110 voltage; may be manually operated. Complete except for lens and filters. New, original government packaging; new low price, for a limited time only, \$29.50. An amazing value from Amazing Bachman's, Dept. PM, 27 Herman Street, Rochester 5, N. Y.

PHOTO FINISHING

TWO Beautiful prints from each picture on roll 30c. Twenty-seven years of satisfied customers. Quick service. Lens Photos, Dept. J4, Janesville, Wis.

CHINACOLOR Prints from your Kodachromes, Ektachromes, Anscoolor. 4x5, \$1.00; 8x10, \$3.50. Box M4203, Washington 12, D. C.

BEAUTIFUL Enlargement from each picture on roll 30c. Cut Rate Photos, Dept. B4, Janesville, Wis.

8 HOUR Service, Box 468, San Francisco. Your 8 exposure roll printed jumbo or regular size 30c; 12 exposures 35c; 16 exposures 50c; 36 exposures \$1.00. Reprints, jumbo or regular 3c. Regular prints deckled. Fine grain developing. Send for free mailers. Quality Photo Service, Box 468, San Francisco 1, Calif.

OVERSEAS Service. Air mail return free. 4c per print. Developing free. Custom Photo, Box 567, San Francisco. "Your nearest postal port." Send for free mailers.

ENLARGEMENTS, Process flexibility permits individual perfection; 5" x 7", send negative, 15c; 8" x 10", 25c. Brandt Photo, Box 222, Kenilworth, Illinois.

DEVELOPING And printing. New electronic process, 8 oversize prints, deckle edged in fanfold, 35c. 12 exposures, 45c. Write for other sizes and prices. Pittsburgh Photo Lab, Box 9665, Pittsburgh 26, Penna.

ROLLS Developed and enlarged 2 to 6 times larger. 8 exposures 25c coin. 12 exposures 35c. 16 exposures 50c. Enlarged reprints 3c each. Alden Photos, 94-3 Astor Station, Boston, Mass.

NEW Negative from your valuable picture and a 5x7 enlargement \$1. C.O.D. accepted. Photo-Craft, P.O. Box 637, N. Miami, Fla.

8 BEAUTIFUL Double size pictures and roll developed 30c, 8 hour service. Free mailers. Pacific-Photo Service, Box 666, San Francisco, Calif.

OIL Coloring photographs can be a fascinating hobby or profitable sideline for those with artistic talent. Learn at home. Easy simplified method. Send for free booklet. National Photo Coloring School, 1315 Michigan, Dept. 343C, Chicago 5, Ill.

2 BEAUTIFUL Hi-Gloss prints each good negative and enlarging coupon with each 8 exposure roll developed 28c. Free mailers. Owlphoto Co., Weatherford, Oklahoma.

ENLARGEMENTS! 5x7, 15c; 8x10, 25c, glossy or dull. Gorgeously oil colored, 50c extra. Negatives made from your favorite photos, 50c. Rolls developed, printed, 25c. L. R., Box 1476-c, Milwaukee 1, Wisconsin.

24-HOUR Film service, 8 exposures 25c. Quality prints mailed within 24 hours after film received. York Photo Finishing Service, Box 1469, York, Penna.

OVERSIZE Prints; overnight service; 35c. Films developed and 8 prints near postcard, only 35c. Electronic process, non-fade, glossy pictures. Write for free mailers. Peachtree Photo Finishers, Dept. PM, P.O. Box 4324, Atlanta, Georgia.

YOU'LL Be delighted. Eight Neverfade prints now only 25c. Two prints each only 35c. Free mailers and price list showing other services. Write today. Hammond Sales Co., Hannibal, Mo.

NEW Process developing and printing. 8 exposure rolls 35c. Mayfair Photo Service, Box 261K, Toledo, Ohio.

PHOTOGRAPHY For pleasure or profit. Learn at home. Practical basic training. Long established school. Write for booklet. American School of Photography, 1315 Michigan, Dept. 3451, Chicago 5.

8 PRINTS All enlarged to nearly postcard size from your roll or negatives 25c; 16-50c. (Trial offer). Willard Studios, Box 3535A, Cleveland, Ohio.

16 DECKLEGE Prints from any standard 8 exposure roll 25c. Quick service. Professional work. Skrudland, Lake Geneva, Wis.

FREE Price list on quality developing, printing, enlarging. Write for it today. Bryan's Photo Shop, Dept. M, Panama City, Florida.

EMBOSSER Christmas cards from your own negative. For samples, send negatives and 25c. Film Capital Service, 818 Dewey Avenue, Rochester 13, N. Y.

STATUETTES From your choice negatives, oil colored, 8" tall, \$1.50. Marra, 7912 Franklin Blvd., Cleveland 2, Ohio.

PORTRAIT Quality 5x7 enlargements 15c, 2 for 25c. NuTone Fotos, Box 228, Pottstown, Penna.

JUMBO Or photo pack prints, 8 exp. roll 35c, 16 exp. roll 65c. NuTone Fotos, Box 228, Pottstown, Penna.

MOTION PICTURES AND SOUND EQUIPMENT

COLOR Movie film now available, 8mm. Ansco color, daylight roll type, and 16mm. 50" magazine type film. Ansco color, daylight. Brand new fresh stock fully guaranteed. Write immediately for prices. Immediate shipment. Indiana's largest camera store. Capitol Camera Co., Inc., 201 W. Washington Street, Indianapolis 4, Indiana.

BARGAIN 16mm. sound programs, feature and shorts \$3.95. Used sound projectors from \$95, sound features from \$47.50, shorts from \$3.50. Miscellaneous sound and silent film "as is", cent a foot. Anything photographic or cinematic accepted in trade. Write for new lists. Library, 68 West 48th St., New York 19, N. Y.

WESTERNS: Three headliners: Abbott and Costello, "No Indians Please," "Stampee," "Cowboy Justice" 16mm. (also toy projectors) \$2.79 each; 8mm. \$1.79 postpaid. M.O. or check. B & C, 263 State, Elmira, N. Y.

8-16 MM. Movie film in bulk for home processing. Big free catalog—bargains in film, processing equipment, supplies. Superior, 105B S. Wells, Chicago 6.

FILMOSOUND 179-C B&H 16mm. sound projector and stand. 52x70 inch Radiant screen on tripod. Purchased new February 1947. Excellent condition. Ben Boatwright, Johnston, S. C.

BARGAINS In good used 16mm. sound films. Complete one reel subjects often available at \$2.95. List for stamp. Blackhawk Films, Davenport, Iowa.

FILM—Free processing 100 ft. 16mm. Weston 12 \$3.25. Weston 24 \$4.90. Weston 64 \$4.95. 25 ft. double 8mm. Weston 12 \$1.50. Weston 24 \$1.89. Weston 64 \$1.99. Free circulars. Fromader Genera, Davenport 4, Iowa.

16-35MM. Silent sound films, projectors. Bedner, 5300 So. Talman, Chicago.

RENT 16mm. sound films 50c reel. Large selection, free catalog. Film Service, 128 Chestnut St., Roselle Park, N. J.

EXCLUSIVE Movies, projectors, screens, free catalog. Home Pix, 1674 Broadway, New York 19.

HOME Movies since 1929. No-wat-ka, 257 Main Ave., Passaic, N. J.

FREE Movie list. Superior Film Service, Box 713, Troy, N. Y.

FREE Movie catalog; sample films, 10c. Goodwill Company, Jackson, Tennessee.

8MM. Sound projector for the price of a silent machine. Write Standard Sales, Box 7525, North Kansas City, Missouri.

BASS Says! 38 years of leadership means satisfaction to you! Finest equipment, 8 and 16 mm., sound cameras, sound projectors. Bass buys 'em, sells 'em, trades 'em. Satisfaction always guaranteed, or your money back! Bass Camera Company, Dept. A, 179 W. Madison St., Chicago 2.

SOUND Features shipped, rental \$3.95. 1,600' shorts, \$2. Free catalog. National Cinema Service, 71 Dey Street, New York City.

I BUY, exchange, swap movies. What have you? What do you want? Lowest exchange rates in world. Catalogue \$1.00. Refundable. Harvey Iris, Box 539, Brockton, Mass.

GUARANTEED Fresh anti-halo outdoor movie film! Weston 12! Daylight loading! Processing free! Three spools double 8 mm. \$3.45! Six single 8 mm. for Univex, \$4.60! Postpaid! Catalog. Eso-S, 47th Holly, Kansas City 2, Missouri.

8-16MM. Silent-sound films. Complete rental library. All latest subjects. Free catalogue. (sample film 10c). Garden Film, 317 West 50th, New York 19.

LEARN Professional motion picture technique at home. Approved for veteran training under G.I. Bill. Free catalog. Motion Picture Institute, Birmingham 4, Mich.

LEARN Movie projection, management. Free catalog. Theatre Institute, Elmira, N. Y.

BRAND New 16mm. sound projectors \$129.50. Send 10c for 1948 photographic catalogue. Sterling's, 679 Northampton, Easton, Pennsylvania.

WE Buy, sell, rent, exchange home movies. Details for dime. Midland, Box 429, Oak Park 4, Ill.

MOVIE Film, machine processing service, bulk film, free literature. Atlantic Films, Reading, Penna.

8-16MM. Film specialties. Catalog dime. Warrington Films, 1418 Knecht Ave., Halthorpe 27, Maryland.

FINEST Movie screens. Inexpensive. Make them yourself. Free literature. Snow White Screens, Danville 4, Illinois.

PROCESS Own movie film. Free literature. Duro Products, 1519 Eggert, Buffalo 21, N. Y.

MUSIC AND MUSICAL INSTRUMENTS

SONGWRITERS! Outstanding, ethical offer. Hibbler, C5, 2157 N. Avers, Chicago 47.

PROFESSIONAL Melody to your poem, \$2. Professionals, Mill Valley 339, Calif.

LEARN Song writing! Fun-profitable. Wonder Wheel jiffy composer, perfect harmony, any note, any chord. Folders free. Barnes, Box 490, Times Square Station, New York 18, N. Y.

SONGWRITERS. Honest outstanding music writing offer. Len-Tex Studios, Leonard 2, Texas.

VALUABLE! Names, addresses, songwriters. Details. Popular, Box 927, Atlanta, Georgia.

POEMS Wanted for musical setting. Send poems for free examination. Five Star Music Masters, 630 Beacon Bldg., Boston, Mass.

PLAY Excellent piano accompaniment by ear with device made from wood. No music or lesson required. Complete instructions (and patterns) to make and to play \$1.00. E. Stevens, 8804 63rd Drive, Rego Park, Long Island, New York.

POEMS Wanted for musical setting. Send poem for immediate consideration and free rhyming dictionary. Richard Brothers, 24 Woods Building, Chicago.

AUTOMATIC Chord-changers for Hawaiian guitars. Complete 40 lessons \$8.95. "By ear" Spanish guitar picture method \$2.00. Guitar Headquarters, Box 886, Ventura, California.

"SEVEN Women Mad At Me." Novelty song 35c. Geo. Wane, Lomita, Calif., 25841 Eshelman Ave.

HILLBILLY, Western records, late numbers 29c. Catalogue 3c. F-L Shop, Box 19-L, New York 35, N. Y.

SONGWRITERS! Piano-vocal recording of your song. Satisfaction guaranteed. 10" discs. \$6.50 one side. \$11.00 both sides. Merel Recording, 115 West 42 St., New York City 18.

ACCORDIONS Below wholesale. Metro, 44 North Albany, Chicago.

LEARN To play piano by music, in one lesson, \$1.00. Miner Chart System, 931 13th Avenue B, Seattle 22, Wash.

SONGWRITERS Attention! The amazing demand for phonograph records, accelerated by countless juke-boxes, warrants your immediate investigation. We are offering new writers the rare opportunity of having celebrated "hit" composer furnish music on reduced percentage basis for any likely poems received this month. The Petrillo ban does not affect us. Recola Records, Hollywood 28, Calif.

1948 ACCORDIONS—Wholesale—Free catalog. American Accordion Center, 5329 Belmont, Chicago.

AMPLIFY Your accordion with our new mike \$22.50. Sounds like organ. Installed in minute. Use any amplifier. Amplifier and mike \$72.50. Write Del Principe, 307 So. Wabash Ave., Chicago.

SONGWRITERS—Protect your songs. Get the facts first. Free booklet, attractive offer. Song Service, 331-C West 46th, New York.

POEMS Wanted to be set to music. Free examination. Send poems. McNeil, Master of Music, 510-PM S. Alexandria, Los Angeles, California.

SONGWRITERS: Send poems for free examination and outstanding offer. United Music Service, 150, Salem, Indiana.

WRITE Songs. Big money and reputation. Write for information. J. Gordon Pub. Co., 201 N. Hoyne Ave., Chicago.

ACCORDIONS—Guitars, trumpets and all musical instruments, new and used. Direct from national distributors, cash and terms. Save money. Del Principe, 307 So. Wabash Ave., Chicago.

ACCORDIONISTS—Do you want to play better, sooner. You can with Visuaid. \$2.00 complete. Guaranteed. Arkay, Box 5772, Cleveland 13, Ohio.

POEMS Wanted for musical setting. Send poems for free examination. Hamann Service, 614 Manhattan Building, Milwaukee, Wisconsin.

RADIOS, SUPPLIES, INSTRUCTION

26 YEARS Experience radio repairing at your fingertips. I've repaired 45,000 radios. Have perfected simple system you can follow step by step. No calculations or formulas. Total price \$2.00 postpaid or COD. Moneyback guarantee. Ross Radio, 14615-M Grandriver, Detroit 27, Michigan.

RADAR Crystals. Supersensitive. Free details. Communications Inc., 110-A University, Seattle 1, Wash.

RADIO As a hobby, can pay its way and yours too. Write. Grand Federal Argentine Box 57, Kansas City 3, Kansas.

MAKE "Loudest" crystal radios. Instructions, loud crystal, catalog, 25c. Amorose, Route Four, Richmond, Virginia.

MAKE Boosters for crystal radios. Ten times volume. Designs, instructions, catalog, 25c. Radio Leader, La Verne, California.

HERE It is. What you been waiting for. "Squeese crystal," \$1.00. Nevalium Company, Elko, Nevada.

INCREASE Your radio range! Buy small, sensitive preselector and receive distant broadcast stations clearly! Easily connected. Five day trial. Send \$12.00. P. H. Peters, 5 Union St., Schenectady 5, N. Y.

"RADIOBUILDER" For experimenters, beginners, 3 issues 25c. Laboratories, Eye-c, San Carlos, California.

MAKE Simple, tubeless, batteryless, distance-getting crystal radios. Crystal and illustrated instructions 25c postpaid. Allen, 427-P, Clinton, Missouri.

TELEVISION: Build your own. Our detailed plans \$1.00. Teleprint, 834 1/2 E. 74th St., Los Angeles 1, Calif.

FREE Radio and television catalog! Money saving prices on radios, hard-to-get-parts, record changers, wire and disc recorders, amplifier systems, tubes, books, amateur and test equipment. Write today! Radionic Equipment Co., Dept. 203, 170 Nassau Street, New York 7, N. Y.

BUSINESS OPPORTUNITIES

START Home business making statuettes, plaques, artificial marble flooring, liquid marble, rubber molds, metalizing baby shoes. Amazing profits. Folder free. Creative, 236-L, Winnetka, Illinois.

MAKE Money making new greaseless doughnuts at home on electric machine. Wholesale to grocers, drug stores, cafes, hamburger shops. Send for free recipes and plans. Ray Do Nut Company, 3605 South 15 Ave., Minneapolis 7, Minnesota.

REPUTABLE Manufacturer has available in several states a franchise for a man who can qualify for the operation of retail business service. This service has lucrative market which assures repeat business year 'round. Minimum capital required \$1500 for equipment necessary to the operation of the business. Write Hinson & Co., Richmond, Ind.

MONEY In easy to make, easy to sell leather link belts. No tools required. Complete kit 50c coin, 5-kits \$2.00. Particulars free. Craftway Industries, Box 149-B, Chicago 90, Illinois.

YOUR Own profitable home business. Preserve live flowers to last forever. New simple discovery. Enormous demand all year 'round. Tremendous profits! Light fascinating work. Send \$2.00 for working equipment, instructions, and valuable sales plans. Satisfaction guaranteed or money promptly refunded. Alfred Hermansen, 210 Fifth Ave., Suite 1102A, New York 10, N. Y.

BUILD A profitable real estate business, spare time. Particulars free. Roseman Agency, 55 Clifford St., Boston 19, Mass.

BE Independent—Operate America's lowest price penny vending machine. Big profits. Immediate shipments. Write for bulletin and prices. Fielding Mfg. Co., Desk (1048), Jackson, Mich.

START Home manufacturing business making Cleaning Compounds, Soaps, Insecticides, Cosmetics, Polishes, Food Flavors. No machinery. Literature free. Kemix, Park Ridge 8, Ill.

LIFETIME Opportunity! Make enormous profits with popcorn, smallest investment. Guaranteed new-used equipment, supplies. Immediate delivery. Poppers Supply, 1315 Vine St., Philadelphia 7, Penna.

SHARPEN Saws—Lawnmowers. Start in spare time. Send for free equipment sheets. Ace Machinery Distributing Co., 309 Laurel, Modesto, Calif.

TRADE Magazines help you get ahead. Latest copies every trade, business or interest. Free price-list. Commercial Engraving Publishing Co., 34C North Ritter, Indianapolis 19, Indiana.

MAKE \$100 Per week or more in a full or spare time baby shoe metalizing business of your own. Write now for free literature on this easy to learn, highly profitable business. Joseph B. Kushner, Metal Finishing Engineer, Stroudsburg 2, Penna.

MAKE At home beautiful jewelry, gifts, novelties, from sea shells, plastics. No tools or experience needed. 60-page beautifully photographed instruction course \$1.00. Beginner's 6-piece jewelry kit \$3.00 (foreign \$4.00). Information free. House of Gifts, Box 4550-XM, Coral Gables, Fla.

YOUR Own business—Baby shoe bronzing. No capital needed. We supply the finished product. Highly profitable. Easy to sell. Write today for Plan M-10. Alice Ames, Inc., 79 Milk St., Boston 9, Mass.

CO-PUBLISH. Advertise for half. Sell subscriptions, advertising, co-publishing memberships like I do. Add prestige. A quarter bring 60-page Progressive Mail Trade Magazine plus book giving co-publishing instructions. Is your future worth a quarter? Joe Flynn, Box 753, San Diego 10, California.

MAKE Hollywood style cement pottery, birdbaths, miniature castles; without moulds. Amazing designs. Stucco-rock walls, mantels, benches, rustic walks, pools. Dime brings chemically colored sample, many pictures. Hollywood Cement-craft, 8527-D Wonderland, Hollywood 46, Calif.

CANDY Manufacturing and marketing, complete course \$6.00, information free. Box 670, Kissimmee, Florida.

PERFUME—Make it yourself. Profitable sparetime home business for men and women. Free information tells how. Write "International," 6347 Parnell X10, Chicago 21, Illinois.

BIG Money. Spare or full time in your home. No selling! Spray new miracle finishes, plush and suede, on signs, radios, automobiles, figurines, lamps, toys, etc. Our business is booming. New easy Flok-Kraft methods. Material costs few pennies, you get dollars. Free samples, complete powerful money making plan free. Write now: Coast, 1507 West Manchester, Los Angeles 44.

WANT Pleasant outdoor work in a business of your own? Good profits selling over 200 widely advertised Rawleigh home/farm necessities. Pays better than most occupations. Hundreds in business 5 to 20 years or more! Products, equipment on credit. No experience needed to start, we teach you how. Write today for full particulars. Rawleigh's, Dept. J-145-PPM, Freeport, Ill.

"WATERLESS Hand Cleaner." Make, sell. No machinery. Build profitable business. Complete formula \$1.00. Ideal Service, Park Ridge 2, Illinois.

I MAKE Big money in the mail-order business. You can do the same at home with copyrighted system. Write me I'll tell you how. F. Little, R.D. #1, Glenshaw, Penna.

RED Hot business. Full information 10c. Free 25c plan. Plants Mail Order, Duenweg, Mo.

"METALLIZING Techniques"—Manual for plating baby shoes, etc. Only \$1. Plastics Research, Box 346, Alhambra, Calif.

START Sewing machine business by electrifying and converting to portables. Free details. Pasaak, P.O. Box 153, Canal Street Station, New York 13, N. Y.

OPERATE Mail order business. Splendid opportunity. Write A.C.R., Box 728, Dover, Del.

MAKE Your own products, details free. Pharmacist, 939 Euclid, Detroit 11.

CO-PUBLISH Mail order magazine. Details free. Feather Specialties, Chippewa Falls, Wis.

BE A used car dealer, guaranteed plan \$1.00. Edw. Smith, 17A Rockland, Yonkers, N. Y.

PROFITS Selling office supplies by mail. Repeat business. Particulars free. Glenn Snyder, 5-B Spring, Beachwood, New Jersey.

\$2.50 STARTS High grade perfume manufacturing business. Big profits. Particulars free. Bob Celaya, Brownsville, Texas.

START Profitable home publishing business. Pays well. Details 25c. Fred Hettick, Box 641, Bismark, No. Dak.

EARN More money. Read "Dollars and Sense," picture trade magazine. Sample dime. Martin, 57 Hart, New Britain PM, Connecticut.

LIQUID Rubber, make flexible molds. Free sample. Chaney, 1130 E. 16th St., Jacksonville 6, Fla.

EXTRA Money. 50c seller. Wonderful flight airplanes. Sample 25c, dozen \$2.00. A. F. Kolinski, 759 South 25th, Milwaukee 4, Wisconsin.

THOUSANDS Articles wholesale. "Supply Source Directory" 10c. Ideal Service, Park Ridge 40, Illinois.

YOUR Own business. No canvassing. Enormous profit easily made at home in spare time. Experience unnecessary. Details free. James McLaughlin, 310 E. Sterner St., Philadelphia, Penna.

PROFITABLE Business. No investment necessary. Distribute finest auto paint. Thousands of buyers. 100% profit. Cover-Nu, 1911-N, Lubbock, Texas.

LEARN Cleaning and pressing business. Big profits. Instruction course \$1.00. A. Harvilla, 140 South Laurel Street, Hazleton, Penna.

NEW Proven business, cleared originator \$400, third month. Details sent free. Germaine, 1450 19th, Columbus 11, Ohio.

AGENTS, Home workers, wagon dealers, mail order dealers, newest hits for all. Fastest sellers, large profits. Literature, free. McCurdy Service, P.O. Box 1877, Miami 11, Fla.

INFORMATION—Supply sources, trade secrets, ideas, money making facts. Be your own boss! 24 page booklet tells how. \$1.00. Tip-Top, Box 9083PM, Dallas, Texas.

FROZEN Custard is sweeping the nation. Plan your money making stand now. "Know-how" details free. Penguin Drive-In, 21077 Center Ridge, Fairview 16, Ohio.

OPERATE Community merchandise club. Hold weekly drawings. Give away many kinds household utility merchandise. Easy, fascinating work. Amazing profits up to \$600 month. Details free. Fast action necessary. Kraft, Aurora 3, Missouri.

OPERATE Profitable mail order business. Splendid opportunity. Details free. Capital Sales, 4020 Everett, Lincoln 2, Nebr.

METALIZE Baby shoes and other non-metallic articles. Fascinating work. Big profits. Shuplate, Box 1388, Lawton, Okla.

A WONDERFUL Business for today and the future. Easy fascinating work at home. Amazing profits, 300 word treatise, 25c. Austin, 206 R1, Roanoke, Virginia.

MAKE Money selling quilt pieces by mail. One man ran \$200 into quarter million. Write Lovell, 2166 South Shore, Erie, Pennsylvania.

MAKE Durable plastic 1c pound. 101 uses. Build charming homes, \$150 a room. Bays Laboratory, 327 S.E. 46, Oklahoma City 9.

BUY Nationally advertised merchandise for others; radios, appliances, etc. Low wholesale prices. Make commission each purchase. Up to \$5,000 year possible. Easy fascinating new business. Free information. Cox, 12 Foss, Saugus 10, Massachusetts.

FREE Sample. Profitable fast seller. Salesmen, distributors, mail dealers write Flinson, Box 4333-B, Kansas City 1, Mo.

"HANDY Guide," amazing new book. Tells where to buy 10,000 useful goods and services. 25c Popular Mechanics Press, 202 East Ontario St., Chicago 11, Ill.

A BUSINESS in your own home! Our chemicals, plus free water and cheap "grocery store" materials can bring you over \$500 monthly earnings. Plans and formulas free. Chemica Division, 1269 S. Norton, Los Angeles 6.

LIQUID Marble—Make in any color. Soundproof plastic flooring. Flexible molds. Cast novelties, plaques, statuary. Big money, your own business. Catalog free. Write, Bing Products, 88-A10A Broad Street, Boston 10, Mass.

UNPAINTED Figurines 5c up. Write Oman, 642 Broadway, St. Paul, Minnesota.

MECHANICALLY Inclined? Resurface butcher blocks. Lifetime business. Roy Crawford, Keyport, New Jersey.

MEN With cars \$250.00-\$300.00 weekly; introduce new "wipe-on" automobile finish. Plastic Products, 3151-N2, Southport, Chicago.

MAIL Dealers! Information guide 10c. Live mailing lists, 200 names \$1.50. Leese, 4718 N. Lavergne, Chicago 30.

WRITE For details to sell tablets by mail. Large profits; small investment. NuAid Co., 608 W. Union, Bethlehem, Penna.

A FACTORY in your home garage! Mfg. and sales rights, mechanics' waterless hand cleaner. \$500-\$800 monthly. No special equipment necessary. Formula free. Western Aircraft Mfg., Dept. D, Los Angeles 6, Calif.

MAIL Order businesses, bought, sold, brokered. Write for free bulletin of exclusive opportunities. Turnipseed, Inc., Box 681, St. Louis, Mo.

ELECTRIC Pencil—Writes, engraves all metals. \$2.95 postpaid. Reb Industries, Elmhurst 4, Illinois.

MAKE Money at home like I do: Write immediately. Duffey, Covington, Ky.

METALLIZE Baby shoes. Excellent profits. New system assures success. Free details. Treasures Forever, 89 Henry Ave., Lynn, Mass.

SEALCT Collection business plans. Local mail order. New edition. Particulars free. Flasco Sales, 2505VT 150th St., Flushing, New York.

BUY The new Concession popcorn machine. Biggest low priced popper on market. \$100 puts you in business, complete. Also caramel corn, candy floss, candy pullers, kettles, heating equipment. Write for new catalog. Concession, Dept. A, Toledo 6, Ohio.

INCOME From local information. No selling. Neher Company, La Verne, California.

LEARN Designing, modeling, molding-plastics, compositions, ceramics. Top-pay, lifetime profession. Inexpensively and quickly learned. Begin earning immediately. Informative literature. Plastics Digest, 2917 Michigan, Kansas City 3, Mo.

SELL \$2. Fire extinguishers. Mailorder, locally. Lorrac Products, Albany 1, N. Y.

HOME Workers wanted to hand-spin Angora wool. Either sex. House of Angora, Springfield, Ill.

RAISE Fishworms, we buy. Attractive folder 3c. Stoner's, Chattanooga 4, Tenn.

GOLDEN Opportunity. "How to Establish and Operate A Successful Mail Order Business." Free information. Palmer Publications, 4219-A Southwest Merigold, Portland 1, Oregon.

PROFITABLE Mail order opportunities. Details 10c. Brown, 18 Gracie Station, New York 28.

EARN \$10.00 An hour. New tool creates opportunity. Details 25c. LaVern's, Box 7, Caldwell, New Jersey.

FAST Sales, cuts food cost. Nets \$9 a case. Sell 6 daily. Exclusive territory. Jeld, Ltd., Burbank, Calif.

WHOLESALE Supply sources and money making plans offer security, success, in your own business. Details free. Reynard Publications, Smithfield 3, Ohio.

MAKE Just 90c profit on every dollar received. Circulars free. Carl Bohman, Saratoga Springs, New York.

MAKE Beautiful vari-colored, highly glazed concrete pottery. Amazing profits. Small capital starts. Write for details. Ozark Enterprises, Box 273, St. Charles, Mo.

FOR More prestige and business, open individual New York office, requiring no room number. Rates, only \$12.00 and \$24.00 yearly. Established 1926. Co-operative Office Service, PM-126 Lexington Avenue, New York 16.

MAKE Money by mail. Howard, 1778A Hamburg St., Schenectady 4, N. Y.

PROFITABLE Proven business, home or shop. Details. Packard, 2013 Chenevert, Houston, Texas.

BIG Profits in your own silk screen printing business. Produce signs, posters, showcards, novelties, etc., in color. No art ability needed. Free folder. Wolff Co., 817 High St., Anderson 16, Indiana.

HANDKERCHIEFS Tremendous money-making opportunity. All year round and Christmas price list ready. Handkerchief Mfg. Sales Co., 60 E. 12th St., Dept. 40, New York 3, N. Y.

SELL Therm-O-Larm. New patented fire detector. Demonstration sells; easily installed. Free folder. Demonstrator \$2.00. Therm-O-Larm Corp., 3133 Fairfax Rd., Cleveland 18, Ohio.

DISTRICT Agents. Power lawn-sickle mowers; engines. Farm Products, M-2000, Excelsior Springs, Mo.

YOUR Own business. Local or by mail. Details free. Vanek, Box 100, Gracie Sta., New York 28, N. Y.

PROFITS Unlimited! Make cleaners, soaps, etc., in home or garage without machinery. Easy instruction booklet, 100 formulas (including Mechanic's Waterless Hand Cleaner). \$1.00. Brown, 9111-J Hoyne, Chicago 20.

LEARN To make seashell jewelry, pins, earrings, novelties. Design and instruction book free with \$2.00 and \$5.00 kits. Also artificial flower supplies. Herbert Diamond Co., Box 4619, Miami 31, Florida.

SELLS On sight! Beautiful flower designed plastic tablecloths. Retail at \$1.98. Wholesale price, \$12.00 dozen. \$1.50 sample. Van der Plate Products, Glen Rock, New Jersey.

BABY Shoe metallizing. Trade secrets never before revealed. Everything you need to know. Amazing offer. Send card. Schoettle, Friendship, Ohio.

WATCHES. All kinds, new, used; retail \$3.65-\$345.00; big discounts; show catalogue, get orders. Brookins, B-1975AK, Little Rock, Ark.

SAWDUST. Turn it into cash. Six methods. Instructions 25c. Charles, 12-BM, Norwood, Ohio.

SELL By mail! Ideas galore! Join Mail Selling Opportunities Club! Details free! D. Wehner, Box 142-A, Roxbury 19, Mass.

NEW Products deserve modern package-molded plastic boxes. 3 1/2" x 2 1/2" x 5/8". Friction slipover cover. Eight boxes. Assorted colors, dollar postal note. Stamp-ade, 1220 Huron, Cleveland 15, Ohio.

START Your own business. Full or part time. Details free. Owen Mail Sales, Box 24, East Providence 14, R. I.

SELLING Anything? For better results open individual New York office, requiring no room number. Rates, only \$12.00 and \$24.00 yearly. Established 1926. Co-operative Office Service, PM-126 Lexington Avenue, New York 16.

COASTER Wagons complete except bed \$2.98. George F. Hall & Co., 518 East 6th St., Cincinnati 2, Ohio.

MANUFACTURING Propositions. Request circular. Richards, 44 North Albany, Chicago.

EARN Extra cash, operate mail order business, home, spare time. Granada, Box 1028-MP, Hamlet, North Carolina.

RESPONSIBLE Franchised dealers wanted for Gregory cars. Americas biggest value in small automobiles. Horan & Son, 620 Chestnut St., St. Louis 1, Mo.

AUTO Bubble shampoo and glaze kit. Easy with garden hose. Big refills repeat. Exclusive. Rivo Airmotive, 6203 S. Hoover, Los Angeles 44, California.

STATE And local distributors wanted for complete line guaranteed paints. Full or part time, two-way plan: Straight commission paid with order, no investment; or start retail store on small capital. High year-round income. Standard Industrial Products, Dept. PM-10, Evansville 4, Indiana.

USE Your home as magazine subscription station. Represent all magazines. Liberal commissions—we supply everything. Big Christmas business ahead. Catalog, full details, free. McGregor Magazine Agency, Dept. 22, Mount Morris, Ill.

DOLLAR'S In personalized baby record books; sell by mail; use same literature we do. No-Co-Ro, Oakland 6-M, California.

LEARN Import-export! Represent manufacturers! Sell-buy abroad, make 1000% profit. Send \$1 for two bulletins, supplying hundreds of overseas addresses seeking connections. Money refunded if unsatisfied. Benko, 246-P Fifth Ave., New York 1.

UNPAINTED Bookends, plaques, statues, figurines. List. Haverly Products, 1219 8th Ave., Altoona, Penna.

FACT Packed book on mail order work twenty five cents. Satisfaction or money refunded. Write Houston Mail Order House, 5306 Pease Avenue, Houston 3, Texas.

MAIL Order offers increased income, independence, unlimited possibilities. Free literature. Manhattan House, 126L, Lexington, New York 16.

START Bottled natural gas business. New, amazing opportunity. Demand enormous. Pays big profits. Literature free. Enso, Pasadena 16, California.

INCORPORATE Your business, free details. Tax Research Bureau, Inc., Delaware Trust Building, Wilmington, Delaware.

LEARN Piano tuning, repairing, at home. Tremendous field! Piano parts, tools furnished. Established 1935. Empire School of Piano Tuning, 606-B East University Ave., Champaign, Ill.

INCREASE Income by mail with inexpensive letters. New, tested, proved methods, plans. Details free. Distinctive, Box 499, Bethlehem, Penna.

NEW Method of casting metal toys and novelties opens opportunity for full or spare time business and profits. Latest 1948 scale model autos, original ashtrays, savings banks, water pistols, etc., easily cast with bronze moulds. Enormous wholesale and chain store Xmas demand keeps manufacturers busy. No experience or special place necessary. Write for details and illustrations of patterns needed. Metal Cast Products Co., Dept. A, 1696 Boston Road, New York 60, N. Y.

NATURAL Molding Latex. Extra thick. Free sample. W. Wooley, 115-A Donald, Peoria, Ill.

CASH For your idea, 280 manufacturers need inventions, patented or unpatented. List free. Invention Bureau, 208M Clinton, Oak Park, Illinois.

MAKE Money sharpening saws at home on electric machine. No experience necessary. Hardware dealers act as your agents to secure work. Send for free book "Independence After 40" shows complete plan for starting in spare time. Foley Mfg. Co., 47 Foley Bldg., Minneapolis 18, Minn.

RUBBER! White liquid rubber! America's finest flexible moulding rubber! New! Extra heavy viscosity! Quick drying! Ideal for home, classroom, or industry. Only \$7.95 per gallon, \$2.95 per quart, and \$1.00 per half-pint sample. Parcel post prepaid! Plastercraft Supply Company, 3051 St. Clair Avenue, Cleveland 14, Ohio.

ANNOUNCING Home study course in commercial baking. Practical basic training. Good field for those with aptitude. Nearly depression proof. Send for free booklet, "Opportunities in the Baking Industry." National Baking School, 1315 Michigan Ave., Dept. 343C, Chicago 5, Ill.

YOUR Own mail order business at home. New, illustrated course. Free booklet. Registrar, 7219 South Broadway, Los Angeles 3.

VENDING Machines earn big money! An investment as low as \$10.50 will start you in this fascinating, profitable business that can lead you to the road of success and independence. Routes can be established and operated in either full or spare time with no experience needed. Write for full details and our free catalog illustrating our nut, candy, gum and stamp vendors; also slot machines, amusement games, etc. Parkway Machine Corporation, 623 W. North Avenue, Dept. 7, Baltimore 17, Maryland.

NO Selling, operate vendors, amazing profits, details free. Silver-King, 623 Diversey, Chicago 14, Ill.

SPECIAL Rubber for making molds. Literature and sample free. Universal, Box 1076-A, Peoria, Ill.

POPCORN Machines, peanut roasters, caramelcorn equipment, griddles, gasoline, bottled gas appliances. Northside Sales, Indianola, Iowa.

HOW And where to obtain capital. Small and large loans. Free particulars. Star Service, Wapakoneta, Ohio.

OWN Mirror shop. Resilver mirrors. Glass sign making. Electroplating. Supply prices. John Sprinkle, V60, Marion, Indiana.

BRONZED Baby shoe mountings and supplies. All metal bronze bookends, picture frames, ash trays, etc. Onyx ash trays, desk sets, plaques. Hardening solution, 30-amp. plating rectifiers with powerstat control, \$85.00. Geared motors for agitation \$20.00. Lead lined tanks. Write for list. Hollywood Bronze Supply, 1770 N. Vermont, Hollywood 27, Calif.

GET Hundreds money making deals, business ideas, plans and manufacturing. Amazing folio free. Austin Mail Service, 5538 Lexington, Chicago, Illinois.

QUICK Money. "Repairing car batteries." At home! Easy too! Batteryman, Grand Junction, Colorado.

WANTED Unused U. S. postage stamps, small discount. Advance Stamp Company, 24 East 23rd Street, New York.

POPCORN Machines. Potato chip outfits. Long Eakins Company, 4860 HI Street, Springfield 99, Ohio.

\$46 FROM Square foot plywood. Jigsaw necessary. Write, Woodarts, X-38, Bridgewater, Mass.

OPERATE Profitable mail order business. Write Walter Service, 4159-A East 112th, Cleveland 5, Ohio.

RECAST Old batteries into new. Latest achievements. Battery Laboratories, Minneapolis.

RE-NEW Leather and leatherette—Make cloth into imitation leather with plastic discovery called Leather-New. Opportunity to make real profits taking care of sales resulting from national advertising. Write for free sample of Leather-New covered material and complete deal. 4723A Troost, Kansas City, Missouri.

COLORGLAZED Concrete pottery made without molds. Patented method. Cemetery products, novelties, tiles. Basement leak-sealing. Money-making projects. Booklet, details free. Men only. National Potteries Company, Grand Rapids, Minnesota.

START Mailorder bookshop—Everything furnished. 25c brings booklet, samples, exciting ideas. General Publications, Ossining, N. Y.

SPECIALTY Manufacturing, the big money business that can be operated anywhere, start on a very small capital; we supply dependable formulas and complete instructions; get interesting free booklet, "Moneymaking Opportunities in Specialty Manufacturing." Howard Robinson, Ph.G., 1300-A South Ohio Street, Sedalia, Mo.

\$25 WEEKLY Working two hours daily. No canvassing. No manufacturing. Lycke, Box 2471, Cleveland 12, Ohio.

137 WAYS To make money, in home or office, business of your own. Full particulars free. Elite Co., 220 Grand St., New York 13.

BRUSH Plating outfits connect to a battery. No tanks necessary. Good paying business at home plating autoparts, bathroom fixtures, bicycles, reflectors, silvering mirrors. No shop or experience required. Outfits furnished. Free booklet. Gunmetal Co., Ave. H, Decatur, Ill.

WOULD You pay 3%—first \$350 made? Color-illustrated book "505 Odd, Successful Enterprises" free! Some offer occasional "day off." Work home. Expect something odd! Pacific, Oceanside, Calif.

MAILING Postcards selling repeat merchandise is profitable. Everything supplied. Details free. Gordon Publishers, Box 23, Pawtucket, R. I.

CO-PUBLISH And advertise in The Central Mail Advertiser. Sample copy for stamp. Low rates. Large circulation. Bagby Printing Co., Georgetown, Ohio.

MAIL Order opportunities. Full or spare time. Hundreds of chances. No charge. Postal brings copy. Blackstone Press, Somerville, New Jersey.

BRONZING Baby shoes is big business. Start your own business for \$3.95. All materials furnished. Metaloids, Box 2095, Wichita, Kansas.

START Home plaster novelty business. Amazing course tells how. Literature free. Kemo-Courses, Dept. A, 4862 Catalpa, Chicago 30, Ill.

MAKE Rubber stamps, Metalize baby shoes, silver mirrors, make plaster novelties. Catalogue of "20 Ideas" free. Universal, Box 1076-A, Peoria, Ill.

1948 CARD Guide, sales plans, better, quicker, cheaper results. Small capital. Guide \$1. Information stamp. Matsonian, No. Grafton, Mass.

FREE Offer. Income for life plan. Bowen's System, 317 American Bank Building, Portland 5, Oregon.

METAL, Onyx, plastic mountings for bronzed baby shoes, 20 styles. Hardening solution. Wholesale. Box 2095, Wichita, Kansas.

LIQUID Marble—Colorful, glossy! Molded, brushed, sprayed! Cast novelties, statuary, colored tiles. Flexible molds. Composition floors. Particulars free. Marbleizing Service, Edwardsville, Illinois.

START Profitable business on \$25.00 capital; like I did, instructions 25c. Alan, Box 2587, West Palm Beach, Florida.

RUBBER Molds, natural liquid rubber, flock filler (for making sectional molds), statuary plasters, felt finishes for novelties. Catalog and "Plastercraft" course free. Blue Rapids Supply, Blue Rapids, Kansas.

SHELL Jewelry, novelties. Profitable home work. Free lesson. Werts, Sharp Park (1), California.

50 BUSINESSES You can start with \$10 and make \$10 per week! Complete—detailed! Copy, \$1.00. Literature free. Carey, 25-P, Waverly Place, Melrose 76, Mass.

OWN—Operate ball gum, nut, cigarette vending machines. Amazing profits, no selling. Write for free details. Cameo Vending, Dept. P, 432 West 42nd, New York.

EARN \$200 Weekly installing new amazing "Styron" plastic wall tile in homes, offices. Easily applied. Tile your own kitchen, bathroom, too. Instructions, everything furnished. Literature free. U. S. Tile Co., 30 W. Washington St., Chicago 2, Ill.

NEW Mail order manual tells how, what, where to sell. Details free. Everett, 542A Barclay, Naperville, Illinois.

WHERE To buy at wholesale 100,000 articles. Free list. Maywoode, 1133 Broadway, New York.

YOU Make them. We sell them! New liquid plastic makes many items! Terrific demand! Earn minimum of \$50.00 per week at home. No experience or machinery required. We supply raw materials and instruction. Write Travaco Laboratories, P.O. Box 1883, Boston 5, Mass.

\$10.00-\$20.00 WEEKLY, Sparetime. Amazing opportunity. Free literature. Teepee Co., Cleveland 3, Ohio.

COPUBLISH Leading m.o. paper. Latest copy Mail Sale Advertiser and proposition, dime. Vanroy W. Shirk, Lebanon, Penna.

MOLD-MAKERS Finest quality natural latex. Sample and instructions on request; also latex for casting rubber articles in plaster molds. Lowest prices. Major Chemical Co., 131 Inman St., Cambridge 39, Mass.

ELECTRIC Appliances—Our new booklet No. 111 gives hints on the care and repair of all electric appliances from clocks to washing machines. Also details for making simple time switches to control appliances. Only 25c. Popular Mechanics Press, 200 East Ontario Street, Chicago.

MONEYMAKING OPPORTUNITIES

EARN \$25 Distributing 50 boxes of greeting cards. Over 20 different top quality assortments for Xmas, birthday plus deluxe boxed stationery. Also make extra money taking magazine subscriptions. Details free! Cassell Co., 11-D Elm St., Westfield, New Jersey.

BE A Notary Public. Largest notary supply house equips you for \$18.97, guarantees your appointment by governor. Honor, prestige. You certify legal papers, collect fees. Easy. At home, office, anywhere. You use official seal made with your name. Notaries needed everywhere. Be one. Write Stationers Exchange, Helotes 16, Texas.

MAKE 100% Selling beautiful hand carved plastic pins and earrings. \$1.00 for sample. Winston Sprague, 817 Gene-see Pk. Blvd., Rochester 11, N. Y.

HUNDREDS Of plans, wholesale supply sources, formulas, novelties. Literature and sample 10c. Lewis Davis, 3431 Campbell, Lynchburg, Virginia.

RAISE Earthworms. This new field offers unlimited profits as a full time or part time business. Send for "The Worm Turns into Profits for You." It's free. Earthworm Culturists, Box 83, Station "C," Atlanta 5, Ga.

EARN Up to \$520 month part or full time keeping books for small firms, simplified system. Write Tax-Saver System, Dept. 1, Ft. Worth, Texas.

RESILVER Mirrors at home. Formula 25c. Ideal Service, Park Ridge 6, Illinois.

START Your own business on our capital. Always your own boss. Hundreds average \$6,000 to \$25,000 annual sales year after year. We supply stocks, equipment on credit. 200 home necessities. Selling experience unnecessary to start. Wonderful opportunity to own pleasant, profitable business backed by world-wide industry. Write Rawleigh's, Dept. J-U1-PPM, Freeport, Ill.

METALIZE Baby shoes. Further information 3c stamp. Metal Crafts, Box 125-R5, Tampa 4, Florida.

EARN While you learn clock repairing. Your income can start immediately. Akron Clock Clinic, 964 Wye Drive, Akron 3, Ohio.

LEARN Year round air conditioning at home. Free information. Don Nelson, Warner Robins 2, Georgia.

MONEY-MAKING Service. Particulars free. BC Company, 760 North Main St., Fall River, Mass.

"WESTERN Advertiser" offers many worthwhile mail order opportunities. Sample copy free. H. Edlund, 577 Kensington, Los Angeles 26, Calif.

PROFITABLE Business at home spare time. Write Treasure-Trove Bookshop, Box 125-R5, Tampa 4, Florida.

OPERATE Successful mail business with our tested plans. Details free. Reynolds, Box 103Y, McAlesterville, Penna.

MONEY Making plans. Send dime for magazine. James Carter, Rocky Mount, Virginia.

\$12.00 PROFIT On 25c investment. Free folder. Suproco, Ogema 5, Wisconsin.

BABY Shoes preserved. Formulas, instructions \$1.00. Supplies and bases. Novelty Bronzing, Box 56, Hyde Park 36, Mass.

START Your own business! Big money manufacturing novelties, plaques, statuary. Free catalog. Write Bing Products, 88-A10B Broad Street, Boston 10, Mass.

EARN \$3.00 Hour! Service aquariums! Professional booklet \$1.00. Aquarium Assembling Service, Box 47, Cathedral Station, New York 25.

EARN Money evenings, copying and duplicating comic cartoons for advertisers. Adservice, Argyle 1, Wisconsin.

FINE Opportunity to have pleasant outside business of your own. Supply every home with food products, flavors, washing preparations, and scores of other daily used items. Work part or full time. Many dealers with us for from five to twenty years. Exclusive territory assigned. No age limit. Selling experience unnecessary. Don't delay. Every day counts. Write now for details. C. I. Togsstad Co., Dept. PM-10, Kokomo, Ind.

"WHOLESALE Catalog," (illustrated 10c). Bargains galore. Stafford, Box 5211B, Indianapolis 1, Indiana.

FAST Sales, cuts food cost. Nets \$9 a case. Sell 6 daily. Exclusive territory. Jeld, Ltd., Burbank, Calif.

BIG Seller, Christmas ceramic jewelry. Send 35c for sample and details. Box 272, Cooper Station, New York 3, N. Y.

\$3.41 PROFIT Per hour interest you? Easy, amazing process velvetizes interiors, signs, novelties, radios, lamps at low cost. Free sample. Sparks, 1145 Queen Anne, Los Angeles 6.

ANALYZE Handwriting for profit! Complete outfit \$1.00. Graphologists, POB-971, Philadelphia.

PRIZE Contest bulletin gives various contests now operating, and valuable hints. 3c stamp. National Contest Bulletin, Box 2685P, Miami, Florida.

WIN Contest money. General Contest Magazine gives hundreds of tips. Lists current contests and rules. Sample 25c. General Contests, 1609 1/2 East 5th, Duluth, Minn.

WOULD You pay 3%—first \$350 made? Color-illustrated book "505 Odd Successful Enterprises" free! Proven! Work at home, office. Expect something odd! Pacific, Oceanside, Calif.

PUBLISH Your own magazine. Handsome 52 page format, well edited, illustrated. Cost low as \$1.00 month. Brings you prestige, profits. 25c brings sample. details. National, Ord. Nebr.

FREE Booklet "How To Raise Worms For Bait." Tells how to propagate, package, sell. Send postcard. El Sobrante Earthworm Farm, 749-A Rincon Road, El Sobrante, California.

INCREASE Your earnings: Local business opportunities; mail order information; wholesale supply sources; valuable money-making tips; information, free details, rush name. Wilkin Company, Hillsboro, Ohio.

EARN Money at home! Thousands do! "Home Worker Magazine" tells how. Sample, 25c. Sizemore, Box 7, 4917 Kostner, Chicago 30, Ill.

SCHOOL Seniors—Sell classmates America's most beautiful graduation name cards. Largest selection. 40% commission. Outsells all others. Free sample kit. Printcraft, Dept. M, 1425 E. Elm St., Scranton 5, Penna.

FORMULAS, PLANS, ETC.

"EVERYBODY Likes candy." Learn to make professionally. (Our 38th year.) Ragsdale Candies, D5, East Orange, New Jersey.

10,000 FORMULAS And trade secrets. Free literature. Stillman, 555 Kingston Ave., Brooklyn 3, N. Y.

MAKE—Sell cleaners, soaps, polishes, flavors, cosmetics. No machinery. Formula literature free. Kemico, Park Ridge 16, Illinois.

\$1.00 GETS You 21 money-making popcorn, candy apple formulas. We supply equipment. Concession Supply Company, Dept. A, Station "B," Toledo, Ohio.

TESTED Formulas. Interesting descriptive booklet free. Pont, Box 635-PM, Terre Haute, Indiana.

PRODUCTS Analyzed. Duplicated. Improved. Formulas. Consulting Scientific Company, Swarthmore, Pennsylvania.

YOU Name it. We'll airmail formula. \$1.00. Brown, 9111 Hoyne, Chicago 20.

SAWDUST Principal ingredient of product universally used. Easily manufactured in cellar or garage. Manufacturer's formula \$2.00. Hoyt, 344 Broadway, So. Portland 7, Maine.

PHOTOGRAPHS anywhere, three formulas \$1.00. "Photo," 2437 Hollywood Ave., Toledo, Ohio.

OPPORTUNITIES! Catalog describing 200 helpful formula, money-making books. Airmailed throughout world for stamps. Adams Brown Company, Boston 67, Mass.

REAL Manufacturing formulas. Lists free. Cummings, Chemist, Gordon Ave., Syracuse 4, N. Y.

PLASTICS

PLASTICS—Sheets, rods, tubing, coatings. Shells, findings, dyes, craft supplies. Lucite scrap 25-65c pound. Illustrated fabricating manual, price list, 10c. Lucite sample, 35c. Courtesy to dealers. Gem-O-Lite, 5350F Riverton, North Hollywood, Calif.

PLEXIGLAS. Lucite, Acetate, sheets, rods, tubes, jewelry findings, craft supplies, over 1700 items. 25c which brings catalog, internal carving folder, information on fabricating plastics, deducted from first order. Plastic Parts, Dept. H-2108, 1157 S. Kingshighway, St. Louis, Mo.

AMAZING Liquid plastic pours cold, hardens in half hour. Clear, colors. Expensive equipment unnecessary. Embed photographs, coins, flowers, seashells. Complete kit only \$3.25. Kristalon Plastics, Dept. A-10, Box 29, Wilmette, Ill.

CRAFTSMAN Special. Supply kit including powdered and liquid, carving and tinting dyes. Luminous powder and cement. \$1.75 postpaid. Lucite, Plexiglas, sheets, rods, tubes, findings. Free catalogue. Craft Plastics, Somerville 1, New Jersey.

LUCITE, Plexiglas. Any article you make polishes itself crystal clear by merely dipping in "Liquid Shine" for thirty seconds. Quart \$2.95, gallon \$8.75 postpaid. Send check or money order. Instructions free. Acwood Products Co., Box 263, Long Island City, N. Y.

DON'T Throw away broken plastic articles. Use WestCol plastic cement. 40c postpaid. WestCol Mfg. Co., 108 North 3rd, Grand Junction, Colorado.

PLEXIGLAS, 19c Per pound and up. Free list. Engineering, Box 5989A Metro. Station, Los Angeles 55, Calif.

INTERNAL Carved roses, orchids, swans, goldfish, butterflies, etc. Jewelry and gifts. Crystal Floral Novelty Co., Somerville, New Jersey.

PLASTIC Injection machine. Plexiglas, jewelry findings, sequins, dyes, cements, tools, drills. Catalog. G. Baker Company, River Edge, New Jersey.

MAKE Your own Christmas gift jewelry. Internally carved flowers beautifully colored in Plexiglas ready for assemblage. Kit contains earrings, brooch, and pendant with silver-plated bow-knot pin. Complete with findings, cement and instructions \$3.95. Pilot Plastics Co., 69 Beekman Street, New York City 7.

BARGAINS In plastics. Lucite, Plexiglas, Catalin. Many colors and sizes. Details free. George Plastics, 6938A George St., Chicago 34, Ill.

RENEW Leather and leatherette—Make cloth into imitation leather with plastic discovery called Leather-New. Opportunity to make real profits taking care of sales resulting from national advertising. Write for free sample of Leather-New covered material and complete deal. 4723B Troost, Kansas City, Missouri.

PLASTIC Materials and supplies for your hobby or business. Catalog and internal carving instructions free. Art Plastics of Calif., 8125 East 14th Street, Oakland 3, Calif.

LUCITE, Plexiglas. Any size sheets. Cost square foot (12"x12") 1/16" 96c; 1/8" \$1.25; 3/16" \$1.52; 1/4" \$1.80; 5/16" \$2.23. Include 10% postage. Almac Plastics, 1150 Broadway, New York 1, N. Y.

PLASTIC—Sheets, rods, tubes, etc. Free list. Plastic Supply Co., 2901 No. Grand Blvd., St. Louis 6, Mo.

BOOKS—All Kinds—Homecraft, Radio, Plastics, Boat Building, Photography, Model Building. Catalog free. Popular Mechanics Press, 200 E. Ontario St., Chicago 11, Ill.

CHEMISTRY

CHEMICALS And apparatus for industrial, analytical, and private laboratories. Catalog 10c. Dept. M-26. Biological Supply Co., 1175 Mt. Hope Ave., Rochester 7, N. Y.

LEARN Chemistry at home, from the house of Winn. Home of supplies for student chemists. New idea chemical and apparatus outfits for home experimenting. Photographic scales, semi-professional microscopes and accessories. Send 15c for retail catalogue. Established 1931. John H. Winn, 124A West 23 Street, New York 11, N. Y.

NEW Laboratory supply catalog of chemicals and apparatus. Contains many thousands of items with illustrations. Send 25c. Standard Science Supply Company, 1232 N. Paulina St., Chicago 22, Illinois.

FREE Catalog: Chemistry, mineralogy, physics, biology. Tracey Laboratories, Evanston, Illinois.

HANDBOOK For chemical experimenters, illustrated, hundreds of experiments, 50c. Experiment booklet 15c. Supply catalog 5c. Reading Scientific Company, Reading, Penna.

LABORATORY Chemicals, apparatus, books. Catalog 10c. Fleischer's Laboratories, Everett 49, Mass.

HELP WANTED

ACT. Sell new Xmas photo greeting folders. Big profits, we deliver. free kit. Spooner, 115 Chauncy, Boston, Mass.

AGENTS WANTED

HERE Is an opportunity for men, women, and children to earn a big cash commission, selling our beautiful tinsel religious mottoes at 25c each. They sparkle in the light and glow like stars in the dark. They are new, they are different from all other mottoes. They sell on sight. Satisfaction guaranteed. Send for 12 mottoes to sell at 25c each. Send no money, we trust you. Pay after you have sold all 12 mottoes. The Diamond Motto Co., 920-PM Manchester St., Lexington, Ky.

PHOTO-Salesmen-agents. Sell beautiful hand-colored plastic enlargements. Collect deposit, we deliver. Profitable sideline. Send card, for free sample kit. Novel Portrait Co., 3343 North Ave., Chicago, Ill.

SELL Guaranteed new product thoroughly sales-tested. Turbine action brush automatically washes cars, windows, boats, floors. No rubbing, no wiping. Be first in your city with this amazing item. Send for sample only \$4.20 with free package "Magic" crystals. Sells for \$6.95. Write for quantity prices. Melaire Distributing Co., Dept. A, 420 Lexington Avenue, New York 17, N. Y.

MAKE Money fast! Sell Christmas cards to friends, neighbors, others. Big variety etchings, religious, 50 for \$1.00, wrappings, stationery. New \$1.25 line "Little Ones," flower box, plastic frost-eds, Saints 'n' Sinners. Special offers, bonus. Fund raising opportunity for individuals, clubs, churches, schools. Mail postal today for feature 21 card \$1.00 Christmas assortment on approval. Hedekamp, 343 Broadway, Dept. 0-42, New York 13.

BRAND New: "Liquid Stitch" repairs snags, stops runs to all hosiery. No woman should be without it. (Ideal gift.) Retail 49c. Take orders, department, variety, drug stores, etc., or carry own stock. Good commissions. Attractive store display. Write: Porter Mfg. & Supply Co., 2500 West Sixth St., Los Angeles 5, Calif.

SUCCESS Seekers. \$1-\$3 advance commissions plus cash bonus plan selling quality shoes direct. Amazing features. 73 styles entire family. Experience unnecessary. Free starting outfit. Moench Shoes, 10 Boston, Mass.

AGGRESSIVE Agents wanted to demonstrate guaranteed Copper-Cote ironing pad and cover sets. Endorsed by housewives everywhere. Sure-fire sales plan helps you get started. Generous commissions. Protected territories for producers. Real deal for live wires. The Sheldon Company, Box 1347, Milwaukee, Wisconsin.

MAKE 100% Profit selling name imprinted Christmas cards and \$1.00 assortments. Also personalized napkins and stationery. Request samples. Dunbar, Sanford 2, Florida.

GUARANTEED Product in protected territory, if you are now selling or intend to sell house-to-house. For full 1 qt. sample amazing High Shine Windsor No Rubbing Wax, send only 25c covering handling and postage. (Sells for \$1.25.) Windsor Wax Co., Inc., Dept. P.M.-2, Hoboken, N. J.

\$1 STARTS You in business. Sell lined ties, 100% wool interlining. Costs you only \$7 per dozen, you make \$5.00 dozen. Send \$1.00 for special introductory offer two ties. Catalog complete line free. Phillip's Neckwear, 20 West 22nd St., Dept. K-28, New York 10.

AMAZING Offer—\$40 is yours for selling only 50 boxes, each containing 25 new, entirely different deluxe Christmas cards with or without name imprinted. Also 50 for \$1.00. Free samples. Other boxes on approval. Write today. It costs nothing to try. Cheerful Card Co., 445, White Plains, N. Y.

WANT Pleasant outdoor work in a business of your own? Good profits selling over 200 widely advertised Raleigh home /farm necessities. Pays better than most occupations. Hundreds in business 5 to 20 years or more! Products-equipment on credit. No experience needed to start, we teach you how. Write today for full particulars. Raleigh's, Dept. J-145A-PPM, Freeport, Ill.

SELL Ultra-blue stock signs to stores. 1000 slogans, comedy, general, religious. "7x11" cost 6c, sells 35c. Make money. 15 samples ultra-blue signs "7x11" \$1.00 postpaid. Lowy, 8 West Broadway, Dept. 416, New York City 70.

ENTIRELY New—Entirely different specialized men's shoe line. Advance commissions to \$2.50. Bonuses, personal discounts. Free selling kit. Concordian Shoes, M-2, West Concord, Mass.

EASY Cash yours—Steady, quick. Sell friends quality Nylon hosiery, lingerie, blouses. Free displays. Complete line greeting cards. Leader Christmas assortment on approval. Special outfit offers. Wear Wright Company, 1709 Arch St., Dept. B, Philadelphia, Penna.

SCHOOL Seniors! Your postal will bring our wonder, Kwick-Sell Cardalog of popular graduation name cards. Biggest profits! Only firm giving free souvenir chest and card case. Don't miss out! Hurry that postal! Craftcards, Box 235-L, Pittsburgh 30, Pennsylvania.

PLASTIC Tablecloth covers, curtains, drapes, baby pants, bowl covers and other plastic articles selling like wildfire! Make big money now! Free details. Write L & M Co., Dept. 58-K, 510 St. Charles, St. Louis, Mo.

SEWING Machine electrification kit. Nationally advertised guaranteed product. Unusual opportunity for right men. Potential earnings unlimited. For complete details write today to Brownell Co., 308 Canal St., New York 13, N. Y.

SPECTACULAR Guarantees, popular prices, make selling easy. Biggest steady repeat profits selling Colt's famous men's, women's guaranteed shoes, hosiery. Experience unnecessary. Free selling outfit. Colt Shoes, 601-J10 Atlantic, Boston 10, Mass.

PATENTED Flood lights. Sell to theatres, lodges, auditoriums, schools, stores, homes. Literature free. Communications Inc., 110-B University, Seattle 1, Wash.

I'LL Put a "shoe store business" in your pocket! Nation's leader trains you to make big money! Fit men, women. Free sample outfit, write today! Consolidated Shoe System, Dept. S-139, Chippewa Falls, Wis.

POCKET Pal: replaces knives, new, safe, beautiful. Always razor sharp. 50c seller. 321% profit. \$15.00 or more daily. Agents, salesmen, distributors. Sample 25c. Nelson Mfg. Co., 222 W. Kellogg, St. Paul 2, Minn.

DEALERS And Agents—Sell E-Z View day or night, anti-glare attachment for car visor. Make 40% on investment. Send for information. Jewel Industries, Inc., Dept. A, P.O. Box 889, Canton, Ohio.

OUTSTANDING 50c Seller. Million dollar flight airplanes. Sample 25c. Dozen \$2.25. A. F. Kolinski, 759 South 25th, Milwaukee 4, Wisconsin.

MAKE Easy money selling finest line name imprinted Christmas cards, 50 for \$1 and others. 20 bargain assortments, stationery, gift wrappings, up to 100% profit. Write for 21 card leader on approval, free offer, and free portfolios. Dept. 221, Silver Swan Studios, 320 Fifth Avenue, New York.

DIRECT From factory. Make \$100.00 weekly selling watches. Advertised brands with guarantee. Free catalogue. Ergim Watch, 833 Columbus Ave., New York.

A DRESS Yours with every 3 you order for yourself and family. Amazing new bonus plan. Everything free. Harford Frocks, Dept. T-9128, Cincinnati, Ohio.

DOUBLE Duty shopping bag. Zips open. Instantly changes from small to large size. Lightning seller. Samples sent on trial. Kristee 126, Akron, Ohio.

REPRESENTATIVES Needed in every state. Write details. M. Thomas, 2 Callo-dine, Eggertsville, N. Y.

AGENTS, Distributors. \$28 upward daily possible. Flo-Glo plastic linoleum finish. Acme, Box 404-PM, Mount Vernon, N. Y.

200 SURGICAL Steel blades \$1.00. Pen sets \$1.00. Jerome Sales, Box 16 Station K, Brooklyn 19, N. Y.

AGENTS Wanted for our coin operated amusement and slot machines in every town and community. Sell, or start your own route. Big profits! Write for free wholesale catalog and deal. Aerobilt Products Co., Dept. 27, 3767 Druid Station, Baltimore 17, Maryland.

GREETING Card salesmen, saleswomen—Add fast-selling pictorial plaques to your card line and double your earnings. Rush name, address for free details, pictures. Marsh-Art, 1308-P Browne, Yakima, Wash.

MAKE Sensational profits! New, sell-on-sight plastic line: Tablecloths, aprons; many other splendid fast-selling items, novelties. Postal brings free details, special deals. Hurry! Royalty, Box K-748, Passaic, N. J.

SELL The famous \$3 "Fire-Killer" extinguisher with bracket, wholesale or direct; exclusive territory. Demonstrating sample \$2; refilled free. "Fire-Killer," Syracuse 1, N. Y.

FREE Nylons given if Kendex hosiery runs or snags! World's only women's hosiery sold with a written guarantee that amazes everybody. Mere words could not possibly express the almost unbelievable opportunity you now have to make money. Fantastic and "impossible" earnings now become a reality. Can you imagine a guarantee that replaces hosiery regardless if damage is due to use or abuse and regardless whether it is the fault of the hose or the wearer? Here is sales dynamite that will blast your earnings to the sky! Even if you never sold a thing in your life, three magic words: "guaranteed against everything" will open doors for you—will make women listen and will pour money in your pocket. Kendex stockings are not sold in stores, so you have no competition. Complete line includes beautiful sheer nylons; long wearing, durable service nylons; three different lengths; genuine outside nylons; latest shades; choice of full fashioned with seams or seamless; lowest priced rayons. Also separate complete line of men's hosiery including nylon, lisle, rayon, cotton, mixtures etc.; plain and fancy; long and short. Thousands of pairs shipped daily. No money or experience needed. Nothing to invest or risk. No samples to buy. Nothing to pay, now or later! Simply write orders. We deliver and collect. Liberal advance cash plus huge cash bonus. Write orders spare or full time; exclusively or as a side line. Become a manager and appoint others to sell for you with steady income on their sales! Complete money-making outfit, including salesbooks in color, samples cut from actual hose, instructions, order blanks etc. furnished free and prepaid. Rush name and address on postcard and start making money next week. Kendex Co., Babylon 176, New York.

REAL Money showing neckties! You can salt away plenty of extra cash right at home part time or full just showing neckties that "sell on sight." Men grab these fashionable Fifth Avenue Ulster Cravats that bristle with style, smart patterns, becoming colors. Practically impossible to resist the low factory price half the retail cost. You net \$40 to \$60 per 100 Ulster Cravats ordered by friends and associates. Gift possibilities wide open—churches, bazaars, fund-raising drives, etc. For information to get started, write Ulster Cravats Co., Inc., Dept. PM-1, 545 Fifth Avenue, New York 17, N. Y.

USE Your home as magazine subscription station. Represent all magazines. Liberal commissions, we supply everything. Big Christmas business ahead. Catalog, full details, free. McGregor Magazine Agency, Dept. 12, Mount Morris, Illinois.

BUY Thousands of nationally advertised products direct from manufacturers. Write for "buy direct and save." Consumers Ass'n, 287-A Lebanon Ave., Mt. Lebanon, Penna.

HOTTEST Xmas item. Sells on sight. Details free. C & C Sales Co., Box 1046, P, Chicago 90, Ill.

GOOD Sparetime profits daily. Information free. Polesi, 666 East 233rd Street, Bronx 66, N. Y.

AMAZING Dust cloth. Picks up dust like a magnet. Cleans glass, furniture, autos beautifully. Sells like wildfire. Carry day's supply under arm. 100% profit. Sample, details free. Hobart Rude, 3953 Whiteside, Los Angeles 33, Calif.

BIG Profit opportunity! Cash in on volume sales, amazing traction tracks. Patented June, 1947. Get cars out of snow, mud, sand in jiffy. No tools, no shoveling, no ashes. Money-back guarantee. Sample \$1.00. Details free. Consolidated Equipment Corporation, 2737 Guardian Bldg., Cleveland, Ohio.

FAST Sales, cuts food cost. Nets \$9 a case. Sell 6 daily. Exclusive territory. Jeld, Ltd., Burbank, Calif.

QUICK Money. 100% profit. Show Christmas cards, stationery to friends, coworkers. No experience. Approval samples. Torres Company, 373 Fulton Street, Brooklyn 1, N. Y.

BIG Profits selling used clothing. Operate from home, auto or store. Men's suits \$4.00. Overcoats \$4.00. Field jackets \$2.00. Ladies' coats \$1.50. Army shirts \$1.50. Other big bargains. Catalog free. Kadetsky & Son, 702 Barber Street, Dept. 103, Chicago 7, Ill.

CHRISTMAS Cards—50 for \$1, other series, over 25 from \$1-\$2.50. Also box assortments. Free sample albums. Commission-bonus. Richar Greeting, 16 East 18, New York 3.

EARN Big money year 'round. Be a one-person-department-store. Take orders for shirts, ties, hosiery, lingerie, Household linens, etc. For information, Corporate Merchandisers, Dept. PM-7, 110 West 34 Street, New York City 1.

SILVER Plating liquid—(NuSilver). Apply with cloth. Durable, guaranteed, genuine, silver finish. Renews silverplated ware, articles, pieces. Silverplates brass, copper. District, state, sales-distributors wanted, exclusive. NuProcess Products, Aurora, Illinois.

\$5.00 CASH Advance commission every sale 38-piece "Lady Ann" silverware. Guaranteed quality, value bring sales galore. Also varied line of other silverware and housewares. Write for sure-fire sales outfit, Dexter Silver Co., Dept. PM-10, 303 Fifth Ave., New York 16.

MAKE Big weekly commissions selling nationally advertised aluminumware, silverware, pressure cookers, canners and gift items. No investment required. Simply take orders, collect commissions, we do the rest. Complete sales kit free. Write Ury Co., Dept. 12C, 222 - 4th Ave., New York 3.

BIG Money—Fast! Sell quality plastic tablecloths (from \$4.00 dozen), curtains, aprons, and complete plastic line. Direct from factory. Free samples. Dur-Ever, 314-C Albany Ave., Brooklyn 13, N. Y.

LARGER Profits; fastest sellers! Newest hits, for men and women. Many offers. Literature for stamp. McCurdy Service, P.O. Box 1877, Miami 11, Fla.

FAMOUS Bostonian shirts now in full production again—This nationally known shirt maker, est. 1863, making one of the finest lines of shirts in the country, is now adding a limited number of sales agents selling direct to the consumer; liberal commission; fast selling, quality line, repeat sales, no investment, immediate commission, establish your own business; make up to \$5000 yearly. Write for free sales kit, Bostonian Mfg. Co., 89 Bickford St., Boston 30, Mass., Dept. PM9.

MAKE Real money next 60 days selling all-metal interlocking weatherstrip sets. Prospects everywhere. Experience unnecessary. Write E-Z-ON-9, Box 1061, Chicago 90, Illinois.

BOYS! Earn big money and bonuses easy selling brass name plates for neighbors' doors. Write Hubstamp, 357-A Congress, Boston, Mass.

BIG Money selling cast iron and aluminum cooking utensils direct to consumer, exclusive designs. Free illustrations. Jones Machine & Foundry Co., Chattanooga 2, Tenn.

BIG Bargains for big profits. Over 100 sensational wholesale values. Men's used suits \$2, pants 35c, topcoats \$1.25, overcoats \$2, shoes 20c. Experience unnecessary. Free catalog. Superior, 1250-A Jefferson, Chicago 7.

FREE Sample! Big profit opportunity with amazing Glow-in-the-Dark house numbers, switch plates, pictures, decals, religious articles. Represent large manufacturer. Madison Mills, 303 Fourth Avenue, New York 10, N. Y.

PLASTIC Christmas cards. Exclusive new plastic, sachet, panoramic and carols Christmas assortments. Five leading 21 card \$1.00 feature assortments. Six portfolios of personal cards. All this plus America's fastest imprint service. Free samples. Elmcraft Card Co., 5930 South Western, Chicago 36, Illinois.

AMAZING Profits. \$25.00 for selling 50 \$1.00 deluxe Xmas boxes. Embossed 50 and 25 for \$1.00, name imprinted. Free samples. Ed-Brite, Dept. 12, 435 North Terrace Avenue, Mt. Vernon, New York.

MAGIC Cleaner—Laundry soap deal. Hotter than a firecracker. Big profits. Sample free. Bestco, 4642 No. Central, Chicago.

AGENTS: Stamping names on pocket-key protectors. Sample check with your name, address, 25c. Stamping outfits. Emblem checks, check-fobs, name plates. Hart Mfg. Co., 303 Degraw St., Brooklyn, N. Y.

MAKE More money selling personal initialed individualized belts, buckles, cap badges, tie holders, name plates, 2,000 emblems to choose. Big profits, whole or part time. Write today; special outfit offer. Hookfast Specialties, Box 1425, Dept. 6, Providence, Rhode Island.

FREE Water and our concentrates, makes flavors, lotions, shampoos, 72 products, labels, bottles furnished. Qualco, E-20030 Russell, Detroit.

INFORMATION—Wholesale supply sources. Money-making plans. Increase your income! Write Reynard Service, Smithfield 3, Ohio.

GOLD Lacquered window sign letters. Large sizes penny each. New foils. Absolutely beautiful. Free samples. Atlas, 544 W. 79th, Chicago 20.

EXCELLENT Sideline for printing and advertising salesmen. Decalcomania name plates in small quantities. Great demand. Also, make money with our line of automobile initials and sign letters. Free samples. "Ralco" XL-Roxbury, Boston 19, Mass.

AGENTS—300% Profit selling genuine gold window letters; stores and offices. Free samples. Metallic Letter Co., 438-B North Clark, Chicago.

CHRISTMAS Cards! Jobbers' prices! Fifty different items from 18c to 38c per box. Gift wraps, seals, Christmas tree windows, books, letterheads. Illustrated catalog free! Fantus, 436 North Wells, Chicago.

SELL Mexican feather bird pictures. Hand-made of real feathers. Sample 25c. Importer, C. Staff, 14960 Evanston, Detroit 24, Michigan.

GREETING Card agents! Double your income with profitable sidelines. Write today! Mosher's, Vineyard Haven, Mass.

SCHOOL Seniors—Earn 40% commission selling classmates America's most beautiful graduation name cards. Largest selection. Outsells all others. Free sample kit. Printcraft, Dept. M, 1425 E. Elm St., Scranton 5, Penna.

LONG Needed invention. Old established company. Easy demonstration. Proved success. Every home, factory, store, farm a prospect. Low price, long profit. Exclusive. Fine outfit furnished. Local territory. No deposit. Get facts quick. Write 259 R. C. Bldg., Red Comet, Inc., Littleton, Colorado.

HIGH-GRADE SALESMEN

FASTEST Selling accessory. Salesmen making up to \$1000 and better monthly. Safety clamps for auto tie-rods, insurance against sudden death. Practically no consumer resistance. You can get in business for as little as \$13.40. Territory being rapidly assigned. If you want to make money write today. Adv. on request. Sample 95 cents. Lox-It Mfg. Co., Clarkdale, Mississippi.

ADVERTISING Book matches—Cash in on big demand; sell union label matches. Cuts for all businesses and political parties. Free powerhouse selling kit, low prices, protection guaranteed on repeat orders. Cash commissions. Superior Match Co., Dept. M-108, 7530 Greenwood, Chicago.

MAKE \$15.00 To \$25.00 per day. Joe Louis' and Marva Louis' (his wife) toilet articles, cosmetics and other products for men and women are sensational. White people like them; colored people buy on sight. Perfumes, powders, pomades, creams, brown creams, flavors, remedies, and many other fast sellers are our features, \$3.95 buys \$10.03 (23 items) retail deal—send \$1.00, pay postman balance. Be first in your community to offer this new line and you will be happy. Joe Louis Products Company, 6 E. Garfield Blvd., Dept. PM-10, Chicago 15, Illinois.

WANT Pleasant outdoor work in a business of your own? Good profits selling over 200 widely advertised Rawleigh home /farm necessities. Pays better than most occupations. Hundreds in business 5 to 20 years or more! Products, equipment on credit. No experience needed to start. We teach you how. Write today for full particulars. Rawleigh's, Dept. J-145B-PPM, Freeport, Ill.

MEN And women—Earn \$25 daily, selling silverware, aluminumware, pressure cookers and 14 more fast selling items direct to consumer. Full or part time. No investment. Write for free sales kit. Colonial Products, Dept. P10, 30 Ormsbee Ave., Providence, R. I.

SELL Delicious candies, nuts, gum. Immediate delivery. Write Casterline, 2631-PM Sunnyside, Chicago 25, Illinois.

FREE Stock sample—Nameplates for homes, desks, 100% profit. Whitney Co., Oakville, Conn.

BIG Money selling tooth powder. J. Walker, 633 Plymouth Ct., Chicago, Ill.

SALESMEN To sell to churches, schools, organizations, in large quantities; forty page book "Our Country's Flag" (copyrighted) illustrating the proper way to display the United States flag on all occasions. Send 50c for sample and full particulars to National Advertising Service, Herald Building, Syracuse, New York.

FAST Sales, cuts food cost. Nets \$9 a case. Sell 6 daily. Exclusive territory. Jeld, Ltd., Burbank, Calif.

SILVER Plating liquid—(NuSilver). Apply with cloth. Durable, guaranteed, genuine, silver finish. Renews silverplated ware, articles, pieces. Silverplates brass, copper. District, state, sales-distributors wanted, exclusive. NuProcess Products, Aurora, Illinois.

ONE Month's earnings. KJD \$2,451.83, EDK \$1,978.37, RVU \$1,240.33. Of course, these are unusual earnings but they indicate the possibilities. Remarkable product! Thousands prospects everywhere. Place on free trial—sells itself. Orders financed by factory. Special demonstrator offer. John Wilson, 2433 Indiana Ave., Dept. 310, Chicago 18, Ill.

LOOK! Pocket \$3.25 every sale. Just show friends beautiful 9-piece aluminum set selling under \$11.00. Featuring 5-in-1 cooker. Your own set at wholesale price. Complete sales kit free. Write Ury Co., Dept. 12CA, 222 - 4th Ave., New York 3.

MAKE \$500.00 A week! Be first with "Neo-Fluorescent." Revolutionary invention! New type fluorescent sign replacing neon. Fantastic virgin market with dealers, mfgs., distrib. nets fabulous profits. Free sample offer. Rose Co., 539-TT So. Franklin, Chicago.

BIG Money quickly and easily taking orders for complete line personalized initialed buckles, belts, cap badges, 2,000 emblems. Fast repeats. Write today, Hook-Fast Company, Box 480-PM, Roanoke, Virginia.

JOBS Open in selling! Send name, address for free copy Opportunity Magazine, listing hundreds of companies who need men now, full or spare time. Experience not essential. Opportunity, 28 E. Jackson, Dept. 17, Chicago 4, Ill.

BIG Money taking orders. Shirts, ties, socks, pants, jackets, sweaters, shoes, uniforms, etc. Sales equipment free. Experience unnecessary. Nimrod, 4922-AN Lincoln, Chicago.

EDUCATIONAL AND INSTRUCTION

BIBLE Course free. Write: Victory Service, Dept. 1048PM, Emmaus, Penna.

TECO Motor kit—Complete parts for small low voltage a.c.-d.c. motor. Quality product for electrical students in high school, industrial, vocational, and home laboratories. Arranged for demonstrating squirrel cage and wound rotor, series, shunt and compound connections, brush settings, air gaps, and other salient technical points pertaining to electric motor operation. (Not merely a toy). Write Teco Incorporated, P.O. Box 127, Boonton, New Jersey.

NOW You can have an office. Many earn up to \$5,000-\$15,000 annually in the collection business. Learn by home study course. Experience unnecessary. Write for free bulletin. No obligation. Franklin Credit School, Dept. 228-K, Roanoke 7, Virginia.

MAKE Up to \$30-\$40 week as a trained practical nurse! Learn quickly at home. Booklet free. Chicago School of Nursing, Dept. M-10, Chicago.

GOOD Jobs and a sound substantial future await you in hotel and institutional field. Men and women, all ages, needed for well-paid positions that offer color, excitement, ever-new and fascinating duties. Record breaking travel means even greater opportunities for trained men and women in hotels, clubs and institutions. Lewis School receiving calls for managers, assistant managers, stewards, hostesses, purchasing agents and 55 other types of important positions! From coast to coast there are important positions that offer splendid opportunities for advancement in a business where you are not dropped because you are over 40. Previous experience proved unnecessary! No need to leave your job to qualify. A good grade school education, plus Lewis Training qualifies you at home, in spare time. Our National Placement Bureau helps to place you; and our amazing Certified Job Plan actually certifies you will "make good" when placed. Write today for free book! Veterans' course approved for Veteran's training. Lewis Hotel Training School, Room NT-368, Washington 7, D.C. (First and only school of its kind—now in its 33rd year.)

"HOW To Break and Train Horses"—A book every farmer and horseman should have. It is free, no obligation. Simply address, Beery School of Horsemanship, Dept. 11010C, Pleasant Hill, Ohio.

PRACTICAL Course—Automobile radiators, repairing, recoring, cleaning. Ralph Hendry, Gait, Canada.

LEARN Typewriter repairing under G.I. bill. Adding machine and calculator courses available. For information write Dept. PM9, Capitol School of Typewriter Mechanics, 1326 New York Avenue, N.W., Washington, D. C.

U. S. Civil Service jobs. Congress ups pay, \$330-\$450. Men, women secure positions, qualify now. Free 40-page book lists positions. Write Franklin Institute, Dept. G24, Rochester, N. Y.

VETERANS—Send for free 36-page colored photo book. World's Largest Watch-making School, Desk 40, 808 Ridge Ave., Pittsburgh, Penna., "Workshop of the World."

LEARN Auctioneering by mail. Sample lesson free. Nelson Auction School, Renville, Minnesota.

HOME Bible course. Simple, helpful, instructive. Total cost \$4.00 includes textbooks, stationery, examinations, certificate. \$1.00 starts you, or simply request prospectus. The Bible Study School, 378 Van Houten Street, Paterson 1, N. J.

CORRESPONDENCE Courses. Used International. Many subjects. Satisfaction guaranteed. Write today. Baker, 5509 Winthrop, Chicago 40.

INVESTIGATORS Trained, men-women, learn fascinating profession. Spare time study. Big pay. Folders free. Investigator, Box 490, Times Square Station, New York 18, N. Y.

INVESTIGATOR Training. Scientific crime detection courses. Free literature. Write today! State age. Institute of Scientific Criminology, Dept. J, 1324 West Broadway, Spokane, Washington.

FOR An extremely profitable lifetime business operate a collection agency-credit bureau. Easily learned. Free folder. Cole & Associates, Syracuse 2, N. Y.

USED Correspondence courses and educational books bought, sold, rented. Catalog free. Educational Exchange, Summerville, Ga.

LEARN Bricklaying. Home instructions by expert. 25c brings information. Write Wall, Pinehill R#6, Jackson, Miss.

MAKE Money in bookkeeping! Introductory lesson 35c. 15 lesson course \$5. Bernard Buchalter, 1280 Ocean Ave., Brooklyn 30, N. Y.

AIR Conditioning, refrigeration and heating. Nine months resident course of complete technical and practical training for those who want to become sales engineers, contractors, estimators, installers, or service men. Write for free booklet. Now accepting enrollments for Oct. and later classes. G.I. approved. Detroit Air Conditioning Institute, 4125 Grand River Ave., Detroit 8, Mich.

NEW Profession. Podiatry—Foot correction. Unlimited field. Learn at home. Write Registrar, American Foot Health Institute, 55 East Washington, Chicago, Ill.

EDUCATED Memory develops alertness, confidence, and success. "Memorology," a new book on the science of memory will enable you to amaze your friends and employer. Literature free. Memorology Club, 2016 Sunnyside Ave., Chicago 25, Illinois.

DEVELOP Photographic mind by Supermemory. Write Thor Books, CM-10, Box 1210, Chicago.

INCREASE Your earning power! Our "Speed-Addition" course will double your speed in 30 days without study. Free "eye-opening" details. Vanderdrift, 517 Lincoln Place, Orange 3, N. J.

3800 LATEST Used correspondence courses. Catalog 50c. EG, Elmsford, N. Y.

PIANO Tuning can be learned with our complete course of printed lessons. Only \$5.00 postpaid. Evansville School of Piano Tuning, 714 S.E. Second St., Evansville, Indiana.

OIL Painting. Simplified home study course. Beginners learn quickly—Ideal for shut-ins. Mature artists also gain additional skill. You purchase only one lesson at a time. Technocratic School of Color, Roland Pierson Prickett, Box P.M., Hampden, Mass.

SHOE Repair school. Teach you quickly! Age 18 to 60. In 12 weeks you can be skilled. Modern Shoe Rebuilding, 806 S. Figueroa St., Los Angeles—2935 Belmont, Chicago.

MEDICAL Laboratory technicians in great demand. We train you in your own home, in your spare time. Also home study course in general chemistry. Free catalogue. Imperial Technical Institute, Box 100, Austin, Texas.

INVESTIGATOR Training. Phillips Secret Service, 1917B North Kenneth, Chicago 39, Illinois.

BOOKKEEPERS! Increase your earnings! Operate your own simplified "dollar-a-week" bookkeeping and tax service. Full or spare time. Details free. No obligation. Ellis, Box 200, Cedar Grove, North Carolina.

USED Correspondence courses and books bought, sold, rented and exchanged. Catalog free. Lee Mountain, Pisgah, Alabama.

LINGUAPHONE Makes languages easy. At home learn to speak Spanish, Portuguese, Italian, French, German, Russian, by quick, easy Linguaphone Conversational Method. Save time, work, money. Linguaphone correspondence courses are available to veterans under G.I. bill of rights. Send for free book. State if G.I. Linguaphone Institute, 83 RCA Bldg., New York, 20, N. Y.

LEARN Photo-engraving at home or in oldest, largest school in America. Work for newspaper or establish own profitable business. New Tasope' Photo-Engraving equipment available soon. Write for information. Veterans ask about G.I. training. The Aurora School of Photo-Engraving, Tasope' Bldg., Aurora, Mo.

SECRET Investigation. Experience unnecessary. Investigators particulars free. George Wagner, M 125 West 86th, New York.

START Learning dental technician trade. Ten simple lessons \$5.00. Grant Laboratory, S. Los Angeles 14, Calif.

HOME Study course, drugless therapy. Free literature. Institute of Drugless Therapy, Tama, Iowa.

BOOKS—All Kinds—Homecraft, Radio, Plastics, Boat Building, Photography, Model Building. Catalog free. Popular Mechanics Press, 200 E. Ontario St., Chicago 11, Ill.

PLAYS, STORIES, MANUSCRIPTS

I WANT New writers to cash hundreds of checks for \$1 to \$100, offered each month. The easiest way to write for pay. No previous experience necessary. Send for free details. No obligation. Saunders M. Cummings, 467-M Independence Bldg., Colorado Springs, Colo.

BUSINESS SERVICE

A CHICAGO Address on world's busiest corner, State & Madison Streets. Increase your sales 50%. Your mail received and forwarded immediately; phone messages taken; conscientious service, \$6.00 monthly. Marcus Secretarial System, 7 W. Madison St., Chicago.

2,500 NAMES And addresses of salesmen, \$7.50. All 1948 names. W. Nothorn, Lake City, Arkansas.

ENVELOPES, Cards, labels addressed (typewritten) in thousand lots. Letters mailed 25c each. H. N. Johnson, Box 85, Jacksonville 1, Fla.

ACTIVE Mailing list of top-flight executives with incomes \$10,000 plus, in mid-west. \$1.00 per hundred; \$8.50 per thousand. Warren, Box 186, Kenney, Ill.

WE Receive, reforward letters; \$3.00 monthly or 25c each. "Hawkins," 1300 Taylors, Washington 11, D. C.

SPECIAL SERVICES

HOSIERY, Handkerchiefs, shirts! Quick shipments. Wholesalers, distributors, write for prices. Spartan Hosiery Company, Spartanburg, South Carolina.

PRETEND Visiting Puerto Rico, 3 scenic cards 25c. You address return, we remit free. Letters remailed 15c. Russell Johnson, McKinley St. #70, Mayaguez, Puerto Rico.

INFORMATION

BIG Money to qualified workers in construction, today's best paying industry, latest authentic information bulletin \$1.00. D. Powers, Box 691, Antioch, California.

FOREIGN Employment for you. Excellent permanent job opportunities for U. S. citizens. Wages at least 20% higher, less taxation, lower living costs. Improved social position. Transportation and housing furnished. Choice of climate and location. South and Central America, Far East, China, Alaska, Africa. Send \$1.00 for copyrighted Digest showing oil, shipping construction, mining, etc. Companies working and hiring. Includes sample application letter, advice on wages, tips, etc. World Wide Company, Dept. PM-10, Madison 1, Wisconsin.

CARTOONING, COMMERCIAL ART, SHOWCARD WRITING, SIGN PAINTING

"HOW To Make Money With Simple Cartoons"—a book everyone who likes to draw should have. It is free; no obligation. Simply address Cartoonists' Exchange, Dept. 910-C, Pleasant Hill, Ohio.

SIGN Painting taught at home. Test lesson free. Ben Kerns Studios, Box 812, Greenville, S. C.

9 ALPHABET 3 Numeral pattern sets and catalog, \$1.00. Sign Letter Distributors, P.O. Box 101, Mineola, N. Y.

FIGURE Drawings by French artist Lalire. Over hundred female poses, body details, \$1.00. Art Headquarters, 1160 25th Avenue North, St. Petersburg, Florida.

LEARN Showcard writing. Fascinating, profitable. No special skill needed. Free information. Sherwood Publishing Co., Irvington, 11-2, N. J.

CARTOONS Printed. Write School of Cartoons, P.O. Box 3291, San Francisco 19, Calif.

CHALK Talks. Laugh producing program, \$1.00. Catalog 10c. Balda The Cartoonist, Oshkosh, Wisconsin.

ADVERTISING AGENCIES, LETTER WRITERS, FOR ADVERTISERS

MAILING Lists guaranteed, thousand typed names \$5.00. Gonzalez, 304 South Broadway, Los Angeles 13, California.

25 WORDS 45,000 Readers, 3 months \$3.00. Renick, Holland 5, New York.

ADVERTISE: 24 Words, 40 newspapers \$3.50. Lists free. Advertising Bureau, 229-C Dixon, Uniontown, Penna.

24 WORDS in 50 weeklies, \$4.96. J. Darnell, 730 Hays, Jackson, Tennessee.

SELLING By mail? Planning to? Want to? You need "Mail Sellers' Handbook." Copy 10c. National, Box 88F, Dorchester, Mass.

EARN Money in your spare time. Progressive Mail Trade tells you how. Large 64 page magazine for a dime. Progressive Mail Trade, 822 Center Ave., Sheboygan, Wisconsin.

ADVERTISERS! Reach nearly 18,000,000 readers. 25 Sunday national key newspapers, 18 words, \$47.75. "Terrific pullers." 20 popular newspapers, \$9.75. "Free booklet." Special—One inch display 2-821,198 circulation, \$42.00. Newmark's Advertising Agency (Established 1893) 217-7th Ave., New York 11.

ADS Placed in out of town newspapers and magazines. Low rates. Catalogue free. Ideas that pay. Baker Advertising Agency, Successors Ankrum Agency, 189 W. Madison, Chicago 2.

MAILING Lists, certified, productive, inexpensive, \$5.00 1000. Homeworkers, agents, buyers, etc. Write Dixie Service, King, N. C.

ADVERTISING Sensation! Reach 2,100,000 families, \$32.90 inch. Display, classified, ratebook (newspapers, magazines, mailing lists), advertising assistance, free. Chicago Advertising Agency, 20-PM West Jackson, Chicago 4.

FREE! 1948 Advertisers Rate and Data Directory. 52 pages! E. H. Brown Advertising Agency, 20 N. Wacker, Chicago 6.

ADVERTISEMENT Writing! Powerful publicity, mailorder letters, literature, campaigns! Reasonable! Established reputation! Investigate! Finkle Adverselling, 1201½ South Ogden, Los Angeles 35.

TYPEWRITERS, DUPLICATORS, OFFICE DEVICES

ADDING Machine, save yourself the petty annoyances of adding, subtracting, multiplying by hand. Small, portable; iron clad guarantee. 11½" x 2½", precision built "Addometer" only \$12.95 complete. Send postcard for details. Tam Products, CM-10, 3814 Wrightwood, Chicago 47.

STANDARD Typewriters \$17.50; duplicators \$12.50; adding machines \$12.25; ship anywhere. "Typewriters," 118 Spruce, Wichita, Kansas.

THE New Master Addressing Machine, \$24.50. Literature free. Specialties, 4141 Fletcher, Chicago 41, Ill.

PHOTOCOPY Anything—Papers, books. No darkroom. \$6.95 complete. Fotoflek, 4801 Yarmouth Place, Cincinnati 29, Ohio.

"PRINTOMATIC" Selffeeding post card stencil printing duplicators \$9.50 up. Office size duplicators. Speedoprints, Hilcos, Excellographs \$33.41 up. Literature free. Pittsburgh Typewriter Supply, 336-WK Fourth Avenue, Pittsburgh 22, Penna.

RECONDITIONED Typewriters, mimeograph, multigraph printing devices, appliances, supplies. Catalog. Dixiegraph Service, King, N. Carolina.

RUBBER STAMPS AND OFFICE SUPPLIES

FOR Type styles and prices, write: Akorn Enterprises, 92 Church St., Mt. Clemens, Michigan.

3 LINES 45c; Cushioned, indexed, 50c. Pads 35c. Stampright, Wauwatosa, Wis.

3 LINES, 50c. Printing. Catalogue. Johnson Press, Box 6-A, New York City 26.

LINE 20c; 2-35c; 3-50c. Stamp Works, Auburn, Nebraska.

DE LUXE Cushioned, indexed, knob handle; three lines \$1.00, two 75c. Quick service. Catalog 10c. Warner Stationery, Box D-43, Havre de Grace, Maryland.

PRINTING, MULTIGRAPHING, MIMEOGRAPHING, GUMMED LABELS

BUSINESS, Personal stationery. State requirements. Samples, price lists free. How Printing Company, 721-23rd Eunice, Webster Groves 19, Missouri.

1949 CALENDAR Novelties. Samples, prices; 3c. Cassel, R4, Middletown, N. Y.

PHOTO-OFFSET Printing. Quality, economy. Speedy service. ABC Press, 1041 Eighteenth Avenue, Newark 2, N. J.

BUSINESS, Personal stationery. State requirements. Samples. Mero Products, 100 Morrison, Punxsutawney, Penna.

100 8 1/2 x 11 HAMMERMILL Letterheads and 100 envelopes \$2.00. Benneville, Box 1931, Pittsburgh 30, Penna.

UNSURPASSED Printing values, price list. Globe, 605 West 151, New York 31.

250 BUSINESS Cards \$1.00 postpaid. Brems, 40-06 97th, Corona 1, New York.

MIMEOGRAPHING, Prompt service. Reasonable, Satuit Co., Box 127, Mattapan, Mass.

125 LETTERHEADS (8 1/2 x 11 Hammermill) \$1.00. Postpaid. Envelopes, business cards, same. Race Printers, Hudson, New York.

BUSINESS Cards, 500 for \$1.50. Samples. D'Yarmett Printing, Newark, Ohio.

100 8 1/2 x 11 LETTERHEADS And 6 1/2 envelopes \$1.00. Quick service. Birchfield Press, R. 5, Hendersonville, N. C.

SAVE Money on your printing. Write today for new, low price list and offset ordering chart free. We photograph your copy and reproduce it on white or colored paper. Advertisers Service Litho, 161 W. Harrison, Chicago 5, Illinois.

MIMEOGRAPHING Specialists — Any copy. Reasonable. Mailers Service, Box 606-H, Chicago 90, Ill.

LETTERHEADS. Envelopes, circulars. Small, large quantities. H.M.G. Company, Mecca, Indiana.

WRITE For samples, prices attractive letterheads, cards, circulars. Journal Printing Co., Newark, Arkansas.

500 3/4 x 2 1/4 FOUR Line gummed stickers 35c; red border 50c. Moritz Printery, Saginaw, Mich.

1000 BUSINESS Cards, \$2.50, prepaid. Samples free. Reliable Print Shop, 905 E. Jefferson, Louisville 6, Ky.

SEND 10c Now, for our 48 page 1948 price list—refunded first order. McCall Press, 1326 South 27th, Omaha, Nebraska.

QUALITY Printing—Reasonable prices. Fast service on catalogs, folders, publications. Write for prices. Bagby Printing Co., Georgetown, Ohio.

MIMEOGRAPHING—Letters, pricelists, formulas, instructions. Lowest prices. Lem's Letter Shop, 5710 Stanton, Detroit 8.

500 6 1/2 ENVELOPES. Printed, \$3.00, 100—\$1.25. 100 printed postals, \$1.00. All postpaid. Dickerson Printing Co., Gas City, Indiana.

DISTINCTIVE Printing, lower cost. Price list free. Walter H. Kane, Woburn, Mass.

FREE Samples. Quality printing. Backus, 209 South Laurel, Richmond 20, Va.

100 8 1/2 x 11 HAMMERMILL Letterheads \$1.00. Envelopes, billheads same. Heroert Hudson, 261 Woonasquatucket, Centredale, R. I.

AMAZING New addressing machine works faster than 10 typists! Addresses mail for churches, clubs, and businesses. Complete machine plus supplies (enough for 500 names) only \$32.50 postpaid. Free information. Order direct. Addresser, San Marcos, Texas.

PRINTING OUTFITS AND SUPPLIES

PLASTIC Printing cuts. Make your own. New Plexiplate process. Plexiservice, Argyle 1, Wisconsin.

PRINTING Equipment, type, supplies. Catalog 10c. Wilson, 809 Flint, Fort Worth 10, Texas.

BARGAINS. Presses, type, supplies. Send stamp. 8 Walden, Cambridge 40, Mass.

BARGAINS—Hand presses, supplies. Catalogs 10c. Customprint, 211-M, Springfield, Missouri.

PRINTERS Supply catalog free. Brighton's, 4234-M South Mozart, Chicago 32, Illinois.

REBUILT Presses, bought, sold. List 3c. Exchange, 212 Curtis, Meriden, Conn.

PRINTING Presses, type, supplies. Lists 3c. Turnbaugh Service, Loysville, Penna.

PRINTING Presses, type, supplies. Send dime for complete illustrated printer's supply book, details and press samples. Kelsey, Inc., A-11, Meriden, Connecticut.

INEXPENSIVE Home-made printing press. Details free. Novelty Shop, Downsville, Louisiana.

PATENT ATTORNEYS

INVENTORS: Learn how to protect your invention. Unless the inventor is familiar with patent matters, he should engage a competent registered patent attorney or agent to represent him. We are registered to practise before the U.S. Patent Office and prepared to serve you in handling your patent matters. "Patent Guide for the Inventor" containing detailed information concerning patent protection and procedure with "Record of Invention" form will be forwarded to you upon request—without obligation. Clarence A. O'Brien & Harvey Jacobson, Registered Patent Attorneys, 81B-K District National Building, Washington, D. C.

IF An inventor believes he has an invention, a search of the most pertinent prior U. S. patents should be made and a report obtained relative to its patentability. Write for further particulars as to patent protection and procedure and "Invention Record" form at once. No obligation. McMorro, Berman & Davidson, Registered Patent Attorneys, 134-R Victor Building, Washington 1, D. C.

PATENT Protection—Unless an inventor is thoroughly familiar with such matters, he is advised to employ a competent registered Patent Attorney as the value of a patent depends largely upon the skillful preparation of the specification and claims. Send for booklet, "Patent Protection for Inventors," outlining preliminary steps to take to obtain patent protection. Victor J. Evans & Co., 331-L Merlin Building, Washington 6, D. C.

C. A. SNOW & Co.—M-427, Snow Building, Washington 1, D. C. Registered Patent Attorneys. Write for information.

PATENTS, Trade marks. Sanders, 6430 Evans, Chicago. Registered U. S. Patent Office.

PATENTS—Trade marks. Irving L. McCathran, 315 McLachlen Bldg., Washington 1, D. C. Registered Patent Attorney.

INVENTORS. For "Record of Invention" form, contact Carl Miller, Registered Patent Attorney, Woolworth Building, New York.

INVENTORS: Without obligation, write for information explaining the steps you should take to secure a patent. John N. Randolph, Registered Patent Attorney, 203 Columbian Bldg., Washington 1, D. C.

"INVENTOR'S Guide" free on request. Frank Ledermann, Registered Patent Attorney, 154 Nassau St., New York 7, N. Y.

PATENT Practice before U. S. Patent Office. Validity and infringement investigations and opinions. Booklet and form "Evidence of Conception" forwarded upon request. Lancaster, Allwine & Rommel, Registered Patent Attorneys, Suite 411, 815-15th Street, N.W., Washington 5, D. C.

PATENTS. "Proof of Invention" folder mailed without obligation. E. E. Vrooman, Registered Patent Attorney, 871 Woodward Building, Washington 5, D. C.

INVENTORS: Write for free brochure "Evidence of Invention." Labiner, World Building, New York 7.

INVENTORS: When you are satisfied that you have invented something of value write me, without obligation, for information as to what steps you should take to secure a patent. Write Patrick D. Beavers (Formerly Randolph & Beavers) Registered Patent Atty., 935 Columbian Bldg., Washington 1, D. C.

FOR INVENTORS

INVENTORS: Learn how to protect your invention. Unless the inventor is familiar with patent matters, he should engage a competent registered patent attorney or agent to represent him. We are registered to practise before the U.S. Patent Office and prepared to serve you in handling your patent matters. "Patent Guide for the Inventor" containing detailed information concerning patent protection and procedure with "Record of Invention" form will be forwarded to you upon request—without obligation. Clarence A. O'Brien & Harvey Jacobson, Registered Patent Attorneys, 81A-K District National Building, Washington, D. C.

PATENT Drawings—Reasonable rates. Send sketch for free estimate. Confidential. Patservice, 31 Waldeck St., Dorchester 24, Mass.

INVENTORS—This firm is registered to practise before the U. S. Patent Office and is available to assist inventors in the preparation and prosecution of their cases. "Patent Protection for Inventors" booklet containing detailed information and steps to take toward patent protection will be sent upon request. No obligation. Victor J. Evans & Co., 332-L Merlin Building, Washington 6, D. C.

IF An inventor believes he has an invention, a search of the most pertinent prior U. S. patents should be made and a report obtained relative to its patentability. Write for further particulars as to patent protection and procedure and "Invention Record" form at once. No obligation. McMorro, Berman & Davidson, Registered Patent Attorneys, 134-P Victor Building, Washington 1, D. C.

INVENTORS—Possibly I can help you. Many years experience. Charles A. Scott, 773 Garson Avenue, Rochester 9, N. Y.

GADGETS—Patented or unpatented. What have you? Reico, Morrison, Okla.

INVENTORS' Financial assistance. Investment Development Company, Box 1434, Amarillo, Texas.

NEED Detail drawings, mechanical or electrical layouts? I'll help you. 30 years experience. Free details. F. Ogden, Consulting Engineer, Suite "L," 18-13th St. No., Minneapolis 3, Minnesota.

YOUR Invention worth \$2.95 to protect it? Buy "Patent Law for the Executive and Engineer" from Research Press, Inc., Dept. 3, Dayton, Ohio.

BEWILDERED, Inventors? Too many schemes? My book will guide you to success. Details free. McLoughlin, 1101 Meade Avenue, Scranton 8, Penna.

PATENT And trade-mark searches \$6.00. Prompt reliable service. Invention protection forms free. Write Raymond L. Smith, Patent Searcher, 410-M Bond Building, Washington 5, D. C. (Formerly with U. S. Patent Office).

PATENT Searches \$6.00; trade-mark searches \$5.00; progress reports on pending applications for patent \$5.00. Invention protection forms free. Write Miss Ann Hastings, Patent Searcher, P.O. Box 176, Washington 4, D. C.

DRAWINGS, Models, and experimental devices. Shadyside Engineering Laboratory, Sunbury, Ohio.

"INVENTOR'S Guide" free on request. Frank Ledermann, Registered Patent Attorney, 154 Nassau St., New York 7, N. Y.

INVENTORS: If you have an invention for sale, patented or unpatented, write Institute of American Inventors, Dept. 40A, 1926 Eye St. N.W., Washington 6, D. C.

INVENTORS: Without obligation, write for information explaining the steps you should take to secure a patent on your invention. John N. Randolph, Registered Patent Attorney, 202 Columbian Bldg., Washington 1, D. C.

CASH For your idea. 280 manufacturers need inventions, patented or unpatented. List free. Invention Bureau, 208M Columbia, Oak Park, Illinois.

INVENTORS: The usual first step is to have a search of the U. S. Patents conducted, so I can report on patentability. Write, without obligation, Patrick D. Beavers (Formerly Randolph & Beavers), Registered Patent Atty., 936 Columbian Bldg., Washington 1, D. C.

PATENT Searches: reliable, efficient, air-mail service; \$6.00. Write for free invention protection form. Patent Research Service, 703P Albee Bldg., Washington 5, D. C.

LITTLE Library of Useful Information. 102 different books. Catalog free. Popular Mechanics Press, 200 E. Ontario St., Chicago 11, Ill.

INVENTIONS WANTED

ATTENTION! Sell your inventions direct. Send \$2.00 for directory listing manufacturers buying various inventions. Free, "protective assignment contract." Invention Market Research, 342-PM Madison Ave., New York 17.

EARN Up to \$2,000 year, inventing simple items. Special cash markets. Hendrickson, Argyle 7, Wisconsin.

HIGHEST Royalties; cash. Official U. S. I. R. C. certification. Request free booklet "M." Universal Marketing Co., 354 South Spring St., Los Angeles 13, Calif.

INVENTORS—What have you, patented, patent pending for manufacturers? Submit details, or request free booklet and information. Direct Contacts, 11106-A2 Longwood, Chicago 43.

HIGHEST Royalties—Cash. Official U. S. I. R. C. certified service. Request free booklet "M." Universal Marketing Co., 126 Lexington Avenue, New York 16, N. Y.

CASH For your idea, 280 manufacturers need inventions, patented or unpatented. List free: Invention Bureau, 208M Clinton Oak Park, Illinois.

INVENTORS: Hundreds of manufacturers have requested our assistance in locating marketable new products. Complete information free. Institute of American Inventors, Dept. 40-D, 1926-Eye St. N.W., Washington 6, D. C.

SMALL Inventions wanted by manufacturers. I'll help you sell your invention. Write for circular. Stanley Hull, 7829 Euclid, Cleveland, Ohio.

INVENTIONS Wanted. Patented or pending only. Inventors' Exchange-B, Hartford 1, Conn.

PATENTS FOR SALE

PATENT 234253. Searchlight attachment for gun sights device. Invention. For a telescopic searchlight which encircle along range target flash, searchlight mounted rigidly on telescopic sight. Herman Schmitt, R. 2, Sheboygan, Wis.

INVENTORS: Test the commercial value of your patented or unpatented inventions, quickly and inexpensively. Write for free information. Institute of American Inventors, Dept. 40-B, 1926-Eye St. N.W., Washington 6, D. C.

MANUFACTURING

MODELS, Experimental work; designing; manufacturing. Henry, Engineer, 2815 Hudson Blvd., Jersey City 5, N. J.

PRECISION Dies, gears, parts, inventions, manufacturing. Baum's Metal Specialties, Kansas City, Mo.

CASTINGS, Aluminum, brass, bronze, small quantities solicited. Lehnert Company, Norwood 4, N. J.

PLASTIC Moulds, progressive stamping, production, tools and dies. Steffy Screw Products, New Baltimore, Michigan.

MODELS. Dies; molds; tools; experimental; manufacturing. Booklet, Arizona Tool & Die, 31 Rillito, Tucson, Arizona.

MODELS. Tools, dies, experimental work; large and small lot manufacturing. Van-Ess Specialties Company, 212 W. 14th Street, Covington, Ky.

MODELS—Small lot manufacturing. Metals, plastics, etc. Milburn, Burlington, Kentucky.

SMALL Lot production wanted. Aluminum castings; stampings; screw machine; plastics. J and M Company, Burlington, Kentucky.

BOOKS—All Kinds—Homecraft, Radio, Boat Building, Photography, Model Building. Catalog free. Popular Mechanics Press, 200 E. Ontario St., Chicago 11, Ill.

MODELS, MODEL SUPPLIES

DOWMETAL Magnesium for all model makers. Rod, bar, sheet, and scale structural shapes. Craftsmiths, P.O. Box 3951, Detroit 27, Michigan.

SHIP And yacht model supplies, fittings. Catalogue 25c. Welcher, Fulton, N. Y.

MAKE Your own model gas engine. Four cycle, 1 1/4" stroke. Ideal for model planes, boats and racers. Castings available. 3 prints 75c. Popular Mechanics Press, 200 East Ontario Street, Chicago 11, Illinois.

MODEL Builders! You can now build the famed model speed plane "Gold Rush of '47." the A.M.A. Open Class-B record holder. Speed of 134.91 m.p.h. Send \$1.00 for set of 2 prints to Popular Mechanics, Blueprint Department, 200 East Ontario, Chicago 11, Illinois.

EXPERIMENTAL Work and models for inventors and designers. Steffy Screw Products, New Baltimore, Michigan 13.

200 SHIPS Drawings, clippers to landing barges, shipfittings, engines. List dime. Gullmars, Westhill, Ontario.

BUILD Your own model homes, garages, doll houses, displays, etc. Strong wood panels milled to faithfully reproduce shingles, lapping and brick in three scale sizes. Write postcard for free picture folder. Scale-Built Materials Inc., 4624 Ravenswood Ave., Chicago 40, Ill.

STEAM Engines, boilers, castings. Catalog 25c. Anton Bohaboy, 2297 Price, Rahway, New Jersey.

MINIATURE Steam locomotives, 1/4", 1/2", 3/4" scales. Castings, parts, rail, steam fittings! Thorough drawings with instructions. Catalog 25c. Little Engines, Wilmington, Calif.

BRASS Gears and model supplies for the inventors. Send 10c for catalog. Pierce Model Works, Tinley Park, Ill.

SHIP And yacht model fittings; blueprints. Send 25c for illustrated catalog No. 21—listing hundreds of items. A. J. Fisher, 1002-1 Etowah Ave., Royal Oak, Mich.

LANDLOCKED Sailors! Here's a beautiful, richly illustrated, fully descriptive catalogue of famous model ships—whalers, slavers, corvettes, etc.—available in every detail. Send for **FREE** 25c. Hale-site Yacht Service, 100-100, Hunt- ington, N. Y.

FUN Building models—Airplanes; trains, ships. Everything furnished. Giant catalog 10c. Ben's Hobby Shop, 72 West Washington, Chicago 2, Illinois.

SHIP Models and yacht supplies complete. Large 64 page catalogue 30c. Bill Wild's, 510 East 11 St., New York City 9.

MODEL Railroads exclusively—Complete stock scale; Lionel, American Flyer. Send for catalog, 15c state gauge. Eric Fuchs, 26 Tremont Street, Boston 8, Mass.

BUILD Historic ship models, complete kits 39c to \$8.50; send 10c for catalog. Ideal Models, 19 West 18th Street, New York 11, N. Y.

KEEP In touch with the activities of the British modelmaking fraternity. Send a dollar bill for year's subscription (4 issues) Modelcraft Magazine and list. 77 Grosvenor Road, London, S. W. 1.

HOME CRAFTSMEN

UNPAINTED Plaster ornaments. Beautiful designs. Easily decorated, water colors or oils. Profit or hobby. Free illustrated list. Distributors, Firestone Natural Latex Loxite, for molds. Dealers wanted. Midwest Novelty Mfg. Co., 108-A Cedar, Anaconda, Montana.

DOWELS, Selected birch, 36" lengths, 1/8" to 1" diameters. Essential for hobbyists, craftsmen, home workshops. Dollar brings generous sample assortment. The Dowel King, 54-44 80th Street, Elmhurst, N. Y.

FREE Catalog: make money by making beautiful, dainty sea shell jewelry. Artcraft Shell Supply, P.O. Box 2181, Sarasota, Florida.

BE Smart, make your own Christmas gifts or start a business. \$1.00 brings an illustrated instruction book on making shell jewelry, etc., with materials complete for two pins. Send for catalog. Woods Shellcraft, Box 306, Bradenton, Florida.

LAWN Chairs, garden figures, furniture, novelties, toys, etc., 68 popular plans with full size patterns, \$1.00. Mastercraft 10M, 7041 Olcott, Chicago 31, Ill.

BIG Profits from small bits of wood. Write Dollhouse Novelties, 19 Baker Street, Saugus, Massachusetts.

SHELLCRAFT! Make beautiful seashell jewelry. Income or hobby! Large illustrated catalog! Supplies, instructions, 10c postage. (Buy direct from manufacturer.) Pace's, Box 279M, Bradenton, Florida.

PATTERNS—New designs, what-nots, toys, lawn ornaments, novelties. 5 assorted \$1. List 10c. Joanes Patterns, P.O. Box 141, Omaha 7, Neb.

LEATHERCRAFT Catalogue and textbook. America's finest. The leatherworker's bible. Mail postcard for details. Artcraft Leather, Dept. PM-10, 271 Twelfth St., Oakland 7, California.

LEATHERCRAFTERS: Free! 3 sheets new designs with latest catalogue. Enclose 25 cents handling charge. Leather Specialties, Dept. M, 358 E. Broadway, Long Beach 2, California.

JEWELRY Supplies — Rhinestones, moonstones, pearls, findings. Herber, 1360-A Hicks, New York 67.

50 PATTERNS Toy furniture, action toys, etc., \$1.00. Continental Homecrafters, 907 Birch, Eau Claire 3, Wisconsin.

MAKE Rubber toys for Christmas market. Details free. Toycrafters, Box 333, Carlsbad, New Mexico.

MAKE Peppermills on lathe. Imported grinders, hardware, diagrams, \$1.50. Details 10c. Kirkham's, Glens Falls, N. Y.

LEATHERCRAFT Lace bargains! Francis Byrd, 3406 Montrose Ave., Richmond, Va.

SWISS Musical units \$3. Musical albums, boxes. 131 West 42nd, New York 18.

LEATHER Designs. Handbags. Billfolds. Belts. Miscellaneous designs, \$1.00 each. Any three \$2.50. Lampkin Artcrafts, Box 641M, Culver City, California.

CATALOG: Patterns plywood novelty furniture, lawn ornaments, letters, numerals, piques, frames, silhouettes, weathervanes, toys. Decal transfers. Over 100 other items. 200 articles illustrated. 25c. refunded first order. (No stamps please). Wo-Met Shop, Box 167, Ashburn, Georgia.

BUSY-WORK Velcoat kit, with which you can give any surface a soft, velvet-like finish in six exciting colors. Each color in individual gun, ready for use. Matching adhesives, brush, designs, work booth and instruction book. \$4.95. Free samples and literature. Busy-Work Shops, Box 8715, Pittsburgh 21, Penna.

SPECIAL 77 Full sized patterns. Lawn ornaments, toys and novelties \$1.00. Modern Woodcraft, Saginaw, Michigan.

JEWELRY Making is simple with our metal, plastic, and sterling findings, wire, chain; chemicals, kits, rosary parts. Everything. Lowest prices. Catalog 25c (refunded first order). Pittshire, Box 90-E, Pittsfield, Mass.

BEAUTIFY The kitchen. You can install laminated plastic table covering. Five color samples 25c. Roberts Company, Broomall, Penna.

OREGON Myrtlewood seasoned prices on request. M. Weaver, 3923 SE Tibbetts, Portland 2, Oregon.

JARS For nuts, bolts, screws, small parts; easy to quickly select what you need. Valuable for repairshops and hobbyists. Costs little. Literature free. Dratz, Lake Geneva, Wis.

BANDSAWS, Jigsaws, earn amazing profits. Nu-Art, 33 Rosemont, Weymouth 91, Massachusetts.

TORTOISE Shell makes beautiful custom jewelry. Bracelet, earrings and pin blanks. All 4 \$1.00 unpolished. Sam Patchett, 5053 Cristobal, Canal Zone.

SWISS Music units \$3.50. Two tunes \$4.50. Kits \$4.75 up. Irving Meyers, 126 Lexington Ave., New York 16, N. Y.

LEATHER, Retail, mail orders, catalog, tools, lacing, supplies. National Handicraft Co., 30 Frankfort St., New York City 7.

PLASTIC Jewelry supplies. Free catalog. J & M Novelties, Box 464P, Griffith, Indiana.

KNOCKDOWN Cedar chests. Lumber and veneers. Free price list. Giles & Kendall Company, Huntsville, Ala.

LEATHERCRAFT! Complete stocks of leathers, tools, supplies. Immediate shipment. Free catalog. Kit Kraft, 3203 W. Washington Blvd., Los Angeles 16, California.

CERAMIC Jewelry supplies, bar pins, ear screws, for ceramic and woodworkers; also glass and seashell assemblers. Free catalog. Philadelphia Badge Co., Dept. B-1, 1007 Filbert St., Philadelphia, Penna.

LEATHERCRAFTERS: Belt kits, projects, leather, supplies. Free catalog. Art Leather, 411 Joseph Ave., Rochester 5, N.Y.

COPPER And brass materials. Complete line for craftsmen and workshops. Catalog A free. Groundmaster Company, Boulder, Colorado.

SEA Shells. Interested in making shell jewelry, lamps, novelties. We have all supplies at wholesale. Write for price list. Sea Shells, 269 W. Flagler Street, Miami, Fla.

SHELLCRAFT Jewelry kit \$1.69 postpaid. Free instructions, catalogue. Shell-Art Novelty, Fifth and Moore, Philadelphia 48, Penna.

SHELL Jewelry supplies. Wholesale only. McFarland Plastic Co., Sarasota, Fla.

LEATHERCRAFT Kits. Stamp for catalog. Roy's Leathercraft, 2539 Devon, Chicago 45.

BEAUTIFUL Texas ebony. Large piece, \$1. Sample, dime. Particulars, stamp. Many other hardwoods. StarCraft (1), Edinburg, Texas.

SPECIAL Offer: 80 full size toy, novelty, and lawn ornament patterns only \$1.00 postpaid. Lynds, Box 193D, Medway, Mass.

FREE Price list, instructions, with 2 sample packages different colored flock for 25c. A & M Crafts, 672-C East 91 Street, Brooklyn 12, New York.

BUILD Your own trailer—midget house, utility. Complete details 25c. Popular Mechanics Press, (C-43), 200 E. Ontario, Chicago.

MAKE IT YOURSELF

BUILT-IN Kitchen cabinets. \$1.00 brings detailed plans and specifications showing construction methods. Will fit any kitchen. Thombert Co., Box 447M, Newton, Iowa.

SOLAR Water heater systems efficient any locality. Standard materials, low cost and easily built. Free facts. Solar Water Company, Box 175, Coral Gables, Florida.

BUILD Better tilting table circular saw. Details free. Ward Manufacturing Co., Walsenburg, Colo.

BUILD Concrete block machine. Inexpensive. Practical. Motor vibrator or hand. Free details. Clyde Lee, Dept. A, Mountain View, Okla.

FORMICA Top dinette tables, chrome trim. We sell top, legs, all parts. Factory prices. Also chrome plated chairs. Send for catalogue. Quality Chrome Company, 5649 S. Halsted, Chicago 21.

MAKE It yourself book of handicrafts \$1.00. Free catalogue, interesting books. A. Faller Company, 201 Dewey Street, Newark 8, New Jersey.

"CONCRETE Block homes." 32 page booklet: drawings, instructions on how to build. \$1.00. H. C. Lightfoot, Civil Engineer, Richboro 1, Penna.

ZEOLITE Home water softener. Plans for building your own \$1. Materials available from us. Lake Region Mfg. Co., Inc., 3920-J Lynn Ave., Minneapolis 16, Minn.

X ceptional values. Leisure Craft Kits. Free circular. Everything furnished to make jewelry and other items. Leisure Hour Products, 416 Rose Street, West Hazleton, Penna.

MAKE Your own handy lightweight concrete blocks quickly with new block-maker. Circular stamp. Manual 25c. Peerless, New Lenox, Illinois.

WATCHES, OLD GOLD, JEWELRY

GEMS. Precious and semi-precious, all genuine, from world wide sources. Deal direct, no overhead, save money. Catalog 10c. Hill Co., Route 7, Salem, Oregon.

WATCHMAKERS! Beginners! Watches, movements. Descriptive price list 15c. Box 1874A, Chicago 90.

ZIRCONS. Loose. Pure white. Special 3 zircons approximate total weights 3-kts. \$6.00. We can supply zircons in all sizes and mountings of all types. Send order or write for details today. B. Lowe, Holland Bldg., St. Louis, Mo., PM.

SPECIAL Offering. Swiss made chronograph watches, sweep second hand, timing buttons. \$21.95. Deposit \$6.00 on c.o.d. Cash orders postpaid. Midwest Enterprises, 917 Brown, Ann Arbor, Mich.

ZIRCONS. Sapphires, rubies, others. Best quality; lowest prices. Free colored catalogue. Imhusex, Box 232, White Plains, N. Y. Agents wanted.

SEND Your discarded jewelry, watches, crowns, bridges, spectacles, silver, etc., for cash offer. Goods returned promptly if offer unsatisfactory. Old State Metal Co., P.O. Box 1054, Houston 1, Texas.

NEW York's leading pawnbroker offers out-of-towners bargains in unredeemed ladies' and gentlemen's wrist watches. Bulova, Benrus, Elgin, Waltham. Fifteen jewels, \$15.00; 17 jewels, \$19.50. Send money order. State first and second choice. Kaskel's, Established 1882, 9 Columbus Avenue, New York 23, N. Y.

HIGHEST Prices paid for old gold, silver, platinum, diamonds, watches. Ship at once; cash by return mail. Satisfaction guaranteed. United Smelting Works, (The Old Reliable), 39-B South State, Chicago 3.

STUN Your friends with genuine, sparkling, brilliant-white zircons. Cut, polished, mounted just like diamonds. Amazing diamond-like appearance. Top-quality. Hard for even experts to tell the difference. Beautiful settings 14K gold. Over 100 gorgeous latest-style rings to choose from. Attractive low prices. Send for big free catalog: U. S. Zircon Syndicate, 139 N. Clark, Dept. 15, Chicago 2.

WATCHMAKERS' Journal contains helpful hints on watch repairing. Sample copy 15c. Dean Co., 116 Nassau St., New York 7, N. Y.

HIGHEST Cash for old, broken jewelry. Mail gold teeth, watches, rings, silverware, diamonds, spectacles. Satisfaction guaranteed. Free information. Rose Smelting Co., 29-A East Madison, Chicago.

TOBACCO, SMOKERS' SUPPLIES

SAVE 50% Popular cigars. Resagos. Only 5c. Free catalog trial offer. Sidney Ram, 156 N. Franklin, Chicago 6, Illinois.

SECONDS \$5.00 Pipes, 2 for \$1.00. Pipe making kits 75c. Literature free. Carvapipe, 2829-G Dixie, Hamilton, Ohio.

PIPE Lovers magazine, Long Beach 12, California, contains pictures, articles, gadgets, ideas. Sample 10c.

BRIAR Pipe, 60 cleaners, complete. Send \$1.00. Lincoln, 10 South 18th, Philadelphia 3, Penna.

CIGARS Direct from manufacturer; full size 5 1/2" long, blended with Havana, packed in Humidoe type boxes. Box of 50 "El Tirano" cigars \$3.75, regularly 15c each, packed in Humidoe type boxes. Satisfaction guaranteed. Send check or money order. Eastern Penn Cigar Company, 129 N. Penn Street, York 15, Penna.

MAKE Smoking pipes, briar blocks and stems. Send for circular. Michelson & Sternberg, 23 West 47th Street, New York 19.

PIPE Smokers dream. Pipe that never clogs. Assures sweet, dry, mellow smoke. Genuine imported briar; gives real smoking enjoyment. Unconditionally guaranteed. Particulars free. Bunnell Pipes, 1661-A Elm Street, Stratford, Conn.

SURVEYING INSTRUMENTS

GUARANTEED Factory rebuilt transits and levels, sale, or rent, with purchase option. We will repair, trade or buy old instruments. Write for list M-48. Warren-Knight Co. (Manufacturers of Surveying Instruments), 136 North 12th St., Philadelphia 7, Penna.

RAZORS, BLADES, SHARPENING

100 NEW Razor blades, plus free gift, only \$1 prepaid, agents wanted. Weiss, 3518 32nd Street, Union City, New Jersey.

SCHICK "Super" electric shavers \$13.75; Remington "Foursome" \$14.75; Sunbeam "Shavemaster" \$17.75. New, latest models. Prepaid. Saves you 23%. Stanley A. Wentling, Palmyra, Penna.

FOR THE HOME

SPRING-Flo faucet; while they last, \$7.89 postpaid. Hydraulic Products Co., Southold, N. Y.

FOR SALE — MISCELLANEOUS

WAR Surplus, aircraft items, shop equipment, machinery and a million other items. Free catalog. Atlas Equipment, 229 Southwest Blvd., Kansas City 8, Mo.

USED Dresses 89c, skirts 59c, blouses 49c, ties 7 1/2c. Suits, O'coats. List free. Calumet Sales, 4719 Kennedy Ave., East Chicago, Indiana.

AIRPLANE Control cable 3/32" diameter, 7x7 strand, rustproof, over 1000 lbs. breaking strength. Ideal control model jet planes, brake cables, etc., 100 ft. \$3.00; 200, \$5.00; 500, \$10.00; postpaid. Write for catalog. Samet Salvage Company, High Point, N. C.

GUARANTEED Portable water softener. Same process used in standard softeners. Connects to any faucet. 2,500 grains capacity. \$9.95 each. Free literature on request. Lake Region Mfg. Co., 3920-J Lynn Ave., Minneapolis 16, Minn.

WANTED—MISCELLANEOUS

SINGER Sewing machine dropheads wanted. \$15 for long bobbin model, \$25 round bobbin model. Write serial number and model. Dept. M, Box 129, New York 16, N. Y.

CASH Paid for almost anything. Catalogue 50c. Buyers' Bulletin, Box 415, Evansville, Indiana.

\$10.00 EACH For certain Lincoln pennies; Indianheads \$50.00. Send dime for catalogue of prices paid. Lincoln Coin Company, Elkhart 9, Indiana.

WILL Pay up to \$5,000 for certain old books. Catalog 10c. Ohio Historical Publishing Co., PMO, Columbus 1, Ohio.

SEWING Machines and adding machines. Dowd, 2021 Pecan, San Angelo, Texas.

METEORITES Wanted, iron or stone. Highest prices. Stuart Perry, Adrian, Mich.

QUICKSILVER (Mercury) urgently needed! Immediate payment. Wholesale Terminal, Norwood, Massachusetts.

PERSONAL

NATIONALLY Advertised new watches 15-35% off list. Letters mailed from New York 25c each. Anything you need reasonable. Schickler, 323 Stockton St., Brooklyn, New York.

SEND Seven ties and \$1.00, receive seven cleaned ties. Mail Me Ties, Box 4411-A, Philadelphia 40, Penna.

LOSING Hair? Have dandruff? Write for free confidential booklet on care of scalp and hair. Eugene Burt, 1928 State Ave., Kansas City, Kansas.

BALDNESS—Can it be prevented? Booklet free. Vanguard Reports, 3009-P Military Road, Washington 15, D. C.

MEXICAN Law. General Practice Attorney, 1203 Arizona Street, El Paso, Texas.

HOW You can find out! Information discreetly developed, any matter, person, problem, anywhere. Personal-business assignments, representations undertaken. Nation-wide. Officially licensed, bonded service established 1922. Reasonable. Confidential. William Herman, 170 Broadway, New York.

HAIR Falling? Dandruff? Write Trichologist, 137 Lewis St., Phillipsburg, N. J.

RUPTURED? Positive comfort, no understraps, no steel, no elastic. Write Smith Manufacturing Company, Preston, Ontario.

MISCELLANEOUS

FAMOUS Croft lilies, 3 mature bulbs \$1.00, 12 for \$3.50. Shap's Outdoor Nurseries, Crescent City, Calif.

GIVE And sell earring kits for Christmas presents. Contains two beautiful hand painted (pink rose) Snow White Lucite costume buttons, two earwires, assembling directions. Start now. Write for wholesale prices. William E. Moore, Costume Button Jewelry, Box 546, Winnemucca, Nevada.

SALE: Brilliantly colored outdoor pictures 25c, 7-81. View. Western cards: 200, \$1; 500, \$2. 100 cards or 500 labels free with first order. Persil, 438 New York Ave., Brooklyn 25, N. Y.

BEST Baby bottle warmer. Uses any heat. Perfect. Illustrated literature free. Hager's, 1032 West Compton Blvd., Gardena, California.

BRAZILIAN Orchids. Palm leaves, Uva flowers, etc. Information with Orquidario Catarinense. Exporters, Corupa, Santa Catarina, Brazil.

"CESSPOOL Sense." Send for your free copy today. Septic Bend Co., Rockland, Mass.

DRAFT Cards, identification, social security, membership, vehicle registration and other wallet cards and photos protected, preserved in plastic. Free details. Dura-Seal Laminating Co., 827 N. Charles St., Baltimore 1, Md.

WIN Cash, cars in prize contests! Write for copy filled with current contests, winning hints and tips. Send only 25c. Wright Contest Digest, Dept. 17-K, P.O. Box 2266, St. Louis 9, Missouri.

COMPASSES, Officers wrist or pocket models. New, choice \$1.00 postpaid. Central Sports, Delphos 5, Ohio.

LUMINOUS Paint kit (non-toxic). Complete 3 bottle kit, instructions and brush \$1.00 postpaid. Kling Color Co., 5925 Lowe, Chicago 21.

CHRISTMAS Price list and leather cards samples 25c. Mexican Products Co., 126 No. Main, Tulsa 3, Okla.

RURAL Directories for mailing lists. \$5.00 per county. Minn., Wis., Iowa. 467 Broadway, St. Paul 1, Minn.

"RECEIVE Mail." Money-making offers, opportunities, catalogs. Name listed 10c. Ideal Service, Park Ridge 10, Ill.

AMAZING Bargain catalog. Save up to 75%. Watches, clothing, sporting goods, novelties, etc. 25c (refunded first order). Tip-Top, Box 9083PM, Dallas, Texas.

CIVIL Service job instructions. Free literature. Baker, 5509-B Winthrop, Chicago 40.

PANNING Gold - Free instruction booklet. Catalogue mining books; supplies. Old Prospector, B-170, Dutch Flat, Calif.

TI-TRADE. Send 6 ties and \$1.00. Receive 6 equal quality, cleaned. Color preferences. Box 8065, Washington 5, D. C.

EVERBEST Ball pen. Longer wear. Sample 25c. Four, dollar. Capener, 849 Almaden, San Jose, California.

GROW Colorful metallic gardens. Formula 50c. Box 5356, Chicago, Illinois.

SUNFLOWER Seed—The miracle food. Illustrated book gives full information. Price 25c. Lorane, P.O. Box 150-PM, Portland 7, Oregon.

RECEIVE Interesting mails. 25c keeps your name on preferred mailing list for six months. Bentz, Jr., Chatawa 13, Miss.

SEND Me 5 pocket books and a quarter. I'll return to you five different ones. Joe Pygman, 1215 East Main, Decatur, Illinois.

LIFESIZE Sketches from photos \$4.00. V. Droogan, 74 Chestnut St., Albany, N. Y.

HOUSES Of Earth by A. B. Lee, Box 171, Washington, D. C. \$1.00.

ENGRAVED Plastic desk titles, window display nameplates. Plain \$3.00, colored \$3.50. Work sample 25c. Desco Products Distributors, 6334B Sepulveda, Van Nuys, Calif.

FIGURINES, Plaques. Write for list. Cochran's, 1536 W. 7th, St. Paul 2, Minn.

PERSONALIZED Pencils—Individual or firm name. Dozen 60c, gross \$4.80. Cash delivered. Pencil Market, 611 15th St., Knoxville 16, Tenn.

LOCK Together 1," plywood toys, high-chair, cradle, hangar, garage. No nails, screws or glue. 4 patterns \$1.00. Wm. Longstreet, 1474 Newman Ave., Lakewood 7, Ohio.

SPECIFICATION And prints of permanent magnet motor, \$10.00; plus right to make model. Illustrating literature ten cents. George J. Altman, 150 Broadway, New York 7.

BIRD Baths, pots, urns, benches, pipe, made at home! We sell forms. Concrete Machinery, Hickory 4, N. C.

"DID Moses Write Pentateuch?" 10c. Christian Evidence League, Malverne, N. Y.

MEDICAL Laboratory technicians in great demand. We train you in your own home, in your spare time. Also home study course in general Chemistry. Free catalogue. Imperial Technical Institute, Box 973-J, Austin, Texas.

TATTOOING Machines, outfits. Free catalogue. Jensen, 120 West 83rd Street, Los Angeles 3.

LUCITE Bar, name pin, safety clasp. Price \$2.00. Made to order. Nightingale Pin Co., P. O. Box 1772, West Palm Beach, Florida.

TREASURE Finders! Goldak's new 11 pound lightweight, gold, silver and mineral locator, money-back guaranteed superior any other device. Free information. The Goldak Co., 1542 West Glenoaks Blvd., Glendale 1, Calif.

M-SCOPE Metal, mineral locators sensational new electronic lightweight models, immediate shipment. Fisher Research Laboratory, Inc., manufactures some of the finest metal locators for the U. S. Army. Built for Arctic, Tropic use. Unsurpassed efficiency, low prices. Time-payment plan available. Send for free 16-page illustrated booklet. Fisher Research Laboratory, Inc., Palo Alto, Calif.

TATTOOING Outfits, supplies. Illustrated list free. Zeis, 728 Lesley, Rockford, Illinois.

70 BIBLE Lessons, 25c. Bulletin, Box 87, Cathedral Station, New York 25.

Profit and Fun CARVING LEATHER *at home spare time full time*

New Device makes it possible for beginners to improve overnight. Now is the time to cash in on this Big Paying business - year round profits are easy if you follow new method of instruction to be found only in Baird's home study course. Big sale for bill folds, wallets, belts, purses, gun holsters, saddles, and other leather articles. Make up to \$50.00 per week spare time or up to \$500.00 or more monthly full time

Start your own business. Make Xmas presents and other gifts. The Baird Course is Complete. Full instructions - Tools and equipment - including new device that makes learning easy. Write for full details and interesting catalog - containing many profitable suggestions - Sent Free - Write Now. Dept. D

BAIRD SCHOOL OF LEATHER CARVING • 221 Manitou Ave., Manitou Springs, Colorado

HOW TO BE SUCCESSFUL IN THE FAST GROWING PLASTICS INDUSTRY

LEARN at HOME in Spare Time -

Consider the important Plastics field for your future career. More products are being manufactured from plastics than ever before—making more opportunities for trained men and women. Mail the coupon below for illustrated literature which shows the many uses of plastics and what trained men must know to succeed in the Plastics Industry.

STUDY AT HOME OR COME TO CALIFORNIA

Take famous Plastics Institute home training or come to Los Angeles for practical work in modern laboratories and shops. Students from foreign countries and many states now attending.



START YOUR TRAINING NOW—mail coupon and get started on the road to success in the great and growing field of Plastics.

SEND FOR FREE CATALOG TODAY

PLASTICS INDUSTRIES TECHNICAL INSTITUTE
Dept. PM 10-8 1601 S. Western Ave., Los Angeles 6, Calif.

Gentlemen: Please send me free literature and information on job opportunities. I am interested in Home Training attending school in Los Angeles

Name _____ Age _____

Street _____ Zone _____

City _____ State _____

Veteran _____ Non-Veteran _____

PLASTICS INDUSTRIES TECHNICAL INSTITUTE

Approved for Veterans • Available for Non-Veterans

IN A FEW SHORT WEEKS
YOU CAN BE READY
FOR A GOOD PAY JOB in



DRAFTING!

I SEND YOU A PROFESSIONAL SET
OF DRAFTING INSTRUMENTS TO MAKE
TRAINING EASY

• It's easy to learn drafting when you have these superior tools to work with. My practical, down-to-earth method of teaching will prepare you for a secure, good income drafting job in a few short weeks. You learn by actually working at the drafting board. Tiresome theory has been cut to the bone. What's more, when you learn by my practical methods, you don't forget. Get the full story at once. Mail the coupon NOW!

Charles N. Zelenko, Director

GET
FREE
BOOK

CLEVELAND ENGINEERING INSTITUTE
PM-10 2325 Chester Avenue, Cleveland 14, Ohio
Send me a FREE Drafting Lesson and your Success Book, showing opportunities in drafting. No obligation.

Name _____
Address _____
City _____ State _____
Hrs. work _____ Vet Non Vet

NEW ALL PURPOSE WORK GLOVE

Rhinosol makes 'em tough

OUTWEARS LEATHER NO ODOR

RESISTS ACID, OIL, SOLVENTS

BRAND NEW—Toughest, softest, best work glove you ever saw. Here at last is a work glove that really wears. Outlasts many leather gloves, because treated with Rhinosol, new super-chemical, they outwear higher priced gloves made of leather. Soft, pliable, yet extra strong. Long fingers, knit wristlets. RHINOSOL RESISTS HEAT, OIL, ACIDS, SOLVENTS. Makes the ideal work glove for all uses around shop, farm or home.

SEND NO MONEY; TRY 5 DAYS!

To get gloves prepaid, tear out this ad and send with low introductory price of \$1.00. Or just send name and address and pay postman \$1.00 plus C.O.D. Use five days and if not satisfied, return for money back. Only one pair to customer at this special low introductory price. Order today.

FRANCIS SUPPLY COMPANY

DEPT. J-3 1836 EAST FULTON STREET COLUMBUS, OHIO



\$1.00
POST PAID
NO RISK
GUARANTEE

CHEMISTRY

LEARN AT HOME... Chemical knowledge is essential for thousands of good jobs in industry, business, science. IPC enables you to master practical chemistry. It's the ONLY home study chemistry course which enables you to learn by performing actual experiments—using chemicals and apparatus supplied with the course—in addition to your IPC textbook studies. Compares with recognized college courses in General Chemistry. Write today for free descriptive booklet.

INSTITUTE OF PRACTICAL CHEMISTRY
3 PROSPECT AVENUE, HAGERSTOWN, MD.

STRENGTHEN Your VOICE!

YES—you can now build yourself a powerful speaking and singing voice with this amazing new scientifically sound tested method. Self-training... no music or piano required. Results GUARANTEED. Just send your name for the sensational details. FREE chart of your vocal mechanism included!

PERFECT VOICE STUDIOS, Studio K-10, Kimball Hall Building, Chicago, Ill

GET INTO BUSINESS for YOURSELF

meet the demand for...

Metalized BABY SHOES

...in your own home in spare time



WE HELP YOU • STEP BY STEP!

- HOW TO START
- HOW TO BRING THE BUSINESS
- HOW TO METALIZE THE WARNER WAY
- HOW TO PYRAMID PROFITS

This is a lifetime opportunity! No matter what you're doing now, you can get set for the future while beating today's high cost of living. Our plan offers everything you need to know... a completely charted path to personal independence — with your home as your "factory."

This tested and proved plan is working right now. Backed by an old company, it's sent to you on a No-Risk Trial, Money-Back Guarantee! The exclusive Warner Method applies an actual coat of pure metal, in genuine Gold, Silver or Bronze finish, "Eternalizing" Baby Shoes and other keepsakes forever. The de-

mand for these Metalized Keepsakes is big... and getting bigger every day. (More than a million dollars' worth last year.) In every way, it's a proved proposition. Proud parents everywhere buy on sight!

A NEVER ENDING MARKET

No matter where you live, small town or big city, there is a never ending, ready-to-buy market for "Eternalizing" Baby Shoes — more than 3,500,000 babies this year. This tested plan reaches out and brings in the business. Spare or Full Time, you can make money!

BE YOUR OWN BOSS

Get the facts on this new opportunity. Mail the coupon below... TODAY. We'll send you fully descriptive literature, on our No-Risk Trial and Positive Guarantee: "Money Back If You Say So."

Isn't This What You Are Looking For!

1. Steady Income
2. Permanent Future
3. Wide-open Market
4. No House to House
5. Plan Works for You
6. Backed by 25 Year Old Company
7. No-Risk Trial
8. Money-Back Guarantee

SEND THIS COUPON NOW, FOR SURE!

WARNER ELECTRIC COMPANY, Dept. 310
1512 Jarvis Ave., Chicago 26, Illinois
Please send, without obligation, complete details about your No-Risk Trial, Money Back Plan for "Eternalizing Baby Shoes for Plus Profits."

NAME _____

ADDRESS _____

CITY _____ ZONE _____ STATE _____

WARNER ELECTRIC COMPANY, Dept. 310
1512 JARVIS AVE. CHICAGO 26, ILLINOIS



Learn ELECTRIC APPLIANCE

Service & Repair

AT HOME IN YOUR SPARE TIME

We teach you this interesting, good-paying business from A to Z—at home. Our practical, thorough, shop-method course qualifies you to take a job at once, or start in for yourself. A grade school education is all you need. This is an ideal time for men of all ages (up to 60) to get into this active, constantly expanding field, for every year sees millions of new homes wired for electricity . . . and multiple millions of new electric appliances produced. Everyone, literally, is a customer for the man who knows how to service and repair electric devices.

This business is particularly suited to the man who is handy with tools, and likes to keep busy with his hands . . . the men who are the makers, builders, and servicers of life. If you are not completely happy in your present work, there is a WIDE-OPEN OPPORTUNITY for you in this field . . . which is getting bigger and better every day.

YOU LEARN

How To Repair
Washing Machines
Vacuum Cleaners
Electric Ranges
Lamps, Motors,
Irons, etc.
REFRIGERATION
and
House Wiring

**This
ELECTRICAL
APPLIANCE
TESTER
and a
BIG KIT OF TOOLS
INCLUDED
at No Extra Cost!**

Earn While You Learn

You can actually start earning before your course is finished with the Kit of Tools and Tester we send you. With your first set of lessons, I show you easy jobs that can be done in your spare time, at home. And remember—just one good repair job can pay for the complete cost of the course. A business can be started in your garage or basement—expanding from there, as you grow. Let's talk it over by mail.

Make it a point to get posted about our course by sending TODAY—without obligation—for our free booklet telling the entire story.

OPEN YOUR OWN SHOP Be Independent and Secure

No new-fangled machine can ever take your place in this work . . . as it calls for trained hands to service appliances—so your job is safe, even in a depression. If you open your own shop, you not only enjoy security and independence . . . and can have others work for you . . . it's just a step to a prosperous appliance business where the **BIG PROFITS LIE**. There's no satisfaction like being your own boss, and here's a real opportunity to make that a reality. Or, of course, you can take a well paid job in this active line, as trained men are needed. Remember, this is AN ELECTRICAL AGE. Getting into this field now is to ride the tide of progress.



**Send
for this
FREE
BOOKLET**



No Salesman Will Call

MAIL COUPON TODAY

PACIFIC TRAINING SCHOOL — Dept. P-810
7217 So. Broadway, Los Angeles 3, Calif.

Please send me your FREE BOOKLET:
"Today's Big Opportunity — Appliance Servicing"

NAME _____ AGE _____

ADDRESS _____ ZONE _____

CITY _____ STATE _____

Please print plainly

LINGUAPHONE



is your *Passport*
to the World

In your own home, alone or in a group, you can now learn to speak

**SPANISH • PORTUGUESE
FRENCH • RUSSIAN
ITALIAN • GERMAN**

or any of 23 other languages by the world-famous

LINGUAPHONE Conversational METHOD

You learn the new language by listening to voices of native teachers. It is amazingly simple; thousands have succeeded. Educators hail Linguaphone as a notable advance in simplifying the mastery of languages. That is why so many Linguaphone Sets are used in schools, colleges, universities, as an aid to *fluent* speaking.

Available to Veterans under
G I BILL OF RIGHTS

SEND FOR FREE BOOK

LINGUAPHONE INSTITUTE
98 RCA BUILDING, NEW YORK 20, N. Y.

LINGUAPHONE INSTITUTE
98 RCA Bldg., New York 20, N. Y.
Send me the FREE Linguaphone Book.
I am , am not a World War II Veteran
I want to learn.....language.
Name

Address..... City.....

Get Ready for Big Opportunities!
Business Jobs

**TOOLS AND EQUIPMENT
SENT WHEN YOU START**

Get a better job with more pay and pleasant working conditions. Get into Drafting — where all products start. I will train you at home — give you experience — on the same kind of jobs you will do with the best paying firms. I furnish instruments and all equipment when you start. Write today for vital facts and FREE book. Give age.

ENGINEER DOBE • Dept. 17 • Libertyville, Ill.

I Will Train You at Home
Until You Get a

**GOOD PAY JOB in
DRAFTING**

THIS BOOK WILL MAKE YOU MORE MONEY IN RADIO!

The RADIO DATA BOOK has the vital information you need! It is the radio bible of all radio men everywhere. It gives you complete instruction, all the facts—completely illustrated. Every subject is thoroughly covered . . . Test Equipment, Antennas, Recording, 150 Basic Circuits, 50 Operating Circuits, Testing & Measuring, Sound Systems, Complete Tube Manual, All Formulas, Graphs, Tables, All Symbols, Codes, Standards, Complete Dictionary and Bibliography . . . 12 Big Sections, 1148 pages, over 1000 illustrations! Get your copy today . . . the RADIO DATA BOOK will be your most profitable investment! Only \$5.00 at bookstores, radio jobbers or send direct to:

BOLAND & BOYCE, INC., PUBLISHERS
MONTCLAIR, N. J.

Send only \$1—pay postman balance. Money back in 10 days if not satisfied!

The Secret of TRUE PRAYER



is again revealed to the world. Are your prayers answered? Has even one been answered? If one, why not all? If none, something is wrong. There is one right way and many wrong ways to pray, yet True Prayer is still your best aid for securing health, happiness and plenty.

RICKENBACKER prayed successfully, while a bishop flying to Iceland on church duties failed to have his prayers save his life.

The answers are found in ten little books

TEN LESSONS IN PRAYER

designed to help all pray as effectively as the early Christians taught by Jesus and the Disciples.

The "MIRACLE OF ANSWERED PRAYER," a booklet explaining the need of learning to pray correctly will be mailed on receipt of name and address by

TRUE PRAYER STUDY GROUP, Box 902P
Greenville, South Carolina

Learn SHOE REPAIRING

Practical Shop Training

Excellent opportunities for good jobs or a successful business of your own. Prepare quickly — practical shop work and shop management, taught by experts. Here is a field for a man who wants to be his own boss and build an independent future. Approved for Veterans. Help in finding part-time work while a student, employment service to graduates. Write today for FREE information.

CHICAGO SCHOOL OF SHOE REBUILDING
124 E. 26th ST. DEPT. PM-10 CHICAGO 16, ILLINOIS

INVENTORS

HIGHEST ROYALTIES and CASH

FOR YOUR INVENTIONS
INVENTION MARKETING SERVICE "UNPARALLELED" BY ANY
OTHER AGENCY IN THE WORLD

Write for FREE booklet without obligation

UNIVERSAL MARKETING CO.

354 South Spring St. (Suite M) — Los Angeles 13, Calif.

TRAVEL - for 'UNCLE SAM'

ARE YOU JOB-SATISFIED?

GET A U. S. GOVERNMENT JOB

Many Positions to Be Filled

Railway Mail Clerks — Postoffice Clerks — Mail Carriers —
Stenographers — Typists, Statistical Clerks — Storekeeper-
Gauger, etc. 40 page Civil Service Book—FREE.

MEN — WOMEN

Veterans Get Preference

Mail Coupon immediately—today sure.

Although not government controlled, this can be your first step toward a secure Civil Service career.

AS HIGH AS \$3,351

FIRST
YEAR

COUPON

FRANKLIN INST., Dept. G86, Rochester 4, N. Y.

Gentlemen: Rush to me without charge, 40 page book with list of U. S. Government big paid positions. Advise me also regarding salaries, hours, work, vacations, etc. Tell me how to qualify for a position.

Name.....

Address..... Vet?.....

NOW! Build Your Future On

DIESEL

OPPORTUNITIES

IN INDUSTRY

ON WATER

ON LAND



DIESEL POWER IS GOING PLACES!

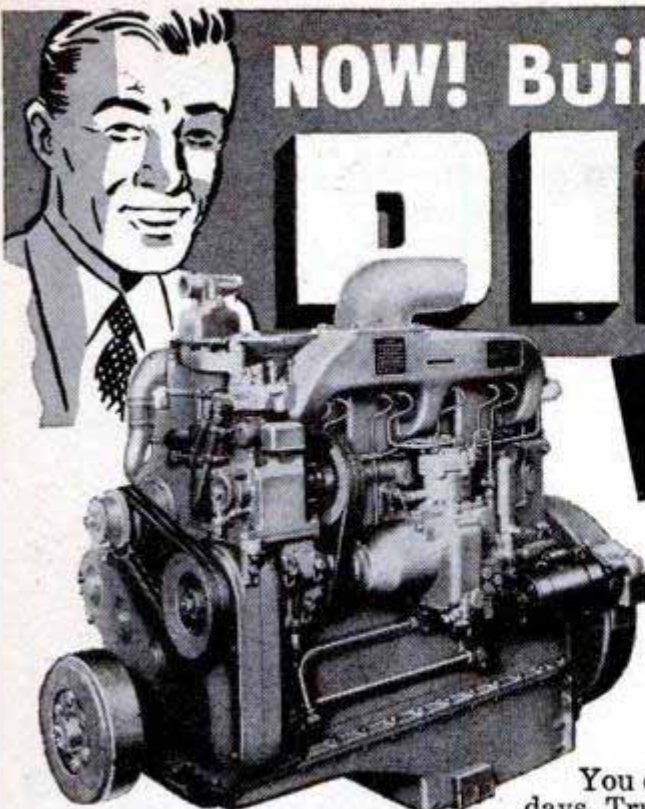

COMPACT DIESEL TRUCK ENGINE

6 cylinders, 5 1/2" bore and 6" stroke, maximum horse power rating 200 H.P. at 2100 RPM.

You don't have to look far to see Diesel Power in action these days. Trucks, buses, tractors, streamliners and switching engines, ocean-liners and small watercraft, power and lighting plants, farm and road equipment — more and more depend on Diesel each day. And now aircraft are experimenting with the lighter units. On the farm, in factories, in communities large and small — Diesel is growing as it proves to be efficient, economical, dependable, streamlined power.

Diesel Knowledge is Earning Power

THE NEW AND INCREASING USES OF DIESEL open a broad field for trained men who can install, maintain, operate and repair DIESEL EQUIPMENT. Diesel engines need DIESEL-trained men! Now is the time to prepare for these opportunities.

LEARN NOW WHILE YOU KEEP YOUR JOB

If you are between 17 and 60 and mechanically inclined, you can get thorough, individual instruction right in your home. Through UEI balanced training, you learn first through home study the fundamentals of Diesel in all its phases, given to you in practical, easy to understand lessons from men with years of successful experience training this way. You will learn how Diesel Engines operate, how fuel systems work, how to make repairs, all about the latest accessories and auxiliary equipment, and a world of other Diesel basic "know how."

ACTUAL SHOP PRACTICE

Then you get valuable practice in our big shop, working on costly equipment under DIESEL MEN who really "know their stuff." This course is new and up to the minute, including latest techniques for handling new and old equipment under today's conditions. UEI offers placement service for graduates and has numerous other features which have contributed to the reputation of this outstanding school—now in its 21st success-making year. Coupon below brings you complete information.

DO IT NOW! It costs you nothing to get all the facts about Diesel opportunities and training. Simply mail the coupon below. Time is important—and the time to begin is NOW! Make up your mind after you get the facts, but write for them at once. Send coupon today!

Mail Coupon FOR FREE FACTS

OTHER U.E.I. Training Opportunities

Practical Shop Training Follows Preliminary Home Study

AUTO BODY AND FENDER REPAIR
Includes Welding, Metal Work, Spray Painting and Refinishing.

MECHANICAL REFRIGERATION
Servicing and Installation for all commercial and domestic types.

AIR CONDITIONING
Installation, operation and maintenance of home and industrial equipment.

RESIDENT COURSES
Day and evening classes in Diesel, Air Conditioning, Refrigeration are also available.

Founded 1927



UTILITIES ENGINEERING INSTITUTE

2521 Sheffield Ave., Dept. 1108-D, Chicago 14, Ill.

UTILITIES ENGINEERING INSTITUTE, Dept. 1108-D
2521 Sheffield Ave., Chicago 14, Illinois

Please send me FREE facts about UEI training and opportunities in the field checked below.

- DIESEL
- REFRIGERATION AIR CONDITIONING
- AUTO BODY AND FENDER REPAIR

Name _____ Age _____

Address _____

City _____ Zone or County _____ State _____

Check here for special information if you are under 17.

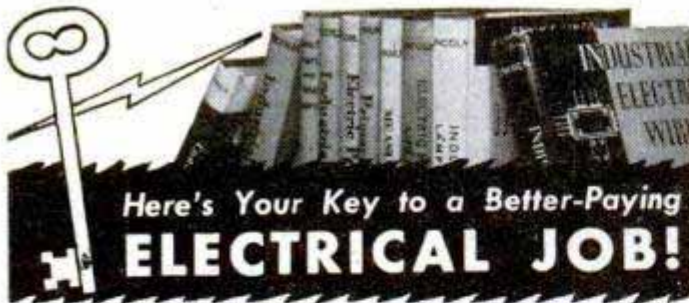

Here's Your Key to a Better-Paying
ELECTRICAL JOB!

THE FAMOUS MURRAY HILL 10-VOL. LIBRARY OF
APPLIED ELECTRICITY

10 complete books — 2812 pages — over 1500 illus.
A PRACTICAL reference library & home study course

Here, at your fingertips is the "know how" of industrial electrical equipment — installation — operation — repair — maintenance! Tells all about modern methods. Tells what equipment to use, how to use it. Contains hundreds of charts, diagrams, and data compilations for on-the-job reference. Illustrates and explains all kinds of electrical materials. Covers industrial electrical wiring, conductors and wiring layouts, controls, switch and panel boards, electrical heating and furnaces, protective equipment, power factor correction, all kinds of batteries, measuring instruments, lamps and lighting, motors and generators, motor controls, etc. The ideal set of books for practical men who want to get ahead!

10 DAYS' TRIAL

SEND NO MONEY . . . EASY TERMS

Bought singly the books in this library would cost you \$25.50. Under this offer you save \$1.50, also have the privilege of paying in monthly installments while you use the books. See for yourself how this Library can pave your way to good pay—a better electrical job. Just send the coupon, today.

Dept. PM108, MURRAY HILL BOOKS, INC.
232 MADISON AVE., NEW YORK 16, N. Y.

Send the Library of Applied Electricity (10 vols., \$24.00) for 10 days' examination. In 10 days I will send \$4.00, plus postage, and \$5.00 monthly for 4 months, or return books, postpaid. (Postage paid if first remittance accompanies order. Trial offer good in U.S. only.)

Name _____
Address _____
City (Zone) & State _____
Position _____ Company _____

Learn A Trade NOW!
PRACTICAL SHOP TRAINING!

In Our Chicago Shops

- AUTO MECHANICS
- DIESEL MECHANICS
- REFRIGERATION
- BODY-FENDER
- WELDING—ARC and GAS
- MACHINIST
- PIANO TUNING

Above Approved For G. I.'s and Civilians

One of America's Leading Practical Schools
7 Floors of Fully Equipped Shops
Over 48,000 Successful Graduates
Expert Individual Instruction
Learn by Doing—Low Living Expense
Established 1902—Day and Evening Classes

Also the following Home Study Courses

- PLASTIC
- REFRIGERATION
- DIESEL

—CALL IN PERSON OR MAIL THIS AD TO—
GREER SHOP TRAINING

(Dept. PM-2108) 460 South State St., Chicago 5, Ill.
Please send without obligation free information regarding trade checked above. (Specify whether you are a Veteran or Civilian)

Name _____ Age _____
Address _____
City _____ State _____

START A BUSINESS AT HOME...

Like John Lehman, Who Says:

"The complete Fyr-Fyter extinguisher line gives me a steady income and real independence."



Yes, capable men like John Lehman will find an outstanding opportunity with Fyr-Fyter. You can be your own boss . . . operate in your own town and vicinity . . . build a permanent, steady income. No capital needed. We carry accounts, make deliveries, pay profits weekly. Thousands of prospects due to the vast need for fire protection.

Write for FREE BOOK

Get details on Fyr-Fyter's famous sales kit . . . facts on the complete, Underwriters' approved Fyr-Fyter line . . . how you earn while you learn. Write today! No obligation.

Fine Business for men past 40



FYR-FYTER CO. Dept. 90-46, Dayton, Ohio

GLOWS in the DARK **FREE Sample!**

Be the first to sell luminous house numbers, light switch plates, wall protectors, pull cords. Also luminous pictures, statues, decals, and a host of religious, nursery and other objects that glow in the dark. Get into this new and growing industry. Enormous demand . . . no competition . . . sensational demonstration . . . big profits. Represent a large manufacturer, established over 34 years. Write today for liberal money-making offer and free sample to show how they glow in the dark.
MADISON MILLS, 303 Fourth Ave. Dept. K-4 NEW YORK 10, N. Y.



BE A SUPERVISOR



Franklin Technical Institute Helps Young People Get Ahead

The door to well-paid supervisory jobs in industry is wide open—to the man or woman with specialized technical training. 50,000 graduates of this Boston school have gone out to good jobs in engineering and technical fields.

Practical two-year day courses in industrial electricity and electronics, industrial chemistry, mechanical and machine design, structural and architectural design, automotive service and management, electric wiring and maintenance. Also preparatory and evening classes. G.I.-approved, 40th year.

FRANKLIN TECHNICAL INSTITUTE
43 Berkeley St. Boston, Mass.
Please send free information on all courses.

Name _____ Age _____
Address _____
City _____ State _____

DRAW ME!

TRY FOR A

Free Art Course



Copy this girl and send us your drawing—perhaps you'll win a COMPLETE ART COURSE FREE.

FIVE PRIZES—five complete art Home Study courses FREE including Drawing Outfits (Value of each course, \$240.00).

FREE! Each contestant submitting a drawing of sufficient merit will get a grading and our opinion as to whether his or her talent is worth developing.

Vocational Training for talented artistic persons is of tremendous importance. Almost everything must be designed before it can be manufactured.

Only talented persons can be trained as designers and illustrators. Splendid opportunities are available for trained Advertising Artists, Illustrators and Cartoonists. Many of our former students are earning excellent incomes. Here's an opportunity for you to learn more about this interesting profession.

RULES

Contestants must be amateurs. Our students not eligible. 1. Make copy of girl 5 inches high, on paper 7 inches high. Draw only the girl, not the lettering. 2. Use only pencil or pen. 3. No drawings will be returned. 4. Print your name, address (town, county, state), age, phone number and present occupation on back of drawing. If you live in an apartment give apartment number. 5. All drawings must be received by October 30, 1948. Prize winning drawings will be selected by our faculty.

ART INSTRUCTION INC

ESTABLISHED 1914

Dept. 10138-C, 500 So. 4th Street, Minneapolis 15, Minn.

Don't Envy The PLUMBER-Be One

Make \$15 to \$50 a Day
(and work every day)

Every skilled workman will tell you Plumbers have the best of it. WINTER and SUMMER the Plumber is busy at top wages. No skilled Plumber is ever out of a job . . . compare his opportunities with any trade, and decide where your opportunity is.



The
Plumber
Protects
The
Health
of the
Nation

Own Your Own PLUMBING BUSINESS

No other business offers you the opportunity of starting in your own business, and making good profits, with little investment other than Universal's training and a kit of tools.

JOURNEYMAN PLUMBER Gets Good Salary

Master Plumbers own their own shop. A Journeyman works for a Master. With Universal's training a journeyman can depend on high wages from the start.

FREE

**DETAILS SHOW
YOU HOW TO START**

You can start now to success as a plumber by simply filling out the coupon and mailing it . . . or just write Universal Plumbing School, 839 Holmes, Kansas City, Mo. FREE details showing how will be sent by return mail.

Plumbing, to the man with know how, means profit. Investigate Universal's unique "Shop Method" system . . . This system, developed over a quarter century ago by a master plumber, offers you the opportunity to quickly get into the plumbing business. This is not a "war born school" . . . but a plumbing school developed and operated by plumbers since 1923.

BE A PLUMBER In Just 32 Weeks

Now, just 32 weeks of intensive training equips you to be a plumber. No need ever serve an apprenticeship. Don't envy the plumber's big profits . . . enjoy them.

System Shows How With Tools . . . Not Books

Universal's highly developed method makes plumbers by a special developed system showing how to use plumbing tools . . . not books. Every instructor is a Licensed Master Plumber capable of showing every trick of the trade . . . Lead Work . . . Blueprint for plan reading, etc. This business offers a wonderful opportunity for the man who likes to work with tools.

Over 7,000 Successful Plumbers Recommend This School

This system has made more than 7,000 plumbers. Each will testify it was the Universal Plumbing School that started him on the road to profits. Investigate our past performance . . . then decide. Universal is the largest and only school in America devoted exclusively to plumbing. It was established in 1923 under a system developed by a plumber and is owned and operated by licensed plumbers.

Don't waste your time looking over "war born schools" . . . investigate this system . . . then get into the profitable plumbing business.

JUST MAIL COUPON

Send me FREE details about the plumbing business and tell me how to make profits as a plumber . . . I understand there is no obligation.

Name _____

Address _____

City _____ State _____

G. I. Approved. Established 1923

UNIVERSAL PLUMBING SCHOOL

839A HOLMES

KANSAS CITY, MO.

SEND FOR FREE CATALOG!

Out of Pawn!

GENUINE DIAMONDS

Direct to You—Save up to 50% and more on fine quality, Genuine Diamonds, reset in beautiful modern mountings, styled for Ladies and Men—Sold with an Iron-Clad Money-Back Guarantee. Over 100,000 satisfied customers. Order now from this ad. Write us for FREE ILLUSTRATED CATALOG of other Unredeemed Diamond Pledges from \$5.00 to \$5000. Send today. Reference: Any Bank or any Mercantile Agency.

1/5 CARAT
\$125 Value

\$49
Tax incl.

1/2 CARAT
\$200 Value

\$95
Tax incl.

BERMAN'S COLLATERAL LOAN BANK

Dept. P.M., 636-38 W. Balto. St.

Baltimore 1, Md.

Get this Great Catalog of MAGIC



Amazing tricks, mystifying and spooky stage and party illusions. Easy to do—no skill—perfect instructions. Fool your friends. Loads of fun. Add "life" to any party. 350 pages. 600 illustrations. Mail \$1.00 for catalog, credited on your first order for \$5.00 or more.

NATIONAL MAGIC COMPANY
119 S. State St., Dept. P-10
Chicago 3, Ill.

3-Pc PAINT STRIPE SET *Only* \$1.00



3 SEPARATE TOOLS—Each makes different width

Stripe perfect lines—straight, curved, with any paint, lacquer, enamel, easy as drawing lines with ruler! Beautiful furniture, toys, autos; make signs and imitation tile. Simple instructions included.

SEND NO MONEY. Mail order. Pay postman only \$1.00 plus postage. If not delighted return in 5 days for money back. Order Now.

STRADER MFG. CO.

259 Strader Ave. Dept. B-351
Cincinnati 26, Ohio

CARBURETOR TOO RICH MAKES MOTORIST TOO POOR



Car owners who are wasting money and not getting proper gas mileage due to over-rich mixtures will be pleased to learn how to save gasoline by VACU-MATING over-rich mixtures. VACU-MATIC fits all cars, trucks and tractors. It is automatic and operates on the supercharge principle. Easily installed in a few minutes.

SALESMEN WANTED! Big Profits!

Send name, address on penny postcard for free particulars and how to get yours for introducing.

VACU-MATIC CO., 7617-1397 W. State St., WAUWATOSA, WIS.

MONEY for MEN ALL DATA FREE

THE PLASTEX Industry needs manufacturers on small scale and for big production of Lamp and Clock Stands, Art Goods and Novelties in Plastex and Marble imitation. Experience unnecessary. 1/2c material makes regular 10c store sellers. Rubber moulds furnished for speed production. Small investment brings good returns. Big chain store orders now being placed. Ambitious men have chance for real prosperity. Our Free booklet will interest and benefit you.

PLASTEX INDUSTRIES, Dept. A
3400 Third Ave. New York 56, N. Y.



BEYOND EARTH

What Strange Cosmic Power Influences Humans?

BY WHAT RIGHT does man presume that he is the chosen being of the universe and that the earth alone shapes his existence? In the infinite spaces above, tenanted by vast and magnificent worlds, are Cosmic forces which influence the life of every mortal. As iron filings respond to the attraction of a magnet, so too, your acts are the result of an impelling influence upon your will. Just as the unseen Cosmic rays give the earth form and substance, so too, from the infinite reaches, an invisible subtle energy affects the thought processes of every human. Life itself bows to this strange universal force—why, then, should YOU not understand and COMMAND IT? You are like a pendulum either to be swung forward to happiness and the fulfillment of your dreams, or backward into discouragement and disillusionment. Why remain poised in a state of anxiety, uncertainty, and anticipation? Learn to draw to yourself these Cosmic forces which will give your mind the creative impetus that will assure the end in life you seek.

For You — A Gift Copy of the Sealed Book

Not for the curious nor the skeptical, but for the modern man and woman the Rosicrucians, a progressive movement of thinking persons, offer a free, Sealed Book, telling how you may acquire the truth about these phenomenal Cosmic powers little understood today and which make for freedom and attainment in life. THIS IS THE DAY AND AGE OF MASTERY. Throw off the age-old custom of—"let life be as it may"—and learn to *create it as you wish it.*

USE THIS GIFT COUPON

Scribe V.D.L., The Rosicrucians (AMORC)
Rosicrucian Park, San Jose, California

Please send me without obligation the free, Sealed Book, which tells how I may obtain the unusual facts about the Cosmic forces which affect my life.

NAME.....

ADDRESS.....

CITY..... STATE.....

The ROSICRUCIANS
(AMORC)
SAN JOSE, CALIFORNIA

✦ *The Rosicrucians are NOT a Religious Organization* ✦

113 Booklets filled with Money and Time-Saving Helps

Little Library of Useful INFORMATION

5 for \$1.00
12 for \$2.00
25¢ Each

Here at amazingly low cost is the practical help and information you have always wanted. Articles in previous issues of Popular Mechanics have been classified according to subject and are now available in these handy reprint booklets. Check Titles wanted, clip ad and mail today.

* Recent titles.

WORKSHOP EQUIPMENT

- Power-Driven Saws—74:** Complete details on scrollsaw, two circular saws, sliding cut-off saw, bandsaw.
- Drill Presses, Plane, Grinders—79.**
- Sanders—80:** Complete constructional details on 8 useful machines.
- Wood & Metal-Turning Lathes—81:** Two wood lathes, small metal-turning lathe.
- Filing Machine, Hacksaw, Cutoff Wheel, Shaper—82.**
- Metal Lathe Tools You Can Make—101.**
- Workbenches & Tool Cabinets—47.**
- Spray Painting—94:** Constructing spray guns, compressor, using spray gun.
- From Pattern to Casting—91:** How to make your own patterns and small castings.
- *Handy Farm Implements—114:** Grain elevator, dump truck, spreader and cover.
- *Tractor Attachments—116:** Buckrake, stacker, scoop, auger and spray attachment.
- *How to Build a Concrete Block Machine—110.**

SHARPENING—USING TOOLS

- Correct Measurement—106:** How to use micrometers, gauges, calipers, etc.
- Tool and Saw Sharpening—92.**
- Using & Sharpening Drills & Wood Bits—90.**
- Successful Wood Turning—32:** All the information you need to master this art.
- *How to Use Your Drill Press—125:** Includes instructions on preparing the work, methods of clamping, drill speeds and feeds, sharpening twist drills, testing and grinding chucks.
- How to Read Blueprints—71:** Tells you how to understand signs, symbols, and lines.
- Metal Turning Lathe Kinks—99:** Simple homemade tools, time and labor-saving shortcuts you can use.
- Operating a Metal Turning Lathe—100.**
- Heat Treating & Case Hardening—102.**
- Working with Glass—103:** Cutting, drilling, etching, blowing.
- *Using Basic Tools—120:** How to use hammer, files, screwdriver, and cold chisel.

ELECTRICAL BOOKLETS

- Rewinding & Servicing Electric Motors—75:** Repairing and rewinding a.c. and d.c. motors. Locating trouble. Converting auto generators into 110 V. a.c. motors.
- House Wiring—89:** All the information you need to do a complete wiring job or install extra outlets.
- Electromagnets & Solenoids—44:** Designing and building.
- Transformer Construction—41:** Easy-to-understand instructions for all transformers.
- The Boy Electrician—43:** Easy-to-build motors, experiments.
- *Build Your Own Relays—123:** Complete instructions, graphs and wiring diagrams for a.c., d.c., and thermal relays.
- Soldering & Brazing—17.**
- Arc & Spot Welders—8:** Building and operating 110 v. a. c. arc and spot welders.
- Electroplating with Copper, Nickel, Chromium, Lead, Zinc, Cadmium—86.**
- Plating Leather & Other Non-Metallic Objects—Plating with Gold, Silver, Alloys—87.**
- *How to Fix Electrical Appliances—111:** Repairing clocks, washing machines, vacuum cleaners, electric irons, cords, small motors, etc.

HOME IMPROVEMENT BOOKLETS

- Simple Home Improvements—104:** Modernizing; making storm sash, ironing boards, etc.
- Building Extra Rooms in Attic—23.**

- Attractive Basement Playrooms—24.**
- Lower Your Fuel Cost—31:** Practical kinks that will save you hundreds of dollars.
- Hanging Wallpaper—38:** Tricks of hanging wallpaper, removing old paper, etc.
- Curing Leaky Basements—45.**
- Fitting Home Game Room—55:** Construct own game & tennis tables, shuffleboard court, action game, portable playrooms.
- Ridding the Home of Insect Pests—107:** Exterminating and protecting against moths, flies, termites, mosquitos, etc.
- Built-in Fixtures—78:** Step and space-saving kitchen units, built-in beds, corner cabinets, vanities, linen chest.
- Constructing Indoor & Outdoor Fireplaces—88:** Stone fireplaces, portable mantels, garden fireplaces.
- *Painting Your House Inside and Out—117.**

GARDENING BOOKLETS

- Back-Yard Gardening—39:** Selecting, planning and getting the best results.
- Lawn & Garden Novelties—72:** Jig-sawed ornaments, parkway numbers, sundials, flower boxes.
- Trellises, Pergolas, Fences—76.**
- Lawn & Garden Furniture—77:** Modern bent-tube furniture, arbor and seat combinations, swings, lawn chairs.
- *Lawn and Garden Equipment—124:** Complete details for building rotary lawn cutter, hedge trimmer, and lawn edger. Also articles on sharpening and motorizing your lawn mower.
- Playground Equipment—73:** Two playhouses, ferris wheel, roller coaster, treadmill, play store, slide, two merry-go-rounds.
- Colored Concrete Garden Furniture—6:** Garden benches, pottery, flower boxes, bird baths and sundial pedestals in colored concrete. How to build small concrete mixer.
- Bird Houses—7:** Easy to build homes for all kinds of birds.
- Farm & Garden Tractors—8:** Two tractors you can build from old automobile parts.

CRAFT WORK—HOBBY BOOKLETS

- Working with Plastics—61:** Using brilliantly colored plastics in craftwork.
- Magazine Racks—49:** Ten attractive racks.
- Clock Cases—50:** Large Hall, Colonial wall and mantel, ship's wheel, miniature grandfather, desk, Spanish style banjo.
- Serving Trays for Every Occasion—53:** Fourteen different designs.
- Children's Room Furniture—51:** Twelve attractive pieces.
- Book Ends—52:** Ten designs offer good selection.
- Small Tables—54.**
- Smoking Stands—56:** Seven designs given.
- Jigsawed Novelties—57:** Sewing kits, string holders, place-card holders, plywood kitchenware, plant and flower holders, coin banks.
- Desks—58:** Colonial writing desk, two modern-type desks, student's study desk of plywood, combined chest and writing desk.
- Book Cases—59:** Eight designs.
- Doll House & Doll Furniture—60.**
- 25 Shelves You Can Make—64.**
- Novelties Turned on Lathe—62.**
- Inlay Pictures—Veneering—63.**
- Whittling and Wood & Soap Carving—65.**
- Action Toys—66:** 21 easy-to-make toys.
- High Flying Kites—67.**
- Windmills & Weathervanes—68.**
- Lamps in Wood, Metal, Plastic—69:** Selection of 14 designs.

- Metal Craft—28:** Brass tapping and making of novelties both decorative and useful.
- Small Looms—37:** Building hand looms for weaving rugs, etc.; leather novelties.
- Plain & Novelty Wood Finishing—40.**
- Gem Cutting—42:** How to cut and polish semi-precious stones.
- Rustic Furniture—18:** How to build chairs, benches, tables, gates, summer house, etc.
- *Projects in Plastics—112.**
- *Bows and Crossbows—115.**
- *Marionettes—113:** Designing and operating puppets, how to build stage and backdrops.
- *Furniture Upholstery and Repair—122:** Details on upholstering, modernizing beds, and instructions for repairing wooden furniture.

BOAT BUILDING BOOKLETS

Build a boat at home—you can do it

- 14 Ft. Outboard Runabout—2:** Here is a low-cost, fast 14-foot V-bottom boat. Suitable for motors of 4 to 24 hp.
- Rowboats, Bicycle Boat, Small Dinghy—83.**
- Small Sail Boats—84:** 12-ft. sailing dinghy, 6-ft. "training ship" for young sailors, how to sail a boat.
- Two Outboard Runabouts—85:** 14-Ft. family outboard weighs about 400 lbs. and 12-ft. plywood outboard weighs about 110 lbs. Both are V-bottom type.
- Build Your Own Canoe, Kayak, Surfboard—30:** Complete details on 16-ft. Canadian-type canoe, 17-ft. kayak, and 12-ft. hollow surfboard.
- Fast Class-E Ice Yacht—22:** Build your own Class-E ice yacht.

AUTOMOBILE BOOKLETS

- Automobile Kinks and Shortcuts—10:** Money-saving hints on upkeep, operation.
- Building Trailers—27:** Small Streamlined house trailer; several utility trailers.
- Motor-Driven Midget Car & Scooter—34:** Both use gas engine of washing machine type.
- Curing Auto Electrical Troubles—95.**
- *House Trailer—121:** Complete instructions and diagrams for building modern 17 ft. trailer.

PHOTOGRAPHY BOOKLETS

- Photo Enlargers—1:** Condenser lens type; simple vertical; horizontal.
- Photo Printers & Drier—25:** Describes three practical printers, timer and negative drier.
- Photo Darkroom Equipment—96:** Cabinets, light-tight box, timer, agitator, washer.
- Picture Projector, Trick & Table Top Photography—97:** Projectors that enlarge magazine illustrations and shop drawings. Tips for table toppers, photomontages, tricks.
- Photo Kinks—98:** 63 time and money-saving ideas you can use.
- *Photo Lighting—119.**
- *Home Movie Equipment—118:** Converting projector to sound, making titler, film cleaner, projector stand.

MISCELLANEOUS BOOKLETS

- Cleaning Preparations—11:** Easy-to-make cleaners for walls, glass, etc. Removing fabric stains.
- Re-Silvering Mirrors—70:** Formulas for silvering and coloring.
- Knots and Ropework—105.**
- Chemical Experiments—93:** Easy-to-perform experiments. Inexpensive lab.
- Taxidermy—9:** How to prepare skins and obtain life-like poses.
- Log Cabins & Tourists Cottages—14:** Year-round log cabins; inexpensive tourists' cabin.
- Magic for Everybody—29:** Simple tricks to puzzle your friends.
- Trapping Small Animals—33:** How to lure fur bearers, prepare bait and traps, dress skins.
- Tricks of Training Your Dog—35.**
- Small Furnaces—36:** Gas or electric.
- Telescopes—20:** Design and construction.
- Poultry Houses—108:** Structures, brooders and incubators.
- Guns and Decoys—109:** Cleaning, shooting guns; making decoys.

POPULAR MECHANICS PRESS,

200 E. Ontario St., Chicago 11, Ill.

I enclose _____ (U. S. bills may be mailed if carefully wrapped) for "Little Library" booklets numbers:

Name _____

Address _____ Zone _____

City _____ State _____

Be an EXPORTER

HIGH INCOME • Travel • ADVENTURE

... await in World Trade. Some World Traders travel all over the globe enjoying a luxurious living as they go, supplying traders in other lands with U.S.A. products or buying Import merchandise for customers at home. Others conduct their Export business, either full or part time, from here by "mail order."

An Uncrowded Big Money Industry

United States' World Trade has passed the \$18 Billion mark. Its vast treasure of career opportunities has only been scratched. In the past, beginners have had to receive their instruction "on the job" or by taking courses that required full time class work. This has greatly limited the number of trained men and women in Export-Import. But now, through an amazing new teaching method, you can ...

LEARN QUICKLY AT HOME

For quick results you can now study Export-Import at home under the system used for years in on-the-job training, by a "hard-facts," practical Exporter who learned this business not by academic theory but through years of active trading with customers in almost every nation in the world.

ALL PRACTICAL—NO RED TAPE

You train with copies of authentic documents from the Mellinger Company files. You learn from simply worded, plainly stated facts about the actual workings of Exporting and Importing.

Past Experience Unimportant

No previous special experience or schooling is necessary. I teach you simple, direct methods based on my own 25 years of practical experience. You use my experience. You do not have to know or study a foreign language.

WORK FOR OTHERS

Export-Import includes practically all businesses, which means a great variety of salaried positions for trained men and women. Thus there are branches of this great industry which are of interest to persons of practically every taste and aptitude. We are glad to provide employment counsel to our students.

OR START YOUR OWN BUSINESS

The really big money opportunities in World Trade are through conducting your own business in which the profit on one good deal may equal a year's salary working for others. I tell you in my course how to start your own full or part time business in a small office or even in your own home. You may be surprised to learn that it is simpler to own your own business in Export than it is to open a small store or shop.

INQUIRIES FROM ABROAD answered via Air Mail with full details about course; also trade co-operation plan.

\$60 BILLION EXPORT MARKET... SEEN AS MARSHALL PLAN RESULT

Men well informed in World Trade are predicting a \$60 Billion market in U. S. Exports alone over the five years following the recently inaugurated Marshall Plan (E. R. P.) and a great increase in the billions of dollars worth of annual Imports into this country. The purpose of the plan is to stimulate World Trade for U. S. Exporters and Importers

BUY AND SELL WITHOUT CAPITAL

You need little or no capital to start your own business. My course shows you how I have made big commissions — and how you may, too — acting as buyer for customers abroad. You can do a world-wide business by mail order without investing your own money in the goods.

You Can Operate Anywhere

You can operate your business on a mountain top in Virginia or on the plains of Nebraska—in your own home—anywhere. Any man or woman can export. You don't have to live in a city. Your customers are all over the world.

ACT NOW FOR QUICK SUCCESS

Fortunes are being made in World Trade as you read these lines. Start now and get established while THIS FIELD IS UNCROWDED. World Trade certificate awarded on completion of course LOW PRICE will surprise you. Send coupon today. Air mail reaches me overnight.

B. L. MELLINGER, Director, 1422-BF Westwood Blvd., Los Angeles, Calif.

MAIL FOR FREE DETAILS

B. L. Mellinger, Director, The Mellinger Co.

1422-BF Westwood Blvd., Los Angeles 24, Calif.

Please send FREE LITERATURE showing how I may enter the profitable career of World Trade.

Name _____

Address _____

City _____ State _____

Veteran? _____ Occupation? _____ Age? _____

Location preferred? _____

WAR SURPLUS OPTICAL BARGAINS

ASSEMBLE YOUR OWN BINOCULARS!

Save More Than 1/2 Regular Cost



GOVERNMENT'S 7X50 BINOCULARS

Complete Optics!
Complete Metal Parts!
We supply full instructions

METAL PARTS—Set includes all Metal Parts—completely finished—for assembly of 7 X 50 Binoculars. No machining required. Bodies have been factory hinged and covered. A sturdy Binocular Carrying Case is optional with each set of Metal Parts.

Stock #842-H \$39.40

Postpaid, plus \$4.80 for Case—Total \$44.20

OPTICS—Set includes all Lenses and Prisms you need for assembling 7 X 50 Binoculars. These are in excellent condition—perfect or near-perfect—and have new low reflection coating.

Stock #5102-H \$25.00 Postpaid
(These are standard American made parts ... not Japanese, French or German.)

NOTICE! If you buy both Binocular Optics and Binocular Metal Parts, add 20% Federal Excise Tax to above prices.

ARMY'S 6x30 BINOCULARS

COMPLETE OPTICS & METAL PARTS—Model M-13A1, 6 X 30 Binoculars. (Waterproof Model). Everything you need—ready for assembly. When finished will look like a regular factory job costing \$102. to \$120. The Optics are new, in perfect or near-perfect condition. Have new low reflection coating. Metal Parts are new and perfect, all completely finished. No machining required. Bodies factory hinged and covered. Complete assembly instructions included.

Stock #830-H \$40.00 Postpaid
plus \$8.00 tax—Total—\$48.00

TERRIFIC BARGAIN - BUBBLE SEXTANTS

These Army Air Forces Bubble Sextants cost Govt. about \$125 each. Bargain at our price of \$12.50. Wooden carrying case included. Wartime used but **COMPLETELY REPAIRED AND COLLIMATED**. Return within 10 days for full refund if dissatisfied. Directions for use accompany shipment.

Stock #924-H \$12.50 Postpaid
Same SEXTANT as above, but **BRAND NEW** and with Automatic Averaging Device and Illuminated Averaging Disc for nighttime use. Govt. cost \$217. Perfect working order guaranteed.

Stock #933-H \$22.50 Postpaid
6 POWER GALILEAN TELESCOPE—(Commercial Surplus) 28mm dia. Achromatic Objective Lens. Sturdily constructed of Aluminum. 7" long, extends to 9". Complete with carrying case.

Stock #941-H \$3.00 Postpaid

● **ANNOUNCING!** 1948 Annual Gadget Contest. ●
IT'S FUN! IT'S EASY! **BIG CASH PRIZES** for Optical Gadget IDEAS! Write for Entry **BLANK** and Complete Details!

We have literally millions of war surplus lenses and prisms for sale at bargain prices ranging 10¢ and up. Write for Catalog "H" — Sent Free!

Order by Stock No. Satisfaction Guaranteed

EDMUND SALVAGE COMPANY
P. O. AUDUBON, NEW JERSEY

PAINT YOUR CAR WITH "BRITE-AGAIN!"

New **AUTO ENAMEL**
Applied with **POWDER PUFF** Gives Mirror-Like "Professional" Finish!

for only
\$1.79
One Quart Does Entire Job

Now, with "BRIGHT-AGAIN!", Wype Corp's. ONE-COAT Auto Enamel, you can give your car a brilliant, glistening finish such as is sprayed on by Professional Auto Painters—at a fraction of regular cost! Just **WIPE ON** with Powder Puff—which we furnish at no extra charge. Takes about an hour to apply. "Covers" beautifully. **NO streaks. NO lap-marks. Dries dust-free** in one hour. Goes over any other color, lacquer or enamel. Order **TODAY!**



NO BRUSHING SPRAYING MASKING

and yet you get a beautiful paint job that looks like it was sprayed on!

"BRIGHT-AGAIN!"

Comes in
6 Popular Colors

Black Gray
Dark Blue Dark Green
Light Blue Light Green

All Colors
Only \$1.79 Per Qt.

WYPE CORP., Dept. 16-K, 2214 Dolman, St. Louis 4, Mo.

Say You Saw It in
POPULAR MECHANICS

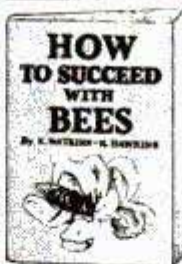

BEE RAISING PAYS BIG PROFITS

Get **HOW TO SUCCEED WITH BEES**, written by two outstanding experts, which gives more than 190 successful plans to produce big crops of honey. Join the ranks of spare time moneymakers and send for this guaranteed 96-page book today. Tells all about queens, equipment, summer, winter and spring management, swarming, increasing colonies, how to produce section honey and extracted honey, etc. 19th edition, fully revised, only \$1.00.

POPULAR MECHANICS PRESS
200 E. Ontario St. Chicago 11, Ill.

MAGIC

SPECIAL OFFER—Complete Miracle Poker Chip Trick—25¢; Instruction Book of over 260 Tricks and Stunts—25¢; Big regular Catalog—25¢. **NOW ALL 3 FOR ONLY 25¢**

STEINERS MAGIC, 316-M East 61 Street, New York City, N. Y.

Bewilder—Mystify—Entertain for **FUN** or **PROFIT**. Use easy to do magic: Talking Skull, Rabbit in Hat, Multiplying Balls, Appearing Cigarette, etc. Catalog 25¢.

FREE Sample Of New PLASTIC Shows How To Make Leather and Leatherette LIKE NEW!

Magically Changes Cloth To Imitation Leather
SAVE MONEY - TIME AND EFFORT by renewing Luggage — Leather Covered Furniture — Golf Bags — Auto Seat Covers — Restaurant Furniture, Booths or any Leather or Leatherette item with new plastic discovery called **Leather-New**. Coat cloth or cloth covered items such as Glider Cushions, Tarpaulins, Porch Furniture, Etc. and make them look and wear like they were leather. Spreads easily with brush or spray gun—leaves **NO BRUSH MARKS**. Simple Acids, Caustics and Alcohols do not stain this finish—It is sun and mildew proof. Stays Fresh and Clean as long as real leather. Comes in all standard colors. Just mail coupon for Free sample of **Leather-New** coated material which shows effects.

LEATHER-NEW PRODUCTS • 4723A Troost • Kansas City, Missouri

OWN A PROFITABLE LIFETIME BUSINESS

Cash in on big profits to be made in this new business—Profits up to \$700.00 monthly possible, renewing booths and furniture for bars, restaurants, grills, movie houses, etc. Mail name and address on 1c postcard—I'll show you how. **Jack Edwards, Sales Mgr.**

JUST MAIL COUPON

No Obligation

LEATHER-NEW PRODUCTS
4723A Troost, Kansas City, Missouri

Name _____
Address _____
City _____ State _____

Fill Out—Mail Today

DO ANY JOB EASIER MAKE MORE MONEY

Used by Army, Navy, Other Government
Depts., 200 Schools and Industrial Firms.

Mail Coupon

FREE TRIAL in Your Home.
Send No Money!
We Ship C.O.D. in U. S.
and Will Refund Money
if Not Satisfied.



Get Ready for BIGGER OPPORTUNITIES and BEST PAYING JOBS

Do it now! Get the better pay that goes to men with specialized knowledge. Get into one of these big opportunity fields. Big money and many other advantages await you if you prepare now. Here is the help you need—EASY—QUICK—AT LOW COST. Thousands of men have already used these famous books. Beginners and experienced men alike have doubled and tripled their earnings with this help. You too, can now get the special knowledge you need for top pay, better jobs, or a business of your own. This is your GOLDEN OPPORTUNITY.

AIR CONDITIONING

Big air conditioning boom interrupted by war now bigger than ever and alive with new opportunities! Get this non-technical book by international authority and be ready for your share of millions to be spent. Covers whole field. 450 pages. Illustrated. \$4.00.

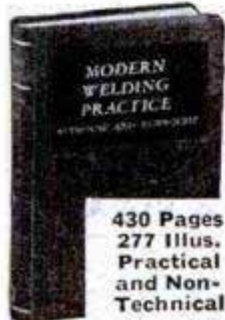

MODERN WELDING PRACTICE

Newest book on all types of welding and heat treatment of metals. Written by recognized specialists in training men for production jobs. Practical and Non-Technical.

430 Pages
277 Illus.
Practical and Non-Technical

Covers everything you need to know. Prepare for best pay jobs now. Price \$4.00.

SHEET METAL LAYOUT

Makes sheet metal layout work so simple that anyone can learn. Get this new instructor and get into the easiest, cleanest and best paying part of all sheet metal work. 143 jobs worked out in drawings and carefully explained. Gives standard for all sheet metal fittings. \$3.50.



AUTO BODY and FENDER REPAIR

Opens the Door to One of the Big Opportunity Fields of the Day

THE LOW COST, EASY WAY TO A GOOD PROFITABLE BUSINESS OF YOUR OWN

Owners will spend big money to keep their good older cars looking like the new ones coming out. This is a practical money-making guide, ideal for shop owners and every man who wants a share of the millions to be spent in keeping old cars looking new. Tells how to get a good job or start business of your own with small capital. Covers everything including tools, methods and materials. Only book of its kind. 325 pages, 232 illustrations. \$3.50.

HOUSE WIRING LATEST EDITION

Get this sixth edition of this standard and practical electrical wiring book. It gives complete practical instruction on every phase of house wiring in one handy volume. Goes further than most books on subject. Hand-book style. Gives National Electric Code, 400 pages, 669 illustrations. Electrical work will reach a new high with millions of new homes to be built. Get started now. \$3.00.

DYKE'S FAMOUS CARBURETOR BOOK

This famous book has been the standard guide in the best paying auto work for a generation. It has helped thousands of men make money. New edition covers engine tune-up, compression, ignition, carburetion, fuel pump valves, etc. Use this book to specialize in this big field. 244 pages, 549 illustrations. \$3.50.

Modern Gas and Electric REFRIGERATION

New Printing—Almost 1000 Pages,
408 Pictures, 17 Diagrams in Colors

The Book of the Hour

Thousands of Refrigerators need repairs! Owners will pay big for competent service. Get this non-technical guide to all types of refrigerators and get your share of this new profit. Get a job or start your own service business. This book will help you make money anywhere. Price \$5.00.

Make Big Money
Keeping Old Cars
Looking New. Get
This Book Today!

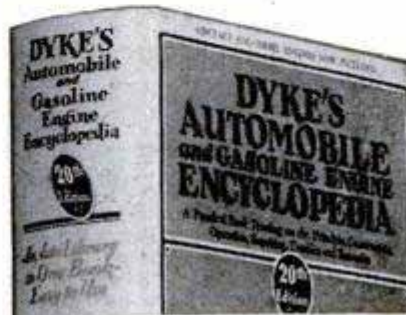

BIG 20th EDITION
Leading Auto Book for Over 36 Years

World's Greatest AUTO BOOK

New Material on Transmissions, Trucks, Tractors, Diesels, Aircraft and Auto Engines

Now with millions of cars needing repairs and thousands of men needed to do the work, you need the famous DYKE Auto Book more than ever before. This big 20th Edition covers all principles, construction, repair, adjustments, testing, troubles and remedies of all cars. Over a half million copies of 20 editions of Dyke's have been sold. Gives specifications of old and newer cars. World's biggest book value. \$7.00. This big book, a complete auto library in one volume, has 1483 pages—4600 illustrations and diagrams—weighs 6 lbs.—equal to 4 ordinary books.

BAILEY'S HANDBOOK For Engineers and Firemen

World famous handbook of universal questions and answers for Stationary, Marine and DIESEL engineers and firemen. Prepares for any license examination. This is the one book that men should have if they want to reach the top in installation, maintenance and operation of Diesel and steam plants. Pocket size, \$2.00.

Goodheart-Willcox Co., Inc.
1321 S. Michigan Ave., Dept. 17, Chicago 5, Ill.

SEND NO MONEY! Mail Coupon

GOODHEART-WILLCOX CO.,

1321 S. Michigan Ave., Dept. 17, Chicago 5, Ill.

Send books checked, C.O.D. I will pay postman, plus few cents charges. If not satisfactory I will return books in 5 days and you will refund money paid. (Outside U.S. or possessions remit with order.)

- | | |
|--|--|
| <input type="checkbox"/> Gas & Electric Refrigeration \$5.00 | <input type="checkbox"/> Air Conditioning \$4.00 |
| <input type="checkbox"/> Dyke's Auto Book \$7.00 | <input type="checkbox"/> Engineers Handbook . . . \$2.00 |
| <input type="checkbox"/> Dyke's Carburetor Book \$3.50 | <input type="checkbox"/> Body and Fender Repair \$3.50 |
| <input type="checkbox"/> Modern Welding \$4.00 | <input type="checkbox"/> Shop Math. (2 vols.) . . . \$3.00 |
| <input type="checkbox"/> Airplane Welding \$3.50 | <input type="checkbox"/> House Wiring \$3.00 |
| <input type="checkbox"/> Sheet Metal Layout . . . \$3.50 | <input type="checkbox"/> A.C. Power Wiring . . . \$4.00 |
| | <input type="checkbox"/> D.C. Power Wiring . . . \$4.00 |

If remittance accompanies order we will pay all postage charges under same return privilege.

Name _____
Address _____
City _____ State _____



Learn

WATCH REPAIRING

In Your
SPARE TIME
At Home



**TRAINED
WATCH MAKERS
ALWAYS IN DEMAND**

The need for trained Watch Makers everywhere is increasing daily with increased watch production. Watch Repairing is a big pay profession—steady the year around. No dull seasons. Work for others or start your own shop!

From The
LARGEST
APPROVED
SCHOOL
of its kind

BIG PAY IN AN UNCROWDED FIELD

Now—without loss of time from your present work you may learn the fascinating art of WATCH REPAIRING in your spare time right in your home . . .

just as ambitious men and women are doing right now. As an expert Watchmaker you can enter an uncrowded field with big pay possibilities and an assured future. No previous mechanical experience needed.

ACTUAL WATCH REPAIRING is taught you with each Lesson. All necessary tools and watch is furnished for actual, professional watch repairing use. We teach you how to take any watch apart and make all repairs and part replacements. You EARN AS YOU LEARN with actual repair jobs, with a Diploma issued upon completion of our highly practical Course.

WRITE TODAY!
No Salesman Will Call

ILLINOIS SCHOOL of WATCH REPAIRING

2870-DC ELSTON AVE.

CHICAGO 18, ILLINOIS

New Method...



You too can make these beautiful copper pictures and plaques right in your own living room.

BIG PROFITS!

Can be Yours...
Right in Your Own Home

No Experience Needed

At last a way to get in on the Big Money made every day in Copper Art—Plaques—Bowls—Trays—Gifts—Souvenirs of all kinds. No art talent necessary—our NEW METHOD makes it so easy, even a child can do it. Big Markets waiting. Anyone can learn quickly—you start making money right from the start. Don't miss this opportunity to cash in at once on this big-paying easy to operate business. Be your own boss. SEND NO MONEY—act NOW to get all the free details—just send your name on a penny postcard today—Do it Now! Write today—



No Selling
Money-Back
Guarantee

HOLLYWOOD COPPER ART STUDIO Dept. M

7266 Sunset Boulevard
Hollywood 46, California



"LEARN-BY-DOING"

ELECTRICITY

PRACTICAL TRAINING
NOT "HOME STUDY"

G.I. APPROVED Get actual experience in great shops of M.T.I. Learn all phases Practical Electricity; Housewiring, Motors, Const., Maintenance, etc. Living arrangements, Part-time jobs, etc.

Send coupon TODAY.

MICHIGAN TECHNICAL INSTITUTE Veteran
2281 W. Fort St., Detroit, Mich., Dept. PM-10
Name _____
Street _____
City _____ State _____

SAY YOU SAW IT IN POPULAR MECHANICS

LAW

Study at home in spare time. Achieve personal success and larger earnings. Learn by doing. Moderate cost, easy terms. Send for details.

SOUTHERN EXTENSION, Room 10, 117 1/2 S. Monroe, Tallahassee, Fla.



=i LEARN CODE

TWO DOTS MAKE LETTER "I"
EASY PICTURE WAY MEMORY METHOD. COMPLETE ALPHABET 6 LESSONS SEND ONE DOLLAR—OTTO LUTHER, NEW PRESTON, CONN.

Make Money With MAGIC—



PARLOR or STAGE TRICKS—I'll

• **WORLD'S FINEST MAGIC** • Show You How!

SPECIAL! . . . Most Perfect Playing Card Trick Deck; using standard deck of cards. . . . No sleight of hand, long practicing, or awkward moves. Do tricks like the professionals. . . . Name any chosen card AMUSE instantly. And many other tricks (no YOUR PRICE PER DECK marked cards). . . . Cards can be thor-FRIENDS oughly shuffled. **LARGE 160 PAGE CATALOG ONLY 35c**

ONLY — \$1.00 Established Over 38 Years
CHICAGO MAGIC CO., Dept. P-10, 2300 No. Mason Av., CHICAGO 39



Train Now
for Big Pay
Open to

Carpenters & Brick Masons

IN A FEW SHORT MONTHS IN MODERN WELL EQUIPPED
Midwest Shops

Approved for Veterans. Non-veterans may pay tuition by the month. MAIL COUPON TODAY FOR FREE INFORMATION.

Get into the billion dollar building trades. Demand widespread, check your own neighborhood for shortages of carpenters and brick masons. Our graduates are actively employed in the Building Trades, stepping directly from school into jobs or business of their own in various parts of the country. Many of our students supplement their income with part time earnings while attending school. Pleasant inexpensive living quarters in beautiful, healthful surroundings. Enroll now. Limited classes. MSBT teaches building trades only.

MIDWEST SCHOOL OF BUILDING TRADES,
Dept. PM-10A
411 N. Center Street, Bloomington, Ill.
Please send me free information about training in the field I have checked:
 Carpentry Masonry
Name _____
Address _____
City _____ State _____
Are you a veteran? Yes No

**LOW
FACTORY
PRICES!**

... on the Sensationally **NEW 1949** **MIDWEST RADIOS**

**NEW
SERIES 16
SUPER DE LUXE
AM-FM
CHASSIS**

30 DAYS TRIAL

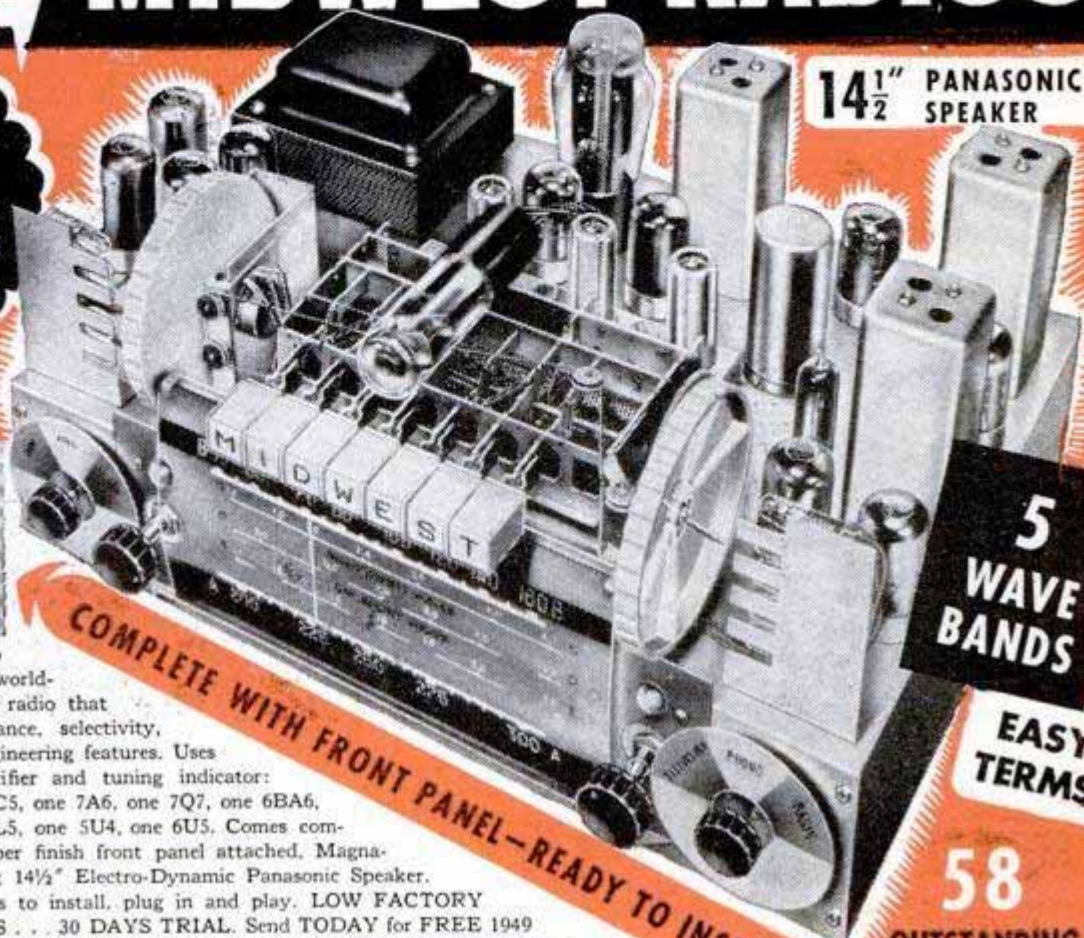

**14 1/2" PANASONIC
SPEAKER**

**5
WAVE
BANDS**

**EASY
TERMS**

58

**OUTSTANDING
FEATURES**

*Including the
Exclusive Midwest*

FLASH-O-MATIC
Volume and Band Indication

TELEVISION
Audio Switch-Over

FIDEL-A-STAT
Color-Ray Tone Selection

TRI-MAGNADYNE
Coil System

...Plus **NO-DRIFT FM**
and many other features

COMPLETE WITH FRONT PANEL—READY TO INSTALL!

Here is the last word in radio engineering . . . a powerful, world-ranging, magnificently-toned radio that is unsurpassed for performance, selectivity, sensitivity, and advanced engineering features. Uses these latest-type tubes, rectifier and tuning indicator: three 7A7, three 7A4, two 7C5, one 7A6, one 7Q7, one 6BA6, one 6BE6, one 6C4, one 6AL5, one 5U4, one 6U5. Comes complete with satin stripe copper finish front panel attached, Magna-Tenna Loop Aerial and giant 14 1/2" Electro-Dynamic Panasonic Speaker. Requires only a few minutes to install, plug in and play. **LOW FACTORY PRICES . . . EASY TERMS . . . 30 DAYS TRIAL.** Send **TODAY** for **FREE** 1949 Midwest Radio Catalog of separate Chassis and beautiful Console and Table models.

**A Complete Line of FINE RADIOS and RADIO-
PHONOGRAPHS . . . Available in SEPARATE
CHASSIS Like the POWERFUL SERIES 16 AM-FM
Model above or in COMPLETE CONSOLES like this...**



Beautiful SYMPHONY GRAND AM-FM Radio-Phonograph with TELEVISION Audio Switch-Over and NEW Intermix AUTOMATIC RECORD CHANGER

A Magnificent musical instrument and a masterpiece of cabinet design—the finest Midwest Radio in 29 years of manufacture. Offers world-ranging radio reception and newest automatic Intermix Record Changing Phonograph. Uses Series 16 Super DeLuxe AM-FM Chassis. Giant 14 1/2" Panasonic Speaker; Tri-Magnadyne Coil System; Built-In Loop Antenna. Other luxurious console and table model cabinets available with Series 16, 12, and 8 chassis—on Easy Terms and 30 Days Free Trial.

Rush for Free Catalog!

**FILL IN COUPON AND MAIL TODAY OR JUST
SEND NAME AND ADDRESS ON 1¢ POSTCARD**

MIDWEST RADIO & TELEVISION CORP.

Dept. 253, 909 Broadway, Cincinnati 2, Ohio

Please send me your new **FREE 1949 Catalog.**

NAME _____

ADDRESS _____

CITY _____

ZONE _____

STATE _____

BUY DIRECT FROM FACTORY and SAVE!

MIDWEST RADIO & TELEVISION CORP.

Dept. 253 909 Broadway, CINCINNATI 2, OHIO



E. J. SWEENEY
87,675 men have
come to E. J.
Sweeney Schools
—WHY?



**DO
IT
NOW**

Get Ready Quick for a TOP PAY JOB AUTO BODY, FENDER and PAINT MEN

Let me show you how to get ready—fast—for high pay and a steady job with a real future in auto body and fender work. My new Free literature tells how you can learn this specialized trade quickly and easily by the Sweeney System of Practical Experience. See actual photos of up-to-date modern equipment and big roomy shops. For a real opportunity to make good money, get in auto, body and fender work. Send for the facts today. 1054 Want Ads in newspapers in one state in one month alone show the amazing demand for trained men. Here is actual proof that there is opportunity for you today in this big field. Read the complete story on opportunities today in my Free literature. Mail a post card for yours today.

APPROVED FOR VETERANS TRAINING

SWEENEY AUTO SCHOOL, Inc.
Dept. 22, 2901 East 14th St., Kansas City 1, Mo.

**FREE
LITERATURE
POSTPAID**

MAIL COUPON FOR DETAILS

E. J. Sweeney, President
Sweeney Auto School, Inc.
Dept. 22, 2901 East 14th St.
Kansas City 1, Mo.

Name _____

Address or RFD _____

City _____ State _____

Veteran

Non-Veteran

BE A MAGICIAN

Learn this fascinating hobby by mail

You can amuse and mystify your friends from the first instructions. Learn magic secrets the easy way. Send 10c for full details, illustrated magic catalogue, and your first trick.

CALIFORNIA MAGIC DEPOT

Dept. M, 2491 Telegraph Ave.

Berkeley, California

"SEA CRAFT" BLUEPRINTS READY NOW!



Build this luxurious cabin cruiser yourself and save money. What a beauty it is! A 25-foot boat readily adaptable as a sport fisher, express cruiser, or utility boat. Cruises effortlessly at 15 knots with a marine engine or converted auto motor. Its spacious cabin sleeps four and has a galley complete with fresh-water tank, sink, and cook stove. Has open cockpit large enough for fishing, lounging, etc.

During war the Coast Guard used "Sea Craft" for ship-to-shore travel. Order today your complete set of seven large-size blueprints scaled 1 inch to the foot. These, plus a 40-page two-color illustrated booklet giving step-by-step instructions, only \$10.00.

POPULAR MECHANICS PRESS
200 EAST ONTARIO ST. CHICAGO 11, ILL.

LEARN TRIG QUICKLY—EASILY

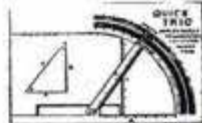

BY COMPETITIVE TESTS

It was found that QUICK TRIG gave answers faster to one with a slight knowledge of trig than to an expert on trig with a slide rule. Simply set the slides and read the answers for all three sides and angles of a triangle. Also gives degrees, sines, cosines and tangents of angles. Entirely automatic. Easy instructions included FREE. We mail C.O.D. plus postage or enclose \$1.00, the full price, and we will mail postpaid. Send now for your QUICK TRIG, to

REED MFG. CO., 11350-A Burbank Blvd., N. Hollywood, Calif.

LEARN MEAT CUTTING EASILY - QUICKLY At Home - In Spare Time



The steady, dependable trade of Meat Cutting taught easily, quickly by improved HOME METHOD. National School, established over 25 years, has organized its famous "Learn By Doing" Classroom, Cutting room and Retail Market training system into sound, practical HOME STUDY form.

Now, by the miracle of this EXTENSION TRAINING you can prepare in Your Spare Time At Home, for a better job, bigger responsibilities or success and security in a store of your own. Remember, PEOPLE MUST EAT!

Buying, cutting, percentage, pricing, advertising, selling—a complete meat education. For beginner or men with ex-

perience. Thousands of successful graduates. Send coupon for FREE Bulletin NOW!

MAIL THIS COUPON TODAY FOR FREE BULLETIN

National School of Meat Cutting Div. U-98, Toledo 4, Ohio

Send me your FREE Bulletin on Meat Cutting and Meat Merchandising. No obligation. No Salesman will call.

Name _____

Street _____

City _____ State _____

Makes all **HOME JOBS** Easy

Save Money - Enjoy the Fun
of Doing it Yourself!
Keep Your Home, Furnishings
and Equipment Up-to-date!

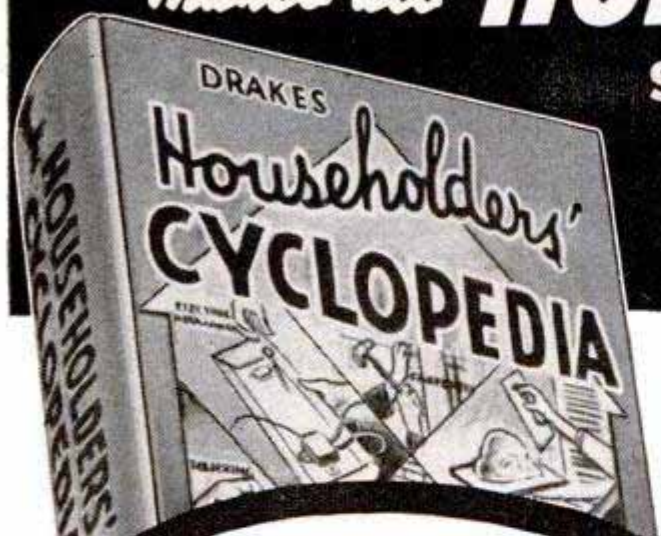

with
DRAKE'S *Householder's*
CYCLOPEDIA

*AN AMAZING
NEW AND DIFFERENT
KIND OF BOOK!*

640 Fact-Packed Pages!
**1000 How-to-do-it
Illustrations!**



**More Than 700 Jobs
Like These Explained
and Illustrated!**

**ELECTRICAL
CONVENIENCES**

Appliance Repairing
Wiring and Lighting
Installations
Fans and Ventilators
Electrical Troubles
and Remedies
Motor Upkeep and
Repairs
Refrigerator Troubles
and Remedies

**HEATING AND
PLUMBING**

Radiant Heating
Boilers and Their Care
Heating Controls
Gas and Oil Heating
Kinks
Fireplaces and
Chimneys
Stoker Care and
Adjustment



Plumbing Repairs and
Replacements
Plumbing Installations

**FURNITURE CARE
AND REPAIR**

Cleaning and Spot
Removing
Repairs and Refinishing
Upholstering

**PAINTING AND
DECORATING**

Paints and Painting
Wallpaper and Paper
Hanging

**HOUSE REPAIRS AND
IMPROVEMENTS**

Brick and Brickwork
Basement
Waterproofing
Concrete
Floors and Flooring
Foundations
Glass and Glazing
Gutters and
Downspouts

1000 specially prepared pictures and diagrams show the inner workings of mechanical and electrical devices, how they are taken apart, put together, and adjusted. They show too, successive steps in making things with wood, masonry and metal.

Mortar, Mixing and
Using
Screens, Making and
Repairing
Stucco
Walks—Laying
Wallboard and How to
Use it
Weatherproofing
Wood and Lumber
Woodworking

**MISCELLANEOUS
MONEY SAVING HELPS**

Driveways
Gas Appliance Care
Key Fitting
Metal Working
Sewing Machines
Soldering Methods
Tools and How to Use
Them

Tells Everything — Shows Everything — Repairing,
Remodeling, Modernizing, Carpentry, Painting,
Decorating, Plumbing, Heating, Electric Wiring
and Appliance Repairs, Furniture Repairs, Etc.

This amazing, practical and simplified book shows how to do hundreds of jobs yourself and eliminate expensive labor costs and annoying delays. It tells how to adjust, install and repair all kinds of household electrical and mechanical appliances and conveniences. It gives the answers to hundreds of home making questions and saves time, trouble and money. It gives step by step instructions, explaining the simplest and least costly, effective methods for hundreds of jobs requiring only ordinary materials and simple hand tools which anyone can use.

Use this amazing book to improve your home in many ways, to make alterations, extensions and repairs. Use it to rejuvenate and modernize your equipment and furnishings. Use it to make your home the delightful livable place you have always wanted, without having to worry about the cost. With the Householders Cyclopeda to guide you, that extra attic room is easy, the basement playroom becomes a reality, modern plumbing and wiring, efficient heating and other improvements can easily be yours.

Get this helpful book now. Turn spare hours into the things you want and save money besides. Mail the coupon below for quick delivery right to your home. Mail to Frederick J. Drake & Co., 117 Green Bay Road, Dept. 17, Wilmette, Ill.

**MAIL COUPON
NOW**

**FREDERICK J. DRAKE & CO., Dept. 17
117 Green Bay Road, Wilmette, Ill. (Suburb of Chicago)**

Rush to me at once, Drake's Householders Cyclopeda, the new How-To-Do-It Book, in full cloth, library style binding, price \$5.00. I understand that if not pleased with this book I may return it after 5 days examination and you will refund my money.

- I enclose remittance for \$5.00 in full payment for prepaid delivery.
- Send C.O.D. I will pay postman, plus postage and C.O.D. charges.

Name _____

Address _____

City _____ Zone _____ State _____

**Information that Simplifies Hundreds
of Jobs and will Save Hundreds of
Dollars for you Every Year!**

No Shop
Needed

Operate YOUR OWN Business



Clean and Mothproof Rugs and Upholstery

Can you qualify? . . . If you are dependable, honest and willing to work, send for **FREE** Booklet explaining how you can become "your own boss" in a growing business of your own. You'll use proven successful methods of established **DURACLEAN** Dealers. Service rendered "in the home," offices and public buildings. Easy to learn. No experience necessary.

DURACLEAN cleans by absorption! No scrubbing. No soaking or shrinkage. Fabrics dry in just a few hours. Dirt, grease and many unsightly spots vanish as if by magic . . . colors revive. Upholstery and floor coverings last longer.

DURAPROOF kills moths and carpet beetles. Makes material resistant to both! Another year 'round service. **DURAPROOF**, to our knowledge, is the only moth proof service backed by a **National Money Back, 4 YEAR WARRANTY**. Guards against mildew, too. Also rendered "In the Home."

These services are **Nationally Advertised!** Leading furniture and department stores recommend **DURACLEAN** Dealer's service. Almost every building in your territory houses a potential customer. Even auto dealers buy your service to revive upholstery in used cars. You get many voluntary and repeat orders.

Some dealers establish a shop or an office after business has grown. Others continue to operate from their own home. Profits up to \$15 and \$20 for a day's service on **EACH** of your service men. Territories are limited! Write now for **FREE** Booklet explaining details of these **Nationally Advertised** services.
See our full page "ad" in September House & Garden.

Duraclean Co., 16-Oct., Deerfield, Illinois



START AS HIGH AS \$3,351 YEAR

Many Early Examinations Expected. Prepare **NOW!** Veterans Get Special Preference! 40 Page Civil Service Book **FREE** Mail Coupon Today **SURE**

Franklin Institute
Dept. G-85
Rochester 4, N. Y.
(Not Government Controlled)

Gentlemen: Rush to me, **FREE** of charge, list of U. S. government big pay jobs. Send **FREE** 40-page book describing salaries, vacations, hours, work, etc. Tell me how to qualify for one of these jobs.

Name _____

Address _____ Vet? _____

COUPON



S. T. Christensen
President

WRITE ME TODAY!

\$5.00 TO \$6.00 PER HOUR!

This fascinating lifetime opportunity can be yours if you are mechanically inclined (can hold and use tools). It is not unusual for appliance repairmen to charge on this basis of \$5.00 to \$6.00 per hour.

NO PREVIOUS EXPERIENCE NEEDED!

Think of going to a friend's or your neighbor's home. Picking up and carrying back to your work bench their Sewing Machine, Vacuum Cleaner, Iron or other appliance. Then using your **Christy Course** and **Christy Electronic Kit** to help you locate the trouble and easily repairing the appliance from the clear instructions given. I will help you . . . by showing you exactly how much **PROFIT** to charge for each repair job.

CHRISTY APPLIANCE COURSE & ELECTRONIC KIT . . . SENT TO YOU

Rush your name and address by the next mail and I will send to you our special form where you can get our complete course and electronic Kit on our simple, easy payment plan. Pay me later with your **EARNINGS WHILE LEARNING**.

Mr. S. T. Christensen, Pres.
Christy Supply Co., Dept. D-6203
2835 N. Central Ave., Chicago 34, Ill.

Now for EVERY WORK SHOP! NEW Invention Electroplates by BRUSH



Easy to Plate CHROMIUM GOLD, SILVER, NICKEL, COPPER . . . For Pleasure and Profit!

If you have a workshop—at home or in business—you need this new **Warner Electroplater**. At the stroke of an electrified brush, you can electroplate models and projects—you can replate worn articles, faucets, tools, fixtures, silverware, etc. with a durable, sparkling coat of metal . . . Gold, Silver, Chromium, Nickel, Copper or Cadmium. Method is easy, simple, quick. Everything furnished—equipment complete, ready for use. *By doing a bit of work for others, your machine can pay for itself within a week.* So make your shop complete by getting a **Warner Electroplater** right away. Send today for **FREE SAMPLE** and illustrated literature. **ACT AT ONCE! Mail Coupon.**
WARNER ELECTRIC CO., DEPT. W-7
1512 Jarvis Avenue, Chicago 26, Ill.

FREE Details & Sample!

WARNER ELECTRIC CO., 1512 Jarvis Avenue, Chicago 26, Dept. W-7
Gentlemen: Send Free Sample and Details to:

Name _____
Address _____
City _____ State _____

BE YOUR OWN BOSS — IN YOUR OWN BUSINESS



PLASTICS TECH
 Founder of the first Plastics
 Fabrication Home
 Training Course

Let me send you
FREE
 the whole exciting story
 of your opportunity
 in **PLASTICS**

by practicing at home

Get the full free story at once on the amazing new opportunity plastics holds for you today—in your own business or on the job. Learn how to do fascinating experiments in your own home with interesting materials like those shown at left. It's easy and it's fun. And it means either more money or being your own boss, to come and go as you please.



BUILD YOUR OWN FUTURE —
In Your Own Business - As Your Own Boss!

Send the coupon today. Learn how you can start at home, with little money, to build your own big paying business. Discover your future. We give you at home at your own convenience the fundamental knowledge of plastics you need for success. And also the practical experience. You will learn to fabricate, shape, form, finish, cement, cast, compound and make molds.

You make products like these early
 in the Course.



Many Beginners Make \$10
 to \$20 a week in spare time
 while learning

One Texas Student, though only 1/3 finished with his training has already sold his first large order to a local dept. store. You too may do the same. A wonderful opportunity for spare time cash is yours for the asking.

LEARN ALSO OF OUR
"RESIDENT CLASSES"
ADVANCED TRAINING

Highly specialized advanced plastics engineering training is offered in our Cleveland resident classes and laboratories. Prepares you for professional positions. Check coupon if you desire this information.

MAIL COUPON TODAY!

This may be opportunity at your door. Don't miss it. Just mail coupon in an envelope or paste on penny postcard. Do it now!

PLASTICS TECH
SCHOOL OF AMERICA, INC.
LEADER IN HOME TRAINING
 Dept. PM-10
 4707 Euclid Ave., Cleveland, O.

Learn PLASTICS

FABRICATION AND CASTING!

**THIS EASY WAY
 IN SPARE TIME**



Mail coupon at once, and we will immediately send our new book showing your opportunity for success in plastics. It will show you how easy it is to learn plastics by actually doing the work at home in your spare time.

GET 1948 SUCCESS BOOK FREE

PLASTICS TECH, Dept. PM-10
4707 EUCLID AVENUE, CLEVELAND 3, OHIO

Mail me **FREE**, without obligation, your 1948 Home Study Opportunity Book in Plastics. I want to know how I can be my own boss in this field.

NameAge

StreetZone

CityState

.....I am also interested in Veteran Resident School Training. **LEADER IN HOME TRAINING**

Learn to Use the **SLIDE RULE**

EASY! QUICK! NEW LOW COST!
 Newly Revised and Simplified Step by Step Method

10 in. SLIDE RULE
 and Famous **\$2.98**
 Book Both for Only

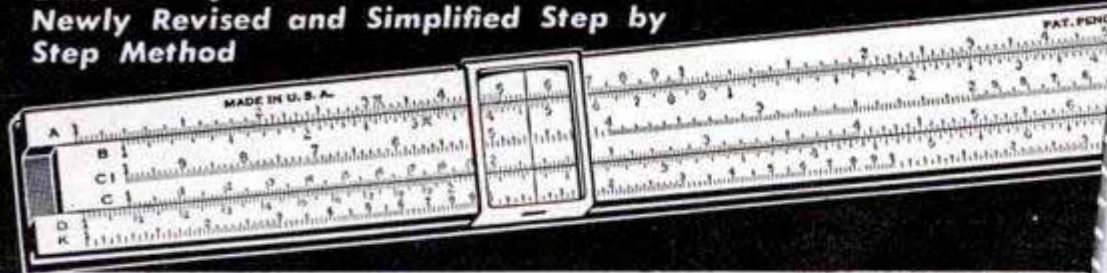

Practical Help for Bigger Pay — Better Jobs — for Mechanics, Draftsmen, Shop Men, Accountants — All Who Use Figures

Get this new revised and simplified edition of the "Slide Rule and How to Use It." Thousands of older editions sold at much higher price. Now — a more simplified book at a lower price with genuine full size Mannheim type beginner's Slide Rule included at no extra cost. Do all kinds of figure work. Stop wasted time. Stop pencil errors. Learn quickly to multiply, divide, extract roots, find ratios and percentages, squares, areas of circles, radii, volume, etc. Do it in a flash and learn now with this book and slide rule combination.

Practical Step by Step Guidance

No other book like it. Contains complete instruction and removable work sheets that make the slide rule simple as A.B.C. Also Five Place Logarithm Table, Tables of Trigonometric Functions of Angles, review of Mathematics from simple arithmetic through calculus, and with complete answers to check yourself on every problem. It can easily be worth hundreds of dollars to you in promotions, better pay, saving time and error. It's a book for students, mechanics, business men—everyone should learn to use the slide rule, now that it is so easy.

Learn in a Few Hours to Do Many Calculations

There is nothing mysterious about the slide rule and its use. Just read the book and follow the rules. You'll be amazed at the problems you can solve in just a few hours. Mail the coupon now. Book and slide rule will be sent at once. Use them for 5 days, then if you are not satisfied in every way, return them and your money will be refunded without delay. Use the coupon. Mail now.

208 PAGES
LOG TABLES
 Helpful Review
 of Mathematics

Mail Coupon
 Money Back if
 Not Satisfied

Austin Publishing Co., Dept. 17
165 N. Pine Ave., Chicago 44, Ill.

Send me "The Slide Rule and How To Use It" and 10" full size Mannheim type beginner's Slide Rule. Total cost for both \$2.98. I understand you will refund amount paid you if I return them in 5 days.

Remittance Enclosed Send C.O.D. Postage and Charges Extra
 Send Postpaid

Name.....

Address.....

City..... State.....

AUSTIN PUBLISHING CO., Dept. 17, 165 N. Pine Ave., Chicago 44, Ill.

New Easy Way TO MAKE BIG MONEY!

FULL
OR SPARE
TIME

AT
HOME

Permanently
METALLIZED
BABY SHOES

Costs You Only 5¢-You Get \$6.00

Now is the time to cash in on this big-paying, easy-to-operate year 'round business, and you need no experience! With actual illustrations and step by step instructions, YOU can start earning money in only one week—up to \$1000 per month full time, or

**LARGEST NUMBER OF
SUCCESSFUL BUSINESSMEN**

Our course has the largest number of successful businessmen in this field today! They are all men and women who acted and are making money. This course is guaranteed—your money will be fully refunded if you are not more than satisfied. There is nothing to lose, so act at once.

- Money Back Guarantee
- Most Successful Name in Metallizing
- Big Income
- Huge Demand
- Sales Plans
- Future Security
- Your Own Boss

\$50 to \$75 per week spare time . . . at \$5.00 per hour. Working only a few hours you can make more money than most people make working an entire week.

IMMEDIATE RESULTS

This tested and proven method shows you complete details, so that you may start at once, metallizing Baby Shoes, with real GOLD, SILVER or BRONZE. They will last forever, retaining every priceless detail of the natural shoes; something for which there are 5 million new customers waiting to buy every year.

BEGIN AT HOME

Don't pass up this real opportunity to start your own business on a shoestring right at home.

ACT NOW! We will send you all the details absolutely free.

SEND NO MONEY
USE
THIS
COUPON



FREE!

Two actual metallized Baby Shoes guaranteed to be the most attractive on the market—or a pair of your own Baby Shoes metallized if you prefer.

Name _____
Address _____
City _____ State _____

KIKTAVI
Company Dept. P-4
2111 W. Manchester
Los Angeles 44, California

Rush me FREE full particulars at once.

VETERANS Learn WATCHMAKING

**JEWELRY
ENGRAVING**

Above Average Pay
No Age or Physical
Limitation
In One of the Most Highly
Respected Careers
Trained Men Always in
Demand

Trades with
Greater Security

Learn by our Advanced Training Method . . . Only Latest Scientific Equipment and Facilities.

Write Today for Complete Information and Catalog



Approved
G. I. Training

KANSAS CITY SCHOOL OF WATCHMAKING

America's Most Progressive Horological School
617-621 Wyandotte St. Kansas City 6, Mo.

STEEL HANDBOOK

Second Edition — 1948

GIVES: Approximate analysis, Heat treatments, Suggested applications and Index to suppliers. Steels are listed by their common trade names.

INCLUDES: Carbon tool steels, Special alloy steels, Hot work steels, Non-deforming tool steels, High chrome-High Carbon, Shock resisting steels, High speed steels, etc.

ALSO: Machinery steels, Stainless steels, S.A.E.-A.I.S.I. steels.

POCKET SIZE 3 1/4 by 6 1/4. Flexible Binding, 140 pages

PRICE \$1.00 PER COPY

(COD orders 25 cents extra and postage)

H. M. HALVORSEN, PUBLISHER

P. O. Box 63, Harper Station

Detroit 13, Michigan

INVENTORS

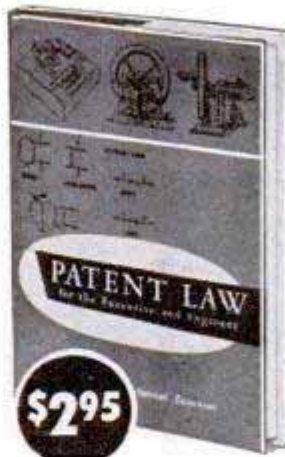

NO PATENT PROTECTION . . . NO PROFITS. Authoritative book on patent law, already bought by thousands of INVENTORS, ENGINEERS & EXECUTIVES will pay for itself . . . You CAN'T AFFORD TO BE WITHOUT IT. Learn simply and easily how protected inventions can make money for you; how to deal with your attorney . . . A MUST FOR INVENTORS, MECHANICS, ENGINEERS, who have money making patentable ideas . . . Easy to read and understand, only \$2.95. FREE: for cash or money order with your order, we will send a set of 8 1/2 x 11 invention records. Check or money order only.

RESEARCH PRESS, 139 N. Perry St., Dayton 2, Ohio

Send me "Patent Law for the Executive and Engineer."
Check or Money Order enclosed (You pay postage and send FREE complete set of Invention Records).
Five days approval. I'll remit \$2.95 plus postage or return the book in five days.

Name _____ Title _____
Address _____
City _____ Zone _____ State _____ PM10

AVIATION CABLE

Flexible 133 strand wire cable, 5/32 in. diam., 3300 lb. break test. Lengths up to 450 ft. Use for tow rope, guy wire, clothes line, etc. Wgt. per 100 ft., 4 lbs. Specify length wanted. No. 421—Per Ft. **4c**



WAR SURPLUS AND HUNDREDS OF OTHER BARGAINS

ARMY BANDO-LEERS



Of fine heavy khaki. Big roomy pockets with snap button fasteners. Fine for hunters, campers, boy scouts, etc., also for shop work in carrying small parts, etc. Material alone is worth this price. Shp. wt. 1 lb. 11 Pocket Type No. **49c** 5 Pocket Type No. **29c** 129 Each 128 Each

MESS KITS

Regulation two-piece Army Mess Kits with folding handle. Used, but perfect. Weight 2 lbs. No. **69c** A116—Ea.



CANTEENS

Reg. U. S. issue canteen. Plastic screw top chained to body. Slightly used but perfect. Wgt. 1 lb. 117—Metal **69c** 118—Plastic—Ea.



CANTEEN CUPS

All metal. Folding handle. Wgt. 1 lb. No. A120—Each **25c**

CANTEEN COVERS

Heavy canvas. Button fastener. New No. 530—Each **69c** Used No. 119—Each **35c**

WIRE CUTTER

Heavy duty, compound leverage. Cuts up to 1/4 inch wire. Upper jaw acts as feeder to cutting edges. Insulated handles. Ideal for farm fence work and shop use. Shp. wgt. 2 lbs. Stock No. **\$1.95** 392—Each



Heavy Duty RUBBER GLOVES BRAND NEW
Extra heavy—extra long. Brand new, high quality gum rubber for softness and ease in use. Designed for heavy duty industrial service—protection in handling chemicals, acids, etc. A real bargain at this low price. Stock No. 295—Per Pair, Only **79c**

ARMY AIR CORPS TYPE

SUN GLASSES
Ideal for driving, sun glare, sports and work. 24 carat gold plate frames with Pyralin sweat bar—adjustable nose bands. Large aviation type lenses. Case included. Shp. wgt. 1 lb. No. 238—Per Pair **\$2.95**



POPULAR RECORD ASSORTMENT

Fifty records of modern dance, race, blues and hillbilly selections. No two alike. Famous name bands and artists included. Used in juke boxes, but guar. perfect. Shipped exp. collect only—no exchanges or refunds. Wgt. 28 lbs. No. A303—50 records **\$9.64**

No. A300—25 Records. All Dance. Wgt. 14 lbs. \$4.88	No. A301—25 Records. Hillbilly, Race and Blues. Wgt. 14 lbs. Set... \$4.88	No. 302—25 Records. All Hillbilly numbers. Wgt. 14 lbs. Set... \$4.88
---	---	--

STIRRUP PUMP

Works with any pail or bucket. Shoots a high pressure stream up to 30 feet. Use it for spraying garden and trees, for whitewashing, fire fighting, drainage, etc. Complete with 10 foot flexible hose. All brand new. Regular \$3.80 value. No. 244—Each **\$1.49**



ELECTRIC MOTOR

Small but powerful. Shaded pole type, designed for fan application. 115 V 60 cycle. Has 1/4 inch shaft, one inch long. Operates at 3150 RPM under no load, 2000 RPM under 2.33 oz. inches load. Full load current .6 amp. Ideal for use on toys, window displays, etc. Shp. wgt. 1 1/2 lb. Stock No. 555—Each **\$1.95** only.



McCLELLAN SADDLE

Brand new! Top grade cowhide. 12 inch seat. Hair girth. Has straps for blanket roll and knapsack. Gun boot and sabre loops. Shipping weight 15 lbs. Stock No. A145. Each. **\$16.95**



BAYONET BLADE

Fine forged steel. Ground but not polished. May be made into throwing or hunting knife or spear. Blade 6 1/2 x 7 1/8 inches, 1 1/4 inches overall. Will take and hold a fine edge. Shp. wt. 1 lb. No. 664-R—Each **49c**



15 JEWEL STOP WATCH U. S. AIR CORPS SURPLUS

Genuine Elgin 15 jewel movement. Ideal for split second timing in racing, sports, time study, etc. Full sweep split second hand graduated in 1/10th seconds. Stem wind, start, stop and reset. Used but guaranteed perfect. Wgt. 1 lb. No. 200—Each **\$9.95**



VEEDER ROOT COUNTING MACHINE

Five wheel type—counts to 99,999 and repeat. Nickel finish case. Has 1/8 inch round shank. Use it for any counting job. Brand new. Shp. wgt. 1 lb. No. 241—Each **98c**



CLINOMETER

Shows degree of incline. The pendulum acts as a plumb bob. It swings back and forth over a calibrated scale that shows you the degree of incline. Use on ships to show amount of roll—may be used for any purpose where it is desired to determine the degree of incline. Plastic body 12 x 7 inches. Brass pendulum in black finish. Shipping weight 3 lbs. Stock No. 393. Each only **\$3.95**



RUBBER OVERBOARD SUIT

Here is a buy! Fits over your regular clothes and shoes. Can be cut apart for waist high waders, hip high or knee high boots, also arm length rubber gloves. Heavy gun rubber over fabric. Fine for commercial fishermen, sewer diggers, etc. Use it as is or cut it up for waders. All brand new! Wgt. 14 lbs. No. 183, Each. **\$4.95** Please include 75c for postage.



7 LB. EXPERIMENTER PARTS ASSORT. KIT



A "gold mine" for the radio serviceman. Hundreds of valuable radio parts, new radar and electronic parts and sub-assemblies, coils, resistors, trimming condensers—worth many times this low price. A130R—7 lbs. **\$1.79**

RAIN SUITS

New 2 piece rain suits. Of durable wear resisting water and wind repellent OD fabric. Bib style pants, zipper fly. Jacket has parka attached. Guaranteed 100% weatherproof. Small, medium and large sizes. Shp. wgt. 3 lbs. No. R549—Ea. **\$4.95**



Officers Watch Compass

Brand new gov't surplus. Army-Navy model. Single jewel mounted needle. Silver colored dial. A splendid value. Shp. wgt. 1 lb. A174—Each ... **98c**



OXYGEN TANK

Loaded with aviator's breathing type oxygen at 1800 pounds pressure. Tank measures 13 1/2 x 5 1/2 inches with rounded ends. Tank is of solid metal fitted with brass release valve at top. Brand new! Loaded—ready for all types of emergency use. Shp. wgt. 13 pounds. Ship exp. only. Stock No. 390—Each, **\$3.50** only.



AVIATOR'S OXYGEN

Ball out type. Consists of all metal tank, release valve, gauge and breather hose, all enclosed in khaki colored cloth bag. These tanks are loaded with oxygen at 1800 pressure. Ideal for use as reserve oxygen supply for all types of emergency use. Shipping weight 4 pounds. All brand new. Stock No. 391—Each **\$4.95**



HIGH PRESSURE SHATTERPROOF TANKS

TYPE D2 400 LB. TEST A high pressure shatterproof tank of 500 cubic inch capacity—for 50 pound pressure or 6.9 cubic feet. All metal—measures 6 1/2 x 2 1/2 inches. Threaded plug end vents. Shp. wgt. 6 lbs. No. 388— \$2.45 Each	TYPE F1 400 LB. TEST A high pressure shatterproof tank of 1000 cubic inch capacity—for 50 pound pressure or 13.8 cubic feet. All metal—measures 9 1/2 x 17 inches. Threaded plug end vents. Shp. wgt. 1 1/2 lbs. No. 389— \$3.75 Each
--	---



AMMUNITION BOX

Used for 50mm ammunition. Heavy, all metal design with latching top and folding handle. Provides safe, fire-proof storage for valuables, etc. Measures 12x8x7 1/2 inches. Used but in new condition. Shp. Wgt. **79c** 8 lbs. No. 338—Each



Waterproofing Compound
Gov't surplus! A liquid formula for tents, tarpaulins, canvas clothing, etc. Use on old or new materials. Gallon covers 100 to 120 sq. ft. Stays flexible—will not peel or chip. Shp. wgt. 10 lbs. No. 423—Per Gallon. **\$1.49**

ORDER DIRECT FROM THIS AD

Values galore! Hundreds of hard-to-find items for home, shop and outdoors. Make remittances by money-order, bank draft or personal check. Send 25¢ deposit on C.O.D. orders. No C.O.D.'s on orders for less than \$5.00. Include sufficient postage on parcel-post orders—any overage will be promptly refunded. All quotations F.O.B. Chicago. Used items and materials are guaranteed serviceable and as described. Your money back if not more than satisfied.

SEND 10c TO COVER POSTAGE AND MAILING ON BIG CATALOG—READY IN ABOUT 30 DAYS

STARK'S Dept. PM10
509 So. State St.
CHICAGO 5, ILL.

WILLARD 1 1/2 VOLT STORAGE BATTERY

A rechargeable, wet plate battery good for years of service. Brand new. Battery is shipped dry but fully charged—any battery station will add acid. Use singly or in multiples for radio sets, bell circuits, alarm systems, etc. Measures 5 1/4 x 4 3/8 inches. Ball floats indicate condition of charge. Shp. wgt. 4 lbs. Stock No. 297—**\$2.95** Each Only.



HE KNOWS THE WAY—
HE'S GOT P.A.*

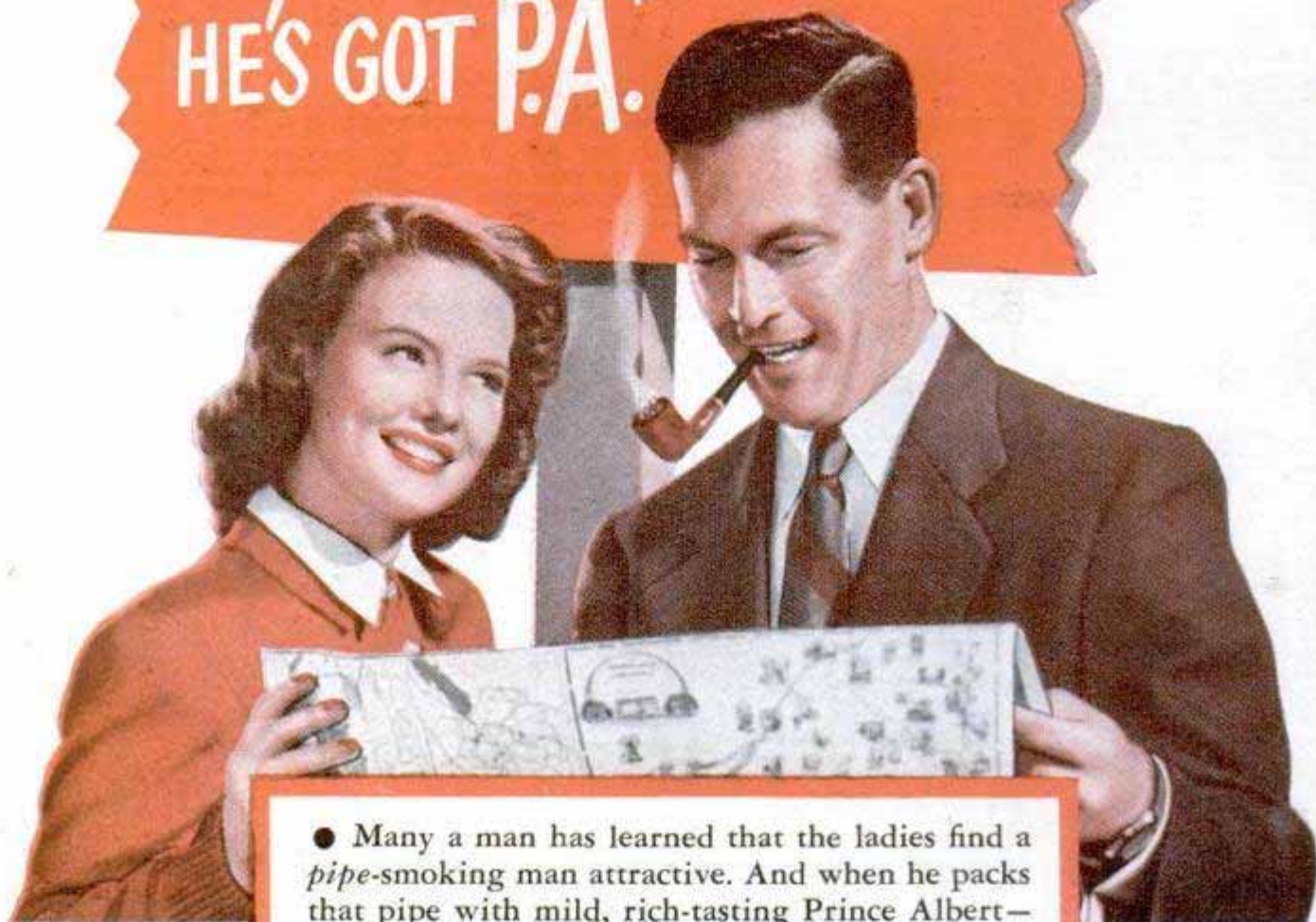

● Many a man has learned that the ladies find a pipe-smoking man attractive. And when he packs that pipe with mild, rich-tasting Prince Albert—it shows he knows real smoking pleasure!

NEW
HUMIDOR TOP
Locks Out the air—
Locks In the Fresh-
ness and Flavor!

P.A.* means **P**ipe **A**ppeal
P.A. means **P**rince **A**lbert

I SURE LIKE THE
WAY P.A. ROLLS UP FAST
AND EASY TO MAKE A
RICH-TASTING CIGARETTE!



Get P.A.—Prince Albert, the National Joy Smoke—in the new pocket tin with the Humidor Top. Enjoy that rich taste—that tongue-easy mildness. P.A.'s choice, crimp cut tobacco is specially treated to insure against tongue bite. You'll see why Prince Albert is America's largest-selling smoking tobacco!

R. J. Reynolds Tobacco Co., Winston-Salem, N. C.



THE NATIONAL JOY SMOKE

WE DROVE TO *Alaska*

Part I

Photos by Frank Fritz

At the trip's start, photographer Frank Fritz, left, and the writer with their shiny new car



By Aubrey O. Cookman, Jr.

DON'T LET "Caspar Milquetoasts" talk you out of that long-dreamed-of trip up the Alaska Highway. It is a last look at frontier life, a first-hand exposure to real wilderness and the problems pioneers face that you'll never forget.

It can be made, and was, by two very average motorists—a *Popular Mechanics* staff photographer, Frank Fritz, and the writer—traveling without advance reservations.

First, be sure that you have (1) a mechanically sound automobile with good tires, (2) adaptability to simple, and sometimes rude, accommodations,

OCTOBER 1948

POPULAR OCTOBER 1948 MECHANICS

WRITTEN SO YOU CAN UNDERSTAND IT
VOL. 90 NO. 4

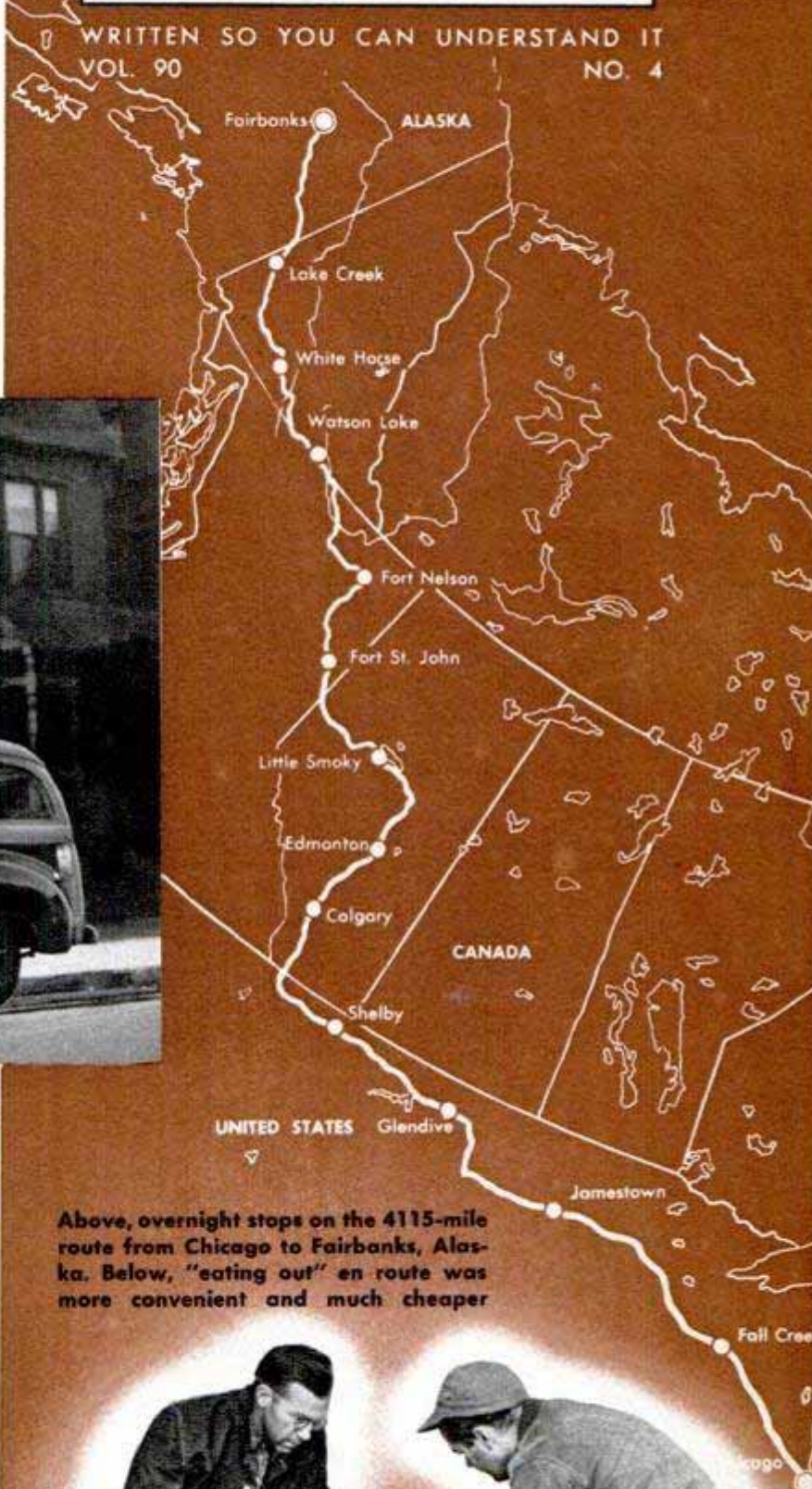

Above, overnight stops on the 4115-mile route from Chicago to Fairbanks, Alaska. Below, "eating out" en route was more convenient and much cheaper





Poorly marked roads were a problem in Canada. The travelers faced this after missing a turn near Cardston

(3) a healthy cash reserve and (4) plenty of time. Thus equipped you can lick any eventualities that might arise.

You can discount most of the wild exaggerations making the rounds about ferocious animals nuzzling your tent at night, bloodthirsty, king-size mosquitoes, the impossibility of finding overnight sleeping space, and \$5.00 ham-and-egg breakfasts en route. Other than the ever-present dust along the gravel road, a nuisance most U. S. hard-road drivers have happily forgotten, the hardships aren't much worse than would be experienced over similar distances elsewhere.

Certainly, there are problems peculiar to travel over the Alaska Highway, but more of that later. In this installment and two others we'll describe our experiences, good and bad, over 4115 miles from Chicago to the edge of the Arctic Circle—in just two weeks.

To satisfy the first requirement, a sound automobile, we made the trip in a 1948 Plymouth station wagon. Ours was brand new—but that is not the essential; the essential is a car in A-1 operating shape. That handy garage "just around the corner" at home isn't much help if you run into serious trouble on the Alaska Highway.

Narrow and badly rutted, one of the worst stretches on the entire route was the first 16 miles north of Carway, Alta., along the U.S.-Canada border. It is scheduled for improvement next spring

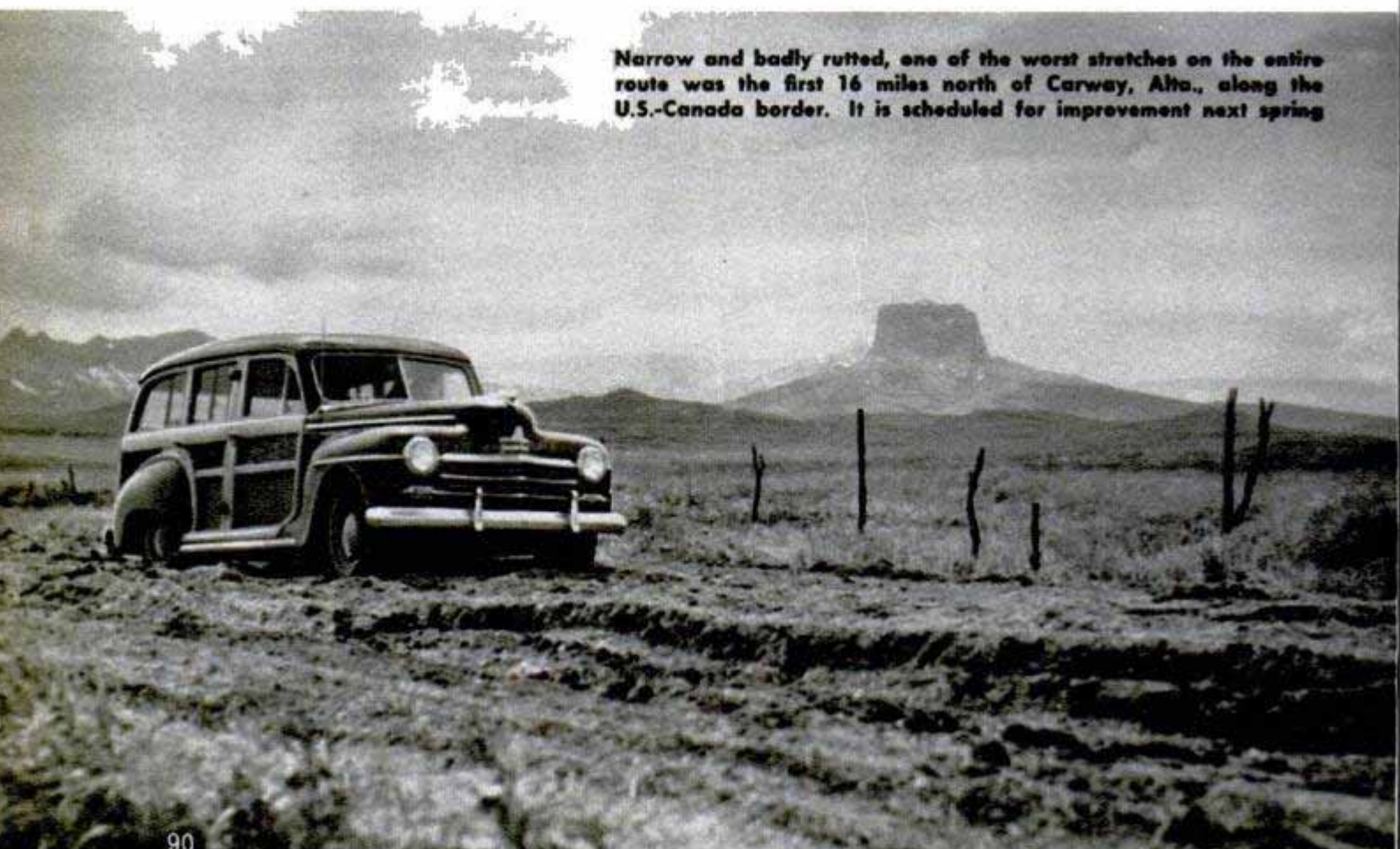

The average age of cars we saw on the road was well over three years. A 1923 Reo from Missouri had chugged along as far as Whitehorse in the Yukon when last seen.

It is smart to take along a few extra parts and at least two complete spare tires on wheels. Though they fortunately weren't needed, we packed a set of points, spark plugs and a fan belt with our luggage on advice that they might be difficult to purchase en route. Our total of six punctures in new six-ply tires going through Canada and Alaska underscores the recommendation of a second spare tire.

For variety, as well as a ready answer to overnight-lodging dilemmas, take along and use camping equipment. Elbow room is one thing you'll have plenty of on your drive, so don't worry about finding a place to pitch your tent. Along the highway, particularly the latter part, you'll find excellent free camping sites.

Carrying portable cooking equipment and a fair-size food supply also widens your choice when meal times roll around. Eating costs go up as you go north, so the budget bugaboo will likely influence your rustling up at least some of your meals.

A "must" for the journey is an official listing of all accommodations and facilities from the beginning of the highway at Dawson Creek, B. C., to its terminus at Fair-



Pete Elder's homemade gravel loader, in use near High Prairie, Alta., typifies the pioneer ingenuity demonstrated along the way

banks, Alaska. All points are listed according to their mileage from Dawson Creek, a handy reference system used all along the road.

A typical entry, brief and to the point, reads: "Mile 804, Teslin, Yukon Territory. hotel, store, meals, gas and oil, 40 beds." At other points, repairs and camp grounds are noted. Altogether there are 45 stopping places listed, most of them about 30-40 miles apart with the widest separation, 92 miles. This material can be had free by writing either the Alaska Road Commission, Juneau, Alaska, or the Northwest

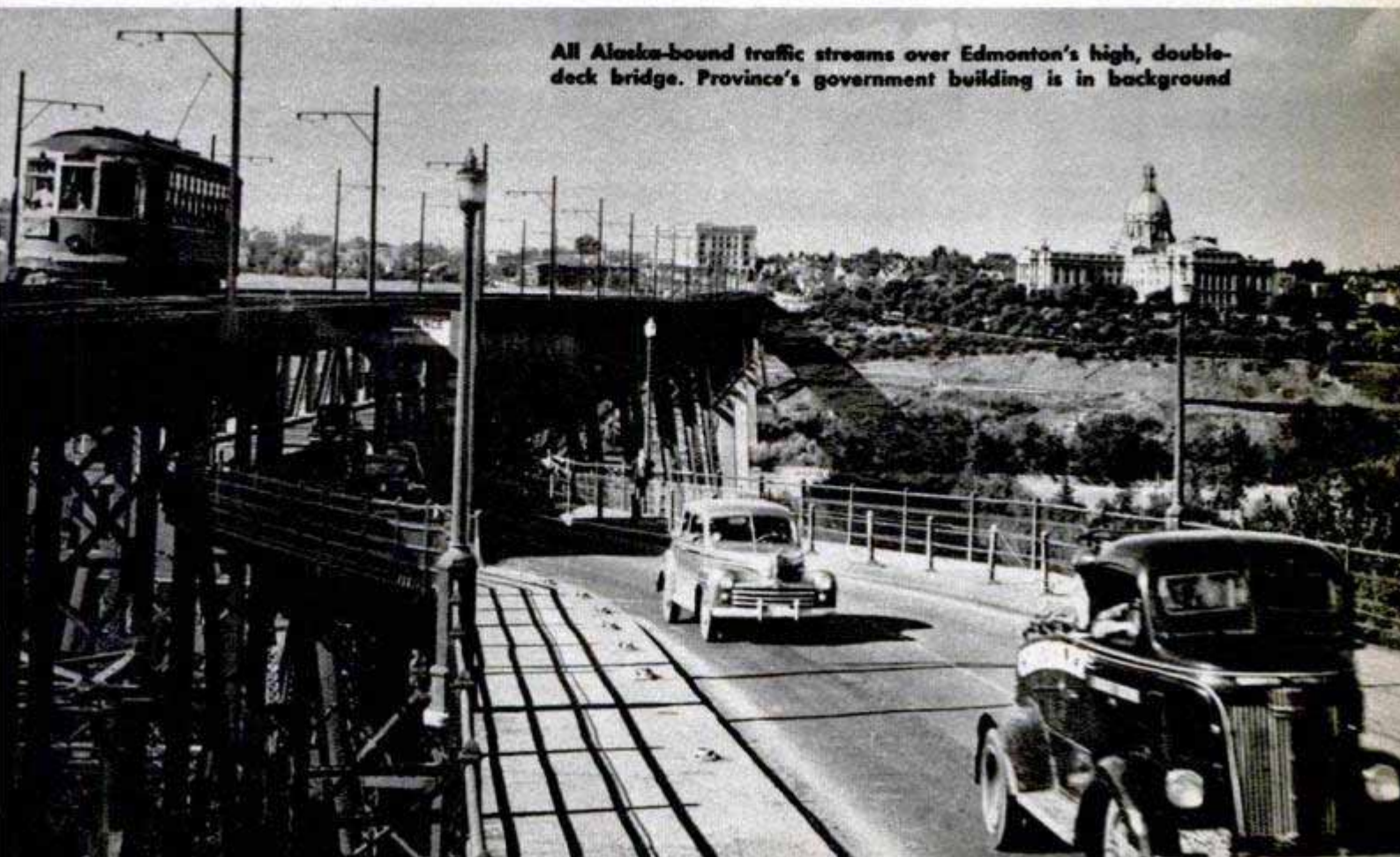

All Alaska-bound traffic streams over Edmonton's high, double-deck bridge. Province's government building is in background



When trouble comes, at 40 or 50 degrees below zero, construction shacks abandoned after the Alaska Highway's completion afford welcome refuge



Surveying crews are familiar sights on the poorer Canadian roads. This year Alberta alone is expected to spend 15 million dollars on road work

Hacked through wilderness and over muskeg swamps, a typical section of the 1523-mile-long Alaska Highway. It was completed in less than a year

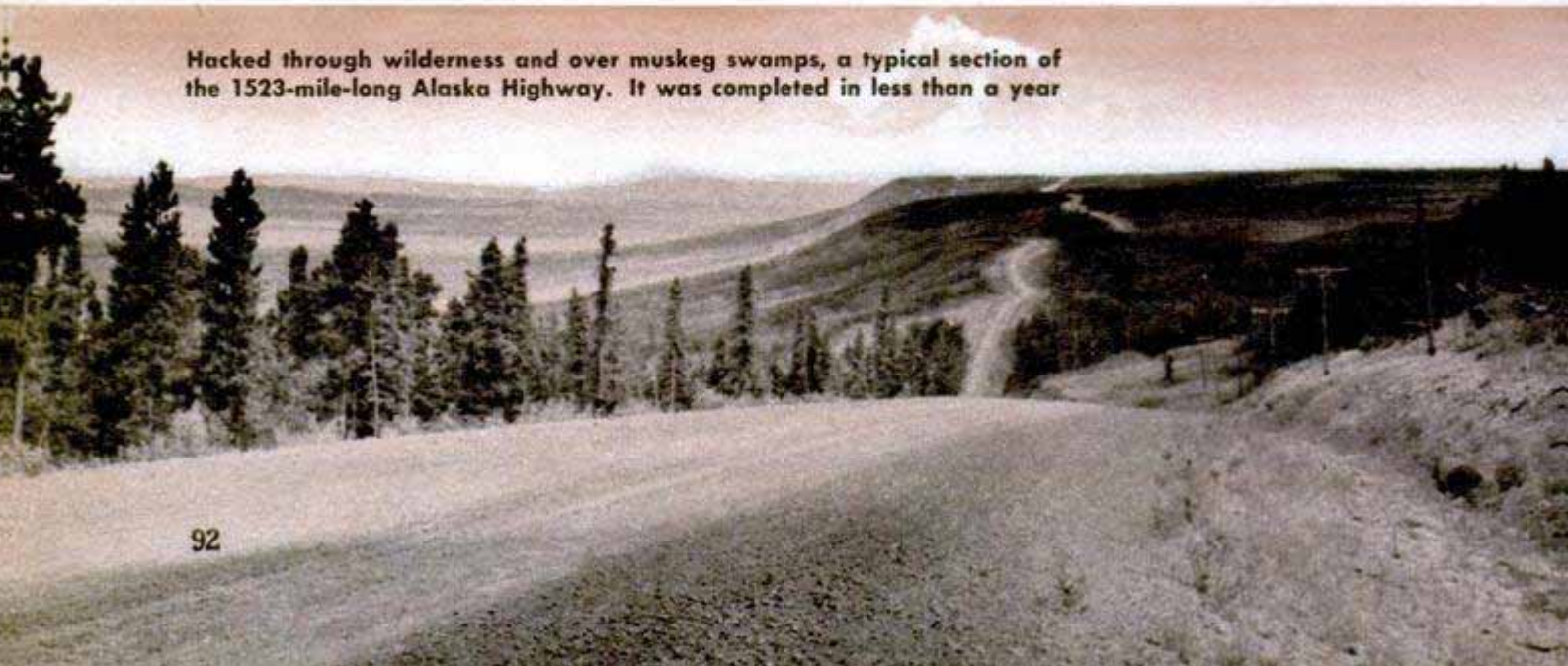

Highway System, Whitehorse, Y. T., Can.

It is no longer necessary to get a permit to use the road. Prospective travelers formerly had to satisfy officials that their car was in good mechanical shape and supplied with 25 pieces of spare parts and equipment as insurance against breakdown in remote areas. A spare rear axle was one of the recommended items. Now the travel decision is left entirely up to the motorist.

The highway was begun in April, 1942, when the Japanese threatened to cut off our sea approach to Alaska. Building over muskeg swamps, hundreds of streams and rivers, and alongside mountains, a force of 14,000 U. S. Army Engineers and civilian contractors completed the 1523-mile gravel road in the amazingly short space of seven months. It is 26 feet wide, four feet broader than the requirement for new public roads in the U. S.

By far the greater share of the road, 1221 miles, is in Canada and maintained by the Canadian government. The Alaska Road Commission maintains it from the border to Fairbanks.

Our journey began from *Popular Mechanics'*

New six-ply tires were no insurance against flats. Cookman repairing first of six on last 2000-mile lap of grueling Alaska trip

home office in Chicago and followed the most direct route, U. S. 14, from the city's edge to Madison, Wis., thence over U. S. 12 to St. Paul, Minn. From there it was U. S. 10 to Anoka, Minn., and then U. S. 52 to Fargo, N. D., where we picked up U. S. 10 again to Glendive, Mont. Montana state routes 18 and 13 brought us to U. S. 2 at Wolf Point, which we followed all the way to Glacier National Park.

Most of our mileage was through the slightly rolling, thinly populated Great Plains country, only mildly scenic except for the Wisconsin Dells region, North Dakota's badlands region and Glacier National Park. From a sight-seeing standpoint, more interesting approaches would be from the south. One choice winds through the Black Hills of South Dakota and Yellowstone National Park, while another swings through hundreds of miles of magnificent mountain scenery in Colorado and Wyoming, and includes both Rocky Mountain and Yellowstone National Parks.

Except for an occasional short detour, the roads in all cases were hard surface and well marked. Western tourist facilities are on the upgrade again and we were almost always able to get comfortable, reasonably priced accommodations without advance notice. In only one instance, a night in a basement room at a Jamestown, N. D., hotel, was our luck bad. If you are carefully scheduling your trip, however, it is advisable to write or wire ahead to recommended hotels and cabins for lodgings, particularly if more than two are making the trip.

Time is an important item in most trip-planning so it is well to know that your rate of travel will be much faster in the United States than in Canada and Alaska. Based on our experience, averages of around 50 or 55 miles per hour could be maintained to the Canadian border, since communities are widely spaced and small. Between there and the beginning of the Alaska Highway, surfaces are generally gravel and in poorer

Trees and logs hurtling along in the fast current sometimes halt traffic for days at this free ferry over Big Smoky River



condition, with a drop of about 10 miles an hour, or more, in safe-driving speed.

On the highway itself, we settled for an average of about 40 miles an hour, after learning the hard way what sharp gravel can do to tires. Another factor likely to influence your timing is that hours of daylight increase considerably as you go north. Over the latter half there are about 20 hours of daylight during June and July.

Driving north from Glacier park, we tried

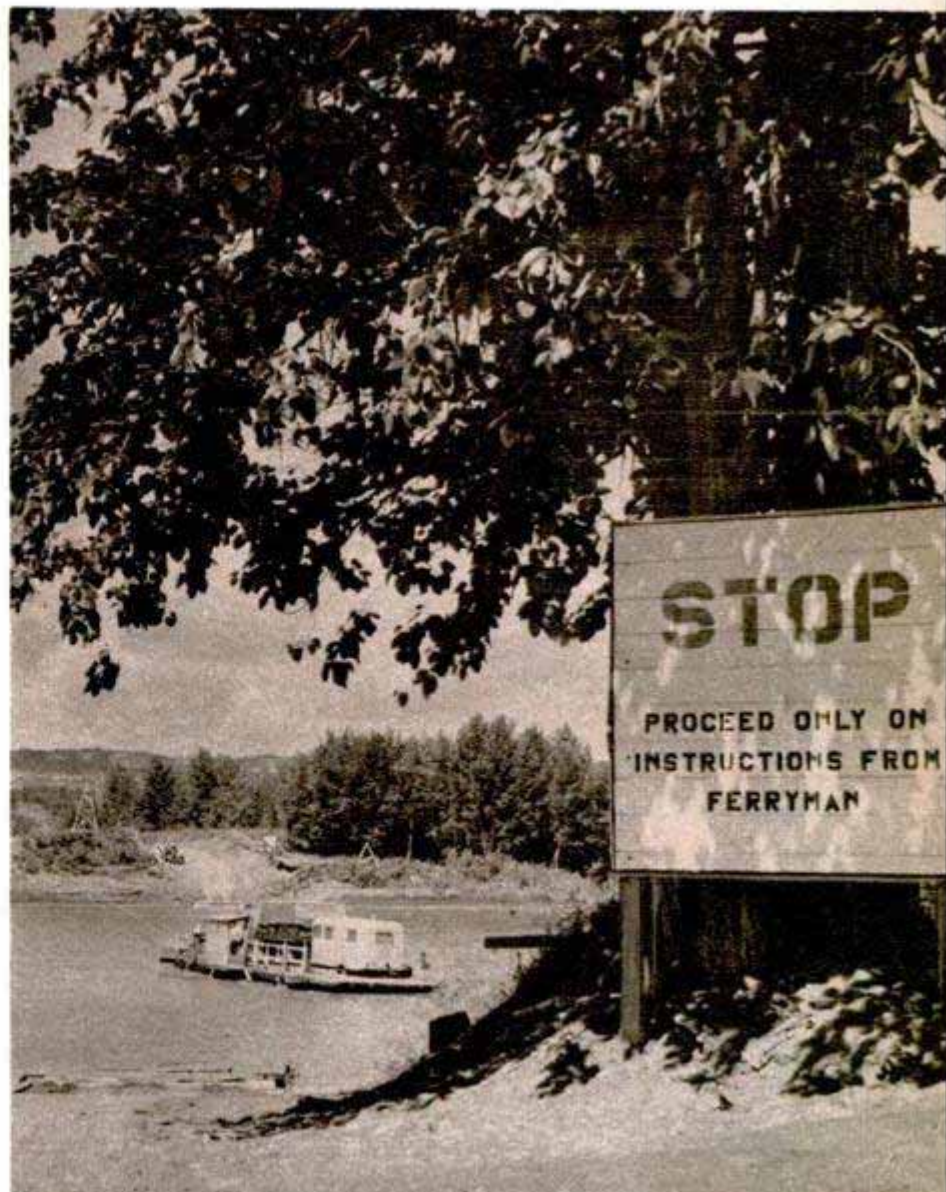

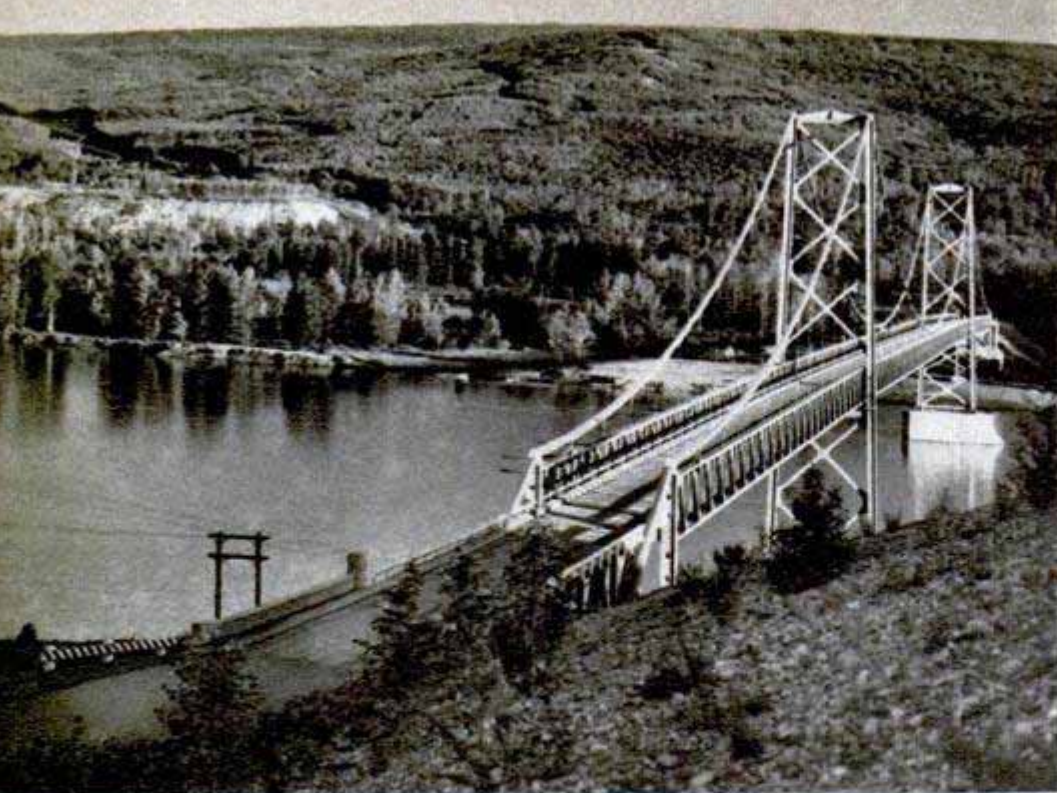

Most impressive man-made structure on the entire highway is Peace River bridge at Mile 35. Its winding approach can be seen in left background

Distance Between Overnight Stops, Chicago-Fairbanks

	Miles
1. Fall Creek, Wis.	345
2. Jamestown, N. D.	474
3. Glendive, Mont.	348
4. Shelby, Mont.	423
5. Calgary, Alta.	322
6. Edmonton, Alta.	198
7. Smoky River, Alta.	295
8. Ft. St. John, B. C.	246
9. Fort Nelson, B. C.	251
10. Watson Lake, Y. T.	334
11. Whitehorse, Y. T.	274
12. Lake Creek, Y. T.	234
13. Fairbanks, Alaska	371
TOTAL	4115

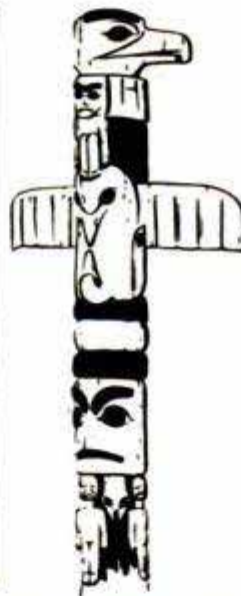

For the use of campers, benches and tables dot the roadside. Hundreds of clear, cold streams nearby insure good water for drinking and cooking

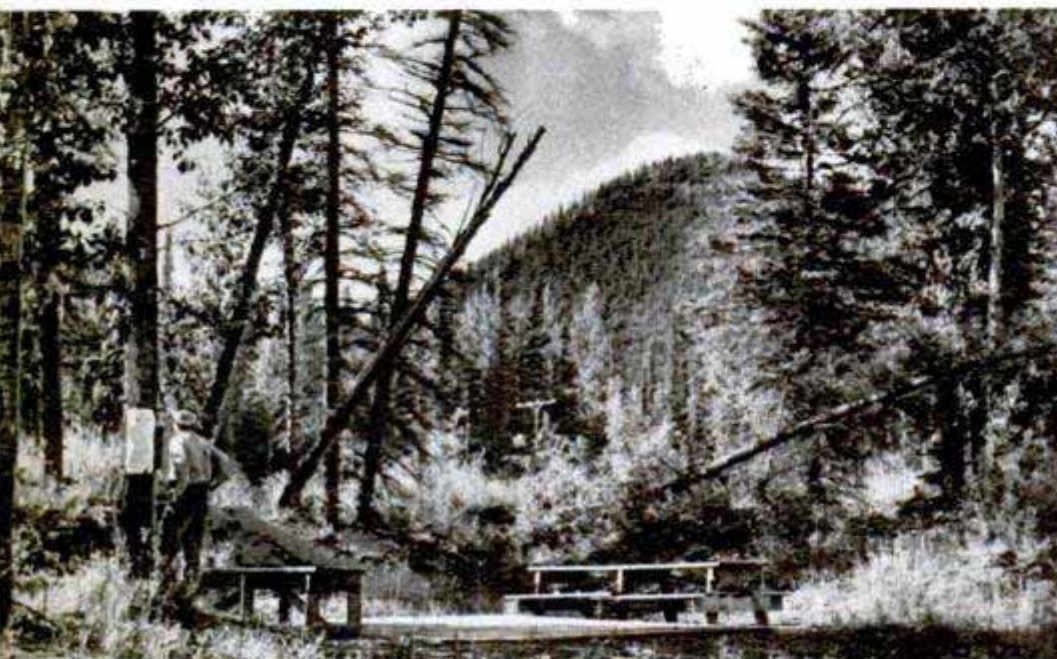

to out-expert the motor club's routing directions, and lost. Instead of turning left on U. S. 89 at Babb, Mont., and heading for the customs and immigration offices at Chief Mountain, we took a right fork that promised mileage saving. Probably, we'd have made as good time and had more comfortable riding over the longer, but paved, road to the left.

Passing through the U. S. Customs and Immigration office on the way up to Carway, Can., was a mere formality. There was no inspection and we were waved on immediately. A double wire fence marks the boundary between countries.

Entering Canada was almost as simple. Passports aren't required but it is recommended that visitors carry sufficient personal identification in case questions arise. We were asked how much money we carried, to make sure that we had enough to cover expenses.

We had to produce proof of car ownership and state the purpose of our visit. Since smoking is a more expensive habit across the border, travelers are permitted to bring in 200 cigarettes, 50 cigars and two pounds of tobacco. There was no duty on our camping equipment, cameras and film or the small stock of food. The traveler's declaration is generally accepted at face value and only under suspicious circumstances are cars or baggage searched.

After a stop that didn't take more than 20 minutes in all, and with apologies for the condition of the next 16 miles of road into Cardston, Alta., the Canadian customs officer cheerily waved us on our way to Alaska.

(Continued next month)

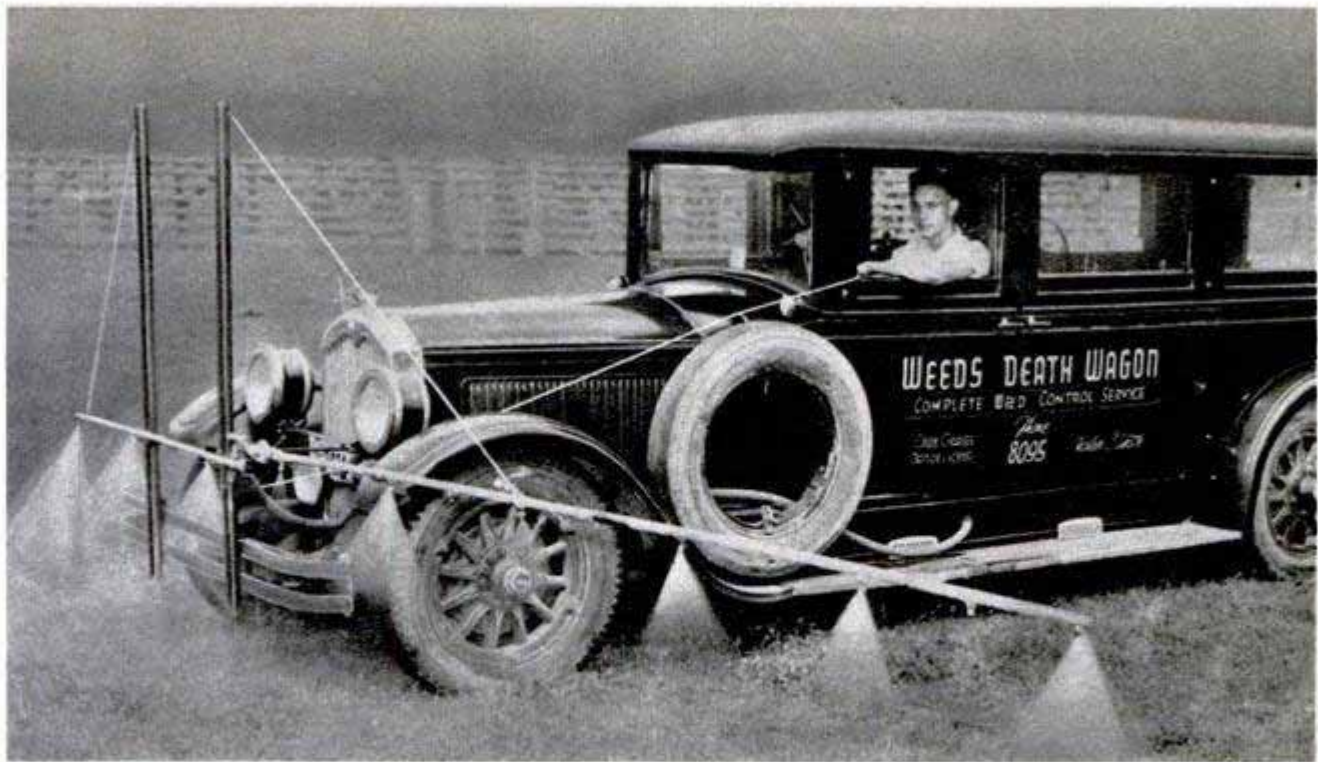

Death Wagon for Weeds

Death is carried to weeds by an old hearse equipped with spray equipment. The hearse was converted into a weed killer by Harlan Smith of Pueblo, Colo.

Pressure tanks and other equipment are carried inside, and spray beams are mounted on the front bumper. For ridding small lawns of dandelions, weeds and crab grass, Smith parks the hearse at the curb and unrolls hose to reach all corners of the lawn.



British Model Racer Is Diesel-Powered

Powered by a tiny Diesel engine, a British model racing car set what is believed to be a world record for its class when it made two runs over a quarter-mile distance at 41.7 miles an hour. Over the half-mile distance, the car, which has a wheel-base of 14 inches, averaged 41.86 miles an hour. Its record for the one-mile course was 41.4 miles an hour. The Diesel engine uses a mixture of Castrol XXL, paraffin and ether in equal parts and develops 7500 revolutions per minute under load. The engine fits neatly beside the driver's seat.

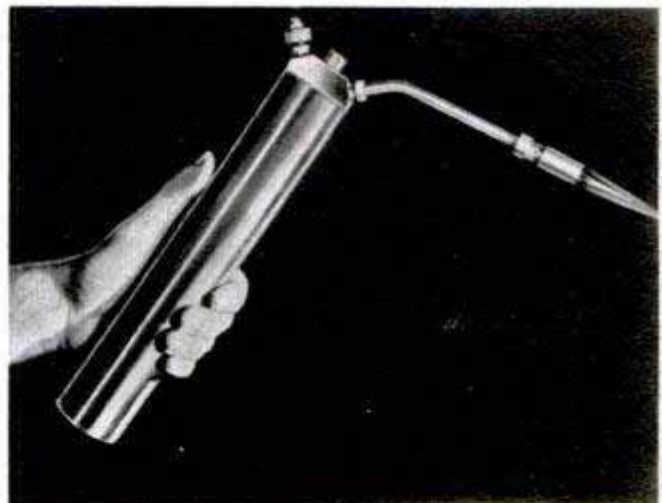

Hand Torch Burns Seven Hours For Less Than a Nickel

Fuel costs are a fraction of a cent an hour with a hand-size heating torch that burns propane-butane gas. Only 12 inches long, the torch can be adjusted from a pin-point blue flame for close, accurate work to a $\frac{1}{8}$ -inch blowing flame for paint burning or pipe-joint heating. It operates at temperatures from 900 to 3800 degrees Fahrenheit and will burn seven hours without refilling. The fuel tank serves as a handle and holds one pint of liquid or 4.5 cubic feet of gas. The cost of refueling the torch ranges from two to four cents.

THE ATOMIC PILE



By S. W. Clatworthy

THE PICTURE diagram on these pages is the first detailed illustration of an atomic pile to be made public. The drawing is based on official reports, but the precise form of the details is necessarily conjectural. It is a large, 1,000,000-kilowatt pile of the best known type—the uranium-graphite water-cooled pile as used for the production of plutonium bombs, but which may prove to be the best first stage for atomic energy. This great hulk contains chiefly a built-up cubic mass of solid graphite. Graphite is used because the obstruction it offers to neutrons is within a certain required range. "Heavy" water would be much better, but it is too costly to produce.

Fission—splitting into roughly equal halves—occurs in uranium nuclei only when they are struck by slow neutrons. But the one or two neutrons then emitted from each fission are fast, and incapable of causing further fission. As they fly from one slug of uranium to another they are slowed down in the graphite sufficiently to cause fission in a second slug; the graphite is therefore termed the moderator. These slugs are spaced in a lattice arrangement. Repetitive fission commences spontaneously from stray neutrons and, as the pile grows, the fission sequence spreads. This could be disastrous but con-

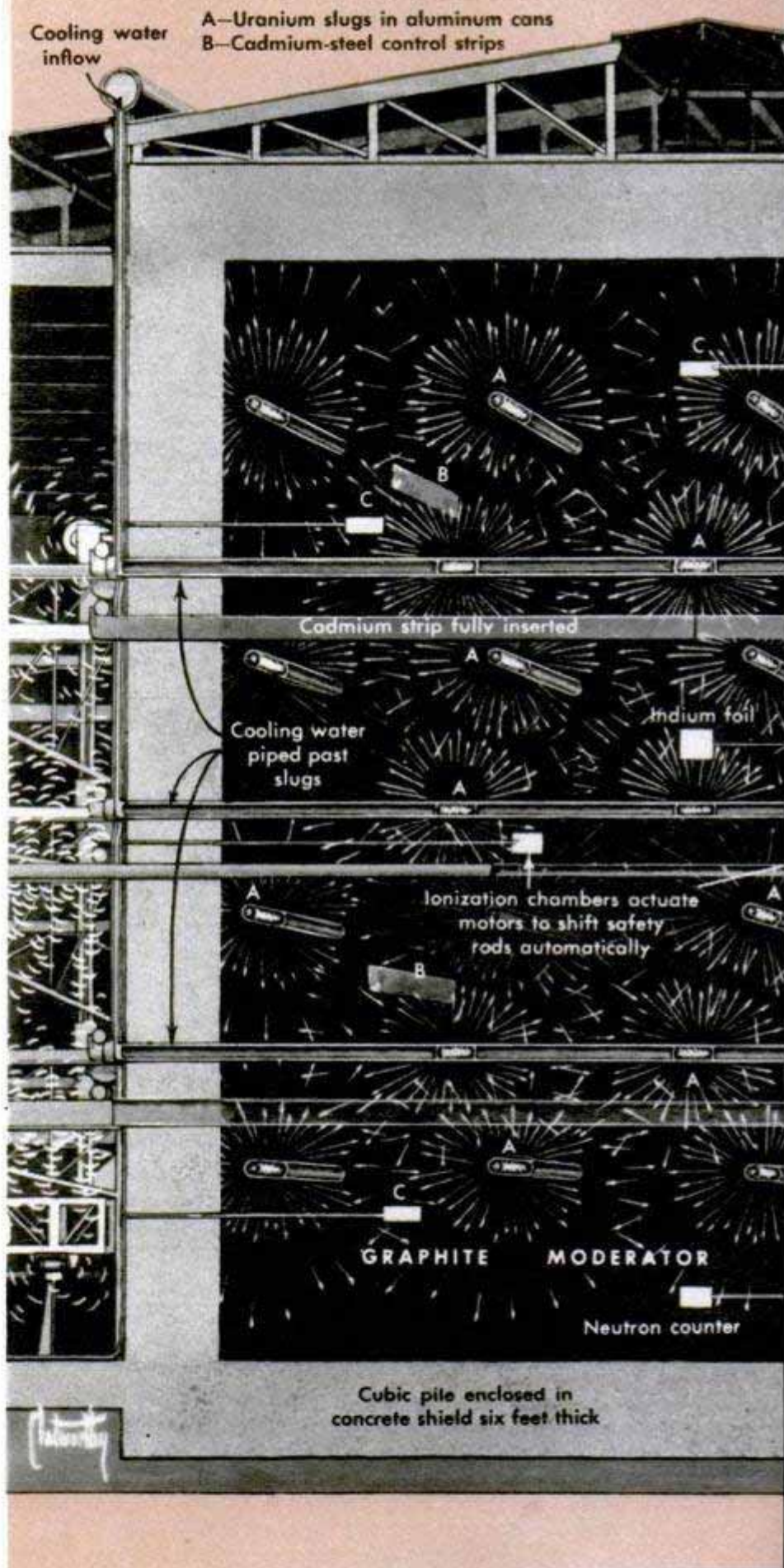

trol devices are built in. These are strips of cadmium steel inserted in channels through the graphite which stop some of the neutrons. The strips are pushed in to reduce neutron intensity or drawn out-

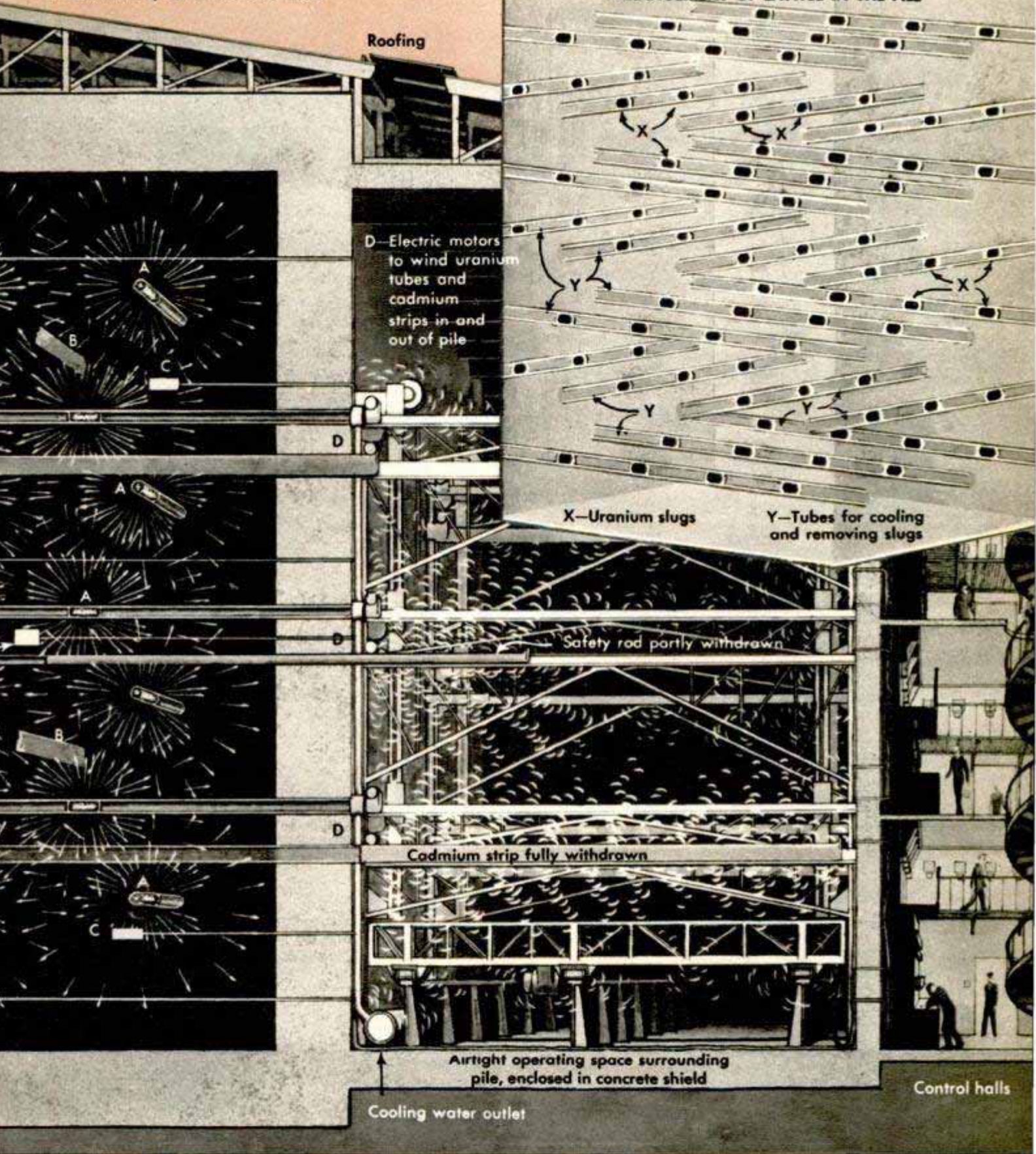

Roofing

D—Electric motors to wind uranium tubes and cadmium strips in and out of pile

ARRANGEMENT OF LATTICE IN THE PILE

X—Uranium slugs

Y—Tubes for cooling and removing slugs

Safety rod partly withdrawn

Cadmium strip fully withdrawn

Airtight operating space surrounding pile, enclosed in concrete shield

Cooling water outlet

Control halls

Drawing by S. W. Clatworthy; copyright, 1948, King Features Syndicate, Inc.

ward to increase it. There are also two central control rods of boron steel, automatically operated through instruments by fluctuations in the neutron intensity itself, which they detect. These piles can be sim-

ply, precisely and completely controlled with an ample margin of safety. The whole great cube is enclosed in an unbroken shield of solid concrete six feet thick to keep in the ultra-lethal radiation.

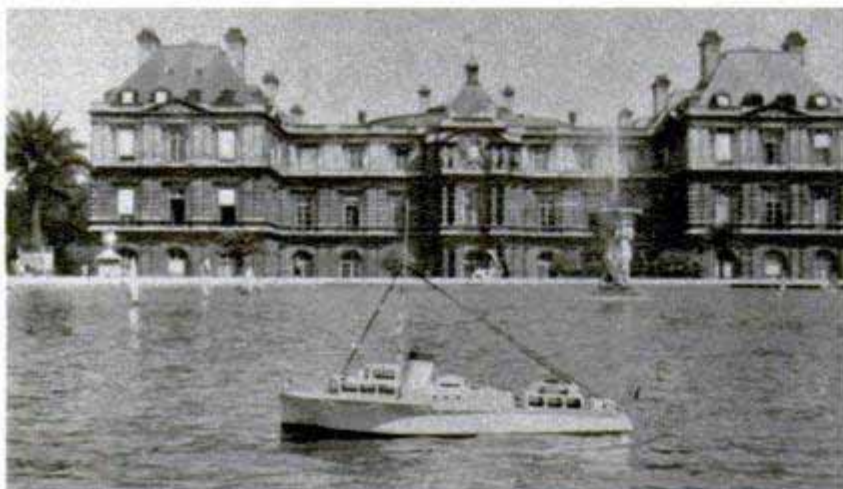
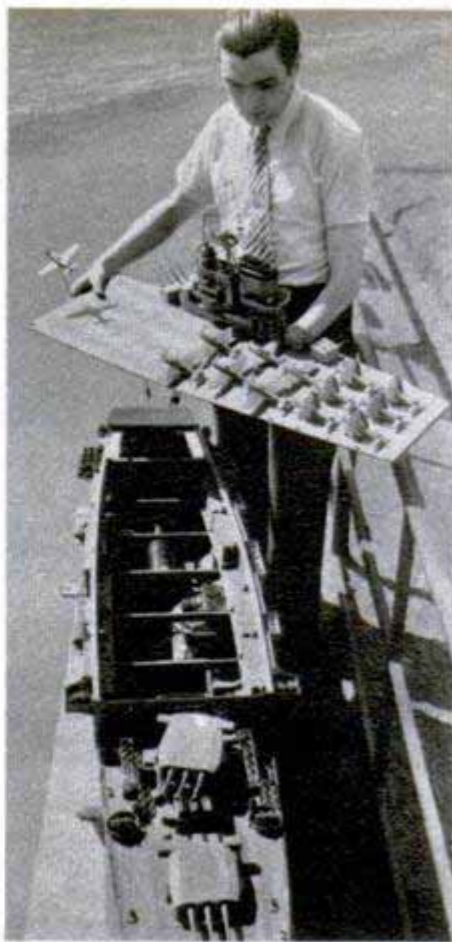
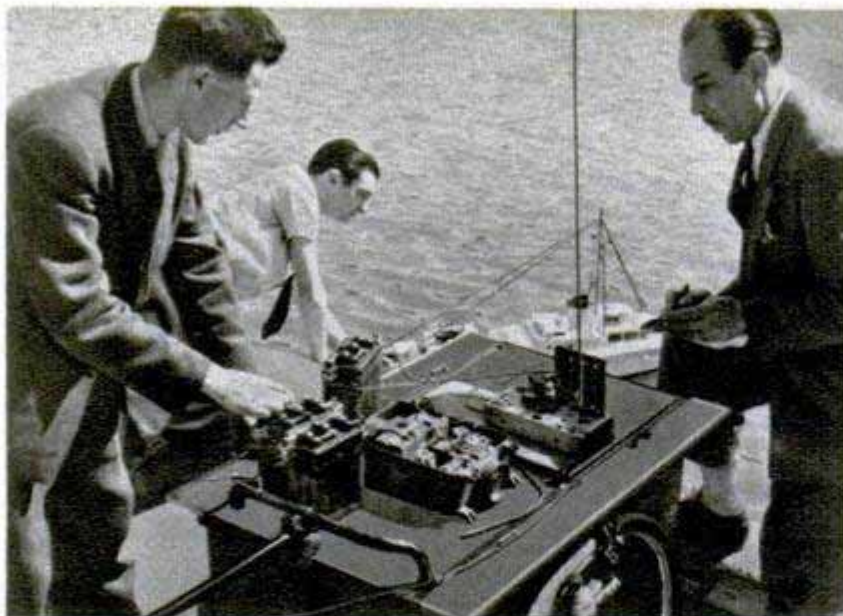

Top left, model builder launches miniature craft while assistant stands by radio controls. Left, this boat won first prize in French contest. Above, builder assembles aircraft carrier

Radio Operates Turrets and Guns of Model Warship

Even the turrets and guns of a model aircraft carrier built in France can be controlled by radio. The boat was built by Jean Falconnet of Paris and is complete to

tiny planes on the flight deck. A radio transmitter controls the engine and guides the craft. Another of Falconnet's boats won first prize in a competition held near Paris.

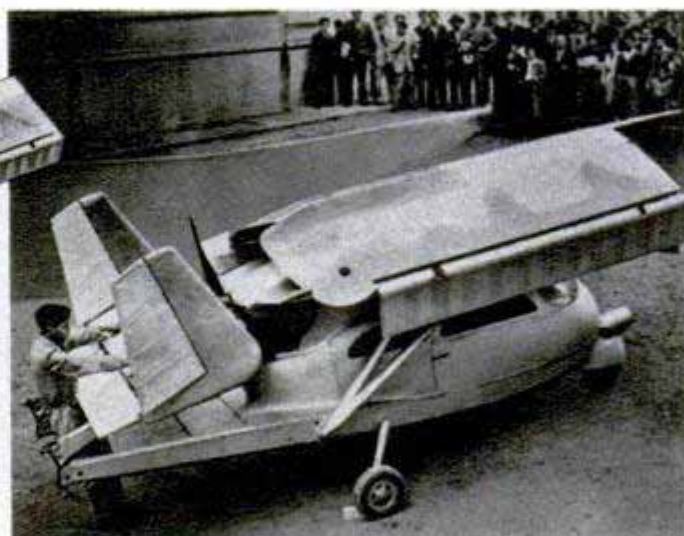
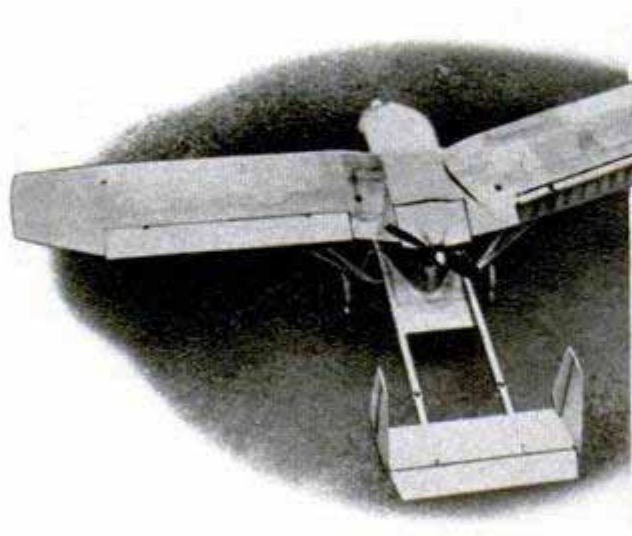

FOLD-UP PLANE built in a machine shop in Tarcento, Italy, can be converted into an automobile for highway travel. The wings fold parallel with the fuselage and the tail section pivots forward to shorten the body. The plane is driven by a pusher-type propeller. On the road the vehicle travels about 60 miles an hour

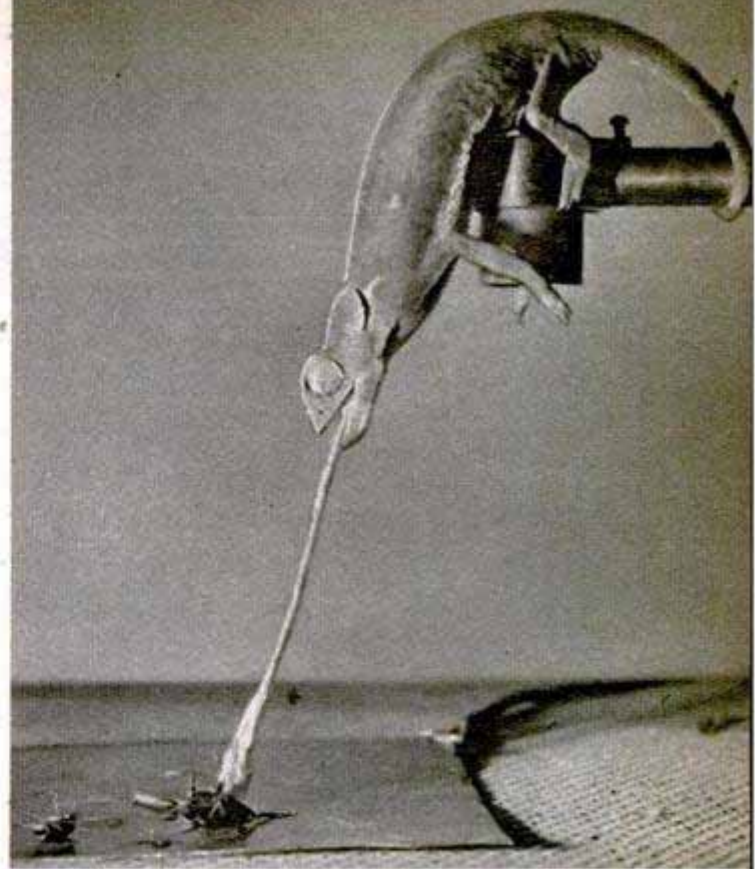
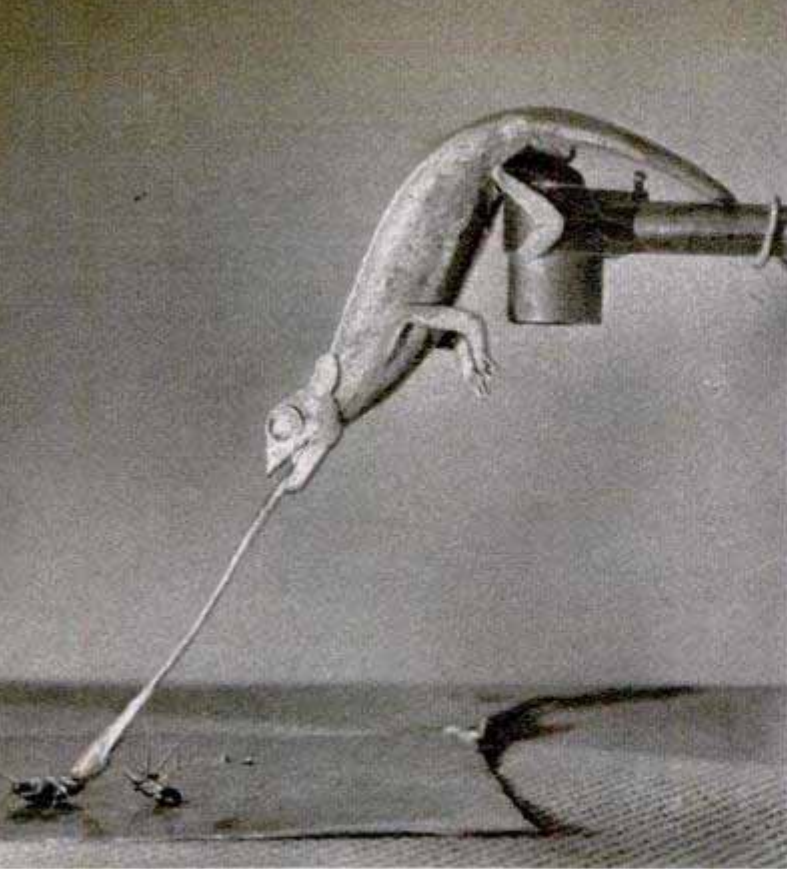

Too fast to be seen by the human eye, the long tongues of chameleons and toads dart in and out as they eat. Their tongue tips are tacky and the food, usually small insects, sticks to the tips and is thrown back into their mouths. To photograph the action, London Zoo technicians designed a trigger device that fires a Dawe electronic flash lamp as the tongue hits the food

REPTILE SNAPS OWN PICTURE WITH FLICK OF THE TONGUE

Top, stopped by an exposure of two millionths of a second, tongue of chameleon is fully extended as it darts after food. Below, a toad gets his dinner. Right, the circuit used in top pictures. For photos of toad, two copper plates were used, one for the toad and the second for the food. Tongue completes circuit by touching food plate. Current was too minute to be felt

Kodak Ltd. photos

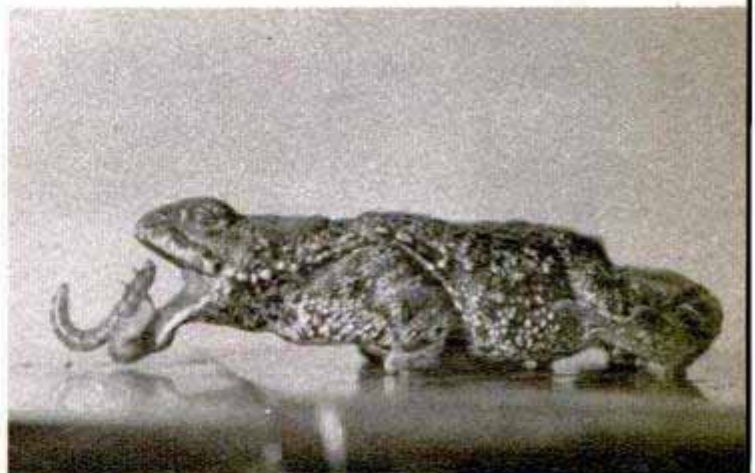
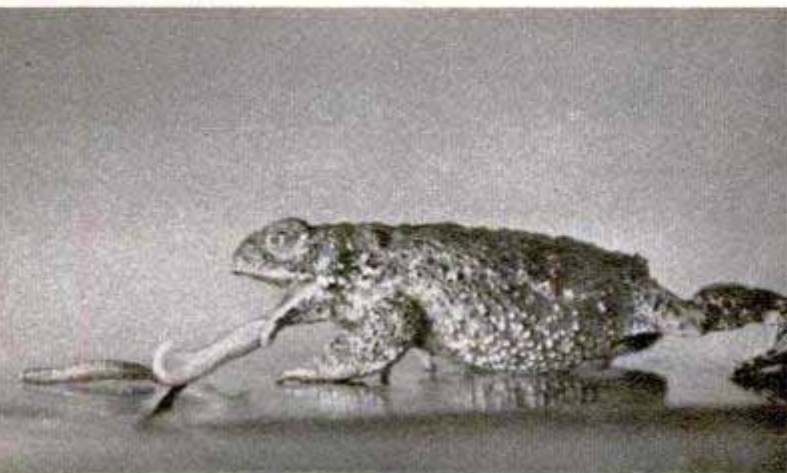
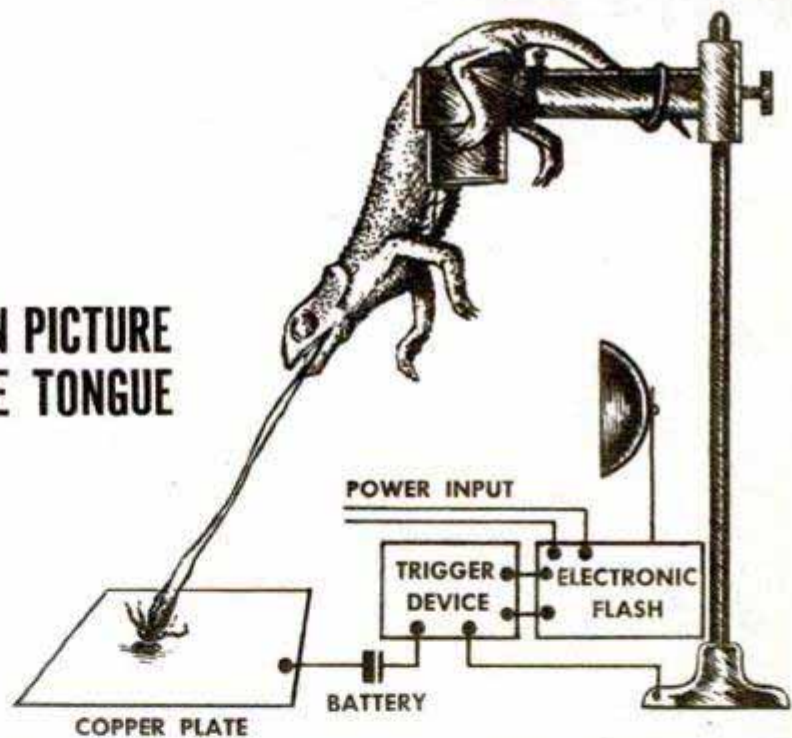

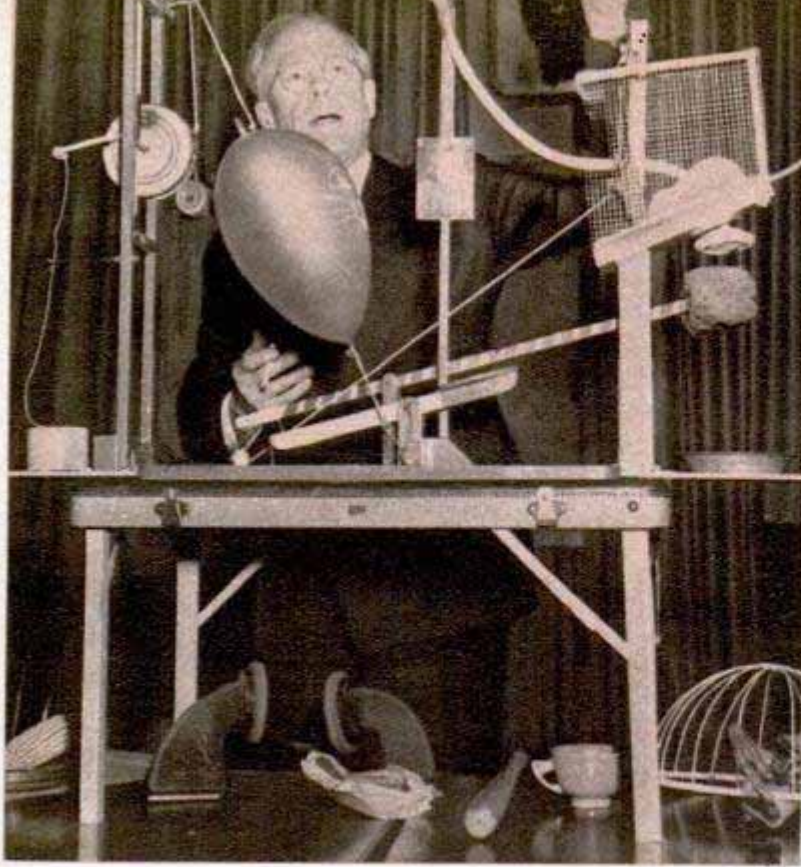

"Professor" Oakes demonstrates his cigarette lighter which involves water, sponge, rat cage and balloon

By William J. Duchaine

Here the professor brings gales of laughter from an audience as he exhibits the Oakes Doughnut Dunker

RUSSELL E. OAKES of Waukesha, Wis., has been "making things" ever since he was big enough to wield a jackknife. Away back when makers of electric drills offered lathe attachments, Oakes had the yen for power tools. So he started equipping his shop, suffering occasional pangs of guilt over such an "extravagance," and never dreaming he was laying the foundation for one of the most unusual careers in the U. S.

The Oakes hobby, which has more than justified any expenditures he has made, has brought enjoyment to thousands of persons. Oakes is now "Professor" Oakes, the wizard of Waukesha. Perhaps you have seen some of his weird and imaginative inventions in the movies where they have been featured. Or, you may have encountered the busy inventor in person. Oakes

**WORKSHOP
WIZARD
on the stage**



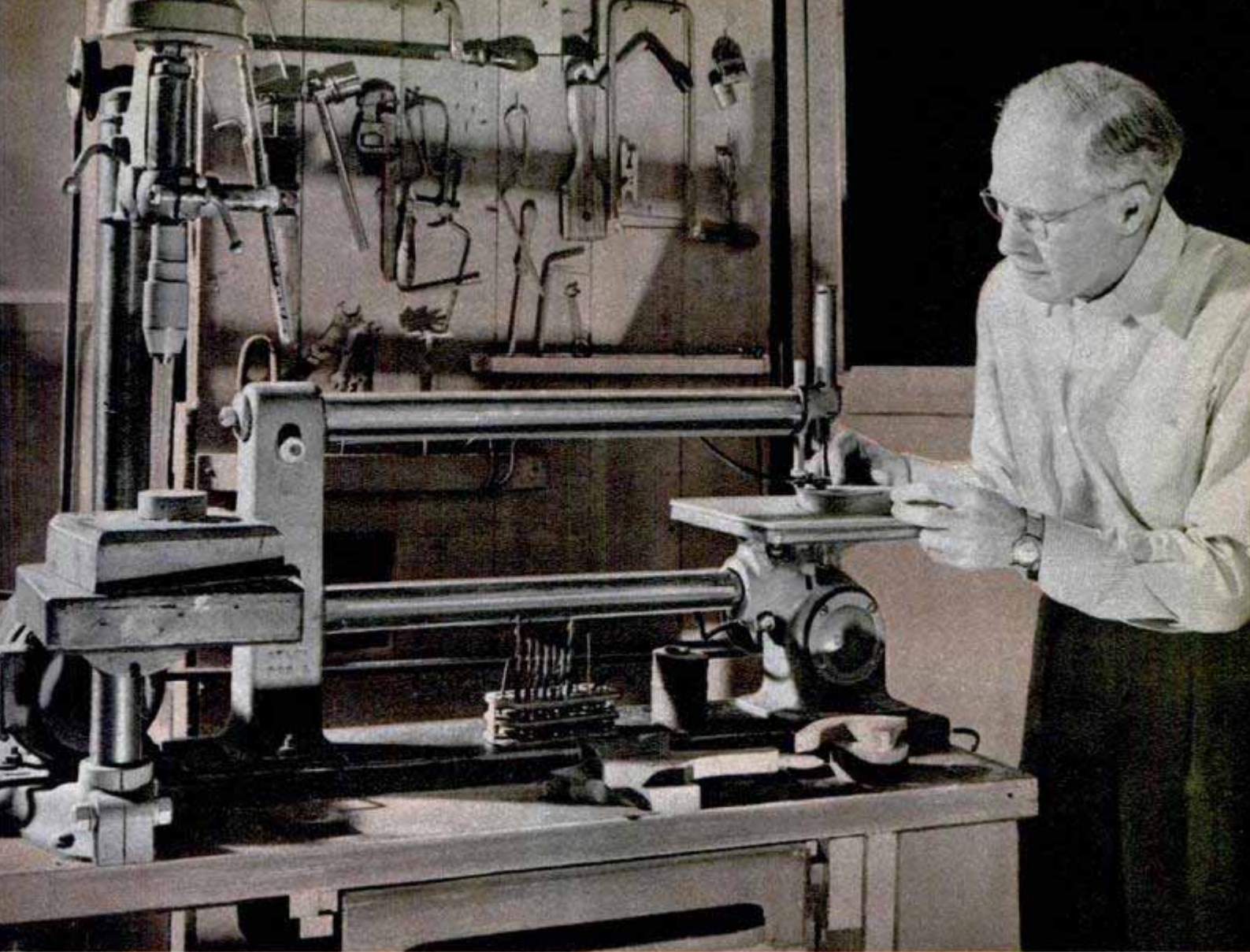

When Oakes gets an idea he rushes to his home workshop to add to his list of 60 "goofy gadget" inventions

gives humorous talks and demonstrations of his inventions. Recently his services have been in such demand that his hobby has become his profession.

Oakes has some 60-odd inventions to his credit. To call them odd is an understatement. He simply calls them goofy gadgets.

Oakes served as a writer and idea man with a Milwaukee advertising agency for 17 years. Most of his leisure time he spent in his home workshop.

Back in 1935, a friend induced him to demonstrate his mirth-provoking devices at a banquet held for salesmen of a hydraulic-jack manufacturer. Attired in a Prince Albert coat, Oakes began his program with the announcement of his greatest contribution to science. Then he demonstrated his Hydraulic Cigar Lighter.

The lighter is a Rube Goldberg mechanism and the hydraulic salesmen got a big kick out of its demonstration. First, Professor Oakes asked for a glass of water. He poured the water into a funnel. The water flowed from the funnel onto a sponge operating a lever which opened the gate of

a rubber rat's cage, revealing a piece of cheese. When the rat snapped at the cheese, she hit a paddle, operating another lever. This lever punctured a balloon and released a weight which caused a flywheel to revolve. Sandpaper on the flywheel ignited a firing unit. Then, all the professor had to do was to tip up another lever and light his cigarette.

Oakes has devised many "labor saving" inventions to make the pastime of eating more enjoyable. He's particularly proud of his Catsup Getter-Outer. Everyone knows how difficult it is to coax the catsup out of a bottle. With the Oakes Catsup Getter-Outer, you merely place a plate bearing a hamburger sandwich on a special platform. Then you turn a crank and a mittened hand does the pounding!

The Fresh-Bread Tester is another vitally important invention in the food-handling line. The tester makes it unnecessary for homemakers to squeeze the bread to ascertain its age. They merely insert the bread between two "hands," and pull a long lever. If the bread is hardened with



Fresh-bread tester makes squeezing unnecessary. Day-old bread gets amber light; soft bread "Fresh"

Below, the "professor" puts finishing touches on a Catsup Getter-Outer. When crank on rear of device is turned the mittened hand pounds bottom of bottle

age, it resists more. Day-old bread flashes an amber light. But if the bread is soft and yielding, the word "Fresh" appears—and a green light shows it is safe to buy the loaf.

Recently, Oakes introduced his "patented" Dripless Doughnut Dunker to a group of men attending a smoker given by the Green Bay (Wis.) Chamber of Commerce. The mechanical dunker dips the delectable morsel—either bite by bite or totally—and holds it for the convenience of the nibbler, while a hinged drip pan catches the coffee overflow and saves the tablecloth. In addition to protecting the tablecloth, the dunker also is a godsend to the diner who likes to dunk but is afraid to scald his thumb and forefinger, Oakes explains.

To those worried about the high-cost-of-living bugaboo, Professor Oakes recommends his Sugar Conserver device. It is guaranteed to get more "mileage" out of each lump of sugar by making a single lump serve a family of four. First, the coffee is placed on a turntable. The operator turns a crank, and a cam arrangement lowers the lump into the cup. After two seconds, a bell rings and the sugar is yanked out of the cup. The next cup then moves into position, repeating the action. A dial indicates the number of cups sweetened!

Oakes has a unique invention to benefit

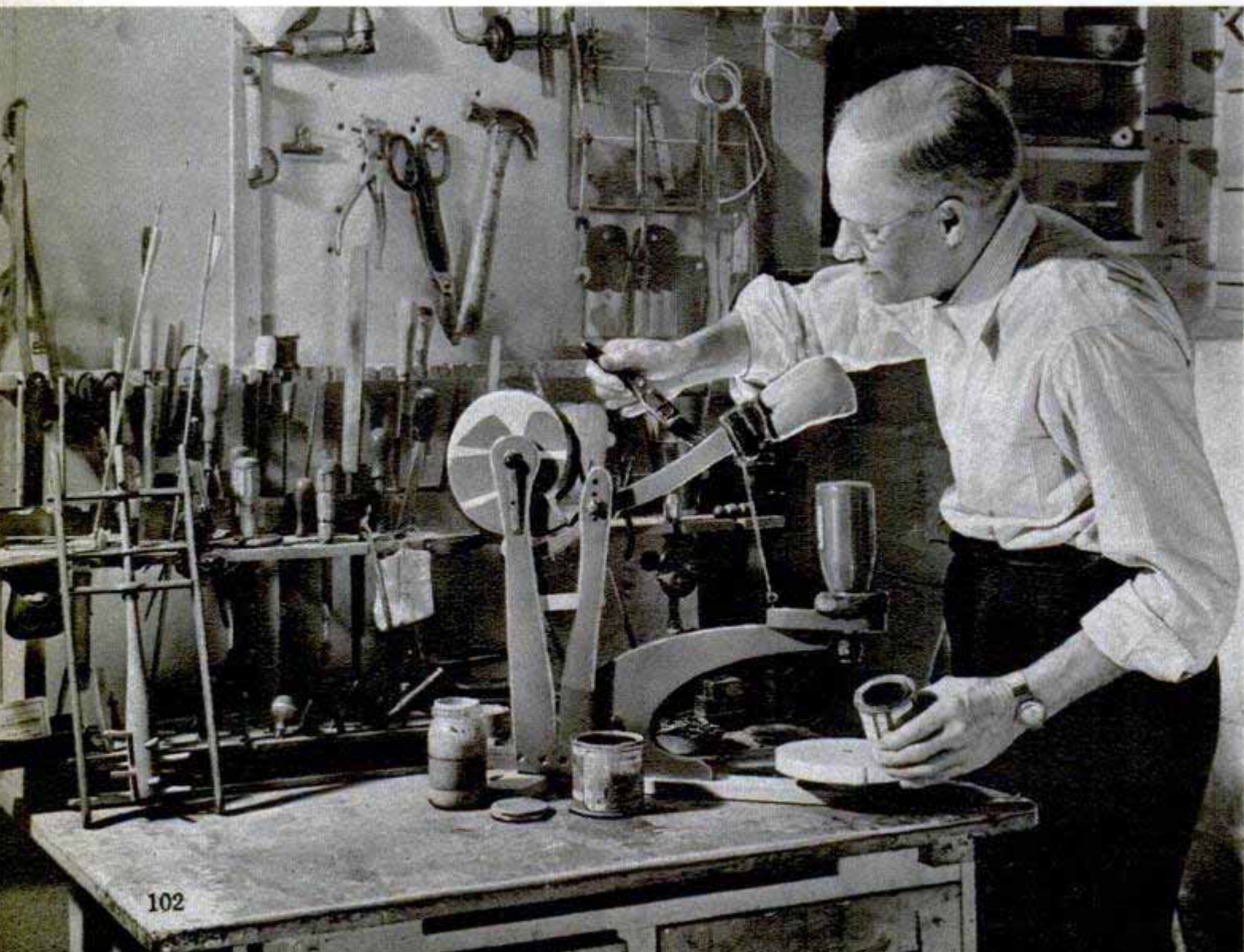

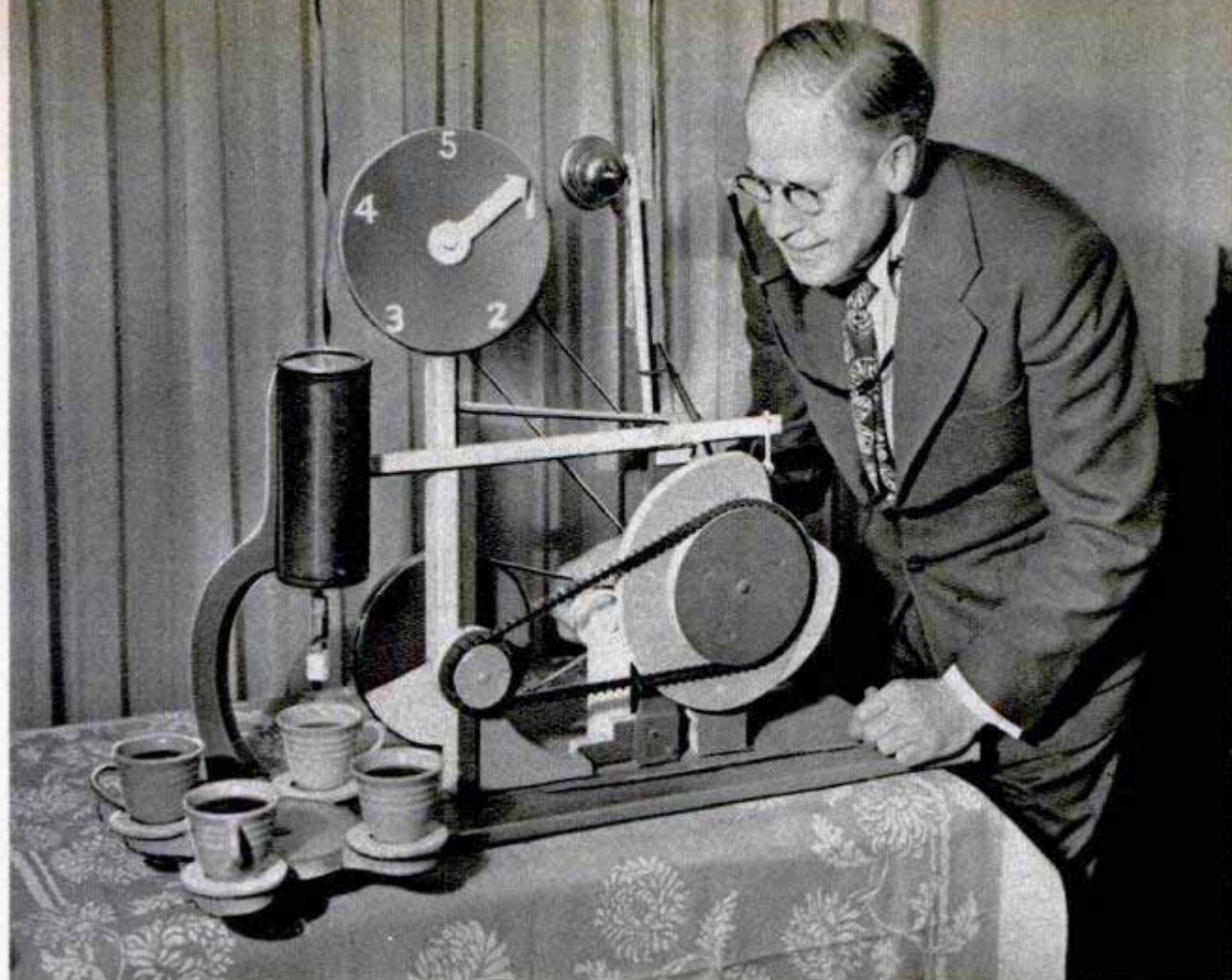

Lump-sugar conserver is operated by turning a crank and cam arrangement lowers a lump into the cup. After two seconds a bell rings, the sugar is yanked out and next cup moves into position. Below, Oakes works his back patter. Hot air (breath) inflates balloon on top to power patting device

the type of person who is always patting himself on the back. It's the mechanical Back Patter. When the man brags into a microphone arrangement, the hot air rises to inflate the "air chamber." Then by operating a lever the wind turns a paddle wheel, which in turn operates a crank to cause a hand to pat his back in a gratifying fashion.

One of the most prolific inventors since the days when Benjamin Franklin flew a kite, Professor Oakes also has "patents" on a Chatter Eliminator. It fits over the head like a radio headset. The rubber pads over the ears help eliminate conversations behind you. Assume you are at the movies. The amplifiers on this gadget face toward the screen so you can hear every endearing term spoken by the movie stars. But if the picture is dull you can reverse the headset and pick up the gossip from behind.

The Self-finding Golf Ball is a great boon to golfers who are always slicing the ball into the rough. When it lands in the tall grass, the ball sends up a red flag and blows a horn to indicate its location.

For picnickers, there's the Sandwich Shoosher, a sort of third hand

(Continued to page 244)





"Eggplant" Scares Tropical Lizards

Looking like fantastic "eggplants," tropical shrubs in Puerto Rico are decorated with eggshells to scare away destructive lizards that prey on them. Residents of the area claim that tropical sunlight, reflected by the white shells, keeps the lizards from damaging the shrubbery.

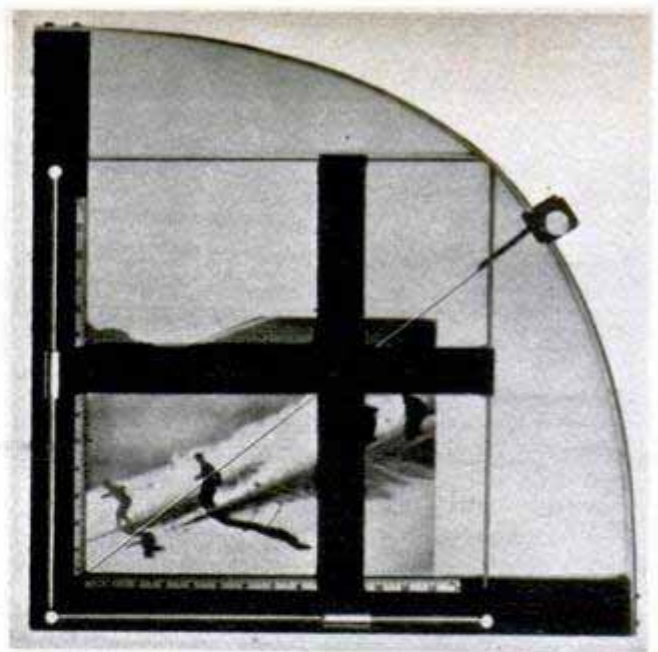

Photo Triangulator

Designed for editors, layout men and artists, a triangulator quickly shows how a photograph will appear in any desired proportion. The photograph is placed on the triangulator and the two sliding leaves moved to correspond to the size you want the picture to be when printed. A wire, fastened to a holder that slides along a curved rod on the open side of the device, is moved to the point where it cuts diagonally across the photograph. The masking leaves may now be moved to any position to determine the best composition and, as long as they cross at some point along the diagonal wire, the masked area will be in proper proportion for the size chosen.

Motor-Driven Chart Shows 2000 Items

As many as 2000 separate inventory items can be scanned in 45 seconds with a motor-driven production-control machine. The machine combines data from all departments into a single presentation of complex plant activities and is a boon to supervisors. Eliminating wall charts and card systems, the unit consists of a graph chart on rollers driven by an electric motor. Controls enable the user to move the 50-yard-long chart in either direction at varying speeds. Production goals and units completed are charted on a nonmoving scale at the top of the machine and can be compared



quickly with inventory lines on the moving chart. Shortages show up quickly and corrective steps can be taken without delay.

THIRTY-ONE television stations now are beaming pictures to a million or more screens from New York to Hollywood. To millions of sports fans these figures are big news, for the television bill of fare is heavy with athletic programs.

About 850,000 receivers of every price and size will roll from the assembly lines of more than 45 companies by the end of the year, and a whopping share of these screens will end up in the living rooms of sports enthusiasts. The fan now can view almost any kind of sport from baseball, football, basketball, boxing and hockey to track events and even rodeos.

This doesn't mean that he's completely satisfied with the method of airing athletic contests. Frequently, baseball fans are given an excellent view of home plate while there's a crucial double steal under way at second and third. Nor is the football fan satisfied when the cameraman is tricked into following Smith around right end when



CBS photo

Monitoring screens Nos. 1, 3 and 4 show views of separate cameras. No. 2 shows picture on air. Top screen picks up picture after it is broadcast

Television covers the game

Behind-the-plate camera shoots through netting to show the pitched balls

KTLA photo

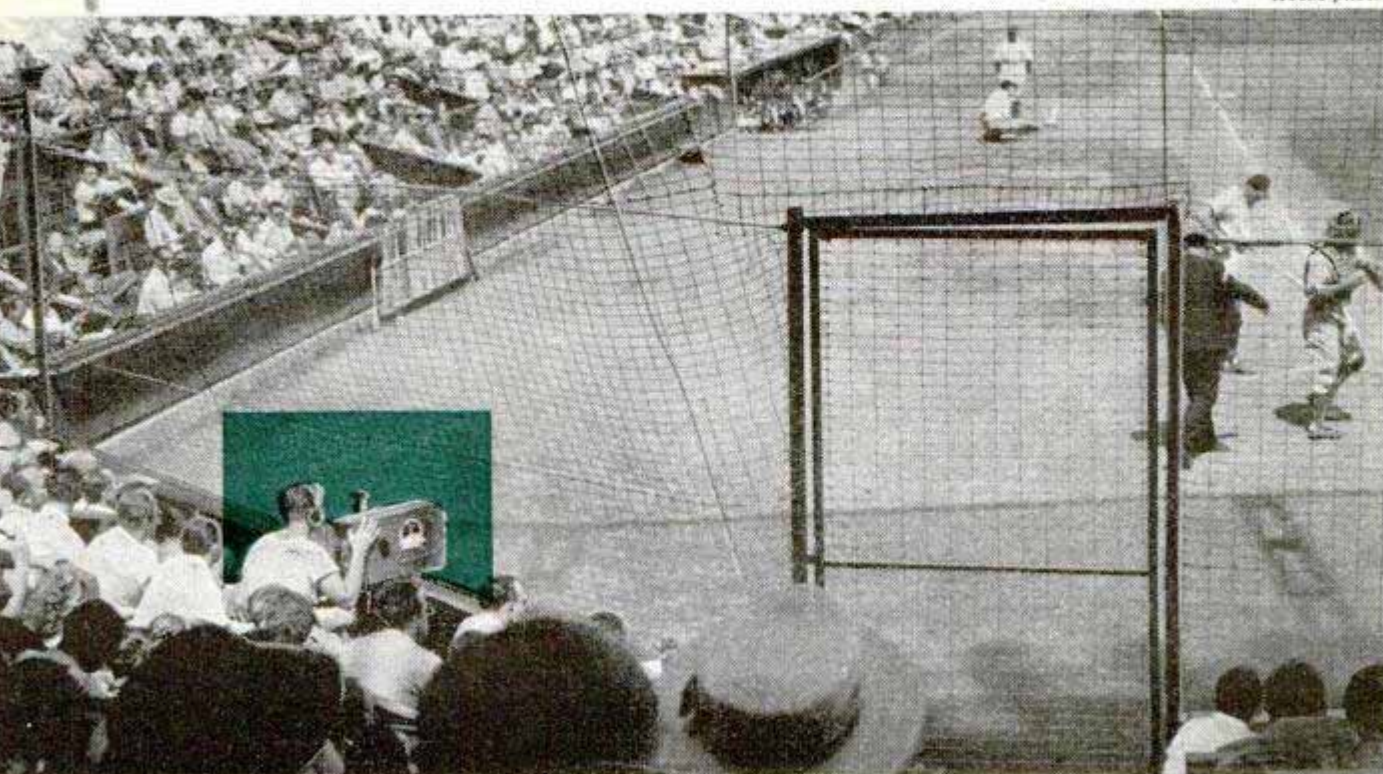

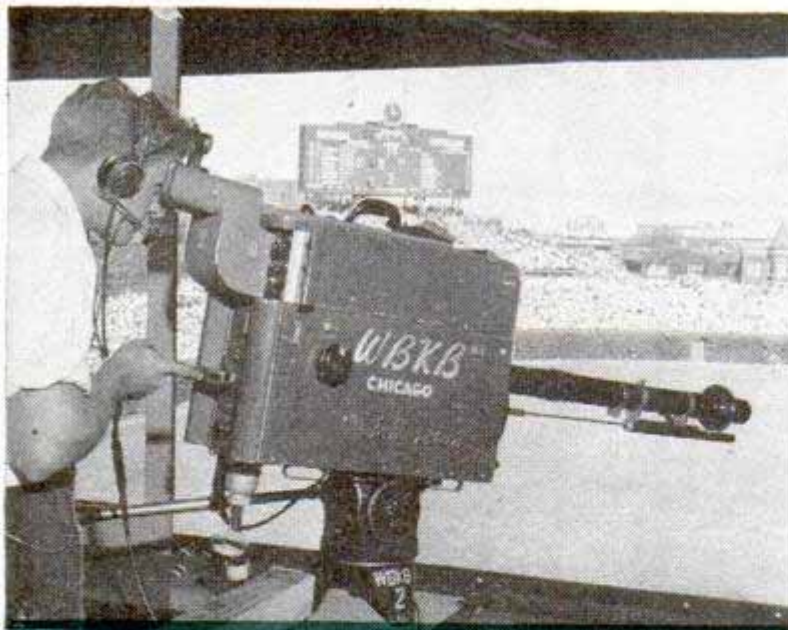

At Wrigley Field in Chicago, cameraman gives his Zoomar lens a pregame test. By manipulating lever he can change focus for a close-up of ball or wide-angle shot of field

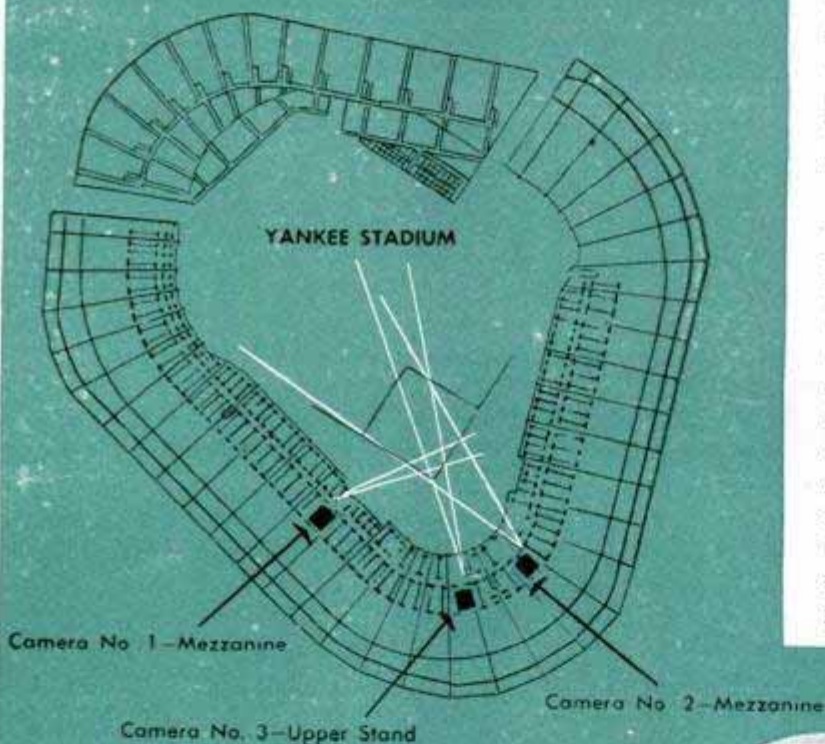

Diagram shows placement of Du Mont's cameras for airing baseball games. Camera No. 1 picks up infield close-ups and dugout shots. No. 2 covers pitcher and batter. No. 3 high in stands follows outfield hits

Right, photos of a television screen show what the sports fan sees from his easy chair. Left to right, a batter lays down a bunt, a runner slides safely into third, and usual player-umpire argument starts



Jones carries the ball the other way for the winning touchdown.

Fortunately, these incidents are rare, and most stations are feeling their way into systems that will put the right picture on the screen at the right time.

There are a good many bugs that face the producer of a sports program. Let's take a look at the infant art from cameraman to commentator to producer to find out how these problems are overcome. In baseball, probably the most popular sport that is telecast, the producer has the following typical setup:

Two or three video cameras are placed in the stands in the area running from behind first base to behind third base and are connected with the control room by coaxial cable. The commentator, who generally is near one of the cameras, has a line running from his mike through the control room to the transmitter. The producer in the control room has lines for communication with the cameramen and commentator.

The producer is the key man who decides what you'll see in the comfort of your living room. Before the game he locates his cameras, depending on local conditions as much as personal judgment, and briefs his cameramen on how he wants the game covered—the focal area of each camera in various situations that may arise during the game. This is vital since a lack of coordination among the boys behind the lenses might result in all cameras fo-

cusing on one point when the producer wishes to show his customers something happening at another point.

In most ball parks the producer is buried deep in the stands. In front of his seat are monitoring screens which show what each camera is viewing at any given moment. The producer orders the engineer to throw onto the air waves the most important picture. Some producers also have a regulation receiver which picks up the transmitted signals so they can see exactly what the home viewer is seeing. When such a receiver is not in use, the commentator's voice is piped in through a loudspeaker so the producer can instruct any cameraman to cover the incident being described.

In New York City, the National Broadcasting Company, Du Mont and the Columbia Broadcasting System are airing the games of the Giants, Yankees and Dodgers respectively. NBC at the Polo Grounds has three cameras hung in cages from the upper tier of the grandstand, one directly behind the plate and the other two halfway between home and first base. Producer Bill Garden uses a wide-angle lens behind the plate to show most of the playing area. On an outfield smash, the Zoomar lens, which can be converted from wide-angle to close-up with the movement of a rod, follows the ball through the air until it is returned to the infield. The third camera is used for close-ups.

Although some cameramen say the Zoomar lacks the clear image other lenses pick up, it provides a thrill to the viewer, who can fly through the air behind the ball or



Camera's turret mounts four different types of lenses. Cameraman can change from one lens to another by manipulating the controls

enjoy the sensation of catching a pegged ball practically in his own mitts.

Du Mont uses one camera directly behind third base for close-ups, another at an angle slightly to the right of the plate to cover pitcher and batter, and a third in the upper stands to follow hit balls.

CBS, covering the Dodgers at Ebbets Field, uses only two cameras less than six feet apart to the left of home plate in the grandstand. Two wide-angle lenses on one camera and two close-up lenses on the other do the job.

Producers often disagree on the placement of the cameras. Three lenses can cover more ground than two, but the shift from one side of the diamond to the other may confuse the sports fan at the other end of the air waves.

One problem in televising a baseball

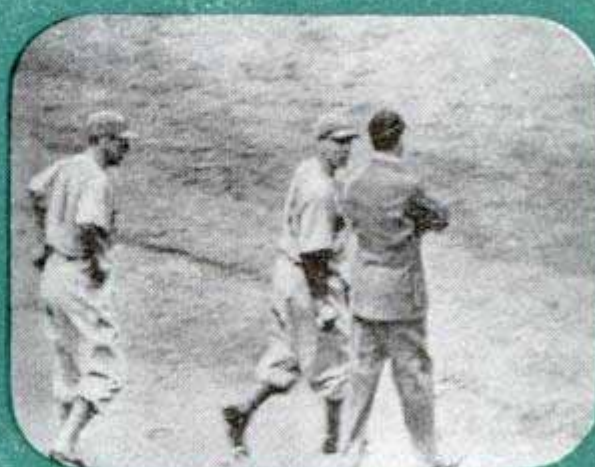



KTLA photo

High in the stands at the Los Angeles Coliseum a cameraman points long lens at football action on field below

game hasn't been overcome with complete satisfaction. The producer is the boss, but can't see the game from the control room except through the eyes of his camera lenses. The commentator can see the whole game, but must follow what appears on his monitor so that video and audio don't go riding off in opposite directions. The cameraman can be guided only by his pre-game instructions and his own judgment in what to pick up. The problem of correlating all the members of this televising team is difficult to solve.

Football is another fine television spectacle and one that can be aired with less difficulty than baseball. It's played on a somewhat smaller field, the ball is much larger and doesn't travel as far or as fast.

Station KTLA in Hollywood, which is running a heavy sports program, telecasts

all home games of one of the professional football teams and probably will telecast some of the collegiate gridiron games this fall. Its facilities were used last year to put the Rose Bowl on the air waves.

In televising football, two cameras high above the 50-yard line and as close to the playing field as possible make an ideal setup. NBC in New York uses its Zoomar lens to follow the ball on kickoff and punts. On plays from formation, both teams are shown in a wide-angle shot—or at least the offensive team and the defensive line. This is cut back to a close-up of the offensive backfield as the play develops.

Two unfortunate things can happen in a football telecast. On a sparkling, open-field run, such a long lens may be used that the sports fan sees only the runner and none of the blocking. The other—and big-

CBS telecasts basketball game from New York. Commentator's monitoring screen, left, shows him what's on air



gest bugaboo to the cameraman—is that he will be fooled by the offensive team and follow a decoy instead of the ball.

Track and field meets may gray the hair of a producer since the field looks like a three-ring circus with a good many events in the process at the same time. No one wants to miss part of the mile race or the pole vault, but they frequently overlap. CBS licked this problem by covering the runners until the vaulter appeared and then cutting to him.

Station WBKB of Chicago has an aggressive sports program that includes ice hockey, boxing, harness racing and wrestling in addition to football and baseball. Hockey is particularly difficult to televise because the black puck won't show up well on grayish ice. This problem is partially met by leading a rush, either three-man or solo, down the ice so that a fast pass won't zip out of range.

Fights are easy to air since they are held in a restricted area and a cameraman can follow every move of the participants. Don Lee's Station KHJ in Los Angeles telecasts boxing matches every Friday night and wrestling on Monday. The scene is viewed by two image-orthicon cameras and microwaved to the main transmitter atop a mountain overlooking the city. Sound is piped over a balanced phone line to the transmitter.

KHJ also has televised tennis matches from a small court set up by the studio, and outdoor swimming events from its own pool. It has discovered that rodeo action is particularly suitable for television, but auto races often appear dull



Du Mont photo

Camera behind the plate in the upper stand of Yankee Stadium chases a hit ball to the outfield and shows a close-up of the player fielding it



CBS photo

Strikes and spares are nothing new to television sports fans. The telecast of a bowling tournament requires an additional battery of lights. Below, Willie Hoppe, billiard champ, performs for video audience on special events show. Fans now can see almost any kind of sports event on screen

NBC photo

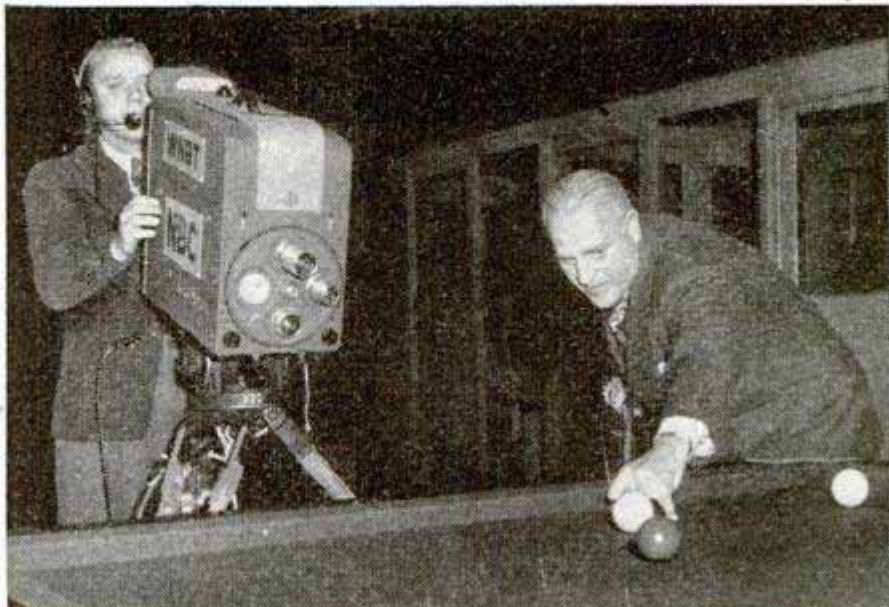



Television eye high in the grandstand follows the horses around Santa Anita race track in southern California

because there are no breaks in the action.

Basketball is a television natural that can be handled with a single camera and lens under the proper lights. Running and harness races pose no difficulties except how to fill in the half-hour waits between events when an entire card is telecast. Golf can't be covered well until helicopter-borne cameras can be brought to bear on tee, fairway, rough and green.

To view these programs, the sports fan has his choice of a good many new receivers, many of them featuring larger screens. One company has announced a projection-type set with a retractable screen 20 inches wide by 15 inches high. Late this year another manufacturer expects to bring out a 16-inch picture receiver in both tube and projection models. RCA Victor recently unveiled the first commercial equipment for showing life-size television programs to large audiences in hotels, clubs, churches and schools. The picture may be adjusted from three

by four feet to seven by nine feet. Other manufacturers are bringing out models that combine AM and FM with a record player and television screen. General Electric's receiver has a 10-inch tube with an aluminum-backed fluorescent screen.

Thus the sports fan, once he has bought and installed his receiver, can enjoy a holiday doubleheader, a billiard lesson or a thrill-packed rodeo for practically no additional expense. His living room may become the grandstand of the neighborhood.

Line-of-sight "dish" antenna at baseball park beams pictures to main transmitter on mountain



Giant Pipe Bender

Bending steel pipe 50 inches in diameter and almost an inch thick is less than a day's work for the giant pipe bender designed and used at the M. W. Kellogg Company. The bend is of uniform contour and has a round cross section without the wrinkles that usually result on the inside of a bend. Heat is applied to raise the metal to 1450 degrees Fahrenheit and hydraulic pressure bends the pipe. Electronic controls regulate the operation, assuring the exact bend desired. It takes less than a day to bend a 30-foot section of the pipe.

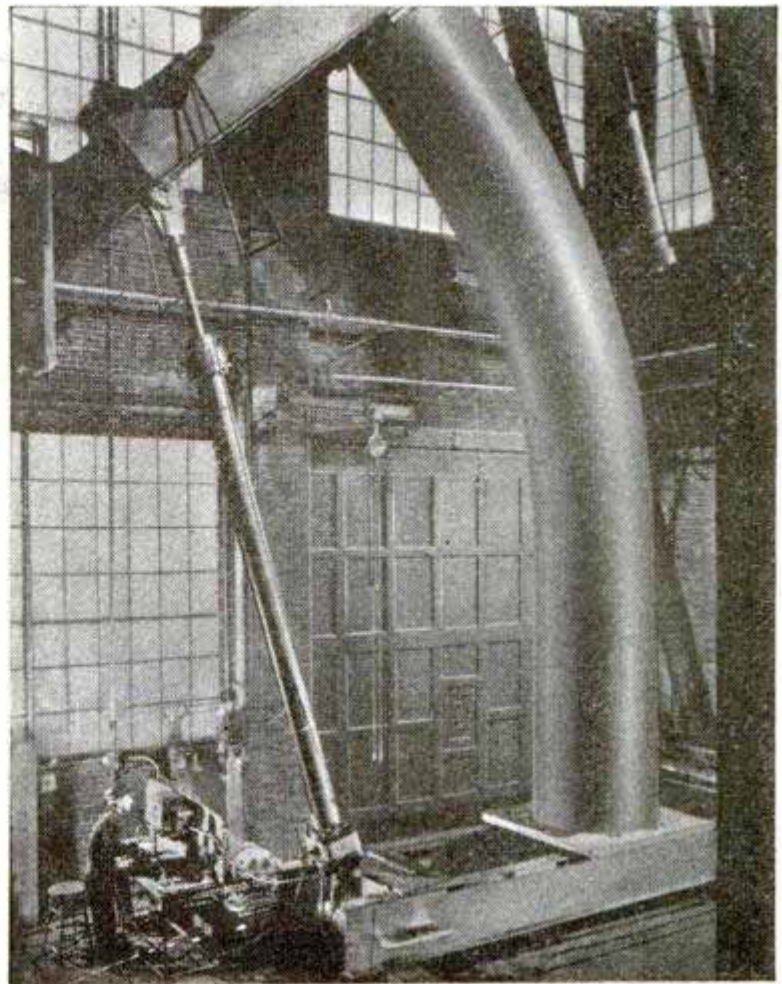

Atomic Superbomb

While the world still trembles over the destructive capabilities of the present atomic bomb, science is forecasting an atomic superbomb, a thousand times more violent than the present type. The superbomb would be made principally from the double-weight variety of hydrogen, called heavy hydrogen or deuterium. The tremendous energy-releasing reaction of deuterium bombardment was known long before the discovery of the fission of uranium, but construction of such a bomb was apparently held up by the

problem of discovering a means of starting the reaction. It is believed that the explosion of a fission bomb may be used to trigger the newer deuterium bomb.

HOOKUP DIAGRAM

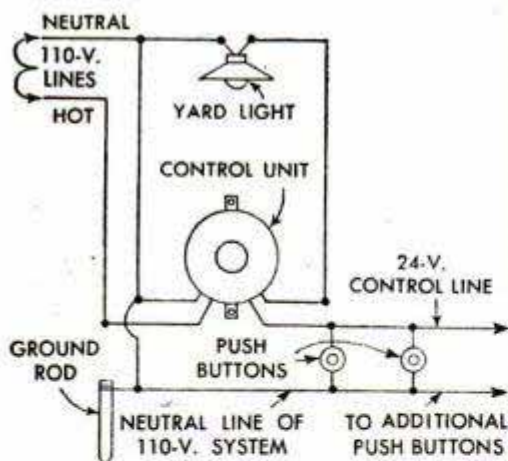

Any number of remote switches for the yard light can be used in the 24-volt control circuit shown in above model. Insert shows wiring diagram

Remote Control For Yard Light

Only one wire is needed to install any number of control switches for a yard light or other electrical device when a 24-volt control unit is used. The remote switches are connected to the unit by a single low-voltage line such as is used with bells or telephones. The other side of the circuit connects to the neutral ground wire of the wiring system. Pressing any push-button switch turns the light on or off by energizing a magnetic ratchet in the control unit. The low-voltage control unit saves the cost of installing expensive circuits to each switch and also reduces fire and shock hazards.

CAR QUIZ



1 _____



6 _____



2 _____



7 _____



3 _____

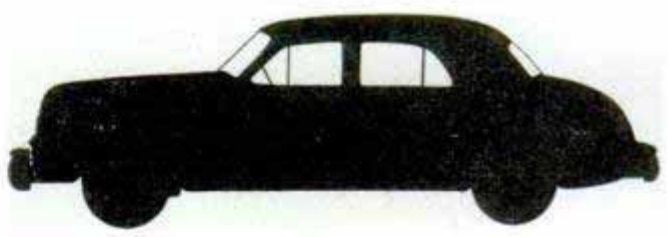

8 _____



4 _____



9 _____



5 _____



10 _____

HOW MANY OF THESE SILHOUETTES OF 1948 U. S. AUTOMOBILES CAN YOU IDENTIFY?
EACH CAR HAS BEEN DRAWN TO SCALE. (Answers on page 268)



11



16



12



17



13



18



14

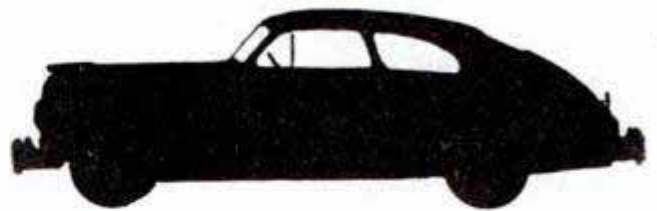

19



15



20

SCHOOL FOR FISHERMEN

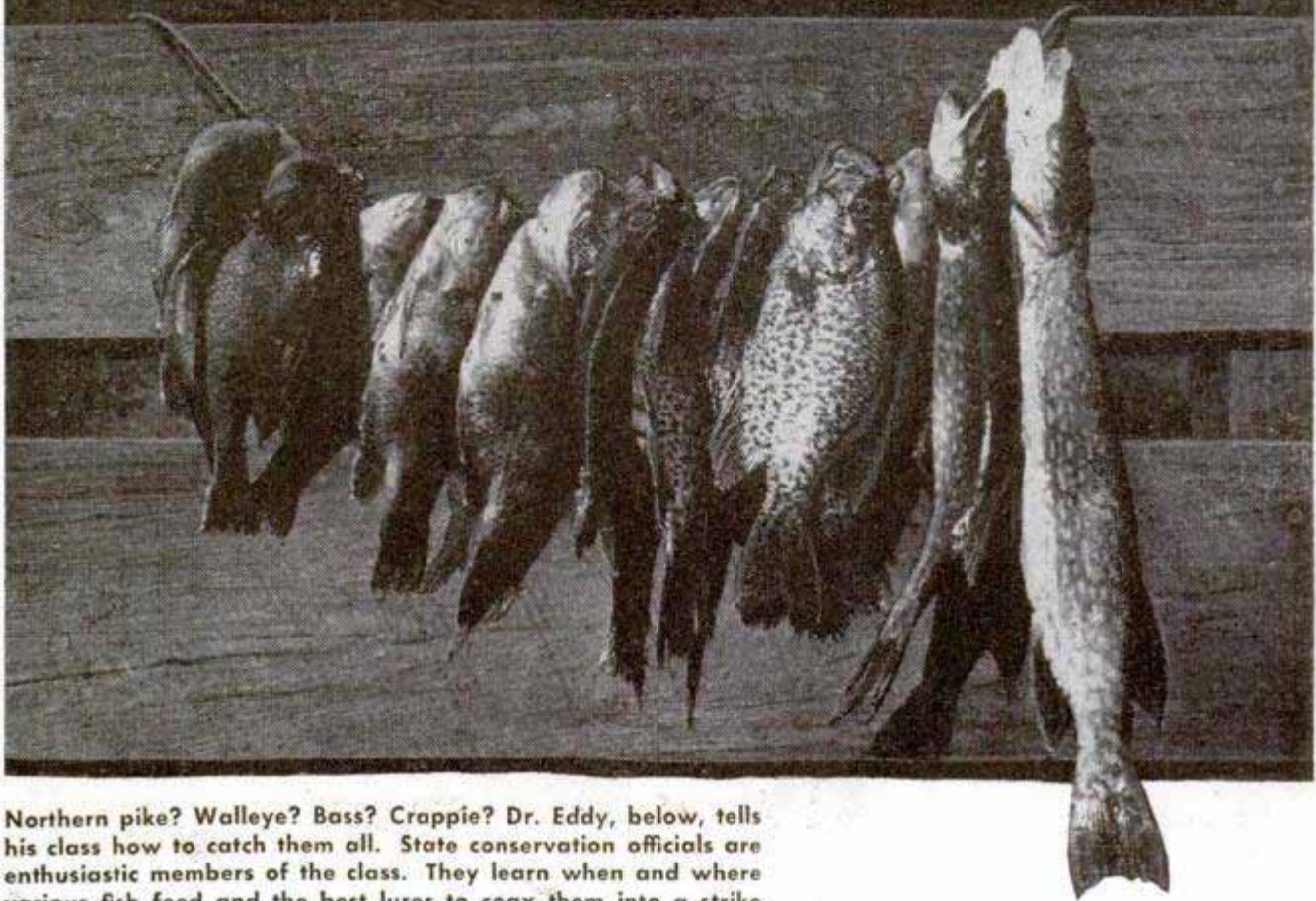

Northern pike? Walleye? Bass? Crappie? Dr. Eddy, below, tells his class how to catch them all. State conservation officials are enthusiastic members of the class. They learn when and where various fish feed and the best lures to coax them into a strike

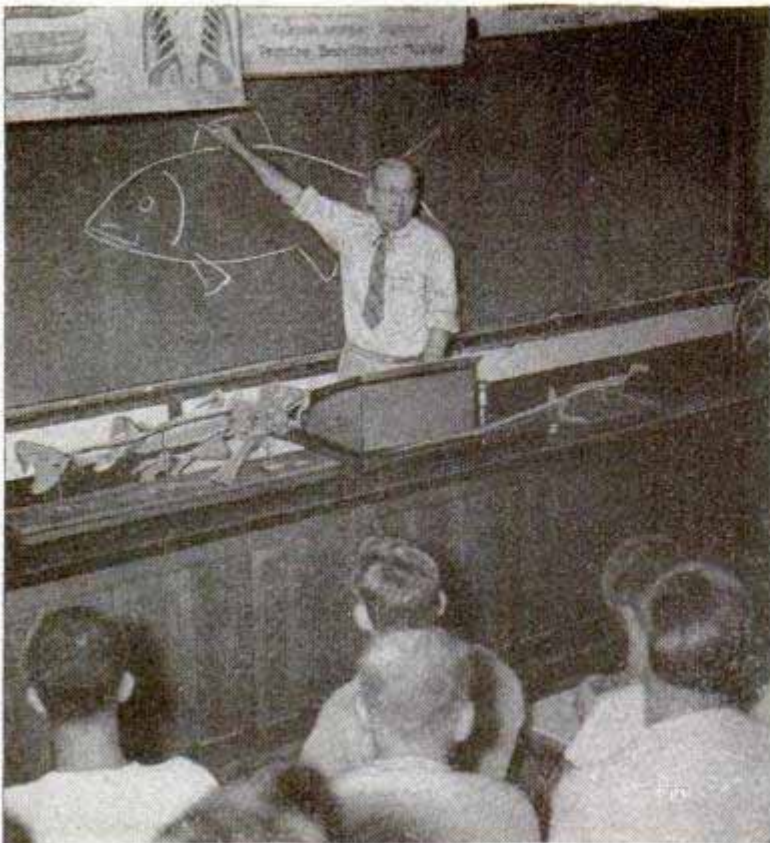

By Dr. Samuel Eddy

*Professor of Zoology, University
of Minnesota*

WHAT MAKES FISH bite? What time of day am I most likely to catch them? Where?" These are the questions most frequently asked me by students of my course in fishing at the University of Minnesota.

Several colleges and universities offer fishing courses in their physical education departments. These courses generally consist of the mechanics of bait-casting and fly-fishing. In Minnesota nearly every high school boy lives within hiking distance of a lake and can plunk down his bait within inches of his target. The course at the university, therefore, is in the zoology department and offers a scientific study of why fish bite

Angler pulls in a big northern with a fly rod. Learning about the private lives of fish can help any fisherman land them

and where to find them. The course is based on research in lake dynamics and the feeding habits of different types of fish. Many conservation officials attend this course—men who can't be taught fish stories but are eager to learn fish facts.

Soon after man invented the fishhook he discovered that sometimes he caught a good many fish and other times he caught none. For thousands of years he has been trying to figure out why. He has blamed spirits, weather and the moon. Even today he may consult a fishing almanac or calendar that is supposed to tell him what day the fish will bite.

Some modern anglers consult the barometer in the belief that fish bite more readily when atmospheric pressure is increasing. A fish swimming a few feet up or down in the water is subject to changes in pressure far greater than slight fluctuations in air pressure.

There are only three reasons why a fish bites. It's hungry, mad or just curious.

Some fish are natural fighters and strike viciously at any moving object. A few, such as the sunfish, are insatiably curious and will crowd around a strange bait.

Hunger is the main reason fish strike. When a fish has eaten all it can hold, it takes very little additional food for the next 24 hours. Under natural conditions, a fish starts hunting food early in the morning and fills its stomach as fast as possible. It then has little interest in a baited hook until evening, when it may look around for a bedtime snack.

The working hours of fish vary. Most

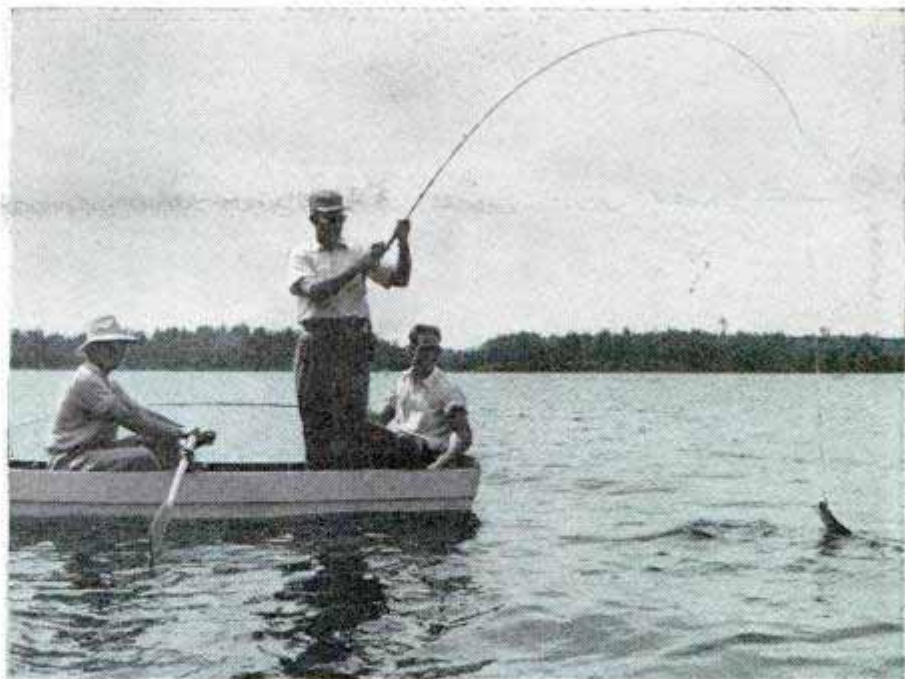

Under Dr. Eddy's guidance, students gather water-life specimens, which show amount of food available for fish

St. Paul Pioneer Press photo





Pilot of Popular Mechanics' plane tests some of Dr. Eddy's advice on fishing. (He caught two northern pike)

hunt their food at night. Sunfish and crappies are primarily daytime feeders, starting the job when the sun is high enough to penetrate the water. Northern pike and muskellunge move into shallow water at daybreak to hide in the weeds and wait for their prey. In the late afternoon they move out to deep water for the night.

It's usually a waste of time to fish in the middle of a lake where the water is more than 30 feet deep. In most lakes there is insufficient oxygen in the deeper waters, but a few lakes near the Canadian border have plenty of oxygen even in the deep areas. Lake trout seek these deep bottoms in the summer to escape the heat of the surface. Test nets prove one rule: fish seldom go deeper than 30 feet except in these lake-trout lakes, where they are found at almost any depth.

game fish have primarily daytime habits although if they are still hungry they may lurk around after dark. Large fish, which have difficulty in stuffing their stomachs, often strike after dark. Consequently, the fisherman may catch his largest brook trout or northern pike late in the evening.

The walleye or pike perch is a well-known night feeder, lying in water from 10 to 20 feet deep just outside the weeds during the day, but moving into shallow water at night to feed on small fry. Large bass frequently do the same thing. Bass feed most frequently in the evening and early in the morning. Eels and bullheads

Sunfish, crappies and perch are so sociable that they like to travel in schools. The fisherman who catches one of these fish is wise if he drops anchor and tries for the rest of the school. Incidentally, these schools seem to be organized into "grades," as the fish are age-conscious and those of one size tend to school together. You'll find the larger ones in deeper waters just outside the weeds and smaller ones inside the weeds. Favorite playground of this type of fish is around brush piles, old docks and fallen trees.

Young bass tend to school, but older

Dr. Eddy tries his luck from forward hatch of Popular Mechanics' "Apache III," a twin-engine Grumman Mallard



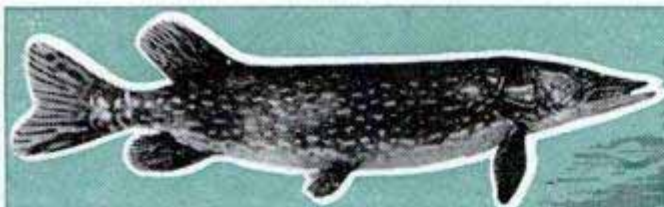

NORTHERN PIKE—Eddy recommends fishing in deeper waters late in evening for large ones. Good bait is a spoon



PAN FISH including crappies and sunfish—still-fishing with worm in weeds close to shore is most popular method



BASS — still-fishing in early morning or evening in weed-strewn water about 15 ft. deep can bring in big ones



WALLEYES—one good system is to cast in 20 feet of water just off weed bed during daylight. Bait is a plug



TROUT—lakes with deep water and rocky banks are best. Wet or dry fly gets brown trout, troll for big lake trout



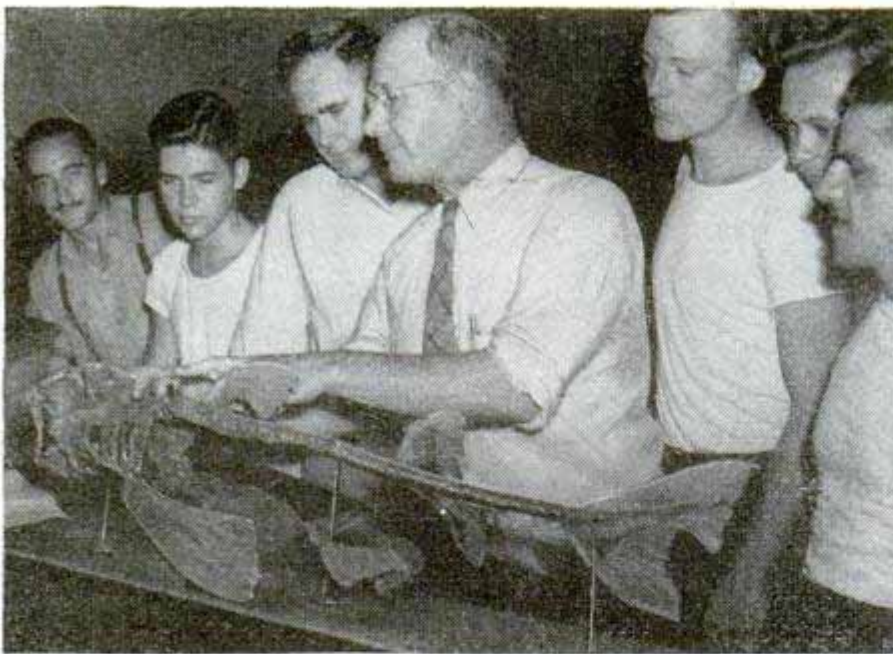

Dr. Eddy reviews structure of fish skeleton for some of his students

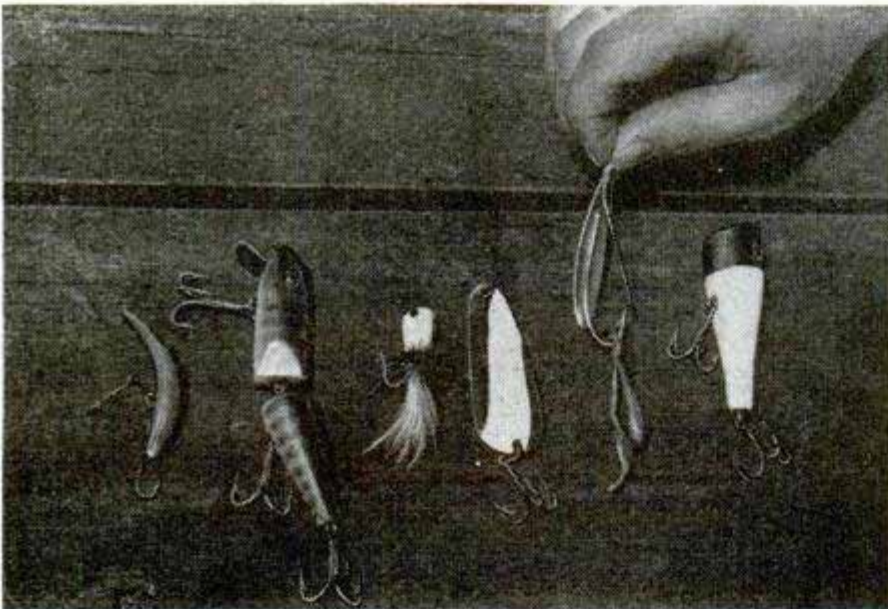

† Author recommends these basic baits. Below, pan fish such as crappies and perch hide in weeds during day

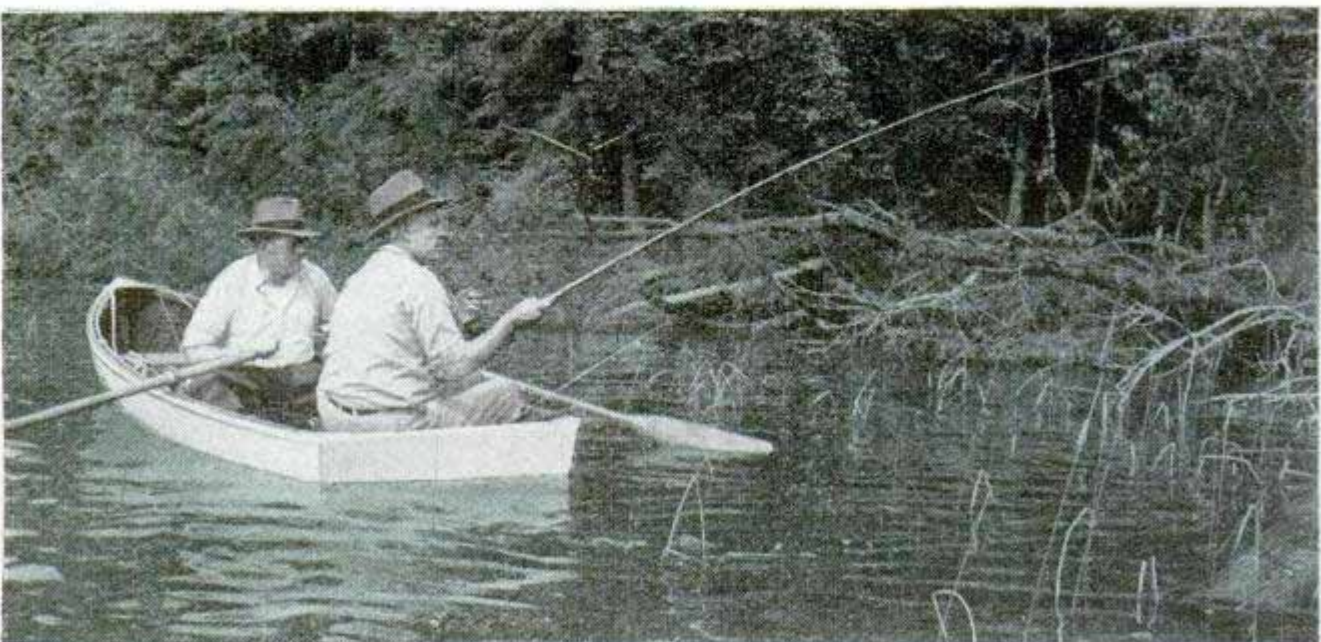

bass are rugged individuals, each selecting his own territory where he can lurk in the shade of weed beds and lily pads. Northern pike like to run alone, and can be found scattered over weed beds. Although walleyes are often solitary, they may range around the lake in groups, hunting for food.

Most game fish locate their food by sight, as the senses of taste and smell are apparently poorly developed or they would not strike and swallow bits of wood and even pebbles. Therefore, you'll find them most easy to fool with moving artificial baits. A northern pike is attracted by the movement of its prey; the moment the bait makes another move the fish strikes in a flash. Bass hit hard the moment they sight the moving object. Walleyes may strike on sight but often they peck cautiously at the bait.

Other fish such as catfish, suckers and carp have a well-developed sense of taste, usually located in the skin around the head. Bullheads seem to have their taste organs in their "whiskers."

When offered food they do not strike as it settles through the water but gyrate madly until their whiskers come close to the food; then they turn and engulf the bait in their huge mouths.

Most pan fish, such as sunfish, crappies and rock bass, seem to use a combination of sight and taste in locating food. They see the food and if it moves they may strike it. Frequently they will make a series of short dashes at it, apparently tasting or nibbling before seizing it. If the hook is too large they can clean off the bait without ever taking the hook in their mouths.

We discover the "biting rate" of fish by taking a "creel census" in which every fisherman on a lake is asked how many fish he has caught and the time he spent in catching them. Seasonal changes in the rate of biting have long been known to experienced anglers and are clearly shown by the census. In June most fish have finished spawning, yet food production has not increased sufficiently to satisfy them. Consequently they are hungry most of the day and bite readily. In July they are not very hungry and in August they bite very poorly. As the summer progresses, heavy growths of insects, worms, minnows and other organisms leave the fish fat with their stomachs full.

The temperature of the water in August is highest for the year, causing many fish to lose their appetites. During September the water cools, the excess food has been consumed and the fish become hungry, providing many more strikes.

In winter when the temperature falls to just above freezing, sunfish, bass and bullheads lose all interest in food. However, crappies, perch, northern pike and wall-

eyes are hungrier than ever and may offer the best fishing of the year.

During some years fishing is very poor, while in others it is excellent. This does not necessarily mean that there are fewer fish. Apparently in some years conditions are favorable for the production of a large food crop and the fish have no appetite for even the most tantalizing lure.

"What kind of lure shall I use to catch a certain kind of fish?" That's another question which frequently pops up in class discussions. Still-fishing is best for pan fish such as crappies, sunfish, perch and rock bass. Many others such as black bass, northern pike and walleyes may also be caught by this method, especially if the hook is baited with a minnow.

Baits for still-fishing range from live minnows to angleworms, grasshoppers, grubs and even bits of liver and fish. Looping a worm back and forth on the hook presents a much more enticing bait than merely threading it on the hook. Minnows should not be threaded except for casting, but should be hooked through the back muscles just under the dorsal fin, giving them a chance to move and give action to the lure. When fishing for pan fish, keep the hook a foot or so above the bottom.

For casting or trolling, try to make your bait or lure imitate natural food. Fish are nearsighted and not so particular about the detailed appearance of the lure as its action. Most sports stores offer a bewildering array of artificial baits, but only those that give plenty of action in the water should be considered.

Spoons are very effective for northern pike and may work for walleyes. Artificial

(Continued to page 268)

↓ Night is good time to still-fish for large walleyes, bass, northern and bullheads. Right, bait developed by Dr. Eddy has safety pin, two hooks which hold minnow for casting. Drawings show ways of threading worm

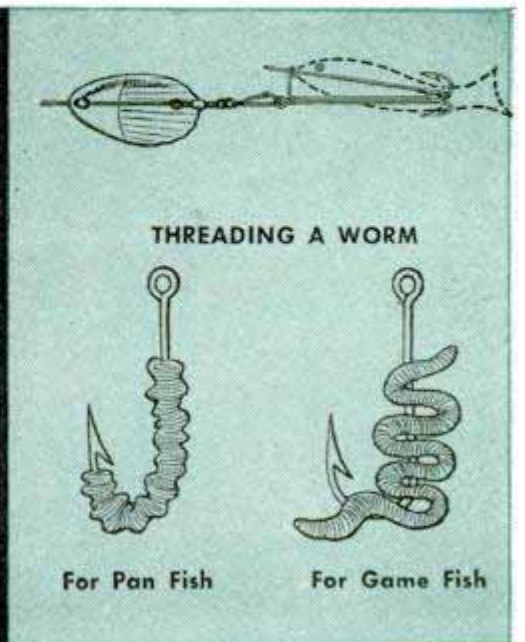



Three-Way Gear System For Outboard Motors

Both the dangers and hard work of rip-cord starting are eliminated by a neutral, reverse and forward-gear system devised for outboard motors. It adds only one to five pounds to the motor's weight, depending on the horsepower. The reverse gear minimizes overshooting the destination and simplifies docking. Use of neutral during stops cuts down the number of starting operations. It also makes it possible to avoid immediate acceleration on starting that often causes accidents.

"Handful" Generator

Current for lighting small motor vehicles such as power bicycles, scooters and motorboats is provided by a tiny generator with a friction disk that is mounted against the engine flywheel. The power unit, only 3½ inches in diameter and 1½ inches thick, produces 35 watts at 6 to 8 volts. It gives steady, flickerless light even when the motor is idling. To provide automatic voltage regulation, four segments are attached to the rotor shaft, each by a separate leaf spring. At low speeds all four segments run clear

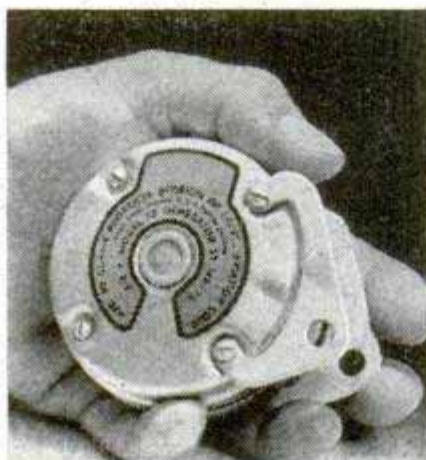

of the rotor to allow the full magnetic field to act on the coils. At predetermined speeds the segments extend by centrifugal force, touch the rotor and shunt the magnetic field to regulate the voltage.



Shadow Box in Kit Form Depicts Chinese Scene

With a kit that includes all the required parts, hobbyists can build a shadow box that depicts a Chinese scene. The completed project shows an old man sitting beneath a Ming tree. The kit contains the glued and sanded frame, the box, tree, foliage, moss for the tree, cement, colored sand and the hand-painted ceramic figure.

Luminous Flashlight

Coated with a luminous material, a new flashlight can be quickly spotted in the dark in case of power failure or other emergency. The case glows with a bright blue-white light for several hours and then glows in a more subdued manner all night.

1949 Kaiser

First postwar car to undergo extensive model changeover, the 1949 Kaiser offers 72 changes in styling and 30 in engine and mechanical features including a boost in horsepower from 100 to 112 with the six-cylinder engine. The '49 has a new simplified clutch and improved steering, accelerator and brake mechanisms. Restyling of the body resulted in a silhouette three inches lower, new grille, bumpers and rear fenders.

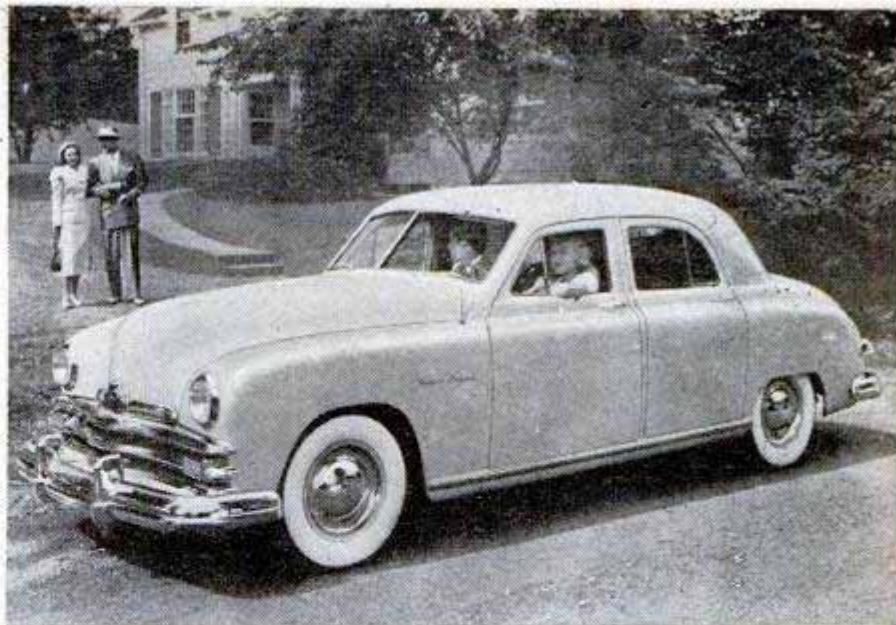

Two-Place Helicopter

Exceptional maneuverability and braking power highlighted first tests at Seattle of a coaxial-rotor helicopter secretly designed and built on a ranch in an isolated part of the state. The two-seater's only control surfaces are a pair of contrarotating 27-foot-long rotors. Its 125-horsepower engine is shock-mounted on rubber, with dual mufflers silencing engine noise. From a hovering standstill the craft reaches its cruising speed of 80 miles an hour almost immediately. An overriding clutch permits the rotors to continue turning for a safe landing in case there is an engine failure.

Timer Turns Off Water Heater

Water heaters turned on manually can be converted to semiautomatic operation with a timer that turns off the gas at the end of any desired period, eliminating the need for a second trip to the basement. A maximum interval of one hour is possible with the timer. The gas can be turned off manually at any time if desired.

Our WHERE-TO-FIND-IT INDEX, listing manufacturers' names and addresses and sources of further information for products in this issue, is available free upon request. For your copy of the index, just write Bureau of Information, Popular Mechanics, 200 East Ontario Street, Chicago 11

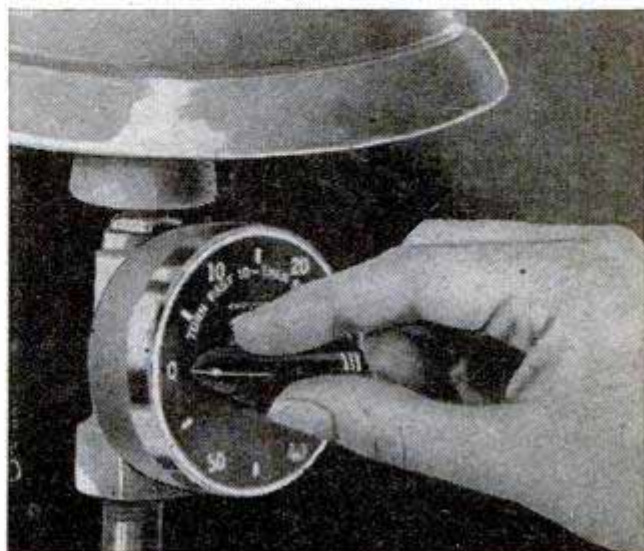

GAUGES

- the guide to
perfection

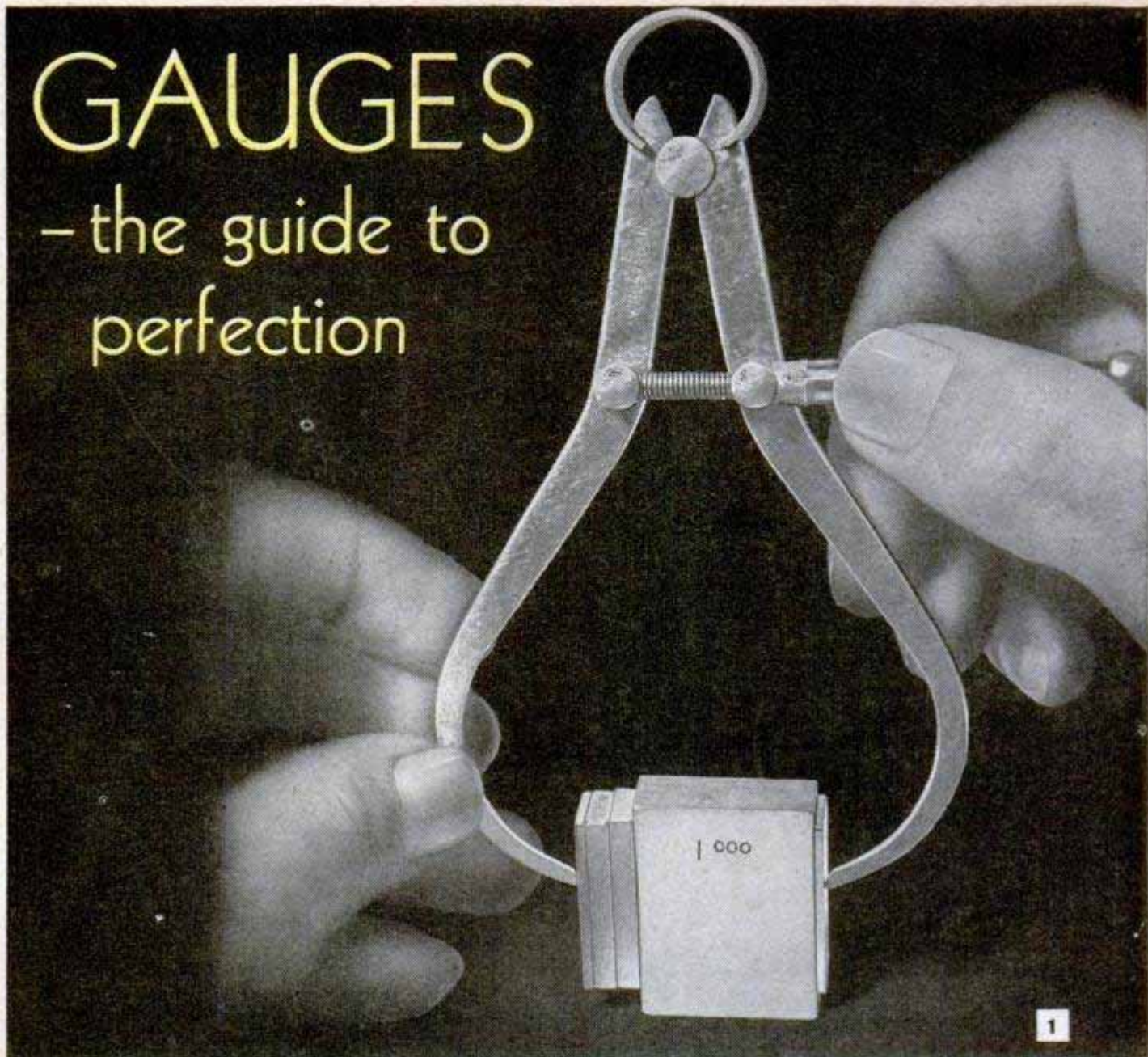

Ordinary calipers are precision tools in the hands of a skilled machinist. Here a pair is being set with gauge-block assembly

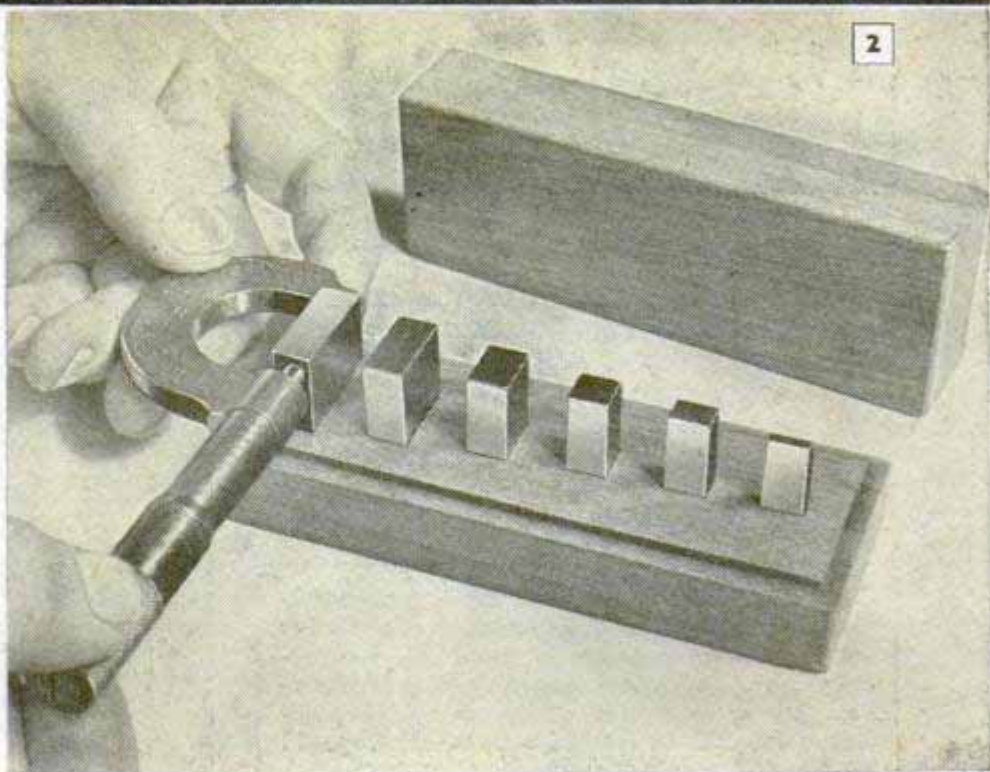

By
Alexander Maxwell

Designed specifically for testing micrometers, a set of gauge blocks provides checks at every stage point from $\frac{1}{8}$ to one inch

THE FAMILY excitedly piles into the car and you point the radiator cap toward the blue horizon and step on the gas, perfectly confident of making the long journey before you. A huge plane roars up from the New York airport and heads east. Those on board relax, knowing full well they will eat supper in London. The steam turbine roars loudly, turning huge generators that make your electricity. Meters on the control board show the current being delivered and the needles are as stationary as if glued to the dials. The light never fails. The electric refrigerator runs on and on, year after year, and no one ever pays any attention to it.

Something strange and remarkable has happened. Things don't break down as often as they once did. Time was, not so long ago, when the average motorist considered himself lucky if his car ran a week without something folding up. A journey of a thousand miles made the headlines. It was only 21 years ago that planes started crossing the Atlantic and 10 that they did it with any degree of assurance. Refrigerator manufacturers advertised they used non-poisonous, odorless gas. Every year, or maybe more often, the service man called and replenished that which had leaked out. Yes, times have changed.

There are a number of factors responsible for the changes, but all are secondary to the worldwide acceptance of the Johanson block ("Jo-block") as a unit of measurement. In World War I it was a novelty more or less ignored by manufacturers and honored only by the serious machinist who bought a set out of his own income and took it home with him every night. In

World War II the government specified that all contractors not only had to own Jo-blocks, they had to use them.

This ultimatum provoked smiles from many of the leading industries because they learned the hard way that there is no shortcut to perfection—competition had forced the decision long ago. Others moaned long and lustily about the terrific expense incurred. But they bought the blocks and they used them. Hardly had the first month's production reports been tallied after the change-over than there were raised eyebrows and gasps of astonishment. The improvement in quality and decrease in the number of rejects were rapidly paying for the blocks.

A Jo-block itself is a harmless looking slug of steel. It is smooth and highly polished. It is not the block itself, but what it does that gives it value. It settles the often disputed question, "How long is an inch?" The length of an inch is of vital importance to modern industry. In a machine shop, there may be three steel rulers, each one foot long. They are all top quality and all supposed to be accurate. For ordinary measurements they are, but on ruler No. 1 the third inch is $\frac{3}{1000}$ inch shorter than the others. That means any measurement over two inches will be in error. Ruler No. 2 has a slight bow to it which gives an over-all error of $\frac{3}{1000}$ inch, but none when the inches are checked individually. Ruler No. 3 is accurate. What happens when the three machinists using these rulers to set their calipers turn out three parts of a mechanism? The parts don't fit and have to go back for hand dressing. Everything is blamed but the rulers, but that doesn't pay

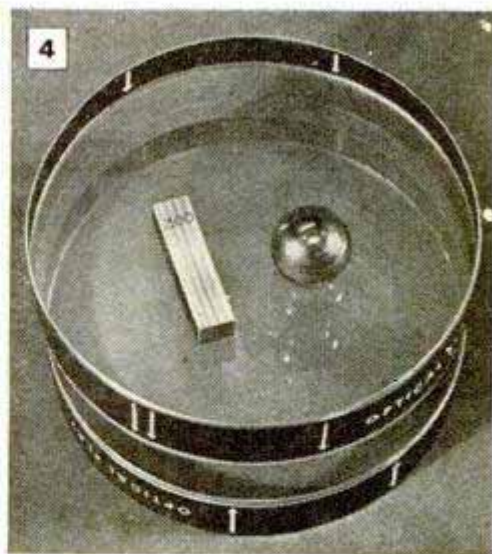
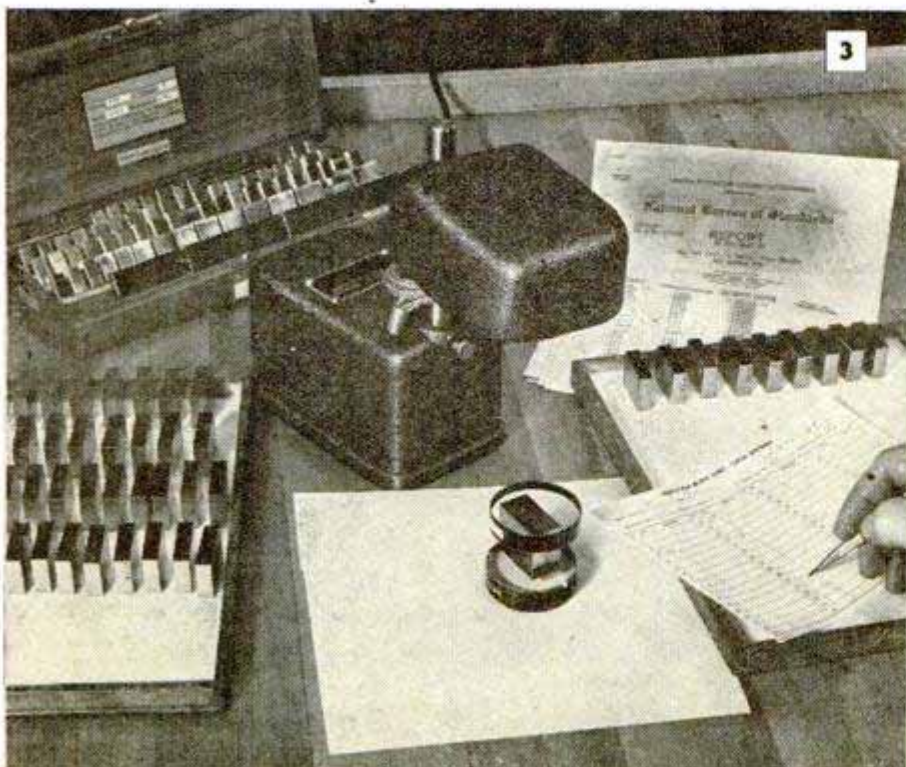

Left, a completed gauge block being tested alongside the master block between optical flats. Above, testing diameter of ball bearing by same system. Lines on block check diameter

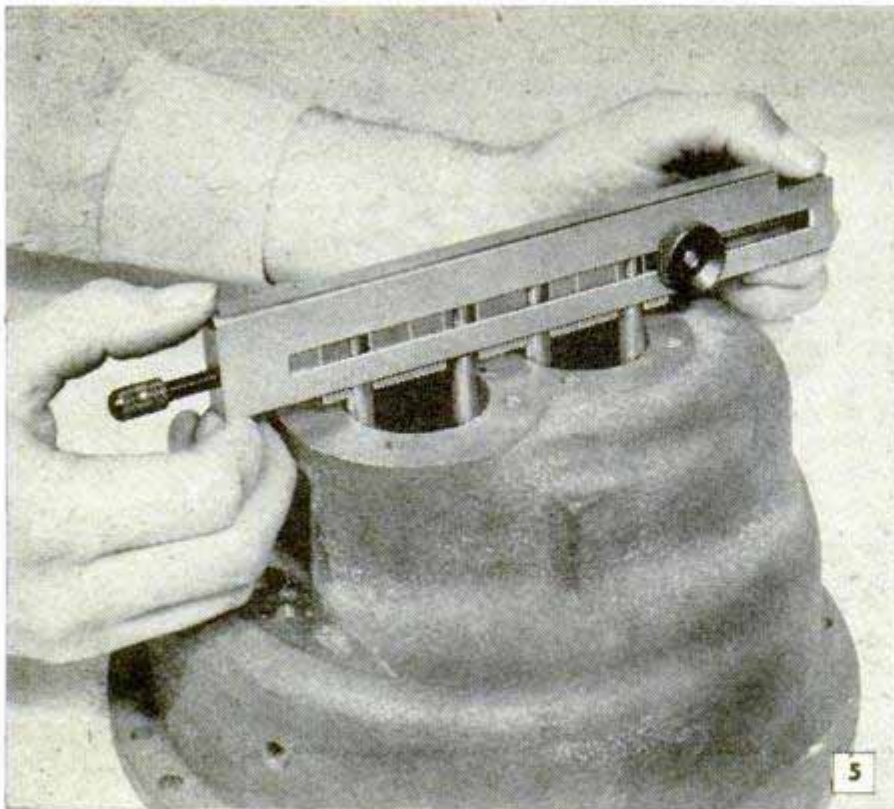

Blocks are inserted in a holder to make a gauge to measure internal diameters in production

lated length of kernels of grain placed end-to-end. Queen Elizabeth put a stop to all that foolishness by having a metal bar engraved into 36 units, each an inch, the total a yard. That was good until it was discovered that metal expands and contracts in heat and cold. Astronomy and optics at last came to the rescue. Light waves are constant. They are the same everywhere. Why not use light as a standard? It was done, and 39,450.3 waves of cadmium light now constitute one inch.

for the time lost and tempers ruined. This is a very elementary example of how a variation of inch lengths can gum up precision manufacturing. The same statements can be applied to micrometers, comparators or more complex measuring devices.

The length of an inch was never really standardized until quite recently. It started out being $\frac{1}{12}$ the length of the king's foot. New king, new inch. Then it was the width of his thumbnail; then the accumu-

The governments of the United States and Great Britain make available a standard inch to anyone requesting it. France does the same with the standard centimeter. Incidentally, the length of the inch is based directly upon the French centimeter, so there is no conflict between them. It was a Dane, E. S. Johansson, who first did something about making a standard inch available to the man who needed it the most, the machinist. He perfected a technique of stabilizing steel so that its tendency to ex-

Dial gauges are easier to read than micrometers, but they are useless until calibrated with gauge blocks

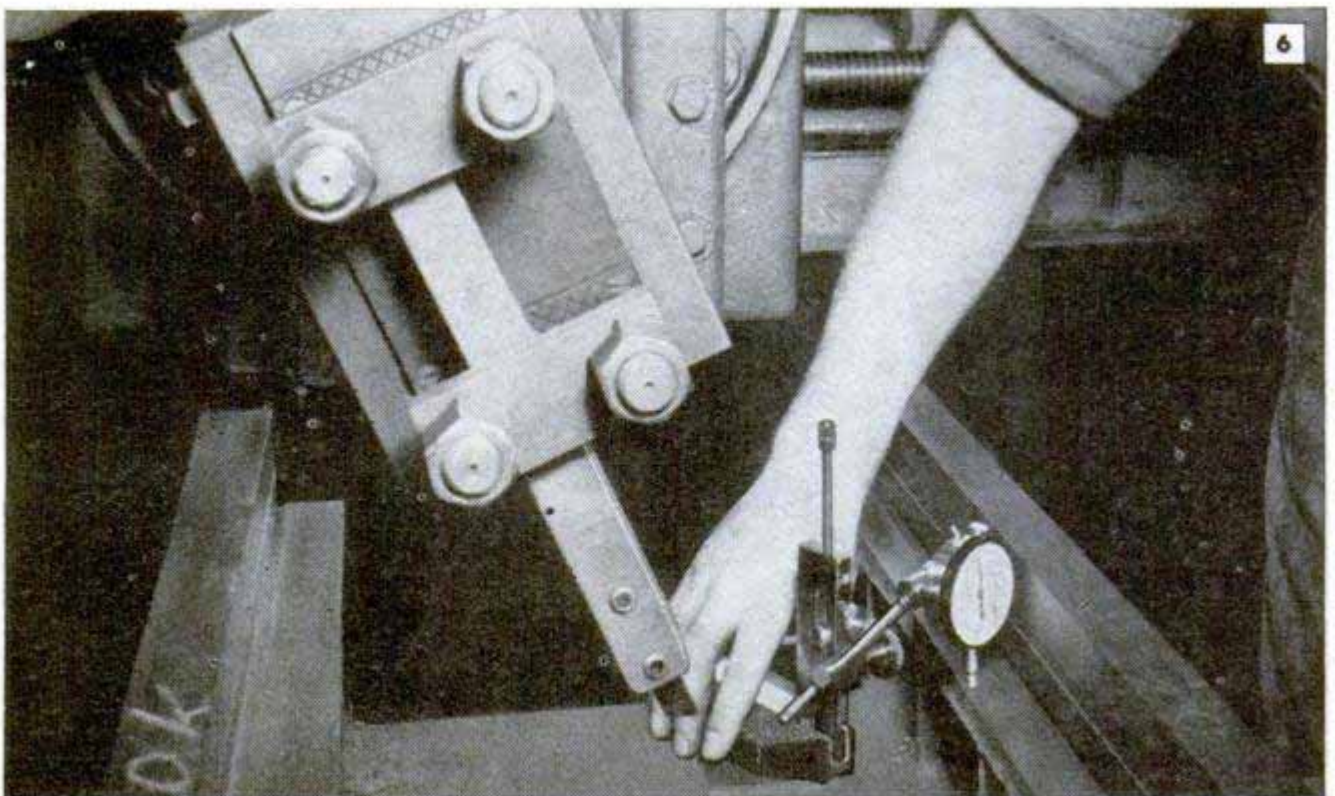

pand when heated would be minimized. He then proceeded to use light waves to check his grinding. His one-inch block was exactly one inch, down to the last light wave. It created a mild sensation, but not until Henry Ford, who was looking for just such a device, took notice and brought Johanson and his business to America, did anything important happen. The rest is history. Ford got the jump on all his competitors and everybody else had to buy Jo-blocks or go out of business.

The demand for gauge blocks grew so rapidly when the nation started tooling up for World War II that a dozen firms took it upon themselves to create an adequate supply. In use, the gauge block is simplicity itself. The blocks are available in inches and multiples of an inch as well as decimal fractions of an inch. The largest practical block is four inches and the smallest is .010 inch which is a mere wafer of steel. The measuring surfaces are so flat and smooth the blocks will stick together when wrung and an assembly can be lifted and handled as a unit. It takes a good tug to pull them apart.

Calipers were used by the pyramid builders of Egypt and by just about everybody else since. Simple as they are, in the hands of a skilled machinist they will measure down to a thousandth of an inch. It was customary to set them with a steel ruler but by wringing an assembly of gauge blocks (photo 1), an accurate dimension can be obtained quicker and easier.

A micrometer caliper carries its own cal-

ibration and all that is required is to check it periodically against a master. Too energetic or improper use often results in springing or thread stripping. Then the "mike" will read accurately up to a point and from there on errors may multiply fast. An ingenious set of gauge blocks (photo 2) has been devised especially for checking micrometers. Starting at $\frac{1}{8}$ inch, readings are taken at every stage point, namely, $\frac{1}{4}$, $\frac{3}{8}$, $\frac{1}{2}$, $\frac{3}{4}$ and one inch. If errors are present, they will show up here. Quality-control inspectors in one large plant discovered only 20 percent of the company-furnished micrometers were accurate after a period of service. A system of testing every mike in the building each week end and adjusting or repairing it was set up and the percentage of spoilage dropped by almost half.

The manufacture of gauge blocks is an exacting, highly specialized procedure. It involves the cutting and grinding of blanks to limits, then a long process of stabilization. The blanks are placed in a wire basket, heated to the boiling point of water, then plunged into a sharp-freeze cooler and the temperature brought down to 150 degrees below zero. White with frost they are again heated to the boiling point, then again cooled, until the molecules at last give up the struggle and remain permanently passive. Now, no reasonable degree of heat or cold will alter the size of the block. They are laid away to season, then ground down to final size, and lapped. Lapping is the step which makes the slug of

Left, checking spur gear with dial gauge. Right, this gauge gives several bore measurements simultaneously

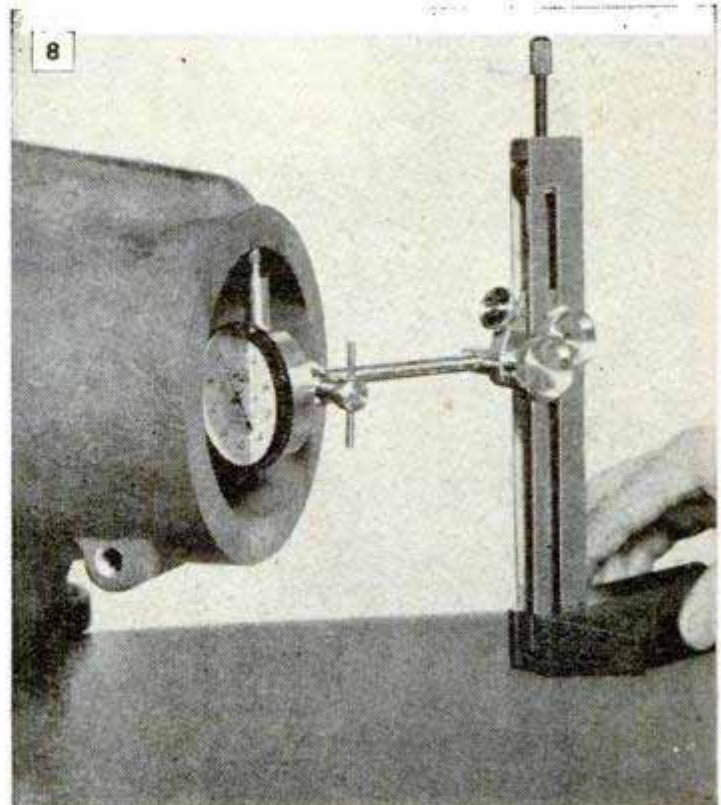
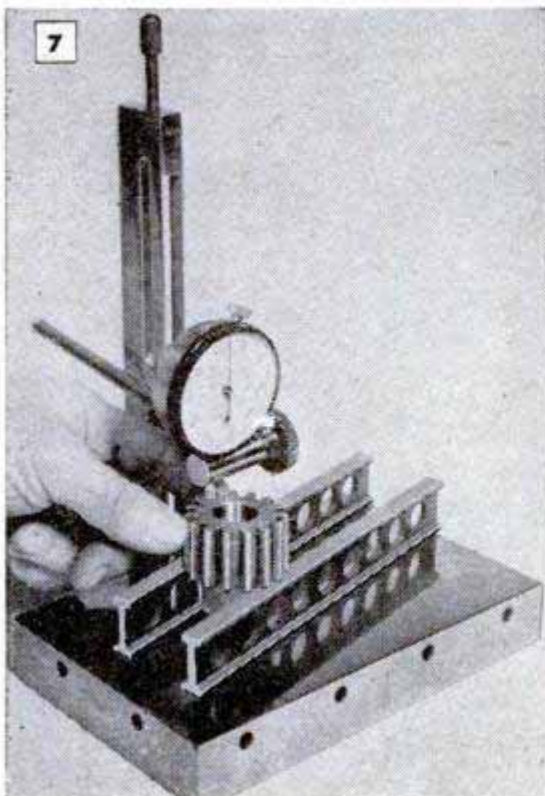

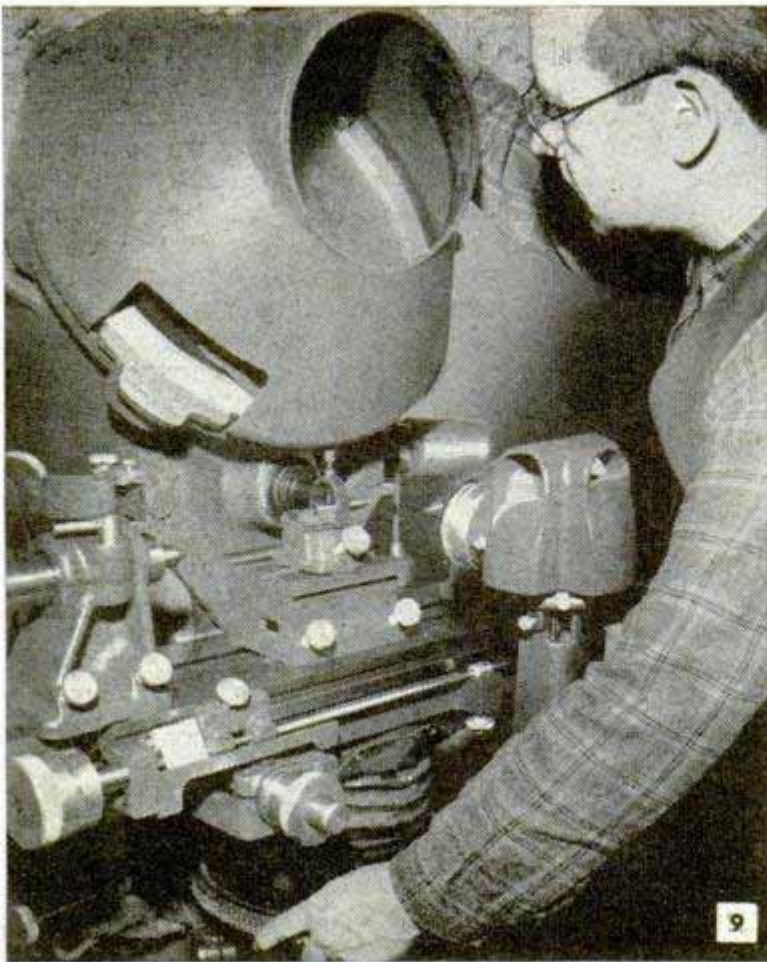

Optical comparator projects magnified image of part on screen

steel into a gauge block or proves it is worthless. Sixty-four blanks are placed in slots in a rotating disk. The lower faces of the blocks rest on one lapping plate. Then another free-floating plate is lowered until it touches the upper faces of the blocks. The holding disk is slowly rotated and the 64 blocks are crushed, smoothed, scraped and polished until the two surfaces are ab-

Light-beam comparator indicates size by shining light on dial



solutely parallel and mirror-bright. The work is done in an air-conditioned, dust-free room.

Each revolution of the lap reduces the diameter of the blocks one millionth of an inch. Periodically they are removed, measured and replaced. Then the lap is rotated six times, once or even a quarter revolution. If the block is oversize, more metal can always be taken off. If it is under, all that can be done is grind it down to the next size.

Now comes the calibrating against a standard (photo 3). This requires the use of a pair of optical flats, which are glass or quartz plates ground and polished to an absolutely flat surface. Light from a monochromatic source, a cadmium vapor tube giving rays of an exotic orange pink, is directed upon the flats. Now a master gauge block, which has been certified by the Bureau of Standards in Washington, is wrung to the lower flat. Alongside is wrung the block to be calibrated. The upper flat is placed on top of the two blocks. Light passing through and striking the two gauge blocks reflects a brilliant rainbow pattern

of light and dark lines. It is the position of these lines which tells the story. The dark lines are interference patterns where reflected light from the under surface cancels out reflection from the blocks. Each dark band indicates a vertical distance of one half wave length. If there is one dark band the difference in height between the two blocks is 11 millionths of an inch. If

there are two dark bands then it is 22 millionths. If the two blocks are identical there are no dark bands, only straight lines of brilliant color. If these lines are curved it means there is a bow in the block. If there are whorls or eyes it means a high or low spot is present. Blocks which develop irregularities that persist are junked. A surprising paradox is that the more exact the measurement, the easier it is to observe. With a pair of optical flats anyone can detect surface irregularities as slight as three millionths of an inch. If an inch were as high as a 16-story building a three millionth would be the thickness of this magazine page.

Optical flats are not confined to calibrating gauge blocks. They can be used directly in industry

for measuring the wear on a plug gauge and matching the diameter of ball bearings (photo 4). Notice that the color lines are so brilliant they can be photographed. To optical flats go the credit for the supreme perfection of gas seals on refrigerators and the high compression ratio of Diesel engines. Bearing surfaces and pressure seals are measured directly by means of flats as the machine is built.

Manufacturers of precision equipment, which includes everything from toy trains to locomotives and from vacuum cleaners to airplanes, use a tremendous quantity of gauge equipment. By use is meant actual consumption, not mere employment. Take plug gauges for instance. Each plug is lapped to a close tolerance. After the machinist or inspector has inserted it in fifty or a hundred holes, some wear is bound to occur. Periodically the plugs are collected and measured by the quality-control department. Rejects are ground down to the next smallest usable size. At first glance this seems like a terrible waste of expensive equipment, but the failure of one unit in service would often offset the cost of a thousand plug gauges. Modern industry cannot afford to take a chance.

In addition to being used to set instruments and check other gauges, the Jo-blocks themselves can be used as production gauges. When a special setup is to be measured or a short production run inspected and time and circumstances do not warrant the purchase of a special plug gauge, the blocks can be placed in a holder between caliper

(Continued to page 250)

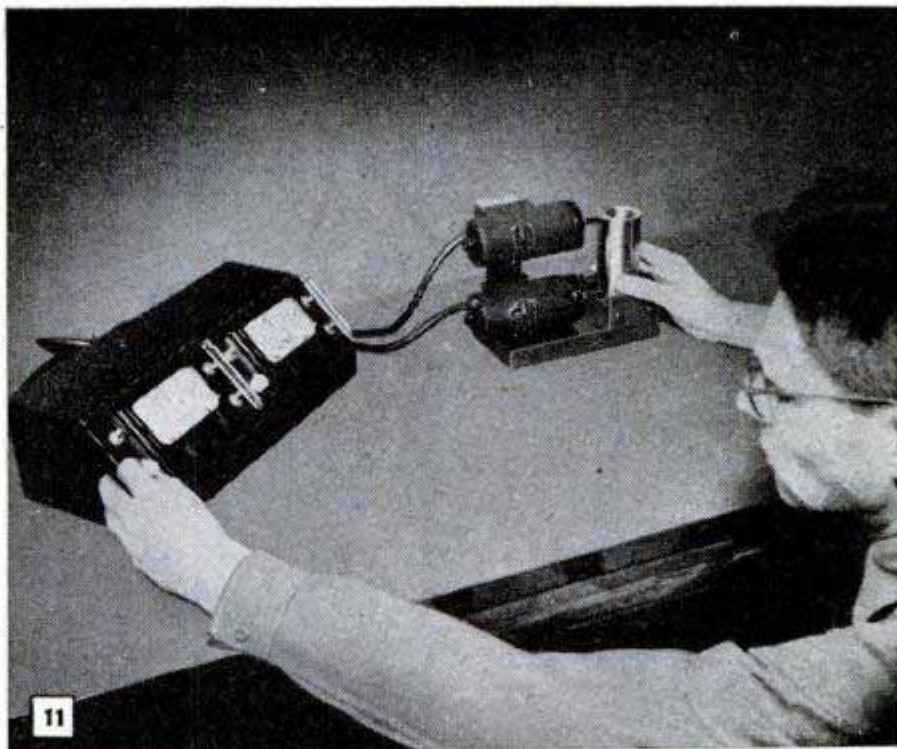

This electromagnetic comparator works the same way as a phonograph pickup arm. Its sensitive needle reacts to infinitesimal amounts of pressure

Below, electronic segregator sorts the good from the bad as the pieces are dropped into the hopper by the operator as fast as 10,000 an hour

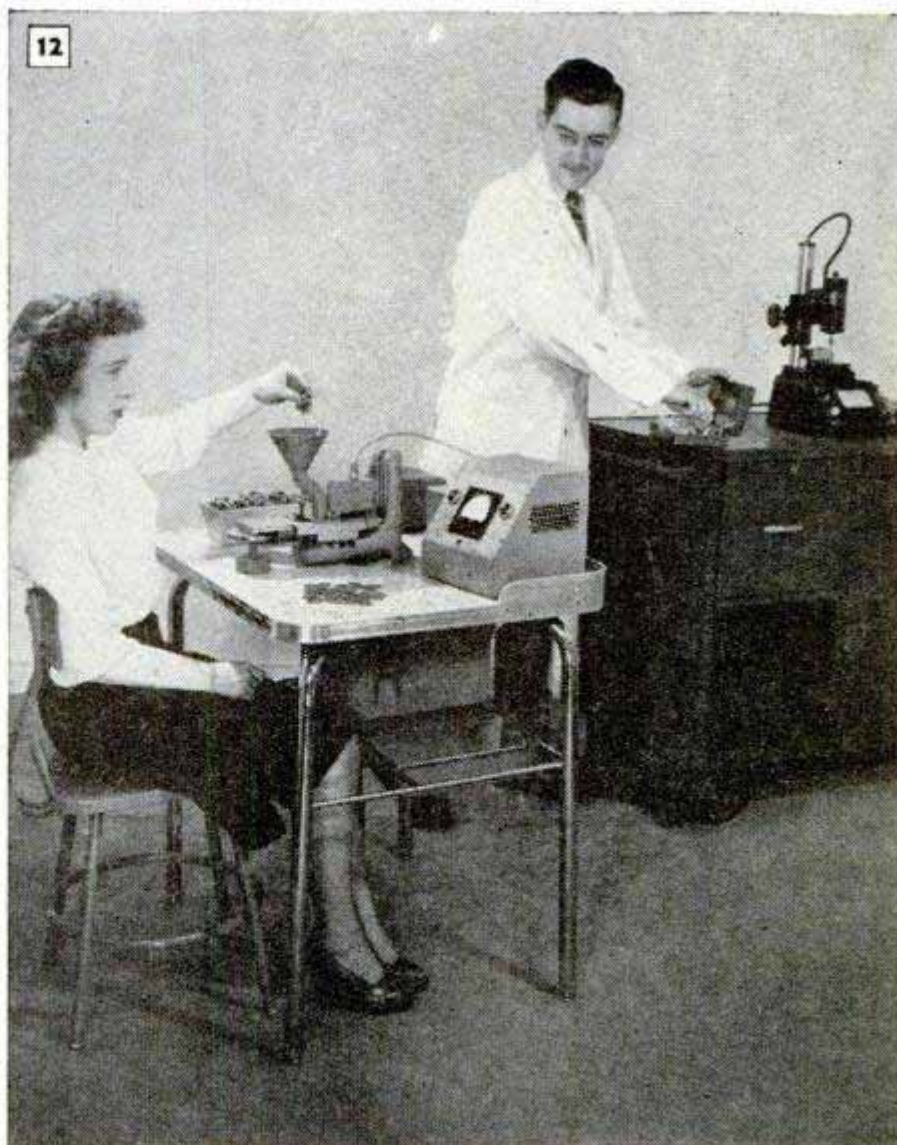

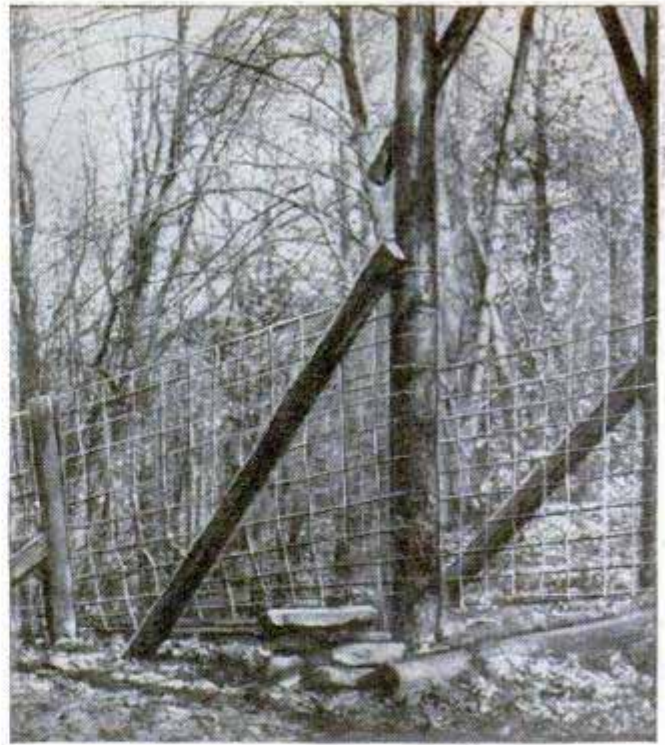

Wire-Fence Suspension Bridge Is Practically Floodproof

Made of wire fencing, a 75-foot suspension bridge has eliminated the annual chore of rebuilding a foot bridge over a creek after every spring flood. Hanging high above the creek, the wire bridge, built by an Ohio farmer, is not damaged by the swollen river. A two-ton chain pull was used to stretch the fence between trees on one bank of the creek and two posts on the opposite bank. Heavy timbers brace the posts against the pull of the bridge. Two lengths of fencing are used as guard rails.

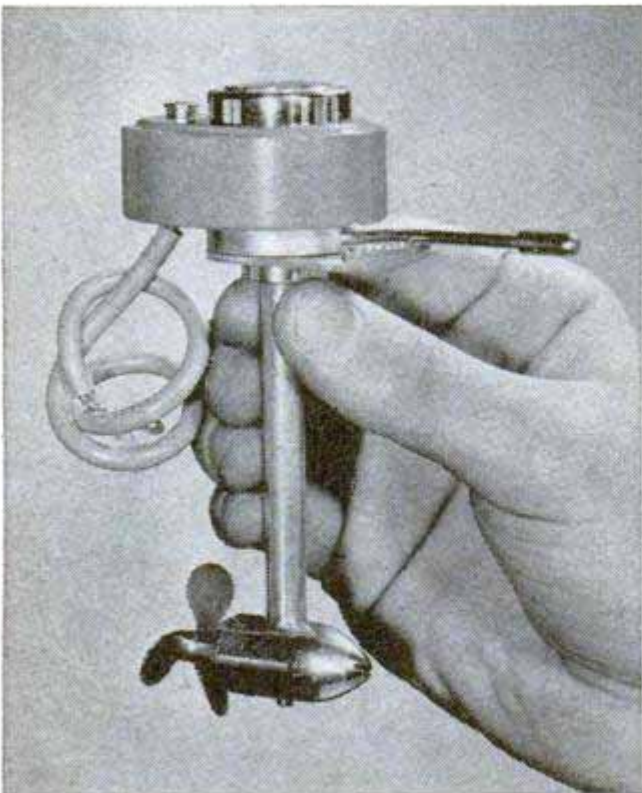
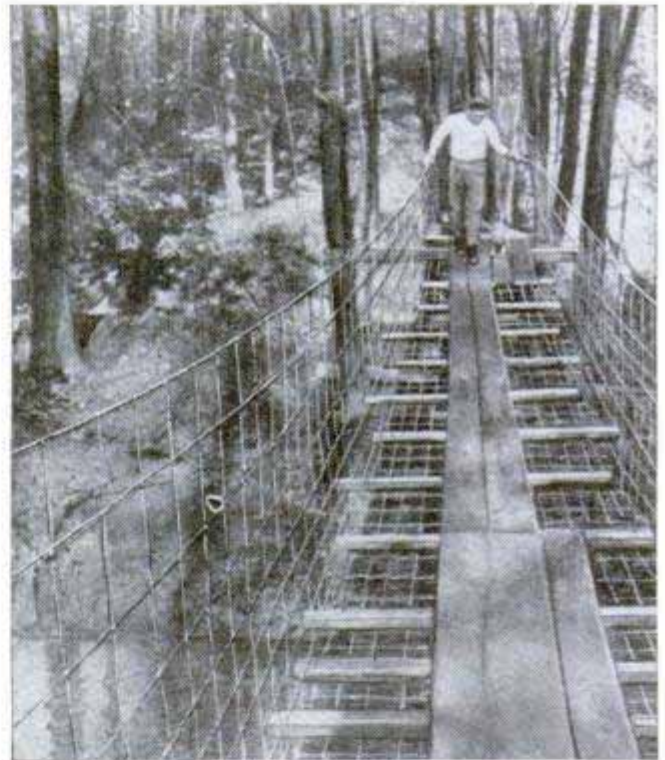

← Outboard Motor for Model Boats

Operating on a six-volt dry cell battery, an electric motor for model boats turns over at 5000 revolutions per minute. The motor can be installed on any boat from 12 to 24 inches long. Designed to look like an outboard motor, it is rustproof and has an adjustable tiller that can be locked to guide the boat in any direction. The motor is about five inches tall, has a 1 $\frac{3}{8}$ -inch-diameter propeller and weighs five ounces.

☞ Blind persons in Omaha circle raised numbers on special bank checks to denote amounts and sign them with thumbprint and signature.

Lightweight Indian motorcycles are built in two models. Left, the Arrow, single cylinder; at right, the Scout, vertical twin

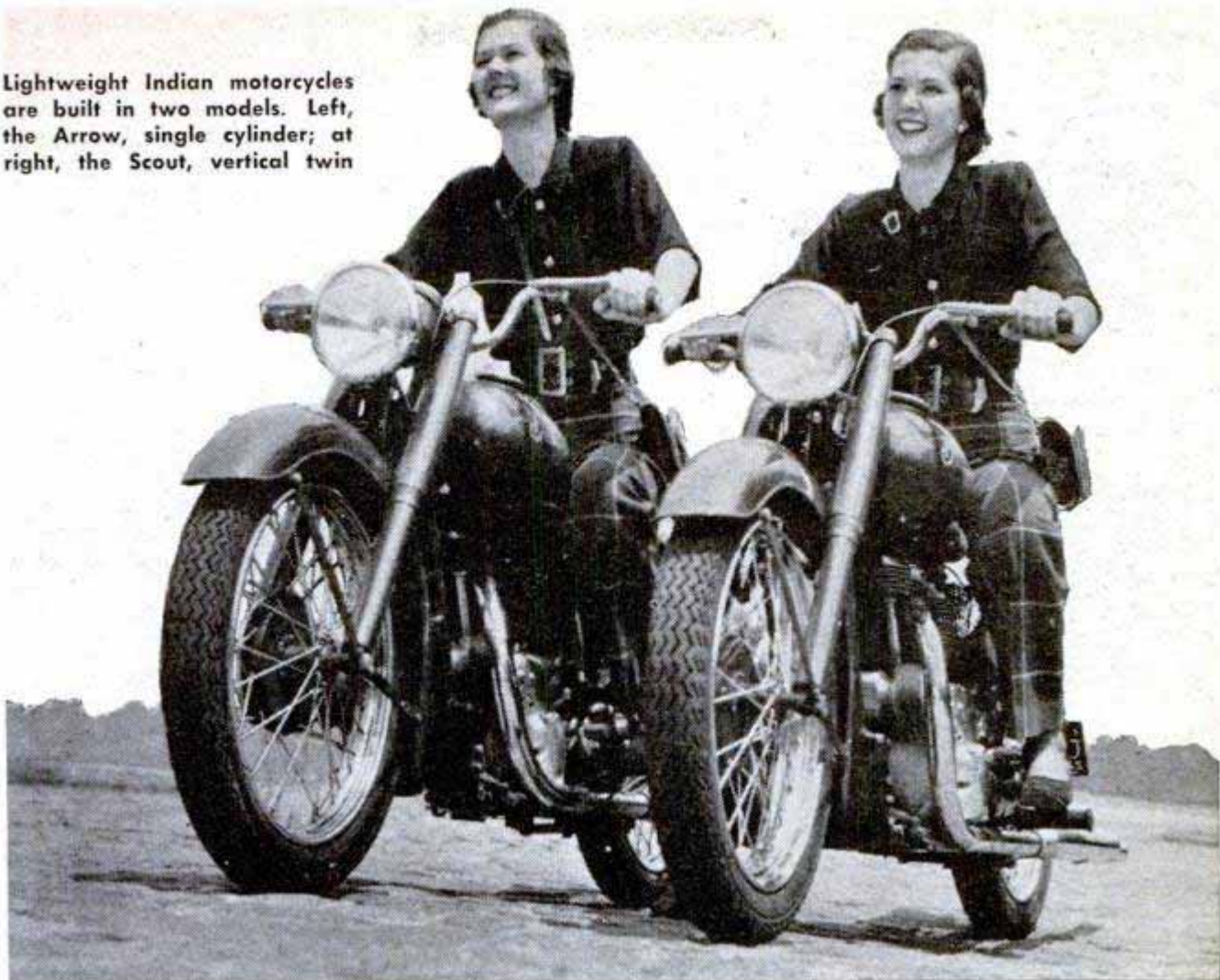

LIGHTWEIGHT MOTORCYCLES

Designed to outperform popular lightweight European motorcycles, two American models in that class are now in production. A single-cylinder model weighs 240 pounds and cruises at 60 m.p.h., going almost 100 miles on a gallon. The vertical-twin model weighs 275 pounds, and has a top speed of more than 90 m.p.h. Both have overdrive.

Lever on handle bar (left) replaces the old foot clutch and a light touch of the toe (below) operates shift pedal. Right, the controls are located so driver need not take hands off handle bars or feet off foot spuds

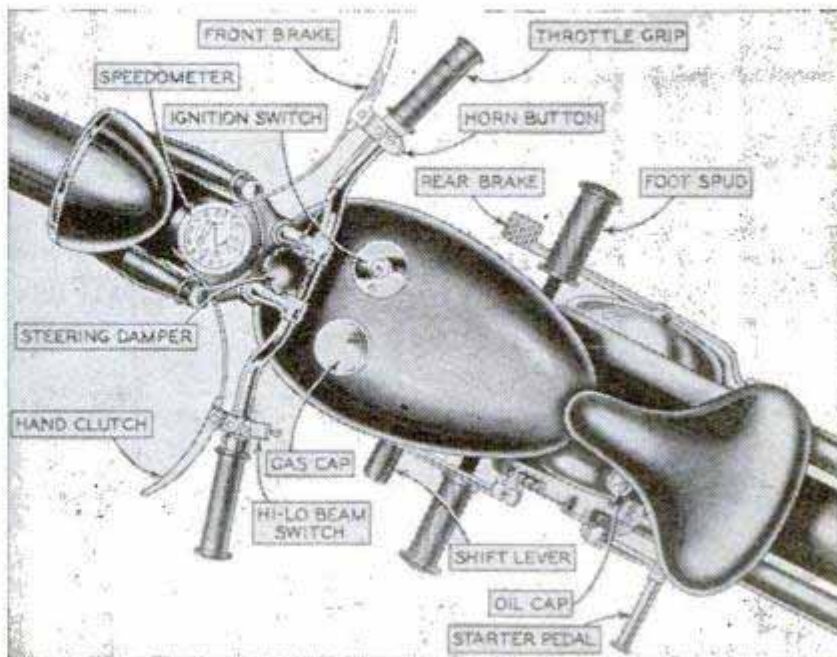
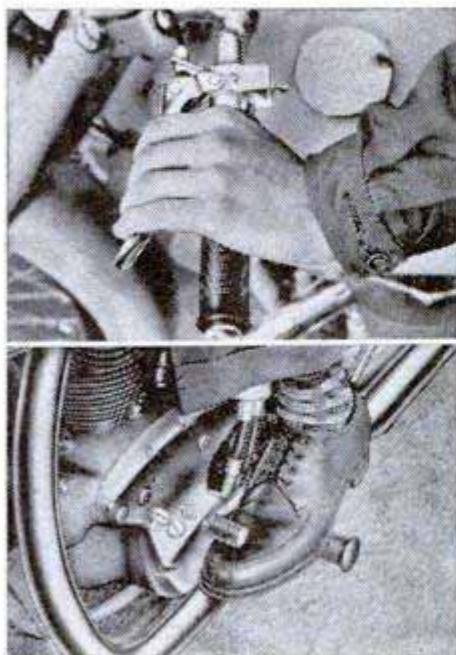

HOW TO WATCH A FOOTBALL GAME



What did you see in the photo above? If you are an average fan your full attention was on the ball carrier—completely missing blocker, center foreground, who is making gain possible

ON THE COVER is a rope maze used by both college and professional football coaches to teach players to run with a high knee lift that makes them more difficult to stop. It is also used in drilling them to twist, dodge and zigzag more effectively. Three ropes two feet apart extend the length of this patented training maze, with cross ropes every three feet, creating a ladder design. The ropes are about 15 inches above ground

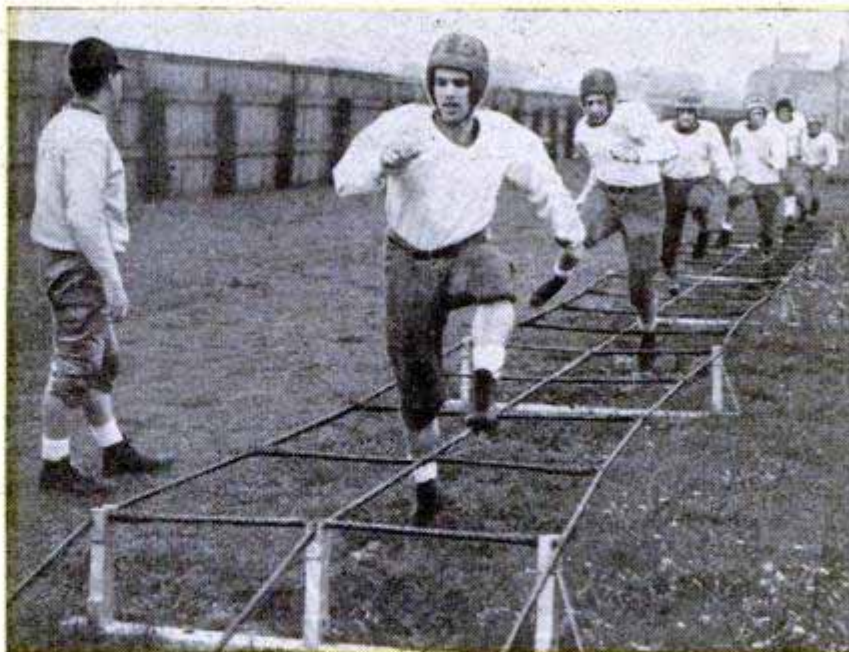

University of Notre Dame photo

HOW ABOUT sitting down with me some time this week, Bernie, and explaining just what those backs of yours were doing in last Saturday's football game?"

Who asked that question? Some foreigner, trying to get the hang of a game watched by millions of Americans every fall? Far from it. The puzzled questioner was Bobby Hargrave, a star Notre Dame quarterback of the early 1940s. He was asking an old teammate, Bernie Crimmins, now Notre Dame's backfield coach, about a game he'd seen the week before.

Hargrave's plight isn't surprising when you stop to consider how much the "T" formation, the spinner system and other offensive twists have changed the football picture—especially from the stands. They all put the emphasis on deceptive ball-handling and faking so artful that even opposing coaches and scouts are fooled. One backfield was adept enough at this sleight of hand last year to gain national fame as the "Four Magicians."

Up through the 1920s and until the late '30s, football remained a fairly simple game to watch.

As drawn by Coach Crimmins, success of this end-run play depends on two perfectly timed blocks, by right tackle and the fullback, and clever faking by the quarterback who hands the ball to back racing toward line of scrimmage. Broken line is path of ball to actual carrier

It put a premium on speed, shiftiness and power. Plays were set in motion by direct passes "floating" from the center to one of the backs, five to six yards behind the line of scrimmage, in full view of the spectators.

Now, with the popular "T" for example, there is a short, quick snapback—a man in motion to one side—and a concerted effort to hide the ball-carrier's identity.

The days when a dozen plays were enough to carry teams through a championship season are now long gone. One top professional team each season hands its squad members a full-size book of 500 plays, with instructions to know every one of them in complete detail.

No less an authority than Frank Leahy, Notre Dame's head coach and a man whose great teams entertain millions yearly, says

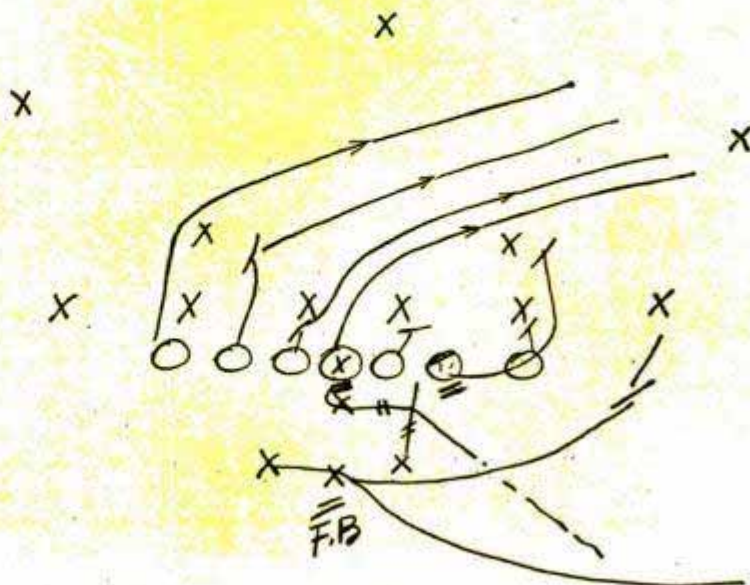

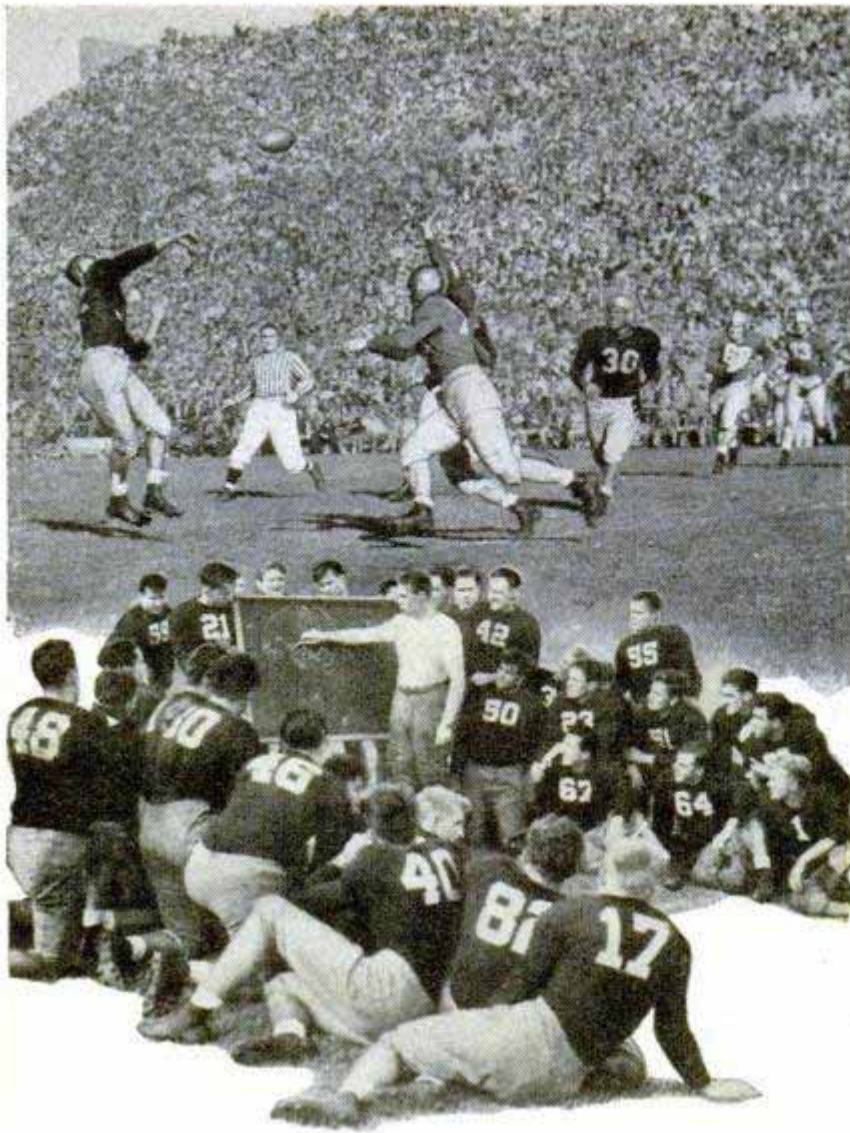

Top, two men rushing passer are coming in correctly, with hands raised high, forcing a high, fast throw. Above, Coach Frank Leahy of Notre Dame giving chalk talk in which each man's assignments are given

the average fan sees only about one fourth of the important action taking place on the field. Most spectators miss the blocks, fakes and decoys that mark a real team, according to Leahy. Others say that fans see even less of the vital play, the "little things" that may mean victory instead of defeat.

Here are six suggestions Crimmins offers fans on how to see more real football at a football game. As the first man in Notre Dame's history to win varsity letters at three different positions—halfback, fullback and guard—and as a coach and scout since, Bernie knows whereof he speaks. At guard he was practically a unanimous choice on the major All-American elevens of 1941.

1. Keep a wide vision, was his first and most significant piece of advice. Spectators generally make the mistake of riveting their full attention on a single point of action, totally oblivious of things happening only 5 or 10 yards away. Let your vision roam, Crimmins and

Below, illustrating the quick exchange of offensive and defensive roles, all 13 players at right have already switched their attention to the receiver, although the ball has barely left the kicker's toe

University of Notre Dame photo



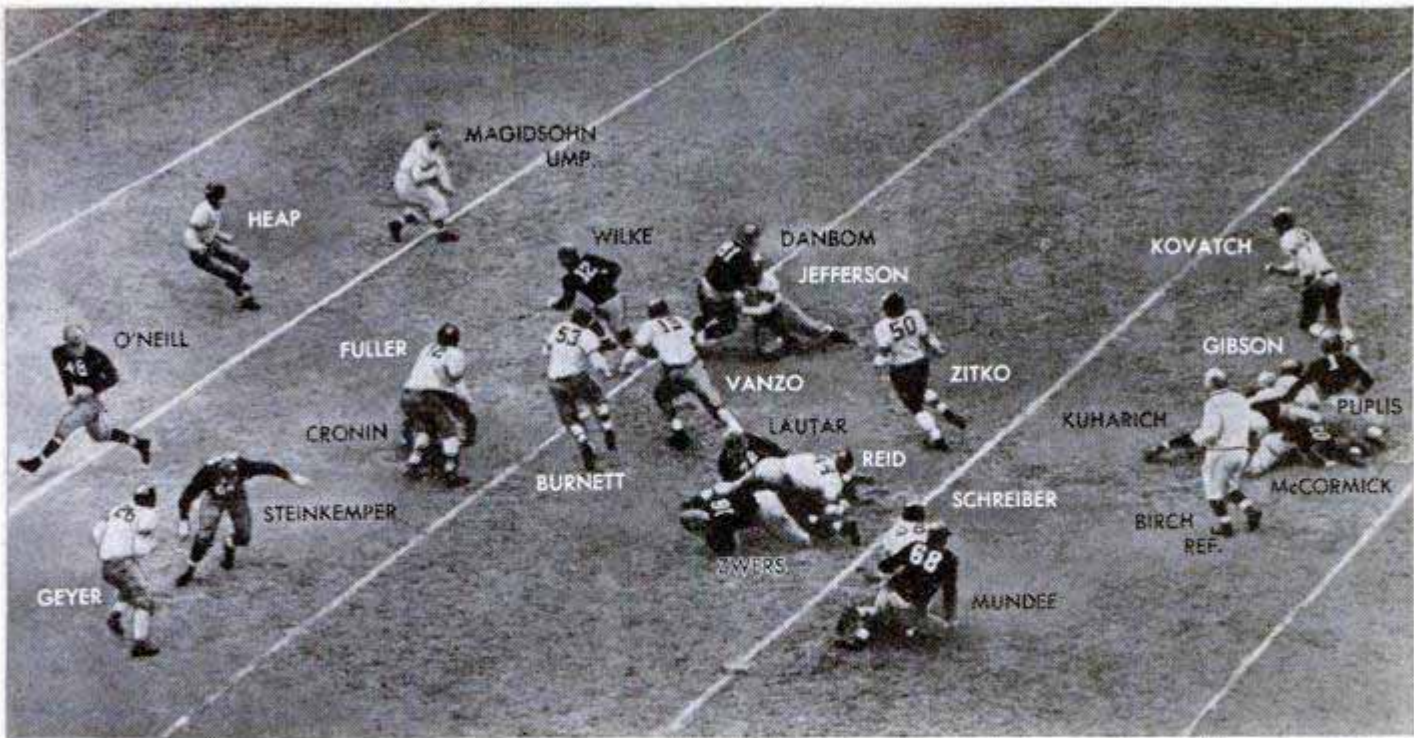

One of football's rarities, a photo taken during Notre Dame's "perfect play" against Northwestern in 1936 that includes all 22 players. Wilke's path was cleared from far right as he sprinted 33 yards to a touchdown

others urge, so that you take in a bigger picture around the ball or its handler.

2. Select a half dozen of the outstanding players on the field, both linemen and backs, and focus your main—but not complete—attention on their efforts during parts of the game. This will help increase your understanding of each position's responsibilities, as executed by experts. Particularly note how they block, tackle and use their hands and weight. On the 1948 Notre Dame team, for example, Crimmins suggests that the play of Fischer, Hart, Martin, Sitko, Tripucka and Swistowicz should provide some interesting watching.

3. Once a play has progressed to the stage where a pass is almost certain, shift your full attention to the probable receivers and especially note their maneuvering, one of the most difficult and entertaining of football skills. The "acts" put on by ends and backs trying to get into position to catch the ball unhampered are the most vital part of the play, rather than their

In this pass play, the offense "gangs up" on defensive half-back (circled x at right) and gives him impossible task of guarding two receivers, one in front and another behind him. Line backer (circled x at left) should shift right to help him

catching ability or the thrower's accuracy.

Generally, the receiver can do one of three things: run directly at the defensive back and then break to either side; run toward the defensive man and then retreat back toward the passer, or run out, stop, and then start up again quickly in an attempt to deceive and outrun the defenders. Some players will fake as many as four or five times on a single play before catching the ball. But whatever they do, and how they do it, offers action that is easy to watch if you're looking for it.

4. For a tip-off on pass plays keep an eye on the five men in the center of the offensive line. Knowing that those five men

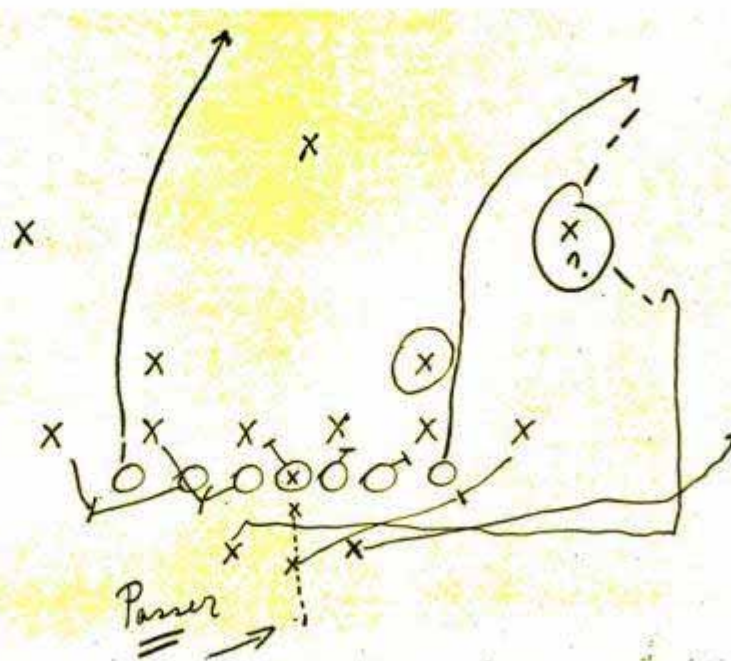

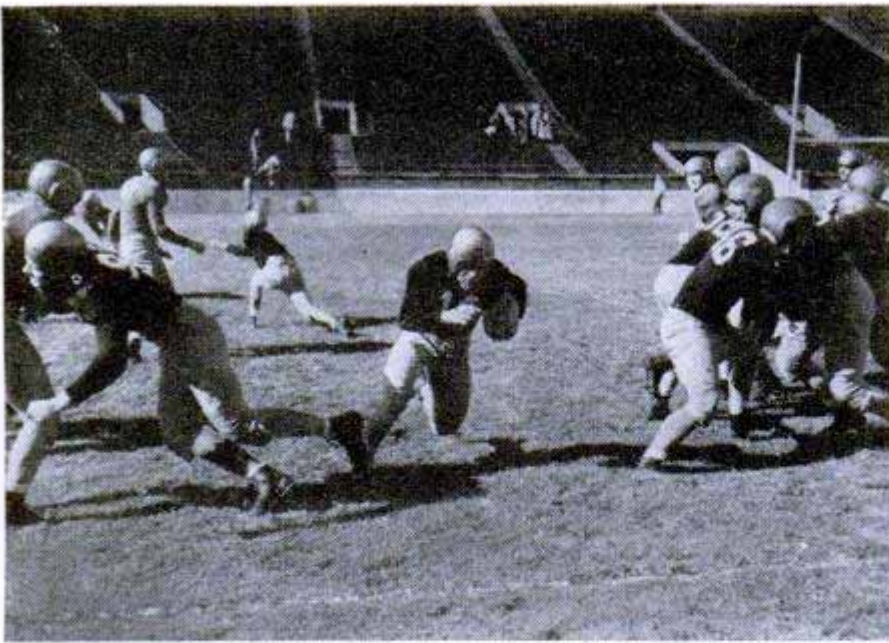

On off-tackle run, players at right are blocking correctly, but the man at left is "reaching" and off balance. Quarterback is completing his fake in background. Crimmins' diagram below shows how this play works

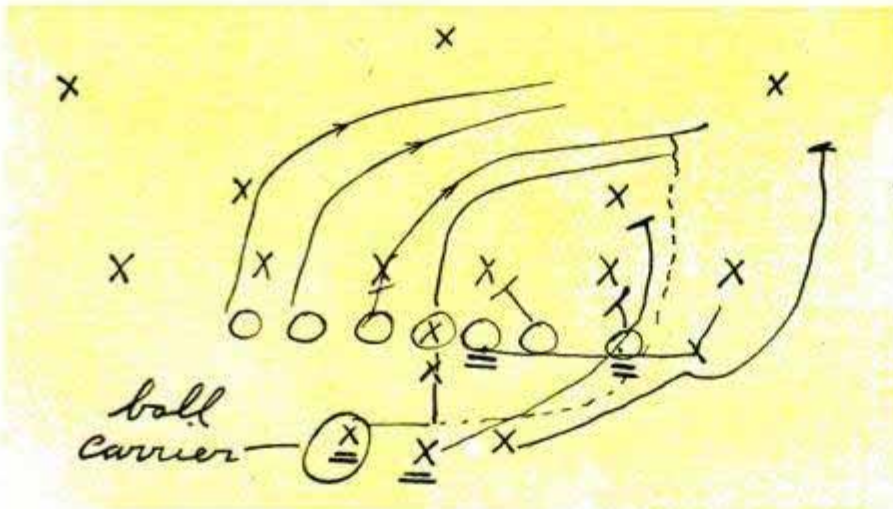

Key men in play below are the three blockers in the center foreground. Ball carrier, right, will cut in when opposition is blocked out of play



can't penetrate the line of scrimmage on a pass play, though they can move ahead after the ball is thrown, line backers and defensive halves watch them as a partial clue to the play that is shaping up. You can do the same thing.

5. Learn how at least three or four of the game's most frequently used plays work, so you'll better understand how the eleven players function together as a unit. On well-coached teams, every man has a definite assignment on every play. How well each does his job, from the ball-handler to an end racing away as a pass decoy, decides the play's success.

6. Ignore the ball and watch the players on punts. You'll see an abrupt change of roles once the ball leaves the kicker's toe. Blockers immediately become tacklers and tacklers switch to blocking, with the defensive ends sweeping downfield to force the receiver to take a path between them.

Crimmins and most other trained observers prefer to watch games from near the center of the field and high up—in the second deck if there is one. Occasionally, they'll choose a seat high in the end zone, if they are looking for some special detail. This is one of the few spectator sports where seats closest to the playing field are not considered best by experts. With the choice of locations in an empty stadium, many big-time college coaches trudge up to the second deck during practice so they can better detect individual playing flaws. So don't feel badly if you fail to get that sought-after sideline seat on the 50-yard marker.

Simplified Hydraulic Brake for Cars Has 50 Percent Fewer Parts

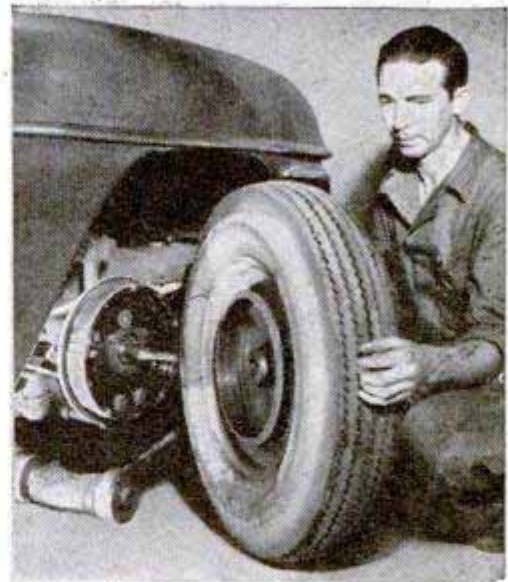
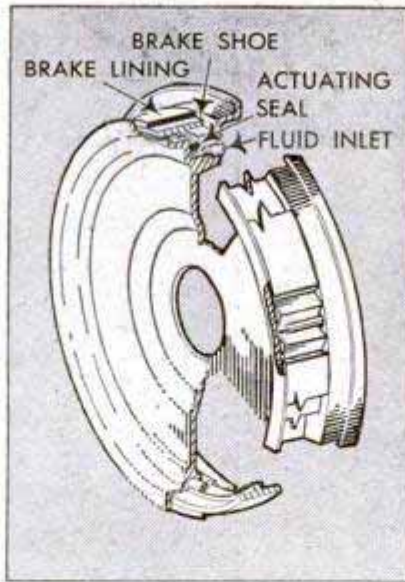
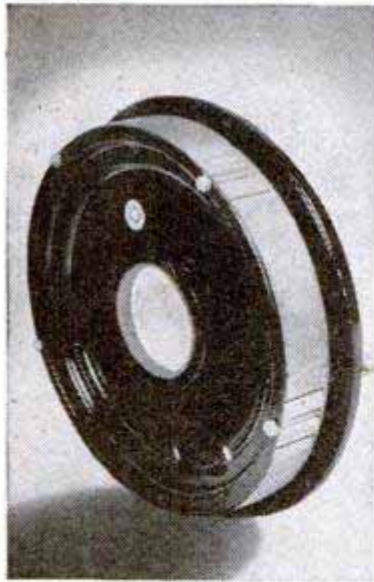

Simplified Martin brake was adapted from new airplane brake and engages all of drum. Complete brake assembly is shown at left. The brake at right is inspected after extensive road tests. It showed but few signs of wear

Originally developed for use on airplanes, a new hydraulic automobile brake has 50 percent fewer parts than conventional types. The brake requires no wheel cylinders, pistons or linkages and is said to be ideally suited for the smaller wheels with less room for brake mechanism. A continuous ring seal fits in a groove in the brake-shoe support and hydraulic fluid, actuated by the brake pedal, enters this groove and forces the shoe outward. This actuates the brake shoe in virtually a 360-degree engagement with the drum. In con-

ventional brakes the shoe lining engages only a fraction of the drum. The brake is extremely responsive to a light touch of the foot because full movement of the actuating seal is attained with relatively little fluid. The new brake, developed by the Glenn L. Martin Company, has been under tests for two years. Although it has been licensed for manufacture by the U. S. Rubber Company, extensive road tests in all kinds of weather are continuing and no plans for mass-producing or marketing the brake have been announced.

Hearing-Aid Battery "Breathes" as Used

Hearing-aid A-batteries which actually "breathe" are said to last three times as long as conventional types. An activated-carbon electrode acts as a "lung," permitting oxygen from the atmosphere to enter the battery to depolarize it. In conventional batteries, manganese dioxide is added to the mix to perform this depolarization. Because air does it in the new battery, more energy-producing chemicals can be packed in the same size case to provide more power. Air polarization is more efficient, also adding to battery life. When shipped, the battery has a sealing strip to prevent it from "breathing" until it is ready

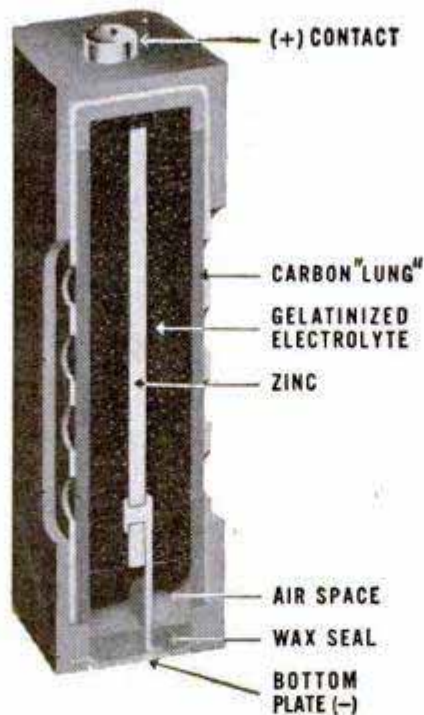

for use. The new battery has virtually constant voltage and can be used continuously without decreasing its effective life.



Hand Truck Moves Paper Rolls

Designed specifically to handle rolls of paper, a hand truck lifts and transports heavy cylindrical objects of any type. It can be used for moving drums, barrels and coiled wire as well as paper rolls. The truck is wheeled up to the roll and the top arm swung in place against the roll. A fingertip control locks the arm in place, holding the load securely. The truck is then tilted back and the load wheeled away. Two models are available, one for loads up to 800 pounds, the other for loads up to 1500 pounds.

Walking Robot → Has Radio Controls

Controlled by a radio installed in a truck, a 400-pound robot can walk under its own power. The mechanical man, built by Reat Younger of Springfield, Mo., stands over six feet tall and weighs 400 pounds. Younger was intrigued by a robot he saw in a motion picture when he was a boy, and started building his own automaton while he was in high school. He now is working on plans to make the robot walk through a complicated system of transmitters, receivers and relays.

☐ Overseas shipments of steel products from this country during World War II totaled an estimated 123,800,000 tons.

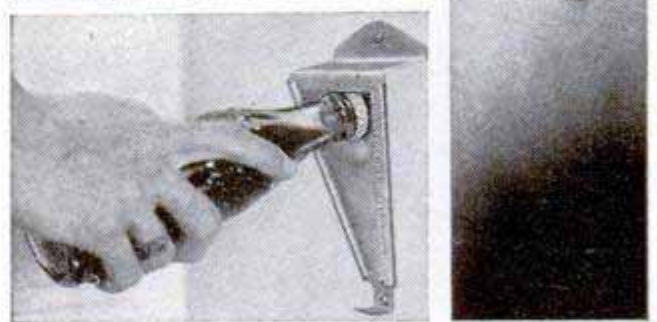

Opener Pries Lids From All Jars

Lids can be removed from all types of glass containers including Mason jars with an opener that fastens to the wall. Metal teeth grip the lid of a Mason jar firmly while the container is rotated. A recess with a projecting lip pries the tops from soft-drink bottles.

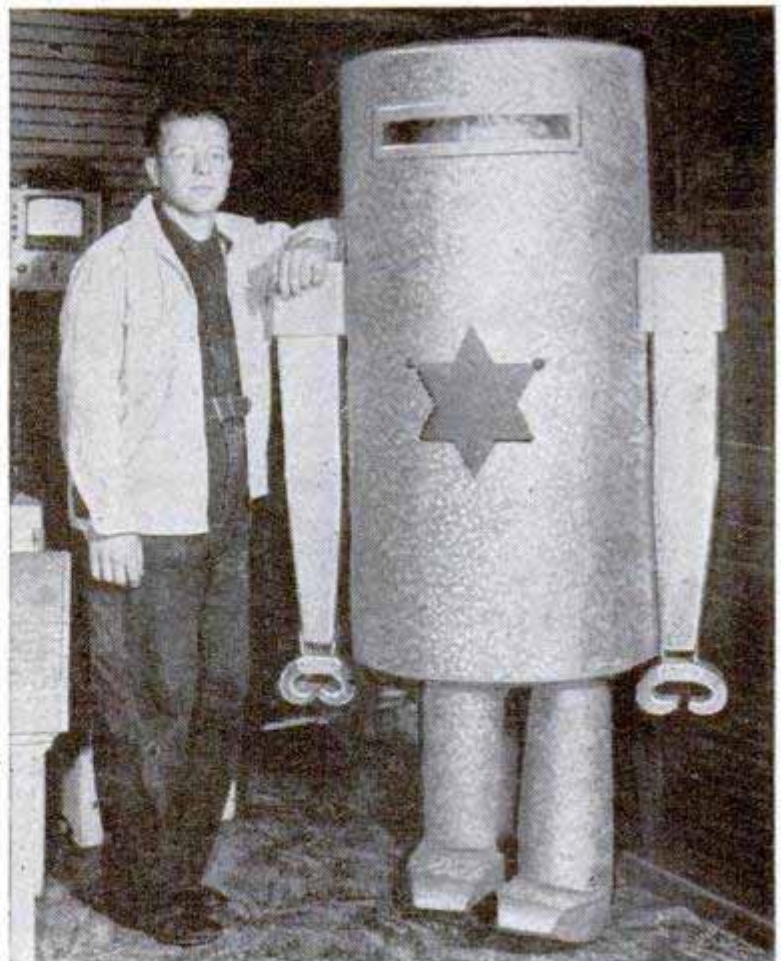

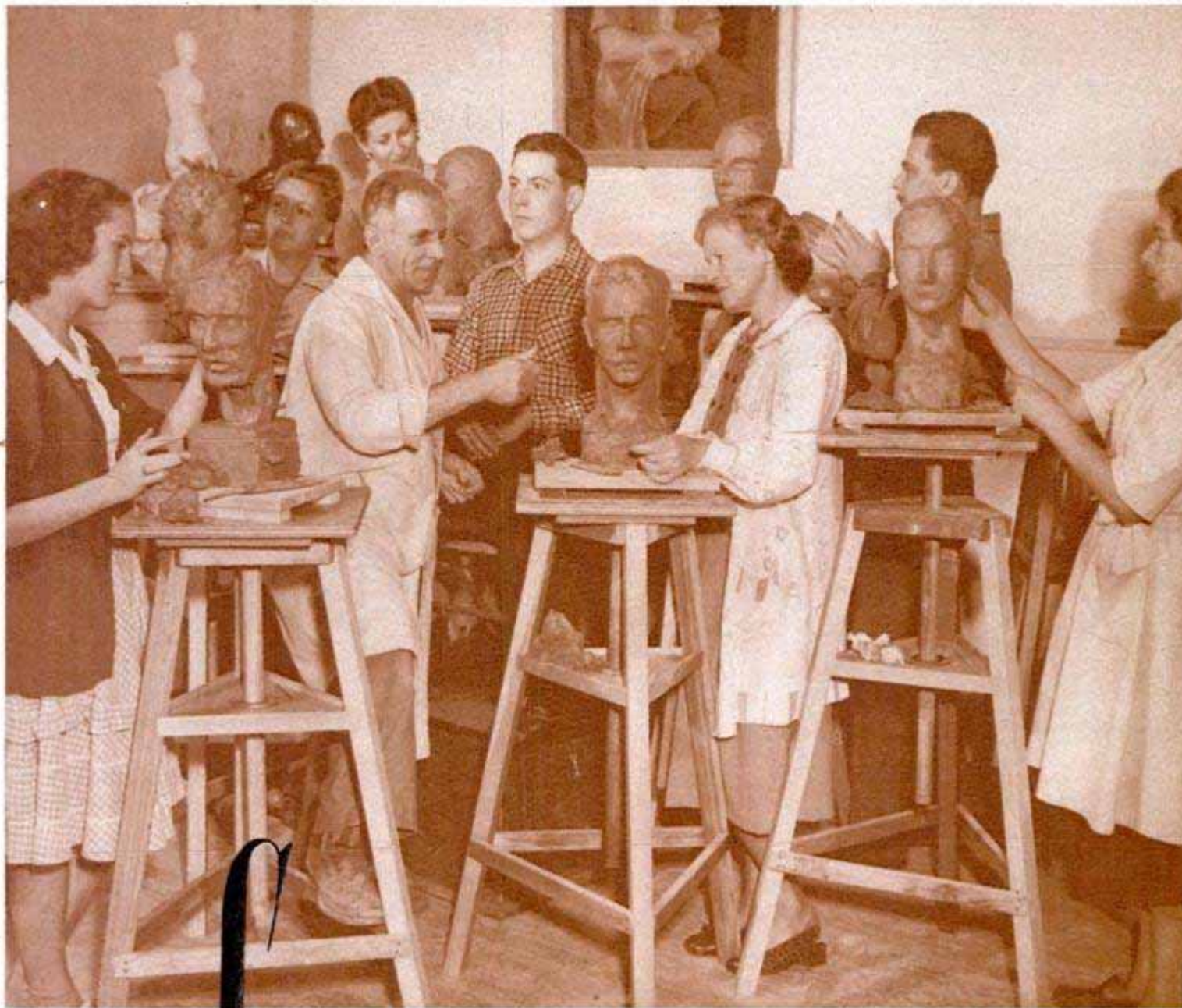

Amateur artists in clay are taught by Sculptor Ott at his once-a-week class

SCULPTURE FOR FUN

By Richard W. Emery

Photos by Ray Chapin

A GOOD sculptor can design anything from a kitchen kettle to a monument with his clay. He knows that sculpture is not just for the art gallery. It's a means of putting into three dimensions the ideas that can be sketched on paper in only two.

Industrial modelmakers are sculptors. Their work is practical. It may or may not be art—but just like the statue in the park, it starts out with clay.

In the sculptor's hands, clay is a wonderful building material. It can be measured, it can be cut, it can be added to, or bent or hammered. From a clay model, a plaster mold can be made. And the original clay

model can then be reproduced over and over in a permanent material such as metal or concrete.

Because clay modeling is a popular hobby, many sculptors teach classes of amateurs who claim no artistic genius. They frankly admit they are "sculpting" just for fun, and they'll laugh with you over shortcomings of their work.

"But just wait," they say. "My next one will be better!"

In a sunny studio in the hills of Laguna Beach, Calif., a distinguished sculptor, Peterpaul Ott, puts his own work aside one day each week to teach a beginners' class.

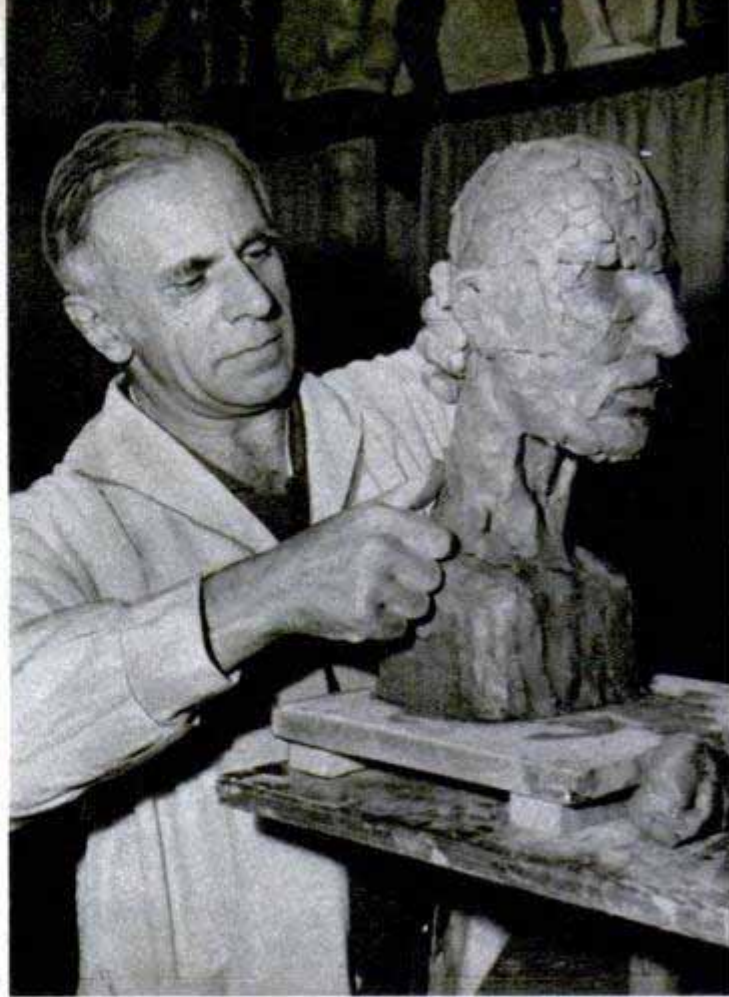
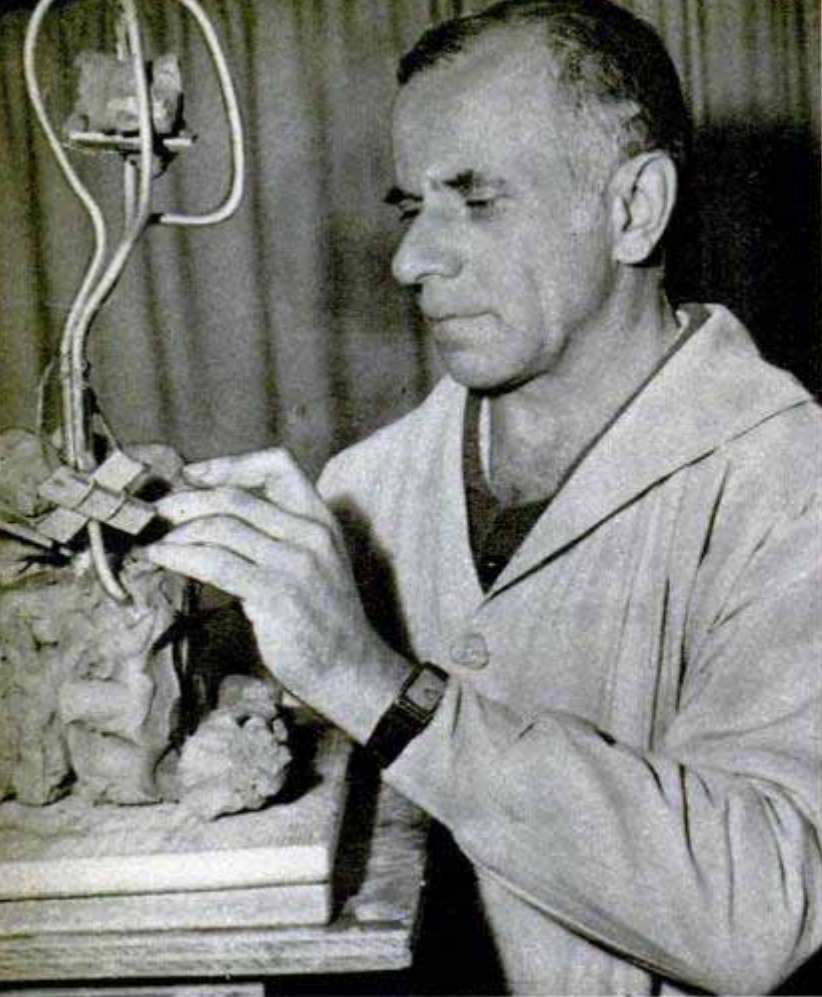

Left, sculpturing a head starts with this frame, called an armature. The wooden crosspieces or butterflies prevent clay from sagging. Right, clay is added, first in large, then in smaller pieces to form the figure

"And why not?" he asks. "I have always thought, why should sculpture not be fun? In the Old World where I was taught, if we made a mistake we got our knuckles rapped with a stick!

"There was no fun in those lessons. Here in my class, if we make a mistake we laugh about it. We start over. That is a better way! That is the American way.

"And once in a while, I find a pupil who learns rapidly and well. And I go along with his progress. For him—whoever he is—I have great hopes. Sculptors are needed in America."

To start a beginner, Ott supplies a board and plastic clay.

"First, pick up a handful of clay. Work it between your fingers. Mold it into simple geometric figures—get acquainted with it!"

The clay needs an anchor to keep it from skidding on the modeling board. If the model is small—up to fist-size—a couple of nails driven partly into the board will hold the clay. Larger models call for larger armatures, which serve as skeletons for the work to be done. A wooden peg, driven in at a slant, will hold a sculptured head on the board. For head and shoulders, the armature is a sturdy skeleton of pipe and wire, with floating supports called "butterflies" to prevent the clay from sagging.

The work in clay modeling calls for building a model to proportion by adding smaller and smaller quantities of clay. The principle is the inverse of the cutting and chipping process. In general, the wire skeleton should be designed so that its wires represent the center of the arm, leg, body or head.

Above left, sketch shows placement and proportion of features. Left, facial features rest on curve formed by round head. Below, geometric figure aids in forming lips

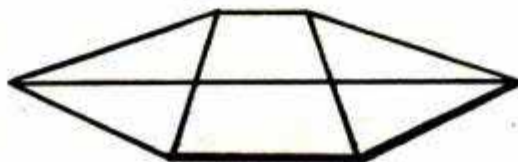
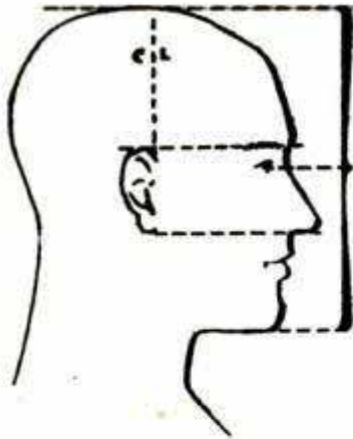

"You can then add clay equally around the wire. Students like to rush ahead on one part of their model—a nose, or an arm, we'll say. They cannot wait to finish it.

"After a few bad starts that way, they learn that they must bring their work up to the same degree over the whole model before going farther. The work must progress as a unit. Only then, can proportions be kept right!"

Ott gives his pupils this Rule One: *Don't start details until proportions are right.* The rule applies to constructing the armature and to later work with clay. You can compare the armature with the subject of your modeling by sighting with one eye, lining up key points as shown in the sketch on page 140. Later, the same check can be applied to the clay masses.

"Use your eyes! Sharpen your observation! As your work progresses, turn your model constantly; sculpture must be round. You must look at your work not just from front and back and sides, but from high and low."

How about calipers? Ott says not for first measurements. He believes that much of the fun in sculpturing comes from training your eye to measure what it sees, and from training your hands to translate those measurements into three-dimensional clay.

"Use calipers only to check possible mistakes," he says.

When your sculpture piece approaches right proportions in its over-all outlines, build it very gradually out to final dimensions by adding tiny pellets of clay. Roll them between your fingers one at a time and press them upon the surface of your work where it needs more clay.

Below, the eye is not shaped like a buttonhole (left), but fits inside a figure shaped as in center and looks like the sketch at the extreme right

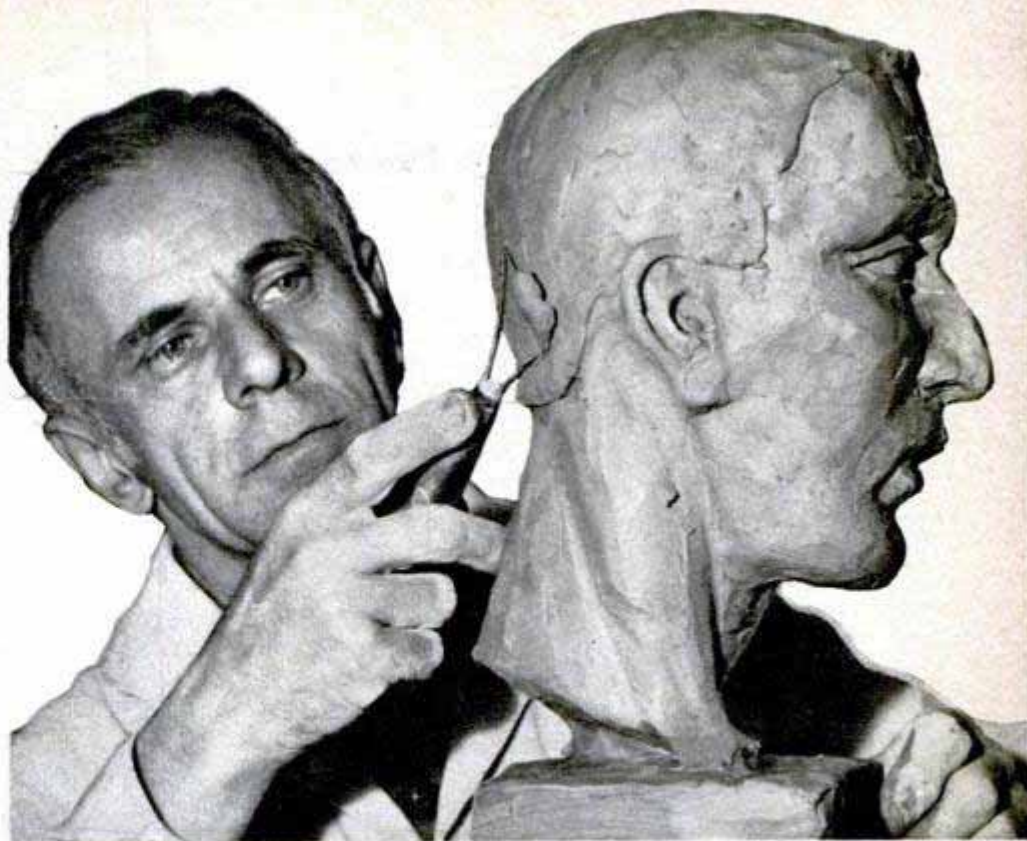

Above, a wire tool is used for final trimming where too much clay has been added. Below, Sculptor Ott instructs his students to use their fingers rather than tools for all but the final work on the figures. But for delicate work such as forming an eyelid, he uses a wooden modeling tool because the fingers are too blunt for this

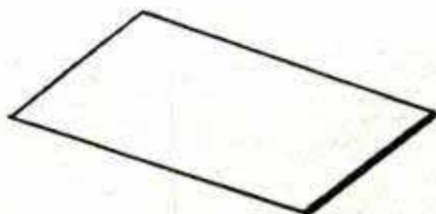
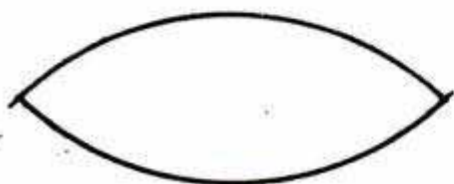

This process will give your work an alligator complexion, but don't let that disturb you. The problem is to get the work in correct proportion; in the finishing stage you can polish up the surface by filling cracks between flattened pellets.

Rule Two in Ott's class for beginners is this: *Build with small pieces of clay.*

The sculptor suggests, also, that his students keep a generous supply of clay close to their work. "That's always a student's problem," he says, "having enough clay. Keep it handy in a big bucket where it can be covered between working periods."

Ott believes that the best tools for clay modeling are the fingers.

"The longer you work with sensitive fingers instead of insensitive tools, the better for your work. *Tools should be used only for finishing!*" (That's Rule Three.)

Beginners trying their first sculpture of a head are almost sure to make the head somewhat square, instead of round, Ott says. To check against this error, study your work from all angles as you build. Complete the basic form of the head and then add the projecting features—the eyebrows, nose, cheeks, lips, chin and ears. Note the basic form in the accompanying illustration, which shows the relation between this curved surface and the features.

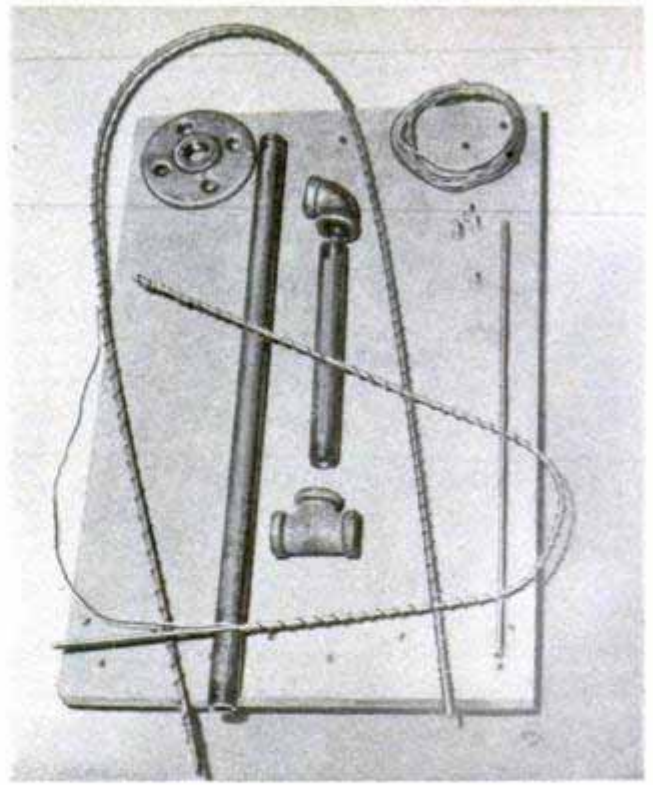

These look like something the plumber might carry, but they form the frame that holds the clay upright

Somewhere in your first sculpturing project, you may suddenly decide that you've got the proportions hopelessly wrong, or the pose awkward, or that you've tackled a subject too tough for your unskilled hand.

That's where Rule Four comes in: *When you've made a bad start, start over again.*

It's easier and better to do that than to try to correct major mistakes. Your second effort will go faster, and it will improve.

When you've reached the stage where

(Continued to page 246)

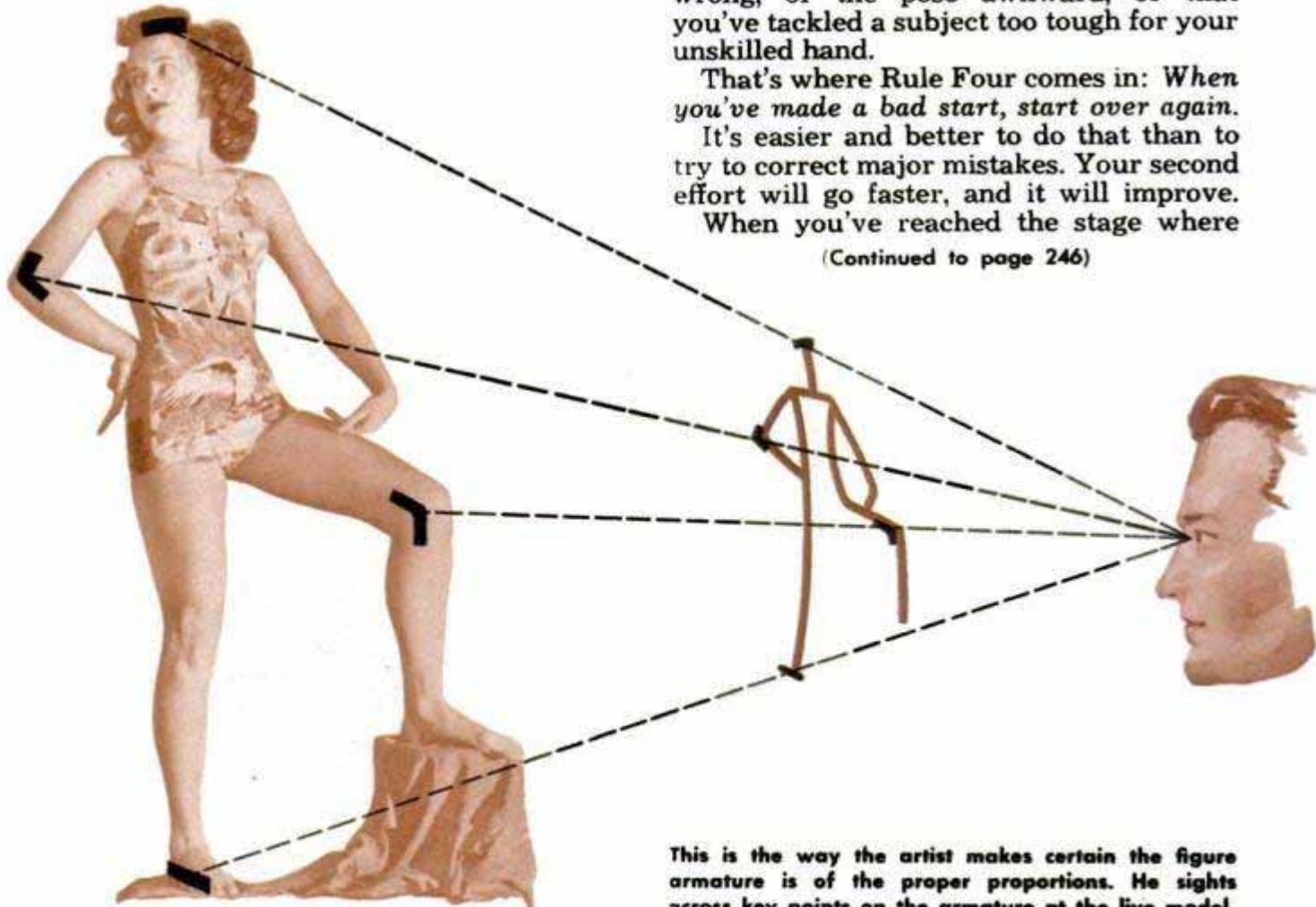

This is the way the artist makes certain the figure armature is of the proper proportions. He sights across key points on the armature at the live model. The wire of the armature must be aligned with center of arms, legs and body since clay will be added



Upper left, Ott, having assembled the figure armature, is now bending it to match the subject's pose. This will provide the framework on which he builds up the clay figure. Above, small pieces of clay are pressed around the wire armature as the figure slowly develops into a likeness of the model. The entire sculpture is kept in approximately the same stage of development in order that its proportions remain accurate. For most of the work, Ott needs no tools but his fingers. Only in final work are tools used

Above, rear view of the sculpture shows how the armature is supported by a pipe. Clay already covers the front of the wire frame and small pellets of clay are being added to the rear. On completed figures, equal amounts of clay surround the frame on all sides. At right, Ott poses with a finished bronze. Made by pouring molten metal into mold made from clay statuette

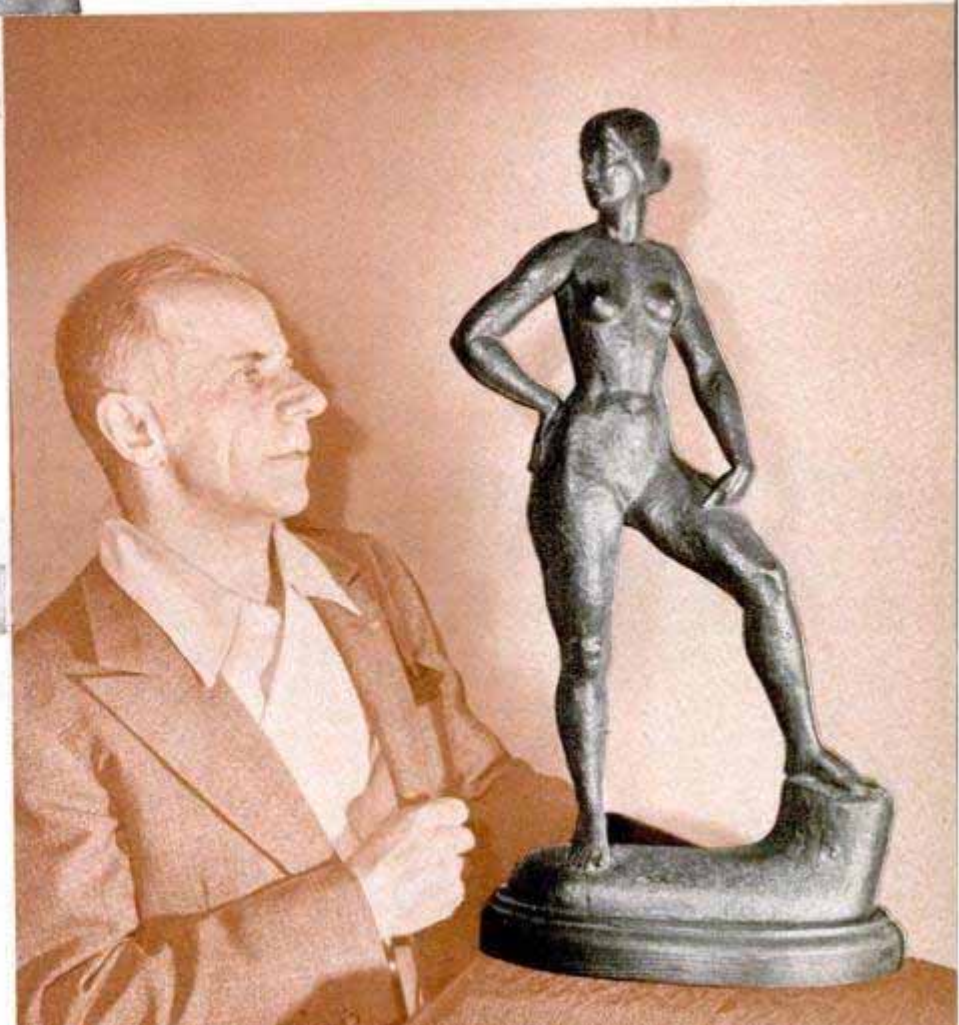



"Trailer" Unit Powers Lawn Mower

In 10 minutes you can convert your hand lawn mower into a power mower by adding a gasoline motor mounted on a trailerlike chassis. The motor drives two rubber-tired wheels that push the mower. To attach it, you remove the handle from your mower and bolt the chassis in place. The handle is then attached to the rear of the chassis. It can also be used to push hand cultivators or other wheeled implements.

Daggerlike Tool Opens Boxes

Resembling a long dagger, a box-opening tool can be used for six different purposes. It serves as a hammer, crowbar, nail remover, tacker, knife and staple remover. The tool is made of steel and has a long blade that is unsharpened so that it can be used as a handle.

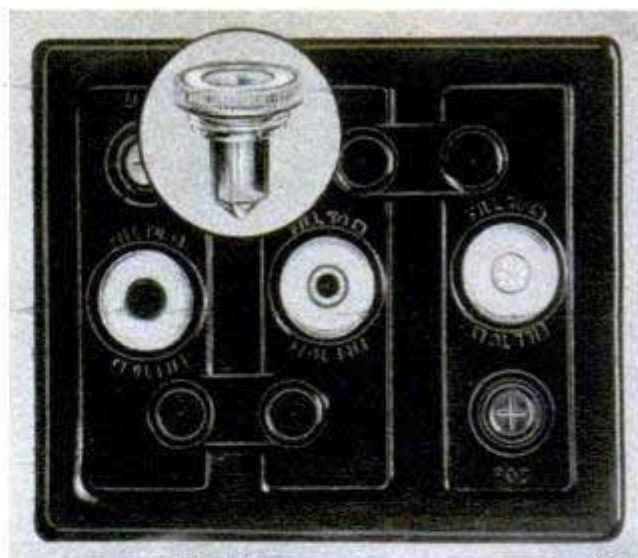
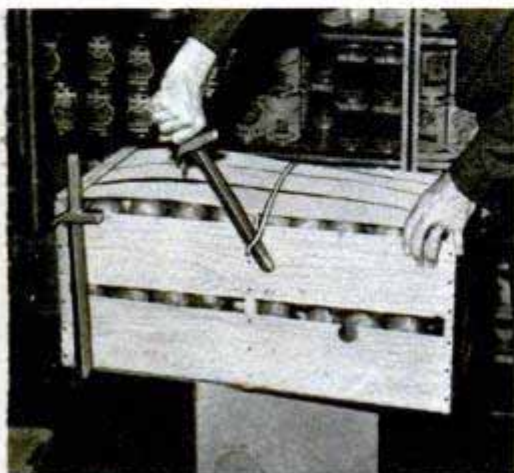

Battery Plug Shows Water Level

Motorists can "see into" their storage batteries to determine the water level when a new battery plug is used. Prisms at the bottom of the plug refract light when not in contact with water. When the prisms are covered with water a solid black disk can be seen through the plug, meaning that no water is needed. When the water is low the words "add water" can be seen by looking down the barrel.

Auto Desk Swings Out of Way

Swinging out of the way when not in use, an auto desk provides a sturdy writing surface and is complete with paper pad and pencil. It is attached with one bolt to one of the "knock out" holes found under the dash. The desk is handy for salesmen, doctors, shoppers and others who have occasion to jot down notes while driving.



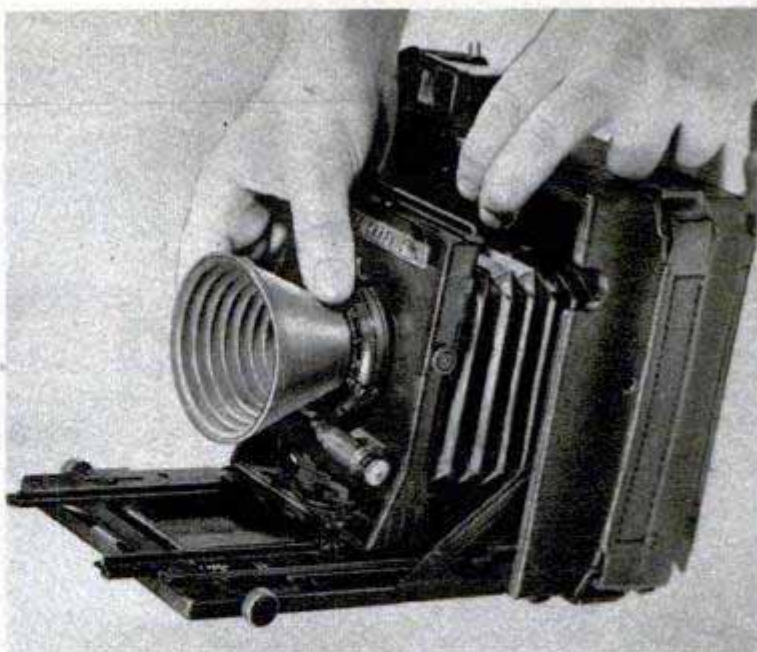

FOR CAMERA FANS

LENS SHADE and filter holder (top) is always on your camera ready for use. Made of soft rubber, the shade cements to the lens mount. It is flexible and the camera can be closed with it in place. Concentric grooves inside the cone act as filter holders. Its one size can be trimmed to fit almost any lens

BORDERLESS EASELS are easily made by pouring a long-lasting adhesive from a can. Heated until it melts, the material is poured into a shallow tray and allowed to cool. It hardens into a smooth, even surface that holds paper securely. The easel can be used for copying work as it needs no glass or pins

EXTENSION FLASH (below) eliminates long cords as it is fired by a photoelectric cell built into its reflector. When the bulb on the camera goes off, the light is picked up by the "eye" on top of the extension light and an electronic switch fires the slave bulb. The eye can be aimed in any direction



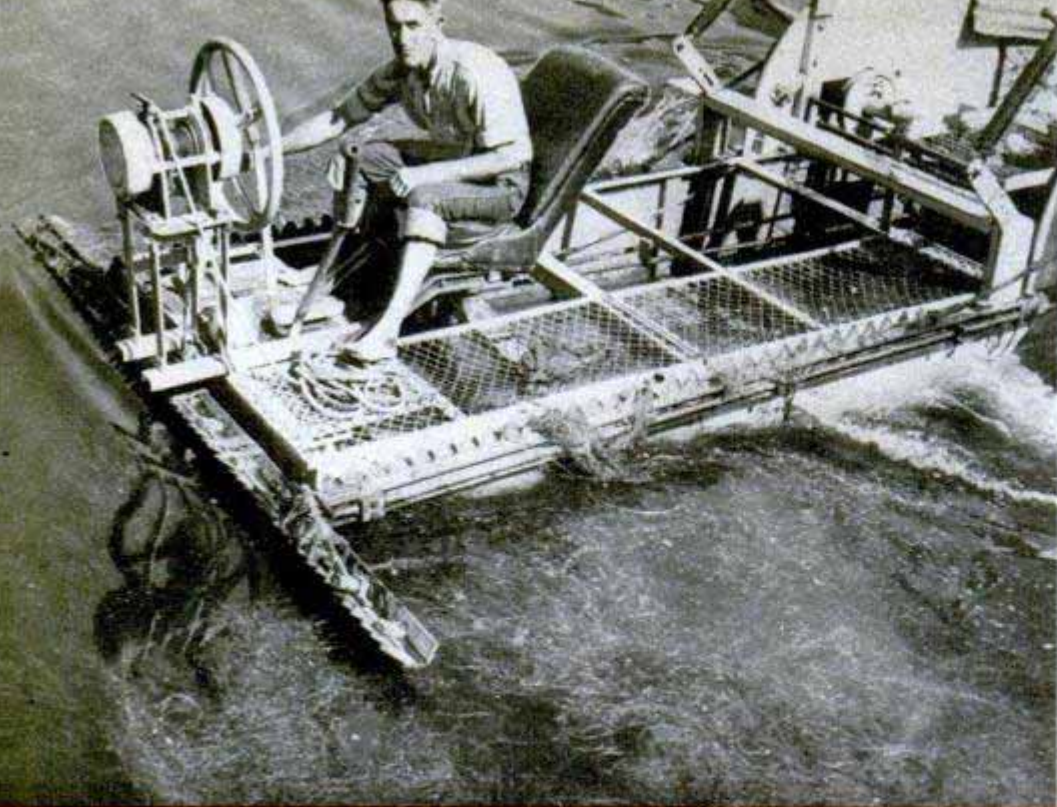

Mechanical weed cutter (note blades under water) is being rebuilt to operate by hydraulic power so it can be used with new hydraulic boat

Hydraulic Jet Drives Work Boat

To operate dredge, water is pumped under pressure through upper pipe and reverses to flow back through lower pipe to create needed suction

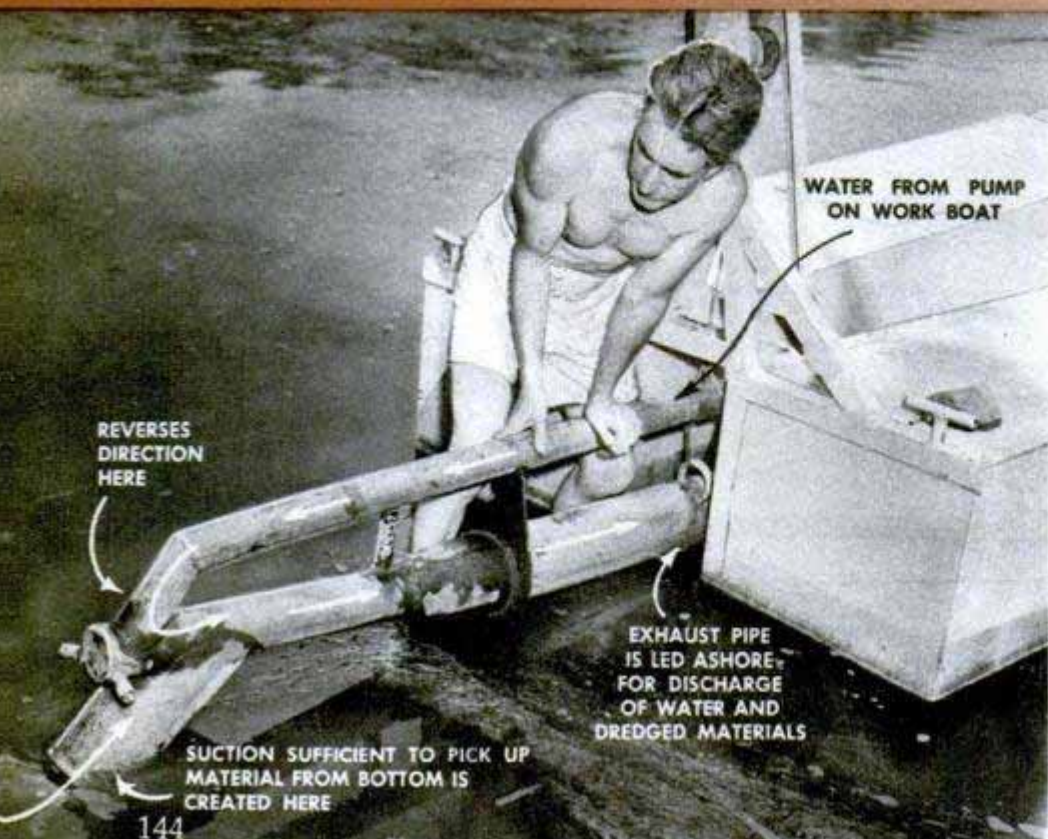

AN UNDERWATER hydraulic jet takes the place of a propeller on a novel work boat used for dredging, fire fighting and other odd jobs at Malibu Lake near Los Angeles. The all-hydraulic boat is powered by a 500-gallon-per-minute pump driven by a 90-horsepower engine.

Water from the pump is discharged through a curved underwater nozzle pipe to push the boat at speeds up to 12 miles per hour. A steering wheel turns the nozzle in any direction.

The boat is a simple 8 by 12-foot plywood box with a draft of 6 inches. Water for fire fighting is supplied by the pumping unit at a pressure of 120 pounds per square inch.

For dredging operations the work boat is attached to a float that supports a double dredging pipe that may be lowered to the bottom. Water under pressure from the pump flows through one dredge pipe and returns through the other, creating a suction that sweeps in materials through an open nozzle. Water and materials are pumped ashore through a flexible tube that is supported on floats. The dredge can handle up to 150 cubic yards a day.

Delbert Dickenson, who planned and built the craft, is constructing a weed-cutting attachment, hydraulically operated, that will allow the boat to replace the mechanical weed cutter now used at the lake for cutting lake grasses and weeds. The weed cutters resemble hay cutters and are lowered to the bottom for shearing the grass close to the roots. The cut grasses are gathered in a net and are towed to the beach where an endless belt lifts them to a truck.



Where's the fire? Pumping unit can shoot a heavy stream of water 100 yards or more and carries ample hose

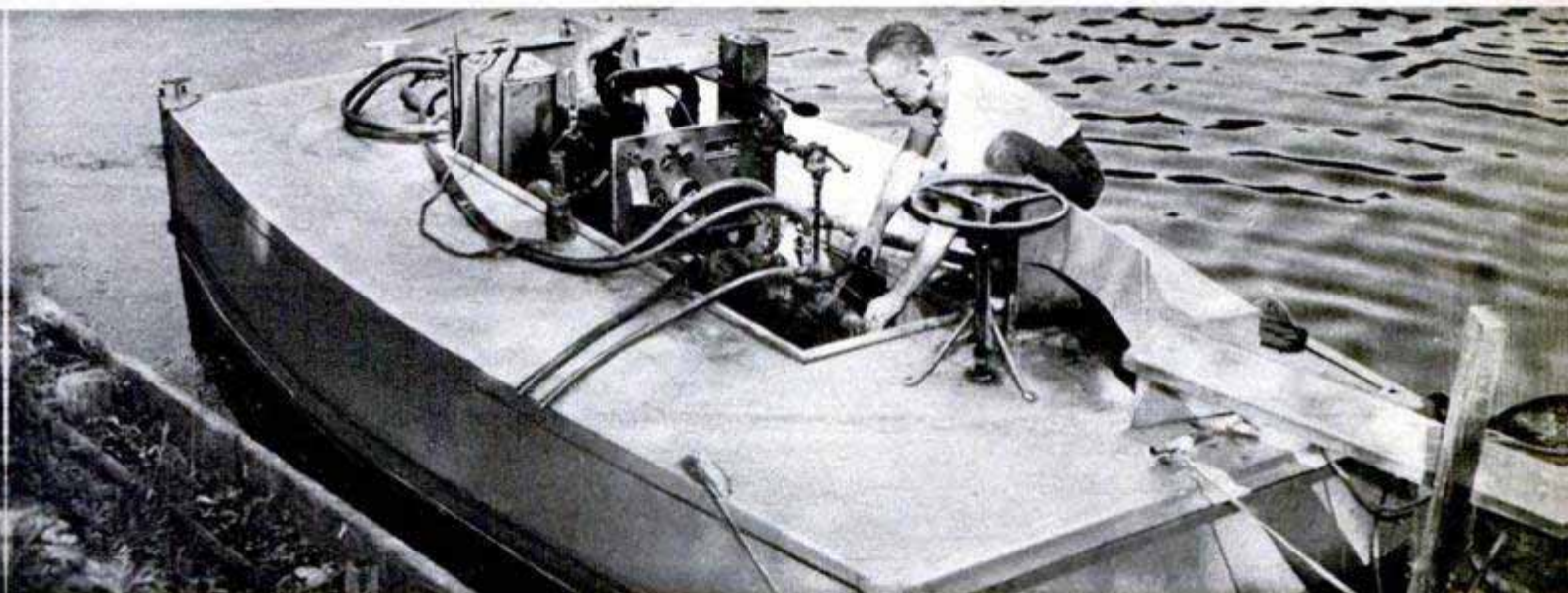

Mounted amidships in the plywood hull is the pumping unit which consists of a 90-hp. gasoline engine and a 500-gallon-per-minute pump. The propulsion nozzle is under the steering wheel at the near end of the boat

Floating drums serve as supports for large rubber tube that carries the dredged material ashore. Shallow portions of Malibu Lake are being deepened and the dredged materials are used to build up shore elevations

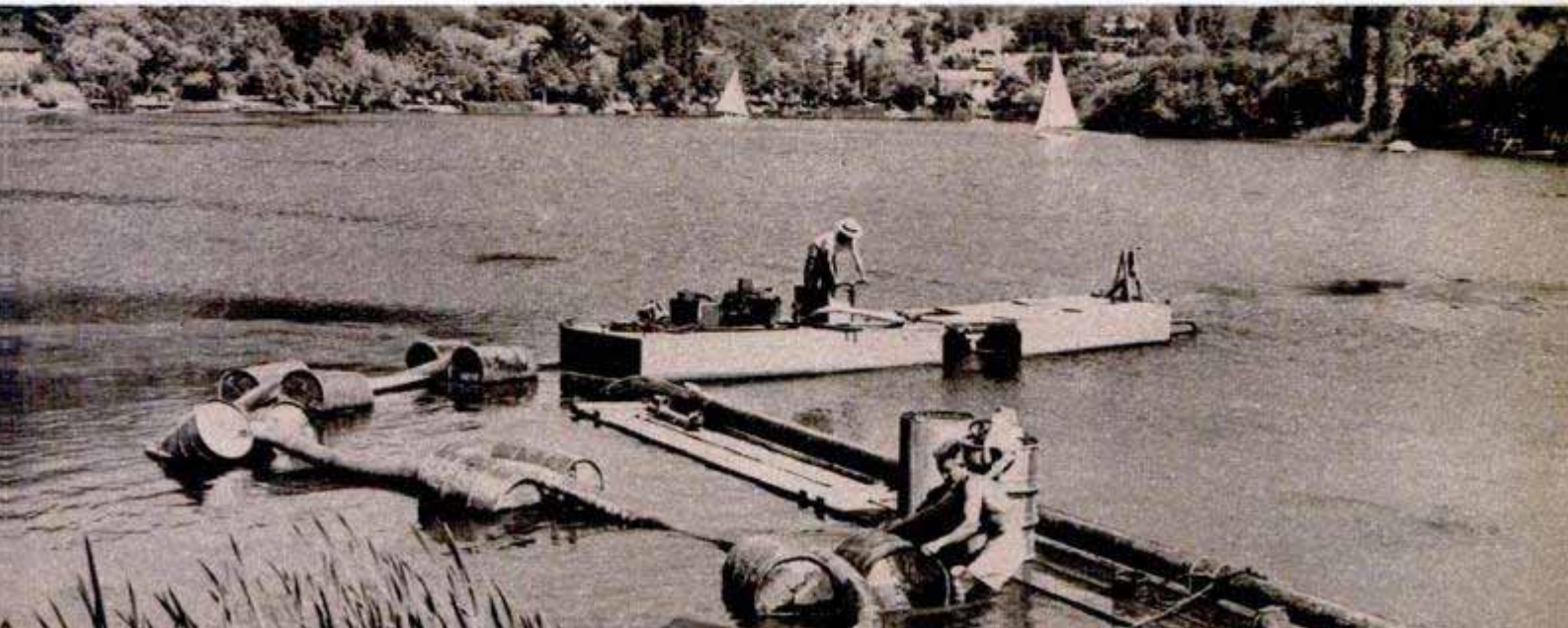

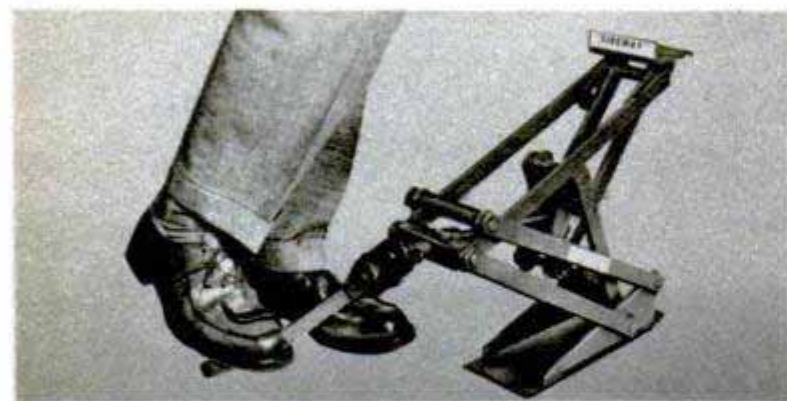
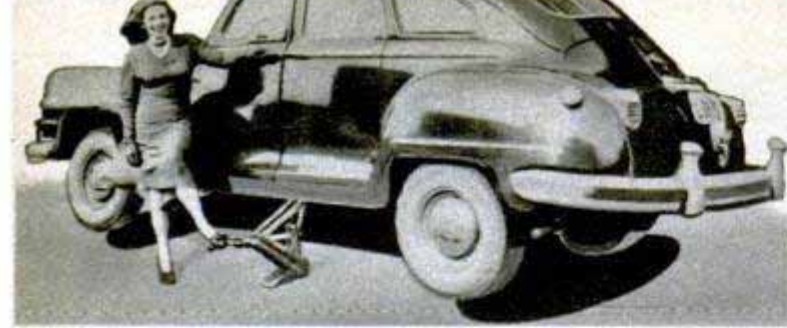

Jack Raises Car Sideways

Automobiles are jacked up from the side by a foot-operated jack that is placed under the chassis frame. It's not necessary to get under the car to put the jack in place and there's no danger of the car slipping off the jack. The foot lever has a ratchet action and the car is both raised and lowered smoothly.

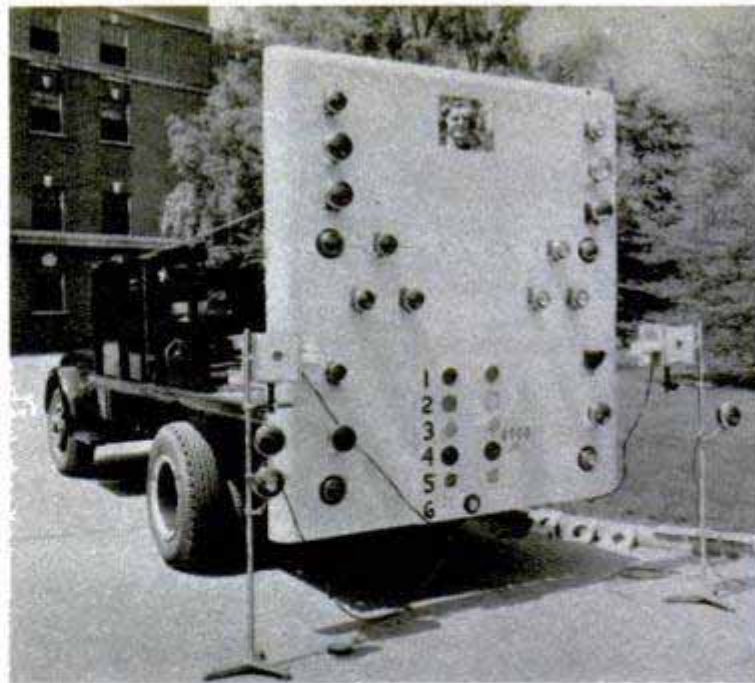

Tester for Truck Lights

Test equipment consisting of more than a score of red and amber "stop" and "turn" lights mounted on a panel may result in more effective signals for trucks. The lights are studied at distances up to 500 feet under both day and night conditions. Tests show that lights should be red or amber at the rear of a truck; preferably red, amber or white at the front; that they should be at least four inches in diameter, and that they need not bear printed instructions or arrows. The studies were made by the Society of Automotive Engineers with the cooperation of General Electric.

← Giant Frying Pan

Only a Paul Bunyan could flip flapjacks from a giant frying pan that weighs 1100 pounds. The big skillet is made of steel. It was used to fry clams for 2500 people attending a Chamber of Commerce clambake at Long Beach, Wash.

Convertible-Top Cover

Convertible-top covers made of translucent plastic protect canvas automobile roofs from rain, snow, salt air and dirt. The covers fit snugly and can be installed in five minutes. They are easily cleaned with soap and water and can be washed in any standard washing machine. Tops can be raised or lowered with the covers in place.

Popular Mechanics is always ready to supply further information to readers about various products described in any issue. Just write to Bureau of Information, Popular Mechanics, 200 East Ontario Street, Chicago 11, for a prompt reply

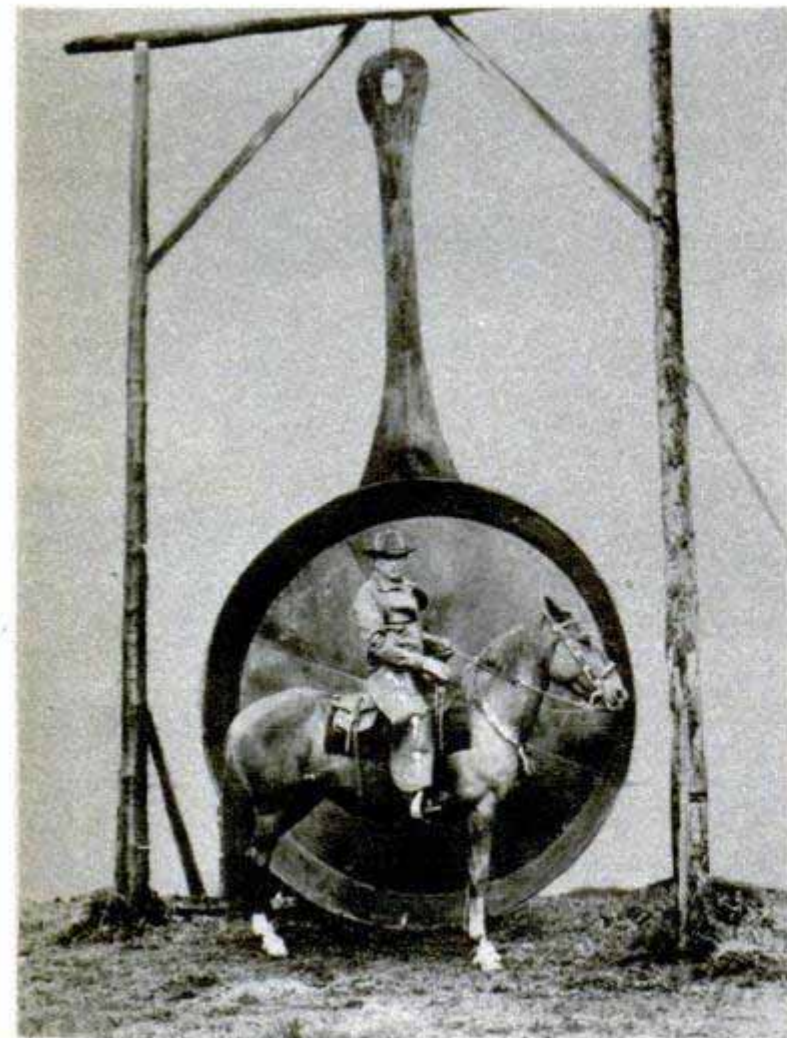



musical toys from planes

Above, some of the materials salvaged from the war-surplus planes. Top right, the Tennessee trio didn't stop with musical instruments. The sportsmen's trailers were once training planes

When three Tennesseans bought 350 war-surplus planes for \$1750, nobody dreamed it was the start of a musical-instrument business. But that's what happened. While salvaging miles of aluminum tubing from the planes, they discovered that various lengths produced musical tones when tapped. That started them producing toy xylophones. Mahogany veneer from the fuselages is now used in building cabinets for tiny grand pianos which make their music with lengths of the salvaged tubing instead of strings.

Right, one of the three men has a background that fits the new business. He made this xylophone with plate-glass strips and paper tubes. Below, the tiny baby grand piano. Below right, playing a duet on aluminum-tubing instruments



The world's peoples are increasing faster than the earth's ability to feed them.

Against the looming specter of starvation scientists pit their ability to solve the secret of chlorophyll, whereby we may grow

more food from light

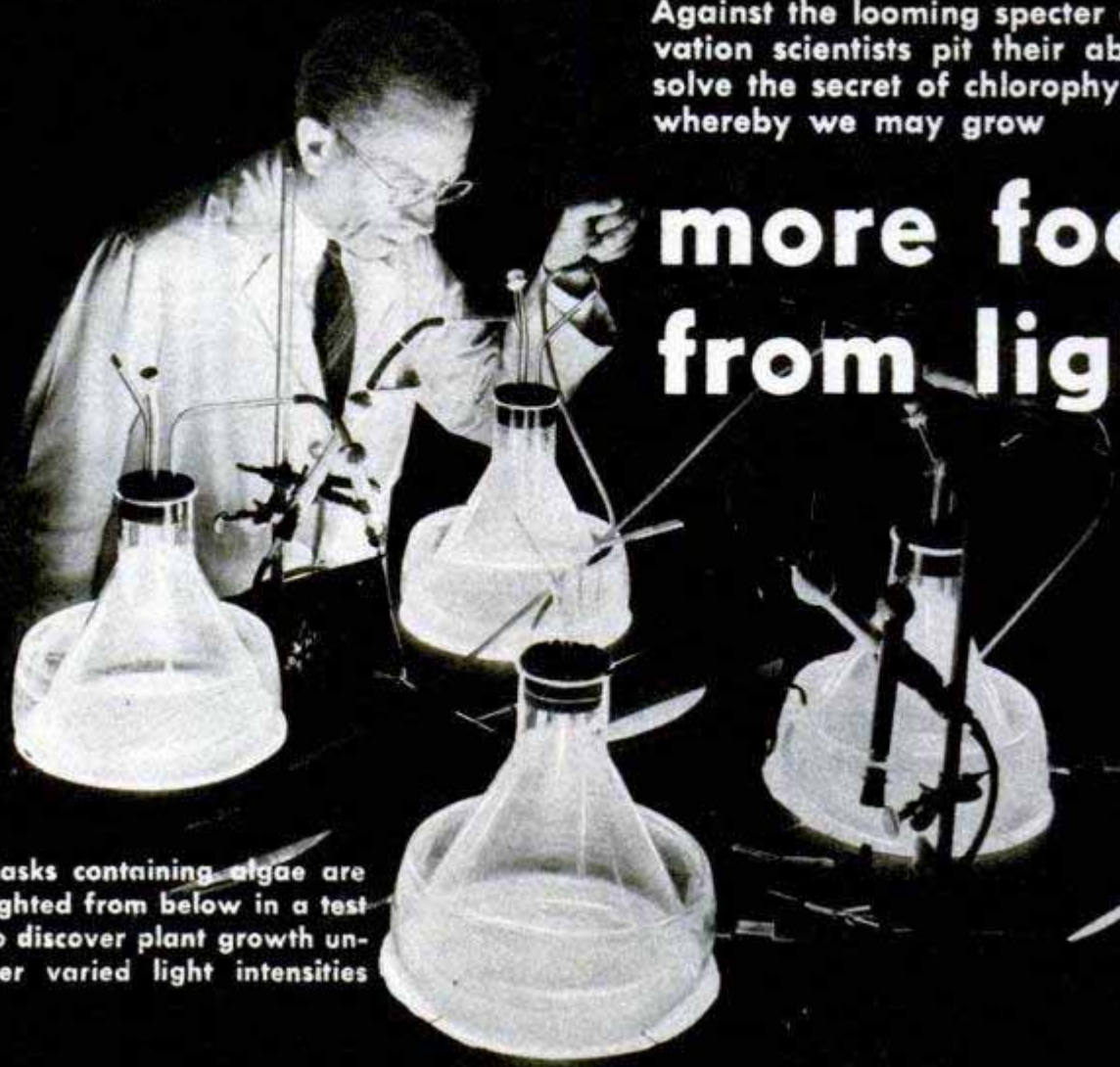

Flasks containing algae are lighted from below in a test to discover plant growth under varied light intensities

By Thomas E. Stimson, Jr.

SCIENCE has a task confronting it that is far more important than the job of putting atomic energy to work. Science must, almost immediately, find a new way of creating the fats, sugars and proteins that are needed to fill the world's stomach. The timetable of necessity shows that this must be done in the next 52 years. By the year 2000 the need for food will be desperate. This is because 50,000 people are being

added to the world's population every day. In spite of the war, for example, the populations of the countries encompassed by the Marshall Plan have increased by some 100 million people in the last decade. Agriculture can't keep abreast of the increasing demand for something to eat.

What science hopes to do is to discover some way of controlling or duplicating the process of photosynthesis, the method by which living plants convert light energy into chemical energy. If this can be done it will open the way to manufacturing foods in almost any amounts that are needed. The difficulty is that photosynthesis is so complicated that even after a century of research the process is still a mystery.

"A plant takes carbon dioxide from the atmosphere and water and a few minerals from the ground and then by means of light it converts these ingredients into palatable foods," states Dr. C. Stacy French, who directs the division of plant biology of

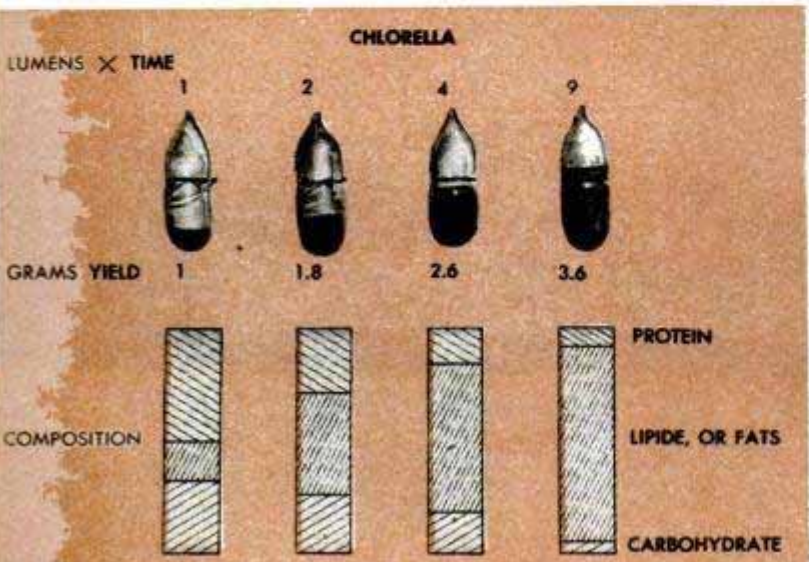

Chart shows how composition of Chlorella can be controlled by varying the period of exposure to light

Pure-white barley, grown in the dark, is exposed to light to determine the time required for it to become green



working knowledge of photosynthesis is developed it will be possible to force plants to produce whatever foodstuffs are desired. A plant's fat-production apparatus, for instance, could be blocked off so that proteins or carbohydrates would be manufactured in greater than normal amounts. Or, if desired, an abundance of vegetable oil could be produced in a plant from which only moderate quantities can be taken now.

One important step in this direction was taken recently when Dr. H. A. Spoehr of the Carnegie research group was able to produce plants that assayed 85 percent in good vegetable fat. Doctor Spoehr performed his experiments with *Chlorella*, a common freshwater alga. This microscopic form of plant life is a standard laboratory guinea pig of photosynthesis research workers. *Chlorella* has a simple structure, is similar in photosynthesis characteristics to other plants, and is easy to

the Carnegie Institution of Washington.

"Presumably the plant's green chlorophyll, triggered by solar energy, splits the molecules of water in two. The oxygen is given off as a gas and the hydrogen apparently is attached to some substance that then is able to reduce carbon dioxide into sugars, fats and proteins.

"We can't duplicate the process and we don't understand all the reactions that occur. We don't even know what catalysts, if any, are involved."

Some authorities think that as soon as a

handle and measure. Ordinarily, this alga has a fat content of around 10 percent.

Working in the photosynthesis laboratory of the institution, located on the campus of Stanford University in California, Doctor Spoehr found that by controlling the amount of light that is radiated on the *Chlorella* and by controlling other factors he could produce vegetation that has a fat content of 85 percent and a protein content of almost 9 percent. By changing the environment he increased the amount of protein to 58 percent and at the same time reduced the fat to 4 percent. The

amounts of carbohydrates varied from almost 6 percent to about 37 percent.

This important accomplishment doesn't suggest that we will soon be able to harvest cubes of butter from convenient bushes or to grow beans that are as big as your fist and that are super-rich in protein. Structurally, the higher



Small evergreen tree in center has a white top. It was placed in the dark after a period of growth in the light

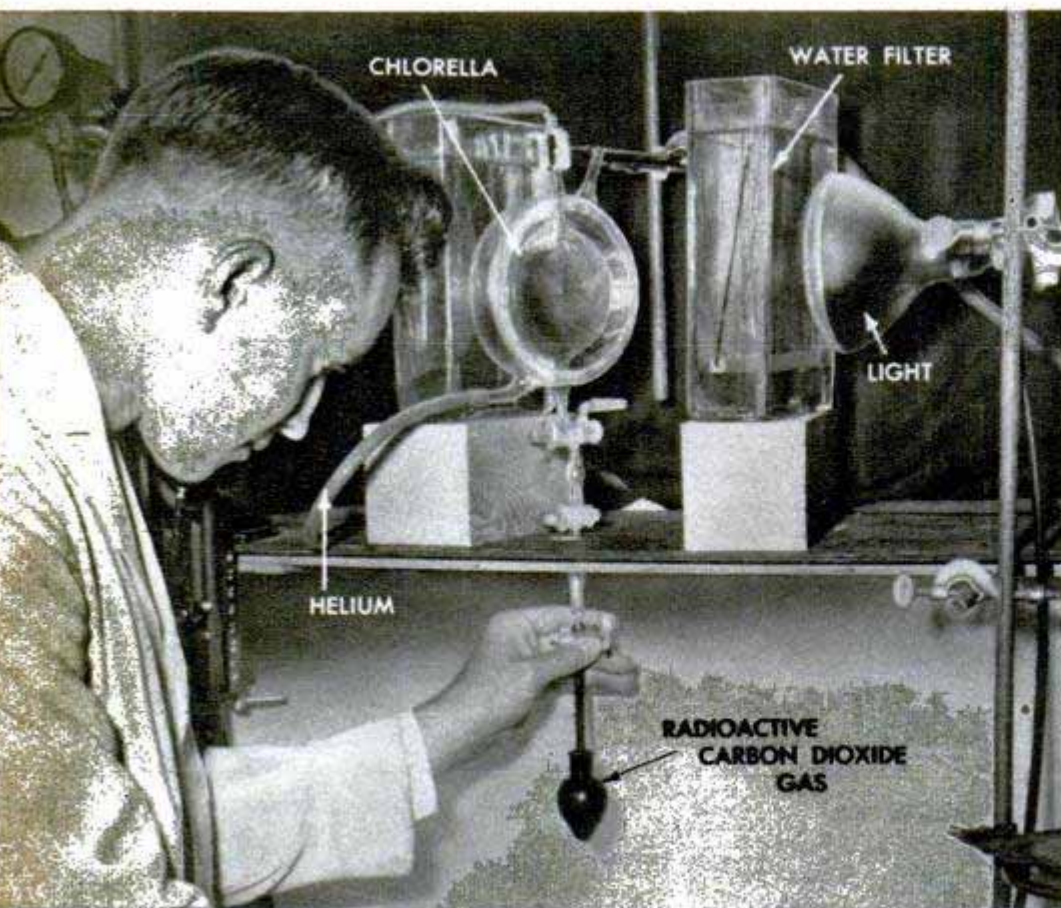

Chlorella in flask is illuminated and transferred to lightless black container below it, proving photosynthesis can occur briefly in dark

plants are so complicated that it's hard to say when such miracles will come about.

It does suggest, however, that algae might become important sources of fats or proteins. The next step is for some laboratory to investigate the commercial possibilities of food production from Chlorella on a larger scale than the test-tube experiments conducted so far.

Informally, Doctor Spoehr estimates that to produce one pound of fat it would be necessary to grow a culture of Chlorella for 30 days in about 30 gallons of water that contains some 600 grams of nutrient salts. Filtered air containing five percent carbon dioxide, instead of the $\frac{3}{100}$ of one percent in the atmosphere would have to be bubbled through the water. Sunlight would be used for illumination to keep the photosynthesis process in operation. Two major problems would be the keeping of the algae at their best growth temperature, from 70 to 75 degrees Fahrenheit, and to keep the water agitated so all algae would receive light.

It might be possible to grow the algae in long, tall glass tanks that are only a few inches in cross section, in Pyrex pipes or even in transparent plastic bags. If investigation shows that the costs are too high, the next suggestion is to attempt cultivation of salt-water algae and other simple plants that thrive in the ocean. Possibly a bay that is almost landlocked could be dammed off from the ocean so that algae could be grown on a vast scale. Marine farming, in fact, is considered an industry that civilization will have to take up in the future.

Doctor Spoehr's work does not reveal the actual mechanics that are involved when a plant manufactures the materials that we use as food. That, still, is the basic problem under study at almost a dozen research centers in the United States alone. Living plants are subjected to all sorts of treatments in these laboratories,

then the plants are taken apart by means of chemicals, by ultra-high-speed centrifuges, and even by means of supersonic generators to discover what has happened to them. Chlorophyll and other pigments are tested by means of spectrographic apparatus. The effects of certain wave lengths of light on chlorophyll are studied.

In short, every modern technique and tool that seems applicable, including the

Tubes show pressure changes resulting from liberation of oxygen during photosynthesis as Chlorella flasks inside cabinet are exposed to light

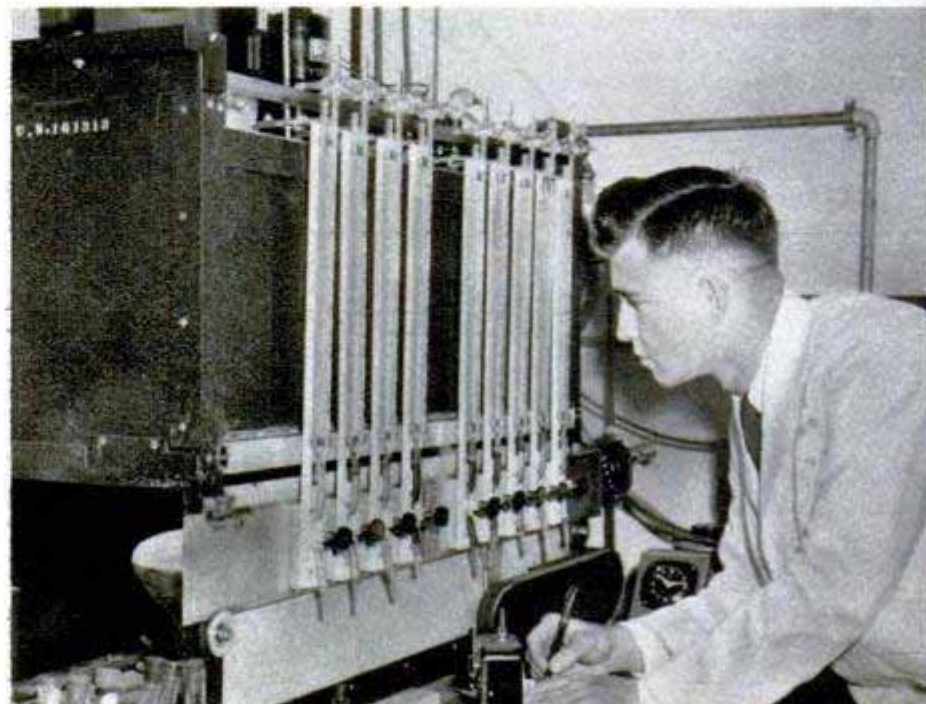

use of radioactive materials, has been drafted.

Specifically, the Carnegie photosynthesis laboratory is probing the means by which chlorophyll is formed in a plant, is studying the yellow carotenoid pigments that may or may not have something to do with photosynthesis, and is trying to learn more about the functioning of the chloroplasts, tiny bundles in which chlorophyll is contained.

At Carnegie you find such oddities as pure white plants that were grown in the dark or even small green trees whose upper halves are white.

Barley, for instance, that is grown in the dark isn't able to produce chlorophyll and so it doesn't take on a green color. It lives only on the substance contained in its seeds. At a certain time in its growth it is placed in a lighted cold room where the length of time required for it to turn green under the action of the overhead lights is studied at various temperatures.

The green tree with the white tip was grown out of doors, then it was placed in the dark where it continued to grow by drawing on the materials stored up in its system. This growth in the dark produced a crop of white leaves. Unless it is exposed to light by the time it uses up its reserves, the tree dies.

Each photosynthesis laboratory is working on some particular portion of the sub-

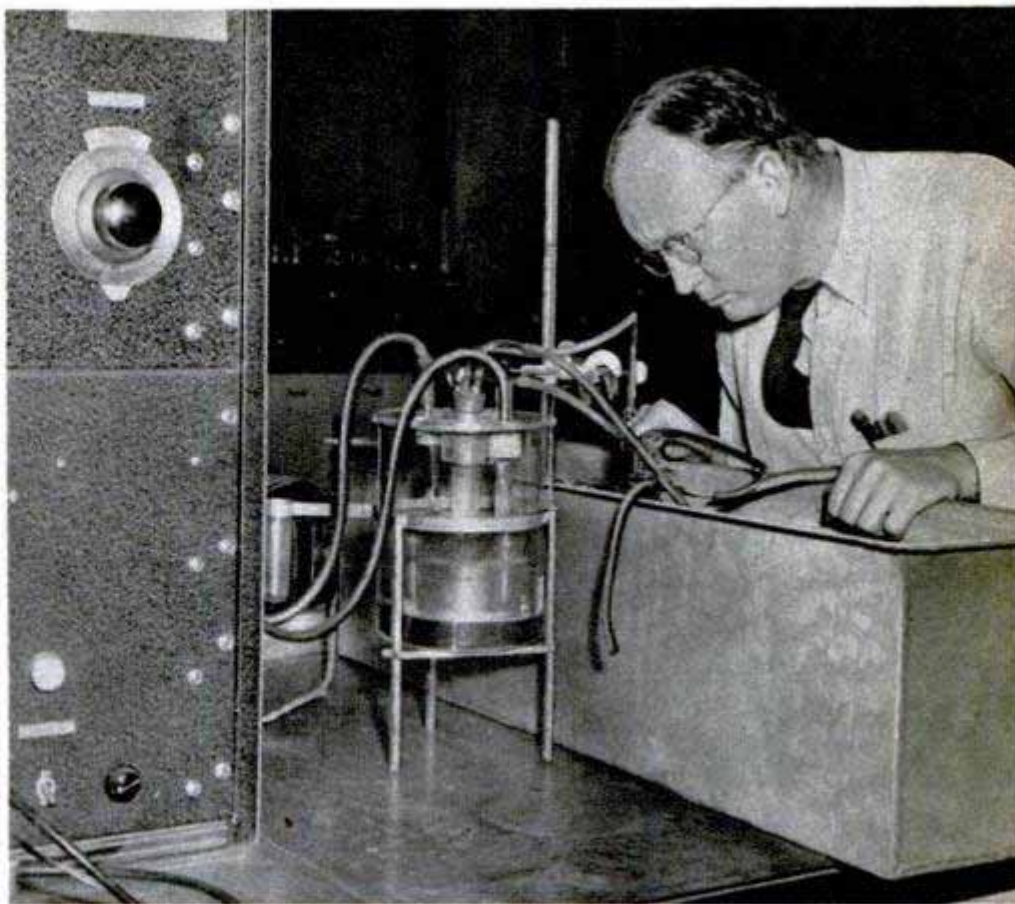

Supersonic generator (center) uses silent sound to break down vegetation so that the chloroplasts can be separated for intense study

ject. A Stanford research group that has its laboratory beside the ocean at Pacific Grove, Calif., is investigating an ocean alga that contains green chlorophyll but that seems to use a red substance for photosynthesis instead of its chlorophyll. Purple bacteria that convert carbon dioxide into organic matter under the influence of light are being investigated.

At Oak Ridge, the University of Chicago and the University of California, studies that make use of radioactive isotopes are in progress. At California, for instance, a research team consisting of Dr. Melvin Calvin and Dr. Andrew A. Benson, plus a group of young scientists, is trying to isolate the intermediate steps of the photosynthesis process. They feed radioactive carbon dioxide to *Chlorella*, then try to find out what transformations occur.

In one type of study, *Chlorella* is exposed to light and to ordinary carbon dioxide for several hours and then for only 30 seconds it is exposed to

Apparatus measures color shades of chlorophyll and other plant pigments to determine what portions of the sun's rays are used in photosynthesis

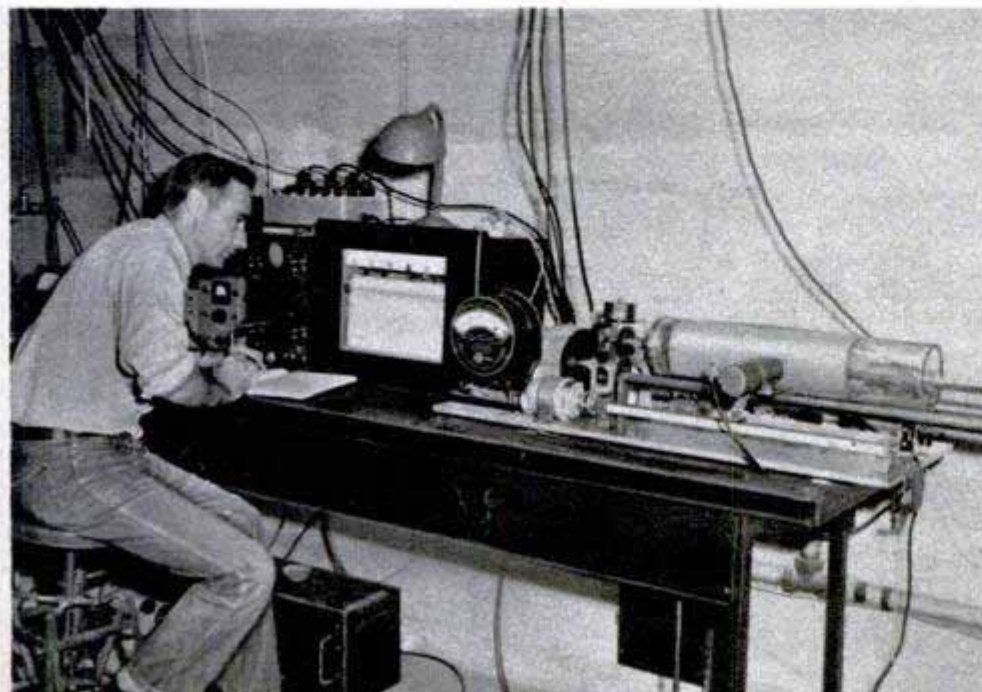

Right, scientist examines flask containing a high concentration of *Chlorella*. Bindings around the top of the flask are filters to keep out contamination

Below, Dr. H. A. Spoehr, who produced *Chlorella* with a high fat content, tests green leaves to discover acid content as he seeks secrets of photosynthesis

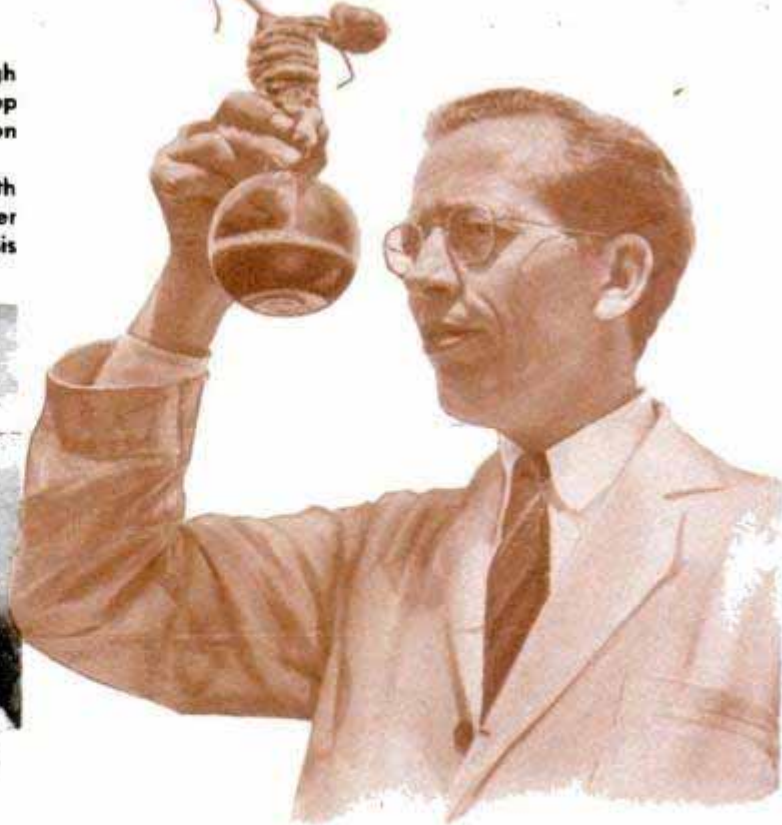
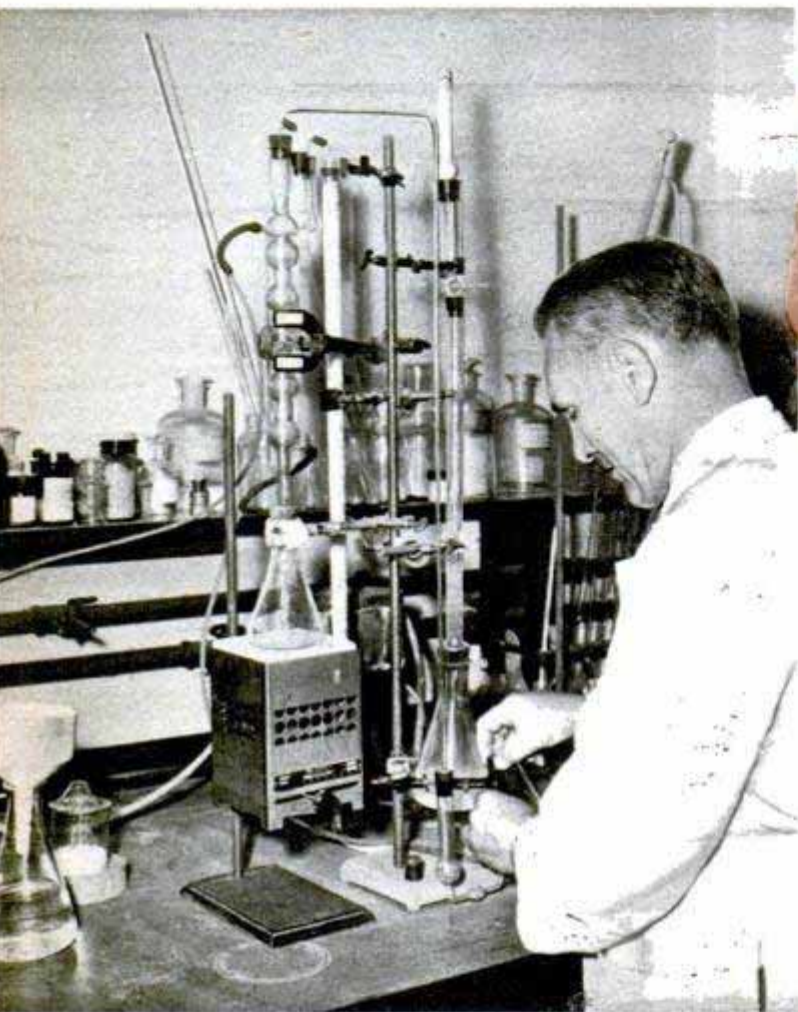

favor of a possibly more simple oxidation-reduction process that is induced by light and that proceeds with the aid of special pigments. The belief is growing that some of the steps are not unique but are similar to some other biochemical reactions such as occur, for instance, in oxidative and fermentative decompositions.

Even the latest theories are mere broad conceptions that don't explain the actual mechanics involved. In this connection the University of California scientists have evolved a step-by-step explanation of photosynthesis that they haven't been able to disprove and that they are now engaged in testing. Within a year, possibly, a major announcement on how photosynthesis works will be made by these scientists.

It's too soon now to speculate as to whether the theory will permit industry to manufacture food by a synthetic process or whether it will be a key for extracting more food from growing plants. Certainly research will continue until either or both of those goals are realized.

The entire animal kingdom, and that includes man, can be described as a parasite that lives on the millions and millions of members of the plant kingdom. Without plants we would, of course, have no hope for survival. These plants produce proteins, sugars and fats from inorganic materials by photosynthesis. To do this, they require only sunshine. The rays of sunlight are the difference between life and death for the living things of the world. Only when we have learned to duplicate the photosynthesis process will we cease being parasites that live on the plants of the world.

radioactive carbon dioxide. After that it is taken apart to learn what happened to the radioactive tracer.

In other experiments the algae are exposed to light in an atmosphere of helium that guarantees the absence of carbon dioxide and then the algae trickle down into a dark flask containing a radioactive atmosphere of carbon dioxide. Apparently the plants are able to store up and save some of the light energy, for in the darkened flask they convert the carbon dioxide into normal products of photosynthesis.

Theory after theory has been advanced in attempts to explain the photosynthesis process. Until recently it was thought that carbon dioxide combined with chlorophyll and water and that in a photochemical reaction these constituents were rearranged into chlorophyll and formaldehyde peroxide. Next, this arrangement changed into chlorophyll, formaldehyde and oxygen, after which the formaldehyde was converted into sugar.

This hypothesis has been dropped in

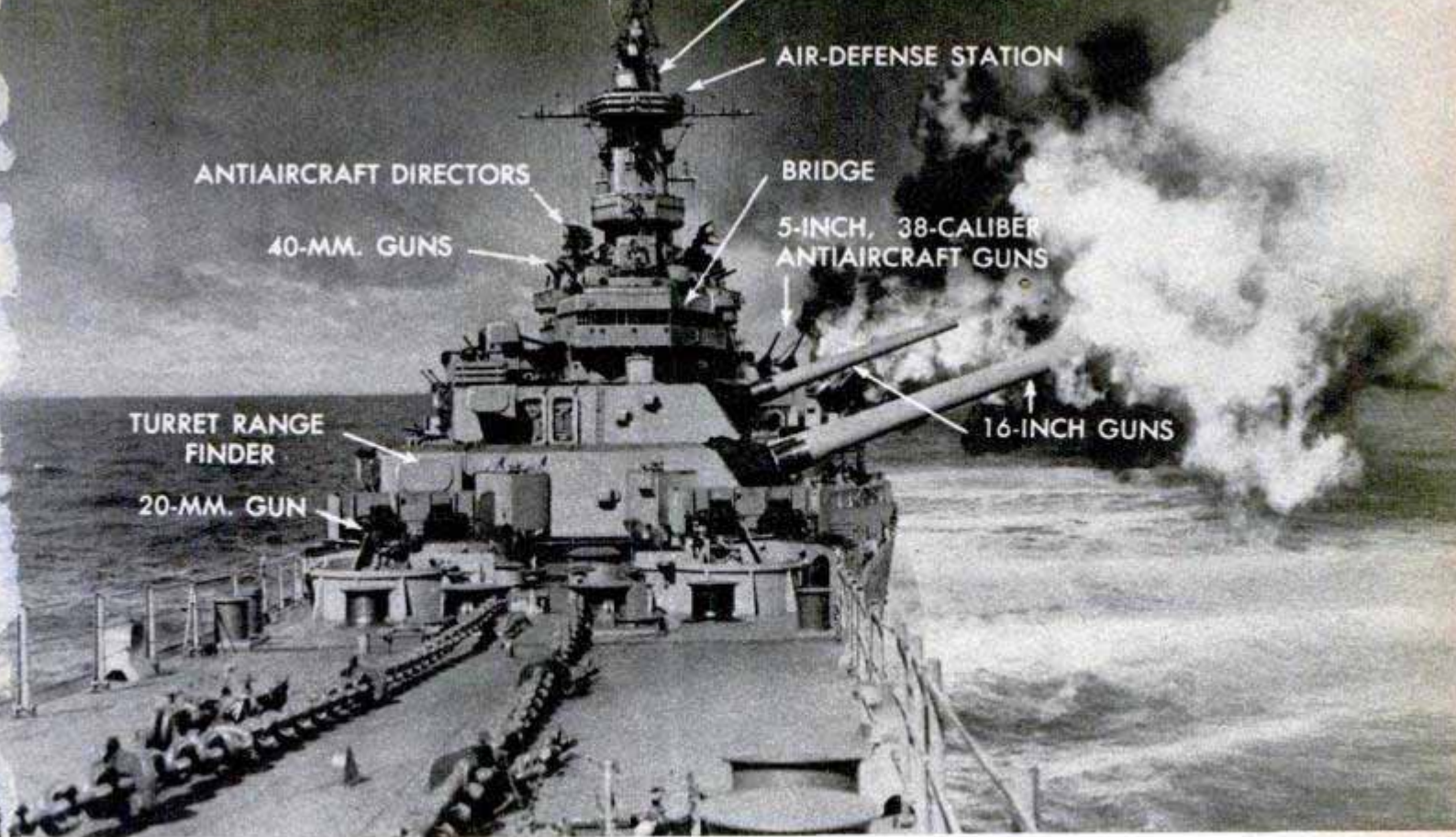

Fire and smoke belch from the 16-inch guns of the USS Missouri as she hurtles a broadside during exercises

By Andrew Hamilton

LOUDEST voice in the U. S. Fleet is "big mouthpiece," the 16-inch naval rifle. Its barrel weighs more than 100 tons and fires a one-ton projectile. The main batteries of a modern battleship thunder at the rate of one to two shots per gun per minute; the projectiles have a muzzle speed of more than 1800 miles per hour; they can hit a target more than 20 miles away with remarkable accuracy.

The Navy's biggest weapon is the result of millions of hours' brain work and sweat by engineers of the Bureau of Ordnance. It is the culmination of a 350-year development of the naval gun.

At the beginning of World War II, arm-chair strategists had practically relegated the battleship and its 16-inch guns to the Smithsonian Institution. But the big mouthpieces of the U. S. Fleet fired more than 25,000 rounds, representing more than 30,000 tons of ammunition, at enemy targets from North Africa to Tokyo.

The first 16-inch gun was mounted on the USS Maryland, commissioned in 1921. Today's 45,000-ton battleships have three turrets of three 16-inch guns each—two forward and one aft. Guns can be elevated to an angle of 45 degrees (to provide maximum range) and can be swung to command the entire circle of sea around a battleship. They can be fired separately or all nine in one thunderous broadside.

How They Fire The Battleship's Big Guns

Captain of a battlegun's gun crew peers through a powerful periscope to get a true bearing on target
U. S. Navy photos



MEN AND MACHINES "PASS THE AMMUNITION" INSIDE A BATTLESHIP'S TURRET

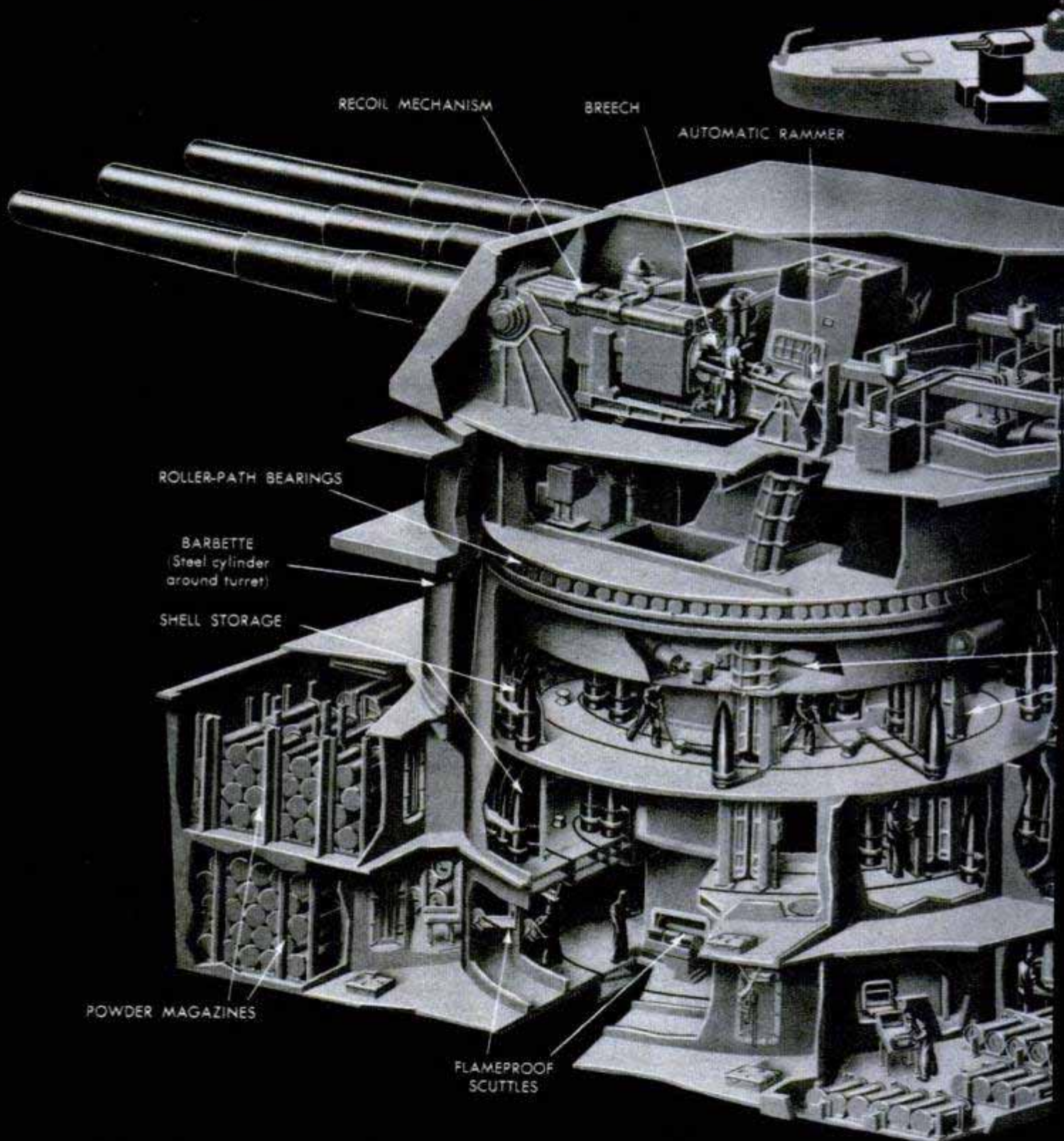

A complete turret with its guns and equipment weighs more than 1800 tons. One of the most complicated engineering feats in the construction of a battleship is the installation of its nine 16-inchers, their turrets and mechanism. This is how it's done: Turrets are put together and then completely disassembled. Next, a 350-ton crane lifts the individual parts onto a

barge, which is towed alongside the fitting-out pier. The turrets are then put back together again. Special gauges are used to insure leveling accuracies of $\frac{1}{4}$ inch, centering accuracies of $\frac{1}{64}$ inch.

A 16-inch gun is like an iceberg—the gun barrels and turret housing visible above decks are only a small part of a great, heavily armed fort which extends

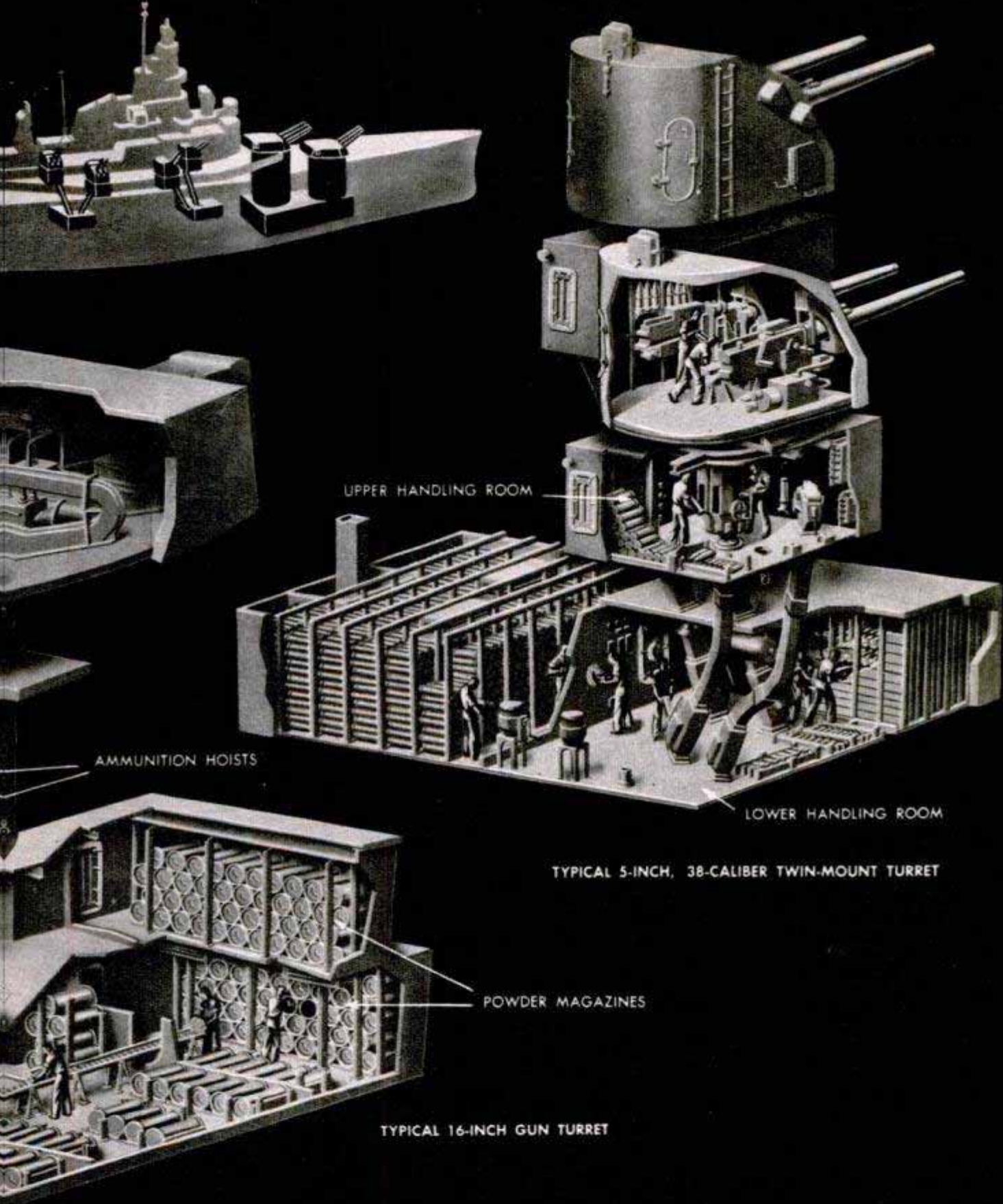

into the bowels of the ship. Inside the turret are breech and recoil mechanisms where the guns are loaded. The turret structure revolves on roller-path bearings. Below this is the turret foundation containing elaborate power-driven hoists and elevating and training-gear motors. All this equipment is protected by a huge steel cylinder called a barbette. At the base of

the barbette are shell-storage compartments and powder magazines.

Large naval guns are fired by the old "powder and shot" methods used by the gunners in John Paul Jones' navy. Steel projectiles, 6 feet high and 16 inches across, are fed into the breech, bags of powder are rammed in, the breech is locked shut and the gun is fired.



One-ton shell slips easily into the breech of 16-inch gun. The effective range of the missile is 20 miles

Sounds simple, but don't be fooled. Loading, sighting and firing a 16-inch naval rifle is one of the most complicated operations of modern warfare. Some of the most efficient machines and intricate devices naval engineers have been able to dream up go into the process of "laying a shell on a dime" at 20 miles.

Gun crews are divided roughly into two teams which load, direct and fire a big gun—the pointer group and the loading crew. In addition, there is the party whose main job is to "pass the ammunition." Ammunition is stored below decks in fireproof compartments fitted with double-locking, flameproof scuttles and water-flooding systems designed to halt the spread of fire or explosion. Projectiles and powder are kept in separate magazines.

Projectiles are of two general kinds: (1) armor-piercing shells (used against ships), which have a tough steel nose and a small explosive charge of not more than 2.5 percent of grayish-cast TNT, and (2) high-capacity shells (used for bombardment of shore positions), thin-skinned and containing a 10 to 25-percent bursting charge.

The propellant charges for the one-ton projectiles are cylindrical bags of smokeless powder—which is neither a powder nor completely smokeless. This powder consists of brownish pellets of nitrated cellulose, perforated to insure complete combustion. The pellets are placed in silk bags with a quilted bottom that contains a small amount of black powder as a primer charge. During shipment or storage, these



Automatic ramrod shoves bags containing 60 pounds of smokeless powder into breech of "big mouthpiece"

bags are encased in airtight containers.

From the storage compartments, projectiles and powder bags move by conveyor belts and power-driven mechanical hoists toward the turret. While the ammunition is moving in a steady stream toward the gun breeches, activity is taking place in other parts of the ship that would make a mathematician go mad if he had to figure out the problem in longhand multiplication and division. Fortunately, the Navy has developed computing and calculating machines that do most of the heavy thinking rapidly and accurately.

The battle problem boils down to this: How to hit a moving target on or beyond the horizon, taking into account its course and speed, your own course and speed, the course and speed of the wind, the roll of your ship and even the rotation of the earth during the flight of the projectile.

The Navy's fire-control system is one of its most carefully guarded secrets—ranking second only to the atom bomb. At the end of World War II the Navy revealed much about such weapons as the V-T fuse, sonar, radar and influence mines. But it has remained close-mouthed as a clam about its fire-control secrets.

Without getting technical, here is how it is done: First, you must locate the target. Seaplanes are sent up to do the "spotting." A cruiser, that gets in closer, may also help. Radar has stepped up the accuracy of naval gunnery considerably—and can be used even when the target is out of sight over the horizon, day or night.



After the big gun has been fired, bluejackets clean the bore with a cylindrical brush pulled by a rope

Information from many sources is relayed to the plotting room, far below decks, where ranges to be set on the guns are worked out. Here are located the precise computing machines called rangekeepers—heart of the Navy's fire-control system.

As outlined in *Naval Weapons and Their Uses*, published by the U. S. Naval Institute, Annapolis, Md., this machine supplies the following data:

(Continued to page 238)



Dangerous business! Far at sea a big battleship takes a load of ammunition from an LST supply ship

From the bridge the executive officer passes an order to his "talker" who transmits it to the turrets

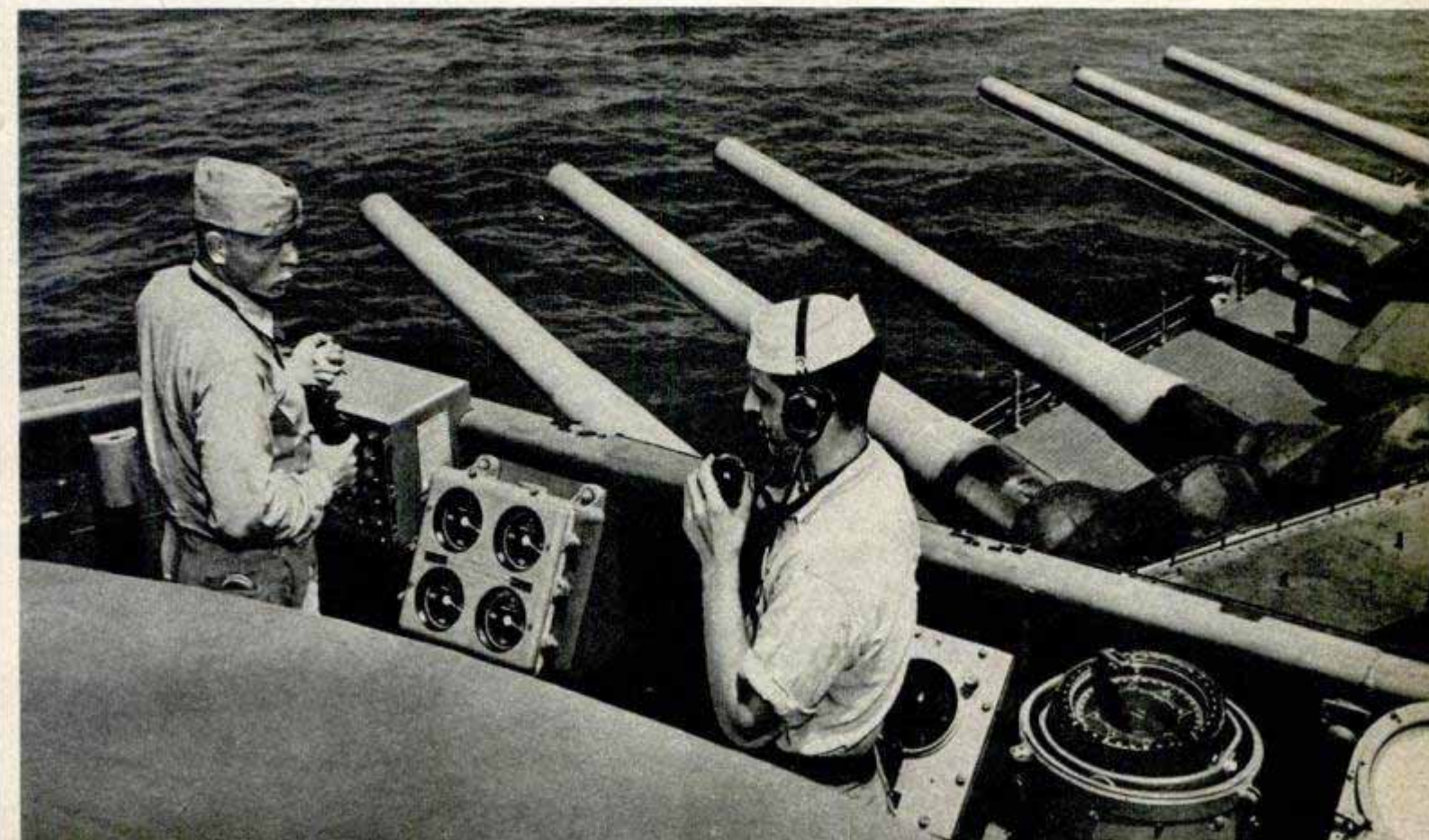

"Snow Jeep" Tows 1500-Pound Load Across Drifts at 30 M.P.H.

Heavy loads can be towed across deep snow by a "snow jeep" that travels along the surface on broad Caterpillar treads.



The vehicle, developed by George Bettes of Sparta, Mich., is an improved version of the snow jeep portrayed on the cover of *Popular Mechanics*, February 1947. Bettes spent several months in the James Bay region of Canada making tests. During that time the machine was used by a doctor and the Royal Canadian Mounted Police for emergency missions. Powered by a four-cylinder, 26-horsepower engine, the snow jeep travels 30 miles an hour. The aluminum body is heated and seats four. Weighing 1475 pounds, the vehicle can turn in its own radius on snow or bare ground and will tow a load of 1500 pounds. Mr. Bettes is building a larger one for long trips.

142-Ton Transformer Serves City of 200,000

Capable of handling enough power to meet the electrical needs of a city of 200,000 persons, a 142-ton transformer, the most powerful ever made in this country, has been built by Westinghouse. The giant, which handles 150,000 horsepower of electrical energy, is of a new "form fit" design that reduces weight by about 20 percent. In operation, great amounts of heat are generated in the core and coils and this heat is carried off by oil circulating through the assembly. Propellerlike fans force cooling air over radiators through which the circulating oil passes. The transformer takes power at 13,200 volts and builds it up to 115,000 volts before feeding it into the transmission network.

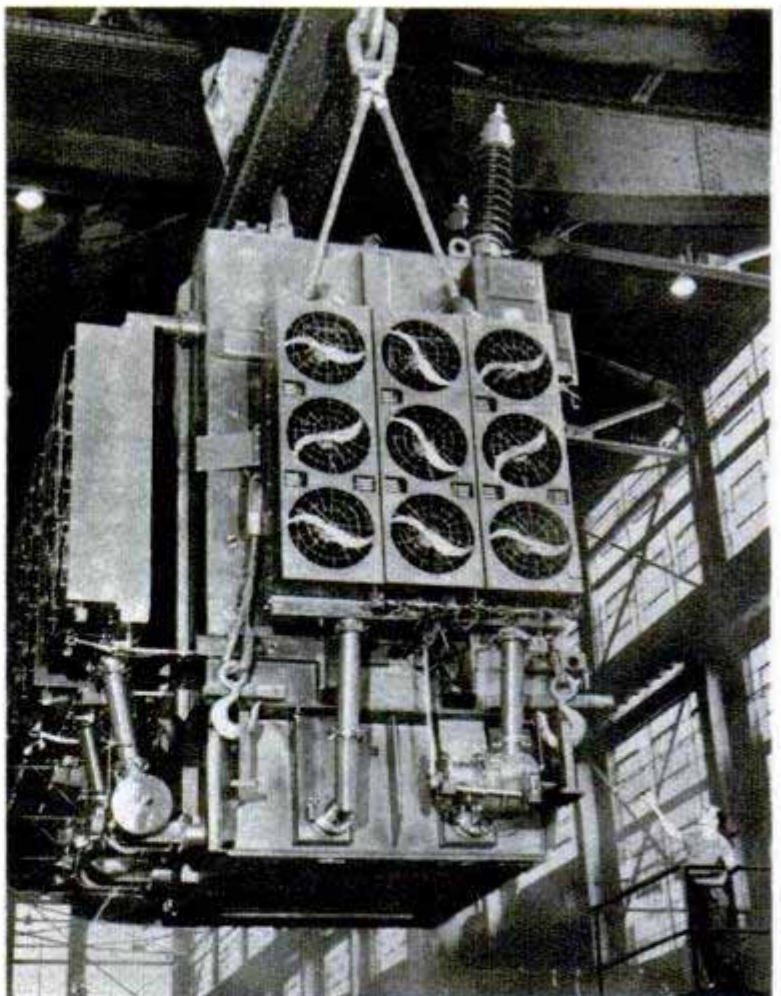

Waste Anthracite Silt May Provide Gasoline

Anthracite silt, washed from the coal after mining, may provide gas for heating homes and gasoline for automobile engines in the near future. About 200 million tons of silt are available today and more is being produced every year. Tests are to be made in a pilot plant at Wilkes-Barre, Pa. The silt, as

fine as granulated sugar, is noncoking, noncaking and free of tar. It also has a low sulphur content and a high ash-fusion temperature.



Avalon Seadrome Made From Barge

Floating in Avalon Bay off Catalina Island is a seadrome for amphibians made from a large barge. The drome, which speeds the loading and unloading of passengers from five amphibians operating between the island and the mainland, is 35 by 110 feet with two 30 by 45-foot ramps. It has a roomy deckhouse with rest-rooms, baggage and radio room and a glassed-in passenger lounge. Passengers are transported from the seadrome to the downtown ramp at Avalon, a few hundred yards distant, by water taxi. Travel time between Long Beach, Calif., and downtown Avalon is 25 minutes. A boat or water-taxi trip from the mainland to the island takes over two hours

Amphibians are easily wheeled up the barge's ramp to discharge and load riders. Water taxis complete trip to Avalon, a few hundred yards away

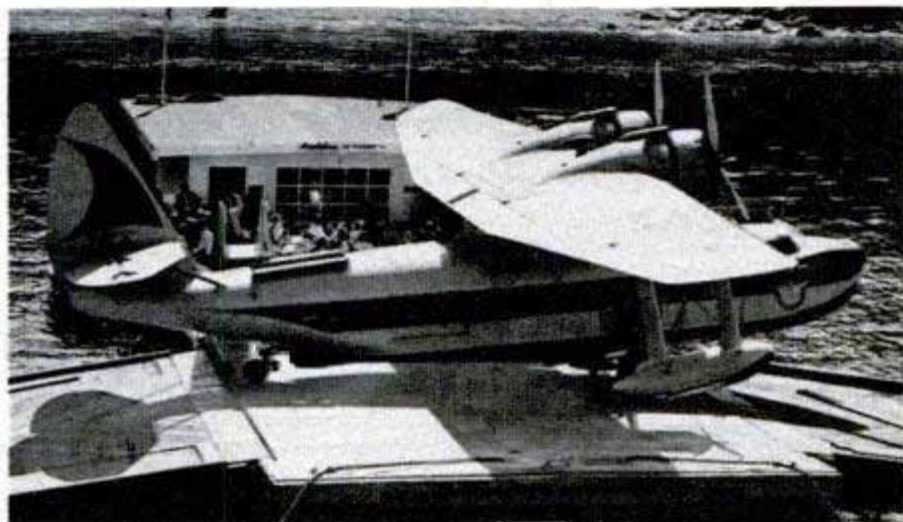

and land-plane service to the airport atop the island requires a 45-minute bus trip into Avalon. The new seadrome replaces a floating dock in the bay which could not be used in rough weather, upsetting the 28-flights-a-day schedule.

Navy Tests Longer Hull to Make Flying-Boat Landings Safer



Official Navy photo

For safer rough-water landings, the Navy is experimenting with a longer hull in the newest Martin flying boat. It is expected to reduce pitching and bouncing, as well as giving the tail section added buoyancy to protect it from wave damage. The longer planing surface also cuts the time and distance required for take-off. Designated the XP5M-1, the craft has two 2700-horsepower Curtiss-Wright engines and flies with an 11-man crew.



COMPACT VACUUM CLEANER flattens to a thickness of five inches and can be hung in broom closet



KITCHEN CLEAVER is very versatile. It cuts, chops, opens jars, bottles and even pulls nails

WHAT'S NEW *For Your Home*

Sources of supply for these products may be obtained from Bureau of Information, Popular Mechanics Magazine



COASTER-HANDLE keeps liquid stains off furniture and broad base reduces danger of upset glasses



TABLE-TOP REFRIGERATOR has the usual storage space and also provides a counter-height work area



SILVER DETARNISHER is battery operated. Unit is self-contained and works by electrolytic action

DISH SHELVES eliminate stacking in crowded cupboards. They're made in three different sizes



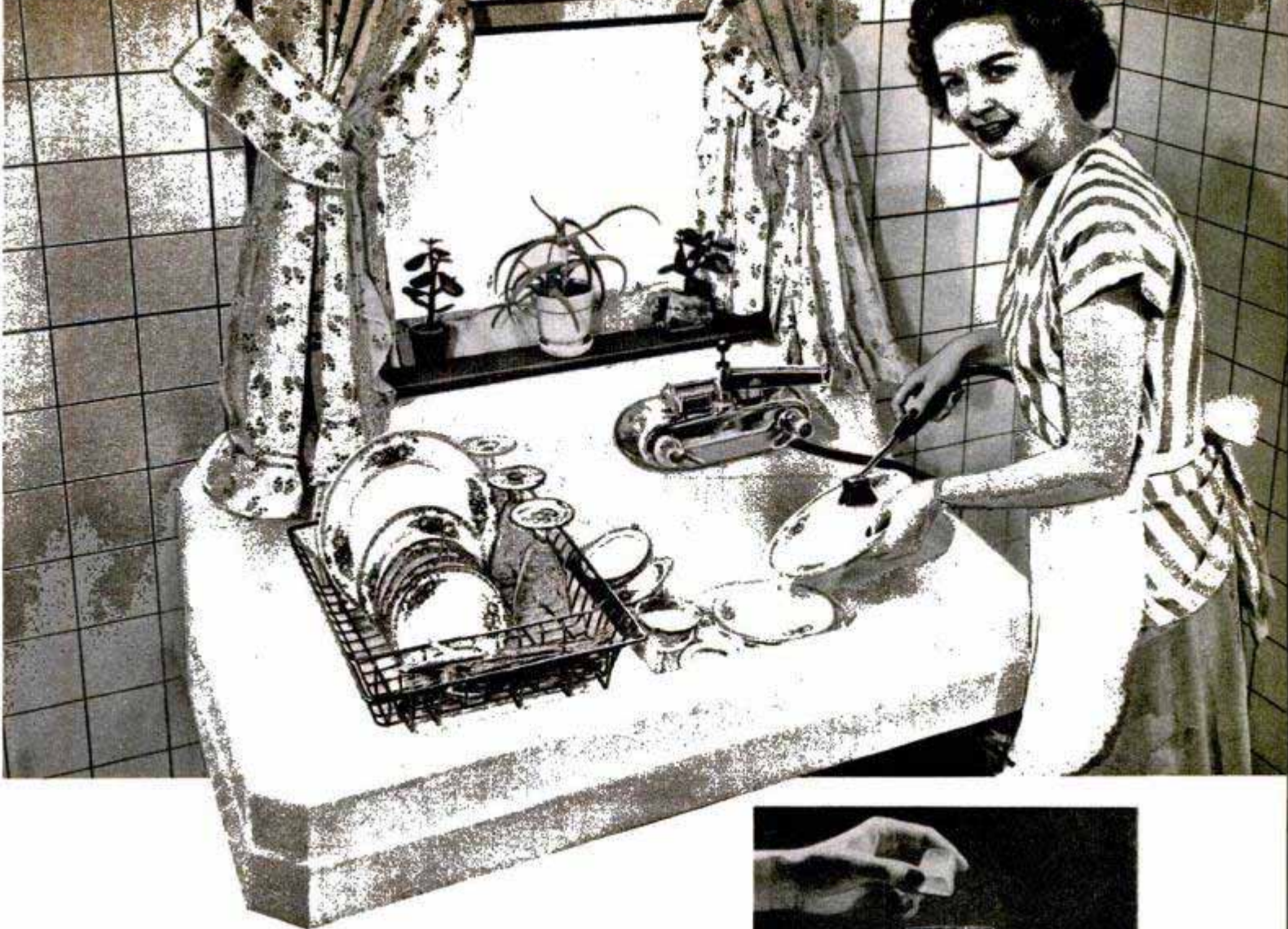

DISHWASHING FAUCET can be fitted on any sink. Soap is dissolved in small tank behind spout. Mixer pipes either clear or sudsy water into brush head

PLASTIC ICE CUBES won't dilute your drink because the water is sealed inside crystal-clear plastic. When the cube "melts," simply freeze it again



AGITATOR UNIT converts laundry tub into full-size washing machine. Clamped to rim of tub, it swings up out of way when not in use

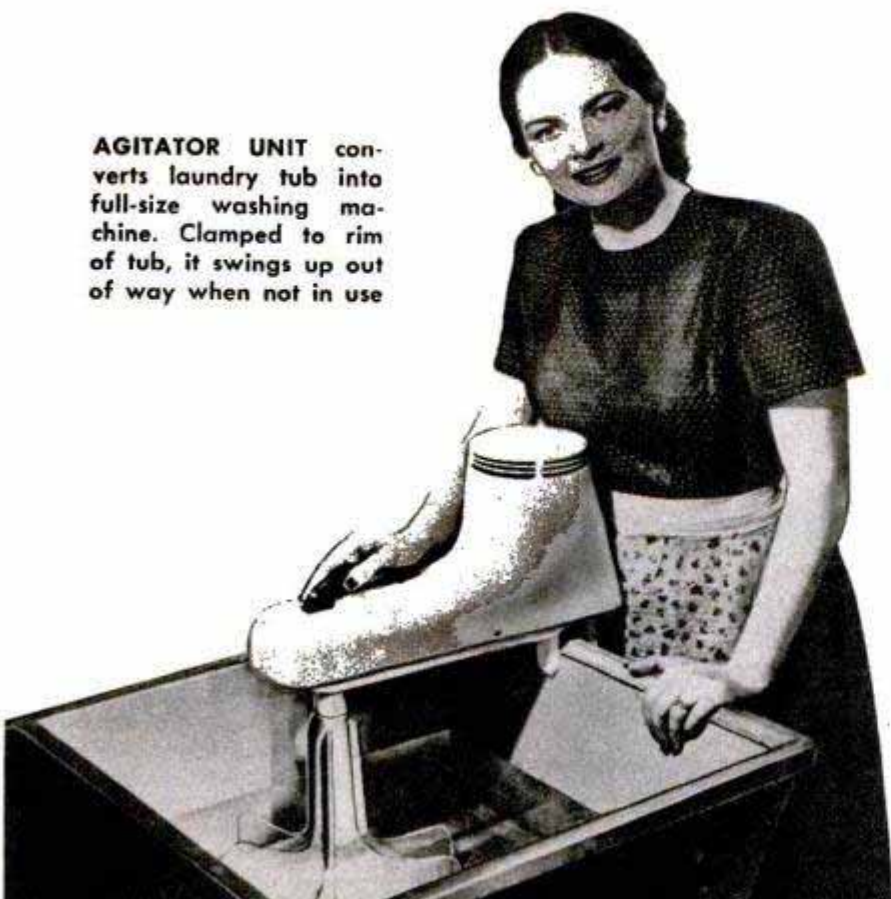

CORERS for tomatoes and apples don't cut all the way through but leave seal to hold juices. They are designed for coring fruit before filling and baking

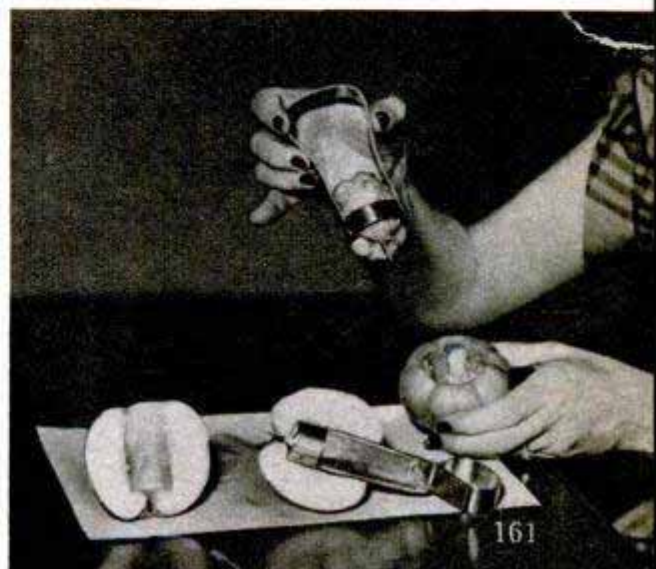



"Horace"—Britain's Uncomplaining Test Pilot

Hinged in eight places, "Horace, the model airman" spends his days whizzing up and down a high tower track in tests of new pilot ejector seats. Britain's Ministry of Supply made the scientifically designed

dummy flier for plane designers. Cordite cartridges propel the ejector seat upwards. Fully dressed for his work, Horace weighs 200 pounds, is over six feet tall and is as much as two men can manage.

Sound You Can't Hear Detects Light You Can't See

Infrared light, invisible to the eye, can be detected with crystals vibrated by high-frequency sound waves, inaudible to the ear. This strange combination of super-human light and sound may even be ex-

tended to detect radar waves which, like infrared light, are becoming increasingly important in modern warfare. Developed at the University of Illinois, the detector uses two crystals with a gas confined be-

tween them. These crystals are vibrated at an even rate by high-frequency sound waves. When infrared rays strike the layer of gas between the crystals, the rate and pattern of the vibrations are changed to such an extent that it can be observed by instruments, thus detecting the presence of infrared light.

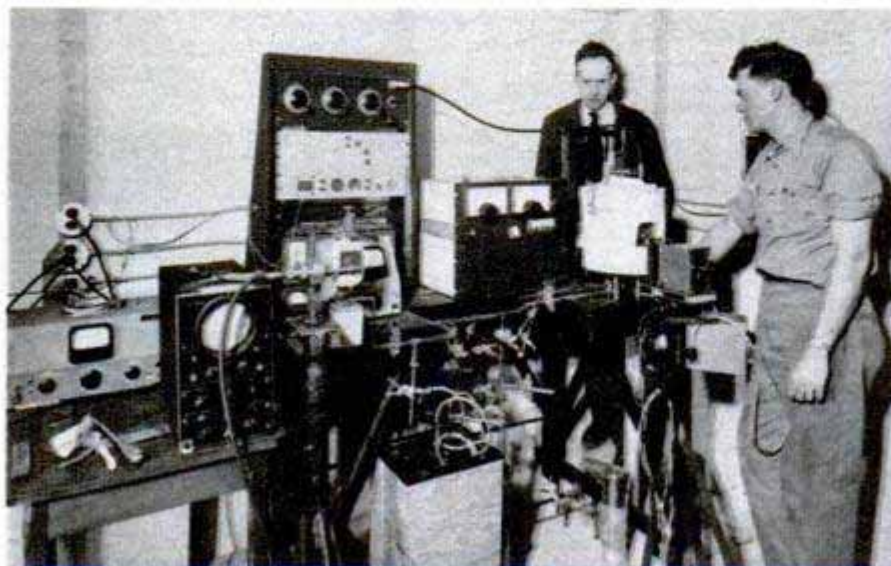

In the white casing at right of the picture, two crystals, with a layer of gas between them, detect infrared rays projected on the crystals by a shutter unit opposite the opening in casing

100,000,000 U.S. MOTOR VEHICLES

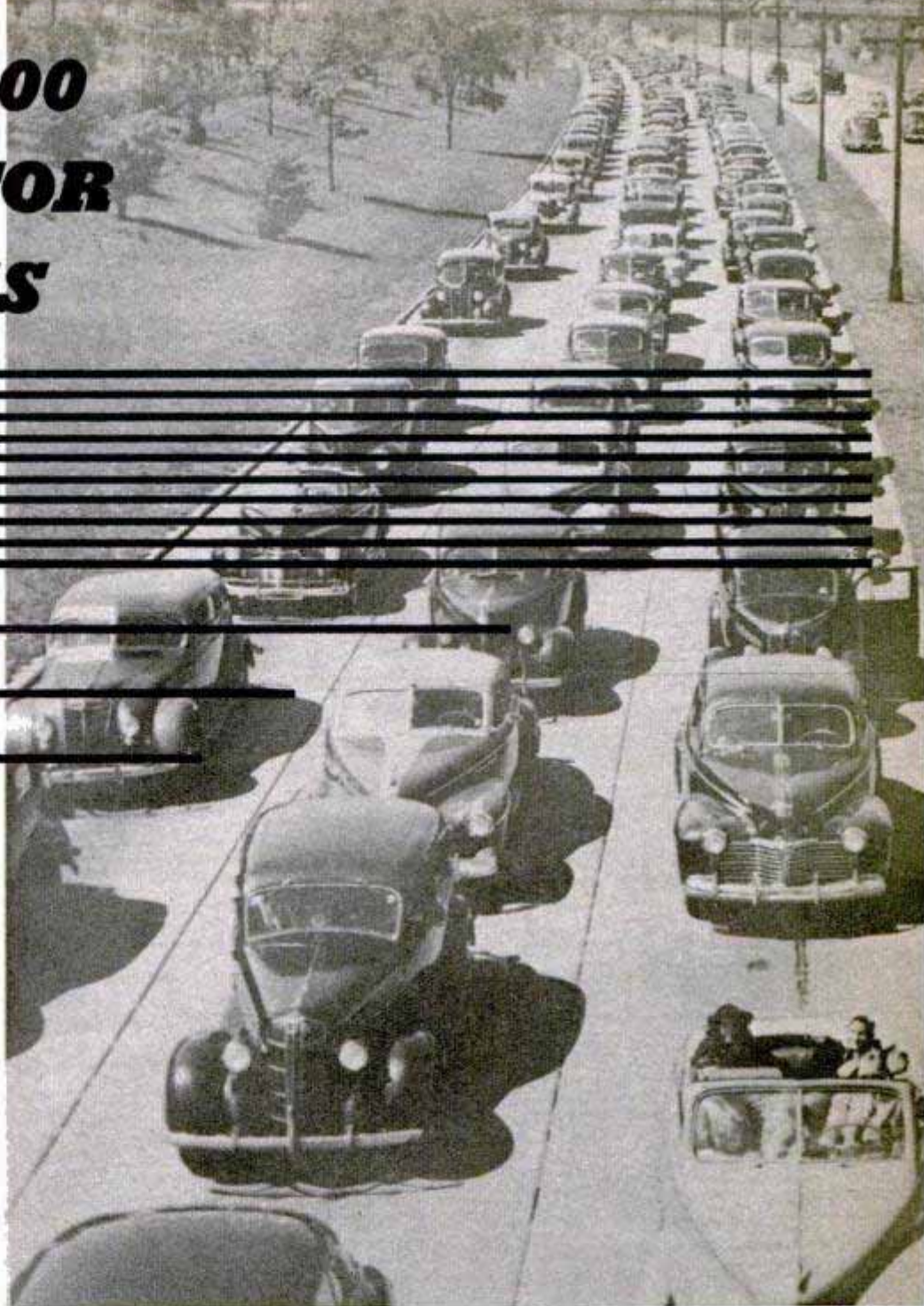

United States 100,000,000

United Kingdom 7,000,000

Canada 5,250,000

France 4,500,000

Germany 2,750,000

Russia 2,500,000

Italy 1,250,000

Czechoslovakia 180,000*

Japan 150,000

Belgium 120,000

Sweden 90,000

Austria 75,000*

Switzerland 16,000

Poland 11,000

Hungary 6,000

Spain 6,000

Denmark 3,000

Finland 1,000

Netherlands 1,000

WORLD TOTAL 124,000,000

*Some of the vehicles produced in Austria and Czechoslovakia during World War II are included in the total for Germany

Here is the dramatic picture of U. S. automotive production—100 million vehicles, surpassing our nearest competitor by 93 million

POPULAR MECHANICS, which has recorded the development of the automotive industry from its early days, joins the nation in saluting the U. S. automotive industry for the production of more than 100 million motor vehicles. Eighty percent of these vehicles were passenger cars. The one-hundred-millionth unit was turned out last August. Automotive production has mounted steadily from 1900, when 4192 cars were built, to 1941 with an all-time high of 4,840,502 cars and trucks. During the wartime year of 1943 only 139 passenger cars were built. Those were the days when the industry devoted its tremendous energies to the production of military vehicles. In 1947, production climbed back to 3,558,178 passenger cars and 1,239,472 trucks for a total of 4,797,650 units. Despite supply shortages in various branches of car production, the industry is striving to exceed that figure in '48.

EXPLORING THE OCEAN BOTTOM

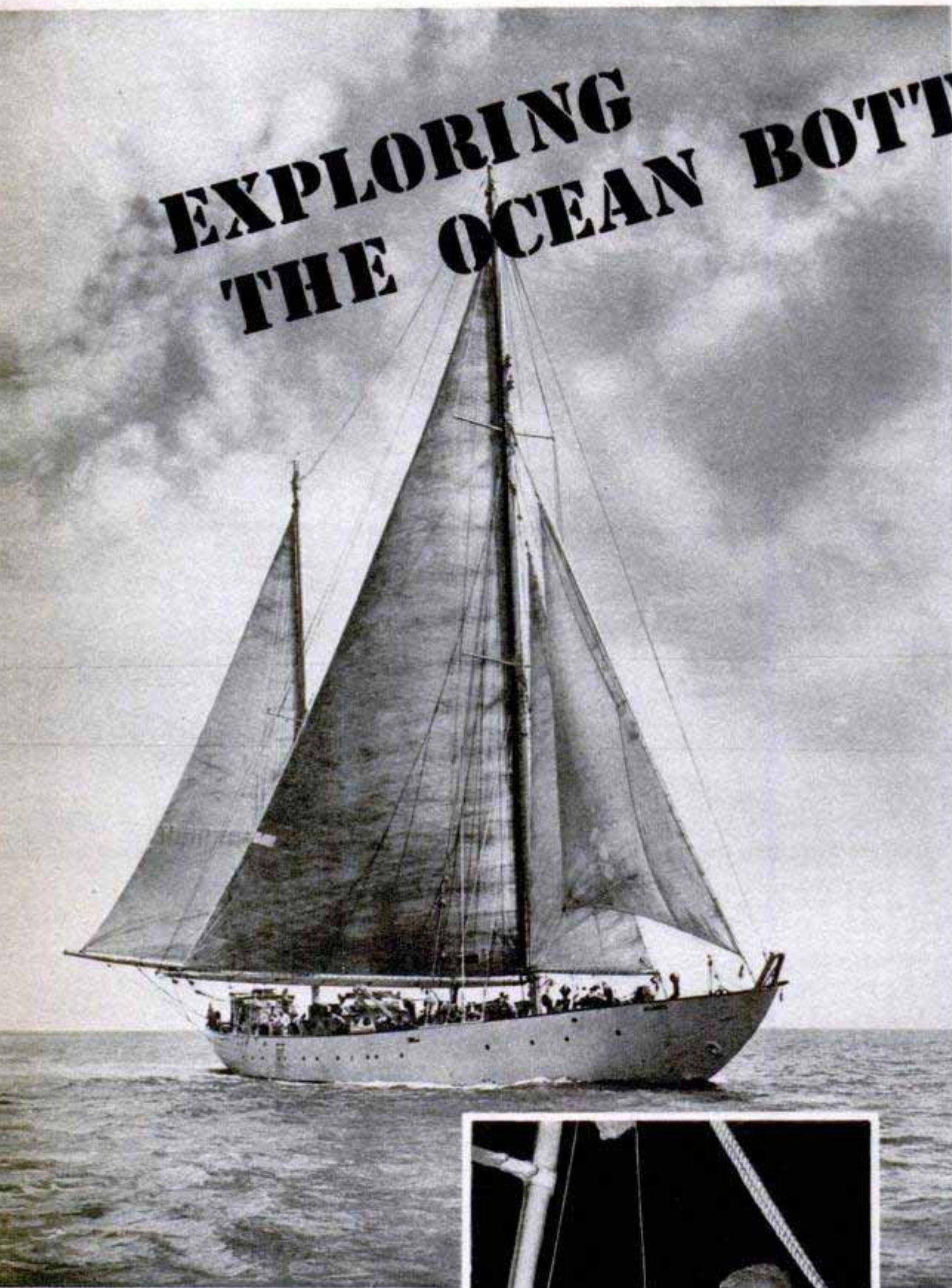

Research ship Atlantis under full sail heads out into the Atlantic to search the ocean floor. Auxiliary Diesel engine provides extra power

Crewman prepares to lower Ekman meter which records information on ocean currents. Dials show direction and speed of the current



AT A DEPTH of 3½ miles the long frame containing the camera settled through the water and struck the ocean floor with a soundless bump that triggered the flash bulb and opened the shutter of the camera. The film recorded the strange creatures that live beneath the overwhelming pressure of the ocean.

No human saw the same sight as the camera, which was lowered on a long wire from the research ship, Atlantis. The photo is one of a series taken during a recent cruise of the Atlantis for the Woods Hole Oceanographic Institution, a private, non-profit organization.

During the cruise the Atlantis covered 20,000 miles to chart the contours of the sea bottom in portions of the Atlantic Ocean. The expedition brought back much new information on ocean depths, currents, water temperatures and marine life. Special instruments acted as eyes and ears for the scientists to discover the nature of the terrain and wildlife miles beneath the surface of the ocean.

The Atlantis is a 142-foot steel sailing ship covered with so many instruments that there was scarcely room for the 9 scientists and 17 crew members who made the expedition. M. J. Pollak, scientist-in-charge, states that by means of the instruments the ocean-depth explorers were able to bring back much valuable data concerning the land that lies beneath the sea.

A new sea mount which rises more than 6000 feet above the ocean floor was discovered southeast of Bermuda. The scientists also learned that the Ampere Bank in the Atlantic, west of Gibraltar, is at least 36 feet shallower than was formerly believed.

The photographs were taken with a special underwater flash camera designed by Dr. M. W. Ewing, professor of geology at Columbia University, who took the Atlantis on another cruise late in the summer to find out more about the Mid-Atlantic

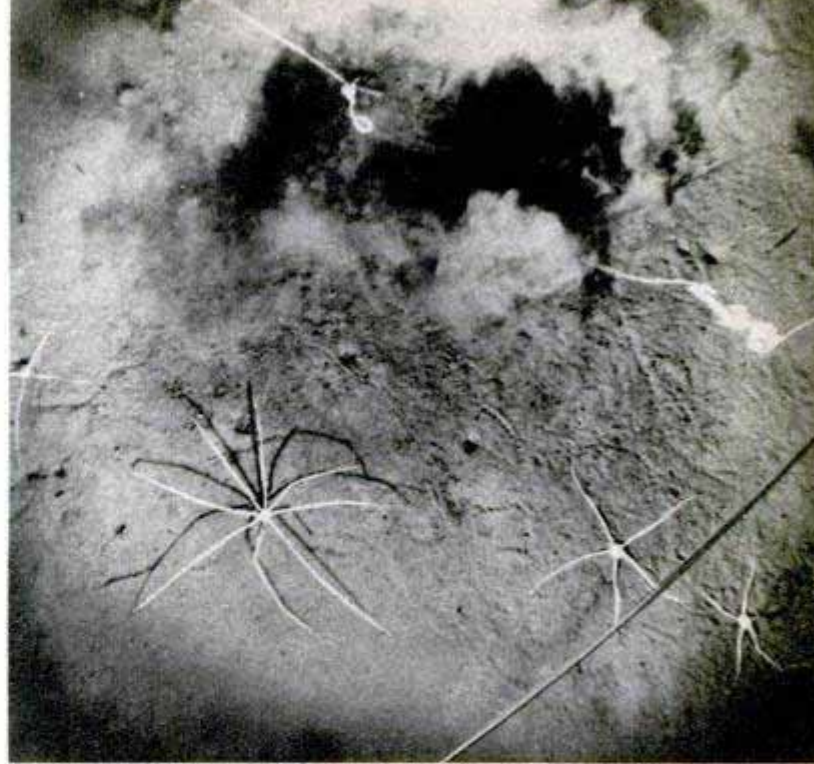
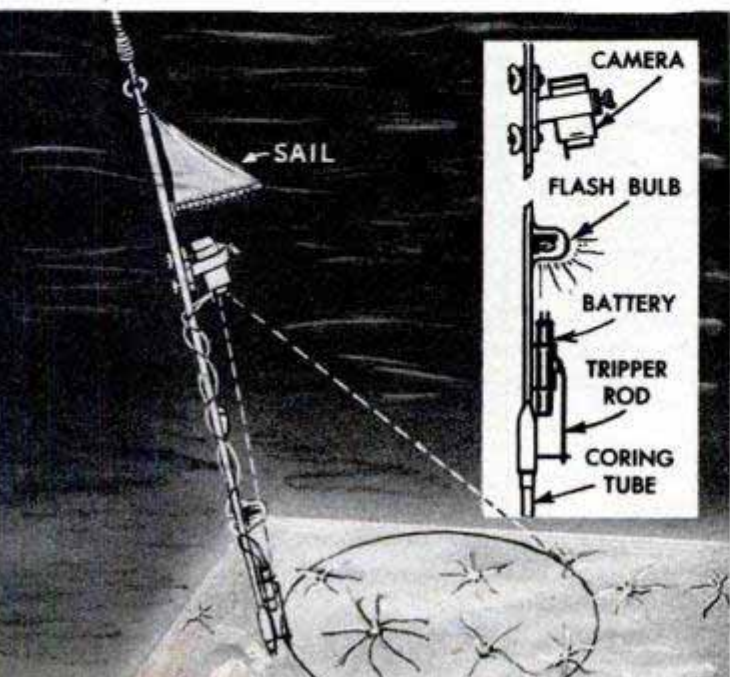
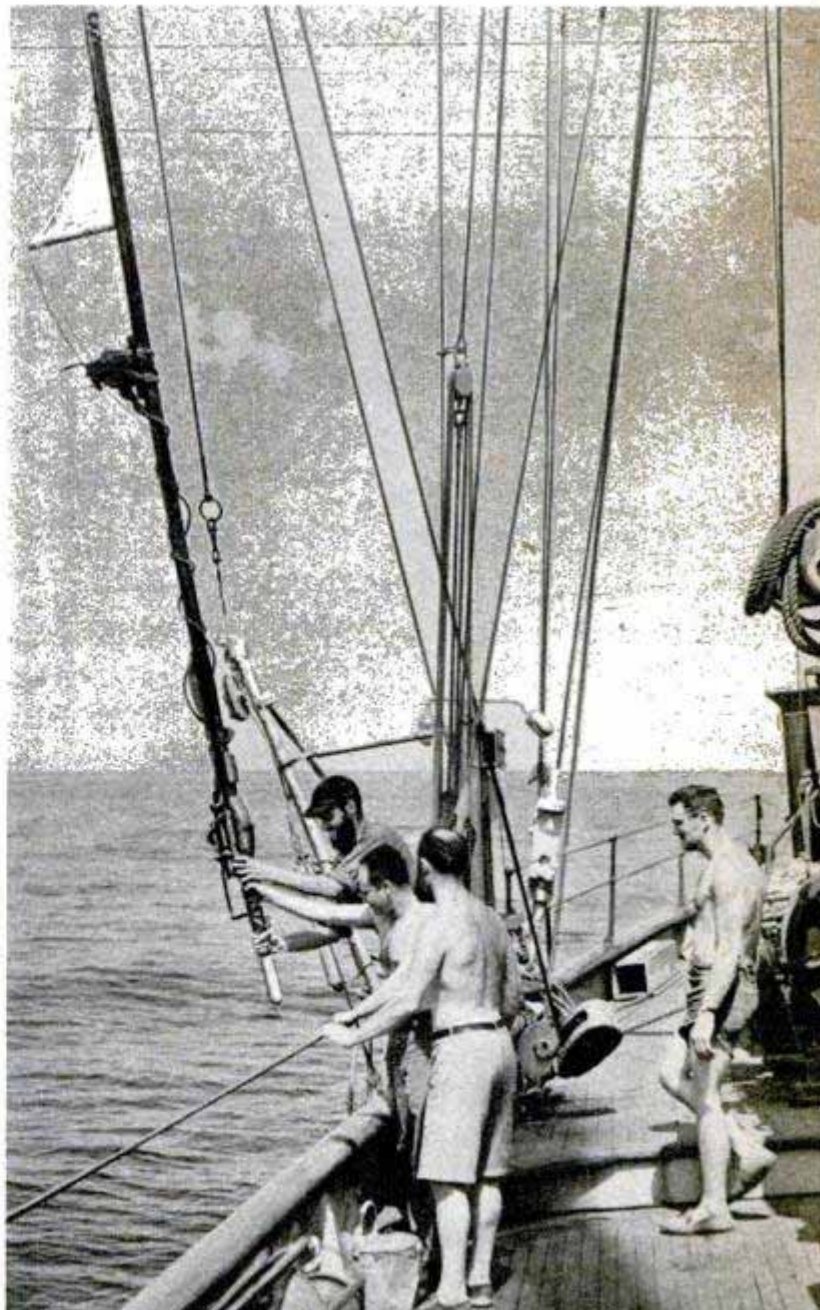

Photo snapped more than a mile beneath the surface shows sea spiders, largest one 28 inches in diameter. Below, underwater camera is lowered into the ocean. Drawing, bottom, shows how above photo was taken



Ridge. During this cruise he planned to make color photos of the ocean bottom.

To take the black-and-white photos, the camera was lowered on a wire by an electrically powered winch. When the frame struck the bottom, a trigger mechanism flashed the bulb and exposed the film. Several hours were required to reel out the wire and retrieve the camera each time a photo was taken. Exactly the right amount of wire had to be payed out in lowering the camera, as too much wire could foul the instrument.

The pictures, valuable because they reveal deep-sea life in natural surroundings, indicate that life on the deep ocean bottom is far more plentiful than was formerly believed. One photo reveals a 28-inch sea spider at a depth of 6000 feet, an ocean denizen that looks like a giant "daddy long legs." Pictures taken in the Mediterranean area show colonies of mysterious holes, each about 2½ inches in diameter and in groups that spread out for 12 square feet. It has not yet been determined what type of sea life makes its home in these sea-bottom caves.

Many of the photos show no living creatures, but are valuable because they record the nature of bottom deposits and may indicate bottom currents.

The expedition also discovered that the

Scientist in the laboratory of the Atlantis checks thermometers to learn temperatures at various levels



mysterious "false echo" on depth finders occurs in the Mediterranean. For some time, operators of depth finders have noted that they receive a false reading in certain areas. Some of the scientists believe this layer, moving some 1200 feet below the surface, is made by myriads of shrimp. Since the upward and downward movements of the layer are influenced by light, light-transparency tests were made during the cruise of the Atlantis. The scientists used a photoelectric cell and a wooden disk painted white to discover how far light penetrates beneath the surface. Such information reveals how much light is available for microscopic ocean plants.

An instrument called the Ekman current meter was used to determine the speed and direction of subsurface ocean currents. The meter contains a propeller and a compass. The compass automatically records the direction of flow, while the propeller is driven by the moving water to indicate the speed.

An instrument resembling a miniature torpedo was towed behind the Atlantis to make sound observations. The instrument was towed at some distance astern to escape the noises made by the ship's engines.

Reversible thermometers accurate to within 1/100 degree Centigrade recorded the water temperatures at various depths. An instrument called the bathythermograph was lowered more than 2000 times to record water temperature at depths to 800 feet while the ship was underway.

The scientists picked up all possible marine information during the cruise of the Atlantis. They followed flights of migratory birds on the radar screen and recorded data on ocean waves. Samples of sediment were scooped from the bottom and records of the sea-surface temperature, the air temperature and wind force were made. More than 2500 samples of sea water from various depths were brought back to the home port for chemical analysis. They will yield data that may indicate the flow of horizontal and vertical currents.

Very fine mesh nets were towed behind the Atlantis to obtain plankton, the minute plant and animal life which forms the basic source of food in the ocean. This information proved that the Mediterranean area is relatively poor in marine life.

The Atlantis left home port on another expedition during the summer to study the underwater mountain range which divides the Atlantic Ocean. There, valuable information on the origin and history of the continents is hidden beneath miles of water. In their attempt to chart parts of the ridge the scientists use the sonic depth finder to determine the topography of the

(Continued to page 248)

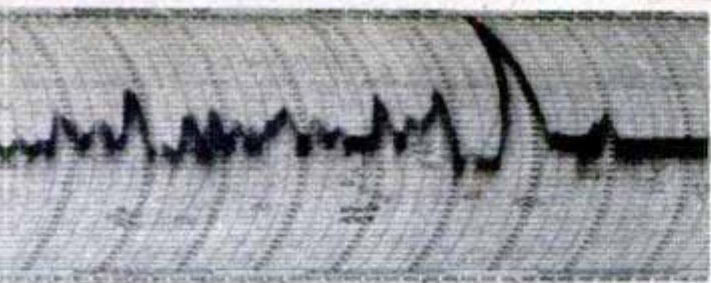

↑ Recording pen of the Fathometer traced this record on graph paper, which shows a sea mount rising about 6000 feet above the ocean floor southeast of Bermuda

Instrument for picking up sound under→ the surface is hoisted back aboard the Atlantis. It is towed behind the ship to escape interfering noise from engine

↓ Hydrographic winch pays out wire to which the underwater instruments are attached. Dials, shown in inset, show length of wire and angle so depth at which instrument is operating can be determined

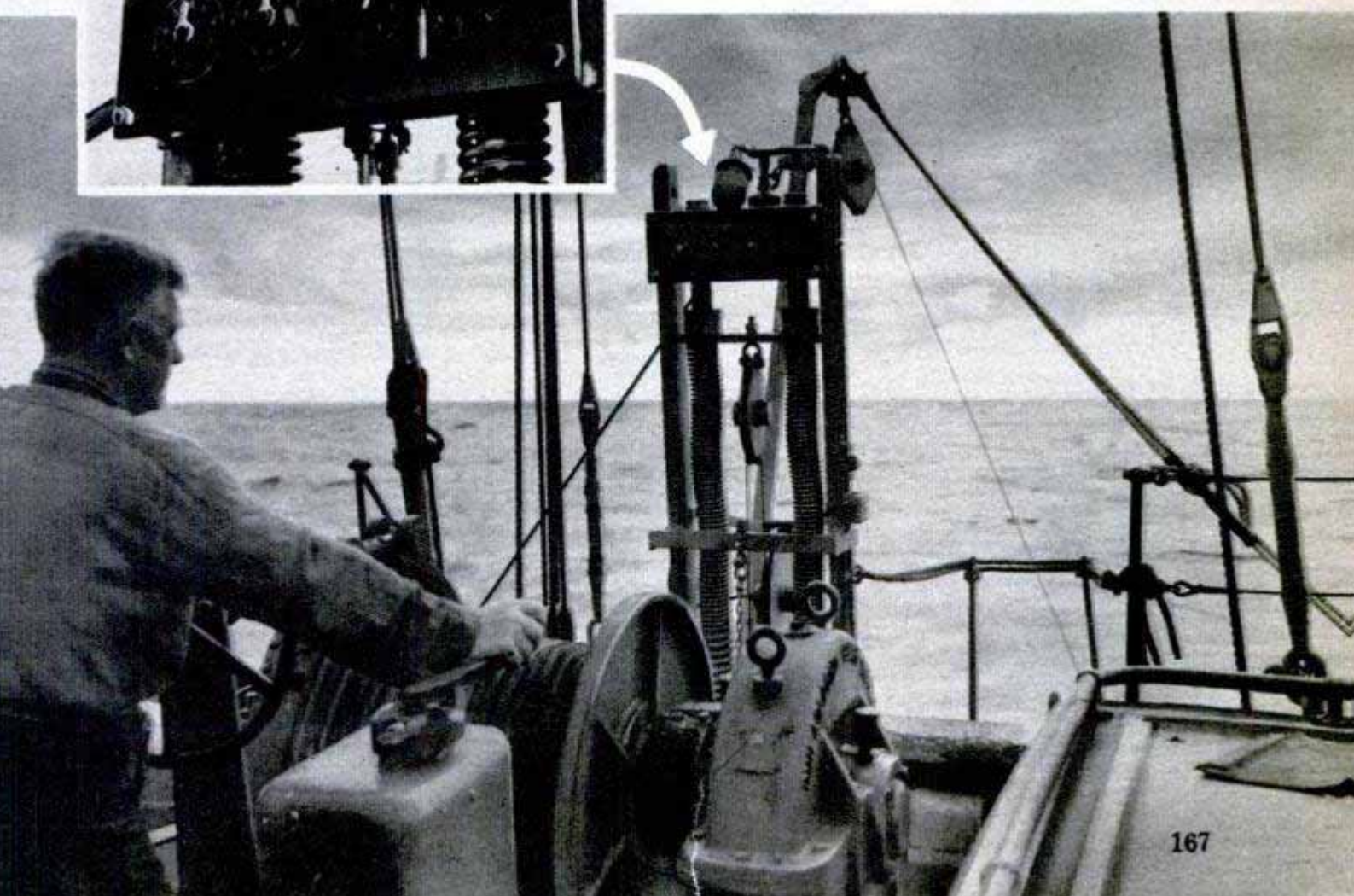
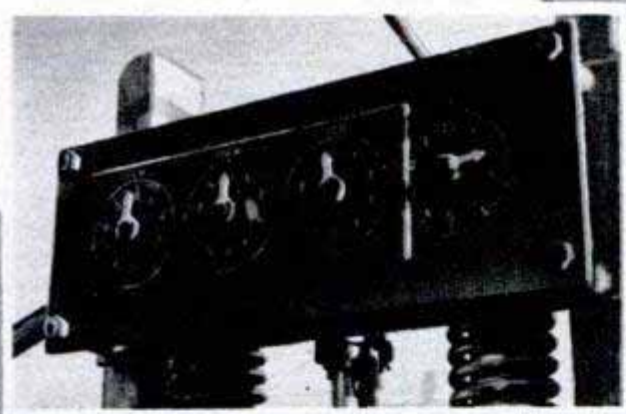
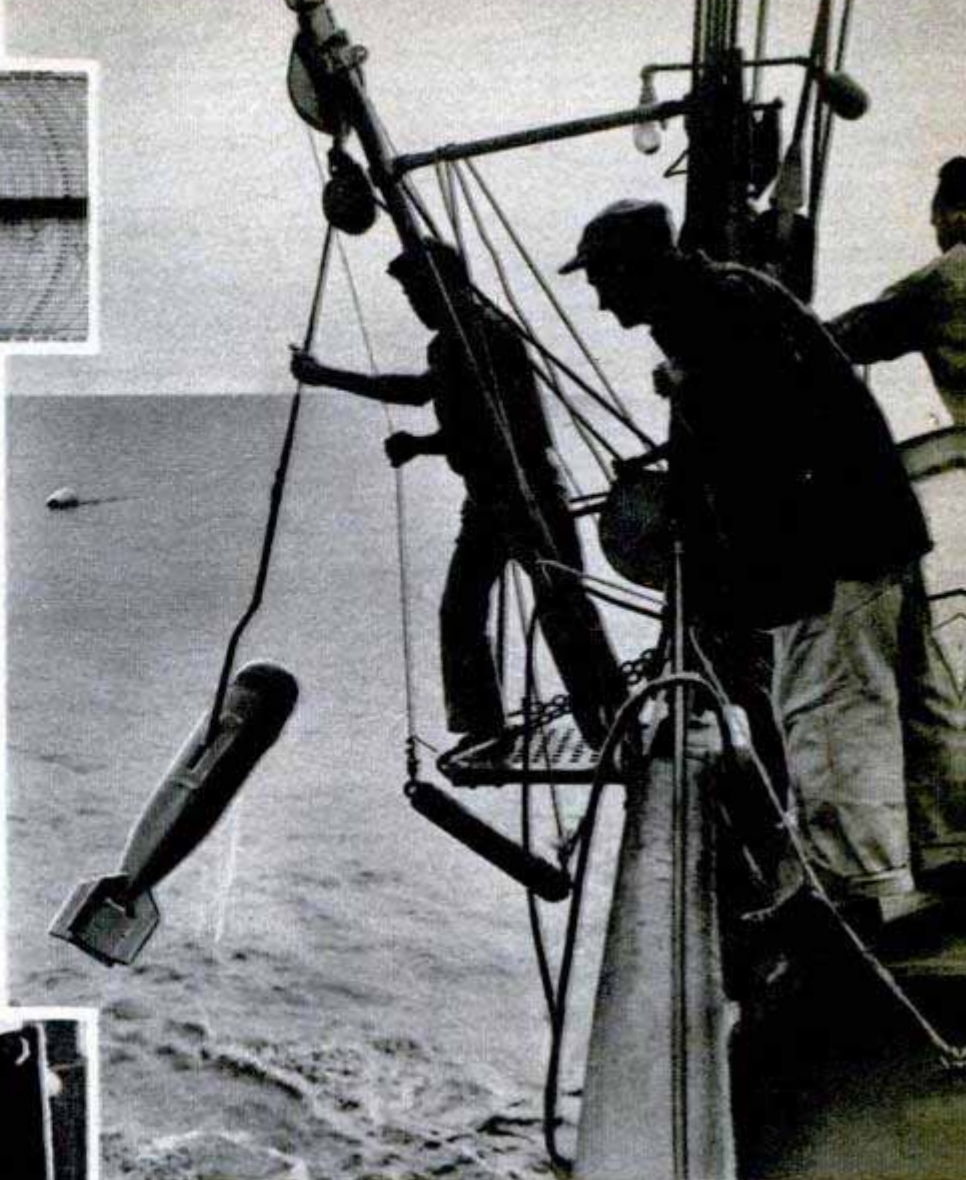

Portable Garage Designed to Solve Parking Problem in Large Cities

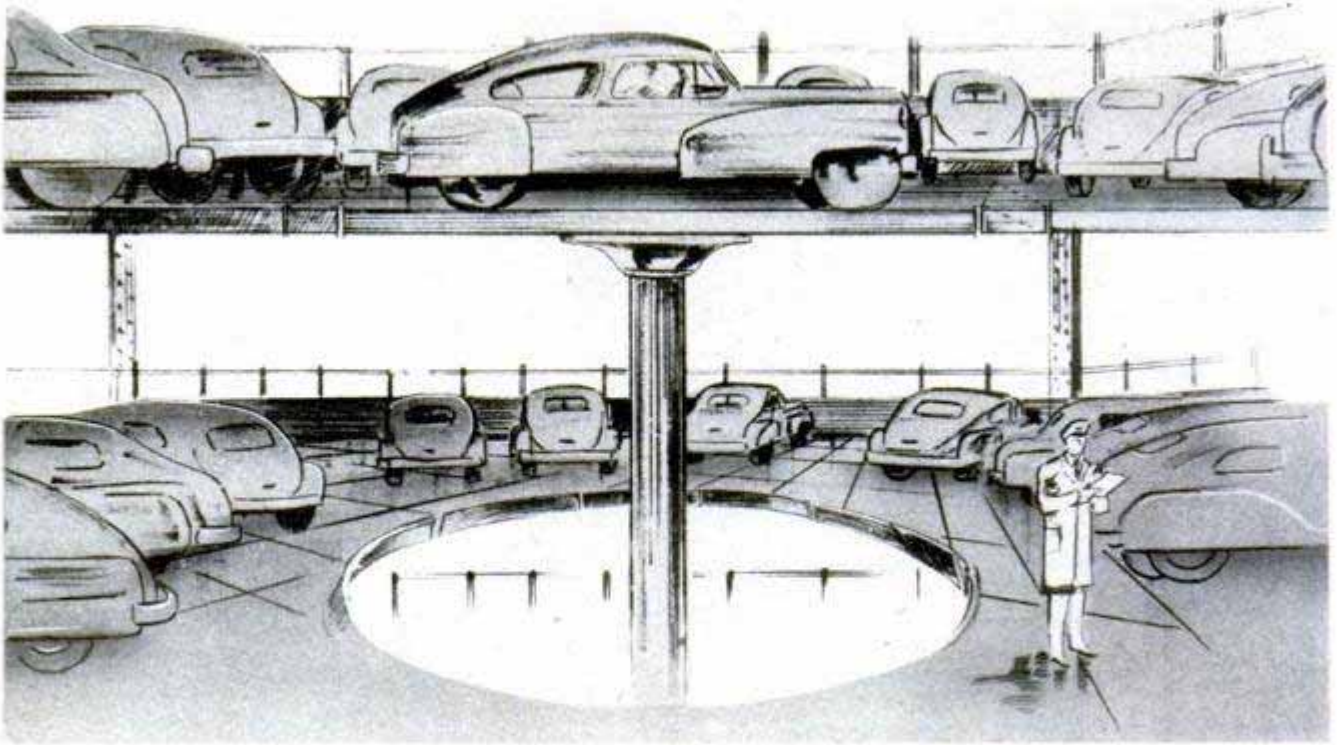

Top, turntable on the elevator enables the attendant to swing the car around until it faces a vacant stall. Below, a cutaway drawing of the proposed garage

Designed so that it can be taken apart and moved easily, a portable garage will provide maximum parking space on small, vacant lots in downtown shopping areas. The garage consists of several floors connected by a circular elevator. No walls or roof are used. The garage will be fabricated of structural-steel parts that bolt together, thus making it easy to disassemble and move when the space is to be used for some other purpose. A turntable platform in the center of the building is raised and lowered by a hydraulic elevator. The car is driven on the platform and the elevator lifts it to the desired floor. The attendant then

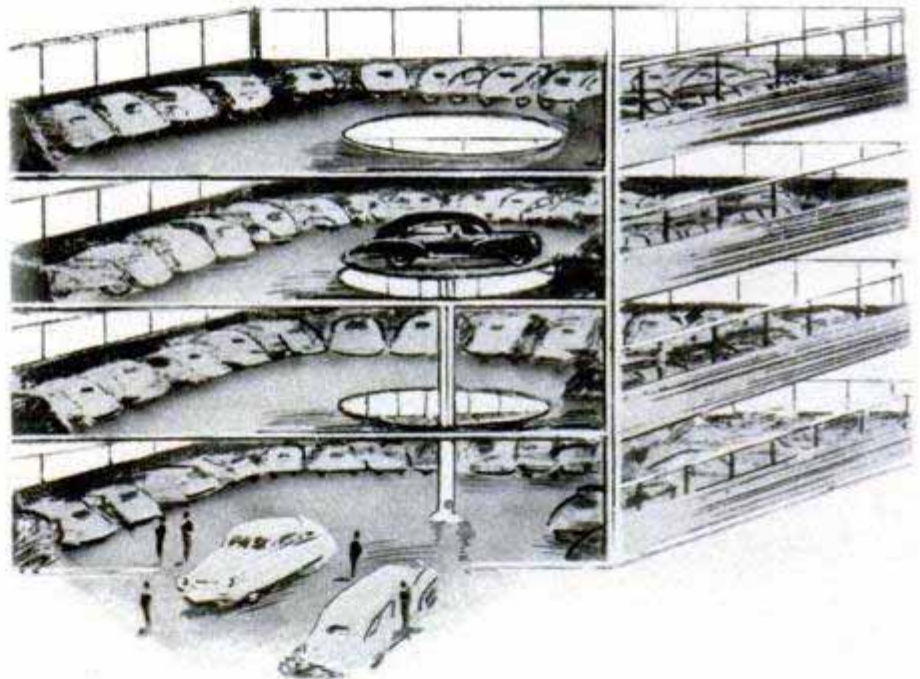

swings the turntable around until the car heads toward a vacant parking stall. An automatic curb springs up when the elevator leaves each floor to prevent cars from accidentally rolling into the opening.

Detector Guards Workers Against Beryllium Particles

Quantities of beryllium as minute as six one-trillionths of a pound are detected in the air by a technique designed to protect workers who might inhale the particles. An infinitesimal amount of beryllium goes into the air in machine shops where beryllium alloy is being cut. To measure the rare element, the mouth of a tube is placed where

the worker's face normally is located. Air is drawn through the tube by a pump and passed through a fine filter capable of snaring the tiny beryllium fragments. The filter is burned in a furnace and the ash analyzed under the spectrograph to find out whether beryllium is present in amounts that would be dangerous to the worker.



War-Surplus Glider Becomes Trailer Home

Once part of the Air Force, a war-surplus Army glider is now the comfortable trailer home of a Navy veteran and his family. Veteran Russel Bouton, a carpenter, converted the glider by removing the wing and tail and lining the interior with birch plywood. The pilot's compartment became a modern kitchen-dining room with plenty of natural light provided by the Plexiglas nose. A living room in the center and a separate bedroom in the tail section furnish enough room for four adults and two children. Hydraulic brakes that were part of the original glider are operated from the tow jeep for braking the trailer.

Above, there's plenty of daylight in the kitchen-dining room built in the Plexiglas nose. Below, exterior view of trailer



← **JOINTED STEM** on a new pipe enables the smoker to tilt the bowl or bit in any direction for convenient holding. The center unit of the stem is made of a lightweight alloy. It uses replaceable filters and the stem, being flexible, is almost unbreakable

Our **WHERE-TO-FIND-IT INDEX**, which lists names and addresses of the manufacturers or distributors of the products described in this issue, is available to readers without charge. For your copy, just write to Bureau of Information, Popular Mechanics, 200 E. Ontario St., Chicago 11, Ill.

Revolution in Weaving

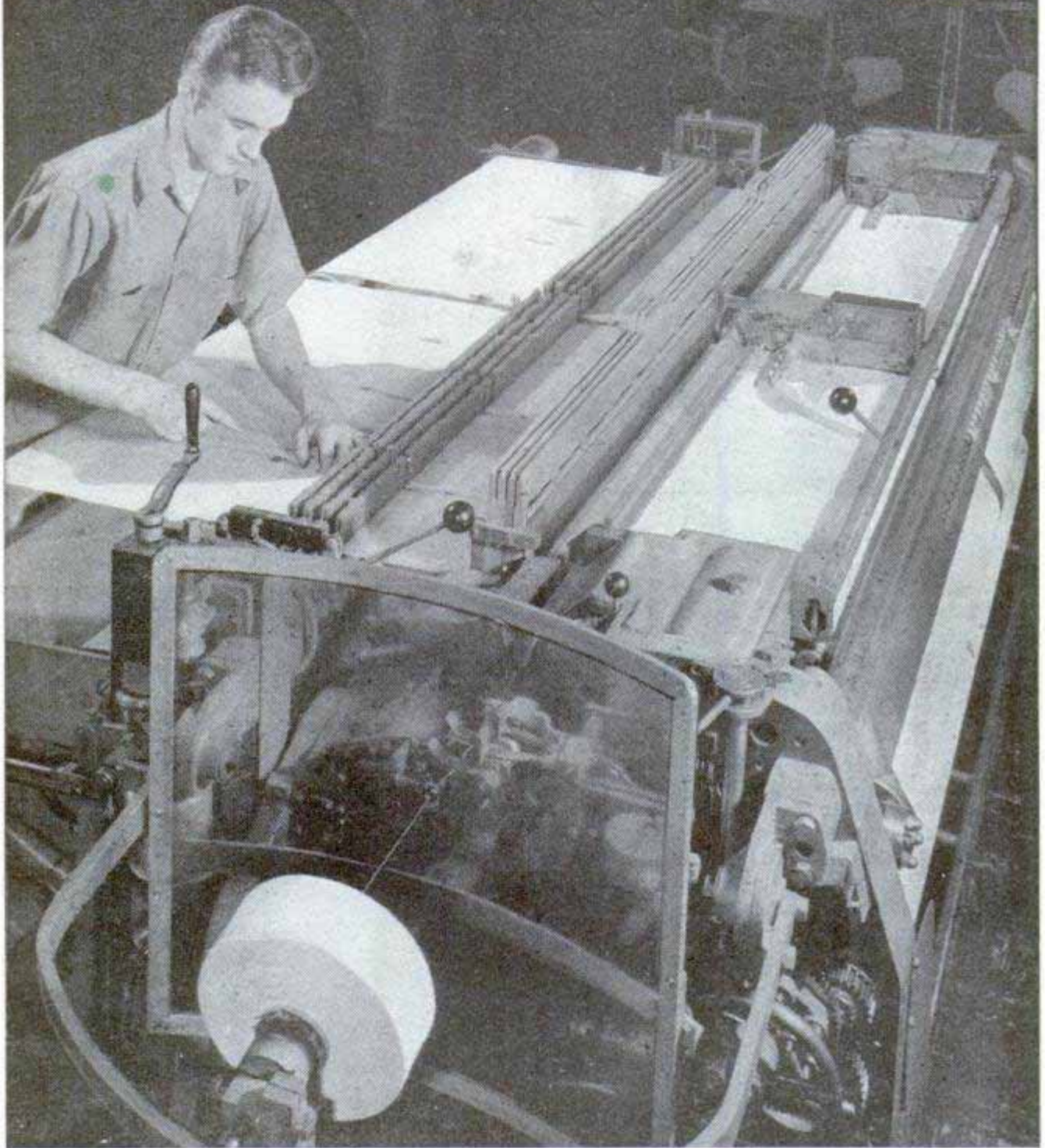

New loom uses a tiny shuttle and no bobbins. Filling thread is supplied by the large cone in the foreground

WEAVING, one of the world's oldest industries, is on the verge of a revolution. Leading the revolt is an invader from Switzerland that has eliminated the wooden shuttle and bobbin and promises to speed up the weaving process by 300 percent or more.

The welcome invader is a weaving machine that represents the first radical ad-

By Arthur R. Railton

vance in the weaving art in decades. The machine is so much more advanced mechanically than the traditional power loom that its American manufacturers, the Warner & Swasey Co. of Cleveland, Ohio, insist it can't properly be called a loom.

Basically, weaving is the interlacing of threads at right angles to form a fabric.

Whether this weaving is done by hand or by power machinery, a loom is used to hold a series of warp threads while cross threads (called weft or filling) are pulled through at right angles to the warp with a shuttle. To make these cross threads interlace with the warp to hold the fabric together, a thread-shifting arrangement, called a harness, is used. The harness shifts warp threads up and down, creating the over-and-under pattern of the fabric.

The new Warner & Swasey-Sulzer weaving machine or loom, being produced in an improved version based on the original design of Sulzer Brothers in Switzerland, doesn't change this basic weaving technique. Warp and weft are still interlaced. But the method of weaving has been brought up to date by modern industrial methods.

In the conventional power loom, the shuttle, which carries the filling or weft thread back and forth, is a slender piece of wood tapered on both ends like a double-ended torpedo. The cross thread or filling unwinds from a bobbin inside the shuttle. Leaving a trail of filling thread that is continuous through the fabric, the shuttle is driven back and forth across the warp. Because it carries the bobbin, the shuttle has to be large and because it is large it rubs against the warp threads as it travels to and fro at tremendous speeds, causing yarn abrasion.

As the filling thread is continuous, only one shuttle can be used. It makes thousands of trips across the warp, leaving a trail of thread like a spider dropping from

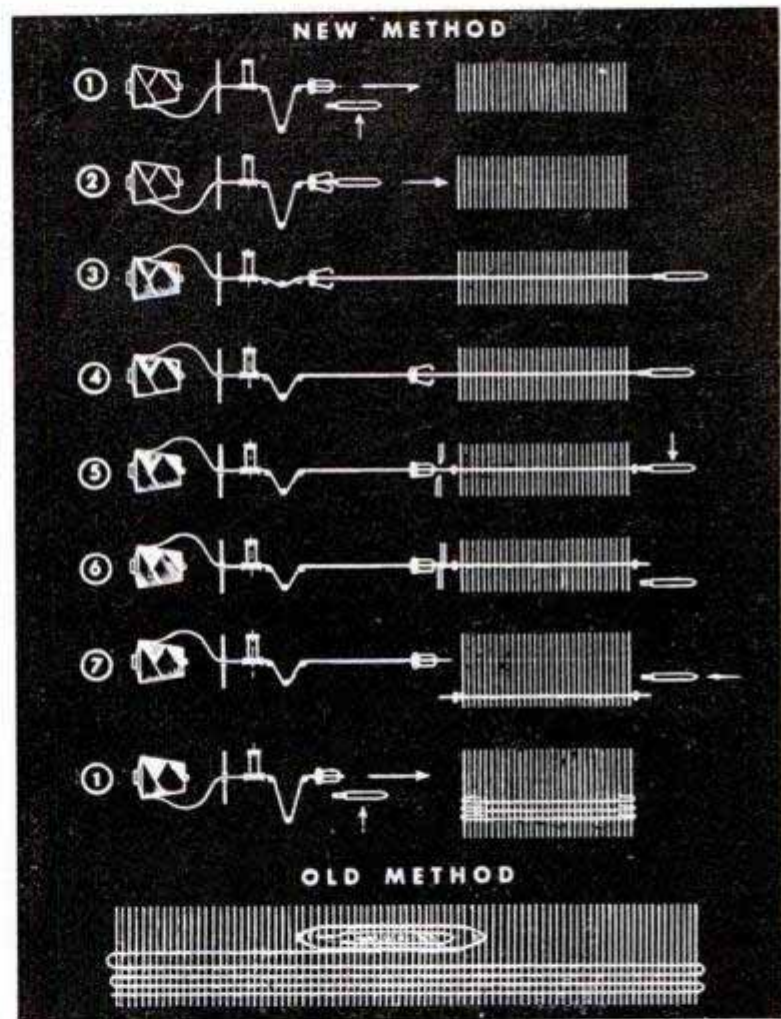
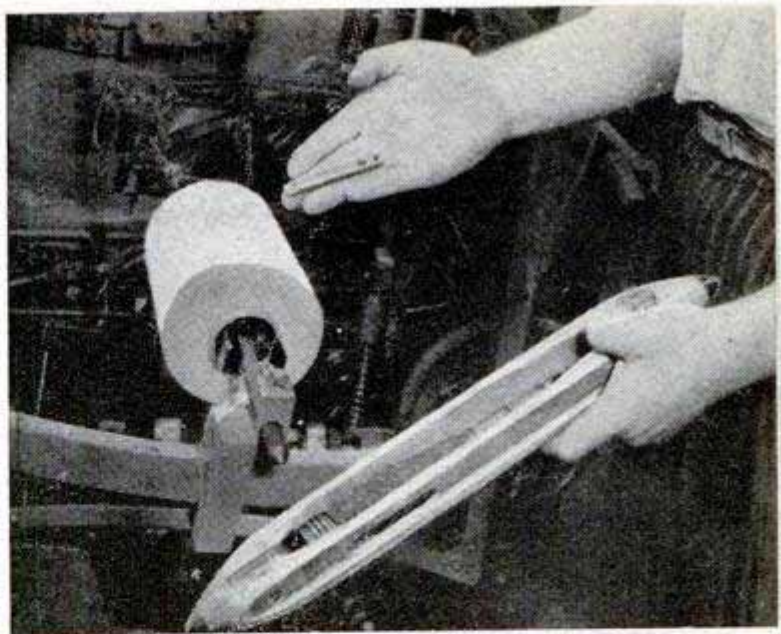

Top, tiny, new shuttle compared with old. Right, the new and old weaving systems. Below, sketch of new shuttle action with enlarged drawing of shuttle and scissors

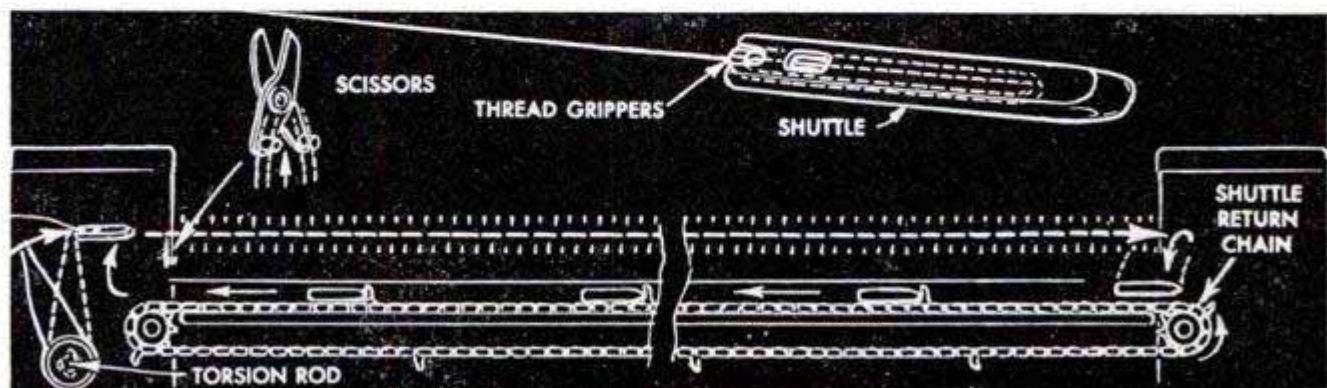

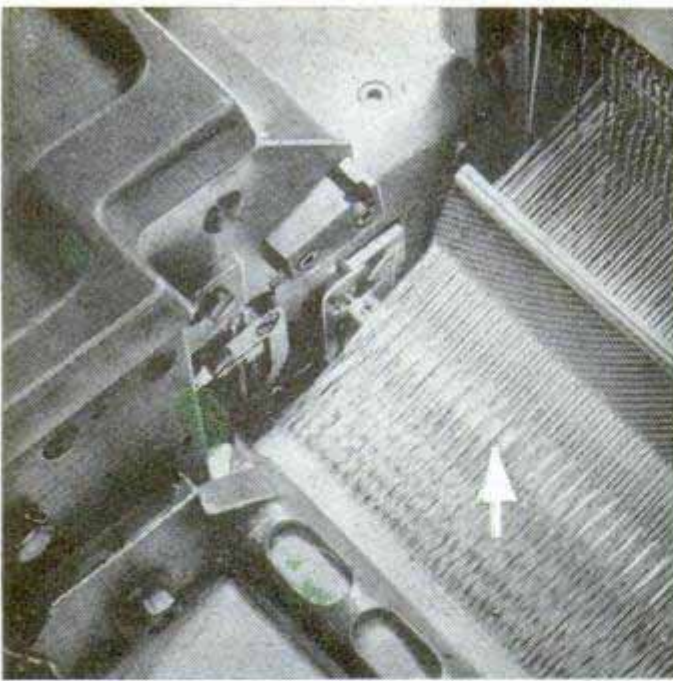

Left, shuttle (arrow) starts across loom between warp threads. Right, close-up shows tucking-needle action

the ceiling. Large and comparatively heavy, the shuttle limits weaving speed and cloth width. Also because of the large shuttle, the harness has to raise and lower the warp threads a relatively long distance to permit the shuttle to pass through.

The Warner & Swasey machine has surmounted these limitations that have plagued weavers for years. It does it by eliminating the traditional shuttle and replacing it with tiny, all-metal shuttles that are "fired" across the warp like bullets from a machine gun. Unlike the old-fashioned shuttle, the new type doesn't carry a supply of filling thread. With mechanical fingers, the slim, one-ounce gripper shuttle grabs the end of the thread from a large, fixed cone, pulls it across the warp at about 65 miles an hour, releases it and drops down on a conveyor chain to return for an-

other thread. As soon as one shuttle has completed its cross-warp trip, another is fired, pulling another thread with it.

The fingers which grip the thread are set into the shuttle at the rear. They close and open at precisely the right time to grab and release the thread. As soon as these fingers have gripped the thread, a steel torsion rod about 30 inches long is released, flipping the shuttle at terrific speed through guides to the opposite side of the warp.

Instead of having a continuous filler thread running through the fabric, the new machine cuts off each thread when the shuttle has pulled it through the warp. Tiny scissors cut the thread at the starting end as it is held by two grippers. These grippers move the thread out of the way of the next shuttle and wrap it around two

needles, one at each end, that tuck it into the warp so rapidly you see nothing but a blur as they move. Tucking the thread prevents it from pulling loose in the fabric.

This cycle is repeated as many as 240 times a minute with shuttles being fired across the warp so fast they are invisible. About 16 shuttles are used to provide an almost continuous stream when the loom is operating.

The filling thread comes from a large cone mounted on a curved bar at one end of the

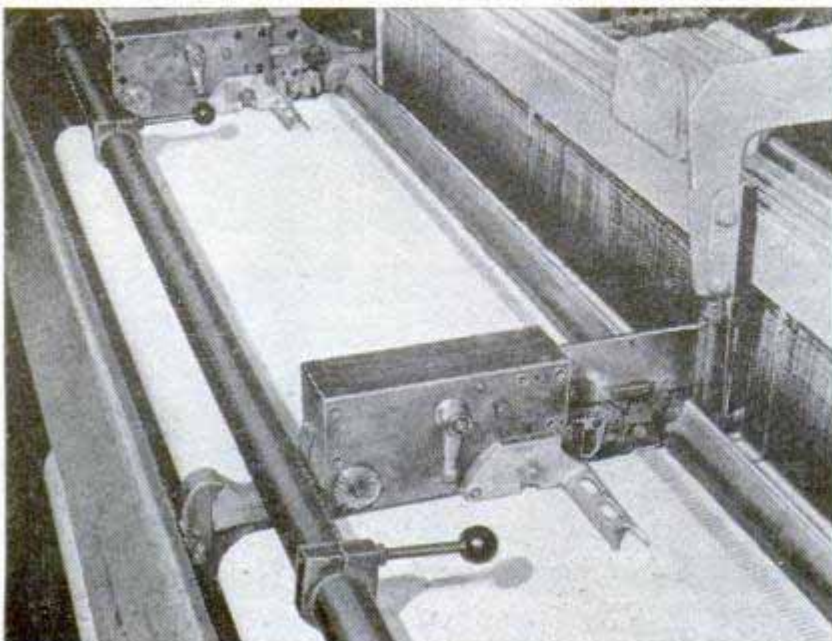

Tucking units, mounted at any place across the warp, enable the loom to weave several widths simultaneously

machine. Several cones (they're called packages or "cheeses") can be mounted on the bar and their threads tied together to provide a continuous supply of filling. Mechanical fingers hold the filling thread at the correct tension by an ingenious cam arrangement.

Because of the small size of the shuttles and because they travel inside a tunnel of guides, there is no rubbing of the warp threads by the shuttles as in conventional looms. The small shuttle also reduces the up-and-down travel of the harness and thus speeds up loom action.

Operation of the new machine is just about foolproof. Automatic controls prevent one cycle from beginning until the previous one has been completed. The controls stop the loom at once, preventing damage to the machine and fabric.

Because the shuttle uses no bobbins, the new weaving machine eliminates several processes preliminary to the weaving. Filling yarn doesn't have to be wound on hundreds of small bobbins. The packages or cones, which are used just as they come from the winding room, contain many times as much thread as the small bobbins.

By placing tucking units, consisting of needles, scissors and grippers built into a small assembly requiring only one inch of cloth width, at any place across the loom, the weaver can convert the machine for weaving more than one width of cloth at the same time. Thus with the 110-inch machine, it is possible to weave three strips of cloth, each about a yard wide. Conventional looms weave only one width at a time because of the continuous filling thread.

Adapting the Swiss machine for American mass production was a laborious task. Warner & Swasey engineers worked two years on the problem before it was completely solved. The basic step was the conversion of all machine dimensions from metric to English units of measure. But the biggest task was reducing the number of parts that required time-consuming machining. The Swiss

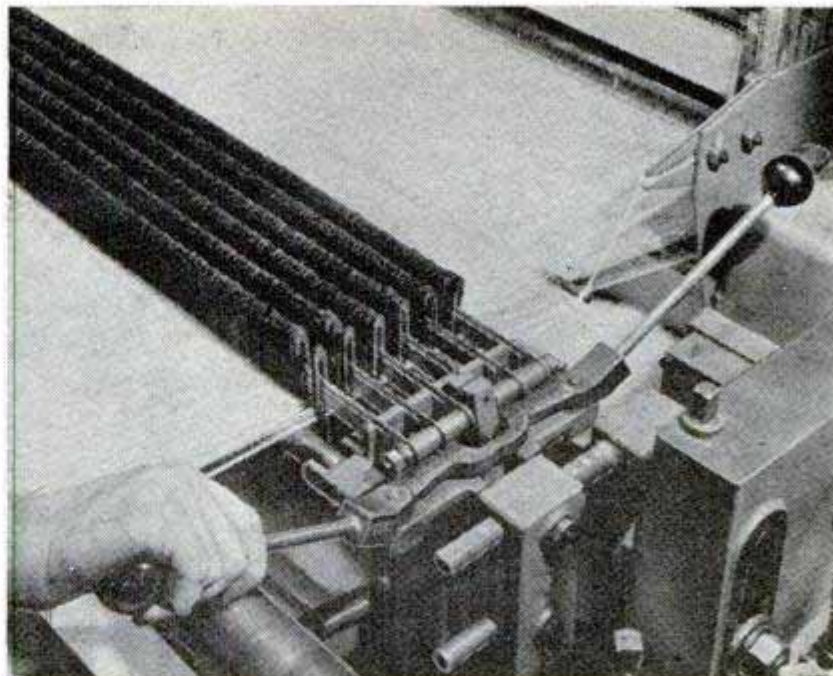

Copper strips rest on warp threads and drop, stopping loom, when a thread breaks. Lever separates strips to reveal the broken thread

models were produced carefully and with considerable hand work. No attempt was made to design them for mass-production. Cleveland engineers had to redesign many parts for modern production methods. For example, one cam, requiring 35 minutes to machine originally, was redesigned so that it is now made in only two minutes.

In 1661 a Polish inventor built what may have been the first successful power loom. The shortsighted rulers of his day promptly killed him and destroyed his loom, claiming it would ruin the people who did hand weaving for a living. Warner & Swasey believe that their loom is the greatest advance in weaving since that first power loom, but this tragic story doesn't worry them. The world now knows that labor-saving devices are not detrimental, but beneficial to society.

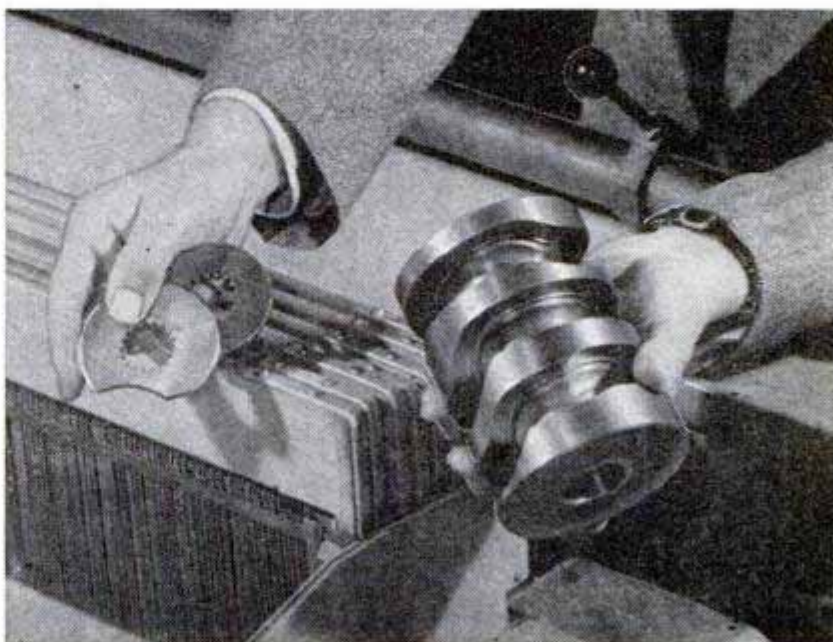

Large cam at right is part of Swiss model. Flat cams are the new design that cuts production time 95 percent



Two-Brush Polisher Also Scrubs, Waxes

Waxing, polishing, scrubbing and sanding are all part of the day's work for a double-brush, floor-maintenance machine. When the long handle is removed and two hand grips substituted, the machine can be used for polishing automobiles and furniture. The two brushes revolve in opposite directions assuring perfect balance and easy directional control.



Top right, for floor work, the long handle is used. Top left, hand grips convert it for use in sanding and (left) polishing

Car Trouble Light Has Warning "Flare"

Combining a trouble light with a red "flare," an emergency light for motorists plugs into the cigarette-lighter socket. The light has a powerful electromagnet that holds it against the body or motor. The white bulb is protected by a guard and the opposite end is made of red plastic that glows brightly as a warning to approaching cars.

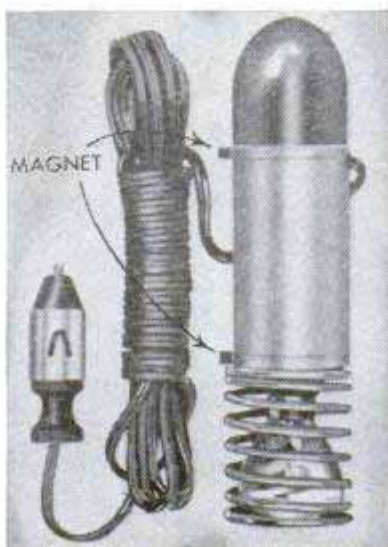

Coded Recordings

Confidential messages are recorded in code on paper records that can be played back only on a recorder equipped with a coding disk identical with the one used during the recording. This disk, made of plastic, consists of concentric wavy grooves that control the path of the pickup arm around the paper record. Only two copies of each control pattern are made so that complete secrecy is assured. Recording is done magnetically on the paper record, leaving no grooves or marks to guide the pickup. Without the deciphering device, the pickup arm cannot follow the magnetic path on the record and the message is garbled and unintelligible. The record can be folded and placed inside an

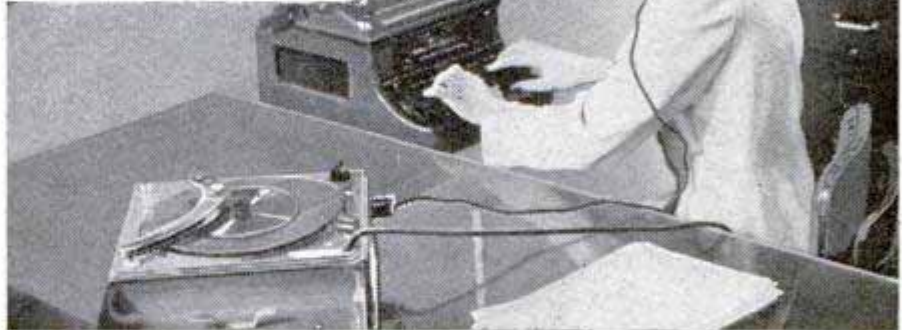

Dictation can be played back only by using coding disk (top) identical with one used for recording. Grooves control path of the recording head

ordinary letter envelope for mailing. It is designed for transmission and filing of confidential material.

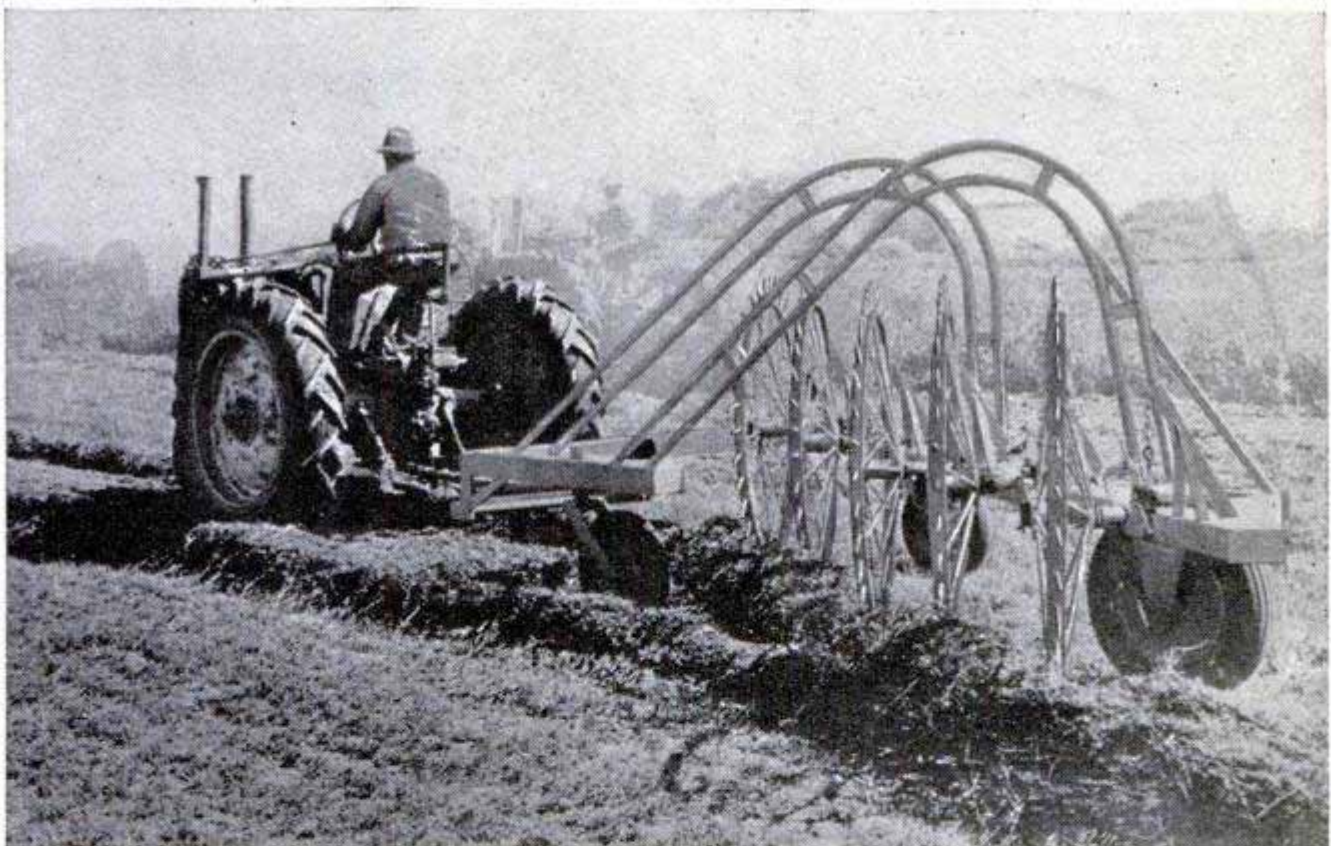

Side-Delivery Rake Reduces Excess Leaf Shatter

Excess rolling and leaf shatter are eliminated by a side-delivery rake that makes windrows for baler pickups and windrow harvesters. Having no gears, chains or sprockets, the rake is almost foolproof in operation. Five large wheels rotate freely

on individual axles, raking the crop gently into narrow windrows. It can be used with any tractor and its full-floating action permits its use on contours and rough land without difficulty. Maintenance is simplified because it has few wearing parts.

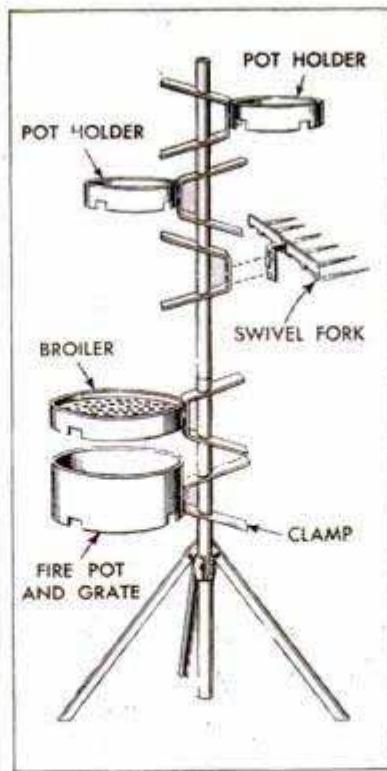

Portable Cooker Stands on Tripod

With a tripod base that holds it upright, an outdoor cooker has adjustable racks for holding a skillet, coffee pot and wieners. The six-pronged wiener fork toasts four at a time and swivels to cook both sides. Wood, charcoal or coke can be burned in the fire pot. The racks and fire pot have clamp-type brackets that lock in any position on the upright tube or can be removed entirely. For ease in carrying, the cooker packs into a compact kit, the long upright being made in two sections.

Rear-Engine Tractor

Tractor operators see exactly what the implements are doing without turning around when driving a rear-engine tractor that mounts its implements just behind the front wheels. Any implement can be attached or removed in five minutes or less. The engine, located behind the seat, is economical to operate, using from two to three quarts per hour under medium to heavy loads in average soil.

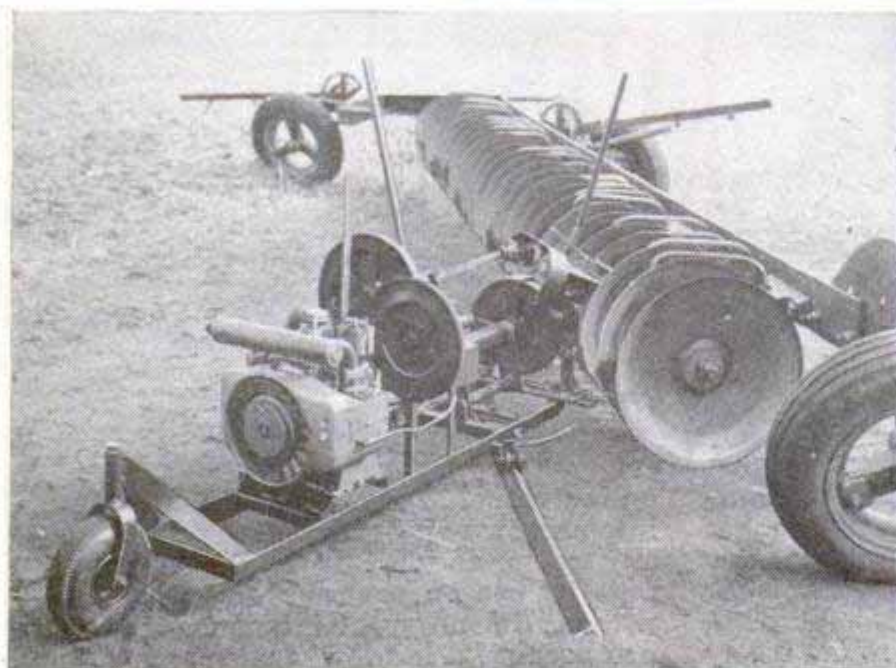

Disks Are Ground Without Dismantling

Disk blades on farm implements are sharpened right on the machine by a portable grinder powered with either a gasoline engine or electric motor. It will sharpen a one-way disk in less than an hour without the bother of dismantling. A fiber drive roller rotates the blade against the emery wheel insuring complete sharpening. A metal track, laid on the ground parallel with the chassis of the implement, holds the grinder at the correct angle.

The CRAFTSMAN

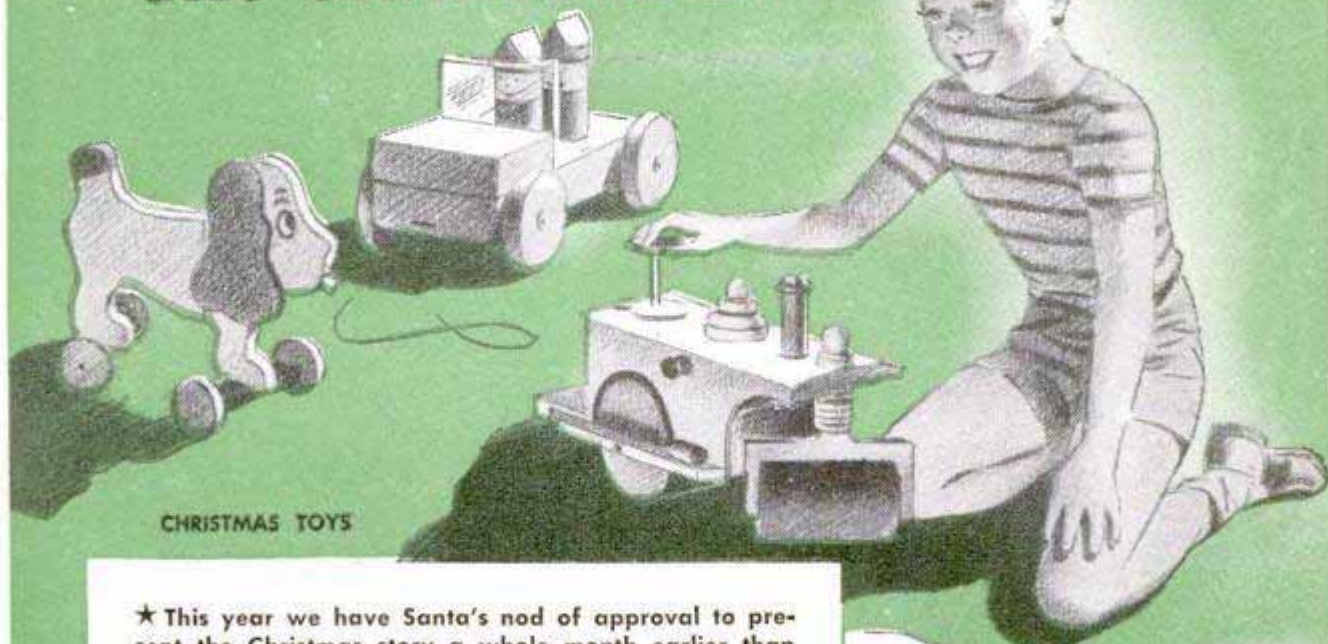

CHRISTMAS TOYS

★ This year we have Santa's nod of approval to present the Christmas story a whole month earlier than usual. On page 190, several of our experienced toy designers present their own ideas of what are tops in easy-to-make toys. Dads with long Christmas-gift lists, small workshops and limited time will find this story made to order, and early enough to get a head start.

★ To craftsmen who like to work with fine hardwoods, pipecrafting will be a challenge to manual skill. Yet it takes only a few tools plus the craftsman's touch to make a fine briar pipe any smoker would be proud to own. Our story on page 208 is of special interest because it gives step-by-step instructions both on making and repairing pipes.

★ An article of particular interest to homeowners, and those planning new homes, outlines approved methods of preventing wall condensation in houses already built and also those in the planning stage. Page 197.

★ New power demands on single-cylinder, air-cooled engines range from the simple motor scooter to complicated machines requiring drives capable of delivering uniform speeds. These unusual power demands on the little "one lungers" make a regular service schedule necessary. A practical shop article, written by an authority on gas-engine tune-up, begins on page 222.

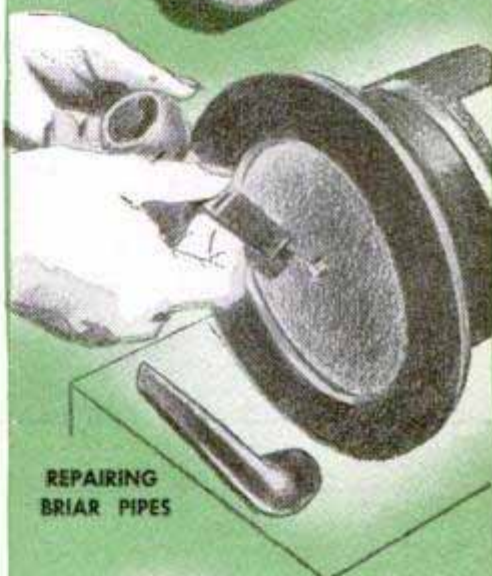

REPAIRING
BRIAR PIPES

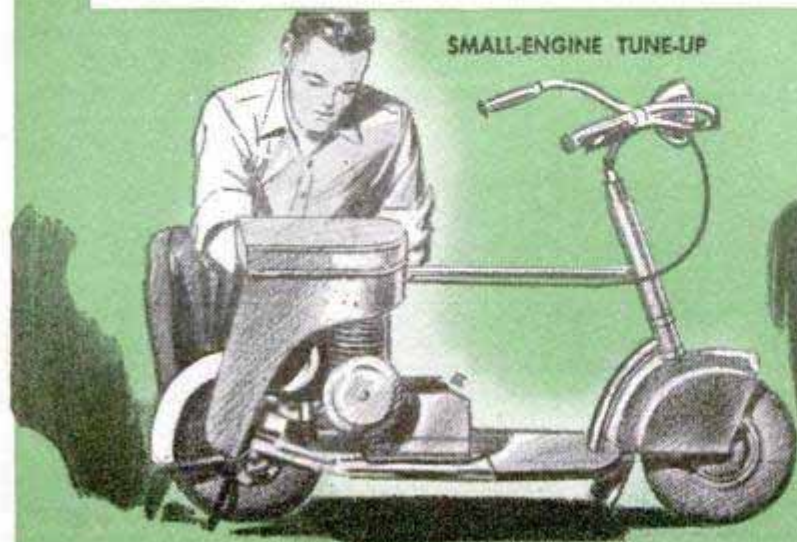

SMALL-ENGINE TUNE-UP



PREVENTING
WALL
CONDENSATION

PICTURE CARVING

By Hi Sibley



PAINTING" pictures with a jackknife is a fascinating pastime in which a scene is carved in sunken bas-relief to give a striking third-dimensional effect. Carving is done in a plank only 2 in. thick, but the illusion of depth is emphasized by carving the scene in perspective, working from a vanishing point.

First enlarge the pattern in Fig. 2 and mark the vanishing point as given. The picture can be enlarged to almost any size, although the original picture, depicting a Swiss kitchen and shown on the opposite page, was carved $6\frac{1}{2}$ by $9\frac{1}{2}$ in. In enlarging the pattern, rule on paper the same number of squares as given below and then duplicate the scene by drawing the lines in each square in a corresponding square on the paper. Mark off a border around

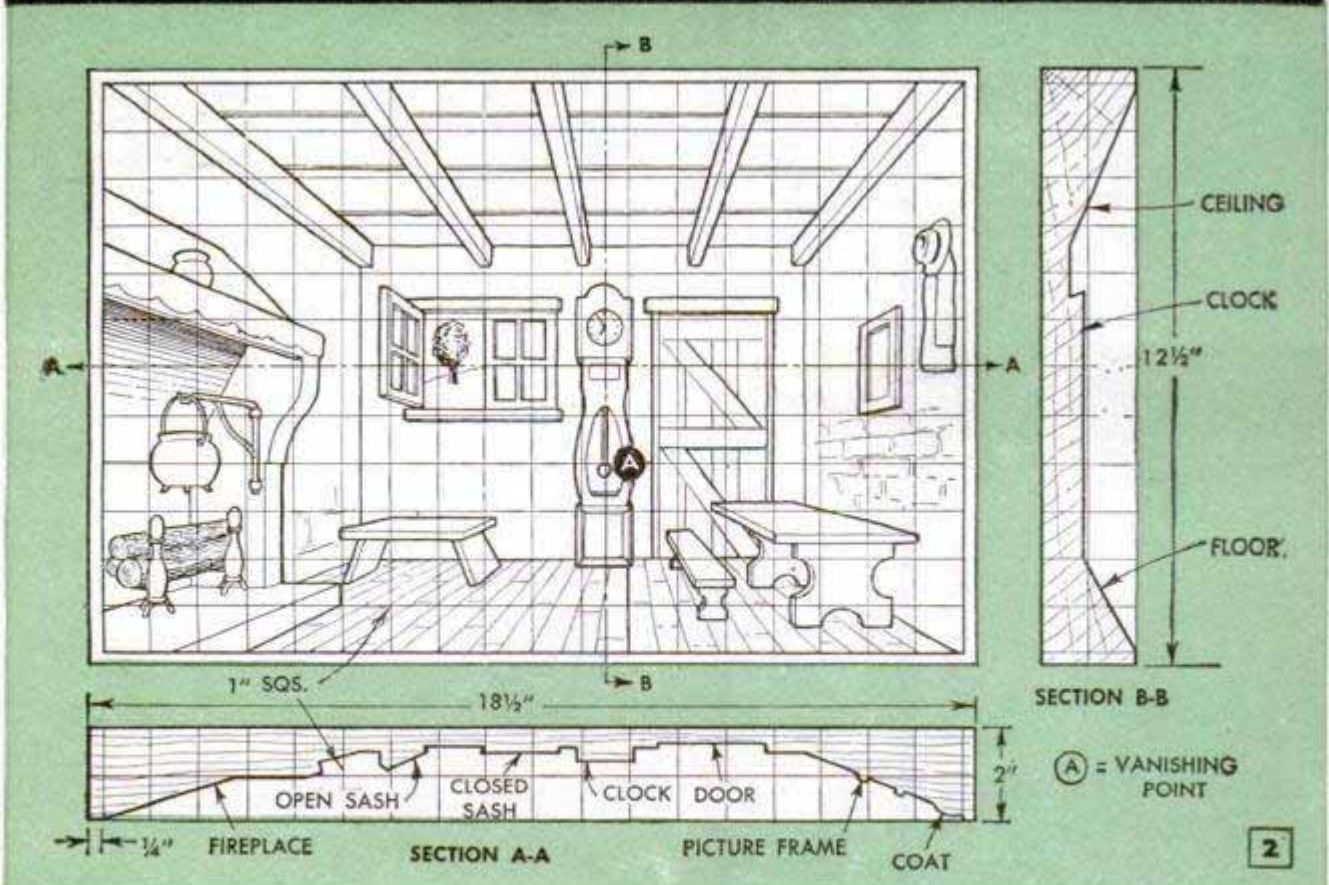
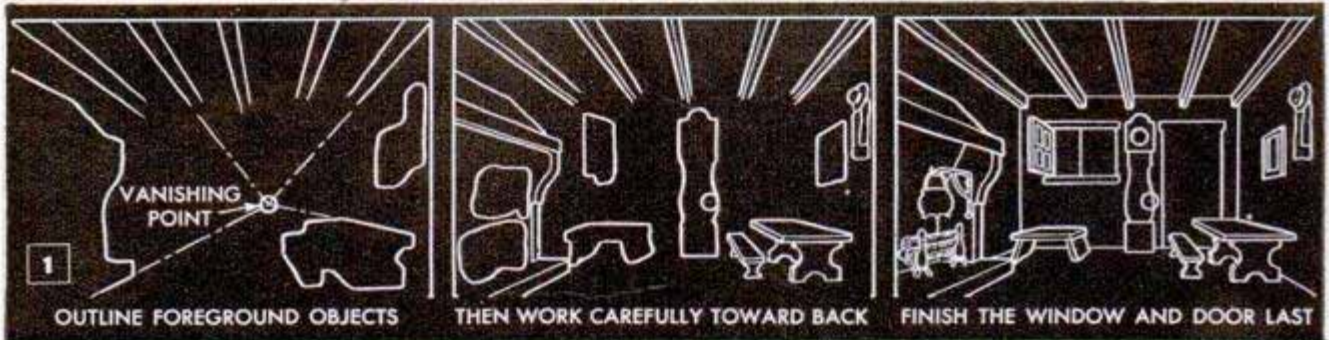

in RELIEF

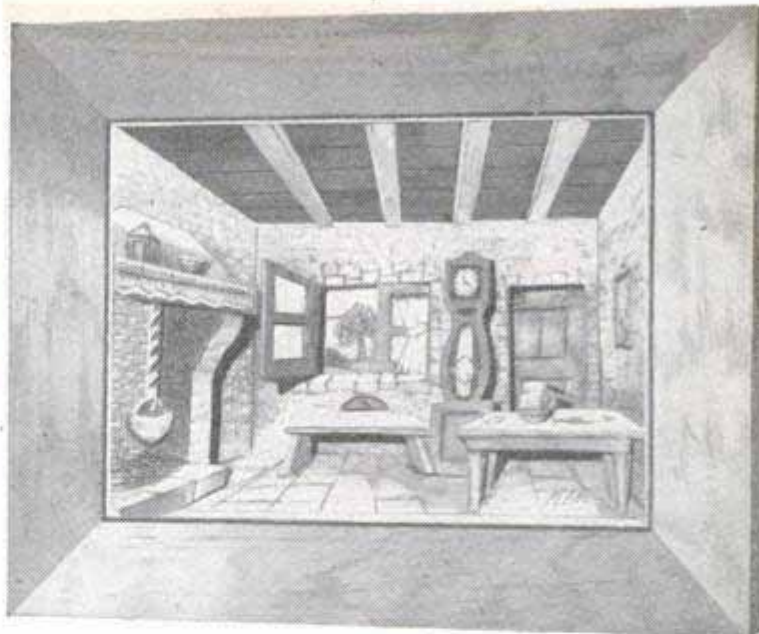
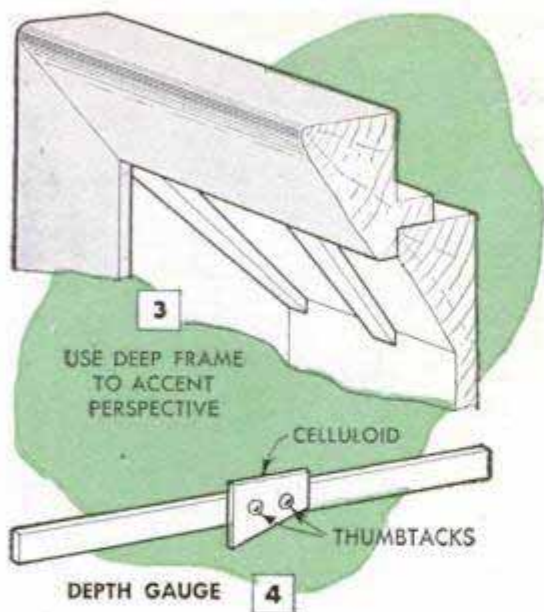

Completed carving mounted in wide frame. Landscape scene behind open window is represented by picture pasted in place

the picture $\frac{1}{4}$ in. from the edge and score the line with a knife.

Start carving the ceiling beams and then outline the objects in the foreground, gradually cutting away the remaining area. The three stages to follow in carving are given in Fig. 1. Work carefully and proceed cautiously. A depth gauge, like the one in Fig. 4, is required to check the carving for depth at various levels. The gauge consists

of a piece of celluloid or stiff cardboard fastened to a straightedge with thumbtacks. The gauge is set for depth by adjusting it to conform with sectional views A-A and B-B, Fig. 2, which also must be enlarged to actual size.

When the carving is completed mount it in a deep frame, as in Fig. 3. Small brads driven through the tongue formed in the frame hold the picture in place.

Halloween "Pumpkin" Delights the Children by Blinking One Eye

When my little nephew asked me to make a pumpkin-face for him last Halloween, I decided to make something different, and it proved to be the sensation of the neighborhood. I took a large cardboard box, cut a smiling face in one side, and pasted a sheet of orange-colored crepe paper behind the openings. At first, I put a single 60-watt bulb in the box and placed a flasher between the bulb and socket so the face would flash on and off to attract attention. Then, one of the children suggested that it would be nice if I could make just one of the eyes blink on and off. So, I enclosed one eye with a cardboard partition, installing one socket equipped with a flasher unit inside the partition and two more in the other part of the box. The sockets are wired in parallel, as shown in the detail. Twenty-watt bulbs were used throughout. A rubber grommet protects the cardboard where the extension cord enters the box. It's best to use sockets that have enclosed terminals and also to seal the carton shut so the children are not likely to injure themselves. The box can be placed in a window or on the front porch.

Arthur Trauffer, Council Bluffs, Iowa.

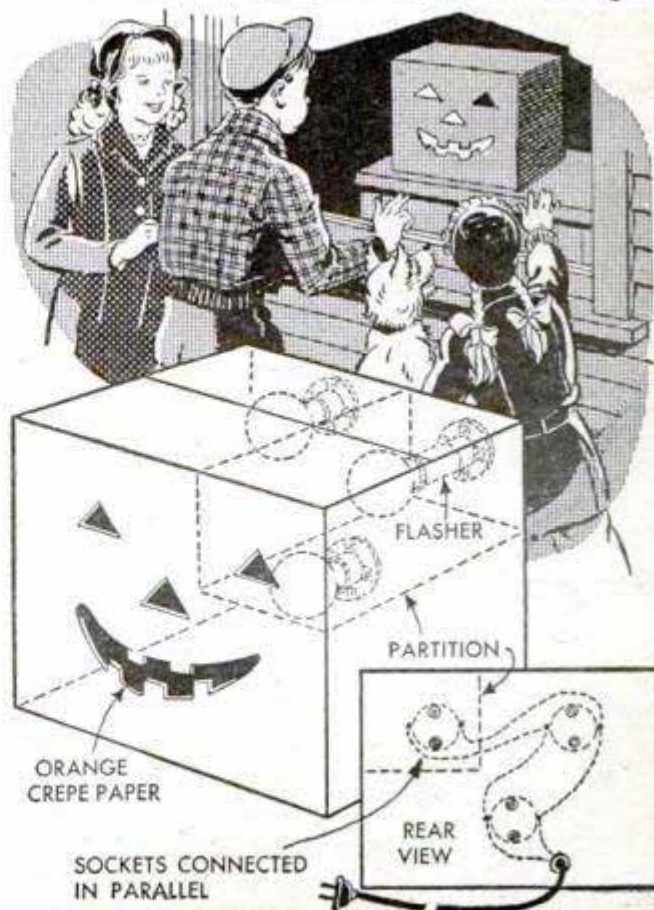

Quick-Change Mounting Block For Home-Workshop Motor

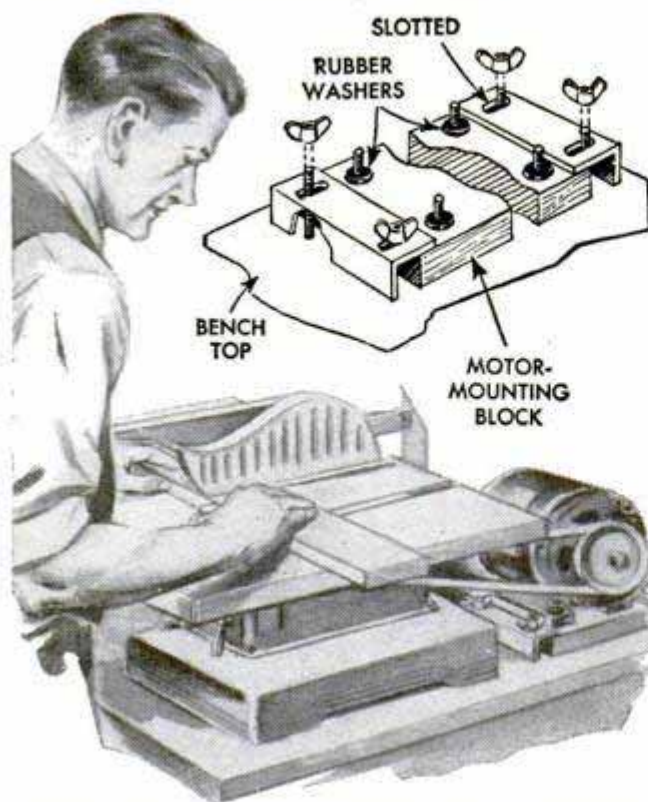

If you do not have enough electric motors to use one on each power tool, a mounting block, such as the one shown, will enable you to use a single motor for several tools and change it quickly from one to the other as desired. As in the detail, the block is a piece of hardwood to which the motor is bolted. In the correct position behind each tool, short lengths of angle iron are mounted with bolts and wing nuts, the bolt holes in the iron being slotted to permit adjustment of the angle-iron pieces. In use, the hardwood block to which the motor is fastened is merely slipped in between the two angle irons so that the upper edges of the latter frame the block. In this way, tightening the wing nuts clamps the block and holds it in place, while loosening them allows the block to be slipped out and moved to another tool. If necessary, one side of each angle iron can be ground down so that its height closely approximates the thickness of the wooden block.

D. I. Symington, London, Ont., Can.

Garden Rake Makes Tool Rack

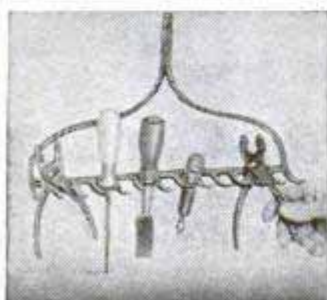

The metal head from a broken garden rake provides a handy rack for small tools in the basement workshop or garage. Just remove the broken handle and

hang the head from a nail driven into a stud or wall. Screwdrivers, chisels, pliers, etc., fit nicely between the teeth.

Benj. Nielsen, Aurora, Neb.

Steel Wool Strains Water When Bathing Dog in Tub

Next time you give the dog a bath in the sink or tub, try placing a wad of steel wool in the drain opening. This permits the water to drain out of the tub, but catches the dog hair which will clog the drain.



Oilcan Loads Air Rifle

Repeating air rifles are loaded quickly and easily by using an oilcan to insert the shot in the small, tubular magazine. To modify the can for this purpose, remove the spout and drop a pellet into it. Then,

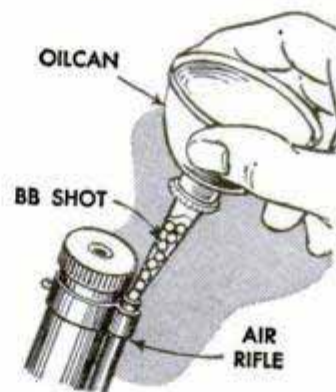

with a wire, measure the distance the shot has lodged from the end of the spout, and saw off the tip of the spout slightly above the place where the pellet stopped. After this, remove the burr caused by the saw. To load the rifle,

just fill the oilcan with BB shot, replace the spout and feed the pellets into the magazine from the tip of the spout. This not only saves time, but reduces the chance of spilling the shot.

Keeping Brick Fireplaces Clean

A brick fireplace is easier to keep clean if its front is coated with liquid wax. The wax gives the bricks a slight gloss and a comparatively smooth finish, filling the porous surface in which dust usually accumulates. In this way, soot and dust are less likely to collect and any that does can be wiped off quickly. A small brush makes a handy applicator.

Dorothy Morley, Highland Park, Ill.



KEYBOARD ART

By Paul Hadley

WHILE purely entertaining, doodling with a typewriter gives vent to the imagination and originality of both the experienced and the hunt-and-peck typist. Fill-in pictures are the easiest to "draw" with a typewriter. An example is shown in the flower which is made with the letter X alone. Such pictures, whether a flower or a portrait, are made by using an outline of the subject as a typing guide. This is done by tracing the outline lightly on paper and backing it with carbon paper to type the picture. Caricature or cartoon "drawing" combines letters with symbols as shown in the examples below. Here, half-spacing of the typewriter is required, as in the case of the owl's beak and feet. The log cabin shows what can be done in drawing a picture in perspective.

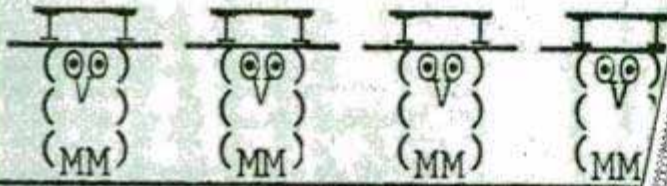
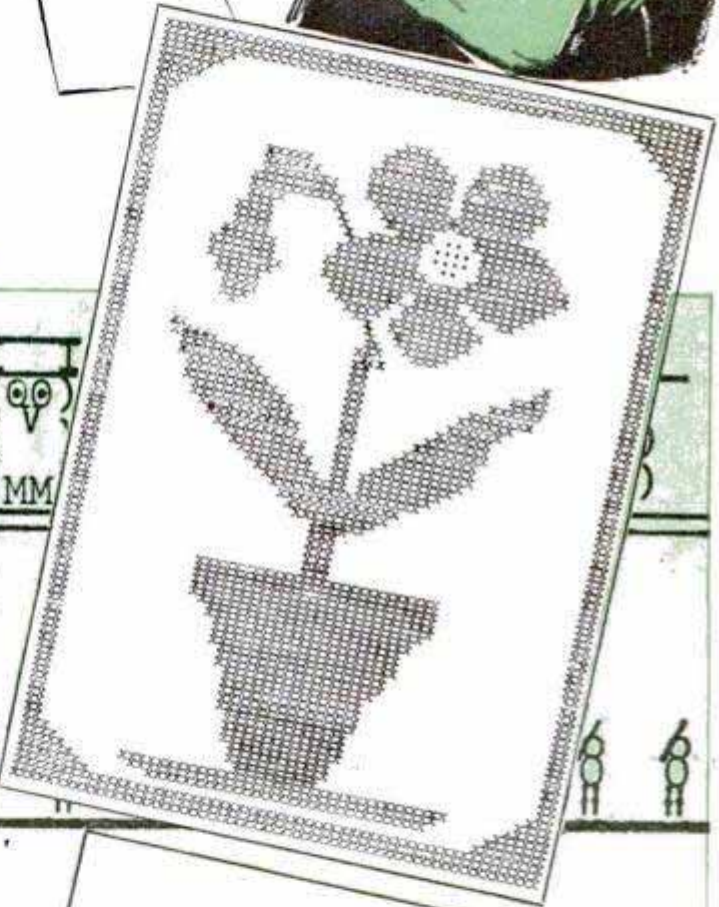

Capital letters I, O, V and M are combined with dashes, parentheses and periods to draw the owls. Half-spacing is required to locate the eyes, beak and feet of the owl



Quotation marks represent the legs of the soldier. His body is formed by a large and small letter O and the gun is a diagonal

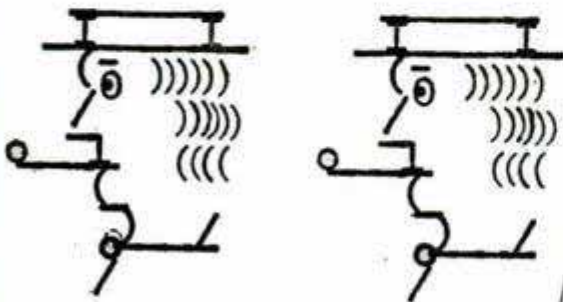

Above uses diagonals, parentheses, dashes, hyphen, period and letters I, O, 1 and o





SHARP CREASES are avoided when storing a large linen tablecloth for long periods if the cloth is rolled on a broomstick or mop handle

SOAP LUBRICATES NEEDLE to prevent breakage when stitching seams in canvas and other heavy material. Rub the soap along the line of stitch

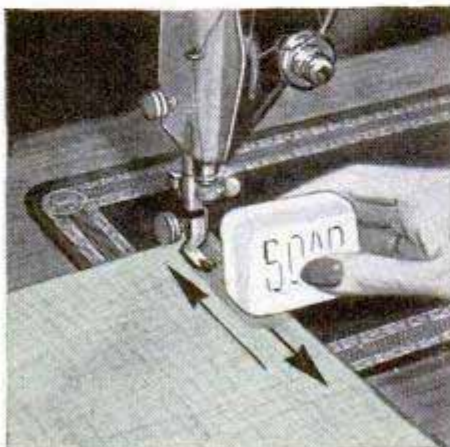

REMOVING DECALS is made easy if cellulose tape is applied to transfer and used to lift it off. The design will adhere and peel with tape

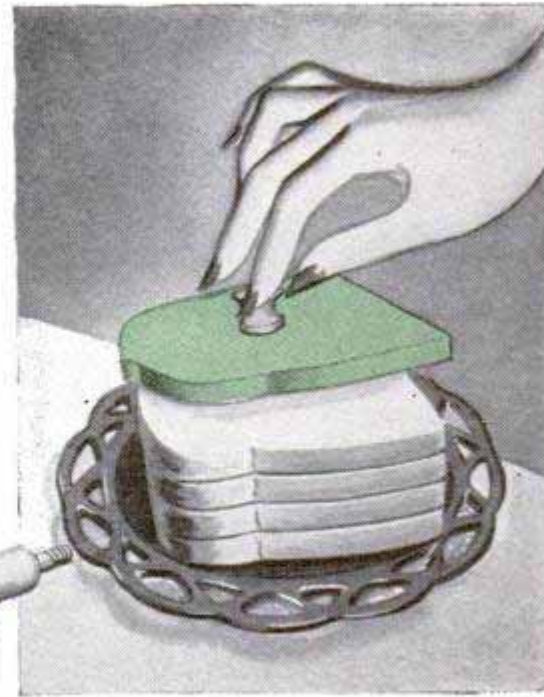
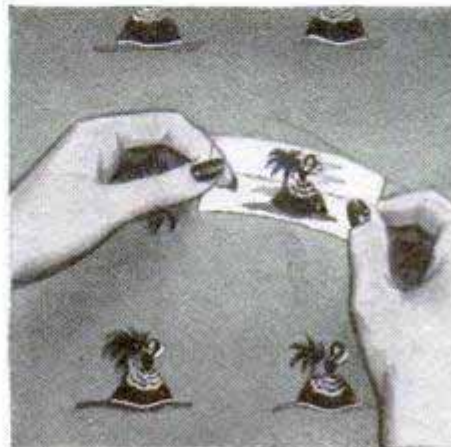

WOODEN BREAD COVER prevents top slice from drying when bread is on table during or after a meal. Cut the cover to represent a slice of bread, then paint it a bright color and fasten small drawer knob to the top to serve as a handle



SPONGE WATERS PLANT when buried at the bottom of a flowerpot. By retaining water, the sponge serves as wick to feed plant roots. Idea is especially desirable when plants are unattended for several days

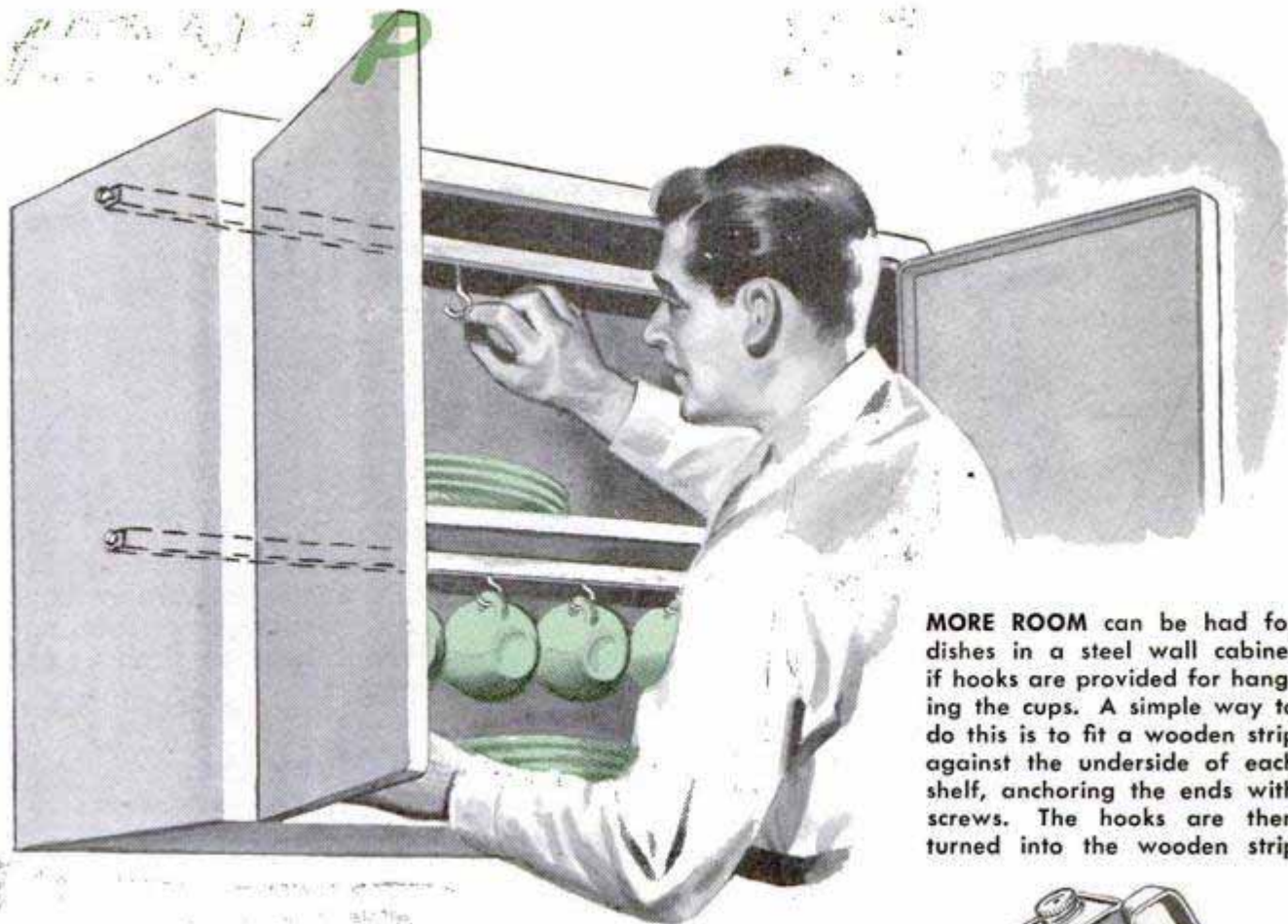

MORE ROOM can be had for dishes in a steel wall cabinet if hooks are provided for hanging the cups. A simple way to do this is to fit a wooden strip against the underside of each shelf, anchoring the ends with screws. The hooks are then turned into the wooden strip

WATERING CAN for plants which reduces spilling to a minimum is made from flat can of type shown. Spout is length of copper tubing soldered over hole near bottom of can and braced near top. Vent hole is punched in top of screw cap and suitable handle provided



WORN SPOTS in rugs are made less noticeable by filling in the original pattern with waterproof drawing inks. Use colors that match as closely as possible and apply carefully with regular bottle quill

TRIPPING OVER RUG will not happen if curled corners are anchored to the floor with strips of adhesive tape. This is especially useful in the case of small linoleum rugs that have a tendency to curl when new. Apply tape by folding back-to-back

WALLPAPER CLEANER that sticks and streaks the paper can be made more convenient to handle if cornstarch is kneaded into cleaner. Add cornstarch, about three tablespoonfuls, until cleaner is no longer sticky. Cornstarch will not retard cleaning

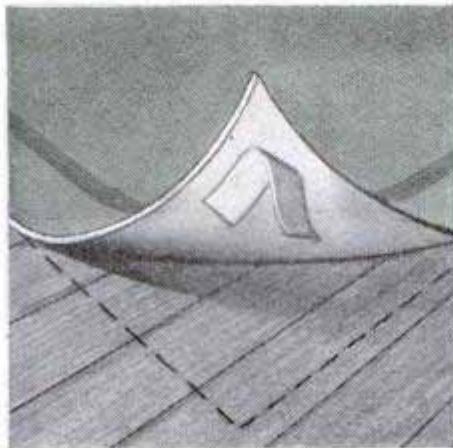
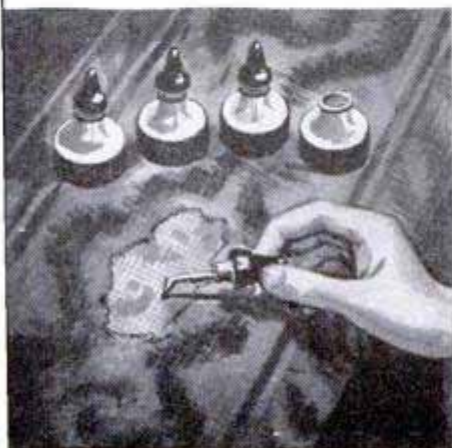

Steaming Brightens Illustrations Drawn With Indelible Pencil



Drawing or writing done with an indelible pencil will become brighter and last longer if steamed by ironing under a damp blotter. The blotter should be damp but not so wet that the paper will wrinkle.

Improved Veneer-Taping Method

If transparent cellulose tape is used instead of the usual paper or cloth-backed tape to hold veneer for gluing, it is possible to see when a perfectly matched joint is obtained. This is particularly helpful when intricate marquetry work is being done, and if shifting of the pieces is necessary, the cellulose tape is easily stripped off and reused.



Wood-Burning Pen Provides Light



Wood-burning pens of the type having a screw-in heating element make excellent trouble lights if the element is replaced with a 7-watt light bulb. Because of its small diameter and extension cord, this light is ideal for illuminating otherwise inaccessible places when checking plumbing and wiring. In addition, by lowering the light

into closed containers, such as barrels and drums, they can be checked for holes and cracks.—Don G. Pittwood, Moscow, Idaho.

Gas Burner Preheats Blowtorch

The smoke and much of the delay usually encountered in preheating a gasoline blowtorch is eliminated if the nozzle is preheated with the flame from a Bunsen burner.



The torch nozzle and mixing chamber should be heated, but under no circumstances should the flame contact the tank. Ordinarily, about one minute is sufficient time to preheat the torch in this manner.

Heat Lamp of Many Uses Made From Spare Parts

An old bridge lamp which has long been relegated to the attic, can be converted into a handy heat lamp by combining it with parts from a gooseneck desk lamp. All you have to do is remove the base from the latter, the top from the bridge lamp, solder the two rigidly together and add a metal photoflood reflector for a shade. Using an infrared bulb, the lamp is ideal for drying hair and fingernail polish or for treating muscular aches. Also, the unit makes an excellent health lamp when equipped with an ultraviolet bulb. *Caution:* When using either of the above bulbs, follow manufacturer's directions carefully or obtain instructions from your physician.

Mrs. W. E. White, Eugene, Ore.



Storm Sash Opens When Window Is Raised

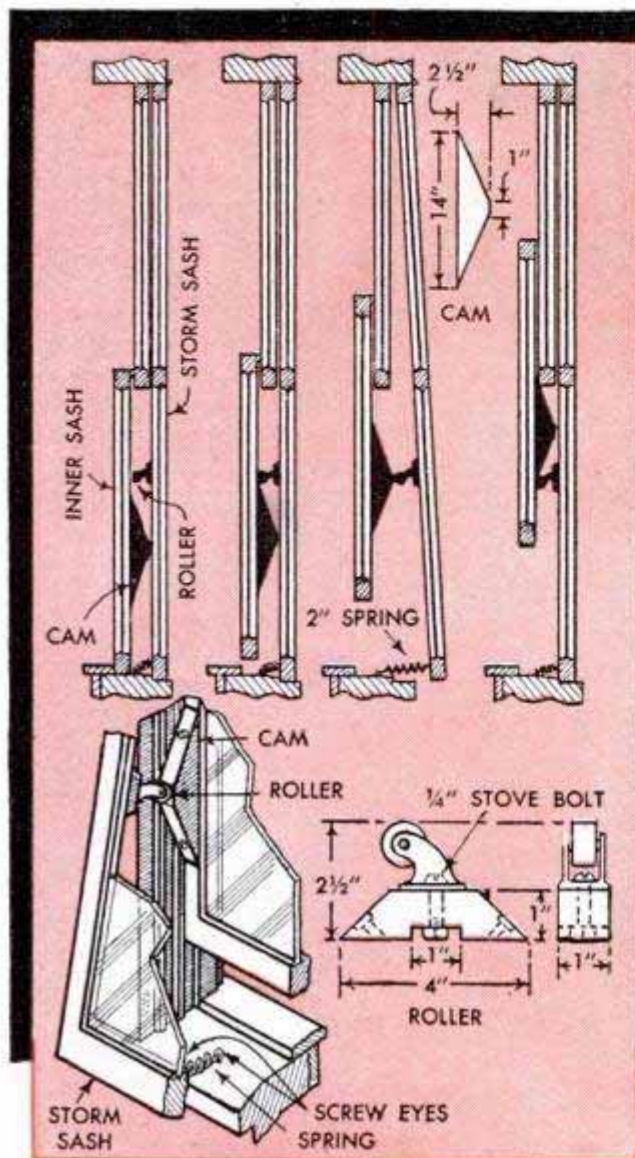

Raising the inner window will open the storm sash to admit fresh air directly into the room. Merely lowering inner sash closes the storm sash tightly

Designed particularly for use on bedroom windows, but an excellent idea for other windows where periodic ventilation along with adequate insulation is important, this novel device permits a hinged storm window to be opened and closed simply by raising and lowering the bottom sash of the inner window. It also prevents anyone from closing the inside window and forgetting to close the storm window. A caster-and-cam arrangement produces the automatic action while a tension-spring attachment for the bottom of the storm sash holds the sash tightly closed or firmly against the cam. As the inner window is raised, the storm sash opens, gradually reaching a maximum opening of approximately 3 in. when the roller is midway on the cam. Raising the window higher causes the storm sash to close entirely. In this closed position, air which normally enters around the storm sash gives a minimum amount of ventilation. The variety of positions of both sashes allowed by the device affords a wide range of ventilation. A

wooden cam is fastened to each side of the lower sash and a caster assembly to each side of the storm sash with countersunk screws, as shown. Stove bolts anchor the casters to their mounting blocks. The 2½-in. dimension both for the cams and the roller assemblies should be varied, if required, to provide a clearance of ½ in. between cams and storm sash and rollers and inner sash. This clearance assures complete closing of the storm sash and avoids the possibility of rattling. When assembling the device, make sure that the casters and cams are in correct alignment so that the caster rolls true throughout the entire length of the cam. Two springs, 2 in. long and with a stretch of 4 in., are attached with screw eyes between the bottom rail of the storm sash and the window sill. The screw eyes should be fastened to the storm sash about 2 in. from each side and 1 in. from the bottom of the rail. Those on the sill should be attached opposite the ones on the storm sash and just outside the inner window sash.—Martin J. Gresho, Chicago.

It's Easy to CEMENT

By Sam Brown



NO MATTER how much care is given to shaping and polishing the parts of plastic articles, such as those shown in Fig. 10, their entire appearance can be ruined by poorly cemented joints. Here is a simplified cementing technique along with two jigs to help produce the good joints upon which the beauty of plastic craftwork depends. This method applies only to the acrylic plastics (Plexiglas and Lucite).

All cements for acrylic plastics are solvents for the plastic, the bond being made by a softening and intermingling of the plastic at the joining surfaces. The best type of solvent for craftwork is vinyl trichloride, commercially known as Plexiglas

3	CEMENTS	NATURE OF CEMENT	SETTING TIME*	DRYING TIME	REMARKS
	VINYL TRICHLORIDE	SOLVENT TYPE WATER-WHITE	30 SEC.	3 HRS.	BEST CEMENT FOR CRAFTWORK
	ETHYLENE DICHLORIDE	SOLVENT TYPE WATER-WHITE		3 HRS.	FAST-SETTING. SECOND-BEST CHOICE FOR CRAFTING
	METHYLENE DICHLORIDE	SOLVENT TYPE WATER-WHITE		3 HRS.	TOO FAST. JOINTS MAY DRY BEFORE ASSEMBLY
	SOLVENT MIX	ANY OF ABOVE MIXED WITH PLASTIC SHAVINGS	1 MIN.	4 HRS.	SLOWER-SETTING THAN PURE SOLVENT. GOOD FOR BRUSH APPLICATION
	MONOMER MIX	THE ORIGINAL PLASTIC IN LIQUID FORM	4 HRS.	24 HRS.	MAXIMUM STRENGTH. BEST BOND FOR SOAK CEMENTING

*NOT HARDENED, BUT WORK CAN BE REMOVED FROM JIG.

4 RESULTS

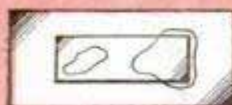

POOR CONTACT

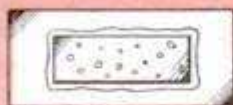

BUBBLES



CRAZING

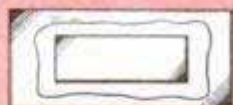

RUNOVER

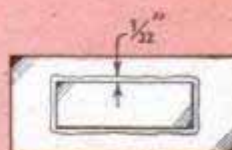

PERFECT JOINT

Above, poor contact indicates a badly fitted joint or insufficient cement. Bubbles are likely to occur with heavy cements. Crazing results from faulty cement or heavy clamping pressure. Runover happens most frequently when heavy cements are used. The perfect joint is crystal clear with just a slight runover



DIP WORK IN CEMENT

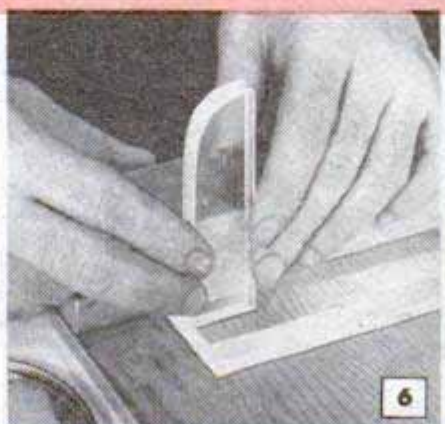

FIT JOINT IN JIG

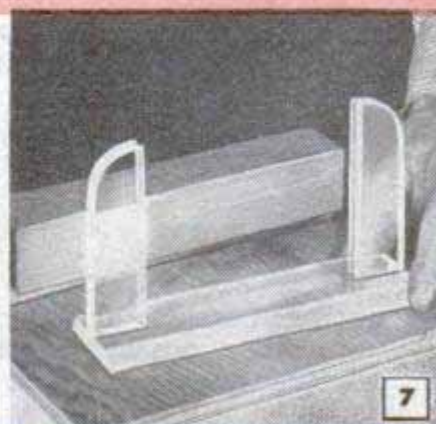

IT'S SET IN 30 SECONDS

PLASTICS

1-C cement. Fig. 3 lists the five most suitable cements in their order of preference.

The best method of application to use with pure solvent-type cement is a fast dip. To do this, obtain a shallow container, such as the lid from a glass jar. Next fold a piece of soft cloth twice to form a pad and place the pad in the lid. Then, with an eye dropper, add solvent to the container until it is level with the top of the pad. The work to be cemented is pressed on the solvent pad, Fig. 5. Due to the slight give of the pad surface, the work actually is immersed to a depth of about $\frac{1}{32}$ in. In order to distribute the cement evenly, the work is dipped three times in rapid succession and the joint is made immediately, Fig. 6. Cement is applied to one surface of the joint only. As quick and exact positioning of the cemented part is essential, a cementing jig should always be used. The joint is held in place with very light pressure of the fingers for about 20 to 30 sec. after which the work can be removed from the jig, Fig. 7. The joints are quite rigid within a minute and completely cured in about three hours.

Fig. 1 shows a simple jig for picture frames which also can be used for a cigarette box as in Fig. 2. As this type of T-joint is common in all plastic projects, it is worthwhile to make an adjustable jig like the one shown in Fig. 9. The dimensions are not critical and the sawcuts across the base serve as guide lines when positioning the work. A portion of the center of the movable top piece is routed out to provide a finger hole. This hole is helpful when cementing small pieces, as can be seen from Fig. 8. The corner jig, detailed in Fig. 12, is used as shown in Fig. 11. The rabbet in the guide strip prevents the cement from sticking to the wood.

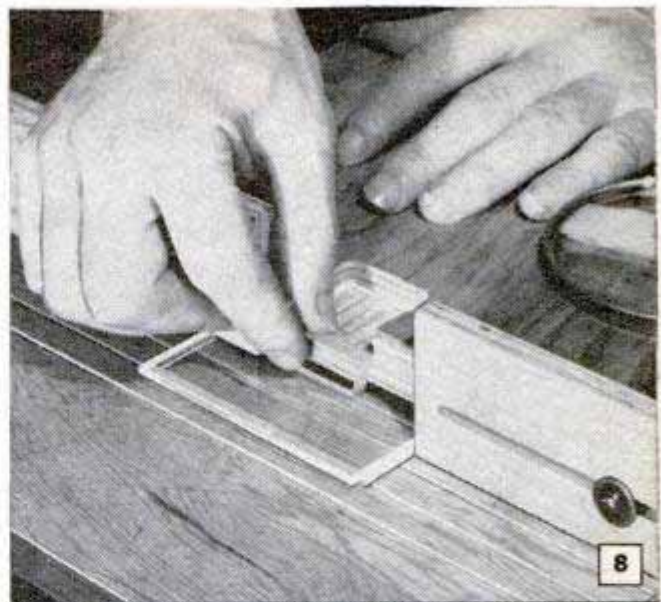

ABOVE, CEMENTING HANDLE ON BOX LID WITH T-JOINT JIG DETAILED BELOW

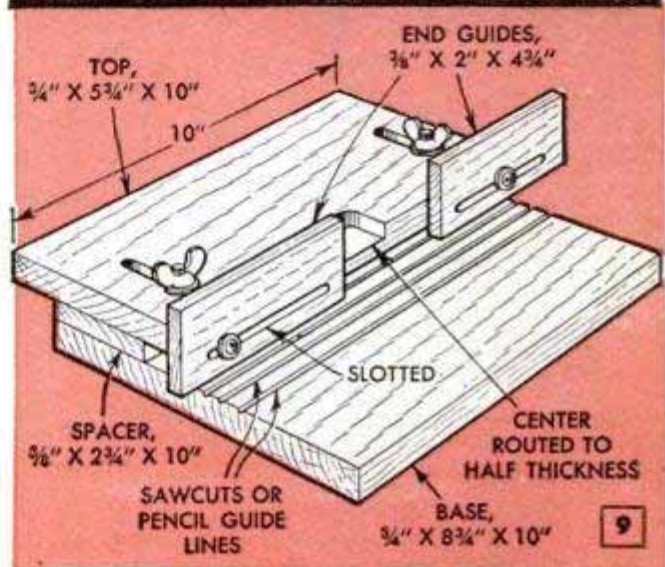

Because the cement has no body and will not cover unless the joint is in good contact, the work to be cemented must have close, smoothly fitted joints. Joints direct from the saw (hollow-ground planer blade) are satisfactory, as fine saw marks will vanish completely if the joint is perfectly cemented. Joints finished with 80 or 100 grit sandpaper also are satisfactory, but care

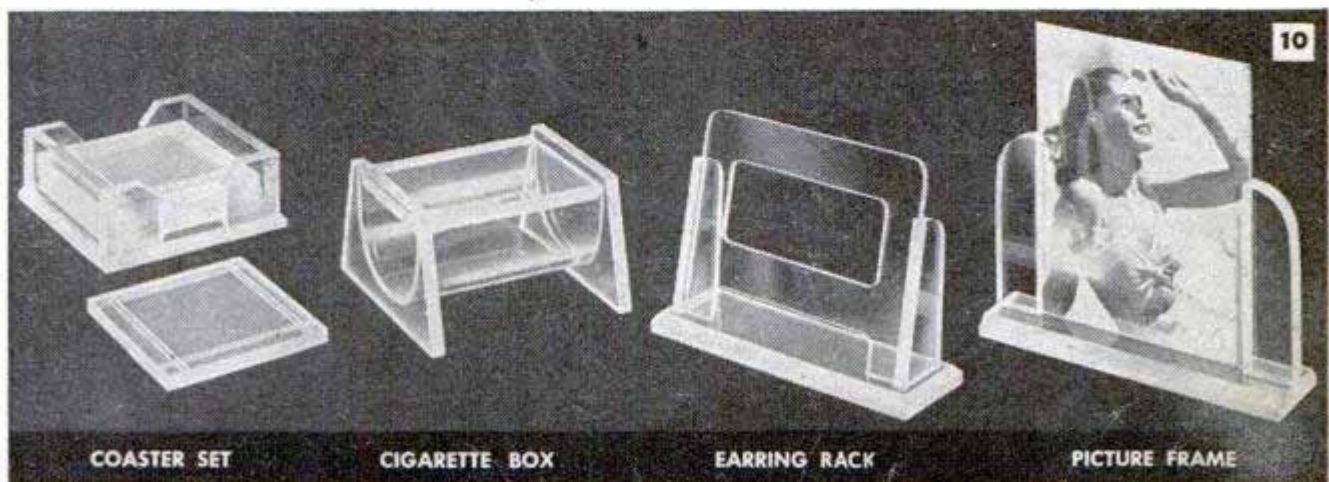

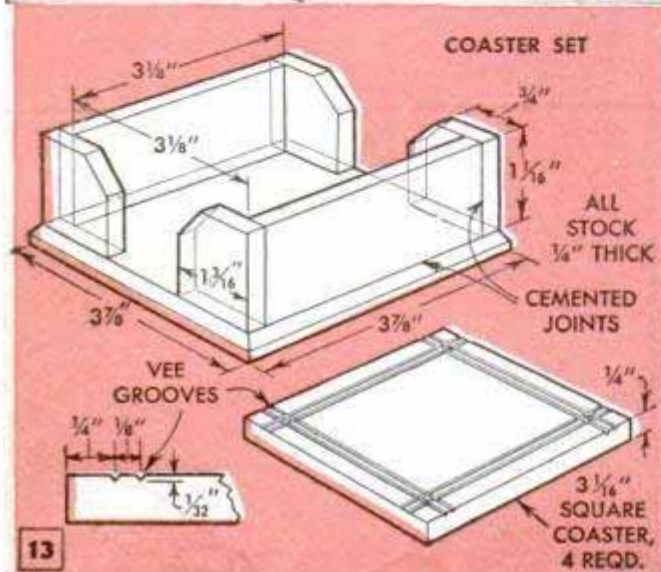
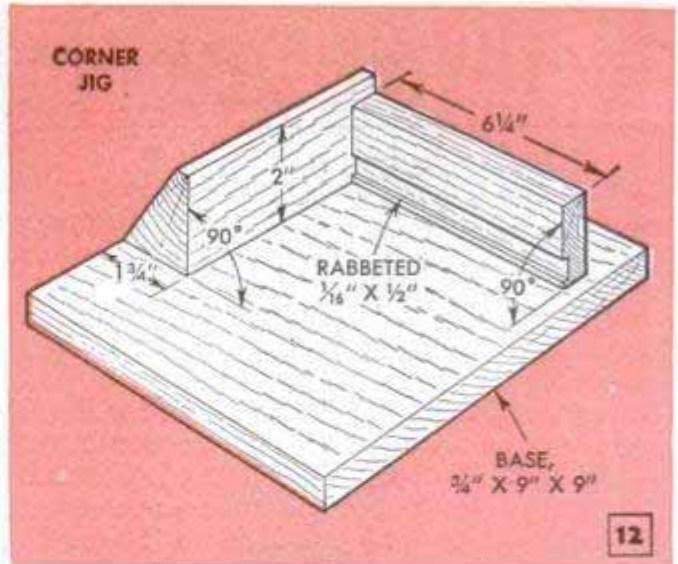
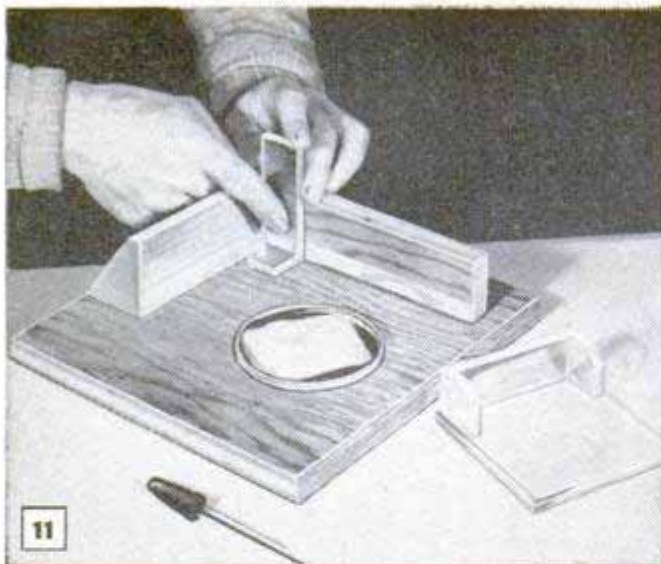

must be taken not to round off the corners.

Fig. 4 shows the usual faults of plastic joints, poor contact being the most common one when pure solvent is used. An accurate-fitting joint, and dipping the work three times and immediately fitting it, will eliminate this fault. It is important that the plastic edge carry all the cement possible. For this reason, all joints should be made with the cemented piece vertical and with the second piece flat and horizontal, as in Fig. 6, as more solvent can be carried on a horizontal joint without danger of runover. The bubble fault is common with heavy cements but rarely occurs with pure solvent. Crazeing, which consists of hairline cracks at the joint, usually is caused by too much pressure at the joint or by use of certain solvents, such as acetone. Runovers are common if you use any type of thick cement made by dissolving a small quantity of plastic shavings in a solvent. The thicker the mixture, the more likely you are to apply too much of it to the joint, thus resulting in runover of the excess. Thick cements are not used with the dipping technique, but are handy for brush application on some types of joints.

However, work of this kind should be clamped very tightly. The perfect joint is absolutely clear with a slight runover of cement all the way around.

In addition to the cements listed in Fig. 3, acetone and glacial acetic acid are solvent-type cements which can be purchased at almost any drugstore. Both do fairly good work except that acetone is somewhat too fast and liable to craze, while acetic acid is slow drying and tends to corrode and etch the polished surface around the joint, thus spoiling the appearance.

The coaster set, dimensioned in Fig. 13, makes an excellent project in plastic cementing. Use the dip application of solvent cement for all joints, assembling the ends first. The assembled sides can be dipped one end at a time. Remember to get the work thoroughly wet, shake it lightly to remove any excess cement and assemble immediately. If a drop of solvent should accidentally fall on the work, do not rub it. If rubbed it will smear, but if allowed to remain untouched, it will dry and disappear with little damage to the polished surface. Fig. 14 shows how the vee grooves in the coasters are cut on a circular saw.

Whether it's a 10 by 20-ft. pond for tiny tots on their "double runners" or a large-size rink for adults, the whole family will enjoy a skating rink which can be made in the back yard or on a vacant lot. If the rink is prepared in the fall before the ground freezes, the pond area can be banked by one of two methods. One way is to enclose the area with 2 by 8 or 2 by 10-in. planks set on edge and staked to hold them in position. The other method is simply to bank the pond area with earth. If the ground already is frozen, well-iced snow banks will effectively confine the water within the rink area. These banks are built up as flooding and freezing of the pond progresses. The flooding is done with a fine spray so that not too much water collects in any one spot. The ice should be built up in layers, allowing time for the first application of water to freeze solid before the next one is applied. A heavier stream of water may be used as the crust of ice becomes more solid. However, do not use a stream heavy enough to wash away the base or collect in pools and leak through holes in the crust. If snow is on the ground, this should be packed with a lawn roller before flooding. Sometimes it is advisable to roll the rink again after the crust starts to harden. After the ice has built up to a thickness of $\frac{1}{2}$ to $\frac{3}{4}$ in., a good surface will begin to form. At this time the rink is filled, or leveled. Some of the low

Book for usage

An Ice-Skating Rink in Your Back Yard Is Inexpensive and Fun for Everyone



spots in the ice probably will contain small holes up to about $\frac{1}{4}$ in. in dia. These should be packed with slush to make them watertight, and the whole area sprayed with a film of water. After the film freezes, the low spots in the surface are filled with water and allowed to freeze solid. This procedure is repeated until the surface is fairly level. During the filling operation, pay special attention to the banks to make sure that they are solid enough to prevent the escape of water in case of a thaw. The pond is finished by spraying until the surface becomes as nearly level as possible. The maintenance of a rink, of course, depends on weather conditions and the amount of use. It should be resurfaced as required to prevent the formation of holes and to keep the surface in good skating condition. This also is necessary to keep the base watertight.

Paul H. Dunakin, Wheaton, Ill.



Shirt Fitted With Game Pocket Worn During Warm Weather

For hunting small game, such as squirrels, in fairly warm weather when an ordinary hunting coat is uncomfortable, just sew a game pocket to the inside of a shirt and wear the shirt as a coat. This type of pocket can be made from lightweight canvas and will adapt any shirt to a useful hunting coat.

☐ A few spare nickels kept in the glove compartment of the car will make certain that you have change available when it is needed for a parking meter.

Start Your CHRISTMAS

ELEVEN EXCITING TOYS

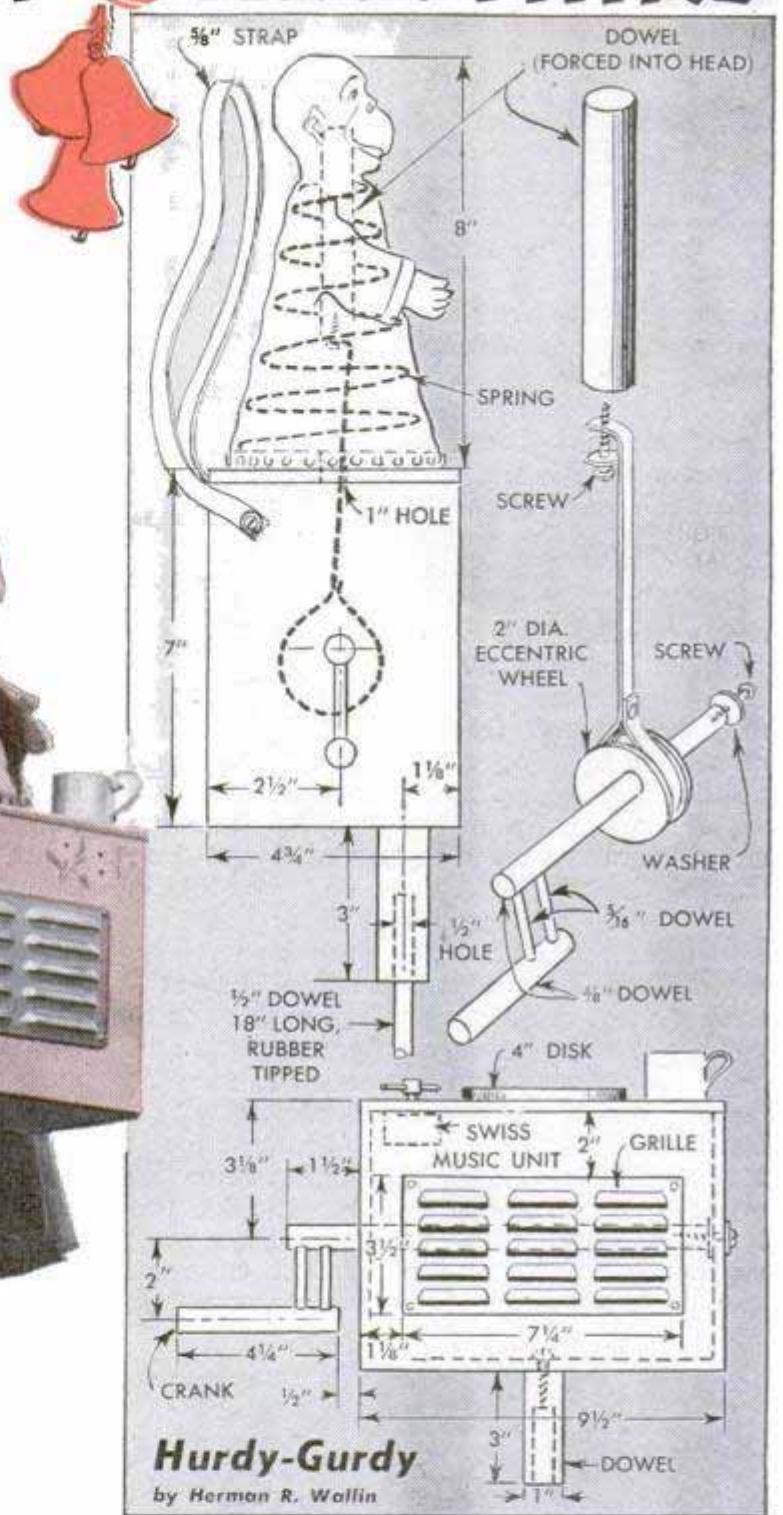

HURDY-GURDY is a musical action toy in which a puppet monkey on a spring bobs up and down to the tune of a Swiss music unit. The monkey is actuated by an eccentric which provides movement to the head as a handle is turned. Details above show assembly. Leather strap connects the eccentric to the monkey. Make sounding box of plywood and attach a dowel leg to the bottom. Cover the grille opening with a metal window ventilator and tack the monkey to the edge of a disk fastened to the top of the box. The handle which rotates the eccentric is supported at one end by a screw and washer. Music unit is located so that winding key projects through top of box.

WORKSHOPPING Early

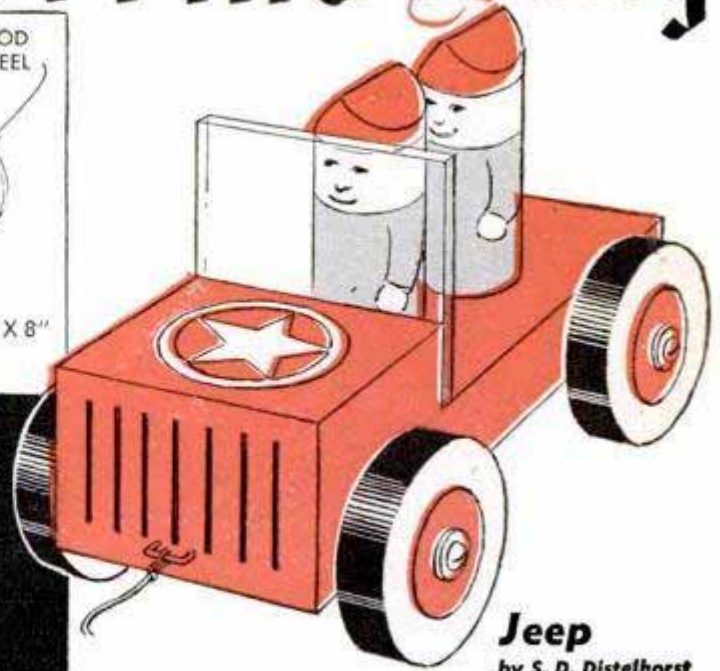
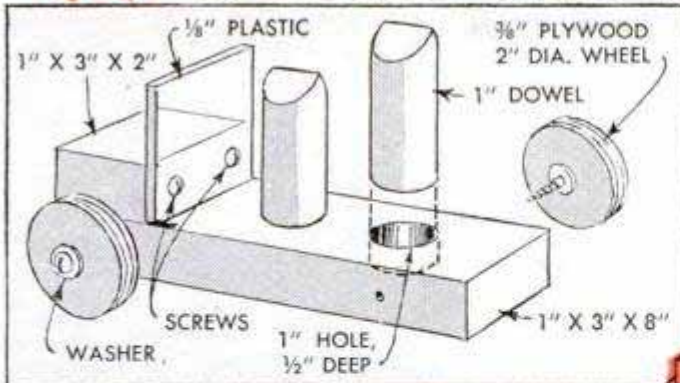

Jeep
by S. D. Distelhorst

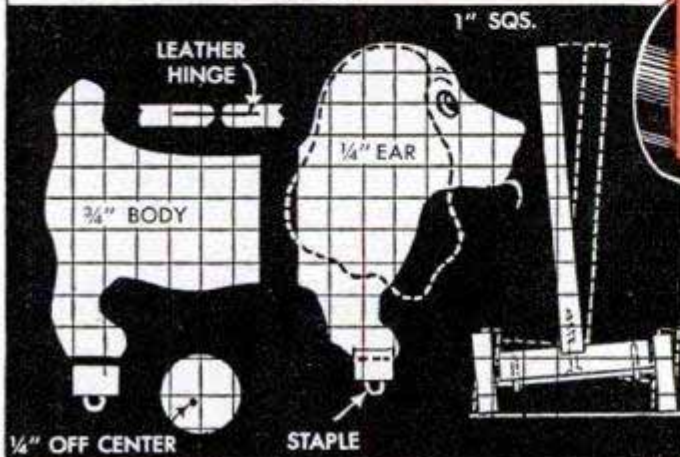

Wiggle Dog
by John P. Arnold

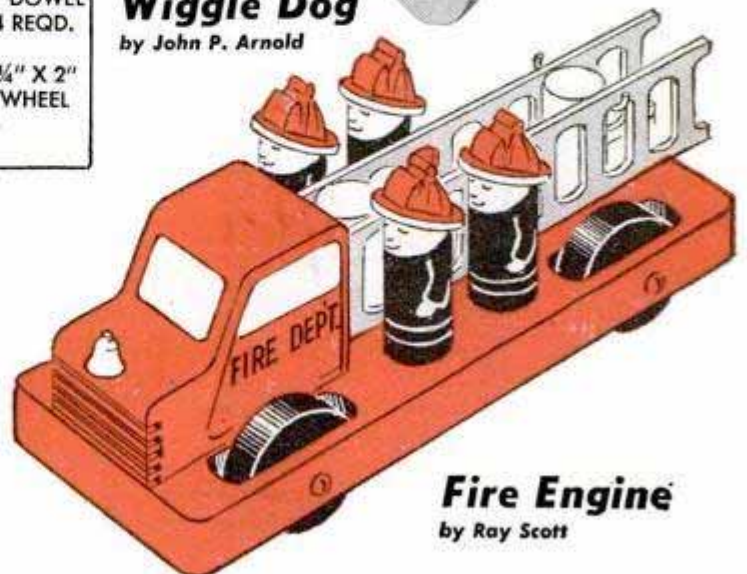
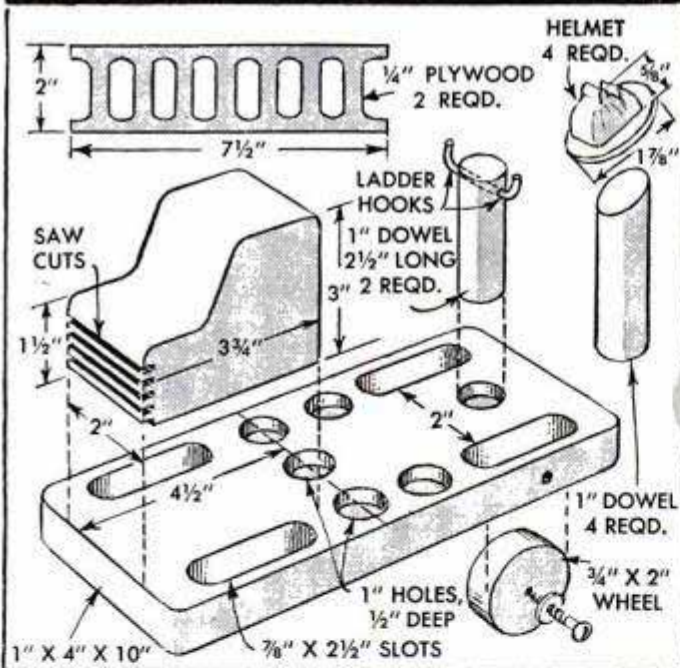

Fire Engine
by Ray Scott

JEEP AND FIRE ENGINE are two simple pull toys. In both cases, the men are dowels or pieces of broomstick that are set in blind holes. The jeep body consists of two wooden blocks and a piece of plastic. Ladders of fire engine hang on L-hooks screwed in fixed posts

WIGGLE DOG not only wiggles but wobbles. Double action is produced by wheels being mounted off-center and the two-part body connected by leather hinge. Wheels are fixed on dowel axes which rotate in staple bearings. Body is solid wood, wheels and ears plywood



Target Game

by Clyde C. White

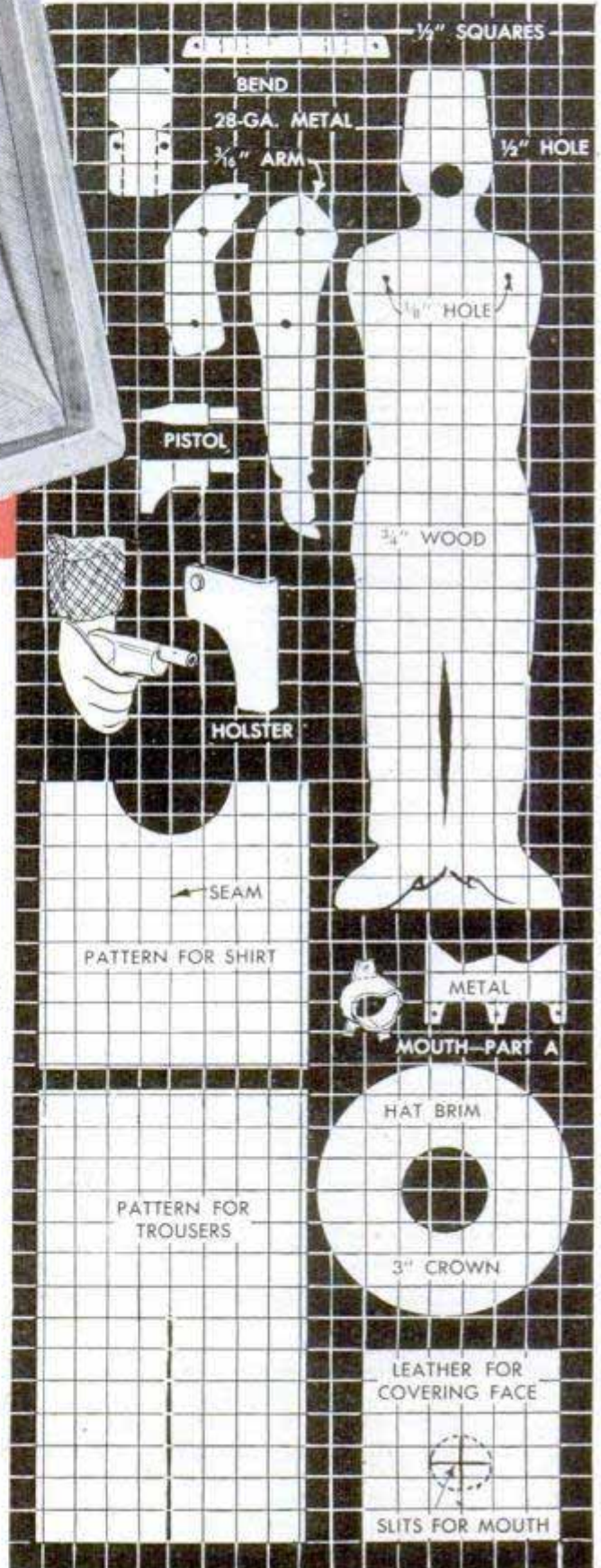
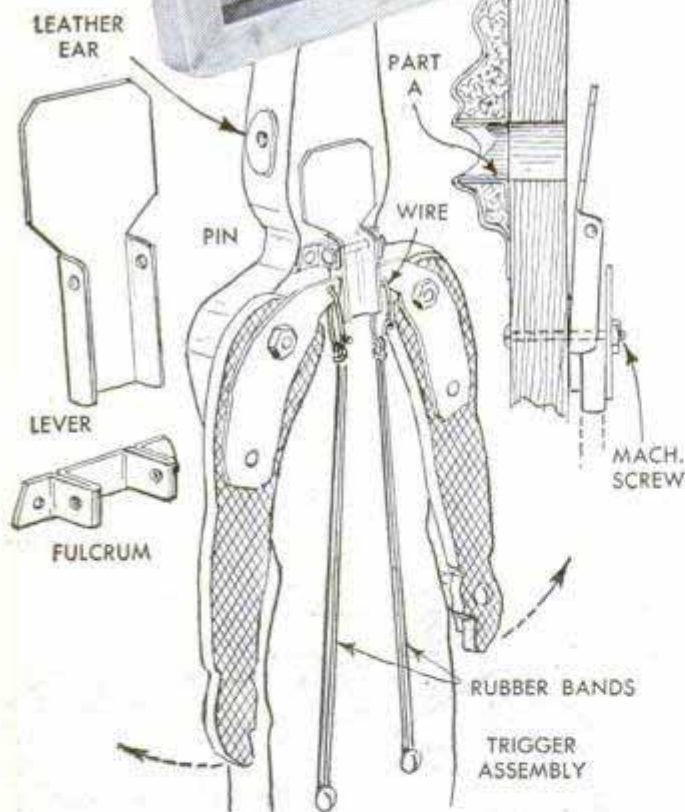

TARGET GAME consists of armed bandit who defies capture until direct hit in the mouth with a pellet trips mechanism and causes bandit to throw up his arms in surrender. Body is wood, arms hard-pressed board, and rest of parts are metal. Rear view shows how trigger is set, rubber bands providing the spring action. Cloth bag tacked to wooden frame catches pellets. Stick is used to support frame at an angle. Dress the bandit in the manner shown in the photo



Gunshot Joey

by C. L. Meehan

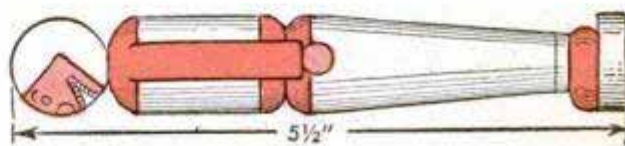
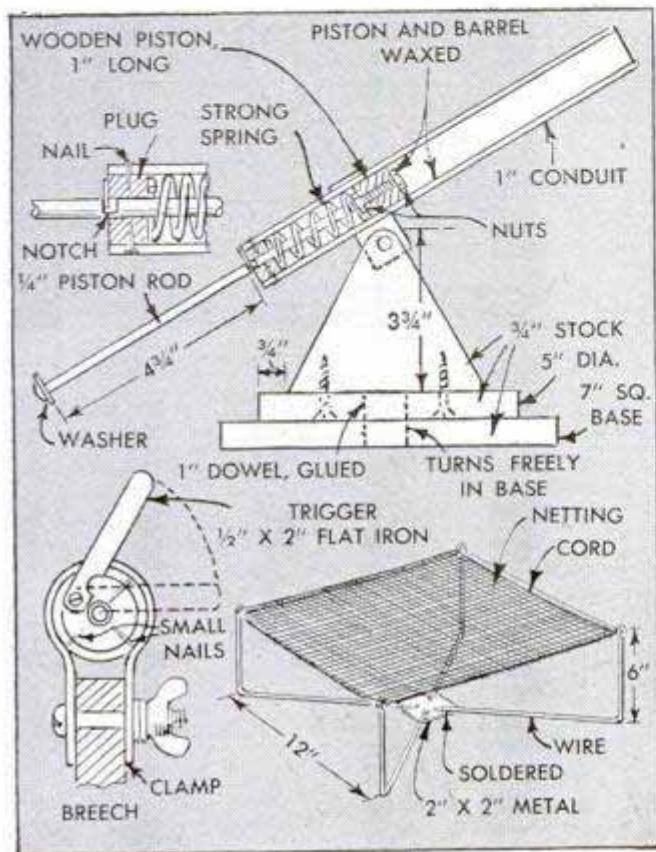

GUNSHOT JOEY, the human cannon ball, performs his daring feat just as in the circus. Cannon is fired by releasing trigger which engages notch in a spring-loaded piston. Joey must fit freely in cannon

BOBBY HORSE gives the small tot a merry ride. Wagon is typical box construction, the wheels being screwed to a cleat axle. Detail shows method of fastening tongue to wagon and to jigsawed horse head

WHIRLING DOOLEYS go on and on—when they reach bottom of spiral, the shaft is turned end-for-end in the base and around they go again. Two wires twisted together in a spiral form shaft. Riders are weighted

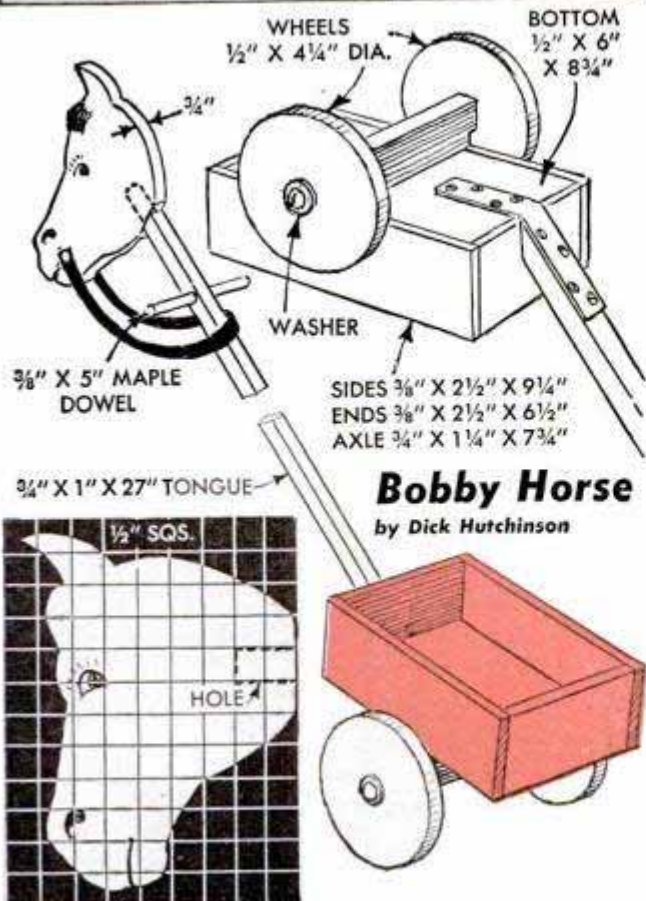

Bobby Horse

by Dick Hutchinson

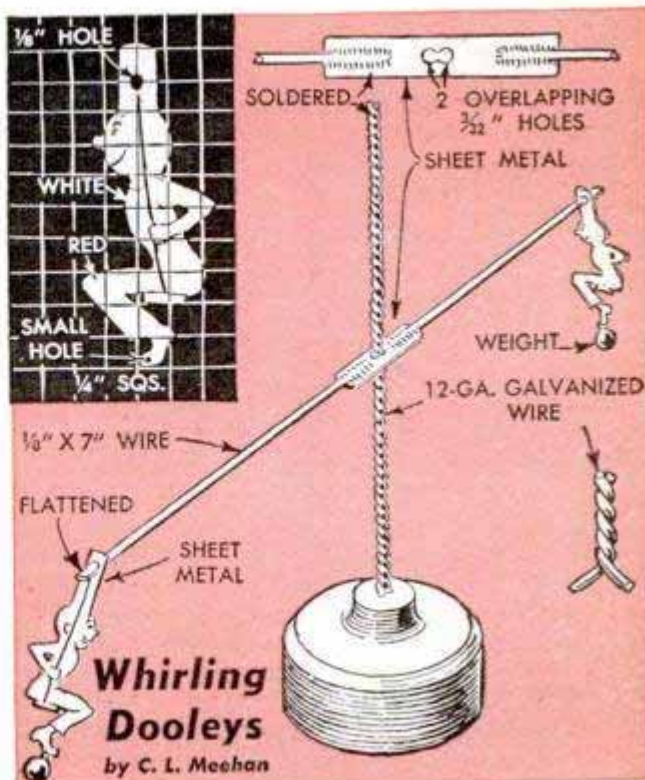

Whirling Dooley

by C. L. Meehan

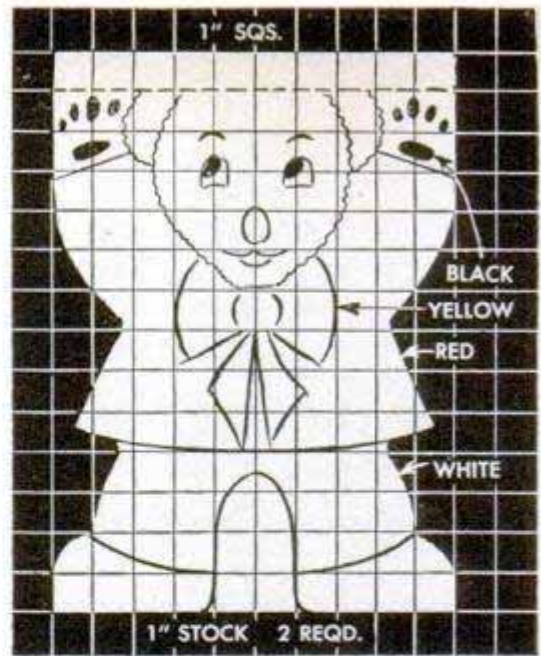

Serving Cart

by Roberta Fairall

SERVING CART for the tiny hostess makes tea parties more fun. Upraised arms of jigsawed cut-outs hold scalloped tray. Pull-apart detail shows assembly. Except for tray top, entire cart is made of 1-in. stock and braced as shown. Both wooden cutouts can be sawed at one time. Tenons on the ends of cross cleats provide axles for the wheels

WEAVING BLOCKS will keep youngsters entertained for hours. Dowel pegs fitted in wooden bases provide forms on which string is wound in and out around the pegs like a basket. When done it is stiffened with shellac before removing

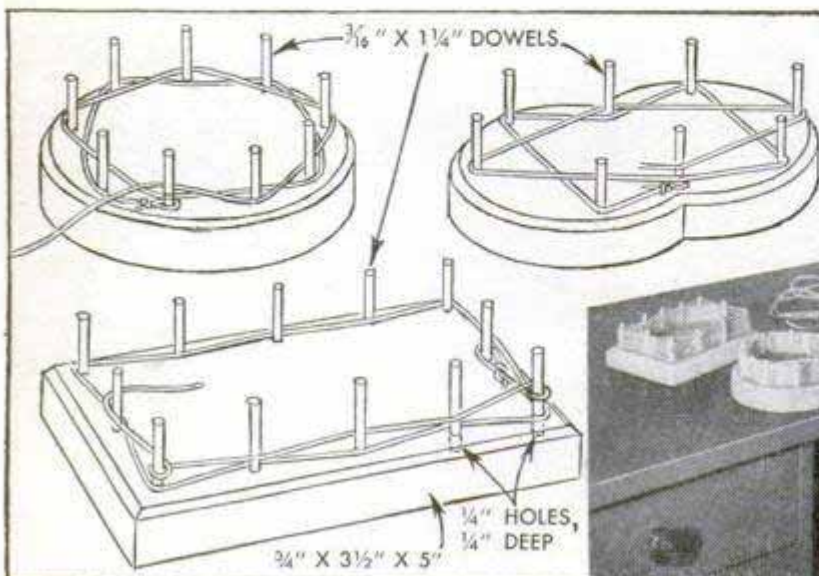
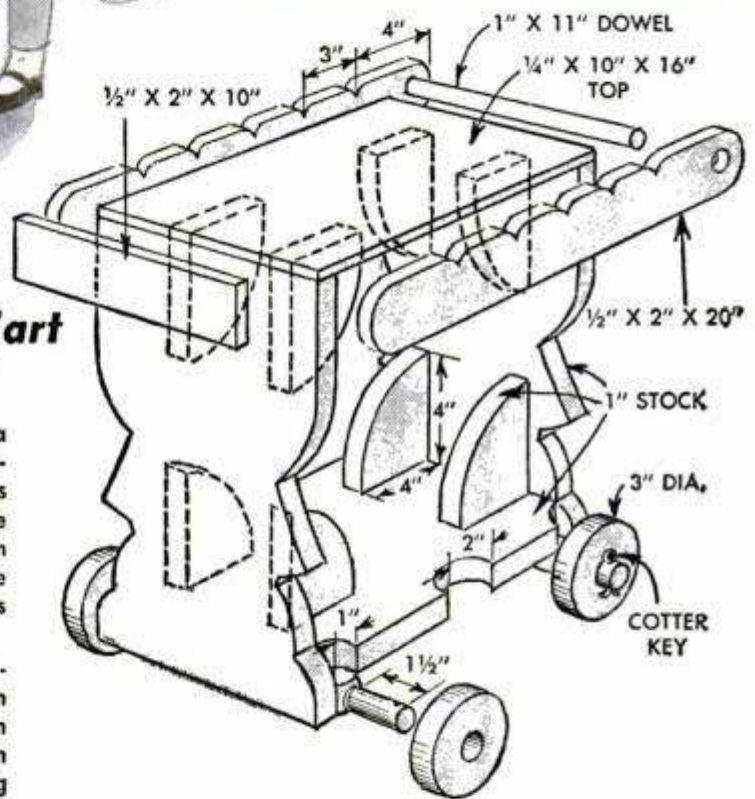

Weaving Blocks

by Herman R. Wallin

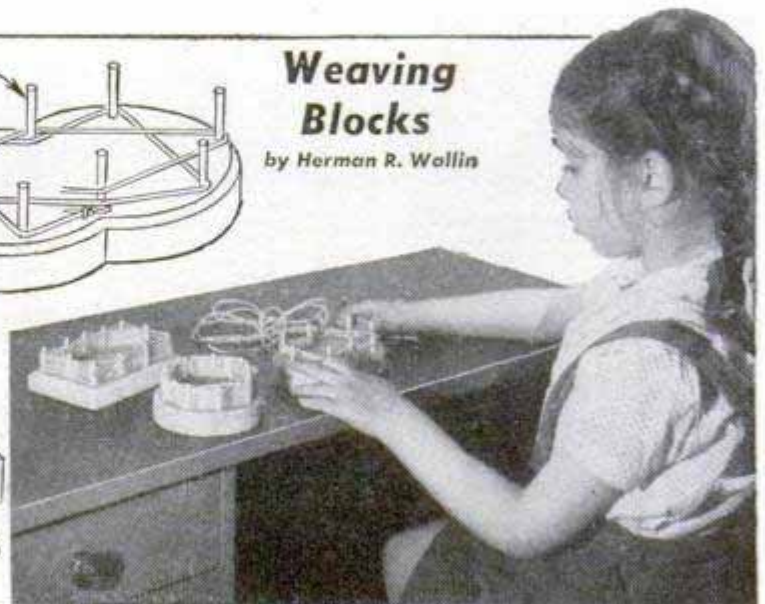

Rotating Base for Construction Set Provided by Throw-Out Bearing

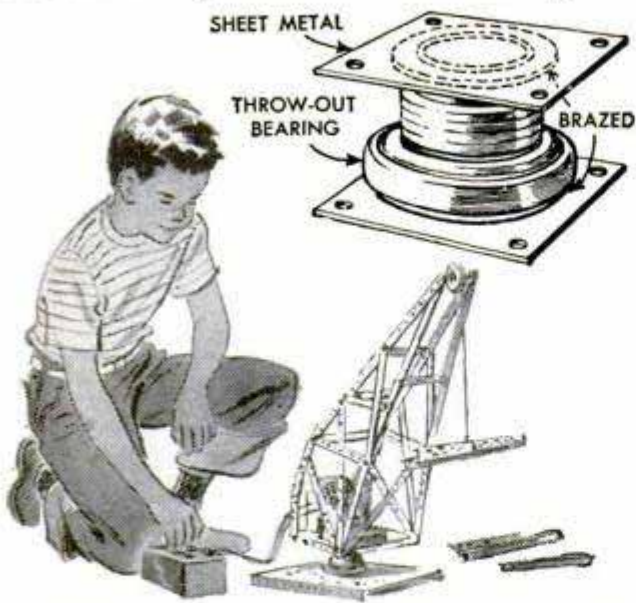

The throw-out bearing from an automobile clutch makes an excellent rotating base for model cranes and similar pieces of equipment assembled from a toy construction set. After cutting and drilling two sheet-metal plates to fit the base plates supplied with the construction set, braze them to the throw-out bearing. This results in a sturdy, smooth-turning base that adds to the appearance of the model. Paint the bearing and plates to match other pieces in the set.—Bill Jeter, Hornbrook, Calif.

Pipe Loosens Steel Tent Pegs

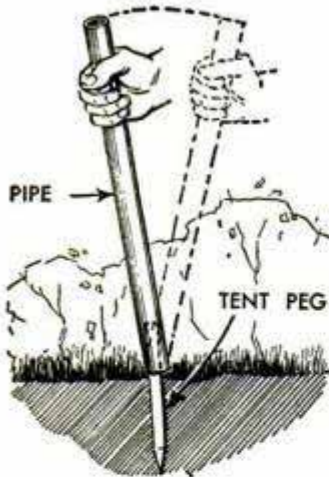

Steel pegs used to anchor large tents are easy to remove from the ground if they are first worked loose with a length of pipe. The pipe should be fairly long to provide leverage and should have an inside diameter large enough to fit over the top of the peg.

Extension-Cord Connector

Made from two blocks of wood bolted together, this clamp prevents breaking the connection of an extension cord. It is especially handy when using an extension cord to



operate portable electric tools, hedge shears, or a vacuum cleaner where there is a considerable strain on the connection. The clamp is made by drilling two parallel holes, slightly smaller in diameter than the extension cord, through a wooden block. Then the block is sawed apart lengthwise through the centers of both of the holes. The cords are placed in the holes, as shown, and the two pieces of the block are bolted together. Thus, any strain on the extension cord will be absorbed by the block and the connection will not be broken.

Tumblers Stored on Wooden Pegs Conserve Space in Kitchen Cabinet

Many women find that the space in their kitchen cabinets is insufficient to store all the things they desire to have conveniently at hand. The husband of one woman solved this problem by inserting wooden pegs in the cabinet side at an angle so that glass tumblers could be inverted over them. By doing this, space otherwise not used could



be utilized. Diameter of the pegs is determined by the weight of the tumblers. Also, the length of the pegs depends on the size of the glass to be placed over them. If there is not sufficient space for the pegs on the cabinet sides, they could be put on the inside surfaces of the doors, positioning them so they will not contact dishes on the shelves when the doors are closed. If this is done, care should be taken not to overload the doors and thus cause them to sag or the hinges to bend out of shape.

DRY WALLS

Moisture condensation in any part of the house can result in rotted framing, ruined paint jobs and damaged walls

By W. Clyde Lammey

WHEN water vapor comes in contact with a cold surface it condenses to form either frost or water droplets, depending on the temperature of the surface. In older homes having porous, uninsulated walls and ceilings, the space within the walls or ceilings is constantly warmed by passage of heat. Ordinarily, there is no condensation except on the windows, for the warm, moist air passes directly through both walls and ceilings and the vapor does not condense within the structure. One occasional exception is when uninsulated walls are painted on the room side with several coats of oil paint. This acts as a vapor barrier and to some extent as insulation, allowing cold air to penetrate the wall from the outside. When the air in the house is excessively humid and the structure is in an exposed location, moisture will condense on the room side of the wall as in Fig. 2, detail B.

Condensation troubles usually begin when weather stripping, storm sash, calking and insulation are used,

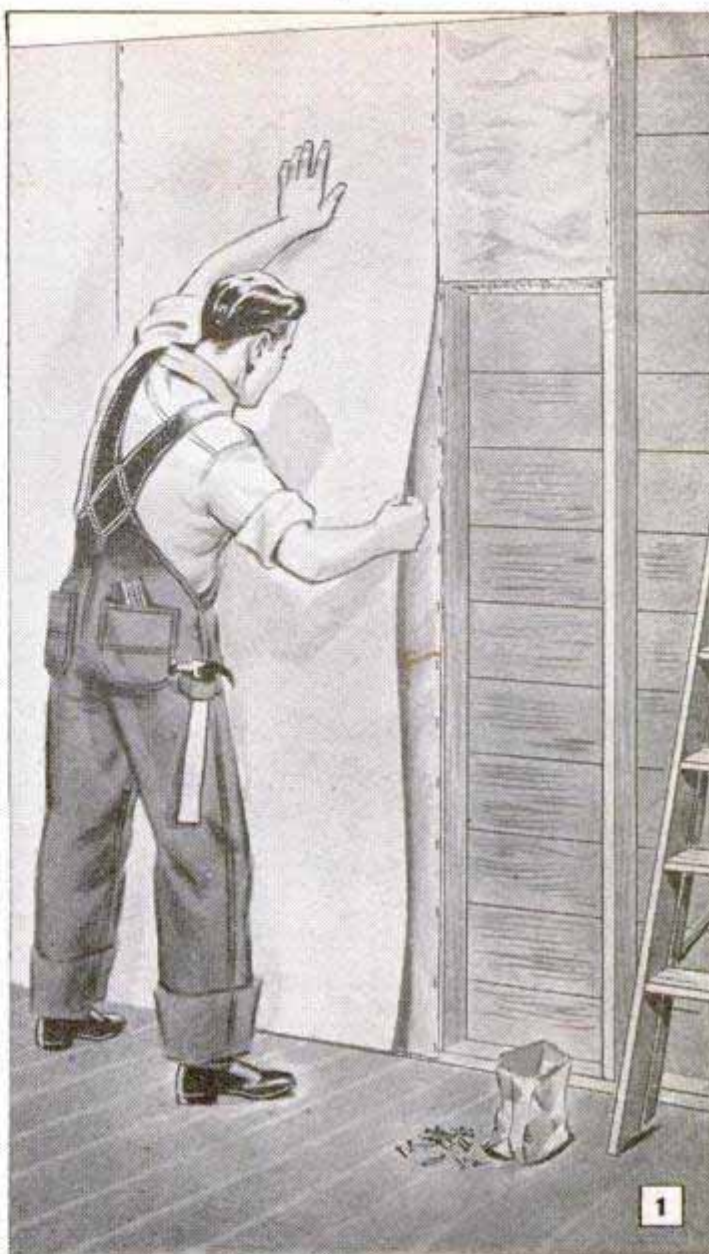

To avoid condensation troubles in homes under construction, vapor barriers are installed between the plaster and studding. The barrier prevents moisture from air in the room penetrating to inner wall space

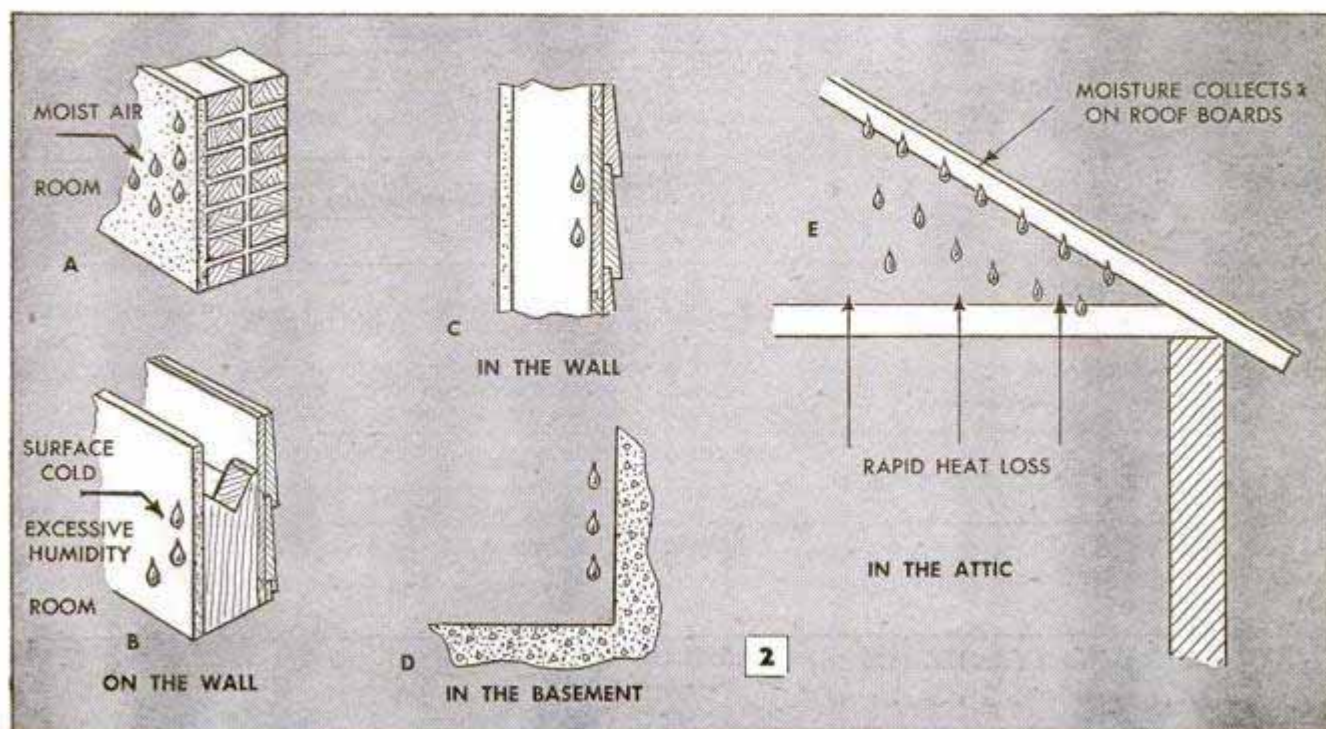



3 Blistering and peeling of paint are more often due to dampness within the walls than to any other common cause



4 ■ - Average Jan. Temperature 35° F. or Less

as leakage of moist, warm air through the walls is greatly reduced. Certain of these weatherproofing materials are more or less porous but at the same time they reduce heat loss to the minimum. This greatly reduced heat loss allows cold air to penetrate the walls from the outside. Warm, moisture-laden air from the inside meets this dry, cold air and vapor in the warm air condenses within the wall, Fig. 2, detail C.

In winter, moisture condensation usually will be evident as damp spots on the ceilings and room-side surfaces of exterior walls, water and ice on inside surfaces of windows and loose particles of ice on the attic floor. If the attic is not fully insulated or if the insulation of the attic floor is not adequate, the heat loss is correspondingly more rapid, Fig. 2, detail E. Moisture will condense on the underside of the roof boards, particularly on nail points which project through them. The beads of ice which form on the nail points eventually loosen and drop to the attic floor. When these melt the water is likely to cause damage to the plastered ceiling underneath.

Blistering and peeling of the paint on the outside of the exterior walls, Fig. 3, are more often due to condensation than to any other common cause. The paint acts temporarily as a vapor barrier and as a result moisture coming from inside the house gathers underneath it and forms blisters, eventually causing the paint to peel and expose the bare wood.

5	PLACE	CAUSES
	WINDOWS (Inside surfaces of windows.)	Excessive condensation on the windows may cause: <ul style="list-style-type: none"> ● Paint to peel from sash. ● Water to run down frame causing dampness around frame and perhaps paint-peeling on outside of building.
	EXTERIOR WALLS 1. Condensation on exterior walls and ceilings of room. 2. Condensation within ceilings and walls (inside of exterior wall).	Moisture may condense directly on cold surfaces of room. This occurs in certain uninsulated homes. Unobserved condensation may also occur within wall. Probability depends on humidity of inside air, outside temperature, and vapor permeabilities of wall.
	CLOSET WALLS (Problem similar to that of exterior walls.)	Condensation on or within such walls is caused by closet being unheated. The inner surface temperature of the wall becomes lower than the temperature at which moisture in inside air condenses.
	ATTICS (Problem is essentially the same as condensation within walls.)	Condensation in attics may occur when: <ul style="list-style-type: none"> ● Insulation is applied without vapor barriers in the upper ceiling or attic floor. (Roof boards become very cold as a result.) ● Attic doors are poorly fitted. (Large volumes of high-humidity air pass from living quarters to attic.) ● Vapor penetrates the side walls and passes to attic.
	FLOORS (First floor in basementless house.)	Concrete floors laid on ground present condensation problem.
	BATHROOM	Vapor from running bath water or shower condenses.
	KITCHENS AND LAUNDRIES	Humidities are high because of cooking, washing and drying processes.

In homes under construction, vapor barriers to prevent wall condensation should be used wherever the average January temperature is 35 deg. F. or colder, Fig. 4. In new homes various types of vapor barriers are available for application to inside walls under the plaster or other finishing material, as in Fig. 1. To be fully effective the vapor barrier should be continuous and unbroken, with joints lapped and securely tacked.

In homes already built, oil paint applied to walls and ceilings, as in Fig. 6, has proven value as a vapor barrier. Usually two coats of interior oil paint will be required to obtain best results. As a rule, water-emulsion paints are not good barriers. Condensation on the room side of uninsulated masonry walls above and below grade, Fig. 2, details A and D, often can be prevented, or at least minimized, by some means of ventilation. This can be a window fan, in the case of a basement, or an outside cold-air intake in a warm-air heating system which brings fresh, dry air into the house continuously. This arrangement has proved effective in homes having solid masonry walls where visible condensation and frost sometimes occur on the room side of the walls. In basementless homes built over a shallow excavation or "crawl space," ample ventilation under the floor, plus insulation between the floor joists, will minimize any tendency toward condensation. Fig. 5 gives causes and cures in more detail, although the causes and cures given will not apply fully in every instance. Much depends on peculiarities of the individual structural design.

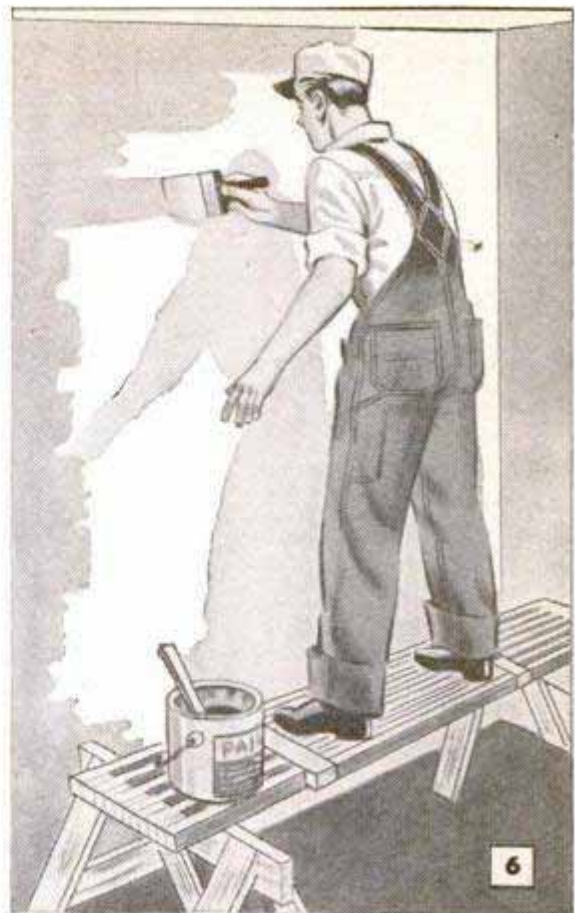

Oil-base paints and also varnishes applied to the room side of walls and ceilings form effective vapor barriers in homes already built. Usually two coats of paint will be required for best results. As a rule the water-emulsion paints are not good barriers to moisture

CURES

- Install:
Double windows
or
Storm sash.
- Insulate walls.
- Use vapor barriers.
- For condensation on walls:
Insulate, if house is uninsulated.
- For condensation within walls:
Use vapor barriers.
- Ventilate attic.
- Prevent moisture from reaching attic by:
Weather-stripping attic door.
Using vapor barriers to prevent moisture from penetrating side walls, and ceilings under attics. Seal off basement air from stud space.
- Insulate by using gravel, cinders, crushed stone or other insulating material underneath floor.
- Install mixing faucets for hot and cold water.
- Avoid running excessively hot water.
- Install ventilator to bring in outside air. (Cold drafts are avoided by careful installation.)
- Decorate bathroom walls with vapor-resisting material (oil paint, linoleum, tile, etc.).
- Ventilate (exhaust fan).
- Decorate kitchen walls with vapor-resisting material (oil paint, linoleum, tile, etc.).
- Avoid excessive evaporation of water.

NOTES

Double windows permit about 33% relative humidity at 70° without condensation, compared to 14% with single window.

Insulation keeps inner surface temperature of the wall warm enough to prevent condensation.

A vapor barrier must be continuous and unbroken.

Excessive humidities can be reduced most effectively by proper ventilation. Water found in attics is more often caused by condensation than by leaky roofs.

Install insulation at edges of slab.

Catch Basin in Eaves Trough Collects Leaves and Twigs

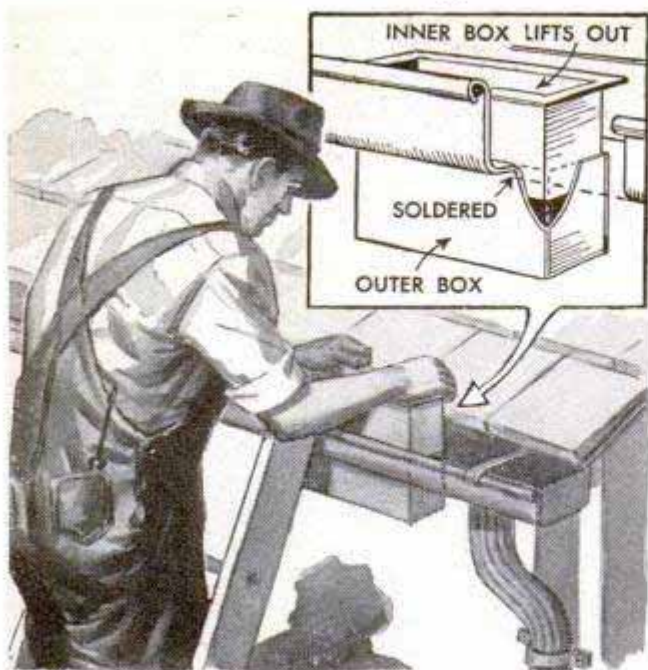

This catch basin, built into the eaves trough a few inches in front of the drop outlet, collects leaves and sticks which otherwise would be likely to clog the downspout. The basin consists of two sheet-metal boxes of soldered construction. The outer box is soldered to the edges of a rectangular hole cut in the bottom of the trough. The inner box, which is slightly smaller than the outer one, has a flange around its top edge so that it rests on the bottom of the eaves trough. The catch basin is easy to keep clean simply by removing the inner box and discarding the refuse.

Adam Szczepanowski, Michigan City, Ind.

Fan Circulates Warm Air Uniformly Through Stove-Heated Home

In many homes where a space heater is used, the warm air tends to collect just below the ceiling of the room in which the stove is located, leaving the other rooms

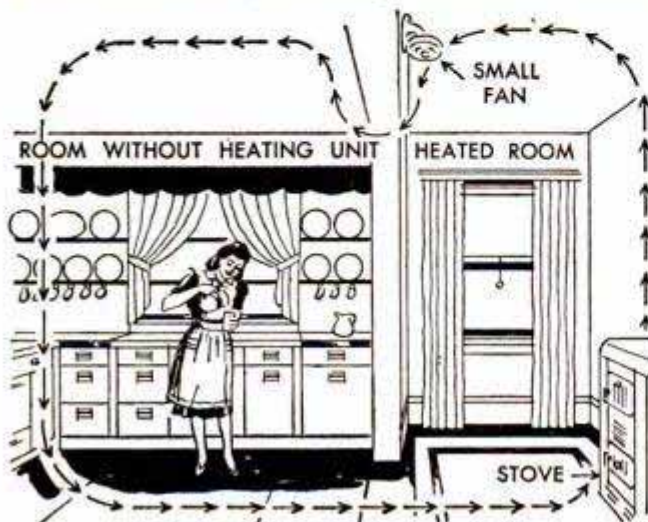

uncomfortably cool. An easy way to distribute the heat and relieve this situation is to mount a small electric fan over the doorway between the rooms. The fan is directed downward and through the doorway so that it draws the warm air from the ceiling and circulates it throughout the unheated room as shown in the drawing.

Wm. E. Danneman, Chicago.

Separating Steam-Boiler Sections

When repairing the old sectional-type steam boiler in my home, I found that the sections would have to be separated. Fearing to damage the boiler by doing this with the usual sledge hammer and wedges, I devised a method which does the job without danger of breakage.

First, I removed the tie rods from the boiler and cut extra threads on one end of each rod. Then, with a nut turned all the way on the extra threads, this end of the rod was inserted through one lug. As the opposite end of the rod now cleared the other lug, it was possible to turn a nut on it so that both nuts were between the lugs. When all the side rods were replaced on the boiler in this fashion, I used them as jacks to separate the boiler sections. This was done by gradually turning all the nuts on the extra-threaded rod ends so that the stress was even on all sides of the boiler as the sections were forced apart.—Clair M. Potts, Vestal, N. Y.

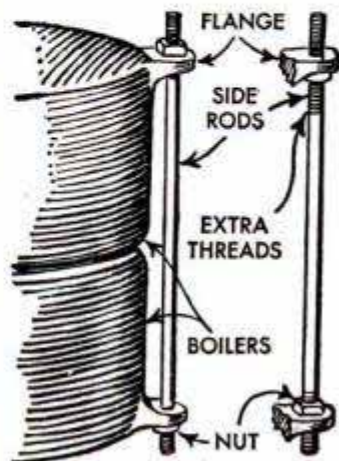

Reinforcing Document Corners

If several documents or drawings must be clipped together and mailed in an envelope, their corners can be reinforced by covering them with envelope corners as shown, and fastening with ordinary paper clips. This protects the corners from damage due to rough handling and holds the papers together while minimizing the indentations caused by the paper clips.

W. F. Schaphorst, Newark, N. J.

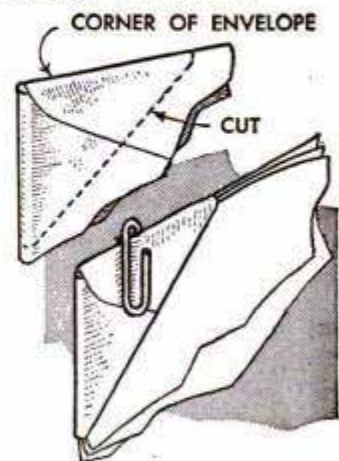



LICK COLD-WEATHER STARTING PROBLEMS

DO YOU step into your car on a cold morning with a doubt in your mind that the motor will start? It will if it is in good mechanical condition. And good mechanical condition does not necessarily refer to a new car. Unless your car has already passed the 50,000-mile mark, the chances are that a few simple checks of the fuel and ignition systems, to bring them to peak condition, will enable you to start the "old bus" on the coldest mornings.

Probably the most frequent cause of hard starting in winter is a weak or defective battery. As winter approaches, the load on the car battery increases. Also, as temperature lowers, the efficiency of the battery decreases. As the weather grows colder, careful drivers keep a check on the battery charge with a hydrometer, Fig. 8, and if periodic checks show that the load is steadily decreasing the hydrometer readings below 1.250, the charging rate is increased sufficiently to main-

tain the full-charge reading, 1.250 or slightly higher. Many motorists supplement normal generator charging with a trickle charger connected to the battery overnight. If the battery is more than a year old, it's a good precaution to take a voltmeter reading of each cell at least twice a year. If a defective cell is detected by this test, the battery should be replaced.

Defective or weak-battery symptoms also can be caused by a loose ground connection or badly corroded cable connections. Often it is necessary to make a careful check to be sure that one defect is not mistaken for another. Keeping all battery and ground connections clean and tight will avoid any trouble from this source.

Cars kept in unheated garages frequently give trouble in starting due to wet spark plugs. When the temperature rises after a cold snap the engine "sweats," due to moisture condensation. Moisture coats the plugs and cables and the high-tension current jumps from the

By Glen F. Stillwell

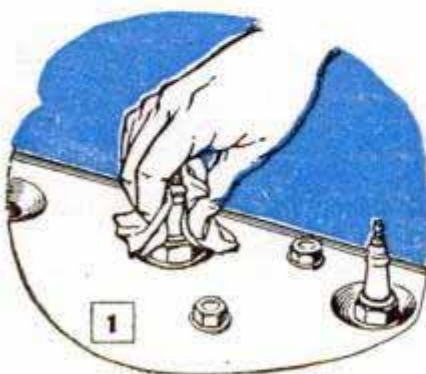

Wipe moisture from spark plugs and cables with a soft, dry cloth

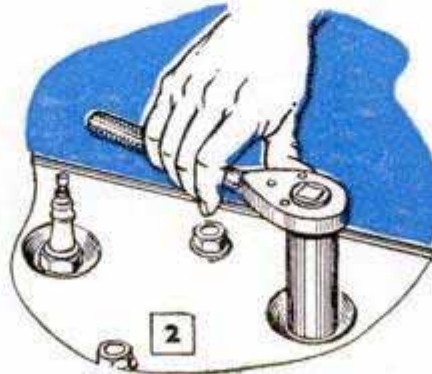

Use a deep-wall socket when tightening spark plugs to avoid breaks

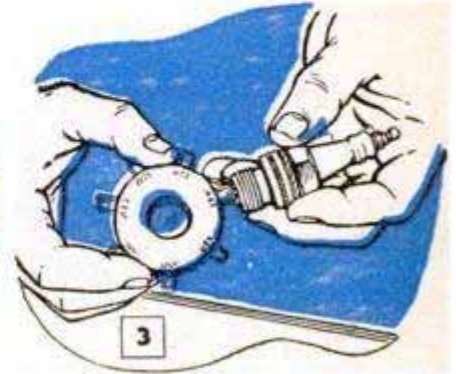

Check the electrode gap with a wire gauge made for the purpose

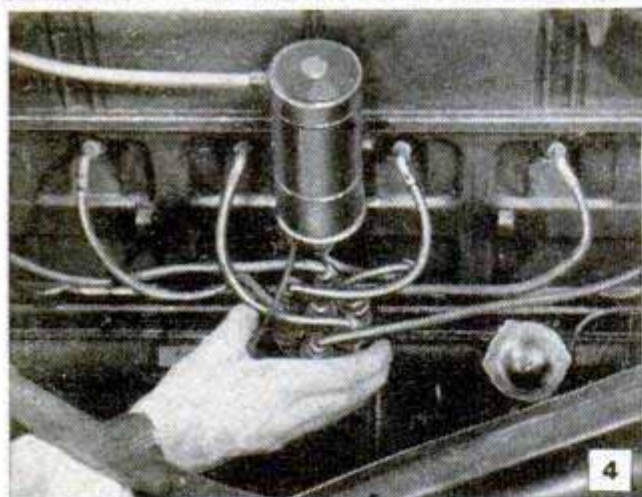
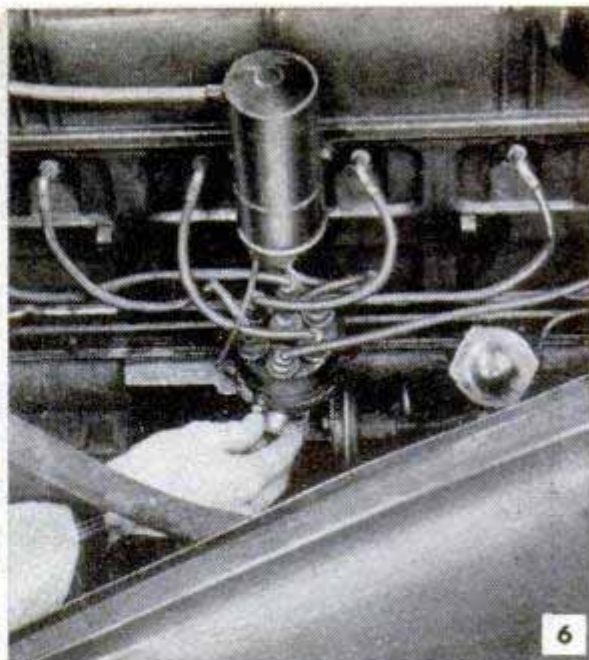

Above, lift the distributor carefully to avoid damaging the gasket. Below, clean the inside of the cap thoroughly with a dry cloth. Examine cap inside and out for cracks. Also check condition of rain guards

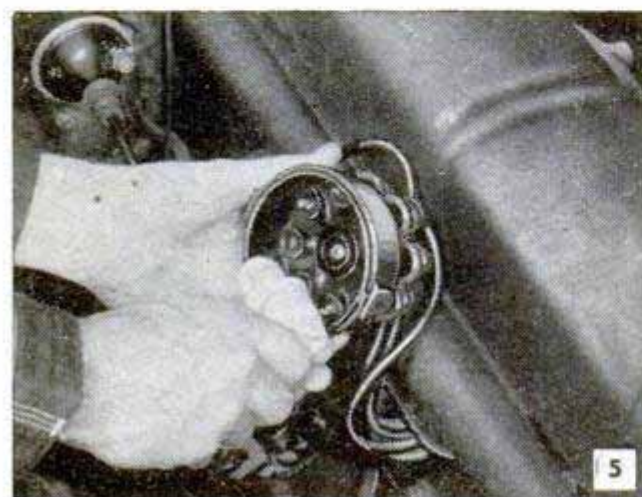

Overlubricating distributor may force grease into breaker mechanism and foul the points

plug terminal to the cylinder head, "shorting out" the plug. When this is the cause of failure to start, remove the cables and wipe the plugs and the cables with a dry cloth as in Fig. 1.

Exact gap spacing of the spark-plug electrodes, Fig. 3, is especially important in cold-weather operation of the car. Commonly recommended gap settings range from .025 to .029 in., but there are variations up to .040 in. Wide gaps and irregular gap settings in the same engine are a common cause of hard starting in cold weather. Some manufacturers recommend two settings, one for warm weather and another for cold-weather driving. In adjusting the gap always bend the side electrode and when removing plugs use a special spark-plug wrench or a deep-walled socket as in Fig. 2, to avoid cracking the porcelain. Make it a practice to clean the electrodes with fine sandpaper each time the plugs are removed. As plugs are replaced, always check the gaskets. Any that are scored should be renewed.

Making sure that the battery, battery cables and the spark plugs are in good condition eliminates a number of the common causes of wintertime starting troubles. This leaves the distributor still to be examined. Remove the cap, Fig. 4, and wipe the inside with a clean cloth, Fig. 5. Examine the cap carefully for cracks and indications of arcing. Unless the distributor is kept in good order by frequent cleaning and inspection, there is a tendency in some types of distributors for a dirt track to form inside the cap where the rotor contact travels. Here, fine dust, moisture and oil combine to form a heavy, sticky coating which in time will cause arcing, burn-

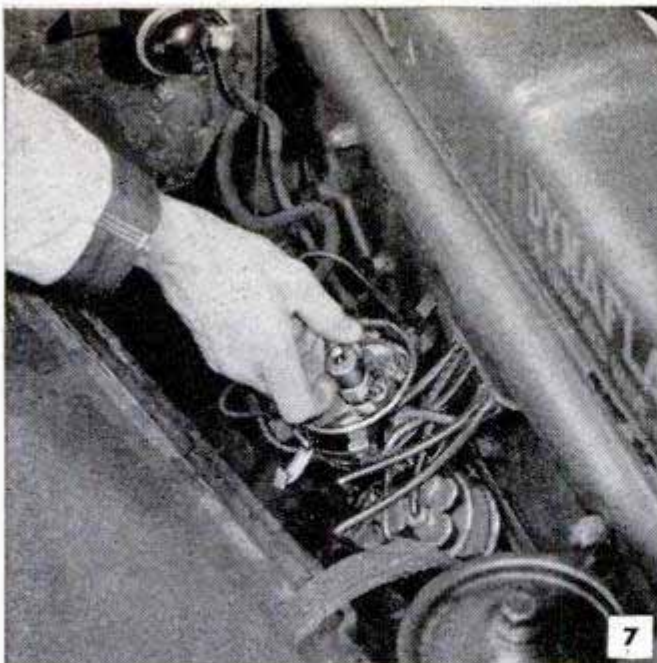

Remove rotor by pulling it off the driving shaft. When replacing be sure that it is properly positioned

ing and even cracking of the cap. Examine the top of the cap particularly for cracks. Be sure the spark-plug cables and the center cable from the coil make good electrical contact inside the socket terminals. Also be sure the rain guards over the cables fit tightly and have no cracks or wide breaks. Condition of the guards is especially important to good winter performance as they prevent moisture or a water splash from entering the distributor and suddenly "drowning" the ignition system.

Next, lift the rotor, Fig. 7, and examine the breaker mechanism. If the points are burned and deeply pitted so that they make only a partial contact, the parts should be renewed; also the condenser, which is a likely source of this trouble. On the other hand, if the parts seem to be in reasonably good condition, the points can be dressed to a true contact with a breaker-point file. The specified breaker-point gap ranges from .018 to .022 in. Check with a thickness gauge and set the gap according to the manufacturer's instructions. After setting the gap be sure the eccentric screw is tightened to hold the adjustment. Avoid overlubrication of the distributor shaft. Give the grease cup a turn or two after each 1000 miles, Fig. 6.

Automatic chokes generally have a winter and summer setting, which makes it possible to vary the richness of the starting mixture of fuel, and some are fitted with a fast-idle mechanism that simplifies starting a cold engine and gives better control during the warm-up period. The choke is operated automatically by a thermostatic control so located that it is actuated by changes in manifold temperature. Where the choke-control system includes a fast-

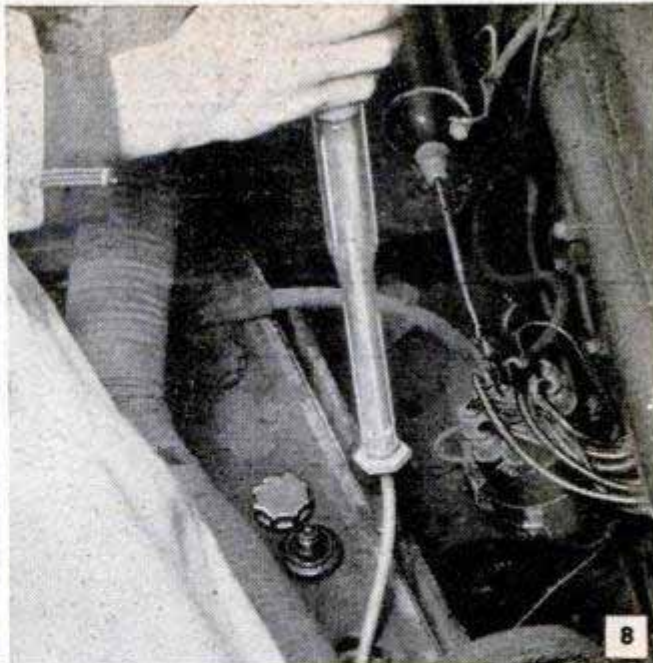

Hydrometer readings of 1.250 or above normally indicate full battery charge. Check cells with voltmeter

idle control, the thermostat actuates not only the choke valve but also a vacuum valve or piston which measures the idling fuel mixture. As soon as the engine reaches normal operating temperature, the choke becomes inoperative, but as the engine cools after operation, all parts of the choke mechanism return to the starting position. By carefully following the manufacturer's directions for setting, anyone can adjust the automatic choke. On older cars equipped with manually operated chokes, correct operation depends on the skill of the driver. Overchoking will flood the engine and make it difficult if not impossible to start. Flooding also will dilute the crankcase oil with unburned fuel, which passes the pistons. Running with the engine partially choked also can result in rapid wear of cylinder walls and piston rings as the raw fuel washes away oil which normally reaches the upper part of the cylinders. Ordinarily, the trick in operating the manual choke is to synchronize operation of the choke with that of the starter so that a rich fuel mixture is drawn into each of the cylinders on the first intake stroke. After the engine starts, the choke is closed by stages until the engine has reached operating temperature.

Poor compression due to leaky valves or worn rings causes hard starting any time. Such an engine needs both a valve and ring job to put it in proper condition for winter service. If poor compression is the cause of hard starting, an instrument check of the engine will show what parts are at fault. Sometimes a defective head gasket or possibly spark-plug gaskets are the cause of poor compression. These parts are quite commonly at fault in older cars.

Shock Absorber of Elastic Tape Safeguards Exposure Meter



The accuracy of a sensitive exposure meter is more likely to be maintained if jarring of the instrument during use is kept to a minimum. One way of accomplishing this is to attach a shock absorber of elastic tape to the neck strap. After the tape is looped around the strap and through the eye on the meter case, the ends are sewed together carefully to provide a strong joint.

Funnel Aids Filling Film Tank

Cementing the top part of a plastic funnel to the cover of a roll-film developing tank makes filling the tank much easier and reduces spilling to a minimum. The cup-



shaped funnel shown was taken from a discarded lamp fixture, but you can make any small funnel do by cutting off the spout. The handle of the actuating rod is lengthened by cementing it to a piece of hard-rubber tubing.

C. A. Oldroyd, Lancaster, Eng.

Ferrotypic Polish Lubricates Reel

If film does not slide easily when loading the reel of a daylight developing tank, wax the grooved spiral track with ferrotypic waxing solution, applied sparingly with a brush and polished with a soft cloth.



Determining Correct Exposure When Using Filters

Instead of bothering with complicated factors in determining the correct exposure time when using a filter on the camera lens, simply take a light reading through the filter by placing it in front of the meter. The reading obtained will give the proper lens settings for that particular filter under light conditions of the moment. The filter must be larger than the meter light opening so that the meter will not register extraneous light around the edge of the filter.

Spotting Prints With Eyebrow Pencil

When a regular spotting pencil or retouching paint is not available, tiny specks or lint that are difficult to retouch on small negatives can be touched up on the enlargement with an ordinary eyebrow pencil or a grease-type marking pencil. Such pencils are available in black and brown for spotting black-and-white or sepia prints. They work well on both dull and semigloss enlargements.

Detergent Cleans Condensing Lens

Cleanliness is essential if the condensing lens of an enlarger is to do its best work. To keep the lens sparkling, wipe it with a sponge moistened in a solution of dilute detergent of the kind used to wash dishes.

A scant drop of detergent in 8 oz. of water generally is sufficient.



CONTROLLED ENLARGING LIGHT

By C. H. Schrepfer

ALTHOUGH the light output of an enlarger can be controlled to a certain degree by regulating the iris diaphragm in the lens-mount, this inexpensive rheostat provides a variable light control for high and low-intensity requirements. By being able to increase and decrease the light intensity to correspond with the density of the negative, many excellent enlargements can be made from poor negatives which otherwise would be lost. In the case of a thin negative, a low light intensity lengthens the exposure and gives highlights time to register, while with a very dense negative, a high-intensity light will permit penetration with a shorter exposure. In addition, the rheostat permits control of excessive heating of the enlarger lamp house and thus avoids possible damage to the negative by using a low-intensity light while focusing and cropping. The rheostat can be used similarly in prolonging the life of photoflood lamps by using them at full brilliancy only at exposure.

The wooden front and rear panels of the rheostat case are 1 by 8 by 8 in. Five 1/2-in. holes are drilled 1/4 in. deep in the rear panel to seat the ends of the porcelain resistors, while an equal number of 1/4-in. holes are drilled through the front panel to take the brass contact points. Note that the

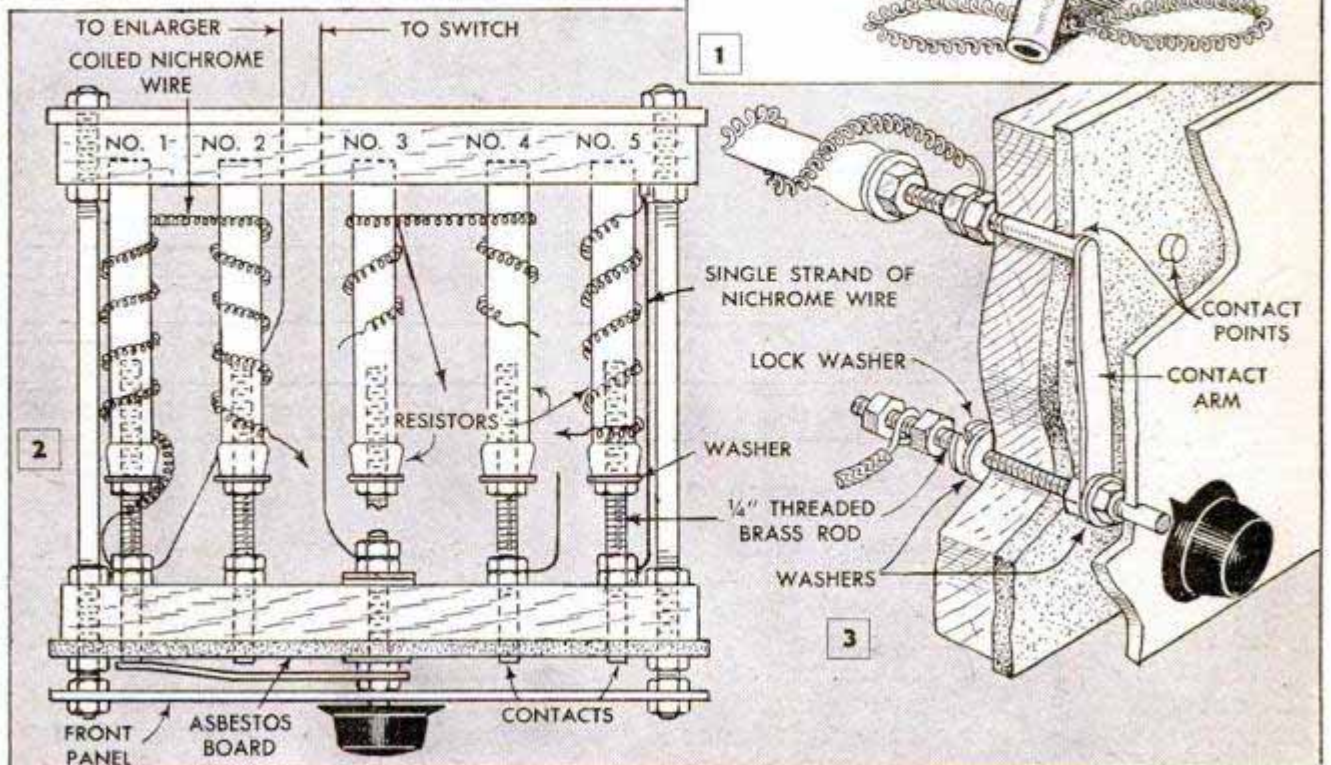
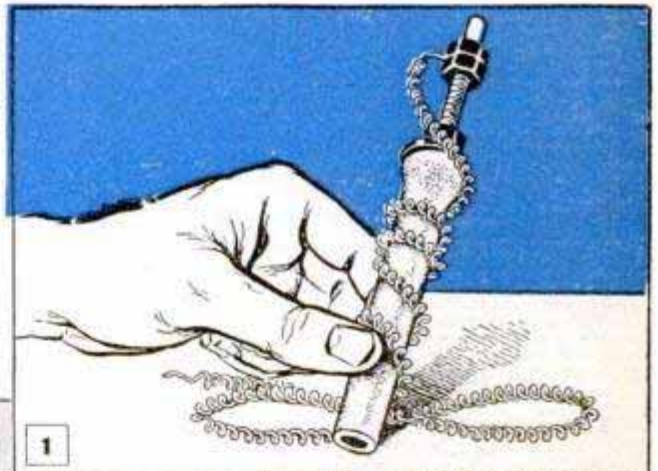
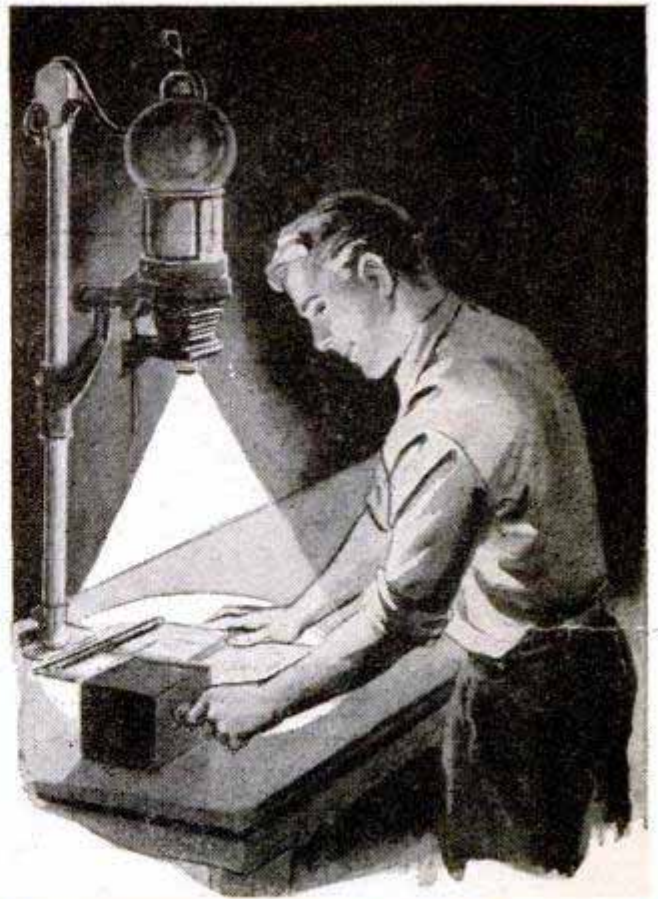

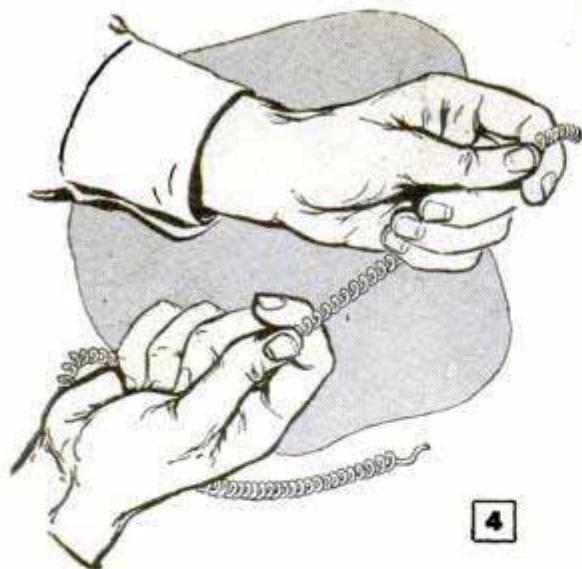

4

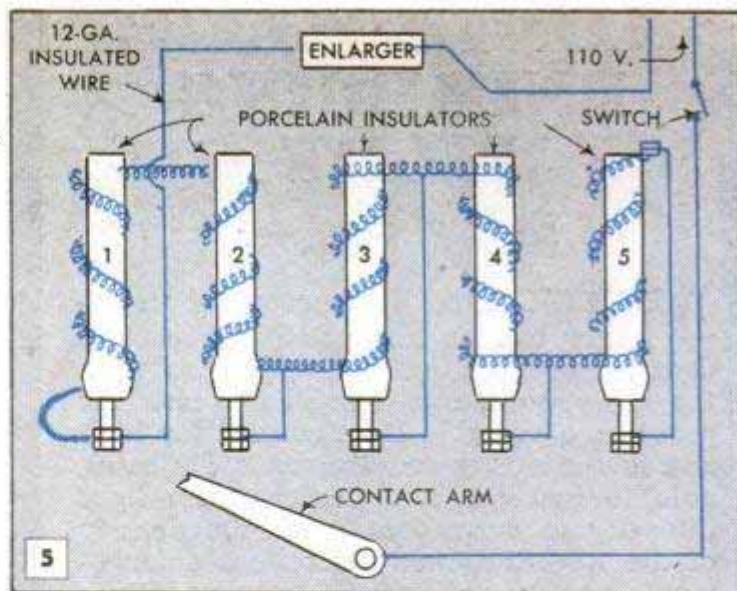

5

latter holes must be drilled on a radius equal to the length of the contact arm. Fig. 1 shows what each resistor looks like when fitted with a contact. Each contact consists of a threaded, 1/4-in. brass rod fitted with 3 nuts and a washer. These are inserted part way in the ends of common, knob-type insulators and then all 5 resistors are clamped in place between the wooden panels by a tie rod at each corner, as shown in Fig. 2. Before the outside nuts are in place, insulate the wooden panels with a 1/4-in. asbestos board. Aligning the holes in the asbestos to register over the protruding contact points is simplified if the board is drilled at the same time as the wooden panel. An outer control panel of hard fiber or Bakelite supports the contact shaft and knob which is installed as in Fig. 3. Note that a lock washer is used to produce tension on the contact arm. The upper end of the contact arm is bent V-shape to engage the end of the contact points which are cupped slightly for positive contact.

The contact arm is made from a piece of 20-ga. brass, 3/8 in. wide and 6 in. long. It is drilled to fit over the end of the shaft.

The resistors are made by winding coiled Nichrome wire around the porcelain insulators, stretching the wire slightly, as in Fig. 4, so that coils of the wire do not touch each other. Follow the wiring diagram in Fig. 5 when winding the wire from one insulator to the next. On resistor 1, the No. 12 insulated wire is connected to the Nichrome wire at the same terminal on the contact. The contact lead from resistor 5 is fastened to the Nichrome wire by means of a connector. Now, top, bottom and sides of the unit are covered with plywood to complete the case. Several holes should be made in the sides to ventilate the element.

By means of the 5 contacts, the rheostat will reduce light intensity from a high of 250 w. to a low of 50 w. The use of a photoelectric meter to check the rheostat will determine the exact difference of light intensity in foot-candles at each contact.

Foot Switch for Enlarger or Contact Printer Made From Auto Parts

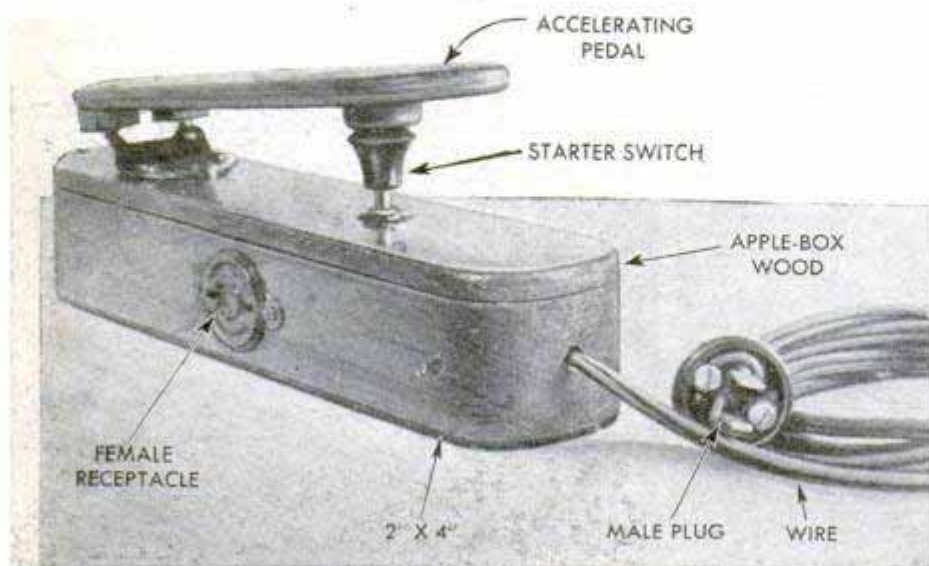

Here is a low-cost foot switch for your enlarger or printer. It consists of an auto starter switch and a female receptacle fitted in a wooden base. The receptacle is wired to one switch terminal and a rubber-covered extension cord is wired to both terminals of the switch. An auto accelerator pedal is mounted as shown. To use the switch, plug the enlarger or printer in the female receptacle and the switch in a wall outlet.

If you've been wanting a pan-head tripod for outdoor action shots, here's an inexpensive substitute that will pan a home-movie camera with good results. It's easily carried and is set up by simply pressing the pointed end of the shaft into the ground with the foot. The shaft can be of round hardwood or a length of pipe and is cut in two parts several inches below the top. If pipe is used, a pointed steel rod is pressed tightly into the lower end of the shaft. The two parts of the shaft are held together with a strong compression spring crosspinned with metal dowels or headless nails. A setscrew fastens the camera to a bracket bolted to the top of the shaft.

Pan-Head "Tripod" Made of Hardwood or Pipe Utilizes Compression Spring for Swivel Joint

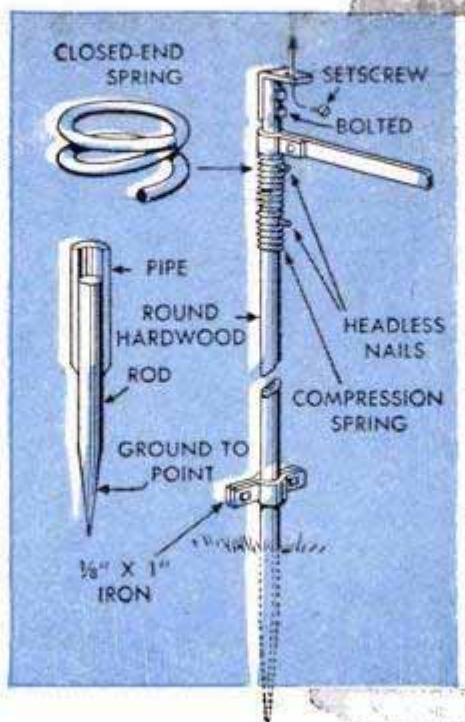

Iodine Bleaches Pinhole Spots On Photo Negatives



Should a negative be spotted with objectionable pinholes, household iodine can be used to bleach the spots and salvage an otherwise good negative. To do this, touch the spots lightly with

iodine by using the glass applicator and then touch them with hypo to stop the action of the iodine. Finally, remove the hypo with a bit of cotton placed on the end of a toothpick and dipped in water. The iodine bleaches the spots by converting concentrated deposits of silver to silver iodide which is transparent.—Bob Hurst, Chicago.

Making Slow Exposures

Some small cameras are fitted with shutters that will not work at speeds slower than $\frac{1}{25}$ sec. and, thus, when it becomes necessary to make exposures of $\frac{1}{3}$ sec., the usual method is to set the shutter at "bulb" and click it as quickly as possible. A more accurate way is to leave the shutter set at $\frac{1}{25}$ and then click the shutter five times in

succession without moving the camera during the process. A tripod is necessary, of course, and the subject must not move during the five exposures. Variations of this idea cover slower shutter speeds.

Test Strips Are Easier to Handle When Left in Sheet Form

Test strips used in making enlargements, as well as contact prints, are more convenient to handle and store if they are partially pre-cut and left in sheet form. The common practice of cutting them free makes it inconvenient to retrieve the strips from the bottom of the envelope. But if the strips are cut almost to the edge of the sheet, they can be torn off as needed.

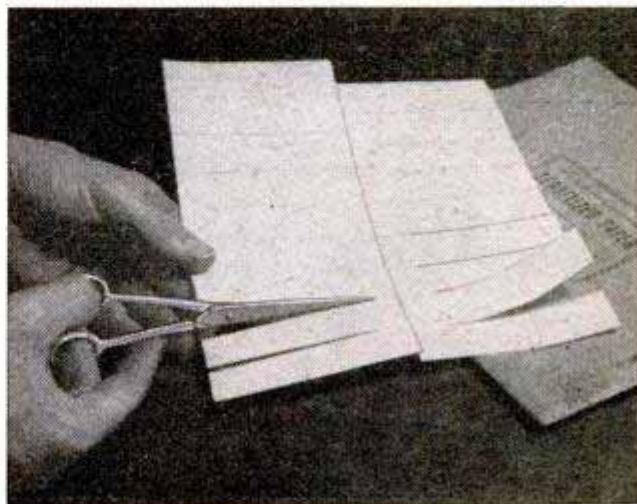

TO MAKE OR REPAIR

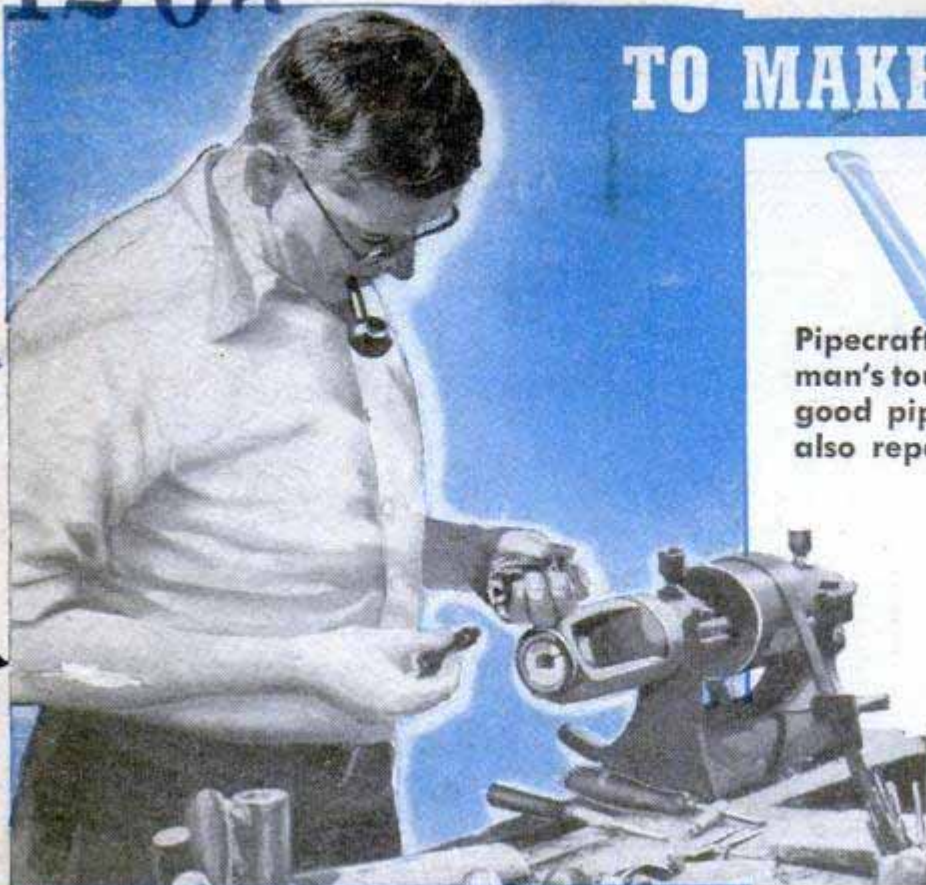

Pipecrafting calls for the craftsman's touch but anyone can make a good pipe with only a few tools—also repair that favorite old briar

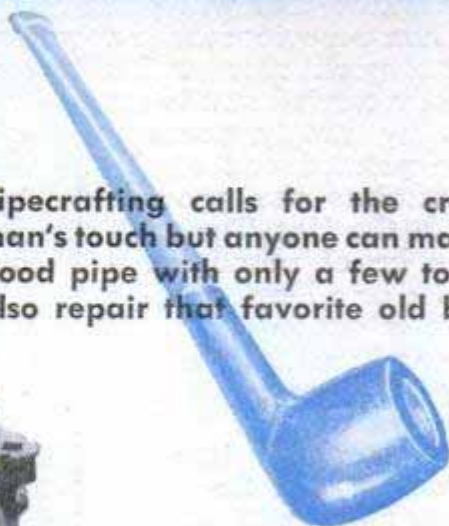

By
Richard W. Emery

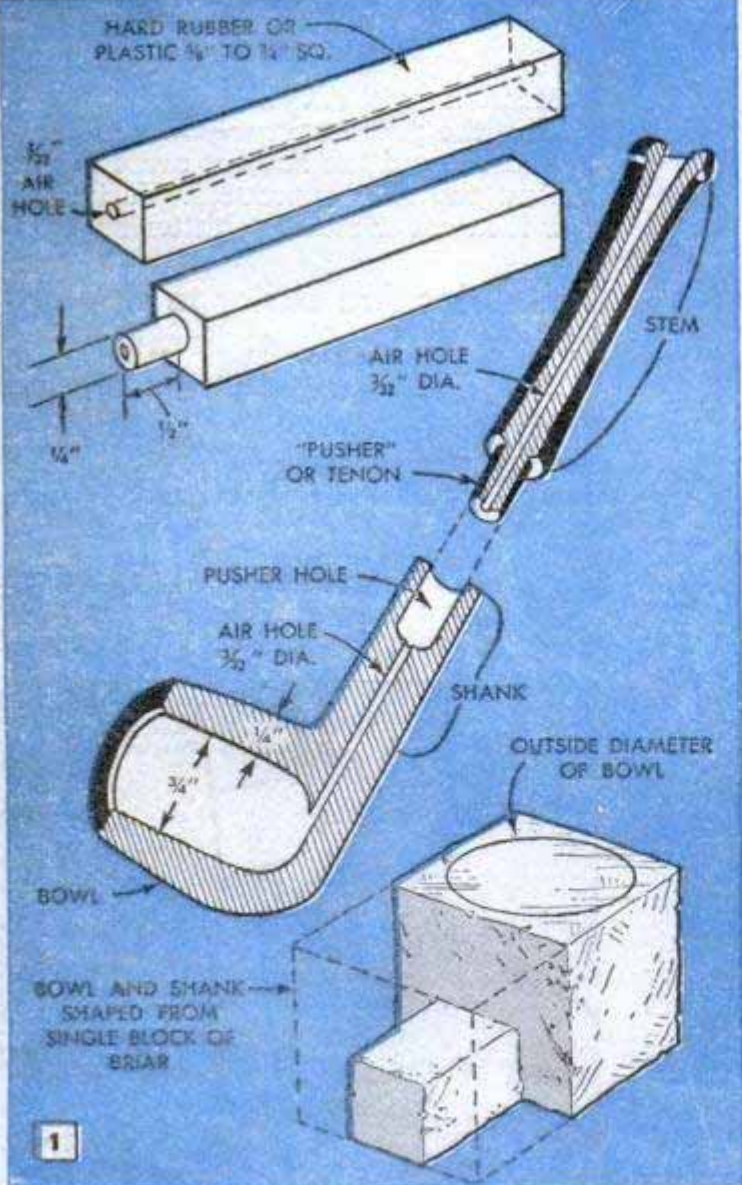

GENUINE briar, as used in pipe-making, is a tough, hard root-wood and comes in pieces of comparatively small size. The grain in a single piece may vary from a distinct burl or "flame" figure through several gradations to a plain, flat grain. In cutting the rough blank for a pipe of conventional design from any but the choicest blocks of briar, the pipe maker often must modify the design to eliminate flaws in the material, or to take full advantage of the variations in the grain.

The bowl and shank of the conventional pipe are shaped from a

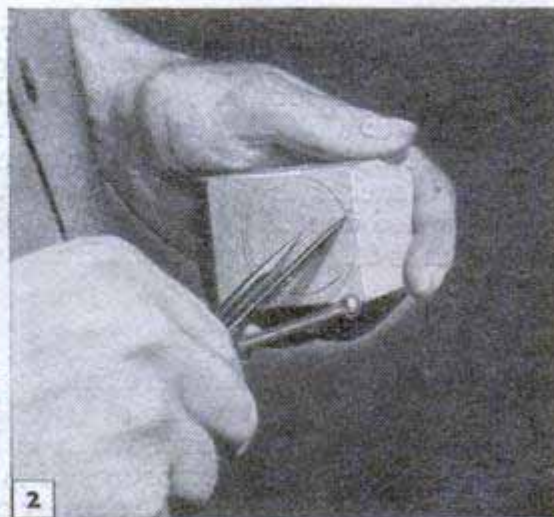

Scribe the inner and outer diameters of the bowl on the blank with sharp-pointed scribe

A BRIAR PIPE

single blank of briar, Fig. 1, but the stem, or bit, usually is a separate part made from hard rubber or plastic. The bit is flattened at the outer end to form a comfortable mouthpiece. The air hole, usually $\frac{3}{32}$ in. in dia., is drilled lengthwise through the bit before the final shaping. Before cutting a blank of briar to the rough shape, examine it carefully for flaws and pattern of grain. Then square the top surface which is to be the top of the bowl. Scribe the inside and outside diameters of the bowl on the wood, Fig. 2. In sawing the blank to the rough shape, Fig. 3, make the first cut from the end of the shank to the bowl and the second down from the top of the bowl to meet the first cut. Allow waste for shaping the bowl and shank to exact size. Shape the shank roughly by running additional cuts in from the end of the shank to the bowl. Then two cuts run in from the outside to meet the last two at the shank will produce a blank shaped as shown in Fig. 4. Next, mount the blank in a special chuck in the lathe and bore the tobacco hole as in Fig. 5. Round the bottom of the hole to a uniform radius. Counterbore the shank while the work is still in the blank or make a special chuck to hold the semifinished part as in Figs. 7 and 8. Counterboring forms the air hole and the pusher hole as in Fig. 1.

Now the blank is ready for shaping, which is done on a recessed wooden disk faced with abrasive, Fig. 6. Both the outer face of the disk and the recessed center are coated with abrasive grains bonded to the surface with a special adhesive. In use, the speed of the abrasive disk should not exceed 2000 r.p.m., otherwise there is danger of burning and discoloring the work. The

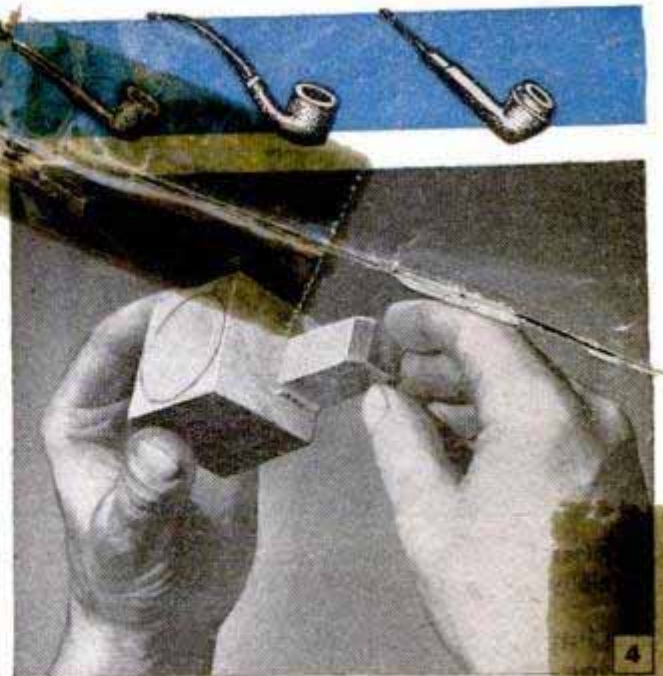

When sawed to rough shape, the completed shank-and-bowl blank is ready for sanding to final form.



Boring the tobacco hole in the bowl, using a special chuck. Bottom of the hole is rounded uniformly.

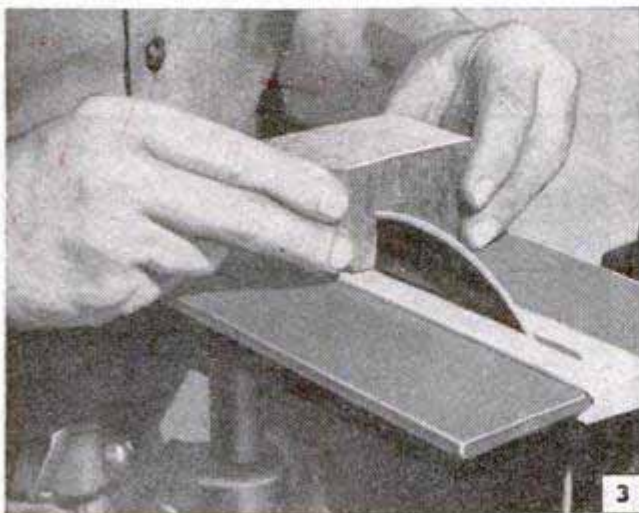

Next, the rough blank is sawed to shape with a circular saw. Be sure to allow stock for finish-sanding.

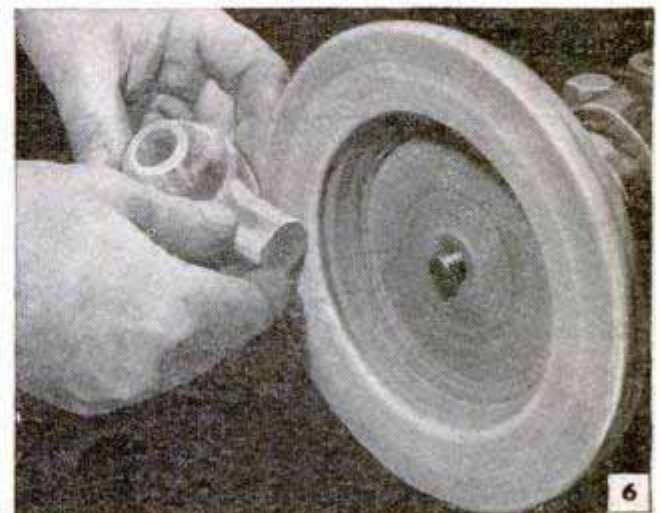

Final shaping of bowl and shank is done on a recessed abrasive disk made especially for the purpose.



After final shaping, the work is clamped in a specially made chuck tightened with a friction ring

shaping procedure is simply that of bringing the shank and the bowl gradually to the rounded contours by alternately rounding over the corners of both shank and bowl. By working in this manner, the bowl and shank can be brought accurately to uniform shape and size.

At this stage the stem should be shaped. This is done on the abrasive disk but special care is taken to avoid overheating. Some hand-finishing will be necessary after assembly of the pipe. Turning the tenon to fit the pusher hole in the shank is the tricky job, but with care it can be done in a special chuck mounted on the lathe faceplate. Make several trial fits as in Fig. 9. After the stem is fitted to the shank, press it into the shank and touch lightly to the abrasive disk, Fig. 11, to finish the joint flush. If the stem fits too loosely, expand the end by heating it and inserting a metal taper pin as in Fig. 10.

High-grade pipes of fine briar usually are oil-finished and polished by hand. To do this, mix fine pumice and sweet oil to a light paste and rub the bowl, shank and

The stem is held in the same chuck when turning the tenon. Always trial-check the fit in the pipe shank

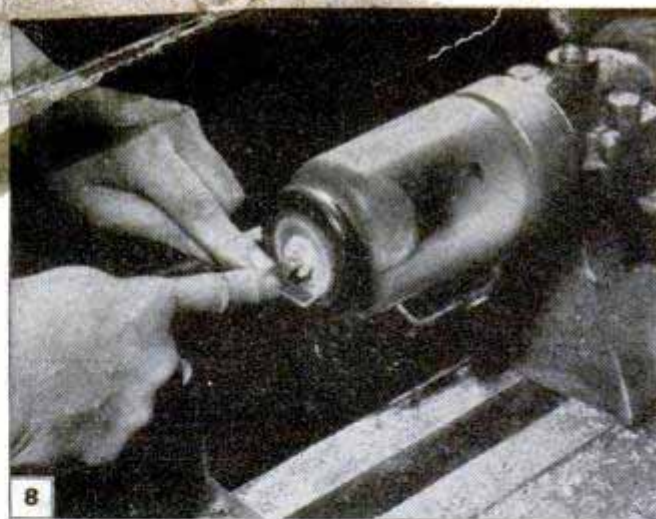

Counterboring the shank to form the air hole and the pusher hole. Pusher hole must be of exact diameter

stem to a high luster. That's all. The pores of the wood in a good pipe should never be sealed with varnish or lacquer.

Figs. 12 to 18 inclusive detail the methods of repairing common breaks in the stem and shank. If the stem tenon snaps off, leaving a portion in the shank, Fig. 12, just square the broken end and turn a new tenon on the stem. A second method is the use of an insert tenon as in Fig. 13. If the stem is short, this method often is the best. If, on the other hand, the shank breaks close to the stem, cut the shank as in Fig. 14 and drill a new pusher hole. Pipe repairers often add a metal band, Fig. 16, as a part of this repair. When the shank breaks close to the bowl, the repair problem is somewhat more involved. Then the repairman uses what he calls a bone screw, which is merely a coarsely threaded tenon or dowel made from bone and available from pipe suppliers. Broken ends of the shank are squared and joined as in Fig. 15. Use a waterproof glue and, as soon as the glue has dried thoroughly, refinish the shank and stem on the disk as in Fig. 11, to

If pusher fits too loosely, expand it by holding the bit over heat and inserting taper pin in the air hole

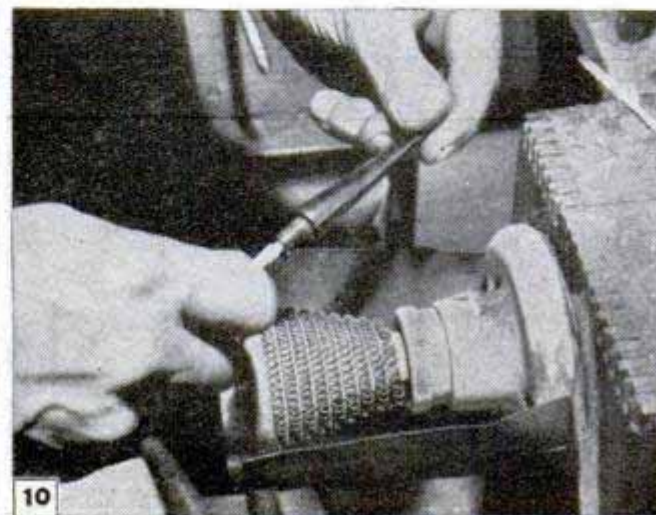

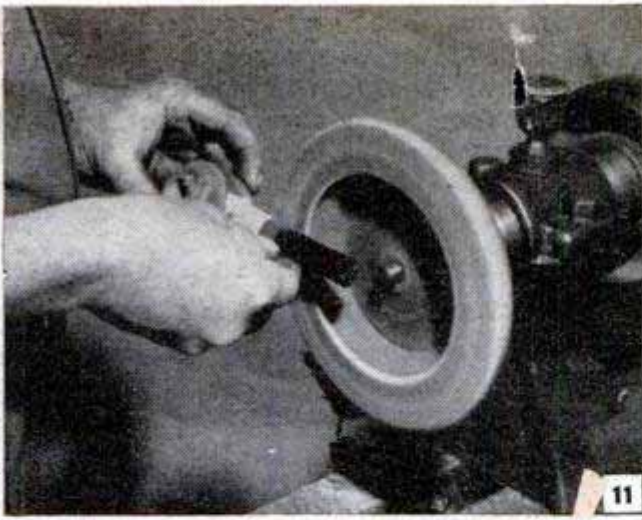

When the stem has been fitted to the shank, sand joint flush to assure a neat, close fit of these two parts

bring the parts of the joint flush. Then polish with oil and pumice. If care is taken in fitting the parts, the joint will be practically invisible. If the wood shows lighter at the joint (which it is likely to do on an old pipe) it can be brought back to the original color with a drop or two of stain. This is applied after finishing on the disk. Curved-stem pipes, Fig. 17, can be repaired in much the same way as a straight-stem pipe, provided the break is not too close to the bowl. In the former, the pusher hole must be taper-reamed. If the bit of a straight-stem pipe becomes unduly loose in the shank, the bit tenon is turned down slightly and fitted with a cork sleeve as in Fig. 17. The sleeves are available from dealers in pipes and accessories. Be careful when knocking out the ash to avoid striking the pipe shank close to the bowl.

Keep pipes in a rack when not in use. As a rule, the type of rack which holds the pipe with the bowl down is considered best, although there is some difference of opinion among pipe smokers on this point.

If you break the shank of your favorite briar, it can be repaired by using a coarse-threaded bone screw

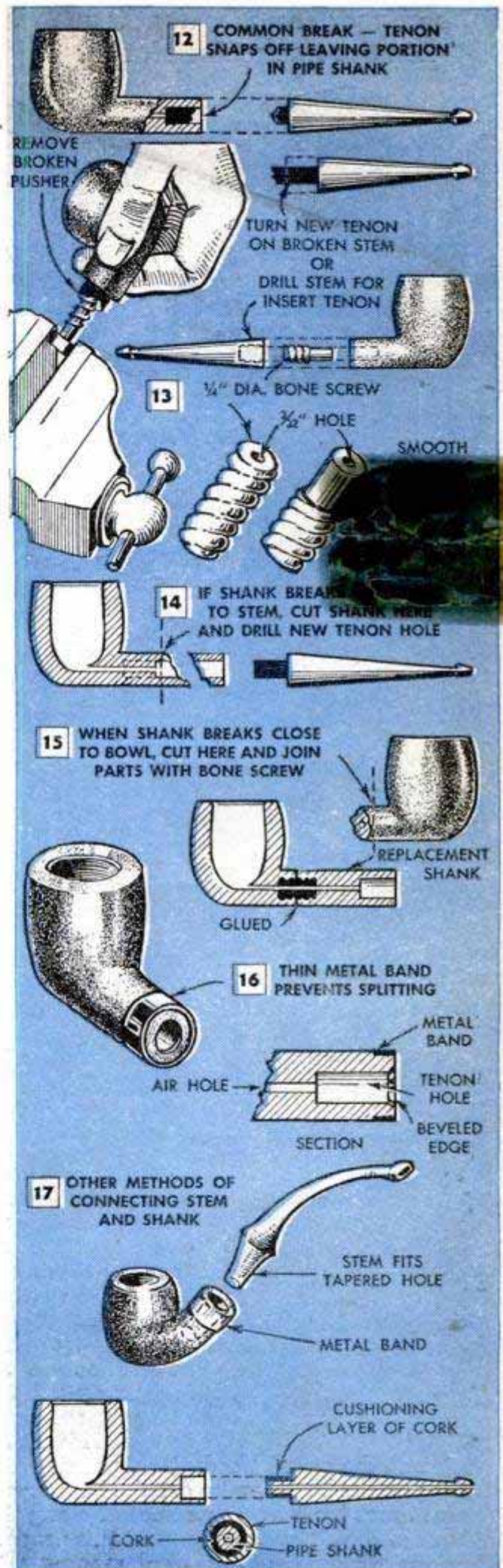

Forefinger Provides Reading Glass When Spectacles Are Not Handy



People who wear spectacles will find this an excellent emergency measure when they wish to read a short printed item but discover that they have forgotten their glasses. By crooking the index finger, as shown in the drawing, and holding the hand near the eye, the field of vision through the hole formed by the finger is localized and the printing becomes readable. The smaller the opening made with the finger, the greater will be the exaggeration of the type. The paper is best held approximately 8 to 10 in. from the eye. A little experimenting will determine the correct size for the hole in the crooked finger and the distance at which the paper should be held.—R. Logan, Spokane, Wash.

Cutting Hard-Pressed Board



Hard-pressed board, especially the tempered type, can be cut faster than by sawing if it is scored with a sharp chisel guided along a wooden strip. A butt chisel is best suited for this purpose as it is easily held against the strip. To do this, position the strip on the board and score the board several times by drawing the chisel along the edge of the strip. Then, repeat this process on the other side of the board, making sure

it is done directly opposite the original scoring. After this, snap the board apart at the cut and smooth the rough edges with a coarse file. Of course, this method can be used only for straight cuts.

Pio Panieri, Roslyn, Wash.

Cork-Plugged Vents in Storm Sash Regulate Amount of Air

If your storm sash are without ventilators, and turn buttons prevent swinging the window open at the bottom, a simple method of installing vents in each sash is to bore three or more large holes through the sash at the bot-

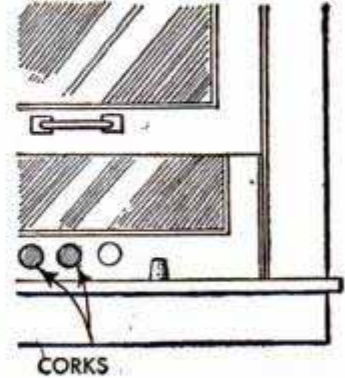

tom. Then by fitting corks in the holes, it is easy to regulate the amount of air as desired by inserting or removing the corks.

Freezing Saves Leftover Food

Leftover cooked foods which ordinarily would spoil in a few days, can be safely saved for future use by freezing in the refrigerator. Of course, care must be taken to make sure the food has not spoiled before freezing. However, if the food is several days old but still good, heat it thoroughly and then cool it quickly before putting in the freezer.

Mrs. R. McLeod, Knoxville, Tenn.

Smudge From Candle Flame Speeds Filing a Handsaw

Time will be saved when sharpening a handsaw if the saw teeth are first blackened with a candle flame. The smudge makes it easy to see the fresh file cut and eliminates refiling teeth already sharpened, thus considerably speeding up the job.

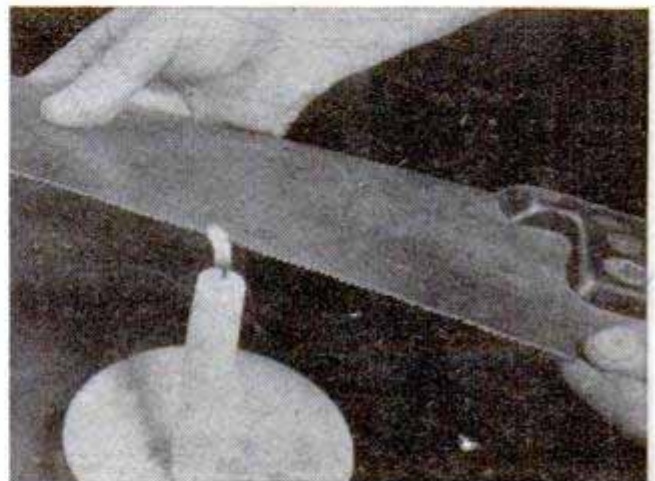



Build your own

ARC WELDER

Part II

By
Evan Wright



The welder parts are wired temporarily and used to weld the cabinet frame

NO ATTEMPT has been made to rewind the transformer, described in Part I, with enough primary resistance to prevent blowing the line fuses when an excessive load is thrown on the secondary. In fact, it is best to have the primary resistance comparatively low to permit a current-controlling device known as a reactor to be introduced in the primary circuit, as shown in the wiring diagram, Fig. 20. Selection of the various welding currents or "heats" is controlled by inserting plugs, connected to a primary loop and two welding cables, into jacks connected to the transformer leads. A jack board, Fig. 21, supports the jacks which are labeled for ease in selecting the different secondary and primary combinations. Further adjustment of the current is made by regulating the reactor.

To make the reactor, cut enough laminations to make a core the size indicated in the upper detail of Fig. 19. Note that the center lamination is slightly longer than the others, and has holes drilled in each end. The laminations are held together by wrapping tightly with tape. A square tube having inside dimensions just large enough to permit easy insertion of the core is glued together as detailed in Fig. 19. One half of the tube is wrapped with 200 turns of wire of the same size used in the transformer primary coil. Each layer of wire should be insulated with cotton cloth and shellac.

To make the jack board, cut out and drill 3 pieces of hard-pressed board to the dimensions given for the cover plate, Fig. 21. The holes should make a snug fit with the 3-in. lengths of

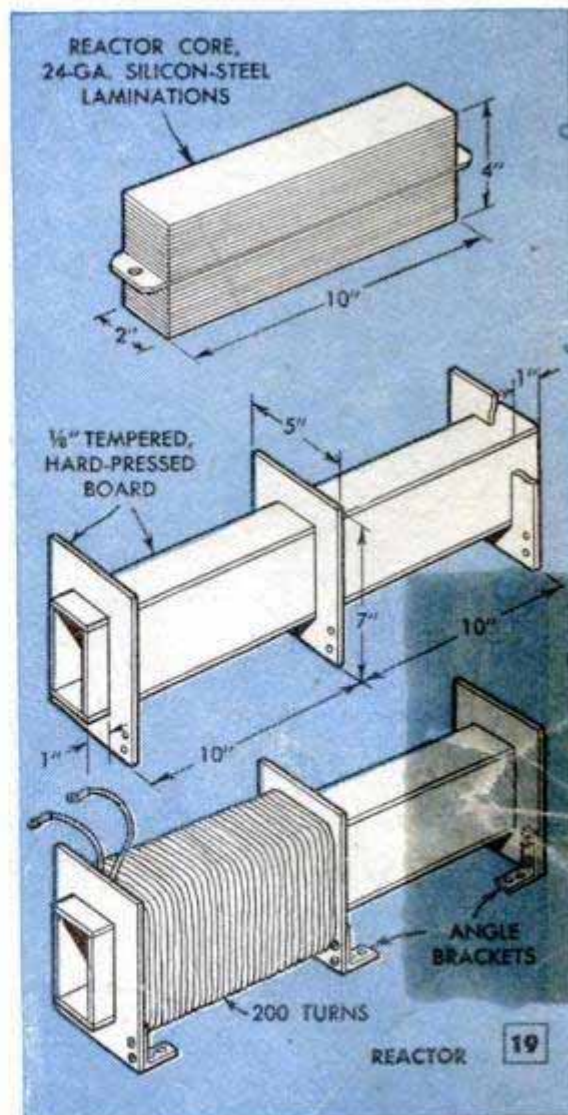

Reprinted in S-9.

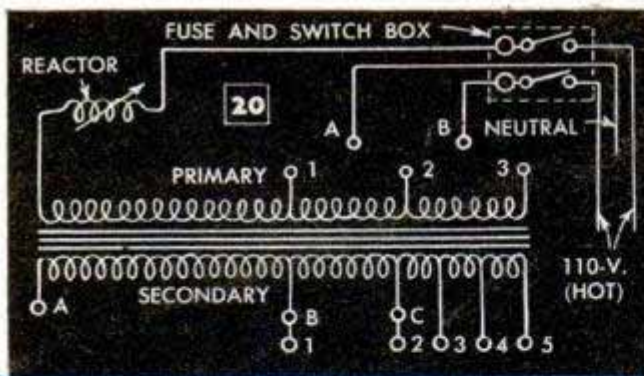
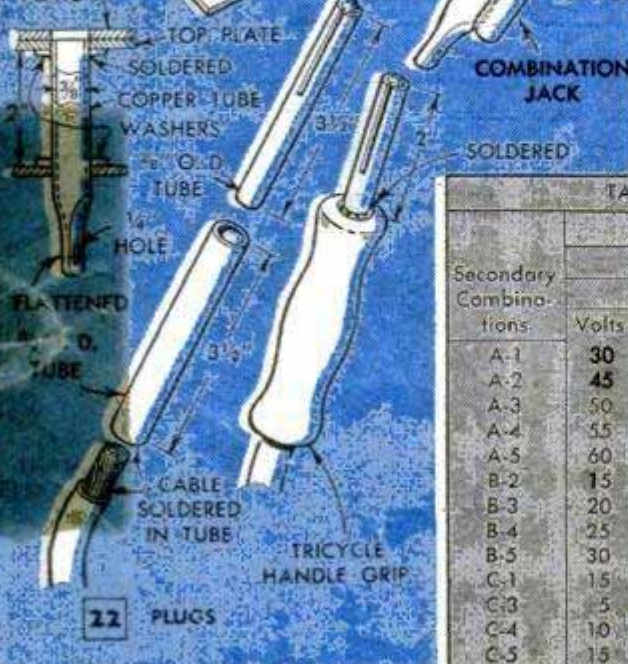
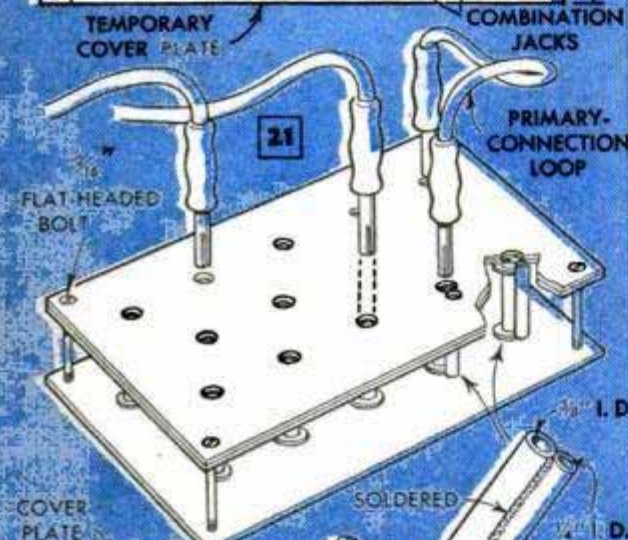
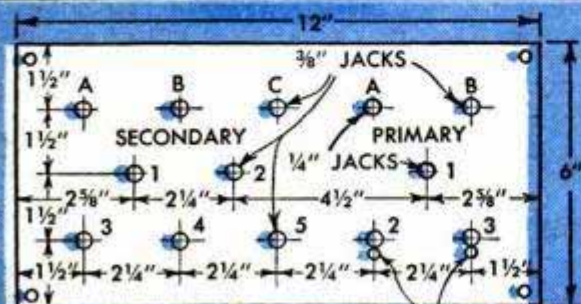

TABLE III — SECONDARY CONNECTIONS

A-1	30 turns	B-1	dead	C-1	15 turns
A-2	45 turns	B-2	15 turns	C-2	dead
A-3	50 turns	B-3	20 turns	C-3	5 turns
A-4	55 turns	B-4	25 turns	C-4	10 turns
A-5	60 turns	B-5	30 turns	C-5	15 turns



copper tubing used for the jacks. Note that jacks A and 1 for the primary are made of $\frac{1}{4}$ -in. i.d. tubing and that combination jacks 2 and 3 of the primary consist of $\frac{1}{4}$ and $\frac{3}{8}$ -in. tubes soldered together so that either of the two loops, described later, can be used. All others are of $\frac{3}{8}$ -in. i.d. tubing. The jacks are sandwiched between the pieces of board which are spaced by washers soldered to the jacks as indicated in the sectional drawing, Fig. 21. The whole unit is held together by bolts at each corner of the boards. The ends of the jacks that project through the bottom of the jack board are flattened and drilled for connection with the transformer leads.

The primary-connection loop, Fig. 21, is next. Although only one loop is used at a time, two are required, one with $\frac{1}{4}$ -in. plugs, the other with $\frac{3}{8}$ -in. plugs. These two loops of different sizes are necessary to prevent a connection across B and 1 on the primary, which would give high-voltage currents on the secondary that would be dangerous to handle and unsuitable for arc welding. The plugs, Fig. 22, are made from lengths of $\frac{1}{4}$ and $\frac{3}{8}$ -in. copper tubing each of which is split lengthwise with a saw for a distance of $1\frac{1}{2}$ in. from one end to produce a tight fit when inserted into the bore of the jack tubes. The other end is soldered into a $3\frac{1}{2}$ -in. length of $\frac{1}{4}$ or $\frac{3}{8}$ -in. i.d. copper tubing so split end projects 2 in. A 12-in. length of No. 8 gauge flexible wire is soldered to the ends of the larger tubes. The plugs are then insulated with tricycle handle grips, leaving the split tubing exposed for a distance of 2 in. Plugs for the ground and electrode-holder cables are made in the same manner. These cables are of No. 2 gauge rubber-covered flexible wire each about 20 ft. long. In use, these cables are plugged into the secondary circuit.

The transformer and other electrical parts now can be mounted in a temporary wooden frame as shown in Fig. 18, and used to weld the frame for the welder

TABLE IV — NO-LOAD VOLTAGES AND MAXIMUM AMPERAGES

Secondary Combinations	Primary Combinations									
	110 Volts						220 Volts			
	A-1		A-2		A-3		B-2		B-3	
A-1	30	110	20	165	15	220	40	165	30	220
A-2	45	73	30	110	23	143	60	110	45	148
A-3	50	66	33	100	25	132	67	98	50	132
A-4	55	60	37	89	28	118	73	90	55	120
A-5	60	55	40	82	30	110	80	83	60	110
B-2	15	220	10	330	8	415	20	330	15	440
B-3	20	165	13	252	10	330	27	244	20	330
B-4	25	132	17	195	13	252	33	200	25	264
B-5	30	110	20	165	15	220	40	165	30	220
C-1	15	220	10	330	8	415	20	330	15	440
C-3	5	660	3	1100	3	1100	7	940	5	1320
C-4	10	330	7	470	5	660	14	508	10	660
C-5	15	220	10	330	8	415	20	330	15	440

cabinet, Fig. 24. The wiring diagram, Fig. 20, indicates how the connections are made to a split 220-volt power line. Use a d.p.s.t. switch and box with two 30-ampere fuses. The transformer leads are connected to the jacks, which are labeled to correspond with the tags on the leads. By making a connection across primary jacks A and 1 with the connection loop, 110 volts are impressed on the 110 turns. The combinations of jacks A-2 and A-3 give 110 volts through 165 and 220 turns respectively. When connections across B-2 and B-3 are used, the voltage is 220 through 165 and 220 turns. Table III gives the number of turns for the various secondary combinations. Table IV gives the approximate no-load voltages with the different combinations of primary and secondary hookups. These voltages can be varied by adjustments of the reactor.

Before starting to weld, several accessories must be purchased. An electrode holder as shown in Fig. 25 is connected to one of the 20-ft. cables and a lug or clamp is connected to the other to serve as a ground cable. A helmet of the type shown in Fig. 25 or a hand-held face shield, shown in Fig. 18, must be used to protect the eyes and face from the rays of the welding arc. Do not attempt to arc weld with dark-colored goggles such as used for oxyacetylene welding. To protect the hands, leather welders' gloves should be used. In addition you will need 5 lbs. each of $\frac{1}{16}$, $\frac{3}{32}$ and

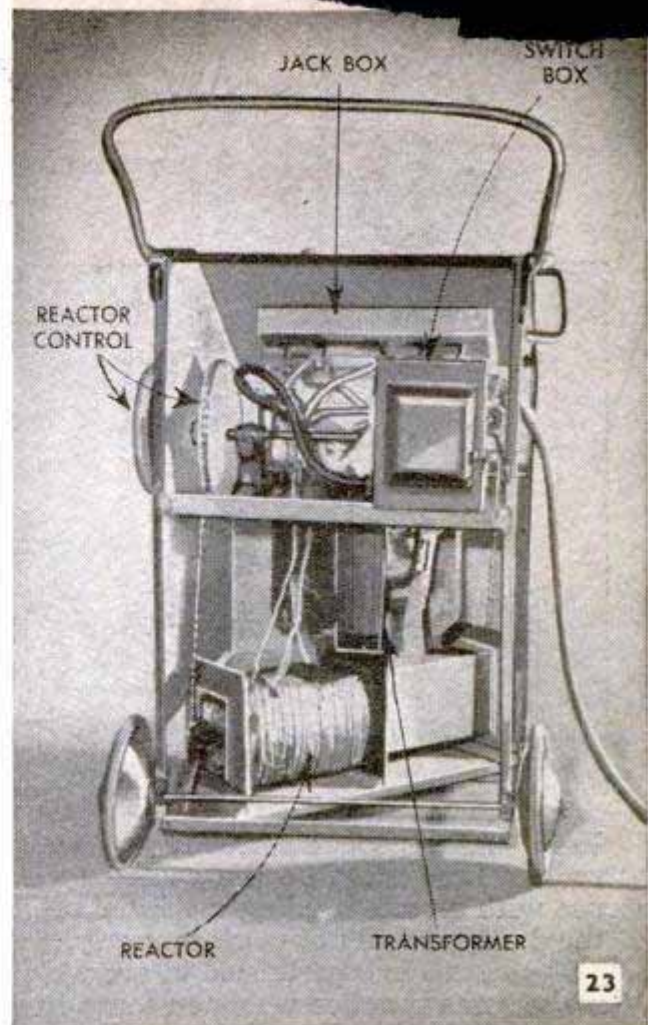

The electrical parts are mounted in a frame having two wheels for ease in moving around the workshop

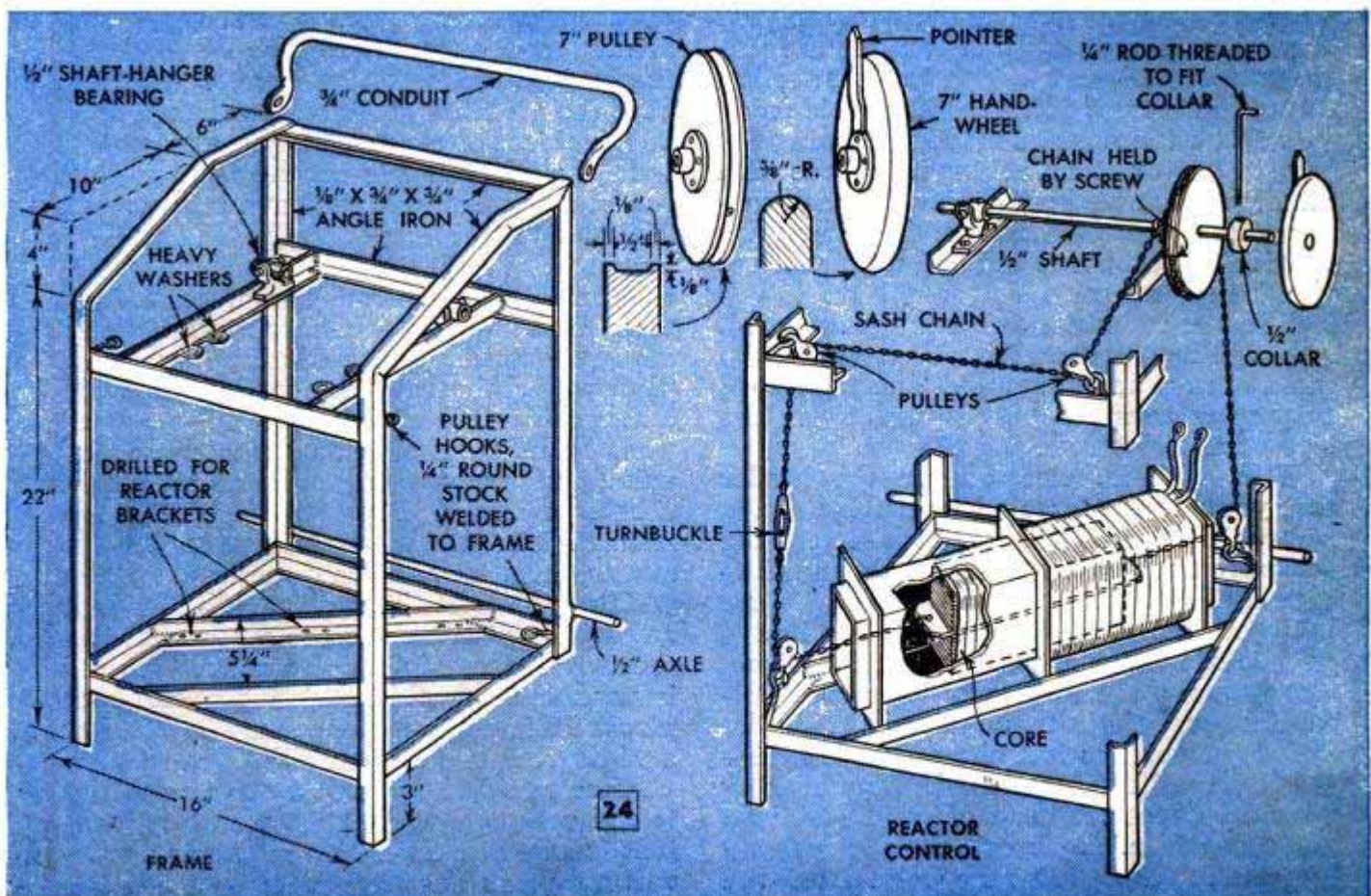

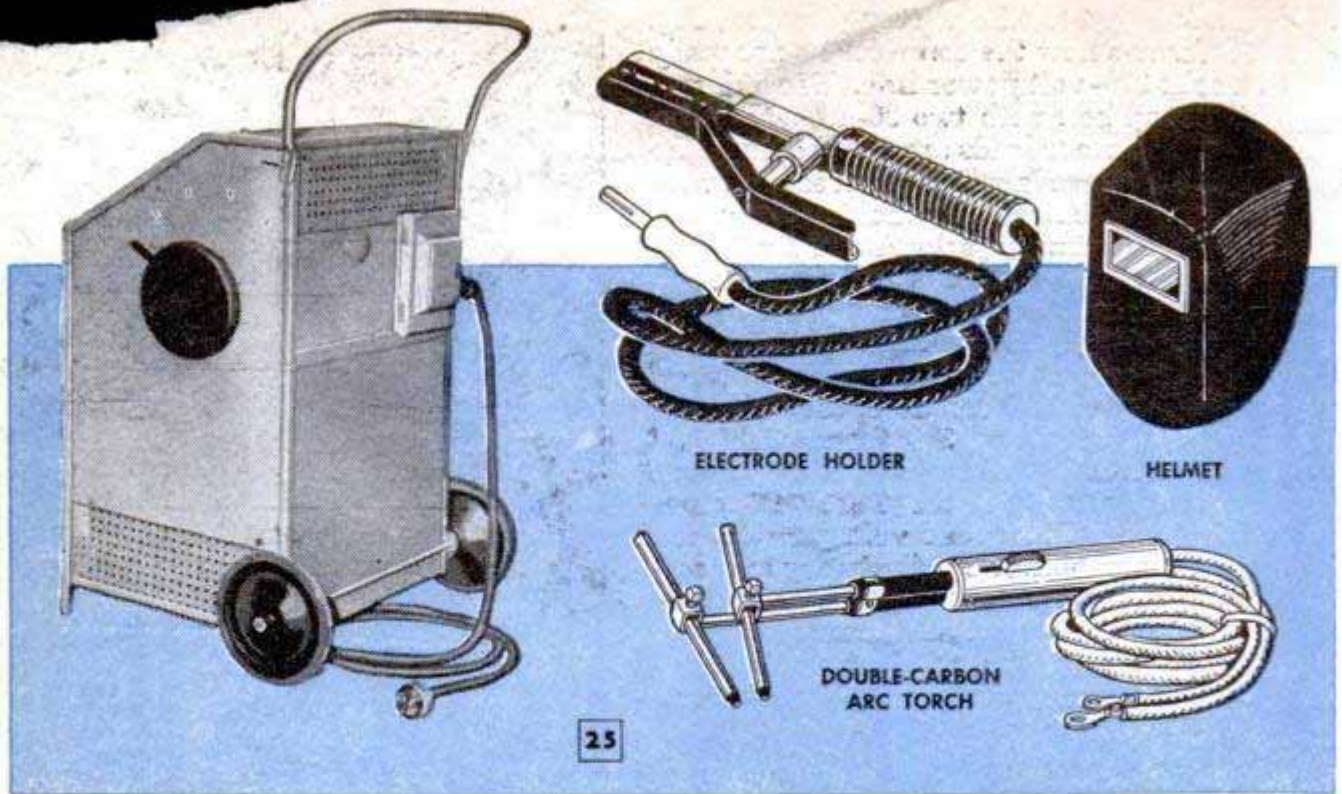

$\frac{1}{8}$ -in. mild-steel electrodes or welding rods. These must be the coated type for use with an a.c. welding machine, because the d.c. type will not work properly.

If you are inexperienced in arc welding, make some practice welds on scrap iron to get the feel of handling the arc before welding the frame. To start welding, clamp the ground-cable lug to the work and then connect the cable to jack B on the secondary. Connect the electrode-holder cable to jack 5 on the secondary. Then connect the primary across B and 2 with the connecting loop. Adjustment of the reactor, which may be laid on the floor, is made by sliding the core in the tube and locking it in place with small wooden wedges. Start with the reactor wide open and cut down the current by moving the core into the coil until you get the desired current. You may have to use a different combination on the jack board. Arc welding requires from 30 to 40 volts to maintain an arc manually. The amperage may vary considerably depending on the size of the electrode used.

With a $\frac{1}{8}$ -in. electrode in the holder and your eyes protected with the helmet, scratch the tip of the electrode across the scrap iron as you would a match, and then quickly lift it about $\frac{1}{8}$ in. to form an arc between the tip and the iron. When a puddle of molten metal forms on the iron, slowly move the rod toward the right. Simultaneously with this movement feed the rod downward as it melts off, thus maintaining a uniform arc length. The melting rod will deposit a bead of weld metal on the scrap iron. To break the arc, merely pull the rod away from the weld. After the

weld cools, remove the coating of slag, which covers the surface of the weld, with a cold chisel and wire brush. The surface of a good weld will have uniform ripples in it. If the tip of the rod sticks or "freezes" to the work, move the rod from side to side vigorously while pulling upward. If this does not free the rod it must be immediately released at the jaws of the holder to avoid overheating and injury to the rod coating. Difficulty in starting and maintaining an arc usually can be overcome by increasing the welding current slightly. Practice welding straight, flat beads with various sizes of electrodes, and experiment with the adjustments on the welder until the best current settings have been found. Then butt two pieces of scrap iron together, leaving a gap of $\frac{1}{16}$ in. Make a small weld at each end of the scrap-iron pieces to hold them together, and run a continuous weld along the joint. After cooling, break the pieces apart through the center of the weld and examine it for depth of weld penetration. Insufficient penetration is caused by using too low a welding current or too fast a rate of travel. Fillet welds, which are used to join two pieces of metal at right angles, also should be practiced. When welding joints of this type, hold the rod at an angle which bisects the angle between the two plates. If difficulty is encountered in producing a weld that is fused into both pieces uniformly, the work may be tilted at a 45-deg. angle and the rod held vertically.

After satisfying yourself of your ability to make a good weld, start making a cabinet frame, Fig. 24, which supports all the various parts shown in Fig. 23. All the

angle-iron parts for the frame should first be cut, fitted and tack-welded together. Then, after checking for trueness, make continuous welds at all the joints. The entire assembly is mounted on wheels. Dimensions for locating the angle-iron supports for the transformer are not given as they must be determined from the size and type used. Four large washers, welded to the supports to correspond with the bolt holes in the mounting brackets of the transformer, hold it firmly in place. The reactor is set on angle irons welded diagonally across the bottom of the frame and is controlled by a handwheel, as shown in Fig. 24. By turning the handwheel, the position of the core in the tube is adjusted. However, as a strong pull is exerted on the core when the reactor coil is energized, the core must be locked in place after it is adjusted. This is accomplished by turning the $\frac{1}{4}$ -in. rod, Fig. 24, which is threaded to fit a tapped hole in a $\frac{1}{2}$ -in. collar on the handwheel shaft. The rod, which extends through the top panel of the cabinet, acts as a setscrew and thus prevents the shaft from turning. The jack board is supported by a panel of hard-pressed board covering the slanted portion at the top of the frame. This panel becomes the permanent jack-board cover. The temporary jack-board cover may be used as a template to drill the holes accurately. The switch box is welded to the rear of the frame and the electrical parts are wired as in Fig. 20. A length of 3-wire (No. 10 gauge) flexible cable and a 3-way plug and receptacle are used for connection between the switch box and power line. The sides of the frame are covered with panels of hard-pressed board and perforated metal, as shown in Fig. 25. All panels are bolted to the inside surface of the angle-iron framework. After painting the entire cabinet, label the jacks and number five equally spaced positions of the reactor handwheel to indicate the position of the core in the reactor coil. A record of best operating current adjustments for various rod sizes should be kept for reference.

The double-carbon arc torch, Fig. 25, is a useful accessory for this welder as it supplies a self-contained arc flame for welding and heating metals.

The End

Water Helps to Remove Tires

Sometimes an auto tire which has "frozen" to the wheel rim is almost impossible to pry or jar loose. However, if water is poured into the groove formed by the rim and the tire bead and allowed to stand for a few minutes, the tire will loosen with comparatively little effort.

Charles R. Best, Lethbridge, Alta., Can.



PHOTOGRAPH OF WINDOW DISPLAY

Photograph of Window Display Aids Customer's Selection

As his window display contained many items that the customers often could not name specifically, one enterprising merchant kept a large photo of his window display handy at the store counter. This saved time for both the customer and himself by enabling the customer to point out the desired item without leaving the counter.

Lathe Dog Holds Rods for Cutting

Several lengths of small rod or tubing may be cut off accurately at one time if they are clamped in a lathe dog. As these dogs come in different sizes, use one in which the material can be clamped as shown. After the work is clamped, the dog is held in a bench vise for cutting. To prevent damaging thin-wall tubing, a small V-block should be used between the clamping bolt and the tubing.



Improved Clamp Positions Work For Welding Angle-Iron Corners

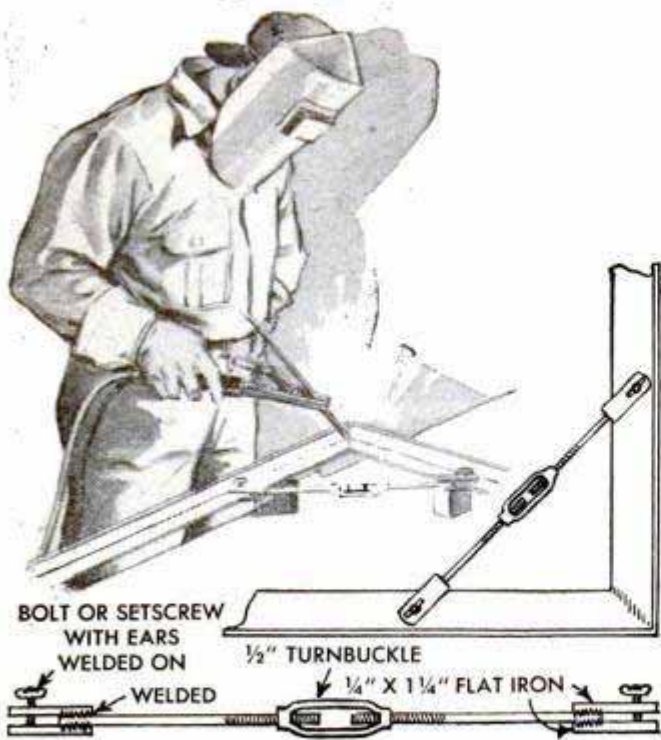

Some time ago our shop had a job of assembling and welding a large number of angle-iron stands. Cutting and bending the top frame was simple enough but holding the mitered corners in position and the legs square for welding posed a problem. We finally devised a simple clamp consisting of a turnbuckle and two threaded rods having a flat-iron yoke welded to each end. The clamp is attached to the work with thumbscrews tapped in the yokes and then the turnbuckle is used to draw the joint together. In the case of the legs, we tack-welded each one lightly to the frame and then fastened two clamps, one on each side of the leg, to hold the leg square.

Hobart Bros., Troy, Ohio.

Portable Poultry Feeder

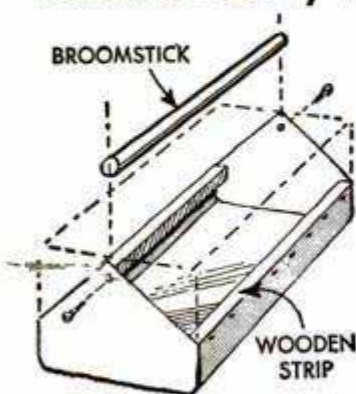

which runs the length of the can. This not only eliminates sharp edges which might injure the chickens, but also forms a lip reducing the amount of feed scattered about during feeding. Wood screws, driven

An inexpensive poultry feeder can be made easily from a rectangular-shaped 5-gal. can, utilizing a piece of broomstick for a handle. The feeder is cut from the can, as shown, and each side is nailed to a strip of wood

through an oversize hole in each end of the can, hold the broomstick handle in place. This should be fastened loosely so it will rotate to prevent the chickens from roosting on it. Sharp edges on the ends of the feeder should be smoothed before using.

A. Zanelli, Clifton, N. J.

Simplified Method to Cut Keyway In Large Pulley or Gear

Desiring to substitute a keyway for the setscrew often used to fasten older-type pulleys and gears to a shaft, one small-shop owner formed the keyway in the following manner. He turned a metal plug slightly oversize for a force fit in the bore of the pulley and drove it in the hub so that it was flush with both sides. Then he drilled a hole, centering it over the edge of the bore, knocked the plug out and used a round pin for a key. Although more work, a regular key can be used by filing the half-round hole square.

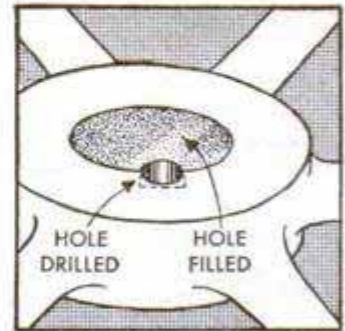

Oil-Gauge Stick Readily Located By White Enamel on Handle

If the oil-gauge stick in your car is difficult to find in the darkness under the hood, try painting the handle of the stick with white enamel to make it stand out. White enamel applied to the engine block where the oil-gauge stick enters it also will aid in replacing the stick. Because of the heat from the engine, this paint must be renewed occasionally, but the time saved when checking the oil is well worth the trouble.—H. Leeper, Canton, Ohio.

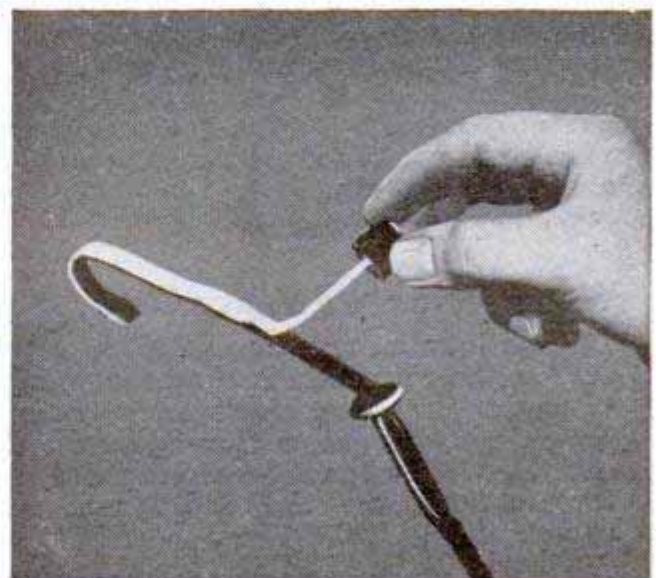

TRUE HOLES in LIGHT METAL

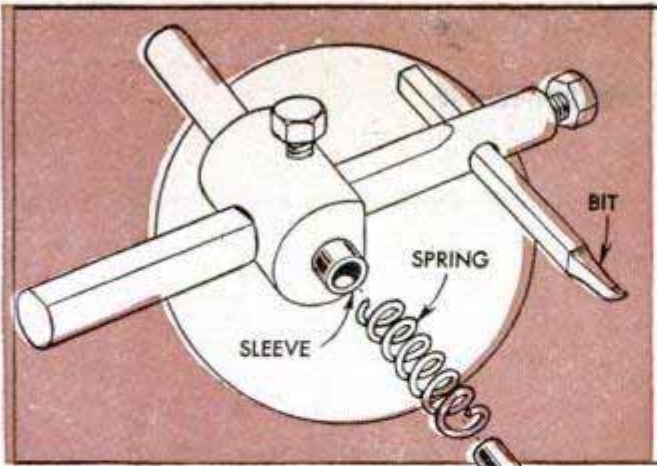

1

CENTER, RUNNING FIT IN SLEEVE BORE

60° CENTER

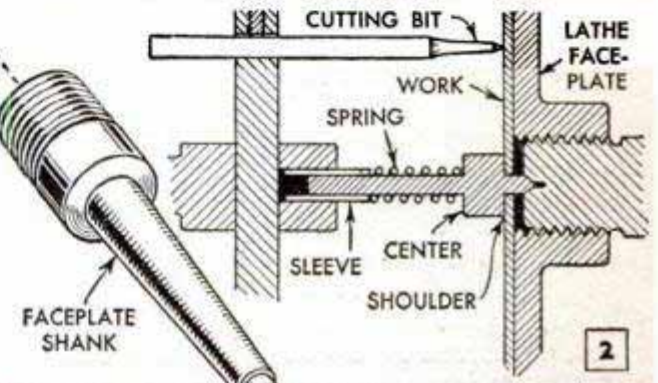
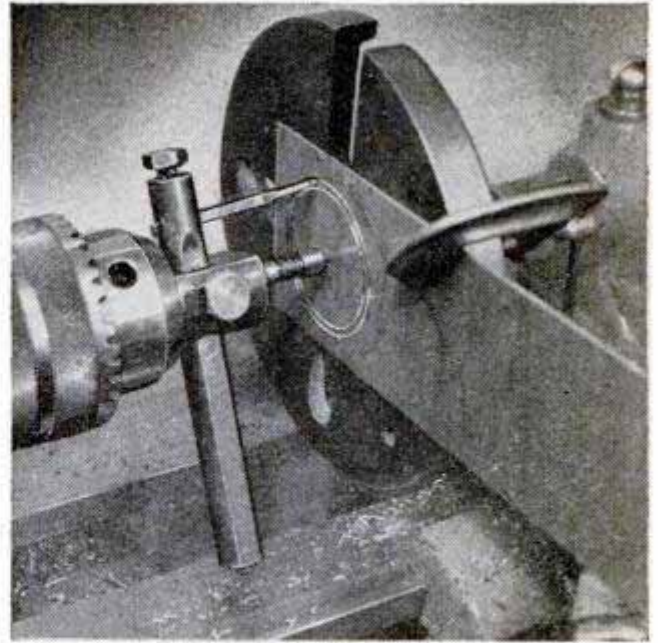

2

USING this exceptional tool, it's possible to cut a true hole every time without the usual distortion or elongation. The tool is attached to the headstock of a lathe and the work is backed by a faceplate screwed on the end of a specially turned shank inserted in the tailstock spindle. The tool is made from a standard adjustable hole cutter by removing the center drill and installing a steel sleeve, spring and center fixture, as in Figs. 1 and 2. The shank of the center should be a running fit in the sleeve bore and the bearing surface should be kept well oiled. A 15-lb. diemaker's spring is required to produce the desired thrust. Faceplate shank is threaded to fit the faceplate and the shank is turned to a Morse No. 1 or 2 taper, depending on the tailstock spindle. Dimensions for both tapers are given in Fig. 3. The threaded end of the shank is center-drilled to take pointed tip of the center fixture. In operation, the pilot hole in the work fits over the 60-deg. center which is engaged by the faceplate shank. The faceplate is advanced to allow the flat face of the center fixture to grip the work. When once adjusted, the feeding is done with the tailstock ram. Should a disk be desired without the pilot hole, it can be cut by clamping the work to the faceplate.

Various cutter bits and their uses are indicated in Fig. 4. These bits are made only from the hardest alloy steel honed to a razor edge. When a bit is used on a hole of smaller diameter than that for which it was designed, it may rub. In this case, part of the heel must be ground away to give the desired-clearance. When using the tool, remember to keep the feed pressure light, as heavy feed will cause the bit to dig in.

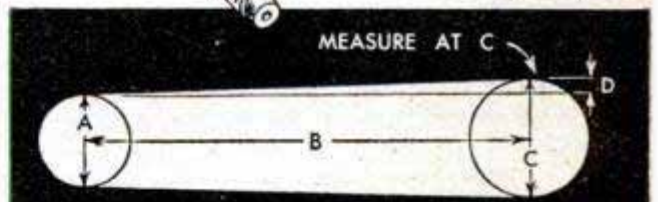

SPECIFICATIONS FOR MORSE TAPERS

MORSE #1	MORSE #2
A—0.369"	A—0.572"
B—2 ³ / ₁₆ "	B—2 ³ / ₁₆ "
C—0.475"	C—0.700"
D—0.0498 PER IN.	D—0.0499 PER IN.

3

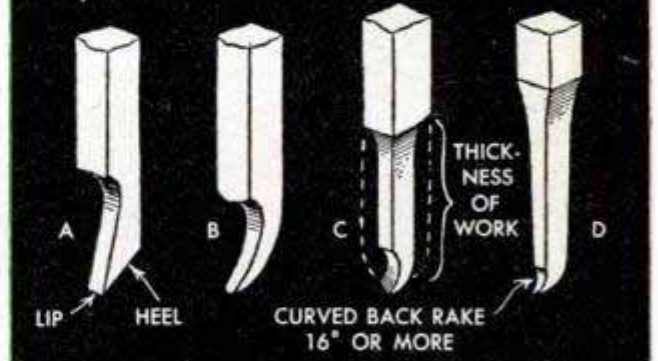

BIT SHAPES FOR VARIOUS TYPES OF WORK

- A—LARGE HOLES IN SOFT METAL
- B—HOLES IN BRONZE OR STEEL
- C—SMALL HOLES IN SOFT METAL
- D—HOLES IN THIN METAL, 1/32" TO 1/16" THICK

4

Sickle Section Bolted to Handle Forms Handy Bundle Cutter



A useful tool for cutting grain-bundle bands is made by bolting a section from a power sickle to a slotted wooden handle. The latter can be cut from a broomstick or tool handle. A leather thong or piece of rope looped through a hole drilled in the end of the handle will permit carrying the tool on the wrist.

Tools Permanently Magnetized With Battery and Wire

If you have a screwdriver, tack hammer or other tool that you wish to magnetize, this may be done easily with a storage battery and a length of heavy-gauge, flexible wire. First, slot the face of the tool with a hacksaw to provide two poles, similar to those on a horseshoe magnet. Then, form

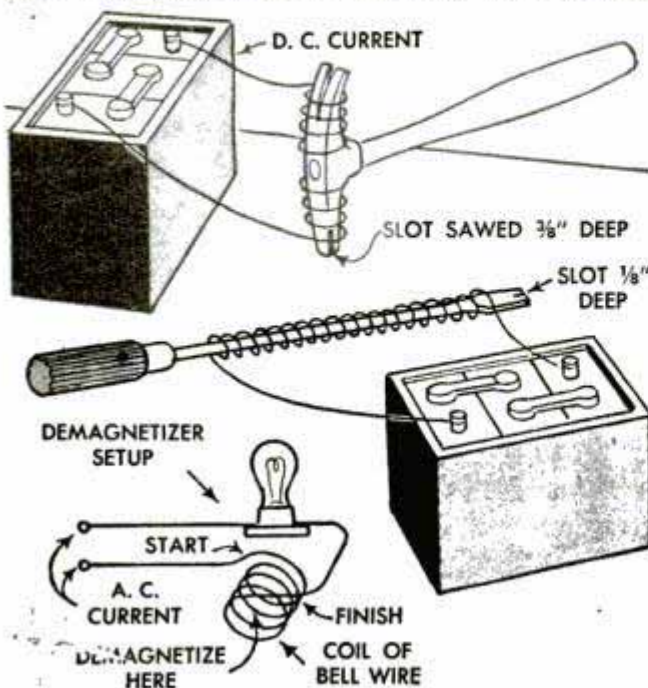

the wire into a coil of about 10 turns and fasten each end to a storage-battery post. Insert the tool through the coil, allowing it to remain there approximately 10 min. Rub it lightly on a piece of iron or steel during this period. To make a demagnetizer, take a coil of bell wire and connect it in series with a lamp bulb on a.c. current. Pass the tool through this coil several times, testing it for magnetism each time until the tool is completely demagnetized.

Phillip Wilson, Streator, Ill.

Repairing Lawn-Mower Gears

Some lawn-mower drives are fitted with round pawls, and when the pawls and ratchets become unduly worn, the drive will slip or engage and release intermittently. This may be corrected by inserting new pins made from pieces of nail.

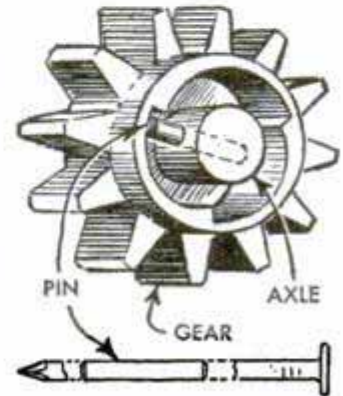

These should be about $\frac{1}{16}$ in. longer than the old pins and the edges should be chamfered slightly instead of rounded, so the pins will not slip over the ratchet teeth. These pins will remain serviceable for about one season and they will not cause additional wear on the gears. You may have to file the pins lightly and check several times before you obtain the proper length.—C. Siegrist, Rexmont, Pa.

Collar Prevents Chattering Of Boring Bit

Excessive chattering of a milling-machine fly cutter is reduced considerably if the tool bit is supported and locked in a keyed collar instead of being mounted directly on the arbor itself, as is the common practice.

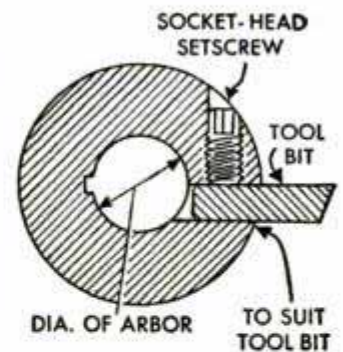

A square hole is made in the edge of the collar to take the tool bit. The bit is locked in place with a socket-head setscrew which is fitted in a tapped hole drilled at right angles to the square hole. The square hole is located so that the face of the tool bit is on the center line of the collar and therefore does not change the outline of the cutting edge. The hole for the tool bit is made by filing a round hole square.

M. R. Therien, Barriefield, Ont., Can.

Circle-Cutting Jig Slides in Saw-Table

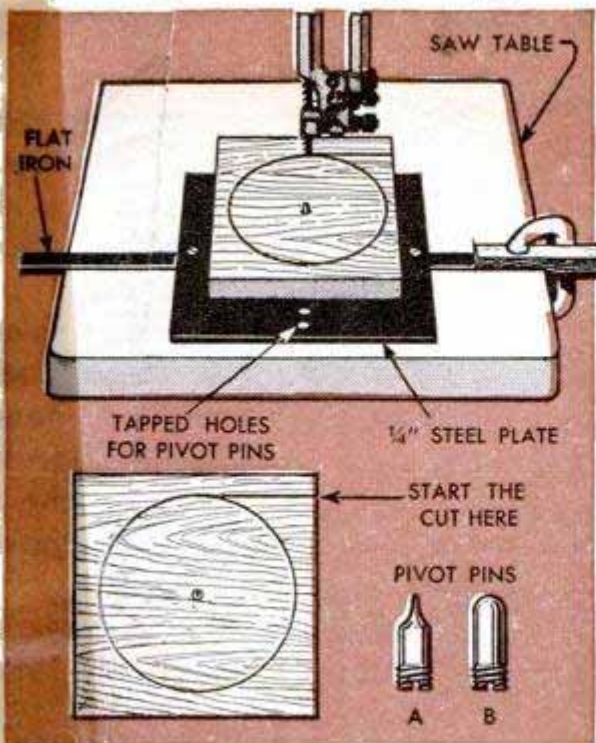

Cutting out wooden disks on a band-saw or accurately finishing them on a sander becomes a quick, accurate operation when this sliding pivot jig is used. It consists of a steel base fastened to a length of flat iron, the latter sliding snugly in the miter-gauge groove of the saw or disk-sander table. A row of holes spaced to handle a variety of disk sizes is drilled and tapped across the base, as shown, to take threaded pivot pins, A and B. Pin A is for stock in which a hole has not been drilled, and B is for drilled stock. A stop is clamped in the end of the table groove to align the pivot pin correctly at a 90-deg. angle with the cutting edge of the saw blade. The sliding feature allows the jig to be pulled away from the saw blade or sanding disk for mounting and removing the work. For use on the band-saw, the work is mounted and the jig is pushed forward, permitting the saw to take a straight cut into the wood. Then, when the stop is reached, the work is rotated on the pivot and the disk sawed. The jig op-

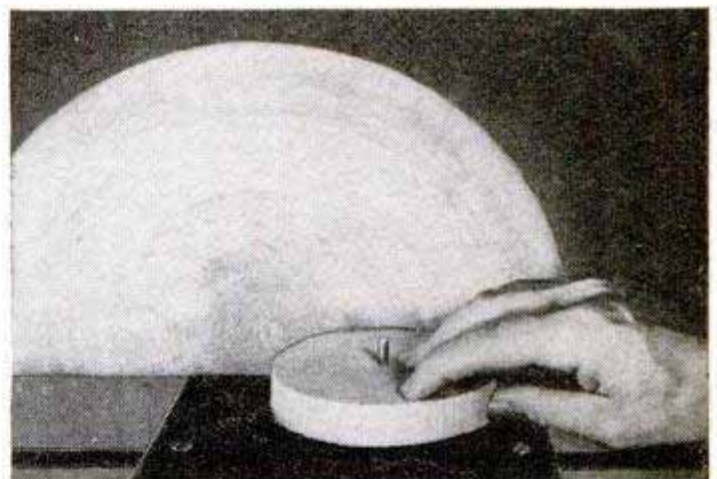

erates similarly on the sander and is readily moved to any position, thus avoiding loading of the sandpaper at any one point. If the bandsaw or sander table does not have a miter-gauge groove, the jig may still be used by attaching a guide strip to its base so that it overhangs and rides against the edge of the table. A stop can be clamped to the table top.

John P. Arnold, Doylestown, Pa.

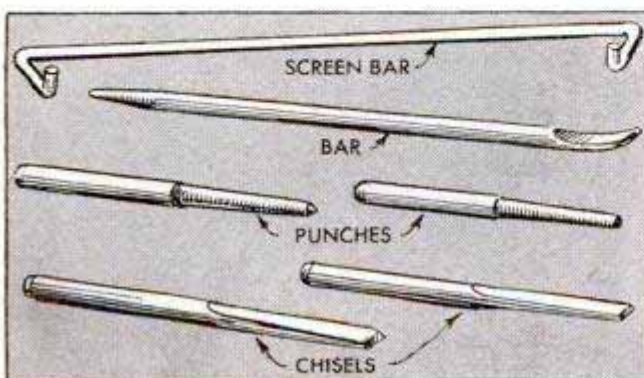

Bars From Potato-Grading Unit Used to Make Hand Tools

Round, spring-steel bars of the type used on potato-grading equipment, provide excellent material from which to make a variety of small tools needed around the farm or shop. The bars usually have a diameter of $\frac{1}{2}$ or $\frac{5}{8}$ in., and being of high-carbon steel they are exceptionally suitable for pry bars, chisels, punches and similar tools.

Earl R. Goddard, Denver, Colo.

MORE POWER FOR

By Ed Packer

New power applications prove the adaptability of small one-cylinder engines for use on almost any type of small power-driven machine. These uses emphasize the need for careful attention to a special service schedule that will keep these engines operating at top efficiency over a long period of time

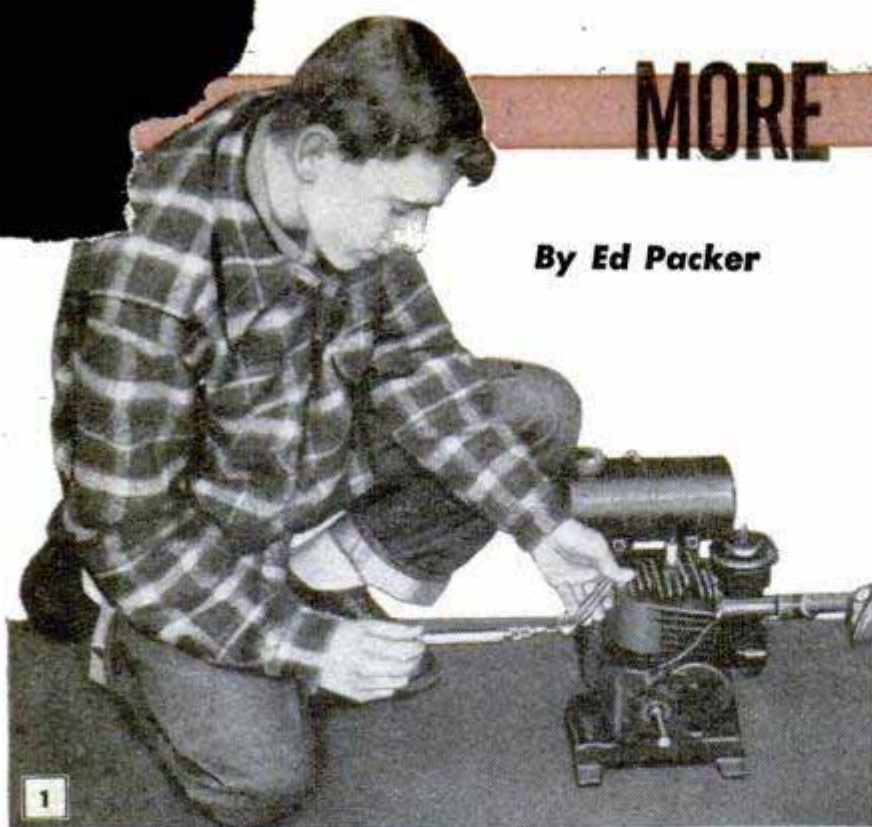

If a torque wrench is not available, use a socket wrench and spring scale to tighten cylinder-head bolts

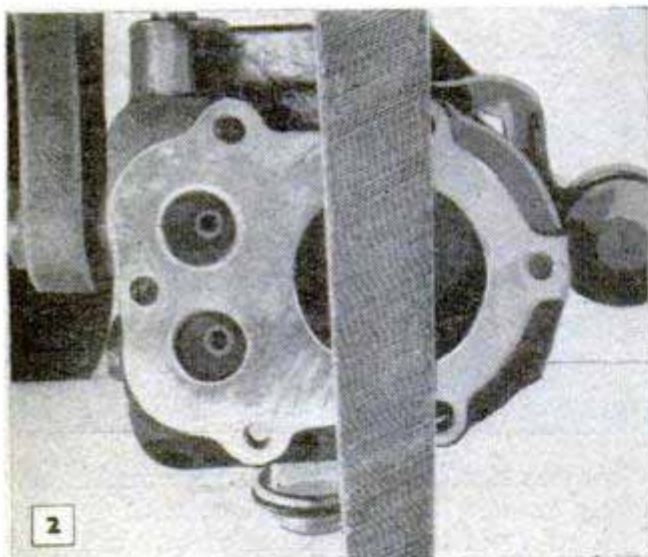

Distorted areas, due to head bolts drawn too tightly, can be located by passing a file lightly over the head flange. Careful filing removes the high places

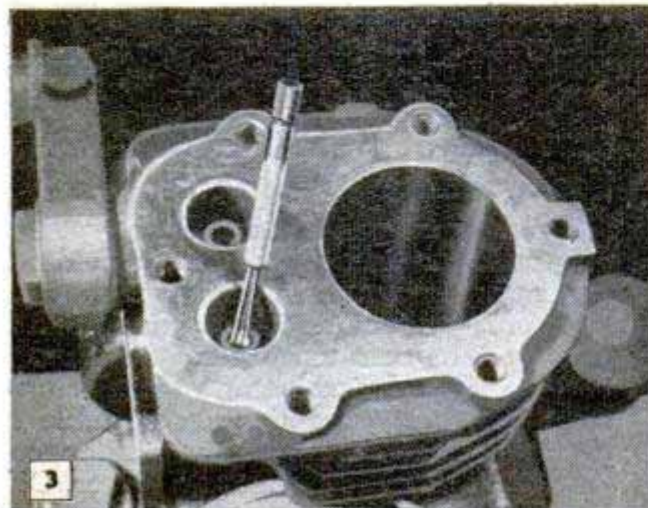

SINGLE-CYLINDER engines of the air-cooled type are designed to operate at relatively high speeds and this means that all working parts, especially the piston rings and valves, must function perfectly at very high temperatures over long periods of time. Special care and servicing on a regular schedule are necessary to keep the engine in condition to deliver top performance. Most of this simple servicing can be done by the owner.

More power and smoother operation often result from cleaning out the carbon. These engines have small parts and care must be taken when dismantling and re-assembling not to cause permanent damage. Use a torque wrench when tightening cylinder-head and crankcase bolts to assure uniform tension. Another method, used where a torque wrench is not avail-

Lower left, check valve guides for clearance with an expanding ball gauge. Below, measure valve stem and gauge with a "mike" to get the actual clearance

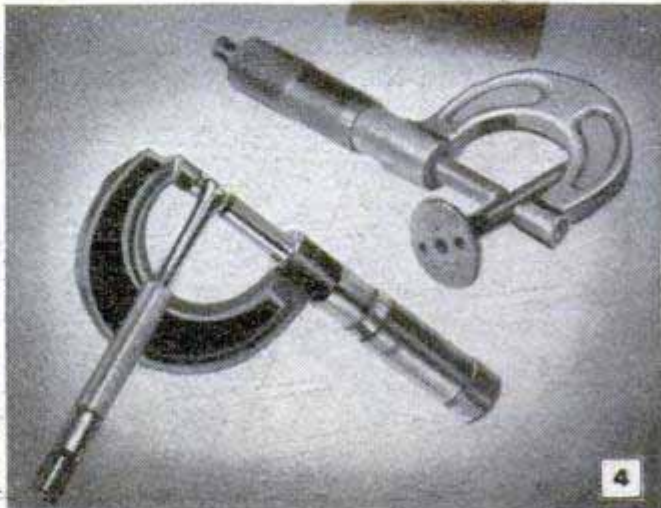

"ONE LUNGER" ENGINES



able, is illustrated in Fig. 1. Here the mechanic is drawing each bolt down to the same tension by means of a common socket wrench and a spring scale, which is pulled at exactly right angles to the wrench. The manufacturer's recommended torque should be followed.

Fig. 2 shows a simple way of checking the top of a cylinder block for distortion. Pressing down at the center of contact as the file is moved lightly across the top of the block, reveals the high spots. Such distortions can seriously affect the operation of the valves, causing compression leaks and rapid wear of the valve stems and guides. When reassembling the head to the cylinder block, always use a new gasket and be especially careful to draw the head bolts to a uniform tension. If the engine manual gives the order in which the bolts are to be tightened, it's important that this be followed.

It's a good idea to keep a record of the engine compression. When available, use a compression gauge like that shown in Fig. 6. Two things happen to engine compression in the course of normal use. As carbon accumulates, compression builds up and the engine begins to run hot and knock under load. When there has been a 10-lb. rise in the compression, it usually is wise to clean out the carbon. Following this rise in compression there may be an actual drop in pressure as carbon interferes with the normal action of the valves and rings. Usually this indicates the necessity of servicing the valves. In connection with valve servicing, here's a trick that is worth knowing. Before the engine

As many small engines do not have adjustable tappets, the ends of the valve stems are ground to give correct clearance. Use a V-block as shown below

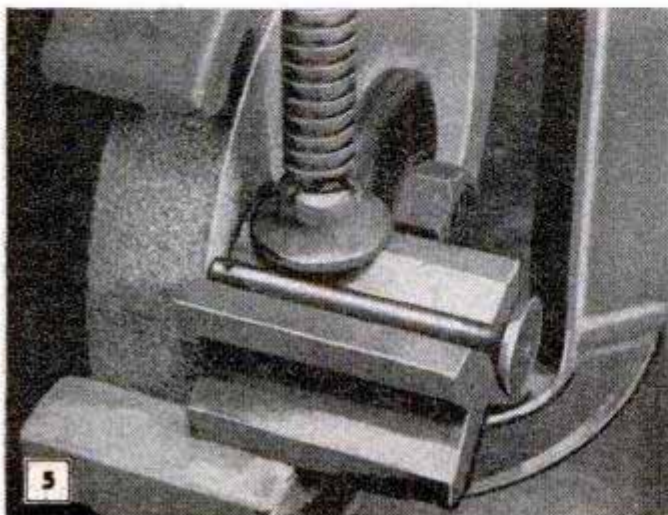

FOR MOTOR SCOOTERS



GARDEN TRACTORS



FARM LIGHT PLANTS

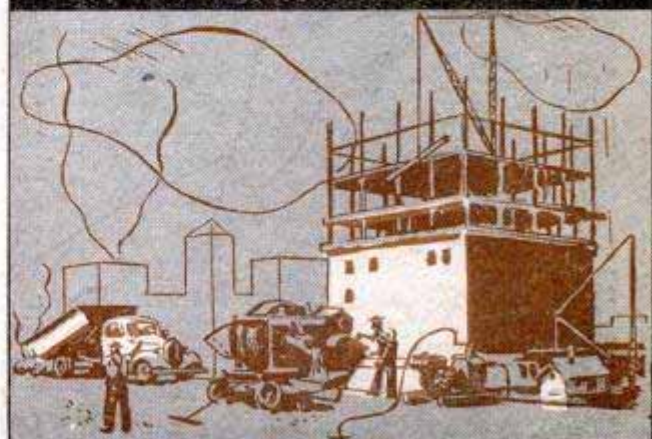

AND CONTRACTORS' TOOLS

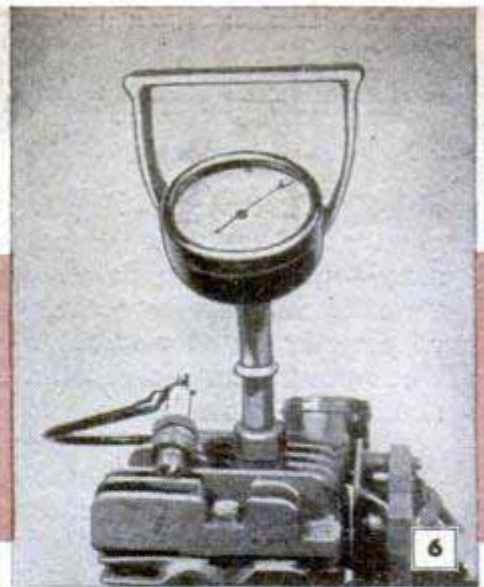
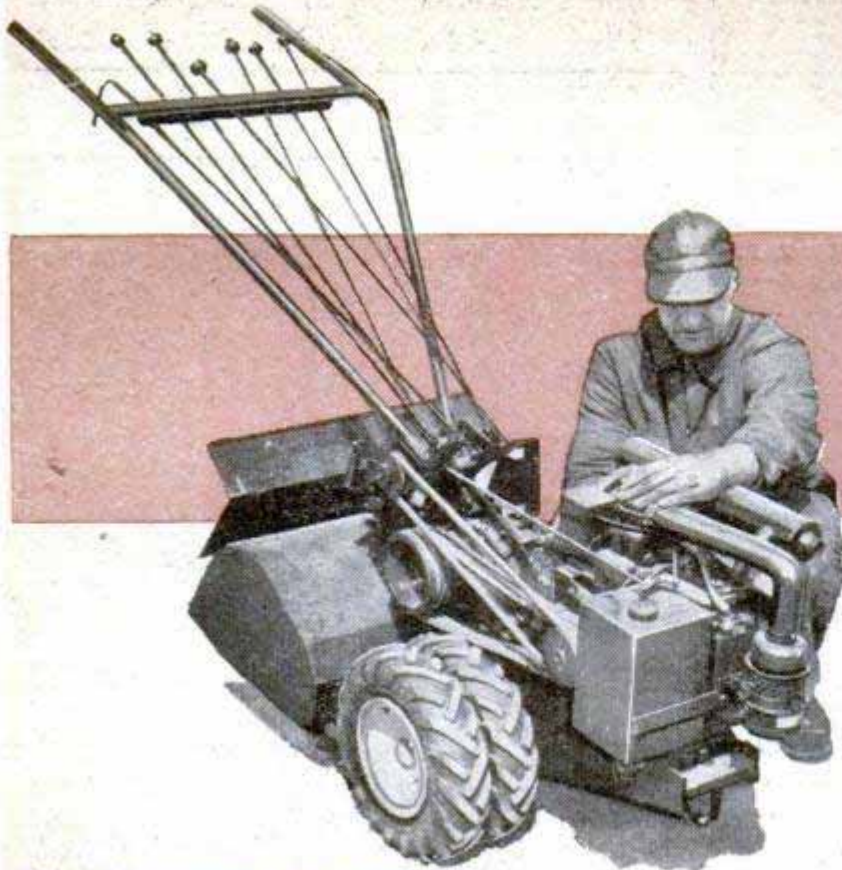

Before disassembling an engine, check compression with a dial gauge such as shown above. It gives a true reading

Engines operating in dusty conditions, such as on garden tractor at the left, usually need more frequent attention

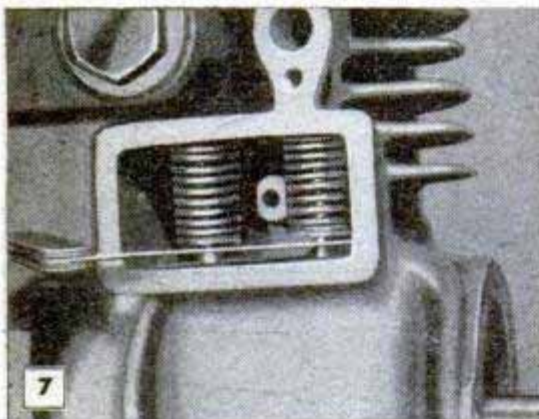

Above, check and double check valve clearances with a feeler gauge. Below, whenever engine is disassembled measure the crankpin

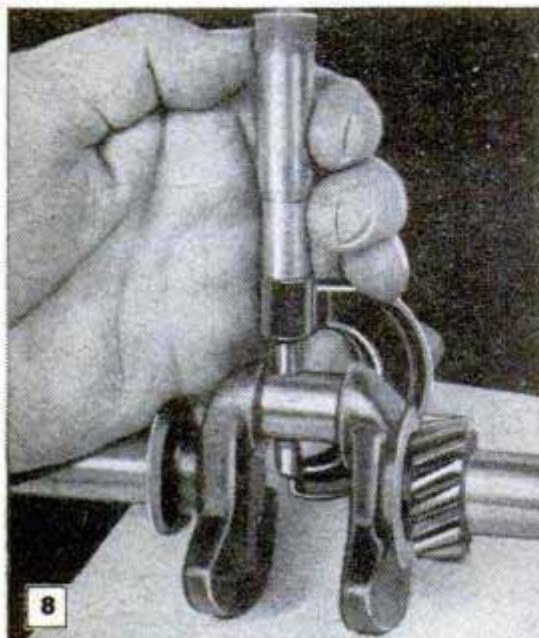

is opened, allow it to idle on closed throttle for a minimum of 5 min. Then, shut it off without accelerating. As the engine is disassembled, the intake valve should be closely inspected for signs of oiliness. This condition indicates a need for new valve guides. Unless one has the necessary equipment for this work, the engine should be taken to a qualified mechanic. One of the tools needed for a valve job of this nature is a precision expanding ball gauge of the type shown in Fig. 3. This instrument accurately checks the inside diameter of each valve guide, giving readings in thousandths of an inch, Fig. 4. By comparing this reading with the valve-stem diameter, also being checked in Fig. 4, the actual clearance is easily determined. In reaming new guides, follow the manufacturer's service manual.

Valve clearance, that is, clearance between the stem and tappet, controls timing of the valves. Too little clearance will cause the valves to burn and pit. In most "one lugger" engines there is no adjustment on the tappets so the valve stem must be ground to give the correct clearance specified in the service manual. To do this, clamp a V-block to the grinder tool rest, as in Fig. 5, for facing off the end of the stem. Most service manuals on the small engines call for an exhaust-valve clearance of .007 to .009 in. with the intake valve set for .005 to .007-in. clearance. Keep in mind that refacing valves or reseating always reduces valve clearance. Always double check when measuring clearances, Fig. 7, to be sure that the piston is on top dead center of the compression stroke.

After the valves have been serviced, it may be found that the engine still lacks power. This can mean a scored cylinder wall or badly worn rings.

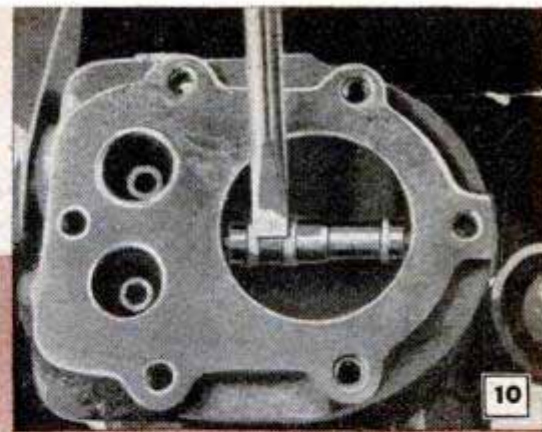
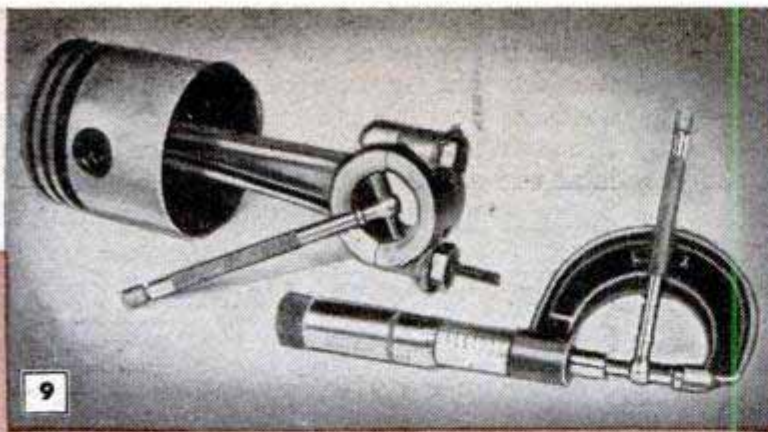

Left, use a telescoping gauge to determine the exact inside measurement of the connecting-rod bearing. Then mike the gauge to get the true diameter. Right, check diameter of cylinder bore at top and bottom

If the engine is disassembled for the purpose of installing new rings or other parts, check the crankpin and connecting-rod bearing. If the micrometer, Fig. 8, shows an out-of-round or tapered condition of the pin up to .001 in. the shaft is still serviceable. But if the wear is greater than this, it may be necessary to machine the pin and install an oversize connecting-rod bearing. When reassembling the engine, see that the connecting-rod bearing is not set up too tight. One way of checking this bearing is to use the telescoping gauge, as in Fig. 9, and then measure the gauge with a micrometer. The clearance should not be less than .0005 in. The crankshaft bearings, if of the plain-bearing type, should have similar clearances.

Checking the cylinder bore with an inside micrometer, as in Fig. 10, is always desirable, but a fairly good check of cylinder conditions can be had by running the piston up and down in the cylinder, trying feeler blades between the cylinder and the piston skirt. The measurement is always made between the skirt of the piston and the lower half of the cylinder wall. Clearances ranging to .0045 in. are generally satisfactory on small engines of the air-cooled type. When measuring the diameter of a new or used piston, the measurement always should be made at right angles to the wrist pin, as in Fig. 11. Some pistons are cam ground to allow for extra expansion of metal at the center.

When installing new rings, first roll them around the ring grooves to be sure that they are free. This play should not exceed .002 in. Now slide the piston, without the rings, upside down into the cylinder bore. To test the rings for end gap, place them, one at a time, on top of the piston skirt, as in Fig. 12. Tap each ring lightly with the piston from below to be sure that the ring stands square with the bore. The ring gap for these small engines should range between .007 and .017 in. As the rings are checked for end gap, they should be laid out carefully in order that the ring with the greatest gap goes in the top ring groove, and the ring with the least gap goes in the lowest ring groove. When reassembling these parts, oil liberally. Before reassembling the magneto, check the breaker-plate assembly, Fig. 13, and be sure that the condenser-mounting screw is tight.

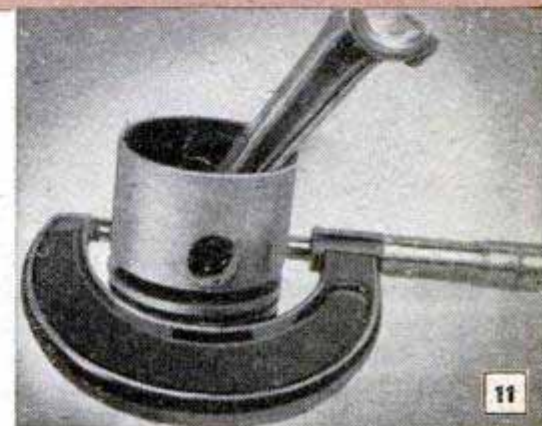

When checking piston diameter, always place the mike at right angles to the wrist pin

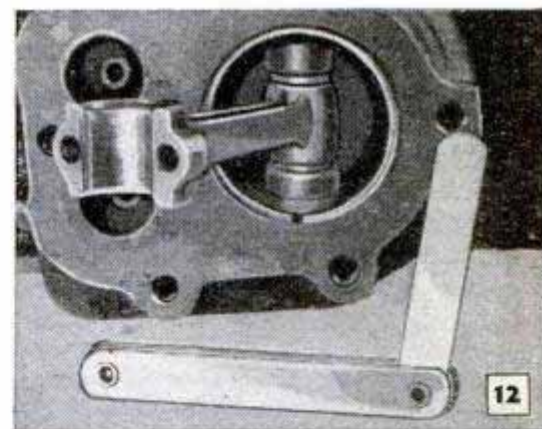

To check the end gap of rings, place them in the cylinder on top of the piston skirt

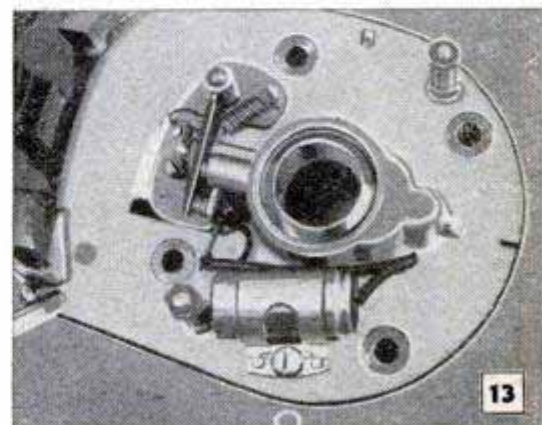

Renew worn parts of the distributor and be sure the condenser connections are tight

Outlining Letters With Glass Cutter Aids Amateur Sign Painter

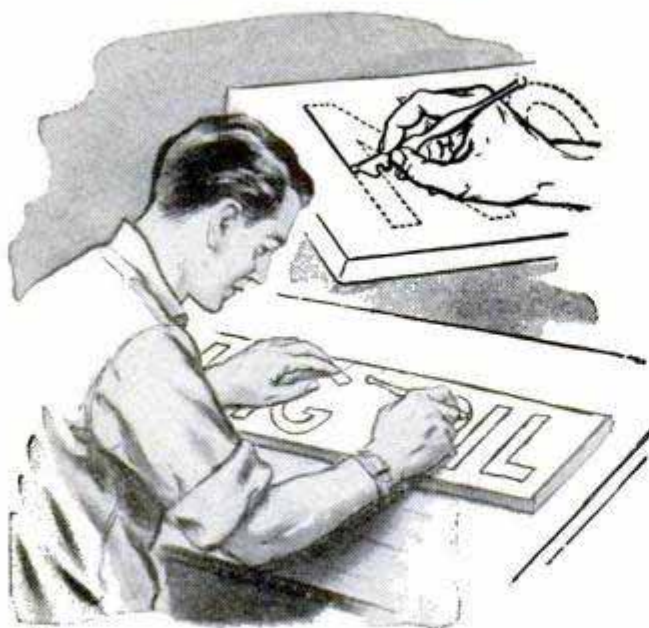

The amateur sign painter can do a quick, neat job of lettering a wooden sign if he first outlines the letters with a glass cutter. The V-shaped groove made by the cutter keeps the paint from flowing onto the background of the sign.

G. E. Hendrickson, Argyle, Wis.

Marker for Lathe Threading Chart Reduces Possibility of Error

Accurate reading of a lathe threading chart is simplified by use of a sheet-metal marker. When setting up the lathe the marker is moved to the proper position on the chart, and, if left in place, the threads or carriage feed to which the lathe is set can be noted at a glance. The guide is formed by bending the ends of a 1/2-in.-



wide strip of sheet metal so that they clip under the edges of the threading chart. The marker will operate best if the bends are made to permit a slight clearance between the strip and chart face so the only contact is at the edges and back of the chart.

Henry Hanscom, Elmhurst, Ill.

Removing Broken Head Bolts From Engine Block

Sometimes cylinder-head stud bolts break in the engine block just above the threads. Every mechanic knows how nearly impossible it is to remove these with the ordinary tools, but one man devised the following method that does the job without removal of the head. With the head tightly in place, he selects a twist drill that is an exact fit in the bolt hole, and with it drills a shallow hole in the center of the broken bolt. Then, he uses a 1/4-in. twist drill to drill a hole completely through the bolt stub, leaving little more than the threads to be cleaned. This he does with a standard tap of the proper size.

Stub Boring Bar Fits Lathe Spindle

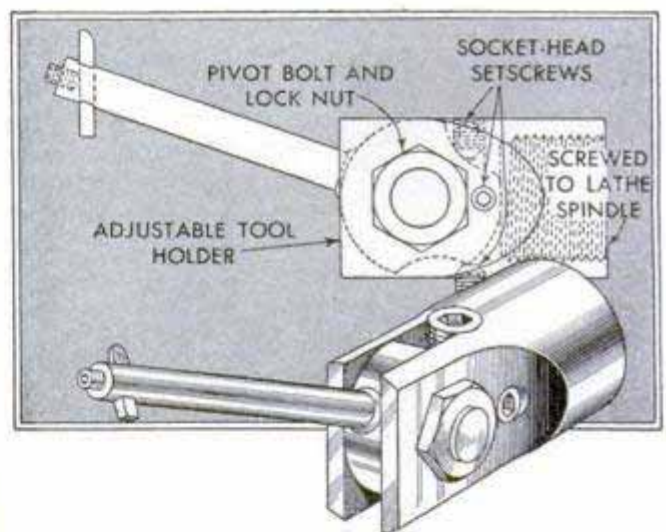

Designed for boring and facing operations on work which is too large to swing between centers, this unusual boring tool is screwed onto the threaded lathe spindle and operated eccentrically, in a manner similar to a fly cutter. The tool-bit holder pivots and is adjusted for swing by means of two socket-head setscrews, while a third setscrew serves to hold the bar in position until the locknut on the pivot bolt is tightened securely. The locking setscrew should be a wringing fit to overcome the tendency to loosen by vibration. With the work remaining stationary and the tool rotating, the size and shape of the work determine the manner of mounting it, whether it be on an angle plate or the saddle of the compound rest.—George Holman, Marissa, Ill.

Muffin-Pan Rack Keeps Small Parts Handy

Muffin pans furnish the many separate compartments of a single-post small-parts rack. Mounted on a rod at the back of the workbench, the pans can be swung out of the way when not in use and pulled quickly over the bench for easy selection of a particular part. The rod is inserted through screw eyes turned into the bench back and is held in place by means of a collar. Each muffin pan is bolted to a corner bracket which, in turn, is welded to a washer. Then, the brackets are fastened to the rod with short lengths of soft wire. —Wilbur E. Baur, Leonia, N. J.

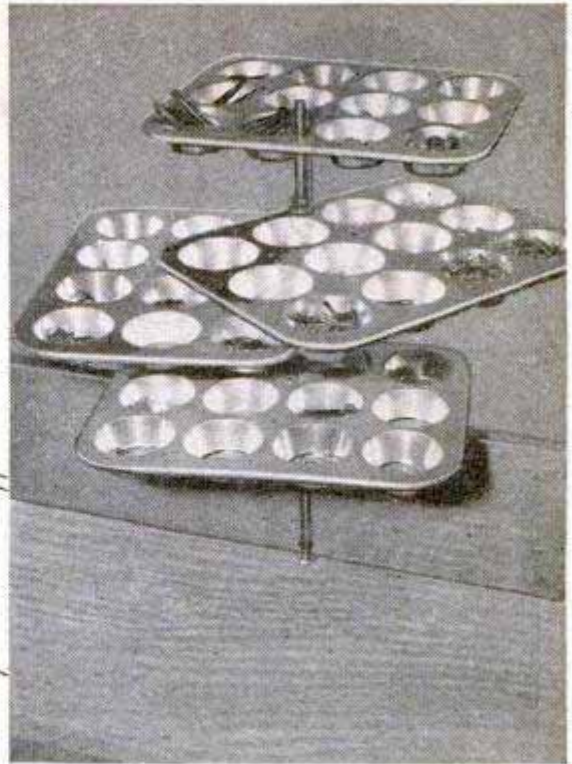
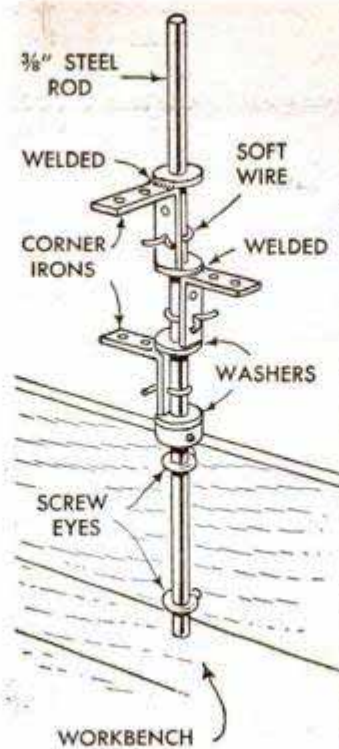

Lathe Pinch-Hits for Special Machine When Marking Calibrations

An occasional job of calibrating cylindrical work can be done neatly and uniformly, right in the lathe, by using a threading tool bit in the compound rest and a depth stop clamped to the lathe chuck. A thread-cutting stop on the cross slide also is helpful in setting the tool to a uniform depth for each cut. With the compound rest set parallel with the work, a base line is scribed on the work by advancing the cross slide. Next, a stop, consisting of a length of flat iron tapped at one end for a long setscrew, is attached to one of the jaws of the chuck with a C-clamp. Note before scribing the base line that this

jaw of the chuck must be positioned to give the desired amount of swing. Adjustment of the setscrew in the stop determines the length, or depth, of the calibrations. To scribe the calibrations, the scale on the collar of the compound rest is set at zero. Then, with the stop set for the short lines, the tool bit is advanced to enter the base line and the stop is pressed downward until the setscrew touches the lathe bed. After each cut, the tool is withdrawn and the compound rest is turned to the next calibration. The procedure then is repeated for as many calibrations as required. To make the long lines, the setscrew is backed out and scribing is done as before.

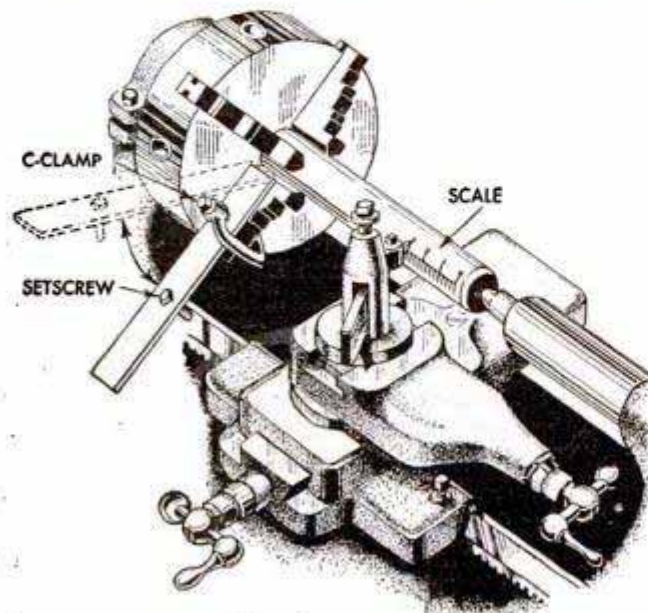

Modifying 45-Deg. Triangle Increases Its Usefulness

Cutting a 45-deg. triangle as shown in the drawing increases its range to include angles of 15, 30, 60 and 75 deg. These, of course, are obtained by placing the triangle in various positions against the T-square. To modify the triangle, mark off the 30-deg. line and cut slightly above the line. Then carefully finish to the line with a fine file.

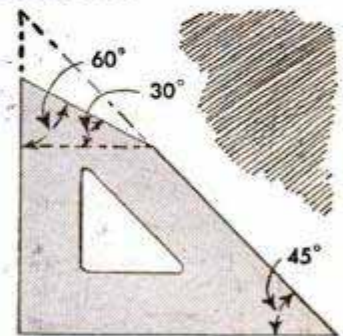

Toggle Bolts Anchor Outlet Box In Soft Wallboard

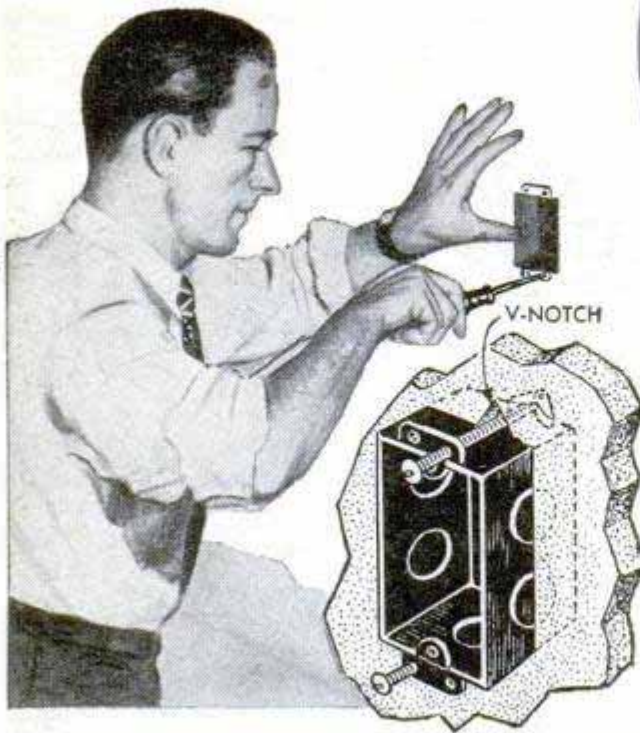

One man solved the problem of installing electrical outlet boxes in walls paneled with soft wallboard by anchoring the boxes with small toggle bolts instead of wood screws, which, of course, couldn't be made to hold firmly in wallboard. The openings for the boxes were cut slightly oversize and then V-notched at the top and bottom to take the toggle part of the bolt. The notches were aligned with holes in the mounting brackets and then both box and bolts were slipped into the opening at the same time, thus getting the toggle in position to grip the wallboard at the rear when the bolts were tightened. The notches will be covered by the outlet surface plate.

Polarity Tester for Electric Current

Many times it is necessary to know the polarity of an electrical circuit, but a tester for this purpose not only is quite expensive but also may not be available. A simple tester can be made from two small copper rods and a glass jar that measures 2 to 3 in. across the top. Select a cork that will fit the jar and slot opposite sides of the cork to take the copper rods. Then dissolve 1½ teaspoonfuls of table salt in a cup of water and pour into the jar. Ad-

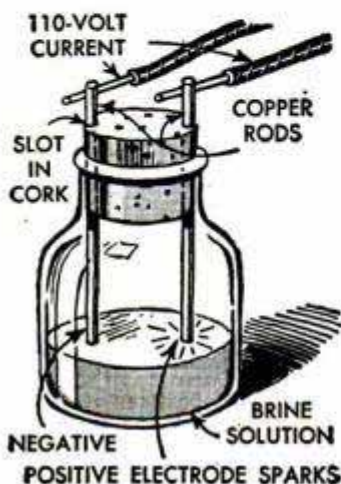

just the rods so they just touch the liquid, and hold the bared ends of the wires in the circuit to be tested against the projecting ends of the rods. The rod that sparks at the surface of the liquid is the positive side of the circuit. The other rod, of course, is the negative side.

Herbert E. Fey, New Braunfels, Tex.

Socket-Head Wrenches Adapted To Ratchet End Wrench

To speed the driving of socket-head setscrews and bolts, I made up a set of wrenches in the following manner that could be used in a ratchet-type end wrench. First, I selected several regular hexagon nuts of a size to fit the ratchet wrench.

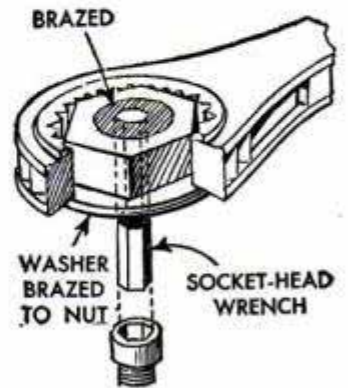

Then I cut off short lengths of each size socket-head wrench and brazed a length in the center of each nut. To provide a collar or shoulder so that the ratchet wrench would not slip down over the nut in use and hinder its operation, I brazed a washer to the bottom of each nut as shown. Thus, I was able to use the wrench rapidly by merely working the handle back and forth.—Howard Care, Lakewood, Ohio.

Radius Arms Kept Tight On Knee-Action Car

After experiencing considerable difficulty in keeping the radius arms tight on his knee-action car, one man altered the arms as shown. All he did was remove the arms from the car and slot them from the thread holes along the arm for a distance of approximately 2 in., using a regular hacksaw fitted with two blades for this purpose. Then, he drilled a hole through the arm near the center of the slot to take a small bolt. When the arms had a tendency to loosen up, all that was necessary was to tighten the bolt, thus partially closing the slot and, in turn, reducing the diameter of the threaded opening at the end of the arm. This treatment apparently did not weaken the arm and made it possible to keep it tight.

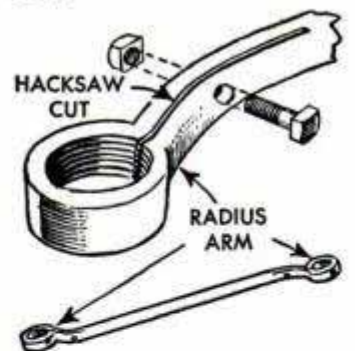

Carl J. Fritz, McKeesport, Pa.

Do Not Remove



DUAL-SPEAKER TV SET

USING two 6-in. oval loudspeakers to reproduce the FM sound in a realistic manner with more than ample volume, this 22-tube television receiver includes a 7-in. picture tube. It tunes all 13 television channels by means of 8 front-panel controls. An unusually efficient circuit provides a well-defined screen image bright enough for excellent visibility under all normal room-lighting conditions.

Housed in a neat metal cabinet that provides shielding not to be found in the usual wooden cabinet, this National TV receiver is claimed to give excellent, interference-free pictures in difficult receiving locations. It is also available in wooden cabinets of advanced styling, if the extra shielding is not required. Although in the low-priced group, the engineering is of the high-quality, low-loss type which is just as necessary in a good television set as in a high-grade, communications-type short-wave receiver.

Photos A and C show this receiver housed in a soft-toned, gray-finished metal cabinet. All front-panel operating controls are identified in photo C. The top rear view of the chassis, photo B, shows all tubes and the dual speakers in position; these speakers are connected in the circuit as indicated in Fig. 1. Other nonoperating controls are located at the rear and on the bottom of the receiver chassis.

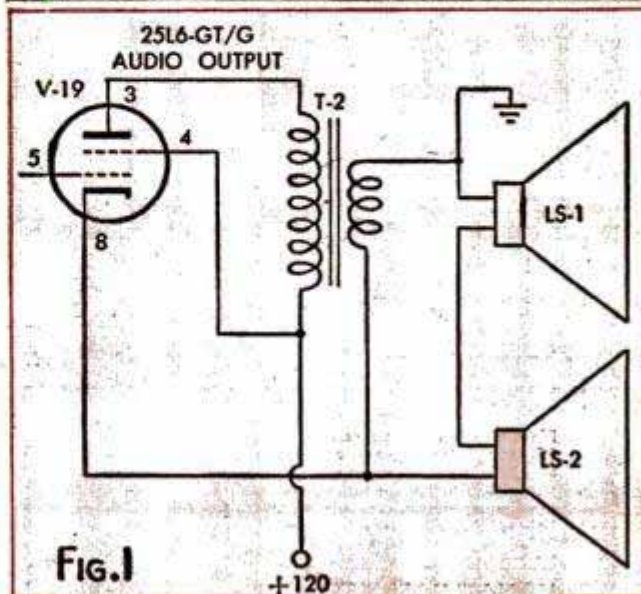
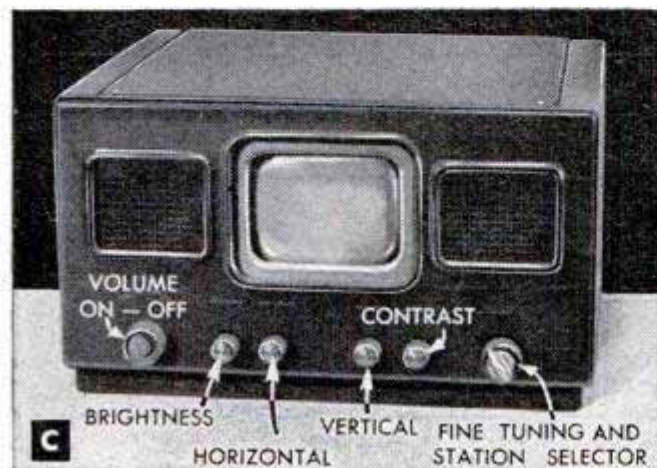
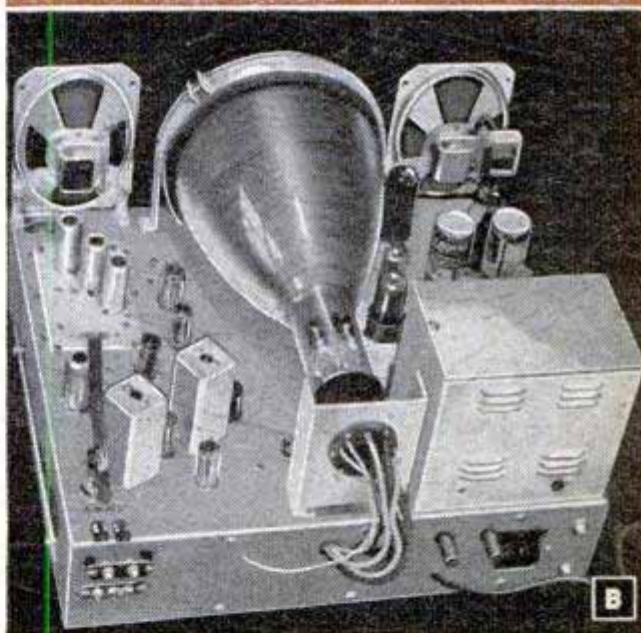
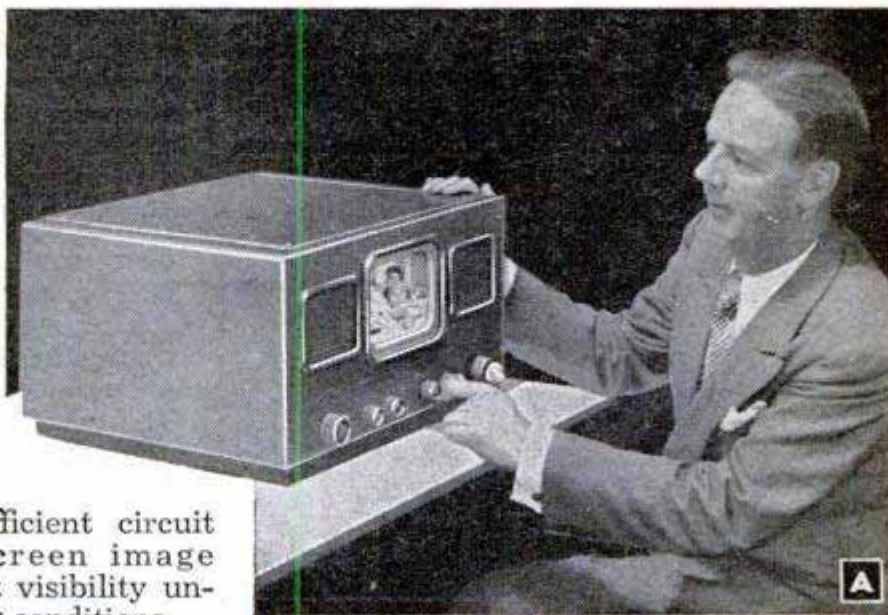

LOW-COST PHONE SYSTEM

By L. M. Dezettel—W9SFW

ONLY TWO miniature tubes are employed in this simple and inexpensive intercommunication system that provides 2-way phone service between master station and other rooms, garage or workshop. It may also be used as an electronic nurse by locating one of the remote speaker units in the nursery and the master station in the living room. The baby's cry or other sounds will be picked up, amplified and reproduced at the master station.

The system consists essentially of a high-gain amplifier and 2 speakers that are connected with the master-station unit. The circuit is so arranged that one speaker is used as a microphone. A switching circuit switches the order of use. When the push button on the master station is in the "listen" or up position, the speaker at each remote station is connected to the input of the amplifier, and the speaker of the master station to the output. Thus a person can talk into the speaker at the remote point, and he will be heard in the speaker at the master unit. When the switch is pressed, as indicated in photo D, to the "talk" or down position, the speaker at the master unit, No. 1, connects to the input of the amplifier, and the speaker at the substation to the output. The person operating the master station then talks and is heard at the remote point.

The circuit, Fig. 2, fea-

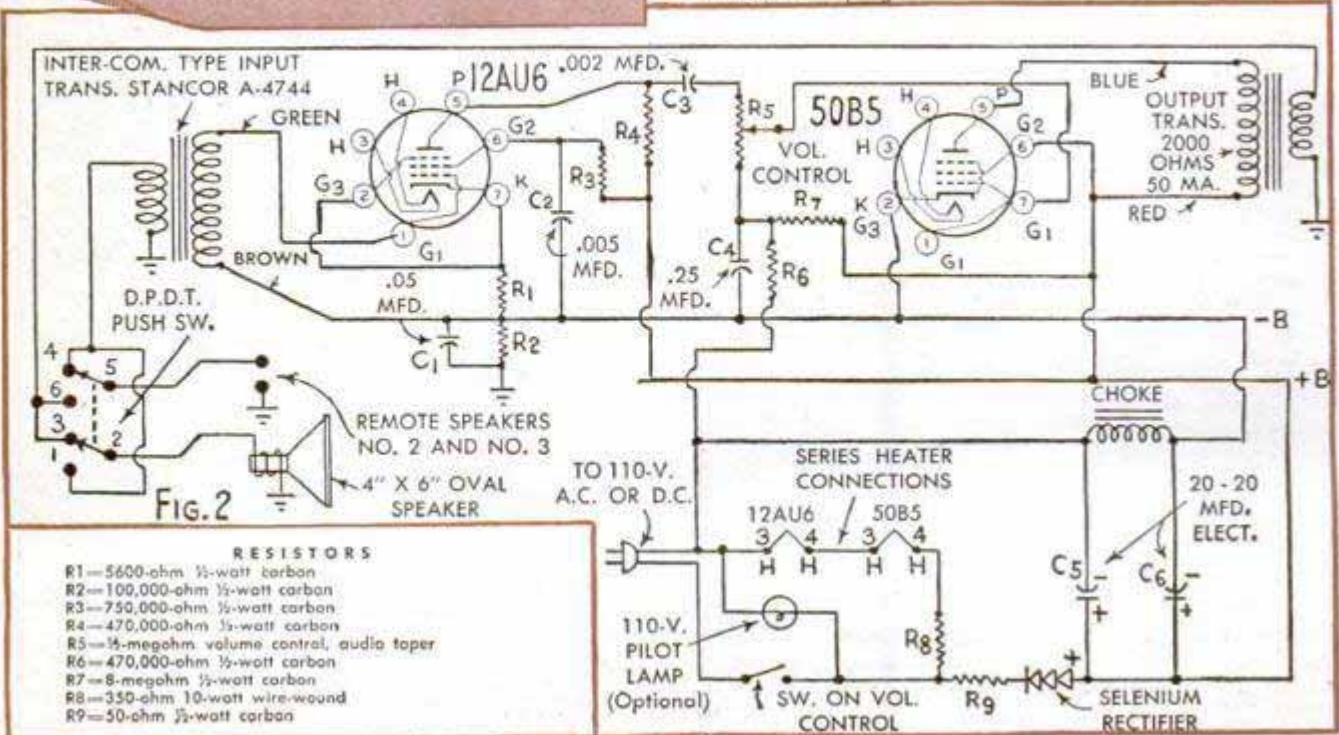
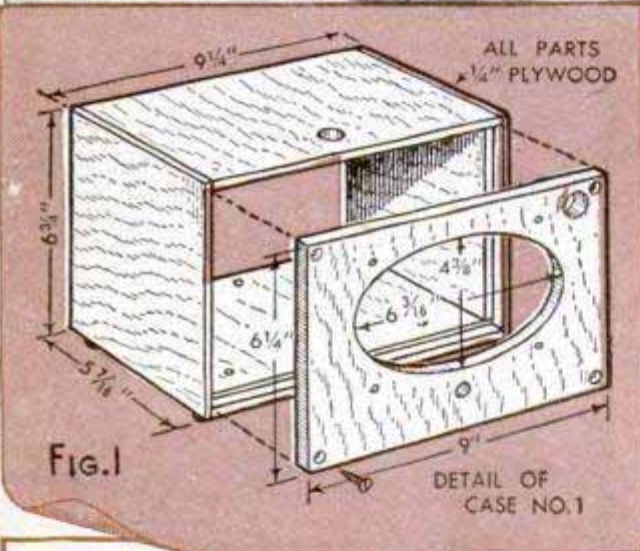
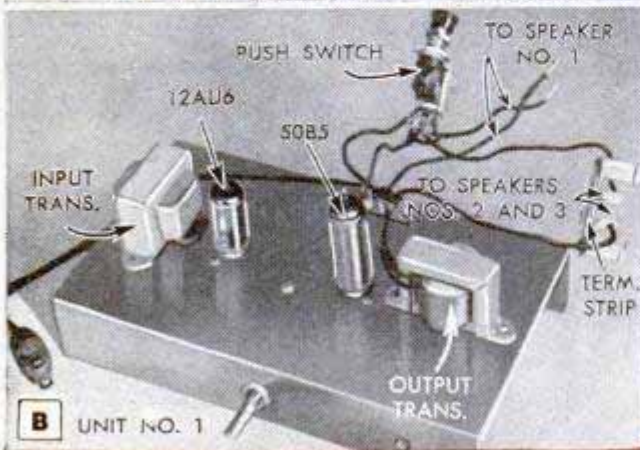
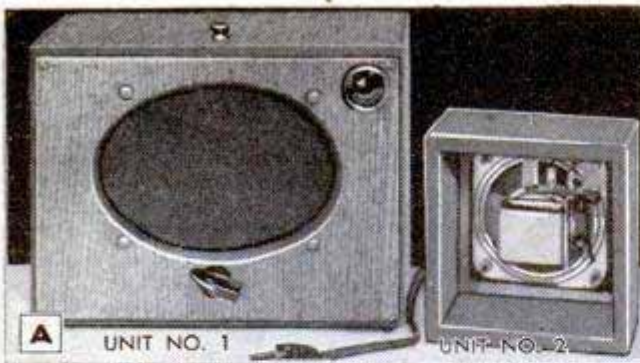

ALSO SERVES AS AN ELECTRONIC NURSE

tures a long-life selenium rectifier, a 12-AU6 tube as a voltage amplifier and a 50B5 beam-power amplifier with its high-power sensitivity. The unusual circuit with the choke in the negative-B side of the filter is to supply the steady fixed bias to the 50B5 tube and is used with the 8-meg. resistor from positive-B to furnish the proper bias voltage. This is a distinct advantage over the customary cathode-bias arrangement where the signal causes changes of the bias.

Construction should start with the chassis base of unit No. 1. Mount the tube sockets in the positions shown in the pictorial wiring diagram, Fig. 3; then mount the input and output transformers, the filter choke and selenium rectifier, and finally, all tie-point strips and soldering lugs. Wire one circuit at a time. For example, using rosin-core wire solder, wire all tube

(Continued to page 234)

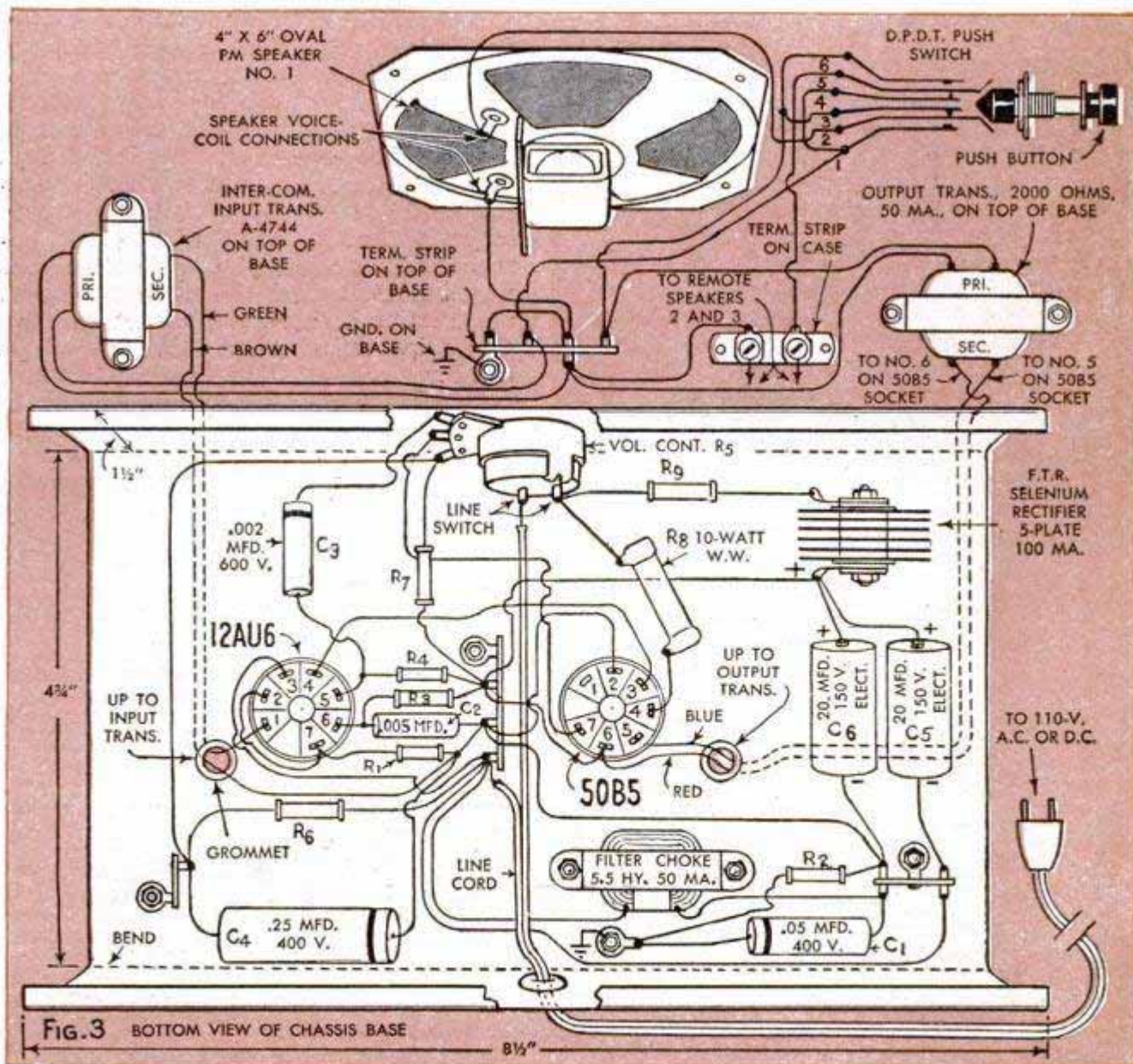

Improving Television Reception In Fringe Areas

By Perry Graffam

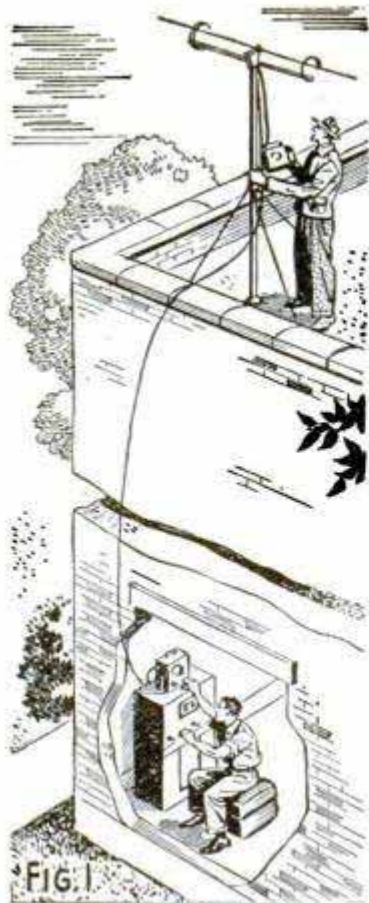
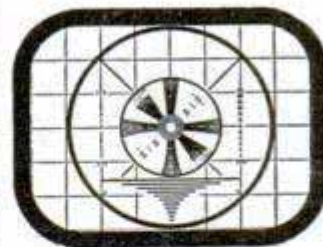
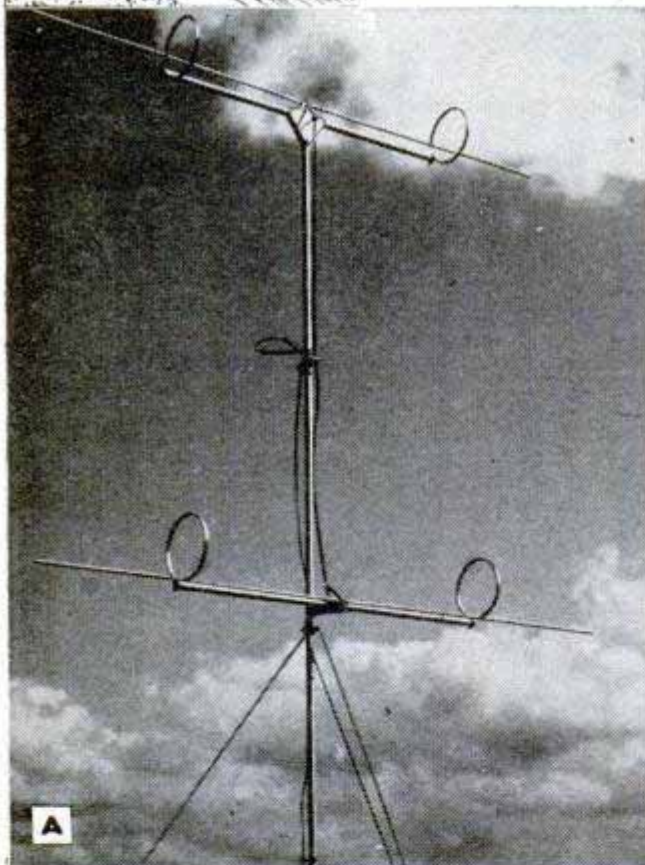

FIG. 1

TELEVISION signals travel in straight lines and do not follow the curvature of the earth's surface as do standard and short-wave signals. For good television reception a receiver must then be in the line of sight of the broadcasting station. Thus, a transmitter on a high building, well above surrounding buildings, and with no hills or mountains intervening, will reach out to distant points and can be received provided that the receiving-antenna installation is properly designed.

A single-section antenna of the type illustrated in Fig. 1 is all that is necessary in the average city installation. It is an all-wave Tricraft type that is claimed to cover both low and high television bands and also FM bands, and is designed so that an additional section, photo A, may be added at any time to increase the pickup of the antenna. The additional section comes in kit form and may be added for country or fringe-area installations where signals are weaker. The second section is installed at an added height which improves the signal strength and reduces noise and multiple images.

Service engineers, in making the primary installation illustrated in Fig. 1, are using an intercommunication system developed by the Raytheon-Belmont Corporation. The operator on the roof orients the directive antenna for best pattern results as reported by his co-worker stationed at the receiver. This is an important procedure, especially where multiple reflected images appear in the pattern as indicated in Figs. 3 and 4. For long-range reception an additional two-section array may be installed in the same plane as the first section. Theoretically, each additional array increases the signal strength and distance covered if no obstructions intervene, as shown in Fig. 2; these signals are, of course, stronger near the transmitter.



Correctly Adjusted

The pattern is clear-cut and steady. There is proper contrast between black, white and the various shades of gray.

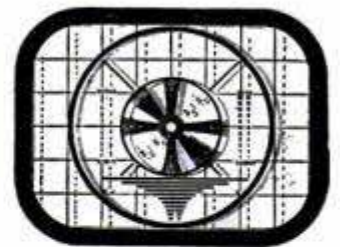

Multiple Images (Ghosts)

Due to signals reflected from tall buildings, mountains, etc. Can be minimized by proper orientation of the antenna.

FIG. 3

FIG. 4

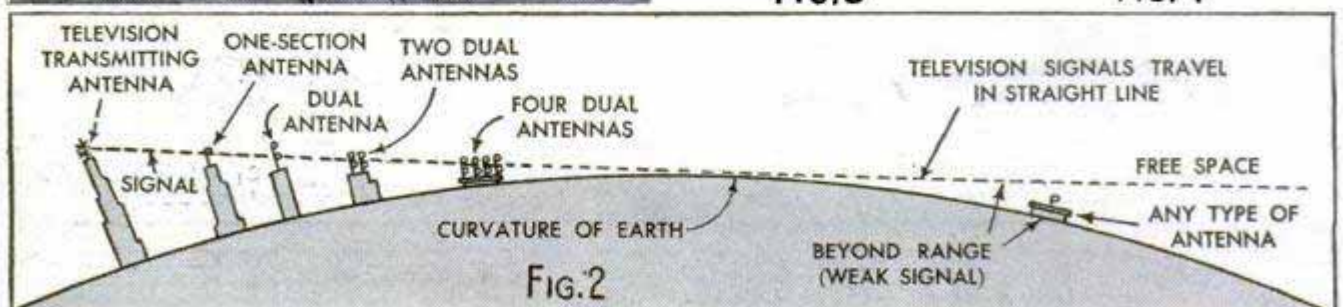

FIG. 2

KODAK REFLEX CAMERA



You won't miss with the big, unusually brilliant ground-glass view finder—you see your picture as you take it.



You catch fast action shots when you convert the focusing hood to open, eye-level frame finder.



You get exciting flash pictures with accessory Kodak Flashholder—shutter has built-in synchronization.



You focus to a hair with the magnifier set into the finder hood—handy for critical close-ups.



You check all settings quickly—depth-of-field scale, lens and shutter speeds—plainly marked and easily adjusted.



You have wide range of operation—twin Kodak Anastar f/3.5 Luminized Lenses; 7 stops from f/3.5 to f/22; 7 speeds from 1/2 to 1/200 second.



You're up-to-date with modern reflex styling and rugged, die-cast aluminum construction.



Smart Field Case included with camera. Price \$120 plus tax; Flashholder, \$9.50 plus tax. Your Kodak dealer has yours in stock now.

More features for your money in this fine "reflex"

Look at all you get with the Kodak Reflex Camera. It's the camera that won't let you miss—2¼ x 2¼ sparkling black-and-white pictures or 2⅞ x 2⅞ Kodacolor Prints.

Prices subject to change without notice

"Kodak" is a trade-mark

EASTMAN KODAK CO., ROCHESTER 4, N. Y.

Kodak

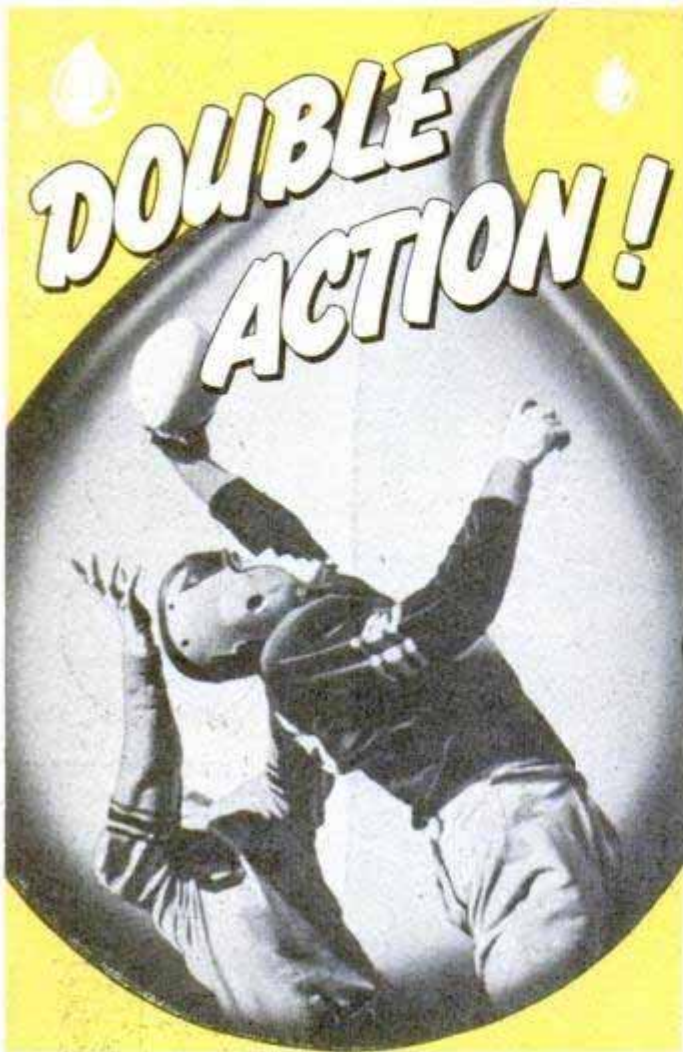

PENNZOIL

MOTOR OIL

FLOWS FAST-STAYS TOUGH!

For safe driving during changeable fall weather, get instant and lasting lubrication... Change to double-action Pennzoil!



At this sign of better dealers, coast to coast

Tough-film PENNZOIL* gives all engines an extra margin of safety

Low-Cost Phone System

(Continued from page 231)

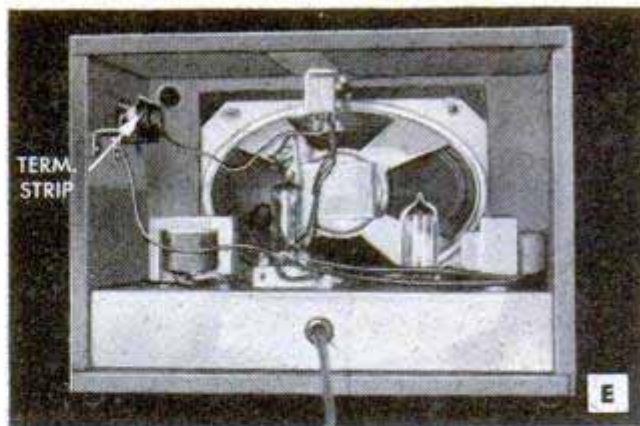

heater connections which are connected in series as indicated in the schematic circuit diagram, Fig. 2, before going on to the next. It is a good idea to check off each part of the diagram as it is completed. An extra few minutes spent in careful wiring and thorough checking always saves time and later possible trouble shooting.

After the chassis wiring is completed, wire the push switch in its normal position following the numbered terminals as shown in Fig. 3; these correspond to the numbers indicated in Fig. 2. The push-switch is mounted in the top of the cabinet detailed in Fig. 1. The remote-station cabinets are detailed in Fig. 4, and the speakers are mounted as shown by means of rosette-head screws. The speaker opening in each case is backed with brown-flocked, metal grille screen. Photos A, B, C, D and E show views of the completed units.

To test the system, connect one of the remote-station units to the terminal strip mounted inside the master-station cabinet at the point indicated in photo E. The 2-conductor line can be any insulated wire

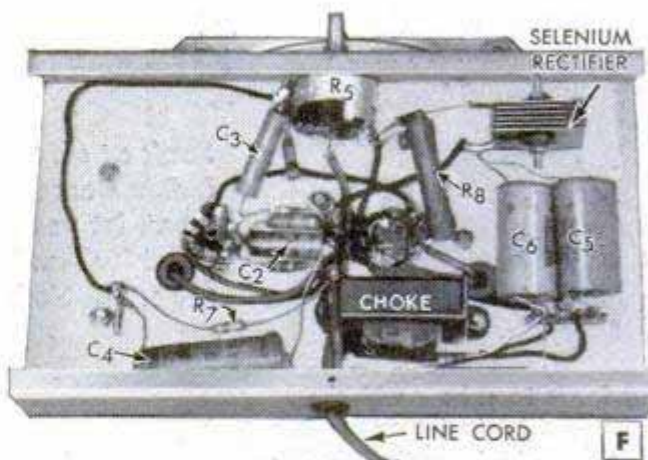

not smaller than No. 18 and lengths up to 500 ft. may be used. Plug in the master set, turn it on and let it warm up a few minutes. Have someone call on a remote

(Continued to page 236)

Here's Why New AUTO-LITE STA-FUL Battery

*...needs water
only 3 times a year**

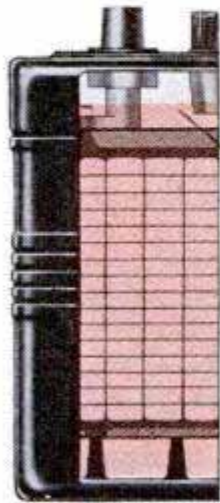

ORDINARY BATTERY



BOTH BATTERIES FULL



STA-FUL BATTERY

HERE'S WHAT HAPPENS INSIDE AN ORDINARY BATTERY

This battery is now full. Small liquid reserve gives battery plates little protection against damage and loss of power if evaporation lowers liquid level.

HERE'S WHAT HAPPENS INSIDE AUTO-LITE "STA-FUL"

The new "Sta-ful" has more than 3 times the liquid reserve of ordinary batteries. Gives its plates added protection. Battery lasts longer too!



ORDINARY BATTERY



ADVANCED STATE OF EVAPORATION

Equal Liquid Loss From Both Batteries

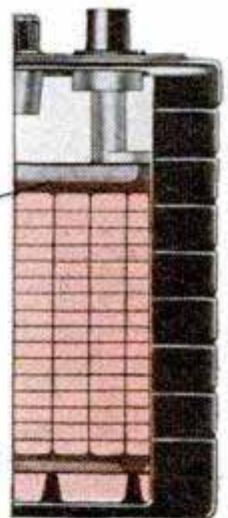

STA-FUL BATTERY

Plates at the left are now exposed and inactive because of the small liquid reserve provided in ORDINARY battery.

The "Sta-ful" Battery plates are still kept fully covered and protected because of the more than 3 times greater liquid reserve.

*In normal car use

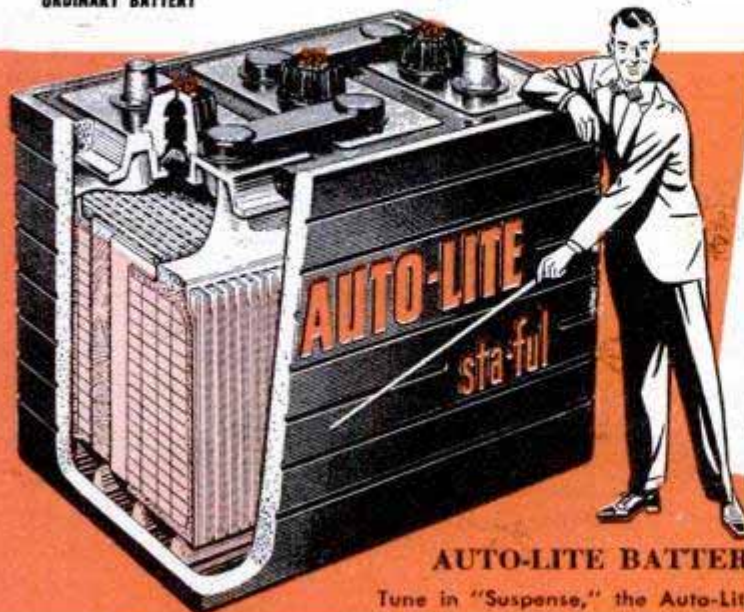

Why the "Sta-ful" Design Is Possible
Fibre-glass mats help to keep the power-producing material from shedding—add to battery life. This makes possible the "Sta-ful" construction with its smaller sediment well which permits room for a liquid reservoir with over 3 times the usual capacity at the top of the battery. Make your next battery an Auto-Lite "Sta-ful."

AUTO-LITE BATTERY CORPORATION, Toledo 1, Ohio

Tune in "Suspense," the Auto-Lite Radio Show—Thursdays, 9:00 P.M.—E.T. on CBS

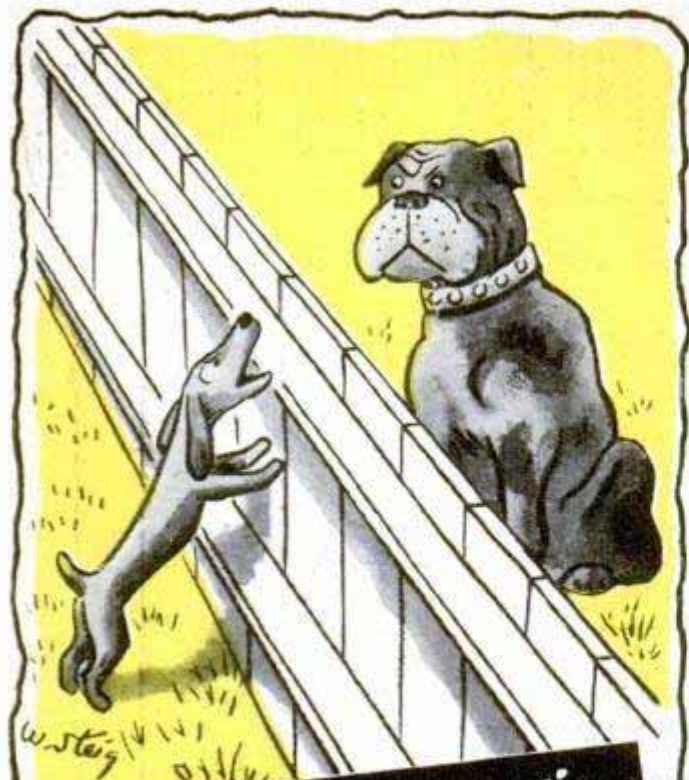

What's Extra Protection Worth to You?



To keep your engine alive and powerful—give it Casite's extra protection.

Casite cuts engine wear and cuts repair bills—because it improves lubrication. No matter what kind of motor oil is being used, Casite helps it get around—quickly and into the tight spots. Casite retards the formation of sludge and gum . . . frees sticking valves and rings . . . cleans motors and keeps them clean. The Casite Corporation, Hastings, Michigan, and the Casite Division, Hastings Ltd., Toronto.

75¢ A PINT
95¢ in Canada

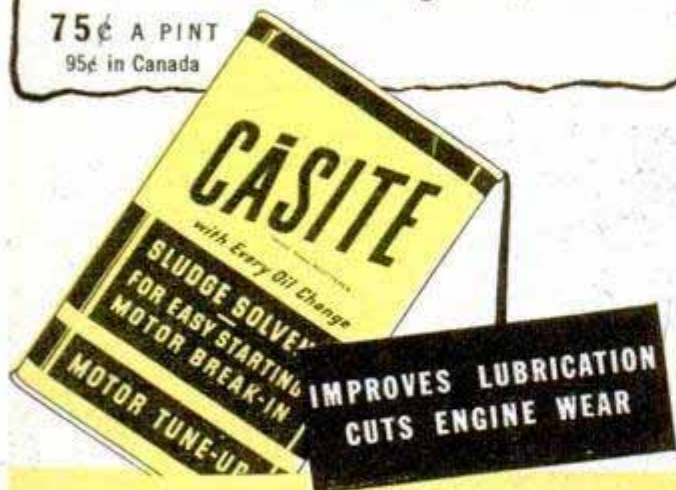

BETTER AND SMOOTHER PERFORMANCE OR DOUBLE-YOUR-MONEY-BACK

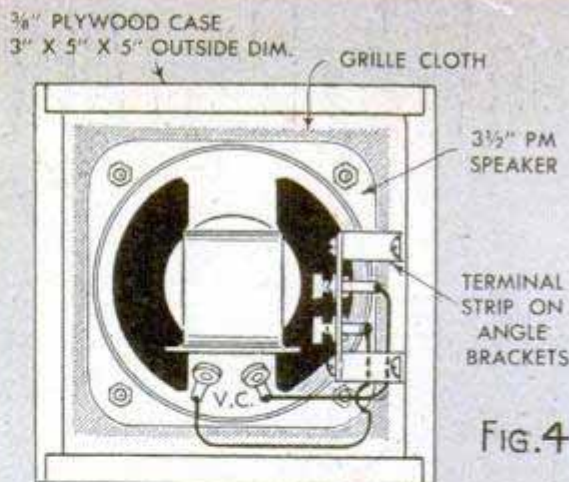

REMOTE SPEAKERS NO. 2 AND NO. 3 (2 REQD.)

station; push the switch and call back. If excessive hum is heard, reverse the position of the line cord in the wall socket. If howling is encountered, it is due to acoustic feedback resulting from the proximity of the 2 stations. Try lowering the volume, or separate the 2 stations as far as possible. Remote-station unit, No. 3, may be connected in parallel at the terminal strip in the master station. Detailed student material list R-371 is available from Popular Mechanics Radio and Electronics department upon the receipt of ordinary letter postage.

Television-Receiver Construction

Students and experimenters not familiar with TV-receiver construction often request plans and articles on the subject and wonder why such articles do not appear in various publications. For a student-type TV receiver suitable for home-workshop construction, specially wired and tested units would have to be available from radio-parts houses. For a 13-channel receiver kit, lock-in sweep oscillators, and completely wired and tested r.f. front-end tuners for both FM and AM would be required as the average experimenter is not equipped with the necessary instruments for assembling and testing such stages.

Although the high voltage used in a television receiver is in the order of from 2000 to 7000 v., it is of the r.f. type at very low amperage. However, elaborate precautions are necessary to prevent the possibility of a dangerous shock. There are several specially engineered commercial television receivers available in kit form. Precautions have been taken to provide safety interlocks and all critical wiring and checking has been completed. Such kits are possible only under specialized manufacturing and laboratory-testing conditions.

Dependable

CHAMPION

America's Favorite Spark Plug



When the fire department is called, fire apparatus must start instantly, accelerate quickly, and reach the scene of action with all possible speed. This requires absolutely dependable spark plugs. That's why leading producers of fire-fighting equipment specify Champion Spark Plugs. They, like other experts such as race drivers and operators of fleets of buses and trucks, know that Champions insure the utmost in performance and dependability. Champion Spark Plug Company, Toledo 1, Ohio

FOLLOW THE EXPERTS

DEMAND NEW DEPENDABLE CHAMPIONS

FOR YOUR CAR

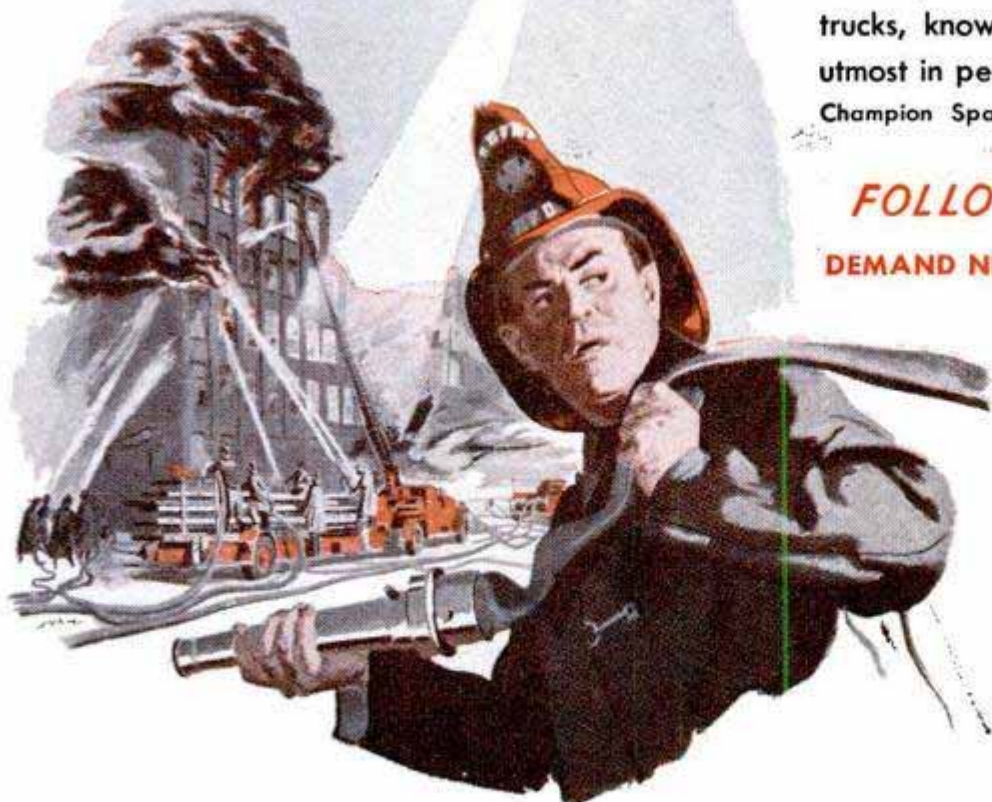

Listen to the CHAMPION ROLL CALL . . . Harry Wismer's fast sportscast every Friday night, over the ABC network

How They Fire the Battleship's Big Guns

(Continued from page 157)

(1) Range, from range finders located in each turret, (2) target bearing, electrically, from a director high in the ship, (3) own ship's course, electrically, from the gyrocompass, (4) own ship's speed, electrically, from the speed indicator, (5) wind, manually, from estimate, (6) target course, manually, from estimate, (7) target speed, manually, from estimate, (8) muzzle velocity loss, due to gun erosion and powder temperature, (9) other non-standard conditions such as air density and parasitic errors, manually, from previous calculations, (10) time, electrically, by constant-speed motor.

Information computed by the range-keepers is supplied instantly to the bridge and fire-control tower. Here is located a super-gunsight that tries precisely to "keep on" the enemy target. Its minutest movements are transmitted to the guns in the turrets. A gyroscopic device regulates firing so that guns always shoot at the same stage of the ship's roll.

The gunnery director tries to straddle the enemy with short and long salvos of two to find the proper mean between them. Radar has stepped up the accuracy of this

initial salvo. He does not usually try to fire a broadside until he is well on his target. Then he presses the master key that may fire up to all nine of the 16-inch rifles in one tremendous thunderclap that shoves the monster 45,000-ton ship sideways in the water.

The next salvo means working out an entirely new gunnery problem. The enemy ship has moved. Your own ship may have veered to dodge a torpedo. Other ships may have fired at the target at approximately the same time, making "spotting" difficult. A lucky enemy hit on your own ship may have knocked out a part of the fire-control system, making it necessary to use auxiliary controls.

A decade ago, when battleships of the fleet went out for gunnery practice, it was customary to lash down everything movable, throw away the wardroom china and sometimes even to jettison the ship's piano lest it be reduced to kindling wood by the shock of firing the big guns.

Such have been the improvements in ship design and the recoil mechanism of big guns that when all nine guns of the USS Missouri were test-fired in a broadside, only a few soap dishes were cracked.

Most of the 16-inch guns of the fleet are

(Continued to page 244)

If it's a Prize-Winner you're after... **GET A GRAFLEX!**

If you're interested in profiting from one of the most wonderful of hobbies — photography — let your local dealer show you one of the great cameras in the Graflex line. From the Pacemaker *SPEED GRAPHIC* to the RB Series B Graflex, you can choose the one camera that suits your particular needs.

Be like the thousands of non-professional and professional photographers who depend on Graflex cameras to get those outstanding shots that win prizes or are sold to the hundreds of outlets that demand great pictures. Enter the big 1948 Graflex Photo Contest — \$5000.00 in prizes! See your local Graflex dealer now for official rules and entry forms.

Graflex, Inc., Rochester 8, New York

SPEED GRAPHIC photo by Lynwood Chace; stroboscopic light, 1/11.

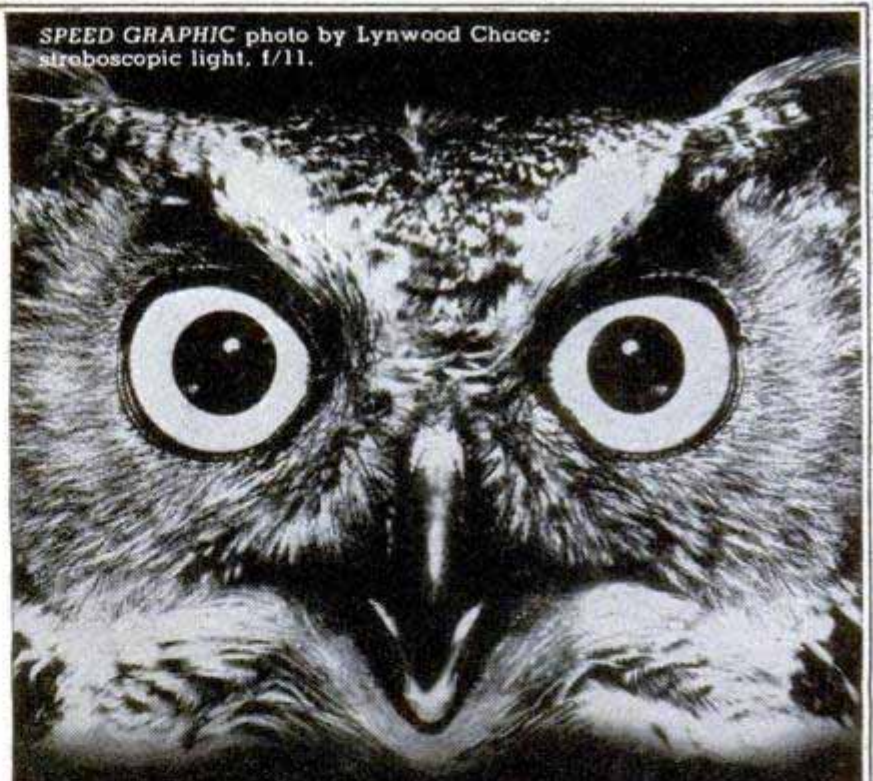

PRIZE-WINNING CAMERAS
GRAFLEX
Western Division:
3045 Wilshire Boulevard
Los Angeles
New York Offices:
50 Rockefeller Plaza

NEW FIVE-IN-ONE SHOPSMITH OUTWORKS SINGLE PURPOSE POWER TOOLS

SHOP SMITH AS CIRCULAR SAW Has maximum distance of 46" between blade and fence. Tilts to any angle—positive lock. New principle provides micro-adjustment of distance between fence and saw blade. *Specifications:* Saw Blade: 8" Dia. Depth of cut 2 3/4". Table: 14 1/2" x 17"; with extension, 54" x 17". *Equipment:* 8" saw blade and arbor. Table extension. Mitre gauge. Rip fence. Saw guard.

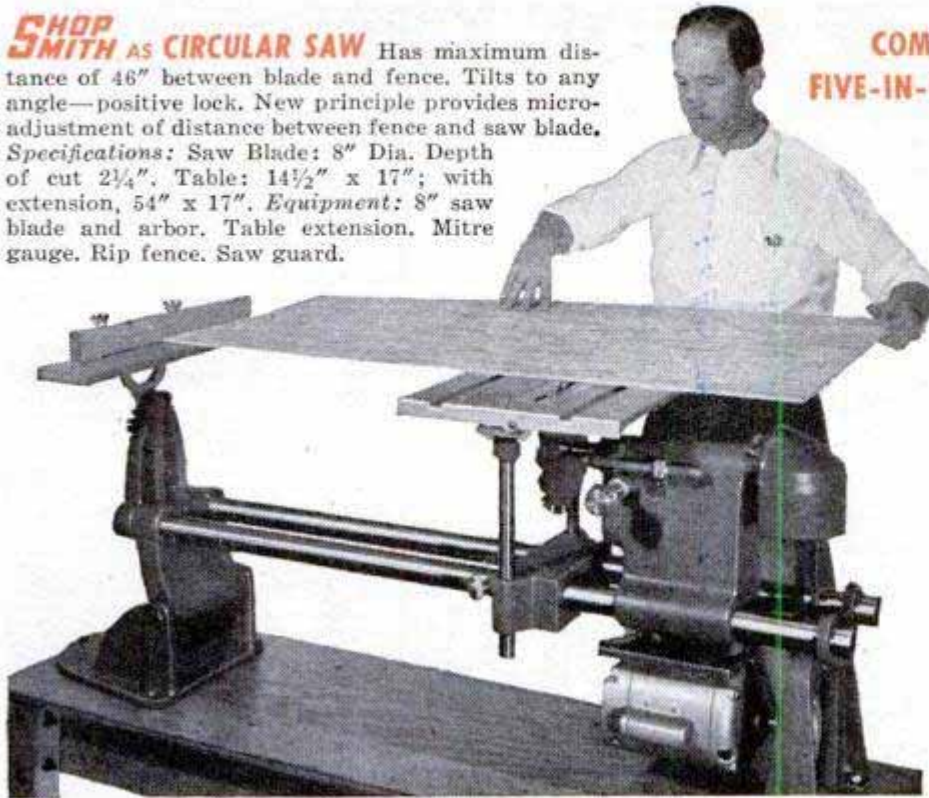

COMPLETE FIVE-IN-ONE TOOL **\$159.50**

With special 1/2 H.P. ball bearing motor, \$195.50



SHOP SMITH AS VERTICAL DRILL PRESS

Capacity: Drills to center of 15" circle. Clearance: Table to chuck—27" max. Spindle: 3/8" Dia., 6 spline, hardened tip. Spindle Feed: 4 1/4". 4 grease-sealed

Fafnir ball bearings. Variable speeds. Table: 14 1/2" x 17". *Equipment:* 1/2" Jacobs key chuck. Fence.

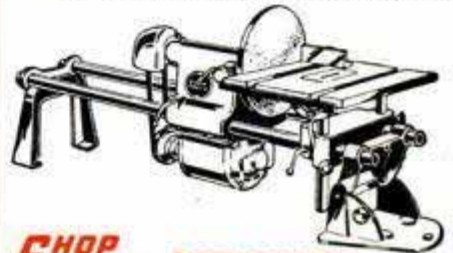

SHOP SMITH AS DISC SANDER

Disc Diameter: 12". Table Dimensions: 14 1/2" x 17". Tilting Table. *Equipment:* 12" disc. Mitre gauge.

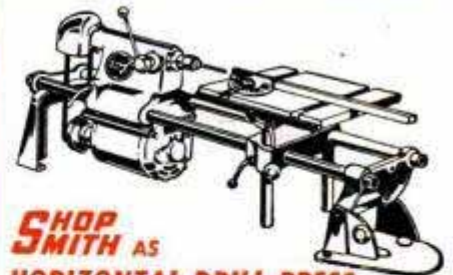

SHOP SMITH AS HORIZONTAL DRILL PRESS

Only SHOPSMITH performs this highly useful function. No limit to length of work. Provides accurate method of drilling for doweling, etc.

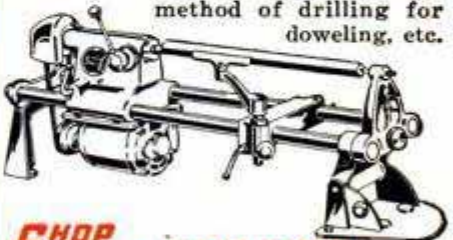

SHOP SMITH AS WOOD LATHE

34" between centers. Swing: 15". Variable speeds. Quill Feed: 4 1/4". *Equipment:* Tool rest. Drive center. Dead center.

SHOPSMITH Brings You Five Sturdy Tools—Circular Saw—Wood Lathe—Disc Sander—Horizontal And Vertical Drill Press—All Engineered Into One Space-Saving Unit—59" Long By 21" Wide

WAIT TILL YOU SEE IT!

WITH SHOPSMITH you get the *five* basic tools shown here—also convertible to grinder, buffer, router, drum sander, shaper, scratch brusher. And you can change from tool to tool *in less than one minute.*

BUILT RUGGED

Has cast iron headstock and carriage. Centerless ground and polished steel ways. Heavily reinforced table. Four life-long grease-sealed Fafnir ball bearings. Weighs over 200 pounds.

PRECISION MACHINED

Each SHOPSMITH part is precision-machined, factory-tested. Carriage is precision-bored and gauged. Gives cutting tool and work support constant relationship. *You can work more accurately with SHOPSMITH.*

Thousands of craftsmen are finding new fun and profit with SHOPSMITH right now. And more SHOPSMITHS are on the way. If it isn't in your city today, it will be soon. Write for full details and free descriptive folder.



Magna Engineering Corporation,
465 California Street,
San Francisco 4, California



MODERN... and a cinch to build with EASI-BILD* Full-Size Patterns!

You can build this bookcase for less than half the store cost. New, full-size patterns, step-by-step directions, and assembly illustrations make it easy. Use *Cascamite Resin Glue*, described below, for strong, stainfree joints throughout.

*Trade-Mark © 1948, Easi-Bild Pattern Co.

How to choose a glue!

Follow these directions and you'll solve
all your gluing problems:



For boats, outdoor furniture, sports equipment—joints that must withstand outdoor exposure—*CASCOPHEN* (Resorcin Resin Glue). The first completely durable glue available to home-craftsmen.



For furniture, toys, heavy-duty home repairs—strong, stainfree, moldproof, highly water-resistant *CASCAMITE* (Urea Resin Glue). Mixes quickly with cold water!



For models, photo prints, labeling—general home, school, or office gluing, use the new, clean, white fast-setting *CASCOREZ* (Polyvinyl Resin Glue). Liquid, ready to use!

SEND COUPON FOR BOOKCASE PATTERN TO:

Casco Pattern Dept. PM-108
P. O. Box 215, Pleasantville, N. Y.

Enclosed is¢ for material checked below
() Bookcase, Pattern #42—50¢
() 32-page Pattern Book, illustrating 94 projects—20¢

Name _____

Address _____

City _____ Zone _____ State _____

THE BORDEN CO. • CHEMICAL DIVISION
Makers of Casco Glues

Clinic



for Homemakers

As a service to our readers in solving the hundreds of problems pertaining to a home—inside or out—the editors of *Popular Mechanics* invite you to present your problems to The Clinic Editor for help and advice. Address your questions to The Clinic Editor, *Popular Mechanics Magazine*, 200 East Ontario Street, Chicago 11, Ill.

Crystal Lacquer "Frosts" Windowpane

Q—I have two windows, one in a hall and the other in the bathroom, with clear panes which I would like to coat in some way so that at least the lower panes will admit light but obstruct vision. Thus far I have been unable to obtain "frosted" glass of the kind made for this purpose. Is there any material or coating I can apply to the existing panes to get the desired effect?

M.R.—San Francisco, Calif.

A—A special lacquer is available for this purpose which crystalizes as it dries into irregular frostlike patterns. The sash must be removed so that it can be placed in a horizontal position as the lacquer dries. Although this special lacquer can be applied with an ordinary varnish brush a better job will be had if a spray gun is used. Apply a fairly heavy coating only to the inside surface of the glass and protect the painted or varnished sash frame with masking tape, as most lacquers will soften paint.



Pointing Stonework

Q—The front wall and fireplace chimney of my home are of stone laid with what I suppose is called a beaded mortar joint, or pointing. The joint is about $\frac{5}{8}$ in. wide. In some joints the pointing has chipped and in others it has broken out altogether. What is the formula for making this mortar, or pointing, whichever it is, and can I do this repair job myself? I'd like to try it.
J.B.—Philadelphia, Pa.

A—Ordinarily, laying or pointing ornamental stonework is a highly specialized job calling for special skills. However, if you wish to try the job yourself, first clean the walls and chimney with a stiff-bristle brush and scrape all loose material out of the affected joints. Wash down the chimney and walls with a hose to clear away all loose dust and sand. Then make a white pointing mortar by mixing 1 part white portland cement, 1 part hydrated lime and 6 parts of fine sand with water to the consistency of a fairly heavy paste. Apply this mortar to the joints with a pointing trowel made especially for the purpose. Keep the wall damp but not wet. Some stonemasons smooth the joints lightly before the mortar sets with a clean paint brush dipped in water.

(Continued to page 242)

LIONEL TRAINS



**Real Engineer Speed
Control Throttles on
NEW LIONEL Transformers**

They're amazing! Fingertip control of direction and whistles. Full throttle speed control! Only one of the exciting features in the new LIONEL catalog for 1948! Get it, today! Read about the new Santa Fe and N. Y. Central DIESELS—the new

PULLMANS—the new Operating Accessories—the new TRAIN SETS! Finer LIONEL Trains than any year in all our history! SMOKE that puffs realistically! Built-in WHISTLE! Only LIONEL has true scale detail realism! Write for special offer NOW!

Send for special offer!

- 1 We send you beautiful 36-page Full Color LIONEL Train Catalog.
- 2 Set of 3-Dimensional Views of LIONEL Trains in action.
- 3 Pair of Stereoptican Eyeglasses for viewing scenes.
- 4 Special KIT of 6 cut-out colorful buildings for your Train Layout to create realism.

Entire package only 25¢ to cover mailing and handling costs. Quantities limited, so please order early. It's a wonderful offer, boys!

Send for it Today!



LIONEL TRAINS, P.O. Box 351
Madison Square Station
New York 10, New York

I enclose 25¢. Please send me special offer of 36-page Full Color Catalog, Stereoptican Views of LIONEL, Stereoptican Eyeglasses, and Kit of 6 building cutouts.

Name _____

Address _____

City _____ Zone _____ State _____

Here's "before and after"

proof why **You**
Should Simoniz
Your Car!

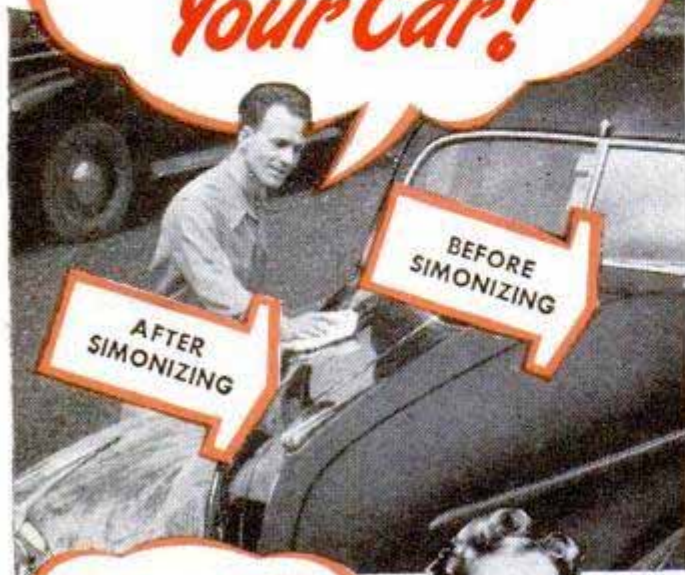

GIVES TWICE THE
SHINE IN 1/2 THE
TIME!



KEEPS COLORS
FROM FADING!



Simoniz Kleener makes dull cars look new again

Nothing equals wonderful Simoniz Kleener—for safely cleaning the finish and making cars look really new again. Anyone can do a professional job of Simonizing without a buffer—just inexpensive Simoniz and Simoniz Kleener. Use Liquid Kleener for a "quickie slick-up" or before applying Simoniz. Extremely dull cars require Paste Kleener. To protect the finish and make it last longer—follow up with famous Simoniz!

THE SIMONIZ COMPANY, CHICAGO 16, ILL.



MOTORISTS WISE
SIMONIZ

T. M. REG. U. S. PAT. OFF.

MAKES THE FINISH LAST LONGER

Refinishing a Porch Sunshade

Q—I have a large porch sunshade made from rough wooden slats and lashed with cord. I would like to refinish this but don't know how to go about it, as it seems impossible to dismantle the shade without damage. Apparently the original finish was a wood-brown stain and this has faded and weathered to the point where the bare wood shows through. I would like to paint it but how can I do it without getting the paint on the cords?

B.A.—Denver, Colo.

A—Don't paint it. Refinish with a stain of the same color as the original. If the shade is used on an open porch where it is exposed to some weathering, a shingle stain will give a good protective coating. Place newspapers on a flat surface and unroll the shade on them. Apply stain with a brush to the slats and cords and be especially careful to get an even, uniform coating. When one side is dry turn the shade over and do the other side.

Refinishing Venetian Blinds

Q—I have wide Venetian blinds with wooden slats which were originally stained and finished a light brown color. As the blinds are quite old the finish along the edges and also on about half the width of the slat nearest the window has worn away, exposing the bare wood. I would like to refinish the slats in the original color. Is there any way I can refinish the worn edges to match and if so what materials should I use?

A.E.—Ft. Worth, Tex.

A—It will be necessary to disassemble the blind and go over all the affected slats lightly with fine sandpaper. Unless the wood is badly discolored you probably can match the original color fairly well by simply dampening a cloth with a light-colored oil stain and rubbing the worn edges. After applying the stain, immediately wipe off any excess with a clean cloth. Continue rubbing with the cloth until the new color matches the old as nearly as possible. After staining and allowing to dry, finish each slat with a clear liquid wax of the self-polishing type.



Wooden Arbor Posts Crack Concrete Anchors

Q—A year or so ago I installed 4 by 4-in. wooden posts to support a grape arbor. I anchored the posts in concrete poured in holes 30 in. deep and about 8 in. in dia. Now each of the concrete anchors is cracked in several places and the posts are loose. I have thought of enlarging the holes and adding more concrete. Would this be a satisfactory repair or will it be necessary to dismantle the arbor and reset the posts to make the structure rigid? **A.R.**—Fort Wayne, Ind.

A—To repair the damage, it would be necessary to remove the posts. Inasmuch as the arbor is already built and dismantling and rebuilding it would require considerable labor and time, try filling the cracks with a thin mix of cement. Then coat the top of each anchor with roofing cement to keep water out of the joint between the post and the concrete.



What's Your choice?...

of these sturdy, dependable
Low-Cost
Marlin .22's

TUBULAR MAGAZINE
 18-25 shots on one loading
\$26.95*
**Price slightly higher west of the Rockies.*

MARLIN MODEL 81-DL

Shooting efficiency, with *least* fuss and bother! Magazine holds a load for a full day's hunting. Patented non-jamming feed. Shoots .22 short, long and long rifle cartridges—regular and high speed without adjustment. Quick-release trigger—self-cocking action—side ejection—Off and On safety—American walnut stock. Available with peep sight or open sights; sling strap swivels.



Unbeatable for pests and vermin... owls, rats, hawks and crows, the 81-DL carries up to 25 shots.

BOYS!

Be a ranger. Write Sportsmen's Service Bureau, 343 Lexington Avenue, New York, for FREE booklet.

NEW Marlin Catalog, with complete specifications, now available. Enclose 10 cents with name and address.

CLIP MAGAZINE
 for rapid fire
\$22.90*
**Price slightly higher west of the Rockies.*

MARLIN MODEL 80-DL

Whale of a value—this man-sized .22 repeater! Ready for instant action on vermin or small game. 8 rapid-fire shots to get 'em, no matter how fast they run. Quick-release trigger—self-cocking action—side ejection—Off and On safety—American walnut stock. Available with peep sight or open sights; sling strap swivels. More sport for your money with Marlin's 80-DL!



Marlin's 80-DL is a sure getter of woodchuck, raccoons, rabbits and other fur-bearing game.

THE MARLIN FIREARMS CO. • NEW HAVEN, CONN.

SPORTSMEN'S SET—collar and tie clasp—real jewelry, richly gold-plated. Yours for only 50¢ with box top of Marlin Blades; 25¢ with 3 box tops. Address Dept. 35, MARLIN, New Haven, Conn.



manufactured at the Naval Gun Factory, Washington, D. C. Big Navy guns do not consist of a single tube of steel. They are built up, layer on layer, for extra strength and toughness. They also contain a rifled liner. This gives projectiles a spinning motion for greater accuracy—just as a good passer puts a spiral twist on a football.

After a number of rounds of firing, these riflings become worn and accuracy is reduced. The gunnery officer of a ship keeps an accurate record of the firings of each gun. When the liners get too bad, the guns are returned to the Naval Gun Factory for relining. The gun is lowered into a deep, vertical oven which heats it to a cherry-red. The liner then slips out easily and a new one is slipped in. Once the new liner is locked in the barrel, the cooled-down assembly is lifted from the pit and the tedious rifling process is begun. The rifling machine literally shaves grooves out of the hard steel, the adjustable cutters digging a little deeper with each stroke. The inside is chromium plated and yoke and breech mechanism are reinstalled. The gun is finally subjected to tests as if it were brand new.

The long-range future of the Navy's long-range guns is cloudy at present. Some ordnance experts think the 16-inch rifle

has reached the peak of its usefulness. Some predict that battleships will be converted into "missile ships," their broad decks serving as launching platforms for rockets.

But even if it should go the way of wooden ships and sail, the "big mouth-piece" will long remain a symbol of the U. S. Navy—a powerful, seagoing weapon, an engineering marvel, a strong voice for freedom.

Workshop Wizard on the Stage

(Continued from page 103)

with red fingernails. You merely place the sandwich in the third hand. Then you can drink your coffee in peace—because wagging the thumb operates a Shoosher, enabling you to shoo flies off your sandwich.

There's also the Sure-Strike Bowling Ball. It overcomes two common problems of all bowlers—getting fingers cramped or stuck in the holes, and eliminating low scores. When you give this ball a heave, an automatic clutch operates, enabling you to keep the finger holes in your hand. When the ball slides down the alley and smacks the first pin, automatic extension bars pop out, doubling the width of the ball and really mowin' the pins down.

(Continued to page 246)

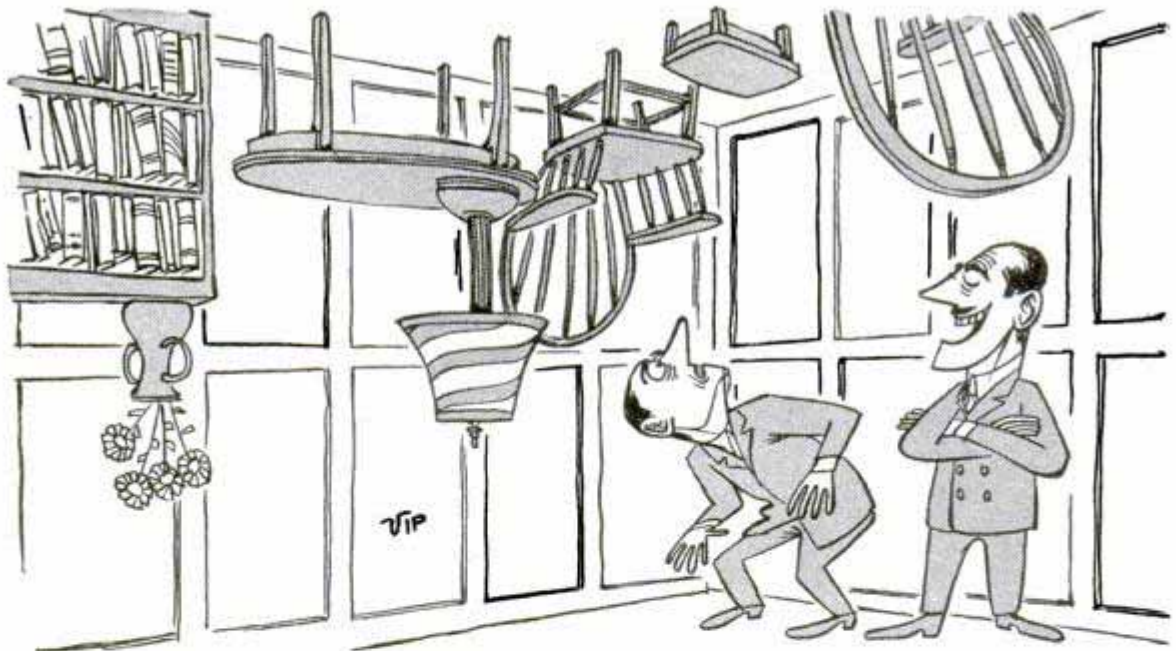

"Without Weldwood Glue we wouldn't be able to pull this gag on Jones"

When you want a wood-to-wood bond that will really hold . . . remember Weldwood Glue. It's quick to mix . . . easy to use . . . tremendously strong . . . stain-free . . . rot-proof . . . and permanent. At hardware stores, lumber yards, chain stores, in 15¢, 35¢, 65¢, 95¢ and larger sizes.



WELDWOOD
PLASTIC RESIN GLUE

United States Plywood Corporation, New York 18, N. Y.

X-actly what your work bench needs . . .

X-ACTO* HOBBY TOOLS

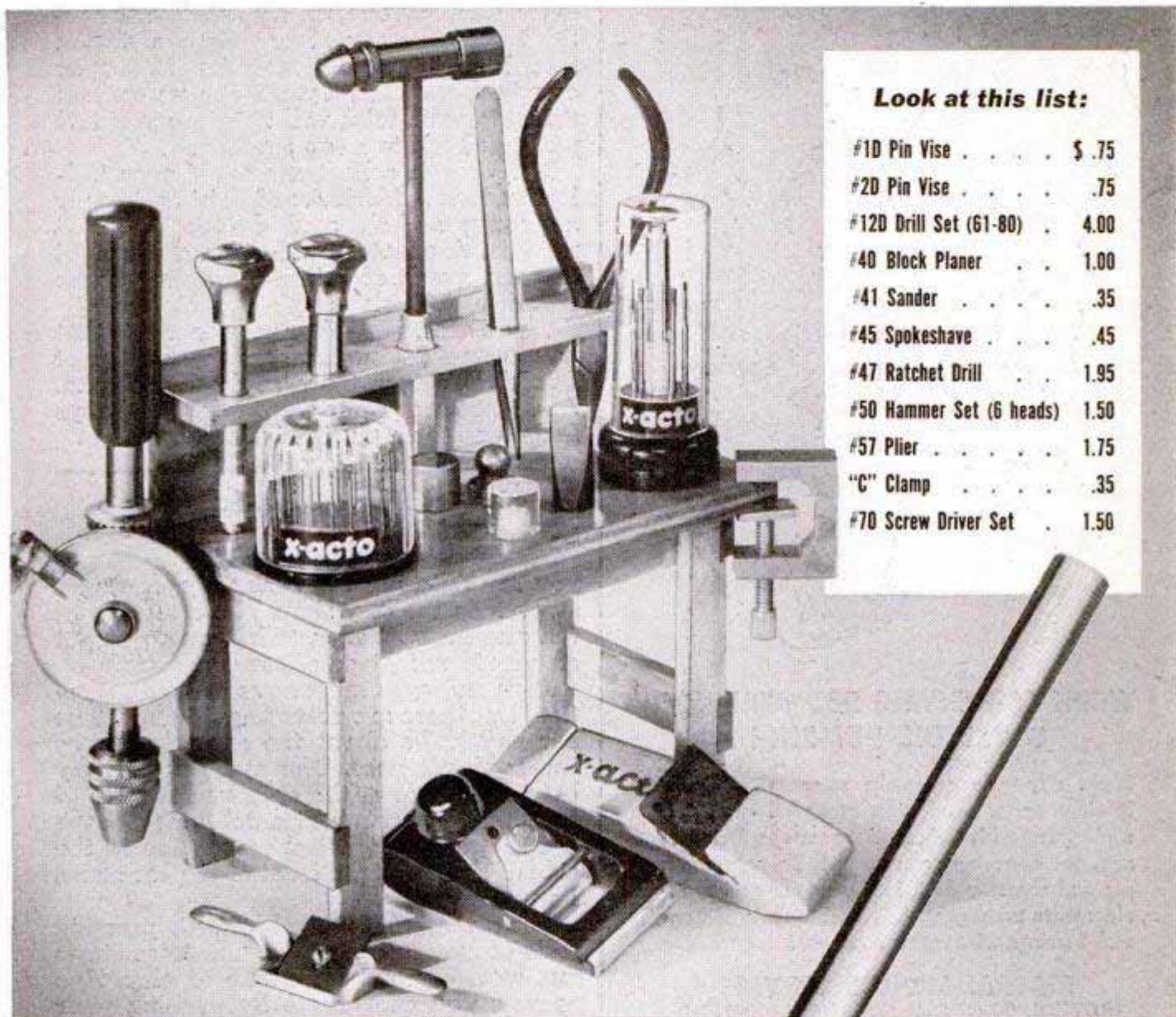

Look at this list:

#1D Pin Vise	\$.75
#2D Pin Vise75
#12D Drill Set (61-80)	4.00
#40 Block Planer	1.00
#41 Sander35
#45 Spokeshave45
#47 Ratchet Drill	1.95
#50 Hammer Set (6 heads)	1.50
#57 Plier	1.75
"C" Clamp35
#70 Screw Driver Set	1.50

Here they are, the just-right tool for every imaginable hobby job . . . specially designed to get into hard-to-reach spaces, work handily on small surfaces . . . with the finesse and dependable accuracy that have made X-acto knives and tools the choice of experts in every art and craft field.

And there are many more. See them at your favorite hardware, gift, hobby or department store. And while you're there, take a look at the line of X-ACTO REFILL-BLADE KNIVES . . . always super-sharp, always ready to help you turn out slicker jobs, quicker. Sold singly and in sets, 50¢ to \$50.

(Prices slightly higher in Canada.)

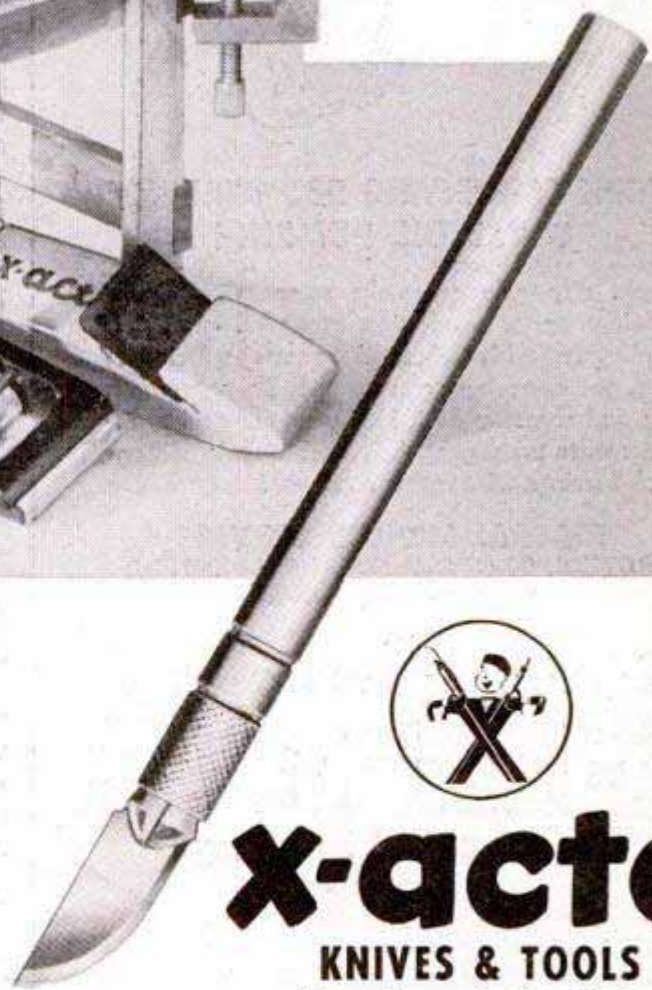

x-acto*

KNIVES & TOOLS

X-acto Crescent Products Co., Inc.
440 Fourth Avenue, New York 16, N. Y.

In Canada:

Handicraft Tools, Ltd., Hermant Bldg., Toronto

*Reg. U. S. Pat. Off.

PERFORMANCE GOES UP IN SMOKE

"It isn't the barn, Jim

... IT'S A CAR THAT NEEDS
**FEDERAL-MOGUL
ENGINE BEARINGS"**

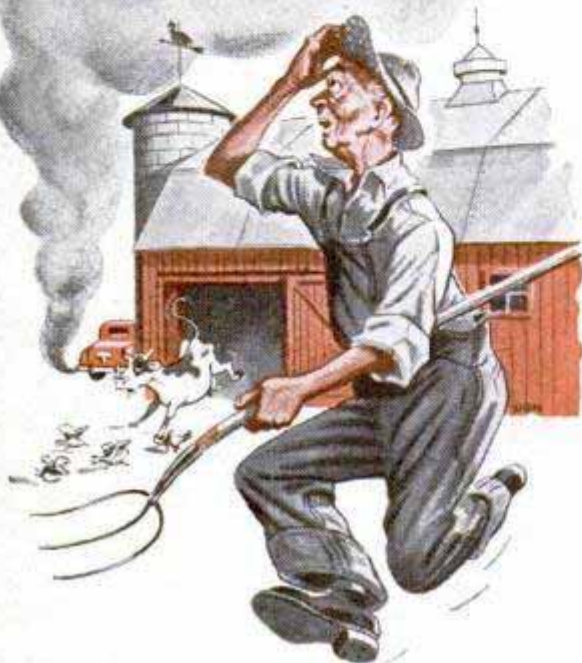

WORN CONNECTING ROD BEARINGS CAUSE OIL PUMPING

Dark, oily exhaust smoke means that engine bearings are worn, letting excess oil coat vital engine parts with carbon. Your car's performance sags, yet operating costs go up! To put power, pep and economy back into your car engine, replace worn bearings with Federal-Mogul Oil-Control bearings. *Ask your mechanic!*

FEDERAL-MOGUL SERVICE
(DIVISION OF FEDERAL-MOGUL CORPORATION)
COLDWATER, MICHIGAN

Replace in Sets with Genuine
FEDERAL-MOGUL
Oil-Control Bearings
in your car



For insomnia victims, Professor Oakes has invented his Automatic Sheep Counter. Insomniacs need no longer worry about the sheep who come up to the fence but refuse to jump. The invention counts only those which actually cross the top bar—and a mechanical counter keeps tab on the number that do go over and reports them to the sleepless one, until a sufficient quantity to produce sleep have passed over the rail. Even then, the counter keeps on counting, and should you wake, a glance at the automatic total will reassure you and put you back to sleep again.

For church collections, the Oakes Collection Box is ideal. A red light flashes for a penny; nickels and dimes are not marked. A quarter produces a green light and the sound of chimes heralds a dollar bill. A button brings a pistol shot.

There are many other goofy gadgets that have come out of the home workshop of Russell E. Oakes, the wizard of Waukesha. And there are more to come, for he always finds time to return to his hobby.

Sculpture for Fun

(Continued from page 141)

you are finishing the surface, your finger strokes on the clay should be crosswise of the muscles, Ott says. "That way, you get convex form instead of concave form."

Ears and eyes must have careful attention, but there are rules to guide you. The ear should be about the same length as the subject's nose. The eye lies halfway between levels of the chin and the top of the skull. Where a horizontal line from the eye intersects a vertical center line on the side of the head, the front of the ear starts its upward curve.

Form the bulging eyebrows by pressing rolls of clay into position. The nose starts out as a carrot-shaped roll of clay. Eye sockets you can create by pushing your thumbs into the clay; then place eyeballs in the sockets and press them down. Rolls of clay will make eyelids—one roll per lid.

Hair is represented in sculpture as a mass. Ott says his beginners worry about what to do in this regard. "They even take out pocket combs and comb the clay, trying to make hair," he says, "but that's not the way."

What to sculpture? "Be versatile," Ott tells his pupils. "It's more fun. In painting, in photography, you have color and two dimensions; in sculpture you have form—the third dimension. You are working with form and masses.

"Try a head—a hand—a foot. Try a

(Continued to page 248)

\$350 IN A SINGLE **WEEK** **GROSS**



IN
MY OWN
BUSINESS

Some Make More, Some Less . . .
Start This Business for **YOUR OWN**

George Held earned \$350 in one week
with

ELECTRIC UPHOLSTERY CLEANER

• Here's YOUR chance to start a money-making, year-round business of your own and make the success you've dreamed about. R. O. Donnelly took in \$40 in seven hours. O. W. Ware landed a \$750 hotel job and made a fine profit. J. S. Corbit grossed \$279.50 his first month. P. D. Ash cleaned 23 auto seats at \$5 each in one week. And so it goes. Homes, hotels, offices, clubs, all places where furniture is used, offer you big profit possibilities. Auto seats and interiors, also.

NO SHOP OR OFFICE NECESSARY

You clean furniture on customers' premises. No hauling costs. No high rents. Supplies are in-

FREE BOOK! MAIL COUPON

VON SCHRADER MFG. CO.
B71, Racine, Wisconsin

Send at once (no obligation) your FREE booklet containing information about your Electric Upholstery Cleaner and how I can own my own permanent, profitable business.

Name _____

Address _____

City _____ Zone _____ State _____

expensive and you operate, at low cost, from your home. What you take in is mostly profit. Surely YOU will want to investigate an opportunity like that—right away. Own your own business. Be your own boss. If you are ambitious, honest and courteous, we will help you to start and succeed.

FULL INFORMATION FREE MAIL COUPON TODAY

Send the coupon or write for Furniture Cleaner Booklet. It tells all about this electric cleaner—how to start YOUR business—how to make a profitable success. Don't delay. It's your BIG opportunity.



MAIL COUPON TO

VON SCHRADER MFG. CO., B71, RACINE, WIS.

FEELS RIGHT...WORKS RIGHT!

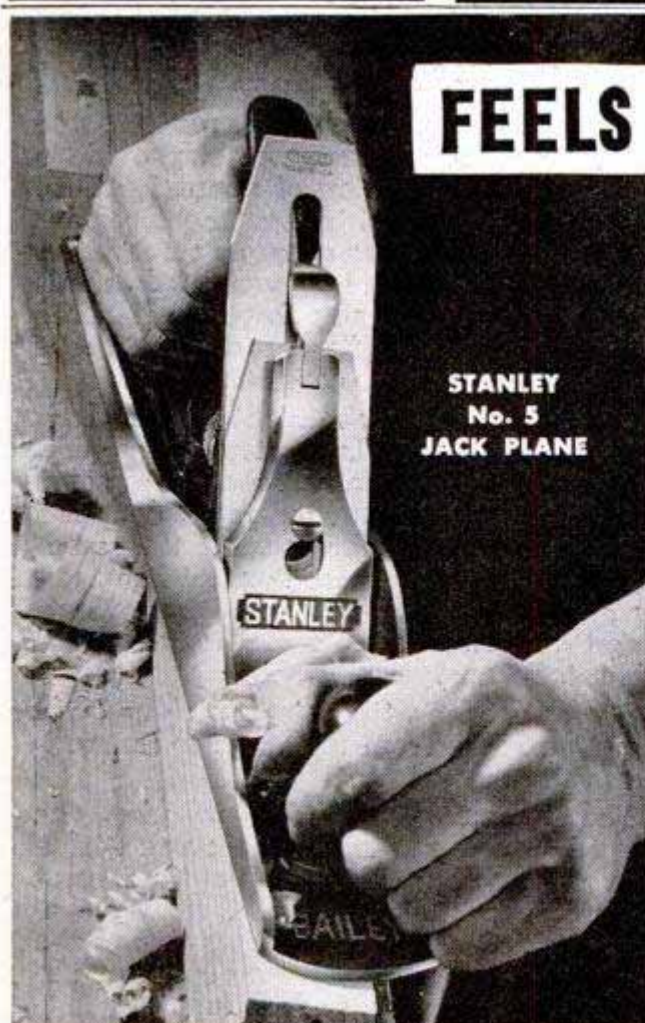

STANLEY
No. 5
JACK PLANE

The minute you grasp a Stanley Plane and ease the cutter into the wood, you feel the fitness of a fine tool . . . the skill of your hand and eye going right down to the face of the work. It's responsive! It's beautifully balanced! It's right in every detail, from the bevel of the cutter to the way the knob and handle fit into your hands. A lot more than good steel goes into a tool like that . . . the best ideas of generations of the best tool users. You can't get more than that in any tool: you always get a full measure of it in Stanley Tools.

Let this coupon bring you these two books

THE TOOL BOX OF THE WORLD

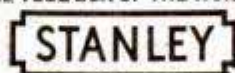

Reg. U.S. Pat. Off.

One is FREE! The other, the latest edition of a famous textbook for the home workshop, clothbound, fully illustrated, just \$1.00

— HARDWARE • HAND TOOLS • ELECTRIC TOOLS —

Stanley Tools, 1108 Elm St., New Britain, Conn.
Please send by return mail:

FREE booklet: "The Joy of Accomplishment". 188-page book: "How to Work with Tools and Wood". \$1.00 enclosed.
(In Canada: Send order to Stanley Tool Co. of Canada, Ltd., Roxton Pond, Quebec.)

Name _____

Address _____

City _____ State _____



**Tightens
blades by
lever action!**

MILLERS FALLS PRESENTS
Still another
NEW TOOL!

80th Anniversary
**No. 300 Hack Saw
Frame and Blade**
\$3.50
Slightly higher in the West

"Greatest thing that's happened to hack saws since they made 'em adjustable!" — that's what tool experts said when they previewed this new Millers Falls hack saw frame. They were talking about its *lever-action* that quickly tightens blades to right tension. And that's just one feature of this rugged "life-time" hack saw. Adjustable to take both 10" and 12" blades. Cutting edge can be set to face right or left, up or down. High-quality steel throughout. Finished in gleaming nickel-plate. Beautifully balanced. And take another look at that tough, resilient, gleaming red *molded* handle — it's rugged! Your hardware dealer has the No. 300 *now*. See it soon! Millers Falls Company, Greenfield, Massachusetts.

Celebrating 80 Years of Toolmaking

Millers Falls Tools

group of simple geometric forms—they are abstractions of other things. If the piece you are sculpturing won't come out right, start anew! Your second attempt will be faster, your third faster still!"

For an easy subject, choose a mature face with strong, prominent features. A man's face is easier to sculpture than a woman's. A baby's is most difficult of all.

The Laguna Beach sculptor, a distinguished man in his profession, is a firm believer in the value of sculpture in recreation and rehabilitation.

"Your hands—and a chunk of clay—and you can create something! You need no tools. You would be astonished what even children can do, in simple sculpturing. If you model, you are creating; and creative work builds your spirit."

Exploring the Ocean Bottom

(Continued from page 166)

ridge. By exploding small bombs underwater, they determine the thickness of the sediment overlying the rock bed of the ocean and by seismic refraction they determine the nature of the rock beneath the hundreds of feet of sediment.

The sediment on the ocean bottom accumulates at the rate of about one inch during each 2000 years, so attempts are being made to obtain 60-foot-long cores of the sediment for study. Fossilized remains of minute sea life give an indication of the climatic changes which took place in the ocean. Such long cores would provide a geological cross section of about 1,444,000 years of the earth's history. The cores are obtained at depths as great as three miles below the surface. A long weighted tube is lowered on a wire and allowed to fall free when nearing the bottom. It obtains a core much as a housewife cores an apple.

All of the ocean sediment obtained by the Atlantis during last summer's expedition was found to be radioactive to some degree, which is true of most deep-sea sediments. The specific cause of the radioactivity in this material has not been determined but the latest expedition will attempt to bring back more material for laboratory analysis.

A rock dredge with a steel-mesh bag will bring up rocks from the ridge to be studied in the laboratory.

The Atlantis is helping to map the rugged sunken mountain chain and with a deep-sea trawl will bring up specimens of the creatures that inhabit the murky bottom of the ocean. The scientists aboard the research ship are explorers of one of the world's last geographic frontiers.

IF YOUR CARPENTRY TURNS
OUT LIKE THIS...IT'S TIME TO
CHECK THE BLUEPRINTS ...

AND

IF YOUR CAR FEELS LIKE THIS...
IT'S TIME FOR MARFAK
CHASSIS LUBRICATION

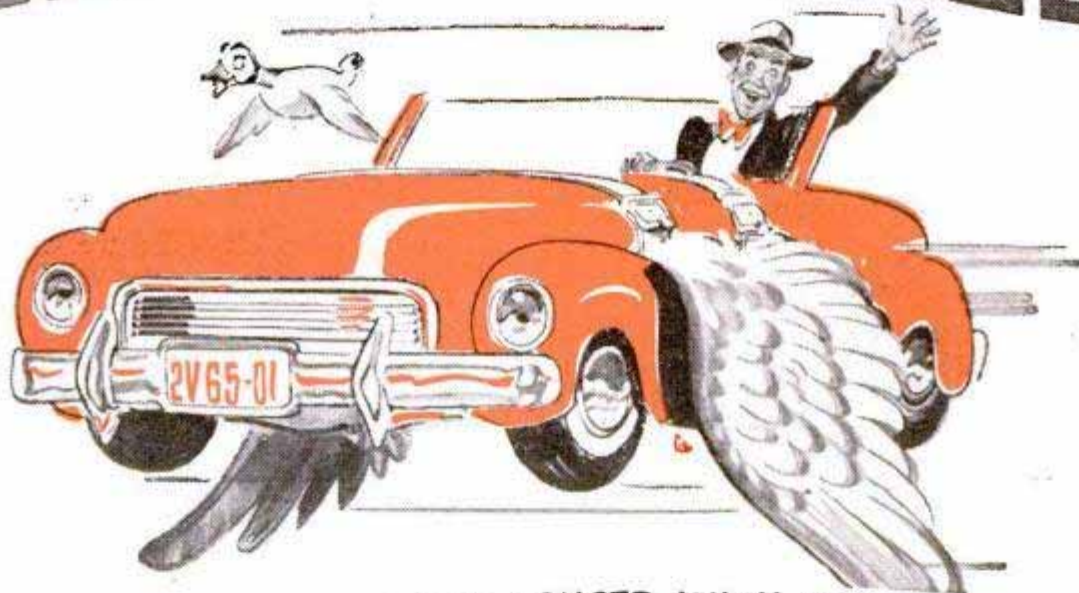
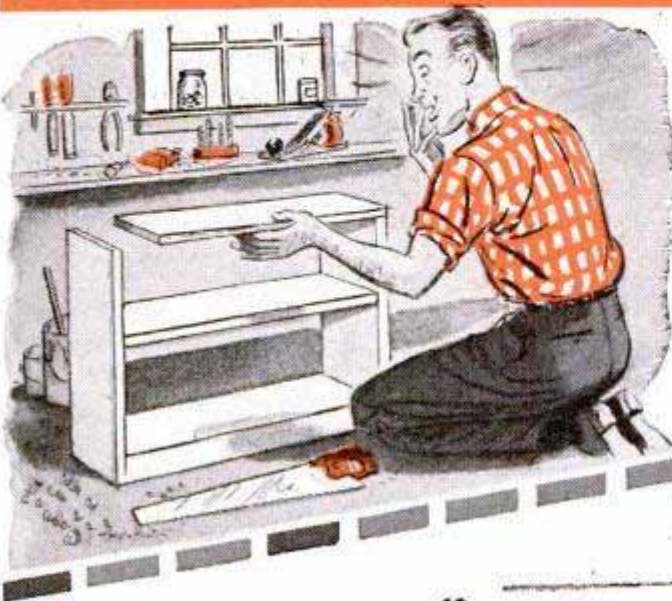

THAT CUSHIONY FEELING LASTS LONGER WITH MARFAK!

Marfak "sticks to the job," protecting costly bearings and wear points — not for just a hundred miles or so, but for 1,000 miles and more. Tough, longer-lasting *Marfak* is specially compounded to resist wash-out, squeeze-out, shock. You can feel this difference in a smoother "cushiony" ride and effortless handling. Ask for *Marfak* Lubrication today at your neighborhood Texaco Dealer, the best friend your car ever had.



THE TEXAS COMPANY
TEXACO DEALERS IN ALL 48 STATES

Texaco Products are also distributed in Canada

Tune in: TEXACO STAR THEATER every Wednesday night. See newspaper for time and station.

**INSTANTLY CONVERTS
LINEAR FEET
TO BOARD FEET**



**Solves many other
woodworking problems
in seconds**
only **10¢**

Easy to use. Fast . . . simply set dial of GREENLEE Handy Calculator to get measurements; slope per foot in degrees; comparative hardness, weights and workability of various woods; bit sizes; nail specifications; tool sharpening hints. 6" diameter heavy varnished cardboard. Special offer by maker of famous GREENLEE tools. Send 10¢ to Greenlee Tool Co., 2110 Columbia Avenue, Rockford, Illinois.



Gauges—the Guide to Perfection

(Continued from page 127)

rods of known diameter (photo 5) and the whole unit becomes an improvised snap gauge, limit gauge, plug gauge, or whatever is desired. A few moments later the component parts may be dismantled and assembled into something different.

The great difficulty in using a micrometer is it is often awkward to read in the measuring position. To overcome this, dial gauges (photo 6) were introduced. Here, the reading can be observed across a room. The dial in itself is valueless. It must be used with a surface plate or a fixture. It is first set up on the surface plate and calibrated with gauge blocks until the desired reading is zero on the scale. Then it is transferred to the work, in this photo a giant planer, dressing the ways of a surface-grinder casting. When set on a prepared base pad, the dial button rests on the way and shows at a glance how much in ten thousandths of an inch must still be removed before the job is down to limits.

Ingenuity of shop men knows no limits and the skilled machinist can improvise a measuring device at a moment's notice. Typical is the setup to measure a run of spur gears (photo 7) which is made out of a bench plate, two parallel beams, dial gauge and holding fixture. Calibrated with gauge blocks it does the work of a made-to-order instrument costing over a hundred dollars. A similar improvisation, a modification of the device used to measure the planer ways (photo 8), makes several measurements at once. It tells the height of bore above base line, diameter of bore and whether or not bore is parallel with base line. Work is placed on a surface plate.

Where large quantities of one item must be measured and inspected, it is economical to invest in specialized instruments such as the optical comparator (photo 9) where a silhouette image, greatly enlarged, is cast on a screen. On the screen is drawn an outline pattern of the part being inspected. The projected shadow should register with this outline. Initial adjustments are involved. As with the simpler instruments, gauge blocks are used to establish a working standard.

Speed is important in modern production and the fatigue factor of the operator is also taken into consideration. A versatile device which inspects as the operator inserts the pieces is the light-beam comparator (photo 10). It has a scale but no needle. A pin point of light does the indicating. This is the highest development of

(Continued to page 252)

AMERICAN FLYER

Developed at the GILBERT HALL OF SCIENCE

WATCH 'EM PUFF SMOKE!
HEAR 'EM CHOO-CHOO

Only American Flyer has real smoke and realistic "choo-choo" sounds synchronized with train speed. The faster your train goes, the heavier are the puffs of smoke . . . the louder and faster the "choo-choos."

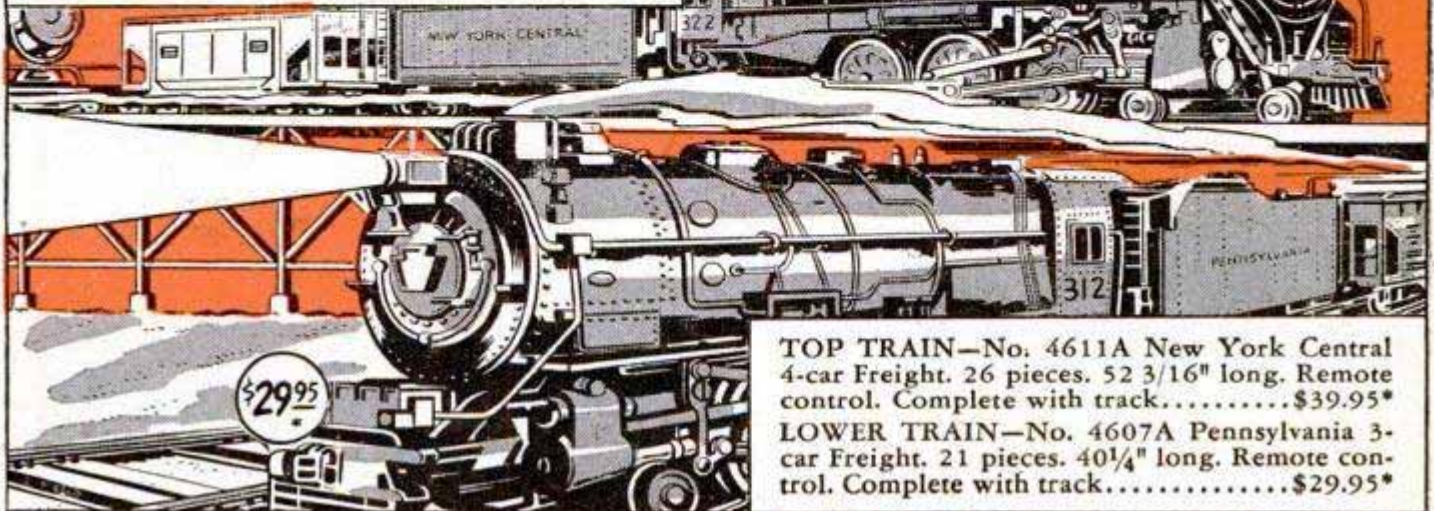

\$39.95

\$29.95

TOP TRAIN—No. 4611A New York Central 4-car Freight. 26 pieces. 52 3/16" long. Remote control. Complete with track.....\$39.95*
LOWER TRAIN—No. 4607A Pennsylvania 3-car Freight. 21 pieces. 40 1/4" long. Remote control. Complete with track.....\$29.95*

NEW TALKING RAILROAD STATION



HISS-SSS

WHO-O-O
...WHO-O-O

NEW YORK-
PHILADELPHIA-
CHICAGO-AND
ALL POINTS
WEST!

ALL ABOARD

\$14.95

CHUG-CHUG

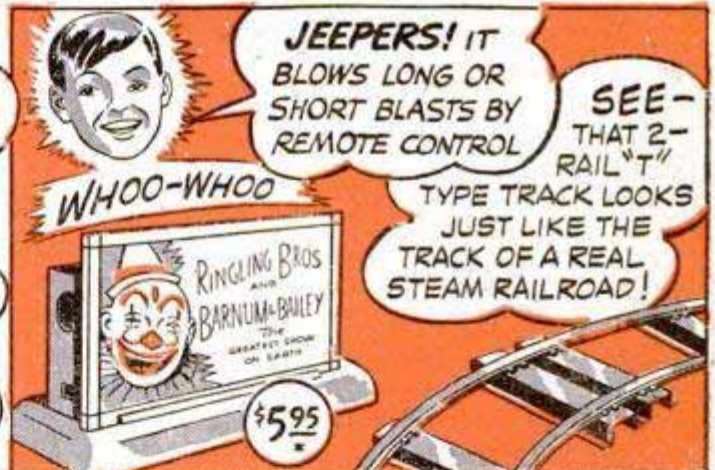

JEEPERS! IT
BLOWS LONG OR
SHORT BLASTS BY
REMOTE CONTROL

SEE-
THAT 2-
RAIL^T^

WHOO-WHOO

TYPE TRACK LOOKS
JUST LIKE THE
TRACK OF A REAL
STEAM RAILROAD!

RINGLING BROS
AND
BARNUM-BAILEY
THE
GREATEST SHOW
ON EARTH

\$5.95

The new American Flyers bring you all the wonder and glory of railroading. They puff real smoke. They reproduce the "choo-choo" sounds of a real locomotive under full steam. Both smoke and "choo-choos" vary in intensity as you increase or decrease the speed of your train. Locomotives, tenders, cars and track are all built to uniform 3/16" scale, so that your train looks like real—hugs the track like real. And a two-loop track layout takes space only 6 feet square. Cars have automatic couplers that couple anywhere. Uncouple by remote control. Die-cast locomotives have superpower worm drive for smooth, steady pull at all speeds from a crawl to 120 scale miles per hour. See and hear the sensational American Flyers at your nearest toy or department store.

*Denver and west, prices slightly higher

HURRY!
SEND FOR YOURS

COLLOSSAL TRAIN BOOK. 32 big pages with color illustrations of American Flyer trains, automatic log loader, coal loader and other sensational equipment. Mail coupon with 10¢, Gilbert Hall of Science, 41 Erector Square, New Haven, Conn. I enclose 10¢. Rush colossal train book.

Name.....
Street.....
City..... State.....
(This offer good only in U. S. A.)

WHEN IN NEW YORK, VISIT THE GILBERT HALL OF SCIENCE. FIFTH AVE. AND 25TH ST. ADMISSION FREE!

For Cabinet Finishing

use **PLASTIC WOOD**

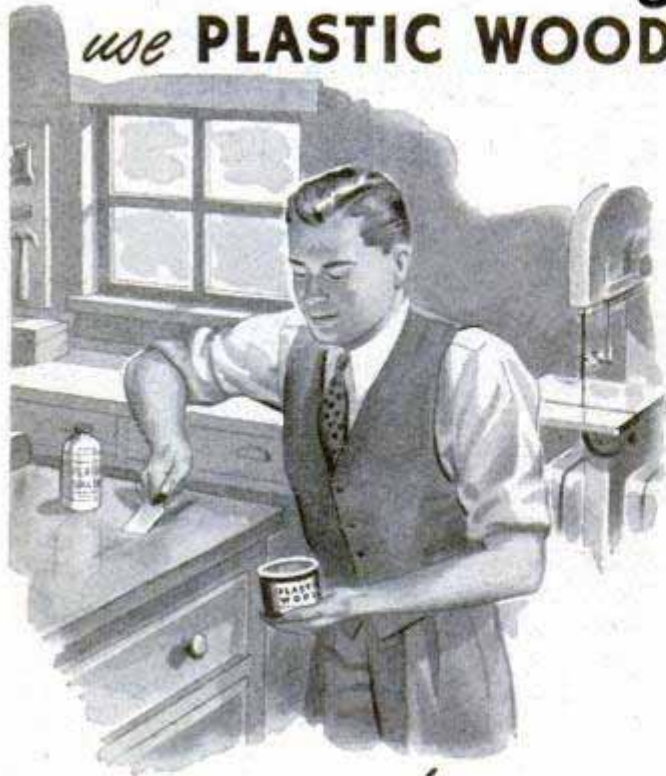

in your
HOME WORKSHOP!

If you'd like a satiny smooth, professional finish on your next cabinet job—use Plastic Wood! It's an ideal filler for cracks or rough grains, dries tight and hard, sands to a swell finish and takes paint, lacquer or varnish perfectly. Here's an extra hint—knot holes or gouges just disappear when this handiest filler is used! *Handles like putty—hardens into wood!*

... dozens of other uses

FOR FILLING . . .

- Countersunk screws
- Chipped furniture
- Nail and screw holes

FOR REPAIRING . . .

- Loose casters
- Broken balusters
- Broken furniture

- *You'll want Plastic Wood SOLVENT, too.* Get both at one time. It is made especially to control the consistency of Plastic Wood . . . useful also in removing dried Plastic Wood from tools and fingers.

T. M. Reg. U. S. Pat. Off.

At all Hardware,
Paint and 10c Stores

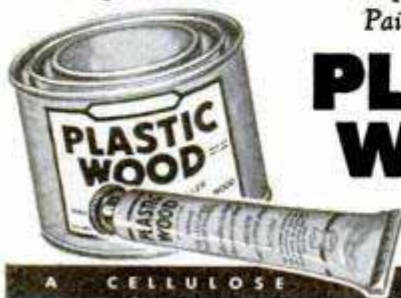

PLASTIC WOOD

Tube or Can

A CELLULOSE FIBRE FILLER

the mechanical measuring devices. It is a far cry from the ancient and honorable caliper, but is still only half way up the scale of precision measuring devices.

The electromagnetic comparator (photo 11) works on the same principle as a phonograph pickup. Pressure on a plunger causes a needle to move. It is extremely sensitive and can be used on tin foil, wire gauze and other materials which would be crushed by less gentle methods. In its conventional form it resembles the light-beam comparator, but it can be used in any position and for just about any measuring purpose. The model illustrated shows a device for checking the squareness and top and bottom diameters of a master gauge.

From here, measuring devices take a leap which staggers the imagination. High-frequency electronics are used to measure to one millionth of an inch at a speed of 10,000 measurements per hour. That is faster than the most skilled operator can feed. Parts are merely dumped in a hopper. The machine runs itself.

This electronic segregator, as the machine is called, does what has never been done before. It takes a complete run of screw-machine products, ball bearings, spark-plug insulators, sheet-metal stampings, thrust plates and kindred items and gives them a complete inspection, sorting the good from the bad, oversize from undersize, or even classifying into five or more size groups, and it does it as fast as the automatic machines can turn them out, sometimes faster.

Earlier methods of quality control depended largely upon spot checking a run and trusting to luck that no bad ones got through. That was good as long as the screw machines were in adjustment. Let a cam slip, and a thousand or more bad parts would be delivered before anyone discovered the trouble. Then either the whole lot had to be hand picked or junked, whichever was more expedient. Now, as fast as the parts are delivered they are degreased, fed into the hopper of the segregator and what comes out is already sorted, classified and counted. Let more than a dozen rejects drop through in succession and a bell rings, stopping the whole works so the trouble can be investigated.

The simple segregator consists of a high-frequency oscillator operating on 30 megacycles, driving a balanced bridge circuit. In one leg of the bridge is a variable condenser, which is the measuring head, and in the other a bank of thyratrons which control the distributing mechanism. As a piece of work is fed in, it unbalances the

(Continued to page 256)

Snap-on
BLUE-POINT

Midget 1/4" Electric Drill

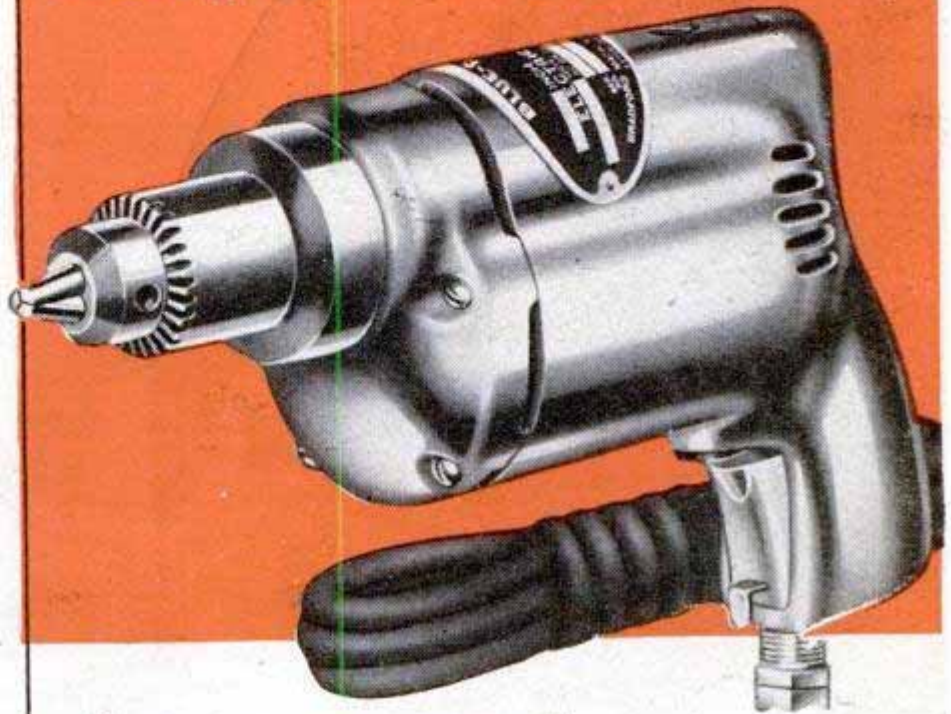

**gives you more speed...
more drilling power in close places!**

Here's a sturdy, dependable electric drill that packs a lot of power, yet is so compact that you can hold it in the palm of your hand. It's a great favorite with mechanics because it gives them drilling speed and power in close places... it gets in wherever your fist will fit. Comes complete with 1/4" Jacobs Chuck, key, and 15 feet of 3-conductor cable and plug. Mail the coupon for complete information.

SNAP-ON TOOLS CORPORATION

8062-J 28th AVENUE • KENOSHA, WISCONSIN
International Division: Kenosha, Wis., U. S. A.



CARBON BRUSH

Made of tightly twisted spirals of steel wire. Removes hard carbon deposits.



ARBOR ADAPTOR

Has 1/2" dia. arbor for use with brushes and grinding wheels up to 4" dia.



CIRCULAR HOLE SAWS

Has 1/4" pilot drill. Saw sizes range from 5/8" to 2". Shank fits 1/2" drill chuck.



CARBON BRUSH

Made of crimped bright music wire. Cleans carbon from cylinder heads and blocks.



WIRE CUP BRUSH

For use with disc Sanders. Fitted with

5/8" x 11-thread bushing. Removes scale, rust, etc.

Snap-on Tools
THE CHOICE OF BETTER MECHANICS



SNAP-ON TOOLS CORPORATION
8062-J 28th Ave., Kenosha, Wisconsin

Please send me more details about Electric Drill and accessories.

Name.....
Position.....
Company.....
Address.....
City..... (.....) State.....

"My Dad's smarter'n your Dad"



BETTY: He is not!

BILLY: He is too. How about that wrench your Dad bought last week? It's already broken—and today he had to borrow one from my Dad.

BETTY: What of it?

BILLY: Well, if he'd bought a *good* wrench, like the one *my* Dad has, it wouldn't be broken now.

BETTY: Oh, you think you're pretty smart, don't you?

BILLY: I'm not saying *I'm* smart, but my Dad is. He says people who buy tools at bargain counters are just throwing money away. He gets all his tools at the hardware store, and he always looks for the brand name before he buys. He wouldn't even pay *one penny* for a wrench like your Dad bought—because there's no brand name on it.

Your **HARDWARE DEALER** sells **QUALITY tools**
and hardware... Buy from HIM



POPULAR MECHANICS

*Before you put
in anti-freeze*

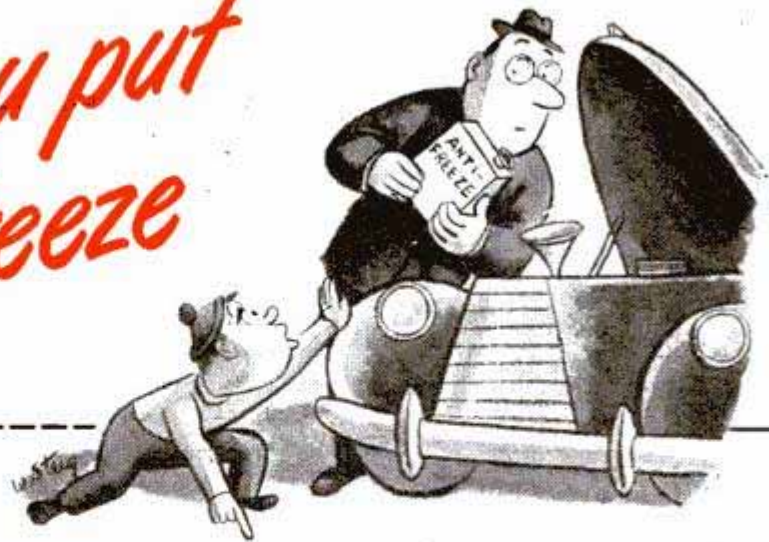

Clean out rust with

DU PONT Cooling System CLEANSER

Don't put anti-freeze into a rust-clogged radiator. Clean out the rust and scale *now* before winter sets in. Just pour a can of DU PONT COOLING SYSTEM CLEANSER into your radiator, run the engine 30 minutes or more, then drain. That's all! It cleans thoroughly without reverse flushing. It's safe, sure, dependable, and easy to use.



Then keep out rust with

DU PONT Acid and Rust INHIBITOR

After cleaning out the radiator, you can keep it free from rust all season by pouring in a can of DU PONT ACID AND RUST INHIBITOR. This neutralizes the acid and prevents damaging rust from forming.



Avoid leaks and loss of anti-freeze with

DU PONT Cooling System SEALER

You can stop leaks quickly and securely—and make the cooling system LEAK-PROOF—by pouring in DU PONT COOLING SYSTEM SEALER. It will not clog the radiator or harm hose or metal parts.



DU PONT

REG. U.S. PAT. OFF.

BETTER THINGS FOR BETTER LIVING
... THROUGH CHEMISTRY

circuit, actuating one of the thyratrons. This in turn opens a gate directing the piece into the proper chute. The operator pushes the pieces past the measuring head and forgets them. They drop down through a hole in the table and into tote trays suspended underneath.

Like the other devices, the segregator is calibrated with gauge blocks for the initial setup. When the runs come faster than a girl can feed by hand, the installation of a ram and hopper speeds things up (photo 12). An electric motor does the driving and the operator's sole responsibility is to keep the hopper filled. As with everything else, wear can destroy the accuracy of the instrument, so the inspector makes frequent checks, testing the gate-opening mechanism by means of gauge blocks. Wear has been reduced by using a diamond for a gauge tip and hard alloy steel for the anvil.

With the number of measuring, checking and inspecting devices now in use one can see the decided improvement in the past 10 years is no accident. It has resulted in other changes, too. The old all-around mechanic who could start right in with the raw forgings and end up with a Rolls Royce, singlehanded, is almost extinct. His work was superb, he used few, if any, measuring devices, handfitting each piece as he went. There are 70-year-old, hand-

fitted Corliss engines still running day and night. The old custom-made autos were laughed off the streets, but they still run. But times have changed. Today the demand is for quantity as well as top quality so machines do the work instead of men. To make all parts fit there is a standard and that standard is the gauge block.

Science Seeks New Means Of Reaching Absolute Zero

Scientists are constantly striving toward a temperature of absolute zero—the absence of all heat—and a newly suggested technique may enable them to cool a substance to within one-millionth of a degree of their goal. By electron demagnetization, temperatures have been reduced to four one-thousandths of a degree above absolute zero. A refinement of this process would demagnetize nuclei, the centers of the atoms, as well as the paths of the electrons. By studying substances at temperatures near absolute zero, scientists hope to solve the mysteries of atomic motion.

Developed in Kentucky, a new tobacco contains only two-tenths of one percent nicotine, which is about one-tenth that in burley tobacco.

You "PLATE" when you LUBRICATE WITH GRAPHITE!



Whether you apply a graphite powder, a graphite stick, a graphite grease or a graphite oil, an adequate amount of graphite becomes microscopically deposited or "PLATED" on the wearing surfaces!

This lubricating "plate" of graphite stubbornly resists the extremely destructive forces of friction, pressures, speeds, heat, cold and solvents that decompose or displace ordinary lubricants. You'll be amazed at how much

more *effectively* the plating action in *Graphite Lubrication* reduces wear, saves lubricant and labor.

There is a ready-to-apply GRAPHITE "PLATING" LUBRICANT for nearly every use in every home, industry, auto, boat, railroad, airplane etc. Illustrated here is one typical product of each of these *four types* of Dixon's Graphite Plating Lubricants stocked by the nation's supply houses.

DIXON'S GRAPHITES

JOSEPH DIXON CRUCIBLE COMPANY

JERSEY CITY 3, N. J.

DIVISION 26-KP-10

POWDER
Dixon's Graph-Air Gun,
Type 4 . . . 40¢



STICK
Dixon's Slipstick
20¢

GREASE
Dixon's Cup Grease
No. 3 . . . 60¢ 1 lb. can



**OIL—Dixon's
Lubricating &
Penetrating
Oil . . . 30¢**



MAILED FREE for the asking—this Data Sheet Directory shows what free descriptive printed matter is available on 20 Dixon Lubricating "Plating" Graphites.

Lever Uncouples Toy Rail Cars

Cars of a toy electric train are uncoupled merely by pressing down on levers behind and above the couplings. The train is made of plastic and is powered by four flashlight batteries. It can be started, stopped and reversed by a single remote-control switch.

Sanding Disk With Adhesive Back

There are no messy adhesive sticks or gluepots to worry about when you use sanding disks with an adhesive backing. You merely spread a little alcohol on the backing and apply the disk to the metal sanding plate. It can be used immediately and there are no high spots to cause uneven sanding. The disk is easily removed when necessary. For internal sanding, the abrasive material is cut into strips and wrapped around a steel rod.

Dog Vise Holds Small Parts in Lathe

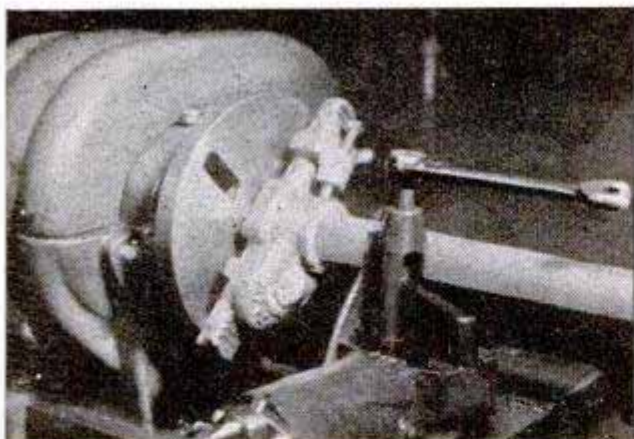

Small parts of almost any shape are held firmly for machining by a dog vise that can be mounted on a lathe or drill press. The tool has two independent adjustable jaws on a rack. It can be mounted on a 9 to 12-inch lathe with a No. 2 center, and has a stock capacity ranging from zero to three inches in diameter. The rack is equipped with pins to prevent the jaws from loosening. The tool also can be used as a vise to position parts for grinding and buffing.

"GRANDAD" KNOWS HIS FILES



He's been using them for years. And, as long as he can remember, they've been Nicholson or Black Diamond files*. For, like every other old-timer—and a good many young craftsmen, too—he takes pride in working with fine tools.

He knows, for example, that Nicholson and Black Diamond quality pays off in faster filing, better work, longer lasting service. What's more, he knows the importance of using exactly *The right file for the job*. That's why he keeps a good assortment of kinds, cuts and sizes. No telling what kind of fix-it-please job those kids will bring in next.

Your hardware dealer will be glad to help *you* make up an all-purpose set of Nicholson or Black Diamond files. See him about it!

**Nicholson has been making good files for three generations.*

Write for your free copy of "File Philosophy" — an interesting, 48-page book on the kinds, care and use of files.



NICHOLSON FILE CO.
22 Acorn St., Providence 1, R. I.
(In Canada, Port Hope, Ont.)



NICHOLSON FILES FOR EVERY PURPOSE

SURE-FIRE

**FOR "STOP-AND-GO"
OR THE ALL-DAY GRIND**

There's a vital reason why the new AC Spark Plugs fire steadily whether your engine is cold or hot, whether it's working hard or loafing.

That reason is AC's patented insulator. *

In heavy traffic and cross-country driving alike, you'll find these plugs outstanding in performance and reliability. Ask your AC Spark Plug Service Dealer about them.

LOOK FOR THIS SIGN



* AC's patented processes make this the finest insulator in spark plug history. Improved electrical insulation, no matter how high the temperature. Better heat conduction. Maximum resistance to heat shock. Less fouling. Harder, stronger, longer-lived.



Spark Plugs
AC SPARK PLUG DIVISION • GENERAL MOTORS CORPORATION

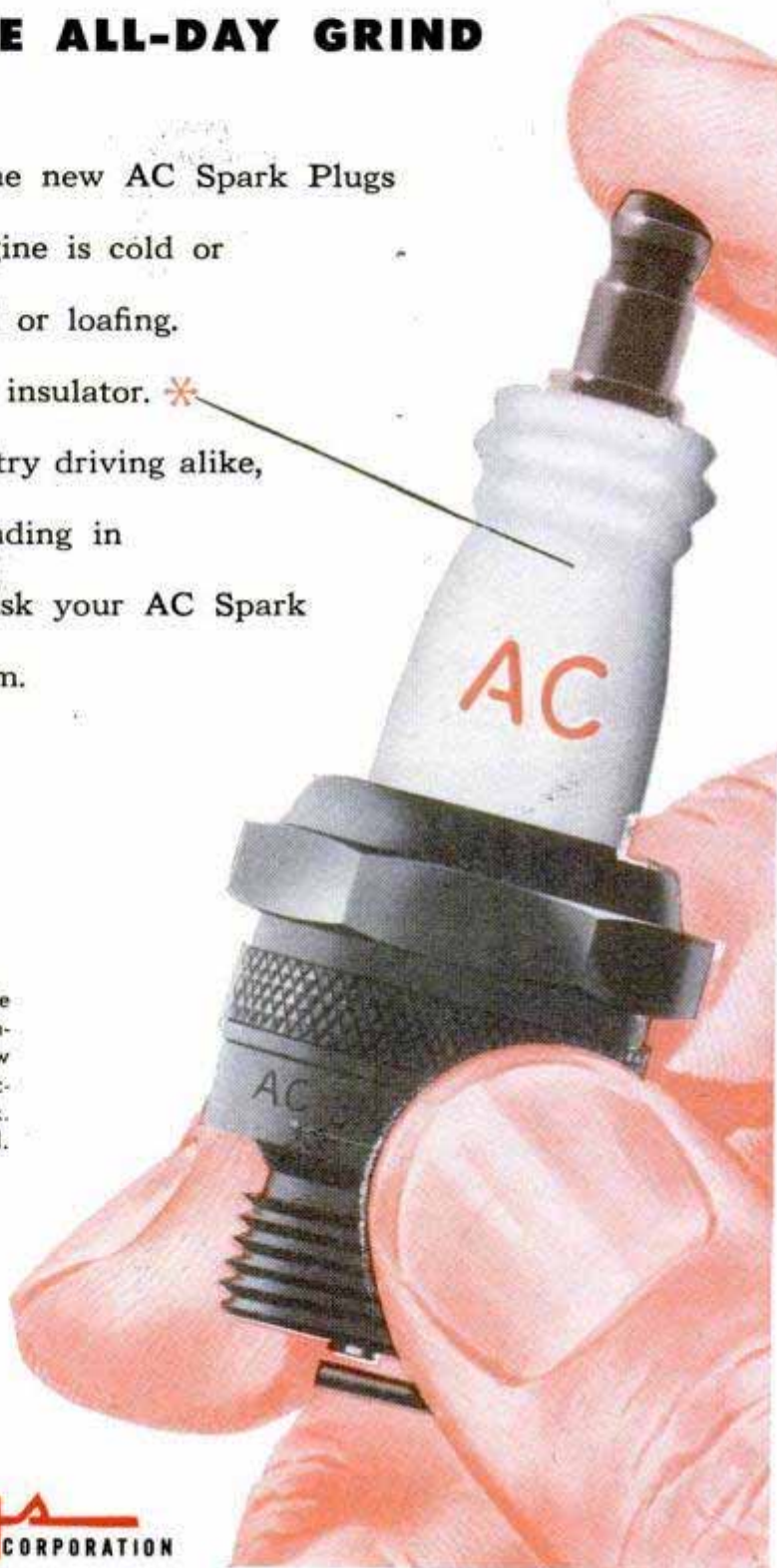

Exterior painting requires PLANNING



Measure surface accurately and estimate amount of paint needed by using average coverage figures of the paint being used. (Eagle RTU White Lead Paint covers 600 to 700 square feet per gallon, depending on condition of surface.)



For best results, paint in dry weather, with temperatures above 40°F. If you must paint on cooler days, start later, after moisture on walls has dried. If possible, allow three days between coats for drying.



Select brushes carefully. Buy brushes with soft, flexible bristles. (Four inches wide for walls, two inches wide for trimming.) A quality brush may cost slightly more, but lasts longer and lets you do a better job.



Use quality paint . . . it's more economical in the long run. Eagle RTU is pure White Lead Paint that's all ready-to-use. You just open, stir and apply . . . it brushes on evenly and easily, is most satisfactory to use.

EAGLE RTU makes EXTERIOR painting EASY

Yes, it's true. Now you can get famed, durable, beautiful white lead paint that's all ready to use. Eagle RTU is *pure* carbonate of white lead, in *pure* linseed oil. It's carefully formulated and mixed for instant, easy use. Eagle RTU has the opacity, covering power and endurance qualities that only pure white lead paint gives—*plus* the convenience of being ready-mixed. It's made by the Eagle-Picher Company, makers of quality white lead since 1843. Two forms: Primer Sealer and Outside White Finish Coat. Quarts, one, two, and five gallon cans.



Since 1843

EAGLE-PICHER

CINCINNATI (1), OHIO

FREE

Hints on House Painting for Home-owners.

Eagle-Picher, Department PM108, Cincinnati (1), Ohio

FREE! Please send me a copy of your booklet "Helpful Hints on House Painting."

Name.....

Street..... Zone...

City.....

County..... State.....

Foremost!



**WITH MEN
WHO KNOW
FINE TOOLS**

To those who work with hand tools (artisans, farmers, mechanics), Plumb is their foremost choice.

One reason is that Plumb tools are perfectly balanced, not fatiguing or weighty. Another is that Plumb tools are made sturdier, they last longer. The specially selected materials, the special analysis steel in the one-piece head and the strong hickory handle, must pass many tests before the tool is finished.

But the foremost reason is that Plumb, for nearly 100 years, has taken extreme care in perfecting hand tools that do a better job faster. Fayette R. Plumb, Inc., Philadelphia 37, Pa.

*The red handle with the black head
—exclusively Plumb.*

Quality Comes FIRST
PLUMB
is FIRST in Quality

PLUMB

HAMMERS • HATCHETS • AXES • FILES



Space-Saving Desk and Stand

Designed as a space-saver, a combination chair and desk can be used as a telephone stand and for writing. It is over three feet high and 35 inches from front to back. The desk section is fluorescently lighted and has compartments for writing materials.

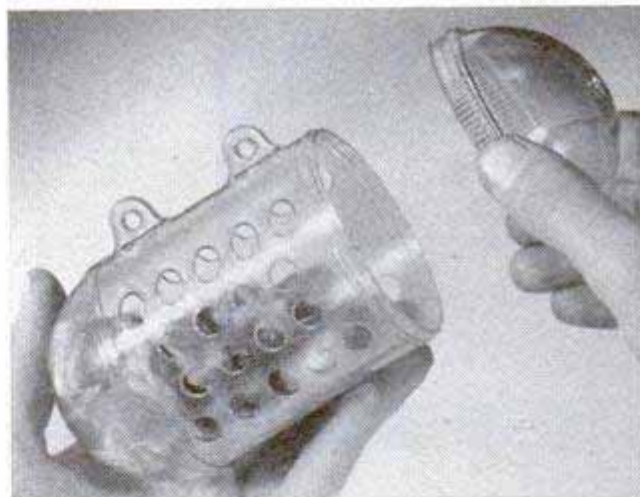

Plastic Bait Container Lures Crabs Into Trap

Transparent bait containers lure crabs into one-way traps, but keep the bait from being eaten by the shellfish. Made of Tenite plastic, the containers are perforated cylinders with rounded ends, one of which unscrews for inserting chopped clams or other bait. Perforations allow the scent and small bits of bait to escape, attracting the crabs. Bait can be inspected without removing the container from the trap.

5 TOOLS

for the price of one!



New PORTER-CABLE DISC GRINDER

Price
Only \$44.50

Grinds, polishes, sands, drills, cuts

Actually no other grinder of the same type compares with the new Porter-Cable Disc Grinder. No other grinder offers the same features. No other grinder is so rugged . . . or so versatile!

ONLY the Porter-Cable Disc Grinder has ALL these advantages!

1. The Porter-Cable Disc Grinder sands old and new woodwork . . . grinds down metals . . . operates on flat and curved surfaces . . . polishes your car, furniture, brass and other metals . . . drills . . . mixes paint . . . does 101 jobs in less time with less work . . . and with more profit.
2. The disc on the Porter-Cable Grinder is 6 inches in diameter . . . cuts 53% larger surface than ordinary machines. Grinds any material—wood, steel, plastic, glass.
3. Its rugged motor is twice as powerful—a reserve protection from overloading.

4. Shaft is extra heavy: $\frac{5}{8}$ inches diameter.
5. Chuck for drills, wire brushes, cut off discs and many other accessories.
6. Spindle has a high-load bearing to take the heavy stress and end-thrust of drilling and tough grinding.
7. Trigger-lock switch avoids fatigue.
8. Porter-Cable Disc Grinder stands up longer . . . holds sustained speed . . . lasts indefinitely.

Guaranteed for all time against imperfections in materials and workmanship

See the Porter-Cable Disc Grinder. Try it. Compare. And you'll agree that no other machine gives you as much for your money! At hardware, lumber and mill supply dealers everywhere. Nearest dealer's name furnished on request.

PORTER-CABLE
SAWS-SANDERS-GRINDERS

PORTER-CABLE

MACHINE CO.
PORTABLE ELECTRIC TOOLS
2050-10 N. Salina St.
Syracuse, N. Y.

EASIER SAWING 5 TO 10 TIMES FASTER PORTER-CABLE GUILD SAW

Weights only 6 $\frac{3}{4}$ lbs. for easy one-hand operation. Blade lowers and raises for cuts from scratch to 1 $\frac{1}{4}$ inches deep . . . tilts for bevels up to 45°. Does anything a hand-saw will do, and more! Price only \$49.50

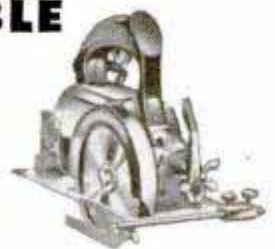

MAKERS OF INDUSTRIAL TOOLS FOR OVER 40 YEARS

YOU, TOO, CAN
MAKE BIG MONEY
 IN BUILDING
 INDUSTRY!

*Do it with
 American*



BE YOUR OWN BOSS!

Big profits for you — be a floor surfacing contractor and sand both new and old floors! Prospects everywhere — that's why hundreds of men make \$35 to \$50 a day in floor surfacing work with an American Floor Sander. Easy to operate — no big overhead — no large investment — no special schooling. Just be your own boss and get ahead! Send coupon for money-making booklet.

A **AMERICAN**
 FLOOR MACHINES

The American Floor Surfacing Machine Co.
 535 So. St. Clair St., Toledo 3, Ohio

Enclosed find 25c in stamps or coin for booklet "Opportunities in Floor Surfacing", telling me how I can start my own floor sanding business.

Name

Street

City..... State.....

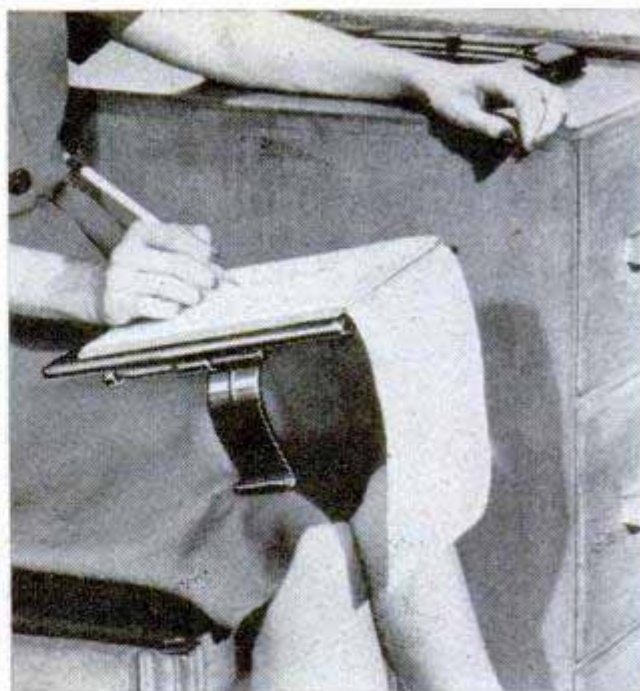

Notebook Holder Clamps to Leg

Clamped to the leg just above the knee in a convenient writing position, a notebook holder provides the stenographer with a firm "desk" during dictation. It has holders for carrying two extra pencils and also a built-in mirror. After the dictation is over, the device can be used to hold the copy during typing. The clamp can be adjusted to serve as a desk stand to hold the notebook at any desired angle.



Bank in a Juke Box

Your money plays a tune in a tiny bank built to look—and play—like a juke box. Made of an unbreakable, colorful plastic material, it has a transparent front window through which can be seen the tiny Swiss music box which plays a tune when a coin is inserted in the slot. The mechanism is wound by a key at the back. The bank holds coins from pennies to quarters.

Keep Brushes like New

BEFORE

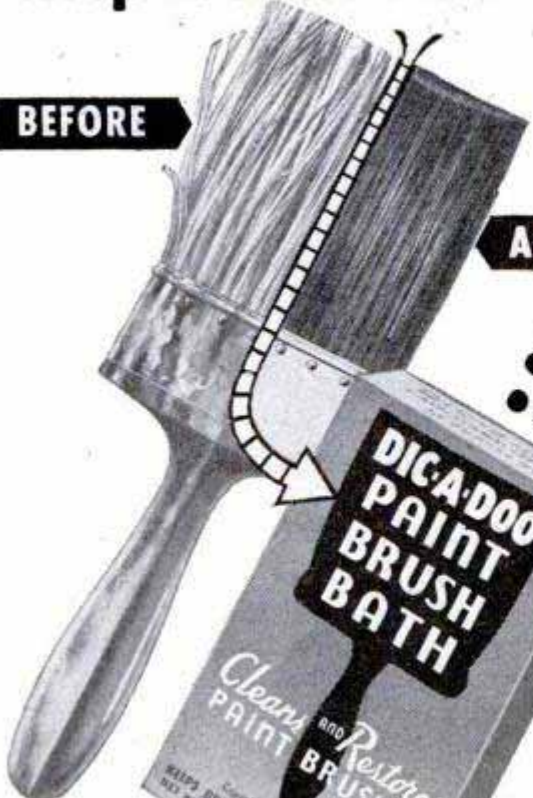

AFTER



• 5c
• 10c
• 25c

**DICA-DOO
PAINT
BRUSH
BATH**

*Clean and Restore
PAINT BRUSHES*

*Keeps Brushes Softer, Fuller
and Brighter*

At Paint, Hardware, Dept., and 5 & 10c Stores
Patent Cereals Co. Geneva, N. Y.

Complete New SUPER POWER TOOL KIT

**DURO Quality
POWER TOOL KIT**



Built by DURO

ONLY \$19.95

America's Greatest Power Tool Value!

Complete With Power Unit, 5 Accessories, Sturdy Case and Full Instructions

Hobbyists, home craftsmen—this is the power tool kit for you! Heavy duty DURO super power unit does cutting, grinding, polishing, engraving, carving and scores of other operations. Smooth, vibrationless in operation . . . this DURO power unit runs at 20,000 RPM—develops 42 watts output. Complete power tool kit contains the power unit with cord, 5 abrasive points and cutting burrs and full operating instructions—for only \$19.95.

FLEXIBLE SHAFT MEANS ADDED UTILITY!



New DURO flexible shaft with ball bearing hand piece makes engraving, free hand carving, sanding, easier, lots more fun. Double the utility of your DURO Super Power Tool Kit with this useful flexible shaft for only **\$13.95**

You can start with this LOW COST Power Tool Kit . . . and BUILD A COMPLETE HOME WORKSHOP

One DURO super power unit is used on all of these home workshop tools! You may buy them singly—or in a group.

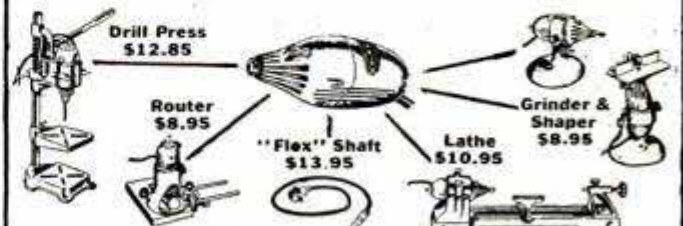

Drill Press \$12.85
Router \$8.95
"Flex" Shaft \$13.95
Lathe \$10.95
Grinder & Shaper \$8.95

WRITE FOR FREE CIRCULAR giving full details on the *Super Power Tool Kit* and the new, low cost home workshop units.

DURO METAL PRODUCTS CO.
2673 N. KILDARE AVE., CHICAGO 39, ILL.

WILL YOU SPEND 3 MONTHS . . . to BUILD A *New* BODY?

Will you work three months for a stronger, more handsome physique? If you have that much ambition, **PARAMOUNT BAR BELLS** are your sure, fast way to physical development. In no time at all you'll actually see your neck, chest, arms, shoulders and thighs growing to new, shapely proportions. Thru the use of Paramount Bar Bells you will be providing these sets of muscles with the right kind of resistance for fast development.



**WRITE FOR
Free ILLUSTRATED CATALOGUE**

**8.95
UP**

See **PARAMOUNT'S** complete catalogue of barbells, dumbbells and home gyms. You can save 20 to 30% on body building equipment. **ACT NOW! WRITE TODAY!**

FACTORY PRICES

INDEPENDENT IRON WORKS
2416 East 23rd St., Dept. 21, Los Angeles 11, California

NOW...SANDING IS FUN!



**Amazing
MOTO-SANDER
AND POLISHER**

Saves Time - Saves Elbow Grease!

Only \$14.85

POSTPAID

Here's an inexpensive Sander and Polisher so easy to handle that a child can use it. All you do is guide it! **Moto-Sander** delivers 7,200 strokes a minute... does a magically smooth job... gets into places other sanders can't reach. Has only two moving parts... never needs oiling or adjustment. Uses 110-120 volt, 60 cycle A.C. electric current. Has 8 ft. (Underwriters' Approved) rubber cord. Furnished with 6 sheets assorted grade Garnet paper for sanding, plus 1/8" thick felt pad and sheepskin pad for wax polishing.

FINE FINISHES - FAST!

Use **Moto-Sander** to get satin smooth sanded finish on woodwork, stairways, doors, furniture; ideal for finish sanding of boats, painted walls, bird houses or scale models. Use it also for speedy, effortless polishing of waxed furniture, automobiles and other surfaces, simply by removing sandpaper and clamping on polishing pad. **Moto-Sander** is the lightest, most practical electric sander on the market, and is patented.

MONEY-BACK GUARANTEE

See Dremel **Moto-Sander** at your dealer's. If he cannot supply you, use coupon below to order on 5-day trial, money-back guarantee. **Moto-Sander** will be sent complete and postpaid for \$14.85 (check or money order in full). Or, send only \$2 with order and pay postman balance plus postage upon C.O.D. delivery. Remember, **YOUR MONEY BACK** if not delighted after 5 days' trial.

DREMEL MFG. CO.

DEPT. SP118-K • RACINE, WIS.
MANUFACTURERS OF THE FAMOUS
MOTO-TOOL AND MOTO-SAW



EASY FOR
AWKWARD PLACES



SANDS FLAT
SURFACES EVENLY



GETS INTO
TIGHT CORNERS



ROUNDS CORNERS
LIKE MAGIC



GREAT FOR
AUTO POLISHING



Self-Powered Telephone System

Self-powered telephones with a range of 20 miles for ringing and talking are now offered for uses where industrial safety requires nonsparking sets or for isolated farm use where telephone service is unavailable. The set is all-plastic, and uses no batteries or other power source. It is designed especially for installation on oil tankers and barges, and in plants where there is an explosive hazard. A manually operated lever is provided for calling.



Gun Drives Heavy-Duty Staples

Broad staples are driven into hard as well as soft woods by an automatic stapling gun designed for installing electric wiring for telephone and intercommunication systems, television, alarm systems and similar installations. The broad-backed staple will hold single or double wire and hollow tubes to baseboards, plaster walls, door and window frames, the gun making it easy to drive staples in difficult places.

**IF YOUR DEALER CANNOT SUPPLY YOU
USE THIS COUPON TO ORDER**

DREMEL MFG. CO. • DEPT. SP118-K • RACINE, WIS.

- Enclosed find \$14.85 (Check or money order in full). Ship **Moto-Sander** at once Postpaid.
- Enclosed find \$2.00 as part payment on **Moto-Sander**. I will pay postman balance plus postage upon C.O.D. delivery.
- Please send Free Catalog of Dremel Tools and Equipment.

NAME _____
ADDRESS _____
CITY _____ ZONE _____ STATE _____



Moto-Tool

THE "POCKET-SIZE
MACHINE SHOP"



Great for
Hobbyists



For Sharpening
Tools

Grinds, Routs,
Drills, Carves,
Engraves, Cleans,
Polishes, Finishes.



MOTO-TOOL KIT No. 2
With 23 Accessories
(High-Speed Steel Cut-
ters, Grinding Wheels,
Polishing Accessories)
\$23.50



APPROX.
27,000 R.P.M.



Saves Time
and Labor



Indispensable
to Machinists

A SHOP TESTED TOOL

Moto-Tool is backed by over 12 years of industrial use . . . packs years of extra pleasure . . . yet, due to increased production, pre-war prices still prevail!

LOOK FOR THESE MOTO-TOOL FEATURES

Oil-less, sealed bearings • Patented automatic chuck lock pin • Oversize armature shaft: hardened, ground, polished • Shock-proof, bakelite housing • Dust filtered air cooling system • Dynamically balanced for vibrationless operation • Exclusive hanger hook • Weight only 13 oz.

New DRILL PRESS

ONLY **\$9.95**

(Less
Moto-Tool)

Only Dremel offers you a portable, precision drill press at such an amazingly low price. Just the thing for creating costume jewelry, model making, wood carving, routing, etc. Utilizes Model No. 2 Moto-Tool, which can be raised or lowered, swung in any direction, or quickly removed for off-hand use. Drill Press stands 12" high. Base is 6 3/4" x 4". Weighs approximately 3 1/2 pounds.



MONEY-BACK GUARANTEE

Buy Dremel Tools from your dealer. If he cannot supply you, use coupon below to order desired items on 5-day trial, money-back guarantee. Items checked will be sent complete and postpaid for check or money order in full. Or, send only \$2 with order, and pay postman balance plus postage upon C.O.D. delivery. Remember, YOUR MONEY BACK if not delighted after 5 days' trial.

DREMEL MFG. CO.

DEPT. T118-K • RACINE, WIS.

Here's
BIG VALUE!



MODEL No. 1
MOTO-TOOL KIT
ONLY **\$17.50**

This highly popular Kit contains lighter Model No. 1 Moto-Tool and 34 practical accessories in attractive, lacquer-finish wood box. It's the biggest bargain in the field.

MOTO-SAW

THE AMAZING ELECTRIC SCROLL SAW

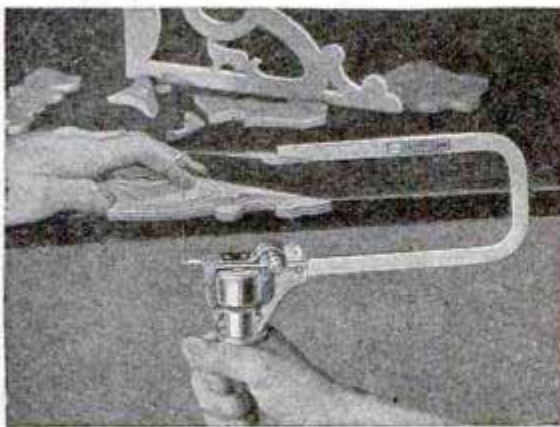

This electric coping saw works like magic! Easily cuts intricate scroll designs in medium-hard wood up to 3/4" thick. Runs 7,200 strokes a minute . . . just guide it! Has only two moving parts . . . never needs oiling. Operates on 110-120 volt, 50 or 60 cycle A.C. electric current. As safe as a handsaw . . . thousands of satisfied users. Comes complete with 3 saw blades, at only... **\$5.85**

USE THIS COUPON TO ORDER

IF YOUR DEALER CANNOT SUPPLY YOU WITH DREMEL TOOLS

DREMEL MFG. CO., Dept. T118-K • RACINE, WISCONSIN

- Enclosed find \$_____ (Check or money order in full). Ship items checked below at once Postpaid.
- Enclosed find \$2.00 as part payment on items checked. I will pay postman balance plus postage upon C.O.D. delivery.
- Moto-Tool Kit No. 2, \$23.50 Moto-Saw, with 3 blades, \$5.85
- Moto-Tool Kit No. 1, \$17.50 _____dozen blades (60c per doz.)
- Drill Press (Less Moto-Tool), \$9.95 Free catalog of Dremel Tools and Equip.

NAME _____ ADDRESS _____

CITY _____ ZONE _____ STATE _____

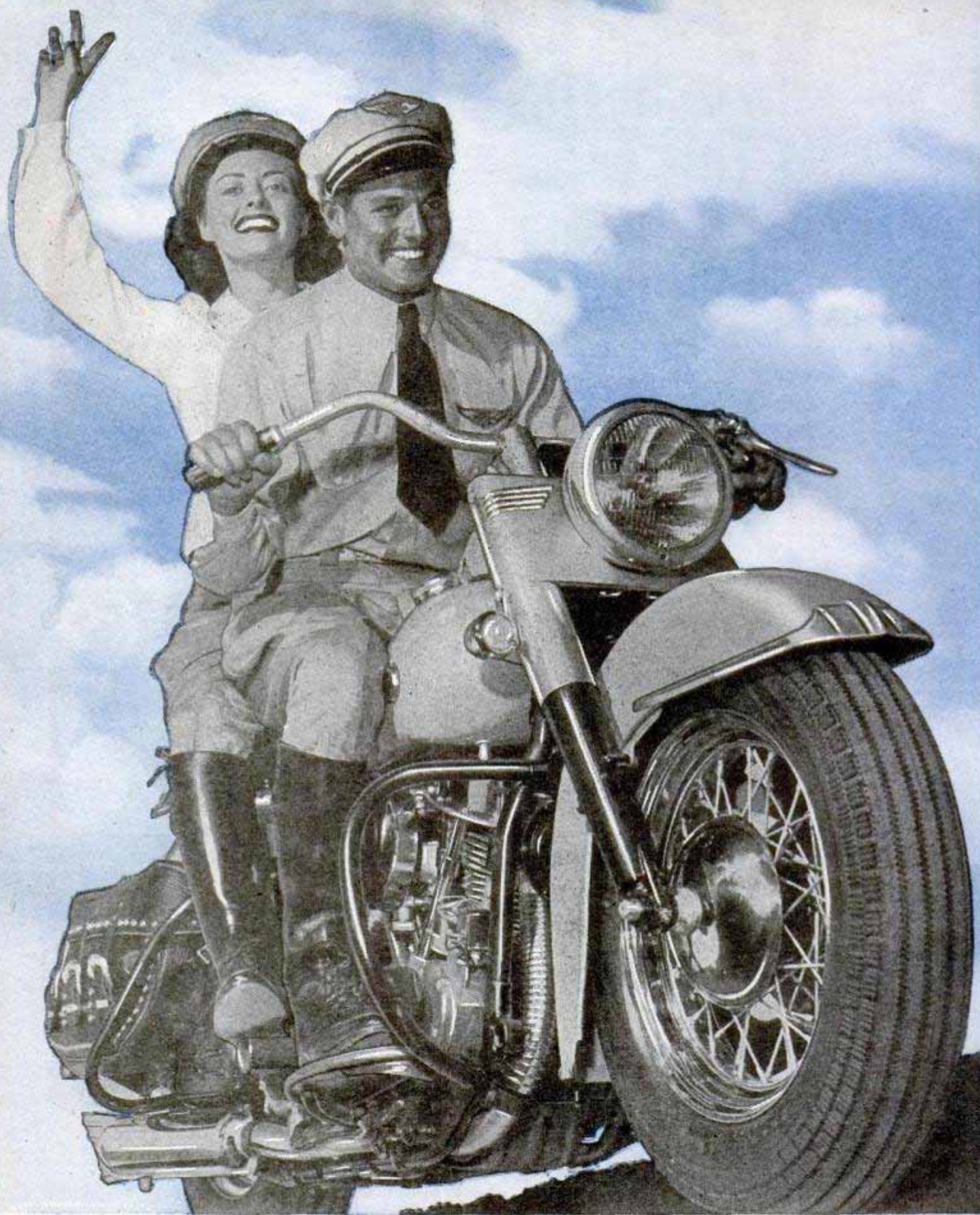

NEW "flight-smooth" comfort that irons out bumps like magic!

NEW "road-hug" stability that makes handling easy and sure!

NEW "sure-grip" steering that gives positive control at all speeds!

NEW "feather-touch" braking that provides stopping power to spare!

NEW "speed look" that makes people stop, look and envy!

NEW unmatched performance for greatest fun and thrills!

HARLEY-DAVIDSON ••• WORLD'S CHAMPION MOTORCYCLE

1949 HARLEY-DAVIDSON

with the new

HYDRA-GLIDE FORK!

HERE'S *your* motorcycle . . . with all the comfort and performance features you ever dreamed of . . . with the sleek, trim, modernly beautiful lines that catch the eye of the girl friend . . . the power, stability and handling ease for which Harley-Davidson Motorcycles have always been famed!

The 1949 Harley-Davidson is sensationally advanced! New Hydra-Glide Fork brings you unheard-of comfort on roughest roads, "road-hugging" control, effortless steering ease. Bigger, faster-action brakes give you increased stopping power. Sealed ray headlight turns night into day. Air flow fenders give you protection in any kind of going. Many other features add to your comfort and pleasure . . . take you into a new world of motorcycling performance, thrills and fun. It's the kind of motorcycle only the finest engineering and most modern production methods can produce. Here it is . . . greatest of a long line of great Harley-Davidsons. *Your* motorcycle! See your dealer today and take a ride.

HARLEY-DAVIDSON MOTOR CO., Dept. P, Milwaukee 1, Wis.

NEW AIR FLOW FENDERS
for streamlined beauty!

NEW SEALED RAY HEADLIGHT
turns night into day!

NEW HYDRA-GLIDE FORK
stops shocks before they reach rider!

NEW, POWERFUL, FRONT BRAKE
takes hold at a touch!

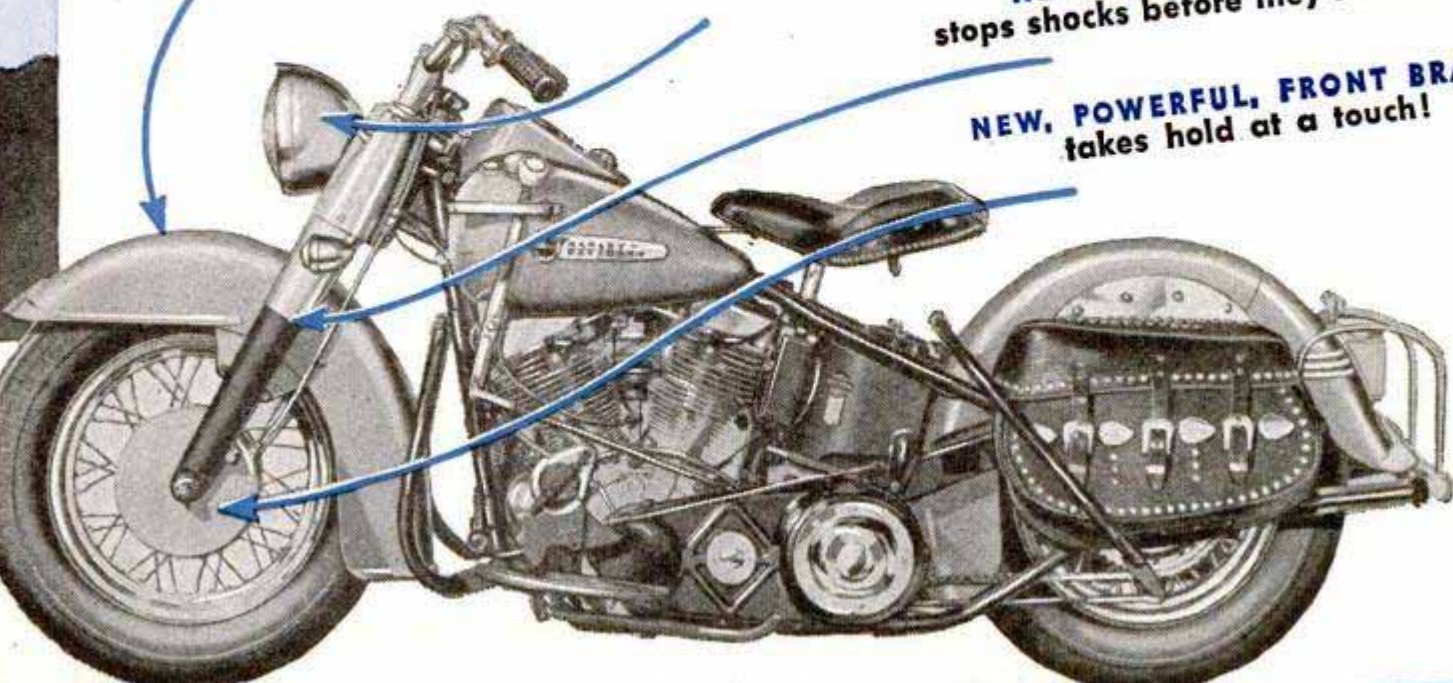

America's Most Useful* Hobby Tools

*Each of these high quality tools can be quickly and easily converted to a number of other handy tools by simply interchanging attachments.



Preferred by Master Craftsmen
MODEL 60 2" CAPACITY

Mall Saw
REG. U.S. PAT. OFF.

\$54⁹⁵

In U. S. A.
Saw Only

Cross Cutting
Lumber



CUTS EVERYTHING FROM WOOD TO STEEL

Used as a hand saw, the Model 60 Mall Saw cuts all kinds of materials, grooves mortar joints, scores tile and other compositions. When set in its sturdy, all-metal table stand, it serves as a table saw—complete with rip fence and miter guide. Other available attachments equip it as a shaper, sander, grinder or wire brush.



Cutting
Concrete

\$32⁵⁰

In U. S. A.
Table Only



As a Table Saw

\$22⁵⁰

In U. S. A.
Drill Only



AS A DRILL PRESS

\$17⁵⁰

In U. S. A.
Stand Only



1/4" HOBBYIST

Mall Drill
MULTI-TOOL

**EASILY CONVERTED
TO 10 OTHER TOOLS**

Takes the work out of drilling in wood, metal or plastics, sanding, wire brushing, grinding, rotary filing, sawing wood or metal, countersinking, shearing metal and hole sawing. Special stand converts it to a drill press. A 1/2" Model is also available.



Sanding

See Classified Telephone Directory for dealer nearest you.
FREE Booklet "Mall Portable Power Tools" mailed upon request.
Write TODAY.

MALL TOOL COMPANY

7805 South Chicago Avenue Chicago 19, Illinois

School for Fishermen

(Continued from page 119)

minnows and some plugs are excellent for walleyes and may snare bass or northern pike. Bass often prefer surface lures that make a splash, but may strike at spinners. The popular live frog on a weedless hook cast in shallow water is hard to beat in early summer. Spinner combinations with pork strips and live minnows work well with most game fish.

Fly-fishing is an art in itself. Although flies will lure most game fish, they are most frequently used for trout, which is the wariest of all game fish and the hardest to fool.

Cork and feather lures on a fly rod will often catch surface-feeding crappies in the late evening. Outside of weed beds where the water drops deeper, grasshoppers on a snelled hook are irresistible to sunfish.

Fishing is mainly an attempt to fool the fish into thinking a lure is something to eat. If he's not hungry he won't bite. Fish also have perverse personalities and will ignore your most enticing lure. The largest fish in the lake may pass up your luscious minnow-spinner combination and proceed to take your small son's worm at the other end of the boat. Then you can use the time-worn excuse—just shrug and call it luck. For luck does play an important part in fishing. If it were not for the chance that you might catch the largest fish of your life, most of the thrill would be removed from angling.

"Forest" Moved by Air

Airplanes have moved an entire "forest" in a project to develop pine woodlands in Iceland. The country is without forests at present. Recently 65,000 two-year-old pine and fir trees, cultivated in Norway, were flown to Iceland, where they were planted. As a result of similar plantings in Norway years ago, the northern part of that country has large areas covered by valuable forests.

ANSWERS TO CAR QUIZ

- | | |
|---------------------------------------|---------------------------|
| 1. Cadillac | 11. Crosley Station Sedan |
| 2. Oldsmobile | 12. Chrysler |
| 3. Nash | 13. Chevrolet |
| 4. Buick | 14. Studebaker |
| 5. Dodge | 15. Packard |
| 6. Plymouth | 16. Lincoln |
| 7. Willys-Overland Jeep Station Sedan | 17. Hudson |
| 8. Frazer | 18. Mercury |
| 9. Kaiser | 19. Pontiac |
| 10. Davis | 20. Ford |



INCH BY INCH... MILE AFTER MILE

It's PLYMOUTH for Roomy, Pillowed Riding Ease

The big, roomy Plymouth won't knock your hat off. And even for the lanky, there's legroom to spare.

This low-priced car is engineered to give you extra inches where inches do the most good. But Plymouth's great ride comes from more than space to move around in. It's an *Air-Pillow Ride*—comfort built into mile after mile.

Seats are chair-height—so a man can sit up like a man. And you literally ride on air when you ride on Airfoam Seat Cushions, available on

Special De Luxe Plymouths at moderate additional cost. Millions of tiny air pillows give to your slightest body pressure, mold themselves to you for restful support.

You ride *between* the axles, not over them. That's a comfort difference. Bigger, fatter Super-Cushion Tires, standard equipment on Plymouth, soak

up road shocks from sides and below. The longest wheelbase in its price field makes for a still more level ride.

These are only a few of the dozen and more Plymouth features that speak up for a great ride—and a great car. There is a difference in low-priced cars, and Plymouth makes the difference.



PLYMOUTH BUILDS GREAT CARS . . . GOOD SERVICE KEEPS THEM GREAT. Your nearby Plymouth dealer will provide the service and factory-engineered parts to keep your present car in good condition while you're waiting for your new Plymouth. PLYMOUTH Division of CHRYSLER CORPORATION, Detroit 31, Michigan

enjoy a pouchful
of fresh tobacco

Rogers
Air-tite®

the finest in
tobacco pouches

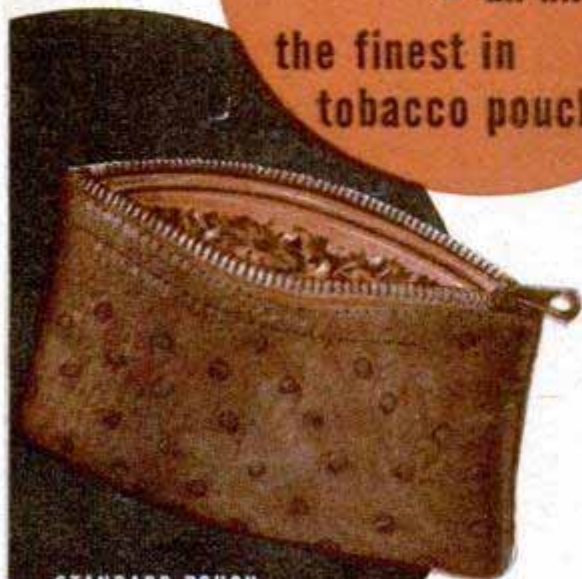

STANDARD POUCH

Holds generous supply
of tobacco. Choice of
leathers. \$1.50 to \$15



COMBINATION POUCH

Holds pipe as well as tobacco.
Choice of leathers . . . \$2.50 to \$20
ROGERS RARITY PIPE \$5

The Rogers Air-tite® with its patented inner pouch of moulded, seamless rubber, protects freshness and flavor. Exquisitely made of fine leathers in a variety of models, by Rogers craftsmen. The largest-selling tobacco pouch made. At better shops everywhere.

● **Rogers imports, inc.**

419 Fourth Avenue, New York 16, N. Y.
manufacturers and importers of the finest smokers' accessories
EXCLUSIVE U. S. DISTRIBUTOR, PETERSON'S PIPES, DUBLIN, LONDON
Rogers Air-tite Pouches in Canada—G. T. Lanning Ltd., Toronto

*TRADE MARK REGISTERED U. S. PAT. NO. 1,801,192. CAN. PAT. NO. 374,167



**Colored Slides Projected on Screen
To Illustrate Children's Records**

Synchronized with a story being told by a children's record, colored slides are projected on a translucent screen built into the record player. There are 17 pictures on the strip and they are changed every 11 seconds by means of a cardboard guide that tracks with the needle. A projector head, mounted at one corner of the phonograph, flashes the slide on the screen by means of a lens and mirrors. Popular story records have been illustrated on strips for use with the instrument.

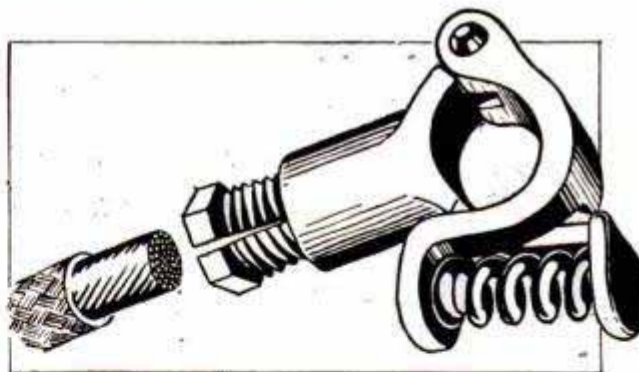

Boltless Battery-Cable Terminal

Battery-cable terminals slip on and off without sticking when they are of a new spring-clamp type that has no troublesome tightening bolt. Two sections of the aluminum terminal are held tightly around the battery post by a 122-pound-pressure steel spring, cadmium plated to resist corrosion. To connect or disconnect the terminal, you merely compress the spring with pliers, loosening it from the post.

☐ To keep it from being flooded, the average anthracite mine pumps out approximately 13 tons of water for every ton of coal that is mined.

CHOOSE YOUR FUTURE!

Select the kind of technical training YOU want... earn GOOD PAY WHILE YOU LEARN

As you may know, the more than 60 courses offered by the U. S. Army Technical Schools are rated among the finest in the world. And now you can choose the kind of technical training you want—before you enlist.

Here's how it works. You select two of the several fields of interest. Then you pick two specialty courses in each of these fields. The Army checks to make sure there's an opening in one of the four courses you have selected, and a place is reserved for you. Then you en-

list, complete basic training, and attend the course you have selected.

You start drawing pay the day you enlist. And in today's expanding Army, there's plenty of room for rapid advancement. You can get ahead *fast!*

If you've graduated from high school and are 18 to 34 (17 with parents' permission), here's the greatest educational opportunity you could hope to find! Begin your career now... while you can choose your future! See your Recruiting Station... today!

Here are only SOME of the COURSES AVAILABLE!

MECHANICAL

Automotive Mechanic
Medical Equipment Mechanic
Locomotive Repairman
Construction Equipment Mechanic
Refrigeration Mechanic

Office Machine Service Man
Marine Engine Mechanic
Track Vehicle Mechanic

CONSTRUCTION

Electrician
Water Supply Technician
Construction Machine Operator
Boilermaker
Ship Carpenter

CRAFTS

Sheet-metal Worker
Leather and Canvas Worker
Tire Rebuilder
Tailor Shoe Repairman

ELECTRICAL and RADIO

Cable Splicer
Telephone and Telegraph Installer Repairman

Telephone Central Office Repairman
Automatic Telephone System Maintenance Man
Power Generator Man
Teletype Repairman

SCIENTIFIC—MEDICAL—TECHNICAL

Surgical Technician
Medical Technician

Medical Aid Man
Map Reproduction

PRECISION TOOL

Watch Repairman
Fire Control Instrument Repairman

MILITARY SCIENCE AND TACTICS

Athletic Instructor
Leadership Course

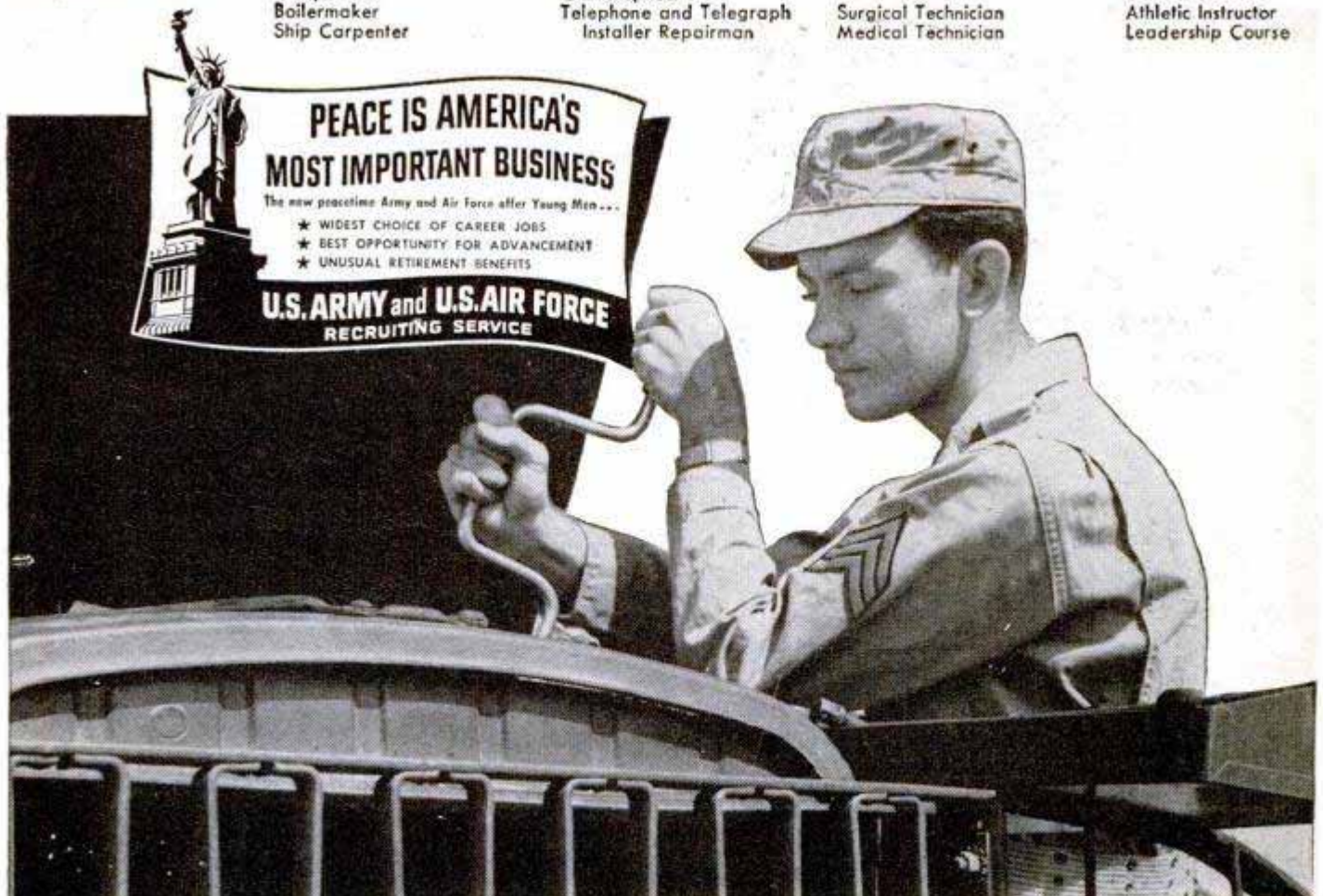

THE BULL BUFFER

PAT. PEND.

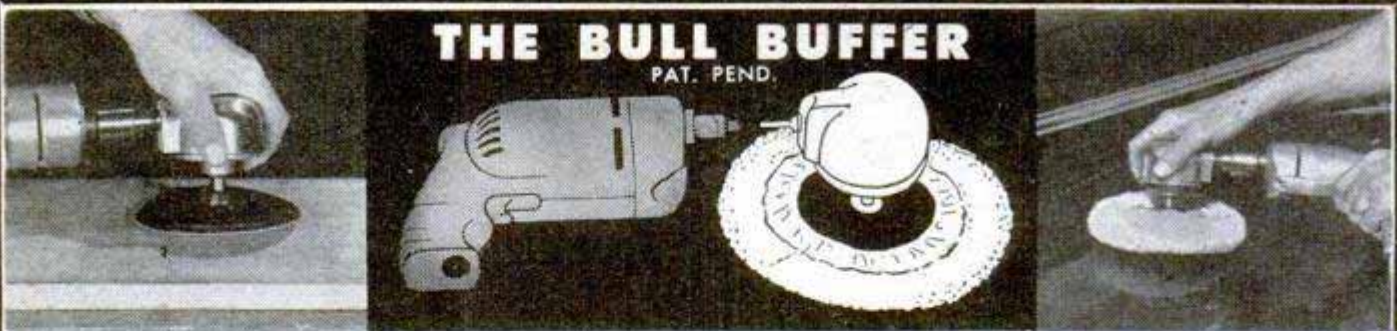

You polish and sand faster, easier—do beautiful, professional work—with this amazing new attachment for your hand drill. And it more than pays for itself the very first time you polish and sand your car, floors, woodwork, furniture. The Bull Buffer fits any chuck on an electric drill

(or flexible shaft). It's the only buffer you can turn in a complete circle while you hold your hand drill stationary. Reaches all curved and flat surfaces. It's packed with power, built of lifetime materials and guaranteed.

If your dealer doesn't stock, send cash, check, or money order for your Bull Buffer, complete as pictured below..... **\$9.95**

ORDER THESE ACCESSORIES FOR YOUR BULL BUFFER:



Cup wire brush attachment for removing paint, rust, scale, etc. **\$1.75**



Jacobs key chuck increases 1/4" drill to 1/2" capacity—reduces speed, increases power. **\$5.00**

- Bull Buffer car cleaner \$.50
- Bull Buffer car polish 1.00
- Extra sheepskin bonnet 1.25
- Extra sanding discs (000-00-0-1-2 1/2-3-4) .. .10
- 1/2" Jacobs No. 6425 key chuck (see photo) .. 5.00
- 2 1/2" cup wire brush (see photo) 1.75



Bull Buffer comes complete with 5-inch rubber disc, sheepskin bonnet, and 2 sanding discs, only **\$9.95**.

BERTRAM F. ENGINEERING COMPANY
 3121 MAIN ST. Dealers write for information KANSAS CITY, MO.

DRESS UP YOUR CAR WITH Ace FENDER PANTS

Install these "heavy steel" prime finished fender skirts yourself—and pocket a "substantial savings." Your car will have that "new look!" Hooks on in a jiffy to any 1935 to 1949 model of the cars listed at the right. Enclose money order—or \$5.00 deposit, and pay balance on delivery. Specify car make, year and model. DEALERS WANTED.

ACE AUTO PRODUCTS
 Dept. PM-10, P.O. Box 366
 Huntington Park, Calif.

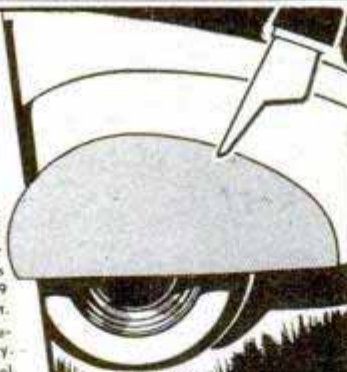

Order by Mail **\$13⁷⁵** pr.

- FORD OLDSMOBILE BUICK
- MERCURY CHRYSLER DODGE
- DE SOTO PLYMOUTH FRAZER
- PONTIAC CHEVROLET KAISER

Quality Lathe Dogs

Heavy malleable iron. Tail fits face plate slot. Standard Dog has square head screw. Safety Dog has headless screw. Prices are for either style.



	Capacity	Price*	Capacity	Price**
STANDARD	1/2"	\$0.85	3/8"	\$0.75
	3/4"	1.00	1/2"	.80
	1"	1.10	3/4"	.95
	1-1/4"	1.25	1"	1.05
SAFETY	1-1/2"	1.50	1-1/4"	1.15
	1-3/4"	1.65	1-1/2"	1.45
	2"	1.80	* 13-inch or larger lathes.	
	2-1/2"	2.05	** 9-inch and 10-inch lathes.	
	3"	2.30	I.o.b. factory	
	3-1/2"	3.15		
	4"	4.25		

SOUTH BEND LATHE WORKS
 455A E. Madison St.
 South Bend 22, Indiana

MAKE \$ MORE MONEY

Applying or Selling

CORKSTONE

A General Purpose Magnesium Oxychloride Flooring

THE MODERN PLASTIC FLOORING

EASY TO APPLY
 Here's your opportunity to get into business for yourself applying or selling Corkstone, the economical, top-grade plastic flooring. Plenty of profit Act without delay!

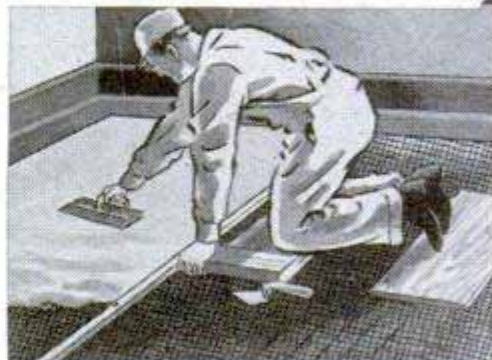

Dealers & Agents Wanted

WRITE FOR DETAILS

LASTING PRODUCTS COMPANY

Franklinton Road Plant.

Baltimore 23, Md.

LAFAYETTE CONCORD KIT-QUARTERS FOR RADIO BEGINNERS HAMS and PROFESSIONALS AMERICA'S GREATEST RADIO VALUES

EXCITING FM TUNER KIT

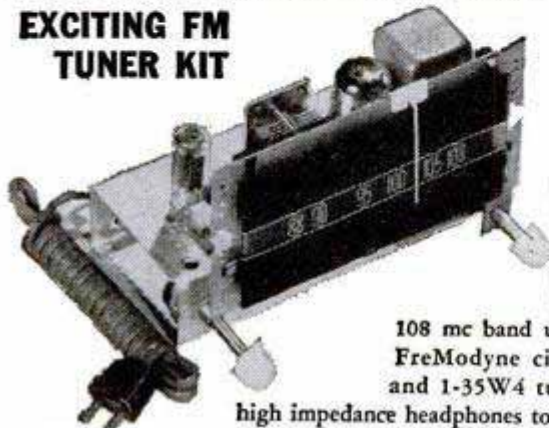

EASY TO USE

Astonishing FM reception at a rock-bottom price. Covers the 88-

108 mc band using the new FreModyne circuit. 1-14F8 and 1-35W4 tube. Connect

high impedance headphones to audio output for a complete FM receiver. Can also be played through conventional AM receiver. Complete including instructions, less tubes.

No. 24534P
\$15.35

Tube kit \$2.46

PLAY RECORDS REMOTE THRU RADIO

Supplies sufficient power to play records through radio receiver at full volume in other rooms, without wired connections. Oscillator frequency variable between 1350 to 1700 KC. Small enough, 4" x 4" x 2", to go into any standard record player. **\$3.49**

No. 24531P, Complete kit, less tube.....
No. 117N7-GT Tube 2.34



SPECIAL BURNING PENCIL

6 in 1 electric tool. Easy to use. Ideal for personal marking and decorative burning of wood, leather, velvet, cork. Embosses foil. Forms plastic. 6 brass tips are interchangeable. Complete kit - pencil, plastic, cork insulated grip, 6 colors of metal foil, emery cloth, and instructions. **\$1.95**

No. 15582P. Only **\$1.95**



RUGGED SELENIUM RECTIFIER

May be used to replace 117Z6, 117Z3, OY4, and other rectifier tubes and socket in AC-DC battery type portable radios, intercoms, etc. Peak inverse V. 380 V; 100 milliamps max. 1 1/4" square x 11/16" high. Amazing value. **75c**



LAFAYETTE-CONCORD

100 Sixth Avenue, New York
901 W. Jackson Blvd., Chicago
110 Federal St., Boston
229 W. Madison St., Chicago
265 Peachtree St., Atlanta
24 Central Ave., Newark
542 E. Fordham Rd., Bronx

AMAZING MAGIC ULTRA-MIKE

Without wires, lets you broadcast through your own radio. Simply turn on radio and tune to any clear channel between 1250 and 1700 KC. For home, office, restaurants, nurseries. New low price. **\$5.98**
No. 22548P, battery operated.



MORE THAN A TOY... A REAL 1-TUBE RADIO



What a gift for your favorite child! Dials like a phone - brings in your favorite radio program. It's colorful, plays anywhere. Not a crystal set, uses 1-3A4 in a super regenerative circuit. Permeability type tuning. Complete with tube and batteries. Only **\$4.75**

No. 24545P.....

BEST BUY 12" PM SPEAKER

Alnico V Permanent Magnet Dynamic Speaker. 1" voice coil with 6-8 ohm impedance. 14-18 W. capacity. Dust proof construction. Ideal for fine FM reception, public address work, etc. An unbeatable value, limited quantity. **\$5.95**

No. 5B7010P.....



180

PAGE CATALOG
BULGING
WITH BUYS

IT'S FREE!

You get more for your money at Lafayette-Concord, because you deal direct with the largest supply house in the world! Enormous purchasing power results in big savings which are passed along to our customers. Take a tip from 500,000 of them: Make Lafayette-Concord your buying headquarters! Our big new catalog, just off the press, lists every part you could possibly need for building television, home radio, ham, phonograph, high fidelity equipment, etc. at absolute rock-bottom prices. You get "same day" service on mail orders from our three great shipping centers in New York, Chicago, and Atlanta. Or shop in person at any of our outlets, listed below. You're going to save plenty either way! Your copy of the catalog is waiting right now. Rush this coupon on a penny post card at once.



**A PENNY POSTCARD
WILL BRING YOU THIS
WORLD'S FINEST RADIO
CATALOGUE FREE**

Rush the coupon below for your copy of this whopping big value guide. You'll save money!

LAFAYETTE-CONCORD, DEPT. LJ-8
100 Sixth Ave., New York 13
901 W. Jackson Blvd., Chicago 7
265 Peachtree St., Atlanta 3

Please rush FREE catalog No. 89.
 Please rush FREE television bulletin.
 I enclose \$..... Please fill attached order. Shipping charges extra.

Name.....
Address.....
City..... Zone..... State.....

**MAIL THE
COUPON NOW**

NOW

THE JIFFY METAL CABINET WITH RUSTPROOF ALUMINUM DRAWERS

32
DRAWER
UNIT
\$8.95

POSTAGE PAID

64
DRAWER
UNIT
\$15.95

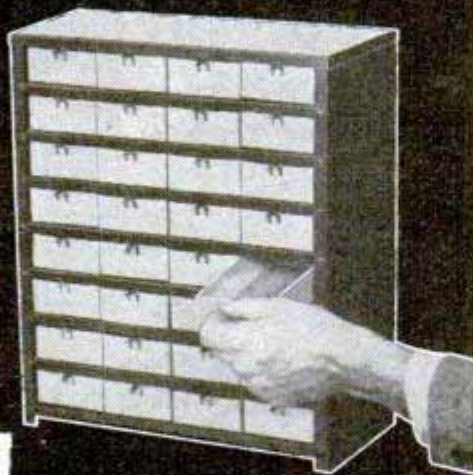

APPROXIMATE
SIZES
DRAWER

1 1/4" Deep
2 3/4" Wide
6" Long

32 DRAWER UNIT

6" Deep
12 3/4" Wide
15 1/4" High

64 DRAWER UNIT

6" Deep
25 1/2" Wide
15 1/4" High

for home or shop,
the handy way to
keep small parts,
washers, nuts, bolts,
nails, screws, etc.

AND STILL AVAILABLE

32
DRAWER
UNIT
\$5.95

POSTAGE PAID

64
DRAWER
UNIT
\$9.95

Solid one-piece aluminum drawers for greater strength and long life—and still at low cost. So handy to keep office, shop, work bench, household and hobbyist needs at your fingertips. Spot welded steel cabinet, enamel finish, and metal flange drawer guides.

32-Drawer Unit—\$8.95. 64-Drawer Unit—\$15.95. Postage Paid. Send check or money order. No C. O. D.'s, please. Add 3% sales tax for Ohio orders.

THE JIFFY METAL CABINET WITH LAMINATED FIBREBOARD DRAWERS

Same steel cabinet as above with covered fibreboard drawers. Suitable for most home needs. Thousands in use. 32-Drawer unit—\$5.95. 64-Drawer unit—\$9.95. Postage Paid. Check or money order. No C.O.D.'s. Add 3% sales tax for Ohio orders.

KAYTEE PRODUCTS
DEPT. M • BOX 588 • CANTON, OHIO

SAY YOU SAW IT IN POPULAR MECHANICS

Presenting THE PICTURE-KING

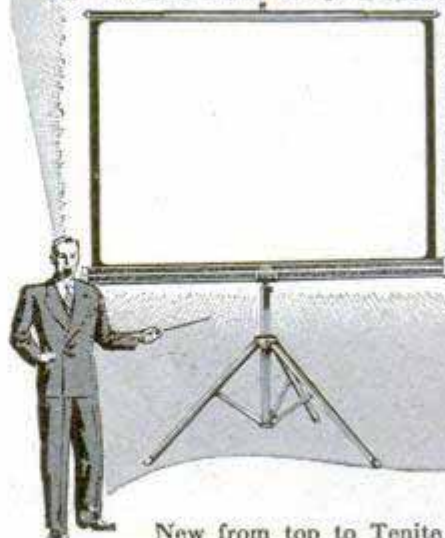

DA-LITE'S
40th
Anniversary
MODEL
AND
FINEST
PROJECTION
SCREEN

New from top to Tenite feet. The beautiful blue Hammerloid octagon case, gleaming chrome end caps, bright (and light) aluminum alloy tripod and colorful Tenite controls establish a new standard. Da-Lite's wide-angle Crystal-Beaded surface brings new beauty and realism to pictures. Be first to own the best. Available now at your dealer's. Write for free sample of fabric and descriptive circular 10 P



DA-LITE SCREEN CO., INC.
2721 N. Pulaski Rd., Chicago 39, Illinois

NEW 30" SHEET METAL BRAKE

Forms angles, channels, vees, flanges, locks, zees. Handles 26 gage sheet steel, heavier gages of aluminum, copper, plastic, etc. Portable. Can be held in a bench vise, or bolted down. All steel. Wt. 40 lbs. Shipped exp. collect. \$24.50.

12" BRAKE. Fits in vise to form difficult and compound bends, up to 20" gage steel 12" wide, \$12.50.

18" CURVE FORMER. Handles 16 gage steel 2" to 30" dia., \$9.50 PP.

VISE IRON BENDER. Forms rings, hooks, eyelets, etc. in 1/2" round or square; 1/2" up to 2" wide in bar iron. Price \$10.00 PP.

with attachment to bend 1/2" pipe, \$12.50.

SHEAR. Cuts 16 gage steel any length and width, \$12.50.

SHEET METAL PLIERS. 2 1/2" wide, \$2.00;

5", \$3.50. 20 page instruction booklet, 50c.

Immediate delivery. Order direct, cash or C.O.D., or send for folder.

1116 So. 27th St. Dept. P10

Omaha 5, Nebr.



VALVE CAP WITH BUILT-IN TIRE GAUGE

Be safe! Check your tires at a glance! Installs in a second just like regular valve cap. Has super sensitive beryllium copper diaphragm . . . no other moving parts. Nothing to wear out. Weighs only 1 1/2 oz. Prolong tire life and guard your safety. Satisfaction guaranteed! Set of 4, \$1, postpaid, plus postage if sent c.o.d. Order through your dealer or direct from

**CAP-GAUGE CO. 1506 WABASSO WAY
GLENDALE 8, CALIF.
NEW! 25c each postpaid**

OTTAWA Buzz Master

A faster brush cutter and wood sawing machine. Propels itself while cutting saplings and brush. 7 H-P motor. Many outstanding and exclusive features. Available attachments: sickle bar, rotary tiller, sprayer, air compressor, snow plow and pulley for belt work. Thousands in use. Send for FREE booklet.



OTTAWA MFG. CO., 1-827 Brush Ave., Ottawa, Kansas

MAGNETS OF ALL TYPES—10c UP
AMAZINGLY POWERFUL!
4 oz. Alnico Magnet, lifts 10 lbs.
\$1.00. Our Leader, 15 oz. Magnet,
lifts 40 lbs. \$2.50. New alloy—will not
weaken! Useful for lifting valuables from tanks,
sinks, or rivers easily! 7 small magnets \$1.00 with
list of many shop and home uses. Satisfaction guaranteed.
R. EYRICH, 2566 N. 49TH ST., MILWAUKEE 10, WIS.

POPULAR MECHANICS

Now you can start that home shop you've dreamed about —or expand your present shop— without spending a lot of money! . . .

8
pleasure-giving
HOMECRAFT®
POWER TOOLS

a complete shopful!
only \$28245

Without motors or lamp attachments

Prices subject to change without notice

Even a modest budget fills your shop with *Homecraft* Power Tools. They're built expressly for the hobbyist who uses tools off and on. You don't pay for size and weight you don't need.

Inspect these popular tools at your *Homecraft* dealer now. See why *Homecraft* Power Tools help you enjoy all the fun and healthful relaxation that woodworking has to offer you. If you don't know who your nearby *Homecraft* dealer is, write today and ask us for his name.

See your *Homecraft* dealer now!



Homecraft Lathe, No. 46-110
 — Handles 36" of stock between centers. Swings 10" over bed. Spindle is carried on oil-impregnated bronze bearing. All thrust is absorbed by sealed-for-life ball bearings. **\$3695**



Homecraft Band Saw, No. 28-110 — Has 6 1/2" capacity under guide and throat capacity of 9 1/2". Fully-adjustable blade guides. Table tilts 45°. **\$3995**
 Lamp Extra



Homecraft Circular Saw, No. 34-110 — Cuts stock up to 2 3/4" thick. Rips to center of 15" panel. Takes moulding cutter-head and dado head up to 13/16" wide. Table tilts 45° to right. **\$3695**



Homecraft Jointer, No. 37-110 — Planes wood up to 4" wide. Cuts 1/4" deep rabbets. Has lubricated-for-life ball bearings. Fence tilts 45° to right and left. **\$3295**

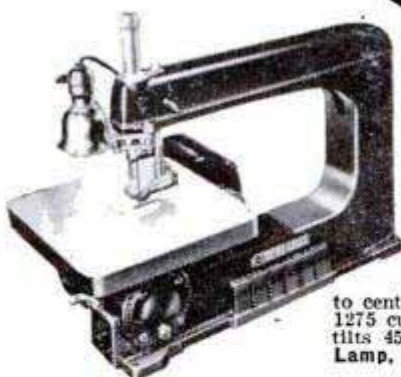

Homecraft Scroll Saw, No. 40-110 — Cuts up to 2" thick, to center of 32" panel. Has speed of 1275 cutting strokes per minute. Table tilts 45° right, 15° left. **\$3195**
 Lamp, belt and motor extra



Homecraft Grinder and Buffer — Can be driven from either bottom or rear. Has long-wearing bronze bearings. **\$980**



Homecraft Drill Press, No. 11-120 — Four speeds from 700 r.p.m. to 4700 r.p.m. Has capacity up to 1/2" holes in cast iron. Oil-impregnated bronze bearings in quill. Ball-thrust bearing in lower end of spindle. **\$4395**



Homecraft Shaper, No. 43-110 — Interchangeable 5/16" and 1/2" diam. spindle. Run in lubricated-for-life ball bearings. Big 15 1/2" x 18" table. **\$4995**
 Motor, belt, and switch extra

HOMECRAFT POWER TOOLS

are built by the makers of Delta-Milwaukee® Power and Machine Tools — the kee® Power with a widespread reputation for safety, accuracy, and dependability, in factories and schools, as well as home shops.

If your goal is a shop equipped with power tools that embody the most advanced principles of engineering, design, and construction, then insist on Delta-Milwaukee Power Tools.
 *Trade Mark Reg. U. S. Pat. Off.

Send 10¢ . . .

— for woodworking handbook and catalog of *Homecraft* Power Tools. It's your guide to happiness!

Tear out coupon and mail today!



Delta Manufacturing Division
 Rockwell Manufacturing Company
 6811 E. Vienna Avenue,
 Milwaukee 1, Wisconsin

Enclosed in 10¢. Send me copy of new *Homecraft* Catalog HC-1.

Name.....

Address.....

City..... (.....) State.....

HM-61

Atlas

10" Tilt/Arbor SAWS

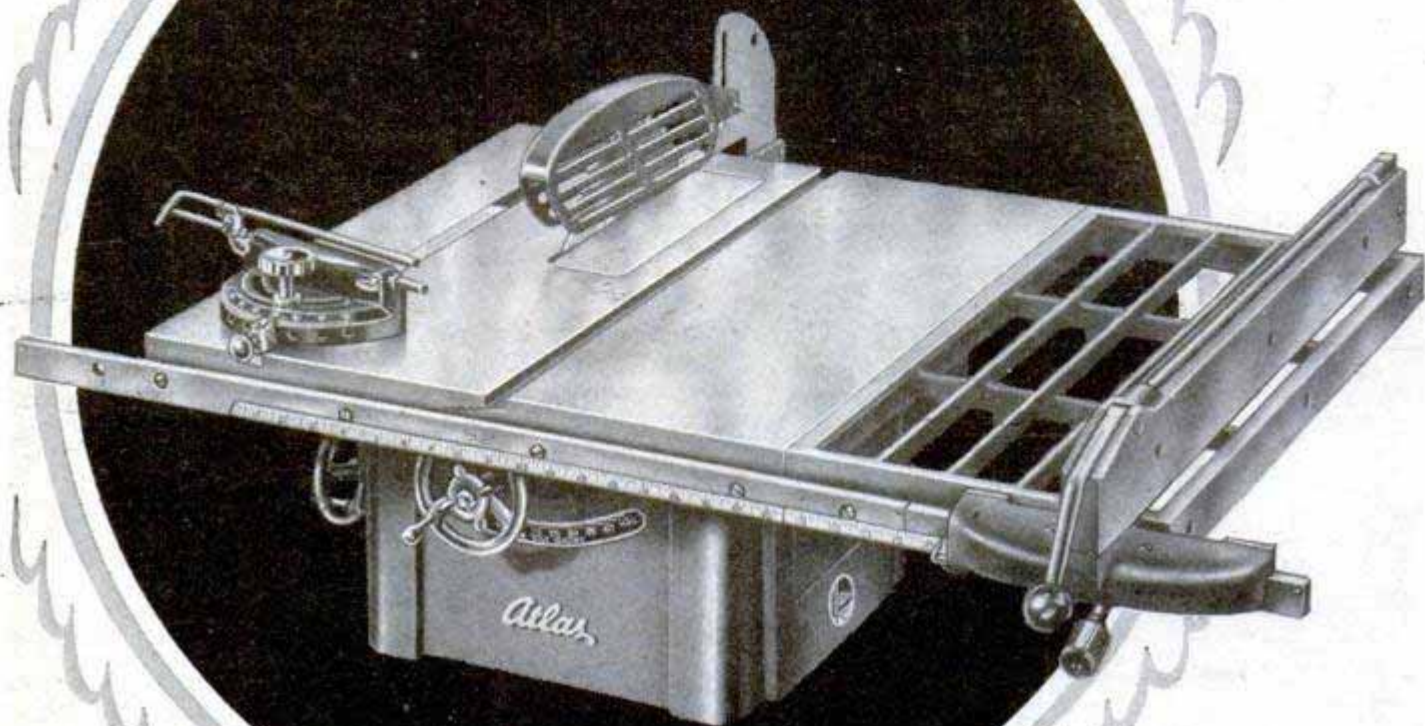

Created for the Real Craftsmen of America

Every home shop owner looks forward to the day when *his* shop is equipped as fine as any in the land. It's more than personal pride in owning the finest. As skill increases most men want and need unlimited capacity in the size of projects they can handle—for greater satisfaction, greater returns from their hobby.

Atlas engineers have reached into the future for such tools! They have designed fast, accurate, versatile wood-working tools matching the precision of Atlas metalworking equipment. Among the first is the 10" Tilt/Arbor bench saw shown here. Others will soon be arriving at your Atlas dealer's. Visit him, and see how economically your "shop of the future" can be yours today!



MATCHED PRECISION TOOLS

FEATURES

● BIG PRECISION-GROUND TABLES

No. 3060 (no extensions) is 25" deep, 22" wide. Gives you 12 $\frac{3}{4}$ " surface ahead of blade — 13 $\frac{3}{4}$ " to right of blade.

No. 3070 (shown at left) is 25" deep, 33 $\frac{3}{4}$ " wide. 12 $\frac{3}{4}$ " surface ahead of blade — 25 $\frac{1}{2}$ " right of blade.

No. 3080 (two extensions) is 25" deep, 45 $\frac{1}{2}$ " wide. 12 $\frac{3}{4}$ " surface ahead — 25 $\frac{1}{2}$ " right — 19 $\frac{3}{4}$ " left of blade.

- CUTS TO 3 $\frac{1}{4}$ " DEEP
- BLADE TILTS 45° — TABLE STAYS FLAT
- QUICK-POSITIONING RIP FENCE
- VERNIER CONTROL FOR FINE ADJUSTMENT
- SKF PRECISION BALL BEARINGS
- DUAL V-BELT DRIVE

OPERATION HIGHLIGHTS

You get some idea of the capacity of this Atlas 10" saw when you realize that with one extension you can rip to the center of plywood and building board panels 4 feet wide. And the work slides smoothly on the *grey-iron precision-ground surface of table and extension.*

The fence with its lever control is a most unusual new development. It locks securely at both ends — unlocks instantly and *lifts off* for positioning on either side of blade. Vernier control gives you fine adjustment.

The other controls — saw height and blade angle — are the smoothest ever...no binding... positive locks.

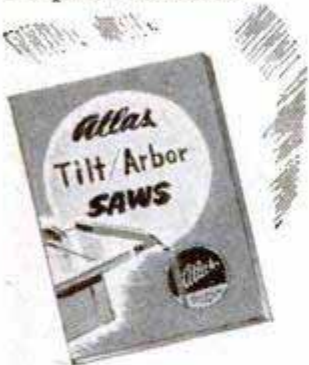

New FREE Catalog

Get *all* the details about all three models. Send a postcard for this new illustrated catalog.

ATLAS PRESS COMPANY

1043 N. Pitcher St. • Kalamazoo, Mich.

Atlas INDUSTRIAL QUALITY TOOLS TO WIDEN YOUR SHOP'S WORK RANGE

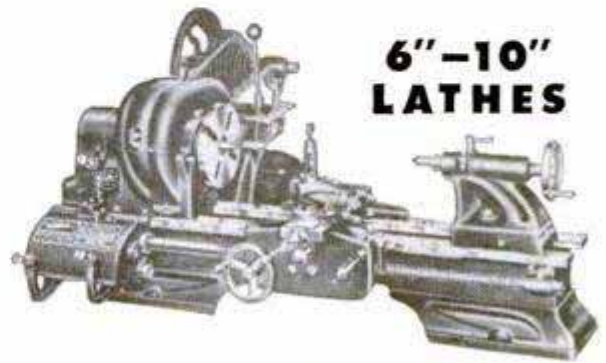

6" - 10" LATHES

For metal machining Atlas 6" and 10" lathes are today's outstanding values in versatility, lasting accuracy, and low price. Ask your dealer or send for new catalog.

DRILL PRESSES

12 $\frac{3}{4}$ " and 15" bench models, and 15" floor type. "Floating-Drive" spindles assure smooth accuracy in drilling and tapping metal and plastics. Attachments to handle wood routing, sanding, mortising, inlaying, and shaping.



10" FLOOR SAW

This is the de luxe saw — a standard table of 27 $\frac{1}{2}$ " x 27 $\frac{1}{2}$ " that can be increased with extensions to 27 $\frac{1}{2}$ " x 59 $\frac{1}{2}$ ". Gives you all the operating features of the 10" bench saws plus its own stand and extra capacity.

FOR METALWORKING AND WOODWORKING

NEW FOREDOM Model #99 at an Amazing LOW PRICE

FLEXIBLE SHAFT MACHINE **\$15.95**
with **PENCIL-SIZE HANDPIECE** **COMPLETE WITH MOTOR**



Grinds, Polishes, Cleans Sharpens, Mills, Carves Engraves, Etches on Metal Wood, Glass and Plastic

5 REASONS WHY FOREDOMS ARE TOPS:
1. Extra power and longer motor life because motor not dwarfed to fit hand. 2. Correct handpiece size for deft, sensitive, fingertip control. 3. No obstructed view of your work. 4. Freedom from gyroscopic action—hence better work. 5. Small handpiece size lets you get into hard-to-reach places.

Hundreds of Uses
Foredoms handle hundreds of tasks. Use them for pleasure or profit, for tinkering or expert craftsmanship. Their versatility is unlimited. Use them to grind, polish, mill, engrave, sharpen, slot, rout, saw, carve, clean, sand, etch, cut, etc. Ideal for internal carving of plastics, the astounding new craft. You can work on wood, glass, plastic and all metals with a Foredom. No. 25 Accessory Set (A truly versatile assortment) only \$5.50 extra.

Over 70,000 Foredoms now in use



← YOUR MOTOR
Foredom PRESTO-FLEX
with **PENCIL-SIZE Handpiece** **\$5.95**

Now turn your old motor, drill press, or electric drill into a Flexible Shaft Tool. Simply attach to your electric drill, drill press or motor. Presto—a flexible shaft machine! Off again in a jiffy! Pencil size handpiece gives you finger-tip control. Gets into tight places you can't reach with any other tool. Handy 35" overall length. And—only \$5.95 complete! Not to be confused with inferior imitations. Precision made, backed by 1/4 century experience in this field. All parts replaceable. Order NOW. If ordered for use on motor, specify motor shaft diameter and add 50c for coupling. (Available for 1/4", 5/16", 3/8", and 1/2" shafts.) No. 50 Accessory Set Available \$1.50 extra. Order TODAY.

SEND NO MONEY
FOREDOM ELECTRIC CO., Dept. B1110 Mail Coupon
27 Park Place, New York 7, N. Y. Now!

Please send me FOREDOMS checked below on 10 day trial.

<input type="checkbox"/> Presto-Flex Tool (\$5.95)	<input type="checkbox"/> No. 50 Accessory Set (\$1.50)
<input type="checkbox"/> Motor Coupling (50c)	<input type="checkbox"/> No. 25 Accessory Set (\$5.50)

Specify motor shaft diameter Catalog on request (\$15.95)

Send C.O.D. plus postage. I will pay postman.
 I enclose payment. Send postpaid.
(Money back either way if not delighted)

Name _____
Address _____
City _____ Zone _____ State _____

SAY YOU SAW IT IN POPULAR MECHANICS

SPECIAL! — TAKE OFF 10%
ORIGINAL TIRES NOT RECAPS
98% NON-SKID
Factory Adjustments, Worn Slightly.
Goodyear, Firestone and Others.
GOLDEN-RULE 14 MO. GUAR.

450-21	\$6.00	600-16	\$5.55	600-20	\$9.00
475-19	6.25	650-16	5.60	650-20	9.00
525-18	6.65	700-15	5.70	700-20	12.00
550-16	5.55	700-16	6.00	825-20	14.50
550-19	7.75	750-16	7.00	900-20	14.50
		650-15	5.00	32x6 (8)	11.00
		550-17	7.00	32x6 (10)	12.80

750-20 "MILITARY" TREAD (Fits 32-6 and 700-20)
Standard Grade, Guaranteed 14 months. \$12.00
Super Grade, Guaranteed 24 months. \$14.00
900-16 Military-Super, Guar. 24 mos. \$8.00

Hundreds of thousands of folks we've never met, send us their remittance in advance to save the C.O.D. charges. Send Ck. or M.O. and this ad. 31 yrs. of "know-how" in our triple inspection.

BLATT COR. GIRARD & LANCASTER STS.
BLATT BUILDING, PHILADELPHIA 31, PA.

PISTON TYPE AIR COMPRESSOR

Piston type, size 2 x 1 3/4, head in valves, bronze bearings, splash lubrication, V-drive, belt drive, intake muffler and cleaner. Capacity 2.8 c.f.m. at 100 lbs. continuous pressure or 150 lbs. intermittent, with 1/2 HP motor. Can be used with 1/4 HP or 1/3 HP at lower speed. Weight 14 lbs. Operating instructions furnished.

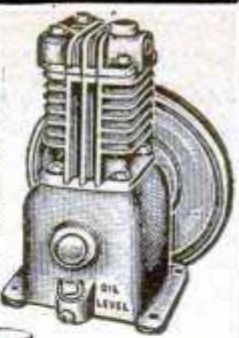

Immediate delivery. **\$17.95**
Price only



1/4" REDUCING VALVE & GAUGE
Oil resistant, pressure 0-to-200 lb. Reduced pressure 0-to-75 lb.; 3 outlets 1/4".
Wt. 2 lbs. **\$5.75**

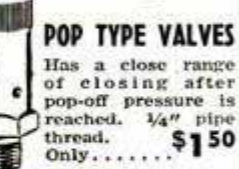

POP TYPE VALVES
Has a close range of closing after pop-off pressure is reached. 1/4" pipe thread.
Only..... **\$1.50**



Check Valves
Prevent leakage after compressor stops.
1/4" \$2.60
1/2" \$4.25



HEAVY DUTY MOTORS
1/4 to 1 1/2 H.P.
Write for Free Catalog

Only \$8.95

Check Valves
Prevent leakage after compressor stops.
1/4" \$2.60
1/2" \$4.25

PRICES ARE F. O. B. CHICAGO
Immediate Delivery. **SOLD ON MONEY BACK GUARANTEE.** Send check or money order today. Write for free folder.

C & M EQUIPMENT COMPANY
1831 S. State St.,
Dept. D-10, Chicago 16, Ill.

AUTOMATIC PRESSURE SWITCH WITH UNLOADER
125-150 lb. pressure. Uses 1/4 to 5 H.P. unit
Only \$8.95



DRIVE WITH NO SUN GLARE

THE ACE AUTO VISOR makes driving more restful and safer... no sun in your eyes... protects windshield from rain, snow, fogging and bug spatters. Streamlined design with **Heavy Chrome Ends** and **Center Chrome Strip** adds beauty to your car. Specify: Prime finish for painting. Hi-polish metal finish—requires no paint.

Enclose check or money order... or \$5.00 deposit, and pay balance on delivery.
ORDER BY MAIL AND SAVE... \$13.50
IMMEDIATE DELIVERY
ACE AUTO PRODUCTS, DEPT. PM10
BOX 366 HUNTINGTON PARK, CALIF.

New 1948 PLASTICS SUPPLIES CATALOG

Just off press. Full details on Plexiglas, Lucite, rods, sheets, tubes, Acetates, cements, dyes, buffing, molding sets, tools, carving kits, accessories. Everything in plastics. Gives prices, sizes, colors, etc. Price 10c, stamps or coin, with ad for catalog.

PLASTICS MFG. & SUPPLY CORP.
DEPT. M-10 • 4707 EUCLID AVE. • CLEVELAND 3, OHIO

MACHINES
MARCOT KEY

MARCOT No. 8 KEY MACHINE, mounted on Cabinet \$ 95.00
Auto Code Book and Auto Depth Keys 12.50
100 Dz. Popular Cylinder Key Blanks Set — Key File, Follow-Through 60.00
Holes, Lock Picks, Bit Key Gauge, Thimble, Pins, Springs... 10.50
"Locksmith Trade Books" 6.75

How to Open Locks without Keys or Picks; Secret of Locksmithing; How to Make Keys by the Impression Method; Master Key Systems. **TOTAL COST \$184.75**
The \$60.00 cost of the Key Blanks would return approximately \$350.00. This would more than pay for your entire KEY MACHINE OUTFIT. IMMEDIATE DELIVERY—Motors available with Key Machine Orders.

A. J. MARCOTTE CO. 1200 N. KEDZIE AVE.
DEPT. PM, CHICAGO 51, ILL.

BRUSH PLATING OUTFITS
for re-plating articles in the home and shop. No tanks necessary. Free particulars.
GUNMETAL CO., AVE. M, DECATUR, ILLINOIS

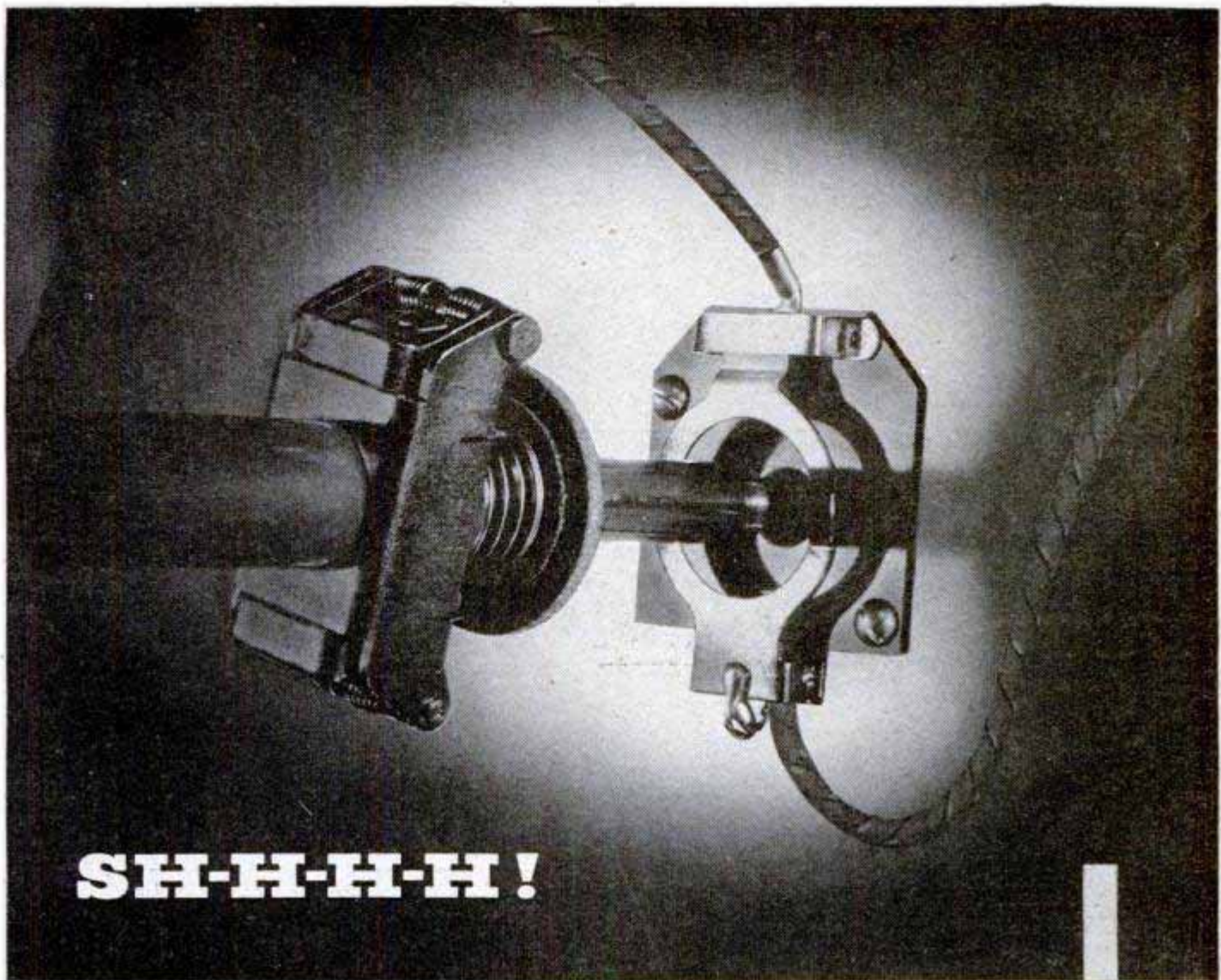

SH-H-H-H!

Take a long look at this centrifugal starting switch from the Hoover Motor. It is quiet, dependable, long-lived. Right from the start, it says "engineered efficiency"—the reason every Hoover Motor delivers cool, quiet, smooth performance even under continuous operation. Any place on your farm for a motor is a place for a Hoover Motor. Order today from your nearest dealer.

Hoover Motors are made in ratings of $\frac{1}{4}$ hp up to 1 hp by the makers of the world-famous Hoover Cleaners.



HOOVER MOTORS

Electric Motor Division . . . The Hoover Company . . . North Canton, Ohio

Penicillin Attacks Germs As Soap Attacks Dirt

Penicillin, the magic weapon in the war on disease, attacks germs in much the same way as soap attacks dirt, according to research conducted at the Massachusetts Institute of Technology. When a penicillin solution is added to a bacterial culture, the drug surrounds the bacteria by coating individual cells. Soap removes dirt by coating each particle and floating it away. The experiments were started when chemists noticed that the molecular structures of penicillin and soap were similar.

Milk Takes to the Air

Milk will be brought to market in airplanes if plans being considered in England prove to be practical. Because of transportation difficulties, some milk-producing areas in England cannot get their milk to distribution centers without damaging delays. Over certain proposed routes, milk can be flown to consumer areas in a Bristol freight plane at a cost of about four cents a quart. A specially constructed metal tank lined with glass will be used. The 1100-gallon tank will be mounted on wheels for quick loading.

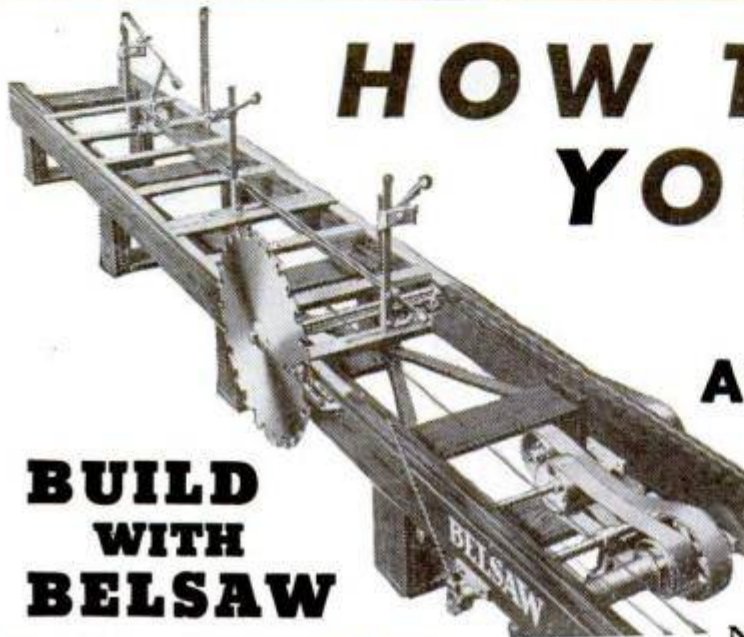

**BUILD
WITH
BELSAW**

HOW TO MAKE YOUR OWN LUMBER AT A BIG PROFIT

Now you can make all forms of finished, low-cost lumber from your own woodlot timber... with a BELSAW One-Man Sawmill.

CUT BUILDING COSTS

Portable BELSAW goes to the trees, cuts *all* the lumber for *all* your buildings... boards, joists, laths, shingles, dimension lumber—well-finished products, at a fraction of lumber-yard costs.

REPAIR, REPLACE FARM BUILDINGS

Thousands of farmers build and repair their own barns, sheds and other out-buildings... even homes... entirely from lumber made with a BELSAW. You can do it too, and *save*.

A low-cost BELSAW pays for itself in savings on your own lumber needs... then you can **MAKE BIG PROFITS SELLING LUMBER** at today's high prices.



Barn and silo—built by C. I. Hendrickson, Wis.



Two-story home—built by Raymond D. Hall, N. C.

Well-built, low-cost homes, barns, farm buildings are being made every day with BELSAW'S help. Find out *now* how you can make all your own straight-t-sawed lumber... for as little as 1/10 of lumber-yard prices... with an All-Purpose BELSAW.

**GET THIS
FREE
BOOK**

**HOW
TO MAKE
LUMBER**

SEND COUPON TODAY!

BELSAW Machinery Co, 811J Field Building
315 Westport Road, Kansas City 2, Mo.

Gentlemen:

Please send my copy of the FREE book "How To Make Lumber"

NAME.....

ADDRESS.....

CITY.....STATE.....

LOOK

AT ALL THE FEATURES ON THIS NEW .22!

IT'S THE



"Pioneer"

765

"You can't buy another rifle with everything this one's got. Look at that hooded sight...streamlined bolt, full size bolt handle... self-cocking... side thumb-safety. And it's all the best, all the way through. What a rifle... a regular man's gun."

AT ONLY **\$13⁵⁰**

HARRINGTON & RICHARDSON ARMS CO.

331 PARK AVENUE, WORCESTER 2, MASS.



NO OTHER RIFLE HAS ALL THESE...

Right, top . . . Exclusive "Red Devil" Hooded Sight. Designed for sure, on-target accuracy.

Center . . . Exclusive "Redi-Feed" drop-in loading platform with super-tensile spring tension. Cartridge automatically falls into right position and may be fed into chamber by merely closing the bolt.

Bottom . . . Special Self-Cocking; side thumb-safety . . . contoured close to stock . . . fool proof, easy thumb operation. Full size bolt, streamlined.

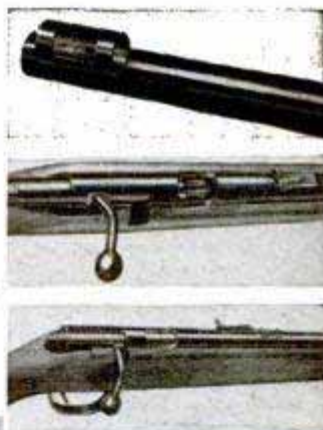

WRITE FOR FOLDER OR SEE YOUR DEALER

Prices subject to change without notice.

FOUNTAIN TOOTHBRUSH



Works much like a fountain pen. Carries the dentifrice in handle. Most sanitary and convenient toothbrush ever devised.

Give a twist of the wrist and in 2 seconds the dentifrice is on the brush and it is ready for use anytime, anyplace. No mess. No waste. No abrasive to injure the teeth or gums. Handy to carry in pocket or purse. Complete dental hygiene at home or away. A perfect brush for every user including denture wearers and those who have halitosis or sore gums. Money back guarantee. 3 months supply of dentifrice and fountain brush only \$1.60 postpaid or C.O.D. plus postal charges.

ESCORT LABORATORIES, INC.

DEPT. A—1119 DIME BUILDING DETROIT 26, MICH.



FIX SEWING MACHINES

BIG MONEY. Spare or full time. Open your own neighborhood shop. Thousands need repairs. Send for complete Service Manual—only \$1.98 postpaid. Money back guarantee.

SEWING MACHINE SERVICE CO., Hamilton 25-FF, Ohio

AUTOMATIC RETOOTHER

MAKES NEW PROFITS

Cuts new teeth in 50 seconds! Any size 4 to 16 points. Old teeth fall off as chips. Easy to operate. A perfect job.

IMMEDIATE DELIVERY

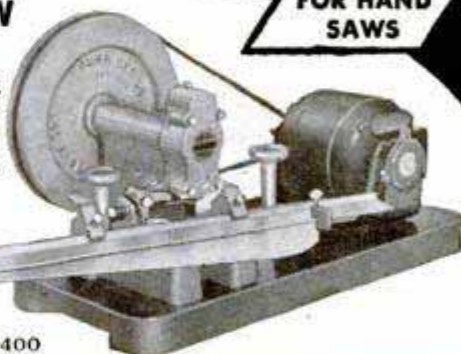

Set saw teeth—400 per minute with new Automatic SAW SET. Perfect hammer and anvil action sets teeth uniformly. No tooth breakage.

VALUABLE BOOK
ORDER BURR'S BLUE BOOK OF COAST TO COAST PRICES FOR SAWSHOP SERVICES. **25c**

BURR MFG. COMPANY 8933-W Venice Blvd. Los Angeles 34, Calif.

OWN A SUCCESSFUL WELDING BUSINESS



IT'S EASY when you own a HOBART arc welder!

Save \$300 to \$500. Build Your Own with this HOBART generator



Industrial AC

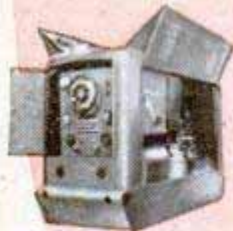

AC-AC Welder Power

Start Your Own Business!

Here's your best opportunity to be your own boss and get into the big money! Start your own welding shop—minimum investment required. People bring repair work to you—automotive, farm equipment, etc. You get extra profits for doing welding jobs in the field. There is profit in every job—and plenty of jobs to keep you busy.

As Your Business Prospers,

add additional welding equipment from Hobart's complete line of arc welders, accessories and electrodes. Your business is sure to grow and you'll want to be able to handle all the big pay jobs. Check coupon for complete line catalog, it's Free.

Become an Expert Welder

Enroll in the Hobart Welding School. Instructions in all phases of welding. Individual instruction. Qualified under G. I. Bill. A non-profit institution.

Hobart Brothers Co., Box M-108, Troy, O.

HOBART

Paste coupon to post card.. and MAIL now!

"One of the World's Largest Builders of Arc Welders"

HOBART BROTHERS CO., BOX M-108, TROY, OHIO

Please send, without any obligation, the items checked below!

- "Build Your Own" Welder Generator
- How to "Build Your Own" Gas Drive Arc Welder Book
- Complete Arc Welder Catalog
- Hobart Welding School Book

Hobart vest pocket Guide To Better Welding



Free!

NAME _____

ADDRESS _____

CITY _____

STATE _____

Now CHEAP OIL BURNER

FOR HEATING AND COOKING STOVES FURNACES
HEAT YOUR HOME, COOK YOUR MEALS WITH CHEAP FURNACE OIL

NO MORE SHOVELING COAL OR ASHES. Sensational Fuelizer Starter Vaporizing System turns Cheap No. 1 Furnace Oil, also Range, Heater, Tractor Distillate, Kerosene and like oils into oil heat—one of the quickest, hottest fires known. LIFETIME GUARANTEE. \$1.00 Bonus Offer for Testing. We will let you try it in your own stove or furnace for one month. Get yours for introducing. Big profits QUICK. Be first. Send in your name today for details and cash in on the tremendous demand for this Amazing Invention.

NORTHWEST MFG. CO., 608-M, Mitchell, S. Dak.

RUPTURED?

HERE'S COMFORTABLE, SAFE RELIEF!



Made of molded rubber, soft and pliable, this form-fitting truss is bringing new comfort, with safe protection, to thousands. Based on nature's way, WEB Truss gives strong support without painful pressure. Has no springs or leather, is completely washable. Under money-back guarantee of satisfaction, you run no risk. Write today for FREE illustrated literature.

WEB TRUSS CO. Dept. M-8 Hagerstown, Md.

WORLD'S LOWEST PRICED ADDING MACHINE

Vest Pocket Size FREE TRIAL \$295

IDEAL FOR BUSINESS OR PERSONAL USE—GUARANTEED ACCURATE. Not a toy. Operates with only a finger flick. Adds, subtracts, multiplies, divides, only Counts up to one billion. Pays for itself over and over. Ideal Gift—for Business, Income Tax and School use. MONEY BACK GUARANTEE. Send name and address. Pay postman only \$2.95 plus postage. (Send full cash if outside U. S.) Beautiful Rich-looking Leatherette Case included at no extra cost. Money back in 10 days if not delighted. AGENTS WANTED.

Calculator Machine Co., (Mfrs.) Dept. 207, P.O. Box 248 Glenview, Illinois

CASH IN ON THE BUILDING BOOM

Only \$199

Amazing. General High-Speed low cost Concrete Vibrator Block Machine. Will produce 1000 blocks in an 8 hour day. All sizes. Easy to start your own profitable business. Complete details sent FREE. Mail \$1 for WONDERFUL BOOK "How To Build Your Own Concrete Block Home."

GENERAL ENGINES CO. (EASTERN DIVISION) DEPT. F • DREXEL BLDG., PHILA. 6, PA.

RACING CAR EQUIPMENT FOR ALL CARS

Engines, Racing Heads, Manifolds, Carburetors, Mufflers, etc. Speed Instructions and literature \$1.00—refunded first order.

LEE MOTORCRAFT CO. 1412 Great Northern Bldg. Chicago, Ill.

With this HOBART "Build your own" Combination A.C. Welder and Power Generator

Saves you \$300 to \$500

over cost of factory built machine. This one, that you can build yourself, ARC WELDS and POWERS TOOLS and ELECTRIC LIGHTS ANYPLACE. Valuable to garages, farmers, contractors and others who want to double their earnings by doing repair and construction work in places where electric power is not available.

Furnished with pulley or shaft for coupling to your own engine.

Hobart Brothers Company Box M-1081, Troy, Ohio
"One of the World's Largest Builders of Arc Welders."

"Power-Up" YOUR SHOP For Greater Usefulness This Year!

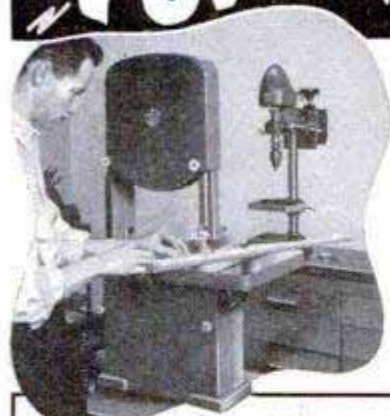

Here they are . . . the new Power King tools to make your home shop more useful, more valuable than ever before in these days of high costs for furniture and home repairs!

Chairs, desks, tables, lamps, cabinets, shelves, cupboards, storm sash, toys . . . there's hardly a thing of wood or plastic that you can't make

easily and expertly with Power King tools in your shop.

What's more, you can equip at low cost. Power King tools, with their precision engineering and construction features usually found only in more expensive equipment, are priced 'way down. See them at your Power King dealer's — soon!

NEW POWER KING TOOLS Add NEW Practical Capacities . . . Perfect Workmanship . . . at LOW COST!

8" SAWS



Saw blade tilts to 45° for angle cutting. 18" x 20" table, with 10 3/8" area ahead of blade. Mitre gauge included. SKF ball bearings. **\$61⁷⁵**

18" JIG SAW



Cuts plywood, plastics, thin metals, boards up to 2" thick. 12" x 12" table tilts 45°. Heavy well-braced. Oil-bath lubrication. **\$42⁷⁵**

12" BAND SAW



Four guides for blade assure accurate sawing. Four ball bearings for saw wheels assure trouble-free operation. 14" x 14" table tilts 45°. **\$79⁷⁵**

4 1/2" JOINTER-PLANER



Planes, trues, rabbets, bevels, and performs other edging and surfacing operations. Table 4 1/2" wide. 2-way tilting fence, SKF ball bearings. **\$44⁷⁵**

9" WOOD LATHE



Handles all inboard and outboard turning operations. 4 speeds from 800 to 3700 RPM. Bronze bearing for spindle, ball bearing absorbs thrust. **\$39⁷⁵**

11 1/4" DRILL PRESS

For drilling wood and metal, also for routing, mortising,

dovetailing, and other woodworking. 9 speeds, 700 to 4000 RPM. Oilite Bronze bearings.



\$42⁷⁵

SHAPER

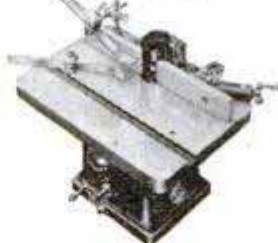

Speeds work on chairs, lamps, desks, tables, etc. 10 1/2" x 15" table raises and lowers — alloy steel spindle is stationary. Takes all cutters with 1/2" bore. **\$43⁷⁵**

BELT & DISC SANDERS



For a professional finish on wood, metal, and plastic pieces of any shape. 10" dia. disc, 4" belt. Table tilts 45°, may be used on either disc or belt. **\$62⁷⁵**



NEW FREE CATALOG!

Send today for illustrated catalog of new low-cost Power King tools. Your name and address on a penny post card will bring it.

Prices F. O. B. Kalamazoo less motor.

ATLAS PRESS CO.
1035 N. PITCHER ST.
KALAMAZOO 13D, MICH.



MATCHED PRECISION TOOLS FOR MACHINING AND WOODWORKING

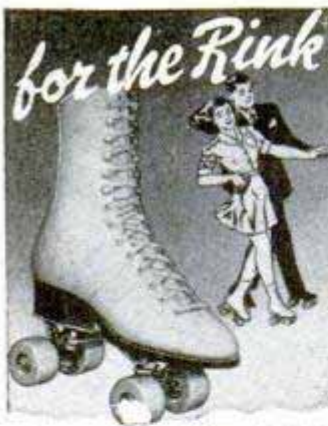

"CHICAGO" ROLLER SKATES

Forty years of leadership reflect the outstanding quality and performance of these beautiful "CHICAGO" Shoe Skates. Stars and Champions are made on "CHICAGOS." Be popular—get on the road to Stardom. Own a pair of the World's Finest Skates.

VALUABLE BOOKLET
 "Secrets of Rink Skating." Contains valuable Skating Suggestions for beginners, dance patterns, skate selection and care. Send 10c to cover mailing.



CHOICE OF CHAMPIONS

CHICAGO SCOUT FLYING Roller Skates

Boys and Girls all want "CHICAGO" Sidewalk Skates. The World's Greatest Roller Skates for youngsters or grown-ups. The Triple Tread, Ball Bearing Steel Wheels give more action—Speed and Longer Life.



for the Sidewalk
 No. 101

Demand "CHICAGOS" from your Dealer.



Send for FREE Booklet "How to Roller Skate." Enclose 10c for Skate Club pin. Value 25c.

CHICAGO ROLLER SKATE CO.

Mfgs. of Rink & Sidewalk Roller Skates, Industrial Fuses—Screw Machine Products

4414 W. Lake St. Chicago 24, Ill.

SAY YOU SAW IT IN POPULAR MECHANICS



"I never knew Good POWER TOOLS Could Be So Inexpensive"

Every time you change a tool (average time 30 seconds) you have a different machine.

New, Improved

EMRICK 5-in-1 Machine \$39.95 COMPLETE

Never before such an amazing bargain in power tools as this Emrick 5-in-1 Workshop! Yes, it includes Lathe, Saw, Drill Press, Grinder and Sander—all for \$39.95 complete (U.S. only). Yes, it does the same work as power tools costing up to 8 times more. Yes, it handles big capacity, heavy-duty work—takes 1/4 to 1/2 H.P. motor. We have been building quality tools since 1898—thousands of satisfied customers. Use coupon now—or write us. You'll be the happiest man in town when you own an Emrick.

- LATHE**
10" Swings;
30" Centers
- SAW**—Takes 6" to 8" Blade
- DRILL PRESS**
Pulls 1/2" Drill in Steel
- GRINDER**
5" Emery Wheel
- SANDER**
8" Diameter

FREE 10-DAY TRIAL OFFER

EMRICK, INC., 1740 Clinton, Kalamazoo, Mich.

I enclose \$18.00. Ship Emrick Workshop (complete less motor and saw blade) on balance c.o.d. basis. Unless completely satisfied, I may return within 10 days and get my money back.

Name _____ (PLEASE PRINT) Send FREE catalog.
 Street _____
 City _____ State _____

Amazing Get Acquainted TULIP Offer

*Our Famous Hardy PLANTING STOCK

Our Biggest Bulb Bargain!

Dozens of brilliant flaming colors in this Rainbow Mix Assortment . . . Darwin, Triumph, Breeder and Cottage Tulips for remarkable low cost of less than 2c per bulb. These are our prize selection of famous young especially selected strain and smaller because they are first and second year bulbs . . . 1 1/2" to 2 1/4" in circumference. Satisfaction guaranteed or money back.



12 Dutch Iris Bulbs Extra

SEND NO MONEY! Order now, pay later. Bulbs reach you for full planting for only \$1.69 plus C.O.D. postage. Cash orders prepaid. Prompt action brings 12 genuine first year Dutch Iris Bulbs, gorgeous new purples and blues, without extra cost. Send order to

MICHIGAN BULB CO. Dept. RB-1905 Grand Rapids 2, Mich.

WONDERFUL SAVINGS ON

nationally advertised

WATCHES

So Finely Reconditioned . . . They look like new!

ELGIN or WALTHAM Man's 7-Jewel pocket watch in new chromium case 12 & 16 size
\$10

LADIES' SWISS WATCH 7 jewels, dome crystal, newest dot dial, gold-filled expansion bracelet, 10k RGP case.
\$14



Add 10% Fed. Tax, 25% deposit with order, balance C.O.D.

Or send full amount and we pay postage. Agents: Ask About Money-Making Plan
KANE WATCH CO., Rm. 123
 104 Canal St. New York 2, N. Y.

FREE WATCH CATALOG

Original HOLLYWOOD WOLF WHISTLE



CAR HORN

Give the WOLF CALL



You, too, can become a Hollywood Wolf. Give the wolf call and make other weird noises with the original HOLLYWOOD WOLF WHISTLE on your car. Precision made. Works off the intake manifold. Easily installed in 15 minutes. Works in trucks, motorcycles, motor boats, outboard motors, too. Guaranteed. If your dealer cannot yet supply you, order direct, giving us your dealer's name. No C.O.D.'s or stamps. No individual foreign orders. AUTOMOTIVE DEALERS & JOBBERS write for information on this fast selling, proved item.

YODER MFG. COMPANY

2403-211 East 103rd St., Los Angeles 2, California

DESCRIPTIVE LITERATURE ON REQUEST

HAMSTERS!



Get the unique Golden Hamster today. Profitable, Prolific, Educational, friendly. 1000's needed by labs and pet shops. Raised anywhere. No experience required. Send 10c for literature or \$5 for pair and literature.

AZALEA CITY HAMSTERY

1412 East Linwood Dr. Dept. F Mobile 18, Alabama



CODE-RECEIVING SPEED

Learn to send and receive Radio Code with greater speed. Stop nervous tension. Have confidence. Be proficient. Same system used by radiotelegraph specialists. Thousands of operators needed. Rush name for FREE book.

CANDLER SYSTEM CO.

Dept. 5-L, Box 928, Denver 1, Colo., U. S. A.

An outstanding tool
 added to the
SHOPMASTER
 Family of
 Fine Woodworking
 Tools . . .



**The NEW 8" TILTING
 ARBOR BENCH SAW by
 SHOPMASTER**

It's new, and by SHOPMASTER. This 8-inch Tilting Arbor Bench Saw brings new accuracy, new ease of operation for amateur and professional wood craftsmen.

The saw table is always level. Saw blade tilts a full 45 degrees, and saw can be raised to a 2 1/4 inch cut. Convenient controls, sealed-for-life ball bearings, and adjustable belt tightening are but three of the many outstanding features.

See this new SHOPMASTER Saw at your dealer today, and his complete display of the outstanding SHOPMASTER Tools and SHOPMASTER accessories.

SHOPMASTER, INC.



SHOPMASTER, INC.

1214 Third St. S., Minneapolis, Minn.

Please send me complete information and the illustrated full-color catalog on SHOPMASTER Power Tools and accessories.

Name _____

Address _____

City _____ State _____

12" DRILL PRESS



12" BAND SAW



LATHE

8" TABLE SAW



15" JIG SAW



SABER SAW



6" JOINTER-PLANER

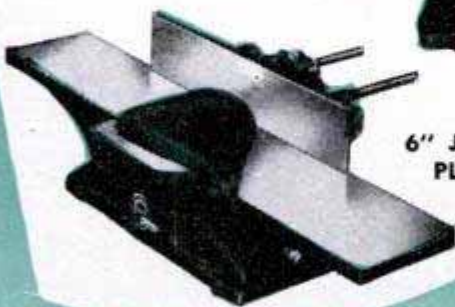

P.S. Christmas is coming. Leave this ad where the rest of the family can take the hint.

Slick shaves cost next to nothing



STROP YOUR RAZOR
AS A BARBER
DOES!

RAZOR, STROP
AND
5 VALET BLADES

\$125

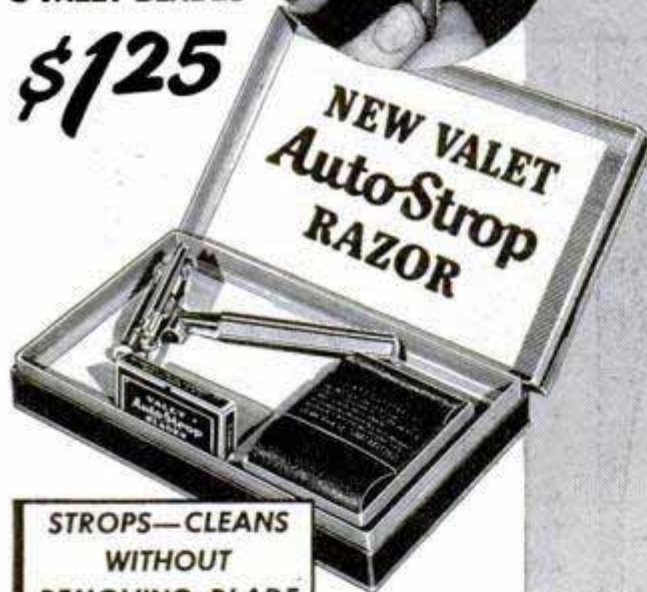

STROPS—CLEANS
WITHOUT
REMOVING BLADE

SELF-SHARPENING . . . ONE PIECE

SAY YOU SAW IT IN POPULAR MECHANICS

HANDIEST TOOL around the Home Workshop

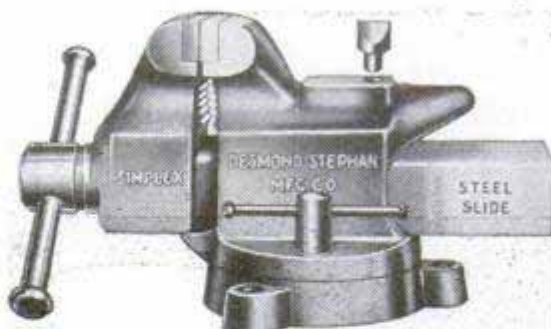

Desmond SIMPLEX Enclosed Screw VISE

- ★ Steel Jaw Inserts
- ★ Steel Slide
- ★ Cut-off-tool
- ★ Pounding Anvil
- ★ Swivel Base
- ★ Pipe Jaws

SEE YOUR HARDWARE STORE OR WRITE TO

The Desmond-Stephan Mfg. Co., Urbana, Ohio.
Send information to

NAME _____
ADDRESS _____
CITY _____ STATE _____



FREE for Trailer Builders

Safety-Engineered

- TORQ-LESS AXLES • BULL DOG HITCHES
AND PARKING JACK LITERATURE

HAMMER BLOW TOOL CO.

Dept. 127 • WAUSAU, WIS.

FREE . . . WRITE TODAY!



THEY'RE SUPER SCOPES!



36" 17 POWER

Extends to 36 inches, Precision and Polished Lenses. Ideal for Studying Stars, Plane Spotting, etc. Satisfaction Guaranteed or Money Refunded. Send Check or Money Order to . . .

\$2.50

Post Paid

CRITERION CO., Dept. PM2

438 Asylum St.

Hartford 3, Conn.



LEARN TO REPAIR AND SERVICE

SEWING MACHINES, MOTORS, REFRIGERATORS, BICYCLES, LAWN MOWERS ETC. START WITH A FEW COMMON TOOLS. BUILD EQUIPMENT, OR BUY AT COST FROM DIRECTORY OF MANY JOBBERS. NO STUDY OF ELECTRICITY ETC. FREE ADVISORY SERVICE. SEND POSTAL FOR DETAILS. 5 DAY FREE EXAMINATION.

REPAIRMAN'S SERVICE | COMPLETE \$475 POST PAID. C.O.D.'S 35¢ EXTRA WITH ORDER

222-M. 4TH. AVE. JAMESVILLE, WIS.

ILLUSTRATED COURSE

EARN BIG MONEY
AND BE YOUR OWN BOSS
Sharpening Lawn Mowers

THE UNIVERSAL GRINDER
PUTS YOU INTO BUSINESS
WITH SMALL INVESTMENT

Earn as much as \$400.00 a month in your basement or garage. Mr. Felber of Ind., writes, "MY UNIVERSAL GRINDER is faster and more accurate than any other grinder. Its efficiency enabled me to sharpen 450 mowers in 4 1/2 months. More than paid for itself the first month. Every customer satisfied." Mr. Hardy of Mississippi writes, "Received my Universal Grinder the first part of May and by August 18 had sharpened over 1000 mowers." Mr. Bacon of California writes, "The lawn mower business, with my Universal Grinder, has been a gold mine these last two years."



Only on the UNIVERSAL GRINDER can the inside face, the edge of the stationary blade, and the reel blades, be ground to proper clearance ALL IN ONE SET-UP WITHOUT REMOVING ANY BLADE FROM THE MOWER
Free Folder

Rogers Mfg. Co., Dept. M-108, Lindsey, Ohio

6 POWER TELESCOPE



\$1
WE PAY POSTAGE

Here it is! . . . just in time for Fall and Winter fun outdoors! Beautiful 6-power Telescope . . . and at an amazing low price! NOT A TOY! Sturdily built of tough, ebony-like plastic. A beauty to look at—a thrill to look through. See the moon SIX TIMES LARGER than with the naked eye. See birds, wild life, scenery UP CLOSE from miles away. A once-in-a-lifetime buy!

Order today! **SEND NO MONEY!** Just send name and address. Pay postman only \$1.00 plus postage on delivery. We pay postage if you send a dollar bill. Hurry! Quantities limited . . . order now! Money back in 10 days if you're not delighted!

ELLIOTT PRODUCTS, Dept. K-10
 2906 Fullerton Ave., Chicago 47, Ill.

EXTRA!

Beautiful, leatherette carrying case. Protects scope from rain, dust, dirt. Makes it easy to carry anywhere. Yours WITHOUT EXTRA COST if you order right away!



Manufacture for the Building Industry



Get in the Dunbrik-Dunstone business today and ride the tide of the biggest building cycle in history. It's the outstanding manufacturing opportunity in the building field, with broad market potentials and high income possibilities.

A Wide-Open Opportunity

Dunbrik (and Dunstone) is masonry at a new peak point of colorful beauty and modern design. Easy to make in local plants, using local material and local labor. Low costs means you can give more quality for less money—even undersell lumber. We supply all necessary equipment; back you with liberal cooperation. Write today for full information.

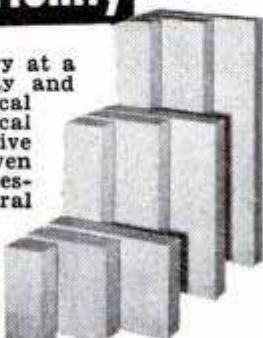

W. E. DUNN MFG. CO.
 600 W. 24th STREET
 HOLLAND, MICH.

DUNBRIK DUNSTONE

A TOOLSHOP IN YOUR HAND!

- GRIND • DRILL • ROUT
- POLISH • ENGRAVE
- CUT • SAND • SAW, etc.

Make Things From
 Wood—Plastics—Metals—Glass—Linoleum—Leather—Alloys—Horn—Stone—Bone, etc.

***HANDEE TOOL OF 1001 USES**

THERE'S ONLY ONE GENUINE HANDEE
 FIRST TOOL OF ITS KIND — TODAY'S FINEST

Smooth, steady power at your fingertips! Perform precision operations not possible with any other portable tool! With a Handee you can turn out professional looking projects for pleasure or profit—ship, plane and train models, delicate, internally carved costume jewelry, wood carvings, puppets, initialed tumblers, etc. AC or DC, 25,000 r.p.m. Wt. 12 oz.

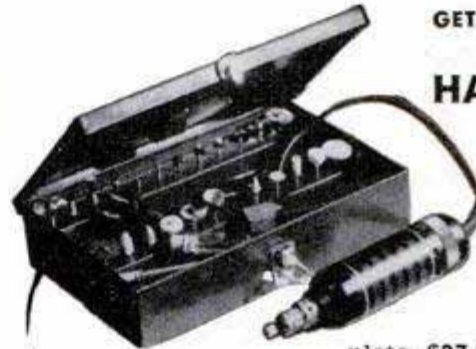

GET A GOOD START GET THE HANDEE KIT

HANDEE Tool and 40 most popular accessories packed in compact steel carrying case. You'll be amazed at what you can accomplish! Complete, \$27.50. Handee only, with 7 accessories \$20.50.

FOR YOURSELF OR A FRIEND... THE GIFT OF A LIFETIME!



NEW PLASTIC-CRAFT KIT

For internal carving. Contains special plastic cutters, buffers, sanding discs, buffing compounds, dyes, cement, a liberal supply of clear plastics, and instructions. At stores or postpaid \$6.95

*Reg. U. S. Pat. Off.

Get a Handee at stores everywhere. If they can't supply you we'll send it postpaid. Satisfaction guaranteed! Ask for free 52-page Manual

CHICAGO WHEEL & MFG. CO.
 1101 W. Monroe St., Dept. PM, Chicago 7, Ill.
 Send Handee Kit Handee Tool Plastic-Craft Kit C.O.D.
 Remittance enclosed Send Free Manual

Name _____
 Address _____

Talk about Versatility..

THIS HANDY DRILL

is in a **CLASS**
by **ITSELF!**



Home-Utility
1/4" Drill
\$18.95



Drilling for
Cabinet Work
Sanding
Curves,
Corners, Flats
Grinding Off
Burrs
Sharpening
Tools and
Knives
Polishing
Hardware
Removing
Rust and Old
Paint
Drilling Out
Broken Rivets

"I used to think a Drill was only for drilling—but my Home-Utility 1/4" Drill has enough power and speed for sanding, light grinding, buffing and wire brushing, too! And for better, faster workshop drilling, it's a world-beater. Just when you think you've exhausted its uses, you'll find new ones for this handy Home-Utility Drill. To top it off, it's built by BLACK & DECKER, the people who've been making quality electric tools for 38 years. That means a powerful motor, husky housings, full-size gears and bearings. At only \$18.95, you won't find a bigger value!" Order Home-Utility Tools from your hardware, electrical or implement dealer.

ELECTRIC
HOME-UTILITY
TOOLS

Products of THE BLACK & DECKER MFG. CO.
Dept. H10M, Towson 4, Maryland

A GREAT SURPLUS BARGAIN

**AIR REGULATOR
and GAUGE**

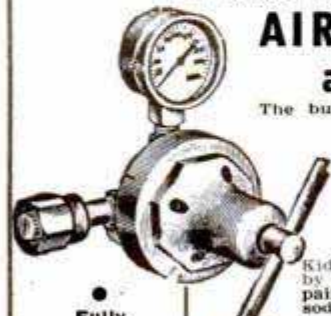

The buy of a lifetime in a standard make air pressure regulator. Used on liquid carbonic tanks and air pressure tanks of all kinds to regulate the pressure. Fitted with standard 1/2 inch pipe thread. Dial calibrated 0 to 200 lbs. Reduced pressure 0 to 150 lbs. Made by U. S. Gauge, Air Reduction Co., Walter Kiddle—all famous makers. Used by artists for air brush work, sign painters, retouchers, welders, etc., soda fountains and taverns.

Fully
Guaranteed

All Brand
New and in
Perfect
Condition

A \$15.00 VALUE **\$5.95**
(Wt. 4 lbs.)

Price F. O. B. Chicago. Immediate delivery. Sold on money back guarantee. Send check or money order today. Write for free folder.

C & M EQUIPMENT CO.
1831 S. State St., Dept. D-10, Chicago 16, Ill.

Stucco Spraying
• Today's Outstanding
Business Opportunity



Beauty and protection are sprayed on old and new buildings . . . exterior and interior surfaces . . . by COLORCRETE. It's a plastic, water-resistant material, spread evenly over surfaces and forced into cracks by air pressure. Fuses to masonry with enduring tenacity. Many textures. Range of 30 smart colors. Fully proven by 20 years of actual use under all conditions.

Big Earnings for Colorcretors

Colorcrete ties in with today's huge building program. Renews old buildings. Makes new construction more attractive and enduring. Large waiting market, because building owners get long lasting beauty and protective values at low price. Yet your selling price can be several times your basic cost. Machine is easy to operate. Moderate investment. Write or wire for complete information.

COLORCRETE INDUSTRIES, INC.

570 Ottawa Avenue Holland, Michigan

COLORCRETE

Plastic Coasters
and Tiles

**EMBED REAL FLOWERS
in NEW Magic PLASTIC**



Now create many unusual things like the distinctive pansy coaster shown—made by embedding real pansies in Castolite—the "magic" liquid casting plastic. Comes crystal clear, or may be dyed to produce striking color effects. Make really different jewelry, book ends, picture frames, candle sticks, figurines. Embed real flowers, butterflies, coins, medals, photos, for plaques, paper weights, tiles, other art objects. Use only home tools. Follow simple step by step method. New pleasure, fine profits are possible. Send 25c for exciting new Home Project Manual. Write today.

MANUAL
25c

THE CASTOLITE COMPANY, Dept. L-1, Box 391, Woodstock, Ill.

AMAZING NEW TRAP CATCHES ANIMALS ALIVE!

CAN'T HARM CHILDREN, PETS, BIRDS, POULTRY

It's amazing how the new HAVAHART catches rats, rabbits, squirrels and other animals, yet it's harmless to children and pets. Simple to set, rustproof. No springs! No jaws! Animal walks in to get bait, and the doors close! Send postal for free booklet.

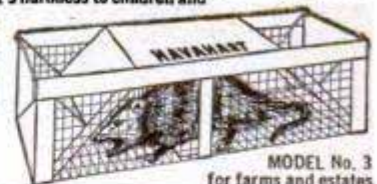

HAVAHART,
121 Water Street
Ossining, N. Y.

MODEL No. 3
for farms and estates

NEW BAND SAW BRAZER



**SAVES TIME
AND MONEY . . .**

better than welding—easy to use—operates on 60 cycle lighting circuit. Complete kit includes resistance brazer, silver solder, flux, and instructions

Introductory **\$18.50**
price

THE ERWOOD COMPANY

214 WOODSTOCK STREET
CRYSTAL LAKE, ILLINOIS

Send Your Order to
DEPT. PM11

**At last—a new art
and hobby
modeling
in leather!**



You can now actually create solid 3-dimensional novelties from GENUINE LEATHER. No tools needed—kit contains all materials. Z-WAY LEATHERCRAFT method assures your skill since ready-cut and shaped leather parts, when cemented together, sanded, and colored will definitely take on shape of authentic 3-dimensional leather model of Mallard ducks, hunting dogs, flying geese. Be first in your group to sculpture in leather. Win praise and profit for your new hobby! prepaid **3.00**

Choose from these 8 leather kits: **ORDER TODAY**

- # 501—3 flying Mallard Ducks for wall ornaments. . .
- # 502—3 flying Canadian Geese for wall ornaments. . .
- # 503—3 flying Quail for wall ornaments.
- # 504—Mallard Duck, Canadian Goose, Quail for wall . . .
- # 601—Mallard Duck on Leather base Pen Stand
- # 602—Setter Dog on Leather base Pen Stand
- # 701—Mallard Duck on Leather base Ash Tray
- # 702—Setter Dog on Leather base Ash Tray

LEATHERSMITHS, INC.

Dept. M • 106 Water Street • New York 5, N.Y.

Drive Relaxed!
WITH
HANDE-FEED
Finger-Tip
GAS CONTROL



MINIMIZES DRIVING FATIGUE. RELIEVES and RELAXES THE FOOT. Fits steering post of any car. Connects directly to carburetor. Simply lift lever to increase engine speed; when released, engine idles. Pivots for use with right or left hand. Does not interfere with gear shift or steering, or cut out foot accelerator. Easy to install, do it yourself in about 15 min. Instructions with every unit. Chrome finish. Only \$9.95 postpaid if you send M. O. or check. C. O. D.'s plus postage.

ASK YOUR DEALER—
OR ORDER DIRECT.
We pay postage
if you send remittance
with order.

\$9.95
POSTPAID

TRANS-CONTINENTAL, INC., DEPT. 3 BOX 3812, ST. LOUIS, MO.

SHINE WITHOUT 'POLISH'

New Invention! • Sells Like Wild



Replaces messy pastes, liquids. Simply glide over shoes—and PRESTO!—you have a lustrous, long-lasting shine. No mess. No muss. No soiled hands. Clean. Handy. **WORKS LIKE MAGIC!** For Men's, Women's and Children's Shoes. Low priced. Lightning seller!

SAMPLES FOR AGENTS Sample offer sent immediately to all who send name at once. A penny postal will do. **SEND NO MONEY—just your name.** KRISTEE CO., 690 Bar Street, AKRON, OHIO

MACHINE SHOP EQUIPMENT



The 1949 edition of the famous Center Tool Co. Catalog is now ready! Every workshop owner should have a copy. 240 pages full of illustrations, descriptions, and prices of the latest tools made by best known manufacturers in U. S. You pay the cost of printing—50c. **We refund your 50c with your first order of \$10.00 or more.** Prompt delivery on most tools. Send check or money order today!

CENTER TOOL CO., 153 Centre Street, Dept. C, New York 13

Duo...the handiest tool!

USE IT FOR HOMECRAFT •
IN THE HOME • ON FURNITURE
AUTOS • BOATS • METAL • PLASTICS



DUO SANDER-POLISHER \$36.50

ACCESSORIES AS LISTED \$13.95

COMPLETE WITH ALL ACCESSORIES \$50.45
PRICES F.O.B. MUSKEGON

HERE'S WHAT THE DUO DOES!

- | | |
|--|---|
| SANDS!
Accessories:
3" pad assembly, 3 grades each of 3" and 5" abrasive discs. | DRILLS!
Accessories:
Drill chuck and adapter. (Drills supplied by dealer.) |
| POLISHES!
Accessory:
5" lamb's wool bonnet. | STEEL WOOLS!
Accessories:
2 steel wool pads. |
| GRINDS!
Accessories:
Drum and cone adapter assembly, 3 grades each of drum and cone abrasive sleeves. | BUFFS!
Accessory:
Wool buffing pad. |
| | WIRE BRUSHES!
Accessory:
1/2" steel wire brush. |

MANUFACTURED BY CLARKE...

Pioneer and Leader in Floor Sanding, Edging and Maintenance Equipment. Sales and Service Offices in all Principal Cities

The most versatile tool you ever saw—at lowest cost! Accessories easily and quickly interchangeable. Use it for all types of construction, maintenance, refinishing and repair. Lightweight, powerful, rugged. Listed by Underwriter's Laboratories, Inc. AC or DC. Order from your dealer or order with coupon.

DEALERS!
Write for information on the fast selling Duo!

Send Coupon Now

CLARKE SANDING MACHINE COMPANY

4510 Clay Avenue, Muskegon, Michigan.
Please ship _____ Duo Portable Electric Machines.
 Complete with all accessories \$50.45 Sander-Polisher Only \$36.50 Ship C.O.D. plus shipping charges Ship postpaid. Money order enclosed Send information on individual accessories

NAME _____
ADDRESS _____
CITY _____ ZONE _____ STATE _____

Make this amazing **FREE**
"SCREEN TEST"
 today!



Project your pictures on
 Free Sample of Radiant's
 new "Million Mirror"
 screen fabric—and see
 for yourself the remark-
 able difference it makes!

See how millions of tiny glass mirrors, firmly imbedded in the pure white screen surface, make your pictures fairly glow with life! See what happens when light is reflected instead of absorbed! You will enjoy clearer, sharper black and whites—richer, brighter, more brilliant colors. Here is projection as real as life itself! The new 1949 Radiant Screens have many unusual and exclusive features. See them at your dealer today!

Write today and get absolutely FREE
 a sample of the new Radiant "Million Mirror" Screen Fabric ALSO a copy of the *Basic Film Source Directory* your guide to film sources.

RADIANT MANUFACTURING CORP.
 1257 South Talman Avenue Chicago 8, Illinois

CADET DUAL VACUUM HORNS

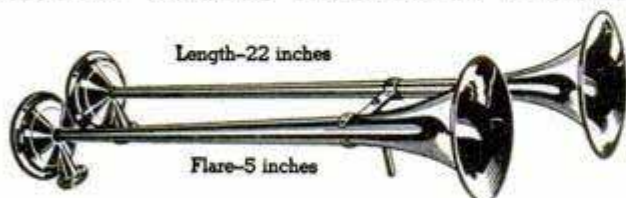

At the Low Price We Can All Afford

Here is your chance to get air horn results—looks, blast and beautiful organ tone—at a fraction of the cost of air horns. Spun brass with gleaming chrome finish or lasting lacquer. Positive operation. Complete unit consists of one pair of beautiful vacuum horns with the mounting brackets, valve, control handle, hose, fittings and installation instructions. Can be mounted on front fender or on top of or under the hood. A must for safety and smart appearance for any car. Chrome finish \$29.50—Lacquer finish \$23.75. Send check or money order and we will pay the postage—*or order C.O.D.*

The Protectorod Company Dept. 801
 4033 Windsor Road • • Youngstown 7, Ohio

The **NORWOOD** Director

EXPOSURE METER



—SO AMAZINGLY
 SIMPLE TO USE

—SO ACCURATE
 UNDER ALL
 PICTURE MAKING
 CONDITIONS

**IT'S DIFFERENT
 IT'S BETTER**

Expert photographers acclaim it "tops"—yet its simplicity of operation, plus its consistent accuracy makes it easily the best for the novice. No guessing—no compromises—no indecision. Perfect for any picture with any camera—anywhere. See your photographic dealer **\$29.95 plus tax**. Write for illustrated booklet, "Correct Exposure is Easy."

AMERICAN BOLEX COMPANY, INC.
 521 Fifth Avenue • New York 17, N. Y.

CHARLEY-HORSE?



SORE MUSCLES?

When muscles are stiff and sore from unusual exercise or strain, use **HEET®**, the liniment that's *strong* yet does not burn the skin. Wonderful relief from muscular soreness comes as comforting **HEET** quickly starts to *penetrate*. Just brush it on with the applicator. **HEET** starts at once to ease muscular pain and *keeps on* working for hours. Ask your druggist for **HEET** liniment.

Ball Bearing Live Center

Designed for maximum strength and rigidity, the Ball Bearing Live Center is recommended for high speeds, heavy roughing cuts, etc. 60 degree point runs in substantial precision ball bearing which is easily replaceable.



Center with No. 2 taper shank \$13.75

With No. 3 shank \$16.25

f. o. b. factory

SOUTH BEND LATHE WORKS
 455A E. Madison St.
 South Bend 22, Indiana

Indoor AND Outdoor Temperature at a glance

inside your home!



MARSH Duo-Temp

Everybody wants one of these new Marsh Duo-Temp thermometers because Duo-Temp alone shows both indoor and outdoor temperature right on the wall of any room—just as clearly as a clock tells time. There are two easy-to-read pointers on one big dial. One pointer shows outdoor temperature; the other, indoor temperature. No hard-to-read easily broken glass tubes. Outside temperature is transmitted to instrument by the same Marsh precision-built bourdon tube thermometer used in industrial applications. Light gray case with deep dubonnet dial and gold characters graces any interior. This highly accurate product of an 80 year old precision instrument manufacturer carries a lifetime guaranty. Easy to install. Size 3 3/8" square.

ONLY \$7.50

POSTPAID
(No C.O.D. orders please)

DEALERS: Be first with this fast selling instrument. Write for plan.

Jas. P. Marsh Corporation

Dept. 26, Skokie, Illinois

make your own Gems 29.50 F.O.B.

All necessary lapidary equipment is furnished, including a super-charged diamond blade for sawing, and all wheels for grinding, shaping and polishing; also complete instructions. The complete equipment as shown, less motor and belt, for only \$29.50. f.o.b., Burlington, Wisconsin. Write today for information and literature.

B&I MANUFACTURING CO.

Dept. S Burlington, Wis.

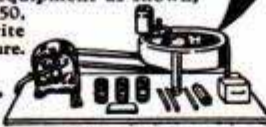

You Can't Be Stumped Driving By HULL AUTOMOBILE COMPASS

Erase all doubt at every turn, relax and enjoy every mile with the constant assurance of a Hull Compass. Streamline, \$3.95. Beaconlite (illuminated), \$5.95. At your dealer's. Write for circular.

HULL MFG. CO., P.O. Box 246-D10, Warren, Ohio

RUPTURED?

Get Relief This Proven Way

Why try to worry along with trusses that gouge your flesh—press heavily on hips and spine—enlarge opening—fail to hold rupture? You need the Cluthe. No leg-straps or cutting belts. Automatic adjustable pad holds at real opening—follows every body movement with instant increased support in case of strain. Cannot slip whether at work or play. Light. Waterproof. Can be worn in bath. Send for amazing FREE book, "Advice To Ruptured," and details of liberal truthful 60-day trial offer. Also endorsements from grateful users in your neighborhood. Write: CLUTHE SONS, Dept. 31, Bloomfield, New Jersey

Who will create a new mechanical toy?

and—Win an Income for Life!



Test your wits and your hands. You can earn big money if you design a new or different motor driven toy, powered by the mighty MINI MOTOR.

The manufacturer of the MINI MOTOR (also the famous "75" water pistol and "500" machine water gun) offers you a 5% royalty for the rest of your life on all sales of your "brain-child," if it is manufacturable.

Used to operate toy airplanes, racing cars, speed boats or whatever you may design, the MINI MOTOR (flashlight battery operated, wgt. 2 oz.) is light as a feather, built with hairbreadth precision and is powerful enough to run a toy bulldozer. You may find unexplored uses for this wonder motor which costs only \$2, yet may make you rich.

Fill in the coupon below and mail it with your check or money order for \$2. You will receive your motor by return mail with full instructions and suggestions to help you get started in this toy award plan, and also a contract for your protection. Nationally known engineers and scientists will judge the designs. Don't tell us your ideas until you receive your contract.

You have four months to work — so get in line early and be a winner.

ARPIN PRODUCTS, INC.
424 ALDEN STREET
ORANGE, N. J.

Enclosed money order check for \$2.
Please send the MINI MOTOR and my contract to me at once.

Name.....

Address.....

City..... Zone..... State.....

BUILD IT, FIX IT

WITH

AMBROID

"IT STAYS STUCK!"



For a quick job with permanent results use multi purpose, fast drying Ambroid liquid cement. For home workshop, household or factory. A quality leader for 38 years. Ready-to-use Ambroid is waterproof, transparent, quick drying, extra strong, flexible, heat and corrosion resistant. For assembling, repairing or mending jobs, keep Ambroid handy. At your dealer's or send 25c for a big 2 oz. tube postpaid. Money back guarantee.

Also 50¢ 4-oz. tube. Pts., qts., gals., for industrial use.



303 Franklin St., Boston 10, Mass.

SO EASY TO REMOVE SNOW

with Garden-All's
efficient Snow Plow!



Write for
Folder.

Garden-All

LAWN and GARDEN TRACTOR

SO STURDY!
SO VERSATILE!
SO EFFICIENT!

Garden-All supplies a tool for every lawn and gardening need for every season. See them all before buying.

It's so simple, so easy to remove snow when you have a Garden-All Snow Plow (Utility Scraper). You can do the work so thoroughly and so quickly that the job becomes a pleasure! And in other seasons you can use the Utility Scraper for light grading and terracing! The heavy-duty blade is adjustable for left, center or right cut; also perpendicularly. It's a very versatile tool at any season and, no matter how you use it—for snow or earth—it's built to the job with speed and efficiency!

GARDEN-ALL TRACTOR, INC.

Dept. P, 110 W. UNION STREET, LIBERTY, INDIANA

Don't Risk

Engine Overheating

Keep cooling systems
ALWAYS up to par
with regular

Warner care



Warner Liquid Solder (Non-Metallic)

• Deposits tiny fibers to repair leaks anywhere in the cooling system.

Warner Radiator Cleaner

• Thoroughly cleans cooling system of rust, oil muck and grease.

Warner Cooling System Protector

• Prevents rust, scale and corrosion.

No delays—just pour in and keep on driving.
Do it yourself, or ask your service man.



Warner-Patterson Co., 920 S. Michigan Ave., Chicago 5

New ARMY MINE DETECTOR

AN/PMS-1 is a portable device for detecting Metallic and Non-metallic objects. You can use them to ferret out all kinds of Buried-Treasures, in the Mountains or on the Beaches. Its private use suggests the following: In the hills or mountains, all types of Metals and Non-metals; on the beaches any type of objects such as jewelry and coins. For commercial use such as tracing buried cable, wire and sewer tile. Locating buried metal or wooden boundary stakes, etc.

TECHNICAL FEATURES:

This unit actually is a Ultra high Frequency transmitter. A variation in radiance resistance, caused by any change in soil density, shows in a deflection of the Microammeter, discriminating between Metallic or Non-metallic objects by a swing to the right or left. Audio response in the Headset also indicates changes by an increase or decrease in the volume of the 1000 cycle tone. By lengthening dipole rods operator will be able to increase the depth sensitivity.

This unit comes complete with spare tubes, antenna, dipole and reflector, and instructions manual, in wooden chest 9 1/2" height x 28 1/4" length x 15 1/2" depth. Weight in operation is only 22 lbs. I.B.S.S. Batteries. Power supply: Three 45 volt and one 6 volt batteries. Uses standard batteries. Original COST \$285.00. Shipping Weight appr. 80 lbs. F. O. B., N. Y.

Our Special Price **\$26.40**

with battery
\$17.50 without battery



No C.O.D.

Send Orders to: **COLUMBO TRADING CO., INC.**
304 Canal St., Dept. P.M., N. Y. 13, N. Y.

INCREASE YOUR COMFORT PROTECT YOUR HEALTH

Easy with A-P THERMOSTAT TEMPERATURE CONTROL on your oil heater. Pays its way in steadier heating comfort, turning the heat up and down automatically.

At your appliance dealer—or order A-P Thermostat Temperature Control direct for prompt delivery. Mention heater make and model number A-P Control used. **ONLY \$22.97 postpaid.**

Complete with Thermostat, Conversion Top, Transformer, wiring, accessories, instructions.

For **FREE** Booklet—"3 Times More Comfort" write



AUTOMATIC PRODUCTS CO.

2522 N. 32nd Street, Milwaukee 10, Wisconsin

Get that **NEW-CAR FEEL** again!

SEALED POWER PISTON RINGS

The only ring with the **Full-Flow Spring!**

SEALED POWER CORP., DEPT. G-10, MUSKEGON, MICH.



New SpeedWay COMBO KIT

\$29.50

at your local hardware
and electric stores.

**Every home needs these
basic tools!**

Not only the home craftsman, model maker and mechanic, but everyone with a home, a car or a hobby needs a SpeedWay Combo Kit.

Here are the basic power tools needed wherever things are made, installed or repaired. No. 69 SpeedWay 1/4" Drill, with attachments for sanding and polishing

A No. 129 SpeedWay Hand Grinder, that takes all arbor-mounted grinding wheels, rotary files, cutters and brushes, and accessories as shown (left)

With this kit you can drill holes up to 1/4" diameter, can grind, cut and shape steel, brass, wood, plastics, bone, etc. Tedious jobs like sand-papering, polishing and filing, scraping off rust, etc., actually become fun.

Designed and built by SpeedWay—manufacturers of quality power tools for over 40 years. These are not toys but capable electric tools with lots of power and correct operating speeds.

Sold by all leading hardware, electric, tool and department stores. (Ask for a demonstration.)

Write for *FREE* descriptive circular and the name of your nearest dealer.

Speedway Manufacturing Co.

1863 So. 52nd Avenue
CICERO, ILLINOIS



Powerful 1/4" Capacity Electric Drill—drills holes in steel or wood. Quality drill bit included.



with adapter, rubber backer and abrasive discs, it makes a portable power sander. (Adapter backer and 10 assorted abrasive discs included)



with the slip-on lamb's wool bonnet, it is a portable power-driven polisher or buffer.



Snapped in the chromium plated Speed Stand, it becomes a horizontal drill stand, bench sander or polishing head.



High-Speed Hand Grinder (20 000 R P M)—For all mounted cutting burrs (for cutting steel, wood, bone, plastics), grinding stones, brushes and abrasive discs. Seven assorted accessories plus 1/8" and 3/32" collets included.



Instruction Manuals—easy-to-follow guides to year 'round fun and useful pleasure with your Combo-Kit.

Note: The tools in the Combo-Kit operate on either 110-120 V AC or DC current.



Flex-O-Shaft

HANDLES LIKE
A PEN*

\$35⁰⁰



Flex-O-Shaft is an improved all-purpose machine for homes, schools, shops, or factories. The slender, light-weight aluminum hand piece is ideal for grinding, drilling, sawing, buffing, scoring, etching, polishing, and scores of other uses. There is no bulky, throbbing, pulling motor in your hand. The light-weight motor can hang on the wall, or can be set down on working table. Speed is controlled by foot-operated rheostat, leaving hands free. This precision ball-bearing tool is as easily guided as a pen, speeding up operation because of ease in handling. It is a wonderful, compact, power house for making all kinds of objects. This unit consisting of Flex-O-Shaft with 6-ft. cord, 1/16 H. P. Motor, Rheostat with cord and plug, all for \$35.00. Send for complete information today! Use coupon below.

Flex-O-Shaft
and complete
Tool Kit with
66 accessories
only

\$50⁰⁰



FLEX-O-SHAFT SALES CO. (Dept. C)
Prairieview, Illinois

- Please send complete information on the Flex-O-Shaft Kit.
 Please send one Flex-O-Shaft Kit. \$50.00 enclosed. Shipping charges C.O.D.

Name _____

Address _____

City _____ Zone _____ State _____

ELECTRICITY *Anywhere*

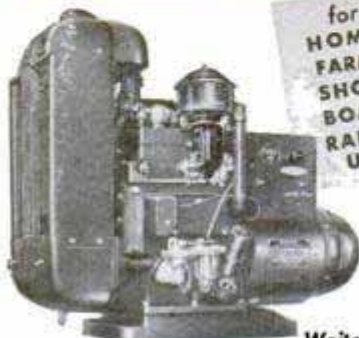

for
HOMES
FARMS
SHOPS
BOATS
RADIO
USE

● Onan gasoline-engine-driven Electric Plants supply reliable, economical electric service for any use. Portable, stationary or standby models. Water or air-cooled, compact and rugged.

A.C.: 350 to 35,000 watts in all standard voltages and frequencies. D.C.: 600 to 10,000 watts. 115 and 230 volts. BATTERY CHARGERS: 500 to 3,500 watts; 6, 12, 24, 32 volts.

Write for folder

D. W. ONAN & SONS INC.
2546 Royalston Ave., Minneapolis 5, Minn.



DEAF?

-Here's Good News!

Thousands are regaining the joy and happiness of hearing with a revolutionary new and amazingly economical hearing aid that's ready to wear without individual "fitting." Costs half or less than half the price of others. Operates at less cost (3/4 of a cent per hour battery cost) than any other single-unit hearing aid of equal power. It has the acceptance of the American Medical Association, Council on Physical Medicine.

This new, light-weight, single-unit hearing aid is the product of the Zenith Radio laboratories, world-famous for their 30 years of research and leadership in *radiomics* exclusively.

Anyone who wishes to try this amazing new hearing aid can do so for 10 days—at home, at work, anywhere—on a Hear Better or Pay Nothing (money-back) offer.*

If you want to delight family and friends who want you to hear and enjoy life with them, just drop a postcard to the Zenith Radio Corporation, Hearing Aid Division, Dept. PM108, 5801 Dickens Ave., Chicago 39, Illinois, for full, free information about their Hear Better or Pay Nothing offer. Made by the makers of world-famous Zenith Radios.

*Trial offer available on direct sales by Zenith Radio Corporation or its subsidiaries.

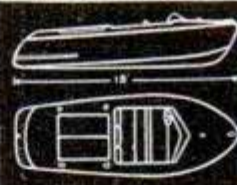

BOAT PATTERNS • BLUEPRINTS

70 Modern plywood designs by leading naval architects. Large scale, fully detailed blueprints, full size paper patterns available. Kayaks to cruisers, row-power-sail, (6 to 30 ft.). Send 25c (coin) for Design Catalog, or \$1.00 for Catalog plus booklet, "How to Build Plywood Boats."

MARINE MART, Buffalo 7-B, New York

THOUSANDS OF SUFFERERS USE
BREATHEASY
FOR
ASTHMA

CARRY IT WITH YOU
USE IT ANYWHERE

*Sold on Money-Back
Guarantee*

Write To Dept. PM

BREATHEASY DISTRIBUTORS, INC
65 CEDAR STREET
SEATTLE 1 WASHINGTON

RADIOMEN'S HEADQUARTERS * WORLD WIDE MAIL ORDER SERVICE!

COMPRESSED AIR INSTANTLY, Anywhere!!

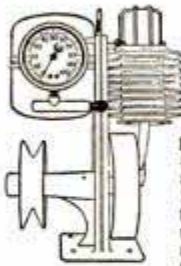

Portable Air Compressor and storage tank. Ruggedly built of best materials using lifetime lubricated ball-bearing on connecting rod and oil impregnated main bearing on shaft. Unusual design forever eliminates valve trouble, the most common fault in air compressors. **PATENTED** unique air intake system increases efficiency tremendously over other compressors so that air output is much greater than that from larger compressors powered by heavier motors. Will deliver appr. 3500 cu. in. air per min. at maintained pressure of 30 lbs., or will inflate a 90 lb. truck tire in less than 1 min. Complete with 100 lb. gauge, fingertip adjustment allows setting of output pressure at any value, which will automatically be maintained. Works from any 1/4 H.P. motor. Useful for spraying paints or lacquers, disinfectants, insecticides, annealing or brazing with natural gas.

inflating tires, etc. Price \$14.50 postage prepaid anywhere in U.S. Efficient, adjustable syphon type spray gun complete with 12 ft. of 100 lb. tested hose for only \$7.75 with pint container, also prepaid. 25% required on C.O.D. orders. Send for free catalogs of radio parts and surplus items.

Terrific Value

ONLY

\$20.95

Equipped with 1/4" Jacobs Geared Chuck and Key



PORTABLE ELECTRIC DRILL

(Sold at less than established factory price so we cannot mention brand name)

Not an intermittent duty drill, but a full size rugged tool. Most convenient type switch, natural grip handle, and balance like a six shooter. Precision cut gears—turbine type cooling blower—extra long brushes. No stalling under heaviest pressure because of powerful 110 Volt AC or DC motor and multiple ball bearing thrust. Other bearings self-aligning lifetime-lubricated Oilite type. Made for toughest year-in and year-out service in plant or on construction jobs. Amazing perpetual factory guarantee assures you of a lifetime of trouble-free use.

Full refund (you pay transportation) if not pleased with drill after trial.

HEAT GUN

Streamlined pistol grip heat gun in vivid red housing, that delivers a powerful 20 Cubic Ft. per minute blast of hot air at 160° Fahrenheit. Ordinary blowers have small fan motors, but this has a lifetime-lubricated AC-DC motor of the rugged vacuum cleaner type, that produces a hurricane of either hot or cold air. Perfect for blowing out dirt or dust, drying out ignition systems, warming up carburetors, drying paint, thawing out radiators, etc. Warning:—Keep this away from your wife, or she will be using it to dry her hair because it will do it in half the time of her ordinary hair dryer, to say nothing of her using it to dry stockings or clothing, or defrost the refrigerator instantly. Only \$12.95. Satisfaction guaranteed or money refunded if returned prepaid within 5 days.

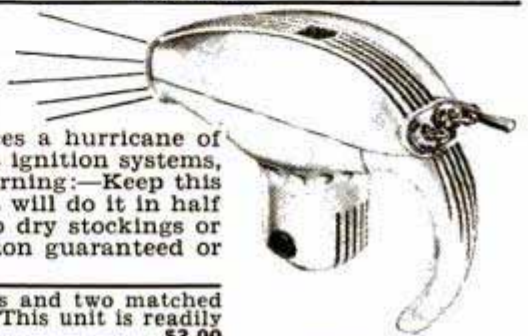

ALUMINUM GEAR BOX 18x8x7 that contains two powerful electric motors and two matched gear trains. 62 gears in all varying in size from 1/2 to 4 inches in diameter. This unit is readily converted to rotate a beam antenna or for any other similar use..... \$3.00

Sensational Value in AC-DC Pocket Tester

This analyzer, featuring a sensitive repulsion type meter housed in a bakelite case, represents the culmination of 15 years achievement in the instrument field by a large company specializing in electronic test equipment.

Specifications of the AC-DC Model Volt-Ohm-Milliammeter:

AC Volts—0-25,50,125,250
DC Volts—0-25,50,125,250
Milliamperes AC—0 to 50
DC Milliamperes—0 to 50
Ohms Full Scale—100,000
Ohms Center Scale—2400
Capacity—.05 to 15 Mfd.



Total Price, prepaid anywhere in the USA—\$7.00
Similar DC Meter, lacking the AC operated ranges of above, \$5.50 prepaid.

RT-1248 INTERCOMMUNICATION TRANSCIVER

This brand new 15 tube transmitter-receiver was designed for mobile service on 12 volts, and will operate in the "Citizens' Band," where no gov't. license to transmit is necessary. It's a cinch for any experimenter to connect this unit for 110 VAC operation by following the instructions and diagrams supplied, which cover numerous applications, including television. For those intending to use on car or boat, a new dynamotor, exactly as originally supplied, costs only \$15.00. Don't fail to write for FREE descriptive bulletin. RT 1248 transceivers only \$29.95 each, or two for \$53.90.

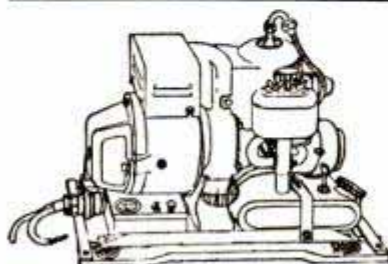

PE-109 32-VOLT DIRECT CURRENT POWER PLANT

This power plant consists of a gasoline engine that is direct coupled to a 2000 watt 32 volt DC generator. This unit is ideal for use in locations that are not serviced by commercial power or to operate many of the surplus items that require 32 volts DC. The price of this power plant is only \$75.00. We run and test every unit before shipment. We can also supply a converter that will supply 110 V AC from the above unit or any 16-32 V DC source for \$12.95.

CABLE ADDRESS BUFRAD

Minimum order \$3.00—All prices subject to change—25% deposit with C.O.D. orders.

BUFFALO RADIO SUPPLY, 219-221 Genesee St., Dept. PM, BUFFALO 3, N. Y.

\$9.95 TAKES ALL THREE BIG BARGAINS

1. SENSATIONAL, FASCINATING, MYSTERIOUS SELSYNS.

Brand new Selsyns made by G. E. Company. Two or more connected together work perfectly on 110V AC. Any rotation of the shaft of one selsyn and all others connected to it will rotate exactly as many degrees in the same direction, following unerringly as if the units were connected together by shafting instead of wire. This is true whether you twist the shaft of the master unit a fraction of a revolution or many revolutions. Useful for indicating direction of weather vanes, rotating directional antennas, or controlling innumerable operations from a distance. Complete with diagram and instructions. Per Matched pair \$4.95.

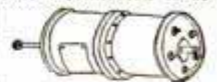

2. RADIO HEADSETS.

Latest supersensitive type with rubber earpieces. Every pair guaranteed perfect, \$5.99 per pair OR 3 PAIRS FOR \$16.00.

3. HOME WORKSHOP AT BARGAIN PRICE.

Accurate and precise 2 speed guaranteed hobby lathe, the essential machine for the home workshop. Sturdy enough for light production work or factory standby service. Supplied with 56" of belting for connecting to any available electric motor or power take-off, such as on a jeep or tractor. Also included in this unbelievable offer are such accessories as a 1/2" drill chuck with specially hardened tool steel jaws, a 4" electric furnace high speed grinding wheel, a cotton buffing wheel with a large supply of buffing compound, and a 4" steel wire scratch brush. Your cost \$6.00. Sole export agent. Distributor inquiries invited.

ORDER NOW—DON'T DELAY—NO C.O.D.s

PRESSURE QUEEN

Outperforms them all

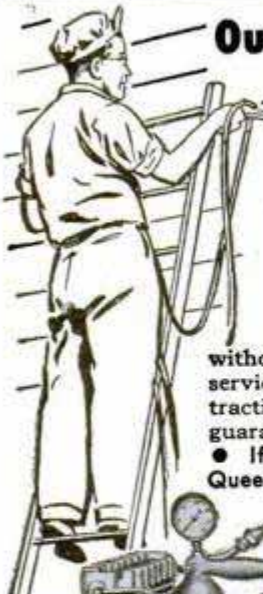

The only portable spray painting outfit having 4 cylinders in space usually required for one. Paints buildings; refinishes automobiles; inflates tires; lubricates chassis and farm machinery. Does more work in an hour than hand brushing in a day. Uniform pressure without pulsation. Ideal for home, farm, service station, machine shop and contracting painter. Factory tested and guaranteed.

• If your dealer does not sell Pressure Queen, order direct for immediate shipment,

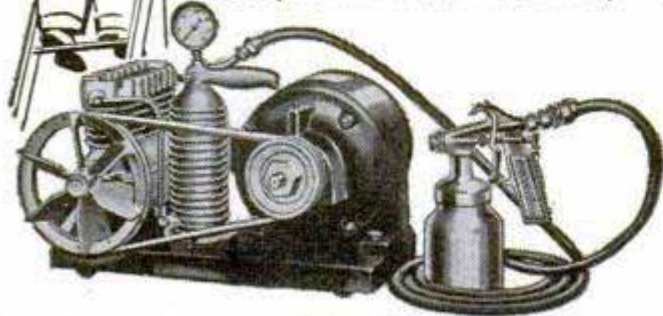

THE CAMPBELL-HAUSFELD CO.

1046 RAILROAD AVE.

HARRISON, OHIO

Another GREAT NECK First!



ALL NEW!
REVOLUTIONARY
MAXIMUM-GRIP
PLASTIC HANDLE
SCREW DRIVER

★ **Unbreakable!**
 ★ **Twistproof!**
 ★ **Modern Design!**

Blade lengths from 4" to 10"



GREAT NECK—leader in tool design—offers the new, handsome *maximum-grip* screw driver you've been waiting for! Richly colored *unbreakable* plastic handle is slip-proof, non-explosive, non-absorbent to grease or oils. Entire blade is of specially hardened and oil tempered *quality* alloy tool steel, highly mirror-polished. Bit is precision-ground to exact size. Blade is deeply embedded and twistproof. Here is a beautiful *engineered* tool to give good service for many years!

THE QUALITY TOOL FOR CRAFTSMEN, MECHANICS, HOBBYISTS—EVERYONE!

ASK FOR GREAT NECK TOOLS BY NAME

NOW AT HARDWARE COUNTERS

GREAT NECK SAW MFRS., INC. • MINEOLA, N. Y.

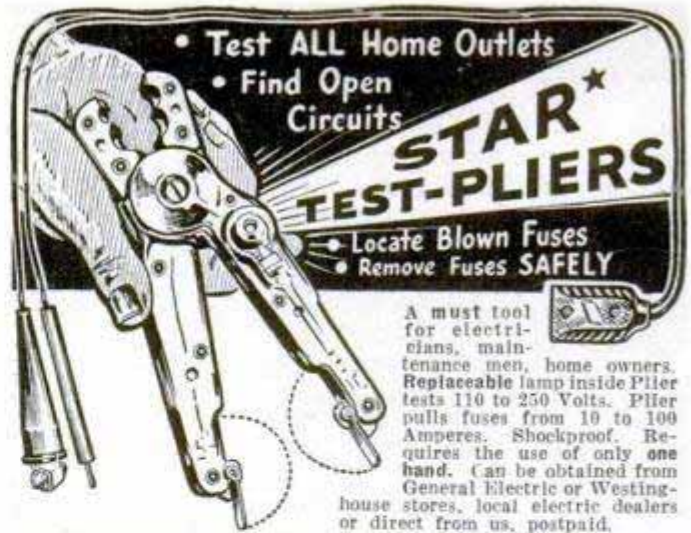

• Test ALL Home Outlets
 • Find Open Circuits

STAR TEST-PLIERS

• Locate Blown Fuses
 • Remove Fuses SAFELY

A must tool for electricians, maintenance men, home owners. Replaceable lamp inside Plier tests 110 to 250 Volts. Plier pulls fuses from 10 to 100 Amperes. Shockproof. Requires the use of only one hand. Can be obtained from General Electric or Westinghouse stores, local electric dealers or direct from us, postpaid.

Price \$2.75 without Leads, \$1.50 additional for Leads. Order TODAY.
STAR FUSE CO., 233 Canal St., New York 13, N. Y.

One Year Written Guarantee!
ARMY AIR CORPS 16 JEWEL

ELGIN
\$19⁹⁵



Made for Pilots and Navigators of the U. S. Army Air Forces. They had to be good. Sturdy 16 Jewel Elgin men's wrist watches. Shock resistant. Sweep second hand. Luminous hands and dial. Stainless steel back. Unbreakable crystal. Water repellent. Made by ELGIN one of America's outstanding watch manufacturers. Fully reconditioned. One year written guarantee sent with each watch. Supply limited! **SEND NO MONEY.** Simply pay postman \$19.95 plus 10% tax and postage on delivery. Cash orders sent postpaid. **UNITED PRODUCTS CO., 7941 S. Halsted, Dept. RES-1109, Chicago 20.**

BUILD YOUR OWN ZEOLITE WATER SOFTENER



You can do it inexpensively with only a wrench and a little spare time. Famous Zeolite process as used by leading manufacturers. Send \$1 for easy-to-follow directions and list of materials. (Materials available locally or from us.) Or inquire about factory-built LARCO Softeners \$55.20 up. **LAKE REGION MFG. CO., INC., 3920-A Lynn Ave., Minneapolis 16, Minn.**

BARGAINS FROM WORLD WAR II

Thousands of Bargains in Military, Outdoor & Sport Goods for Hunter, Farmer, Scout. Send 10c for NEW 32-page catalog, just issued, returned with first order.

A and N SUPPLY CO.

4720 LESTER ST.

RICHMOND 15, VA.

COMPASS SAW KIT \$3.69

Postpaid or from your dealer. No C.O.D. orders

Spartan COMPASS SAW KIT
 for WOOD and METAL



Every home craftsman should have one. Contains cast aluminum handle and 4 blades for cutting wood, metal, lath, plaster, BX cable, etc.

Spartan Saw Works, Springfield 7, Mass.

Save on Auto Needs at J. C. WHITNEY & CO., 1917 Archer Ave., Chicago 16, Ill.

Our Finest Precision REBUILT
MOTOR BLOCK
ASSEMBLIES

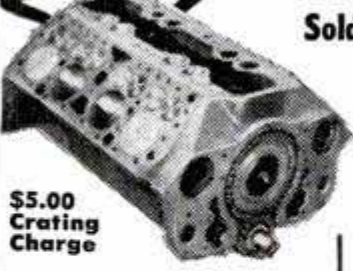

\$5.00
Crating
Charge

Sold Outright or Exchange

Rebuilt by skilled mechanics. Assembly has Reborn Block with New Pistons, Pins, Rings, Reground Crankshaft, all New Bearings. Guaranteed 90 Days. Allowance on Old Motor We ship at outright price. Send your motor prepaid, must be suitable for rebuilding. Send in notarized bill of sale showing title number if any. We refund difference when we receive your motor.

BUICK Outright Exch.
34-47 6 cyl. \$199.00 \$160.00

CHEVROLET Outr. Exch.
29-47 6 cyl. 117.50 87.50

CHRYSLER Outright Exch.
34-47 6 cyl. 162.50 130.00
35-47 8 cyl. 199.00 160.00

DE SOTO Outright Exch.
34-47 6 cyl. 162.50 130.00

DODGE—3 1/4" bore Outright Exch.
35-47 6 cyl. 144.00 109.00

3 3/8" bore Outright Exch.
34-47 6 cyl. 162.50 130.00

FORD Outright Exch.
28-31 4 cyl. 119.00 87.00

FORD Outright Exch.
32-34 V8 .. \$139.00 \$ 99.00
35-47 V8 .. 149.00 99.00

HUDSON-TERRA. Outright Exch.
35-47 6 cyl. 175.00 135.00

MERCURY Outright Exch.
39-47 V8 .. 149.00 99.00

Oldsmobile Outright Exch.
37-47 6 cyl. 175.00 135.00
35-47 8 cyl. 199.00 160.00

PLYMOUTH Outr. Exch.
35-47 6 cyl. 139.00 109.00

PONTIAC Outright Exch.
37-47 6 cyl. 175.00 135.00
35-47 8 cyl. 199.00 160.00

Studebaker Outright Exch.
35-47 6 cyl. 175.00 135.00
35-47 8 cyl. 199.00 160.00



\$5.00
Crating
Charge

60 HP. JEEP Engines

Reconditioned, Tested and Guaranteed in perfect running order and ready to run. Every part is checked to be perfect and carries a 90 Day Guarantee same as a new engine.

COMPLETE with ... Generator, Starter, Distributor, Coil, Fan and Fan Belt, Water Pump, Fuel Pump, Intake and Exhaust Manifolds, Carburetor, Oil Filter, Spark Plugs, Flywheel, Clutch and Pressure Plate, Wiring.

Outright, **\$179.50**
PG58R-003, Ea.

New JXD Hercules 6-cyl. Engine

Removed from new vehicles. Engine is guaranteed same as new. Complete with 6 volt ignition, Carburetor, Wiring, etc. 6 cyl. 4" bore, 4 1/4" stroke. 320 cu. in. displacement. 84 H.P. at 2800 RPM. Each motor guaranteed 5 hr. test run. Complete with Built-in Mechanical Governor. READY TO RUN.

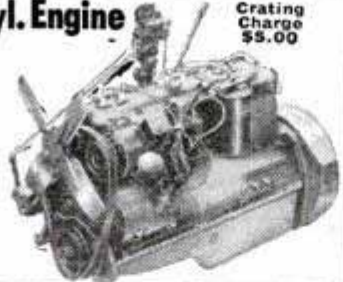

PMG-58N-
JXD
Each **\$450.00**

Crating
Charge
\$5.00

65 KW. 225 Volt D.C. GAS ELECTRIC GENERATING UNIT

RECONDITIONED!
Equipped with 6 cyl. INLECT Hercules Gas Engine—4 1/2" bore, 5 1/4" stroke. Complete with Carburetor and Electrical equipment. 225 Volt—65 KW General Electric Generator is attached and develops 290 amp. D.C. current at 1800 R.P.M. Complete as shown.

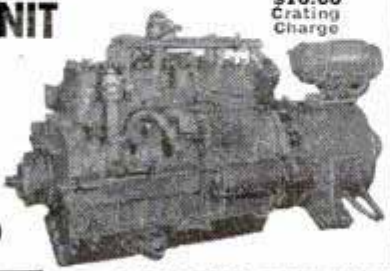

PMG60R-
191—
Each **\$695.00**

\$10.00
Crating
Charge

RADIATOR **\$79.50**
for above unit...

RADIATORS
FOR ALL CARS & TRUCKS
Write in for Our Low Prices.
Give year, make & model.

SEND 25% CASH WITH ORDER, BALANCE C.O.D.

J.C. WHITNEY & Co.
1917 Archer Ave. Chicago 16, Ill.

NEW CONVERTIBLE TOPS

Choice of Black or Tan. All Tops Tailor Made for Easy Installation.

Sensational Value!

As Low as
\$24.95

"ZIPPER TYPE"
REAR CURTAIN

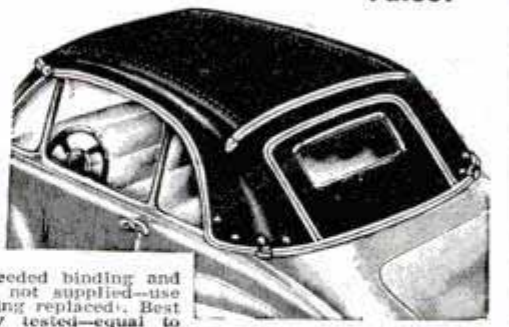

Each top packed complete and consists of main top proper, rear curtain and all needed binding and fittings. (Glass is not supplied—use glass from top being replaced). Best quality. Laboratory tested—equal to or better than the original. All metal parts are of heavy bright chrome plated rust resistant. Tops are heavily stitched with treated thread and sewed for durability and appearance.

Car	Year	Price
BUICK	1936-48	\$41.75
CADILLAC	1936-48	41.75
CHEVROLET	1936-48	39.50
CHRYSLER	1935-38	33.00
CHRYSLER	1940-48	39.50
DE SOTO	1935-38	33.00
DE SOTO	1940-48	39.50
DODGE	1935-38	33.00
DODGE	1940-48	39.50
FORD		
1928-31 Roadster & Cpe.		24.95
1933-39-Rdstr. & 2 pas. Cpe.		33.00
1928-39-Phaet. & Sedan		42.95
1936-42-5 Pas. Clb. Cpe.		37.95
1946-48-6 Pas. Clb. Cpe.		39.95

Car	Year	Price
Hudson also		
Terra, to '38	1936-40	\$39.95
HUDSON	1941-47	46.95
LASALLE	1936-40	41.75
MERCURY	1939-42	37.95
MERCURY	1946-49	39.95
NASH & LAFAYETTE	1937-41	39.95
OLDSMOBILE	1936-48	41.75
PACKARD	1936-48	45.95
PLYMOUTH	1935-39	33.00
PLYMOUTH	1940-48	39.50
PONTIAC	1936-48	41.75
STUDEBAKER	1948	44.15

NOTE: Specify color wanted also Model or Series, Body Style, Year & Make when ordering.

JEEP FRONT FLOOR MATS Rubber with Felt Back. For all Jeeps. Ea. **\$3.95**

All Weather Aluminum Adjustable Visor

Black satin finish, made of aircraft aluminum with stainless steel center strip. Ultra-Modern Air Flow Styling. No drilling—engineered to fit most cars. Adjustable for height and width. No painting required. Glare proof underside. Individually boxed.



MA48N-20—Fits most cars having Windshield Divider Strip, including 1949 Ford and Mercury. EACH **\$9.95**
Specify year & model of auto or truck when ordering.

FORD V8 DUAL & SINGLE MUFFLERS



MUFFLERS that give that Motorboat tone

Made of high quality steel For:
FORD DeSoto
Plymouth Chrysler
Chevrolet BUICK
DODGE Pontiac

FORD V8 DUALS
Increases power. Reduces back pressure. Saves Gas.
MD20N-208—
Complete Set **\$15.95**

Also Universal type to fit all other cars. Specify year, make & model when ordering.
MD20N-210
\$4.95
ea.

FENDER SKIRTS for Modern Beauty

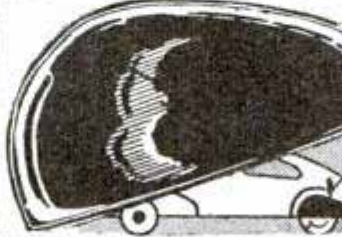

For most makes of cars including '49 Ford & Mercury. Made of all metal, prime finish, with Rubber beading to prevent rattle. Easy to Install.

MC31N-9
\$12.95
Per Pair
Be sure to specify year, make & model of car.

REPLACEMENT GRILLES

For Most Cars
Write in for Our Low Prices.
Give year, make & model.



When Screws Won't Stay TIGHT, Use SMOOTH-ON

Apply Smooth-On No. 1 Iron Cement to screw threads and into the screw hole. Insert and tighten up the screw. It will take hold and, when set, will STAY TIGHT, for Smooth-On expands slightly as it hardens, wedging the screw in place. This is only one small use for this general-purpose iron cement. With it you can stop leaks and seal cracks in cast metal parts, tighten loose knobs, casters, tool and utensil handles, make many auto repairs. Buy it in 1/4-oz., 7-oz., or 1-lb. size at your hardware store. If they haven't Smooth-On, write us.

FREE 40-page Repair Handbook

Many original uses for Smooth-On around the house, on the car, etc. Simple directions. 170 illustrations. Send postcard for YOUR free copy.

SMOOTH-ON MFG. CO., Dept. 37K,
570 Communipaw Ave., Jersey City 4, N. J.

Do it with

SMOOTH-ON

THE IRON CEMENT OF 1000 USES



BUILD and ENJOY YOUR OWN BOAT!



ASSEMBLED IN 8 HOURS

WITH A Plywood Boat Kit

LIGHTWEIGHT, 12-FEET LONG

ONLY \$54.00
(Freight paid)

READY CUT — needs no forms nor special tools to assemble. Kit includes all hardware, paint, etc. (less cns).

Send for Free Folder

TAFT MARINE WOODCRAFT

Dept. M, 636 39th Ave. N.E.

Minneapolis 18, Minn.

WHEELS



Spotwelded Heavy Gauge Steel LOWER PRICES!

- 5"—5 1/2" solid tire, 3/8" bushing, ea. 49c
- 8" with 1" solid tire—
- 1 1/2" OR 3/8" steel bearing, ea. 1.00
- with 1 1/2" KILIAN BALL B'R'GS, ea. 1.25
- 10" with 1 1/2" KILIAN BALL B'R'GS, and 1.75 semi-pneumatic tire, ea. 2.29

ADD 10% to ALL prices for P.P.: 15% West of Miss. Send check or moneyorder only. We guarantee satisfaction. Mail order NOW!

C. W. YOUNG MFG. CORP.

208 BURNET AVE.

SYRACUSE, N. Y.

TRIM YOUR OWN



TRIM HAIR AT HOME—SAVE BARBER BILLS
Trims hair as it combs! Easy! Quick! Keeps men's, women's, children's hair trim, neat, freshly-cut looking all the time! Trims, tapers, thins out uneven hair. Use like ordinary comb. Safe. Simple. No experience required. Fine for legs, underarms! *Sells Like Wild!*

SAMPLES for AGENTS

Sample offer sent immediately to all who send name at once. Penny postal will do. SEND NO MONEY. Just your name. KRISTEE CO. 691 BAR ST., AKRON, OHIO



LUMBER

A BOARD OR A CARLOAD

Harold Hunt wants to send you big, new No. 15-B Catalog. Over 148 pages of woodworking ideas. 12 pages of rare woods in colors. UNEQUALLED BARGAINS in imported and American woods, supplies, hard-to-find hardware. Send only 15c to cover postage and handling.

CRAFTSMAN WOOD SERVICE CO. 2729 S. Mary St. Dept. A-98 Chicago 8, Ill.

TOP GRADE KILN-DRIED WALNUT MAHOG. CHERRY WHITE HARD MAPLE POPLAR OAK AROMATIC RED CEDAR

QUICK CASH PROFITS on "7-X"

FREE BIG 7-X SAMPLE WRITE TODAY

You can earn up to \$1,000 a month handling "7-X"—new miracle ALL-PURPOSE Hand and Fabric Cleaner. ABSOLUTELY WATERLESS. Not a liquid. Instant acting. Easy to use. 100% PROFIT—thousands of sales to mechanics, painters, factories, print shops, garages, etc. Wonderful demonstrator. SEND PENNY POST CARD TODAY for BIG FREE SAMPLE and complete details of our MONEY-MAKING SALES PLAN.

SUNNY CAL CO., Dept. H, Kansas City 15, Kansas

SAY YOU SAW IT IN POPULAR MECHANICS



NEW WELDING OUTFIT

Complete like picture \$54.50

Electric Welding Outfits from \$39.00 up. Distributor inquiries invited.

EAGLE WELDING EQUIPMENT CO. Dept. 40, 5085 Broadway Chicago 40, Ill.

ONLY *Royalton*

FILTERWELL

has All Three

- 1 Economy Price \$1
- 2 Ajustomatic* Stem
- 3 Imported Briar

* Patented

← AJUSTOMATIC STEM NEVER LOCKS OUT OF LINE

← FILTER ABSORBS TARS & JUICES

All Royalton Pipes have the Ajustomatic Stem

Before you buy your next pipe check all features of the Royalton Filterwell: patented Ajustomatic screw-stem, plus fine imported briar in a filter pipe at \$1.00... Luxury smoking at amazingly low price!

At leading stores. If unavailable locally write to
HENRY LEONARD & THOMAS, INC. OZONE PARK 17, N. Y.

Amazing New Utility —
with sanding attachment
for Dumore Duplex

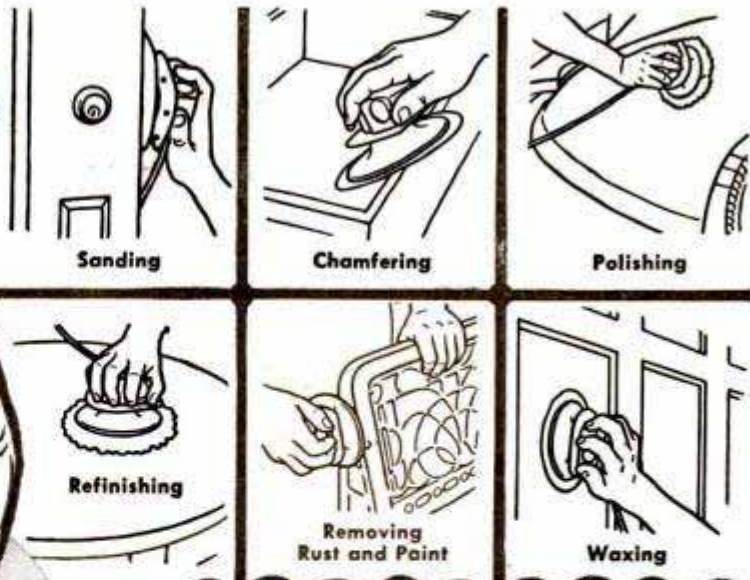

— do these and dozens of
other jobs with Dumore's
Handy Sandy
sanding
attachment
... only **\$9.95**

Powerful new "Handy Sandy"

(sanding and polishing attachment)

makes Dumore Duplex the most useful tool in your shop!

Here's a low-priced sander and polisher that *really does a job for you!* It's a powerful, practical tool — not just a toy. The rugged 1/14 HP Duplex Grinder motor gives it the punch *you want* on man-sized jobs.

Attached to the end of the Duplex flexible

shaft, the Dumore Handy Sandy is a light-weight, maneuverable sander. It fits your hand, and fills the bill for rough clean-up work or sensitive finishing operations. Get a Handy Sandy for your shop today. It makes tough work in wood and metal a pleasure.

More Power, More Capacity for Easier Work

That's what you get from a Dumore Duplex — the grinder that takes 3/32", 1/8", and 1/4" tools for a wide range of work. Deluxe Kit (as illustrated) with 27 accessories, \$27.50; Standard Kit with 9 accessories, \$19.75. Attachments extra. See it at your dealer's, or order direct today!



The Dumore Handy Sandy fits right onto the flexible shaft attachment of your Dumore Duplex Grinder.

Tear out this coupon and mail today —
for complete information on the Handy Sandy,
Dumore Duplex, and other Duplex attachments.

The Dumore Co., Dept. K-51, Racine, Wis.

Please send me the items checked:

- "Handy Sandy" attachment complete with 5 1/2" rubber disk, sheepskin polishing pad, two sanding disks, and wrench; \$9.95 enclosed.
- Duplex Deluxe Kit with 27 accessories, \$27.50 enclosed.
- Duplex Standard Kit with 9 accessories, \$19.75 enclosed.
- Flexible Shaft for Duplex Grinder, \$6.25 enclosed.
- Information on the Duplex Grinder and attachments. Shipping charges C.O.D.

Name.....

Address.....

City..... State.....

H-22

NEW!

5-POUND, 37-INCH AUTOMATIC CARBINE

RIFLE
\$26.95
\$27.80
west of
Rockies

BRAND NEW DESIGN— Another Mossberg "first". Carbine-style, .22 cal., 7-shot, clip type automatic, with **HINGED FORE-END**. Model #152.



Hinged fore-end forms 5" hand grip in "down" position. Snaps back when conventional position is desired.



In prone shooting fore-end gives helpful ground support.

There's no other rifle in the world quite like this new Mossberg #152. It's well worth a trip to your dealer's to see it.

Scope shown is Mossberg 4-power Model #4M4, \$9.95

Send for descriptive folder



86510 St. John St., New Haven 5, Conn.

IT'S NEW THE PUTTY MASTER PLACES GLAZIERS SKILL IN YOUR HANDS



IT'S EASY

A putty knife with the patented shaper that anyone can operate—packs, shapes and trims putty perfectly with one stroke and allows only the right amount of putty to be applied—a time and money saving item that will more than pay for itself.

Only \$1.00 Postpaid
anywhere in the United States.

I am enclosing \$1.00—please send me one Duo-Fast Putty Master.

PUTTY MASTER

864 Fletcher Street, Chicago 14, Illinois

Name _____

Address _____

City and State _____

FIND UNDERGROUND MINERALS and METALS with M-SCOPE

New sensational lightweight models, unsurpassed efficiency Low prices. Time-payment plan. Write for free 16 page booklet.

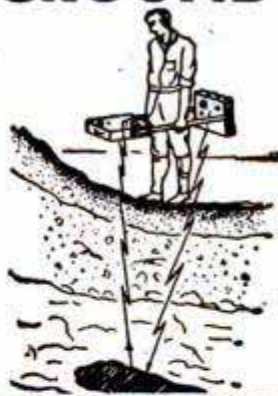

FISHER RESEARCH LABORATORY, INC.
PALO ALTO CALIFORNIA

Adjustable Collet Bushing Chuck—

provides an accurate method for mounting centerless armature shafts and similar parts in a lathe. Use in either head or tail spindle. The brass collets are adjustable for running or driving fits. Chucks supplied with 3 collets; 9/16", 5/8", and .637" capacity. Extra round collets, 1/4" to 1" by 16ths, \$1.10 each.



Chuck with No. 2 shank . . . \$9.45
Chuck with No. 3 shank . . . \$9.95
f.o.b. factory

SOUTH BEND LATHE WORKS

455A E. Madison St.
South Bend 22, Indiana

DO TONGUE AND GROOVE—FLUTING— NOTCHING AND INLAY—

Aladdin's Tool AND YOUR DRILL PRESS

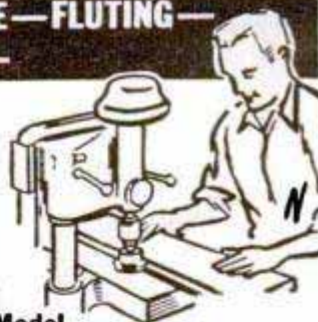

Patent Pending

DeLuxe Model

\$11.95 Makes any cut wood shaping tools costing up to \$300 can make. Comes complete with adaptor, six blades, balance blade and bottom bearing in sturdy wood box.

THE DESIGN COMPANY
2603 Warwick, Dept. R-25 Kansas City 8, Mo.

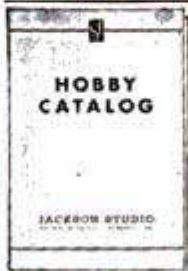

HOBBY
CATALOG

JACKSON STUDIO

CRAFT CATALOG

NEW 1949 edition, 84 pages crammed with big selection of tools and materials for plastics, ceramics, hand power tools, plans, etc., etc. A gold mine of hard-to-find items such as foam rubber, kits, books and "How To" information. Every crafter should have a copy. Send 25c now to

JACKSON, Dept. 71

5440 N. Shoreland Ave., Milwaukee 11, Wis.



PINTON TYPE
COMPRESSOR

EASY PROFIT IN PAINT SPRAYING

Paints walls, ceilings, screens, furniture and machinery faster, better. All complete as shown less motor. Carry anywhere. Fully guaranteed. Could be used with 1/4 H.P. motor or less. Price \$35.00 less motor F.O.B. Chicago, \$5.00 deposit balance C.O.D. or see your dealer. With motor \$55.00.

IDEAL AUTOMATIC PUMP CO., Dept. P.M. 8
801 W. Washington Blvd. Chicago 7, Ill.



Make Miss Syncro Cut-Out
FREE at your hardware store
 on the **AMAZING, NEW, SAFE**

SYNCRO POWER SAW!

MAGNETIC

1. PASTE GIRL ON WOOD



2. SAW AROUND GIRL



3. RESULT—a realistic photo "cut-out" suitable for mantel, desk, dresser use, or as "gift".

Now you can enjoy a **FREE PERSONAL TRIAL** on SYNCRO'S new, improved jig saw—so **SAFE** small children can use—so powerful, versatile, it's the handiest fun or profit tool for any home or home workshop! **DO THIS NOW** Paste "Miss Syncro" (or snapshot of yourself, family, sweetheart) on a piece of $\frac{1}{4}$ " plywood, or $\frac{1}{2}$ " softwood—take it to your hardware store that displays SYNCRO—present Free Trial Coupon. Then flip switch on his SYNCRO SAW and cut out a wooden silhouette of "Miss Syncro" or your snapshot—take home for desk, mantel or dresser use. SYNCRO is easy to operate—has built-in motor! Plug into any 50-60-cycle, 110-120 Volt A.C. only—switch on and saw! Portable—use anywhere. Practical for craftsmen—cuts plastic, wood, thin metals, clean, smooth, no sanding needed Educational for children—safe—use in schools! Hundreds of thousands sold! Many use it to earn extra cash making signs, photo cut-outs, jewelry, initial pins, book-racks, what-not-shelves, etc The **ONLY** safe jig saw made! Biggest, most powerful with greatest clearance of any magnetic jig saw! **NEW ADJUSTABLE** arm permits sawing ANY length material. New Off-On switch Quieter operating *Still* only \$17.50 at dealers in U.S.A. If none near you, send only \$17.50 (plus one dollar to cover cost of shipment) direct to factory with name, address of favorite hardware dealer—we'll ship saw to you **POSTPAID** on 10 Days Money-Back Trial and include **FREE** full-size Pattern No. 82! Or rush postcard for full, free details (Dealers' Write, wire for "Special Direct to Dealers Introductory Demonstration Deal Offer") **Hurry!**

DEVELOP A SPARE TIME BUSINESS!

Full size Pattern simplifies making professional signs, name plates, house numbers, lawn ornaments for gifts, own use or profit Just trace pattern on wood, saw assemble Send 25c for Sign-Name-Numbers Pattern No. 74 to: SYNCRO CORPORATION PATTERN DIVISION, Dept B-100, P.O. Box 215, Pleasantville, N.Y.

R.A. JONES
Lives Here

Phone **532** Ladies

JOHN SMITH

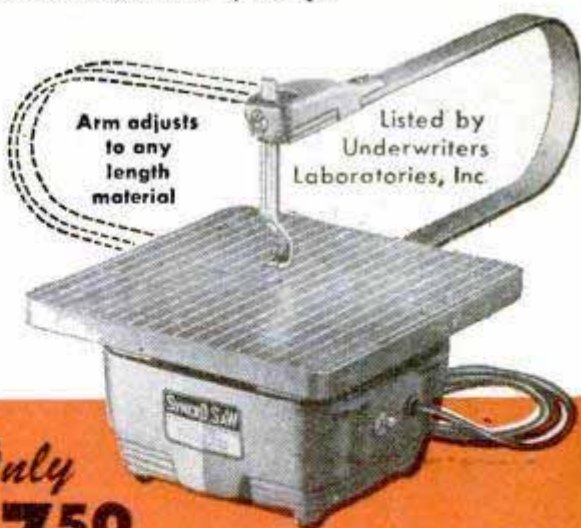

Arm adjusts to any length material

Listed by Underwriters Laboratories, Inc.

Only **\$17.50**

COMPLETE INCLUDING BUILT-IN MOTOR!

FREE TRIAL COUPON

MR. SYNCRO DEALER: This Coupon entitles bearer to cut-out, on your SYNCRO SAW, absolutely **FREE**, one illustration of "Miss Syncro" or any other snapshot or picture which has been pasted on $\frac{1}{4}$ " plywood or $\frac{1}{2}$ " softwood—or to personally try Syncro at store using material you furnish.

SYNCRO CORPORATION, Rochester, Mich.

The **ONLY** SAFE Family Power Saw!

SYNCRO

CORPORATION

Dept. H-108, Rochester, Michigan, U. S. A.
 World's Largest Makers of Electric Jig Saws



"Miss Syncro ... the Magnetic Jig Saw Girl"

**HEATHKIT 3-TUBE
ALL-WAVE RADIO**
110-volt A.C. operation



An ideal way to learn radio. This kit is complete ready to assemble, with tubes and all other parts. Operates from AC. Simple, clear detailed instructions make this a good radio training course. Covers regular broadcasts and short wave bands. Plug-in coils. Regenerative circuit. Operates loud speaker. Add postage for 3 lbs.

\$8.75

Headphones per set \$1.00
2 1/2" permanent magnet loudspeaker..... \$1.95

**INTERPHONE
2-WAY CALL SYSTEM KIT**

Ideal call and communication system for homes, offices, factories, stores, etc. Makes excellent electronic baby watcher, easy to assemble with every part supplied including simple instructions. Distance up to 1/5 mile. Operates from 110-V A.C. 3 tubes, one master and one remote speaker. Shipping Wt. 5 lbs.



\$14.50

HOME WORKSHOP GRINDER



Easily assembled 110V AC or DC ball bearing fully enclosed motor from Army surplus dynamotor. Purchaser to make simple changes and shaft extensions, detailed instructions and all parts supplied. Motor approximately 1/30 H.P., 5,000 R.P.M. Ideal for tool-post grinder, flexible shaft tool, model drill press, saw. Shipping wt. 6 lbs.

\$3.95

**HEATH CO. DEPT. M
BENTON HARBOR, MICH.**

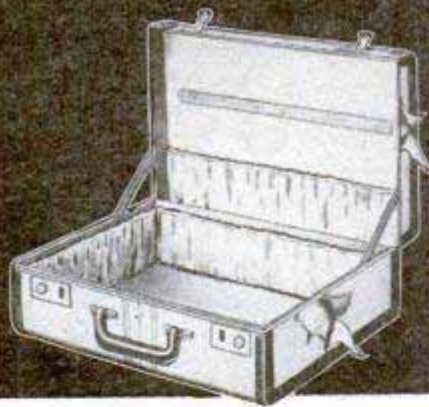

FIXES LUGGAGE, FURNITURE,
DISHES, TOYS,
AND BOOKS

It's transparent, water-proof, flexible and durable. Get a tube today.



DUCO CEMENT

REG. U. S. PAT. OFF.

**SENSATIONAL!... HARMIC'S
New Alcohol Blow Torch
with 1800° flame**

**ONLY
\$2.00**

POSTPAID

Highest quality brass, triple-plated chrome finish. Extra heavy case. *No moving parts* — no adjustment — just fill with denatured alcohol and light. *Absolutely safe.*



Its 1800° F. flame is just the thing for preheating work... improving the quality of your soldering... bending glass tubing. *Hundreds of uses* in every home workshop.

Thousands of satisfied users. Order today. Send \$2.00 — cash or money order. We ship postpaid. No C.O.D. Money-back guarantee.

TRINITY PRODUCTS
949 Commonwealth Ave., Boston 15, Mass.

Ball-Bearing SPEED WHEELS



- Juvenile wheels, solid tire—No Bearings
- 7" wheels 60c
 - 6" wheels 50c
 - 4" wheels 30c
- Semi-pneumatic tired wheels
- 12 x 1.75" \$3.25
 - 10 x 1.75" \$2.75
 - 10 x 1.25" \$2.00
 - 8 x 2" \$2.00

- Industrial wheels for heavy loads
- Semi-Pneumatic
- 400 x 8, 2 ply tire and tube.... \$12.50
 - 12 x 3.00", bolt hub, ea..... \$9.75
 - 10 x 2.75" Hollow Core..... \$6.75
 - 10 x 2.75" Single Tube \$7.25
 - 8 x 2.50" \$4.90
 - 8 x 2.00" bolted wheels, ea.... \$4.75
 - 6 x 2" lug base \$3.30
 - 6 x 2" \$2.80

**DEALERS WANTED
MANUFACTURERS
INQUIRIES INVITED**

Free blueprints with all wheel orders.
Send check with order. Shipments f.o.b. Akron.

JIM BROWN TOY COMPANY
1097 Home Ave. Akron 10, Ohio

Sand Casting — Forging — Heat Treating — Case Hardening
BRONZE FOUNDRY



In your own workshop allows you to design and build your own GASOLINE ENGINES, STEAM ENGINES, STATUARY, ART OBJECTS, SPECIAL TOOLS, NEW INVENTIONS, ETC. You can also make forgings and case harden steel. Your shop is not complete without a FOUNDRYETTE. Three sizes are available capable of making bronze castings of 1 1/2, 3 and 6 pounds weight, aluminum copper, brass, etc., \$22.50, \$29.50, \$12.00 f.o.b. Kansas City. Domestic gas supply and 110 volt AC or DC energy required for operation. Write for circular.

KANSAS CITY SPECIALTIES CO.
Box 6022, Dept. P-9 Kansas City, Mo.

Say You Saw It in
POPULAR MECHANICS

FEET HURT?

TRY DR. BARRON'S NEW FOOT CUSHION for fast relief where it hurts. 1—Corns. 2—Metatarsal Callouses. 3—Weak Arches. 4—Sore Heels. **LIKE WALKING ON A PILLOW!** Light, spongy, Ventilated. Fits all shoes. Cushions arches and feet, heel to toes. Dr. Barron says: "Wonderful for aching feet!" Send \$1.98 for A PAIR, or C.O.D. plus postage. State shoe size, if man or woman. **30-DAY TRIAL GUARANTEE.** Money back if no blessed relief.



ORTHO, INC., Dept. 49-M, 2700 Broadway, N. Y. C. 25

Harvey E. Whitman
Jackson, Mich.
Senior 1st Award
\$4,000 Scholarship



Howard Eichen
San Francisco, Calif.
Senior 2nd Award
\$3,000 Scholarship



Leon Levand
Washington, D. C.
Senior 3rd Award
\$2,000 Scholarship



Howard K. Graves
South Bend, Ind.
Senior 4th Award
\$1,000 Scholarship



Ronald Johnson
Portland, Ore.
Junior 1st Award
\$4,000 Scholarship



Tom Goad
Birmingham, Mich.
Junior
Dup. 1st Award
\$4,000 Scholarship



Major Award Winners 1948 Competition BOYS! \$65,000 IN AWARDS



Harold L. Simon
San Antonio, Tex.
Junior 2nd Award
\$3,000 Scholarship

Paul E. Jaquish, II
Saginaw, Mich.
Junior 3rd Award
\$2,000 Scholarship



Build model cars for the 1949 Fisher Body Craftsman's Guild Competition—734 awards—university scholarships worth up to \$4,000 each—cash—trips—tool chests!



Richard A. Norton
Chicago, Ill.
Junior 4th Award
\$1,000 Scholarship

Any boy 12 years old or over and not yet 20 on September 1, 1948, may enter the competition to design and build a model car. Junior and Senior Divisions with identical awards let you compete with boys of your own age. No dues or entrance fees. Awards include Model Builders' Tool Chests, cash, all-expense trips to the Guild Convention, and 8 university scholarships worth \$1,000 to \$4,000 each. (Duplicate awards are given if sons of General Motors employes win.) Judges include deans or presidents of 10 leading technical schools and universities.

Write for free membership. Each new member receives a membership card and button, a full set of plans and instructions, *all free*. Competition closes at midnight July 1, 1949. You can win one of these awards! Mail the coupon NOW and get started.

FISHER BODY CRAFTSMAN'S GUILD

Sponsored by: Fisher Body Division of General Motors
General Motors Bldg., Detroit 2, Michigan

Gentlemen: Enroll me in the Fisher Body Craftsman's Guild 1949 Model Car Competition. Send me full instructions without charge.

Name _____

Address _____

City _____ Zone _____ State _____

I was born on the _____ day of _____, 19 _____

Parent or guardian _____

Name of school _____

City _____ State _____ Dept. 2

FREE CATALOG

FOR HOBBYISTS
WATCHMAKERS
MODEL MAKERS
HOME CRAFTERS

100 PAGES

MONEY SAVING PRICES



Ask for Cat. # 7P

TOOLS

Tweezers, pliers, screwdrivers, files, motors, Saws, Drills, etc.

MATERIALS

Watch Parts, Solder, Gold Wire, Bead Clasps, Spring Rings, etc.

SUPPLIES

Oils, Cements, Polishing Materials, Cleaning Solutions, etc.

BURTON M. REID SONS INC.

1st and Wash "The House of Friendly Service" Springfield, Ill.

WORLD'S MOST POWERFUL

Completely Different Than Any Other!

HY-SCORE

AIR PISTOL

Famed HY-SCORE used by experts. Expensively made. Looks and feels like a Luger. Revolutionary mechanism blasts pellets at close-to-firearm speed. EXTREMELY ACCURATE. Cal. .177 or .22. \$19.85 including free 500 HY-SCORE pellets (pellet value \$1.49 for cal. .177, \$1.88 for cal. .22). Also sample dart.

If your dealer cannot supply, write for free booklet, Dept. PM-10

HY-SCORE ARMS CORP. • BROOKLYN 1, N.Y.



NO PUMPING!

EVERYBODY NEEDS ONE!

KIPPY-KIT

Brushes
Your Clothes
—Shines
Your Shoes



Ideal for Gifts!

So handy! So useful! You need Kippy Kit everywhere—home, car, office or shop! Brush of tough life-time fibres; shoe polisher of soft, long-wearing wool. Kippy Kit makes the perfect gift for all occasions. Take your choice of Art Leather, Plastic Patent Black, Genuine Sheep, Calf or Pigskin Leathers. Overall length 7"x3 1/2". At department, men's wear and gift stores. If your store can't supply you write direct.

Write for Folder

\$1.25 TO \$3.75

KIPPY KIT CO., BOX 149 CIRCLEVILLE, OHIO

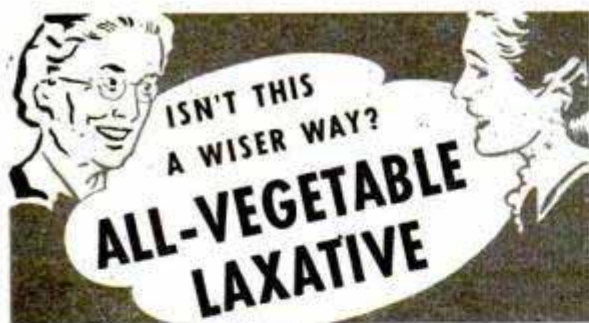

NATURE'S REMEDY (NR) TABLETS
 —A purely vegetable laxative to relieve constipation without the usual griping, sickening, perturbing sensations, and does not cause a rash. Try NR—you will see the difference. Uncoated or candy coated—their action is dependable, thorough, yet gentle as millions of NR's have proved. Get a 25c box and use as directed.



FUSSY STOMACH?
 RELIEF FOR ACID
 INDIGESTION,
 GAS AND
 HEARTBURN



NOW YOU TOO CAN BUILD 15 RADIOS

COMPLETE KIT \$14.75

Absolutely No Knowledge of Radio Necessary
You Need NO Additional Parts

The PROGRESSIVE RADIO KIT is THE ONLY COMPLETE KIT. Contains everything you need. Instruction Book, Metal Chassis, Tubes, Condensers, Resistors and all Radio parts. The 36-Page Book written by Expert Radio Instructors teaches you to build radios in a Professional Manner. You start with a 1-tube receiver. Before you are done with this kit, you will have built 11 Receivers, 1 Public Address System and 3 Transmitters.

SPECIAL FREE OFFER!

Electrical and Radio Tester sent absolutely FREE with each Progressive Radio Kit. PLUS FREE membership in Progressive Radio Club. Entitles you to free expert advice and consultation service with licensed radio technicians.

Write for further information, or ORDER your KIT **\$14.75**

Postage prepaid with check or money order (Postage not prepaid with C.O.D. orders)

PROGRESSIVE ELECTRONICS CO., Dept. PM-15
 497 Union Avenue Brooklyn 11, N. Y.

SAY YOU SAW IT IN POPULAR MECHANICS



WRITE FOR YOUR **FREE** COPY OF THE NEW **KRW HYDRAULIC PRESS BOOK**

Describes all manner of Production and Shop Work on KRW Hydraulic and Bench Type Arbor Presses. 32 pages illustrating the new KRW Hand-operated, Electric-operated and Air-operated Hydraulic Presses.

Write for your copy today.



K. R. WILSON, DEPT. 17, 215 MAIN ST., BUFFALO 3, N. Y.

Builders of Shop Equipment for Ford Dealers Since 1916

PRINT YOUR OWN POST CARDS

COMPLETE OUTFIT only **\$7.50**



Amazing results in sales, inquiries and contacts... saves time and money... very easy to use GEM STENCIL DUPLICATOR is ideal for Advertising, Announcements, Notices, Labels, Forms, Price Lists—hundreds of uses for every type of business and organization. Comes complete with all supplies, instructions and 60-page Book of Ideas.

FREE TRIAL OFFER: Try it before you buy it! Write and a GEM OUTFIT will be sent you postpaid. After 10 days, send only \$7.50 or return the GEM, no questions asked. The GEM must sell itself; you be the judge.

BOND EQUIPMENT CO. • Dept. 135
 513 Olive St. • St. Louis 7, Mo.

SEND NO MONEY • FREE TRIAL OFFER

PNEUMATIC AIR TOOLS

SAVE \$64.00 AND UP

Ideal fender and bumping hammers, and for riveting brake lining, concrete breaking and many other uses. Like new. At these unheard of low prices it pays to order a good supply.



CHICAGO PNEUMATIC RIVETER & CHIPPING HAMMER

CP4X Pistol grip handle, with air control. Takes up to 3/16" rivet. Weight 6 lbs. List price \$73.00. SPECIAL PRICE..... **\$8.95**

Size CP3 — Takes 5/32" Rivet — \$ 7.95
 Size CP9 — Takes 1/4" Rivet — \$10.95

Prices are F.O.B. Chicago. Immediate delivery. SOLD ON MONEY BACK GUARANTEE. Send check or money order today.

DEALERS — WRITE . . .
C & M EQUIPMENT COMPANY 1831 S. State St., Dept. D-10
 Chicago 16, Ill.



SAVE on High Quality Dress Trousers for Fall and Winter wear

\$12.50 VALUE

\$7.95 PR.

Huge direct-to-you volume enables us to give exceptional value! Fully guaranteed. Genuine virgin wool and fine-spun rayon blended. Warm. Twill weave resists wrinkles, holds crease, gives amazing wear. Expert fashion tailored for perfect fit. Zipper front. Roomy pockets. Blue, Tan, Sand, Lt. or Dk. Brown, Blue-Gray. WAIST: 28-38 pleated or 28-50 plain.

Send Only \$1

with name, waist size, 1st and 2nd color selection. Pay postman balance plus C.O.D. Or, send entire amount, save C.O.D. Money back within 10 days if you're not pleased.

LINCOLN TAILORS

DEPT. PM-10 LINCOLN, NEBR.



Take Your Shop Weld with You

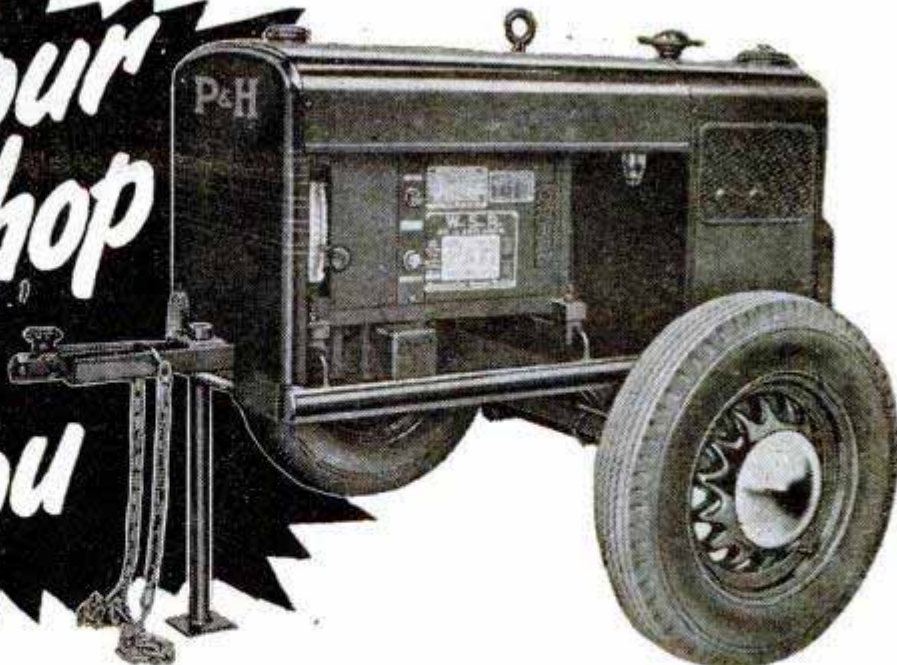

These industrial and commercial arc-welding jobs are easier to do and cost less when you use P&H DC Arc Welders: All types of industrial welding. Sub-contracting work for large manufacturers

Air conditioning
Home heating
Truck body building
Trailer building

Automotive Repairs { blocks fenders frames

Fuel-oil tanks
Contractors' welding
Bridge work

Construction equipment repairs { excavators tractors graders ditchers, etc.

Kitchen equipment
Cabinet work
Fabricated housing
Fabricated garages
Cast iron repairs
Maintenance work for industrial plants
Ventilating systems
Bicycle repairs
Stainless steel bar equipment
Ornamental iron work
Fabricating equipment of your own design

P&H Model WG-200 Welding Generator mounted on a Jeep.



Go after the Profitable welding jobs with a handy P&H Portable Welder

Don't limit yourself to the welding business that can be brought to your shop. Use an easy-towing P&H portable welder to provide full weld-shop facilities wherever there's a need for them. Go out after interesting jobs, do a wide variety of work, make more money.

There are two sizes of P&H Portable Welders

Both welders are sturdy. Both are economical. Fool-proof idling devices keep gasoline consumption to a minimum. The WN-200, is powered with an air-cooled motor. It gives you a welding service range from 30 to 260 amps. A power take-off lets you operate handy electric tools.

The WA-300 has a welding service range of 30 to 375 amps. This unit uses a water-cooled gasoline engine.

Both can be furnished as stationary models to mount on a truck, or as two-wheeled trailers. The WN-300 is also available with a 4-wheel mounting.

Easy to use

The generator used in P&H portable welders has only one simple heat control. Volt-ampere regulation is automatic. Just select the heat you want from the clearly marked plate found on every P&H welder. Then move the single control to the setting picked. The machine does the rest. There is no fussing with dials, gadgets, or special instruments. Welding is easier, faster, and better.

You can count on P&H machines to give you satisfying, trouble-free service

There are only two major parts in P&H DC welding generators—the rigid frame and a compact rotating member. A powerful air stream cools them. Special insulation coatings resist heat and assure high efficiencies.

You can build your own DC Welder

Lots of people with spare gasoline or electric motors on hand save money by build-

ing their own welder. We have 2 sizes of bare welding generators for this purpose. The WG-200 gives you 30 to 260 amps and the WG-300 30 to 375 amps. If you have a Jeep with rear power take-off, you can use a P&H bare generator to make a neat portable welding outfit.

There's a money-saving P&H DC Arc Welder for every welding need

Take the WA-200, for example. It requires only 3½ square feet of floor space. A single WA-200 unit gives you 30 to 285 amps. Its construction is such that it can be stacked one on top of the other. Thus you can combine the output of two machines (60 to 570 amps) without using more space.

The WSR-500 is larger than the WA-200, giving you a welding service range from 60 to 500 amps.

All P&H DC Arc Welders have these important features: Single heat control. Automatic voltage regulation. Only two major parts. Powerful air-stream ventilation. Easy operation.

Your P&H distributor can show you why it pays to own a P&H machine. For complete literature, send the coupon below, clipped to your business letterhead.



ARC WELDERS
4673 W. National Ave.
Milwaukee 14, Wis.

Manufacturers of America's Most Complete Arc Welding Service

TEAR OUT COUPON, ATTACH TO YOUR BUSINESS LETTERHEAD, AND MAIL TODAY

HARNISCHFEGER CORPORATION
4673 W. National Avenue, Milwaukee 14, Wis.
Yes, I'm interested in the easy operation and dependability of P&H DC Arc Welders. I would like information on the items I have checked below:

- P&H Portable Welders
 P&H Bare Welding Generator for building my own welder
 P&H Industrial Welders
- Send address of distributor
 Send representative
 Send Free Book, "Simplified Welding"

Name.....
Position.....
Address.....
City..... State.....

Home
 Business

2,400 MILES

for \$18.50



New Crosley Station Wagon, as practical as it's smart. All-steel. 4-cylinder. Seats 4, or 2 with 1/4 ton load. Costs \$600 to \$700 less than any other station wagon, operates for about 1/2 as much. Harry Crossley, 13 Lyman St., Laconia, N. H., drove his Crosley 2,400 miles, averaged 36 miles per gallon of gasoline. Total costs, \$18.50.

CONVERTIBLE: →
Open to all outdoors



← **PANEL DELIVERY:**
Full 1/4 ton capacity.

SEDAN: Over →
20,000 now on the road.



← **PICKUP:**
Cuts service and delivery costs.

CROSLLEY

a FINE car

For beautiful, full-color catalog, write: Crosley Motors, Inc., 2532-HR Spring Grove Ave., Cin'ti 14, Ohio

AT LAST!
New **MAN-SIZED AIR GUN!**

No Pumping
One single break

HY-SCORE

Super-Powered!

.177 or .22



Now 1949 model. All steel like a regular firearm, 41 3/8 inches long, 4 3/4 lbs., rifled barrel. Single shot. **EXTREMELY ACCURATE.** Small game and targets. Cal. .177 or cal. .22 price \$29.85. (Order Hy-score pellets \$1.49 for cal. .177, \$1.88 for cal. .22, per box 500).

If your dealer cannot supply, write for free booklet PM-10

S. E. LASZLO · BROOKLYN 1, N.Y.

New!

EXPANSIVE BIT

**CUTS BETTER!
COSTS LESS!**

FOR PROFESSIONAL AND HOME USE!

Specially engineered cutting blade sets new standard of accurate, fast, clean, smooth cutting in hard or soft wood.

CUTS EASIER—Simplified design; tilted blade; no center lip.

CHROME VANADIUM STEEL BLADES
Holds sharp cutting edge longer.

ALL CHROMED BODY—No rust; looks better; lasts longer.

QUICK, ACCURATE ADJUSTMENT
Positive lock; no blade slippage.

SELF-CLEARING LEAD SCREW
Constant feed; no loading.

WIDE CUTTING RANGE!

No. 250 (7 3/4" sq. shank)
cuts 1/2" - 1 1/2" . . . \$1.69

No. 251 (8 1/4" sq. shank)
cuts 3/4" - 3" . . . \$1.89

No. 250

No. 251

MONEY BACK GUARANTEE

SEE YOUR DEALER OR WRITE

Robert H. Clark Company

9330 SANTA MONICA BLVD., BEVERLY HILLS, CALIF.

HIGH PRESSURE HYDRAULIC PUMP
FOR HOME, SHOP AND FARM USE



Genuine Vickers constant displacement high pressure pump. Use it for any type of liquid pumping job. Will pump 400 gal. per hour at 3550 R.P.M. Precision piston type design provides 1000 lbs. per square inch pressure. Self priming. Standard thread 3/8 inch intake and discharge ports. With 3/8 inch splined shaft—just add pulley and power and you're ready to go.

HAS HUNDREDS OF USES

These pumps are brand new. Original acquisition cost approx. \$100.00. Can also be used as hydraulic motor; for rams, opening doors, hydraulic lifts, etc.—also for any liquid transporting job. War surplus, but brand new. Ship. wt. 7 lbs. **\$9.95** Send check or money order. Satisfaction guaranteed. Postpaid in U.S.A. Each only

SOUTHWEST AERO SUPPLY, Dept. PM10
Drawer 488 South Houston, Texas.

NONE BETTER!

SUPER DRILL GRINDER

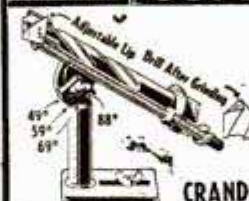

Sharpens round shank drills from 3/32" to 1/2" in diameter, up to 6" long. Grinds old drills like new in 4 different point angles, using hand or power grinding wheels. Money-back guarantee.

Price only \$2.95

At Dealers or Postpaid

CRANDALL MFG. CO. 1512 W. Slauson, Dept. FA-34, Los Angeles 44, Calif.

BOATS! ASSEMBLE YOUR OWN PACKAGED BOAT



INBOARD

OUTBOARD

UTILITY

16 models of outstanding design—8 to 18 ft.—prices from \$34.50 up. These complete plywood kits save you 50% or more. Assembly is simple, all parts pre-cut—frames pre-assembled. Send 25c (coin) for complete, illustrated literature.



SKIFF

PRAM

KAYACK

MARINE MART

BUFFALO 7-B NEW YORK

**STRIPE
WITH
PAINT
EASY
AS
USING
A
PENCIL**

PAINTERS' STRIPING TOOL

NOW you can do your own expert striping on furniture, bikes, model planes, bulletins, autos, toys, signs, linoleum, wall board... make plain walls look like tile! It's easy to paint straight, curved, circular, even parallel lines with any color. Handiest paint tool in your workshop! Type "M" Master Painters' Striping Tool complete with tip for 1/16" stripe, \$1.00. Tool with 1/64", 1/32", 3/64", 5/64", 3/32", 1/8" — \$1.50... all tips 75c ea. Tool with complete set of 7 tips \$5.00. (COD's postage collect.) WENDELL MFG. CO., 4234-B Lincoln Ave., Chicago 18, Ill.

**A TOOL...
NOT A BRUSH**



Dealers
Write
Today!

**\$1.00
POST
PAID**



**RID YOUR DOG OF
WORMS
USE
PARKE-DAVIS
NEMA
WORM
CAPSULES**

KEEP YOUR DOG FRISKY!

Dependable, easy to give, scientifically prepared and low in cost, NEMA Worm Capsules effectively remove large round worms and hookworms in dogs and cats.

FREE! Send for illustrated, helpful worm booklet.
PARKE, DAVIS & CO., DETROIT 32, MICH.

DRUG STORES SELL PARKE-DAVIS PRODUCTS

BUILD YOUR POWER TOOLS

WITH POLY BALL BEARING ARBORS
HEAVY DUTY GRINDER

Model D-12
Pictured

3/4" x 17 1/2" precision spindle, self-lubricating ball bearings, heavy casting, V belt, 2 step pulley driven through rear or base.

ONLY

\$18.25

FREE!
Write for
POLY illustrated literature.



Ship. wt. 13 pounds

POLY BALL BEARING ARBORS

C4-1/2 x 12 1/2 spindle, housing 2x8, \$7.95 pp.

C5-5/8 x 12 1/2 spindle, housing 2x8, \$8.45 pp.

C6-3/4 x 12 1/2 spindle, housing 2 1/2 x 8, \$9.45 pp.

D8-1 x 17 1/2 spindle, housing 2 5/8 x 11, \$18.75 pp.

C4-1/2 Pictured

SHAPER ARBORS 3 inches between collars. C4-1/2 \$14.25, C5-5/8 \$14.25, C6-3/4 \$15.25, D8-1 \$23.00, B25-1 1/2 x 2" cap flange mounts \$5.50, PILLW BLOCKS—Ball Bearing, 1/2 \$3.50, 3/4 \$3.50, 3/8 \$4.25.

POLY PRODUCTS, 2032-A E. Walnut, Pasadena 8, Calif.

LOW PRICED STEAM CLEANER

Jenz Super Chief

Portable—No moving parts—Cleans anything—Motors—Chassis—Machinery—Floors—Buildings—Remove wallpaper—Dairy & Creamery—Oil Rigs etc. Oil fired—Economical—fully tested and warranted. 75# Steam in less than 10 min. Model 70, Complete as illustrated..... **\$276.50**

P.O.B. factory.
**HI-PURE LABORATORIES
EVANSVILLE, IND.**

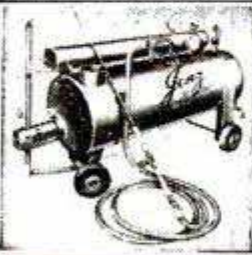

WOULD YOU LIKE TO MAKE

\$100 a week...
in your own

ELECTROPLATING BUSINESS
FULL OR SPARE TIME

Write NOW for free illustrated booklet that will start you on the road to financial independence!

JOSEPH B. KUSHNER

Metal Finishing Engineer Stroudsburg 12, Penna.

FREE

ALLIED'S NEW 1949 RADIO CATALOG!



180

Value-Packed Pages
Send for it now!

**SAVE ON
EVERYTHING
IN RADIO**



**TELEVISION AND
NEW HOME RADIOS**



SERVICE SUPPLIES

BUILDERS' SUPPLIES



AMATEUR GEAR



SOUND SYSTEMS

Leading Buying Guide

Get ALLIED's new 1949 Catalog—biggest and most complete in Radio! It's the preferred Buying Guide of Servicemen, Engineers, Soundmen, Amateurs, Builders and Experimenters. ALLIED—Radio's Largest Supply House—brings you the world's greatest stocks of quality radio and electronic equipment—at money-saving low prices—plus speedy shipment and helpful personal service.

Everything In Radio. See ALLIED's great values in new Television receivers, home radios and radio-phonos (with new Dual-Speed Changers), latest Amateur receivers and station equipment, Sound Systems and High-Fidelity amplifying equipment, new Builders' Kits and supplies. Plus thousands of quality parts, tubes, test instruments, tools, books and diagrams—the world's largest stocks—at unbeatable low prices. Be sure to send for your FREE new 180-page ALLIED Catalog today!

ALLIED RADIO

ALLIED RADIO CORP.
833 W. Jackson Blvd., Dept. 5-KK-8
Chicago 7, Illinois

Rush FREE 1949 ALLIED Catalog.

Name.....

Address.....

City.....Zone.....State.....

**FREE
CATALOG**

SAY YOU SAW IT IN POPULAR MECHANICS

Pull the trigger and the iron heats itself!

QUIK-SHOT

SOLDERING IRON

Most amazing iron you ever saw!

NO Electricity!
NO Blowtorch!
NO Flame!

Needs **NO EXTERNAL HEAT** of any kind!

A small chemical cartridge supplies intense heat. Pull the trigger; the iron

HEATS ITSELF

Reaches working temperature in 5 seconds! Holds it 6 to 10 minutes. Peak wattage rating of 200. For large jobs or small. Interchangeable $\frac{3}{8}$ ", $\frac{1}{2}$ ", $\frac{5}{8}$ " tips. Lasts a lifetime. **SAFE!** No sparks or flames!



Open tip, insert cartridge, screw shut.



Pull spring rod "trigger" button on handle, and release.

Price with 1 Tip (Specify Size) and 4 Cartridges. Postpaid. **5.95**

Additional Tip. **1.50**
Extra Cartridges **4 for .49**

Write for more information

KEMODE MFG. CO., Dept. C

2 W. 46th St., New York 19, N. Y.

MASTER CRAFTSMEN use these finest fillers!



Fills holes in 1 application

Saw, cut or Sand it

Fills dents and scratches

Cracks are easily filled

Weatherproof-Waterproof

Broken edges made whole

Smooth texture Takes high finish

- SAVES TIME
- SMOOTH TEXTURE
- EASIER TO WORK
- SHRINKS ONLY 1%
- STAYS IN

FOR a perfect surfacing job on wood, metal or plastic—use the expert's choice—Duratite. Easy to use—faster—shrinkage is so slight, it fills completely in just *one* application—stays in! 7 wood colors. Ask your dealer or send for large tube.

WEBB PRODUCTS COMPANY

228 S. G St., San Bernardino, Calif
Enclosed find 25c, send large tube Duratite Wood Dough.

Name _____
Address _____
City _____ State _____

SEND FOR LARGE TUBE



FOR LARGE CAVITIES

DURATITE

FOR SMALL CAVITIES



WOOD DOUGH and SURFACING PUTTY



For Trained men in the uncrowded field of Wood production Engineering

The steps to top positions in the wood working industry, through resident study and training in Grand Rapids, or correspondence home study course are all described when you Write Now and

GET THIS FREE BOOK

Veterans make wood working your vocation. You can study and train FREE under G. I. Bill. State preference for resident or correspondence course, with Name, Age, occupation, and if veteran Write now to

KLOK INSTITUTE
LOUIS ST. N.W.
GRAND RAPIDS 2, MICH.



BUILD YOUR OWN POWER LAWN MOWER

WHY BREAK YOUR BACK MOWING FIELD OR LAWN?

FREE Write for Building Instructions

The Rite-Way Mower Attachment Ball Bearing



SAVE MONEY SAVE TIME

Now anyone can save time and effort mowing field or lawn by building their own whirl type power mower. Build according to your own ideas and needs at small cost. Cut close to fences, walks, buildings, etc. Build in short time with parts and instructions we furnish. Save hours of time and back breaking labor. Write today for FREE information.



T & H MFG. Co., Dept. MP-17
811 E. 31. Kan. City 3, Mo.

BENCH GRINDER OR BUFFER



Life Time Sealed Ball Bearings. Base Constructed to Rest Firmly Without Bolting. Stone Guards May Be Removed For Use As Polishing Head. Tool Rests May Be Raised or Lowered—Used On Face or Side of Stone. 6" x 1" x 1/2" Grinding Stones—Can Be Used Until Worn to 2". Conveniently Located Toggle Switch.

13" Between Grinding Wheels for More Versatility. Base Drilled for Permanent Mounting if Desired. Bearings and Stones are Standard—May Be Purchased at Your Hardware or Automotive Stores. Can Be Purchased Complete with 1/2 H. P. Motor and Grinding Wheels. \$45.45.

Or Less Motor and Grinding Wheels. \$18.95. NOT A TOY—Suitable for Use in Hobby Shops or in Any Place Where a Heavy Grinder or Buffer is Required. Send for free Booklet Number 22-A. Immediate Delivery.

MODERN MANUFACTURING CO.

160 N. FAIR OAKS AVE. PASADENA 7, CALIF.

SPEED AND POWER HANDBOOK

Very latest methods! Construct your own superchargers, water injectors, compression heads, fuel saving devices—easily, practically without cost. Get racing speed, acceleration, dynamic power increases from any automobile! Build stock conversions! Fast roadsters! Hotrods! Get ingenious formulas! Speed secrets! Also "Economy Information"—Tuning techniques! Ignition, Carburetion, Fuels, Mileage tricks! Illustrations! Catalogues, including "California Re-styling Ideas"—Glossy photographs! Drawings! Model revising! Customizing! Streamlining! Sport changes! Leatherlike bound — \$1.98 complete.



NEWHOUSE AUTOMOTIVE INDUSTRIES

5941-B4 Hereford Los Angeles 22, Calif.

"Paint-it-Yourself" with

ONE COAT COVERS
NU-ENAMEL
NO BRUSH MARKS

NU-ENAMEL DEALERS EVERYWHERE

Sale! WAR SURPLUS BARGAINS Sale!

POWER WINCH

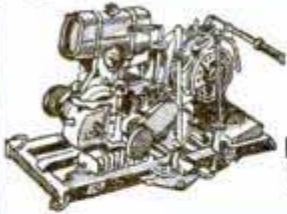

Ideal for
CONTRACTORS
FARMERS
ELEVATORS
MOVERS
RR CAR MOVERS
WELL DRILLERS
MINES, ETC.

New two cyl. gasoline driven hoists, powered by 11 hp, 2 cyl. Waukesha air cooled engine, gear shift, 2 speed with twin disc clutch, throttle and hydraulic brake. Capacity on single line approximately 4,000 pounds. Dimensions: 36" wide, 60" long, 36" high. Mfg. Benson Winch Co. Comes equipped with complete repair kit tools and box. Can also be used as hand winch. In original crate for export.

\$325.00

Only
Wt. with crate approx. 1500 lbs.



PORTABLE AIR COMPRESSOR

Hand truck job with Quincy 1 cyl. compressor, 4 gal. tank, automatic pressure switch, pop-off drain, stop-cock, 25 ft. hose, blow gun, v-drive, air gauge, 25 ft. cord, 10" ball-bearing puncture proof Goodrich silvertown tires, 100 lbs. pressure, 1/2 H.P. elec. motor. New—only.....

\$12500

ASSEMBLE YOURSELF — SAVE \$30

Complete kit of all parts necessary to assemble the above portable compressor

\$9500

Also 3/4 hp 110 or 220 volt with 20 gal. tank, automatic

\$15500



Close Out ELECTRIC MOTORS

(HEAVY DUTY — DOUBLE END SHAFTS)

Ball bearing 3/8" double end shaft, capacitor type electric motors with reversing switch built into motor. With overload protector and 6 ft. of cord. Motor is completely enclosed and operates on 110 volt AC, 60 cycle.

1/2 HP, 1750 & 3450 RPM (specify speed) NEW.....

\$2995

1/2 HP, Dayton capacitor type, single end shaft, 110 volt AC, 60 cycle, 1750 RPM, B-B. NEW.....

\$2600

3/4 HP, Dayton capacitor type with single end shaft, 110 volt AC, 60 cycle, 1750 RPM, B-B.....

\$3695

1/2 HP Delco motor — sleeve bearing — split phase, 110 volt AC, 60 cycle, 1750 RPM. NEW.....

\$1450

6 FT. FLEXIBLE SHAFT

For use with above motors—ball bearing, made with Baldwin piano wire.....

\$1495

and other bargain items

Briggs-Stratton GAS ENGINES

SAVE \$25

Rope start, 1750 RPM. All brand new and guaranteed.

2 1/2 HP Model AP..... list price \$102.10. OUR PRICE.....

\$7700

3 1/2 HP Model BP..... list price \$111.50. OUR PRICE.....

\$8600

5 to 7 HP Model ZP..... list price \$137.00. OUR PRICE.....

\$10200



Electric Rubber Cable (all new) CORD SETS

Extension cords, 100 ft. heavy duty. Plug, socket and guard. Number 16 wire. Worth at least \$10.00.

OUR PRICE.....

\$485

Same as above — 50 ft. length.....

\$385

Heavy Duty Electric Cable

3 wire + 10 submarine cable and lugs—can be placed underwater, underground or overhead. Also for portable tools. Will carry 40 amps.

50 ft. 100 ft. 250 ft.

\$7.50 \$14.00 \$30.00

RUBBER CABLE

150 ft. reels, 3 wire + 6 with 60 amp Crouse & Hines 2 male and 2 female connectors. Perfect for welders, hay loaders, saws, electric ranges, etc. List price \$190.00 per reel. OUR PRICE.....

\$4500

U. S. Surplus HORNS and HOWLERS



Motor driven, not a vibrator) Heavy duty with great power and long life. 110 volt AC current. Weather proof. For alarm or signal horn on boats, school yards, factories, etc. List price \$47.00. OUR PRICE only

\$945

Money-Back Guarantee on all items

All prices F.O.B. Milwaukee, 25% deposit required on all C.O.D. orders. Many other bargain items, write for our free circulars.

C & H ELECTRIC CO.

Dept. M-10
434 W. JUNEAU AVE.
MILWAUKEE 3, WISCONSIN



AC ARMY LIGHT PLANTS

New 750 watt 110 volt light plant with Briggs-Stratton model AP gas engine.....

\$13500

New 1000 watt 110 volt light plant with Briggs-Stratton model BP gas engine.....

\$16500

New 2500 watt 110 volt light plant with Briggs-Stratton model Z, 6 hp gas engine and Leland Generator.....

\$26500



Rebuilt 5000 watt 110 volt 60 cycle light plant with automatic remote control. Powered by Jeep 4 cyl. gas engine. Rebuilt like new and guaranteed.....

\$62500

10,000 watt 110 and 220 volt light plant with automatic remote control powered by Jeep 4 cyl. gas engine. Rebuilt like new and guaranteed.....

\$72500

PORTABLE DC LIGHT PLANT

3000 watt 110 volt DC powered by 6 hp Briggs-Stratton model ZP gas engine. Portable on wheels. Generator re-built and guaranteed, only.....

\$16500

GENERATORS

3000 watt 110 volt DC generator. Manufactured by Deleo. Rebuilt and guaranteed. Only.....

\$5000

BALL BEARING ARBOR

Grinding and saw arbor. Has 1/2" double end shaft with 2" center pulley. New Departure double roll precision aircraft ball bearings. Self aligning pillow block. Right and left hand thread. 10,000 RPM. Bearings alone list at \$14.00. Complete arbor, only.....

\$495

PLASTIC HOSE

Good for water, oil, air, etc. Will stand 75 lb. pressure. Available only in 50 or 100 ft. lengths.

1/8", 3/16", 1/4" (your choice) per foot.....

2c

5/16", 1/2" (your choice) per foot.....

3c

9/16", 5/8" (your choice) per foot.....

4c

3/4", 1" (your choice) per foot.....

6c

1 1/4" per foot.....

8c

SAY YOU SAW IT IN POPULAR MECHANICS

BRAND NEW MFG. BY Black & Decker, A.C. D.C. Drill

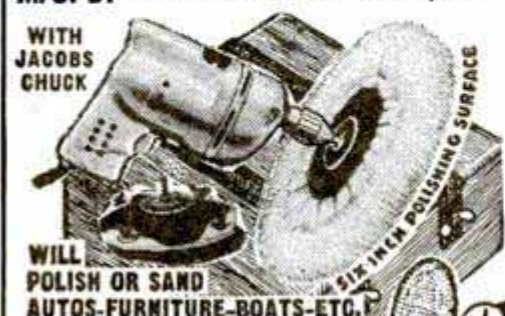

WITH JACKS CHUCK
WILL POLISH OR SAND AUTOS-FURNITURE-BOATS-ETC.
WILL DRILL STEEL-IRON-WOOD OR PLASTICS.
ADD \$3.00 FOR 13 HIGH SPEED STEEL DRILLS.
Tool Chest can be used STATIONARY POWER TOOL

WITH THESE FLEXIBLE POLISHING & SANDING ATTACHMENTS IN THIS STURDY CONVERTIBLE TOOL CHEST

ALL FOR **22.95**
We pay all charges with check or money orders.

YOUR DRILL WILL POLISH & SAND WITH THESE ATTACHMENTS

Ready to slip into chuck of any drill



This Flexible Lamb's Wool Polishing Attachment. 6" Polishing Surface

1 Extra Lamb's Wool Bonnet. A Generous Supply of Assorted Sandpaper

\$5.00 FOR EVERYTHING COMPLETE

Polish or Sand Your Furniture — Silverware, Wood Work, Floors, etc., with this Flexible

POLISHER SANDER
Sand evenly with a new "FAST METHOD" changing sandpaper. No screw or Hole in Sandpaper. Complete with instructions How to apply Sandpaper & Clean Polishing Bonnets.

JONRICH CO. E. Office 112 W. 42nd St. N. Y. 18, Dept. P.M.

THE GREATEST
THING

IN
PLASTICS!

PLASTICAST



A NEW HOME INDUSTRY AND HOBBY!

PLASTICAST is a transparent liquid plastic; can be poured into ANY kind of mold or container. Hardens in a few minutes into a transparent solid, clear-as-glass, tough as steel plastic! No tools machinery or skill required. IDEAL for imbedding pretty flowers, butterflies, photos, medals, souvenirs, biological specimens, etc. Makes a **PERMANENT** and **ATTRACTIVE** display. Make attractive jewelry, gems, lenses, knick-knacks, novelties. Easily cast into sheets, rods, blocks, ANY color, ANY shape! **EVERYTHING** furnished, including molds, for making about \$50.00 worth of unusual novelties! **PLASTICAST OUTFIT, Complete with 3 molds . . . \$3.50**

PLASTIDUR . . . (LIQUID IVORY). Ideal for casting all OPAQUE articles. Hardens in a few minutes into an extremely hard IVORY-like plastic! May be dyed any color or cast into any shape. Works in **EVERY** type of mold! Non-inflammable, waterproof. Durable. Ideal for statuary, novelties, figurines, toys, gadgets, tools, knobs, bases . . . a million useful applications! Outfit comes complete with molds, dyes, accessories, instructions, etc. for making about \$100.00 worth of attractive jewelry, etc! **\$5.00**

PLASTIDUR OUTFIT, Complete with 3 molds . . . \$5.00
Our Casting Plastics are as easy to use as pouring water out of a glass!

TERMS: We pay the postage (U.S.A. & Canada only) if full cash accompanies your order. C.O.D. accepted (U.S.A. only) if \$1.00 deposit is included for each item ordered. C.O.D. orders not postpaid.

FREE A very attractive and useful novelty made with one of our plastics given absolutely free with every one of our catalogs! Catalog lists many new materials for making **MOLDS and CASTINGS** with Liquid Plastics, Liquid Marble, Latex, Elastex, Castwood, Wax, Metals, Plaster, Shellcraft, Internal Carving, Molds, Moulage, etc. Price of catalog only 10c. **DEALERS: WRITE FOR ATTRACTIVE WHOLESALE PRICE LISTS**

PLASTICAST CO. (Dept. C)

5961 Madison St. Chicago 44, Illinois (Order by mail only) P. O. Box 987 Palo Alto, Calif.

MAKE YOUR OWN JOINTER WITH LEWIS CASTINGS!



THIS HEAVY DUTY LEWIS JOINTER planes, rabbets and produces excellent surfaces on all work up to 6" wide! Castings available rough or semi-finished. Build it yourself and save!

Free Catalog describes many Lewis Power Tool Castings. Write today!

LEWIS MACHINE TOOL CO. P.O. Box 7446, Sta. L, Dept. M, Los Angeles 23, California

SAY YOU SAW IT IN POPULAR MECHANICS

Make money

on Easy-to-Assemble
Larson
Leathercraft
Items

Profit by growing demand for belts, purses, gloves, woolskin toys and mittens—and 100 other popular leather items. No experience necessary; instructions free with materials.

Largest complete stock of leather and leathercraft supplies in America, including moderate priced tooling leathers and top quality calfskins. Immediate delivery. Write today.

Send 10 cents at once for new 24-page leathercraft catalog of gift suggestions and profitable ideas.



J. C. LARSON COMPANY
824 S. Tripp Avenue, CHICAGO 24, ILL.

Sharpen Lawnmowers MAKE \$5.00 PER HOUR

You need no experience to operate the Ideal Lawnmower Sharpener. It is simple to adjust, simple to operate. Sharpens blades easily, speedily, accurately. Ideal sturdy, strong construction is the result of 45 years of engineering design. **WRITE TODAY FOR FREE BOOK.**



The FATE-ROOT-HEATH CO.

DEPT. D-3, PLYMOUTH, OHIO

TYPEWRITERS!

ALL MAKES — REBUILT LIKE NEW
For School, Business or Home Use

Write for Information

M. & M. TYPEWRITER CO.
84 W. Washington St. Chicago, Ill.



Sensational New Electric ① WELDER ② CUTTER!



WELDER UNIT



CUTTER UNIT

Uses 110-115 AC or DC • INSTRUCTIONS INCLUDED
WELD - BRAZE - CUT - MELT - SOLDER - HEAT TREAT

The **WELDRITE** combination—tested and proven by countless commercial and amateur users, is now offered direct to you at the amazingly low price of only \$12.00. No Gas—No Gauges—No Spark Lighter needed. Always ready for immediate use—Just plug **WELDRITE** into 110-115 AC or DC outlet. Uses standard welding and brazing materials available at all welding supply stores. **WELDRITE** furnished complete with Converter Unit, #1 Single Holder with attached Alligator clip, for welding metal up to 3/16" thickness, using up to 3/32" rod, and #2 Double Holder with Copper Coated Dual Carbon Electrodes for Cutting, Brazing, Heat Treating, Soldering, etc. Starting welding materials and instructions included.

Ideal for home workshop. Invaluable for body

and fender shops, garages, repair and machine shops, manufacturers, etc.

SEND NO MONEY! 10 DAY TRIAL OFFER

Order your **WELDRITE** Electric **WELDER-CUTTER** C.O.D. today. Pay postman \$12 plus postage charges (wt. 4 lbs.) or send \$12 and we pay postage. Either way, if not satisfied, return **WELDRITE** in 10 days, and money will be refunded. **WELDER HOOD**—Approved lens found in hoods costing to \$10—only \$3.95. California orders please add 2% sales tax.

CALIFORNIA TECHNICAL PRODUCTS CO.

448 So. Hill St., Los Angeles 13, Calif. Dept. A-10

BOTH only \$12
LOWEST PRICE IN HISTORY!

THE NEW QUALITY WOODWORKER DOES EVERYTHING!

SPINDLES DESIGNED FOR JACOBS CHUCK

CAREFULLY MACHINED SEMI-STEEL CASTINGS

BED CAN BE LENGTHENED TO ANY SIZE

IMMEDIATE DELIVERY!

\$22.75 F. O. B. Royersford, Pa.

(As Shown)

BALL BEARING THRUST—BRONZE BEARINGS
PROFESSIONAL TYPE, 2 x 4 x 48" HARDWOOD BED

Jacobs chuck #6426 1/2" capacity \$4... #508 ground cast iron table for sawing or sanding, tilts to 50°, accurate scales show degrees, takes 8" blade, cuts 2 1/2" deep, screw regulates depth of cut \$11.95... Miter gauge #540, cast iron, accurate scale shows degrees \$3.75... Combination extension and fence #556, screw adjustment \$3.75... Arbor #500, 3/8" dia. for saw blade, buff or grinding wheel \$1.50... Sanding disc #503, 10" aluminum \$3.50... Disston-made saw blade 8" dia., 5/8" hole, combination, rip or crosscut \$3.50 ea. ... Face plate #505, 5 3/4" dia. \$3.75... G. E. Motor 1/2 H. P. 110 V. A. C. \$13.95... All prices F. O. B. Royersford, Pa.

Write for free illustrated literature

Sanding

Outboard Turning (face plate #505) Grinding or Buffing

Cutting Large Workpiece with Extension #556

Drilling with Jacobs Chuck

Cutting compound angle

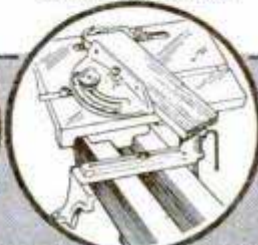
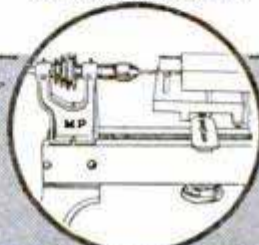
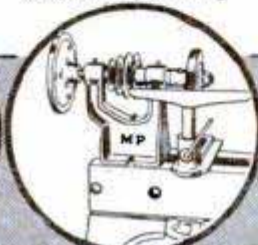
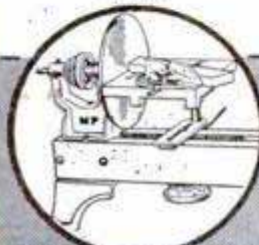

AMERICAN MACHINE & TOOL CO., INC., DEPT. 15, ROYERSFORD, PA.

SAVE with WAR SURPLUS NAVY OVERALL PANTS

Wool blanket lined, with storm tabs on bottom of legs. Water repellent cloth, in a bib-top suspender style, with button and zipper front. Gov't. cost \$10.00.

488



BRAND NEW

MAIL CHECK MONEY ORDERS OR C.O.D.'S TO

MONEY-BACK GUARANTEE
WORLD WAR SURPLUS STORES
841 S. BLUE ISLAND AVE.
CHICAGO 7, ILL. Dept. P.M.

Add 25c per item for Postage and Handling. Illinois Residents add 2% Tax. Send for Free Catalog.

FREE

YOUR CHOICE . . . 65c 3/4" x 3/8" x 4" INDIA OIL STONE . . . Or . . . 2-Cell DURAL FLASHLITE, With Tool Kit

Ideal Gift for Your Son!

11 pc. TOOL KIT

Regularly \$20.30

Limited Time **\$16.95**

Here's What You Get!
8"x25" Metal Tool Box with Tray & Saw Bracket \$9.00—6" Block Plane \$1.50—20" Hand Saw \$3.00—16 oz. Claw Hammer \$1.25—1/16" Nail Set .20—3/16"x4" Screwdriver .60—1/2"x6" Screwdriver .70—6" Steel Rule \$1.00—6" Try Square \$1.25—6" Spline Plier .80—185 pg. book "How to Work with Tools & Wood" by Stanley, \$1.00. All Tools Stanley or Equal Quality. Guaranteed Satisfaction or Your Money Back. Any Item May Be Ordered Individually. Order C.O.D. or Send Check and Save Charges. Send 3c stamp for our catalog.

PRECISION TOOL SERVICE
55 E. WASHINGTON CHICAGO, 2

MACHINISTS TRADE IN YOUR OLD PRECISION TOOLS!
Write for Prices!

For Smartness, Utility and Greater Night-time Safety!

Wall's Ruff-N-Redy No.12 "Stratoliner Dispatch" CYCLE BAGS

Made of heavy weight leatherette (colors our option). Reflective bead designs on sides flash at night in headlights of car for your safety and protection.

Each set includes two balanced, streamlined bags.

Try your bicycle dealer first, but if he can't supply you, send . . .

\$3.49

for your pair, postage paid.

No C.O.D. ORDERS, Please



H. B. WALL & SONS
Box 1416-B, S.S.S. Springfield, Missouri

The SEAMAN ROTARY TILLER is a Many-Job Farm Machine!



You can use a Seaman Tiller for:

- Complete Seedbed Preparation
- Pasture Renovation
- Aerating Soil
- Weed Eradication
- Mixing in Cover Crops
- Orchard Cultivation
- Mixing in Fertilizer
- Light Brush Removal
- Working Sod
- Erosion Control
- Nursery Work
- Better Moisture Control

In addition, the motorized models can now be adapted to Irrigation Service simply by attaching a Centrifugal Pump to the Tiller Power-take-off.

Ask your dealer about SEAMAN ROTARY TILLERS, and write for your copy of Bulletin NST, just off the press! It tells about many interesting farm service applications and new, outstanding improvements. Motorized and power-take-off models, 3-ft. to 7-ft. tillage widths.

SEAMAN MOTORS, INC.

364 NO. 25TH ST., • MILWAUKEE 3, WISCONSIN

SAY YOU SAW IT IN POPULAR MECHANICS

DEAFNESS EXPLAINED

IN NEW FREE BOOKLET

New, authoritative booklet, fully illustrated, can help you solve *your* hearing problems. Learn more about hearing loss—its causes—its correction.

Western Electric Dept. 380-PM10
195 Broadway, New York 7, N. Y.

Send free copy of "Modern Science and Your Hearing."
Include illustrated booklet on two new *all-in-one*
Western Electric Hearing Aids.

Name.....

Address.....

City..... Zone..... State.....

Distributed in Canada through Northern Electric Co., Ltd.

EXCLUSIVE TERRITORIES OPEN!
Write for Full Details Today.

---AN ARTMOORE PRODUCT---

Cut Housework in Half with NEW ART CLEANER

WRINGS
LIKE
THIS



REFILLS
EASILY
REPLACED

Again available with genuine Latex sponge rubber head! Over a million in use—doing a better, faster, *easier* job of scrubbing dusting, waxing floors. 10 inches wide. Self-wringing, self-cleaning—48-in. hard wood handle means no kneeling, no stretching. If agent hasn't called, write direct.

\$5.95
Postpaid

ARTMOORE CO.

Dept. PM-108, 1319 N. 3rd, Milwaukee 12, Wis.

A Better Way TO BUY LIFE INSURANCE

Newly developed Policy Selector enables you to quickly determine the best life insurance policy for your particular needs. Shows you how to buy it right. Enables you to get more protection for your insurance dollar.

SENT FREE.... The Service "SELECT-A-POLICY" insurance planner is yours for the asking. No cost. No obligation. Sent BY MAIL! No agent will call. Just write—

DEPT. 643

The SERVICE LIFE INSURANCE CO. Omaha 2, Nebr.

Write For
**FREE "POLICY
SELECTOR"**

Service Life Bldg

CLEANS HARDEST PAINT BRUSHES

IN LESS THAN 1 HOUR!

TIME
SAVER
Liquid
BRUSH
CLEANER
mfd. by
CELCO
CORP.

110 E. 42nd St.
NEW YORK 17, N. Y.



Cleans wet brush for change of color or lay-up almost instantly... Use over and over again.

If not available at Paint or Hardware stores—send 60c for full pint—postpaid, U.S.A. only.

Also at 50c for a full pint.

TIME SAVER PAINT REMOVER

"A Little Removes a Lot of Old Paint!"

SATISFACTION GUARANTEED... Dealers, ask your jobbers!



13 new WORKBENCH PLANS

Constructional details on 13 sturdy, easy-to-build benches... large cabinet bench with 29 drawers, streamlined cabinet bench, drop-down bench for narrow garage, portable apt. bench, carpenters' folding-leg bench, etc. Send dollar bill today. Ask for free plan catalog.

CRAFTPLANS, Dept. P-124, 7241 Madison, Kansas City 5, Mo.

FOR BIG MEN ONLY!

QUALITY SHOES IN SIZES 10 TO 16

We specialize in large sizes only—sizes 10 to 16 widths AA to EEF. Wing Tips, Loafers, Moccasins, Dress Oxfords, High Dress Shoes, Work Shoes, Sox. Styling specially designed for large sizes. Satisfaction guaranteed. FREE Catalog.

Write for
FREE Catalog

KING-SIZE, Inc.
624 Brockton, Mass.

POPULAR MECHANICS

LOOK! NEW 1949 ELECTROCAR with 3 real speed shifts

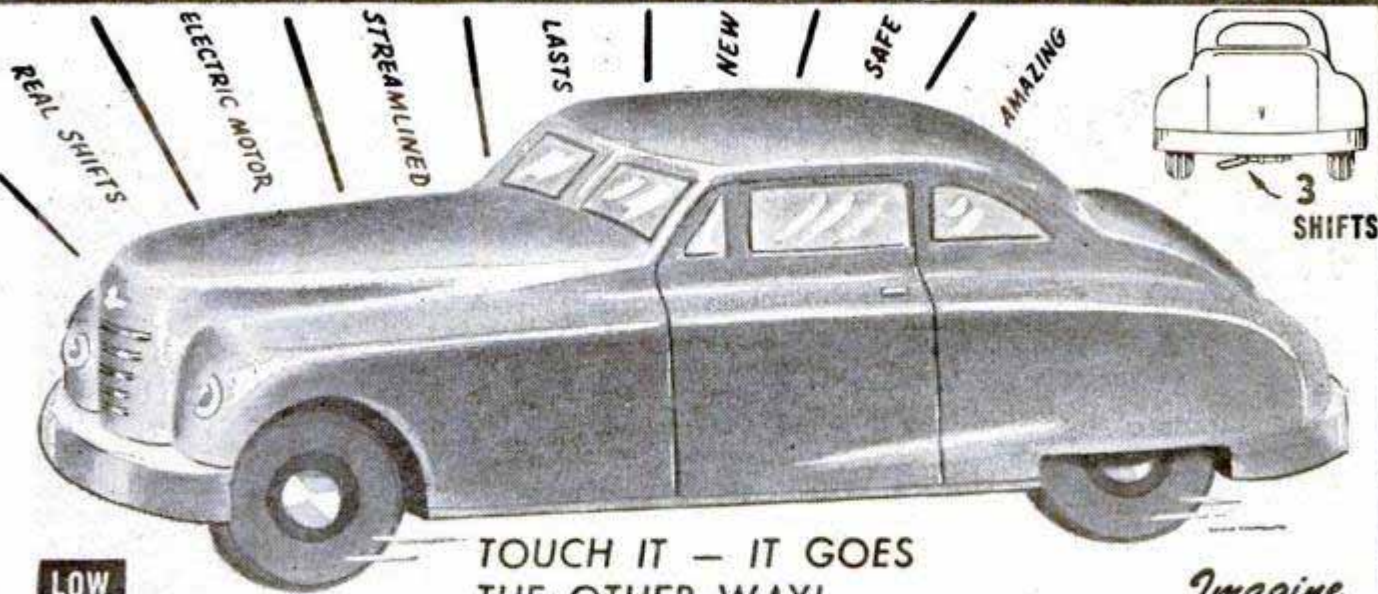

LOW
SECOND
HIGH
REVERSE

TOUCH IT — IT GOES THE OTHER WAY!

Here is the sensationally new scale-model car that captivates every child (and mommy and daddy, too.) One flick of the magic gear lever and off it goes — in low, second, high — or reverse. Runs for hours. Driven by an electric motor, powered by two flashlight batteries — safe, economical — easily replaced. Over 10 inches long — comes completely assembled with batteries, headlights, balloon-type rubber tires — in shiny red durable plastic body. Lasts forever. RUSH ORDER TODAY!
SEND NO MONEY (C.O.D. you pay postage. Remit with order, we pay postage.)

Imagine
only **298**
Complete

ELECTROCAR CO. 59 East 8th St. N. Y. 3 Dept. P.M.

Home-Workshop Owners

SHARPEN CIRCULAR SAWS LIKE AN EXPERT



No waiting . . . no expense . . . keep circular saw blades sharp and true right in your own workshop. With SURE-SHARP anyone can do expert job on hollow-ground, cross-cut, and combination saw blades. Precision gauge — any pitch or angle! Can't miss in producing perfectly sharpened saw. Fits 6-in. to 12-in. circular saws with 1/2, 5/8 or 3/4-in. centers. Guaranteed!

Money-Back Guarantee

Order now - soon pays for itself

SURE-SHARP Mfg. Co. BOX 24, SANTA ANA, CALIF

GOV'T SURPLUS

BRAND NEW ★ COATED
6x30 PRISM BINOCULARS



Individual Focus
Similar to
BAUSCH & LOMB DESIGN
COMPLETE WITH GENUINE
LEATHER CARRYING CASE

Reg. \$89.50
plus 20% Fed. Tax.

SPECIAL \$49.50
plus 20% Fed. Tax.

BUY WITH CONFIDENCE AT

HABER & FINK, Inc. Dep't N, 12 Warren St. New York 7, N. Y.

Here's the wrench Mechanics want!

BILLINGS WRENCHES
Buy them at Your Hardware Store

The Billings & Spencer Company, Hartford 1, Conn.

DIAL your SAW CUTS!



AMAZING NEW

Warren



DADO SAWING WASHERS MAKE ALL THESE CUTS ON YOUR SAW!

Smooth, accurate grooves—12 widths, any angle. No chatter, no burning, chewing, or sanding! Just dial desired width with Micro-matic adjustment! 5 sizes fit any saw arbor— $\frac{1}{8}$ ", $\frac{3}{16}$ ", $\frac{1}{4}$ ", $1"$, $1\frac{1}{8}"$. See your dealer or use coupon below! Satisfaction guaranteed.

DEALERS, ORDER DIRECT!

WARREN WASHERS CO., DEPT. 50,
70 Medbury Ave., Detroit 2, Michigan

Enclosed \$4.95 for one set of Warren Washers,
postpaid. My arbor size is _____

NAME _____

ADDRESS _____

CITY _____

STATE _____



\$4.95
set
pat.
pend.

Nu-WAY

WEATHER STRIP

FOR WINDOWS AND DOORS

KEEPS COLD OUT • HEAT IN

Easiest strip in the world to put on. Can be used on any type door or window. 100% all-wool felt, reinforced with white metal.



Macklanburg-Duncan Co.

Oklahoma City 1, Oklahoma



AT LEADING LUMBER YARDS AND HARDWARE STORES

K-R-O KILLS RATS

• Comes in POWDER and BIS-KIT form. Both contain *red squill*; are safer around farm animals and pets. POWDER, 75¢; BIS-KITS, 35¢ and \$1.00. If unavailable from your druggist or seedsman, order direct; adding 15¢ for mailing and handling. Money-back guarantee. *The K-R-O Company, Springfield, Ohio.*

END BATTERY TROUBLE

Get Better Car Performance—Longer Life for Battery, Lights, Radio, Ignition, Points

Amazing new Powermaster Wattage Regulator—greatest advancement in ignition system engineering since invention of the generator—only fully automatic regulator that controls wattage charging rate to battery. Maintains full battery charge. Insures peak operation of ignition system. Reduces water consumption of battery. No "freezing" of contacts—open or closed. Lets you drive on a dead battery or without a battery yet protects lights, radio, etc. regardless of driving speed. Replaces old voltage regulator. Quick and easy to install. No extras. Guaranteed up to 100,000 miles a year on car or truck operation. Costs no more than a replacement of your burnt out voltage regulator. If you're going to drive your car for 2 years you can't afford to be without the Powermaster.

Write for further details—give make and model of car.

SCIENTIFIC ELECTRIC CO., P.O. Box 2162, Sta. H. Cleveland, Ohio

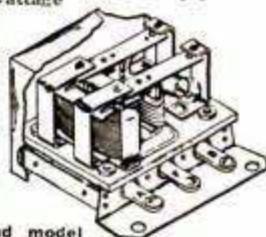

MILITARY TRUCK PARTS



Every part for every G.I. type vehicle from jeep to 20-ton prime mover 6x6 40% to 80% below list.

NORTHWESTERN AUTO PARTS CO.
334 NORTH SEVENTH ST. • MINNEAPOLIS 11, MINN.



BUILD FINE GRANDFATHER CLOCK NOW

The simple sensible Red-i-Kut way—as thousands have—SAVE HALF. SHOP TESTED PLANS "SPIRIT OF THE CENTURY" Narrow waist 83" tall or stately "SPIRIT OF AMERICA" straight side model with pictures. EASY-TO-FOLLOW PLANS tell all—plus BROCHURE of fine brass weight Westminster, tube chime, movements, dials and mahogany case kits. Send \$1.00 today—Both Plans \$1.50 NOW. KUEMPEL CHIME CLOCK CO. Minneapolis 16, Minn.

SPEED UP-CUSTOMIZE



YOUR CAR! "Sport Motorists" Hand-

book shows how to make simple conversions that give RACING SPEED, CUSTOM BEAUTY, POWER INCREASES from any car (New or Old!). Reveals latest Hollywood Restyling and "Souping Up" methods! Speed Tuning! Racing Tricks! Economy Secrets! Mileage Tips! Shows Beautiful Sport and custom body changes—that anyone can make! Photos—Instructions or constructing inexpensive "Doll-Up" accessories. Speed equipment. Superchargers, California mufflers, gas savers, water injectors, powerizers, streamliners, Sport Cars, "Hot Rods," Speedsters, etc. Also includes fascinating Custom Car, Hot Rod and Racing PICTO—\$2.00 POST-RIAL Section! "Complete—Only book of its kind!" **ALMQUIST ENGINEERING, Milford 40, Pennsylvania** SEND FOR FREE "SPEED & CUSTOM SUPPLY" CATALOG



How a Part Tube of TIP-TOP SOLDER Fixed 3 Leaky Water Pipes!

"I had three water pipes with bad leaks. Being an expensive amount of work to be done, I decided to try TIP-TOP. I took a part of a tube of TIP-TOP LIQUID SOLDER and fixed those pipes in a few minutes. It's been seven months now and they are still under our high water system."

Mr. W. W. E., North Carolina

TIP-TOP LIQUID SOLDER saves you big money on repair bills. Forms perfect bond on metals, wood, leather, paper, glass . . . most any material. Water and gasoline proof.

Always keep a tube handy in car, kitchen, on work bench. Get TIP-TOP at your hardware dealer or write TIP-TOP PRODUCTS, Omaha, Nebraska, today. Insist on TIP-TOP, the original and superior liquid solder.



BEARINGS

Bore	O.D.	Type	Price, each
3/16	11/32	Needle	\$0.22
5/32	9/32	Needle	.25
3/4	1"	Needle	.25
1"	1 5/16	Needle	.25
1 31/32	3 5/32	Ball	1.45
7 3/16	8 1/2	Ball	5.50
6 3/8	7 5/8	Ball	5.50
7/8	1 7/8	Ball	.45
1/2	1 11/16	Ball	.25
3/16	25/32	Roll End	.45

**Fafnir,
N.D.,
Torrington,
Norma,
MRC &
Heim**

All Brand New—Minimum order \$2.50
Include 10% each order for handling & postage.
BENJAMIN SALES CO.
8774 Linwood Ave., Dept. M, Detroit 6, Mich.

BUILD HEAVY DUTY MACHINES

SAVE UP TO 90%— You can build, using our practical, easy-to-read plans, all kinds of machines, for home, farm or shop—scooters, portable sawmills, metal working machines, concrete machinery of all kinds, printing equipment, woodworking machines, midjet autos, dish washers, farm equipment, freezers, tractors.

FREE CATALOG HANDBOOK
183 SETS OF PLANS
VALUABLE INFORMATION

NICHOLS EQUIPMENT COMPANY
D-1510 PURVIS, MISS.

FIRST IN FUN FOR FAMILIES ASSEMBLE THIS CLOCK FOR ONLY \$3.95

IT'S EASY — IT'S FUN — IT'S INSTRUCTIVE
(A small screwdriver is the only tool required.)
Complete, Ready to Assemble—Accurate—Lasts for Years
Exquisite Design—Ebony Black Plastic Case

See what makes a clock "tick." See how smart you are mechanically by timing yourself as you assemble this beautiful, weight driven pendulum clock which you can't buy in finished form in stores for twice the price.

You save all assembly costs and you can sell to friends and neighbors to make extra cash.

WILCOX, INC. Dept. P-10, 971 Goodrich Blvd. Los Angeles 22, Calif.

RUPTURE Troubles ENDED

Advanced method. No leg straps, no elastic, no steel. Entirely different. Guaranteed. Write:
SMITH MANUFACTURING COMPANY
DEPT. PM PRESTON, ONT., CAN.

MAKE YOUR STOP LIGHT SHOUT

AMAZING STOP LIGHT FLASHER
Makes Your Stop Light Flash 115 Times Per Min. A SENSATION! Automatic, instant acting when foot brake applied. Non-rusting. Dust, Oil, Vapor & Waterproof. Used by Police & Fire Depts. Attach in 5 min. to any model car or truck. Approved by safety engineers. FREE BOOKLET with order. Tells how to SAVE MONEY ON YOUR CAR. ORDER NOW if dealer can't supply. SEND NO MONEY. Pay postman \$3.00 plus postage. Send \$3.00 we pay postage. Satisfaction or money back.

DEALERS & AGENTS WANTED
MACCHI & CO., 927 Larkin St., Dept. MO, San Francisco, Calif.

Parts For Military Type TRUCKS and JEEPS

We have for immediate delivery genuine parts for all makes and models, 4x2—4x4—6x4 and 6x6. All models from 1/4 ton to 20 tons. All makes: Autocar, Biederman, Brockway, Chevrolet, Diamond T, Dodge, Federal, Ford, GMC, International, Mack, Oshkosh, Reo, Studebaker, White, Willys and Jeps.



We have parts lists available on most models. Write stating model of Army built Truck.

New All Purpose WINCH

3,000 LBS. RATED CAPACITY — IDEAL FOR JEEP

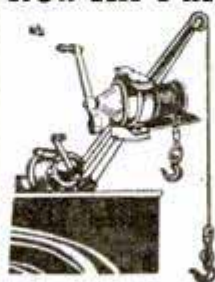

Spur gear type winch complete with crank, 50 ft. 1/4 inch cable and hook and 89 inch boom with pulley. Ideal for lifting or pulling. Winch bracket can be mounted on truck or at material location. Plenty of power, 27 to 1 ratio. Weight of entire unit unpacked 142 lbs., boxed 238 lbs. Special, each... **\$59.50**

NEW G. E. GENERATOR

Heavy Duty General Electric Model 96A1939 Type CD. An 80 volt DC unit with shunt winding. KW 9.6120 amps speed 1430-3430. Equipped with 4 groove V-belt pulley drive. Shipping weight 669 lbs. Only **\$125.00**

NEW RADIATORS

Ideal for Stationary Engines

Originally manufactured to be used on Army Halftracks. A COPPER radiator with a core 3 3/4" x 25" x 27", overall size 28" wide x 35" high. Inlet and outlet connections 1 1/2 inches. Modine Part No. AD 4689-013. Complete with shroud and cap. An excellent buy. **\$35.00** each.....

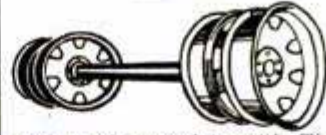

TRAILER AXLE

Heavy duty trailer axle suitable for many types of trailer construction. Also excellent for building of heavy farm trailers and wagons. It is a 15,000 lb. capacity square type straight trailer axle complete with Timken roller bearings, hubs, and 6 hole 750 x 20 Budd Wheels. Without brakes. Axle is 2 1/2 inches square and 70 inches between wheel mounting flanges. Std. width. AN EXCELLENT BUY.

With Single Wheels.. \$49.50 With Dual Wheels.. \$59.50

PISTONS WITH PINS

.020 oversize 4 inch bore. For White Model 160 AX engine. Each **\$3.00**
.020 oversize 4 inch bore for Hercules model JXD engine. Each **\$3.00**
.020 or .060 or semi oversize 5 1/2" bore for Hercules model HXD engines. Each **\$9.00**
.010 oversize 3-25/32" Bore for GMC model 270 engine. **\$3.00**

STEERING ASSEMBLY

Ross steering gear assembly model T-75110 used on the White model 666 army truck also for Brockway, Biederman, Dart and other heavy trucks. Brand new, an excellent buy. Each... **\$35.00**

MUFFLER

New heavy duty Truck Muffler. An exceptional value. Can be used on any truck with 2 1/2" inlet pipe. Specifications—Overall length 28", Diameter 10", Inlet connection 2 1/2", tail pipe connection 2 inches. List \$12.00. Our price, each... **\$1.95**

CONN ROD BOLT

G. M. #3670953, per hundred **\$3.00**

All prices quoted are FOB, Kansas City. 25% deposit required on COD orders.

American AUTO PARTS CO.
1830 LOCUST — DEPT. PM
KANSAS CITY, MISSOURI.



SAY YOU SAW IT IN POPULAR MECHANICS

THE NEW LOW-PRICED MONO-CYCLE BIKE MOTOR



\$89.50
Plus Tax
3 H.P. ENGINE

FITS ANY BIKE EASY TO INSTALL

Mono-Cycle is the rugged Bike Motor with plenty of power. Its light weight mono-cycle engine weighs only 18 lbs., does not alter balance of bicycle, has only three moving parts, set world endurance record. Fits any bicycle, boy's or girl's. Can be installed in less than one hour. Built for real service, Mono-Cycle starts easy, provides smooth power with minimum vibration. Belt release lever enables rider to pedal bicycle as easily as before bike motor was installed.

SEND COUPON TODAY

- Please send me full information on Mono-Cycle Bike Motor.
 Please send me Mono-Cycle Bike Motor. I enclose check, money order, for \$93.98 which includes \$4.48 Federal Excise Tax.

NAME _____

ADDRESS _____

CITY _____

SENSATION MOWER, INC. LOX PM 10, RALSTON, NEBR.

MILL IT...ON YOUR LATHE!

PALMGREN

MILLING ATTACHMENT

3 SIZES

No. 250 Illustrated

2 1/2" JAW Only **\$24.75**

CONVERT LATHE IN 10 SECONDS

Now you can Mill, Slot, Grind, Groove, Square Shafts, Saw at Angles, Recess and many other important jobs. **SAVE TIME and MONEY!** Why send work out or use costly methods when a PALMGREN MILLING ATTACHMENT will solve your problem.

Precision built, it has accurate graduations for rotary angle adjustments, also graduated vertical feed screw. Fits South Bend, Atlas, Craftsman, Logan, Sheldon and all other lathes. Thousands now in use in small and large machine shops, repair shops, railroads, schools, home work shops, etc. **ORDER SIZE NEEDED TODAY!**—it will quickly pay for itself.

IMMEDIATE DELIVERY

Nos.	Width Jaws	Depth Jaws	Jaws Open	Weight Pounds	Fits Tool Post	Price F.O.B. Factory
150	1 1/2"	1"	1 5/8"	6 1/2	1" Dia.	\$18.75
250	2 1/2"	1 7/16"	2 1/2"	11	1 1/4" Dia.	24.75
400	4"	1 1/2"	4"	25	2" Dia.	39.75

Order From Your Dealer or Jobber: Write for Circular No. 351 Mfrs. of PALMGREN PRODUCTS Since 1915

CHICAGO TOOL and ENGINEERING CO.

8365 South Chicago Ave. Chicago 17, Ill.

JUST A FEW OPERATIONS YOU CAN DO ON YOUR LATHE!

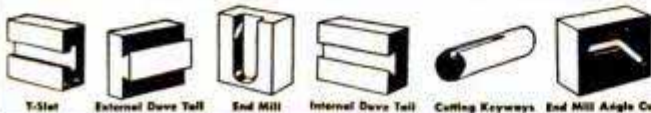

We'll Start You Complete in this PRODUCTS BUSINESS

And Help You Put It Over

The great building industry is your profitable market for masonry products. Low investment... high returns... wide-open opportunity to establish a lifetime business.

The biggest building years in the nation's history are just beginning. New construction, involving billions of dollars, means huge demands for block, drain tile, and other masonry products which YOU can manufacture locally, from local materials, with local labor for local consumption. Remember, MASONRY products are in mesh with today's building preference!

Use our modern machines and equipment to insure the finest quality products at pared-to-the-bone manufacturing costs. Sold direct from factory to you. Backed by 40 years of pioneering and manufacturing. Write for new catalog. Describes complete line of equipment with prices plainly marked. Tells how we help you in manufacturing and merchandising. Write TODAY.



CONCRETE EQUIPMENT COMPANY

512 Ottawa Avenue
Holland, Mich.

GIVES YOU 2 DRILLS IN 1

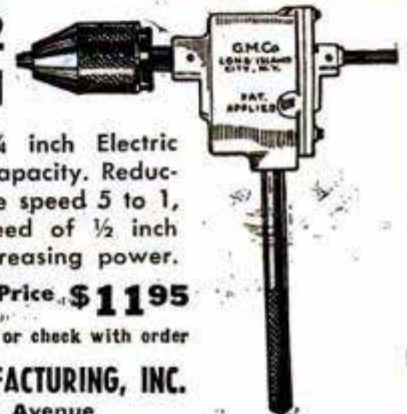

Converts any 1/4 inch Electric Drill to 1/2 inch capacity. Reduction gears reduce speed 5 to 1, the average speed of 1/2 inch Drill thereby increasing power.

Jobbers write Price **\$11.95** for proposition

M.O. or check with order

G. M. CO. MANUFACTURING, INC.

1308 43rd Avenue
Long Island City 1, New York



Easy and Cheap to Operate

SAVE TIME, WORK, MONEY!

SHAW DU-ALL

and "PEPPY PAL" TRACTORS

PLOW

These rugged walking or riding tractors ideal for farm, truck garden, orchard, poultry farm. They operate on a few cents an hour. A child can handle them.



CULTIVATE

DO DOZENS OF JOBS

The Shaw Du-All or Peppy-Pal does many jobs quickly and easily. Plows, cultivates, harrows, disks, bulldozes, sprays, hauls, grinds, and saws wood.



MOW

BUILT FOR RUGGED WORK

Sturdy, extra-strength construction means low upkeep, long life. Full year's guarantee.

LOW FACTORY PRICES

Buy direct or through your dealer! Almost anyone who owns a garden can afford a Shaw Du-All or Peppy Pal. Mass production holds prices down—quality up.



RIDE

RIDING TRACTORS

4 models, from 5 to 12 1/2 H. P., 58 in. wheelbase, 36 in. wide, 24 in. plant clearance. Hand or electric starter. Improved steering device, brakes enclosed in differential housing. Heavier frame and bearings. Standard hitch for trailers and wagons. Plow, harrow, cultivator, cutter bar, snow plow, bulldozer available.

SHAW MFG. CO.

FREE: Illustrated folders giving complete details and price lists—write today!

4510 Front St., Galesburg, Kan.
668-G North 4th St., Columbus, O.

O. D. WOOL SHIRTS
13 to 15
269

PANTS
28 to 34
295

Perfect condition, designed for reissue. All have been cleaned and pressed by the Q. M. Corps. 100% all wool serge. Priced less than the cheapest work clothes. Add 12c postage per garment.

BRAND NEW KHAKI SHIRTS-PANTS
14 to 17
299

NEW. Tailored of 8.2 chino khaki sultan material. Shirts have flap pockets, pants have cuffs. 10c post. per garment.

GEN. NYLON 50 FT
59c

PARACHUTE CORD

NEW. Ideal for many uses. 550 lb. tensile strength, 3/16" diam. Each hank 50 ft. Add 7c postage.

50% WOOL HOSE
NEW. Medium wt. Khaki and nat. Please add 3c postage ea. pr. **39c**

CUSHION SOLES
NEW. 63% wool, double sole. Desert sox. Khaki and white. Add 4c postage per pr. **49c**

NAVY T-SHIRTS
WHITE
69c

NEW. Combed yarn, full cut. Small, medium, and large. Please add 5c postage each.

WAR SURPLUS
AND OTHER
BARGAINS

ORDER FROM THIS AD PLEASE

MAIL ORDERS
Please send remittance with order. Include postage. Guaranteed satisfaction. You are privileged to return any unsatisfactory purchase for refund.

WATCH CAPS
77c

NEW. Color, blue. 100% pure wool knit. Please add 5c postage each.

all wool WRISTLETS
13c 8 PAIR \$1.00

NEW. 100% O.D. wool knit. For glove and mitt inserts, wristlet replacements, etc. Worth 75c per pair. Add 3c postage per pair.

1399

B-15 Style FLIGHT JACKET

NEW. Renders greatest warmth per oz. of weight. Mountain cloth outside, pile lined body and sleeves. Genuine mouton collar, 4 pockets—2 outside, 2 inside. Wool knit cuffs and waistband. Add 27c postage.

SIZZLING SPECIALS

- Army Style Combat Boots **6.55**
NEW. Rugged, comfortable, 10" high. Reversed uppers, full oak leather sole, with composition outer sole. Add 27c postage.
- Navy Style Field Shoes **4.99**
NEW. An excellent work shoe. Reversed uppers, full leather sole, composition outer sole. Add 22c postage.
- Down and Feather Sleeping Bags **12.99**
NEW. Mummy style. Filled with mixture of down and chicken feathers. Water repellent poplin cover. Zipper opening. Add 45c postage.

DUST MASKS
33c

NEW. \$1.50 value. Ideal for millers, farmers, paint and insecticide spraying. Add 6c postage for each.

NAVY SUN GLASSES
NEW. \$4.00 value. Ground lenses. App. by Navy. Complete with case. Add 5c postage.

AVIATORS
24K Style GOLD PLATED RIMS
189c

NEW. 4-base curve, ophthalmic ground, shuts out 96% of the ULTRA-VIOLET RAY. 24K gold plated rims. Adjustable nose piece. New sensational price.

GREATEST WATCH VALUE IN USA

17 JEWEL Military Style WRIST WATCH

NEW. Genuine Incabloc, guaranteed fine quality 17 jewel Swiss movement. Precision case with stainless steel back. WATER RESISTANT, SHOCK PROOF, ANTI-MAGNETIC. Sweep second hand, radium dial, fine leather strap. Save up to \$20.00. Please add \$2.00 federal tax. 3c back guarantee.

1995 PLUS 10% FED. TAX

WAR SURPLUS CIRCULAR

SEND FOR FREE

Over 150 War Surplus bargains, also other items.

SIoux FALLS SURPLUS STORE
113 NO. PHILLIPS SIoux FALLS, S. DAK.

HYDRAULIC CYLINDERS

Powerful, double acting, 1 1/2" diameter, 27" stroke. Will lift 1750 lbs. at 1,000 lbs. hydraulic pressure (air or oil). Can be used on presses, balers, loaders, lifts, jacks, and a million other uses. Government cost over \$50.00. All brand new—shipping weight 10 lbs. **\$12.50 each.**

HEATERS

Gasoline, burning 40,000 B.T.U., built by Stewart Warner for USAAF as cabin and engine heaters. Brand new and in original cases. Small modification makes ideal installation in trucks, buses, trailers, boats, small buildings, etc. No exposed flame. Crated shipping wt. 40 lbs. A bargain at **\$28.50 ea.** FOB Wash., D. C.

MICHEHL INDUSTRIES
930 F ST. N.W. WASHINGTON 4, D. C.

BINOCULARS	
U. S. Navy 7 x 50.....	\$95.00
BINOCULARS	
U. S. Army 6 x 30.....	\$57.50
5 Power Ranger	\$2.00
TELESCOPES	
Engineers Metal Army Type and	\$2.00
SIGHTING LEVELS	
SURPLUS GOVT. TRIPODS for Level, Transit, Cameras, etc. Used. Good Condition.	\$5.95
NEW TRIPODS for Transits, Levels, etc. Value \$75.00. Special.	\$13.50

PUBLIC SPORT SHOPS
11 S. 16th St., Phila. 2, Pa. No COD's

GENUINE SWISS
2-Push-Button
CHRONOGRAPH WRIST WATCH
\$995

ONLY... 995

A Sensationally low price for such a precision timepiece... A **WRIST WATCH** and **STOP WATCH** in one!

IT HAS EVERYTHING!

Note These Features...
 • It's a **TIMEKEEPER!**
 • It's a **STOP WATCH!**
 • It **MEASURES DISTANCE**
 • It **MEASURES SPEED** of Airplanes, Cars, Race Horses, etc.
 It has Sweep Second Hand, Chrome Case, Precision Workmanship.

EXPANSION BRACELET of matching stainless steel 49c additional.

SEND NO MONEY! Rush order today. Pay postman only \$9.95 plus 10% tax and postage. Satisfaction guaranteed or money refunded if returned within 10 days.

SWISS IMPORT CO., Dept. 81
P. O. BOX 5284, CHICAGO, ILLINOIS

WITH MOLLY YOU CAN FASTEN ANYTHING and do it quickly, neatly and safely. MOLLY will hold fixtures securely to floors, ceilings or any hollow wall construction... Simple to install, all you need is a screw driver. Sold by leading hardware stores everywhere.

Write for Free Descriptive Folder

MOLLY CORP.
522 COURT STREET
READING, PA.

WHERE SCREWS WON'T HOLD - USE MOLLYS

You Too, Can Fire Rockets

There's a new thrill coming as you watch one of these rockets soar up into the blue... With speed and action just like a full size rocket. You can have fun or experiment seriously with this model.

V-2 ROCKET

May be used over and over. Charge capsules are available everywhere. Complete unit consists of a V-2 Rocket, launching device, and a generous supply of capsules for only \$1.98. When payment is sent with order, we pay postage. Or send no money and pay postman \$1.98 plus mailing costs.



Rocket being fired at Wendover Field, Utah.

SOARS OVER 200 FEET IN THE AIR

\$1.98

Walsh Products, Inc., 209 N. Maple Ave., East Orange, N.J.

for **COMFORT, ECONOMY** and **LONG WEAR**

Riegel WORK GLOVES



Ask for the Riegel Brand wherever work gloves are sold. Full descriptive literature sent free if requested on business letterhead. Riegel Textile Corp. 342 Madison Ave. New York 17, N. Y.

"THIS TRADE MARK IS YOUR GUARANTEE OF VALUE"

BUILD THIS CONCRETE BLOCK MACHINE

Sell blocks; or build your home, garage, barn at 1/2 cost by making and laying your own blocks.

This simple machine which you can build yourself at a cost of about \$15 (excluding motor) will make a block in 30 seconds using only one form. 2 to 4 forms can be used on each vibrator.

Power driven concrete mixer plans also. Write for further information. No obligation.

U-BUILD-IT SERVICE
Dept. 3-A, 206 West Wilder Ave., Tampa 3, Fla.

DUAL TAIL PIPE EXTENSION

Fits all cars - chrome plated
DEEP TONE

produced by 2 1/2 inch outlets **\$2.95**

Postage free on prepaid orders
DEALER INQUIRIES INVITED

LYONS PRODUCTS COMPANY
PAT. PEND. 2426 So. LaBrea Ave., Dept. PM-10, Los Angeles 16, Calif.

BURN WATER IN YOUR CAR!

THE NEW OCTA-GANE WATER INJECTING CARBURETOR GIVES YOU BETTER MILEAGE & PICK-UP MORE POWER & MORE PEP CLEANER & COOLER MOTOR

New OCTA-GANE is the only water injecting carburetor engineered on the Venturi Principle. Only \$24.25 complete with tank. Send only \$1.00 down with special offer coupon at right. Send today! Mail postcard for particulars.

CONTINENTAL CARBURETION
DIV. 10-B, 1478 UNIVERSITY AVE., BERKELEY, CAL.

DEALERS: Write on your letterhead for discounts.



CONTINENTAL CARBURETION CO.
Div. 10-B, 1478 University Ave., Berkeley, Cal.

Sirs. Please ship me immediately one complete OCTA GANE assembly under the plan checked below.

- \$1.00 enclosed, pay postman balance c.o.d
- \$24.25 enclosed, ship fully prepaid.

(PLEASE PRINT)

Name _____

Address _____

City _____ State _____

Make, Year & Model Car _____

THIMBLE DROME RACER



Car Only
\$425

POSTPAID

Completely
Finished

SPEED! ACTION! Now easily adapted for miniature gas engine or other power.

panel and numbers. Equipped with bridle lugs for cable track racing. Car is 9 3/8" long, 4" high. Weighs 18 oz.

Model Racing SENSATION

With or Without New Gear Drive Transmission

JOIN IN THE MODEL RACING FUN

New, accurate scale model of midget racer, the classiest thing you ever laid eyes on. Die cast malleable aluminum body, turned aluminum rubber-tired wheels, Chrome exhaust stacks. Wobble pump. Simulated leather seat and back. Instrument

THIMBLE DROME RACER, Car Only, Without Transmission and Engine, postpaid	AR DEN ENGINE — .099. For Thimble Drome Operation, Postpaid
\$4.25	\$12.75
THIMBLE DROME RACER, With Geared Transmission and Pinion Gear for Arden Engine INSTALLED. (Less Engine) Postpaid	AR DEN GLO-PLUGS. For In- gitionless operation. Postpaid
\$10.35	\$.85

Order today—you can't beat this for fun! Include remittance with order. If COD send \$1.00 deposit on car, \$2.00 deposit on transmission and engine. Rush order for immediate delivery.

HOME-SHOP PRODUCTS CO.

DEPT. 17, 4821 SHERIDAN ROAD, CHICAGO 40



Concealed
Tamper-
Proof Lock



NO KEYS
Simply Press
Button



OPENS . . .
Automatically
Locks when Closed

WRITE FOR CATALOG SHEET

STEELE MFG. CO.

445 WINCHESTER AVE.

ASHLAND, KY.

EVINRUDE Catalog Free



Describes complete line of 1948 Evinrude Outboard Motors—sensational new "Sportwin" model — 2 models with revolutionary "Weedless Drive" — 3 thrilling four-cylinder models. Gives helpful information on boats, speeds, etc. Profusely illustrated. Write

EVINRUDE MOTORS
5689 N. 27th St., Milwaukee 9, Wis.

Easy way to remove paint



Write for
**WONDER-
PASTE
leaflet**

In refinishing furniture, woodwork, etc. all cracked or peeling portions of the old finish should be removed. It's easy with **WONDER-PASTE REMOVER**. Applied with an ordinary paint brush, this remarkable paste quickly softens up the toughest finish, whether paint, varnish, enamel, lacquer or shellac. Will not run, even on an upright surface. Turns the finish into a soft sludge that comes off easily at every stroke of the scraper. A long-time favorite of painters. Get Wonder-Paste at your paint or hardware store. Write for Wonder-Paste leaflet, and for advice on your particular removing problem.

Wilson-Imperial Co., 119 Chestnut Street, Newark 5, N. J.

LITE-O-GLASS*

* TRADE MARK



Storm Doors
and Windows

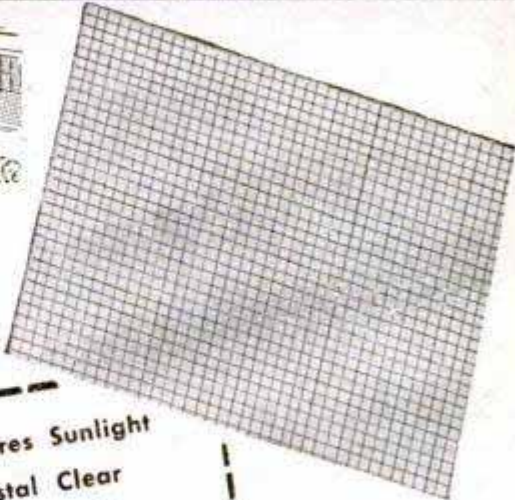

- Insures Sunlight
- Crystal Clear
- Shatterproof
- Waterproof
- Flexible

LITE-O-GLASS is a fine mesh galvanized screen wire, imbedded in a solid sheet of waterproof, transparent glazed coating. Super strong and longer lasting. Available in 36" widths.



Hot and Cold
Bed Frames

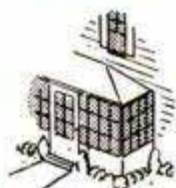

Enclosed
Porches

you buy

100 Sq. ft. roll for **\$13.00**

and get a 50 ft. roll

Not 100 ft. at regular price, but 150 ft. for only \$13.00 — direct from factory to you. All-purpose LITE-O-GLASS may be cut with shears . . . makes permanent installations!

FREE

Limited
Time
Offer

ACE WINDOW SCREEN CO. of Chicago
1634 S. Pulaski Rd. • Chicago 23, Ill.

Please send me 100 ft. roll of LITE-O-GLASS at regular price, plus 50 ft. roll **FREE!**

- Enclosed is check or money order for \$_____
- Send C.O.D. I will pay postman \$13.00 plus postage.

Name _____

Address _____

City _____ State _____

Ace Window Screen Co.
OF CHICAGO

1634 South Pulaski Road • Chicago 23, Illinois

World's Most POWERFUL,
Most USEFUL, Most
COMPLETE
Hand Tool !



New
WISE-GRIP
WRENCH



Tremendously POWERFUL—double-lever action gives one hand TON Gripping Power! Amazingly USEFUL—adjusts to ratchet action or LOCKS to the work, freeing both hands—is actually many tools in one. Now has important new features: 1—INVOLUTE JAW CURVE gives tremendous holding power, all shapes. 2—THIN NOSE, stronger than ever, gets into close quarters. 3—SUPER WIRE CUTTER cuts wire, small bolts. 4—KNURLED JAW TIPS hold to the very tip. 5—Easier to open from locked position. Fine alloy steel. Nickel plated. WITH cutter—7", \$2.25; 10", \$2.50. WITHOUT cutter—7", \$1.85; 10", \$2.25.

If not at your dealers, order direct.
Postage paid if price accompanies order.

Made Only by PETERSEN MFG. CO., Dept. M-10, DeWitt, Nebr.

It's Wise To Go
WHIZZER
Ride 5 Miles For a Penny!

With all necessary attachments
\$109.97
Fed. Tax Incl.
F. O. B.
Pontiac, Mich.

Here's America's thriftiest power transportation—the new '48 Whizzer Bike Motor. Gives you 125 miles per gallon . . . 35 mph . . . 2½ rugged horsepower . . . dependable 4-cycle design. PLUS steel cable core notched V-belt drive . . . Twist-Grip controls . . . auto-type carburetor . . . deluxe chrome trim. Fits any man's balloon tire bike—it's America's finest bike motor!

RIDE ONE AND YOU'LL BUY ONE!

See your Whizzer Dealer—or write Whizzer Motor Co., Pontiac, Mich. For 10 years—world's largest bike motor builder.

KAYAKS
AQUA VIE
Easy to Build
OUTBOARDS ROWBOATS
25¢ COIN FOR ALL THREE
AQUAMOBILE V-18
V-23 CRUISER
U-MAK-IT BOATS
Easy to Build
Cut-To-Fit for Quick Assembly. Everything Complete plus Illustrated Instructions. No Experience Necessary. Simple as A. B. C. SEND 25¢ POSTAGE (COIN) TODAY FOR 3 MONEY SAVING ILLUS. CATALOGS Showing all '48 Models (marine plywood) & construction details.

KAYAKS
ROWBOATS
DINGHIES
INBOARDS
OUTBOARDS
RUNABOUTS

KAYAK BOAT CO. 703 P. WHITTIER ST. NEW YORK 59, N. Y.

DRAINS CELLARS, WASH TRAYS
CIRCULATES OIL
Pumps 1800 GPH 300 gal. 30' high, use ⅓ to ½ HP motor. Will not clog. **\$6.50**
Postpaid if cash with order. (Add 50c for west of the Mississippi.)
Thousands in use since 1936
LABAWCO PUMPS, BELLE MEAD 7, N. J.

MOTOR BARGAIN
1/30 HP 24 volt DC motor 2450 R.P.M. .95 amps ¼" shaft size overall 3" x 4". Weight 3 lbs. **\$2.45**
USE AS 6 VOLT GENERATOR—Generate your own power. Can be operated on your bicycle wheel. Furnishes sufficient power for two 6 volt bulbs. Resistor furnished free with each motor enables you to maintain constant voltage. Special Price \$2.45, or 4 for \$7.50. Lots of 24 for \$36.00. Prices are F.O.B. Chicago. Immediate delivery. Send check or money order today. Sold on money back guarantee.
C & M EQUIPMENT CO. 1831 S. State St., Dept. D-10 Chicago 16, Ill.

New Designs in
FRANZITE GRIPS
Modernize Your Gun! Improve Your Score!
Most durable grips made. Positively unbreakable! For Colt, Smith & Wesson, Hi-Standard, Origes, Luger & Mausers in a wide choice of beautiful designs in ivory, pearl, walnut, onyx, etc. Low prices. FREE CATALOG. Dealers Wanted.
SPORTS, INC. (Mrs.) 5501 Broadway, Dept. P-10, Chicago 40, Ill.

MACHINE STEEL AND BRASS USERS
TOP-GRADE ¼" GROUND AND POLISHED
DRILL ROD—ONLY 82c. . . . 3 Foot Bar
A WIDE ASSORTMENT, BIG STOCK
COLD FINISHED STEEL, in rounds, flats, squares, hexes
FREE CUTTING BRASS in rounds and hexes
WRITE FOR FREE PRICE AND STOCK LIST
This Chesterfield Price and Stock List is yours for the asking. Prices, specifications and uses are shown on the complete line of machine steel and brass. A must for every home hobbyist, small shop and farmer. You'll surely want your copy today. Write immediately.
AN INTRODUCTORY OFFER FOR YOU!
For your first order of \$5.00 or more, we will give you ABSOLUTELY FREE, a handsome calibrated 6½" rule! AND YOUR NAME IS ENGRAVED IN GOLD LETTERS ON THE FACE OF THE RULE! When you write for the stock list, you will get full details.
DON'T DELAY! WRITE TODAY!

CHESTERFIELD STEEL SERVICE CO.
Dept. M-10 P. O. Box 3058 CLEVELAND 17, OHIO



USE OUR CAPITAL

NO SALES EXPERIENCE NEEDED

The biggest opportunity ever, to quickly establish a money-making, lifetime business, now awaits you as a McNess Dealer. Sell things farmers need and use up. Serve same families year after year. Pleasant work--no bosses--easy to do. We supply capital to work on. Also provide offers--advertising--premiums and trade secrets that bring sales.

First to apply get best trading areas. Don't wait--write us today for McNess proposition. Tell us county and state you want to serve. Ask for free McNess Book.

The McNESS CO., 645 Adams St., Freeport, Ill.

REAL DIESEL ENGINE

\$2.95

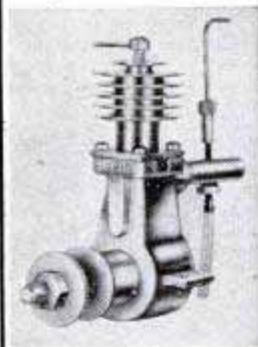

WE'RE CRAZY, they tell us, giving away a real diesel engine, complete with cylinder and piston, carburetor, crankshaft and connecting rod. All parts completely machined, ready for easy assembly. **ONLY \$2.95.** How do we do it? We're selling thousands of **DEEZILS.** So production's up; costs tumble down. **DEEZIL** is a precision engine. Actually runs at 7500 RPM. Produces 1/7 HP. Ideal for planes, boats, midget cars. Send \$2.95 plus 15c postage today.

GOTHAM HOBBY CORP.

107 East 126th Street New York 35, N. Y. Dept. "P"

Crosman TARGET PISTOLS

.177 or .22 Cal.



NOW you can shoot indoors as well as outdoors, for Crosman adjustable "power without powder" is safe, and there's no noise or powder reek. Fine balance, rifled barrel, push-type safety, adjustable rear sight; grip fits either hand. Only \$14.95! At your dealer's; write for literature.

Crosman Arms Co., Inc. 3 HENRIETTA STREET ROCHESTER 7, N. Y.

PILOTS' JACKETS



(Right) **B-15 STYLE BOMBER JACKET.** Sturdy water repellent mountain cloth. Warm fleecy all-wool lining. Genuine Mouton Fur (Beaver-dyed Lamb) collar and chin strap. 34-46.....\$12.95
REGULATION B-15 JACKET. Made same as for AAF. Heavy alpaca wool pile lining. 34-46.....\$16.95
CAP (illustrated). O.D. wool outside, alpaca pile flaps. . . . \$1.25
 (Left) **A-2 STYLE JACKET.** Pliable brown leather. 34-46.....\$17.95
A-2 Jacket, Mouton Fur Collar \$21



Write for FREE illus. list clothing. Orders sent postpaid except C.O.D. Satisfaction or money back

CONSUMER'S CLOTHING CO. Inc., Box P, 20 Greene St., New York 13, N.Y.

Get More FOR YOUR Money! WITH A NEW



DRUM and DISC SANDER

DISC TABLE 11 1/4" x 6"

USES STANDARD SIZE SANDPAPER

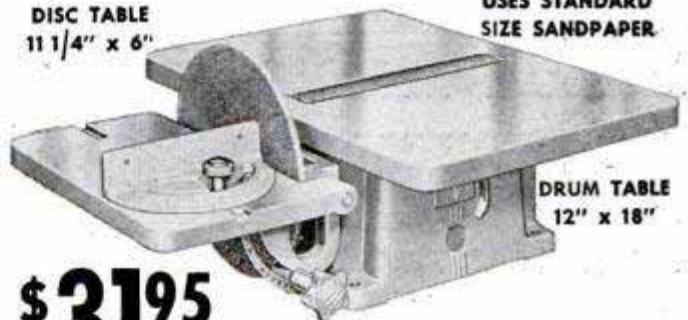

DRUM TABLE 12" x 18"

\$31.95

DUST - SEALED OIL - SEALED BEARINGS

Depth of cut from roughing to finishing is completely adjustable with cam lever lock. Work rides on large planer-type table. Disc Table and Mitre Gauge make a variety of compound angles possible to finish rough sawed joints.

GET A FREE CATALOG!

See Foster's New TABLE SAWS, JIG SAWS, BAND SAWS, JOINTERS, DRILL PRESSES, LATHES, PLANERS, SHAPERS AND SANDERS.

FOSTER MANUFACTURING CO.
 1 KINSEY AVE., BUFFALO 17, N. Y.
 Please send Catalog No. 23 showing Foster Power Tools.
 NAME _____
 ADDRESS _____
 CITY _____ STATE _____

A NEW KIND OF MOTORCYCLING
WITH



SAFE - COMFORTABLE - POWERFUL

Automatic Clutch. Telefloat Spring Suspension.
Foot Gear Shift. 95 miles per gallon. 70 Miles per hour.
See and drive it at your nearest JAWA DEALER or
write for free folder.

JAWA MOTORCYCLE CO.

Dept. M

460 FOURTH AVE., NEW YORK 16, N. Y.

DEALER INQUIRIES INVITED

NOTHING ELSE LIKE IT...

Get this **REVERSIBLE**
2-in-1 Screw Driver
(Stock No. DU2)

Combines a standard size
Phillips (No. 1) Cross Point
and regular (3/16") bit in ONE
driver. Ends the hunt for that missing tool! Break and shock-
proof plastic handle... oil tempered chrome vanadium steel
blade. Precision-built throughout... no play or wobble.
Fully Guaranteed. Finest tool you ever owned! Only 75¢



5-in-1 Screw Driver Kit
(Stock No. ZB50)

Consists of leatherette tool roll, 1
break and shock-proof plastic
handle, and 5 interchangeable oil
tempered, chrome vanadium steel
blades: 1/8", 3/16", and 1/4" regular;
No. 1 and No. 2 Phillips. Fits easily
into back pocket. An ideal all-
purpose screw drive kit. Fully Guar-
anteed. Price, only \$2.50

Gift Packaged Screw Driver Set

(Stock No. A6)

A beautiful assortment of 6
famous Amberyl handled screw
drivers in a blue enameled steel
box. Very finest quality through-
out! A set every man will be
proud to own... the ideal gift.
Square, round, stub and igni-
tion size blades ranging from
3/16" to 1/2". Fully Guaranteed.
Price, only \$4.50



See your Dealer, or send check or money order direct.
We Pay Postage.

VACO PRODUCTS COMPANY

317 EAST ONTARIO STREET, CHICAGO 11, ILLINOIS

Electrically Welded Endless

Paramount

**BAND
SAW
BLADES**



Made in widths from 1/8" to 1-3/4"

Make your hand saw do more work for you. The proper
width of blade will extend the scope of this important ma-
chine. Burrill's Paramount Blades are made from tough
Nickel Alloy Steel properly tempered. Teeth accurately set
and filed, and all saws carefully straightened. Send order
and check today. Delivery will be made as promptly as con-
ditions permit, from a few days to a week or two. You can
obtain these saws at the following prices:

1/8"-3/16"-1/4"-5/8" wide, 5'6" long, \$1.04 each
1/8"-3/16"-1/4"-5/8" wide, 6'6" long, \$1.16 each
1/8"-3/16"-1/4"-5/8" wide, 7'6" long, \$1.27 each

Other sizes at proportional prices

NO C.O.D. SHIPMENTS ACCEPTED

State Make of Machine

Your satisfaction is guaranteed

BURRILL SAW & TOOL WORKS

407 E. Main St., Iliou, N. Y.

HOT WATER INSTANTLY
From COLD WATER FAUCET

ONLY

• Easy to attach
• Simple to use

**AMAZING
BARGAIN**
Reg. \$6.95

\$3.65



Regulate temperature by turn-
ing faucet. Operates on A.C.
or D.C. current. Has 8 ft.
rubber cable & plug. Send C.O.D.
express charges collect. Send cash
and we pay postage.

MAIL ORDER PROMPTLY FILLED
MONEY BACK GUARANTEE IN 5 DAYS

PROVEN PRODUCTS 527-L-5th Ave.,
N. Y. C. 17

LOW COST FIRE PROTECTION



Prevent loss and tragedy in your home
with Therm-o-larm. This new fire detector
warns of overheated conditions. Easily con-
nected to your doorbell wires. Sounds alarm
continuously when fire danger exists. Enjoy
the security this fire guard gives you while
you sleep.

PRICED AT ONLY \$2.00

WRITE FOR FREE FOLDER

Opportunity for men to demonstrate and
install. Write for information.

THERM-O-LARM CORP.

Pat. 2,418,384

3133 Fairfax Rd. Cleveland 18, Ohio



Print Your Own

Cards, stationery, circulars, tags, labels, photo and movie
titles, advertising, etc. Save money. **Print for Others,**
Good Profit! easy rules sent. Raised Printing like Engraving, too.
Send time for press samples, supply book, all details and advice on
your needs. No obligation. **KELSEY INC., B-37, Meriden, Conn.**

How to Make Liquid Marble

Make amazing Liquid Synthetic Marble at home in your
kitchen, basement or garage. Terrific demand! **BIG
PROFIT!** No heat, pressure or machinery needed. No
experience necessary. **MOLD, TROWEL or BRUSH**—make
in almost any color.

FLEXIBLE MOLDS: Valuable information for novelty cast-
ing. 3c material makes \$1.00 item. **PERMA-TEX Plastic
Flooring:** Make lifetime floors in any color or shade. Can
be laid over wood, concrete, brick, etc. Work out beautiful
patterns in contrasting and harmonious colors. **WRITE
FOR FREE CATALOG!**

BING PRODUCTS

Dept. PM-10B
88 Broad St., Boston 10, Mass.

"DANGDEST THING YOU EVER SAW!"

Flex-O-Pic



An Amazing Convenience around
AUTOS
RADIO SHOPS
AIRPLANES
BOATS
ALL HOME WORKSHOPS
WORKS
AROUND CORNERS!

A Specialty Tool for HARD-TO-REACH PARTS AND PLACES

Specially invented for tricky service jobs. Expanding and retracting fingers in flexible housing reach in anywhere and grab hold of anything. Works around corners, S-turns, etc. 100 different uses around the home or shop. Mother will like it too. Try it on a 5-day money-back guarantee. Send name and address for C.O.D. delivery, or send \$1.00 now, and we ship prepaid. Descriptive circular free.

NOW ONLY \$1.00

DEALERS:

This is a terrific item! Write for complete details.

EMCO ENTERPRISES, Inc.

6750 Stony Island Dept. PM-10 Chicago 49, Ill.

CURIOUS?

ABOUT A SHIP-IN-A-BOTTLE

Here is the secret plus all of the material less bottle. See your dealer first. Catalog 10c.

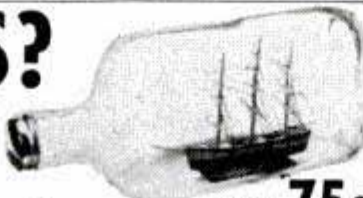

Postpaid in U.S.A. 75c

BRAUN-CRAFT, 1232 Etowah, Dept. PM-10, Royal Oak, Mich.

WIND ELECTRIC MOTORS

like GE., Westinghouse and others do

WITH OUR STATOR HOLDERS
ADJUSTABLE ARMATURE HORSES
SKEIN WINDERS - DEREELERS ETC.

If you want to start a shop of your own—write us
SEND FOR CATALOG

MOTORCRAFT, BOX 470, MUNCIE, IND.

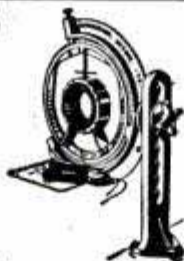

FREE INSTRUCTION SHEETS

with

EASY-TO-OPERATE
SLIDE RULE

PROFESSIONAL-GRADE RULE—NOW.. \$6.50

10" Plastic Mannheim Type with case

Order from FREDERICK POST CO., Dept. FF
Box 803, Chicago 90, Ill. Ask for "No. F1452P"

BUILD OR BUY A LAWN SWEEPER

No tiresome raking. The quick and easy way for cleaning your lawn. Picks up leaves, grass, acorns, sticks, and combs the grass. Easily built from available parts. Mail 10c for complete plan telling you how. Catalog listing parts, also factory built sweeper, sent free with plan.

LeJAY MFG. CO., Minneapolis 8, Minn.



SHEEPSKIN LEATHER JACKET

NAVY J4 FLYING TYPE—SIZES 36-46—CONVERTED
Now you can get a WELL TAILORED, LONGER LASTING, WARM jacket at absolute minimum cost because you are buying direct from the Manufacturer. Check These Special Features: Length 27", Mouton Collar, By-swing Sleeve, Full Cut heavy-duty Talon Zipper, Double Lined Leather Cuffs and Wristlets, Extra Leather Reinforcement on Top Sleeve, Leather Windbreaker.

Take advantage of this amazing value now! Complete Money Back Guarantee if not satisfied. \$18.95
Renovate Your Jacket
Lengthen the life of your leather jackets at manufacturer's wholesale rates. Send for FREE descriptive circular and price list today.

Prepaid orders shipped postage free. C.O.D. orders — you pay postage.
Berlew Mfg. Co., Inc.
Dept. M
Merrick, New York



SHATTERLESS "ALL PURPOSE" STEEL BOTTLE

HAS HUNDREDS OF USES *FOR LIQUIDS, GASES, STORAGE, AIR PRESSURE, ETC.



Formerly used by AAF for oxygen storage. You can use it now as an air pressure tank for inflating tires, operating horns, air motors, etc. May also be used as a buoy or float or for water supply storage on boats, trailers and trucks. Ideal as shipping container for gases, chemicals, etc. Bottle is non-shatterable with working pressure up to 500 lbs. psi., and weighs only 6 lbs. when empty. Internal volume 500 cu. in. (approx. 9 qts.). Has 3/8 in. pipe thread at each end. Approx. size 24 x 6 in. They won't last long at this low price. Order now!

REGULAR STEEL, EA. \$2.95
Stainless Ea. \$3.95

WAR SURPLUS HYDRAULIC PRESSURE ASSEMBLY \$49.50

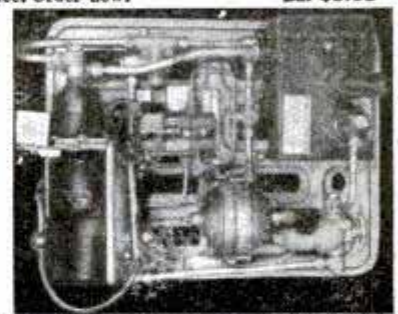

COMPLETE UNIT

Complete to the last detail—and at a price that you couldn't begin to buy half of the parts for. It is completely equipped, ready to go—just add the oil and put it to work. Unit is mounted on an alloy rack and contains the following high quality components: hydraulic reservoir 5 x 10 x 9 inches; large Purolator filter; hydraulic pressure accumulator; pressure relief valves; hydraulic pressure control unit; solenoids; genuine Pesco valves; Pesco hydraulic gear type pump of 1000 lbs. per sq. in. pressure at 1750 R.P.M. (motor turns at 4000 R.P.M.); full 2 1/2 horse power Pesco electric motor, AC or DC 24 volts, 4000 R.P.M. (will run on 110 AC by use of transformer); all connectors, tubing, fittings, etc. are included. Unit measures: 24 x 18 x 6 inches overall. Just add the hydraulic oil and you can put the system to work on any type of hydraulic power action. Has hundreds of uses. For cash with order will include full gallon high grade hydraulic oil plus hydraulic control valve and send shipping charges collect. Shipping wgt. approx. 60 lbs. Guaranteed perfect. Price complete, only..... \$49.50

24 VOLT, 200 AMP GENERATOR. Will operate above hydraulic unit. Just add pulley and motor to turn the generator. Good used condition. Approx ship. wgt. 50 lbs. \$22.50
Each only.....

ALL PURPOSE GENERATOR



Aviation type generator, ideal for use on boats, trucks, light and power plants, welders, water wheels, etc. Rated 24 volts, 25 amps at 2500 RPM. Has 1/8 inch shaft. Measures 10 x 5 inches overall. Highest quality aviation design. Actual weight 23 1/2 lbs. Two for \$30.00. \$1750
Each.....

SERVO ACTUATING UNIT

A combination hydraulic and electrical actuating unit that includes a 1/10th horsepower (6000 RPM) 24 volt motor. May be adapted to many uses such as operating garage doors, gates, etc. All units are brand new and guaranteed perfect. Shipping weight approximately 27 lbs. Each..... \$5.95



AMPLIFIER RACK

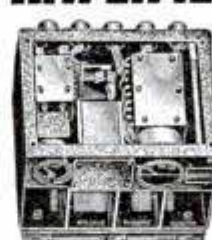

Sperry A-5 Auto Pilot assembly. Includes a great array of valuable electronic parts such as a 2 1/4 inch 0-120 AC volt meter, 3 1/4 inch, 350-450 frequency meter, plus relays, capacitors, resistors, condensers, plugs, switches, etc. Measures 14 x 10 x 12 inches. Approximate shipping weight 30 lbs. The meters alone are worth more than the price quoted for the complete assembly. Each only..... \$6.95

POWER AMPLIFIER

A 4 tube power amplifier (not audio) that contains a compact assembly of condensers, transformers, switches, resistors, sockets, terminal strips, chassis and panel. A real value for the radio and electronic experimenter. Shipping weight approximately 5 lbs. Each only..... \$1.95

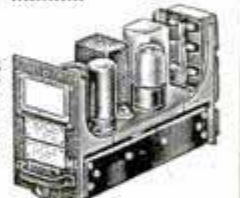

CONTROL UNIT

Made by Sperry. Designed to provide electronic control for the various units of the auto pilot. Measures 7 1/2 x 8 x 4 1/2 inches. Includes 6 toggle switches, 2 three-way switches, 3 dial indicators, plugs, resistors, etc. Parts alone are worth many times this low price. Stp. wgt. 8 lbs. Each..... \$4.95

Send stamp for FREE CATALOG. All prices F.O.B. Houston. Mail orders promptly filled. Send check or money order.

AERO INSTRUMENT COMPANY, Dept. PM10
MUNICIPAL AIRPORT HOUSTON 17, TEXAS

SEND FOR FREE CATALOG

WAR SURPLUS VALUES

MONEY BACK GUARANTEE

SHEEPLINED JACKET



Air Corps Type B-3. Like new. All leather with full sheep lining and large sheepskin collar. Zipper front, adjustable waist tabs. Sizes 40, 42.

PLUS 25¢ FOR MAILING **18.95**



PARKA COAT

New Army Air Force Type B-11. Finger tip length. Fully alpaca lined with mouton fur parka hood. Zipper and button front. Sizes 36 thru 46.

PLUS 25¢ FOR MAILING

24.95

OFFICERS' PINKS

Brand new Fine quality officers' elastic trousers. Sizes 28 thru 42. Reg. \$17.95 value.

PLUS 25¢ FOR MAILING

11.50



AVIATORS' JACKET

Brand new. Air Corps Type B-15. Alpaca lined. Mouton fur collar, zipper front. Sizes 36 thru 46.

PLUS 25¢ FOR MAILING

9.88



SEND CASH WITH ORDER OR SAY C. O. D.

SHEEPLINED FLIGHT PANTS



Beisone, excellent condition. All leather. Sizes small, med., large.

PLUS 25¢ FOR MAILING

4.98

CUSHION SOLE SOX

Army reject. O.D. color. 63% wool.

PLUS 15¢ FOR MAILING

6 pr. 3.50



NATIONAL JOBBING CO.

1703 No. 24th St. Dept. N-4 Omaha, Nebr.

3 TOOLS IN ONE

PLIER-WRENCH-CUTTER



BERNARD Parallel Action PLIERS (#102). Jaws close parallel like a vise. Cutters on outside of head for easy, quick use. Compound leverage action doubles gripping power.



BERNARDS work like a wrench. Parallel jaws fit snug on nut.

Cutters on outside of head. Easily cuts baling wire.

Compound leverage doubles gripping power. 6 1/2" size cuts 8-penny nail.

Breaks glass perfectly. Jaws close flat against glass.

At your local hardware store. Write for free literature

SARGENT & CO.
(SCHOLLHORN DIV.)

87510 Water Street
New Haven 9, Conn.

Faithful Quality Since 1870

BERNARD

FLASH Your Turns

SIMPLEX Directional Switch



signals your intention of making a right or left hand turn. There are no bulky arrows or clumsy bumper attachments. The additional bulbs flash at your parking and rear lights as well as at the switch.

\$5.00

Postpaid
Send Check or Money Order. On C.O.D. Mailing Charges Extra

There is no need to disrupt your present wiring.

You can install it yourself in less than one hour. Easy to attach. Flashes 50 to 60 times per minute. Adaptable to most medium and low priced cars of recent manufacture.

DEALER INQUIRIES INVITED

Progressive Tool & Mfg. Co., 1303 Jackson Blvd., Chicago 7, Ill.

You can build the flagship of Columbus SANTA MARIA!

These are actual patterns you can trace on your material, cut out with electric vibra or jig saw. No shop necessary. Anyone can build it. If you can draw and saw out a letter "A." Over all size is 30"x30" for your mantel.

Pattern #4 - Price \$1.00

Another beautiful model you can build is the accurate reproduction of the old



"Sacramento Stage Coach"

If you are a professional man looking for a hobby, a manual training instructor, or student, a scout or physically handicapped, want to earn more money, these are the patterns you have been looking for. Copyrights reserved.

Pattern #3 - Price \$1.00

GEORGE ANDRUS, 3040 James Ave. So., Minneapolis 8, Minn.



ADJUSTABLE BASE FOR TYPEWRITER . . . 3 POSITIONS

"JIFFY TYPE DESK" the type of desk YOU NEED

SAVES SPACE . . . SAVES MONEY
(4 to 1) ← (50% less)

← for typewriter - flat top writing desk →

SIZE ● An Elegant Piece of Furniture ●
FROM THE HOUSE OF HIGH QUALITY FURNITURE
22 Ready to assemble unfinished . . . without Stationery
x Compartment . . . Finish it yourself **\$62.50**
24 ONLY

Desk with Fluorescent Light and Stationery Compartment . . . assembled and Finished in Light Oak, Walnut, Mahogany, School Brown, Blond, Bleached Mahogany, **\$79.50**
Maple or from your sample . . . ONLY

Desk assembled but not finished with Fluorescent Light and Stationery Compartment **\$72.50**
ONLY

ALL PRICES FOB, CHICAGO IMMEDIATE SHIPMENT
THE ABOVE PRICES INCLUDE CRATING
ON C.O.D. ORDERS WE REQUIRE A 25% DEPOSIT

S. NEMES, Manufacturer, Dept. P-10, 2631 Lehman Court, CHICAGO 14

WITH FLUORESCENT LIGHT AND STATIONERY COMPARTMENT



STOPS LEAKS PERMANENTLY

Cut your fixture replacement, water and fuel bills with Economy Renewable Seats. Make economical, permanent repairs quickly and easily with the Junior Kit (illus.). Repair bathroom, kitchen and laundry fixtures. Everything you need included in steel box. This is a natural for the "Fixit" shops—get extra income from making permanent repairs on your customers' faucets.

Senior Master Kit also available—repairs faucets and valves up to 1" pipe. At Better Jobbers and Hardware Stores . . . or Write Direct

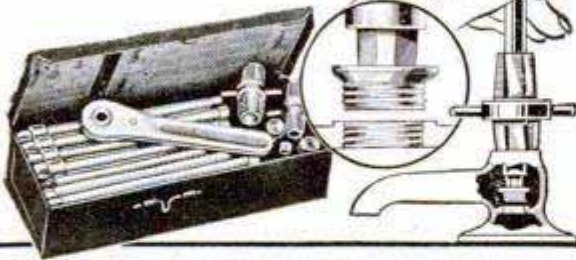

ECONOMY VALVE SEAT CO.

3122 N. California Ave. Chicago 18, Ill.

LAWN MOWER SHARPENER



lawn mower sharpening at low cost!

\$4250

less motor.

turn spare time into dollars

Order direct from
QUAD CITY PRODUCTS
Company, Inc.
Box 42, Rock Island, Ill.

BOWLING TEAMS! SAVE MONEY



Everything for BOWLERS
Bowling Shoes—Shoe Bags
Bowling Balls — Trophies
Lettered Bowling Shirts

Professional Style—Full Cut—Also
Women's Bowling Blouses

WRITE FOR FREE CATALOG

Bacharach Rasin Co. Inc. (Dept. G1)
14 N. Howard St., Baltimore 1, Md.

LAWN ORNAMENT-NOVELTY PATTERNS



28 Lawn Ornament Patterns, 25c. Other patterns: 15-20" high; Dutch Girl, Dutch Boy, Pirate, Bull Terrier, Mexican Girl, Mexican Boy, Dwarf, Penguin, Flower Girl, 10c each. 25 Novelty Patterns, 30c. All 62 Full Size Patterns, \$1.00 Postpaid. Strother Pattern Service, Dept. AR-8, Box 383, Belington, W. Va.

AIR COMPRESSORS

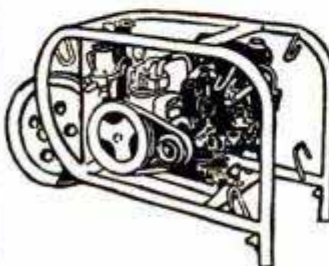

Bendix-Westinghouse
Original cost approx. \$250

SALE **\$59.50**
PRICE

Less Engine

Write for illustrated circular giving full particulars

The Original
Midwest Buy Anything Company

Not connected with any other firms of similar names
1520 Locust Kansas City, Mo.



YOUR MONEY'S WORTH



Efficient, streamlined bandsaws for small production shops, home workshops, schools. For cutting all materials fast and with less waste. Unexcelled in quality and performance because they are made by the world's largest bandsaw manufacturer—DoALL—having years of engineering experience and knowhow. Utility models have 16" throat and 12" work height capacities; fixed or variable speeds; many attachments to fit machine to any type of work. Also blades for all purposes.

SEE THEM WORK. Use coupon for more information and address of DoALL sales office nearest you where you can try one yourself.

The DoALL COMPANY
Band Saws • Machine Tools • Gage Blocks
Des Plaines, Illinois



Send data on UTILITY SAWS and address of nearest DoALL Sales Office.

Name _____
Address _____
City _____ State _____

SANDEE *Specials*

SANDEE MUFFLERS
V-8
DUALS
& SINGLES



MUFFLERS Steels & Aluminums with a MELLOW Motorboat Tone

SINGLES, Chev V 8 Plymouth, Steels \$5.50, Aluminum \$7.00
Chry. Olds, Buicks etc. Steels \$7.50, Aluminum \$9.00 V 8 and MERCURY DUALS, Steel \$17.50, Aluminum \$21.00 Split Manifold Sets Steels \$35.00, Aluminum \$45.00 49 Ford Duals, \$2.50 extra

SANDEE ALUMINUMS ARE GUARANTEED FOR LIFE OF YOUR CAR

Streamline Your Car with SANDEE FENDER SKIRTS... \$17.20 pr.

Sparkling beauty you'll like. Constructed of heavy gauge body steel finished in prime perfect fit



For Ford Chev (except Fleetline), Merc Plym De Soto, Chrvs Dodge, Kaiser, Frazer, Buick (except 42 48 Super) Olds Series 60 & 70 1937 40 Pont 6 1939-40

Beautify your car bring out the flowing lines inherently designed there

for **AMAZING** acceleration

DIXIE WESTERN DUAL INTAKE MANIFOLDS for V-8 FORDS AND MERCURYS \$15.00

Gas Line and Throttle Kit \$2.50 extra
Chrome Plated Velocity Stacks \$3.00 pair

By test increased acceleration by 26%—increased power and speed by 11%

All DIXIE WESTERN manifolds are brightly polished cast aluminum

ATTENTION service station men, garage men, and auto parts store owners, we have a profitable dealer's discount on quantity orders of any of the above merchandise

SANDEE MUFFLER COMPANY
Box 296 La Tijera Station
Los Angeles 43 California

WE SHIP C.O.D.

Please ship _____ Mufflers, Dual Set Single
Fender Skirts, Dixie Western Manifold

Make of Car _____ Model _____ Year _____

Name _____

Address _____

City _____ State _____

Check Enclosed \$ _____ Ship C O D \$ _____

SANDEE MUFFLER CO.

Factory Address

5643 Carryne Place Culver City, California

SAY YOU SAW IT IN POPULAR MECHANICS

HAM RADIO OPERATORS GADGETEERS, etc.



Blower Type FL, style 1171145B, Serial No. KO, 115 V 400 cycle 6700 RPM. Used by the army to cool transmitting tubes in Radar sets. Blower ideal for radio builders, photography (dark room), etc. Our price only **\$2.95**

PRICES FOB, KANSAS CITY

Write for new catalog

NATIONAL SURPLUS SALES CO.

723 E. 18th ST.

KANSAS CITY, MO.

New MILLING ATTACHMENT



SIZES FOR 8" to 16" METAL LATHES

Build it yourself from our sets of semi-machined castings and save \$8. Can be finished on your lathe alone. Complete drawings and instructions furnished with castings.

Mill keyways, slots, splines, dovetails, flutes for reamers, special cutters. Produce gears, ratchets, racks; bore, face, etc. with this precision attachment.

FREE Illustrated folder and price list of castings, milling cutters, etc. Write today. Mention your lathe.

HURON MACHINE AND TOOL CO.
YALE 4, MICHIGAN

Only \$16.95 Complete DUAL PURPOSE SPRAY GUN

USES ONLY 25 LBS. AIR PRESSURE
FLOCKS AND SANDBLASTS



AT HOME: You can refinish Lamps, Radios, Book Ends, Statues and hundreds of things with lovely colorful flocking. ETCH GLASS: Many designs and initials can be sandblasted on shower doors, ash trays, glassware. AUTO INTERIORS: Transform ugly dirty auto interiors to "new car beauty" with a BLASTO DUAL PURPOSE SPRAY GUN. Makes reflectorized signs too. Merely spray flock similar to Velvet, Plush, Suede and Mohair inside your car. ANTIQUE WOOD . . . REMOVE PAINT. MAKE EXTRA MONEY by doing any or all the above for profit. BLASTO is highest quality and carries a 5 day money-back guarantee. Operates on small air compressor. Send \$16.95 cash, check or money order for postpaid delivery. Write for free information. Full line of Flocking Supplies.

BLASTO SPRAY GUN MFG. Dept. PM-10, 7007 Haas Avenue
Los Angeles 44, California

\$4.95 REAL ENGINE VALUE

A miniature gas engine that really operates.

Thousands of Buzz "B" gasoline engines have been sold at twice the price. Now is your chance to buy a real 1/8 H.P. gas engine for only \$4.95. Turns up over 8,000 r.p.m. For Boats, planes, midget cars, etc. Guaranteed and ready to run. Includes Champion spark plug and tank. Send only \$1.00, engine shipped collect for balance, same day.



WRITE FOR FREE CATALOG OR SEND 10c FOR NEW MAMMOTH ILLUSTRATED CATALOG OF THOUSANDS OF HOBBY ITEMS.

America's Hobby Center, Inc., Dept. SB-108, 156 West 22nd St., N. Y. 11



GEIGER COUNTERS FOR LOCATING RADIOACTIVE MINERALS - FOR HOSPITAL AND INDUSTRIAL USE.

Write for Details and Prices

OMAHA SCIENTIFIC SUPPLY CORP.

Dept. M, 3623 LAKE ST., OMAHA 4, NEBR.



Powell SETS THE PACE

DEALER INQUIRIES
INVITED

- 7 H.P. Motorcycle-type Engine
- Faster pick-up than a car
- Automatic clutch
- Smooth, simplified control

- Solid steel frame
- Highway cruising speed of 45 miles per hour
- Chrome-plated fenders,

- handlebars, and sport muffler —looks like a custom job
- Costs no more than ordinary scooters

Write for FREE FOLDER and address of nearest dealer

Powell MANUFACTURING COMPANY

DEPT. PM-8
COMPTON, CALIF.



**YOU CAN
MAKE MONEY
With This New
PLEXIGLAS
KIT**

Now hobbyists can build a replica of a royal French coach in crystal clear plastic. Holds cigarettes, candy, nutmeats, etc. Anyone can assemble it in one evening and sell it to gift shops at a big profit. Our shop can't produce enough to meet demand so you have a chance to cash in on this big market now. We supply complete pre-cut Kit; Plexiglas parts, cement, sandpaper and easy to follow instructions, all for only \$3.95. Put Kit together and you have either a beautiful home accessory or a product you can sell.

SEND NO MONEY! Just send your name and address. Pay postman only \$3.95 plus postage for each Kit ordered, or send cash and we pay postage. If not delighted return kit within 10 days for full refund. Ask for FREE price list of scrap plastic with a hundred uses.

SPARKLE PLASTICS, Dept. P-4, 12553 Pinehurst, Detroit 4, Mich.



**LATEST
MODEL**

- Beautiful nickel plated case
- Guaranteed by famous factory
- Adjusted for dependable accuracy
- Assorted cases and dials
- Unbreakable glass

GIVEN without extra charge genuine rabbit's foot and chain, well known symbol of good luck. Rush order today and pay on delivery \$3.83 plus shipping charges or enclose remittance and save charges.

ROLLDEX, Dept. W19, P. O. Box 445, Huntington, N. Y.

NEW POWERFUL ELECTRIC MOTOR

For Rotating Ham, FM, Television Antennas; Barbecue Spits, Min. RR Turntables, Telescopes

- Operates on 110V AC, 60-Cycles (Requires only 12MFD Condenser)
- Appr. 3/4 RPM—Hi-Torque—No Free Swing
- Quiet
- With Full Instructions
- Easy to Mount
- Postpaid in Cont. USA

\$5.95

**ALVARADIO, Dept. P-1
907 S. Alvarado Los Angeles 6, Calif.**



**WOODWORKERS ... Get this
CONSTANTINE MASTER MANUAL**

Get the Most Fun From Your Hobby Indispensable to woodworkers. Newest, biggest edition, more pages, more color, helpful how-to-do-it articles, pre-war and new items, more bargains. Send 25c today and we will include **FREE! FULL YRS. SUBSCRIPTION** to Chips and Chats, published bi-monthly. Keeps you up-to-date on everything in woodworking, offers big money-saving bargains. Send now.

**ALBERT CONSTANTINE & SON, Inc.
791-F 135th Street, New York 54, N. Y.**



FULLSIZE, CUT-TO-SHAPE BOAT PATTERNS

and specifications. Designed by Naval Architect. Cruisers, runabouts, sloops, outboards, sailing canoe, etc. Low prices. Send 10c (coin) for illustrated catalog. **SPECIAL:** Send \$1.00 for "HOW TO BUILD BOATS" book, postpaid. PolyWog Houseboat Plans, \$10. **Cleveland Boat Blueprint Co. Dept. 666, Cleveland 13, Ohio**



SAY YOU SAW IT IN POPULAR MECHANICS

**PRECISION JEWELERS SCREW DRIVERS
Complete Set of 8 for Every "Hobbyist"**



At last—a complete set of precision screw drivers to meet the needs of every model builder. Not a miniature but the same type set used by U. S. Navy for precision instruments and watches during the war. Brass knurled handles, hexagon heads, finest tempered steel blades. Sizes 2-9. Never before a set of this quality and precision at such a low price. Your money back if not satisfied. **C.O.D. \$2.00 plus postage or send \$2.00 and we pay postage.**

PINE WATCH CO., Rm. 40A, 29 Eldridge St., New York 2, N. Y.

**Monthly income
in a small town...
AVERAGED OVER \$200**

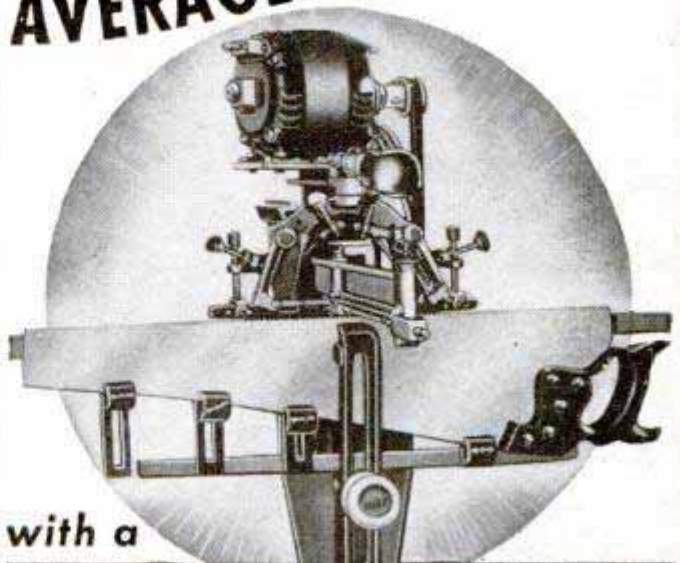

with a

**FOLEY automatic
SAW FILER**

In the small town of Searles, Minn. (Pop. 86), Mr. Conrad Stadick averages from \$200 to \$250 per month reconditioning all kinds of saws, lawn mowers, scissors, etc. Men in communities of all sizes make up to \$2 or \$3 an hour working full time or part time. That extra money comes in mighty handy in these days of rising prices.

It's no trick to take care of the saw filing for your neighborhood hardware or lumber dealer—plus looking after the saws for farmers, townspeople, manual training departments and factories. Best of all, it's a cash business, there's no canvassing, no eyestrain and no experience needed.

**FILES HAND... BAND...
CIRCULAR SAWS**

INDEPENDENCE AFTER 40: This free book shows just how you can start at home in your spare time working in your basement or garage. It's an immediate cash business that can develop into a full-time repair shop.



Send For FREE BOOK

**FOLEY MFG. CO., 1016-B Foley Bldg.
Minneapolis 18, Minn.**

Send me free book "INDEPENDENCE AFTER 40!"

Name _____

Address _____

THE THRILL RIDE OF 1949!



LOWTHER LIGHTNIN'

Beautifully Designed—Packed with Power—Tops in Value—Two thousand people stormed our Joliet factory preview to see this new super-scooter sensation—the Lowther Lightnin'! Powered with rugged 6.7 H.P. Briggs and Stratton engine, equipped with standard automobile hydraulic brake and luxurious two-passenger saddle, cushioned with foam rubber. Foot controls both gas and brake. Easiest controlled motor scooter ever built! Cruises at 35 M.P.H. and you'll get over 50 miles per gallon. Costs no more than ordinary scooter.



SEE YOUR LOWTHER DEALER OR USE THIS COUPON

HARRY A. LOWTHER COMPANY
Industry Avenue, Joliet, Illinois, Dept. P.M. 10
Send me folder and prices on Lowther Lightnin'.

NAME.....

ADDRESS.....

CITY.....ZONE.....STATE.....

ESTABLISHED DEALERS OR DISTRIBUTORS—Write on letterhead
—for attractive proposition. Desirable territories still open.

WAR SURPLUS



NYLON THREAD

Amazing Strong Thread used to sew Parachutes

NOW AVAILABLE For Home Use...

GIANT SPOOL only \$1.69
BLACK or WHITE
APPROX 5000 FEET

This genuine Du Pont Nylon thread is practically unbreakable. What every hobbyist, sportsman, sailor, camper wants. Used in model making, sail mending, tent repairing, bow and arrow winding, bamboo rod wrapping, kite flying and repairing, and many other uses. Used by Air Force on parachutes because of its amazing strength and dependability. Here is your chance to get a giant spool of 5000 feet—almost a mile of Nylon thread at the sensational low war surplus close-out price of only \$1.69. Black or white. Order TODAY.

SEND NO MONEY, TEST AT OUR RISK
Just send your name and address. Specify white or black or two giant spools for only \$3.29. On arrival, deposit only \$1.69 per spool (\$3.29 for two spools) plus C.O.D. postage on our guarantee if you are not delighted, you can return in 10 days and your money back. Cash with order, we pay postage. Limited Supply. Write Today.

LEEWARD PRODUCTS
Dept. F49M, 189 W. Madison St., Chicago 2, Illinois

New Advertising Machine



Prints & Illustrates 1¢ Post Cards

FREE Learn how thousands of business men, in every line, are boosting sales in spite of conditions—with 1¢ messages—printed and illustrated in a few minutes on gov't post cards—with amazing new patented **CARDMASTER**. Your "today's" ideas, read by your prospects next morning. Not a toy, but a sturdy advertising machine, built to last for years. Low price, sold direct. Guaranteed for five years. Send name today. **SEND NAME** We'll send **FREE** illustrated book of money-making **IDEAS** for your business and complete, unique advertising plans. **RUSH YOUR NAME TODAY.**
CARDMASTER COMPANY
4546 RAVENSWOOD, Dept. 1310, CHICAGO 40, ILL.

100 PRACTICAL USES

Glider Model FLAME GUN

KILL WEEDS, crab grass, Canada thistle, stalks, seeds and roots. Destroy brush, caterpillar nests, diseased trees, grasshoppers, chinch bugs, etc. Clear irrigation ditches, split rocks, burn tree stumps..... Sterilize poultry houses, kennels, barns. Use as portable home forge. Melt ice, thaw pipes. Safe, inexpensive. Burns only 6% kerosene —94% Air! Thousands satisfied users. Write for FREE CATALOG.....

7 MODELS from \$22 up

HAUCK MFG. CO.,
78 Tenth St., Brooklyn 15, N.Y.

MOVIE MAKERS' FAVORITE SINCE 1937

SATISFACTION GUARANTEED

Solar Type 12-Film (Weston 12 Outdoor) Ortho, Non-Halo, Fine Grain

16MM 50 Ft. \$1.90	16MM 100 Ft. \$3.30	DOUBLE 8mm
--------------------	---------------------	------------

24-HOUR FREE PROCESSING SERVICE
Order now. Send cash and save shipping cost or \$1.00 deposit on C.O.D. Illinois residents add 2% sales tax.

SOLAR CINE PRODUCTS, INC.
4247 So. Kedzie Dept. PM10 Chicago 32, Illinois

Write For Circular

BUILD YOUR OWN ENLARGER



Enjoy Photography's most fascinating hobby at a fraction of usual cost. With simple step-by-step instructions and diagrams plus a screwdriver and pliers you assemble your own Enlarger and Save! Get all features of more expensive Enlargers: precision machined aluminum alloy castings, 90° tilt for wall projection of prints, spherical aluminum lamphouse, helical rack and pinion focusing with extra large knobs, unconditional guarantee. For 35mm to 2 1/4 x 3 1/4 negatives. Time payment plan.

Write Today for Free Illustrated Folder
CALIFORNIA TECHNICAL PRODUCTS CO.
448 S. Hill, Dept. M-10, Los Angeles 13, Calif.

YOUR CARDS & PHOTOS SEALED IN PLASTIC

Permanently preserve your photos, Soc. Sec., Div. Lic., Draft Cards between two sheets of non-inflammable, water-proof, flexible plastic. Same Day Service.

WALLET SIZE 50¢
3" x 5" .90, 4" x 5" \$1.25, 5" x 7" \$1.75

Postage Prepaid, send Check, Money Order, or C.O.D. To
SEAL IN PLASTIC, 648 1/2 S. Main St., Los Angeles 14, Calif.

Build YOUR OWN BOAT



Complete parts cut to exact size—ready to assemble. Marine water-proof plywood, rustproof carlocks. Ideal for car top. Also models with laminated frames; mahogany decked runabouts. Build for sale at attractive profit. Exclusive franchise to local builders. Send 10 cents (dime) for illustrated literature today.

\$39.50 and up

OZARKA 722 WASHINGTON AVE. WOODSTOCK, ILL.

DON'T WEAR EXPENSIVE WATCHES TO WORK!

take this opportunity NOW!



GENUINE SWISS WATCH \$5.99*

The perfect watch for work and play. Luminous dial and hands. Sweep second hand Unbreakable crystal. Leather type band or expansion bracelet. Guaranteed against mechanical defects or your money back.

*No C.O.D.—We pay postage—Add 10% Fed. Tax

M and R IMPORT CO. 77-54 Austin St., Forest Hills, N. Y.

Order Now: Offer ends midnight November 30, 1948

NEW FLUORESCENT FIXTURE with CIRCLINE LAMP!



GUARANTEED FOR 1 YEAR!

A strikingly beautiful fixture in polished aluminum finish. Suitable for every room. Model C-32AP (illustrated), \$9.50. Model C-32S with etched glass shade, \$12. Sent POSTPAID anywhere in the U. S. upon receipt of cash order. C. O. D.'s sent F. O. B. factory. Write for free literature on full line.

HANOVER LIGHTING SALES
Box 186, Dept. ME, Hanover, Pa

950 POST PAID

DEALERS—AGENTS MAKE BIG PROFITS

WE HAVE THOSE SPECIAL AC AND DC ELECTRIC MOTORS — ALL VOLTAGES — ALL CYCLES — ALL SIZES — ALL BARGAINS

Also standard electric motors, fans, gas engines, light plants, blowers and many other items at big discounts. Send 10c for illustrated circular.

C. MARSHALL SALES
3546 West Fullerton Avenue Chicago 47, Illinois



GERSTNER Tool Chests

Strong, durable chests, attractively finished, will please the better machinist and toolmaker. Free catalog.

GERSTNER TOOL CHESTS
448 Columbia St. Dayton 7, Ohio

SAY YOU SAW IT IN POPULAR MECHANICS

MORE POWERFUL PORTABLE

BENCH GRINDER—\$13.50 DELIVERED

FULL 1/12 H.P. MOTOR AT 3450 R.P.M. BY DYNAMOMETER TEST

With adjustable tool rests and removable cast wheel guards for buffing. Diamond-trueed 4" x 1/2" coarse and fine wheels . . . dust proof bearings . . . off-on switch . . . 6 ft. rubber cord . . . baked hammertone finish . . . 110-120 volts a.c., 60 cycle . . . guaranteed one year against defective workmanship or materials. Send check or money order, we prepay postage.



ALHAMBRA PRODUCTS, BOX 328, ALHAMBRA, CALIF.

WAR SURPLUS AND OTHER BARGAINS

HEATER OR COOLER



For trailers, autos, offices, darkrooms, homes. DUMORE Motor, 1/6 cont. HP, Amperage 7.5, RPM 6400, 24 Volts. May also be used as dryer. Simple installation, radiator type, copper coils. Transformer advertised in this ad will operate this unit from house current. Weight 13 lbs. New, \$15.00

TRANSFORMER: Jefferson Electric step up or step down transformer. Input, primary 110-117 Volts A.C. Output, from 5 Volts to 650 Volts. Suitable for use with war surplus gadgets, heater relays, radio test filaments, electric trains, house chimes, etc. Weight 10 lbs. New, \$7.95 Each.



SEND CHECK, MONEY ORDER or CASH

FANCY BRIAR PIPES

We have been awarded 100,000 fancy briar pipes by Quartermaster Corps Assorted shapes and sizes. All popular makes. Buy now for Christmas Gifts _____ Set of 6, \$3.50



MICROMETER

Chrome plated, precision engineered and carefully tooled to give long life . . .

all new. 0-1" capacity, \$2.25.
1-2" capacity, \$3.50 Each.



WILLARD WET PLATE BATTERY



This extra long life rechargeable battery is ideal for portable radios, mobile units, bell circuits, alarm systems, rural telephones, Strobe bulbs, etc. 2 V 20 Amps. Only 5" high. Visible ball float hydrometer built in Lucite case. Shipped dry. Any battery service will supply standard battery electrolyte. Used singly or in multiples. Shipping Wgt. 3 1/2 lbs. _____ All new. \$2.75 each

25% DEPOSIT REQUIRED ON C.O.D. ORDERS

SHIP'S BELL: U. S. Navy Surplus Solid Brass with smooth polished finish. 5" Diameter. Great for Patios, Doorways, in Dens, Ranches, etc. Matching solid brass wall bracket included. Weight 3 1/4 lbs. All New. \$5.95 Each.



MICROSWITCH:

Type Z - 2"x1"x 1/2". Used open or closed. For automatic contacting-light, sound, model train systems, chimes, etc. New. _____ 3 for \$1.



CONDUIT WRENCH: Mfd. by JOAR. Jaws

pass over conduit, pipe or tubing, slips down to snugly encircle fittings. Slight pressure tightens or loosens fittings. Will not mar or kink material. Set of 8. All new wrenches, Nos. 4-6-7-8-10-14-22-28, (Reg. cost \$50.00), \$10.00 per set.



Weight 4 lbs.

ALL PRICES F.O.B. CULVER CITY, CALIF.

4 in 1 SCREWDRIVER:

3 smaller sizes fit into 6" overall size. Fine steel bits. Solid brass handles. All New. Each _____ \$1.



HIGH SPEED DRILL BITS

Like new! Original value over \$16.00. 25 assorted sizes & lengths \$2.50.



CLAMPS—Adel Aluminum Co., Rubber lined, hundreds of uses in any shop. Assorted sizes, all new _____ 5 Doz. \$1 — 500 \$5

AIRBORNE SALES CO., INC. DEPT. PM 10-B CULVER CITY, CALIF.

AIR RIFLES BENJAMIN AIR PISTOLS PIONEERS - LEADERS

SEND FOR FREE FOLDER OF LATEST MODELS TODAY If you want a REAL GUN for PRACTICAL USE inside or outdoors get a SAFE - CLEAN - ECONOMICAL - BENJAMIN with Adjustable Power and Amazing Accuracy. For BEST RESULTS use BENJAMIN H-C PELLETS. WRITE AT ONCE. BENJAMIN AIR RIFLE CO., 812 MARION ST., ST. LOUIS 4, MO.

SEND FOR FREE CATALOGUE
AND MANUAL

QUALITY

Aluminum Guard Easily Removed
For Dadoing



NEW IMPROVED TABLE MODEL TILT-ARBOR SAW

TABLE
18" x 16"

SAW BLADE TILTS TO 50°
TABLE STAYS LEVEL

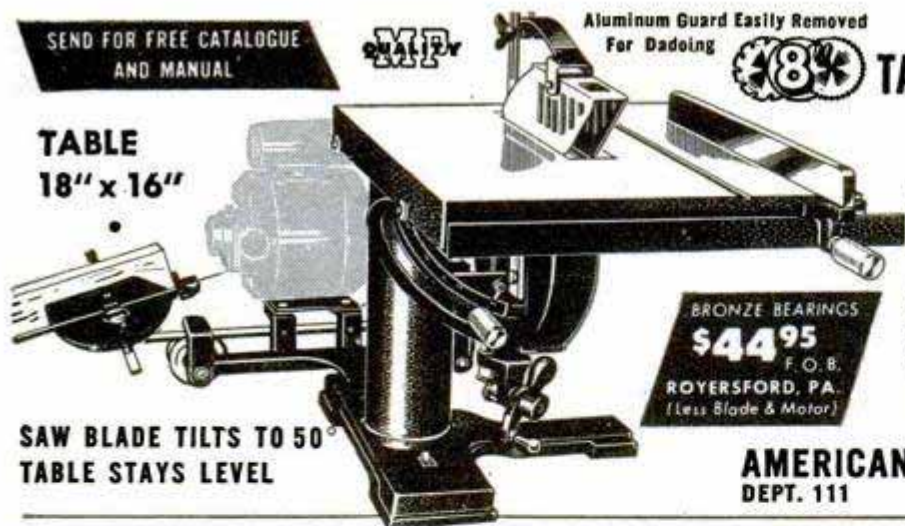

BRONZE BEARINGS

\$44.95

F. O. B.

ROYERSFORD, PA.
(Less Blade & Motor)

OIL IMPREGNATED BRONZE BEARINGS OR DOUBLE
SHIELDED BALL BEARINGS, BOTH WITH THE PATENTED
BALL BEARING TRANS-AXIAL MOTOR DRIVE

MODEL #2021X AS SHOWN WITH COMPLETE MITRE
GAUGE. Precision etched scales show angles on mitre
gauge and saw cradle. STEEL BAR RIP FENCE. ALUMI-
NUM SAW INSERT AND GUARD. STEEL SPLITTER.
BALL BEARING TRANS-AXIAL DRIVE 3/8" GROUND
ARBOR. "COMPO" OIL IMPREGNATED BRONZE BEAR-
INGS WITH OIL CHAMBER AND CUP. (OR, DOUBLE
SHIELDED BALL BEARINGS, \$5 EXTRA). TABLE 18"
x 16". BUILT IN SWITCH. Depth of Cut 2 3/16". Shipping
Wt. 110 lbs. Requires 3/4 or 1/2 H.P. Motor.

(BALL BEARING FLOOR MODEL WITH 18" x 32" TABLE
INCLUDING EXTENSION \$79.50)

AMERICAN MACHINE & TOOL CO., Inc.
DEPT. 111 ROYERSFORD, PA.

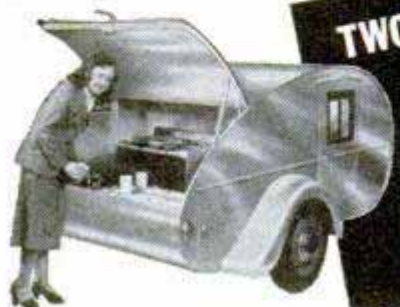

TWO DAYS'
FUN
SAVES
\$200!

You've seen the CUB Sports Trailer on local lots
for more than \$500. You've envied CUB owners
who could afford the luxury of an all-metal trailer.
Now you can have a CUB of your own—for
\$279.50.

Here, for the first time, is a full-size trailer in con-
struction kit form—at less than the cost of materi-
als alone. Best of all, assembly is so simple that
you can build the CUB with a crescent wrench and
screw-driver—in less than two days.

Actually, the CUB is all but ready to roll when it
leaves our factory. Aluminum panels are precision
cut and guaranteed to fit, holes are all drilled, and
every practical sub-assembly is completed by fac-
tory craftsmen. You simply tighten a few bolts—
and hit the road with a streamlined sportster that
pays for itself on one vacation.

The CUB is 12' 7" long, 6' wide, 5' high, sleeps
two, adds only 75 pounds tongue-weight to your
car, and includes galley, wheels, fenders—all essen-
tial parts except tires and tubes.

F.O.B. Los Angeles, price for full kit—\$279.50

(C.O.D. shipment will be made if at least \$50
deposit accompanies order)

Write for illustrated booklet . . . FREE

National Trailer Stores

Dept. 54, Box 2353, Terminal Annex,
Los Angeles 54, California

safe
FOR FAST BATTERY
CHARGING . . .



• FAST BATTERY CHARGER & COMPRESSOR

GUARANTEED not to harm batteries. Users all over the world say "Wouldn't
be without it!" SIMPLE-FAST and SAFE TOOL! Starts motors and inflates
tires QUICKLY. Charges in 30-45 min. Model GKN gas powered for
farm use. Model SN, charger only. See your dealer or write factory.
VALUABLE TERR. OPEN FOR SPECIALTY SALESMEN AND
DISTRIBUTORS. WRITE NOW. Mfr'd & GUARANTEED by

H&H PRODUCTS MFG. CO.

DEPT. M 306 BOYD STREET-LOS ANGELES 13, CALIFORNIA



Model K
\$149.50
F. O. B.

WINDMILL--RAINBOW--FLASHER

SPINNING AUTO LIGHT

PATENTED



Spins with the wind. The most beautiful
light in the world. Red, White and Blue.
Everybody wants one. Easily put on
auto, Bicycle, Airplane or Boat. Pay
Mailman \$2 plus postage or send \$2
and we pay postage. Be First.

Agents Wanted.

SPIN LIGHT CO.

373 1/2 BELMONT AVE. PATERSON, N. J.

PRICES SLASHED! ALUMINUM PIPES

\$4.50 pipe for \$1.00. Im-
ported briar bowl, hard
rubber stem, air cooled
aluminum shank, straight
or curved. No filters required.
A perfect Xmas gift. Send check
or money order, we pay postage.
C.O.D. orders filled on request. Write
for FREE catalog of pipes and cigars.

Satisfaction Guaranteed or Your
Money Back
Eddie THE CIGAR MAN
Dept. M-6, 1096 Bedford Ave., Brooklyn 5, N. Y.



\$1

SPARE TIME CASH DO WELDING for PROFIT

INCREASE YOUR EARNINGS AT HOME THIS EASY WAY

BUILD TRAILERS — PLAYGROUND EQUIPMENT — TANKS — TOOLS

PROFITS IN WELDING!

Get Started Today!

Do welding at home or in your shop, build or repair hun-
dreds of items—The ATOMIC WELDER is an IDEAL
HEAVY DUTY All-Purpose welder. Safe, rugged, com-
pact and EFFICIENT. WILL OPERATE FOR ONLY A
FEW CENTS PER DAY.

Plugs into either 110 or 220 AC line. Can be used
consistently on 30 AMP fuse. ALL PARTS DESIGNED
TO GIVE LIFETIME SERVICE.

SATISFIED USERS FROM COAST-TO-COAST SAY:

1. "Have bought two other welders—ATOMIC WELDER
is the only one that lives up to claim."
2. "Did not heat after four hours use."
3. "Welds any thickness material."

ORDER WITH CONFIDENCE

Try your ATOMIC WELDER FOR 30 DAYS. If not satisfied return as is and your money will be refunded.

IMMEDIATE DELIVERY! SAVE 80% By assembling your own Arc Welder,

All Parts READY MADE—READY TO ASSEMBLE

ATOMIC WELDER can be used as a current transformer for operating
war surplus equipment of odd voltage from 6 volts to 1000 volts

Write for
FREE BOOKLET
P-22

ATOMIC ARC WELDER COMPANY

1038 SOUTH 19TH STREET

OMAHA, NEBRASKA

DEALERS WANTED!
Write today for
liberal discounts



60 LBS.
READY MADE
PARTS
Only
\$24.95



ASSEMBLE

King Midget



45 MILES AN HOUR

90 MILES A GALLON

New, low cost transportation. Practical. Safe. A pleasure to drive. Home assembly keeps cost low. Just bolt together our factory built units. Immediate delivery. Send 25c for detailed circular with large picture, 4-view drawings, price of all parts. Or send for actual Assembly Book with 42 photographs, blue-prints, drawings, sketches AND above literature—all for \$1 (refunded first order).

MIDGET MOTORS MFG. CO. Athens, Ohio

HOME CRAFTSMEN BUY DIRECT



A real machine, mirror polished table 12" x 15". Table hinged to base for oiling & blade changes. Base of Steel & Aluminum Alloys enamel finished. Bronze bearings, 2" of bearing length. Saw blade adjustable—0 to 2 1/4" cut. Uses 6 or 7" Saw Blades, with 1/2" hole. Fitted for Dado Saws for grooving. Aluminum saw guard and ripping fence. Calibrated Cut Off Slide adjustable to any angle.

Complete With Blade

Only **\$19.95**

TINKER CRAFT SALES CO.
428 New York Bldg.
St. Paul, Minn.

SAVE ON BLADES

SAC 1075 Steel

6" dia. \$2.00 Combination 2.15
7" dia. 2.25 Combination 2.40
8" dia. 2.54 Combination 2.70
8 Piece Dado Head 1095 Steel
5 15/16x3/8. From 1/4" to 5/8" in
1/16 variations \$5.60.

There is **MONEY**
in **LAMPS**



Easy to get your share. No experience necessary. Start lamp business in your home, attic, basement or garage. Highly profitable. Fascinating. Illustrated instructions and wholesale catalog \$1. Simple as A.B.C. Write TODAY.

THE GEARON COMPANY, Dept. PM
27 S. Desplaines Chicago 6, Illinois

DUAL CROSS and ROTARY FEED

PALMGREN ROTARY, INDEX, MILLING TABLE No. 83

Has 8" table, 360° movement and 4" cross feed travel. Adjusting wheels and dials graduated in degrees and thousands. Slotted for bolting to table. No. 83 Priced \$49.50. No. 82 without rotary feed \$39.75. Write for Circular No. 10
CHICAGO TOOL and ENGINEERING CO.
8365 South Chicago Ave., Chicago 17, Ill.



- ★ SCIENTISTS
- ★ FARMERS
- ★ HOBBYISTS
- ★ STUDENTS

Use the **VICTOR RAIN-GAGE**

Be weatherwise! Use this scientific instrument that accurately measures up to 6" of rainfall. Designed by a meteorologist. Not a toy but a real rain measuring device. Simple, easy to read. Rustproof and unbreakable. Instructions and 11-year record book included. Makes an ideal gift. Satisfaction guaranteed.



Only **\$240**

If your dealer can't supply you, order direct, giving dealer's name. Send no money. Pay postman \$2.40 plus COD charges, or send check or money order for postpaid delivery. Ask about other weather instruments.

VICTOR RAIN-GAGE CO.
AIRPORT P. O. ★ WICHITA, KANSAS

Siegler PATENTED
OIL HEATER

**TWICE THE HEAT
WITH LESS OIL
IN YOUR HOME**

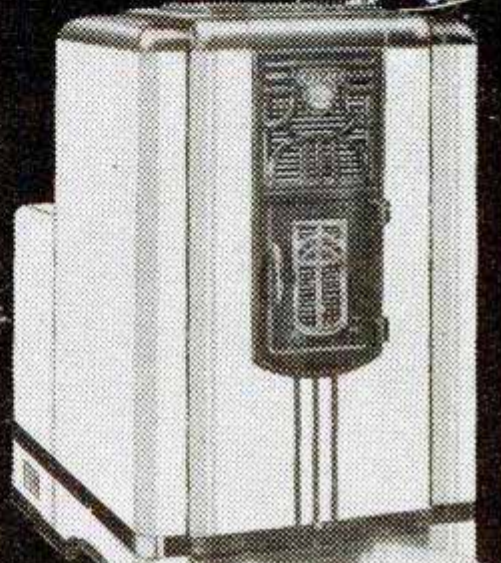

*FORCED
AIR*
*Tropical
Floor Heat*

**GETS TO THE BOTTOM OF THE
COLD FLOOR PROBLEM**

See Your Furniture, Hardware or Appliance Dealer

**MAIL THIS COUPON TODAY TO
SIEGLER'S, Dept. PM-10
BOX 111, CENTRALIA, ILL.**

For FREE Information and the name of your Siegler dealer.

NAME _____
ADDRESS _____
CITY _____ STATE _____

**TRADE NOW AND SEE HOW SIEGLER
SAVES AS IT PAYS FOR ITSELF**

SAY YOU SAW IT IN POPULAR MECHANICS



**ENSHRINE THEIR MEMORIES WITH
U.S. MONUMENTS**

Erected.
Freight
paid.

There is none better. Our free catalog is ready for you. Write today. A-18, U. S. Marble & Granite Co., Oneco, Fla.

GOVERNMENT SURPLUS CLOSEOUTS

While Quantities Last
NOTE PRICES



200 Amp. 5700 Watts
28 Volts WESTINGHOUSE
FORD, G.E.

GENERATORS

Used but apparently in good shape.
WERE \$39.95

NOW \$5.95

Shipping Wt. 65 lbs.

New 350 W., 110 V. A.C. Lighting Plant

Powered by a 1 1/2 H.P. Briggs & Stratton Gas Engine. All New. Were \$179.50. NOW **\$99.99**

AVIATION ENGINE STARTER

Used, guaranteed good condition. Type 1257. Volts 24. Clutch set at 1200 ft. lbs. 7" dia. 17" long. Shipping wt. 50 lbs.

Only **\$8.95** each

Mfg. by Eclipse Aviation Co. Division of Bendix Aviation Corp.



Slightly Used BATTERY CHARGER

12 V. Powered by a 7/8 H.P. Continental Gas Engine. ONLY **\$39.95** each

Value New over \$125.00



BARNARD'S CUTTING PLIERS

Drop forged and scientifically heat treated. Made of nickel chrome steel. Metallic blue finish. 4 to 1 leverage, 6 1/2" overall lth. Ship. wt. 1 lb.

Note new low price: **59c** ea. 50c ea. in lots of 6. Special prices in gross lots. Equal in size, quality and strength of one selling at \$3.00

New Surplus
250 W.
115 V. D.C.

LIGHTING PLANTS \$79.95

Special Only
Were \$129.50



New Surplus RUBBER GLOVES

MAN'S SIZE — 14" LONG

Good for use in garages, plating shops, removing varnish, etc. (Not for electricians.) Ship. wt. 1 1/2 lbs.

59c Pair

49c pr. in doz. pr. quantities

These are Dbl. Thick Extra Heavy Pr. Gloves

SORRY NO C.O.D. OR OPEN ACCOUNT ORDERS ACCEPTED
All Goods Shipped F.O.B. Chicago
\$1.00 Additional On All Orders Outside U.S.A. Proper
MAIL ORDERS DIRECT TO

GOVERNMENT SURPLUS & HARDWARE SALES

1627-29 N. DAMEN AVE. CHICAGO 47, ILLINOIS, U.S.A. Tel. ARMITAGE 2518

STOP CHANGING MOTOR OIL!

End this needless waste and expense forever with

RECLAIMO Today's Most Advanced Oil RE-REFINING Filter

Continuously cleans and RE-REFINES motor oil as you drive (by utilizing motor heat)—keeps oil in high grade lubricating quality at all times—reduces motor wear to a minimum! Proves conclusively that "Oil Does Not Wear Out Mechanically" as stated by U. S. Bureau of Standards, (Bulletin 86).

"RECLAIMO"

- REMOVES SOLIDS (by filtration)
- REMOVES WATER (by distillation)
- PREVENTS Excess Fuel Dilution
- PREVENTS Acid and Sludge Formation

MAINTAINS Stable Viscosity ELIMINATES All Oil Changes
CAR • TRUCK • TRACTOR OWNERS!

You'll want to know more about Reclaimo's Oil, Motor and Money-Saving Features. FREE 40-PAGE BOOK "OIL FACTS" gives you the complete "Reclaimo" story plus details about our New 90-Day No Risk-No Cost TRIAL OFFER! WRITE for YOUR COPY TODAY!

RECLAIMO MFG. CO.

5083 ELSTON AVE., Dept. 82, CHICAGO 30, ILL.



NEW ADDED FEATURE!
Gas - Moisture Vapor Injector
Increases Mileage with Smoother Performance



Do a Better Job

WITH ONE OF THESE EMPIRE LEVELS

Smallest, most handy and accurate level made. "Cigar-shaped"—no sharp corners to tear pocket. Aluminum stock. Only 3 oz. wgt. 9" long. Has Level, Plumb, 45° Vials.
No. 26.....\$2.00

EMPIRE TORPEDO LEVEL



ALUMINUM LEVEL — No. 151

Cast and Machined, a Beautiful Tool, with Patented, Removable Level and Vial.
With 2 Plumb, 2 Levels, 2 — 45° Vials. 18".....\$6.00
24".....\$6.50 28".....\$7.00

Order EMPIRE LEVELS from your local dealer.
Write direct for literature.

EMPIRE LEVEL MFG. CO.

BOX 97, DEPT. P-254 MILWAUKEE 13, WISCONSIN

HOME and OFFICE Security SAFE!



with 3 TUMBLER COMBINATION
Electrical welded steel plates. Furnace Tested. Fire-Burglar resistant. Insulated. (Key lock if preferred.)

ONLY **\$28.45**
Ideal for: Bonds, Insurance, Stocks, Deeds, Valuables.
SEND NO MONEY. Pay Expressman on delivery, plus shipping and COD charge. If not satisfied return within 5 days for complete refund.

EMILEEN CO., 33 West 42 St., N. Y. C.

GANE

BURNS MORE OXYGEN — LESS GASOLINE
AIR-FLOW NEEDLES
For Cars, Trucks, Tractors
"HAIR-LINE" ADJUSTMENT
Perfect Fuel-Air Mix
Gives You
STATE MAKE - MODEL OF CAR - KIND OF CARBURETOR - CYLINDER TAKES 2 DUAL CARBURETORS TAKES 4

SEND CHECK, M. O. **CAMERON CO.**
539 East Adams Street PHOENIX, ARIZONA
ORDER NOW! \$1.50 EACH—POSTPAID

**FASTER PICK-UP
SMOOTHER MOTOR
EASIER STARTING
PERFECT IDLING
MORE MILES PER GALLON**
INSTRUCTIONS ENCLOSED



LELAND ELECTRIC GENERATOR

2.5 KVA, 120 volt, 60 cycle, 1 phase, AC. Any comparable new generator will cost you twice our price.

Remit by Bank Draft

HOPFER & COMPANY

3124-A E. 14th St., Oakland, Cal.

\$125 Freight Prepaid In U.S.A.



BEST BUFFING BONNETS

Hand Made of Finest Lambskin For Buffing and Polishing
5" — \$1.20 Special \$1 Ppd.
6" — \$1.40 7" — \$1.65 8" — \$1.85
Bargain — Any 3. Sizes \$4 Ppd. U.S.A.
For Sales Tax in California ADD 2 1/2%

BEST BUFFER CO. 259 W. Harriet St. Altadena, Calif.

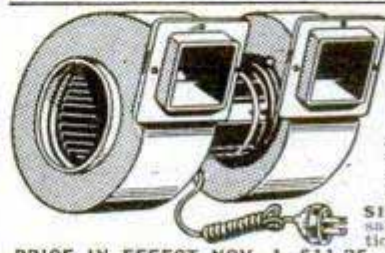

HEAVY CAST ALUMINUM DOUBLE EXHAUST BLOWER

Only **\$15.85**

Install it yourself with any household tools. Double intake and exhaust from 2 balanced wheels. Flanges for attachment to ducts. Vibrationless cont. duty motor. 110V., A.C., 50-60 cycles. Heavy duty cord attached. **NEW PRICE IN EFFECT NOV. 1—\$16.85.**
SINGLE EXHAUST BLOWER—same heavy cast alum. construction as DOUBLE—\$10. **NEW**

PRICE IN EFFECT NOV. 1—\$11.25. Add 50c handling; \$1 west of Miss. Send check, M.O. Money-Back Guarantee. Free Lit.
UNIVERSAL YONKERS CORP., (M-10) 137 Alexander St., Yonkers 2, N.Y.

UTILITY GRINDERS



Lifetime lubricated ball bearings. Two 6 x 3/4 inch wheels, one coarse, one fine. 115 V., single phase, 60 cycle—3450 rpm. Bright red glossy finish.

1/4 hp — \$25.00 net
1/3 hp — \$27.50 net

HOME WORKSHOP MOTORS

Capacitor type, sealed ball bearings, 1725 rpm. Standardized mounting, with cord, plug and switch.

1/4 hp—\$22.50 net
1/3 hp—\$25.00 net
1/2 hp—\$33.00 net

FOB Milwaukee. Send check or money order.

LAD, INC.

161 W. Wisconsin Ave. Milwaukee 3, Wis.

How to save up to 10 days' fuel every month



IMPORTED SWISS WATCH

7 DAY MONEY BACK GUARANTEE NOW ONLY \$4.98 PLUS 50¢ Fed. Tax

Get the all-purpose Wrist Watch you have always wanted—at this amazing low price!

5 BIG FEATURES Plus Handsome Metal Stretch-band, Precision Made—Modern Dial—Chrome Plated Case—Unbreakable Crystal—Hands and Numbers glow in dark. Supply limited. Order Now!

SPECIAL Watch with large red Sweep hand for exceptional accuracy. \$1.00 extra. SENT ON APPROVAL! Deposit \$4.98 plus tax and postage with postman or send money order, save postage. (Same money-back privilege.) For better watch with large Sweep Hand, add \$1.00.

THE JEWELBOX, 1674-B Broadway, N.Y. 19, N.Y.

CANVAS COVERS Waterproof tarpaulins, war surplus (Used), perfect condition. Originally made for tents. Approx. 5'x8'. Two buttoned together make approx. 80 sq. ft. Complete with buttons attached. Suitable for use as canvas dams, hay covers, truck covers, machinery and equipment covers, etc. Packed in bales of 30, priced 30 covers, \$1.25 ea.; 15 covers, \$1.50 ea. Less than 15, \$1.75 ea. All FOB, Kansas City.

AMERICAN SUPPLY CO.

329 W. 5th Dept. PM Kansas City, Mo.

MEN'S SUSPENDERS

Make them yourself . . . leather links in brown or tan Calf Skin. All parts for making complete set of suspenders included in kit for **1.00**

SEND CASH SAVE POSTAGE

1949 Catalog of Handicraft Supplies 10c

CLEVELAND CRAFTS CLEVELAND 15, OHIO



WAKE UP YOUR SCALP Want better looking hair? Embarrassed by falling dandruff, itching scalp? Then try VITABRUSH, new electric driven scalp brush that gives your scalp a vigorous and invigorating "workout" in just three minutes of fun. Cleans scalp. Stimulates blood supply. Restful. Pleasant. Write today for complete information and satisfaction-guaranteed offer. Hershey Mfg. Co., 3717 Field Bldg., Chicago 3.

Get this new Carey booklet—"26 WAYS TO SAVE FUEL THIS WINTER"—and keep your home more comfortable.

Learn about the "Carey-Over" Plan which shows you how to carry over 10 days' fuel supply in any month . . . to help heat your home the next month. Save fuel—get up to 3 months' fuel supply for the price of two!

Get your free copy today from your local Carey Approved Home Insulator or mail coupon to Dept. PM-10, The Philip Carey Mfg. Company, Cincinnati 15, O.



Carey

ROCK WOOL INSULATION

years serving home and industry

Please send my FREE copy of "26 Ways To Save Fuel This Winter."

NAME _____

ADDRESS _____

CITY _____ ZONE _____

STATE _____

ELECTRIC HAND GRINDER OUTFIT

for cutting wood, metal or plastic.

MASTER **\$9.75** \$45 Value
KIT Only Postpaid in U.S.A.

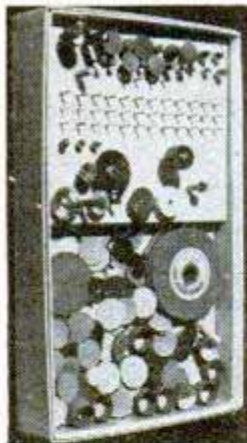

- 115 Grinding, Cutting and Polishing WHEELS PLUS 150 assorted tools** most useful for Home or Shop.
- 3 Grinding Wheels from 1" to 3" dia.
 - 1 Rotary File, High Speed Steel.
 - 3 Rotary Cutters 3/8" Shank.
 - 6 Rotary Cutters 3/32" Shank.
 - 6 Mounted Grind. Wheels 1/8" Shank.
 - 6 Mounted Wheels 3/32" & 1/4" Shk.
 - 3 Rubber Wheels.
 - 4 Speed Drills 3/32" Shank.
 - 30 Rotary Cutting Burs 3/32" Shank.
 - 2 Mandrels 3/32" Shank.
 - 1 Mandrel 1/8" Shank.
 - 1 Screw Type Mandrel 3/32" Shank.
 - 3 Rotary Bristle Brushes 3/32" Shank.
 - 1 Rotary Wire Wheel Brush.
 - 1 Circular Saw
 - 1 Mandrel for Circular Saw 1/4" Shank.
 - 2 Rubber Cylinders and Mandrel 3/32"
 - 10 Cut-off Discs and grinding wheels.
 - 1 Rotary Drum Sander 1/8" Shank.
 - 15 Bands for Rotary Drum Sander.
 - 15 Rotary Felt Wheels 1" dia.

Compact container. Special rack for drills. Over 260 tools and items.

18 ROTARY CUTTERS

Ass't Sizes 1/8" or 3/32" Shk. Will fit all electric hand grinders. Ideal for cutting wood, metal or plastic.

\$13.50 Val. **ONLY \$5.85** post-paid in U.S.A.
\$2.00 with COD orders

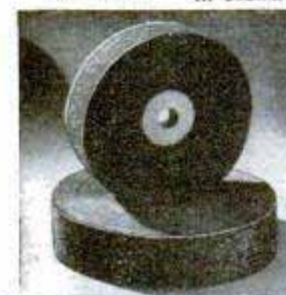
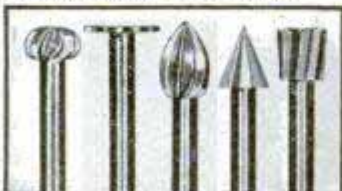

3-50 YD. ROLLS

ABRASIVE CLOTH NOW **\$5.95** FOR Chicago
1 1/2"-100 and 400 Grit
2"-100, 120, and 150 Grit
Bargain!! Three 50 yd. aluminum oxide rolls of finest abrasive cloth from mfgs. like Minn. Mining, Carborundum, Sandpaper Inc. A \$27.00 list value for only \$5.95. Specify widths and grit sizes. Send check or M.O. Or send on \$2.00 deposit and let bal. come C.O.D.

SPECIAL • 100 PIECES • \$1.00 Postpaid

Grinding Wheels, Cut-off Wheels, Sanding Discs, Mounted Stones, Sharpening and Honing Stones, Rotary Cutting Burs, Abrasive Cartridges and many other items.

SCHUPACK SUPPLY & MFG. CO.

7331 Cottage Grove Ave., Dept. PM-10 Chicago 19, Ill.

6" thickness PLANER

Chips Fly Out

PLANES, ROUTS, RABBETS AND MAKES MOULDINGS

\$7.50 Postpaid

PAT. PEND.

Planes up to 6" stock perfectly. Chips fly out. No binding. Mached and balanced. Comes complete with 3 Planer Blades. Easy and safe to use. Satisfaction guaranteed.

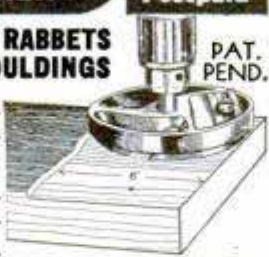

SHAPER HEAD Fits all Drill Presses...

3 Moulding Knives \$1.00 extra

PAT. PEND.

At Last...a Shaper Anyone Can Use!

MAKES MOULDINGS LIKE THESE

A real precision tool, easy and safe to operate. Cuts beautiful mouldings. Ideal for Professionals or Hobbyists. Comes with 3 Shaper Blades.

\$4.00 Postpaid

3 Planer Knives \$1.00 extra Dept. 3

LIGHTNING TOOL CO. SOUTHWICK, MASS.

FIRES SNUFFED OUT AUTOMATICALLY!

with Famous

RED COMET FIRE EXTINGUISHERS!

When fire starts Red Comets go into action. release powerful spray, create a blanket of fog which smothers fire—without human aid! Can be mounted in homes, shops, autos, boats—in any enclosed space! Write for FREE LITERATURE today!



RED COMET, INCORPORATED

267 Red Comet Building Littleton, Colorado
SALESMEN! Operate your own business—sell Red Comets! Every home, farm, store a prospect. Territories open! Write!

Do lathe jobs on drill press with DRILLATHE \$2.56

Postpaid

A rugged tool that converts drill press into lathe. Precision made of cast aluminum. Comes complete with high speed tool bit. Money back guarantee. Send \$2.56—we pay postage.

BRAEMER PRODUCTS

Box 2636 Lakewood, Ohio

SURFACE OR BENCH PLATE Only \$3.50
6" square—C.I.—weighs 6 lbs., surface ground to .001 flatness. Money back guarantee. Send \$3.50, postage collect.

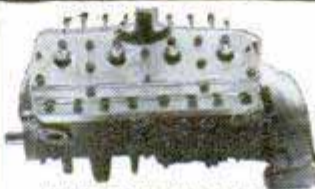

Slip On

HEAD COVERS

for

FORDS & MERCURYS

\$3.95 pair

TARZIAM AUTOMOTIVE

730 ELLIS STREET

SAN FRANCISCO, CALIF.

HOW TO CUT RAFTERS

New vest pocket book gives lengths, side cuts, plumb cuts, deductions. For all rafters for any building from one inch to forty feet wide. Gives numbers to cut on square. Also degrees for same cuts for Radial Saws. All standard pitches from 1/4 to 3/4. Just open book to pitch page and there are your lengths, side cuts, etc. Anyone who knows what a jack rafter is can frame a roof if he has this great book. Price one dollar, \$1.25 in Canada. Builders' Topics, Dept. 5, Lock Box 828, Seattle, Washington. CARPENTERS, PLUMBERS, PLASTERERS, ELECTRICIANS, ETC. subscribe for Builders' Topics, the monthly magazine for HE-MAN CONSTRUCTION WORKERS. Only \$1.00 per year. (In Canada—\$1.25). Sample copies 25c.

ELECTRONIC EDUCATIONAL KITS THE ELECTRIC EYE



This is not a toy but rather a skillfully engineered kit ready for assembly. The parts furnished are commercial parts used in the best electronic equipment. This unit assembled, will be adaptable to uses such as opening garage doors, counting, burglar alarm, etc. Ideal for the beginner as well as the highly developed engineer. Worth \$25.00 but priced to sell at only \$9.95. Unit completely assembled \$14.95. DOWNS BALANCE C.O.D.

ELECTRONIC PRODUCTS, 6516 Foster Ave., Chicago

PRINT ANY PHOTO

on Paper, Cloth, Leather or Wood

SIMPLE, EASY TO USE

Magic liquid takes only 2 minutes to reproduce any snapshot you have onto stationery, handkerchiefs, ties, scarfs, etc. Use same picture over and over again if you wish. Won't wash off. Won't hurt negative or fabric it's used on. Personalize your belongings! An ideal gift. Complete outfit enough to transfer 100 photos—only \$1.00 postpaid. Sent C.O.D. for \$1.21.

TIFFANY CO.

2128 Montrose Ave., Dept. JA, Chicago 18, Ill.



SPECIAL OFFER! SAVE 1/2 PORTABLE AIR COMPRESSOR SPRAY PAINTING OUTFIT

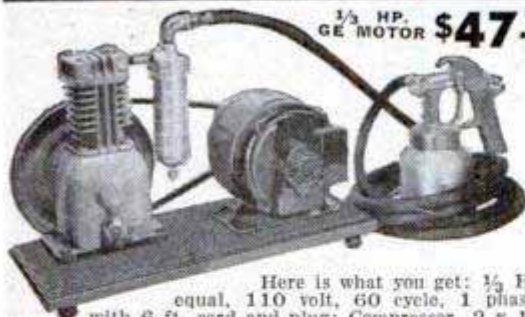

3/4 HP. GE MOTOR \$47.50 COMPLETE LESS BASE

2.8 C. F. M.
Displacement
Compact
Power Plus

Complete as shown, less base

Here is what you get: 3/4 HP. GE motor or equal, 110 volt, 60 cycle, 1 phase, 1750 RPM. with 6 ft. cord and plug; Compressor, 2 x 1 3/4 piston type; Spray gun with qt. cup, 2 nozzles, round-fan spray, oil and water trap, 20 ft. hose and fittings; belt and pulley. All bolts necessary for mounting on base. We pass the big saving in labor on to you. All you have to do is mount on base as shown. Complete operating instructions furnished. Weight 50 lbs. Special Price.....

\$47.50

ALSO SOLD SEPARATELY:

Spray Gun, 2 nozzles, 20 ft. hose, weight 6 lbs. \$ 9.45
Air Compressor with oil and water trap, weight 15 lbs. 19.95
1/2 H.P. G.E. Motor, weight 26 lbs. 14.50

PRICES ARE F.O.B. CHICAGO. Immediate delivery. SOLD ON MONEY BACK GUARANTEE. Send check or money order today. WRITE FOR FREE FOLDER.

C & M EQUIPMENT COMPANY 1831 S. State St., Dept. D-10, Chicago 16, Ill.

HIGH SPEED DRILLS



High speed steel drills. Some threaded shanks. Assorted sizes — just right for the home or machine shop. Mfd. by Cleveland Twist Drill Co. and Century Twist Drill Division. All new! While they last—

SET OF 15—\$2.50 F.O.B. Culver City, Calif. Send check, money order, or cash. 25% deposit required on C.O.D. orders.

JACKSON-DUFFY CO., Dept. PM10-8
P. O. BOX 168, CULVER CITY, CALIF.

6" DISC GRINDER Only \$11.95

MONEY BACK GUARANTEE

New, streamline design for a wide variety of sanding operations — wood, metal and plastics. Constructed like production line sanders — durable, long-life, accurate — 1800 RPM. Order Today!

CHILDS & CO., P. O. Box 457, CONNEAUT, OHIO

USE SIMPLE HOME-MADE EQUIPMENT

Make HOLLYWOOD STYLE cement pottery and birdbaths. Beautiful chemically colored garden things. Amazing designs. Dime brings pictures, color sample, details.

HOLLYWOOD CEMENTCRAFT
8527-A WONDERLAND AVE.
HOLLYWOOD 46, CALIF.



A Schult is Tops



FOR TRAVEL-LIVING COMFORT AND VALUE

Your modest investment buys more in a Schult... many plus-values that add to convenience, living comfort, and long-term satisfaction. Private bedrooms, built-in furniture, complete kitchens, and closet space galore are features you'll appreciate. All-season comfort is assured by efficient insulation, good heating, and cross ventilation.

From roof to road your Schult is a quality product, the result of more than a decade of customer research

and able engineering, now backed-up by new, accurate machine construction methods.

No wonder Schult is the most lived-in trailer coach, the world around... recognized everywhere for outstanding value. Ask your Schult dealer to show you the latest, easy-trailing models... there's one to suit your purse and purpose... or write today for free Schult catalog. SCHULT CORPORATION, Dept. 3210, Elkhart, Ind. In Canada: John Inglis Co., Ltd., Toronto.



Free..
Write for book on trailer living, with details of latest Schult models.



SCHULT Trailer Coaches

SAY YOU SAW IT IN POPULAR MECHANICS

GIVE YOUR CAR THE "WOLF CALL"

of Deep Tone DUAL MUFFLERS

The rich, low, mellow sound of "straight thru" ADVANCE mufflers is something all your friends will admire.

Also greater power, speed, and economy result from the reduced back pressure of this scientific design. Rugged steel tube throughout (no aluminum); blowout-proof.

SIMPLE TO INSTALL. No welding, cutting, or holes to drill. Complete with rubber mounted clamps (no rattle) and all necessary fittings.

ADVANCE MUFFLERS, 6800 S. Vermont Ave., Dept. PM10-8, Los Angeles 44, Calif.
Send Check, Money Order, or we will mail C.O.D.
You pay postage upon receipt.

Dual Muffler Set (Ford, Mercury only) \$20.00 Single Muffler (other makes) \$5.50
Single Muffler (Ford, Chev., Plym.) 4.86 2 1/2" Chrome tail pipe tips 1.75

Car make _____ Year _____ Model _____

Name _____

Address _____ City _____ State _____



ADVANCE MUFFLERS

6800 S. Vermont Ave., Los Angeles 44, Cal.

WAR SURPLUS

ACT NOW, -SAVE BIG MONEY

ELECTRIC MOTOR 1/2 H.P. 27 V. D.C. R.P.M. 4000, #750. For intermittent or continuous duty. 5/8" SHAFT, VARIABLE SPEED MOTOR. Can be adapted to 110 V. A.C. or R.E.A. line by rearranging armature brush leads. Unused. Instructions incl. Ea. **\$550**

Surplus Bargain Close-Out LUBE PUMP

Pumps liquid up to 3 G.P.M. Pressure up to 200 lbs. per Sq. In. For high vacuum, air pressure, liquids operating hydraulic units etc. Made of finest bronze and steel size 3 1/2" x 8 1/2" Dia. 1/2" Threaded and keyed shaft. Complete instructions incl. Ea. **\$350**

GREATEST PUMP VALUE IN YEARS. THOMPSON BOOSTER PUMP. Use them for HOMES, FARMS, RANCH AND SHOPS. Motor Driven centrifugal pump will empty 50 ga. drum of water in approx. 20 min., **\$750** ea. runs on 24 V. D.C./A.C. New.

VICKERS PUMP. High Pressure Hydraulic pump. Use it for any type liquid pumping job. 400 gal. per hr. at 3750 R.P.M. rated 1000 P.S.I. NEW Only **\$750**

BEAM ANTENNA ROTATOR MOTOR, Brand New. Can be adapted to 110 V. 60 cycles. Fine for operating Attie ventilating LOUVERS, such as used with ATTIC FANS, Furnace Dampers or check Drafts at any distance. Instruction incl. Diagrams for Radio, Etc. **\$395**

SEXTANTS SURPLUS BARGAIN. Close out Fairchild Type A-10 army air force bubble sextant averaging type includes light system for night readings used but in good condition. Wood case includes accessories and instructions. Ea. **\$750**

DYNAMOTORS New. Check list and order now. G. E. Input 27 V. D.C. Output 115 V. A.C. Wt. 16 lbs. Ea. **\$450**

DYN. New. G. E. Type D. Input 28 V. Output 1000 V. D.C. Model D. Wt. 38 lbs. Ea. **\$495**

DYN. New. Model DY-22/ARC. Input 28 V. D.C., Output 210 V. D.C. Cont. Duty. Ea. **\$100**

DYN. New. Model 23350. Input 27 V. D.C. Output 285 V. D.C. Ea. **\$100**

NEW CUNO OIL FILTER aircraft type keeps oil clean without cartridge replacement. For AUTOS, TRUCKS AND TRACTORS. Install at home in a few minutes. STOP CHANGING MOTOR OIL. Instructions included. Ea. **\$495**

SEND CHECK OR MONEY ORDER. NO C.O.D.'s. PRICES F.O.B. K.C.

GENERAL SALVAGE COMPANY
Dept. 9, 2920 E. 27th St. Kansas City, Mo.



NOW! FILE YOUR OWN SAWS

Do expert saw filing at home. Precision filing easy without experience. Two simple adjustments. Keeps any hand saw extra sharp and true-cutting. Complete with file. Money back guarantee. Cash with order, prepaid. (COD postage extra.) Order today.

THE SPEED CORP., Dept. PM1
2025 N. E. Sandy, Portland 12, Oregon

BALL BEARING STEEL WHEELS

Complete With Wheels, Tires & Bearings Made To Outwear Other Type Wheels

SIZE	TIRE	BEARINGS	LOAD Lbs.	ONE	TWO	FOUR
6" x2"	Solid	Ball 1/2", 5/8"	300	\$ 3.25	\$ 6.25	\$12.00
8" x2"	Solid	Ball 1/2", 5/8"	250	\$ 4.25	\$ 8.00	\$15.50
10"x1 3/4"	Semi-Pneu.	Ball 1/2", 5/8"	125	\$ 3.00	\$ 5.50	\$10.50
10"x2 1/2"	Semi-Pneu.	Ball 5/8"	250	\$ 5.50	\$10.00	\$19.00
12"x2 1/2"	Semi-Pneu.	Ball 1/2", 5/8"	150	\$ 5.50	\$10.50	\$20.00
12"x2 1/2"	Semi-Pneu.	Ball 1/2", 5/8"	225	\$ 5.75	\$11.00	\$21.00
12"x3"	Semi-Pneu.	Ball 1/2", 5/8"	340	\$ 8.50	\$16.00	\$31.00
16"(4.00x8)	Pneumatic	Roller 3/4"	520	\$12.50	\$24.50	\$48.00
16"(5.00x8)	Pneumatic	Ball 3/4"	375	\$13.00	\$25.50	\$50.00

NOTE: Other wheels from 3" dia. to 23" with loads from 100 lbs to 1700 lbs. in fibre, solid rubber, semi-pneu., pneumatic 2 to 8 ply, axles to match.

ORDER NOW
Add 10% for Prepaid Shipment in U.S.A.
25% DEPOSIT ON C.O.D. ORDERS
Descriptive Circulars and Lists of our products will be mailed promptly if you enclose 10 cents in your letter.

OSBORN WHEEL COMPANY, 115 So. Main St., Dept. P-10, Doylestown, Penn.

MAKE YOUR OWN!

WITH

Griffin READCUT LEATHER PROJECTS

Over 100 KITS in every kind of Tooling and Carving Leather, accurately cut, all parts included. Only Top Grade Leathers used. You do the choosing. You do the tooling, carving, stamping, the punching and assembling.



SEND FOR COMPLETE CATALOG
It's free to leather workers. A postal card will do

SINCE 1924
OUT OF THE WEST, THE HOME OF LEATHER CARVING
Griffin Craft Supplies
Dept. PM 5515-21 GROVE STREET
OAKLAND 9 CALIFORNIA

EVERYTHING FOR THE LEATHER WORKER
Largest, most complete stock of Leathercraft Tools and Accessories in U.S.A.
HIDES AND SKINS of Craft Leathers of every kind if you prefer to cut your own.



Why Pay More?

TUBE GIVEN WITH EVERY TIRE
Send this AD with Order
Slightly Used
High Original Treads
★ BUY IN CONFIDENCE ★
Safe! Dependable! Standard Brands
GUARANTEED to give A-1 Service
Positively Not Re-caps!

600-16 ..	\$5.72	700-15 ..	\$5.92
650-15 ..	5.12	700-16 ..	6.22
650-16 ..	5.80	750-16 ..	7.22
900-16 ..	\$8.52	900-20 ..	\$15.52
650-20 ..	9.52	1000-20 ..	15.52
700-20 ..	12.52	1100-20 ..	15.52
750-20HD ..	12.52	32x6 (8) ..	11.82
825-20 ..	15.52	32x6 (10) ..	13.82
750-20 MILITARY 8 PLY	\$13.52		

1/2 million tires shipped to satisfied customers. Trial will convince you. Orders Rushed. SEND MONEY ORDER OR CHECK.

STANDARD
834 N. Broad St. Phila. 30, Pa.

90" Long
40" Wide

The New 1949 Model "D" RACER

6.6 H.P. ENGINE

10 Inch CLUTCH

ALL CHAIN DRIVE

Complete as Shown ONLY \$299.50 (Plus \$7.50 crating)
As Shown F.O.B. Doylestown
Less Engine, Jack Shaft and Clutch
ONLY \$159.50 F.O.B.
(Plus \$7.50 crating)

Pulls Up Hills With Ease. Runs as low as 2 miles per hour or UP TO 35 MILES PER HOUR. Safe and Easy to Operate for Work or Play. ANY AGE. Equipped with 4.00 x 8 High Speed Wheels and Many Other Features.

Ride Around in Your Own Car

MANIFOLD PRESSURE
BOOST CONTROL

The **\$1.95**
Gadget
of the
MONTH



The best buy we've had in months. Brand new in original cartons. Contains a vacuum booster pump, a bellows assembly and innumerable other valuable parts. Our supply is limited so rush your order now to avoid disappointment. (Add 40c each to cover postage and handling)



WILLARD
2 VOLT
BATTERIES
ONLY **\$1.25**
each

Brand new. Compact spill-proof. Built-in Hydrometer. Group several together for higher voltages. Uses Standard Electrolyte. Guaranteed. Add 35c to cover postage and handling.

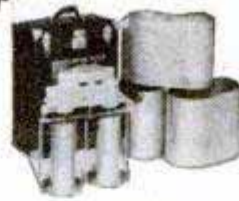

Film
Developer
ONLY **\$2.10**

One of the finest bargains offered. This unit is complete with three stainless steel tanks that nest one inside the other. Includes a carrying case. The film winder has a 110-volt 60-cycle motor and automatically reverses itself. Spools are 4 inches in diameter by 10 inches high. Tanks are 11 1/2 inches high by 8 1/2 wide by 16 1/2 inches long.

(Shipped express charges collect)

SURPLUS NYLON ROPE

Brand new genuine government surplus Nylon Rope. 1 1/16" diameter, originally used as a glider tow rope. Contains 3 strands of copper wire, which was used for communications. This wire DOES NOT seriously effect the flexibility of the rope. Excellent for use on boats, trucks, or any other place where large rope may be used. A real buy at only 12c a foot in cut lengths or a complete 250' bale for only \$25.00. Shipping weight 1/2 lb. per ft. Minimum order 20 ft. Michigan Residents Add 3 Percent Sales Tax. Enclose Postage.

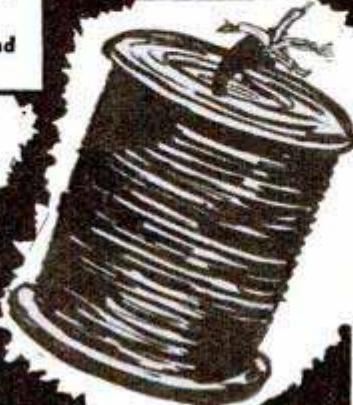

Today's
Best Buy
\$18.00

New 4 conductor 16 gauge rubber covered cable. Color coded. Used by United States Government as Field Telephone Cable. 1300 feet on steel reel. F.O.B. Our warehouse Shipped motor freight or express shipping charges collect.

RUBBER GLOVES

New genuine Government surplus Rubber Gloves, Gauntlet type, 14 inches long. Have all kinds of uses where it is necessary to protect the hands, such as washing cars, walls, or such.

— Sizes —
small, medium, large

3 pair for \$1.00, plus 30c postage and handling.

Minimum order - 3 pair



N. SILVERSTINE CO.

6532 EAST McNICHOLS ROAD DETROIT 12, MICHIGAN

Seven Acres of Surplus!

We cannot accept orders for shipment outside U.S. or its possessions. All merchandise subject to prior sale. Minimum order \$2.00. No C.O.D. shipments. Mich. Residents add 3% Tax.

A Perfect Tool Holder

for Home Workshop Lathes

Holds 3/16", 1/4", and 5/16" tool bits, round or square. Holds all bits in four or more positions. This one holder will take place of R.H. Offset — L.H. Offset — Straight and Boring Bar holders. Shank size 7/8" x 3/8". Other sizes available.

EDWARD BLAKE COMPANY

437 Cherry Street, West Newton 65, Mass.



No. 5
HOLDER
and WRENCH
Only **\$6.00** Cash
POSTPAID IF CASH
WITH ORDER

MICROSCOPES SUPPLIES-ACCESSORIES & SCIENTIFIC INSTRUMENTS
BEL SPENCER NEW & USED LEITZ ZEISS MEDICAL INDUSTRIAL AMATEUR
BOUGHT-SOLD-EXCHANGED-REPAIRED
Send for FREE LIST
NATIONAL SCIENTIFIC INSTRUMENT CO. 119 CHAMBERS ST. NY 7

**If Ruptured
Try This Out**

Modern Protection Provides Great Comfort and Holding Security

Without Torturous Truss Wearing

An "eye-opening" revelation in sensible and comfortable reducible rupture protection may be yours for the asking, without cost or obligation. Simply send name and address to William S. Rice, Inc., Dept. 32-C, Adams, N. Y., and full details of the new and different Rice Method will be sent you Free. Without hard flesh-gouging pads or tormenting pressure, here's a Support that has brought joy and comfort to thousands — by releasing them from Trusses with springs and straps that bind and cut. Designed to securely hold a rupture up and in where it belongs and yet give freedom of body and genuine comfort. For full information—write today!

**NOW ANY
TRUCK REPAIR JOB
is a "Snap" for You!**



FREE
7-DAY
TRIAL

Giant Manual Makes All Repair Jobs Seem Simple

NOW, it's easy as "falling off a log" to do ANY repair job on ANY trucks built since 1936—with this amazing new MoToR's TRUCK REPAIR MANUAL! 952 big pages crammed with more than 300,000 facts make your work so easy! 1400 pictures and crystal clear directions take engines and units apart, show them inside out, explain steps piece by piece. Guaranteed to contain EVERY fact you need to know to do ANY job—save countless work hours—make yourself more money. Learn to be an expert mechanic at home!

Here's Everything To "Keep 'Em Rolling"

Truck Manufacturer's Manuals are used to give EVERY repair fact about ALL trucks. Covers ALL type Engines, Fuel Systems, Ignition Systems, Clutches, Transmissions, Transfer Cases, etc.

SEND NO MONEY EXAMINE IT FREE

See for yourself what a money-maker and time-saver this book will be for you. EXAMINE IT FREE! Unless convinced it will pay for itself the first time you use it, return in 7 days, pay nothing.

Mail Coupon Now!

MoToR Book Dept., Desk T4910, 572 Madison Ave., N. Y. 22

Rush to me MoToR's TRUCK REPAIR MANUAL. If O.K. I will remit \$2 in 7 Days, and \$2 monthly for 3 months, plus 35c delivery charge with final payment. Otherwise I will return book postpaid in 7 days. (Foreign price: remit \$10 with order.)

Print Name _____

Address _____

City & Zone No. _____ State _____

Check Box and SAVE 35c delivery charge by enclosing with coupon entire payment of \$8.00. Same 7 Day refund privilege.

• MERCHANTS • PRINTERS • DENTISTS • EDITORS • PAINTERS • DOCTORS • ARTISTS • MECHANICS • MODEL BUILDERS • HOMEOWNERS • LABORATORY TECHNICIANS • ELECTRICIANS

2 CONRAD CUTTERS & SCRAPERS

with 6 CONRAD single edge blades for only \$1.00



AS A SCRAPER

AS A CUTTER

Precision built, the new patented streamlined CONRAD is a real help to all kinds of cutting and scraping. The plastic handle is molded and ribbed to fit your hand, and prevents slipping under every condition. Depth of cut is controlled by large knurled thumbscrew sliding in slot. Blade is held in vise-like grip. Insures true cutting at all times, and on various kinds of materials from balsa to heavy duty cutting

on linoleum, rubber, cardboard and the like. Safety feature allows blade to slide back into handle when not in use. Swivel eye permits hanging. The CONRAD takes all standard type single edge blades.

As a scraper, the CONRAD is designed for full play of the blade. Here too, blade is held in bear-trap grip to insure steady long-wearing blade life. Designed to get in to those hard spots and give years of real scraping service.

In addition: with each order you will receive—free—1 package of CLIX—famous double edge razor blades for better shaving. Write today to

FREE!

CONRAD RAZOR BLADE CO., INC.
Dept. PM 10, 444 Madison Avenue, N. Y. 22
• PRINTERS • DENTISTS • EDITORS • PAINTERS • TAILORS •

MAKE BIG MONEY WEAVING TEXTILES AND RUGS AT HOME!



Unusual opportunity to establish dignified, steady, year-around, **BIG-PROFIT BUSINESS OF YOUR OWN**—with small investment to start. No previous experience necessary. **ALL-WEAVE ELECTRIC LOOM** weaves beautiful Rugs, Drapes, etc., from old rags, standard rug filler material or new yarn. Capacity 40 to 50 yards per day. Fits in corner any room or basement. **IDEAL MONEY-MAKER FOR HANDICAPPED PEOPLE!** Simple to operate; veterans and folks unable to be active can easily weave on it. **STEADY DEMAND FOR RUGS and TEXTILES AT BIG PROFITS!**—in homes, apartments, hotels, stores, etc. Loom pays for itself quickly. Start with one loom—build up regular factory. Write for **FREE** information today!

ALL-WEAVE LOOM CORP.: Dept. C-1
9128 St. Charles Rd. St. Louis, Mo.

Save Time and Money with this Press



Ten-ton press, ideal for all kinds of pressing, separating, straightening, and bending jobs. Ample capacity for home shops. Easily adjustable table takes work up to 18 inches wide and 11½ inches high. Roller-bearing ram for long life. Send for free bulletin showing press and wide variety of accessories.

UT-10A Press f.o.b. factory \$31.00

DAKE ENGINE COMPANY

624 Seventh Street, Grand Haven, Michigan

LAW

STUDY AT HOME for Personal Success and LARGER EARNINGS. 39 years expert instruction—over 114,000 students enrolled. LL.B. Degree awarded. All text material furnished. Easy payment plan. Send for **FREE BOOK**—"Law and Executive Guidance."

AMERICAN EXTENSION SCHOOL OF LAW
Dept. 94-PM 646 N. Michigan Ave. Chicago 11, Ill.

BORING TOOL



for machining any size hole up to 1½" dia. Compact, sturdy, easily adjusted, unique positive locking arrangement, precision made, all parts hardened to resist wear. Many used in production and experimental shops. Shank is 1½" dia. by 1½" long, body is 1½" dia. by 2½" overall length, and takes a 3/8" dia. boring bar. **PRICE ONLY \$18.50 POSTPAID** (includes one high speed boring bar and one adjusting wrench). It will quickly pay for itself. Send check or money order.

PUMP & PRODUCTS CO.
P.O. BOX 5254 CLEVELAND, OHIO

Say You Saw It in POPULAR MECHANICS

POPULAR MECHANICS

Outdoor Sports Manual!

All sportsmen, attention! Here are 156 pages of helpful hints for the Hunter, Fisherman, Trapper, Camper, Archer, and Boatman. How to make your own decoys, recondition your fishing rod, outfit the fur bearers, make an insect and vermin proof tent, shoot a modern crossbow, and service your outboard motor. These and a pack bag full of other articles for outdoor men. Your News Dealer has it in the 60c paper edition and we can supply the beautifully bound \$2.00 library edition.

Popular Mechanics Press
200 E. ONTARIO ST. CHICAGO 11

NEW! HANDY, FLEXIBLE SHAFT

Converts Any Motor, Drill Press, Electric Drill, Electric Fan Into A Handy Rotary Tool

Attach ROTA-SHAFT in a Jiffy. Can Be Used for Grinding, Polishing, Sharpening, Cleaning, Engraving, Marking Tools, Carving, On Metal, Plastic, Wood, Glass.

Yes! Only \$2.95 and ROTA-SHAFT turns your old motor, drill press, electric drill or electric fan (10 inch or larger) with blades removed, into an efficient, versatile Flexible Shaft Tool for doing hundreds of grinding, polishing, sharpening jobs, especially in hard-to-get-at places. Attaches to motor shaft or in chuck. Convenient handpiece for ease of handling. Generous 40-inch overall length. Comes complete with buff and sanding disc ready to use in a drill press chuck. Order today.

ONLY \$2.95

OLD FAN MOTOR

YOUR ELECTRIC MOTOR

VACUUM CLEANER MOTOR

SEND NO MONEY! Just mail order. Pay postman only \$2.95 plus postage on delivery, or send \$2.95 and we pay postage. Try 10 Days—if not delighted return for money-back.

If you order Rota-Shaft for use on motor add 35c for Special Coupling and State Shaft Diameter. **MAIL ORDER NOW!**

STRADER PRODUCTS CO., Dept. E-101
259 Strader Ave. Cincinnati 26, Ohio

BRAND NEW SURPLUS BARGAINS

New Precision Bilt MICROMETERS

Chrome finished nationally known makes. Gives a lifetime of accurate detailed service. Individually boxed.

1" Central	\$3.50
1" Central, Tubular	3.75
1" Reed	4.00
2" Central	4.95
4" Central	6.25
5" Reed	7.25
6" Central	7.75



Work Table LAMP

Overall dimensions, 24 1/2", wt. 1 lb. Has 3 flexible ball joints. 110 volt. Less bulb and plug. Real sur- \$2.95 plus bargain. Only

Bulbs 38c extra
Add 25c handling and mailing

PUNCH SETS

STEEL A to Z

3/4"	\$6.50	3/8"	\$7.95
1/16"			\$1.95



Prices FOB, Kansas City, Mo. No COD's.
Write for our new Catalog

ATLAS EQUIPMENT & SALVAGE CO.

229 S. W. Blvd. Kansas City, Mo.

MORE POWER FOR YOUR WHIZZER

WEBER'S CAST ALUMINUM CYLINDER HEAD FOR WHIZZER BICYCLE MOTORS

- PROVIDES INCREASED POWER • SAVES GASOLINE
 - ELIMINATES GASKET TROUBLE • SMOOTH COMBUSTION
- WEBER'S Hi-Compression Cylinder Head is designed with an unrestricted gas chamber, and machined for perfect sealing thus eliminating all gasket complications.



\$5.95

C.O.D. OR CASH WITH ORDER

SEND YOUR ORDER TODAY

WEBER TOOL COMPANY • 4200 WHITESIDE • LOS ANGELES 33, CALIF.



BUILD a BOAT

- Row Boat—12 Foot
- Dinghy—8 Foot
- Dinghy—14 Foot Sailing
- Training Ship—6 Foot
- Sea Sled—9 Foot
- Outboard—12 Foot
- Cruiser—18 Foot
- Bicycle Boat—Kayak
- Row Boat—Sectional
- Dinghy—Sailing
- Canoe—16 Foot
- Sailing—12 Foot
- Outboard—12 Foot
- Outboard—Runabout
- Pontoons Ice Yacht

FOR PLEASURE OR PROFIT DESCRIBES 17 LOW COST BOATS Get this outstanding book and build a boat at home for your own use or to sell at a profit. You can do it. Just the boat you've always wanted—power, sail or row boat—17 different kinds and sizes.

Order BUILD A BOAT on postal card and pay only \$1.50 plus postage on delivery. Return in 5 days if not pleased and get money back. Or send \$1.50 with order and we'll pay postage. (Outside U. S. \$1.70 with order.) Order today.

POPULAR MECHANICS PRESS
Dept. 598, 200 E. Ontario, Chicago 11

Say You Saw It in
POPULAR MECHANICS

BOICE-CRANE POWER TOOLS

for shop men and
homecraftsmen.



BAND SAWS



JIG SAWS



DRILL PRESSES



THICKNESS PLANERS



SPINDLE SANDERS



SAW-JOINTERS



LATHES



SPINDLE SHAPERS



BELT SANDERS

Write for literature on this
versatile, low-cost,
sturdy line.

BOICE-CRANE COMPANY
943 Central Ave., Toledo 6, Ohio

1/4" GLASS SHATTERPROOF DUPLATE WINDOW

Cross-Section



Ideal for:

BOATS
TRAILERS
COTTAGES

O.D. 30 1/2 x 16 x 1"

\$1.79

each
NEW 2 FOR \$3.50

Freight or Express F.O.B. Everett, Wash.

Net wt. 17 lbs. each Air tight plastic moulding extends 1/2" above glass. Satisfaction guaranteed or your money back. Free surplus list.
DICK ROSE—ERECO, 2912 Hewitt Ave., Everett 21, Wash.

Make INSTA-CHANGE Fluorescent Ad Signs in 2 Minutes with Magic "Press-on" Letters

"GOLD MINE" FOR MEN WHO CALL ON
STORES, RESTAURANTS, TAVERNS, etc.

FREE! Actual sample Free — Mysterious "MAGIC LETTERS" Pull off, Stick on—any place you put them! Get amazing INSTA-CHANGE Display Sign Demonstrator. Show America's most spectacular Fluorescent Display Sign to business men in your territory and cash in on a flood of BIG-PROFIT orders! IT'S TERRIFIC!

Anyone can make up a complete new sign in just 2 minutes! Merchants save hundreds of dollars on sign writing bills. Be first in your territory. Rush coupon today for facts about Demonstrator, and actual sample of mystifying "MAGIC LETTERS"—all FREE!

FREE SAMPLES

MAXILUME CO., 125 W. Hubbard St., Dept. 810, Chicago 10, Ill.



FREE SAMPLE

MAXILUME CO., Dept. 810,
125 W. HUBBARD STREET • CHICAGO 10, ILLINOIS
Rush actual sample of Mysterious INSTA-CHANGE Sign "MAGIC LETTERS" and complete selling kit absolutely FREE. No cost to me, now or ever.

Name _____

Address _____

City _____ Zone _____ State _____

REAL SURPLUS VALUES EMERGENCY SUPPLY TANK



Fill at any gas station. 150 lbs. airs 3 flat tires. Inflates rubber boats. Use for touch-up spray jobs, tire service truck, air horns, dust out motors, machinery, etc.

Shatterproof 12"x24" stainless steel tank with carry handle, check valve, two feet hose and tire filling chuck. Only **\$7.95**
Tank only 12"x24", tapped each end 1/4 pipe thread, 500 lb. pressure. Build your own. Ideal for paint spray, air receivers, net floats, buoys, etc. Each **\$4.75**
Small size tank, 6"x24". Only **\$2.98**

Portable SPOT-LITE



PISTOL GRIP SPOT AND EMERGENCY LIGHT

For police cars, auto wreck trucks, cars, boats, etc. Red, green, amber and blue snap-on lenses free.

4 1/2 inch spot with 26 volt sealed beam lamp **\$1.95**
With 6 volt, sealed beam lamp **\$2.49**
6 inch spot with 26 volt lamp **\$2.95**
With 6 volt lamp **\$3.95**
26 volt replacement bulb **49c**
6 volt sealed beam **\$1.23**

A. C. LIGHT PLANTS

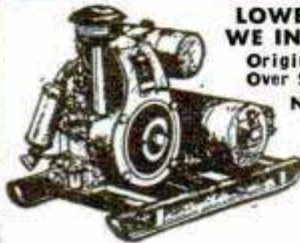

LOWEST PRICE EVER OFFERED WE INVITE PRICE COMPARISON

Original Cost **\$249.50**
Over \$400.00
Now Only **\$249.50**

2500 Watts 110 AC Volts. Same as R.E.A. or City Current. Nearly new condition. Fully guaranteed. Powered by Briggs-Stratton 6 1/2 hp. Air Cooled Engine. Prices FOB., K. C.

BRIGGS-STRATTON ENGINES

1 1/2 HP MODEL N— GOVT. SURPLUS

In good operating condition with 30 day written guarantee **\$39.50**

Engines will develop almost 2 Hp at 3600 RPM. Hurry, don't wait, buy now while limited supply lasts. Suitable for lawn mowers, garden tractors, motor bicycles and scooters, midget cars, etc. Will power many kinds of machinery.



PRICES FOB, K. C. NO COD'S

MIDWEST SURPLUS SALES CO.
2533-P-INDIANA
KANSAS CITY 1, MO.

SEND FOR
FREE CATALOG

HUNDREDS OF VALUES



SAY YOU SAW IT IN POPULAR MECHANICS

DIE-LESS DUPLICATING

Many small parts can be formed without dies, to duplicated accuracy of .001" with DI-ACRO Precision Machines. — Benders, Brakes, Shears. Save die expense and time delay. Ideal for experimental and research work, making samples, models, etc., as well as regular production runs. Write for descriptive literature.

O'Neil-Irwin Mfg. Company

341 8th Ave.
Lake City, Minnesota



AC's NEW "RECORD BREAKER" SPARK PLUGS FOR ALL MODEL ENGINES

More Speed Longer Life No Heat Failure

Users say these new AC's outperform any other spark or glow plug. AC's patented, aircraft type insulator, copper glass seal, tapered electrodes, make the difference. New engineering throughout. Hot and cold type in each of three thread sizes.

AC SPARK PLUG DIVISION • GENERAL MOTORS CORPORATION
Flint 3, Michigan

75c AT YOUR
HOBBY DEALER



NOW YOU CAN OWN A . . . GENUINE 17 JEWEL SWISS WATERPROOF WATCH

These brand new, genuine imported Swiss Watches are truly the greatest value in America today! They make an ideal present for yourself as well as relatives and friends. Especially suited for rugged Army and Navy use.

ONLY
\$22.50

(Price includes Federal Tax)



All features marked on the watch

CHECK ALL THESE OUTSTANDING

FEATURES • 17 Jewels • Shock Resistant • Antimagnetic • Luminous Radium Dial and Hands • Incabloc • Sweep Second Hand • Fine Leather Strap • Chrome Case with Stainless Steel Back • All Watches Accurately Timed and Checked for Perfect Performance • Individually Packed in Attractive Gift Box.

GUARANTEE— Money back in 10 days if not satisfied for any reason. Mail orders promptly filled.

Send check or money order today—postage prepaid or C.O.D.—you pay postage. Don't delay—order now!

ELBECO CO., Dept. A
115 Broadway New York 6, N. Y.



TALK-SING thru your own radio with RADIO MICROPHONE

Be the life of the party. Put on your own broadcasts at home. Talk-Sing make announcements from any room. Wonderful voice practice. Microphone easily attached to any radio. Follow enclosed instructions. SEND NO MONEY—pay postman \$1.98 plus postage. Send Money Order or check and save postage.



EMPIRE RADIO & TELEVISION CO. (Dept. M4) 1521 Bedford Ave. Brooklyn 16, N. Y.

Amazing Invention!

GUARDS AGAINST EXPENSIVE DAMAGE

• PROTECT YOUR CAR •

The MAGIC BRAIN of your car! Read about it in Sept. Issue of Popular Mechanics on Page 167 . . . New Improved Model SAVES YOUR Generator, Battery, Starter, Coil, Distributor, Points, Regulator, etc. You can install the GEN-O-BATT in 12 minutes without tools.

GEN-O-BATT Generator Co., Dept. P, 1136 Dodge Av., Evanston, Ill.

CONTROLS ENTIRE ELECTRICAL SYSTEM OF YOUR CAR

WARNS OF TROUBLE THE INSTANT IT OCCURS
Write for FREE Information

SPECIAL OFFER!

LOCK-STITCH SEWING AWL

Famous, patented lock-stitch sewing awl complete with needles, waxed thread and direction folder. Hundred uses — sewing, repairing leather goods, canvas, belting, harness, saddles, gun cases, awnings, golf bags. Extra needles and thread available. Satisfaction guaranteed or money back. Send currency, check or money order.

\$1.
Postpaid

Yates Mfg. Co., 611-H Main St., Lake Geneva, Wisconsin

New...Self-Contained SPRAY GUN

No Hose! No Tanks! No Pumps!
No Motor!

It's true! A high-pressure spray gun as self-contained, as compact and portable, as a flashlight! Uses no current. Pressure comes from inexpensive CO₂ cartridge. A cartridge sprays 10 to 30 oz. of liquid (depending on viscosity). Use gun for paints, liquid insecticides, oils, etc. For home, farm, workshop, garden, garage. Comes with 3 cartridges. Fully guaranteed. The Becker Spray Gun is shipped postpaid for only \$18.50; or send only \$2 — we'll ship C.O.D., you pay postman balance plus postage. Extra cartridges, 10 for \$1, postpaid.



\$18.50

(With 3 cartridges)
POSTPAID

SULLIVAN-BECKER CO., Dept. 118-K, KENOSHA, WIS.

CAR SHABBY? Apply KP-CLEAR

This revolutionary discovery, an outgrowth of war research, will make your old car finish like new, with one easily applied application. NOT A WAX. NOT A POLISH. It deposits a brilliant, protective PLASTIC coating which dries in one hour. SEND NO MONEY—just pay postman \$2.00 plus postage and C.O.D. charges. Or send \$2.00 and we send postpaid.

\$2.00

Enough to
renew the
finish on
one car.

KIMBALL PRODUCTS CO.

Dept. 101, 26970 Princeton Inkster, Michigan



NOW! MAKE YOUR OWN

LEATHER BELTS & HANDBAGS

Portfolio of 10 NEW handbag patterns, full size, easy to follow instructions for transferring, tooling, etc. No. 332 only \$1.30
47 NEW Western and Novelty Belt Designs No. 397 set only 75c

A full stock of quality leather and lucite fittings.
Large catalog included with first order for materials.

OSBORN BROS., Dept. M, 225 W. Jackson Blvd., Chicago 6, Ill.



PRACTICAL BOOKS ON HOME PLANNING BUILDING · REPAIRS

Plan Now—Build When You Can
Books Sent C.O.D. Anywhere in U.S.A.

Select from this list of helpful books. In U. S. books sent postpaid if remittance accompanies order. Outside U. S. include 15% extra for shipping charges.

- How to Plan a House \$5.00
- Your Home and How to Build It Yourself \$3.00
- Painting, Decorating \$1.75
- Carpentry \$2.50
- Painting, Furniture Finishing and Repairing
Includes floor renewal \$1.50
- How to Remodel a House Complete, practical \$5.00
- Building Insulation \$4.50
- Concrete Handbook
Do work for yourself, others \$1.50
- Blueprint Reading for Building Trades \$1.50
- Practical Bricklaying \$2.00
- Primer for Home Builders \$2.50

FAMOUS PLAN BOOKS

Books contain floor plans, photos, descriptions of homes.

AMERICA'S BEST LOW COST HOMES. 125 designs \$1.00

DE LUXE SMALL HOMES. 210 designs. \$1.00

OUR FUTURE HOME. Wide selection of residences, summer homes, garage apartments \$1.00

MODERN HOME & GARDENING. 42 popular designs. Improvements, garden short-cuts, etc. \$50c

Set of
Four
Books
\$3.50



Stair
Building
\$2.50

POPULAR MECHANICS PRESS

DEPT. 646 • 200 E. ONTARIO STREET, CHICAGO 11

HELPFUL BOOKS

Send post card asking for FREE catalog
Popular Mechanics Press, 200 E. Ontario, Dept. 601, Chicago 11

Save on SURPLUS BARGAINS



Perfect all wool
Olive Drab
**SLEEPING
BAG**

Handy for fishing trips, hunting, camping, boating, just roughing it or use as auto robe and many other purposes. Warmth of 2 blankets; zipper slide fastener; tiestrap on bottom; approx. Gov't cost \$12.90. Our Price each..... **\$3.95**

Outside Cover for Sleeping Bag—Water repellent...\$2.40



ALL RUBBER SUIT Perfect for fishermen, trappers, and all who work in and on the water. For trapping, dam and caison work. You can make boots, hip high water waders, rubber gloves, rain capes, etc. Fits right over your clothes and shoes. Cost Gov't \$4.95 approx. \$25. Our price.....

RAINSUIT New. Small, medium and large. One piece coverall type with hood, belt and zips up. State size. Only..... **\$3.95**

RUBBER SHEETING Brand new, 68" x 80". Grommets. Used as bed mattress cover, hunter and campers tent bottoms, etc. Original government cost over \$12.00 each. Packed 15 to a case. Minimum order one case. Each..... **\$3.95**

PUP TENTS Perfect—2 man size for scouting, camping, etc. Without pole..... **\$2.95**

SQUAD TENTS 16'x32'6" with 6'6" door, fire and mildew resistant, heavy duck OD color. Excellent for storage of machinery, equipment, truck covers, etc. Original cost \$48.00 \$172.00. Our price.....



PYRAMIDAL TENTS

16'x16', 8 man tent. Reconditioned, perfect, fire and mildew resistant, of heavy duck. Complete with tie ropes. Cost Gov't. over \$100.00. Our sale price..... **\$2650**

WALL TENT 9'x9' waterproof canvas, front and back windows, 3'6" wall, open at back. Ends 8' high. Only..... **\$1995**

PLYWOOD TRUNK TYPE LOCKER

Galvanized sheet steel cover, size 29" long x 17 1/2" high x 16" wide. Reinforced at all corners and edges. Complete with two clamp down fasteners. Trunk type latch lock, O. D. color. Perfect condition. Our price... **\$795**

JUNGLE HAMMOCKS Made of high grade Poplin for U. S. Army, perfect for the home, yard, outings, etc. Complete with ropes and canopy. Weatherproof top. Special only..... **\$4.45**

FLASHLIGHT

INSPECTION LAMP ASSEMBLY

NEW—Gov't. surplus. Lights up the "Hard-to-get-at" places. Fine for the home, mechanics, electricians, etc. Plastic 12" extension. Adjustable to any angle. Each..... **\$1.29**



Send check or M. O. Add 10% for handling and mailing.

AMERICAN SUPPLY COMPANY

329 W. 5th STREET DEPT. PM KANSAS CITY, MO.

WHEELS + WHEELS

- 5-in. disc wheel, 5/8-in. tire, 5/16-3/4 sleeve..... \$.30
- 6-in. disc wheel, 5/8-in. tire, 5/16-3/4 sleeve..... \$.35
- 7-in. disc wheel, molded tire, 3/4-in. sleeve..... \$.45
- 8-in. disc wheel, 1 1/8 tire, 1/2-in. sleeve..... \$.70
- 7-in. disc wheel, 1-in. tire, 1/2-in. B.B..... \$.80
- 8-in. disc wheel, 1 1/8 tire, 1/2-in. B.B..... \$1.00
- 10-in. disc wheel, semi-pneumatic 1 3/4 tire, 1/2-in. B.B..... \$1.50

Above wheels painted red.

10-in. alum. wheel, semi-pneumatic 2 3/4 tire, 5/8-in. B.B..... \$4.50
Hub caps for 5", 6", 7" wheels \$.03 extra. Plus Postage

UNITED WHEEL MFG. CO., 2756 W. 115th St., Chicago, Ill.

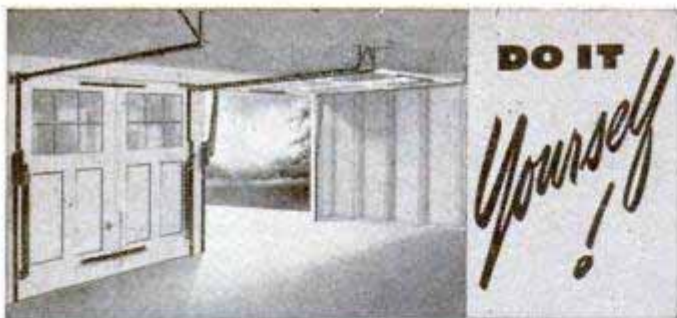

Change over to overhead door convenience

Here's just what you've been wanting—modern, new Garage Door Hardware, specially designed for quick, economical conversion to overhead door convenience. Balanced... smooth... quiet. Made by Richards-Wilcox, acknowledged leader in Door Hardware, the new R-W 999 Garage Door Hardware is adaptable to a single piece door, or two doors fastened together to form a single piece door. Comes complete, with everything needed for installation and operation.

**MAIL
COUPON
FOR
FREE
FOLDER**

Richards-Wilcox Mfg. Company
Aurora, Illinois-PM-8

Gentlemen: Please send me literature and information on your R-W 999 Garage Door Hardware.

Name.....

Street.....

City.....State.....

My Dealer is.....

Richards-Wilcox Mfg. Co.
AURORA, ILLINOIS, U.S.A.

LEADERS IN DOOR HARDWARE FOR 68 YEARS

Say You Saw It in Popular Mechanics

AMES UNIVERSAL DIAL INDICATOR SETS NEW SURPLUS

OUR \$15.00
PRICE

Reg. sold for
\$23.00

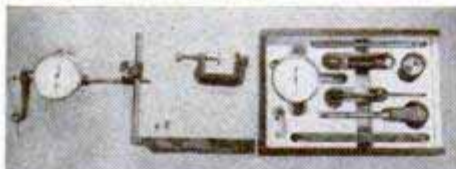

You get a complete set including Dial Gage with hole Attachment, Bar with Upright, Clamp sliding swivel, Dial holding rod and three contact points. Hole attachment also, can be adjusted to almost any position, and used in places inaccessible to ordinary indicators. All this along with a beautiful box for only \$15.00. Write today before limited supply of these AMES KITS are exhausted.

Catalogue of other tools—40c—refunded on first \$10 purchase. Free with indicator set.

VETERAN TOOL AND SUPPLY CO.
88 Baxter Street New York 13, N. Y.

STEADY PROFITS

**YOUR OWN
BUSINESS WITH
CORADIO**

The Coin Operated Radio

Place these specially built radios that play 1 or 2 hours for 25c in the thousands of available hotel rooms, tourists courts, etc. They yield immediate profits and steady income. Install Coradio, the finest made. Limited capital required. Send for further information. Write today.

CORADIO Coin Operated Radio
DEPT. C

212 Broadway, Phone: BEekman 3-0038-9
NEW YORK 7, N. Y.



NOW! You'll be
DRIVING IN HEAVIEST RAINS
WITH **WINGFLEX**
ON VENTILATOR WINDOWS

WINGFLEX drains off rain flowing down open ventilators. Keeps water from dripping in. Lets musty odors out. Prevents windshield "fog".

Fits All
Cars Except
new Stude.



\$1.95
PR.
POSTPAID

Amazing new WINGFLEX lets you drive in greater safety with ventilator wings open... in stormiest weather! Shield drains off rain flowing down windows... protects upholstery and clothing from water dripping in. Circulating air relieves musty odors, stuffiness inside car... prevents windshield "fog"... reduces risk of accidents. Snap-clamp secures to bottom of ventilators, rubber seal prevents leaks. Made of chrome plated steel. Fits all cars except new Studebaker. \$1.95 pr. ppd. Send check or M.O. C.O.D.'s plus postage.

PRODUCT CO., Dept. PM-1
705 Olive, St. Louis 1, Mo.

The
**EXCEL
POWER
HACKSAW**

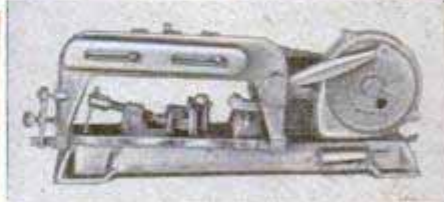

Just what you need for those tough, tedious metal sawing jobs.

Draw-cut, automatic shut-off.

Vise angles up to 45°. Saws stock up to 4" x 4".

EXCEL MACHINE TOOLS
Designed & Manufactured by
COVEL MANUFACTURING COMPANY
Benton Harbor Michigan

**ONLY
\$4725**
Less motor
F.O.B. Benton Harbor
Write Dept. PM-108 for free Bulletin



SPEED REDUCER

Made of bronze and steel. Size 3" x 1 3/4", weight 1 1/4 pounds. Rugged 5/16" shaft. Ratio: 1 to 1, 10 to 1 or 20 to 1 (please specify). Complete with knuckle joint, \$7.50; without knuckle joint, \$6.50; knuckle joint alone, \$1. Mailed postpaid on receipt of Money Order.

WAK INDUSTRIES
CHARLOTTE, N.C.

METALS

sold in small quantities for the home workshop. Steel, Brass, Copper, Aluminum, etc. In Bars, Shapes, Tubes and Sheets. Write for free price list.

CASHMETALS CO., 2720 California Ave., Pittsburgh 12, Pa.

TIME CONTROL SWITCH—\$3.00

Turn off or on radios, lights, window displays, fans or any electrical appliance up to 1/2 hp. motor at any time up to 12 hours after setting. We supply complete kit with instructions for attachment to any spring-wound alarm clock for \$3.00 postpaid. Specify whether appliance is to be turned on or turned off. Satisfaction guaranteed or money refunded. Send cash, check, or money order to:—

BLAKE-HANES
REDWOOD, MISSISSIPPI

STATION WAGON CABS AND BODIES FOR ALL JEEPS—SMART MAPLE—OAK WOODS

Year around comfort for Jeep owners. Kiln dried hardwoods, safety glass. Finest hardware, varnishes, top materials. Full opening rear door, locks.

CABS \$144.50 Plus Tax

FOB Cleveland. Complete, semi-assembled. Full bodies slightly higher. Send 25% with order, balance COD.

STATION WAGONS, INC. (PM)
6619 Euclid Avenue, Cleveland, O.



POPULAR MECHANICS

- ★ WRIST WATCH
- ★ STOP WATCH
- ★ TELEMETER
- ★ TACHOMETER

Phenomenal Value!
17 JEWEL • 2 PUSH BUTTON
CHRONOGRAPH

ONLY \$ **29⁷⁵** PLUS 10% TAX



- INCABLOC SHOCK RESISTANT FEATURE**
- Sweep Second Hand
 - Radium Dial • Anti-Magnetic • Unbreakable Crystal. (formerly \$71.50)
- IDEAL FOR**
- Physicians • Engineers
 - Radio Men • Sportsmen
 - Photographers • Aviators

OUR GUARANTEE

MONEY BACK IN 10 DAYS

If not satisfied for any reason

ADLEW JEWELERS Dept. 117

117 W. 42nd St., N. Y. C. 18

Mail Orders Promptly Filled • Shipped C.O.D. or send check or money order.

Address mail-orders to:
 ADLEW JEWELERS, 152 West 42nd St. N.Y.C. 18 (Dept. 117)

Also available in 18-k Gold Case. \$64.50 (plus 10% tax), formerly \$125.



OWN THIS FINE 8 PC. COMB. BOX AND OPEN END WRENCH SET

in transparent leatherette roll. Made of hi-grade alloy steel and heat treated. 9 sizes 13/64 to 7/16. At your local dealer.

PRICES Retail \$3.00 per set Dealer \$24.00 per doz. sets

DISTRIBUTORS WANTED

Send \$2.00 only for sample set postpaid.

STEPHENS TOOL WORKS Box 306, La Tijera Sta., L.A. 43, Calif.

INVENTORS

Whether an invention is patentable can be substantially determined by a search of the U. S. Patent records. Without obligation, write for information explaining the steps you should take to secure a patent.

JOHN N. RANDOLPH

Registered Patent Attorney

201 Columbian Building, Washington 1, D. C.

MAKE MONEY MAKING DOUGHNUTS

Make new greaseless doughnuts at home on electric machine. Sell for cash to grocers, cafes, drug stores, etc. No exp. nec. Good profits. Small investment. Send for free recipes and plans.

MART RAY CO. • 3605 S. 15 Ave. • Minneapolis 7, Minn.



HAND-WOVEN TIES

from the mountain people of New Mexico. 100% fine-spun virgin wool. Worn by over 50,000 men, including many famous ones, who have discovered these ties give real distinction at less than ordinary tie cost. Supplied only by mail. Write for my Rainbow Folder showing 64 beautiful fall patterns in full color, with a noted artist's suggestions for matching ties and suits. Webb Young, Trader, Patio 300, Santa Fe, N.M.

Talk AS FAR AS 17 MILES WITH ARMY FIELD TELEPHONES

Amazingly simple to install and operate. Just hook up terminals of two or more phones to any two-strand wire and you are ready to talk! Powered by standard flashlight batteries. Compact . . . rugged . . . portable.

Hundreds of uses for quick, low-cost, dependable 2-way communication around home, shop, farm, industry. Performance equals present-day commercial telephones. Up to six phones can be used efficiently on a single line, making a complete telephone system. No maintenance required. Each phone complete with self-contained hand-operated ringer. Every phone checked for perfect operation and fully guaranteed. Originally cost government \$39.90 each.

- USED**—good, serviceable condition \$ 7.45 ea.
- USED**—excellent condition 8.95 ea.
- RECONDITIONED**—(by U. S. Signal Corps) . . . 10.75 ea.
- Like New, slightly used 12.95 ea.
- BRAND NEW PHONES**—Mfg. by Western Electric, Stromberg Carlson and Kellogg, with canvas case, etc. 16.75 ea.

We are the original firm to introduce Army Field Telephones on the national market. We deal exclusively in this item, and our experience in handling this equipment has resulted in the satisfaction of thousands of customers and many repeat orders.

ARMY FIELD TELEPHONE WIRE

Weatherproof — Durable

2-conductor, twisted, 3 copper and 4 steel strands, tinned, insulated.

On Original Steel Reels



- W-110B** — Unused, new, but stored in open. Half-mile reels (2500 to 2750 feet). Wt. 85 lbs. Each **\$14.25**
- 500-foot coil** (14 lbs.) \$3.50
- 1000-foot coil** (28 lbs.) 6.50

W-130 LIGHTWEIGHT ASSAULT WIRE

WEIGHS ONLY 16 LBS. New, half-mile reels (2600 feet). Each **\$15.00**

All prices FOB Sacramento. No COD. California residents add 2 1/2% for sales tax.

FIELD TELEPHONES—SWITCH-BOARDS—TELEPHONE WIRE AND RELATED ITEMS.

For complete details...

Write for **FREE** illustrated folder

Now as Low as **\$7⁴⁵** ea.

SEND CHECK OR MONEY ORDER **LORIS SALES**
 P. O. Box 1896-B-10 Sacramento, California

SAY YOU SAW IT IN POPULAR MECHANICS

ZIPSCOOT \$49⁷⁵

America's Outstanding Scooter Value! This smart looking speedster is easily and quickly assembled from our factory finished kits. Uses standard gasoline motor. Speeds up to 30 miles per hour. 100 miles per gallon of gas. Send 25 cents for assembly information, drawings, and illustrations. Kits available for immediate shipment.

Zipscot Company, Toledo 6, Ohio

PAY RAISING—EXTRA MONEY BOOKS

Use these books to prepare for a better job—bigger pay—to start a profitable spare time or full time business of your own, improve your home, start a hobby. Popular Mechanics specializes in supplying outstanding self-help books on many subjects. Send for our FREE catalog.

- Outdoor Sports Manual**
Hunters, Fishermen, Trappers, Campers, Archers, Boatmen, here is your book! . . . \$2.00
- Shop Notes Library**
3 Vols.—1948, 47, 44. (No Dup. Mat.) . . . \$2.00
- Painting, Furniture Finishing and Repairing** . . . \$1.50
- Rewinding and Servicing Electric Motors (No. 75)** . . . 25c
- Elementary School Subjects for Home Study**
Covers high points of grammar, spelling, arithmetic, history, science, geography, etc. 635 pages. . . . \$1.89
- High School Self Taught**
Covers 25 subjects with study guide and self-testing quizzes. Completely revised and enlarged edition, 1280 pages, 300 illustrations. . . \$3.95
- Garden Book**
Build your trellises, lawn furniture, fireplaces, ornaments, etc. . . . \$1.00
- Diving, Cutting and Welding in Underwater Salvage Operations**
Only book of its kind . . \$2.00
- Picture Framing**
Modern methods for making and painting picture frames. Fully illustrated. . . \$2.75
- Frog Industry**
Breeding, feeding, dressing and marketing. . . . \$2.00
- New Fields for the Writer**
Television, radio, film, drama \$1.00
- 20 Careers of Tomorrow**
Covers plastics, metallurgy, textiles, radio, electronics, television, transportation, chemistry, etc. . . . \$2.50
- Breaking Into Advertising** \$1.00
- Into the Freezer and Out**
A complete handbook on the home freezing of foods. \$2.50
- Concrete Handbook**
New book on using concrete around home, garden, farm \$1.50
- Zero Storage in Your Home**
How to prepare, store and freeze food properly. . . \$2.50
- This Way Up**
The successful philosophy of practical business men \$2.00
- Welding, Brazing and Soldering**
How to build own equipment and how to use it effectively . . \$1.25
- Modern Refrigeration**
Electric, Gas, Be service expert \$5.00
- Dyke's Auto Ency. (includes Diesels, airplane engines)**
New 20th Ed. World's greatest book for mechanics \$7.00
- Household Mechanics**
The "fix-it" book to end all "fix-it" books. Covers electric appliances, painting, carpentry, etc. . . . \$2.75
- Oil Burner Handbook** . . . \$2.50
- Build Your Own Boat**
Describes 17 popular boats—rowboats, sailboats, plywood outboard, etc., 192 pages \$1.50
- House Wiring (No. 89)** . . . 25c
- Turn Scrap Into Money**
Convert old auto generators into motors, welders, etc. . . . \$1.00
- Popular Mechanics Farm Manual**
Packed with practical ideas and usable information that can easily be worth hundreds of dollars to every farm family and to homeowners everywhere. Send for free descriptive folder giving complete contents! . . . \$3.00
- Woodworking for Every-body** \$2.75

- Sheet Metal Work** . . . \$3.00
- Tool and Saw Sharpening (No. 92)** 25c
- Forging Practice** . . . \$1.50
- Action Toys (No. 66)**
Plans for 21 easy-to-make toys 25c
- Foundry Work** . . . \$2.25
- Pattern Making** . . . \$2.25
- Wood, metal** . . . \$2.25
- Forty Power Tools**
Build own saw, drill, lathe, sander, etc., from scraps—save money . . . \$1.25
- Carpentry** . . . \$2.50
- The Young Craftsman**
Over 450 things boys can make \$1.50
- Five Acres and Independence**
How to make money on small farm \$2.50
- Your Home and How to Build It Yourself**
Step by step construction of the famous POPULAR MECHANICS house. Wonderfully illustrated . . . \$3.00
- Artistic Penmanship Self Taught**
New self study course with 48 lessons of interesting and varied exercises . . . \$2.95
- Knots, Ties and Splices**
For everyone who uses rope . . . \$1.25
- What to Make for Children**
Junior tough on toys? Build him playthings that will last. . . . \$2.00
- LeJay Manual of Homemade Electric Equipment**
How to construct 100 items that are scarce and valuable . . . \$1.50
- How to Estimate for the Building Trades: Material and labor costs for masonry, plumbing, electricity, carpentry, heating, hardware, painting, etc. 629 pp.** \$5.50
- Pay Dirt**
How to make soil fertile by obeying Nature's laws. \$3.00
- Rabbits for Food and Fur** . \$2.50
- Tool Making** . . . \$4.00
- Tool Design** . . . \$4.50
- Plumbing Installation & Repair** . . . \$2.00
- Ropp's Calculator**
Figuring made easy. . . 75c
- Slide Rule Simplified** . . \$2.75
- Drake's Refrigeration Service Manual** . . . \$2.00
- Primer for Home Builders**
All the information you need to know in building a house . . . \$2.50
- Oxy-Acetylene Welding and Cutting**
Up-to-date handbook on gas welding and cutting. . . \$2.75
- Toys You Can Make of Wood** . . . \$2.50
- A.B.C. of Poultry Raising** . \$2.50
- Ice Cream for Small Plants**
Some technical formulas for ice cream, ices and frozen desserts on a commercial scale . . . \$2.50
- Furniture Joinery** . . . \$2.50
- Essentials of Upholstery** . \$3.25
- Radio Physics Course**
A thorough training in radio fundamentals . . . \$5.00
- Modern Home Medical Adviser**
How to recognize diseases, practice proper hygiene, and know what to do in medical emergencies. 900 pages, 136 illustrations. . . . \$2.49

A Thousand and One Ideas You Can Use on the Farm!



POPULAR MECHANICS FARM MANUAL

Use it to Step up Farm Efficiency — Increase Production — Improve Farm Appearance — Save Time, Labor, Money!

A Must for Every Farm Family! Saves Money for City Homeowners Too!

Here is the experience of hundreds of successful farm operators brought together in one handy, easy-to-read, easy-to-use, working handbook by the editors of Popular Mechanics. It is brimful of short cuts, labor-saving ideas, ingenious apparatus and methods that will simplify the day's work and lighten some of the more tedious chores, make money and save money for you.

HELPS IN THE FIELD — IN THE BARN — IN THE HOME

Every department of the farm is covered in the Farm Manual. Every member of the family will find in it something that he or she can use to tremendous advantage in farm operation, maintenance and improvement, from the building and care of equipment to painting the farm home and fast freezing fruits and vegetables. It covers farm buildings, the farmhouse and other homes and is of interest equally to the woman looking for home improvement, beauty and convenience and the man striving for easier and more profitable operation.

ORDER TODAY — FOR YOURSELF — FOR A GIFT

Use the coupon below. Mail it today. Book will be sent at once, postpaid if you include payment with your order. If you don't think the Farm Manual is worth even more than you paid for it after five days' use, send it back by mail and your money will be refunded. This may be the best investment you ever made. Rush coupon today.



284

FACT-PACKED PAGES
•
Hundreds of Illustrations

Popular Mechanics Farm Manual is packed with practical ideas and usable information that can easily be worth hundreds of dollars to farm families and homeowners everywhere.

Farm Machinery and Implements
How to make and get the most out of farm implements.

Farm Workshop Equipment and Repairs
Ideas that can save hundreds of dollars.

Poultry and Livestock
How to build equipment, gadgets. Care of farm animals and poultry.

Vegetable Storage—Processing
Winter storage, home freezing tips, make your own freezer.

Farm Home Improvement
Fencing, repairing electrical appliances, plumbing, electrical wiring, saving coal, painting, curing leaky basements, hanging wall paper, making garden tools, garages, working with concrete, painting, etc.

Farm Hints and Kinks
Forty pages of illustrated, practical ideas, short cuts, etc., that will save time, labor and money.

MAIL COUPON • Money Back if Not Satisfied

POPULAR MECHANICS PRESS, Dept. 665
200 East Ontario St., Chicago 11, Ill.

Send _____ copies of the Farm Manual at once.
 Remittance (\$3.00 each) enclosed. Send postpaid. Add 15% if outside U.S.A.
 Send C.O.D. (\$3.00 each) plus delivery charges. U.S.A. only.
 If sent as a gift to another, send name and address on separate sheet.

Name _____

Address _____

City _____ Zone or Route _____ State _____

MAIL THIS COUPON TODAY

Check the books you want, write your name and address below, and mail this advertisement with money order or check. Outside U. S. A. include 15% additional for shipping charges.

Books selected will be mailed promptly on our "money back if you're not entirely satisfied" guarantee.

Name _____

Address _____

City _____ State _____

Mail to POPULAR MECHANICS PRESS

Dept. 651—200 East Ontario St., Chicago 11, Ill.

SPEEDWAY 1/4" AC-DC DRILL

1000 RPM WITH 6' LINE CORD
POLISHING SENSATION

Puts a sparkling finish on your car, boat, furniture, silverware, leather goods, etc.

Nationally advertised DRILL with one year factory guarantee.

\$11.80

High Pile Lambs-wool Bonnet with 7" polishing surface mounted on a flexible rubber disc which can also be used as a sander. Sander paper also included.

POLISHER AND SANDER \$1.95



SPECIAL COMBINATION OFFER!

DRILL AND POLISHER only \$12.50 complete

10 pc. high-grade drill set from 1/16" to 1/4" with metal stand \$2.25 extra. Send check or money order. Shipped F.O.B., N.Y.C. MONEY BACK IN TEN DAYS if not satisfied.

THE ORDER MART
Dept. H 62 Warren Street, N.Y.C.

MENS FULLY GUARANTEED NEW 15-JEWEL WRIST WATCH \$13.95 PLUS TAX
ORIGINALLY sold up to \$55

Sacrificed because they're post-war surplus

WATER PROOF—SHOCK PROOF

Luminous dial... sweep second hand... anti-magnetic... imported Swiss precision movement and case. You get them now for a small fraction of original prices. Don't delay! Order now... while they last. Send only \$1 down payment with order. Pay balance to postman on arrival, plus postage. Or we pay postage if you enclose \$13.95 plus \$1.39 Fed. Tax. Receive Reg. \$2 expansion band FREE with prepaid order. Money back in 5 days if not delighted. Order now.



MARYLAND DISTRIBUTORS, Dept. 110
501 E. BALTIMORE ST. BALTIMORE 2, MD.

IMPORTED FINNISH KNIVES



Made by Iisakki Jarvenpaa Now Only \$2.95 prepaid
Beautiful design and workmanship. All-leather sheaths. Limited quantity—get yours now for the hunting season.

Send Money Order to:
FINNISH KNIFE IMPORTERS, Dept. 119
Box 5664, Chicago, Illinois

LIQUID MARBLE COMPOSITION FLOORS FLEXIBLE MOLDS MOLD Novelties, Statuary, Art Goods in Flexible Plastic Molds: material makes \$1 seller. Make Marbleized floors, Tile Walls. Colorful, glossy, amazing! Easily learned; start in garage or basement. Particulars free. MARBLEIZING SERVICE, Dept. 10-F, Edwardsville, Ill.

BUILD YOUR OWN BOAT—ONLY \$35
NEW Guaranteed, Complete KIT

Includes all PRE-CUT marine wood parts, screws, glue, hardware, building jig. Easy to build in few spare hours. Aircraft shell design gives amazingly tough, 65 lb. boat for hunters, fishermen, yachtsmen, boys 8 to 10.

FREE DETAILS. Write Dept. P.M.

PRITCHARDSONS' 2744 W. 37TH PL. CHICAGO 32, ILL.

OVER 250 SURPLUS BARGAINS

Write for FREE Catalog PM-7 TODAY!

FISLER SALES CO. 721 Walnut Kansas City 6, Mo.

WAR SURPLUS BARGAINS

110 VOLT, 60 CYCLE, 2500 WATT POWER PLANTS
GOVERNMENT COST \$535.00



Famous Army PE-75 Plants, Briggs 6.5 h.p. engine—driving 110 volt, 2500-watt Leland A-C Generator. Ideal size for farm, ranch, contractors, etc.

Only \$266.80
FREIGHT PAID

- New 2500-watt plants with tools & spare parts... \$266.80
- Fully recond. plants 2500-watt \$229.80
- "As is" 2500-watt plants. Re-adjustment adjustments... \$180.80
- New 2500-watt plants without driving engine \$124.80
- Reconditioned 600-watt 110-volt 60-cycle plants... \$127.80

6 H.P. GAS ENGINES NEW COST \$140.00
BRIGGS-STRATTON, BUSY BEE

World's Finest Gas Engines. Ideal size for garden tractors, pumps, sprayers, saws, etc. The buy of the year! Will not be duplicated.

- Briggs Model ZZ-6.5 h.p. Fully reconditioned... \$86.80
- Briggs Model ZZ-6.5 h.p. Brand new. Original carbon... \$115.50
- Busy Bee, 6.5 h.p. gas engine (a real unit) Brand new... \$82.90



ONLY \$86.80
PREPAID

ROTARY GEAR PUMP
PRECISION BUILT ORIGINAL PRICE \$24.00



Precision pump made for B-29s, 4" x 8" size, 1/2" shaft. Mechanics say "Most versatile pump made." Useful for pumping liquids, vacuum, pressure; capacity to 3 g.p.m. Vacuum 29 in. Pressures to 200 lbs. Full instructions and operating data furnished with pump.

\$3.95
POSTPAID

Also brand new \$1200 Power Winch with 11 h.p. engine at \$186.50 for Kentucky. Will pay all freight up to \$15.00. Flexible steel tow line, 50' complete with hooks. \$2.95 Ppd. We guarantee customer satisfaction. Reference National Bank of Commerce. Order direct from ad or send for catalog. We accept checks.

LECO ENGINEERING CO. Box 908-PM-10 Lincoln, Nebr.

BROWNSCOPE CO.
Dept. 10M, 24 West 45th St., New York 19, N. Y.

BINOCULARS TELESCOPES MICROSCOPES

Write for **BIG BARGAIN CATALOG**
It's FREE

BROWNSCOPE CO.
Dept. 10M, 24 West 45th St., New York 19, N. Y.

GIL-BILT 12 Inch Band Saw

- Cuts to center of 24 in. circle
- Handles stock up to 6 in. thick
- 18x18 in. table tilts 45 degrees
- Each wheel turns on two heavy 5/8 in. flanged Oilite bearing
- Two blade guides. Each has self-lub. jaws and ball thrust bearings
- Choice of cast aluminum wheels or make-your-own wood wheels on metal hubs. Both have heavy rubber tires
- Takes all 78 in. blades up to 3 1/2 in. wide
- Upper wheel alignment mechanism of cast aluminum, completely assembled

GIL-BILT 8 Inch Tilting Table Saw

- 21x27 in. table tilts full 45 degrees
- 8 in. blade cuts from 0 to 2 1/2 in.
- New Departure ball bearing arbor, precision, ready to run
- Graduated miter gauge, cast aluminum head mounted on 3/4x3/4 in. bar
- Self aligning rip fence guide
- Cast aluminum, ready to install

GIL-BILT Build-It-Yourself Features

- Sturdy wood, steel and aluminum construction
- No machining—build easily with hand tools
- No blueprint reading. Pictorial type plans, full scale patterns

GIL-BILT Step-By-Step Plans, simplified pictorial type drawings, actual photographs, full size patterns. Plans for either of above tools... \$1.00

GIL-BILT 8 Inch Table Saw Metal Parts Kit includes Plans, ball bearing arbor, cast aluminum tilt arms, rip fence guide, miter gauge, and all other metal parts (less blade)... \$15.95

Same kit with 8 inch combination blade... \$19.90

GIL-BILT 12" Band Saw Metal Parts Kit includes Plans, rubber tires, 3/16 in. wide blade, hubs, bearings, shafts, guides, and all other metal parts... \$16.95

Same kit with two 12 in. cast aluminum wheels... \$20.95

GILLIOM POWER TOOLS P.O. Box 1-PK, Lambert Field, St. Louis 21, Missouri

BUILD YOUR OWN POWER TOOLS

Marvelous...

FOR **FALL** COLOR SHOTS



The meter with a **MEMORY!**

NEW  **EXPOSURE METER**

Gives correct exposure . . . helps your camera capture the full beauty of autumn color. Exclusive Trident Analyzer. Measures reflected or incident light. And it's so easy to use. Type PR-1, **\$32.50***. General Electric Company, Schenectady 5, N. Y.

Also famous Type DW-58 meters—\$19.95* and \$21.95*
*Fair Trade price. Fed. tax inc.

GENERAL  ELECTRIC

606-46

Get more fun from

FOOTBALL!

. . . over the radio
or at the game!

SEND FOR NEW SENSATIONAL

FOOTBALL SCORE BOARD

with
SLIDING YARDAGE MARKER



Follow all the thrill-packed action! Keep the facts at your fingertips . . . score, downs, gains, losses, position of ball on field. Not a mere toy—useful and practical. 6½ inches long. Durable, long-lasting—use again and again. Tear out this ad, write your name and address in the margin, mail with twenty-five cents to **ALBERT RICHARD SPORTSWEAR, 1659 S. Second St., Milwaukee 4, Wis.**

ONLY 25¢ POSTPAID

Open-End Ratchet Wrench

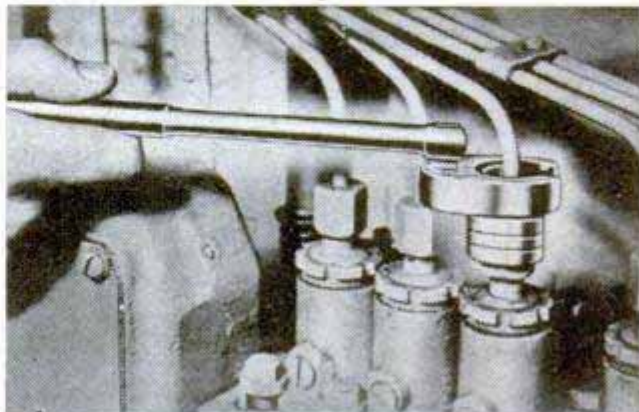

Fittings around pipes, tubes, conduits and cables can be tightened or loosened easily with a ratchet wrench that has an open channel in the head and the sockets. The channel permits the head to pass over the pipe and then down on the fitting. The ratchet mechanism is inside the head, which operates in a 7½-degree arc or less. Available in most sizes, the open sockets can be purchased individually or in sets. With a small adapter, the wrench can be used with standard sockets.

Typewriter-Line Justifier

Typewritten copy with both margins justified is produced by an electric typewriter with a reel attachment. In the past, methods for aligning the right-hand margin of typewritten copy have required preliminary calculation by the typist or typing each line twice. In the new method the characters are typed on a reel of special paper tape made stretchable by fine creping. The operator then presses the tabular key and a gripper seizes one end of the paper strip while the carriage moves to the margin with the other end. The back of the tape is coated with adhesive and the line is glued to a sheet of paper in much the same way a telegram is formed. The method is effective for reproduction by photo-engraving, photo-offset and gravure.

Ⓞ Measuring 17 inches in circumference, a hailstone that fell at Potter, Neb., July 6, 1928, rates as the largest ever recorded in the world.

PROFITS AND SPEED

THE MODERN LAWN MOWER SHARPENER

PRICE
\$241⁵⁰
LESS
MOTOR

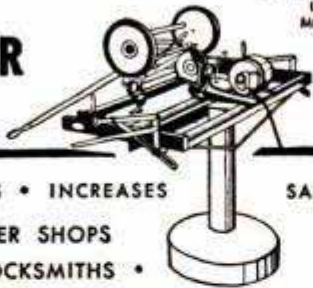

INCREASES PROFITS • INCREASES SALES!
FOR LAWN MOWER SHOPS
FIXIT SHOPS • LOCKSMITHS •
HARDWARE STORES • GOLF COURSES • SCHOOLS
PARKS • PLAYGROUNDS • INSTITUTIONS •
CEMETERIES • AND ALERT INDIVIDUALS!

*Sharpens All Reel Type Mowers • Hand, Power or
Gang • 10 to 20 Minutes • No Dismantling
No Extra Attachments Needed*

All reel type mowers, from 5-inch edgers to 36-inch power mowers, are quickly sharpened to extreme ends of both left and right twist reel blades. Handle, wheels, roller and motor remain in place when sharpening is in process. Bed knife is sharpened in same brackets that hold mower in grinding position. No extra attachments required. One lever puts mower or bed knife in grinding position. 100% steel construction. Grinding head rides on five ball bearing races. Small, compact, easy to operate. Sharpens wood chisels, joiner knives and planer blades without extra attachments.

**ORDER
NOW**
Immediate
Delivery

*Skate Sharpener Attachment Available
Send For Free Bulletin No. 10B*

MODERN MFG. CO. 160 N. FAIR OAKS AVE.
PASADENA, CALIFORNIA

ELECTRIC MOTORS

NEW-SURPLUS

1/28th H.P. 110 A.C.
60 CYCLE

2500 R.P.M. Minimum
— 2750 Max. — Start
90 V. — Runs Clockwise.
1 3/4" long by 2 3/4"
wide, 1/4" shaft.

\$2.95



AIRCRAFT GALLEY STOVES

Operates on 110 and 24 volts. Fine
for trailers, boats, camps, etc. Includes
steam table, hot cup, and grille. New,
complete with all accessories.

NEW
\$19.95 EACH

SERVO UNIT

Control for the auto-
matic pilot. Makes
good hoist or water
pump. Operates on 24
volts. New, complete
with 1/4 H.P. motor.

\$4.95
EA.

MOTOR & GEAR ASSEMBLY

Adaptable for garage
door openers, electric
hoists, rotating radio
beams, etc. Lifts 2800
lbs. Operates on 24
volts. New,
complete with
1/8 H.P. motor

\$4.95
EA.



All prices F.O.B. Detroit. Send cash or money order. No C.O.D.'s—
Orders shipped by railway express.

RADIO CENTER

2530 E. DAVISON

DETROIT 12, MICH.



Hearing Aid for Cat

"Unfortunate" heard for the first time recently when the cat's owner, Mrs. A. H. Cooper of Fort Worth, Tex., had a hearing aid fitted to the feline. The hearing aid is the latest of a series of steps by Mrs. Cooper to improve the life of the unfortunate cat, which was born deaf, crippled in the hind legs and had no teeth until the age of two. The owner massaged the cat's gums until the teeth finally came through and had a wheeled support built which enables the cat to scoot around the house.

Mountain Eggs Lack Oxygen

Extra oxygen piped into incubators on high-altitude ranches produces more and healthier chicks, according to poultry researchers of the University of Wyoming. Eggs in the mountain states always have turned out a relatively low percentage of healthy baby fowl. The researchers discovered that at a 7000-foot elevation not enough oxygen passes through the eggshells to keep the embryos alive—the unhatched chicks literally smother. Under the new system oxygen must be piped into the incubator throughout the incubation period or the effect is worse than no supplementary oxygen at all.

PROTECT LIVES and PROPERTY with these

LOW COST FIRE EXTINGUISHERS

A little foresight now may save LIVES and PROPERTY later. Equip your home, your garage, your office, your boat with **AutoFyrstop**, the modern fire extinguisher and alarm that is setting new records . . . Write for **FREE** literature today.



We have openings for high grade salesmen in choice territories. If interested in outstanding money-making opportunity, write for plan TODAY!

AUTOFYRSTOP CO., Dept. PM-1048
2035 Washington Ave., Philadelphia 46, Pa.

Now ROTARY DRILL CONCRETE Easily!

CONCRETE • BRICK
ASPHALT • SLATE
WALLBOARD
and most other
construction
materials

SLIP A CARBOLOY MASONRY DRILL INTO YOUR ROTARY DRILL, HAND BRACE OR DRILL PRESS AND WATCH IT GO—AND GO FAST!

- DRILLS 4 TIMES FASTER!
- STAYS SHARP 50 TIMES LONGER!
- CUTS CLEAN, TRUE-SIZED HOLES!



Tipped with CARBOLOY Cemented Carbide—harder than the hardest steel.

Goodbye to back-breaking masonry drilling! Carboloy Masonry Drills—round shank for shallow holes, fluted for all-purpose drilling—cut through masonry jiffy-quick! Priced as low as \$1.40. Ask about Economy 3-Drill Set, 3/16", 1/4", 5/16", 3/8", 1/2" and 5/8" in canvas kit, \$10.40 postpaid or C.O.D., from your dealer or direct. Ask for leaflet SA296.

CARBOLOY COMPANY, INC.

11185 E. 8 Mile Ave., Detroit 32, Mich.

Start a NEW BUSINESS
Or Add to Your Present
Repair Business

Sharpen Dull Pipe Wrenches
Pipe Taps & Dies
"Gum" Circular Saws

Write for Information.



Pat. applied for

J. C. MOORE INDUSTRIES P.O. Drawer 276
FREDONIA, PA.

HOW FAR
WILL THE OLD
CAR GO?



Truck and Fleet Owners Stretch Car Miles, Prolong Motor Life, Cut Engine Repairs and Save Gas and Oil with **VACU-VENT** The perfect Crank Case Ventilator Fume Filter—Motor Miser.

NOW YOU CAN HAVE Their Secret—Install VACU-VENT on Your Car, Your Boat or any Gasoline Engine. Installation is simple. Send for Free Descriptive Folder.

Dept. P. MOTOR ECONOMY PRODUCTS, Inc. 407 W. 36 St.
N. Y. C. 18

Amazing NEW TOY GUN

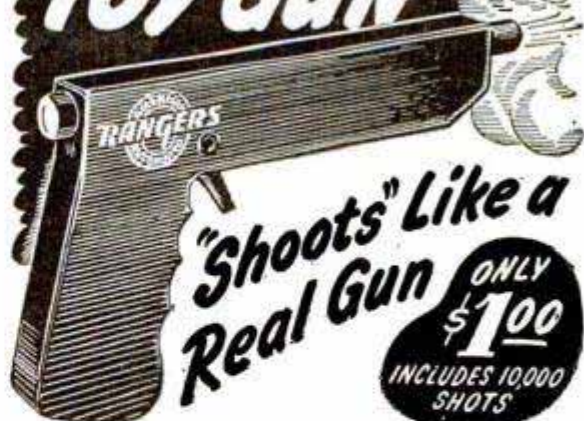

"Shoots" Like a
Real Gun **ONLY \$1.00**
INCLUDES 10,000 SHOTS

COMPLETELY SAFE

Here is the gun that will thrill every boy. When you pull the trigger, it cracks out like a real gun and smoke puffs out of the muzzle. The American Rangers Automatic is a quick acting, repeating pistol that never misses. It shoots 60 to 75 shots without re-loading. Looks like a real gun. Absolutely SAFE. Contains no explosives. Each gun comes boxed with 10,000 shots of smoke powder or enough ammunition to last a full year. This smoke powder is harmless. Will not hurt the eyes and may even be eaten. Only \$1.00 each or 3 guns for \$2.00. Only limited quantity available. Write for yours NOW.

SEND NO MONEY

Try 10 Days - At Our Risk

Just send name and address. On arrival deposit only \$1.00 plus C.O.D. postage for one gun or \$2.00 plus C.O.D. postage for three guns. If not completely satisfied return and your money refunded. Save money. If you send cash with order, we pay postage. Write TODAY.

SPECIALTIES MFG. CO., Dept. 508

1367 N. Sedgwick

Chicago 10, Ill.

SAY YOU SAW IT IN POPULAR MECHANICS

PROTECT YOURSELF in case you enter a hospital on account of SICKNESS or ACCIDENT

The New Family Mutual Hospitalization Plan gives you protection that is high in value but low in cost—only \$1.00 per month for each adult, 50c per month for each child.



FOR SICKNESS OR ACCIDENT

Hospital Room and Board up to	\$6.00
Operating Room up to	a day for 30 days \$10.00
X-Ray Examinations up to	\$10.00
Laboratory Examinations up to	\$10.00

FOR ACCIDENT

Ambulance up to	\$10.00
Emergency Accident—Dispensary up to	\$6.00
Loss of Limbs, sight, etc., or loss of life up to	\$500.00
Maternity Indemnity up to	\$35.00

The policy provides indemnities for actual expense incurred at the time of hospitalization but will in no case exceed the amounts shown above.

Be protected against hospital bills, in case sickness or accident strikes you, by allowing the Family Mutual Life Insurance Company to aid you in meeting your hospital expenses. You may choose any hospital. Benefits for children are one-half those paid to adults.

DON'T DELAY—MAIL THE COUPON TODAY

FAMILY MUTUAL LIFE INSURANCE CO., WILMINGTON 99, DEL.

Family Mutual Life Insurance Co. Dept. P-1
601 Shipley St., Wilmington 99, Del.
Please send me, without obligation, complete information on your Economical Hospitalization Plan.
NAME _____
ADDRESS _____
CITY _____ STATE _____

Better Sights FOR BETTER "SHOTS"

For faster, more accurate sighting equip with a combination of

MARBLE'S SIGHTS

Flat Top Rear. Price \$2.00

Semi-Buckhorn Rear Price \$2.00

Marble's Flexible Rear Sight, with automatic spring joint. Can be locked down. With 2 discs. Price \$5.50.

At your dealer, or write for Catalog

Marble Arms & Mfg. Co.
578 Delta Ave. Gladstone, Mich. (222)

Sheard "Gold" Front Sight \$1.75

Standard Front Sight \$1.25

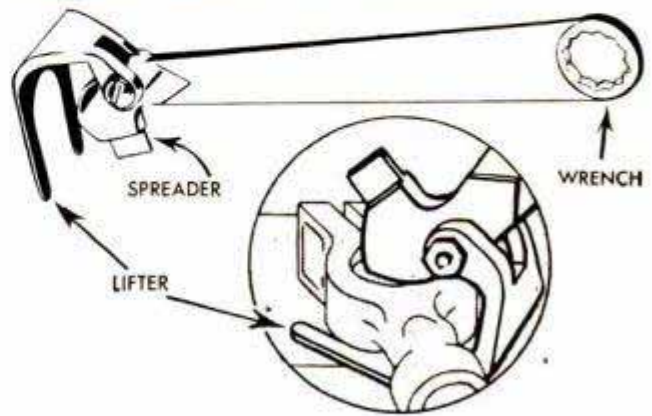
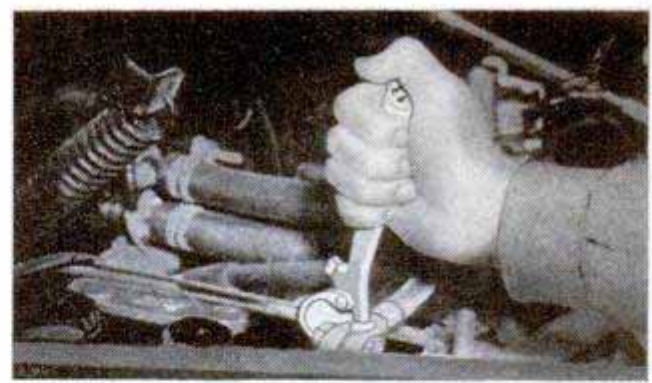

Battery-Cable Tool

Combining three tools in one, a battery tool serves as a wrench, terminal spreader and lifter. A box wrench in the end of the handle loosens the nut and a short blade spreads the cable terminal. To remove the cable, a two-pronged lifter is placed under the terminal and upward pressure on the handle pries it loose.

100-Below-Zero Battery Developed by Signal Corps

Temperatures of 100 degrees below zero have little effect on an electric battery being developed by the Army Signal Corps. Experimental test cells are already functioning at this temperature. The batteries are needed for planes flying in the stratosphere, sometimes at 70 degrees below zero, and for use in artificially cooled research chambers.

50,000-Watt Vacuum Tube

Radiating as much energy as the largest standard broadcasting station in this country, a new vacuum tube produces 50,000 watts at the extremely high frequency of one billion cycles a second. Called a magnetron, the tube heats up everything near it, including human beings, who develop a fever when standing nearby. The intense radiations have heated eggs so quickly that they explode with a loud report. Unlike most vacuum tubes, it uses an unheated cathode that emits electrons when bombarded with high-speed electrons.

TELESCOPING MEASURING TOOLS

Highly Precise Beautifully Finished and fully guaranteed the greatest advance in telescoping tool design in 23 years. The straight leads make for ease of inserting the tool with the hole or slot being measured and very definitely add to accuracy in making angle measurements.

Micrometer Accuracy
Inside Measurements
5/16 inch to 6 inches

\$5.95

C.O.D. Plus Postage
In case \$1.50 extra

Completely finished parts. Save \$10. Assembled quickly. No tools needed.

THE HUNDREDS ON ALL FOUR TOOLS ARE HARDENED AND POLISHED GROUND TO VERY CLOSE LIMITS

Tool 23 measures approximately 900 to 2300 inches

Tool 24 measures approximately 2300 to 6 inches

Tool 22 measures approximately 400 to 900

Tool 21 measures approximately 300 to 400

ALCO SHOP • 2845 So. Delta • San Gabriel, Calif.

Your weight does the work with a "YANKEE" QUICK-RETURN SPIRAL SCREW DRIVER

● Save your wrist: drive and draw screws faster. Just push on a "Yankee" 130A Spiral Driver. Your weight and the spiral turns the screw without blisters or fatigue. Quick-return spring in handle holds blade in slot and returns the handle after every stroke.

★ Write for the "YANKEE" Tool Book .. FREE ..

"YANKEE" TOOLS NOW PART OF **STANLEY** THE TOOL BOX OF THE WORLD

NORTH BROS. MFG. CO.
Philadelphia 33, Pa.



FOR MOPPING
FOR WAXING
FOR CLEANING RUGS

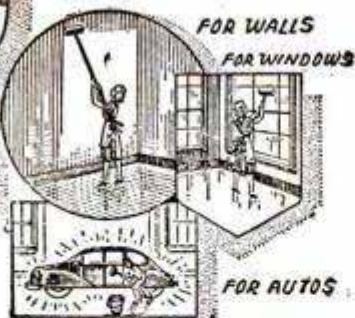

FOR WALLS
FOR WINDOWS



FOR AUTOS

Hands Never Touch the Water—Can be put in Boiling Water. Housewives Like It.

Housewives Are Enthusiastic

Everyone that sees this outstanding Cell-U-Mop immediately wants one. That's the reason our distributors are so successful.

48" Long Handle

48" Long Handle

**FINE TOOLS
NEED
FINE OIL!**



• Lubricates



• Prevents Rust

• Cleans • Polishes

SOLD EVERYWHERE

3-IN-ONE Oil

... Quick Easy Way to BIG PROFITS

Read What Others Are DOING!

"Enclosed you will find 56 orders representing 9 1/2 hours' work on Monday and Tuesday."

"Enclosed are twelve orders secured after supper this p.m."

Sales QUICK, EASY EVERYWHERE

SALES ARE EVERYWHERE . . . Sells quick to Taverns, Clubs, Hotels, Hospitals, Stores, Restaurants, Large and Small Buildings and the Homes . . . Scores can be sold on a single street . . . Note the Drain Bracket in the illustration . . . This squeezes out the water so thoroughly that HANDS NEVER TOUCH THE WATER . . . Makes no difference what you ever sold, you will like this proposition . . . Your name on a Post Card will bring you FREE PARTICULARS.

We Teach You How!

Gets down under and around for MOPPING, DUSTING or WASHING . . .

DOES THE WORK OF 6 TOOLS IN 1
HOLDS 20 TIMES ITS WEIGHT IN WATER



Get Choice Territory NOW!

CELL-U-MOP CO., Dept. P-10, FREEPORT, ILL.

SAVE with WAR SURPLUS

All-Rubber or Rubberized
OVERSHOES

- All Rubber or Rubberized
- Heavy Duty
- 4-Buckle
- All Sizes
- Worth \$5 a pair if new

• Used—but in perfect condition

1.98 PR.



MAIL CHECK MONEY ORDERS OR C.O.D.'S TO

MONEY-BACK GUARANTEE!

WORLD WAR SURPLUS STORES

841 S. BLUE ISLAND AVE. Dept. P.M.
CHICAGO 7, ILL.

Add 25c per item for Postage and Handling.

Illinois Residents add 2% Tax. Send for Free Catalog.

PLASTIC KITS IDEAL TRAINING

For hobbyists. Complete instructions, templates and Lucite to make ten beautiful useful gifts, picture frames, candle holders, dishes, etc. All for \$2.00 prepaid.

PLASTIKITS, Lawrence, Michigan

SAY YOU SAW IT IN POPULAR MECHANICS



The New Improved All-Purpose

DYNAMIC Super Charged ARC WELDER

Industrial Transformer Type

IT WELDS • IT BRAZES • IT SOLDERS

IDEAL FOR AUTO—HOME APPLIANCE AND FARM REPAIRS. This portable, industrial transformer type welder easily carried right to the job can be operated from any convenient properly wired 110 Volt 60 Cycle Line. Can also be supplied for 220 volt 60 cycle operation and other voltages and cycles at slight additional cost.

EASY-TO-OPERATE. If inexperienced you can easily learn to do a variety of high grade welding jobs by following the practical, simplified Welding and Operating Instructions furnished. Once you see the DYNAMIC WELDER in operation you won't want to be without it. Its simplicity will amaze you. In a year the DYNAMIC only costs you about 7c a day. Comes complete ready to operate with helmet, rods, cables, holder, operating and welding instructions, etc.

SAVES YOU VALUABLE TIME AND MONEY!

DESIGNED TO DO HIGH GRADE WELDING inexpensively—Maintenance Men, Farmers, Mechanics, Machine Shops, Foundries, Auto, General Repair and Job Welding Shops, all using the DYNAMIC find it so indispensable and useful that they can not afford to be without it. Works on Iron, Steel, Brass, Bronze and Other Metals. Has 8 metallic and carbon arc heat stages. Does work you would think only possible with a larger, more expensive machine.

DYNAMIC WELDER CO., 15 East 23rd Street, P, CHICAGO 16, ILL.

ONLY
\$28.50
COMPLETE

DO YOUR OWN WELDING

Just a few repair jobs will pay for this machine. A practical and profitable machine tool for any workshop. Make money doing repair work for others.

Write for Particulars Get Details on our 10 day Trial Offer Member Chicago Association of Commerce.

SPECIAL GIFT OFFER! ARC TORCH WORTH \$6.80 YOURS at NO EXTRA COST!

Twin Carbon Electric Arc Torch worth \$6.80 with every DYNAMIC WELDER. Act now to get this valuable premium at the single low price of welder alone.



— Mail Coupon FOR FREE FACTS —
10-DAY TRIAL OFFER

Dynamic Welder Co., 15 E. 23rd St., P. Chicago 16
Send me FREE details of your ELECTRIC Arc Torch Gift Offer and Dynamic Welder 10-Day TRIAL OFFER.

NAME _____
ADDRESS _____
CITY _____ ZONE _____ STATE _____

GROBAN'S SURPLUS BARGAINS!

WESTINGHOUSE AIR COMPRESSOR

BRAND NEW

War Surplus Bargain

2-Cylinder Piston Type

Ideal for:

- Paint Spraying
- Industrial Uses
- Tire Inflating
- Spraying Insecticide
- Operating Air Tools

For the:

HOME... FARM... FACTORY

Designed for automotive truck or tractor mounting. Can be run off fan belt or power takeoff. Comes with automatic clutch. Can be installed for use on: farm trucks, jeeps, tractors, tire or garage service trucks, contractor or road building machinery, pneumatic devices, etc.

Can be operated with 1/2 H.P. or more electric motor or equivalent portable gas engine.

Light weight, compact and versatile unit... delivers "oil free air"... simple in operation; requires minimum of maintenance; operates under all climatic conditions; suggested operating pressure 75 P.S.I.; equally efficient operation in either direction of rotation; approx. displacement 3.27 CFM at 600 RPM, 6.54 CFM displacement at 1200 RPM. Has 2 inch bore—1 1/2 inch stroke. Overall dimensions: width 9", height 11 7/8", depth 6 5/8"; approx. wt. 23 lbs.

A REAL BUY...
worth many times
this price

\$26.95

Send check or money order today.
SATISFACTION GUARANTEED.

F.O.B.
CHICAGO

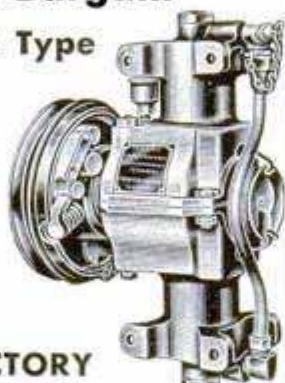

Self-Priming ELECTRIC PUMP Compact — BRAND NEW



APPLICATIONS: oil burners, aquariums, fluid metering, fuel pump, tool post grinder, coolant pump, pressure lubricating pump, general industrial, etc.

MOTOR MFD. BY BLACK & DECKER; double ball bearing series wound, continuous duty, 1/30 H.P. electric motor, rated 12,000 R.P.M. Transformer included for use on 110 VAC current. Also applicable for 24-32 VDC.

PUMP MFD. by WELDON TOOL CO. with standard 1/4" tubing ports; rated 2 G.P.H.; remove pump and use motor as high speed grinder.

OVERALL DIMENSIONS: 7 3/4" long x 3 1/4" high. Approx. wt. 5 lbs. \$51.00 value...

\$12.95

postpaid

THREE-IN-ONE MULTI-PURPOSE PUMP

Three independent pump sections running off of one shaft, for single or multiple pumping. Use one as a vacuum pump capable of drawing 25 inches of mercury. Use one or two as a liquid pump for hydraulics, insecticide spraying, pond and basement draining, stock watering, aeration, etc.

Supplied with 4" V belt pulley. Inlets and outlets 3/8". Easy to use — foot mounting. Constructed of bronze and aluminum to exacting ordinance specifications. Dimensions: 6"x5"x4 3/8". Ship. wt. 10 lbs. Government acquisition cost \$74.00. YOUR PRICE

Satisfaction Guaranteed



\$19.75

F.O.B.
Chicago

GROBAN SUPPLY CO.

DEPT. PM10, 1507 S. MICHIGAN AVE., CHICAGO 5, ILLINOIS

Polio Study Reveals Location Of Two Vital Brain Centers

Two tiny bits of tissue, each no bigger than a grape seed, are the vital centers of the brain that control breathing and blood circulation. Really twins, the two centers work together and provide the body with a spare should one of them be damaged or destroyed by injury or disease. Their exact location in the medulla, which connects the spinal cord with the brain, was discovered by doctors during a Minnesota infantile-paralysis epidemic.

Downspout Shield Is Self-Cleaning

Leaves can't clog the downspout and cause the eave trough to overflow when a self-cleaning shield is installed. The shield, made of aluminum, has long tinelike fingers that prevent leaves from entering the spout. The water washes the leaves up on

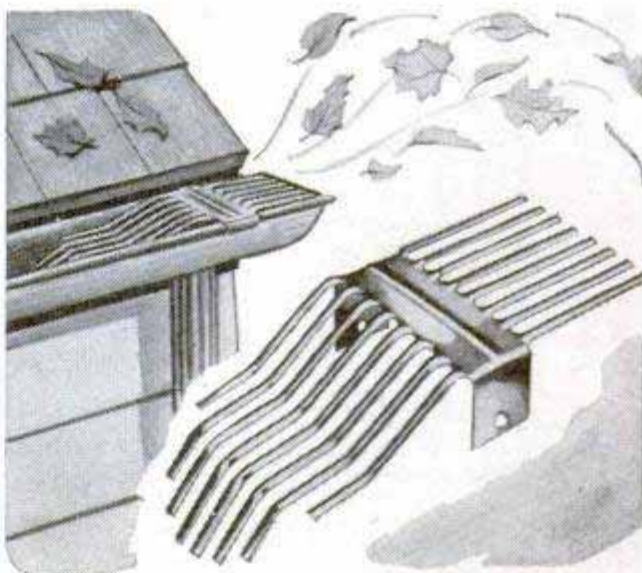

the shield permitting fine dirt to pass through. After the rain, the leaves dry out and are blown away by the wind. No screws are needed to attach the shield. It is merely snapped over the edge of the trough. For center and corner downspouts, two shields are used.

Fish to Be Frozen at Sea in Tests

Fish may soon be frozen at sea immediately after they are caught if equipment tests being made by the Fish and Wildlife Service prove satisfactory. This will enable boats to remain at sea for longer periods and also will save valuable by-products now lost when fish are processed on the boat. The fish will be brought ashore and defrosted at regular processing plants. After the fillets have been cut, they will be frozen and packed for distribution.

GROBAN'S SURPLUS BARGAINS!

Self-Priming BRONZE PUMP

Brand New

Positive Displacement

Gerotor Type

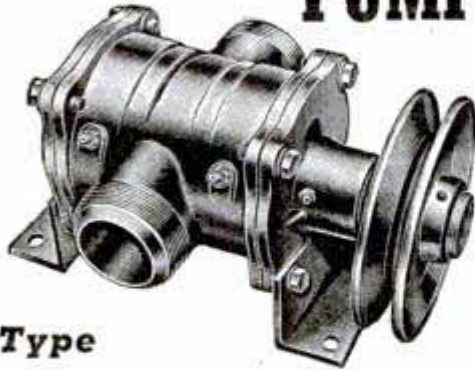

Perfect for draining basements, irrigation, fire fighting, sprinkling, pressure booster, insecticide and other spraying, fuel transfer, stock watering, industrial pumping, deep well jet pumping and home water systems. Rated 25 ft. suction and 100 ft. head pressure at 65 gallons a minute with 1725 RPM at one H.P.

Complete engineering report and instructions **FREE** with pump

Supplied with mounting brackets and 6" V belt pulley, ready for instant use. Standard 1 1/2" inlet and outlet pipe thread. Dimensions: 9 1/2" x 7 1/4" x 4 1/4". Ship. wt. 18 lbs. A \$142.00 value. . . .

\$32.50

F.O.B. Chicago

ALL-PURPOSE WATER PUMP

Brand New

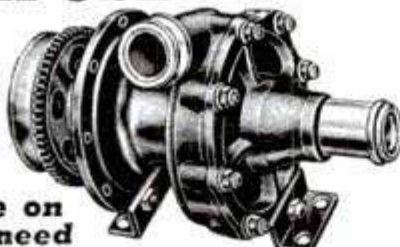

Ready for use on any pumping need

Use it for: DRAINING BASEMENTS

HOME WATER SYSTEMS

FIRE PROTECTION

PRESSURE BOOSTER

IRRIGATION

DRAINING PONDS, TANKS, etc.

SPRINKLING SYSTEMS

STOCK WATERING

INDUSTRIAL PUMPING

Complete with pulley and mounting brackets, ready for use.

Belt Driven — Centrifugal Pump

An extraordinary value for all types of intermittent or continuous pumping in the home . . . farm . . . factory. Built to exact specifications of Packard Motor Car Co. for use in Rolls-Royce Merlin Aircraft Engines. May be run with electric motor, gas engine or power take-off on tractor. Delivers up to 25 gallons a minute with 1/4 H.P. motor; 80 gal. a min. with one H.P. motor. Will deliver up to 44 ft. head or 25 ft. suction. Use 1" outlet hose; 1" or 1 1/2" inlet hose (recommended).

COMPLETE ENGINEERING REPORTS AND OPERATING INSTRUCTIONS FREE WITH PUMP

Has cast aluminum housing, accurately machined 5" bronze impeller; 3 1/2" V belt pulley and mounting brackets. Shaft rotates on ball bearing; has grease gun fitting.

Original cost approx. \$88.00. Shipping weight 10 lbs. A REAL BUY. Mail orders filled promptly. **\$21.50** SATISFACTION GUARANTEED F.O.B. Chicago

BRAND NEW

AIR OR OIL HYDRAULICS



Use hydraulics on arbor presses, hydraulic presses, hay lifts, manure loaders, lift trucks — push or pull, tilt or turn, press or squeeze, open or close, lift or lower — and other hydraulic and industrial applications. Use with either air or oil . . . of finest precision workmanship.

1. Double action, 1 1/2" bore, 5" stroke, will lift 1760 lbs. in one second with Vickers MF6 Pump. Wt. 3 lbs. A \$35.00 value. **\$8.95** postpaid
2. Double action, 1 1/2" bore, 9" stroke, will lift 1760 lbs. in one second with Vickers MF6 Pump. Wt. 4 lbs. A \$45.00 value. **\$10.95** postpaid
3. Use these cylinders on farm trucks, bulldozers, hay lifts, manure loaders, etc. Double action, 1 1/2" bore, 27" stroke. (Will lift 1760 lbs. in 2 seconds with Vickers Pump.) Wt. 8 lbs. A \$55.00 value for only **\$12.95** postpaid
4. Double action, 2 3/8" bore, 8" stroke. (Will lift 4400 lbs. in one second with Vickers Pump). Will withstand 1500 P.S.I. against wall. Wt. 7 lbs. A \$65.00 value. **\$14.50** postpaid
5. Double action, 3" bore, 12" stroke. All steel hydraulic cylinder, will lift up to 12,000 lbs. (7000 lbs. in 3 seconds with Vickers Pump.) Complete with fittings. Wt. 12 lbs. A \$78.00 value. **\$19.50** postpaid
6. Double action, 3 1/2" bore, 11" stroke. (Will lift 9600 lbs. in 7 seconds using Vickers MF6 Pump.) Complete with fittings. Wt. 15 lbs. A \$92.00 value **\$22.50** postpaid

Hydraulic Control Valves

Brand New



Outlets are standard 1/4" pipe thread and inlet takes standard 1/4" copper tubing fitting.

1. Four-way control valve for use with double action hydraulic cylinder, may be used with 1500 P.S.I. hydraulic system to open and close hydraulic cylinders. Brand new. Ship. wt. 4 lbs. A \$38.00 value. **\$7.95** postpaid
2. Four-way control valve for use with two hydraulic double action cylinders. Each cylinder may be operated independently of the other or in conjunction with the other. Oil may be locked in any of the cylinders to hold the piston at any required position. Brand New. Ship. Wt. 6 lbs. A \$60.00 Value. **\$10.95** postpaid
3. Same as valve item 2, except that unit is designed for three double action cylinders. Brand New. Ship. Wt. 8 lbs. A \$72.00 value. **\$12.95** postpaid
4. A two cylinder double action valve with a unique arrangement, to lower them simultaneously or to raise one and lower the other at any predetermined rate and speed. Brand New. Ship. Wt. 8 lbs. A \$75.00 value. **\$14.95** postpaid

VICKERS MF6 HYDRAULIC PUMP OR MOTOR



Compact, powerful, rated 1,000 P.S.I., .507 cu. in. per revolution, 8 gal. per min. at 3750 r.p.m. Change rotation by reversing flow. Delivers up to 6 H.P. BRAND NEW, Wt. 4 1/2 lbs., \$60.00 value for **\$14.95** Postpaid

Brand New CHECK and RELIEF VALVE. **\$2.95** post-adjustable for any pressure. paid

VICKERS HEAVY DUTY HYDRAULIC PUMP BRAND NEW



For tractors, bull-dozers, construction machinery, lift trucks, industrial applications, etc. Used on Ross carriers. Delivers 18 gal. per minute at 1000 P.S.I. at 1200 R.P.M. using 10 H.P. Has 1 1/2" intake; 1 1/4" outlet; threaded and keyed 3/4" shaft for direct or pulley drive. Wt. 40 lbs. Dimensions: 5 3/4" diameter, 7 1/2" high. Original value \$148.00. NOW **\$39.50** F.O.B. Chicago

GROBAN SUPPLY CO. DEPT. PM10, 1507 S. MICHIGAN AVE., CHICAGO 5, ILL.

Any Drill Press Gives 15 ESSENTIAL OPERATIONS With BARRON Workshop TOOLS

● You can plane woods and plastics, rabbet, tenon, panel, groove, bead, contour, rout, mortise, surface sand, drum sand, cut moldings, shape, dovetail, grind and drill with Barron's time-tested and proved precision workshop tools. They save time, money, broaden your workshop technique. A full line of drill press spindle adapters and 1/2" Dovetail cutter also available. All tools sold on 10 day money back guarantee.



**ROTARY WOOD
PLANER**

3" dia. safety planer fits any drill press. Over 100,000 now in use.
\$7.50 Complete



**2 1/2 x 3" DRUM
SANDER**

A "must" for sanding contours and straight edges. Also available in 1" dia. at **\$2.10**
\$3.95 With 5 Sleeves



**ROTARY SURFACE
SANDER**

4" dia. aluminum housing and heavy rubber pad. A perfect finishing sander.
\$5.95 With 20 Discs



**AUXILIARY
DRILL PRESS TABLE**

Fits any drill press. Has 234 sq. inch working surface for holding work pieces flat and true. Equipped with adjustable steel fence.
\$9.85 F.O.B. Detroit



**ALL-METAL
SHAPER FENCE**

Ideal for shaping and molding operations, other uses. All metal, nothing to warp. A real buy at
\$7.95 F.O.B. Detroit



**ROUTER & ROUND END
MORTISING BITS**

New type hi-speed steel spiral flute bits. Available in individual sizes or sets of 6 attractively packaged from 1/8" to 1/2" at **\$9.50**



**WRITE
FOR
FREE
WORKSHOP
GUIDE**



**SAFETY SHAPER &
MOLDING CUTTER**

New, patented design eliminates set screw. More versatile than any other similar design on market. **\$9.00** with 3 Sets Standard Blades

See Your Dealer . . . Or Write Direct

BARRON TOOL CO., INC.
569 Architects Bldg., Detroit 1, Mich.

BARRON PRECISION WORK SHOP TOOLS

SAY YOU SAW IT IN POPULAR MECHANICS

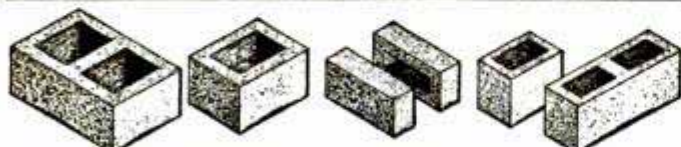

Make Concrete Blocks and Bricks

New superior method makes square, true, easy-to-lay units which will pass any building code. Small investment, high production, big profits. One \$30.00 machine will make four 5"x8"x12" blocks per minute—1000 per day. Pays for itself in a few days. Sell blocks or save 25 building cost by making and laying your own.

POST CARD BRINGS FREE FOLDER

Economy Manufacturing Company
Dept. P Stone Mountain, Georgia

PIPE SMOKERS' DELIGHT

Enjoy the relaxing luxury of a fine pipe imported from Czechoslovakia. Both pipes are bowl capped and stems horn bit, bruyere bowls with moisture traps. Stem of long pipe is made of genuine cherry. We also have the long pipe in metal-lined bowl at \$4.25. State which you prefer.

Direct from
Czechoslovakia

\$3.95



\$2.95

ORDER TODAY!

Send cash, check or money order for full amount and we prepay postage. C.O.D.'s—postage extra on C.O.D. orders.

MACH CO., Dept. 001

CZECHOSLOVAK IMPORTERS
2553 S. RIDGEWAY AVE. CHICAGO, ILLINOIS

CUBIC-INCHER RADIO SET \$2.39

SIGNAL-POWERED
NO ELECTRICITY



Entire set less than one cubic inch in size, rests in bowl of teaspoon! Radar 1N34 detector, world's best for crystal sets. Works anywhere—never wears out—needs nothing to operate. Safe and foolproof. Reception is guaranteed. With connecting leads and complete directions. **\$2.39** postpaid without phone. **\$3.19** postpaid with phone. Foreign orders 10% extra, prepaid only.

CARING PRODUCTS Dept. M-5, Box 1308
Chicago 90, Ill.

E-Z THREAD QUICK CHANGE GEAR BOX

To fit SOUTH BEND 9" and 13", POWER-KRAFT, LOGAN 9" and 10", CLAUSING and SHELDON Lathes. Aluminum alloy casting, Torrington needle bearings and steel cut gears. Will cut 78 threads. Easily installed.

Price — **\$69.50 F.O.B.**

MONGE MACHINE SHOP
NORTH CHICAGO, ILL.



**MACK'S GAS TORCH
AND SOLDERING IRON**
4,000 B.T.U. attaches to any gas hose; furnished with 2 jets for natural and bottled gas; equipped with adjustment set screw. **\$2.00** Postpaid



Mack's GAS BURNER
Jet Power, Self-Acting (Pat. pending), 24,000 B.T.U., for natural and bottled gas, industrial and home use. **\$2.00** Guaranteed. Postpaid

**Mack's Automatic
Water Heater**
Approx. 20 gal. capacity and larger for home and industry. Easily installed. Amazingly low-priced. **\$32.50** Guaranteed. Del.



Prompt Delivery - Order Now - Factory Service - Send Check or Money Order

McDaniel

MANUFACTURING CO., INC.

1012 1/2 PULMANTON ST. • DALLAS 2, TEX.

GUM GRIPPER Tightens FALSE TEETH or NO COST

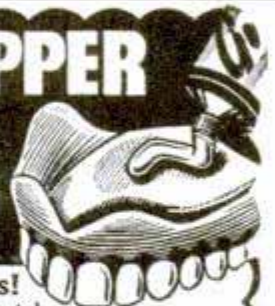

Lasts from 3 to 6 Months!

New discovery makes loose dental plates fit snug and comfortable for months—almost like having your own teeth again. For uppers and lowers.

Easy to Apply at Home . . . Simply squeeze some "GUM GRIPPER" evenly on your denture, put plate in your mouth where it sets and hardens in few minutes. No heat—no fuss—no muss. Will not harm any denture.

SEND NO MONEY . . .

Order a tube today, for only \$1.00 (deposit with your own postman). Each application of "GUM GRIPPER" guaranteed to last from 3 to 6 months and delight you completely or your money will be cheerfully refunded.

GUM GRIPPER, INC.
127 N. Dearborn St., Dept. 71W, Chicago 2, Ill.

SAVE UP TO 85% in WAR SURPLUS... SENSATIONAL VALUES

at "GADGETEER'S HEAVEN" IN MANY ITEMS WE HAVE THE WORLD'S LARGEST SUPPLY

NEW HYDRAULIC CYLINDERS, VALVES, PUMPS, FITTINGS, HOSE & TANKS

51 sizes & types.
World's Largest Supply
1001 Labor Saving Adaptations for pulling, pushing, lifting operations. Finest precision workmanship and materials. Liquid and air operation, developing terrific power.

20,000 Available WRITE FOR CATALOGUE PRICED TO SELL AT 15% GOVT. COST.

PUMPS NEW HYDRAULIC VACUUM AIR

For every purpose at 15% of Value.

PV-1
May be used as air or fuel pump for pressure or vacuum. Will pump 1 1/2 gals. oil at 2000 R. P. M. Builds air pressure 20 lbs. per sq. in. at 1000 R.P.M. Vacuum draws 24 in. of mercury at 1750 R. P. M.

Valve Type **\$9.49**

ROME C FUEL
800 GPH at 30 PSI. can also be used as hydraulic for 4 GPM at 400 PSI or for Vacuum drawing 15 in. mercury at 1500-RPM. **\$6.29 ea.**

NEW PRESSURE TANKS

Stainless steel - Shatter proof. Rustless. 10,000 available in 6 different sizes. 1951 used.

G-1 12 1/2 x 24 inches - 3160 Cu. in. capacity **\$4.75**

D-2 8 1/2 x 24 in. - 500 Cu. in. capacity **\$2.49**

F-1 - 10" x 18" 1000 Cu. in. Capacity **\$3.95**

F-2 8 x 48 in. - 1000 Cu. in. capacity **\$3.95**

A-4 5" x 8" 104 cu. in. Capacity **\$1.35**

Excellent portable tanks for emergency use in car or trailer. Ideal for painting, cooking, spraying, ocean buoy, underwater fishing or diving. #OR-1 Oxygen Resistor with 100 lb. gauge will fit all tanks **\$1.39**

DC GENERATOR NEW

140 AMP
Direct Current Generator, especially suited for adaptation to homemade welding unit. A fast moving item at **\$17.95**

P-1 GENERATOR 200 AMP \$22.50 ea.

K-1 GENERATOR 75 AMPS. \$14.50 ea.

HERE THEY ARE! THOSE TERRIFIC MIX VALUES

GADGET MIX

Especially prepared for the ROBBYIST. Nivets, Spacers, Bolts, Screws, Nuts, Gears, etc. A good mixer. **\$1.19**

BEARING MIX

Ball, Ball & Roller Bearings in excellent assortment. Sizes from 1/2" to 2". One of our "BEST SELLERS". 15 BEARINGS **#175 for ONLY \$2.95**

HINGE MIX

12 pairs of strap and butt hinges. Sizes 1" x 1" to 1 1/2" x 4" in length to 8" deep. **#170H. \$1.09**

ABRASIVE AND GRINDING WHEEL MIX

50 Pieces including bearing stone, pencil rolls, wheels, abrasive wheels, etc. A really sharp value. **#175AG. 99c**

SPRING MIX

Torsion, Compression & Tension Springs, steel, brass. A treasure trove for small mechanics. **#206 89c**

COMBO-MIX

Combination of all above, all in one package deal. At special introductory price **\$5.79**

Gilbarco Gasoline Filter Funnel

12" Dia. x 18" High. Has fine wire screen, cylindrical filter. Glass gauge for checking water accumulation. Drain cock for water removal, shut off valve for control of flow of filtered Gasoline. Complete with 2 hoses 1 1/4" & 3/4" x 10" long hoses.

BE SURE OF YOUR GAS AIRCRAFT, TRUCKS, GARAGE

NEW \$5.95

Stewart-Warner Gasoline New HEATER

AIRCRAFT TYPE. New. 14V. 10 Amp. 40,000 B. T. U. Diameter 8 in. Length 15 in. Stainless steel housing. Complete with Spark plug, gas valve, Thermostatic Control Switch. Adaptable to most cars, Trucks, Home, Boats, etc.

SW-1 A SWELL DEAL for ONLY **\$6.95**

SW#2 HEATER
A smaller Compact Car-like Gasoline fired heater with motor, fan blower, Automatic, Thermostatic Control. Copper element, glow type spark plug. Made by Stewart-Warner, 24V D. C. - Can operate on 3 Volt. Ideal for Auto, Boat, Light Aircraft, etc. A Swell at **\$5.95**

Here's a Real "Lite Special"

Farm, Auto, New U. S. Navy Portable Pistol Grip. Sealed Beam, 12v. Search Spot, Emergency. Light - featherweight Gov. Cost our price **\$35.00**

3 Extra fillers - Red **\$25.00**
Green & Amber **83c Set \$2.95**

NEW FLEXIBLE GOOSENECK LAMP

110 V. A. C. 13 ft. wire with socket, switch and plug. In mounting bracket suitable for home or workshop. Wire alone worth our price of **99c each.**

Vickers Hydric Transmission VT-1

Sell contained, 2 H. P. constant torque at all speeds with variable volume reversible, piston pump (controlled by outside lever) supplying piston hydraulic motor. Automatic pressure, dash pot for smooth control. Power output R. P. M. 10 to 1/2 input R. P. M. in both directions. Input R. P. M. 1800 continuous 4000 intermittent. Dash pot can be removed for greater R. P. M. Ideal for Lathes, Duplicator Setup on Mills, Conveyors, Small Cars, Drives, Gearing, Etc.

COST GOVERNMENT APP. \$400.00
You'll Chortle when you get it for ONLY **\$19.50**

PLASTIC PARALLEL STRAIGHT EDGE

with knobs and rubber pads for non slippage on work surface. A must for navigators, mechanics, draftsmen, engineers... You've never seen 'em at **97c ea.**

WINCH HOIST

now equipped with mounting frame, handle, cable, etc. complete. Thousands of Satisfied Users! Hundreds have written, telling us it's the most wonderful tool in the world!

Capacity 2500 lbs. 20:1 ratio
Bronze Worm Gear
Ideal for Garages, Truck loading, Machine Shops, Boat Builders, etc.

\$100 Value for ONLY \$16.99

Plomb Snap-On Socket Set

NEW 6 SOCKETS
3 1/4", 3 1/2", 3 3/4", 4", 4 1/2", 5" in. extension, pocket, flat-handle.

All in steel case, New. A **\$3.95**

FIRE EXTINGUISHER

Little Lux Col Type. Built to Gov't. spec. wirebound phosphate New York. Fully recharged. 1 1/2" lb. 26" x 4" Trigger control with horn #18 1999- \$35 Value **#601A \$13.25**

2 lb. Col type **#602 \$11.75**

10 lb. Charged with horn Col **#603 \$25.75**

15 lb. Break Disc type New **#604 \$29.75**

15 lb. Wheel Control **#605 \$32.95**

15 lb. Squeeze top, New **#606 \$39.95**

All above Col type, fully charged and with horn. Indispensable for small or large planes, Trucks, Auto, Home, Factory, Etc.

New Electric Motors

#500 new 1/2 H.P. 27 Volt D. C. 24 Volt A. C. This motor can be readily adapted to 110 A. C. by the simple method of rearranging armature brush leads. We furnish free diagram of instructions with each order. A Sensational Value @ **\$5.95**

Converted to 110 A. C. Equipped with plug and 3/4" ft. Heavy Duty Cord **\$8.49 ea.**

1 1/2 H. P., 24 Volt D. C. Motor, Series Wound. New, **#501. \$3.95 ea.**

#502 - 2 H.P., 24 V D.C.M. used, **\$8.95**

COMPRESSOR, 1000 lb. pr. 2 stg. with 1/2 H. P. 27 V. D. C. motor. **\$17.95**

NEW PEXTO PLIERS

4 INCH PAINTERS DUSTER BRUSH Only **59c ea.**

Side cutting beveled head a **\$3.50 Value** Only **\$1.79**

RAWHIDE Mallet
2 1/2 lb. with metal center, insert type, head, 1 1/2" x 4". Used for non marking of metal on plastic surfaces, driving pins, etc. leather replaceable. **\$1.19**

METAL SNIPS Compound action. Hard steel blades. Expansion spring. Locking device. Right Hand and Left Hand **\$2.59**

ELECTRIC SOLDERING IRON

#198 100 Watt **\$3.95**
#198A 200 Watt **\$2.95**

PNEUMATIC AND AIR TOOLS

10,000 in various popular makes, sizes, types. Cleco, Aro, Ingersoll Rand, Chicago, Pneumatic, Buckeye, etc.

RIVET
#180 Goose-neck
#181 Pistol

GUNS
Pistol & Goose-neck Type
101 Base, Chipper, Boring, Hammer, Breaking, cement and auto body work.

Chicago Pneumatic, Cleco, Ingersoll Rand Makes. **E3, E2, 3X, 2X, OY \$55 Value \$8.95**

PNEUMATIC ALLIGATOR SQUEEZER
#186 Squeezor **\$15.95**

AIR DRILLS OR MOTOR SPECIAL
ARO PISTOL **\$15.00**

with 3/4" JCB Chuck Straight

PNEUMATIC ANGLE DRILL
With Terry Adapter ea. **\$12.50**

CHI. PNU. IMPACT WRENCH
Model 337re 3/8" sq. dr. fwd. & revrs. 6 spd. cntrl. **\$17.50**

Send for Catalogue and List of Other Sizes, Types of Pneumatic Tools.

HIGH PRESSURE OXYGEN BOTTLE

New. Will hold up to 3,000 lbs. PSI. with Co2 used as air inflator or fire extinguisher, with oxygen for sick room or deep-water diving, etc. Completely equipped with brass valve, 26" hose, dial gauge, & canvas bag **\$2.29 ea.**

TANK
Capacity 21.7 gallons. Aluminum 4 threaded ports. Filler Capacity, Size 7" x 28" x 28". Ideal for Water or Gas Tank on Auto, Boat, Truck, Tractor, Etc. New, **#126 \$5.29**

PIANO HINGE

Overall Width	Length	Price
1 1/4" (3/4" side)	72" alum.	\$1.00 ea.
2" (1" side)	72" alum.	\$1.19 ea.
1 1/2" (3/4" side)	53" cad. steel	.75 ea.
3/4" (1/4" side)	33" steel	\$1.00 ea.

AIRCRAFT CABLE

Alloyed steel, rust resistant, 3/16" dia. 18 ft. long, with turnbuckle ends. **99c ea.**

On reels in any length

1/16"	3c ft.	5-32	5c ft.
3-32	4c ft.	3-16	6c ft.
1/8"	4 1/2c ft.	9-32	8c ft.

RUBBER GOODS

MEOPRENE SHEET NUMBER

Thickness	Width	Price per sq. yd.
#325 .020"	1/64 36"	.75
#329 .125"	1/8 46"	\$4.75

Item #329 is laminated rubber sheet with cloth center. Flexible but very fine for heavy wear. Rubberized Hosp. or Bed Sheet **\$2.29**
54" x 72". \$10.00 Value Only

PALLEY SUPPLY CO.
THE LARGEST FIRM OF ITS TYPE IN THE WORLD

Order from this Ad. All sales final. All Prices F. O. B. Los Angeles. Pay by M. O. or Check. P. O's. Accepted from D & B firms. 1/3 deposit with C. O. D's. FREE LARGE ILLUSTRATED CATALOG

DEPT. P. M. 108 - 6321 SAN FERNANDO RD. GLENDALE 1, CALIFORNIA

SOUTH BEND 10" Precision Lathes

The 10" Swing, 1" Collet Capacity South Bend Precision Lathe is engineered for the most exacting close-tolerance machine work. The direct belt drive to the carefully balanced spindle assembly provides smooth, vibration-free speeds up to 1357 r.p.m. Slow speeds for heavy cuts on large diameters are driven through back-gears. Full quick change gear equipment makes any of 48 different threads and 48 different feeds instantly available.

The precision, speed, and versatility of this lathe assures an efficient output on toolroom or

manufacturing jobs. The 1 1/8" bore through the head stock spindle makes it especially suited for machining parts from bar or tube stock. A complete line of practical attachments greatly simplifies tooling the lathe for a wide variety of operations.

South Bend Precision Lathes are made with 9", 10", 13", 14 1/2", 16", and 16/24" swings. We also manufacture Turret Lathes with 1/2" and 1" maximum collet capacity, and 14" Precision Drill Presses. Immediate deliveries can be made and a Time Payment Plan is available.

SOUTH BEND LATHE WORKS

BUILDING BETTER TOOLS SINCE 1906

455 E. MADISON ST., SOUTH BEND 22, IND.

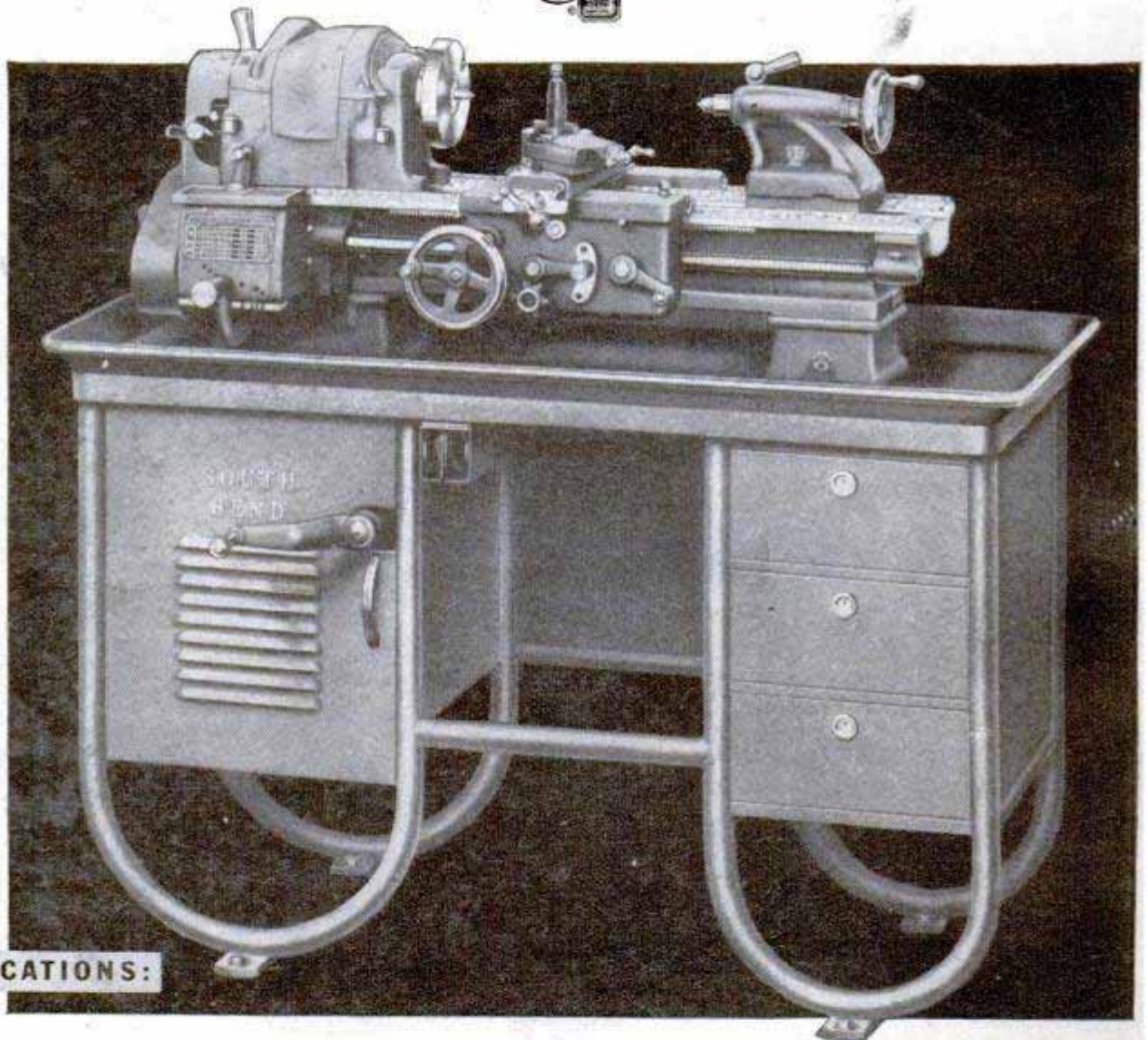

SPECIFICATIONS:

Catalog No. 187-Y5 South Bend 10"-1" Collet capacity Quick Change Gear Bench Lathe illustrated. **\$994³⁵**
 Price—f.o.b. factory with 3 ph., 60 cy., 220 v., A.C. motor; drum switch; and bench

SWINGS: 10 1/8" over bed and saddle wings, 5 3/4" over saddle cross slide.
BED LENGTHS . . . 3, 3 1/2, 4 and 4 1/2 feet
CENTER DISTANCE . . 14 3/4 to 32 3/4 inches
COLLET CAPACITY 1 inch
SPINDLE BORE 1 1/8 inches

12 SPINDLE SPEEDS . . 50 to 1357 r.p.m.
CROSS SLIDE TRAVEL 5 1/4"
COMPOUND REST TOP ANGULAR FEED: 2"
POWER LONGITUDINAL FEEDS: 48 R.H. or L.H.0015" to .0836"
48 POWER CROSS FEEDS: .0006" to .0309"

THREAD CUTTING: 48 R.H. or L.H. pitches 2—224 per inch

PRICE RANGE OF SOUTH BEND 10" PRECISION LATHES
 Quick Change Gear Lathes . \$755 to \$1009
 Toolroom Lathes \$1050 to \$1263
 These prices f.o.b. factory, less electrical equipment . . .

Printed by Popular Mechanics Company, Chicago, Ill., U. S. A.

JOHNNY LUJACK, GREAT ALL-AMERICAN COLLEGE AND PROFESSIONAL FOOTBALL STAR,

says,

"Like Football, Motorcycling is one of America's great national sports. The new Indians make it possible for everyone to enjoy it!"

Come ride these great

new *Indian*

LIGHTWEIGHT
MOTORCYCLES

**SENSATIONAL IN
PERFORMANCE...
YEARS AHEAD IN
DESIGN**

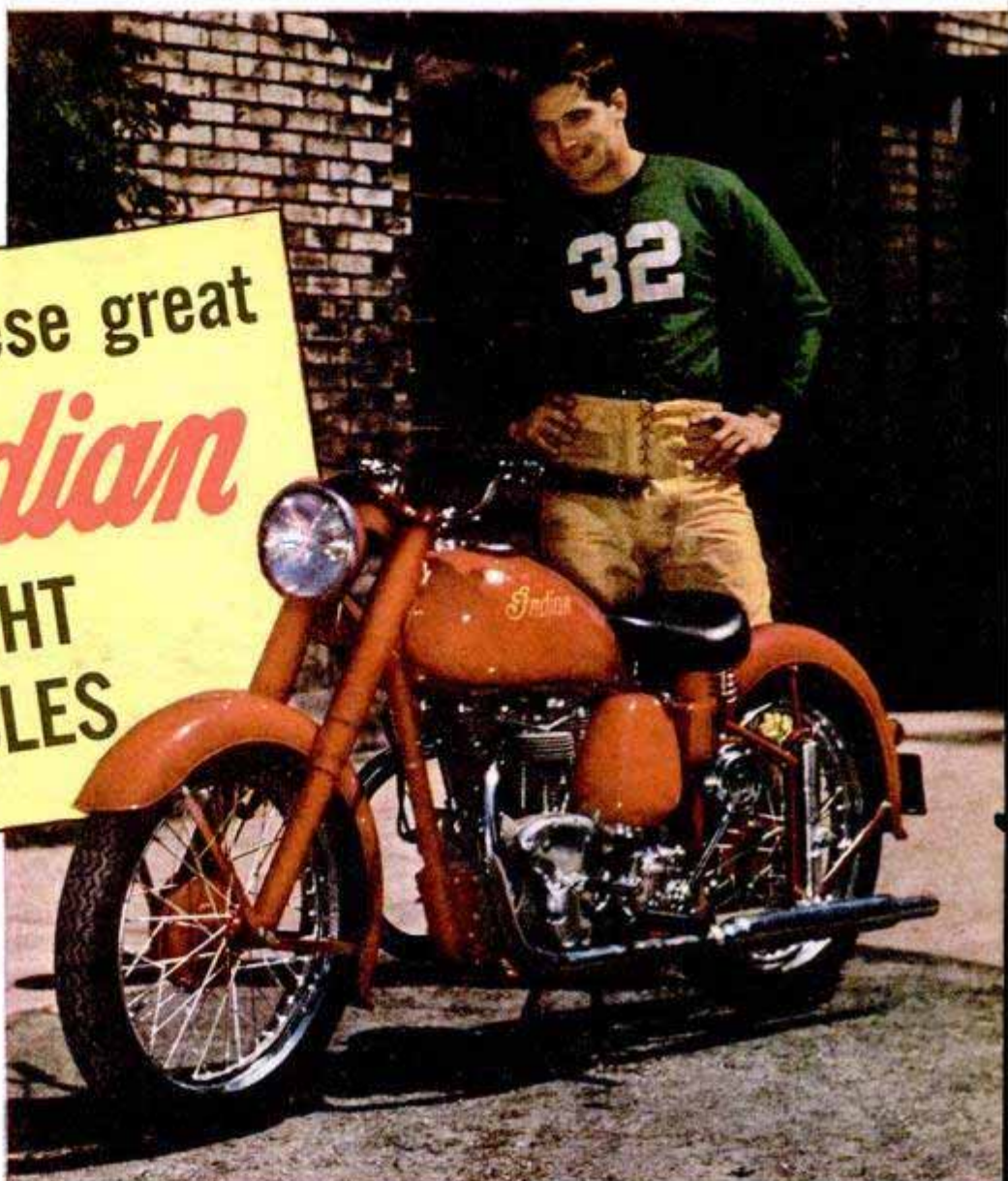

NOW, THOUSANDS WHO NEVER RODE BEFORE CAN ENJOY MOTORCYCLING

Never been on a motorcycle? You can learn to ride these new safety lightweight Indians in a few minutes. And then you'll join hundreds of thousands who make motorcycling their hobby.

Indian now makes it possible for everyone to enjoy this sport by introducing the new lightweight Arrow and Scout, the world's most modern motorcycles.

These machines are completely different from any previous motorcycles. In one step,

Indian has gone years ahead in design, in construction, in styling...using new materials and new methods to produce revolutionary new machines—the safest and easiest to ride ever built. See them at your Indian dealer's and take a trial ride.

Indian WORLD'S MOST MODERN MOTORCYCLES

DEALER INQUIRIES INVITED

Indian Motorcycle Company, Springfield, Mass.

SEND FOR FREE CATALOGUE

Tells all about new Arrow and Scout



Indian Motorcycle Co., Dept. PM108, Springfield, Mass.
Please send me Catalogue containing complete information about your new Indian lightweight models.

- I own a _____ motorcycle
 I do not own a motorcycle
 I am over 16 under 16

Name _____
Address _____
City _____
State _____

When safety's
a must,
it's

PRESTONE
TRADE-MARK

Anti-Freeze



GUARANTEED!

Ask your dealer to show you the guarantee. It's your assurance of all-winter safety.

\$3.50 PER GAL.

"Prestone" anti-freeze is America's Number One brand. Year after year, more motorists depend on it than on all other brands of all-winter anti-freezes combined. There is nothing else like it!

PRESTONE
BRAND

The registered trade-marks "Prestone" and "Eveready" distinguish products of National Carbon Company, Inc.



SAFETY'S A MUST with Fire Chief Ivan Curry, of Osseo, Wisconsin. "In my job a freeze-up can be fatal. It pays to have 'Prestone' anti-freeze—the best anti-freeze you can buy, I find that 'Prestone' anti-freeze also prevents rust!"



SAFETY'S A MUST with Ambulance Driver David Landew, of Muhlenberg Hospital, Plainfield, N. J., who says, "I put one shot of 'Prestone' anti-freeze in my radiator every fall and I *know* I'm safe from freeze-ups all winter long!"



SAFETY'S A MUST with Police Captain Emerson Payne, of Jeffersonville, Indiana, whose car is out in every kind of weather. "No matter how quickly the weather changes, 'Prestone' anti-freeze keeps my car free from freeze-ups."



In your car too!

NO RUST...

NO FOAM...

NO FREEZE...

NO FAILURE...

One shot lasts all winter!

Anti-Freeze

NATIONAL CARBON COMPANY, INC.
30 East 42nd Street, New York 17, N. Y.
Unit of Union Carbide  and Carbon Corporation