

ANC



# POPULAR MECHANICS

## MAGAZINE

WRITTEN SO YOU CAN UNDERSTAND IT

REG. U.S. PAT. OFF.

JET "TAKE-OFF" FROM MUD  
— *Page 102*





**ALAN LADD**

ON HIS NEW INDIAN SCOUT

now starring in

**"BEYOND GLORY"**

A PARAMOUNT PICTURE



# **NEW *Indian* LIGHTWEIGHTS** **REVOLUTIONIZE SPORT OF MOTORCYCLING**

*A new sport is sweeping America—motorcycling!* And Indian is enabling hundreds of thousands to enjoy it by bringing out new lightweight models that anyone, of any age, can ride in comfort and safety. Years ahead in design, incorporating ideas never previously heard of in motorcycles, the new Indian Arrow and Scout are truly revolutionary. If you've never ridden a motorcycle, you don't know what you're missing. See your Indian dealer today and find out!

***Indian*** —WORLD'S MOST MODERN MOTORCYCLES

Dealer Inquiries Invited

Indian Motorcycle Company • Springfield, Mass.

**SAFEST MOTORCYCLES EVER BUILT**  
**LEARN TO RIDE IN ONE EASY LESSON**  
**COSTS LITTLE TO OWN AND OPERATE**  
**SENSATIONAL IN PERFORMANCE**  
**YEARS AHEAD IN DESIGN**

SEND FOR FREE CATALOGUE

Indian Motorcycle Co., Dept. PM98  
Springfield, Mass.

Please send me Catalogue containing complete information about your new Indian lightweight models.

I own a \_\_\_\_\_ motorcycle  
 I do not own a motorcycle  
 I am over 16  under 16

Name \_\_\_\_\_

Address \_\_\_\_\_

City \_\_\_\_\_ State \_\_\_\_\_





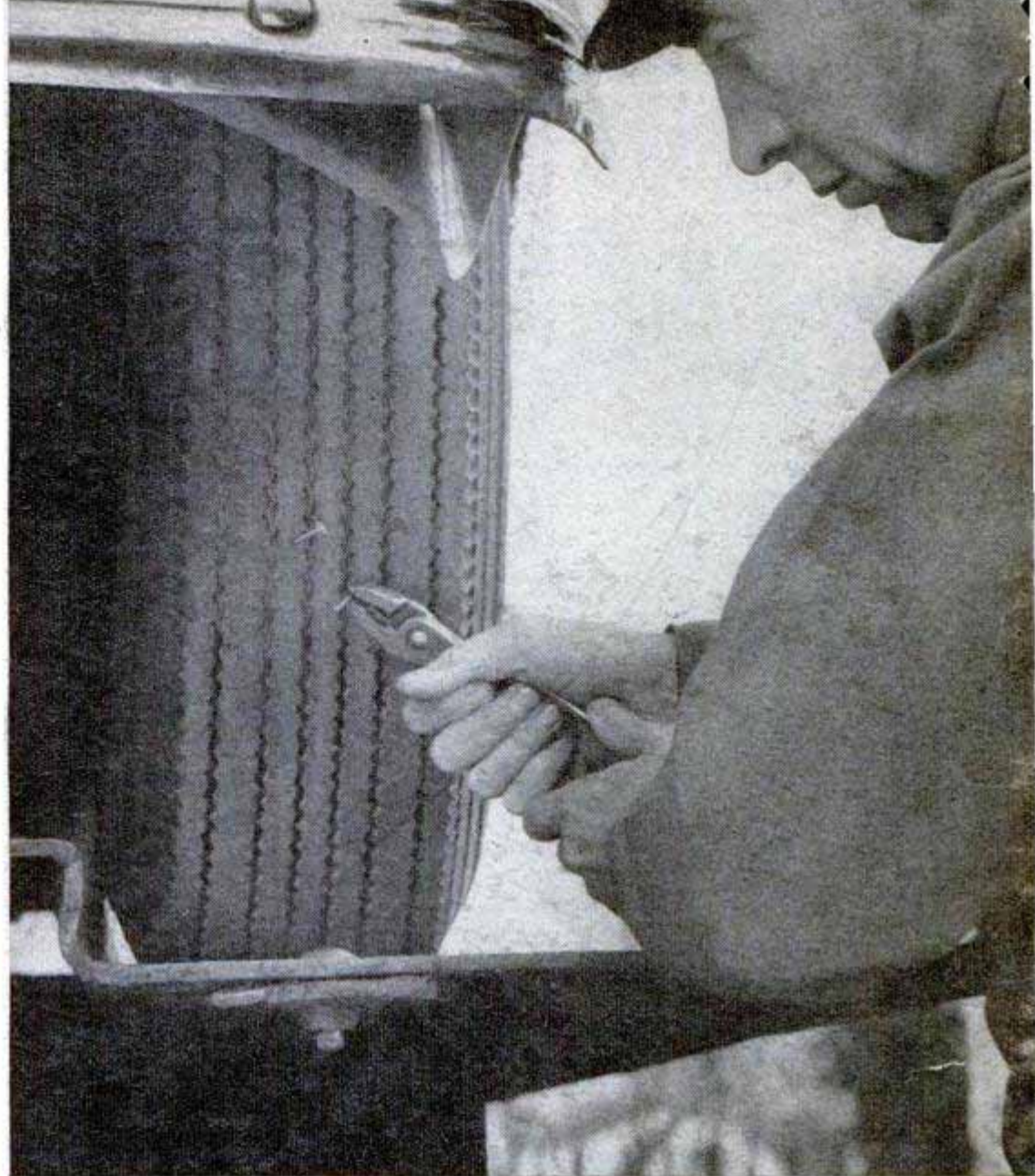
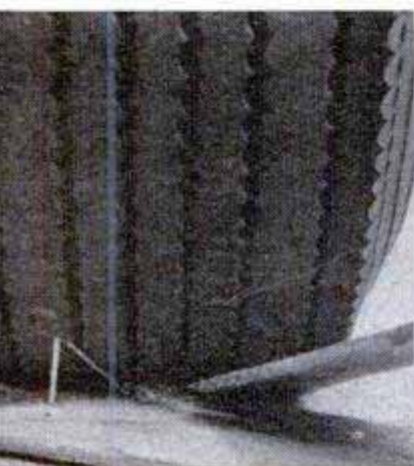
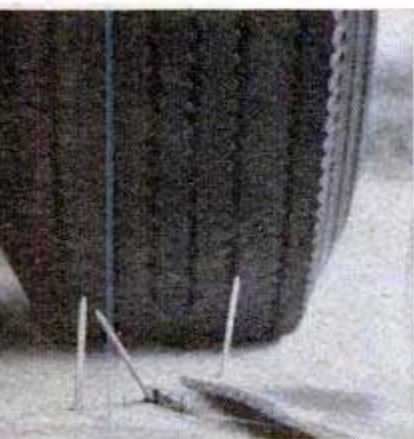

## puncture-sealing B. F. Goodrich tube for the tire that outwears prewar tires

**P**UNCTURE? What of it? Your tire won't go flat if you're riding on B. F. Goodrich Seal-o-matic tubes. When a nail, spike or piece of glass sticks into one of these tubes, you roll right along as though nothing had happened.

Here's how Seal-o-matics work: There's a layer of very soft, sealing rubber inside the tube. The instant anything punctures the tube, this special lining surrounds it, seals the hole, keeps air from escaping. You don't even know you've had a puncture. A week or a month later you can pull out

the nails or other sharp objects your tire has picked up. The self-sealing lining then fills the holes and makes permanent repairs. No patches, no expense, no need to take the tire off the wheel!

Seal-o-matics usually outlast two or more sets of tires. They are made with thicker walls than ordinary tubes. These thicker walls resist chafing and pinching. And because air has less chance to work through the thicker rubber, Seal-o-matics hold air pressure longer—help tires to wear better by keeping them properly inflated.

When you put these tubes into B. F. Goodrich tires, you have the greatest combination on wheels — tubes that give extra safety inside tires that outwear prewar tires. Let your B. F. Goodrich dealer show you how little it costs to equip your tires with a set of Seal-o-matics. *The B. F. Goodrich Company, Akron, Ohio.*





New York Telephone Company men watch as a crossbar dial system reports to its test frames at exchange "Watkins 9," New York.

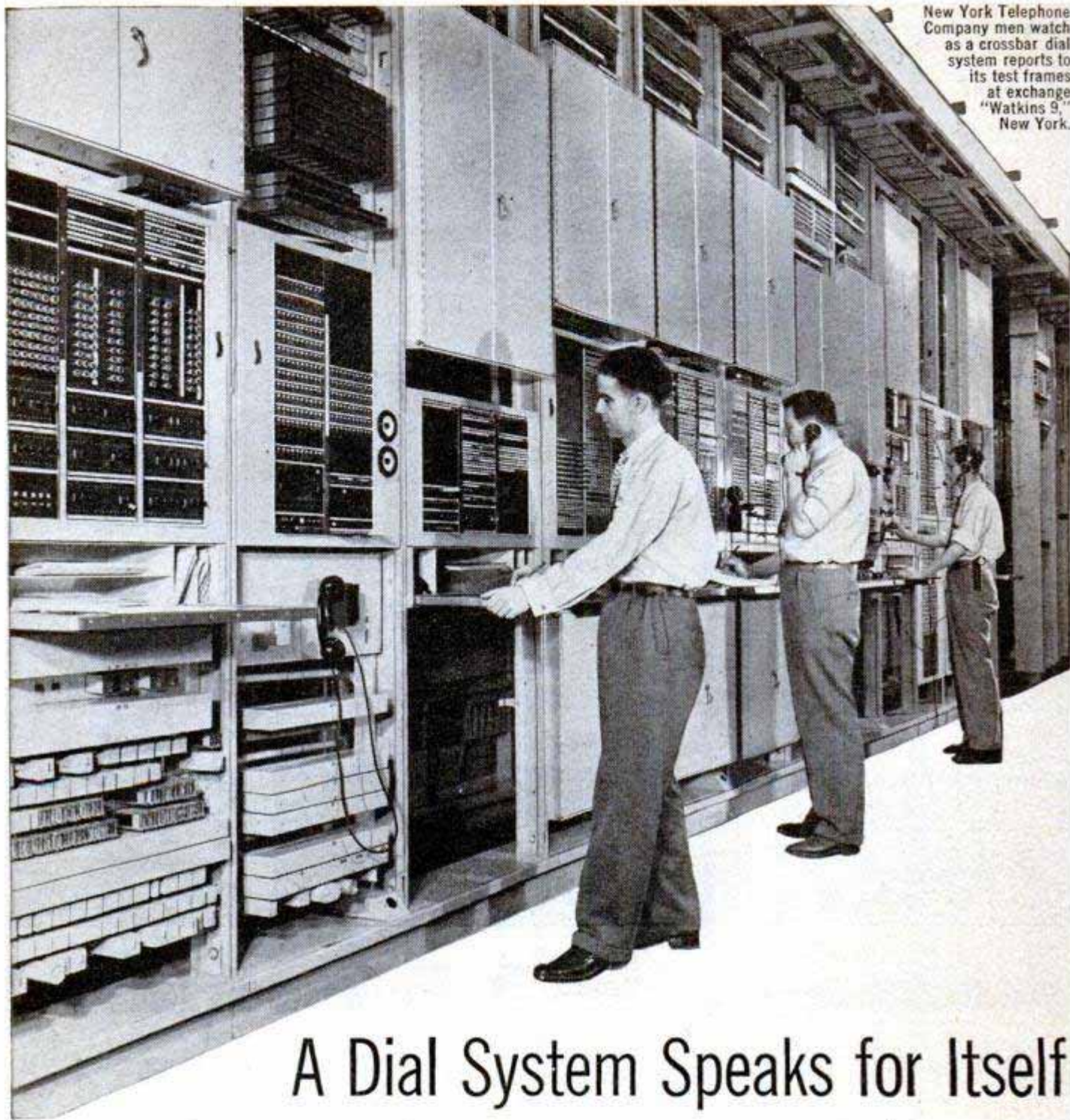

## A Dial System Speaks for Itself

As dial systems have been improved, so also have the means of keeping them at top efficiency. Even before trouble appears, test frames, developed in Bell Telephone Laboratories, are constantly at work sending trial calls along the telephone highways. Flashing lamps report anything that has gone wrong, and the fault is quickly located and cleared.

If trouble prevents one of the highways from completing your call, another is

selected at once so that your call can go through without delay. Then on the test frames lights flash up telling which highway was defective and on what section of that highway the trouble occurred.

Whenever Bell Laboratories designs a new telephone system, plans are made for its maintenance, test equipment is designed, and key personnel trained. Thus foresight keeps your Bell telephone system in apple-pie order.



**BELL TELEPHONE LABORATORIES** EXPLORING AND INVENTING, DEVISING  
AND PERFECTING FOR CONTINUED IMPROVEMENTS AND ECONOMIES IN TELEPHONE SERVICE



# Popular Mechanics Magazine

Registered in U. S. Patent Office and Canada

H. H. WINDSOR, Founder

H. H. WINDSOR, Jr., Editor and Publisher

## Next Month

**NO FISH STORIES** but six pages of tips on catching big ones are in store for anglers in the October issue. PM took Dr. Samuel Eddy, professor of zoology at the University of Minnesota and authority on lake fishing, on a flying fishing trip. Through 20 years of research Doctor Eddy knows what fish eat, where they eat and what time they eat, even to a bedtime snack. In his own words, he tells where to fish and what lures to use.

**CLIMB THE LADDER** to the gun turret and touch off the Navy's loudest voice in another October feature, "How They Fire the Battleship's Big Guns." Cutaway drawings will show the complicated mechanism required to fire the 16-inch naval rifle, which can hurl a one-ton shell 20 miles. Another story will tell how a little slug of steel has revolutionized precise measurement, and how gauges are used as guides to perfection. All anyone needs is curious hands and a chunk of clay to "Sculpture for Fun," another October yarn.

**CHRISTMAS** in October? No, but it's time to think about Christmas gifts again, and Santa has suggested that our Craftsman section present a bigger and better story on making toys—a whole month earlier than usual. Pipe smokers, who always seem to have a favorite pipe that's ready for the hospital, will find an October Craftsman article dealing with the repair and refinishing of pipes. The practical shop story for the month describes approved methods of cementing plastics that can be used in any home workshop.

**RADIO** experimenters will find a simple loudspeaker phone system that also serves as an electronic "nurse," in the October Radio and Electronics section.

Volume 90

SEPTEMBER 1948

Number 3

Managing Editor.....	Roderick M. Grant
Assistant Managing Editor.....	Wayne Whittaker
Shop Notes and Crafts Editor.....	James R. Ward
Radio and Electronics Editor.....	Frank L. Brittin
Aviation Editor.....	Aubrey O. Cookman, Jr.
Associate Editor.....	Clifford B. Hicks
Eastern Editor.....	Bill Reiche
Western Editor.....	Thomas E. Stimson, Jr.
Art Director.....	Frank Beatty

### Assistant Editors

Donald R. Brooks

Arthur R. Railton

### Assistant Editors, Shop Notes and Crafts

W. Clyde Lamme Wayne C. Lecky Frank N. Stephany A. E. Youngquist

## In This Issue

<b>Mass Attack on Heart Disease</b> - - -	<b>81</b>
<b>Britain's Biggest Flying Boat</b> - - -	<b>88</b>
<b>Portable Bowl for the Midgets</b> - - -	<b>92</b>
<b>Jets Look for Jobs</b> - - - - -	<b>102</b>
<b>Slag Used to be Useless</b> - - - - -	<b>114</b>
<b>They Rebuilt a Farm in a Day</b> - - -	<b>120</b>
<b>Inventions Screened Here</b> - - -	<b>129</b>
<b>Goodby, Lighthouse Keeper!</b> - - -	<b>136</b>
<b>"Cold Rubber" for Your Tires</b> - - -	<b>146</b>
<b>Spying on Mars by Invisible Light</b> -	<b>151</b>
<b>Week-End Cavemen</b> - - - - -	<b>162</b>

## For the Craftsman

<b>Distinctive Flower Vase</b> - - - - -	<b>170</b>
<b>Ceramics</b> - - - - -	<b>181</b>
<b>Pick the Right Model Engine</b> - - -	<b>194</b>
<b>Staging Publicity Shots</b> - - - - -	<b>200</b>
<b>Build Your Own Arc Welder</b> - - -	<b>205</b>
<b>Steps in Stair Building</b> - - - - -	<b>212</b>
<b>Servicing Wheel Bearings</b> - - - - -	<b>218</b>
<b>Radio and Electronics</b> - - - - -	<b>221</b>
<b>Clinic for Homemakers</b> - - - - -	<b>232</b>

## Table of Contents continued on page 8

Published monthly by POPULAR MECHANICS COMPANY, 200 East Ontario Street, Chicago 11, Ill. H. H. Windsor, Jr., president; Paul H. Dunakin, vice president and general manager; D. F. Windsor, vice president and secretary-treasurer; William Harrison Pettridge, vice president and assistant to the publisher; Clover L. Perkins, advertising manager; Alan M. Deyoe, circulation manager. Single copy in the United States and Canada, 25 cents; subscription rates in United States and possessions, Canada, Philippines and countries of the Pan-American Postal Union, 1 year, \$2.50; 2 years, \$4.50; 3 years, \$6.00. To all other countries add \$1.00 a year over United States prices for overseas postage. If you plan to move, notify us at least 30 days in advance so you will not miss an issue. Give both old and new addresses. Entered as Second Class Matter, September 15, 1903, at the Post Office at Chicago, Illinois, under Act of March 3, 1879. Entered as Second Class Matter at Post Office Dept., Canada. Copyright 1948 by Popular Mechanics Company. Copyright under international Copyright Union. Copyright in France. All rights reserved under Pan-American Copyright Union. Printed in the United States of America.





## IN AN F-80 BUILT FOR TWO

**T**HIS is the TF-80C. Like its fighter counterpart, the F-80, it is fast, sleek, jet-propelled. But there is one important difference. *The TF-80C is a two-seater!* It's a trainer-fighter (TF) — the Air Force's first "jet" fully equipped for both instructor and student.

The new "Shooting Star" trainer will help speed jet training for Aviation Cadets. Instead of the usual "build up" in propeller-driven fighters, the student will be able to begin jet training as soon as he completes basic training. It means a safer, more interesting training program.

The TF-80C is powered by the same engine and has the same general features as the standard F-80B. The fuselage, however, is three

feet longer and contains two completely instrumented cockpits. The instructor sits in the front seat, may switch off the dual controls in the student's cockpit at any time.

Young men who choose careers in the U. S. Air Force share in the training advantages of projects such as this. You'll have a chance to learn more of these benefits on Air Force Day — September 18.

Attend the Air Force Day events in your community or at your nearest Air Force Base. It will be a good opportunity to find out about the Aviation Cadets. Learn how you can qualify and make an appointment to take your examinations for pilot training.

**U. S. Army and U. S. Air Force Recruiting Service**



**AIR FORCE DAY IS  
SEPTEMBER 18, 1948**





**"THERE YOU ARE MA'AM...YOU'LL GET  
BIG FUEL SAVINGS  
AND REAL COMFORT THIS WINTER!"**

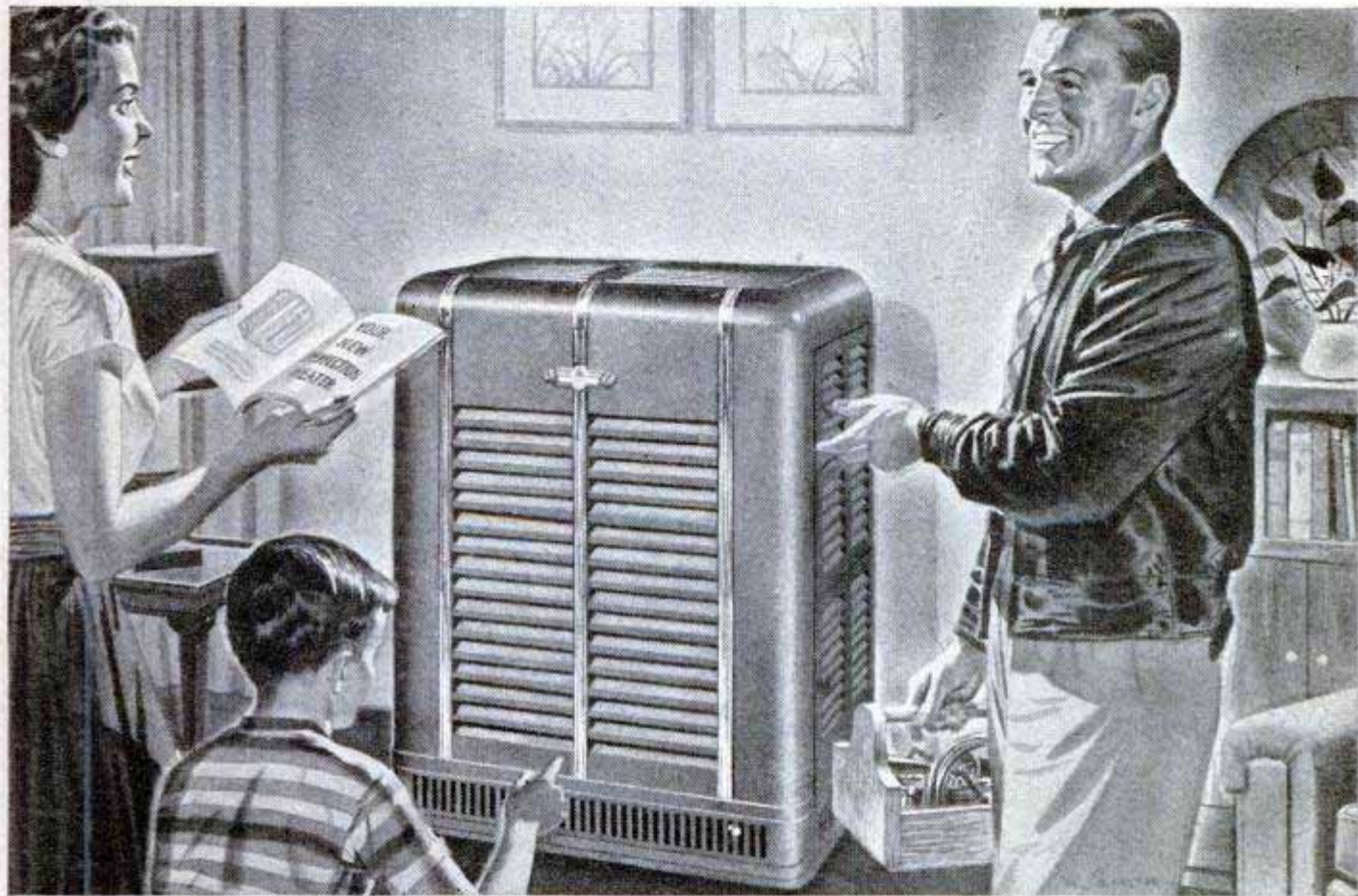

**Save Money With "Midget" Pilot!**

The "Multi-Heat" burner with its "Midget" Pilot is an exclusive Perfection design . . . it's a tiny pilot burner within the main burner. Uses fuel "by the drop". No other burner matches its low consumption.

**More Heat Per Gallon With Perfection's "Heat Extractor".**

Heat that would otherwise flit up the chimney is caught by the "Heat Extractor" and directed roomward. Adds to your comfort! Saves fuel by getting the most possible value from each gallon!

**Completely Automatic! Relax in Comfort!**

No need to jump and adjust the fire for every weather change. A new Perfection Heater with Perfection's thermostatic controls automatically cuts fire back from high or low to money-saving pilot when rooms are warm . . . returns to higher fire when needed.

**"Floor-Flo" Blower!**

**Warmth Where You Need It!**

Perfection's "Floor-Flo" blower gives better circulation of warm air into far corners. It pours cozy heat across the floor, helps keep the most heat where you need it. Not merely a fan. Quiet as a summer breeze!

**THE**  
*new* **PERFECTION** **"MORE-COMFORT-PER-GALLON"**  
*Oil Heater*

PERFECTION STOVE COMPANY, 7036-B Platt Ave., Cleveland 4, Ohio

*Manufacturers of Oil Ranges and Cook Stoves, Oil Heaters, Oil Water Heaters, Oil and Gas Winter Air-Conditioning Furnaces.*

ATLANTA • CLEVELAND • CHICAGO • JERSEY CITY • KANSAS CITY • OAKLAND • ST. PAUL

This One



01EK-C7F-C50A



# Thoughts... THAT MOVE MOUNTAINS



## ... IS MIND POWER REAL?

**H**AVE YOU READ volumes on the power of thought? Perhaps you have listened to lengthy theoretical addresses on the forces of mind. You may have wondered if these same writers and lecturers on mind power know how to use it. How many mountains of personal obstacles—everyday trials and tribulations—have *they* moved? What are these subtle principles whereby man can skillfully remove the barriers that impede his progress? How can *you* displace the obstructions and hindrances to *your* goal... the mountains in *your* life? Can practical information about inner power be reduced to mere words... words for public dissemination? Or, is there a secret method especially and uniquely preserved for the worthy seeker... practicable only under ideal circumstances? If so, who has the secret method? Where can it be found?

*The*  
**ROSICRUCIANS (AMORC) San Jose, California**

Investigate the Rosicrucians (NOT a religion), the oldest *practical* philosophical fraternity on earth. See if they cannot show you a method for attainment such as you may not have dreamed possible. Thousands of men and women today are enjoying mental mastery... realization of ideals... the attainment of their objectives. They *know* the secret methods for converting mountains of personal problems into green valleys of achievement.

### ACCEPT THIS OFFER

A FREE book, *The Mastery of Life*, is yours for the asking. It explains how easily you may enter upon the path of attainment. Fill in and send coupon *today!*

SCRIBE H. Q. Q.  
THE ROSICRUCIANS (AMORC)  
San Jose, California

Please send me the book, *The Mastery of Life*, which explains how I may learn to use my faculties and powers of mind.

Name \_\_\_\_\_

Address \_\_\_\_\_

City \_\_\_\_\_

Zone Number \_\_\_\_\_ State \_\_\_\_\_





# If YOU were Boss would YOU promote "YOU"?

valuable asset to any business organization. He never wants for a good job and above average earnings. He gets ahead.

## Be honest now—

suppose that a better job had opened up in your company—carrying with it promotion and more money—could you qualify?

*If you were boss, would you select "YOU" for that better job?*

Consider before you answer.

First of all, could you *fill* the job? Has your experience fitted you for the step forward—have you been preparing for promotion apart from experience gained on the job?

Or have you just been filling a niche, doing daily tasks well but making no real and intelligent effort to learn and qualify for the job ahead so that if an opening should occur you would be ready to fill it?

The man who gets real promotion makes his own breaks—the man who slaves in the ordinary job at low pay just wishes and dreams of promotion and more money. Which are you?

Business is always willing to pay the man who knows—and pay him well. The man who is ready and willing to take responsibilities—and capable of directing the efforts of other men is a

We have helped thousands of men achieve promotion and more money—success sometimes beyond their dreams—a success that was started by a coupon similar to the one below.

Get out of that rut—don't be satisfied with a mediocre job at small pay—be a success in business—this coupon may be your first step.

So send it today—right now—tomorrow never comes for the man who consistently puts things off.

## La Salle Extension University A Correspondence Institution

Dept. 964-R

417 S. Dearborn, Chicago 5

If you can help me get the ability and knowledge for real promotion, I want to know it. Please send me your free 48 page booklet telling how I can succeed in the field I have checked below. I understand you will send this without obligation to me.

- |  |  |
|--|--|
| <input type="checkbox"/> Accounting                    | <input type="checkbox"/> Salesmanship          |
| <input type="checkbox"/> C. P. A. Coaching             | <input type="checkbox"/> Law: LL.B. Degree     |
| <input type="checkbox"/> Bookkeeping                   | <input type="checkbox"/> Foremanship           |
| <input type="checkbox"/> Business Management           | <input type="checkbox"/> Industrial Management |
| <input type="checkbox"/> Effective Speaking            | <input type="checkbox"/> Traffic Management    |
|  | <input type="checkbox"/> Business English      |
| <input type="checkbox"/> Stenotypy (Machine Shorthand) |  |

Name.....Age.....

Position.....

Address.....Zone, if any.....

City and State.....



# SIX WINNERS

## out of the first 10

### at the 500 mile

# MEMORIAL DAY RACE

## at Indianapolis

# USED PYROIL

To men who know auto performance best, PYROIL is a *must*. Year after year, winners of the gruelling 500 Mile Memorial Day races have relied upon Pyroil.

Pyroil will add miles to your car by maintaining a constant film of oil on cylinder walls and by preventing sludge and carbon formation. Ask your gas station attendant to add PYROIL.

### PYROIL FOR AIRCRAFT ENGINES

Use Aircraft Pyroil B for lubricating oil, Aircraft Pyroil A for gasoline.

### GIVEN!

An attractive Pyroil metal savings bank — takes coins up to 50c pieces — is yours for the asking — sent postage paid.

Manufactured and Guaranteed by Pyroil Company, 83 Pyroil Bldg., La Crosse, Wisconsin.



Canadian Distributors:  
Central Purchasing Agencies, Ltd., Toronto, Ontario

**PYROIL COMPANY**  
83 Pyroil Bldg., La Crosse, Wisconsin

I want my car to last and run properly. Please tell me more about Pyroil and how it can accomplish this for me.

Name \_\_\_\_\_

Address \_\_\_\_\_

City or Town \_\_\_\_\_ State \_\_\_\_\_



## TABLE OF CONTENTS (Continued)

<b>AUTOMOTIVE</b>	
Shields end convertible drafts.....	95
Cafeteria gas station.....	109
Gas turbines for cars.....	110
European cars.....	143
Portable suit rack for motor trips.....	145
Automatic "prodger" keeps driver awake.....	145
Self-defrosting windshield glass.....	150
Handy reflectors give bright warnings to motorists.....	150
Two-wheel car.....	155
Turbine-driven auto.....	156
British version of jeep.....	160
Generator regulator.....	167
<b>AVIATION</b>	
Natural gas runs big aircraft engine.....	112
Replacement parts for airplanes shipped in tin cans.....	135
Swiveling tail propeller.....	155
<b>FARM</b>	
"Airborne" chickens roost in glider nose.....	87
Tractor "altimeter" aids contouring.....	91
Cultivator has engine in rear.....	95
Two-way plow cuts ditches.....	118
Wheelless tiller rolls on its tines.....	167
<b>FISH AND FISHING</b>	
Telescoping fish pole of aluminum.....	119
Fishermen can carve casting plugs with materials from kit.....	134
All-metal bilge pump fits in tackle box.....	165
<b>HOUSE AND HOME</b>	
Even baby can have a swivel chair.....	97
"Touch" latch for doors requires no knobs.....	100
Safety light socket ends shock hazard.....	128
What's new for your home.....	158
Child's height-measuring standard doubles as clothes rack.....	161
<b>INDUSTRY</b>	
Pulp from wheat straw produces quality paper.....	101
Blower forces heat from stack of sugar beets at night.....	112
Pusher unloads lift truck without use of pallets.....	113
Waste pulp of Mexico produces valuable wax.....	113
Electronic "pistol" detects pipe leaks.....	113
Gas turbine powers generator.....	134
Printing rolled on surface by hand-operated marker.....	135
Mobile power plant.....	144
"Cold rubber" for your tires.....	146
Lightweight air compressor.....	148
Invisible "raincoat" for bricks.....	148
Recovery of diamond dust speeded by new process.....	161
Log sulky.....	166
<b>LAWN AND GARDEN</b>	
Lawn mowers "push" themselves.....	65
Address for house trimmed in hedge.....	142
Lawn-sprinkler system controlled by clock.....	155
<b>MODELS AND NOVELTIES</b>	
Miniature racer zips track at 124 miles an hour.....	142
"Crew" of model sailboat takes orders from skipper by radio.....	156
Pint-size tractor has gas engine.....	166
Rider lies down to drive motorcycle.....	166
<b>PHOTOGRAPHY</b>	
Microfilm reader.....	91
Exposure computer built into camera.....	100
Movie-film waker.....	119
Camera takes "movies" on standard cut film.....	168
<b>RECREATION</b>	
Basement swimming pool.....	86
"Bean ball" shields for ball players.....	97
Magnet-driven cars race on tiny oval.....	118
"Splashketball".....	128
<b>TOOLS</b>	
Lock screw adjusts dado collar.....	91
Belt and back-stand for grinder smooth bonded brake shoes.....	95
Guides for ellipse drawing.....	101
Bar tool for bending metal parts adjusts to 100 positions.....	101
Combination power tool.....	108
Vise cradles doors for finishing.....	119
Kit converts ordinary garage doors for overhead opening.....	128
Ratchet-type bumper jack extends at both ends.....	168
<b>TRANSPORTATION</b>	
Dome-type coach has all-around vision for sight-seers.....	87
A century of railroads on parade.....	126
Midget bike becomes motorcycle.....	134
China's ricksha goes mechanical.....	145
<b>MISCELLANEOUS</b>	
Radio-phone talks held between cities.....	87
One crane builds another.....	96
How the war came to me in Tokyo.....	98
Retractable rear-view mirror.....	100
Pocket-size wind indicator.....	100
Spring-arm phone holder leaves both hands free.....	101
Atomic-powered rocket for carrying man to moon.....	108
Youth designs and builds trailer.....	135
Machine uses a continuous tape to address letters.....	135
Sudden death comes to a bomb as wartime range is converted to peace.....	148
Marabou stork learns to play ball.....	149
Protons will hit 180,000 miles a second in synchrotron.....	150
One-man boat loader.....	156
Ball-point pen worn on tile clip.....	157
Portable swimming pool.....	157
Elastic shoelaces.....	157
Door jig helps fit hinges.....	160
Multi-purpose charcoal grill.....	161
Sharpener adjusts for any point.....	165
DDT is made twice as deadly by adding dash of oil.....	168

(Continued to page 10)





# The GI's have it!



**GOOD NEWS** for Veterans! I. C. S. Courses—all 400 of them—are now available under the G.I. Bill of Rights and Public Law 16.

Here's your chance to learn while you earn . . . to master a trade or profession and qualify for promotions and pay raises *on the job*.

The coupon brings full details of the course you check—and complete instructions on how to enroll. Mail it today!

## INTERNATIONAL CORRESPONDENCE SCHOOLS



BOX 5635-K, SCRANTON 9, PENNA.

Without cost or obligation, please send me full particulars about the course BEFORE which I have marked X:

- |  |  |  |  |
|--|--|--|--|
| <p><b>Air Conditioning and Plumbing Courses</b></p> <p><input type="checkbox"/> Air Conditioning<br/><input type="checkbox"/> Heating<br/><input type="checkbox"/> Refrigeration<br/><input type="checkbox"/> Plumbing<br/><input type="checkbox"/> Steam Fitting</p> <p><b>Chemistry Courses</b></p> <p><input type="checkbox"/> Chemical Engineering<br/><input type="checkbox"/> Chemistry, Analytical<br/><input type="checkbox"/> Chemistry, Industrial<br/><input type="checkbox"/> Chemistry, Mfg. Iron &amp; Steel<br/><input type="checkbox"/> Petroleum Refining<br/><input type="checkbox"/> Plastics<br/><input type="checkbox"/> Pulp and Paper Making</p> <p><b>Civil Engineering, Architectural and Mining Courses</b></p> <p><input type="checkbox"/> Architecture<br/><input type="checkbox"/> Architectural Drafting<br/><input type="checkbox"/> Bridge and Building Foreman<br/><input type="checkbox"/> Building Estimating<br/><input type="checkbox"/> Civil Engineering<br/><input type="checkbox"/> Coal Mining<br/><input type="checkbox"/> Contracting and Building<br/><input type="checkbox"/> Highway Engineering<br/><input type="checkbox"/> Lumber Dealer<br/><input type="checkbox"/> Reading Structural Blueprints<br/><input type="checkbox"/> Sanitary Engineering<br/><input type="checkbox"/> Structural Drafting</p> | <p><input type="checkbox"/> Structural Engineering<br/><input type="checkbox"/> Surveying and Mapping</p> <p><b>Communications Courses</b></p> <p><input type="checkbox"/> Electronics<br/><input type="checkbox"/> Practical Telephony<br/><input type="checkbox"/> Radio, General<br/><input type="checkbox"/> Radio Operating<br/><input type="checkbox"/> Radio Servicing<br/><input type="checkbox"/> Telegraph Engineering</p> <p><b>Electrical Courses</b></p> <p><input type="checkbox"/> Electrical Drafting<br/><input type="checkbox"/> Electrical Engineering<br/><input type="checkbox"/> Electric Light and Power<br/><input type="checkbox"/> Lighting Technician<br/><input type="checkbox"/> Practical Electrician</p> <p><b>Internal Combustion Engines Courses</b></p> <p><input type="checkbox"/> Auto Technician<br/><input type="checkbox"/> Diesel-Electric<br/><input type="checkbox"/> Diesel Engines<br/><input type="checkbox"/> Gas Engines<br/><input type="checkbox"/> Aviation</p> <p><b>Mechanical Courses</b></p> <p><input type="checkbox"/> Aeronautical Engineer's, Jr.<br/><input type="checkbox"/> Aircraft Drafting<br/><input type="checkbox"/> Forging<br/><input type="checkbox"/> Heat Treatment of Metals<br/><input type="checkbox"/> Industrial Engineering<br/><input type="checkbox"/> Flight Engineer<br/><input type="checkbox"/> Foundry Work</p> | <p><input type="checkbox"/> Industrial Metallurgy<br/><input type="checkbox"/> Machine Shop<br/><input type="checkbox"/> Mechanical Drafting<br/><input type="checkbox"/> Mechanical Engineering<br/><input type="checkbox"/> Mold-Loft Work<br/><input type="checkbox"/> Patternmaking—Wood, Metal<br/><input type="checkbox"/> Reading Shop Blueprints<br/><input type="checkbox"/> Sheet-Metal Drafting<br/><input type="checkbox"/> Sheet-Metal Worker<br/><input type="checkbox"/> Ship Drafting<br/><input type="checkbox"/> Tool Designing<br/><input type="checkbox"/> Toolmaking<br/><input type="checkbox"/> Welding Engineering<br/><input type="checkbox"/> Welding—Gas and Electric</p> <p><b>Railroad Courses</b></p> <p><input type="checkbox"/> Air Brake<br/><input type="checkbox"/> Diesel Locomotive<br/><input type="checkbox"/> Locomotive Engineer<br/><input type="checkbox"/> Locomotive Fireman<br/><input type="checkbox"/> Locomotive Machinist<br/><input type="checkbox"/> Railroad Section Foreman<br/><input type="checkbox"/> Car Inspector</p> <p><b>Steam Engineering Courses</b></p> <p><input type="checkbox"/> Boilermaking<br/><input type="checkbox"/> Combustion Engineering<br/><input type="checkbox"/> Engine Running<br/><input type="checkbox"/> Marine Engineering<br/><input type="checkbox"/> Steam Electric<br/><input type="checkbox"/> Steam Engr.</p> | <p><b>Textile Courses</b></p> <p><input type="checkbox"/> Cotton Manufacturing<br/><input type="checkbox"/> Loom Fixing<br/><input type="checkbox"/> Textile Designing<br/><input type="checkbox"/> Rayon Weaving<br/><input type="checkbox"/> Woolen Manufacturing</p> <p><b>Business and Academic Courses</b></p> <p><input type="checkbox"/> Accounting<br/><input type="checkbox"/> Advertising<br/><input type="checkbox"/> Bookkeeping<br/><input type="checkbox"/> Business Administration<br/><input type="checkbox"/> Business Correspondence<br/><input type="checkbox"/> Certified Public Accounting<br/><input type="checkbox"/> Commercial<br/><input type="checkbox"/> Commercial Art<br/><input type="checkbox"/> Cost Accounting<br/><input type="checkbox"/> Federal Tax<br/><input type="checkbox"/> Foremanship<br/><input type="checkbox"/> Good English<br/><input type="checkbox"/> Higher Mathematics<br/><input type="checkbox"/> Motor Traffic<br/><input type="checkbox"/> Retailing<br/><input type="checkbox"/> Retail Store Management<br/><input type="checkbox"/> Salesmanship<br/><input type="checkbox"/> Sign Lettering<br/><input type="checkbox"/> Spanish<br/><input type="checkbox"/> Traffic Management</p> <p><input type="checkbox"/> First Year College<br/><input type="checkbox"/> French<br/><input type="checkbox"/> High School<br/><input type="checkbox"/> Postal Civil Service<br/><input type="checkbox"/> Secretarial<br/><input type="checkbox"/> Stenography</p> |
|--|--|--|--|

Name \_\_\_\_\_ Age \_\_\_\_\_ Home Address \_\_\_\_\_  
 City \_\_\_\_\_ State \_\_\_\_\_ Working Hours \_\_\_\_\_ A.M. to \_\_\_\_\_ P.M.  
 Present Position \_\_\_\_\_ Employed by \_\_\_\_\_

Special tuition rates to members of the Armed Forces. Enrollment under G.I. Bill and P.L. 16 approved for World War II Veterans. Canadian residents send coupon to International Correspondence Schools Canadian, Ltd., Montreal, Canada.



# ISN'T IT A HONEY!

...with the "super-imposed-image" Range Viewer



## UNIVERSAL'S BUCCANEER

—double frame 35mm. candid with "super-imposed-image" Range Viewer formerly only on expensive imports... yet only...65.00

IT sure IS a honey... this Universal Buccaneer; The slick, double quick Range Viewer finds your range and composes your picture in a single look.

It goes into split-second action... takes "out of this world" color shots, indoors or out; brilliant black and white on dull days or bright. Its shutter release automatically locks against double exposures. No more wasted film or picture disappointments.

It's only the Buccaneer that combines all these features: coated f3.5 lens for all-purpose use; built-in flash synchronizer... versatile shutter speeds: 1/10th to 1/300th, time and bulb; built-in extinction type exposure meter with calculator. See Universal's Buccaneer—the camera that experts endorse.

UNIVERSAL CAMERA CORPORATION  
New York, Chicago, Hollywood



**UNIVERSAL'S METEOR**  
The economy candid with 15 "professional" features! Coated lens, synchronized flash unit, variable aperture ..... 15.00



**UNIVERSAL'S MERCURY II**  
"The greatest candid for color." 35 mm. single frame. Extreme depth of focus, coated f2.7 lens, speeds to 1/1000th sec. .... 82.90

For Pictures that *Click*...click a **UNIVERSAL**

(Continued from page 8)

## Craftsman and Shop Notes Index

### AUTOMOTIVE

Push-button switch operates starter when adjusting valve tappets .....	209
Drive shaft aligned to differential with aid of guide rods .....	217
Servicing wheel bearings .....	218
Compressed air helps rewire car .....	220
Throw switch in horn circuit regulates volume .....	220

### FARM

Block clamp on pump pipe prevents dropping in well .....	176
Hinge on bottom of mailbox signals mail delivery .....	188
Movable hog wallow on runners .....	210

### FISH AND FISHING

Rubber-band lure for small fish simulates crawling motion .....	172
Fishing-lure holder for boat hooks over gunwale .....	176
Raise your own fishing worms for year-round use .....	190

### HOUSE AND HOME

Setting windowpanes correctly .....	172
Removable fence fits doorway to keep baby penned in room or porch .....	173
Solving home problems .....	174
Retractable garage ladder is stored by folding under attic floor .....	177
Slipping window-shade clutch corrected by small springs .....	188
Tags aid in locating drain plugs .....	188
Concrete hotbeds .....	189
Counter rack keeps trays handy .....	190
Dust-free picture framing .....	190
These locks foil prying fingers of tiny tots .....	191
Installation of second-floor storm windows easily done by one man using guide strips .....	193
Weighted-curtain doorway for pet .....	193
Spring hinge on casement window facilitates opening .....	196

### METALWORKING

Reproducing pitted wrought iron .....	196
Forch lantern in hammered copper .....	197
Cutting holes in sheet metal .....	198

### PAINT AND PAINTING

Handy scraper from hacksaw blade removes flaked paint .....	172
Infrared lamp loosens paint .....	176
Retouching marred furniture .....	176
Painting venetian-blind slats is simplified by jig .....	192

### PHOTOGRAPHY

Photographing old coins .....	199
Nonslip edge on trimmer bed aids cropping buckled prints .....	204
Dial thermometer clipped in place .....	204
Sliding mask for double exposures produces trick shots .....	204
Backing paper used as separators .....	204
Reading low values of photo meter .....	204
Clothespin holds print tongs .....	204

### RADIO AND ELECTRONICS

"Wireless" sound-movie projector .....	221
Portable 3-tube phono player with automatic record changer .....	222
Television today .....	224
Preamplifier for TV signals .....	226

### RECREATION

Rack holds table-tennis paddles .....	176
"Canned" ice for picnics .....	187
Decoy anchor line is nontangling .....	198
Table-tennis ball dispenser .....	198

### TOOLS

Drawing ellipses with a compass and triangles .....	177
Frame holds batt-type insulation overhead to free hands for nailing .....	180
Dividing a board in half .....	180
Homemade hole saw increases production by removing disk while machine is running .....	209
Cone mandrel chucks work between lathe centers .....	210
Plug gauges of cold-rolled steel .....	210
Retapping threads in nuts .....	210
Helpful knurling stunt .....	210
Sawhorse slotted to hold saw .....	210
Holder permits routing with hand grinder .....	211
Hoisting tongs provide safe hitch for lifting heavy pipe .....	211
Pipe fittings and flat iron provide housings for ball-bearing pillow blocks and arbors .....	217
Adjusting nicked jointer knives results in smooth cut .....	217
Set-screw replaces clamp bolt to increase lathe-dog safety .....	220

### TOYS AND NOVELTIES

Distinctive flower vase .....	170
Thread spool aids in twisting crepe-paper streamers .....	172
This horn fish "swallows" your cigarette ashes .....	173
Novelty boxes .....	178
Pin-up bracket provides hanging holder for ivy or potted plant .....	179
Amusing and educating spelling game provides hours of worthwhile fun .....	180
Darts whittled from shingles are thrown long distances .....	195

### MISCELLANEOUS

Doorknob rattle silenced with rubber washer .....	188
Rifle support and muzzle cap made from tin can .....	190
Removing cork pushed into bottle .....	190
Moisture-resistant brick walls .....	192
Keeping clock in good condition .....	193
Before you buy a model engine .....	194
Length of pipe fitted with tee bends rigid conduit .....	196
Envelopes form pocket dispenser for cleansing tissues .....	196
Shop drawers of gallon cans slide on curtain-rod runners .....	198
Insulating board holds pin tags for rapid marking .....	220
Short cuts speed inventory of stacked materials .....	220

**IMPORTANT NOTICE**—It is the intention of this magazine to provide its readers with information regarding the latest developments in the mechanical arts. We take no responsibility as to whether the disclosures contained in our articles are covered by patents and advise readers to investigate this subject before making, using, or selling any of the products, machines, or processes described in order to avoid possible liability for patent infringements.



**AUDELS REFRIGERATION & AIR CONDITIONING GUIDE.....\$4**

New from Cover to Cover—1280 Pages, Fully Illus. Covering basic principles, servicing, operation & repair of household, commercial & industrial refrigeration & air conditioning. A gold mine of essential important facts for engineers, servicemen, users.

**AUDELS CARPENTERS & BUILDERS GUIDES—4 Vols. ....\$6**

A practical illustrated trade assistant on modern construction for carpenters, joiners, builders, mechanics and all woodworkers. 4 vols., 1600 pages, 3700 illustrations, flexible covers. Pocket size. Each volume sold separately \$1.50 a vol.

**AUDELS AUTOMOBILE GUIDE.....\$4**

A practical quick ready reference book for auto mechanics, service men, operators & owners. Explains theory, construction & servicing of modern motor cars, trucks, buses & auto type Diesel engines. 1700 pages, fully illustrated, 55 chapters. Indexed. A standard book for mechanics. New fluid drive covered.

**AUDELS DIESEL ENGINE MANUAL..\$2**

A practical, concise treatise with questions and answers on the theory, operation and maintenance of modern diesel engines including General Motors 2 cycle Diesel. 384 pages, fully illus., flexible binding, pocket size. All details plainly brought out, this book is of extreme value to engineers, operators & students.

**AUDELS WIRING DIAGRAMS.....\$1**

210 Pages. Illustrated. Gives practical facts on wiring of electrical apparatus. It shows clearly how to wire apparatus for practically all fields of electricity. Each diagram is complete & self-explanatory. Highly Endorsed Pocket Companion.

**AUDELS PLUMBERS & STEAMFITTERS GUIDES—4 Vols. ....\$6**

A Practical Trade Assistant & Ready Reference. Explains in plain language & by clear illustrations, diagrams, charts, graphs, pictures principles of modern plumbing practice including Marine Pipe Fitting and Air Conditioning. 4 Vols.—1670 Pages—3642 Diagrams. Pocket size. Each Vol. Sold Separately \$1.50 a Vol.

**AUDELS SHEETMETAL WORKERS HANDY BOOK.....\$1**

Practical inside information. Fundamentals of Sheet Metal Work. 388 pages. Illustrated. 11 sections. Clearly written. Essential & important facts, figures, pointers in everyday language. Ref. Index.

**AUDELS SHEETMETAL PATTERN LAYOUTS.....\$4**

Developed by Experts for Sheet Metal Workers, Layout Men & Mechanics. A Practical Encyclopedia in 10 Sections, size 7 x 10 x 2—1125 Pages—350 Layouts—1600 Illustrations. 1001 Key Facts. Fully indexed for ready reference in answering your layout problems. Covers all phases of sheet metal work including Pattern Cutting, Pattern Development & Shop Procedure.

**AUDELS ANSWERS ON BLUE PRINT READING.....\$2**

For Mechanics & Builders. Covers all types of blue print reading including ship & airplane. 416 pages, fully illustrated.

**AUDELS NEW MACHINIST & TOOLMAKERS HANDY BOOK.....\$4**

Covers modern machine shop practice in all its branches. 5 practical books in 1. New from cover to cover. Tells how to set up & operate lathes, screw and milling machines, shapers, drill presses and all other machine tools. 1600 pages, fully illustrated, 5 x 6 1/2 x 2. Indexed. 5 sections. 1—Modern Machine Shop Practice. 2—Blue Print Reading & How to Draw. 3—Calculations & Mathematics for Machinists. 4—Shop Physics. 5—How to Use the Slide Rule. 60 chapters. Easy to read and understand. A shop companion that answers your questions.

**AUDELS MATHEMATICS & CALCULATIONS FOR MECHANICS \$2**

Mathematics for home study or reference. 700 pages, 550 illus. Practical mathematics from beginning. How to figure correctly. Easy, correct methods covering complete review. Illus. & Indexed.

**AUDELS HANDY BOOK OF PRACTICAL ELECTRICITY.....\$4**

For maintenance engineers, electricians & all electrical workers. 1440 Pages, 2600 Illus. Covers important electrical information in handy form—including Marine Wiring, Radio Principles, Welding. Indexed. A Key to a practical understanding of electricity.

**AUDELS RADIOMANS GUIDE.....\$4**

A key to the practical understanding of radio including Frequency Modulation, Television, etc., Aircraft & Marine Radio. For radio engineers, servicemen, amateurs, 914 Pages, 633 Illustrations & Diagrams. Photos. Review Questions & Answers, Reference Index. Authentic, clear, concise.

**AUDELS ELECTRONIC DEVICES.....\$2**

Tells What You Want to Know About Electric Eye. Easily Understood. Covers photo-electric cells & their applications. Amplifiers, illumination, frequencies, voltage, photocell, tubes, Ohm's Law, wiring diagrams, etc.

**AUDELS WELDERS GUIDE.....\$1**

A concise, practical text on operation & maintenance of all welding machines for all mechanics. Over 400 pages, illustrated. Covers all methods of electric and acetylene welding including airplane work.

**AUDEL, Publishers, 49 W. 23 St., N. Y. 10**

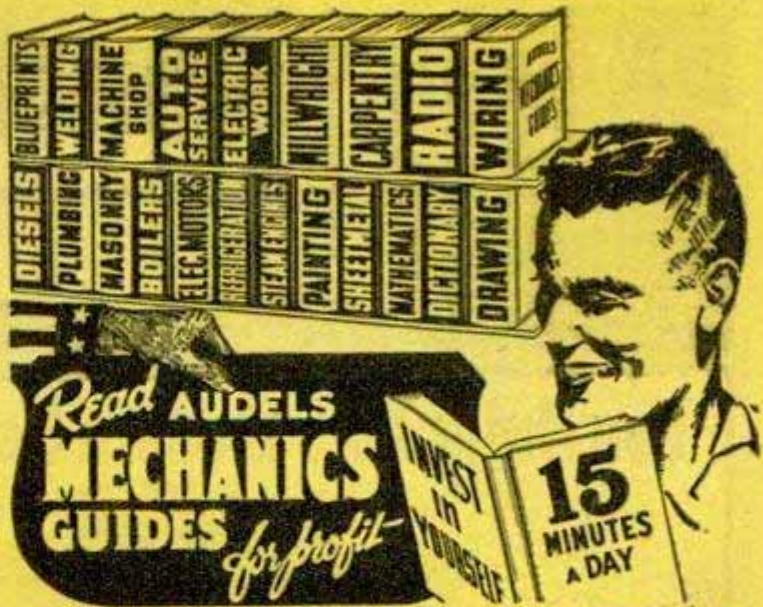

**AN AUDEL GUIDE IS A GOOD FRIEND!**

Step Up Your Own Skill with the Practical Facts and Figures of Your Trade. Save time and money with right methods, short cuts, labor saving ideas. CHECK NOW! You can look over any Audel Guide in your home. Start the Easy Payments if satisfied.

**CUT HERE MAIL ORDER**

AUDEL, Publishers, 49 W. 23 St., New York 10, N. Y.

Please mail me for 7 days' free examination the books marked (X) below. I agree to mail \$1 in 7 days on each book or set ordered, and to further mail \$1 a month on each book or set ordered until I have paid purchase price. If I am not satisfied with Guides I will return them.

- Audels HOUSE HEATING GUIDE ..... \$4
- Audels ELECTRIC MOTOR GUIDE ..... 4
- Audels OIL BURNER GUIDE ..... 1
- Audels REFRIGERATION & Air Conditioning Guide ..... 4
- Audels POWER PLANT ENGINEERS GUIDE ..... 4
- Audels PUMPS, HYDRAULICS & AIR COMPRESSORS ..... 4
- Audels WELDERS GUIDE ..... 1
- Audels BLUE PRINT READING ..... 2
- Audels SHEET METAL WORKERS Handy Book ..... 1
- Audels SHEET METAL PATTERN LAYOUTS ..... 4
- Audels AIRCRAFT WORKER ..... 1
- Audels MATHEMATICS and CALCULATIONS ..... 2
- Audels MACHINISTS & TOOLMAKERS Handy Book ..... 4
- Audels MECHANICAL Dictionary ..... 4
- Audels AUTOMOBILE GUIDE ..... 4
- Audels DIESEL ENGINE MANUAL ..... 2
- Audels MARINE ENGINEERS Handy Book ..... 4
- Audels MECHANICAL DRAWING GUIDE ..... 1
- Rogers MECHANICAL DRAWING and DESIGN ..... 2
- Audels MILLWRIGHTS and Mechanics Guide ..... 4
- Audels CARPENTERS and Builders Guides (4 vols.) ..... 6
- Audels PLUMBERS and Steamfitters Guides (4 vols.) ..... 6
- Audels MASONS and Builders Guides (4 vols.) ..... 6
- Master PAINTER and DECORATOR ..... 2
- Audels GARDENERS & GROWERS GUIDES (4 vols.) ..... 6
- Audels ENGINEERS & FIREMANS EXAMINATIONS ..... 1
- Audels ENGINEERS and Mechanics Guides (8 vols.) ..... 12
- Audels Answers on Practical ENGINEERING ..... 1
- Audels ELECTRICIANS EXAMINATIONS ..... 1
- Audels WIRING DIAGRAMS ..... 1
- Audels Handy Book of PRACTICAL ELECTRICITY ..... 4
- Audels ELECTRICAL POWER CALCULATIONS ..... 2
- Audels ELECTRONIC DEVICES ..... 2
- Audels ELECTRIC Dictionary ..... 2
- Audels RADIOMANS GUIDE ..... 4
- Audels NEW ELECTRIC LIBRARY at \$1.50 a Volume Vols. I, II, III, IV, V, VI, VII, VIII, IX, X, XI, XII

Name.....

Address.....

Occupation.....

Employed by..... PM



I Will  
Show You  
How to

# Learn RADIO

## You Build This Modern Superheterodyne Receiver

As part of my Course, I send you the Speaker, Tubes, Chassis, Transformer, Loop Antenna—EVERYTHING you need to build this modern, powerful Radio Receiver. You also get parts to build many other real Radio circuits like those pictured here. Mail coupon for complete information.

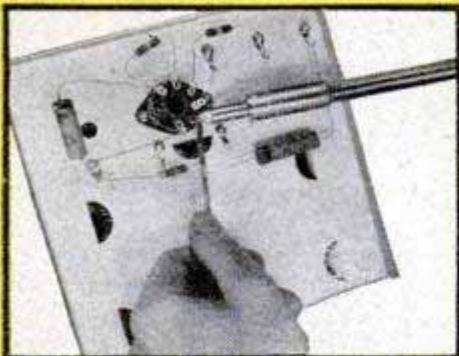
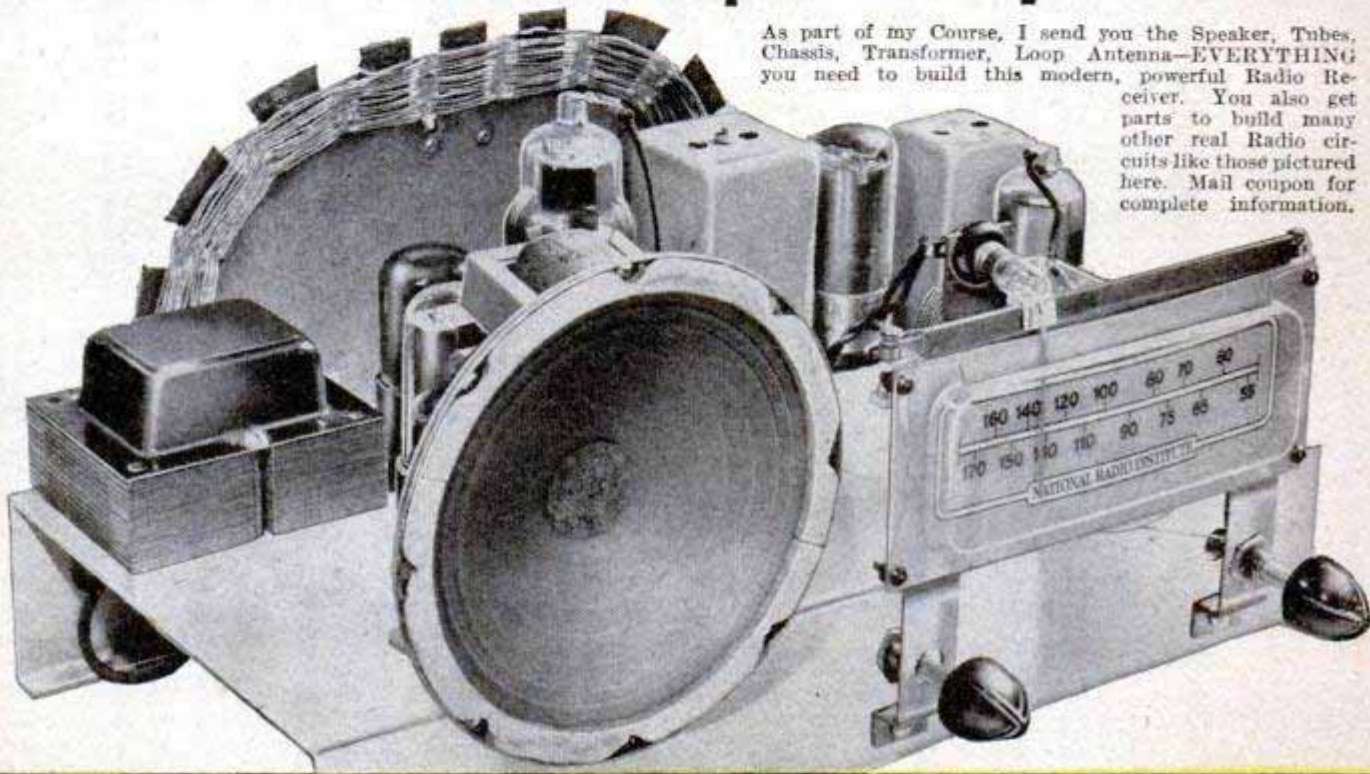

You build this Radio Circuit early in Course with Soldering Equipment and Radio parts I send; practice mounting, connecting, soldering Radio parts.



You practice Radio Servicing with this Tester built from parts I send. Also use it to help earn EXTRA MONEY fixing neighbors' Radios.

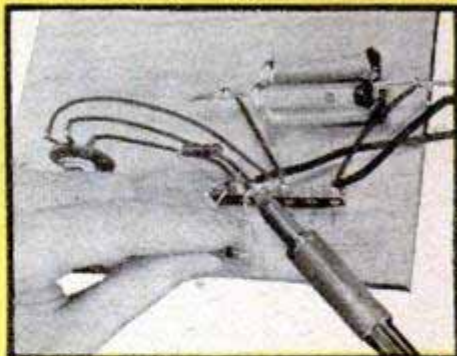

You practice "FM" Servicing on this Frequency Modulation (FM) Signal Generator, built with parts I supply; learn by repairing circuit defects.

## MEN I TRAIN AT HOME GET GOOD JOBS LIKE THESE

### MADE \$1500 WHILE LEARNING

"By the time I finished my NRI training I had made \$1500. When I started the Course I did not know a resistor from a condenser. I have bought my home. My income from Radio work, etc., is about \$3,000 a year." — WILLIAM THOMAS, Baldwyn, Mississippi.



### ASSISTANT TO CHIEF ENGINEER AT STATION WHJB

"Have been employed for the past two years as assistant to the chief engineer at Radio Station WHJB. Knew nothing about Radio when I enrolled for the NRI Course." — CECIL J. GIUNIPERO, Greensburg, Pennsylvania.



### KNEW NOTHING ABOUT RADIO

"I knew nothing about Radio when I enrolled. At present I am doing spare time work. I have more than paid for my Course and I have about \$200 worth of equipment which has paid for itself." — RAYMOND HOLT-CAMP, Vandalia, Illinois.



### FULL-TIME JOB BEFORE FINISHING COURSE

"After completing about two-thirds of my Course I entered a Radio Repair shop. Later I branched out for myself and opened a shop in my own home. I am much pleased with the work I had during my first year of business." — A. H. AYERS, Washington 10, D. C.





# by Practicing in Spare Time

I Send You  
Big Kits  
of Radio Parts

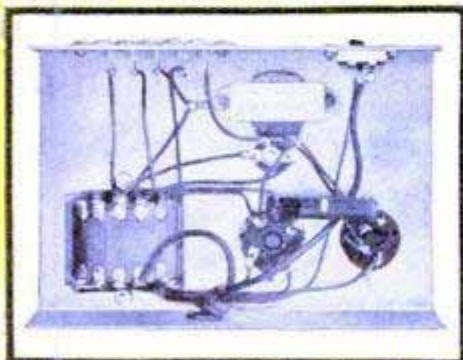

You build this Vacuum Tube Power Pack, make changes which give you experience, learn how to locate and correct power pack troubles.

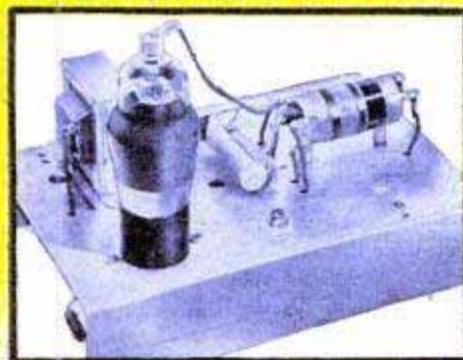

You build this A. M. Signal Generator which provides amplitude-modulated signals for many tests and experiments, gives you practical experience.

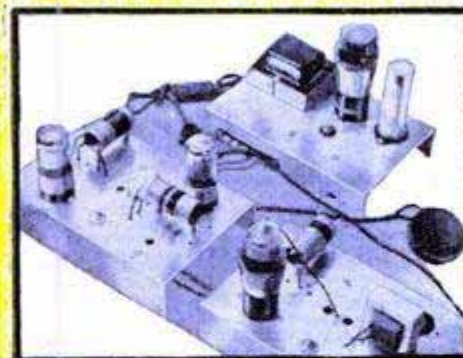

You build this Superheterodyne receiver circuit. You conduct FM (Frequency Modulation) experiments, get more experience to help you win success in Radio.

## KNOW RADIO Win Success I Will Train You at Home

Want a good-pay job in the fast-growing Radio and Television-Electronics industries? Want to be boss of your own money-making Radio shop? I've trained hundreds of men *with no previous experience* to be Radio technicians. I can do the same for you! My train-at-home method gives you practical experience with **BIG KITS OF PARTS** I send. You get Radio and Television principles from easy illustrated lessons. All equipment yours to keep.

### VETERANS

You Can Get  
This Training  
Under  
G. I. Bill.  
Mail Coupon.

#### Make EXTRA MONEY in Spare Time

The day you enroll, I send EXTRA MONEY booklets. Use your know-how to make EXTRA MONEY fixing Radios in spare time. The next step is your own Radio shop or a good-pay Radio job.

#### N.R.I.—Trained Men Face Bright Future

Think of money-making opportunities in Police, Aviation, Marine Radio, Broadcasting, Radio Manufacturing, Radio Repairing, Public Address work . . . think of even greater opportunities in booming Television, FM, Electronic fields!

Our 34th Year of Training  
Men for Success in Radio

#### See What N.R.I. Can Do For You

My special **DOUBLE FREE OFFER** gives you actual lesson on Radio repairing short-cuts absolutely free. You also get my 64-page book, "HOW TO BE A SUCCESS IN RADIO-TELEVISION-ELECTRONICS." See how quickly, easily you can get started. Send NOW! J. E. SMITH, Pres., Dept. 8JP, National Radio Institute, Pioneer Home Study Radio School, Washington 9, D. C.

### Good for Both—FREE

MR. J. E. SMITH, Pres., Dept. 8JP  
National Radio Institute, Washington 9, D. C.

Mail me FREE, your Sample Lesson and 64-page book. (No salesman will call. Please write plainly.)

Name.....Age.....

Address.....

City.....Zone.....State.....

Check If Veteran

Approved for Training under GI Bill

## SAMPLE LESSON FREE

Gives hints on Receiver servicing, locating defects, repair of Loudspeaker, I. F. Transformer, Gang Turner, Condenser, etc. Mail coupon.

My Radio Course Includes  
**TELEVISION • ELECTRONICS  
FREQUENCY MODULATION**



for  
Engineers  
Inventors  
Machinists

A Book That Shows You

## 3000 ILLUSTRATIONS and DESIGNS OF MECHANICAL MOVEMENTS, DEVICES, CONTRIVANCES AND DETAILS!

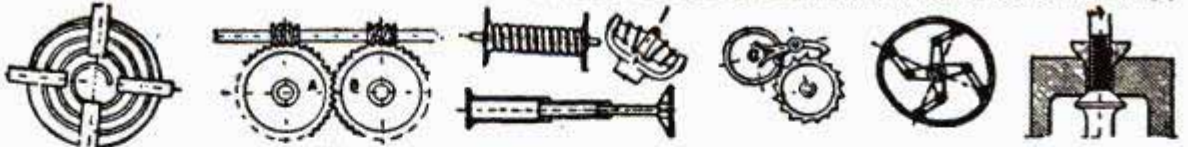

Every conceivable kind of mechanical motion and work is briefly explained and illustrated in this unusually helpful book. As far as known, the only work in existence which aims to provide side by side suggested sketches of the various methods in use for accomplishing any particular mechanical movement or work, in a form easily referred to. Every engineer, inventor or mechanic finds the need of devising, simplifying or improving some mechanical process or method. In doing this he has to rely on memory or experience. Here is a reference book of nearly 3000 MEANS AND METHODS for producing any kind of movement or work, classified and arranged for easy reference!

SUCH AS: Accumulators, Anti-friction, Ball and Socket, Bearings, Blowings, Brakes, Cams, Chain Gear, Chopping, Chucks,

Circular Motions, Clutches, Conveying, Cranes, Cranks, Cutting Doors, Drilling, Eccentrics, Engines, Expanding, Filtering, Gears, Governors, Grips, Grinds, Heating, Hinges, Hydraulics, Indicators, Journals, Levers, Links, Lowerings, Lubricators, Measuring and Weighing, Mixing, Nozzles, Parallel Motions, Pipes, Pivots, Power Propulsion, Raising, Ratchets, Rotary Engines, Safety Appliances, Shafting, Signals, Slides, Sounds, Speed, Spindles, Springs, Starting, Striking, Swivels, Tanks, Traps, Turbines, Valves, Water Wheels, Winding, Wipers, etc. If you work with machinery of any kind, you need this ENGINEERS' SKETCH BOOK by Thomas W. Barber—355 pages, durably printed and bound in cloth. Price

**\$2.98**

for  
Artists  
Craftsmen  
Designers  
Decorators

A Book With Over

## 2000 DRAWINGS and ILLUSTRATIONS OF DESIGNS, ORNAMENTS AND FORMS



Almost every conceivable kind of adornment and artistic decoration is listed and ILLUSTRATED in this unusually helpful and encyclopedic reference and idea book. This BRAND NEW WORK with 109 Black and White Full Pages and 13 in Color of illustrations shows the entire range of ornament in all its different styles from the dawn of civilization down to the present. Design and form in every phase of art, craft, or trade is included and classified.

There are Ornaments, Designs, Forms, Shapes, Symbols; wreaths, silhouettes, borders, monograms, alphabets, frames, columns, crests, patterns, bows, leaves, lozenges, feathers, plumes, chains, geometric forms, animals, religious symbols, fraternal signs, rules, patriotic symbols, etc. Most of the designs shown are FULL SIZE, and easy to trace, copy or

reproduce. Printed in black and white. They will prove to be a gold mine of ideas, for CREATING and DECORATING your ART, CRAFT or COMMERCIAL PRODUCTS.

A valuable reference source for artists, craftsmen, designers, decorators, printers, painters, sculptors, wood carvers, chasers, modelers, hobbyists, ceramists, jewelers, architects, textile workers, scenic designers, display creators, engravers, metal workers, plastic workers, leather workers, embroiderers, rug craftsmen, etc. If you work with designs of any kind, you need this "2000 DESIGNS, ORNAMENTS and FORMS" by M. Estrin—a beautifully printed and spiral-bound volume. Price

**\$1.98**

a  
Basic  
Book on  
Handicrafts

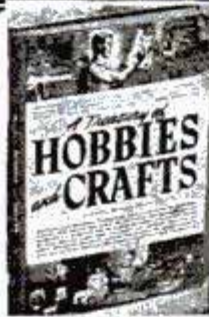

## A Book That Tells You THE WORKING PROCEDURE OF 14 HANDICRAFTS AND INCLUDES OVER 200 MAKE-IT-YOURSELF PROJECTS

A gold mine of fun and craft instructions for both the beginner hobbyists and the expert. Here are more things to make and do than have ever before been crammed into a single volume at this low price. From an ash-tray to a breakfast-table-and-bench set, over 200 projects are explained, with tools and equipment needed, simplified working drawings, pictures and step by step directions that make it easy to turn out finished handicrafts that everyone will admire.

Each craft and each project COMPLETELY EXPLAINED in this book—"A TREASURY OF HOBBIES AND CRAFTS." There is a unique enjoyment in making something with your own hands. If you have made it yourself, it will give you more pleasure than anything like it that you can buy.

- |                     |                     |                  |             |                |
|---------------------|---------------------|------------------|-------------|----------------|
| Costume Jewelry     | Metal Vases         | Plastic Craft    | Wooden Toys | Book-Cases     |
| Book Ends           | Miniature Furniture | Portrait Drawing | Rings       | and many, many |
| Soap Sculpture      | Candy Dish          | Whittling        | Earrings    | more things.   |
| Leather Accessories | Basketry            | Metal Craft      | Pendants    |                |
| Albums              | Photography         | Model Railroad   | Trays       |                |
| Letter Openers      | Indoor Gardening    | Mag.             | Wallets     |                |
|                     |                     | Stuffed Dolls    | Dog Leashes |                |

**PRICE \$1.98**

### GENERAL LEATHERCRAFT

Pleasant profitable hobby for making handsome and practical things in leather. This book gives full, simplified craft instructions with every page lavishly illustrated by photos, drawings, and dimensional work diagrams. PART I explains leather manufacture, craft leather, tools and equipment, where and how to buy leather supplies! PART II shows all basic operations: how to use tools, prepare leather for embossing, tooling, flat modeling, lacing, etc. PART III gives step-by-step methods to make Key Cases, Belts, Wallets, Handbags, Picture Frames, Novelty Jewelry—a total of 35 projects. PART IV provides you with 17 PAGES of full-size Designs and Monograms, for decorating your projects. So popular, this book has had 12 printings. 112 pages, 5 1/2 x 11 inches

**\$1.50**

### GENERAL PLASTICS by Raymond Cherry

Plastic—the miracle product of modern times—lends itself beautifully to the craftsman's art. This instructive book, for the beginner or adept hobbyist, contains over 40 easy plastic projects fully described and illustrated with start-to-finish working diagrams, drawings, and photos. Shows exactly how to design, lay out material, cut, bend, shape and finish attractive and useful items such as plastic Lamps, Vases, Tie Racks, Handbags, Jewelry, etc.—all simple to turn out, with this modern how-to-make-it book. 128 pages 7 3/4 x 10 1/4 inches

**\$1.50**

### "It's Fun to Draw"

A Complete Self-Instruction Course and Reference Book With Over 1000 "How-to-do-it" Drawings.

Anyone who has learned to write, can learn to draw! "It's Fun to Draw" removes the mysticism that has surrounded art for years. By reducing the elements of drawings to its essence, it teaches the BEGINNER—to draw, and to advance into more and more difficult subjects. This book guides you from the first stroke on paper to selling the finished art work. Includes specific instruction, advice, tricks, time-savers, on—Still Life, Animals, Human Figure, Portraits, Lettering, Advertising Art, Color work, etc. 8 1/2 x 11 inches — 128 pages. Price

**\$1.00**

### IT'S FUN TO BUILD THINGS Make and Fix Things for Your Home



The simplified picture-directions in this book guide you through the ABC's of every basic step right to the finished job. So easy you can't go wrong. Clear, easy-to-understand, non-technical language and mere than 200 pictures. Just one article you make—or one repair job you do—with the help of this book, can easily save you many times the cost of the entire volume. Packed with hundreds of practical projects, ideas and suggestions.

#### Partial List of Things to Make

Window Seats, Cupboards, Closet Fittings, Panels, Hideaways for the Family Silver, Boxes and Chests, Folding Screens, Benches, Magazine Racks, Coffee Tables, and other "furniture," Bookshelves, Trick Stair (folding bar, secret compartment, etc.), Ideas for Desks, Dressing Tables, End Tables, Shelf Units. Plus information of all the tools and supplies needed, how to buy lumber, information on sawing, where to build, drawing your plans, size Painting and Finishing (Oil Stain, Shellac, Brushing \$1.50 Lacquer, Enamel, Paint, etc.)

**\$1.50**

HOBBY & CRAFT BOOK HOUSE, Dept. PM-1  
147 West 49th St., New York 19, N. Y.

Please send me the book or books I have checked below.  
If not satisfied, I can return for full refund.

- |  |        |
|--|--------|
| <input type="checkbox"/> Engineer's Sketch Book                                  | \$2.98 |
| <input type="checkbox"/> 2000 Designs and Ornaments                              | 1.98   |
| <input type="checkbox"/> Treasury of Hobbies & Crafts                            | 1.98   |
| <input type="checkbox"/> General Leathercraft                                    | 1.50   |
| <input type="checkbox"/> General Plastics  | 1.50   |
| <input type="checkbox"/> It's Fun To Draw  | 1.00   |
| <input type="checkbox"/> It's Fun To Build Things                                | 1.50   |
| <input type="checkbox"/> Fun in Body Building                                    | 1.00   |
| <input type="checkbox"/> I enclose \$_____ in full payment. Send books postpaid. |        |
| <input type="checkbox"/> Send C.O.D. for \$_____ plus postage.                   |        |

Name \_\_\_\_\_  
Address \_\_\_\_\_  
City and Zone \_\_\_\_\_ State \_\_\_\_\_

### FUN IN BODY BUILDING

Wouldn't YOU like to have a healthy, mighty handsome body that women will admire and men envy? A powerful physique that can dish it out and take it too. Muscles of steel in your arms, legs, back—and every part of your body. "FUN IN BODY BUILDING" tells you simply and surely how you can change yourself into a Mighty Man! Shows you how to increase the size and power of your muscles, in very short time. GIVE YOU COMPLETE COURSE OF EXERCISES, which you can perform in the privacy of your home, and which are GUARANTEED TO ADD INCHES AND MIGHT TO EVERY MUSCLE AND PART OF YOUR BODY! Book also contains information on food, sleep, functions, clothes, anatomy, organs, etc. Included with every order a copy of "Secrets of Strong Man Feats" which shows you how to perform strong man stunts

**\$1.00**

HOW TO ORDER: Fill out the convenient coupon, check the titles of the books you want and mail the order. If you send payment with order we pay all delivery charges — if C.O.D., plus postage. MONEY BACK GUARANTEE: If, for any reason, not completely satisfied return books and get money back at once.

HOBBY & CRAFT BOOK HOUSE  
Dept. PM-1, 147 W. 49th St. New York 19, N. Y.





# INVENTORS



Learn how to protect your invention. The U. S. Patent Laws provide that any new and useful art, machine, article of manufacture, or composition of matter, or any new and useful improvement thereof, may be patented if the act of invention is involved. Therefore, every inventor with a valuable invention should take advantage of the Patent Laws and proceed for patent protection in order to safeguard his rights.

A patent gives the inventor the exclusive right to prevent others from making, using, or selling the invention claimed in the patent for a period of seventeen years.

The Patent Laws were enacted for the benefit of the inventor to give him protection for the features of his invention which are patentable. These features must be properly and concisely set forth and claimed in a formal application for patent, in order to comply with the requirements of the Patent Laws. For that reason, unless the inventor is familiar with patent matters, he should engage a competent registered patent attorney or agent to represent him. We are registered to practice before the U. S. Patent Office and are prepared to serve you in the handling of your patent matters.

A specially prepared booklet entitled "Patent Guide for the Inventor", containing detailed information with respect to patent protection and procedure, together with a "Record of Invention" form will be promptly forwarded to you without obligation upon request.

## CLARENCE A. O'BRIEN & HARVEY JACOBSON

Registered Patent Attorneys

81-J DISTRICT NATIONAL BUILDING • WASHINGTON 5, D. C.

**Patents**

**Trademarks**

**Copyrights**

CLARENCE A. O'BRIEN & HARVEY JACOBSON

Registered Patent Attorneys

81-J District National Bldg., Washington 5, D. C.

Please send me copy of "Patent Guide for the Inventor" and also "Record of Invention" form. This request does not obligate me.

Name \_\_\_\_\_

Address \_\_\_\_\_

City \_\_\_\_\_ State \_\_\_\_\_

(Please write or print plainly.)



I'll Send You 8 Big Kits of Training Equipment  
including

**TWO-BAND 6 TUBE SUPER RECEIVER**  
**AND 16 RANGE METER SET-UP**  
for Testing

Learn Fast... Earn Fast  
**HOME TRAINING**  
Planned For Your Needs  
You Build All These  
**TESTERS... and MORE!**

I give you a fine, moving-coil type Meter Instrument on Jewel Bearings—with parts for a complete Analyzer or Circuit Continuity Tester. You learn how to check and correct Receiver defects with professional speed and accuracy.



**Practice Does It!**

Soldering, wiring, connecting Radio Parts... building circuits with your own hands—you can't beat this method of learning. When you construct this Receiver and Filter Resistor and Condenser Tester, etc., you get a really practical slant on Radio that leads to a money-making future.

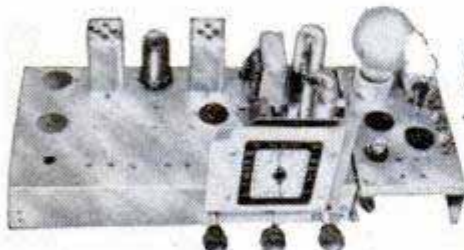
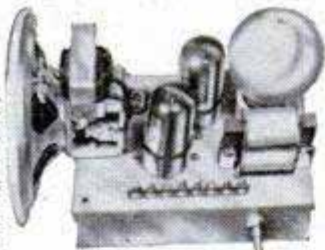

Building this Signal Generator and multi-purpose Tester will give you the kind of valuable experience and practice that is so important as a foundation for making good money in Radio. It makes a breeze out of fixing Radios, and you don't have to spend money on ready-made Equipment.

**VETERANS:**  
Approved for G.I. Training under  
Public Laws 16 and 346

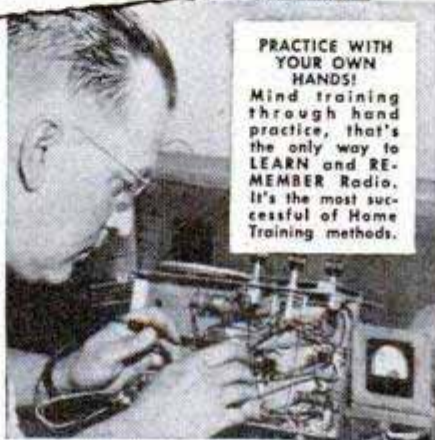

**PRACTICE WITH YOUR OWN HANDS!**  
Mind training through hand practice, that's the only way to LEARN and REMEMBER Radio. It's the most successful of Home Training methods.



**OVER 175 PRACTICAL EXPERIMENTS**  
You'll find out how to build countless Radio Circuits. You'll learn a new, fast way to test Radio Sets without mfg. Equipment.

**LOW COST HOME RADIO TRAINING!**  
**Easy Monthly Payments!**

My perfected Radio Training prepares you to start your own Radio Service Shop—or to land a big pay Radio job. With my help you get neighborhood Radio jobs while learning—for extra cash and rich experience. I train you RIGHT—by putting you to work with your hands in your own home during spare hours. You get 8 big kits of real professional Radio Parts and Equipment—and use them to build, test and trouble-shoot a powerful 6 tube superhet receiver, a 16 range test meter set-up and over 175 fascinating, instructive Radio experiments. My Training is down-to-earth, really PRACTICAL—it's the Training you need

to make money in Radio. Theory is cut to the bone—you don't need any previous schooling or experience. Sprayberry Training starts you out at the very beginning of Radio—the lessons are completely illustrated, simply written and easy to understand.

Get the facts about Sprayberry Training NOW. Find out what it can do for you—prepare for amazing opportunities in Radio Servicing, Television, FM, Radar and Industrial Electronics. Fill out and mail coupon for my two big Books—FREE. No obligation—and no salesman will call. Mail coupon TODAY!

**MAIL COUPON FOR THESE 2 BOOKS!**



"How to Read Radio Diagrams and Symbols" and "How to Make Money in Radio, Electronics and Television." Immense, practical value to you — and they're yours FREE!

F. L. Sprayberry, Pres.,  
**SPRAYBERRY ACADEMY OF RADIO,**  
1098 Sprayberry Bldg., Pueblo, Colo.

Please rush my FREE copies of "How to MAKE MONEY in RADIO, ELECTRONICS and TELEVISION" and "How to READ RADIO DIAGRAMS and SYMBOLS."

Name \_\_\_\_\_ Age \_\_\_\_\_

Address \_\_\_\_\_

City \_\_\_\_\_ State \_\_\_\_\_

Check here if a Veteran  
(Mail in envelope or paste on penny postcard)



# INVENTORS

Patent laws encourage the development of inventions.

We recommend that an inventor employ a registered Patent Attorney or agent, if the inventor is not familiar with patent matters. This is because the value of a patent depends largely upon the skillful preparation of the specification and claims in the patent application.

The firm of McMorrow, Berman and Davidson is registered to practice before the United States Patent Office. Additionally it engages patent attorneys able to readily understand inventors' disclosures, to advise concerning patentability, and to prepare appropriate specifications and claims.

If an inventor believes he has an invention, a search of the most pertinent prior U. S. patents should be made and a report obtained relative to its patentability. Where such report indicates that the invention appears patentable, in order to secure protection, diligence should be exercised in making application for a patent.

Send for a copy of Patent Booklet entitled "How To Protect Your Invention." This booklet contains information on patent protection and procedure. You will also receive an "Invention Record" blank. This will be promptly forwarded to you upon request—no obligation.

## McMORROW, BERMAN & DAVIDSON

*Registered Patent Attorneys*

PATENTS • TRADE MARKS • COPYRIGHTS

135-P VICTOR BUILDING, WASHINGTON 1, D. C.

### McMORROW, BERMAN & DAVIDSON

*Registered Patent Attorneys*

135-P Victor Building, Washington 1, D. C.

Send me your Patent Booklet, "How To Protect Your Invention", and also "Invention Record" form at once. I understand this request does not obligate me.

Name.....

Address.....

City.....

(WRITE OR PRINT NAME CLEARLY)



# HE Mailed This Coupon



**CHARLES ATLAS**  
115 East 23rd St., New York 10, N. Y.

I want the proof that your system of "Dynamic Tension" will help make a New Man—gives me a healthy, husky body and big muscle development. Send me your free book, "Everlasting Health and Strength."

Name **THOMAS MANFRE**.....  
(Please print plainly)

Address **87th St.**.....  
City **Brooklyn**..... State **N.Y.**.....

...and Here's the Handsome Prize-Winning Body I Gave Him!

Thomas Manfre of New York mailed my coupon. Got my free book. Won my Atlas-Champion, Sterling Silver Cup. He says: "Look at me NOW! 'Dynamic Tension' WORKS! I'm proud of the natural, easy way you made me an 'Atlas Champion!'"

### Let Me Prove I Can Make You a New Man!

Would you like greater development—a muscular body? Then listen: I was once a 97 lb. weakling. Afraid to fight, ashamed to be seen in a swimming suit. Then I discovered the secret that changed me into "World's Most Perfectly Developed Man." My secret is "Dynamic Tension." Its purpose is to give you powerful rippling muscles you like to see in your mirror. And for those with systems sluggish from lack of exercise—to help them tone up their entire body, inside and out.

### Only 15 Minutes a Day

My method—"Dynamic Tension"—will turn the trick for you. No theory—every exercise is practical. And man, so easy! Spend only 15 minutes a day in your own home. From the very start, you'll be using my method of "Dynamic Tension" almost unconsciously every minute of the day—walking, bending over, etc.—to BUILD MUSCLE and VITALITY.

### FREE BOOK "Everlasting Health and Strength"

In it I talk to you in straight-from-the-shoulder language. Packed with inspirational pictures of myself and pupils—fellows who became NEW MEN in strength, my way. Let me show you what I helped THEM do. See what I can do for YOU! For a real thrill, send for this book today. AT ONCE.



**CHARLES ATLAS**,  
Dept. 8J, 115 E. 23rd St.,  
New York City.

**CHARLES ATLAS**  
Dept. 8J, 115 East 23rd St., New York, N. Y.

I want proof "Dynamic Tension" will help make me a New Man—with healthy, husky body, big muscle development. Send FREE book, "Everlasting Health and Strength" and details about Trial Offer.

Name \_\_\_\_\_ Age \_\_\_\_\_  
(Please print or write plainly)

Address \_\_\_\_\_

City \_\_\_\_\_ State \_\_\_\_\_

SAY YOU SAW IT IN POPULAR MECHANICS

### CHARLES ATLAS

An untouched photo of Charles Atlas, twice winner and holder of the title "The World's Most Perfectly Developed Man."



## WE THINK IN WORDS

# LEXIPOWER

## THOUGHT IS POWER

Acquiring a superior VOCABULARY is basic training for a top position in any profession, trade or business. To get in the upper brackets financially and socially, develop a masterful VOCABULARY through the fascinating, entertaining and profitable new science of LEXIPOWER. You are judged and rated by every sentence you utter. Executive ability and professional capacity are demonstrated by what you say—not by what your hands do. More POWER to you through LEXIPOWER. Benefit at once! You start using the POWER of LEXIPOWER after the first Lesson. Write NOW for FREE details about LEXIPOWER Dime-a-Day LESSON CLUB.

### LEXIPOWER LESSON CLUB

517-L W. Deming Place

Chicago 14, Ill.

## LEARN MONEY-MAKING CARTOONING

IN SPARE TIME — by Easy Picture Chart Method

Same Simplified Method that has helped train creators of "Terry & Pirates," "Freckles," "Out Our Way," "Winnie Winkle," "Regular Fellers," "Strange As It Seems," "The Neighbors," and many others. Earn while learning. Send 10c for Picture Chart (to test your ability), and full details. (State age.)



THE LANDON SCHOOL, 4809 Clevel. Transit Bldg., Cleveland, O.

## EXPERT PHOTOGRAPHY MADE EASY

LEARN PHOTOGRAPHY NOW

—for both a sound and secure future and immediate opportunities. Ever-increasing demand for trained men and women. Excellent earnings. Resident or home study. 38th year. Write for full details.

### NEW YORK INSTITUTE OF PHOTOGRAPHY

Dept. 49, 10 West 33 Street

New York 1, New York

**LAW** STUDY AT HOME for Personal Success and LARGER EARNINGS. 39 years expert instruction—over 114,000 students enrolled. LL.B. Degree awarded. All text material furnished. Easy payment plan. Send for FREE BOOK—"Law and Executive Guidance."

### AMERICAN EXTENSION SCHOOL OF LAW

Dept. 93-PM

646 N. Michigan Ave.

Chicago 11, Ill.

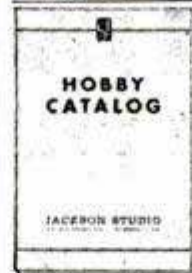

## CRAFT CATALOG

NEW 1949 edition, 84 pages crammed with big selection of tools and materials for plastics, ceramics, hand power tools, plans, etc., etc. A gold mine of hard-to-find items such as foam rubber, kits, books and "How To" information. Every crafter should have a copy. Send 25c now to

### JACKSON, Dept. 70

5440 N. Shoreland Ave., Milwaukee 11, Wis.

## ARTISTS MAKE MONEY

Do you like to draw? Send name, address, age and occupation for FREE ART TEST, to find out your ability.

### ART INSTRUCTION, Inc.

9138 ART INSTRUCTION BLDG., MINNEAPOLIS 15, MINN.

## Learn BAKING At Home

Baking is one of America's high industries in wages. Nearly depression-proof. Thorough basic home course lays sound foundation. If you have aptitude, write for FREE BOOKLET, "Opportunities in Commercial Baking." National Baking School, 1315 Mich. Ave., Dept. 1356, Chicago 5



## LEARN MOVIE PROJECTION THEATRE MANAGEMENT

The Motion Picture Theatre Business offers big opportunities for trained men. Get into a fascinating field with a promising future. Train at home in spare time. Free Catalog. Established 20 years.

THEATRE SCHOOL, 370 Washington St., Elmira, New York



# Arthur Godfrey says:

"I.C.S. made the impossible—easy!"

You've often heard Arthur Godfrey, famed "Huck Finn of Radio," now winning new renown with his coast-to-coast "Talent Scouts" and other CBS programs. But this is the first time you've heard the star on the subject of I. C. S.:

*"I had to quit high school before the end of my second year. Later in life, at the U. S. Naval Materiel School at Bellevue, D. C., I had to master a working knowledge of math, all the way from simple decimals and fractions through trigonometry, in the first six weeks or be dropped from the course. So I took an I. C. S. Course and finished at the head of the class! I. C. S. made the impossible—easy!"*

As usual, the former Navy radio operator and present Lt. Commander in the U. S. Naval Reserve knows what he's talking about. As an I. C. S. graduate, Mr. Godfrey is in the best of all positions to tell you about the educational system that's served so long as talent scout for American industry.

Study his statement. Then mark your interest on the coupon and mail it today for full information on what I. C. S. can do for you!



## INTERNATIONAL CORRESPONDENCE SCHOOLS



BOX 5636-K, SCRANTON 9, PENNA.

Without cost or obligation, please send me full particulars about the course BEFORE which I have marked X:

- |  |   |  |  |
|--|---|--|--|
| <p><b>Air Conditioning and Plumbing Courses</b></p> <ul style="list-style-type: none"> <li><input type="checkbox"/> Air Conditioning</li> <li><input type="checkbox"/> Heating</li> <li><input type="checkbox"/> Refrigeration</li> <li><input type="checkbox"/> Plumbing</li> <li><input type="checkbox"/> Steam Fitting</li> </ul> <p><b>Chemistry Courses</b></p> <ul style="list-style-type: none"> <li><input type="checkbox"/> Chemical Engineering</li> <li><input type="checkbox"/> Chemistry, Analytical</li> <li><input type="checkbox"/> Chemistry, Industrial</li> <li><input type="checkbox"/> Chemistry, Mfg. Iron &amp; Steel</li> <li><input type="checkbox"/> Petroleum Refining</li> <li><input type="checkbox"/> Plastics</li> <li><input type="checkbox"/> Pulp and Paper Making</li> </ul> <p><b>Civil Engineering, Architectural and Mining Courses</b></p> <ul style="list-style-type: none"> <li><input type="checkbox"/> Architecture</li> <li><input type="checkbox"/> Architectural Drafting</li> <li><input type="checkbox"/> Bridge and Building Foreman</li> <li><input type="checkbox"/> Building Estimating</li> <li><input type="checkbox"/> Civil Engineering</li> <li><input type="checkbox"/> Coal Mining</li> <li><input type="checkbox"/> Contracting and Building</li> <li><input type="checkbox"/> Highway Engineering</li> <li><input type="checkbox"/> Lumber Dealer</li> <li><input type="checkbox"/> Reading Structural Blueprints</li> <li><input type="checkbox"/> Sanitary Engineering</li> <li><input type="checkbox"/> Structural Drafting</li> </ul> | <ul style="list-style-type: none"> <li><input type="checkbox"/> Structural Engineering</li> <li><input type="checkbox"/> Surveying and Mapping</li> </ul> <p><b>Communications Courses</b></p> <ul style="list-style-type: none"> <li><input type="checkbox"/> Electronics</li> <li><input type="checkbox"/> Practical Telephony</li> <li><input type="checkbox"/> Radio, General</li> <li><input type="checkbox"/> Radio Operating</li> <li><input type="checkbox"/> Radio Servicing</li> <li><input type="checkbox"/> Telegraph Engineering</li> </ul> <p><b>Electrical Courses</b></p> <ul style="list-style-type: none"> <li><input type="checkbox"/> Electrical Drafting</li> <li><input type="checkbox"/> Electrical Engineering</li> <li><input type="checkbox"/> Electric Light and Power</li> <li><input type="checkbox"/> Lighting Technician</li> <li><input type="checkbox"/> Practical Electrician</li> </ul> <p><b>Internal Combustion Engines Courses</b></p> <ul style="list-style-type: none"> <li><input type="checkbox"/> Auto Technician</li> <li><input type="checkbox"/> Diesel-Electric</li> <li><input type="checkbox"/> Diesel Engines</li> <li><input type="checkbox"/> Gas Engines</li> </ul> <p><b>Mechanical Courses</b></p> <ul style="list-style-type: none"> <li><input type="checkbox"/> Aeronautical Engineer's, Jr.</li> <li><input type="checkbox"/> Aircraft Drafting</li> <li><input type="checkbox"/> Forging</li> <li><input type="checkbox"/> Heat Treatment of Metals</li> <li><input type="checkbox"/> Industrial Engineering</li> <li><input type="checkbox"/> Aviation</li> <li><input type="checkbox"/> Flight Engineer</li> <li><input type="checkbox"/> Foundry Work</li> </ul> | <ul style="list-style-type: none"> <li><input type="checkbox"/> Industrial Metallurgy</li> <li><input type="checkbox"/> Machine Shop</li> <li><input type="checkbox"/> Mechanical Drafting</li> <li><input type="checkbox"/> Mechanical Engineering</li> <li><input type="checkbox"/> Mold-Loft Work</li> <li><input type="checkbox"/> Patternmaking—Wood, Metal</li> <li><input type="checkbox"/> Reading Shop Blueprints</li> <li><input type="checkbox"/> Sheet-Metal Drafting</li> <li><input type="checkbox"/> Sheet-Metal Worker</li> <li><input type="checkbox"/> Ship Drafting</li> <li><input type="checkbox"/> Tool Designing</li> <li><input type="checkbox"/> Welding Engineering</li> <li><input type="checkbox"/> Welding—Gas and Electric</li> </ul> <p><b>Railroad Courses</b></p> <ul style="list-style-type: none"> <li><input type="checkbox"/> Air Brake</li> <li><input type="checkbox"/> Diesel Locomotive</li> <li><input type="checkbox"/> Locomotive Engineer</li> <li><input type="checkbox"/> Locomotive Fireman</li> <li><input type="checkbox"/> Locomotive Machinist</li> <li><input type="checkbox"/> Railroad Section Foreman</li> </ul> <p><b>Steam Engineering Courses</b></p> <ul style="list-style-type: none"> <li><input type="checkbox"/> Boilermaking</li> <li><input type="checkbox"/> Combustion Engineering</li> <li><input type="checkbox"/> Engine Running</li> <li><input type="checkbox"/> Marine Engineering</li> <li><input type="checkbox"/> Steam Electric</li> <li><input type="checkbox"/> Ship Fitting</li> <li><input type="checkbox"/> Toolmaking</li> <li><input type="checkbox"/> Car Inspector</li> <li><input type="checkbox"/> Steam Engr.</li> </ul> | <p><b>Textile Courses</b></p> <ul style="list-style-type: none"> <li><input type="checkbox"/> Cotton Manufacturing</li> <li><input type="checkbox"/> Loom Fixing</li> <li><input type="checkbox"/> Textile Designing</li> <li><input type="checkbox"/> Woolen Manufacturing</li> <li><input type="checkbox"/> Rayon Weaving</li> </ul> <p><b>Business and Academic Courses</b></p> <ul style="list-style-type: none"> <li><input type="checkbox"/> Accounting</li> <li><input type="checkbox"/> Bookkeeping</li> <li><input type="checkbox"/> Business Administration</li> <li><input type="checkbox"/> Business Correspondence</li> <li><input type="checkbox"/> Certified Public Accounting</li> <li><input type="checkbox"/> Commercial</li> <li><input type="checkbox"/> Cost Accounting</li> <li><input type="checkbox"/> Federal Tax</li> <li><input type="checkbox"/> Foremanship</li> <li><input type="checkbox"/> Good English</li> <li><input type="checkbox"/> Higher Mathematics</li> <li><input type="checkbox"/> Motor Traffic</li> <li><input type="checkbox"/> Retailing</li> <li><input type="checkbox"/> Retail Store Management</li> <li><input type="checkbox"/> Salesmanship</li> <li><input type="checkbox"/> Sign Lettering</li> <li><input type="checkbox"/> Spanish</li> <li><input type="checkbox"/> Advertising</li> <li><input type="checkbox"/> Commercial Art</li> <li><input type="checkbox"/> First Year College</li> <li><input type="checkbox"/> French</li> <li><input type="checkbox"/> High School</li> <li><input type="checkbox"/> Postal Civil Service</li> <li><input type="checkbox"/> Secretarial</li> <li><input type="checkbox"/> Stenography</li> <li><input type="checkbox"/> Traffic Management</li> </ul> |
|--|---|--|--|

Name \_\_\_\_\_ Age \_\_\_\_\_ Home Address \_\_\_\_\_  
 City \_\_\_\_\_ State \_\_\_\_\_ Working Hours \_\_\_\_\_ A.M. to \_\_\_\_\_ P.M.  
 Present Position \_\_\_\_\_ Employed by \_\_\_\_\_

Special tuition rates to members of the Armed Forces. Enrollment under G.I. Bill and P.L. 16 approved for World War II Veterans. Canadian residents send coupon to International Correspondence Schools Canadian, Ltd., Montreal, Canada.



# P A T E N T S

**A** patent is a valuable right. On the basis of a constitutional provision Congress has established a system under which inventors may secure the exclusive right to prevent the unauthorized use, manufacture and sale of their inventions for periods of seventeen years. The inventor secures this protection by obtaining a patent.

**U**nless an inventor is thoroughly familiar with such matters, he is advised to employ a competent registered patent attorney, as the value of patents depends largely upon the skillful preparation of the specification and claims.

**We** recommend that you authorize us to conduct a search through the United States patents pertinent to your invention and to submit a report setting forth our opinion with respect to its patentability.

**This** firm is registered to practice before the U. S. Patent Office and is available to assist inventors in the preparation and prosecution of their cases. Detailed information and the preliminary steps to take to obtain patent protection will be furnished upon request. *Form below for mailing convenience.*

**VICTOR J. EVANS & Co.** *Merlin M. Evans*  
REGISTERED PATENT ATTORNEY

330-K MERLIN BUILDING, WASHINGTON 6, D. C.

*Please send me without obligation a copy of your booklet "Patent Protection For Inventors" together with your convenient "Evidence of Invention" form.*

Name.....

Address.....

City and State.....

PATENTS

TRADEMARKS

COPYRIGHTS



These Men are Learning

# ELECTRICITY

ON REAL EQUIPMENT  
in the GREAT SHOPS of COYNE



**Why Spend Years Preparing for a Good Job?  
Train Quickly at COYNE—Be Making Real  
Money While Others are Still Puttering Along!**



B. W. COOKE

Yes, you can get ready for Good Pay—a Big Future in ELECTRICITY—by coming to COYNE in Chicago to train on actual equipment! Here you work on real motors, armatures, switchboards—do actual wiring and trouble-shooting—get the "all-around" training you need.

**Not a "Home-Study" Course**

We do not teach by mail. All training is given in our Great Shops, plus necessary theory. Expert instructors guide you. No advanced education or previous experience needed.

**EARN WHILE LEARNING**

If you need part-time work to help out with living expenses while at Coyne, we'll help you get it. Don't be held back by lack of money.

**COYNE ELECTRICAL AND RADIO SCHOOL**

B. W. COOKE, Pres.

500 S. Paulina St., Dept. 68-72 Chicago 12

This modern fireproof building is occupied entirely by COYNE. Located in Chicago, the Electrical Center of the World.

FOUNDED 1899



**Electrical Refrigeration Included**

Added training now included in great new field of Electric Refrigeration—Industrial Electronics also included. Both mean added opportunities.

**GI Approved—Finance Plan for Non-Vets**

COYNE is authorized to train men under the G.I. Bill. Non-veterans may enroll now, pay most of tuition after graduation. Whatever your problem, COYNE can help you! Mail the coupon now.

**GET THE FACTS!**

BIG FREE BOOK tells all about your future in Electricity and how you can get ready quickly at COYNE. Dozens of pictures. Rush coupon today!

**PREPARE FOR PERMANENT JOBS LIKE THESE**

- Light and Power Wiring
  - Power Plant Work
  - Armature Winding
  - Substation Operator
  - Maintenance Electrician
  - Electrical Testing
  - Signal Maintenance
  - Industrial Electronics
  - Electric Refrigeration and many others
- Our Employment Bureau for graduates gives FREE Lifetime Job Service.

**FREE BOOK**



B. W. COOKE, Pres.  
COYNE ELECTRICAL  
AND RADIO SCHOOL, Dept. 68-72  
500 S. Paulina St., Chicago, 12, Ill.

Send me your big FREE BOOK on ELECTRICITY and tell all about your training offer. This does not obligate me in any way and no salesman will call on me.

NAME.....  
ADDRESS.....  
CITY.....STATE.....





NOW-YOU CAN GET

# BIG MONEY FOR LITTLE IDEAS

## CRYING NEED FOR 2100 INVENTIONS

**B**IG money waiting for people with ideas for new inventions, improvements, novelties! Thousands of manufacturers looking for new products to meet hundreds of post-war demands. YOU can cash in—if you KNOW which inventions are really needed!

It's often the *littlest* things that make the *biggest* money! The rubber pencil tip, ordinary paper clip, clamp fruit-jar top made fortunes for their inventors. The Kiddie Kar brought a cool million. A 70-year-old grandmother made \$350,000 with an overall buckle idea.

### This Book Will Get You Started

Don't waste time and work on something nobody wants! The big secret is in *knowing WHAT to invent!* That's just what this book gives you. Its author, Raymond F. Yates, noted science editor and inventor, lists and describes over 2100 PRACTICAL, money-making ideas that are crying aloud to be invented!

These 2100 needed inventions are the things *most needed and surest to make money* in EVERY field. For quick reference, you get them under 34 different headings: Electrical, Radio, Automotive, Agricultural, Mechanical, Building, Household, Clothing, Food, Toys, Time-Savers, etc., etc.

This book ALSO tells how to think inventively; how to PROTECT your ideas; how to develop an invention STEP-BY-STEP; the most needed inventions in *everyday* life, etc.

### FREE EXAMINATION OFFER

See for yourself what this amazing book can do for you. It doesn't cost a penny to find out! Simply mail coupon below without money—now. The book will be sent to you for 5 days' FREE examination. If you're not convinced that it's jam-packed with money-making ideas for YOU, return it in 5 days, pay nothing. Otherwise send only \$2.50, plus few cents actual postage, as payment in full.

Would YOU like a slice of the \$280,000,000 in royalties that is paid out to American inventors every year? Then you owe it to yourself to get started with this book NOW! Don't break your heart working on things that there's no eagerly-waiting market for! Any ONE of the 2100 "self-starting" ideas fully described in this great book will bring somebody a fortune—and it may as well be YOU! So mail coupon at once! WILFRED FUNK, Inc., Publishers, Dept. T499, 227 East 44 Street, New York 17, N. Y.



### FREE 5-DAY EXAMINATION

WILFRED FUNK, Inc., Publishers, Dept. T499  
227 East 44 Street, New York 17, N. Y.

Please send me 2100 NEEDED INVENTIONS for FREE EXAMINATION. If I keep the book I will send you \$2.50 plus few cents actual postage. Otherwise I will return it within 5 days, without further obligation.

Name \_\_\_\_\_

Address \_\_\_\_\_

City \_\_\_\_\_ Zone No. \_\_\_\_\_ State \_\_\_\_\_  
(if any)

Check here if enclosing \$2.50 WITH this coupon, and we will pay all postage charges. Same 5-day return privilege, for full refund, applies. (Canadian Orders—25c extra for carrying charges. Only U. S. currency accepted.)

SAY YOU SAW IT IN POPULAR MECHANICS

# CARTOONING

Taught by 9 Professionals

A new idea in cartooning schools—45 lessons by NINE Famous Professionals:—Boltinoff, Lariar, Nofziger, Roir, Ross, Roth, Salo, Schus and Wolfe. Over 2,000 instruction Drawings! Course includes: Comic Strips, Magazine, Sport, Politicals, Animals, Advertising, Book Illustration, CUTE GIRLS, etc. Your homework criticized by all 9 famous teachers. 2 years to finish.

Approved for Veterans.

Dept. PM

The PROFESSIONAL SCHOOL  
OF CARTOONING, INC.  
505 Fifth Avenue, New York 17, N. Y.

FREE

Criticism of one of your cartoons—send 10¢ to cover mailing charges.



## WHY DON'T YOU WRITE?

Writing short stories, articles on business, sports, homemaking, gardening, shop crafts, local and club activities, etc., will enable you to earn extra money. In your own home, on your own time, the New York Copy Desk Method teaches you how to write—the way newspaper men learn, by writing. Our unique "Writing Aptitude Test" tells whether you possess the fundamental qualities essential to successful writing. You'll enjoy this test. Write for it, without cost or obligation.

Veterans: This course approved for Veterans' Training.

NEWSPAPER INSTITUTE OF AMERICA  
SUITE 5598-P, ONE PARK AVENUE, NEW YORK 16, N. Y.

## Be a PIANO STYLIST the Professional Way—at Home!

Piano Playing is Fun — It's Easy, Too

COMPLETE TRAINING — POPULAR MUSIC!

Beginners, Medium, Advanced—it makes no difference—anyone can learn to play JAZZ—SWING—BOOGIE. It's different from them all... this complete, easy to follow instruction. Valuable material in the big, new, 150 page CAVANAUGH BOOK! Piano secrets revealed. You actually learn HOW to add notes, chords, basses, breaks, fillers, tricks, hot licks to popular songs. Hundreds have been thrilled and have learned to play with this successful method. Not Ear or Correspondence. It's all in one big book which took 10 years to compile. Decide NOW to play modern music.

Get all the facts—FREE! Send postcard for FREE folder giving full details about this new Piano Book. See how you can learn Piano the easy way! Amaze your friends with your Piano Styles. Don't wait—Write today!

CAVANAUGH PIANO SCHOOLS

Dept. P 475 Fifth Ave. New York 17, N. Y.

## Get into Good Paying AUTO BODY and FENDER WORK



**BIG DEMAND** in Auto Body and Fender work. Start training now in your spare time at home for good pay work. Practical shop experience included. U. E. I. Training covers metal work, welding, painting, etc. Placement service—or we will show you how to start your own shop. Behind U. E. I. TRAINING is a large national organization founded 1927. Write today for FREE FACTS—No obligation.

Approved  
for Training  
under G. I. Bill

AUTO-CRAFTS DIVISION • UTILITIES ENGINEERING INSTITUTE  
2523 Sheffield Avenue, Dept. 198-X, Chicago 14, Illinois

POPULAR MECHANICS



# WHICH OF THESE *Opportunities* INTERESTS *You* MOST?

Accounting  
Air Conditioning  
Architecture & Building  
Automotive Engineering  
Aviation—Practical  
Aviation Drafting & Design  
Better Foremanship  
Bookkeeping  
Business Management

Contracting  
Diesel Engineering  
Drafting & Design  
Electrical Engineering  
Electricity—Practical  
Electronics, Industrial  
High School Courses  
Machine Shop Operations  
Mechanical Engineering

Plastics Engineering  
Plumbing—Practical  
Private Secretary  
Radio Operating & Servicing  
Railway Training  
Refrigeration  
Sheet Metal Pattern Drafting  
Shop Management  
Tool Making

## THINK! LOOK FORWARD!

Business is making big, new plans

Men and Women are preparing for the future

### WHAT ARE YOU DOING ABOUT YOUR TOMORROWS?

● *Today*, choose the job you want—and prepare for it. Or if you are already engaged in the work you like best, start training *now* for quicker promotion. Acquire the knowledge that will help you to get ahead faster, make more money and have greater security.

Invest part of your spare time in more rapid progress. Start training now, in spare time in your own home. Be ready to grasp your opportunity and step out ahead of those who lack the ability you have attained.

American School, founded in 1897 as an educational institution *not for profit*, can help you to reach your goal just as it has helped others during the past fifty-one years. Give serious thought to the list above. Pick one or more subjects that interest you. Then check the coupon at right, add your name and address and mail it at once. The school will send you details on its training plan and outline of study prepared by specialists. There is no charge, no obligation, so send the coupon immediately.

PRACTICAL, EFFECTIVE HOME • STUDY TRAINING SINCE 1897

Take This First Easy Step

**CHECK, CLIP AND MAIL COUPON NOW**

AMERICAN SCHOOL, Dept. G645, Drexel at 58th, Chicago 37, Ill.  
*Without obligation. Please send FREE and postpaid, bulletin and details of the Subject checked.*

- |  |  |  |
|--|--|--|
| <input type="checkbox"/> PLASTICS ENG'R            | <input type="checkbox"/> Accounting            | <input type="checkbox"/> Drafting and Design for Men and Women |
| <input type="checkbox"/> Refrigeration             | <input type="checkbox"/> Electrical Engr.      | <input type="checkbox"/> Radio                                 |
| <input type="checkbox"/> Architecture and Building | <input type="checkbox"/> Electricity-Pract.    | <input type="checkbox"/> High School                           |
| <input type="checkbox"/> Contracting               | <input type="checkbox"/> Electronics, Industr. | <input type="checkbox"/> Air Conditioning                      |
| <input type="checkbox"/> Practical Plumbing        | <input type="checkbox"/> Bookkeeping           | <input type="checkbox"/> Mechanical Eng.                       |
| <input type="checkbox"/> Automotive Engineering    | <input type="checkbox"/> Private Secretary     | <input type="checkbox"/> Shop Management                       |
| <input type="checkbox"/> Aviation Drafting         | <input type="checkbox"/> Diesel Engineering    | <input type="checkbox"/> Tool Making                           |
| <input type="checkbox"/> Aviation                  | <input type="checkbox"/> Sheet Metal           | <input type="checkbox"/> Better Foremanship                    |
| <input type="checkbox"/> Business Mgmtment         | <input type="checkbox"/> Pattern Drafting      | <input type="checkbox"/> Machine Shop Operations               |
| <input type="checkbox"/> Railway Training          |  |  |

Name ..... Occupation .....

Address ..... Age .....

City ..... State .....

**AMERICAN SCHOOL**

Dept. G645, Drexel at 58th Street, Chicago 37



Less than **50¢** A week buys as much as **\$1746** of Old Line Legal Reserve **LIFE INSURANCE**

**YOU ACTUALLY PAY** only \*\$2.00 a month at all ages for the amounts shown below.

\*THIS IS HALF THE PERMANENT RATE WHICH TAKES EFFECT THE 6TH YEAR.

AT AGE	FOR MONTHLY PREMIUM OF	YOU GET A POLICY FOR
20	\$2.00	\$1746.
25	2.00	1582.
30	2.00	1408.
35	2.00	1250.
40	2.00	1086.

Proportionate amounts at all other ages, 15-55. Mail coupon now for full facts and amounts at your age.

Here is a unique plan that lets you budget your Life Insurance like rent. The rate is the same no matter what your age! The amounts vary but, even at 40 you can get \$1086 of this Solid, Old Line, Legal Reserve Life Insurance protection! And not only that—but your policy will be

**FULLY PAID-UP IN 30 YEARS**

with no more premiums to pay, yet your

insurance continues in force the rest of your life.

**POSTAL LIFE** operating under the rigid New York State Insurance laws has sold Life Insurance by mail and over the counter for 43 years and has satisfied policyholders everywhere. Over \$14,000,000 in assets! More than \$60,000,000 paid out in benefits!

Postal Policies are participating! Mail Coupon today!

**Get the FACTS by mail!**

Postal Life Insurance Company  
511 Fifth Avenue, Dept. D—824  
New York 17, N. Y.

Mail me complete information about your new "\$2.00-per-month", 30-payment Modified 5 Whole Life Policy at my age.

NAME .....  
OCCUPATION .....  
DATE OF BIRTH .....  
ADDRESS .....  
Include Postal Zone, if any.

**Free.. TO YOU WHO WANT SUCCESS IN AVIATION**

BEAUTIFUL 28-PAGE BOOKLET -- WRITE DEPT. 69A



**Embry Riddle International**  
SCHOOL OF AVIATION  
MIAMI 30, FLORIDA

**Learn ORNAMENTAL HORTICULTURE**

A thorough, constructive home training for employment or advancement in Nursery Operations, Park Supervision or maintenance, Landscape Designing or Landscape Gardening. My 3 way Plan shows you how to start your own business, get a better job, or earn extra money in spare time. Send for Free Book. APPROVED FOR VETERANS.

**NATIONAL LANDSCAPE INSTITUTE**  
Dept. P-9, 310 So. Robertson Los Angeles 36, California

**An ASSURED FUTURE for You**

**Learn Profitable WATCH REPAIRING**



**BIG MONEY WHILE LEARNING**  
*Study at Home — or at Our Accredited School*  
Complete Home Correspondence Course or G. I. Approved Residence School Plan. Also, Post-Graduate Plan at school for correspondence students.

**Write Today for COMPLETE DETAILS to American Institute of Specialized Watch Repair**  
Dept. No. 100 270-76 East Building Grand Rapids, Michigan

**BOYS-IT'S FREE!**

This exciting book "THE WONDERS OF CHEMISTRY" Shows how to amaze your friends with chemical magic, describes many fascinating home experiments, tells of fun, thrills, adventure and big future opportunities for boys who know chemistry. Send today!



**THE PORTER CHEMICAL COMPANY**  
32 Prospect Avenue Hagerstown, Md.

**NEW WRITERS NEEDED**

New writers needed to re-write ideas in newspapers, magazines and books. Splendid opportunity to "break into" fascinating writing field. May bring you up to \$5.00 per hour spare time. Experience unnecessary. Write today for FREE details. NO OBLIGATION. Postcard will do.

**COMFORT WRITER'S SERVICE**  
Dept. 11, 200 South 7th St. St. Louis, Mo.

**MEN and WOMEN**

**Learn WORLD TRADE**

Buy and sell world-wide without capital. Travel abroad if desired. Men or women! Your own business — profits unlimited. Export manager salaries to \$10,000 a year. Practical, low cost home study course teaches you quickly in spare time. No previous special experience or schooling needed. World Trade Certificate awarded. Write today for FREE DETAILS. State if veteran. Airmail reaches us overnight. THE MELLINGER CO., Exporters-Importers, 1422-AX Westwood, Los Angeles 24, Calif.



# Do you want to:

- ① Make Good Money?
- ② Have a Real Job?
- ③ Build for Future Security?
- ④ Have Your Own Business?

**THEN** get the facts about  
**OUR GREATEST OFFER**  
**IN 17 YEARS . . . to help**  
 you learn **TELEVISION..**  
**RADIO..ELECTRONICS**  
**IN YOUR OWN HOME**

Here's good news...big news...our **BIGGEST NEWS** in 17 years. Now you get and keep many shipments of Radio-Electronic parts . . . work over 200 "Learn-By-Doing" Experiments . . . build and keep a quality 6-tube "Super" Receiver with Magic Tuning Eye . . . build and keep a commercial-type, jewel-bearing Multi-Meter . . . use fascinating, instructive **HOME MOVIES** to help you grasp important points faster, easier . . . get real Employment Service.

Mail coupon below. Get the complete story. See how we do **BOTH**—(1) Prepare, then (2) Help you get started in America's thrilling Radio-Television-Electronic field.

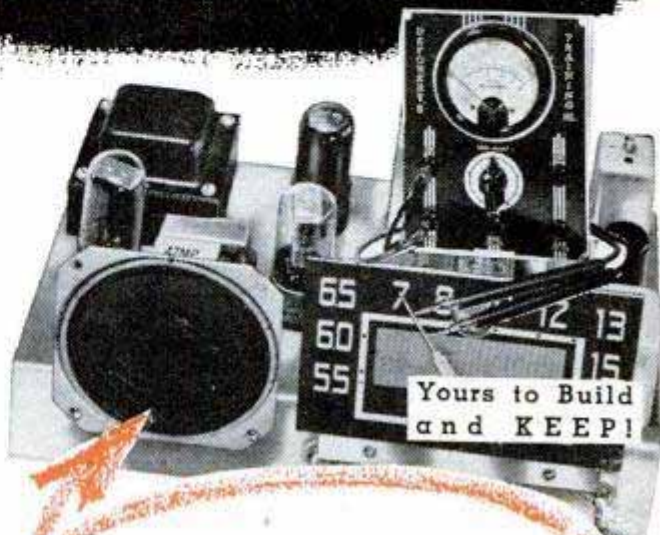

Using the many shipments of parts and assemblies (left), you build and keep this 6-tube "Superhet" Receiver and jewel-bearing Multi-Meter (above) to give you practical experience **AT HOME** in **ASSEMBLY...WIRING . . . SOLDERING . . . TESTING . . . TROUBLE SHOOTING!**



You **KEEP** all of this equipment . . . **WORK OVER 200 "LEARN-BY-DOING" PROJECTS!**

**TRAIN IN CHICAGO LABS**  
 If you prefer, you can get all of your training in our modern, well-equipped Chicago Laboratories. Write for all the details . . . there is no obligation.

**LEARN FASTER . . . EASIER RIGHT:** You receive the loan of a 16mm. Motion Picture Projector and many reels of "Learn-By-Seeing" film to speed your understanding of important points. You get this remarkably effective training aid **ONLY** from D.T.I.

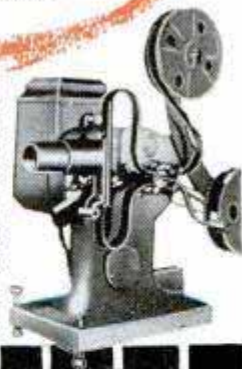

## DeFOREST'S TRAINING, INC.

CHICAGO, ILLINOIS

Associated with DeVry Corporation,  
 Builders of Electronic and Movie Equipment

DeForest's Training, Inc.  
 2533 N. Ashland Ave., Dept. PM-E9  
 Chicago 14, Illinois

**MAIL TODAY**

Send me complete details showing how I may make my start in Radio-Electronics-Television. No obligation.

Name \_\_\_\_\_ Age \_\_\_\_\_

Address \_\_\_\_\_ Apt. \_\_\_\_\_

City \_\_\_\_\_ Zone \_\_\_\_\_ State \_\_\_\_\_

If under 16, check here for special information.  If a discharged veteran of World War II, check here.



# AUDELS Carpenters and Builders Guides 4 vols. \$6



Inside Trade Information for Carpenters, Builders, Joiners, Building Mechanics and all Woodworkers. These Guides give you the short-cut instructions that you want—including new methods, ideas, solutions, plans, systems and money saving suggestions. An easy progressive course for the apprentice and student. A practical, daily helper and Quick Reference for the master worker. Carpenters everywhere are using these Guides as a Helping Hand to Easier Work, Better Work and Better Pay. To get this assistance for yourself, simply fill in and mail the FREE COUPON below.

## Inside Trade Information On:

How to use the steel square—How to file and set saws—How to build furniture—How to use a mitre box—How to use the chalk line—How to use rules and scales—How to make joints—Carpenters arithmetic—Solving mensuration problems—Estimating strength of timbers—How to set girders and sills—How to frame houses and roofs—How to estimate costs—How to build houses, barns, garages, bungalows, etc.—How to read and draw plans—Drawing up specifications—How to excavate—How to use settings 12, 13 and 17 on the steel square—How to build hoists and scaffolds—skylights—How to build stairs—How to put on interior trim—How to hang doors—How to lath—lay floors—How to paint



AUDEL, Publishers, 49 W. 23rd St., New York 10, N. Y. Mail Audels Carpenters and Builders Guides, 4 vols., on 7 days free trial. If OK I will remit \$1 in 7 days and \$1 monthly until \$6 is paid. Otherwise I will return them. No obligation unless I am satisfied.

Name \_\_\_\_\_

Address \_\_\_\_\_

Occupation \_\_\_\_\_

Employed by \_\_\_\_\_ PM

## Learn this Profitable Profession



IN 90 DAYS AT HOME

## Money-Making Career Open to Men and Women, 18 to 50

Hundreds of men and women between 18 and 50 make \$10 to \$20 in a single day giving scientific Swedish Massage and Hydro-Therapy treatments. There is big demand from doctors, hospitals, sanatoriums and clubs. Graduates earn large full time incomes from these or in private practice in their own offices. Others make good money from home treatments given in spare time. Learn this interesting, money-making profession in your own home, through our home study course. Same instructors as in our nationally known resident school. You can win independence and prepare for future security by qualifying for your Diploma. Course can be completed in 3 to 4 months. Many earn while they learn. Begin your training at once.



## Anatomy Charts & Booklet FREE

Enroll now and we will include, at no extra cost, many needed supplies. Fit yourself to help meet growing demand for Scientific Swedish Massage. Send the coupon at once for complete details. Anatomy Charts and 32-Page Illustrated Booklet, FREE, postpaid.

THE COLLEGE OF SWEDISH MASSAGE  
Dept. B64-L, 100 East Ohio St., Chicago 11, Illinois

Please send me FREE and postpaid, Anatomy Charts, 32-page Booklet and complete details on Home Training.

Name \_\_\_\_\_

Address \_\_\_\_\_

City \_\_\_\_\_ State \_\_\_\_\_

SAY YOU SAW IT IN POPULAR MECHANICS

## Famous BAILEY DIESEL SCHOOLS Now Accepting CIVILIAN STUDENTS!

Bailey has a national reputation for "finest training methods." Bailey teaches you fundamentals, plus the practical application of theory in plenty of actual shop work. Bailey is approved by industry. Bailey graduates get the jobs!

Civilian men and boys over 17 who are ambitious to get ahead will act now. Send for FREE catalog. No salesman will call.

**BAILEY TECHNICAL SCHOOLS**  
1655 So. Grand Blvd., St. Louis, Mo.



## Drafting PAYS BIG

Learn in Spare Time — At Home or at Allied School in Chicago  
KEY POSITIONS OPEN IN INDUSTRY

- Mechanical Drafting
  - Tool and Die Making
  - Tool Design and Engineering
  - Machinist Trade
  - Product Design and Illustration
- Train Now!**  
In Nationally Known, Fully Approved School and Endorsed by Industry . . .

Established in 1928  
FREE EMPLOYMENT SERVICE

• • • Write for Catalog — A 1c Postcard will do  
**ALLIED SCHOOL OF MECHANICAL TRADES**  
1338-1340-1342 So. Michigan Ave.  
429 Allied Bldg. CHICAGO 5, ILL.



## LEARN MEAT CUTTING

through actual practice. Profitable Meat Cutting and Successful Meat Merchandising taught easily, quickly. LEARN BY DOING at Toledo in just six short weeks under actual market conditions. For beginners or men with experience. All subjects taught thoroughly and completely. Diploma, Job help. Get store of own. People must eat. School in operation nearly 25 years. Approved for GI training. Send today for FREE illustrated catalog. No obligation. NATIONAL SCHOOL OF MEAT CUTTING, Dept. 50-E, Toledo 4, Ohio



## make MONEY CASTING AT HOME

Make your own rubber molds quickly, cheaply with X.L. RUBBER. Cast thousands of perfect figurines, book ends, plaques, ornaments, ash trays, etc. GREAT PROFITS!  
Write for NEW Catalog.  
X.L. Rubber, Pts. \$2.00; Qts. \$3.50; Gallons \$8.95; Models and enough rubber for 3 molds \$1.00 — Foreign \$1.50.

PLASTIC ARTS STUDIO Route 2 • Dept. 2 • Muncie Ind.



## MUFFLERS STEELS and ALUMINUMS with a motorboat tone

SINGLES, Chev., V-8, Plymouth, Steels \$5.50, Aluminum \$7.00. Chry., Olds., Buicks, etc., Steels \$7.50, Aluminum \$9.00. V-8 and MERCURY DUALS, Steel \$17.50, Aluminum \$21.00. Split Manifold Sets, Steels \$35.00, Aluminum \$45.00. Aluminums are guaranteed for life of your car.

DEALERS WANTED  
**SANDEE MUFFLER CO.**  
BOX 296 LA TIJ., LOS ANGELES 43, CALIF  
2624 W. SLAUSON AVE., LOS ANGELES, CALIF.



# It Will Pay You to Read These Vital Facts about YOUR FUTURE in **REFRIGERATION AND AIR CONDITIONING**

This open letter has only one purpose—to help you decide if Refrigeration and Air Conditioning can give you the kind of future you want. If you are looking for better pay, real job security, steady advancement—perhaps a business of your own some day—you're the man who will go places FAST in this thriving, fast growing industry!

## Good Jobs Open Now

Many fine jobs are open NOW in Refrigeration and Air Conditioning for men with proper training. They should have a real liking for machinery; and they shouldn't be worried about getting their hands dirty. These men constantly will be meeting up with different kinds of work—installing, repairing, servicing, maintaining and rebuilding Refrigeration and Air Conditioning equipment. There won't be any dull moments—and every day will seem more interesting than the last.

**Does this sound good to you? If it does, read every word that follows:**

## Start with Home Study

You can get the training you need to handle a good paying job in this fascinating field in a few short months. The Industrial Training Institute—America's foremost school of practical training—will start preparing you at home in your spare time. You can keep your present job and income while training. You can train as fast or as slowly as you wish—ITI training is geared completely to your own personal needs. This Home Spare-Time Study is the **first step** in the famous ITI 2-Way Training Plan.

## Everything Easy to Grasp

Your ITI Home Study lesson Work Sheets are so practical and down-to-earth that you can do many profitable service jobs while you're still learning. This is a fine opportunity to earn while you learn—and get priceless practical experience at the same time.

**VETERANS:** ITI residence training is fully approved under the G. I. Bill.

Get the Facts   

**MAIL COUPON TODAY!**



**INDUSTRIAL TRAINING INSTITUTE**  
Formerly the L. L. Cooke School of Electricity & Refrigeration & Air Conditioning Institute

Dept. J-1, 2150 LAWRENCE AVE., CHICAGO 25, ILL.

## WORK IN HUGE SHOPS

Then step Number 2! Just as soon as you finish the Home Study part of your ITI training, we pay your transportation to Chicago where your training continues in our giant ITI shops for **FOUR FULL WEEKS**. Here you actually work with every kind of modern Refrigeration, Air Conditioning and Heating equipment. You see remarkable demonstrations that make every point crystal clear. You get the equivalent of years of on-the-job experience—including a complete course of training in the ITI Experimental Home—the amazing building that contains the secrets of Air Cooling, Heating and Conditioning.

## HELP IN FINDING A JOB

With this training—the most practical and complete ever offered—you graduate from ITI ready to handle any practical job in the industry. But we don't stop there. The ITI Job Placement Help Department will do everything possible to help you find the kind of job you want in the locality you want to work. And ITI graduates may use this service at any time—even years after finishing school.

## 30 Years of Training Experience

ITI has been training men for industry since 1916—over 32 years of successful and useful experience. ITI graduates all over the world fill key jobs at top pay. These men have advanced steadily to success because their ITI training gave them a flying start. Today specialized training is absolutely essential to advancement and bigger pay. ITI, with its five large buildings, over \$500,000.00 worth of training facilities and equipment and large staff, is ready to give you training that's **best** of all for you—and none but the best will do! You don't need any special schooling or experience. If you are ambitious, mechanically inclined and have the will to win—you can master ITI training quickly and easily. There's no complicated theory, no dull mathematics. The ITI course is 100% practical—built for the practical man by practical men.

## Mail Coupon for FREE BOOK!

Find out about ITI training today. Just fill in and mail the coupon below. We'll rush you the big FREE ITI book, "Your Future in Refrigeration and Air Conditioning" with full facts about ITI training. Take this first step toward success and big pay NOW. There's no obligation.

MR. C. H. SMITH, President  
INDUSTRIAL TRAINING INSTITUTE, Dept. J-1  
2150 Lawrence Ave., Chicago 25, Ill.

Please send me the FREE ITI book, "Your Future in Refrigeration and Air Conditioning" and full information about the opportunities for trained men in this fast growing field. I understand I'm under no obligation.

Name \_\_\_\_\_

Address \_\_\_\_\_ Age \_\_\_\_\_

City & Zone \_\_\_\_\_ State \_\_\_\_\_

Are you a veteran? \_\_\_\_\_



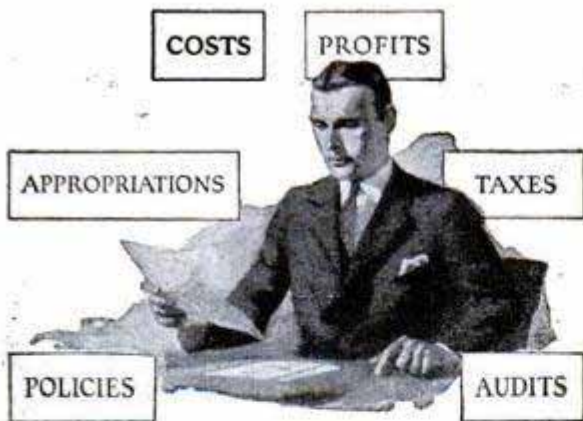

## BECOME AN EXPERT ACCOUNTANT

### The Profession That Pays

The demand for skilled accountants—men who really know their business—is increasing. National and state legislation is requiring of business much more in the way of Auditing, Cost Accounting, Business Law, Organization, Management, Finance. Men who prove their qualifications in this important field are promoted to responsible executive positions.

### Send for Free Book—

#### "Accountancy, the Profession That Pays"

Why let the other fellow walk away with the better job, when through home-study you can equip yourself for a splendid future in this profitable profession?

Knowledge of bookkeeping unnecessary. We train you from ground up, or according to your individual needs. Low cost; easy terms.

Send for free 48-page book describing the LaSalle accountancy training and the opportunities in this highly profitable field—plus "Ten Years' Promotion in One," a book which has helped many men.

If you have the urge, the will to increase your income, mail the coupon NOW.

## LASALLE EXTENSION UNIVERSITY

### A CORRESPONDENCE INSTITUTION

417 S. Dearborn Street—

Dept. 964-HR, Chicago 5, Ill.

Please send me "Accountancy, the Profession that Pays"—plus "Ten Years' Promotion in One"—without obligation.

- Higher Accountancy
- C.P.A. Coaching
- Bookkeeping
- Law: LL.B. Degree
- Business Management
- Salesmanship
- Traffic Management
- Foremanship
- Industrial Management (Machine Shorthand)
- Stenotypy



Name.....Age.....

Address.....

City, Zone, State.....

# SHORTHAND IN 6 WEEKS

## LEARN AT HOME—LOW COST

Write 120 words per minute. Easy for adults.  
Famous Speedwriting system. No signs; no symbols; no machines; uses ABC's. Easy to learn and use. Fast preparation for a position. Nationally used in leading offices and Civil Service; also by executives, writers, speakers, lawyers, scientists, students at college. Over 100,000 taught by mail. The very low cost will surprise you. Also typing. 25th Year.

WRITE FOR FREE BOOKLET TO

# Speedwriting

Dept. 1509-8, 55 W. 42 St., N.Y. 18

# ELECTRICIANS' SCHOOL

HOUSE AND COMMERCIAL WIRING • MOTOR REPAIR  
AND REWINDING • ELECTRIC REFRIGERATION

Approved for Veterans Training

## PENNSYLVANIA INSTITUTE

SCHOOL OF ELECTRICITY

42nd and SPRUCE STS. PHILADELPHIA 4, PENNA.

# START A PHOTOGRAPHY CAREER IN

Photography can be your key to a pleasant, profitable career. Learn the professional way with expert Yawn training. Individual instruction by masters of the camera. Excellent equipment. Thorough 17-week courses in all branches of modern photography—Basic, Commercial, Portrait, Color. Coeducational. G.I. approved. Folder.

Howard W. Yawn, Director  
Dept. A, 511-19 N. Broad St., Philadelphia 23, Pa.

## YAWN SCHOOL OF PHOTOGRAPHY INC.

# THERE'S MONEY IN CARTOONS!

RAYE BURNS will teach you HOW to CREATE ORIGINAL CARTOONS at home that you may SELL! Course contains 26 lessons and over 600 illustrations. All for Only... **\$2.85**

Send name and address for free details.

RAYE BURNS SCHOOL, Dept. M, Box 3583, CLEVELAND, OHIO

# LAW FREE BOOK

Your FREE copy of "The Law-Trained Man" shows how to gain prestige and greater earnings through Blackstone home law study. All instruction material furnished including 18-volume Law Library written by 65 well-known law authorities. Lawyers, Judges among our graduates. LL.B. degree. Low cost; easy terms. Write today.

**BLACKSTONE COLLEGE OF LAW** 225 N. Michigan Ave. Dept. 56, Chicago 1, Ill.

A Correspondence Institution Founded in 1890

# Sensational New Electric ① WELDER ② CUTTER!

Uses 110-115 AC or DC • INSTRUCTIONS INCLUDED  
WELD - BRAZE - CUT - MELT - SOLDER - HEAT TREAT

The WELDRITE combination—tested and proven by countless commercial and amateur users, is now offered direct to you at the amazingly low price of only \$12.00. No Gas—No Gauges—No Spark Lighter needed. Always ready for immediate use—Just plug WELDRITE into 110-115 AC or DC outlet. Uses standard welding and brazing materials available at all welding supply stores. WELDRITE furnished complete with Converter Unit, #1 Single Holder with attached Alligator clip, for welding metal up to 3/16" thickness, using up to 3/32" rod, and #2 Double Holder with Copper Coated Dual Carbon Electrodes for Cutting, Brazing, Heat Treating, Soldering, etc. Starting welding materials and instructions included.

and fender shops, garages, repair and machine shops, manufacturers, etc.

**SEND NO MONEY! 10 DAY TRIAL OFFER**  
Order your WELDRITE Electric WELDER-CUTTER C.O.D. today. Pay postman \$12 plus postage charges (wt. 4 lbs.) or send \$12 and we pay postage. Either way, if not satisfied, return WELDRITE in 10 days, and money will be refunded. WELDER HOOD—Approved lens found in hoods costing to \$10—only \$3.95. California orders please add 2 1/2% sales tax.

**CALIFORNIA TECHNICAL PRODUCTS CO.**  
448 So. Hill St., Los Angeles 13, Calif. Dept. A-9

**BOTH only**  
**\$12**  
**LOWEST PRICE IN HISTORY!**



MAIL THIS

*Opportunity* COUPON TODAY!

SEND  
FOR THIS  
30 PAGE  
**FREE**  
BOOK

RADIO TRAINING ASSOC. OF AMERICA, DEPT. PM1  
5620 Hollywood Boulevard., Hollywood 28, Calif.

Send free illustrated book showing how I can make good in Radio and Television, through training direct from Hollywood.

Name \_\_\_\_\_ Age \_\_\_\_\_

Address \_\_\_\_\_

City \_\_\_\_\_

Zone \_\_\_\_\_ State \_\_\_\_\_

LEARN HOW YOU CAN MAKE GOOD IN

# RADIO

## TELEVISION-ELECTRONICS

*through practical HOME-STUDY plus*

### 10 BIG KITS of RADIO PARTS R. T. A. GIVES YOU!

YOU WILL DO SCORES  
OF PRACTICAL JOBS  
AND EXPERIMENTS

JUST A FEW OF THE  
JOBS YOU'LL DO...

With RTA's 10 big kits you'll build a TRF Receiver, High-Frequency Converter, Complete 6 Tube AC-DC Superheterodyne plus more than a hundred other valuable and practical experiments. Thus RTA methods give you BALANCED TRAINING — Theory PLUS Real Shop Experience, right in your own home.

**25 Years of Home Training Experience**  
Select your school carefully. Select a school like RTA, with more than a quarter century of practical experience in the home-training field... a school that is right "on-the-spot" in Hollywood, where newest technical improvements are introduced!

**EARN EXTRA MONEY**  
*while learning AT HOME*

Under RTA's easy, practical home-training plan, you study in SPARE TIME ONLY and RTA's Hollywood Experts show you how to earn WELCOME EXTRA CASH, even while learning! In fact, like many RTA students—you may actually get MORE SPARE TIME WORK than you can handle.

**MASTER HOLLYWOOD  
TECHNICIANS Guide You**

Direct from Hollywood, the very heart of America's Broadcasting, Television, Radio and Sound industries, RTA brings you practical "Time-Tested" Home Training. Because RTA is so favorably located in Hollywood, it is in an excellent position to bring you ACTUAL METHODS developed by the Radio-Television industry, leading to real money-making opportunities!

**400 MILLION RADIO  
and TELEVISION SETS**

will be built in the next 10 years. 72 million dollars is being spent RIGHT NOW for radio repairs ALONE! When you are thoroughly trained you can imagine what opportunities await you in Your Own Radio Sales & Service Business, Television, FM, Manufacturing, etc.

**RADIO TRAINING ASSOCIATION OF AMERICA** 5620 HOLLYWOOD BLVD.  
HOLLYWOOD 28, CALIF.



BE A WINNER AT ANYTHING YOU TACKLE WITH **PROGRESSIVE POWER**

Now **ALL 5 FAMOUS JOWETT COURSES** in 1 Volume for only **25c**

DARLING, THAT BULLY WON'T PICK ON YOU AGAIN!

JOE YOUR NEW ENERGY AND APPEARANCE SURE DO A GOOD JOB. YOU EARNED YOUR PROMOTION.



**George F. Jowett**  
Whom experts call "Champion of Champions"  
● World's wrestling and weight lifting champ at 17 and 19.  
● World's Strongest Arms. ● 4 times World's Perfect Body — plus other records.

Let's Go, Pal! I'll prove I can make YOU an **"ALL-AROUND" HE-MAN**

**FAST — OR NO COST!**  
says George F. Jowett  
World's Greatest Body Builder

Enjoy My "Progressive Power" Strength Secrets! Give Me 10 Easy Minutes a Day — Without Strain! I'll teach you the "Progressive Power Method" through which I rebuilt myself from a physical wreck the doctors condemned to die at 15, to the holder of more strength records than any other living athlete or teacher! "Progressive Power" has proven its ability to build the strongest, handsomest men in the world. And I stand ready to show you on a money back basis—that no matter how flabby or puny you are I can do the same for you right in your own home. Let me prove I can add inches to your arms, broaden your shoulders, give you a man-sized chest, powerful legs and a Rock-like back—in fact, power pack your whole body so quickly it will amaze you! Yes, I'll jam you with power and confidence to master any situation—to win popularity—and to get ahead on the job! Through my proven secrets I bring to life new power in you inside and out, until YOU are fully satisfied you are the man you want to be.

**PROVE IT TO YOURSELF IN ONE NIGHT**  
Send only 25c for my 5 easy-to-follow, picture-packed courses now in 1 complete volume "How to Become a Muscular He-Man." Try it for one night! Experience the thrilling strength that surges through your muscles.

I am making a drive for thousands of new friends fast—REGARD-  
**LESS OF COST!**  
**SO GET NOW MY 5 Muscle Building COURSES**  
(Valued at \$5 each)  
**All in 1 Great Complete Volume Packed With How-To-Do-It Pictures!**  
Now, this "get-acquainted," extremely low price of only **25c** is your chance to build a body you'll be proud of! Follow Jowett's easy method of muscle building **NOW!**  
**For Only 25c**



**10 DAY TRIAL!**  
Think of it—all five of these famous courses now in one picture-packed muscle-building volume for only 25c. If you don't actually FEEL results within **ONE WEEK**, send it back and your money will be promptly refunded!  
Photo Book Of Famous Strong Men!

**FREE!**  
Photos that inspire you to mfgt and muscle. Free with order.

**FREE GIFT COUPON!**

Jowett Institute of Physical Culture Dept. PM-89  
230 Fifth Avenue, New York 1, N. Y.

Dear George:—Please send by return mail, prepaid, **FREE** Jowett's Photo Book of Strong Men, along with all 5 Muscle Building Courses, 1. Molding a Mighty Chest, 2. Molding a Mighty Arm, 3. Molding a Mighty Grip, 4. Molding a Mighty Back, 5. Molding Mighty Legs—Now all in One Volume "How to Become a Muscular He-Man." Enclosed find 25c. NO C.O.D.'S.

NAME \_\_\_\_\_ AGE \_\_\_\_\_  
(Please Print Plainly, Include Zone Number)

ADDRESS \_\_\_\_\_

**FREE BOOK TELLS HOW YOU CAN LEARN TO MOUNT BIRDS and ANIMALS**

**BE A TAXIDERMIST—Learn by Mail**  
Easy home lessons teach you quickly how to MOUNT BIRDS, ANIMALS, GAME-HEADS, FISH—to TAN LEATHER, FURS. Save your hunting trophies. Have a home museum. It's thrilling! Taxidermy is wonderful, FUN, A PLEASURE HOBBY AND A MONEY MAKER.—Investigate! Get this strange FREE BOOK.  
**EXTRA MONEY:**—Earn in your spare time. Sell your mounts; and do work for other sportsmen. Students report \$30 to \$75 and more per month. Big demand. Fine prices. If you want REAL PROFIT from spare time WRITE TODAY.  
**FREE BOOK**—with 100 photos of wild game. Tells about Taxidermy and how YOU can learn, easily, quickly. Old reliable school. 275,000 students. — STOP this minute and TEAR OUT THIS AD NOW as a reminder; then write; get the free book. You will be delighted, AMAZED. RUSH postal or letter and learn how to have more FUN, FASCINATION, PROFIT. State your AGE.  
**Northwestern School of Taxidermy, Dept. 2509 Omaha, Neb.**

**How to Make Money with Simple Cartoons**

A book everyone who likes to draw should have. It is free; no obligation. **FREE BOOK**  
Simply address  
**CARTOONISTS' EXCHANGE**  
Dept. 99-D Pleasant Hill, Ohio

**SEND FOR THIS FREE!**

Make money. Know how to break and train horses. Write today for this book **FREE**, together with special offer of a course in Animal Breeding. If you are interested in Getting and Riding the saddle horse, check here ( ) Do it today—now.  
**BEERY SCHOOL OF HORSEMANSHIP**  
Dept. 1109D Pleasant Hill, Ohio

**ENGINEERING DEGREE IN 27 MONTHS**

**INDIANA TECHNICAL COLLEGE**

Aeronautical, Chemical, Civil, Electrical, Mechanical, and Radio Engineering (inc. television). Drafting, 1-yr. Gov't approved for G.I.'s. Low rate. Earn board. Large industrial center. Students from 48 states, 18 countries. Demand for graduates. Enter September, December, March, June. Catalog.  
598 E. Washington Blvd., Ft. Wayne 2, Ind.

**Photography for PLEASURE or PROFIT**

Learn at home. Spare time. Practical basic training. Long-established school. Many have earned while learning. Send coupon below for free booklet, "Opportunities in Modern Photography" and full particulars.

**AMERICAN SCHOOL OF PHOTOGRAPHY**  
1315 Michigan Avenue Dept. 1356 Chicago 5, Illinois  
Send booklet, "Opportunities in Modern Photography," full particulars and requirements. No salesman will call.  
Name \_\_\_\_\_ Age \_\_\_\_\_  
Address \_\_\_\_\_  
City \_\_\_\_\_ Zone \_\_\_\_\_ State \_\_\_\_\_





# GET INTO DRAFTING

The Draftsman Plays a most Important Part in INDUSTRY

## DRAWING OUTFIT INCLUDED with Drafting courses

All the tools you need including folding drawing table. With them you can put your ideas on paper quickly and with accuracy. With training you are all set to master Drafting in months, — not years — at home.

### Learn in Spare Time—At Home!

(or at the College in Chicago)

A few hours of pleasant home study every week — that's all. With Chicago Tech's help, you train yourself step by step. This tested method — developed over 44 years of C.T.C. progress — prepares men for good positions in industry.



Practically everything that's built or manufactured these days is constructed from blue print drawings prepared by the draftsman. He is the KEY man in industry. No new machines can be built, no bridges erected, no buildings constructed until the draftsman has completed his work.

Drafting is clean, interesting, professional-type work. The draftsman is paid well to start. And he has real opportunities for advancement to high-pay jobs in Engineering. The tremendous production programs ahead in industry will require more draftsmen than ever before.

Send today for free information. See what this training has done for others, what it can do for you. Simply MAIL COUPON TODAY in an envelope or use a penny postcard.

## CHICAGO TECHNICAL COLLEGE

M-211, Tech Building, 2000 South Michigan Ave.  
Chicago 16, Illinois

### MAIL COUPON NOW

Chicago Technical College  
M-211 Tech Bldg., 2000 So. Michigan Ave.  
Chicago 16, Illinois

Mail me FREE Drafting Lesson with information about big opportunities in DRAFTING and how I can train at home.

- Architectural Drafting       Electrical Drafting  
 Machine Drafting         Structural Drafting  
 Builders' Course

Name \_\_\_\_\_ Age \_\_\_\_\_

Address \_\_\_\_\_

City \_\_\_\_\_ Zone \_\_\_\_\_ State \_\_\_\_\_

## MAKE MORE MONEY

being our

## PURCHASING AGENT

No Experience or Money Required—We Finance All Purchasing—  
Exceptional Opportunity—

For details write Dept. C

### PURCHASING MANAGER

2719 LAWRENCE AVE. CHICAGO 25, ILL.



Learn to Write at Home  
in spare time

You can become a good Business Writer, and you can learn Shaded Writing also at home in spare time by my Simplified Method, without cost of going away to school. Write for my FREE BOOK, "How to become an Expert Penman," which shows what others have learned. Send 10c for Special Penpoint and your name with a flourished bird written on a card. Write TODAY.



Send for this FREE Book

T. M. TEVIS, BOX 25K, CHILLICOTHE, MO.

## PRACTICAL MATHEMATICS LIBRARY

Easy self-instruction in 25 branches by college experts. Helps you qualify for better job. 4 volumes, 1300 pages, 600 illustrations. Sent for free trial. Only \$2.00 down, \$2.00 a month; total \$9.80 plus postage. (Cash price \$9.50, postage free.) 160-page Logarithm book free with order. National Educational Alliance, Inc., Dept. 569, 37 West 47th St., New York 19, N. Y.

## SUCCEED IN THE POULTRY BUSINESS!



Poultry is providing many trained men and women with a good, comfortable living, either part or full time. For 27 years our Home Study Course has been helping thousands obtain training and "know how" that means extra income from the start. Don't delay — Write today for prospectus describing courses, methods, service, opportunities.

NATIONAL POULTRY INSTITUTE

DEPT. 50 ADAMS CENTER, N. Y.

## WANT A GOVERNMENT JOB?



START  
as high as  
\$3,351 Year  
Prepare NOW For  
Next Examinations  
20,000 Appointments  
Every Month

### VETERANS GET SPECIAL PREFERENCE

Many Early  
Appointments Expected  
City Mail Carriers  
City Postoffice Clerks  
Ass't Statistical Clerks  
Stenographers-Typists  
Storekeeper—  
Gaugers, Etc.

40-Page Civil  
Service Book  
FREE

Mail  
Coupon  
today—  
SURE



### FRANKLIN INSTITUTE

(Not Government Controlled)

Dept. F86

Rochester 4, N. Y.

Rush to me, entirely free of charge, 40-page book with: (1) A full description of U. S. Government jobs; (2) A list of U. S. Government jobs; (3) Tell me how to qualify for a job.

COUPON

Name \_\_\_\_\_

Address \_\_\_\_\_

Vet? \_\_\_\_\_

SAY YOU SAW IT IN POPULAR MECHANICS



# Learn RADIO - TELEVISION



## in the GREAT SHOPS OF COYNE

Get ready for a better job, bigger pay NOW in Radio. Cash in with "All-around" knowledge of Radio—Television. Train on actual equipment. You learn easily at COYNE because it's real shop training. Thousands of graduates in Industry.

### Not a "Home-Study" Course!

You get actual shop work on full-size equipment plus necessary theory. Whether you had previous experience or not makes no difference at Coyne.

### Easy To Start Own Shop

Right along with our course, we include special training on how to operate your own Radio Shop.

### GI Approved—Finance Plan for Non-Vets EARN WHILE LEARNING

If you need part-time work to help out with living expenses while at Coyne we'll help you get it. Don't be held back by lack of money. Free employment service to graduates.

### SEND FOR FREE BOOK

Get the facts! BIG FREE BOOK tells about your future in Radio and Television and how you can prepare at Coyne. Dozens of pictures. No obligation—no salesman will call.

Established 1899

### MAIL COUPON TODAY!

B.W. COOKE, President  
COYNE Electrical and Radio School  
500 S. Paulina St., Dept. 68-3H Chicago 12, Ill.

Please send me your Big Free Radio and Television Book and all the facts.

NAME.....

STREET.....

CITY..... STATE.....

### COYNE

Gives You All-Around Radio Training

RADIO MFG.  
TELEVISION  
FREQUENCY MODULATION (FM)  
RADIO SERVICE (Your own shop)  
SOUND SYSTEMS



# STUDY AT HOME

With An Educational Institution

Men with specialized training win higher positions, insure larger earnings, and are bigger successes in business and public life. Opportunities NOW greater than ever before. Send for our Catalog.

## ARTS and SCIENCES

Courses in Philosophy; Education; Letters; Public Health; Medical Jurisprudence; Psychology; Sociology; Physics; Chemistry; Plastics; Geology; Political Science; Theology; Business and Commerce; Accounting; Mathematics; Statistics; Agriculture.

## ENGINEERING

Courses in Electrical, Civil, Mechanical, Drafting, Architectural, Steam, Aeronautical, Radio, Structural, Mining, Industrial, Petroleum, Marine, Chemical, Diesel, Automobile, Refrigeration, and Air Conditioning Engineering.

## LAW

Complete Professional Law Course includes 18 Hornbook Series college grade textbooks. Courses also in Commercial Law, Patent Law and Medical Jurisprudence.

McKinley-Roosevelt Incorporated, 4610-K, Sheridan Rd., Chicago 40, Ill.

# Learn MECHANICAL DENTISTRY

America's OLDEST School of Dental Technology

Complete training:

PLATE, BRIDGEWORK, CASTING, PORCELAIN, PLASTICS

Licensed by N. Y. and N. J. States  
VETS: Approved P.L. 346 and 16

N. Y. SCHOOL OF MECHANICAL DENTISTRY

138 Washington St. NEWARK 2, N. J.

Also: 125 W. 31 St. NEW YORK 1, N. Y.

IMMEDIATE ENROLLMENT — DAY AND EVE.



## BE AN ARTIST

Send for interesting picture book "BUILDING A FUTURE"

Explains the unique position of the professional artist in American life. Gives examples of huge professional income. Tells definitely how YOU can acquire PROFESSIONAL skill—AND PROFESSIONAL INCOME—within one year—in spare time at home. No obligation. Book is free. Write name, address and age on penny postcard and mail TODAY to:

GRANT SCHOOL OF ART

Dept. 168, 53 W. Jackson Blvd., Chicago 4, Ill.

## HOW TO CUT RAFTERS

New vest pocket book gives lengths, side cuts, plumb cuts, deductions. For all rafters for any building from one inch to forty feet wide. Gives numbers to cut on square. Also degrees for some cuts for Radial Saws. All standard pitches from 1/8 to 5/8. Just open book to pitch page and there are your lengths, side cuts, etc. Anyone who knows what a jack rafter is can frame a roof if he has this great book. Price one dollar, (\$1.25 in Canada). Builders' Topics, Dept. 5, Lock Box 828, Seattle, Washington. CARPENTERS, PLUMBERS, PLASTERERS, ELECTRICIANS, ETC. subscribe for Builders' Topics, the monthly magazine for HE-MAN CONSTRUCTION WORKERS. Only \$1.00 per year, (In Canada—\$1.25). Sample copies 25c.

## BUILD YOUR OWN PROFESSIONAL ENLARGER

SAVE UP TO 50% — With complete MINILITE Enlarger Kit, plus simple step by step instructions, diagrams, screwdriver and pliers, assemble your own Professional Enlarger in 2 hours. Get all features of more expensive Enlargers—for 35MM to 2 1/4" x 3 3/4" Negatives, Precision Machined Aluminum Alloy Castings, Rotating Glassless Dustproof Negative Carrier, Aluminum Spherical Gear and Rack, Tapered Flexible Bellows, Magnification of 1 to 7 times at base. Assembled Enlarger weighs only 7 lbs. Utilize your own Camera Lens or f4.5 or f6.3 lens, which we can supply. Complete Kit (less lens and baseboard), only \$27.45 (inc. Federal Tax) postage paid. 10 DAY TRIAL—with Money Back Guarantee. EASY MONTHLY PAYMENTS. Save up to 50%.

Write today for Free Illustrated Folder.

CALIFORNIA TECHNICAL PRODUCTS 448 So. Hill St., Dept. M-9  
Los Angeles 13, Calif.





# They Never Knew It Was SO EASY To Play

**Thousands Now Play Popular Songs  
Who Didn't Know a Note of Music Before**

**You, too, can learn your favorite  
instrument at home, without  
a teacher, this quick,  
easy, money-saving way**

**T**HINK of the fun YOU are missing! The popularity, friendship, good times! Why? Because you think it's *hard* to learn music. You have an idea that it's a slow, tedious task, with lots of boring drills and exercises.

That's not the twentieth-century way! Surely you've heard the news! How people all over the world have learned to play by a method so simple a child can understand it—so fascinating that it's like playing a game. Imagine! You learn without a teacher—in your spare time at home—at a cost of only a few cents a day! You learn by the famous print-and-picture method—every position, every move before your eyes in big, clear illustrations. You CAN'T go wrong! And best of all, you start playing real tunes almost at once, from the very first lesson.

No needless, old-fashioned "scales" and exercises. No confused, perplexing study. You learn to play by playing. It's thrilling, exciting, inspiring! No wonder hundreds of thousands of people have taken up music this easy way. No wonder enthusiastic letters like those reproduced here pour in from all over the world.

Sound interesting? Well, just name the instrument you'd like to play and we'll prove you CAN! (Instruments supplied when needed. Cash or Credit.) Mail the coupon or write. Do it now! 50th year.

**U. S. SCHOOL OF MUSIC  
79 Brunswick Bldg.  
New York 10, N. Y.**



**Learned Quickly at Home.** "I didn't dream I could actually learn to play without a teacher. Now when I play for people they hardly believe that I learned to play so well in so short a time." \*H. C. S., Calif.

Music is the magic key to friendship, fun, romance. The person who can play a musical instrument is always sure of a welcome. Why not let music open up a new world for you. Thousands have discovered unexpected pleasure and profit in music, thanks to the unique method that makes it amazingly easy to learn.

**Send for FREE Booklet and  
Print and Picture Sample**

See for yourself how this wonderful self-instruction method works. Sit down, in the privacy of your own home, with the interesting illustrated booklet, "How to Learn Music at Home." No salesman will call—decide for yourself whether you want to play this easy way.



**Invited to Parties.** "Before I took your course I didn't know one note of music. Then three months later I started to play for dances. I've been invited to many parties. The course is easy and interesting." \*R. M., Vancouver, B. C.

**Well Worth Money.** "The course is fully self explanatory. When one is finished with it there is little one need learn. It is well worth the money and I fully believe you have the finest course on the market today." \*R. E. G., Clarksburg, W. Va.

**Surprised Friends.** "People who hear me play don't understand how I do it. They ask if I haven't had lessons from a teacher. To their surprise they find I haven't. I'm glad to be a student of your School." \*M. H., Athol, Kans.

**U. S. SCHOOL OF MUSIC  
79 Brunswick Bldg., New York 10, N. Y.**

I am interested in music study, particularly in the instrument indicated below. Please send me your free booklet, "How to Learn Music at Home" and the free Print and Picture Sample.

Piano  
Guitar  
Hawaiian Guitar  
Violin  
Piano Accordion  
Saxophone  
Trumpet, Cornet

Reed Organ  
Tenor Banjo  
Ukulele  
Clarinet  
Trombone  
Flute  
Piccolo

Modern  
Elementary  
Harmony  
Mandolin  
Practical Finger  
Control

Name \_\_\_\_\_ Have You This Instr.?  
(PLEASE PRINT)

Address \_\_\_\_\_

City \_\_\_\_\_ State \_\_\_\_\_

Note: If you are under 16 yrs. of age, parent must sign coupon

SAVE 2c—Stick coupon on penny postcard.



← LEARN →

# AVIATION

AN ESSENTIAL INDUSTRY IN PEACE OR WAR

**MAXIMUM TRAINING IN MINIMUM TIME**

for 19 years Cal-Aero Technical Institute has specialized in....

✓ **AERONAUTICAL ENGINEERING**

2 year course - kept abreast of new research and scientific development.

✓ **MASTER AVIATION MECHANICS**

1 year course - C. A. A. approved for Airplane and Engine License.

Modern "live" training equipment, including helicopters, jets, rockets, wind tunnel... Classes start monthly - Room and board available on our airport... Cal-Aero Tech Training is carefully designed for just one thing - **TO MAKE MORE MONEY FOR YOU.** More than 7000 successful graduates in addition to 26,000 pilots and 7500 mechanics trained for Army & Navy Air Forces, prove that our career training is unsurpassed. **APPROVED FOR VETERANS**



**CAL-ACRO**  
**TECHNICAL INSTITUTE**

GRAND CENTRAL AIR TERMINAL  
GLENDALE 1, CALIFORNIA  
LOS ANGELES COUNTY

## MAIL THIS COUPON TODAY!

Please send full information on Aviation Training FREE--without obligation.

Name \_\_\_\_\_ Birth Date \_\_\_\_\_

Street \_\_\_\_\_ Zone \_\_\_\_\_

City \_\_\_\_\_ State \_\_\_\_\_

CHECK ONE  VETERAN  NON-VETERAN PM-9

## Learn A Trade NOW! PRACTICAL SHOP TRAINING!

### In Our Chicago Shops

- AUTO MECHANICS
- DIESEL MECHANICS
- REFRIGERATION
- BODY-FENDER
- WELDING—ARC and GAS
- MACHINIST
- PIANO TUNING

Above Approved For G. I.'s and Civilians

One of America's Leading Practical Schools  
7 Floors of Fully Equipped Shops  
Over 48,000 Successful Graduates  
Expert Individual Instruction  
Learn by Doing—Low Living Expense  
Established 1902—Day and Evening Classes

### Also the following Home Study Courses

- PLASTIC
- REFRIGERATION
- DIESEL

—CALL IN PERSON OR MAIL THIS AD TO—

## GREER SHOP TRAINING

(Dept. PM-298) 460 South State St., Chicago 5, Ill.

Please send without obligation free information regarding trade checked above. (Specify whether you are a Veteran  or Civilian )

Name \_\_\_\_\_ Age \_\_\_\_\_

Address \_\_\_\_\_

City \_\_\_\_\_ State \_\_\_\_\_

**SOUTH BEND**

## LATHE COLLETS

Precision Steel and Brass Collets for use in any make of lathe or other machine that they will fit.

### SPECIFICATIONS

Collet No.	Thread Dia. In.	Thread Length In.	Th'ds Per In.	Body Dia. In.	Collet Length In.	Head Dia. In.	Head Taper Deg.
3	.650	3/4	26	.6495	2-11/16	.852	12
2	.855	13/16	20	.8595	3-5/16	1.095	15
5	1.250	3/4	20	1.2495	3-9/32	1.452	10
4	.950	13/16	20	.9495	3	1.150	10



	No. 3	No. 2	No. 5	No. 4
STEEL COLLET	\$3.75	\$4.00	\$4.75	\$4.25
BRASS COLLET	2.00	2.25	2.50	2.35

**SOUTH BEND LATHE WORKS** 455A E. Madison St. South Bend 22, Ind.

## CADET DUAL VACUUM HORNS

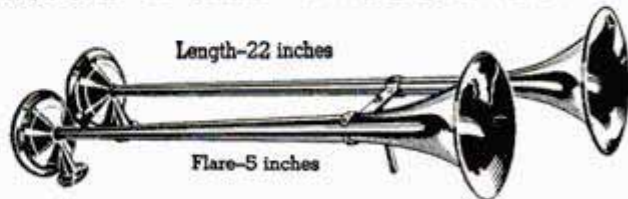

Length—22 inches

Flare—5 inches

### At the Low Price We Can All Afford

Here is your chance to get air horn results—looks, blast and beautiful organ tone—at a fraction of the cost of air horns. Spun brass with gleaming chrome finish or lasting lacquer. Positive operation. Complete unit consists of one pair of beautiful vacuum horns with the mounting brackets, valve, control handle, hose, fittings and installation instructions. Can be mounted on front fender or on top of or under the hood. A must for safety and smart appearance for any car. Chrome finish \$29.50—Lacquer finish \$23.75. Send check or money order and we will pay the postage—*or order C.O.D.*

The Protecturod Company Dept. 701  
4033 Windsor Road • Youngstown 7, Ohio

## MACHINE SHOP EQUIPMENT



The 1949 edition of the famous Center Tool Co. Catalog is now ready! Every workshop owner should have a copy. 240 pages full of illustrations, descriptions, and prices of the latest tools made by best known manufacturers in U. S. You pay the cost of printing—50c. **We refund your 50c with your first order of \$10.00 or more.** Prompt delivery on most tools. Send check or money order today!

CENTER TOOL CO., 153 Centre Street, Dept. C, New York 13

## FALSE TEETH

### KLUTCH holds them tighter

KLUTCH forms a comfort cushion; holds dental plates so much firmer and snugger that one can eat and talk with greater comfort and security; in many cases almost as well as with natural teeth. Klutch lessens the constant fear of a dropping, rocking, chafing plate. 25c and 50c at druggists... If your druggist hasn't it, **don't waste money on substitutes**, but send us 10c and we will mail you a generous trial box. © I. P. INC.

KLUTCH CO. Box 4893-I ELMIRA, N. Y.

FREE BOOK



## RAISE HAMSTERS

The new wonder animals from Syria. Often called Toy Bears. Delightful pets. Everyone wants them. Laboratories need thousands. Clean, odorless. Raise anywhere. A profitable and interesting hobby or business. We furnish breeding stock with manual of instructions.

Write today for free illustrated literature.

GULF HAMSTERY, 1536 BASIL, MOBILE, ALA.



# MEN IN DEMAND!

Trained Men Are Needed  
NOW, And No End To This  
Need Is IN SIGHT In The Tre-  
mendously Growing Billion \$

# AIR CONDITIONING and Refrigeration INDUSTRY



## By Your Own Initiative—NOW—TODAY

You can start the training program that will make you a valuable **SPECIALIST** in the profitable, fast multiplying industry which Air Conditioning and Refrigeration has become. **TOO FEW** ambitious men have taken advantage of the unlimited opportunities for big-paying jobs and steady promotions **WAITING FOR YOU** in all parts of the United States.

### GRADUATE... ...SUCCESSSES

"My A.C.T.C. training is the best investment I ever made. When I finished lesson 33, I started doing service work for a dealer here. I made enough to pay for my training even before I completed it, and my earnings are ever increasing." A.A., Jr.  
"When I reached the 25th lesson, I started doing spare time service work in the evenings and made about \$200.00 in that way. So far my total earnings in this field have amounted to \$2,274.00. This spring I had six or seven offers to change jobs. I consider your course the best investment I ever made." O.M.S.  
"I started doing spare time work for dealers and individuals immediately after beginning my course with you. My work was on both commercial and domestic equipment. Most of my work was done in the evenings and I made around \$2,000.00." J.F.K.

- **WHERE YOUR FUTURE LIES-** Two big fields are open to you after you have completed the practical, low-cost and complete training course established by Air Conditioning Training Company. You may enter industrial air conditioning and refrigeration. Scores of big companies installing equipment in factories, hotels, department stores, restaurants, and homes need men with training... training that YOU can obtain in your spare time. AND you may build your own business around maintenance and repair of home refrigerators, air conditioning units. It is estimated that over 16,000,000 service calls are needed every year on these units in private homes alone, not to mention stores and all other types of business establishments.
- **KEEP YOUR PRESENT JOB—TRAIN AT HOME-** You can master the Air Conditioning Training Company course at home in your spare time, take as long or as short a time as you wish. You learn **HOW TO DO IT** quickly and simply. No previous schooling (such as mathematics, etc.) is necessary. This course is designed by experts in the field to give you **FACTS** and **KNOW-HOW**.
- **WHEN HOME TRAINING IS COMPLETED** you are brought to Youngstown, Ohio, for two weeks of intensive, practical experience on actual equipment in our complete, modern laboratories. Your transportation to and from Youngstown is included in A.C.T.C.'s plan. Also board and lodging during the intensive training period. When you have completed the A.C.T.C. course you are eminently fitted to your own valuable position in this interesting, exciting new industry.



Send for this  
**Free**  
**Information**

containing **FACTS** about the air conditioning industry and the one school that concentrates on fitting you for a lifetime good-paying career in this field. Send this coupon today. Remember, Air conditioning Training specializes in **AIR CONDITIONING** and **REFRIGERATION ONLY!**



**AIR CONDITIONING TRAINING CO.**  
789-791 Wick Avenue—Dept. PM-24  
Youngstown, Ohio

Gentlemen:

Please send me, with no obligation, complete information on how I can train in my spare time for a good future in Air Conditioning and Refrigeration.

NAME.....

ADDRESS.....

CITY..... STATE.....

## AIR CONDITIONING TRAINING CO.

Dept. PM-24 • 789-791 WICK AVENUE • Youngstown, Ohio  
One of America's Finest Practical Training Institutes



# I'LL SHOW YOU HOW TO MAKE MONEY IN WATCHMAKING!



You want to get out on your own—I'll show you how to make your future secure. Train yourself for a profitable business or a career in watch repairing—a craft which has no age or physical requirements. Trained men are always needed in watchmaking.

## IT'S A FASCINATING BUSINESS!

Enjoy the thrill of accomplishment—when you're able to disassemble and repair any make watch! I'll show you all the methods to make you a skilled watchmaker—dispel the mysteries of the trade! You'll like this clean work, unusually good pay, short hours and the satisfaction of offering a service that is needed in almost every community. Write for free book today!



Approved for Veterans

### WHAT YOU LEARN

You'll get nationally-accredited training in: material classification and ordering, approved repair methods, crystal grinding, history of the profession, lathe operation, and watch-rate recording machine operation. In delightfully cool Denver, Colorado—at the foot of the Rocky Mountains, you'll get practical work-bench experience plus visual and sound instruction, demonstration by working models, books and lectures in complete hair-spring manipulation, balance and escapement work, escapement adjusting.

### MAIL COUPON FOR FREE BOOK.

American Academy Inc., School of Horology  
1549 Lawrence St., Dept. A, Denver 2, Colo.

Yes, Mr. Hagans—rush your free booklet on how to make money in watch repair! No obligation. No salesman will call.

Name \_\_\_\_\_

Address \_\_\_\_\_

City \_\_\_\_\_ Zone \_\_\_\_\_ State \_\_\_\_\_

Check here if veteran (Paste on penny postcard)

# Do you want

- ➔ ..to go to College?
- ➔ ..or to enter a Profession?
- (Such as Accounting, Architecture, Nursing, Dentistry, Teaching, Social Work, Osteopathy, Beauty Culture, Optometry, Embalming, Chiropody, Law, Medicine, etc.)
- ➔ ..or get an Office Position?

To get anywhere, you practically MUST finish High School FIRST. You can complete our simplified High School Course in SPARE time at home, as FAST as your time and abilities permit. Equivalent to resident school work—prepares you for college, pre-professional examinations, business, industry. Standard texts furnished. Diploma. Credit for H. S. subjects already completed. Single subjects if desired. Low tuition, easy terms. American School, Chicago, est. 1897—endorsed by educators. Finish your high school education NOW. Write TODAY!

## High School Course at Home Many Finish in 2 Years

American School, Dept. H645, Drexel Ave. at 58th St., Chicago 37, Ill.

Gentlemen: Send me FREE information covering special training in subjects checked below. No obligation on my part.

- |  |  |
|--|--|
| <input type="checkbox"/> High School Course          | <input type="checkbox"/> Diesel Engineering                  |
| <input type="checkbox"/> Architecture and Building   | <input type="checkbox"/> Drafting and Design for Men & Women |
| <input type="checkbox"/> Automotive Engineering      | <input type="checkbox"/> Plastics                            |
| <input type="checkbox"/> Business Management         | <input type="checkbox"/> Private Secretary                   |
| <input type="checkbox"/> Electrical Engineering      | <input type="checkbox"/> Mechanical Engineering              |
| <input type="checkbox"/> Elec. and Gas Refrigeration | <input type="checkbox"/> Aviation                            |
| <input type="checkbox"/> Air Conditioning            | <input type="checkbox"/> Salesmanship                        |
| <input type="checkbox"/> Railway Training            | <input type="checkbox"/> Radio                               |
| <input type="checkbox"/> Electronics, Industrial     |  |

Name.....

Address.....

# EXTRA MONEY FOR YOU!

## ORDERS GALORE for Lucky Pennies

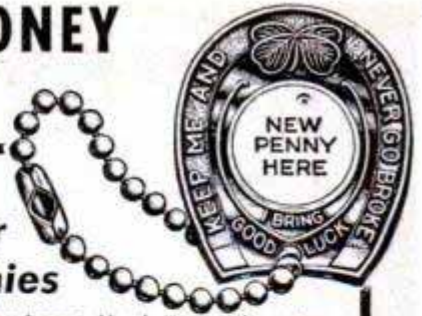

From every kind of business. Men! Make big extra money showing how lucky penny key chains stimulate business. You can earn \$100.00 to \$150.00 a week in spare time. Contains brand new copper penny and customer's ad stamped on back. Write for details and new catalog.

HOUSE OF MEINHARDT  
4138 SHERIDAN, DEPT. M9 CHICAGO 13

# MAKE MONEY this easy way at home

Make your own costume jewelry. Easy, pleasant, interesting. No experience needed. We supply settings and sparkling, imported rhinestones in many colors at wholesale prices. Big market for costume jewelry gives you steady profits. Write for details now. Sparkle Mart, Dept. A, 475 Fifth Avenue, New York

## NONE BETTER! SUPER DRILL GRINDER



Sharpens round shank drills from 3/32" to 1-1/16" in diameter, up to 11" long. Grinds old drills like new in 4 different point angles, using hand or power grinding wheels. Money-back guarantee.

Price only \$2.95

At Dealers or Postpaid

CRANDALL MFG. CO. 1512 W. Slauson, Dept. FA-33, Los Angeles 44, Calif.

## TALK-SING thru your own radio with RADIO MICROPHONE

Be the life of the party. Put on your own broadcasts at home. Talk-Sing make announcements from any room. Wonderful voice practice. Microphone easily attached to any radio. Follow enclosed instructions. SEND NO MONEY—pay postman \$1.98 plus postage. Send Money Order or check and save postage.

EMPIRE RADIO & TELEVISION CO. (Dept. M4) 1521 Bedford Ave. Brooklyn 16, N. Y.

THOUSANDS OF SUFFERERS USE

# BREATHEASY

FOR

# ASTHMA

CARRY IT WITH YOU  
USE IT ANYWHERE

*Sold on Money-Back Guarantee*

Write To Dept. PM

BREATHEASY DISTRIBUTORS, INC.  
65 CEDAR STREET  
SEATTLE 1 WASHINGTON





# Learn RADIO

TELEVISION, ELECTRONICS  
*by*  
SHOP METHOD HOME TRAINING

Let NATIONAL SCHOOLS, of Los Angeles, a practical Technical Resident Trade School for almost 50 years, train you for today's unlimited opportunities in Radio

You receive all parts, including tubes, for building this fine, modern Superheterodyne Receiver. This and other valuable standard equipment becomes your property.

*these two FREE books will tell you how*

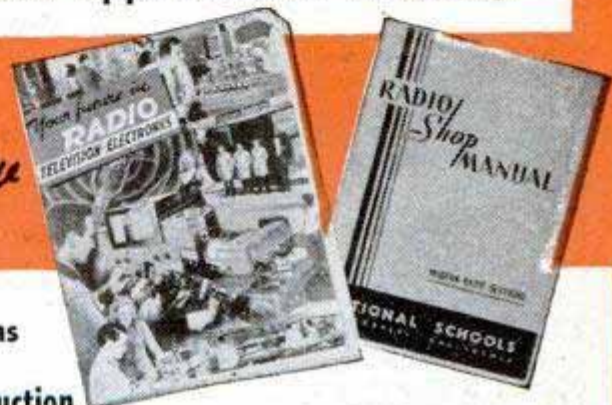

## GOOD JOBS AWAIT THE TRAINED RADIO TECHNICIAN

You are needed in the great, modern Radio, Television and Electronics industry! Trained Radio technicians are in constant and growing demand at excellent pay—in Broadcasting, Communications, Television, Radar, Research Laboratories, Home Radio Service, etc. National Schools Master Shop Method Home Study Course, with newly added lessons and equipment, can train you in your spare time, *right in your own home*, for these exciting opportunities. Our method has been proved by the remarkable success of National Schools-trained men all over the world.

### You Learn by Building Equipment with Standard Radio Parts We Send You

Your National Schools Course includes not only basic theory, but *practical* training as well—you learn by doing. We send you complete standard equipment of professional quality for building various experimental and test units. You advance step by step until you are able to build the modern superheterodyne receiver shown above, which is yours to keep and enjoy. You perform more than 100 experiments—build many types of circuits, signal generator, low power radio transmitter, audio oscillator, and other units. The Free Books shown above tell you more about it—send for them today!

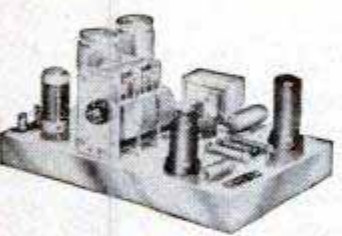

### NOW! NEW PROFESSIONAL MULTITESTER INCLUDED

This versatile testing instrument is portable and complete with test leads and batteries. Simple to operate, accurate and dependable. You will be able to quickly locate trouble and adjust the most delicate circuits. You can use the Multitester at home or on service calls. It is designed to measure AC and DC volts, current, resistance and decibels. You will be proud to own and use this valuable professional instrument.



### Lessons and Instruction

Material Are Up-to-Date, Practical, Interesting

National Schools Master Shop Method Home Training gives you basic and advanced instruction in all phases of Radio, Television and Electronics. Each lesson is made easy to understand by numerous illustrations and diagrams. All instruction material has been developed and tested in our own shops and laboratories, under the supervision of our own engineers and instructors. A free sample lesson is yours upon request—use the coupon below.

*Here's Just a Few of the Interesting Facts you Learn with the*

### FREE MANUAL

1. Routine for diagnosing Radio Troubles.
2. Preliminary inspection of Receivers.
3. How to Test and Measure Voltages.
4. How to Test Speaker in Audio Stages.
5. How to Trace the Circuit and Prepare Skeleton Diagram.
6. Complete Reference Table for Quickly Locating Receiver Troubles.

Both Resident and Home Study Courses Offered

**APPROVED FOR VETERANS**  
CHECK COUPON

## NATIONAL SCHOOLS

LOS ANGELES 37, CALIFORNIA EST. 1905

MAIL OPPORTUNITY COUPON FOR QUICK ACTION

National Schools, Dept. PM-9  
4000 South Figueroa Street  
Los Angeles 37, California

(Mail in envelope or paste on penny postcard.)

Mail me FREE the books mentioned in your ad including a sample lesson of your course. I understand no salesman will call on me.

NAME \_\_\_\_\_ AGE \_\_\_\_\_

ADDRESS \_\_\_\_\_

CITY \_\_\_\_\_ ZONE \_\_\_\_\_ STATE \_\_\_\_\_

Check here if veteran of World War II



## THE OPPORTUNITY OF A LIFETIME



For the electrical man who is prepared for advancement

WAS there ever such an opportunity to get started in electrical maintenance and repair—and at top-notch wages? Are you ready—with experience and ability—to cash in on it? Others are getting just the sort of background needed—quick! practical!—to handle the great variety of electrical maintenance and repair work TODAY—from this well-known electrical library. You can too!

## THE LIBRARY OF ELECTRICAL MAINTENANCE AND REPAIR

5 vols., 1826 pages, 1724 illustrations

Gives you the "know-how" to tackle any wiring or motor job. Five books show you HOW—to install all types of motor and generator units—to inspect and repair motor starters and generators—to diagnose motor and generator troubles—to figure new windings for old cores—DC and AC windings—to test armature windings—test induction motors, etc., etc. One book is full of trouble-shooting charts that show quickly symptoms, causes, specific remedies, etc.

Take the first step toward improving YOUR future—Mail this coupon TODAY

No money down—special price—easy payments—FREE trial

McGraw-Hill Book Co., 330 W. 42 St., New York 18, N. Y.

Send me for ten days' free examination the Electrical Maintenance and Repair Library. If satisfactory I will send you \$2.50 in 10 days and \$3.00 monthly until the price of \$17.50 is paid. If not wanted I will return books postpaid.

Name \_\_\_\_\_

Home Address \_\_\_\_\_

City and State \_\_\_\_\_

Company \_\_\_\_\_

Position \_\_\_\_\_

PM-9-48

NEW FROM COVER TO COVER

# AUDELS REFRIGERATION and AIR CONDITIONING GUIDE



4 Books in One! Covering:  
Basic principles, Servicing, Operation, Repair of  
1—Household Refrigeration  
2—Special Refrigeration Units  
3—Commercial & Industrial Refrigeration  
4—Air Conditioning Systems  
A gold mine of essential important facts for ENGINEERS, SERVICEMEN & USERS.

A Good Book is a Good Friend! Here you have at your fingers' ends a Complete Library in ONE VOLUME, the necessary data you have been looking for on: MODERN UNITS, SYSTEMS & MACHINES, REFRIGERANTS, including Freon, Lockers, Water Coolers, Quick Freezing & Air Conditioning Systems. 1280 Pages, 46 chapters all Fully Illustrated & Indexed for Ready Reference.

ANSWERS YOUR QUESTIONS Get This Information for Yourself. Mail Coupon Today. No Obligation Unless Satisfied. ASK TO SEE IT.

**\$4 COMPLETE • PAY ONLY \$1. A MONTH**

AUDELS, Publishers, 49 W. 23rd St., New York 10, N.Y.

MAIL AUDELS NEW REFRIGERATION GUIDE for free examination. If O. K. I will send you \$1 in 7 days; then remit \$1 monthly until price of \$4 is paid. Otherwise I will return it.

Name \_\_\_\_\_

Address \_\_\_\_\_

Occupation \_\_\_\_\_

Employed by \_\_\_\_\_

PM

One Year Written Guarantee!  
ARMY AIR CORPS 16 JEWEL

# ELGIN

\$17.95



Made for Pilots and Navigators of the U. S. Army Air Forces. They had to be good. Sturdy 16 Jewel Elgin men's wrist watches. Shock resistant. Sweep second hand. Luminous hands and dial. Stainless steel back. Unbreakable crystal. Water repellent. Made by ELGIN one of America's outstanding watch manufacturers. Fully reconditioned. One year written guarantee sent with each watch. Supply limited! **SEND NO MONEY.** Simply pay postman \$17.95 plus 10% tax and postage on delivery. Cash orders sent postpaid. UNITED PRODUCTS CO., 7941 S. Halsted, Dept. LES-1009, Chicago 20.

## Have an OFFICE of YOUR OWN!

LEARN NEW PROFITABLE PROFESSION  
At Home in 60 Days, Men & Women, 18 to 70!

Be Your Own Boss and the Boss of Others. Be Respected. Meet Interesting People.

Earnings of men and women in this profession run as high as \$5,000-\$15,000 yearly. Others make good money in spare time. Little money needed to start. A business where your earnings begin sooner. Easy to learn. No selling or goods to buy. No experience necessary. A depression-proof business. A course of action to guide you step by step as you earn. All 53 lessons sent at once to use as operating manuals. Easy terms. Diploma. Money-back agreement. Write for FREE BULLETIN.



FRANKLIN CREDIT SCHOOL  
Dept. 75-J ROANOKE 7, VIRGINIA

BY MAIL in Easy Lessons

For Extra Cash Extra Fast

SELL CHRISTMAS CARDS

Show EMBOSSED Name-Imprinted Christmas Cards. Amazing values low as 50 for \$1.00 sell quickly. You make wonderful earnings showing FREE SAMPLES. Also sell 21-Card Christmas Assortment; \$1 marvel seller pays you up to 50¢! Everyday Cards, Stationery and other MONEY-MAKERS. Get your FREE Personal SAMPLES and beautiful Christmas box on approval NOW! Write ARTISTIC CARD CO., INC. 436 WAY STREET ELMIRA, N.Y.

50 for \$1 WITH NAME Get FREE SAMPLES

## LIQUID MARBLE

COMPOSITION FLOORS FLEXIBLE MOLDS MOLD Novelties, Statuary, Art Goods in Flexible Plastic Molds; 5c

material makes \$1 seller. Make Marbleized floors, Tile Walls. Colorful, glossy, amazing! Easily learned; start in garage or basement. Particulars free. MARBLEIZING SERVICE, Dept. 10-F, Edwardsville, Ill.



## RAISE Money Making CHINCHILLAS

Several females and a male start a large herd which will furnish you an income for years. Just a few feet of space are required. No experience needed. We furnish all instructions. Write world's largest breeder today for free details.

WILLOW BROOK FARM, R-36, Sellersville, Pa.

## Refit and Tighten FALSE TEETH



With AMAZING PLASTI-LINER

If your plates are loose and slip or hurt; refit them better than new, with this pliable, non-porous strip. Just lay on plate, bite and it molds perfectly, hardens for lasting fit and comfort. Ends forever the mess, bother and expense of temporary applications that last only a few hours or few months. Will not injure plates, and guaranteed to give satisfaction or your money back. Write for Plasti-Liner today. Pay postman \$1.25 for one reliner, \$2.25 for both upper and lower—or send money now; save C.O.D. charges. PLASTI-LINER CO., Dept. 43E, Buffalo 2, N. Y.



**LOW  
FACTORY  
PRICES!**

# ... on the Sensationally **NEW 1949** **MIDWEST RADIOS**

**NEW**  
**SERIES 16**  
**SUPER DE LUXE**  
**AM-FM**  
**CHASSIS**

**30 DAYS TRIAL**



**14 1/2" PANASONIC  
SPEAKER**

**5  
WAVE  
BANDS**

**EASY  
TERMS**

**58  
OUTSTANDING  
FEATURES**

**COMPLETE WITH FRONT PANEL—READY TO INSTALL!**

Here is the last word in radio engineering . . . a powerful, world-ranging, magnificently-toned radio that is unsurpassed for performance, selectivity, sensitivity, and advanced engineering features. Uses these latest-type tubes, rectifier and tuning indicator: three 7A7, three 7A4, two 7C5, one 7A6, one 7Q7, one 6BA6, one 6BE6, one 6C4, one 6AL5, one 5U4, one 6U5. Comes complete with satin stripe copper finish front panel attached, Magna-Tenna Loop Aerial and giant 14 1/2" Electro-Dynamic Panasonic Speaker. Requires only a few minutes to install, plug in and play. **LOW FACTORY PRICES . . . EASY TERMS . . . 30 DAYS TRIAL.** Send TODAY for FREE 1949 Midwest Radio Catalog of separate Chassis and beautiful Console and Table models.

**A Complete Line of FINE RADIOS and RADIO-PHONOGRAPHS . . . Available in SEPARATE CHASSIS Like the POWERFUL SERIES 16 AM-FM Model above or in COMPLETE CONSOLES like this...**



**Beautiful**  
**SYMPHONY GRAND**  
**AM-FM Radio-Phonograph with**  
**TELEVISION Audio Switch-Over**  
**and NEW Intermix AUTOMATIC**  
**RECORD CHANGER**

A Magnificent musical instrument and a masterpiece of cabinet design—the finest Midwest Radio in 29 years of manufacture. Offers world-ranging radio reception and newest automatic Intermix Record Changing Phonograph. Uses Series 16 Super DeLuxe AM-FM Chassis. Giant 14 1/2" Panasonic Speaker; Tri-Magnadyne Coil System; Built-In Loop Antenna. Other luxurious console and table model cabinets available with Series 16, 12, and 8 chassis—on Easy Terms and 30 Days Free Trial.

- Including the Exclusive Midwest
- FLASH-O-MATIC**  
Volume and Band Indication
- TELEVISION**  
Audio Switch-Over
- FIDEL-A-STAT**  
Color-Ray Tone Selection
- TRI-MAGNADYNE**  
Coil System
- ...Plus **NO-DRIFT FM**  
and many other features

**BUY DIRECT FROM FACTORY and SAVE!**

**MIDWEST RADIO & TELEVISION CORP.**

Dept. 252 909 Broadway, CINCINNATI 2, OHIO

**Rush for Free Catalog!**

**FILL IN COUPON AND MAIL TODAY OR JUST SEND NAME AND ADDRESS ON 1¢ POSTCARD**

**MIDWEST RADIO & TELEVISION CORP.**  
Dept. 252, 909 Broadway, Cincinnati 2, Ohio

Please send me your new FREE 1949 Catalog.

NAME \_\_\_\_\_  
ADDRESS \_\_\_\_\_  
CITY \_\_\_\_\_ ZONE \_\_\_\_\_ STATE \_\_\_\_\_



**NOW! Enjoy Learning to Speak**

# SPANISH AT HOME

**FRENCH-GERMAN-ITALIAN**



COUNT CORTINA

**BIG OPPORTUNITIES** and **JOBS** waiting for those who can speak Spanish. Millions of dollars being invested in Mexico, Central and South America — **BUSINESS** and **TRAVEL** increasing.



## Only 15 Minutes a Day

Learn to **SPEAK** Spanish like a **NATIVE!** The **CORTINA-PHONE METHOD**, famous for **OVER 65 YEARS**, teaches you — **BY LISTENING** to these **30 NEW CORTINA** recordings. Right in your own home, relaxed and at ease.



## Sent on 5 Days Approval

**THOUSANDS** have learned **SPANISH** this quick, easy way for **PLEASURE** and **BUSINESS**. Why not you? Free 32-page book, "The Cortina Short-Cut," describes this famous method fully and tells how you can try it in your own home for 5 days. **NO COST IF NOT DELIGHTED**. Mail coupon for free book—**NOW!**



Spanish Course Available Under **G. I. BILL OF RIGHTS**

**Write NOW!**

**CORTINA ACADEMY** (Established in 1882)  
Dept. 649, 105 W. 40th St., New York 18, N. Y.

Please send me—without obligation—your free book. I am interested in (check)

**SPANISH**  French  Italian  German

Name \_\_\_\_\_

Address \_\_\_\_\_

City \_\_\_\_\_ State \_\_\_\_\_

If **VETERAN** check here

## 22 Big Money-Makers in a Single Line! Amazing New Fluorescent Lights with *Circular Tubes*

THE HOMELITER



**FREE Sales Outfit**

Don't send a penny. Sample Outfit is **FREE**. Rush name on penny post card for money-making facts about sensational new "CIRCLINE" Fluorescents. Latest scientific development gives you 22 new type circular tube fixtures for kitchens, dinettes, halls, and play rooms. Also Floor and Table lamp for living rooms and pin-ups for shaving and vanity tables. Sells on sight to homes, restaurants, stores, offices. No other fluorescents like **CIRCLINE**. Salesmen who order samples quickly reorder in large quantities. All fixtures complete with tubes. No waiting. Also immediate delivery on all standard type Fluorescent Fixtures. This is too good to miss. Big, quick profits waiting. Hush name on postcard today for **FREE Sales Outfit**.



**NEW MAXILUME PIN-UP MIRROR LIGHT**

**MAXILUME COMPANY • 125 W. HUBBARD • DEPT. 89 • CHICAGO 10, ILLINOIS**

*Out of Pawn!*

## GENUINE DIAMONDS



**Direct to You**—Save up to 50% and more on fine quality, Genuine Diamonds, re-set in beautiful modern mountings, styled for Ladies and Men—Sold with an **Iron-Clad Money-Back Guarantee**. Over 100,000 satisfied customers. Order now from this ad. Write us for **FREE ILLUSTRATED CATALOG** of other **Unredeemed Diamond Pledges** from \$5.00 to \$5000. Send today. Reference: Any Bank or any Mercantile Agency.

1/5 CARAT \$125 Value

**\$49** Tax incl.

1/2 CARAT \$200 Value

**\$95** Tax incl.

**BERMAN'S COLLATERAL LOAN BANK**

Dept. P-13, 636-38 W. Balto. St.

Baltimore 1, Md.

## MAKE BIG MONEY IN PLASTICS

**SENSATIONAL NO RISK OFFER**  
For 30 Days Only!

Start Your Own Big Money Business for just a few dollars! Mammoth Course of Instructions, newest processes, just off the press. Over 60 pages of complete step-by-step instructions and formulas for purring all profitable Plastics. Professional Mold Making. Colorful Tile, Composition Flooring, Imitation Marble and Plaster Casting, including Art Novelty Manufacturing. Miscellaneous Tips, Valuable Marketing Suggestions and Directory. This is Your Opportunity!

\$3.95 Complete Postpaid Money-Back Guarantee.

C.O.D. Orders—\$1.00 Deposit.

Save C.O.D. Charges—Send Check or Money Order to

**COLONIAL PLASTICS CO.**

216 S. 7th St.

St. Louis, Mo.

Dept. 405

## BE A HOTEL EXECUTIVE

For good pay, interesting work with a future, learn hotel management. Write for Free folder describing our complete, practical training for executive positions and opportunities in this big field. **Veteran Approved. Free Placement Service.**

**FLORENCE UTT HOTEL SCHOOL** Dept. 1  
1007 Broadway, Kansas City 6, Mo.



**CLEANS CLOTHES AT HOME!** SAVES DRY CLEANING BILLS!

**NEW INVENTION!**

Banishes old-style clothes cleaning... no messy chemicals, liquids, or powders. Use like brush. Simply glide over surface. Cleans Suits, Dresses, Coats, Hats, Ties, Suede Shoes. Also Window Shades, Wallpaper, Drapes, Upholstered Chairs, Davenport, Carpets, Rugs, Automobile Cushions. Keeps them spot and stain free. **Saves costly cleaning bills. Sells like wild!**

**SAMPLES FOR AGENTS!** Sample offer sent immediately to all who send name **AT ONCE**. A penny postal will do. **SEND NO MONEY**—just your name. **KRISTEE CO., 689 Bar Street, AKRON, OHIO**





# Now ANY **AUTO REPAIR JOB** Can Be "Duck Soup" For You!

**MoToR's New AUTO REPAIR MANUAL  
 Shows You How to Service and Repair  
 ANY Part of ANY Car!**

**FREE 7-DAY  
 OFFER!**

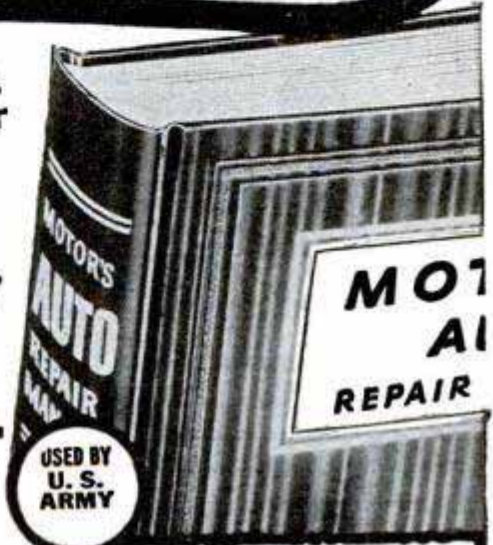

**N**OW you can "polish off" the **HARDEST** jobs the **EASIEST** way! MoToR's **AUTO REPAIR MANUAL** is ready to show you how to repair anything from carburetor to rear end—with the *least* possible amount of time and effort!

Suppose plain-talking car engineers from every auto plant in America got together and showed you all the things you needed to know about repairing and servicing the cars they had designed and manufactured! That's really what you get in this big manual! Right at your fingertips, the main "dope"

from over 150 *Official Factory Shop Manuals*, covering every make car built since 1935!

Easy to use, too! Quick-index leads you to right page in jiffy! Just follow simple instructions step-by-step.

**SEE HOW MUCH YOU GET!**

Over 700 pages, 8½x11 inches, bound in sturdy covers. 200,000 service, repair, adjustment, replacement, tune-up facts on all makes and models, 1935 to 1948! More than 1700 cut-away photos, diagrams, drawings show you exactly **WHAT** to do and **HOW** to do it. Used by U. S. Army, trade and technical schools everywhere; thousands of auto servicemen.

Now **YOU**—without cost—can see for yourself what a wonderbook MoToR's Auto Repair Manual really is. **TRY** it—**FREE** for 7 days! Learn first-hand how it can pay for itself the first few times you use it.

**SEND NO MONEY**

**7-Day Free Examination**

Just mail coupon at right, without money! When the postman brings your book, pay him nothing. First make it show you what it's got! Unless you agree this is the greatest time-saver and work-saver you've ever seen—return book in 7 days and pay nothing. Mail coupon today! Address: MoToR Book Dept., Desk 1K, 572 Madison Ave., New York 22, N. Y.

Published by MoToR, The **Leading Automotive Business Magazine**. MoToR's manuals assure high standards of repair work.

**Covers All These Makes!**

- |           |            |
|-----------|------------|
| American  | Lincoln    |
| Bantam    | Lincoln    |
| Auburn    | Zephyr     |
| Austin    | Mercury    |
| Buick     | Nash       |
| Cadillac  | Oldsmobile |
| Chevrolet | Packard    |
| Cord      | Pierce     |
| Crosley   | Arrow      |
| De Soto   | Plymouth   |
| Dodge     | Pontiac    |
| Ford      | Reo        |
| Frazer    | Studebaker |
| Graham    | Terraplane |
| Hudson    | Willys     |
| Hupmobile |            |
| Kaiser    |            |
| Lafayette |            |
| La Salle  |            |

**Clear, Pictured Facts on Every Job on Every Car Built Since 1935!**

Nearly 200,000 service and repair facts on all 32 makes. Over 700 big pages; including 70 pages of carburetor text, charts, illustrations, covering all models. Over 200 charts, tables; Tune-up Chart; Valve Measurements; Torque Wrench Reading; Starting Motor; Engine Clearances; Generator; Body Service; Dash Gauges; Brake Specifications; Front End Measurements, etc.. Engines; Electric, Fuel, Cooling, Lubricating Systems; Transmissions; Universals; Front Ends; Wheels; Rear Ends, etc.

**MAIL COUPON NOW FOR 7-DAY FREE TRIAL**

MoToR Book Dept., Desk 1K, 572 Madison Ave., New York 22, N.Y. Rush to me at once: (check box opposite book you want).

- MoToR's **AUTO REPAIR MANUAL**. If O.K. I will remit \$1 in 7 days, (plus 35c delivery charge), then \$2 monthly for 2 months with a final payment of 95c one month later. Otherwise I will return book postpaid in 7 days. (Foreign price, remit \$8 cash with order.)
- MoToR's **TRUCK REPAIR MANUAL**. (Described at left.) If O.K., I will remit \$2 in 7 days, and \$2 monthly for 3 months, plus 35c delivery charges with final payment. Otherwise I will return book postpaid in 7 days. (Foreign price, remit \$10 cash with order.)

Print Name..... Age.....  
 Print Address.....  
 City..... Zone No. .... State.....  
 (if any)

Occupation.....  
 Check box and **SAVE 35c** delivery charge by enclosing **WITH COUPON** entire payment of \$5.95 for Auto Repair Manual (or \$8.00 for Truck Repair Manual). Same 7-day return-refund privilege applies.

**Same FREE 7-Day Offer Applies on MoToR's TRUCK REPAIR MANUAL**

For mechanics, truck specialists, service stations, fleet owners. Covers **EVERY** job on **EVERY** truck made since 1936! 1400 pictures, 952 pages, 300,000 facts. Used by Armed Forces.

All types Gasoline Engines, Diesels, Hesselman, Fuel Systems, Governors, Lubrication Systems, Ignition Systems, Starters, Generators, Clutches, Transmissions, Axles, Torque Dividers, Transfer Cases, Brakes, Steering, etc.

**ALSO SERVICES** buses, farm and industrial tractors, contractor and road building equipment, stationary power machinery, etc. (on all parts described in Manual.)

Check box in coupon at right.





Draw Your Way to Happiness-



# ART FOR PLEASURE AND PROFIT

Learn to Draw in Spare Time—at Home!  
**TRAINED ARTISTS** are capable of earning \$60, \$75 AND MORE A WEEK

Prepare yourself for a pleasant, profitable Art career. **COMMERCIAL ART, DESIGNING, CARTOONING**—all in one complete home study course. Enjoy a career with no age or physical limitations. Many pleasant art positions available in this great field. You can become your own boss, work at home and on your own time. Many students earn extra money while learning by designing greeting cards, rendering signs, lettering, etc. **W. S. A.** is now in its 34th successful year of training men and women. No previous art experience necessary, we teach you step-by-step and prepare you for good jobs. **TWO ART OUTFITS** and other features included with training. Write for **FREE BOOK, "Art for Pleasure & Profit"**—tells about our course, instruction service and commercial opportunities for you.

APPROVED FOR VETERANS UNDER G. I. BILL

**FREE BOOK** gives details

**WASHINGTON SCHOOL OF ART**, Studio 129M  
 1115—15th St., N.W., Washington 5, D. C.  
 Please send me full information and your Free Book, "Art for Pleasure and Profit."

Name \_\_\_\_\_ AGE \_\_\_\_\_  
 Street \_\_\_\_\_  
 City \_\_\_\_\_ Zone \_\_\_\_\_ State \_\_\_\_\_  
 I am entitled to training under the GI Bill



# INVENTORS

When you are satisfied that you have invented a matter of value—write me, without obligation, for full information as to what steps you should take to secure a Patent.

The usual first step is to have a search of the prior U. S. Patents conducted, so that I can report to you on the question of Patentability.

## PATRICK D. BEAVERS

(Formerly RANDOLPH & BEAVERS)

Registered Patent Attorney

934 Columbian Building Washington 1, D. C.

**PATRICK D. BEAVERS, Registered Patent Atty.**  
 934 Columbian Bldg., Washington 1, D. C.

Please send me full information on how to secure Patent Protection and Trademark Registration.

Name \_\_\_\_\_  
 Street \_\_\_\_\_  
 City \_\_\_\_\_ State \_\_\_\_\_

**GLOWS in the DARK** **FREE Sample!**

Be the first to sell luminous house numbers, light switch plates, wall protectors, pull cords. Also luminous pictures, statues, decals, and a host of religious, nursery and other objects that glow in the dark. Get into this new and growing industry. Enormous demand... no competition... sensational demonstration... big profits. Represent a large manufacturer, established over 34 years. Write today for liberal money-making offer and free sample to show how they glow in the dark.

**MADISON MILLS, 303 Fourth Ave.**  
 Dept. J-4, NEW YORK 10, N. Y.

**BIG 3 1/2 POWER BINOCULARS** only \$2.98

Quality plus—yet priced to beat all competition. All metal with adjustable focusing wheel and shoulder strap. Tubes extend for sharp, instant view of distant objects. **SEND NO MONEY!** Clip ad and mail. We'll ship C.O.D. Check here to get handsome Carry Case only 59c extra.

**Illinois Merchandise Mart, Dept. 2227**  
 1227 Loyola Ave., Chicago 26, Ill.

**HOME BARS** 25 DESIGNS

HOME BARS for genial hosts. Fun to make and use. 25 designs... built-in, portable bars; cellophane, only \$1.00. New catalog of modern projects 10c. Send currency or check today. Money-back guarantee. **CRAFTPLANS**, Dept. P-123, 7241 Madison, Kansas City 5, Mo.

**Definite Hand Control!** **Improves Handwriting In 3 Hours**

Guaranteed to correct poor Penmanship in few hours. Write, **C. J. OZMENT, 34-P, St. Louis, Mo.**

**RADIO ENGINEERING**, Broadcasting, Television, FM, Servicing, Electronics, Aviation, Marine & Police Radio taught thoroughly. Engineering course equivalent to 3 years' college radio work. Approved Veteran Training. Catalog free.

**VALPARAISO TECHNICAL INSTITUTE**, Dept. D, Valparaiso, Ind.

**PATENTS** "Proof of Invention" Folder mailed without obligation.

**E. E. VROOMAN, Registered Patent Atty.**  
 871 Woodward Building, Washington 5, D. C.

**PATENTS AND TRADE MARKS**

**C. A. SNOW & CO.**  
 REGISTERED PATENT ATTORNEYS

WRITE FOR INFORMATION TO  
 428 SNOW BUILDING, WASHINGTON 1, D. C.

**INVENTORS**

IF YOU WISH TO PROTECT YOUR INVENTION, You should take steps to protect it by a U. S. Patent. Write me for "Record of Invention" form.

**CARL MILLER**  
 REGISTERED PATENT ATTORNEY

Woolworth Bldg., 35th Floor, Dept. 98A, New York City  
 Please send me "Record of Invention" form.

NAME \_\_\_\_\_  
 ADDRESS \_\_\_\_\_





# Learn BUILDING

AT HOME • All Blue Print Building Plans, Specifications, Lessons Furnished

## FIND OUT ABOUT TRAINING AND OPPORTUNITIES FOR YOU IN BUILDING

Established in 1904, Chicago Technical College offers you thorough, practical training in Building, by home-study. Mail coupon for free information. See what this Course has done for others, what it can do for you. Read what Chicago Tech graduates say about their work, earnings, success. Learn the rewards awaiting you as a trained builder — and how quickly, easily you can get started. Simply MAIL COUPON TODAY in an envelope or paste on a penny postcard.



Earn more money as a building tradesman. Prepare for advancement and increased pay as a building foreman, superintendent, inspector, estimator, material buyer or salesman. Train to be a building contractor, have your own money-making business in this busy, prosperous building field.

More than 19 million new homes needed in U. S., say experts. New building now at rate of one million homes a year, plus 200,000 commercial buildings, plus expanding farm building construction.

Mail coupon today. FREE book tells how you learn Building Construction — How to Read Blue Prints, and Estimate Building Costs — at home in your spare time. Learn modern construction methods and materials, how to lay out work and direct all building operations. This is the training needed for rapid advancement to higher-paid jobs, or your own successful building business.

## MAIL COUPON NOW

**CHICAGO TECHNICAL COLLEGE**  
M-152, Tech Bldg., 2000 So. Michigan Ave.  
Chicago 16, Illinois

Mail me FREE building Lesson with information about big opportunities in BUILDING and how I can train at home.

Name \_\_\_\_\_ Age \_\_\_\_\_

Address \_\_\_\_\_

City \_\_\_\_\_ Zone \_\_\_\_\_ State \_\_\_\_\_

**CHICAGO TECHNICAL COLLEGE**  
M-152, Tech Building, 2000 South Michigan Ave.  
Chicago 16, Illinois

## ELECTRICAL TRAINING

Intensive 32 weeks' residence course in fundamentals of industrial electrical engineering, including radio, electronics. Prepares for technician, engineering aides. Approved for veteran training. 54th year. Enter November 22, April 4. Catalog.

**BLISS ELECTRICAL SCHOOL**  
7640 TAKOMA AVENUE  
WASHINGTON 12, D. C.



## INVENTORS

LEARN WHY YOUR INVENTION SHOULD BE STYLED AND ENGINEERED BEFORE YOU APPLY FOR A PATENT. SEND FOR FREE ILLUSTRATED BOOK, "INDUSTRIAL DESIGN AND THE INVENTOR." **ETTEL INDUSTRIAL DESIGN**  
ROOM 40 - 112 SOUTH 106TH ST. - SEATTLE 88, WASH.

## Plastics Scrap Kits \$3.95

Get 25c Plastics Supply Catalog FREE

By ordering a 10 lb. plastics scrap kit now, you get our regular 25c Plastics Supply Catalog FREE, while they last. This is a great buy in plastics scrap. Complete assortment of manufacturers surplus. Variety of colors, shapes, sizes. Small pieces are easy to work with. Ideal for making costume jewelry, pins, book-ends, cigarette trays, etc. Mail your order now to be sure of getting your free catalog.

**PLASTICS MFG. & SUPPLY CORP.**

DEPT. M-9 4707 EUCLID AVE. CLEVELAND 3, OHIO

## New Advertising Machine



**PRINTS and ILLUSTRATES 1¢ POST CARDS**

Send Coupon

**CARDMASTER CO., 4546 Ravenswood DEPT. 139, CHICAGO 40, ILL. FREE!**

Send FREE Illustrated Book\* and complete, unique advertising plans and money making ideas for my business.

\* Shows HOW thousands of business men in every line are boosting sales in spite of conditions with 1c messages printed and illustrated in few minutes on gov't post cards—with amazing, new, patented **CARDMASTER**. Your "today's" ideas, read by your prospects next morning. Not a toy, but a sturdy advertising machine built to last years. Sold direct at low price. Guaranteed five years. **SEND NAME TODAY. All FREE!**

NAME \_\_\_\_\_

ADDRESS \_\_\_\_\_

CITY \_\_\_\_\_ ZONE \_\_\_\_\_ STATE \_\_\_\_\_

## How to Write

Short Stories, Mysteries, Articles. FREE Book Shows How You Learn at Home for Extra Income or Full-Time Career

The demand for writers is creating great new opportunities for people with an urge to write. It's not as hard to succeed as you may imagine. At home, you too may learn fiction writing, the best basis for all fields—short stories, novels, features, articles, radio scripts—technical, mechanical and business items. Palmer Institute's Home Study Training (Established 1917) is endorsed

by Rupert Hughes, Keith Monroe, and other famous authors and by scores of successful graduates. Complete instruction material, professional coaching develop your own style. FREE book shows how you may enjoy an ideal part time or full time career. Write today (no salesman will call). Veterans: advise us if you are eligible for G.I. Training.

**PALMER INSTITUTE OF AUTHORSHIP • Desk T-98 • 1680 N. Sycamore • Hollywood 28, Calif.**



# DIESEL

## IS GOING PLACES ARE YOU?



Look around—you will see Diesel Power in action all about you! In tractors, trucks, buses, trains, boats, power and lighting plants, farm and road equipment. Diesel's the Field of the Future! Low cost dependable power—new uses are constantly developing—and every Diesel engine increases the need for Diesel-trained men!

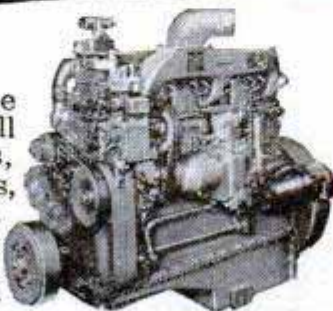

### LEARN DIESEL AT HOME IN SPARE TIME!

If you are over 17, under 60, and mechanically inclined, you can get thorough Diesel instruction right at home. With U.E.I. balanced training, you learn fundamentals first, through home study. Practical, easy-to-understand lessons explain DIESEL operation... fuel systems... how to make repairs... auxiliary equipment, etc.

### ACTUAL SHOP PRACTICE



START AT HOME  
FINISH IN OUR SHOP

Then, you finish your training on actual engines in our Shop. You work on costly equipment under expert Diesel men who know latest techniques. On graduation, you get job-placement assistance. U.E.I. has 20 years of successful experience in fitting thousands for employment in new opportunity fields.

**GET THE FACTS** It costs you nothing to get full information on Diesel opportunities and how they can apply to you! **FULL FACTS SUPPLIED FREE.** Simply mail the coupon below now!

**UTILITIES ENGINEERING INSTITUTE  
DIESEL DIVISION**

**GET THE  
FACTS  
FREE**

FOUNDED  
1927



**MAIL THIS COUPON TODAY!**

UTILITIES ENGINEERING INSTITUTE, Diesel Division, Dept. 198-D  
2521 SHEFFIELD AVE., CHICAGO 14, ILLINOIS

Please send me FREE FACTS about U.E.I. Training Opportunities. I am interested in:

DIESEL  REFRIGERATION  
 AUTO BODY & FENDER REPAIR  AIR CONDITIONING

NAME \_\_\_\_\_

ADDRESS \_\_\_\_\_

CITY \_\_\_\_\_ ZONE or COUNTY \_\_\_\_\_ STATE \_\_\_\_\_

Check here for special information if you are under 17.

SAY YOU SAW IT IN POPULAR MECHANICS



## Why Pay More?

TUBE GIVEN WITH EVERY TIRE  
Send this AD with Order  
Slightly Used  
High Original Treads  
★ BUY IN CONFIDENCE ★  
Safe! Dependable! Standard Brands  
GUARANTEED to give A-1 Service  
Positively Not Re-caps!

600-16 .. \$5.72	700-15 .. \$5.92
650-15 .. 5.12	700-16 .. 6.22
650-16 .. 5.80	750-16 .. 7.22
900-16 .. \$8.52	900-20 \$15.52
650-20 .. 9.52	1000-20 15.52
700-20 .. 12.52	1100-20 15.52
750-20HD 12.52	32x6 (8) 11.82
825-20 .. 15.52	32x6 (10) 13.82

750-20 MILITARY 8 PLY \$13.52

1/2 million tires shipped to satisfied customers.  
Trial will convince you. Orders Rushed. SEND  
MONEY ORDER OR CHECK.

**STANDARD**  
834 N. Broad St. Phila. 30, Pa.

## Make Funny Money!



SELL COMIC Christmas, Everyday Greeting Cards. Published for people with a sense of humor! Rip-Roaring Laughs! Quicker Cash Profits. Hilarious Boxed Assorts. FREE samples.

NOVO PRODUCTS, Dept. PM-1  
1757 No. Park, Chicago, Ill.

**NEW! DIFFERENT!**  
Unlike Any  
Other Cards

## ACCOUNTING

STUDY AT HOME for C.P.A. and BIG PAY Accounting opportunities with 44 year old school. No previous training needed. Texts furnished. EASY PAYMENTS. Send for FREE BOOK. G. I. Approved.

MacCORMAC EXTENSION SCHOOL  
Dept. M 1170 E. 63rd St. Chicago 37, Ill.



**TEN DAYS  
FREE TRIAL**  
of the Famous  
*Selrodo*  
INHALANT  
METHOD



FOR  
**RELIEF FROM BRONCHIAL**

## ASTHMA and HAY FEVER

If not *completely* satisfied, return to us without payment of any kind—If you get wonderful relief as thousands of others do, send \$7.50. (Specially priced trial set.)

(CAUTION: Use Only As Directed)

C-L-I-P THIS ADVERTISEMENT and send it with your name and address to:

STANSBURY CHEMICAL CO.

Dept. 484A

1929 Aurora Avenue, Seattle 9, Washington



THESE 5 TRADES ASSURE YOU  
**HIGH PAY • Future Security**

- **PLUMBING** Every phase of plumbing: Pipe-Cutting and Threading, Lead-Wiping, Rough-in Projects on Installations, Completed Installations of entire plumbing systems, Blueprint reading, Estimating.
- **DRAFTING** College-level courses in General Machine and Architectural Drafting, with fundamentals in Drafting Mathematics—all under graduate engineers.
- **SHOE REPAIRING** From simplest repairs on boots and shoes to the finest details of reconditioning and rebuilding, under expert craftsmen.
- **ELECTRICAL** Technical and shop training include Basic Electricity, Residential Wiring, Industrial Wiring, General Testing and Trouble Shooting, and Appliance Repair.
- **AUTOMOTIVE & TRACTOR** Applied training on latest model automobiles and tractors, including engine overhaul, transmission and differentials, carburetion, generator and ignition systems, engine tune up, Hydramatic and Vacumatic Transmissions, and general service.

*Choose One of these 5 Essential Trades*

Our complete courses of thorough training prepare you to go right into the field as a Qualified Tradesman at High Pay in only 34 weeks (39 in Shoe Repair). All courses under especially trained instructors with practical experience. 6 Hour Classes 5 Days a Week. Our Employment Department helps you.

**VETERANS** "Approved for veterans' training by the State Department of Education under Public Law 346."  
 "Approved for veterans' training by the Veterans' Administration under Law 16."

*Send Coupon for Free Information Now*

*"There's Always a Demand for the Man who KNOWS!"*

**CHOOSE ONE OF THESE 5 LEADING TRADES**

Get Out of that Rut... Be a Skilled Tradesman! Have a Lifetime Career... Own Your Own Business and Be Secure in Your Old Age.

**NOW** while Enrollment is still open, send for FREE information.

THE 5 DIVISIONS OF

**NATIONAL TRADE SCHOOL**

2610 Grand Ave., Kansas City 8, Mo.

- Plumbing
- Drafting
- Shoe Repairing
- Electrical
- Automotive & Tractor

NAME \_\_\_\_\_

ADDRESS \_\_\_\_\_

CITY \_\_\_\_\_ STATE \_\_\_\_\_

VETERAN \_\_\_\_\_ OCCUPATION \_\_\_\_\_

Now for EVERY WORK SHOP!

**NEW Invention Electroplates by BRUSH**



**Easy to Plate CHROMIUM GOLD, SILVER, NICKEL, COPPER ... For Pleasure and Profit!**

If you have a workshop—at home or in business—you need this new Warner Electroplater. At the stroke of an electrified brush, you can electroplate models and projects—you can replating worn articles, faucets, tools, fixtures, silverware, etc. with a durable, sparkling coat of metal... Gold, Silver, Chromium, Nickel, Copper or Cadmium. Method is easy, simple, quick. Everything furnished—equipment complete, ready for use. *By doing a bit of work for others, your machine can pay for itself within a week.* So make your shop complete by getting a Warner Electroplater right away. Send today for FREE SAMPLE and illustrated literature. **ACT AT ONCE! Mail Coupon.**

**WARNER ELECTRIC CO., DEPT. T-9**  
 1512 Jarvis Avenue, Chicago 26, Ill.

**FREE Details & Sample!**

WARNER ELECTRIC CO., 1512 Jarvis Avenue, Chicago 26, Dept. T-9

Gentlemen: Send Free Sample and Details to:

Name \_\_\_\_\_

Address \_\_\_\_\_

City \_\_\_\_\_ State \_\_\_\_\_

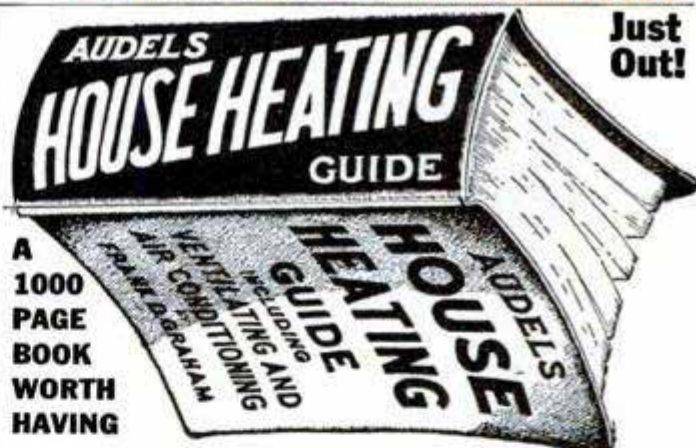

**Just Out!**

For Heating, Ventilating and Air Conditioning Engineers, Plumbers, Maintenance Men, Contractors, Building Superintendents and Mechanics seeking practical, authentic information on Heating, Ventilating, Air Conditioning. 1000 Pages—910 Illustrations—57 Chapters explaining the working principles of all Modern House Heating, Ventilation and Air Conditioning systems. Fully illustrated and indexed. This up to date book of reference gives answers to 1001 questions on Heating, Ventilating, Air Conditioning & Radiant Heating.

**\$4 COMPLETE • PAY ONLY \$1 A MONTH**

To get this assistance for yourself, fill in and

**MAIL ORDER**

**AUDEL, Publishers, 49 W. 23rd St., New York 10, N. Y.**  
 MAIL AUDELS HOUSE HEATING GUIDE for free examination. If O. K. I will send you \$1 in 7 days; then remit \$1 monthly until price of \$4 is paid. —Otherwise, I will return it.

Name \_\_\_\_\_

Address \_\_\_\_\_

Occupation \_\_\_\_\_

Employed by \_\_\_\_\_ PM



Where Will You Be  
in SIX MONTHS?

Don't take chances with your future. My practical, modern course can prepare you for a drafting job that will offer security. Get the full story FREE.

GOOD JOB SECURITY    NO JOB NO INCOME

# GET INTO DRAFTING

Easy to Learn  
**STUDY at HOME in SPARE TIME**

You want security, a home, a car, a bank account, freedom from money troubles. Drafting is a field where you can earn money enough to have them. Because of rapid industrial expansion, draftsmen are needed badly. Study at home in your spare time. We send you drafting equipment and lessons used in our famous resident school. Get full details at once.

● LOW COST ● EASY PAYMENTS

**CLEVELAND ENGINEERING INSTITUTE**  
PM-9, 2325 Chester Ave., Cleveland 14, Ohio

Send me a FREE Drafting Lesson and your Success Book, which shows how easy it is to prepare for good pay and security in drafting.

Name.....  
Address.....  
City..... State.....  
Has work..... No obligation..... Vet..... Nonvet.....

GET FREE SUCCESS BOOK

## The Steady Pay Profession Good Times or Bad!

### SCIENTIFIC CRIME DETECTION



**FREE!**

"BLUE BOOK OF CRIME"

This book is full of exciting information on scientific crime detection. It will show how you can get started in a grand career. Now, at amazingly low cost. Clip coupon now... Mail it today.

**It Is Easy to Learn!**

I will teach you this fascinating science during your spare time at home. It pays to be an expert in Finger Printing, Firearms Identification, Police Photography and Criminal Investigation. I have trained hundreds of men and women now successfully serving in identification bureaus throughout America. You, too, may quickly prepare yourself to become a well-paid valued officer of the law, often sharing in the generous rewards offered for wanted criminals.

**OVER 800**

of all Identification Bureaus in the U. S. employ students and graduates of I. A. S. A majority of these men are heads of Bureaus. Many of them knew nothing about crime detection before training with me. Now they have steady jobs, good salaries and a fine future. Write today for full particulars and free book. Give age.

**INSTITUTE OF APPLIED SCIENCE**  
1920 Sunnyside Ave., Dept. 1356, Chicago 40, Ill.

**INSTITUTE OF APPLIED SCIENCE**  
1920 Sunnyside Ave., Dept. 1356, Chicago 40

Gentlemen: Without any obligation on my part, send me the "Blue Book of Crime," and complete list of Identification Bureaus employing your students or graduates, together with your low prices and Easy Terms Offer. (Literature will be sent ONLY to persons stating their age.)

Name..... Age.....  
Address.....  
RFD or Zone..... State.....

## WANTED MAN WITH CAR



No Time Like Now to Get In  
**McNess Business**

It's no trick to make good money when you use your car as a McNess "Store on Wheels." Farmers buy everything they can from McNess Men because McNess Products are tops in quality, represent extra values. Attractive business-getting prizes and premiums; also money-saving deals to customers make selling McNess daily necessities a snap.

**We Supply Capital—Start Now!**

There's no better work anywhere. Pays well, permanent, need no experience to start, and we supply capital to help you get started quick. You begin making money first day. Write at once for McNess Dealer Book. It's FREE. Tells all—no obligation. (1)

**THE McNESS CO., 619 Adams St., Freeport, Ill.**

Use Your CAR to Raise Your PAY



## DEEP TONE Dual Mufflers for Ford, Mercury

Scientifically designed straight-thru muffler reduces back pressure. Greater power, speed, and economy. NEW brilliant Deep Tone makes your car stand out. Heavy blowout-proof construction. Rugged steel tube throughout (No Aluminum).

**Simplified Installation.** No cutting, no holes to drill. Rubber mounted clamps eliminate usual rattle. Complete with all necessary fittings, etc. Order direct and save: State year and model. Sent C.O.D. from Los Angeles. Price \$20.

"Deep Tone" single muffler for Chevrolet, Ford, Plymouth—\$4.99.  
All other makes—\$5.50. Chrome tail pipes, 2 1/2" dia. \$1.75

**ADVANCE MUFFLER CO.**

6800 S. Vermont Dept. PM. 98 Los Angeles 44, Calif.

## Be an INVESTIGATOR

**JAMES S. BOLAN, FORMER POLICE COMMISSIONER OF NEW YORK CITY** offers MEN & WOMEN an attractive opportunity to prepare for a future in *Investigation & Criminology* by comprehensive Home Study Course. Free placement service assists graduates to obtain jobs. APPROVED UNDER G. I. BILL OF RIGHTS. Write for Free Booklet PM.

**THE BOLAN ACADEMY, INC.**  
EMPIRE STATE BLDG., NEW YORK 1, N. Y.

# If Ruptured Try This Out

**Modern Protection Provides Great Comfort and Holding Security Without Torturous Truss Wearing**

An "eye-opening" revelation in sensible and comfortable reducible rupture protection may be yours for the asking, without cost or obligation. Simply send name and address to William S. Rice, Inc., Dept. 32-C, Adams, N. Y., and full details of the new and different Rice Method will be sent you Free. Without hard flesh-gouging pads or tormenting pressure, here's a Support that has brought joy and comfort to thousands — by releasing them from Trusses with springs and straps that bind and cut. Designed to securely hold a rupture up and in where it belongs and yet give freedom of body and genuine comfort. For full information—write today!



# LEARN DIESEL

## AUTOMOTIVE AND ALLIED MECHANICS

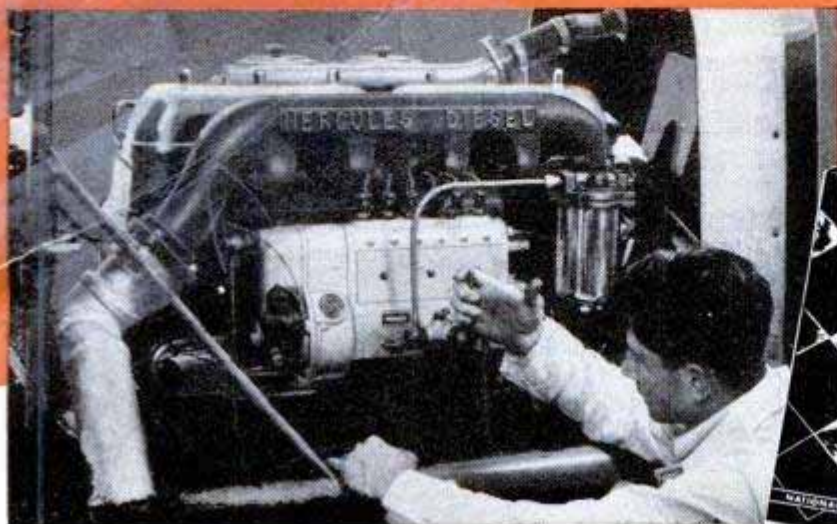

at Home  
in Spare Time



These Two  
**FREE BOOKS**  
will tell you how

### Good pay and interesting job opportunities in the Diesel industry!

Diesel engines are used in locomotives, tractors, farm machinery, stationary and portable power plants, oil pipeline pumping stations, Diesel trucks and buses, power shovels, excavating machinery and many other applications. Trained Diesel and automotive mechanics are in steady and growing demand to install, maintain and repair Diesel, semi-Diesel, and gasoline engines in these and other fields. Or you can operate your own service shop or commercial garage!

### You Can Qualify for These Opportunities with National Schools' Master Shop Method Home Training!

Behind all National Schools' training is a permanent faculty of experienced instructors and engineers who supervise your home study. We teach you Diesel-electric; Internal Combustion Engines (including Diesel, Gasoline and Butane Types); High-octane fuels; advanced engine principles, etc. Your instruction material is interesting, well-illustrated, easy to understand . . . and complete!

### Complete Training in Automotive and Allied Mechanics

Your course also teaches you basic and advanced gasoline engine principles, construction, repair, chassis units, drive systems, motor tune-up, etc. Your progress is rapid, but thorough.

### We Qualify You in Specialized Fields

As a National Schools graduate, you are thoroughly grounded not only in basic engine principles, but also are fully qualified to specialize in Diesel fuel injection, automotive carburetion, ignition, and motor tune-up. You are not just a "grease monkey," but a technically trained, and well-rounded mechanic!

### Earn While You Learn

With our Master Shop Method Home Training, you study at home in your spare time. You need not interrupt your present job. You receive Spare Time Work Lessons which enable you to earn while you learn!

*Some of the Interesting Positions Open to Trained Diesel and Automotive Mechanics:*

- Diesel Automotive Dealer, Shop Owner, Foreman, Superintendent
- Diesel Power Plant Operator or Maintenance Engineer (Hotels, Factories, Office Bldgs., Pumping and Irrigation plants, farms and ranches.)
- Diesel Fuel Injection Man
- Automotive Carburetion and Ignition Man (Motor Tune-Up)
- Diesel-Automotive Sales
- Marine Diesel-Automotive Engineer
- Truck or Bus Emergency Mechanic
- Technicians and Mechanics for special work according to type of equipment handled
- And many others

Act Now! It costs you nothing to get complete information. Send the coupon for the Free Sample Lesson and Big Illustrated Book "Your Future in Diesel." You will enjoy these valuable books. Both Home Study and Resident Training Offered.

**Approved for Veterans**

**CHECK COUPON BELOW**

**NATIONAL SCHOOLS**

LOS ANGELES 37, CALIF. • EST. 1905



**MAIL OPPORTUNITY COUPON FOR QUICK ACTION**

NATIONAL SCHOOLS, Dept. PMD-9  
4000 South Figueroa Street  
Los Angeles 37, California

(Mail in envelope or paste on penny postcard)

Mail me FREE the book, YOUR FUTURE IN DIESEL, together with the Sample Lesson. I understand I may keep and use the information with no obligation.

Name \_\_\_\_\_ Age \_\_\_\_\_

Address \_\_\_\_\_

City \_\_\_\_\_ Zone \_\_\_\_\_ State \_\_\_\_\_

Check here if Veteran of World War II



# Paint Your Car! AND 1001 OTHER ITEMS

**AMAZING NEW**

## "Super" CARONIZE

**FACTORY-FINISH TYPE  
AUTO ENAMEL**



**One Quart Covers! One Hour to Apply! One Hour to Dry!**

*Just Wipe it on!*   
Handy Applicator  
INCLUDED AT NO EXTRA COST

**Makes Your Old Car  
Gleam Like New!**

Now you can quickly and easily make your old car look almost NEW! Just give it a speedy coat of new "SUPER" CARONIZE. With "SUPER" CARONIZE all back-breaking labor is eliminated... NO BRUSHING, SPRAYING, MASKING, BUFFING OR SCRAPING is necessary. Simply clean car and WIPE ON this sensational new fast-drying paint. In just a short time, your car will GLEAM with a mirror-bright finish that LASTS FOR YEARS. "SUPER" CARONIZE won't peel, crack, chip in spite of rain, snow or sun.

**THE RESULT OF MONTHS OF LABORATORY RESEARCH!**

"Super" Caronize smoothly covers your car because it contains genuine THERMOREZ, the very same type synthetic resin as is used in finishing newest cars. If you are getting a new car, a brilliant "Super" Caronize finish may increase your trade-in value \$100 and more.

**ONLY**  
**\$ 2.95**  
Enough to Paint Almost Any Auto

*Guaranteed*  
**3 FULL YEARS**

The only wipe-on enamel in America that gives you a 3-year WRITTEN guarantee against chipping, cracking or peeling when applied according to directions.

**16 CHOICE OF BEAUTIFUL NEW COLORS**

- Black • Maroon • "Fiery" (Bright)
  - Red • Cloud Grey • "Washington" (Dark)
  - Blue • Brewster (Dark) Green
  - Monticello (Light) Blue • Jewel (Light) Green • Orange • "Lettuce" (Very Light) Green • Light Yellow • Tan
  - Ivory • Chrome • Clear • White
- "Super" Caronize White is absolutely non-yellowing

**AMAZING FOR AUTOS and 1001 OTHER PAINT USES**

**AT HOME**  
Caronize colors are wonderful for all refrigerators, gas stoves, furniture. All porcelain, metal and wood surfaces. "Super" Caronize Clear gives a durable coating to floors, linoleum and all household woodwork.

**OUTDOORS**  
Perfect for all lawn furniture, swings, bird-baths and other items of this type. Also recommended for boats, canoes, etc.

**ON THE FARM**  
Durable for tractors and all other kinds of farm implements, dairy and utensil uses.

**STORES AND OFFICES**  
Excellent for desks, table tops, files and 1001 other uses in stores, shops, taverns, beauty parlors, offices, etc.



**SEND NO MONEY  
RUSH ORDER TODAY!**

Use coupon below. Send us your color choice today! Pay postman only \$2.95 plus postage. Or send cash and we pay postage.

**Fill Out and Mail This Coupon Today! Send No Money!**

Please send me ..... qts. of "Super" Caronize at \$2.95 per qt.  
COLORS: \_\_\_\_\_

NAME ..... (Please Print)

ADDRESS .....

CITY ..... STATE .....

Send Postpaid, remittance enclosed       Send C. O. D. plus postal charges

**CARONIZE, INC.**      DEPT. PM9      1801 Singleton Ave.      St. Louis 3, Mo.      **AGENTS AND DISTRIBUTORS**  
Write for Free Information



**WORLD'S  
BEST  
WANT AD  
MEDIUM**

# CLASSIFIED Advertisements



Advertisements in this section 75 cents per word, each insertion, minimum 10 words, payable in advance  
To be inserted under proper classification, copy must be in our office the 22nd of the  
second month preceding date of issue

F. W. Johnson, Manager, Classified Advertising  
Popular Mechanics Magazine, 200 East Ontario Street, Chicago 11, Illinois

**1050**

**CLASSIFIED  
ADVERTISEMENTS**

**1050**

**OPPORTUNITIES  
FOR YOU**

## AUTOMOBILES, MIDGET CARS

**CUSTOMIZE** Your car! Authentic California restyling plans galore! Working sketches, specific model changes. Comprehensive; complete! 130 photographs! Largest, finest, or refund! \$2 postpaid. Post Publications, Box 723-BE, Arcadia, California.

**STUDEBAKER.** Floyd Clymer's new book (no connection with Studebaker Corporation) gives impartial, uncensored report 3000-mile economy, speed, record tests. Part by part equipment analysis. 3000 Studebaker owner opinion tabulations. 200 owner letters. Good, bad comments, no punches pulled. \$1.50 postpaid. Clymer's book on Kaiser-Frazer same price. Clymer, Dept. A-9S, 1268 So. Alvarado, Los Angeles 6, Calif.

**MIDGET Car, factory built \$40.** 1 1/2 h.p. Clinton motor \$30. Factory built scooter \$75. Three-speed motorcycle transmission \$12.50. 14 h.p. outboard motor \$40. Race cars, midgets and big cars. Hundreds of other bargains. Mail order only. Send 25c in coin. Behnke's, Dept. B, 5721 Leland, Chicago 30, Ill.

**MIDGET Car book—Complete plans** for easily building inexpensive midget racers, two passenger highway runabouts, streamlined roadsters, 3-wheel cars, scooters, etc. Motor data, supply sources. 75 photographs, blueprints! \$1.98 (guaranteed). Alquist Engineering, Milford 37, Pennsylvania.

**USED-CAR Buyer's handbook.** Includes authoritative specific late model evaluations! Complete tests, dealers' tricks, graphic photographs! \$1 postpaid. Post Publications, Box 723-TE, Arcadia, California.

**CUSTOM California doll-up accessories.** Solid hood sides, grille panels, lowering blocks, fender skirts, mufflers, speed equipment, novelty horns. Picture catalogue with scores of items. 25c. Eastern Auto Supply, 3319F South Grand, Los Angeles 7, Calif.

**HOT Rod Racing Book.** 90 photographs, illustrations famous record holders used California Dry Lakes. Contains hotrod tips, closeup action shots, specifications, 8 beautiful drawings suitable framing. \$1.50 postpaid. Clymer, Dept. A-9V, 1268 So. Alvarado, Los Angeles 6, Calif.

**FORD Racing manifolds.** The famous Columbia Ford racing manifolds, increased speed and efficiency for 60-'85' Fords and Mercurys. Now only \$32.50 for 85' Fords and Mercurys. \$27.50 for 60' Fords. Write for free circular. P.O. Box 2372, Portland, Oregon. Dealers invited.

**"VAPO-STEAMATIC" Water injection.** Easily constructed (for less than \$1.00). Finest automatic "moist-humidity" system. Engineering triumph; gets up to 33 miles per gallon. Tremendously increases horsepower! Eliminates ping, carbon, overheating. Reduces wear; lengthens engine life! Copyrighted "Installation Handbook;" (illustrated); including "mileage information;" parts lists, picture catalogues, etc.; \$1.00 complete. Newhouse Automotive Industries, 5941-B1 Hereford, Los Angeles 22.

**MODEL A Ford instruction book.** Complete details care, maintenance, 35 charts, drawings. A must for "A" owners. \$1.00 postpaid. Clymer, Dept. A-9W, 1268 So. Alvarado, Los Angeles 6, Calif.

**BUILD Automatic clutch, midget autos, racers, scooters, tractors.** 183 plans. Free handbook. Nichols Equipment Co., Dept. 1111, Purvis, Miss.

**CALIFORNIA Steelpacked mufflers.** Deep, mellow, tone. Easily installed, complete with fittings. Ford, Mercury, \$17.95 set. Deceptone singles, Chevrolet, Plymouth, Ford, \$4.95. Specify make, year. Eastern Auto Supply, 3319G South Grand, Los Angeles 7, Calif.

**FAMOUS Car catalog reprints.** Duesenberg, Italian Maserati racing and new sport car, Mercedes-Benz, new rear-engined Isotta-Fraschini V-8, Rolls-Royce "Silver Wraith," Miller race cars, Cord, Rayfield Cyclecar, V-8 Chevrolet, Stanley steamer, Doble steamer. Specify catalog desired, \$1.00 each postpaid. Clymer, Dept. A-9X, 1268 So. Alvarado, Los Angeles 6, Calif.

**"POWERIZER" Water injector—** Increases speed, acceleration, mileage to 30%. Easily assemble yourself for few cents! Sensational performance! Prevents wear, knock, oil pumping! Manual includes "installation drawings;" "hop up" tips; speed literature. \$1.00. Alquist Engineering, Milford 37, Pennsylvania.

**INTERCHANGEABLE Parts book.** New book tells every automobile part that interchanges with others. Same parts many times vary 100% in price. This book enables garages, mechanics, dealers, owners to buy under cheapest listing. Tremendous savings for users. \$15.50 postpaid. Clymer, Dept. A-1P, 1268 So. Alvarado, Los Angeles 6, Calif.

**MERCEDES, Pioneer of an industry.** Profusely illustrated history of development of gasoline engine and thrilling early races. Send \$2.00. Alec Ulmann, Riverside, Connecticut.

**"SPEED Up, customize your car!"** Famous racing; speed equipment; beautifying accessories; mufflers; dual manifolds; heads; Hollywood disks; streamliners; skirts; "superchargers;" hotrod; custom supplies. Low factory prices! Handbook catalog with photos, recommendations; 20c (refunded first order). Alquist Engineering, Milford 37, Pennsylvania.

**CLYMERTONE, Twin muffler sets,** beautiful sound, complete with necessary welded pipes, E-Z installation. Ford V-8, \$20.00. Chevrolet set with split manifolds, \$37.50. Specify car model. Clymer, Dept. A-94, 1268 So. Alvarado, Los Angeles 6, Calif.

**FORD-MERCURY Owners 1938-1948,** give your engine that "Hot Rod Look." Install our polished aluminum cylinder head covers over original heads. Price \$9.00 per pair. Beautiful snap-shot free upon request. Tarzian Automotive, 730 Ellis St., San Francisco, Calif.

**HIGH Compression heads, V-8.** More speed, acceleration, power. Offenhauser or Edlebrock \$75.00 complete set. Dual manifolds complete with throttle kit, fuel lines. Edlebrock \$49.00. Offenhauser \$55.00. Give make, model V-8. Catalog 10c. Clymer, Dept. A-93, 1268 So. Alvarado, Los Angeles 6, Calif.

**IGNITIONIZER—**Gives speedway performance! New power, economy, pep! Boosts coil efficiency; starting! More mileage guaranteed. Instant installation! Specify car. \$2.98. Alquist Engineering, Milford 37, Pennsylvania.

**AUTOMOTIVE Trouble Shooting,** 500 questions and answers \$2.00 postpaid. Charles Nelson, 2908 Washington Avenue, Santa Monica, California.

**SEE Our ad under motorscooters** for midget car bargains. Midget Motors Directory, Athens, Ohio.

**RACING Car builder book.** 22 drawings. Racing rules. Contains information on cams, compression, balance, midgets, big cars, roadsters. V-8 speed data. \$2.00 postpaid. Clymer, Dept. A-RE, 1268 So. Alvarado, Los Angeles 6, Calif.

**"CUSTOM Styling" manual—**Easily make car look Hollywoodized, custom, ultra-beautiful by quick inexpensive methods! 100 photographs, instructions on customizing, restyling, streamlining; new and old cars. Also speed, model, sport, conversions; accessories; mufflers; engine "soup up" specifications! Most complete book \$2.00. Alquist Engineering, Milford 37, Pennsylvania.

**CLYMER'S 1948 Indianapolis Race Year Book.** Complete information, 100 photographs, charts, drawings, cartoons. \$1.50. Deluxe fabriroid bound \$2.50 postpaid. Clymer, Dept. A-548, 1268 So. Alvarado, Los Angeles 6, Calif.

**"SPEED And Power" handbook—**Very latest methods! Construct your own superchargers, water injectors, compression heads, fuel saving devices; easily, practically without cost. Get racing speed, acceleration, dynamic power increases from any automobile! Build stock conversions! Fast roadsters! Hotrods! Get ingenious formulas! Speed secrets! Also "economy information;" tuning techniques! Ignition. Carburetion. Fuels. Mileage tricks! Illustrations! Catalogues. Including "California Re-Styling Ideas;" glossy photographs! Drawings! Model revising! Customizing! Streamlining! Sport changes! Leatherlike bound; \$1.98 complete. Newhouse Automotive Industries, 5941-B2 Hereford, Los Angeles 22.

**BRITISH Racing cars.** Illustrations, photographs, historical information on British racers. Sunbeam, Bentley, M.G., Riley, Lagonda, Austin, others. Just published. \$1.50 postpaid. Clymer, Dept. A-9L, 1268 So. Alvarado, Los Angeles 6, Calif.

**STUDEBAKER Champion power and racing equipment.** Engines 135 to 177 inch. Engineering help and list free. Frank Morgan, Studebaker Dealer, Marysville, California.

**CHEVROLET Instruction Book.** 77 photographs, charts, drawings. A combined book on maintenance, servicing, 1938, 1939 and 1940 models. Complete manual necessary owner, repairman. \$1.50 postpaid. Clymer, Dept. A-9N, 1268 So. Alvarado, Los Angeles 6, Calif.

**"SPEED & Mileage" manual—**Easily obtain greater speed, mileage, racing performance from any automobile! "Original" most complete book shows soup up methods; speed tuning; mileage secrets; racing tricks! Photographs! Instructions on building inexpensive speed equipment! Economizers! Custom accessories! Mufflers! "Water injectors!" Superchargers! "Hot-rods!" Speedsters! Fast conversions! Engines! All about "economy tuning," compression, manifolds, ignition, balancing, fuels! Latest "Hollywood customizing," streamlining information; fascinating pictorial section; catalogues; parts lists! Everything \$1.98. Alquist Engineering, Milford 37, Pennsylvania.

**MODEL "T" and "A" Ford Instruction Book.** 572 pages, complete information maintenance, servicing both models. 223 charts, drawings. Few unbound copies available \$3.50 postpaid. Clymer, Dept. A-TA, 1268 So. Alvarado, Los Angeles 6, Calif.



1949 MERCURY. Floyd Clymer's new book (no connection with Ford Company) gives impartial, uncensored report 3000 mile economy, speed, record tests. Part by part equipment analysis. Good, bad comments. No punches pulled. Clymer's report on 1949 Ford, Kaiser-Frazer, Studebaker. \$1.50 each postpaid. Clymer, Dept. A-9M, 1268 So. Alvarado, Los Angeles 6, Calif.

**INSTALL** The Thomas vapor injector in your car, now! Get higher test performance with regular gas, save gas and save engine wear; especially in hot dry climates. Send us make, model, and the year of car. Upon the receipt of eight dollars (\$8.00) a Thomas vapor injector with complete instructions for installation, will be mailed prepaid to any part of continental U. S. If not satisfied after ten days return for refund to the Thomas Engineering and Novelty Company, Washington 16, D. C., Box 5528.

**DUALTONE** Chrystalline packed California mufflers for all automobiles. Large chrome tailpipe extensions, chromed carburetors, fuel pumps, long shackles, dual manifolds, hi-compression heads, flywheels, camshafts, fender skirts, Plexiglas tops. Send 20c illustrated catalogue, deduct from first order. Dualtone Mufflers, 2636C India St., San Diego 1, California.

**CHEVROLET** Speed manual now available to discriminating Chevrolet owners who desire real "hotrod" performance from their 1937 to 1948 Chevrolets. Filled with photographs, complete information, proven methods showing you how to make your road car into a genuine 110 m.p.h. job, or how to build 134.52 m.p.h. Chevrolet hotrod. Every page worth the purchase price of only \$2.00 postpaid. California Bill, Box L-1, Eaglerock, Los Angeles 41, Calif.

**CALIFORNIA** Speed equipment, hotrod, dual, single, mufflers, doll-up accessories, cams, head, dual manifolds. Catalog 25c coin. Von Esser's, 2840 No. Kedzie, Chicago 18, Illinois.

**MAKE Your Model "A"** do 100 m.p.h. Lightning acceleration, breath-taking top speed. Complete details, photographs. \$1 postpaid. Four Barrel, Box L-1, Eaglerock, Los Angeles 41, Calif.

**FROM** Speedway to roadway! Track-proved hi-speed heads and manifolds now available for your passenger car! No special tools needed! Increase horsepower 25%! Astounding getaway! Free illustrated catalog. Speedsport, 6215AA Diversey, Chicago 39.

**FENDER Skirts**—Factory direct; streamlined to your fender contours; 16 ga. anodized aluminum with self latching brackets. No holes to drill. Teardrop skirts Chevrolet, Ford, Buick, Oldsmobile, 35-41. Streamlined box skirt Ford 41-48. Specify year, model. Price f.o.b. \$1.95. Send check, money order. Freight collect. E. and E. Mfg. Co., 5322D Banks Street, San Diego 10, California.

**INSTALL V-8 engine** in your Model A for extreme acceleration, more top speed, smoother performance. Complete details, photographs. \$1 postpaid. A-V-8, Box L-1, Eaglerock, Los Angeles 41, Calif.

**HOT-ROD Manual**, fast Fords, photos, instructions, \$1.50. Airmailed \$1.75. Racing parts list 25c. Hollywood Hot-Rod, Los Feliz, Box 9626P, Hollywood 27, California.

**MAKE Your Ford fast!** Complete details, photographs. How to construct 120 m.p.h. Hotrod. \$1 postpaid. California Bill, Box L-1 Eaglerock, Los Angeles 41, Calif.

**WE Sell direct** to customers over 200 speed equipment parts manufactured by us. Ford A-B-V8-6-4- (Ferguson). Studebaker Champion, Chevrolets and Willys. Cylinder heads, dual intake manifolds, flywheels, oversize valves, compound springs, camshafts and other supplies. Complete engines ready for race for cars, boats and midgets. \$1.00 to cover illustrated literature and price sheet. R & R Mfg. Co., Robert M. Roof, Box 546, Anderson, Indiana.

**BUILD Speedy midget track racer** from castoff parts! Plans, specifications, construction information, \$1.00. Motor Supply, Box CS-1682, Toledo, Ohio.

**AUTOMOBILE Racing**, Sixth Edition, 100 illustrations. Working drawings with building instructions for Ford-60 midget, California roadster, Offenhauser racer. Details on racer parts. Sample entrance blank. World's record 158.5 m.p.h. rear engine four-wheel drive car. Interesting information for fans, drivers, mechanics. \$2.00 postpaid; \$2.25 c.o.d. Ray Kuns, Department 63, Cincinnati 27, Ohio.

**AUTOMOBILE Racing book**, fifth edition, well illustrated. Instructions on building bodies, frames, engines. Ford A and B conversions. Plans. AAA rules, specifications. Roadster racing. Indianapolis cars. \$1.00 postpaid, \$1.30 C.O.D. Ray Kuns, Dept. 47, Madisonville, Cincinnati 27, Ohio.

**EASILY Built professional midget racer**, motorscooter, midget roadster, or midget motorcycle from cast off parts. Plans, specifications for all four contained in illustrated handbook, 25 cents. Directory of bargain priced used parts and motors included free! Midwest, 3839 Drummond, Toledo, Ohio.

## AUTO SUPPLIES AND EQUIPMENT

**REPAIR** Dents and holes in auto bodies with Duro Plastic Metallic Auto Body Solder. Applied with putty knife. Pints \$1.50, quarts \$2.50 prepaid. Leonard Sales Company, Box 6412, Cleveland, Ohio.

**GASKET-SEALING** Compound, genuine Permatex No. 2. Government surplus \$3.95 per gallon can. Sherwood Associates, Box 327, Jackson Heights, N. Y.

**AUTO Parts**—All kinds; prices upon request; no catalog. Meyer's Auto Parts, 820 Dryades, New Orleans, La.

**SLIDAWAY** Car table as illustrated in Popular Mechanics, July, page 119. \$5 each postpaid. Bush Mumpower, Fairfield, Alabama.

**SAVE Money!** New invention increases auto mileage. Reduces carbon. Details free. Adam Spoor, 218 S. 4th St., Geneva, Illinois.

**CLEAN**—Shine your car without wax or polish. Gardenbay Cleaners, 77-14 21st Ave., Jackson Heights, N. Y.

**MORE Gasoline mileage**. Free descriptive, illustrated, instructions. Neherco, La Verne, California.

**MOTORISTS** Save gasoline by Vacuumating overrich mixtures. Fits all cars. For free particulars write Vacuumatic, Dept. 1387, Wauwatosa, Wis.

**THE ABC of water injection**. Complete information free. Advanced Automotive Products, Dept. 12, 563 Lake Road, Webster, N. Y.

**WELDING** Adds to your profits. Low cost repairs on bodies, blocks, fenders. Easy with Hobart Welders. Free catalog. Write Hobartweld, Box M-982, Troy, Ohio.

**VAPOR Injection** for cars. Faster getaway, improved climbing. Eliminates knock, carbon. Installs 10 minutes, \$3.98 plus postage. Radear Products, 140-27 169th St., Jamaica 5, N. Y. Dept. PM-2.

**AIR Horns**—"Strombos" most powerful of all signals! Complete passenger car kits; all cars. Models available for boats, trucks, buses, and diesel locomotives. For the "right of way" right away! Buy Strombos. Illustrated bulletins on request. Strombos Company, 4525 Twelfth, Detroit 8, Michigan.

**CONVERTIBLE Tops**—Completely sewn. Easily installed. Reasonable prices. Free literature. Rio Top Company, 1370 Roanoke, Newport News 14, Virginia.

**GENUINE Ford parts** mailed c.o.d. anywhere by America's original mail-order parts specialist. Speedy, reliable service. Baker Corp., Brookline 46, Mass. Authorized Ford dealer for a quarter century.

**GOVERNMENT Surplus**. Low voltage circuit tester in steel box. Cost \$202.00. Our price \$27.50. Will test batteries, starters, generators, voltage regulators, grounds, short circuits. Wilt Electrical Company, 7829 S. Racine Ave., Chicago 20, Ill.

**CAR Trouble?** Million new, used parts. Describe needs. Automotive, 2928A North Western, Chicago 18.

**AUTO Parts**. Buy direct. Get dealers' prices. Represent us in your territory. Write requirements. Specify car make. Mechanics Auto Parts, Factory Warehouse, 3807-PM N. Ashland, Chicago 13.

**BEAUTIFUL Rich-looking seat covers**. Mono, 6545 Santa Monica Blvd., Hollywood 38, California.

**AUTO Parts** for all cars, transmissions, motors, differentials, fenders, carburetors. Security Auto Parts, 1923-PM Grace, Chicago 13.

**PLATING** Outfits for auto parts. Connect to a battery. No tanks used. Free particulars and proofs. Gunmetal Co., Ave. J, Decatur, Ill.

## AUTO TRAILERS

**ACTUAL Photographs** and plans for 12' camp and travel trailer \$1.00. Exceptionally roomy. Trails perfectly. Ed Christensen, Box 687, Thief River Falls, Minn.

**MODERN Trailer coach book** contains plans 9 different trailers, etc., \$4.00. Satisfaction guaranteed. Circulars 20c. Craftsmann Books, Box 1153, Milwaukee 1, Wis.

**TORKSPRING Axle** assures low center gravity, swayless action. Install on new or old trailer. S. H. Edwards, Inc., Richmond, California.

**BUILD Your own trailer!** Save money! Have every feature you want! Plans for house, sport, camp and utility trailers. Catalog describing 9 models 10c. 15c in Canada and overseas. Jim Dandy, Box 125-A, Wausau, Wisconsin.

**TRAILER** Plans, parts, accessories; complete line. Prompt delivery. Catalog 25c (coin). Catalog plus booklet, "Trailer Building," 50c (coin). Marine Mart, Buffalo 7-B, New York.

## MOTORCYCLES, BICYCLES, MOTORSCOOTERS AND SUPPLIES

**MOTORSCOOTER** \$7.50. Midget racer \$10, motorbike \$5 less motors; Harley single \$40, midget car \$55 complete. Motors \$4 up. Plenty brand new engines and surplus motorscooters. Over 5000 small tires \$1 up. Mailorder only. Send 25c for Big War-Bargain catalogue listing the above and hundreds of other bargains in motorscooters, motorcycles, midget racers, outboards, engines, etc. (35c by First Class Mail). Midget Motors Directory, Athens, Ohio.

**BOYS**—All bicycle repair secrets revealed. Illustrated "Bicycle Repair Manual," \$1.00. Klausner Cycles, Shelbyville, Illinois.

**HARLEY-DAVIDSON** Parts, accessories, oil, expert service. Tires all sizes. Rebuilt 45" motors. Send \$2.25 for Army 45 Motorcycle Manual. 25c for accessory catalog and bulletins. Knuth's (Harley-Davidson Dealers), 2491 Fondulac, Milwaukee, Wis.

**WHEELS!** Build wagons, scooters, mowers, trailers, wheelbarrows, grocery carts, baby carts, play pens, baby carriages, 4" to 16". Free list. Truelsen Mfg. Co., 811 E. 31, Kansas City, Mo.

**INCREASE** The efficiency of your motor scooter. Send dime for information on scooter trailers. Ideal for delivering, camping, etc. Scooter Trailers, 51 16th St., Merced, California.

**BICYCLES**. New. Specially priced. \$29.95. Accessories. Bulletin 10c. Lipski's, 3447 Lawrence, Chicago.

**MOTORCYCLE Pistons** and parts, new, used. Harley, Indian, Henderson, Super-X. List 10c. Ballak, 811 N. 9th, St. Louis 1, Missouri.

**BICYCLE** Supplies wholesale, retail. List 10c. Universal, 4713 Virginia, St. Louis, Missouri.

**MOTO-SCOOT** \$35. Midget racer \$15, Indian motorcycle \$30, Cushman motorscooter with extra tire \$20, motors \$3 and up, homemade motorscooter \$10. Send 25c for new catalog listing these and many other sensational bargains in used motors, wheels, tires, motorscooters, midget cars, motorbikes, etc. Associated, Box 1764-CS, Toledo, Ohio.

**MIDGET Car** with three-speed transmission \$35, Cushman motorscooter \$15, Shaw bicycle motor \$15, Harley-Davidson motorcycle \$15, motorbike outfit \$15. Rush 25 cents for special new catalog listing amazing bargains in motorscooters, used motors, tires, parts, midget cars, etc. Gail, 538 Erie, Toledo, Ohio.

**MOTORCYCLE News**, monthly. Yearly subscription \$1.00. Latest worldwide information. Motorcycle News, 5424-A Sawyer, Chicago 25.

**TIRES** And industrial wheels, suitable for scooters, wheelbarrows, farm equipment, etc. All sizes. Bicycles and accessories. Largest assortment in America. Send dime for list. Cycle Transport Company, 1241 So. Michigan Ave., Chicago 5, Illinois.

**MOTORCYCLISTS** Chromium accessories. New and reconditioned motors. Complete stock Indian parts. Expert motor rebuilding. Indian Motorcycle Sales, Kansas City 1, Missouri.

**HARLEY-DAVIDSON** Parts, accessories, batteries, and tires, 24 hour service. Authorized factory dealer. Philadelphia Harley-Davidson Company, 857 North Broad Street, Philadelphia 23, Penna.

**WHEELS**—For home and industrial use. New design gives greater strength. Build mowers, trailers, wagons or industrial equipment. Cast aluminum. Choice of bearings. Semi-pneumatic tires. Immediate delivery. Buy direct at factory prices. Write for free descriptive pamphlet. C. E. Chesney Co., 209 East 31st St., Kansas City, Mo.



**COMPLETE** One Stop Harley Davidson Sales Service, 813 Ohio Street, Wichita Falls, Texas.

**MOTOR** Scooters, bicycle engines. 120 miles gallon. Dime for catalog. Clymer, Desk A-95, 1268 So. Alvarado, Los Angeles 6, Calif.

### AVIATION

**FAMOUS "Zweng" books** include Mechanic's Rating With Examinations, \$3.00; Flight Engineer, \$4.00; Link Instructor \$4.00; Parachute Technician \$3.00; Aviation DeLuxe Dictionary \$6.00. Surplus Sextants \$12.50. (Free catalog). Pan American Navigation Service, 12021-C Ventura Blvd., North Hollywood, Calif.

**LIGHTPLANE** Blueprints. Circular designs, motors, 20c. Craftsman Books, Box 1153, Milwaukee 1, Wisconsin.

**PROPELLERS.** 2-3 Blade. Sleds, air-drive boats. Catalog. Standard Aircraft, Ft. Worth, Texas.

**BLUEPRINT** Revealing sixteen transonic airfoil shapes, 25c. Machen, Station "F," Toledo, Ohio.

**PROPELLERS.** Plans for ice sleds, snow sleds, air boats. Catalog 10c. Banks-Maxwell, Ft. Worth.

**VETERANS:** Flight training under the G. I. Bill. Tuition paid. Private, commercial, flight instruction, instrument and multi-engine ratings. Opportunities to work for living expenses or tuition, if not a veteran. Write Gottschalk School of Aeronautics, Adrian, Mich.

### ELECTRICAL SUPPLIES

**SURPLUS** Items: Fractional horsepower synchronous motors up to 75 inch ounces torque, some reversing, \$1.00 to \$4.50; electrical relays SPST, DPDT, interlock, others, \$1.00 to \$5.00; micro switches to 10 amp. ratings, 50c to 90c; magnet wire; enamel heavy Formvar #18 to #29, 32c to 40c per lb.; small d.c. solenoid valves. Aeronautical Sales Company, P.O. Box 381, Niagara Falls, N. Y.

**ELECTRIC** Pencil: Engraves all metals, \$1.00. Beyer Mfg., 229-H Dixon, Uniontown, Penna.

**LAMPS**—Build own originals, parts wholesale, any amounts. Catalogue 10c. Brown Lamp Co., Box 501, Wellington, St. Louis 12, Mo.

**FREE** Catalog—Motors, welders, welding supplies, generators, fencers, electric mowers, freezers, other electrical items. LeJay Company, Minneapolis, Minn.

**WESTINGHOUSE.** General Electric, dynamotors, D.C. input 28 volts; D.C. output 575. Each \$4.75. Wilt, 7829 S. Racine Ave., Chicago 20, Illinois.

**ELECTRIC** Pencil—Writes, engraves all metals, 110 volts, \$2.95 postpaid. Battery model \$1.00. Reb Industries, Dept. 265-DJ, Elmhurst, Illinois.

**"CONSTAVOLT"** Selenium rectifiers! Full voltage at full load. New! Automatic! Free booklet. Lectralabs-3, Wakefield, Rhode Island.

**LAMP** Parts wholesale. Large variety available for building, repairing, or remodeling. Order in any quantity. New 1948 catalog 10c. Gearon Company, 27 South Desplaines, Chicago.

**LELAND** Electric generators, 2.5 kva, 120 volt, 60 cycle, single phase with radio filter. Turns at 1800 r.p.m., producing 2500 watts, \$125.00 freight prepaid. Hopper & Company, 3124 East 14th Street, Oakland, California.

**WATTHOUR** Meters. Reconditioned G.E., West., 115 v. \$2.95. T. Price, 310 14th, Raymond, Wash.

**ELECTRIC** Fans? Assemble your own. 16" correctly balanced aluminum fan blade, 1/2" bore, \$2.25. 18" all welded guard, \$2.50. Use any ordinary motor. No c.o.d. Ted Riseman, 207 North Fifth, Springfield, Illinois.

### WELDING, SOLDERING, PLATING

**RADIATOR** Repairing. Our low priced self-instruction system teaches this profitable business. No acid. No boiling. Little equipment needed. Is there a radiator man in your community? Radiator Service And Supply, McBain, Michigan.

**WELDERS**—Govt. surplus tested gasoline driven. Save up to 50%. Iowa Machinery Co., Des Moines.

**WELDING**—A profitable trade. Learn quickly at best equipped school in U. S. G. I. approved. Demand for trained men. Write Hobart Welding School for free catalog. Box M-985, Troy, Ohio.

**OXY-ACETYLENE** Small cylinders sold outright by largest Linde mailorder distributor of Purox welding and cutting apparatus, Oxweld rod and supplies. Freight prepaid in U. S. Free literature. A-A Welding Supply Co., Dept. A, 9228 So. Ada Street, Chicago 20, Illinois.

**TRANSFORMER** Welders, 110v. Welds 1/2" steel, \$32.50. Morris Welding Service, 1850A State, Schenectady 4, N. Y.

**"BUILD-UR-OWN"** Portable arc welder. Save \$350. Easy with Hobart generator plus auto engine. Free instruction book. Write Hobartweld, Box M-984, Troy, Ohio.

**"POWER-WELDER."** New combination a.c. welder; a.c. power plant. Portable. Go anywhere after profitable jobs. Makes you independent of power lines. Gives you welding, plus power for tools, lights, motors. Free catalog. Write Hobartweld, Box M-983, Troy, Ohio.

**OXY-ACETYLENE** Welding outfit—New. Includes everything: two full oxygen and acetylene cylinders, torches, goggles, lighter, regulators, hose, welding rod, and carrying case. Only \$89.75. Cylinders refilled anywhere. Ideal for hobbyists, garages, repair shops. Guaranteed. Burdett Oxy-Weld Co., 3397 Lakeside Ave., Cleveland 14, Ohio. Welding supplies since 1923.

**OWN** Mirror shop. Resilver mirrors. Glass sign making. Electroplating. Supply prices. John Sprinkle, V55, Marion, Indiana.

**RECTIFIERS:** Ramyr Selenium platers, 10, 30, 50, 100 amp. sizes. Immediate shipment. Complete line of bronze baby shoe mounts. Write for list. Hollywood Bronze Supply, 1770 N. Vermont, Hollywood 27, Calif.

**WELDERS!**—New portable Champion special transformer welder; 110/120 volts, a.c. 8 heat stages. Welds, brazes, solders, cuts all metals. Complete with electrode holder, helmet, rods, carbons, fluxes, cables. Also special flame weld torch. Easy to use. Full directions. Splendid for shop, farm and home repairs. Guaranteed. Only \$27.50. Money back guarantee. Also resistor model, now \$14.95. Magic Welder Co., 239 MP Canal St., New York, N. Y.

### MACHINERY, TOOLS, SUPPLIES

**BEAUTIFULLY** Finished, watertight aluminum tool or tackle boxes. 19x7 1/2 x 7. 2 trays. Weight 3 lbs. \$6.50 postpaid. Tools, supplies for machinists, home craftsmen. Catalog 10c, refunded. Precision Tool Service, Dept. M, 55 E. Washington, Chicago 2, Ill.

**INSTRUCTIONS** For perfect tapping, simple, saves time and taps. 25c. Chas. Carvo, 6080 Dequindre, Rochester, Mich.

**\$2.85 POSTPAID.** Big box, over 2000 mixed steel cadmium plated machine screws, nuts, washers, etc. Meltz Aircraft, New Brunswick, N. J.

**BACK** Geared metal and wood cutting 12" band saw, 6" jointer, ball bearing, 47" long. Ball bearing spindle shaper, 15x20" table, 8" bench saw, tilting table, ball bearing. Lowest priced line of high grade tools on market. Free catalog. Backus Machine Co., Boyd, Wisconsin.

**CHUCKS.** (Genuine Westcott) Independent, Universal, threaded 1 1/2"-8 for South Bend, Atlas, Logan, Clausen, Craftsman lathes. Also other chucks to 16". Top value. Free literature. Westcott Chuck Co., 3600 Walnut, Oneida, N. Y.

**HOME** Lathe owners — Build your own attachments. Send for picture, sample of work and list of blueprints. Cut gears, ratchets, etc. Make neat screws easy way. The Home Shop, 415 Raymond Ave., Glendale 1, Calif.

**POWER** Tools. Build your own with Lewis Castings. Save up to 80%! Complete castings, materials and blueprints supplied for 23 woodworking and metalworking tools. Free catalog. Write today. Lewis Machine Tool Co., 3217 Union Pacific Avenue, Dept. M, Los Angeles 23, Calif.

**CONCRETE** Block machines \$39.50 up. Catalog free. Concrete Machine Company, 5466 Gravois, St. Louis 16, Missouri.

**SURPLUS** Items: Fractional horsepower synchronous motors up to 75 inch ounces torque, some reversing, \$1.00 to \$4.50. Cut brass gears; 15 to 90 tooth with hubs, 35c to 70c each. Wide variety stainless, ferrous and nonferrous bar stock and tubing; diaphragm valves; interval timers. Detailed price list free. Aeronautical Sales Company, P.O. Box 381, Niagara Falls, N. Y.

**FOOT** Switch—Operates all power tools. Free details. Guaranteed, \$3.95; two for \$6.50 postpaid. Reb Industries, Dept. 265-DI, Elmhurst, Illinois.

**MACHINE** Tools for wood and metal. We specialize in small machinery. Tell us your needs. We will quote. Kandler, Kalamazoo 12, Michigan.

**LAWN** Mower sharpener, \$3.65. Guaranteed. Goodwin Mfg. Co., Crab Orchard, Ky.

**DRILL** Grinder for twist drills, \$2.95. See ad on page 36.

### BOATS, OUTBOARD MOTORS

**BUILD** Your own boat by the Welch System, ready cut parts. No experience necessary. Save 3/4 cost. Rowboats to cruisers. Illustrated catalog 25c. Midwest Boat Company, Menomonee Falls, Wis.

**SUPER-BOAT** \$20. Easy to make your own with readymade streamlined laminated one-piece super-hull developed by Navy. Light, sturdy, leakproof. Anyone can convert into dinghy, outboard, scooter, cartopper, other craft. 9'x4', Warwood, 480 Lexington Avenue, New York 17.

**MARINE** Fittings, accessories. Thousands of items (pictured, prices). Prompt delivery. Catalog \$1.00. Marine Mart, Buffalo 7-B, New York.

**OUTBOARD** Motors—Good values, used motors. Also used parts for most makes and models. Crandall-Hicks Co., 911 Commonwealth, Boston, Mass.

**MARINE** Conversions for Ford and Jeep engines. Catalog 10c. Lehman Manufacturing Company, Department D, Newark 2, New Jersey.

**NEW.** Used, rebuilt marine motors. Marine conversions, fittings. Free catalog. Stokes Marine Supply, Dept. 24, Coldwater, Michigan.

**OUTBOARD** Motor parts. New-used, all makes. New pistons (standard, oversize). Cylinders rebored. Outboard Motor Mart, 309 Atlantic Ave., Boston 10, Mass.

**BUILD** Marine motors, Ford or Jeep. Federal Marine Motors, 9011 Cottage Grove, Chicago 19, Ill.

**COMPLETE** Blueprints for light weight, collapsible boat, \$1.50. Maurer Agency, Lincoln, Illinois.

**CANVAS** Covers, new, 20' 54' heavy o.d.; water, fire, mildew resistant; grommets, ropes; war surplus, \$65. Also paints, clothing, tents, Morsan, 10-15G 50th Ave., Long Island City 1, N. Y.

**MARINE** Engines, new, used. Conversion supplies, hardware, propellers, shafting. Catalog D. Lind Supply, Coldwater, Michigan.

**P-38 BELLY** Tanks. New, steel, 10 foot or 6 foot size, \$9.95. Anzio Boat Company, 89H, Merced 9, Calif.

**HERRESHOFF** 33' Sharpie 15" draft, sleeps four. Inexpensive to build. Plans begin August (40c). Catalog boatbuilding plans 10c. Rudder, 15 Murray Street, New York 7.

**P-38 BELLY** Tank speed boat, complete plans, instructions \$1.00. Twintank Boat Company, 1032 62nd St., Oakland 8, Calif.

**BUILD** Your boat from our accurate paper patterns, thirty designs 7-54 feet. Forty years careful designing. Send 10c for folders. Illustrated book, small boat construction \$1.50 postpaid. German Boat Company, W. Saginaw, Michigan.

**BOAT** Plans by graduate naval architects. Send specific requirements for free suggestions. Westlawn Associates, Montville 5, N. J.

### ENGINES, MOTORS, DYNAMOS

**BARGAINS** In war surplus hydraulic transmissions, switches, motors, geared speed reducers, aviation instruments, etc. Delta Sales, P.O. Box 968, Shreveport, Louisiana.

**NEW** General Electric, all purpose 1/2 horsepower motors, 115 volts, 60 cycles, splitphase, speed 1725, \$12.50. Plenge, 114 Elliot Place, Bronx, New York.

**MOTORS:** New, 1/2 h.p., G. E., rubber mounted, \$16.50. Lang, 1823 South San Pedro St., Los Angeles, Calif.

**WINDING** Data, listing 225 motors, single and three phase, \$1.00. Motor Data Co., Box 7631, Kansas City 3, Mo.

**24 BRAND** New Clinton 1 1/2 H.P. air cooled engines (in original cartons) with integral 6 to 1 reduction gear; rope starting; \$49.50 each. F.O.B. Chicago. Mead Specialties Co., 4114 N. Knox Ave., Chicago 41, Illinois.



$\frac{1}{2}$  H.P. Refrigeration motors, \$12.50, rebuilt, sizes to  $\frac{1}{2}$  H.P. List 10c. Send M.O. A.C. Motors, 3101 N. 32nd St., Philadelphia 32, Penna.

**MOTORS!**  $\frac{1}{2}$  H.P. D.C. converted to A.C. All new. High speed 110 volt, 25 or 60 cycle, ball bearing motors. Actual value about \$75.00. Now \$15.00 each or 3 for \$40.00. With forward and reverse switch \$19.50, 3 for \$50.00. Countless uses for home mechanics. Can be used in any position. Order today! Immediate delivery! No c.o.d. orders. "Amazing Bachman's," 27 Herman Street, Rochester 5, New York.

**MOTOR** Repair men, send for bulletins on motor winding tester and a.c. motor winder. Motor Industries, Quincy, Illinois.

### ATHLETIC EQUIPMENT, BODY BUILDING COURSES

**BARBELLS!** 95 Pound set \$10.80; extra plates 10c pound. Send for free course and catalog. Bur Barbell Company, Lyndhurst, New Jersey.

**DEADLY** Judo—Fiercest fighting technique. Trick knockouts. (200 photographs, plus illustrations.) Expert instructions, three volumes. Complete \$2.25. Variety House, Box 46-B, Wall Station, New York 5.

**BARBELLS**, Exercise equipment. Courses. Free booklet. Good Barbell Co., Reading, Penna.

### SPORTING GOODS, GUNS, FISHING TACKLE, ARCHERY, TRAPPING

**NEW** Riflescopes, sights, mounts, spot-tingscopes and binoculars at large discounts. Write for prices. Clark McNutt, 389 Champion, Battle Creek, Michigan.

**WHAT** Every duck hunter needs. Reel fastens to decoy. Handles anchor perfectly. Special offer, one dozen c.o.d., price only \$2.25. Decoy Reels, 1811 Main, Eau Claire, Wis.

**AMMUNITION**, 125 Sizes in stock. American, foreign. Dime for list. Central Sports, Delphos 5, Ohio.

**POCKET** Knives, all kinds, guarantee under price market. 1009 Stockton #5, Jacksonville 4, Florida.

**FELT** Letters anyone can sew on athletic uniforms. Adhesive backed. Sample. Modern Embroidery & Felt Lettering Co., 815 $\frac{1}{2}$  N. 8th, St. Louis 1, Mo.

**SEND** 10c For list 100 used guns. Frayseth's, Willmar, Minnesota.

**SHOOTERS:** Handload your own ammunition. For full information send 60c for a copy of the B & M book "Handloading Ammunition." Circular free. Belding & Mull, Box 428B, Phillipsburg, Penna.

**SHOTGUNS**, Rifles, handarms, ammunition, rods, reels. List 10c. Rudolph's, Atchison, Kansas.

**5000 BARGAINS**, Firearms, binoculars, war relics. Catalog 40c. Smith Firearms, Rummene, New Jersey.

**BOWS**—Arrows, write headquarters for archery equipment. Quality products. Popular prices, catalog 10c. Large illustrated handbook instructions, aiming and shooting, 50c. Archery, 617-B So. State, Chicago 5.

**SHOTGUNS**, Rifles, revolvers, over 500 modern, obsolete. Also cartridges, list 10c coin. Ed Howe, 52 Main, Coopers Mills, Maine.

### TAXIDERMY

**FINEST** Glass eyes; taxidermy supplies. Catalog free. Elwood Company, Department 234, Omaha 2, Nebr.

### FIELD GLASSES, TELESCOPES, MICROSCOPES, MAGNIFIERS

**BINOCULARS**, Gun scopes, spotting scopes, camera lenses, 20% to 50% increased visibility by hard coating your optics. Eyeglass and custom coating. Binoculars, gun scopes, bought, sold, exchanged, condition unimportant. Write for details. Optical Coating Laboratory, Inc., Dept. 4, 711 Eighth N.W., Washington 1, D. C.

**TELESCOPES** And binoculars—New guaranteed Saturn, Mohrson, Zeiss, etc. instruments. Tinsley Laboratories, Dept. 40, Berkeley 4, California.

**GIANT** Astronomical telescope 100 diameters magnification, with tripod. Full power, clear vision, \$15.00. Suffolk Science Service, Manorville, N. Y.

**BUILD** Extraordinary reflecting telescope; principle of 200" Mount Palomar. Complete optical parts including fully polished and aluminized mirror, eyepiece lenses and "flat." 3" (40 power) \$6.00; 4" (60 power) \$10.00; 5" (80 power) \$15.00. Simple instructions. Sharp, clear definition guaranteed. Also spotting and bird use. Thousands satisfied makers. Do not confuse with inferior items offered at any price. Bulletin 10c. Ross, Section C, 68 West Broadway, New York, N. Y.

**COMPARE!** 8x30 New French binoculars \$60.00, worth \$125.00. No c.o.d. S. Vasas, 214 W. Elm, Chicago 10, Ill.

**REFLECTING** Telescope kit. Consists 3" diameter aluminized mirror, diagonal, erect image eyepiece 25X, 50X, 100X powers, tube, etc. Assembled in one hour. Interesting work. Your achromatic planetarium ready. View hundreds fascinating celestial wonders plus terrestrial spotting. \$5.00 postpaid, with tripod \$7.95. Postcard brings plans, list outstanding optical values. Pfelegor Optical Co., PM-9, Sunbury, Penna.

**POWERFUL** Astronomical telescopes easily made. Perfect lenses and instructions; 100X \$3.00, 100X and 200X \$4.00, 100X, 200X and 400X \$6.00. Clear vision, full power guaranteed. Instructions alone 10c. Suffolk Science Service, Manorville, N. Y.

**BINOCULARS**, Telescopes, watches, guns. Buy, sell, trade. Schweer's, Donnellson, Iowa.

**ASTRONOMICAL** Telescopes, binoculars, microscopes; bought, sold, repaired. Books. Lists 10c. Rasmussen-Reece, Amsterdam, N. Y.

**TELESCOPES**, Binoculars, microscopes, big bargain catalog free. Brownscope Company, 24 West 45th Street, New York.

### DOGS, PETS, BIRDS, RABBITS

**RABBIT** Hutch. New type, revolutionary, super sanitary, automatic enabling two people care for thousand does. Full plans, photographs \$5.00. Reliable Fur Industries, Dept. P.M., Montebello, California.

**RAISE** Angoras rabbits. Write today. Southern Angora Rabbits, 4170 Tutwiler, Memphis, Tennessee.

**ANGORAS**, Giant Chinchillas, White Giants. World's most profitable rabbits. Finest pedigree, heavy-producing, prize-winners. Literature free. Grinsteeds, Edwardsville, Illinois.

**\$50.00 WEEKLY** Raising Angoras for us. Free literature. Angoraville, 1215-34th Northeast, Cedar Rapids, Iowa.

**\$3000 RAISING** Pedigreed and registered Angoras. Vaughn's Rabbitry, Otley, Iowa.

**\$250.00 MONTHLY** Raising angora rabbits. Particulars free. White's Rabbitry, Newark, Ohio.

**MINK** Raising amazingly profitable. Free folder gives inside "secrets" on feed; care. Lawrence Molgard, Brigham City 12, Utah.

**RAISE** Guinea pigs. Make money at home. Big demand. Booklet free. Taylor, Box 426A, Hapeville, Georgia.

**MINK** Raising information free. Complete. Lake Superior Mink Farm, Superior E E I, Wisconsin.

**WRITE** For descriptive circular "Angora Wool Growing." House of Angora, Springfield, Illinois.

**RAISE** Chinchilla rabbits. Year-round money-makers from furs, meat, breeders. Experience unnecessary. Write today. Willow Farm, Sellersville 15, Penna.

**RAISING** Rabbits, cavies, hamsters, chinchillas is profitable. Big demand. Magazine 10c. Instruction book and magazine 25c. Book and magazine (monthly) one year, \$1. Address. Small Stock Farmer, Fairlawn 2, New Jersey.

**INCREASE** Your income by raising domestic rabbits. Small space needed. Ready market for delicious meat, fur and wool. Largest magazine in the industry tells you how. \$1.50 per year. Sample 15 cents. No stamps. Small Stock Magazine, Lamoni 20, Iowa.

**\$3000 YEARLY** Raising Angora rabbits. We buy your output. Contract particulars free. Kise's Enterprises, St. Paul 8, Minn.

**SEE** Gulf Hamstery ad page 34. Shows picture of Hamster.

### FARMS, FARM LANDS, REAL ESTATE

**GOVERNMENT** Lands \$2.00 acre up. Information all states twenty-five cents. National Tax Service, 834-A Majestic Bldg., Detroit.

**JUST** Out! Strout's new fall-winter farm catalog—Free! Red cover. Chock full of bargains coast-to-coast. Eqpd. and uneqpd. farms, groves, retirement places, etc., etc. Write today for your free copy. Strout Realty, 255-P 4th Ave., New York 10, N. Y. 20 W. 9th St., Kansas City 6, Mo. 453 S. Spring, Los Angeles 13, Calif.

**UNITED'S** Fall catalog. Bargains galore! Farms, ranches, groves, businesses, homes. Exciting free catalog of up-to-the-minute values. Midwest, famous Ozarks, California, many states. America's biggest bargains! Write for free copy today. United Farm Agency, 1408-PM Consumers Bldg., Chicago 4, Ill.

**RAYBURN'S** Ozark Guide. Eureka Springs 11, Arkansas. For homeseekers. Year, \$1.50.

**\$5.00 MONTHLY** Buys 40 acres, near town. Price \$200.00. Free list. Box 425-P, Carthage, Mo.

**LOTS** \$300—Convenient payments. California's finest garden section. On Morro Bay's scenic shores. Wonderful fishing, hunting, boating, bathing. Fertile soil, softest water, temperate climate, congenial community. Free literature. Richard Otto, Department M, San Luis Obispo, California.

**CHEAP** Homes, farms, stock ranches, peach orchards, valley farms, wonderful free range, mild, pleasant winters, cool summers in beautiful, healthy Ozarks. Free literature, land lists. Write G. W. Starr, Ozono, Arkansas.

**GOOD** Farms—Ranches. Washington, Minnesota, Montana, Idaho, Oregon, North Dakota. Dependable crops, favorable climate. Write for literature, lists describing typical farm opportunities. Specify which state. J. W. Haw, 119 Northern Pacific Ry., St. Paul 1, Minn.

**OZARK** Lands for all purposes. Actual river frontages. 5 acres \$90.00 and upwards. Free list and literature. Hubbard, 424-I Minnesota Ave., Kansas City 4, Kansas.

**WEST'S** New picture catalogue, describes 1000 farm and business bargains. Free. West's Farm Agency, HE-18, Pittsburgh 17, Pennsylvania.

### POULTRY, FARM SUPPLIES

**RAISE** Fryers new easy way. One-man home plant earns \$500 monthly. Details free. Fortune Fryer Farm, Box A, Simi, California.

**EARN** \$4 To \$12 hourly. Chick and turkey sexing, culling and caponizing—G.I. approved. Pilch's School, Box P.M., Thompsonville, Connecticut.

**KNOW** How to raise poultry for profit. Read Northeastern Poultryman. Every issue packed with helpful hints and practical suggestions. Latest articles on breeding, feeding and management. Subscribe now, 1 year 65c. 2 years one dollar, foreign subscriptions \$1.00 a year. Northeastern Poultryman, Dept. P.M., 376 Boylston St., Boston 16, Mass.

### PROFITABLE OCCUPATIONS

**FIX** Typewriters, full or part time. Inexpensive copyrighted home study course quickly trains you for high earnings. Factory methods cover all phases with drawings and illustrations. No curiosity seekers. Typewriter Repair, 9915 Corbet, Tarentum, Pennsylvania.

**VENETIAN** Blinds! Easy, profitable, full or spare time business. Small capital. Construction blueprints, instructions, supply sources \$1.00! Hunter, 2172 Green, Cleveland 21, Ohio.

**LOCKSMITHING** Secrets—Key fitting, lock opening, repairing, prices to charge, supply sources. Illustrated book only \$1.00. Wechsler Supply, 7 W. 36, New York City.

**OWN** Mirror shop. Resilver mirrors. Glass sign making. Electroplating. Supply prices. John Sprinkle, V50, Marion, Ind.

**WOULD** You pay 3%—first \$350 made? Color-illustrated book "505 Odd, Successful Enterprises", free! Some offer occasional "day off." Work home. Expect something odd! Pacific, Oceanside, Calif.

**\$40.00 WEEKLY** Made growing mushrooms, fresh, dried. Dominion patent 331583. Free spawn. North American, 169P Yonge, Toronto, Canada.

**BE** The Popular Mechanics representative in your neighborhood and earn big profits in your spare time. Write Popular Mechanics Magazine, Room 408M, 200 E. Ontario St., Chicago, Ill.

**GET** Into photo offset printing. Big demand, uncrowded field. Learn at home. Build your own simple equipment. Write John L. Moon, Box 1775, Spokane, Wash.



**WANT** Pleasant outdoor work in a business of your own? Good profits selling over 200 widely advertised Rawleigh home/farm necessities. Pays better than most occupations. Hundreds in business 5 to 20 years or more! Products, equipment on credit. No experience needed to start we teach you how. Write today for full particulars. Rawleigh's, Dept. I-145-PPM, Freeport, Ill.

**INTERESTED** In Latin American and foreign employment? \$1.00 brings Foreign Service Directory listing exporters and importers, oil, construction, mining, aviation companies. Hot tips for applications. Global Reports, Box 883-M, Hollywood 28, Calif.

**OPERATE** A letter shop. Unlimited opportunity. Send for free prospectus. Dougherty, 255 Washington, Phillipsburg, N. J.

**HYDROPONICS.** Soilless vegetables, cheap chemicals. Free information, Box 57B, Bristol, Virginia.

**MUSHROOMS** Grown boxes, barrels. Instructions. 50c. Spawm \$1.00. Gordons, 553 William, Winnipeg, Manitoba.

**ALASKA**—The Last Frontier offers unlimited opportunities. \$1 brings government map and directory listing firms in fishing, construction, mining, aviation, fish and game rules, homestead data. Alaska Opportunist, Box 883-M, Hollywood 28, Calif.

**42,000 ACRES** Rich irrigated western farm lands available to qualified WWII veterans for homestead lottery by U. S. Govt. in 1948. \$1.00 brings complete folio with maps, showing locations, soils, climate, crops, and full details how you too may secure that "ranch out west." Western farms richest of all. 40 acre units gross up to \$25,000 yearly. Western Associates, P.O. Box 290, Caldwell, Idaho.

**NOVELTY** Manufacturing. You can start profitable business small investment. Plastex Products, 711 Laguna, San Francisco.

**MAKE** Soaps, cleaners, detergents. Easy instructions. 100 formulas. No machinery needed. \$1.00. Brown, 9111-G Hoyne, Chicago 20.

**TYPISTS**—Profitable business at home. Complete copyrighted information, 50c. Gaunt, 3521A Broadway, Chicago 13, Ill.

### BOOKS, PERIODICALS, PICTURES, POSTCARDS

**WE** Can supply you with almost any book. (Magazine subscriptions). House of Kilroy, (Booksellers), Box 772, Detroit 31, Mich.

**PLEASURE** Profit book list free. Johnson, Box 49, Astoria Station, Long Island City, N. Y.

**BIG** Sparetime profits taking magazine subscriptions. Complete supplies, confidential catalog free. Cassell Publishers Service, Westfield, New Jersey.

**BOOK** Lovers! Send six fictions, good condition, with \$1. We return six different fictions. Robert Miller, 20 Kelly Pl., Springfield 4, Mass.

**BOOKHUNTERS!** All subjects. Send wants! Jaher Book Service, 620-P East 178 Street, New York 57.

### MAGIC TRICKS, PUZZLES, JOKER NOVELTIES

**ILLUSTRATED** Book explaining 279 magic tricks, 25c. Baffling trick card given with each order. Garvey, 44-2 Bates Road, Brockton 11, Mass.

**FOUR** Good card tricks with catalog, 25c. Stivers, 40 Salem, Medford, Mass.

**WORLD'S** Largest professional magic shop. Keeps you in touch with latest tricks. To receive mailings, send 50c for new catalog. Holden's, M220 West 42nd St., New York.

**SNEEZING,** Itching, powders. Eighteen other tricks free with joker's catalog 25c. 2404-N Fifteenth, Philadelphia.

**OPPONENTS** Foiled, great western belt trick 10c. Schiff, 2319 Newton, Milwaukee 11.

**VENTRILOQUISM** Taught. 3c stamp bring particulars. Smith, 801 Bigelow, Peoria 5, Ill.

**MAGIC** Tricks, puzzles, books, cards, punch boards. Catalog 10c. Specialty, Box 671, St. Louis 1, Mo.

**500** TRICKS. Send only 10c for Douglas' famous 112-page catalog 500 tricks. New magic for amateur, professional. America's fastest service for 25 years. Douglas Magicland, Dept. 1, Dallas, Texas.

**BE** A magician. Large professional magic catalog of latest tricks, 35c. Ireland, C-109 North Dearborn, Chicago 2.

**LARGE** Catalogue of the best magic for professionals and amateurs. Send 25c. Mazda Magic Co., 1135 Westgate Ave., Oak Park, Ill.

**"VENTRILLO,"** Professional voice throwing instrument and "unusual" catalog 25c. POB-971, Philadelphia.

**MAGICIANS'** Headquarters. 400-page professional catalogue, pocket, parlor, stage tricks. World's finest magic. Send \$1.00 for catalogue (refunded first \$5.00 order). Kanter's, M-1311 Walnut, Philadelphia 7, Penna.

**LEARN** Magic, ventriloquism, mind-reading. Write for particulars. Quackenbus, Big Flats, N. Y.

**BIG** Magic magazine, trick and price lists—25c. Lloyd M. Jones, 4064 39th Avenue, Oakland 2, California.

**DOLLAR** Magic set free with Mammoth catalog 25c. "Mysto," 4462-PM Germantown, Philadelphia.

**VANISHING** Half dollar trick and catalog 25c. Sterling Magic Co., Royal Oak, Mich.

**PROFESSIONAL** Catalog, 128 pages, 25c. Williams, 900 Plymouth, Ellwood City, Penna.

**MAGIC** List free. "Marean" Magic Shop, Box 551-R, Hopewell, Virginia.

**MAGIC** Catalog; magic vanisher. Both 10c. Wade Magic, 1423 Palou, San Francisco 24, Calif.

**ASTOUNDING** Phenomenon! Amazes, confuses, mystifies all. Magic light bulb, lights up in hand, mouth or ear, no wires, professional magicians secret trick. Its easy with special bulb and instructions. Complete bulb with big catalog 400 other tricks \$2.00. The Magician, 2463-C, Kensington Ave., Philadelphia 25, Penna.

**3** MAGIC Catalogs and "Magic Is Fun" magazine sent for only 25c. Robbins Co., 152-F West 42nd Street, New York.

**200** ELECTRIC Stunts. 110 volts. \$1.00. Kutting Sons, Campbell, Calif.

**5c** BRINGS Catalogue magic-jokers' tricks! Postways, Box 5325-S, Philadelphia 42.

**TRICKS,** Secrets, cards, punchboards, etc. explained. Big illustrated circular free. Mack, Box 1278-E, San Francisco.

**TRICKS** And jokes you've always wanted but never knew where to get. Write for free illustrated price list. Western Latex Co., Room 1320P, 431 South Dearborn, Chicago 5.

**ILLUSTRATED** Catalogue, 10c. Penny changes to dime 50c. DeLux Magic Studio, Box 2606, New Orleans, Louisiana.

**MAKE** Magic burning ink. Touch paper with cigarette or ember. Watch words spell out. Formula 25c. Brown, 9111 Hoyne, Chicago 20.

### COINS, TOKENS, CURRENCY

**20** DIFFERENT Indian head cents \$1.00. 4 Whitman coin albums \$1.00; handbook 75c; 254 page guidebook \$1.50. Our large retail catalogue 15c. Bebee Coin Company, 1180 East 63rd, Chicago 37, Illinois.

**COINS** Wanted, will pay up to \$2000 for certain coins, send 25c for catalogue. Burton's, 111 So. Third, Columbus, Ohio.

**GET** Profit and pleasure in collecting old coins. Send 10c for 56 page illustrated coin catalog. You'll be delighted with it. Send for it now. B. Max Mehl, 370 Mehl Bldg., Fort Worth, Texas. Largest rare coin establishment in U. S. Established 48 years.

**FREE!** Foreign coin, banknote and coin collectors illustrated catalog to approval service applicants. Send 3c postage. Tatham Coinco, Springfield-125, Mass.

**COMMEMORATIVE** 1/2, Oregon, Texas, Kentucky, Cleveland, Long Island, \$2.00 ea. Illustrated catalogue 25c. Norman Shultz, Salt Lake 9, Utah.

**4-IN-1** Special \$1.00 bargain offer: (1) United States 1893 Columbian world's fair half dollar; (2) album for holding coins; (3) large 56 page coin catalog; (4) genuine wooden nickel. Yes! All four items for only \$1.00. Order today. Money back if not pleased. Ben's Coin Company, 72 W. Washington, Chicago 2, Illinois.

**MONTHLY** Price list for those who wish to buy scarce and rare coins. Sample copy 15c. \$1.50 annually. James Randall, 116 South Michigan Avenue, Chicago, Ill.

**100** COINS And bills \$1.00. Oddehon, Box 482, St. Louis, Mo.

**OLD** Money wanted. Will pay \$100.00 for 1894 dime, S. mint, \$50.00 for 1913 Liberty head nickel (not buffalo). Big premiums paid for all rare coins. Send 4c for large coin folder. May mean much profit to you. Numismatic Co., Dept. 20, Fort Worth, Texas.

**FREE** Foreign coin with bargain list 10c. 4 Whitman folders \$1.00. Allen's, 227 North Hermosa, Albuquerque, New Mexico.

**FOREIGN** Bills—10 different, 15c. Bills and coins, lists. Oliver Arnold, Macon, Mo.

**4** WHITMAN Folders \$1.00 complete stock. Foreign coin, bill included with bargain price list 10c. Little, 337 North Menard, Chicago 44.

### STAMP COLLECTING

**SENSATIONAL!** Set Capejuby, Brunel, Perak, Honduras, Paraguay, Nigeria, and over 100 different others. Everything 10c with approvals. D. O'Keefe, 7517 Merrill Ave., Chicago, Ill.

**YOU'LL** Like our American and British Colonial approvals. Write now. Chesapeake Stamps, 748 Overbrook, Baltimore 12, Maryland.

**EXOTIC** Pictorial collection; Djibouti Mosque, Fezzan Ghadames, Sakalava Chieftain, Reunion, St. Pierre Miquelon, Devils Islands, Tunis, Monaco, Guadeloupe, Martinique, etc. Everything 5c. Imperial, Drawer 1491, Tampa, Florida.

**GIFT** Six Roosevelt San Marino to approval applicants. Deane Stamps, Box 87, Miami 35, Florida.

**STAMP** Collecting—World's greatest hobby! "Stamp Collecting For Pleasure and Profit" \$1.00 postpaid. Details free. Bruce, Box 341-A, Palo Alto, Calif.

**FIJI** Included! Stamps from 40 countries 10c. No approvals. Elsea, Bowling Green, Ohio.

**MAGIC** Bag penny approvals. Resch Stamps, 3739 North Wilton, Chicago.

**SPAIN'S** "Goya Nude" set complete 35c. Approvals. Royal Stamp Company, Tamaqua, Penna.

**REDUCED!** Worldwide different—200-25c; 500-50c; 1000-\$1.25; 2000-\$3.25; 5000-\$15.00. Beacon Sales, Maynard 2, Mass.

**200** WORLD Wide 27c. Pacific Metro, Box 5704, Los Angeles, Calif.

**CHOICE** Of 35c worth of stamps from our first U. S. selection free to applicants enclosing 3c postage. Large selection to choose from. Act now! S. C. Engel & Co., 38 Park Row, New York.

**FREE.** Irish commemorative collection, including rebellion issue with approvals. Raymax, 123-Z William St., New York City 7.

**"CONFEDERATE** States." Twelve different unused 10c. approval applicants only. "Stamps," Box 87, Albany 1, New York.

**HISTORICAL** Collection! Cavalry Charge! "Bulgaria" Flaming Sword! "Ireland" Big She-Wolf! "Italy" Fort! Legionnaires! Field Marshall! "Pitcairn Mutiny Island" Commemoratives and pictorials! 3c approvals. Star Stamp Co., Jamestown, New York.

**FREE** U. S. price list, postage 3c. Mark Hanna, 335 5th Ave., Pittsburgh 22, Penna.

**FREE!** U. S. monthly lists. Cole, 43-A Rinevalt, Buffalo 21, N. Y. Precancels also available!

**WHAT** Have you to offer? Collection? "Shoebbox" accumulations? Anything in stamps? We urgently need them. Spot cash paid. Cosmopolitan Stamp Co., 1457 Broadway, New York City.

**FREE,** Triangle, Roosevelt, Vatican, Ethiopia, Hitler heads. Request approvals. Florida Stamp Company, Box 807, Miami 5, Fla.

**SPANISH** Air set free to approval applicants. Flamingo Stamp Company, Box 4038, Pinewood Station, Miami 38, Florida.

**FREE** Monthly illustrated bulletin showing recent issues. Penny approvals on request. Reed Company, Box 980, Chicago 90, Illinois.

**WORLD**—500 Diff. 50c, 1000 \$1.25, 75 Canada 25c, approvals, lists. Victoria Stamp Co., London 4, Canada.

**PENNY** Approvals that satisfy. Neil Gronberg, Box 5441-P, Philadelphia 43, Penna.

**10** DIFFERENT Iraq 5c to approval applicants. Jeffery Stamp Co., 9726 Chappel, Chicago 17, Illinois.

**WORLDWIDE** Packet 50 stamps 5c with approvals. Carlins Approval Service, Box 307, Fresno, Calif.

**200** DIFFERENT Stamps—Cataloging up to 15c each, only 3c to approval applicants! Littleton Stampco, Littleton 42, N. H.



200 DIFFERENT. Including Roosevelt triangle, 5c to approval applicants. H. Avalon Stamp Co., Springfield, Mass.

WORLD'S Largest stamp (7½x14 inches). A real curiosity! Retail for 50c, only 3c to approval applicants. Tatham Stamp Co., Springfield 30, Mass.

FLAG Stamp free with U. S. approvals. Wenigman, 929 Oakdale, Chicago.

25 ALL Different stamps 10c. Tunis. Wakeman Ave., Newark 4, New Jersey.

ZOWIE-E! A barrel of fun for only a dime. 500 United States stamps—absolutely unpicked and unsorted—just as received from church missions. Many varieties, including large commemoratives, airmails, high denominations up to \$5.00! Stampdom's biggest package of fun—and you might find something really valuable! Price only 10c to serious approval service applicants. Money back if not delighted. Illustrated bargain lists with each order. Mystic Stamp Company, Dept. 80, Camden, New York.

WOW! \$10.00 Worth of fun. Only 10c! What a treasure hunt! Big package 500 foreign stamps from foreign missions, other sources. Includes stamps from Africa, South America, Free French, Somali, Palestine, etc. Includes airmails, commemoratives and stamps worth up to 50c. This offer sent for 10c to approval applicants only. Jamestown Stamp Co., Dept. 22, Jamestown, N. Y.

DANDY United States approvals. Write immediately. Sullivan, Endicott Building, St. Paul, Minnesota.

50 DIFFERENT United States 10c. No approvals. Seidenberg, Cassopolis, Mich.

FREE! 100 Worldwide different stamps to approval buyers. Big U.S. and illustrated bargain lists sent with approvals. Bookman, Maplewood, N. J.

BRITISH, Spanish and French Colonies. Vatican, Hitler heads, and airmail packet, free with approvals. Pan-American Stamp-co, Box 145, New York 33, N. Y.

STAMP Collections wanted. Complete collections, duplicate lots, surplus stock, mint and used. Prefer trade for printing or other items, buy outright if priced right. What have you, what's wanted? Vanroy Shirk, Lebanon, Penna.

U. S. Price list. Send postage. State Stamp Service, 1225 Park Building, Pittsburgh 22, Penna.

DEALERS—Wholesale list. Postage 3c. Frank, 5031 Queensberry, Baltimore 15, Md.

FIRST Day covers on approval. Knobel, 1918 S.W. 12th Street, Miami 35, Florida.

U. S. Price list. Send postage. Stanley Gibbons, 38-P Park Row, New York.

UNITED States approvals complete coverage, fine quality, attractive prices. Seminole Stamps, Box 1138-P, Coral Gables, Florida.

FREE Beautiful airmails. Commemoratives, pictorials, eight countries. Approvals enclosed. Green and Company, Norwood 12, Ohio.

WHOOPIE! Wow! 25c worth of stamps free to buyers. Write M & N Co., 742A Sheffield Ave., Brooklyn, N. Y.

51 DIFFERENT Belgium; used, unused, pictorials, etc. Catalogs high. Only 5c. if you request approvals. L. Frazer, Box 4600, Portland 2, Oregon.

GOOD U. S. approvals. Must be seen to be appreciated. Panther's, Dorchester 24, Mass.

500 DIFF. 1c Each on approval. Roscoe Stamp, 1321 Roscoe, Chicago, Ill.

CHINESE "Martyrs," nineteen different mints, ten cents, with approvals. Old Dominion, Sharp Street, Winchester, Virginia.

FREE! 100 Diff. with approvals. Kloster, 4126 Winona St., San Diego 5, Calif.

SENSATIONAL! Mint! Russia, U. S., Madagascar, Vatican, airmails, only 3c. Approvals. Standard, Box 43 West Farms, New York 60, New York.

OLD Scarce U. S. seconds on approval. Slightly defective, bargain prices. Herfield, Clintonhill Station, Newark 8, N. J.

SURPRISE Packet 3c; approvals. Schmidie, 721 S.E. 139, Portland 16, Oregon.

U. S. Price list free. S. Stone, Box 52-P, Dorchester 24, Mass.

100 DIFFERENT Stamps from 100 different countries 25c with approvals. Jewels "Stamps," Tamaqua, Penna.

FREE! Nicaragua diamond issue, approvals. Martin, Box 1128, Miami Beach, Florida.

SPECIAL! Bicolor Vatican set 3c. Catalogs 90c. Approvals. Rostamps, 1921 Schiller, Little Rock, Ark.

FREE—Complete China "Great Wall" airmail set. Approvals. Sanders, 6126-S Carpenter, North Hollywood, Calif.

INFORMATIVE. Free, monthly illustrated price list. Frances Reese, Box P30, Martinsville, Indiana.

GIGANTIC Bargains! Samoa, Abyssinia, Fiji, Albania, Angola, Morocco, Philippines, and 100 different others, 10c with approvals. Hurschel Smith, Sunnyside, Wash.

COVERS. All different, cacheted. First days, 15-\$2.00. Navals, 25-\$2.00. Airs, 10-\$1.00. Misc., 10-\$1.00. Hurschel Smith, Sunnyside, Wash.

U. S. Price list free. Sikes, 1831 E. Allegheny, Philadelphia 34, Penna.

BEAUTIFUL Sets, packets and singles. Wholesale discounts. Sent on approval. N. H. Philatelic Ass'n., Inc., Deerfield 6, N. H.

GIVEN! Big stamp packet. Bargain approvals. Premiums. Verne, 916-0 Falowfield, Charleroi, Penna.

FREE! Canadian sets, royal visit. George VI, George V, coronation, jubilee, others, to approval applicants. Ensign, Box 118-M, South Orange, N. J.

GIBRALTAR Packet free—Nice collection Gibraltar, New Zealand Centennial, British Uganda, French Colonials, early British Colonial, West Indies, South American, war stamps plus Philatopic Monthly Magazine. All for 5c postage. Empire Stamp Company, Dept. PM, Toronto 5, Canada.

AUSTRIA Costumes set complete 15c to serious approval applicants (foreign only). Ace Stamp Company, 501 N.W. 35th St., Oklahoma City 3, Okla.

TWENTY-FIVE United States stamps, dime. Approvals on request. Robert Verne Anderson, Route #1, Madrid, Iowa.

FREE—Famous Americans set, plus Flag Set, plus the National Parks Set, plus the Presidential Set to the \$5. A total of 90 stamps absolutely free to customers for our unsurpassed U. S. or foreign selections. Send 3c postage for 15 of the above mentioned stamps and full particulars. Triboro Stamp Company, 145 Nassau St., Dept. 109, New York.

EXCHANGE Stamps universe. Particulars free. "Exchangers," Bry 126, Seine, France.

POSITIVELY Greatest free offer—Latest Scott's International \$6.00 stamp album—covering entire world, contains 36,000 illustrated descriptive spaces; Scott's 1948 Standard \$7.00 catalogues "Philately's Encyclopedia"—absolutely free to applicants for foreign approvals becoming customers. "Approval Service," Box 1700, San Francisco, California.

START Your own stamp business. Write for free circular. Donald Shepard, Box 5139, Chicago.

1946 SARAWAK "White Rajah" commemorative, plus Eastern Rumelia, Italian East Africa, Cilicia, Southwest Africa, Kwangchowan. Everything 3c with approvals. Viking, 130-ZZ Clinton St., Brooklyn, N. Y.

DOMINICAN Republic. Buy directly. Trial package \$1. Rodolfo Cohn, Puerto Plata, Dominican Republic, R. D.

SUPERB 1869s Wanted. Also earlier. Top prices paid. Ed P. Larson, 7124 Crandon, Chicago 49, Ill.

COLLECTION Builder approvals. Henry Jay Service, 15 Park Row, New York 7, N. Y.

SPECIALS—200 Diff. U. S. \$1.00. 100 mint Hitlers \$1.00. Stuart Wingard, Academy Street, Amsterdam, N. Y.

PREMIUMS To real approval customers. Williams, 613 Wood, Pittsburgh 21, Penna.

66 DIFFERENT Stamps, including U. S. battleships 6c. World wide approvals. Telic-Arts, Devon, Conn.

ILLUSTRATED Stamp magazine, 26 weeks 25c. Stamp Journal, Kalamazoo, Michigan.

15,000 DIFFERENT Stamps 2c each! In books of 100 to 1,000. Gordon Davison, Box 1019B, Manchester, N. H.

LIBERIAN Triangulars, 10c with approvals. Vargo Stamps, 6044 South Fairfield, Chicago 29, Illinois.

TROPICAL Beauty. Six beautiful mint stamps from Somali Coast, 7c to approval applicants only. GeeKay, 13 E. Overlea, Baltimore 6, Maryland.

POUND Stamps containing thousands \$1.00. Longacre Shop, 108 West 42nd, New York 18.

WORLDWIDE Collections, 500-44c, 1000-\$1.45, 2000-\$3.35, 5000-\$16.50, free lists. Florman, 2401 Davidson, Bronx 53, N. Y.

POSITIVELY Greatest free offer—Rare octagonal (eight sided) stamp, gorgeous diamond, giant triangle, also mammoth and midget stamps, total value \$2.00, all free to approval buyers. Plus free, Scott's International \$6.00 album and latest stamp catalogues. Odd Stamps, P.O. Box 1700, San Francisco, California.

SUPER Offer; Nicaragua bicolored triangle, new Egypt air, scarce Zanzibar, China airs cataloging 60c, Hitler, Princess Elizabeth, elephant, giraffe, Colombia multicolored orchid stamp and 50 other good stamps, 5c to new applicants for premium approvals. Moulblow, 740 Hegney, Bronx 56, N. Y.

BERLIN Bears, complete set of eight and 100 different stamps only 10c to approval applicants. Reich Stamp Co., 4647 Kenmore, Chicago 40, Ill., Dept. M11.

NICARAGUA "Tin Pan Alley" diamond, Ecuador showing George Washington, and American flag in natural colors, Fezzan, Trieste, "American Army" stamp, first U. S. commemorative, \$100.00 Shanghai, Corsica, Anzac, Antique, others. All 5c. Approvals. Capital Stamp Co., Dept. 2, Little Rock, Ark.

CARDINALS—Beautiful Vatican City set, picturing various Cardinals, 14 values, 10c. Approvals. Powell, 619 Franklin, Lynchburg, Virginia.

GERMANY, "Nazi Army Issue"; ships, planes (13), free to approval customers. William Deems, Ravenswood, W. Va.

FREE, 25c Worth of stamps to U. S. approval applicants. Village Stamp Co., 90-39 214 St., Queens Village 8, N. Y.

COLLECTION Of 50 different countries, including Roosevelts, triangles, airmails and many more pictorials, 25c to approval applicants. Fields, 1939 E. 85, Cleveland 6, Ohio.

TRIANGLES! Diamonds! Octagons! Midgets! Giants! Roosevelts! Hitlers! U.S. \$1.00-\$5.00 stamps! Stamp Magazine! Everything 10c with approvals! Thrifty Stamps, Silver Spring, Maryland.

SNAPPY United States approvals that please. Premiums that satisfy. Jarr Stamps, Box 217-s, Madison Square, New York 10.

STAMP Buyers' Guide (Box 1649P, Oakland 4, California), plus 50 different German stamps, for 10c.

LOOK At this! 50 different Greece only 25c to approval applicants. Floyd Frederick, 513½ Green Street, Lancaster, Penna.

WHAT Canadian stamps do you need? Box 525, Sherbrooke, Quebec.

307 ALL Different 10c. You will find scores of new varieties here for your collection! Big and little stamps, bisected stamp, commemoratives, triangles, high values! Bicolored beauties! Strange countries! Every stamp is different. All for only 10c to approval applicants. Write today and receive special Ionian Island stamp extra. Garcelon Stamp Company, Box 400, Calais, Maine.

FIFTY Different worldwide given to new approval applicants. Additional fifty, not over 1,000, 10c per fifty. Jack Dudak, Streator 9B, Illinois.

WHOLESALE Price list for dealers. Stampbrokerage, Box 1737P, Oakland 4, California.

ENORMOUS Bargains! 2000 foreign stamps \$1, 5000, \$2; 2000 United States \$1, 5000, \$2. Order now. Standard Co., Atlantic Building, Washington A-4226, D. C.

FINE U. S. foreign approvals. Rossom, 218 West 59th St., Chicago 21, Ill.

SWASTIKA, Hitler, 10 mint blocks, 10c to collectors requesting our free illustrated monthly price list of mint sets. Philatelic Corner, 175 Stratford Rd., Buffalo 16, N. Y.

COLLECTORS Possessing valuable extra stamps may exchange them through this club. Particulars for stamp. McPherson, Branch, Michigan, U. S. A.

#### PRECIOUS STONES, MINERALS

GEMS, Precious and semi-precious, all genuine, from world wide sources. Deal direct, no overhead, save money. Catalog 10c. Hill Co., Route 7, Salem, Oregon.

GEMSTONES, Rough, polished. Crystallized specimens. Every variety, lowest prices. List free. Plummer's 5068 Brighton, San Diego 7, California.



**METAL Detectors.** The very latest circuit. Free literature. Hedden Metal Detectors, 3329 Liberty Avenue, Pittsburgh 1, Penna.

**BEAUTIFUL** Arizona agates, polished samples and listings \$2.00. Unpolished samples \$1.00. Arizona Agate Mines, Cave Creek, Arizona.

### HOBBIES AND COLLECTIONS

**GIANT** Conch or helmet shell \$1.00. Painted conch lamp \$2.00. Southern Importers, Box 1685-B, Miami 35, Florida.

**WORLDWIDE** Hobby magazine; twelve issues \$1.00; sample 10c. Klings', Blue Island, Illinois.

**BIG** Campaign ribbon packet, illustrated book \$1.00. Insigniacrafts, 236-28th Ave. N.W., Calgary, Canada.

**UNUSED** Match book covers, 100 all different \$1.00. Free catalog. Charles Edelman, 1311C East 84, Cleveland 3, Ohio.

**INVENTING** Can be an interesting and profitable hobby. Write for complete particulars. Institute of American Inventors, Dept. 40-E, 1926-Eye St. N. W., Washington 6, D. C.

**50 DIFFERENT** Army embroidered patches \$1. Other bargains. Insignia Mart, 703A Broadway, New York 3, N. Y.

### CAMERAS, PHOTO SUPPLIES

**YOUR** Prized negatives make beautiful photo enlargements easily, economically with the new Precise Photo Enlarger, only \$22.20 complete, nothing else to buy. Send postcard for details. Tam Products, CM-9, 3814 Wrightwood, Chicago 47.

**BASS** Says! At the sign of the old "Horse Trader," 38th year. Thousands of satisfied customers everywhere! Finest brands including Kodak, Bell & Howell, Argus, Zeiss, Leitz, etc. Satisfaction always guaranteed, or your money back! Bass buys 'em, sells 'em, trades 'em. Write or wire. Bass Camera Company, Dept. AG, 179 W. Madison St., Chicago 2.

**PHOTOCOPY** Anything—Papers, books. No darkroom. \$6.95 complete. Fotoflek, 4801 Yarmouth, Cincinnati 29, Ohio.

**PHOTOGRAPHY** For pleasure or profit. Learn at home. Practical basic training. Long established school. Write for booklet. American School of Photography, 1315 Michigan, Dept. 3432, Chicago 5.

**FREE!** 116-Page illustrated photographic catalog, send 3c stamp. Bloom's Camera Center, 1657 Main, P.M., Springfield, Mass.

**4" ACHROMATIC** Lenses, perfectly figured, \$45.00. James Bray, 860 Walnut Ave., Burlingame, California.

**ELECTRIC** Immersion heaters to fit your tanks. Mail requirements. Inemco, Allegan, Mich.

**FREE** Bargain list. Cameras, projectors, equipment. Seymour's, P.O.B. 796-M, New York 1.

**PRESS-VIEW** Camera, interchangeable lens board with extreme swing, 360° revolving back, \$49.50! Free literature. Dave Grinnell, 1446 1/2 Toberman St., Los Angeles 15, California.

**200X TELEPHOTO** Camera easily made. Trifling cost. Telephoto lens and instructions \$3.00. Instructions alone 10c. Suffolk Science Service, Box 208, Manorsville, N. Y.

**K-21 AAF** Aerial combat cameras, manufactured by Graflex; motor driven, with flexible shaft; 24 volt operation; including step-down transformer to 110 voltage; may be manually operated. Complete except for lens and filters. New, original government packaging; new low price, for a limited time only, \$29.50. An amazing value from Amazing Bachman's, Dept. PM, 27 Herman Street, Rochester 5, N. Y.

**CAMERA "Specials"** for P.M. readers. Argus, Revere, Kodak. Buy, sell, write or wire. Charles Wolfe, 167 Canal St., New York 13, N. Y.

### PHOTO FINISHING

**SAME** Day service quality finishing jumbos, contact. Lowest prices. Free mailers and price list. Roy Photo Service, Dept. M, G.P.O. Box 644, New York 1, N. Y.

**8 BEAUTIFUL** Double size pictures and roll developed 30c. 8 hour service. Free mailers. Pacific Photo Service, Box 666, San Francisco, Calif.

**ROLLS** Developed and enlarged 2 to 6 times larger. 8 exposures 25c coin. 12 exposures 35c. 16 exposures 50c. Enlarged reprints 3c each. Alden Photos, 94-3 Astor Station, Boston, Mass.

**SENSATIONAL** Introductory offer! Send snapshot or negative, this ad and 10c. We'll send you a beautiful 7x5" enlargement! Or, Kodak roll developed and printed (with free coupon) only 25c; or 8 giant prints from roll, 30c. Reprints from negatives, any quantity, regular size, 3c; Giant size 4c. Candid rolls—36 exp. 35mm. developed, vaporated, enlarged to 3x4, \$1.00, 18 exp. 50c. Free mailers. Free premium offers sent on request. American Studios, Dept. 364, La Crosse, Wisconsin.

**OIL** Coloring photographs can be a fascinating hobby or profitable sideline for those with artistic talent. Learn at home. Easy simplified method. Send for free booklet. National Photo Coloring School, 1315 Michigan, Dept. 343C, Chicago 5, Ill.

**2 BEAUTIFUL** Hi-Gloss prints each good negative and enlarging coupon with each 8 exposure roll developed 28c. Free mailers. Owlphoto Co., Weatherford, Oklahoma.

**ENLARGEMENTS!** 5x7, 15c; 8x10, 25c. glossy or dull. Gorgeously oil colored, 50c extra. Negatives made from your favorite photos, 50c. Rolls developed, printed, 25c. L. R., Box 1476-c, Milwaukee 1, Wisconsin.

**24-HOUR** Film service, 8 exposures 25c. Quality prints mailed within 24 hours after film received. York Photo Finishing Service, Box 1469, York, Penna.

**OVERSIZE** Prints; overnight service; 35c. Films developed and 8 prints near postcard, only 35c. Electronic process, non-fade, glossy pictures. Write for free mailers. Peachtree Photo Finishers, Dept. PM, P.O. Box 4324, Atlanta, Georgia.

**YOU'LL** Be delighted. Eight Never-fade prints now only 25c. Two prints each only 35c. Free mailers and price list showing other services. Write today. Hammond Sales Co., Hannibal, Mo.

**NEW** Process developing and printing. 8 exposure rolls 35c. Mayfair Photo Service, Box 261K, Toledo, Ohio.

**ENLARGEMENTS** In album form developed and printed in one continuous story-telling arrangement. Any 8 exposure roll reproduced in this novel, loose-leaf way for only 30c. Reprints 4c each. Extra prompt service! Clip this ad for free mailers. Larga-Pic, Box Z2, Brookline, Mass.

**"BETTER** Photo finishing." Jumbo prints 40c a roll. Reprints 3c. Best by test. 35mm. positives \$1.50 strip. 36 ex. Sealstone Photo, Box 468, Seal-Beach, Calif.

**EVERY** Picture an enlargement! New electronic developments give you bigger and better enlargements at the same low prices. Any 8 exposure roll developed and printed enlarge size, only 30c; reprints 4c each. Fast, accurate service guaranteed. Send for free mailers today! Enlarge Photo Service, Box 791-D, Boston 2, Mass.

**PHOTOGRAPHY** For pleasure or profit. Learn at home. Practical basic training. Long established school. Write for booklet. American School of Photography, 1315 Michigan, Dept. 3451, Chicago 5.

**8 PRINTS** All enlarged to nearly postcard size from your roll or negatives 25c; 16-50c. (Trial offer). Willard Studios, Box 3535A, Cleveland, Ohio.

**16 DECKLEDGE** Prints from any standard 8 exposure roll 25c. Quick service. Professional work. Skrudland, Lake Geneva, Wis.

**FREE** Price list on quality developing, printing, enlarging. Write for it today. Bryan's Photo Shop, Dept. M, Panama City, Florida.

**EMBOSS** Christmas cards from your own negative. For samples, send negatives and 25c. Film Capital Service, 818 Dewey Avenue, Rochester 13, N. Y.

**STATUETTES** From your choice negatives, oil colored, 8" tall, \$1.50. Marra, 7912 Franklin Blvd., Cleveland 2, Ohio.

**CHINACOLOR** Enlargements from your Kodachromes, Ektachromes, Anscoolor. 4x5, \$1.00; 8x10, \$3.50. Box M4203, Washington 12, D. C.

**PORTRAIT** Quality 5x7 enlargements 15c. 2 for 25c. NuTone Fotos, Box 228, Pottstown, Penna.

**JUMBO** Or photo pack prints, 8 exp. roll 35c. 16 exp. roll 65c. NuTone Fotos, Box 228, Pottstown, Penna.

**8 HOUR** Service, Box 468, San Francisco. Your 8 exposure roll printed jumbo or regular size 30c; 12 exposures 35c; 16 exposures 50c; 36 exposures \$1.00. Reprints, jumbo or regular 3c. Regular prints deckled. Fine grain developing. Send for free mailers. Quality Photo Service, Box 468, San Francisco 1, Calif.

**OVERSEAS** Service. Air mail return free. 4c per print. Developing free. Custom Photo, Box 567, San Francisco. "Your nearest postal port." Send for free mailers.

### MOTION PICTURES AND SOUND EQUIPMENT

**8MM.** Sound projector for the price of a silent machine. Write Standard Sales, Box 7525, North Kansas City, Missouri.

**BASS** Says! 38 years of leadership means satisfaction to you! Finest equipment, 8 and 16 mm., sound cameras, sound projectors. Bass buys 'em, sells 'em, trades 'em. Satisfaction always guaranteed, or your money back! Bass Camera Company, Dept. A, 179 W. Madison St., Chicago 2.

**GUARANTEED** Super X reversible panchromatic 16mm. surplus film! 6-100 foot rolls ready for camera \$8.10! Bulk, 600 feet, \$5.00! Processing available. Filmcraft, 47th and Holly, Kansas City 2, Missouri.

**SOUND** Features shipped, rental \$3.95, 1,600' shorts, \$2. Free catalog. National Cinema Service, 71 Dey Street, New York City.

**I BUY,** exchange, swap movies. What have you? What do you want? Lowest exchange rates in world. Catalogue \$1.00. Refundable. Harvey Iris, Box 539, Brockton, Mass.

**GUARANTEED** Fresh anti-halo outdoor movie film! Weston 12! Daylight loading! Processing free! Three spools double 8 mm. \$3.45! Six single 8 mm. for Univex, \$4.60! Postpaid! Catalog. Eso-S, 47th Holly, Kansas City 2, Missouri.

**FREE** Movie list. Superior Film Service, Box 713, Troy, N. Y.

**8-16MM.** Silent-sound films. Complete rental library. All latest subjects. Free catalogue, (sample film 10c). Garden Film, 317 West 50th, New York 19.

**LEARN** Professional motion picture technique at home. Approved for veteran training under G.I. Bill. Free catalog. Motion Picture Institute, Birmingham 4, Mich.

**LEARN** Movie projection, management. Free catalog. Theatre Institute, Elmira, N. Y.

**MOVIES—8-16MM.** "variety subjects, rare, cold, or indifferent;" silent and sound. Free lists. AeroTraders, Adams, Mass.

**BRAND** New 16mm. sound projectors \$129.50. Send 10c for 1948 photographic catalogue. Sterling's, 679 Northampton, Easton, Pennsylvania.

**COMPLETE** Stocks always of Castle, Official, Pictorial films, 8mm., 16 mm., sound. Musicals, soundies, free catalogs. We exchange your films and equipment, or buy them for cash. Frank Lane, 5 Little Bldg., Boston, Mass.

**WE** Buy, sell, rent, exchange home movies. Details for dime. Midland, Box 429, Oak Park 4, Ill.

**GOOD** Used 16mm. sound projectors. Particulars. Robert Salmon, 3558 So. 11th East, Salt Lake City, Utah.

**YOU** Develop it. Get a 33 ft. developing rack, safe light, all chemicals, trays and instructions for \$5.85. Fully guaranteed. Free circulars and film samples. Promader Genera, Davenport 4, Iowa.

**MOVIE** Film processing—Finest automatic machine processing, 8mm., 16mm. 48 hour service. Also duplicating, editing, titling, other lab. services. Send for list of prices. Fotoshop, Inc., Room 229, 18 E. 42nd Street, New York City 17.

**MOVIE** Film, machine processing service, bulk film, free literature. Atlantic Films, Reading, Penna.

**EXCLUSIVE** Movies, projectors, screens, free catalog. Home Pix, 1674 Broadway, New York 19.

**HOME** Movies, 8-16mm., silent, sound. Free list. Ultra Pictures, 6710 Melrose, Hollywood, Calif.

**ELECTRIC** Movie cameras, 16mm., Army GSAP, original condition, value \$200, complete with f/3.5, new \$32.50, used \$19.50. Accessories available for home conversion. Free literature. Completely converted Lektro, 16mm. ready-to-operate \$59.50 guaranteed. Magazine film for same, \$2.50, includes processing. Fotoshop, Room 205, 18 E. 42nd St., New York City 17.

**8-16MM.** Film specialties. Catalog dime. Warrington Films, 1418 Knecht Ave., Halthorpe 27, Maryland.



**FINEST** Movie screens. Inexpensive. Make them yourself. Free literature. Snow White Screens, Danville 4, Illinois.

**TITLE Making**, free instruction book. Westwood Company, 635 Victoria St., San Francisco 12, California.

**KODAK Super-X** movie film at give away prices! Govt. surplus but good as gold! Tested and fully guaranteed. 16mm. 100' \$2.95; 50' magazine \$2.50; 8mm. 25' Double 8 \$1.65. Processing included. Stock up now! Fotoshop, Room 253, 18 E. 42 St., New York City 17.

**MOVIE Film** at tremendous savings! Kodak Super X, govt. stock, tested, guaranteed! 16mm. 100 ft., \$2.95; 50 ft. magazine, \$2.50; Double 8mm. 25 ft. \$1.65. Super XX, 50c add'l. each roll. Free processing. Fast service. Photo Surplus Sales, Box J-15, 12 Duane St., New York City.

**PROCESS Own** movie film. Free literature. Duro Products, 1519 Eggert, Buffalo 21, N. Y.

### MUSIC AND MUSICAL INSTRUMENTS

**ACCORDIONISTS:** Sensational professional chord charts; set: \$1.00. "Music Box," technical bulletin: \$1.00 yr. "Accordion World," official magazine: \$2.00 yr. Famous "Schillinger" system, 1640 pages: \$30.00. Personalized accordion lessons, by mail: \$2.00 each. Free catalogue, music, accessories. Caroli, Box 21, Lefferts, Brooklyn 25, N. Y.

**SONGWRITERS!** Outstanding, ethical composing offer. Ray Hibbeler, C5, 2157 N. Avers, Chicago.

**SONGWRITERS Attention!** The amazing demand for phonograph records, accelerated by countless juke-boxes, warrants your immediate investigation. We are offering new writers the rare opportunity of having celebrated "hit" composer furnish music on reduced percentage basis for any likely poems received this month. The Petrillo ban does not affect us. Recola Records, Hollywood 28, Calif.

**LEARN Piano** playing quickly. New speed method. Very simple. Public schools approve. Literature free. Speed Method, 435 Abiso, San Antonio 5, Texas.

**1948 ACCORDIONS**—Wholesale—Free catalog. American Accordion Center, 5329 Belmont, Chicago.

**GUARANTEED Satisfactory** piano score arranged, \$6.00. Lee, 344 Primrose, Syracuse 5, N. Y.

**AMPLIFY Your** accordion with our new mike \$22.50. Sounds like organ. Installed in minute. Use any amplifier. Amplifier and mike \$72.50. Write Del Principe, 307 So. Wabash Ave., Chicago.

**BE Independent**, tune pianos, music unnecessary. Practical Piano Tuning shows you how. \$2.00 postpaid. Chord-Slide Co., P3122 Lawrence Drive, Corpus Christi, Texas.

**SONGWRITERS—Protect** your songs. Get the facts first. Free booklet, attractive offer. Song Service, 331-C West 46th, New York.

**POEMS Wanted** to be set to music. Free examination. Send poems. McNeil, Master of Music, 510-PM S. Alexandria, Los Angeles, California.

**SONGWRITERS:** Send poems for free examination and outstanding offer. United Music Service, 150, Salem, Indiana.

**WRITE Songs.** Big money and reputation. Write for information. J. Gordon Pub. Co., 201 N. Hoyne Ave., Chicago.

**ACCORDIONS—Guitars,** trumpets and all musical instruments, new and used. Direct from national distributors, cash and terms. Save money. Del Principe, 307 So. Wabash Ave., Chicago.

**JIMMIE Rodgers,** Ernest Tubbs, other records bought, sold. Evans, 2215-A, 7th, Lubbock, Texas.

**VOICE! Subconscious! Effortless—control!** Mind power! Psychology! \$1.65. Mr. Cor, 902 No. Jersey Ave., Norwalk, Calif.

**ACCORDIONISTS—Do** you want to play better, sooner. You can with Visuaid. \$2.00 complete. Guaranteed. Arkay, Box 5772, Cleveland 13, Ohio.

**REAL Composer** of music will co-operate with lyric writers in song production. Fine publication proposition. National distribution of publication. C. Isabel Mayer, Box 3896, Portland 8, Ore.

**POEMS Wanted** for musical setting. Send poems for free examination. Hamann Service, 614 Manhattan Building, Milwaukee, Wisconsin.

**POEMS Wanted** for musical setting. Send poems for free examination. Five Star Music Masters, 630 Beacon Bldg., Boston, Mass.

**VALUABLE!** Names, addresses, songwriters. Details. Popular, Box 927, Atlanta, Georgia.

**POEMS Wanted—Proven** service. Send poems. Radio Composers, WDP, Clinton, N. C.

**SWISS Music** movements. Assorted tunes \$1.90. Direct from manufacturers agent. Helax Company, 233 West 72 Street, New York.

### RADIOS, SUPPLIES, INSTRUCTION

**RADIOMEN, Servicemen,** beginners—Make more money, easily, quickly. \$250 weekly possible. We show you how. Information free. Merit Products, 216-32A 132nd Avenue, Springfield Gardens 13, New York.

**FREE Catalog,** radios, phonographs, records. Bargain prices. Mail post card today. Jmad Co., 122 Clinton St., Buffalo 3, N. Y.

**MAKE Simple,** tubeless, batteryless, distance-getting crystal radios. Crystal and illustrated instructions 25c postpaid. Allen, 427-P. Clinton, Missouri.

**BATTERY Set** to A.C. eliminator. Guaranteed, complete \$5.00. Sadler Radio, 1112 Benton, Kansas City, Mo.

**SUITCASE Size** radio shop—Build it and double your profits. Free literature. Write Grand Federal, 3516 Woodend, Kansas City 3, Kansas.

**MAKE "Loudest"** crystal radios. Instructions, loud crystal, catalog: 25c. Amorose, Route Four, Richmond, Va.

**TELEVISION:** Build your own. Our detailed plans \$1.00. Teleprint, 834½ E. 74th St., Los Angeles 1, Calif.

**MAKE Boosters,** Crystal and tube radios. Plenty instructions, catalog, 25c. Radio Leader, La Verne, California.

**"ALL About** Headphones," latest complete repair handbook, including "Radio-builder" 25c. Laboratories, Eye-c, San Carlos, California.

**FIX Any** radio. Amazing new instrument locates radio troubles double quick. Simple instructions show you how. Thousands in use. Write today for 24-page booklet, "The Inside Story." Feller Engineering Co., Dept. 9PM8, 945 George St., Chicago 5, Illinois.

**FREE Radio** and television catalog! Money saving prices on radios, hard-to-get-parts, record changers, wire and disc recorders, amplifier systems, tubes, books, amateur and test equipment. Write today! Radionic Equipment Co., Dept. 203, 170 Nassau Street, New York 7, N. Y.

### BUSINESS OPPORTUNITIES

**COASTER Wagons—Start** your own business. Wagons ready to assemble except bed. All metal chassis, 6¾" rubber tired wheels. Wt. 14#, \$2.98. Metal bed 24"x12". 75c extra. George F. Hall Co., 518 East 6th St., Cincinnati 2, Ohio.

**MAKE Money** this easy way at home. Make your own costume jewelry. Pleasant, interesting. No experience needed. We supply settings and sparkling rhinestones at wholesale prices. Steady profits. Write for details now. Sparkle Mart, Dept. B, 475 Fifth Ave., New York.

**IMPORTED From** Mexico. Best gift item on market. Beautiful bird pictures, hand made of real feathers. Hand carved cedar frames. Retail \$2.49. Sample \$1.50, dozen \$14.50. Joseph Miciak, 172-14 89th Ave., Jamaica, N. Y.

**LOOKING For** something that repeats to start profitable mail order business? Everything furnished. Free sample. Wave Products, Dept. P1, 900 E. Taylor, Kokomo, Ind.

**START Sewing** machine business by electrifying and converting to portables. Free details. Pasaak, Dept. PM, Pauling Ave., Tappan, N. Y.

**BE Independent—Operate** America's lowest price penny vending machine. Big profits. Immediate shipments. Write for bulletin and prices. Fielding Mfg. Co., Desk (948), Jackson, Mich.

**USE Your** home as magazine subscription station. Represent all magazines. Liberal commissions—we supply everything. Big Christmas business ahead. Catalog, full details, free. McGregor Magazine Agency, Dept. 22, Mount Morris, Ill.

**"HARNESSING The Earthworm."** Author will mail valuable free booklet: "Successful Earthworm Breeding." Thomas J. Barrett, Dept. 14-D, Box 488, Roscoe, Calif.

**SOMETHING New.** Sell by appointment in department stores. Wonderful mail business. Investigate. Slade Enterprises, 4409 West Lisbon, Milwaukee, Wis.

**DOLLAR'S** in personalized baby record books; sell by mail; use same literature we do. No-Co-Ro, Oakland 6-M, California.

**EXTRA Money.** Distributors, agents. Classy new wonderful flight airplanes are different, try. Sample 25c, dozen \$2.00. A. F. Kolinski, 759 S. 25th St., Milwaukee 4, Wisconsin.

**MAIL Order** system of successful operators now revealed. Smallest capital. Different, dynamic. Quick action. Details free. Schroder, 221 Bush, Covington 5, Ky.

**DOLL Hospital** instruction. Very profitable. Information, Box 755, Southkent Br., Grand Rapids, Michigan.

**TWISTEE Animal** balloons. Make new shapes yourself. Twelve balloons in package. Sells 50c, costs 25c. Hottest selling balloon item. Many others. Ellswood Distributors, La Junta, Colorado.

**GOODYEAR—Has** 75% solids—natural Malaya rubber for molds, send \$1.00 for trial. Write for full particulars. Goodyear, Lake Geneva, Wis.

**THOUSANDS** Of homes need precast concrete steps. Atlas mold, 5 shovels material, 20c reinforcing plus little elbow grease equals \$3.00 to \$5.00. Part or full time, \$20.00 to \$100.00 weekly all year. Write for details or send \$30.00 for mold and get started. Atlas Concrete Products, 626 Guadalupe, San Antonio, Texas.

**BIG Money** made operating trailer parks and auto courts. Complete instructions with building plans. \$2.00. Karavan Industries, 1007 No. Water Street, Milwaukee, Wis.

**POTTERY—Made** without molds! Self-hardening, no firing. Gorgeous colors. Bird baths, wishing wells, benches, cemetery products. Particulars free. Rapid Pottery System, Edwardsville, Illinois.

**MANUFACTURE:** Fast sellers from soapflakes. Richard, 109 West 68, New York 23.

**MAKE \$5.00** Per hour full or spare time right at home preserving baby shoes in real bronze, gold, silver and pearl. Full details free. Kiktavi Co., 2111A Manchester Blvd., Los Angeles 44.

**LEARN Import-export!** Represent manufacturers! Sell-buy abroad, make 1000% profit. Send \$1 for two bulletins, supplying hundreds of overseas addresses seeking connections. Money refunded if unsatisfied. Benko, 246-P Fifth Ave., New York 1.

**NEW Industrial** hand cleaner. Free manufacturing-distributing plans. Unusual money-making proposition. "Acro-Sol-Ex," 623 West 14th Ave., Denver 4, Colorado.

**"PLIASTONE"**—New building material. Resurface old homes, build new ones. Composition floors; colored tile. Particulars free. Marbleized Service, Edwardsville, Illinois.

**PROFIT Or** hobby: Unpainted plaster ornaments. Beautiful designs, easily decorated, water colors or oil paints. Illustrated list free. Loxite for molds. Firestone product. Dealers use letter head. Midwest Novelty Mfgs., 108-A Cedar, Anaconda, Montana.

**START Your** own business and make money in credit bureau and collection work. Write for free details. Credit-Inspection Bureau, 120 W. Evans, Florence, S. C.

**"MAILORDER** booklet guide." 2500 words. Dependable literature, 3c. Wayne Burger, Baltic, Ohio.

**UNPAINTED** Bookends, plaques, statues, figurines. List. Haverty Products, 1219 8th Ave., Altoona, Penna.

**FACT Packed** book on mail order work twenty five cents. Satisfaction or money refunded. Write Houston Mail Order House, 5306 Pease Avenue, Houston 3, Texas.

**PERFUME—Make** it yourself. Profitable, sparetime, home business for men and women. Free information tells how. Write "International," 6347 Parnell-X-7, Chicago 21, Illinois.

**FAST Profits** repairing clocks. Details. Jones, 1210P Dudley, Utica 3, N. Y.

**BECOME A** finance man. Particulars free. George Lenhoff, Lincoln 8, Nebr.

**MAIL Order** offers increased income, independence, unlimited possibilities. Free literature. Manhattan House, 126L, Lexington, New York 16.



**TRADE** Magazines help you get ahead. Latest copies every trade, business or interest. Free price-list. Commercial Engraving Publishing Co., 34C North Ritter, Indianapolis 19, Indiana.

**LIQUID Rubber.** Make flexible molds. Free sample. Chaney, 1130 E. 16th St., Jacksonville 6, Fla.

**YOUR Own business.** No canvassing. Enormous profit easily made at home in spare time. Experience unnecessary. Details free. James McLaughlin, 310 E. Sterner St., Philadelphia, Penna.

**GOOD Business, merchandise.** Under-sell competitor. Own boss. Building, advertising, only capital. Stamp for details. The Mart, Box 603, Kerrville, Texas.

**START** Bottled natural gas business. New, amazing opportunity. Demand enormous. Pays big profits. Literature free. Enso, Pasadena 16, California.

**LOOK Here!** Wanted men to start in business on our capital. Sell some 200 farm-home products. Thousands our dealers now make quick sales, big profits. For particulars write Rawleigh's, Dept. I-192-PPM, Freeport, Ill.

**MAKE Money** by mail. Howard, 1778A Hamburg St., Schenectady 4, N. Y.

**GROW Earthworms** commercially; extremely profitable; illustrated details 3c. Stoner's, Chattanooga 4, Tenn.

**INCORPORATE** Your business, free details. Tax Research Bureau, Inc., Delaware Trust Building, Wilmington, Delaware.

**MAIL Order beginners!** Get started right—avoid costly mistakes. Fact packed booklet shows you how. 25c postpaid. Satisfaction or refund. Croft, 2031 Elm, Youngstown 4, Ohio.

**FAST Sales,** cuts food cost. Nets \$9 a case. Sell 6 daily. Exclusive terr. Jeld, Ltd., Burbank, Calif.

**LEARN** Piano tuning, repairing, at home. Tremendous field! Piano parts, tools furnished. Established 1935. Empire School of Piano Tuning, 606-B East University Ave., Champaign, Ill.

**START** Home manufacturing business making Cleaning Compounds, Soaps, Insecticides, Cosmetics, Polishes, Food Flavors. No machinery. Literature free. Kemix, Park Ridge 8, Ill.

**INCREASE** Income by mail with inexpensive letters. New, tested, proved methods, plans. Details free. Distinctive, Box 499, Bethlehem, Penna.

**NEW Method** of casting metal toys and novelties opens opportunity for full or spare time business and profits. Latest 1948 scale model autos, original ashtrays, savings banks, water pistols, etc., easily cast with bronze moulds. Enormous wholesale and chain store Xmas demand keeps manufacturers busy. No experience or special place necessary. Write for details and illustrations of patterns needed. Metal Cast Products Co., Dept. A, 1696 Boston Road, New York 60, N. Y.

**NATURAL Molding** Latex. Extra thick. Free sample. W. Wooley, 115-A Donald, Peoria, Ill.

**START** Home business making statuettes, plaques, artificial marble flooring, liquid marble, rubber molds, metalizing baby shoes. Amazing profits. Folder free. Creative, 236-L, Winnetka, Illinois.

**METALIZE** Baby shoes and other non-metallic articles. Fascinating work. Big profits. Shuplate, Box 1388, Lawton, Okla.

**A FACTORY** in your home garage! Mfg. and sales rights, mechanics' waterless hand cleaner. \$500-\$800 monthly. No special equipment necessary. Western Aircraft Mfg., Dept. D, Los Angeles 6, Calif.

**NEW, Easy,** profitable business sweeping country. Be first in your community. Full, exciting particulars 25c. Hunter, 2172 Green, Cleveland 21, Ohio.

**"FIX Cracked batteries!"** Easy! Big profit! Cement \$1.00 can! Details free! Stevens, Grand Junction, Colorado.

**CASH** for your idea, 280 manufacturers need inventions, patented or unpatented. List free. Invention Bureau, 208M Clinton, Oak Park, Illinois.

**ANNOUNCING** Home study course in commercial baking. Practical basic training. Good field for those with aptitude. Nearly depression proof. Send for free booklet. "Opportunities in the Baking Industry." National Baking School, 1315 Michigan Ave., Dept. 343C, Chicago 5, Ill.

**BELTS!** Make 'em and make money. No tools! Sample 50c. Artinc Leather, 411 Joseph Ave., Rochester 5, N. Y.

**1000% PROFIT** Selling snake orchids. Devour live insects. Enterprises-A, Toronto 12, Canada.

**HOSIERY, Handkerchiefs, shirts!** Quick shipments. Wholesalers, write for prices Spartan Hosiery Company, Spartanburg South Carolina.

**AMAZING Offer!** Become successful weekly newspaper publisher! "Know-how" will open all doors to this interesting, lucrative business. Send only \$1 for 50 big pages of priceless information. Buyers say literally worth weight in gold to ambitious reporter, editor, advertising manager, publisher, writer, etc. Yours for only \$1, postpaid. Guaranteed. Hurry! Success Publications, 66 E. Forest, Detroit 1, Michigan.

**YOUR Own** mail order business at home. New, illustrated course. Free booklet. Registrar, 7219 South Broadway, Los Angeles 3.

**MAKE Money** sharpening saws at home on electric machine. No experience necessary. Hardware dealers act as your agents to secure work. Send for free book "Independence After 40" shows complete plan for starting in spare time. Foley Mfg. Co., 47 Foley Bldg., Minneapolis 18, Minn.

**RESILVER** Mirrors at home. Formula 25c. Ideal Service, Park Ridge 6, Illinois.

**RUBBER!** White liquid rubber! America's finest flexible moulding rubber! New! Extra heavy viscosity! Quick drying! Ideal for home, classroom, or industry. Only \$7.95 per gallon, \$2.95 per quart, and \$1.00 per half-pint sample. Parcel post prepaid! Plastercraft Supply Company, 3051 St. Clair Avenue, Cleveland 14, Ohio.

**SPIN** Angora wool. Ideal home business. Descriptive circular free. House of Angora, Springfield, Illinois.

**VENDING** Machines earn big money! An investment as low as \$10.50 will start you in this fascinating, profitable business that can lead you to the road of success and independence. Routes can be established and operated in either full or spare time with no experience needed. Write for full details and our free catalog illustrating our nut, candy, gum and stamp vendors; also slot machines, amusement games, etc. Parkway Machine Corporation, 623 W. North Avenue, Dept. 7, Baltimore 17, Maryland.

**NO Selling,** operate vendors, amazing profits, details free. Silver-King, 622 Diversey, Chicago 14, Ill.

**SPECIAL** Rubber for making molds. Literature and sample free. Universal, Box 1076-A, Peoria, Ill.

**POPCORN** Machines, peanut roasters, caramelcorn equipment, griddles, gasoline, bottled gas appliances. Northside Sales, Indianola, Iowa.

**HOW** And where to obtain capital. Small and large loans. Free particulars. Star Service, Wapakoneta, Ohio.

**OWN** Mirror shop. Resilver mirrors. Glass sign making. Electroplating. Supply prices. John Sprinkle, V60, Marion, Indiana.

**BRONZED** Baby shoe mountings and supplies. All metal bronze bookends, picture frames, ash trays, etc. Onyx ash trays, desk sets, plaques. Hardening solution, 30-amp. plating rectifiers with powerstat control, \$85.00. Geared motors for agitation \$20.00. Lead lined tanks. Write for list. Hollywood Bronze Supply, 1770 N. Vermont, Hollywood 27, Calif.

**MAKE** Money making new greaseless doughnuts at home on electric machine. Wholesale to grocers, drug stores, cafes, hamburger shops. Send for free recipes and plans. M. Ray Company, 3605 South 15 Ave., Minneapolis 7, Minnesota.

**MAKE** Liquid marble, artificial marble flooring, flexible molds, statuary, art goods, novelties. Literature free. Kemico, Park Ridge 50, Ill.

**GET** Hundreds money making deals, business ideas, plans and manufacturing. Amazing folio free. Austin Mail Service, 5538 Lexington, Chicago, Illinois.

**QUICK** Money. "Repairing car batteries." At home! Easy too! Batterymen, Grand Junction, Colorado.

**WANTED** Unused U. S. postage stamps, small discount. Advance Stamp Company, 24 East 23rd Street, New York.

**MAKE** And sell candy professionally, inexpensive to start, information free. Box 670, Kissimmee, Florida.

**POPCORN** Machines. Potato chip outfits. Long Eakins Company, 4860 Hi Street, Springfield 99, Ohio.

**READ** "Advance"—The voice of mail order. Offers money-making opportunities, sources of supply, personal guidance, etc. Issued monthly. Sample copy 25c. Yearly subscription \$2.00. American Mail Trade Association, 313 East 21st Street, Suite 450, New York 10, N. Y.

**\$46 FROM** Square foot plywood. Jigsaw necessary. Write, Woodarts, X-33, Bridgewater, Mass.

**OPERATE** Profitable mail order business. Write Walter Service, 4159-A East 112th, Cleveland 5, Ohio.

**RECAST** Old batteries into new. Latest achievements. Battery Laboratories, Minneapolis.

**RE-NEW** Leather and leatherette—Make cloth into imitation leather with plastic discovery called Leather-New. Opportunity to make real profits taking care of sales resulting from national advertising. Write for free sample of Leather-New covered material and complete deal. 4723A Troost, Kansas City, Missouri.

**COLORGLAZED** Concrete pottery made without molds. Patented method. Cemetery products, novelties, tiles. Basement leak-sealing. Money-making projects. Booklet, details free. Men only. National Potteries Company, Grand Rapids, Minnesota.

**START** Mailorder bookshop—Everything furnished. 25c brings booklet, samples, exciting ideas. General Publications, Ossining, N. Y.

**SPECIALTY** Manufacturing, the big money business that can be operated anywhere, start on a very small capital; we supply dependable formulas and complete instructions; get interesting free booklet, "Money-making Opportunities in Specialty Manufacturing." Howard Robinson, Ph.G., 1300-A South Ohio Street, Sedalia, Mo.

**\$25 WEEKLY** Working two hours daily. No canvassing. No manufacturing. Lycke, Box 2471, Cleveland 12, Ohio.

**137 WAYS** To make money, in home or office, business of your own. Full particulars free. Elite Co., 220 Grand St., New York 13.

**BRUSH** Plating outfits connect to a battery. No tanks necessary. Good paying business at home plating autoparts, bathroom fixtures, bicycles, reflectors, silvering mirrors. No shop or experience required. Outfits furnished. Free booklet. Gunmetal Co., Ave. H, Decatur, Ill.

**WOULD** You pay 3%—first \$350 made? Color-illustrated book "505 Odd, Successful Enterprises" free! Some offer occasional "day off." Work home. Expect something odd! Pacific, Oceanside, Calif.

**MAILING** Postcards selling repeat merchandise is profitable. Everything supplied. Details free. Gordan Publishers, Box 23, Pawtucket, R. I.

**CO-PUBLISH** And advertise in The Central Mail Advertiser. Sample copy for stamp. Low rates. Large circulation. Bagby Printing Co., Georgetown, Ohio.

**MAIL** Order opportunities. Full or spare time. Hundreds of chances. No charge. Postal brings copy. Blackstone Press, Somerville, New Jersey.

**BRONZING** Baby shoes is big business. Start your own business for \$3.95. All materials furnished. Metaloids, Box 2095, Wichita, Kansas.

**BUILD** To financial independence today. Sell office supplies by mail. Glenn Snyder, 5-B Spring, Beachwood, New Jersey.

**START** Home plaster novelty business. Amazing course tells how. Literature free. Kemo-Courses, Dept. A, 4862 Catalpa, Chicago 30, Ill.

**MAKE** Rubber stamps. Metalize baby shoes, silver mirrors, make plaster novelties. Catalogue of "20 Ideas" free. Universal, Box 1076-A, Peoria, Ill.

**INCOME** From local information. No selling. Neher Co., LaVerne, Calif.

**HOME** Business, bronzing baby shoes. Costs you 3c. You get \$3.00. Sample bronzing powder and mail order plan, \$1.00. Barrett Bronzing, Jacobsburg, Ohio.

**MAKE** Strange, durable plastic 1c pound. Makes charming floors, walls, mantels, roofs. 101 uses. Build better—far less. Bays Laboratory, Oklahoma City 9.

**YOUR Own** business. Shortage, wide demand bring amazing profits! Concrete drain tile machine (\$67.50). Ceeten Products, Cornelia, Ga.

**1948 CARD** Guide, sales plans, better, quicker, cheaper results. Small capital. Guide \$1. Information stamp. Matsonian, No. Grafton, Mass.

**HAVE** You seen this formula advertised before? Send \$1.00 cash for deodorant block formula. Simple manufacturing methods revealed, supply sources furnished. Better Deodorants, 1222A Melville, Vancouver, Canada.

**FREE** Literature describing many money-making plans. Jenkins, Atmore, Alabama.



**FREE Offer.** Income for life plan. Bowen's System, 317 American Bank Building, Portland 5, Oregon.

**HALF Million articles wholesale.** Directory 25c. Publishers, 3006-P9 Williams, Detroit 16.

**MAKE Money at home like I do!** Write immediately. Duffy, Covington, Ky.

**METAL, Onyx, plastic mountings for bronzed baby shoes, 20 styles.** Hardening solution. Wholesale. Box 2095, Wichita, Kansas.

**LIQUID Marble—Colorful, glossy!** Molded, brushed, sprayed! Cast novelties, statuary, colored tiles. Flexible molds. Composition floors. Particulars free. Marbleizing Service, Edwardsville, Illinois.

**START Profitable business on \$25.00 capital; like I did, instructions 25c.** Alan, Box 2587, West Palm Beach, Florida.

**OWN—Operate ball gum, nut, cigarette vending machines.** Amazing profits, no selling. Write for free details. Cameo Vending, Dept. P, 432 West 42nd, New York.

**ENJOY Life.** Learn waterproofing business. Others making thousands. Needed everywhere. Proof free. Bryan, Box 702, Cincinnati 1, Ohio.

**BUILD A profitable real estate business, spare time.** Write, Roseman, 55 Clifford St., Boston 19, Mass.

**EARN \$200 Weekly** installing new amazing "Styron" plastic wall tile in homes, offices. Easily applied. Tile your own kitchen, bathroom, too. Instructions, everything furnished. Literature free. U. S. Tile Co., 30 W. Washington St., Chicago 2, Ill.

**SELECT Collection—Money making plans.** Home-mail order. New edition. Particulars free. Flasco Sales, 2505A 150th St., Flushing, N. Y.

**50 BUSINESSES** you can start with \$10 and make \$10 per week! Complete—detailed! Copy, \$1.00. Literature free. Carey, 25-P, Waverly Place, Melrose 76, Mass.

**BIG Money** installing Aeroglass. Eliminates storm windows, frost, ice. Blue, Excelsior, Minn.

**SHELL Jewelry, novelties.** Profitable home work. Free lesson. Werts, Sharp Park 1, California.

**LATEX** For flexible molds, also rubber compounds for casting rubber objects. Lowest prices. Major Chemical Co., 131 Inman St., Cambridge 39, Mass.

**START Your own photographic supply business on small capital.** Sell nationally-advertised cameras, projectors, darkroom needs, accessories. Easy sales, big profits. Free details, prices. Peace Products Co., Dept. 23-L, 152 West 42nd St., New York City.

**BE A used car dealer.** Guaranteed plan \$1. Smith, 17A Rockland, Yonkers, N. Y.

**RUBBER Molds, natural liquid rubber, flock filler (for making sectional molds), statuary plasters, felt finishes for novelties.** Catalog and "Plastercraft" course free. Blue Rapids Supply, Blue Rapids, Kansas.

**METALLIZE Baby shoes.** Excellent profits. New system assures success. Free details. Treasures Forever, 89 Henry Ave., Lynn, Mass.

**UNPAINTED Figurines, plaques, bookends, ashtrays, novelties, rubber molds, liquid rubber, casting and painting supplies.** List free. Oman, 642 Broadway, St. Paul 1, Minn.

**WAR Surplus** without bidding. New products. Closeouts. Sacrifice offers. Advance information each week. Subscribe to Surplus Reporter. Business men, rush name for free sample copies. Write: Surplus Reporter, 223 West Main, Tipp City 2, Ohio.

**TENNIS Players.** Earn easy money. Send 25c for sample and details. Fawcett Products, 3808 Strandhill Road, Cleveland 20, Ohio.

**SAWDUST.** Turn it into cash. Six methods. Instructions 25c. Charles Co., 12-BK, Norwood, Ohio.

**FREE Folder** patented household specialty. Flinson, Box 4333-B, Kansas City 1, Mo.

**VARIETY Stores** are profitable. I help you start. Fred Carpenter, Hamlin, Texas.

**LIQUID Marble—Make in any color.** Soundproof plastic flooring. Flexible molds. Cast novelties, plaques, statuary. Big money, your own business. Catalog free. Write, Bing Products, 88-A9A Broad Street, Boston 10, Mass.

**NEW Mail order manual** tells how, what, where to sell. Details free. Everett, 542A Barclay, Naperville, Illinois.

**GET It for them wholesale.** Be community buyer nationally advertised utility merchandise, radios, appliances, etc. Savings to 40%. Start spare, full time. This pleasant easy work can earn \$5000 year. Free information. Cox, 12 Foss, Saugus 10, Massachusetts.

**\$250.00 MONTHLY.** Raising Angora rabbits. Multiply fast. Wool brings \$9.00 pound. Plenty cash markets. Particulars free. White's Rabbitry, Dept. P, Newark, Ohio.

**SELL By mail!** Learn how! Join Mail Selling Opportunities Club! Details free! B. Wehner, Box 142-A, Roxbury 19, Mass.

**MAKE Your own gold, silver, metallic, sign letters for store windows, etc.** Samples, literature free. Art Enterprises, Box 352, New Westminster, British Columbia, Canada.

**WHERE To buy at wholesale 100,000 articles.** Free list. Maywoode, 1133 Broadway, New York.

**PRESIDENTIAL Campaign** advertising specialty, hot, profitable seller. Ace, Brentwood, Maryland.

**ALL Kinds American, Swiss watches,** new and used; retail \$3.65-\$345.00; profit 33 1/3% up; show our catalogue, get orders. Brookings, B-AJ1975, Little Rock, Ark.

**YOU Make them.** We sell them! New liquid plastic makes many items! Terrific demand! Earn minimum of \$50.00 per week at home. No experience or machinery required. We supply raw materials and instruction. Write Travaco Laboratories, P.O. Box 1883, Boston 5, Mass.

**\$10.00-\$20.00 WEEKLY, Sparetime.** Amazing opportunity. Free literature. Teepee Co., Cleveland 3, Ohio.

**HOME Mail order business** operated profitably on small capital. Details free. Webster, Lock Box 1292, Chicago 90, Ill.

**SALESMEN:** Nice profits selling costume jewelry. Free information. Master Makers, Box 207, DuBois, Penna.

**BABY Shoes** preserved. Formulas, instructions \$1.00. Supplies and bases. Novelty Bronzing, Box 56, Hyde Park 36, Mass.

**COPUBLISH** Leading m.o. paper. Latest copy Mail Sale Advertiser and proposition, dime. Vanroy W. Shirck, Lebanon, Penna.

**YOUR Own business.** No canvassing. Enormous profit easily made at home in spare time. Experience unnecessary. Details free. James McLaughlin, 310 E. Sterner St., Philadelphia, Penna.

**START Real Estate business,** America's finest profession spare time. Details free. Educational Book Co., 2907 Berwick Ave., Baltimore 14, Md.

## MONEYMAKING OPPORTUNITIES

**SELL Watches, booklet free.** Jewelbox, W-1455 Broadway, New York City.

**LEARN Air conditioning.** Trained men needed. Enormous profits. Write Don Nelson, Warner Robins 2, Georgia.

**HELP Wanted** to operate our successful mail business. Free details. Reynolds, Box 103Y, McAllisterville, Penna.

**ANALYZE Handwriting** for profit! Complete outfit \$1.00. Graphologists, POB-971, Philadelphia.

**TESTED Money making plans.** Free details. James Carter, Rocky Mount, Virginia.

**THOUSANDS Articles** wholesale. "Supply Source Directory" 10c. Ideal Service, Park Ridge 40, Illinois.

**PRIZE Contest** bulletin gives various contests now operating, and valuable hints. 3c stamp. National Contest Bulletin, Box 2685P, Miami, Florida.

**WIN Contest money.** General Contest Magazine gives hundreds of tips. Lists current contests and rules. Sample 25c. General Contests, 1609 1/2 East 5th, Duluth, Minn.

**WOULD You pay 3%—first \$350 made?** Color-illustrated book "505 Odd Successful Enterprises" free! Proven! Work at home, office. Expect something odd! Pacific, Oceanside, Calif.

**PUBLISH Your own magazine.** Hand-size 52 page format, well edited, illustrated. Cost low as \$1.00 month. Brings you prestige, profits. 25c brings sample, details. National Ord. Nebr.

**"WATERLESS Hand Cleaner."** Make, sell. No machinery. Build profitable business. Complete formula \$1.00. Ideal Service, Park Ridge 2, Illinois.

**SHINGLERS, Roofers** earn big money lifetime. Start neighborhood business. Complete illustrated instructions. Money back guaranteed. Cedar shingling \$1.00, asphalt shingling \$1.00, both \$1.75. Shingler, Box 88B, Penticton, Canada.

**FREE Booklet "How To Raise Worms For Bait."** Tells how to propagate, rackage, sell. Send postcard. El Sobrante Earthworm Farm, 749-A Rincon Road, El Sobrante, California.

**LOOK Here! Wanted—Men** to start in business on our capital. Sell some 200 farm-home products. Thousands our dealers now make quick sales, big profits. For particulars write Rawleigh's, Dept. I-192A-PPM, Freeport, Ill.

**INCREASE Your earnings;** Local business opportunities; mail order information; wholesale supply sources; valuable money-making tips; information, free details, rush name. Wilkin Company, Hillsboro, Ohio.

**SERIGRAPH Printing.** Easy, profitable. Samples free. Joseph Bolger, 148 Concord, River Edge, N. J.

**FAST Sales, cuts food cost.** Nets \$9 a case. Sell 6 daily. Exclusive terr. Jeld, Ltd., Burbank, Calif.

**BIG Money at home!** Operate manufacturing! Mailorder businesses. Free details. Country Mail Service, Rt. 2, Box 99-M, Burnsville, N. C.

**METALLIZE Baby shoes.** Further information 3c stamp. Metal Crafts, Box 125-R5, Tampa 4, Florida.

**"WHOLESALE Catalog,"** (illustrated 10c). Bargains galore. Stafford, Box 5211-PM, Indianapolis 1, Ind.

**EARN Money at home!** Thousands do "Home Worker Magazine" tells how. Sample, 25c. Sizemore, Box 7, 4917 Kostner, Chicago 30, Ill.

**EARN Money** evenings, copying and duplicating comic cartoons for advertisers. Adservice, Argyle 1, Wisconsin.

**SCHOOL Seniors—Sell** classmates America's most beautiful graduation name cards. Largest selection, 40% commission. Outsell all others. Free sample kit. Printcraft, Dept. M, 1425 E. Elm St., Scranton 5, Penna.

**EARN Up to \$520** month part or full time keeping books for small firms. Simplified system. Write Tax-Saver System, Dept. F. Ft. Worth, Texas.

**CONCRETE Block molds, 8x16x4 \$6.70** others, literature free. Lehnert, Norwood 2, N. J.

**START Your own business!** Big money manufacturing novelties, plaques, statuary. Free catalog. Write Bing Products, 88-A9B Broad Street, Boston 10, Mass.

**EARN Extra money.** Easy pleasant work. Write: Reminder, Thurmont, Maryland.

## PLASTICS

**LUCITE Plexiglas.** Any article you make will obtain highest possible crystal clear gloss by merely dipping for thirty seconds in Liquid Shine. Quart \$2.95, gallon \$8.75 post paid. Send check or money order. Instructions free. Acwood Products Co., Box 263, Long Island City, N. Y.

**YOUR Own business in plastics.** Details free. Harco, Edgewood, Maryland.

**PLASTIC Injection machine, Plexiglas, jewelry findings, dyes, cements, tools, drills.** New catalog. G. Baker Company, River Edge, New Jersey.

**BARGAINS** in plastics. Lucite, Plexiglas, Catalin. Many colors and sizes. Details free. George Plastics, 6938A George St., Chicago 34, Ill.

**RENEW Leather and leatherette—Make** cloth into imitation leather with plastic discovery called Leather-New. Opportunity to make real profits taking care of sales resulting from national advertising. Write for free sample of Leather-New covered material and complete deal. 4723B Troost, Kansas City, Missouri.

**SEPTEMBER Special.** Supply kit including powdered and liquid, carving and tinting dyes. Luminous powder and cement. \$1.75 postpaid. Lucite, Plexiglas, sheets, rods, tubes, findings. Free catalogue. Craft Plastics, Somerville 1, New Jersey.

**PLASTIC Materials** and supplies for your hobby or business. Catalog and internal carving instructions free. Art Plastics of Calif., 8125 East 14th Street, Oakland 3, Calif.

**LUCITE, Plexiglas.** Any size sheets. Cost square foot (12"x12") 1/16" 96c; 1/8" \$1.25; 3/16" \$1.52; 1/4" \$1.80; 5/16" \$2.23. Include 10% postage. Almac Plastics, 1150 Broadway, New York 1, N. Y.



**AMAZING** Liquid plastic pours cold, hardens in half hour. Clear, colors. Expensive equipment unnecessary. Embed photographs, coins, flowers, seashells. Complete kit only \$3.25. Kristalon Plastics, Dept. A-9, Box 29, Wilmette, Ill.

**CELLULOID**—New, beautiful selection. Mottles, opaques, onyx, pearls. Used by ring makers everywhere. One pound assortment—pieces approximately 30 sq. in. each. Price \$1.00. Please add 10c for postage. Craft Service, 337 University Avenue, Rochester 7, New York.

**AGENTS** Make big money selling plastic tablecloths. U. S. patented plastic aprons, magic combination of purse and shopping bag. Also other items. Sells on sight. Samples free. Shneider Products Co., 83 Atlantic Ave., Revere, Mass.

**PERSONALIZE** Plastic gifts, clock faces, etc., with 1/2" plastic letters and numbers. Samples 10c. A. H. Dreher, 2232 Brockway, Cleveland 18, Ohio.

**PLEXIGLAS**, Lucite, Acetate, sheets, rods, tubes, jewelry findings, craft supplies, over 1700 items. 25c which brings catalog, internal carving folder, information on fabricating plastics, deducted from first order. Plastic Parts, Dept. H-2098, 1157 S. Kingshighway, St. Louis, Mo.

### FORMULAS, PLANS, ETC.

**"EVERYBODY Likes Candy."** Learn to make professionally. (Our 38th year.) Ragsdale Candies, D5, East Orange, New Jersey.

**MAKE**—Sell cleaners, soaps, polishes, flavors, cosmetics. No machinery. Formula literature free. Kemico, Park Ridge 16, Illinois.

**YOU** Name it. We'll supply formulas. Air mail. \$1.00. Brown, 9111 Hoyne, Chicago 20.

**21 MONEYMAKING** Candy apple, popcorn formulas. Send \$1.00 m.o. We can supply equipment for starting very profitable popcorn, candy floss business at little cost. Concession Supply, Dept. A, Sta. "B," Toledo, Ohio.

**PHOTOGRAPHS** anywhere, three formulas \$1.00. "Photo," 2437 Hollywood Ave., Toledo, Ohio.

**10,000 FORMULAS** And trade secrets. Free literature. Stillman, 555 Kingston Ave., Brooklyn 3, N.Y.

**TESTED** Formulas. Interesting descriptive booklet free. Pont, Box 635-PM, Terre Haute, Indiana.

**OPPORTUNITIES!** Catalog describing 200 helpful formula, money-making books. Airmailed throughout world for stamps. Adams Brown Company, Boston 67, Mass.

**REAL** Manufacturing formulas. Lists free. Cummings, Chemist, Gordon Ave., Syracuse 4, N. Y.

### CHEMISTRY

**TERRIFIC** Bargains in chemical laboratory apparatus. Catalogue 10c. Ross, Section C, 68 West Broadway, New York, N. Y.

**CHEMICALS** And apparatus for industrial, analytical, and private laboratories. Catalog 10c. Dept. M-26. Biological Supply Co., 1176 Mt. Hope Ave., Rochester 7, N. Y.

**LEARN** Chemistry at home, from the house of Winn. Home of supplies for student chemists. New idea chemical and apparatus outfits for home experimenting. Photographic scales, semi-professional microscopes and accessories. Send 15c for retail catalogue. Established 1931. John H. Winn, 124A West 23 Street, New York 11, N. Y.

**NEW** Laboratory supply catalog of chemicals and apparatus. Contains many thousands of items with illustrations. Send 25c. Standard Science Supply Company, 1232 N. Paulina St., Chicago 22, Illinois.

**FREE** Catalog: Chemistry, mineralogy, physics, biology. Tracey Laboratories, Evanston, Illinois.

**HANDBOOK** For chemical experimenters, illustrated, hundreds of experiments, 50c. Experiment booklet 15c. Supply catalog 5c. Reading Scientific Company, Reading, Penna.

**LEARN** Elements of industrial and commercial chemistry, illustrations \$2.00. Maurer Agency, Lincoln, Illinois.

**LABORATORY** Chemicals, apparatus, books. Catalog 10c. Fleischer's Laboratories, Everett 49, Mass.

**EDISON'S** Home laboratory made him famous. Start yours today. Catalogue, chemicals and apparatus 15c. Microscopic stain catalogue 20c. Both for 25c. National Scientific Company, 2204 North Ave., Chicago 47, Ill.

### HELP WANTED

**MAKE** Big profits in little spare time. Show friends deluxe name-imprinted designs of breath-taking beauty. 25 for \$1.50; 25 for \$1.95 and 25 for \$2.95. Gorgeous Christmas and everyday card assortments. Write for free samples. Western Art Studios, 257 S. Spring St., Los Angeles, Calif.

**AGENTS** Wanted—Quality paint manufacturer seeks representation on commission basis. Time and territory your own. Sell to the farm trade, factories, home owners, etc. Competitive prices. Scott-Leed Paint & Varnish Co., 2948 E. 81st, Cleveland, Ohio.

**BOYS** Wanted. Over \$50 week! Sell name plates for front doors. Write Dept. 7, National, 214 Summer, Boston, Mass.

**ACT.** Sell new Xmas photo greeting folders. Big profits, we deliver, free kit. Spooner, 115 Chauncy, Boston, Mass.

### AGENTS WANTED

**AGENTS.** Salesmen. Fast seller; new; different. Every woman needs; waiting to buy. Mr. F. made \$304.20 in 3 days. Selling like wildfire. Sample furnished. Boulevard Art, 75-MA West VanBuren, Chicago.

**FREE** Nylons given if Kendex hosiery runs or snags! World's only women's hosiery sold with a written guarantee that amazes everybody. Mere words could not possibly express the almost unbelievable opportunity you now have to make money. Fantastic and "impossible" earnings now become a reality. Can you imagine a guarantee that replaces hosiery regardless if damage is due to use or abuse and regardless whether it is the fault of the hose or the wearer? Here is sales dynamite that will blast your earnings to the sky! Even if you never sold a thing in your life, three magic words: "guaranteed against everything" will open doors for you—will make women listen and will pour money in your pocket. Kendex stockings are not sold in stores, so you have no competition. Complete line includes beautiful sheer nylons; long wearing, durable service nylons; three different lengths; genuine outside nylons; latest shades; choice of full fashioned with seams or seamless; lowest priced rayons. Also separate complete line of men's hosiery including nylon, lisle, rayon, cotton, mixtures etc.; plain and fancy; long and short. Thousands of pairs shipped daily. No money or experience needed. Nothing to invest or risk. No samples to buy. Nothing to pay, now or later! Simply write orders. We deliver and collect. Liberal advance cash plus huge cash bonus. Write orders spare or full time; exclusively or as a side line. Become a manager and appoint others to sell for you with steady income on their sales! Complete money-making outfit, including salesbooks in color, samples cut from actual hose, instructions, order blanks etc. furnished free and prepaid. Rush name and address on postcard and start making money next week. Kendex Co., Babylon 167, New York.

**BIG** Money selling cast iron and aluminum cooking utensils direct to consumer, exclusive designs. Free illustrations. Jones Machine & Foundry Co., Chattanooga 2, Tenn.

**MEXICAN** Feather pictures. Unusual novelty. \$1.00 (stamps) brings \$2.00 worth samples, details. Refunded if unsatisfied. Aztec Art-P. Apartado 762, Mexico City.

**AGENTS** Sweet smelling perfume novelties sell on sight. Gorgeous samples. Free particulars. Mission, 2328R West Pico, Los Angeles 6, Calif.

**SELL** Ultra-blue stock signs to stores. 1000 slogans, comedy, general, religious. "7x11" cost 6c, sells 35c. Make money. 15 samples ultra-blue signs "7x11" \$1.00 postpaid. Lowy, 8 West Broadway, Dept. 399, New York City 70.

**BIG** Bargains in big profits. Over 100 sensational wholesale values. Men's used suits \$2, pants 35c, topcoats \$1.25, overcoats \$2, shoes 20c. Experience unnecessary. Free catalog. Superior, 1250-A Jefferson, Chicago 7.

**FREE** Sample! Big profit opportunity with amazing Glow-in-the-Dark house numbers, switch plates, pictures, decals, religious articles. Represent large manufacturer. Madison Mills, 303 Fourth Avenue, New York 10, N. Y.

**POSITIVELY** New. On market only short time. Hundreds of virgin territories open. Retail \$1.50. Write for details. Sample \$1.00. Farrell Company, 1377 Galbraith, Cincinnati 31, Ohio.

**MAKE** More money direct from factory. Fibre brooms, floor dusters, patented wet mops, Aluminum mop wringers. Big profits. Write Burtz Fibre Broom Co., Columbia, Penna., Dept. A.

**PLASTIC** Christmas cards. Exclusive new plastic, sachet, panoramic and carols Christmas assortments. Five leading 21 card \$1.00 feature assortments. Six portfolios of personal cards. All this plus America's fastest imprint service. Free samples. Elmcraft Card Co., 5930 South Western, Chicago 36, Illinois.

**AMAZING** Profits. \$25.00 for selling 50 \$1.00 deluxe Xmas boxes. Embossed 50 and 25 for \$1.00, name imprinted. Free samples. Ed-Brite, Dept. 12, 435 North Terrace Avenue, Mt. Vernon, New York.

**\$25 YOURS** For selling only fifty \$1.00 boxes, new exclusive different Christmas and all-occasion cards; also extra cash bonuses. Send for Champion Cheerio 21-card box on approval. Free samples 6 new personal groups and stationery. Write today. Dept. 27, Pen-Brush, 154 Nassau St., New York 7.

**MAGIC** Cleaner — Laundry soap deal. Hotter than a firecracker. Big profits. Sample free. Bestco, 4642 No. Central, Chicago.

**SELL** The famous \$3 "Fire-Killer" extinguisher with bracket, wholesale or direct; exclusive territory. "Fire-Killer," Syracuse 1, N. Y.

**AGENTS:** Stamping names on pocket-key protectors. Sample check with your name, address, 25c. Stamping outfits. Emblem checks, check-fobs, name plates. Hart Mfg. Co., 303 Degraw St., Brooklyn, N. Y.

**MAKE** More money selling personal initialed individualized belts, buckles, cap badges, tie holders, name plates. 2,000 emblems to choose. Big profits, whole or part time. Write today; special outfit offer. Hookfast Specialties, Box 1425, Dept. 6, Providence, Rhode Island.

**FREE** Water and our concentrates, makes flavors, lotions, shampoos, 72 products, labels, bottles furnished. Qualco, E-20030 Russell, Detroit.

**INFORMATION** — Wholesale supply sources. Money-making plans. Increase your income! Write Reynard Service, Smithfield 3, Ohio.

**GOLD** Lacquered window sign letters. Large sizes penny each. New foils. Absolutely beautiful. Free samples. Atlas, 544 W. 79th, Chicago 20.

**EXCELLENT** Sideline for printing and advertising salesmen. Decalcomania name plates in small quantities. Great demand. Also, make money with our line of automobile initials and sign letters. Free samples. "Ralco" XL-Roxbury, Boston 19, Mass.

**NEW** Extra money plan. Make up to 100% profit; without experience; showing Christmas, Everyday Card assortments, wrappings, stationery, coasters. Unusual, attractive. Bonus. Special offers. Send for free samples 30 different name imprinted Christmas cards, 50 for \$1.00, 25 for \$1.00 and \$2.00, stationery, coasters. Christmas, Everyday assortments on approval. Thomas Terry Studios, 90 Union Ave., Westfield, Mass.

**\$5.00 CASH** Advance commission every sale. 38-piece "Lady Ann" silverplate table service. Guaranteed quality, value bring sales galore. Sells for only \$14.95, including tarnish-resistant chest. Bonus premiums. Write for free outfit. Dexter Silver Co., 303 Fifth Ave., Dept. PM-9, New York.

**MAKE** Money fast! Sell Christmas cards to friends, neighbors, others. Big variety etchings, religious, 50 for \$1.00. Wrappings, stationery. New \$1.25 line "Little Ones," flower box, plastic frosted, Saints 'n' Sinners. Special offers, bonus. Fund raising opportunity for individuals, clubs, churches, schools. Mail postal today for feature 21 card \$1.00 Christmas assortment on approval. Hedenkamp, 343 Broadway, Dept. S-42, New York 13.

**AT** Last! Something new and sensational in Christmas cards. Gorgeous satin, velour designs never before offered. Amazing value! Gets orders fast. Name-imprinted Christmas cards, 50 for \$1 up. Big profits. 30 other assortments 60c to \$1. Imprinted stationery. Samples on approval. Puro Co., 2801 Locust, Dept. 840-L, St. Louis, Mo.



**AMAZING** Daily profits, steady repeat business selling famous Colt shoes direct. Exclusive features make selling easy. Experience unnecessary. Patented Footograph assures accurate fitting. Free selling outfit. Colt Shoes, 601-J5 Atlantic, Boston 10, Mass.

**AGENTS**—300% Profit selling genuine gold window letters; stores and offices. Free samples. Metallic Letter Co., 438-B North Clark, Chicago.

**EARN** Big money year 'round. Be a one-person-department-store. Take orders for shirts, ties, hosiery, lingerie, Household linens, etc. For information, Corporate Merchandisers, Dept. PM 6, 110 West 34 Street, New York City 1.

**ENTIRELY** New—Entirely different specialized men's shoe line. Advance commissions to \$2.50. Bonuses, personal discounts. Free selling kit. Concordian Shoes, M-1, West Concord, Mass.

**AMAZING** Offer—\$40 is yours for selling only 50 boxes, each containing 25 new, entirely different deluxe Christmas cards with or without name imprinted. Also 50 for \$1.00. Free samples. Other boxes on approval. Write today. It costs nothing to try. Cheerful Card Co., 413, White Plains, N. Y.

**CHRISTMAS** Cards! Jobbers' prices! Fifty different items from 18c to 38c per box. Gift wraps, seals, Christmas tree windows, books, letterheads. Illustrated catalog free! Fantus, 436 North Wells, Chicago.

**SILVER** Plating liquid—(NuSilver). Anyone can apply with cloth. Durable, guaranteed, genuine silver finish. Renew silverplated ware, articles, pieces. Silverplates brass, copper. Sales-distributors wanted, exclusive. NuProcess Products, Aurora, Illinois.

**QUICK** Cash. Sell friends wonder value name imprinted Christmas cards 50 for \$1.00 up to 25 for \$2.50. 43 sensational money makers. Up to 100% profit. Bonus. Special offers. Write for 9 free self-selling sample portfolios name imprinted Christmas cards and stationery. Rainbow Greeting Card Co., 38 East 1st St., Dept. 17-B, New York.

**SCIENTIFIC** Discovery Savol Waterless Hand Cleaner Creme removes stains, paint, ink, etc. Contains Lanolin. Sample pound 50c postpaid. Free particulars. Valtex Company, Rochester 7, New York.

**OUR** Salesmen earning \$150 weekly. Sell Diamolite ring line house to house on credit. Commission \$2.00 on \$6.95 ladies' rings, \$3.00 on \$12.95 man's ring. Acme Mercantile, 115 Union St., Nashville, Tenn.

**EASY** Profits to 100%. Sell friends superior value 21-card \$1.00 Christmas assortment, 50 for \$1.00 personals, everyday, gift wrappings, stationery. Experience unnecessary. Request 1948's newest super deluxe Christmas assortment and name imprinted Christmas card samples on approval. Holiday Card Co., 463 Congress St., Dept. MR, Portland, Maine.

**SELL** Garages, filling stations guaranteed tire patch. Protected territory. Economy Rubber Co., Riverdale Station, Box 552-E, Dayton 5, Ohio.

**\$1 STARTS** You in business. Sell lined ties, 100% wool interlining. Costs you only \$7 per dozen, you make \$5.00 dozen. Send \$1.00 for special introductory offer two ties. Catalog complete line free. Philip's Neckwear, 20 West 22nd St., Dept. K-27, New York 10.

**BIG,** Easy profits to 100% selling new, novel Christmas card, gift wrapping, panorama, Christmas carol assortments. Bonus. Special offers. Request free samples 50 for \$1.00. Personals, silver imprint line, name imprinted and floral stationery and feature Christmas samples on approval. New England Art Publishers, North Abington 248, Mass.

**SELL** Luxury perfumes for profits and repeats. Generous samples \$1.00 deductible first order. Edward Lawson, 10-21 Joiner Street, St. Augustine, Florida.

**BE** Renewal headquarters for all magazines. Christmas gift sales starting now. Big profits. No experience. No capital needed. Free catalog tells how. Write: McGreggor Magazine Agency, Dept. 12, Mount Morris, Illinois.

**CHRISTMAS** Cards. Earn \$3.00 an hour. Take orders galore from friends. America's fastest selling 21 Christmas folder assortment. Smart, distinctive! Costs 50c. Sells \$1. A complete line. Samples on approval. No investment. Sunshine Art, Dept. PM-9, 115 Fulton St., New York 8, N. Y.

**MAKE** Easy extra money. Sell Christmas cards. 9 beautiful lines. 25 for \$1 up. Name imprinted. Samples free. Cyphers Card Company, 74 W. Huron St., Buffalo, N. Y.

**SOLVE** Your money problems. Sell friends 50 and 25 for \$1.00, 25 for \$1.95 name imprinted Christmas cards—free sample portfolios. 32 different boxes. Profits to 100%. Bonus. Feature Christmas, all-occasion assortments on approval. Special offers. Write Pilgrim Greeting Card Co., 111 Summer, Dept. AH-1, Boston, Mass.

**SELL** Gold embossed monogram stationery. Sample free. Dunbars, Sanford, Fla.

**AGENTS** To sell a fast moving item. Acclaimed by users throughout the country. Exclusive territories open for honest, proven salesmen. Big profits to aggressive agents. If you can sell, then this is your opportunity. Write today. Speed Waxer Company, 4451 Elston Ave., Chicago 30, Illinois.

**SELL** Mexican feather bird pictures. Hand-made of real feathers. Sample 25c. Importer, C. Staff, 14960 Evanston, Detroit 24, Michigan.

**BIG** Money maker! Waterproof table covers, food protectors. Other terrific sellers. Postal bringers free selling equipment. Star, 261M Fifth Ave., New York 16.

**AGENTS**—Sell Cover-Tite for garbage cans \$1.49. Windproof, dogproof. Sample 89c. Western Welding Mfg. Co., 4439 W. State St., Milwaukee 8, Wis.

**MARVELOUS** New needle threader. Wonderful invention. Eagerly sought by housewives, sewing clubs and elderly people with poor eyesight. Even blind person can thread needle instantly. \$1.00 profit on each sale. Be first in your locality. Send \$2.00 for sample. New England Metal Products Co., Oakville, Conn.

**MAKE** \$20 A day selling big value stay-polished solid brass name plates for doors; other easy sellers. Write today. Hubstamp, 357-A Congress, Boston, Mass.

**CHRISTMAS** Cards 50 for \$1. Other series of 25 from \$1-\$2.50. Also box assortments. Free sample albums. Commission. Bonus. Richar Greetings, 16 E. 18th, New York 3.

**START** Your own business on our capital. Always your own boss. Hundreds average \$6,000 to \$25,000 annual sales year after year. We supply stocks, equipment on credit. 200 home necessities. Selling experience unnecessary to start. Wonderful opportunity to own pleasant, profitable business backed by world-wide industry. Write Rawleigh's, Dept. I-U-PPM, Freeport, Ill.

**100% PROFIT.** No investment—Handle quality Fotostamps. Amazing glossy photographs, gummed stamp form. Business year round. Free samples, particulars. American Photo Stamp Co., 103 East 125th St., Dept. PM 9, New York 35.

**POCKET** Pal; replaces knives. New, safe, beautiful. Always razor sharp. 50c seller. 321% profit. \$15.00 or more daily. Agents, salesmen, distributors. Sample 25c. Nelson Mfg. Co., 222 W. Kellogg, St. Paul 2, Minn.

**CALL** On friends with sensational Christmas cards in handy assortments. Sell for \$1.00. Profit up to 50c. Also popular-priced personal Christmas cards, everyday assortments, stationery, imported napkins. Samples on approval. Wallace Brown, Dept. J-4, New York 10, N. Y.

**A DRESS** Yours with every 3 you order for yourself and family. Amazing new bonus plan. Everything free. Harford Frocks, Dept. S-9128, Cincinnati, Ohio.

**GREETING** Cards, stationery, gift wrappings. Personalized napkins, book matches, playing cards. 4154g Fifth Street, Philadelphia 40, Penna.

**SHINE** Shoes without polish. New invention. Lightning seller. Shoes gleam like mirror. Samples sent on trial. Kristee 126, Akron, Ohio.

**FAST** Sales, cuts food cost. Nets \$9 a case. Sell 6 daily. Exclusive terr. Jeld, Ltd., Burbank, Calif.

**MORE** Money in closeouts. Pricelist free. Metro, 60 South Street, Boston 11, Mass.

**GREETING** Card agents! Double your income with profitable sidelines. Write today! Mosher's, Vineyard Haven, Mass.

**FACTORY** Agents. Sell dealers. Power mowers, engines. Farm Products, M-2009, Excelsior Springs, Mo.

**"BROADWAY** Ballyhoo"—Lyrics, wit, humor publication. Distributors wanted. \$30.00 thousand. Sample 10c. Noveline Enterprises, 1451 Broadway, New York.

**SELL** Merchandise. Big profits. 3518 32nd Street, Union City, N. J.

**EVERY** Housewife a prospect for automatic Speedi-Waxer. Send for details two big profit sales plans. Darby Corporation, Dept. 8M, 241 Centre St., New York 13, N. Y.

**FINE** Opportunity to have pleasant outside business of your own. Supply every home with food products, flavors, washing preparations, and scores of other daily used items. Work part or full time. Many dealers with us for from five to twenty years. Exclusive territory assigned. No age limit. Selling experience unnecessary. Don't delay. Every day counts. Write now for details. C. I. Tognstad Co., Dept. PM-9, Kokomo, Ind.

**CHRISTMAS** Cards. Earn \$5.00 with every ten 21 card \$1.00 boxes you sell. Also new plastic cards, personalized cards and stationery, note paper and wrappings. Send for samples today. Howard P. Ellis, Dept. PM-10, Pitman, N. J.

**SELL** Cosmetics. Attractive containers. LaDien Grenard, D6, 913 Main, Kansas City 6, Missouri.

**DISTRIBUTE** Polishes, waxes, etc. McBride Products, D7, 913 Main, Kansas City 6, Missouri.

**DIRECT** From factory. Make \$100 weekly selling watches. Advertised brands with guarantee. Free catalogue. Ergim Watch, 833 Columbus Ave., New York.

**EASY** Cash yours; steady, quick. Sell friends quality Nylon hosiery, lingerie, blouses. Free displays. Complete line greeting cards. Leader Christmas assortment on approval. Special outfit offers. Wear Wright Company, 1709 Arch St., Dept. B, Philadelphia, Penna.

**BUY** Thousands of nationally advertised products direct from manufacturers. Write for "Buy Direct And Save." Consumers Ass'n., 287-A Lebanon Ave., Mt. Lebanon, Penna.

**SCHOOL** Seniors—Earn 40% commission selling classmates America's most beautiful graduation name cards. Largest selection. Outsells all others. Free sample kit. Printercraft, Dept. M, 1425 E. Elm St., Scranton 5, Penna.

**300% PROFIT** Selling "Famous-Arts" Christmas cards. Boxed assortments. Sensational value, quick easy sales. Start earning at once. Send \$1.35 (refundable) for 3 assorted boxes; brings \$5.25; or rush name for free money-making plans. Elmore Smith Co., 362-P West 52nd St., New York 19, N. Y.

**NYLONS**—Genuine DuPont. Highest quality. Lowest prices. Sims, Warwick, New York.

**SPECTACULAR** Guarantees, popular prices, make selling easy. Biggest steady repeat profits selling Colt's famous men's, women's guaranteed shoes, hosiery. Experience unnecessary. Free selling outfit. Colt Shoes, 601-J9 Atlantic, Boston 10, Mass.

**SCHOOL** Seniors! Your postal will bring our wonder, Kwick-Sell Cardalog of popular graduation name cards. Biggest profits! Only firm giving free souvenir chest and card case. Don't miss out! Hurry that postal! Craftcards, Box 235 (L), Pittsburgh 30, Pennsylvania.

#### HIGH-GRADE SALESMEN

**BRAND** New! Revolutionary products! Salesmen make \$10,000 yearly selling one complete lighting line. "Neo-Glo" fluorescent changeable message sign replacing neon. "All-Lite" table lamp using upright fluorescent tube, spectacular "Circiline" fixtures using circular tube. Verticals, dual-rays, pin-up lamps, a complete line of fluorescent and incandescent fixtures covering every commercial, industrial, residential need. A triple sales plan insures your success whether you choose selling dealers, direct, straight commission or distributorship on our capital. Get set now with our growing progressive organization. To get you started, we will send a beautifully illustrated catalog showing over 200 profitable, sales-tested styles and models. Order blanks, sales helps, everything needed to start at once included. It costs you nothing. Rush name quickly, today, and start making real money. Rose Company, 539-PP South Franklin, Chicago, Illinois.

**BIG** Money quickly and easily taking orders for complete line personalized initialed buckles, belts, cap badges, 2,000 emblems. Fast repeats. Write today. Hook-Fast Company, Box 480-PM, Roanoke, Virginia.



**JOB** Open in selling! Send name, address for free copy Opportunity Magazine, listing hundreds of companies who need men now, full or spare time. Experience not essential. Opportunity, 28 E. Jackson, Dept. 17, Chicago 4, Ill.

**BIG** Money taking orders. Shirts, ties, box, pants, jackets, sweaters, shoes, uniforms, etc. Sales equipment free. Experience unnecessary. Nimrod, 4922-AN Lincoln, Chicago.

**YOU** Can be the first in your territory with 1950 calendars. Salesmen's applications are now being considered for the world's latest Sinco advertising specialties and calendars. Write today. H. W. Sinclerton Co., Dept. PM, Salt Lake City, Utah.

**\$30 DAILY** Profit for you! Salesman to sell nationally advertised adding machine or only \$12.95 complete. A desk model portable, precision built, fully guaranteed, every inch a business machine. Easy to operate, easy to sell, easy for you to make big money at 49% profit! For life-size color photo and full details with no obligation, write today to Lightning Adding Machine Co., Inc., Dept. ZD5, 543 So. Spring Street, Los Angeles 13, Calif.

**SILVER** Plating Liquid — (NuSilver). Anyone can apply with cloth. Durable, guaranteed, genuine silver finish. Renew silver-plated ware, articles, pieces. Silver-plated brass, copper. Sales-distributors wanted, exclusive. NuProcess Products, Aurora, Illinois.

**TWISTEE** Animal balloons, twelve balloon package, cellophane 25c. Novel rubber and plastic toys. Add to your line or sell exclusive. Ellswood's, La Junta, Colo.

**ADVERTISING** Book matches—Cash on big demand; sell union label matches. Cuts for all businesses and political parties. Free powerhouse selling kit, low prices, protection guaranteed on repeat orders. Cash commissions. Superior Match Co., Dept. M-98, 7530 Greenwood, Chicago.

**LONG** Needed invention. Old established company. Easy demonstration. Proved success. Every home, factory, store and arm a prospect. Low price, long profit. Exclusive. Fine outfit furnished. Local territory. No deposit. Full information sent air mail. Write 312 R. C. Bldg., Red Comet, Inc., Littleton, Colorado.

**MAKE** \$15.00 to \$25.00 per day. Joe Louis' and Marva Louis' (his wife) toilet articles, cosmetics and other products for men and women are sensational. White people like them; colored people buy on sight. Perfumes, powders, pomades, creams, brown creams, flavors, remedies, and many other fast sellers are our features. \$3.95 buys \$10.03 (23 items) retail deal—send \$1.00, pay postman balance. Be first in your community to offer this new line and you will be happy. Joe Louis Products Company, 6 E. Garfield Blvd., Dept. PM-9, Chicago 15, Illinois.

**SALESMEN.** Earn \$100.00 weekly, selling only six pair shoes daily. Commission and bonus. Wide variety for men, women, children. No investment. Experience unnecessary. Tanners Shoes, 300, Boston, Mass.

**I'LL** Put a "shoe store business" in your pocket! Nation's leader trains you to make big money! Fit men, women. Free sample outfit; write today! Consolidated Shoe System, Dept. S-138, Chippewa Falls, Wis.

**LOOK** Here! Wanted—Men to start in business on our capital. Sell some 200 farm-home products. Thousands our dealers now make quick sales, big profits. For particulars write Rawleigh's, Dept. I-192B-PPM, Freeport, Ill.

**SELL** Delicious candies, nuts, gum. Immediate delivery. Write Casterline, 2031-PL Sunnyside, Chicago 25, Illinois.

**FAST** Sales, cuts food cost. Nets \$9 a case. Sell 6 daily. Exclusive terr. Jeld, Ltd., Burbank, Calif.

**PLASTIC** Advertising specialties sales kit \$1.00 refundable. Phil Brautigam, P.O. Box 8201, Portland, Oregon.

**SALESPEOPLE.** Crew managers, sell leading plastic line; tablecloths, aprons, etc. Postal brings free details. No investment necessary. Mark Steele, 58 Walker St., New York.

**BIG** Money selling fluorescent lighting fixtures for manufacturer in your territory. Complete line. Latest designs. Low prices. Free outfit. National Lighting, PM-4221 Harrison, Chicago.

**REPRESENTATIVE** — Selling high-quality nylon hosiery and lingerie to stores. Excellent sideline for traveller now contacting general and department stores. Rosalee Hosiery Company, 386 Main Ave., Clifton, N. J.

**\$50 QUICK** Sell new revolutionary rubber stamp inker. All businesses buy. We show you. Hudson Specialty, Chicago 40.

**SAFE** Manufacturer seeks high class salesmen for distributors in exclusive territories. 5 models meets the requirements of homes and businesses. Underwriters approved. Gary Safe Co., 530 Stanford Ave., Los Angeles 13, Calif.

**ALL** Kinds American, Swiss watches, new and used; retail \$3.65-\$345.00; profit 33 $\frac{1}{2}$ % up; show our catalogue, get orders. Brookins, B-1975AJ, Little Rock, Ark.

**DISTRIBUTORS.** Top line automatic fire equipment. 65% profits. Over \$5000 a year men only. Red Ball Co., Box 1552, Salt Lake City, Utah.

## EDUCATIONAL AND INSTRUCTION

**AIR** Conditioning, refrigeration, and heating. Nine months resident course of complete technical and practical training for those who want to become sales engineers, contractors, estimators, installers, or service men. Write for free booklet. Now accepting enrollments for Sept. and Oct. classes. G. I. approved. Detroit Air Conditioning Institute, 4125 Grand River Ave., Detroit 8, Mich.

**CAN** A man my age become a hotel executive even though he has no previous hotel experience? Would you like to step into a well-paid position as hotel or club manager, purchasing agent, social director or assistant manager, etc.? The success of Lewis graduates from 18-50 proves you can—though you never had a minute's experience in hotel work. C. P. Hearne says: "Shortly after receiving my diploma from the Lewis School, I gave up my job in a power plant and accepted a position obtained for me by the Lewis Placement Bureau as assistant to the manager of a famous country club. Now manager and had three raises in salary." Our free book, "Your Big Opportunity" explains how you can qualify for a well-paid position in leisure time, how you are registered free of extra cost in Lewis National Placement Service; shows how you can be a Lewis certified employee—certified to "make good" when placed. Write for it today. Course approved for Veteran's Training, Lewis Hotel Training School, Desk NS-324, Washington 7, D. C.

**MEDICAL** Laboratory technicians in great demand. We train you in your own home, in your spare time. Also home study course in general chemistry. Free catalogue. Imperial Technical Institute, Box 973-J, Austin, Texas.

**INVESTIGATOR** Training, Phillips Secret Service, 1917B North Kenneth, Chicago 39, Illinois.

**BOOKKEEPERS!** Increase your earnings! Operate your own simplified "dollar-a-week" bookkeeping and tax service. Full or spare time. Details free. No obligation. Ellis, Box 200, Cedar Grove, North Carolina.

**USED** Correspondence courses and books bought, sold, rented and exchanged. Catalog free. Lee Mountain, Pisgah, Alabama.

**LINGUAPHONE** Makes languages easy. At home learn to speak Spanish, Portuguese, Italian, French, German, Russian, by quick, easy Linguaphone Conversational Method. Save time, work, money. Linguaphone correspondence courses are available to veterans under G.I. bill of rights. Send for free book. State if G.I. Linguaphone Institute, 83 RCA Bldg., New York, 20, N. Y.

**LEARN** Photo-engraving at home or in oldest, largest school in America. Work for newspaper or establish own profitable business. New Tasope' Photo-Engraving equipment available soon. Write for information. Veterans ask about G.I. training. The Aurora School of Photo-Engraving, Tasope' Bldg., Aurora, Mo.

**"PROFIT** And Pleasure in Aviation." Guide to 300 jobs. Operate your own business and have fun too! Many other features in this brand new course. Low price will amaze you! Free literature. A. F. St. John, 823 Commerce Building, Rochester 4, N. Y.

**SPEED** And skill in radio code to qualify for amateur or commercial radiotelegraph license. Learn at home with the famous Candler System used to train radiotelegraph experts and champions. Good pay or fascinating and profitable hobby. Free book. Candler, Dept. 5-K, Box 928, Denver, Colorado.

**NOW** You can have an office. Learn credit-collection business by new home study course. Many earn up to \$5000-\$15,000 annually. Free bulletin. Franklin Credit School, Dept. 202-J, Roanoke 7, Va.

**SECRET** Investigation. Experience unnecessary. Investigators particulars free. George Wagner, M 125 West 86th, New York.

**MAKE** Up to \$30-\$40 week as a trained practical nurse! Learn quickly at home. Booklet free. Chicago School of Nursing, Dept. M-9, Chicago.

**"HOW** To Break and Train Horses"—A book every farmer and horseman should have. It is free, no obligation. Simply address, Beery School of Horsemanship, Dept. 1109C, Pleasant Hill, Ohio.

**FOR** An extremely profitable lifetime business operate a collection agency; credit bureau. Easily learned. Free folder. Cole & Associates, Syracuse 2, N. Y.

**"UNCLE** Sam" jobs! Congress raises pay \$330 to \$450. Men—Women. Qualify at home for examination. 40-page book; sample lessons—free. Write Franklin Institute, Dept. P-24, Rochester, N. Y.

**CORRESPONDENCE** Courses. Used International. Many subjects. Satisfaction guaranteed. Write today. Baker, 5509 Winthrop, Chicago 40.

**AMAZE** Others. Add columns instantly. Add faster than adding machine. Free details. P. Math Institute, Box 463, Nashville 2, Tenn.

**NATIONAL** School of Foot Correction, Juneau 1, Alaska. Extension. Degree. Details, 25c coin.

**START** Learning dental technician trade. Ten simple lessons \$5.00. Grant Laboratory, S. Los Angeles 14, Calif.

**USED** Correspondence courses and educational books bought, sold, rented. Catalog free. Educational Exchange, Summer-ville, Ga.

**SUPERMEMORY** Makes data stick like burrs! Write Thor Books, CM-9, Box 1210, Chicago.

**BECOME** A Doctor of Psychology or Metaphysics. Teach secret of contentment, happiness. Win degree of Ps.D. or MsD. Solve mental worries. Free book. College of Universal Truth, 5153-C North Clark, Chicago.

**HOME** Study course, drugless therapy. Free literature. Institute of Drugless Therapy, Tama, Iowa.

**STUTTER!** My simple instructions really help stop it. Joseph Gerard, 2067 West 10 St., Brooklyn 23, N. Y.

**OIL** Painting—Economic, home study course. Write Carlos Art Academy, Correspondence Division, Watertown, N. Y.

**SEND** Only \$1.00 for "Secrets of Magic." Teaches 186 different amazing tricks. Robbins Co., 152-P West 42nd, New York.

**SHOE** Repair school. Teach you quickly! Age 18 to 60. In 12 weeks you can be skilled. Modern Shoe Rebuilding, 4577 Hollywood Blvd., Los Angeles; 2935 Belmont, Chicago.

**EDUCATE** Your memory, develop alertness, confidence. Be successful. Amaze your friends and please your employer with an improved memory. You cannot afford to be forgetful. Memorology, a new amazing book on the science and laws of the memory made practical will help you. \$1.00 postpaid. Literature free. Memorology, 2016 Sunnyside Ave., Chicago 25, Illinois.

**NAME** The course. We have it. Write DeVoto Schools, 35 Vicente, San Francisco 16, Calif.

**REFRIGERATION** Graduates, apprentices: want practical, tested methods on how to be bigger success in refrigeration industry? Copyrighted pamphlet explains how to analyze personality and scholastic achievements, ways to get kind of work you want, unusual ideas to gain experience, starting own business. \$1 postpaid. Refrigeration Advisory Service, 3155 Chippewa, St. Louis, Mo.

**DENTAL** Technician training—Interesting home study. Worldly opportunities. Details. Dental Crafts And Sciences, Box 1321C, Palo Alto, Calif.

**LEARN** Appliance and building repair. Simplified home study course. Free literature. Temple Enterprises, 4232A Iberville, New Orleans 19, La.

**RADIO** Announcing. Train for this interesting, profitable profession at home in spare time! Details free. Radio Arts Center, 721 South Salina Street, Syracuse, N. Y.

## SPECIAL SERVICES

**MFG.**—Wholesale sources. Most any item. "Service," 1332B Findlay, New York 56.



## BUSINESS SERVICE

NEW York postmark. Letters remailed 25c, postcards 20c, other services. Gem Company, 471 Fourth Avenue, New York City.

INDUSTRIAL Oakland. Information \$1. Remailing 25c. Marcel Adams, Fairmont, San Leandro, Calif.

DENVER Postmark! 5 postcards \$1.00. Letters 25c. Toms, 725 Logan, Denver 3.

WE Receive, reforward letters: \$3.00 monthly or 25c each. "Hawkins," 1300 Taylors, Washington 11, D. C.

## PLAYS, STORIES, MANUSCRIPTS

I WANT New writers to cash hundreds of checks for \$1 to \$100, offered each month. The easiest way to write for pay. No previous experience necessary. Send for free details. No obligation. Saunders M. Cummings, 467-M Independence Bldg., Colorado Springs, Colo.

## INFORMATION

FOREIGN Employment for you. Excellent permanent job opportunities for U. S. citizens. Wages at least 20% higher, less taxation, lower living costs. Improved social position. Transportation and housing furnished. Choice of climate and location. South and Central America, Far East, China, Alaska, Africa. Send \$1.00 for copyrighted Digest showing oil, shipping construction, mining, etc. Companies working and hiring. Includes sample application letter, advice on wages, tips, etc. World Wide Company, Dept. PM-8, Madison 1, Wisconsin.

"EVERYBODY Likes Candy." Learn to make professionally. (Our 38th year.) Ragsdale Candies, D15, East Orange, New Jersey.

## CARTOONING, COMMERCIAL ART, SHOWCARD WRITING, SIGN PAINTING

"HOW To Make Money With Simple Cartoons"—a book everyone who likes to draw should have. It is free; no obligation. Simply address Cartoonists' Exchange, Dept. 99-C, Pleasant Hill, Ohio.

SIGN Painting taught at home by an old master. Ben Kerns, Box 812, Greenville, S. C.

CHALK Talks. Laugh producing program, \$1.00. Catalog 10c. Balda The Cartoonist, Oshkosh, Wisconsin.

LEARN Showcard writing in spare time. Fascinating, profitable. Free information. Sherwood Publishing Co., Irvington 11-1, New Jersey.

FAMOUS \$75 Lockwood art course now only \$6 postpaid. Other smashing art bargains. Catalog 10c. Art Book Shop, Arnold 5-A, Missouri.

## ADVERTISING AGENCIES, LETTER WRITERS, FOR ADVERTISERS

EARN Money in your spare time. Progressive Mail Trade tells you how. Large 64 page magazine for a dime. Progressive Mail Trade, 822 Center Ave., Sheboygan, Wisconsin.

ADVERTISERS! Reach nearly 18,000,000 readers. 25 Sunday national key newspapers, 18 words, \$47.75. "Terrific pullers." 20 popular newspapers, \$9.75. "Free booklet." Special—One inch display 2-821,198 circulation, \$42.00. Newark's Advertising Agency, (Established 1893) 217-7th Ave., New York 11.

ADS Placed in out of town newspapers and magazines. Low rates. Catalogue free. Ideas that pay. Baker Advertising Agency, Successors Ankrum Agency, 189 W. Madison, Chicago 2.

MAILING Lists, certified, productive, inexpensive, \$5.00 1000. Homeworkers, agents, buyers, etc. Write Dixie Service, King, N. C.

24 WORDS In 64 weeklies \$4.96. H. J. Darnell, 730 Hays, Jackson, Tenn.

ADVERTISING Sensation! Reach 2,100,000 families, \$32.90 inch. Display, classified, ratebook (newspapers, magazines, mailing lists), advertising assistance, free. Chicago Advertising Agency, 20-PM West Jackson, Chicago 4.

FREE! 1948 Advertisers Rate and Data Directory. 52 pages! E. H. Brown Advertising Agency, 20 N. Wacker, Chicago 6.

ADVERTISE: 24 Words, 40 newspapers \$3.50. Lists free. Advertising Bureau, 229-C Dixon, Uniontown, Penna.

CATALOG Consultants. Entire production service specialists. Mail order advertising, management, operation. Write to Adsmiths, Dept. A, 30 W. Washington, Chicago.

ADVERTISEMENT Writing! Powerful publicity, mailorder letters, literature, campaigns! Reasonable! Established reputation! Investigate! Finkle Advertising, 1201½ South Ogden, Los Angeles 35.

## TYPEWRITERS, DUPLICATORS, OFFICE DEVICES

ADDING Machine, save yourself the petty annoyances of adding, subtracting, multiplying by hand. Small, portable; iron clad guarantee. 11½" x 2½", precision built "Addometer" only \$12.95 complete. Send postcard for details. Tam Products, MC9, 3814 Wrightwood, Chicago 47.

DUPLICATORS \$9.95 Up. (New.) Immediate delivery. "Free circular." Rucker, 2836-PM Slevin, Louisville 12, Ky.

"PRINTOMATIC" Selffeeding post card stencil printing duplicators \$9.50 up. Office size duplicators, Speedoprints, Hilcos, Excellographs \$33.41 up. Literature free. Pittsburgh Typewriter Supply, 336-WK Fourth Avenue, Pittsburgh 22, Penna.

RECONDITIONED Typewriters, mimeograph, multigraph printing devices, appliances, supplies. Catalog. Dixiegraph Service, King, N. Carolina.

## RUBBER STAMPS AND OFFICE SUPPLIES

LINE 20c; 2-35c; 3-50c. Stamp Works, Auburn, Nebraska.

DE LUXE Cushioned, indexed, knob handle; three lines \$1.00, two 75c. Quick service. Catalog 10c. Warner Stationery, Box D-43, Havre de Grace, Maryland.

QUALITY Stencils, inks, priced right, Riddle, 360 S. Hill, Los Angeles 13.

## PRINTING, MULTIGRAPHING, MIMEOGRAPHING, GUMMED LABELS

BUSINESS, Personal stationery. State requirements. Samples, pricelists free. How Printing Company, 721-23 Eunice, Webster Groves 19, Missouri.

PRINTED 6¼. "Hammermill bond envelopes," 5,000, \$19.50 i.o.b. Keith's Press, Elizabethtown, New York.

MIMEOGRAPHING Specialists—Any copy. Reasonable. Mailers Service, Box 606-H, Chicago 90, Ill.

500 LETTERHEADS And envelopes \$7.00 prepaid. Prompt service. Sumar Press, Creative Printing, 81 W. Van Buren, Chicago 6, Ill.

LETTERHEADS. Envelopes, circulars. Small, large quantities. H.M.G. Company, Mecca, Indiana.

WRITE For samples, prices attractive letterheads, cards, circulars. Journal Printing Co., Newark, Arkansas.

500 ¾x2¼ FOUR Line gummed stickers 35c; red border 50c. Moritz Printery, Saginaw, Mich.

1000 BUSINESS Cards, \$2.50, prepaid. Samples free. Reliable Print Shop, 905 E. Jefferson, Louisville 6, Ky.

SEND 10c Now, for our 48 page 1948 price list—refunded first order. McCall Press, 1326 South 27th, Omaha, Nebraska.

QUALITY Printing—Reasonable prices. Fast service on catalogs, folders, publications. Write for prices. Bagby Printing Co., Georgetown, Ohio.

MIMEOGRAPHING—Letters, pricelists, formulas, instructions. Lowest prices. Lem's Letter Shop, 5710 Stanton, Detroit 8.

150—8½x11 LETTERHEADS, 125 Envelopes, beautifully printed, \$2.00. Calder's, Box 3422-MP, Philadelphia 22, Penna.

100 HAMMERMILL Letterheads with 100 envelopes \$2.00 Postpaid. Benneville, Box 1931, Pittsburgh 30, Penna.

500 6¼ ENVELOPES, Printed, \$3.00. 100—\$1.25. 100 printed postals, \$1.00. All postpaid. Dickerson Printing Co., Gas City, Indiana.

DISTINCTIVE Printing, lower cost. Price list free. Walter H. Kane, Woburn, Mass.

250 BUSINESS Cards \$1.00 postpaid. Brems, 40-06 97th, Coronal, New York.

QUALITY Printing: Business, personal stationery. State requirements. Samples. Mero Products, 100 Morrison, Punxsutawney, Penna.

STATIONERY—Personalized with picture of you, your home, anything! GA, 138 N. Locust, Appleton, Wis.

100 8½x11 HAMMERMILL Letterheads \$1.00. Envelopes, billheads same. Herbert Hudson, 261 Woonasquatucket, Centredale, R. I.

FREE Samples. Quality printing. Backus, 209 South Laurel, Richmond 20, Va.

1000 6¼ ENVELOPES \$5.00 With your name and address printed on them. Sample free. Ewell Farley, Box 15, Everts, Ky.

PRINTER Wanted: ticket work. State experience, salary. Standard, 65 Duane, New York 7.

BUSINESS Cards, 500 for \$1.50. Samples. D'Yarmett Printing, Newark, Ohio.

1000 BUSINESS Cards (embossed) \$2.95 postpaid. Zephyr Printing, Box 312pmm, Venice, California.

## PRINTING OUTFITS AND SUPPLIES

BARGAINS—Hand presses, supplies. Catalogs 10c. Customprint, 211-M, Springfield, Missouri.

PRINTERS Supply catalog free. Brighton's, 4234-M South Mozart, Chicago 32, Illinois.

REBUILT Presses, bought, sold. List 3c. Exchange, 212 Curtis, Meriden, Conn.

PRINTING Presses, type, supplies. Lists 3c. Turnbaugh Service, Loysville, Penna.

PRINTING Presses, type, supplies. Send dime for complete illustrated printer's supply book, details and press samples. Kelsey, Inc., A-11, Meriden, Connecticut.

INEXPENSIVE Home-made printing press. Details free. Novelty Shop, Downsville, Louisiana.

HALFTONE Screens, Low-priced, efficient. American Graphic, 1041-A Eighteenth Avenue, Newark 6, N. J.

PLASTIC Printing cuts. Make your own. New Plexiplate process. Plexiservice, Argyle 1, Wisconsin.

## PATENT ATTORNEYS

PATENT Protection—Unless an inventor is thoroughly familiar with such matters, he is advised to employ a competent registered Patent Attorney as the value of a patent depends largely upon the skillful preparation of the specification and claims. Send for booklet, "Patent Protection for Inventors," outlining preliminary steps to take to obtain patent protection. Victor J. Evans & Co., 331-K Merlin Building, Washington 6, D. C.

INVENTORS—Patent laws encourage the development of inventions. Our firm is registered to practice before the U. S. Patent Office. Write for further particulars as to patent protection and procedure and "Invention Record" form a once. No obligation. McMorrow, Berman & Davidson, Registered Patent Attorneys 134-M Victor Building, Washington 1 D. C.

INVENTORS: Learn how to protect your invention. Unless the inventor is familiar with patent matters, he should engage a competent registered patent attorney or agent to represent him. We are registered to practise before the U.S. Patent Office and prepared to serve you in handling your patent matters. "Patent Guide for the Inventor" containing detailed information concerning patent protection and procedure with "Record of Invention" form will be forwarded to you upon request—without obligation. Clarence A. O'Brien & Harvey Jacobson, Registered Patent Attorneys, 81B-G District National Building, Washington, D. C.

PATENTS—Trade marks. Irving L. McCathran, 315 McLachlen Bldg., Washington 1, D. C. Registered Patent Attorney.

INVENTORS. For "Record of Invention" form, contact Carl Miller, Registered Patent Attorney, Woolworth Building, New York.

INVENTORS: Without obligation, write for information explaining the steps you should take to secure a patent. John N. Randolph, Registered Patent Attorney, 203 Columbian Bldg., Washington 1, D. C.

"INVENTOR'S Guide" free on request. Frank Ledermann, Registered Patent Attorney, 154 Nassau St., New York 7, N. Y.

PATENTS. "Proof of Invention" folder mailed without obligation. E. E. Vrooman, Registered Patent Attorney, 871 Woodward Building, Washington 5, D. C.

PATENT Practice before U. S. Patent Office. Validity and infringement investigations and opinions. Booklet and form "Evidence of Conception" forwarded upon request. Lancaster, Allwine & Rommel, Registered Patent Attorneys, Suite 411, 815-15th Street, N.W., Washington 5, D. C.



**INVENTORS:** Write for free brochure "Evidence of Invention." Labiner, World Building, New York 7.

**INVENTORS:** When you are satisfied that you have invented something of value write me, without obligation, for information as to what steps you should take to secure a patent. Write Patrick D. Beavers (Formerly Randolph & Beavers) Registered Patent Atty., 935 Columbia Bldg., Washington 1, D. C.

**THOMAS Appleby,** Registered Patent Attorney, formerly U. S. Navy Patent Division. Free information. Portland Building, Washington 5, D. C.

### FOR INVENTORS

**PARTS Manufacturer** wants patented or patent pending inventions to manufacture and market. Your share guaranteed. Industrial Engineer, 3401 Martin Avenue, Detroit 10, Mich.

**FINANCIAL Aid** for invention development. TNB, Box 1434, Amarillo, Texas.

**INVENTORS!** Have you good patentable ideas? Write Patent Agent Metzler, 11 West 42nd, New York.

**"INVENTOR'S Guide"** free on request. Frank Ledermann, Registered Patent Attorney, 154 Nassau St., New York 7, N. Y.

**INVENTORS:** Learn how to protect your invention. Unless the inventor is familiar with patent matters, he should engage a competent registered patent attorney or agent to represent him. We are registered to practise before the U. S. Patent Office and prepared to serve you in handling your patent matters. "Patent Guide for the Inventor" containing detailed information concerning patent protection and procedure with "Record of Invention" form will be forwarded to you upon request—without obligation. Clarence A. O'Brien & Harvey Jacobson, Registered Patent Attorneys, 81A-G District National Building, Washington, D. C.

**INVENTORS:** If you have an invention for sale, patented or unpatented, write Institute of American Inventors, Dept. 40A, 1926 Eye St. N.W., Washington 6, D. C.

**INVENTORS:** Without obligation, write for information explaining the steps you should take to secure a patent on your invention. John N. Randolph, Registered Patent Attorney, 202 Columbia Bldg., Washington 1, D. C.

**I SELL Patents.** Established in 1900. Charles A. Scott, 773PM Garson Ave., Rochester, N. Y.

**INVENTORS:** The usual first step is to have a search of the U. S. Patents conducted, so I can report on patentability. Write, without obligation, Patrick D. Beavers (Formerly Randolph & Beavers), Registered Patent Atty., 935 Columbia Bldg., Washington 1, D. C.

**CASH For your idea.** 280 manufacturers need inventions, patented or unpatented. List free. Invention Bureau, 208M Clinton, Oak Park, Illinois.

**INVENTORS—**This firm is registered to practice before the U. S. Patent Office and is available to assist inventors in the preparation and prosecution of their cases. "Patent Protection for Inventors" booklet containing detailed information and steps to take toward patent protection will be sent upon request. No obligation. Victor J. Evans & Co., 332-K Merlin Building, Washington 6, D. C.

**INVENTORS—**Patent laws encourage the development of inventions. Our firm is registered to practice before the U. S. Patent Office. Write for further particulars as to patent protection and procedure and "Invention Record" form at once. No obligation. McMorrows, Berman & Davidson, Registered Patent Attorneys, 134-L Victor Building, Washington 1, D. C.

**READ Safest, surest methods** for greatest possible royalties, in "Inventors' Business Manual." Information free. Ric-Craft, Dept. M, Box 1466, Tampa, Florida.

**PATENT Searches:** reliable, efficient, air-mail service; \$6.00. Write for free invention protection form. Patent Research Service, 703P Albee Bldg., Washington 5, D. C.

**RELIABLE Patent and trade-mark searches** made in U. S. Patent Office \$6.00. Invention protection forms with Certificate of Search free. Write Raymond L. Smith, Patent Searcher, 410-M Bond Building, Washington 5, D. C. (Formerly with U. S. Patent Office.)

**LITTLE Library of Useful Information.** 102 different books. Catalog free. Popular Mechanics Press, 200 E. Ontario St., Chicago 11, Ill.

### INVENTIONS WANTED

**WE Sell patents.** Submit details. Universal Guaranty Company, Lakewood, New York.

**INVENTORS—**What have you, patented, patent pending for manufacturers? Submit details, or request free booklet and information. Direct Contacts, 11106-A2 Longwood, Chicago 43.

**HIGHEST Royalties—Cash.** Official U. S. I. R. C. certified service. Request free booklet "M." Universal Marketing Co., 126 Lexington Avenue, New York 16, N. Y.

**CASH For your idea.** 280 manufacturers need inventions, patented or unpatented. List free. Invention Bureau, 208M Clinton, Oak Park, Illinois.

**INVENTORS:** Hundreds of manufacturers have requested our assistance in locating marketable new products. Complete information, free. Institute of American Inventors, Dept. 40-D, 1926-Eye St. N.W., Washington 6, D. C.

**SMALL Inventions** wanted by manufacturers. I'll help you sell your invention. Write for circular. Stanley Hull, 7829 Euclid, Cleveland, Ohio.

**INVENTIONS Wanted.** Patented or pending only. Inventors' Exchange-B, Hartford 1, Conn.

### PATENTS FOR SALE

**DRY Shave mechanical razor,** royalty basis. Shave anywhere. No wiring, blade changing, batteries or springs to wind. Professionally styled for plastics and low cost production. Enormous sales potentialities. Patents pending. Warren Vert, 4940 Lindenwood, St. Louis 9, Mo.

**PATENT 2405907** For new designed streamlined triple airplane, seaplane and glider device. The invention itself adapts to large plane construction, as well as small sample type plastics engineering. Herman Schmitt, R. 2, Sheboygan, Wis.

**NEW Kind of nut lock washer** for wood, plastic and metal. Patent No. 2,245,231. G. T. Sheley, 776 N. Warman Ave., Indianapolis, Ind.

**PENDING:** Novel spring cord reel for ironing. Other uses. Simple hookups. Mendelsohn, 275 Ocean Ave., Brooklyn 25, N. Y.

**PENDING —** Self-locking clothespin. Simple construction. Werner, Milner, Colorado.

**\$500.00. PREVENT** Inadvertent self-sealing of envelopes. #2,420,963. Samples. Inventor. Malo, 4550-M Foster, Chicago 30.

**FOR Sale—**New type auto sho-lite, nut and bolt holder, screwdriver assister, auto door panel clips or fasteners, screwless and nailless curtain rod and bracket, new type curtain rod (bracket), door panel tool to remove cranks and handles, new type daveno. Wm. H. McCartney, 1610 Trade St., Salem, Oregon.

**PATENT Pending toy.** Rights for sale, "rack pool" board game and "up and in" bowling game. Both children's skillful and educational games. Harvey M. Westcott, So. Westport, Mass.

**INVENTORS:** Test the commercial value of your patented or unpatented inventions, quickly and inexpensively. Write for free information. Institute of American Inventors, Dept. 40-B, 1926-Eye St. N.W., Washington 6, D. C.

### MANUFACTURING

**COMPLETE Design, model, light manufacturing facilities.** Jones Sporting Goods Manufacturing Co., Banning, Calif.

**EXPERIMENTAL Work, models.** Reasonable. Nelson Manufacturing, 948 First, Woodburn, Oregon.

**PLANT Layout, architectural, home and factory.** Let us bid on your requirements. P.O. Box 202, Monroe, Michigan.

**WOLVERINE Stool** for barbers \$26.75. F.O.B. Monroe, Michigan. Send for literature. Discounts. P.O. Box 202, Monroe, Michigan, Wolverine Mfg. Company.

**MODELS.** Tools, dies, experimental work; large and small lot manufacturing. Van-Ess Specialties Company, 212 W. 14th Street, Covington, Ky.

**MODELS —** Small lot manufacturing. Metals, plastics, etc. Milburn, Burlington, Kentucky.

**PRECISION Dies, molds, experimental.** Special machines. Booklet. Arizona Tool & Die, 31 Rillito, Tucson.

**PERMANENT Moulds** for plastics, aluminum castings. Send drawings. Unamit Mould & Machine Company, Bunker Hill, Ill.

**SMALL Lot production** wanted. Aluminum castings; stampings; screw machine; plastics. J and M Company, Burlington, Kentucky.

### MODELS, MODEL SUPPLIES

**CHUTE-SENDER** Carries parachute up kite string; releases chute; returns for reloading. Easy to make. Send \$1.00 for drawing. Manning Gibbs, 29 S. Duke, York, Penna.

**STEAM Engines, boilers, castings.** Catalog 25c. Anton Bohaboy, 2297 Price, Rahway, New Jersey.

**MINIATURE Steam locomotives,** 1/4", 1/2", 3/4" scales. Castings, parts, rail, steam fittings! Thorough drawings with instructions. Catalog 25c. Little Engines, Wilmington, Calif.

**BRASS Gears and model supplies** for the inventors. Send 10c for catalog. Pierce Model Works, Tinley Park, Ill.

**SHIP And yacht model fittings;** blueprints. Send 25c for illustrated catalog No. 21—listing hundreds of items. A. J. Fisher, 1002-1 Etowah Ave., Royal Oak, Mich.

**RADIO Control planes.** Complete. Less than \$100.00. 10c please. Hobby Center, 12240 Gratiot, Detroit.

**LANDLOCKED Sailors!** Here's a beautiful, richly illustrated, fully descriptive catalogue of famous model ships—whalers, slavers, corvettes, etc., authentic in every detail. Send for it today. Only 25c. Halesite Yacht Service, Inc., Halesite, Huntington, N. Y.

**FUN Building models—**Airplanes, trains, ships. Everything furnished. Giant catalog 10c. Ben's Hobby Shop, 72 West Washington, Chicago 2, Illinois.

**SHIP Models and yacht supplies** complete. Large 64 page catalogue 30c. Bill Wild's, 510 East 11 St., New York City 9.

**HISTORIC Alaskan totem poles—**Complete kit makes 3 entirely different 6" models. Only \$1.95. Gale, 1233 S. Wabash, Chicago.

**MODEL Railroads** exclusively—Complete stock scale; Lionel, American Flyer. Send for catalog, 15c, state gauge. Eric Fuchs, 26 Tremont Street, Boston 8, Mass.

**POWER Models—**Steam and gasoline engines, steam traction engine, metals, tools. Catalog 35c. Chas. Cole, Ventura, Calif.

**BUILD Historic ship models,** complete kits 39c to \$8.50; send 10c for catalog. Ideal Models, 19 West 18th Street, New York 11, N. Y.

**DOWMETAL Magnesium** for the model maker now available in rods, bars, sheets, and scale structural shapes. Write for prices. F. C. Perry, P.O. Box #3951 Strathmore Station, Detroit, Mich.

**AIRPLANE Supplies,** balsa, accessories, list 3c. Imperial, River Edge, N. J.

### HOME CRAFTSMEN

**TORTOISE Shell** makes beautiful custom jewelry. Bracelet, earrings and pin blanks. All 4 \$1.00 unpolished. Sam Patchett, 5053 Cristobal, Canal Zone.

**125 TOY Plans.** Send 10c for illustrated catalog. Continental Homecrafters, 907 Birch, Eau Claire 3, Wisconsin.

**SWISS Music units** \$3.50. Two tunes \$4.50. Kits \$4.75 up. Irving Meyers, 126 Lexington Ave., New York 16, N. Y.

**LEATHER,** Retail, mail orders, catalog, tools, lacing, supplies. National Handicraft Co., 30 Frankfort St., New York City 7.

**LEATHERCRAFT—**Silversmith. Tools, dies, engravers. Made to order. Belt toppers, billfolds, key cases. Louis Jones, 1405 Throckmorton, Ft. Worth, Texas.

**PLASTIC Jewelry supplies.** Free catalog. J & M Novelties, Box 464P, Griffith, Indiana.

**KNOCKDOWN Cedar chests.** Lumber and veneers. Free price list. Giles & Kendall Company, Huntsville, Ala.

**LEATHERCRAFT!** Complete stocks of leathers, tools, supplies. Immediate shipment. Free catalog. Kit Kraft, 3203 W. Washington Blvd., Los Angeles 16, California.

**CERAMIC Jewelry supplies,** bar pins, ear screws, for ceramic and woodworkers; also glass and seashell assemblers. Free catalog. Philadelphia Badge Co., Dept. B-1, 1007 Filbert St., Philadelphia, Penna.

**LEATHERCRAFTERS:** Belt kits, projects, leather, supplies. Free catalog. Art Leather, 411 Joseph Ave., Rochester 5, N. Y.



**COPPER** And brass materials. Complete line for craftsmen and workshops. Catalog A free. Groundmaster Company, Boulder, Colorado.

**SHELLS**, Plastics, findings. Lowest prices. Free catalog. Frances Jones, Box 251, Sarasota, Fla.

**SEMI-FINISHED** Cowboy buckle sets, rings, etc., in silver. Will cast 10 or 10,000 items in gold or silver from your model or drawing. Free circular. Southwestern. Box 3506, Station A, El Paso, Texas.

**SHELLS**, Plastics, findings. Beginner's kit \$3.00. Free catalog. Stelle's, Route 1, Box 69X, Orlando, Florida.

**SEA Shells**. Interested in making shell jewelry, lamps, novelties. We have all supplies at wholesale. Write for price list. Sea Shells, 269 W. Flagler Street, Miami, Fla.

**BIG Profits** from small bits of wood. Write—Dollhouse Novelties, 19 Baker Street, Saugus, Massachusetts.

**SHELLCRAFT** Jewelry kit \$1.69 postpaid. Free instructions, catalogue. Shell-Art Novelty, Fifth and Moore, Philadelphia 48, Penna.

**LEATHERCRAFT** Supply catalog free. Art Craft Supply, 1205 Throckmorton, Fort Worth, Texas.

**SHELL** Jewelry supplies. Wholesale only. McFarland Plastic Co., Sarasota, Fla.

**LAWN** Chairs, garden figures, furniture, novelties, toys, etc. 68 popular plans with full size patterns, \$1.00. Mastercraft 9M, 7041 Olcott, Chicago 31, Ill.

**SHELLCRAFTERS**. Write for catalog. Tropicrafts, P.O. Box 1951-P, Fort Myers, Florida.

**LEATHERCRAFT** Kits. Stamp for catalog. Roy's Leathercraft, 2539 Devon, Chicago 45.

**LEATHERCRAFT** Catalogue and textbook. America's finest. The leatherworker's bible. Mail postcard for details. Artcraft Leather, Dept. PM-9, 271 Twelfth St., Oakland 7, California.

**BEAUTIFUL** Texas ebony. Large piece, \$1. Sample, dime. Particulars, stamp. Many other hardwoods. StarCraft (1), Edinburg, Texas.

**METALLIZE** Wax candles resembling plated gold, copper, silver; decorate with colored flowers; beautiful for Xmas, anniversary presents; secret process; low cost; illustrated circular free. Candlecraft, 716 39th Ave., Seattle 22, Wash.

**LEATHER** Designs; carving, tooling. All new! Patterns and instructions for making many articles. \$1.00. Lampkin Artcrafts, Box 641-M, Culver City, Calif.

**SPECIAL Offer**: 80 full size toy, novelty, and lawn ornament patterns only \$1.00 postpaid. Lynds, Box 193D, Medway, Mass.

**FREE** Price list, instructions, with 2 sample packages different colored flock for 25c. A & M Crafts, 672-C East 91 Street, Brooklyn 12, New York.

**MAKE** Your own jewelry; all types of findings, metal and plastic; cameos, beads, shell kits, illustr. catalog 20c. Hobby Art, POB 276, Dept. 7, New York 18, New York.

**SHELLCRAFT**—Create attractive jewelry from shells. Instruction book free or send \$1 for 450 Caribbean shells and findings to make \$6 worth. Shell Company, Miami 36, Florida.

### MAKE IT YOURSELF

**MODERN** Built-in furniture at fabulous savings. Free literature. Wood Market, 3M North Street, Mount Vernon, N. Y.

**THOSE** Who work nights, trouble sleeping days. For \$1.00 I will send you description my invention to keep out light and at same time give ventilation. Money back if not satisfied. Can be easily made. Roscoe Trueworthy, 2A White Rock, Gorham, Maine.

**"CONCRETE** Block homes." 32 page booklet: drawings, instructions on how to build. \$1.00. H. C. Lightfoot, Civil Engineer, Richboro 1, Penna.

**BUILD** Charming two bedroom home yourself. Save one-half. Eligible for loan. Simple, economical methods are detailed for you on full size patterns. Write. Pattern Plan, 372 E. Orme, Phoenix, Arizona.

**ZEOLITE** Home water softener. Plans for building your own \$1. Materials available from us. Lake Region Mfg. Co., Inc., 3920-J Lynn Ave., Minneapolis 16, Minn.

**ROUND** Cactus wood for one table lamp. Postpaid \$1.00 or C.O.D., refundable. Natural Desert Displays, Coolidge, Arizona.

**BUILD** Inexpensive, practical concrete block machine. Motor vibrator or hand. Write, Clyde Lee, Dept. A, Mountain View, Okla.

**X** ceptional values. Leisure Craft Kits. Free circular. Everything furnished to make jewelry and other items. Leisure Hour Products, 416 Rose Street, West Hazleton, Penna.

**CONVERT** Range boiler to electric water heater. Element, thermostat, instructions \$9.85. Inemco, Allegan, Mich.

**BUILD** Concrete block machines, portable saw mills, shop, home, farm machines. 183 plans. Catalog-handbook free. Nichols Equipment Co., Dept. 1410, Purvis, Miss.

**HOUSE** Plans, specifications, prepared. Lowest charges. Save 90%! MacDonald Realty, Austin, Texas.

**MAKE** Your own handy lightweight concrete blocks quickly with new block-maker. Circular stamp. Manual 25c. Peerless, New Lenox, Illinois.

### WATCHES, OLD GOLD, JEWELRY

**NATIONALLY** Advertised watch at spectacular savings. New York's leading pawnbroker now offers out-of-towners big bargains in unredeemed wrist watches. Your choice ladies' or men's Bulova, Benrus, Walton, Elgin. Fifteen jewels—\$15.00; 17 jewels—\$19.50. Send check or money order. State first and second choice ladies' or gentlemen's. Every watch guaranteed. Kaskel's, Established 1882, 9 Columbus Avenue, New York City.

**STUN** Your friends with genuine, sparkling, brilliant-white zircons. Cut, polished, mounted just like diamonds. Amazing diamond-like appearance. Top-quality. Hard for even experts to tell the difference. Beautiful settings 14K gold. Over 100 gorgeous latest-style rings to choose from. Attractive low prices. Send for big free catalog. U. S. Zircon Syndicate, 139 N. Clark, Dept. 15, Chicago 2.

**WATCHMAKERS**, Beginners: watches; movements. Price list! Box 1874, Chicago 90, Ill.

**WATCHMAKERS'** Journal contains helpful hints on watch repairing. Sample copy 15c. Dean Co., 116 Nassau St., New York 7, N. Y.

**ASSEMBLE** Rhinestone, pearl jewelry. Instructions 10c. Herber, 1360-A Hicks, New York 67.

**"KEEPOCKET"** Holds everything in your pocket at any body position. Work, sport or dress clothing. Mechanics, shop and office workers. Attractive appearance. Sample 25c. State Line Service, Inc., Unionville, N. Y.

**HIGHEST** Cash for old, broken jewelry. Mail gold teeth, watches, rings, silverware, diamonds, spectacles. Satisfaction guaranteed. Free information. Rose Smelting Co., 29-A East Madison, Chicago.

### TOBACCO, SMOKERS' SUPPLIES

**SECONDS** \$5.00 Pipes 65c. Pipemaking kit. \$1.00. Free literature. Carvape, 2829-G Dixie, Hamilton, Ohio.

**BEAUTIFULLY** Handmade imported pipes from Czechoslovakia. Collectors, smokers write for free folder now. Adolf Nosek, Importer, 4927 34th St., San Diego 4, Calif.

**MAKE** Smoking pipes, briar blocks and stems. Send for circular. Michelson & Sternberg, 23 West 47th Street, New York 19.

**PIPE** Smokers dream. Pipe that never clogs. Assures sweet, dry, mellow smoke. Genuine imported briar; gives real smoking enjoyment. Unconditionally guaranteed. Particulars free. Bunnell Pipes, 1661-A Elm Street, Stratford, Conn.

### FOR SALE — MISCELLANEOUS

**PAINT**. White house paint, for wagon jobbers, auctioneers and house to house men only; 95c gallon in 5-gallon cans; single gallons \$1.00. Surplus black enamel 75c gallon. Minimum order 50 gallons. FOB Kansas City. Mail check or money order for immediate shipment. No correspondence. Trading Post, 2104 Burlington, North Kansas City, Mo.

**BARGAIN** In used clothing. Free family catalog. Globe Mail Order Co., Dept. C, 372 Thatford Ave., Brooklyn 12, N. Y.

**TRADE**—Anything you have for something you want! No buying; no selling! Write Trader-Hollywood, Box 3070, Hollywood 28, Calif.

**HULL** Automobile compass, value \$4.95, brand new, \$2.50. Prisms for 6x30 or 8x30 binoculars, brand new, \$1.50 each. Offset prisms to be attached to 7x50 B & L binoculars, gives double the field of the ordinary 7x50 binocular. Cost \$98.00, special \$25.00. Green sunshades for binoculars, size 6x30 and 7x50, snap on type, value \$7.50, special \$1.25 per pair. Forward money order. No c.o.d. shipments. Send 25c for catalog of new and used guns, ammunition, binoculars and powder flasks. Public Sport Shops, 11 S. 16th Street, Philadelphia, Penna.

### FOR THE HOME

**SEWING** Machines motorized complete \$15.00. Gropman, Box 187, Staten Island, New York.

**UNDERWRITERS** Approved floor safes, invisible when installed. Replaces safe deposit box for valuables, sent anywhere in U. S. \$65.00. Gary Safe Co., 530 Stanford Ave., Los Angeles 13, Calif.

### WANTED—MISCELLANEOUS

**CASH** Paid for home workshop products. Details free. Home Workshop Sales Bureau, Dept. M-1, Farnsworth, Great Lakes, Ill.

**SEWING** Machines and adding machines. Dowd, 2021 Pecan, San Angelo, Texas.

**METEORITES** Wanted, iron or stone. Highest prices. Stuart Perry, Adrian, Mich.

**ANYTHING** Of value. Robert, 207 North Fifth Street, Springfield, Illinois.

**QUICKSILVER** (Mercury) urgently needed! Immediate payment. Wholesale Terminal, Norwood, Massachusetts.

### PERSONAL

**BALDNESS**—Can it be prevented? Restore health to your scalp. Give your hair a chance to grow. Free booklet. Vanguard Reports, 3009-M Military Road, Washington 15, D. C.

**HOLLYWOOD**. Los Angeles, remail service. 25c per letter. Shockey, 1638 LeMoyne, Los Angeles 26, Calif.

**MEXICAN** Law. General Practice Attorney, 1203 Arizona Street, El Paso, Texas.

**SWAPPERS!** Traders! Trade anything. Information: "Swappers" Gazette-PM, Louisville 12, Kentucky.

**HOW** You can find out! Information discreetly developed, any matter, person, problem, anywhere. Personal-business assignments, representations undertaken. Nation-wide. Officially licensed, bonded service established 1922. Reasonable. Confidential. William Herman, 170 Broadway, New York.

**HAIR** Falling? Dandruff? Write Trichologist, 137 Lewis St., Phillipsburg, N. J.

**RUPTURED?** Positive comfort, no understraps, no steel, no elastic. Write Smith Manufacturing Company, Preston, Ontario.

### MISCELLANEOUS

**WHEELS** Semi-pneumatic ball bearing 8x1.75 \$1.65, 8x2 \$1.76, 10x1.75 \$1.92, 10x2 \$2.08— $\frac{1}{2}$ " 10x2.75 \$4.63— $\frac{3}{8}$ ". C.O.D. plus postage. Wheel House, 4439 W. State St., Milwaukee 8, Wis.

**REPLICA** Of ancient fire-making device 25c. Greider Products, Springfield, O.

**WALLET** Photos, cards, preserved in plastic. 25c each. Quick service. Dura-Seal, Box 1384, Baltimore 3, Md.

**ATTENTION** Clubs and teams. 6-inch chenille letters for sport jackets, sweaters. \$1.00. No C.O.D. Give colors. Box 154, Passaic, N. J.

**NEW**. No more touching hamburgers by hand. Production item. \$1.00. Lee, 50 South Riverside, Waterbury, Conn.

**PERSONALIZED** Pencils—Individual or firm name. Dozen 60c, gross \$4.80. Cash delivered. Pencil Market, 611 15th St., Knoxville 16, Tenn.

**LOCK** Together  $\frac{1}{4}$ " plywood toys, high-chair, cradle, hangar, garage. No nails, screws or glue. 4 patterns \$1.00. Wm. Longstreet, 1474 Newman Ave., Lakewood 7, Ohio.

**BIRD** Baths, pots, urns, benches, pipe, made at home! We sell forms. Concrete Machinery, Hickory 4, N. C.

**CELLOPHANE** Tape. Bargain. Send \$1 for 5000 inches. Bartman, 39 Alabama Ave., Brooklyn 7, N. Y.

**JUMPING** Beans—100 \$1, 500 \$3.50, 1000 \$6. Mexican Products Co., 126 N. Main, Tulsa 3, Okla.



**BLACK** And white cameo brooch and earring set, hand-made \$4.95. Western Trade Winds, Farmington, Illinois.

**STARTLING** Revelations! Read "Prophetic Years 1947-1953." Free literature. Progress Company, 4033 Chowen, Minneapolis 10, Minn.

**CALENDAR** Covers years 1500 through 2300, 25c. Brown, 7818B Hampson, New Orleans, La.

**SQUARE** Dance instructions. Calls, 25 sets, \$1.00. Rayburn, Eureka Springs, Arkansas.

U. S. Surplus clothing, men's, women's. Amazing bargains. Free catalog. N. Y. Clothing Co., 2079A-Second Ave., New York 29.

"INTERESTING Mails,"—25c will keep your mail box full for three months. Bentz, Jr., Chatawa 48, Mississippi.

**STOP** Foot torture with Kindschi Foot Balancers. Thousands have gained instant foot relief. Money back guarantee. Write for free trial offer. Kindschi Foot Appliances, Dept. A7, 321 W. Jefferson, Dallas 8, Texas.

"DID Moses Write Pentateuch?" 10c. Christian Evidence League, Malverne, N. Y.

**GOLD** Bond blue black ink powder, guaranteed: waterproof, etc. Makes 4 ozs., 10c. Celester Bibbs, 2233 Eastern Ave., Indianapolis, Ind.

**THRIFTEE-FIX**—Mends most anything. Save over \$10.00 repair bills. 25c. Circular free. Celester Bibbs, 2233 Eastern Ave., Indianapolis, Ind.

**LET'S** Swap neckties! Send us 2 to 6 and \$1.00. Receive same number different, handsomely cleaned. Collegiate Tie Exchange, Box 84, Friley, Ames, Iowa.

**FREE**—Assortment photographs of typical Mexico, Aztec Indians, pyramids, scenery. Send 15 cents postage stamps, mailing cost. "Ahora," Apartado 2807M, Mexico City.

**PANNING** Gold—Free instruction booklet. Catalogue mining books; supplies. Old Prospector, B146, Dutch Flat, Calif.

**SPECIFICATION** And prints of permanent magnet motor, \$10.00; plus right to make model. Illustrating literature ten cents. George J. Altman, 150 Broadway, New York 7.

**CESSPOOL** Trouble cured by the new Septic Bend Co., Rockland, Mass.

"HOW To Win Prize Contests." Amazing booklet \$1.00. Box 28EM, Jackson Heights, New York.

**MEDICAL** Laboratory technicians in great demand. We train you in your own home, in your spare time. Also home study course in general chemistry. Free catalogue. Imperial Technical Institute, Box 973-J, Austin, Texas.

**TATTOOING** Machines, outfits. Free catalogue. Jensen, 120 West 83rd Street, Los Angeles 3.

**LUCITE** Bar, name pin, safety clasp. Price \$2.00. Made to order. Nightingale Pin Co., P. O. Box 1772, West Palm Beach, Florida.

"RECEIVE Mail." Moneymaking offers, opportunities, catalogs. Name listed 10c. Ideal Service, 100. Park Ridge, Ill.

**TREASURE** Finders! Goldak's new 11 pound lightweight, gold, silver and mineral locator, money-back guaranteed superior any other device. Free information. The Goldak Co., 1542 West Glenoaks Blvd., Glendale 1, Calif.

**M-SCOPE** Metal, mineral locators sensational new electronic lightweight models, immediate shipment. Fisher Research Laboratory, Inc., manufactures some of the finest metal locators for the U. S. Army. Built for Arctic, Tropic use. Unsurpassed efficiency, low prices. Time-payment plan available. Send for free 16-page illustrated booklet. Fisher Research Laboratory, Inc., Palo Alto, Calif.

**TATTOOING** Outfits, supplies. Illustrated list free. Zeis, 728 Lesley, Rockford, Illinois.

**70 BIBLE** Lessons, 25c. Bulletin, Box 87, Cathedral Station, New York 25.

**NOW** Ready: New, amazing Classified Advertising Record Book—prepared especially for classified advertisers. Here is a book that tells you instantly whether or not your advertising in any publication is paying you real results. You can tell immediately how many inquiries each publication produced—how much cash received from every ad. Spaces are provided for the name and address of the publication, date of issue, space used, rate, cost of ad, key number, etc. You have a complete record of each publication right before your eyes. Plenty of space to keep accurate record of 28 separate publications. You can have a copy by sending only 10c to cover postage and handling. Send for your copy now. W. F. Johnson, Classified Adv. Mgr., Popular Mechanics Magazine, 200 E. Ontario Street, Chicago 11, Illinois.

## LEARN WATCH MAKING



**JEWELRY REPAIR**  
*Engraving*  
**G. I. APPROVED**

Prepare NOW! Our Master Course covers everything needed for high-salaried positions in Jewelry Field. Latest equipment makes learning a pleasure. High percentage of graduates successfully placed. Housing available. (Schools in Warren, O. and P'gh, Pa.) Catalog FREE.

**A. W. THACKER ACADEMY FOR JEWELERS**  
Dept. P • 423 Federal St. • Pittsburgh 12, Penna.

## LEARN TO WRITE

*a Good Hand!*

**FOR BUSINESS AND SOCIAL SUCCESS!**

Easy to improve your handwriting at home quickly with my new instruction books just off the press. Master all the secrets of better penmanship. Simple and easy, fully illustrated, highly endorsed. Begin today. Write for:  New Free Book, "How to Become a Good Penman," or check books wanted, \$1.00 each.  Business Writing  Artistic Writing  Card Writing  Engraving Alphabets  Bird and Dasher Flourishing  Complete Set \$4.50  Enclose 10c for your name beautifully written and special penpoint for shaded writing. S. A. Ziller, President, TAMMELYN SCHOOL OF PENMANSHIP, 441 Ridge Bldg. In Business Over 52 Years Kansas City, Mo., U.S.A.

## TRI-STATE COLLEGE

B. S. Degree in 27 months in Civil, Electrical, Mechanical, Chemical, Aeronautical, Radio Engineering; Bus. Admin., Acc't and Sec. Science. Graduates successful. 65th year. Enter Sept., Jan., March. June. Catalog. 498 College Ave., Angola, Ind.

SAY YOU SAW IT IN POPULAR MECHANICS



## Bar Bells

Buy Direct From Factory  
Write for free booklet and price list **\$8.95 up**

**INDEPENDENT IRON WORKS**  
2416 East 23rd Street, Dept. B  
Los Angeles 11, Calif.

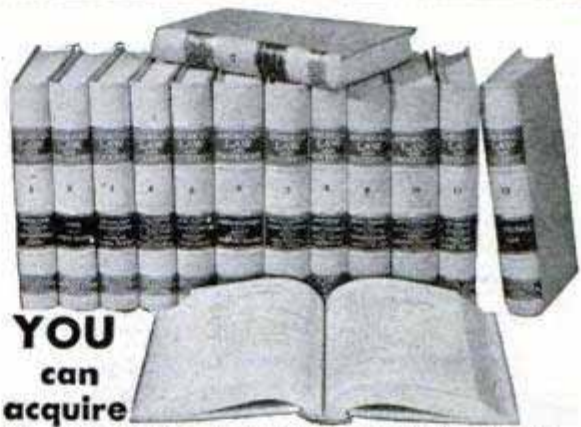

**YOU**  
can  
acquire

## LAW NIGHTS AT HOME!

**L. L. B. DEGREE**

LaSalle's famous Law Library—used as reference in many Law libraries and Law offices—has enabled thousands to master Law surprisingly fast, in spare hours at home, for business and professional advancement.

These 14 remarkable volumes, compiled by leading professors and lawyers, cover the whole basic field of Law in condensed, orderly, simplified manner.

You advance rapidly with this great library, plus special lectures furnished. We guide you step-by-step with personalized Problem Method of instruction . . . you learn by doing—handling legal problems—not by memorizing rules.

Send for two FREE 48-page booklets, "Law Training for Leadership," and "Evidence," answering questions about Law and its value to you, and telling how LaSalle Law graduates are winning rapid advancement in business and public life. Mail coupon below. No obligation.

### LA SALLE EXTENSION UNIVERSITY

*A Correspondence Institution*

417 S. Dearborn St. Dept. 964-L Chicago 5, ILL.

Send me your two FREE booklets described above, without obligation.

Name.....Age.....

Street.....

City, Zone & State.....



Prepare at  
**P. I. A.** for **Big**  
**Opportunities**  
in Aviation

MAIL COUPON FOR COMPLETE INFORMATION  
INCLUDING STARTING DATES OF CLASSES

**PITTSBURGH INSTITUTE OF AERONAUTICS—Dept. C**  
Aviation Bldg., 100 Seventh St., Pgh., Pa.

Name ..... Age.....

Address .....

City ..... State.....

- Aircraft & Engine Mechanics (A & E)       Non-Veteran  
 Aircraft Instruments                               Veteran  
 Aeronautical Drafting & Design  
 Aviation Secretarial & Airline Reservations



MULTI-MILLION DOLLAR EQUIPPED AND GOVERNMENT-APPROVED  
SCHOOL WITH FACILITIES AT THE AVIATION BLDG. IN DOWNTOWN  
PITTSBURGH AND ALSO AT ALLEGHENY COUNTY MUNICIPAL AIRPORT.

Today, more than ever before, America and the whole world is  
AIR CONSCIOUS. A real opportunity in Aviation key positions  
await **TRAINED MEN AND WOMEN**. Advance rapidly into well-  
paid jobs—grasp this great OPPORTUNITY while it offers most.

DAY AND EVENING CLASSES • **G. I. Approved**



**T. B. LYONS, President**  
B.S., M.A., Ph.D.

Dr. T. B. Lyons, President and  
Treasurer, has had wide experi-  
ence in school administration and  
aviation. He was for many years  
connected with the Pittsburgh  
Board of Education, and was Gen-  
eral Manager of the Graham Avia-  
tion Co. which operated a Primary  
Training School for the U. S. Army  
Air Forces at Souther Field, Ga.  
Dr. Lyons is a graduate of Lock  
Haven State Teachers College and  
the University of Pittsburgh and is  
listed in WHO'S WHO in American  
Education. He assumed his duties  
at P. I. A. Dec. 1, 1944.



**PITTSBURGH INSTITUTE OF AERONAUTICS**

AVIATION BUILDING, 100 SEVENTH STREET, PITTSBURGH 22, PENNSYLVANIA — ATLANTIC 0800  
FOUNDED 1929

**9 BIG BUILDING BOOKS**

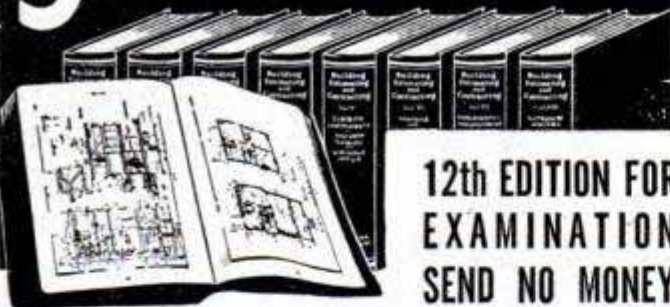

**12th EDITION FOR  
EXAMINATION  
SEND NO MONEY**

Learn to draw plans, estimate, be a live-wire builder, do remodel-  
ing, contracting. These 9 practical, profusely illustrated books  
cover subjects that will help you to get more work and make  
more money. Masonry, concrete forms, carpentry, steel square,  
roof framing, construction, plumbing, heating, painting, deco-  
rating and many other subjects. More than 4000 pages — 2750  
illustrations.

**BETTER JOBS — BETTER PAY UP-TO-DATE  
EDITION**

A nationwide building boom is in full swing  
and trained men are needed. Big opportunities  
are always for **MEN WHO KNOW HOW**. These  
books supply quick, easily understood training  
and handy, permanent reference information  
that helps solve building problems.

These books are  
the most up-to-  
date and complete  
we have ever pub-  
lished on these  
many subjects.

**Coupon Brings Nine Big Books for Examination**

**AMERICAN TECHNICAL SOCIETY—Publishers since 1898**  
Dept. G-619 Drexel at 58th Street Chicago 37, Ill.

You may ship me the Up-to-Date edition of your nine big books,  
"Building, Estimating and Contracting," without any obligation to  
buy. I will pay the delivery charges only, and if fully satisfied in ten  
days, I will send you \$2.00, and after that only \$3.00 a month, until  
the total price of only \$34.80 is paid. I am not obligated in any way  
unless I keep the books.

Name.....

Address.....

City..... State.....

Please attach a letter stating your age, occupation, employer's name  
and address, and name and address of at least one business man as a  
reference. Men in service, also please give home address.

**SPEECH DEFECTS**

... overcome in the privacy  
of your own home!

Your money back if our system  
fails to correct your *stuttering,*  
*stammering, lispings.*

Send for this **FREE** booklet today ➔

It contains a valuable Analy-  
sis Chart and all details.



**VOCALON Institute**

264 W. 40th St., New York 18, N. Y.

**INVENTING**

—**FOR PROFIT!** If you have an inventive turn of mind,  
write for free 28-page booklet explaining  
how the Institute of American Inventors  
is helping inventors pre-test the profit  
possibilities of proposed devices to fill today's unprece-  
dented demand for useful new inventions.

**INSTITUTE OF AMERICAN INVENTORS**

Dept. 4, 1926 Eye St., NW, Washington 6, D. C.

**Profit with LARSON Leathercraft**

Make as gifts—or to sell—practical leather items.  
Complete stock of leathers, tools and accessories. No  
experience necessary. Instructions with materials. Send  
ten cents for new catalog of 101 money-making ideas.

**J. C. LARSON COMPANY**  
824 S. Tripp Ave. Chicago 24, Illinois



Plan for a **TOP PAY Job-Learn**

# DRAFTING

Practical, Modern  
Home-Training Plan

Drafting Outfit and  
Slide Projector Included  
at **NO Extra Cost**



Cut Out  
Mail  
Coupon  
for  
**FREE**  
Lesson

Here is a modern, practical way to learn DRAFTING right in your own home. You are furnished all the instruments and supplies you need to actually do the assignments, and the entire Drafting Outfit is included at no extra cost. You receive a fine projector together with a set of slides—one of the important modern training helps to make your progress more rapid.

Almost  
Everything  
Starts  
on the  
Drafting  
Board

**Visual Aid Instructions Help  
You Learn Quickly, Easily**

Lessons are written simply, clearly—there is a wealth of illustrations. Your supplies include drafting board, triangles, T-square, drafting instruments. Draftsmen have key jobs in industry—many executives advanced to top key positions with aid of a knowledge of Drafting. C.T.I. offers you many valuable advantages including **PLACEMENT and CONSULTATION SERVICES**. Find out now about this up-to-date C.T.I. training program in Drafting. Mail coupon for full information and **FREE Lesson**. No obligation. (OTHER SHOP AND HOME TRAINING COURSES OFFERED BY NATIONALLY KNOWN C.T.I. ARE ALSO LISTED IN THE COUPON.)



HOME OF  
C.T.I.



**VETERANS**  
Just mail coupon — we will handle all details.

**NON-VETERANS**  
Don't let the lack of ready cash prevent you from taking this training now. Investigate our low Easy-Payment Plan and our Pay-After-Graduation Plan.

**Commercial Trades Institute, Dept. J2-9**  
1400 W. Greenleaf, Chicago 26, Ill.

**Fill Out, Cut Out, Mail Today**

**FACTS FREE FOR MEN WHO WANT TO GET AHEAD**

**COMMERCIAL TRADES INSTITUTE, Dept. J2-9**  
1400 W. Greenleaf, Chicago 26, Ill.

Send free illustrated Brochures and other information about the field I have checked below.

- |   |                                      |                                     |
|---|--------------------------------------|-------------------------------------|
| <input type="checkbox"/> Refrigeration and Air Conditioning | <input type="checkbox"/> DRAFTING    | <input type="checkbox"/> Building   |
| <input type="checkbox"/> Automotive Mechanics               | <input type="checkbox"/> Electricity | <input type="checkbox"/> Diesel     |
| <input type="checkbox"/> Body & Fender Repairing            | <input type="checkbox"/> Radio       | <input type="checkbox"/> Television |

Name \_\_\_\_\_

Address \_\_\_\_\_

City \_\_\_\_\_ State \_\_\_\_\_

Veteran  Non-Veteran

**FREE** — IMPORTANT INFORMATION  
Telling **HOW TO GET STARTED**  
IN ONE OF THESE GREAT FIELDS



# HIGH PAY JOBS FOR MEN WHO QUALIFY IN DIESEL

**ASSURE YOUR FUTURE.** Steady, big pay jobs await men qualified in Diesel, Tractor and Heavy Equipment. Can you take advantage of Diesel job and advancement opportunities in this fast-growing field?

## COMPLETE DIESEL COURSE AVAILABLE

If you are ambitious and want to get ahead in this lucrative field, you'll want to know about the complete training in Diesel provided by Interstate. Trains you at home in spare time. Does not interfere with your present job. Covers all phases of operation. Up to the minute. Revised regularly to cover new developments. Free placement advisory service.

## YOU OWE IT TO YOURSELF

to investigate I.T.S. home Diesel training. Thousands of students agree it has helped them to better jobs... better pay. It can do the same for you!

## SEND FOR FREE BOOK TODAY!

We'll gladly send you our big 24-page book "Getting Ahead In Diesel" FREE! Paste coupon on penny card and mail to



INTERSTATE TRAINING SERVICE  
4035 N. E. Sandy, Portland 13, Ore.

Please see that I receive FREE BOOK "Getting Ahead In Diesel":

Name \_\_\_\_\_ Age \_\_\_\_\_

Address \_\_\_\_\_

City \_\_\_\_\_ Zone \_\_\_\_\_ State \_\_\_\_\_ (13)

**YOU  
can  
draw!**

**AMAZING NEW HOLLYWOOD PLAN**  
Yes, YOU can draw **GIRLS, CARS, FRIENDS** and even **MAGAZINE COVERS**. It's so simple, no matter what your age. Many artists make more than \$150.00 per week in advertising and cartoons. Be your own boss, draw for money anywhere. Our Commercial Art-ists will teach you the secrets from **HOLLYWOOD**. Drawing materials furnished. Be a success. Write NOW for free details



**HOLLYWOOD SCHOOL OF ART**  
DIVISION OF AXELSON STUDIOS

6533 Hollywood Blvd. -  
Hollywood 28, Calif.

Name \_\_\_\_\_

Address \_\_\_\_\_

City \_\_\_\_\_ Zone \_\_\_\_\_ State \_\_\_\_\_

# WANT AS HIGH AS \$3,351 A YEAR?

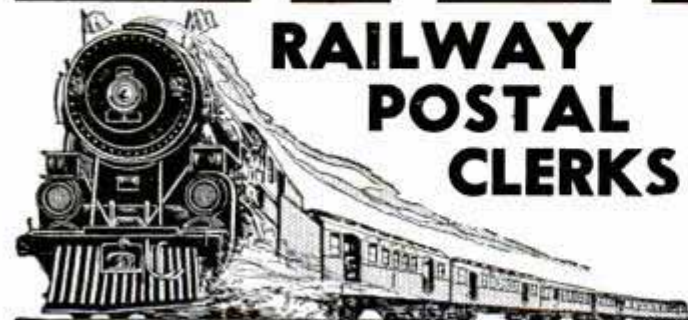

## RAILWAY POSTAL CLERKS

City and Rural Carriers - Postoffice Clerks -  
Inspectors - Accountants - Clerks at Washington  
- Many other Government Jobs



**HERE'S A NEW AND  
VITAL BUSINESS!**

## LEARN ELECTRICAL APPLIANCE REPAIRING

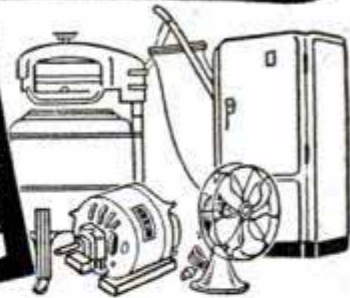

**APPLIANCE REPAIRMEN USUALLY CHARGE ON BASIS  
OF \$5.00 TO \$6.00 PER HOUR**

This fascinating big money making opportunity can be yours if you are mechanically inclined (can hold and use tools). Act Now!

## NO PREVIOUS EXPERIENCE NEEDED!

Think of going to a friend's or your neighbor's home. Picking up and carrying back to your work bench their Sewing Machine, Vacuum Cleaner, Iron, or other appliance. Then using your Christy Course and Christy Electronic Kit to help you locate the trouble and easily repairing the appliance from the clear instructions given. I will help you... by showing you exactly how much PROFIT to charge for each repair job.

## CHRISTY APPLIANCE COURSE AND ELECTRONIC KIT

... SENT TO YOU!

Rush your name and address by the next mail and I will send to you our special form where you can get our complete course and electronic kit on our simple, easy payment plan. Pay me later with your EARNINGS WHILE LEARNING.

Mr. S. T. Christensen, Pres.

**CHRISTY SUPPLY CO.**

2835 N. Central Ave. Dept. D-6103 Chicago 34, Ill.



**CORRESPONDENCE COURSES IN  
RADIO and ELECTRICAL ENGINEERING**

Tuition  
\$25

**ELECTRICAL ENGINEERING.** Get good grasp of wide electrical field. Modern. Very understandable. Theory made easy.  
**RADIO ENGINEERING.** Extra fine course in radio, public address, photo-electric work. Trains you to be super-service man, real vacuum tube technician. Tuition ONLY \$25, either course. Deferred payment plan. Servicemen needed badly.  
**FREE** Write for free copies of school catalogs, student magazines, etc.  
**LINCOLN ENGINEERING SCHOOL, Box 931-P117, Lincoln, Nebr.**

# CHEMISTRY

**LEARN AT HOME...** Chemical knowledge is essential for thousands of good jobs in industry, business, science. IPC enables you to master practical chemistry. It's the ONLY home study chemistry course which enables you to learn by performing actual experiments—using chemicals and apparatus supplied with the course—in addition to your IPC textbook studies. Compares with recognized college courses in General Chemistry. Write today for free descriptive booklet.

**INSTITUTE OF PRACTICAL CHEMISTRY  
3 PROSPECT AVENUE, HAGERSTOWN, MD.**

## TRAVEL FOR "UNCLE SAM"

Prepare Now for Many Coming Examinations  
Veterans Get Special Preference

**FRANKLIN INSTITUTE, Dept. F85, Rochester 4, N. Y.**  
(Not Government Controlled)

Sirs: Rush to me without charge, copy of 40-page book, "How to get a U. S. Government Job," list of positions, and full particulars telling how to qualify for them.

Name \_\_\_\_\_

Address \_\_\_\_\_ Vet? \_\_\_\_\_





## DO YOU WANT TO MAKE MORE MONEY?

The answer is always YES! Everyone knows that it takes training to get ahead. It is also important to get your training in a trade or profession that is growing and has a big future. See the 11 career fields listed below—two proven Home-Study Courses (\*) and

nine School Shop-Courses in cities named.

**Choose the career that fits you best—then check and mail the coupon today. Get free booklet on course checked. DON'T DELAY!**



AMERICAN SCHOOLS OF WATCHMAKING

AERO INDUSTRIES TECHNICAL INSTITUTE

AMERICAN SCHOOLS OF AIRCRAFT INSTRUMENTS

PLASTICS INDUSTRIES TECHNICAL INSTITUTE

GENERAL TRADES SCHOOLS

HEMPHILL DIESEL AND AUTOMOTIVE SCHOOLS

**Six Nationally Famous Technical Schools with Hundreds of Successful Graduates**

# 11 CAREER FIELDS FOR YOUR SUCCESS

CHOOSE THE ONE THAT FITS YOU BEST

*Approved for Veterans—Available for non-veterans*

### TECHNICAL CRAFTS CORP.

5145 W. San Fernando Road, Dept. PM9-C, Los Angeles 26, California

Note: Use the above address to get information on all courses.

Gentlemen: Please send me complete, free information on course checked.

- |   |  |
|---|--|
| <input type="checkbox"/> Diesel Home Study*   | <input type="checkbox"/> Plastics Home Study*                  |
| <input type="checkbox"/> Aircraft Instruments—Los Angeles   | <input type="checkbox"/> Plastics—Los Angeles                  |
| <input type="checkbox"/> Aircraft Mechanics, A & E—Oakland  | <input type="checkbox"/> Diesel—Los Angeles, Memphis, New York |
| <input type="checkbox"/> Aircraft Engineering—Oakland   | <input type="checkbox"/> Tile Setting—Los Angeles              |
| <input type="checkbox"/> Watchmaking and Repairing—Los Angeles                                      | <input type="checkbox"/> Plastering—Los Angeles                |
| <input type="checkbox"/> Automotive Tune-up—Los Angeles and Memphis                                 | <input type="checkbox"/> Upholstering—Los Angeles and Chicago  |
| <input type="checkbox"/> Refrigeration, Radio, Electrical Appliance, Service and Repair—Los Angeles |  |

Your Name \_\_\_\_\_ Age \_\_\_\_\_ Veteran \_\_\_\_\_

Street \_\_\_\_\_ City \_\_\_\_\_

State \_\_\_\_\_ Present Occupation \_\_\_\_\_



# Don't Envy The PLUMBER-Be One

Make \$15 to \$50 a Day  
(and work every day)

Every skilled workman will tell you Plumbers have the best of it. WINTER and SUMMER the Plumber is busy at top wages. No skilled Plumber is ever out of a job . . . compare his opportunities with any trade, and decide where your opportunity is.



The Plumber Protects The Health of the Nation

## Own Your Own PLUMBING BUSINESS

No other business offers you the opportunity of starting in your own business, and making good profits, with little investment other than Universal's training and a kit of tools.

## JOURNEYMAN PLUMBER Gets Good Salary

Master Plumbers own their own shop. A Journeyman works for a Master. With Universal's training a journeyman can depend on high wages from the start.

## FREE

DETAILS SHOW YOU HOW TO START

You can start now to success as a plumber by simply filling out the coupon and mailing it . . . or just write Universal Plumbing School, 839 Holmes, Kansas City, Mo. FREE details showing how will be sent by return mail.

Plumbing, to the man with know how, means profit. Investigate Universal's unique "Shop Method" system . . . This system, developed over a quarter century ago by a master plumber, offers you the opportunity to quickly get into the plumbing business. This is not a "war born school" . . . but a plumbing school developed and operated by plumbers since 1923.

## BE A PLUMBER In Just 32 Weeks

Now, just 32 weeks of intensive training equips you to be a plumber. No need ever serve an apprenticeship. Don't envy the plumber's big profits . . . enjoy them.

### System Shows How With Tools . . . Not Books

Universal's highly developed method makes plumbers by a special developed system showing how to use plumbing tools . . . not books. Every instructor is a Licensed Master Plumber capable of showing every trick of the trade . . . Lead Work . . . Blueprint for plan reading, etc. This business offers a wonderful opportunity for the man who likes to work with tools.

### Over 7,000 Successful Plumbers Recommend This School

This system has made more than 7,000 plumbers. Each will testify it was the Universal Plumbing School that started him on the road to profits. Investigate our past performance . . . then decide. Universal is the largest and only school in America devoted exclusively to plumbing. It was established in 1923 under a system developed by a plumber and is owned and operated by licensed plumbers.

Don't waste your time looking over "war born schools" . . . investigate this system . . . then get into the profitable plumbing business.

## JUST MAIL COUPON

Send me FREE details about the plumbing business and tell me how to make profits as a plumber . . . I understand there is no obligation.

Name \_\_\_\_\_  
Address \_\_\_\_\_  
City \_\_\_\_\_ State \_\_\_\_\_

G. I. Approved. Established 1923

**UNIVERSAL PLUMBING SCHOOL**

839 HOLMES

KANSAS CITY, MO.

Sensational New Electric

① WELDER  
② CUTTER!

NOW!  
10 DAY TRIAL

BOTH only \$12



Uses 110-115 AC or DC  
WELD - BRAZE - CUT

MELT - SOLDER - HEAT TREAT  
WELDRITE furnished complete with Converter Unit, #1 Single Holder with attached Alligator clip, for welding metal up to 3/16" thickness; using up to 3/32" rod, and #2 Double Holder with Copper Coated Dual Carbon Electrodes for Cutting, Brazing, Heat Treating, Soldering, etc. Starting welding materials and instructions included.

Ideal for home workshop. Invaluable for body and fender shops, garages, repair and machine shops, manufacturers, etc.

WELDER HOOD  
With Wilson Weld Lens No. 10, approved by American Optical Company. Used in Hoods costing to \$10, 3.95 only . . . . .

NAME \_\_\_\_\_

ADDRESS \_\_\_\_\_

**SEND NO MONEY!** 10 DAY TRIAL OFFER \$12 plus P.O. charges.  
Order your WELDRITE Electric WELDER-CUTTER C.O.D. today. Pay postman \$12 plus postage charges (wt. 4 lbs.) or send \$12 and we pay postage. Either way, if not satisfied, return WELDRITE in 10 days, and money will be refunded. WELDER HOOD—Approved lens found in hoods costing to \$10—only \$3.95. California orders please add 2% sales tax.  
**CALIFORNIA TECHNICAL PRODUCTS CO.**  
448 So. Hill St., Los Angeles 13, Calif. Dept. CA-9

Send Weldrite C.O.D.  
 Send Weldrite & Hood C.O.D. \$15.95 plus chgs.  
 Send Weldrite postpaid. I enclose \$12.  
 Send Weldrite & Hood postpd. I enclose \$15.95 Same 10 day Trial Offer  
 Send Free Folder.

## CONCRETE Construction

New Practical Book Makes All Jobs Easy!



### SAVE MONEY ON HOME REPAIRS AND IMPROVEMENTS

Get this brand new book by Siegle, America's authoritative instructor on all construction subjects. Real professional information for all building and construction men and ideal for home repairs and improvements. Covers layouts and all types of form building, concrete materials, mixes and methods, tests, repairs, reinforcing. Can easily be worth many times its cost on one single job. Cloth binding. Fully illustrated. Only \$2.50. Order No. 1 on coupon below.

### OTHER DRAKE BOOKS THAT MAKE AND SAVE MONEY

**ELECTRICITY—HOUSE WIRING.** Practical and up-to-date. Fine book for handy home-owner. 200 pages, illus. Book No. 2. \$2.00  
**CARPENTRY.** A most practical and usable book that will give you a working knowledge of all building details. Expert's best methods for measuring, cutting, fitting, all materials. 300 pages, 700 illus. Book No. 3. \$2.50  
**PAINTING AND DECORATING.** A book for painters and home owners. Covers methods, tools and materials for every branch of painting and decorating. No matter what kind of job you want to do it is in this book. 350 pages, 288 illus. Book No. 4. \$3.50  
**SPRAY PAINTING.** New, enlarged edition. Auto painting now included. Complete. Only instruction you need. 160 pages, illus. Book No. 5. \$2.00

### Mail Coupon NOW FOR QUICK DELIVERY

Frederick J. Drake & Co., Dept. 16 1 2 3 4 5  
600 W. Van Buren St., Chicago 7, Ill. (Circle Number)

Send me books checked. If not satisfied I will return them in 5 days and money will be refunded.  
 Check or Money Order enclosed \$\_\_\_\_\_. Send books postpaid.  
 Send C.O.D. plus postage.

Name \_\_\_\_\_

Address \_\_\_\_\_

City \_\_\_\_\_ State \_\_\_\_\_

Drake's Books are Sold by Leading Booksellers



# DO ANY JOB EASIER MAKE MORE MONEY

Used by Army, Navy, Other Government  
Depts., 200 Schools and Industrial Firms.

Mail Coupon

**FREE TRIAL** in Your Home.  
Send No Money!  
We Ship C.O.D. in U.S.  
and Will Refund Money  
if Not Satisfied.



# Get Ready for BIGGER OPPORTUNITIES and BEST PAYING JOBS

Do it now! Get the better pay that goes to men with specialized knowledge. Get into one of these big opportunity fields. Big money and many other advantages await you if you prepare now. Here is the help you need—EASY—QUICK—AT LOW COST. Thousands of men have already used these famous books. Beginners and experienced men alike have doubled and tripled their earnings with this help. You too, can now get the special knowledge you need for top pay, better jobs, or a business of your own. This is your **GOLDEN OPPORTUNITY**.

## AIR CONDITIONING

Big air conditioning boom interrupted by war now bigger than ever and alive with new opportunities! Get this non-technical book by international authority and be ready for your share of millions to be spent. Covers whole field. 450 pages. Illustrated. \$4.00.

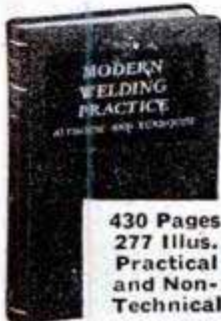

## MODERN WELDING PRACTICE

Newest book on all types of welding and heat treatment of metals. Written by recognized specialists in training men for production jobs. Practical and Non-Technical.

430 Pages  
277 illus.  
Practical and Non-Technical

Covers everything you need to know. Prepare for best pay jobs now. Price \$4.00.

## SHEET METAL LAYOUT

Makes sheet metal layout work so simple that anyone can learn. Get this new instructor and get into the easiest, cleanest and best paying part of all sheet metal work. 143 jobs worked out in drawings and carefully explained. Gives standard for all sheet metal fittings. \$3.50.



## AUTO BODY and FENDER REPAIR

Opens the Door to One of the Big Opportunity Fields of the Day

THE LOW COST, EASY WAY TO A GOOD PROFITABLE BUSINESS OF YOUR OWN

Owners will spend big money to keep their good older cars looking like the new ones coming out. This is a practical money-making guide, ideal for shop owners and every man who wants a share of the millions to be spent in keeping old cars looking new. Tells how to get a good job or start business of your own with small capital. Covers everything including tools, methods and materials. Only book of its kind. 325 pages, 232 illustrations. \$3.50.

## HOUSE WIRING LATEST EDITION

Get this sixth edition of this standard and practical electrical wiring book. It gives complete practical instruction on every phase of house wiring in one handy volume. Goes further than most books on subject. Hand-book style. Gives National Electric Code. 400 pages, 669 illustrations. Electrical work will reach a new high with millions of new homes to be built. Get started now. \$3.00.

## DYKE'S FAMOUS CARBURETOR BOOK

This famous book has been the standard guide in the best paying auto work for a generation. It has helped thousands of men make money. New edition covers engine tune-up, compression, ignition, carburetion, fuel pump valves, etc. Use this book to specialize in this big field. 244 pages, 549 illustrations. \$3.50.

## Modern Gas and Electric REFRIGERATION

New Printing—Almost 1000 Pages,  
408 Pictures, 17 Diagrams in Colors

The Book of the Hour

Thousands of Refrigerators need repairs! Owners will pay big for competent service. Get this non-technical guide to all types of refrigerators and get your share of this new profit. Get a job or start your own service business. This book will help you make money anywhere. Price \$5.00.

Make Big Money  
Keeping Old Cars  
Looking New. Get  
This Book Today!

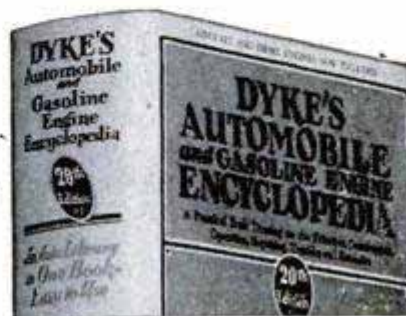

**BIG 20th EDITION**  
Leading Auto Book for Over 36 Years

## World's GREATEST AUTO BOOK

New Material on Transmissions, Trucks, Tractors, Diesels, Aircraft and Auto Engines

Now with millions of cars needing repairs and thousands of men needed to do the work, you need the famous DYKE Auto Book more than ever before. This big 20th edition covers all principles, construction, repair, adjustments, testing, troubles and remedies of all cars. Over a half million copies of 20 editions of Dyke's have been sold. Gives specifications of old and newer cars. World's biggest book value. \$7.00. This big book, a complete auto library in one volume, has 1483 pages—4600 illustrations and diagrams—weighs 6 lbs.—equal to 4 ordinary books.

## BAILEY'S HANDBOOK For Engineers and Firemen

World famous handbook of universal questions and answers for Stationary, Marine and DIESEL engineers and firemen. Prepares for any license examination. This is the one book that men should have if they want to reach the top in installation, maintenance and operation of Diesel and steam plants. Pocket size, \$2.00.

**Goodheart-Willcox Co., Inc.**  
1321 S. Michigan Ave., Dept. 16, Chicago 5, Ill.

## SEND NO MONEY! Mail Coupon

**GOODHEART-WILCOX CO.,**  
1321 S. Michigan Ave., Dept. 16, Chicago 5, Ill.

Send books checked, C.O.D. I will pay postman, plus few cents charges. If not satisfactory I will return books in 5 days and you will refund money paid. (Outside U.S., or possessions remit with order.)

- |  |  |
|--|--|
| <input type="checkbox"/> Gas & Electric Refrigeration . . . . . \$5.00 | <input type="checkbox"/> Air Conditioning . . . . . \$4.00 |
| <input type="checkbox"/> Dyke's Auto Book . . . . . \$7.00             | <input type="checkbox"/> Engineers Handbook . . . \$2.00   |
| <input type="checkbox"/> Dyke's Carburetor Book . \$3.50               | <input type="checkbox"/> Body and Fender Repair . \$3.50   |
| <input type="checkbox"/> Modern Welding . . . . . \$4.00               | <input type="checkbox"/> Shop Math. (2 Vols.) . . . \$3.00 |
| <input type="checkbox"/> Airplane Welding . . . . . \$3.50             | <input type="checkbox"/> House Wiring . . . . . \$3.00     |
| <input type="checkbox"/> Sheet Metal Layout . . . \$3.50               | <input type="checkbox"/> A.C. Power Wiring . . . \$4.00    |
|  | <input type="checkbox"/> D.C. Power Wiring . . . \$4.00    |

If remittance accompanies order we will pay all postage charges under same return privilege.

Name \_\_\_\_\_  
Address \_\_\_\_\_  
City \_\_\_\_\_ State \_\_\_\_\_



# Learn a Skilled Trade NOW! Practical, Thorough SHOP TRAINING!

IN OUR LARGE CLEVELAND SHOPS

- ✓ Refrigeration and Air Conditioning
- ✓ Heating Layout, Installation and Servicing

**APPROVED FOR G. I.'S and CIVILIANS**

One of America's Leading Schools  
Expert Individual Instruction

Learn by Doing — the Practical Boston Tech  
Shop Way — then You Don't Forget

These Growing Industries Offer You . . .

- ✓ Opportunity to be your own boss  
(Little capital needed to start)
- ✓ Or Skilled Good Pay Positions

BOSTON TECHNICAL INSTITUTE, INC.  
Dept. PM-9, 4707 Euclid Ave.  
Cleveland 3, Ohio

Send FREE Success Book on course checked below  
 Refrigeration and Air Conditioning  
 Heating Layout, Installation and Servicing

NAME .....  
 ADDRESS .....  
 CITY ..... STATE .....  
 Please check Veteran  Non-Veteran

## WATCH REPAIRING

Be a Master Watchmaker! Graduates earn big money — many in business for themselves. The famous Sweazey System of Instruction teaches you quickly and easily. Our 41st year.

Write today for free information.

CHICAGO SCHOOL OF WATCHMAKING  
Dept. 198, 1608 Milwaukee Ave. Chicago 47, Ill.

**FREE BOOK**  
TELLS HOW  
TO BE AN . . .

Accountant  
Salesman  
Secretary  
Stenographer

### SECURED FUTURE . . . FREE EMPLOYMENT SERVICE

Enter one of the "substantial earnings" fields through Hill's "Success Plan" training. A lifetime opportunity to join thousands of successful graduates in positions secured through our nation-wide employment service. No matter where you live, what you are doing now, Hill's can train you by study at home or in the resident school. Big Free book shows you the way to substantial earnings and an assured future. G. I. Approved.

Hill's Extension School & Business University  
Dept. PM9, 619 W. Main St., Oklahoma City 2, Okla.  
Please send your free book, "Through Hill's to Success."

NAME .....  
 ADDRESS .....  
 CITY ..... STATE .....

Check here if eligible under G.I. Bill.

**EASY-TO-USE COUPON TODAY**

## PLAY PIANO

The First Day  
OR DON'T PAY!



Amazing New Automatic Chord Selector Enables You to Play Tunes the Minute You Sit Down At The Piano

Though you don't know one note from another now, we guarantee with the Dean Ross Piano Course you either immediately PLAY PIANO with both hands — or the course costs you NOTHING! Secret of this amazing offer is Dean Ross' Magikwik Automatic Chord Selector which guides your fingers — enables you to play the minute you sit down at the piano. With this 10 day trial PLAY or NO PAY guarantee you've nothing to lose — popularity to gain! SEND NO MONEY! Pay postman \$1.98 plus postage for complete course including Automatic Chord Selector — no more to pay! We'll pay postage if you'll send \$1.98 with order. ORDER TODAY!

**DEAN ROSS PIANO STUDIOS, INC.**

Dept. ME-31 45 West 45th St. New York 19, N. Y.

## WATCHMAKING

JEWELRY ENGRAVING AND REPAIR

Enter this high-paying, time-honored profession, or prepare for a business of your own. Watchmakers in great demand. More jobs than qualified workers. Study under expert instructors in a long-established, nationally recognized school. Receive recognized diploma and certificate. Placement service. Approved under G. I. Bill. Write for FREE booklet.



**The Baronian School, Inc.**

2116 WALNUT ST. (DEPT. C) PHILA. 3, PA.

## BE A REAL ESTATE BROKER

**PAYS BIG!** EASY TO LEARN — Start and run your own business quickly.

Many graduates report making up to \$1000 a month. Course of study covers Sales, Property Management, Appraising, Loans, Mortgages and hundreds of related subjects. Course in home study or classroom instruction in leading cities. Big new illustrated catalog from this nationally known school. G. I. Approved. Send a Post Card Today.

WEAVER SCHOOL OF REAL ESTATE (Estab. 1936)  
15 E. Pershing Road Dept. PM-2 Kansas City, Mo.

## LOCKSMITHING & Key Making



**PRACTICAL UP-TO-DATE COURSE**

Easy-to-learn modern information for self-instruction. How to work on locks, de-code, make master-keys, repair, install, service, etc. For every handyman, home owner, carpenter, mechanic, service station operator, fix-it shop, hardware dealer, gunsmith. 53 plain illustrated lessons. FULL PRICE ONLY \$3.95. SEND NO MONEY.

Just pay postman plus C.O.D. postage. Or send \$3.95 with order, we'll ship postpaid. Satisfaction guaranteed or refund.  
NELSON-HALL CO., 1139 S. Wabash Ave., Dept. J-02, Chicago 5, Ill.

## WATCHMAKING

Millions of watches and clocks need repairing. Start your training now for a better paying job or own profitable business. Qualified watchmakers in demand. Outstanding training by experts. Write for free catalog. Approved for veterans.

SCIENTIFIC SCHOOL OF WATCHMAKING, Dept. PM-9  
3923 San Fernando Road Glendale 4, Calif.

### LEARN AND EARN AT HOME

Learn SCREEN PROCESS, the modern machineless method of printing. Uncrowded, profitable field where trained men are always in demand. 2 BIG KITS OF SUPPLIES we send start many of our students making money even before finishing home study course. Write today for FREE BOOK giving full details. APPROVED FOR VETERANS.

CALIFORNIA SCHOOL OF SCREEN PROCESS  
3740 Overland Avenue, Dept. M-98 Los Angeles 34

## APTITUDE TESTS

discover the kind of work or studies best for your success! You get a personal report—a guide for life—more happiness—more prosperity. For men, women, boys and girls. Write for complete facts.

VOCATIONAL COUNSELING INSTITUTE  
956 Maccaebes Bldg., Detroit 2, Michigan



# AMERICA'S GREATEST ELECTRICAL SCHOOL OFFERS YOU

**MORE EQUIPMENT!**

**MORE SPACE!**

**MORE TRAINING!**



## Learn **ELECTRICITY**

It's Easy - "LEARN-BY-SEEING" MOVIES  
It's Fast - "LEARN-BY-DOING" METHODS

and its THOROUGH! . . . There is no other place—no other way to get the same all-around training you get at M.T.I. NOT A HOME STUDY COURSE! . . . You get actual "hands-on-equipment" training in great MODERN SHOPS in Detroit. No previous experience necessary. Learn HOUSE WIRING, A.C., D.C. MOTORS, ARMATURE WINDING, POWER PLANT WORK, etc. New classes start every few weeks. Part time work available. Living arrangements made.

**NO COST TO VETERANS** Train at Gov't expense. Receive \$75 to \$120 month while learning. Coupon brings details.

**MICHIGAN TECHNICAL INSTITUTE**  
Department PM-9, 2281 West Fort Street, Detroit 16, Michigan

*In*  
**NATION'S  
LARGEST  
EXCLUSIVE  
ELECTRICAL  
SCHOOL**



OVER  
**1000**  
PIECES OF ACTUAL  
ELECTRICAL EQUIP-  
MENT TO WORK ON!

**MAIL TODAY  
FOR QUICK  
ACTION!**

**MICHIGAN TECHNICAL INSTITUTE, Dept. PM-9**  
2281 W. Fort St., Detroit 16, Michigan

- Send me catalog and complete information.  
 I am a GI. Send special information.  
 Married.  Single

NAME \_\_\_\_\_

ADDRESS \_\_\_\_\_

CITY \_\_\_\_\_

ZONE \_\_\_\_\_

STATE \_\_\_\_\_

**Asked for**  
by leading aviation companies  
**AHEAD of  
Graduation**



**You're IN Aviation . . . at the Flying Wing School**

You train in a technical institute that is part of a leading aircraft company, Northrop Aircraft, Inc.—the company that developed the huge Flying Wings and other famous aircraft. You get the advantages of actual aviation facilities and activities in advance of graduation. In 2 years or less you can complete the *Aeronautical Engineering Course*. A new class starts every 8 weeks. The *Aircraft & Engine Mechanics Course* requires only 1 year. A new class starts every 4 weeks.



**NORTHROP** *Aeronautical Institute*

Division of Northrop Aircraft, Inc.

James L. McKinley, Managing Director

1527 East Broadway • Hawthorne • Los Angeles County • California

## PROOF of Opportunity in **Aeronautical Engineering**

Stepping directly into responsible aviation positions, members of this recent graduating class at Northrop join the ranks of Northrop graduates now performing important engineering, maintenance and manufacturing duties in scores of leading aviation firms at home and abroad.

Northrop graduates are in demand. Even many of the more recent graduates are in such important work as design, research, testing, stress analysis, aerodynamics and power plant engineering. Helicopter and guided missile design are examples of advanced projects for which Northrop graduates are being chosen.

The training that wins such enviable recognition and rewards for Northrop graduates can mean the same advantages for YOU. Get the Institute catalog and complete information on the opportunities open to you through Northrop training. SEND THE COUPON NOW.

**APPROVED FOR VETERANS**

**NORTHROP AERONAUTICAL INSTITUTE**  
1527 E. Broadway, Hawthorne, Los Angeles County, California

Please send me the Institute catalog and complete information, including starting dates of classes. I am interested in

- Aeronautical Engineering  Aircraft & Engine Mechanics

Name \_\_\_\_\_

Address \_\_\_\_\_

Age \_\_\_\_\_

City \_\_\_\_\_

Zone \_\_\_\_\_

State \_\_\_\_\_

- Check one:  Veteran  In Service  Civilian



# AUTO BODY, FENDER and PAINT MEN

## Get Ready for a TOP PAY JOB In This Big Field



**E. J. SWEENEY**  
87,675 men have come to E. J. Sweeney Schools—WHY?

est modern equipment and big roomy shops. Yes, for a real opportunity to make good money, get in specialized auto body, fender and painting work with practical training. Send today for the complete facts.

1,054 want ads in newspapers in one state in one month alone show the amazing demand for trained men. Here is actual proof that there is opportunity for you today in this big field. Read the complete story on opportunities today in my free literature. Mail a post card today.

APPROVED FOR VETERANS TRAINING.

**SWEENEY AUTO SCHOOL, Inc.**  
Dept. 21, 2901 East 14th St. Kansas City 1, Mo.

**SEND NOW FOR FULL DETAILS!**

E. J. Sweeney, President, Sweeney Auto Schools, Inc.  
Dept. 21, 2901 East 14th St., Kansas City 1, Mo.

Name \_\_\_\_\_

Street \_\_\_\_\_

City \_\_\_\_\_

State \_\_\_\_\_

Veteran

Non-Veteran

## SHOE REPAIR OFFERS BIG INCOME

### LEARN IN 12 WEEKS TIME

You can own your own shop or earn big income as skilled shoe repairman. Growing demand everywhere at top wages for men who know how. We teach you quickly by actually working on shoes and modern machines. Costs nothing under G.I. Bill of Rights. School open to all from 18 to 60 years of age. FREE BIG 16 PAGE BOOK explains everything. Send for your copy today.

**MODERN SHOE REBUILDING SCHOOL**

Established 1927

2937 Belmont Ave., Chicago, Ill. Rush Postcard Today.  
4577 Hollywood Blvd., Los Angeles 27, Calif.

# Let Us Teach YOU To Write

Read these experiences: **WAITER SELLS NOVEL**, a Magazine Institute student, working as a waiter, recently signed a contract for his first novel, with an advance of over \$1,000—after completing only half the assignments of the course. **HOUSEWIFE GETS \$300 CHECK**, a Virginia housewife, after working a few months, in spare time, with the Magazine Institute, sold her first story to a woman's magazine for \$300. (Experiences taken from MI files.)

**SEND FOR FREE CATALOG TODAY.** The free catalog, offering a detailed description of the Magazine Institute plan of modern help to writers, telling about opportunities for writers, and identifying the writers and editors who serve as instructors, will be sent on request. Inquirers will also receive "The Best Job in the World," listing unselected testimonials from successful graduates. **COURSE APPROVED FOR VETERAN'S TRAINING.**

**THE MAGAZINE INSTITUTE, INC., Dept. 639, 50 Rockefeller Plaza, Rockefeller Center, New York 20, N. Y.**



Learn .....

## WATCH REPAIRING

From The LARGEST APPROVED SCHOOL of its kind

### TRAINED WATCH MAKERS ALWAYS IN DEMAND

The need for trained Watch Makers everywhere is increasing daily with increased watch production. Watch Repairing is a big pay profession—steady the year around. No dull seasons. Work for others or start your own shop!

**ACTUAL WATCH REPAIRING** is taught you with each Lesson. All necessary tools and watch is furnished for actual, professional watch repairing use. We teach you how to take any watch apart and make all repairs and part replacements. You **EARN AS YOU LEARN** with actual repair jobs, with a Diploma issued upon completion of our highly practical Course.

### BIG PAY IN AN UNCROWDED FIELD

Now—without loss of time from your present work you may learn the fascinating art of **WATCH REPAIRING** in your spare time right in your home... just as ambitious men and women are doing right now. As an expert Watchmaker you can enter an uncrowded field with big pay possibilities and an assured future. No previous mechanical experience needed.

In Your SPARE TIME At Home



**WRITE TODAY!**  
No Salesman Will Call

## ILLINOIS SCHOOL of WATCH REPAIRING

2870-DB ELSTON AVE.

CHICAGO 18, ILLINOIS

## DON'T BE A JOB SLAVE!

### LEARN WATCH REPAIRING AT HOME



### WITH OUR SELF TRAINING KIT

Get started NOW in this uncrowded field! **EASY** to learn! **BIG MONEY!** **SECURE FUTURE!** Earn while you learn! Even as a sideline you can make \$50 and up each week.—Our new **PRACTICAL SELF-TRAINING KIT** is all you need to start. Contains set of **PROFESSIONAL TOOLS:** (Loupe, 3-4 power; complete set of 6 special screw drivers—finest tempered steel blades; Tweezer AA; Plastic Material tray) and **COMPLETE BOOK** on Modern Watch Repairing. Fully illustrated, easy to understand, shows every step in repair, adjustment and use of tools. **NEW ONLY \$6.25** Post Paid (If C.O.D., plus charges.) Money Back Guarantee. If ordered separately: book \$3.25; set of tools, \$3.50. **MODERN TECHNICAL BOOK & TOOL CO.** Dept. MMC, 55 W. 42nd Street, New York 18, N. Y.

### JUST OUT! New All-Inclusive Tool, Material Catalog

Revised and Enlarged for Watch-Clockmakers, Jewelers, Tool-Instrument Makers, Handicrafters. Over 600 ILLUSTRATIONS and IDENTIFICATION CHART. NEW REDUCED PRICES. All books in these fields; write for literature. **SEND 25c** for catalog—**FREE** with order.



## LABORATORY TECHNICIAN

**BE A LABORATORY SPECIALIST;** complete course. Big demand from hospitals, doctors, clinics. We teach all branches of medical laboratory work, including **Medical and Dental X-Ray.**

Approved by American College of

Medical Technologists

Co-educational Free Placement Bureau

Free Catalog

Accredited for "veteran" training

**CHICAGO COLLEGE OF LABORATORY TECHNIQUE**  
Dept. P.M., 431 S. Wabash Ave. Chicago 5, Illinois

### Get Ready for Big Opportunities!

*Engineer Dobe*

I Will Train You at Home

Until You Get a

**GOOD PAY JOB in**

**DRAFTING**

**TOOLS AND EQUIPMENT SENT WHEN YOU START**

Get a better job with more pay and pleasant working conditions. Get into Drafting—where all products start. I will train you at home—give you experience—on the same kind of jobs you will do with the best paying firms. I furnish instruments and all equipment when you start. Write today for vital facts and **FREE** book. Give a're.

**ENGINEER DOBE • Div. 16 • Libertyville, Ill.**

## STAMMER? GET THIS FREE BOOK!

This new 128-page book, "Stammering, Its Cause and Correction," describes the Bogue Unit Method for scientific correction of stammering and stuttering—successful for 47 years. **Benj. N. Bogue, Dept. 4824, Circle Tower, Indianapolis 4, Ind.**

## Thrilling Work COLORING PHOTOS

Fascinating vocation learned at home by those with aptitude. Thrilling pastime. National method brings out life-like colors. Free booklet. **NATIONAL PHOTO COLORING SCHOOL** 1315 S. Michigan, Dept. 1356, Chicago 5



Learn to Use the **SLIDE RULE**  
**EASY! QUICK! NEW LOW COST!**  
 Newly Revised and Simplified Step by Step Method

**10 in. SLIDE RULE**  
 and Famous **\$2.98**  
 Book Both for Only

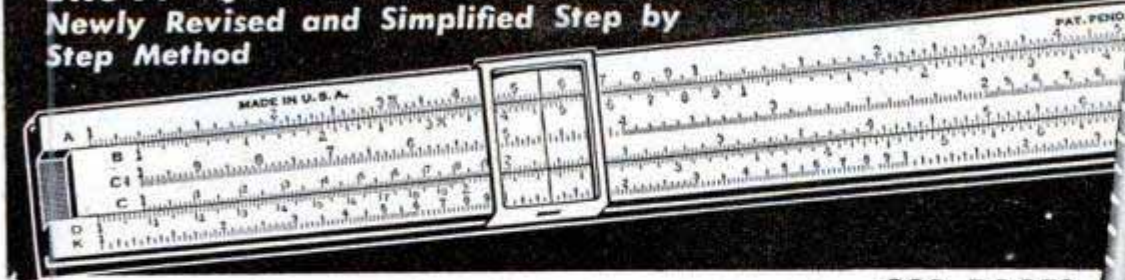

**Practical Help for Bigger Pay — Better Jobs — for Mechanics, Draftsmen, Shop Men, Accountants — All Who Use Figures**

Get this new revised and simplified edition of the "Slide Rule and How to Use It." Thousands of older editions sold at much higher price. Now — a more simplified book at a lower price with genuine full size Mannheim type beginner's Slide Rule included at no extra cost. Do all kinds of figure work. Stop wasted time. Stop pencil errors. Learn quickly to multiply, divide, extract roots, find ratios and percentages, squares, areas of circles, radii, volume, etc. Do it in a flash and learn now with this book and slide rule combination.

**208 PAGES**  
**LOG TABLES**  
 Helpful Review of Mathematics

**Mail Coupon**  
 Money Back if Not Satisfied

**Practical Step by Step Guidance**

No other book like it. Contains complete instruction and removable work sheets that make the slide rule simple as A.B.C. Also Five Place Logarithm Table, Tables of Trigonometric Functions of Angles, review of Mathematics from simple arithmetic through calculus, and with complete answers to check yourself on every problem. It can easily be worth hundreds of dollars to you in promotions, better pay, saving time and error. It's a book for students, mechanics, business men—everyone should learn to use the slide rule, now that it is so easy.

**Learn in a Few Hours to Do Many Calculations**

There is nothing mysterious about the slide rule and its use. Just read the book and follow the rules. You'll be amazed at the problems you can solve in just a few hours. Mail the coupon now. Book and slide rule will be sent at once. Use them for 5 days, then if you are not satisfied in every way, return them and your money will be refunded without delay. Use the coupon. Mail now.

**Austin Publishing Co., Dept. 16**  
**165 N. Pine Ave., Chicago 44, Ill.**

Send me "The Slide Rule and How To Use It" and 10" full size Mannheim type beginner's Slide Rule. Total cost for both \$2.98. I understand you will refund amount paid you if I return them in 5 days.

Remittance Enclosed  Send C.O.D. Postage and Charges Extra  
 Send Postpaid

Name \_\_\_\_\_  
 Address \_\_\_\_\_  
 City \_\_\_\_\_ State \_\_\_\_\_

**AUSTIN PUBLISHING CO., Dept. 16, 165 N. Pine Ave., Chicago 44, Ill.**

**Now Easy to Start**  
**A BIG BUSINESS**  
*in Spare Time*

**Metalizing**  
**BABY SHOES**  
 AND OTHER  
 KEEPSAKES



**MAIL COUPON TODAY for NO RISK OFFER of COMPLETE PLAN**

**DO YOU** want extra money right away in a business you can run from your house with no house-to-house selling? Do you want to start small—the easy, inexpensive way—and watch how our guidance jumps you into bigger and bigger profits every week? Do you want a business that the whole family can help with—a business that is stable, permanent, steady—with a lifetime certainty of good income?

Silver, or Bronze) on Baby Shoes or other keepsakes. Amazing results, yet so simple and easy by my plan that you can become an Expert Metalizer in a few days.

**SEND NO MONEY**  
**Just Your Name—but Quick**

Find out fast how the love every mother has for her baby's first shoes can be turned into quick cash—big profits—a permanent lifetime business for you. Complete step-by-step Business System sent to you on no risk trial—costs nothing if you return it. But get the Free facts first. Then decide. Send penny postcard or coupon today. Time is precious!

**WE SHOW YOU**  
 How to start at home in spare time  
 How to Metalize the easy Warner way  
 How to bring in the business  
 How to start at low cost  
 How to pyramid profits



**WE FURNISH EVERYTHING**

All supplies and mountings from one source, for quick shipment, keeps investment low!

**DON'T WASTE A MINUTE**  
**GET THE FACTS ON METALIZING**

My own shop does big business by same methods I will reveal to you. Exclusive Warner Electroplating Process—trade secrets available for first time—puts coating of actual metal (22K Gold, Genuine  
**WARNER ELECTRIC CO., Dept. 39,**  
**1512 JARVIS AVE., CHICAGO 26, ILLINOIS**

**3¢ MAY START A FORTUNE**

**Ray Brandell, Mgr., Warner Electric Co.,**  
**1512 Jarvis Ave., Dept. 39, Chicago 26, Ill.**

Don't send the PLAN. First send all facts free. I'll decide after I investigate. Everything you send now is FREE. No obligation.

Name \_\_\_\_\_  
 Address \_\_\_\_\_  
 City \_\_\_\_\_ Zone \_\_\_\_\_ State \_\_\_\_\_



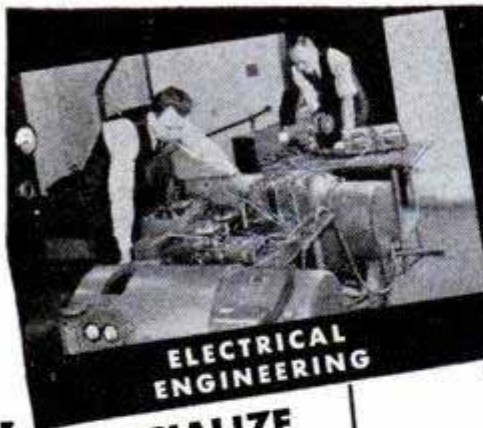

**ELECTRICAL ENGINEERING**



**ELECTRONICS**

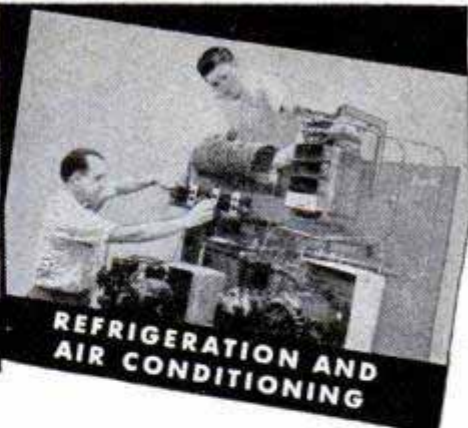

**REFRIGERATION AND AIR CONDITIONING**

**SPECIALIZE**  
In 6 Months to 3 Years  
**COURSES**

**SERVICE**

- 6 to 12 Months
- Electricity
  - Welding
  - Refrigeration
  - Heating

**TECHNICIAN**

- 1 to 2 Years
- Electricity
  - Radio
  - Electronics
  - Refrigeration, Heating and Air Conditioning

**PROFESSIONAL**

- 3 Years
- Electrical Engineering Bachelor of Science Degree
  - Major in Machinery or Electronics

**PRACTICAL TECHNICAL TRAINING**

Train for a substantial career in industry . . . or a business of your own. Our time-tested Concentric System enables you to build your career step by step. Each 6-month course is complete in itself, yet prepares you for advanced courses. Stay as long as circumstances permit, until you reach the top step in your technical training. More than 1,538 students now enrolled from 48 states and 13 overseas countries. Faculty of 72 specialists. World-wide alumni counselor committee. Terms start January, April, July and September. **SEND COUPON TODAY!**

**MILWAUKEE SCHOOL OF ENGINEERING**  
"A Technical Institute - Founded 1903"

Milwaukee School of Engineering  
Dept. PM-948, N. Broadway and E. State, Milwaukee, Wis.  
Without obligation send me free booklet "Career Building" and more details on course in \_\_\_\_\_

Name \_\_\_\_\_ Age \_\_\_\_\_

Address \_\_\_\_\_

City \_\_\_\_\_ State \_\_\_\_\_



**TRAIN Your VOICE!**  
**Results GUARANTEED**

We build, strengthen the vocal organs—not with singing lessons—but by sound, scientifically correct silent and vocal exercises and absolutely guarantee complete satisfaction with results. Write for Voice Book, FREE. Sent to no one under 17 years old unless signed by parent. Perfect Voice Studios, Studio 135-9, Kimball Hall Bldg., Chicago 4, Ill.

**DO YOU LOVE HORSES?**

• ARE YOU INTERESTED IN HORSE TRAINING AND MANAGEMENT?

**SUBSCRIBE FOR The "EXPERT HORSEMAN" 2 YEARS \$1.00**

**FREE BOOK**—You will also receive a booklet that tells how you can learn to break colts, gait show horses, train rodeo, stock, and race horses, break bad habits, handle any horse and train circus trick horses. **SEND \$1.00 TODAY**

**ANIMAL LOVERS ASSOCIATION**  
Box No. KA111, TARZANA, CALIFORNIA

**LEARN MEAT CUTTING EASILY-QUICKLY**  
**At Home-In Spare Time**



The steady, dependable trade of Meat Cutting taught easily, quickly by improved HOME METHOD. National School, established over 25 years, has organized its famous "Learn By Doing" Classroom, Cutting room and Retail Market training system into sound, practical HOME STUDY form.

Now, by the miracle of this EXTENSION TRAINING you can prepare in Your Spare Time At Home, for a better job, bigger responsibilities or success and security in a store of your own. Remember, **PEOPLE MUST EAT!**

Buying, cutting, percentage, pricing, advertising, selling—a complete meat education. For beginner or men with ex-

perience. Thousands of successful graduates. Send coupon for **FREE Bulletin NOW!**

**MAIL THIS COUPON TODAY FOR FREE BULLETIN**

**National School of Meat Cutting Div. U-97, Toledo 4, Ohio**  
Send me your **FREE Bulletin** on Meat Cutting and Meat Merchandising. No obligation. No Salesman will call.

Name \_\_\_\_\_

Street \_\_\_\_\_

City \_\_\_\_\_ State \_\_\_\_\_



**\$350** IN A SINGLE WEEK **GROSS**



IN MY OWN BUSINESS

Some Make More, Some Less... Start This Business for **YOUR OWN**

George Held earned \$350 in one week with

### ELECTRIC UPHOLSTERY CLEANER

● Here's YOUR chance to start a money-making, year-'round business of your own and make the success you've dreamed about. R. O. Donnley took in \$40 in seven hours. O. W. Ware landed a \$750 hotel job and made a fine profit. J. S. Corbit grossed \$279.50 his first month. P. D. Ash cleaned 23 auto seats at \$5 each in one week. And so it goes. Homes, hotels, offices, clubs, all places where furniture is used, offer you big profit possibilities. Auto seats and interiors, also.

#### NO SHOP OR OFFICE NECESSARY

You clean furniture on customers' premises. No hauling costs. No high rents. Supplies are in-

## FREE BOOK! MAIL COUPON

VON SCHRADER MFG. CO.  
B61, Racine, Wisconsin

Send at once (no obligation) your FREE booklet containing information about your Electric Upholstery Cleaner and how I can own my own permanent, profitable business.

Name \_\_\_\_\_

Address \_\_\_\_\_

City \_\_\_\_\_ Zone \_\_\_\_\_ State \_\_\_\_\_

expensive and you operate, at low cost, from your home. What you take in is mostly profit. Surely YOU will want to investigate an opportunity like that—right away. Own your own business. Be your own boss. If you are ambitious, honest and courteous, we will help you to start and succeed.

#### FULL INFORMATION FREE MAIL COUPON TODAY

Send the coupon or write for Furniture Cleaner Booklet. It tells all about this electric cleaner—how to start YOUR business—how to make a profitable success. Don't delay. It's your BIG opportunity.



MAIL COUPON TO

VON SCHRADER MFG. CO., B61, RACINE, WIS.



### OPEN YOUR OWN SHOP Be Independent!

Here's a great growing field that's getting bigger every day as more houses are wired for electricity. You can start small—even in your spare time—with the tools we send you—in your basement or garage and GROW AS BIG AS YOU LIKE, with NO FEAR OF LOSING YOUR JOB in a depression. Or, you can take a well paid job, to start... as there is a big need for service mechanics. Let's talk it over by mail.

**New Book "HOW TO START YOUR OWN BUSINESS"**  
Sent if you act promptly

This valuable book covers locating your shop, contains drawings of how to build and wire workbenches, where and how to advertise, what to charge, how to hire solicitors, etc. Sent to students who enroll promptly.

## Would You Like To Work for Yourself? Then Learn ELECTRIC APPLIANCE Repair & Service

Recent University Discoveries prove that one of three major classifications of men are only thoroughly happy when working with their hands. This doesn't mean they don't use their heads, too. But it does mean that nature intended A BIG GROUP of men to be the builders, makers, fixers and servicers of life. If you are in this group—not completely happy in your present work—seeking increased income, and handy with tools—A SUGGESTION: Get into electrical appliance service and repair.

### LEARN AT HOME In Your Spare Time

Our practical, thorough course teaches you this interesting, good paying business AT HOME—During Your Spare Time. A Grade School education is all you need. We teach repairing washing machines, vacuum cleaners, electric ranges, lamps, irons, motors, etc., REFRIGERATION and HOUSE WIRING. Our lessons are understandable and easy to grasp. You'll enjoy every minute of them. And you'll enjoy the work itself when you get into it.

I include A BIG KIT of Special APPLIANCE TOOLS at NO EXTRA COST



H. T. Armstrong, General Manager  
PACIFIC TRAINING SCHOOL—Dept. P-89  
7217 So. Broadway, Los Angeles 3, Calif.  
Please send me your FREE BOOKLET:  
"Today's Big Opportunity—Appliance Servicing"

NAME \_\_\_\_\_ AGE \_\_\_\_\_  
ADDRESS \_\_\_\_\_  
CITY \_\_\_\_\_ STATE \_\_\_\_\_

MAIL COUPON for FREE BOOKLET



# New Easy Way TO MAKE BIG MONEY!

FULL  
OR SPARE  
TIME

AT  
HOME

Permanently  
**METALLIZED  
BABY SHOES**

**Costs You Only 5¢-You Get \$6.00**

Now is the time to cash in on this big-paying, easy-to-operate year 'round business, and you need no experience! With actual illustrations and step by step instructions, YOU can start earning money in only one week—up to \$1000 per month full time, or

**LARGEST NUMBER OF  
SUCCESSFUL BUSINESSMEN**

Our course has the largest number of successful businessmen in this field today! They are all men and women who acted and are making money. This course is guaranteed—your money will be fully refunded if you are not more than satisfied. There is nothing to lose, so act at once.

- Money Back Guarantee
- Most Successful Name in Metallizing
- Big Income
- Huge Demand
- Sales Plans
- Future Security
- Your Own Boss

\$50 to \$75 per week spare time . . . at \$5.00 per hour. Working only a few hours you can make more money than most people make working an entire week.

### IMMEDIATE RESULTS

This tested and proven method shows you complete details, so that you may start at once, metallizing Baby Shoes, with real GOLD, SILVER or BRONZE. They will last forever, retaining every priceless detail of the natural shoes; something for which there are 5 million new customers waiting to buy every year.

### BEGIN AT HOME

Don't pass up this real opportunity to start your own business on a shoestring right at home.

**ACT NOW!** We will send you all the details absolutely free.

**SEND NO MONEY**  
USE  
THIS  
COUPON



**FREE!**

Two actual metallized Baby Shoes guaranteed to be the most attractive on the market—or a pair of your own Baby Shoes metallized if you prefer.

Name \_\_\_\_\_

Address \_\_\_\_\_

City \_\_\_\_\_ State \_\_\_\_\_

**KIKTAVI**  
Company Dept. P-3  
2111 W. Manchester  
Los Angeles 44, California

Rush me FREE full particulars at once.

# VETERANS Learn WATCHMAKING

**JEWELRY  
ENGRAVING**

Above Average Pay  
No Age or Physical  
Limitation  
In One of the Most Highly  
Respected Careers  
Trained Men Always in  
Demand

*Trades with  
Greater Security*

Learn by our Advanced Training Method . . . Only Latest Scientific Equipment and Facilities.

Write Today for Complete Information and Catalog



Approved  
G. I. Training

## KANSAS CITY SCHOOL OF WATCHMAKING

America's Most Progressive Horological School  
617-621 Wyandotte St. Kansas City 6, Mo.

# PRACTICAL AUTO INFORMATION

**Keeps Cars Rolling by Making Repairs  
and Adjustments Easy!**

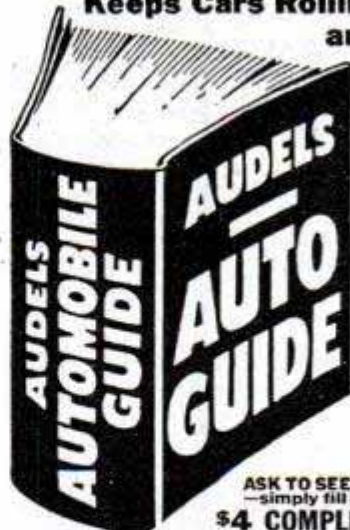

**AUDELS AUTO GUIDE**  
For Every Mechanic, Driver,  
Owner and Repair Shop.

**Sent on 7 Days Approval**  
Shows How to Tune Up—Keep  
Brakes Safe—Batteries Powerful—  
Tire Mileage Up—Save Gas—  
Lubricate Correctly.

**ANSWERS YOUR QUESTIONS**  
Contains all you need to know  
about 1—Construction, 2—  
Operation, 3—Service, 4—  
Repair of Modern Motor Cars,  
Trucks, Buses & Diesel Engines  
in every detail.

**NEW FLUID DRIVE TREATED**  
Easy to understand—  
1540 Pages, 1540 Illustrations.  
Gives definite directions on  
How to handle service jobs.

**ASK TO SEE IT—** Get this information for yourself—  
simply fill in and mail coupon today.  
**\$4 COMPLETE • PAY ONLY \$1 A MO.**

**AUDEL, Publishers, 49 West 23rd St., New York**  
Mail AUDELS AUTOMOBILE GUIDE (\$4) for free examination. If O. K., I  
will send you \$1 in 7 days; then remit \$1 monthly until \$4 is paid.  
Otherwise, I will return book promptly.

Name \_\_\_\_\_  
Address \_\_\_\_\_  
Occupation \_\_\_\_\_  
Employed by \_\_\_\_\_ PM



### AVIATION CABLE

Flexible 133 strand wire cable, 5/32 in. diam., 3300 lb. break test. Lengths up to 450 ft. Use for tow rope, guy wire, clothes line, etc. Wgt. per 100 ft., 4 lbs. Specify length wanted. No. 421—Per Ft. .... **4c**

### NYLON CORD

Genuine Nylon, approx. 3/16" O.D.—wound from many fine strands for 650 lb. break test. Use for clothes line, etc. Shp. weight 1 lb. No. 551. Per 100 feet..... **98c**

### MESS KITS

Regulation two-piece Army Mess Kits with folding handle. Used, but perfect. Weight 2 lbs. No. 69c

### CANTEENS

Reg. U. S. issue canteens. Plastic screw top chained to body. Slightly used but perfect. Wgt. 1 lb. 117—Metal **69c**  
118—Plastic—Ea. **69c**

### CANTEEN CUPS

All metal. Folding handle. Wgt. 1 lb. No. A120—Each... **25c**

### CANTEEN COVERS

Heavy canvas. Button fastener. New No. 530—Each... **69c**  
Used No. 119—Each... **35c**

### WIRE CUTTER

Heavy duty, compound leverage. Cuts up to 1/4 inch wire. Upper jaw acts as feeder to cutting edges. Insulated handles. Ideal for farm fence work and general use. Shp. wgt. 2 lbs. Stock No. **\$1.95**  
392—Each

### Heavy Duty RUBBER GLOVES

Extra heavy—extra long. Brand new, high quality gum rubber for softness and ease in use. Designed for heavy duty industrial service—protection in handling chemicals, acids, etc. A real bargain at this low price. Stock No. 295—Per Pair, Only **79c**

### AMMUNITION BOX

Used for 50mm ammunition. Heavy, all metal design with latching top and folding handle. Provides safe, fire-proof storage for valuables, etc. Measures 12x 6x7 1/2 inches. Used but in new condition. Shp. Wgt. 8 lbs. No. 338—Each... **79c**

### ARMY AIR CORPS TYPE

SUN GLASSES  
Ideal for driving, sun glare, sports and work. 24 carat gold plate frames with Pyralin sweat bar—adjustable nose bands. Large aviation type lenses. Case included. Shp. wgt. 1 lb. No. 238—Per Pair... **\$2.95**

### PLASTIC BOX

Clear transparent plastic, 4 1/4 x 7 1/2 x 1 1/2 in., with 17 compartments, hinged lid. Use for fishing tackle, jewelry, small parts, etc. Shp. wgt. 1 lb. No. 260—Each... **98c**

### Waterproofing Compound

Gov't. surplus. A liquid formula for tents, tarpaulins, canvas clothing, etc. Use on old or new materials. Gallon covers 100 to 120 sq. ft. Stays flexible—will not peel or chip. Shp. wgt. 10 lbs. No. 423—Per Gallon... **\$1.49**

# WAR SURPLUS AND HUNDREDS OF OTHER BARGAINS

### POPULAR RECORD ASSORTMENT

Fifty records of modern dance, race, blues and hillbilly selections. No two alike. Famous name bands and artists included. Used in juke boxes, but guar. perfect. Shipped exp. collect only—no exchanges or refunds. Wgt. 28 lbs. No. A303—50 records... **\$9.64**

No. A300—25 Records. All Dance. Wgt. 14 lbs. .... <b>\$4.88</b>	No. A301—25 Records. Hillbilly, Race and Blues. Wgt. 14 lbs. Set... <b>\$4.88</b>	No. 302—25 Records. All Hillbilly numbers. Wgt. 14 lbs. Set... <b>\$4.88</b>
---	---	--

### STIRRUP PUMP

Works with any pail or bucket. Shoots a high pressure stream up to 30 feet. Use it for spraying garden and trees, for whitewashing, fire fighting, drainage, etc. Complete with 10 foot flexible hose. All brand new. Regular \$3.80 value. No. 244—Each... **\$1.49**

### 15 JEWEL STOP WATCH

Genuine Elgin 15 Jewel movement. Ideal for split second timing in racing, sports, time study, etc. Full sweep split second hand graduated in 1/10th seconds. Stem wind, start, stop and reset. Used but guaranteed perfect. Wgt. 1 lb. No. 200—Each... **\$9.95**

### VEEDER ROOT COUNTING MACHINE

Five wheel type—counts to 99,999 and repeat. Nickel finish case. Has 1 1/2 inch round shank. Use it for any counting job. Brand new. Shp. wgt. 1 lb. No. 241—Each... **98c**

### ARMY TENTS

16x16 Ft.  
A value you can't beat. Big 16x16 ft. pyramid tent with 4 foot drop wall. Used but in excellent condition. Poles not included. Fine for camping out, carnivals, etc. Wgt. 100 lbs. Stock No. 521—Each only... **\$35.00**  
Center and corner poles. Express collect. No. 500—Only... **\$3.00**

### RUBBER OVERBOARD SUIT

Here is a buy! Fits over your regular clothes and shoes. Can be cut apart for waist high waders, hip high or knee high boots, also arm length rubber gloves. Heavy gum rubber over fabric. Fine for commercial fishermen, sewer diggers, etc. Use it as is or cut it up for waders. All brand new! Wgt. 14 lbs. No. 183, Each... **\$4.95**  
Please include 75c for postage.

### 7 LB. EXPERIMENTER PARTS ASSORT. KIT



A "gold mine" for the radio serviceman. Hundreds of valuable radio parts, new radar and electronic parts and sub-assemblies, coils, resistors, trimming condensers—worth many times this low price. A130R—7 lbs., ... **\$1.79**

### RAIN SUITS

New 2 piece rain suits. Of durable wear resistant 9D fabric. Bib style pants, zipper fly. Jacket has parka attached. Guaranteed 100% weatherproof. Small, medium and large sizes. Shp. wgt. 3 lbs. No. R549—Each... **\$4.95**



### Officers Watch Compass

Brand new gov't. surplus. Army-Navy model. Single jewel mounted needle. Silver colored dial. A splendid value. Shp. wgt. 1 lb. A174—Each... **98c**

### OXYGEN TANK

Loaded with aviator's breathing type oxygen at 1800 pounds pressure. Tank measures 15 1/2 x 5 1/2 inches with rounded ends. Tank is of solid metal fitted with brass release valve at top. Brand new! Loaded—ready for all types of emergency use. Shp. wgt. 13 pounds. Ship exp. only. Stock No. 390—Each... **\$3.50**

### AVIATOR'S OXYGEN

Ball out type. Consists of all metal tank, release valve, gauge and breather hose, all enclosed in khaki colored cloth bag. These tanks are loaded with oxygen at 1800 pressure. Ideal for use as reserve oxygen supply for all types of emergency use. Shipping weight 4 pounds. All brand new. Stock No. 391—Each... **\$4.95**

### HIGH PRESSURE SHATTERPROOF TANKS

TYPE D2 400 LB. TEST  
A high pressure shatterproof tank of 500 cubic inch capacity—for 50 pound pressure or 13.8 cubic feet. All metal—measures 8 1/2 x 24 inches. Threaded plug end vents. Shp. wgt. 6 lbs. No. 388—Each... **\$2.45**

TYPE F1 400 LB. TEST  
A high pressure shatterproof tank of 1000 cubic inch capacity—for 50 pound pressure or 13.8 cubic feet. All metal—measures 9 1/2 x 17 inches. Threaded plug end vents. Shp. wgt. 11 1/2 lbs. No. 389—Each... **\$3.75**

### ORDER DIRECT FROM THIS AD

Values galore! Hundreds of hard-to-find items for home, shop and outdoors. Make remittances by money-order, bank draft or personal check. Send 25% deposit on C.O.D. orders. No C.O.D.'s on orders for less than \$5.00. Include sufficient postage on parcel-post orders—any overage will be promptly refunded. All quotations F.O.B. Chicago. Used items and materials are guaranteed serviceable and as described. Your money back if not more than satisfied.

SEND 10c TO COVER POSTAGE AND MAILING ON BIG CATALOG—READY IN ABOUT 30 DAYS

**STARK'S** Dept. PM9  
509 So. State St.  
CHICAGO 5, ILL.

### WILLARD 1 1/2 VOLT STORAGE BATTERY

A rechargeable wet plate battery good for years of service. Brand new. Battery is shipped dry but fully charged—any battery station will add acid. Use singly or in multiples for radio sets, bell circuits, alarm systems, etc. Measures 5 1/4 x 4 x 3 inches. Ball floats indicate condition of charge. Shp. wgt. 4 lbs. Stock No. 297—Each Only... **\$2.95**



# New Shotgun Value

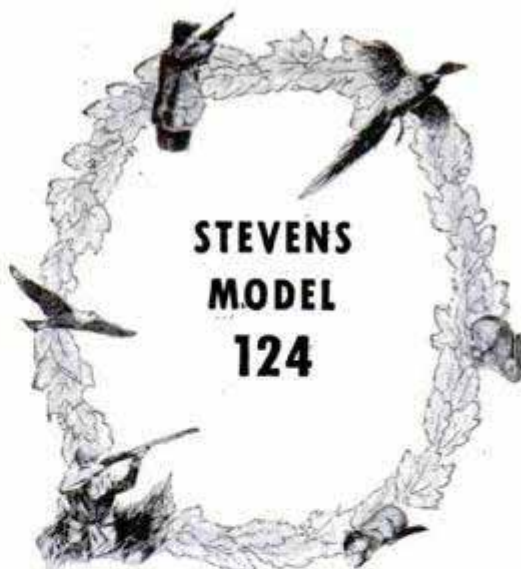

Here it is! The NEW Stevens Model 124 . . . a fast handling, dependable 12 gauge *repeating shotgun* with streamlined balance and good looks. Its sensational low price . . . made possible by *entirely new design* . . . puts *this "repeater"* within the reach of every shooter. Its introduction marks another forward step in our pioneering development of new models . . . new values . . . new gunbuilding methods.

SAVAGE ARMS CORPORATION  
Firearms Division, Chicopee Falls, Mass.

STEVENS

MODEL  
124

12 GAUGE  
REPEATING  
SHOTGUN

#### OUTSTANDING FEATURES

The new Stevens Model 124 is featured by a compactly efficient, fast, simple to operate, *cross bolt action* that's new in repeating shotgun design. This action is opened by pulling cross bolt out and back . . . closed by pushing bolt forward and in. Opening stroke of bolt ejects fired shell . . . closing stroke moves loaded shell from magazine to chamber. *Firing pin remains locked until action is completely closed.* To open when in firing position, an action release is provided at the lower left of receiver.

**SAFETY** — Push button type at forward end of trigger guard.

**BARREL** — 28" — modified or full choke. Special alloy gun barrel steel. 12 gauge — chambered for 2 3/4" shells.

**RECEIVER** — Polished and blued, solid frame, side ejection. Tubular magazine — with one shell in chamber — making 3-shot repeater.

**STOCK and FOREARM** — Durable, service-proven, beautiful TENITE. Fine checkering . . . capped, full pistol grip . . . and handsome burl finish give stock custom-built features and appearance.

**WEIGHT** — About 7 lbs.

Write For Illustrated Folder

SEE THIS GUN VALUE AT YOUR DEALER'S

"First in the field"



**STEVENS**

PIONEERING BETTER GUNS  
AND GREATER VALUES SINCE 1864



**SAVAGE**

WORLD FAMOUS FOR DEPENDABILITY  
AND ACCURACY



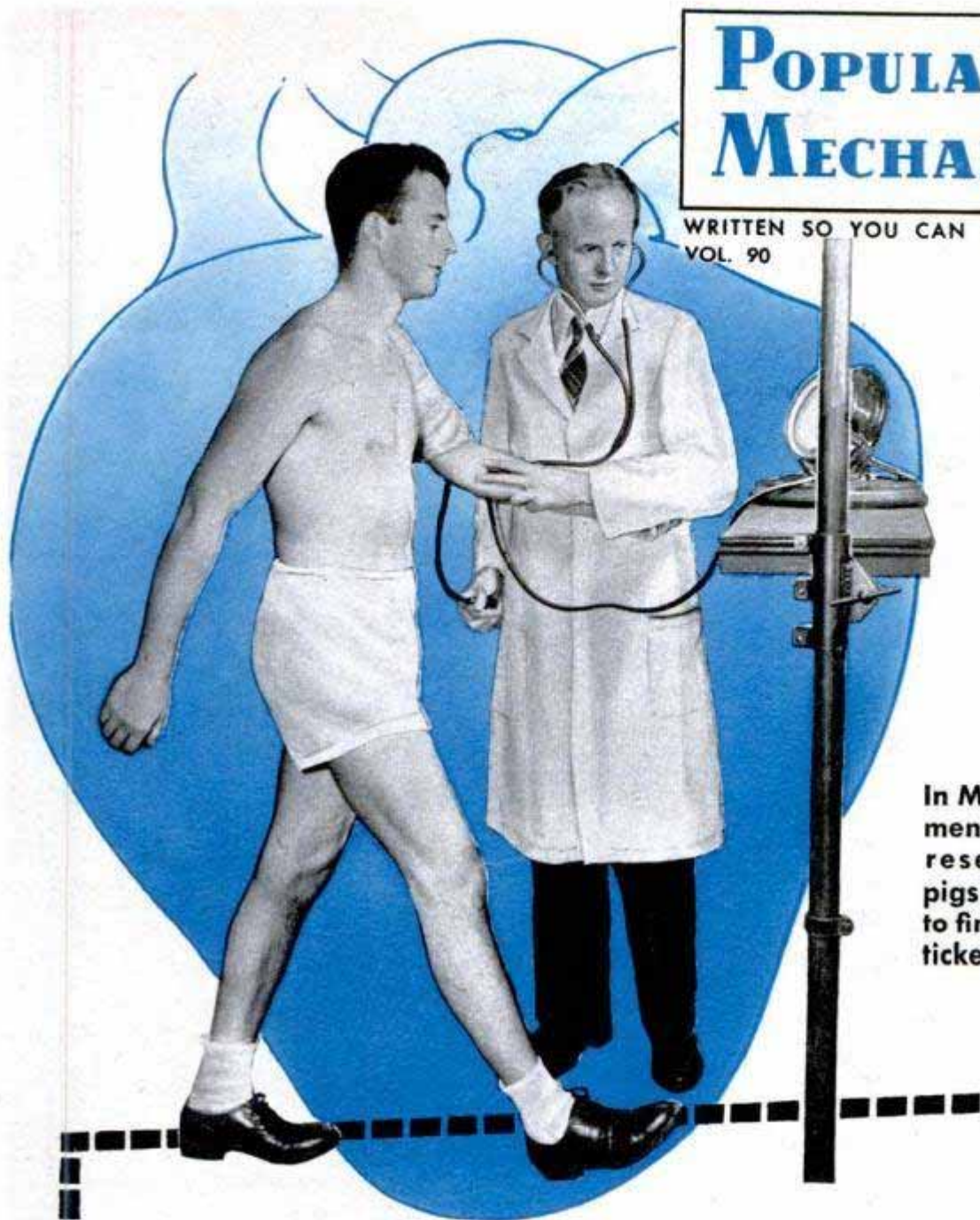

In Minneapolis 500 men are serving as research guinea pigs in experiments to find why a man's ticker stops ticking

## *MASS ATTACK on Heart Disease*

By Clifford B. Hicks

**R**ECENTLY a Minneapolis executive in his forties approached a life insurance company for a big policy—\$250,000. Because this is a large amount of money to gamble on a man's life, the insurance company called in top-flight physicians who examined the prospect from head to toe. They gave every organ of his body a clean bill of health.

Seven days after the policy was issued the executive was dead of a heart attack.

Even the finest doctors had no way of knowing that this man was subject to cardiovascular disease—the medical term for disorders of the heart and blood ves-

sels. Medical science, despite its magic strides in other fields, has uncovered very little basic knowledge of who will be subject to these disorders; why heart disease attacks some persons and leaves others alone, and what can be done to warn prospective victims of their fate.

In Minneapolis 500 men are starting their second year of service as guinea pigs in a mass experiment to lay bare some of the facts on heart disease. It's a project that will last at least five years, may carry over for 10, and ideally should be run as a "last man's club" until every one of the 500 volunteers is dead. The goal is to find



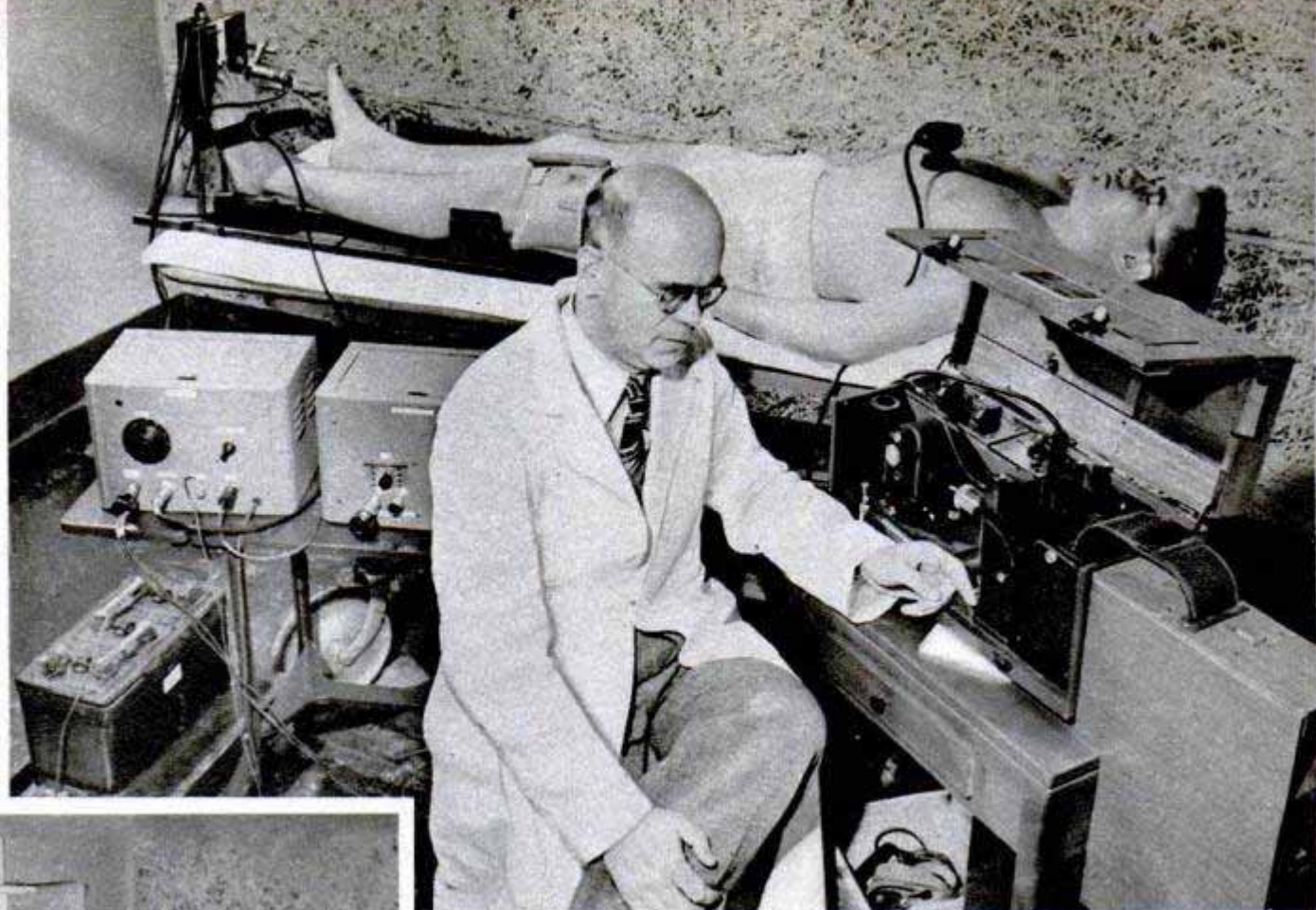

Sound instrument on volunteer's chest records pulse starting from his heart. Photoelectric cell, shown at left, detects pulse when it reaches the big toe. Time interval shows elasticity of blood vessels

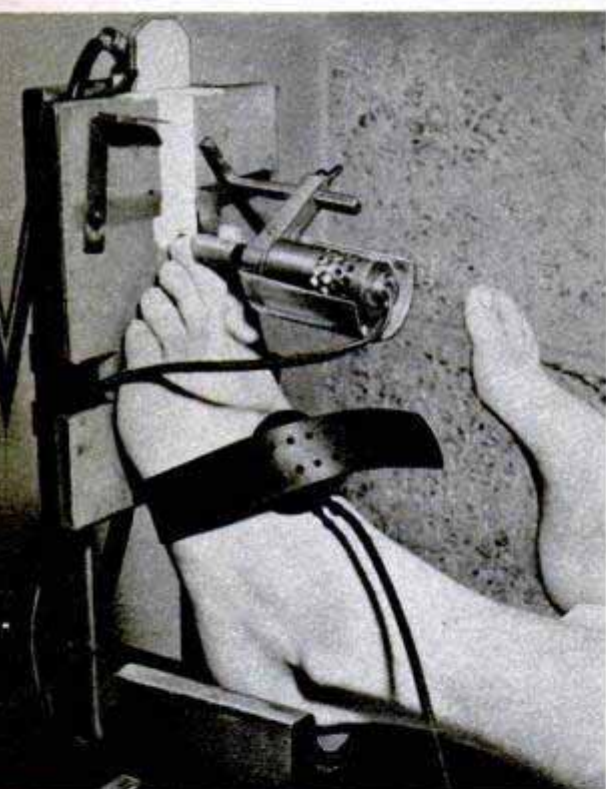

out why a man's ticker stops ticking and why his blood vessels grow hard.

The man who conceived this mass approach is 44-year-old Dr. Ancel Keys, director of the University of Minnesota's Physiological Hygiene Laboratory. Doctor Keys' last piece of wizardry was a dramatic wartime study of starving human beings. A large group of conscientious objectors underwent severe starvation while he watched the effects. The results of these experiments are being applied today to sustain life in famine areas.

Doctor Keys feels that cardiovascular diseases are the major threat to our national health. He points out that heart disease has been the nation's number-one killer for 25 years. It causes more fatalities in the United States than the next five leading causes of death—including ac-

Caliper-type instrument measures the amount of fatty tissue beneath the volunteer's skin to help in analyzing the effect of underweight or overweight on diseases of heart and blood vessels. Weight on scales is no true indication of the amount of fat on the volunteer's body

St. Paul Pioneer Press photo





cidents—combined. Cardiovascular diseases cause as much disability as cancer, tumors, nervous and mental diseases.

Yet medical science has only assumptions and theories as a foundation for its fight against cardiovascular disease. No one knows for sure what causes high blood pressure or why blood vessels grow hard.

Doctor Keys points out that relatively little basic research on heart disease is under way, despite its status as public enemy number one. He attributes this in large part to a lack of funds. For every death from infantile paralysis, \$525 is spent annually on research in this country; for every death from cancer, \$2.13 goes into the lab, but for every heart disease fatality, only 17 cents is contributed for research and investigation.

In planning his attack on this sudden killer Doctor Keys ruled out a search for new methods of treating those who already have contracted the disease. He doesn't belittle such efforts, but claims that this type of research can only prevent a bad pumper from growing rapidly worse. The approach is limited. High blood pressure and heart disease seem incurable for the same reason an old car is incurable unless it has a new engine—and you can't buy a new engine for your body. Half the adults in the United States are being chased down a blind alley by this form of death. It's not a matter of whether they'll be caught, but how long until they are.

"The real problem lies in a comparison of two classmates," says Doctor Keys. "Both apparently have taken care of themselves. Yet one is hale and hearty at 80 and the other is picked off at the peak of his value, 30 years before. Why?"

Doctor Keys and his staff of experts in many medical fields cast about for a method of answering this question. They wanted to find out exactly why one man develops

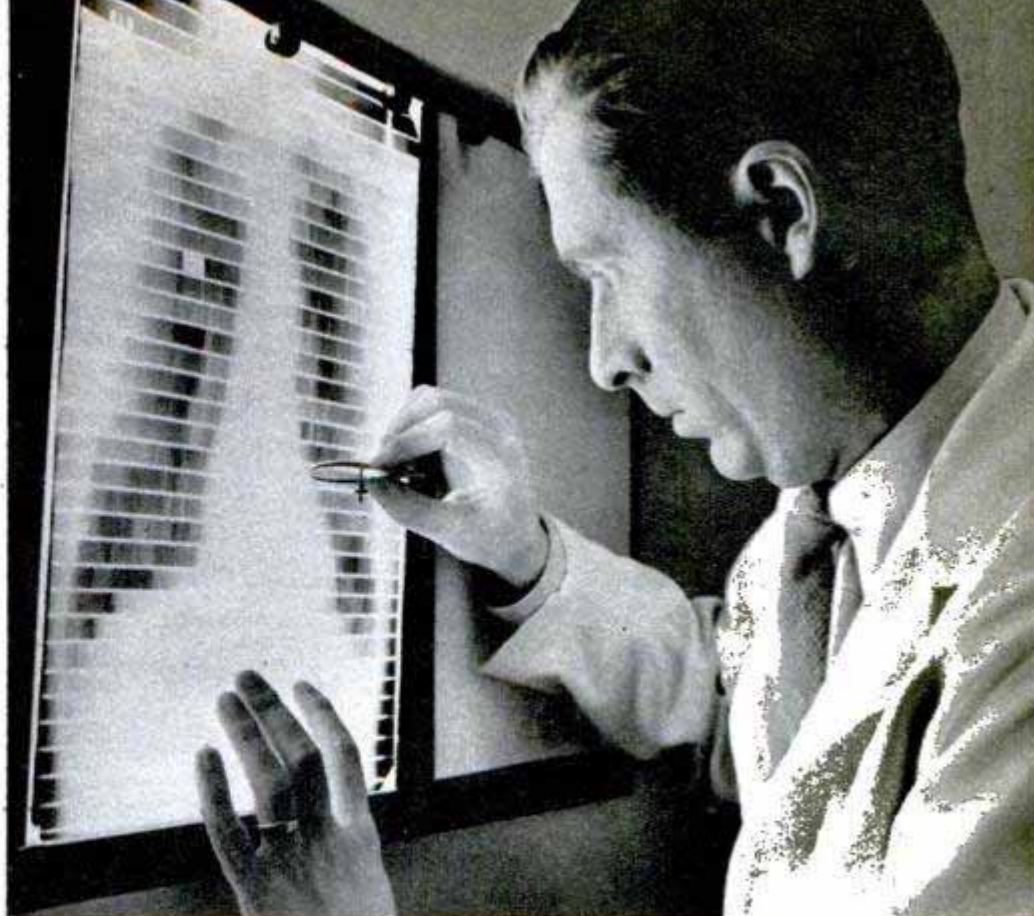

Minneapolis Tribune photos

By means of a continuous-exposure X-ray, one of the scientists measures the dimensions of heart when it is full and when it is empty of blood

heart disease and his classmate doesn't. The disease can't develop by chance. Therefore they conclude that there are definite factors in the way a man lives that must bring on the disorder.

A study of a man's life requires years of investigation. The team of scientists determined to cut this period as short as possible by choosing human guinea pigs who are in the prime of life at a period when heart disease is most likely to strike. By watching these men closely they might be able to put a finger directly on the cause of the disorder. They further decided that they would need three groups totaling

Research assistant gives subject's blood a color test to measure the amount of cholesterol, a fatty substance absorbed from butter and eggs





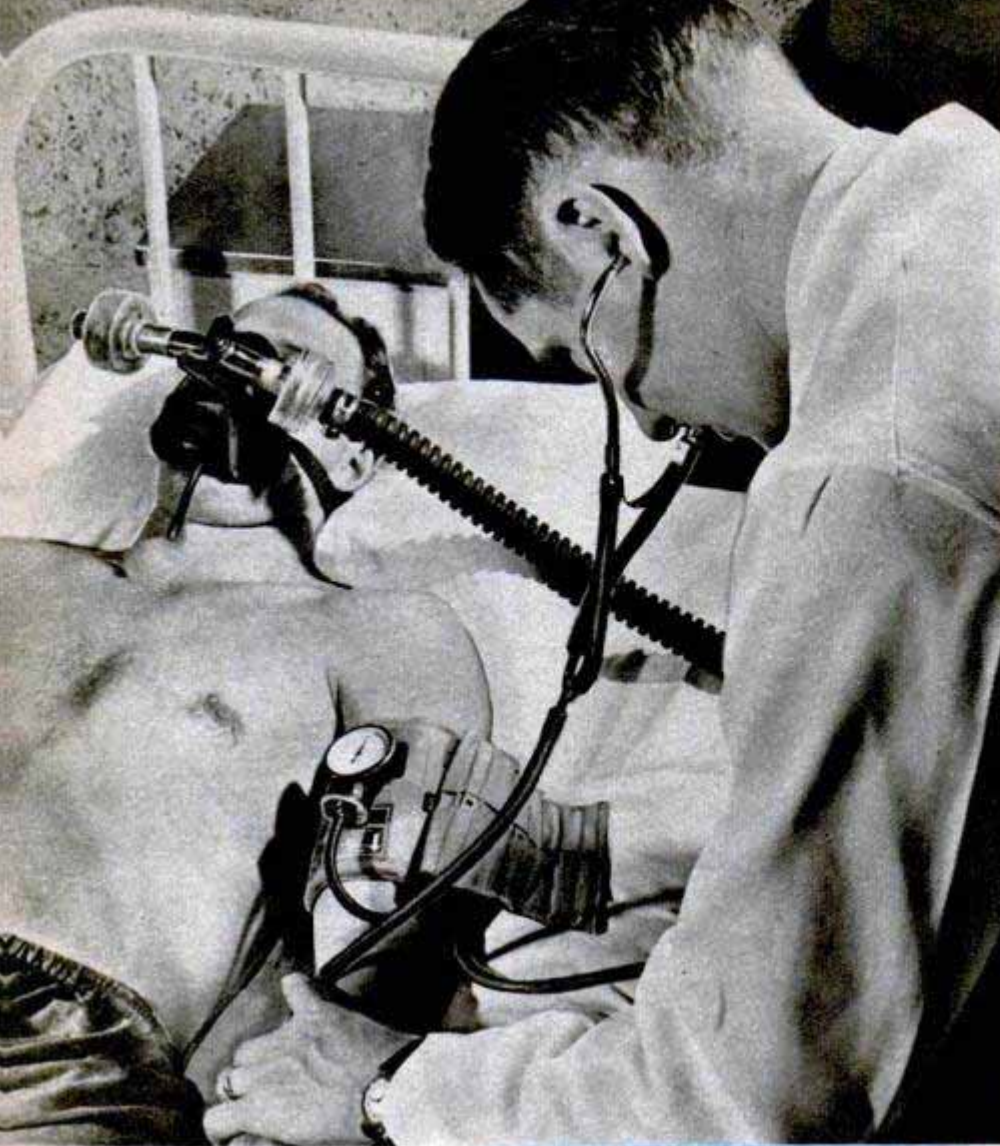

Blood pressure soars when a subject breathes air rich in carbon dioxide. Too much variation means he is subject to high blood pressure

500 volunteers: The prime-of-life group between 45 and 54 years old; a group of young men that they could watch for early symptoms, and a small group of men who already had heart disease that they could use as a control group for comparisons.

Accordingly, Doctor Keys examined 180 college men for facts on the younger group. To get volunteers for the prime-of-life group he asked 25 Twin Cities business concerns for a list of the names of men in the proper age group and who are executives or hold other responsible positions. One thousand invitations to participate were mailed to these men, and about 300 were chosen from the resulting 900 volunteers. Each man is pledged to return for a thorough examination each year. How does the volunteer ben-

Half the people in the United States die from some form of heart disease. Doctor Keys shows how Minneapolis heart deaths climb steadily each year

efit? He is warned if the exam turns up any flaw in his health, and his doctor is given all information covered by the examination.

Doctor Keys and his associates, Doctors Taylor, Henschel, Simonson, Brozek, Mickelsen and Chapman, divided these 300 men into six groups of 50. Five of the groups were classified according to weight and age. Into the sixth group went men who have kept themselves in top shape over a period of years as witnessed by athletic directors who have worked with them. Thus the laboratory has a preliminary check on the effect of weight on heart disease, and hopes to find out what effects exercise may have on the ticker. If the scientists are successful the research may have a strong influence on living habits, as many persons feel that vigorous exercise is beneficial while some doctors advise that middle-agers cut down activities.

Why does Doctor Keys concentrate only on a group of men whose business responsibilities and living habits are similar? He is attempting to confine his research to a circle small enough to eliminate many of the variables. When heart disease shows up in the group, he wants to be able to put his finger on the cause, cutting down as far as possible the chance that the man's occupation has paved the way for the killer.

And heart disease most certainly will

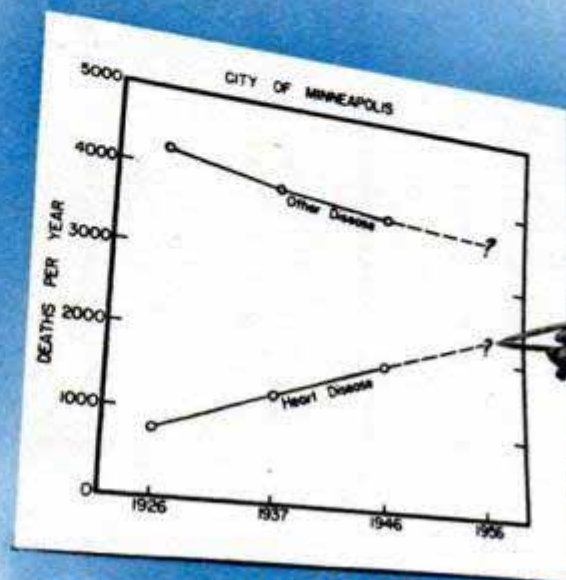



strike this group. Insurance statistics prove that some of the participants will develop cardiovascular disease this year, even though they now are well. Eventually about half of these men will die of the disease.

The program calls for an exhaustive medical exam each year, an exam that plunges into fields strange to most exams. For example, little is known about the effect of fat on heart disease. True obesity has not really been examined in this connection. Insurance tables are made up according to actual weight, which is a poor indication of how fat a person is. People can be above average weight because they have much muscle, or because they have a heavy bone structure, or because they really are fat.

In order to find out how fat his "guinea pigs" are, Doctor Keys first weighs them on conventional scales, then seats them in a chair suspended above a six-foot tank and dunks them in water. Because fat is buoyant in water, their weight afloat compared with their weight in the air gives a true measure of how fat they are.

In another test the volunteer dangles his hand in a bucket of ice water. Local cold restricts the blood vessels, causing the blood pressure to shoot up. When this effect is pronounced, it indicates that the subject may be especially susceptible to heart disease even though he is in top shape during the test.

Exercise, of course, invariably boosts blood pressure. The volunteers "hike" uphill at various speeds on a motorized treadmill while a running record of their blood pressure is made.

The time it takes blood from the heart to reach the big toe is another phase of the research, as it indicates how elastic the volunteer's arteries are. Blood vessels, like rubber bands, gradually lose their elasticity. In the laboratory tests, a photoelectric cell is attached to the volunteer's big toe and a sound recorder is placed above his heart. The cell measures the light passing through the toe, thereby detecting the blood pulse. The time when the pulse started from the heart is known from the sound record.

Another lab project is to find out how much influence cholesterol has on heart disease. It is found in the

(Continued to page 254)

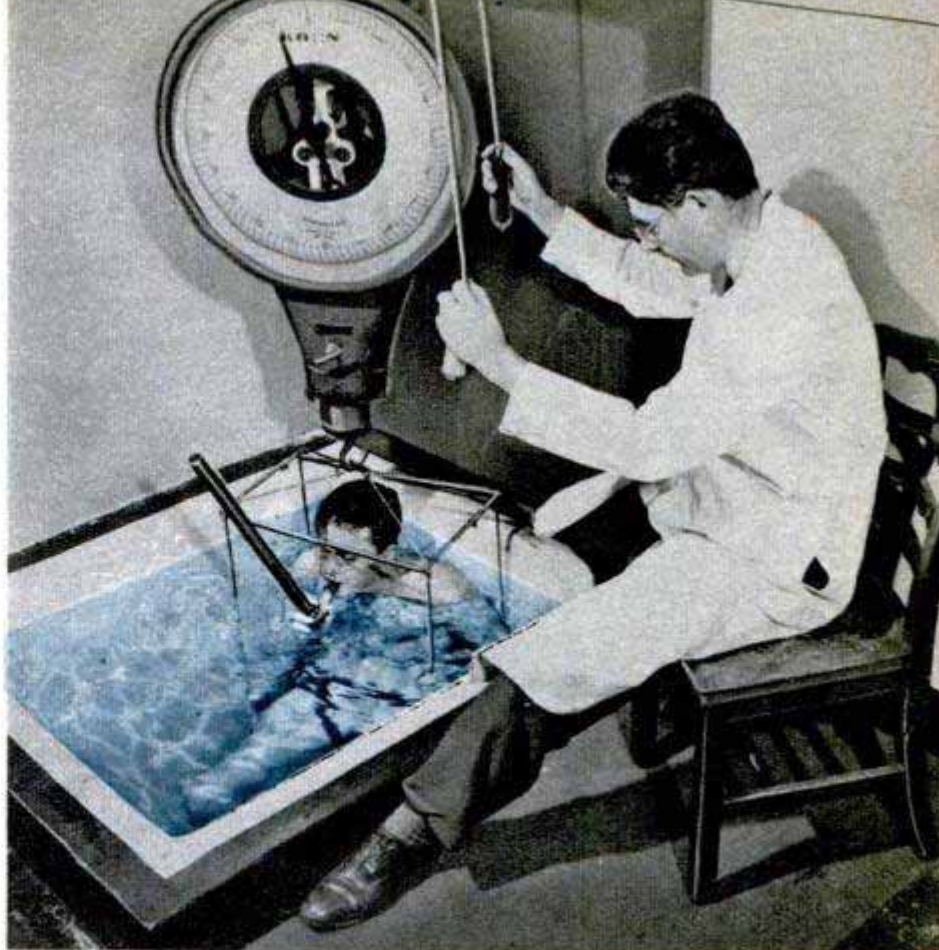

Comparing a volunteer's weight in water with his weight in air gives a true indication of the amount of fat he carries.

↓ How does cold weather affect blood pressure? In four out of ten subjects who dangle hand in ice water, pressure rises

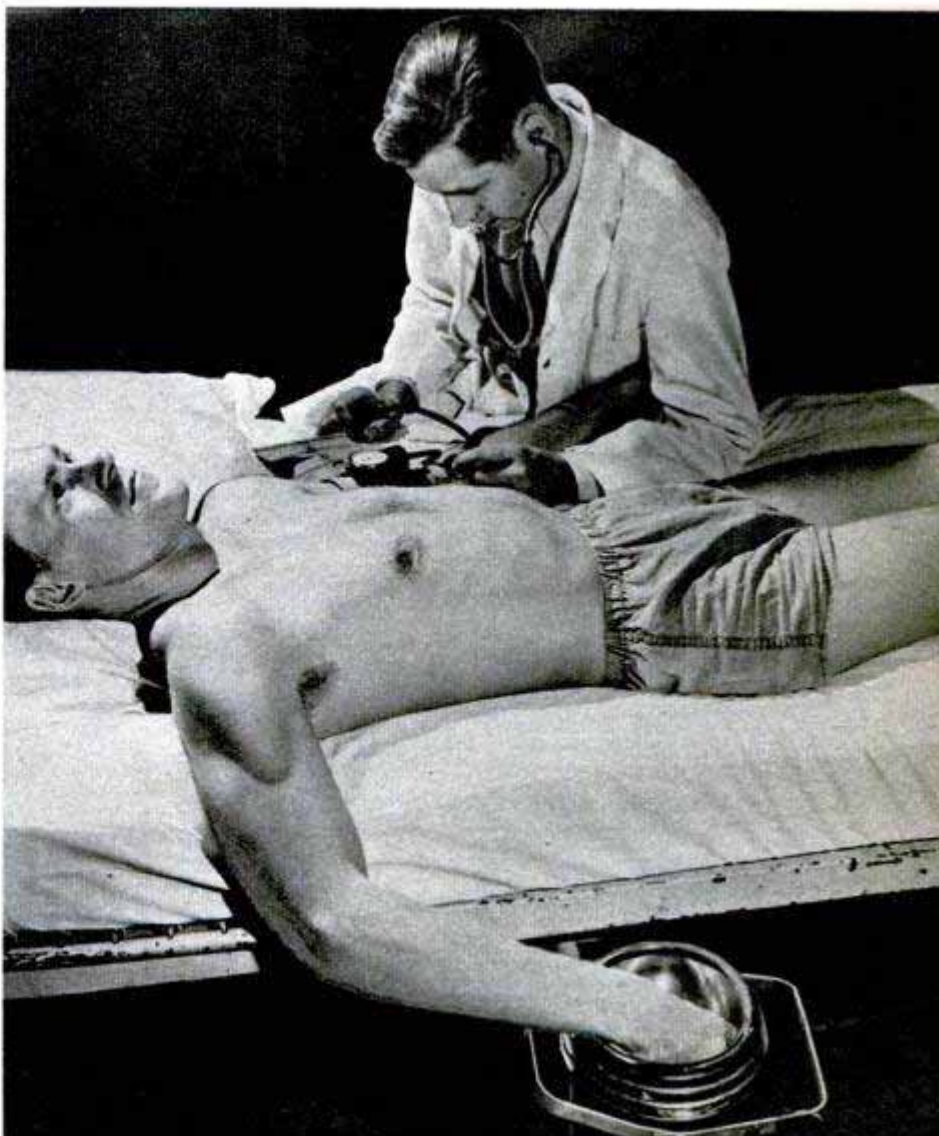





## Basement Swimming Pool

Jallette and his family take a dip in the swimming pool they built in the basement of their home. Concrete floor was dug up to make room for the pool. Below, from outside there's no sign that the house rests on a swimming-pool foundation



When members of the Jallette family of Woonsocket, R. I., want to go swimming they just dive into the basement. The cellar swimming pool was started 12 years ago when Ludger Jallette decided he couldn't afford the time to take his family to the beach. There was no room for a swimming pool in the yard, so Mrs. Jallette suggested they build one in the basement. The concrete floor was torn up with pick and shovel. At one point they hit quicksand; at another they struck a ledge they couldn't dig up. All the windows in the home were opened and a friend dynamited the ledge without blowing the house apart. The result is a concrete swimming pool that can be used all year. From the exterior, the home looks just as it always did, with no hint that there's a swimming pool under it for a foundation.

☞ Air freight and air express carried by the 35 established airlines of the United States has grown from 30,914,463 ton-miles in 1945 to an estimated 103,000,000 ton-miles in 1948.



## Radio-Phone Talks Held Between Cities

To "assemble" top company officials in Chicago and Denver for bi-weekly staff meetings, United Air Lines is using a unique combination of radio, telephone and loudspeakers. Four nondirectional microphones and a loudspeaker at the conference table in Chicago are controlled by a recording secretary. He listens in on all conversations and regulates voice volume in both cities. His master-control cabinet plugs directly into any telephone circuit and connects with Denver through one of the company's private wires. Staff members at the Denver end use three "push to talk" handsets. A red light flashes



in Chicago when the conference-table mikes are alive, and goes off when the loudspeaker is turned on to receive voices of the officials from Denver.



## "Airborne" Chickens Roost in Glider Nose

Something their designers never anticipated was that the noses of wartime gliders make excellent chicken houses. English users have found they are dry, draftproof and that the original windows provide sufficient light. Costing only a fraction as much as conventional chicken houses, they are eight by nine feet across the base and approximately seven feet high at the center.

**DOME-TYPE COACH** for Italian train has all-around vision for sight-seers. Built by an Italian manufacturer, it was put on exhibit at the 26th International Fair in Milan

Our **WHERE-TO-FIND-IT INDEX**, listing names and addresses of manufacturers and sources of further information for products in this issue, is available free upon request. This index is one of the many services offered to our readers by the Bureau of Information. For your index, write to Bureau of Information, Popular Mechanics, 200 E. Ontario St., Chicago 11, Ill.

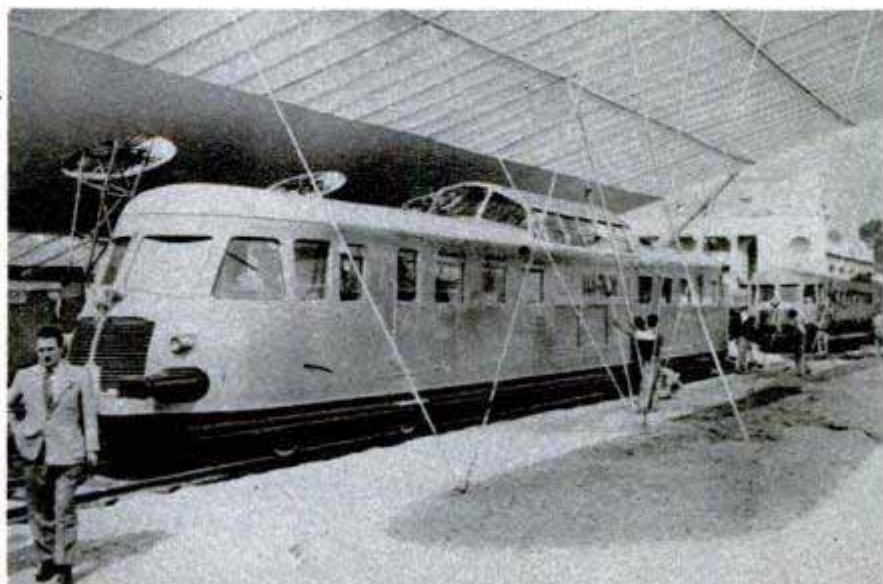



SAUNDERS-ROE 45 COMPARED WITH

OTHER LARGE FLYING BOATS

MARTIN MARS

S.R. 45

HUGHES HERCULES

# BRITAIN'S

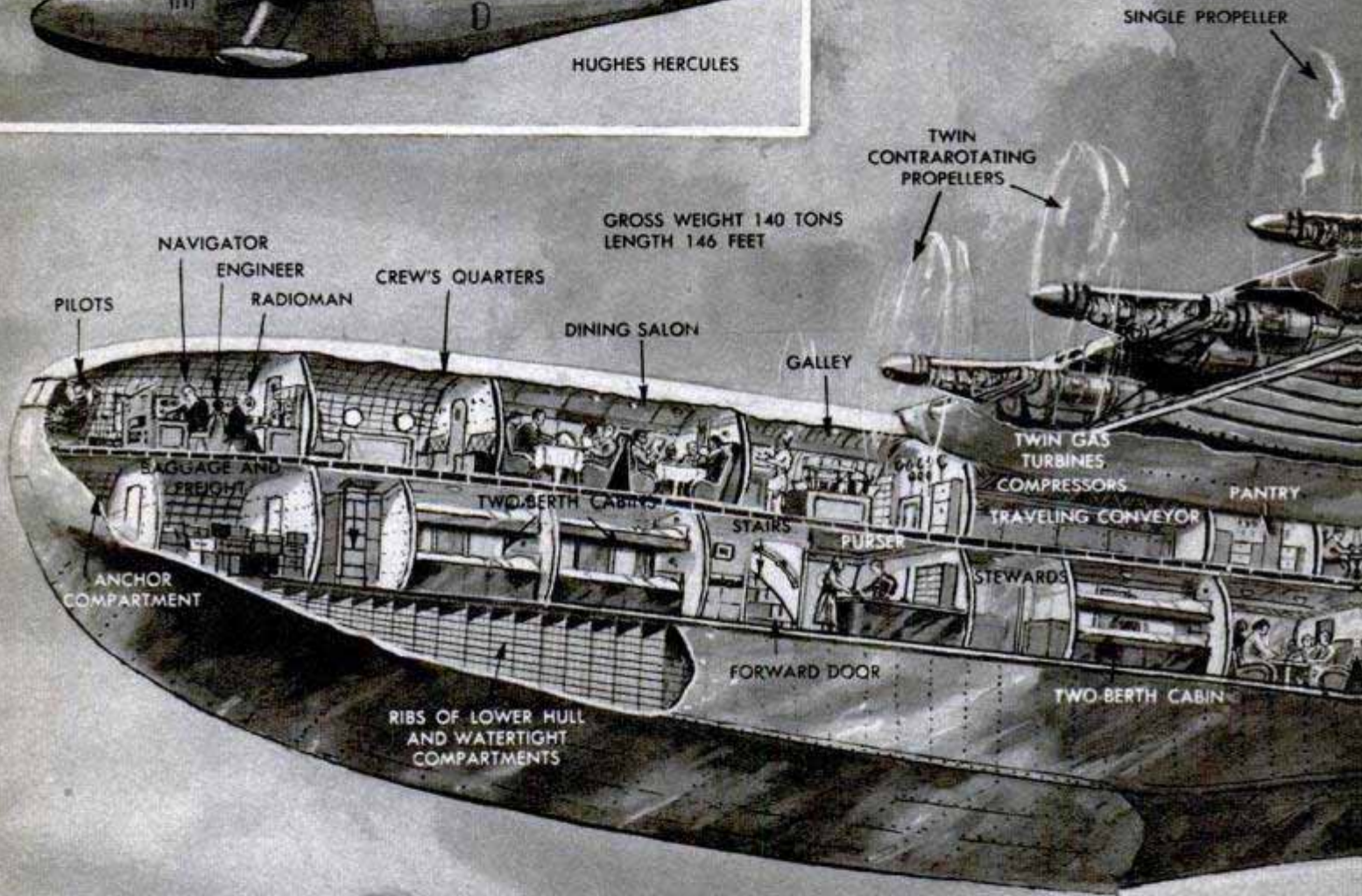

G. H. HAVIS  
1948





# BIGGEST Flying Boat

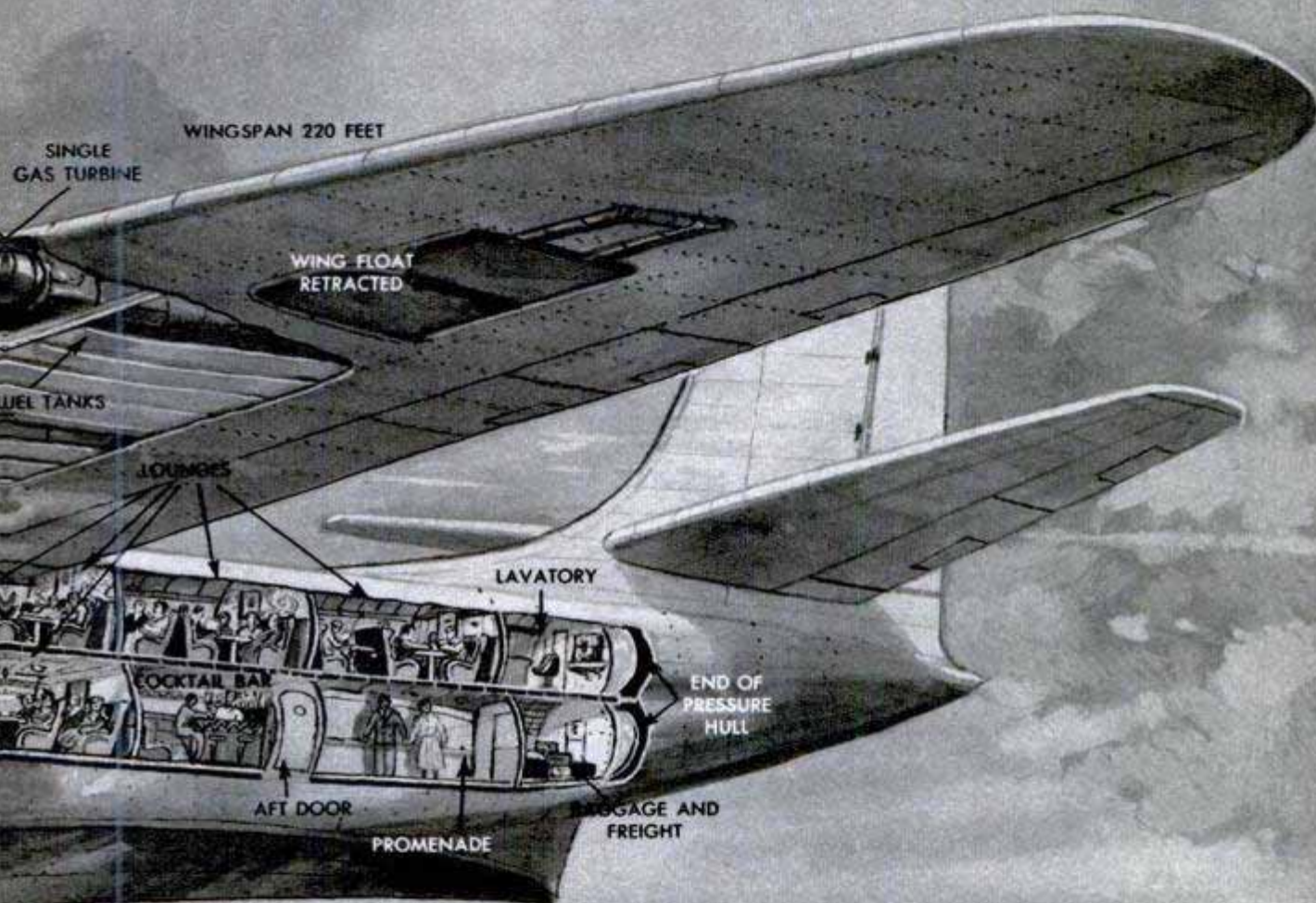
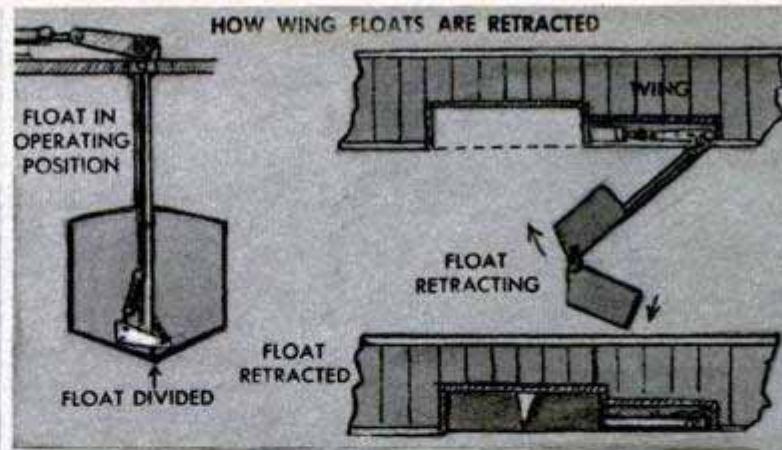

FLOATS that "break in two" and fold snugly up into the wings will be pioneered when the Saunders-Roe 45, Britain's largest flying boat, takes to the air next year. To streamline the 140-ton craft for 350-mile-an-hour flights, the two floats are divided into watertight halves. During retraction the halves gradually hinge apart until they assume a thinner, flat shape that can be drawn up flush into the underneath side of the wing. (See upper-right illustration.) Eight of the plane's 10 gas-turbine engines, each 3500 horsepower, will work in pairs to turn four sets of contrarotating propellers. A special clutch system will make it possible for defective engines to be uncoupled in flight, with the other of the pair continuing to drive the propellers. The two outboard engines will be conventional installations. Cruising altitude will be above 30,000 feet. Three of the giant air boats are being built



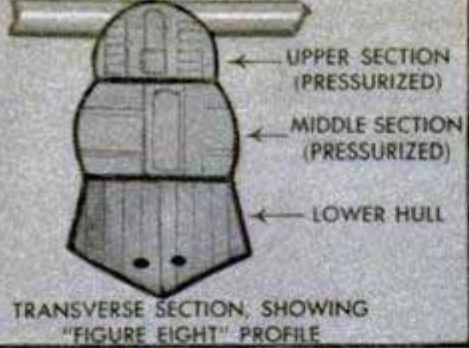

UNIQUE ENGINE ARRANGEMENT OF BRITISH S.R. 45, LONG-RANGE FLYING BOAT

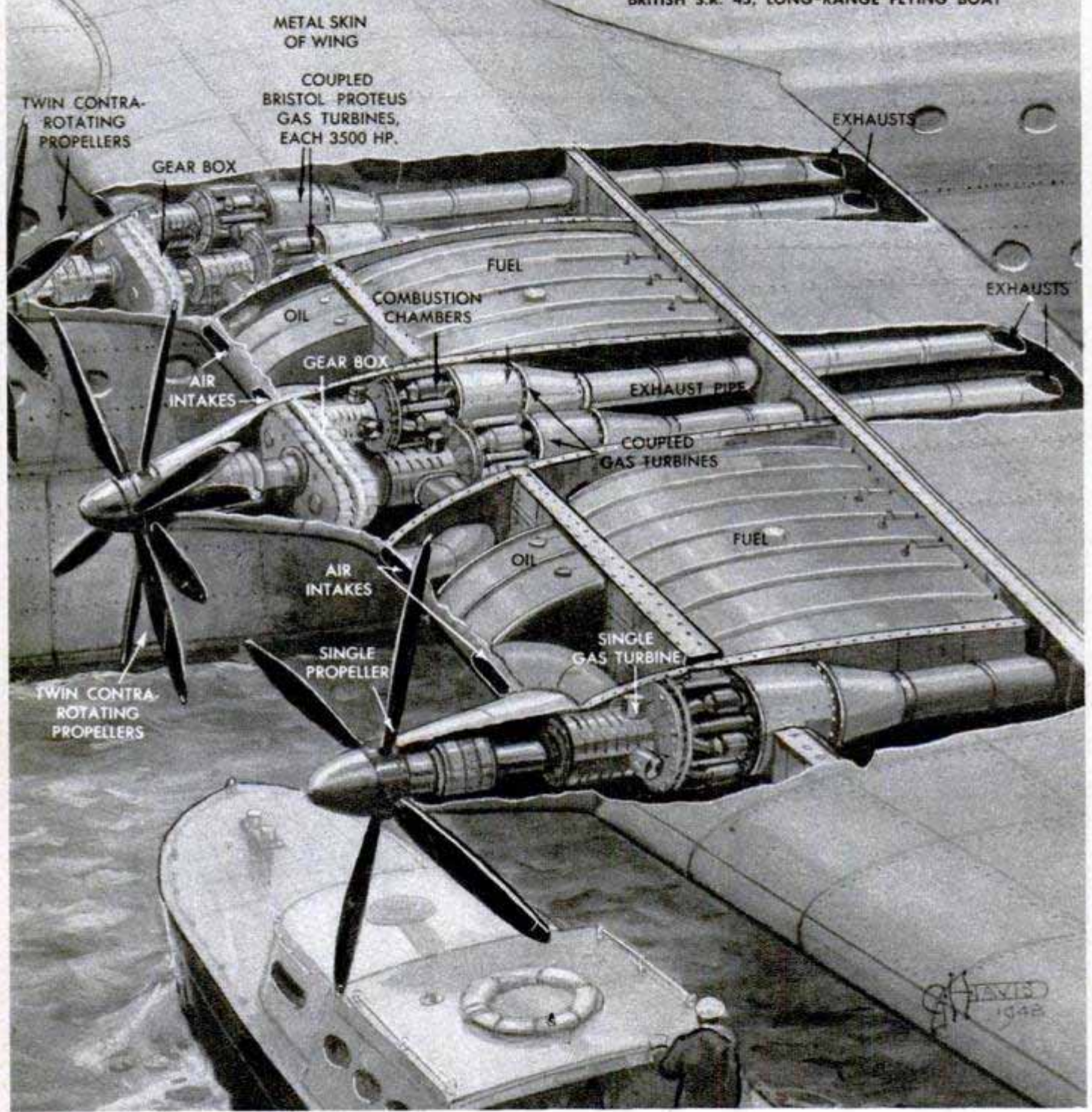

Using two-stage reduction gears, eight engines work in pairs to turn four sets of contrarotating propellers

at Cowes, England, and each is expected to carry upwards of 100 passengers on direct New York-London service. From tail to nose they measure 146 feet, with wings

spanning 220 feet. The double-deck "figure eight" fuselage, which will be completely pressurized, is slightly more than 24 feet high at the center entrance.



## Microfilm Reader

Microfilmed material containing letters less than  $36/10,000$  inch high can be read or copied on photographic paper with a projector that reduces eyestrain. The machine is designed for business use in reading and copying 16-mm. microfilm. An iris diaphragm enables the reader to control the illumination. One motor with four speeds carries the film through the machine, making it possible to reach an approximate location at high speed and then switch to a slower scanning speed. Copying the film on photographic paper can be accomplished in two minutes without a darkroom.



## Tractor "Altimeter" Aids Contouring

Contour farming is made easier with a gauge that shows when the tractor is traveling on the level. It makes preliminary surveying and staking unnecessary. Mounted on the hood, the gauge has a pointer that indicates what percentage of the slope, up or down, the tractor is off the contour line. Side-hill tilt doesn't affect the indicator.

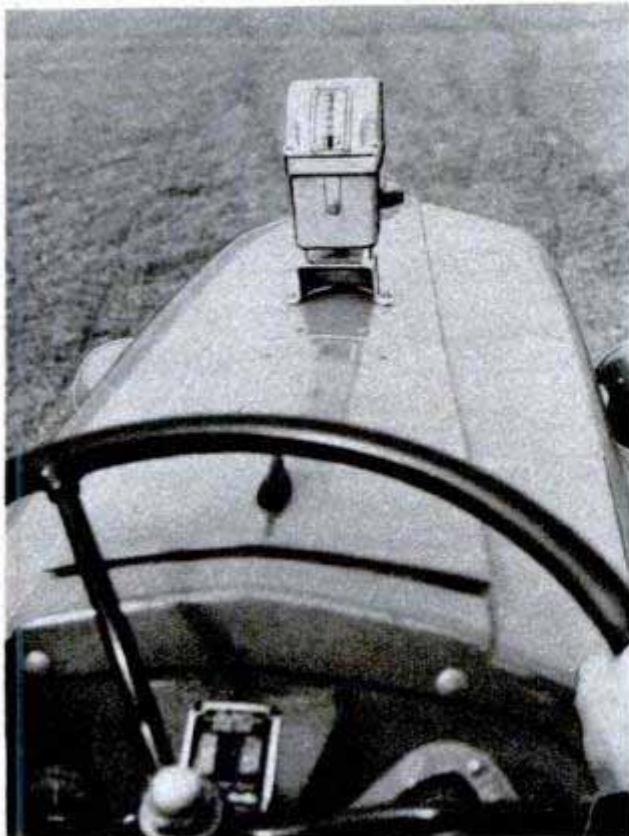

## Lock Screw Adjusts Dado Collar

By means of a self-locking screw, an adjustable collar converts any circular-saw blade into an accurate dado cutter. The thumbscrew is turned to tilt the blade off center and the self-locking feature holds it at this angle. The attachment comes in two sizes, one for saw blades up to 10 inches in diameter, the other for blades 12 inches or larger.

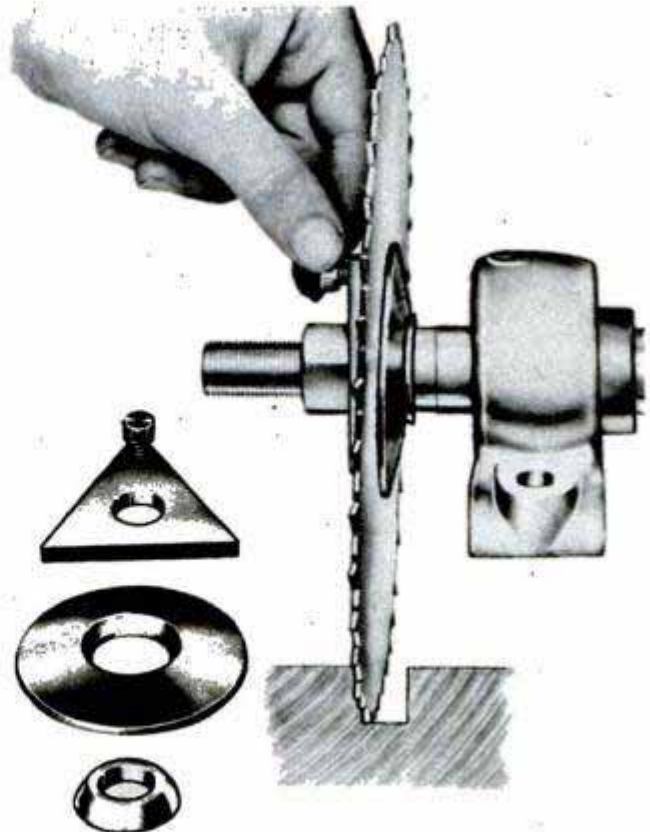



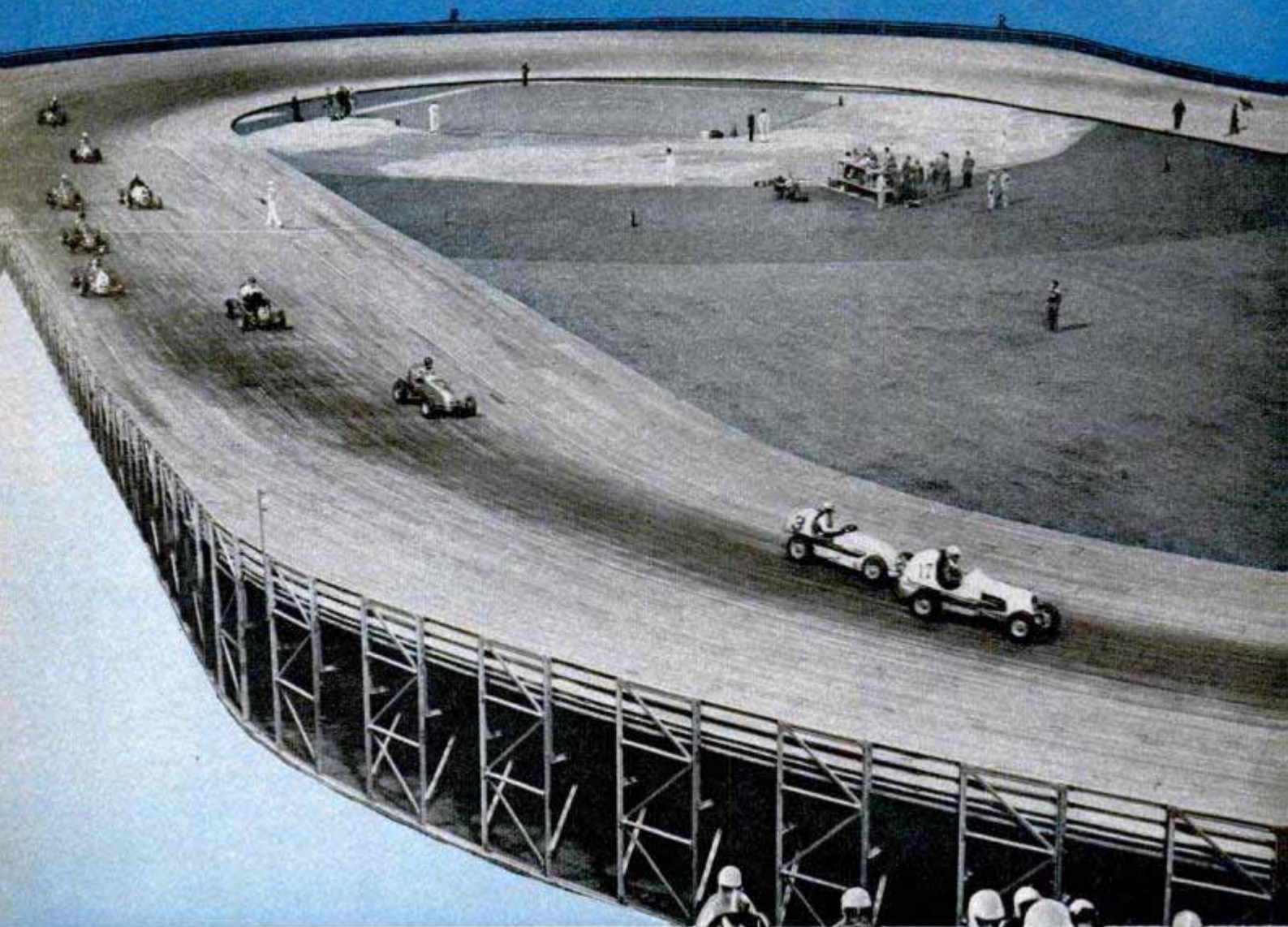

## PORTABLE BOWL for the MIDGETS

By Bill Reiche

WITH THE DEVELOPMENT of a fast, portable track which can be erected or dismantled in a matter of hours, midget-auto races now can go on tour.

The diminutive speed demons, which provide spectator thrills out of all proportion to their wheelbases, have been a big-time attraction even without the aid of a traveling raceway. About 30 million people see the races each year. But the tracks are something of a problem.

The mighty midgets sprint and skid on ovals that generally run a fifth or a sixth of a mile to the lap, which keeps the action right under the spectators' eyes. Outdoors,

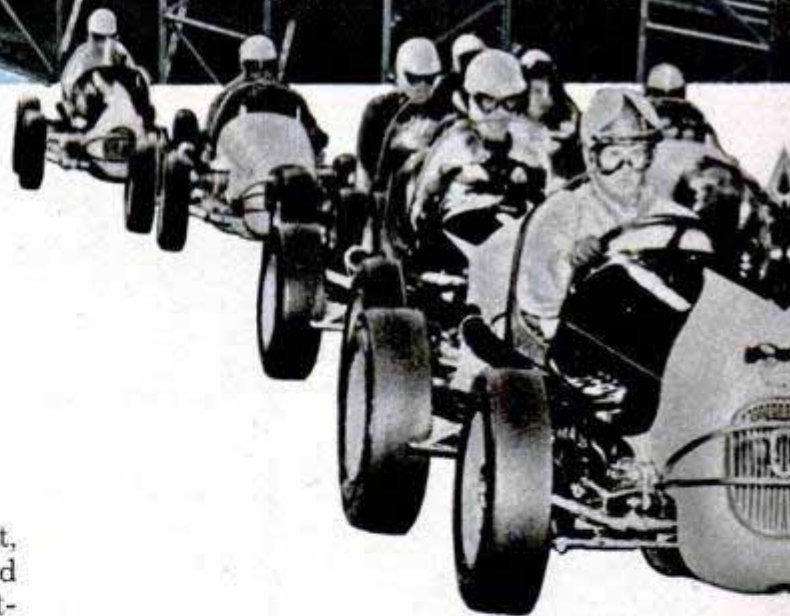

dirt or board tracks are used, and occasionally concrete or macadam, but open-air racing is limited as to season except in the far South.

The greatest potential audience is in the larger cities, but there the cost of property makes it difficult to use a central location solely for racing. For all-year-round operation in northern cities, indoor sites such as armories are essential, but their



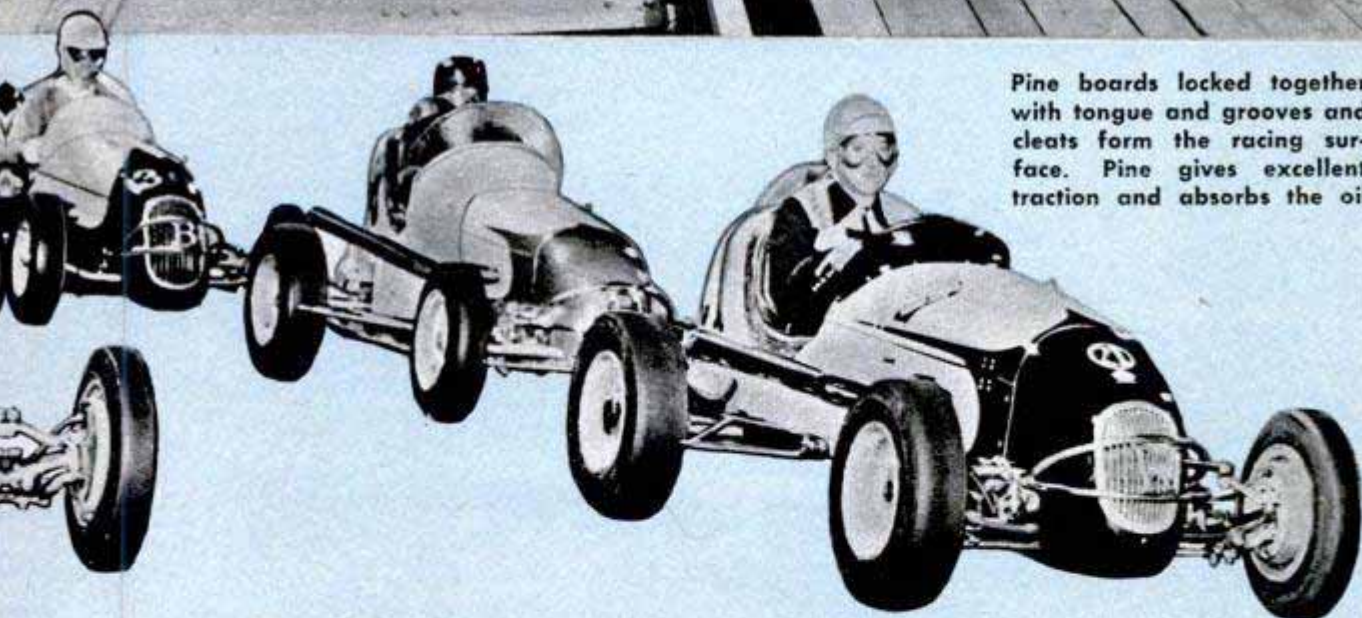

Pine boards locked together with tongue and grooves and cleats form the racing surface. Pine gives excellent traction and absorbs the oil

use for other purposes would be somewhat diminished by a permanent race track.

Nor are the tracks ideally designed for speed, many being inadequately banked or not banked at all. Under these circumstances races often degenerate into parades, since it is almost impossible for a driver to pass the lead car. Passing requires high speeds where the average is 60 miles per hour; unless the turns are

well-banked, the passer can't make the curve and might end up—with car—in the audience. A banked straightaway is also important to a fast race in that it gives a passing driver the benefit of gravity when he pulls down and ahead of another car.

When Alexis Thompson, millionaire sportsman, decided to introduce midget-auto racing to New York City this year he wanted to use a ball park, since it would be





Framework for the oval consists of aluminum trusses secured to vertical members by stainless-steel fittings. Putting together the track is as simple as assembling a child's building set—it just takes more time and labor

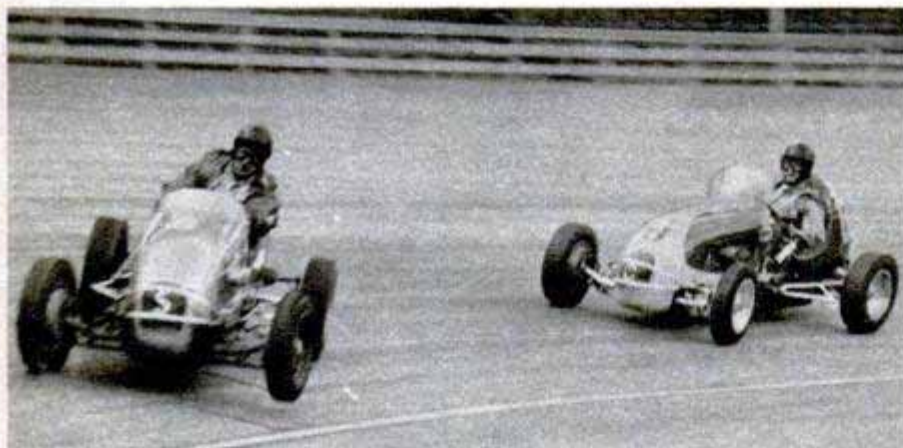

Drivers intentionally skid around the turns to make faster time. Midgets average over 60 miles an hour, which means they must roar down the straightaway at even faster speeds. Passing on a curve is dangerous but gives the crowd a thrill. Below, a jeep pushes a midget racer to start the high-powered engine

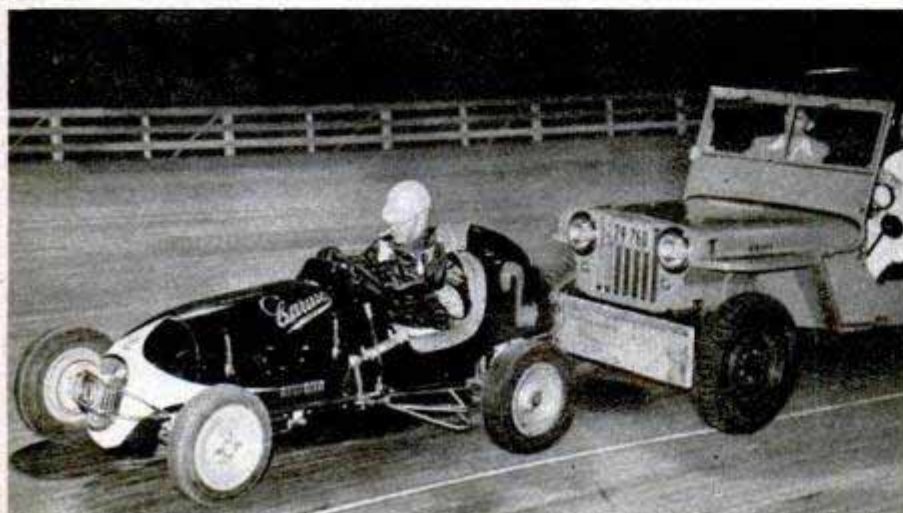

easy to reach and have ample spectator capacity. But the major-league parks are occupied half the days or nights from April to October; this meant he had to get his racing strip in and out of the park without building and demolishing a new setup every time.

A previous sports crisis provided the answer. Outdoor fights in the Yankee Stadium and Polo Grounds had seen 40 or 50 rows of "ringside" seats spread across the playing field. Anguished howls were heard from customers in the 45th row who were attempting to look over scores of heads between them and the ring without benefit of any elevation.

This situation had been met by the New York architectural firm of Leon and Lionel Levy. They devised a rising stand that was rigid, to withstand the explosive physical reactions of boxing devotees, and which could be set up and removed in a fairly short time. The Levy organization was given the assignment of designing a supertrack.

When Mr. Thompson approached Horace Stoneham, who  
(Continued to page 250)





### Shields End Drafts in Convertible

Plastic shields, mounted on the back of the front seat, end the back-draft that is a "pain in the neck" to many convertible users. They also reduce wind noise and permit driving with the top down on cool days. When not in use, the shields fold flat against the back of the seat.



### Cultivator Has Engine in Rear

Built by a British gardener, a small power cultivator permits the operator to watch the blades as they dig into the ground. With its small gasoline engine in the rear, the compact unit is of tricycle construction. The driver sits directly above the blades in a conventional tractor seat.



### Belt and Back-Stand for Grinder Smooth Bonded Brake Shoes

Bonded brake shoes can be smoothed with a single pass against an abrasive belt which can be attached to an ordinary bench grinder with the addition of a back-stand. The belt also can be used to remove worn brake linings which must be replaced. The contact wheel for the belt gives a resilient, wide-area surface for the work.



### Lawn Mowers "Push" Themselves

Mowing the lawn at Rensselaer Polytechnic Institute requires more pull than push. The grass-covered slopes of the campus atop the Hudson River banks make mowing a problem. Keepers of the grounds remove the handles from their mowers, attach long ropes and let the machines roll downhill, cutting as they go. The mowers are then pulled back for the next cut.



# ONE CRANE BUILDS ANOTHER



The German Navy was proud of its four giant floating cranes, which were the most powerful in the world. Above, a photograph taken during the war shows one of them lifting a 350-ton concrete block in a German shipyard. Today, one of these giants is working for the U.S. Navy and it is shown at left after it was reassembled in California. Below, to assemble the 374-foot-high colossus, Naval engineers used the crane mounted on the old battleship, USS Kearsarge. In the photo, the once-largest floating crane in our Navy hoists a jib boom of the former Nazi crane

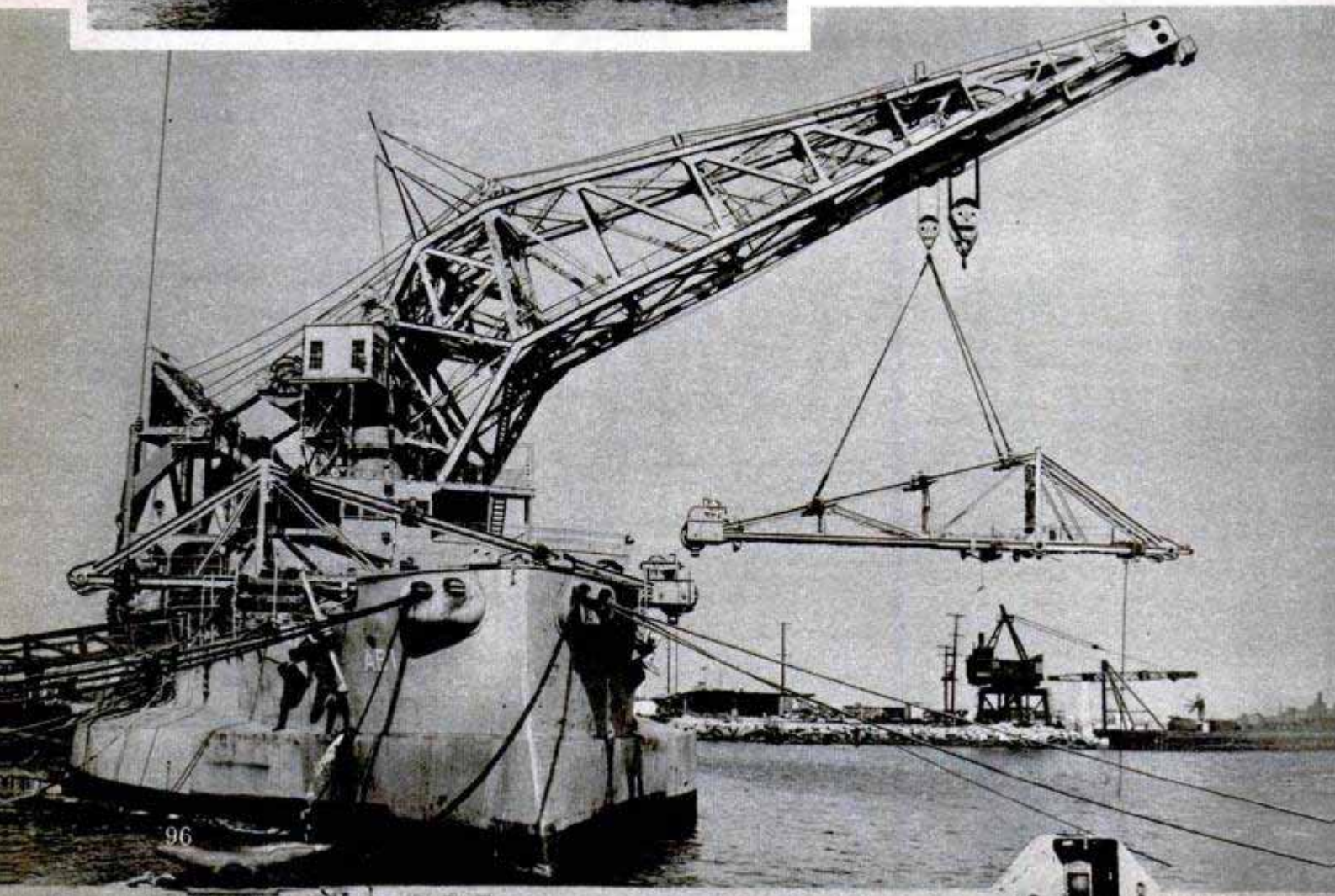



## ◀ One Crane Builds Another

**I**T TAKES a big crane to assemble a bigger one and that's the way the Navy put together the giant floating crane it received from Germany as a war prize. Towering 374 feet in the air, as high as a 30-story building, the 5000-ton colossus is one of four such cranes built by the Germans early in the war. Only one other is now in existence and it is in England. The others were bombed into uselessness.

Known as the YD 171, the giant crane was partially dismantled at Bremerhaven and towed across the Atlantic, through the Panama Canal, scraping through with only three inches clearance on each side, and up to the Long Beach Naval Shipyard.

Parts were made to replace those damaged during the war and the crane was assembled by means of another huge floating crane, mounted on the former battleship USS Kearsarge.

So that the Kearsarge could lift the heavy boom sections to the tremendous heights required, the pontoon of the YD 171 was placed in a battleship dry dock. The Kearsarge was moored alongside and, as the water was pumped from the dock, the pontoon dropped to a level 50 feet below the Kearsarge.

The YD 171 floats on a steel pontoon 204 feet long, 108 feet wide and 17 feet deep, with a mean draft of slightly over 10 feet. Quarters for a crew of 28 are provided inside the pontoon. Self-propelled, the crane makes eight knots and is sufficiently seaworthy for coastal voyages.

Directional propulsion is provided by three Voith-Schneider propellers, two in the stern and one in the bow. Each propeller has six vertical blades and revolves horizontally like a massive egg beater. By adjusting the pitch of the blades, the pilot can move the pontoon in any direction.

Capable of lifting 350 metric tons or more than 750,000 pounds, the crane generates its own electricity with three 900-horsepower Diesels. It is counterbalanced by a 400-ton block under the machinery house and a 200-ton counterweight mounted on the end of the boom.

The entire crane stands on a 60-foot circular base that revolves on a single roller bearing at the center. About eight miles of steel cable, some almost two inches in diameter, are used in the crane. The control cab is about 90 feet above the deck.

With this floating Goliath, the Navy can pick tugs right out of the water as easily as though they were toy sailboats. Flying the American flag, the YD 171, a former enemy, is now on our side, helping maintain the world's most powerful fleet.



## Even Baby Can Have a Swivel Chair

Baby has his own swivel seat and can turn in any direction in a circular baby chair that cannot be overturned. Rubber-covered guard rails keep toys and dishes from sliding to the floor and also protect walls and other furniture. Mounted on four roller-bearing casters, the chair can be pulled from room to room. When the seat is removed, a matching disk converts the chair into a table for the children.

## "Bean Ball" Shields for Ball Players

To protect batters from "bean balls," a new baseball cap has removable fiber shields that are placed behind the lining. Held in place by the sweat band, the shields can be worn on either side or on the front or back. Quickly removed, they can be taken out when the player is not at bat.

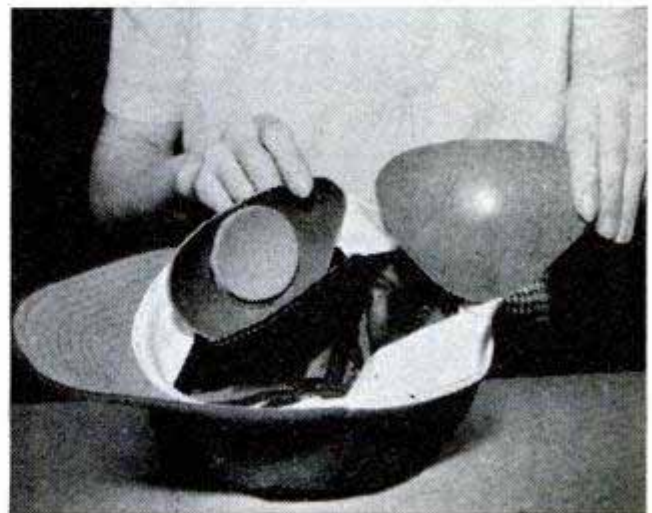



# How the War Came to Me in Tokyo

I AM neither a historian nor a politician. I am not a journalist. I am not a president or representative of any group of people. So this article is only a personal experience of a plain citizen in the war. If therefore this little article is given a chance to tell readers of this magazine something of actual experience of the intense war around a plain citizen, the purpose of it is fulfilled. For instance, how he fought with the intense fire; how he was astonished with the thunder of the navy gun attacking the factories on the shore, or how he was frightened with raining bombs from B-29, will be narrated.

It was early in the morning of December 8, 1941, that I awake to listen to a surprising news from a radio. My radio, in an Ozashiki of 8-mats room, was off at that time, as I usually do not listen to it before taking my breakfast. I am too busy to do so in the morning. I have to leave my house for the office, 20 miles far from my house, before 6:30 a.m., while I get up at about 6:00. All what I can do is to dress me up, nothing else. The reason, therefore, I chanced to switch it on was due to the fact that I had felt something strange vibration of the air around my house, maybe by the vibration of the air from the radio set of the house next to mine.

I experienced such an impatientness in synchronizing the dial as you do in picking up a thrilling news in hurry and was shocked from head to tip to learn an extra special government announcement of the outbreak of the war between Japan and America. I could not believe it at the beginning, but had to recognize it to be true soon. I doubted if it was the true will of our Emperor who was known as a man of peace-loving biologist, but to our sincere regrets its truthness was affirmed by the succeeding announcement of the War Department of the sneak attack of Japanese navy air force to the Pearl Harbor. Everything was finished and had come to the point we were destined to. We had never supposed that our international condition had been so critical as that we should learn it on that very morning.

I do not mean that Japan's foreign relation was satisfactory then at that time or that everything was going all right, but we had never expected the situation was

By **N. Sakata**

so critical. We thought and hoped that something could be done by our government to arrive at the point wherein we could avoid the grave consequence with America. We therefore pinned much hope on the shoulders of our ambassador then in Washington. The newspapers spoke nothing of the imminent war before that time. The only thing we knew was that both Japanese and American governments were both doing their bests to arrive at the mutually beneficial understanding each other to brighten the situation. I therefore surely believed that nobody in Japan thought at that time that the war was inevitable, except military clique. The government had been concealing everything unbeneficial to them behind the curtain.

Japanese mass was so ignorant about the international situation as that they believed blindly that what the government announced was right and correct and that we had been forwarding righteously toward the world's peace. It was only the morning of December 8, 1941, that our dream was awoken and we were forced to find out that the situation had been more critical than we supposed to be. In cars, in streets, in offices, in school campuses, what the people was talking about was of the war or about the prospects of the war. Frankly speaking, we intoxicated ourselves with the good news of the war in the beginning, but we did not

forget to anticipate the possibility of winning it out. Everybody thought that it was a tough job to defeat so many big, wealthy and strong countries. Everybody thought that Japan was facing to a national crisis. Sea-girt Japan is so small in size and limited in her resources. We had been fighting for so many years in China, exhausting her strength and energy. Everyone sighed a heavy breath at the world atlas. Japan is merely a group of tiny islands as compared with those of America, Australia, U.S.S.R. Successive good news however on the war in the beginning forced us to believe that we might have a glorious victory in a long run.

Hundreds of heavily loaded trains intersected the city of Tokyo from north to west day and night all 24 hours to carry soldiers and munitions to the southern

**EDITOR'S NOTE** — *In the January 1924 issue of this magazine there appeared an account of his experiences in the great earthquake of 1923 by N. Sakata, for many years a correspondent in Tokyo for Popular Mechanics. Here, in his own words, is Mr. Sakata's thrilling and harrowing account of his experiences as America carried the war to Tokyo. It has been edited only where necessary to make understandable his Japanese-flavored English.*





**Beneath a shower of incendiary bombs Sakata and his wife search around their blazing home for their son**

theaters. Soldiers waved out of train windows at the cheerful flags of citizens for trips never to return. Every factory was forced to convert productions into things all for the war. I was at that time with an affiliated company of one of the noted American companies, in the department handling the work of procuring the factory material. So far as my work is concerned everything progressed okay in the beginning, but as the stage developed on, I gradually began to feel something anxious in the prospects of the war, though the majority of the people was believing nearing of the victorious end of the war. The government announced Midway naval fighting as the overwhelmingly victory for us, and that we finally arrived at the turning point of the war for us. Actually it was a reverse condition. The conflict at Guadalcanal actually decided the man qualified to enter the glorious goal, though, according to the announcement made by the Japanese government, it was Japan. We were not allowed to possess any short-wave receiving sets in our homes at that time and it was by no means possible for us to listen to the world's truth.

Since those days, to counterbalance demands against supply, it became imperative to the government to establish the ma-

terial coupon system upon all kinds of material in order to give the first priority to the key industry. To this, nobody objected, of course, but it did not work out as scheduled. It was only in the beginning that it worked satisfactorily. It became almost impossible to divide the limited quantity of the material properly to all key plants. Many factories were forced to accumulate so many copies of coupons on the table as "VOID." In spite of so many days of painstaking labor and work spent in securing a single sheet of coupon for a single ton of steel, it was so easy to make them waste papers. Many factories overlooked machines idling without material to work on. Girls and boys were mobilized to factories for doing nothing, though, of course, there were exceptions. Large plants allocated with a large number of students were forced to hire special men dutied for finding some measures to make them busy.

When the plane of Admiral Yamamoto was attacked by American fighting planes on the ocean and died, the whole nation was environed with deep sorrow. We wondered why he dashed himself into the critical battle to kill himself, but thought that it should have been out of his personal belief that, as a typical Japanese general to

(Continued to page 228)



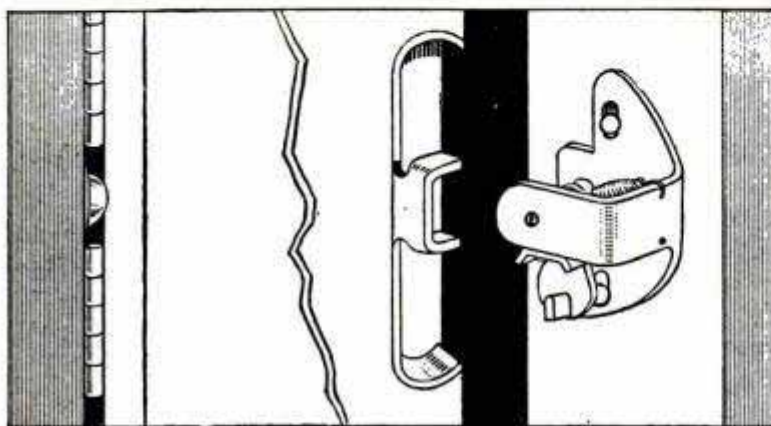
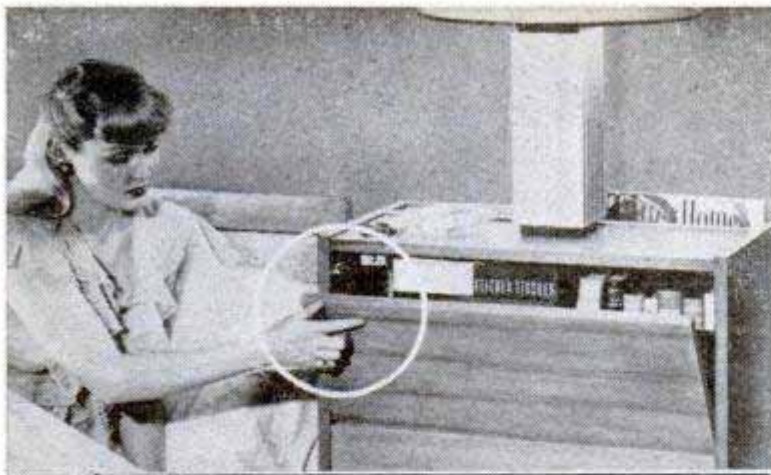

## "Touch" Latch for Doors Requires No Knobs

Touching the flush edge of a door unlatches it when a new fastener is used. The latch eliminates the need for knobs or handles on otherwise unbroken furniture lines. It has a spring-operated arm with two projecting prongs. When the door is pushed shut a catch engages the arm to hold the door flush with the frame. If the door is to be opened, it is touched lightly; this pushes it inward about  $\frac{1}{16}$  inch to disengage the catch, and the door swings out under power from the spring hinges. "Bullet" springs are available for use with ordinary hinges. Doors or drawers held by the latch can be opened with a touch of the elbow or back of the hand should both hands be full.

Top, pressing lightly on the flush door panel releases the latch. Left, prongs on the door engage the pivoted latch to hold door shut until it is touched again

## Exposure Computer Built Into Camera

Correct exposures are computed right on the back of a new folding camera that has a built-in exposure guide. Operated like a slide rule, the computer gives the photographer the correct shutter and aperture settings for various weather conditions and film speeds.

The camera also has built-in flash synchronization and a new type of shutter release. It has an f:4.5 lens and shutter speeds up to  $\frac{1}{200}$  second.

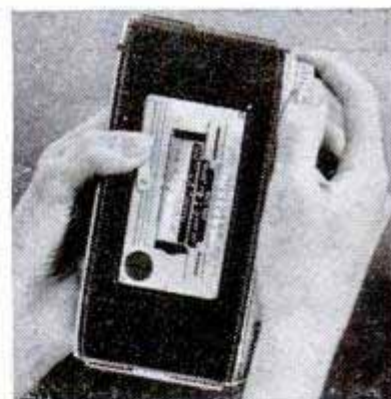

## Retractable Rear-View Mirror

Controlled from inside the cab, an adjustable rear-view mirror for trucks can be extended or retracted to provide clear vision to the rear at all times. When extra clearance is needed, as in entering garages or narrow alleys, the mirror is retracted close to the body. The mirrors come in three lengths, the longest having a maximum extension of 28 inches.

Probably the oldest living tree in the world is a Montezuma cypress, growing in southern Mexico, that has a trunk diameter of 52 feet and is believed to be about 5000 years old.

## Pocket-Size Wind Indicator

You'll always know which way the wind is blowing and how hard if you carry a pocket-size anemometer. Precision built, the instrument has a built-in compass for determining wind direction and a velocity meter that shows wind speed in miles per hour. To protect the curved direction vane and the rectangular pressure vane when the instrument is carried in the pocket, the top half is removed and screwed to the base upside down.





## Spring-Arm Phone Holder Leaves Both Hands Free

Holding the telephone ready for use, a "third hand" of flexible steel leaves both the operator's hands free to take notes during phone conversations. The spring arm holds the receiver to the ear and can be adjusted to the height and position of the user. The third hand was developed in Australia.



## Pulp From Wheat Straw Produces Quality Paper

Pulp for quality paper can be made from wheat straw that is often destroyed after harvesting, the Department of Agriculture has announced. The new process produces yields of 50 percent of screened, bleached pulp, 5 to 10 percent higher than other processes using straw and most processes using wood. Scientists believe that

wheat straw will provide valuable pulp for blending with wood pulp in the production of magazine, book, writing and other papers of fine quality.



## Bar Tool for Bending Metal Parts Adjusts to 100 Positions

With adjustable arms affording more than 100 positions, a handy bending bar bends, straightens, aligns, forms and spreads metal parts. No sledge hammer, vise or press is required. Arms, 36 inches in length, provide sufficient leverage without auxiliary equipment. In addition to straightening auto parts, the tool can be employed for fence pulling, straightening harrow and cultivator attachments and as a supplementary lifting and aligning device for heavy assemblies.

## Guides for Ellipse Drawing

Ellipses of any size from  $\frac{1}{4}$  inch to 12 inches can be drawn quickly and accurately with a set of clear plastic guides. Each guide is cut and ruled for a standard degree of ellipse. The set provides all standard projections from 15 degrees to 60 degrees. The ellipse is drawn in quarters by placing the guide in four positions on two perpendicular lines. A proportional scale etched in each guide gives long and short diameters of various ellipses.

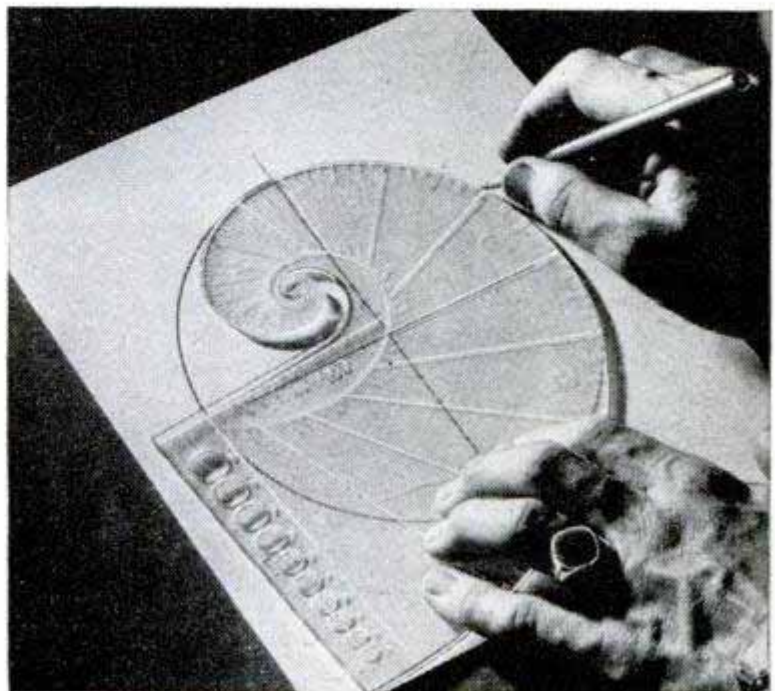

☐ Farmers in the United States are spending a billion dollars a year for repairs, remodeling and new construction on their farms.





Mired in axle-deep mud for Army test shown on cover, a "six by six" weighing 36,000 pounds was boosted to firm ground by 12 JATO units

Five jet-assist units were put on each side of test truck and two more were angled downward in front to blow mud out of the path

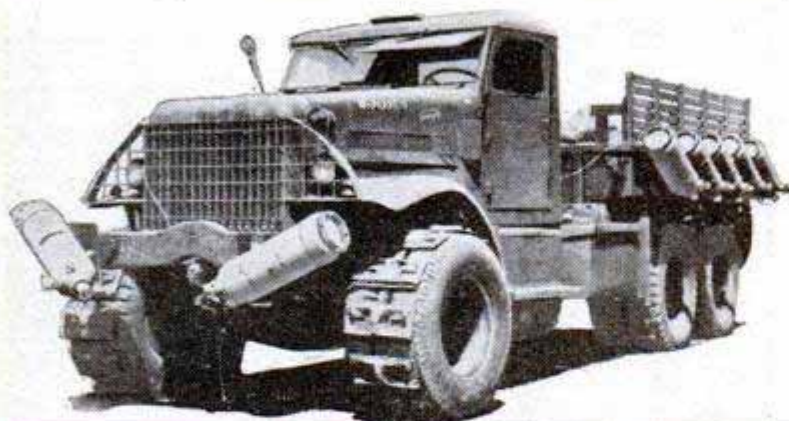

The folks who helped "jet" heavily loaded planes out of tiny New Guinea airfields are now busy finding more homely uses for JATO units. Such as boosting tired trucks out of mudholes and up steep roads, or putting emergency brakes on runaway mine cars

**W**HAT we want," the public-utilities official stated, "is an auxiliary engine that will help our construction trucks and trailers climb up into the mountains. The loaded vehicles weigh 33 tons and right now we grind along at six miles per hour. We want to get up those grades at 45 miles per hour."

The Aerojet engineer thumbed his slide rule for a moment and grinned.

"We have just the thing," he commented. "Five hundred horsepower in a package 18 inches square. How's that? Turn the auxiliary power on at the foot of the grade and cruise along as fast as you want. Only trouble is, you can't afford it. At \$2.50 per gallon, fuel will cost about \$1200 per trip."

The compact motor the engineer described is a lightweight rocket-driven turbine, comparable to the turbine that drives the fuel pumps of a V-2. It uses Diesel oil plus a liquid oxidizer as fuel. It makes relatively little noise and needs no muffler. It's cooled internally by steam in the rocket chamber. It produces 500 horsepower at 30,000 revolutions per minute.

As a booster engine for a truck, the turbine would be connected to the vehicle's drive shaft by a fluid coupling that would also serve

*Jets*  
**LOOK  
 FOR  
 JOBS**



as a gear-reduction device. The idea is entirely practical, except for two things—the present high cost of the oxidizer and the size of the tanks that would be needed.

Emergency rocket brakes for runaway mine cars, rocket-powered posthole diggers, rocket-driven surfboards for lifeguards, rocket-type remote-control fire extinguishers; all these, plus the auxiliary rocket engine for trucks, are among the unique ideas that have sprung out of research in rockets, guided missiles and gas-turbine studies.

Looking into the future, Aerojet Engineering Corporation of Azusa, Calif., has been giving serious study to some of these ideas. Dr. F. Zwicky, Dr. Theodore von Karman, and other scientists on the staff know that a device that seems worthless today may suddenly become important and practical tomorrow. Aerojet, a subsidiary of The General Tire & Rubber Company, manufactures jet-assisted take-off units in various sizes. It built the Navy's Aerobee sounding rocket that recently climbed 80 miles into the stratosphere.

Aerojet's JATO units are standard equipment for helping heavy aircraft up into the air from small fields. The units shorten the take-off runs of jet aircraft and assist very heavily loaded planes in

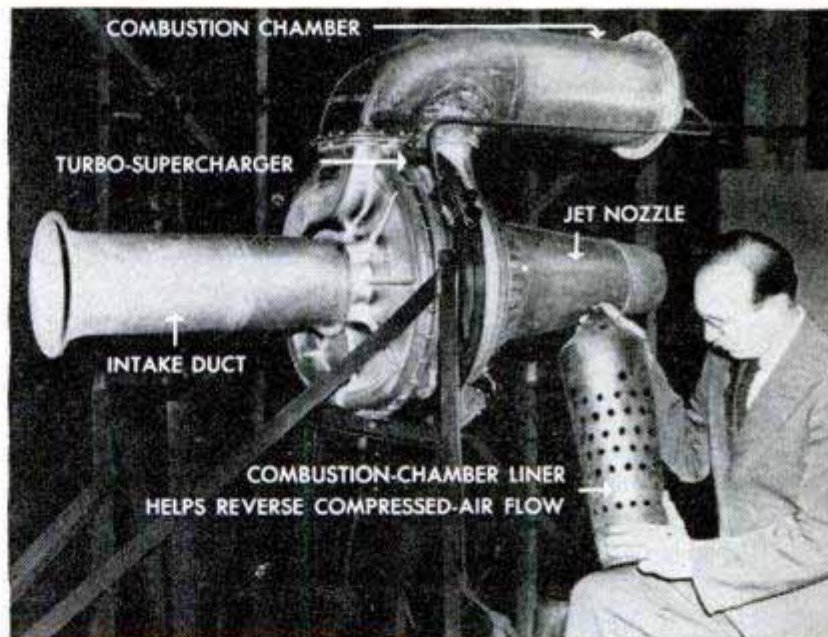
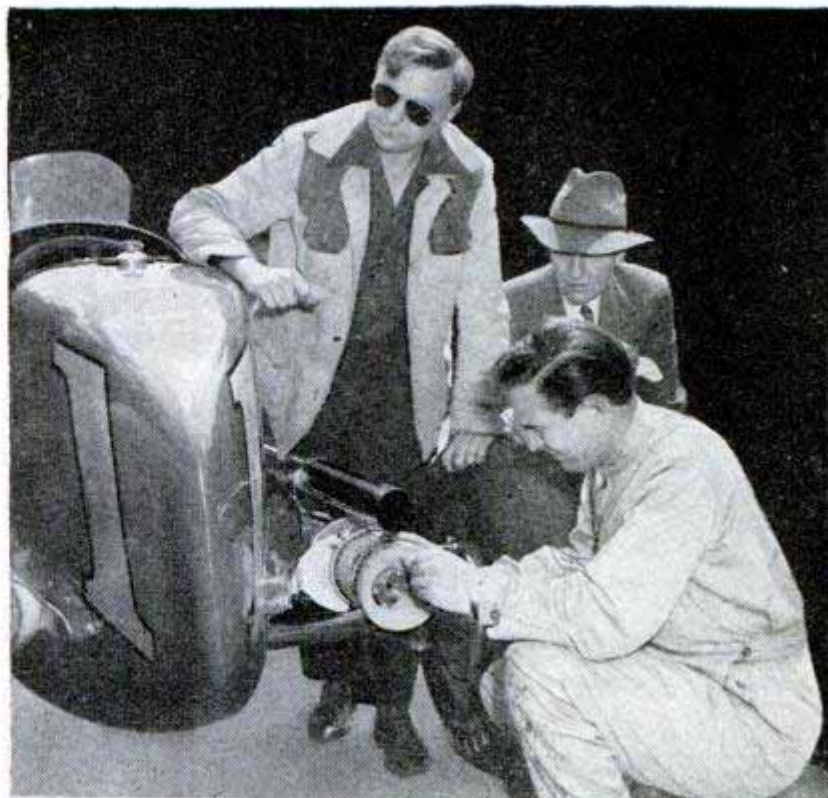

Racing driver Duke Nalon, top, tests additional thrust given by rocket motor at rear of car

Above, war-surplus supercharger and ducting are converted into gas turbine for drone plane

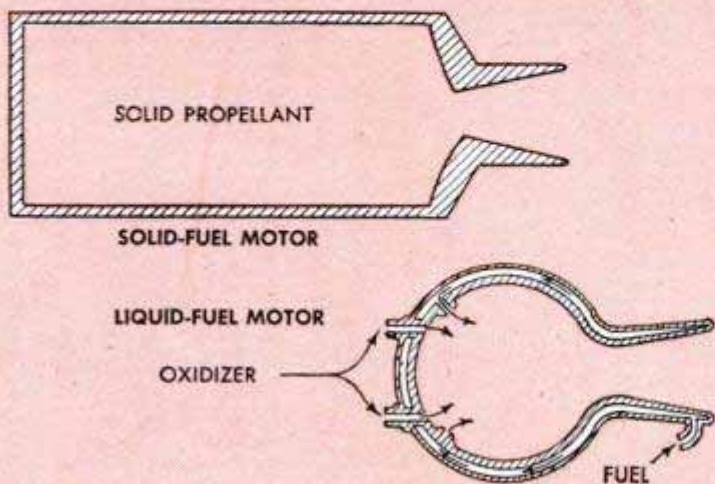

Simplified drawings of two main types of rocket motors. The one above uses solid propellants, as in the case of the JATO units, and the other runs on liquids. Excessive cost of fuel is the bugaboo of rocket development



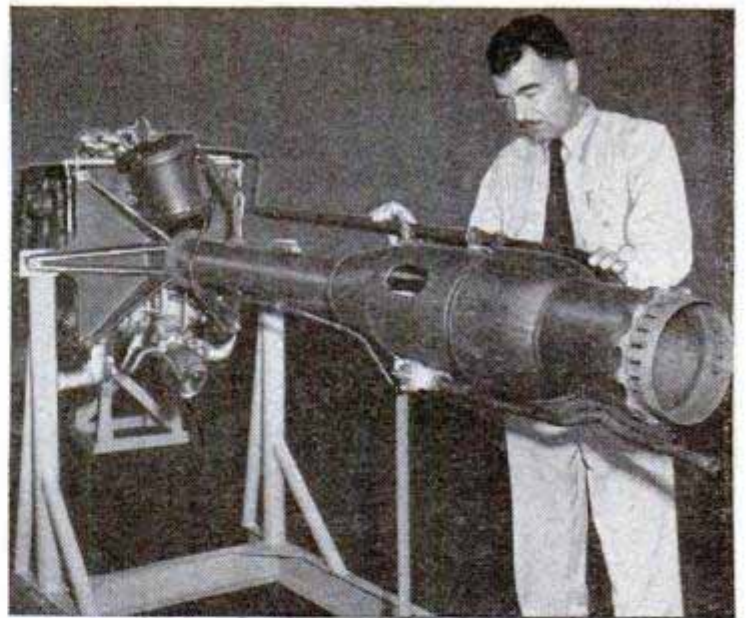
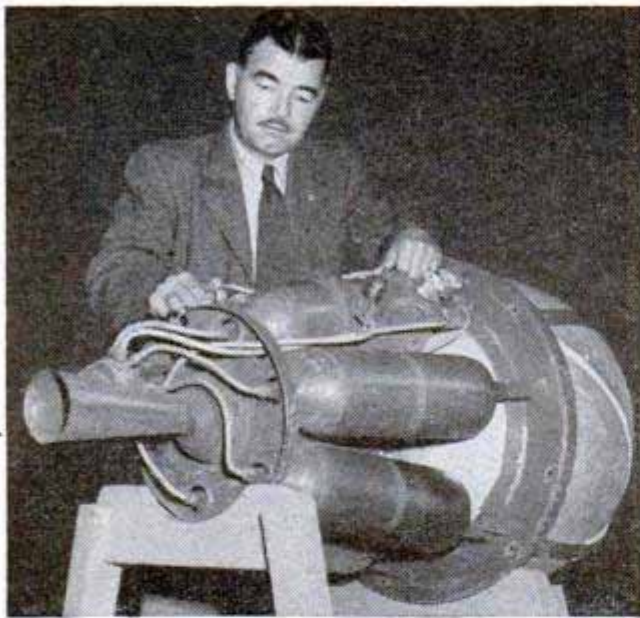

In German device for aiding plane take-offs, left, row of bottles contains compressed air to force fuel into combustion chamber. Plane using 4000-pound-thrust rocket at right consumes two tons of fuel in three minutes

getting off runways at high-altitude airports. When mounted under the fuselage with the nozzle faced forward a JATO becomes a powerful emergency brake. A BT-13 has been stopped in 112 feet from a touch-down speed of 85 miles per hour by means of rocket brakes alone. It is calculated that a rocket exerting a reverse thrust of 54,000 pounds would slow a DC-4 from 111 to 56 miles per hour in no more than 307 feet.

When Aerojet was asked to design an emergency brake for the cars that carry miners up and down steep inclines it came up with a governor-controlled rocket brake that would act automatically if the car's cable happened to snap. For a loaded car of 10,000 pounds on a 30-percent in-

cline, the emergency brake would consist of six standard 1000-pound-thrust JATO units secured to the lower end of the car, each fitted with an elbow nozzle pointing downgrade. With a protective bulkhead the installation would weigh 1500 pounds. It would be set to operate automatically at any time the car attained a speed of 26 feet per second. The blast from the rockets would bring the loaded car to a stop after 7.6 seconds of deceleration, after which grip brakes would clamp onto the rails to hold the car in place.

The traditional task of a rocket motor is to propel something through the air, but Aerojet's Doctor Zwicky points out that there are four media through which a vehicle may be propelled—vacuum, air, wa-

**GETAWAY:** Added lift afforded by JATO units makes it possible for big planes to fly from small fields





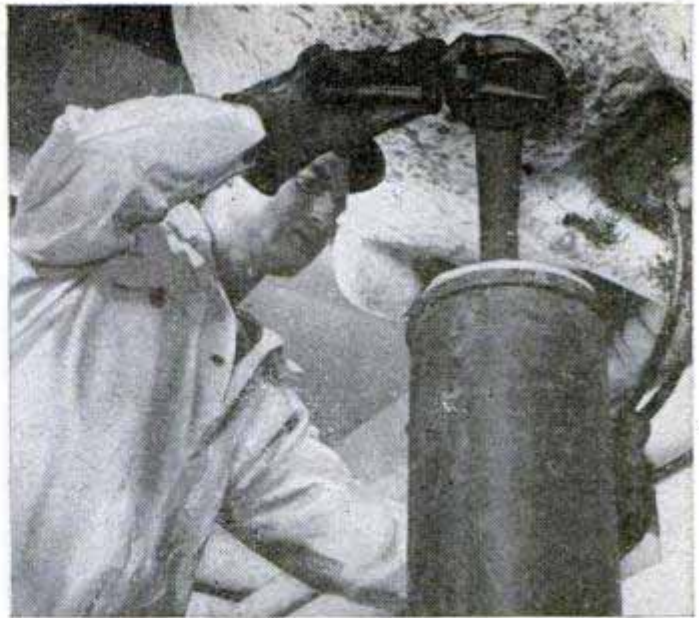
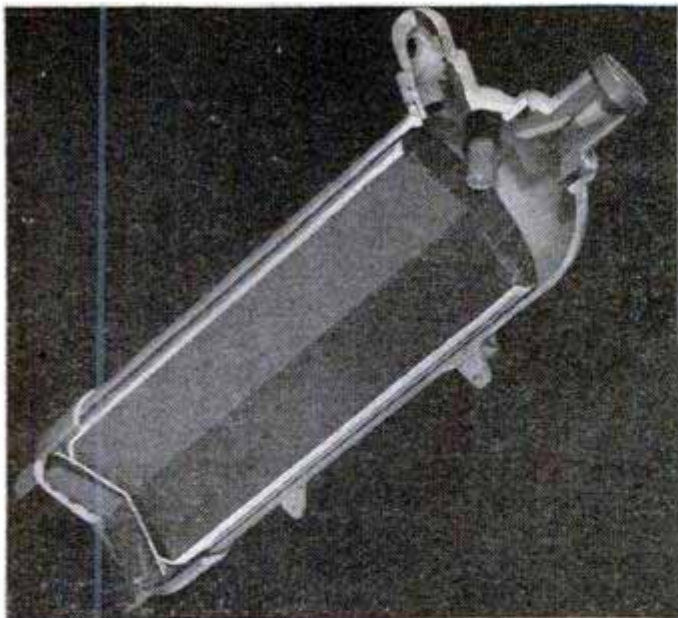

Cutaway of JATO bottle, left, shows solid fuel, igniter and thrust nozzle. Rockets may some day be used as fire extinguishers if fuel with enough carbon dioxide is found. Right, oxidizer being poured into cylinder

ter or the earth. Rockets have conquered each medium including the earth.

A rocket-driven ram for digging post-holes sounds silly when you reflect that one man with a shovel can dig a hole in a few minutes. Under some military circumstances, however, the rocket ram might be desirable and the idea has been tried out experimentally. A steel rod with a JATO unit attached to its top is planted in the ground, then the JATO is fired. The thrust forces the rod downward into the earth.

The ram may have real merit as a tool for prospecting for oil deposits under coastal waters. Here the problem is to bury an explosive charge deep in the ocean bottom so that shock waves reflected from underground strata may be recorded by

seismic instruments. The present technique is to explode the charge underwater, but geophysicists would prefer actually to bury the charge in the subterranean mud. Rocket rams already have been used for taking cores from ocean bottoms and the oil-prospecting companies expect to test them for this new use as well.

The Coast Guard has been thinking about using rockets to help launch rescue craft through heavy surf, and a small rocket attached to a surfboard has been suggested for lifeguards who need speed in getting out to help a drowning person.

Any time a speedboat enthusiast wants to try for a new unlimited world record for power boats, Aerojet is ready to furnish a power plant with which all existing

**BRAKES:** Used as brake for aircraft landing, rockets alone stop a BT-13 traveling 85 miles an hour in 112 feet





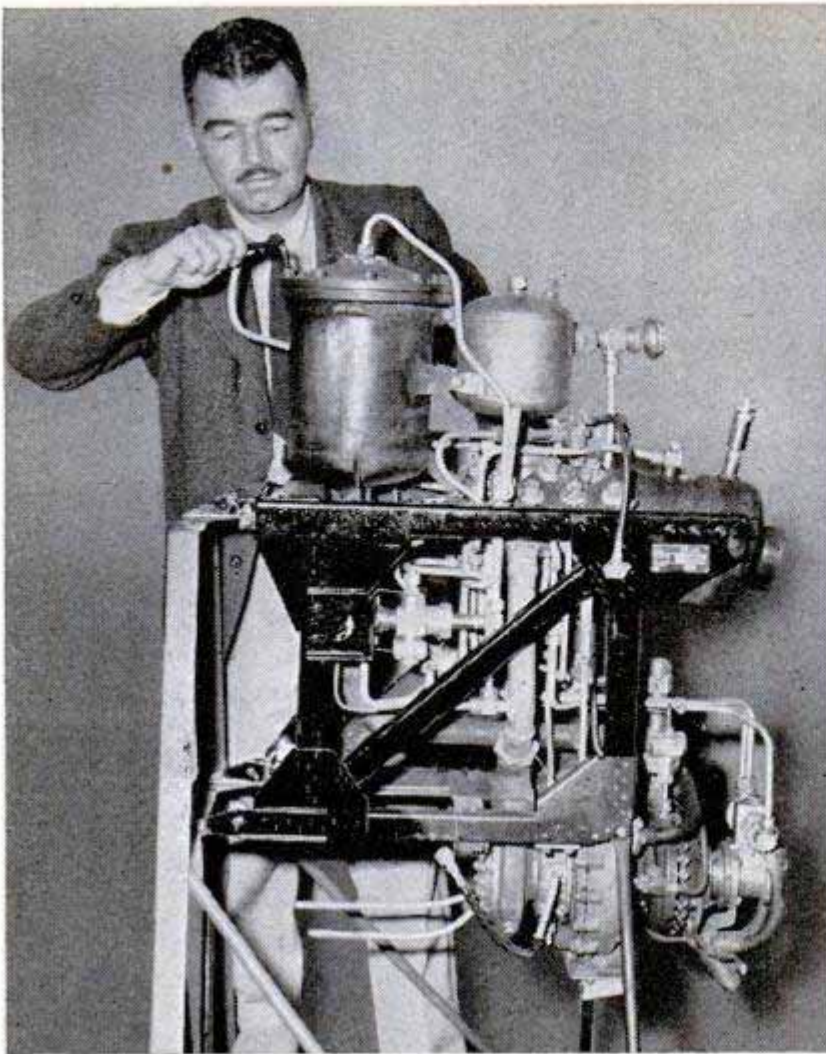

Steam is produced in the built-in turbine of the rocket motor above by spraying hydrogen peroxide over sodium permanganate pellets

marks could be smashed. All that is needed now is a suitable hull. The motors themselves would cost only a fraction of the price of conventional power plants.

Engineers estimate that three 1000-pound-thrust JATO units firing through the stern would drive the boat at a speed of 172 miles per hour over a one-mile course. One motor, of 12-seconds duration, would be fired first to accelerate the boat to high speed from a standing start, then the other pair of motors, each of 30-seconds duration, would be ignited to drive the boat across the measured mile. More rockets would provide even greater speed. John Cobb, incidentally, could have added another 20 or 30 miles of speed to his automobile record of 400 miles per hour at Bonneville salt flats last year if he had attached one rocket motor weighing 200 pounds to the tail of his car.

Once the Army posed a unique question: Suppose a heavy vehicle is stuck in the mud. It can't haul itself out and no towing apparatus is available. Could rockets lick the problem?

Aerojet had to try it to find out, and the answer was an unqualified "yes." A six-

ton "six by six" loaded to 36,000 pounds gross weight and equipped with track-type mud cleats was driven into a mudhole so deep and slippery that the driver couldn't move his vehicle. The rear wheels spun futilely each time he applied the power.

Five JATO units were then attached to each side of the truck, directed downward and toward the rear so as to provide upward and forward movement at the same time. Two additional units were angled downward and toward each other across the front of the truck to serve as sweeps for blowing liquid mud out of the way.

When the driver pressed the firing button there was a terrific roar and a blast of smoke and the truck literally shot out of the mudhole onto dry ground.

That's an expensive way to rescue a truck, of course, but it might pay off in some circumstances. One suggestion concerns the heavily loaded cementing trucks or well-survey trucks used in the oil fields. Rockets might prove to be a cheap way of extricating such a truck, stuck in boggy

ground, in cases where a rush schedule must be observed.

An idea that is very intriguing to rocket men is to use them as fire extinguishers. What they envision is a rocket fuel that would produce a large percentage of carbon dioxide, an effective fire-quenching agent, in its combustion gases. Present fuels produce some carbon dioxide, but not enough to kill a persistent fire.

A fire-extinguishing rocket unit, of course, would have to be securely fastened in place. It could be operated either by remote control or by means of an automatic heat switch. A blast diffuser, too, would have to be attached in front of the nozzle to cut down the rush of combustion gases which otherwise might scatter the fire. If the right chemical fuel is found, rocket extinguishers may become practical.

Fuel, in fact, is the principal bugaboo of rocket development. There are various combinations of chemicals that produce the necessary thrust of gases but the objection is that the fuels are expensive and are consumed at a prodigious rate. A V-2 rocket, the largest built to date, consumes five tons of alcohol and five tons of liquid



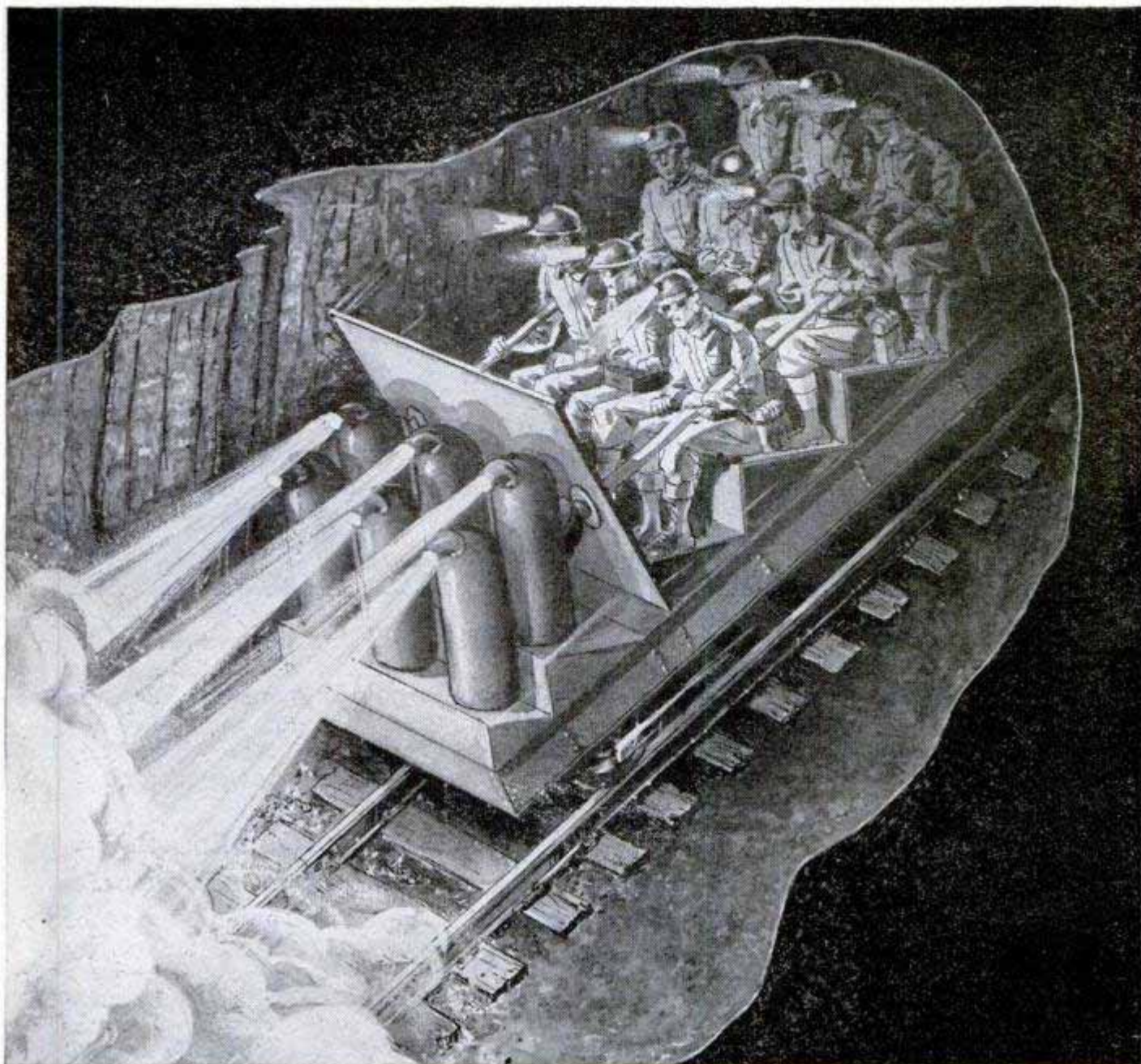

**Emergency rocket brake has been tested for mine cars on steep inclines; it works automatically if cable snaps. One blast would be adequate to halt a fully loaded car on a 30-percent slope after 7.6 seconds of deceleration**

oxygen during the 20 seconds or so that its motor is operating.

For their rocket interceptor planes the Germans devised a different fuel consisting of hydrazine hydrate, methyl alcohol, and water and potassium cuprocyanide. They used an 80-percent concentration of hydrogen peroxide as the oxidizing agent. Even this fuel was inefficient from the weight standpoint. Two tons of it produced only three minutes of powered flight.

Rocket-fuel research is of such scope that major portions of it have been "farmed out." Cal Aero Technical Institute of Glendale, Calif., for instance, is engaged in a big program of testing German rocket and gas-turbine engines for Wright Field, especially to improve upon the original combustion chambers.

An interesting sidelight on gas-turbine

research is the building of small gas turbines from surplus turbo-superchargers. The superchargers were used in nearly all American bombers and in many fighter aircraft during the war and since then it has been discovered that the superchargers can easily be rebuilt into gas turbines.

The original superchargers consisted of a drive shaft to which was attached a turbine wheel and a compressor. Conversion consists principally of adding sheet-metal ducting. Air from the compressor is led to a simple firebox where kerosene or other jet fuel is burned, and the combustion gases are ducted back to the turbine wheel and from there to an exhaust nozzle. One converted turbo unit has enough power to fly a small plane of the drone type, and two of the small gas turbines provide enough power for a one or two-place light plane.



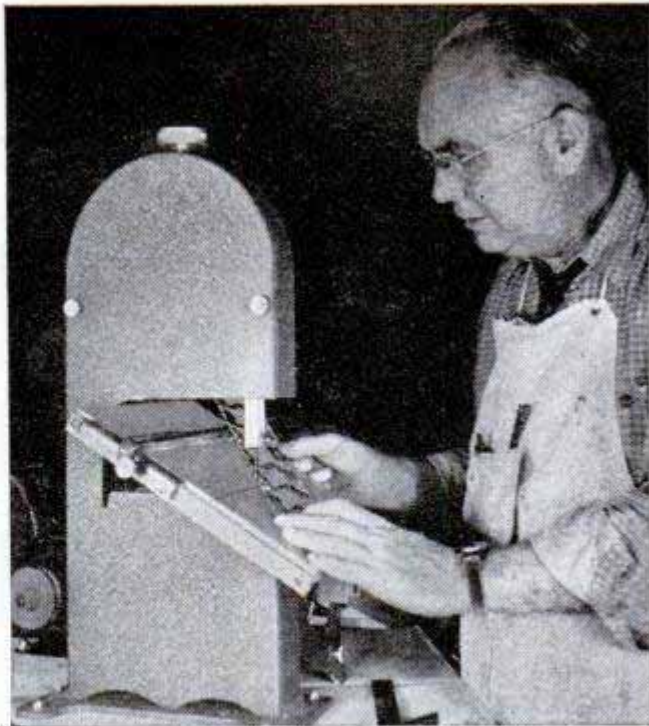

### Combination Power Tool

With its sanding disk mounted on the bandsaw drive shaft, a combination power tool provides the home craftsman with two tools in one. The bandsaw cuts wood, plastic and soft metal to the center of a 14-inch

circle. Using the bearing system of the bandsaw, the vertically mounted sanding disk is nine inches in diameter. Both the bandsaw table and sanding table have angular adjustments for accurate work. They operate on  $\frac{1}{8}$  or  $\frac{1}{4}$ -horsepower motors.

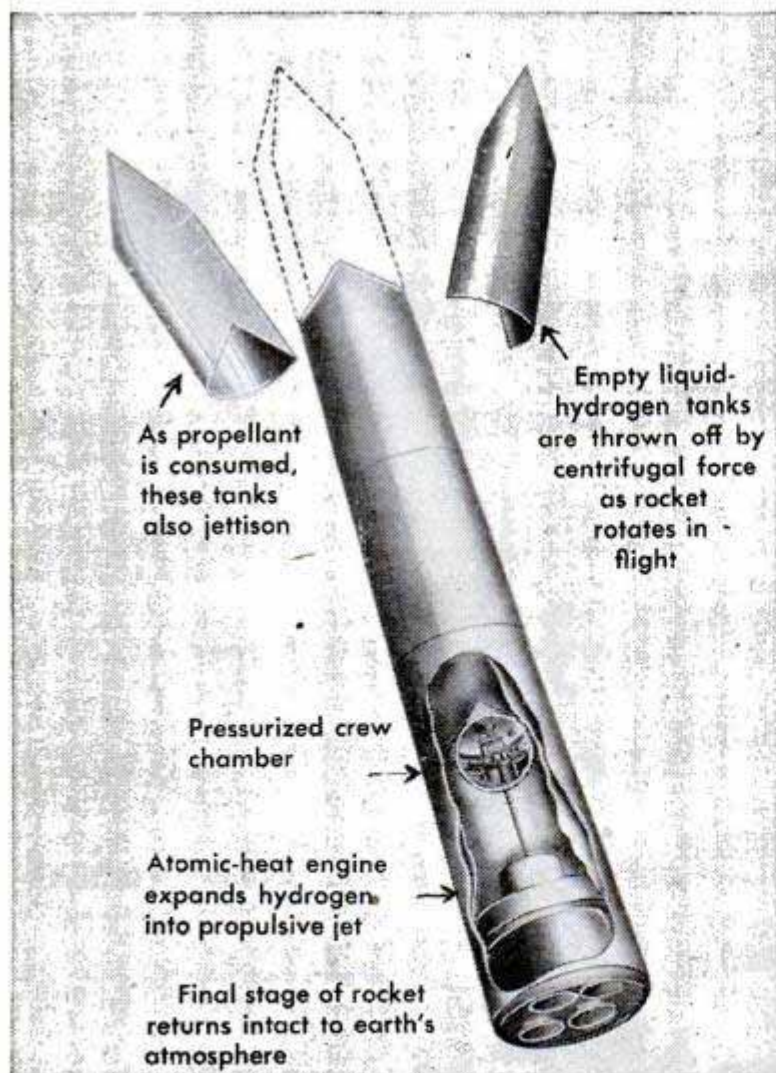

### Atomic-Powered Rocket For Carrying Man to Moon

Around-the-moon flights of man-carrying rockets, powered by atomic energy, are foreseen by a member of the British Interplanetary Society. The rockets would have to weigh about 1500 tons, 80 to 90 percent of which would be stored propellant. A high temperature pile would supply the heat energy to a fluid, like liquid oxygen, just as chemical reaction now does in chemical rockets. The rocket conceived has a single propulsor, or motor, and uses fuel drawn from four tanks that jettison successively from the nose. As the first three tanks emptied en route to the moon, two separate bays in each would divide and be thrown off by centrifugal force. A fourth would head the vessel earthward. Reverse-thrust motors would use the remaining propellant to brake the rocket's speed sufficiently for it to re-enter the atmosphere, where the crew chamber would be parachuted to the surface. A strobo-periscope would provide stationary external vision from the rotating cabin.





## Cafeteria GAS STATION

Service is only as good as the driver makes it at some of the new serve-yourself gas stations in California, but the motorist saves four or five cents per gallon of gas. Top, one of few attendants is at grease rack, where metered outlets show amount of grease used. Top right, at central booth attendants get the change for motorists' money. Right, girl awaits payment as driver helps himself. Below, "oil bar" near rear of station sells numerous brands at cut prices. Cars must be driven to the bar for service

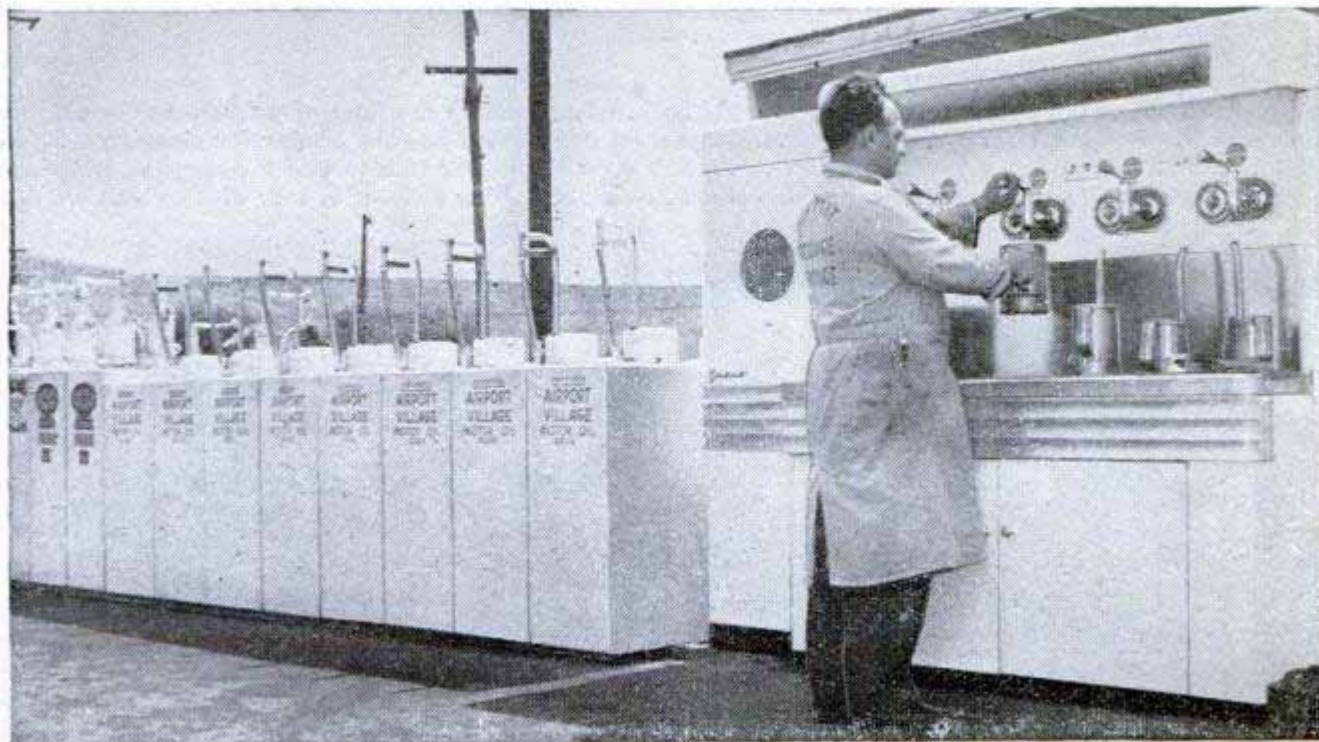



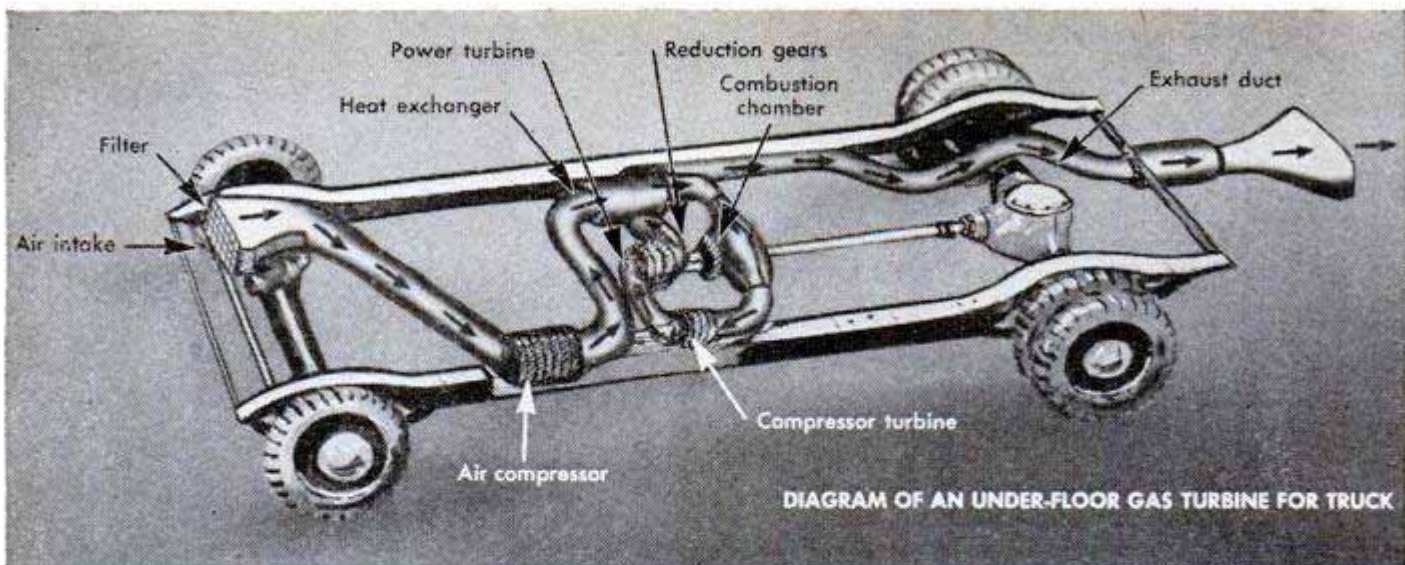

SECTION OF AUTO GAS-TURBINE ENGINE OF A TYPE UNDER TEST IN ENGLAND

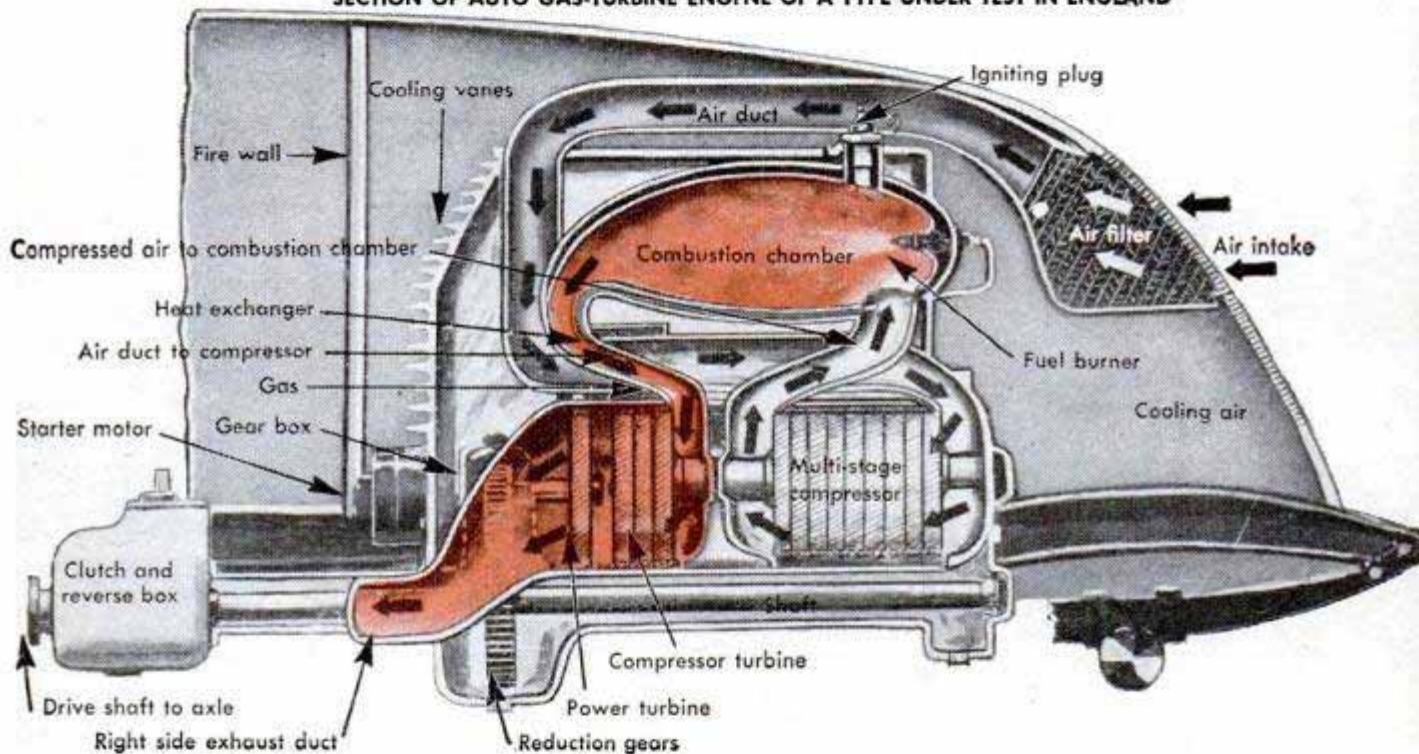

Top sketch shows how a gas-turbine engine could be installed beneath the floor of a truck. In the cutaway diagram above, air is drawn into the engine, compressed and pushed into the combustion chamber where it burns with the fuel. The expanding gases that result drive the power turbine and the compressor turbine. Below, sketch shows how a small gas turbine could be installed either at front or rear of a conventional car

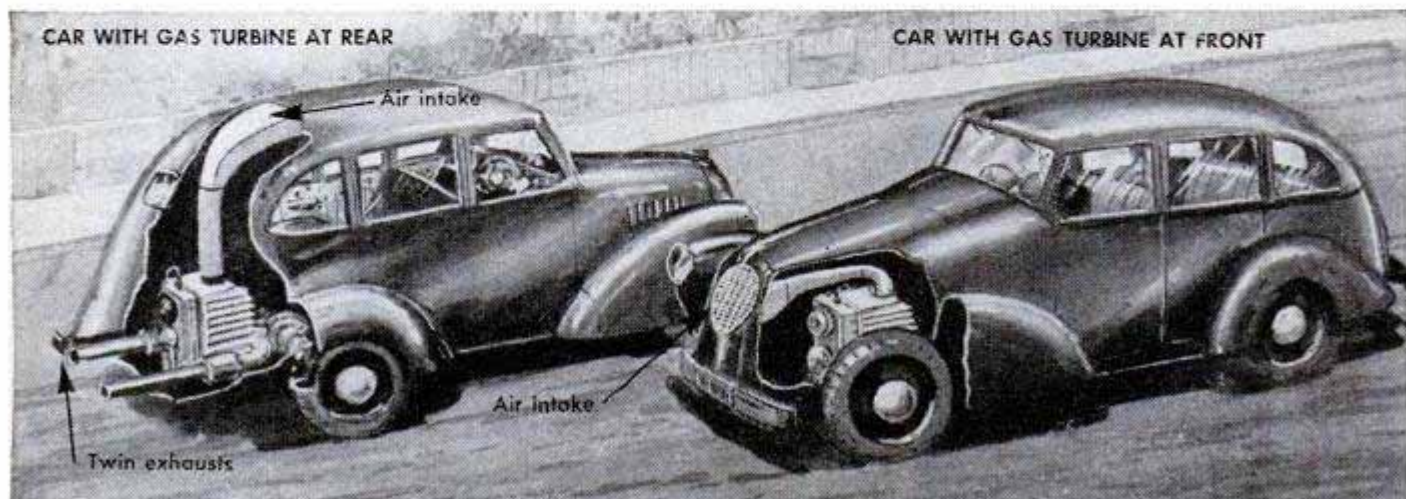



# GAS TURBINES FOR CARS

**W**ITHIN a few years, many automobile engineers believe, the standard family car will scoot along the highways powered by a gas-turbine engine. Especially active in the development of small gas turbines are British engineers. Two turbines small enough to fit under an auto hood are now under test in England.

The gas turbine has many potential advantages over conventional high-compression engines. No gearshift is required, as the speed of the turbine is variable; a turbine-powered car equipped with one reverse gear and one forward gear could be driven just like an auto with fluid drive. The only ignition system required for a gas turbine is a single igniter plug. The engine requires no fan, radiator or water pump as it is self-cooling. It can burn kerosene or any other fuel which burns continuously. It is lightweight, practically free from vibration, and delivers a smooth, continuous flow of power.

The artist's sketches on the opposite page show the smaller of the two turbines under test in England—an engine specifically designed for the family car. It measures three feet long, 18 inches wide, 20 inches high and has a diameter of 15 inches. At a normal speed of 55,000 revolutions per minute the turbine develops 100 horsepower. It weighs only 475 pounds complete with gearbox. The heat exchanger reduces fuel consumption.

In operation, the engine draws air through a filter and passes it into the combustion chamber where the fuel is burned. The high pressure from the expanding gases drives two separate turbines, one for compression and the other for power. A gearbox relays power from the power turbine to the wheels.

Such an engine could be installed either under the hood or in the rear compartment of a conventional car. Besides its other advantages, the turbine has few moving parts and therefore should be much less expensive to maintain.

Larger gas turbine designed in England will power large cars, trucks and buses. It weighs only 250 pounds. Gas turbines can burn most fuels including kerosene, paraffin — even coal

The other engine under test, shown on this page, is designed for larger cars, trucks and buses. It is 17 inches in diameter and five feet long, but weighs only 250 pounds. A single spark plug fires the fuel-air mixture which continues to burn as long as the engine is running. Exhaust fumes are expelled through twin pipes with no more pressure than that in conventional engines. The turbine is designed to run at speeds from 40,000 to 42,000 revolutions per minute. The output is about 160 brake horsepower.

The engineers' biggest bugaboo has been the development of metals which can withstand the intense heat generated in the turbine. Special alloy steels and nickel-chrome alloys are now being used, but they are extremely expensive and boost the cost per unit. Parts must be turned out to very fine tolerances, which makes large-scale production difficult. Another problem is to decrease the rate of fuel consumption; although inexpensive fuels can be burned in a gas turbine, they are burned at about twice the rate of a good piston engine.

Family autos powered by gas turbines will not be on the road until these problems are answered and methods worked out for large-scale production. But British engineers are confident the gas-turbine models now under test are forerunners of engines that will be much more efficient than the complicated piston engines that power today's cars. They believe that within three or four years, motorists will be seeing gas-turbine cars on the highway.

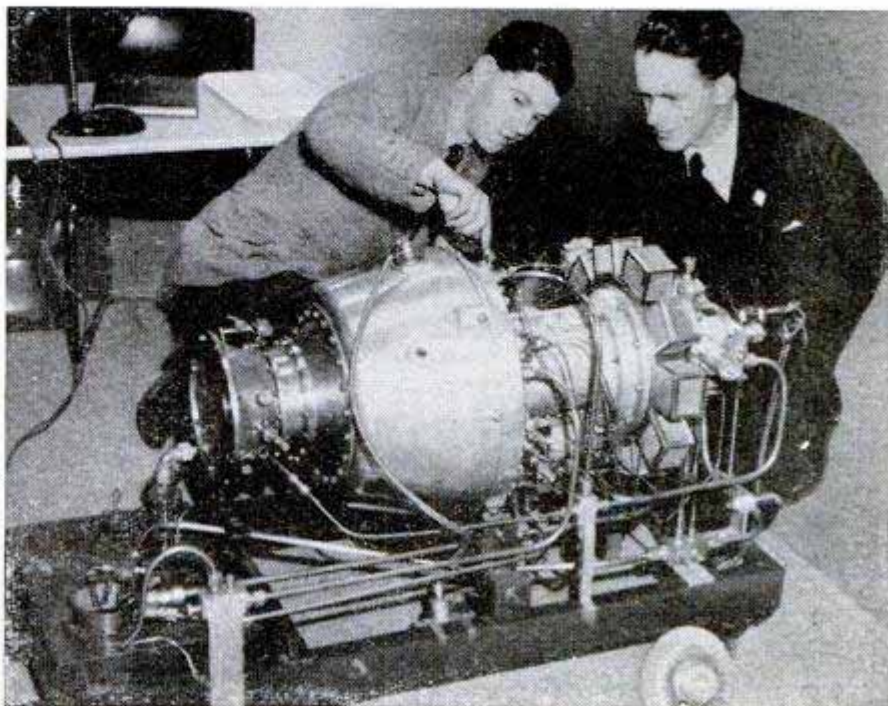



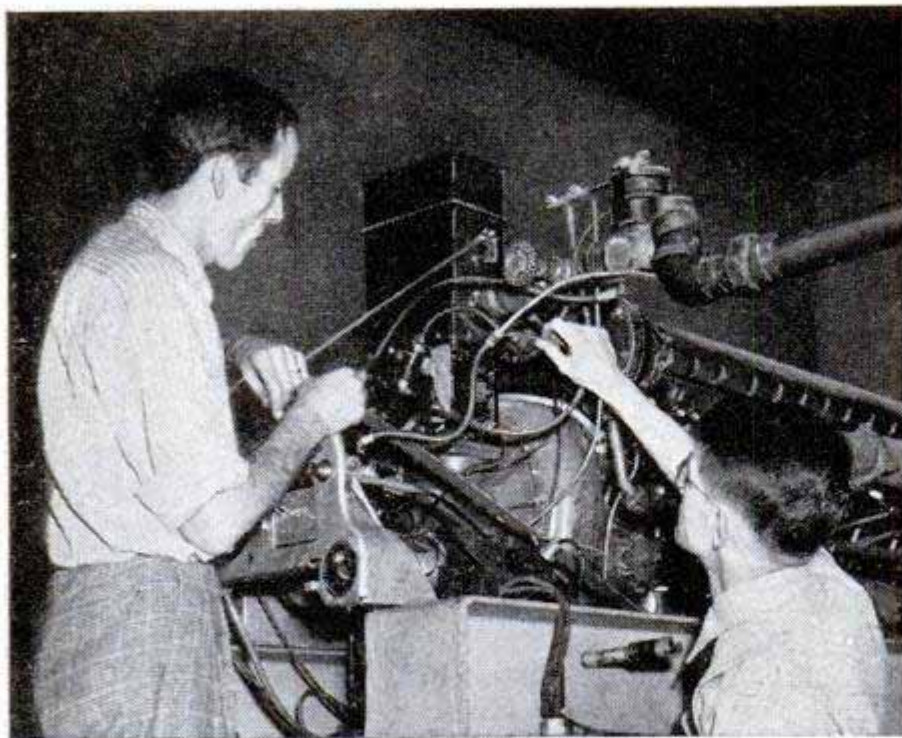

## Natural Gas Runs Big Aircraft Engine

To cut down costs, natural gas has been substituted for high-octane gasoline in running a 12,000-horsepower aircraft engine at the University of Oklahoma. Use of the engine in operating the Department of Aeronautical Engineering's wind tunnel would have been severely restricted by the present high price of aviation gasoline. It is cooled by pumping water from a forced-draft cooling tower. Considerably less engine wear is expected with natural gas.

## Blower Forces Heat From Stack of Sugar Beets at Night to Aid in Storage

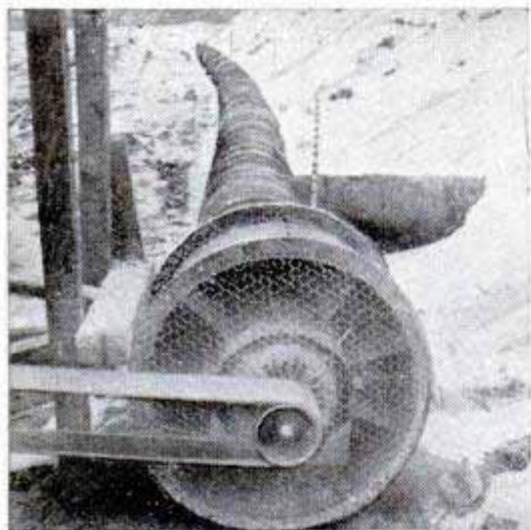

Above, ventilating blower, which is turned on during the night, forces air through main ducts and then into lateral ducts to ventilate the stacks. Above right, stack of beets is covered with heavy paper during the day to prevent natural ventilation. Right, instruments record the temperature in center of pile

Sugar beets can be stored with the aid of artificial ventilation, according to research workers at the Colorado Agricultural Experiment Station. For best results the beets must be held at a temperature near 32 degrees without freezing. This can be accomplished in areas where night temperatures are near freezing. The beets are stacked in huge piles, which are covered with paper during the day to prevent natural ventilation. At night the ventilating blower is turned on to force heat from the inside of the stack. The air is blown through a main duct and then out through lateral ducts throughout the pile. Sugar

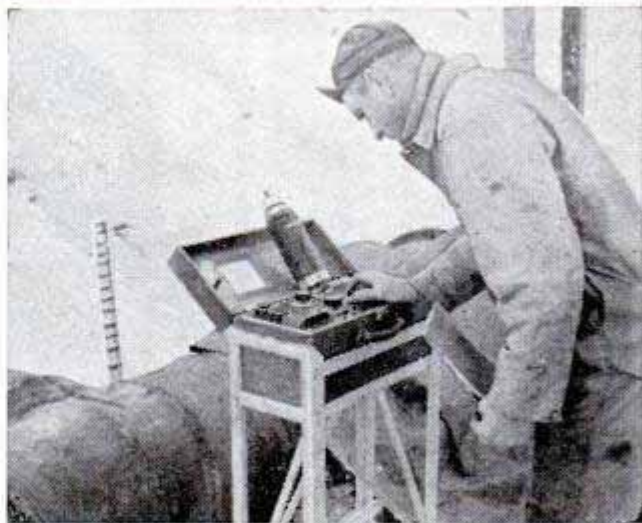

losses in the pile vary from one quarter pound to one pound per ton a day, depending upon the temperature. Respiration of living beet tissue burns this sugar to give off the heat.



## Pusher Unloads Lift Truck Without Use of Pallets

When a hydraulic pusher rack is installed on a lift truck, each load can be removed as a unit rather than piece by piece. The pusher assists in handling material in cartons and bags when the load must be removed from a pallet. Traveling horizontally to shove the load off the forks, the pusher rack is connected to two hydraulic cylinders which receive equal pressure. Maximum forward movement of the rack is 55½ inches. Multiple forks are used in handling loads without pallets.

## Waste Pulp of Mexico Produces Valuable Wax

Brazilian carnauba wax, for years a basic ingredient of shoe and floor polishes, candles and waterproofing materials, now has a Mexican rival. The new wax, which has properties similar to those of carnauba, is extracted from the waste pulp left after processing of henequen or sisal rope fibers. It is hard, has a melting point of about 185 degrees Fahren-

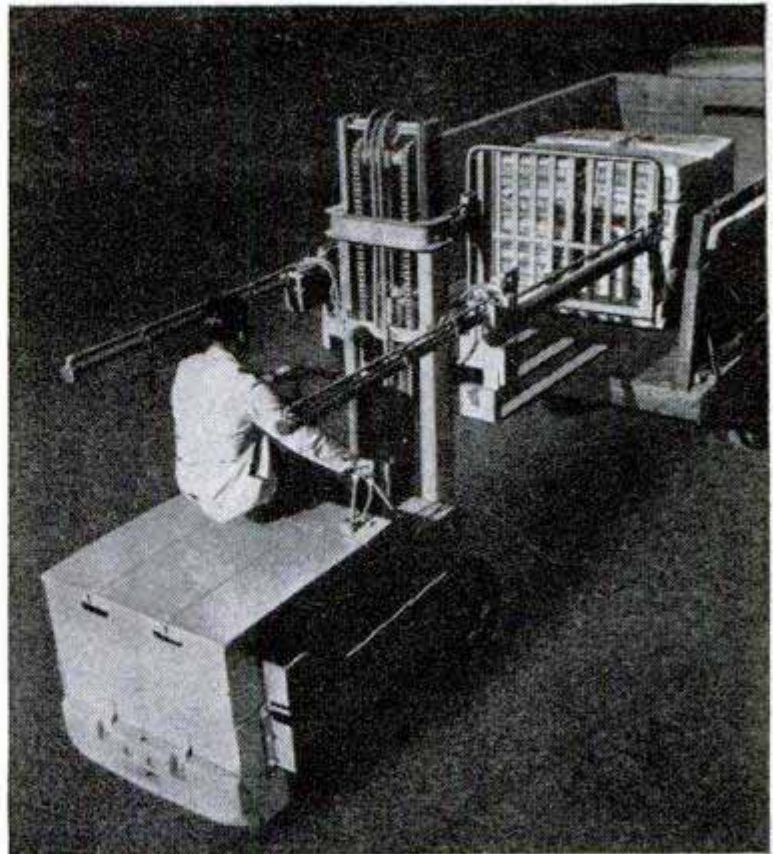

heit and bleaches readily to an almost colorless material. Annual production of 10,000,000 pounds can be obtained from the sisal waste pulp on the Yucatan peninsula.

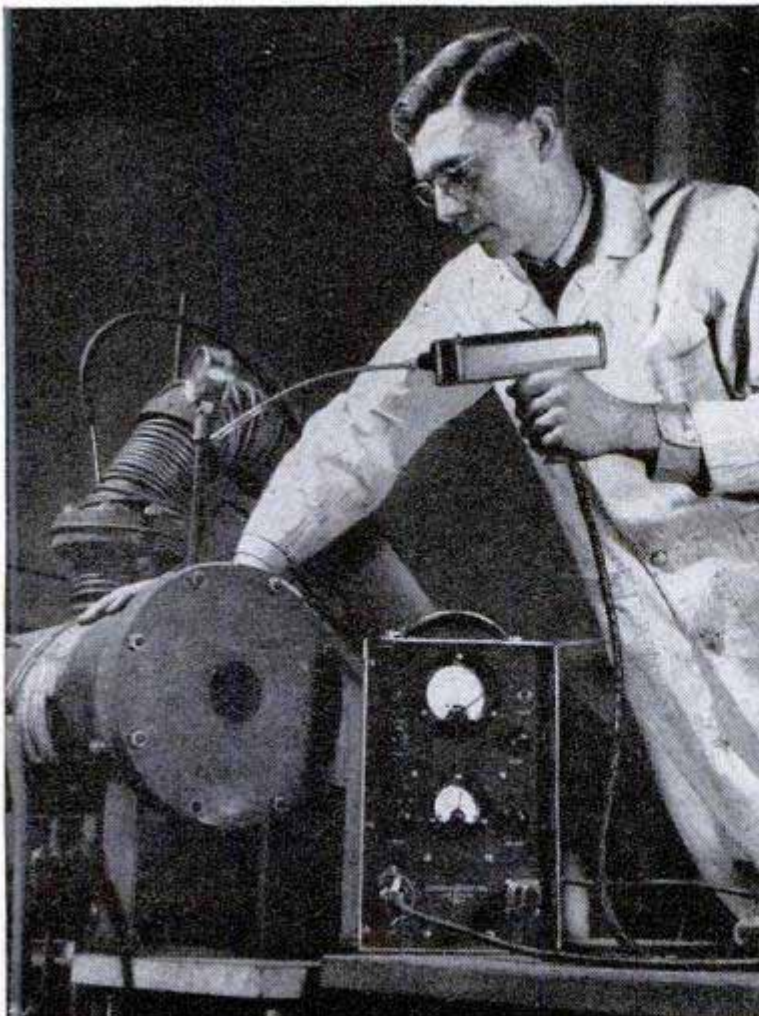

## Electronic "Pistol" Detects Pipe Leaks

Extremely small leaks in boilers, tanks and pipes are detected by an electronic instrument that looks more like a large pistol than a testing device. When aimed at its target, the "gun" sucks in a stream of air. The air is analyzed and the amount of leakage shows on a metering device. Leakage of Freon, such as used in refrigerators, can be measured at a rate as low as one hundredth of an ounce a year. As the instrument, developed by General Electric, detects only compounds of chlorine, bromine, fluorine and iodine, these compounds are introduced as tracers into the system being tested.

Our WHERE-TO-FIND-IT INDEX, listing names and addresses of manufacturers and sources of further information for products and articles in this issue, is available free upon request. For your index, just write to Bureau of Information, Popular Mechanics Magazine, 200 East Ontario St., Chicago 11. Your letter will be answered promptly



# SLAG

# used to be useless

By William J. Duchaine

ONCE a wasted by-product of pig-iron production, slag has now become a hard-working member of the building-material family that pays its own way. For years huge piles of slag accumulated alongside blast furnaces—as useless as a boat on the desert. Blast-furnace operators couldn't give it away.

Today slag brokers are buying all they can get from iron and steel producers. Its new role as a building material has brought the once useless slag into the limelight, and even abandoned stockpiles on the sites of long-dismantled charcoal iron furnaces in Michigan are being bought up and turned into useful materials.

Mineral-wool insulation made from this slag is making many homes warmer in the winter and cooler in summer. Buildings are being constructed of lightweight blocks made of slag and cement. These slag-concrete blocks, much lighter than concrete blocks made with gravel aggregate, can be cut, drilled and nailed almost as easily as wood. Yet the porous blocks are fireproof

and have a high insulation and sound-absorption value.

Slag is drawn from the furnaces during the production of pig iron. The modern blast furnace is a hollow cylinder of steel plate about 100 to 125 feet high, lined with heat-resisting brick. Raw materials—limestone, iron ore and coke—are fed into the top of the furnace and intensely hot blasts of air are forced into the mixture through an opening near the base. The molten slag and iron collect at the lower part of the furnace. The limestone acts as a flux in removing the impurities from the iron during the blast-furnace operation.

These impurities, being lighter than the molten iron, float on top of it forming the slag which is drawn off separately and poured into large slag thimbles mounted on railroad cars. When it cools, the slag solidifies and is crushed into small pieces. These pieces are passed over a magnetic pulley which removes those that contain an appreciable quantity of iron. Returned to the blast furnace, these pieces give up their

The once useless slag pours from the furnace into slag thimbles to start a trip that may end in your home

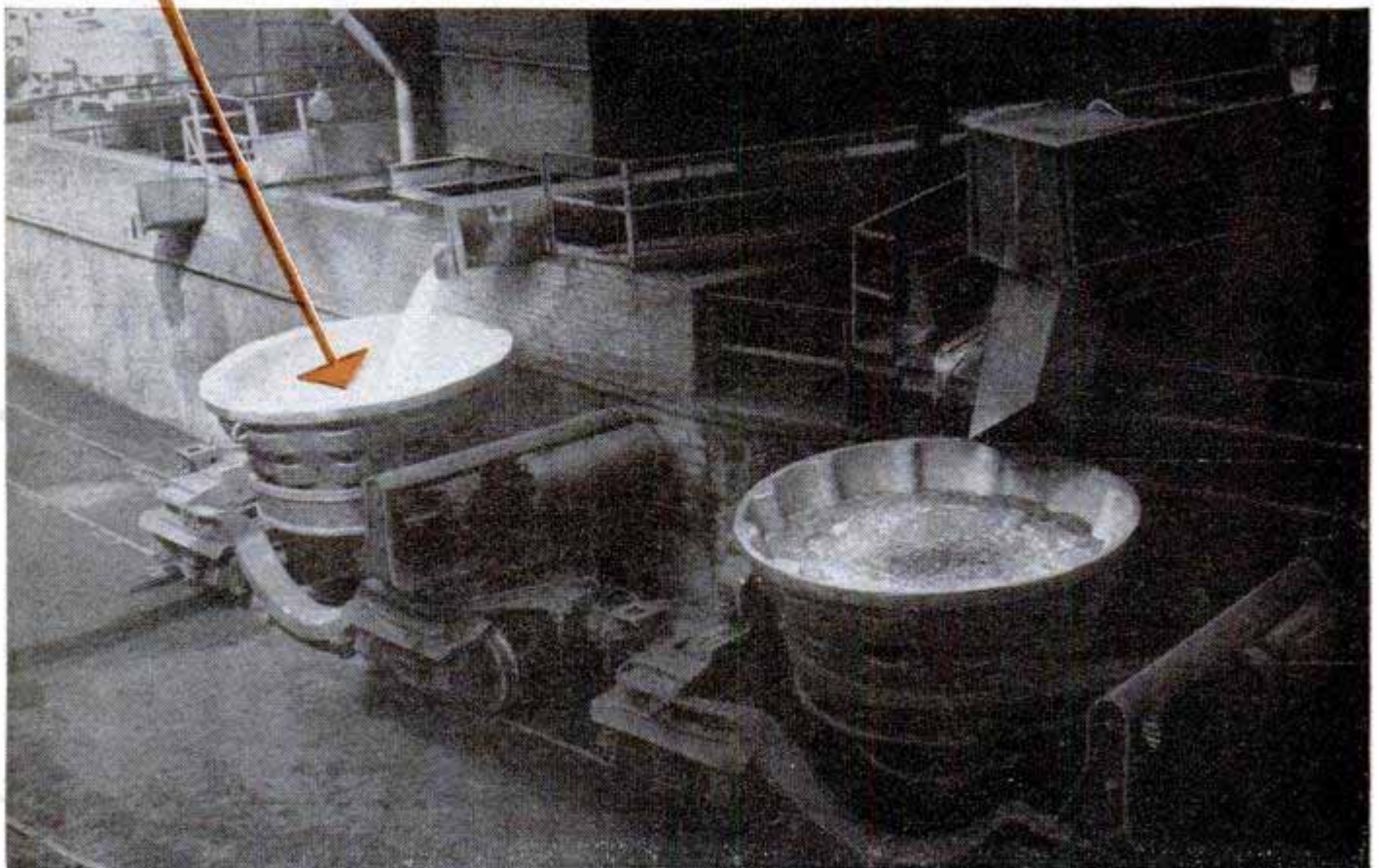



**Mountains of the one-time waste product of the pig-iron furnaces are now being funneled into building blocks and home insulation**

metal during the second heating. Dissolved gases escape from the furnace with the molten slag. Some of this gas is trapped in bubbles inside the slag and as it cools it is honeycombed with tiny pores which expand its volume and decrease its weight. Some slag, which is used as a lightweight aggregate, is specially treated to increase the number of air pockets.

The crushed slag that does not contain enough iron to warrant remelting is then graded according to size by passage over a sieve having various-size openings. The larger pieces are used in the construction of highways and track roadbeds and as trickling filters. Smaller pieces are used for roofing and seal-coating of bituminous highways.

More than 16 million tons of this slag are used annually for

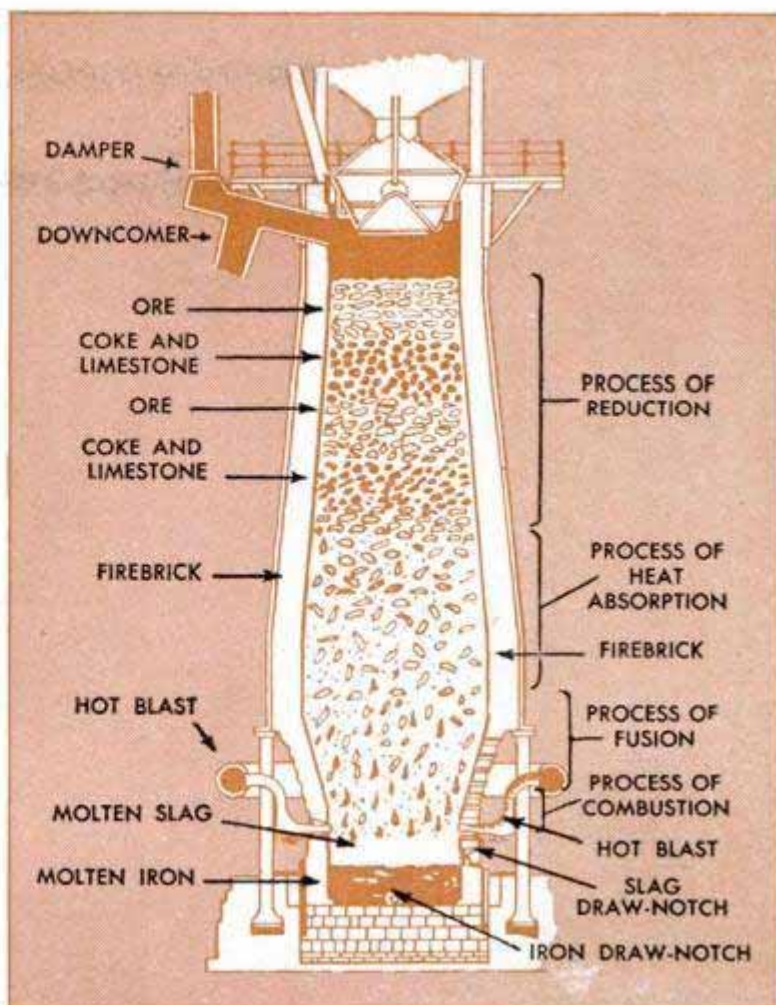

Diagrammatic cross-section drawing of a blast furnace in operation. Ore and other materials are dumped in at the top of the tall cylinder. Molten iron and slag are drawn off the bottom

After leaving the furnace, the slag goes to a dump where it is cooled before being hauled to the crusher





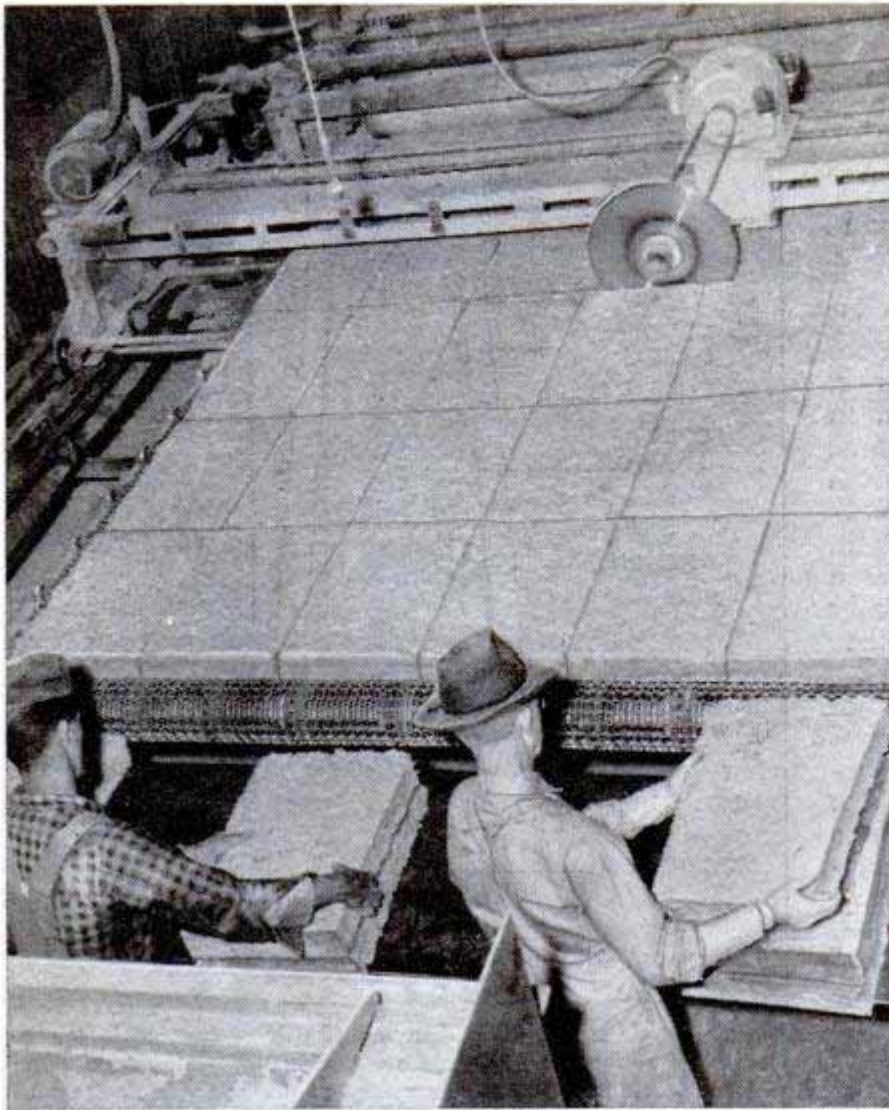

Mineral wool in batt form is cut to the desired sizes by an automatic crosscut saw. Here workers remove the finished batts from the conveyor

highways, track ballast and other construction projects. Our railroads alone are using  $3\frac{1}{2}$  million tons every year to construct and maintain stable and well-drained roadbeds. Slag has also found wide usage in trickle filters at Army posts and in city sewage plants all over the country. Incidentally, the Siegfried and Maginot lines were built of reinforced slag concrete as was the German base at Helgoland.

Most of the mineral wool used for building insulation is made from slag by a pressure-blasting process. By this method, the Tennessee Products and Chemical Corporation of Nashville and Rockdale, Tenn., produces a mineral-wool insulation known as Tensulate.

The raw materials used in the manufacture of this product are slag, coke, river gravel, limestone and dolomite, the last three in small quantities to balance the slag chemically to produce a stable long-fiber wool. These raw materials are charged in melting furnaces or cupolas, which are steel shafts 20 to 30 feet high with an inside diameter of  $4\frac{1}{2}$  feet. Six parts of slag are added to one part of coke by weight plus

small amounts of the other materials.

The slag is melted by the burning coke, oxygen being supplied by blowers which force air into 11 tuyeres near the bottom of the furnace. As the slag melts, it flows continuously through an opening at the bottom. The stream is divided into six or eight pencil-size streams by divider plates. At temperatures of 2600 to 2800 degrees Fahrenheit, these tiny streams of slag are blown with high-pressure steam from V-shaped nozzles. The blasts tear the streams into hundreds of small droplets which are propelled at great speed into a collection chamber.

This chamber is a long, narrow room, the floor of which is an endless conveyor. As the droplets are propelled into the chamber, they form fine, hairlike tails and are forced to the floor by a series of fans. There they become a thick tangled mass that is known as "loose wool."

For use in insulating building sidewalls and attics by hand placement, the loose wool is packed, without further processing, in 40-pound bags as the conveyor carries it from the chamber.

Another form of mineral wool, known as pellet wool, is used for insulating buildings by blowing it through pipes under pressure into the building cavities. To produce this variety, annealing oils and water-proofing material are introduced into the collection chamber. The mineral wool which forms is carried by conveyor to a hammer mill or granulator where it is shredded into small pieces. From there it goes to a rotary screen where the droplets that did not completely turn into tail are screened from the fibers. During the screening process, the pieces of wool are rolled into balls or pellets.

If batts or blankets of mineral wool are desired, a binder material, usually a mixture of synthetic resins, is introduced in front of each steam jet, coating each fiber with resin. The speed of the conveyor belt is precisely controlled to build up a blanket of the desired thickness. As the wool leaves the collecting chamber, it passes under a



roller into a forced convection-draft curing oven where the temperature is maintained at 400 degrees Fahrenheit.

When the binder material has been set by the passage of hot air through the wool, the blanket passes over a section where cool air is forced through it to cool it so that it can be handled. It is then ripped to the desired widths by a series of saws and passed over a steam roller where a vapor paper is applied with an asphaltic adhesive. After they have been cut to the desired lengths by crosscut saws, the batts are compressed and packaged for shipment.

There is also another process which produces specially shaped blankets for industrial use and there are facilities for applying metal backing to the blankets to make heavy-duty, high-temperature insulation.

Another important slag product is the Celocrete building block produced by the Celotex Corporation. By a special process, the molten slag is converted into a hard, cellular, annealed mass, which, when crushed and graded for size, is ready to use with portland cement and water to

(Continued to page 242)

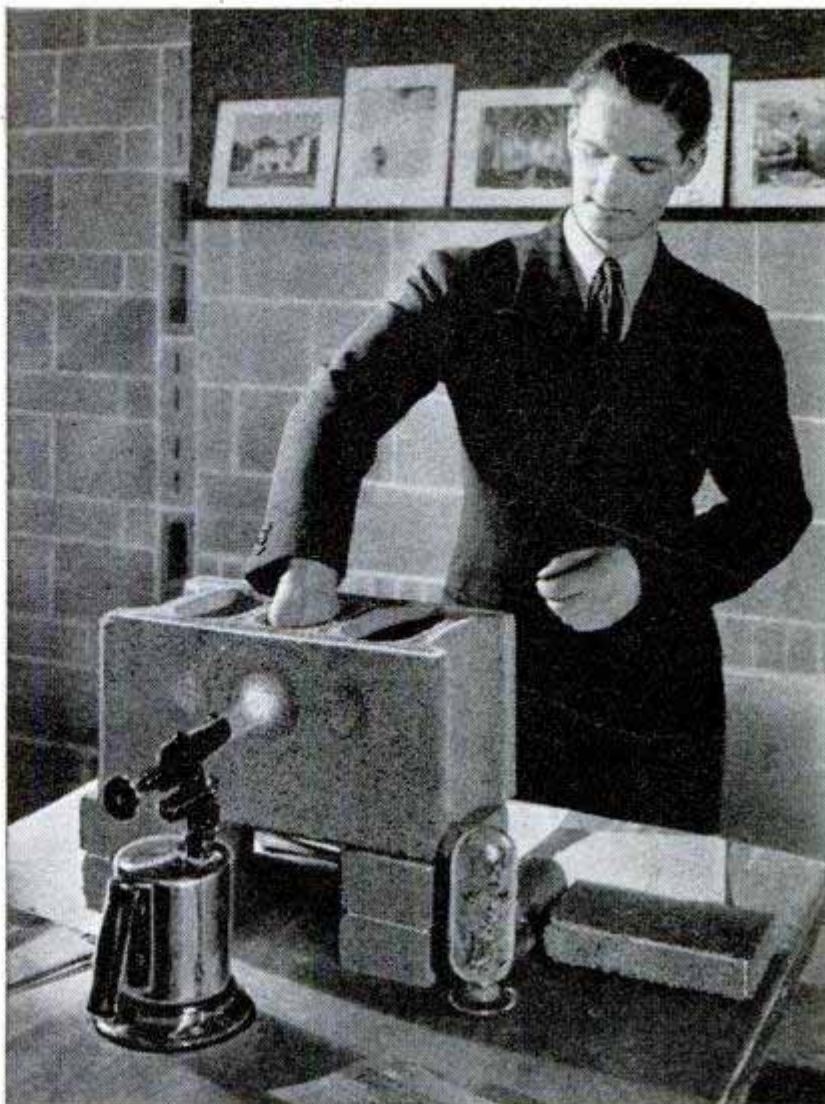

Above, Celocrete units made of slag-concrete are fireproof and have excellent insulating qualities as this photograph proves. Below, a modern one-story home near Cleveland built with blocks of Celocrete





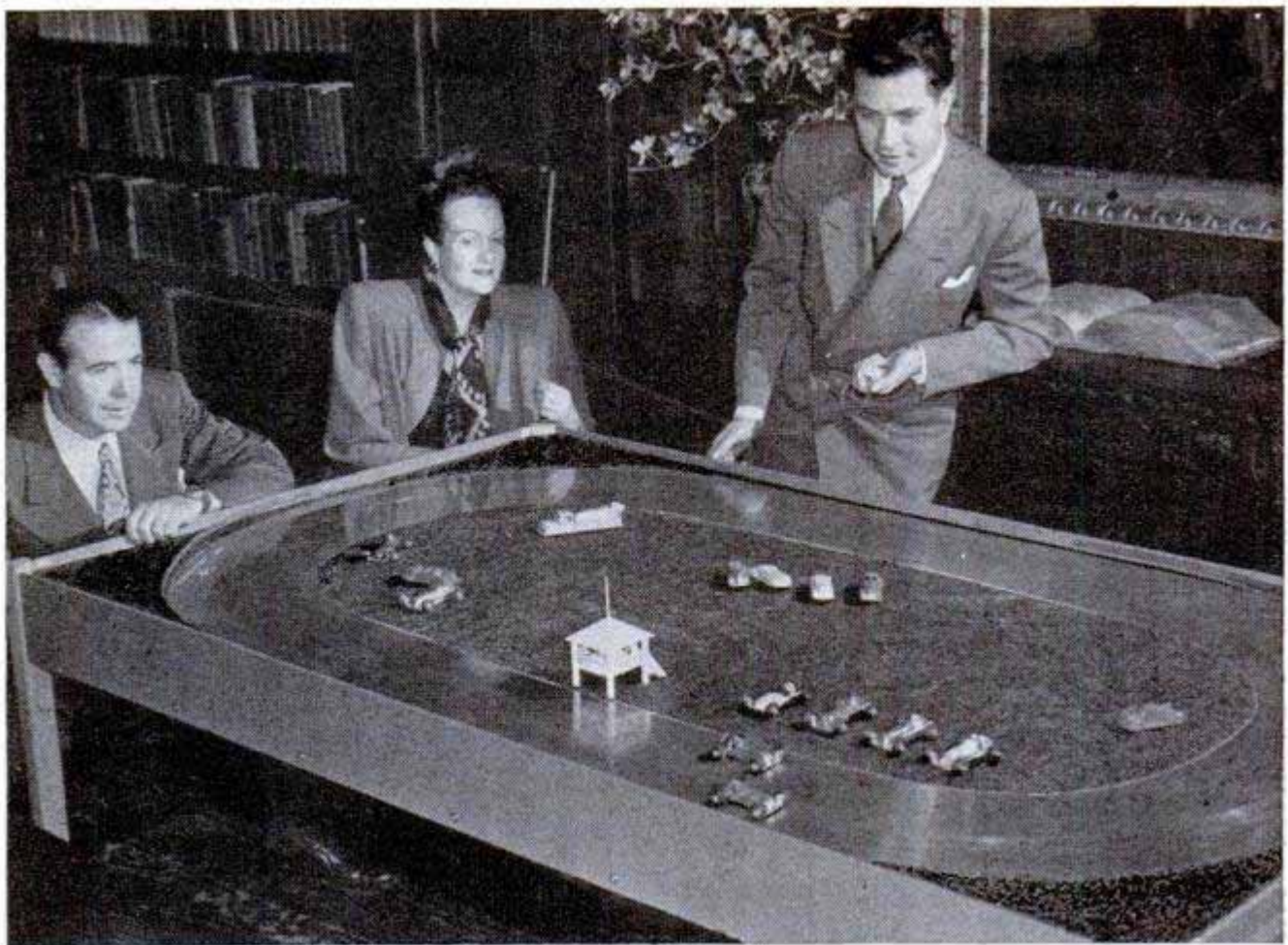

### Magnet-Driven Cars Race on Tiny Oval

Thrills and spills aplenty are enjoyed in the living room with a miniature auto speedway that uses motorless cars. The tiny racers are pulled around an aluminum track by strong magnets riding on rails be-

neath the oval. The magnets attract the front axles of the scale models and speed is controlled by knobs on the sides of the track. Speeds up to seven miles an hour, the equivalent of 160 miles an hour for full-size cars, are possible. Running the cars too fast on curves causes spills as centrifugal force overcomes pull of the magnets.



### Two-Way Plow Cuts Ditches

With a lift-type, two-way plow, the farmer can use both plows at the same time as a V-plow for forming irrigation and drainage ditches. In normal field plowing, each blade is used alternately to turn every furrow the same way, leaving no dead furrows. For contour and hillside work, every furrow is turned uphill forming a miniature terrace to hold moisture and resist washing. The two-way plow is raised and lowered by hydraulic control. When one plow is raised, the other automatically locks into plowing position.

Claim to the world's helicopter speed record has been made by a British pilot who flew a Fairey Gyrodyne at 124.3 miles an hour over an official three-kilometer course in a speed trial.





### Vise Cradles Doors for Finishing

Doors and windows are held for finishing operations before hanging by a vise that grips the floor. The vise, made of aluminum, cradles the work between rubber contact points to prevent marring the surface. It is adjustable from  $\frac{3}{4}$  inch to 3 inches and weighs only  $2\frac{3}{4}$  pounds.

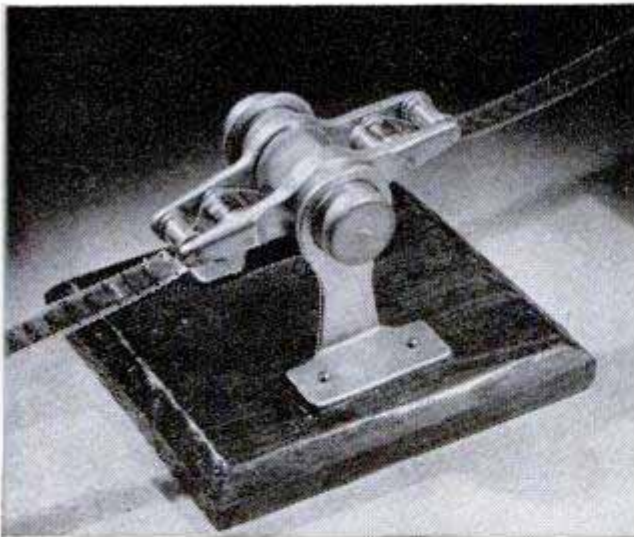

### Movie-Film Waxer

Smoother running of movie film through a projector is assured when the sprocket areas of the film are coated with wax. A film waxer for home projectionists waxes either 8-mm. or 16-mm. film. As the film is reeled through the unit, two paraffin lenses apply wax to the margins of the film to assure free travel through the aperture gate of the projector.



### Telescoping Fish Pole of Aluminum

Four feet long when retracted for convenient packing en route to the lake, an aluminum fish pole telescopes out to a length of 14 feet. Each section is made rigid by a half turn of the rod. The light, strong aluminum has a whipping action. The grip is of rubber, and there is a device for winding the line.

☐ Hotels and motor courts in 47 states which accommodate travelers accompanied by their dogs are listed in a national directory just published.





The Hardgrave family gazes across the fields of the new farm, rebuilt between sunup and sundown. Right, 54 tractors clawed the earth to make the model farm

By Vivien B. Keatley

**B**ULLDOZERS and earthmovers, ditch-diggers and mixers—all kinds of mechanical monsters rumbled up to the gate of an Arizona farm not long ago. Between sunup and sundown they face-lifted the fields, changed the channel of a river, built a pond and so completely altered the appearance of the farm that even its owner scarcely recognized his land.

The one-day demonstration showed 4000 visitors the methods by which a neglected and badly eroded farm can be restored to full productivity. Machines chugged through their chores to demonstrate nearly every known conservation practice in



## They Rebuilt a Farm

rebuilding the farm from the river's edge to the crest of the 35 sloping acres. If Robert Hardgrave, the owner, had contracted to have the job done at prevailing wages and material prices it would have cost him well over \$7500. At day's end he had a new farm for nothing. If Hardgrave had attempted to do the job himself in his spare time he probably would have finished about 1968. With the last chore done, the last tractor waddled off the field at sundown to end the demonstration.

The Mizpah Ranch, bought by Hardgrave, an ex-GI, last October, was chosen by three cooperating Conservation Districts for the one-day demonstration. The Verde River, which irrigates the area, had already eaten away 12 of the best acres of

the farm. Fields were badly eroded and almost nonproductive. The sloping acres represented a big irrigation problem. The pumping system was inoperative. Topsoil was washing away.

An estimated quarter of a million dollars worth of farm equipment, from a garden tractor to a huge land-leveler, showed up to rebuild the farm, turning the demonstration into an equipment show.

The most challenging projects offered by the farm were stream-control measures, leveling about 25 acres, bench-terracing nearly 10 acres, and enlarging a shallow pond to a reservoir holding four acre-feet of water, which soon will be stocked with bass and bluegills.

Mechanical muscles pushed, lifted and



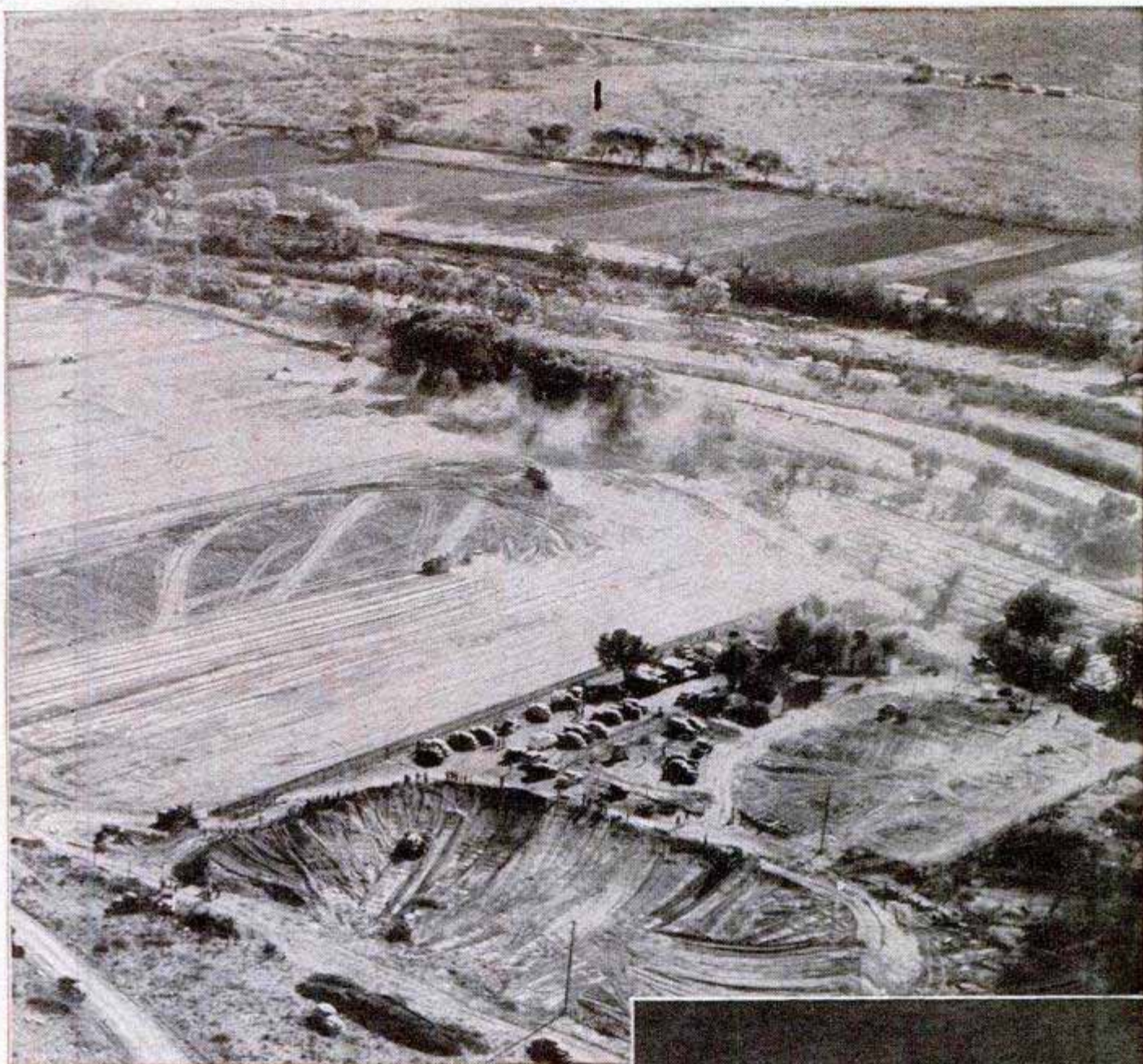

## *in a Day*

carried 12,000 cubic yards of dirt in rebuilding the farm. Machines clawed out irrigation ditches and then lined them or dropped concrete pipe into place. A new electric pump was installed. Neighbors and equipment demonstrators ran an irrigation system, including valves and a siphoning setup, to the irrigation ditches. Water for the house is piped in from an artesian well, so this was not affected by the men and machines.

But linemen ran electricity into the farm, including a heavy wire for Mrs. Hardgrave's new electric stove, replacing an old wood-burner. As a final gesture,

Veterans taking on-farm training survey the land and mark cut-and-fill stakes under Soil Service direction

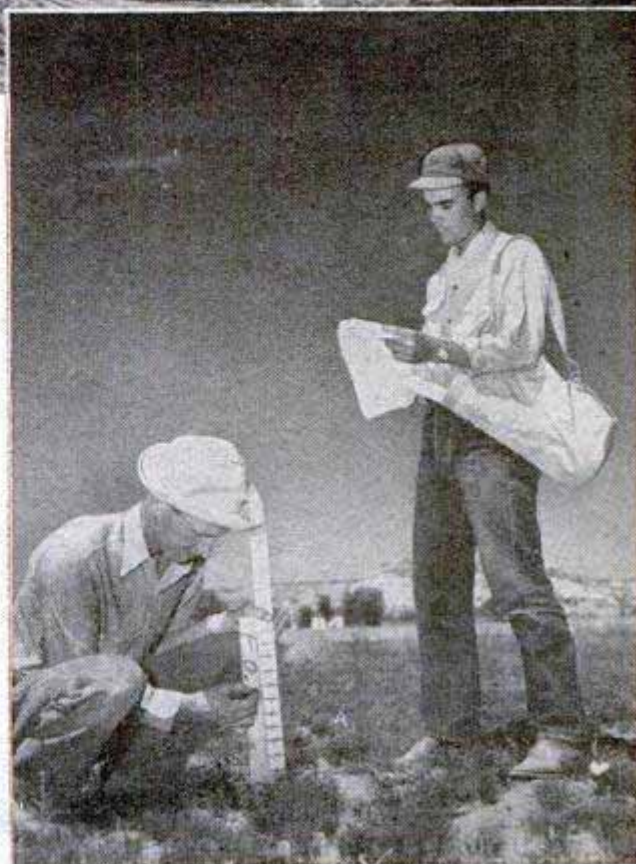



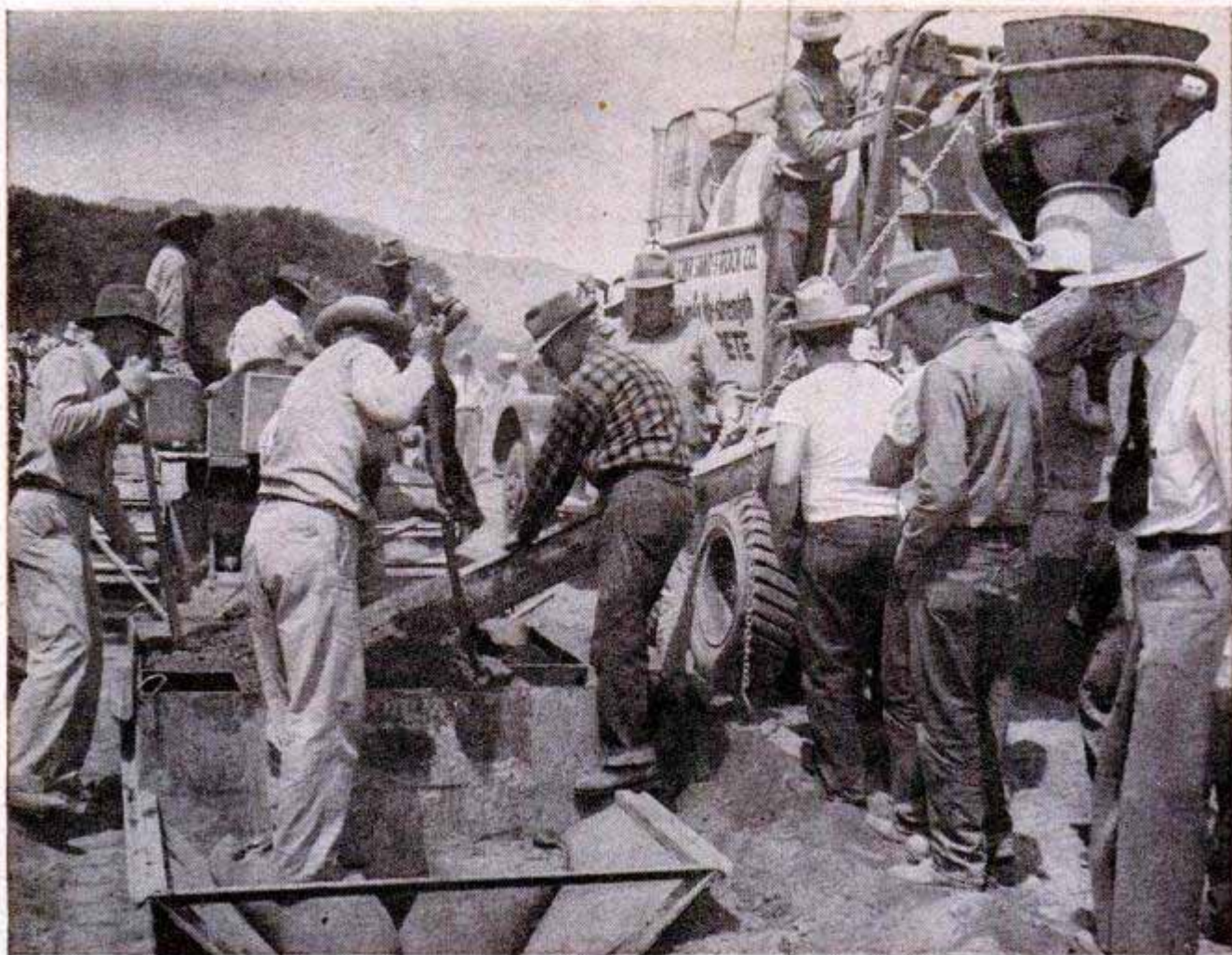

Ditch-lining machine feeds ready-mixed concrete from barrel trucks into the sides and bottom of the ditch. Below, this is the scene 18 minutes after the ditch was started. About 600 feet have been lined with concrete





painters swarmed over the house and barn to apply a free coat of paint so the buildings would look as new as the rest of the farm. At sundown Hardgrave looked across an unfamiliar farm, but one of the finest in northern Arizona.

One of the most expensive projects completed during the day was stream-bank protection. River damage can't be ignored or farm land may be washed away, leaving only a useless gravel bed or even a new river channel.

To protect the Mizpah Ranch river bank, large cables were stretched along the most critical bank areas and anchored to tremendous logs in deep T-shaped holes dug in the bank. Cedars were fastened to these cables to start debris barriers.

Below, nearer the river bank, nine-foot live-willow posts were set six feet apart deep in the ground (in holes dug by mechanical posthole diggers). These will root and grow. Staggered behind the willows are Russian olives. There now are hundreds of other trees, shrubs and vines. The useless part of the river bank has been converted into a wildlife area, where quail and other game birds thrive on berries. The best part of the gravel bank has been planted to panic grass, and will be useful pasture. Fencing has been strung along the willows, to keep cattle from the river out of the wildlife and pasture areas.

River-channel problems have to be solved jointly by everyone along a river, so only a minor straightening job was undertaken. Playing with river channels is a tricky business; undo the channel's damage to one farm and you're apt to pass it along to your neighbor across the river.

For the straightening job, a giant 180-horsepower bulldozer was used. Afterwards, this rugged piece of equipment

Mechanized buckscraper-carryall goes to work on one of the fields, leveling ground for future irrigation

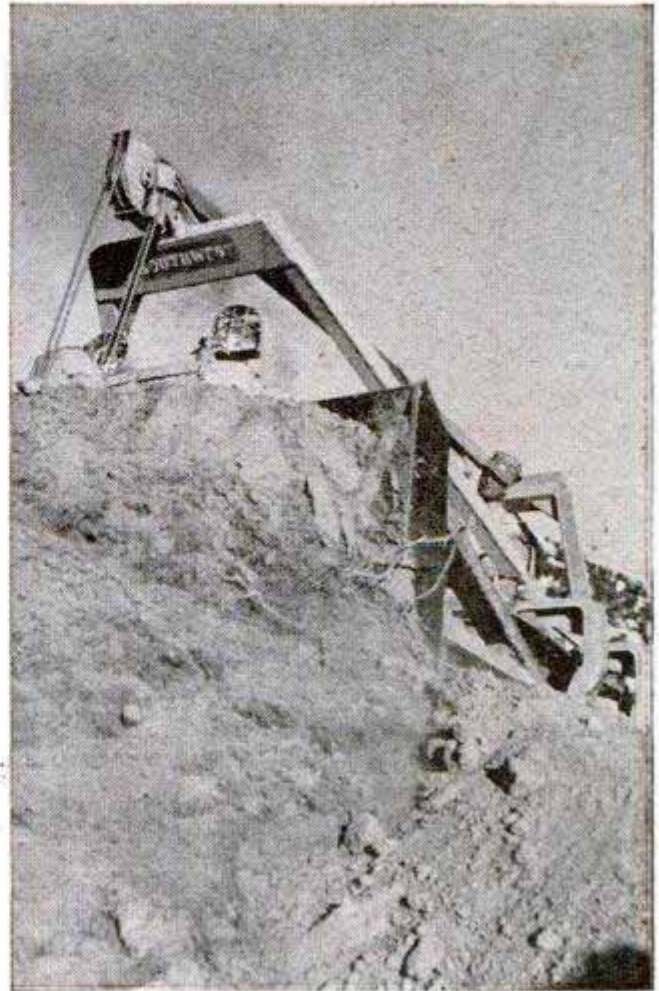

Bulldozer scrapes out the earth for the 14-foot-deep pond that will serve as a water reservoir. Below, ditchdigger scoops up dirt with chain of buckets



"Overland" Scraper  
 SEPTEMBER 1948  
 Counsel on Ford or Ferguson Tractor





**Aluminum siphon tubes shift water from main channel to smaller ditches. They eliminate need for headgates, are inexpensive and primed by hand**

dominated the pond excavation job. It averaged moving three cubic yards of dirt a minute all day long. After excavation the pond was lined with clay dug on the ranch and loaded into dump trucks donated by local contractors. River water now is pumped through concrete pipes into the bottom of the pond which is higher than the cultivated acres. The siphon system pushes the pond water into the irrigation ditches as needed.

Two big land-leveling outfits, one op-

will be fertilized and then seeded.

An interesting sprinkling irrigation system was demonstrated on one field, but the permanent irrigation will be by ditches. The ditches were "laid" by two new rigs, a trencher and a ditch liner.

The trencher is a set of rotating teeth which loosens earth and lifts it to one side, digging a trench 14 to 18 inches wide up to a depth of 40 inches. By retracing, the width can, of course, be doubled. Its advantages over most ditchdigging equip-

erated by a local contractor and one brought in from Phoenix, 150 miles away, were used. Land-leveling and bench-terracing also were done by smaller tractors of almost every make. The tractors used buck scrapers, utility blades, carryalls, two-way and single and disk plows, lift-type disks and border disks, loaders and ditchdiggers. Before they were through, the earthmoving equipment, big and small, had treated every acre to be cultivated on the farm, either by leveling or terracing, bordering, plowing, deep cultivation or floating, and made it ready for irrigation. After irrigation it

**Unlined irrigation ditches are sprayed with heavy oil which forms a crust to prevent ditch-bank erosion**





ment are its motive power—either one of two makes of tractor—and the fact that it costs less than \$2000, or about half the price of a heavy-duty trencher. Its modest cost and simple operation make it a natural for golf-course irrigation systems, small-community or privately owned water and sewer systems, construction foundations and similar uses as well as on farms.

The obvious favorite of the "sidewalk superintendents" was a new combined digger and concrete form. The equipment comes in a three-piece set; there's a pull grader that prepares the ground on the ditch alignment; a special plow to cut the ditch to a true cross section, line and grade, at the same time forming a berm or shoulder; and a slip form that pours fast-drying, premixed concrete to a true section, line and grade. A mixer truck moves alongside the slip form which, like the pull grader and plow, is pulled by any ordinary tractor. The concrete-mixer truck and tractor move in unison; the truck discharges its concrete into the hopper of the slip form. Every five minutes they leave behind them 240 linear feet of concrete-lined and completed ditch! Depending on soil conditions and the thickness of the concrete poured (up to 1½ inches thick), the equipment digs a ditch and lines it with concrete for from 55 to 75 cents a linear foot.

(Continued to page 256)

Top, front-wheel-drive garden tractor plows the earth for Hardgrave's garden. Right, clay is scooped from a deposit near the farm to line the water reservoir. ↓ Behemoths such as this land plane make short work of leveling heretofore nonirrigable 10-percent slope

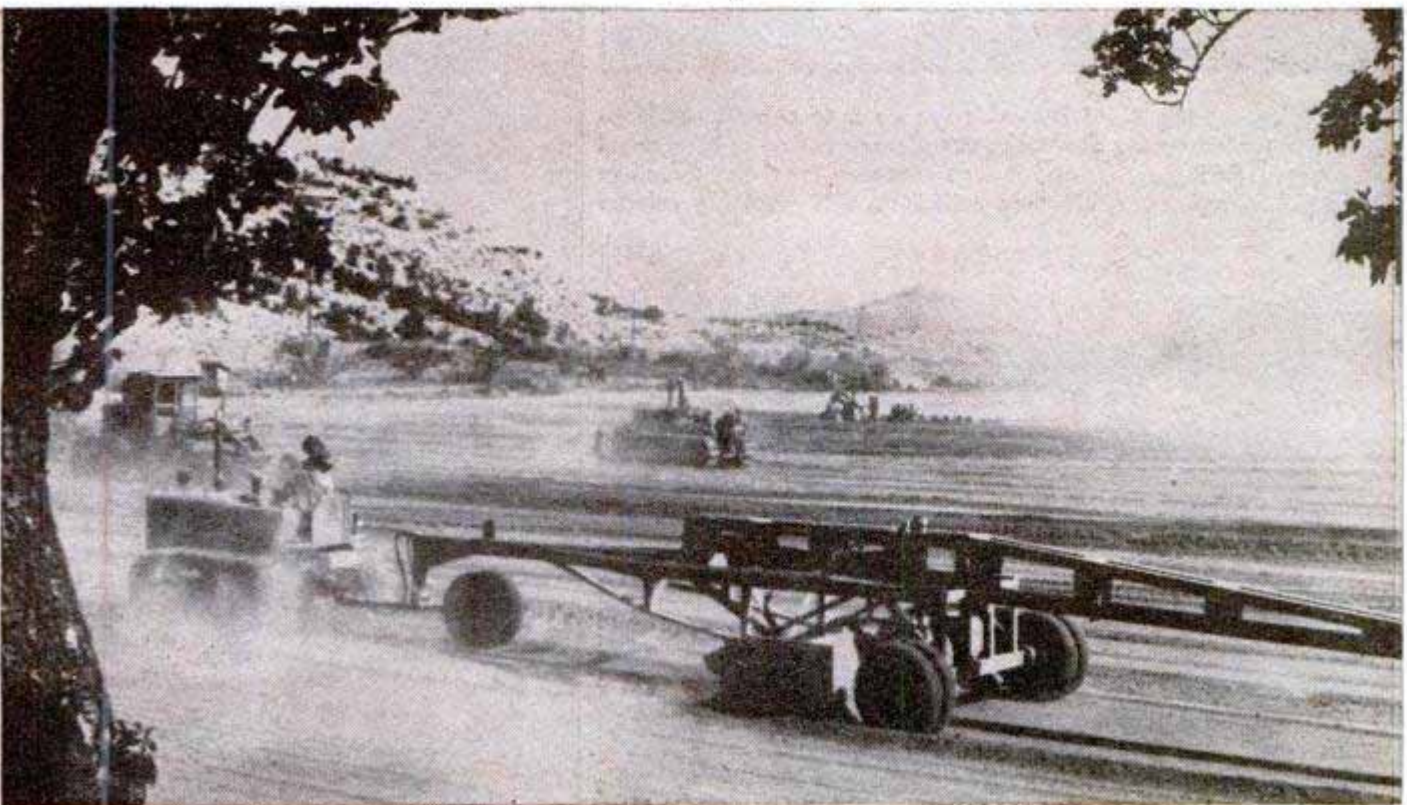
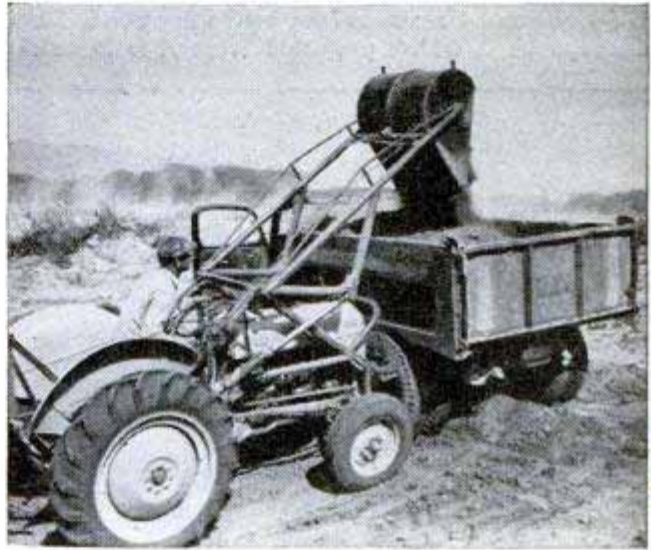

Dealers: Boyd Ten  
Feed stores  
Prescott, Arizona

Kide master Garden tractor  
Food Machinery Corp.  
San Jose, California

Mrs.



# A Century of Railroads



Old-fashioned train runs length of fairground. Below, mockup of Chesapeake & Ohio's projected Train X is low-slung for stability



Below, fairgoers are given a track's-eye view of a modern sleeping car. Mounted upside down, the complete underframe is exposed and explained. Engine behind it was captured from the Germans by the U.S. Army. Right, chromed rails form this revolving column

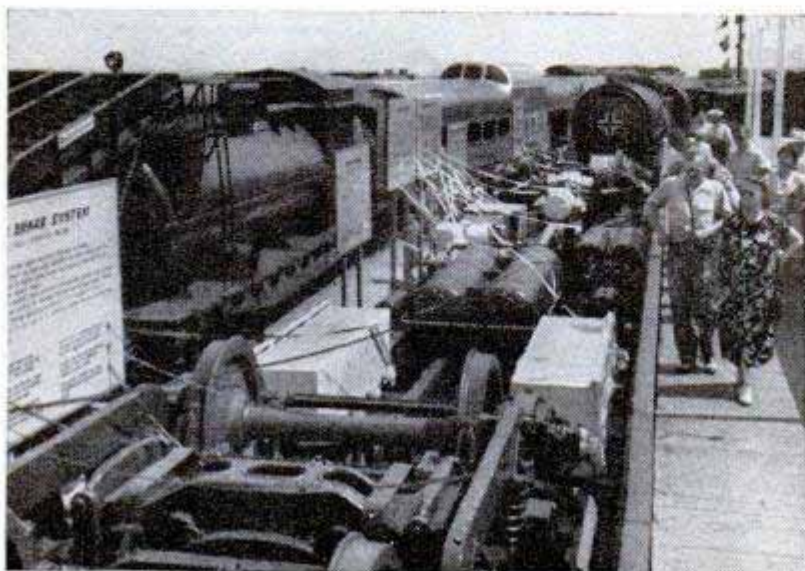

OLD AND NEW fashions in American railroads are on exhibit at Chicago's lake front in a Railroad Fair celebrating 100 years of railroading in the Middle West. Pioneer locomotives with steam up run alongside the newest steam and Diesel-electric trains, while some cars yet unbuilt are shown in mockup form.

Marking the 100th anniversary of the first run of a steam locomotive from Chicago, then a muddy frontier outpost, the Fair has assembled millions of dollars worth of rolling stock to dramatize the progress of the century.

Thirty-eight of the nation's railroads proudly strut their stuff. In an outdoor pageant real locomotives puff on and off the giant stage under their own power. A rodeo, an Indian village, a small-sized reproduction of Old Faithful that really spouts and scores of other features make the Chicago Fair the end of the line for rail fans.





# on Parade

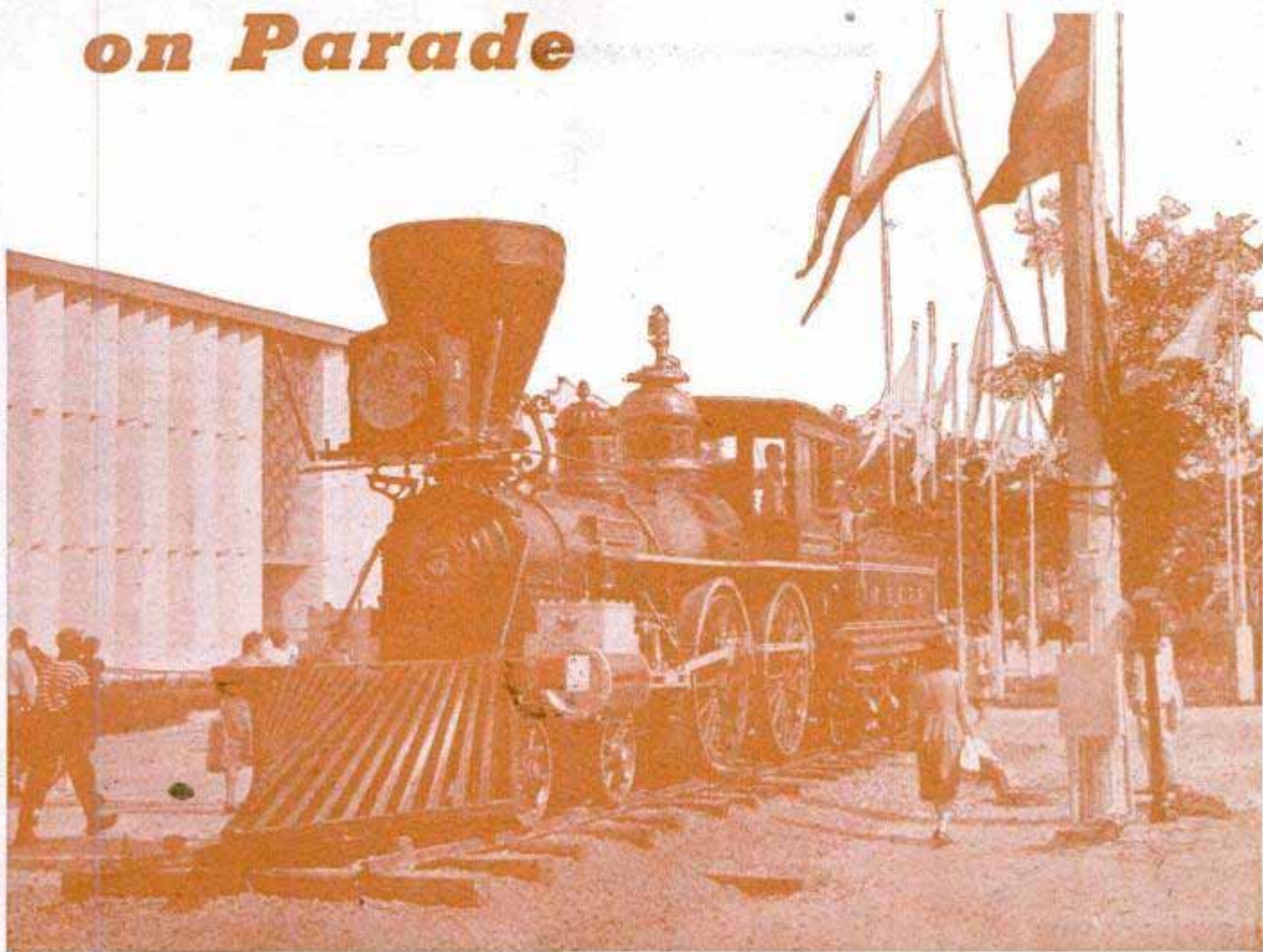

Above, centerpiece of the Fair is the wood-burning "General" which played an exciting role in the Civil War. Captured by Union soldiers, it was pursued and overtaken by Confederate railroaders in a 100-mile race from Big Shanty, Ga., to the Tennessee border. Left, a favorite with youngsters, a 9-foot foam-rubber robot, dressed like an engineer, carries on conversations and acts almost human. It is controlled remotely by an operator hidden behind a one-way glass in wall. Below, this powerful Diesel holds no secrets! Side panels, housing and machinery covers have been cut away to give fairgoers a view of the flow of power in the 1500-horsepower locomotive

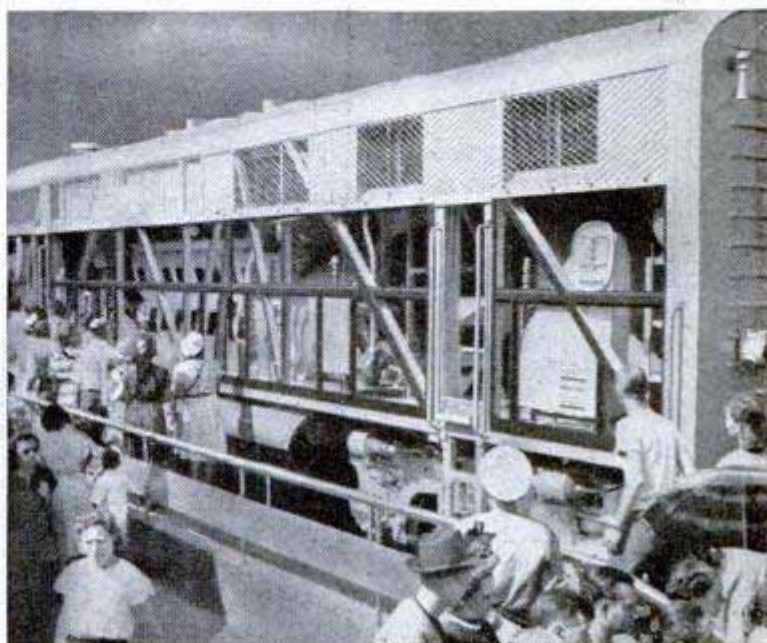



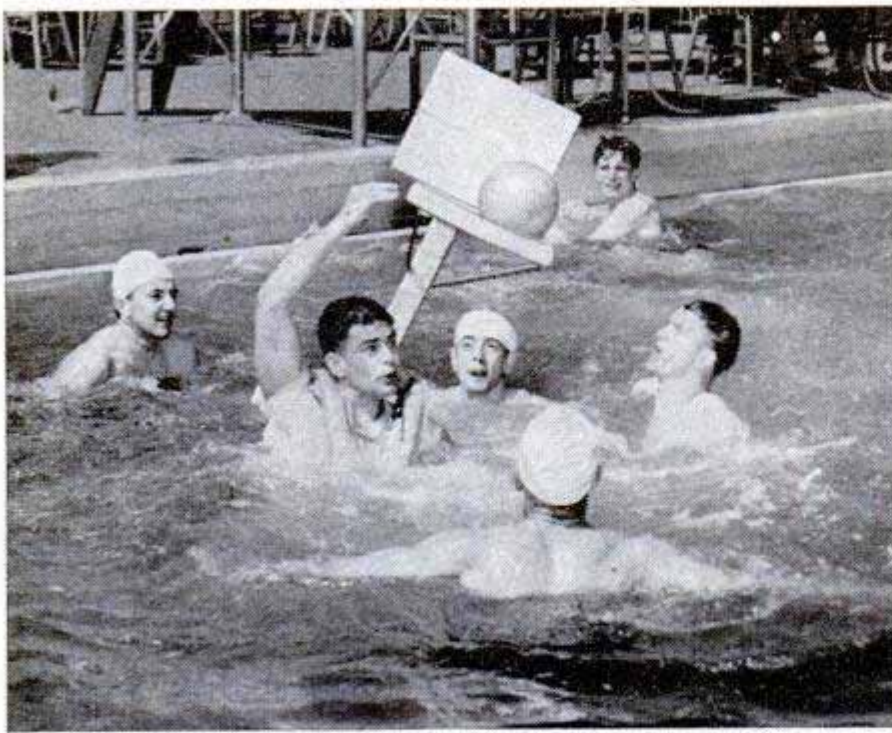

## "Splashketball"

Among the latest sports in swimming pools is "splashketball," a rough-and-tumble game that combines water polo with basketball. Teams of four men each attempt by swimming, jumping and splashing to put the ball through a movable basket. The basket is attached to the goalie by a life preserver, and goalies are allowed to move anywhere in the pool. Excitement comes when a player attempts to make a basket while the goalie tries to avoid him. The players wear caps to identify their teammates.

## Safety Light Socket Ends Shock Hazard

Accidental shocks are impossible with a safety socket that is not "live" until a bulb is screwed tightly in place. A strong spring holds the center contact away from the current-carrying lead. No amount of finger pressure on the center contact will complete the circuit. When the bulb is screwed into the socket, the threaded shell is forced upward and current flows into the bulb. Whether the switch is on or off, the disconnect feature prevents accidental shock to curious children or careless adults.

Although it did not kill them, the atom-bomb rays unleashed at Bikini affected grains of seed corn exposed on the ships during the blast so that they produced plants that were abnormal.



BULB COMPRESSES  
SPRING FORCING  
CONTACTS TOGETHER

## Kit Converts Ordinary Garage Doors For Overhead Opening

Ordinary garage doors of the hinged type can be converted to the overhead lift variety by means of a set of easily installed hardware. Angle irons join the two doors to form a solid unit. Less than one inch

clearance between the top of the door and the ceiling is required. The hardware set includes all necessary fittings to mount either one-piece doors or converted double doors for lift opening.



# Inventions Screened Here

By Ewart Thomas

**WANTED:** A practical method of detecting underground oil deposits.

**WANTED:** A better way of drilling oil wells, especially through hard formations.

**WANTED:** A small economical air conditioner, a better storage battery, a cheap way of distilling sea water.

If you have any practical ideas on these subjects, the Institute of Inventive Research of San Antonio would like to do business with you. These are tough projects and many brilliant minds have pondered over them without much success.

Your ideas should be workable, better than present methods and relatively inexpensive. Otherwise, don't waste your time. Of 1400 ideas and inventions along many different lines that were submitted to the institute in the last 18 months only 12 were considered good enough for development.

One of the few successful ideas was an improved "bump"



Airplane mechanic submitted an idea for a tire-change tool. Result is this hydraulic machine that removes the tire in quick time

Attractive homes house the staff. Slick believes that men work better in fine surroundings so he built the institute on a ranch







Staff member delves into the problem of developing a high-intensity ignition system for combustion engines that will operate on a vacuum tube. ↓ Coin-operated bottle opener is one of the institute's developments. It foils the customer who helps himself to a soft drink but forgets to pay



gate, a gate that is cattle-proof and that automatically swings open when bumped by an automobile. It stays open long enough for the car to pass through and then closes and latches itself. Cattle can't get through and the driver doesn't have to get out of his car to open and then close the gate.

The bump gate had plenty of bugs when it was submitted by its originator. It worked after a fashion, but it wasn't positive. The institute devised a heavy spring leaf that is attached to the bumping plate and that stores up energy enough to unlock the gate and then swing it open. This is one of the gate's most valuable features. Just out of the test stage in which it was bumped thousands of times by automobiles, the gate soon will be on the market. Orders have already piled up from cattlemen who have seen it. The original inventor and the institute will share all royalties.

What is this Institute of Inventive Research?

It's an organization created to help the man who invents a practical device and who hasn't the facilities or finances to develop and market the idea by himself. The institute is one of three companion organizations that have been set up by Thomas B. Slick, Texas oilman and rancher, to do research that will help the Southwest and, in a broader sense, that will be of benefit to everyone.

Thirty-two-year-old Tom Slick has big imaginative ideas and the money to back them up. A Phi Beta Kappa in science, he has always wished for enough leisure personally to go to work on some of the problems



that intrigued him. Other interests always kept him too busy. As an alternative he decided several years ago to assemble groups of research men who could devote all their time to scientific questions.

He backed up this thought with an endowment of a million dollars worth of property and securities. Then he established the Foundation of Applied Research, the Institute of Inventive Research, and the Southwest Research Institute, all nonprofit organizations.

These are imposing names and somewhat confusing, but each organization has its own field of work. Each is young, healthy and busy.

The Foundation of Applied Research has the task of conducting long-range fundamental research in various sciences, particularly in biology and medicine. It operates on grants and gifts.

The Institute of Inventive Research, organized last year, offers a development service to inventors without any fees or preliminary charges. If an invention is developed and marketed successfully, the institute shares in royalties. This helps support the Foundation of Applied Research.

Southwest Research Institute, also recently organized, does research jobs for industry. It is patterned after the famed Mellon, Armour, and Battelle groups and has a backlog of \$50,000 worth of orders for studies. Fees cover costs alone, without profit.

Each of the groups is governed by a board of trustees consisting of public-spirited citizens of the region. Staff scientists and research workers have been carefully selected and at present about 50 people are on the payrolls.

One of Tom Slick's ideas is that men can work best in the proper surroundings. Instead of cramped laboratories in the industrial portion of a city, he visualized a scientific headquarters in the country, remote from city atmosphere. Accordingly, he bought 3500 acres of rolling land, about



In the petroleum lab is an emergency shower. In case of explosion or fire, worker pulls handle to flood water completely over his body



Institute obtained a patent for the inventor of this combination salt-and-pepper shaker. Moving the lever closes one set of holes. Lawn sprinkler successfully developed can be set to spray only at the desired angle so that sidewalks and houses nearby won't get wet





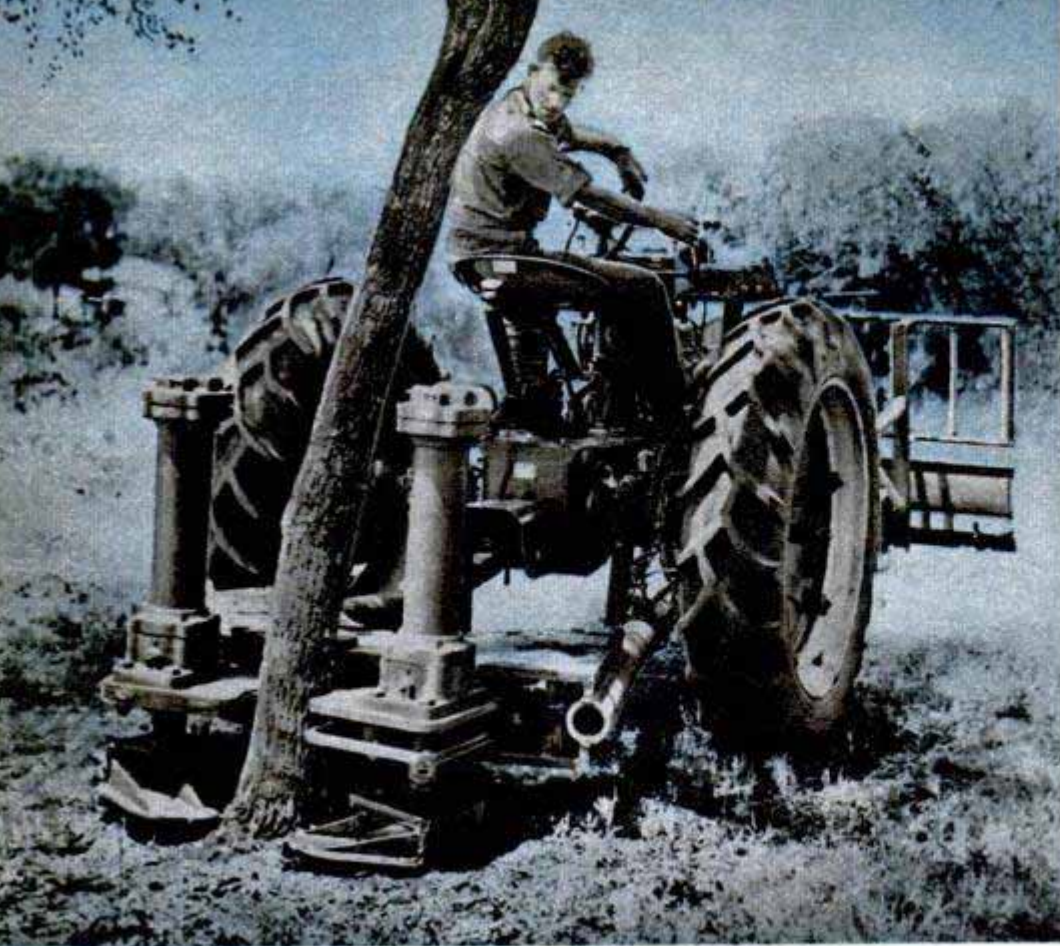

**Puller attachment for a tractor jacks brush and trees out of the ground. Main roots come out, too**

buildings adjacent to the ranch is now under construction. Those already completed are occupied by the offices, laboratories and shops required for research. All equipment needed by the staffs has been provided, from glass-blowing apparatus and laboratory animals to electrical test equipment and complete lines of both wood and metal-working power tools.

Beautiful rambling residences have been built for some of the staff scientists and others are to be started soon. Cable House, an early-day mansion around which some of the buildings are grouped, has been renovated and serves as a guest lodge for distinguished visitors. A swimming pool and other recreational facilities are to be built.

eight miles west of San Antonio, and started the Essar Ranch, the name consisting of the phonetic initials of the words "Scientific Research." The ranch is a going concern, has prize-winning herds of Hereford, Angus and cross-bred cattle, and is used as a field laboratory by the research groups.

A cluster of modern one-story brick

Development work already performed at this center includes perfection of the bump gate as well as the engineering and building of working models of various other inventions. One of these is a small cotton-

**White Brahma bull is bred with other types on the ranch to produce a superior animal that resists disease**





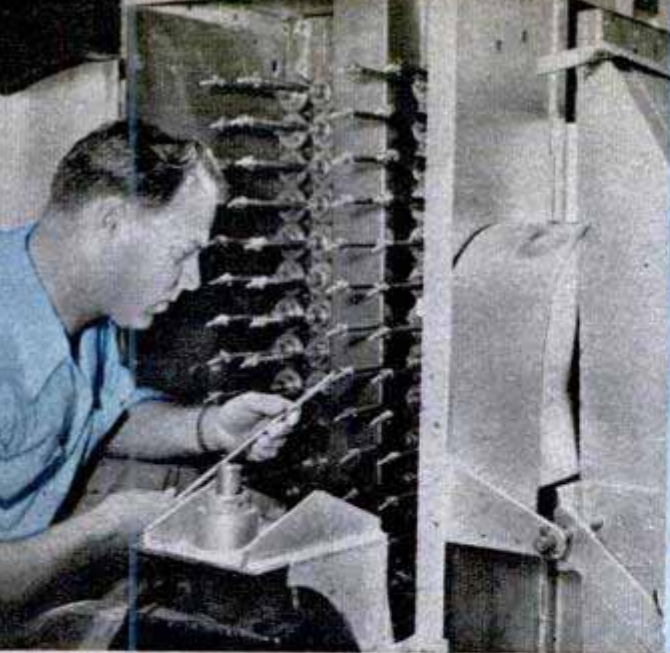

Dry cotton picker shown at right has barbed picks that rotate and move back and forth to pick up the cotton

picking machine that can be attached to almost any tractor and has the advantage of picking the cotton dry, without the use of water, which is objectionable to cotton-gin operators. The picker harvests rows as cleanly as do the large mechanical pickers and costs about half as much.

Another invention developed at the center is a nonoverflow nozzle for use on the gasoline lines of filling stations. Fuel is shut off automatically as soon as the level rises to the nozzle of the hose. Another idea that is now ready for market is a lawn sprinkler that can be adjusted to operate inside 90, 180 or 270-degree angles

as well as in a complete circle. The advantage, of course, is that the sprinkler can be set to water only one corner or portion of a lawn without wetting a nearby sidewalk or house.

The institute assisted a mechanic of Slick Airways in the development of an airplane-tire demounter with which one man can remove a large airplane tire from its wheel in a matter of minutes. Formerly it took a couple of men as long as several hours to do the job and often it was necessary to drive a tractor over the tire to break the bead free from the wheel.

(Continued to page 244)

Cattleproof gate automatically opens when bumped by a car, then closes after car has passed through

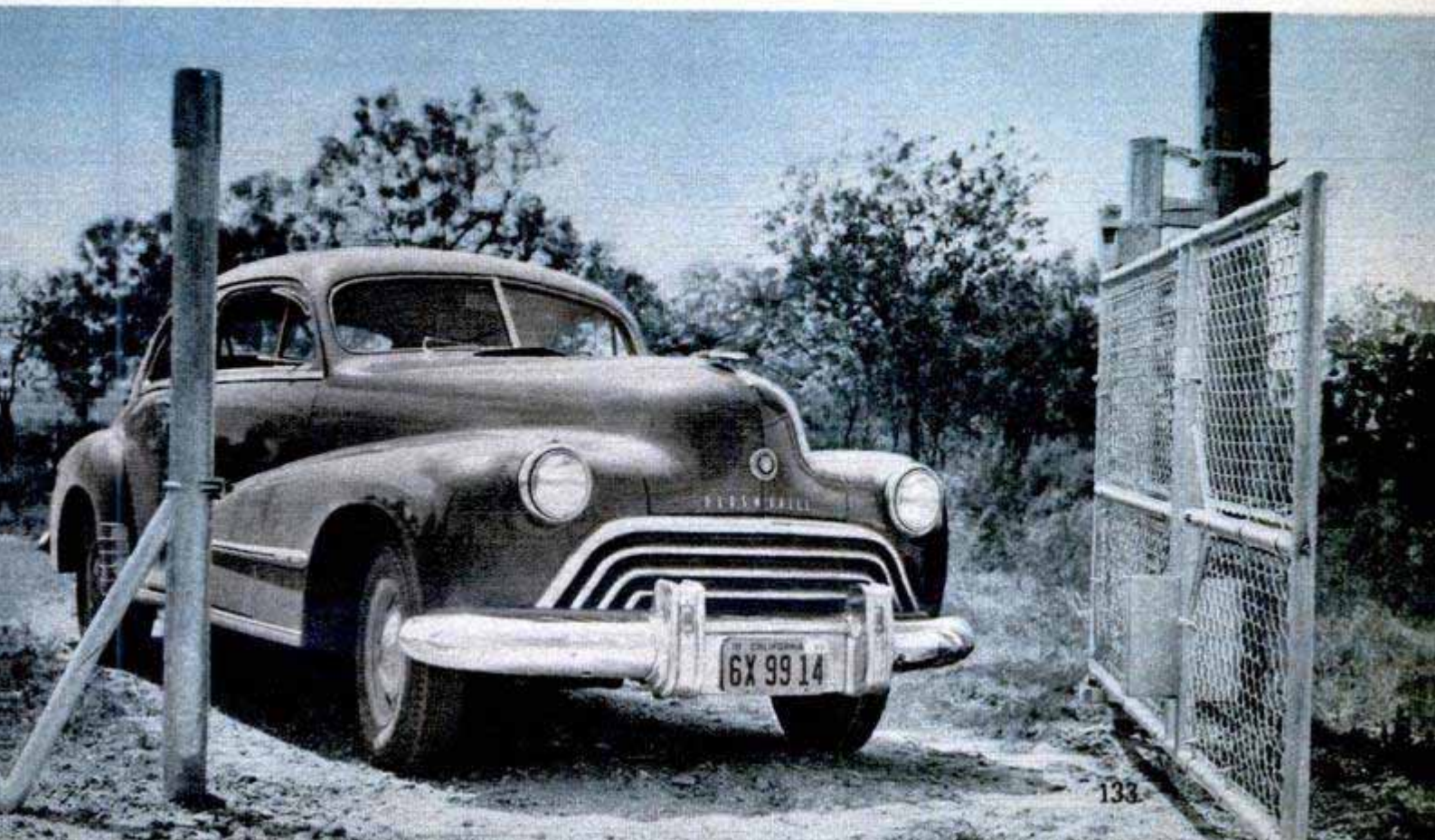





Plugs can be tailor-made to the angler's specifications with the carving kit, which includes all materials, a knife and paints

### Fishermen Can Carve Casting Plugs With Materials From Kit

Anglers can carve their own casting plugs with a kit that contains all the necessary parts. The kit includes materials for making 8 to 10 plugs. Among the parts are

carving blocks, a two-blade knife, instruction sheets with photographs, hooks, fish eyes, screw eyes, sandpaper, brushes, undercoat enamel and six colors of paint.



### Midget Bike Becomes Motorcycle

In an effort to build a vehicle similar to those used by English paratroops, 12-year-old John Molnar, Jr., of St. Louis, Mo., has converted a small bicycle into a miniature motorcycle. The youth bought a  $\frac{3}{4}$ -horsepower motor for five dollars, installed a clutch and fastened it to his bicycle. Other expenses included seven dollars for welding and 75 cents for paint. Now he buzzes down the street at speeds up to 25 miles an hour.

### Gas Turbine Powers Generator

Electricity for commercial use will be generated by a gas-turbine engine when an installation at Oklahoma City is completed. The engine, under construction by General Electric, is a duplicate of a 4800-horsepower gas turbine for a locomotive. Natural gas, plentiful in Oklahoma, will be used as the fuel. In the turbine, the gas will be mixed with air and burned, the resulting gases expanding against hundreds of vanes on a propeller shaft. The shaft will operate the electrical generator.

Our WHERE-TO-FIND-IT INDEX, listing names and addresses of manufacturers and sources of further information for products and articles in this issue, is available free upon request. This index is one of the many services offered to Popular Mechanics readers by the Bureau of Information. For your index, just write to the Bureau of Information, Popular Mechanics Magazine, 200 East Ontario Street, Chicago 11





### Printing Rolled on Surface By Hand-Operated Marker

Packages and crates are marked with one motion of a printer that has its own ink supply. The device is rolled along the surface and prints on every stroke. The type can be changed when various messages are to be printed or, if this is unnecessary, a permanent die is used. Two-color impressions are made by using a different ink on each of the two inking rollers.

### Machine Uses a Continuous Tape To Address 20 Letters a Minute

Printing addresses on envelopes by means of a continuous tape, a small addresser uses no awkward stencil or individual plate for each address. The addresses are typed on a master tape and a carbon copy is placed in the addresser. The printing is transferred to the envelopes in the same way a spirit duplicator operates. The tape will print each address about 100 times without retyping and addresses up to 20 envelopes a minute. Corrections can be made by pasting a slip over the old address.

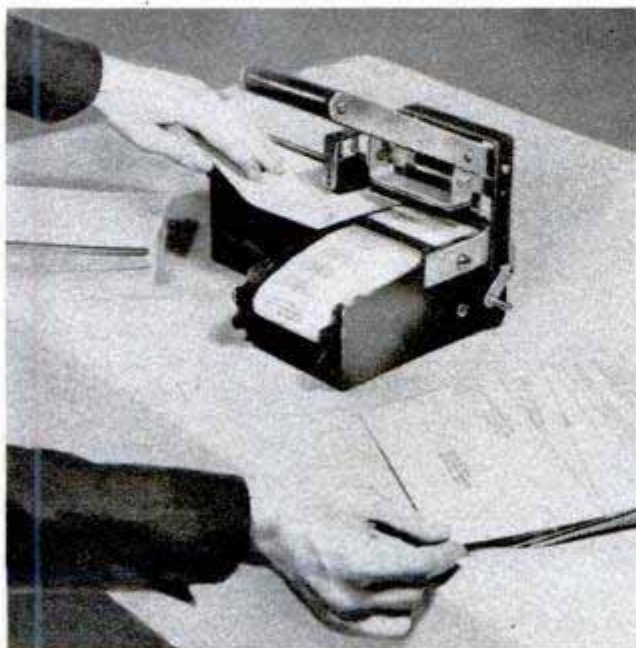

### Replacement Parts for Airplanes Shipped Around World in Tin Cans

Even airplane mechanics now have to have a can opener in their tool kits. Small spare parts, after being coated with plastic and carefully wrapped, are sealed in metal cans to insure safe arrival at their destination. The cans are boxed and shipped to all parts of the world where they are used in servicing transport planes.

### Youth Designs and Builds Trailer

Roomy enough to hold a full-length bed, a camping trailer built by a high-school student cost only \$184. Conrad Grimshaw of Beaver, Utah, designed the trailer and constructed it at school. A wooden cabinet beneath the bed compartment holds dishes, cooking utensils and camping equipment. The trailer can be entered through the front end, which is hinged to lift up, or through a miniature door in the side. The stand is a fixed stake which is snapped into place when the trailer is parked.





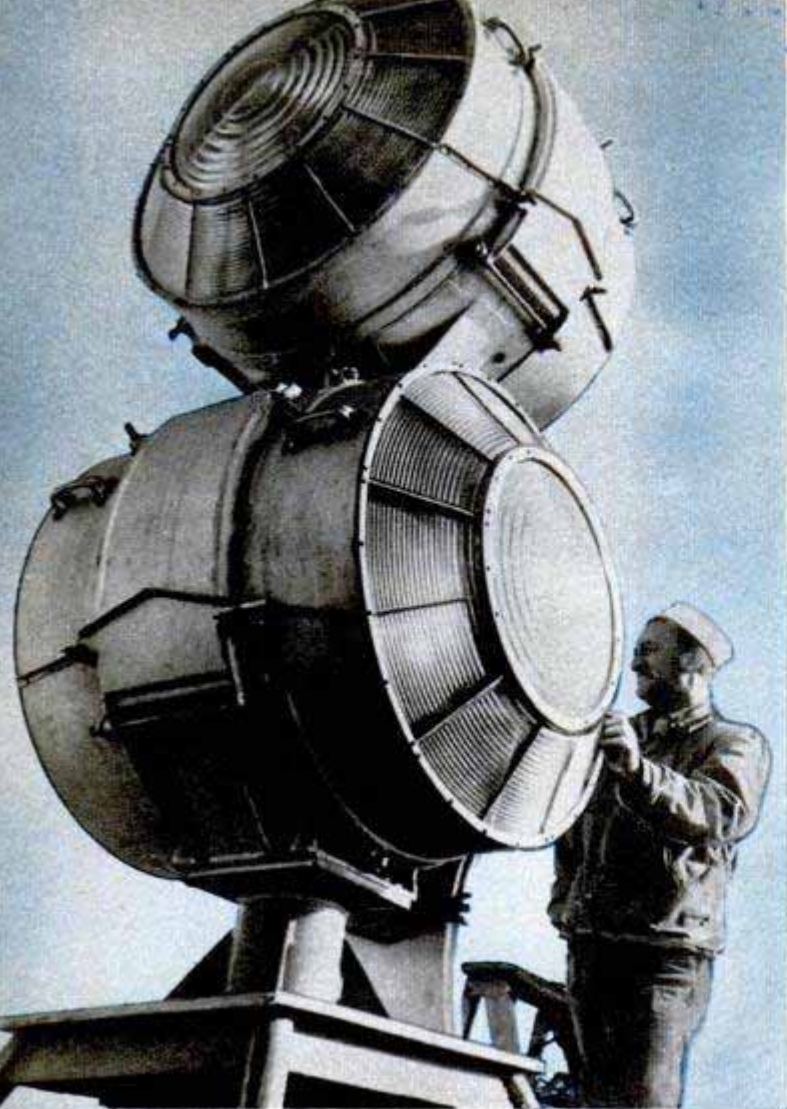

Making the traditional lighthouse structure unnecessary, these all-weather lamps emit four beams of light as they are rotated by a small electric motor

**It will be a sad day, sentimentally, when the lighthouse keeper goes ashore and leaves his post in the heartless but efficient care of a mere robot. But that day is coming when the guardian of the light will visit his station only once a month**

**By Thomas E. Stimson, Jr.**

**S**TORM-SWEPT Tillamook Rock is one of the most desolate and dangerous light stations of the world.

A few miles off the mouth of the Columbia River, it is exposed to the full sweep of Pacific gales. Men and supplies can be hoisted onto the rock in fair weather but other times the station is half-smothered by roaring seas for weeks on end.

Its beacon is a good 133 feet above sea level and yet during one ugly storm a man was almost drowned while working in the room just under the light. A giant wave towered up, broke the glass windows at the top of the lighthouse and poured tons of water into the room below.

In another storm a huge rock that was swept up out of the sea crashed through the roof of the house where the keepers live, smashing the galley range to bits. The house is 100 feet above the sea and now its concrete roof is reinforced by a second protective slab.

Sometimes the keepers on Tillamook Rock wonder why robot mechanisms can't be built to take their places. Surely, they speculate, automatic machinery could be invented that would turn on and off the 75,000-candle-power light and operate the fog diaphones when necessary.

They are right and the answer is that many lonely and dangerous light stations eventually will be left untended except for periodic maintenance visits. Human keepers will be replaced by "thoughtful" machines that will operate the light, watch over it and make routine repairs. All the elements of a completely automatic lighthouse have been perfected.

A big robot lighthouse, in fact, is under construction now at Long Beach, Calif. Some of its equipment will operate automatically; some of the other devices will be controlled by radio from another lighthouse five miles away. It is to be the guinea pig for stations of the future. Only at monthly intervals will a supply boat visit the lighthouse to replenish fuel in its tanks.

*Goodbye, Lighthouse Keeper!*



At the same time the Coast Guard is also preparing to test an automatic lightship. The ship will be completely equipped with automatic navigational aids and is designed to function as dependably as it would with a human captain and crew on board.

The Long Beach lighthouse is to consist of a reinforced concrete blockhouse and tower, 55 feet high, standing on top of stiltlike caissons. Heavy seas will sweep between these stilts without harm. Projecting above the lighthouse will be a 42½-foot steel tower that will serve as the antenna of the radio beacon.

Instead of having one of the traditional lamps the lighthouse will be equipped with a 140,000-candlepower all-weather rotating airway beacon mounted on its roof. Similar lights are in use now at a number of lighthouses.

The beacon will be controlled by an electrically wound astronomical time clock that mechanically computes the varying times of sunrise and sunset all through the year. If the lamp bulb burns out, it will be replaced automatically by a spare lamp that is mounted alongside it.

"The time clock will turn on the lamp a few minutes before sunset each evening and will shut it off again after sunrise the next morning," one of the Coast Guard engineers explains. "The beacon itself will continue to rotate night and day. This is to avoid any chance of the beacon coming to a stop in an east-west direction. If that should happen, the rays of the low sun, intensified by the lens elements, could easily melt and destroy the electric lamps inside. It's safer to keep the beacon rotating."

The lower floor of the lighthouse

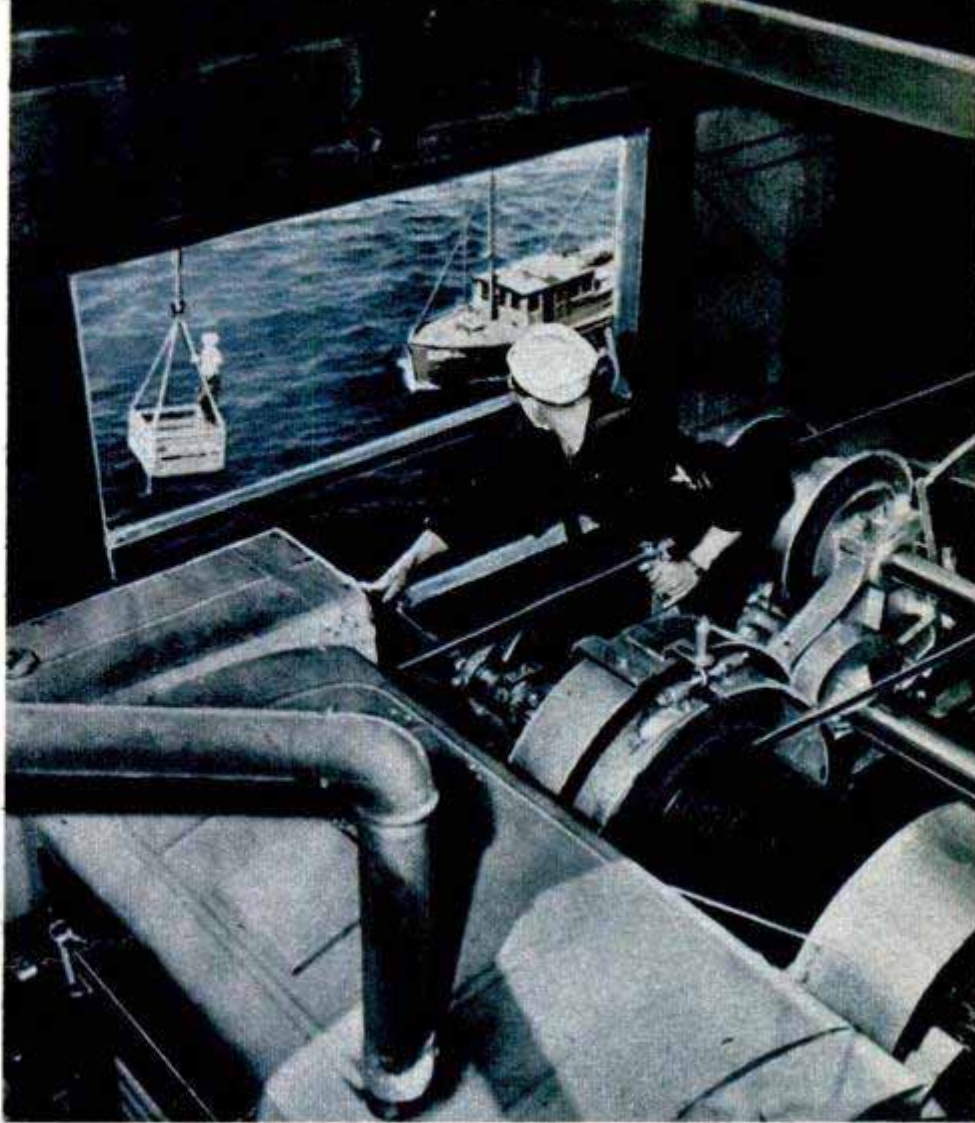

Everything, from men to breakfast cereal, comes to this Puget Sound light in the basket being lowered to the supply cutter

In calm seas, Tillamook Rock looks like a good place to relax, but it's not relaxing when waves beat on the roof of the house

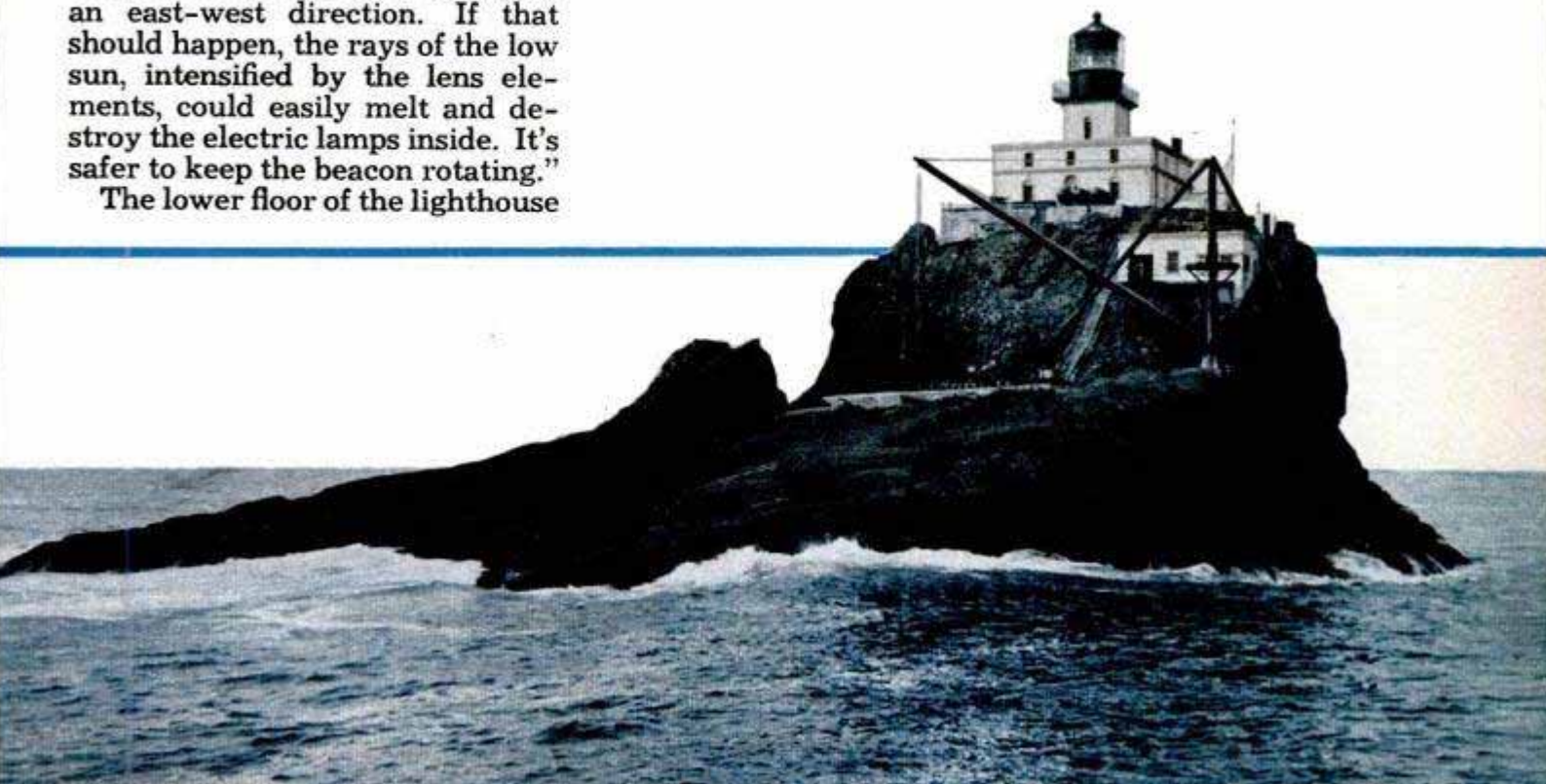





Combination lighthouse and airport beacon is mounted on top of tower at right of hangar. Below, adjusting astronomical clock that turns light on at sunset, off at sunrise. Sun relay at right does the same thing



There's more to lighthouse work than lights. Below, underwater area of bell buoy is sprayed with plastic

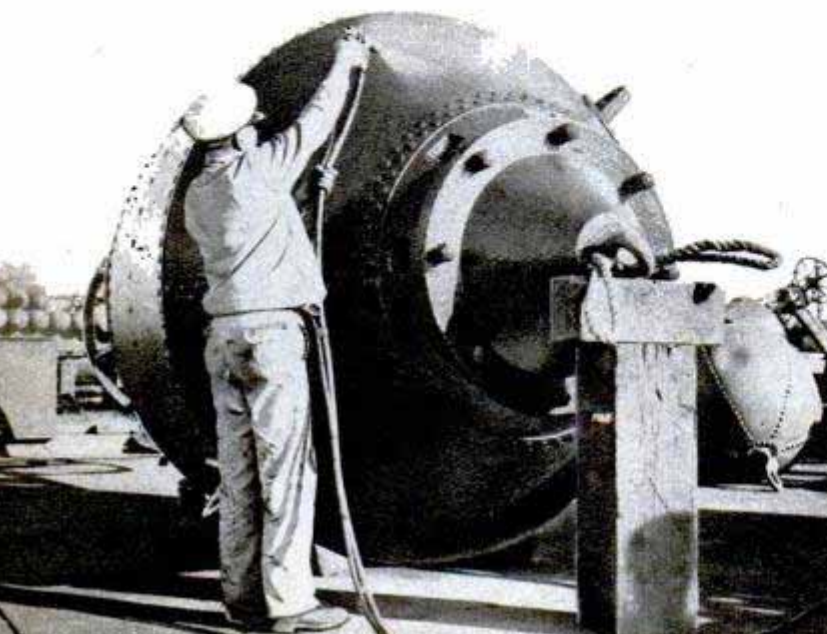

will contain two gasoline-driven generators, one of which will be in operation at all times. Automatic switches will shut down one generator and start the other at 12-hour intervals so as to alternate their use. The same switching arrangement will immediately start up the spare generator if the one in use happens to fail. Current from the generators operates the beacon and radio equipment.

Also on the lower floor will be two gasoline-driven air compressors, fuel tanks for a two-months' supply of gasoline and a large air-storage tank.

Two air-powered 17-inch Tyfon foghorns installed on the lighthouse will be controlled by radio from another lighthouse five miles away, using the new ANRAC circuit. ANRAC (Aids to Navigation, Radio Control) was developed during the war so that coastal aids to navigation could be turned off except when a friendly ship had need of them. A radio impulse from the ship would turn on the beacon or foghorn, then turn it off again after the ship had obtained its bearings. Recently ANRAC has become a standard method of remote control. One of the lighthouses on the Puget Sound, for instance, uses ANRAC circuits to operate a foghorn at a distant point where no keepers are stationed.

The Long Beach robot will also have an FM radiophone transmitter that will automatically turn itself on each time ANRAC puts its foghorns into operation. The keepers at the mother lighthouse will use an FM receiver to listen in and make sure the robot foghorn is actually operating.

One of the problems in designing the



robot structure was to supply electricity to the obstruction lights on top of the radio-beacon tower. The tower acts as an antenna and hence must have no connection to the ground, such as would be supplied by wiring to the lights. The solution was to use a transformer with an air gap to conduct the current up into the tower. The transformer conveys the electricity as desired but its air gap serves to insulate the tower from the ground.

More than a year of planning and testing was devoted to the ideas used in the robot lighthouse before construction started. Among those concerned with the design are Commander E. W. Laird, chief, civil engineering section, 11th Coast Guard District; C. N. Coseboom, senior civil engineer, and John T. Hendrix, chief electrician.

Sometime in the future the new lighthouse may also be furnished with a group of radar reflectors. These reflectors would create a bright spot on the viewing scope of a ship's radar and help the navigator to pinpoint the location of the lighthouse. RACON, too, may also be installed later. This is a radar beacon that transmits its own coded signal whenever it is triggered by radio signals from an aircraft or surface ship. Signals from an ordinary radio beacon provide a bearing but no indication of distance. RACON does both.

Robot lighthouses may seem like a brand-new idea, but the fact is that a large percentage of all aids to navigation are automatic. There are hundreds of untended

**Top, coastguardsman inspects long-lived batteries of untended harbor beacon. Right, most lighthouses still have this old type of lamp which is rotated by clock weights. Below, in calm waters bell buoys are sounded by an electric piston that strikes bell**

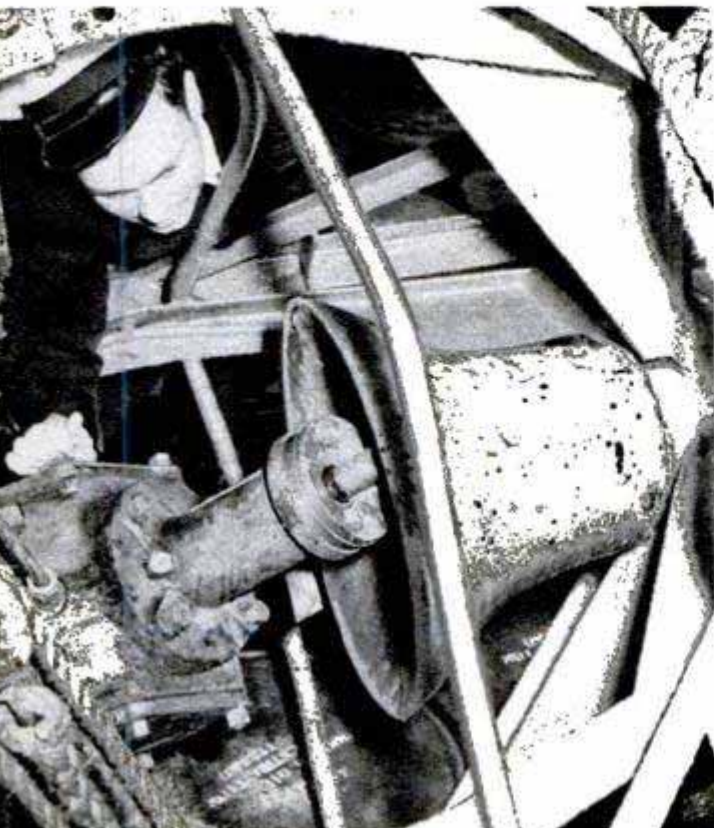
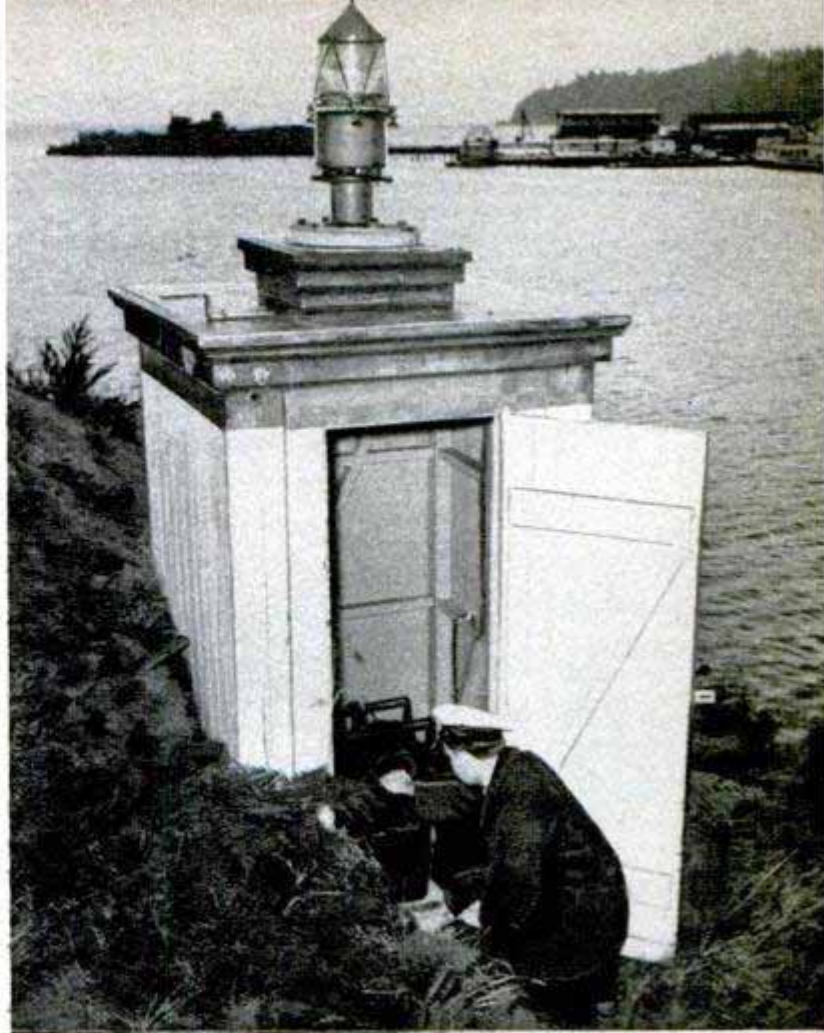



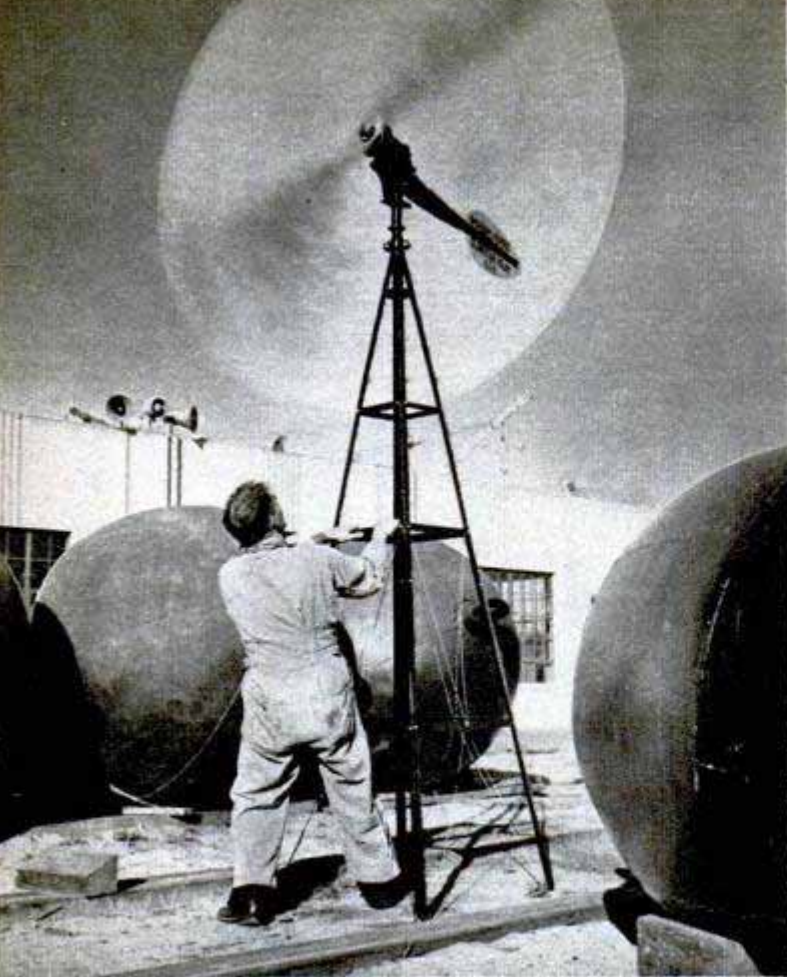

Above, windmills may be used to charge batteries of untended lights. Below, automatic bulb-changer unit



minor lights in harbors and inland waters that flash on and off all through the night and day. The lights consume such small amounts of current that their large marine-type batteries are good for a year without recharging. A rotating carriage into which four bulbs are fitted brings a new bulb into position automatically if the one in use burns out.

Stronger harbor lights that consume larger amounts of power are controlled by time clocks or by sun relays that turn the light on and off at dusk and dawn. The Coast Guard is experimenting with wind-driven battery chargers with the idea of attaching them to small untended lights on shore.

One novel type of automatic apparatus is the mechanical clapper or striker that is used on bell buoys that are planted in quiet water. A bell buoy in rough water can be depended upon to toll almost continuously, but in quiet water there may not be enough roll to operate the clapper. Buoys in these locations are fitted with a piston that slams against the bell at regular intervals. Some of the piston strikers are electrically operated; others are driven by bottled carbon-dioxide gas.

One perplexing problem has been to cause an untended foghorn to operate whenever fog settles in its vicinity. An apparatus that measures the amount of light was not the answer; what had to be developed was a way of measuring the transmissibility of the atmosphere. An apparatus that does this consists of a beam of modulated light from a source some distance away, as across a channel of water, plus a receiving apparatus that is sensitive only to the modulated light.

Successful experimental installations of the device employ the beam from a 25-watt bulb inside a high-intensity range lantern as the light source. The beam is broken up into a series of flickers by means of a "chopper" apparatus.

The receiving apparatus is adjacent to

Below, when fog interrupts the modulated light rays, the automatic control starts the foghorn operating

"CHOPPER" INTERRUPTS LIGHT BEAM 20 TIMES A SECOND TO PRODUCE A MODULATED LIGHT BEAMED AT THE TELESCOPE ACROSS THE CHANNEL

PHOTOELECTRIC TUBE IN TELESCOPE, SENSITIVE TO MODULATED LIGHT ONLY TURNS FOGHORN ON AND OFF

WHEN FOG PREVENTS LIGHT BEAM FROM REACHING TELESCOPE, THE CONTROL TURNS ON THE FOGHORN

FOG

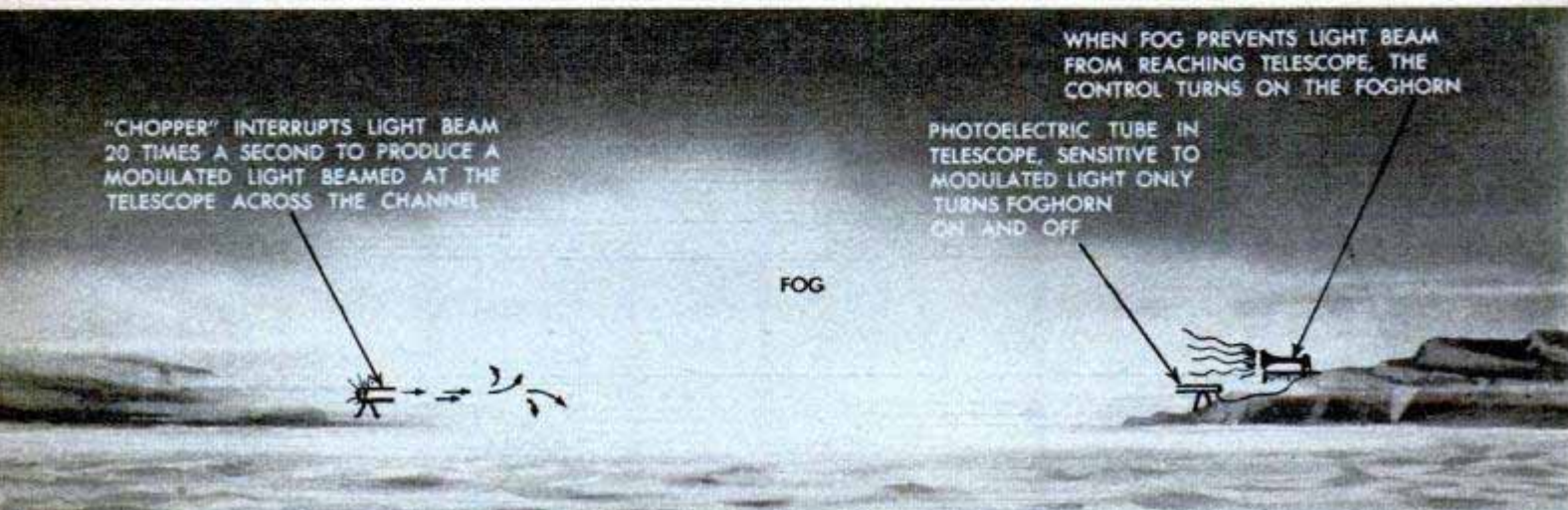



the foghorn and consists of a telescope containing a scanner and a photoelectric cell at the eyepiece end. This is connected to a cam type of timer and the timer is periodically reset as long as modulated light continues to be received. If the light diminishes, the cam rotates until it closes contacts that start the fog signal. The fog signal continues to sound until the atmosphere clears, allowing a flash to be received that stops the foghorn.

A time delay allows such an object as a ship to pass through the beam without starting the foghorn. The receiving apparatus is sensitive only to modulated light and is not affected by sunlight or a searchlight beam.

Foghorns along the coasts have had to be replaced in recent years by larger horns of increased range and intensity because modern ships are larger and travel faster and often are powered by noisy Diesel engines. But the loud, constant sounding of foghorns in periods of low visibility brings strenuous objections from people who live within hearing range.

Still in the experimental stage is a sound-control unit that should satisfy everyone. The foghorn remains mute until a nearby ship blows a sustained blast from its navigation whistle. The blast is picked up by the foghorn which acts as a microphone setting off a relay that starts the horn blowing. It sounds its own characteristic signal over a period of several minutes and then shuts off again. In time, sound-control units may control all foghorns located near built-up areas.

Veteran lighthouse keepers who entered the service when the new-fangled oil-vapor lamps were the very latest thing are wondering what will come next.

Top, drawing of the robot lighthouse that has no crew except radio. It is controlled by a mother lighthouse on shore. Right, siren type of foghorn

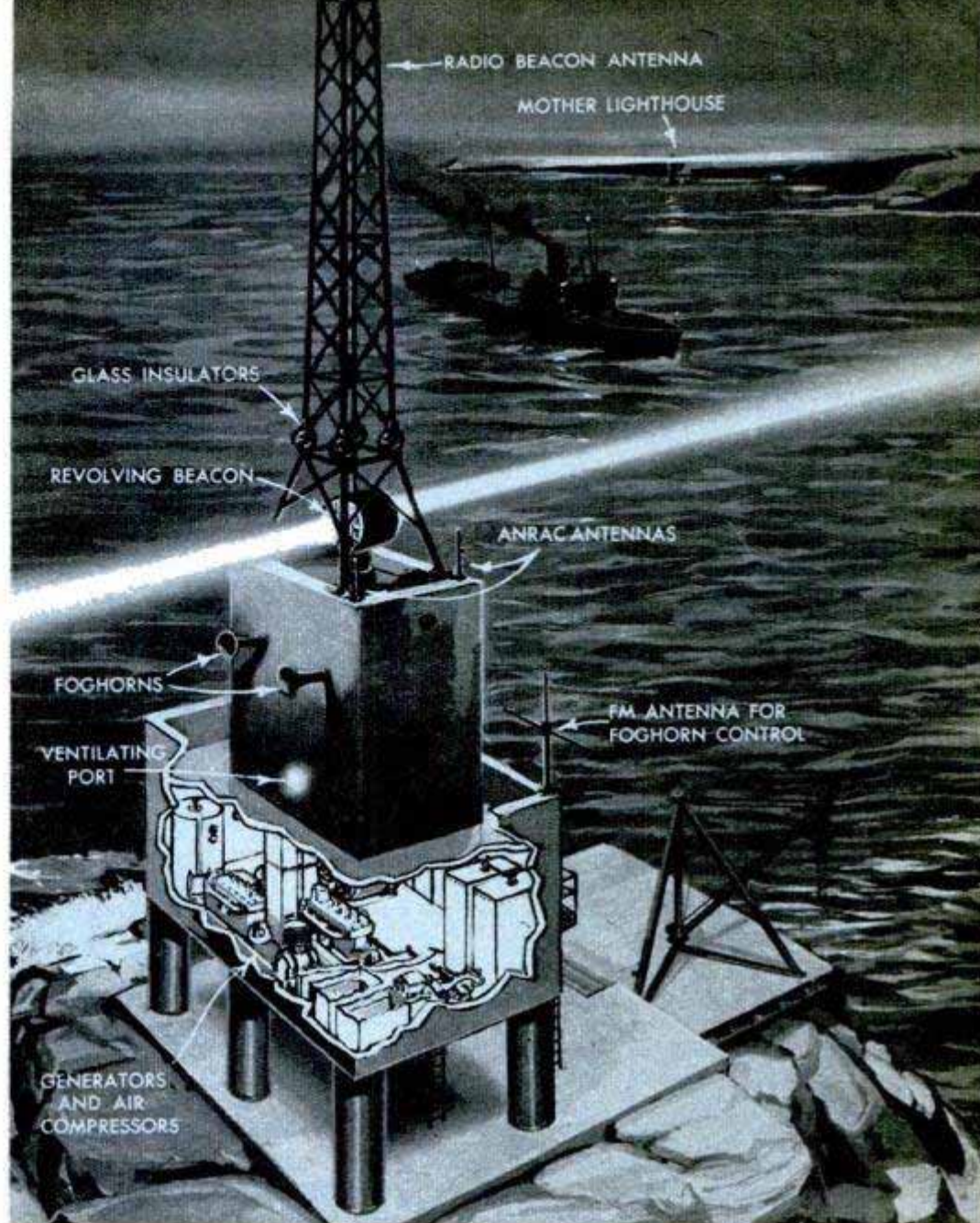



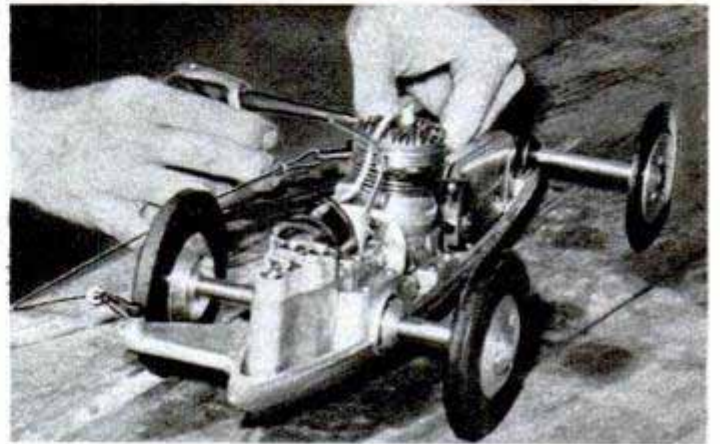
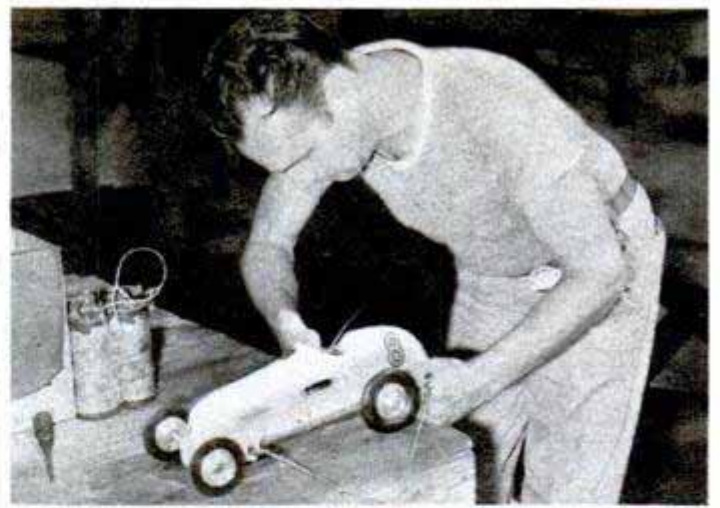

## Miniature Racer Zips Track at 124 Miles an Hour

Flashing around a miniature track, a tiny racing car recently set a world speed record of 123.98 miles an hour. The car is a new model, manufactured and sold complete except for the engine. The bottom pan is a one-piece aluminum casting and the racer has an over-all length of almost 16 inches, a wheelbase of  $10\frac{1}{2}$  inches and a tread of  $6\frac{1}{8}$  inches. The top, which is detachable to expose the engine, is made of plastic. Both

the rear axle and the front wheels are mounted on ball bearings, with rubber cushions acting as shock absorbers. Equipment with the car includes a fuel tank, coil mount, battery container and ignition switch. Miniature racing cars usually are started by pushing them down the track. They may be raced either on a cable which pivots in the center of the track or on special rails to which they are attached.



## House Numerals Trimmed in Hedge

When Leslie Stephens of Cleburne, Texas, needed a new set of numbers for his house he made a big set that is growing even larger. Stephens trimmed a privet hedge in front of the house so the numbers stand out in relief.

☞ Extending from Mount McKinley in Alaska to the Argentine-Chile border, the 10,000-mile Trail of the Americas is the longest continuous foot trail in the world.



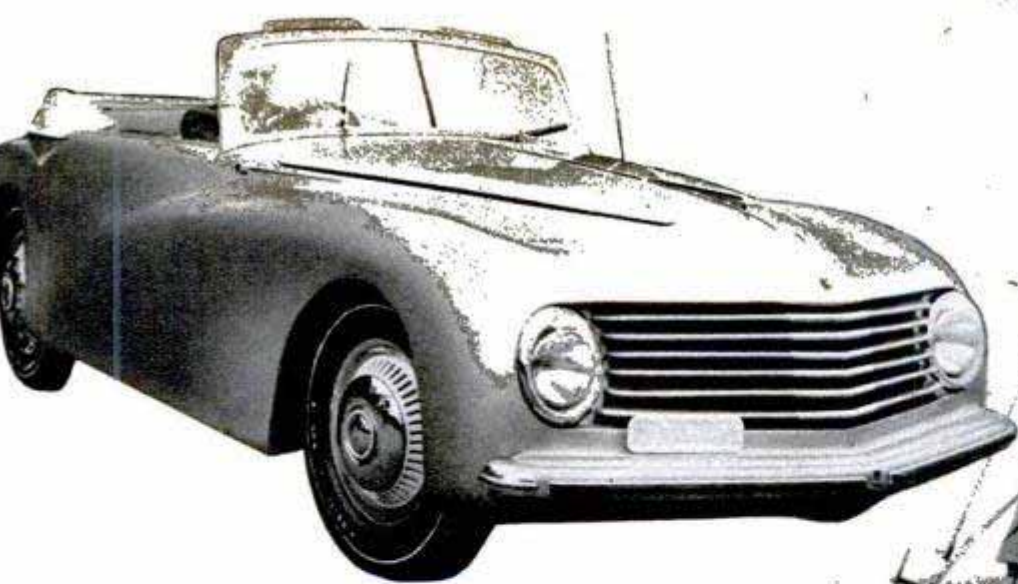

Resembling U. S. cars, the Italian Alfa Romeo convertible has top speed of 100 m.p.h. It costs \$7000

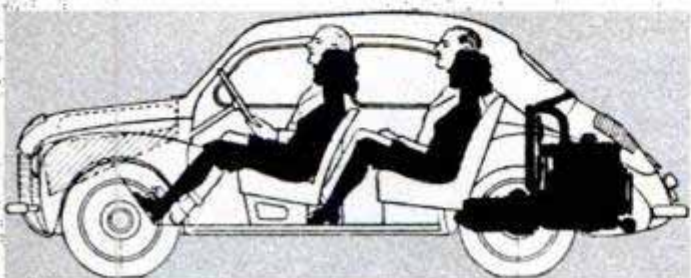

French Renault (above and below) has four-cylinder engine in rear; carries four persons, and costs \$1264



Above, Holland's first postwar car, the Gatso, has a plastic top and duralumin body. It is built mostly of Ford parts including engine. The price—\$4200

## EUROPEAN CARS

Italian-built Fiat (below) is said to run 26 miles on a gallon of gasoline. Top speed is 81 m.p.h. and the price is \$3833. Note absence of chrome on body





# Mobile Power Plant

GAS-TURBINE power plants on rails have been conceived by Allis-Chalmers engineers as emergency units to be used when power plants fail or disaster disables transmission lines. Still in the blueprint stage, the turbine generators mounted on railway trucks for rapid movement will be built in 3000 and 6000-kilowatt units, to operate as a sole source of electric power or to be synchronized with an existing power system. Burning fuel oil, the gas turbines will be serviced by a separate railway tank car, although the smaller model will carry sufficient fuel to operate for six hours. The turbine unit will be coupled with a 3600-r.p.m. generator through a reduction gear. If necessary, the mobile plant could be installed by only two men and operated by one.

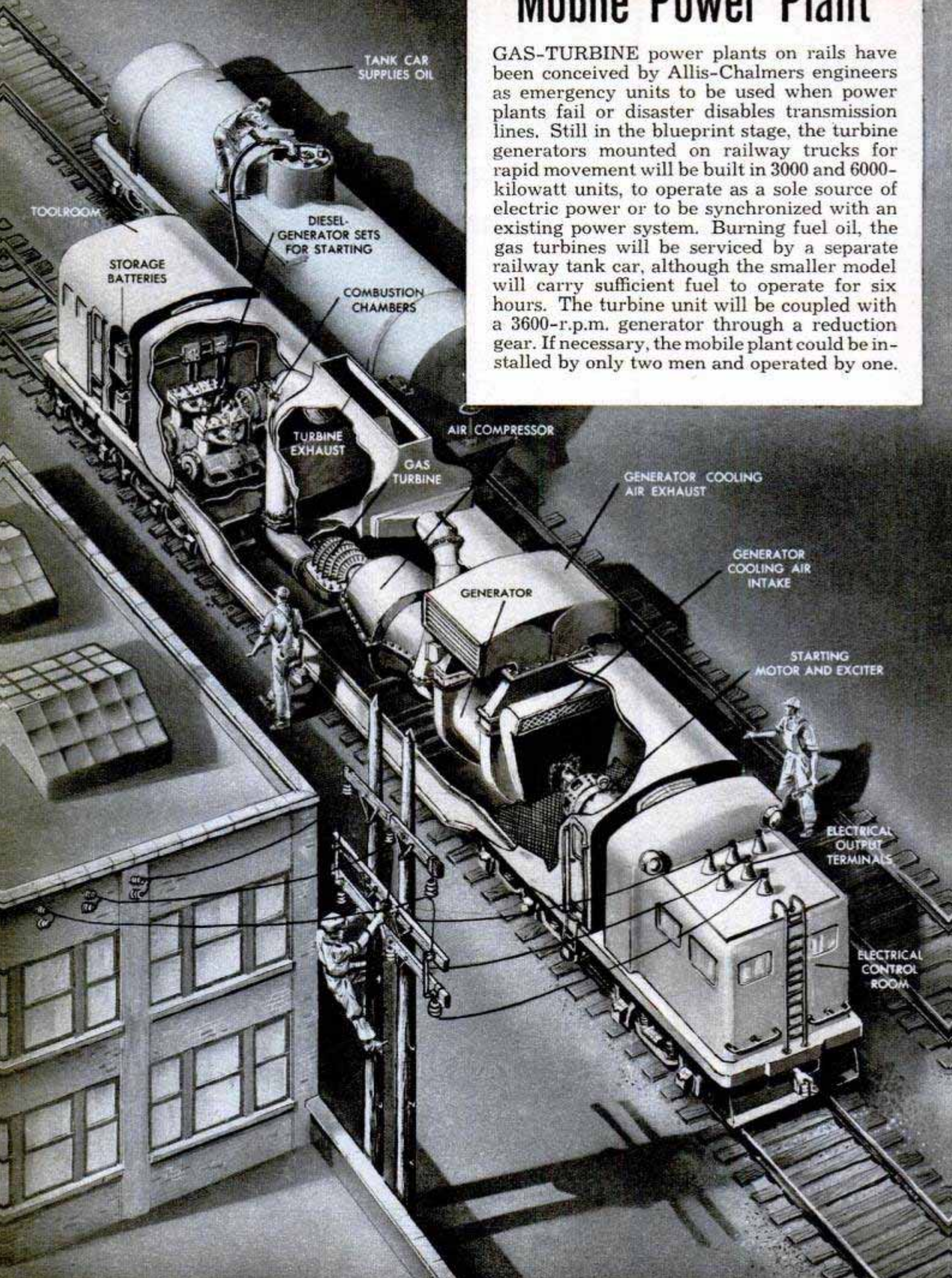

TANK CAR  
SUPPLIES OIL

TOOLROOM

STORAGE  
BATTERIES

DIESEL-  
GENERATOR SETS  
FOR STARTING

COMBUSTION  
CHAMBERS

TURBINE  
EXHAUST

AIR COMPRESSOR

GAS  
TURBINE

GENERATOR COOLING  
AIR EXHAUST

GENERATOR

GENERATOR  
COOLING AIR  
INTAKE

STARTING  
MOTOR AND EXCITER

ELECTRICAL  
OUTPUT  
TERMINALS

ELECTRICAL  
CONTROL  
ROOM



## Portable Suit Rack For Motor Trips

You don't have to pack your suits when you travel by car if you have an automobile clothes rack. Holding as many as four suits without wrinkling, the hardwood rack stands upright on the floor behind the front seat. When you reach your destination you pick up the rack just like a suitcase and take it with you into your hotel room. Placed in the closet or a corner of the room, the rack never has to be unpacked and is always ready to travel. If desired, the rack can be tied to the car robe rail with an attached cord.



## Automatic "Prodder" Keeps Driver Awake

Falling asleep at the wheel is just about impossible when an automatic "prodder" is worn by the driver. The prodder consists of an alertness indicator developed at Tufts College of Psychology. The driver wears a headband containing electrodes that measure alertness. When drowsiness sets in and sleep threatens, the electrodes signal to the indicator which sets off a warning buzzer that instantly arouses the driver.



## China's Ricksha Goes Mechanical

Faster but noisier than the man-drawn variety, a gasoline-powered ricksha has been introduced in Shanghai. Developed by three Chinese engineers, the vehicle, called a Rik-Mobile, has a single-cylinder, two-horsepower engine and goes up to 35 miles an hour. Total weight of the machine is 300 pounds.





# "COLD RUBBER" FOR YOUR TIRES

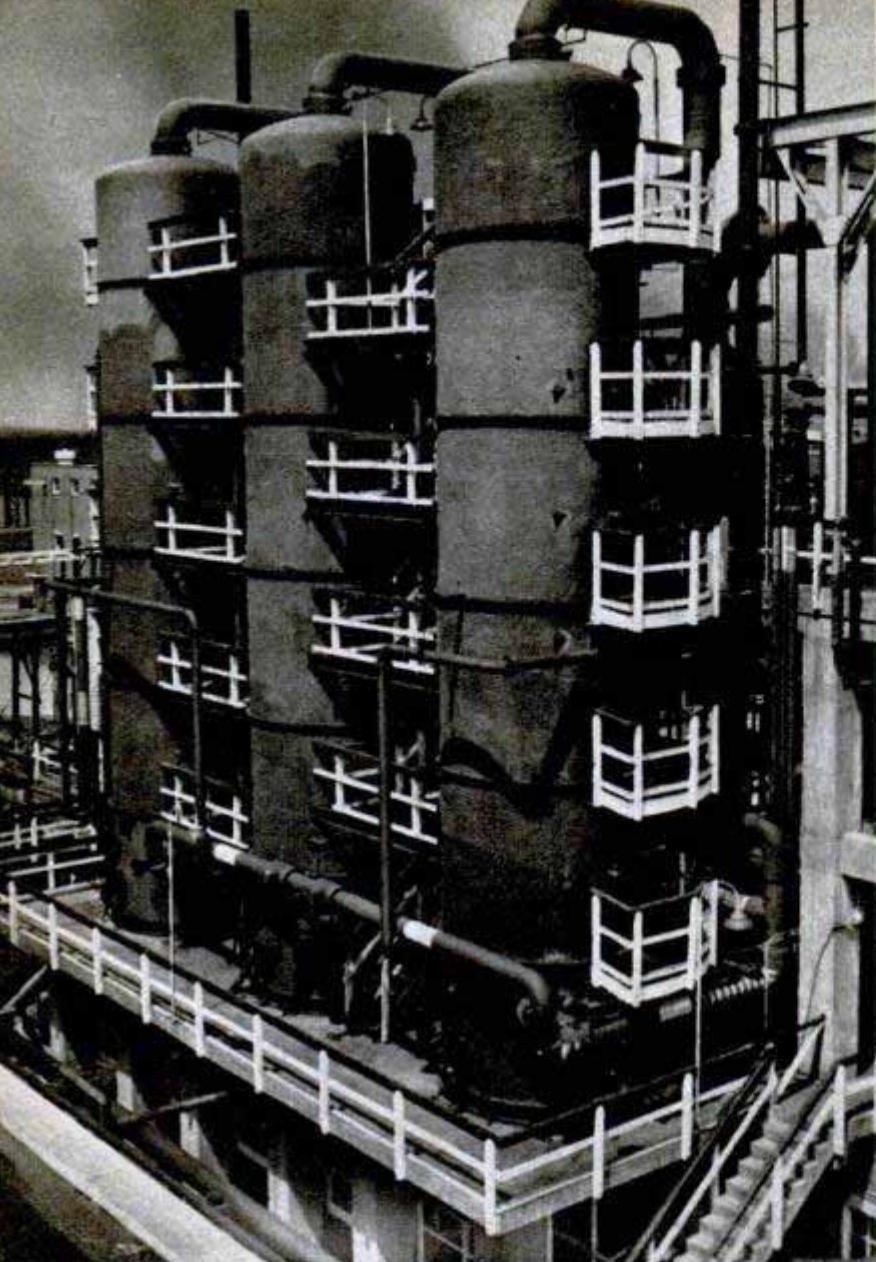

Six stories high, these recovery columns remove the excess styrene from the latex as it drips down to the base. Steam, blown up through the columns, carries the styrene through pipes at top. Separated from steam, it is reused. Below, recipe for "cold rubber" in picture form. The ingredients at left form latex in about 12 hours. Dried and coagulated, the latex becomes rubber. Speed-up chemicals are in center

**S**YNTHETIC tires better than the natural-rubber variety are promised for your car because of a "cold war" science has been waging.

You'll get up to 30 percent more wear out of that set of synthetics when "cold rubber" is used. Produced at 41 degrees Fahrenheit, instead of the working temperature of 122 degrees previously used, the synthetic rubber also has improved tensile strength and crack resistance.

Up to now, the low-temperature process has been impractical because of the longer time required. Instead of the usual 12 hours, it took that many days to produce a batch.

By discovering chemicals that speed the combining of butadiene and styrene, scientists solved the problem. Rubber is now made at low temperatures about as fast as at high temperatures. Still not satisfied, however, the engineers are planning new methods of production at temperatures as low as zero degrees—and that will mean even longer-lived treads for you motorists.

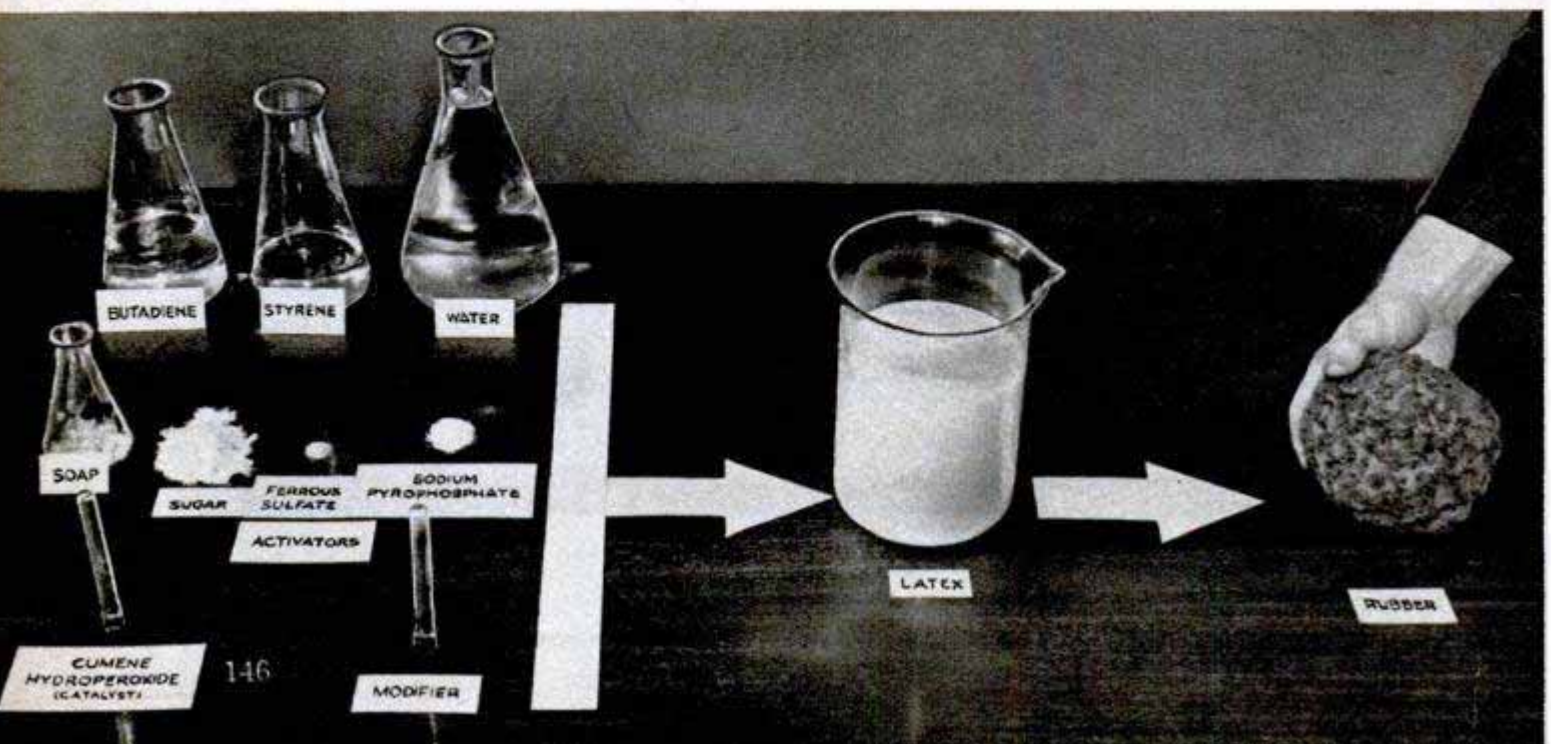





Cooking a batch of synthetic rubber is more complex than baking a cake! Worker sets one of the instruments that record the cooking action for each batch



Above, ingredients for each batch are metered out precisely. Right, sugar is an important ingredient in the speed-up process. Worker pours sackful into dissolving tank. One pound of sugar is used to each 20 pounds of rubber. Below, part of the synthetic rubber plant operated by U. S. Rubber Co. in Borger, Tex. The recovery columns can be seen at the right

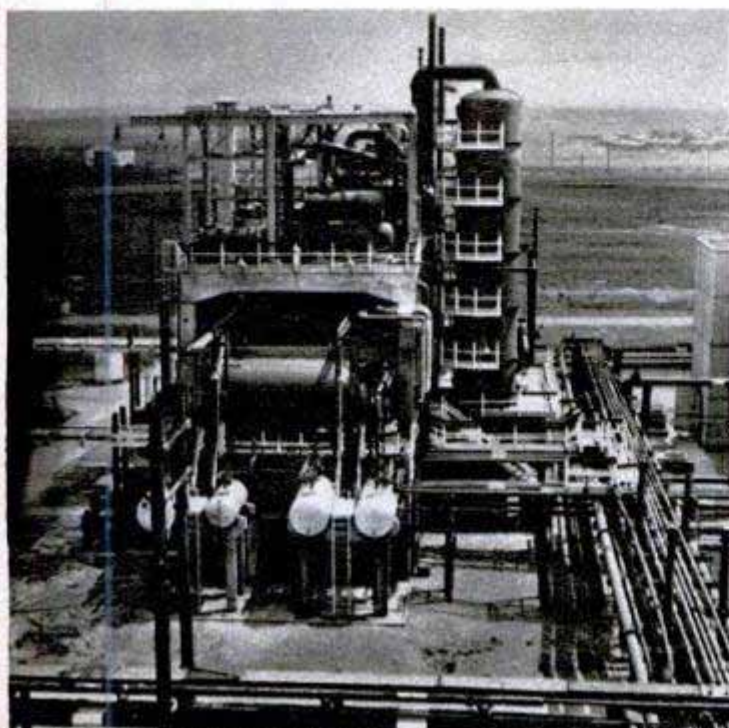





### Lightweight Air Compressor

Light enough to be carried around like a tool kit, a compact air compressor provides plenty of pressure for inflating tractor and truck tires, high-pressure greasing, paint spraying and other tasks requiring compressed air. It has a 110-volt a.c. motor directly connected to the single-cylinder compressor. Maximum working pressure is 90 pounds and it delivers 1.2 cubic feet a minute at 80 pounds pressure. The hollow base of the unit serves as a tank, eliminating air pulsation, and also acts as an oil and moisture separator. A model using an air-cooled gasoline engine is also available.

### Invisible "Raincoat" for Bricks

Brick and other porous masonry are protected from moisture by a semiplastic coating that becomes invisible after it dries. The coating is applied as a watery solution by brush or spray and is waxless and non-inflammable. When applied, it is opaque and milky white, but after application it becomes transparent.

## Sudden Death Comes to a Bomb as Wartime Range Is Converted to Peace



Spotted by workers on irrigation dam, live two-ton bomb is a deadly souvenir of wartime bombing range



Bomb was turned over and sticks of dynamite piled around nose. Explosives were then covered with sand

Dynamite and explosives in bomb detonate sending a dust cloud skyward. Blast is 3000 feet from camera

Split wide open, shell of quarter-inch steel plate was hurled 500 feet by the force of the explosion





# PLAY BALL!

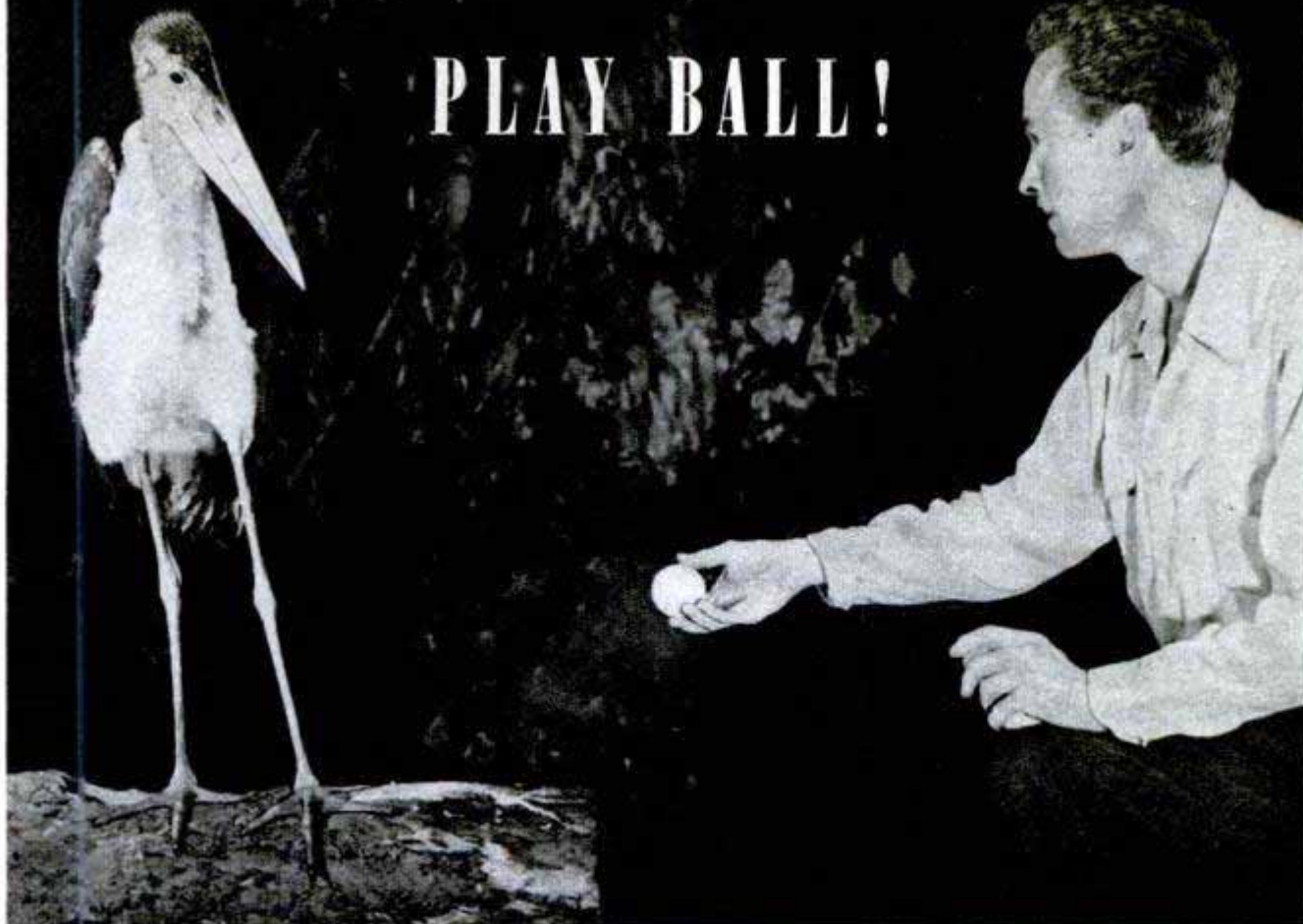

Next time you're looking for somebody to play right field on your ball team it might pay you to visit the zoo and sign up a marabou stork! At least Lynwood M. Chace of New Bedford, Mass., who has a pet marabou, thinks so. The feathered fielder, who came here from Africa, became adept at picking up articles with his bill. Hammers and other tools disappeared too often, so Chace decided he'd better teach the bird a less bothersome trick. He bought a rubber ball and, after a few practice tosses from a short distance (above), the bird learned the art of good fielding. Using his high-speed flash unit, Chace photographed the bird in action to convince doubting Thomases. Left, the stork gets set for a line drive. Whoops! He misjudged the ball (lower left) and it bounces off his "glove." The next toss he fields perfectly (right) to retire the side. Looks proud, doesn't he?







## Self-Defrosting Windshield Glass

Windshields are de-iced quickly and completely when the glass is heated like an electric hot plate by coating it with an invisible film that conducts electricity. Although normally an insulator, glass is a conductor when coated with a film that is basically stannic oxide. The film is placed on an inner surface of the "sandwich type" safety windshield. Current is fed to this surface through electrodes at the top of the glass. Because higher voltage than is available in a six-volt car system is required, an alternating-current generator is used and the current transformed to the voltage needed. In one test at six below zero, a windshield heavily coated with ice was completely de-iced in less than five minutes.

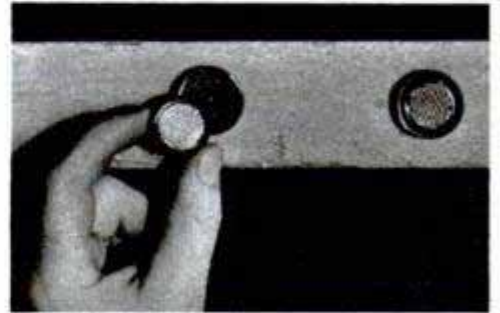

**HANDY REFLECTORS** can be nailed to trees, posts and other danger spots along private drives to warn motorists. One small nail driven through the plastic backing is all that is required to attach a reflector securely. Backing is waterproof and flexible to permit easy insertion of the sparkler. Other types are pin-on reflectors for pedestrians and bicyclists and a thumbtack model that shines brightly despite its size

## Protons Will Hit 180,000 Miles a Second in Synchrotron

Duplicating the action of cosmic rays, a multi-billion-volt proton synchrotron to be built at Brookhaven National Labora-

tory will produce mesons artificially by bombarding hydrogen atoms with high-energy protons. The 60-foot synchrotron

will accelerate protons to energies of three billion electron-volts. In a vacuum, these protons will speed around a doughnut-shaped tube surrounded by powerful magnets. Protons will reach speeds of nearly 180,000 miles a second or 96 percent of the speed of light. Launched at four million volts from a Van de Graaff generator, they enter the tube at an angle. By duplicating the cosmic-ray action, scientists hope to learn much about the properties of nuclear binding forces.

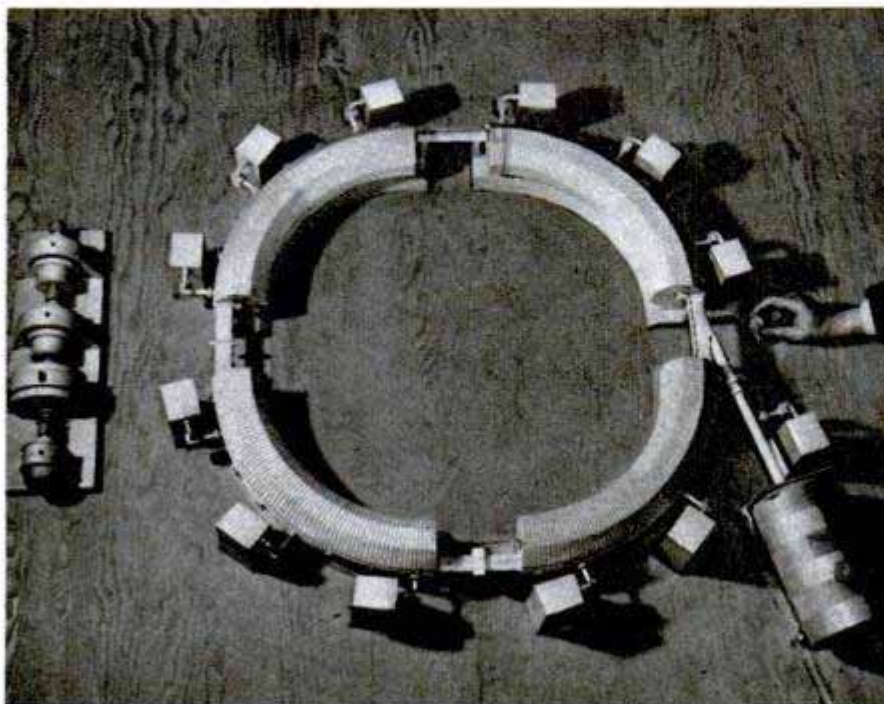

Circular track for the speeding protons is shown by this scale model of the synchrotron



**A**STRONOMERS doubt that Mars has a population resembling the human race but many of them agree that civilized beings may have lived on our sister planet in the past.

Mars, they say, appears to have reached a maturity that the earth will not attain for eons to come. Being smaller than the earth, it lost its heat and atmosphere more rapidly and is now a dying world.

During its more youthful period our next-door neighbor of the solar system quite possibly was prolific in both animal and vegetable life. Vegetation exists on large portions of the planet today, as indicated by recent spectrographic observations.

In the next 10 years it may be that good evidence of a civilized population, past or present, also will be found. The old controversy about the Martian "canals" may be settled once and for all by means of infrared spectrographs and other investigative tools. If the so-called canals exist, it will be almost necessary to conclude that they were laid out by an intelligent race.

The distance of Mars from the sun is about  $1\frac{1}{2}$  times that of our orbit. Like the earth, Mars rotates on an axis. Its day is 37 minutes

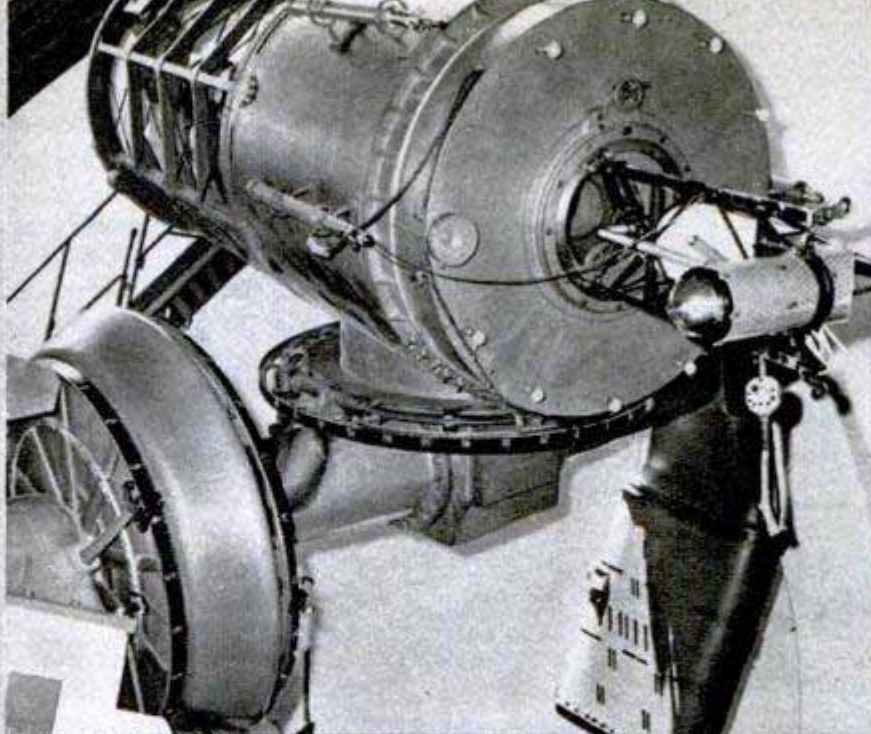

Infrared radiations from Mars gathered by this 82-inch telescope at McDonald Observatory revealed presence of vegetation on the planet

# SPYING ON MARS

## by invisible light

Amateur astronomer tests home-built spectrograph with carbon-arc setup at his shoulder. It is used in photographing spectrum of planets

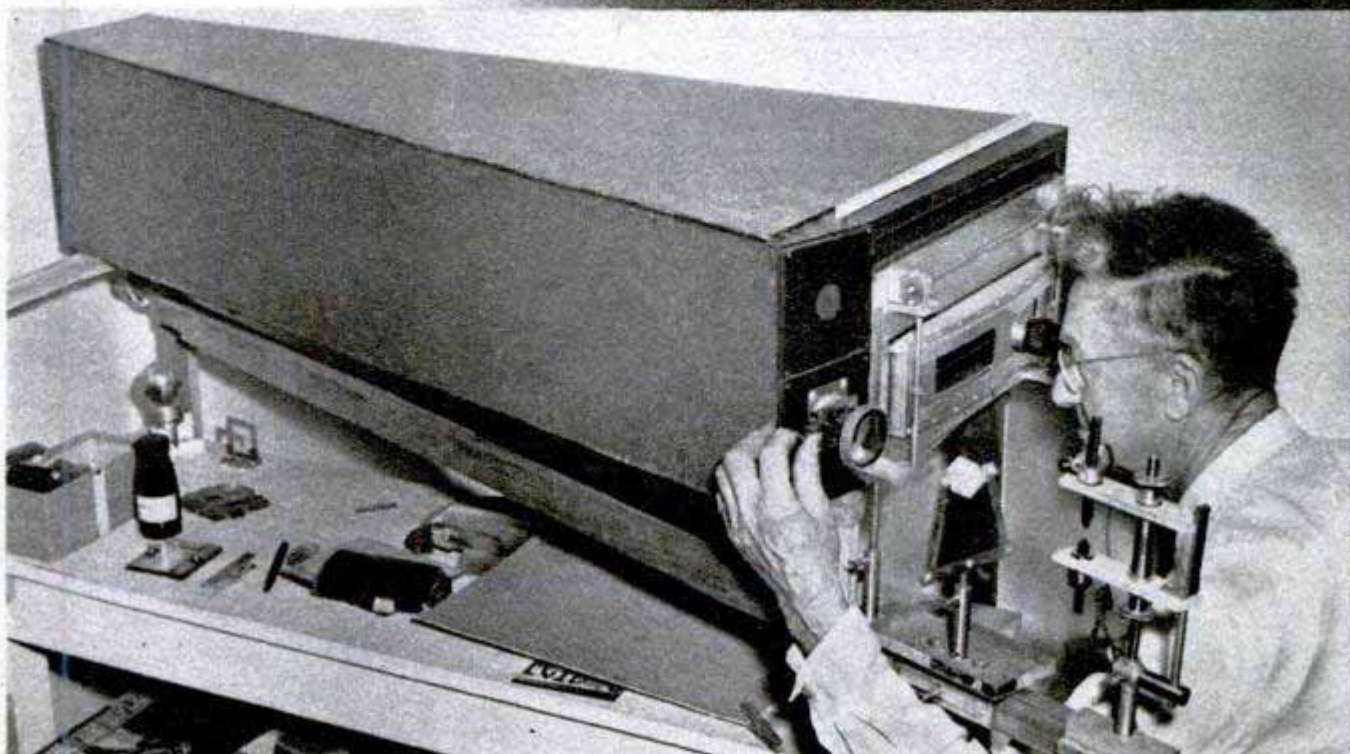



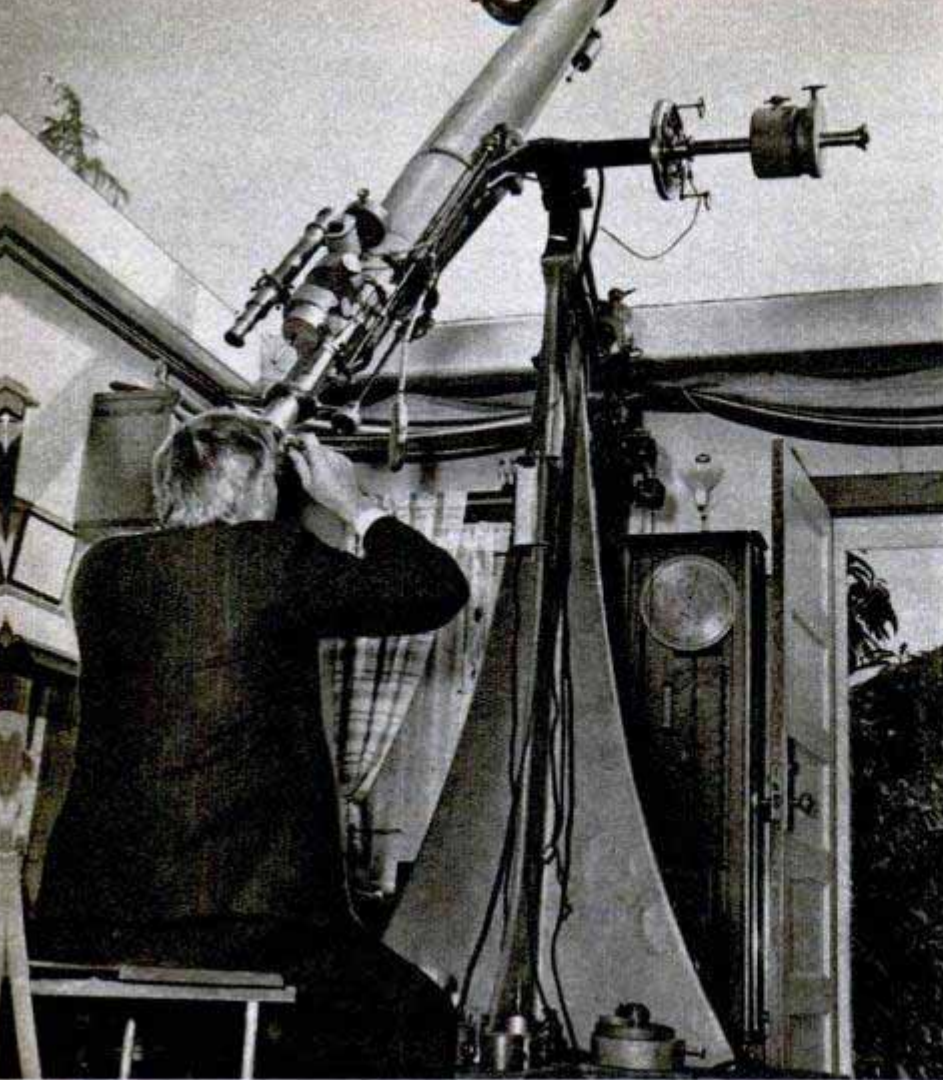

In his den, Dr. Edison Pettit of Mount Wilson Observatory uses 6-inch refractor telescope with which he saw canals on Mars. Below, sighting scope aims 82-inch telescope. The spectrograph is beneath it. Right, slide rule used by astronomers

longer than ours and its year has 687 days. Temperatures on the surface range from a high of 86 degrees Fahrenheit at noon to considerably below zero at night. Its thin atmosphere is possibly 60 miles deep and contains very little water vapor or oxygen, but considerable carbon dioxide. Like the earth, Mars has summer and winter seasons.

When an astronomer peers at Mars, he sees, suspended in space, a small hazy disk marked by large orange or reddish areas and by dark greenish "seas." Also visible, usually, is one of the white polar caps. Occasionally, thin clouds are observed, apparently high-altitude mists composed of ice crystals. Sometimes, too, yellowish clouds that persist for days are seen. These probably are terrific dust storms in the lower atmosphere.

The seasonal markings on Mars are regular and predictable. Autumn in the northern hemisphere is marked by the appearance of the polar cap that grows until it may extend half way to the equator, then recedes with spring and disappears with summer. For a short time during the summer season the greenish seas take on a brownish hue, then become green or gray-green again with fall. Mean-

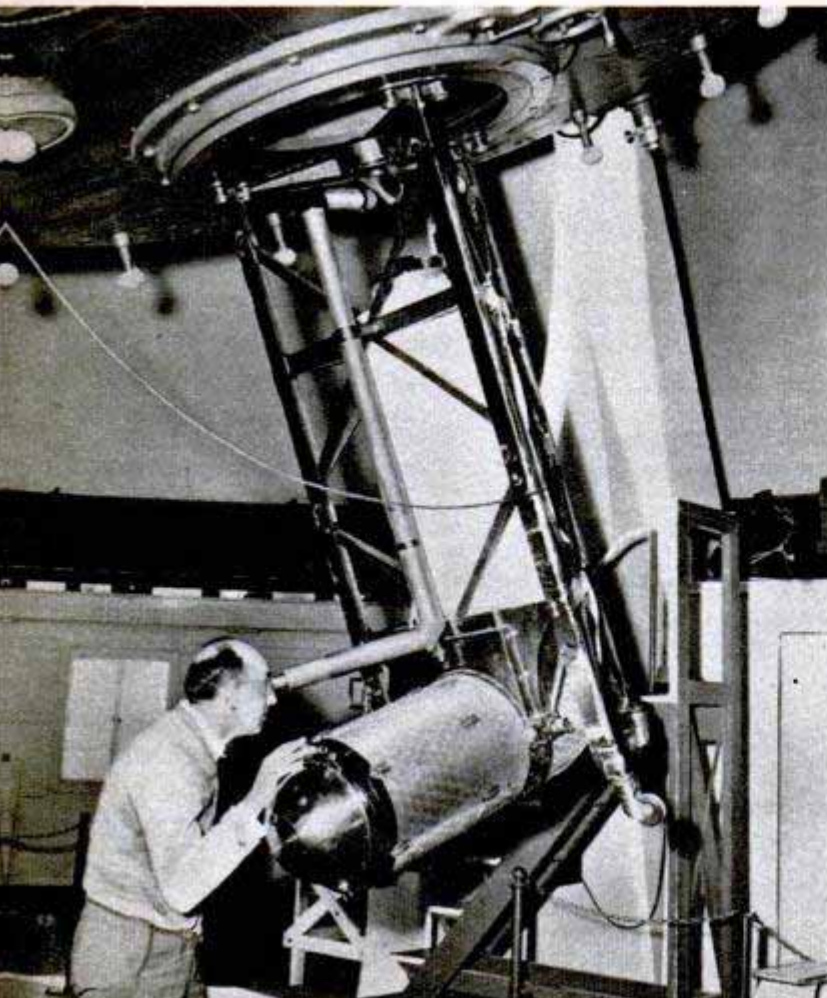



while an opposite cycle occurs in the southern hemisphere.

Based on what they can observe and deduce from 50 million miles away, astronomers think that at one time Mars had plenty of oxygen and water vapor. These atmospheric constituents gradually trickled off into space. Some of the oxygen, too, probably combined with iron in the rocks to form the rusty colors that are visible now.

The red portions of Mars apparently are arid deserts, plateaulike continents on which only traces of earlier mountain ranges remain. One third of the planet is composed of darkish regions that possibly are old ocean beds, now filled with sediment to within a thousand feet or so of the level of the plateaus. The color of the seas is ascribed to vegetation, usually green, that temporarily turns brown in the most arid season.

Some of these premises were confirmed early this year when Prof. Gerard P. Kuiper turned the 82-inch telescope of the McDonald Observatory in western Texas on the planet. Most studies of Mars have been made by means of its visible light; Doctor Kuiper studied instead the invisible infrared rays that are reflected from it.

Energy that passed through the infrared spectrograph attached to the McDonald telescope was focused on a tiny lead-sulphide vacuum tube. The tube acts as a trigger for electrical energy when it is actuated by infrared energy. Instead of photographs Doctor Kuiper obtained jagged lines on pieces of graph paper. From these lines much information was obtained.

In the first place, the polar cap of the planet showed the typical reflection spectrum of cold snow. This confirmed previous thermocouple measurements by which the temperature of the caps had been taken. An earlier suggestion that the caps consisted of frozen carbon dioxide was disproved.

Since the polar caps consist of snow or frost, it follows that some water vapor is present in the Martian atmosphere. From this it can be deduced that the whitish clouds of the planet consist of some form of water, probably tiny ice crystals.

Ice crystals in the atmosphere, in fact, seem to account for the ever-present haze that surrounds



Above, this amateur astronomer tests his 10-inch reflector telescope. Below, view inside a 10-inch reflector telescope shows reflection of mirror in base of tube. Black object in tube holds prism that directs light to eyepiece on the side







Above, drawings made by Doctor Pettit during period of "super seeing" show how disputed canals appeared to him. Canals are said to be evidence that intelligent life once existed on Mars. The dark areas are thought to have been seas and the long canals may have carried water across the arid continents as Martians struggled to survive in the drying-up period. Below, model of the planet Mars on which the canals have been plotted as reported by astronomers

the planet. The conclusion is that the Martian sky would appear white instead of deep blue, somewhat like a hazy day on earth although with extremely good visibility.

When Kuiper made spectrographic examination of the greenish portions of the planet, the reflection spectrum that he obtained was found to be similar to the spectra of lichens and mosses such as grow in the high altitudes of the Rockies and the Himalayas. Absent, however, were any signs of the two highest divisions of plant life—seed plants and ferns.

The lichens and mosses of Mars probably are not identical with those of the earth. Some of the Martian vegetation appears green, some of it looks blue, and all of it changes to brown or red in the dry season. The assumption is that the vegetation must be very dense and may attain giant size.

Astronomers have been looking for a substance in the Martian atmosphere that absorbs the lethal ultraviolet radiations from the sun. Ozone acts as a shield for us on earth, but tests for ozone on Mars have been negative. Sulphur dioxide also could serve as a

(Continued to page 248)

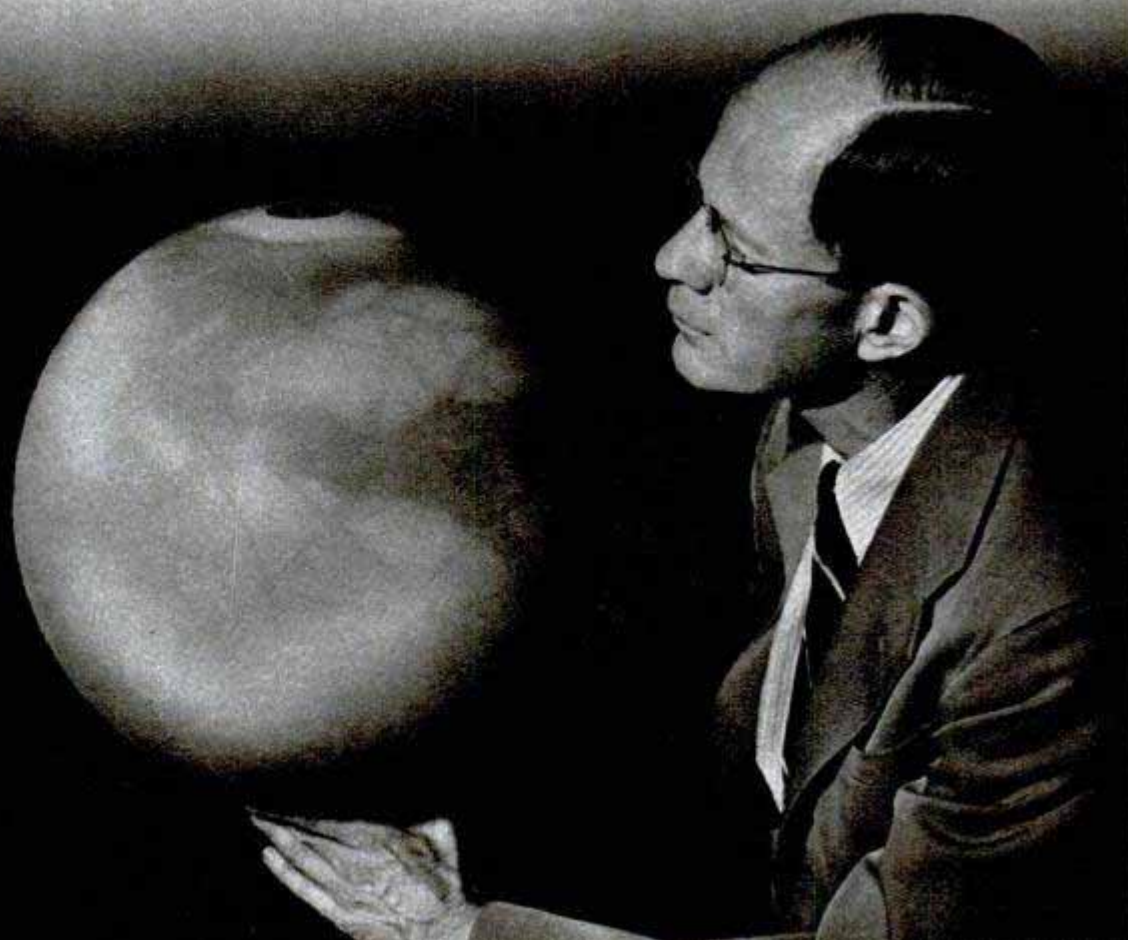



## Lawn-Sprinkler System Controlled by Clock

There's no reason for your lawn to become parched while you're away or because you can't find time to water it. An automatic control for lawn sprinkling is operated by a seven-day clock. You just set the dial and the lawn gets its water automatically at the times you specified. The lawn is divided into sections, each having a separate system of underground pipe. The systems operate one at a time in short rotation giving the lawn a series of brief showers. The period of flow can be varied to provide more water on a sunny area than a shaded one.

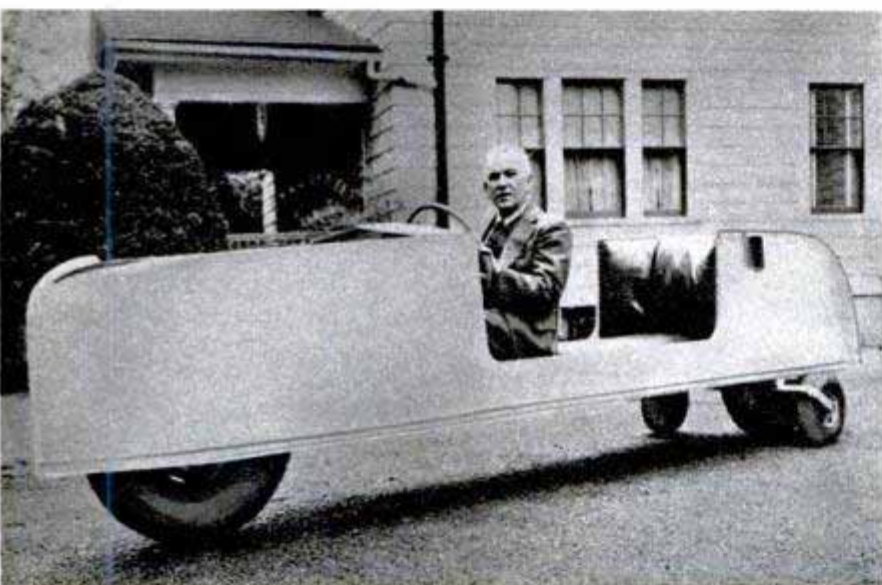
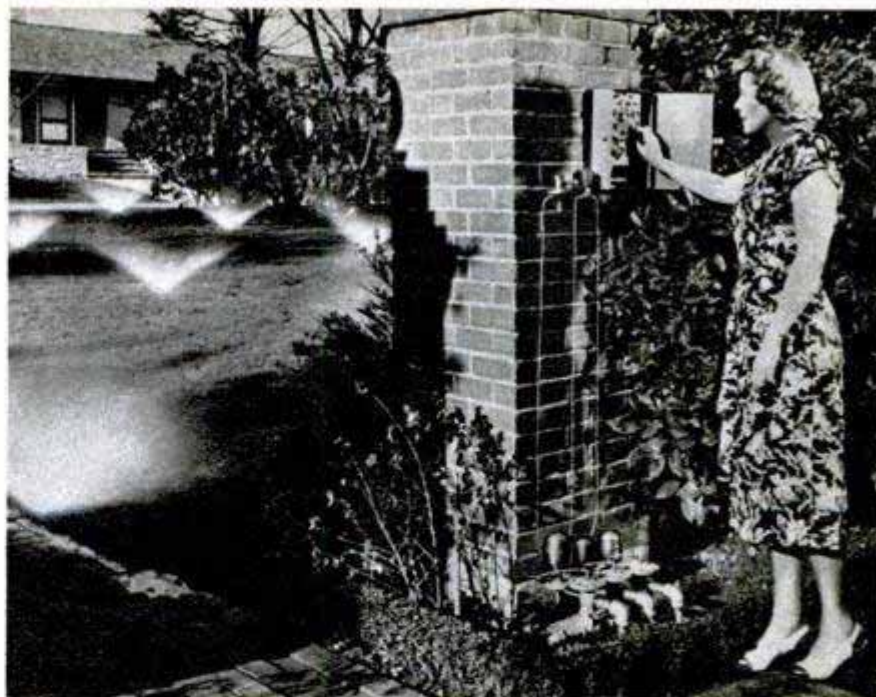

## You Name It!

Automobile or motorcycle? Albert A. LaPointe of West Hartford, Conn., can't decide how to register the vehicle he invented. It has a standard auto wheel in front and a similar wheel in the rear which is flanked by two smaller wheels. When the vehicle reaches a speed of six miles an hour, the side wheels lift two inches off the ground and the car is balanced like a motorcycle. The 25-horsepower engine is installed and housed directly behind the rear seat.

## Swiveling Tail Propeller

Forward push as well as directional control is provided for helicopters by a swiveling tail propeller designed by Daniel R. Zuck of Los Angeles. In contrast to conventional fixed installations, the axis of the propeller mount can be varied in flight by the pilot. During landing and take-off it is swung around sidewise to counteract the torque of the larger main lifting rotors.

☐ Now extinct, the passenger pigeon was the most numerous of all North American birds a century ago and a flock observed in Kentucky was estimated at more than two billion.





## "Crew" of Model Sailboat Takes Orders From Skipper by Radio

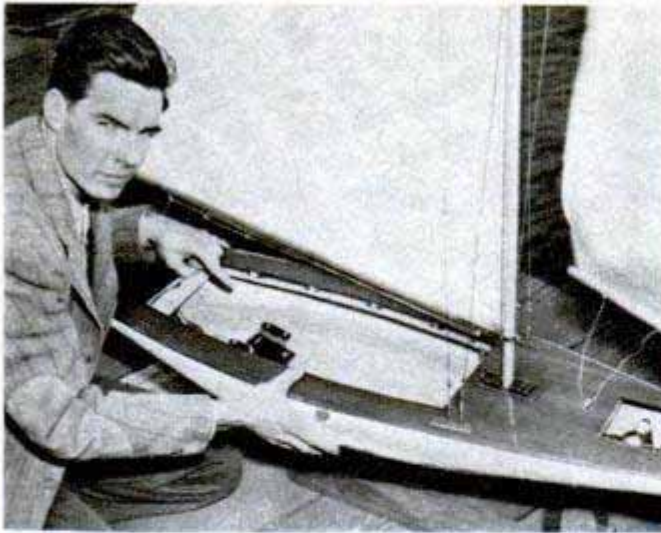

Left, receiver is amidships and motor for sheets is forward. Right, radio-controlled, the boat sets sail

With its "crew" of two motors and a radio receiver, an electronically controlled model sailboat responds to the skipper's commands with a precision that even the best sailors couldn't excel. By means of a shore transmitter, Yates Hickey, Jr., of Seattle can take in or let out the main and jib

sheets and control the rudder even though the boat is several miles from shore. Two small, reversible motors, one in the bow, the other in the stern, control the sheets and rudder. The receiver and batteries are mounted amidships. A portable antenna is used with the shore transmitter.

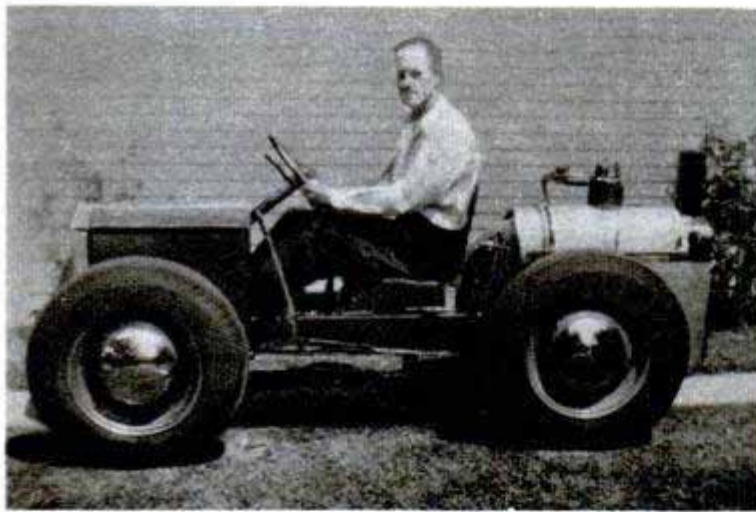

### Turbine-Driven Auto

Wood or coal is burned as fuel in a turbine-driven auto built by J. E. Mitchener of Los Angeles, Calif. He constructed the car on a Model-T Ford chassis cut down to a 58-inch wheelbase and a 29-inch tread. The boiler holds five gallons of water and is of the return-fire tubular type with a superheater. The turbine is installed in front of the boiler and connected with the drive shaft by a belt. Mitchener made all the boiler and turbine parts himself.

### One-Man Boat Loader

One man can load a boat atop his car with a boat loader and carrier based on a counterbalancing system. The loading frame is attached to the gunwales while the boat is on the ground and then the boat is swung up into carrying position easily. The carrier will fit any car and is attached to the rear bumper with two wing nuts. Positive locking prevents shifting of the carrier. It is lightweight and does not interfere with vision or use of the car trunk.





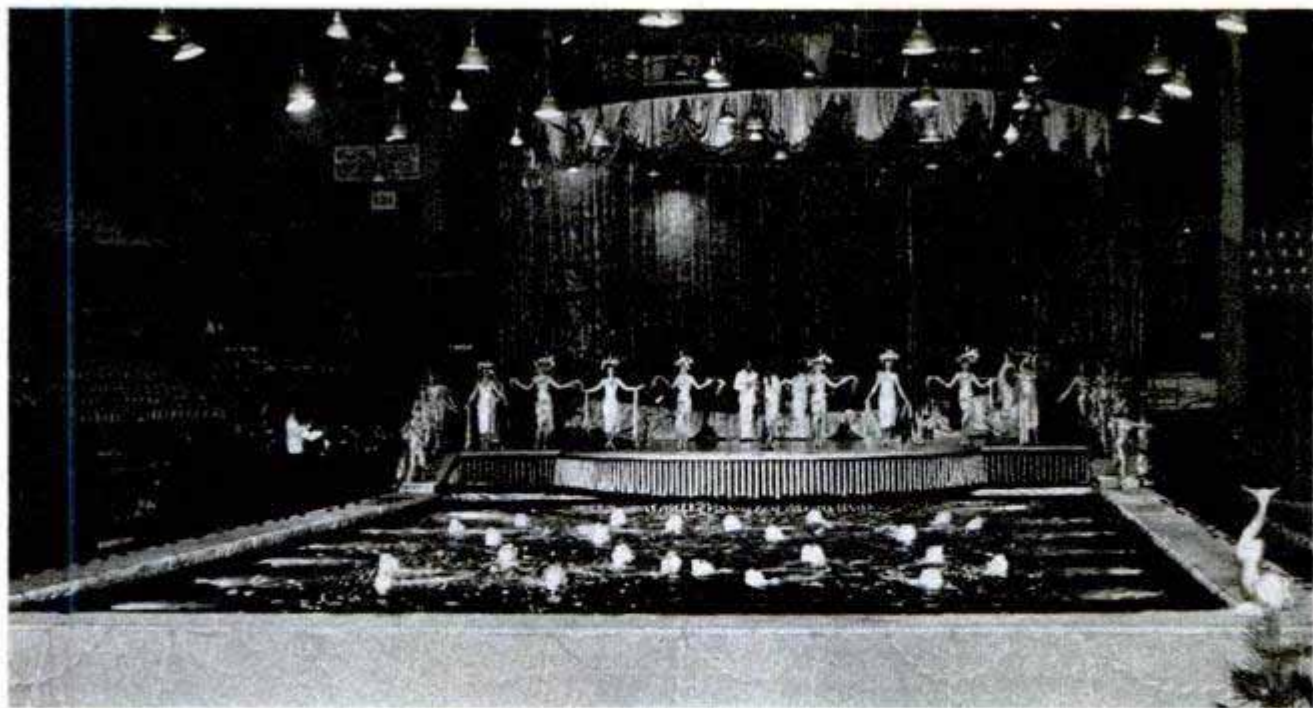

## Portable Swimming Pool

Sixty times a year stagehands with the water show "Aqua Parade of 1948" move a full-size swimming pool from city to city. The "pool" is a nylon water-retaining liner coated with synthetic rubber. It measures 54 by 84 feet and forms a pool 72 feet long, 42 feet wide and four feet deep. The tank holds 98,000 gallons of water and can be erected within three hours. A diving pool that travels with the show is 25 feet in diameter and eight feet deep. The two liners, built by Goodyear, are installed over metal retaining walls to form the pools. The larger pool weighs only 1400 pounds when packaged for shipment, yet it holds about 784,000 pounds of water.

Pool can be erected in less than three hours. Below, diver prepares for plunge into tank made of nylon coated with rubber

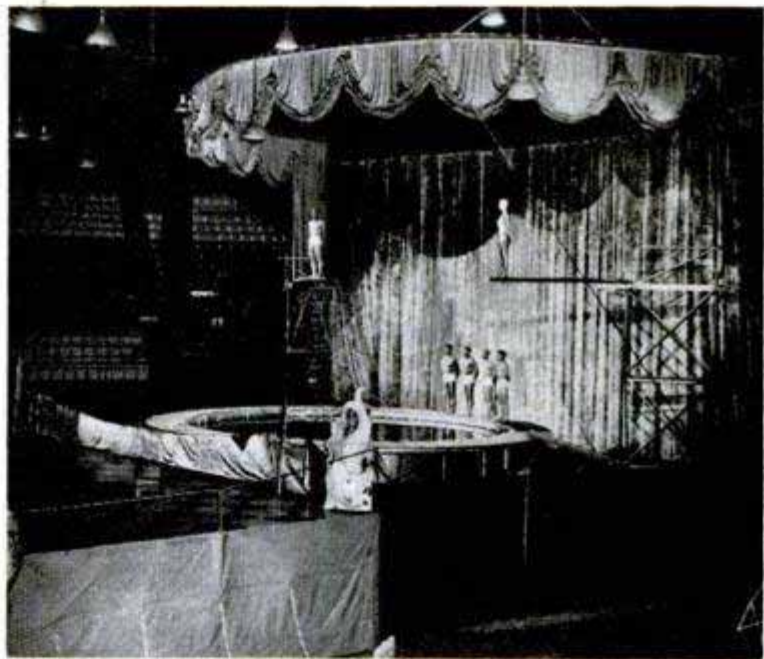

## Ball-Point Pen Worn on Tie Clip

You'll always have a pen handy when you wear a tie clip that holds a detachable ball-point pen. The midget pen has a retractable point to prevent soiling the tie or shirt front. It snaps securely into a friction holder mounted on the front of the tie clip, which does not have to be removed when the pen is being used.

## Elastic Shoelaces

Shoes with elastic laces can be slipped on and off like bedroom slippers. After the laces are adjusted and tied they require no further attention. The laces are of suitable length for all low-cut shoes.



# WHAT'S NEW *For Your Home*

**Sources of supply for these products may be obtained from Bureau of Information, Popular Mechanics Magazine**



**REMOVABLE KEY** must be inserted in this gas range before burners can be turned on, preventing small children from turning on the gas. Key can be stored conveniently but out of reach of young hands

**SLEEPY-TIME BULB** is plugged directly into a wall outlet to light stairs and corridors after dark. The low-wattage lamp costs only 2½ cents a month to operate around the clock, has average life of one year

**CLOTHESLINE CLEANER** for pulley-type lines clamps around the bottom strand. As the line is reeled out both strands pass through a knitted cloth which may be used wet or dry. Cloth is removable for washing



**STEAM-JACKET COOKER** cooks food with steam but not under pressure, permitting the housewife to lift the lid. Steam surrounds hollow walls of the inset

**SHOPPING REMINDER** → has flags that flip over to indicate the needed foods. Ready for shopping, the housewife checks flagged items with pencil, then tears list off the pad

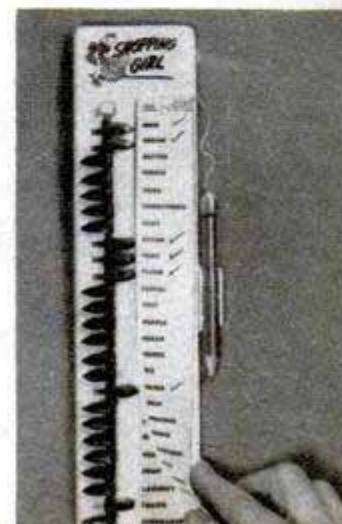



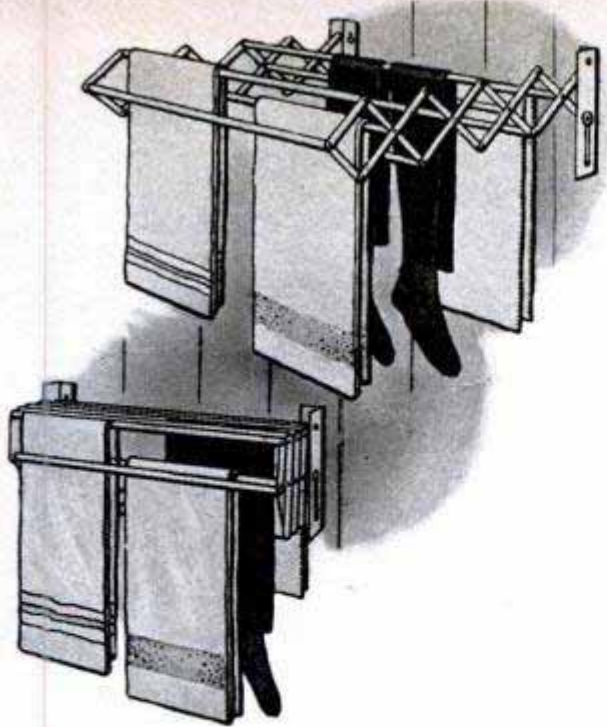

**DRYING RACK** provides 15 feet of hanging surface in only 1½ feet of space. When open, the rack extends 18 inches from the wall; closed, it projects only 2½ inches. Hardwood rods won't snag fine fabrics



**FAN ON WHEELS** can be moved to any part of the house and pulled up or down stairs. It is capable of changing the air in the living quarters of an ordinary four or five-room house every two minutes

**↓ UPHOLSTERY CLEANER** brushes dirt from furniture and rugs with dry suds. One motor rotates the brush and another pumps cleaning solution into the head. Dry suds clean fabric without penetrating upholstery

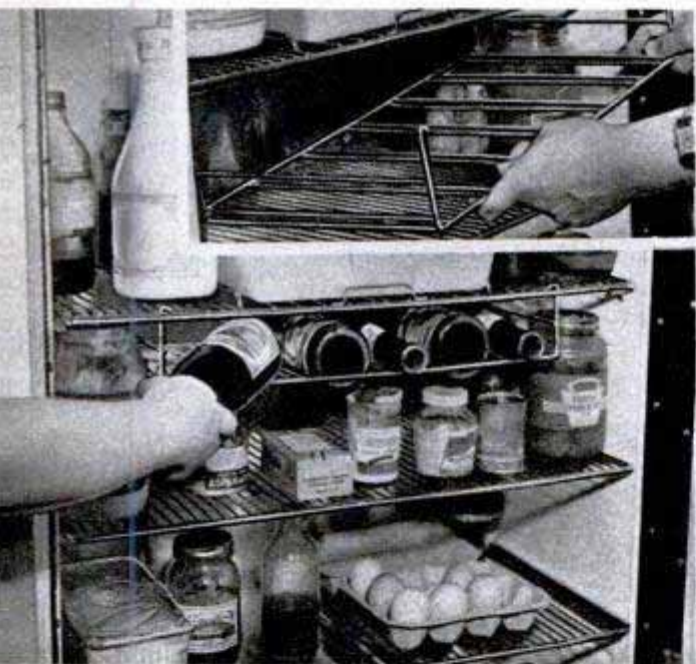

**↑ SPACE SAVER** for refrigerators hangs from regular shelf but it occupies space normally wasted. Made of chromium, it not only holds bottles, cartons of eggs and fruit, but places them within easy reach

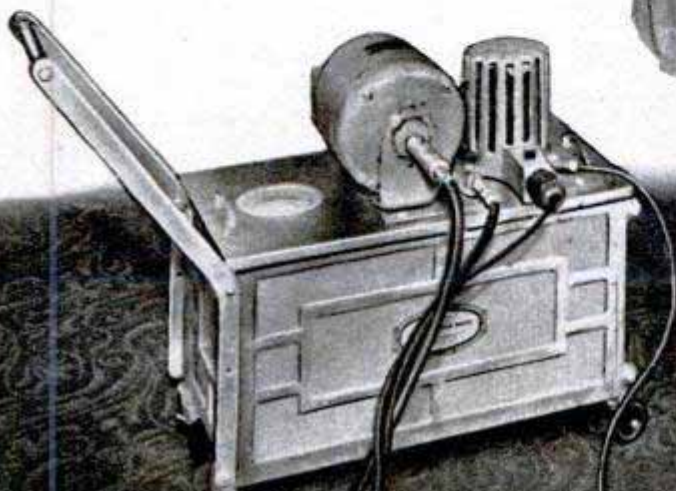





## British Version of Jeep

Similar in appearance to the American jeep, a powerful British vehicle has a road speed of 50 miles an hour and makes 25 to 30 miles on a gallon of gas. The little truck can be fitted with a rear or center take-off shaft for powering farm implements. It has a four-cylinder engine with four forward speeds and a reverse. A transfer box incorporates two speeds, providing a total of eight forward speeds. A power-driven winch can be mounted on the bumper for moving heavy machinery. Engine parts are protected so the vehicle can be used to ford streams.

Small truck, with engine parts protected, plunges through a stream. Below, jeep influence can be seen in British model

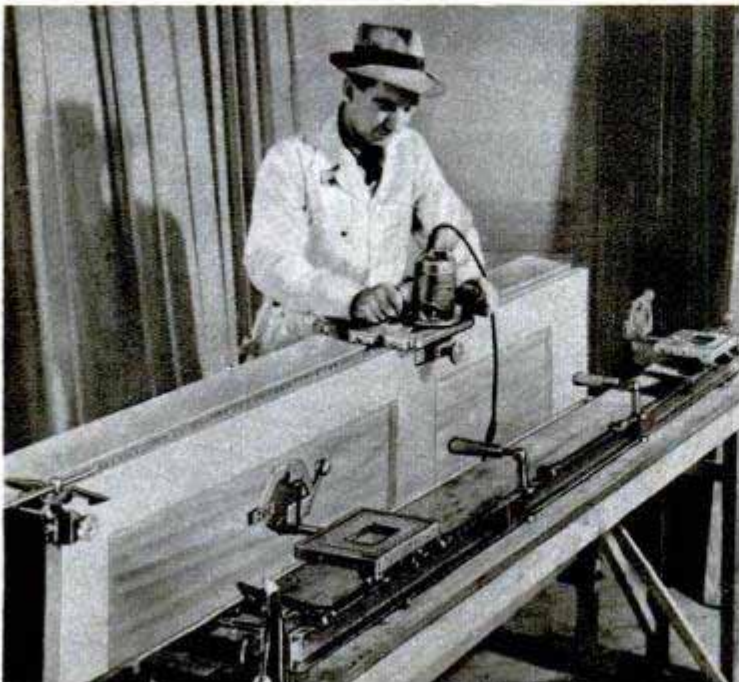

## Door Jig Helps Fit Hinges

Doors can be hung to fit the jamb perfectly with a jig that can be used either in the shop or on the job. The jig permits the carpenter to cut the hinge recesses in the door and the jamb simultaneously, eliminating the tedious job of fitting a door to a frame that already has been installed. The recesses for the lock plate and the keeper plate are positioned and cut in the same manner as those for the hinges. The jig handles doors of any size and frames of any thickness.

☞ Lawns should not be cut less than 1½ inches high because shorter stalks do not provide needed shade for the roots.





## Multi-Purpose Charcoal Grill

When not being used for cooking, a stainless-steel charcoal grill can be left in the yard to be used as an outdoor serving table or birdbath. When the grate and firebox are removed, an aluminum tray (top left) fits over the unit. Set up for cooking, at right, it is large enough to grill steaks for a group. Center, another model comes apart easily without tools and stacks neatly into the base for carrying and storing

## Child's Height-Measuring Standard Doubles as Clothes Rack

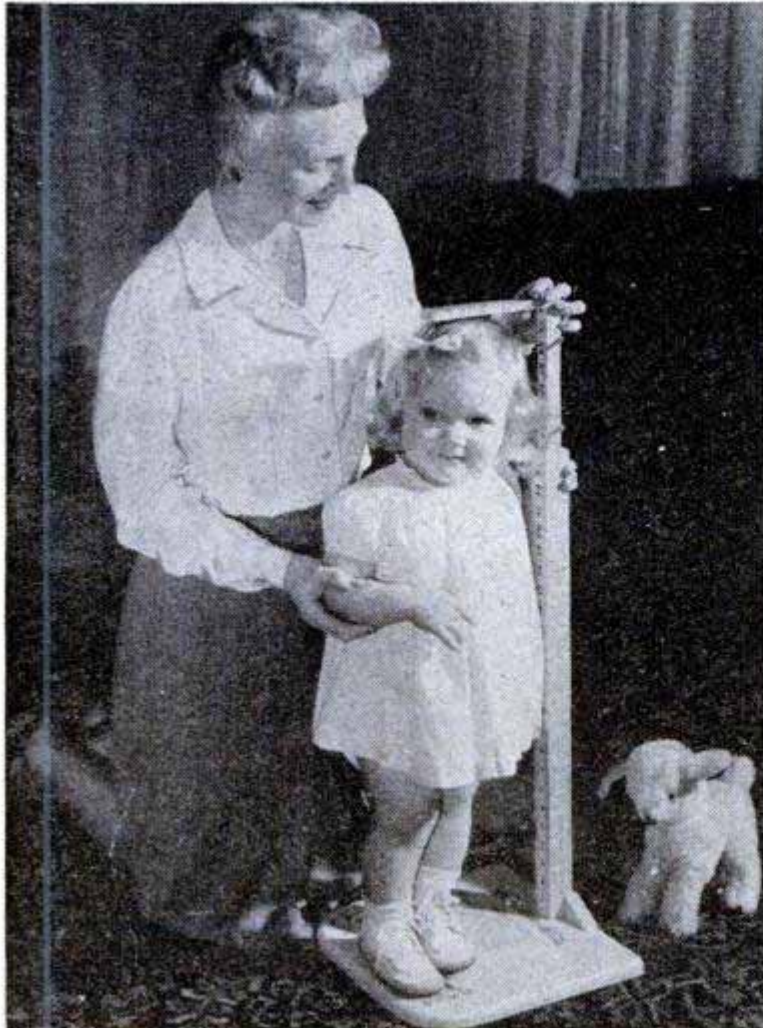

In addition to its main purpose, a new height-measuring standard for children has removable pegs that make it into a clothes rack. It is calibrated in one eighth inches up to four feet and has an average height and weight chart printed on the base. The top scale section can be detached to measure infants too young to stand.

## Recovery of Diamond Dust Speeded by New Process

As fine and white as face powder, diamond dust used for polishing tungsten-carbide dies is being recovered after use by a new and rapid process at the General Electric Laboratory. Previously, the precious powder was recovered only after long treatments in acid that dissolved everything but the diamond dust. The new process combines burning, washing in hydrochloric acid, baking at 800 degrees Centigrade and a final wash in caustic soda. It reduces the time required from weeks to hours and the chemicals needed are negligible. In 1947 the laboratory recovered 1033 carats of diamond dust.



# WEEK-END CAVEMEN

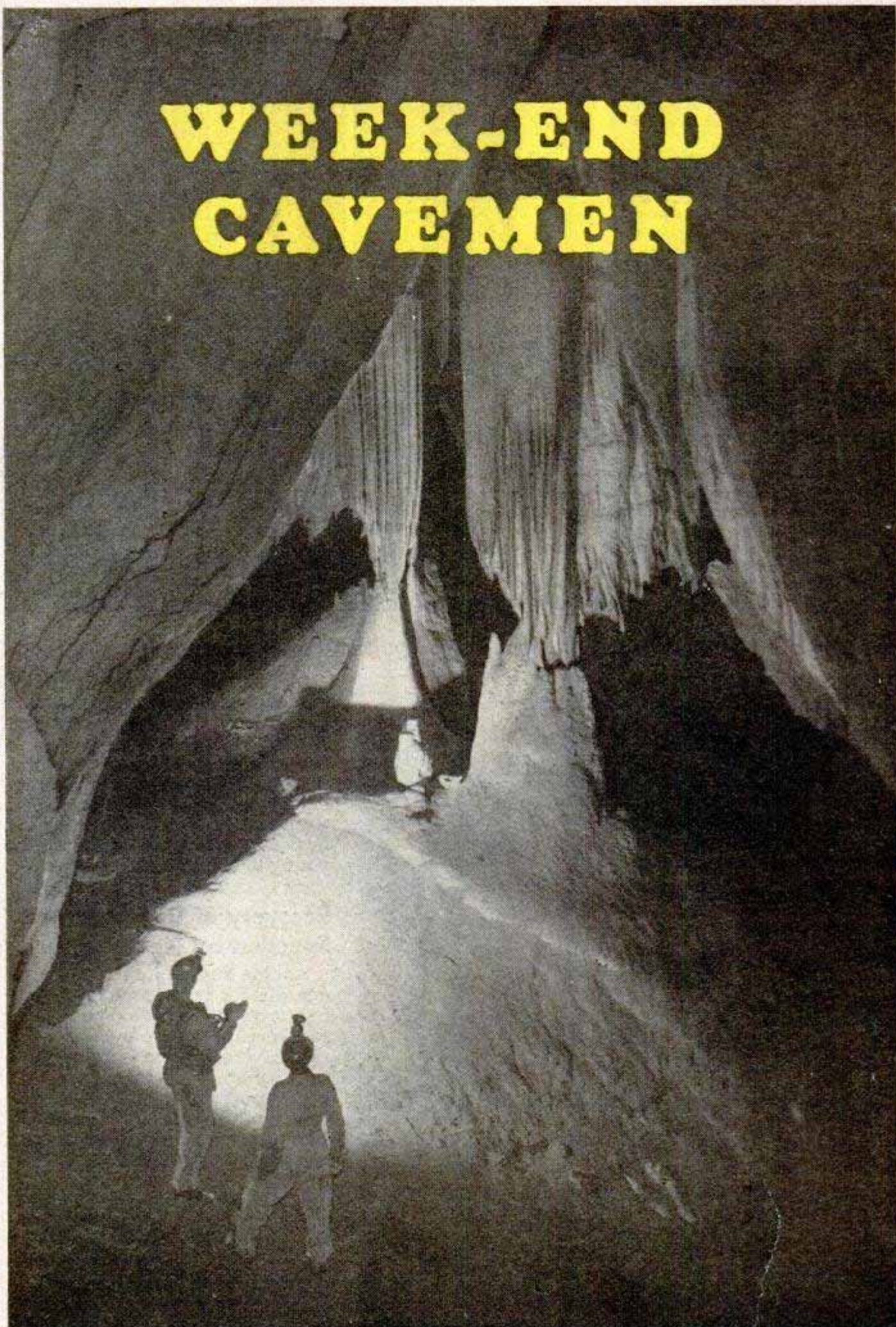





Spelunker is lowered by line through the entrance of a newly-discovered cave for a look at the underworld

By Henry F. Unger

**THEY DON'T CARRY** menacing clubs and drag their mates by the hair, but they are genuine cavemen. They vanish into uncharted caverns and crawl across subterranean floors in a hobby that provides thrills unknown to surface dwellers.

Factory workers, clerks, doctors—all kinds of people from more than 30 states have banded together into an organization of spare-time cave explorers called the National Speleological Society. Real cave hunters, named speleologists, are the backbone of the society and lend it the dignity of a genuine scientific approach. The hobbyists, eager only to see the underground and to explore uncharted caverns, are called spelunkers. About 30 percent of the society's members are women.

Back in 1939 William Stephenson of Maryland founded the society to organize cave exploration. Today "Grottoes" of cave-hunting hobbyists make regular sorties into caverns of the limestone belt.

With most of the surface of the earth explored, members are convinced that there remains an untouched field for pioneers in the underground. Relatively few caves have been explored and still fewer mapped. But cave exploration is no Sunday picnic.

Veterans tell newcomers what equipment to use and what to expect in caves. Above all, new groups are told what to do in the event of separation. A group of more than eight persons is considered too large. A flexible time limit is placed on a band; if

the newcomers fail to pop out of the cave at the expiration of the time limit, another expedition squirms in to see what has happened to them.

Spelunkers are impressed with the phrase "a clear head will find itself." Loss of mental equilibrium is more dangerous than the loss of equipment. One enthusiastic

Nylon rope is tested before this caveman ventures into cavern. He carries electric light and candles





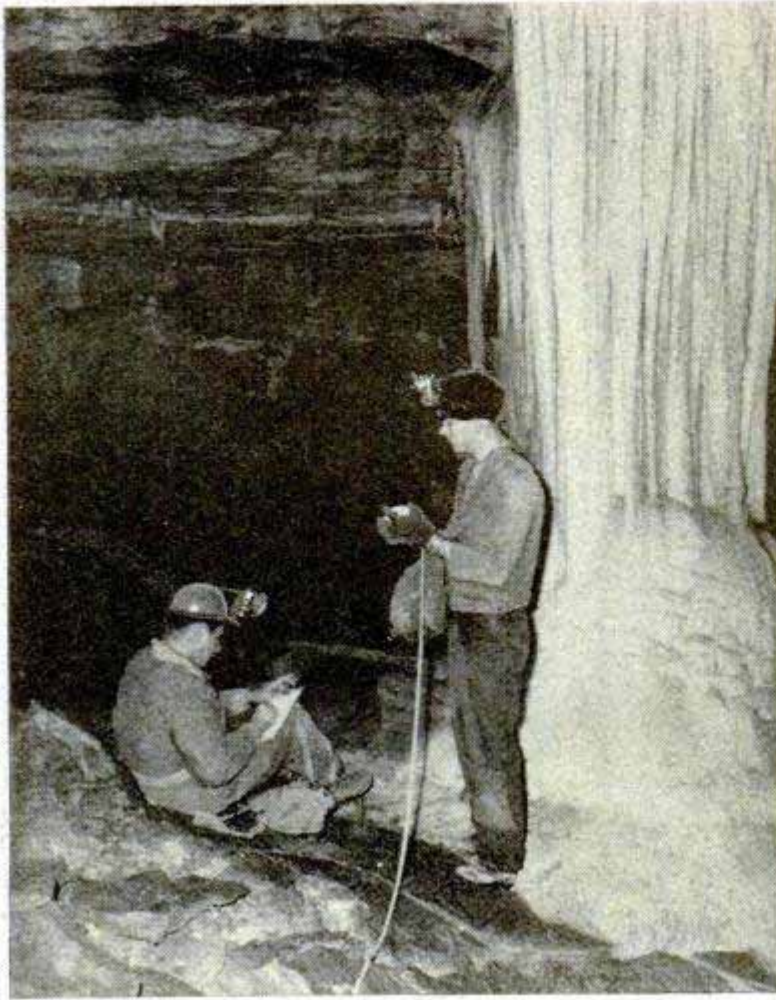

Members of mapping crew measure one of the cave's larger rooms with a tapeline. Below, one explorer helps another wriggle through a small opening into another section of a large cave

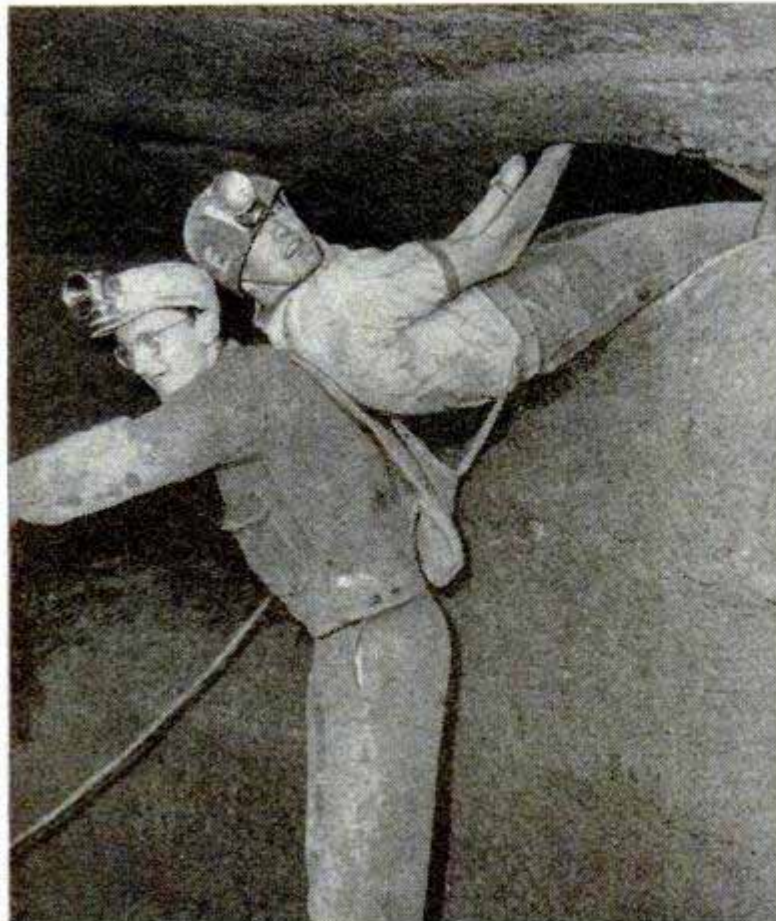

spelunker, lowered by line to the floor of a large cave, immediately vanished into a side passageway, eager to explore by himself. He soon emerged into a large room. For a few moments he wandered about and then entered the wrong passageway. Completely confused, the man became panic-stricken. He shouted without knowing that a voice travels only about 50 feet inside a cave. Despairing, he sat down to cry. His friends pushing ahead through the underground channels finally found him.

But rarely are the cave hobbyists lost and then only for a short time. Explorers are taught never to enter a cave without plenty of spare lighting material. Waterproof matches are essential. Some spelunkers use candles entirely. A flashlight or extra batteries for it might become soaked.

In some circles, amateur cave hunters believe a large ball of string should be payed out to insure a safe return to the entrance. Expert speleologists say this is the bunk. If the cave is a large one, they contend, it would be impossible for the average party to carry enough string. If the cave is small, the explorers are not likely to become lost. The best guide for the return trip is a pile of stones in an unmistakable pattern with the top one pointing in the proper direction.

The newcomer is likely to feel the weight of claustrophobia. Suddenly he will run into a blank wall and find that all the openings lead to other dead ends. Before he moves another step he is urged to stop, sit down and determine where he made his mistake, where he took the wrong turn. The spelunker should remember that he left footprints or some other trace of passage on the floors. He can look for broken matches, candle tallow, anything tossed aside. If necessary, the "lost" spelunker can free himself by the process of elimination—by venturing into one passageway after another to determine the correct one. Many large cave rooms have only small entryways and it is in locating small holes on the return trip that some beginners become confused.

High on the list of speleologist



"musts" is the mapping of a cave. High humidity and the stickiest kind of mud make cave mapping a real task. The speleologist cannot use an ordinary transit or plane table. Poor lighting, short lines of sight and large instruments eliminate this. In using a transit it is necessary to have a steady, pin-point source of light. To measure ceiling heights the mapping experts use a simple balloon filled with hydrogen and attached to a string knotted at five-foot intervals. Photos are taken for later study. A minimum of two persons is necessary for mapping. The lead man on the tape does all the recording, while the rear man makes all compass and tape readings.

When speleologists descend into uncharted caves they root out the information about main rooms and leave side passages for future work. Some caves will provide years of work for the hobbyists. A name often describes a phenomenon connected with the cave; "Breathing Cave," for instance, takes in and expels air in eight-minute cycles.

Hundreds of cave explorers have Prof. Edouard Alfred Martel to thank for methods they use to uncover cave secrets. He is the founder of the science. For 50 years he labored exploring more than 1000 caves, giving future speleologists a basis for their explorations.

Today, scientific information is entered in books which are sent to the society's headquarters in Washington. An extensive library revealing the "innards" of caves has been built up through these contributions. Minerals scooped up by the cave hunters are shipped to the National Museum in Washington.

With members ranging from a 69-year-old speleologist to a nine-year-old spelunker, the society asks only that prospective members be sincere and enthusiastic about the hobby. The society keeps members informed of discoveries and the activities of other members through a monthly newsletter. For some of the members, a glimpse of the delicate rock formations or fossil-packed cliffs is sufficient reward for regular descents into the underground. But for others, it is a chance to do research in archeology, paleontology, mineralogy, natural history, geology and other sciences.

Members of the society can proudly say that they assisted directly in the victory over Japan. When American troops were puzzled about how to dig Japanese soldiers out of caves, officials of the society were called in. They took government experts to every type of cave opening. For days the experts blasted the cave entrances until they mastered a technique that finally was adopted in the Pacific.

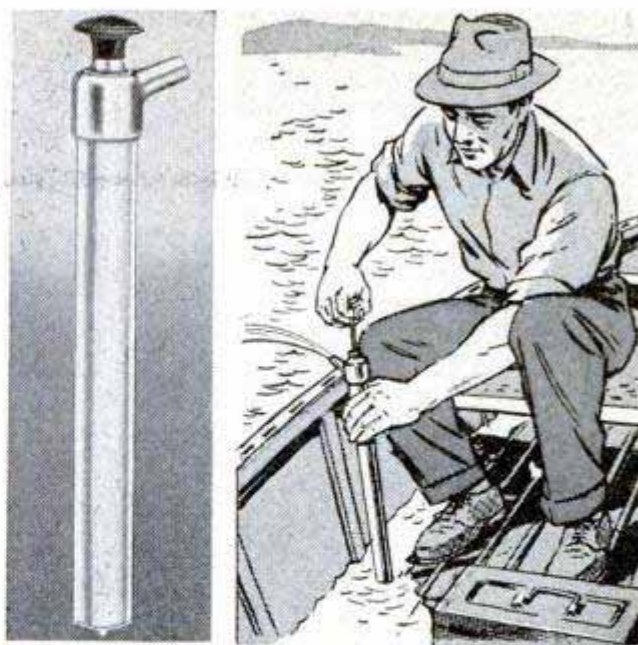

### All-Metal Bilge Pump Fits in Tackle Box

Only 16 inches long, a bilge pump that fits in a tackle box pumps at a rate of two gallons a minute. With no leather parts to wear and go out of order, the pump is all metal and weighs only one pound. Small but powerful, it throws water 12 feet over the gunwales.

### Sharpener Adjusts for Any Point

Pencils are sharpened to any point desired by a sharpener with an indicator cap. Adjusting the cap determines lead length and sharpness. The Bakelite case seals in graphite particles and wood shavings, eliminating soiled fingers. It is easily emptied and its hollow-ground blades are replaceable.





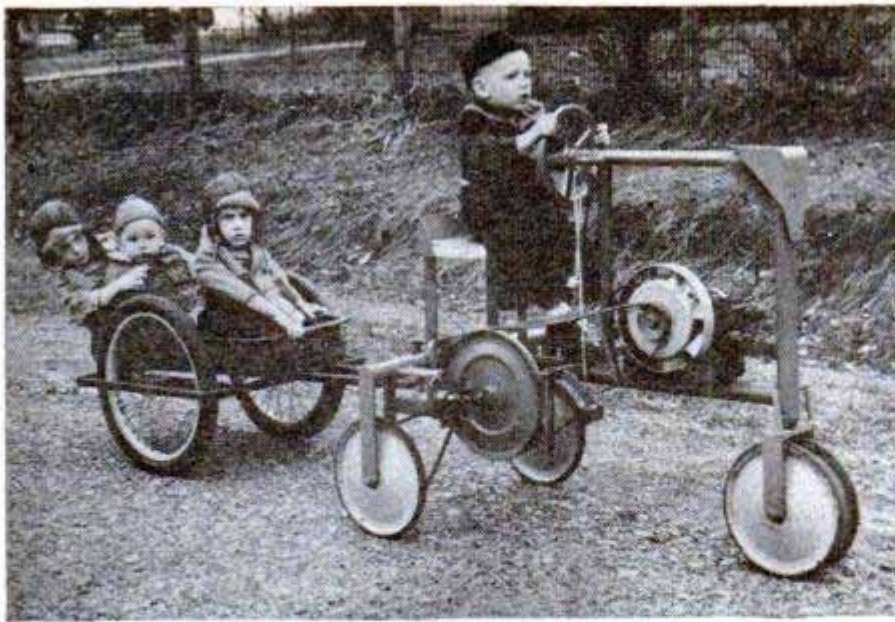

## Pint-Size Tractor Has Gas Engine

Driving his own gasoline-engine tractor, three-year-old Gus Dobert of Nashville, Tenn., is the envy of youngsters of his neighborhood. Made by his father, a machinist, the small tractor has a two-cycle washing-machine engine. Power is transmitted by a V-belt and sprocket chain. The gear ratio insures lots of power but little speed. The clutch pedal tightens the belt on the pulleys.

## Log Sulky

Logs are automatically lifted into position for dragging to the mill by a sulky which eliminates the conventional winch. In tests, the sulky has raised 1200 pounds of truck tires off the ground. Designed for use behind trucks, farm or crawler-type tractors, the sulky has a drum-wound cable which is payed out to hook onto a log. Conventional sulkies use a winch operated by hand or power take-off to drag the log to the towing vehicle and raise its front end off the ground. The operator of the new sulky merely drives off in his truck or tractor. When the sulky wheels

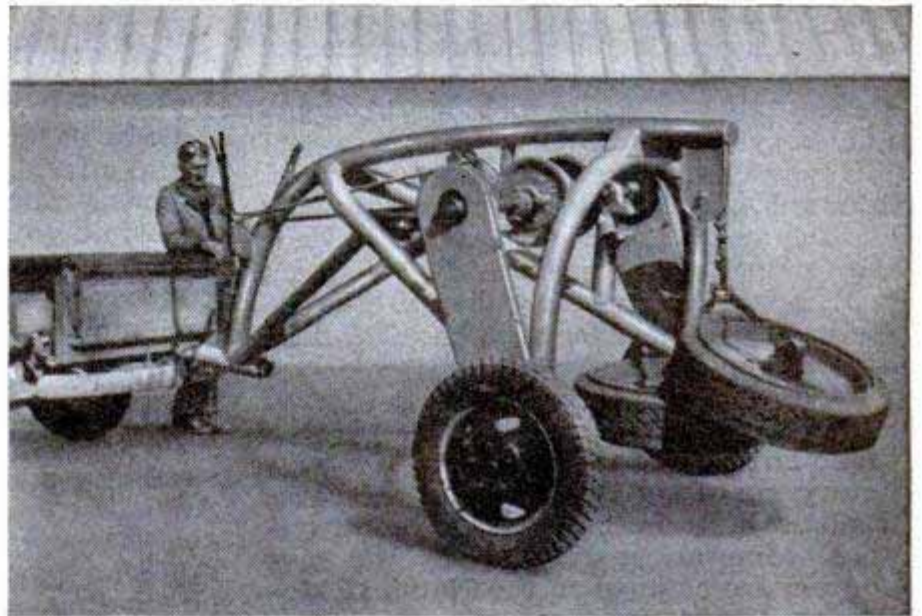

start turning, a chain rotates the drum to pull in the log and elevate the front end of it to a predetermined dragging height.

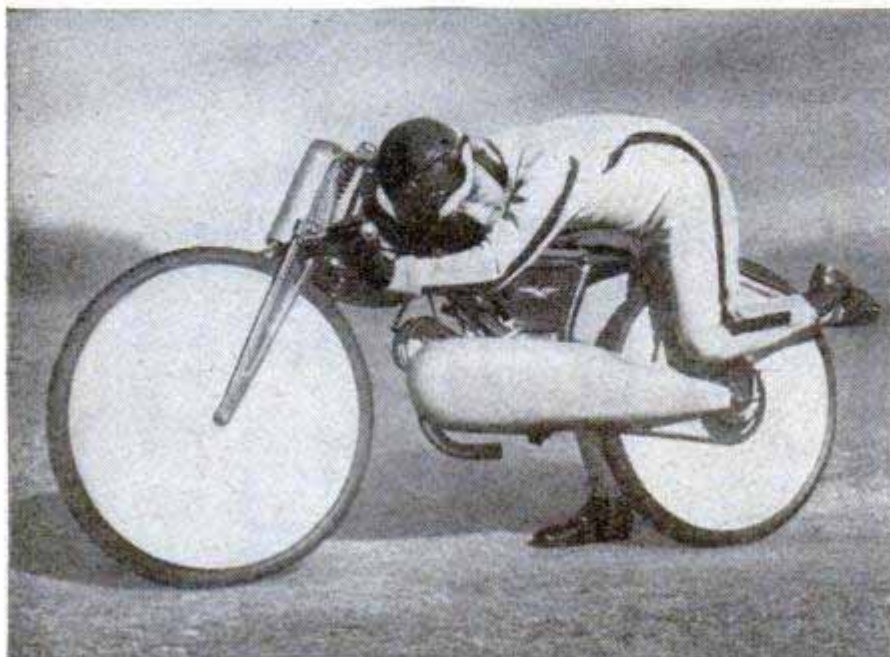

## Rider Lies Down To Drive Motorcycle

Driving from an almost prone position, Alberti Raffaele of Switzerland is attempting to set a new speed record on a motorcycle of unorthodox design. The handle bars are mounted lower than usual and the footrest is above and behind the rear-wheel sprocket.

☐ As much as 50 barrels of water may evaporate from the leaves of a large elm tree on a hot summer day, the Department of Agriculture reports.



## Wheelless Tiller Rolls on Its Tines

With no wheels or tracks, a lightweight power tiller is supported and driven forward by its spikelike soil agitators. Because of this unusual design, no power is wasted driving the machine forward and it cultivates right up to a fence or building. Power goes directly to the cultivating tines which rotate at two different speeds, pulverizing the soil thoroughly and quickly. Two rows of tines in the center rotate at a slow speed, while the four rows on each side of center rotate about five times faster. This difference in speed causes the cultivating action. It will till the soil to depths from 2½ to 10 inches. The machine can be driven over lawns and driveways without digging when only the slow-moving prongs are used.

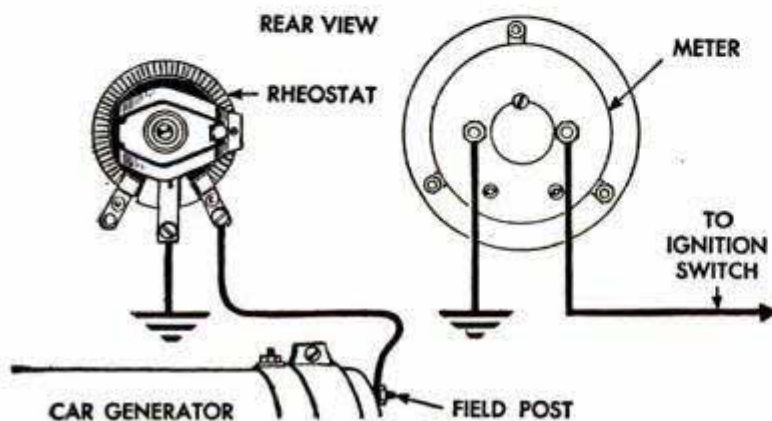
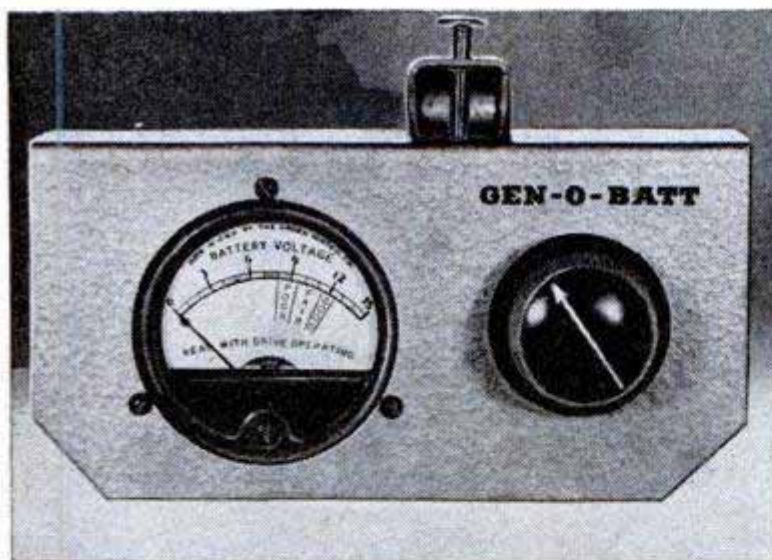
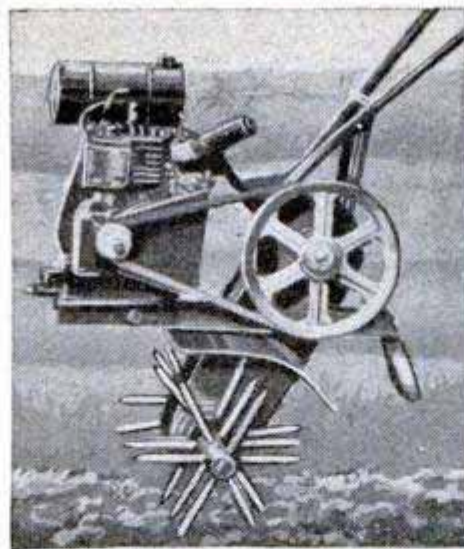

## Generator Regulator

Designed for motorists who experience difficulty in keeping their car batteries fully charged because of short trips or city driving, a manually controlled generator regulator permits the charging rate to be stepped up at will. Conversely, on long trips the charging rate can be reduced to prevent overcharging the battery. The manual regulator works independently of the automatic regulator already on the car, which functions in its normal manner when the manual regulator is not in use. Mounted on the instrument panel, the regulator has a dial that shows the charged condition of the battery.

You may wish to obtain additional information about the new products described each month in Popular Mechanics. If you want to know the name and address of the manufacturer or distributor, just write to Bureau of Information, Popular Mechanics Magazine, 200 E. Ontario St., Chicago 11, Ill.





## Camera Takes "Movies" on Standard Cut Film

"Movies" you can carry in your pocket and show without a projector are taken by a special camera that uses cut film and has no shutter. While posing for the picture, the subject can move and act just as he would for a movie camera. The camera is coupled to speed lights that fire 180 flashes a minute. Each flash produces an exposure. The film is transported automatically between flashes so that 42 separate negatives

are made on one sheet of 4 by 5 cut film. The film is then enlarged and the 42 photographs mounted as pages in a book about the size of a match folder. When the pages are riffled, action of the subject is reproduced. No other lights are needed because the speed lights have built-in modeling lamps that go off when the camera is operating. Operation is automatic once the starter button is pressed.

## DDT Is Made Twice as Deadly by Adding Dash of Oil

Insecticides such as DDT and pyrethrum become more than twice as deadly to insects when coupled with a derivative of sesame oil. At the same time, the insecticide is less dangerous to household pets and

humans. Roaches, against which DDT is not very effective, are easy victims of the insecticide when the sesame-oil product is added. Many insecticide makers are now using this ingredient in their aerosol bombs.

*see INDEX for correct address*

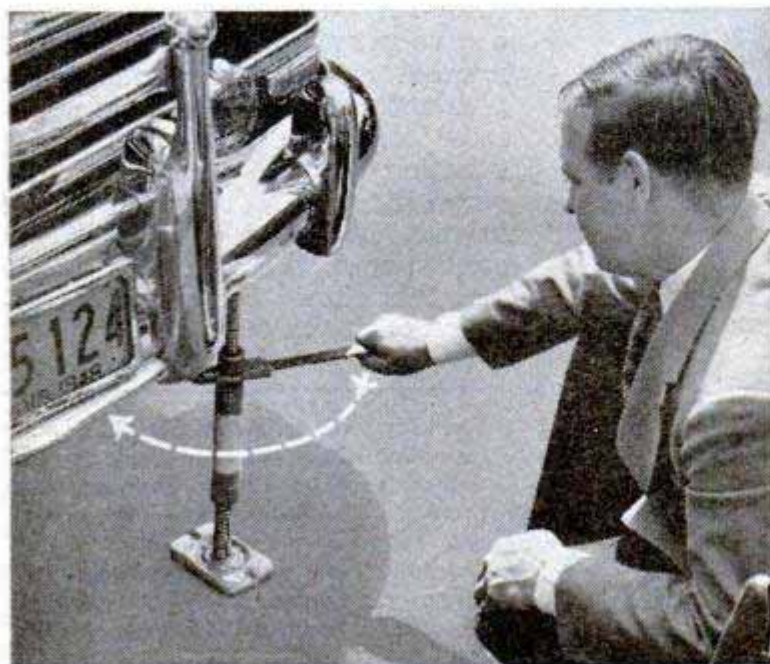

## Ratchet-Type Bumper Jack Extends at Both Ends

From an 11-inch height a ratchet-type bumper jack extends at both ends to reach 28 inches. The jack is turned by hand until it is high enough to reach the bumper. Then a short handle is inserted and worked back and forth to boost the jack still higher. A ratchet permits the jack to be moved up or down with relatively little motion of the handle. The jack is mounted on a wide base, weighs six pounds and will lift 1500 pounds.

¶ Fifteen types of British gas-turbine-propeller engines for airplanes are either in actual use or in various stages of development.





BUILDING STAIRWAYS

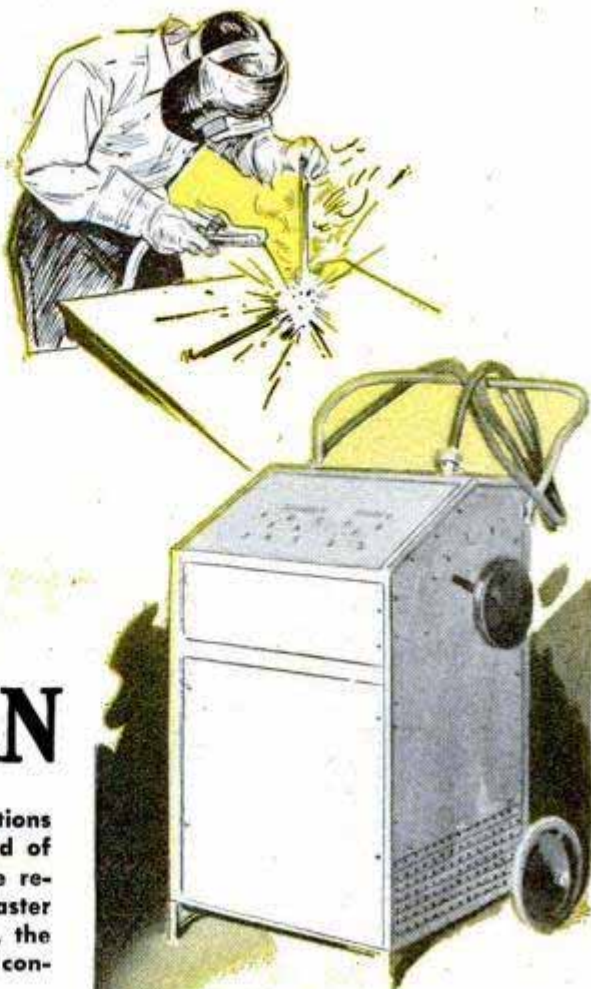

ARC WELDER

# The CRAFTSMAN

★ To give hobbyists authentic step-by-step instructions on pottery making, page 181, we enlisted the aid of a well-known authority on ceramic sculpture. The resulting article describes methods of casting in plaster molds, throwing techniques on the potter's wheel, the processes of coloring, glazing and firing and the construction of a kiln and potter's wheel.

★ Farmers and shopmen will find it easy to follow the directions on page 205 for building an a.c. transformer-type arc welder that will handle 3/16-in. welding rod. Instructions are given for rewinding an old transformer to give the necessary amperage output.

★ Building stairways calls for plenty of woodworking know-how, especially when laying out and building from scratch without any standard pre-cut parts. To help craftsmen who like to tackle such jobs we've prepared a practical article, page 212, on wooden-stair construction.

★ An article on page 194 acquaints you with important points to keep in mind when purchasing a power plant for a model racing plane, boat or car.



CERAMICS

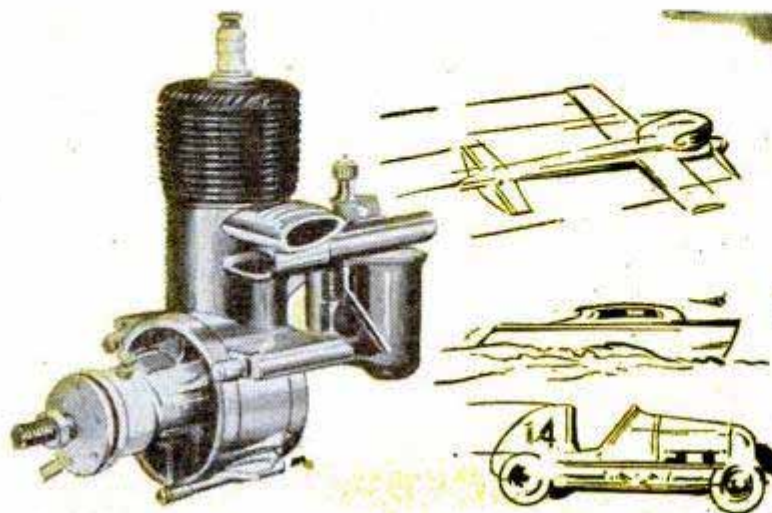

PICK THE RIGHT ENGINE



# Distinctive FLOWER

By Milt Evans

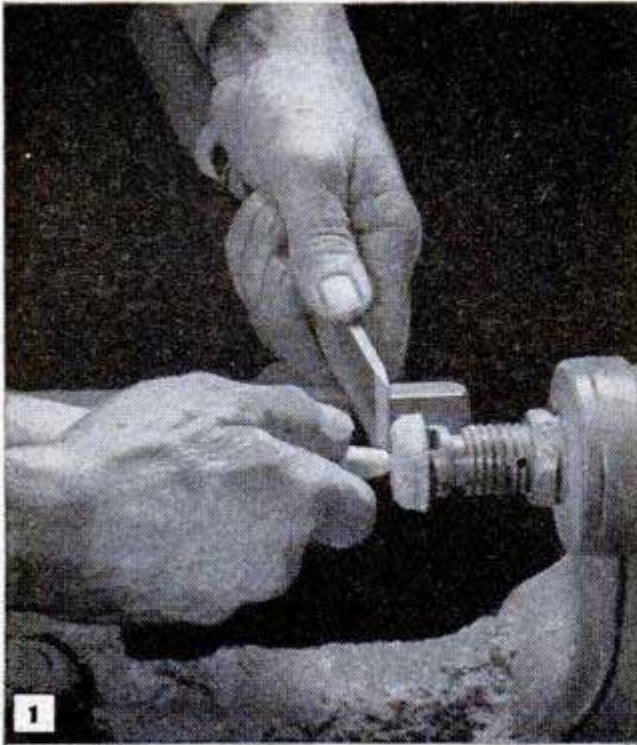

1 When the turning is completed it is cut free of the waste in the manner shown above. The skew is held with the left hand and the work is caught as it falls

CONTRASTING mahogany and maple combine to make this little vase for artificial flowers a striking and unusual ornament. To make it, cut a  $3\frac{5}{8}$ -in. mahogany turning square  $8\frac{1}{2}$  in. long, and plane off the corners 45 deg. Mount the block in a lathe so that it is offset  $\frac{5}{16}$  in. at the tailstock center, as in Fig. 3, detail A, and extend the quill of the tailstock to the limit to give working clearance. Bore inward from the end, using a narrow skew chisel to hollow the inside to correspond with the shape indicated by the dotted lines in the profile view, Fig. 2. To guide the direction of the chisel, mark a line around the turning block  $6\frac{7}{8}$  in. from the tailstock end. Then lay a straightedge on the top of the block in the position shown in Fig. 4, and align the chisel with the straightedge by sighting along the edge of the chisel. When the chisel enters far enough to reduce the core to the point of breaking off, remove the turning from the lathe and break out the waste core by hand.

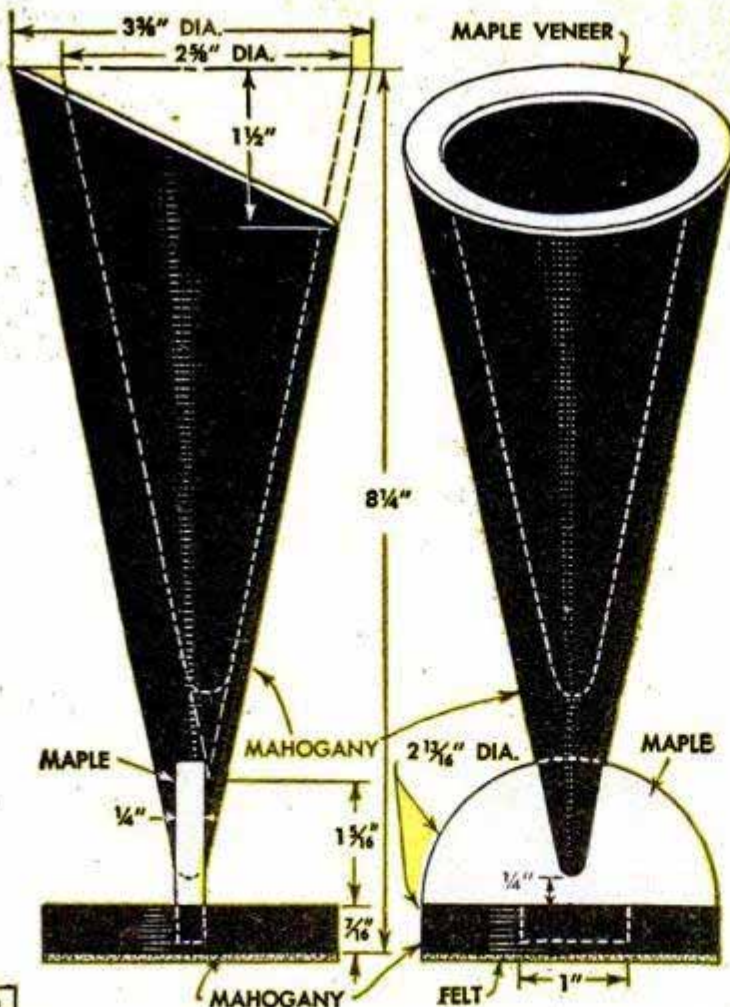

2

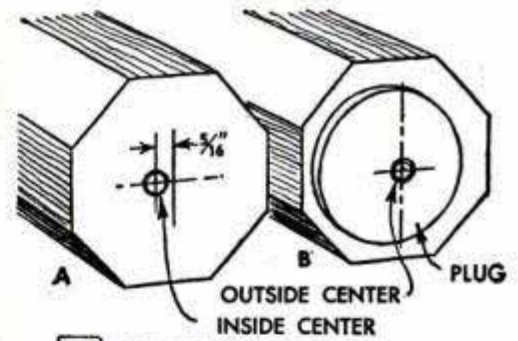

3 CENTERING CONE

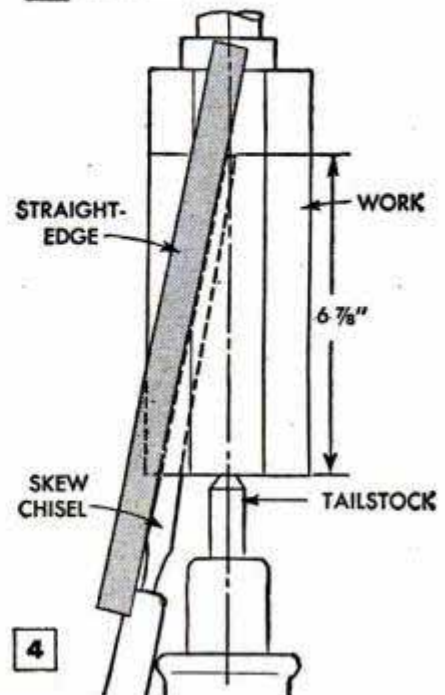

4



# VASE



5 PLUG RE-ESTABLISHES CENTER

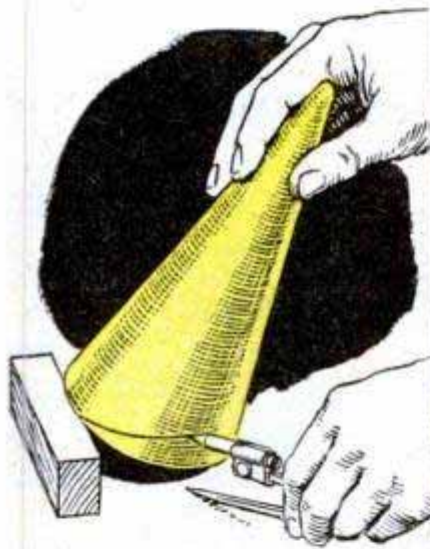

6 METHOD OF MARKING TOP



To provide a center for turning the outside of the vase, plug the open end with a tapered plug, Fig. 5. This plug is glued in place with paper between the parts so that it can be removed easily. Next, mark the true center of the block at the tailstock end, Fig. 3, detail B, and remount the work in the lathe for turning the outside. When cutting the tapered end free from the waste part, hold the skew chisel with the left hand and the work with the right hand to catch it when severed, Fig. 1. Finally, bore a hole in the wooden plug for inserting a chisel to pry it out.

Rest the thick side at the top of the turning on a 1½-in.-thick block and scribe around the cone with a compass set 1½ in., as in Fig. 6. Then, using this line as a guide, roughly saw the slanted end, finishing it smooth on a sanding disk. Glue a piece of

maple veneer to the rim and carefully trim it flush with the sides after the glue dries. The base of the vase consists of a disk of mahogany and a semicircular disk of maple tenoned and glued to it. The base is attached to the vase by slotting the end to fit over the maple piece. The slot can be cut by supporting the work level, and sawing with a bandsaw or a scrollsaw, gradually widening the slot by trimming the sides.

Before staining and filling the mahogany, apply a coat of shellac to the maple parts to prevent them from absorbing stain. If the work is to be lacquered, give it a coat of sealer first. If you want the vase to hold cut flowers, the inside can be lined with a metal cone. A suitable cone is made by rolling a piece of sheet metal and soldering the seam to make it watertight. Complete the vase by gluing felt to the bottom.



## Handy Scraper From Hacksaw Blade Removes Flaked Paint

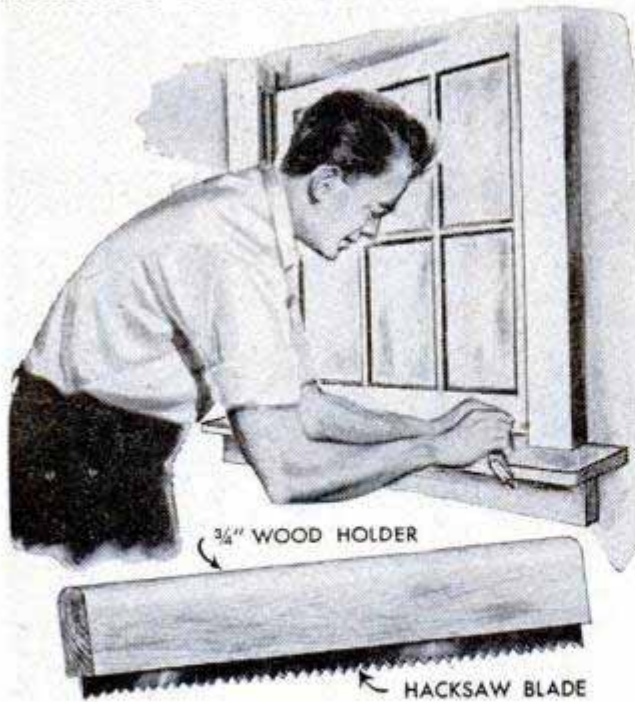

If you do not have a tool to remove flaked or scaled paint from a surface prior to repainting, one can be made by mounting an old hacksaw blade in a wooden handle. A piece of  $\frac{3}{4}$ -in. wood that is wide enough to provide a good grip should be used. One edge of the handle is grooved to hold the hacksaw blade snugly and the other edge is rounded.—W. B. Eagan, Louisville, Ky.

## Thread Spool Aids in Twisting Crepe-Paper Streamers

Here's a quick and easy way to twist crepe-paper streamers used for party decorations. Have someone hold one end of a streamer, or fasten it to a wall with a thumbtack. Then, push the other end through the hole in a wooden spool and tie it to a pencil. By holding the spool with one hand and spinning the pencil with a finger of the other hand, the streamer can be twisted as tight as you want it. In addition, two or more streamers of different colors can be twisted together in this man-

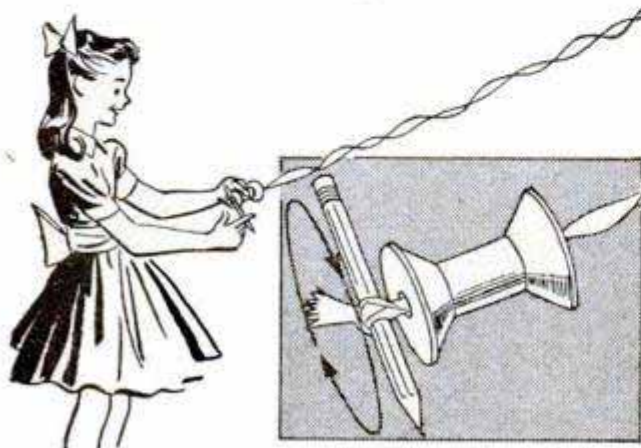

ner, producing a variety of gay color combinations to enhance party atmosphere.  
Herbert E. Fey, New Braunfels, Tex.

## Setting Windowpanes Correctly

When replacing a pane of window glass, it is not advisable to use a pane that fits snugly in the sash, as a tight fit may cause the glass to be cracked when the window is slammed shut. Instead, use a pane of glass that is  $\frac{1}{8}$  in. smaller all around than the rabbeted opening in the sash frame. In this way, putty will be forced between the pane and the sash, acting as a shock absorber. This method also will insure a watertight seal.  
Jo Ro Jung, New Orleans, La.

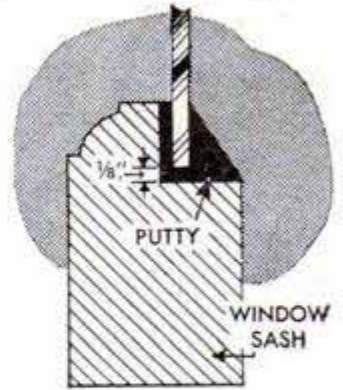

## Rubber-Band Lure for Small Fish Simulates Crawling Motion

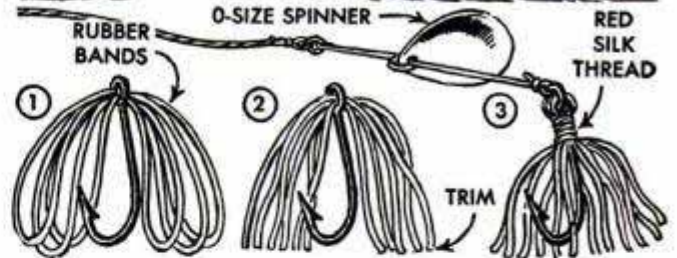

A good artificial bait for bluegills, crappies or sunfish can be made from several white or natural-color rubber bands and a short-shanked hook. To make the lure, insert the rubber bands through the eye of the hook, detail 1, and trim off their ends as in detail 2. Then, tie the rubber bands to the shank of the hook just below the eye with red silk thread, as in detail 3. The rubber bands impart a crawling motion to the bait. You can increase the attraction of the lure by attaching an O-size spinner to the leader above the bait.

☞ To prevent smoking of kerosene lamps, soak the wicks in vinegar before using.



# This Horn Fish Swallows" Your Cigarette Ashes

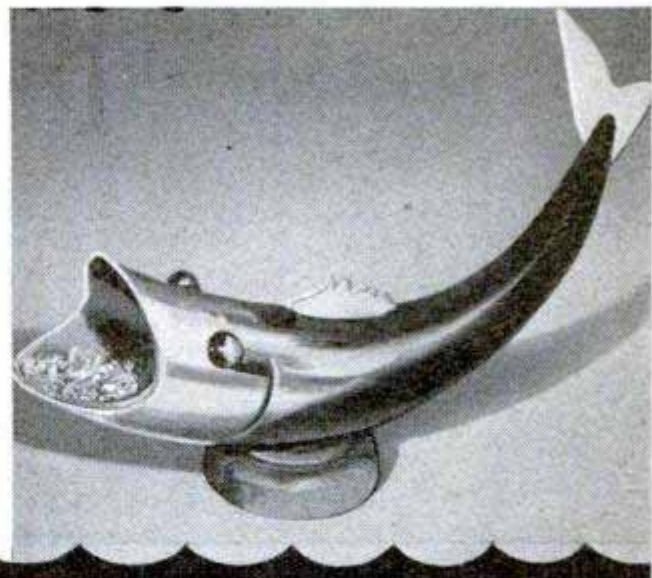
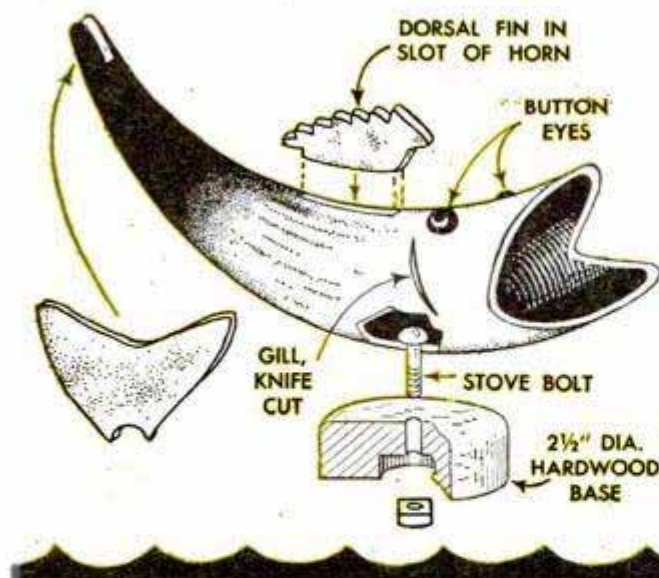

Appropriately dubbed a horn fish, this novel desk ornament is made almost entirely from a cow's horn. Its gaping mouth can be used as an ash tray or to hold paper clips. The mouth is formed by sawing the end of the horn as indicated and the waste piece is saved for the dorsal fin and the tail. Scrape the horn carefully to remove nicks and scratches and also to remove the dull outside layer. Shallow knife cuts are made on each side of the head to represent gills. The waste piece from the mouth is split in half and flattened to make the fin and tail. This is done by placing the pieces in boiling water to make them pliable and then clamping between two pieces of hard-

wood, leaving them to dry 8 to 10 hours.

The slot for the fin is made by drilling a row of adjacent holes and then filing the opening square. The tail piece fits in a slot cut in the point of the horn and both the tail and fin are cemented in place. The eyes are plastic buttons cemented in holes drilled large enough to take the button eyelet. A turned disk of fancy wood, nicely finished, forms a base for the novelty. This is attached to the horn with a small stove bolt, the nut being set flush in a counter-bored hole. The bottom of the base is then covered with felt. Finish by polishing the horn to a high luster with paste wax.

Elma Waltner, Hurley, S. D.

## Removable Fence Fits Doorway to Keep Baby Penned in Room or Porch

Ideal for keeping the baby out of the way while mother's doing the housework or for safely confining him on the back porch for his daily airing, this handy door fence can be slipped in and out in a jiffy. Any light, but well-constructed, fence is suitable for this purpose, and it is held in place by a metal or wooden track fastened permanently to each side of the doorjamb. The tracks are positioned so they will not interfere with closing the door. This type of gate is particularly safe because there is no latch to unfasten and it is sufficiently heavy to prevent a small child from lifting it out of its track. A fence high enough to keep the baby confined but low enough to permit adults to step over it is recommended. The tracks can be painted to match the woodwork, but the fence itself should be a bright color to prevent someone from accidentally falling over it. Similar tracks can be fastened to several doorways, giving mother a choice of rooms in which the baby can be penned.





# SOLVING



**TABLE PLACE MATS** which are heat resistant and can be wiped clean are made from colorful linoleum remnants and pieces of plywood. Cement linoleum to plywood, then paint the edges a bright color. Select linoleum having a floral design



**IRONING-BOARD HOLDER** is improvised from a towel bar to keep board standing upright when stored in a closet. Attach bar to the wall at a height that will allow the ironing board to be slipped under it easily

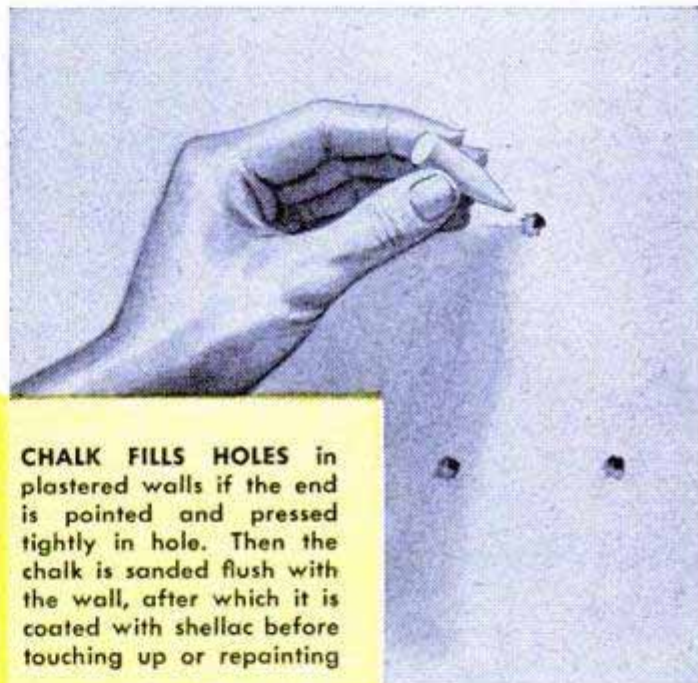

**CHALK FILLS HOLES** in plastered walls if the end is pointed and pressed tightly in hole. Then the chalk is sanded flush with the wall, after which it is coated with shellac before touching up or repainting

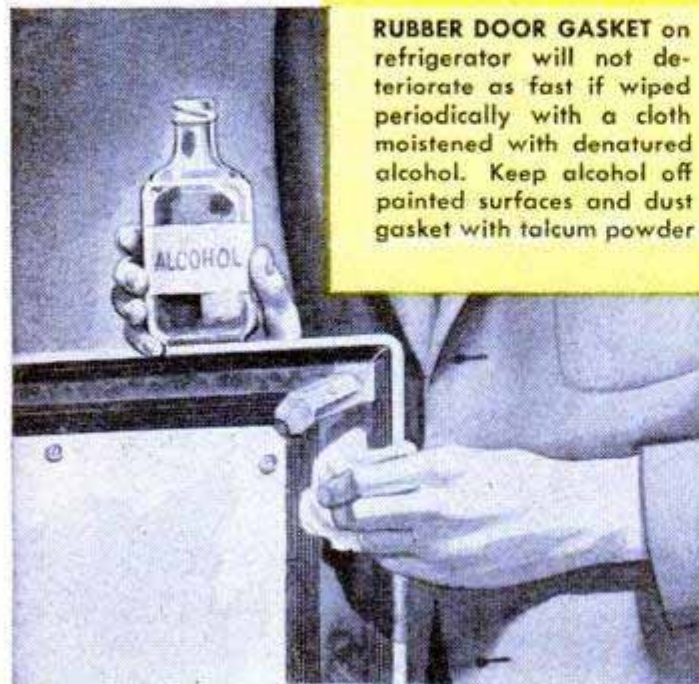

**RUBBER DOOR GASKET** on refrigerator will not deteriorate as fast if wiped periodically with a cloth moistened with denatured alcohol. Keep alcohol off painted surfaces and dust gasket with talcum powder



**STEP-SAVING TRAY** attached to high-chair back is found handy for holding baby's cup, food, toys, etc. Tray is made from scraps of plywood and cut to fit curvature of the chair back before affixing with screws



# HOME PROBLEMS

**POT-COVER LIFTER** for the type which has ring finger grip is another handy use for a spring clothespin. Saves using hot pad and provides a cool handle. Clothespin is snapped to ring to stay upright when in use. May be left on cover permanently or kept in drawer for this purpose



**PAINTING FLOWER POTS** is simplified by resting them upside down on a suitable-size tin can. Can permits rotating the pot without touching it and provides a good support to hold the pot while drying



**TRUE COLOR SAMPLE** to carry when shopping for draperies, rugs and other accessories is had by dipping small stick in the paint being used at time of decorating and using as a guide in selecting the right colors



**SPONGE TIED TO WRIST** can't get away when washing walls or windows and saves getting down from a ladder when it pops from your hand. Speeds work, freeing hand for chamois. Sew string through sponge

**NONSLIP GRIP** for bottle of bleaching fluid is simply a man's sock placed over the bottle. The sock also serves as a jacket to catch any liquid that runs down the outside of the bottle, preventing table-top stains





## Fishing-Lure Holder for Boat Hooks Over Gunwale

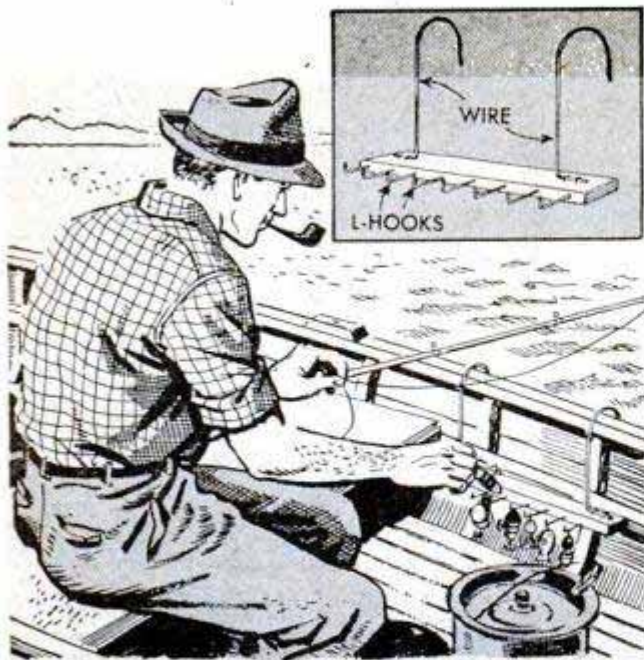

Fishing lures will be at your finger tips for quick selection if they are hung on a rack suspended from the side of the boat. To make the rack, turn several L-hooks into the edge of a piece of scrap wood and staple two lengths of heavy wire to its top. The wires are bent to hook over the gunwale of the boat. Coat hangers provide excellent wire for this purpose.

## Infrared Lamp Loosens Paint

Instead of using a blowtorch to loosen paint for removal with a putty knife, Henry A. Wallis of Brooklyn, N. Y., uses an infrared heat lamp. The lamp is effective and safe to use indoors and does not produce smoke or irritating fumes.

## Block Clamp on Pump Pipe Prevents Dropping in Well

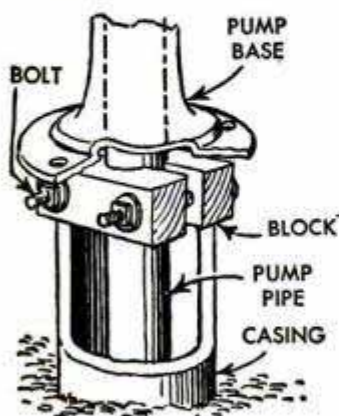

After prolonged periods of use, a pump pipe sometimes will work loose and fall into the well, necessitating the difficult job of fishing it out. A good way to prevent this trouble is to clamp the pipe so it will not drop even though it does

work loose. To do this, notch two hardwood blocks to fit around the pipe and drill them for two bolts. The blocks should be large enough to rest on top of the casing

and when notching them, be sure they will grip the pipe securely. To attach the clamp, the pump and pipe, of course, must be raised slightly above the well platform.

W. B. Kennedy, McCool, Miss.

## Retouching Marred Furniture

Here is an excellent way to touch up scuffed places and off-color spots on your furniture. First, obtain a tube of ground-in-oil color to match the finish. With the tip of the finger apply white shellac to the spot. Then, again with the finger, immediately daub a little of the color on the shellac. The shellac binds the color and both will dry together in a very short time. If there are many scratches, go over the entire surface with a coat of shellac, varnish or furniture polish. A good furniture polish can be made by mixing linseed oil, 2 parts, and turpentine, 1 part. Use a soft, lintless cloth to apply the polish to the surface.

Francis W. Henry, Pottsville, Pa.

## Rack Holds Table-Tennis Paddles

Two wooden arms fastened to a post in the basement recreation room provide a handy rack for table-tennis paddles. The arms are notched with a dado cutter or with a circular saw, and if the latter is used, the material between the cuts is removed with successive side-by-side passes of the work over the blade. One end of each arm is rabbeted so that when the arms are attached to a post the widest part of each paddle will fit snugly in the stopped grooves as shown.—Frank P. Fritz, Cicero, Ill.

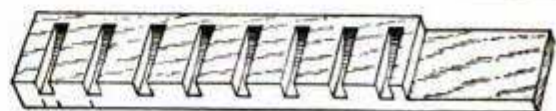
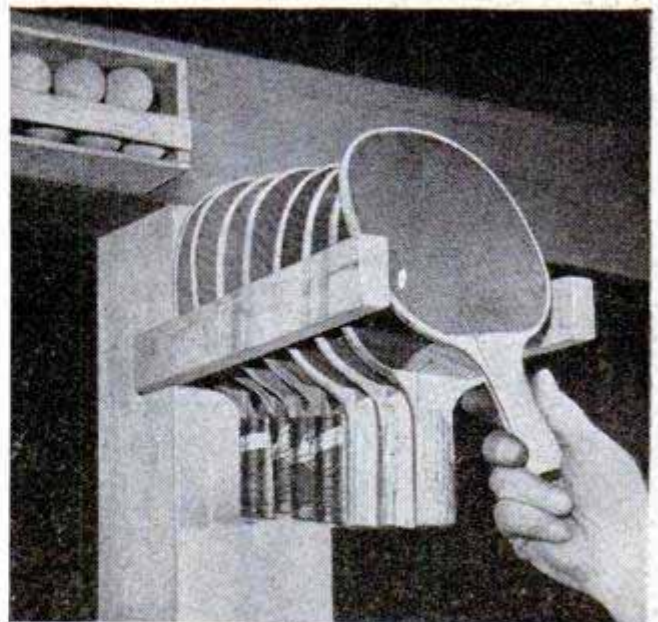



# Drawing Ellipses With a Compass and Triangles

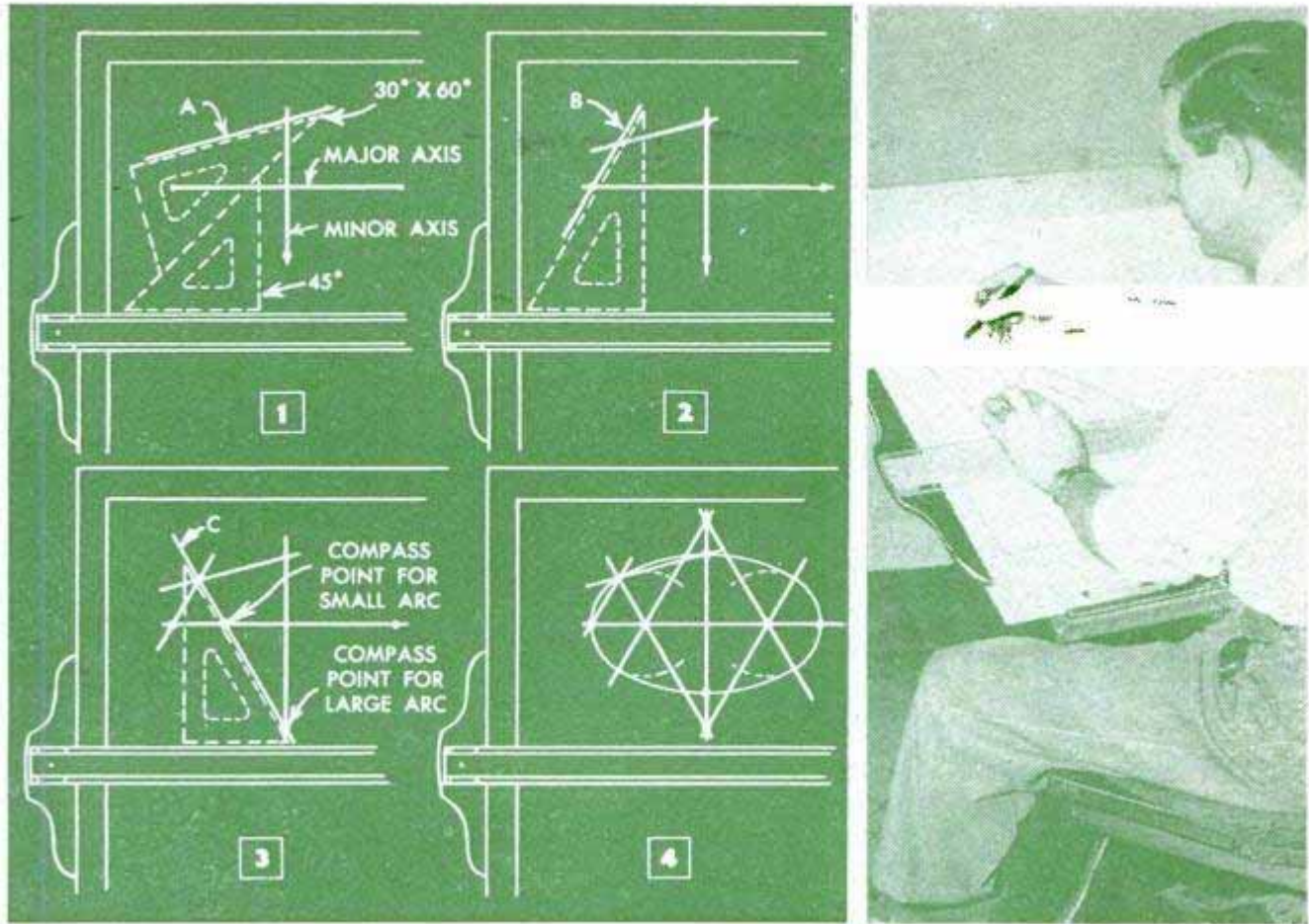

Here is an accurate method for drawing an ellipse suggested and explained in four simple steps by H. Drouyn, of Ottawa, Can. First, draw a major and a minor axis of a given length. Then, with a 30-60-deg. and a 45-deg. triangle placed as shown, draw line A, step 1. Next, from one end of the major axis draw line B with a 30-60-deg. triangle, step 2, to intersect line A. In step

3, a third line, C, is drawn from the point where lines A and B intersect, using a 30-60-deg. triangle placed in a reverse position. This establishes compass points for drawing the small and large radii of the ellipse. Finally, step 4, locate compass points in the same manner on each side of both axes and then complete the ellipse by swinging the circles.

## Retractable Garage Ladder Is Stored by Folding Under Attic Floor

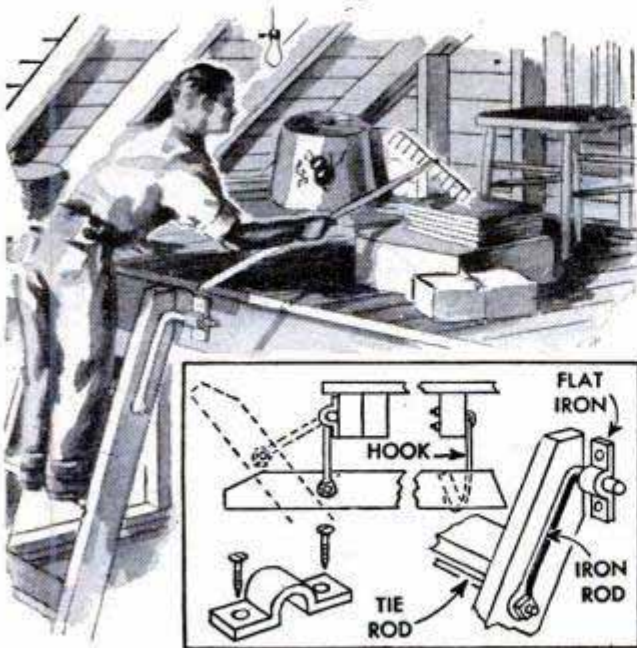

Storage space in the attics of larger garages often is not fully utilized because of the inconvenience of using a conventional ladder to gain access to it. However, this space can be reached with little difficulty and used to maximum advantage if a light-weight, yet sturdy, ladder is hinged to a joist as shown in the detail. Mounted in this manner, the ladder swings up under the floor and out of the way when not in use. It is held in the retracted position with a heavy wire hook stapled or fastened with a U-bolt to a joist.

Willard Midby, Billings, Mont.

Less time is required to hang a washing outdoors when cold weather makes the fingers tingle, if socks, handkerchiefs, etc., are first hung on wire coat hangers while indoors and then hung outside.





This box is built up of six parts cut square from contrasting woods and stacked alternately in order shown



Here, cover of aluminum is combined with two-tone base which is fitted with four ball feet of wood or plastic



Both boxes make attractive plant holders. This requires a metal container to be made to fit the shape of the box

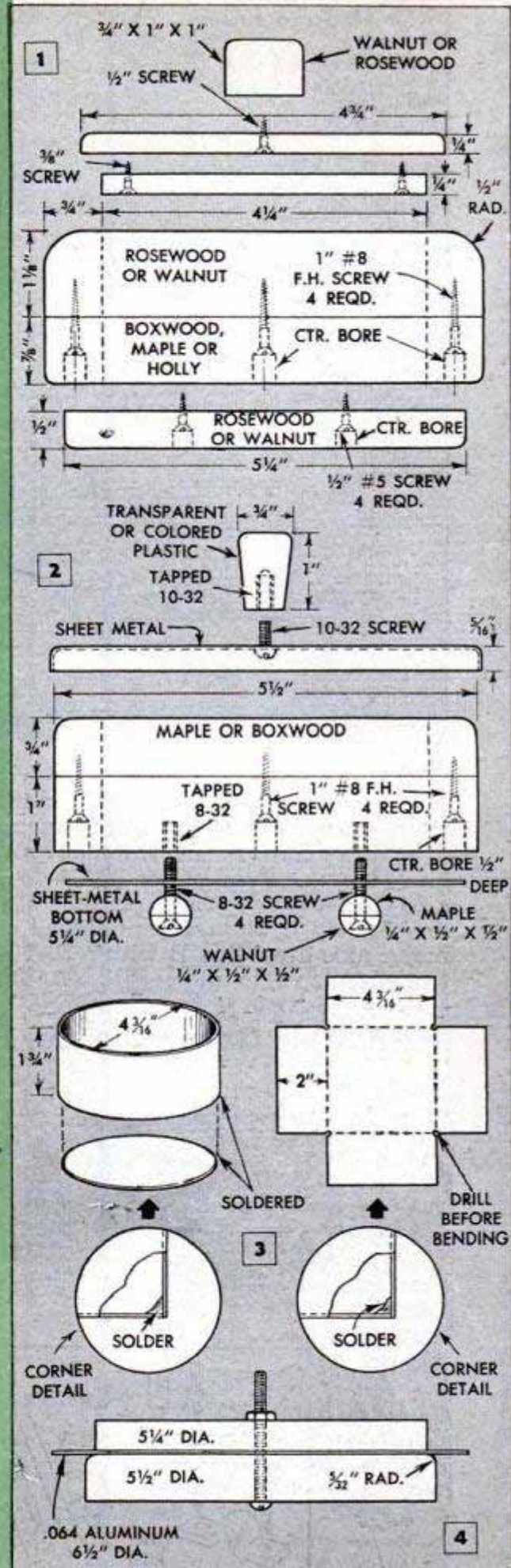



# NOVELTY BOXES

THESE novel candy and trinket boxes of contrasting woods will appeal to the inexperienced craftsman, as they are simple enough to complete in an evening or two with a few hand tools.

The square box, Fig. 1, consists of five blocks of contrasting woods and a knob, stacked in bread-and-butter fashion. The centers are cut from the two blocks that form the main part of the box and the end grain of these two blocks is placed at right angles to each other when gluing and screwing them together. In making up the two-part lid, be sure that the screws which are used to fasten the bottom piece do not pierce the upper face of the top piece. Note that the knob must be fastened to the lid before the bottom piece is attached.

The cover for the circular box, Fig. 2, is made of sheet aluminum and this part is formed first. This is done over a wooden form consisting of two disks, Fig. 4, one being of maple with the edge rounded and the other of pine and slightly smaller. A disk of soft sheet aluminum is sandwiched between the two wooden disks and then all three parts are drilled in the center and clamped together with a bolt. Now, the extending edge of the aluminum is hammered down over the edge of the maple disk, using a softwood block to prevent marring. In forming the edge, the metal will wrinkle, but inasmuch as the metal disk is oversize, this portion is trimmed off. If desired, a

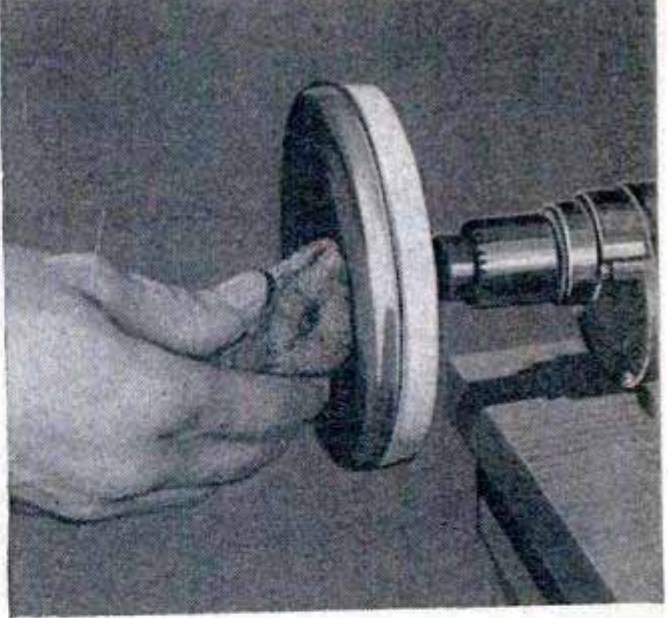

Spun finish is applied to metal cover by mounting work and wooden form in lathe or drill chuck and polishing with fine steel wool while work is spinning

spun finish can be applied to the cover. The bolt is reversed, chucked and then the aluminum is polished with fine steel wool.

The maple disk forms the upper half of the box, and after sawing out its center, it is screwed to a walnut disk of the same size which also has the center cut out. The bottom of the box is covered with an aluminum disk and wooden or plastic ball feet are fastened to the bottom of the box through holes in the metal disk. A plastic knob is attached to the aluminum cover. If the boxes are to be used to hold small plants, a metal liner, Fig. 3, is cut and soldered together to fit the box loosely.

## Pin-Up Bracket Provides Hanging Holder for Ivy or Potted Plant

Here's an attractive little project that can be produced with your jigsaw alone. It's cut from plywood, with 1/2-in. solid stock being used for the arm of the bracket and the parts to which the scrolled pieces are nailed. Jigsaw the latter, following a pattern drawn full size. After nailing the four pieces together to form a cage, cut and nail the two circular shelves in place. This part of the complete plant holder is suspended from the wall bracket with two screw eyes by opening one of the eyes to engage the other and then closing it by squeezing with pliers.

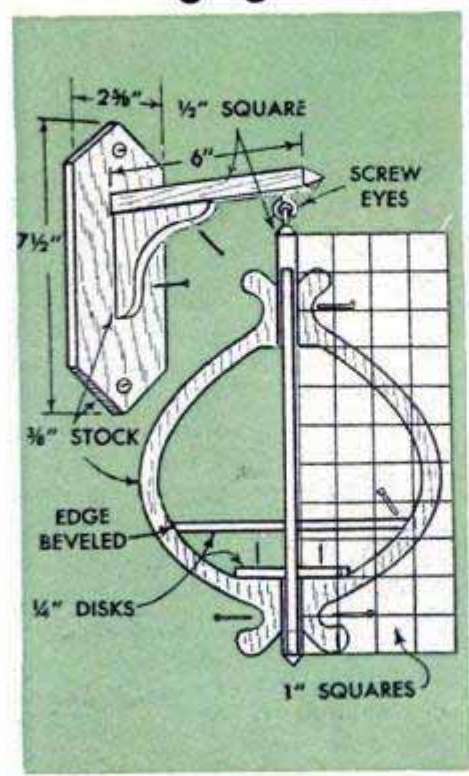



## Amusing and Educating Spelling Game Provides Hours of Worthwhile Fun

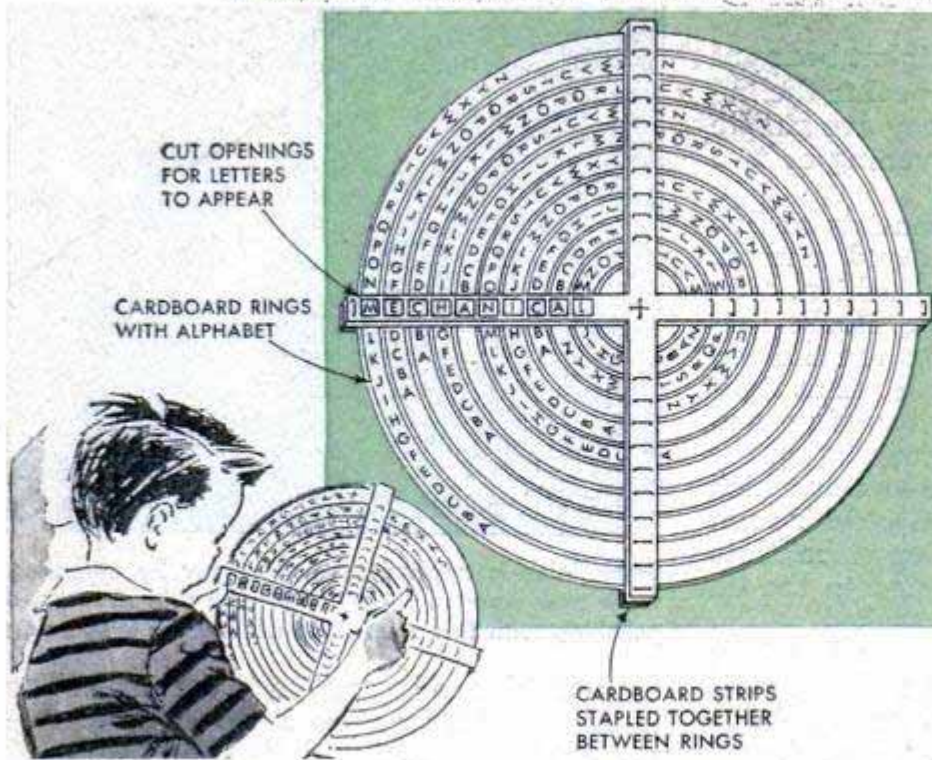

Whether amusing himself alone or playing with other children, the youngster of school age will have hours of educational fun with this unusual spelling game. When the rings are rotated in the frame, letters of the alphabet printed on the rings appear in the windows cut in one of the cross members. The rings are cut from heavy cardboard and the frame, also of cardboard, consists of front and back strips stapled together in the form of a cross. The rings are held in place and spaced to align with the windows by inserting staples between them through the arms of the frame.—Opie Read, Jr., Chicago.

## Frame Holds Batt-Type Insulation Overhead to Free Hands for Nailing

When converting an attic into extra rooms, and it is impossible to insulate the ceiling from above, this self-gripping frame holds batt-type insulation in place and frees both hands for nailing. In use, the batt is rested on the frame and raised into position. Then, the fixed and movable members of the frame are grasped with one

hand and squeezed together. This spreads the hooks apart so they will slip over the outer faces of the joists. When the parts are released, the hooks grip the joists, holding the frame and consequently the batt in place. The frame consists of wooden strips, two springs, and hooks bent from wire clothes hangers. The movable member is not screwed to the frame as it is supported by the long hooks which run through screw eyes turned into the cross members. The dimensions given in the detail can be varied to suit the spacing of the joists. Note that blocks are fitted to the upper side of the frame to raise the batt into nailing position. Frame is moved as nailing progresses.

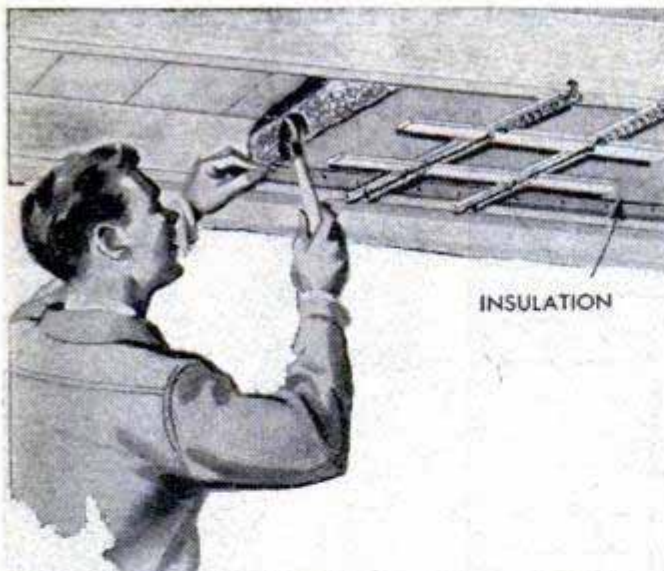

Robert N. Abild, New Britain, Conn.

## Dividing a Board in Half

Many carpenters locate the center of a board quickly by using a square in the following manner. First, a line is drawn across the board perpendicular to its edges. Then the square is placed on the board so that the reading is identical where each leg of the square intersects the line at the edge of the board. When this has been done, the corner of the square is at the exact center of the board.

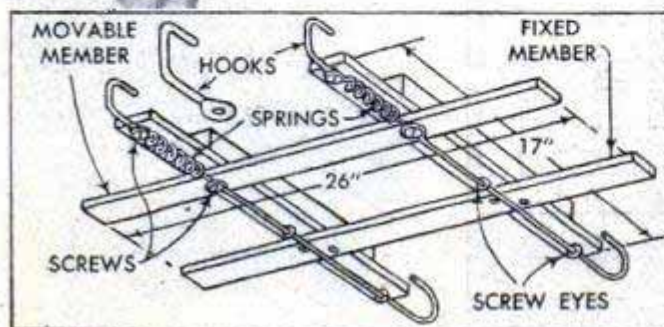
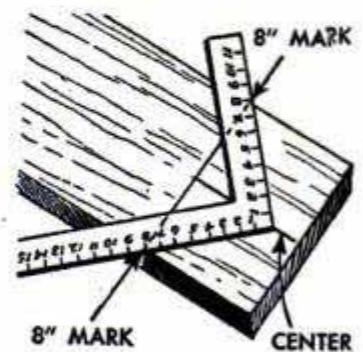





Although ceramics, or pottery making, is one of the oldest of the arts, hobbyists still can turn a neat profit from custom work in their own original designs. Anyone can build the necessary equipment at small initial cost

# CERAMICS

By  
*Hi Sibley*

AS OUTLINED by Miss Jane Poyer, nationally known authority on ceramic sculpture, there are two methods of making pottery. One method is casting in plaster molds and the other is turning or throwing on a potter's wheel. The former process permits a great variety of design ranging from a simple dish to intricate groups of figures. Also, there are many minor variations of both processes. In casting, a clay model of the subject is first made and plaster of paris is poured over it to form a two-part mold. For the more intricate shapes the mold is often made in several parts. When the plaster has set, the mold is opened and the model removed. The mold is again assembled and is filled with liquid clay, or slip. When this has set or solidified sufficiently to hold its shape, the mold is again opened and the clay casting removed. Rough edges are carefully scraped off and the entire surface of the casting is smoothed with a wet sponge. Then it is placed in a kiln for bisque or hard firing. Following this, color is applied with brush or spray, the piece is dipped in a glaze solution and is then glaze-fired in the kiln, giving it the glossy surface of the finished product. In the process of throwing on the potter's wheel, the object is shaped freehand without use of either a pattern or mold.

For general work in ceramics the hand tools required are spatulas, scrapers, a sharp-pointed knife, several soft brushes, a spray gun, and a mortar and pestle for mixing colors. If the firing is done in a home kiln, special kiln furniture will be needed such as shelves, shelf supports and saddles and stilts on which the work is supported while being fired.

Modeling clay can be purchased from dealers already prepared for use, or it may be prepared by the user from the raw clay. Liquid clay or slip also can be obtained from dealers, but if required in quantity,

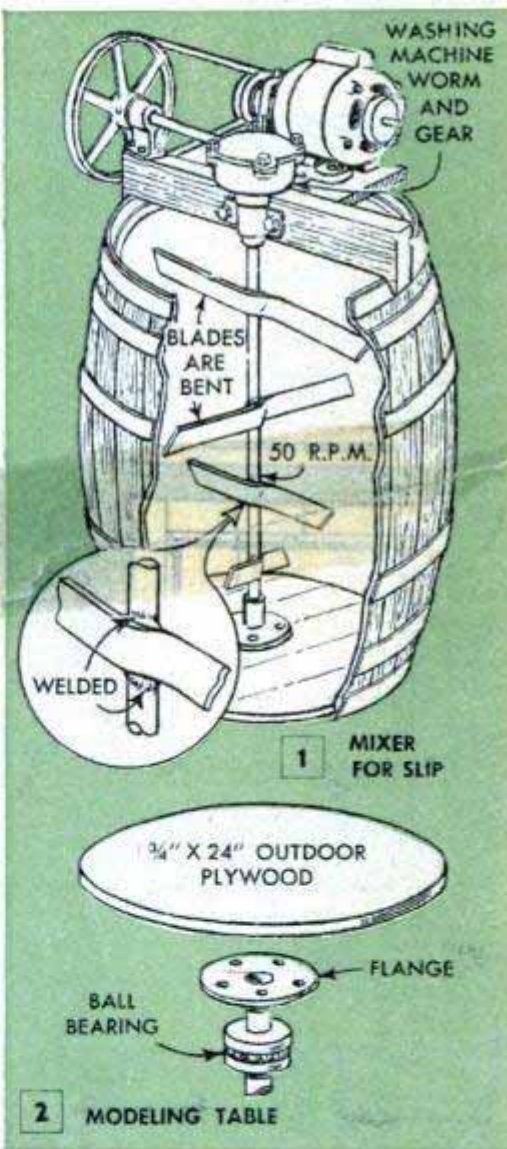

An efficient mixer for slip is made from a hardwood barrel and a reduction gear from an old washing machine. At top of page, Miss Poyer, nationally known ceramics artist, with examples of her work



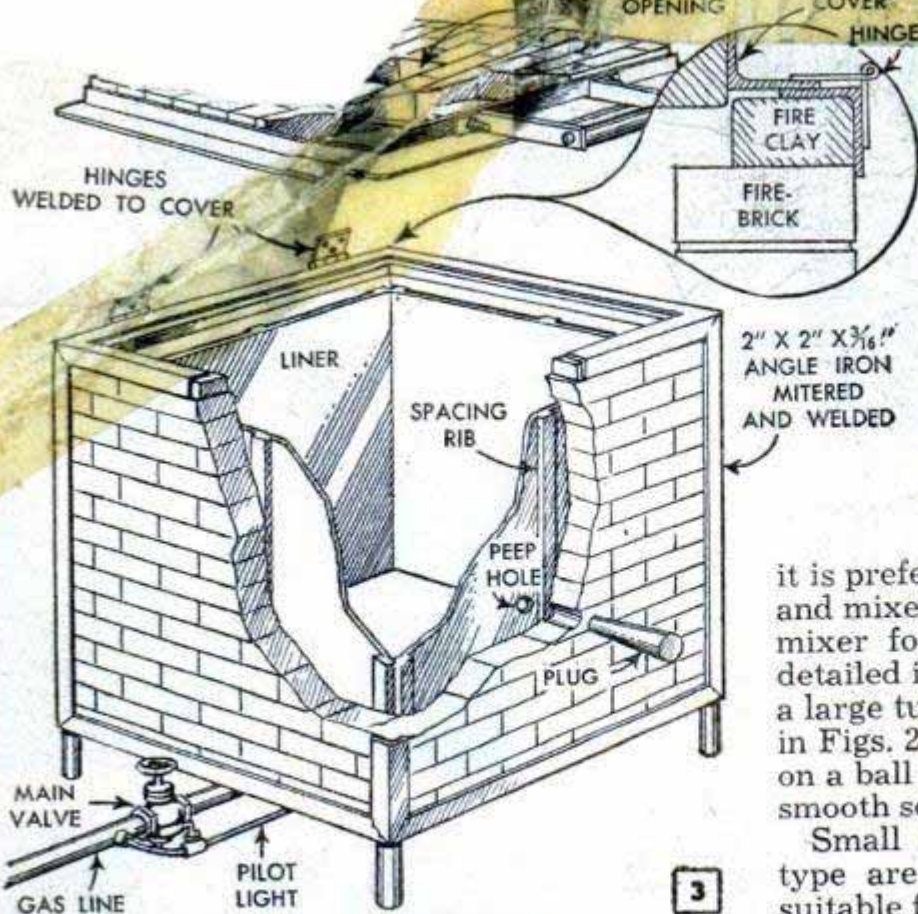

Wooden spatula is used to smooth clay after it is modeled to shape

it is preferably purchased as a powder and mixed as needed. A motor-driven mixer for large quantities of slip is detailed in Fig. 1. Modeling is done on a large turntable, such as that detailed in Figs. 2 and 6. The table is mounted on a ball bearing and its top should be smooth so that it can be cleaned easily.

Small electric kilns of the bench type are convenient to use and are suitable for firing small pieces. A gas-fired kiln, for commercial production,

is detailed in Figs. 3 and 4. It consists of a firebrick shell set in a frame made from angle iron. An inner shell is formed from fire-clay liners and heat from the eight gas burners passes between the liner and the outer wall, and out the opening in the lid, Fig. 3.

The step-by-step process of making a piece of cast pottery is shown in details A to J inclusive, Fig. 5. First, the modeling clay is kneaded on a plaster-of-paris slab, or batt, and the piece, designed in sea-

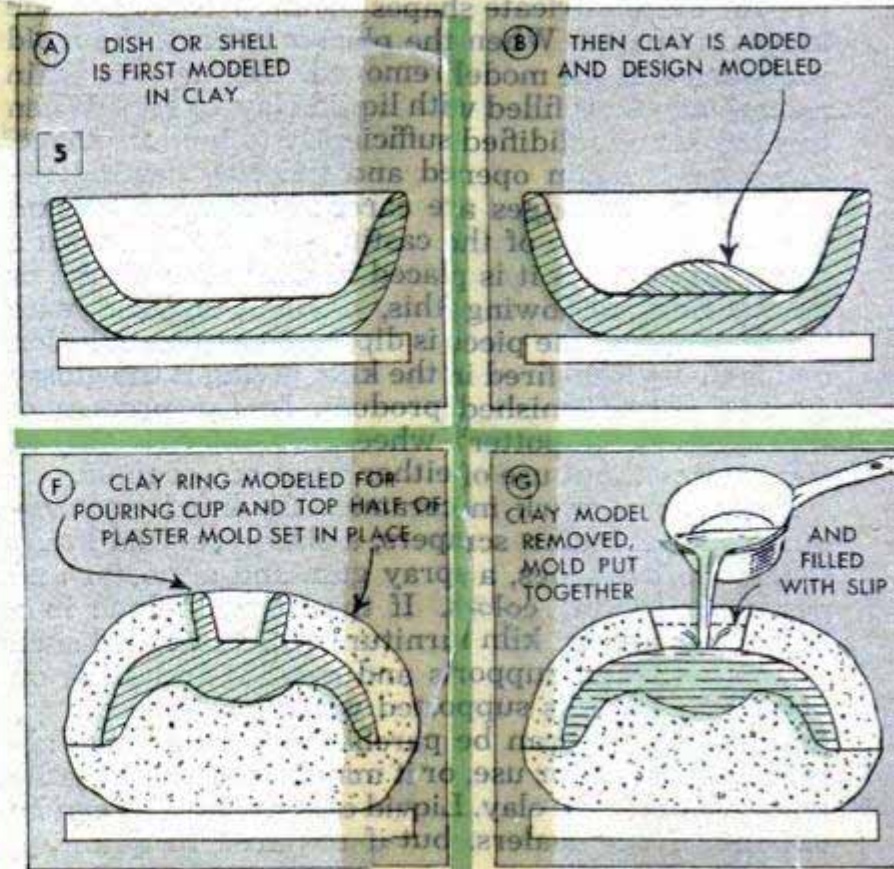
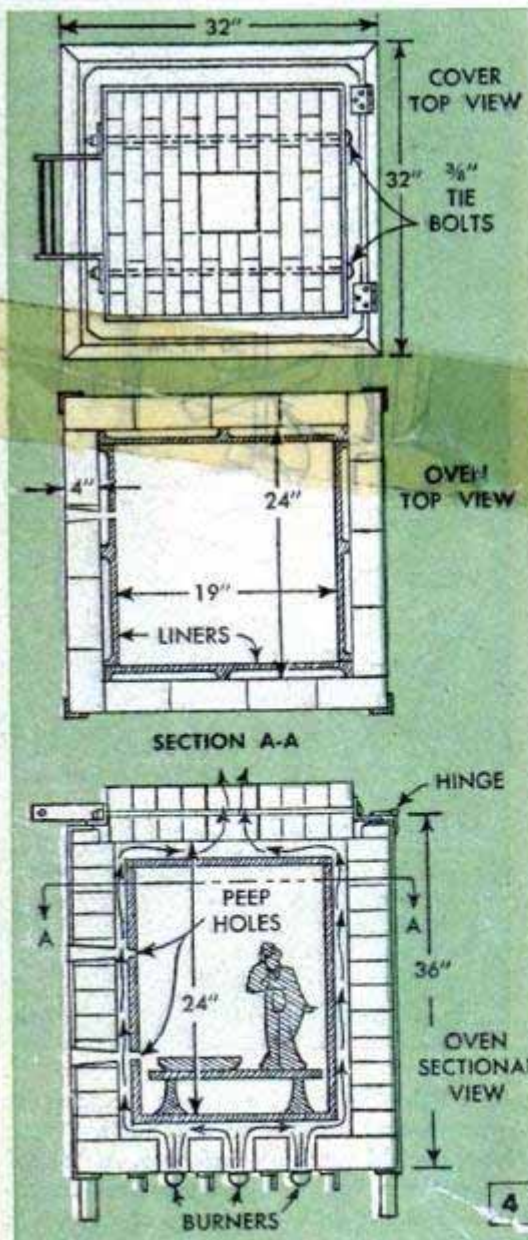



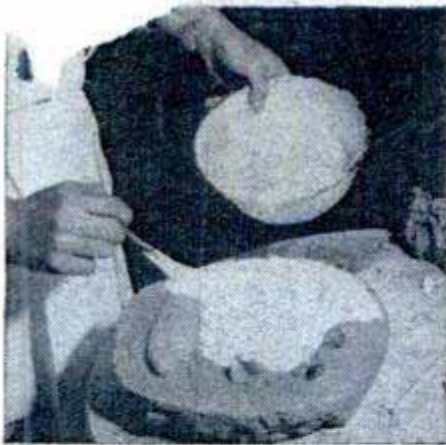

Plaster is brushed on lower half of mold. Coating must be uniform

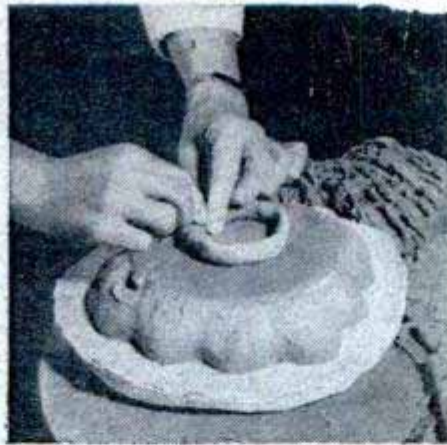

Clay ring makes pouring cup on bottom of shell. Ring is removed



After trimming at the joint, mold is pried open and shell removed

shell motif with a fish ornament at the center, is roughly shaped with the hands on the turntable to the sectional shape shown at A. Then, a clay roll is added to the bottom from which the fish is to be modeled. Both shell and fish are gradually molded into shape with the fingers, which are kept moist with a sponge. Wooden spatulas and wire cutting tools are used in the finish modeling of both parts. Plaster of paris is brushed over the surface and a clay wall is built around and under the shell and brought up flush with the rim. Then build up the plaster on the model until about 2 in. thick, detail C, as a thinner mold will not absorb moisture sufficiently to dry the casting properly. In preparing plaster of paris, pour the dry powder into a basin of water until an island is formed. When this absorbs the water and begins to settle, mix with the hands, squeezing out the lumps.

Now turn the piece upside down, detail D, remove the clay wall around the shell, and apply either a plaster separator or green soap to the rim of the plaster so that the fresh plaster of the other half of the mold will not adhere. Notch the edges on opposite sides so that the two halves can be fitted together again in exact register. Make a clay ring and place it on the bottom of the model, detail E. This is formed into a pouring cup.

Build up the second half of the plaster mold as in detail F. When it has hardened, trim around the joint with a knife and carefully pry the mold open. Remove the clay model or pattern, clean the mold and put it together again. The halves are held in place with strong rubber bands, Fig. 6. Slip is now poured in as in detail G until it fills the mold nearly to the top of the pouring cup. As the plaster mold absorbs

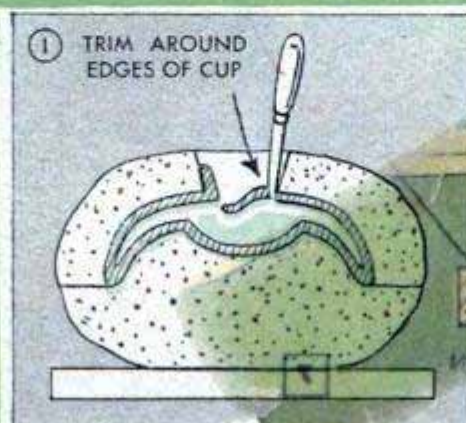
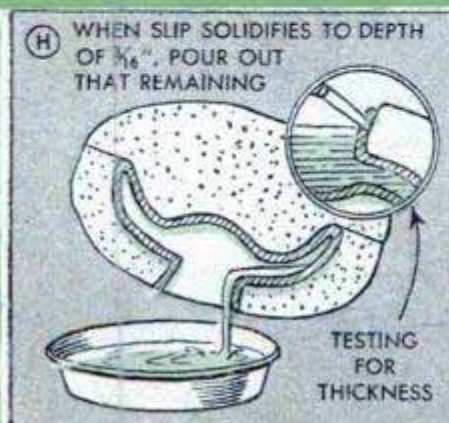
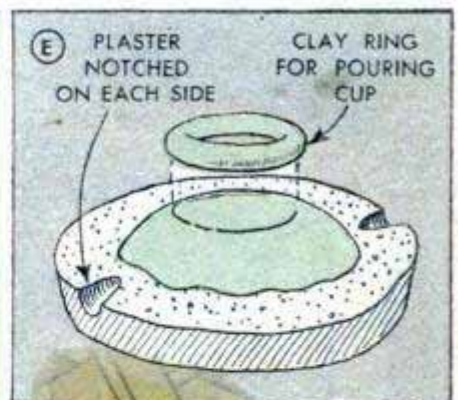
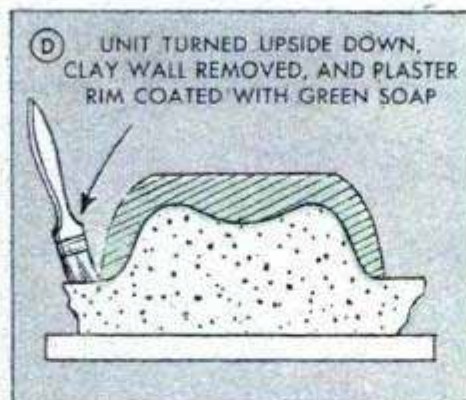
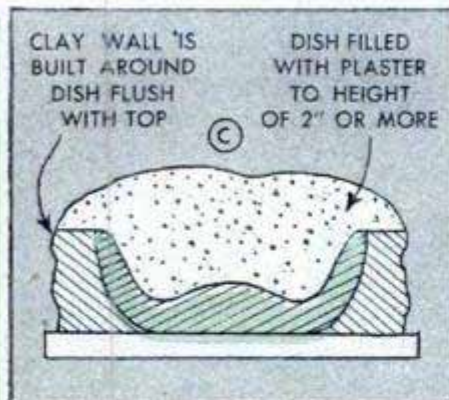





Left, mold is assembled and slip is poured in. Above, after bisque firing and coloring, piece is dipped in glaze

water rapidly, the slip in contact with it will solidify and the level of the slip in the cup will recede. After it has gone down  $\frac{1}{4}$  in. or so, make a knife cut near the top, detail H, to test for thickness and when the solidified slip is from  $\frac{1}{8}$  to  $\frac{1}{4}$  in. thick, invert the mold and pour out the unsolidified slip. Now carefully trim around the edges of the cup, as in detail I, so that the mold can be opened without breaking the shell-like casting, which shrinks away from the mold sufficiently so that removal will be comparatively easy when the mold is opened. Castings with thin edges should be removed with care to avoid breakage.

Finally pry the mold open with a knife blade and lift out the casting very carefully. Scrape off any fins and smooth the piece with a damp sponge. It is now ready for bisque or hard firing and is placed in the kiln on stilts to raise it off the floor. Pyrometric cones, Fig. 8 are placed just opposite the peephole. These are numbered for various temperatures and the cone marked 04 is used for bisque as it bends or "wilts" at 1922 deg. F. The cone becomes red hot and is easily seen in the dark interior of the kiln through the peephole. When it begins to bend, the heat is turned off. Length of firing time depends on the

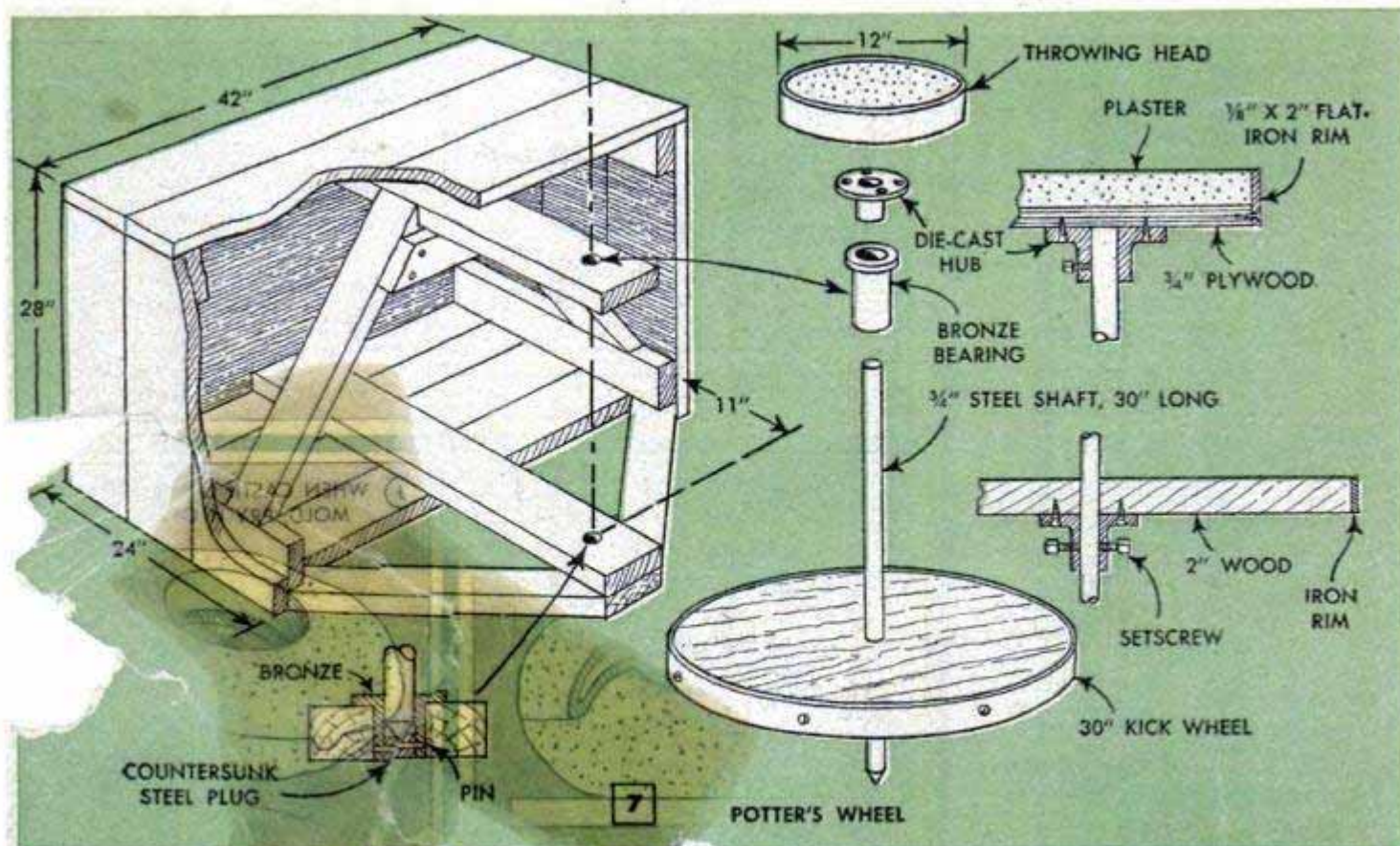



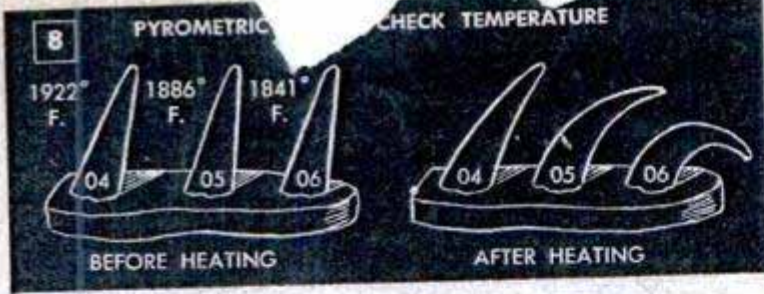

gas pressure, the type of kiln used and other factors. In regular practice, the heat is turned on at lowest adjustment for two hours or so to warm the kiln. Then it is turned up full. Four to eight hours at full heat are required in hard firing.

Coloring with engobe, or colored slip, is the next step. The colored engobe comes in dry form and is prepared according to the directions supplied. Engobe is laid on in a uniform coating but is not brushed out like paint. It will appear flat and colorless before firing, but the application of heat brings out the true color. Colors also are applied with a spray gun. After coloring, the glaze solution is applied, either by spraying or dipping. In dipping, the piece is immersed in the solution, and the portions held by the fingers are later painted over with the solution. The piece is now placed in the kiln and fired for about an hour to set the glaze and impart a glossy finish.

In its simplest form the potter's wheel consists of a rotating disk propelled by means of a kick wheel. A refinement is the electrically driven wheel with variable speeds. A simple design employing the kick wheel is shown in Fig. 7. Essential features are a strongly braced frame, with an easy-turning kick wheel and throwing head, or disk, upon which the subject is modeled. Distance between top of bench and kick wheel either should be adjustable or fixed at the most convenient and comfortable height for the operator, who straddles the shaft and rotates the wheel by a forward motion with the right foot and backward with the left, the motion being from the knees downward. Construction details are shown in Fig. 7, 2-in. material being used throughout to make a rigid structure. The two shaft bearings are flanged bronze sleeves, the lower one having a countersunk plug of brass or cast iron on which the shaft rotates. Ordinarily, the kick wheel is made from wood with a heavy iron rim, or tire, to give the effect of a flywheel. For the throwing head, many potters prefer a plaster surface as the clay adheres well and surplus moisture is absorbed. This type is made with an outdoor-plywood bottom fitted with a sheet-metal rim. When assembled the head is filled to the top of the rim with plaster of paris. Both disk and kick wheel are fastened to the shaft with flanges, the lower one being adjustable by means of setscrews.

Other necessary equipment is illustrated in Fig. 9. The bowl of water always contains a piece of leather or felt for smoothing clay on the wheel. The other items are a sponge, cloth, two brass scrapers, an oval and a triangular rim cutter,

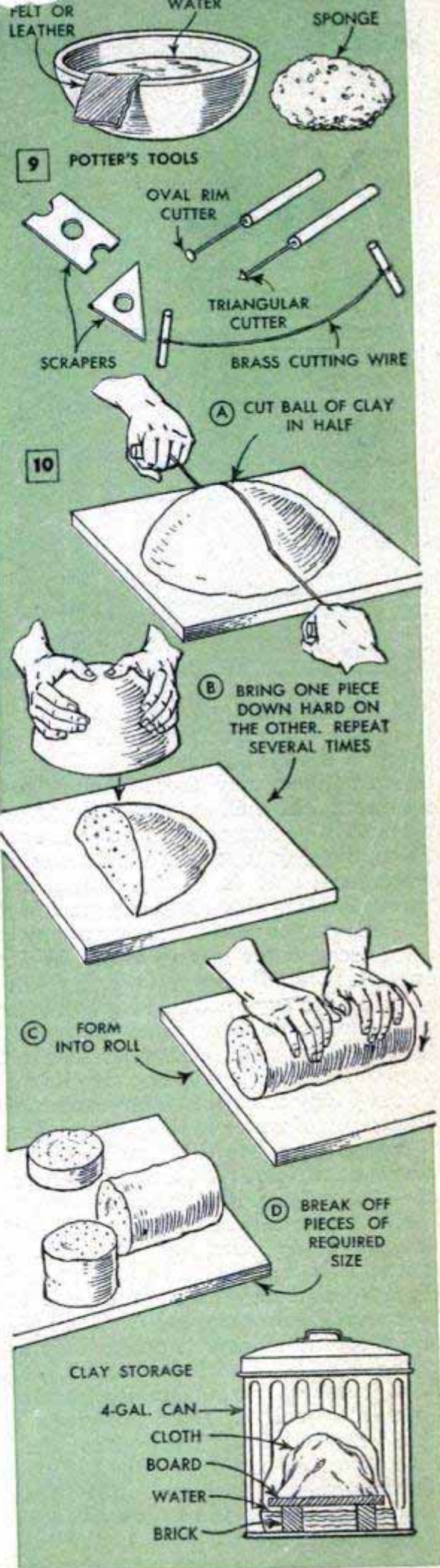



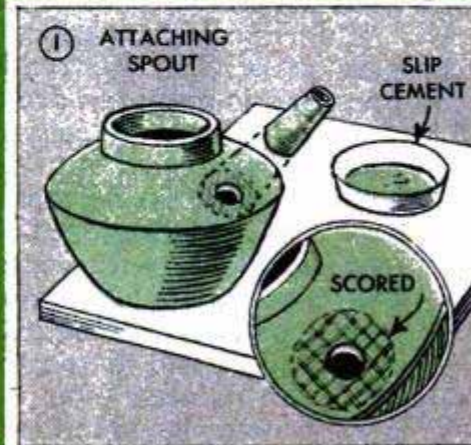
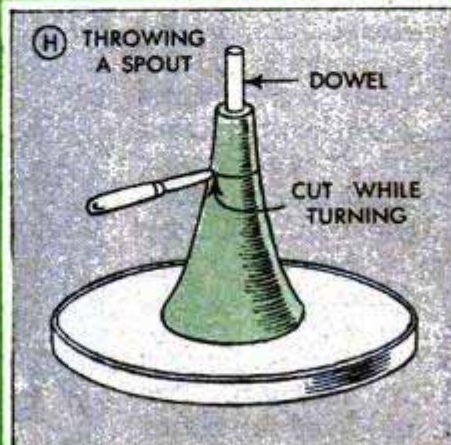
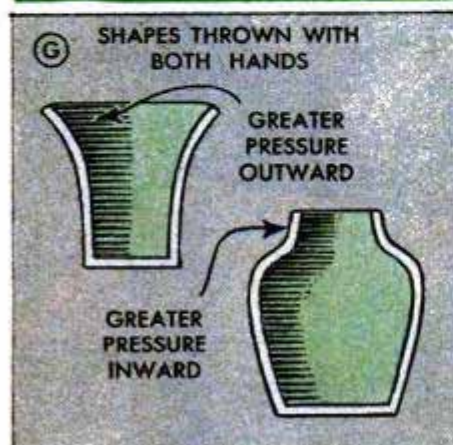
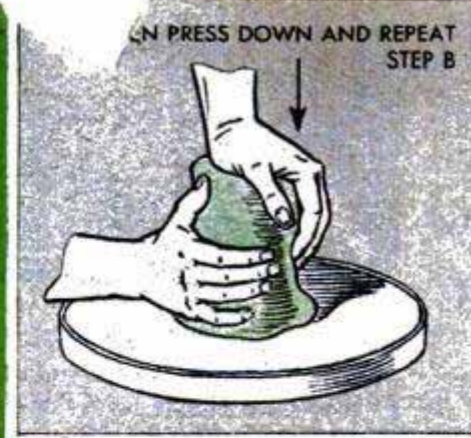
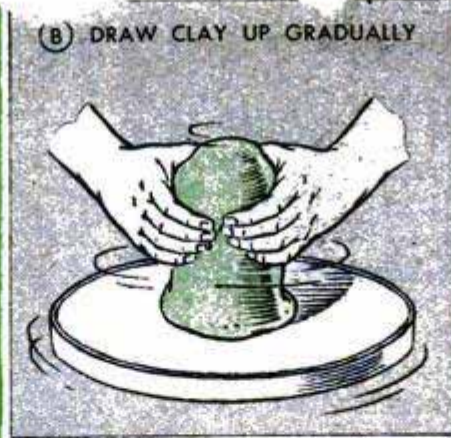

and a brass cutting wire with two wooden handles. Some potters prefer to dig and prepare the clay themselves. Others purchase refined clay from dealers to save time and labor. Clay freshly dug from the pit should be seasoned through the winter. Then, the clay is powdered and mixed with water until it is thin enough to pass through a fine sieve into a large container. It is allowed to settle for several days, then the excess water is poured off. When dry enough to handle, spread it on a clean floor and allow to dry until stiff enough to knead. This can be done by hand, with the bare feet or in a pugmill. Further seasoning in a cool, damp place will improve its quality. Unused clay is kept in a covered can with about 2 in. of water in the bottom. The clay is placed on a board supported above the water on bricks. A cloth is then thrown over the mass, with the ends in the water.

Fig. 10, details A to D inclusive, shows how to prepare clay for the wheel. Work it into a ball the size of a round loaf of bread and place on a clean board. Cut in half with the brass wire, A. Then pick up one piece and bring it down hard on the other as at B. This is known as wedging. Repeat several times, finally forming the mass into a roll, C. Break off pieces of the sizes required, D, and mold them into balls.

In throwing a simple dish, a clay ball is placed firmly in the center of the throwing head, Fig. 11, and the hands are dipped in water. Start the wheel in motion and cup the hands over the clay, pressing down on

the disk, A. Now draw the clay upward with a slight pressure of the hands as at B, and then force it down again with the palm of the left hand. Repeat several times, detail C. This aids in conditioning the clay. Press both thumbs down in the center of the rotating mass to start a hollow, or depression. Widen this by inserting fingers of the left hand, D. Continue widening the hollow by using both hands, at the same time manipulating the rim with the fingers to bring it to the required thickness and height. Ridges are rubbed out with the fingers and a piece of wet felt, and the rim is smoothed with the square scraper, as in E. The knack of forming the clay into the various shapes is easily acquired after a little practice. Cutting the work from the throwing head is done as in detail F. When cutting work from the throwing head with the wire be sure to hold the wire taut as it may loop or kink and cause damage.

Throwing vases and jugs calls for much the same procedure, except that a larger ball of clay is used and the sides are drawn higher. Details G to L inclusive, Fig. 11, show the common technique quite clearly. For making the outward flare of a vase, simply exert greater pressure with the fingers of the left hand inside the rim than with the thumb of the same hand on the outside. The reverse movement shapes the curve in a jug, or teapot, as in G. The spout for a teapot is made by throwing a clay cone around a dowel and cutting it off at the required length with a knife while the



D START DEPRESSION IN CENTER WITH THUMBS AND FORM A RIM AS BELOW



E SMOOTH THE RIM WITH A SCRAPER



F CUT SAUCER FROM THROWING HEAD WITH A WIRE

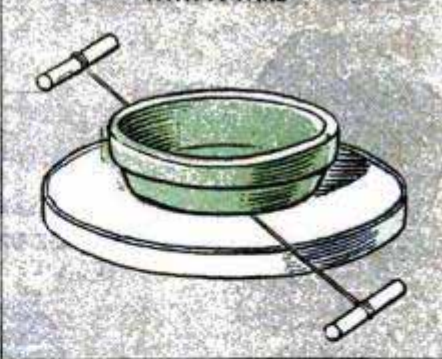

J DRAWING CLAY FOR HANDLE

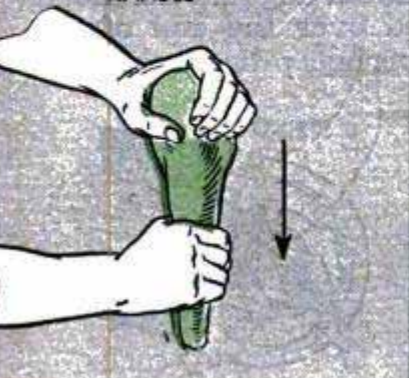

K ATTACHING HANDLE

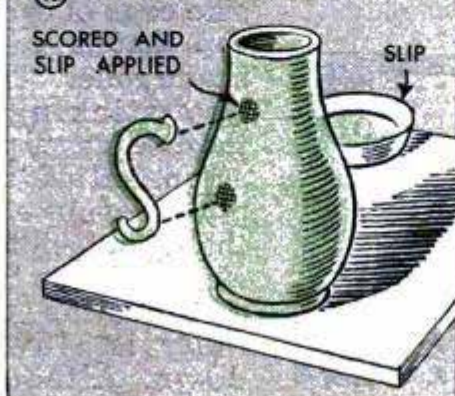

L FORMING A LIP



work is in motion, as at H. A hole is then cut in the pot the size of the dowel. The clay around the hole is scored and slip is applied, which acts as a cement when the spout is gently pressed against the pot, as in detail I. To make handles, start with a pear-shaped ball of clay, as in detail J. Hold the clay in the left hand, wet the right hand and gradually draw a long, conical shape. Then, without using any pressure from the thumb, draw out the shape with the fingers to the size required. The handle is bent to shape and the ends are flattened as shown in detail K. It is then attached to the pot with slip in the same manner as the spout. To form a pouring lip on a jug or vase, work with the index finger of the left hand inside and thumb and index finger of the right hand on the outside, as in detail L. Procedures in coloring, firing and glazing are the same as used when processing castings.

Overlay decorations are applied by means of plaster dies, Fig. 12. A pat of clay is pressed into the die, the excess scraped flush with a straight-edge, and the die with the clay in it is pressed against the surface of the work.

### "Canned" Ice for Picnics

Ice frozen in empty beverage cans may be carried with perishable picnic foods in any closed container. Cans which have been punctured with the special opener are most suitable. These are filled with water almost to the top and placed in the freezing compartment of the refrigerator. Wax paper held with a rubber band seals the top of the can.

A. H. Parks, Bloomfield, N. J.

12

PLASTER DIE



PRESS PAT OF CLAY INTO DIE

CLAY

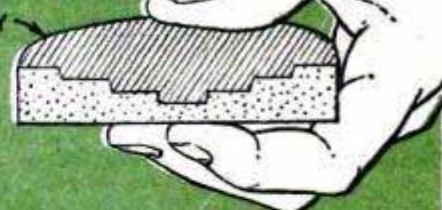

DECORATION IN RELIEF

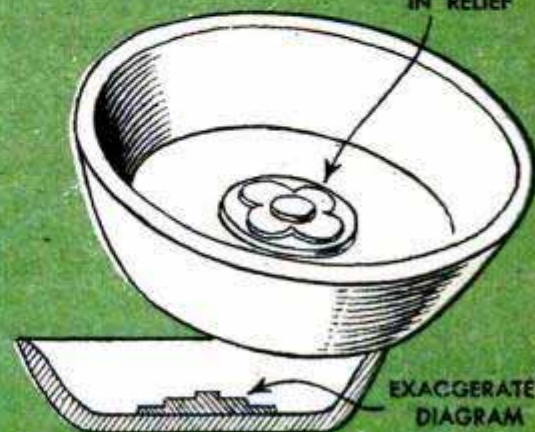



## Signal on Bottom of Mailbox Signals Mail Delivery

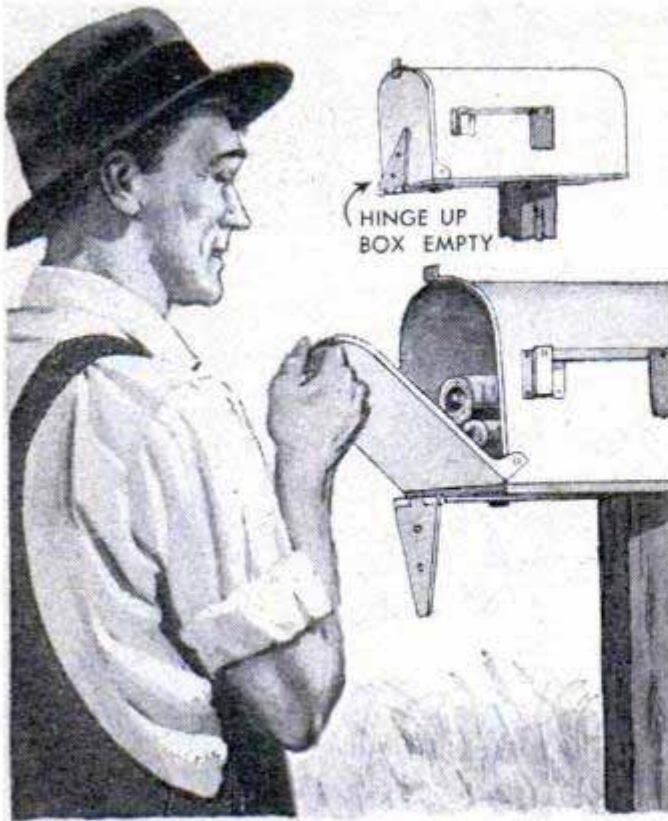

To eliminate unnecessary trips to my mailbox, I devised this automatic signal which shows when mail has been delivered. It consists of a barn-door hinge, screwed to the bottom of the box, so that the hinge barrel projects about  $\frac{1}{2}$  in. from the front of the box, permitting the leaf to be propped up against the door. After I remove the mail from the box, I prop the hinge upright, and when the postman opens the box later to deposit mail, the hinge drops down. As my mailbox faces the house, I painted the hinge leaf bright red so it can be seen from the window.

Joseph Amorose, Richmond, Va.

## Doorknob Rattle Silenced With Rubber Washer

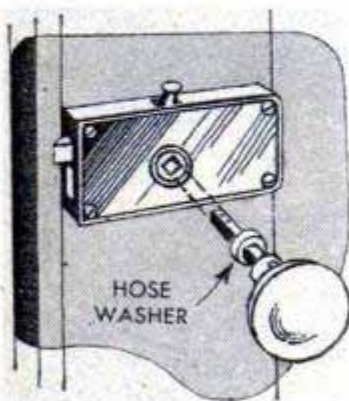

Although thin washers usually are provided to take up end play in the knobs of a rim-type door lock, wear often causes the knobs to become loose and produce an annoying rattle. If this occurs, a rubber washer slipped

over the square shank, as shown, will effectively stop the noise. A small-size hose washer will do, or one can be cut from a piece of sheet rubber or inner tube. In re-

placing the knob, it will be necessary to press the knob against the washer to compress it so that the original setscrew hole in the shank can be used.

A. H. Waychoff, Phoenix, Ariz.

## Slipping Window-Shade Clutch Corrected by Small Springs

If a window shade snaps up to the roller without warning, or is difficult to stop where you want it, chances are that the clutch assembly has become worn. This condition can be remedied by installing a small, U-shaped spring between the outside edge of each clutch dog and the metal cap that is pressed over the end of the shade roller. The springs prevent the dogs from sticking in the disengaged position, and also apply pressure to them to facilitate engaging the notches as the roller is slowed down. Although almost any thin spring material

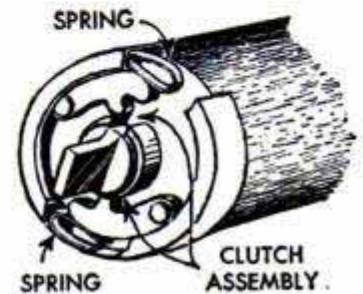

will do, phosphor bronze is the best for this purpose, and the springs should be cut narrow enough so they will not bind between the side of the cap and the face of the clutch assembly. The springs are installed by bending up the overlapped edge of the metal cap near the end of each dog to permit inserting a spring, as shown. Then, when the cap is bent back in place, it is dented at the looped end of each spring.

Wm. E. Danneman, Chicago.

## Tags Aid in Locating Drain Plugs

Inconspicuous drain plugs at key points in a plumbing system are likely to be overlooked when the system is serviced by persons unfamiliar with it. For this reason, it's a good idea to attach a sheet-metal or plastic tag to each



plug. If the tags are painted in bright colors with contrasting lettering, they will be easy to locate. The plugs are drilled and tapped to take a small machine screw which is used to fasten the tag. The plastic tag is wired to the screw, but the sheet-metal tag is attached directly to the plug.

J. Modroch, Danbury, Conn.



# CONCRETE HOTBEDS

*provide subsurface watering*

At right is the installation for the subsurface watering of concrete hotbeds. Watering channels are formed by pressing a length of 2-in. pipe into concrete

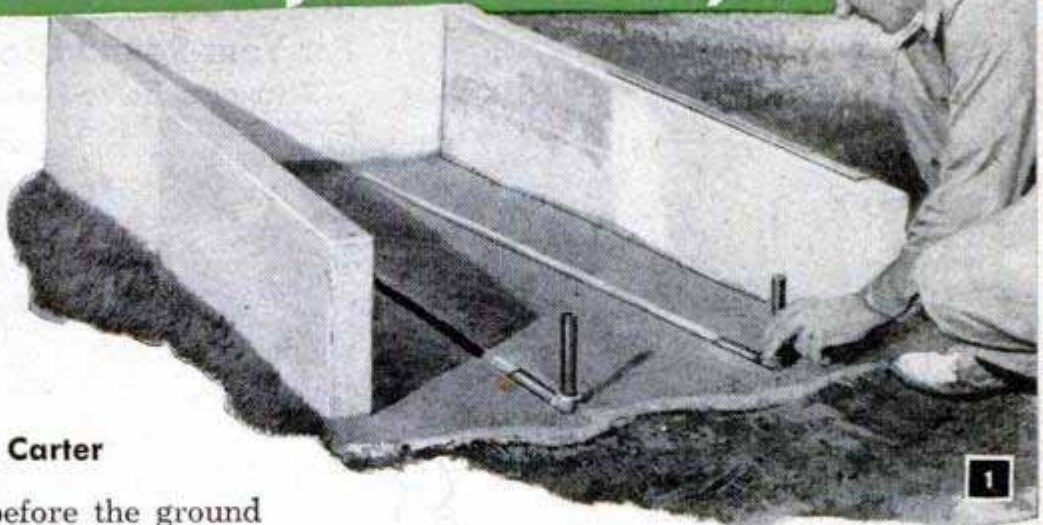

By J. F. Carter

**R**IGHT NOW, before the ground freezes, is the time to build concrete hotbeds. First make hinged forms as in Figs. 3 and 4. Diagonal corners on each form are hinged so that a side and one end open outward. On the upper left-hand corners of both side forms, Fig. 3, the mitered ends are cut at a greater degree so that the hinged side will close. To cast the parts, place the frames on a level surface, Fig. 2, then fill with cement and strike off level. Set the precast sides and ends on a freshly poured concrete bottom, Fig. 1, and form water channels in the bottom with a length of pipe. Screw two 1/2-in. pipe nipples into an elbow and place one of these units in each channel. Water is poured into these through a funnel.

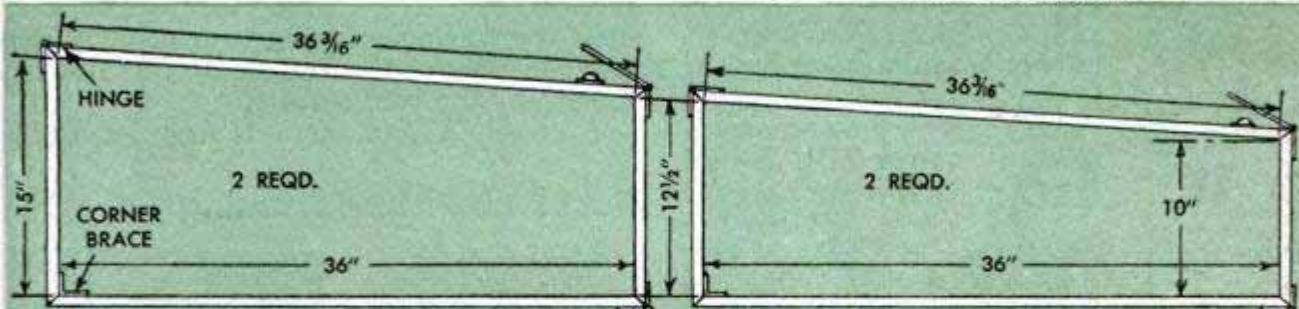

SLOPING SIDE FORMS

NOTE—ALL STOCK 3/4" X 3" PINE

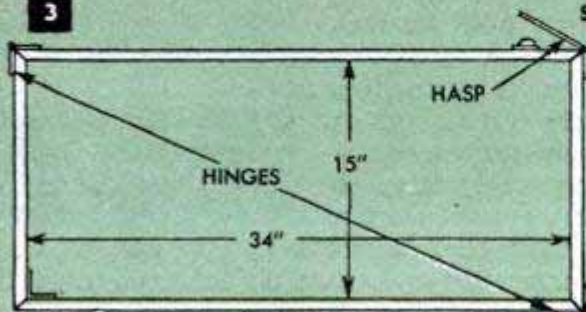

HIGH END

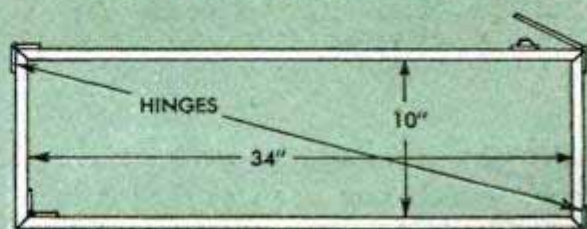

LOW END



## Counter Rack Keeps Trays Handy



If serving trays are used often, this simple rack fastened to the end of a kitchen counter, will save many steps. The rack consists of a bottom board, two side pieces and two front members which are nailed together as shown and then attached to the cabinet from the inside with screws.

Elizabeth Clarke, Syracuse, N. Y.

## Rifle Support and Muzzle Cap Made From Tin Can

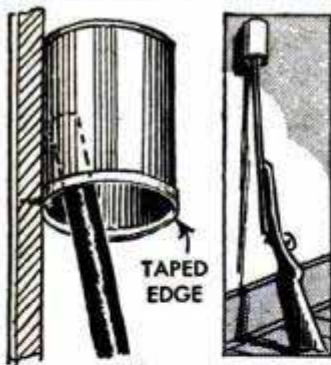

By nailing an inverted can to the wall of his cabin, one man made a useful combination gun support and muzzle cap for his hunting rifle. The can was fastened at a height that permitted the barrel of the gun

to be slipped into it with the butt resting on the floor. In addition to protecting the muzzle against falling dirt and possible damage, the can also allows circulation of fresh air, thus preventing rust caused by accumulation of moisture inside the barrel. Cover the sharp edge of the can with adhesive tape to avoid cutting the hands.

## Removing Cork Pushed into Bottle

A cork which has been pushed into a bottle can be removed by filling the bottle with enough ammonia to float the cork.

After a period of about 48 hours, the ammonia will have caused the cork to crumble and it then can be poured from the bottle.

Gerald Iannuzzi, Jr., Yonkers, N. Y.

## Raise Your Own Fishing Worms For Year-Round Use

You can have fresh, healthy fishing worms in the driest weather when they are hard to find, for ice fishing all winter long, and for fishing in the early spring, if you raise them in the following way.

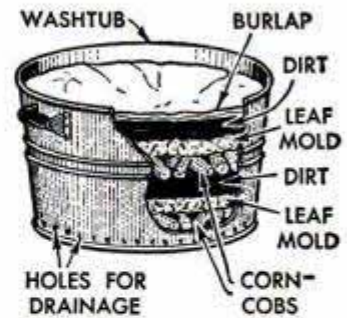

An old washtub, which makes an excellent, easily moved container for the worms, is prepared by punching a row of holes around the lower part of its side and a number of holes in the bottom to allow for drainage. Then, because the worms breed and multiply, cover the bottom of the tub on the inside with a piece of screen wire to prevent small worms from falling through the drain holes. Place a layer of corncobs, broken into short lengths, over the screen wire, next a layer of well-rotted leaf mold, and then a layer of rich soil. Repeat this procedure until the tub is nearly full, and lay several burlap sacks across the top. After dampening the contents of the tub, dig a few hundred worms and place them under the sacks. Feed the worms every ten days with a mixture of coffee grounds, 1 cup, thick, sour milk, 1 cup, and syrup, 3 tablespoonfuls. Merely pour this mixture under the burlap covering. The tub should be kept in a cool part of the basement during the summer months, and in a warm place, preferably near the furnace, during the winter. Keep the contents of the tub damp but not too moist, for the best results.

R. A. Jenkins, Los Angeles, Calif.

## Dust-Free Picture Framing

Removing a picture from its frame to dust behind the glass will be unnecessary if the picture is sealed between the glass face and the backing. Place the three parts on a flat surface, weight them with a heavy object, and coat the edges of all three with nail polish.

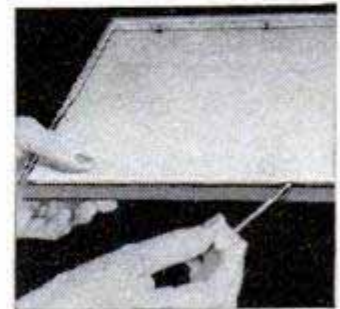

Benj. Nielsen, Aurora, Neb.



# These Locks Foil Prying Fingers of Tiny Tots

Secret locks for metal containers, drawers and closet doors baffle young explorers

By John D. Adams

**I**F THE small fry in your home are at an inquisitive age, you can foil their attempts to explore every drawer and nook in the house by installing these simple locking devices. Figs. 1 and 2 show two types of locks suitable for round containers having a friction lid, such as a metal candy box. In the first type, Fig. 1, there is no indication of a lock except the round ornamental knob at the center of the lid. To all outward appearances this is held in place with six escutcheon pins with polished heads, but one of these, fitted in a slightly oversize hole, is the "key" to the lock. This pin extends through a hole in the cover and when it is partially withdrawn, the knob can be turned to release the four locking bolts which engage the rim of the container when the device is in the locked position. The four locking bolts are identical in size, each having an eye bent in one end. Outer ends of the bolts are held in place by wire guides soldered to the underside of the lid. Wood screws passing through the eyes of the bolts and through elongated slots cut in the lid are turned into the underside of the wooden knob as shown in the sectional view, Fig. 1.

Another lock for the same type of container is shown in Fig. 2. This one has no exposed parts. Four finishing nails are bent with a slight offset and then soldered to the underside of the lid in irregularly spaced positions to form locking lugs. Four narrow notches are cut in the rim of the container, the spacing of the notches being exactly the same as that of the lugs on the lid. To close the container, the lid is placed so that the offset ends of the lugs drop into the notches. Then the lid is given a quarter turn to lock it. To release the lid, it must be turned back to the same position each time, as otherwise the irregular spacing of the notches and locking lugs prevents it from being opened.

The bottom drawer of a dresser or chest of drawers may be locked by the

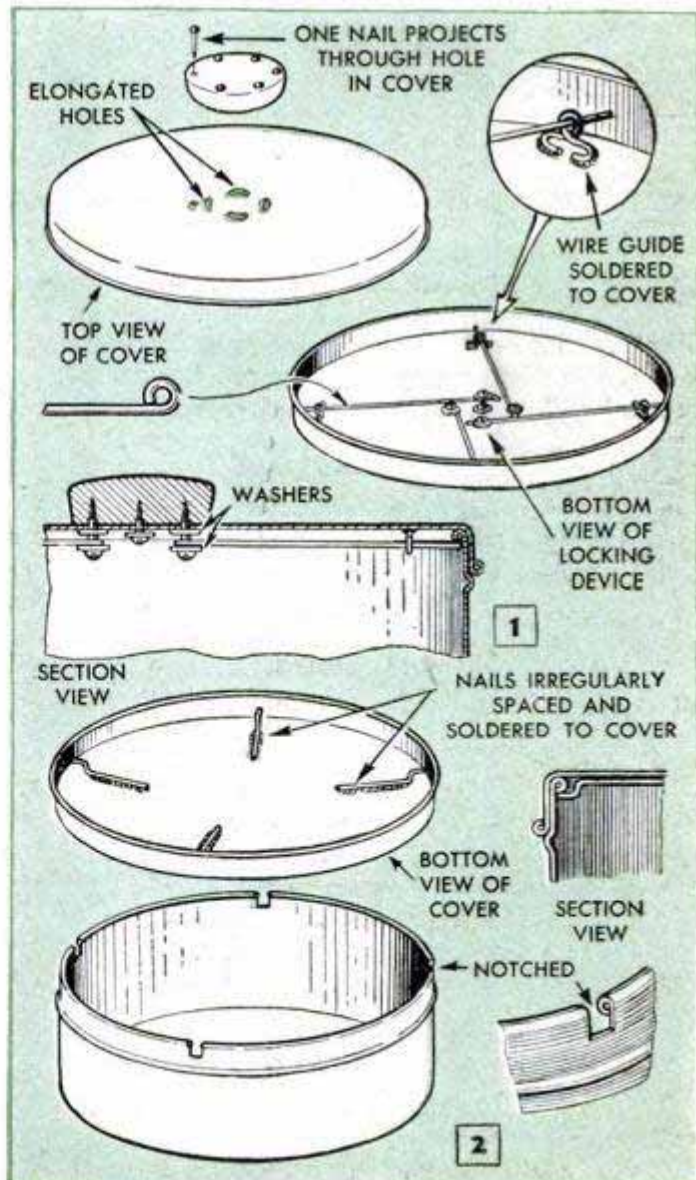



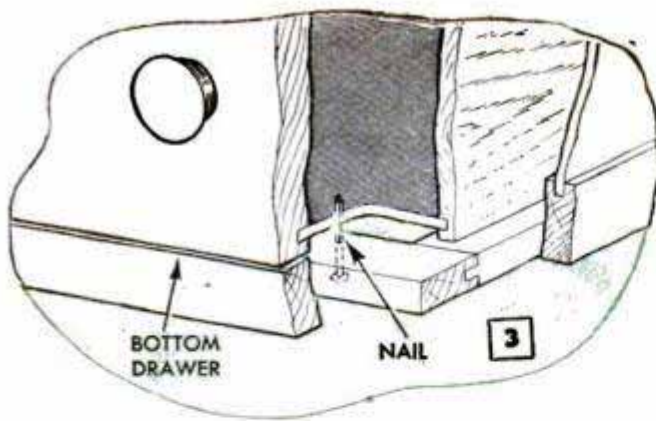

method shown in Fig. 3. With the drawer in the closed position, drill a hole through the rail and through the drawer bottom. The hole should be of a size to take a small nail snugly so that it will not drop out of the rail when the dresser drawer is pulled out. The nail should project through the drawer bottom about  $\frac{1}{2}$  in. when the drawer is in the locked position.

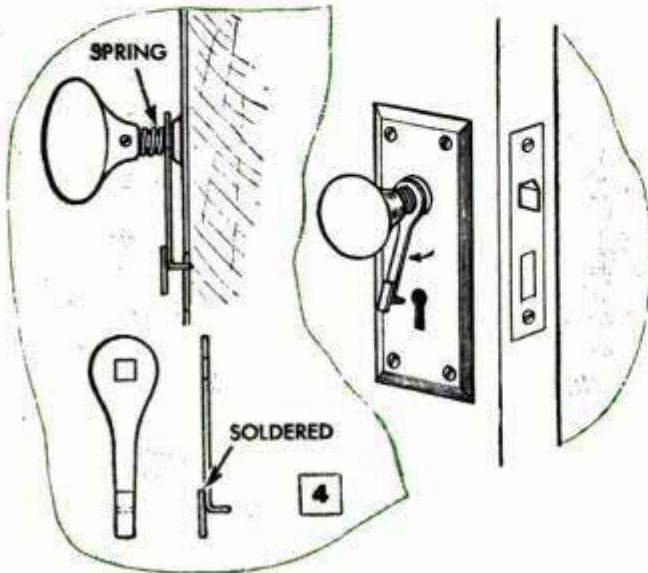

If the lock on the closet door is fitted with the locking lug shown in Fig. 4, it will be impossible to open the door even though the locking bolt has been released with a key. Remove the inside knob, and then drill and shape a piece of heavy sheet metal as shown. File the hole to a snug fit over the square lock shaft and bend the lower end of the piece at right angles to form a lug which will fit into the upper part of the keyhole. Solder or rivet a second piece to the bent end in the position shown. This should project far enough beyond the bend to cover the keyhole completely. Then reassemble, with a short coil spring between the knob and the locking lug. To open the door it will be necessary to insert a nail or length of wire through the keyhole and press the locking lug outward until it clears the keyhole. Then the knob can be turned to withdraw the striker. This will effectively keep the youngsters from entering closets which are used only for storage.

## Painting Venetian-Blind Slats Is Simplified by Jig and Drying Rack

Recalling past experiences in painting the Venetian blinds in my home, I tried to find a way to do a faster and neater job. The results of my efforts are this painting jig and drying rack which have been extremely useful. I used scrap lumber for

the wooden parts of the fixtures and cut small sheet-metal brackets from tin cans. The best way to paint the slats on the jig is first to do one end and then the other while holding the center portion so the slat does not tilt. Then paint the center part of the slat. The slats are turned over and later moved to the drying rack by placing the fingers on the end grain, as this part can be touched up in a jiffy while the slat is on the drier. The drying rack is arranged to space the slats about  $\frac{1}{2}$  in. apart, and as I had a number of blinds to refinish, I made several racks to speed up the work.

Fred Roner, Flushing, N. Y.

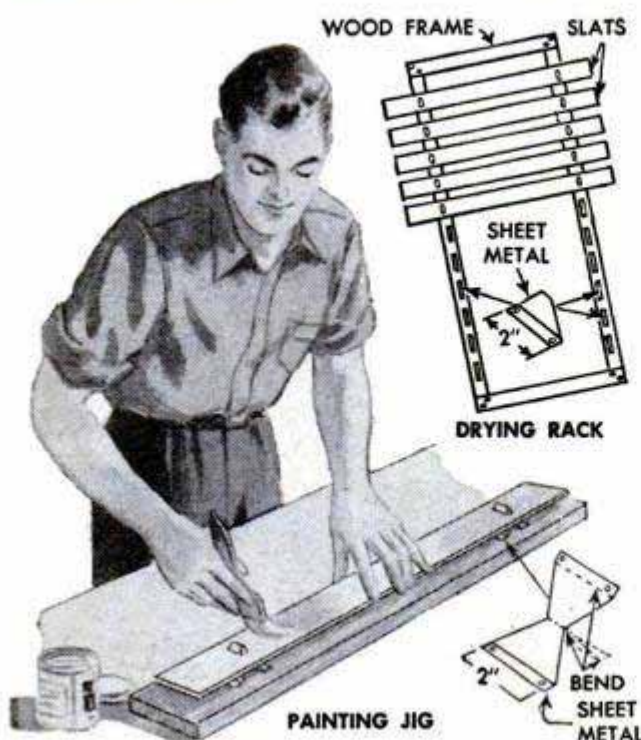

## Moisture-Resistant Brick Walls

Moisture penetration through walls above grade is one of the most serious problems of brick construction. To withstand this penetration, brick-masonry walls should have their tops covered and be constructed with high-lime-content mortars finished with concave mortar joints. Bricks with moderately low water-absorption properties should be used, while the mortar should have the property of retaining moisture. The type of wall does not influence moisture resistance.



Because there was no help available, E. C. Ziesel of La Grange, Ill., had to put up the heavy second-floor storm windows on his home by himself. After some thought, he succeeded in overcoming the awkward and dangerous aspects of the job by devising a pair of guide strips that permitted sliding the window in place from a ladder without the usual delicate balancing. The guide consists of two 1 by 4-in. boards tacked at the top of the window so that each of the boards partially overlaps one side of the casing. The lower ends of the strips are blocked out from the side of the house about one foot to allow for the pitch of the ladder. As the window is lifted, it can be supported by the ladder until engaged by the wooden strips. Then, the strips guide the window into place as it is pushed up from the ladder. After the win-

## Installation of Second-Floor Storm Windows Easily Done by One Man Using Guide Strips

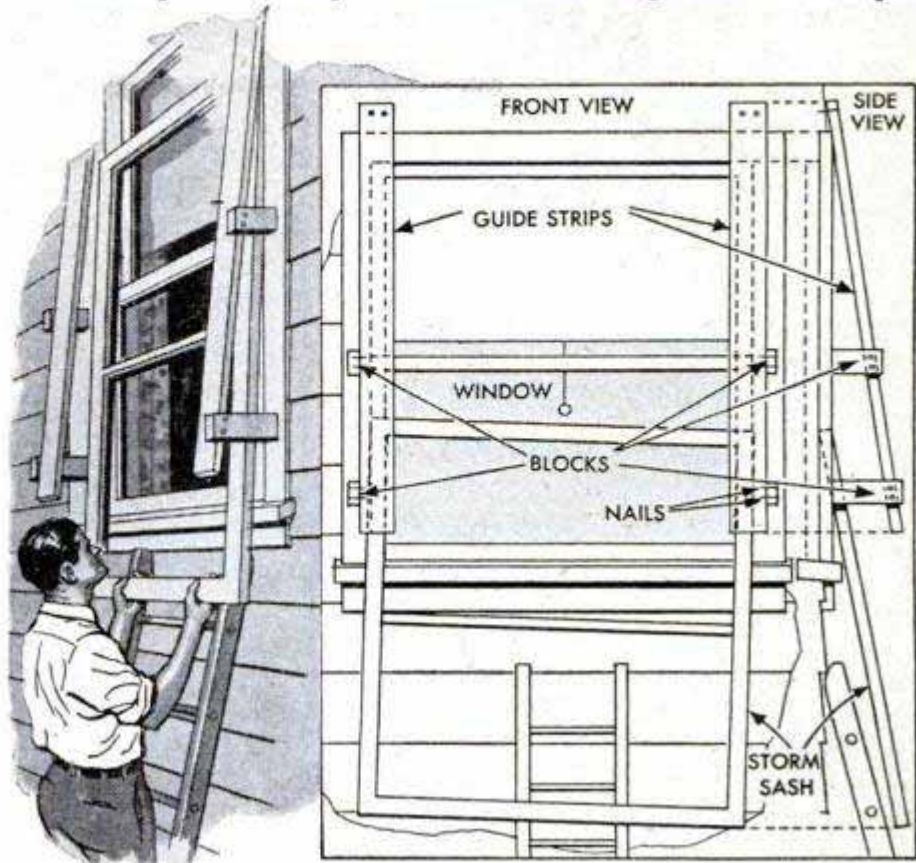

dow is fastened, the guide, being loosely nailed, is readily removed for use on other windows of a similar size.

down is fastened, the guide, being loosely nailed, is readily removed for use on other windows of a similar size.

## Weighted-Curtain Doorway for Pet Permits Unhindered Passage

If your dog or cat sleeps under a porch, or in a barn or garage, here is a door made of heavy, weighted curtains that allows him to enter and leave his quarters without

difficulty. The curtains keep out drafts and insects and, unlike hinged wooden panels, they will not swing back and strike the animal as he passes through. The curtains are cut in two panels so they lap about 1½ in. at the center and about the same distance over the frame at each side. The bottoms of the panels are hemmed and weighted with washers, and their tops are fastened to the doorway with upholsterers' nails. When in place, the curtains should just touch the bottom of the opening.

Hi Sibley, Nuevo, Calif.

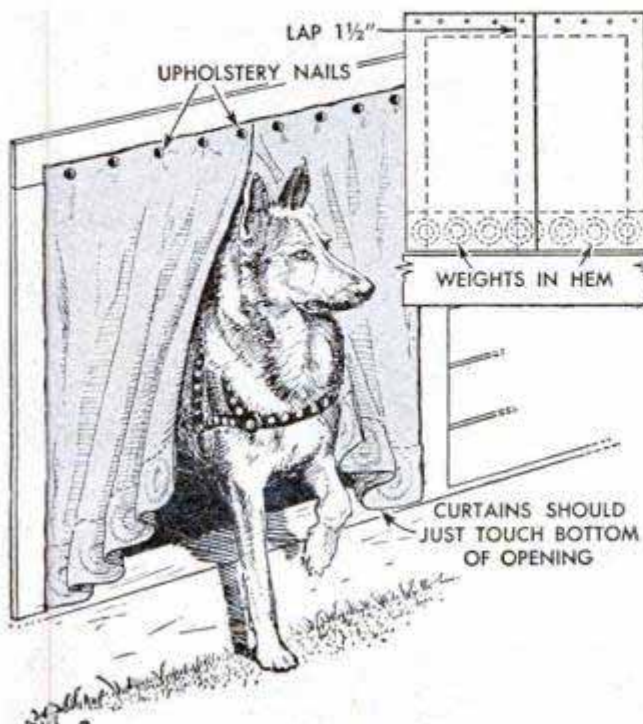

## Keeping Clock in Good Condition

One jeweler keeps his clocks lubricated by placing a small kerosene-soaked cloth inside each clock. The cloth is wrung partially dry before inserting it in the clock, and a few drops of kerosene are applied to the cloth from time to time. Kerosene fumes keep the mechanism lubricated.

Anthony Edwards, South Bend, Ind.

Worn sheepskin-lined slippers, when cleaned and turned inside out, make excellent shoe-polishing mitts.



# BEFORE YOU BUY A MODEL

It's a logical precautionary measure to learn to recognize fine workmanship and materials even though the manufacturer's reputation indicates merit of a model gasoline engine

By Robert Lloyd Brown

**I**N SELECTING a miniature gasoline engine for a model airplane, racing car or boat, the reputation of a particular engine usually can be depended upon. Nevertheless, if you want to make sure you get the engine suited to your purpose, keep in mind several important points which considerably affect the performance of this type of engine. The principal parts of a typical model gasoline engine are identified and located in Fig. 1.

Cast-iron cylinder blocks, either with or without steel liners, or steel cylinders are preferable in certain applications to aluminum-alloy blocks with steel liners. The cast-iron cylinder takes a better internal wall finish, affording a higher compression

ratio, and it runs cooler than steel. However, the steel cylinder has superior strength for a given wall thickness. Steel pistons are preferable to the cast-iron or aluminum-alloy types because they have greater strength, better finish, uniform shape and lighter weight. The wrist pins may be either of bronze or steel, but brass pads should be inserted in the ends of the wrist pins to prevent scoring of cylinder walls.

## KEY TO PARTS OF MODEL ENGINE

- |                      |                   |
|----------------------|-------------------|
| 1. Offset spark plug | 11. Exhaust stack |
| 2. Piston baffle     | 12. Fuel line     |
| 3. Piston rings      | 13. Intake tube   |
| 4. Piston            | 14. Needle valve  |
| 5. Wrist pin         | 15. Rotary valve  |
| 6. Intake by-pass    | 16. Gasket        |
| 7. Connecting rod    | 17. Mounting lugs |
| 8. Timer             | 18. Timer points  |
| 9. Ball bearings     | 19. Cam           |
| 10. Cylinder liner   | 20. Crankshaft    |

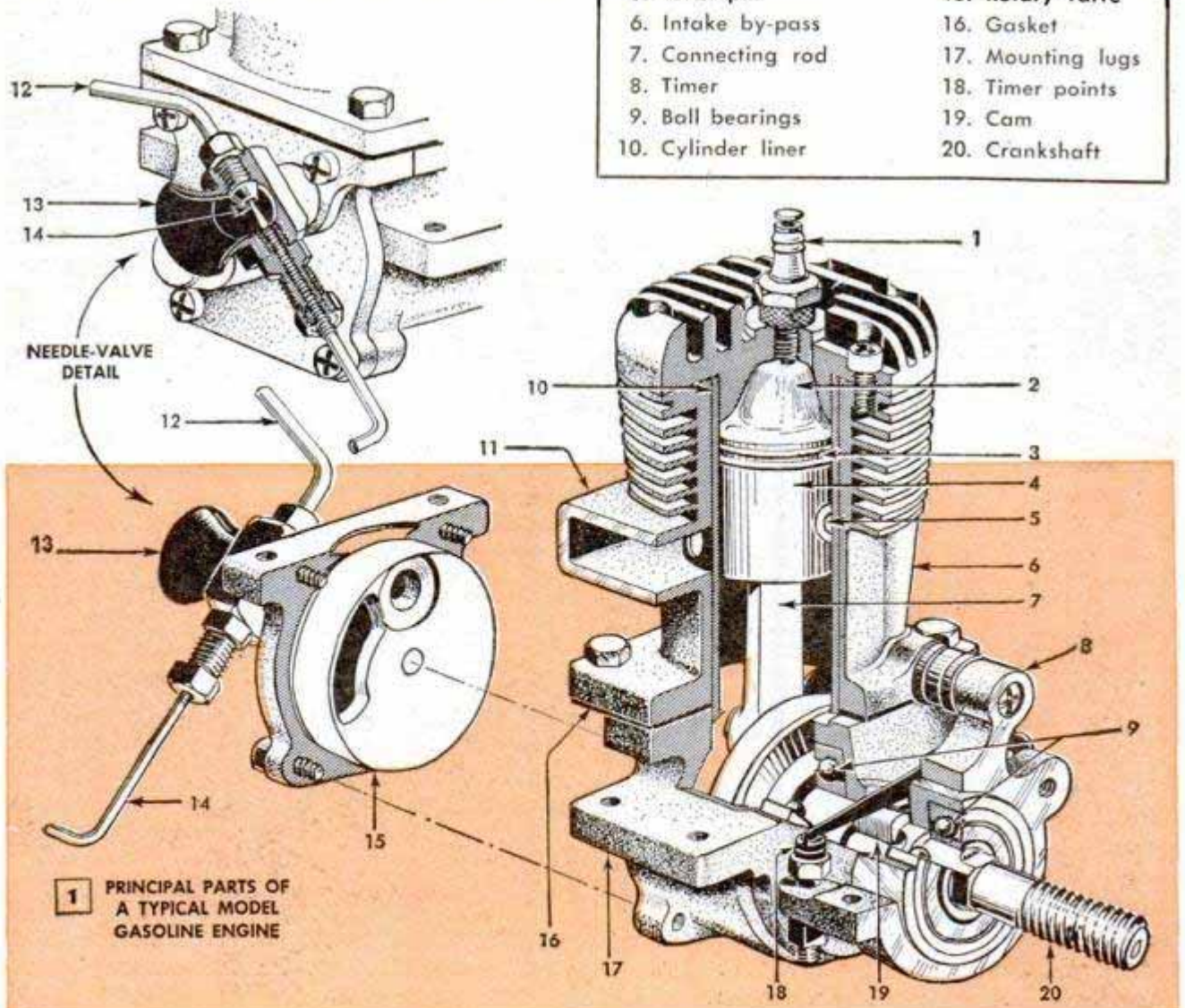



# ENGINE

One of the quickest ways to appraise an engine is to study the crankshaft. If it is carefully machined from high-grade material, it is an excellent shaft, provided the cross-sectional sizes are sufficiently large to prevent distortion or whipping at high speeds. Manufacturers of two-cycle engines designed for installation in model speed planes, where space and weight are extremely limited, quite generally use the composite counterweighted crankshaft shown in Fig.

1. Properly machined and balanced, this type of shaft will attain extremely high speeds without distortion or damaging vibration. Ball bearings are used on parts that are designed to operate at high speeds, but for crankshafts, which rotate at comparatively slow speeds, oil-impregnated bushings are adequate. Take a good look at the crankshaft bearing. The longer it is the better. However, if the bearing is made of bronze and is not the self-oiling type, which requires no supplementary lubrication, it should have lubrication grooves to prevent seizing.

Note the needle valve and valve body of the carburetor. They should be made of

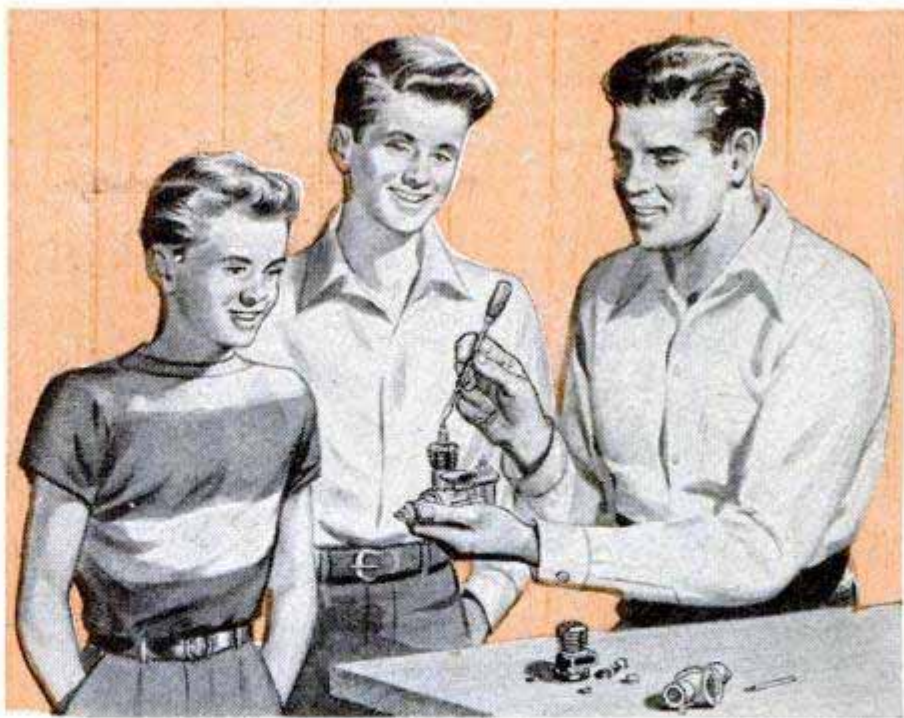

the same material so that their coefficients of linear expansion will be identical. Brass often is used for these parts as aluminum is too soft for this purpose. The needle valve should have a very fine thread to obtain minute adjustments of the mixture. Gas-resistant, transparent-plastic fuel lines are an advantage due to the fact that a clogged fuel line can be detected immediately, as the flow stoppage is apparent.

Ordinary paper, cardboard or cloth does not provide satisfactory engine gaskets. They should be cut from special gasket material that is both heat resistant and strong, and sealed in place with pure orange shellac, for best engine performance.

## Darts Whittled From Wooden Shingles Are Thrown Long Distances

These high-flying darts can be made by any child old enough to use a knife for whittling, and after a little practice, they are easily thrown a surprisingly long way. The darts are shaped from a wooden shingle, as indicated. The thin end becomes the tail, this portion of the shingle being about 2 in. wide. Then a notch is cut about 1 in. from the butt end of the shingle. A piece of string approximately 2 ft. long is tied to a handle and a large knot is made at the end of the string. Fishline or strong twine is best for this purpose, while any stick or tree branch that will not break readily provides a suitable handle. To launch the dart, place the string in the notch and pull tight against the knot. Hold the tail of the dart in one hand, the handle in the other, and keeping the string taut, release the dart as the handle is whipped forward and upward.—M. K. Voedisch, Rockford, Ill.





## Length of Pipe Fitted With Tee Bends Rigid Conduit



When doing a wiring job that requires the installation of rigid, electrical conduit, the conduit can be bent easily with a tool made by fitting a pipe tee with a long piece of pipe for a handle. The tee, of course, must be large enough to permit the conduit to pass through it. With this tool, the conduit can be bent as shown in the drawing. If a bend with a large radius is desired, bend the conduit slightly and slide the tee a few inches before applying pressure again. Repeat this procedure until the proper bend is obtained.

Victor H. Lamoy, Upper Jay, N. Y.

## Spring Hinge on Casement Window Facilitates Opening

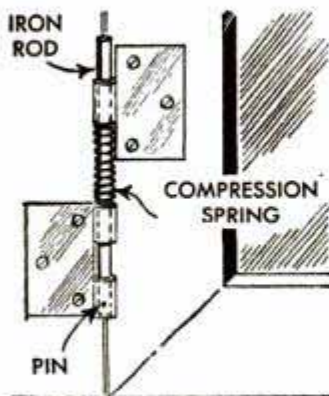

Should the casement windows in your home be of the type that must be raised slightly before they can be opened, here is a method of surface hinging that permits the windows to lift automatically when unlatched. The leaf

of the hinge that is screwed to the window sash is placed a distance above the hinge leaf fastened to the casing. Then, a short length of iron rod is inserted through the barrel of the lower leaf and is held in place with a pin. After a compression spring is slipped over the projecting end of the rod,

the barrel of the sash leaf is set over the rod so that it rests on the spring. If the hinges on the window are altered in this manner, much of the weight of the sash will be supported by the springs, making the window easy to lift when opening. Another advantage is that this method of hinging permits the whole sash to be lifted instead of the unhinged edge only, as is the case when the window is hinged in the usual way. The size of compression spring used should be determined by the weight of the window and the type of hinges.

Adolph Sprenzel, Chicago.

## Envelopes Form Pocket Dispenser For Cleansing Tissues

Cleansing tissues may be kept sanitary while being conveniently carried in a pocket or purse if they are held by a dispenser made from two large envelopes. A ½-in.-wide slot is cut in the side of the envelope into which the tissues are inserted. The tissues should be removed from their box without disturbing the interlocking folds, so they will feed from the envelope in the same manner as they do from the box. This can be done by cutting out the bottom of the box and later resealing it with tape. The envelopes are fastened together so that the second one serves as a cover for the slot. — Andrew Vena, Philadelphia, Pa.

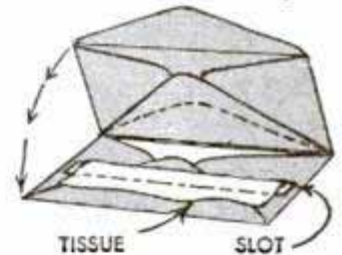

## Reproducing Pitted Wrought Iron

If rusted, deeply-pitted iron cannot be found for hand-wrought craftwork, much the same effect can be attained by etching the pieces of iron available. The etching solution consists of commercial nitric acid, 1 part, and commercial muriatic acid, full strength, 1 part. Mix the solution by placing the nitric acid in a glass jar, and carefully pouring the muriatic acid into this. Then, lay the iron on the ground and apply the solution liberally to its surface, using a cotton swab as an applicator. When the fuming stops, add more of the solution. Wash off with water, and repeat the process until the desired depth of etching is obtained. If the etching is done on finished pieces, heat them to a cherry red after etching to stop the action of the acid. *Caution:* Do not allow the acids to come in contact with the hands or clothing, avoid inhaling the fumes and do all the work outdoors away from children and pets.

Dick Hutchinson, Alhambra, Calif.



# PORCH LANTERN

## *in hammered copper*

HERE'S a quaint and charming porch lantern that will add a distinctive touch to a colonial entrance. The top and bottom bands are formed to fit the ends of a globe taken from a kerosene lantern. The four staves, which attach to the top band with small machine screws, are bent to spring out at the bottom and permit removal of the globe and bulb. Other parts of the lantern are riveted together where indicated with No. 14 brass escutcheon nails. After a trial fit, all parts are antiqued. To do this, clean with fine steel wool and paint with copper-nitrate solution. Next, apply the flame of a blowtorch and heat the copper until it first turns green and then brown. When cool, burnish the metal with emery paper and then wax.

Dick Hutchinson, Alhambra, Calif.

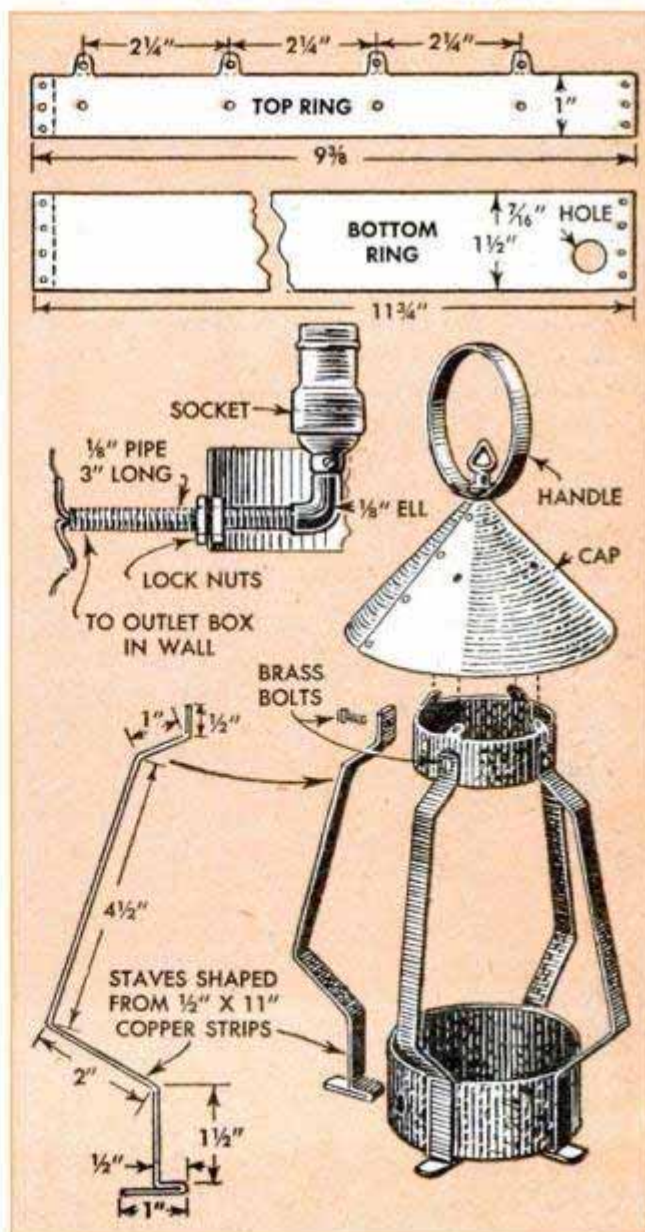
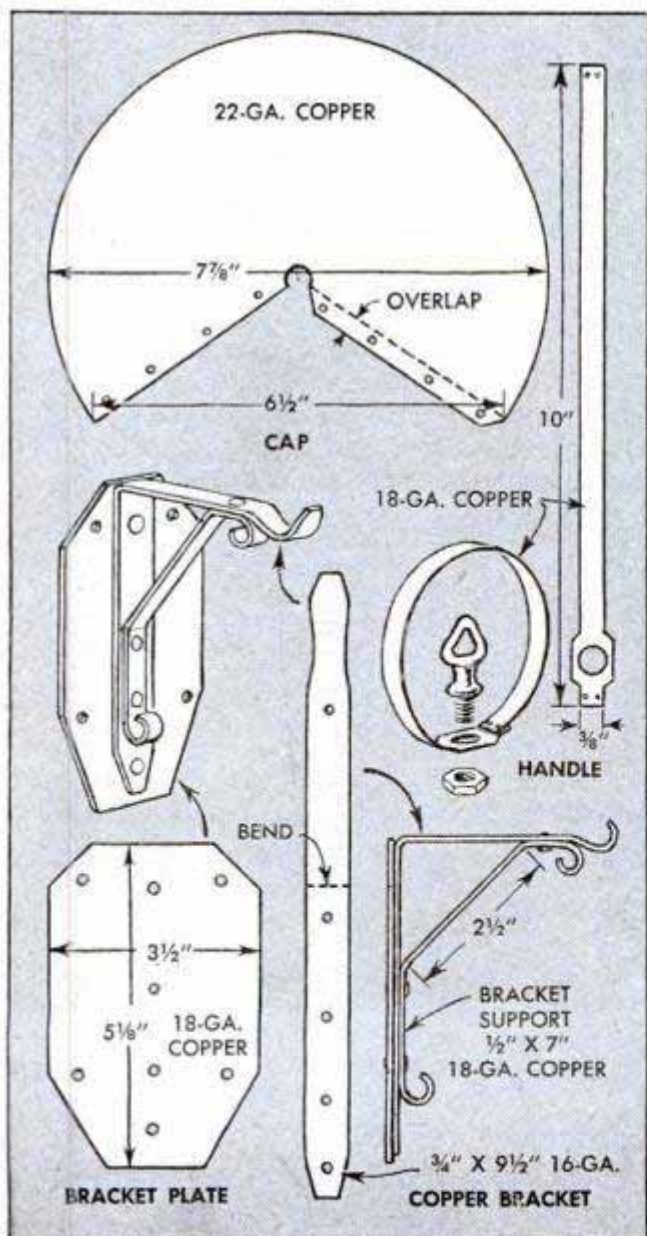



## Shop Drawers of Gallon Cans Slide on Curtain-Rod Runners

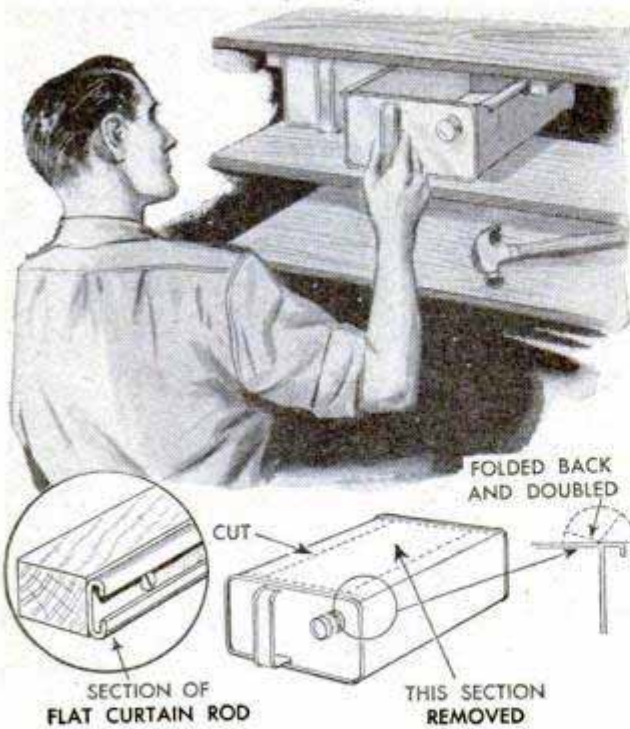

If you wish to install drawers in your workshop but don't care to stand the expense of wooden ones, 1-gal. cans of the type in which motor oil is sold will provide excellent drawers. As the cans are already equipped with a handle, just cut out one side and fold back the edges, as shown in the detail. Runners for the drawers are provided by sections of flat curtain rod in which the edges of the can are bent to slide. These sections are screwed to wooden cleats, which are fastened to the underside of a shelf or table top.

## Decoy Anchor Line Is Nontangling

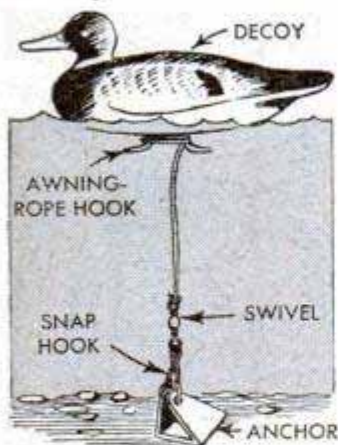

Every wild-fowler who has coiled icy anchor lines around slippery wooden decoys will welcome using an arrangement of the lines which simplifies the disagreeable job of picking up decoy sets. To make this arrangement, screw an awning-rope hook

to the bottom of each decoy, being careful to center it. If off-center, it will cause the decoy to ride unevenly. Wind the anchor line on the awning hook and then attach a snap hook to the swivel at the free end of the line. When you set out the decoy, just snap the hook over the anchor ring. In

taking up the set, release the anchor and wind the line on the hook. There's no tangling and breaking of the lines.

## Cutting Holes in Sheet Metal

When it's necessary to cut a neat, round hole in the bonnet of your furnace for a run of pipe, or for that matter, a large hole in any light sheet metal, here's an easy way to do it. Just take a piece of board slightly longer than the radius of the hole

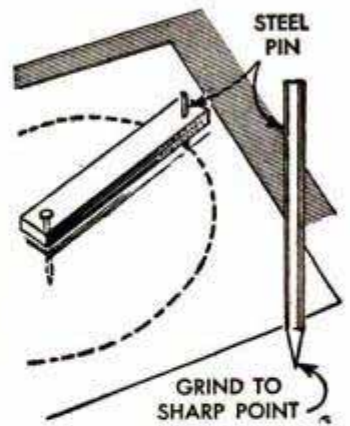

and drive a nail through the board near one end to serve as a pivot. Next, drive a hardened steel pin through the board the exact distance from the nail as the radius of the hole. Then, drive the nail through the sheet metal at the center of the hole and press down on the pin end of the board while rotating it around the pivot. The steel pin will cut through the metal in a short time, leaving a perfectly round hole.

## Table-Tennis Ball Dispenser

Attached to a wall or post in a convenient location in the recreation room, this novel dispenser keeps table-tennis balls handy. Sides and front of the unit are bent from sheet metal and screwed to a wooden back. A slot is cut in the front to indicate the number of balls in the container. A spring stop releases the balls. The length of the dispenser, of course, determines the number of balls it will hold.

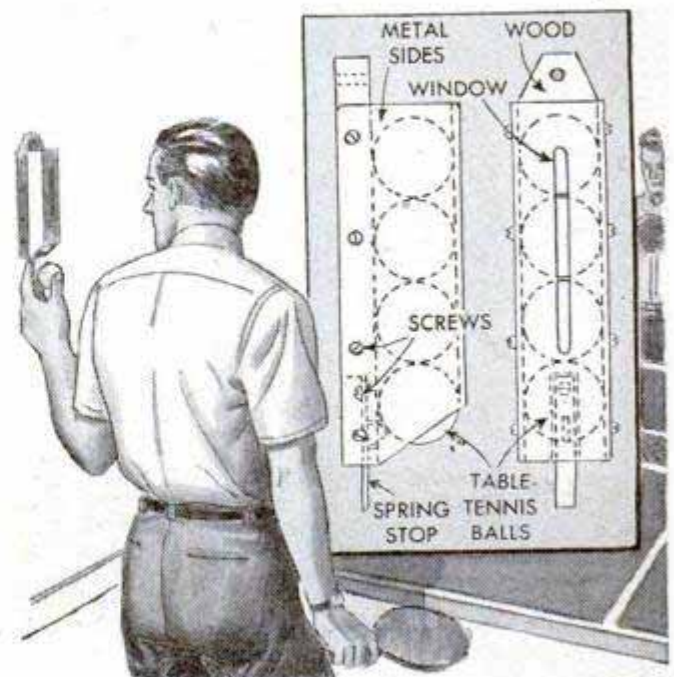



# Photographing OLD COINS

**FLAT LIGHTING** is the answer to the problem of photographing coin collections in sharp relief, and here is a table-top setup for filtering the light to give just the right diffusion. It's accomplished by directing a couple of photofloods through tracing paper stretched over a framework as shown in Fig. 1. Shooting is done through a hole in the center of the paper, using fast film and the relatively short exposure of  $\frac{1}{8}$  sec. at f:22. The coins are placed on a shelf of clear glass and are back-lighted from below with a third lamp as shown in Fig. 2. Note that a cardboard baffle is used to direct the light on the background only and that the light should be strong enough to kill any shadows produced by the two basic lamps. In shooting bronze coins, the background should be white, whereas gold or silver should be photographed against black. Fig. 3 shows a setup for photographing jewelry.



By directing two photofloods through white tracing paper a diffused light is obtained to eliminate glare and shadows. Third lamp lights background for coins



Bronze coins stand out sharply if shot against white or light-colored background. Back light must be strong enough to kill shadows cast on background by coins



Silver and gold coins photograph best if the background is black. Use a cardboard having a dull surface to prevent any reflection cast by the back light

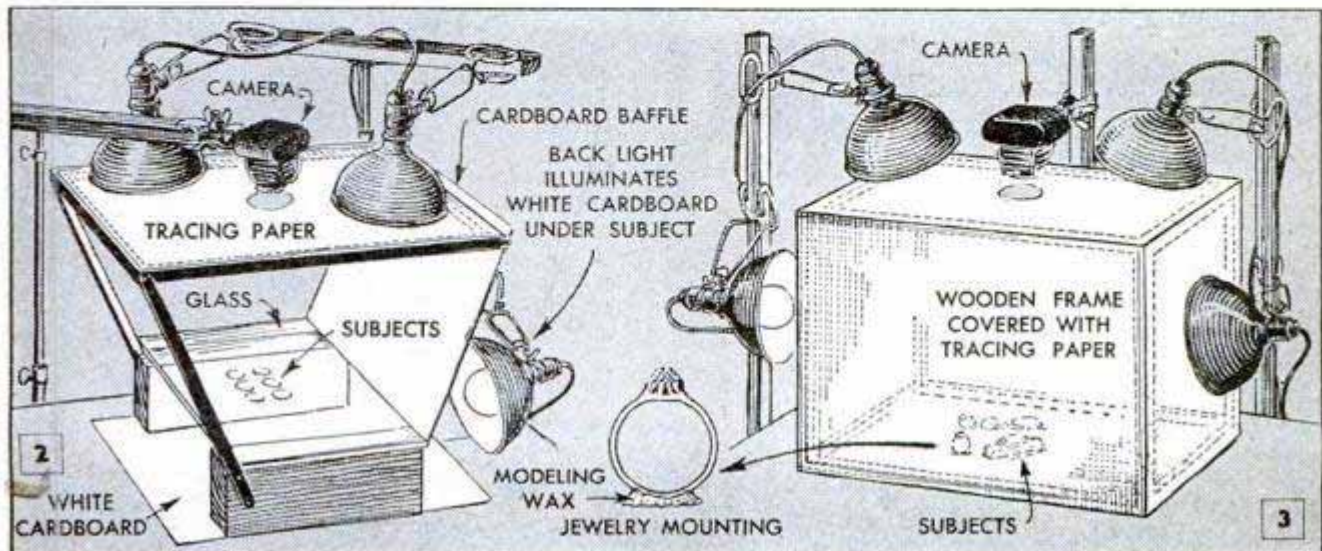



# Stage Your PUBLICITY SHOT



Healthful beach recreation is the basic idea here. Background and foreground set the locale, and the lively action and expressions clinch the idea

By  
**RICHARD W. EMERY**



**C**OMPETITION in the sale of publicity shots is keen and it takes more than just luck to sell an editor. The successful free-lance photographer knows that a good publicity shot must be built around a basic idea that will attract a great amount of attention. If not, his work will never see print. The basic idea may be to entertain, instruct or arouse curiosity, or its purpose may be to kindle a desire to possess something, to go somewhere or to do some particular thing.

There are many reasons for planning setup shots. Advanced planning enables you to create a picture in which the basic idea is presented forcefully and in such a manner that the picture completely tells a story or strongly conveys one thought.

In my work, I like to plan a picture first by making rough pencil sketches of the idea and then work out the details involved in shooting it. I study the location for best camera angles and the subject for best lighting. Most of all, I try to visualize the finished picture. Frequently, in planning a picture on paper, I try to add some

#### Photos by Ray Chapin

↓ Publicity photo illustrates use of props to tell a story. Note also how high camera angle deepens foreground and focuses attention on basic idea. Stunt was used to promote interest in straw-hat sale



↑ Shot of a helmeted pipe fitter holding a ribbon-tied diploma of pipe is saved by the words, "Pipe Fitting School," over door. Without sign and doorway, photo would lack basic idea and tell no story

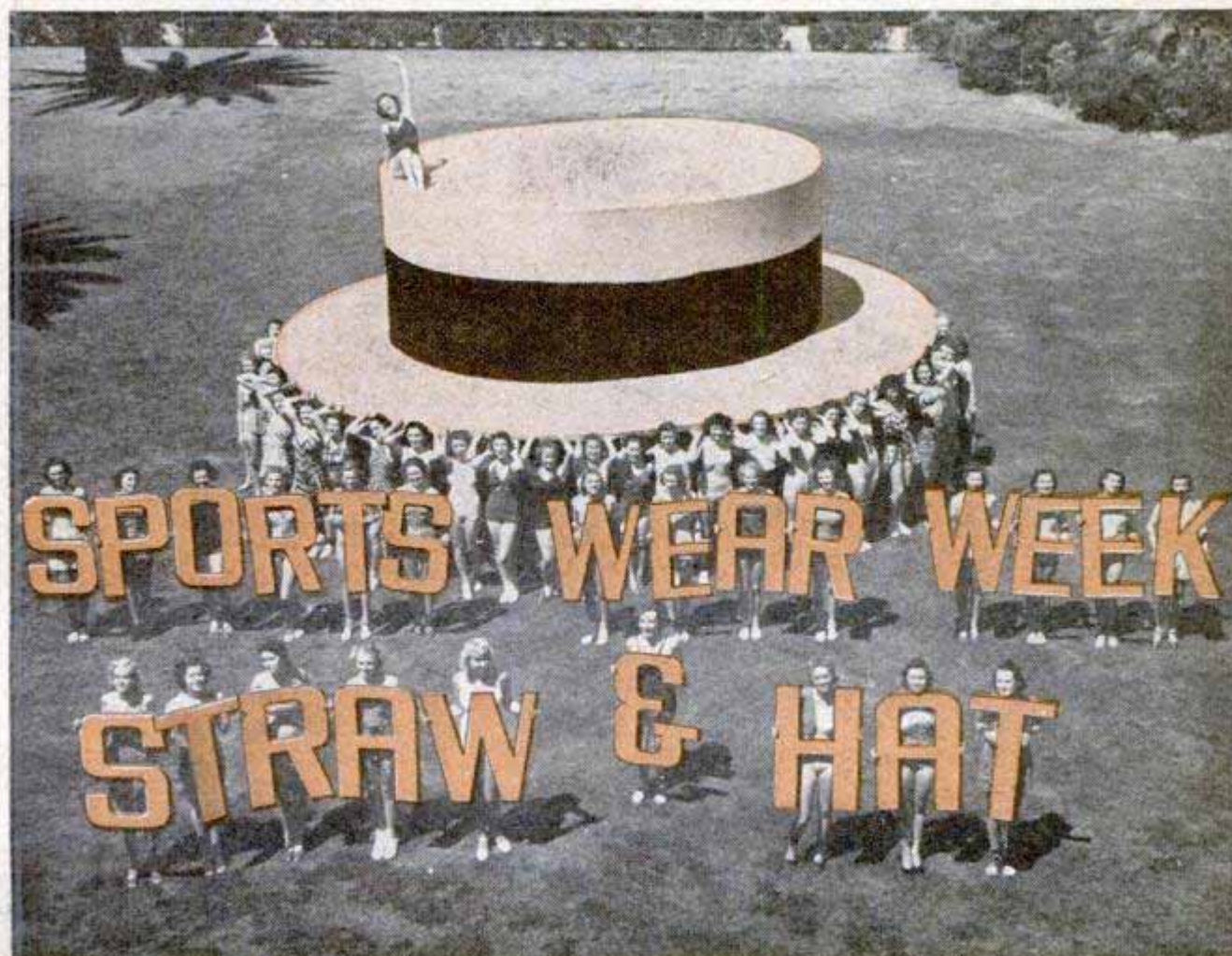



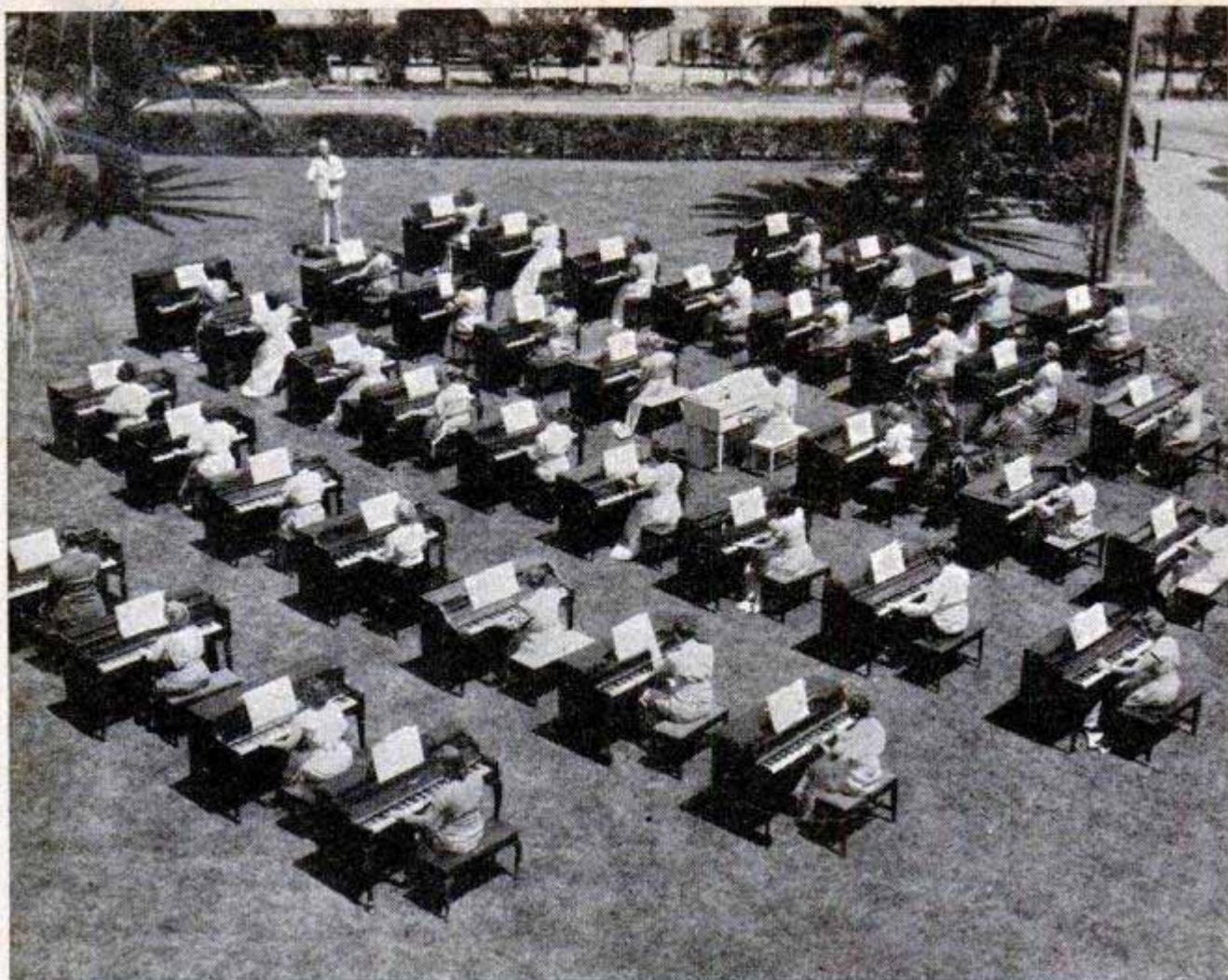

† An outdoor concert of forty pianos produced a curiosity-whetting picture to publicize National Music Week. Here, the pianos express the basic idea or theme



detail or object to the foreground to give purpose and meaning to the composition.

In the typical photo of a person or a group of persons, there are eight factors to consider carefully in following through a basic idea. These are: (1) model or models, (2) clothes or costumes, (3) pose or action, (4) lighting, (5) center of interest or composition, (6) background, (7) props, (8) foreground. In some cases, one or more of the factors may be given less emphasis in order to focus attention strongly on other points of interest. The accompanying publicity shots show how the eight factors are put to work.

In some photos, all eight factors are combined to build up and convey the basic idea,

This shot tells its story through careful use of all eight factors. The three sailboats, photographed in pleasing order, provide picture with a basic theme





← Staged to publicize fishing tournament, this picture blends model, costume and props to tell story. Photo of trophy alone would lack purpose. Note narrow composition which lends photo to cropping for one-column use

Photo of bathing girl on → a cluster of balloons publicizes beach carnival. The basic idea is expressed by the props and the costume of model. Low camera angle exaggerates size of the balloons, adds sky background

↓ Picture of drum majorettes being instructed in marching makes use of foreground action to tell its story. Basic idea is that majorettes have fun while learning to march. Purpose was to attract new members to majorette corps

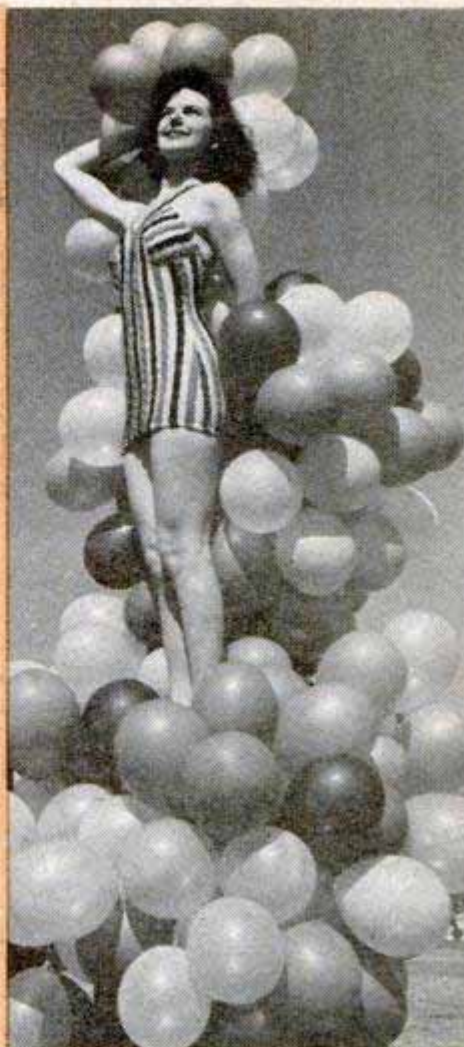



## Nonslip Edge on Trimmer Bed Aids Cropping Buckled Prints

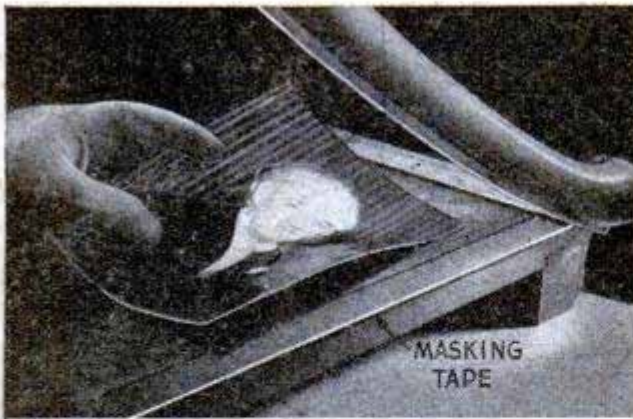

Trimming buckled photoprints is difficult because the paper will creep on the board, resulting in an uneven edge. One way to overcome this is to cover the cutting edge of the board with a strip of masking tape. This produces a nonslip surface that will hold the print firmly in place. When not needed, the tape can be removed as it may tend to slow the trimming operation for prints that are perfectly flat.

## Dial Thermometer Clipped in Place



tray or tank, or when not in use, to the edge of a shelf or bracket. Use adhesive tape to fasten the thermometer.

## Sliding Mask for Double Exposures Produces Trick Shots

Trick double exposures, such as showing the same person twice on one frame, etc., can be made by mounting a square filter holder over the lens as indicated. After this has been done, the holder is fitted



with a sliding mask of black cardboard. By moving the mask to one side and making an exposure and then shifting it to the opposite side for a second exposure, you will expose half the frame at a time,

resulting in two shots of the subject, side by side. It may be necessary to do a little experimenting in cutting the cardboard mask so that it covers just half the lens.

## Backing Paper Used as Separators

Where photographic negatives are stored in paper envelopes, direct contact of the film may cause scratches, or moisture in the air may soften the glue on the envelope and spot the negative. If the backing paper that comes with roll film is cut into pieces and placed between the lengths of film, scratches or spots are not so apt to occur.

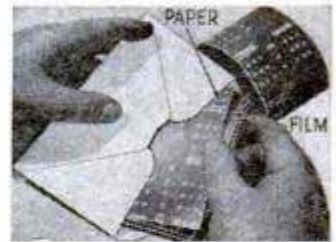

## Reading Low Values of Photo Meter

When taking photographs in a dim light and the lower portion of an exposure meter scale is used, better readings can be obtained if a magnifying glass is placed over the scale glass. Adhesive tape is used to fasten the magnifier in place. When not in use, the glass and tape are easy to remove and do not harm the meter.



## Clothespin Holds Print Tongs

While developing prints, tongs should always be within reach, but not placed where they will be contaminated by chemicals. A convenient place to keep the tongs is between the arms of a spring-type clothespin that has been clipped to the side of a developing tray. One clothespin will hold most tongs, but if not, use two pins and space them apart.

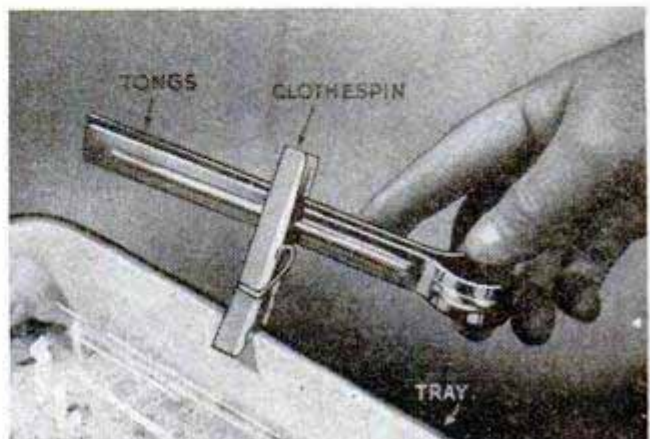



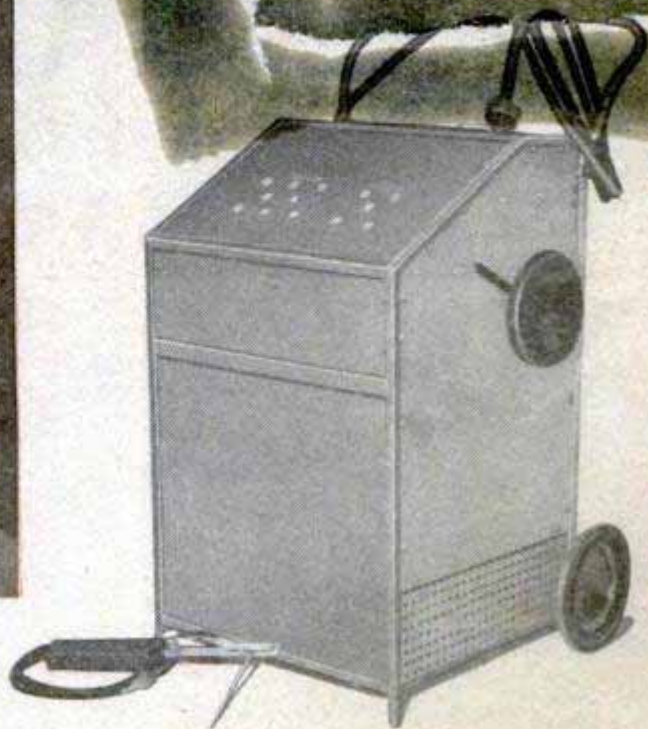

## Build Your Own ARC WELDER

Part I

By Evan Wright

BY REWINDING a discarded or burned-out service transformer and installing it in a housing mounted on a two-wheel cart, this portable a.c. arc welder, shown in the upper right-hand photo, was built entirely with hand tools for less than \$25. It will handle metallic-arc welding rods from the smallest up to  $\frac{3}{16}$  in. in dia. and can be regulated for use with a double-carbon arc torch for brazing, silver and soft soldering, and localized heating when bending, forging or heat-treating metal parts. In addition to welding, the metallic arc can be used for cutting metal and piercing holes when bolted construction is desired.

Selection of a transformer for rewinding is made on the basis of the output desired and the service current available. Where the welder transformer output required is approximately 150 amperes of welding current, the transformer should weigh at least 75 pounds exclusive of its cast-iron container or "pot." A welder of this output will handle almost any job on the farm or in the small shop and can be operated on a 220-volt circuit drawing a maximum of 30 amperes. Most shop, or farm electric

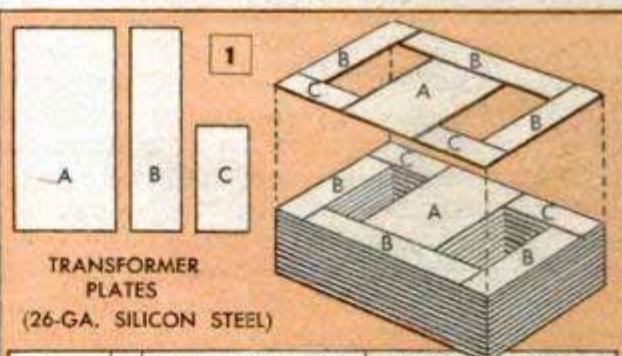

TRANSFORMER PLATES  
(26-GA. SILICON STEEL)

TABLE I	PLATE	100-Ampere Welder			200-Ampere Welder		
		Height of pile	Dimensions		Height of pile	Dimensions	
			Width	Length		Width	Length
50 to 60 cycle current	A	3½"	3½"	7"	4"	4"	8"
	B	10½"	1¾"	7"	12"	2"	8"
	C	7"	1¾"	3½"	8"	2"	4"
25 to 40 cycle current	A	4"	4"	8"	4½"	4½"	9"
	B	12"	2"	8"	13½"	2½"	9"
	C	8"	2"	4"	9"	2¼"	4½"

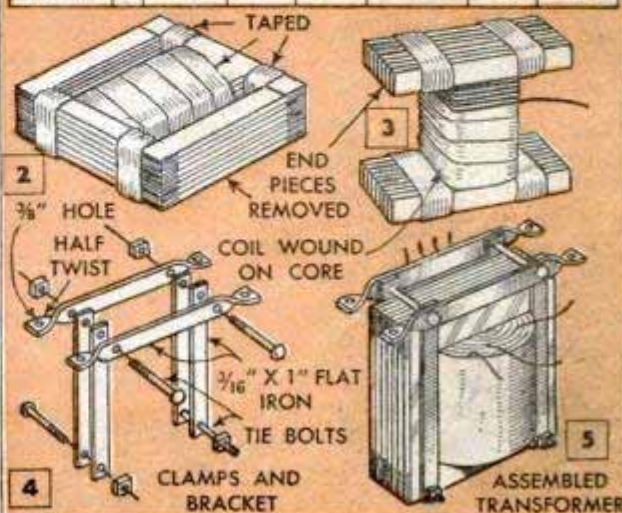

Reprinted in Shop Notes



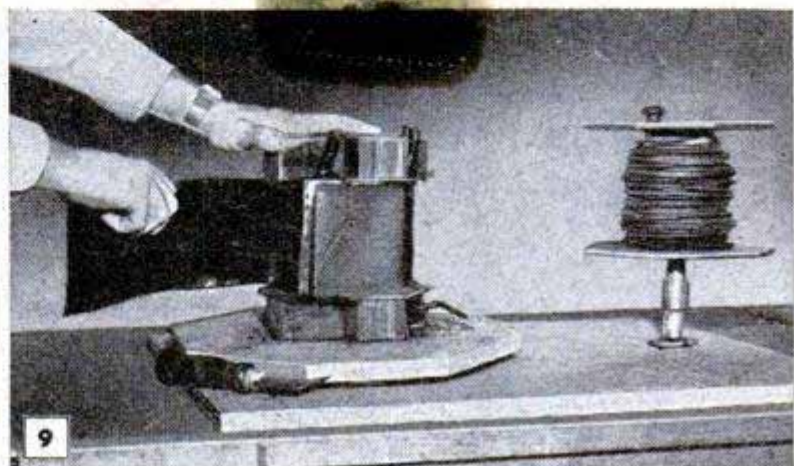

service will meet these requirements. However, check with your local electrician or power company as to the maximum load that may be imposed on the service line. Pole transformers, rated from 2 k.v.a. to 5 k.v.a., are recommended for making welders of approximately 150-ampere, 35 to 40-volt output. A smaller welder made from a rewound light industrial or X-ray transformer will deliver sufficient amperage for most welding jobs in the home shop and can be operated on 110 volts with less than 30 amperes. For light welders, the transformer alone should weigh at least 50 pounds. Pole transformers and X-ray transformers suitable for rewinding usually are of the shell type, and for compactness, a 3 or 4-part transformer is recommended. In buying a junked transformer, take only the transformer itself, as the pot which houses it is not needed. Usually, the transformer can be lifted from the pot by removing 4 or 6 bolts.

If a discarded service transformer cannot be found, you can build one from regular transformer iron of No. 26 to 29 gauge. Rectangular sections are cut to sizes indicated in Table I, Fig. 1, and these are stacked so that the pieces overlap one another in the manner shown. The core and the two sets of outer laminations are taped together tightly, Fig. 2, and then the end laminations are removed. The coils are wound directly on the core, Fig. 3, using

the same size wires and procedure given for rewinding a junked transformer as will be described later. The end laminations are then replaced and clamps and brackets, Fig. 4, bolted to the core to compress and hold it together. Fig. 5 shows the completed transformer.

Dismantling a service transformer is done by first removing the porcelain cap used to distribute the leads. The clamps which hold the core sections also are removed, Fig. 6. These clamps usually are bolted to a cast-iron bracket from which the transformer hangs inside the pot. Coils in a common service transformer designed to reduce 2300 power-line voltage to 220 or 110 volts, usually have half the secondary winding wound directly on the core in two or more layers. These layers are covered with a fireproof insulating material over which the primary wiring is wound. The primary is covered with another insulating blanket and the remainder of the secondary is wound over this.

To proceed with the dismantling of the transformer, remove the 4 sets of outer laminations. These are cemented to each other with an insulating varnish and it may be necessary to use a linoleum knife and pliers to separate them as shown in Fig. 7. On some transformers the laminations are L-shaped, with the short legs alternating from one end to the other. Stack the laminations in a pile in the order in



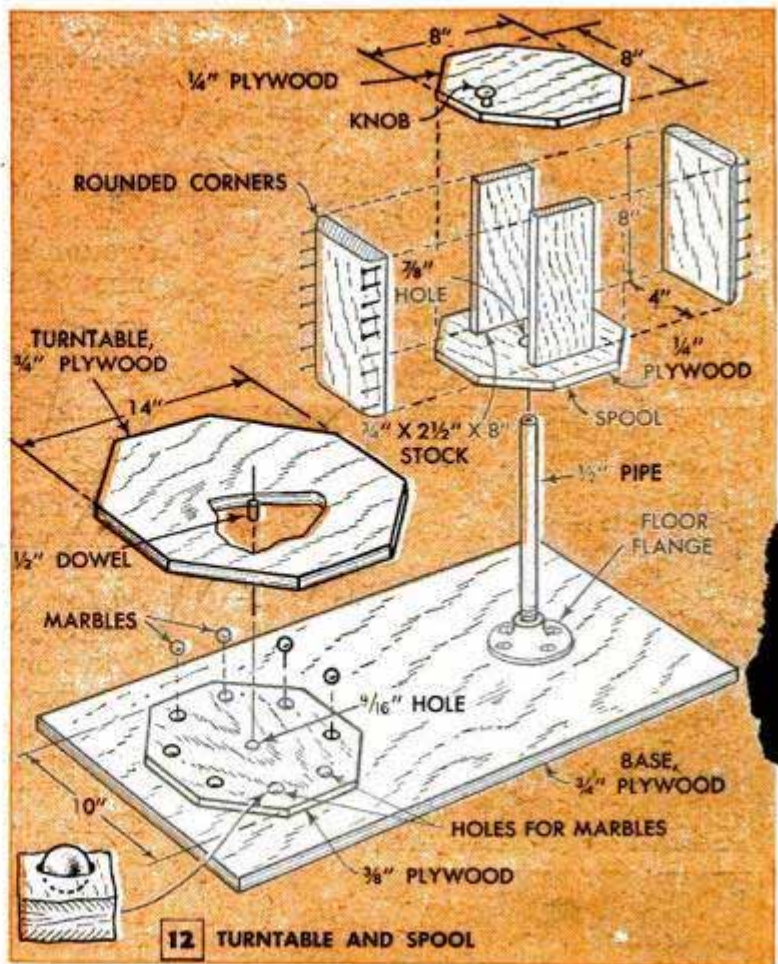
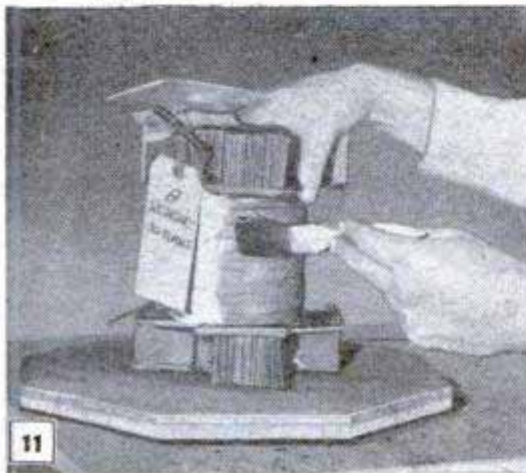
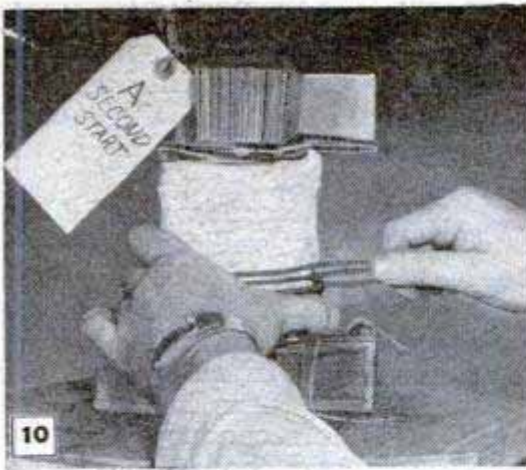

which they are removed and number them to correspond with the side of the transformer from which they are taken. Continue to remove the laminations from the other three sides, keeping each group stacked and numbered separately. After removal of the outer laminations, there remains the central core upon which the coils are wound. Using a turntable and spool, the construction of which is detailed in Fig. 12, remove the outer insulation from the first, or secondary, coil. Fasten the end of the wire to the spool and carefully unwind the coil as shown in Fig. 8. Being of smaller-gauge wire, the primary winding is wound on another spool in the same way. The inner coil, which will be of the same size wire as the first coil, should be wound on the first spool. Thick layers of glass or mica insulation separating the primary and secondary coils are removed, as shown in Fig. 9, and saved for reuse. The binding around the core should not be removed.

For arc welders delivering less than 100 amperes, the secondary coil should be wound with a wire size not less than No. 6 gauge and the primary with wire not less than No. 12 or 14 gauge. For the welder described, the secondary should be at least No. 3-gauge wire and the primary of No. 8 or 10 gauge. Original transformer wire can be reused if it is miked for size and then "paralleled" to make up the required gauge. Paralleling is done by combining a number of small-gauge wires and connecting them at the taps, thus providing a cross-sectional area equivalent to a larger-gauge wire. Table II, below Fig. 12, gives equivalent wire sizes to determine the number

TABLE II - WIRE EQUIVALENTS				
WIRE GAUGE SIZE	NUMBER OF STRANDS AND WIRE SIZE NEEDED FOR SUBSTITUTE			
3	2 of #6	4 of #9	8 of #12	16 of #15
4	2 of #9	4 of #12	8 of #15	16 of #18
6	2 of #11	4 of #14	8 of #17	16 of #20
10	2 of #13	4 of #16	8 of #19	16 of #22
12	2 of #15	4 of #18	8 of #21	16 of #24
14	2 of #17	4 of #20	8 of #23	16 of #26





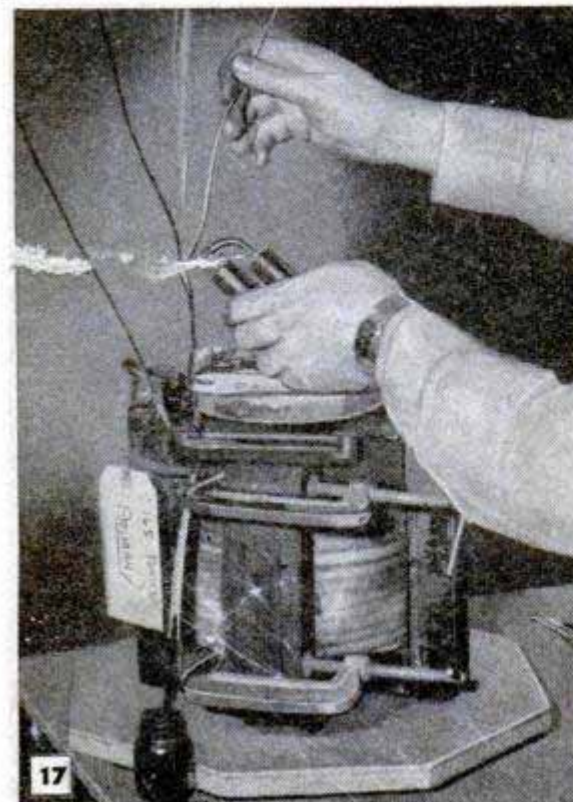
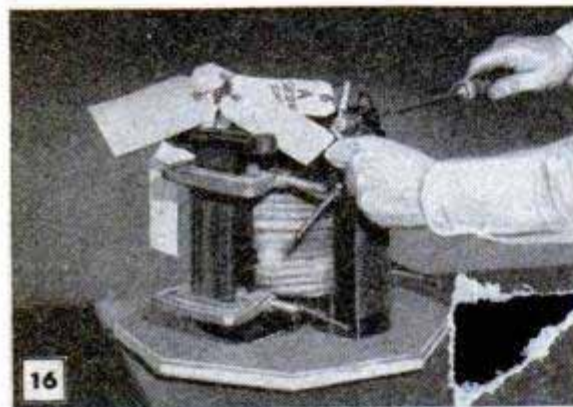
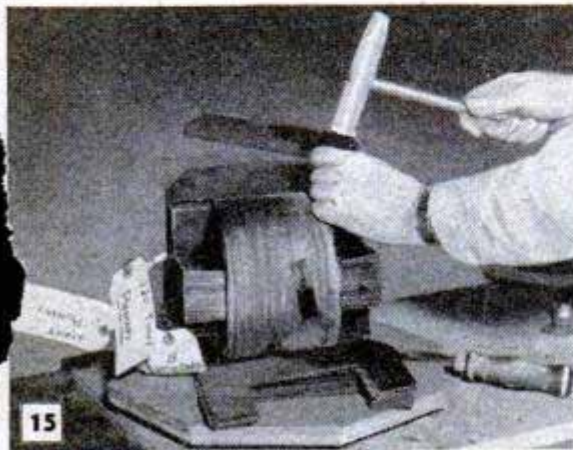
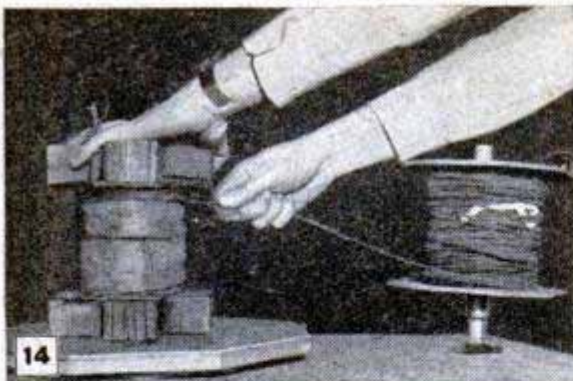

of any specific small wires necessary to make one wire of a desired size. Wires smaller than No. 16 gauge may be paralleled into a single strand by twisting them together with a hand drill. Larger sizes may be paralleled by laying them side by side on the coil.

The first portion of the secondary should be wound around the core by pulling out a lead about 6 inches long, and labeling it with a shipping tag, "A-start secondary." Then lay in the wire, using a single strand or several wires side by side as in Fig. 10. In most cases you should apply the first 15 turns in one layer. Wrap this portion of the secondary with two layers of cotton cloth and shellac it, Fig. 11. The cloth should be completely saturated. Next, wind another 15 turns over the first layer and tag the end of this coil, "B-1 secondary, 30 turns." Now, replace one of the insulating blankets over the secondary turns as in Fig. 13. Wind one layer of the primary over this blanket, first taking off a lead and labeling it, "primary start." Fig. 14 shows 5 strands of the original primary wire twisted together. Wrap this layer with one thickness of cotton cloth and shellac. Continue with the primary winding, insulating each successive layer with cloth and shellac. Take off taps at 110 turns, 165 turns and the final tap at 220 turns. Label these taps, "1 primary, 110 turns," "2 primary, 165 turns" and "3 primary, 220 turns." After this, replace the other insulating blanket and begin the second section of the secondary coil. Label the starting end of this secondary lead, "B-1 start, 3rd layer secondary," and after 15 turns, tap and label, "C-2, 3rd layer secondary, 15 turns." Insulate this with two layers of cloth and apply shellac. Continue on the fourth layer of the secondary, tapping after 5 turns and labeling the tap, "3 secondary, 5 turns." Make 5 more turns and tap, labeling, "4 secondary, 10 turns," then make 5 more turns or a total of 15 turns, and label the final tap, "5 secondary, 15 turns." After this, replace the laminations, driving the pieces into place with a softwood mallet as in Fig. 15. Finally, replace the yokes and brackets, using C-clamps, as in Fig. 16, to hold the laminations in compression until the holding devices are in place.

Long connecting wires are soldered to the leads, Fig. 17. Care must be taken to assure a permanent joint. Larger wires should be lapped and wrapped with fine wire before soldering. The secondary lead marked "B-1 secondary, 30 turns" may be connected with "B-1 start, 3rd layer secondary" and a common lead taken from them. The connecting leads should be about 2 feet long and fitted with lugs soldered in place. These leads may be insulated by wrapping and shellacking or by slipping sections of loom over them. If it is necessary to remove the identification tags when making the soldered joints, they should be immediately replaced to avoid any confusion later.

(To be continued)



Here is a hole-saw attachment for a drill press that speeds up the cutting operation by permitting the stock removed to be ejected from the tool while the drill press is running. Using an ordinary hacksaw blade, wood up to  $\frac{1}{4}$  in. thick can be cut. A wider blade, of course, allows working with heavier stock. A 12-in. hacksaw blade will provide a saw with a maximum diameter of about  $3\frac{1}{2}$  in. The tool is made by cutting a disk from  $\frac{3}{4}$ -in. wood about  $\frac{1}{4}$  in. larger in diameter than the desired size of the saw. Then, the disk is drilled to take a  $\frac{1}{4}$  by 3-in. bolt, countersinking the bottom of the disk for the nut. It also is drilled for two  $\frac{1}{4}$ -in. dowels. The head of the bolt is cut off so it can be chucked in the drill press and it is fastened to the cutter as shown. A shoulder  $\frac{3}{16}$  in. wide is turned on the underside of the disk to the exact diameter of the finished tool. This may be done by chucking the unit in the drill press and improvising a tool rest. To mount the hacksaw blade, heat it to a dull red and cut off one end square. Next, drill small holes near the top edge of the blade at intervals of about 1 in. Heat the blade again, if necessary, and bend it to the desired radius. However, be sure to bend the blade so that the teeth will be in proper cutting position after it is mounted. Finally, nail the blade

## Homemade Hole Saw Increases Production By Removing Disk While Machine Is Running

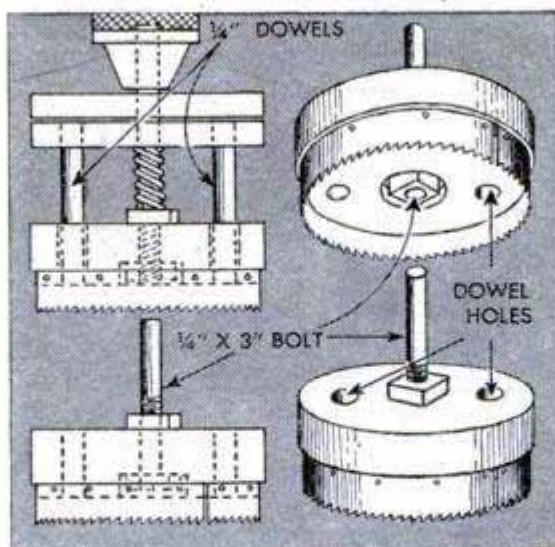

to the cutter disk, starting with the squared end, and trim the other end to fit snugly against it. The ejecting mechanism consists of two disks of  $\frac{1}{4}$ -in. plywood drilled to slide over the bolt. The lower disk is fitted with  $\frac{1}{4}$ -in. dowels aligned with the holes in the cutter disk. A spring and then the lower disk are placed over the bolt, and dowels are inserted in the holes. The upper surface of this disk is waxed to permit the top disk to be grasped during operation without interfering with the rotation of the cutter. The drill-press chuck serves as a stop for the spring. In operation, the top disk is pushed down after the stock is cut. This forces the dowels through the holes in the cutter disk, ejecting the material in the center of the saw.

Ralph S. Wilkes, Elbridge, N. Y.

## Push-Button Switch Operates Starter When Adjusting Valve Tappets



When adjusting valve tappets on new-model cars that are not provided with a crank and have solenoid-type starter switches, difficulty of turning over the motor can be overcome by using a portable switch of the type shown. This consists of a doorbell push button connected to two lengths of insulated wire which terminate in small battery clamps. Each of these wires should be several feet long so that when clamped to the solenoid and to the ground, the push button can be placed within easy reach. In this way, the mechanic can turn over the motor to bring the valve push rods into proper position by pressing on the push button. On cars not having solenoid starter switches, a regular starter switch or a heavy-duty switch should be substituted for the push button to carry the heavy current necessary.



## Cone Mandrel Chucks Work Between Lathe Centers

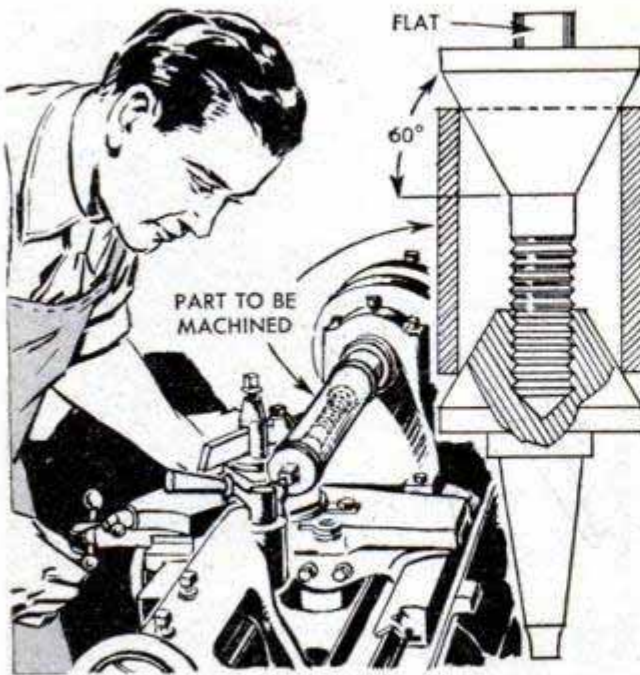

Sleeves and bushings can be machined to a certain diameter along their entire length when chucked in this cone mandrel. It fits into the hollow spindle of the lathe and is supported by the tailstock center. The detail shows how two cones center the work automatically by one cone threading into the other. Note that a flat is filed on the end of the tailstock cone to permit tightening it with a wrench.

Nathan Bogoch, Winnipeg, Man., Can.

## Plug Gauges of Cold-Rolled Steel

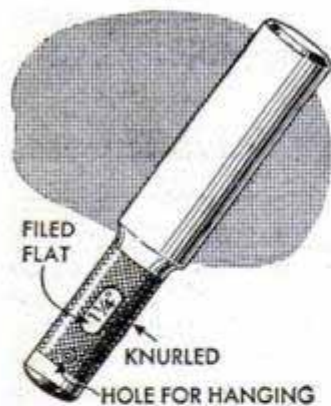

A set of plug gauges made from stock sizes of cold-rolled-steel rod will prove very useful for gauging holes and setting outside calipers where the tolerances are not critical. Although cold-rolled steel is generally undersized, it is advisable to mike the pieces to make sure they are not oversized and not too much undersized. Turn and knurl a handle on each gauge and then file a flat on the knurled portion to provide a space for stamping the size.—Earl R. Goddard, Denver, Colo.

able to mike the pieces to make sure they are not oversized and not too much undersized. Turn and knurl a handle on each gauge and then file a flat on the knurled portion to provide a space for stamping the size.—Earl R. Goddard, Denver, Colo.

## Retapping Threads in Nuts

When retapping damaged or undersized threads in nuts, holding the nut in a vise may result in a distorted or oval-shaped

hole. Instead, clamp the tap in the vise and run the nut on and off the tap with a socket wrench. Besides giving better results, this method saves considerable time when a number of nuts are to be retapped.

John Kretschmar, Monsey, N. Y.

## Helpful Knurling Stunt

Here's a way to save time when using diamond knurls. Instead of making a test cut, stopping the lathe and inspecting the job before proceeding, first flood the work with lard oil and then engage the knurls.

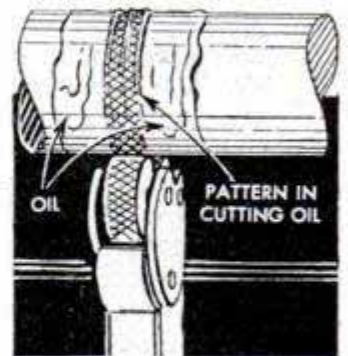

As soon as the oil film forms into uniform rings around the work, throw in the power feed or traverse the carriage by hand. As long as the rings of oil form on the work you will know that the knurling pattern is tracking evenly, because if the pattern begins to "split" or overlap, the rings of oil will not form.

William S. Kals, Vancouver, Can.

## Sawhorse Slotted to Hold Saw

One way to keep your saw at hand between cuts while still protecting the blade from possible damage, is to make a fairly long slot lengthwise through the top of the sawhorse. When finished with a cut merely lower the saw blade into the slot.

## Movable Hog Wallow on Runners

This wooden hog wallow can be towed to any location and it's ideal for lime-sulphur dip or just to cool off the young pigs in hot weather. Two heavy runners support the box and the sloping ends are held watertight with long endgate rods. The type of construction used makes the wallow easy to dismantle should this be necessary.

A. M. Wettach, Mt. Pleasant, Iowa.

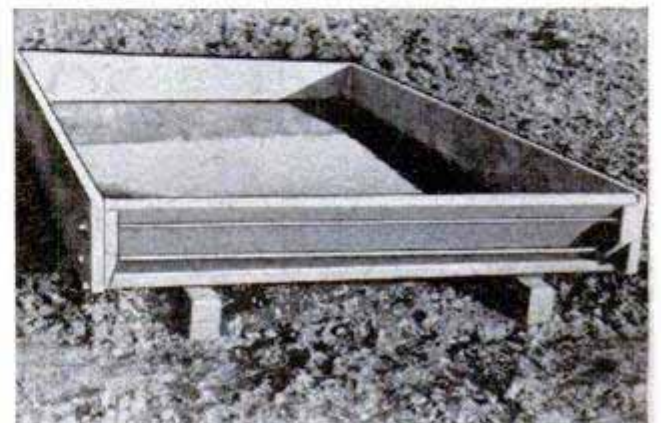



# Holder Permits Routing With Hand Grinder

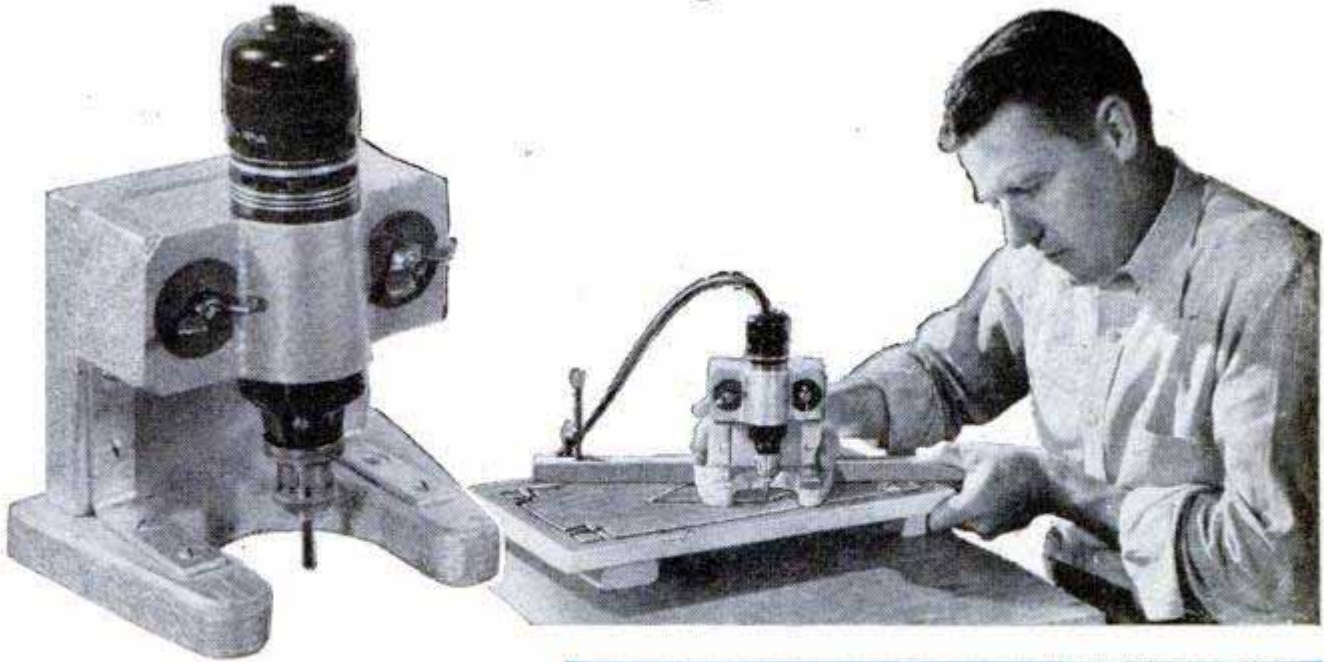

Here is an exceptionally useful jig that permits using a hand grinder for accurate routing to specific depths. In addition to ordinary routing jobs, it's ideal for intricate pattern work as it provides for maximum lateral control of the tool. The base and back of the jig are of  $\frac{3}{4}$ -in. plywood and are fastened together with angle brackets. The holder for the grinder is formed by cutting out one side of a wooden block to suit the diameter of the grinder. Then a sheet-metal strap to clamp the grinder in position is bent, drilled and attached with wing nuts to bolts countersunk in the block. To use the jig, position the grinder in the holder to the proper routing depth and tighten both of the wing nuts.

E. R. Lucas, Poulsbo, Wash.

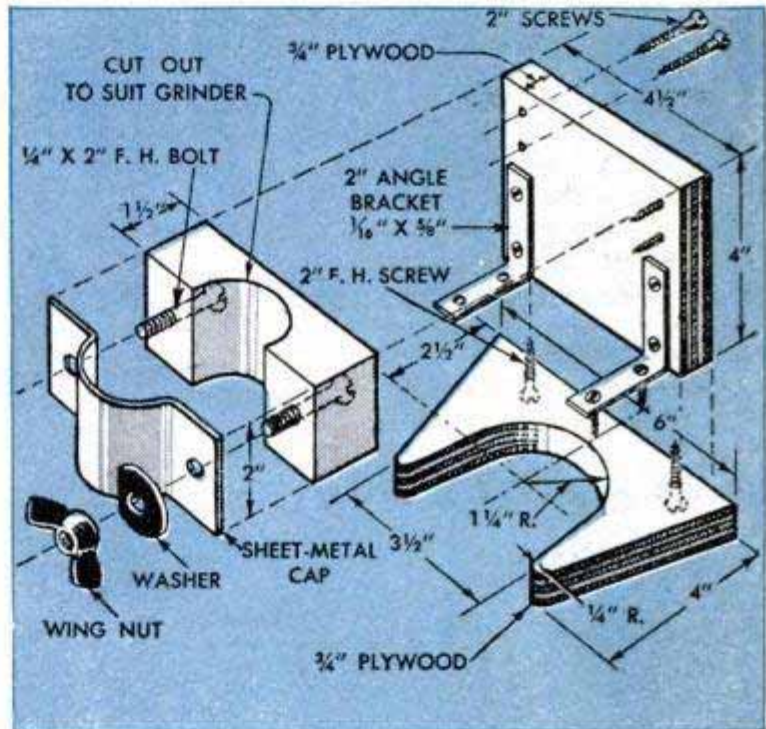

# Hoisting Tongs Provide Safe Hitch for Lifting Heavy Pipe or Poles

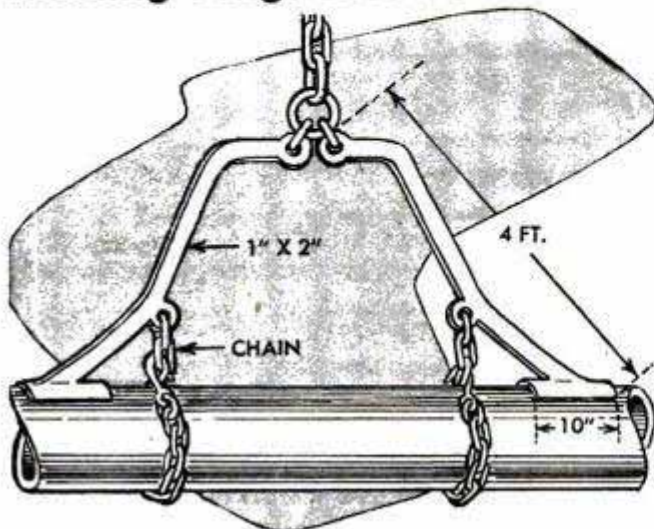

Designed and used by a western contractor engaged in loading power poles, these safe hoisting tongs work similar to a pair of ice tongs—the weight of the object tends to increase the grip. Chained to the load near the point of balance, the tongs keep the load in a horizontal position when lifted. The tongs are made from 1 by 2-in. flat iron, heated and bent to the shape shown. Eyes are welded to take a hoisting ring at the top and two grab chains which wrap around the load. Cupped saddle plates are welded to the ends of the tongs to ride the curvature of the particular pipe or pole being lifted.

William P. Houser, Organ, N. Mex.



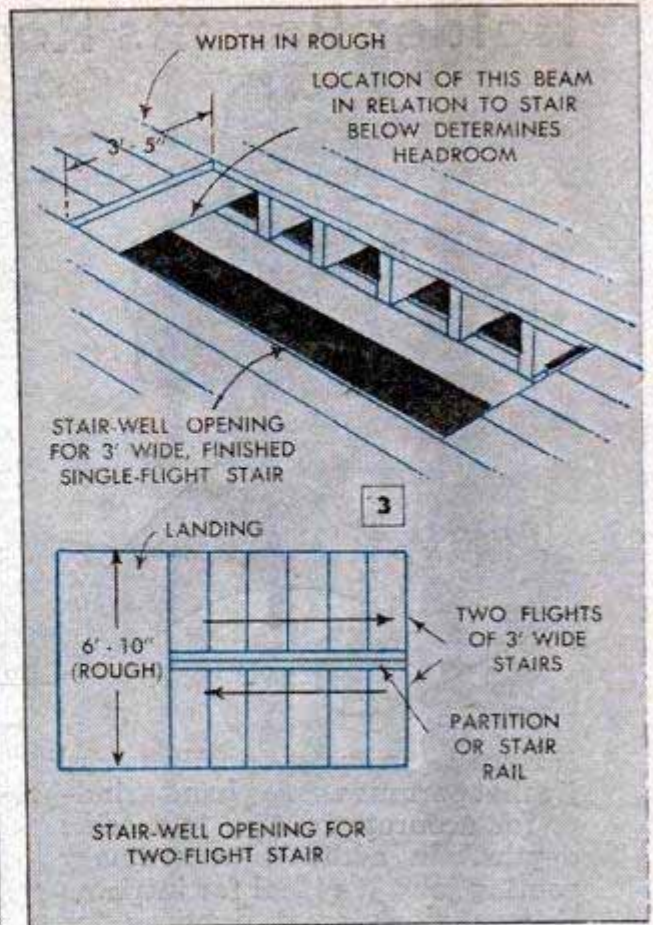

Above, stair rails of the type shown consist of a number of precut parts made from selected hardwoods. Below, layout of stair is based on normal length of step on a level floor

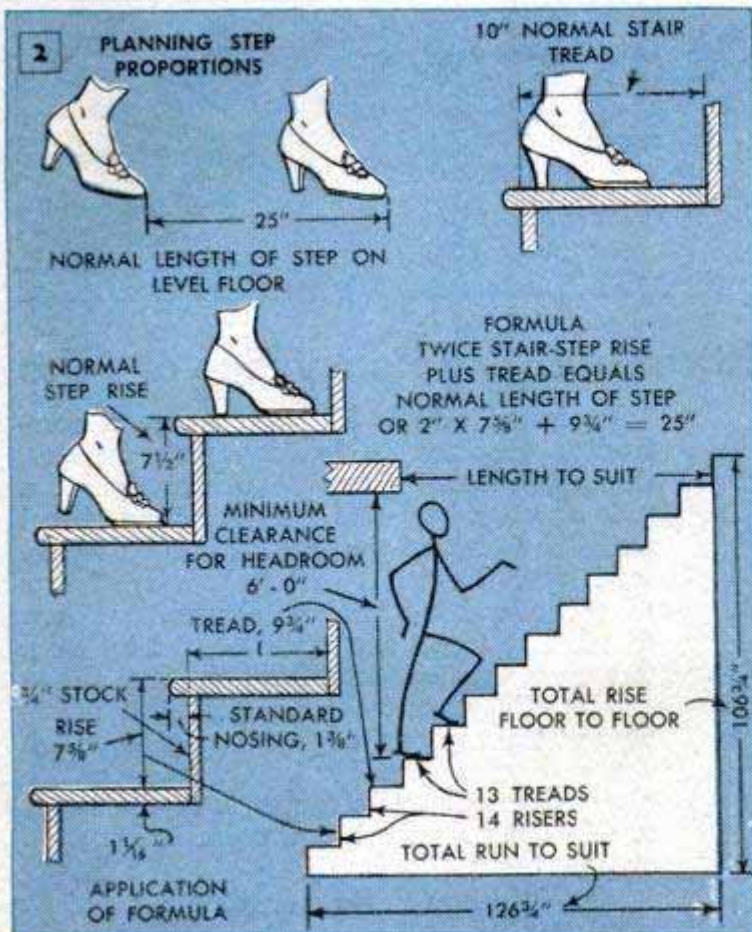

## STEPS IN

INSTALLATION of a safe, attractive stair in either old or new homes is one of the most important details in the interior construction. Stairs that pitch too steeply, or those with abnormal treads and risers and insufficient headroom are a constant accident hazard. For safety, the stair must include all of the basic construction features detailed in Figs. 2 and 3. In the construction or remodeling of small and average-size homes in which stair space usually is limited, the two or three-directional, open-string stair with landings or winder treads often is best as it generally can be placed at the end of a room. In remodeling older homes it sometimes is necessary to use a single-directional closed-string stair, especially in large rooms.

In determining the step proportions for an average stair, use measurements of the typical step shown in Fig. 2. These dimensions should not be varied more than 1/2 in. either way, except in some special cases, such as on long flights made possible by ample space in large homes and buildings. On these stairs, a rise as low as 6 in.



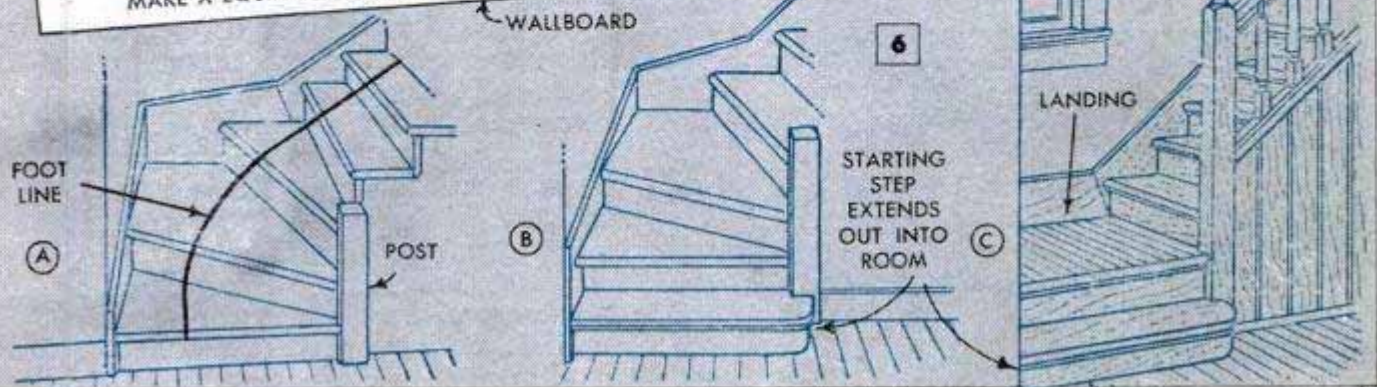
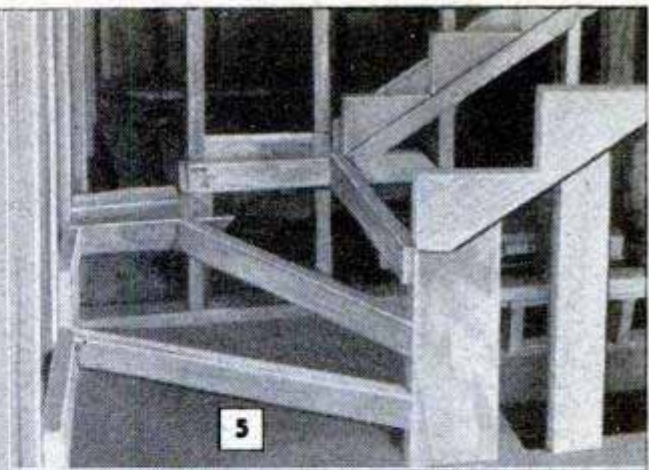
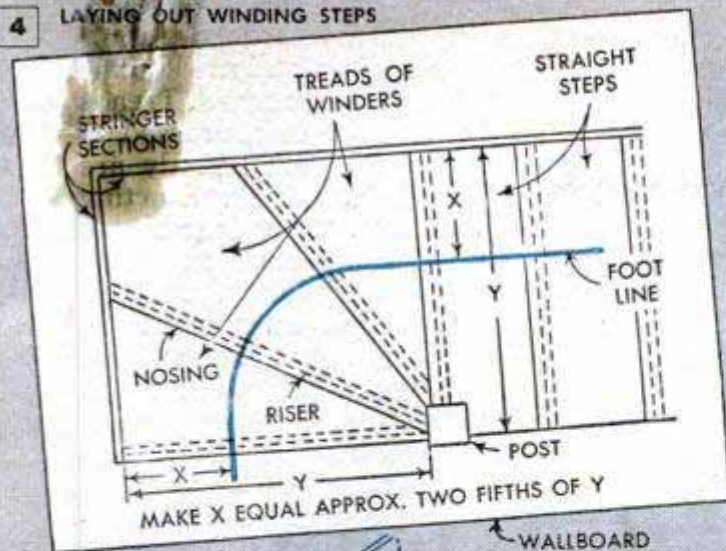

# STAIR BUILDING

By  
John Modroch

and a tread as wide as  $11\frac{1}{2}$  in. may be used. Actual measurements will depend to some extent on how many steps of this proportion can be fitted into the stair space. To determine the number of risers for a given stair, first divide the total rise by the step rise, or a figure close to it that will give an even result. Then to get tread measurement divide the total run by the number of treads, which is always one less than the number of risers.

The stair opening, or well, should be cut wide enough and long enough to provide adequate headroom, Fig. 3. Remember also that dimensions of the opening must allow for the finish stringer, upper-floor nosing, and space for a rail. For example, the total finish allowance for the ordinary 36-in. single-flight open-string stair ordinarily would come to 5 in. These figures are based on  $\frac{3}{4}$ -in.-thick plaster wall and a standard  $2\frac{3}{8}$ -in.-wide rail, plus 1 in. minimum finger room between the rail and wall. Always check walls of the stair well with a level and straightedge to determine beforehand the allowances for out-of-plumb walls, corners and other irregularities.

In planning the installation of a stair in a new location, which often is done in making alterations in old houses, obstacles that interfere with the placement of the stair well may be encountered. These may be

supporting main beams or joists, chimneys or other installations that cannot be moved. If the obstacle is at one end of the proposed opening, the loss in length sometimes can be compensated for by shifting the location of the stair in the opposite direction. If this cannot be done, then winding steps or landings, Figs. 4, 5 and 6, sometimes can be installed. However, there is a definite minimum total run as well as a minimum headroom. Built to any dimension under these limits, the stair is not only difficult to ascend or descend but actually may be dangerous in some locations. Fig. 6, A, B and C, detail the commonly used methods of building approaches to both open and closed stair flights. In detail A, three winder treads are used. Winders are tapered steps which pivot at the newel post. Here the nosing of the winder starting step is flush with the stair wall. Better construction is shown in detail B where the starting step is straight and extends its width into the room. Somewhat simpler construction of the open-string stair employing a landing is indicated in detail C. In laying out winders, the plan should be drawn full size as in Fig. 4. The tread width of winders is gauged by intersecting the foot line, which represents the normal path of travel on winding steps, with a compass set to the tread width of the straight steps.



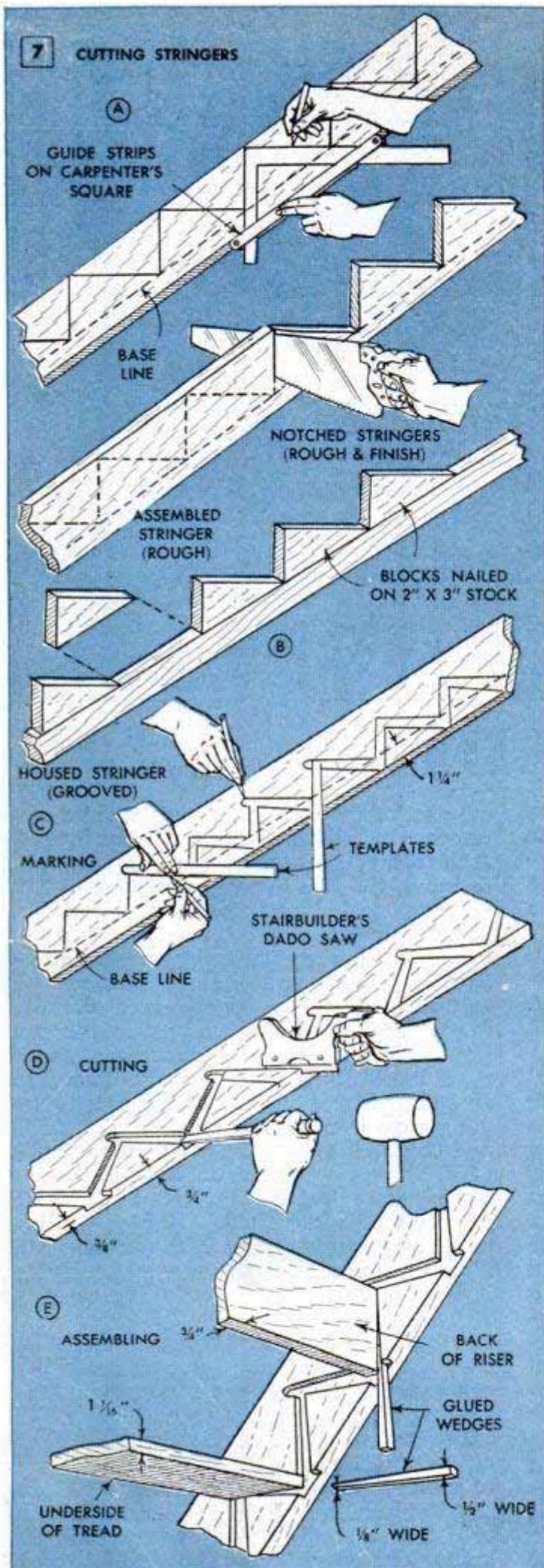

Only thoroughly seasoned lumber should be used in building a stair. Treads and risers in standard lengths and widths may be purchased. Treads preferably should be oak, dressed to  $1\frac{1}{16}$ -in. thickness. Risers usually are cut from pine,  $\frac{3}{4}$  in. thick. Starting steps, built with curved ends to match standard rails and newel posts, nosing returns and cove moldings, also are stock items. Clear  $\frac{3}{4}$ -in. pine boards commonly are used for making finish stringers. Rough stringers are cut from 2-in. stock.

In building a stair, make the stringers first. They may be the open or notched type, details A and B, Fig. 7, or the housed type, detail C, depending on the method of stair installation. On either type, begin by laying out the rise and run of each step as in detail A. On a notched stringer make the saw cuts shown. On a housed stringer, locate and pencil the outlines of the grooves with the aid of two templates, one for the tread grooves and one for the riser grooves, as in detail C. Both templates must include an allowance for wedges, Fig. 7, E. When the layout is completed cut the grooves as in detail D. Be careful when chiseling out the waste to bring the grooves to a uniform depth. At this stage, cut risers and treads to width, but not to length unless the stair is to be assembled beforehand and installed as a unit.

To avoid damage resulting from exposure to moisture in a new-house installation, the stair should not be installed until after the rooms have been plastered and have had time to dry out. However, where the rough-stringer method of construction is used, the stringers may be put in beforehand and temporary tread boards nailed on so that the stair can be put into immediate use. Finish the stair after the plastering is completed and thoroughly dried.

To install a closed-string stair in a plastered stair well, fasten the stringers to the walls by nailing through the plaster into the studding. Next, cut the treads and risers to length and wedge them in the grooves as at E in Fig. 7. Set the wedges in glue and be especially careful to drive them to a uniform tension. Where it is practical to support a notched wall stringer away from the wall, E in Fig. 8, a plain board can be used as the finish stringer, thus eliminating the need for notching or grooving. Slip the board down into the space between the



notched stringer and the wall and aster with finishing nails driven through the plaster into the studding. Then install the risers and treads by butting them against the finish stringer instead of the plaster. Other methods of installing notched stringers are shown in Fig. 8, details A, B, C and D. A method of miter-joining the risers to notched stringers is shown at A, Fig. 9. The use of decorative brackets, detail B in Fig. 9, simplifies the miter-joining of risers and finish stringers on the open side of the stair, making it somewhat easier to produce neatly finished edges, and affording a simple means of correcting open joints caused by errors or inequalities of lumber. Anchor newel posts to the stair structure as shown in Fig. 9, detail C. If the installation permits working under the stair, the groove-and-wedge method as used with housed stringers may be employed for anchoring steps to posts, instead of the cleat-and-nail method shown at C. Wedges produce a tighter job. When installing a stair on subflooring, which is common practice, be sure to allow for the thickness of finish flooring by making corresponding increases in the width of the bottom riser and the length of the stringers and newel post.

An attractive stair rail not only is of decorative value, but it's an essential part of every stair as it reduces the accident hazard to the minimum. The rail must be rigidly mounted on newel posts that have been firmly anchored in the stair structure, and it should be capable of withstanding more than normal strain. To aid stairbuilders in doing good rail jobs at reasonable cost and with a minimum of hand work, ready-made rails are preferable for use on stairs of common measurements. These come in sections that are assembled on the job. Matching newel posts and balusters should be obtained with the rail. If the stair follows a normal layout with average run-and-rise measurements, it is easy to fit these standard parts. To determine the dimensions of parts needed, draw full-size plan and elevation layouts. A typical layout of the balustrade is shown in Fig. 11, the parts lettered A to E inclusive, Fig. 10, being shown in position in the plan view, Fig. 11. A common procedure is to assemble the rail in flight units, beginning at the lower, or starting, newel. First bolt the easement section of the rail to the starting newel cap. Join the gooseneck section of the

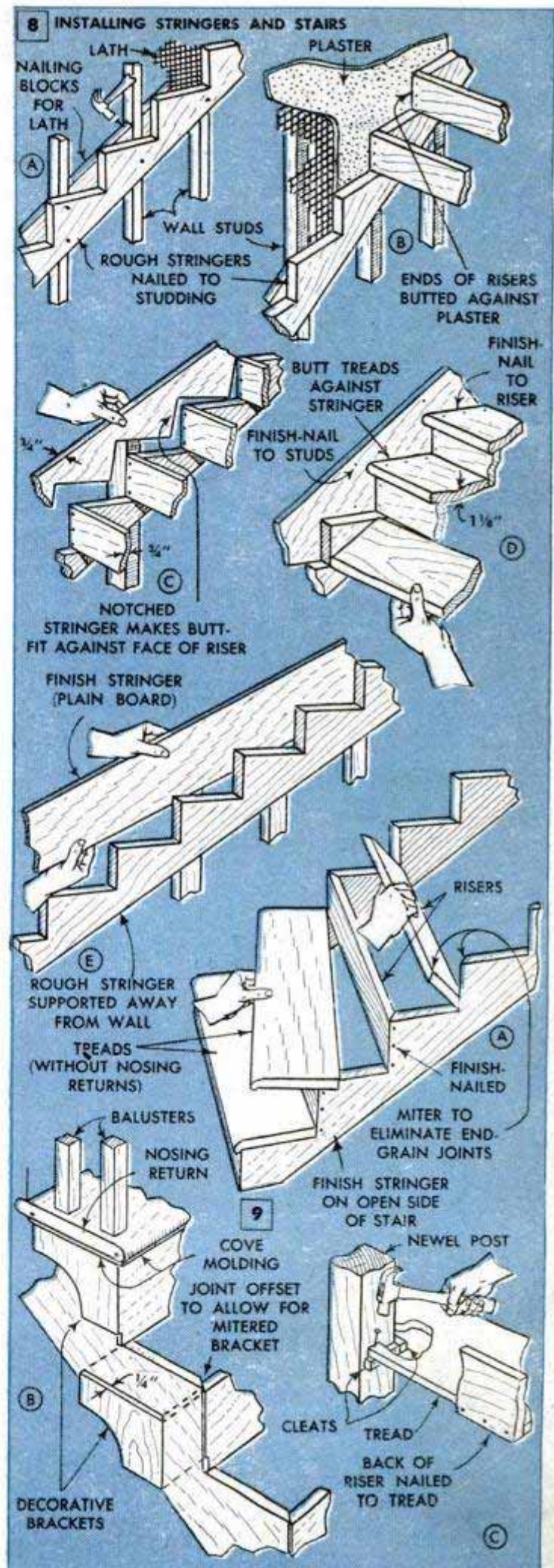



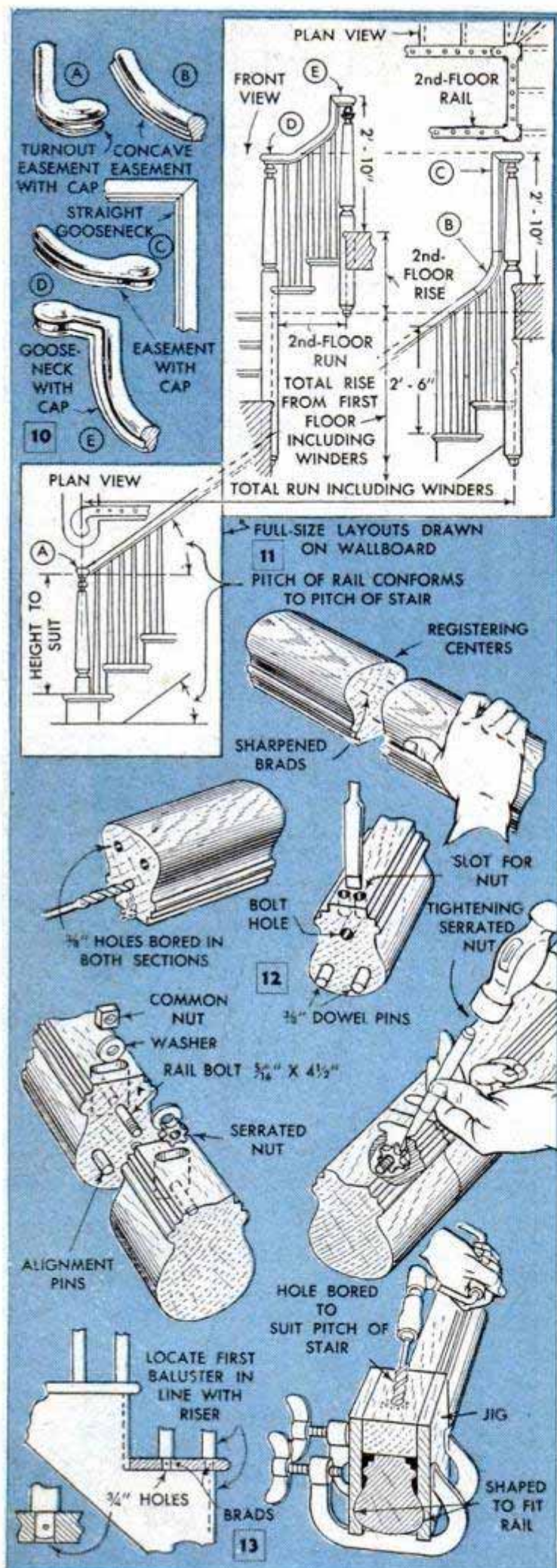

rail to the landing-newel cap. Then bolt the cap-and-easement units temporarily to the straight rail section, hold the assembly on the newel posts as in Fig. 1, and check the rail for length. Straight sections are joined with dowels and special stair-rail bolts as in the five steps shown in Fig. 12. Finally, complete the flight assembly by bolting on the cap-and-gooseneck unit. Assemble any succeeding flight units in the same way. In those styles where easements and goosenecks are not employed or in cases where factory-joined units are used, some of these special operations are unnecessary, of course. After the parts have been fitted and bolted together, fill openings and screw holes either with wooden plugs glued in, or with wood putty.

Balusters are fastened to rails in either of two ways, depending on the style employed. Square balusters, made to fit grooved rails, are held in position by means of spacers, or fillet strips, which are inserted between the balusters. Turned balusters are designed to fit into holes bored in the rails as shown in Fig. 11. Balusters of three different lengths are required for each step except the step directly under an easement, which takes a fourth size of extra length. To locate baluster holes on the rail, set it in place on the posts. Then raise plumb lines from the baluster holes in the step treads up to the rail, using a carpenter's level. Boring the holes at the required angle can be done accurately on the straight sections of the rail with the aid of the simple boring jig shown in the right-hand detail in Fig. 13. Holes in the curved sections of the rail must be bored freehand. In spacing balusters, locate the first one on each step in line with the riser as shown in the left-hand detail in Fig. 13.

Before preparing a newly built stair for painting or varnishing, allow time for the wood to become adjusted to the atmospheric conditions in the house. Otherwise, slight shrinkage may loosen the filling in the joints and spoil the paint job. For this reason, it is best to do all other decorating work in the house first, leaving the stair to the last. Meanwhile, protect the treads from dirt and scuff marks by covering them with heavy paper held in place with cellulose tape. In painting the stair well do not get paint on the stair parts as it will be difficult to remove.



Ball-bearing pillow blocks and arbors were made by one man at a fraction of the purchase price, using secondhand ball bearings mounted in sections of pipe coupling. He selected a pipe coupling with an inside diameter the same or a little smaller than the outside diameter of the bearing. Then he cut the coupling in two, using one half for each bearing housing, and filed down the threads to provide a press fit for the bearing. This section was welded to a piece of flat iron drilled near each end to permit bolting in place.

He made the arbor by welding a piece of pipe between two pillow blocks. Then, removing the square portion from two pipe plugs, he drilled holes through them slightly larger than the arbor. One of these plugs was screwed into each housing, a heavy felt washer being used between the ball bearing and plug to serve as a grease re-

## Pipe Fittings and Flat Iron Provide Housings For Ball-Bearing Pillow Blocks and Arbors

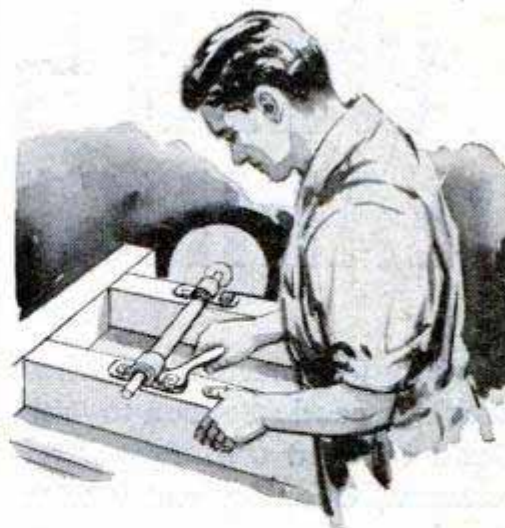
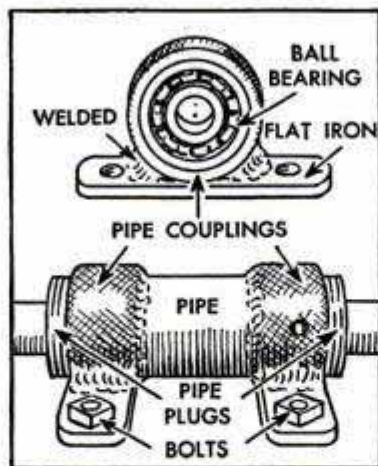

tainer. The unit is drilled and tapped for a grease fitting. The pipe plugs should tighten against the outer races of the bearings to keep them from turning. If desired, the bearing also can be clamped by inserting a setscrew through a hole drilled and tapped in the side of each coupling.

D. C. Marshall, Manhattan, Kans.

## Drive Shaft Aligned to Differential With Aid of Guide Rods

Difficulties often experienced in attaching the drive-shaft housing to the differential housing can be overcome by using guide rods made from long stud bolts or regular bolts with the heads cut off. In either case, the projecting ends of the rods should be ground to a taper point to aid in starting them in the holes in the drive-shaft housing. Two rods are required and are turned into the cap-screw holes in the differential housing, locating

them opposite each other. In use, the drive-shaft housing is lined up in its proper position, then slipped over the guide rods and pushed into place. After a few of the cap screws have been driven, the guide rods can be removed. This method makes it unnecessary to twist and jiggle the drive-shaft pinion and housing assembly to get it in alignment with the differential.

D. W. Brentlinger, Richmond, Calif.

When new spark plugs are installed, they should be properly tightened in the engine block. This is particularly important if all-copper gaskets are employed.

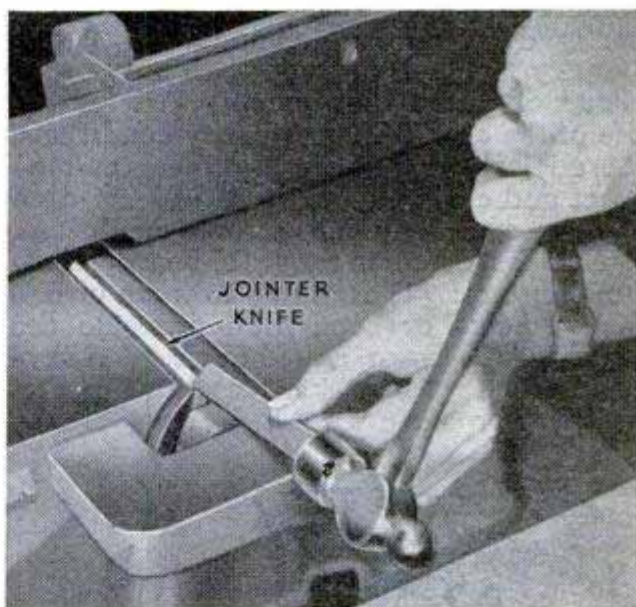

## Adjusting Nicked Jointer Knives Results in Smooth Cut

It's not always necessary to regrind nicked jointer knives to obtain a smooth cut. As the knives usually have  $\frac{1}{8}$ -in. clearance at the ends, it is possible to move them laterally in order to stagger the nicks, so one knife will remove the slight ridges formed by the other knives. To do this, loosen the clamp screws and tap the knives lightly with a piece of brass and a hammer. After moving, the knives must be reset carefully to the proper height.

Henry Hanscom, Elmhurst, Ill.



# SERVICING WHEEL BEARINGS

Like any fine mechanism, wheel bearings need attention to withstand constant use. Proper adjustment, cleaning and lubrication keep them in top condition

*By Phil Ruskin*



Kaiser-Frazer Corp. photo

Testing front-wheel bearings for looseness by rocking wheel. Do not mistake kingpin movement for wheel-bearing looseness

**R**OLLING contact bearings on each of the four wheels support the entire weight of a car. These bearings are expertly designed and engineered for extremely long service, and with only occasional attention they usually last for the life of the car. Under ordinary conditions, it is advisable to remove the wheels and inspect and clean the bearings at least once a year—oftener under extreme conditions.

The most common causes of bearing malfunction are: (1) rust due to worn or defective seals or condensation inside the housing; (2) worn, galled or abraded surfaces resulting from too loose a fit or dirt lock; (3) broken or bent inner ring, shields,

seals or separators caused by improper or careless installation, and (4) damaged raceways, balls or rollers due to dirt or pitting by corrosion. Badly discolored balls and races indicate inadequate lubrication. Dirt or pitting by corrosion is indicated by a general roughness, and excessive looseness or end play is evidence of lapping by dirt or abrasive. Parts are a dull-gray color when lapped or abraded by dirt.

The principal parts of a ball bearing are shown in Fig. 4. Variations of this bearing will be found in the different makes of cars, but basically they are the same. Wear is virtually absent unless foreign matter finds its way into the bearing. However, any

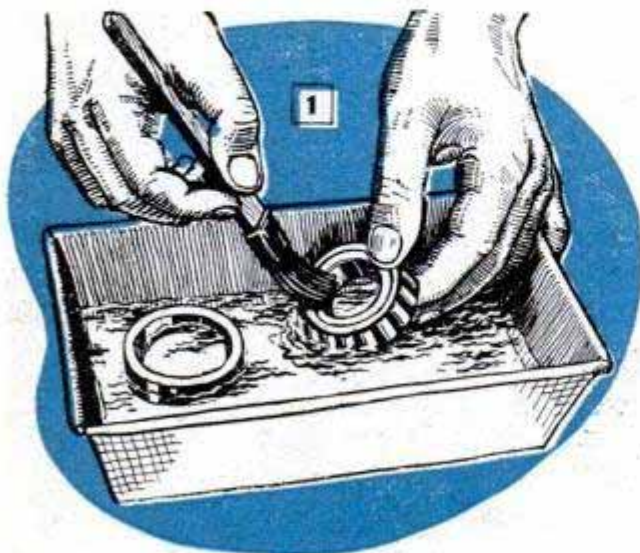

Soft brush assists cleaning of bearings in gasoline. After washing, handle parts only when necessary



Bearing is packed with wheel-bearing grease made especially for purpose. Substitutes should not be used



abrasion or injury to the surfaces may lead to bearing failure, and hitting or dropping a bearing is likely to damage it beyond repair. Also, incorrect kind or amount of lubricant may cause heating or corrosion.

Fig. 3 shows a typical bearing arrangement for the front wheels. To service these bearings, jack up the wheel and remove the ornamental cover and hub cap, if any. Next, remove the cotter pin from the spindle nut and unscrew the nut. Pull the wheel off slightly to loosen the outer bearing and then push the wheel back in place. Carefully remove the outer bearing and place it on a clean piece of paper. The wheel can then be completely removed from the axle. Now, slip the inner bearing and grease retainer from the hub and place them on the paper also. After this, all parts, including the wheel hub and axle spindle should be thoroughly washed in white gasoline and allowed to dry, Fig. 1. Do not handle the bearings more than necessary after cleaning, as perspiration tends to corrode them. Inspect the grease retainer and brake assembly for grease leakage. As this retainer keeps the lubricant within the bearing area and away from the brakes, it should seal tightly. Inspect the bearings for wear and damaged balls or rollers and check for play between the balls and races. However, do not spin the bearing before it has been lubricated. Coat the bearings and the axle spindle with wheel-bearing grease, Fig. 2, but do not use ordinary chassis lubricant or other substitutes. If new bearings are necessary, be sure to get duplicates of the ones being discarded.

To reassemble the parts, first press the inner bearing and grease retainer into the hub. Mount the wheel on the spindle, being careful not to damage the grease retainer, and insert the outer wheel bearing, applying the spacer washer and castle nut. Rotate the wheel slowly, tighten the nut until the wheel just binds and then back off the nut slightly to insert the cotter pin. Check for bearing looseness by rocking the wheel, but first block the kingpin or have someone watch it, so that kingpin movement is not confused with bearing looseness. With the bearing properly adjusted there will be a slight drag when the wheel is turned slowly by hand. When the adjustment is right, secure the cotter pin.

The rear-wheel bearings, Fig. 5, do not require attention as frequently as those on the front wheels. The parts of the rear-wheel assembly are cleaned and the bearing checked in much the same way as those of the front wheel. However, a wheel puller will be necessary to remove the wheel. Probably a puller will also be needed for the bearing. If the bearing is lubricated by high-pressure grease fittings, be careful not to apply too much grease.

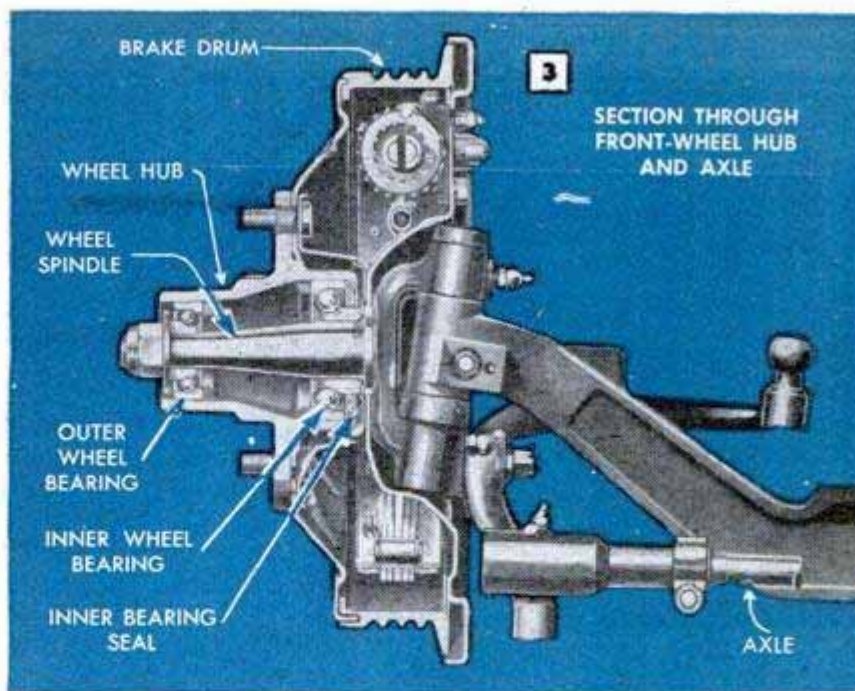

General Motors Corp. photo

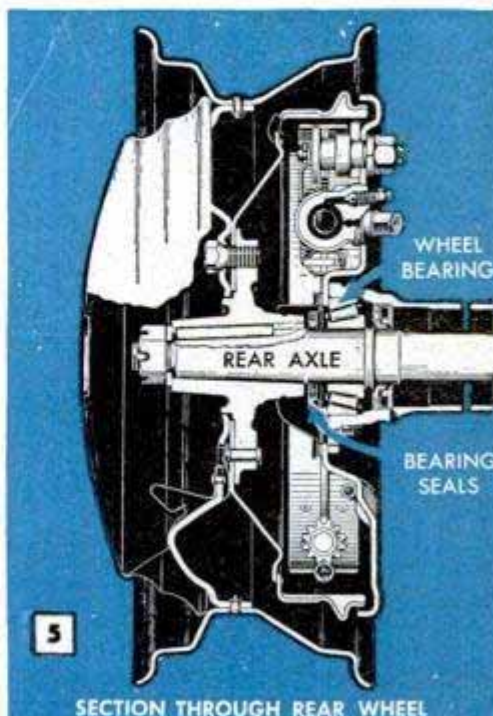
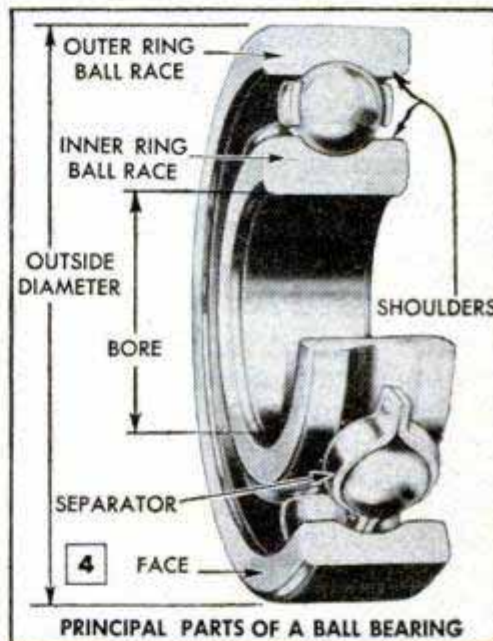

SECTION THROUGH REAR WHEEL

Diagram courtesy Packard Motor Car Co.



## Insulating Board Holds Pin Tags For Rapid Marking

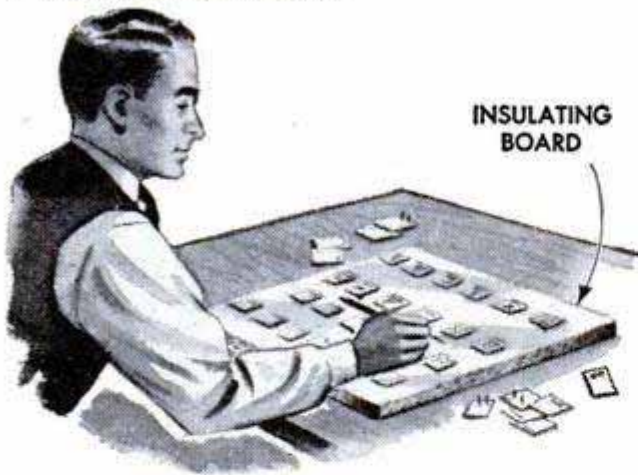

Not only was the job of marking prices on pin tags expedited by one merchant, but he also lessened the danger of injury to his fingers on the sharp ends of the pins. This was done by arranging a number of the tags in rows on a piece of soft insulating board. These were held fast by pressing the pins into the board, and after the tags were marked, they were easily pulled off the board.

G. E. Hendrickson, Argyle, Wis.

## Compressed Air Helps Rewire Car

After several futile attempts to pass a wire through a channel in a car body, one mechanic hit upon the idea of using compressed air to do the job. First, he tied a small piece of cloth to the end of a length of string and placed the cloth in the channel. Next he blew the cloth through the channel with a jet of compressed air. Then the other end of the string was tied to the wire to permit pulling the latter through the channel.—Ed Packer, Chicago.

## Throw Switch in Horn Circuit Regulates Volume

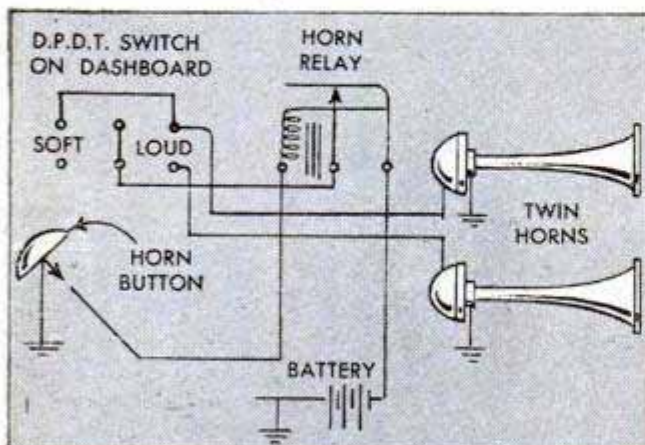

If you have dual horns on your car which are too loud for city driving, the volume can be controlled by installing a d.p.d.t.

(double-pole, double-throw) switch in the circuit, as shown. Where maximum volume is unnecessary or not permitted, just set the switch to allow only one of the horns to sound. Then, when you're out on the highway, both horns are sounded simultaneously by throwing the switch.

Fred Lettino, Long Island City, N. Y.

## Setscrew Replaces Clamp Bolt To Increase Lathe-Dog Safety

Whenever a lathe dog is used there is the possibility of the clamp bolt injuring the operator. To avoid this danger, replace the clamp bolt with a socket-head setscrew, using a screw that does not project above the surface of the dog.—Richard Hanscom, Elmhurst, Ill.

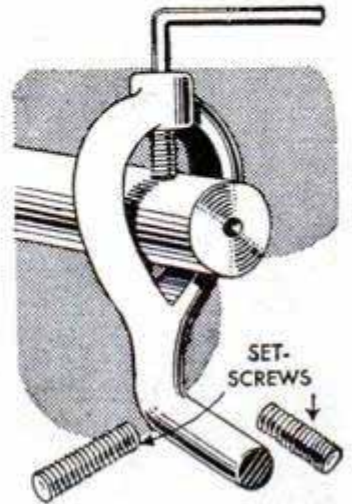

## Short Cuts Speed Inventory Of Stacked Materials

Here are two short-cut methods for counting stock piles of pipe, tubing, iron rod, etc., when taking inventory. To find the total number of items in a pyramid-

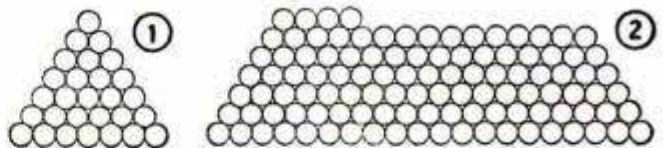

shaped pile, it is necessary to count only the bottom row, multiply that number by a number that is one greater and divide by 2. For example, Fig. 1 shows 7 pieces in the bottom row. One number greater than 7 is 8. Seven multiplied by 8 equals 56. This divided by 2 equals 28, or the number of pieces in the pile. To find the total in a pile stacked as in Fig. 2, count the number of units in the bottom row, then the number of complete rows and finally, the number of pieces in an incomplete row or rows. Thus, in the example, Fig. 2, 20 is multiplied by 2. Then the number of complete rows minus 1 is subtracted from 40 giving 35, after which this figure is multiplied by half the number of complete rows, in this case, 3. Then to the product of 105 (35 times 3), add the number of pieces in the incomplete row, which is 4, making a total of 109 pieces in the pile.





## 'Wireless' Sound-Movie Projector

UTILIZING your home radio for amplifying the film sound track, this 16-mm. sound-movie projector actually "broadcasts" the recorded sound to your receiver where it is picked up and played through the set. You merely tune your receiver to a dead spot and the sound comes out of the loudspeaker. There are no connecting wires or attachments between the projector and the radio set. A 12BE6 tube is employed as an oscillator and a 12AU6 serves as an audio amplifier. Photo A shows the projector in operation, with the receiver at the right of the screen.

Doing away with the delicately adjusted parts in the usual scanning system, graphically illustrated in Fig. 1, this Apollo projector uses a special type of photocell in an infrared-ray scanning system which employs the three tiny parts shown in photo D. The projector weighs about 16 pounds. Additional features include a 2-in. f:2 fully achromatic coated lens, 500-watt projection lamp, and improved high-lumen shutter. Photo B shows the projector equipped with extension arms for 2000-ft. reels. The 200-ft.-reel assembly appears in photo C. The instrument is instantly convertible from sound to silent speed projection.

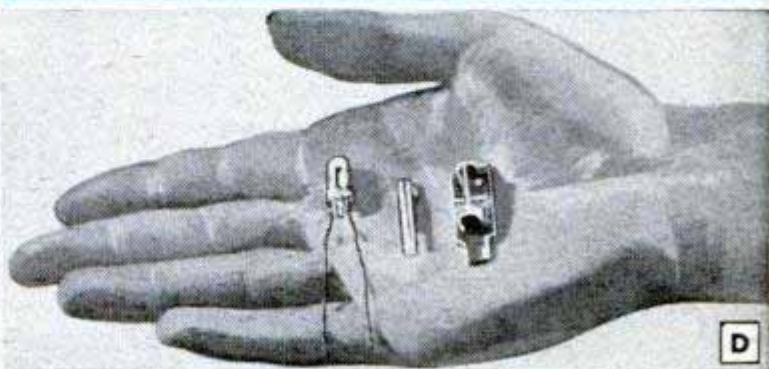
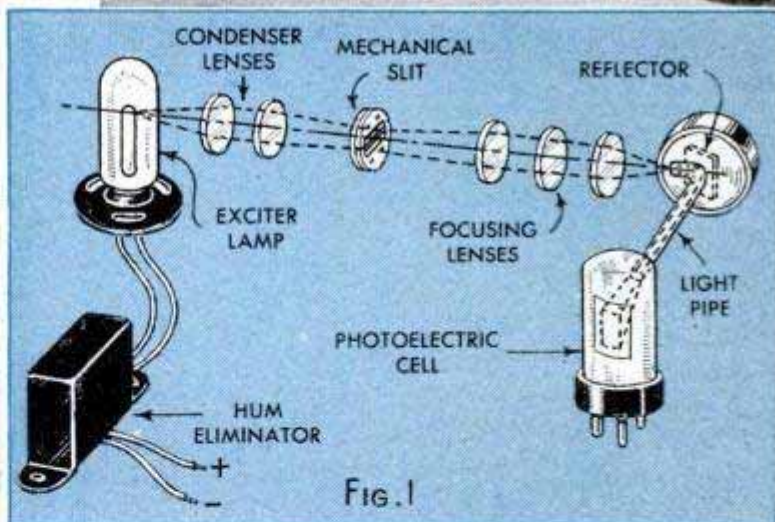
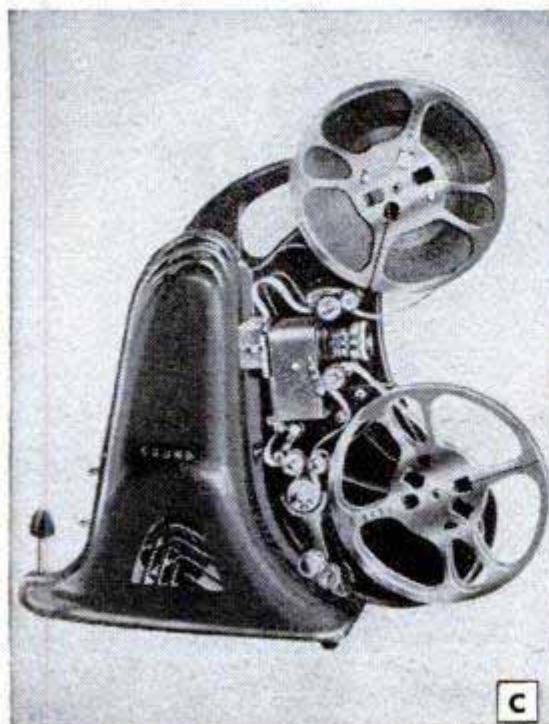
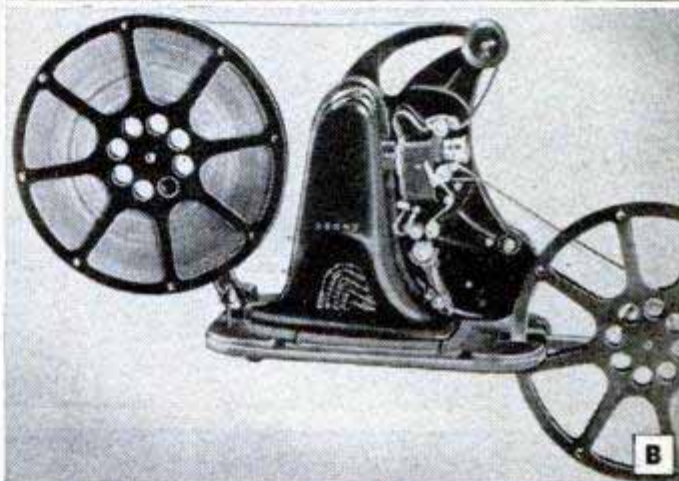
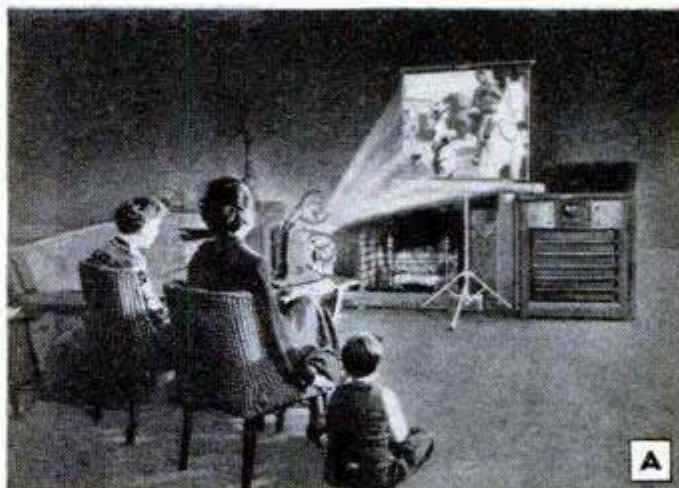



# Portable 3-Tube Phono Player

By Arthur I. Rattray

HERE is an automatic record player and amplifier that is easily portable. It also has eye appeal and gives you good quality reproduction. It may be operated in any location where a 110-volt, 60-cycle a.c. line supply is available. Ideal for small dancing parties or for playing favorite record-album selections, you merely plug it into a socket and it plays 12 ten-inch or 10 twelve-inch records one after the other with the lid closed. The volume is sufficient for a large room.

It employs a 3-tube, high-gain audio amplifier and a 6-in. permanent-magnet (PM) speaker that delivers surprising power without distortion. There is a separate tone-compensating control, volume

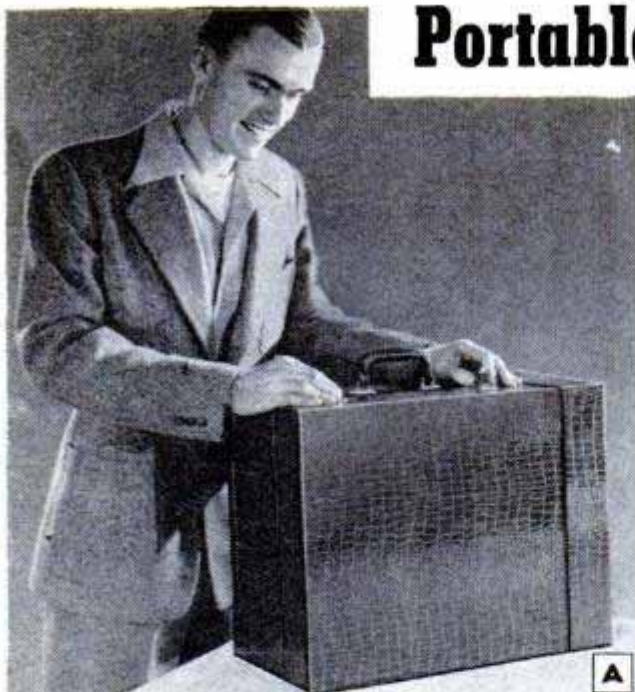

A



AMPLIFIER PANEL

B

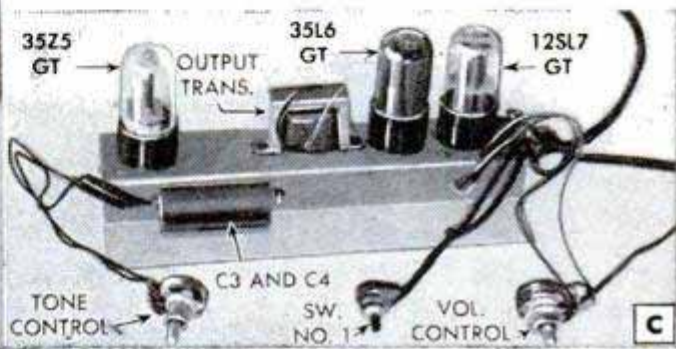

TONE CONTROL

SW. NO. 1

VOL. CONTROL

C

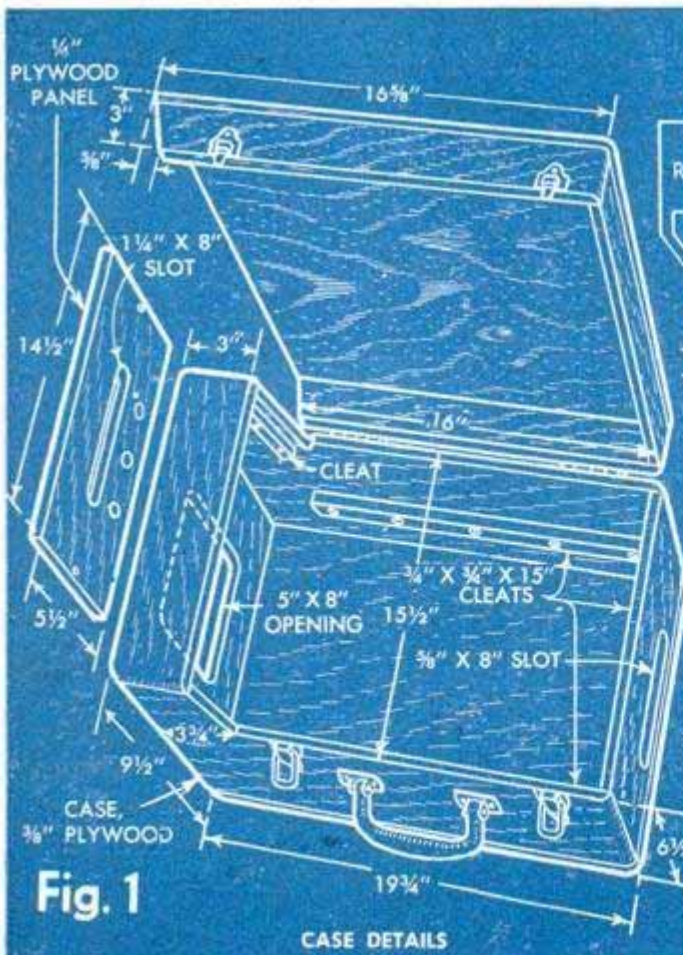

Fig. 1

CASE DETAILS

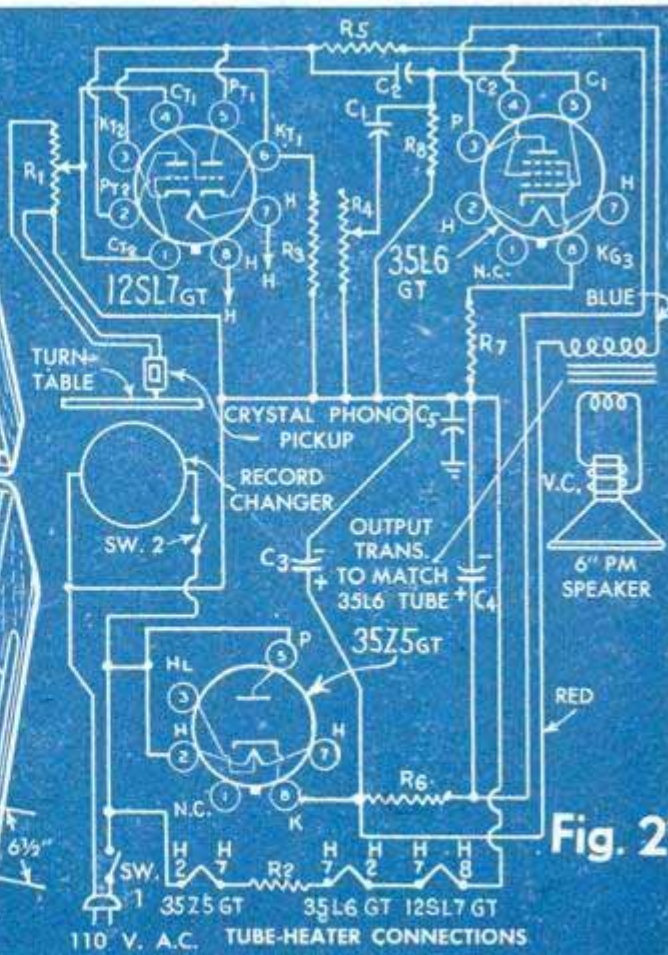

Fig. 2

110 V. A.C. TUBE-HEATER CONNECTIONS



# With Automatic Record Changer

control, and on-off switch. These controls are mounted on a convenient panel on the inside of the case directly in front of the audio amplifier at the left of the turntable, as indicated in photo B. With the lid closed as shown in photo A, the complete automatic record player with built-in amplifier is not much larger than a suitcase.

A standard case of this type is available from all radio-parts houses or, if the builder wishes to construct his own, it can be made of plywood as detailed in Fig. 1. It may be covered with imitation leather or it can be hand rubbed, stained and given a wax or varnish finish if preferred. The speaker opening, and ventilation slots in the case and the control panel are backed with pieces of brown-flocked grille screen. A mounting board for the record-changer mechanism is also made of plywood. The shape and size of the opening will depend upon the type of record changer used. The manufacturer supplies a template with each unit. The one used in the model is a Webster type 50, mounted as shown in underside photo G.

The schematic circuit diagram is given in Fig. 2. It employs one 12SL7-GT high-mu twin triode tube, a 35L6-GT beam-power amplifier tube and a 35Z5-GT half-wave rectifier. Please note that the tube heaters are connected in series, with the 250-ohm 10-watt wire-wound resistor R2 following the 35Z5-GT rectifier tube.

(Continued to page 226)

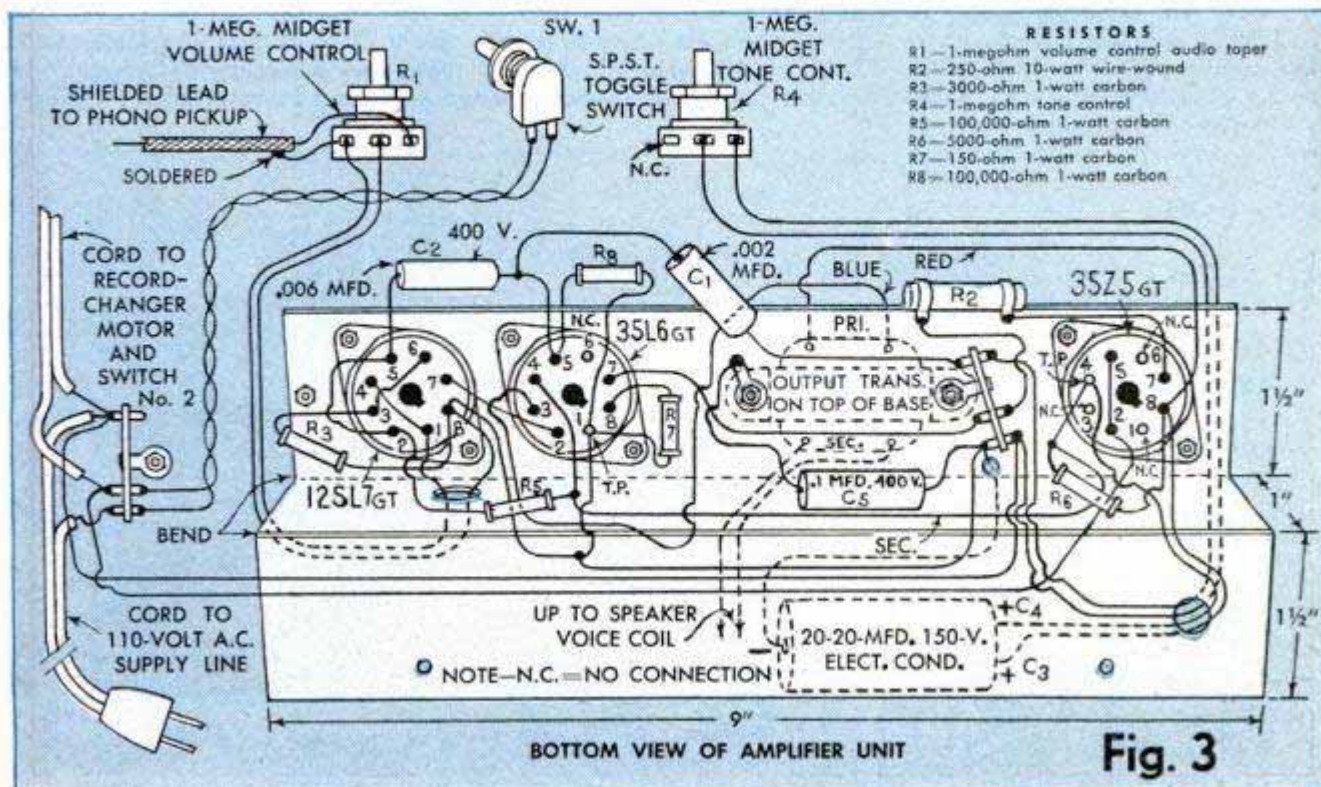
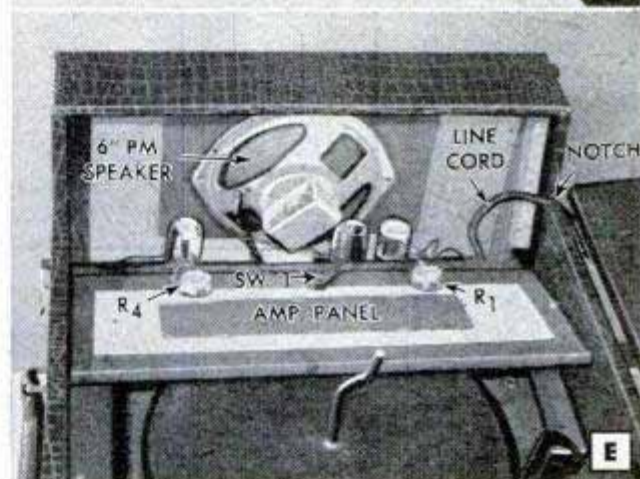



# TELEVISION TODAY

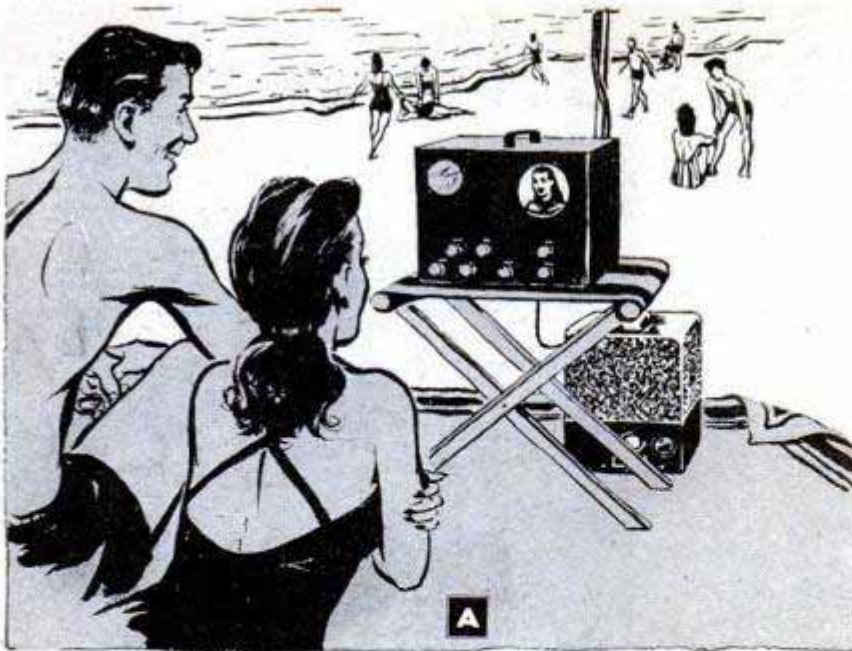

**A**—Two-unit experimental portable television receiver gets a tryout on the beach at Steeplechase Park, Coney Island. Intended for use at picnics, beaches or on boats where power lines are not available, this set is operated with a separate portable power unit which may be seen behind the receiver. The 3-in. screen is located at upper right in the TV set. All controls are simplified and mounted on the front panel within easy reach of the operator. Both units are housed in neat sheet-metal carrying cases

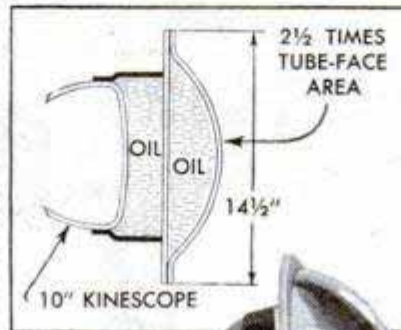
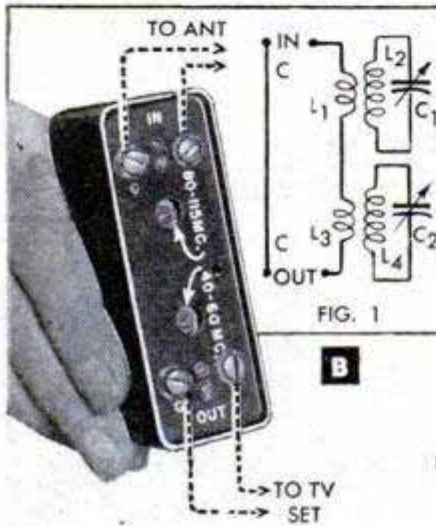

**B**—Interference filter for television sets consists of a "Teletrap" designed to eliminate spurious signals that result in lines, bars or other patterns that interfere with the clarity of TV images. It is claimed to eliminate signals coming from old-band FM and 6-meter "hams"



**C**—"All-Vue" lens made of Lucite, liquid filled and permanently sealed. Spherically designed for optical vision at any angle up to 180 deg., it employs a black collar to connect the picture tube with the lens which is prefocused. It enlarges the TV picture 2 1/2 times

**D**—Television filter designed to end eye fatigue and improve viewing conditions. It consists of a neat, clear plastic frame fitted with a highly polished sheet of amber Lumarith cellulose transparent material. A cord holds the frame over the TV receiver screen



**E**—TV receiver installed on rear of driver's seat in taxicab provides entertainment for riders in a satisfactory Chicago test. The Motorola TV table-model set employs 6-volt tubes and a Mallory "vibrapak" for power supply. A special antenna was used to cover all TV channels





# Introducing **KODAK TOURIST CAMERA f/4.5** with **NEW built-in picture-taking aids**

Here's the very latest thing in folding cameras—newly designed, smartly styled, and equipped to help you get a better picture on every shot.

Check the exclusive picture-taking aids built right into the camera and see why it's the finest folding camera at the price. Camera, \$61.50 plus tax; Field Case, \$10; Kodak Flashholder, \$9.50 plus tax . . . At your Kodak dealer's. Eastman Kodak Company Rochester 4, N. Y.

(Prices subject to change without notice)



"Kodak" is a trade-mark

**A**—Bracket takes accessory range finder

**B**—Bed shutter release gives steady control

**C**—Built-in view finder permits rapid framing

**D**—Sliding computer simplifies exposures

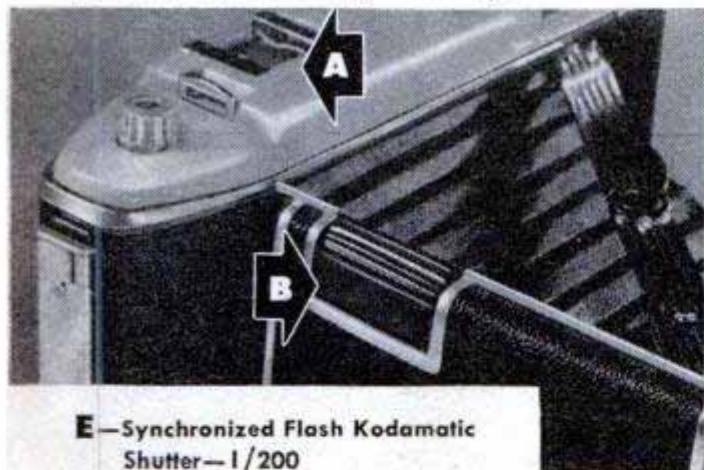

**E**—Synchronized Flash Kodamatic Shutter—1/200

**F**—Depth-of-field scale etched on lens mount

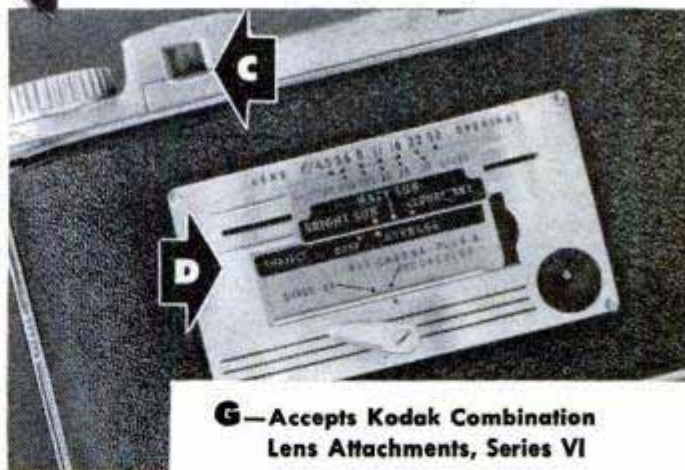

**G**—Accepts Kodak Combination Lens Attachments, Series VI

**H**—Uses Kodak 620 Films, gives 2¼ x 3¼ black-and-white snaps, 2⅞ x 4⅜ Kodacolor Prints

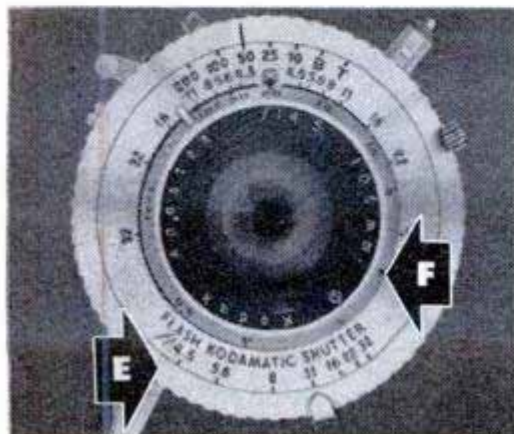

**Kodak**



## Portable 3-Tube Phono Player

(Continued from page 223)

Switch No. 1 is the master line switch on the control panel and switch No. 2 is on the automatic record changer. A complete

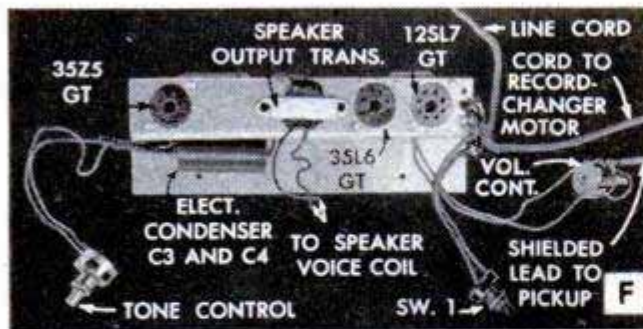

pictorial wiring diagram appears in Fig. 3. This shows an underside view of the sheet-metal chassis base. This metal base is made from either .010 or .020-gauge sheet aluminum easily bent to shape between two pieces of wood in a vise. All dimensions are given in Fig. 3. Photo C shows a top view of the chassis base which is bolted to the bottom of the case with the tubes facing the speaker, as indicated in photo E. Chassis photos C and F should be carefully observed as to the placement of the various parts, and construction should start with this amplifier chassis. Please note that leads for the controls should be long enough to reach the positions indicated on the amplifier control panel in photo E. Switch No. 1 can be either a rotary or toggle, s.p.s.t. type. The speaker is mounted

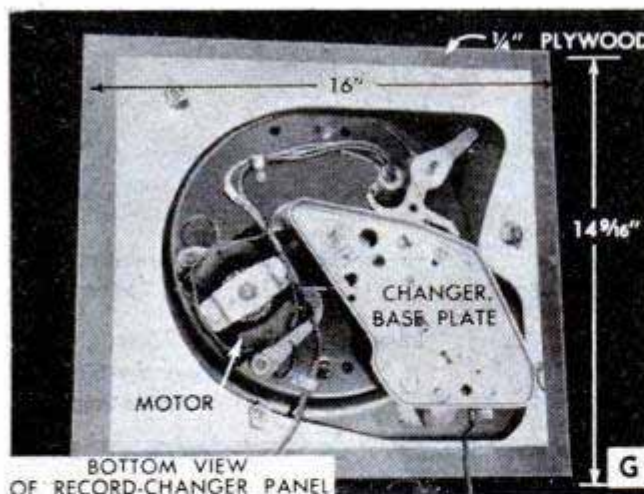

in the case by means of rosette-head ornamental antique-bronze machine screws and the output-transformer secondary leads are then connected to the speaker voice coil. After the controls are mounted on the control panel, cut a small notch, as indicated in photo E, to permit the a.c. line cord and plug to be brought out from the inside of the case when the lid is closed. The a.c. line connections are made on the

insulated terminal strip mounted on the chassis. These supply 110 volts for the changer motor which is controlled by switch No. 2. The power to the amplifier is controlled by master switch No. 1.

The shielded lead to the phono pickup must be carefully connected to volume control R1. The woven-wire shield is soldered to one outside terminal lug on the volume control and the insulated single-wire conductor is soldered to the other outside terminal lug. The 20-20 mfd. electrolytic filter condenser is mounted on the top of the metal chassis as shown in photo C. Be sure that the positive leads C3 and C4 are well insulated where they go through the hole in the chassis. Heavy spaghetti tubing may be used on each lead. The tube sockets should be mounted so that the center keys are in the positions shown in Fig. 3. Note that the common-ground connection for C5 is made to a soldering lug placed under one of the mounting screws that hold the output transformer on top of the chassis. Use rosin-core wire solder and No. 20 insulated hookup wire for the circuit. Make sure that all connections are both electrically and mechanically strong. Detailed student material list R-370 is available from Popular Mechanics Radio and Electronics department upon receipt of ordinary letter postage.

## Preamplifier for TV Signals

This 13-channel, self-powered television signal preamplifier has a pretuned selector system. It employs a nonoscillating circuit combination for easy matching of any antenna impedance to any TV receiver input impedance. It is

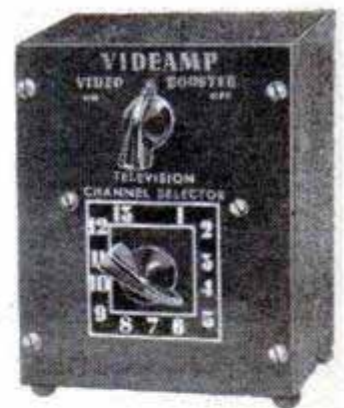

claimed to provide more gain in the antenna circuit, thus increasing the useful range of the receiver in fringe areas and other difficult receiving locations. A 12AT7 or 12AU7 tube is employed and a selenium rectifier is used in the B-supply. All channels are fixed and pretuned. The unit operates on the same 110-120-volt a.c. line as the TV receiver. Installed near the receiver, the connections are quite simple and instructions are supplied for either 300-ohm twin-line lead-in, or coaxial inputs. The case of the unit is insulated from the power source and a ground post is provided for use when coaxial cable connections are used.



**NEW**

**AUTO-LITE**

*Resistor*

**SPARK PLUG**



**New Auto-Lite Spark Plug Has Built-in "Resistor" That Helps Deliver Smoother Idling, Better Radio Reception—Gives Improved Economy and Longer Electrode Life**



**Gives smoother engine idling**

—because of the wider initial spark gap setting possible on the "Resistor" plugs. This assists in burning leaner mixtures, and reduces misfiring at idling and throughout the speed range.



**Improves radio reception**

—by suppressing spark plug interference with radio, radio-telephone, radar and television reception. (Under 35 mv/m from 540 kc. to 150 mc. at 50 ft.)



**Reduces electrode gap growth**

—by increasing electrode life up to 200% and more . . . due to the virtual elimination of the inductive component in the spark discharge.

• • •

**A**UTO-LITE Ignition Engineers, working with leading automotive manufacturers, have developed the new Auto-Lite "Resistor" Spark Plug with this built-in resistor for improved operation and economy. Regular type Auto-Lite Spark Plugs (patented U.S.A.) will continue to be manufactured.

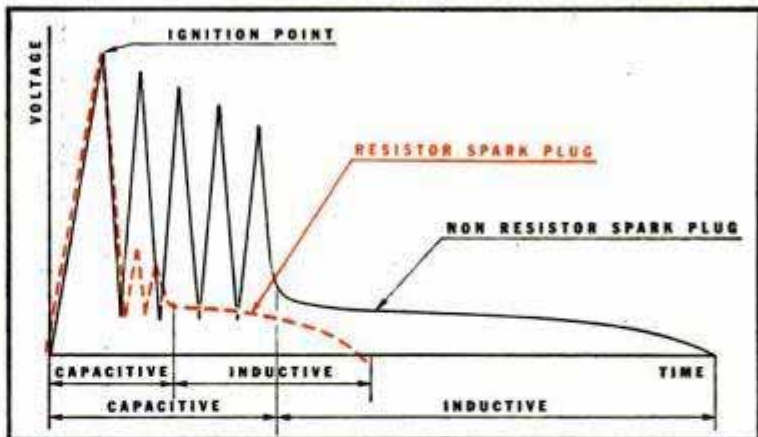

All spark plugs, including the new Auto-Lite Resistor Plug, ignite the fuel on the first peak of the capacitive component. However, the Resistor Plug dampens the remaining peaks so that radio, radar, and television interference is held to an acceptable level. Also, the Resistor virtually eliminates the inductive component that serves only to burn away the electrodes on ordinary plugs. The gap life is thus increased, making possible wider initial gap settings.

**THE ELECTRIC AUTO-LITE COMPANY**

Toronto, Ontario

Toledo 1, Ohio



**ALWAYS READY  
FOR ACTION!**



KIEKHAEFER

**MERCURY  
LIGHTNING**

**Full-Jeweled Power**

(Ball and Roller Bearings Throughout)

Proved through **OVER 10,000 HOURS**  
OF CONTINUOUS PERFORMANCE

The 10 hp. Mercury Lightning steps out, ready to deliver outstanding performance at top speeds . . . slowest trolling. Tested and proved, Full-Jeweled Power is a Kiekhaefer engineering triumph that reduces wear, gives Mercury parts an anti-friction ride on Ball and Roller Bearings . . . assures greater power — longer life. See the complete Mercury line at your dealer. Drive a Mercury and you'll learn why it's **MATCHLESS** in **OUTBOARD EXCELLENCE**.

KIEKHAEFER CORPORATION, Dept. N, Cedarburg, Wis., U.S.A.



Write for **FREE Illustrated Brochure** and name of your nearest Mercury dealer.

NAME.....

ADDRESS.....

CITY.....STATE.....

## How the War Came to Me in Tokyo

(Continued from page 99)

command the whole Navy, he should not stay behind the stage to save his life with his men at the dangerous front. Frankly speaking, I believe that he had no confidence in himself at that time to answer blind expectations of the nation to win the game with the declining navy forces. So he chose the final measure to adorn himself with glorious death as a brave soldier before the final dishonorable defeat came up. The death of the succeeding Admiral Koga aboard the boat shook the foundations of the nation's whole confidence. We should have terminated the war by this time, even upon unfavorable terms to us, if the people in the headquarters truly thought of the Emperor and his people. We relied too much upon the plausible tongue of the propagandizing of the government, but the poor nation could do nothing but doing so. To say anything unfavorable against the government or protest them meant lopping off his head by the force of Kempeitai, military police.

Since the beginning of the year 1945, the attack of superfortless planes B-29s was terrified day after day all over Japan. On one snowy morning in January a part of the most prosperous downtown in Tokyo was flattened in a few hours. The writer lost his elder sister with her five girls by the attack made soon after the above morning attack. I found that fact when her husband, a brother-in-law of the undersigned, called upon him next morning and inquired after her and her daughters. According to his explanations, the sound of an electric warning siren (SIREN) forced them to suspend their dinner. It was their last dinner. They dressed them up immediately for an emergency case, but the bombarding started too soon after the warning sound of the air-raid siren to give them the ample time for the preparation

(Continued to page 230)



**Model Builders  
Attention!**

	V	V-2	V-3
Hex	1/2"	3/8"	5/16"
Thread	3/8"-24	1/4"-32	1/4"-32
Thread Length	7/32	7/32	5/32
Weight, Grams	8	3 1/2	2 1/2

Actual Size V-Plug

Champion Spark Plugs for model gas engines give the same dependable performance as regular Champions. Champion Ceramic insulation—Sillment sealed. Alloy needlepoint electrodes for easy starting. One piece construction.

**CHAMPION**

SPARK PLUG COMPANY • TOLEDO 1, OHIO



# HOW TO TAKE BETTER TIME EXPOSURES

## Paint out the dark spots with your flashlight

...it's a trick that every expert photographer knows and uses. Your stationary lights are fine—but, no matter how many you use, they may leave dark, shadowed areas that show up on your finished picture. Avoid these amateurish black-outs by moving your flashlight beam back and forth across the dark areas while you're making the exposure. Do it just as a painter would use a brush. And be sure to keep your flashlight powered with "Eveready" batteries. Powerful, dependable, they outlast all other brands. \*



..... A little light on the subject of the dark room!

Here's where your flashlight's handy, too! Wrap 2 or 3 layers of dark green or red cellophane over your flashlight lens and you have a safe portable light to use in your dark room. It *won't* streak film and it *will* help you to locate objects and to operate conveniently.

**\*In general-purpose 4-ohm intermittent tests  
THIS "EVEREADY" BATTERY  
OUTLASTS ALL OTHER BRANDS!**

Who thought up this test that takes the guesswork out of buying flashlight batteries? The American Standards Association, no less! ... And this is the test that *most closely approximates the average use* you give batteries in *your own flashlight*. Be bright tonight! Buy "Eveready"!

The trade-mark "Eveready" distinguishes products of  
**NATIONAL CARBON COMPANY, INC.**  
30 East 42nd Street, New York 17, N. Y.

Unit of Union Carbide  and Carbon Corporation





# Speed Sweep

**+ Arbitrin**



Speed Sweep, the brush with the steel back, is designed to sweep cleaner, faster, easier, and to outlast ordinary brushes 3 to 1. Arbitrin sweeping fluid, sprayed on the floor before sweeping, disinfects, deodorizes, and removes stains in the process of sweeping. These, plus many more advantages (16 in all) have proved to be the perfect answer to effective, low cost floor sanitation in over 60,000 factories, offices, schools, and stores. Mail coupon for complete facts. *Milwaukee Dustless Brush Co., 530 N. 22nd St., Milwaukee 3, Wis.*

**Milwaukee Dustless Brush Co.**  
530 North 22nd St. • Milwaukee 3, Wis.

We are interested in complete information about Speed Sweep brushes and Arbitrin sweeping fluid.

Name .....

Address .....

City .....Zone.....State.....

of an emergency. What this means? Nothing but a poor functioning of Japanese Radars stationed at the defending line. They could, the people said, catch the attacking planes only when they were within short range of distance. This meant nothing valuable to the warning headquarters men with such high-speed planes as the superfortless. When the citizen heard of the warning silen, the attacking planes were already above Tokyo. It was ridiculous that we sometime heard the warning air-raid silen after the air-raid was started over us. If American could adapt rocket planes in this war, miserable devastation in the defeated land could have been saved, because it should have expedited the showdown of the struggle.

My brother-in-law told his wife to leave the house immediately, when the silen sounded, with five girls, the eldest one being 18 years old and the smallest five years old, for the place considered preliminarily safer. They did so with nothing on hand. It was the last departure in this life for his family. He stayed however in his house with his eldest son, 16 years old, to fight with the fire for protecting his house, but it was an useless effort. His house was flattened and ashed in less than an hour after the warning silen and when they tried to follow his wife after his house was burnt, the vicinity all around his house was completely entrapped by the fire. They could nothing to save their lives except to submerge themselves into the nearby river up to their necks, sometimes to dive into the water, to protect their eyes from flicking flame and dense smoke. It was nothing but a miracle that they survived until the next morning, under such dangerous condition, though severe scorches upon their faces. Many, many men and women died in a single night. He waited for the return of his family whole on the next day, but in vain. He waited, waited and waited for many, many days since then, but no response. I suppose that they lost their ways amidst the dense smoke and fainted and afterward entrapped by the terrific fire. Many factory buildings with steel skeleton of 10-inch I-beams were collapsed with the intense heat. How could human being resist it?

In this evening, I, with my wife and the eldest son, was watching the far reddened sky from my house, as the superfortless did not attack my residential district in this night. I had never expected death of my sister and lovely nieces in this night. I saw many, many B-29s flying over my head, reflecting their long silvery bodies

(Continued to page 236)



# Car polishing is easy

*with this  
exclusive DuPont  
formula!*



A small section of the surface of an average car magnified 20 times. The left side is shown still covered with Traffic Film. The right side has been cleaned with Du Pont NO. 7 POLISH.



## DU PONT NO. 7 POLISH



### **Especially FOR NEW CARS!**

Here's a wax-polish made especially for new cars—and others whose finish is in first class condition. It

cleans and wax-polishes in one easy operation. Produces a brilliant, lasting lustre. Keeps cars looking new.

### **DU PONT SPEEDY WAX**

**Contains "stroke saving" methyl cellulose**

Here's a polish that turns a chore into a pleasure! It saves time, saves work! Du Pont NO. 7 POLISH is made by a patented formula . . . loosens dirt and grime quickly . . . cleans up *fast*, leaving a dry, brilliant shine. Next time your car needs a cleaning, use NO. 7 POLISH, the short-cut to car beauty!



**BETTER THINGS FOR BETTER LIVING  
. . . THROUGH CHEMISTRY**



# NOW

## THE JIFFY METAL CABINET WITH RUSTPROOF ALUMINUM DRAWERS

32  
DRAWER  
UNIT  
**\$8.95**

POSTAGE PAID

64  
DRAWER  
UNIT  
**\$15.95**

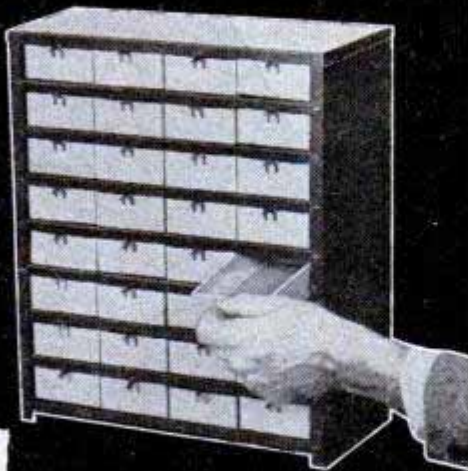

APPROXIMATE  
SIZES  
DRAWER

1 1/4" Deep  
2 1/4" Wide  
6" Long

32 DRAWER UNIT  
6" Deep  
12 3/4" Wide  
15 1/4" High

64 DRAWER UNIT  
6" Deep  
25 1/2" Wide  
15 1/4" High

for home or shop,  
the handy way to  
keep small parts,  
washers, nuts, bolts,  
nails, screws, etc.

### AND STILL AVAILABLE

32  
DRAWER  
UNIT  
**\$5.95**

POSTAGE PAID

64  
DRAWER  
UNIT  
**\$9.95**

## THE JIFFY METAL CABINET WITH LAMINATED FIBREBOARD DRAWERS

Same steel cabinet as above with covered fibreboard drawers. Suitable for most home needs. Thousands in use. 32-Drawer unit—\$5.95. 64-Drawer unit—\$9.95. Postage Paid. Check or money order. No C.O.D.'s. Add 3% sales tax for Ohio orders.

**KAYTEE PRODUCTS**  
DEPT. M • BOX 588 • CANTON, OHIO

# Clinic



## for Homemakers

As a service to our readers in solving the hundreds of problems pertaining to a home—inside or out—the editors of *Popular Mechanics* invite you to present your problems to The Clinic Editor for help and advice. Address your questions to The Clinic Editor, *Popular Mechanics Magazine*, 200 East Ontario Street, Chicago 11, Ill.

### Planing a Flat Side on Wooden Dowels

**Q**—I wish to flatten one side of a number of wooden dowels 3/8 in. in dia. and 10 in. long. The flat should be about 3/16 in. wide. I tried planing, but this was not satisfactory due to the difficulty of holding the dowel in a vise. Is there some way to do this easily? *R.M.—Lexington, Ky.*

**A**—Use the modelmaker's trick of turning the plane upside down and locking it in the vise. Then simply draw the dowel across the cutting edge at a slight angle to give a shearing cut. Due to its long bed, a jointer plane gives best results.



### Belt Squeal in Old-Type Refrigerator

**Q**—I have an older-type refrigerator with V-belt drive. Lately, at intervals, there is a loud squealing noise when the unit is running. There seems to be nothing wrong with the unit and motor bearings appear to have plenty of oil. What is causing this noise? *S.T.—Rochester, N.Y.*

**A**—Belt squeal is the most likely cause of the noise you describe. After some years in service the sides of the V-belt wear smooth and there is a slight slippage as the belt passes around the small-dia. pulley on the motor. This defect will cause no actual harm. The simplest remedy for the annoying squeal is to touch both sides of the belt lightly with a cake of paraffin or a piece of candle when the unit is running. Repeating the application at regular intervals will prevent a recurrence of the noise.

### Removing Oil From Rug

**Q**—Recently I spilled a small quantity of sewing-machine oil on my living-room rug. It spread and made a large stain about 8 or 10 in. in dia. How can I remove the stain without damaging the rug? *M.B.—Little Rock, Ark.*

**A**—One method that has been used successfully is to place several layers of blotting paper over and under the stained area, then go over the blotters with a hot iron. Repeat the process with new blotters until most of the oil has been absorbed. Next, make a paste of fuller's earth or cornstarch and carbon tetrachloride. Spread the paste over the spot and allow to remain for 10 to

(Continued to page 234)



*Write your own Ticket  
to Endless Fun with a*

# HARLEY-DAVIDSON

Want adventure? Like thrills? Eager to go places and see things? Then join the thousands who have found happier, healthier outdoor enjoyment, new friends, and endless fun in motorcycling . . . world's greatest sport! Every trip is delightfully different, every moment memorable, as you take in exciting race meets, endurance runs, hillclimbs . . . go on gypsy tours and sightseeing trips. Get your share of these wonderful times now. See your Harley-Davidson dealer today.



**MAIL THIS COUPON NOW! MAIL THIS COUPON NOW!**

HARLEY-DAVIDSON MOTOR CO., Dept. P, Milwaukee 1, Wisconsin

Send free copy of ENTHUSIAST magazine filled with motorcycle action pictures and stories; also literature on latest models.

Name.....

Address.....

City..... Zone..... State.....





# introducing the JOLLY TAR



*New*  
**RIEDEL WORK GLOVE**  
for Home  
Farm · Industry  
Men's and Ladies' Sizes

For greater comfort when you work...and for lots of extra wear...try Riegel's new "JOLLY TAR" Work Glove. Elastic back strap keeps glove on comfortably...permits circulation of air so hands won't become sweaty. Made of special flannel-backed canvas, soft finish inside, with safety cuff for greater protection.

## OTHER STYLES FOR EVERY NEED

canvas, jersey, leather... knit wrist, band top, gauntlet... double palm, reversible, quilted. Ask for the Riegel brand wherever work gloves are sold. Free catalog if requested on business letterhead.

**Riegel Textile Corp.**

342 Madison Avenue  
New York 17, N. Y.



"THIS TRADE MARK IS YOUR GUARANTEE OF VALUE"

12 hours, or overnight. Remove the dried paste and then beat white-soap shavings to a foam in water to which a small quantity of household ammonia has been added. Sponge the spot thoroughly with the foam, working outward from the center to prevent forming a ring. Use ammonia sparingly, not more than a teaspoonful to  $\frac{1}{2}$  gal. of water, and less if the rug is of a dark color.

### Paint Peels From Wide Cornice

*Q—My home has wide, open cornices and paint will not stay on the underside of these cornices. It peels off within a year and exposes the bare wood. There are indications that previous owners have had the same trouble. What causes this and is there any simple and permanent way to remedy?*

*C.N.—Buffalo, N. Y.*



*A—Undue moisture plus a lack of air circulation are among the probable causes. The trouble is fairly common where a house of this particular type is in a more or less sheltered location with tall shrubbery and large trees close by. During the warm, humid days of summer, moisture tends to collect where there is insufficient air circulation and where the rate of evaporation is very slow. Expansion and contraction of the wood breaks up the paint film and dampness gets underneath. The best remedy is to rebuild the cornice to the more modern, narrow box type. The next best remedy is to scrape off all the loose paint, clear away any tall, dense shrubbery and overhanging tree limbs and allow the cornice to dry thoroughly. Then, when the wood is dry, apply a prepared undercoater cut to a fairly thin, watery consistency with a paint reducer. For such work some painters use a regular paint to which benzol has been added in the proportion of  $\frac{1}{2}$  pint to the gallon. In either case, allow the first coat to dry at least three weeks. Then apply the second coat, brushing out to a thin uniform film. Benzol is used only in the first coat.*

### Cure for Damp Basement

*Q—My basement is very damp during summer months, even when the weather is dry. Water collects on the floor at the base of the walls and drips from the water pipes. Clothing left in the basement becomes coated with a bluish mold. What can I do to eliminate the dampness in this basement?*

*T.R.—Lincoln, Neb.*



*A—Your trouble is due to condensation of moisture on the walls and water pipes, the surfaces of which are colder than the air in the basement. Well-stocked hardware stores can supply a masticlike material for coating water pipes to prevent condensation. Chemicals are available which will help to reduce the moisture content of the air in the basement. These usually are placed in a cloth sack suspended in an open framework. Moisture collects on the cloth and drips into a container. Another method, probably the most effective, is the use of an exhaust ventilating fan mounted in a basement window. Capacity of the fan should be sufficient to completely change the air in the room at least once every hour. Operating the fan for an hour twice each day, once at midday and again in the late evening, should keep moisture condensation at a minimum. However, it sometimes will be found more effective to operate the fan only in the late evening. Open windows and move cabinets and other objects away from the walls so that air can circulate unimpeded.*



# HELPFUL POINTERS on house painting



When painting window frames, don't neglect chipped putty. Scrape out old putty down to the wood, coat with linseed oil and apply new putty. Let dry a day before painting.

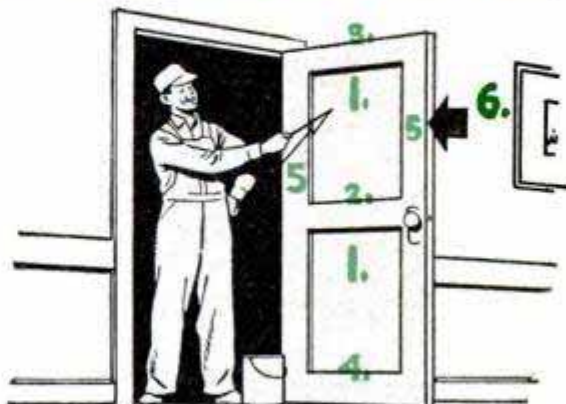

When painting doors, follow this routine. Finish the panels first, the center rail next, then the top and bottom rails, and next the vertical stiles. Always do the edges last.



Use correct brushing technique. Apply half a dozen brushfuls at a time. Work along grain of wood and brush out thoroughly with long vigorous strokes. Then go over lightly to remove brush marks.



Use quality paint . . . it's more economical in the long run, and is easier to use. Eagle RTU is pure white lead paint that's all ready-to-use. It brushes on evenly and easily, making a gleaming, durable white coat.

## Eagle RTU makes any exterior paint job easier

Yes, it's true. Now you can get famed, durable, beautiful white lead paint that's all ready to use. Eagle RTU is pure carbonate of white lead, in pure linseed oil. It's carefully formulated and mixed for instant, easy use. Eagle RTU has the opacity, covering power and endurance qualities that only pure white lead paint gives—plus the convenience of being ready-mixed. It's made by the Eagle-Picher Company, makers of quality white lead since 1843. Two forms: Primer Sealer and Outside White Finish Coat. Quarts, one, two, and five gallon cans.



Since 1843

# EAGLE-PICHER

CINCINNATI (1), OHIO

## FREE

Hints on House Painting for Home-owners.

Eagle-Picher, Department PM98, Cincinnati (1), Ohio

FREE! Please send me a copy of your booklet "Helpful Hints on House Painting."

Name.....

Street.....Zone...

City.....

County.....State.....





## "That's why This 1/4" DRILL Rates Aces-High with Me!"

"Take it from a guy who knows . . . this husky Home-Utility 1/4" Electric Drill belongs in *your* shop! I use mine all the time—drilling holes and driving sanding, light grinding and buffing attachments—for everything from building toys for the kids to repairing appliances and installing fixtures for the 'Mrs.' It's a honey of a Drill, with a powerful motor, husky housings, full-size gears and bearings. It's built by BLACK & DECKER, the folks who've been making quality electric tools for over 37 years. And at \$18.95, you're getting plenty of Drill for your money!"

Order your 1/4" Drill and other Home-Utility Tools from your hardware, electrical or implement dealer.

**ELECTRIC  
HOME-UTILITY  
TOOLS**

Products of THE BLACK & DECKER MFG. CO.  
Dept. H 9 M, Towson 4, Maryland



**15¢**  
At Your  
HARDWARE

Used by leading furniture manufacturers, craftsmen, schools. If your dealer cannot supply you, send 20c (including postage and wrapping) to THE FRANKLIN GLUE CO., COLUMBUS, 15, O.

by the searchlights of the defending army.

But the time had come at last to my turn. It was the night of April 13, 1945, that I lost the whole properties and hopes. It was a beautiful night with glittering stars above and no wind, but with a shining silver moon. It was an ideal night for an air-raiding. Immediately after I relaxed myself from the day's work in that night, I warned my family to prepare for the fighting, saying that "We should have an attack tonight," but nothing happened until 10:30 p.m. The radio broadcast amusement programs as usual until it was suddenly interrupted by the usual air-raid warning.

I switched off all lights; covered the radio set with a heavy blanket to prevent out-flowing of light, even of a pilot lamp. We sacked a little supply of emergency foods in a carrying sack. Deadly and dreadful calmness followed just as you usually experience before some big terrific thing happens. Thirty minutes later, characteristic humming of four engined planes enfolded us. Then, I felt shaking of my house by explosive bombs and incendiary bombs. We concealed ourselves in a large wardrobe closet when another shaking frightened us. Many things fell down upon the floor. The vicinity all around my house was brightened by the fire and incendiary bombs as if The Broadway was reproduced there. We heard cries of the people, noise of burning houses, and screaming of women for help.

I thought it danger to stay in the house any more, lest the house collapse over us. So we dashed into the garden to protect ourselves in the preconstructed sheltering cave in the ground, having 5-inch square lumber atop. My experience shows that this is the worst place in the world to protect us in such a case. It is the most dangerous place.

I believe that I should have stayed in the house because even the Japanese house is safer and stronger than a shabby underground sheltering pit, against the incendiary bombs. In case the explosive bomb hits right upon its objective it makes no difference whether we stay in the house or in the underground sheltering place. It is the final and fatal.

Soon after I dashed out of my house, an incendiary bomb was dropped at one corner of the house, but it penetrated roof and ceiling only at an angle and pierced into the earth without burning my house. Another incendiary bomb hit my underground pit a few seconds after I and my family entered it. I should have been killed there with my wife and son, had it not

(Continued to page 238)



**"That hammer?  
You're kidding!"**



**FRED:** It's a fact, Bill. I've been using this same hammer for 29 years. It helped to build the house you were born in.

**BILL:** Well, I don't know how you do it. I hardly ever *use* a hammer, and yet I've broken two of them in the last year or so.

**FRED:** That so? What kind of hammers were they? What brand, I mean.

**BILL:** Gosh, I don't know. Guess they didn't have any brand names. But they were good bargains.

**FRED:** That's where the trouble is, Bill. Look . . . see the name on this hammer? Whenever you see that brand name, you

*know* it's a good hammer. Stick to the well-known, advertised brands when you buy tools, and in the long run you'll save a lot of money.

**BILL:** That makes sense, Fred. I'll remember it.

**FRED:** And do your buying at the hardware store, where they don't try to sell you anything but quality tools. That way you'll always get your money's worth.

*Your HARDWARE DEALER sells QUALITY tools  
and hardware... Buy from HIM*



# POPULAR MECHANICS



*America's Most Beautiful Bike!*



**THE NEW MONARK Super Deluxe**

The bike that is really different! Super Streamlined air-flow design new "Air-Wing" head shield new mar-proof and chip resistant finish and dozens of other exciting new features. For sale by better stores everywhere.

MONARK SILVER KING, INC., Department B-82  
6501 W. Grand Ave., Chicago 35, Illinois  
Send free folder showing complete line in full color.

Name \_\_\_\_\_  
Address \_\_\_\_\_  
City \_\_\_\_\_ State \_\_\_\_\_

**HEATHKIT 3-TUBE ALL-WAVE RADIO**  
110-volt A.C. operation



An ideal way to learn radio. This kit is complete ready to assemble, with tubes and all other parts. Operates from AC ..... Simple, clear detailed instructions make this a good radio training course. Covers regular broadcasts and short wave bands. Plug-in coils. Regenerative circuit. Operates loud speaker. Add postage for 3 lbs.

**\$8.75**

Headphones per set ..... \$1.00  
2 1/2" permanent magnet loudspeaker ..... \$1.95

**INTERPHONE 2-WAY CALL SYSTEM KIT**

Ideal call and communication system for homes, offices, factories, stores, etc. Makes excellent electronic baby watcher, easy to assemble with every part supplied including simple instructions. Distance up to 1/5 mile. Operates from 110-V A.C. 3 tubes, one master and one remote speaker. Shipping Wt. 5 lbs.



**\$14.50**

**HOME WORKSHOP GRINDER**



Easily assembled 110V AC or DC ball bearing fully enclosed motor from Army surplus dynamotor. Purchaser to make simple changes and shaft extensions, detailed instructions and all parts supplied. Motor approximately 1/30 H.P., 5,000 R.P.M. Ideal for tool-post grinder, flexible shaft tool, model drill press, saw. Shipping wt. 6 lbs.

**\$3.95**

**HEATH CO. DEPT. M BENTON HARBOR, MICH.**

5-inch square protecting lumbers above the pit. The bomb must have been dropped from some altitude, but it could not penetrate 5-inch lumber and rebounded, leaving 1 1/2 inch deep burnt cave in it. However, its heavy shock loosened earth and lumber members and we were entrapped in it. We could not stand up in it with heavy pressure above. We tried to get out of it, but could only do that with blood and hurt on our faces and hands. When we got into the open space, we were terrified to see the dreadful scene outside.

Stars were glittering above as if they did have no concern with human conflict down below. Oil scattered from incendiary bombs were burning on the ground; above fences; on the branches of trees; and above roof of houses, as if thousands of small Christmas candles were lighted up all one time for devil's sake. I could not walk without trodding over them, as such devil candles were burning every one square foot of the area. In the high air, when a master set of the incendiary bomb disassembles to scatter its baby incendiary bombs length and width of the area, it flashed a beautiful illumination just like a festival display of fireworks. We could see many, many of them in the air. Soon they hit objectives down below and burnt everything contacted.

We could only see in the sky B-29s, but none of our night fighters to defend Tokyo. Occasional explosions of our guns resounded unanxious echoes. I thought that everything came up to the last moment. So I gave up my efforts to quench the fire of my house and resolved to get out of the place. I cried for my wife and boy, but in vain. We could see none of our neighbors.

I cried, cried and cried for them, but no response at all whatsoever. So I decided to go back into the burning pit again, risking my life, to catch them; though it was very, very dangerous to do so. The burning houses and trees hampered me to go back to the space easily. I could not reach the spot without going over the burning lumbers scattered upon the ground. My shoestrings were cut by the burning fire. My shoes were about to crack, but I dashed to the spot. Nobody was around there by that time. I forced myself into the underground pit again, but to my disappointment, at the same time to my joy, none was there.

When I crawled out of the pit again, the situation was found to be more terrific than before. The road was completely covered with burning material. The burning houses were falling down on the road. I thought my wife and son were dead, but

(Continued to page 240)



Do A Better Painting Job — Faster, With Less Fatigue

# DEVOE BLACK PRINCE

For All Flat Wall Paints — The Finest Brush Ever Made!



Here's the brush that every master painter has always wanted! A specially designed brush that carries a greater load of paint to the surface in fewer dips. A brush with balance so perfect it does away with wrist fatigue and shoulder weariness!

Formulated entirely of softest, multiple flag rare and very expensive Chinese Tientsen and Manchuria bristles. Provides many more thousands of flag ends contacting the painted surface to achieve more brushing and leveling action with one stroke than ordinary brushes do with 2 or 3.

Order your Black Prince by mail right now. Just send check or money order—\$14.30 for 3½"; \$19.10 for 4"—and your Black Prince will be shipped postpaid.

## DEVOE

Devoe & Reynolds Co., Inc. Dept. EB  
787 1st Ave., N. Y. 17, N. Y.

## MOTO-TOOL ★ THE "POCKET-SIZE" MACHINE SHOP

**A TESTED TOOL THAT PACKS YEARS OF PLEASURE**

If you get a kick out of making things, you'll have fun with a Moto-Tool. It grinds, drills, routs, carves, polishes . . . does work better, faster . . . on practically any material. Moto-Tool is backed by 10 years of successful industrial service . . . also used by every branch of the Armed Forces. Compare Moto-Tool with other grinders and see for yourself why it's better.

**10 Reasons Why Moto-Tool's a Better Buy**  
 Oil-less, sealed bearings • Patented automatic chuck lock pin • Oversize armature shaft: hardened, ground, polished • 110 Volt, AC-DC motor • Sliding snap-type switch • Handy hanger hook: cord protector • Shock-proof bakelite housing • Dust-filtered air-cooling system • Dynamically balanced for vibrationless operation • Weighs only 13 oz.

**MONEY-BACK GUARANTEE:**  
 Buy Dremel Moto-Tools from your dealer. If he cannot supply you, order direct from the factory on 10 day trial, money-back guarantee. Shipped postpaid for payment in full (send check or money order); or send only \$2, we will ship C.O.D. You pay postman balance plus postage. Catalog of Moto-Tools and Accessories FREE.

**DREMEL MFG. CO.**  
 Dept. 118-J • Racine, Wisconsin

APPROX.  
27,000 R.P.M.

**New DREMEL DRILL PRESS ONLY \$9.95**  
(Less Moto-Tool)

Here's a portable, precision drill press at an amazingly low price. Just the thing for creating costume jewelry, model making, wood carving, routing, etc. Utilizes Model No. 2 Moto-Tool, which can be raised or lowered, swung in any direction, or quickly removed for off-hand use. Drill Press stands 12" high. Base is 6¾" x 4". Weighs approximately 3½ pounds.

**PRE-WAR PRICES STILL PREVAIL**

Moto-Tool Kit No. 2, with 23 accessories (high speed steel cutters, grinding wheels, polishing accessories) and heavy-duty professional Model 2 Moto-Tool in natural-finish, hardwood case. \$23.50 (Items purchased separately would cost	about \$30.00; you save \$6.50.)
Moto-Tool Kit No. 1, with 34 accessories and Model 1 Moto-Tool in wood case. \$17.50	
Model 1 Moto-Tool, with one emery wheel point . . . . .	\$9.85



THE FAITHFUL  
**HEART**  
OF YOUR FUEL  
SYSTEM

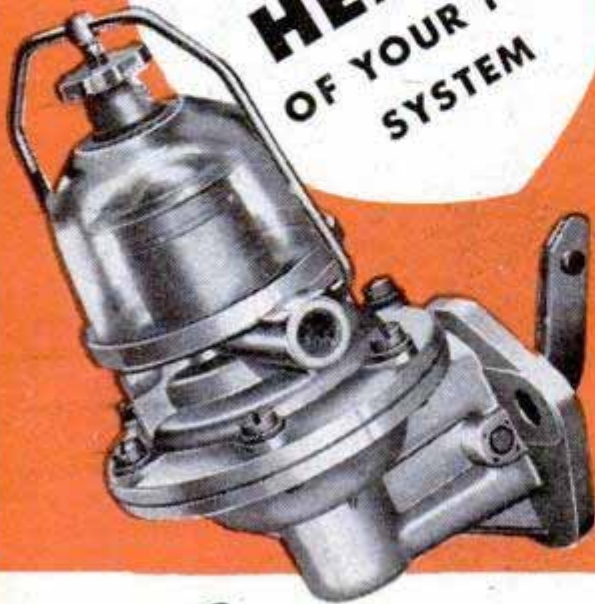

**OVER  
30,000,000 IN USE  
TODAY**

Pulsing steadily, nearly 100,000 times an hour, your AC Fuel Pump is the strong, reliable heart of your fuel system. It has given you long, faithful service because of its inbuilt quality and scientific design.

You can prolong that faithful service indefinitely, if you insist upon a new AC when you replace your present pump.

There is no satisfactory substitute for quality.



AC SPARK PLUG DIVISION • GENERAL MOTORS CORPORATION

was fortunate to find my wife screaming for me about 100 meters ahead. You cannot imagine how I was delighted to see her, but my son was still missing. We tried to find him again and again, but the situation did not allow me to stay there any longer. If we stayed, we would have been entrapped with dense smoke, terrific heat and flame. We had to abandon him.

We however could not leave that spot without knowing anything about him. I made up my mind to force my wife to leave the spot with me, but she resisted. She was not crying. She was calling the name of our son for her life as if she was not aware of anything dangerous around her. We then heard the far crying voice of our son calling his mother. I could not believe it. Fire was crazing around us and we were amidst the horrible flame and heat, but we found him there. He said that he had once left the spot with his friend, but, shocked with a thought of his parents, he dashed back into the fire again to search for us.

It was a fine spring morning next day. I lost everything I had, except a small daily-life necessary things stored underground place. I will (not) cry over spilt milk. Another day for another dollar. What we have done is what we have done. This was the morning of April 14, 1945. Nobody knew that American Marine floated, over Iwo Jima, atop Mount Suribachi, at 10:20 a.m. of February 23, 1945, the Stars and Stripes. We should have abandoned the war by this time if we had a foresight.

We stayed in Tokyo until June 8, 1945 without doing anything, but left Tokyo for Fukushima, 100 miles from the capital. Tokyo was attacked by B-29s day and night during these days and we all gave up hope for our lives. Tokyo was assaulted by hundreds of small carrier planes in daylight time. It meant that all of Japanese war ships had been destroyed and that we had nothing to defeat the enemy's carrier boats. The battle was nearing its final, but military clique was still insisting continuing the war to the last point. Poor Japanese nation.

When I was in Fukushima, everything was peaceful at the beginning, but it was soon changed into a battle. In one night, we awoke to hear terrible thunder and shaking of the ground. My house was standing amidst green rice fields and there was nothing worldly things around us. When I was awoken suddenly by the thunder, I immediately opened the door and dashed outside to find out what was going on. Several streaks of glittering lightning

(Continued to page 242)



# Ingenious New Technical Methods

To Help You  
Increase Efficiency

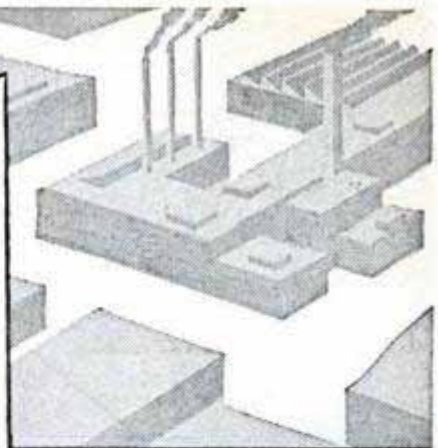
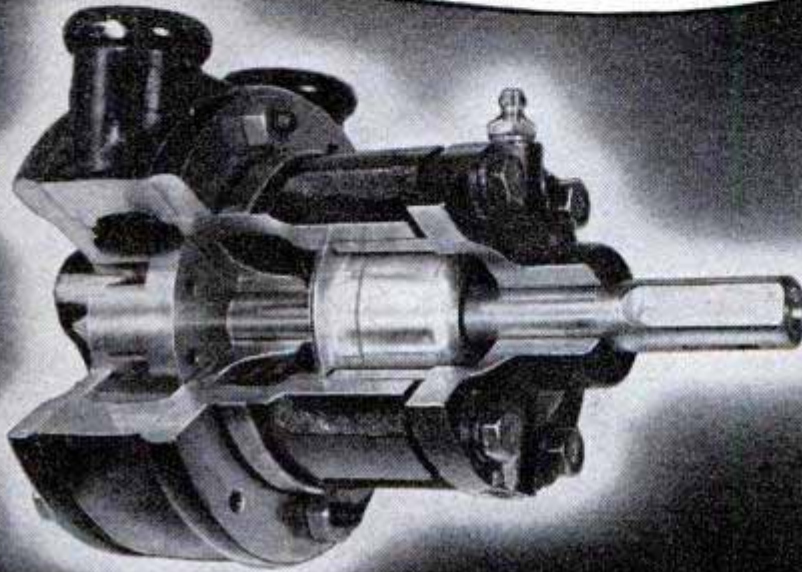

## New Cartridge Seal Solves Rotating Shaft Sealing Problems

Stepped-up efficiency in sealing of rotating shafts can now be accomplished with a new Cartridge-type Seal mounted on the shaft.

The Cartridge-type Seal shown above is mounted within a Tuthill Pump. The seal contains all parts in one housing cup and insures positive double sealing. A high grade permanent lubricant is contained within the inside chamber of the housing.

Surfaces within the Cartridge-type Seal are lapped flat to within a few millionths of an inch to insure perfect mating. And, being a complete unit, only one mounting face is necessary. Clamps are eliminated, and adjustments or alignments are not required. Simply push the Cartridge-type Seal onto the shaft, tighten mounting screws and that's all.

Just as new engineering developments increase efficiency and performance, so can workers' efficiency be increased through the use of chewing gum. The act of chewing helps relieve nervous tension, thus helping to make the work go smoother and easier. That's why plant owners everywhere more and more are making Wrigley's Spearmint Chewing Gum available to all.

Complete information may be obtained from  
Cartriseal Corporation  
200 No. Laflin Street Chicago 7, Illinois

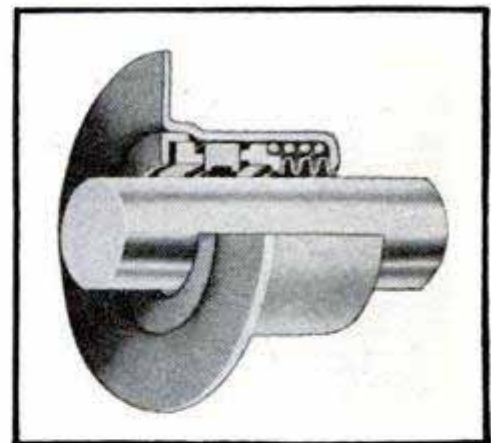

Cartridge-type Seal



AC-74.



# Need a Puncharoo?

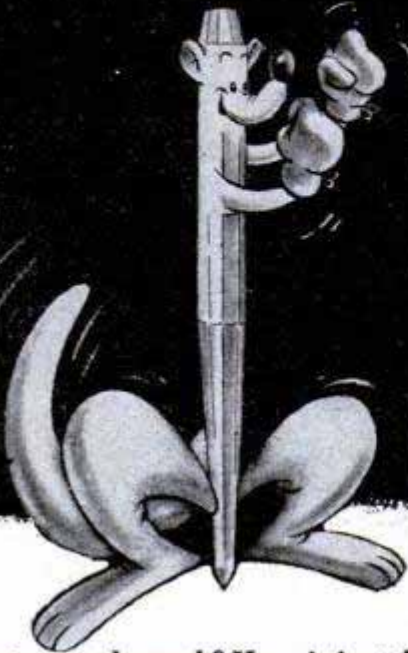

Want a *good* punch? Here is just the tool you're looking for... one of a really complete line of punches that include rivet or pin, prick, center, starting, aligning and drift types. And are they good? They're tougher than a kangaroo's hide and last longer than a rich uncle! Special steels, accurate forging and controlled tempering make them better—and their high quality is typical of *all* tools made by Plomb Tool Company. Buy them from your dealer. He's sure to have the tools you want because...

**Tools You Need...  
We Make!**

Write for catalog to  
2255V Santa Fe Ave.  
Los Angeles 54

4884

**PROTO** *First in Quality* **TOOLS**

MFD. IN U.S.A. BY

**PLOMB TOOL CO.**

Prick  
Punch

Center  
Punch

Starting  
Punch

Rivet or  
Pin Punch

Drift  
Punch

Aligning  
Punch

occasionally flashed from the far distant mountains up into the rice fields around my house, accompanied by thunder. It was an attacking by guns of War Vessels. I thought that I finally came up to the point wherein I had to breathe my last life. You cannot imagine how terrible it was. A half hour seemed to me as if one week at that time. A few days later, village folks told me that Hidachi Airplane Factory was assaulted by American War Boat from off the shore, 20 miles apart.

In concluding, I wish to tell you that we Japanese people keep in our minds heart felt thanks for your nation-wide assistances given to us after the termination of the war. I sometime see articles saying that the present attitudes of Japanese people for DEMOCRACY is superficial, external and cannot be relied, but I strongly protest. I can tell you with confidence that the majority of Japanese people are eagerly contriving to achieve the real democracy. We are combating now with the vicious and aggradizing inflation and with delinquency of morals, but the future of Japan is bright. We will be one of the best peace-loving and cultured nations in the world. We hate the war.

## Slag Used to be Useless

(Continued from page 117)

make lightweight concrete without sand or other materials. It is chemically inert and has no corrosive effect on structural or reinforcing steel, plaster or paint.

These lightweight building blocks have an advantage over ordinary concrete blocks in that wood can be nailed directly to them without the use of nailing plugs or strips. The cellular characteristic of slag gives them a high sound-insulating efficiency when plastered, and sound-absorptive ability when left exposed.

Among the large structures built of slag-concrete blocks are the Trinity Church and the new armory in Chicago and the Porter Memorial Hospital in Valparaiso, Ind. It is becoming more and more popular for building small homes and its insulating qualities cut down heating costs in northern sections.

Towering piles of once worthless slag are now looked upon as industrial gold mines by the men who buy and process it into building materials that make for more comfortable living.

☐ Insects cause an annual crop loss in this country of approximately four billion dollars, according to figures from the Department of Agriculture.





OIL PUMPING in an engine warns that you need new piston rings. It's the *first* sign of worn out rings and the danger signal of undue engine wear.

Fortunately, rings are replace-

ment parts. And when you replace with Hastings Piston Rings, you *stop* oil pumping, *check* cylinder wear and *restore* performance. It's the best money you can spend on your car.

## HASTINGS *Steel-Vent* PISTON RINGS

**GET AN EXPERT CHECK-UP — WITHOUT OBLIGATION**

*There's good common sense in having your motor checked over now and then—especially now, when so many repairmen are set up to give a Hastings Spot Check without charge or obligation. Drive in to your repairman, and ask for it.*

HASTINGS MANUFACTURING CO. • HASTINGS, MICH.  
Hastings, Ltd., Toronto





Use it  
anywhere!

-in your  
shop-

-on  
location

This one unit gives  
(1) **A.C. power and lights**  
plus (2) **A.C. welding**

Get these  
**EXTRA PROFIT** advantages  
with just one low investment

**Make More \$\$\$ With Alternating Current Welding.**  
Do arc welding anyplace with this portable gas engine drive A.C. Arc Welder. In the shop or in the field you'll find more welding advantages in this newly developed rotary A.C. Ideal in the field where electric power is not available, especially for inert-gas-shielded arc welding requiring A.C. for hard to weld metals.



Electric Drive

**Save More \$\$\$ With Alternating Current Power.**  
This same machine is converted, by simply flipping a switch, to a portable Alternating Current Power Unit to furnish lights and power to operate electrical tools and equipment. A real value in case of normal power failure—prevents loss of production time, makes you independent of power supply.



Build Your Own

**You Can "Build Your Own" Or Buy Complete.**  
You can buy this unit as a generator only for connecting to your own power source or you can buy it complete, ready to go to work. Either way you get a combination alternating current arc welder and alternating current power unit. Two machines built into one and for a little more than the price of one. Return coupon today for information on this revolutionary new machine. It can make and save you many \$\$\$.



AC Welder

**HOBART BROTHERS CO., Box M-98,  
Troy, Ohio**

*Hobart "one of the  
world's largest builders of arc welders"*



Hobart Trade School

Yes... I want to know more about...

—the new Hobart A.C. Arc Welder and A.C. Power Unit Combination.  
Send information on items checked:

- |   |   |
|---|---|
| <input type="checkbox"/> A.C. Welder-A.C. Power         | <input type="checkbox"/> Industrial A.C. Welder |
| <input type="checkbox"/> Build Your Own D.C. Welder     | <input type="checkbox"/> Shop Type A.C. Welder  |
| <input type="checkbox"/> Shaft Extension Electric Drive | <input type="checkbox"/> Hobart Trade School    |
- Hobart Brothers Company, Box M-98, Troy, Ohio**



**FREE!**

Vest Pocket Guide..

Name \_\_\_\_\_

Address \_\_\_\_\_

City \_\_\_\_\_

State \_\_\_\_\_

## Inventions Screened Here

(Continued from page 133)

Also under development is a brush-pulling attachment for use with a tractor. An efficient machine for pulling brush is badly needed in the Southwest where millions of acres of ground are covered with dense mesquite brush that chokes off the grass. Before cattle can graze properly or before the ground can be used for agriculture the mesquite must be removed. Usually a bulldozer is used to tear down the brush, but this is expensive and the mesquite often grows back in a season or two.

The institute's brush puller actually jacks each bush or small tree right up out of the ground, removing enough of the root system to prevent regrowth. The machine grips any tree up to eight inches in diameter and has an upward stroke of 40 inches, after which it can take a fresh grip if another lift is required. Hydraulic cylinders provide 40,000 pounds of pressure to the jacking device.

Some of these ideas were originated by staff members, some are developments of inventions submitted by individuals. Submission of an invention to the institute should be done by mail whether or not a patent already has been applied for. If no patent papers are available, the institute suggests that the inventor submit a simple sketch that shows the working parts of the device, a written description of how it works and what it will do, and the signature of the inventor, witnessed and dated by two persons not related to him.

Mere suggestions are practically worthless; the institute is interested only in concrete workable ideas that are new and useful. A staff of experts evaluates the material that is submitted, selects ideas that appear to be suitable for development by the institute, and works out suitable contracts with the inventors. The organization does not engage in financing, promotion, or manufacture. It merely brings a selected invention to the marketable stage and then seeks a manufacturer for it. If the institute drops a project, it turns back all rights to the original inventor, including any work it has done on the idea and any patents that have been issued, without cost and without any strings attached.

The Institute of Inventive Research has been busy during its short life and so has its companion, the Southwest Research Institute. One job this organization did for a client was to develop a coin-operated bottle opener for attachment to the side of a soft-drink refrigerator.

Instead of using an expensive soft-drink

(Continued to page 246)





*Make this Cut-Out FREE*

...on the amazing

**NEW-SAFE**

**SYNCRO**  
MAGNETIC

**JIG SAW AT YOUR HARDWARE STORE**



**1. PASTE GIRL ON WOOD**



**2. SAW AROUND GIRL**



**3. RESULT**—a realistic photo "cut-out" suitable for mantel, desk, dresser use, or as "gift".

Now you can enjoy a **FREE PERSONAL TRIAL** on SYNCRO'S new, improved jig saw—so **SAFE** small children can use—so powerful, versatile, it's the handiest fun or profit tool for any home or home workshop! **DO THIS NOW** Paste "Miss Syncro" (or snapshot of yourself, family, sweetheart) on a piece of  $\frac{1}{4}$ " plywood, or  $\frac{1}{2}$ " softwood—take it to your hardware store that displays SYNCRO—present Free Trial Coupon. Then flip switch on his SYNCRO SAW and cut out a wooden silhouette of "Miss Syncro" or your snapshot—take home for desk, mantel or dresser use. SYNCRO needs **NO MOTOR!** Plug into any 50-60-cycle, 110-120 Volt A.C. only—switch on and saw! Portable—use anywhere. Practical for craftsmen—cuts plastic, wood, thin metals, clean, smooth, no sanding needed. Educational for children—safe—used in schools! Hundreds of thousands sold! Many use it to earn extra cash making signs, photo cut-outs, jewelry, initial pins, book-racks, what-not-shelves, etc. The **ONLY** safe jig saw made! Biggest, most powerful with greatest clearance of any magnetic jig saw! **NEW ADJUSTABLE** arm permits sawing **ANY** length material. New Off-On switch. Quieter operating. *Still* only \$17.50 at dealers in U.S.A. If none near you, send only \$17.50 (plus one dollar to cover cost of shipment) direct to factory with name, address of favorite hardware dealer—we'll ship saw to you **POSTPAID** on 10 Days Money-Back Trial. Or rush postcard for full, free details. (Dealers! Write, wire for "Special Direct to Dealers Introductory Demonstration Deal Offer.") **Hurry!**

**EASILY MADE PROJECTS**



Ladies Lapel Pin



Attractive Book Rack



Arm adjusts to any length material.

*Only*  
**\$17.50**  
(No Motor to Buy)

**THE SAFE FAMILY PROJECT TOOL**



"Miss Syncro the Magnetic Jig Saw Girl"

**SYNCRO** CORPORATION  
Dept. H-98

Rochester, Michigan, U. S. A.

World's Largest Makers of Electric Jig Saws

**FREE TRIAL COUPON**

**MR. SYNCRO DEALER:** This Coupon entitles bearer to cut-out, on your SYNCRO SAW, absolutely **FREE**, one illustration of "Miss Syncro" or any other snapshot or picture which has been pasted on  $\frac{1}{4}$ " plywood or  $\frac{1}{2}$ " soft wood—or to personally try Syncro at store using material you furnish.

**SYNCRO CORPORATION, Rochester, Mich.**



# Shave with extra ease... save money, too

STROP YOUR  
RAZOR AS  
A BARBER  
DOES!



STROPS—CLEANS  
WITHOUT  
REMOVING BLADE

RAZOR, STROP  
AND  
5 VALET BLADES

**\$1.25**

SELF-SHARPENING . . . ONE PIECE

**Sharpen  
Lawnmowers** MAKE  
\$5.00 PER HOUR

You need no experience to operate the Ideal Lawnmower Sharpener. It is simple to adjust, simple to operate. Sharpens blades easily, speedily, accurately. Ideal sturdy, strong construction is the result of 45 years of engineering design. WRITE TODAY FOR FREE BOOK.



**The FATE-ROOT-HEATH CO.**

DEPT. D-3, PLYMOUTH, OHIO

dispenser that is coin-operated and holds only one brand of refreshment, many gas stations and stores place their soft drinks in an unlocked icebox. Customers help themselves and a forgetful one sometimes neglects to pay for his drink. The coin-operated bottle opener takes care of this automatically. The customer picks up his cold drink and then places a coin in the opener device. The coin allows the blade to slide down into place where it remains until a bottle has been inserted and the cap has been removed; then the blade is retracted until another coin is deposited in the opener.

Southwest Institute did some of the work in developing vacuum pads that are placed on fresh concrete in order to dry the concrete to 24-hour strength in a quarter of an hour, allowing the finish coat to be put on without delay. It worked out a design for stressing sheet aluminum for use in building construction, and it perfected an air-flow meter for use in calibrating the blowers used for cooling refrigerated meat shelves and other refrigerated storage compartments.

At present it is working on a vacuum-tube ignition system for internal-combustion engines that would replace the present ignition system and is developing an automatic cooker for corn chips, a food snack manufactured in the Southwest.

Meanwhile the third member of the research trio, the Foundation of Applied Research, is busy on problems of its own. It is seeking to reduce the present lengthy periods of experiments through which allergy patients must proceed in finding the remedy for their affliction and it is following up a lead in cancer research, using a self-sustaining artificial heart, that holds promise of interesting developments.

Considerable research has been done for the petroleum industry. One of the present projects concerns the possibility of mapping underground structures by the reflected seismic waves of explosions that are set off at the surface. At present it is necessary to drill holes as deep as 300 feet and explode the charges at the bottoms of the holes. The new idea would make use of the directional force of the so-called shaped charges that were perfected during the war. If successful, the method will materially cut the present costs of geophysical surveying.

Rich for decades in cattle, oil and agriculture, the vast Southwest has been growing rich in industry as well in the last few years. Tom Slick's three research organizations already are solving some of industry's problems. They fill a regional need that was becoming acute.



A NAME TO REMEMBER WHEN YOU THINK OF BETTER LATHES AND SHAPERS

# Logan

**ACCURACY IN A  
9-INCH SWING**

Plus Logan speed,  
ruggedness and  
versatility at \$159.50

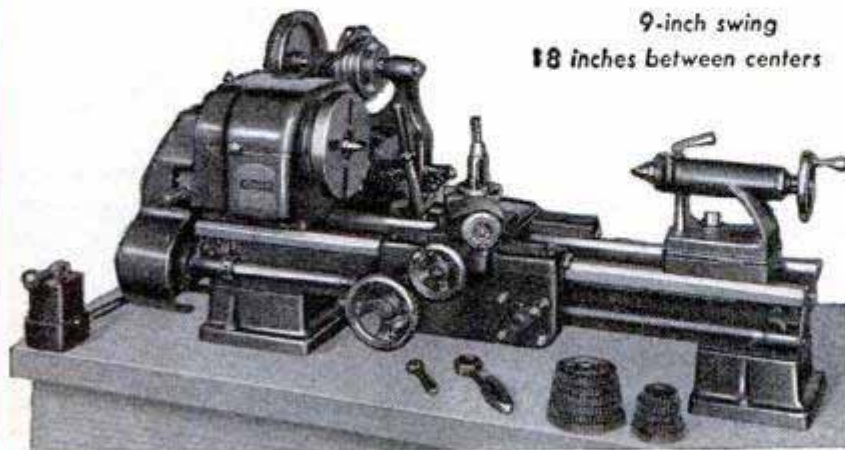

9-inch swing  
18 inches between centers

• This lathe will produce precision results on any job you give it, and it retains its accuracy through years of use. Bed ways precision ground to within .0005" of parallelism. Ball bearing spindle needs no bearing adjustment from 30 to 1450 rpm. In brief, it is a LOGAN Lathe built in a compact 9-inch size. See it at your Logan dealer's, or write for information.

**DISTRICT OFFICES**

Woolworth Bldg.  
New York 7, N. Y.  
CO 7-8024

550 W. Washington Blvd.  
Chicago 6, Illinois  
Central 1246

2516 N. Ontario St.  
Burbank, Calif.  
Charleston 8-1024

700 Commerce St.  
Dallas 2, Texas  
Central 4075

**LOGAN ENGINEERING CO.,**

Dept. BB-9  
CHICAGO 30, ILLINOIS

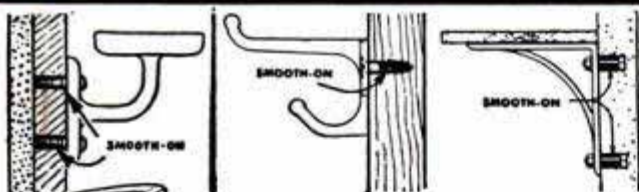

**Loose Bathroom Fixtures  
Just Need SMOOTH-ON**

Cup holders, shelf brackets, hooks, towel racks, soap dishes, etc. stay in place, once you anchor them with Smooth-On No. 1 Iron Cement. You apply it to screws and bolts and into the holes where they belong. Smooth-On hardens quickly and the repair stays tight, for Smooth-On expands a little as it sets. Get a 1 $\frac{3}{4}$ -oz., 7-oz. or 1-lb. container of Smooth-On No. 1 and keep it handy not only for tightening loose parts and fixtures, but to stop leaks and seal cracks. If your hardware store hasn't Smooth-On, write us.

**FREE Repair Ideas**

Send for YOUR free copy of the 40-page Smooth-On Handbook of time-saving, money-saving repairs you can make in the home, on the car. Just mail us a postcard.

SMOOTH-ON MFG. CO., Dept. 37J  
570 Communipaw Ave., Jersey City 4, N. J.

Do it with

**SMOOTH-ON**

THE IRON CEMENT OF 1000 USES



**Now Own This**  
PORTABLE ALL-PURPOSE DIRECT DRIVE  
**AIR COMPRESSOR**



ONLY  
**\$83.95**



F.O.B. Factory  
Complete  
With  
Air Chuck

For  
PAINTING  
SPRAYING  
GREASING  
INFLATING  
CLEANING  
DUSTING

Economical Air Power For Garages, Machine Shops, Home Work Shops, Farms, Contractors and wherever air power is needed for operating small air tools. Easily carried. Weighs only 50 lbs. Piston type, single cylinder. 3" bore, 1/2" stroke. Displaces 3 1/2 C. F. M. Maximum working pressure 90 lbs. Sturdy, efficient, trouble-free. Of finest quality and workmanship. Motor is 1/2 h. p., single phase, 60 cycle, 110 volt. (Gasoline models available. Also lower priced belt drives.) Equipped with 15-foot electric cord, plug and switch; 20-foot rubber covered 1/4" air hose with automatic air chuck. Fully guaranteed. See your dealer or write factory sending check, bank draft or money order.

General Products Division  
**TOKHEIM OIL TANK & PUMP CO.**  
1628 Wabash Ave., Fort Wayne 1, Indiana





## Spying on Mars by Invisible Light

(Continued from page 154)

shield, but Kuiper found no trace of it. "There may still be another substance in the Mars atmosphere, as yet unidentified, able to reduce the ultraviolet radiations," he states. "But it may be that living organisms on Mars have developed a protective layer comparable to a strong sun tan so that the ultraviolet radiations are not harmful to them any longer."

Any animal life on the planet may have perished long ago, unable to adapt itself to the rigorous conditions that prevail there now. If an intelligent race still persists the assumption is that its members would spend most of their time underground, insulated against ultraviolet radiations and low temperatures and where oxygen and water could be conserved.

The reason why there is so much speculation about intelligent life on Mars is that various astronomers have observed long, straight, canal-like markings that crisscross the arid plateaus. Some of the lines are parallel and close together, some cross others at spots that spread out like oases. Thousands of miles long, the straight lines must be artificial. No such instances of patterns of straight lines are known in nature. The lunar cracks, for instance, are not at all comparable.

A plausible suggestion is that these lines are waterways built by the Martians in a desperate attempt to prolong their existence when the planet was drying up. The dark color of the lines suggests that vegetation continues to grow in them even though water no longer can be observed.

Other astronomers have been unable to spot these canals and suggest that they are simply an optical illusion that comes from a too-intense concentration of vision. Possibly, they say, the lines are simply an unconscious joining together of dark spots that are at the limit of visibility.

The turbulence and shimmer of our own atmosphere make the dispute difficult to settle. Only for a few seconds at a time, from any point on earth, is the atmosphere sufficiently at rest to permit the "super seeing" that astronomers desire. These periods may total only an hour a year.

Dr. Edison Pettit of the Mount Wilson Observatory viewed Mars during one of these periods and he was astonished to see the canals come into view, though previously he had doubted their existence.

"I was studying the equatorial markings of the planet when suddenly a canal appeared to descend from the equator to the

(Continued to page 250)

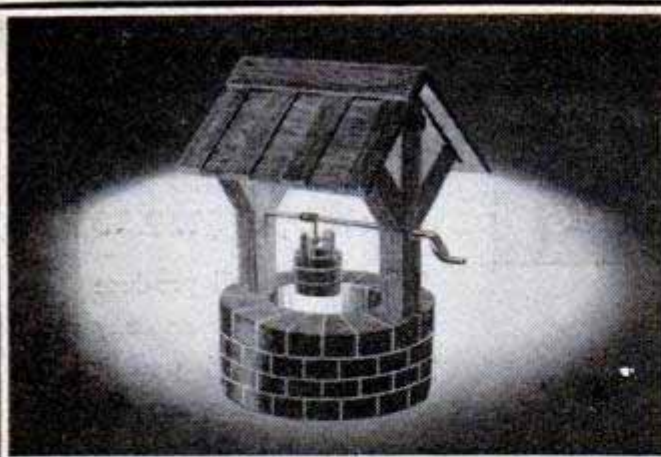

### New! Wishing Well Table Lamp

For garden, nursery, kitchen, any room in your home. Changeable colored light (clear, blue, amber or red). Roof and posts of California redwood. Suede-like, velvety-soft textured base in choice of brown, red, blue, black, white, orange or yellow. Completely wired and ready for use, indoors or out. \$5.95 postpaid, direct from manufacturer. 10-day money-back guarantee. U. S. Patent 2297153.

JACK JOHNSON CO., Dept. 288  
3365 Army Street San Francisco 10

## PRESSURE QUEEN

### Outperforms them all



The only portable spray painting outfit having 4 cylinders in space usually required for one. Paints buildings; refinishes automobiles; inflates tires; lubricates chassis and farm machinery. Does more work in an hour than hand brushing in a day. Uniform pressure without pulsation. Ideal for home, farm, service station, machine shop and contracting painter. Factory tested and guaranteed.

● If your dealer does not sell Pressure Queen, order direct for immediate shipment.

**THE CAMPBELL-HAUSFELD CO.**

1046 RAILROAD AVE.

HARRISON, OHIO



**LAFAYETTE  
CONCORD  
KIT-QUARTERS  
FOR  
RADIO BEGINNERS  
HAMS and PROFESSIONALS  
AMERICA'S GREATEST RADIO VALUES**

**Easy 3 tube AC-DC Student's Kit**

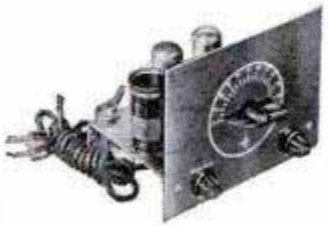

Get into fascinating educational radio with this easy-to-assemble kit. Contains all the parts needed to build complete radio. Full instructions. No special tools. Send for this bargain-buy now. **\$5.95** Less tubes. *Only.....*

**Exciting new 5 tube\* AC-DC Kit**



POPULAR SUPERHET . . . easy to assemble. Wonderful to listen to. All top features. Includes true tone reproduction, automatic volume control, streamlined airplane dial with wide tuning that covers

550 to 1600 Kc, built-in loop antenna, and a new Alnico V speaker. Handsome, modern plastic case and 5 tubes\* (including rectifier) included at this low price. Kit contains all parts. Thrill to putting it together. **\$13.75** Send for yours now while quantity lasts. *Only*

**Build Your Own Hi-Fidelity Phono Amplifier**

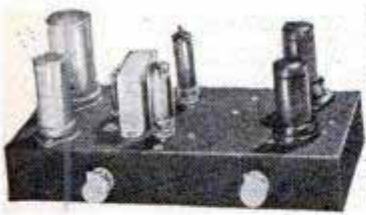

4 TUBE AC-DC KIT will bring you real high fidelity record enjoyment. Minimum of construction problems. Will provide long trouble-free operation. Quality of tone will amaze your friends.

Built-in equalization network permits the use of a low gain pickup without the use of an additional preamplifier. Two twin triode 12SC7 tubes used as pre-amp and audio driver tubes. Pair of 50B5 beam power amplifiers in push-pull provide an audio output over 4 watts. Frequency response well over 12,000 cycles. Power supply consists of 2 selenium rectifiers in a voltage doubler circuit eliminating rectifier tubes. Order this fine kit—contains full instructions. **\$13.95** *Great value at* less tubes

**LAFAYETTE-CONCORD**

100 SIXTH AVE., NEW YORK 13    229 W. MADISON ST., CHICAGO 6  
265 PEACHTREE ST., ATLANTA 3    110 FEDERAL ST., BOSTON 10  
24 CENTRAL AVE., NEWARK 2    542 E. FORDHAM RD., BRONX 58

**SPECIAL INTERCOM VALUE  
HOME • NURSERY • OFFICE  
GARAGE • STORE • FACTORY**



**\$12.95**

A real 2-way system. Calls can originate at either station. Picks up your voice or a baby's whimper at 15'. Ready to operate, all you need is a screwdriver. Strong plastic cabinets. Saves time and effort. Ideal for nursery or general use in the home. Remote can be placed up to 2000' from master station. Eliminates needless climbing of stairs. Practical uses everywhere. Complete with 50' of wire. An unbeatable Lafayette value. Supply will be limited to readers of this magazine. So send coupon **\$12.95** with order .....

**BIG NEW 180 Page  
FREE CATALOG!**

**your copy is waiting . . . get it!**



LAFAYETTE and CONCORD have combined to form the world's largest radio supply organization. Their new catalog — just off the press tells with terrific sock what this means to you. 180 pages jam packed with hundreds of thousands of items at absolute rock-bottom prices. Lists every part and kit you could possibly need for building

television, home radio, ham, phonograph, high fidelity equipment, etc. *Make Lafayette your buying headquarters!* Half a million other radio men and hobbyists have done so! They don't miss up on these amazing values. Why should you? Shop in person at one of our outlets or order by mail—either way you'll save *big* money. Start now by rushing the coupon to us on a penny post card at once.

**USE THIS COUPON NOW FOR  
FREE CATALOG AND  
ORDERING**

LAFAYETTE-CONCORD, DEPT. LI-8  
100 Sixth Ave., New York 13, or  
901 W. Jackson Blvd., Chicago 7

Please rush FREE catalog No. 89  
 I enclose \$..... Please fill attached order.

NAME.....  
ADDRESS.....  
CITY.....ZONE...STATE.....







## Amazing MOTO-SANDER AND POLISHER

**Saves Time — Saves Effort!** Dremel has developed a combination electric Sander and Polisher for home or shop . . . so easy to handle that a child can use it. New, inexpensive "Moto-Sander" delivers about 7,200 strokes a minute. Because of its high speed and fast, reciprocating action, Moto-Sander does a magically smooth job of sanding . . . gets into places other sanders can't reach. Rubber cushioned sanding pad measures 2 1/4" x 5 1/2". Cam-type-clamp paper holder permits changing sandpaper in seconds. Moto-Sander has only two moving parts . . . never needs oiling or adjustment . . . weighs only 2 1/2 lbs. Uses 110-120 volt, 60 cycle A.C. electric current (only). Gives no radio interference. Comes with 8 ft. (Underwriters' Approved) rubber cord plus 6 sheets assorted grade Garnet paper, plus 1/4" thick felt pad and sheepskin for wax polishing.

### FINE FINISHES — FAST!

Use Moto-Sander to get satin smooth finish on woodwork, stairways, doors, furniture; ideal for sanding boats, painted walls, bird houses or scale models. Just guide it. Uses #2/0 Garnet paper or finer. For speedy, effortless polishing of waxed furniture, automobiles and other surfaces, use felt pad or sheepskin (furnished) in place of sanding paper. Moto-Sander is the lightest, most practical electric sander on the market—the only one of its kind and is patented.

**MONEY-BACK GUARANTEE:** If your dealer does not yet have Moto-Sander, send only \$14.85 . . . we'll pay postage. Or send \$2 now, and pay postman balance plus postage. Money back if not delighted after 5 days' trial.

**DREMEL MANUFACTURING CO.**  
Dept. SP118-J • Racine, Wis.



EASY FOR  
AWKWARD PLACES



SANDS FLAT  
SURFACES EVENLY



GETS INTO  
TIGHT CORNERS



ROUNDS CORNERS  
LIKE MAGIC

lower polar cap, wriggling as it descended and then becoming steady," Doctor Pettit reports. "Almost simultaneously another north-south line appeared and within a few seconds a third was observed. They seemed to fade in and out. An hour later a fourth canal could be seen and for short periods all four were visible."

For several nights, both with a six-inch refractor telescope and a 20-inch reflector, Pettit continued his observations, mapping the canals as new ones appeared due to the rotation of the planet. He deliberately refrained from studying drawings made by other observers and not until his observations were completed did he compare his drawings with theirs. The agreement was surprising.

Mars will be in opposition (closest) to the earth in the spring of 1952 and again in 1954, after which astronomers will have to wait 15 years for another close view. For the last few decades astronomers have spent most of their time reaching as far out into space as their instruments would permit, learning more about objects that are millions of light-years away. Routine observations of the planets have been left for the most part to amateur astronomers. Today, however, there is an increasing inclination by astronomical science to re-view our own planetary system once more and to check up on the work that was done on nearby objects as much as 50 years ago.

Mars is of major interest in this program and it is anticipated that the world's leading observatories will train their telescopes on the planet during the oppositions of 1952 and 1954. With luck and with the right photographic equipment, sharp, clear photographs of Mars may be obtained. If the photographs reveal no canals, it will be necessary to re-examine the entire canal theory. If, on the other hand, the presence of canals is confirmed, science will have evidence that the earth is not the only planet on which higher forms of life have occurred.

## Portable Bowl for the Midgets

(Continued from page 94)

owns the Giants baseball team, and proposed that he rent the Polo Grounds for racing, the baseball magnate had grave misgivings. He insisted that the track be designed so that it would not damage the turf and that it must be erected immediately before and taken down immediately after every semiweekly program so that the grass on the field would receive sun

(Continued to page 252)

# Free Leathercraft

## instructions

All materials for making easy-to-assemble leather goods. Free instructions included. No experience necessary.

**MAKE AS GIFTS — OR TO SELL**



Belts, gloves, purses, wool-skin toys and mittens, 100 other practical, money-making items. Largest complete stock of leather and leathercraft supplies in America. Immediate delivery.

Send 10 cents for new catalog of gift suggestions and profitable ideas. Write today.

**J. C. LARSON COMPANY**  
824 S. Tripp Avenue, CHICAGO 24, ILL.



**NOTHING ELSE LIKE IT...**

**Get this REVERSIBLE 2-in-1 Screw Driver**

(Stock No. DU2)

Combines a standard size Phillips (No. 1) Cross Point and regular (3/16") bit in ONE driver. Ends the hunt for that missing tool! Break and shock-proof plastic handle... oil tempered chrome vanadium steel blade. Precision-built throughout... no play or wobble. Fully Guaranteed. Finest tool you ever owned! Only 75¢



**5-in-1 Screw Driver Kit**

(Stock No. ZB50)

Consists of leatherette tool roll, 1 break and shock-proof plastic handle, and 5 interchangeable oil tempered, chrome vanadium steel blades: 1/8", 3/16", and 1/4" regular; No. 1 and No. 2 Phillips. Fits easily into back pocket. An ideal all-purpose screw drive kit. Fully Guaranteed. Price, only . . . . \$2.50

**Gift Packaged Screw Driver Set**

(Stock No. A6)

A beautiful assortment of 6 famous Amberly handled screw drivers in a blue enameled steel box. Very finest quality throughout! A set every man will be proud to own... the ideal gift. Square, round, stub and ignition size blades ranging from 3/16" to 1/2". Fully Guaranteed. Price, only . . . . \$4.50



See your Dealer, or send check or money order direct. We Pay Postage.

**VACO PRODUCTS COMPANY**

317 EAST ONTARIO STREET, CHICAGO 11, ILLINOIS

**Keep Brushes like New**

**BEFORE**

**AFTER**

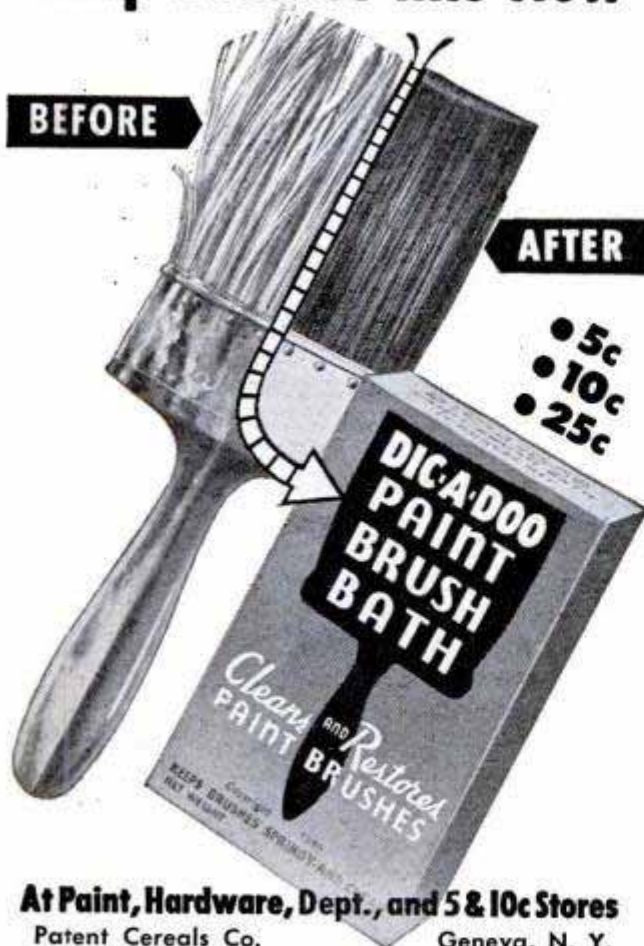

• 5c  
• 10c  
• 25c

**DICA-DOO  
PAINT  
BRUSH  
BATH**

*Clean and Restore  
PAINT BRUSHES*

At Paint, Hardware, Dept., and 5 & 10c Stores  
Patent Cereals Co. Geneva, N. Y.

**CARBURETOR**

**YELLO BOLE**

REG. U. S. PAT. OFF.

*Honey-treated*



For the man with a sensitive tongue  
**CARBURETOR**  
cools your smoke,  
makes it mild

\$2.50



1. Smoke from tobacco
2. Cool air is drawn in through Carburetor
3. Smoke is cooled by mixing with air from Carburetor

Cool air drawn through the patented<sup>o</sup> Carburetor keeps the bottom of the bowl dry, so there is never a "wet heel". Bowl is treated with honey, so no "breaking-in" is required. A pipe that beginners can enjoy without having to accustom themselves to it. Ask for Carburetor Yello-Bole at dealers, \$2.50. Kaufmann Bros. & Bondy, Inc., Estab. 1851, 630 Fifth Avenue, New York 20.

<sup>o</sup>U. S. PAT. NO. 2,082,106



This picture of Honey Girl is displayed wherever Yello-Boles are sold.



Identify Yello-Bole pipes by the honey-seal in the bowl. It keeps the honey fresh.



**NEW FOREDOM Model #99**  
 at an **Amazing LOW PRICE**  
**FLEXIBLE SHAFT MACHINE**  
 with **PENCIL-SIZE HANDPIECE** **\$15<sup>95</sup>**  
**COMPLETE WITH MOTOR**



**Grinds, Polishes, Cleans Sharpens, Mills, Carves Engraves, Etches on Metal Wood, Glass and Plastic**

**5 REASONS WHY FOREDOMS ARE TOPS:**

1. Extra power and longer motor life because motor not dwarfed to fit hand.
2. Correct handpiece size for deft, sensitive, finger-tip control.
3. No obstructed view of your work.
4. Freedom from gyroscopic action—hence better work.
5. Small handpiece size lets you get into hard-to-reach places.

**Hundreds of Uses**

Foredoms handle hundreds of tasks. Use them for pleasure or profit, for tinkering or expert craftsmanship. Their versatility is unlimited. Use them to grind, polish, mill, engrave, sharpen, slot, rout, saw, carve, clean, sand, etch, cut, etc. Ideal for internal carving of plastics, the astounding new craft. You can work on wood, glass, plastic and all metals with a Foredom. No. 25 Accessory Set (A truly versatile assortment) only \$5.50 extra.



**YOUR MOTOR**  
**Foredom PRESTO-FLEX**  
 with **PENCIL-SIZE Handpiece** **\$5.95**

- Now turn your old motor, drill press, or electric drill into a Flexible Shaft Tool. Simply attach to your electric drill, drill press or motor. Presto—a flexible shaft machine! Off again in a jiffy! Pencil size handpiece gives you finger-tip control. Gets into tight places you can't reach with any other tool. Handy 35" overall length. And—only \$5.95 complete! Not to be confused with inferior imitations. Precision made, backed by 1/4 century experience in this field. All parts replaceable. Order NOW. If ordered for use on motor, specify motor shaft diameter and add 50c for coupling. (Available for 1/4", 5/16", 3/8", and 1/2" shafts.)
- No. 50 Accessory Set Available \$1.50 extra. Order TODAY.

**Over 60,000 Foredoms now in use**

**SEND NO MONEY**

**FOREDOM ELECTRIC CO., Dept. B119**      **Mail Coupon**  
 27 Park Place, New York 7, N. Y.      **Now!**

Please send me FOREDOMS checked below on 10 day trial.

<input type="checkbox"/> Presto-Flex Tool (\$5.95)	<input type="checkbox"/> No. 50 Accessory Set (\$1.50)
<input type="checkbox"/> Motor Coupling (50c)	<input type="checkbox"/> No. 25 Accessory Set (\$5.50)
<input type="checkbox"/> Flexible Shaft Machine (\$15.95)	<input type="checkbox"/> Catalog on request

Specify motor shaft diameter  
 Send C.O.D. plus postage. I will pay postman.  
 I enclose payment. Send postpaid.  
 (Money back either way if not delighted)

Name \_\_\_\_\_  
 Address \_\_\_\_\_  
 City \_\_\_\_\_ Zone \_\_\_\_\_ State \_\_\_\_\_

**TOYS COMPLETE PLANS FOR JUST 10¢**  
**STANLEY**  
**PLAN SET No 16**

Happy evenings for you . . . joyous days for your children . . . holiday gifts for all. Detailed plans for easy to make, hard to buy toys . . . wheelbarrow, rocking horse, kiddie push car, scooter and toy wagon. Send just 10¢ and ask for free list of all the Stanley Plan Sets. **STANLEY TOOLS, 198 Elm St., New Britain, Conn.**

and rain. Thompson himself wanted a well-banked oval to insure fast times and one which was sufficiently rugged that it wouldn't come apart under the terrific centrifugal force of a dozen cars hitting one of the banked turns at better than a mile a minute.

The Levys designed a track so simple that it can be erected or dismantled without any tools by a crew of 200 men in 15 hours or less. The foundation consists of a series of aluminum trusses, some as long as 24 feet, but all so light they can easily be carried by two men. Metal thickness is 1/4 inch and the top and bottom members are Ts. The supports within the trusses are riveted.

The track is 36 feet wide on the straight-aways and 44 feet on the turns. It has a 12-foot apron next to the infield for warm-ups and disabled cars. Three trusses extend from the inner edge of the apron to the outer rail where they are braced with aluminum cross stays. The fasteners by which trusses are secured to the vertical members are made of stainless steel.

The racing surface consists of one to four-inch pine boards, which give excellent traction and absorb oil. These are assembled into units of four or five boards, either straight or curved to the radii of the turns. The boards slip together by tongue and groove and are secured by wood and aluminum cleats on the underside. The board units are grooved on the underside and are slipped over Ts on the top sections of the trusses.

The units are numbered to show their location on the track. This feature, plus the put-it-together-with-your-bare-hands aspect, make assembly, disassembly and reassembly as simple as working with a child's building set.

All the components of the track fit with extremely fine tolerances to assure the necessary rigidity. An observer standing beneath a turn cannot see the slightest sway when a dozen cars roar over his head at about 80 miles an hour with 48 tires doing their level best to push the corner out of the mobile track.

The track is 500 feet long, 230 feet wide, consists of 2200 sections, weighs 650,000 pounds and cost \$150,000. So evenly distributed are the 325 tons that the ball-park turf is unmarred.

While the weight is substantial, the entire track could be transported from city to city in 30-odd big trailer trucks, making it possible to bring the thrills of midget racing to any city or town that boasts a full-size baseball park. The track is scheduled for use in California this winter.



# PROFITS AND SPEED

## THE MODERN LAWN MOWER SHARPENER

PRICE  
**\$241.50**  
LESS  
MOTOR

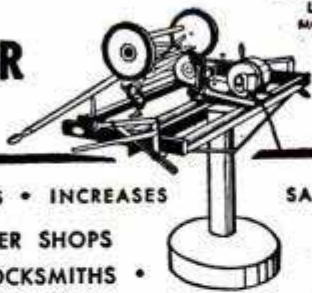

INCREASES PROFITS • INCREASES SALES  
FOR LAWN MOWER SHOPS  
FIXIT SHOPS • LOCKSMITHS •  
HARDWARE STORES • GOLF COURSES • SCHOOLS  
PARKS • PLAYGROUNDS • INSTITUTIONS •  
CEMETERIES • AND ALERT INDIVIDUALS!

*Sharpens All Reel Type Mowers • Hand, Power or  
Gang • 10 to 20 Minutes • No Dismantling  
No Extra Attachments Needed*

All reel type mowers, from 5-inch edgers to 36-inch power mowers, are quickly sharpened to extreme ends of both left and right twist reel blades. Handle, wheels, roller and motor remain in place when sharpening is in process. Bed knife is sharpened in same brackets that hold mower in grinding position. No extra attachments required. One lever puts mower or bed knife in grinding position. 100% steel construction. Grinding head rides on five ball bearing races. Small, compact, easy to operate. Sharpens wood chisels, joiner knives and planer blades without extra attachments.

**ORDER  
NOW**  
Immediate  
Delivery

*Skate Sharpener Attachment Available  
Send For Free Bulletin No. 10B*

**MODERN MFG. CO.** 160 N. FAIR OAKS AVE.  
PASADENA, CALIFORNIA

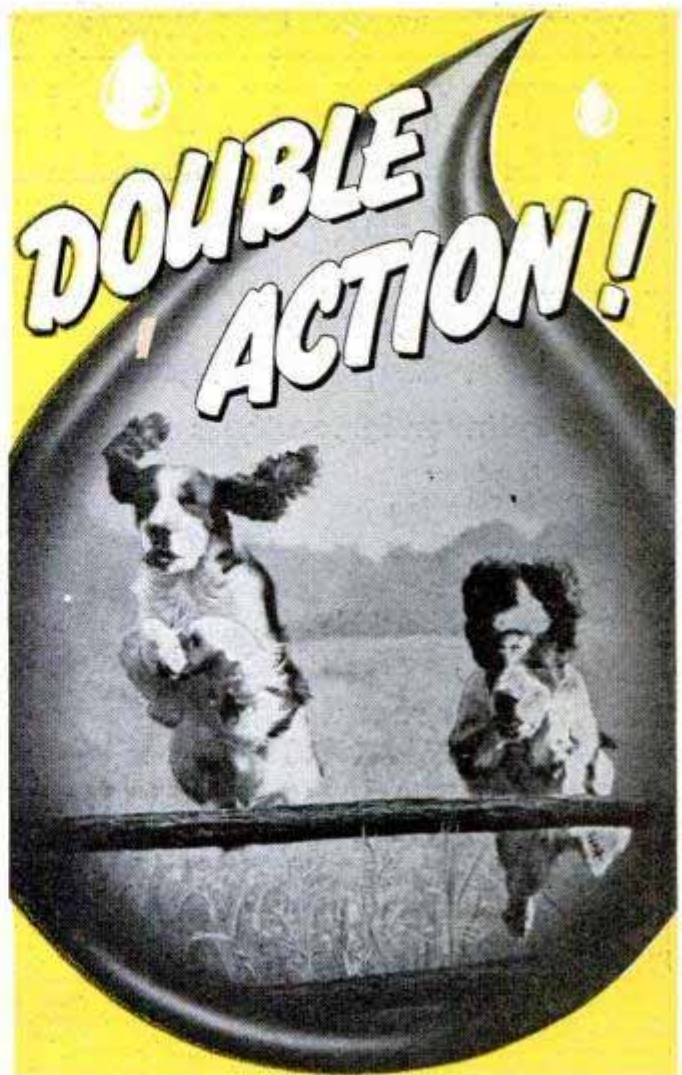

# PENNZOIL

**MOTOR OIL**

**FLOWS FAST-STAYS TOUGH!**

Enjoy instant protection for "cold-snap" warm-up, lasting safety for Indian Summer heat... Change now to double-action Pennzoil!



Copyright, 1948, The Pennzoil Co.

At this sign of better dealers, coast to coast

\*Registered Trade Mark

Member Penn. Grade Crude Oil Ass'n., Permit No. 2

**Tough-film PENNZOIL\* gives all engines  
an extra margin of safety**



**IMMEDIATE DELIVERY!**

Complete  
as shown

**\$24.95**

F. O. B. ROYERSFORD, PA.



## BENCH SAW

CUTS THROUGH 2 5/16"

**UNCONDITIONALLY GUARANTEED ONE YEAR**

Comes complete with Floating motor mount—miter gauge with adjustable stop—aluminum guard—soft aluminum insert—spring steel splitter—heavy gray iron fence—(no motor—no blade). Table 12" x 14". Tilts to 45°—Oilite bearings. Shipping Wt. 48 lbs.

**AMERICAN MACHINE & TOOL CO. Inc.**

DEPT. 100

ROYERSFORD, PA.

WRITE FOR FREE BOOKLET AND GUARANTEE BOND



**GROBAN'S SURPLUS BARGAINS!**

# WESTINGHOUSE AIR COMPRESSOR

**BRAND NEW  
War Surplus Bargain**

**2-Cylinder Piston Type**

*Ideal for:*

- Paint Spraying
- Industrial Uses
- Tire Inflating
- Spraying Insecticide
- Operating Air Tools

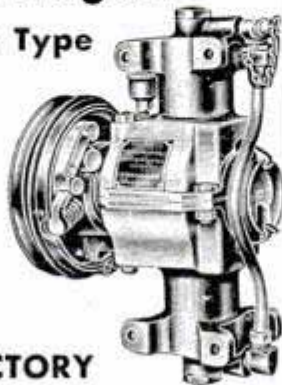

**For the:**

**HOME... FARM... FACTORY**

Designed for automotive truck or tractor mounting. Can be run off fan belt or power takeoff. Comes with automatic clutch. Can be installed for use on: farm trucks, jeeps, tractors, tire or garage service trucks, contractor or road building machinery, pneumatic devices, etc. Has 2 inch bore — 1½ inch stroke.

**Can be operated with ½ H.P. or more electric motor or equivalent portable gas engine.**

Light weight, compact and versatile unit... delivers "oil free air"... simple in operation; requires minimum of maintenance; operates under all climatic conditions; suggested operating pressure 75 P.S.I.; equally efficient operation in either direction of rotation; approx. displacement 3.27 CFM at 600 RPM, 6.54 CFM displacement at 1200 RPM; Overall dimensions: width 9", height 11⅞", depth 6⅝"; approx. wt. 23 lbs. ....

**A REAL BUY...  
worth many times  
this price**

**\$26.95**

Send check or money order today.  
**SATISFACTION GUARANTEED.**

F.O.B.  
CHICAGO

## 37 Piece Manganese Bronze Letter Stamping Kit

**BRAND NEW**

5/16" letters, 2½" length, can be used hot or cold—ideal for stamping or burning lettering on leather, wood, plastic and soft metals such as aluminum, lead, copper, brass, etc. Complete alphabet, numbers and punctuation. Available in veneer fitted case. Excellent for marking, identifying and stamping. Worth many times this unsurpassed price of .....

**\$6.95**

Prepaid in U.S.



## Clutch with Universal Joint

**BRAND NEW**

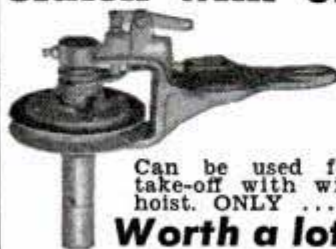

Formerly used on Amphibious Jeeps. Has 5 inch ball bearing pulley. Used on garden tractors, midget cars, lawn mowers, etc.

Can be used for power take-off with winch and hoist. **ONLY** .....

**Worth a lot more!**

**\$4.95**

F.O.B.  
Chicago

**GROBAN SUPPLY CO.**

DEPT. PM9, 1507 S. MICHIGAN AVE., CHICAGO 5, ILLINOIS

## Mass Attack on Heart Disease

(Continued from page 85)

blood as a fatty substance, and in some types of fatty foods including butter, milk and egg yolk. Many doctors believe that this substance may cause hardening of the arteries. That's the reason so many middle-aged men are advised to cut down their intake of butter. Doctor Keys hopes to find out the exact influence of cholesterol on the arteries. His opinion at present is that the substance has much less effect than previously supposed.

Not only physical but mental and emotional tests are given the volunteers. They fill out a 500-question form, which gives the psychiatrists associated with the program a picture of their personalities and the emotional strains and tensions under which they live. Every person has "regulating machinery." Under excitement, this machinery prepares him for quick action by pumping more blood through his veins and boosting his blood pressure. The trouble is that no one can voluntarily control this machinery, and under certain circumstances it is so unstable that it may overact to shove a person dangerously close to a heart attack. The psychiatrists who work on the project are attempting to find out how the volunteers are likely to react to emotional excitement.

All 500 volunteers have been given their first-year's examination, and soon will report for their second. At the outset every one of the 500 was believed to be in good health and free from significant diseases of the heart and arteries. The first-year's special tests, however, showed that many of the volunteers were less healthy than they supposed. Of the 300 men in the prime-of-life group, nine were so abnormal they had to be dropped. Ninety others had already developed heart trouble of some kind. Fifteen men had stomach ulcers and several others had diabetes and thyroid disease. Most of these men thought they were in perfect health.

Because it's a long-term project, Doctor Keys will not predict the results as yet. In his opinion, though, the three most important factors in heart disease are obesity, exercise and emotion. A person who is fat seems to be more likely to be attacked.

"The big job is to find out how diet, physical activity and emotion predispose a person toward heart disease," says Doctor Keys. "As these 500 men are studied year after year the characteristics that precede heart disease should become evident. When we have that knowledge we shall be able to devise preventive hygiene."



# GROBAN'S SURPLUS BARGAINS!

**BRAND NEW**

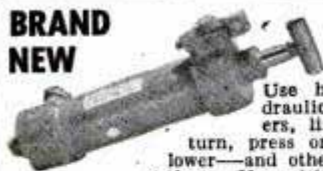

## AIR OR OIL HYDRAULICS

Use hydraulics on arbor presses, hydraulic presses, hay lifts, manure loaders, lift trucks — push or pull, tilt or turn, press or squeeze, open or close, lift or lower — and other hydraulic and industrial applications. Use with either air or oil . . . of finest precision workmanship.

- Use these cylinders on farm trucks, bulldozers, hay lifts, manure loaders, etc. Double action, 1 1/2" bore, 27" stroke. (Will lift 1760 lbs. in 2 seconds with Vickers Pump). A \$55.00 value for only . . . . . **\$12.95**  
Wt. 8 lbs. . . . . postpaid
- Double action, 2 3/8" bore, 8" stroke. (Will lift 4400 lbs. in one second with Vickers Pump). Will withstand 1500 P.S.I. against wall. A \$65.00 value, available now at . . . . . **\$14.50**  
Wt. 7 lbs. . . . . postpaid
- Double action, 3" bore, 12" stroke. All steel hydraulic cylinder, will lift up to 12,000 lbs. (7000 lbs. in 3 seconds with Vickers Pump). A \$78.00 value. Wt. 12 lbs. . . . . **\$19.50**  
Wt. 12 lbs. . . . . postpaid
- Double action, 3 1/2" bore, 11" stroke, will lift 9800 lbs. in 7 seconds using Vickers MF6 Pump. A \$92.00 value. Wt. 15 lbs. . . . . **\$22.50**  
Wt. 15 lbs. . . . . postpaid



## Brand New Hydraulic Control Valves

Outlets are standard 1/2" pipe thread and inlet takes standard 1/4" copper tubing fitting.

- Four-way control valve for use with 1" double action hydraulic cylinder, may be used with 1500 P.S.I. hydraulic system to open and close hydraulic cylinders. Brand new. Shp. **\$7.95**  
Wt. 4 lbs. A \$38.00 value. . . . . postpaid
- Four-way control valve for use with two hydraulic double action cylinders. Each cylinder may be operated independently of the other or in conjunction with the other. Oil may be locked in any of the cylinders to hold the piston at any required position. Brand New. Shp. **\$10.95**  
Wt. 6 lbs. A \$60.00 value. . . . . postpaid
- Same as valve item 2, except that unit is designed for three double action cylinders. Brand New. Shp. **\$12.95**  
Wt. 8 lbs. A \$72.00 value. . . . . postpaid
- A two cylinder double action valve with a unique arrangement, allowing the operator to raise both cylinders simultaneously, to lower them simultaneously or to raise one and lower the other at any predetermined rate and speed. Brand **\$14.95**  
New. Shp. Wt. 8 lbs. A \$75.00 value. . . . . postpaid

## VICKERS MF6 HYDRAULIC PUMP OR MOTOR

Compact, powerful, rated 1,000 P.S.I., .507 cu. in. per revolution, 8 gal. per min. at 3750 r.p.m. Change rotation by reversing flow. Delivers up to 6 H.P. BRAND **\$14.95**  
NEW. Wt. 4 1/2 lbs., \$60.00 value for . . . . . Postpaid

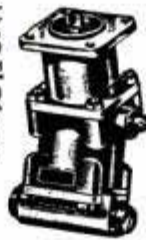

## VICKERS HEAVY DUTY HYDRAULIC PUMP BRAND NEW



For tractors, bull-dozers, construction machinery, lift trucks, industrial applications, etc. Delivers 18 gal. per minute at 1000 P.S.I. at 1200 R.P.M. using 10 H.P. Has 1 1/2" intake; 1 1/4" outlet; threaded and keyed 3/4" shaft for direct or pulley drive. Wt. 40 lbs. Dimensions: 5 3/4" diameter, 7 1/2" high. Original value \$148.00. NOW **\$39.50**  
F.O.B. Chicago

## ELECTRIC PUMP

**Compact — BRAND NEW**

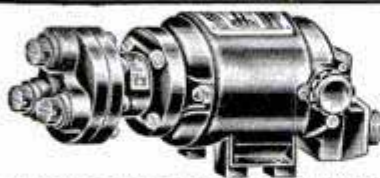

Applications: oil burners, aquariums, fluid metering, fuel pump, tool post grinder, coolant pump, pressure lubricating pump, general industrial, etc.

Motor mfd. by Black & Decker; double ball bearing series wound, continuous duty, 1/30 H.P. electric motor, rated 12,000 R.P.M. Transformer included for use on 110 VAC current. Also applicable for 24-32 VDC.

Pump mfd. by Weldon Tool Co. with standard 1/4" tubing ports; rated 2 G.P.H.; remove pump and use motor as high speed grinder.

Overall dimensions: 7 3/4" long x 3 1/4" high. Approx. wt. 5 lbs. \$51.00 value. **\$12.95**  
postpaid

## BRAND NEW ALL-PURPOSE WATER PUMP

Ready for use on any pumping need

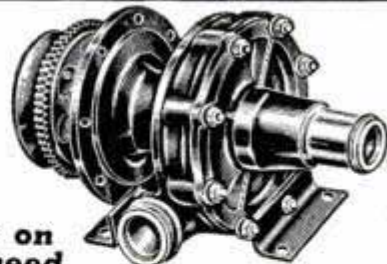

Use it for: **Belt Driven — Centrifugal Pump**

- DRAINING BASEMENTS
- HOME WATER SYSTEMS
- FIRE PROTECTION
- PRESSURE BOOSTER
- IRRIGATION
- DRAINING PONDS, TANKS, etc.
- SPRINKLING SYSTEMS
- STOCK WATERING
- INDUSTRIAL PUMPING

Complete with pulley and mounting brackets, ready for use.

An extraordinary value for all types of intermittent or continuous pumping in the home . . . farm . . . factory. Built to exact specifications of Packard Motor Car Co. for use in Rolls-Royce Merlin Aircraft Engines. May be run with electric motor, gas engine or power take-off on tractor. Delivers up to 25 gallons a minute with 1/4 H.P. motor; 80 gal. a min. with one H.P. motor. Will deliver up to 44 ft. head or 25 ft. suction. Use 1" outlet hose; 1" or 1 1/2" inlet hose (recommended).

**COMPLETE ENGINEERING REPORTS AND OPERATING INSTRUCTIONS FREE WITH PUMP**

Has cast aluminum housing, accurately machined 5" bronze impeller; 3 1/2" V belt pulley and mounting brackets. Shaft rotates on ball bearing; has grease gun fitting.

Original cost approx. \$88.00. Shipping weight 10 lbs. A **\$21.50**  
REAL BUY. Mail orders filled promptly. **SATISFACTION GUARANTEED**  
F.O.B. Chicago

## VACUUM-AIR HYDRAULIC GENERAL PURPOSE PUMP

Original Cost

**\$45.00**

Now Only **\$9.95**

Prepaid in U.S.A.

Use them for OIL BURNERS

• SPRAYING MACHINES

• MILKING MACHINES

• COMPRESSORS

• VACUUM PUMPS

• HYDRAULIC SYSTEMS

• MANURE LOADERS

PRESSES, etc.

**BRAND NEW!**

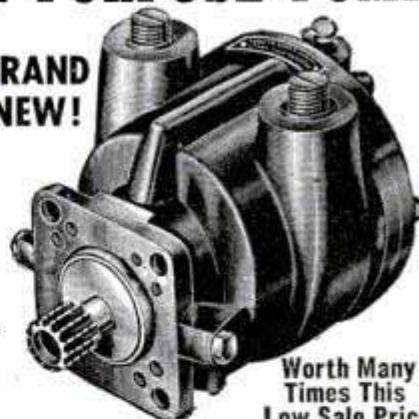

Worth Many Times This Low Sale Price

• Originally cost \$45.00. May be used as air or fluid pump—for pressure or vacuum. Standard 3/8 inch pipe thread with interchangeable ports. Will pump 7 1/2 gal. SAE 30 oil per minute at 300 RPM. Builds air pressure of 30 lbs. per sq. in. at 1000 RPM. Vacuum will draw 26 inches of mercury at 1750 RPM. Develops up to 120 lbs. per sq. inch of hydraulic pressure, which in conjunction with a 3 inch hydraulic cylinder will lift 840 lbs. minimum. Runs forward or reverse. Self aligning shaft. Die cast aluminum housing 6x4x4 inches. Has stainless alloy steel vanes and impeller. Made by Bendix Avia, Corp. Spline terminal for direct drive—readily replaced with a pulley. Recommend a 1/4 H.P., or stronger electric motor. Rated capacity 1500 RPM with high overload factor. Special price for quantity users. Complete illustrated engineering report and instruction booklet FREE with every pump. Send check or money order today! Postpaid **\$9.95**  
in U.S.A. . . . .

**GROBAN SUPPLY CO. DEPT. PM 9, 1507 S. MICHIGAN AVE., CHICAGO 5, ILL.**





**ARCHITECTS! DRAFTSMEN!  
ENGINEERS! STUDENTS!  
YOU NEED THESE C-Thru  
TIME SAVERS...**

**C-Thru ADJUSTABLE TRIANGLE ... ONLY \$4<sup>00</sup>**

A sturdy clear plastic adjustable triangle — will save you hours each week. Plot angles from 0° to 90° in a jiffy. Accurate angular scale set quickly by a twist of brass thumb screw. You'll discover many other valuable features when you own a C-Thru Adjustable Triangle ... get yours today.



**C-Thru 12" SPEE-DOTTER ... \$1<sup>50</sup>**

Draw dotted lines with one stroke of your pencil or pen. Clear plastic ... may be used for drawing accurate parallel lines or as metric or inch ruler. Interchangeable templates produce evenly spaced sharp (a) dotted lines (b) dash and dot lines (c) dash and two dot lines as illustrated:



(a)----- (b)----- (c)-----  
**Your Dealer Has C-THRU Drawing Supplies ... or order from:**

**C-THRU Ruler Co.**   
WINDSOR STREET, HARTFORD, CONN., U.S.A.

**BE YOUR OWN BOSS  
WITH A WOODBOSS**



**THIRTY SEVEN  
POUNDS OF  
CUTTING  
MAGIC**



FALLING



BUCKING

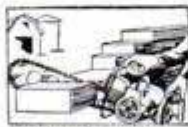

SAWING TIMBERS

Hundreds of case histories prove that a man with a Woodboss Saw is always in demand. You and Woodboss can earn \$200 to \$300 a week! Contract logging or sawing for city, county or construction companies; contract falling and bucking, cutting cordwood, to mention a few. Be your own boss with a WOODBOSS.

Dept. M Write for free booklet and full particulars.

**WOODBOSS, INC.** 2712 N. Mississippi Ave., Portland 12, Ore.

**They Rebuilt a Farm in a Day**

(Continued from page 125)

Another piece of equipment used in the demonstration was a new rotary scraper. It looks like a Rube Goldberg doodlebug, and operates on the principle of a water wheel. Its series of "paddle wheels" digs in and picks up a little dirt, carries it to the top and drops it through an opening into a cylinder, then deposits it wherever it is needed. It can be pulled behind any kind of tractor of more than 20 horsepower, and performs something of the same function as a carryall. Its advantage is said to be its ability to operate successfully in very dry, loose soil, often difficult to handle. It cuts about two inches at a time.

Two primary purposes are served by demonstrations such as the one on Bob Hardgrave's irrigated farm. First, interested observers see with their own eyes exactly what can be done with equipment already in their own farm yard. Second, they see the value of contracting for heavy equipment. Soil Conservation District members often decide either to buy such heavy equipment cooperatively or to schedule the work so the members can afford to bring in a contractor.

Mizpah Ranch started out in farm life as an orchard irrigated by an artesian well. The flow of the well is now sufficient only for household use. The river pumping system was inadequate to reach the high slopes of the farm. The rich river-bottom fields were being cut away; because of the slope of the upper fields, topsoil was washing away. During recent years the ranch has been chiefly a subsistence farm, producing enough food for one family's needs.

Hardgrave bought it last October. By next October, as a result of the demonstration, Mizpah Ranch will be able to support 12 milk cows, 15 to 20 sheep and a horse or two, all with permanent irrigated pasture; there will be food for 15 to 20 hogs and 200 to 400 chickens. Fields formerly useless for irrigation because of their slope are now contour-plowed and planted to orchard and vineyard. There's a big family garden. And during the 1948 growing season, cash crops on nearly 30 acres will include tomatoes, corn, beans, melons and squash, besides alfalfa, green manure and forage crops.

The careful program of crop rotation planned by the Soil Conservation District will be followed. As a result, the new farm which was "given" Bob Hardgrave will reverse its history. Instead of becoming worse, it will grow better and even more productive through the years to come.



# PHOTOGRAPHERS, profit from your hobby! Enter the 1948 GRAFLEX PHOTO CONTEST!

**62 PRIZES TOTALING  
\$5000.00**

Three classes! (A) Teen-agers (B) Non-professionals (C) Professionals. Two Divisions! *Action*: spot news, action, candid shots. *Feature*: portrait, pictorial, general salon work. Color section open to all groups! Lots of chances to win! Contest extends from September 1 to December 1, 1948.

GET ENTRY FORMS FROM ANY GRAFLEX DEALER

**GRAFLEX INC.**  
ROCHESTER 8  
NEW YORK

PRIZES		
(A)	Action Division	Feature Division
1st .....	\$150.00	\$150.00
2nd .....	100.00	100.00
3rd .....	50.00	50.00
10 Honor Awards (5 in each division)—\$10.00 each		
(B) (C) each	Action Division	Feature Division
1st .....	\$350.00	\$350.00
2nd .....	200.00	200.00
3rd .....	100.00	100.00
10 Honor Awards (5 in each division) — \$25.00 each		
COLOR		
1st .....	\$350.00	
2nd .....	200.00	
3rd .....	100.00	
10 Honor Awards — \$25.00 each		

**Special Press Award — \$300.00** — open to all groups. Enter any photo published in a newspaper or magazine between October 1, 1947 and December 1, 1948.  
**NOTE:** Only pictures made within the above dates with a GRAPHIC, Graflex, Crown or Century camera, anywhere in the world, are eligible in the contest.

Western Division: 3045 Wilshire Blvd., Los Angeles, Calif.  
New York Sales and Service Offices: 50 Rockefeller Plaza



**BUILD YOUR OWN  
2500 WATT ELECTRIC  
LIGHT  
PLANT**

All you need is an electric generator; a small engine to drive generator at proper speed; 2 dual sheaves; 2 V-belts; and a welded angle iron base. No wiring is involved, and you do not need to know anything about electricity to make this assembly.

Start out by buying the 2.5 KVA Leland Alternator shown above. It is a 120 volt, 60 cycle, single phase, A.C. generator, complete with radio filter box, and self regulating voltage. It must turn at 1800 r.p.m. for bright, even lighting. Requires 3 3/4 H.P. to turn generator at full load—so buy an engine of at least 6 H.P. to have plenty of reserve.

We will ship you the GENERATOR ONLY, without pulley or belts, for \$125.00 freight prepaid. If your needs are urgent, we will assemble your set, using above generator and a 6 H.P. Salsbury gasoline engine, manually started, governor controlled, and ship to you \$297.00 freight prepaid. Same unit but with Ensign conversion to run on natural gas \$347.50 freight prepaid.

To eliminate time lapse for personal checks to clear, we suggest remittance by bank draft or cashiers check.

**HOPFER & COMPANY**  
3124 EAST 14TH STREET, OAKLAND, CALIFORNIA

**Be Your Own Boss**

There's a great feeling to being in something for yourself, where all the profits go into your own pocket. American floor sanders make it possible for you to realize this ambition without special schooling or a big investment. Begin small and work up to as large an enterprise as you desire... It all depends on your ambition to get ahead.

Ask for "tell-all" booklet entitled "Opportunities in Floor Surfacing". Use coupon and enclose 25 cents in coin or stamps to cover handling.

**AMERICAN FLOOR SURFACING MACHINE CO.**

535 So. St. Clair St. • Toledo 3, Ohio  
Gentlemen:  
Enclosed find 25c in stamps or coin for booklet "Opportunities in Floor Surfacing," telling me how I can start my own floor sanding business.

Name \_\_\_\_\_  
Street \_\_\_\_\_  
City \_\_\_\_\_ State \_\_\_\_\_



Another GREAT NECK First!



**ALL NEW!**  
**REVOLUTIONARY**  
**MAXIMUM-GRIP**  
**PLASTIC HANDLE**  
**SCREW DRIVER**

★ Unbreakable!  
 ★ Twistproof!  
 ★ Modern Design!

Blade lengths from 4" to 10"



GREAT NECK—leader in tool design—offers the new, handsome maximum-grip screw driver you've been waiting for! Richly colored unbreakable plastic handle is slip-proof, non-explosive, non-absorbent to grease or oils. Entire blade is of specially hardened and oil tempered quality alloy tool steel, highly mirror-polished. Bit is precision-ground to exact size. Blade is deeply embedded and twistproof. Here is a beautiful engineered tool to give good service for many years!

THE QUALITY TOOL FOR CRAFTSMEN, MECHANICS, HOBBYISTS—EVERYONE!

ASK FOR GREAT NECK TOOLS BY NAME

**NOW AT HARDWARE COUNTERS**

GREAT NECK SAW MFRS., INC. • MINEOLA, N. Y.

## REDUCTION GEAR HEAD

3 to 1  
 Right Angle Drive



Brand New, Precision made, machined, heat-treated spiral gearing (very quiet), 3 double row, 1 single row, quality ball bearings. Grease-packed housing of tough aluminum alloy. Splined drive-shaft extension, as is, fits standard pulleys or drives. Driven shaft 13/16 inches diam. extends from housing 5 inches, can be extended from housing either direction, or a shaft can be extended through housing providing a double drive. Housing and driven shaft, 9 1/4 in. over all. Drive-shaft extension and housing 6 3/4 in. over all. Width over all 3 1/2 in. . . . Weight app. 5 1/2 lbs. . . . Power input max. 2 H.P. . . . This

Reduction Gear Head is suitable for reducing present speed of any machinery one third, and have been successfully used as drives for whirling-blade Power Lawn Mowers. Suitable for small Automobiles, Scooters, Boats, Drills, Grinders, Buffers, Sanders, Saws, Hoists, Mixers, Lathes, Drill Presses, Pumps, Compressors, Refrigeration, Fans, Circulators, etc. . . . A quality, well-engineered product by leading precision American Manufacturer and designed for heavy-duty operation. We have only a limited amount for sale at about one fifth the original cost, and while they last offer them at:

**\$16.00 each Postpaid**

Send check or Money Order, No COD's, Guaranteed as represented, new and unused.

**PRONTO MFG. CO., Oldsmar, Florida**



## NEW SURFACE PLATE, V-BLOCKS, ANGLE PLATE

**SURFACE PLATE** for checking, laying out, etc. Precision ground to .001". 12" x 17" x 3", top 3/4" thick. \$37.50

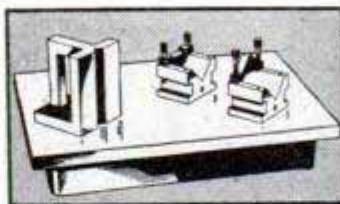

**V-BLOCKS** for holding cylindrical parts. Precision ground. 1-15/16" x 2-15/16" x 2-1/4". Cap. 1/4" to 2". Per matched pair.. \$32.00

**ANGLE PLATE.** Precision ground. 3-1/4" x 3-1/4" x 4-1/4" \$20.00

**SOUTH BEND LATHE WORKS** 455A E. Madison St. South Bend 22, Ind.

## GIVES YOU 2 DRILLS IN 1



Converts any 1/4 inch Electric Drill to 1/2 inch capacity. Reduction gears reduce speed 5 to 1, the average speed of 1/2 inch Drill thereby increasing power.

Jobbers write Price **\$1195** for proposition

M.O. or check with order

**G. M. CO. MANUFACTURING, INC.**

1308 43rd Avenue  
 Long Island City 1, New York

V-8  
 DUALS  
 & SINGLES



DEALERS WANTED

## MUFFLERS

**STEELS and ALUMINUMS** with a motorboat tone

**SINGLES**, Chev., V-8, Plymouth, Steels \$5.50, Aluminum \$7.00. Chry., Olds., Buicks, etc., Steels \$7.50, Aluminum \$9.00. V-8 and MERCURY **DUALS**, Steel \$17.50, Aluminum \$21.00. Split Manifold Sets, Steels \$35.00, Aluminum \$45.00. Aluminums are guaranteed for life of your car.

**SANDEE MUFFLER CO.**

BOX 296 LA TIJ., LOS ANGELES 43 CALIF  
 2624 W. SLAUSON AVE., LOS ANGELES, CALIF.



## TRAILER BUILDERS' SUPPLIES!

**TO BUILD, REPAIR OR MODERNIZE!** And save money. You must have our big Catalog. We are the largest and most complete trailer supply house in the States. Our new

large 1948 catalog 10c; blue prints and building instructions, 25c.  
**NATIONAL TRAILER EQUIPMENT CO., 1007 N. Water St., Milwaukee 2, Wis.**



The Modern PLASTIC for lasting Home Repairs

PERMANENTLY mends cracks or holes in wood, tile, stone or plaster. Sticks and stays put—Does not chip, shrink or fall out. Easy to use. Economical. Mold it, chisel it, polish or paint it. If unobtainable from your lumber, paint or hardware dealer, the big 4-lb. can will be sent you postpaid (in U.S.) for only \$1. Full money-back guarantee, order now.

**DONALD DURHAM CO.**  
 Box 804-U, Des Moines, Ia.



# COMPASS SAW KIT \$3.69

Postpaid  
or from  
your  
dealer.  
No C.O.D.  
orders

**Spartan**  
COMPASS SAW KIT  
for WOOD and METAL



Every home craftsman should have one. Contains cast aluminum handle and 4 blades for cutting wood, metal, lath, plaster, BX cable, etc.

**Spartan Saw Works, Springfield 7, Mass.**

## Save Fingers with Steel-Grip Finger Guards



Hundreds of factories are saving time and protecting workers with Steel-Grip Finger Guards. Used for handling rough, sharp articles, buffing, grinding, sanding, polishing, punch press work, many other jobs. Wear on fingers or thumb, front or back. Durable leather, elastic web back for snug, cool, comfortable fit. Easy on and off. One size fits all, men or women. Send 10c each for samples or trial order box of 50 at \$4.25 less 10%.

Catalog of Steel-Grip Safety  
Apparel free on request.

**INDUSTRIAL GLOVES COMPANY**  
1402 Garfield Blvd., Danville, Ill.  
(In Canada: Safety Supply Co., Toronto)



Famous Industrial  
Safeguards Since 1910

# DON'T YOU BELIEVE IT! ... THAT ALL PISTON RINGS REQUIRE "RUN-IN"



Some people think that all piston ring replacement jobs call for miles of slow driving to "seat" the rings. This is not true. With a new set of Burd "Graf-Flox" Piston Rings you can start right off from the first mile . . . at your usual rate of speed. It's possible because Burd's "Graf-Flox" process applies a deeply penetrating layer of colloidal graphite . . . insures faster seating without danger of rings scoring, seizing, or sticking in piston grooves.

Burd "Graf-Flox" Piston Rings *stop* fuel and oil losses . . . *restore* pep and power. Mail the coupon . . . it will bring you two FREE booklets.

**BURD PISTON RING CO.**  
ROCKFORD, ILLINOIS



# BURD

AUTOMOTIVE  
PRODUCTS



*"Engineered  
for results"*



MAIL THIS COUPON FOR THESE FREE BOOKLETS

BURD PISTON RING CO., DEPT. 118-J  
Rockford, Illinois

I'd like copies of your "Servicemen's Handy Hand-book" which tells how to keep my car in good working order, and the booklet "No Job For a Dub."

Name .....

Address .....

City..... State.....



SAY YOU SAW IT IN POPULAR MECHANICS

## NEW BAND SAW BRAZER



**SAVES TIME  
AND MONEY ...**

better than welding—easy to use—operates on 60 cycle lighting circuit Complete kit includes resistance brazer, silver solder, flux, and instructions

Introductory price **\$18.50**

**THE ERWOOD COMPANY**  
214 WOODSTOCK STREET  
CRYSTAL LAKE, ILLINOIS

## • 2 BIG UTILITY ITEMS •

at Big Savings

Pre-cut and READY TO ASSEMBLE. Made of Kiln dried pine. For the Home Mechanic or Craftsman.

Every housewife appreciates this jar storage space. Holds 90 quarts or 130 pints. Ideal for Basement or Closet. 24" Wide, 48" High and 12" deep. ONLY

**\$5.65**

fob Chicago (weight 34 lbs.)

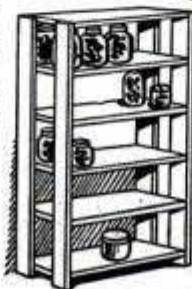

**WORK BENCH**

An outstanding value. In a few minutes you have a real work bench. 71 inches Long, ONLY 35 inches High and 20 inches Wide.

**\$8.50**

fob Chicago (weight 71 lbs.)

**GEE LUMBER CO.**

Dept. K-9, 2600 West 79th St.

CHICAGO 29



**IT'S NEW**  
**THE PUTTY MASTER**  
**PLACES GLAZIERS SKILL**  
**IN YOUR HANDS**

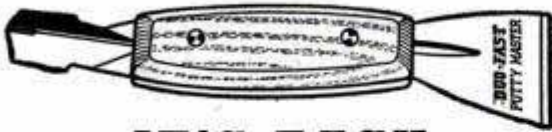

**IT'S EASY**

A putty knife with the patented shaper that anyone can operate—packs, shapes and trims putty perfectly with one stroke and allows only the right amount of putty to be applied—a time and money saving item that will more than pay for itself.

**Only \$1.00 Postpaid**  
*anywhere in the United States.*

I am enclosing \$1.00—please send me one Duo-Fast Putty Master.

**PUTTY MASTER**

864 Fletcher Street, Chicago 14, Illinois

Name \_\_\_\_\_

Address \_\_\_\_\_

City and State \_\_\_\_\_

**A TOOLSHOP**  
**IN YOUR HAND**

There's Only One Genuine Handee  
 First tool of its kind—today's finest. Smooth, steady power at your fingertips. Easy to handle. Make ship, plane and train models, bookends, costume jewelry. Grinds, drills, polishes, routs, carves, sands, saws, engraves on metal, wood, plastic, glass, leather, etc. 25,000 r.p.m. AC or DC. Wt. 12 oz. With 7 accessories \$20.50. In case with 40 accessories \$27.50. At stores or sent postpaid. A fine gift for a friend or yourself. CHICAGO WHEEL & MFG. CO., 1101 W. Monroe St., Dept. PM, Chicago 7, Ill. Free 52-page manual.

**HANDEE** **TOOL OF 1001 USES**

Engineers All Metal Army Type Hand-Sighting  
**LEVELS**   
**\$2.00** **PRECISION QUALITY**

**WHEATSTONE BRIDGES**  
 Portable. Used, in excellent condition. Manufactured by Thompson Lever Mfg. Co., Philadelphia. **\$49.50**  
 Value \$150.00. **Special** . . . . .

Send 25c for catalog of new and used guns, ammunition, binoculars and powder flasks.  
**PUBLIC SPORT SHOPS**  
 11 S. 16th St., Phila. 2, Pa. No COD's

For Quick Advancement *Learn* **WOOD PRODUCTION ENGINEERING**

**VETERANS** training is **FREE** under G. I. BILL.

For quick advancement learn Furniture Drafting and Engineering. You can master these subjects in a short time, either through Home Study or by coming to Grand Rapids. Write for Free Information Today. State interest, whether correspondence course . . . or residence course . . . Also state if veteran.

**KLOK INST.** LOUIS ST. N.W. GRAND RAPIDS, MICH.

**FOR THE MAN with a WORKSHOP . . .**  
**an AMP "SHEARITE"**

The wonder tool that cuts machine screws without damaging threads. For #10-32, 8-32, 6-32 and 4-40—brass or steel. Cuts and strips electrical wire too, sizes 22-10. Only \$3.95 complete, postpaid. Send cash, check or money order.

**\$3.95 POSTPAID**

**RICHARD RENNER ASSOCIATES, Dept. PM**  
 315 South 15th Street, Philadelphia 2, Pa.

**ELECTRIC WELDER**

AC or DC 110 Volts  
 Pre-war type—All metal—No chemical—5 year written guarantee. Welds 1/8" thick metal or money back. Repairs tanks, tools, fenders, machine parts, etc. Comes complete with rods, unit directions and eye shield.

**\$6.45 COMPLETE**

On C.O.D. mailing charges extra.  
**ESSAY MFG. CO., INC., Dept. P.M., Quiney 69, Mass.**

**GARDEN TRACTOR**

3, 4, 5 H.P. On market nearly a quarter century. No belts. No chains. Worm driven. 2 clutches. Power turning. All tractors guaranteed. Full line of attachments. Buy direct from factory. Write Dept. 107 for free catalogue.

**RED E TRACTOR COMPANY** RICHFIELD, WISCONSIN

**The easy way to paint!**

*Speedy Sprayer*



**ONLY \$26.95 LESS MOTOR**

Favorite of home owners and craftsmen for 20 years! SPEEDY SPRAYER gives your work that professional paint finish everyone admires. Sprays paint, enamel, varnish, lacquer, etc. . . . 4 to 7 times faster than hand brushing! Lightweight, portable, uses any 1/4 H.P. motor. Improved diaphragm principle assures clean, oil-free air. You'll find dozens of time and money saving uses for SPEEDY SPRAYER, including spraying insecticides 2-4-D and DDT. Complete outfit, without motor, only \$26.95.

At leading hardware, lumber, and auto supply dealers. **FREE**—write for handy booklet "How to Spray."

**W. R. BROWN CORPORATION**  
 5717 Armitage Ave. • Chicago 39, Ill.



**O.D. WOOL SHIRTS**  
13 to 15  
**269**

**PANTS**  
28 to 34  
**295**

Perfect condition, designed for reissue. All have been cleaned and pressed by the O. M. Corp. 100% all wool serge. Priced less than the cheapest work clothes. Add 12c postage per garment.

**BRAND NEW KHAKI SHIRTS-PANTS**  
14 to 17  
**299**

NEW. Tailored of 8.2 chino khaki suntan material. Shirts have flap pockets, pants have cuffs. 10c post. per garment.

**GEN. NYLON 50 FT. PARACHUTE CORD**  
**59¢**

NEW. Ideal for many uses. 550 lb. tensile strength, 3/16" diam. Each hank 50 ft. Add 7c postage.

**50% WOOL HOSE**  
NEW. Medium wt. Khaki and nat. Please add 3c postage ea. pr. **39¢**

**CUSHION SOLES**  
NEW. 83% wool, double sole. Desert sock. Khaki and white. Add 4c postage per pr. **49¢**

**WAR SURPLUS AND OTHER BARGAINS**

**ORDER FROM THIS AD PLEASE**

**MAIL ORDERS**  
Please send remittance with order. Include postage. Guaranteed satisfaction. You are privileged to return any unsatisfactory purchase for refund.

**WATCH CAPS**  
**77¢**

NEW. Color, blue. 100% pure wool knit. Please add 5c postage each.

**all wool WRISTLETS**  
**13¢ 8 PAIR \$1.00**

NEW. 100% O.D. wool knit. For glove and mitt inserts, wristlet replacements, etc. Worth 75c per pair. Add 3c postage per pair.

**1399**

**B-15 Style FLIGHT JACKET**

NEW. Renders greatest warmth per oz. of weight. Mountain cloth outside, pile lined body and sleeves. Genuine mouton collar, 4 pockets—2 outside, 2 inside. Wool knit cuffs and waistband. Add 27c postage.

**NAVY T-SHIRTS**  
**WHITE 69**

NEW. Combed yarn, full cut. Small, medium, and large. Please add 5c postage each.

**SIZZLING SPECIALS**

- **Army Style Combat Boots** **6.55**  
NEW. Rugged, comfortable, 10" High. Reversed uppers, full oak leather sole, with composition outer sole. Add 27c postage.
- **Navy Style Field Shoes** **4.99**  
NEW. An excellent work shoe. Reversed uppers, full leather sole, composition outer sole. Add 22c postage.
- **Down and Feather Sleeping Bags** **12.99**  
NEW. Mummy style. Filled with mixture of down and chicken feathers. Water repellent poplin cover. Zipper opening. Add 45c postage.

**DUST MASKS**  
**33¢**

NEW. \$1.50 value. Ideal for millers, farmers, paint and insecticide spraying. Add 6c postage for each.

**GREATEST WATCH VALUE IN USA**

**17 JEWEL Military Style WRIST WATCH**

NEW. Genuine Incabloc, guaranteed fine quality 17 jewel Swiss movement. Precision case with stainless steel back. **WATER RESISTANT. SHOCK PROOF.**

**ANTI-MAGNETIC.** Sweep second hand, radium dial, fine leather strap. Save up to \$20.00. Please add \$2.00 federal tax. Money back guarantee.

**1995 PLUS 10% FED. TAX**

**WAR SURPLUS CIRCULAR**

**SEND FOR FREE**

Over 150 War Surplus Bargains, also other items.

**SIoux FALLS SURPLUS STORE**  
113 NO. PHILLIPS SIoux FALLS, S. DAK.

**NAVY SUN GLASSES**  
**66¢**

NEW. \$4.00 value. Ground lenses. App. by Navy. Complete with case. Add 5c postage.

**AVIATORS 24K Style GOLD PLATED RIMS**  
**189**

NEW. 4-base curve, ophthalmic ground, shuts out 96% of the ULTRA-VIOLET RAY. 24K gold plated rims. Adjustable nose piece. New sensational price.

Sand Casting — Forging — Heat Treating — Case Hardening

**BRONZE FOUNDRY**

In your own workshop allows you to design and build your own GASOLINE ENGINES, STEAM ENGINES, STATUARY, ART OBJECTS, SPECIAL TOOLS, NEW INVENTIONS, ETC. You can also make forgings and case harden steel. Your shop is not complete without a FOUNDRYETTE. Three sizes are available capable of making bronze castings of 1½, 3 and 6 pounds weight, aluminum, copper, brass, etc. \$22.50, \$29.50, \$42.00 f.o.b. Kansas City. Domestic gas supply and 110 volt AC or DC energy required for operation. Write for circular.

**KANSAS CITY SPECIALTIES CO.**  
Box 6022, Dept. P-8 Kansas City, Mo.

**FENDER SKIRTS . . . . . \$17.20 PER PAIR**



For Ford Chev., Merc., Plymouth, DeSoto, Chry., Dodge Kaiser-Frazer and Buick. Beauty your car bring out the flowing lines inherently designed there. Sparkling beauty you'll like. Constructed of heavy gauge body steel, finished in prime, perfect fit.

**SANDEE MUFFLER CO**  
Box 296, La Tijera Sta.  
Los Angeles 43, Calif

Gentlemen Please send me one set of Sandee Fender Skirts to fit my . . . . .  
(year and make of car)

Check for \$17.20 enclosed  
 Ship C.O.D.

**For Bigger, Better, More Profitable Crops**

**ROTARY TILLAGE STARTS IN FALL**

Put Nature to work for you. Mulch surface vegetation throughout tilled depth now and disintegration will start this fall—continue through the winter—assure a soft, humus soil next spring. As a result, your ground can be worked much easier, weeks earlier. And the minerals and moisture that you've helped to put back into the soil will produce a bigger, better, more profitable crop. This increased yield will more than pay for your M-E Rotary Tiller, so choose the model you need and place your order now. Garden models: G-16 in 5 or 7½ H.P. Wisconsin Motor; G-26 in 7½ H.P. Wisconsin Motor or 10 H.P. Onan Motor.

Request Free Demonstration on your own soil

**BUY YOUR M-E ROTARY TILLER NOW**

Model G-26  
Cuts 26-inch swath.

Patents pending

**ROTARY TILLERS**  
REBUILDS SOIL — NATURE'S WAY  
Milwaukee Equipment Mfg. Co., So. Milwaukee, Wis., U. S. A.

Milwaukee Equipment Mfg. Co.  
Dept. PM-9, So. Milwaukee, Wis.  
Please send illustrated folder.

Name \_\_\_\_\_  
Address \_\_\_\_\_



TONGUE AND GROOVE - FLUTING - NOTCHING - INLAY - ANY JOINT

# Aladdin's Tool

## AND YOUR DRILL PRESS

Makes any cut wood-shaping tools costing up to \$300.00 can make—more too. Sturdily built, lasts a lifetime.

**TWO MODELS—  
IMMEDIATE DELIVERY**

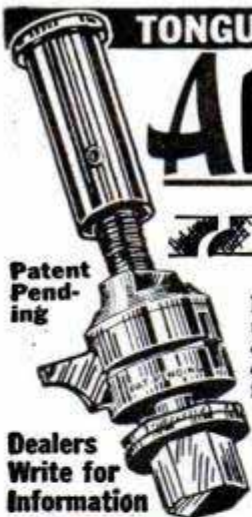
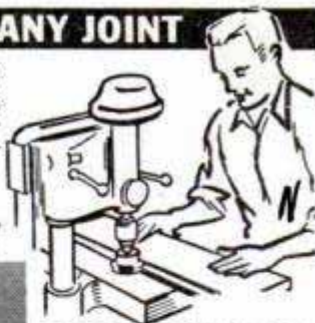

Patent Pending

Dealers Write for Information



DeLuxe Model includes bottom bearing that anchors tool to bottom of press. Regular Model without bearing. Comes complete with adaptor and 6 blades making 12 standard cuts—balance blade—beautiful wood box. Over 100 different, practical cuts can be made with the 6 blades. See your dealer or send check or money order for delivery to your door. All other orders C.O.D. plus postage.

## THE DESIGN COMPANY

2603 Warwick, Dept. S-24, Kansas City 8, Mo.



### DELUXE MODEL

**\$11.95** with bottom bearing as illustrated

### REGULAR MODEL

without bottom bearing .. **\$7.95**



# MENDS

DISHES, TOYS, ETC.

It's clear, water-proof, flexible, durable.



# DUCO CEMENT

REG. U. S. PAT. OFF.

## Only \$16.95 DUAL PURPOSE SPRAY GUN

Complete

USES ONLY 25 LBS. AIR PRESSURE

FLOCKS AND SANDBLASTS



AT HOME: You can refinish Lamps, Radios, Book Ends, Statues and hundreds of things with lovely colorful flocking. ETCH GLASS: Many designs and initials can be sandblasted on shower doors, ash trays, glassware. AUTO INTERIORS: Transform ugly dirty auto interiors to "new car beauty" with a BLASTO DUAL PURPOSE SPRAY GUN. Makes reflectorized signs too. Merely spray flock similar to Velvet, Plush, Suede and Mohair inside your car. ANTIQUE WOOD . . . REMOVE PAINT. MAKE EXTRA MONEY by doing any or all the above for profit. BLASTO is highest quality and carries a 5 day money-back guarantee. Operates on small air compressor. Send \$16.95 cash, check or money order for postpaid delivery. Write for free information. Full line of Flocking Supplies.

BLASTO SPRAY GUN MFG. Dept. PM-9, 7007 Haas Avenue  
Los Angeles 44, California

## DRAINS CELLARS, WASH TRAYS CIRCULATES OIL



Pumps 1800 GPH 300 gal.  
30' high, use 1/8 to 1/2 HP **\$6.50**  
motor. Will not clog.

Postpaid if cash with order.  
(Add 50c for west of the Mississippi.)

Thousands in use since 1936

LABAWCO PUMPS, BELLE MEAD 7, N. J.

## SHEETMETAL FORMING TOOLS

30" BRAKE. Forms angles, channels, vees, flanges, locks, zeos. Handles 26 gage sheet steel, heavier gages of aluminum, copper, plastic, etc. Portable. Can be held in a bench vise, or bolted down. All steel. Wt. 40 lbs. Shipped exp. collect.



**\$24.50**

12" BRAKE. Fits in vise to form difficult and compound bends, up to 20 gage steel 12" wide, \$12.50, PP. 18" CURVE FORMER. Handles 16 gage steel 2" to 30" dia., \$9.50. SHEAR Cuts 16 gage steel any length and width, \$18.50.

VISE IRON BENDER. Forms rings, hooks, eyelets, etc. in 1/2" round or square; 1/4" up to 2" wide in bar iron. Price \$10.00 PP., with attachment to bend 1/2" pipe, \$12.50.



SHEET METAL PLIERS. 2 1/2" wide, \$2.00; 5" wide, \$3.50. 20 page instruction booklet, 50c.

Immediate delivery. Order direct, cash or C.O.D., or send for folder.  
VISE BRAKE MFG. CO., 1116 So. 27th St., Dept. M9, Omaha 5, Nebr.

## WRITE FOR YOUR FREE COPY OF THE NEW KRW HYDRAULIC PRESS BOOK

Describes all manner of Production and Shop Work on KRW Hydraulic and Bench Type Arbor Presses. 32 pages illustrating the new KRW Hand-operated, Electric-operated and Air-operated Hydraulic Presses.

Write for your copy today.

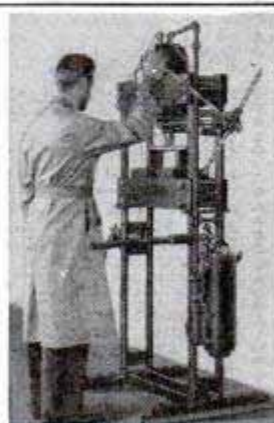

K. R. WILSON, DEPT. 17, 215 MAIN ST., BUFFALO 3, N. Y.

Builders of Shop Equipment for Ford Dealers Since 1916



# EARN BIG MONEY AND BE YOUR OWN BOSS Sharpening Lawn Mowers

## THE UNIVERSAL GRINDER PUTS YOU INTO BUSINESS WITH SMALL INVESTMENT

Earn as much as \$400.00 a month in your basement or garage. Mr. Felber of Ind., writes, "MY UNIVERSAL GRINDER is faster and more accurate than any other grinder. Its efficiency enabled me to sharpen 450 mowers in 4 1/2 months. More than paid for itself the first month. Every customer satisfied." Mr. Hardy of Mississippi writes, "Received my Universal Grinder the first part of May and by August 18 had sharpened over 1000 mowers." Mr. Bacon of California writes, "The lawn mower business, with my Universal Grinder, has been a gold mine these last two years."



Only on the UNIVERSAL GRINDER can the inside face, the edge of the stationary blade, and the reel blades, be ground to proper clearance ALL IN ONE SET-UP WITHOUT REMOVING ANY BLADE FROM THE MOWER

Free Folder

Rogers Mfg. Co., Dept. M-98, Lindsey, Ohio

## IT'S EASY TO REMOVE PAINT VARNISH, ENAMEL, SHELLAC, LACQUER

Don't paint over a cracked or peeling surface. It's so easy to remove it with Wonder-Paste. Applied with a brush, Wonder-Paste softens up any number of coats of paint, varnish, enamel, shellac, or lacquer... reduces it to a soft, unresisting sludge that yields readily to a putty knife.

Ask for Wonder-Paste at your paint or hardware store. Used by painters everywhere.



## WONDER-PASTE

Write for Literature

Wilson-Imperial Company • 119 Chestnut Street, Newark 5, N. J.

## This Machine Should Cost \$69.95

### 5 POWER TOOLS in ONE

Drill press pulls 1/2" drill in steel; saw takes 8" blade; lathe 10" swing, 30" centers; sander 8"; emery wheel 5". Handles big, heavy work—tools easily interchangeable—uses 1/2 to 1/2 H.P. motor. Factory-to-you price only \$34.95 complete. Send \$17.50 (balance C.O.D.) on 10-day FREE trial, money-back guarantee, or write for FREE catalog.



EMRICK, INC., 1739 Clinton, Kalamazoo, Michigan

See it - Use it!  
FREE TRIAL - 10 DAYS

**SPECIAL Fishing Line** YOUR CHOICE \$1.00 FOR 1.00

- 750' 2-PLY NYLON 25 lb. T
- 150' 3-PLY NYLON 85 lb. T
- 250' 3-PLY NYLON 45 lb. T
- 300' SILK LINE 30 lb. T
- 500' 3-Ply Nylon 35 lb. T
- 500' Linen Line 32 lb. T
- 3 Ply Nylon Rope 1/4" dia. 6c Ft. Braided Nylon Line
- 1/16 dia. 250 lb. T 2c ft. Paehner & \$2. Braided Nylon Line 1/8" dia. 550 lb. T

Koller Lite Wght. Fly Reel 8c ft. All lines available in longer lengths. Send Check, M.O., no C.O.D.'s. MAC-MILLS, Dept. 9-E, Pleasant Valley, New York, N. Y.

## FREE for Trailer Builders

Safety-Engineered

• TORQ-LESS AXLES • BULL DOG HITCHES AND PARKING JACK LITERATURE

## HAMMER BLOW TOOL CO.

Dept. 126 • WAUSAU, WIS.

FREE WRITE TODAY!



## MILL IT... ON YOUR LATHE!

# PALMGREN

'MILLING' ATTACHMENT

3 SIZES

No. 250 Illustrated

2 1/2"

JAW

Only

24 7/8

CONVERT LATHE  
IN 10 SECONDS



Now you can Mill, Slot, Grind, Groove, Square Shafts, Saw at Angles, Recess and many other important jobs. SAVE TIME and MONEY! Why send work out or use costly methods when a PALMGREN MILLING ATTACHMENT will solve your problem.

Precision built, it has accurate graduations for rotary angle adjustments, also graduated vertical feed screw. Fits South Bend, Atlas, Craftsman, Logan, Sheldon and all other lathes. Thousands now in use in small and large machine shops, repair shops, railroads, schools, home work shops, etc. ORDER SIZE NEEDED TODAY!—it will quickly pay for itself.

### IMMEDIATE DELIVERY

Nos.	Width Jaws	Depth Jaws	Jaws Open	Weight Pounds	Fits Tool Post	Price F.O.B. Factory
150	1 1/2"	1"	1 3/4"	6 1/2	1" Dia.	\$18.75
250	2 1/2"	1 7/16"	2 1/4"	11	1 1/4" Dia.	24.75
400	4"	1 1/2"	1 1/2"	25	2" Dia.	39.75

Order From Your Dealer or Jobber: Write for Circular No. 351  
Mfrs. of PALMGREN PRODUCTS  
Since 1915  
8365 South Chicago Ave.  
Chicago 17, Ill.

## CHICAGO TOOL and ENGINEERING CO.

JUST A FEW OPERATIONS YOU CAN DO ON YOUR LATHE!

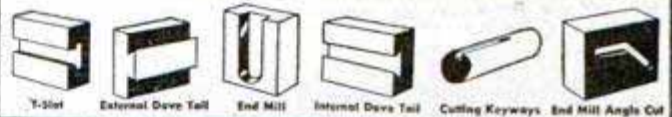

## YOUR NEXT STEEL TAPE RULE



...Personalized!

Compare these features  
with any others.

- 7/16" lip
- Clearly etched graduations both sides of blade
- Lever brake—no creeping blade
- Replaceable blade
- 6 or 8 ft. lengths
- Direct reading inside measure
- Chrome plated steel case—no rough edges

# MASTER

REG. U.S. PAT. OFF.

WOOD AND STEEL TAPE RULES

Master Rule Mfg. Co., Inc.  
201 Main Street, White Plains, N. Y.

PM-9

I enclose \$2.25 for the 6 ft. Streamline  
\$2.50 for the 8 ft. Streamline

Engrave my name (75c extra). Please print clearly.

NAME.....

ADDRESS.....

CITY..... STATE.....



**YOUR WORKSHOP NEEDS**

# LENK

*Self-Generating*  
**BLOTORCH**

A sturdy, high-heat torch  
for soldering and heat  
application jobs!



*Low Priced—*

**WITH HIGH PRICED FEATURES:**

- Flame control and shut-off valve.
- Built-in automatic cleaning pin which insures non-clogging burner.
- Tank made of heavy gauge brass.
- Factory tested and guaranteed.
- Backed by 30 years of dependability.

Buy yours at your dealer's  
or send name of your dealer with check  
or money order

About



**FREE!** Write for booklet "TIPS ON SOLDERING" for gasoline model, \$3.25 for alcohol. Others low as \$1.50

**THE LENK MANUFACTURING CO.**  
30-38 Cummington Street, Boston, Mass.

## NEW REVOLVING BINS for HOME WORKSHOPS

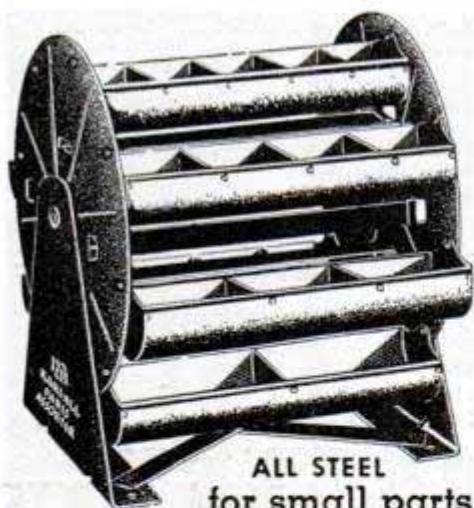

**STANDARD MODEL:**  
10½" x 10¾" x 12" — eight trays, 28 bins.

**\$5.95**  
Prepaid in U.S.A.

**JUMBO MODEL:**  
18¾" x 10¾" x 12" — eight trays, 56 bins.

**\$8.95**  
Prepaid in U.S.A.

**ALL STEEL**  
for small parts storage

### The KARI-ALL PARTS ASSORTER

Keep nuts, bolts, screws, nails and other small parts always at your finger tips in the KARI-ALL. Rotates like a Ferris wheel. May be used on work bench or attached to wall or ceiling. All steel—built to last a lifetime. Send check or money order. No C. O. D.

**DIAGRAPH-BRADLEY INDUSTRIES, INC.**

3749 Forest Park Blvd., St. Louis 8, Mo.

**DEALERS WANTED**

SAY YOU SAW IT IN POPULAR MECHANICS

**At last—a new art**

**and hobby  
modeling  
in leather!**



You can now actually create solid 3-dimensional novelties from GENUINE LEATHER. No tools needed—kit contains all materials. Z-WAY LEATHERCRAFT method assures your skill since ready-cut and shaped leather parts, when cemented together, sanded, and colored will definitely take on shape of authentic 3-dimensional leather model of Mallard ducks, hunting dogs, flying geese. Be first in your group to sculpture in leather. Win praise and profit for your new hobby! . . . . . prepaid **3.00**

Choose from these 8 leather kits: **ORDER TODAY**

- #501—3 flying Mallard Ducks for wall ornaments. . . . .
- #502—3 flying Canadian Geese for wall ornaments. . . . .
- #503—3 flying Quail for wall ornaments. . . . .
- #504—Mallard Duck, Canadian Goose, Quail for wall . . . . .
- #601—Mallard Duck on Leather base Pen Stand . . . . .
- #602—Setter Dog on Leather base Pen Stand . . . . .
- #701—Mallard Duck on Leather base Ash Tray . . . . .
- #702—Setter Dog on Leather base Ash Tray . . . . .

**LEATHERSMITHS, INC.**

Dept. P • 106 Water Street • New York 5, N.Y.

**It's EASY!  
ECONOMICAL!**

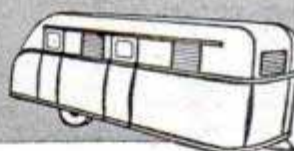

**Build Your Own Trailer with NATIONAL'S Simplified Plans**

Beat the housing shortage with a full-size house on wheels or add new pleasure to your vacations and week-ends with a sleek sport trailer. Step-by-step instructions and complete bill of materials with every plan. *Three different models.*

- NATIONAL MODEL 27: A 27-ft. luxury liner with 3 rooms, lavatory, sleeping space for six. Plans . . . . . **\$1.00**
- NATIONAL MODEL 28: A 20-ft. cabin trailer that's good-looking and sturdy, with beds for four. Plans . . . . . **\$1.00**
- NATIONAL CAMPER: The sport trailer you've wanted for hunting, fishing, vacations. Sleeps two. Plans . . . . . **.50**

**ORDER ALL THREE—AND GET ONE FREE**  
Complete set \$2.00

Big parts catalog **FREE!**  
FREE with any order!

**NATIONAL TRAILER STORES**  
Dept. 51 • Box 2353 Terminal Annex • Los Angeles 54, Calif.

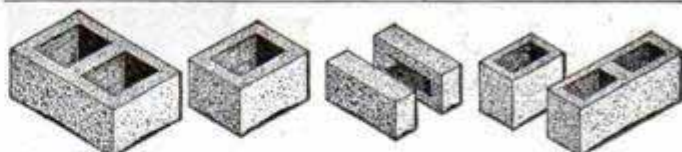

### Make Concrete Blocks and Bricks

New superior method makes square, true, easy-to-lay units which will pass any building code. Small investment, high production, big profits. One \$30.00 machine will make four 5"x8"x12" blocks per minute—1000 per day. Pays for itself in a few days. Sell blocks or save 2/3 building cost by making and laying your own.

POST CARD BRINGS FREE FOLDER

**Economy Manufacturing Company**  
Dept. P Stone Mountain, Georgia

*for AMAZING acceleration*

**DIXIE-WESTERN**

**DUAL INTAKE MANIFOLDS for V-8 FORDS AND MERCURYS**

**\$15.00** Gas Line and Throttle Kit \$2.50 extra

Chrome Plated Velocity Stocks — \$1.60 ea

By Test: Increased Acceleration by 26%  
Increased Power and Speed by 11%

All DIXIE-WESTERN manifolds are brightly polished cast aluminum.

**DIXIE-WESTERN MANIFOLD CO.**  
Box 364 • Los Angeles 43, California

Dealers Wanted

POPULAR MECHANICS



# BALL BEARING STEEL WHEELS

Complete With Wheels, Tires & Bearings Made To Outwear Other Type Wheels

SIZE	TIRE	BEARINGS	LOAD	ONE	TWO	FOUR
12"x2 1/2"	Semi-Pneumatic	Ball 1/2" or 5/8"	150 lbs.	\$ 5.50	\$10.00	\$18.00
12"x2 1/2"	Semi-Pneumatic	Ball 1/2" or 5/8"	225 lbs.	\$ 6.00	\$11.00	\$20.00
12"x3"	Semi-Pneumatic	Ball 1/2" or 5/8"	340 lbs.	\$ 7.00	\$13.50	\$26.00
10"x1 3/4"	Semi-Pneumatic	Ball 1/2" or 5/8"	125 lbs.	\$ 3.00	\$ 5.50	\$10.00
10"x2 1/2"	Semi-Pneumatic	Ball 5/8"	250 lbs.	\$ 5.50	\$10.00	\$18.00
8"x1 7/8"	Solid	Ball 3/4"	640 lbs.	\$ 8.00	\$15.00	\$29.00
6"x2"	Solid	Ball 1/2"	340 lbs.	\$ 4.00	\$ 7.50	\$14.00
4.00"x8"	Pneumatic 16" O.D.	T.R. 1"	700 lbs.	\$13.50	\$26.00	\$50.00
5.00"x8"	Pneumatic 16" O.D.	T.R. 1"	700 lbs.	\$15.50	\$30.00	\$59.00

The above Pneumatic Wheels are Complete With Wheels, Bearings, Tires and Tubes . . . 4 Ply Tires for One Inch Straight Axles.

**ORDER NOW** Add 10% for Prepaid Shipment in U.S.A. 25% DEPOSIT ON C.O.D. ORDERS

FOR CIRCULARS SEND 10c: On Power Racers, Steering Wheel Assemblies, Auto Type Axles, Parts, Sulkies, Etc.

**OSBORN WHEEL COMPANY, 115 So. Main St., Dept. P-9, Doylestown, Penn.**



The New 1949 Model "D" RACER



Complete as Shown ONLY \$299.50 (Plus \$7.50 crating) As Shown Less Engine, Jack Shaft and Clutch ONLY \$159.50 F.O.B. (Plus \$7.50 crating)

Pulls Up Hills With Ease. Runs as low as 2 miles per hour or UP TO 35 MILES PER HOUR. Safe and Easy to Operate for Work or Play. ANY AGE. Equipped with 4.00 x 8 High Speed Wheels and Many Other Features.

Ride Around in Your Own Car

## ELECTRICITY Anywhere



for HOMES FARMS SHOPS BOATS RADIO USE

Onan gasoline-engine-driven Electric Plants supply reliable, economical electric service for any use. Portable, stationary or stand-by models. Water or air-cooled, compact and rugged.

A.C.: 350 to 35,000 watts in all standard voltages and frequencies. D.C.: 600 to 10,000 watts. 115 and 230 volts. BATTERY CHARGERS: 500 to 3,500 watts; 6, 12, 24, 32 volts.

Write for folder

**D. W. ONAN & SONS INC.**  
2545 Royalston Ave., Minneapolis 5, Minn.



## CASH IN ON THE BUILDING BOOM!



MAKE BUILDING BLOCKS RIGHT IN YOUR OWN BACKYARD AMAZING GENERAL BLOCK MACHINE

CAPACITY 1000 BLOCKS PER DAY

\$199 LESS MOTOR ONLY F.O.B. PLANT SHIPPING WEIGHT 400 lbs.

Cinder and Concrete Blocks in big demand. Sell all you produce, to contractors and builder supply yards, at 15c to 25c each. Easy to start your own profitable business.

GENERAL BLOCK MACHINE can be operated indoors or out, in floor space 9 ft. x 10 ft. All steel construction. Vibrator mounted in sealed ball bearings. Simple to run. Powered by 1/2 H.P. electric motor or 1 H.P. gas engine. Produces up to 1,000 8x8x16 blocks in 8 hour day. Superior 3 core type, meeting all building code requirements. Produces 4x8x16, 8x8x16, 12x8x16 blocks. Material for blocks, cinders; cement; and sand; obtainable anywhere. Full instructions and mixing formulas with each machine. Immediate Delivery. Mail coupon at once for full details, sent free without obligation.

HOW TO BUILD YOUR OWN CONCRETE BLOCK HOME Only \$1 Prepaid

Wonderful book written and illustrated by our staff of experts.

## GENERAL ENGINES CO. (EASTERN DIVISION) DEPT. P—DREXEL BLDG., PHILA. 6, PA.

Shows you 8 ways to save money and how to make and lay blocks, laying out building lines, mixing your own concrete, building steps, porches and concrete floors, includes floor plans for 6 beautiful easy to construct concrete block bungalows. Mail coupon at once with \$1.

Name .....  
Address .....  
City ..... Zone ..... State .....

## A Rare Bargain in PIPE TOBACCO

Surplus from compounded private formulae, saved in oak barrels, aged, seasoned, counter-blended and aromatized. A deluxe quality mixture of delicious flavor—guaranteed to give a new thrill in pipesmoking. Never cloy or jades the palate. Always good. Always different! SMOKE AT OUR RISK! Order an introductory 1/2-lb. of BARGAIN BARREL for \$1. Smoke a few pipefuls. If not fully satisfied, return for refund. Order TODAY!



**SIDNEY P. RAM** 156 N. Franklin Dept. Chicago 6, Ill. PM

## Get that NEW-CAR FEEL again! SEALED POWER PISTON RINGS

The only ring with the Full-Flow Spring! SEALED POWER CORP., DEPT. G-9, MUSKEGON, MICH.

New Easy Way TO MAKE

## BIG MONEY! AT HOME Costs You Only 5¢-You Get \$5.00

FULL OR SPARE TIME



Write Now

Now is the time to cash in on this big-paying easy-to-operate year-round business, and you need no experience! Metallize Baby Shoes in real GOLD, SILVER, BRONZE, and PEARL. Everything furnished so YOU can start earning money in just one week—up to \$1,000 per month full time or \$50 to \$75 per week spare time—at \$5 per hour. They will last FOREVER, and there are 5 million eager customers every year, waiting to buy. DETAILS FREE—Send no money—a post card with your name will bring all the facts. Don't pass up this opportunity to start your own business on a shoestring—so ACT NOW. Write at once to

- Big Income
- Huge Demand
- Sales Plans
- Future Security
- Your Own Boss
- Money Back Guarantee
- Most Successful Name in Metallizing



FREE!

Course includes FREE—two actual metallized Baby Shoes guaranteed to be the most attractive on the market—or a pair of your own Baby Shoes metallized if you prefer

**KIKTAVI COMPANY, Dept. P-2, 2111 West Manchester, Los Angeles 44, California**



SEND FOR FREE CATALOGUE  
AND MANUAL

QUALITY

Aluminum Guard Easily Removed  
For Dadoing

## NEW IMPROVED TABLE MODEL TILT-ARBOR SAW

OIL IMPREGNATED BRONZE BEARINGS OR DOUBLE  
SHIELDED BALL BEARINGS, BOTH WITH THE PATENT-  
ED BALL BEARING TRANS-AXIAL MOTOR DRIVE

MODEL #2021X AS SHOWN WITH COMPLETE MITRE  
GAUGE. Precision etched scales show angles on mitre  
gauge and saw cradle. STEEL BAR RIP FENCE. ALUMI-  
NUM SAW INSERT AND GUARD. STEEL SPLITTER.  
BALL BEARING TRANS-AXIAL DRIVE  $\frac{5}{8}$ " GROUND  
ARBOR. "COMPO" OIL IMPREGNATED BRONZE BEAR-  
INGS WITH OIL CHAMBER AND CUP, (OR, DOUBLE  
SHIELDED BALL BEARINGS, \$5 EXTRA). TABLE 18"  
x 16". BUILT IN SWITCH. Depth of Cut  $2\frac{3}{16}$ ". Shipping  
Wt. 110 lbs. Requires  $\frac{1}{8}$  or  $\frac{3}{8}$  H.P. Motor.

(BALL BEARING FLOOR MODEL WITH 18" x 32" TABLE  
INCLUDING EXTENSION . . . . . \$79.50)

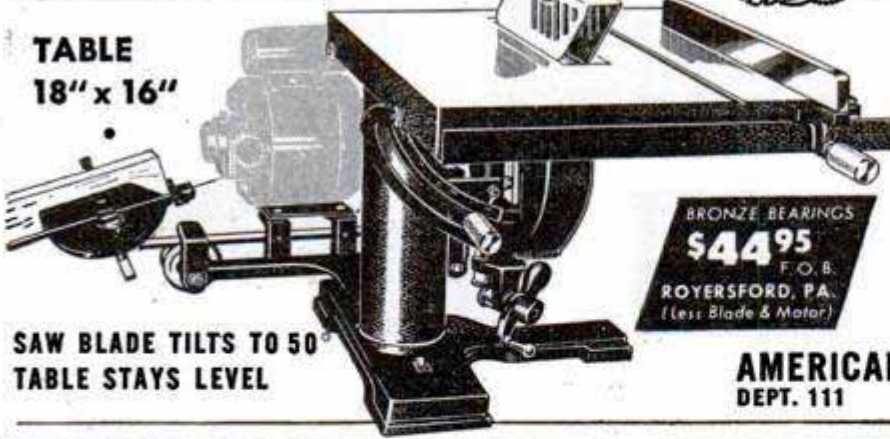

TABLE  
18" x 16"

SAW BLADE TILTS TO 50°  
TABLE STAYS LEVEL

BRONZE BEARINGS  
**\$44.95**  
F.O.B.  
ROYERSFORD, PA.  
(Less Blade & Motor)

**AMERICAN MACHINE & TOOL CO., Inc.**  
DEPT. 111 ROYERSFORD, PA.

## for Homecraft Use!



Use Kester Cored solders for hobby-craft work as well as home repairs and be sure of the finest solder bonds. Acid-Core solder for general work; rosin-core solder for all electrical work.

### KESTER SOLDER COMPANY

4251 Wrightwood Ave., Chicago 39, Illinois

Eastern Plant: Newark, N. J. Canadian Plant: Brantford, Can.

An Entirely  
**NEW  
SPARK  
PLUG**



for all  
**MODEL  
ENGINES**

### "AIRCRAFT TYPE" PATENTED INSULATOR ... COPPER GLASS SEAL

Users say they never had a plug so good. More hours of continuous use — more speed — greater reliability — much longer life. It solves any problems of early fouling, preignition, compression leakage, failure under heat.



AT YOUR  
HOBBY DEALER

AC SPARK PLUG DIVISION  
GENERAL MOTORS CORPORATION,  
Flint 3, Michigan

### PRECISION JEWELERS SCREW DRIVERS

Complete Set of 8 for Every "Hobbyist"



At last—a complete set of precision screw drivers to meet the needs of every model builder. Not a miniature but the same type set used by U. S. Navy for precision instruments and watches during the war. Brass knurled handles, hexagon heads, finest tempered steel blades. Sizes 2-9. Never before a set of this quality and precision at such a low price. Your money back if not satisfied. C.O.D. \$2.00 plus postage or send \$2.00 and we pay postage.

PINE WATCH CO., Rm. 40A, 29 Eldridge St., New York 2, N. Y.

"I'LL TAKE THE WHITE ONE EVERY TIME!"



**WYTEFACE**  
TRADE MARK  
**STEEL MEASURING TAPES**



**KEUFFEL & ESSER CO.**



**New** **STREAMLINED Electric Drills**



**Model 250**  
Full 1/4-inch Capacity \$1995

**Model 500**  
Full 1/2-inch Capacity \$3465

In its capacity range, each model represents an advancement in the combination of high power, quality and refinement in construction, long-life performance, and unusual handling ease and convenience. See these new *Electric Drills* at your hardware dealer, or write—

**PORTABLE ELECTRIC TOOLS, INC.**  
255-59 W. 79th Street, Chicago 20, Ill.

**Genuine Snap-on Tools**

Available Only Through Snap-on's Direct-To-User Tool Service

WRITE FOR INFORMATION  
SNAP-ON TOOLS CORP. • Kenosha, Wisconsin

**Build YOUR OWN BOAT**



Complete parts cut to exact size—ready to assemble. Marine water-proof plywood, rustproof oarlocks. Ideal car top. Also models with laminated frames; mahogany decked runabouts. Build for sale at attractive profit. Exclusive franchise to local builders. Send 10 cents (dime) for illustrated literature today.

**\$39.50**  
and up

**OZARKA** 721 WASHINGTON AVE. WOODSTOCK, ILL.

**CURIOUS?**

ABOUT A SHIP-IN-A-BOTTLE

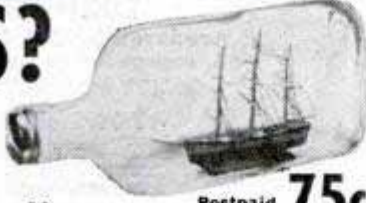

Here is the secret plus all of the material less bottle. See your dealer first. Catalog 10c.

Postpaid in U.S.A. **75c**

BRAUN-CRAFT, 1232 Etowah, Dept. PM9, Royal Oak, Mich.

**SWISS MUSIC MOVEMENTS**



Make toys, novelties musical with fine imported units. Variety of nursery, popular and Christmas tunes. Musical toys are 100% more saleable and profitmaking. Catalog free. MERRITIME EXPRESS, 13 E. 60 St., New York 22, N. Y.

**AGENTS 300% Profit SIGN LETTERS**

For Store Fronts and Office Windows. Anyone can put them on. Free Samples. Liberal Offer to General Agents. METALLIC LETTER CO., 430 N. Clark, Chicago 10

SAY YOU SAW IT IN POPULAR MECHANICS

**"FINEST** precision writing instrument of its kind in the world!"



84 character keyboard same as on big office machines

*58iq Machine Aids*

1. TOUCH SELECTOR
2. VARIABLE LINE SPACER
3. FLOATING SHIFT
4. ONE STROKE RIBBON REVERSE
5. TYPEBAR SPEED BOOSTER

ASK DEALER FOR DEMONSTRATION AND BUDGET PLAN

**Smith-Corona**  
PORTABLE TYPEWRITERS

**NOW, YOU TOO CAN WELD!**  
IT'S EASY—WITH THE

HIGH IN PERFORMANCE —LOW IN COST!



**miller**  
*"Hobby Arc"*  
HOME WELDER  
110 VOLTS

Designed and built by the men who make the Miller industrial welders. Compact, light in weight, low in cost yet able to do a man sized welding job with electrodes up to 1/8". Operates on AC current on a 30 ampere fuse. Shipped complete with electrodes, electrode holder, helmet and cables.

TRY IT IN YOUR WORKSHOP

**miller** ELECTRIC MANUFACTURING CO. APPLETON, WISCONSIN



**Powell SETS THE PACE**

DEALER INQUIRIES INVITED

- 7 H.P. Motorcycle-type Engine
- Solid steel frame
- Faster pick-up than a car
- Highway cruising speed of 45 miles per hour
- Automatic clutch
- Chrome-plated fenders, handlebars, and sport muffler —looks like a custom job
- Smooth, simplified control
- Costs no more than ordinary scooters

Write for FREE FOLDER and address of nearest dealer

**Powell MANUFACTURING COMPANY** DEPT. PM-8 COMPTON, CALIF.



# FREE

## ALLIED'S GREAT RADIO CATALOG!

172 Value-Packed Pages  
SEND FOR IT TODAY



### Everything in Radio At Lowest Prices!

Get ALLIED'S latest Catalog—biggest and most complete in Radio! Tremendous values in new Television receivers, home radios, latest Amateur receivers and Ham station equipment, Sound Systems. Everything for the Builder and Experimenter—thousands of parts, tubes, test instruments, tools, books, diagrams and builders' Kits—the world's largest stocks—all at money-saving low prices! Get your copy today.

The Only COMPLETE  
Radio Catalog

FREE  
Catalog!  
Send  
for it

### ALLIED RADIO

ALLIED RADIO CORP., 833 W. Jackson Blvd., Dept. 5-J-8  
Chicago 7, Ill.

Rush FREE 172-Page ALLIED Catalog.

Name.....

Address.....

City..... State.....

# New BRUSH Electroplater

ESPECIALLY BUILT FOR  
MECHANICS, MODEL MAKERS  
HOME CRAFTSMEN



### Easy to Plate GOLD, SILVER, NICKEL, COPPER, etc... For Pleasure and Profit!

If you have a workshop—at home or in business—you need this new Warner Electroplater. At the stroke of an electrified brush, you can electroplate models and projects—you can replate worn articles, faucets, tools, fixtures, silverware, etc. with a durable, sparkling coat of metal... Gold, Silver, Nickel, Copper, Cadmium, and after a bit of practice, even Chromium! Everything furnished—equipment complete, ready for use. By doing a bit of work for others, your machine can soon pay for itself. So make your shop complete by getting a Warner Electroplater right away. Send today for FREE PLATING SAMPLE and illustrated literature. ACT AT ONCE.

**WARNER ELECTRIC CO., Inc., Dept. T-12**  
1512 Jarvis Ave., Chicago 26, Illinois

### FREE Details & Sample!

WARNER ELECTRIC CO., Inc., 1512 Jarvis Ave., Chicago 26, Ill., Dept. T-12  
Gentlemen: Send Free Sample and Details to:

Name.....

Address.....

City..... State.....

### PNEUMATIC AIR TOOLS

#### SAVE \$64.00 AND UP

Ideal fender and bumping hammers, and for riveting brake lining, concrete breaking and many other uses. Like new. At these unheard of low prices it pays to order a good supply.



Chicago Pneumatic  
RIVETER & CHIPPING  
HAMMER

CP9X offset handle, with air control. Takes up to 1/4" rivet, weight 8 lbs. List Price \$79.00. Special Price..... **\$10.95**



RIVETER & CHIPPING HAMMER

Chicago pneumatic CP4 with air control, push button throttle, takes up to 3/16 rivet. Weight 6 lbs. List Price \$73.00. Special Price..... **\$8.95**

#### ARO AIR DRILLS—NEW. \$22.50

1/4" with Jacobs Chuck..... \$19.50

Size 3/16"..... \$19.50

Prices are F.O.B. Chicago. Immediate delivery. **SOLD ON MONEY BACK GUARANTEE.** Send check or money order today.

DEALERS—Write for free folder.

**C & M EQUIPMENT COMPANY** 1831 S. State St., Dept. D-9  
Chicago 16, Ill.

## SAVE MONEY

build your own

### SMITH COMPRESSOR

Now, use the world-famous Smith Air Compressor to operate rock drills, paving breakers, spray guns, sandblasting, etc., at low cost! Just order the Smith Compressor Head and Accessories with complete instructions for assembling. All you need is a Ford Motor and shop facilities. Capacity 60 cu. ft.—ample power for most compressor jobs. Pressure up to 100 lbs. per square inch. Head equipped with high speed compressor valves; automatic unloading and idling.

WRITE **GORDON SMITH & CO., Inc.**  
TODAY! 410 College Street Bowling Green, Ky.

### DUAL TAIL PIPE EXTENSION

Fits all cars — chrome plated

#### DEEP TONE

produced by 2 1/2 inch outlets **\$2.95**

Postage free on prepaid orders

DEALER INQUIRIES INVITED

**LYONS PRODUCTS COMPANY**

PAT. PEND. 2426 South LaBrea, Dept. PM-9, Los Angeles 16, Calif.

### GERSTNER Tool Chests

The sturdy structure of Gerstner Chests assures many years of satisfactory service. Free catalog for machinists and toolmakers.

**GERSTNER TOOL CHESTS**

448 Columbia St. Dayton 7, Ohio



**BE FAIR TO YOUR HAIR** Want better looking hair? Embarrassed by falling dandruff, itching scalp? Then try VITABRUSH, new electric driven scalp brush that gives your scalp a vigorous and invigorating "workout" in just three minutes of fun. Cleans scalp. Stimulates blood supply. Restful. Pleasant. Write today for complete information and satisfaction-guaranteed offer: Hershey Mfg. Co., 157 S. La Salle, Chicago 3.

SAY YOU SAW IT IN POPULAR MECHANICS



**We'll Start You  
Complete in this**

**PRODUCTS BUSINESS**

**And Help You  
Put It Over**

The great building industry is your profitable market for masonry products. Low investment . . . high returns . . . wide-open opportunity to establish a lifetime business.

The biggest building years in the nation's history are just beginning. New construction, involving billions of dollars, means huge demands for block, drain tile, and other masonry products which YOU can manufacture locally, from local materials, with local labor for local consumption. Remember, MASONRY products are in mesh with today's building preference!

Use our modern machines and equipment to insure the finest quality products at pared-to-the-bone manufacturing costs. Sold direct from factory to you. Backed by 40 years of pioneering and manufacturing. Write for new catalog. Describes complete line of equipment with prices plainly marked. Tells how we help you in manufacturing and merchandising. Write TODAY.

**CONCRETE  
EQUIPMENT COMPANY**

512 Ottawa Avenue  
Holland, Mich.

**10 SHELF PLANS**  
NEW FULL SIZE

New, full size, easily built, beautiful wall shelf plans ready to trace on lumber, cut out and assemble. Corner and wall racks with 1 to 3 shelves. Stores charge about \$75.00 for these shelves. Make money selling them. Finest selection available. PLUS BONUS of 48 other novel cut-outs, Dutch Boys, Girls, Toys, etc., etc. PLUS FREE new 1949 Handicraft Catalog. Send only \$1 to



**JACKSON, Dept. 60**  
5440 N. Shoreland Ave.  
Milwaukee 11, Wis.

**ALL PURPOSE FOLDAWAY  
TABLE or BENCH LEGS**

Make sturdy folding tables, benches or work horses with these steel channel, riveted folding legs. Black enameled and rubber tipped. 30" high for table tops 5.98 pr.; 24" high for benches or work horses 4.98 pr. Send for free circular.



**\$4.98**  
(LEGS ONLY)

**THE DIAMOND MFG. CO.**  
1000 ALBANY AVE. SCENECTADY 7, NEW YORK

**SAVE TIME, WORK, MONEY!**

**SHAW  
"DU-ALL"**

and "PEPPY PAL" TRACTORS

Easy and Cheap to Operate



These rugged walking or riding tractors are ideal for farm, truck garden, orchard, poultry farm. Operate on a few cents an hour. A child can handle them.

**DO DOZENS OF JOBS** Both riding and walking tractors quickly and easily plow, cultivate, harrow, disk, bulldoze, spray, haul, grind, saw wood, etc. **LOW FACTORY PRICES** Buy direct or through your dealer. Year's guarantee!

**RIDING TRACTORS** 4 models from 5 to 12½ H.P., 58 in. wheelbase, 36 to 52 in. wide, 24 in. plant clearance. Hand or electric starter. Walking Tractors 1½ to 3 H.P.

**FREE** Illustrated folders giving complete details and price lists—write today!

**SHAW  
MFG. CO.**

4506 FRONT ST., GALESBURG, KANS.  
6686 NORTH 4TH ST., COLUMBUS, O.

**Only CASCO gives you**

**A COMPLETE  
ELECTR-O-TOOL  
KIT**

for only **14<sup>95</sup>**

You get routers, sanding discs, buffing wheels, mandrels, chocks, grinding wheels, drill, wrench, rubber polishing wheel — all of the most popular accessories plus the famous precision-built Casco power-head with genuine fractional HP AC-DC motor—all in a sturdy tool box, everything for just \$14.95!



**EVERYTHING A CRAFTSMAN NEEDS  
TO TURN OUT PROFESSIONAL WORK!**

Job-tested in industry! Smooth vibrationless operation at 20,000 RPM. 14-part ribbed commutator turned within .0005. On-off switch for easy one-hand control. Oilless bearings. Unbreakable plastic Tenite case. Special safety sleeve and shaft lock. Non-slip chuck. Triple cooling for steady performance under load. 90-day guarantee.

On sale in leading stores!

Standard 21-pc.

**CASCO 14<sup>95</sup>**

Electr-o-tool kit with famous Casco electric power-head and popular accessories. Sturdy carrying box.



10c brings you this 36-page PROJECT BOOK

Casco Products Corp., Dept. PM-9  
Bridgeport 2, Conn.

Enclosed is 10c to cover cost of mailing my 36-page Casco PROJECT BOOK.

My hobby is \_\_\_\_\_

Name \_\_\_\_\_

Address \_\_\_\_\_

City \_\_\_\_\_ State \_\_\_\_\_







HOME INTERIORS  
*Trim Ideas*  
WITH  
**CHROMTRIM**  
METAL MOULDINGS

Modernizing?  
Remodeling? Use..  
**CHROMTRIM**  
"Trim-it-Yourself"  
METAL MOULDINGS

You'll find hundreds of uses for this handy metal trim around your home. Kitchen, bathroom, stairs or attic can be streamlined in a jiffy. Chromtrim comes in convenient 6' lengths, 8 shapes, all ready to tack on.

Chromtrim is easy to cut — Economical to use — Bends simply to any shape.

Send 10¢ for "Trim Ideas" — 16 pages brimming with Chromtrim projects, ideas, and directions for use.

R. D. Werner Co., 291 Fifth Ave., N.Y. 16  
Enclosed is 10¢ for CHROMTRIM "Trim Ideas" booklet PM-9.

Name \_\_\_\_\_  
Address \_\_\_\_\_  
City \_\_\_\_\_ Zone \_\_\_\_\_ State \_\_\_\_\_

**R. D. WERNER CO., INC.**  
295 Fifth Avenue, New York 16, N. Y.

**MAGNETS** OF ALL TYPES—10¢ UP  
AMAZINGLY POWERFUL!  
5 oz. Alnico Magnet, lifts 10 lbs. \$1.00. Our Leader, 15 oz. Magnet, lifts 40 lbs. \$1.95. New alloy—will not weaken! Useful for lifting valuables from tanks, trunks, or rivers easily! 7 small magnets \$1.00 with list of many shop and home uses. Satisfaction guaranteed.  
R. EYRICH, 2566 N. 49TH ST., MILWAUKEE 10, WIS.

DIRECT FROM FACTORY — REGULATION

**JUMP BOOTS**



**\$9.95**  
plus postage

These are new, regulation 10" Jump Boots, just like the paratroopers wore, designed for all-around foot comfort, built for all hard, outdoor wear. Heavy, pliable, elk-finish cowhide; hard box toe; Goodyear welt; full, grain-leather inner sole; 2 full grain leather outer soles; all-weather, non-marking, no-skid rubber half sole; beveled, non-trip heel; heavy inner ankle webbing assures snug fit, firm support; steel instep shank; long, leather rawhide laces.

**YOUR MONEY BACK IF NOT SATISFIED**

Sizes  
3½ to 13½  
All Widths

**GEORGIA SHOE MFG., CO.** Flowery Branch, Ga.

Send me a pair of JUMP BOOTS. Enclosed is check \_\_\_\_\_  
Money Order \_\_\_\_\_ for \$9.95. I will pay postage on arrival.

NAME \_\_\_\_\_

ADDRESS \_\_\_\_\_

CITY \_\_\_\_\_ STATE \_\_\_\_\_

Size and width of shoe \_\_\_\_\_ 92

## AIR COMPRESSOR



Brand New General Electric: ½ hp 27 volts AC-DC. 2 stage piston type 1000 lbs. per sq. inch rated pressure 17 AMP series wound motor equipped with fan for cooling. Can be adapted to 110 AC with 27 volt transformer. Thousands now in use for spraying, inflating tires, laboratory use, etc. May be used with low-pressure paint spray gun. Shipping weight, 20 lbs., FOB, Kansas City, Mo. .... **\$17.95**  
TRANSFORMERS: 27 volt. New FOB, Kansas City, Mo., Only. .... **\$14.95**

## FLASHLIGHT INSPECTION LAMP ASSEMBLY

Water, Vapor and Shock Proof

NEW—Govt. Surplus. Lights up the "Hard-to-get-at" places. Fine for mechanics, electricians, radio repairmen, filling station attendants, in the home, and many other uses. Plastic 12" extension (6" stiff and 6" flexible). Adjustable to any angle. Originally priced over \$4.00. Our price with extra bulb Postpaid. .... **\$1.50 Ea.**

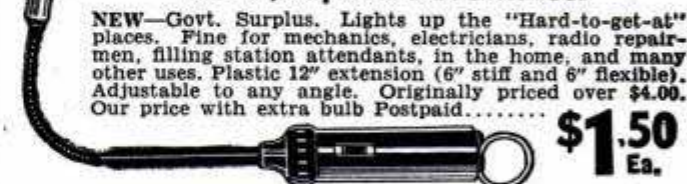

Write for latest circular of surplus bargains

**NATIONAL SURPLUS SALES CO.** 723 E. 18th Street  
Kansas City, Missouri

**PAINTERS' STRIPING TOOL** A TOOL... NOT A BRUSH

**NEW, IMPROVED**



Modern—streamlined—fits the hand like a fountain pen! Easy to use as a pencil. Draws parallel lines—straight, curve or circular. Does expert job on autos, furniture, toys, bikes, model planes, signs, bulletins, linoleum. (Makes wall board look like tile.) Every painter and craftsman needs one! Type "M" MASTER Painters' Striping Tool complete with tip for 1/16" stripes, \$1.00. Extra tips 1/64", 1/32", 3/64", 1/16", 5/64", 3/32", 1/8"—75c each. Tool with complete set of 7 tips \$5.00. (C.O.D. orders 25c extra.) Paint dealers, write!

**\$1.00**  
POST PAID

**EASY AS USING A PENCIL!**

**WENDELL MFG. CO.**  
4234-B Lincoln Ave., Chicago 18, Illinois

**CANVAS COVERS** Waterproof tarpaulins, war surplus (Used), perfect condition. Originally made for tents. Approx. 5'x8'. Two buttoned together make approx. 80 sq. ft. Complete with buttons attached. Suitable for use as canvas dams, hay covers, truck covers, machinery and equipment covers, etc. Packed in bales of 30, priced 30 covers, \$1.25 ea.; 15 covers, \$1.50 ea. Less than 15, \$1.75 ea. All FOB, Kansas City.

**AMERICAN SUPPLY CO.**

329 W. 5th Dept. PM Kansas City, Mo.

Original  
**HOLLYWOOD WOLF WHISTLE**



CAR HORN

Give the WOLF CALL



You, too, can become a Hollywood Wolf. Give the wolf call and make other weird noises with the original HOLLYWOOD WOLF WHISTLE on your car. Precision made. Works off the intake manifold. Easily installed in 15 minutes. Works in trucks, motorcycles, motor boats, outboard motors, too. Guaranteed. If your dealer cannot yet supply you, order direct, giving us your dealer's name. No COD's or stamps. No individual foreign orders. AUTOMOTIVE DEALERS & JOBBERS write for information on this fast selling, proved item.

DESCRIPTIVE LITERATURE ON REQUEST

**YODER MFG. COMPANY**

2403-21K East 103rd St., Los Angeles 2, California



# New ARMY MINE DETECTOR

AN/PBS-1 is a portable device for detecting Metallic and Non-metallic objects. You can use them to ferret out all kinds of Buried-Treasures, in the Mountains or on the Beaches. Its private use suggests the following: in the hills or mountains, all types of Metals and Non-metals; on the beaches any type of objects such as jewelry and coins. For commercial use such as tracing buried cable, wire and sewer tile. Locating buried metal or wooden boundary stakes, etc.

### TECHNICAL FEATURES:

This unit actually is a Ultra high Frequency transmitter. A variation in radiance resistance, caused by any change in soil density, shows in a deflection of the Microammeter, discriminating between Metallic or Non-metallic objects by a swing to the right or left. Audio response in the Headset also indicates changes by an increase or decrease in the volume of the 1000 cycle tone. By lengthening dipole rods operator will be able to increase the depth sensitivity.

This unit comes complete with spare tubes, antenna dipole and reflector, and instructions manual, in wooden chest 9 1/2" height x 28 1/4" length x 15 1/2" depth. Weight in operation is only 22 lbs. LESS Batteries. Power supply: Three 45 volt and one 6 volt batteries. Uses standard batteries. Original COST \$285.00. Shipping Weight appr. 30 lbs. F. O. B., N. Y.



No C.O.D.

Our Special Price **\$26.40** with battery  
\$17.50 without battery

Send Orders to: **COLUMBO TRADING CO., INC.**  
304 Canal St., Dept. P.M., N. Y. 13, N. Y.

## HEAVY CAST ALUMINUM BLOWER ONLY \$10.00

SINGLE EXHAUST BLOWER DELIVERS APP. 100 CU. FT. AIR PER MINUTE. Ready to install yourself with any household tools. It's built for that. Housing is solid cast aluminum to last indefinitely. 110 V., A.C., 50-60 cycles. Cont. duty motor.

DOUBLE EXHAUST BLOWER. 2 heavy cast alum. housings. Double intake and exhaust. Only \$16.85. Add 50c handling; \$1 west of Miss. Send check, M.O. Money-Back Guarantee. Free literature.

UNIVERSAL YONKERS CORP., (M-9) 137 Alexander St., Yonkers 2, N. Y.

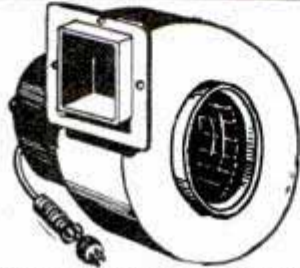

## MARCOT KEY MACHINES

MARCOT No. 8 KEY MACHINE, mounted on Cabinet ..... \$ 95.00  
Auto Code Book and Auto Depth Keys ..... 12.50  
100 Dz. Popular Cylinder Key Blanks Set — Key File, Follow-Through Rods, Lock Picks, Bit Key Gauge, Thimble, Pins, Springs. . . 60.00  
"Locksmith Trade Books": ..... 6.75

How to Open Locks without Keys or Picks; Secret of Locksmithing; How to Make Keys by the Impression Method; Master Key Systems. **TOTAL COST ..... \$184.75**  
The \$60.00 cost of the Key Blanks would return approximately \$350.00. This would more than pay for your entire KEY MACHINE OUTFIT. IMMEDIATE DELIVERY—Motors available with Key Machine Orders.

**A. J. MARCOTTE CO. DEPT. PM, CHICAGO 51, ILL.**  
1200 N. KEDZIE AVE.



Balance 4" x 9" Base. With either Metric or Avoirdupois Weights .. \$7.00

Catalog with 3000 Illustrations of laboratory apparatus, and over 10,000 prices sent for \$1.00.

LABORATORY MATERIALS CO.  
7321 Vincennes Ave. Chicago 21, Ill.



## WOOD SHAPER \$29.50

9" x 16" surface ground cast iron table Cast iron base and guard. Ball bearing 1/2" spindle. 3/4" x 1/4" mitre groove NOT A TOY. Wt. 40 lbs. F.O.B. Memphis. Write for descriptive folder. (PAT. PENDING)  
V. J. Gegumis & Sons, 2564 Everett, Memphis, Tenn.



Hands Never Touch the Water—Can be put in Boiling Water. Housewives Like It.



48" Long Handle

**Housewives Are Enthusiastic**  
Everyone that sees this outstanding Cell-U-Mop immediately wants one. That's the reason our distributors are so successful.

# ... Quick Easy Way to BIG PROFITS

## Read What Others Are DOING!

"Enclosed you will find 56 orders representing 9 1/2 hours' work on Monday and Tuesday."  
"Enclosed are twelve orders secured after supper this p.m."

### Sales QUICK, EASY EVERYWHERE

SALES ARE EVERYWHERE . . . Sells quick to Taverns, Clubs, Hotels, Hospitals, Stores, Restaurants, Large and Small Buildings and the Homes . . . Scores can be sold on a single street . . . Note the Drain Bracket in the illustration . . . This squeezes out the water so thoroughly that HANDS NEVER TOUCH THE WATER . . . Makes no difference what you ever sold, you will like this proposition . . . Your name on a Post Card will bring you FREE PARTICULARS.

We Teach You How! Get Choice Territory NOW!



**CELL-U-MOP CO., Dept. P-9, FREEPORT, ILL.**

# Troubled with DEAFNESS?



—then you'll be thrilled with the new revolutionary Zenith "75" Radionic Hearing Aid. You can order it by mail without risking a penny. Let a 10-Day Trial at home, at church, at business, prove it's the finest hearing aid you can buy regardless of price. Saves you over \$100.00.

## HEAR BETTER or Pay Nothing

Light, compact single unit. Costs less than a cent an hour for battery consumption. Comes ready to wear. Accepted by the Council of Physical Medicine, American Medical Association. Send postcard now (no obligation) for full particulars telling how tens of thousands of hard-of-hearing men, women and children have found new joy and happiness with this amazing new hearing aid.

Look only to your doctor for advice on your ears and hearing



**ZENITH** RADIO CORPORATION  
HEARING AID DIVISION

Dept. PM98, 5801 W. Dickens Ave., Chicago 39  
Makers of the World-Famous Zenith Radios.  
Leaders in Radionics Exclusively for 30 Years.



# Talk AS FAR AS 17 MILES WITH ARMY FIELD TELEPHONES



Amazingly simple to install and operate. Just hook up terminals of two or more phones to any two-strand wire and you are ready to talk! Powered by standard flashlight batteries. Compact . . . rugged . . . portable.

Hundreds of uses for quick, low-cost, dependable 2-way communication around home, shop, farm, industry. Performance equals present-day commercial telephones. Up to six phones can be used efficiently on a single line, making a complete telephone system. No maintenance required. Each phone complete with self-contained hand-operated ringer. Every phone checked for perfect operation and fully guaranteed. Originally cost government \$39.90 each.

- USED—good, serviceable condition.....\$ 7.45 ea.
- USED—excellent condition ..... 8.95 ea.
- RECONDITIONED—(by U. S. Signal Corps)... 10.75 ea.
- Like New, slightly used..... 12.95 ea.
- BRAND NEW PHONES—canvas case..... 15.00 ea.
- BRAND NEW PHONES—Mfg. by Western Electric, Stromberg Carlson and Kellogg, with canvas case ..... 16.75 ea.
- NEW WESTERN ELECTRIC FIELD PHONE HANDSETS, pst. pd..... 4.75 ea.

We are the original firm to introduce Army Field Telephones on the national market. We deal exclusively in this item, and our experience in handling this equipment has resulted in the satisfaction of thousands of customers and many repeat orders.

## ARMY FIELD TELEPHONE WIRE

WIRE—UNUSED W-110-B 2-strand (illustrated)—500 ft. \$3.50, 1000 ft. \$6.50 (mile reels available).  
NOTE: By popular demand, we are now making available this hard-to-get item for the first time:



### — SPECIAL —

NEW—1/2 MILE REEL 2-STRAND LIGHTWEIGHT W-130 ASSAULT FIELD TELEPHONE WIRE. Weighs only 16 pounds.  
With purchase of phones, per reel.....\$15.00  
If desired without phones, per reel..... 16.50

For complete Telephone Systems using from 7 to 48 telephones, Brand New Switchboards are available from \$32.50 to \$65.00 complete. All prices FOB Sacramento. No COD. California residents add 2 1/2% for sales tax.

FIELD TELEPHONES—SWITCHBOARDS—TELEPHONE WIRE AND RELATED ITEMS.

For complete details...

Write for FREE illustrated folder

Now as Low as \$7.45 ea.

SEND CHECK OR MONEY ORDER **LORIS SALES**  
P. O. Box 1896-B-9 Sacramento, California

Say You Saw It in Popular Mechanics

## MAKE up to 600 an hour DO RUG WEAVING AT HOME!

Start your own business at home weaving rugs, carpets, etc. The DEEN ALL-WEAVE LOOM turns out 2-3 rugs every hour. No experience needed. Ideal for handicapped people. Small investment gets you started. Write today for FREE booklet.

THE HOME WEAVING CO.  
134 Oak St. Lake Ozark, Missouri



# PROSPECT WITH A TX-5 GEIGER COUNTER

LOCATES RADIOACTIVE MINERALS

The TX-5 is light weight, battery operated. Locates deposits of radioactives. Simply switch "on"—clicks in headphones indicate presence of radioactives. Extra sensitive, yet ruggedly built.

Each unit comes complete with headphones, probe, batteries and manual. For prospecting and mining operations.

Write for details and price. Dept. PM-9

OMAHA SCIENTIFIC SUPPLY CORP.,  
3623 LAKE, OMAHA 4, NEBR.

Geiger Counters for  
-OIL PROSPECTING  
-MINERAL LOCATION  
-HOSPITAL WORK  
-INDUSTRIAL USE

## STOP THIS LEAK SOMETHING NEW!

- 1-Adjustable Collar
- 2-Improved Guide Rod
- 3-New Rubber Ball
- 4-Press-On Solid Brass Seat

Just The 3 Things To Stop These Leaks

INSTALL IT YOURSELF

Any man, woman or child can install this NEW UNIT in less than 3 MINUTES. No tools or skill needed. 3 KITS \$1.60 EACH  
6 KITS \$1.50 EACH  
12 KITS ONLY \$1.25 EACH.

SEND NO MONEY —

Merely pay postman on delivery plus postage. Or send cash and we pay postage.

ORDER YOUR SUPPLY TODAY

COMPLETE KIT ONLY \$1.79

Postpaid in U.S.A.

Gee Co., Dept. L-9, 2600 West 79th St., CHICAGO 29

## \$4.95 REAL ENGINE VALUE

A miniature gas engine that really operates. Thousands of Buzz "B" gasoline engines have been sold at twice the price. Now is your chance to buy a real 1/8 H.P. gas engine for only \$4.95. Turns up over 8,000 r.p.m. For Boats, planes, midget cars, etc. Guaranteed and ready to run. Includes Champion spark plug and tank. Send only \$1.00, engine shipped collect for balance, same day.

WRITE FOR FREE CATALOG OR SEND 10c FOR NEW MAMMOTH ILLUSTRATED CATALOG OF THOUSANDS OF HOBBY ITEMS.

America's Hobby Center, Inc., Dept. B-98, 156 West 22 St., N. Y. 11

## FURNACES FOR HOME AND SHOP

COAL—LP—GAS—OIL. Fittings, pipes and registers. Water heaters, Ranges and floor furnaces. COOLING, evaporative, water coil or refrigerated. BLOWERS with motors. Of interest to contractors and builders. DEALERS.

FREE BOOKLET

**PEERLESS SALES & SUPPLY**  
4318 Sheridan Lincoln 6, Nebr.

## New Designs in FRANZITE GRIPS

Modernize Your Gun! Improve Your Score! Most durable grips made. Positively unbreakable! For Colt, Smith & Wesson, Hi-Standard, Ortgies, Luger & Mausers in a wide choice of beautiful designs in ivory, pearl, walnut, onyx, etc. Low prices. FREE CATALOG. Dealers Wanted.

SPORTS, INC. (Mfrs.) 5501 Broadway, Dept. P-9, Chicago 40, Ill.

**BASS IS BEST**  
WEEJUNS  
LEISURE COMFORT

**BASS IS BEST**  
QUAIL HUNTERS  
FIELD and STREAM

**BASS IS BEST**  
SKI BOOTS  
EXTRA CONTROL

**BASS IS BEST**  
SPORTCASINS  
GOOD GOLF STRATEGY

G. H. BASS & CO.  
60 MAIN STREET  
WILTON, MAINE



# Weld Cast Iron this Easy Way



Use P & H Nicast electrodes — and get sound, fully machinable welds

**Nicast is ideal for making quick, easy repairs in cast iron, reclaiming cast-iron parts, and correcting machining errors**

Yes, welding cast iron is easy when you use P&H Nicast electrodes. Why? Because Nicast operates in a low heat range — no preheating, no postheating, no other time-consuming preparation is required. And, too, you can weld with Nicast in any position — flat, vertical, overhead, horizontal.

### Here's why Nicast welds are easy to machine

The steady, soft arc produced by Nicast has just the right amount of penetration. This feature, with the low amperage required, prevents dilution of carbon from the parent metal to the fusion zone and to the weld metal deposited. This absence of diamond-hard carbon particles is what makes Nicast easier to machine than other electrodes.

There is no hard fusion zone to drill, tap, mill, or machine. Tools and cutters stay sharp longer, break less often. Your work is finished in less time. And you make more profit on every cast-iron repair job you do with Nicast.

### Nicast welds are sound

After machining or grinding, Nicast welds almost match the color of the parent metal. But more important, they are non-porous and free from cracks. Prove this to yourself by checking a multiple-pass Nicast weld under hydrostatic pressure.

### Nicast can be used on any type of welder

This versatile P&H electrode operates equally well on AC or DC current. You can use it to reduce welding time and save money, no matter what type of welding machine you have.

And speaking of welding machines, we suggest that you get all the facts about the new

P&H AC Arc Welder. This is the only welder with easy-to-use Dial-lectric Control. It has no moving parts and needs no maintenance.

Connectible to 220-or 440-volt current, the P&H Dial-lectric has many features that help to reduce welding costs. Here are a few that make for better, faster welding: Built-in remote control. Easy quick-start arc. High-low welding range. Elimination of arc blow. A three-quarter turn of radio-like knob for complete welding range. Compact design. Sizes range up to 650 amps.

Go after profitable cast-iron welding jobs. Your nearby P&H distributor can supply you with Nicast electrodes — the electrodes especially designed to do cast-iron work faster and better. Nicast is available in  $\frac{1}{8}$ ,  $\frac{3}{32}$ ,  $\frac{1}{4}$ , and  $\frac{5}{16}$  sizes and comes in handy 10-lb. containers. See your P&H distributor today or mail us the coupon below, clipped to your business letterhead.

These cast-iron arc-welding jobs are easier to do and cost less when you use P&H Nicast Welding electrodes:

- Iron casting repairs
- Building up worn castings
- Welding cast iron to steel
- Correcting machining errors on castings
- Maintenance work for industrial plants
- Automotive repairs:
  - Cylinder blocks
  - Cylinder heads
  - Transmission housings
  - Clutch-plate fingers, etc.

P&H Dial-lectric AC Welder with built-in remote control. Sizes to 650 amps.



### WELDING ELECTRODES

4673 W. National Ave.  
Milwaukee 14, Wisconsin



Manufacturers of America's Most Complete Arc Welding Service

**TEAR OUT COUPON. ATTACH TO YOUR BUSINESS LETTERHEAD AND MAIL TODAY**

HARNISCHFEGER CORPORATION  
4673 W. National Avenue, Milwaukee 14, Wisconsin

Yes, I'm interested in welding cast iron the easy way with P&H Nicast electrodes, and in the new P&H AC Arc Welder with revolutionary Dial-lectric Control. I would like information on the items that I have checked below:

- P&H Nicast Electrodes     P&H AC Arc Welders  
 Send representative     Send address of distributor  
 Send Free Book, "Simplified Welding"

Name.....  
 Position..... Company.....  
 Address.....  
 City..... ( ) State.....  
 Home Business



**Now! You Can Install  
DUAL WHEELS!  
IN LESS THAN TEN MINUTES**

on your Trailer, Pick-up Truck, Farm Wagon or Jeep and on any other vehicle equipped with passenger type wheels.



Complete set for 2 wheels.....only **\$28.50**  
DU-ALL Adapters eliminate expense of changing to truck-type wheels and hubs. Use your spares for duals! Complete—nothing more to buy—no machining or alterations needed.

**6 Models to Fit 90% of All Light Vehicles**

- DA 201—FORD All Pass. & 1/2 Ton 1928 to 1947 (Except 1936-1939)..... **\$28.50**
- DA 202—FORD All Pass. & 1/2 Ton 1936 to 1939 & 3/4 Ton 1938-1941..... **\$32.50**
- DA 203—JEEP All Military & Civilian..... **\$28.50**
- DA 204—CHEVROLET All Pass. & 1/2 Ton 1928 to 1947..... **\$28.50**
- DA 205—PLYMOUTH—DODGE All Pass. & 1/2 Ton 1933 to 1947..... **\$28.50**
- DA 206—INTERNATIONAL 1/2 Ton 1935-1947..... **\$28.50**



**JEEP STANDARD WHEEL TREAD ADAPTERS.** Extends width of tread to standard 58" width. Complete set for 4 wheels. No. TA 410..... **\$36.00**

**GI MILITARY TRUCK PARTS**

Axles, Trunion Bars, Pillow Blocks, Transfer Cases, Gears, Wheels, and every part for every G. I. type vehicle from jeep to 20 ton prime mover. 6x6 Stude., GMC, Dodge; 4x4 Chev., Dodge, Ford, Auto Car, Half track, Scout car, etc.

**TRAILER AXLE ASSEMBLY**

20,000 lb. capacity—4 1/2" round axle; 54" between brakes; 72" between wheel flanges.

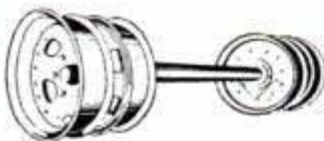

**GI-503 NEW COMPLETE ASSEMBLY** including latest type double cylinder Hydraulic Brakes, 6 hole Budd hubs, bearings, etc. For single or dual wheels. A War Surplus special. Complete **\$158**

**GI-504 BUDD WHEELS** to fit 20x7—for 8.25x20 tires. Our Price Each..... **\$6.75**

**16" DROP CENTER WHEELS** For Model T Fords... and all old models with off-standard hubs. Heavy duty, double disc wheels to replace all obsolete wood wheels of odd sizes—for trailers or passenger vehicles.

Two Types, Only **\$6.45 each**

WFLIN—For Model T Fords. With all holes drilled, ready to bolt on.  
WF400N—Universal Fit with Center Hole in Blank Disc for drilling to size.

**SEND FOR FREE 64-PAGE CATALOG**

**The NORTHWESTERN  
Auto Parts Co.**

834 North 7th Street • Minneapolis 11, Minnesota

**SAY YOU SAW IT IN POPULAR MECHANICS**

**NO MORE BACK BREAKING MOWER PUSHING**

**Build a POWER LAWN  
MOWER yourself from  
your old HAND MOWER**



We supply complete ATTACHMENT that needs no welding. Easy to install in less than an hour. fits any make or size of mower for Electric Motor or Gasoline Engine.

**ENGINE:**

OUR 1 1/2-2 H.P. 4 Cycle Air Cooled with High and low Adjustable Jets Dependable Starting. Light weight, 30 lbs.

Both the ATTACHMENT and the ENGINE are ABSOLUTELY GUARANTEED, you are getting the very best that money can buy at a price you can afford.

Orders filled in seven days. Send for FREE FOLDERS.

**PRECISION BUILT  
To Last A Lifetime**

**ROYAL-OAK LAWN MOWER SHOP**

Box 48

Royal-Oak, Mich.

**FIND UNDERGROUND  
MINERALS  
and METALS  
with M-SCOPE**

New sensational lightweight models, unsurpassed efficiency Low prices. Time-payment plan. Write for free 16 page booklet.

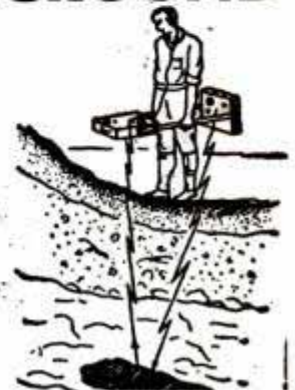

**FISHER RESEARCH LABORATORY, INC.**  
PALO ALTO CALIFORNIA

**HYDRAULIC CYLINDERS**



Powerful, double acting hydraulic units, all brand new. Length closed—3'. Extended—5'3". Makes a fine portopower for auto body work, hydraulic lifts, presses, etc. where positive power movement in two directions is desired. Gov't surplus. Only a few at **\$12.50 ea.** Shipping wt. 10 lbs.



**H E A T E R S**

Gasoline, burning 40,000 B.T.U., built by Stewart Warner for USAAF as cabin and engine heaters. Brand new and in original cases. Small modification makes ideal installation in trucks, buses, trailers, boats, small buildings, etc. No exposed flame. Crated shipping wt. 40 lbs. A bargain at **\$28.50 ea.** FOB Wash., D. C.

**MICHEHL INDUSTRIES**

930 F ST. N.W.

WASHINGTON 4, D. C.

**NAVY T-SHIRT**



Brand new. First quality. Snowy white. Soft fine knit cotton. Sizes small, med., large... **3 for \$2**

**PILOT'S GLOVES**



Brand new. Air Corps surplus. Very soft, pliable leather, unlined. Ideal for driving. Sizes 9 and 10... **2.25**

**Money Back Guarantee**

**WAR SURPLUS VALUES**

**AVIATORS' JACKET**

Brand new. Air Corps Type B-15. Fully alpaca lined, including sleeves. Zipper front. Large mouton fur collar. Sizes 34 thru 44..... **14.95**



**NAVY JACKET**



Brand new. Navy N-1 Jacket. Fully alpaca lined. Zipper and button front. Sizes 36 thru 44... **13.88**

Sent Postpaid if Money Enclosed - C.O.D.'s Sent Charges Collect

**NATIONAL JOBBING CO.**

1703 No. 24th St. Dept. H-3 Omaha, Nebr.

**OFFICERS' PINKS**

Brand new. Fine quality officers' elastic trousers. Sizes 29 thru 42. Reg. \$17.95 value... **11.50**



**NAVY KNIFE**

Brand new. Tempered steel 5 1/4 inch "Parkerized" blade. Laminated leather handle. Complete with sheath. **98c**



Send for FREE CATALOG



# GENIUS at WORK



12" DRILL PRESS



12" BAND SAW

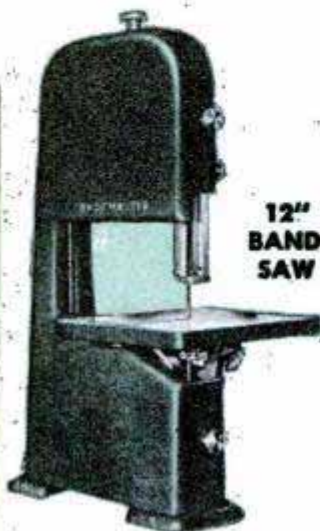

THE ADVANCED DESIGN OF

## SHOPMASTER TOOLS

*gives ease of operation  
with professional results*

Whatever it is you make, a simple stool or an elaborate cabinet, it will contain that indefinable extra craft touch only you can put into it.

Most Americans have this ability to design and make things. They like to work with their hands. They know and take pride in good tools.

Shopmaster Tools have been designed to meet the needs of American craftsmen, both amateur and professional. Expertly engineered to give precise results with ease of operation, they have the rugged construction necessary for long years of service. And, best of all, they are priced within the reach of all.

See Shopmaster Tools at your dealer, or for free catalog, illustrated in full color, write to:

**SHOPMASTER, INC.**

1214 Third St. South, Minneapolis 15, Minn.

LATHE



15" JIG SAW

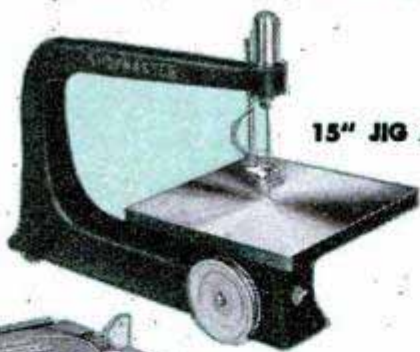

SABER SAW



8" TABLE SAW



6" JOINTER-PLANER

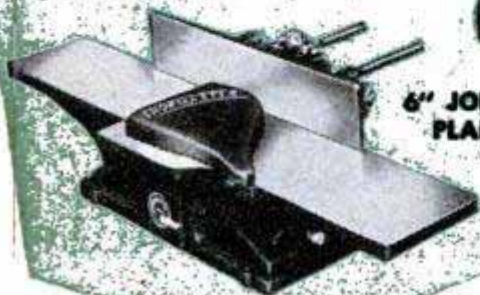

*P.S. Christmas is coming. Leave this ad where the rest of the family can take the hint.*



# ELECTRIFY YOUR SEWING MACHINE

IDEAL GIFT FOR MOTHER  
WIFE OR SISTER

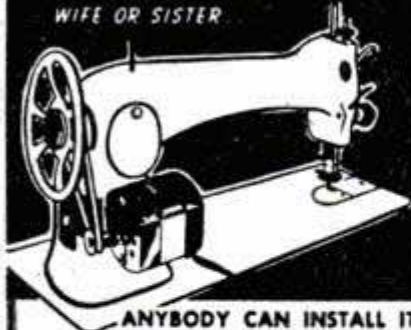

## SEWING MACHINE MOTOR KIT...

90 DAY GUARANTEE  
**\$16.<sup>75</sup>**  
COMPLETE

ANYBODY CAN INSTALL IT!

ADJUSTABLE FOR USE WITH ANY TYPE OF SEWING MACHINE

FULL SATISFACTION OR MONEY BACK

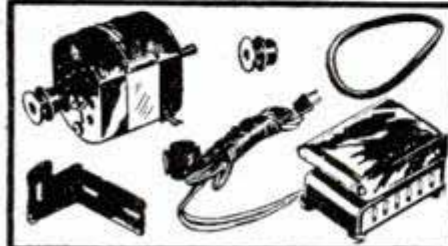

COMPLETE SET CONSISTS OF:

- MOTOR—Fan-Cooled, Universal AC or DC, 60 cycle, 115 volts.
- BELT—Long wearing rubber
- PULLEY—Single grooved steel hubbed pulley.
- BRACKET—New and improved.
- FOOT CONTROL—7 step rheostat.
- CORD SET—Extension cord with plug and socket.
- Installation Instruction Sheet.

### SPECIAL OFFER!

If you send your order within a twenty day period we include a FREE Sewing Machine Light complete with attachment Socket & Light bulb (value \$2.75) with your kit.

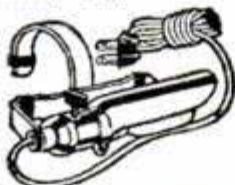

PM-948

**BROWNELL DISTRIBUTORS, INC.**  
308 Canal Street, New York 13, N. Y.

Please rush your kit at \$16.75. The make of my machine is ..... Handwheel turns:  towards me  away from me.

NAME .....

ADDRESS .....

CITY ..... ZONE ..... STATE .....

To save postage and C.O.D. charges, I am enclosing \$16.75 , check , money order . Send C.O.D. I'll pay postman \$16.75 plus C.O.D. fees

# 10,000 miles for \$53.17



All-steel Crosley 2-Door Sedan. Seats 4 huskies with plenty of room for luggage. Over 25,000 now on the road, operating for about 1/2 as much as other cars. Typical owner's report: Joseph Paper, 4663 Pimlico Rd., Baltimore, Md., drove his Crosley 10,000 miles, averaged 47 miles per gallon of gasoline. Total cost \$53.17. Five smart Crosley models to choose from—all with 4-cylinder, liquid cooled COBRA ENGINE.

## CROSLLEY

a FINE car

For beautiful full-color catalog, write: Crosley Motors, Inc., 2532-HQ Spring Grove Ave., Cincinnati 14, Ohio

Home-Workshop Owners

# SHARPEN CIRCULAR SAWS LIKE AN EXPERT

No waiting... no expense... keep circular saw blades sharp and true right in your own workshop. With SURE-SHARP anyone can do expert job on hollow-ground, cross-cut, and combination saw blades. Precision gauge — any pitch or angle! Can't miss in producing perfectly sharpened saw. Fits 6-in. to 12-in. circular saws with 1/2, 3/8 or 1/4-in. centers. Guaranteed!



**\$6.95**

POSTPAID IN U.S. COMPLETE INCL. 1 FILE

Money-Back Guarantee

Order now - soon pays for itself

SURE-SHARP Mfg. Co. BOX 24, SANTA ANA, CALIF

# SHINE WITHOUT 'POLISH'



New Invention! • Sells Like Wild

Replaces messy pastes, liquids. Simply glide over shoes—and PRESTO! — you have a lustrous, long-lasting shine. No mess. No muss. No soiled hands. Clean. Handy. WORKS LIKE MAGIC! For Men's, Women's and Children's Shoes. Low priced. Lightning seller!

SAMPLES FOR AGENTS Sample offer sent immediately to all who send name at once. A penny postal will do. SEND NO MONEY—just your name. KRISTEE CO., 688 Bar Street, AKRON, OHIO

The New Improved All-Purpose

# DYNAMIC Super Charged ARC WELDER Industrial Transformer Type

IT WELDS • IT BRAZES • IT SOLDERS

IDEAL FOR AUTO—HOME APPLIANCE AND FARM REPAIRS. This portable, industrial transformer type welder easily carried right to the job can be operated from any convenient properly wired 110 Volt 60 Cycle Line. Can also be supplied for 220 volt 60 cycle operation and other voltages and cycles at slight additional cost.

EASY-TO-OPERATE. If inexperienced you can easily learn to do a variety of high grade welding jobs by following the practical, simplified Welding and Operating Instructions furnished. Once you see the DYNAMIC WELDER in operation you won't want to be without it. Its simplicity will amaze you. In a year the DYNAMIC only costs you about 7c a day. Comes complete ready to operate with helmet, rods, cables, holder, operating and welding instructions, etc.

SAVES YOU VALUABLE TIME AND MONEY!

DESIGNED TO DO HIGH GRADE WELDING inexpensively—Maintenance Men, Farmers, Mechanics, Machine Shops, Foundries, Auto, General Repair and Job Welding Shops, all using the DYNAMIC find it so indispensable and useful that they can not afford to be without it. Works on Iron, Steel, Brass, Bronze and Other Metals. Has 8 metallic and carbon arc heat stages. Does work you would think only possible with a larger, more expensive machine.

DYNAMIC WELDER CO., 15 East 23rd Street, N, CHICAGO 16, ILL.

ONLY \$2850 COMPLETE

DO YOUR OWN WELDING

Just a few repair jobs will pay for this machine. A practical and profitable machine tool for any workshop. Make money doing repair work for others.

Write for Particulars Get Details on our 10 day Trial Offer Member Chicago Association of Commerce.





# You "PLATE" when you LUBRICATE WITH GRAPHITE!



Whether you apply a graphite powder, a graphite stick, a graphite grease or a graphite oil, an adequate amount of graphite becomes microscopically deposited or "PLATED" on the wearing surfaces!

This lubricating "plate" of graphite stubbornly resists the extremely destructive forces of friction, pressures, speeds, heat, cold and solvents that decompose or displace ordinary lubricants. You'll be amazed at how much

more effectively the plating action in *Graphite Lubrication* reduces wear, saves lubricant and labor.

There is a ready-to-apply GRAPHITE "PLATING" LUBRICANT for nearly every use in every home, industry, auto, boat, railroad, airplane etc. Illustrated here is one typical product of each of these four types of Dixon's Graphite Plating Lubricants stocked by the nation's supply houses.

**POWDER**  
Dixon's Graph-Air Gun,  
Type 4... 40¢



**STICK**  
Dixon's Slipstik  
20¢

**GREASE**  
Dixon's Cup Grease  
No. 3... 60¢ 1 lb. can



**OIL—Dixon's**  
Lubricating &  
Penetrating  
Oil... 30¢



## DIXON'S GRAPHITES

JOSEPH DIXON CRUCIBLE COMPANY JERSEY CITY 3, N. J.  
DIVISION 26-KP-9

MAILED FREE for the asking—this Data Sheet Directory shows what free descriptive printed matter is available on 20 Dixon Lubricating "Plating" Graphites.

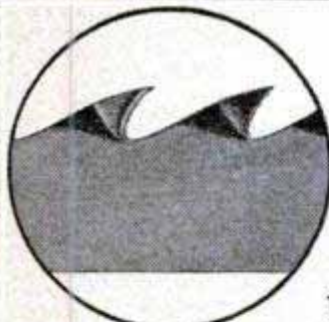

## Eclipse HARLEDGE Woodcutting BANDSAW

Lasts five times as long.  
Priced no more than other

saws.  
Only the tooth is hardened. The rest of the blade is left soft and flexible (it can be tied in a small knot!)  
Pays for itself by eliminating resharpener and brazing costs.

Send for literature and price lists.

**ALWOOD Company Not Inc.**  
2035 Charleston St. Chicago 47, Illinois

## DRESS UP YOUR CAR WITH Ace FENDER PANTS

Install these "heavy steel" prime finished fender skirts yourself—and pocket a "substantial savings."—Your car will have that "new look!" Hooks on in a jiffy to any 1935 to 1949 model of the cars listed at the right. Enclose money order—save freight—or order C.O.D., freight collect. Specify car make, year and model.

DEALERS WANTED  
**ACE AUTO PRODUCTS**  
Dept. PM-8, P. O. Box 366,  
Huntington Park, Calif.



Order by Mail \$16<sup>95</sup>

FORD OLDSMOBILE BUICK  
MERCURY CHRYSLER DODGE  
DE SOTO PLYMOUTH FRAZER  
PONTIAC CHEVROLET KAISER

## HANDY DUMP TRAILER!

Especially for your fall garden clean-up!

# Garden-All

LAWN and GARDEN TRACTOR



Write for Folder

All-steel welded and reinforced; 10-gauge 12" x 22" x 42" removable body; sliding end gate; adjustable seat; Self-aligning brakes.

Capable of hauling 1000 lbs.



Garden-All's Dump Trailer is so handy for hauling equipment to and from your garden. Or for leaves, brush, cut grass, manure or dirt. The body tilts to any angle desired. Remove the body, install the riding seat, and you have a riding sulky to use with Garden-All's sickle bar or lawn

mower. Chassis constructed of electrically welded tubing; 1-inch axle with roller bearings; 2 ply 4.00 x 8 tires. See all other Garden-All attachments too!

## GARDEN-ALL TRACTOR, INC.

Dept. P, 110 W. UNION STREET, LIBERTY, INDIANA



# THE BULL BUFFER

PAT. PEND.

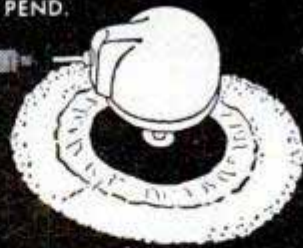
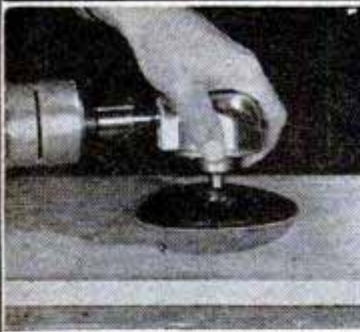

You polish and sand faster, easier — do beautiful, professional work—with this amazing new attachment for your hand drill. And it more than pays for itself the very first time you polish and sand your car, floors, woodwork, furniture. The Bull Buffer fits any chuck on an electric drill

(or flexible shaft). It's the only buffer you can turn in a complete circle while you hold your hand drill stationary. Reaches all curved and flat surfaces. It's packed with power, built of lifetime materials and guaranteed.

If your dealer doesn't stock, send cash, check, or money order for your Bull Buffer, complete as pictured below..... **\$9.95**

## ORDER THESE ACCESSORIES FOR YOUR BULL BUFFER:



Cup wire brush attachment from that hard-to-scrape surface. **\$1.75**

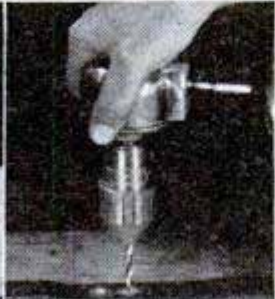

Jacobs key chuck increases 1/4" drill to 1/2" capacity—reduces speed, increases power. **\$5.00**

- Bull Buffer car cleaner ..... **\$ .50**
- Bull Buffer car polish ..... **1.00**
- Extra sheepskin bonnet ..... **1.25**
- Extra sanding discs (000-00-0-1-2 1/2-3-4) .. **.10**
- 1/2" Jacobs No. 6425 key chuck (see photo) .. **5.00**
- 2 1/2" cup wire brush (see photo) ..... **1.75**

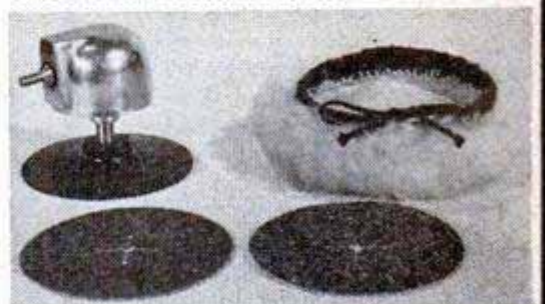

Bull Buffer comes complete with 5-inch rubber disc, sheepskin bonnet, and 2 sanding discs, only **\$9.95**.

# BERTRAM E. ENGINEERING COMPANY

3121 MAIN ST.

Dealers write for information

KANSAS CITY, MO.

## V-8 VALVE JOBS MADE EASY!

with *Johnson* ADJUSTABLE TAPPETS



Provide accurate adjustment and quiet performance for Ford and Mercury V-8 engines.

Save money! Make tappet installations yourself.

No expensive shop tools needed.

Complete instructions with each set of tappets.

Adjustments easily made to proper clearance and maintained for many thousands of miles.

SEE YOUR JOBBER OR WRITE DIRECT TODAY

*Johnson* PRODUCTS INC.  
MUSKEGON, MICHIGAN

"Tappets Are Our Business"

## MORE POWERFUL PORTABLE

# BENCH GRINDER-\$13.50

DELIVERED

FULL 1/12 H.P. MOTOR AT 3450 R.P.M. BY DYNAMOMETER TEST

With adjustable tool rests and removable cast wheel guards for buffing. Diamond-trueed 4" x 1/2" coarse and fine wheels . . . dust proof bearings . . . off-on switch . . . 6 ft. rubber cord . . . baked hammertone finish . . . 110-120 volts a.c., 60 cycle . . . guaranteed one year against defective workmanship or materials. Send check or money order, we prepay postage.

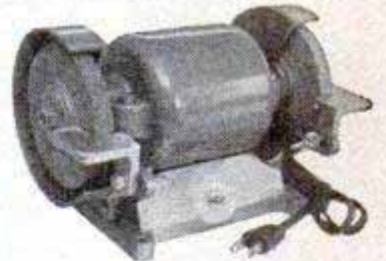

ALHAMBRA PRODUCTS, BOX 328, ALHAMBRA, CALIF.

# HOLD-E-ZEE

AUTOMATIC GRIP SCREW-DRIVERS

UNSURPASSED QUALITY

Plus the EXCLUSIVE GRIPPER



Gripper slides up out of way when not in use. Insulating handles. Complete range of sizes. AT LEADING DEALERS EVERYWHERE

UPSON BROS., INC., 85 EXCHANGE ST., ROCHESTER 4, N. Y.



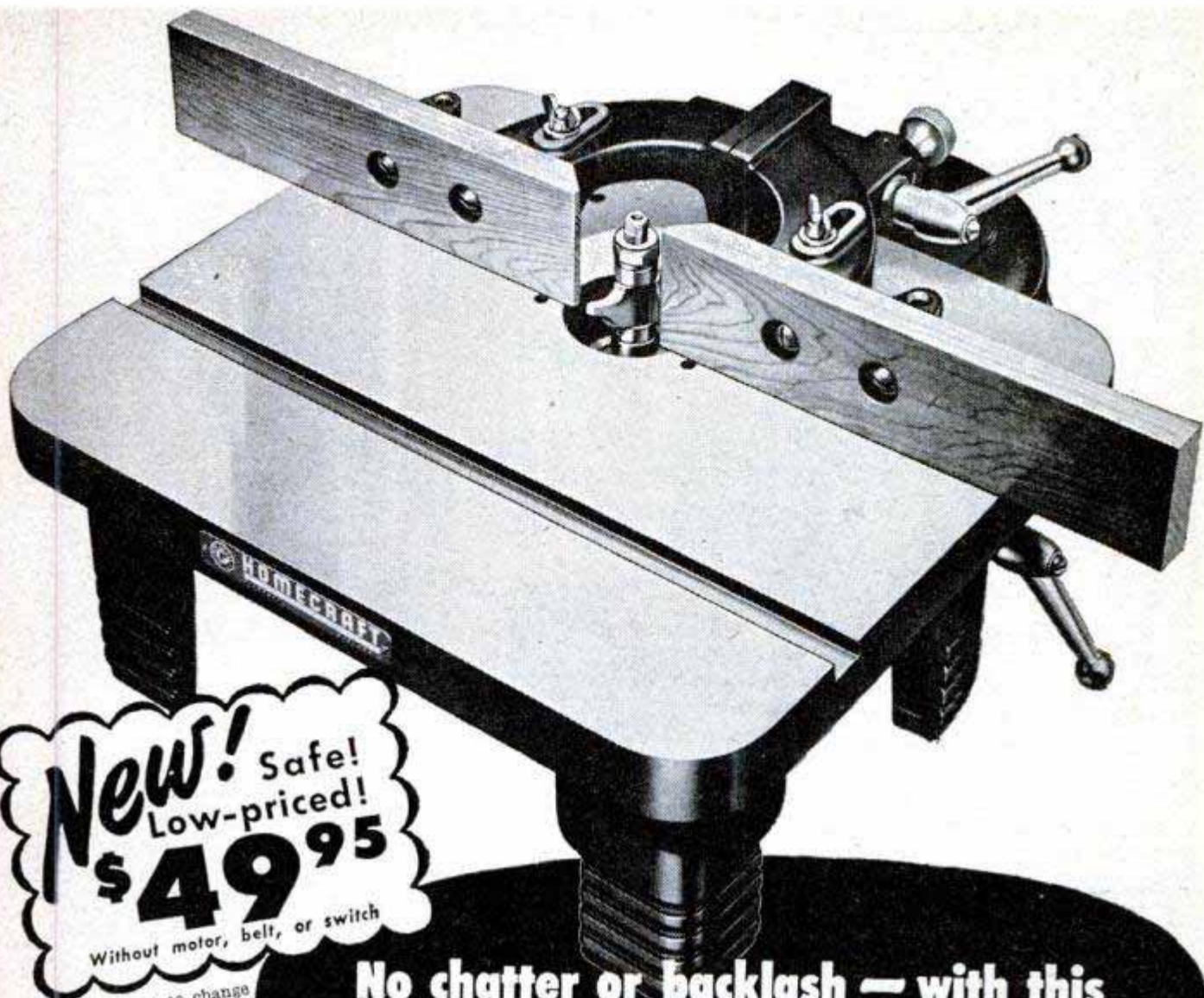

**New! Safe!**  
**Low-priced!**  
**\$49.95**  
 Without motor, belt, or switch

Price subject to change without notice.

**No chatter or backlash — with this**  
**HOMECRAFT® SHAPER**

**No. 43-110**

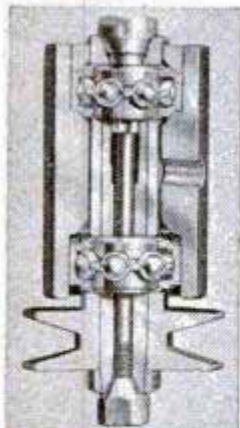

Short, stiff spindle runs in closely-spaced ball bearings that are lubricated for life. This cuts out whip and helps prevent chatter.

This Homecraft Shaper is "made to order" for you, the hobbyist. It is low in price. You don't pay for size and weight you don't need. But — features like these add up to a lot of shaper for the money:

- The spindles — 5/16" and 1/2" in diameter — can be interchanged. Thus, you can use a wide variety of cutters. You can make cope and reverse moulding, sash mouldings, door mouldings, brick moulds, base moulds, edges for cabinet work, etc.
- Fence is 25 1/4" long, when fully extended. For safety, you can adjust cutter-opening to cutter size.
- Big, heavily-ribbed 15 1/2" x 18" table is finish-ground, for accuracy.

- Belt and motor pulley and spindle pulley are completely guarded.
- Shaper runs at 9,000 r.p.m. — for smooth, clean work — and can be reversed.

Ask your Homecraft dealer to show you this No. 43-110 shaper, and his complete display of Homecraft Power Tools that range in price from \$9.80 to \$49.95. Visit him now!

**HOMECRAFT®**  
**POWER TOOLS**

General Sales Office — Chicago 2, Illinois

**TEAR OUT COUPON AND MAIL TODAY!**

**HOMECRAFT POWER TOOLS**

are built by the makers of Delta-Milwaukee® Power and Machine Tools — the tools with a widespread reputation for safety, accuracy, and dependability, in factories and schools, as well as thousands of home shops. If your goal is a shop equipped with power tools that embody the most advanced principles of engineering, design, and construction, then insist on Delta-Milwaukee Power Tools.

Send **10¢**



— for woodwork- ing handbook and catalog of Home- craft Power Tools. It's your guide to hobby happiness!



**DELTA MANUFACTURING DIVISION**  
 Rockwell Manufacturing Company  
 681K E. Vienna Ave., Milwaukee 1, Wis.  
 Enclosed is 10c. Send me copy of new Homecraft Catalog HC-1.

Name.....

Address.....

City..... State.....

HM-60



**It's Wise To Go**  
**WHIZZER**  
 America's Thriftiest Power Transportation



With all necessary attachments  
**\$109.97**  
 Fed. Tax Incl.  
 F. O. B.  
 Pontiac, Mich.

Save money every day with the new '48 Whizzer Bike Motor—ride 5 miles for a penny. Precision made in every part . . . Twist-Grip controls . . . steel cable core notched V-belt drive . . . Quick-Start ignition . . . auto-type carburetor . . . 4-cycle design . . . deluxe chrome trim . . . 2½ rugged horsepower. It's America's finest bike motor!  
**RIDE ONE AND YOU'LL BUY ONE!**

See your Whizzer Dealer—or write Whizzer Motor Co., Pontiac, Mich. For 10 years—world's largest bike motor builder.

**BUILD IT, FIX IT**  
 WITH  
**AMBROID**

**"IT STAYS STUCK!"**

For a quick job with permanent results use multi purpose, fast drying Ambroid liquid cement. For home workshop, household or factory. A quality leader for 38 years. Ready-to-use Ambroid is waterproof, transparent, quick drying, extra strong, flexible, heat and corrosion resistant. For assembling, repairing or mending jobs, keep Ambroid handy. At your dealer's or send 25c for a big 2 oz. tube postpaid. Money back guarantee.

Also 50¢ 4-oz. tube. Pts., qts., gals., for industrial use.



303 Franklin St., Boston 10, Mass.

**BRAND NEW SURPLUS BARGAINS**

**New Precision Bilt MICROMETERS**

- Chrome finished nationally known makes. Gives a lifetime of accurate detailed service. Individually boxed.
- |                     |       |        |
|---------------------|-------|--------|
| 1" Central          | ..... | \$3.50 |
| 1" Central, Tubular | ..... | 3.75   |
| 1" Reed             | ..... | 4.00   |
| 2" Central          | ..... | 4.95   |
| 2" Reed             | ..... | 5.25   |
| 4" Central          | ..... | 6.25   |
| 5" Reed             | ..... | 7.25   |
| 6" Central          | ..... | 7.75   |

**WINDSHIELD WIPER KIT**

Complete with Wiper, wiper bracket and blade. 1/6 HP 24 V DC motor, 5,000 reverse or 10,000 forward RPM. With flexible shaft. Only.....



**\$6.95**

**REAL FIRE PROTECTION! War Surplus Bargain—New, Unused FIRE EXTINGUISHERS**



Approved by Underwriters. 1 gal. capacity fully charged, ready to use. Anyone can operate them. Carbon-tetrachloride is non-conductor—will not freeze; stored pressurized type shoots 40 foot stream; height 23", diameter 5"; anyone can use them. Ideal for home, office, garage, boats, workshop, summer cabins, etc.

**\$14.95**

Lists for approx. \$65.00. Our price

Prices FOB, Kansas City, Mo. No COD's.

Write for our new Catalog

**ATLAS EQUIPMENT & SALVAGE CO.**

229 S. W. Blvd.

Kansas City, Mo.

**CUBIC-INCHER RADIO SET \$2.39**  
 SIGNAL-POWERED  
 NO ELECTRICITY



Entire set less than one cubic inch in size, rests in bowl of teaspoon! Radar IN34 detector, world's best for crystal sets. Works anywhere—never wears out—costs nothing to operate. Safe and foolproof. Reception is guaranteed. With connecting leads and complete directions. \$2.39 postpaid without phone. \$3.19 postpaid with phone. Foreign orders 10% extra, prepaid only.

Dept. M-4, Box 1308 Chicago 90, Ill.

**SHEEPSKIN LEATHER JACKET**



NAVY J4 FLYING TYPE—SIZES 36-46—CONVERTED. Now you can get a WELL TAILORED, LONGER LASTING, WARM jacket at absolute minimum cost because you are buying direct from the Manufacturer. Check These Special Features: Length 27", Mouton Collar, By-awing Sleeve, Full Cut, heavy-duty Taison Zipper, Double Lined Leather Cuffs and Wristlets, Extra Leather Reinforcement on Top Sleeve, Leather Windbreaker.

Take advantage of this amazing value now! Complete Money Back Guarantee if not satisfied. **\$18.95**

Renovate Your Jacket Lengthen the life of your leather jackets at manufacturer's wholesale rates. Send for FREE descriptive circular and price list today.

Prepaid orders shipped postage free. C.O.D. orders — you pay postage.

Berlew Mfg. Co., Inc. Dept. M Merrick, New York

**5,000,000 FEET OF LUMBER @ \$35 per M. B. M.**

One man did it. You can too, with a BELSAW All-Purpose Sawmill. Replace or repair farm buildings with your own well-finished, low-cost lumber. Portable BELSAW goes to the trees, brings back ALL the lumber for ALL your buildings . . . boards, joists, lath, shingles.

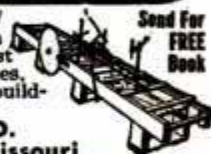

811-H BELSAW MACHINERY CO.

315 Westport Road, Kansas City, Missouri

**SAY YOU SAW IT IN POPULAR MECHANICS**

**SHATTERPROOF "ALL PURPOSE" STEEL BOTTLE**

HAS HUNDREDS OF USES —FOR STORING LIQUIDS, GASES, etc. WILL TAKE UP TO 500 lbs. PRESSURE. MAY BE USED FOR INFLATING TIRES, etc.



Formerly used by AAF for oxygen storage! You can use it now as an air pressure tank for inflating tires, operating horns, air motors, etc. May also be used as a buoy or float or for water supply storage on boats, trailers and trucks. Ideal as shipping container for gases, chemicals, etc. Bottle is non-shatterable with working pressure up to 500 lbs. psi. and weighs only 3 lbs. when empty. Internal volume 500 cu. in. (approx. 9 qts.). Has 3/8 in. pipe thread at each end. Approx. size 24x8 in. They won't last long at this low price. Guaranteed brand new. Order now!

REGULAR STEEL, EA.

**\$2.95**

Stainless Ea. \$3.95

FOB Houston. Mail orders promptly filled. Send check or money order. Satisfaction guaranteed.

**AERO PARTS SUPPLY, Dept. PM-9 MUNICIPAL AIRPORT HOUSTON 17, TEXAS**



# "DANGDEST THING YOU EVER SAW!"

## Flex-O-Pic

An Amazing Convenience around  
AUTOS  
RADIO SHOPS  
AIRPLANES  
BOATS  
ALL HOME WORKSHOPS

**A Specialty Tool for HARD-TO-REACH PARTS AND PLACES**

Specially invented for tricky service jobs. Expanding and retracting fingers in flexible housing reach in anywhere and grab hold of anything. Works around corners, S-turns, etc. 100 different uses around the home or shop. Mother will like it too. Try it on a 5-day money-back guarantee. Send name and address for C.O.D. delivery, or send \$1.00 now, and we ship prepaid. Descriptive circular free.

**NOW ONLY \$1.00**

### DEALERS:

This is a terrific item! Write for complete details.

**EMCO ENTERPRISES, Inc.**

6750 Stony Island Dept. PM-9 Chicago 49, Ill.

## SAVE OIL... SAVE MONEY ADD COMFORT

An A-P AUTOMATIC Temperature Control Set on your present Oil Burning Heater can save up to 10% on oil consumption. Provides more healthful, comfortable, steadier room temperatures — at the mere touch of a Thermostat dial. Easy to install.

At better dealers everywhere — or for immediate delivery ORDER DIRECT! (Give Heater name and control model number.) ONLY \$22.97 prepaid.

"Pays for itself in Savings." For FREE Booklet "3 Times More Comfort" write



**AUTOMATIC PRODUCTS CO.**

2522 N. 32nd Street, Milwaukee 10, Wisconsin

## BENCH GRINDER OR BUFFER



Life Time Sealed Ball Bearings. Base Constructed to Rest Firmly Without Bolting. Stone Guards May Be Removed For Use As Polishing Head. Tool Rests May Be Raised or Lowered—Used On Face or Side of Stone. 6" x 1" x 1/2" Grinding Stones—Can Be Used Until Worn to 2". Conveniently Located Toggle Switch.

13" Between Grinding Wheels for More Versatility. Base Drilled for Permanent Mounting if Desired. Bearings and Stones are Standard—May Be Purchased at Your Hardware or Automotive Stores. Can Be Purchased Complete with 1/3 H. P. Motor and Grinding Wheels. \$45.45.

Or Less Motor and Grinding Wheels. \$18.95. NOT A TOY—Suitable for Use in Hobby Shops or in Any Place Where a Heavy Grinder or Buffer is Required. Send for free Booklet Number 22-A. Immediate Delivery.

**MODERN MANUFACTURING CO.**

160 N. FAIR OAKS AVE. PASADENA 7, CALIF.

## U-BUILD-IT TRAILER COMPANY

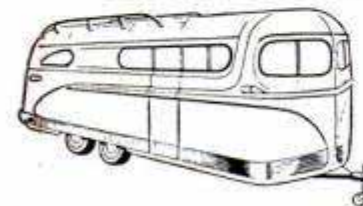

supplies all parts to size for quick, easy assembly of complete metal trailer body—Roof Caps, Roof Bows, Doors, Complete Chassis, Roof Corners, Roof Ends. Build this modern

streamlined design economically yourself.

*Write*

for complete working plans showing detailed construction, location of parts for 12 ft., 16 ft., 20 ft., 24 ft. and 28 ft. lengths. Only \$100

U-BUILD-IT Trailer Co.

Dept. B P.O. Box 611 Elkhart, Ind.



## OWN YOUR BUSINESS

### Start in Spare Time with a FOLEY SAW FILER

Here is a steady repeat CASH business you can start at home in your basement or garage, while you are working at your regular job. No experience is necessary to turn out perfect cutting saws—"the first saw I sharpened came out 100%. I think the Foley Saw Filer is a marvel of perfection," writes C.E.P. Every saw you sharpen will bring you new customers. You will find you can make up to \$2 or \$3 an hour—\$20 to \$30 a week in your spare time as a starter.

With a Foley Saw Filer you can file all hand saws, also band and cross-cut circular saws. It is easy to operate—simple adjustments—no eye-strain. Patented jointing principle evens up all irregular teeth and make an old saw cut just like new.

### This Free Book Shows How to Start

"INDEPENDENCE AFTER 40!" shows you how to get plenty of saws to file without canvassing, and how you can develop into a general repair shop that will be your own business. This is a helpful, practical book that tells just what to do—send for your free copy today.



### Send For FREE BOOK

FOLEY MFG. CO., 916-8 Foley Bldg., Minneapolis 18, Minn.

Send me free book "INDEPENDENCE AFTER 40!"

Name \_\_\_\_\_

Address \_\_\_\_\_



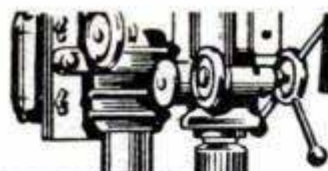

**NEW!**

**HANDY, FLEXIBLE SHAFT**

**Converts Any Motor, Drill Press, Electric Drill, Electric Fan Into A Handy Rotary Tool**

Attach ROTA-SHAFT in a Jiffy. Can Be Used for Grinding, Polishing, Sharpening, Cleaning, Engraving, Marking Tools, Carving, On Metal, Plastic, Wood, Glass.

Yes! Only \$2.95 and ROTA-SHAFT turns your old motor, drill press, electric drill or electric fan (10 inch or larger) with blades removed, into an efficient, versatile Flexible Shaft Tool for doing hundreds of grinding, polishing, sharpening jobs, especially in hard-to-get-at places. Attaches to motor shaft or in chuck. Convenient handpiece for ease of handling. Generous 40-inch overall length. Comes complete with buff and sanding disc ready to use in a drill press chuck. Order today.



**ONLY \$2.95**

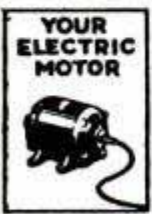

**SEND NO MONEY!** Just mail order. Pay postman only \$2.95 plus postage on delivery, or send \$2.95 and we pay postage. Try 10 Days — if not delighted return for money-back.

If you order Rota-Shaft for use on motor add 35c for Special Coupling and State Shaft Diameter. **MAIL ORDER NOW!**

**STRADER PRODUCTS CO., Dept. E-101**  
259 Strader Ave. Cincinnati 26, Ohio

**A New Star!**

**Multi-Purpose Tool for ALL Craftsmen**

**FOR HOME WORKSHOP OR PROFESSIONAL USE**

**Economy JIG & VISE**



Thousands of uses for this NEW, EXCLUSIVE Multi-Purpose Vise and Jig. For use with drill press or hand drill on plastic, wood or metal. Self Centering Cones Hold Work to 1-3/16" for drilling. A "must" for hobbyists, refrigerator, plumbing, radio men, etc. Fully Guaranteed. At better dealers or order direct. Descriptive literature free.

**\$5.95**

**ORDER TODAY**  
**ECONOMY VALVE SEAT COMPANY**  
3122 N. California Ave., Chicago 18, Ill.

**MOTOR BARGAIN**

1/30 HP 24 volt DC motor 2450 R.P.M. .95 amps 1/4" shaft size overall 3" x 4". Weight 3 lbs. **\$2.45**

**USE AS 6 VOLT GENERATOR**—Generate your own D.C. can be operated on your bicycle wheel. Furnishes sufficient power for two 6 volt bulbs. Resistor furnished free with each motor enables you to maintain constant voltage. Special Price \$2.45, or 4 for \$7.50. Lots of 24 for \$36.00. Prices are F.O.B. Chicago. Immediate delivery. Send check or money order today. Sold on money back guarantee.

**C & M EQUIPMENT CO.** 1631 S. State St., Dept. D-9 Chicago 16, Ill.

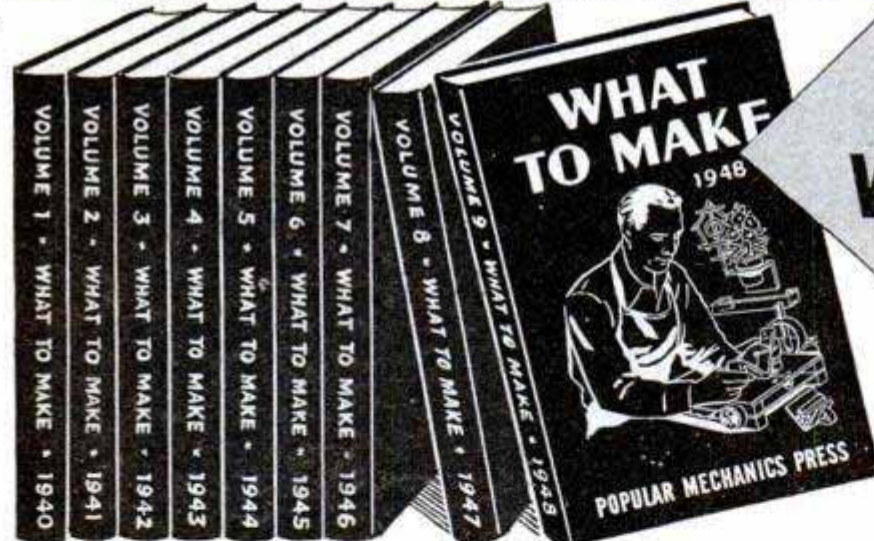

**OUR 1948 WHAT TO MAKE**

Send for your copy of this new 1948 clothbound edition now! Keep your set up-to-date. This volume contains 240 pages of wonderful projects every craftsman can easily make at home. Contains the best articles that have appeared in the Popular Mechanics "Craftsman Department."

**POPULAR MECHANICS HOME WORKSHOP AND HOBBY GUIDE**

If you do not have the earlier volumes of this useful series you are missing a wonderful source of inspiration for making thousands of fascinating things. Every book is completely different from the others. You do not have to be an expert to turn out practical and attractive articles that will amaze your family and friends if you let a What To Make Book be your guide. Here are a few of the thousands of subjects covered: Birdhouses, sideboards, benches, furniture, book ends, chairs, toys, games, photo equipment, Dutch windmill, leathercraft, book-binding, ship and yacht models, reclining chairs, fruit baskets, bobsled, hamper, garden furniture, log cabins, porch furniture, tables, hostess trays, footstools, desks, lamps, fireplace screens, bookcases, wall cabinets, glass furniture, gem cutting, wood carving, archery, quilting frame, miniature gardens, weather vanes, greenhouse, doghouses, sundials, turned bowls, pier cabinets, coffee tables, clocks, jig-sawed novelties, skate sails, closet fittings, storm sash and doors, hose and shoe cabinet, cabinet for phonograph set, looms, raffia work, Christmas cards, lapelleras, water skis, picture frames, toboggan, playhouse, dollhouse, glass decorations, lighting fixtures, fireplaces, home modernization, etc.

**MAIL COUPON**

Postage paid if remittance accompanies order. Outside U.S.A. 15% additional.

**POPULAR MECHANICS PRESS**  
200 E. Ontario St., Chicago 11, Ill.

Please send What To Make Books as checked below. I will pay postman price and few cents postage. It is understood my money will be refunded if I'm not satisfied.

What To Make Vol. 9 . . . . . \$1.75  
 What To Make Library (9 vols.) . . . . . \$14.00

Name \_\_\_\_\_  
Street and No. \_\_\_\_\_  
City \_\_\_\_\_ Zone \_\_\_\_\_ State \_\_\_\_\_

**LIBRARY CLOTH BINDING . . . . . Single volumes \$1.75, 9 volume set only \$14.00**



# WAR SURPLUS AND OTHER BARGAINS

## RETRACTING ACTUATOR UNIT

Mfd. to actuate Flying Fort bomb bay doors. 40 to 1 Gear Ratio. Shaft RPM: 95. 24 Volts D.C. Reversible Motor. Lifts heavy loads, depending on size of pulley. 4 1/2" diameter mounting flange. In great demand for powering farm hoists, heavy garage doors, turntables, directional antenna systems, motion advertising display units, hauling fish nets and for scores of other uses requiring power at low speed. Pays for itself over and over in saving hard manual labor. Illustration shows offset type. Also available in straight line type with 110 Shaft RPM. Original Gov't acquisition cost \$300. All new \$27.50 each. Shipping Wgt. 20 lbs.

**TRANSFORMER:** Jefferson Electric step up or step down transformer. Input, primary 110-117 Volts A.C. Output, from 5 Volts to 650 Volts. Suitable for use with war surplus gadgets, heater relays, radio test filaments, electric trains, house chimes, etc. Weight 10 lbs. New \$7.95 Each.

### 25% DEPOSIT REQUIRED ON C.O.D. ORDERS

**SCOOP!**  
We have been awarded 100,000 fancy briar pipes by Quartermaster Corps. Assorted shapes and sizes. All popular makes. Buy now for Christmas Gifts. Set of 6, \$3.50

**MICROMETER**  
Chrome plated, precision engineered and carefully tooled to give long life... all new. 0-1" capacity, \$2.25. 1-2" capacity, \$3.50 Each.

**COOLER or HEATER:**  
For trailers, autos, offices, darkrooms, homes. DUMORE Motor, 1/6 cont. HP, Amperage 7.5, RPM 6400, 24 Volts. May also be used as dryer. Simple installation, radiator type, copper coils. Transformer advertised in this ad will operate this unit from house current. Weight 13 lbs. New, \$15.00

### SEND CHECK, MONEY ORDER or CASH

**VOLTAGE REGULATOR**  
Like new. 24 V. Carbon Pyle Type, Eclipse, Westinghouse or Leece Neville Mfr. Weight 2 1/2 lbs. \$5.50 each.

**MICROSWITCH:**  
Type Z - 2" x 1" x 1/4". Used open or closed. For automatic contacting-light, sound, model train systems, chimes, etc. New. 3 for \$1. Aluminum Spring Actuator to fit above Microswitch 3 for \$1.

### WILLARD WET PLATE BATTERY

This extra long life rechargeable battery is ideal for portable radios, mobile units, bell circuits, alarm systems, rural telephones, Strobe bulbs, etc. 2 V 20 Amps. Only 5" high. Visible ball float hydrometer built in Lucite case. Shipped dry. Any battery service will supply standard battery electrolyte. Used singly or in multiples. Shipping Wgt. 3 1/2 lbs. All new. \$2.75 each

### ALL PRICES F.O.B. CULVER CITY, CALIF.

**WEATHERSTRIPPING ADHESIVE FELT—**  
Dutch Brand, made by Van Cleef Bros. 3/4" wide, 3/16" thick. Adheres with strong grip to any surface in any climate. No nailing required. 101 different uses, in aircraft, autos, boats, trailers, etc. Linen backed. 50 Ft. rolls \$1.50 per roll

**CONDUIT WRENCH:** Mfd. by JOAR. Jaws pass over conduit, pipe or tubing, slips down to snugly encircle fittings. Slight pressure tightens or loosens fittings. Will not mar or kink material. Set of 8. All new wrenches, Nos. 4-6-7-8-10-14-22-28, (Reg. cost \$50.00), \$10.00 per set. Weight 4 lbs.

**CLAMPS:** Rubber lined, aluminum, hundreds of uses in any shop. Assorted sizes, all new. 5 Doz. \$1. - 500 \$5.

## AIRBORNE SALES CO., INC. DEPT. PM 9-8 CULVER CITY, CALIF.

SAY YOU SAW IT IN POPULAR MECHANICS



How a Tube of TIP-TOP LIQUID SOLDER Saved a Ten-Mile Walk!

"Recently, I drove 10 miles back in the deep woods on a squirrel hunt. I discovered a leak in my gas tank. All my gas was gone except about a gallon. I plugged the hole with Tip-Top Liquid Solder and saved a 10 mile walk."  
Mr. J. T. M. — Alabama

Tip-Top licks hundreds of mending problems, saves you big money on repair bills. This amazing Liquid Solder forms a perfect joint in metal, wood, glass... almost any material. Tip-Top is water, oil, and gasoline proof... has outstanding adhesive properties.

Keep a tube handy on your work bench, in the kitchen, and in your car for emergency repairs. Buy Tip-Top at your hardware dealer today or write Tip-Top Products, Omaha, Nebraska. Insist on Tip-Top, the original and superior Liquid Solder.



## MULTI-PURPOSE



## FLOODLAMPS HERE AT LAST

A REVOLUTIONARY Floodlamp with 1001 uses. Clamps on anywhere. For photographers, craftsmen, painters, mechanics. For use in home or outdoor lighting. Use as sun lamp or for drying purposes with infra-red bulb. OUTSTANDING FEATURES—Brilliant 9" aluminum reflector, nickled push socket, rubber covered spring clamp with ball swivel—adjusts to any angle, molded plug with 20' of rubber cord. 660W—250V. Save 50%—buy direct from factory. Send only \$2.49... We'll pay postage. C.O.D.'s accepted. Quality guaranteed.

SONELCO PRODUCTS CO., DEPT. 1A AKRON 3, OHIO

## ALLISON END PLATES

ADAPTER PLATES—To convert Allison engines to direct drive. \$95.00 Each  
ALLISON EXHAUST STACKS—P-38 model. \$95.00 Per Set  
All new—heavy duty—stainless steel. Shipped to Continental U.S.A. prepaid.  
GROSSO AND GROSSO  
5509 Klump Street North Hollywood, Calif.

## AUTO ENGINE SPEED CONTROL GOVERNORS



In Montreal, 7546 Wiseman; in Skaneateles, N. Y., Horle Welding Supply.

**Agents Wanted**  
CANDEE-SMITH GOVERNORS  
2641 S. Hill St., Los Angeles 7, Calif.

## ASSEMBLE YOUR OWN BOAT

FROM PRE-CUT AND PRE-ASSEMBLED PARTS  
Save 50% — Build from our complete, easy-to-assemble Plywood Kits. 16 Models to choose from, all parts pre-cut, frames pre-assembled. Finest designs (8 to 18 ft.)—Exclusive features—Outstanding performance.  
8 ft. Dinghy \$34.50  
14 ft. Super-Deluxe \$128 \$34.50 up.  
SEND 25c (COIN) FOR ILLUSTRATED LITERATURE.  
MARINE MART, BUFFALO 7-B, NEW YORK







SWIVEL  
JAW

**NEW!**

SEYMOUR SMITH  
**Snap-Lock**  
PLIER-WRENCH

**3**  
NEW  
Features

1. Swivel Jaw holds odd-shaped pieces.
2. Capacity Indicator pre-sets jaw spread.
3. Release unlocks jaws instantly by a touch of the finger.

Tremendous grip. Use as a plier or, when locked closed, for holding articles to be drilled, welded, ground, etc. 1000's of uses around home, farm, garage, shop. No. 2607, 7", \$1.75; No. 2610, 10", \$2.25. At your dealer or write direct. Free circular.

CAPACITY  
INDICATOR



INSTANT  
LOCK  
RELEASE

SEYMOUR SMITH & SON, INC.  
900M Main St., Oakville, Conn.

**SPECIAL OFFER! SAVE 1/2**  
**PORTABLE AIR COMPRESSOR**  
**SPRAY PAINTING OUTFIT**

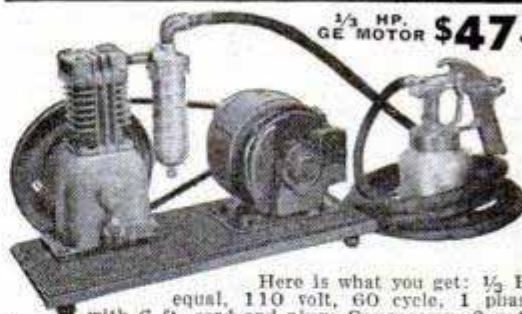

1/2 HP. GE MOTOR \$47.50 COMPLETE LESS BASE

2.8 C. F. M.  
Displacement  
Compact  
Power Plus

Complete as shown, less base

Here is what you get: 1/2 HP. GE motor or equal, 110 volt, 60 cycle, 1 phase, 1750 RPM, with 6 ft. cord and plug; Compressor, 2 x 1 3/4 piston type; Spray gun with qt. cup, 2 nozzles, round-fan spray, oil and water trap, 20 ft. hose and fittings; belt and pulley. All bolts necessary for mounting on base. We pass the big saving in labor on to you. All you have to do is mount on base as shown. Complete operating instructions furnished. Weight 50 lbs. Special Price..... **\$47.50**

**ALSO SOLD SEPARATELY:**

Spray Gun, 2 nozzles, 20 ft. hose, weight 6 lbs..... \$ 9.45  
Air Compressor with oil and water trap, weight 15 lbs. 19.95  
1/2 H.P. G.E. Motor, weight 26 lbs..... 14.50  
PRICES ARE F.O.B. CHICAGO. Immediate delivery. **SOLD ON MONEY BACK GUARANTEE.** Send check or money order today. **WRITE FOR FREE FOLDER.**

C & M EQUIPMENT COMPANY 1831 S. State St., Dept. D-9, Chicago 16, Ill.

**BUILD and ENJOY YOUR OWN BOAT!**



ASSEMBLED IN  
8 HOURS

WITH A  
**Plywood Boat Kit**

LIGHTWEIGHT, 12-FOOT LONG

**ONLY \$54.00**  
(Freight paid)

READY CUT — needs no forms nor special tools to assemble. Kit includes all hardware, paint, etc. (less oars). Send for Free Folder

Taft Marine Woodcraft

Dept. M, 636 39th Ave. N.E. Minneapolis 18, Minn.

Make your **STOP LIGHT SHOUT!**



**AMAZING STOP LIGHT FLASHER!**

Makes Your Stop Light Flash 115 Times Per Min. A SENSATION! Automatic. Instant acting when foot brake applied. Non-rusting. Dust, Oil, Vapor and Waterproof. Used by police and fire depts. Attach in 5 min. to any model car or truck. Approved by leading safety engineers.

FREE WITH ORDER. "HOW TO SAVE MONEY ON CAR 'Motoring Hints' BOOKLET." ACT NOW! If dealer can't supply send \$3.00 cash or M.O. We pay postage.

MACCHI & CO., Dept. MS  
927 Larkin St., San Francisco, Calif.  
DEALERS AND AGENTS WANTED

**BUILD YOUR POWER TOOLS**

WITH OUR GUARANTEED INDUSTRIAL  
**POLY BALL BEARING ARBORS**  
New Departure Self Lubricating Bearings 10,000 R.P.M.



(No extra charge for left hand threads)  
C4-1/2x12 1/2 spindle, housing 2x8 \$7.95 PP.  
C5-5/8x12 1/2 spindle, housing 2x8 \$9.25 PP.  
C6-3/4x12 1/2 spindle, housing 2 1/2x8 \$9.25 PP.  
D8-1x17 1/2 spindle, housing 2 1/2x11 \$17.00 PP.  
\$3.50 PP. 1 INCH BETWEEN WASHER AND COLLAR  
SHAPER ARBORS 3 inches between collars. C4-1 1/2 \$14.25, C5-5/8 \$14.25, C6-3/4 \$15.25, D8-1 \$23.00. B25-1 1/2x2" cap. flange mount \$5.50.  
PILLOW BLOCKS—Ball Bearing, 1/2 \$3.50, 3/4 \$3.50, 1 \$4.25

POLY PRODUCTS, 2032-A E. Walnut, Pasadena 8, Calif.

**ELECTRIFY YOUR OLD SEWING MACHINE**

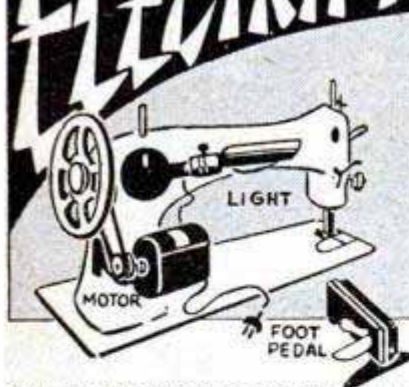

Only  
**\$15.95**  
COMPLETE

**MONEY  
BACK  
GUARANTEE**

**EASY TO  
INSTALL**

**PERFECT  
GIFT FOR  
MOTHER OR WIFE**

SEW LAMP INCLUDED FREE! Convert your old sewing machine into an electric machine at a fraction of the cost of a new one! Complete kit and instructions. Detachable motor can be used for other purposes.

**HERE'S WHAT YOU GET:**

MOTOR—AC or DC, 60 cycle, 115 vo/ts.  
BELT—fine quality rubber. PULLEY—single grooved steel hubbed. BRACKET—newest type. FOOT CONTROL—7-step rheostat. CORD SET—extension cord, plugs, socket. PLUS—a FREE sew lamp!

**KITS SHIPPED SAME DAY ORDER RECEIVED**

**SEND FOR YOURS TODAY!**

BRANT SEWING MACHINE CO. INC.  
1720-22 Race Street, Cincinnati 10, Ohio

Rush your \$15.95 kit. My machine is a \_\_\_\_\_  
Hand wheel turns  toward me  away from me.

NAME \_\_\_\_\_

ADDRESS \_\_\_\_\_

CITY \_\_\_\_\_ ZONE \_\_\_\_\_ STATE \_\_\_\_\_

I am enclosing \$15.95  check  money order or  send C. O. D. and I pay postman \$15.95 plus a few cents postage.



# PAY RAISING—EXTRA MONEY BOOKS

Use these books to prepare for a better job—bigger pay—to start a profitable spare time or full time business of your own, improve your home, start a hobby. Popular Mechanics specializes in supplying outstanding self-help books on many subjects. Send for our FREE catalog.

- Outdoor Sports Manual  
Hunters, Fishermen, Trappers, Campers, Archers, Boatmen, here is your book! . . . \$2.00
- Shop Notes Library  
3 Vols.—1948, 47, 44. (No Dup. Mat.) . . . \$2.00
- Painting, Furniture Finishing and Repairing . . . \$1.50
- Rewinding and Servicing Electric Motors (No. 75) . . . 25c
- Elementary School Subjects for Home Study  
Covers high points of grammar, spelling, arithmetic, history, science, geography, etc. 635 pages. . . \$1.89
- High School Self Taught  
Covers 25 subjects with study guide and self-testing quizzes. Completely revised and enlarged edition, 1280 pages, 300 illustrations. . . \$3.95
- Garden Book  
Build own trellises, lawn furniture, fireplaces, ornaments, etc. . . \$1.00
- Diving, Cutting and Welding in Underwater Salvage Operations  
Only book of its kind . . \$2.00
- Picture Framing  
Modern methods for making and painting picture frames. Fully illustrated. . . \$2.75
- Frog Industry  
Breeding, feeding, dressing and marketing . . . \$2.00
- New Fields for the Writer  
Television, radio, film, drama . . . \$1.00
- 20 Careers of Tomorrow  
Covers plastics, metallurgy, textiles, radio, electronics, television, transportation, chemistry, etc. . . \$2.50
- Breaking Into Advertising  
Into the Freezer and Out  
A complete handbook on the home freezing of foods. \$2.50
- Concrete Handbook  
New book on using concrete around home, garden, farm . . . \$1.50
- Zero Storage in Your Home  
How to prepare, store and freeze food properly. . . \$2.50
- This Way Up  
The successful philosophy of practical business men \$2.00
- Welding, Brazing and Soldering  
How to build own equipment and how to use it effectively . . \$1.25
- Modern Refrigeration  
Electric, Gas, Ice service expert . . . \$5.00
- Dyke's Auto Ency. (includes Diesels, airplane engines)  
New 20th Ed. World's greatest book for mechanics \$7.00
- Household Mechanics  
The "fix-it" book to end all "fix-it" books. Covers electric appliances, painting, carpentry, etc. . . \$2.75
- Oil Burner Handbook . . . \$2.50
- Build Your Own Boat  
Describes 17 popular boats—rowboats, sailboats, plywood outboards, etc. 192 pages \$1.50
- House Wiring (No. 89) . . . 25c
- Turn Scrap Into Money  
Convert old auto generators into motors, welders, etc. . . \$1.00
- Popular Mechanics Farm Manual  
Packed with practical ideas and usable information that can easily be worth hundreds of dollars to every farm family and to homeowners everywhere. Send for free descriptive folder giving complete contents! . . . \$3.00
- Woodworking for Every-body . . . \$2.75

- Sheet Metal Work . . . \$3.00
- Tool and Saw Sharpening (No. 92) . . . 25c
- Forging Practice . . . \$1.50
- Action Toys (No. 66)  
Plans for 21 easy-to-make toys . . . 25c
- Foundry Work . . . \$2.25
- Pattern Making  
Wood, metal . . . \$2.25
- Forty Power Tools  
Build own saw, drill, lathe, sander, etc., from scraps—save money . . . \$1.25
- Carpentry . . . \$2.50
- The Young Craftsman  
Over 450 things boys can make . . . \$1.50
- Five Acres and Independence  
How to make money on small farm . . . \$2.50
- Your Home and How to Build It Yourself  
Step by step construction of the famous POPULAR MECHANICS house. Wonderfully illustrated . . . \$3.00
- Artistic Penmanship Self Taught  
New self study course with 48 lessons of interesting and varied exercises . . . \$2.95
- Knots, Ties and Splices  
For everyone who uses rope . . . \$1.25
- What to Make for Children  
Junior tough on toys? Build him playthings that will last. . . \$2.00
- LeJay Manual of Homemade Electric Equipment  
How to construct 100 items that are scarce and valuable . . . \$1.50
- How to Estimate for the Building Trades: Material and labor costs for masonry, plumbing, electricity, carpentry, heating, hardware, painting, etc. 628 pp. . . \$5.50
- Pay Dirt  
How to make soil fertile by obeying Nature's laws. . . \$3.00
- Rabbits for Food and Fur . . \$2.50
- Tool Making . . . \$4.00
- Tool Design . . . \$4.50
- Plumbing Installation & Repair . . . \$2.00
- Ropp's Calculator  
figuring made easy . . . 75c
- Slide Rule Simplified . . . \$2.75
- Drake's Refrigeration Service Manual . . . \$2.00
- Primer for Home Builders  
All the information you need to know in building a house . . . \$2.50
- Oxy-Acetylene Welding and Cutting  
Up-to-date handbook on gas welding and cutting. . . \$2.75
- Toys You Can Make of Wood . . \$2.50
- A.B.C. of Poultry Raising . . \$2.50
- Ice Cream for Small Plants  
Some technical formulas for ice cream, ices and frozen desserts on a commercial scale . . \$2.50
- Furniture Joinery . . . \$2.50
- Essentials of Upholstery . . \$3.25
- Radio Physics Course  
A thorough training in radio fundamentals . . . \$5.00
- Modern Home Medical Adviser  
How to recognize diseases, practice proper hygiene, and know what to do in medical emergencies. 900 pages, 136 illustrations . . . \$2.49



# Complete New SUPER POWER TOOL KIT

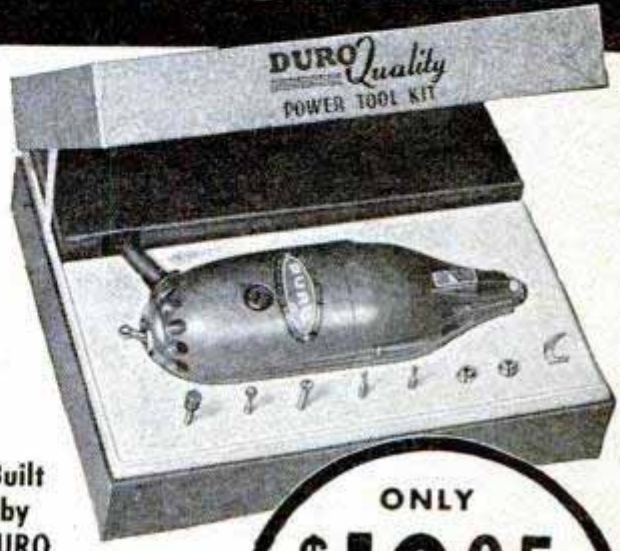

Built by DURO

ONLY \$19.95

America's Greatest Power Tool Value!

Complete With Power Unit, 5 Accessories, Sturdy Case and Full Instructions

Hobbyists, home craftsmen—this is the power tool kit for you! Heavy duty DURO super power unit does cutting, grinding, polishing, engraving, carving and scores of other operations. Smooth, vibrationless in operation . . . this DURO power unit runs at 20,000 RPM—develops 42 watts output. Complete power tool kit contains the power unit with cord, 5 abrasive points and cutting burrs and full operating instructions—for only \$19.95.



## FLEXIBLE SHAFT MEANS ADDED UTILITY!

New DURO flexible shaft with ball bearing hand piece makes engraving, free hand carving, sanding, easier, lots more fun. Double the utility of your DURO Super Power Tool Kit with this useful flexible shaft for only \$13.95

## You can start with this LOW COST Power Tool Kit . . . and BUILD A COMPLETE HOME WORKSHOP

One DURO super power unit is used on all of these home workshop tools! You may buy them singly—or in a group.

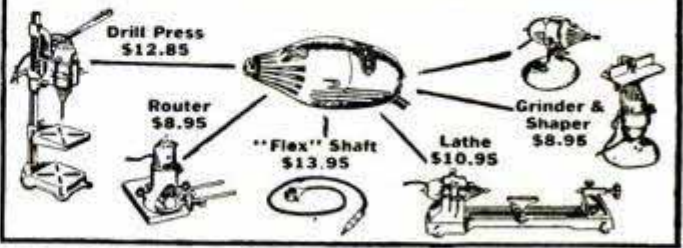

WRITE FOR FREE CIRCULAR giving full details on the Super Power Tool Kit and the new, low cost home workshop units.

**DURO METAL PRODUCTS CO.**  
2688 N. KILDARE AVE., CHICAGO 39, ILL.

## MAIL THIS COUPON TODAY

Check the books you want, write your name and address below, and mail this advertisement with money order or check. Outside U. S. A. include 15% additional for shipping charges.

Books selected will be mailed promptly on our "money back if you're not entirely satisfied" guarantee.

Name \_\_\_\_\_

Address \_\_\_\_\_

City \_\_\_\_\_ State \_\_\_\_\_

Mail to **POPULAR MECHANICS PRESS**  
Dept. 651—200 East Ontario St., Chicago 11, Ill.



## Parts For Military Type TRUCKS and JEEPS

We have for immediate delivery genuine parts for all makes and models, 4x2—4x4—6x4 and 6x6. All models from 1/4 ton to 20 tons. All makes: Autocar, Biederman, Brockway, Chevrolet, Diamond T, Dodge, Federal, Ford, GMC, International, Mack, Oshkosh, Reo, Studebaker, White, Willys and Jeeps.



We have parts lists available on most models. Write stating model of G. I. Truck.

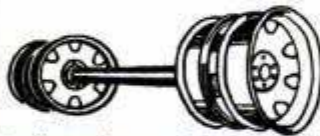

### TRAILER AXLE

Heavy duty trailer axle suitable for many types of trailer construction. Also excellent for building of heavy farm trailers and wagons. It is a 15,000 lb. capacity square type straight trailer axle complete with Timken roller bearings, hubs, and 6 hole 750 x 20 Budd Wheels. Without brakes. Axle is 2 1/2 inches square and 70 inches between wheel mounting flanges. Std. width. AN EXCELLENT BUY.

With Single Wheels. . \$49.50 With Dual Wheels. . \$59.50



### HYDRAULIC JACKS

Government Surplus, slightly used 5 ton Hydraulic Jacks of popular brands. Guaranteed serviceable, complete with handle. Shipping weight, 25 lbs. Each . . . . .

**\$7.95**

### 30 DAY SPECIAL ON OIL FILTER ELEMENTS

FRAM C-31D Military Senior for GMC, Chevrolet, White and all trucks with military senior filter. Each . . . . . **50c**  
PUROLATOR PD-51 or 26637 for JEEP, Dodge and all with military junior filter. Each . . . . . **50c**

DODGE AND PLYMOUTH PISTONS with pins, **\$1.95**  
3 1/4" Bore .020 over size. Each . . . . .

PISTON RING SETS, Dodge and Plymouth. **\$1.95**  
Each . . . . .

BRAKE LINING SETS. Chevrolet and GMC Trucks 36-48 Rear—4 pieces of lining, manufactured by American Brake Block and Grizzly. Rear Set BLMA No. 654D . . . . . **\$2.95**

FRONT SET, (Grizzly only). **\$1.95**  
BLMA No. 644D . . . . .

JEEP BRAKE LINING SETS. (Grizzly) for 2 wheels front or rear. BLMA No. 2011 D. per set. . . . . **\$1.25**

JEEP OIL FILTER ELEMENTS **50c**  
PD 51 Purolator . . . . .

C31D FRAM OIL FILTER ELEMENT. **50c**  
Military Senior . . . . .

All prices quoted are FOB, Kansas City.  
25% deposit required on COD orders.

**American AUTO PARTS CO.**

1830 LOCUST — DEPT. PM  
KANSAS CITY, MISSOURI.



## Government Surplus Offered at a Fraction of Cost THE HANDYMANS TOOL CHEST

Filled with FAMOUS BRAND TOOLS & SUPPLIES

For Tire Shops, Vulcanizers, Garages, Mechanics,  
Home Work Shops, Hobbyists, etc.

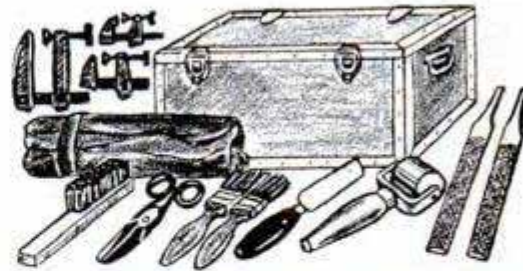

You can buy any one or all of the tools at these low prices

3 Square Wetzler Clamps 6" Deep, 7 1/2" throat, each \$1.50;  
2 Great Western 1/2 round 10 inch bastard files, 37 1/2c ea.;  
Wire Steel Brush 35c; Goodsell Steel knife 50c; Wiss 6" Steel Scissors \$1.25; Burton Brushes 1" wide, 25c each;  
Hogson & Pettis steel roller \$1.75; Tool Chest 24" long, 17 1/2" wide, 11" deep; all edges are metal bound and riveted; made of 3/8" x 3/8" Plywood; painted O.D. Color, \$5.95 (Total \$15.55).

Original Government cost for complete kit over \$60.00.

OUR PRICE COMPLETE KIT (includes tools and chest) . . . . .

**\$7.50**

By buying entire kit as a unit you save over 50%, plus receiving many extra items which come with the chest (at NO extra charge). Supply limited—ORDER NOW.

F.O.B. K. C. NO C.O.D.'S. SHIPPING WGT. 115 LBS.  
Send check or money order for prompt delivery.

**B & G SUPPLY CO.** 800 E. 18th ST.  
KANSAS CITY, MO.

## USED BUT REBUILT IN CLEAN, GOOD CONDITION! ARMY SHOES \$2.59 A Pair

Now you can wear these sturdy, all weather Army Shoes. Will last and stand up under the toughest wear. Fits comfortably. Thick soled, strong leather. Russet tan color only. All sizes. Valued about \$5 a pair. Now only \$2.59 a pair. Also higher for Combat Boots only \$3.75. Special: Both Army Shoes and Combat Boots \$5.98. Send shoe size and photo, name and address, SEND NO MONEY! Pay postman on delivery price plus postage. Money Back Guaranteed. Order Now! Also send for our free catalog of shoes, hats, suits, army clothes, etc.



EUNICE MAIL ORDER HOUSE  
STATION 8, P.O. BOX 101, DEPT. PM-K, N.Y.C.



### NOW! FILE YOUR OWN SAWS

Do expert saw filing at home. Precision filing easy without experience. Two simple adjustments. Keeps any hand saw extra sharp and true-cutting. Complete with file. Money back guarantee. Cash with order, prepaid. (COD postage extra.) Order today.

**\$2.95 EACH**

THE SPEED CORP., Dept. PM1  
2025 N. E. Sandv, Portland 12, Oregon

SAY YOU SAW IT IN POPULAR MECHANICS

## Woodworking MADE EASY

### Be Your Own Designer



Furnish your home or apartment with your own original pieces. This new, NON-PROFESSIONAL, method of building furniture can be learned by anybody. It is a unique method of building any desired piece of furniture in your own small home or apartment; no fancy workshop is necessary. I furnished my apartment with many original pieces AND SO CAN YOU! No blueprints or drawings are necessary. I built the cabinet shown with the simple hand tools pictured at the left. You can design your own pieces or copy any piece you desire. YOU CANNOT FAIL. This course consists of step by step photographs and instructions and is sold with a money-back guarantee for your satisfaction.

**E. H. NEWMAN**

4915 Broadway

New York 34, N. Y.



Send for yours today.  
COMPLETE COURSE **\$5.00**  
ONLY . . . . . post paid.



# THE OPPORTUNITY of a LIFETIME to Establish Yourself in a NEW BIG MONEY MAKING BUSINESS!

Set a Detector in Every Room, Basement, Attic, Barn, Factory or Wherever a Fire Can Start . . .

FIRE takes a tremendous toll of LIVES and PROPERTY every day . . . in every locality . . . Why not catch it WHEN IT STARTS! . . . Before it makes headway! . . . That's what "Wak-Em" Fire Alarm does . . . a SUPER SENSITIVE Thermostat that SETS OFF THE ALARM at the spot WHERE THE FIRE IS STARTING . . . Many times a pail of water will put out a fire at the start . . . BUT . . . give it time and THEN IT IS TOO LATE for anybody to stop destruction. NOW it is possible, with the "Wak-Em" Fire Alarm installed, to WARN YOU from the spot . . . WHERE THE FIRE IS STARTING . . . because the Detector SETS OFF THE ALARM and WARNS YOU . . . A continuous "watch dog" DAY and NIGHT . . . The kind of protection NEEDED IN EVERY HOME IN THE CITY or THE FARM.

EVERY HOME, STORE, FACTORY, etc.

— Sales Are Everywhere . . .

SIMPLE, COMPACT . . . BUT EFFECTIVE and EASILY INSTALLED BY ANYONE with a screw driver to the home current . . . That's all, and once installed it is the faithful servant to WARN AGAINST FIRE DESTRUCTION. It makes no difference what you have or have not sold here is a REAL OPPORTUNITY.

WANTED—  
DISTRIBUTORS—AGENTS—EVERYWHERE

Write or Wire Today  
**Wak-Em Fire Alarm, PLANO, ILL.**

THIS could be YOUR HOME...



CATCH the fire WHEN and WHERE SAVES LIVES and PROPERTY IT STARTS

THE BEST Type of Fire Protection AT LOWEST COST

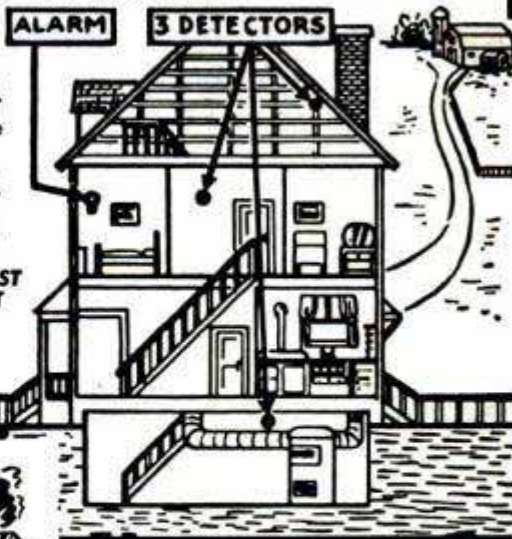

3 Detector Set with 4" Bell Alarm ONLY \$6.75 Postpaid

## GENUINE U.S. ARMY AIR CORPS SURPLUS!

**Gooseneck Trouble Flashlite** \$1.50 EA.

New! For every mechanical need. Lights up those out-of-the-way places with bright flood beam. Ideal for mechanics, radio repairmen, warehousemen, in the home, etc. Adjustable to any angle. Flexible 12" extension. An amazing bargain, order TODAY!

Orig. Govt. Cost Over \$3.00

SAVE! We ship Post prepaid if \$1.50 in money order, cash or check accompanies your order; or shipped C.O.D. if you prefer. WRITE FOR OUR FREE SURPLUS BARGAIN PRICE LIST.

FEDERAL SURPLUS SALES, 561-63 W. Roosevelt Rd., Chicago 7, Ill.

**Imported Swiss Watches**

Guaranteed by Mfr. for full year!

For a tiny \$6.95, you can own this genuine SWISS wrist watch, and everyone knows the world-wide reputation of skilled Swiss watchmakers. Stream-lined handsome case in chrome-plate, with leather strap!

Supply is limited—Order now!

Every watch has a timed and tested movement . . . guaranteed in writing for one year! With sweep second hand, to 1/5 of a second! Luminous dial; unbreakable crystal!

ONLY \$6.95 plus 69c tax

Swiss Watch Distributors  
211 Paramount Bldg. Atlanta, Ga.

Money-back Guarantee if you're not delighted

WRITE NOW FOR FREE CATALOG NO. M-32

**THE FOSTER LINE**

**POWER TOOLS**

FOSTER MFG. CO., 1 KINSEY AVE., BUFFALO 17, N. Y.

**M. Z. A. Waukesha motor; 40 gal. gas tank; tubular type friction clutch Rotor.**

## Prepare a COMPLETE SEEDBED at rates up to 20 Acres Per Day with this 5-FOOT SPECIAL SEAMAN ROTARY TILLER

Yes, you can prepare a COMPLETE SEEDBED, ready for planting, at rates up to 20 acres per 10 Hr. day (depending on soil conditions and the kind of tillage you require), with this 5-Ft. "Special" Motorized SEAMAN ROTARY TILLER. No other soil preparation is needed.

But over and above this great saving in time and labor, you get a BETTER SEEDBED, capable of producing greater yields—a seedbed that holds more moisture. With the SEAMAN TILLER surface trash and fertilizer are thoroughly mixed into the seedbed.

See your Seaman dealer. And write for "Questions and Answers" pamphlet which tells what you want to know about SEAMAN TILLERS—supplied in motorized and power take-off models, 3 ft. to 7 ft., tillage widths.

**SEAMAN MOTORS, INC.**

364 No. 25th St. MILWAUKEE 3, WIS.

SAY YOU SAW IT IN POPULAR MECHANICS.

NEW! EASY!

# EARN BIG MONEY!

RIGHT IN YOUR OWN HOME FULL OR SPARE TIME

PUT YOURSELF IN THE SUCCESS PICTURE! a few cents worth of material . . . BRINGS YOU DOLLARS!!

Yes, lush profits are waiting to be tapped in this new field. New MIRACLE finish gives a velvety, luxurious surface to radios, toys, lamps, signs, store displays, figurines—Makes old objects beautiful and saleable—Makes new things worth much more. Learn in a few days—it is easy to become an expert and establish yourself in a successful lifetime business. Start earning BIG MONEY—\$500 to \$1,000 per month

full time—up to \$75 per week spare time. Everything furnished—including complete, simple-to-understand instructions on this NEW method that is EASY to learn. Send NO money—a post card will do—it's too good to miss! Write now for details. FREE sample of FLOK-KRAFT covered material, and hundreds of useful and profitable IDEAS. Do it now—be first!

COAST INDUSTRIES, 1510-11 West Manchester, Los Angeles 44, California



**THIS  
5  
ROOM**

**ALADDIN**

**\$1396**

**FREIGHT  
PAID**

**HOW TO BEAT  
THE BUILDING GAME**

The Aladdin Readi-Cut System of construction enables you to save 18% lumber waste and up to 30% labor costs, and guarantees you will receive the highest quality lumber and a COMPLETE house as specified, shipped anywhere.



**81 DESIGNS TO CHOOSE FROM—HERE'S WHAT YOU GET**

You get all the lumber cut to fit by fast machinery-production line methods—marked and numbered, ready to erect practically without the use of a saw; also siding, flooring, trim, all millwork, doors, windows, glass, hardware, nails, roofing, paint and complete drawings with instructions. Many Aladdin home buyers erect their own houses.



**"BUILD IT YOURSELF"**  
**THE ALADDIN CO.**

SEND 25c FOR  
CATALOG R  
BAY CITY,  
MICHIGAN



**FIX SEWING MACHINES**

**BIG MONEY.** Spare or full time. Open your own neighborhood shop. Thousands need repairs. Send for complete Service Manual—only \$1.00 postpaid. Money back guarantee.  
SEWING MACHINE SERVICE CO., Hamilton 25-EE, Ohio

**WAR SURPLUS**

**DON'T MISS THESE BARGAINS**

**ELECTRIC MOTOR** 1/2 H.P. 27 V.D.C. R.P.M. 4000, #750. For intermittent or Continuous Duty 3/8" SHAFT. VARIABLE SPEED MOTOR. Can be adapted to 110V A.C. or R.E.A. line by re-arranging armature brush leads. Unused. Instructions incl. Ea. **\$5.50**

**Surplus Bargain Close-Out  
LUBE PUMP**



Pumps liquids up to 3 G.P.M. Pressure up to 200 lbs. per Sq. In. For high vacuum, air pressure liquids, operating hydraulic units etc. Made of Finest Bronze and steel. Size 3 1/2" x 8 1/2", Dia. 1/2" Threaded and keyed Shaft. **\$3.50**  
Complete instructions incl. Ea.

**GREATEST PUMP VALUE IN YEARS, THOMPSON BOOSTER PUMP.** Use them for Homes, Farms, Ranch and Shops Motor Driven centrifugal pump will empty 50 gal. drum of water in approx 20 min., runs on **\$7.50**  
24 V. D. C. /A.C. New

**ROMEC FUEL**  
800 GPH at 30 PSI, can also be used as hydraulic for 4 GPM at 400 PSI, or for Vacuum drawing 15 in. mercury at **\$4.50**  
1500 RPM. Ea.



**NEW RADIO RECEIVER BC-341** a U. S. A. Signal-Corp type with 3 tubes including 1/VT-103, 1/VT 91-A 1/VT-104 new in original packing. **\$3.95**

**SELSYN CONTROL TRANSFORMERS** Model #2JIG1, 57.5 V 400 cpy, can be used on 110V 60 cpy. Instructions incl. **\$1.00** ea.

**DYNAMOTORS** New. Check list and order now. G.E. 485 KVA Input 27 V D.C. Output 115 V. **\$4.50**  
A.C. Wt. 16 lbs. Ea.

**DYN.** New G.E. Type D Input 28 V. A-19, Output 1000 V. D.C. Wt. 38 lbs. Ea. **\$4.95**

**DYN.** New Type S-3418 -1 Input 9 V Output 400 V. 7 Amps and .08 Amps. Ea. **\$2.50**

**DYN.** NEW Model #23350 Input 27 V. D.C. 1.75 Amps output 285 Volts-D.C., **\$1.35**  
.075 Amps. Ea.

**DYN.** New Model #DY-22/ARC, Input 28 V. D.C. output 210V, D.C. Duty Cont. Ea. **\$1.35**

**BEAM ANTENNA ROTATOR MOTOR.** Brand new Operates directly on 110 V. A.C. 60 cycles. Instructions **\$3.95**  
Incl.

**NEW CUNO OIL FILTER** aircraft type keeps oil clean without cartridge replacement. For AUTOS, TRUCKS AND TRACTORS. Install at home in a few minutes. STOP CHANGING MOTOR OIL. Instructions **\$4.95**  
included. Ea.

**NEW NYLON CARGO LANDING NETS** mesh 2 1/4"x2 1/4". Approx. 9 ft. by 9 ft. Wt. 4 1/2 lbs. For Fishing, Hammocks, Farms, **\$2.50**  
and Rugs. Ea.

SEND CHECK OR MONEY ORDER. NO C.O.D.'s. PRICES F.O.B. K.C.

**GENERAL SALVAGE COMPANY**

Dept. 8, 2920 E. 27th St. Kansas City, Mo.

**GOV'T SURPLUS**  
**BRAND NEW ★ COATED**  
**6x30 PRISM BINOCULARS**  
No. C.O.D.'s  
*Individual Focus*  
*Similar to*  
**BAUSCH & LOMB DESIGN**  
COMPLETE WITH GENUINE LEATHER CARRYING CASE  
**Reg. \$89.50**  
plus 20% Fed. Tax.  
**SPECIAL \$49.50**  
plus 20% Fed. Tax.  
BUY WITH CONFIDENCE AT  
**HABER & FINK, Inc.** Dept N. 12 Warren St. New York 7, N. Y.

**WORLD'S LOWEST PRICED**  
**ADDING MACHINE** Vest Pocket Size  
FREE TRIAL  
**\$2.95**  
IDEAL FOR BUSINESS OR PERSONAL USE — GUARANTEED ACCURATE. Not a toy. Operates with only a finger flick. Adds, subtracts, multiplies, divides, only Counts up to one billion. Pays for itself over and over. Ideal Gift — for Business, Income Tax and School use. MONEY BACK GUARANTEE. Send name and address. Pay postman only \$2.05 plus postage. (Send full cash if outside U. S.) Beautiful rich-looking Leatherette Case included at no extra cost. Money back in 10 days if not delighted. AGENTS WANTED.  
**CALCULATOR MACHINE CO., (Mrs.)**  
Dept. 206, P. O. Box 248 Glenview, Illinois

**SAVE on High Quality**  
**GABARDINE Dress Trousers** \$12.50 VALUE  
for Fall and Winter wear  
Huge direct-to-you volume enables us to give exceptional value! Fully guaranteed. Genuine virgin wool and fine-spun rayon blended. Warm. Twill weave resists wrinkles, holds crease, gives amazing wear. Expert fashion tailored for perfect fit. Zipper front. Roomy pockets. Blue, Tan, Sand, Lt. or Dk. Brown, Blue-Gray. WAIST: 28-38 pleated or 28-44 plain.  
**Send Only \$1** with name, waist size, 1st and 2nd color selection. Pay postman balance plus C.O.D. Or, send entire amount, save C.O.D. Money back within 10 days if you're not pleased.  
**LINCOLN TAILORS** DEPT. PM-9 LINCOLN, NEBR.



**EXCLUSIVE TERRITORIES OPEN!**  
Write for Full Details Today.

**AN ARTMOORE PRODUCT**  
**Cut Housework in Half**  
with **NEW ART CLEANER**

WRINGS LIKE THIS

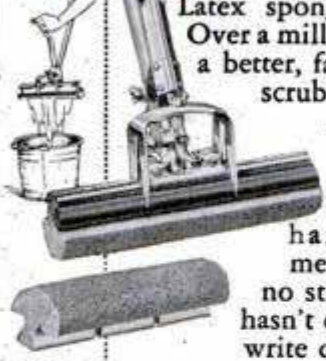

Again available with genuine Latex sponge rubber head! Over a million in use—doing a better, faster, easier job of scrubbing dusting, waxing floors. 10 inches wide. Self-wringing, self-cleaning—48-in. hardwood handle means no kneeling, no stretching. If agent hasn't called, write direct.

**\$5.95**  
Postpaid

**ARTMOORE CO.**

Dept. PM-88, 1319 N. 3rd, Milwaukee 12, Wis.

REFILLS EASILY REPLACED

**SUPER-MITE RADIO PACKS AMAZING POWER!**

Not much larger than a pack of cigarettes and using war-born midjet tubes, this powerful little set gets coast-to-coast reception! Power is supplied by midjet hearing-aid battery. Brilliant red chassis, black and silver dial, streamlined control knobs. Complete set ready to wire as shown only \$3.99 postpaid. Tubes 95c each. Not available elsewhere at 10 times this price!



**\$3.99**

**ELECTRONIC RESEARCH**

1216 Park Row Bldg. New York City 7

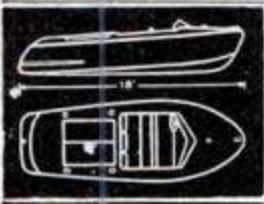

**BOAT PATTERNS • BLUEPRINTS**

70 Modern plywood designs by leading naval architects. Large scale, fully detailed blueprints, full size paper patterns available. Kayaks to cruisers, row-power—sail, (6 to 30 ft.). Send 25c (coin) for Design Catalog, or \$1.00 for Catalog plus booklet, "How to Build Plywood Boats."

MARINE MART, Buffalo 7-B, New York



**SURPLUS AIRCRAFT INSTRUMENTS**

12 ALL DIFFERENT, NEW OR GOOD USED CONDITION—AS ILLUSTRATED **\$14.75** OVER \$2000.00 Govt. Cost for only \$14.75, FOB, 25¢ wt.

They contain sensitive meter movements, pressure movements, selsyn motors, miniature Gyro, jewel and ball bearings, gears, valves, etc. 12 Aircraft Instruments, mixed New and Used, faulty condition—\$9.75.

SEND FOR BIG ILLUSTRATED SURPLUS CATALOG, 10c (refunded 1st order)

We include with catalog a miniature drop oiler FREE. Catalog lists and illustrates a huge variety of surplus motors, actuators, ball bearings, gears, lamps, instruments, radio parts and many other items.

Mark 9 Gunsight **\$1.95** (postpaid)

QUINN'S GADGET SHOP • 2253 E. 14th St. • Oakland 6, Calif.

**Flex-O-Shaft**

HANDLES LIKE A PEN\*

**\$35.00**



Flex-O-Shaft is an improved all-purpose machine for homes, schools, shops, or factories. The slender, light-weight aluminum hand piece is ideal for grinding, drilling, sawing, buffing, scoring, etching, polishing, and scores of other uses. There is no bulky, throbbing, pulling motor in your hand. The light-weight motor can hang on the wall, or can be set down on working table. Speed is controlled by foot-operated rheostat, leaving hands free. This precision ball-bearing tool is as easily guided as a pen, speeding up operation because of ease in handling. It is a wonderful, compact, power house for making all kinds of objects. This unit consisting of Flex-O-Shaft with 6-ft. cord, 1/16 H. P. Motor, Rheostat with cord and plug, all for \$35.00. Send for complete information today! Use coupon below.

Flex-O-Shaft and complete Tool Kit with 66 accessories only

**\$50.00**



**FLEX-O-SHAFT SALES CO. (Dept. C)**  
Prairieview, Illinois

Please send complete information on the Flex-O-Shaft Kit.  
 Please send one Flex-O-Shaft Kit. \$50.00 enclosed. Shipping charges C.O.D.

Name \_\_\_\_\_

Address \_\_\_\_\_

City \_\_\_\_\_ Zone \_\_\_\_\_ State \_\_\_\_\_

SAY YOU SAW IT IN POPULAR MECHANICS

**Save 80% ASSEMBLE YOUR OWN ARC WELDER Only \$24.95**

**OWN A GENUINE INDUSTRIAL-TYPE HEAVY-DUTY WELDER**  
ALL PARTS READY-MADE — READY TO ASSEMBLE

**WELDS ANY THICKNESS METAL**

Why pay expensive assembling and shipping costs? The ATOMIC WELDER PARTS come packed in a compact box—YOU SAVE THE DIFFERENCE! EASY TO ASSEMBLE WITH SIMPLE, STEP-BY-STEP instructions, in a few hours. Also included are 10 easy lessons in Arc Welding. IDEAL HEAVY-DUTY WELDER for all-purpose arc welding. Safe, rugged, compact and EFFICIENT. WILL OPERATE FOR ONLY A FEW CENTS PER DAY. USES 1/8" ELECTRODES. Plugs into either 110 or 220 AC line. Can be used consistently on 30 amp. fuse. ALL PARTS DESIGNED TO GIVE LIFE-TIME SERVICE.

**DO WELDING FOR PROFIT:**

Increase YOUR earnings this easy way. The Atomic Arc Welder is designed by practical Welding Engineers to give you a quality Arc Welder at low cost. Complete step-by-step instructions furnished free. Shipping weight 60 lbs. — Immediate delivery.

Satisfied Users From Coast to Coast Say:  
1. "Have bought two other welders — Atomic Welder is the only one that lives up to claims."  
2. "Did not heat up after four hours of constant use."  
3. "Welds any thickness of material."

**ORDER WITH CONFIDENCE!**

Try your ATOMIC WELDER for 30 days. If not satisfied, return as is. Your money will be refunded with no questions asked. What could be fairer than that?

**IMMEDIATE DELIVERY — WRITE FOR BOOKLET P-21**

**ATOMIC WELDER COMPANY, 1038 So. 19th Street, Omaha, Nebr.**

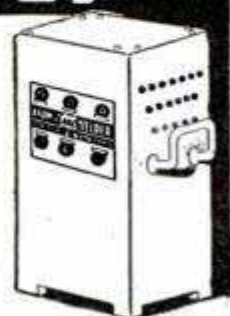

**DEALERS WANTED**  
**WRITE TODAY FOR**  
**LIBERAL DISCOUNTS.**

**Buy Only NECESSARY PARTS**  
60 lbs. OF PARTS INCLUDING SECONDARY AND SHUNT COILS WOUND COMPLETELY WITH DOUBLE GLASS COVERED ELECTROLITIC COPPER.



A NEW KIND OF MOTORCYCLING  
WITH



**SAFE - COMFORTABLE - POWERFUL**

Automatic Clutch. Telefloat Spring Suspension.  
Foot Gear Shift. 95 miles per gallon. 70 Miles per hour.  
See and drive it at your nearest JAWA DEALER or  
write for free folder.

**JAWA MOTORCYCLE CO.**

Dept. M

460 FOURTH AVE., NEW YORK 16, N. Y.

DEALER INQUIRIES INVITED

## Announcing the NEW HURRICANE '48 Model PORTABLE ROUTER and Shaper

Motor: Universal, 110 volt AC-DC, 1 1/4 HP. Speed, 18,000 r.p.m. no load. Weight 11 1/4 lb., height 9 inches, diameter 4 inches. Switch conveniently located on body of motor with plug-in cable.

Cooling: Air cooled, by turbine type wheel.

Bearings: New Departure sealed ball bearings.

Finish: Outer housing all highly polished.

Template Guide: One 3/8" furnished with machine.

Gauges: Straight and circular of aluminum.



124.50

F.O.B.  
Chicago

A beautifully constructed precision machine for professional use. ORDER NOW at your dealer or direct. Firms not rated, 25% deposit required. Bal. C.O.D.

**HURRICANE MACHINE WORKS**

6316 WENTWORTH AVE.

CHICAGO 21, ILLINOIS

Electrically Welded Endless

*Paramount*

**BAND  
SAW  
BLADES**



Made in widths from 1/8" to 1-3/4"

Make your band saw do more work for you. The proper width of blade will extend the scope of this important machine. Burrill's Paramount Blades are made from tough Nickel Alloy Steel properly tempered. Teeth accurately set and filed, and all saws carefully straightened. Send order and check today. Delivery will be made as promptly as conditions permit, from a few days to a week or two. You can obtain these saws at the following prices:

1/8"-3/16"-1/4"-3/8" wide, 5'6" long.....\$1.04 each  
1/4"-3/16"-1/2"-3/4" wide, 6'6" long.....\$1.16 each  
3/8"-3/16"-3/4"-1" wide, 7'6" long.....\$1.27 each

Other sizes at proportional prices

**NO C.O.D. SHIPMENTS ACCEPTED**

State Make of Machine

Your satisfaction is guaranteed

**BURRILL SAW & TOOL WORKS**

407 E. Main St., Iilon, N.Y.

make your own *Gems* **29.50**  
F.O.B.

All necessary lapidary equipment is furnished, including a super-charged diamond blade for sawing, and all wheels for grinding, shaping and polishing; also complete instructions. The complete equipment as shown, less motor and belt, for only \$29.50, f.o.b., Burlington, Wisconsin. Write today for information and literature.

**B&I MANUFACTURING CO.**  
Dept. S Burlington, Wis.

Go Right Ways Without Delays With a  
**HULL AUTOMOBILE COMPASS**

(Left to right)

Beaconite illuminated \$5.95  
Streamline standard \$3.95  
Streamline Marine \$2.75

Fully Guaranteed At your dealer's.  
Write for circular.

**HULL MFG. CO., P. O. Box 246-D9, Warren, Ohio**

**PALMER VERTICAL MILLING ATTACHMENT  
FOR ANY BENCH LATHE**

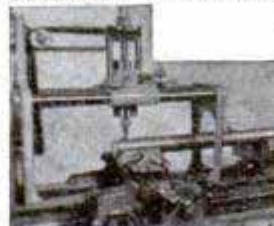

Quickly converts lathe to milling machine. Cuts, mills, and grinds. Complete: \$99.50. Send for Bulletin 548.

**PALMER INDUSTRIES**  
6149 So. Sangamon St.  
Chicago 21, Ill.

**OFFICER'S PINKS**

Quality Year Round  
Dress Trousers **\$8.95**  
PR

Beautifully tailored of finest ELASTIQUE material. Officers have to look well dressed. Fully guaranteed. Wrinkle-proofed to hold crease. Tailored for correct fitting, styling and comfort. **BRAND NEW!** Zipper front. Roomy pockets. Sizes 30-42 in assorted lengths. Sold thousands. Item now scarce. Order while supply lasts. SEND NO MONEY. Just name, address, size. Pay postman only \$8.95 (previously \$14.95) plus charges on delivery. Cash orders sent postpaid.

**LEONARDS & LEE SURPLUS SALES**  
3400 Armitage Ave. Dept. 250 Chicago 47, Ill.

SAY YOU SAW IT IN POPULAR MECHANICS



Get This Fascinating New Popular Mechanics Book

# WHAT to MAKE for Children



**175 Things  
Dad and Mother  
can Make for  
Young Folks  
at Home!**

This is a book by the editors of Popular Mechanics. It will show you how to make, at little or no cost, many of the things so dear to the hearts of younger children—things that money won't buy, such as playroom and nursery toys and trappings, dolls and dollhouses, gymnasium equipment, things to ride on, toys that "work" and go.

**A BOOK FOR THE ENTIRE FAMILY**  
Mother and Dad and Big Sister and Brother can save many dollars and have worlds of fun too, making all these things for the little tots. Only discarded materials or inexpensive new materials and only simple tools are needed, with WHAT TO MAKE FOR CHILDREN as a guide.

**SIMPLIFIED INSTRUCTIONS — ANYONE CAN FOLLOW**  
The book contains 175 different projects with detailed "how-to-do-it" instructions, dimensions and more than 250 sketches, drawings, plans and photographs covering every detail of construction.

Order WHAT TO MAKE FOR CHILDREN today. Mail coupon below for immediate delivery. Money back if not satisfied.



POPULAR MECHANICS PRESS, Dept. 49C  
200 East Ontario St., Chicago 11, Ill.



**175 PROJECTS  
250 ILLUSTRATIONS**

Action Toys—Dolls—Pull

Toys—Play Houses—  
Games



Swings—Furniture—

Steds—Playground Equip-  
ment—Desks—Sandboxes



Wagons—Coasters—

Merry-go-round—Animals  
—Cribs—Dozens of Others



**Mail  
Coupon**

Send at once \_\_\_\_\_ copies of WHAT TO MAKE FOR CHILDREN at \$2.00 each. Remittance enclosed. I understand I may return the book in 5 days if not satisfactory and you will refund my money.

Name \_\_\_\_\_

Address \_\_\_\_\_

City \_\_\_\_\_ State \_\_\_\_\_

if you feel **DOZEY**  
when you drive...



take a **NōDōz** Awakener



...and stay **ALIVE!**

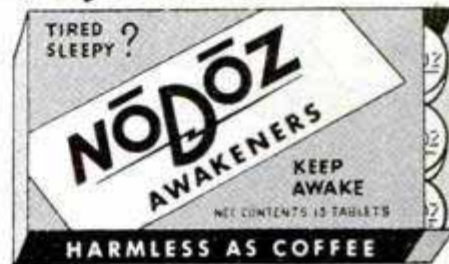

**25¢ AT DRUG STORES**

Send 10c for generous sample!

NoDoz Awakeners, Dept. S1  
45 Second St., San Francisco 5.

## IMMEDIATE DELIVERY ON NEW HEAVY DUTY **CERWECO** BENDING BRAKES



Heavy steel-plated welded construction. Ideal machine for sheet metal shop and short run production jobs. Easy and simple to set up. One man handles easily. Quick independent clamping of sheets. Quick set screw adjustment for upper clamping plate. Well balanced bending apron. Renewable bending edge bars. Apron arranged for various forming molds. 4 ft. model illustrated—up to 16 gauge mild steel capacity.

4 Ft. Model—\$185.00, F.O.B. St. Louis, Mo. 25% cash with order, balance C.O.D. **\$185.00**

DEALERS WANTED: Write for information on complete line of brakes.

**CERTIFIED WELDING & ENGR. CO.**

4506-R Delmar

FOREST 6522

St. Louis 8, Mo.



## ELECTRIC HAND GRINDER OUTFIT

for cutting wood, metal or plastic.

**MASTER \$9.75 \$45 Value**  
**KIT Only \$9** Postpaid in U.S.A.

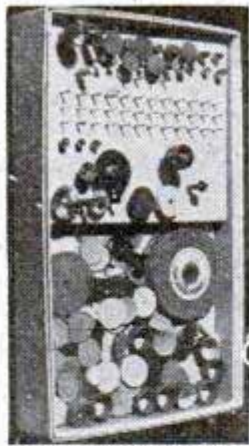

Compact container. Special rack for drills. Over 260 tools and items.

**115 Grinding, Cutting and Polishing WHEELS PLUS 150 assorted tools most useful for Home or Shop.**

- 3 Grinding Wheels from 1" to 3" dia.
- 1 Rotary File, High Speed Steel.
- 2 Rotary Cutters 1/8" Shank.
- 6 Rotary Cutters 3/32" Shank.
- 6 Mounted Grind. Wheels 1/8" Shank.
- 6 Mounted Wheels 3/32" & 1/4" Shk.
- 3 Rubber Wheels.
- 4 Speed Drills 3/32" Shank.
- 30 Rotary Cutting Burs 3/32" Shank.
- 2 Mandrels 3/32" Shank.
- 1 Mandrel 1/8" Shank.
- 1 Screw Type Mandrel 3/32" Shank.
- 3 Rotary Bristle Brushes 3/32" Shank
- 1 Rotary Wire Wheel Brush.
- 1 Circular Saw
- 1 Mandrel for Circular Saw 1/8" Shank.
- 2 Rubber Cylinders and Mandrel 3/32"
- 10 Cut-off Discs and grinding wheels.
- 1 Rotary Drum Sander 1/8" Shank.
- 15 Bands for Rotary Drum Sander.
- 15 Rotary Felt Wheels 1" dia.

• The right attachment for every job.  
**ORDER TODAY.** Send check or send \$2.00 deposit with C.O.D. order.

### 18 ROTARY CUTTERS

Ass't Sizes on 1/8" or 3/32" Shank

Will fit all electric hand grinders. Ideal for cutting wood, metal or plastic.

\$13.50 Value

**ONLY \$5.85** post paid

\$2.00 Deposit on C.O.D. Orders

in U.S.A.

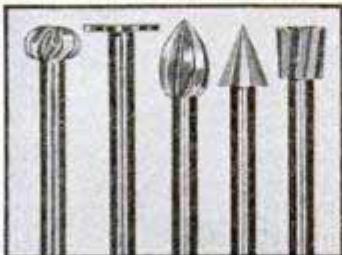

### TOOL & DIE MAKERS 8-PIECE KIT

\$12.00 Value

- 3 Rotary Files, High Speed Steel 1/4" Shank.
- 1 Mounted Polishing Wheel on 1/4" Shank.
- 4 Mounted Grind. Wheels 1/4" Shank.

\$2.00 Deposit on C.O.D. Orders

**Now \$4.50** postpaid in U.S.A.

### SPECIAL • 100 PIECES • \$1.00 Postpaid

Grinding Wheels, Cut-off Wheels, Sanding Discs, Mounted Stones, Sharpening and Honing Stones, Rotary Cutting Burs, Abrasive Cartridges and many other items.

### SCHUPACK SUPPLY & MFG. CO.

7331 Cottage Grove Ave., Dept. PM-9

Chicago 19, Ill.

## Don't Risk Engine Overheating

Keep cooling systems ALWAYS up to par with regular

**Warner** care



#### Warner Liquid Solder (Non-Metallic)

- Deposits tiny fibers to repair leaks anywhere in the cooling system.

#### Warner Radiator Cleaner

- Thoroughly cleans cooling system of rust, oil muck and grease.

#### Warner Cooling System Protector

- Prevents rust, scale and corrosion.

No delays—just pour in and keep on driving. Do it yourself, or ask your service man.

Warner-Patterson Co., 920 S. Michigan Ave., Chicago 5

## UTICA TOOLS

FOR MORE TOOL MILEAGE

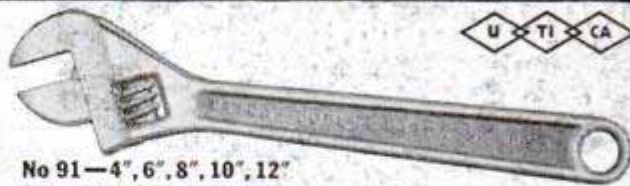

No 91—4", 6", 8", 10", 12"

Adjustable Steel Wrench

## UTICA DROP FORGE & TOOL CORPORATION

UTICA 4, NEW YORK

A GREAT SURPLUS BARGAIN

### AIR REGULATOR and GAUGE

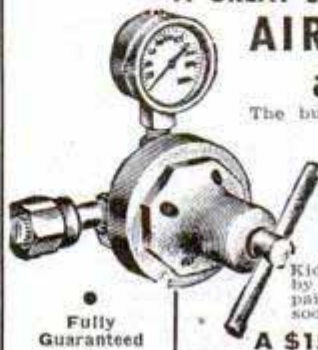

The buy of a lifetime in a standard make air pressure regulator. Used on liquid carbonic tanks and air pressure tanks of all kinds to regulate the pressure. Fitted with standard 1/2 inch pipe thread. Dial calibrated 0 to 200 lbs. Reduced pressure 0 to 150 lbs. Made by U. S. Gauge, Air Reduction Co., Walter Kiddie—all famous makers. Used by artists for air brush work, sign painters, retouchers, welders, etc., soda fountains and taverns.

Fully Guaranteed

All Brand New and in Perfect Condition

**A \$15.00 VALUE \$5.95** (Wt. 4 lbs.)

Price F. O. B. Chicago. Immediate delivery. Sold on money back guarantee. Send check or money order today. Write for free folder.

**C & M EQUIPMENT CO.**

1831 S. State St., Dept. D-9, Chicago 16, Ill.

### BURIED TREASURE. MINERALS AMAZING NEW GOLDAK LOCATORS

**SENSATIONAL NEW MODEL!** ONLY 11 pounds weight! One hand operation! Money-Back Guarantee of Superiority. Write for full details.

#### THE GOLDAK CO.

1542 WEST GLENOAKS BLVD. GLENDALE 1, CALIFORNIA

World's largest maker of fine locators.



### WINDMILL--RAINBOW--FLASHER

SPINNING AUTO LIGHT



Spins with the wind. The most beautiful light in the world. Red, White and Blue. Everybody wants one. Easily put on auto, Bicycle, Airplane or Boat. Pay Mailman \$2 plus postage or send \$3 and we pay postage. Be First.

Agents Wanted. **SPIN LIGHT CO.** 373 1/2 BELMONT AVE. HALEDON, N. J.

#### PISTON TYPE COMPRESSOR



#### EASY PROFIT IN PAINT SPRAYING

Paints walls, ceilings, screens, furniture and machinery faster, better. All complete as shown less motor. Carry anywhere. Fully guaranteed. Could be used with 1/4 H.P. motor or less. Price \$35.00 less motor F.O.B. Chicago. \$5.00 deposit balance C.O.D. or see your dealer. With motor \$55.00.

**IDEAL AUTOMATIC PUMP CO., Dept. P.M. 8**

801 W. Washington Blvd.

Chicago 7, Ill.

### STATION WAGON CABS AND BODIES FOR ALL JEEPS—SMART MAPLE—OAK WOODS

Year around comfort for Jeep owners. Kila dried hardwoods, safety glass. Finest hardware, varnishes, top materials. Full opening rear door, locks.

**CABS \$144.50** Plus Tax

FOB Cleveland. Complete, semi-assembled. Full bodies slightly higher. Send 25% with order, balance COD.

**STATION WAGONS, INC. (PM)** 6619 Euclid Avenue, Cleveland, O.





**NO MORE LOST KEYS**

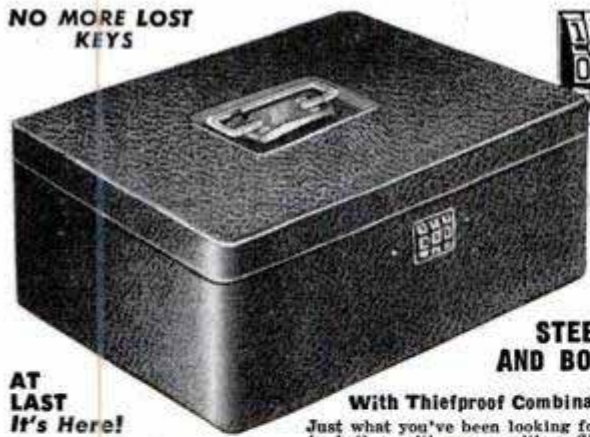

ONLY  
**\$3.95**

**HEAVY STEEL CASH AND BOND BOX**

**With Thiefproof Combination Lock!**

**AT LAST It's Here!**

finger. Set combination to any number you prefer. Safe protection for stocks, bonds, insurance policies, contracts, discharge papers, other important papers in home, store or office. Heavy steel prevents papers from burning in average fire. 11 1/2 x 6 x 4 3/8 inches. For your boy or girl at college, school, camp, service; shut-ins. **SEND NO MONEY**—Pay postman \$3.95 plus postal charge or send \$3.95 and we pay postage. Satisfaction guaranteed. **LEONARD INDUSTRIES, Dept. PM-9, 179 W. Washington St., Chicago 2, Ill.**

**BUILD THIS**

**CONCRETE BLOCK MACHINE**

Sell blocks; or build your home, garage, barn at 1/3 cost by making and laying your own blocks.

This simple machine which you can build yourself at a cost of about \$15 (excluding motor) will make a block in 30 seconds using only one form. 2 to 4 forms can be used on each vibrator.

Power driven concrete mixer plans also. Write for further information. No obligation.

**U-BUILD-IT SERVICE**

Dept. 3-A, 206 West Wilder Ave., Tampa 3, Fla.

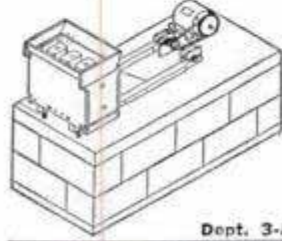

**MACHINE STEEL AND BRASS USERS**

**TOP-GRADE 1/4" GROUND AND POLISHED**

**DRILL ROD Only 82c 3 Foot Bar**

**A WIDE ASSORTMENT, BIG STOCK**

**COLD FINISHED STEEL**

**IN ROUNDS, FLATS, SQUARES, HEXES**

**FREE CUTTING BRASS**

**IN ROUNDS AND HEXES**

**WRITE FOR THIS FREE PRICE AND STOCK LIST**

**AN INTRODUCTORY OFFER FOR YOU!**

For your first order of \$1.00 or more, we will give you, **ABSOLUTELY FREE**, a handsome calibrated 6 1/2" rule! **AND YOUR NAME IS ENGRAVED IN GOLD LETTERS ON THE FACE OF THE RULE!** When you write for the stock list, you will get full details.

**DON'T DELAY! WRITE TODAY!**

**CHESTERFIELD STEEL SERVICE CO.**

Dept. M-9 • P. O. Box 3058 • Cleveland 17, Ohio

**OVER 250 SURPLUS BARGAINS**  
Write for **FREE Catalog PM-7 TODAY!**  
**FISLER SALES CO.** 721 Walnut  
Kansas City 6, Mo.

**3/16" PLEXIGLASS WINDOW \$3.49**

EXCELLENT FOR:

- BARN WINDOWS**
- BOAT HATCHES**
- WINDSHIELDS**
- HOBBYISTS**

Each  
4 for \$12.00  
OD 44x31x5  
inches  
Nt. wt.  
18 lbs.  
Express or  
Freight



**SATISFACTION GUARANTEED - FREE ILLUSTRATED LIST**  
**DICK ROSE ERECO, 2912 Hewitt Ave., Everett 21, Wash.**

**FEET HURT?**

**TRY DR. BARRON'S NEW FOOT CUSHION** for fast relief where it hurts. 1—Corns. 2—Metatarsal Callouses. 3—Weak Arches. 4—Sore Heels. **LIKE WALKING ON A PILLOW!** Light, spongy, Ventilated. Fits all shoes. Cushions arches and feet, heel to toes. Dr. Barron says: "Wonderful for aching feet!" Send \$1.98 for A PAIR, or C.O.D. plus postage. State shoe size, if man or woman. **30-DAY TRIAL GUARANTEE.** Money back if no blessed relief.



**ORTHO. INC., Dept. 49-K, 2700 Broadway, N. Y. C. 25**

**Now CHEAP OIL BURNER**  
**FOR HEATING AND COOKING STOVES-FURNACES**

**HEAT YOUR HOME, COOK YOUR MEALS WITH CHEAP FURNACE OIL**

**NO MORE SHOVELING COAL OR ASHES.** Sensational Fuelizer Starter Vaporizing System turns Cheap No. 1 Furnace Oil, also Range, Heater, Tractor Distillate, Kerosene and like oils into oil heat—one of the quickest, hottest fires known. **LIFETIME GUARANTEE. \$1.00 Bonus Offer for Testing.** We will let you try it in your own stove or furnace for one month. Get yours for introducing. Big profits **QUICK.** Be first. Send in your name today for details and cash in on the tremendous demand for this Amazing Invention.

**NORTHWEST MFG. CO., 608-L, Mitchell, S. Dak.**



**CHAMPION WORLD'S FINEST KEY MACHINE**

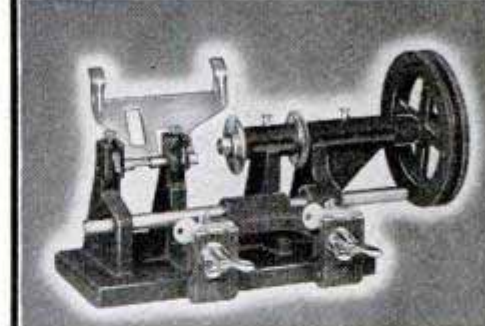

**ONLY \$90.00**  
**WITH MOTOR \$115.00**

At last — a key machine that's low priced, yet will do everything the most expensive machines will do. The **CHAMPION** is precision made throughout. Has highest quality needle bearings in head — oilite bearings in carriage, for ease in operating. Actual cutting visible to operator. 2 cutters, for steel and cylinder keys. Cutting wheel cannot clog.

*The CHAMPION is unconditionally guaranteed to produce better keys, easier, simpler, quicker. It is the FINEST LOW COST KEY CUTTER OBTAINABLE ANYWHERE!*

Hand operated, only \$90.00 complete. With motor, base, switch and 8 ft. cord, \$115.00. Send for illustrated folder today.

**REPAIR SHOP SERVICE** Box 264K Skokie, Ill.



# FOR BIG MEN ONLY!

**QUALITY SHOES**  
**SIZES 10 TO 16**  
**WIDTHS AA TO EEE**

- Wing Tips
- Dress Oxfords
- Moccasins
- Loafers
- Work Shoes
- Hi-tops
- Sox



WRITE FOR  
**FREE**  
 CATALOG

We specialize in large sizes only—sizes 10 to 16, widths AA to EEE, built with extra wear and comfort features that big men need. Styling specially designed for large sizes. Fully guaranteed. Exceptional values. Write TODAY for FREE Catalog and Special Sox Offers.



**KING-SIZE, Inc., 623 Brockton, Mass.**



**Carve for Fun and Profit!**  
**No skill needed**  
**with Dumore Carvit**

Anyone can make woodcarvings with a Carvit! It copies low-cost models you can buy in any dime store. The result—beautiful ornaments, unusual gifts, fine carvings that sell. Write for Free folder with full details  
**The Dumore Company**  
 Dept. J-51 Racine, Wisconsin

**GENUINE SWISS**  
**2-Push-Button**  
**CHRONOGRAPH**  
**WRIST WATCH**



**ONLY \$9.95**

A Sensationally low price for such a precision timepiece . . . A **WRIST WATCH** and **STOP WATCH** in one!

**IT HAS EVERYTHING!**

Note These Features . . .

- It's a **TIMEKEEPER!**
- It's a **STOP WATCH!**
- It **MEASURES DISTANCE**
- It **MEASURES SPEED** of Airplanes, Cars, Race Horses, etc.

It has Sweep Second Hand, Chrome Case, Precision Workmanship.

**EXPANSION BRACELET** of matching stainless steel 49c additional.

**SEND NO MONEY!** Rush order today. Pay postman only \$9.95 plus 10% tax and postage. Satisfaction guaranteed or money refunded if returned within 10 days.

**SWISS IMPORT CO., Dept. 81**  
 P. O. BOX 5284, CHICAGO, ILLINOIS



- Test ALL Home Outlets
- Find Open Circuits

**STAR TEST-PLIERS**

- Locate Blown Fuses
- Remove Fuses SAFELY

A must tool for electricians, maintenance men, home owners. Replaceable lamp inside Plier tests 110 to 250 Volts. Plier pulls fuses from 19- to 300 Amperes. Shockproof. Requires the use of only one hand. Can be obtained from General Electric or Westinghouse stores, local electric dealers or direct from us, postpaid.

Price \$2.75 without Leads, \$1.50 additional for Leads. Order TODAY.  
**STAR FUSE CO., 233 Canal St., New York 13, N. Y.**

**Ball-Bearing SPEED WHEELS**

Juvenile wheels, solid tire—No Bearings

- 7" wheels . . . . . 60c
- 6" wheels . . . . . 50c
- 4" wheels . . . . . 30c

Semi-pneumatic tired wheels

- 12 x 1.75" . . . . . \$3.25
- 10 x 1.75" . . . . . \$2.75
- 10 x 1.25" . . . . . \$2.00
- 8 x 2" . . . . . \$2.00

Industrial wheels for heavy loads

- 400 x 8, 2 ply tire and tube . . . \$12.50
- 12 x 3.00", bolt hub, ea. . . . . \$9.75
- 10 x 2.75" Hollow Core . . . . . \$6.75
- 10 x 2.75" Single Tube . . . . . \$7.25
- 8 x 2.50" . . . . . \$4.90
- 8 x 2.00" bolted wheels, ea. . . . \$4.75
- 6 x 2" lug base . . . . . \$3.30
- 6 x 2" . . . . . \$2.80



**DEALERS WANTED**  
**MANUFACTURERS**  
**INQUIRIES INVITED**

Free blueprints with all wheel orders.  
 Send check with order. Shipments f.o.b. Akron.

**JIM BROWN TOY COMPANY**  
 1097 Home Ave. Akron 10, Ohio

**3-Pc PAINT STRIPE SET** Only \$1.00



3 SEPARATE TOOLS—Each makes different width

Stripe perfect lines—straight, curved, with any paint, lacquer, enamel, easy as drawing lines with ruler! Beautify furniture, toys, autos; make signs and imitation tile. Simple instructions included.

**SEND NO MONEY.** Mail order. Pay postman only \$1.00 plus postage. If not delighted return in 5 days for money back. Order Now.

**STRADER MFG. CO.**  
 259 Strader Ave. Cincinnati 26, Ohio Dept. B-351

**WOODWORKERS . . . Get this**  
**CONSTANTINE MASTER MANUAL**

Get the Most Fun From Your Hobby Indispensable to woodworkers. Newest, biggest edition, more pages, more color, helpful how-to-do-it articles, pre-war and new items, more bargains. Send 25c today and we will include **FREE! FULL YRS. SUBSCRIPTION** to Chips and Chats, published bi-monthly. Keeps you up-to-date on everything in woodworking, offers big money-saving bargains. Send now.

**ALBERT CONSTANTINE & SON, Inc.**  
 791-E 135th Street, New York 54, N. Y.



**Rupture Troubles Ended**

Advanced method has healed thousands. No leg straps, no elastic, no plasters. No pressure on hips or spine. Flexo-pad. Entirely different. Endorsed by doctors, mechanics, clerks. Very light. **INEXPENSIVE. GUARANTEED.** Write for information and trial.

**SMITH MANUFACTURING COMPANY**  
 EST'D 1893; DEPT. PM, PRESTON, ONTARIO



# "SEA CRAFT" BLUEPRINTS READY NOW!



Build this luxurious cabin cruiser yourself and save money. What a beauty it is! A 25-foot boat readily adaptable as a sport fisher, express cruiser, or utility boat. Cruises effortlessly at 15 knots with a marine engine or converted auto motor. Its spacious cabin sleeps four and has a galley complete with fresh-water tank, sink, and cook stove. Has open cockpit large enough for fishing, lounging, etc.

During war the Coast Guard used "Sea Craft" for ship-to-shore travel. Order today your complete set of seven large-size blueprints scaled 1 inch to the foot. These, plus a 40-page two-color illustrated booklet giving step-by-step instructions, only \$10.00.

**POPULAR MECHANICS PRESS**  
200 EAST ONTARIO ST. CHICAGO 11, ILL.

## WHAT TO MAKE SERIES

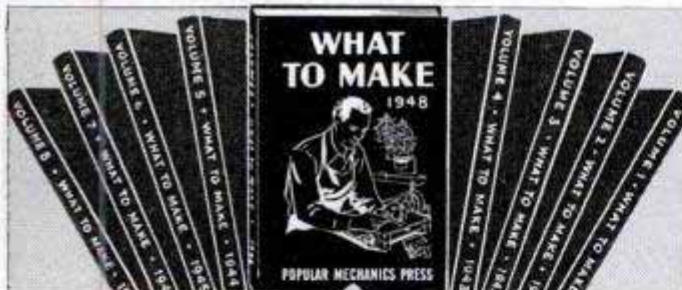

Send for your copy of the new 1948 clothbound edition now! Keep your set up to date. This is the 9th in this famous series of Home Workshop and Hobby Guides. If you do not have the earlier volumes you are missing a wonderful source of inspiration for making fascinating things at home. Every book is different... contains material not in the other volumes.

**POPULAR  
MECHANICS  
1948  
EDITION**

Partial contents:  
Birdhouses, sideboards, benches, furniture, book ends, chairs, toys, games, photo equipment, Dutch windmill, leathercraft, bookbinding, ship and yacht models, reclining chairs, fruit baskets, bobbled, hamper, garden furniture, log cabins, porch furniture, tables, hostess trays, footstools, desks, lamps, fireplace screens, bookcases, wall cabinets.

### PACKED WITH FUN AND PROFIT FOR EVERY HOME CRAFTSMAN

Nine big books ..... 1900 pages, 4000 pictures  
\$1.75 a volume ..... \$14.00 for set of nine

POPULAR MECHANICS PRESS, 200 E. Ontario St., Chicago 11, Ill.

Please send What To Make books as checked below. I will pay postman price and few cents postage. It is understood my money will be refunded if I'm not satisfied.

What To Make Vol. 9 ..... \$1.75  
What To Make Library (9 vols.) ..... \$14.00  
Postage paid if remittance accompanies order.  
Outside U.S.A. 15% additional.

Name \_\_\_\_\_  
Street and No. \_\_\_\_\_  
City \_\_\_\_\_ Zone \_\_\_\_\_ State \_\_\_\_\_

**Woodworkers!!**  
Make your circular saw the most versatile tool you own!

CUT GROOVES LIKE THIS

\$4.95  
SET

POSTPAID  
INCLUDING TAX



WARREN DADO SAWING WASHERS WILL FIT THE ARBOR OF ANY POWER CIRCLE SAW AND CAN BE USED WITH ANY DIAMETER SAW BLADE. CUTS GROOVES CLEANER, EASIER AND FASTER THAN AND DADO CUTTER ON THE MARKET... MICROMATIC ADJUSTMENT PERMITS A CUTTING ANGLE CHANGE IN 15 SECONDS... SAW BLADE HELD RIGID... WILL NOT CHATTER... WARREN DADO SAWING WASHERS CAN BE LEFT ON THE ARBOR OR QUICKLY REMOVED FOR CUT OFF SAWING.

ORDER YOUR SET OF FOUR WASHERS TODAY. TRY THEM FOR TEN DAYS, IF NOT SATISFIED, YOUR MONEY WILL BE REFUNDED IN FULL. DEALER INQUIRIES INVITED



DADO SAWING WASHERS  
**Warren**

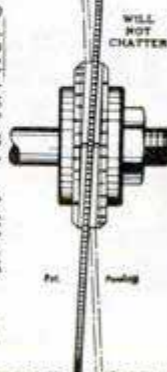

Arbor  1/2  3/4 *Gentlemen:* Please send \_\_\_\_\_ sets of sawing washers:  
Sizes  3/8  1 Name \_\_\_\_\_ PLEASE PRINT  
 Free Circular Address \_\_\_\_\_  
 Check City \_\_\_\_\_ State \_\_\_\_\_  
 Money Order ALL SETS SHIPPED POSTPAID 29

**WARREN DADO SAWING WASHERS CO.**  
P. O. BOX 98 NORTH END STATION  
DETROIT, MICHIGAN



### COMPLETELY SAFE

Here is the gun that will thrill every boy. When you pull the trigger, it cracks out like a real gun and smoke puffs out of the muzzle. The American Rangers Automatic is a quick acting, repeating pistol that never misses. It shoots 60 to 75 shots without re-loading. Looks like a real gun. Absolutely SAFE. Contains no explosives. Each gun comes boxed with 10,000 shots of smoke powder or enough ammunition to last a full year. This smoke powder is harmless. Will not hurt the eyes and may even be eaten. Only \$1.00 each or 3 guns for \$2.00. Only limited quantity available. Write for yours NOW.

### SEND NO MONEY Try 10 Days - At Our Risk

Just send name and address. On arrival deposit only \$1.00 plus C.O.D. postage for one gun or \$2.00 plus C.O.D. postage for three guns. If not completely satisfied return and your money refunded. Save money. If you send cash with order, we pay postage. Write TODAY.

**SPECIALTIES MFG. CO., Dept. 508**  
1367 N. Sedgwick Chicago 10, Ill.



**WAR SURPLUS BARGAINS**

**110 VOLT, 60 CYCLE, 2500 WATT POWER PLANTS**  
GOVERNMENT COST \$535.00



Famous Army PE-75 Plants. Briggs 6.5 h.p. engine—driving 110 volt, 2500-watt Leland A-C Generator. Ideal size for farm, ranch, contractors, etc.

Only **\$266.80** FREIGHT PAID

- New 2500-watt plants (with tools & spare parts) ..... \$266.80
- Fully recond. plants 2500-watt \$229.80
- "As is" 2500-watt plants. Require minor adjustments ..... \$180.80
- New 2500-watt plants without driving engine \$124.80
- Reconditioned 600-watt 110-volt 60-cycle plants ..... \$127.80

**6 H.P. GAS ENGINES NEW COST**  
**BRIGGS-STRATTON, BUSY BEE \$140.00**

World's Finest Gas Engines. Ideal size for garden tractors, pumps, sprayers, saws, etc. The buy of the year! Will not be duplicated.

- Briggs Model ZZ-6.5 h.p. Fully reconditioned ..... \$86.90
- Briggs Model ZZ-6.5 h.p. Brand new. Original carton ..... \$115.50
- Busy Bee, 6.5 h.p. gas engine (a real unit) Brand new ..... \$82.90



ONLY **\$86.90** PREPAID

**ROTARY GEAR PUMP**  
PRECISION BUILT ORIGINAL PRICE \$24.00



Precision pump made for B-29s. 4" x 8" size, 1/2" shaft. Mechanics say "Most versatile pump made." Useful for pumping liquids, vacuum, pressure; capacity to 3 g.p.m. Vacuum 29 in. Pressures to 200 lbs. Full instructions and operating data furnished with pump.

**\$3.95** POSTPAID

We guarantee customer satisfaction. Reference National Bank of Commerce. Order direct from ad or send for catalog. We accept checks. We pay all freight in USA.

**LECO ENGINEERING CO.**  
Box 908-PM9, Lincoln, Nebr.

**ASSEMBLE**

*King Midget*



**45 MILES AN HOUR 90 MILES A GALLON**

New, low cost transportation. Practical. Safe. A pleasure to drive. Home assembly keeps cost low. Just bolt together our factory built units. Immediate delivery. Send 25c for detailed circular with large picture, 4-view drawings, price of all parts. Or send for actual Assembly Book with 42 photographs, blueprints, drawings, sketches AND above literature—all for \$1 (refunded first order).

**MIDGET MOTORS MFG. CO. Athens, Ohio**

**NEW ALL PURPOSE WORK GLOVE**  
Rhinosol makes 'em tough



**OUTWEARS LEATHER NO ODOR**  
**RESISTS ACID, OIL, SOLVENTS**

BRAND NEW—Toughest, softest, best work glove you ever saw. Here at last is a work glove that really wears. Outlasts many leather gloves, because treated with Rhinosol, new super-chemical, they outwear higher priced gloves made of leather. Soft, pliable, yet extra strong. Long fingers, knit wristlets. **RHINOSOL RESISTS HEAT, OIL, ACIDS, SOLVENTS.** Makes the ideal work glove for all uses around shop, farm or home.

**SEND NO MONEY; TRY 5 DAYS!**

To get gloves prepaid, tear out this ad and send with low introductory price of \$1.00. Or just send name and address and pay postman \$1.00 plus C.O.D. Use five days and if not satisfied, return for money back. Only one pair to customer at this special low introductory price. Order today.

**\$1.00** POST PAID NO RISK GUARANTEE

**FRANCIS SUPPLY COMPANY**  
DEPT. I-3 1836 EAST FULTON STREET COLUMBUS, OHIO

**BUILD YOUR OWN TILTING TABLE SAW!**



- 21x27 in. table tilts full 45°
- 8 in. blade cuts from 0 to 2 1/2 in.
- Ball bearing arbor, precision machined, ready to run
- Sturdy cast aluminum rip fence guide and miter gauge completely machined ready to install

**SAVE \$50 OR MORE**

• Sturdy wood, steel and aluminum construction  
• No machining—build easily with hand tools  
**GIL-BILT Step-by-Step Plans**—simplified perspective drawings, full size patterns, 15 actual photographs ..... \$ 1.00  
**GIL-BILT Special Metal Parts Kit** includes Plans, ball bearing arbor, cast aluminum tilt arms, rip fence guide, miter gauge, and all other metal parts (less blade) ..... \$15.95  
Same kit with 8" combination blade ..... \$19.90  
**GILLIOM POWER TOOLS** P. O. Box 1-R, Lambert Field St. Louis 21, Missouri

**WAR SURPLUS SPECIAL**

100's of uses, signal & control systems for electric trains, Christmas tree lights, etc.



**ELECTRIC CIRCUIT TESTER**

24 G.E. Mazda, 313 Pilot lights and sockets. 7 test leads and plugs mounted in bakelite box. New original packages. \$3.00 ea., 2 for \$5.00 Postpaid.

**BARDANAL, INC.**

1222 W. Washington Blvd., Whittier, California



**LELAND ELECTRIC GENERATOR**

2.5 KVA, 120 volt, 60 cycle, 1 phase, AC. Any comparable new generator will cost you twice our price.

Remit by Bank Draft

**\$125** Freight Prepaid In U.S.A.

**HOPFER & COMPANY**  
3124-A E. 14th St., Oakland, Cal.



**AMAZING BURGLAR ALARM**  
**GUARANTEED TO STOP THIEVES**

**FOR CARS • HOMES • FARM BUILDINGS**

A South Dakota manufacturer has discovered an easy way to protect cars, homes, farm buildings from Burglars, sneak and chicken thieves. The manufacturer is so sold on his sensational **DEVIL DOG Burglar Alarm** that he is willing to let you try it for ten days and will offer you \$1.00 for testing it. New sales plan promises big money to hustlers. Be first to get your **DEVIL DOG Burglar Alarm** for introducing in your territory. **CASH-IN** on the tremendous demand this device will create. Shipped prepaid from factory on ten year guarantee. Rush name and address for details to

**NORTHWEST ELECTRIC CO., Dept. L-303, Pukwana, S. Dak.**



# SORE MUSCLES?

## BODY ACHES?



When muscles are stiff and sore from unusual exercise or strain, use HEET®, the liniment that's strong yet does not burn the skin. Wonderful relief from muscular soreness comes as comforting HEET quickly starts to penetrate. Just brush it on with the applicator. HEET starts at once to ease muscular pain and keeps on working for hours. Ask your druggist for HEET liniment.

## EVER NEED THIS?

\$2.98  
less  
bat.  
(6-volt)



Maybe tonight's the night you'll need a good electric lantern. Here it is! Has dozens of uses, indoors and out. Shoots 800 foot beam. Light "stays put" at any angle you set. Buy at hdwe., sport, or electrical stores.

# Delta REDDYLITE

DELTA ELECTRIC CO., MARION, INDIANA

## CARBURETOR TOO RICH MAKES MOTORIST TOO POOR



Car owners who are wasting money and not getting proper gas mileage due to over-rich mixtures will be pleased to learn how to save gasoline by VACU-MATING over-rich mixtures. VACU-MATIC fits all cars, trucks and tractors. It is automatic and operates on the supercharge principle. Easily installed in a few minutes.

### SALESMEN WANTED! Big Profits!

Send name, address on penny postcard for free particulars and how to get yours for introducing.

VACU-MATIC CO., 7617-1384 W. State St., WAUWATOSA, WIS.

## New SWISS WATCH

This brand new 17 Jewel Swiss Watch has every desirable feature: chrome case with stainless steel back; sweep-second hand and radium dial; it is waterproof, shockproof and anti-magnetic. Delivered complete with stainless steel expansion band for only \$25.75 Federal Tax included. This watch has a full one year guarantee—order yours now. Five dollar deposit required on C.O.D.'s.

Money refunded if not completely satisfied.

### REGISTERED JEWELERS

172 1/2 Canal Street New York 13, N. Y.

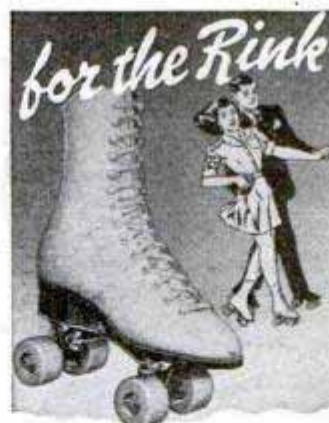

## "CHICAGO"

### ROLLER SKATES

Forty years of leadership reflect the outstanding quality and performance of these beautiful "CHICAGO" Shoe Skates. Stars and Champions are made on "CHICAGOS." Be popular—get on the road to Stardom. Own a pair of the World's Finest Skates.

#### VALUABLE BOOKLET

"Secrets of Rink Skating." Contains valuable Skating Suggestions for beginners, dance patterns, skate selection and care. Send 10c to cover mailing.



## CHOICE OF CHAMPIONS

### CHICAGO SCOUT FLYING Roller Skates

Boys and Girls all want "CHICAGO" Sidewalk Skates. The World's Greatest Roller Skates for youngsters or grown-ups. The Triple Tread, Ball Bearing Steel Wheels give more action—Speed and Longer Life.

Demand "CHICAGOS" from your Dealer.

Send for FREE Booklet "How to Roller Skate." Enclose 10c for Skate Club pin. Value 25c.



No. 101

## CHICAGO ROLLER SKATE CO.

Mfgs. of Rink & Sidewalk Roller Skates, Industrial Fuses—Screw Machine Products

4414 W. Lake St.

Chicago 24, Ill.

## New IMPROVED Electric MOTO-SAW

ONLY \$5.85

(with 3 Saw Blades) Postpaid



SAFE AS A HAND SAW  
JUST GUIDE IT!

More like magic than any tool you ever saw. Imagine an electric scroll saw only slightly heavier than a hand coping saw . . . a tool that takes no effort to run, no pressure to feed. Works at any angle—on big assembly jobs—or on the tiniest piece you can hold in your fingers. Runs 7200 strokes a minute . . . so fast the blade seems to stand still. Sturdily built . . . only two moving parts . . . never needs oiling. Easily cuts intricate designs—so smooth it eliminates sanding. Novice or craftsman, a thrill awaits you when you get a Moto-Saw in your hand.



THOUSANDS OF SATISFIED USERS  
U. S. Patent 2233862  
Other Patents Pend.  
Dremel Mfg. Co.  
Dept. 5118-J  
Racine, Wisconsin

No Limit to Length of Stock it Will Cut. Saws to Center of 19" Widths.

It's fast . . . cuts on an average of 1 ft. per minute up to 3/4" medium hard wood. Operates on 110-120 V. 50 or 60 cycle alternating current. If your dealer does not yet have Moto-Saw, send \$5.85 . . . we'll pay postage. Or send \$1, pay postman balance plus postage. MONEY BACK if not delighted after 5 days' trial.

# FREE Sample Of New PLASTIC Shows How To Make Leather and Leatherette LIKE NEW!



## Magically Changes Cloth To Imitation Leather

SAVE MONEY - TIME AND EFFORT by renewing Luggage—Leather Covered Furniture—Golf Bags—Auto Seat Covers—Restaurant Furniture, Booths or any Leather or Leatherette item with new plastic discovery called Leather-New. Coat cloth or cloth covered items such as Glider Cushions, Tarpaulins, Porch Furniture, Etc. and make them look and wear like they were leather. Stains easily with brush or spray gun—leaves NO BRUSH MARKS. Simple Acids, Caustics and Alcohols do not stain this finish—It is sun and mildew proof. Stays Fresh and Clean as long as real leather. Comes in all standard colors. Just mail coupon for Free sample of Leather-New coated material which shows effects.

LEATHER-NEW PRODUCTS • 4723A Troost • Kansas City, Missouri

### OWN A PROFITABLE LIFETIME BUSINESS

Cash in on big profits to be made in this new business—Profits up to \$700.00 monthly possible, renewing booths and furniture for bars, restaurants, grills, movie houses, etc. Mail name and address on 1c postcard—I'll show you how. Jack Edwards, Sales Mgr.

## JUST MAIL COUPON

No Obligation

LEATHER-NEW PRODUCTS  
4723A Troost, Kansas City, Missouri

Name \_\_\_\_\_  
Address \_\_\_\_\_  
City \_\_\_\_\_ State \_\_\_\_\_

Fill Out—Mail Today



Sensational Value!

# PAINT SPRAYER WITH ELECTRIC MOTOR

**DOES ALL ORDINARY PAINT SPRAY JOBS**

Positively unheard of 'til now—an electric powered sprayer outfit at such a low price. Not a toy! Not a makeshift. It's a real, practical all-purpose sprayer outfit complete with compressor, 110 volt A.C. or D.C. electric motor, suction type, continuous flow spray gun, paint container, 10 ft. air hose, 6 ft. electric cord and plug. Use it for home shop, auto and 'round the house jobs, and do a good job—quick. Rush order today. Only \$19.95 complete. Send check or M.O. If C.O.D. send a five dollar bill for deposit.



Uses  
**Lacquers,  
Varnishes,  
Paints,  
Etc.**

Complete Only  
**\$19.95**

Weights Only 8 lbs. Portable. Use it Anywhere.

**HOME SHOP PRODUCTS CO.**  
DEPT. 16, 4821 SHERIDAN ROAD CHICAGO 40

## ZIPSCOOT \$49.75

**America's Outstanding Scooter Value!**  
This smart looking speedster is easily and quickly assembled from our factory finished kits. Uses standard gasoline motor. Speeds up to 30 miles per hour. 100 miles per gallon of gas. Send 25 cents for assembly information, drawings, and illustrations. Kits available for immediate shipment.

**Zipscoot Company, Toledo 6, Ohio**



## PRINT YOUR OWN POST CARDS

COMPLETE OUTFIT  
only  
**\$7.50**

Amazing results in sales, inquiries and contacts... saves time and money... very easy to use. **GEM STENCIL DUPLICATOR** is ideal for *Advertising, Announcements, Notices, Labels, Forms, Price Lists*... hundreds of uses for every type of business and organization. Comes complete with all supplies, instructions and 60-page Book of Ideas. Every Gem is fully **GUARANTEED FOR LIFE!**

**Free Trial Offer:** Try it before you buy it! Write or use coupon below and a GEM OUTFIT will be sent you postpaid. After 10 days, send only **\$7.50** or return the GEM, no questions asked. The GEM must sell itself; you be the judge.

**SEND NO MONEY • FREE TRIAL OFFER**

**BOND EQUIPMENT CO. • Dept. 135**  
**513 Olive Street, St. Louis 1, Mo.**  
Rush me the GEM as outlined above:

NAME \_\_\_\_\_

ADDRESS \_\_\_\_\_

CITY \_\_\_\_\_

STATE \_\_\_\_\_

*A Thousand and One Ideas You Can Use on the Farm!*



POPULAR MECHANICS

# FARM MANUAL

Use it to Step up Farm Efficiency — Increase Production — Improve Farm Appearance — Save Time, Labor, Money!

**A Must for Every Farm Family! Saves Money for City Homeowners Too!**

Here is the experience of hundreds of successful farm operators brought together in one handy, easy-to-read, easy-to-use, working handbook by the editors of Popular Mechanics. It is brimful of short cuts, labor-saving ideas, ingenious apparatus and methods that will simplify the day's work and lighten some of the more tedious chores, make money and save money for you.

**HELPS IN THE FIELD — IN THE BARN — IN THE HOME**

Every department of the farm is covered in the Farm Manual. Every member of the family will find in it something that he or she can use to tremendous advantage in farm operation, maintenance and improvement, from the building and care of equipment to painting the farm home and fast freezing fruits and vegetables. It covers farm buildings, the farmhouse and other homes and is of interest equally to the woman looking for home improvement, beauty and convenience and the man striving for easier and more profitable operation.

**ORDER TODAY — FOR YOURSELF — FOR A GIFT**

Use the coupon below. Mail it today. Book will be sent at once, postpaid if you include payment with your order. If you don't think the Farm Manual is worth even more than you paid for it after five days' use, send it back by mail and your money will be refunded. This may be the best investment you ever made. Rush coupon today.



284

FACT-PACKED PAGES

Hundreds of Illustrations

Popular Mechanics Farm Manual is packed with practical ideas and usable information that can easily be worth hundreds of dollars to farm families and homeowners everywhere.

**Farm Machinery and Implements**

How to make and get the most out of farm implements.

**Farm Workshop Equipment and Repairs**

Ideas that can save hundreds of dollars.

**Poultry and Livestock**

How to build equipment, gadgets. Care of farm animals and poultry.

**Vegetable Storage—Processing**

Winter storage, home freezing tips, make your own freezer.

**Farm Home Improvement**

Fencing, repairing electrical appliances, plumbing, electrical wiring, saving coal, painting, curing leaky basements, hanging wall paper, making garden tools, garages, working with concrete, painting, etc.

**Farm Hints and Kinks**

Forty pages of illustrated, practical ideas, short cuts, etc., that will save time, labor and money.

**MAIL COUPON • Money Back if Not Satisfied**

**POPULAR MECHANICS PRESS, Dept. 665**  
200 East Ontario St., Chicago 11, Ill.

Send \_\_\_\_\_ copies of the Farm Manual at once.

Remittance (\$3.00 each) enclosed. Send postpaid. Add 15% if outside U.S.A.

Send C.O.D. (\$3.00 each) plus delivery charges. U.S.A. only.

If sent as a gift to another, send name and address on separate sheet.

Name \_\_\_\_\_

Address \_\_\_\_\_

City \_\_\_\_\_

Zone or

Route \_\_\_\_\_

State \_\_\_\_\_



## DIE HOLDER FOR LATHES

Mounts in tailstock spindle of lathe for holding 1-1/2 inch diameter button threading dies. Permits perfect alignment of die with work-piece to produce accurate threads. Die Holder precision-made from steel—shank accurately ground.

**SOUTH BEND LATHE WORKS**  
455A E. Madison St., South Bend 22, Indiana



**DIE HOLDER** with  
No. 2 Taper Shank . . \$4.00  
No. 3 Taper Shank . . \$4.50

See your dealer—or sent direct postpaid.

## SOUTH BEND

## 8 LITTLE GIANTS



### OWN THIS FINE 8 PC. COMB. BOX AND OPEN END WRENCH SET

in transparent leatherette roll. Made of hi-grade alloy steel and heat treated. 8 sizes 13/64 to 7/16. At your local dealer.

**PRICES** Retail \$3.00 per set  
Dealer \$24.00 per doz. sets

**DISTRIBUTORS WANTED**  
Send \$2.00 only for sample set postpaid.

**STEPHENS TOOL WORKS**  
Box 306, La Tijera Sta., L.A. 43, Calif.

## OTTAWA Buzz Master

A faster brush cutter and wood sawing machine. Propels itself while cutting saplings and brush. 7 H-P motor. Many outstanding and exclusive features. Available attachments: sickle bar, rotary tiller, sprayer, air compressor, snow plow and pulley for belt work. Thousands in use. Send for FREE booklet.



No Other Like It!

**OTTAWA MFG. CO., 1-827 Brush Ave., Ottawa, Kansas**

## EVINRUDE Catalog Free



Describes complete line of 1948 Evinrude Outboard Motors—sensational new "Sportwin" model — 2 models with revolutionary "Weedless Drive" — 3 thrilling four-cylinder models. Gives helpful information on boats, speeds, etc. Profusely illustrated. Write

**EVINRUDE MOTORS**  
5689 N. 27th St., Milwaukee 9, Wis.

## 1000 FT. BLOWER WITH 1/6 H.P. MOTOR \$45.00 FOB Chicago



1000 cubic feet free air per minute for cooling, heating, drying, blowing, ventilating, air conditioning, dust collecting, etc. 14 inches high, 14 inches wide, 12 inches deep, 6 inch wheel, blower complete with cont. duty 1/6 H.P., 110-Volt, 60 cycle, A.C. motor. List price \$65.00. While they last \$45.00. Send deposit, Bal. C.O.D.

Dealers Write for Bargain Listings  
**C. MARSHALL SALES**  
3546 W. FULLERTON, CHICAGO, ILLINOIS

## PULVEX FLEA POWDER

### TWO KINDS

**WITH 5% DDT**  
... for dogs. Kills fleas and lice quick. Keeps fleas off 5-7 days. Many home uses.

**OR WITH ROTENONE**  
... for cats, dogs. Quickly kills fleas, lice. Kills fleas when put on a single spot. Pre-war formula.

EITHER KIND: 25c & 50c



SAY YOU SAW IT IN POPULAR MECHANICS

SEPTEMBER 1948



DO YOUR OWN

*Calking*  
WITH **NU-CALK**

**SPEED LOAD**  
AND THIS NEW **SPEED LOADER**

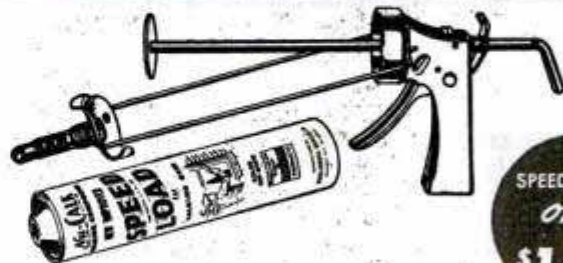

SPEED LOADER  
only  
**\$1.95**

Every home should be calked and here's the combination that enables you to do the job yourself. Just snap a Nu-Calk SPEED LOAD into the SPEED LOADER Calking Gun and you're ready to calk. You have an easy, fast, economical way to apply the world's finest calking compound.

Macklanburg-Duncan Co., Oklahoma City 1, Okla.



**NO MAIL ORDERS**  
SOLD ONLY THROUGH LEADING  
HARDWARE STORES, LUMBER YARDS  
AND BUILDING SUPPLY DEALERS

# MAKE \$ MORE MONEY

Applying or Selling

## CORKSTONE

A General Purpose Magnesium Oxychloride Flooring

### THE MODERN PLASTIC FLOORING

#### EASY TO APPLY

Here's your opportunity to get into business for yourself applying or selling Corkstone, the economical, top-grade plastic flooring. Plenty of profit Act without delay!



### Dealers & Agents Wanted

WRITE FOR DETAILS

### LASTING PRODUCTS COMPANY

Franklinton Road Plant.

Baltimore 23, Md.

299



# ELECTRICIANS

Get this Great Book

Book of 150 Shop Prints. Wiring Diagrams. Full Size 8 1/2 x 11"



# FREE

For Merely Examining  
Coyne's NEW Pay Raising

## 8 Volume Set APPLIED ELECTRICITY

Here's a brand new set of electrical books to give you the "know how" on all branches of electricity from appliance repairing to D.C. and A.C. equipment, electrical refrigeration, Industrial Electronics, etc. 3,400 subjects, 11,500 facts. Latest methods explained in easy to follow instructions. To prove how valuable and Practical this set can be to you. I'll give you a FREE copy of my book "150 Shop Prints and How to Read Them" just for looking over this set. Written by the Coyne Staff and backed by 47 years' experience, this set has helped many ambitious electrical workers to bigger pay and added opportunity.

**OFFER LIMITED • ACT NOW!** If you act promptly, I'll send you the 8 volume set Applied Practical Electricity for 7 days FREE examination... together with the 150 Shop Print Book. Look the set over 7 days. If you like it send either \$22.75 cash or \$3.00 after 7 days and \$3.00 per month until \$24 is paid. If you don't want the set, return it and YOU OWE NOTHING. In either event you keep the 150 Shop Print Book absolutely FREE.

Coupon below is just a request to see the books free and to get my gift book for doing it. ACT—Send coupon Today!

Technical Book Div. COYNE ELECTRICAL SCHOOL  
500 S. Paulina St., Dept. 68-R6, Chicago 12, Ill.

**FREE BOOK**  
Coupon

SEND NO MONEY



B. W. Cooke, Director COYNE ELECTRICAL & RADIO SCHOOL  
500 S. Paulina St., Dept. 68-R6, Chicago 12, Ill.  
O. K. send me, postpaid, Coyne's new 8 volume, "Applied Practical Electricity" for 7 Days FREE TRIAL per your offer. Also send, absolutely FREE, the book of 150 Shop Prints as a gift.

Name \_\_\_\_\_ Age \_\_\_\_\_  
Address \_\_\_\_\_  
Town \_\_\_\_\_ Zone \_\_\_\_\_ State \_\_\_\_\_

## WILL YOU SPEND

# 3 MONTHS...

## to BUILD A New BODY?

Will you work three months for a stronger, more handsome physique? If you have that much ambition, **PARAMOUNT BAR BELLS** are your sure, fast way to physical development. In no time at all you'll actually see your neck, chest, arms, shoulders and thighs growing to new, shapely proportions. Thru the use of Paramount Bar Bells you will be providing these sets of muscles with the right kind of resistance for fast development.



WRITE FOR

Free **ILLUSTRATED CATALOGUE**

**8<sup>95</sup>**  
UP

See **PARAMOUNT'S** complete catalogue of barbells, dumbbells and home gyms. You can save 20 to 30% on body building equipment. **ACT NOW! WRITE TODAY!**

FACTORY PRICES

## INDEPENDENT IRON WORKS

2416 East 23rd St., Dept. 21, Los Angeles 11, California



## FAMOUS WAR SURPLUS AIRCRAFT FLASH UNIT

PURCHASED DIRECT FROM U. S. GOVERNMENT

All amateurs and professionals should have it. The Unit is made to be used with batteries, but we furnish without extra charge all necessary parts, Reflectors, Connectors, Cords, Spares, and Transformers, with Diagrams and Instructions to convert to 110 Volts A.C. The light output is 110 watt secs. 2 Condensers, total 50 mfd. 2 High Speed Flash Tubes, Plastic sealed, Unbreakable.

**\$54.00**

BRAND NEW—NEVER BEEN USED. A TERRIFIC WAR SURPLUS BARGAIN while they last. All complete  
**CINEX INC., Dept. M.P., 165 W. 46th St., New York 19, N.Y.**

## MAKE UP TO \$500 AN HOUR

—as an Independent AMERICLEAN SERVICE OPERATOR in your own locality. Quick, new Method **CLEANS, RESTORES** Rugs, Carpets like new, without taking off floor; also Upholstery, Auto Upholstery; Walls, Wallpaper, Moth-proofing, too. No machine or equipment to buy. No experience or shop needed; operate from your home. F.N., Ind., writes: "Made almost \$98 a week in spare time." H.I., Wash., writes: "Two jobs brought about \$30 in 7 hours." K.A.L., Wyo., writes: "Next week I have \$130 worth of business to do." C.C.T., Ind., writes: "Netted \$55 on 2 jobs." Many others making Big Money. Big, year-around demand. Steady, repeat business. Only \$10 starts you, spare or full time. Territories going fast. Write for FREE details today!

**YOUR OWN BOSS \$**

### AMERICLEAN CO., Inc.

211 North 7th St. Dept. G-21 St. Louis 1, Mo.

## Now! Everyone can afford a SPRUNGER BENCH SAW

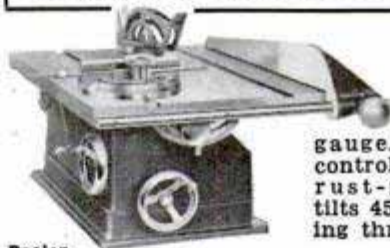

Own the best—for production or craft use. 8" blade. Rips, crosscuts, bevels, miters, dados. Big, accurate miter gauge. Easy-working handy controls. 16" x 20" rust-proof table tilts 45°. Ball bearing throughout.

**68<sup>50</sup>**

Price subject to change.

Dealer inquiries invited.

See your dealer, or write . . .

**SPRUNGER BROS., INC., 140 Main St., TOPEKA, IND.**

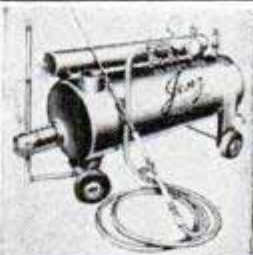

## LOW PRICED STEAM CLEANER

Jenz Super Chief

Portable—No moving parts—Cleans anything—Motors—Chassis—Machinery—Floors—Buildings—Remove wallpaper—Dairy & Creamery—Oil Rigs etc. Oil fired—Economical—fully tested and warranted. 75# Steam in less than 10 min. Model 70, Complete as illustrated. . . . . **\$276.50**

HI-PURE LABORATORIES  
EVANSVILLE, IND.

## LAW FREE BOOK



Your FREE copy of "The Law-Trained Man" shows how to gain prestige and greater earnings through Blackstone home law study. All instruction material furnished including 18-volume Law Library written by 65 well-known law authorities. Lawyers, judges among our graduates. LL.B. degree. Low cost; easy terms. Write today.  
**BLACKSTONE COLLEGE OF LAW** 225 N. Michigan Ave. Dept. 56, Chicago 1, Ill.  
A Correspondence Institution Founded in 1890

## HAMSTERS!



Get the unique Golden Hamster today. Profitable, Prolific, Educational, friendly. 1000's needed by labs and pet shops. Raised anywhere. No experience required. Send 10c for literature or \$5 for pair and literature.

### AZALEA CITY HAMSTERY

1412 East Linwood Dr. Dept. F Mobile 18, Alabama



Plastic Coasters  
and Tiles

## EMBED REAL FLOWERS in NEW Magic PLASTIC



Now create many unusual things like the distinctive pansy coaster shown—made by embedding real pansies in Castolite—the "magic" liquid casting plastic. Comes crystal clear, or may be dyed to produce striking color effects. Make really different jewelry, book ends, picture frames, candle sticks, figurines. Embed real flowers, butterflies, coins, medals, photos, for plaques, paper weights, tiles, other art objects. Use only home tools. Follow simple step by step method. New pleasure, fine profits are possible. Send 50c for exciting new Home Project Manual including special new supplement showing how to get started. Write today.

MANUAL  
50c

THE CASTOLITE COMPANY  
BOX 391 WOODSTOCK, III.

DEPT. K-1

## INVENTORS

HIGHEST  
ROYALTIES and CASH

FOR YOUR INVENTIONS  
INVENTION MARKETING SERVICE "UNPARALLELED" BY ANY  
OTHER AGENCY IN THE WORLD  
Write for FREE booklet without obligation

UNIVERSAL MARKETING CO.

126 Lexington Ave. (Suite M)

New York 16, N. Y.

## How to Make Liquid Marble

Make amazing Liquid Synthetic Marble at home in your kitchen, basement or garage. Terrific demand! BIG PROFIT! No heat, pressure or machinery needed. No experience necessary. MOLD, TROWEL or BRUSH—make in almost any color.

**FLEXIBLE MOLDS:** Valuable information for novelty casting. 3c material makes \$1.00 item. PERMA-TEX Plastic Flooring: Make lifetime floors in any color or shade. Can be laid over wood, concrete, brick, etc. Work out beautiful patterns in contrasting and harmonious colors. WRITE FOR FREE CATALOG!

BING PRODUCTS Dept. PM-9B  
88 Broad St. Boston 10, Mass.

## Speed and Power Handbook

Very latest methods! Construct your own superchargers, water injectors, compression heads, fuel saving devices—easily, practically without cost. Get racing speed, acceleration, dynamic power increases from any automobile! Build stock conversions! Fast roadsters! Hotrods! Get ingenious formulas! Speed secrets! Also "Economy Information"—Tuning techniques! Ignition, Carburetion, Fuels, Mileage tricks! Illustrations! Catalogues. Including "California Re-styling Ideas"—Glossy photographs! Drawings! Model revising! Customizing! Streamlining! Sport changes! Leatherlike bound—\$1.98 complete.



NEWHOUSE AUTOMOTIVE INDUSTRIES  
5941-B4 Hereford Los Angeles 22, Calif.

## BUILD YOUR OWN FAST FREEZER

PLANS  
\$1

It's easy to build this household appliance with LeJay Plans. Made from new or used parts. Save up to 75%. No expert knowledge needed. Plans show 5 sizes and are easy to follow. All details clearly explained. Enjoy making one of these freezers. Mail \$1 for set of plans and catalog. LEJAY MFG. CO., 447 LeJay Bldg., Minneapolis 8, Minnesota



5 sizes  
8 to 40 cu.ft.

## CLOSEOUT!!!

110 V-AC  
Heavy Duty MOTORS

Brand New, Fractional H.P. Ideal for Models, Fans etc. Never again at this price. 100 practical uses. Send Check or M.O. no C.O.D.'s. \$3.95

f.o.b.  
N.Y.C.  
10 for  
\$35.00

MANUEL KLEIN 74 M Cortlandt St.  
New York 7, N. Y.

# WAR SURPLUS OPTICAL BARGAINS

ASSEMBLE YOUR OWN BINOCULARS!

Save More Than 1/2 Regular Cost

## GOVERNMENT'S 7X50 BINOCULARS



Complete Optics!  
Complete Metal Parts!

We supply full instructions

**METAL PARTS**—Set includes all Metal Parts—completely finished—for assembly of 7 X 50 Binoculars. No machining required. Bodies have been factory hinged and covered. A sturdy Binocular Carrying Case is optional with each set of Metal Parts.

Stock # 842-H ..... \$39.40  
Postpaid, plus \$4.80 for Case—Total ..... \$44.20

**OPTICS**—Set includes all Lenses and Prisms you need for assembling 7 X 50 Binoculars. These are in excellent condition—perfect or near-perfect—and have new low reflection coating.

Stock # 5102-H ..... \$25.00 Postpaid  
(These are standard American made parts.)

**NOTICE!** If you buy both Binocular Optics and Binocular Metal Parts, add 20% Federal Excise Tax to above prices.

## ARMY'S 6x30 BINOCULARS

**COMPLETE OPTICS & METAL PARTS**—Model M-13A1, 6 X 30 Binoculars. (Waterproof Model). Everything you need—ready for assembly. When finished will look like a regular factory job costing \$102. to \$120. The Optics are new, in perfect or near-perfect condition. Have new low reflection coating. Metal Parts are new and perfect, all completely finished. No machining required. Bodies factory hinged and covered. Complete assembly instructions included.

Stock # 830-H ..... \$40.00 Postpaid  
plus \$8.00 tax—Total—\$48.00

## TERRIFIC BARGAIN - BUBBLE SEXTANTS

These Army Air Forces Bubble Sextants cost Govt. about \$125 each. Bargain at our price of \$12.50. Wooden carrying case included. Wartime used but COMPLETELY REPAIRED AND COLLIMATED. Return within 10 days for full refund if dissatisfied. Directions for use accompany shipment.

Stock # 924-H ..... \$12.50 Postpaid

Same SEXTANT as above, but BRAND NEW and with Automatic Averaging Device and Illuminated Averaging Disc for nighttime use. Govt. cost \$217. Perfect working order guaranteed.

Stock # 933-H ..... \$22.50 Postpaid

**6 POWER GALILEAN TELESCOPE**—(Commercial Surplus) 28mm dia. Achromatic Objective Lens. Sturdily constructed of Aluminum. 7" long, extends to 9". Complete with carrying case.

Stock # 941-H ..... \$3.00 Postpaid

We have literally millions of war surplus lenses and prisms for sale at bargain prices ranging 10c and up. Write for Catalog "H" — Sent Free!

Order by Stock No.

Satisfaction Guaranteed

## EDMUND SALVAGE COMPANY

P. O. AUDUBON, NEW JERSEY

AIR  
RIFLES

BENJAMIN

AIR  
PISTOLS

PIONEERS - LEADERS

SEND FOR FREE FOLDER OF LATEST MODELS TODAY  
If you want a REAL GUN for PRACTICAL USE inside or outdoors get a SAFE - CLEAN - ECONOMICAL - BENJAMIN with Adjustable Power and Amazing Accuracy. For BEST RESULTS use BENJAMIN H-C PELLETS. WRITE AT ONCE. BENJAMIN AIR RIFLE CO., 812 MARION ST., ST. LOUIS 4, MO.

Profit  
and Fun

## CARVING LEATHER

at home  
spare time  
full time

New Device makes it possible for beginners to improve overnight. Now is the time to cash in on this Big Paying Business—year round profits are easy if you follow new method of instruction to be found only in Baird's home study course. Big sale for bill folds, wallets, belts, purses, gun holsters, saddles, and other leather articles. Make up to \$50.00 per week spare time or up to \$500.00 or more monthly full time.

Start your own business. Make Xmas presents and other gifts. The Baird Course is Complete. Full instructions—Tools and equipment—including new device that makes learning easy. Write for full details and interesting catalog—containing many profitable suggestions—Sent Free—Write Now. Dept. B

BAIRD SCHOOL OF LEATHER CARVING • 221 Manitou Ave., Manitou Springs, Colorado



# PRECISION MICROMETERS

**WAR SURPLUS  
ALL NEW! STANDARD BRANDS  
MANUFACTURED TO GOVERNMENT SPECIFICATIONS**

- No. 901 Reed Micrometer 0" to 1". Black C metal frame with ten thousandths calibrations. Decimal equivalents on the thimble **\$4.50**
- No. 802 Reed Micrometer, as above, 1" to 2" **5.75**
- No. 806 Reed Micrometer, as above, 5" to 6" **6.75**
- No. 436 Starrett Micrometer 4" to 5". Black C metal section frame. Decimal equivalents on thimble and reading is by thousandths **5.00**
- No. 463 Starrett Micrometer, as above, 5" to 6" **6.50**
- Tubular Central Tool Co. Micrometer 0" to 1". Ball anvil point to measure accurately tubing & other rounding surfaces. Black C metal frame. Decimal equivalents on thimble and reading is by thousandths **4.25**
- Central Tool Co. Micrometer 4" to 5". Black flat C metal frame. Decimal equivalents on the thimble and reading is by thousandths **4.75**
- Central Tool Co. Micrometer, as above, 5" to 6" **5.50**
- Goodell-Pratt Spring Dividers No. 517, 8" **1.50**
- Greenfield Screw Extractor. Small end 3/8", large end 19/32" **.50**
- Brown & Sharpe Dial Test Indicator No. 730, complete **25.00**

Send check, money order or cash. 25% Deposit required on C.O.D. Orders.  
on C.O.D. orders. All prices F.O.B. Culver City, Calif.

**AIRBORNE SALES CO., INC.** DEPT. PM 9-8  
CULVER CITY, CALIF.

- ★ WRIST WATCH
- ★ STOP WATCH
- ★ TELEMETER
- ★ TACHOMETER

**Phenomenal Value!**  
17 JEWEL • 2 PUSH BUTTON  
**CHRONOGRAPH**



ONLY **\$29.75** PLUS  
10% TAX

- INCABLOC SHOCK  
RESISTANT FEATURE**
- Sweep Second Hand
  - Radium Dial • Anti-Magnetic • Unbreakable Crystal. (formerly \$71.50)
- IDEAL FOR**
- Physicians • Engineers
  - Radio Men • Sportsmen
  - Photographers • Aviators

**OUR GUARANTEE**  
**MONEY BACK** IN 10  
DAYS

If not satisfied for any reason

**ADLEW JEWELERS**  
Dept. PM-8  
117 W. 42nd St., N. Y. C. 18

Mail Orders Promptly Filled • Shipped  
C.O.D. or send check or money order.  
Address mail-orders to:  
ADLEW JEWELERS, 152 West 42nd St.  
N.Y.C. 18 (Dept. PM-8)

Also available in  
18-k Gold Case.  
\$64.50 (plus 10%  
tax), formerly  
\$125.

## EASY TO BUILD

**U-MAK-IT BOAT KITS** for Home Assembly. Complete with Illustrated Instructions. No Experience Necessary. SEND 25c Postage (Coin) Today for 3 Money Saving Illus. Catalogs Showing all '48 Models & Construction Details.

**KAYAK BOAT CO.**  
703P-WHITTIER ST., N. Y. 59, N. Y.

**KAYAKS  
INBOARDS  
OUTBOARDS  
ROWBOATS  
RUNABOUTS  
DINGHIES  
V23 CRUISER**



## TECK Galvanized Guaranteed MUFFLERS

**A SMOOTHER  
AND QUIETER  
RUNNING MOTOR**

Genuine Hot Dip Galvanizing is the LONGEST WEARING. Lowest cost practical rust prevention known to modern science. Enjoy better motor performance with a TECK Galvanized MUFFLER.

**Note  
These  
Low  
Prices**

**GALVANIZED MOTOR MUFFLERS, INC., Dept. P-9, 401 South Talman Ave., CHICAGO 12, ILL.**

## QUICK BIG PROFITS ON New Magic Cleaner

**ABSOLUTELY WATERLESS!  
SET UP YOUR OWN BUSINESS**

"7-X" MAGIC ALL-PURPOSE HAND CLEANER is selling like hot cakes—with 100% profits on every sale. **ABSOLUTELY NO WATER NECESSARY**—ideal for cleaning grime, paint, grease, etc., from hands instantly. Wonderful for cleaning paint brushes, tar, gum, dirt from upholstery and leather. Polishes chrome, car finish, and has hundreds of household and industrial uses. Every industry and housewife a buyer—be your own boss in a growing profitable business. You can EARN UP TO \$1000 a month handling "7-X" MAGIC CLEANER.

**SEND 10c Stamps or Coin for BIG  
TEST SAMPLE — FULL DETAILS FREE!**

Write today for full facts and enjoy a BIG PROFITABLE BUSINESS of your own. Thousands of quick sales right in your own territory. Send 10c stamps or coin to cover postage and packing **LARGE TEST SAMPLE** of "7-X"—we'll show you how to make big money starting right now.

**SUNNY CAL CO. • Dept. A • Kansas City 15, Kansas**

## DUAL CROSS and ROTARY FEED

**PALMGREN** ROTARY, INDEX, MILLING  
TABLE No. 83

Has 8" table, 360° movement and 4" cross feed travel. Adjusting wheels and dials graduated in degrees and thousandths. Slotted for bolting to table. No. 83 Priced \$49.50, No. 82 without rotary feed \$39.75.

Write for Circular No. 10  
**CHICAGO TOOL AND ENGINEERING CO.**  
8365 South Chicago Ave., Chicago 17, Ill.



## MONEY for MEN ALL FREE

THE PLASTEX Industry needs manufacturers on small scale and for big production of Lamp and Clock Stands, Art Goods and Novelties in Plastex and Marble imitation. Experience unnecessary. 1/2c material makes regular 10c store sellers. Rubber moulds furnished for speed production. Small investment brings good returns. Big chain store orders now being placed. Ambitious men have chance for real prosperity. Our Free booklet will interest and benefit you.

**PLASTEX INDUSTRIES, Dept. A**  
3400 Third Ave. New York 56, N. Y.

## NEW! LOW COST! RESPIRATOR

Wear when sanding, grinding, paint spraying, sweeping, dusting, furnace cleaning, etc. Handy as a pair of glasses. Just keep mouth closed and breathe through nose as all you do to operate. Protects against nuisance dusts, lint, coal, cement, grain dust, hay fever pollen. Has 9 sq. in. filter. For EYE protection against paint spray, dusts, gases, fumes, smoke, order our Fog-Proof Rubber GOGGLES ..... \$2.00 p.p.

**JERRY BRYANT, Dept. PM**  
919 N. Michigan Ave. Chicago 11, Ill.



Order Today **\$1.00**  
POST PAID

## E-Z THREAD QUICK CHANGE GEAR BOX

To fit SOUTH BEND 9" and 13", POWR-KRAFT, LOGAN 9" and 10", CLAUSING and SHELDON Lathes. Aluminum alloy casting, Torrington needle bearings and steel cut gears. Will cut 78 threads. Easily installed.

Price — \$69.50 F.O.B.  
**MONGE MACHINE SHOP**  
NORTH CHICAGO, ILL.

## PLASTICATED "GI" CLOTHS

WATERPROOF, LIGHTWEIGHT, 8 X 10 foot, 1001 uses as painter's dropcloth, lawn, furniture, machinery, merchandise cover, beach blanket, or shelter. Many uses camping, fishing, or picnic trips.

Send one dollar, and we will ship one cloth prepaid—  
**SAX-ON • Dept. M • 3840 Fullerton • Chicago 47, Ill.**

**SAY YOU SAW IT IN POPULAR MECHANICS**

## For All Makes of Cars

• HOT DIP GALVANIZED AFTER FABRICATION •

**AT LAST! 4 Times MORE SERVICE**

For Dodge, DeSoto and Chrysler Cars ONLY \$8.00 . . . Nash \$8.75. Hudson \$8.75, Oldsmobile \$9.22, Pontiac 9.25, Buick \$9.40, Packard \$9.50, Studebaker \$8.90, etc., etc. All 16 Gauge Throughout . . . Also TECK Mufflers for Trucks . . . We Prepay Postage on Cash Orders . . . We Ship C.O.D. Plus Postage.

POPULAR MECHANICS





RID YOUR DOG OF  
WORMS  
USE  
PARKE-DAVIS  
**NEMA**  
WORM  
CAPSULES

**KEEP YOUR DOG FRISKY!**

Dependable, easy to give, scientifically prepared and low in cost, NEMA Worm Capsules effectively remove large round worms and hookworms in dogs and cats.

FREE! Send for illustrated, helpful worm booklet.  
**PARKE, DAVIS & CO., DETROIT 32, MICH.**  
DRUG STORES SELL PARKE-DAVIS PRODUCTS

## BEARINGS

Bore	O.D.	Type	Price, each
.250	.750	Ball	\$0.15
.1875	.6299	Ball	.15
.1895	.500	Needle	.15
.2495	.625	Needle	.15
1"	1 1/4"	Needle	.15
1 1/2"	3"	Ball	1.25
35MM	100MM	Ball	2.25

All Brand New—Minimum order 10 bearings.

**BENJAMIN SALES CO.**

8774 Linwood Ave. Dept. M Detroit 6, Mich.

Fafnir,  
N. D.,  
S. K. F.,  
Torrington,  
Schatz &  
Norma

### MOVIE MAKERS' FAVORITE SINCE 1937

SATISFACTION GUARANTEED

Solar Type 12-Film (Weston 12 Outdoor) **\$1.59**

Ortho, Non-Halo, Fine Grain

16MM **\$1.90** • 16MM **\$3.30** DOUBLE

50 Ft. • 100 Ft. 8mm

**24-HOUR FREE PROCESSING SERVICE**

Order now. Send cash and save shipping cost or \$1.00 deposit on C.O.D. Illinois residents add 2% sales tax.

**SOLAR CINE PRODUCTS, INC.**

4247 SO. KEDZIE, DEPT. PM9 CHICAGO 32, ILLINOIS



Ask Your Hardware Store for  
**FULLER'S**  
Unbreakable Amber Handle  
SCREW DRIVERS

America's most popular line of moderately-priced screw drivers! Wide range of sizes.  
**FULLER TOOL CO., Inc.**  
911 LaSalle St. New York 59  
World's largest makers of Amber-Handle Tools

## INVENTORS

Whether an invention is patentable can be substantially determined by a search of the U. S. Patent records. Without obligation, write for information explaining the steps you should take to secure a patent.

**JOHN N. RANDOLPH**

Registered Patent Attorney

201 Columbian Building, Washington 1, D. C.

## BRUSH PLATING OUTFITS

for re-plating articles in the home and shop. No tanks necessary. Free particulars.

**GUNMETAL CO., AVE. M, DECATUR, ILLINOIS**

## LUMBER

**A BOARD OR A CARLOAD**

Harold Hunt wants to send you big, new No. 15-B Catalog. Over 148 pages of woodworking ideas. 12 pages of rare woods in colors. UNEQUALLED BARGAINS in imported and American woods, supplies, hard-to-find hardware. Send only 15c to cover postage and handling.

**CRAFTSMAN WOOD SERVICE CO.**

2729 S. Mary St. Dept. A-97 Chicago 8, Ill.

TOP  
GRADE  
KILN-  
DRIED  
WALNUT  
MAHOG.  
CHERRY  
WHITE  
HARD  
MAPLE  
POPLAR  
OAK  
AROMATIC  
RED CEDAR

## SMALL VERTICAL SPEED REDUCER

Just the thing for Home and Shop Bench work, Animated and Revolving Displays, Revolving Antennae, Light Production work. Sturdy, compact, (see dimensions), efficient. Case of aluminum, gears of specially selected nickel bronze; worm of hardened steel. Roller bearings throughout. Torque capacity, 25 to 150 inch lbs. Available in 4 different assemblies (see below) and in any one of these standard ratios:

4-1	25-1	64-1	200-1
8-1	30-1	75-1	300-1
10-1	40-1	80-1	400-1
16-1	50-1	100-1	600-1
20-1	60-1	150-1	800-1
		1600-1	

When ordering be sure to specify assembly and ratio required. Shipping weight in carton 8 1/2 lbs. Prompt delivery. Full Money Back Guarantee.

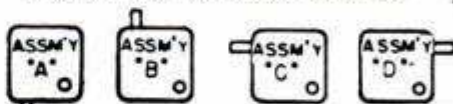

### THE OHIO GEAR CO.

1409 EAST 179th ST. • CLEVELAND 10, OHIO



**\$26.75**

WEST OF ROCKIES

**\$27.50**

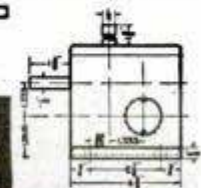
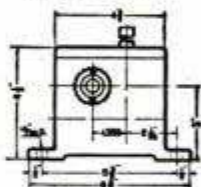

## LAWN MOWER SHARPENER



lawn mower sharpening at low cost!

**\$4250**

less motor.

turn spare time into dollars

Order direct from  
**QUAD CITY PRODUCTS**  
Company, Inc.  
Box 42, Rock Island, Ill.

## STOP CHANGING MOTOR OIL!

End this needless waste and expense forever with

**RECLAIMO** Today's Most Advanced Oil RE-REFINING Filter

Continuously cleans and RE-REFINES motor oil as you drive (by utilizing motor heat)—keeps oil in high grade lubricating quality at all times—reduces motor wear to a minimum! Proves conclusively that "Oil Does Not Wear Out Mechanically" as stated by U. S. Bureau of Standards, (Bulletin 86).

- REMOVES SOLIDS (by filtration)
- REMOVES WATER (by distillation)
- PREVENTS Excess Fuel Dilution
- PREVENTS Acid and Sludge Formation

MAINTAINS Stable Viscosity ELIMINATES All Oil Changes  
CAR • TRUCK • TRACTOR OWNERS!

You'll want to know more about Reclaimo's Oil, Motor and Money-Saving Features. **FREE 40-PAGE BOOK "OIL FACTS"** gives you the complete "Reclaimo" story plus details about our **New 90-Day No Risk-No Cost TRIAL OFFER!** WRITE FOR YOUR COPY TODAY!

**RECLAIMO MFG. CO.**

5083 ELSTON AVE., Dept. 80, CHICAGO 30, ILL.



**NEW ADDED FEATURE!**  
Gas - Moisture Vapor Injector  
Increases Mileage with Smoother Performance





# Stucco Spraying

## Today's Outstanding Business Opportunity



Beauty and protection are sprayed on old and new buildings... exterior and interior surfaces... by COLORCRETE. It's a plastic, water-resistant material; spread evenly over surfaces and forced into cracks by air pressure. Fuses to masonry with enduring tenacity. Many textures. Range of 30 smart colors. Fully-proven by 20 years of actual use under all conditions.



### Big Earnings for Colorcretors

Colorcrete ties in with today's huge building program. Renews old buildings. Makes new construction more attractive and enduring. Large waiting market, because building owners get long lasting beauty and protective values at low price. Yet your selling price can be several times your basic cost. Machine is easy to operate. Moderate investment. Write or wire for complete information.

**COLORCRETE INDUSTRIES, INC.**  
570 Ottawa Avenue Holland, Michigan

# COLORCRETE

## HOME CRAFTSMEN BUY DIRECT



A real machine, mirror polished table 12" x 15". Table hinged to base for oiling & blade changes. Base of Steel & Aluminum Alloys enamel finished. Bronze bearings, 2" of bearing length. Saw blade adjustable—0 to 2 3/4" cut. Uses 6 or 7" Saw Blades, with 1/2" hole. Fitted for Dado Saws for grooving. Aluminum saw guard and ripping fence. Calibrated Cut Off Slide adjustable to any angle.

Complete With Blade

Only... **\$19.95**

**TINKER CRAFT SALES CO.**  
428 New York Bldg.  
St. Paul, Minn.

**SAVE ON BLADES** SAC 1075 Steel  
6" dia. \$2.00 Combination 2.15  
7" dia. 2.25 Combination 2.40  
8" dia. 2.54 Combination 2.70  
8" Piece Dado Head 1095 Steel  
5 15/16 x 7/8. From 1 3/8" to 3/8" in  
1/16 variations \$5.60.

## PISTON TYPE AIR COMPRESSOR

Piston type, size 2 x 1 3/4, head in valves, bronze bearings, splash lubrication, "V" Belt drive, intake muffler and cleaner. Capacity 2.8 c.f.m. at 100 lbs. continuous pressure or 150 lbs. Intermittent, with 1/2 HP motor. Can be used with 1/4 HP or 1/3 HP at lower speed. Weight 14 lbs. Operating instructions furnished.

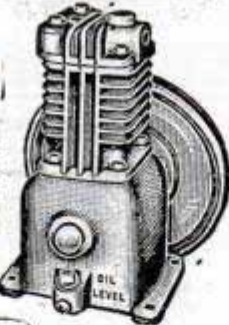

Immediate delivery. **\$17.95**  
Price only



**1/4" REDUCING VALVE & GAUGE**

Oil resistant, pressure 0-to-200 lb. Reduced pressure 0-to-75 lb.; 3 outlets 1/4".  
Wt. 2 lbs. **\$5.75**

**Check Valves**  
Prevent leakage after compressor stops.  
1/4" .....\$2.60  
1/2" .....\$4.25



**POP TYPE VALVES**

Has a close range of closing after pop-off pressure is reached. 1/4" pipe thread.  
Only..... **\$1.50**



Only **\$8.95**

**AUTOMATIC PRESSURE SWITCH WITH UNLOADER**  
125-150 lb. pressure. Uses 1/4 to 5 H.P. unit  
Only **\$8.95**

PRICES ARE F.O.B. CHICAGO. Immediate delivery. **SOLD ON MONEY BACK GUARANTEE.** Send check or money order.

WRITE FOR FREE FOLDER  
**G & M EQUIPMENT COMPANY**  
1831 S. State St., Dept. D-9  
Chicago 16, Ill.



## PRACTICAL BOOKS ON HOME PLANNING BUILDING · REPAIRS

MAIL ORDER TODAY

Plan Now—Build When You Can  
Books Sent C.O.D. Anywhere in U.S.A.

Select from this list of helpful books. In U. S. books sent postpaid if remittance accompanies order. Outside U. S. include 15% extra for shipping charges.

- How to Plan a House \$5.00
- Your Home and How to Build It Yourself \$3.00
- Painting, Decorating \$1.75
- Carpentry \$2.50
- Painting, Furniture Finishing and Repairing  
Includes floor renewal \$1.50
- How to Remodel a House Complete, practical \$5.00
- Building Insulation \$4.50
- Concrete Handbook Do work for yourself, others \$1.50
- Blueprint Reading for Building Trades \$1.50
- Practical Bricklaying \$2.00
- Primer for Home Builders \$2.50

## FAMOUS PLAN BOOKS

Books contain floor plans, photos, descriptions of homes.  
**AMERICA'S BEST LOW COST HOMES.** 125 designs \$1.00  
**DE LUXE SMALL HOMES.** 210 designs \$1.00  
**OUR FUTURE HOME.** Wide selection of residences, summer homes, garage apartments \$1.00  
**MODERN HOME & GARDENING.** 42 popular designs. Improvements, garden short-cuts, etc. \$0.50

Set of Four Books **\$3.50**



Stair Building **\$2.50**

## POPULAR MECHANICS PRESS

DEPT. 646 • 200 E. ONTARIO STREET, CHICAGO 11

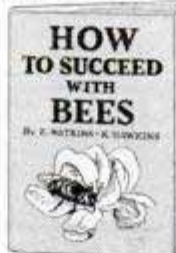

## BEE RAISING PAYS BIG PROFITS

Get HOW TO SUCCEED WITH BEES, written by two outstanding experts, which gives more than 190 successful plans to produce big crops of honey. Join the ranks of spare time moneymakers and send for this guaranteed 96-page book today. Tells all about queens, equipment, summer, winter and spring management, swarming, increasing colonies, how to produce section honey and extracted honey, etc. 19th edition, fully revised, only \$1.00.

**POPULAR MECHANICS PRESS**  
200 E. Ontario St. Chicago 11, Ill.



## POPULAR MECHANICS Outdoor Sports Manual!

All sportsmen, attention! Here are 156 pages of helpful hints for the Hunter, Fisherman, Trapper, Camper, Archer, and Boatman. How to make your own decoys, recondition your fishing rod, outwit the fur bearers, make an insect and vermin proof tent, shoot a modern crossbow, and service your outboard motor. These and a pack bar full of other articles for outdoor men. Your News Dealer has it in the 60c paper edition and we can supply the beautifully bound \$2.00 library edition.

**Popular Mechanics Press**  
200 E. ONTARIO ST. CHICAGO 11



**DRIVE WITH NO SUN GLARE**

**THE ACE AUTO VISOR** makes driving more restful and safer... no sun in your eyes... protects windshield from rain, snow, fogging and bug spatters. Streamlined design with **Heavy Chrome Ends** and **Center Chrome Strip** adds beauty to your car. Specify:  Prime finish for painting.  Hi-polish metal finish—requires no paint.

Enclose money order and save freight... or order C.O.D., freight collect.

Easy to Install. No Holes to Drill. Heavy Chrome Ends. Center Chrome Strip. Clear Vision Sides.

**ORDER BY MAIL AND SAVE... \$13.50**  
IMMEDIATE DELIVERY  
**ACE AUTO PRODUCTS, DEPT. PM9**  
BOX 366 HUNTINGTON PARK, CALIF.



# MAKE YOUR OWN!

WITH

## Griffin READYCUT LEATHER PROJECTS

Over 100 KITS in every kind of Tooling and Carving Leather, accurately cut, all parts included. Only Top Grade Leathers used. You do the choosing. You do the tooling, carving, stamping, the punching and assembling.



SEND FOR COMPLETE CATALOG. It's free to leather workers. A postal card will do.

SINCE 1924

OUT OF THE WEST, THE HOME OF LEATHER CARVING

**Griffin Craft Supplies**

Dept. PM 5515-21 GROVE STREET OAKLAND 9 CALIFORNIA

### EVERYTHING FOR THE LEATHER WORKER

Largest, most complete stock of *Leathercraft Tools and Accessories* in U.S.A.



HIDES AND SKINS of Craft Leathers of every kind if you prefer to cut your own.

## AMAZING MYSTERY BUTTON



Startles Everybody. With this *Electronic Button* you can make your own Telephone Amplifier—Defectophone. Attach this button to piece of cardboard—transmit conversation to another room. Music also transmitted to distant places. Most interesting electrical apparatus ever discovered. Enables you to perform hundreds of experiments. So tiny it can be concealed in dozens of places. A Pre-War Product. Electronic Button including 5000 word instruction booklet with 50 illustrated experiments, postpaid, only **\$1.00**. Electronic Products Company, Saint Charles 3, Ill.

**MIX PAINT**  
Only \$1.00  
TAX INCL.

POSTAGE PAID FOR N.Y. & CAN. IN THE U.S.A. BY MAIL C.O.D.

MAIL \$1.00 TODAY TO

### NEW HIGH-SPEED WAY

SAVES HOURS—MAKES PAINTS SMOOTHER

Mix all paint in one quarter the time by just slipping the Paint Mixer in the chuck of any hand drill or drill press. It is wonderful for quart, gallon, or 5-gallon cans. The shaft is of finest 1/2-inch cold rolled steel, 12 inches long. Four-bladed propeller is of heavy gaged steel, 3 inches in diameter, scientifically designed to cut up hard lumps of paint. Satisfaction guaranteed.

**PAINTERS' AID COMPANY**  
2229 BARRY AVENUE, LOS ANGELES 25, CALIF.

## FOUNTAIN TOOTHBRUSH!

Works Much Like a Fountain Pen

Carries dentifrice in handle. Most sanitary and convenient toothbrush ever devised. Money back guarantee. Brush and three months supply of dentifrice only **\$1.60** postpaid, or **\$1.75** C.O.D.

See page 138 June issue, *Popular Mechanics* for picture and description.

**ESCORT LABORATORIES, INC.**

1119 DIME BLDG.

DETROIT 26, MICH.

## SUPERCHARGERS

Aircraft surplus, turbo type, complete. Can be converted into blowers, turbines, etc. Cost to Gov't approximately \$3,000. Sale price **\$22.50** each while they last. FOB, Washington, D. C. No COD. Send check or money order to: **MICHEHL INDUSTRIES, 930 F ST. NW, WASHINGTON 4, D. C.**

## BUILD ARC WELDER

For Light or Heavy Work. 75-200 amps. No previous experience needed. Complete **PLANS** and valuable Catalog 35c.

**LEJAY MANUFACTURING CO.**  
1347 LeJay Bldg., Minneapolis 8, Minn.

FROM OLD GENERATOR



"Paint-it-Yourself" with

ONE COAT COVERS  
**NU-ENAMEL**  
NO BRUSH MARKS

NU-ENAMEL DEALERS EVERYWHERE

an extra motor

for only

**\$3.95**



The **QUICK CHANGE Motor Mount** gives you the service of two or more motors! Change from one machine to another in moments! Positions for 5-step pulley. Simple screw clamp permits tilting for belt-tension and tightening. The **QUICK CHANGE Motor Mount** allows one motor to work an entire shop! Complete Motor Mount only **\$3.95**. Extra mounting blocks only **\$1.50** per pair. Send check or money order today. Write for **FREE** illustrated circular.

**THE MOTOR MOUNT CO.**

P. O. BOX 827

SPRINGFIELD, MASS.

## SAVE MONEY!

GOV'T SURPLUS

## PUMPS

Brand New, in original crates, 2", 4", 6", Marlow & Carver, gas-engine driven. Cap.—55 g.p.m. to 525 g.p.m.



**LOWEST PRICES EVER OFFERED**

**FREE** 10 GAL. ALL STEEL GAS TANK — WITH EACH ORDER

Write for circular — state size or output required



## MIXING MACHINES

Brand New! Dough, feed, paint, all uses, Briggs and Stratton engine, variable speed — automatic unloading. **\$96.50** ea. F.O.B. B'klyn.

Write for circular or send 25% deposit — Remainder C.O.D.

## BENJAMIN'S FOR MOTORS

2122 Mill Ave.

Brooklyn 10, N.Y.



# NEW *Atlas* 24" JIG SAW

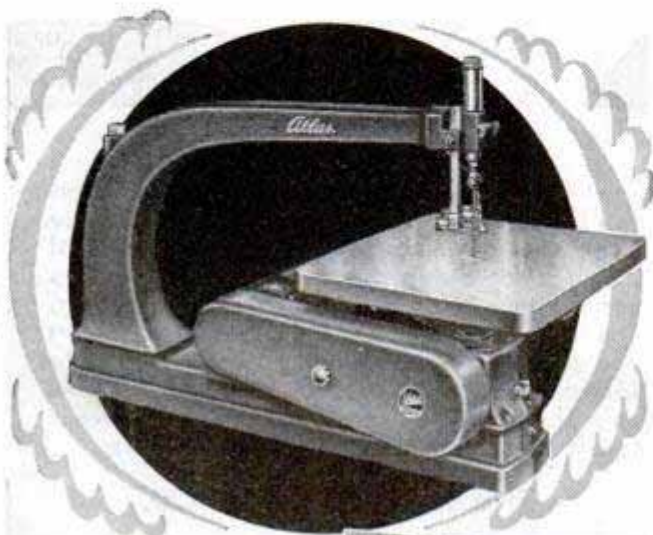

## AN INDUSTRIAL TOOL FOR AMBITIOUS HOME SHOP MEN

This is the jig saw many of America's real craftsmen have long been waiting for. It's big enough to handle any practical jig-sawing project you want to tackle... precisely built for professional workmanship... just what you need if you plan to make your shop pay you a profit.

Artistic furniture, valances, toys, inlaying, costume jewelry of plastic, bone, ivory, metal... whatever you want to make... the big 14" x 14" tilting table, 4 speeds, wide blade and sabre capacity, and smooth operation of this new Atlas will help you do your best work. Full details gladly sent. Write today.



*Send*

THIS COUPON OR POSTCARD FOR FREE LITERATURE ABOUT NEW 24" JIG SAW.

Name \_\_\_\_\_

Address \_\_\_\_\_

City, State \_\_\_\_\_

**ATLAS PRESS CO.**

943 N. Pitcher St., Kalamazoo, Mich.



**MATCHED PRECISION TOOLS FOR  
MACHINING AND WOODWORKING**

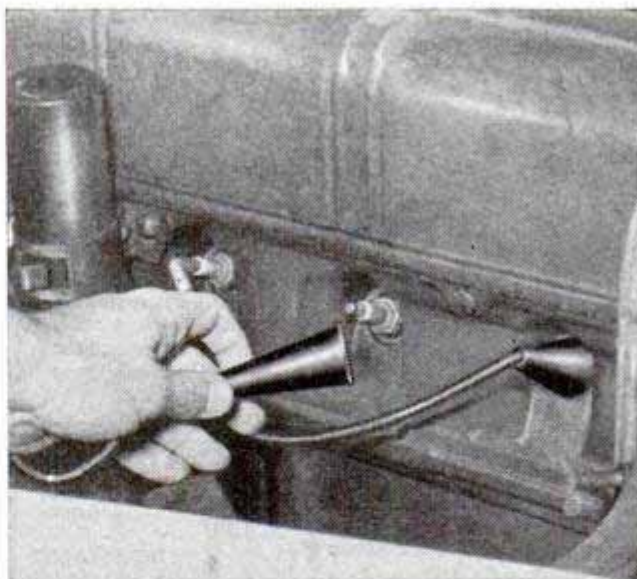

## Spark-Plug "Boots"

One-piece rubber covers keep water and dirt out of spark plugs. The covers are oil and heat resistant and fit into the well around the plug. The terminal clip on the ignition wire slips through the boot to protect the contact from water and dirt.



## Compact Paint Sprayer Needs No Compressor

Paint spraying around the home and farm is simplified by a convenient sprayer that is completely self-contained. Using a vibrating pump, the sprayer requires no motor or air compressor. Paint is poured into the small jar that forms the base of the unit. You just plug the power cord into an electric outlet and you're ready to spray. Designed especially for small paint jobs, the sprayer can also be used with insecticides. A thumbscrew controls the density of spray. A large supply of extra nozzles is provided with each sprayer.





## 7 X 50 PRISM BINOCULARS BRAND NEW \$48

With COATED  
Lenses and Prisms  
**\$58**  
Plus 20% Tax

Ultra-precise optics, made to rigid military specifications. Sealed against moisture and dust in light-weight aluminum bodies. Case and straps. Money-back guarantee. Immediate delivery. We pay postage.

# BROWNSCOPE CO.

Dept. 9M 24 West 45th St. New York 19, N. Y.

## MEN'S FULLY GUARANTEED NEW 15-JEWEL WRIST WATCH \$13.95 PLUS TAX

ORIGINALLY sold up to '55

Sacrificed because they're post-war surplus

### WATER PROOF—SHOCK PROOF

Luminous dial . . . sweep second hand . . . anti-magnetic . . . imported Swiss precision movement and case. You get them now for a small fraction of original prices. Don't delay! Order now . . . while they last. Send only \$1 down payment with order. Pay balance to postman on arrival, plus postage. Or we pay postage if you enclose \$13.95 plus \$1.39 Fed. Tax. Receive Reg. S2 expansion band FREE with prepaid order. Money back in 5 days if not delighted. Order now.



MARYLAND DISTRIBUTORS, Dept. 109  
501 E. BALTIMORE ST. BALTIMORE 2, MD.

## LEARN WATCH REPAIRING



**AT HOME.** By our modern and original system of instruction you can learn every part of the **WATCH REPAIRING TRADE AT HOME.** Prepare yourself for a well-paying position or start in business after completing our course of instruction. Good watch repairers are in demand and generally earn very good salaries. For particulars apply to the Wisconsin School of Watch Repairing 759 North Milwaukee St., Milwaukee 2, Wis.



### GUARANTEED STRONGEST VISE-WRENCH MADE Pre-adjustable, forged steel jaws

The tool with 1001 uses—as portable vise, pipe wrench, pliers, clamp, etc. The handiest tool for mechanic, hobbyist, or householder. Quickly and simply automatically locks itself onto work. Just as simply releases work. Send money order or pay postman \$1.29 (plus postage) when he delivers the Vise-Wrench.

FORDOAK PRODUCTS 12841 FORD ROAD  
DEARBORN, MICH.

# Attention! Buyers!

Here's your directory of 10,000 items about plans, blueprints, tools, machinery, sports, and business opportunities. The latest on schools, courses, hobbies, patents, photography, autos and boats. Cross-indexed to use in a jiffy. Four and a half million readers must be right. You will be too with this HANDY GUIDE to POPULAR MECHANICS advertisers. Send for it today, only 25¢!

POPULAR MECHANICS PRESS, 200 E. Ontario St., Chicago 11, Ill.

SEPTEMBER 1948

# ARMY BALLOONS and KITES

FOR RADIO ANTENNAS, WEATHER  
OBSERVATION, AERIAL PHOTOGRAPHY

## or JUST PLAIN FUN



Tubular canvas bag, about the size of a golf bag, contains 2 heavy duty 4 ft. balloons, 2 hydrogen generators, a folding, aluminum frame box kite with water-repellent cloth sails, and 300 ft. of stranded antenna wire. Price complete with full instructions—only \$9.95 (Originally cost about \$75.00).

### EMERGENCY RADIO TRANSMITTER

The famous "Gibson Girl" radio automatically sends SOS on the International Emergency Wavelength. Every yacht and lifeboat should carry one. Powered by hand cranked generator—no batteries required. Price complete only \$9.95.

Combination of "Gibson Girl" radio, kite and balloon antenna kit for equipping lifeboat—only \$17.50.

Prices F.O.B. Chicago. Send your check (or M.O.) in the above amounts and shipment will be made promptly via express collect.



**WELLS  
SALES, INC.**

320 N. La Salle St., Dept. P-9  
Chicago 10, Illinois

SAY YOU SAW IT IN POPULAR MECHANICS



# AUTO BOOKS ON APPROVAL



SEND NO MONEY. Just mail the coupon for a complete set of 4 Big, Thick Auto Books. 20th Edition. Over 2700 Pages! Whether you are a mechanic or helper, expert or apprentice, auto owner or driver, take immediate advantage of this FREE EXAMINATION OFFER.

### MAKE GOOD MONEY NOW HOLD A PERMANENT JOB

America wants its automobiles kept in good repair. Men with "know how" are in demand, at big pay. These books will help you get and hold an important job, or give you a chance to go into business for yourself now or later. Any man who half tries to improve himself can learn auto servicing and repairing by this quick reference method. Use the JIFFY INDEX to find easily understood answer to any auto problem. These wonder books prepared by eleven of America's great automobile engineers. Many hundreds of valuable illustrations. Send the coupon TODAY.

A year's consulting privileges with our engineers now given with these books without extra charge.

Vocational Publishers Since 1898

AMERICAN TECHNICAL SOCIETY, Dept. A619  
Drexel Ave. at 58th St., Chicago 37, Ill.

I would like to examine your 4-Volume Set of Auto Books. I will pay the delivery charges only, but if I choose I may return them express collect. If after 10 days' use I prefer to keep them, I will send you \$2 and pay the balance at the rate of only \$3 a month until \$24.80 has been paid. Include consulting service as offered above.

Name \_\_\_\_\_

Address \_\_\_\_\_

City \_\_\_\_\_ State \_\_\_\_\_

Please attach letter stating age, occupation, employer's name and address and name and address of at least one business man as reference. Men in service, also please give home address.



# **NEW** FOR HOME WORKSHOPS SCHOOLS & SMALL MFRS. **LOW-COST** **UTILITY MODEL** **DoALL CONTOUR SAW**

**Handy Job Selector**  
Gives proper speeds for sawing and filing. Shows types of blades and files to use.

**Blades for All Jobs**  
Many types and sizes for efficient cutting of all metals and materials. Cut lengths, welded, or in 100-ft. strip-out safety boxes.

**Stepless Variable Speed** "SPEEDMASTER" units, not found in any other Contour Saw, but exclusive with DoALL, give a "million" variable speeds—the right one for any job, to get highest efficiency in cutting performance.

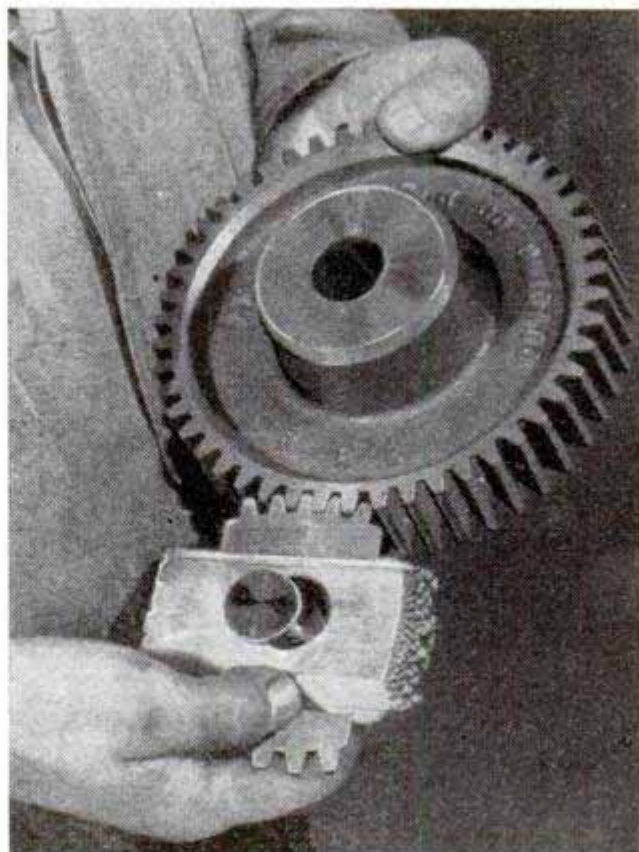

## **Gauge Judges Pitch of Gears**

With a compact gear gauge, engineers and mechanics can select and specify the gears they need in their work. Instead of counting the teeth in the required gear and figuring the pitch, they can fit the gauge to the gear to learn the correct pitch immediately. The gauge is made of stainless steel and consists of 12 leaves with 24 gear shapes.

## **Kitchen Aid Solves Jet Problem**

One of the housewife's kitchen aids, silicon carbide used in knife sharpeners, may solve a major headache for jet and rocket-engine builders. A combination of the carbide and graphite will stand temperatures of 300 degrees Fahrenheit, according to a report before the American Chemical Society, and answers the demand for a material that won't melt under the intense heat of jet and rocket power plants. It will be used in lining parts exposed to extreme temperatures in the same manner firebrick is used to line boiler furnaces. Most metals flow at about 1700 degrees and in tests some engines have melted their combustion chambers and injection nozzles in 20 seconds.

☐ The nation's longest stretch of train radio-telephone service begins this fall on the new Twentieth Century Limiteds, with telephone service along the 436-mile run between New York and Buffalo.

**REVOLUTIONARY CUTTING PROCESS**  
DoALL Contour Sawing does jobs previously considered impossible by sawing—goes far beyond ordinary bandsawing because of unique patented improvements. DoALL, the world's largest bandsaw maker, revolutionized cutting practices in many industries.

Now, advanced craftsmen can use the amazing process of Contour Sawing in low-cost Utility Models having the same superior precision, flexibility and dependability as the larger industrial-type models. Basic machine sells for \$285.

### **NOW YOU CAN . . .**

**Saw Anything:** Including cork, rubber, cloth, wood, metal, hard alloys, stone, porcelain, glass. Internal as well as external cuts, straight or curved, at any angle.

**Precision Saw:** Metal can be cut smoothly to within .005" of layout lines. Uniform blade tension, positive guides and precision-made blades prevent "wander."

**Friction Saw:** New, fast metal-cutting technique permits slicing through hard metals and castings.

**Bandfile:** File bands replacing saw bands are run at slower speeds for continuous filing—external, internal, straight, curved cuts at any angle.

**Polish:** With sanding and polishing bands.

### **SEE IT WORK**

Use coupon for more information and address of DoALL sales Office nearest you where you can see these saws operate.

**The DoALL Co. DESPLAINES, ILLINOIS**

Send data on UTILITY SAWS and address of nearest DoALL Sales Office.

Name \_\_\_\_\_

Address \_\_\_\_\_

City & State \_\_\_\_\_



# RUPTURE-EASER

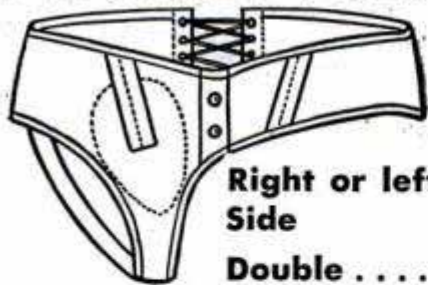

Right or left Side \$3.95  
Double . . . . \$4.95

A strong, form fitting, washable support. Back lacing adjustable. Snaps up in front. Adjustable leg strap. Soft, flat groin pad. No steel or leather bands. Unexcelled for comfort. Also used as after operation support. For men or women. Mail orders give measure around the lowest part of the abdomen. Specify right or left side or double.

**PIPER BRACE CO.**

308 E. 12th DEPT. PM-9 KANSAS CITY 6, MO.



Pat. applied for

Start a **NEW BUSINESS**  
Or Add to Your Present  
Repair Business  
**Sharpen Dull Pipe Wrenches**  
**Pipe Taps & Dies**  
**"Gum" Circular Saws**  
Write for information.

**J. C. MOORE INDUSTRIES** P. O. Drawer 276 FREDONIA, PA.

100 PRACTICAL USES

## Glider Model FLAME GUN

KILL WEEDS, crab grass, Canada thistle, stalks, seeds and roots. Destroy brush, caterpillar nests, diseased trees, grasshoppers, chinch bugs, etc. Clear irrigation ditches, split rocks, burn tree stumps. . . . . Sterilize poultry houses, kennels, barns. Use as portable home forge. Melt ice, thaw pipes. Safe, inexpensive. Burns only 6% kerosene —94% Air! Thousands satisfied users. Write for FREE CATALOG. . . . .

7 MODELS from \$22 up



**HAUCK MFG. CO.,**  
77 Tenth St., Brooklyn 15, N. Y.

## YOU TOO CAN BE A BUSINESS MAN

and make large weekly profits. Write at once for our "Get into a Profitable Business of Your Own" plan.

**CHEMICAL RESEARCH CORP.**

212 WEST 42 STREET NEW YORK 18, N. Y.

## BARGAINS FROM WORLD WAR II

Thousands of Bargains in Military, Outdoor & Sport Goods for Hunter, Farmer, Scout. Send 10c for NEW 32-page catalog, just issued, returned with first order.

**A and N SUPPLY CO.**

4720 LESTER ST. RICHMOND 15, VA.

## BUILD ARC WELDER PLANS 35c

We Show You How to build this new powerful welder without rewinding. For light or heavy work. Uses coils taken from old auto generators. Works on 110 or 220 volts A. C. Has 20 different heats. Send 35c for complete PLANS and valuable Catalog. Write today. **LEJAY MFG. CO., 3347 LeJay Bldg., Minneapolis 8, Minn.**



## MAKE MONEY MAKING DOUGHNUTS

Make new greaseless doughnuts at home on electric machine. Sell for cash to grocers, cafes, drug stores, etc. No exp. nec. Good profits. Small investment. Send for free recipes and plans.

**MART RAY CO. • 3605 S. 15 Ave. • Minneapolis 7, Minn.**

## ANGORA RABBITS GIANT CHINCHILLAS WHITE GIANTS

rabbits! Valuable **ANGORA WOOL** (high priced) —shear regularly; steady cash income! Plentiful markets. Luxurious **CHINCHILLA Furs!** Guaranteed, pedigreed stock. Easily raised anywhere. Illustrated literature free. **GRINSTEAD'S FARM, Dept. 60-R, Edwardsville, Illinois**

## RENOVATE YOUR JACKET

Your old leather jacket will look brand new when our service department repairs, cleans and restores the leather to its original shade and finish. Send for FREE descriptive circular and itemized price list today!

**BERLEW MANUFACTURING CO., INC.**

DEPT. M MERRICK, NEW YORK

## LAWN ORNAMENT-NOVELTY PATTERNS

28 Lawn Ornament Patterns, 25c. Other patterns: 15-20" high; Dutch Girl, Dutch Boy, Pirate, Bull Terrier, Mexican Girl, Mexican Boy, Dwarf, Penguin, Flower Girl, 10c each. 25 Novelty Patterns, 30c. All 62 Full Size Patterns, \$1.00 Postpaid. Strother Pattern Service, Dept. AP-8, Box 383, Belington, W. Va.



**NEW!**

**Atlas POWER KING**

ATLAS PRESS CO. KALAMAZOO, MICH. U. S. A.

**12" BAND SAW**

**Cuts WOOD, PLASTICS, COMPOSITIONS**

Add new work range in your shop with this new Power King band saw. It's smooth, accurate, powerful, solid . . . weighs 135 pounds! 14" x 14" precision ground table. Cuts to center of 24" circle. Saw wheels turn on 4 ball bearings. Blade is guided by 4 Oilite bearings—supported in back by 2 ball bearings. Here's a quality tool you'll be proud to have in your shop—built for years of service. Send for new free literature.

**ATLAS PRESS CO. • Kalamazoo 13D, Mich.**  
909 North Pitcher Street

## FASTEST PLANER in the WORLD at this Low Price... \$215.00

### BELSAW Multi-Duty Planer

Speed up production! Increase your profits! BELSAW power self-feeds at 24 feet per minute. . . . The lowest-priced surfacer that will handle 12x6 in. stock. Planes green or dry sawed lumber into smooth, worked forms. Three high-speed steel knives make 42 cuts per inch. Multi-duty BELSAW takes inexpensive attachments for all planing mill operations—Jointing, Rabbeting, Grooving, Matching. BELSAW is the only 12 in. planer providing attachments for jointing and grinding its own knives. Start planning NOW for BIGGER VALUE and BETTER PERFORMANCE, with BELSAW. Write for FREE specifications, illustrations and low prices.



• LARGER CAPACITY • FASTER OUTPUT • KNIFE SHARPENING ATTACHMENT

**BELSAW MACHINERY CO. 81010 Field Bldg., 315 Westport Rd., Kansas City, Mo.**

## NOW YOU TOO CAN BUILD 15 RADIOS

Absolutely No Knowledge of Radio Necessary

You Need NO Additional Parts

### The PROGRESSIVE RADIO KIT

is THE ONLY COMPLETE KIT. Contains everything you need. Instruction Book, Metal Chassis, Tubes, Condensers, Resistors and all Radio parts. The 36-Page Book written by Expert Radio Instructors teaches you to build radios in a Professional Manner. You start with a 1-tube receiver. Before you are done with this kit, you will have built 11 Receivers, 1 Public Address System and 3 Transmitters.

### SPECIAL FREE OFFER!

Electrical and Radio Tester sent absolutely FREE with each Progressive Radio Kit. PLUS FREE membership in Progressive Radio Club. Entitles you to free expert advice and consultation service with licensed radio technicians.

Write for further information, or ORDER your KIT \$14.75 NOW! ONLY . . . . .

Postage prepaid with check or money order (Postage not prepaid with C.O.D. orders)

**PROGRESSIVE ELECTRONICS CO., Dept. PM-14**  
497 Union Avenue Brooklyn 11, N. Y.





# Excitingly Complete



## FOR COMFORTABLE LIVING!



Your key to a 1948 Schult unlocks a furnished, equipped home that is today's outstanding VALUE in convenience, privacy and amazing completeness.

See the beautifully decorated living room, with china-closet desk and studio couch... the well-organized kitchen, with oven range, refrigerator, sink, and ample storage space... the separate

bedroom, with built-in wardrobes.

Your Schult, a quality product backed by more than a decade of experience, offers many *plus-values* for year 'round living or extended travel. New, machine construction assures better quality than ever. Ask your Schult dealer to show you the latest 1948 models. Schult Corp., Dept. 3209, Elkhart, Ind. In Canada: John Inglis Co., Ltd., Toronto.



Free

Write today for book with pictures, details of latest models.



**SCHULT** Trailer Coaches

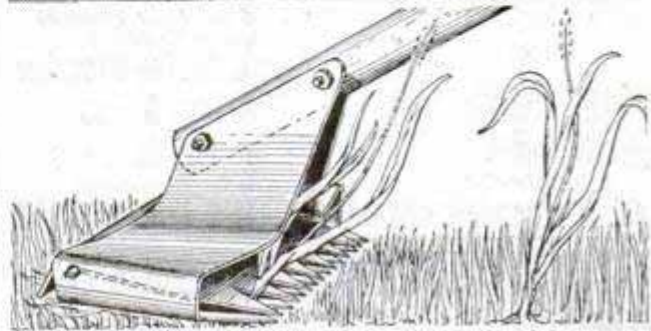

## Crab-Grass Puller

Crab grass and other thick grasses and weeds can be removed from the lawn with a narrow rake that has two rows of sharp teeth. The plate containing one row of teeth is hinged at the rear so that it can be swung free of the other row of teeth. When the rake is pulled along the ground the weeds are gripped between the teeth, but the rake passes over grass with finer blades. The weeds are disengaged by pushing the end of the rake against the ground to swing the hinged plate away from the other teeth.

## Radioactive Cobalt Treats Cancer

Radioactive cobalt has many advantages over radium in the treatment of cancer, according to Dr. William G. Myers of Ohio State University. Cobalt for the medical experiments has been made radioactive by exposing it to the atomic pile at Oak Ridge, Tenn. Doctor Myers discovered that the cobalt gave off two of the types of rays emitted by radium. One of these rays, which must be filtered out in the treatment of cancer, is much less powerful in radioactive cobalt. Consequently, when cobalt is used it requires only a thin casing of steel as protection, while radium requires a much heavier casing of pure gold or platinum. Another advantage of cobalt is that it can be machined to fit the cancerous lesion before it is made radioactive.

## FOR PERFECT GROOVING

### Use CHICAGO SAW Dado Heads

For sharp, clean grooving with or across the grain get Chicago Home Workshop Dado Head Sets. Accurately heat treated, carefully balanced and ground, true running.

Diam.	Set No. 1	Set No. 2	Set No. 3
6"	\$11.06	\$13.33	\$15.98
Cuts to	7/16"	11/16"	13/16"

Bulletin 107 describes all Chicago Saws



**CHICAGO SAW WORKS**

5044 S. Wentworth Ave., Chicago 9, Ill.



# NEW! Hood & Fender Ornament!



Silver Streak for Flashy Driving . . . Adds Zip and Class to any car.

The Hit of the Year! New Silver Streak gives that smart, new-look to all cars. Triple chrome plated to a gleaming silver like finish, die cast, with latest jet propelled lines. Easily installed on hood or fenders. Complete with instruction sheet. List price \$7.50—Special Offer, set of 6 . . . \$4.95 plus postage. 25% deposit with C.O.D. orders. Satisfaction guaranteed. Dealers: write us.



**BLAIR PRODUCTS**  
3319 W. Newport Ave., Chicago 18, Ill.

## USE SIMPLE HOME-MADE EQUIPMENT

Make HOLLYWOOD STYLE cement pottery and birdbaths. Beautiful chemically colored garden things. Amazing designs. Dime brings pictures, color sample, details.

**HOLLYWOOD CEMENTCRAFT**  
8527-A WONDERLAND AVE.  
HOLLYWOOD 46, CALIF.



Genuine WESTERN ELECTRIC  
**MICROPHONE** plus ASSEMBLY UNIT  
LIMITED STOCK • ORDER NOW  
**RICE LABORATORIES**  
233 MULBERRY ST. • ROCHESTER 7, N. Y.

**\$1.00** POST PAID IN U.S.A.  
MONEY ORDER or Dollar Bill (No Stamps)

## BUILD YOUR OWN ZEOLITE WATER SOFTENER

You can do it inexpensively with only a wrench and a little spare time. Famous Zeolite process as used by leading manufacturers. Send \$1 for easy-to-follow directions and list of materials. (Materials available locally or from us.) Or inquire about factory-built LARCO Softeners \$55.20 up. LAKE REGION MFG. CO., INC., 3920-A Lynn Ave., Minneapolis 16, Minn.

## REYNOLDS CIRCULAR SAW GRINDER



FOR JOINTING  
GUMMING • SHARPENING  
ALL TYPES OF CIRCULAR SAWS  
Write for Circular

**REYNOLDS MACHINERY CO.**  
305 EDDY ST., PROVIDENCE 3, R. I.

**CRESCENT TOOLS**  
Give Wings to Work

ASK YOUR  
HARDWARE  
DEALER

## FIBRE ARMS AND LEGS!

Light, correctly fitted, strong and comfortable. Natural appearance. Braces for all deformities. Scientific design. Fair Terms.

BUCHSTEIN-MEDCALF

223 S. 6th St., Minneapolis, Minn.

## UNITED STATES

MONUMENTS AND MARKERS are good. We erect anywhere. Write for FREE Catalog. U. S. MARBLE & GRANITE CO., Oneco, 18, Florida.

Say You Saw It in  
POPULAR MECHANICS

THE GREATEST THING

IN PLASTICS!

# PLASTICAST



## A NEW HOME INDUSTRY AND HOBBY!

**PLASTICAST** is a transparent liquid plastic; can be poured into ANY kind of mold or container. Hardens in a few minutes into a transparent solid, clear-as-glass, tough as steel plastic! No tools, machinery or skill required. IDEAL for imbedding pretty flowers, butterflies, photos, medals, souvenirs, biological specimens, etc. Makes a PERMANENT and ATTRACTIVE display. Make attractive jewelry, pens, lenses, knick-knacks, novelties. Easily cast into sheets, rods, blocks, ANY color, ANY shape! EVERYTHING furnished, including molds, for making about \$50.00 worth of unusual novelties!

**PLASTICAST OUTFIT, Complete with 3 molds . . . . . \$3.50**

**PLASTIDUR . . . (LIQUID IVORY).** Ideal for casting all OPAQUE articles. Hardens in a few minutes into an extremely hard IVORY-like plastic! May be dyed any color or cast into any shape. Works in EVERY type of mold! Non-inflammable, weatherproof, DURABLE. Ideal for statuary, novelties, figurines, toys, gadgets, tools, knobs, bases . . . a million useful applications! Outfit comes complete with molds, dyes, accessories, instructions, etc. for making about \$100.00 worth of attractive jewelry, etc.!

**PLASTIDUR OUTFIT, Complete with 3 molds . . . . . \$5.00**

Our Casting Plastics are as easy to use as pouring water out of a glass! TERMS: We pay the postage (U.S.A. and Canada only) if full cash accompanies your order. C.O.D. accepted (U.S.A. only) if \$1.00 deposit is included for each item ordered. C.O.D. orders not postpaid.

**FREE** A very attractive and useful novelty made with one of our plastics given absolutely free with every one of our catalogs! Catalog lists many new materials for making MOLDS and CASTINGS with Liquid Plastics, Liquid Marble, Latex, Elastex, Castwood, Wax, Metals, Plaster, Shellcraft, Internal Carving, Molds, Moulage, etc. Price of catalog only 10c.

DEALERS: WRITE FOR ATTRACTIVE WHOLESALE PRICE LISTS

**PLASTICAST COMPANY (Dept. C)**  
5961 Madison St. Chicago 44, Ill. (Order by mail only) P. O. Box 987 Palo Alto, Calif.

## MAKES DRIVING EASIER



Automatic accelerator control! Pedal stays put in any position. No more cramped leg from constant pressure on accelerator. Disengages immediately when brake is applied. May also be engaged and disengaged at will, by touch of foot. Drive for miles with both feet free. Save gas by steady driving. Safe. Economical. Easy to install. Mailed complete, postpaid, for \$2.98, with full instructions. Folder on request.

**AUTOMATIC ACCELERATOR CONTROL, Inc.**  
MONROE, MICHIGAN

## OWN a Business

**CLEAN AND MOTHPROOF RUGS AND UPHOLSTERY**



Service rendered "in the home," office or public buildings. Gross profits up to \$15 and \$20 a day on EACH of your service men. Easy to learn . . . quickly established. No experience needed. We'll help finance you!

**DURACLEAN** cleans by absorption! No scrubbing, soaking or shrinkage. Dirt and grease vanish as if by magic . . . matted pile rises . . . colors revive. Everything completely dry in a few hours. Fabrics look newer, last longer. You use patented electrical equipment.

**DURAPROOF** kills moths and carpet beetles. Makes materials resistant to both. To our knowledge, the only moth proof service backed by a National Money-Back, 4 YEAR WARRANTY! Guards against mildew too.

Services Nationally Advertised. We furnish enough material to return your TOTAL investment. Start full or part time. No shop needed. Territories are limited. Write today for Free Booklet explaining details and Easy Terms!

See our full page "ad" in September House & Garden

**DURACLEAN CO. 16-9 Ct. DEERFIELD, ILLINOIS**



## REAL SURPLUS VALUES

### EMERGENCY SUPPLY TANK



Fill at any gas station. 150 lbs. air. 5 flat tires. Inflates rubber boats. Use for touch-up spray jobs, tire service truck, air horns, dust out motors, machinery, etc.  
Shatterproof 12"x24" stainless steel tank with carry handle, check valve, two feet hose and tire filling chuck. Only \$7.95  
Tank only 12"x24", tapped each end 1/4 pipe thread. 500 lb. pressure. Build your own. Ideal for paint spray, air receivers, net floats, buoys, etc. Each \$4.75  
Small size tank, 6"x24". Only \$2.98

## A. C. LIGHT PLANTS

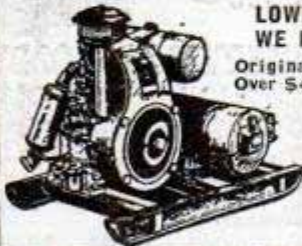

**LOWEST PRICE EVER OFFERED  
WE INVITE PRICE COMPARISON**  
Original Cost Over \$400.00. **\$249.50**  
Now Only...

2500 Watts 110 AC Volts. Same as R.E.A. or City Current. Nearly new condition. Fully guaranteed. Powered by Briggs-Stratton 6 1/2 hp Air Cooled Engine. Prices FOB., K. C.

## AIR COMPRESSORS

Model 2-U-5-4-V-A

Bendix-Westinghouse 4 cu. ft.

Govt. Surplus, 2 cylinder Bus and Truck Type. Ball bearing crank shaft. Pressure feed oil system. Positively one of the finest and most accurately built air compressors on the market.

Original Cost Over \$140.00

In good operating condition with 30 day written guarantee **\$34.50**

Accessories available for compressors, air regulators, safety valves, air gauges, control governor, misc. fittings, hose, paint guns. Write for Prices and Catalogue.



## BRIGGS-STRATTON ENGINES

1 1/2 HP MODEL N -  
GOVT. SURPLUS

In good operating condition with 30 day written guarantee... **\$39.50**

Engines will develop almost 2 Hp at 3600 RPM. Hurry, don't wait, buy now while limited supply lasts. Suitable for lawn mowers, garden tractors, motor bicycles and scooters, midget cars, etc. Will power many kinds of machinery.



PRICES FOB, K. C. NO COD'S

**MIDWEST  
SURPLUS SALES CO.**  
2533-P-INDIANA  
KANSAS CITY 1, MO.

SEND FOR  
**FREE  
CATALOG**  
HUNDREDS OF VALUES



## WHEELS AT BARGAIN PRICES

- ... 4" wheel & tire, 5/16" sleeve bearing. \$0.45 ea.
- ... 5" wheel 5/8" solid tire 5/16" shaft hole 0.65 ea.
- ... 6" wheel 5/8" solid tire 5/16" shaft hole 0.75 ea.
- ... 7" wheel 3/4" solid tire 3/8" shaft hole. 0.85 ea.
- ... 8" wheel 1" solid tire 1/2" sleeve bearing 1.25 ea.
- ... 8x2" wheel, semi-pneumatic tire 7/16" ball bearing. 2.50 ea.
- ... 10x1.75 wheel semi-pneumatic tire 7/16" or 1/2" ball bearing. 3.25 ea.
- ... 12x1.75 wheel semi-pneumatic tire 1/2" ball bearing. 4.00 ea.
- ... 10x2.50 wheel semi-pneumatic 1/2" ball bearing. 4.50 ea.
- ... 6x2" wheel 5/8" ball bearing, solid tires 2.95 ea.

**BUILD YOUR OWN**— Wagons — Scooters — Soap Box Racers — Welding Carts — Baby Pens — Etc.  
To order above wheels write number wheels wanted in space provided, tear out and mail this ad with check or money order and your name and address. If other sizes are wanted write for FREE LIST.

**TRULSON MFG. CO., 811 E. 31 St., Dept. PM-16, Kansas City, Mo.**

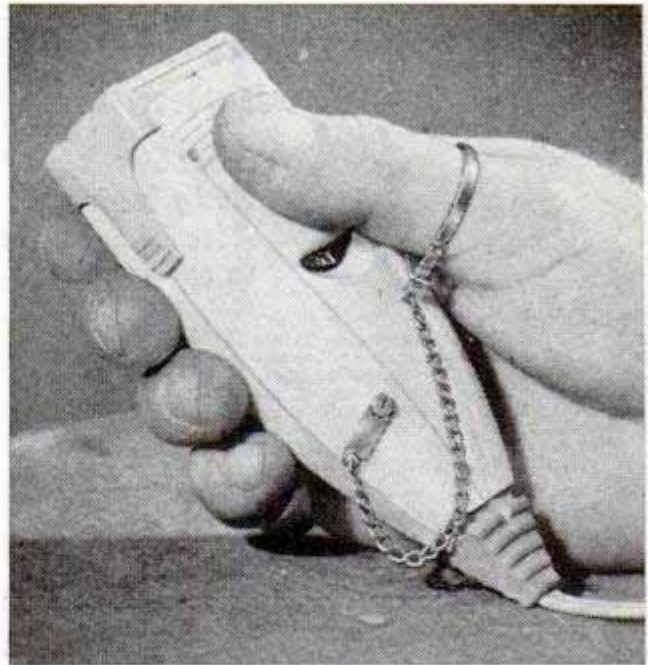

### Chain Prevents Dropping Shaver

To prevent dropping and possible damaging of an electric shaver, a razor guard with chain attached is available. The guard is secured by removing one of the screws from the case and replacing it with a longer screw furnished with the guard. A loop on the end of the chain is worn over the thumb.

### Hand Clutch Control for Tractors

Tractors can be operated with less fatigue with a new hand clutch control that can be installed without drilling any holes in the tractor frame. The clutch permits positive control of the tractor while the driver is standing. It also is helpful when engaging the tow bar of farm implements and eliminates the danger of muddy shoes slipping off the foot clutch. The hand control is made in models to fit Allis-Chalmers and Farmall tractors and does not interfere with use of the foot clutch pedal.





Carries the Same 90 DAY GUARANTEE As a New Motor Assy.

## Our Finest Precision REBUILT MOTOR BLOCK ASSEMBLIES

### Sold Outright or Exchange

Rebuilt by skilled mechanics. Assembly has Reborn Block with New Pistons, Pins, Rings, Reground Crankshaft, all New Bearings. Guaranteed 90 Days. **Allowance on Old Motor** We ship at outright price. Send your motor prepaid, must be suitable for rebuilding. Send in notarized bill of sale showing title number if any. We refund difference when we receive your motor.

\$5.00 Crating Charge

**BUICK** Outright Exch.  
34-47 8 cyl. \$199.00 \$160.00

**CHEVROLET** Outr. Exch.  
29-47 6 cyl. 117.50 87.50

**CHRYSLER** Outright Exch.  
34-47 6 cyl. 162.50 130.00  
35-47 8 cyl. 199.00 160.00

**DE SOTO** Outright Exch.  
34-47 6 cyl. 162.50 130.00

**DODGE**—3 1/4" bore Exch.  
35-47 6 cyl. 144.00 109.00

3 3/8" bore Outright Exch.  
34-47 6 cyl. 162.50 130.00

**FORD** Outright Exch.  
28-31 4 cyl. 119.00 87.00

**FORD** Outright Exch.  
32-34 V8 ..\$139.00 \$ 99.00  
35-47 V8 .. 149.00 99.00

**HUDSON-TERRA.** Outright Exch.  
35-47 6 cyl. 175.00 135.00

**MERCURY** Outright Exch.  
39-47 V8 .. 149.00 99.00

**Oldsmobile** Outright Exch.  
37-47 6 cyl. 175.00 135.00  
35-47 8 cyl. 199.00 160.00

**PLYMOUTH** Outr. Exch.  
35-47 6 cyl. 139.00 109.00

**PONTIAC** Outright Exch.  
37-47 6 cyl. 175.00 135.00  
35-47 8 cyl. 199.00 160.00

**Studebaker** Outright Exch.  
35-47 6 cyl. 175.00 135.00  
35-47 8 cyl. 199.00 160.00



\$5.00 Crating Charge

## 60 HP. JEEP Engines

Reconditioned, Tested and Guaranteed in perfect running order and ready to run. Every part is checked to be perfect and carries a 90 Day Guarantee same as a new engine.

**COMPLETE** with . . . Generator, Starter, Distributor, Coll, Fan and Fan Belt, Water Pump, Fuel Pump, Intake and Exhaust Manifolds, Carburetor, Oil Filter, Spark Plugs, Flywheel, Clutch and Pressure Plate, Wiring.

Outright, **\$179.50**  
PG58R-003, Ea.

Rubber with Felt Back. For all Jeeps. Ea. **\$3.95**

## JEEP FRONT FLOOR MATS

## New JXD Hercules 6-cyl. Engine

Crating Charge \$5.00

Removed from new vehicles. Engine is guaranteed same as new. Complete with 6 volt ignition, Carburetor, Wiring, etc. 6 cyl. 4" bore, 4 1/4" stroke, 320 cu. in displacement, 84 H.P. at 2800 RPM. Each motor guaranteed 5 hr. test run. Complete with Built-in Mechanical Governor. READY TO RUN.

PMG-58N-JXD  
Each . . . . . **\$450.00**



## 65 KW. 225 Volt D.C. GAS ELECTRIC GENERATING UNIT

\$10.00 Crating Charge

**RECONDITIONED!**  
Equipped with 6 cyl. RNLCT Hercules Gas Engine—4 1/2" bore, 5 1/2" stroke. Complete with Carburetor and Electrical equipment. 225 Volt—65 KW General Electric Generator is attached and develops 250 amp. D.C. current at 1800 R.P.M. Complete as shown.

PMG60R-191—  
Each . . . . . **\$695.00**



SEND 25% CASH WITH ORDER, BALANCE C.O.D.

**J.C. WHITNEY & Co.**  
1917 Archer Ave. Chicago 16, Ill.

## Buy and Save on AUTO NEEDS at J. C. WHITNEY & CO.

## NEW Tailor Made CONVERTIBLE TOPS

Choice of Black or Tan. All Tops Tailor Made for Easy Installation.

Sensational Value!

As Low as **\$24.95**

### "ZIPPER TYPE" REAR CURTAIN

Each top packed complete and consists of main top proper, rear curtain and all needed binding and fittings. (Glass is not supplied—use glass from top being replaced). Best quality, laboratory tested—equal to or better than the original. All metal parts are of heavy bright chrome plated rust resistant. Tops are heavily stitched with treated thread and sewed for durability and appearance.



Car	Year	Price	Car	Year	Price
BUICK	1936-48	\$41.75	Hudson also		
Cadillac	1936-48	41.75	Terra, to '38	1936-40	\$39.95
Chevrolet	1936-48	39.50	HUDSON	1941-47	46.95
Chrysler	1935-38	33.00	LASALLE	1936-40	41.75
Chrysler	1940-48	39.50	MERCURY	1939-42	37.95
DE SOTO	1935-38	33.00	MERCURY	1946-49	39.95
DE SOTO	1940-48	39.50	NASH & LAFAYETTE	1937-41	39.95
DODGE	1935-38	33.00	OLDSMOBILE	1936-48	41.75
DODGE	1940-48	39.50	PACKARD	1936-48	45.95
FORD			PLYMOUTH	1935-39	33.00
1928-31 Roadster & Cpe.	24.95		PLYMOUTH	1940-48	39.50
1933-39-Rdstr. & 2 pas. Cpe.	33.00		PONTIAC	1936-48	41.75
1928-39-Phaet. & Sedan	42.95		STUDEBAKER 1948	44.15	
1936-42-5 Pas. Cib. Cpe.	37.95				
1946-48-6 Pas. Cib. Cpe.	39.95				

## All Weather Aluminum Adjustable Visor

Black satin finish, made of aircraft aluminum with stainless steel center strip. Ultra-Modern Air Flow Styling. No drilling—engineered to fit most cars. Adjustable for height and width. No painting required. Glare proof underside. Individually boxed.

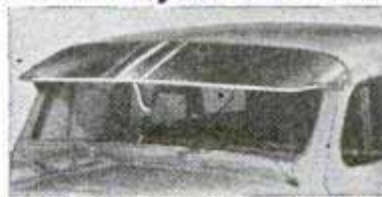

MA48N-20—Fits most cars having Windshield Divider Strip, including 1949 Ford and Mercury. EACH **\$9.95**  
Specify year & model of auto or truck when ordering.

## FORD V8 DUAL & SINGLE MUFFLERS



**MUFFLERS that give that Motorboat tone**  
Made of high quality steel For:  
FORD DeSoto  
Plymouth Chrysler  
Chevrolet BUICK  
DODGE Pontiac

**FORD V8 DUALS**  
Increases power. Reduces back pressure. Saves Gas.  
MD20N-208—  
Complete Set **\$15.95**

Also Universal type to fit all other cars. Specify year, make & model when ordering.  
MD20N-210 **\$4.95** ea.

## FENDER SKIRTS for Modern Beauty

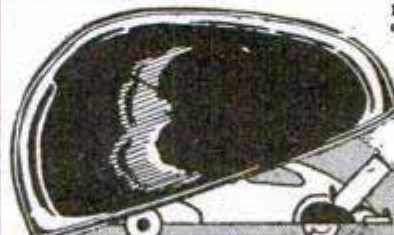

For most makes of cars including '49 Ford & Mercury. Made of all metal, prime finish, with Rubber beading to prevent rattle. Easy to Install.

MC31N-9 **\$12.95**  
Per Pair  
Be sure to specify year, make & model of car.

SEND 25% CASH WITH ORDER, BALANCE C.O.D.

**J.C. WHITNEY & Co.**  
1917 Archer Ave. Chicago 16, Ill.





**NEW CENTURY**  
**18 Piece**  
**HI-SPEED DRILL**  
**AND**  
**WOOD BIT SET**  
**WITH**  
**TOOL BOX**

Compartment Designed to Hold All Popular Priced 1/4" Electric Drills  
 Dimensions of Box 10 1/2" Long, 7" Wide, 5" Deep

- Handy For All
- Mechanics
  - Schools
  - Repairmen
  - Shops
  - Craftsmen
  - Home Workshops

**18 Piece Hi-Speed Drill And Wood Bit Set**  
 5 Carbon Steel Wood Bits with 1/4" diameter shanks for Electric Drills. • 13 Hi-speed twist drills. A complete range of sizes from 1/16" to 1/4" by 64ths. Indexed Drill Holder Keeps Drills At Fingertips  
 Each type and size of drill clearly marked for quick identification—rack tips forward for easy access to drills—when box is closed drills stay securely in rack.  
**Tool Box**  
 22 gauge all metal box provides complete protection for electric drill and twist drills when closed. Always together on the job. Extra storage for drills, buffing wheels, etc., complete

We are Authorized Distributors of the  
 1/4" \$18.95 and  
 1/2" \$35.00  
**Black & Decker**  
**Home Utility**  
**Electric Drills**

**THE ELECTRIC DRILL KING**

Complete Distributors of Electric Drills and Accessories  
 1627 N. DAMEN AVE., CHICAGO 47, ILLINOIS, U.S.A.  
 TEL. ARMITAGE 2518

**Nimrod**  
**PIPELITER**



ASHLEY F. WARD, INC., Dept. 35-L, 2968 Jessamine St., Cincinnati, O.

**Manufacture for the Building Industry**

Get in the Dunbrik-Dunstone business today and ride the tide of the biggest building cycle in history. It's the outstanding manufacturing opportunity in the building field, with broad market potentials and high income possibilities.

**A Wide-Open Opportunity**

Dunbrik (and Dunstone) is masonry at a new peak point of colorful beauty and modern design. Easy to make in local plants, using local material and local labor. Low costs means you can give more quality for less money—even undersell lumber. We supply all necessary equipment; back you with liberal cooperation. Write today for full information.

W. E. DUNN MFG. CO.  
 600 W. 24th STREET  
 HOLLAND, MICH.

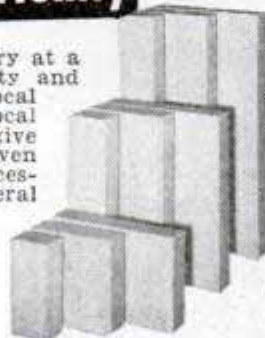

**DUNBRIK DUNSTONE**

**THE NEW "QUICK-KRAFT" SHAPER**



**Navy Standard Battery**

Made by Gould Storage Battery Corp. 6 volt 15 amp hour. Excellent for motors, motorcycles, amateurs, experimenters, radio servicemen, &c. Shipped dry, with complete instructions for charging. 4 1/2" wide 4 3/4" deep 6 3/4" high. Shipping weight 12 lbs. While they last.

**\$4.95**

**MICHAEL STAHL, INC.** 39 Vesey Street  
 New York 7, N. Y., Dept. PM9

**LAW** STUDY AT HOME for Personal Success and LARGER EARNINGS. 39 years expert instruction—over 114,000 students enrolled. LL.B. Degree awarded. All text material furnished. Easy payment plan. Send for FREE BOOK—"Law and Executive Guidance."

**AMERICAN EXTENSION SCHOOL OF LAW**  
 Dept. 93-PM 646 N. Michigan Ave. Chicago 11, Ill.



**BEST BUFFING BONNETS**

Hand Made of Finest Lambskin For Buffing and Polishing  
 5" — \$1.20 Special \$1 Ppd.  
 6" — \$1.40 7" — \$1.65 8" — \$1.85  
 Bargain — Any 3 Sizes \$4 Ppd. U.S.A.  
 For Sales Tax in California ADD 2 1/2%

**BEST BUFFER CO.** 259 W. Harriet St.  
 Altadena, Calif.

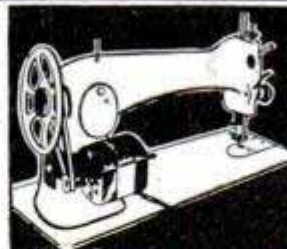

**SEWING MACHINE MOTOR KIT...**

How to Convert Your Old Model Sewing Machine into a Modern All-Electric Machine — in a few minutes. Save up to \$175 over cost of an Electrical-Machine! Send for free folder.

**BROWNELL CO.**  
 308 CANAL ST., NEW YORK 13, N. Y.



**\$\$ SQUABS MAKE MONEY!**

**FREE** Book tells how. Easily raised any climate. Full, spare time. Sell 25 days. Waiting year round market. Easy! **PROFITABLE!** No experience needed.  
**PORCH FARM, Midlothian 8, Ill.**

**SAVE GAS... START INSTANTLY**

Get full engine power. Amazing "Lektron" spark intensifier insures hot spark, quick starts, saves gas, improves mileage. Simple and easy to install. State make of car. Free information on request. Full Money Back Guarantee. Cash or C.O.D. **PAY ONLY \$1.25 plus C.O.D.**

**ELECTRONIC INDUSTRIES, Dept. PM, Cleveland 11, Ohio**

**OWN A Printing Business**  
 Cards, Tickets, Stationery, etc. Good profit in spare time. **PRINT YOUR OWN** greeting cards, movie titles, church work, etc. Save money. Easy rules supplied. Raised printing like engraving too. Have home shop. Sold direct from factory only. Send dime for supply book, suggested outlets, all details and advice on your needs. No obligation. **KELSEY, INC. C-37, MERIDEN, CONN.**



# Sale! WAR SURPLUS BARGAINS Sale!

## AC ARMY LIGHT PLANTS

New 750 watt 110 volt light plant with Briggs-Stratton model AP gas engine... **\$13500**

New 1000 watt 110 volt light plant with Briggs-Stratton model BP gas engine... **\$16500**

New 2500 watt 110 volt light plant with Briggs-Stratton model Z, 6 hp gas engine... **\$22500**

Rebuilt 5000 watt 110 volt light plant with automatic remote control. Powered by Jeep 4 cyl. gas engine. Rebuilt like new and guaranteed... **\$62500**

10,000 watt 110 and 220 volt light plant with automatic remote control powered by Jeep 4 cyl. gas engine. Rebuilt like new and guaranteed... **\$72500**

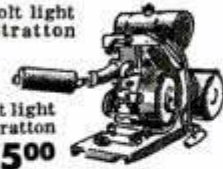

## PORTABLE DC LIGHT PLANT

3000 watt 110 volt DC powered by 6 hp Briggs-Stratton model ZZP gas engine. Portable on wheels. NEW **\$16500** only.

## GENERATORS

3000 watt 110 volt DC generator. Manufactured by Delco. Rebuilt and guaranteed. Only **\$5000**

## STEEL STRONG BOX

Fire resistant steel strong box. Office green enamel finish, lock hasp. Box has inner tray and front flap. Made of heavy 16 ga. steel, 8 1/4" high, 12 1/2" wide and 14" long. A terrific buy for **\$395** new

## Travel-Made ELECTRIC IRON

New streamlined light weight electric travel iron. Easy-grip curved plastic handle. Sparkling chrome finish. Folds up for easy packing. AC or DC. Nationally advertising at \$7.45. OUR PRICE less than **\$395** new wholesale.

## ROTARY PUMP

Heavy duty, designed to pump water, oil, gasoline, etc. Will pump 35 gal. per min. Also used as vacuum pump. Includes lovejoy coupling for 3/8" shaft. 3/4" outlet, 3/4" inlet on bottom. Size of pump, 7 1/2"W x 5"D x 7"H. Compact and sturdy. Four mounting holes in base. Can be used with 1/4, 1/3, or 1/2 HP motors. **\$1695** new Ship. Wt. 17 lbs. Only.

## Electro-Lift HOIST

500 lb. Electro-lift Hoist. 17 ft. of cable—up and down button and trolley. 3 phase, 220 or 440 volt, 60 cycle. Used in A-1 shape. List price \$185.00. OUR PRICE... **\$7500** Specify 220 or 440 volt

## and other bargain items

### Briggs-Stratton GAS ENGINES SAVE \$25

Rope start, 1750 RPM. All brand new and guaranteed. 2 1/2 HP Model AP... list price \$102.10. OUR PRICE... **\$7700**

3 1/2 HP Model BP... list price \$86.00 \$111.50. OUR PRICE... **\$9110**

5 to 7 HP Model ZZP... list price \$137.00. OUR PRICE...

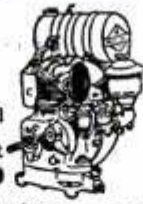

### Electric Rubber Cable (all new) CORD SETS

Extension cords, 100 ft. heavy duty. Plug, socket and guard. Number 16 wire. Worth at least \$10.00. OUR PRICE... **\$485**

Same as above — 50 ft. length... **\$385**

### Heavy Duty Electric Cable

3 wire #10 submarine cable—can be placed underwater, underground or overhead. Also for portable tools. Will carry 40 amps. 50 ft. 100 ft. 250 ft. **\$7.50 \$14.00 \$30.00**

### RUBBER CABLE

150 ft. reels, 3 wire #6 with two 60 amp Crouse & Hines male and female connectors. Perfect for welders, hay loaders, saws, electric ranges, etc. List price \$190.00. **\$4500** per reel. OUR PRICE.....

### LARGE WATER TANK

Backyard Swimming Pool or Water Storage Tank. Made of heavy glass cloth with rubber impregnation on both sides. Diameter 12 ft. Height 5 ft. Holds 3000 gal. of water. Ideal for small irrigation project, watering of animals or backyard swimming pool. Complete with cover, stays and guide lines. **\$3950** Cost Gov't approx. \$350. OUR PRICE **\$2800** Same size, made of canvas without cover..... **\$2800** Due to handling, full amount is required with order on this item.

### BALL BEARING ARBOR

Grinding and saw arbor. Has 1 1/2" double end shaft with 2 and 3" center step pulley. New Departure double roll precision aircraft ball bearings. Right and left hand thread. 10,000 RPM. Bearings alone sell for **\$595** \$4.50 each. Complete arbor only **\$595** new

### JARVIS GRINDERS

2 HP, 60 cycle, 220-440 volt, 3450 RPM. Totally enclosed G.E. motor with shaft. List price \$250.00. **\$7500** new OUR PRICE.....

### Money-Back Guarantee on all items

Order at once! Surplus merchandise is subject to prior sale. All prices F.O.B. Milwaukee. 25% deposit required on all C.O.D. orders unless otherwise stated. Many other bargain items, write for our free circulars.

## C & H ELECTRIC Company

434 W. JUNEAU AVE. MILWAUKEE 3, WISCONSIN

### Rubber Tire HAND TRUCKS

2.75 X 10" ball bearing wheels with Goodrich puncture proof tires. Will carry 500 lb. load. Frame 1-1/16 OD. Approx. weight 30 lbs. Comes in three models—One handle, for small aisles. Two handle, with bar, will carry 5 beverage cases. Two handle for general utility work. Worth at least \$24.00. **\$1600** new OUR PRICE..... Specify model desired



### U. S. Surplus HORNS and HOWLERS

Motor driven, (not a vibrator) Heavy duty with great power and long life. 110 volt AC current. Weather proof. For alarm or signal horn on boats, school yards, factories, etc. List price \$47.00. OUR PRICE only **\$945** new



### Hot Water Mercury Acrostat

Keeps your hot water at any temperature you want. Can be set for 160° to 220°. Any handy man can easily install it on your water heater. Mfg. by White-Rogers, type 1190 size 8 fits 1/2" pipe thread. 25 amps, 110 volt AC-DC, 15 amps 220 volt AC. List price \$12.00. New **\$295** in original box.....



### RUBBER WHEELS

Hollow core rubber wheels made by Goodrich 2.75 X 10. Ball bearing, 1 1/2" or 3/4" bore. 3 1/2" across hub... **\$350** each

RUBBER WHEELS (pneumatic) with tubes. Goodrich or Firestone, 6 x 9 with Timken bearings. High speed, 4 ply tire with overall height of 2 1/2", overall length of axle 42". 2 wheels with tires, tubes and axle. **\$3750** Only.....



### PORTABLE AIR COMPRESSOR

Hand truck job with Westinghouse Bendix, two cyl. compressor, 4 gal. tank, automatic pressure switch, pop-off drain, stop-cock, 25 ft. hose, blow gun, v-drive, air gauge, 25 ft. cord, 10" ball-bearing puncture proof Goodrich Silvertown tires, 100 lbs., 1/2 H.P. electric motor **\$12500** new Only..... **\$8500**

ASSEMBLE YOURSELF — SAVE \$30 Complete kit of all parts necessary to assemble the above portable compressor **\$8500** only..... **\$15500** new

Also 3/4 hp 110 or 220 volt with 20 gal. tank—automatic



### OHM TESTER

Precision ohm tester. Used by Gov't for blasting. Has chloride of silver dry cell. Reads up to 25 ohms. Complete in leather case. List price \$22.50. **\$495** OUR PRICE.....



### MARINE FLOAT (PNEUMATIC)

Made of heavy rubberized fabric, 1/2" rope encircles raft passing thru dee rings as handles. 6 ft. wide, 20 ft. long. Original cost \$525. Can be used as swimming pool, dock, pier, diving raft, etc. Will support 8000 4 tons! Cannot tip. OUR PRICE..... **\$5800** Due to cost of handling, full amount is required with order on this item.



### LINEMAN'S PLIERS

High quality Kraeuter side cutting pliers 6 1/2" 8" 7" diagonal cutter **\$1.85 \$2.10 \$1.85** new new new

COMBINATION ELECTRICIAN'S SET—knife, screwdriver, 6" side cutter & leather kit. Only.... **\$295** new





**NOW! USE YOUR ELECTRIC DRILL for  
POLISHING!  
GRINDING!  
SANDING!**

**Work on curved  
or flat  
surfaces**

You can use it to fix bodies, fenders; wax; polish ears, floors, linoleum; re-finish furniture, wood; metal surfaces; smooth, re-due welds, etc.

**FITS ANY 1/4 IN. CHUCK or DRILL,  
FLEXIBLE SHAFT, MOTOR, etc.**

Designed and engineered for high speed sanding, polishing, finishing, etc. Full 6 1/2 inch rubber face plate bends into curved surface. New clamp arrangement mounts sanding discs instantly—no cementing. Draw-string lamb's wool bonnet slips on for high speed polishing, finishing, etc. Outfit includes 6 1/2" flexible rubber disc with 1/4" metal shank, fibre backed sanding disc and heavy lamb's wool polisher. Equals \$75.00 outfits in performance. You'll find hundreds of time saving uses for it. Fully guaranteed. Shp. wgt. 2 lbs. P.O.B. Chicago. Complete, only

At your favorite hardware store or direct.

**PREHLER PROVED PRODUCTS**

Division Norbert Prehler & Co. Chicago 47, Illinois  
Dept. PM 9 — 1623-25 Milwaukee Ave.



**\$4.95**

**Handy Mail Order List**

**Little Library of Useful INFORMATION**

**5 for \$1.00  
12 for \$2.00  
25¢ Each**

Here at amazingly low cost is the practical help and information you have always wanted. Articles in previous issues of Popular Mechanics have been classified according to subject and are now available in these handy reprint booklets.

- How to Use Measuring Tools—Micrometers, Calipers, etc.—106.
- Power Driven Saws—74.
- Drill Presses, Grinders, etc.—79.
- Wood, Metal Turning-Lathes—81.
- Filing Machine, Hack Saw, Cutoff Wheel, Shaper—82.
- Lathe Tools You Can Make—101.
- Workbenches—Tool Cabinets—47.
- Spray Painting—94.
- From Pattern to Casting—91.
- Tool and Saw Sharpening—92.
- Sharpening Drills, Wood Bits—90.
- Successful Wood Turning—32.
- How to Read Blueprint—71.
- Metal Turning Lathes—99.
- Operating a Metal Lathe—100.
- Heat Treating, Hardening—102.
- Working With Glass—103.
- Servicing Elec. Motors—75.
- Electromagnets & Solenoids—44.
- Transformer Construction—41.
- The Boy Electrician—43.
- Soldering and Brazing—17.
- Arc and Spot Welders—5.
- Electroplating With Nickel, Chromium, Cadmium, etc.—86.
- Plating Leather, Wood, etc.—87.
- Lower Your Fuel Costs—31.
- Curing Leaky Basements—45.
- Fitting Home Game Room—55.
- Indoor & Outdoor Fireplaces—88.
- Backyard Gardening—39.
- Lawn and Garden Novelties—72.
- Trellises, Pergolas, Fences—76.
- Lawn and Garden Furniture—77.
- Playground Equipment—73.
- Concrete Garden Furniture—6.
- Making Serving Trays—53.
- Sanders—80.
- House Wiring—89.
- Treasure Finders—13.
- Hanging Wallpaper—38.
- Built-in Fixtures—78.
- Bird Houses—7.
- Magazine Racks—49.
- Clock Cases—50.
- Book Ends—52.
- Small Tables—54.
- Smoking Stands—56.
- Desks—58.
- Book Cases—59.
- Action Toys—66.
- High Flying Kites—67.
- Telescopes—20.
- Metal Craft—28.
- Knots and Ropework—105.
- Working With Plastics—61.
- Simple Home Improvements—107.
- Ridding Home of Insect Pests—104.
- Children's Room Furniture—51.
- Jigsawed Novelties—57.
- Doll House & Doll Furniture—60.
- 25 Shelves You Can Make—64.
- Novelties Turned on Lathe—62.
- Inlay Pictures—Veneering—63.
- Wood, Soap Carving—65.
- Windmills & Weathervanes—68.
- Lamps from Wood, Metal—69.
- Rustic Furniture—18.
- Wood Finishing—40.
- Boats—14 ft. Outboard—2.
- Boats—14 ft. Sail Dinghy—26.
- Boats—21 ft. Sloop—46.
- Rowboats, Small Dinghy—83.
- Small Sail Boats—84.
- Two Outdoor Runabouts—85.
- Build Own Canoe, Kayak—30.
- Build Glass Ice Yacht—22.
- Auto Kinks, Shortcuts—10.
- Building Trailers—27.
- Motor-Driven Midget Cars—34.
- Stop Auto Elect. Troubles—95.
- Photo Printers and Dryers—25.
- Photo Darkroom Equipment—96.
- Trick and Table Top Photos—97.
- Cosmetic Formulas—12.
- Poultry Houses—108.
- Guns and Decoys—109.
- Re-Silvering Mirrors—70.
- Chemical Experiments—93.
- Log Cabins, Tourist Houses—14.
- Trapping Small Animals—33.
- Farm and Garden Tractors—8.
- Building Extra Attic Rooms—23.
- Attractive Basement Rooms—24.
- Small Looms—37.
- Gem Cutting—47.
- Photo Enlargers—1.
- Photo Kinks—98.
- Cleaning Formulas—11.
- Taxidermy—9.
- Magic—29.
- Training Dogs—35.
- Small Furnaces—36.

Check Titles Wanted, Clip, Mail with Remittance to

**POPULAR MECHANICS PRESS, Dept. 635, 200 E. Ontario, Chicago 11**

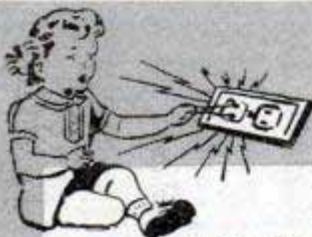

**PROTECT YOUR  
CHILDREN WITH  
NO-SHOK**

Save a life with the new  
**automatic NO-SHOK safety outlet...**

Stop your child from inserting a hair-pin, wire, scissors into current carrying terminals. Buy NO-SHOK today! Easily installed.

**2 FOR  
1.00**  
prepaid

**MERRICK ELECTRIC CO.**

Box 206 \*Reg. Merrick, N. Y.

**AUTOMATIC RETOOTH**

**MAKES NEW PROFITS**

Cuts new teeth in 50 seconds! Any size 4 to 16 points. Old teeth fall off as chips. Easy to operate. A perfect job.

**IMMEDIATE DELIVERY**

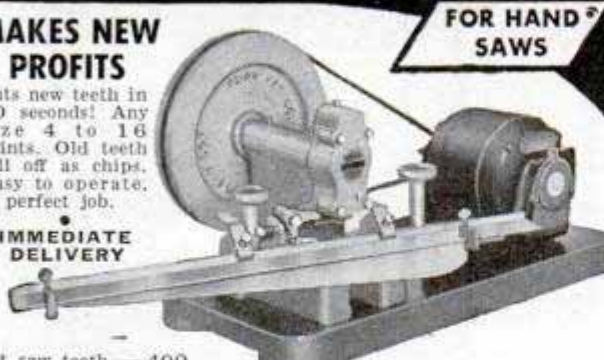

Set saw teeth—400 per minute with new Automatic SAW SET. Perfect hammer and anvil action sets teeth uniformly. No tooth breakage.

**VALUABLE BOOK  
ORDER BURR'S BLUE BOOK OF COAST TO COAST PRICES FOR SAW SHOP SERVICES. 25c**

**BURR MFG. COMPANY** 8933-V Venice Blvd. Los Angeles 34, Calif.

SAY YOU SAW IT IN POPULAR MECHANICS

**SAY YOU SAW IT IN POPULAR MECHANICS**

\*\*\*

**MAKE YOUR OWN  
POWER TOOLS  
at Low Cost**  
from old Auto Parts, etc.



**A New Edition**

**Featuring TOOLS of WOOD**

Now you can have a good lathe, drill press, circular and band saw and other power tools in your home workshop, at a cost of only a few dollars each. Make them yourself from old auto parts, discarded sewing machines and other odds and ends that cost little or nothing. Get this new book—"Forty Power Tools You Can Make." Costs only \$1.25 postpaid. This book gives every detail in plain language you can understand and follow. Hundreds of pictures and plans show every step to follow in making the power tools you want. Actual photographs of finished machines included. Send \$1.50 today. Money back if not satisfied.

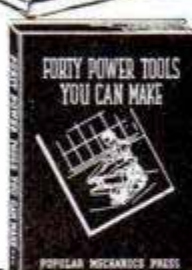

**MAKE EVERY POWER TOOL NEEDED IN YOUR HOME WORKSHOP**

- Some of the power tools you can make are:
- 2 Band Saws
- 9 Sanding Machines
- 2 Circular Saws
- 1 Metal Lathe
- 1 Power Hack Saw
- 1 Jig Shears
- 1 Cut-Off Wheel
- 2 Drill Presses
- 1 Scroll Saw
- 2 Wood Turning Lathes
- 3 Grinders
- 1 Shaper or Moulding Machine
- 1 Vibrating Pencil and others

Information too, about pulleys, belts, motors and drive methods. Just published. No other book like it. Order today.

**POPULAR MECHANICS PRESS**  
Dept. 621 • 200 E. Ontario Street, Chicago 11



# Amazing 2 for 1 Offer!

## Paint Your Car with LUSTR-WIPE

THE MIRACLE NEW AUTO ENAMEL THAT  
**WIPES ON WITH A POWDER PUFF!**

### Fix Body and Fenders

WITH DURO AUTO BODY SOLDER  
**AT NO EXTRA COST!**

**BOTH**  
**LUSTR-WIPE New**  
**Auto Enamel and**  
**DURO Auto Body Solder**  
**AT ONE PRICE**

only \$ **3.95**

Applicator  
 Furnished

**SEND  
 NO  
 MONEY  
 MAIL  
 COUPON  
 NOW**



**ONE QUART OF**  
**LUSTR-WIPE**  
**PAINTS YOUR ENTIRE CAR**  
*Anyone Can Do a Beautiful Job*

LUSTR-WIPE is different than any auto enamel you ever tried. WORKS LIKE MAGIC! Almost ANYONE can paint his own car and get a high gloss finish that looks like a professional spray job. JUST WIPE IT ON with a powder puff. NO BRUSH, NO SPRAY, NO MASKING. NO STREAKS, NO LAPMARKS. Takes about an hour to get a brilliant "factory-finish." Dries dust-free in an hour. Goes over any enamel or lacquer.

**10 POPULAR COLORS**

BLACK	.....	\$3.95 Qt.
GREY (Gunmetal-Dark or Air Wing-Light)	.....	3.95 Qt.
GREEN (Brewster-Dark or Jewel-Light)	.....	3.95 Qt.
BLUE (Washington-Dark or Monticello-Light)	.....	3.95 Qt.
RED or MAROON or SUN BEIGE (tan)	.....	3.95 Qt.

**SEND NO MONEY! ORDER TODAY!**  
 Mail penny postcard. Then pay postman for LUSTR-WIPE plus postal charges. DURO Auto Body Solder will be included AT NO EXTRA COST. Or if you send money with order, WE pay postare.

- NO BRUSHING**
- NO SPRAYING**
- NO MASKING**
- NO STREAKS**

**GUARANTEED FOR 2 YEARS**  
 Not to crack, chip, peel or fade if simple directions are followed. LUSTR-WIPE is NOT a wax or polish but a marvelous Auto Enamel.



## DURO PLASTIC METAL BODY SOLDER

**FIXES FENDERS AND BODIES LIKE NEW**

DURO is foolproof—EASY TO USE. Fixes rust spots, cracked and dented fenders, body dents and rusted out holes QUICK AND EASY. Just apply right out of the can with putty-knife. Dries to metallic hardness overnight. Can be filed down smooth, sanded to the same finish as metal and painted. You never know it's there.

**Fenders  
 Rusted  
 Out?**

LUSTR-WIPE CORP., 166 W. WASHINGTON ST., CHICAGO 2, ILL.

**AGENTS AND DISTRIBUTORS WANTED**  
 Write for tried and tested money-making plan. Also our special quantity prices.

LUSTR-WIPE CORP., 166 W. WASHINGTON, DEPT. 91, CHICAGO 2, ILL.  
 Please send me \_\_\_\_\_ qts. of LUSTR-WIPE Auto Enamel at \$3.95 Qt.  
 With each quart include a can of DURO Auto Body Solder AT NO EXTRA COST.

**COLORS** \_\_\_\_\_ **NAME** \_\_\_\_\_

Send Postpaid, Full Payment of \$ \_\_\_\_\_ (Check or M.O.) Enclosed **ADDRESS** \_\_\_\_\_

Send C. O. D. plus Postal Charges **CITY** \_\_\_\_\_ **ZONE** \_\_\_\_\_ **STATE** \_\_\_\_\_

Send Information for Agents



**SENSATIONAL!... HARMIC'S**  
**New Alcohol Blow Torch**  
**with 1800° flame**

ONLY  
**\$2.00**

POSTPAID

Highest quality brass, triple-plated chrome finish. Extra heavy case. No moving parts — no adjustment — just fill with denatured alcohol and light. Absolutely safe.

Its 1800° F. flame is just the thing for preheating work . . . improving the quality of your soldering . . . bending glass tubing. Hundreds of uses in every home workshop.

Thousands of satisfied users. Order today. Send \$2.00 — cash or money order. We ship postpaid. No C.O.D. Money-back guarantee.



**TRINITY PRODUCTS**

949 Commonwealth Ave., Boston 15, Mass.

**Sensational SHAPER CUTTER**  
**For Endless Molding Contour Designs**



Employs exclusive double notched sets of full 1" and 1/2" split blades. Blades automatically held in position by notched design and in absolute alignment. No set screws to loosen; blades cannot fly out. Provides endless varieties of standard and special contours. Specify type of spindle on drill press or shaper. Available in six standard adapter sizes. Ten-day money back guarantee. Complete literature on request.

**\$9.00** Complete with 3 sets of Hi-speed Tool Steel Cutters

**TOOLS FOR USE ON ALL DRILL PRESSES**

ROTARY WOOD PLANERS  
 ALL-METAL SHAPER FENCES  
 SPINDLE ADAPTERS  
**BARRON TOOL COMPANY, INC.**  
 569 Architects Bldg.: Detroit 1, Mich.

ROTARY SURFACE SANDERS  
 DRUM SANDERS  
 AUXILIARY DRILL PRESS TABLES

FREE  
 Power Tool  
 CATALOG

**BARRON PRECISION WORK SHOP TOOLS**

**NEW! 8 in. Bench Saw**  
**Only \$12.50**



(Less Blade and Motor)

For Home Shop and Professional Use: Hobbyists, Mechanics, Carpenters, Cabinet Makers, Modelists, Farmers, Schools

finish. Quick adjusting full length rip fence; sliding square gauge for cut-off; heavy guard protects from saw blade; slitter; 2-inch V-pulley. Adjustable for depth of cut to 2 inches. A tool you need at a price you can afford!

**ORDER TODAY! MONEY BACK GUARANTEE!**

Rush name and address with only \$2.00 deposit. We ship C.O.D. for \$10.50 balance, plus transportation. Shipping weight approximately 14 lbs. Try for 10 days—and if not entirely satisfied, return to us for refund. ORDER NOW.

**STRADER PRODUCTS CO.**

259 Strader Ave. Dept. A-250 Cincinnati 26, Ohio

**Electrify MOTHER'S OR WIFE'S SEWING MACHINE**

MAKES SEWING A PLEASURE!

COMPLETE WITH SEWING LIGHT  
**\$15.95**

ANYONE CAN INSTALL

BELT BRACKET  
 PULLEY  
 AC-DC UNIVERSAL 750 H.P. MOTOR

SEWING LIGHT

PORTABLE CASE FOR ANY TYPE MACHINE SPECIFY MAKE & NUMBER.  
**\$12.50**

FOOT CONTROL RHEOSTAT

OUTFIT CAN BE USED FOR HOBBY WORK, SHOP, ETC.

Free Catalogue Dealers Write Weight of Kit, 6 lbs., Weight of Case 11 lbs. Postage is extra.

**PASAAK'S**

Dept. PM, P. O. Box 153  
 Canal Street Station  
 New York 13, N. Y.

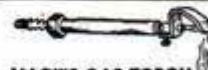

**MACK'S GAS TORCH AND SOLDERING IRON**  
 4,000 B.T.U. attaches to any gas hose; furnished with 2 jets for natural and bottled gas; equipped with adjustment set screw. **\$2.00** Postpaid



**Mack's GAS BURNER**  
 Jet Power, Self-Acting (Pat. pending), 24,000 B.T.U., for natural and bottled gas, industrial and home use. **\$2.00** Guaranteed. Postpaid

**Mack's Automatic Water Heater**  
 Approx. 20 gal. capacity and larger for home and industry. Easily installed. Amazingly low-priced. Guaranteed. **\$32.50** Del.



**McDaniel MANUFACTURING CO., INC.**  
 1012 1/4 POMMATTAN ST. DALLAS 2, TEX.

**RACING CAR EQUIPMENT FOR ALL CARS**

Engines, Racing Heads, Manifolds, Carburetors, Mufflers, etc. Speed Instructions and literature \$1.00—refunded first order.  
**LEE MOTORCRAFT CO.**  
 1412 Great Northern Bldg. Chicago, Ill.

**START YOUR OWN CHEMICAL BUSINESS IN YOUR HOME!**

Manufacture and sell a time proven and accepted household and commercial product.  
**A DEPRESSION PROOF BUSINESS!**  
 We furnish complete equipment and basic chemicals. You can readily net \$500 PER MONTH PROFIT in your own locality. Generous sample of product sent to you FREE upon request. Awarded Good Housekeeping Seal of Approval.  
**AMERICAN COLLOIDS COMPANY** 251 S. Waterman Avenue Detroit 17, Michigan

**FULLSIZE, CUT-TO-SHAPE BOAT PATTERNS**

and specifications. Designed by Naval Architect. Cruisers, runabouts, sloops, outboards, sailing canoe, etc. Low prices. Send 10c (coin) for illustrated catalog. SPECIAL: Send \$1.00 for "HOW TO BUILD BOATS" book, postpaid. PolyWog Houseboat Plans, \$10. Cleveland Boat Blueprint Co. Dept. 666. Cleveland 13, Ohio



Say You Saw It in  
**POPULAR MECHANICS**

**RUPTURED?**

Get Relief This Proven Way

Why try to worry along with trusses that gouge your flesh—press heavily on hips and spine—enlarge opening—fail to hold rupture? You need the Cluthe. No leg-straps or cutting belts. Automatic adjustable pad holds at real opening—follows every body movement with instant increased support in case of strain. Cannot slip whether at work or play. Light. Waterproof. Can be worn in bath. Send for amazing FREE book, "Advice To Ruptured," and details of liberal truthful 60-day trial offer. Also endorsements from grateful users in your neighborhood. Write: **CLUTHE SONS**, Dept. 31, Bloomfield, New Jersey



**UP TO**  
**SAVE 85%**

**in WAR SURPLUS...SENSATIONAL VALUES**  
at "GADGETEER'S HEAVEN"  
IN MANY ITEMS WE HAVE  
THE WORLD'S LARGEST SUPPLY

For that sporting trip  
and year round use, too

**B-15 STYLE JACKET**  
A Garment You'll be PROUD TO WEAR! Water repellent, wind resistant, Nile green, saaten, genuine Zealand Sanitized Poplin. Full zipper front with slash pockets and large genuine Mouton Fur Collar. Heavy Alpaca lined for Warmth. Sleeves also lined with Heavy Rayon Rib-knit cuff and bottom.  
Sizes 34 through 46.  
**LOOK AT THE PRICE! \$11.95**

**Navy Melton Cossack Style Jacket**  
NEW All Wool, Sturdy, Warm Zipper front slash pockets, Taped Collar. Wonderful Buy For Utility and long lasting Qualities.  
Sizes 34 thru 46  
**\$5.69**

**HUNTING KNIFE #307**  
6" chrome vanadium blade handle, leather grip. In leather sheath.  
\$5.98 Value For Only **\$1.79**  
Like above but black Parkerized Finish. #307A **\$1.49**  
**BOLO KNIFE**  
10" x 2" Parkerized Blade 5" Gripped Handle. Weight 1 1/2 lbs. Ideal for Hunting, Clearing Brush, or Trails. **\$1.19**

**MACKINAW**  
Made of heavy water repellent poplin cover. Wool blanket lined, thigh length, sleeve flap for adjustment. An ideal coat for the outdoor man, truck driver, hunter, farmer. Sizes 34 thru 46 **\$7.95**

**CANTEENS & COVERS**  
1 Quart Aluminum, Porcelain Lined and Cvd. Plastic Screw Top. Slightly used but Perfect. Canvas Cover, Felt Lined with Belt Holder. **59c** ea.  
Button Fastened **29c** ea.  
Canteen Cups, Aluminum **19c** ea.

A WONDERFUL PAL FOR THAT TRIP!  
**NEW U. S. Officers INSULATED FOOD CONTAINER**  
Keeps Food Hot or Cold. 3 compartments, containing 2 1/2-Quart Fryer Baking Dish, lined with asbestos and 1 9-Quart Plastic covered compartment. All in light but strong plastic case. Will carry Liquids, Vegetables, Meats, etc. Ideal for the Sportsman, Rancher, Outdoor Man. At a fraction of Gov't. Cost. Only 100 Available. wt. 21 lbs. **\$12.95** Each

**SHARPSITE NIGHT DRIVING GLASSES**  
With 57 mm yellow amber lenses. These lenses are 6 base especially PRECISION Grnd. and Polished to reduce Glare of headlights from on coming cars, also to focus objects sharply and more clearly during night driving. Absolutely one of the greatest boons for Safe Night Driving, or during stormy, murky weather. Highway Patrolmen, Truck Drivers swear by them. A must for your Vacation or Nite Driving. **INTRODUCTORY OFFER ND-1 \$16 VALUE \$5.89**  
In Men's size or Ladies Harlequin style. SAME GLASSES but clip on. Fit-over style without temple bars **\$4.59**

**HERE ARE PLASTIC KITS**  
UNRIVALLED VALUES for ARTISTICALLY INCLINED HOME HOBBYIST!  
Start planning Now! Sizes Now!  
Kit #1 contains 2 lbs. Plastic and Luster sheet in various shapes, 1 ea bottle of clearcast cement, 1 ea. bottle color set cement and 4 bottles of colors in Orchid, Red, Yellow, Peach, etc. Also a Plastic Handbook of uses and instructions. This set easily worth \$3.50. Our Price **\$2.19**  
KIT #2 contains 1 1/2 lbs. of plastic sheet, 1 ea. bottle of clearcast cement, and the Plastic Handbook. A \$2.50 Value for ONLY **99c**

**TEAR SHAPED PLEXI DOME**  
Overall length 21" width at widest point 11." at base 4" 5" deep. **\$1.39** ea.  
#70-1-A

**Signal Corp Control Unit**  
Standard Rock Panel 17" x 9 1/2" x 7". Case is 6 1/2" x 17" x 5" with numerous relays, condensers, 4 key switches, Jones plugs, jacks, resistors, transformers, rheostat. Well enclosed in Padded steel case. Parts alone worth more than our making Price of ONLY **\$2.69**

**Radio ANTENNA Reel**  
Just the thing for tuning beam antenna.  
Powered by 1 1/2 h. p. 24v G. E. Motor. Removable 8" Red-Silk Switch - Can Warm gears, Rev. gear, Solenoid clutch.  
Motor engaged to gear reduction only when electric contact made. Operates in either direction. Ideal for auxiliary power take-off, opening and closing doors, etc. **\$4.29**  
A TREMENDOUS VALUE

**RADIO HEAD SET**  
AN-BH-1 with Leather Sponge Rubber Pad A Wonderful Buy **\$1.00**

**DRIFTMETER**  
Used for Drift & Air Speed. Can be Dismantled for: 1. Accrometric 85MM Double Lens. 2. 51MM 4. Sponge Rubber Discs. 5. Hinges. Metal Parts: 6. Slide Viewer Parts: 7. Tracer Parts. Can be adapted to 35MM Projectors, Portrait and Enlarging Work, Pantograph, etc., by Draftsmen, Artists, etc. Information Bulletin with each **\$4.98**  
Drift Meter. Gov't Cost \$200. Only

**SUNGLASSES**  
Here's the real McCoy. Army Air Force 6 Base over Polished and ground glass-free lens with leather case that can be attached to belt. Gold plated adjustable frame. Pearlloid sweat bar and pads. A real Palley \$17.50 value for **\$3.95**  
**ARMY AIR FORCE TYPE SUNGLASSES**  
4 base, polished and ground lens. 95% Ultra Violet Ray, true gold plated frame, pearlloid bar & pads, leatherette case. Our price **\$2.39** ea.  
**GENUINE AVIATORS (AN-6530)**  
Windproof & Dustproof  
**GOOGLES**  
Sponge and leather protected lens with ground lens in clear, amber and green. Clear set in replaceable metal frame with hinged nose bar. Go-65 Ideal for Motorcycling, etc. **\$1.69** ea.

**NEW AIRCRAFT ALUMINUM BUCKET SEAT**  
Use for boats, jeeps, tractor seats, etc. 17" x 18" seat, 18" x 24" back. Rib enforced. Adjustable height tube mounting.  
Wide, high back gives excellent support. Easily installed. Shipped in original carton.  
You'll appreciate the buy at **\$4.95**

**CUSHIONS**  
Mid. for above Bucket seat, but can be used in trucks, autos, boats, tractors. Made to Gov't. Spec. of finest imitation leather, yellow pigskin col., filled with kapok. Will float. Same as shown in LIFE magazine saving a man from drowning.  
New Back Rest, 22"x16" x 1 1/2" thick **\$2.95**  
Used Back Rest, 22" x 16" x 1 1/2" thick **\$1.95**  
SEAT, New, 17"x16"x3" thick **\$3.49**  
SEAT, Used, 17"x16"x3" thick **\$2.29**

**MESS TRAY**  
6 compartments, rustless, stainless steel. Barbecue, outdoor cooking, save dish-washing. Hospital, Restaurant, Home, or roughing. **New 83c**  
#311  
#311A Used but in Fine Serviceable Condition **59c** ea.

**SLEEPING BAG**  
NEW! 100% wool. Mummy type Heavy duty 20 zipper. Gov't. Cost \$22.00 **\$3.95**  
\$1.95 extra for used water repellent cover.  
Sold only with Sleeping Bag  
**Slope**  
AT REAL VALUES!  
3/16 dia., 3 strand, cotton .01 ft. 1/4" dia. Treated Navy laynard, in 300 ft. rolls **\$1.95**  
3/8" dia., 3 strand, treated jute **.62** ft.  
3/4" dia., 3 strand, jute **.07** ft.  
3/4" dia., 3 strand, sisal **.08** ft.  
7/8" dia., 3 strand, sisal **.08** ft.  
These prices speak for themselves, we also have other types and larger sizes in stock. We welcome your inquiry. No sizes under \$1.00

**VINYLITE TUBING**  
Capable of insulating up to 5000 volts. This Plastic tubing used for protecting wire, decorative purposes, water or other fluid hose. Price per ft.  
1", Black, Clear, Red **.15**  
3/4", Clear, Red **.12**  
1/2", Grey, White **.12**  
3/16", White **.02**  
3/16", Clear **.02**  
No Sale Under \$1.00  
Above sizes are only a sample of the stock we carry, should you desire other sizes or types please send us your inquiry.

**Aviation Emergency Vests**  
Sturdy, Yet Light Weight. Satin Lined with Tie Straps. 14 Outside Pockets, Plus Knife, Gun, or Tool Leather Holder. 2 large 11" x 8" Pockets Inside. Wonderful for Hunting, Fishing, or Mechanic. Cost the Government \$30. A Steel at **\$2.49** ea. AV-1

Here it is!  
Everyman's Favorite the  
**EISENHOWER JACKET**  
Sizes 34 to 40. Used, but in Perfect Condition. **\$3.99** ea. While They Last

**NEW TARPS - HEAVY CANVAS**  
Mildew & Flame Resistant. Cheap Outside Storage. They are Really Moving at These Prices.  
5' x 7' **\$3.95**  
8 1/2' x 10' **\$8.50**  
8 1/2' x 16' **\$11.95**  
Rubberized Linen 7' x 11' NEW **\$5.95**  
Only 3 lb. light weight yet waterproof Ideal for outside car storage.

**Waltham 8 Day U. S. Navy Airplane Clock**  
Runs 8 days without re-winding. 15 jewels, adjustable for temperature & upright position. Watch type escapement. Dial registers 24 hr. day in hr., min. & sec. Also days of the month. Used but guaranteed Reconditioned. A \$30. VALUE FOR ONLY **\$13.95**

'Twas Made for the Air Forces THE BEST  
**Loose Leaf BINDER**  
You ever saw a metal post. Cylindrical locking heavy duty 3/16" fabricated knop cover. End Identification window. Ideal for photo albums, students, publications, Reference books, artist sketch books, etc. Will hold 500 sheets, 8 1/2" x 11". A \$5.00 Value for Only **59c** ea.  
50 Page Binder Band Filler in 25c Extra.

**HORSEHIDE WORK GLOVES**  
ALL LEATHER GAUNTLET TYPE REINFORCED PALMS & FINGER STITCHING. LENGTH 13 1/4" **\$1.95** pr. ALL LEATHER WRIST Length 10 1/4" **\$1.55** pr. Barbed wire, welding, all purpose work gloves. A Steal... Gov't. cost many, many times more.

**LEATHERETTE**  
Heavy Hodge Brown color, With Heavy Backing. Recover your outdoor furniture or your Auto, Truck, Boat or Tractor Seats at a fraction of what you would otherwise pay. In 29 1/2" Widths. Running Yard **95c**

**COMPASS #154**  
#154 Wrist strap Compass **69c**

**PALLEY SUPPLY CO.** THE LARGEST FIRM OF ITS TYPE IN THE WORLD DEPT. P. M. 9-8 — 6321 SAN FERNANDO RD. GLENDALE 1, CALIFORNIA



# SOUTH BEND 9" PRECISION LATHE

This quality-built lathe gives workshop owners the capacity for work of industrial caliber. Its precision and versatility makes it possible to perform a wide range of operations to close tolerances. Numerous attachments are available for special classes of work such as milling, grinding and wood turning.

Mail coupon for complete information or see local distributor. He is listed under "Machine Tools" or "Lathes" in your classified telephone book.



## SOUTH BEND LATHE WORKS

Building Better Tools Since 1906

455 E. MADISON ST., SOUTH BEND 22, INDIANA

### SPECIFICATIONS of 9" Model A Lathes

**SWING**—9¼" over bed and saddle wings.  
5½" over saddle cross slide.

**BED LENGTHS**—3, 3½, 4, or 4½ feet

**DISTANCES BETWEEN CENTERS**—16" to 34"

**SPINDLE SPEEDS**—Twelve, 41 to 1270 r.p.m.

#### OPTIONAL DRIVES

Six Speed—41 to 658 r.p.m.

Sixteen Speed—46 to 1176 r.p.m.

**POWER LONGITUDINAL FEEDS**—Forty-eight—.0015" to .0853"

**POWER CROSS FEEDS**—Forty-eight—.0004" to .0252"

**THREAD CUTTING RANGE**—48 pitches, R. H. or L. H.—4 to 224 per inch

**MAXIMUM COLLET CAPACITY**—½ inch

**SPINDLE BORE**—¼ inch

#### NEW 14 INCH DRILL PRESS

A ruggedly built tool unsurpassed for accuracy, ease of operation and dependable performance. Prices include 1/3 h.p., single ph., 60 cy., 115 V. motor and switch—f.o.b. factory.

Bench Model, \$129.30  
Floor Model, \$144.30

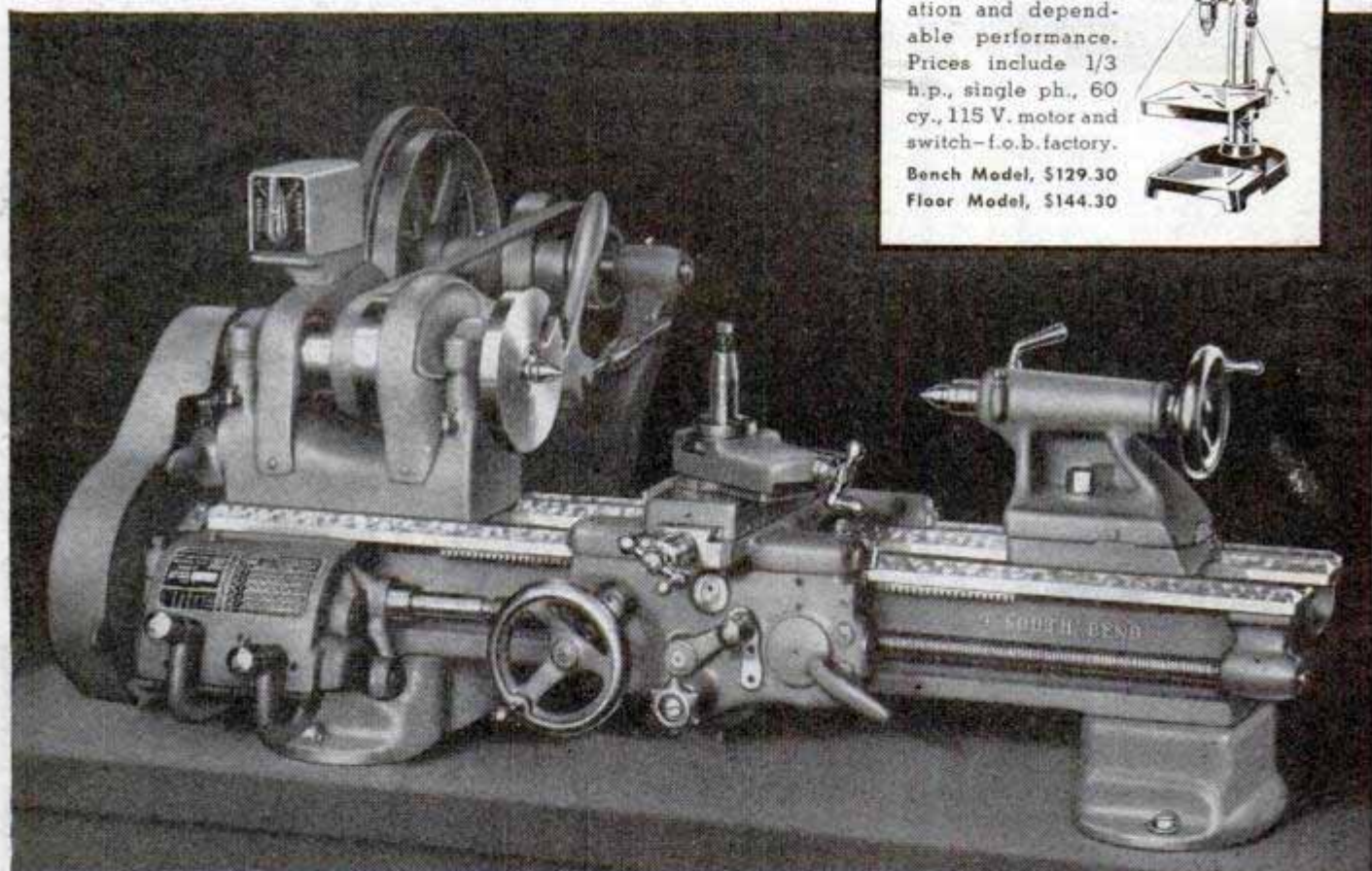

SOUTH BEND LATHE WORKS, 455 East Madison Street, South Bend 22, Indiana

Please send complete information on the following:

- 9" Lathes                       10" and larger Lathes                       Lathe Attachments  
 Drill Presses                       Time Payments

NAME \_\_\_\_\_

STREET \_\_\_\_\_

CITY \_\_\_\_\_ STATE \_\_\_\_\_

9" x 3' Model A 12-Speed Bench Lathe with 1/2 h.p., 1 ph., 60 cy., 115 V. motor and drum switch—f.o.b. factory **\$344<sup>45</sup>**

Other models priced from \$160.



Dependable

# CHAMPION

America's Favorite Spark Plug

The American farmer subjects spark plugs to sustained and severe service in all kinds of engines—car, truck, tractor and other power-driven farm equipment.

As a result, he is a qualified spark plug expert.

Dependable Champion—America's Favorite Spark Plug—is the overwhelming favorite of farmers everywhere.

CHAMPION SPARK PLUG COMPANY, TOLEDO 1, OHIO

***FOLLOW THE EXPERTS***

**DEMAND NEW DEPENDABLE CHAMPIONS FOR YOUR CAR**

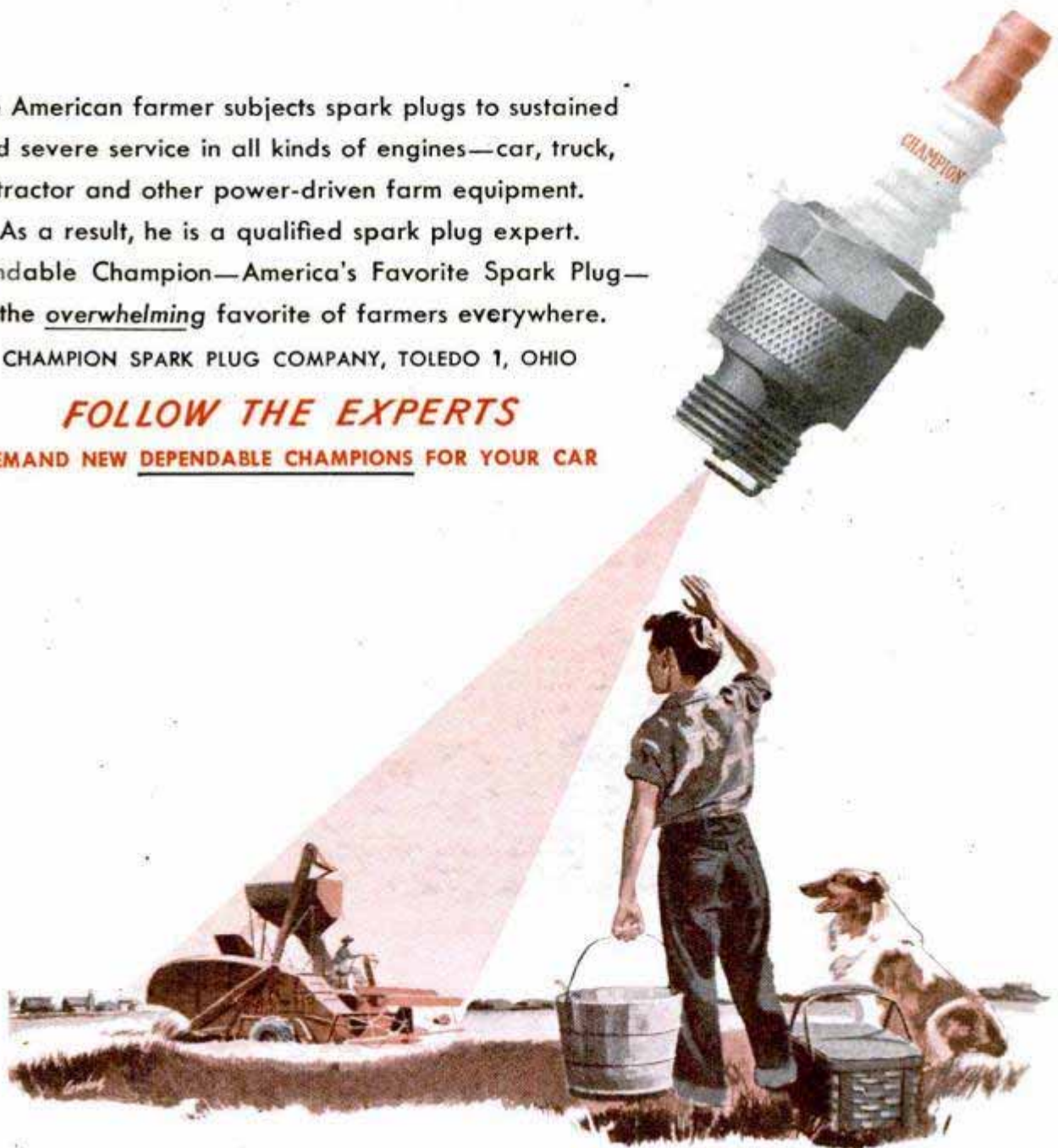

Listen to the CHAMPION ROLL CALL . . . Harry Wisner's fast sportscast every Friday night, over the ABC network