

ANC

POPULAR MECHANICS MAGAZINE



WRITTEN SO YOU CAN UNDERSTAND IT

REG. U.S. PAT. OFF. TRADE MARK, GREAT BRITAIN, No. 410425

25 CENTS



SEE
PAGE 144

NOW... LIGHT
WHEN YOU NEED IT!

Ray-O-Vac LEAK PROOF batteries
stay fresh for years!

(because they're Sealed in steel!)



© 1948 BY RAY-O-VAC COMPANY, MADISON, WIS. RAY-O-VAC CANADA LTD., WINNIPEG, MAN.

Guarantee: If your flashlight is damaged by corrosion, leakage, or swelling of this battery, send it to us with the batteries and we will give you FREE a new comparable flashlight with batteries.

Ask for Ray-O-Vac Leak Proofs

Buy Spares... *they stay fresh*

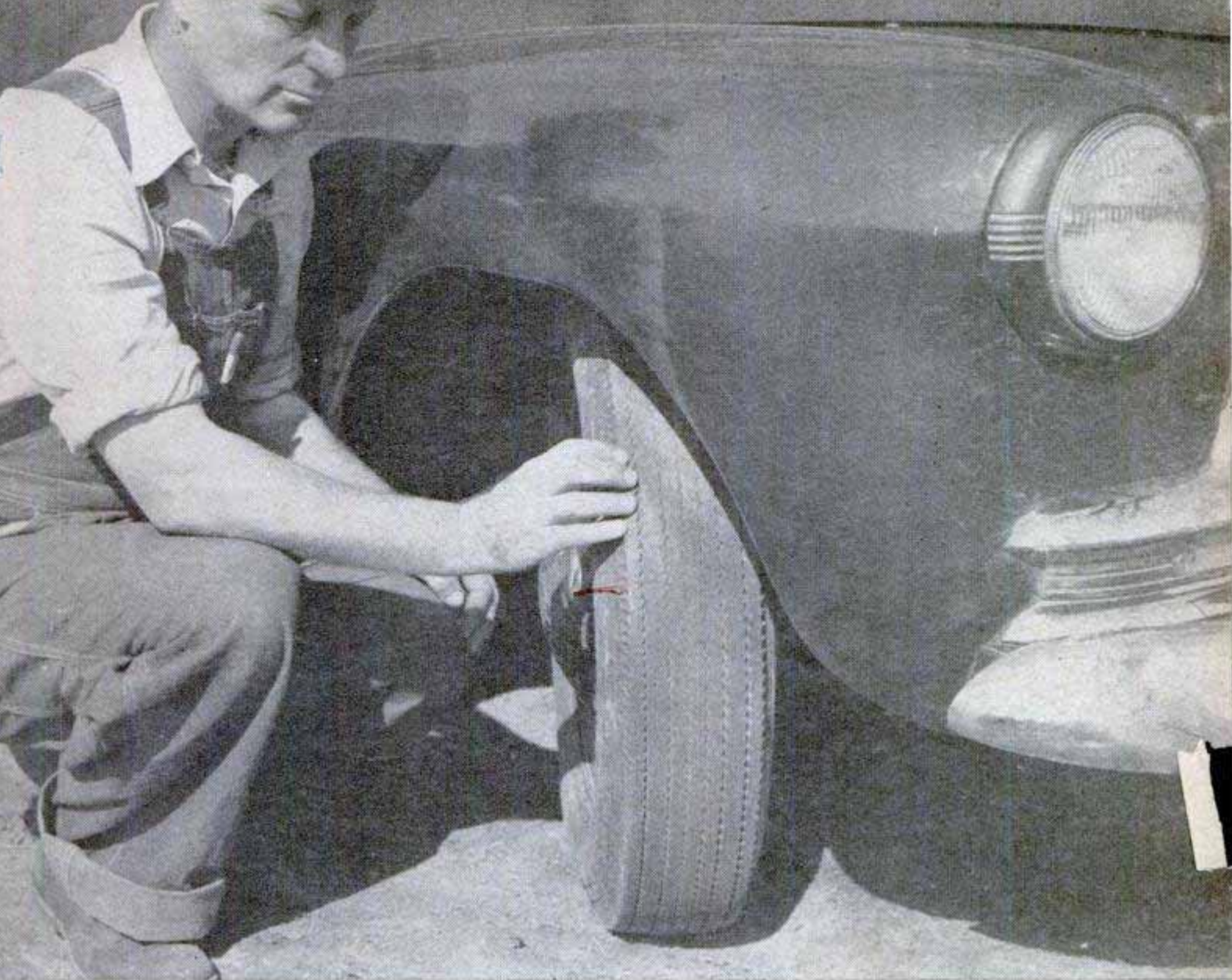

Typical example: the B. F. Goodrich tire that outwears prewar tires

LETTERS keep pouring in from enthusiastic B. F. Goodrich tire users in cities and towns all over the country. They tell of the outstanding mileage in B. F. Goodrich tires.

The B. F. Goodrich tire user shown above is Russell V. Falk, who owns a 320-acre grain and livestock farm in Red Oak, Iowa. At the time this picture was taken, he had rolled up 24,007 miles on his B. F. Goodrich Silvertowns.

He says: "I have used B. F. Goodrich tires for the past seven or eight years and have always

gotten good mileage. I now have 24,000 miles on my second set of passenger car tires which are still good for another 24,000."

Mr. Falk added that driving conditions around his farm are extremely hard on these tires. Yet they still show almost no wear.

B. F. Goodrich Silvertowns outwear other tires. They outwear prewar tires. The tougher, stronger cord body stands up better under the loads and pounding a tire has to take. The tread stubbornly resists

wear because it is broader, flatter and spreads car weight over a greater area.

With the big trade-in allowances now offered by B. F. Goodrich dealers, your old, worn tires are worth more to you on a trade-in than they are on your car. See your B. F. Goodrich dealer if you need tires. He's listed under *Tires* in the yellow pages of your phone book. *The B. F. Goodrich Company, Akron, Ohio.*

B.F. Goodrich

MADE IN U.S.A.

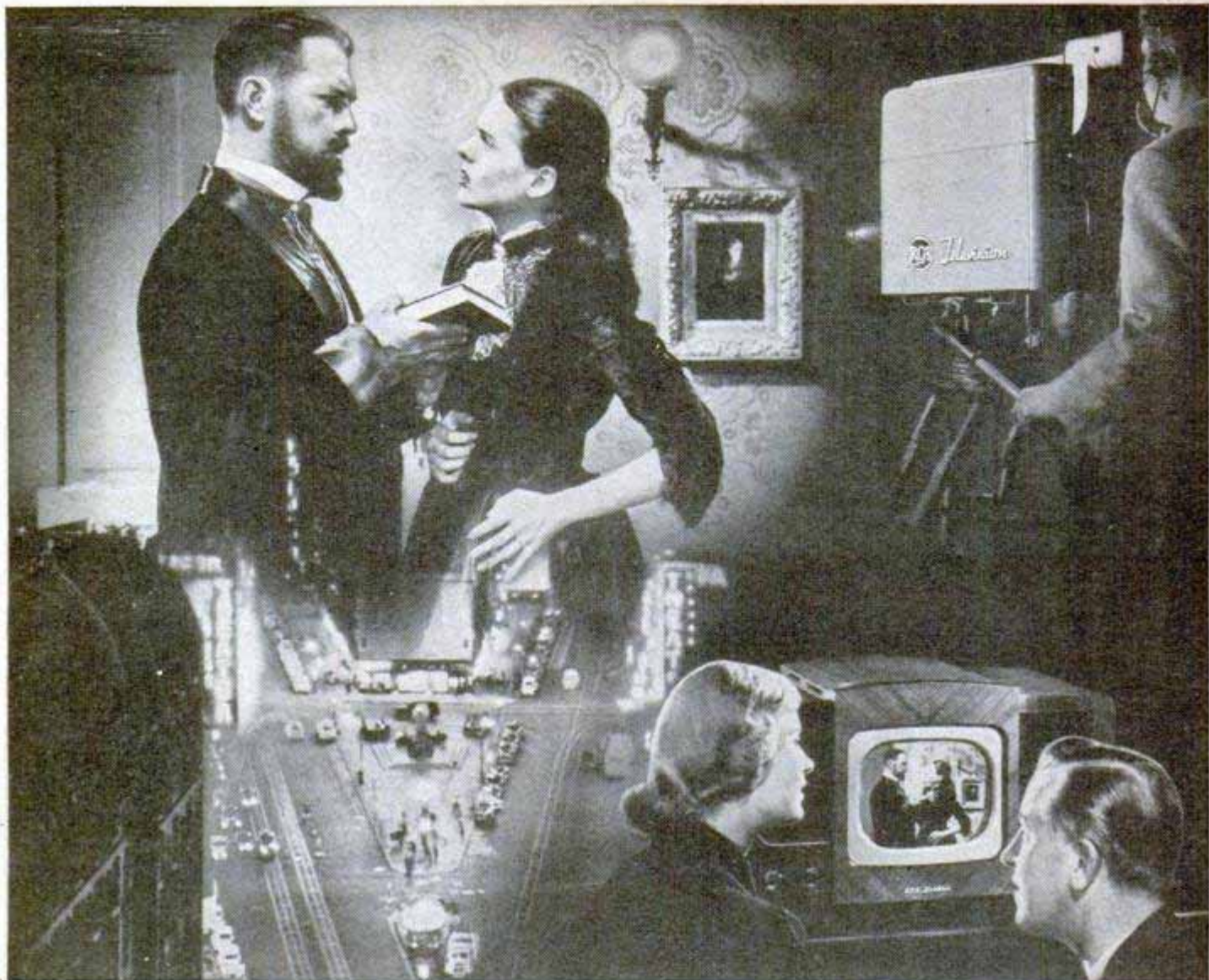

Great drama comes to television in NBC telecasts of Theatre Guild presentations.

How wide is "Broadway"?

To people all over the world "Broadway" means the theatre. So when NBC, in October, 1947, introduced regular telecast performances of Theatre Guild productions, an expansion of "Broadway" began—and some day it will be nation-wide.

Today, if you live in a television area almost anywhere from Boston to Richmond, the new "Broadway" of television runs past your door.

Now you can see great plays, professionally performed by noted actors. That's news, exciting news, to lovers of the theatre.

Celebrated artists run through lines and action before keen-eyed RCA Image Orthicon television cameras. At *your* end of the picture, on an RCA Victor home television receiver, action is sharp, clear, detailed . . . and voices flawless.

That television can make so important a contribution to American entertainment is in good part the result of pioneering and research at RCA Laboratories. Such research enters every instrument bearing the name RCA or RCA Victor.

When in Radio City, New York, be sure to see the radio, television and electronic wonders at RCA Exhibition Hall, 36 West 49th Street. Free admission. Radio Corporation of America, RCA Building, Radio City, N. Y. 20.



RADIO CORPORATION of AMERICA

Popular Mechanics Magazine

Registered in U. S. Patent Office and Canada

H. H. WINDSOR, Founder

H. H. WINDSOR, Jr., Editor and Publisher



HEADLINER of the "Three-Ring Zoo" (page 92) is the rough-and-ready St. Louis cowboy above. His talents include playing the trombone (with the cooperation of zoo mechanics). He answers to the not-so-tough name of Cookie.

NEXT MONTH an ambitious farm project is chronicled in the feature: "They Rebuilt a Farm in a Day." Another September article concerns the most vital piece of human machinery—your heart. "Mass Attack on Heart Disease" tells of an amazing experiment at the University of Minnesota. Also next month every inventor will want to rush to his workshop when he reads "Inventions Screened Here," the story of an organization on the lookout for practical ideas.

CRAFTSMEN in quest of a new hobby will be fascinated with a September feature on ceramics. It covers everything from "throwing" on the potter's wheel to construction of a home kiln and glaze firing. There's also an article on wheel-bearing care and another on making an arc welder out of a discarded transformer.

RADIO experimenters—look for the portable record changer in the September Radio section.

Volume 90 AUGUST 1948 Number 2

Managing Editor.....	Roderick M. Grant
Assistant Managing Editor.....	Wayne Whittaker
Shop Notes and Crafts Editor.....	James R. Ward
Radio and Electronics Editor.....	Frank L. Brittin
Aviation Editor.....	Aubrey O. Cookman, Jr.
Associate Editor.....	Clifford B. Hicks
Eastern Editor.....	Bill Reiche
Western Editor.....	Thomas E. Stimson, Jr.
Art Director.....	Frank Beatty

Assistant Editors

Donald R. Brooks Arthur R. Railton

Assistant Editors, Shop Notes and Crafts

W. Clyde Lammey Wayne C. Leckey Frank N. Stephany A. E. Youngquist

In This Issue

Do We Need Synthetic Oil Now? -	73
Science Takes a Micro-Eye View -	84
Three-Ring Zoo - - - - -	92
New Roads to Timberland - -	100
Rebuilding the Silent Service - -	106
Iron Stevedores of the Coal Docks -	114
Hoover Dam Calls the Doctor -	121
Camp in Comfort - - - - -	128
Photos on Fabrics and Glass - -	132
Fishing for Shark - - - - -	138
Confusion in the Cockpit - - -	146
The Navy's Incredible Eye - - -	154

For the Craftsman

Model Plane—"Gold Rush of '47"	170
Party Magic - - - - -	182
Lubricating Your Auto Engine -	186
High-Speed Flash Unit - - -	191
Hone Tools With the Right Stone -	202
Drilling Data - - - - -	208
Radio and Electronics - - - -	213
Clinic for Homemakers - - - -	226

Table of Contents continued on page 8

Published monthly by POPULAR MECHANICS COMPANY, 200 East Ontario Street, Chicago 11, Ill. H. H. Windsor, Jr., president; Paul H. Dunakin, vice president and general manager; D. F. Windsor, vice president and secretary-treasurer; William Harrison Petridge, vice president and assistant to the publisher; Clover L. Perkins, advertising manager; Alan M. Deyoe, circulation manager. Single copy in the United States and Canada, 25 cents; subscription rates in United States and possessions, Canada, Philippines and countries of the Pan-American Postal Union, 1 year, \$2.50; 2 years, \$4.50; 3 years, \$6.00. To all other countries add \$1.00 a year over United States prices for overseas postage. If you plan to move, notify us at least 30 days in advance so you will not miss an issue. Give both old and new addresses. Entered as Second Class Matter, September 15, 1903, at the Post Office at Chicago, Illinois, under Act of March 3, 1879. Entered as Second Class Matter at Post Office Dept., Canada. Copyright 1948 by Popular Mechanics Company, Copyright under International Copyright Union. Copyright in France. All rights reserved under Pan-American Copyright Union. Printed in the United States of America.

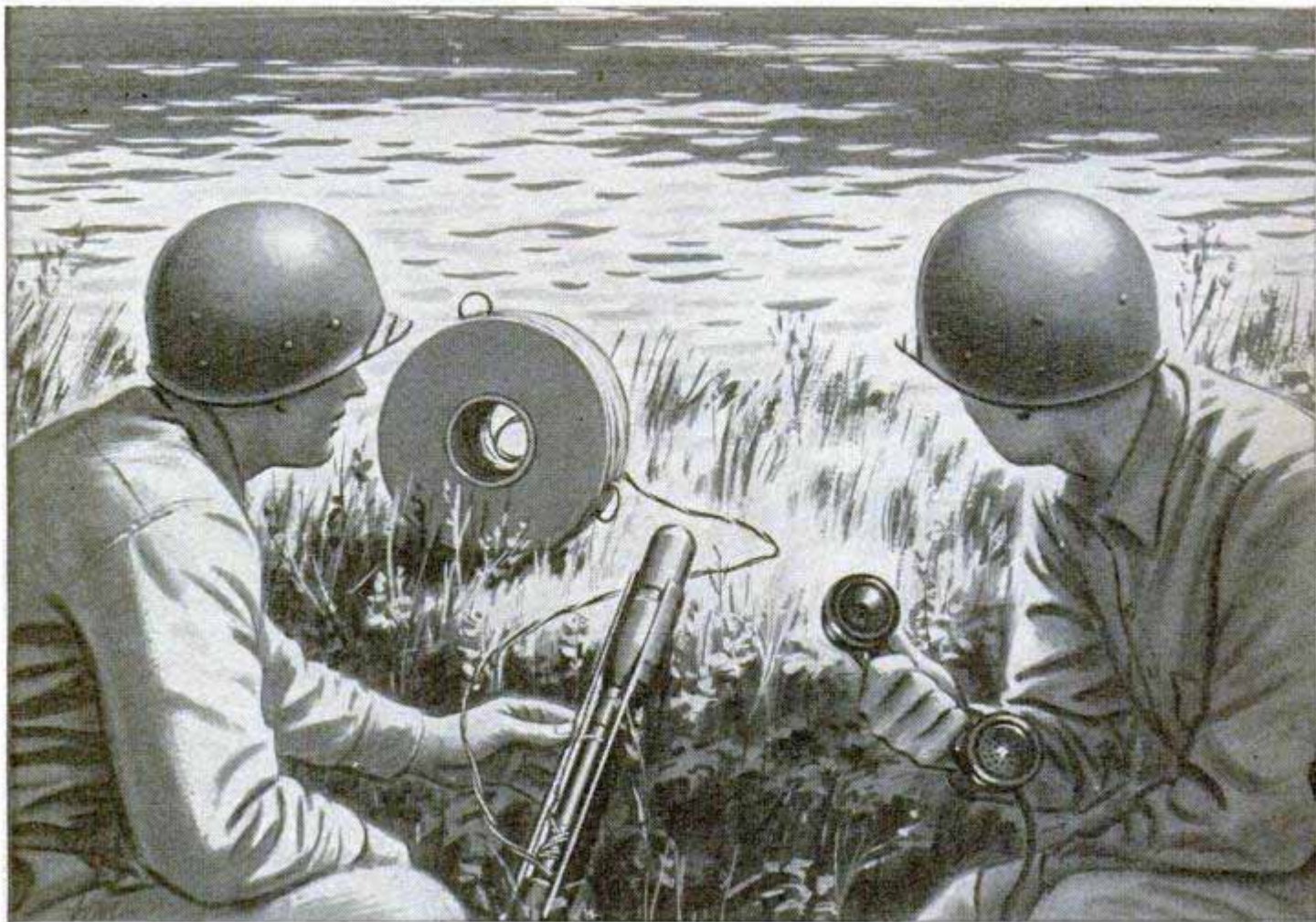

WHERE WILL YOU HAVE YOUR TELEPHONE ?

JUST point out the spot. The U.S. Army can lay a telephone wire at your feet before you can say "Rocket!"

And that's just what you would say, because the modern soldier can use rockets to carry field telephone wire over any kind of terrain up to 150 yards.

Treacherous rivers, cliffs, mountains — even terrain swept by shellfire — none of these is a major obstacle any more. The rockets carry the wire up and over and put it down where you want it!

An improved wire dispenser, tested and proved by the Signal Corps, makes possible this unique method of establishing quick communications under diffi-

cult conditions. It's only one of scores of new developments, new methods, new equipment which the Regular Army soldier works with every day.

As a soldier today, you deal in "futures." You're out in front, with new techniques, new equipment, new developments in science and industry. You do things better and faster than any other soldier because you get the finest kind of equipment to go with your native "know-how."

You can get full details at your U. S. Army and U. S. Air Force Recruiting Station.

CAREERS WITH A FUTURE

U. S. Army



**U. S. ARMY AND U. S. AIR FORCE
RECRUITING SERVICE**

Inseparable

GOOD CRAFTSMANSHIP... GOOD TOOLS

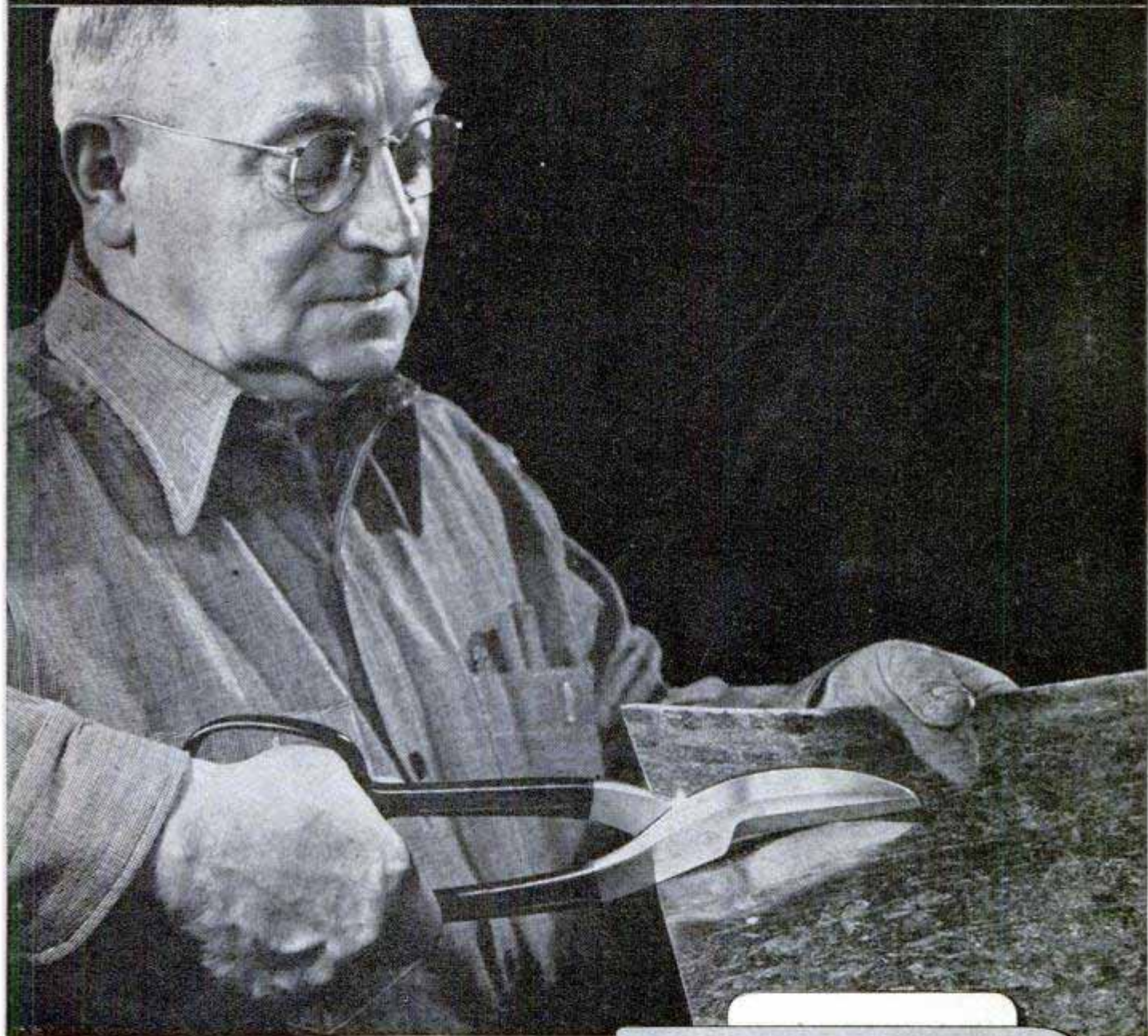

"CRESCENT" is our trade-mark registered in the United States and foreign countries for wrenches and other tools. "Crescent" tools are made only by Crescent Tool Company of Jamestown, N. Y., and are sold by leading distributors everywhere.

CRESCENT TOOLS



*Sign of the Artisan
Symbol of Excellence*

This One

AUGUST 1948



5



You Can Influence Others With Your Thinking

TRY IT SOME TIME. Concentrate intently upon another person seated in a room with you, without his noticing it. Observe him gradually become restless and finally turn and look in your direction. Simple—yet it is a *positive demonstration* that thought generates a mental energy which can be projected from your mind to the consciousness of another. Do you realize how much of your success and happiness in life depend upon your influencing others? Is it not important to you to have others understand your point of view—to be receptive to your proposals?

How many times have you wished there were some way you could impress another favorably—*get across to him or her your ideas?* That thoughts can be transmitted, received, and understood by others is now scientifically demonstrable.

This FREE Book Points the Way

The tales of miraculous accomplishments of mind by the ancients are now known to be fact—not fable. The method whereby these things can be **INTENTIONALLY**, not accidentally, accomplished has been a secret long cherished by the Rosicrucians—one of the schools of ancient wisdom existing throughout the world. Write for the free copy of the fascinating sealed book, "THE MASTERY OF LIFE," which explains how you may receive this unique wisdom and benefit by its application. Address: Scribe G. S. S.

The ROSICRUCIANS

San Jose, (AMORC) California

USE THIS COUPON

Scribe G. S. S.
The Rosicrucians
San Jose, California

I am sincerely interested in an intelligent method of attaining a mastership of life. Send me without obligation, your FREE Book which explains how I may receive and use your age-old method.

Name.....
Address.....
City.....

V-8 VALVE JOBS MADE EASY!

with *Johnson*

ADJUSTABLE TAPPETS



Provide accurate adjustment and quiet performance for Ford and Mercury V-8 engines.

Save money! Make tappet installations yourself.

No expensive shop tools needed.

Complete instructions with each set of tappets.

Adjustments easily made to proper clearance and maintained for many thousands of miles.

SEE YOUR JOBBER OR WRITE DIRECT TODAY

Johnson PRODUCTS INC.
MUSKEGON, MICHIGAN
"Tappets Are Our Business"

PROFITS AND SPEED

THE **MODERN**
LAWN MOWER
SHARPENER

PRICE
\$241⁵⁰
LESS
MOTOR

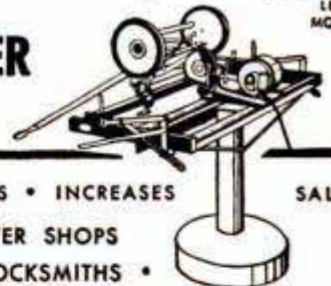

INCREASES PROFITS • INCREASES SALES!
FOR LAWN MOWER SHOPS
FIXIT SHOPS • LOCKSMITHS •
HARDWARE STORES • GOLF COURSES • SCHOOLS
PARKS • PLAYGROUNDS • INSTITUTIONS •
CEMETERIES • AND ALERT INDIVIDUALS!

*Sharpens All Reel Type Mowers • Hand, Power or
Gang • 10 to 20 Minutes • No Dismantling
No Extra Attachments Needed*

All reel type mowers, from 5-inch edgers to 36-inch power mowers, are quickly sharpened to extreme ends of both left and right twist reel blades. Handle, wheels, roller and motor remain in place when sharpening is in process. Bed knife is sharpened in same brackets that hold mower in grinding position. No extra attachments required. One lever puts mower or bed knife in grinding position. 100% steel construction. Grinding head rides on five ball bearing races. Small, compact, easy to operate. Sharpens wood chisels, joiner knives and planer blades without extra attachments.

**ORDER
NOW**
Immediate
Delivery

*Skate Sharpener Attachment Available
Send For Free Bulletin No. 10B*

MODERN MFG. CO. 160 N. FAIR OAKS AVE
PASADENA, CALIFORNIA

Why be a BOOKKEEPER?

...When Accountancy
offers more Money
and Success...

If you are a bookkeeper, you are right on the threshold of a profession that pays far above average—where there's real opportunity to get ahead and move up fast.

Why not step *UP* from bookkeeping—be an accountant—make *real* money!

You can learn Accountancy by the interesting LaSalle Problem Method—in your convenient spare time, at home, without losing a day from your work. You learn by *doing*... you study Accounting principles and solve Accounting problems under the clear guidance of experienced C.P.A.'s. You cover Accountancy from the basic principles right up through Accounting Systems and Income Tax Procedure—to advanced training for the C.P.A. degree if you so desire. And as you go along step-by-step, you master the principles of auditing, business law, statistical control, cost accounting, organization, management, finance, etc.

You go as fast or as slowly as you choose. And you may start "cashing in" on your new ability long before you complete the training—as thousands of others have proved. Many advance quickly to better positions, even before they are half way through. And that is only the *beginning* of a growing and continuing success for the rest of your business life.

Why remain "just a bookkeeper" when Accountancy holds so much for you? Our free 48-page booklet, "ACCOUNTANCY, THE PROFESSION THAT PAYS," tells you what you must know to be an Accountant, and how you can prepare in your leisure time, at moderate cost and on easy terms.

Send the coupon today. Get all the facts and judge for yourself. There is no obligation. You are already started in this field...find out how you can rapidly go to the top! Mail coupon NOW!

FREE BOOKLET

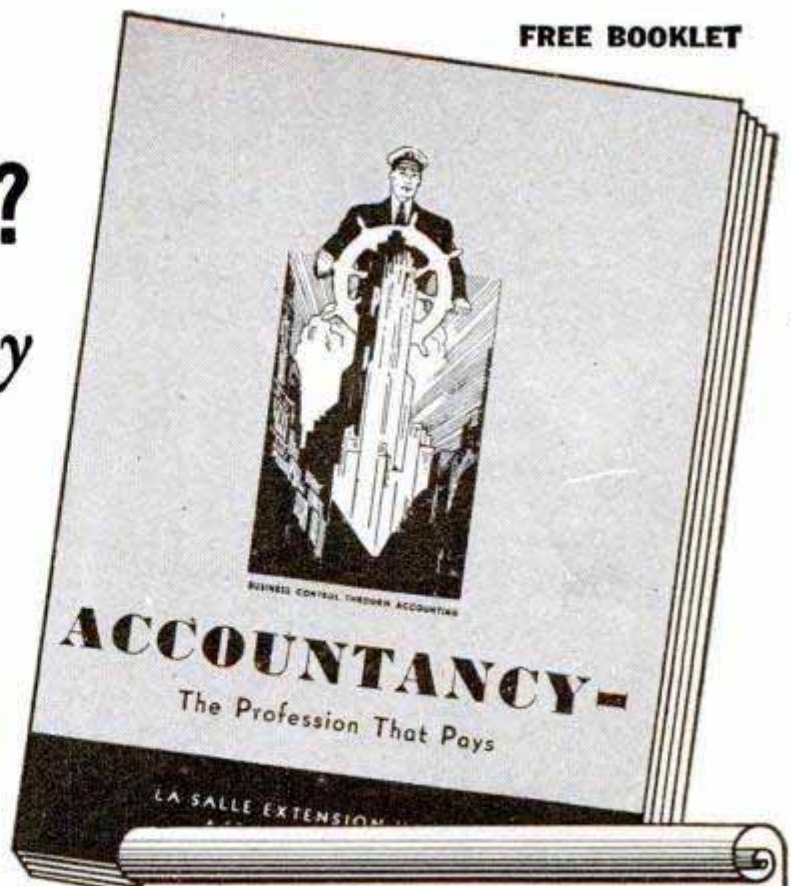

LA SALLE Extension University

A Correspondence Institution

Dept. 864-H • 417 S. Dearborn • Chicago 5, Ill.

I'd like to know more about your home study program to help me prepare for an accounting career. Please send me your free 48-page booklet, "Accountancy, the Profession That Pays."

Name

Position Age

Address

City, Zone and State

**"I'm GOING
to be an
ACCOUNTANT!"**

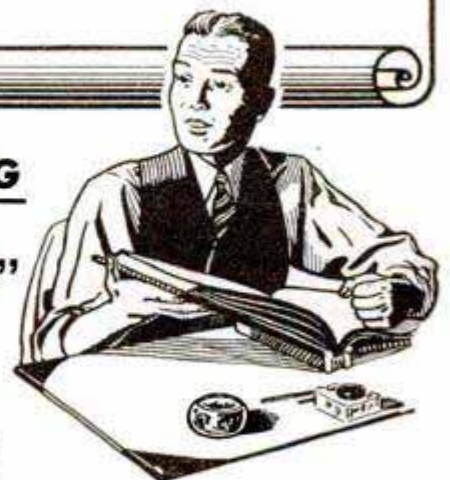

LASALLE

EXTENSION UNIVERSITY

A Correspondence Institution

LUBRICATION

WHERE it is needed!
WHEN it is needed!

● Your car is not lubricated—merely because your oil gauge says so. True lubrication depends upon always having oil where it is needed—and when it is needed. A few starting strokes of the piston against dry cylinder walls can cause more damage than many thousands of strokes sliding on oil. Pyroil gives oil the property of clinging to metal surfaces—it assures a coating of oil insulation against wear. Ask your gas station attendant to add Pyroil—and add miles to your car.

Pyroil for Aircraft Engines

Use Aircraft Pyroil B for lubricating oil, Aircraft Pyroil A for gasoline.

GIVEN!! An attractive Pyroil metal savings bank—takes coins up to 50c pieces—is yours for the asking—sent postage paid.



Manufactured and Guaranteed by Pyroil Company, 82 Pyroil Bldg., La Crosse, Wisconsin.

Canadian Distributors: Central Purchasing Agencies, Ltd. Toronto, Ontario

PYROIL COMPANY

82 Pyroil Bldg., La Crosse, Wisconsin

I want my car to last and run properly. Please tell me more about Pyroil and how it can accomplish this for me.

Name _____

Address _____

City or Town _____ State _____



TABLE OF CONTENTS (Continued)

ATOMICS AND RADAR

Two-color radar.....	89
Dry "raindrops" aid in experiments to eliminate radar's blind spot.....	98
Atomic-ray counter has supersensitive photo-eye.....	99
Preview of U-boat war?.....	110

AUTOMOTIVE

Shield on ventilator wing keeps rain out of auto.....	137
Stray-parts auto goes 130 m.p.h.....	141
Steam engine burning fuel oil installed in standard car.....	158

AVIATION

Aerial "road signs" mark path across U. S.....	112
Electric cart keeps meals hot.....	136
Retractable skis for planes permit landings on snow or concrete.....	137

DENTAL

Dentist "hitches" a ride on movable stool.....	99
Good-bye to toothache?.....	120
Twin dials measure your bite for dental work.....	127

ELECTRICAL

Nonstop electric clock.....	89
Electrical "yardstick".....	120
Mechanical hands.....	131
Radio-control box dictates every move of miniature robot auto.....	152

FARM

Rotary hoe thins plants when pushed along row.....	82
Rotary mower cuts tall grass.....	126
Garden tool makes straight rows.....	126
Revolving plow "hugs" plantings.....	153

INDUSTRY

Mountain of salt is product of solar evaporation.....	83
Giant power shovel scoops up 40 cubic yards of earth in one bite.....	105
Trench digger.....	131
Navy repair shop has glass walls.....	141
Tree cutters.....	144
Mechanical iceman loads fishing boat in 15 minutes.....	145
Synthetic resin aids paper makers.....	153
Bolt-on wall panels cut costs.....	159
Silt returns to the land.....	160

OUTDOOR RECREATION

Leader dispenser holds 100 yards of gut.....	79
Sails crowded on mast almost hide boat during race.....	82
Water skis.....	89
Fishing-rod wrapper.....	141

PHOTOGRAPHY

Dye gives flash bulbs blue coating for use with daylight color film.....	79
Camera "times" take-off and landing tests.....	58
Safety photo trimmer protects fingers.....	127

TOOLS

Double-end collets.....	79
Nonelectric soldering iron.....	99
Iron-rich powder enables torch to cut stainless steel.....	104
Screwdriver kit has six tools.....	104
Tool welds tread on metal floors.....	127
Automatic acetylene torch.....	153
Versatile jimmy gets fire fighters through locked doors.....	158

TRANSPORTATION

Push-a-button subway map finds shortest routes.....	112
Double-decker stroller.....	120
Lightweight motorcycle.....	126
Buses ride trolley in Cincinnati.....	136
Luxury bus has snack bar.....	136
Motorcycle for invalids has one-hand control.....	145

MISCELLANEOUS

Pack gives hot or cold treatments.....	79
Fledglings on parade.....	80
"Magnets" made of plastic.....	90
Cost of living meter.....	90
Television on wings.....	91
Tire "pump" uses gas cartridges.....	113
Bicycle-wheel truing stand.....	113
Soap-filled wicks carried in pocket.....	113
Wickets form movable fence.....	113
Overlay checks shorthand.....	127
What's new for your home.....	142

Craftsman and Shop Notes Index

AUTOMOTIVE

Floor-board opening on jeep gives easy access to breather cap.....	198
Repairing rust holes in car bodies.....	198
Tire-bead breaker helps remove inside car-door handles.....	212

(Continued to page 10)

THOUSANDS OF SKILLED AIRCRAFT WORKERS ARE NEEDED NOW!

REMEMBER those wartime jobs in the nation's aircraft plants? It was not uncommon for unskilled workers to draw \$75-\$100 a week. *Trained men virtually wrote their own tickets.*

If you've been reading the papers, you know what's happening today in the aircraft industry. Congress has just appropriated hundreds of millions of dollars for new planes, equipment and research.

The industry is undergoing an almost explosive expansion program. It means unlimited opportunities for the men who act NOW!

During the last war, I. C. S. trained thousands of aircraft workers—*more than any other technical school.* The training paid off in promotion and increased

pay. Hundreds of letters poured in every month reporting advancement in salary and position.

Fortunately, these courses are still available!

They have been revised and brought up to date to include the latest developments in aircraft design and manufacturing techniques.

Look over the subjects listed in the coupon and pick the one that interests you most. Information will be rushed to you by return mail. Within a short time you can begin your studies—progressing as rapidly as you wish.

Get in on the ground floor! The best jobs won't wait! Mark and sign the coupon now—before you turn this page.

INTERNATIONAL CORRESPONDENCE SCHOOLS



BOX 5633-K, SCRANTON 9, PENNA.

Without cost or obligation, please send me full particulars about the course BEFORE which I have marked X:

- | | | | |
|--|--|--|--|
| <input type="checkbox"/> AIRCRAFT ENGINES
<input type="checkbox"/> MECHANICS
<input type="checkbox"/> PRIVATE PILOT
<input type="checkbox"/> COMMERCIAL PILOT
<input type="checkbox"/> FLIGHT ENGINEER
<input type="checkbox"/> AERONAUTICAL
<input type="checkbox"/> ENG'R'S JR.
<input type="checkbox"/> AIRCRAFT DRAFTING
<input type="checkbox"/> WEATHER OBSERVING
<input type="checkbox"/> ELECTRONICS
<input type="checkbox"/> Air Conditioning and
<input type="checkbox"/> Plumbing Courses
<input type="checkbox"/> Air Conditioning
<input type="checkbox"/> Heating <input type="checkbox"/> Plumbing
<input type="checkbox"/> Refrigeration <input type="checkbox"/> Steam Fitting
<input type="checkbox"/> Chemistry Courses
<input type="checkbox"/> Chemical Engineering
<input type="checkbox"/> Chemistry, Analytical
<input type="checkbox"/> Chemistry, Industrial
<input type="checkbox"/> Chemistry, Mfg. Iron & Steel
<input type="checkbox"/> Petroleum Refining <input type="checkbox"/> Plastics
<input type="checkbox"/> Pulp and Paper Making
<input type="checkbox"/> Civil Engineering, Architectural
<input type="checkbox"/> and Mining Courses
<input type="checkbox"/> Architecture
<input type="checkbox"/> Architectural Drafting
<input type="checkbox"/> Bridge and Building Foreman | <input type="checkbox"/> Building Estimating
<input type="checkbox"/> Civil Engineering
<input type="checkbox"/> Coal Mining
<input type="checkbox"/> Contracting and Building
<input type="checkbox"/> Highway Engineering
<input type="checkbox"/> Lumber Dealer
<input type="checkbox"/> Reading Structural Blueprints
<input type="checkbox"/> Sanitary Engineering
<input type="checkbox"/> Structural Drafting
<input type="checkbox"/> Structural Engineering
<input type="checkbox"/> Surveying and Mapping
<input type="checkbox"/> Communications Courses
<input type="checkbox"/> Practical Telephony
<input type="checkbox"/> Radio, General <input type="checkbox"/> Radio Operating
<input type="checkbox"/> Radio Servicing
<input type="checkbox"/> Telegraph Engineering
<input type="checkbox"/> Electrical Courses
<input type="checkbox"/> Electrical Drafting
<input type="checkbox"/> Electrical Engineering
<input type="checkbox"/> Electric Light and Power
<input type="checkbox"/> Lighting Technician
<input type="checkbox"/> Practical Electrician
<input type="checkbox"/> Internal Combustion
<input type="checkbox"/> Engines Courses
<input type="checkbox"/> Auto Technician <input type="checkbox"/> Aviation
<input type="checkbox"/> Diesel Engines
<input type="checkbox"/> Diesel Engines <input type="checkbox"/> Gas Engines | <input type="checkbox"/> Mechanical Courses
<input type="checkbox"/> Forging <input type="checkbox"/> Foundry Work
<input type="checkbox"/> Heat Treatment of Metals
<input type="checkbox"/> Industrial Engineering
<input type="checkbox"/> Industrial Metallurgy
<input type="checkbox"/> Machine Shop
<input type="checkbox"/> Mechanical Drafting
<input type="checkbox"/> Mechanical Engineering
<input type="checkbox"/> Mold-Loft Work
<input type="checkbox"/> Patternmaking—Wood, Metal
<input type="checkbox"/> Reading Shop Blueprints
<input type="checkbox"/> Sheet-Metal Drafting
<input type="checkbox"/> Sheet-Metal Worker
<input type="checkbox"/> Ship Drafting <input type="checkbox"/> Ship Fitting
<input type="checkbox"/> Tool Designing
<input type="checkbox"/> Toolmaking
<input type="checkbox"/> Welding—Gas and Electric
<input type="checkbox"/> Railroad Courses
<input type="checkbox"/> Air Brake <input type="checkbox"/> Car Inspector
<input type="checkbox"/> Diesel Locomotive
<input type="checkbox"/> Locomotive Engineer
<input type="checkbox"/> Locomotive Fireman
<input type="checkbox"/> Railroad Section Foreman
<input type="checkbox"/> Steam Engineering Courses
<input type="checkbox"/> Boilermaking
<input type="checkbox"/> Combustion Engineering
<input type="checkbox"/> Engine Running | <input type="checkbox"/> Marine Engineering
<input type="checkbox"/> Steam Electric <input type="checkbox"/> Steam Engines
<input type="checkbox"/> Textile Courses
<input type="checkbox"/> Cotton Manufacturing
<input type="checkbox"/> Rayon Weaving
<input type="checkbox"/> Textile Designing
<input type="checkbox"/> Woolen Manufacturing
<input type="checkbox"/> Business and
<input type="checkbox"/> Academic Courses
<input type="checkbox"/> Accounting <input type="checkbox"/> Advertising
<input type="checkbox"/> Arithmetic <input type="checkbox"/> Bookkeeping
<input type="checkbox"/> Business Administration
<input type="checkbox"/> Business Correspondence
<input type="checkbox"/> Certified Public Accounting
<input type="checkbox"/> Commercial
<input type="checkbox"/> Commercial Art
<input type="checkbox"/> Cost Accounting
<input type="checkbox"/> Federal Tax
<input type="checkbox"/> First Year College
<input type="checkbox"/> Foremanship <input type="checkbox"/> French
<input type="checkbox"/> Good English <input type="checkbox"/> High School
<input type="checkbox"/> Higher Mathematics
<input type="checkbox"/> Motor Traffic <input type="checkbox"/> Postal Service
<input type="checkbox"/> Salesmanship <input type="checkbox"/> Secretarial
<input type="checkbox"/> Sign Lettering
<input type="checkbox"/> Spanish <input type="checkbox"/> Stenography
<input type="checkbox"/> Traffic Management |
|--|--|--|--|

Name _____ Age _____ Home Address _____

City _____ State _____ Present Position _____

Employed by _____ Working Hours _____ A. M. to _____ P. M.

Special tuition rates to members of the Armed Forces. Enrollment under G.I. Bill and P.L. 16 approved for World War II Veterans.
 Canadian residents send coupon to International Correspondence Schools Canadian, Ltd., Montreal, Canada.



PENNZOIL

MOTOR OIL

FLOWS FAST-STAYS TOUGH!

This fast-flowing, tough Pennsylvania oil gives your engine the instant and lasting protection it needs. Get them both with double-action Pennzoil!



At this sign of better dealers, coast to coast

*Registered Trade Mark Member Penn Group Cradle Oil Ass'n. Permit No. 2

Tough-film PENNZOIL* gives all engines an extra margin of safety

(Continued from page 8)

ELECTRICAL

Extension lamp for workbench supported by coat hanger	190
Fluorescent ceiling fixture converted to hanging workshop light	199
Motor directional "switch"	211

FARM

Altered pressure-type oilcan meters insecticide	200
Slapper aids driving animals	200
Poultry watering fountain is improvised from five-gallon oilcan	207
Creosote treatment of fence posts	212

HOUSE AND HOME

Improved lawn sprinkler	164
Solving home problems	166
Novel igloo incinerator of troweled concrete combines both utility and attractiveness	168
Pull cord attached to toggle switch permits operation by small children	168
Baking soda removes stains on rare china	169
Reversing fan position accelerates cooling	179
Improved wallpaper seam roller	180
Length of dog's tether adjusted with tent-rope tightener	185
Oxen-yoke ceiling fixture for dining room imparts pioneer atmosphere to ranch home	189
Handy rack holds baby's blankets on end panel of crib	189
Patching small holes in walls	189
Minimizing stains on dresser tops	190

METALWORKING

Bringing out scribe lines on metal with discarded hypo solution	179
Chucking threaded work	198
Household lye distinguishes aluminum stock from similar metals	205

OUTDOOR RECREATION

Chugging catches walleyes	164
Mending kit for fishing trips	164
Bring 'em back alive	165
Substitute for bucktail flies	168
Canoe "sidemount" for light outboard motor permits full tilting and steering control	169
Anchor held in raised position on outside of boat	176
Rolled paper soaked in paraffin kindles outdoor fire in light rain	180

RADIO AND ELECTRONICS

Universal FM receiver-tuner	213
Three-tube pocket set has built-in loudspeaker	214
Television receiver has simplified controls	218
Television magnifying lens	218

TOOLS

Screwdriver from key blank	185
Belt sander	197
Bleeder valve for pneumatic tools improvised from gas shutoff cock	199
Scale on locking lever of tailstock permits critical clamping pressure	200
Holder for carpenter's chalk provided by rubber ball	200
Small clamps from hinges	201
Sawhorse benches have pipe legs	206
Coolant dispenser on tool post rides with the carriage	206
Counterbalanced hold cutter uses lathe tool bit	208
Determining machine-belt sizes with flexible steel tape	212

TOYS AND NOVELTIES

Hitching posts for bikes	177
Portable "screened porch" for baby	181
Shelf brackets are mass-produced in plastic with this simple four-piece wooden mold	190

WOODWORKING

Coffee table	162
Matched cabinet doors hung as one simplifies fitting and hinging	164
Improved woodworkers' clamp assembled from scrap parts	169
Turpentine softens glaze on sanding belts	201
Jig for scroll chamfering and pattern routing	207

MISCELLANEOUS

Filing home-workshop publications	176
Ruler markings renewed with rubber-stamp pad	176
Discardable glue brushes cut from scrubbing brush	176
Adjustable truss for garage ceiling joist prevents buckling walls	178
Removal of roller-chain pins simplified by repair block	180
Fence wire used as floor in garage attic	180
Handle for heavy bundles	185
Fuller ball covers grease fitting	185
Clothespin handles on reflectors prevent burned fingers	196
Paintbrush strains cleaning fluid used to wash small parts	200
Testing gear compound for grit	210
Schedule board ruled with tape permits easy arrangement	212

IMPORTANT NOTICE—It is the intention of this magazine to provide its readers with information regarding the latest developments in the mechanical arts. We take no responsibility as to whether the disclosures contained in our articles are covered by patents and advise readers to investigate this subject before making, using, or selling any of the products, machines, or processes described in order to avoid possible liability for patent infringements.

AUDELS REFRIGERATION & AIR CONDITIONING GUIDE.....\$4

New from Cover to Cover—1280 Pages, Fully Illus. Covering basic principles, servicing, operation & repair of household, commercial & industrial refrigeration & air conditioning. A gold mine of essential important facts for engineers, servicemen, users.

AUDELS CARPENTERS & BUILDERS GUIDES—4 Vols.....\$6

A practical illustrated trade assistant on modern construction for carpenters, joiners, builders, mechanics and all woodworkers. 4 vols., 1600 pages, 3700 illustrations, flexible covers. Pocket size. Each volume sold separately \$1.50 a vol.

AUDELS AUTOMOBILE GUIDE.....\$4

A practical quick ready reference book for auto mechanics, service men, operators & owners. Explains theory, construction & servicing of modern motor cars, trucks, buses & auto type Diesel engines. 1700 pages, fully illustrated, 55 chapters. Indexed. A standard book for mechanics. New fluid drive covered.

AUDELS DIESEL ENGINE MANUAL.....\$2

A practical, concise treatise with questions and answers on the theory, operation and maintenance of modern diesel engines including General Motors 2 cycle Diesel. 384 pages, fully illus., flexible binding, pocket size. All details plainly brought out, this book is of extreme value to engineers, operators & students.

AUDELS WIRING DIAGRAMS.....\$1

210 Pages, Illustrated. Gives practical facts on wiring of electrical apparatus. It shows clearly how to wire apparatus for practically all fields of electricity. Each diagram is complete & self-explanatory. Highly Endorsed Pocket Companion.

AUDELS PLUMBERS & STEAMFITTERS GUIDES—4 Vols.....\$6

A Practical Trade Assistant & Ready Reference. Explains in plain language & by clear illustrations, diagrams, charts, graphs, pictures principles of modern plumbing practice including Marine Pipe Fitting and Air Conditioning. 4 Vols.—1670 Pages—3642 Diagrams. Pocket size. Each Vol. Sold Separately \$1.50 a Vol.

AUDELS SHEETMETAL WORKERS HANDY BOOK.....\$1

Practical inside information. Fundamentals of Sheet Metal Work. 388 pages, Illustrated, 11 sections. Clearly written. Essential & important facts, figures, pointers in everyday language. Ref. Index.

AUDELS SHEETMETAL PATTERN LAYOUTS.....\$4

Developed by Experts for Sheet Metal Workers, Layout Men & Mechanics. A Practical Encyclopedia in 10 Sections, size 7 x 10 x 2—1125 Pages—350 Layouts—1600 Illustrations. 1901 Key Facts. Fully indexed for ready reference in answering your layout problems. Covers all phases of sheet metal work including Pattern Cutting, Pattern Development & Shop Procedure.

AUDELS ANSWERS ON BLUE PRINT READING.....\$2

For Mechanics & Builders. Covers all types of blue print reading including ship & airplane. 416 pages, fully illustrated.

AUDELS NEW MACHINIST & TOOLMAKERS HANDY BOOK.....\$4

Covers modern machine shop practice in all its branches. 5 practical books in 1. New from cover to cover. Tells how to set up & operate lathes, screw and milling machines, shapers, drill presses and all other machine tools. 1600 pages, fully illustrated. 5 x 6 1/2 x 2. Indexed. 5 sections. 1—Modern Machine Shop Practice. 2—Blue Print Reading & How to Draw. 3—Calculations & Mathematics for Machinists. 4—Shop Physics. 5—How to Use the Slide Rule. 60 chapters. Easy to read and understand. A shop companion that answers your questions.

AUDELS MATHEMATICS & CALCULATIONS FOR MECHANICS \$2

Mathematics for home study or reference. 100 pages, 550 illus. Practical mathematics from beginning. How to figure correctly. Easy, correct methods covering complete review. Illus. & Indexed.

AUDELS HANDY BOOK OF PRACTICAL ELECTRICITY.....\$4

For maintenance engineers, electricians & all electrical workers. 1440 Pages, 2600 Illus. Covers important electrical information in handy form—including Marine Wiring, Radio Principles, Welding. Indexed. A Key to a practical understanding of electricity.

AUDELS RADIOMANS GUIDE.....\$4

A key to the practical understanding of radio including Frequency Modulation, Television, etc., Aircraft & Marine Radio. For radio engineers, servicemen, amateurs. 314 Pages, 633 Illustrations & Diagrams. Photos. Review Questions & Answers, Reference Index. Authentic, clear, concise.

AUDELS ELECTRONIC DEVICES.....\$2

Tells What You Want to Know About Electric Eye. Easily Understood. Covers photo-electric cells & their applications, Amplifiers, Illumination, frequencies, voltage, photocell, tubes, Ohm's Law, wiring diagrams, etc.

AUDELS WELDERS GUIDE.....\$1

A concise, practical text on operation & maintenance of all welding machines for all mechanics. Over 400 pages, illustrated. Covers all methods of electric and acetylene welding including airplane work.

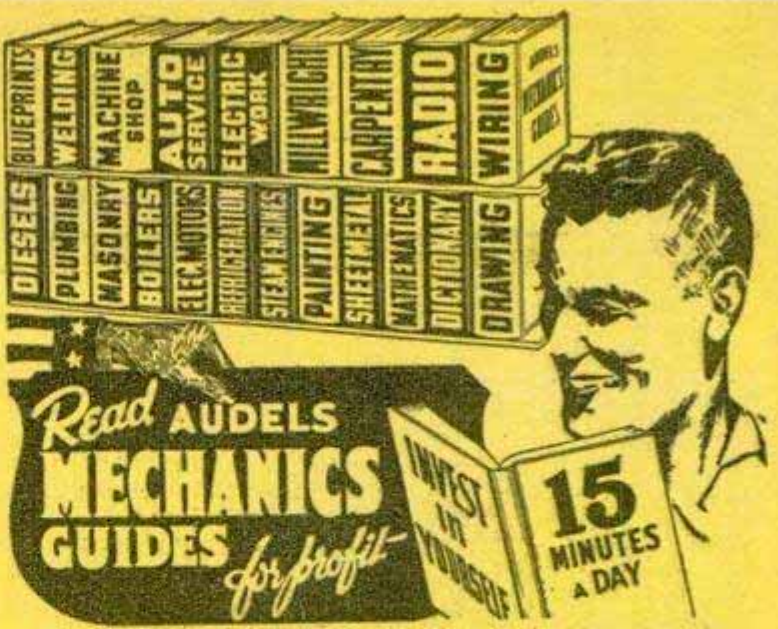

AN AUDEL GUIDE IS A GOOD FRIEND!
Step Up Your Own Skill with the Practical Facts and Figures of Your Trade. Save time and money with right methods, short cuts, labor saving ideas. CHECK NOW! You can look over any Audel Guide in your home. Start the Easy Payments if satisfied.

CUT HERE MAIL ORDER

AUDEL, Publishers, 49 W. 23 St., New York 10, N. Y.

Please mail me for 7 days' free examination the books marked (X) below. I agree to mail \$1 in 7 days on each book or set ordered, and to further mail \$1 a month on each book or set ordered until I have paid purchase price. If I am not satisfied with Guides I will return them.

- Audels HOUSE HEATING GUIDE.....\$4
- Audels ELECTRIC MOTOR GUIDE.....4
- Audels OIL BURNER GUIDE.....1
- Audels REFRIGERATION & Air Conditioning Guide.....4
- Audels POWER PLANT ENGINEERS GUIDE.....4
- Audels PUMPS, HYDRAULICS & AIR COMPRESSORS.....4
- Audels WELDERS GUIDE.....1
- Audels BLUE PRINT READING.....2
- Audels SHEET METAL WORKERS Handy Book.....1
- Audels SHEET METAL PATTERN LAYOUTS.....4
- Audels AIRCRAFT WORKER.....1
- Audels MATHEMATICS and CALCULATIONS.....2
- Audels MACHINISTS & TOOLMAKERS Handy Book.....4
- Audels MECHANICAL Dictionary.....4
- Audels AUTOMOBILE GUIDE.....4
- Audels DIESEL ENGINE MANUAL.....2
- Audels MARINE ENGINEERS Handy Book.....4
- Audels MECHANICAL DRAWING GUIDE.....1
- Rogers MECHANICAL DRAWING and DESIGN.....2
- Audels MILLWRIGHTS and Mechanics Guide.....4
- Audels CARPENTERS and Builders Guides (4 vols.).....6
- Audels PLUMBERS and Steamfitters Guides (4 vols.).....6
- Audels MASONS and Builders Guides (4 vols.).....6
- Master PAINTER and DECORATOR.....2
- Audels GARDENERS & GROWERS GUIDES (4 vols.).....6
- Audels ENGINEERS & FIREMANS EXAMINATIONS.....1
- Audels ENGINEERS and Mechanics Guides (8 vols.).....12
- Audels Answers on Practical ENGINEERING.....1
- Audels ELECTRICIANS EXAMINATIONS.....1
- Audels WIRING DIAGRAMS.....1
- Audels Handy Book of PRACTICAL ELECTRICITY.....4
- Audels ELECTRICAL POWER CALCULATIONS.....2
- Audels ELECTRONIC DEVICES.....2
- Audels ELECTRIC Dictionary.....2
- Audels RADIOMANS GUIDE.....4
- Audels NEW ELECTRIC LIBRARY at \$1.50 a Volume Vols. I, II, III, IV, V, VI, VII, VIII, IX, X, XI, XII

Name.....
Address.....
Occupation.....
Employed by.....

PM

AUDEL, Publishers, 49 W. 23 St., N. Y. 10



SALES ENGINEER

MOLD DESIGNER

RESEARCHER

FABRICATOR

LAMINATOR

PARTS INSPECTOR

MOLDING TECHNICIAN

YOUR OWN BUSINESS

Plastics is one of the fastest growing industries—offering you unusual opportunities for an interesting, successful career and security in the years ahead. Trained men, with plastics know-how will fill the important, well-paying positions. YOU can be one of them. Mail the coupon below for a big, colorful, free catalog on Plastics and complete de-

tails about Plastics Institute, America's oldest and largest plastics school. Resident School located in beautiful Southern California. Comprehensive Home Training Courses to prepare you in your spare time at home for a career in plastics. You can enroll immediately!

Write Plastics Institute, Dept. PM-88, 1601 S. Western Ave., Los Angeles 6, California.



APPROVED FOR VETERANS

LEARN BY DOING

To give you practical experience we supply colorful plastics to make useful, attractive creations. You can also make and sell plastics articles to earn while learning.

NEW YORK CHICAGO LOS ANGELES

Plastics Industries Technical Institute Dept. PM-88, 1601 S. Western Ave., Los Angeles 6, Calif. Mail in Envelope or paste on penny postcard

Gentlemen: Please send me free literature and information on your Resident School Course Home Training Courses. I understand there is absolutely no obligation.

Name (PRINT) _____ Occupation _____

Street (PRINT) _____ Age _____

City _____ Zone _____ State _____

Important: Please fill out coupon completely. If non-veteran, please check. If in Armed Services now, please check.



PLASTICS INSTITUTE in the heart of sunny Los Angeles. Here modern laboratories and shops give Resident School students facilities for practice on the finest of industry-type plastics equipment. Also the headquarters for HOME TRAINING.

FREE BOOKLET

New BRUSH Electroplater

ESPECIALLY BUILT FOR MECHANICS, MODEL MAKERS HOME CRAFTSMEN



Easy to Plate GOLD, SILVER, NICKEL, COPPER, etc... For Pleasure and Profit!

If you have a workshop—at home or in business—you need this new Warner Electroplater. At the stroke of an electrified brush, you can electroplate models and projects—you can replate worn articles, faucets, tools, fixtures, silverware, etc. with a durable, sparkling coat of metal... Gold, Silver, Nickel, Copper, Cadmium, and after a bit of practice, even Chromium! Everything furnished—equipment complete, ready for use. By doing a bit of work for others, your machine can soon pay for itself. So make your shop complete by getting a Warner Electroplater right away. Send today for FREE PLATING SAMPLE and illustrated literature. ACT AT ONCE.

WARNER ELECTRIC CO., Inc., Dept. T-11
1512 Jarvis Ave., Chicago 26, Illinois

FREE Details & Sample!

WARNER ELECTRIC CO., Inc., 1512 Jarvis Ave., Chicago 26, Ill., Dept. T-11
Gentlemen: Send Free Sample and Details to:

Name _____
Address _____
City _____ State _____

DRAFTING

Plan for a TOP PAY JOB · Drafting Outfit Included
SEND FOR FREE LESSON

Here is a modern practical way to learn Drafting right in your own home. You are furnished all the instruments and supplies you need to actually do the assignments, and the entire Drafting Outfit is included at no extra cost. Visual aid instruction helps you learn quickly, easily—you receive projector and slides. Draftsman has Key Job in industry—many executives advanced to present top positions with aid of a knowledge of Drafting. Find out about this up-to-date C.T.I. training program in Drafting. Write today for FREE lesson and full information. No obligation.

COMMERCIAL TRADES INSTITUTE, Dept. J2-8
1400 W. Greenleaf Chicago 26, Ill.



TURRET TOOL BLOCK

Square turret indexes within .0005". Rocker adjustments provided for tools. Mounts on cross slide. Fits current model South Bend Lathes, adaptable to others. Write for dimension sheet.

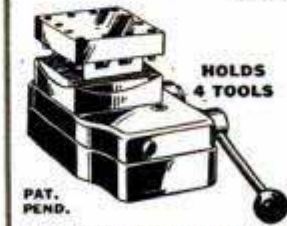

Size Lathes	Size Sq.	Takes Tools	Prices *	**
9"	3"	1/2" x 1/2"	\$40	\$45
10"	3"	3/8" x 3/8"	40	45
13"	3"	1/2" x 1/2"	—	50
14 1/2"	4"	3/8" x 3/8"	—	70
16"	4"	1/2" x 1/2"	70	75

* Double Tool Cross Slide Model
** Compound Rest Cross Slide Model

SOUTH BEND LATHE WORKS 455A E. Madison St. South Bend 22, Ind.

I Will Show You How to Learn RADIO by Practicing in Spare Time

I Send You
Big Kits
of Radio Parts



YOU BUILD this Vacuum Tube Power Pack for practice in correcting power pack troubles.

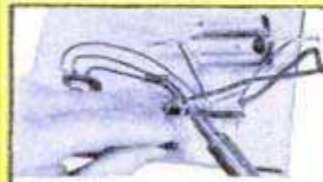

YOU BUILD special circuits for practice in locating and repairing Radio defects.



YOU BUILD this tester with parts NRI sends; it helps you earn Extra Money in spare time.



YOU BUILD AM Signal Generator; provides amplitude-modulated signals for many experiments.



YOU PRACTICE signal tracing with Superheterodyne receiver circuit, built with parts I send.

I Send You All These KITS Too!

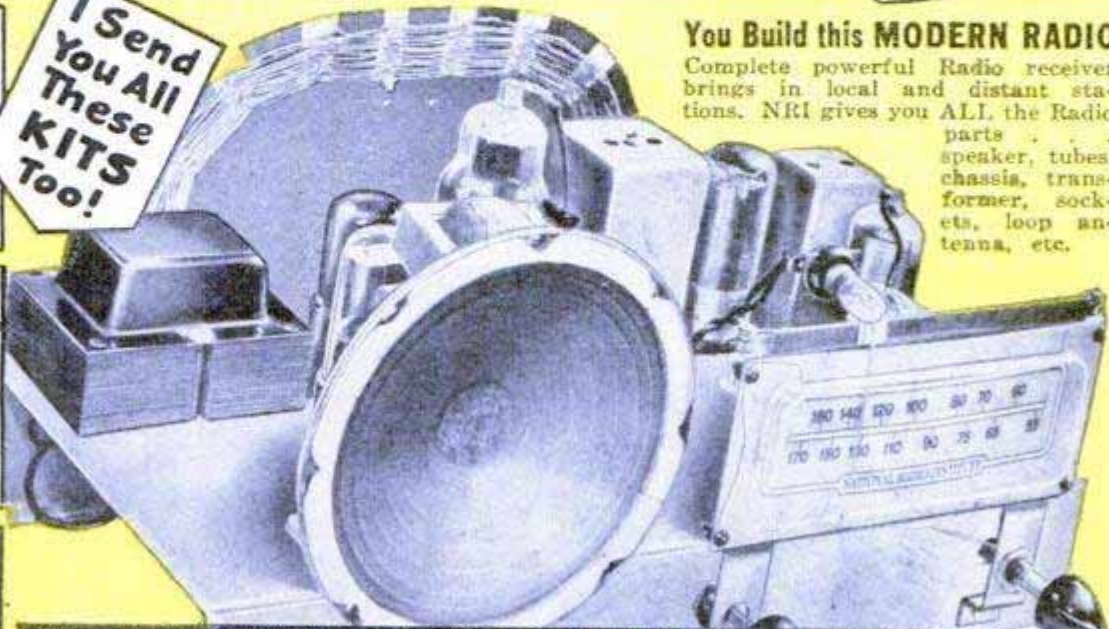

You Build this MODERN RADIO

Complete powerful Radio receiver brings in local and distant stations. NRI gives you ALL the Radio parts speaker, tubes, chassis, transformer, sockets, loop antenna, etc.

KNOW RADIO-WIN SUCCESS! I Will Train You at Home

Want a good-pay job in the fast-growing Radio and Television-Electronics industries? Want to be boss of your own money-making Radio shop? I've trained hundreds of men WITH NO PREVIOUS EXPERIENCE to be Radio technicians. I can do the same for you! My train-at-home method gives you practical experience with BIG KITS OF PARTS I send. You get Radio and Television principles from easy illustrated lessons. All equipment is yours to keep.

Make Extra Money In Spare Time

The day you enroll, I send EXTRA MONEY booklets. Use your know-how to make EXTRA MONEY fixing Radios in spare time. The next step is your own Radio shop or a good-pay Radio job.

N.R.I.—Trained Men Face Bright Future

Think of money-making opportunities in Police, Aviation, Ma-

rise Radio, Broadcasting, Radio Manufacturing, Radio Repairing, Public Address work... think of even greater opportunities in booming Television, FM and Electronics fields!

See What N.R.I. Can Do For You

My special DOUBLE FREE OFFER gives you actual lesson on Radio repairing short-cuts absolutely free. You also get my 64-page book, "HOW TO BE A SUCCESS IN RADIO-TELEVISION-ELECTRONICS." See how quickly, easily you can get started. Send NOW! J. E. SMITH, Pres., Dept. 8 HP, National Radio Institute, Pioneer Home Study Radio School, Washington 9, D. C.

VETERANS

You get this training in your own home under G. I. Bill. Mail Coupon.

I TRAINED THESE MEN



"Long before I graduated, serviced Radios. My shop has latest instruments, all purchased from profits."
—W. A. VAN WAGNER, Syracuse, N. Y.



"Earned enough spare time cash to pay for my course by time I graduated. NRI training is tops!"
—ALEXANDER RISH, Carteret, New Jersey.

Good for Both—FREE

MR. J. E. SMITH, Pres., Dept. 8 HP
National Radio Inst., Washington 9, D. C.

Mail me FREE Sample Lesson and 64-page book. (No salesman will call. Please write plainly.)

Name..... Age.....

Address.....

City..... Zone..... State.....

Check If Veteran

APPROVED FOR TRAINING UNDER G. I. BILL

GETTING ACQUAINTED WITH RECEIVER SERVICING

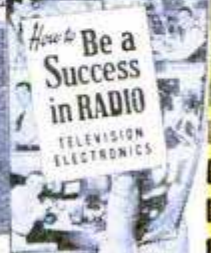

My Course Includes Training in
TELEVISION ELECTRONICS—FM



Embry Riddle

AIRPLANE and ENGINE MECHANICS

COMPLETE PILOT TRAINING

SEND COUPON FOR BOOKLET IN COLOR

EMBRY-RIDDLE OFFERS:

- MODERN hangars, classrooms, shops and airplanes
- EXPERIENCE gained over a quarter of a century of aviation training
- LIVING Facilities on the airport

Ask about credit terms

**Embry-Riddle graduates get good jobs!
DON'T DELAY — WRITE TODAY!**

Dean of Enrollments -- Dept. M
Embry-Riddle School of Aviation
MIAMI 30, FLORIDA
Please Print

NAME _____

ADDRESS _____

City _____

State _____ Age _____

Veteran Non-Veteran } *Check One*

TECHNICAL COURSES

- Airplane and Engine Mechanics (A&E).....[]
- Design Engineering & Maintenance.....[]
- Aeronautical Drafting & Design.....[]
- Radio & Electronics.....[]

COMBINATION COURSES

- Flying Mechanic.....[]
- A&E with Commercial.....[]

FLIGHT COURSES

- Private Pilot.....[]
- Commercial Pilot.....[]
- Flight Instructor.....[]
- Instrument Rating.....[]
- Multi-Engine Rating.....[]

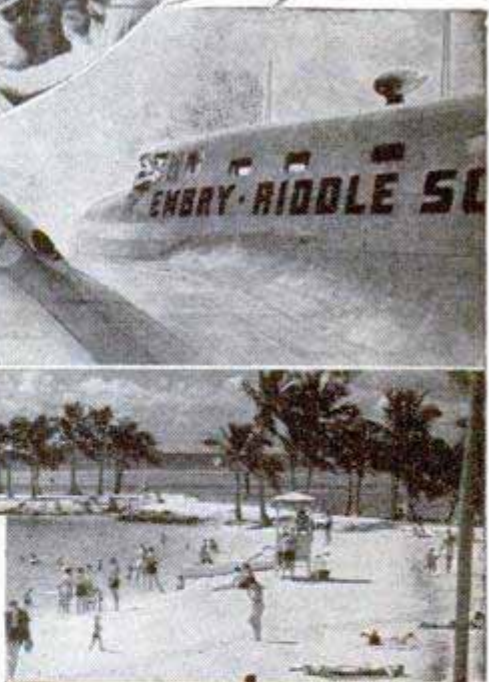

Embry Riddle
International
SCHOOL OF AVIATION
MIAMI 30, FLORIDA

TRAIN IN MIAMI -- AIR CAPITAL OF THE WORLD



INVENTORS



Learn how to protect your invention. The U. S. Patent Laws provide that any new and useful art, machine, article of manufacture, or composition of matter, or any new and useful improvement thereof, may be patented if the act of invention is involved. Therefore, every inventor with a valuable invention should take advantage of the Patent Laws and proceed for patent protection in order to safeguard his rights.

A patent gives the inventor the exclusive right to prevent others from making, using, or selling the invention claimed in the patent for a period of seventeen years.

The Patent Laws were enacted for the benefit of the inventor to give him protection for the features of his invention which are patentable. These features must be properly and concisely set forth and claimed in a formal application for patent, in order to comply with the requirements of the Patent Laws. For that reason, unless the inventor is familiar with patent matters, he should engage a competent registered patent attorney or agent to represent him. We are registered to practice before the U. S. Patent Office and are prepared to serve you in the handling of your patent matters.

A specially prepared booklet entitled "Patent Guide for the Inventor", containing detailed information with respect to patent protection and procedure, together with a "Record of Invention" form will be promptly forwarded to you without obligation upon request.

CLARENCE A. O'BRIEN & HARVEY JACOBSON

Registered Patent Attorneys

81-H DISTRICT NATIONAL BUILDING • WASHINGTON 5, D. C.

Patents

Trademarks

Copyrights

CLARENCE A. O'BRIEN & HARVEY JACOBSON

Registered Patent Attorneys

81-H District National Bldg., Washington 5, D. C.

Please send me copy of "Patent Guide for the Inventor" and also "Record of Invention" form. This request does not obligate me.

Name _____

Address _____

City _____ State _____

(Please write or print plainly.)

HERE'S THE
Complete
Sprayberry
Course!

LEARN RADIO

ELECTRONICS-
TELEVISION!



**I SEND YOU
8 BIG KITS OF
RADIO
PARTS!**

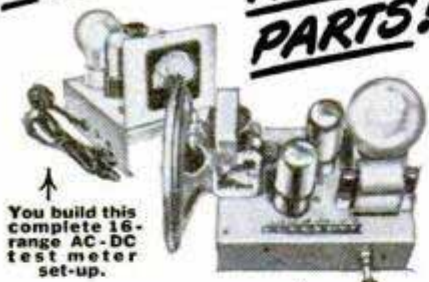

↑ You build this complete 16-range AC-DC test meter set-up.



↑ I show you how to build this speaker tester and many other instruments.
You build, test & troubleshoot this powerful 6-tube superhet Radio.

I'LL TRAIN YOU AT HOME—BETTER—FASTER by Putting You to Work with Your Hands

In this picture I show you exactly what you'll get from me during your Sprayberry Radio Training. This actual photograph speaks for itself! Sprayberry Radio Training is **really COMPLETE**—I start you with interesting, easily understood basic knowledge and I keep the mailman busy bringing you valuable Service Manuals, profitable Business Builders, extra helps and books—and **8 Big Kits of Actual Radio Equipment!** My course is practical and down-to-earth. You get my personal help every step of the way. My method is **BEST** for you—because you train largely by working with your hands—building, testing, trouble-shooting with parts I supply. With these kits you build a powerful 6 tube superhet Radio, a big 16 range test meter and perform over 175 other fascinating practical experiments.

EARN WHILE LEARNING

Shortly after you enroll I send you my famous **BUSINESS BUILDERS** that help you get and do profitable neighborhood Radio Service jobs while learning. These jobs pay well, and pave the way for a Service Business of your own.

All branches of Radio, Television and Electronics are booming! Trained men are needed **NOW!** I'll prepare you for your own profitable Radio Service Business or a big pay radio job in double quick time. You learn at home in spare time—you keep your present job and income while getting set for the future.

My course is so perfectly planned—so easy to grasp and understand—you need no previous knowledge or experience in Radio or Electricity. Get the facts now—find out what Sprayberry Radio Training can do for you. Mail the coupon below and by return mail I'll rush my big book, "How To Make Money In Radio, Electronics and Television" that tells all about Sprayberry Training. I'll also send you a Sample Lesson, "How To Read Radio Diagrams and Symbols"—all **FREE!** You'll read many letters from successful Radio men I've trained.

LOW COST Complete TRAINING

Sprayberry Training is surprisingly Low in Cost—and if you desire, convenient monthly payments can be arranged. This is **COMPLETE, UP-TO-DATE** training—covering Radio Repairing, Television and F. M., Industrial Electronics and many other new developments. Sprayberry Trained men really know Radio. This is training that sticks with you and makes money for you.

Mail COUPON Today!

FRANK L. SPRAYBERRY, President
SPRAYBERRY ACADEMY OF RADIO,
1088 Sprayberry Building, Pueblo, Colorado

Rush my **FREE** copies of "How To Make Money In Radio, Electronics and Television" and "How To Read Radio Diagrams and Symbols." (No salesman will call.)

NAME _____

ADDRESS _____ AGE _____

CITY _____ ZONE _____ STATE _____

Check here if a Veteran.

FREE SAMPLE LESSON and Big Catalog

See how quickly and easily you can get your start in Radio, Electronics, Television with Sprayberry Training. Just fill out, clip and mail the coupon **NOW** for my big **FREE** book and **FREE** Sample Lesson. No obligation. No salesman will call. Read all the facts about Sprayberry Training—then decide. Take the first step **TODAY**—rush the coupon to me.

VETERANS: Approved for G. I. Training under Public Laws 16 and 346. Check coupon and mail today for complete facts.

SPRAYBERRY ACADEMY OF RADIO
FRANK L. SPRAYBERRY, President
Room 1088, SPRAYBERRY BUILDING, PUEBLO, COLORADO



INVENTORS

Patent laws encourage the development of inventions.

We recommend that an inventor employ a registered Patent Attorney or agent, if the inventor is not familiar with patent matters. This is because the value of a patent depends largely upon the skillful preparation of the specification and claims in the patent application.

The firm of McMorrow, Berman and Davidson is registered to practice before the United States Patent Office. Additionally it engages patent attorneys able to readily understand inventors' disclosures, to advise concerning patentability, and to prepare appropriate specifications and claims.

If an inventor believes he has an invention, a search of the most pertinent prior U. S. patents should be made and a report obtained relative to its patentability. Where such report indicates that the invention appears patentable, in order to secure protection, diligence should be exercised in making application for a patent.

Send for a copy of Patent Booklet entitled "How To Protect Your Invention." This booklet contains information on patent protection and procedure. You will also receive an "Invention Record" blank. This will be promptly forwarded to you upon request—no obligation.

McMORROW, BERMAN & DAVIDSON

Registered Patent Attorneys

PATENTS • TRADE MARKS • COPYRIGHTS

135-M VICTOR BUILDING, WASHINGTON 1, D. C.

McMORROW, BERMAN & DAVIDSON

Registered Patent Attorneys

135-M Victor Building, Washington 1, D. C.

Send me your Patent Booklet, "How To Protect Your Invention", and also "Invention Record" form at once. I understand this request does not obligate me.

Name.....

Address.....

City.....

(WRITE OR PRINT NAME CLEARLY)

How to Make YOUR Body Bring You FAME

Instead of SHAME!

Will You Let Me Prove I Can Make You a New Man?

I KNOW what it means to have a body that people pity! I was once a skinny, 97-lb. weakling—such a poor specimen that I was constantly self-conscious, embarrassed. But later I discovered the secret that turned me into the holder of the title, "The World's Most Perfectly Developed Man." I'd like to prove that the same system can make a NEW MAN of YOU!

7 DAY TRIAL OFFER

I don't say I can do all this for you in 7 days. But I DO want to prove I can show you enough results in even THAT short time to convince you that my system of "Dynamic Tension" will give you the kind of body you have always longed to have!

Do you want powerful shoulders—a fine, deep chest—biceps like iron—arms and legs rippling with strength—a stomach ridged with sinewy muscle—a build to be proud of? Then let me prove that "Dynamic Tension" is what you need.

FREE BOOK It costs only a stamp—or a postcard—to mail coupon below. I'll send my new, free book, "Everlasting Health and Strength." It tells about my "Dynamic Tension"

method; shows, from actual photos, how I have developed my pupils—explains about my 7 DAY TRIAL OFFER. Charles Atlas, Dept. 8H, 115 East 23rd St., New York, N. Y.

CHARLES ATLAS, Dept. 8H
115 East 23rd Street, New York, N. Y.

I want the proof that "DYNAMIC TENSION" will help make a new man of me—give me a healthy, husky body and big muscle development. Send me your free book, "Everlasting Health and Strength."

Name _____ Age _____
(Please print or write plainly)

Address _____

City _____ State _____

Charles Atlas

This is an actual snapshot taken at the beach.

Mail Coupon Now for FREE Book

Tells How You Can Learn to MOUNT BIRDS!

FREE BOOK Learn At Home Men, Boys, Hunters, Fishermen, mount and save your lovely wild-game trophies. Be a Taxidermist. Mount Birds, Animals, Heads, Fish, Tan skins. YOU learn easily, quickly in spare time. Have a grand home-museum. The finest and the greatest hobby known, for sportsmen. Fun, real profits.

FREE BOOK Yes, FREE. Beautiful, strange, valuable Book, telling all about Taxidermy. Contains over 100 beautiful game-pictures, and it's yours FREE, if you rush your request. You can mount all kinds of wild-game, and common specimens too. We can positively TEACH YOU. So GRASP this opportunity. RUSH letter or postal for this amazing FREE BOOK. Don't delay. State your AGE, N. W. SCHOOL OF TAXIDERMISTRY, 2508 Elwood Bldg., Omaha 2, Neb.

Be an INVESTIGATOR

JAMES S. BOLAN, FORMER POLICE COMMISSIONER OF NEW YORK CITY offers MEN & WOMEN an attractive opportunity to prepare for a future in Investigation & Criminology by comprehensive Home Study Course. Free placement service assists graduates to obtain jobs. APPROVED UNDER G. I. BILL OF RIGHTS. Write for Free Booklet PM.

THE BOLAN ACADEMY, INC.
EMPIRE STATE BLDG., NEW YORK 1, N. Y.

LAW STUDY AT HOME for Personal Success and LARGER EARNINGS. 39 years expert instruction—over 114,000 students enrolled. LL.B. Degree awarded. All text material furnished. Easy payment plan. Send for FREE BOOK—"Law and Executive Guidance."

AMERICAN EXTENSION SCHOOL OF LAW
Dept. 92-PM 646 N. Michigan Ave. Chicago 11, Ill.

LEARN MONEY-MAKING CARTOONING

IN SPARE TIME — by Easy Picture Chart Method Same Simplified Method that has helped train creators of "Terry & Pirates," "Freckles," "Out Our Way," "Winnie Winkle," "Regular Fellers," "Strange As It Seems," "The Neighbors," and many others. Earn while learning. Send 10c for Picture Chart (to test your ability), and full details. (State age.)

THE LONDON SCHOOL, 4808 Clevel. Transit Bldg., Cleveland, O.

RADIO ENGINEERING. Broadcasting, Television, FM, Servicing, Electronics, Aviation, Marine & Police Radio taught thoroughly. Engineering course equivalent to 3 years' college radio work. Approved Veteran Training. Catalog free. VALPARAISO TECHNICAL INSTITUTE, Dept. D, Valparaiso, Ind.

STAMMER ?

This new 128-page book, "Stammering, Its Cause and Correction," describes the Bogue Unit Method for scientific correction of stammering and stuttering—successful for 47 years. Benj. N. Bogue, Dept. 4824, Circle Tower, Indianapolis 4, Ind.

GET THIS FREE BOOK!

MONEY-MEN ALL FREE

THE PLASTEX Industry needs manufacturers on small scale and for big production of Lamp and Clock Stands, Art Goods and Novelties in Plastex and Marble imitation. Experience unnecessary. 1/2c material makes regular 10c store sellers. Rubber moulds furnished for speed production. Small investment brings good returns. Big chain store orders now being placed. Ambitious men have chance for real prosperity. Our Free booklet will interest and benefit you. PLASTEX INDUSTRIES, Dept. A 3400 Third Ave. New York 56, N. Y.

INTERNATIONAL CORRESPONDENCE SCHOOLS

OFFER YOU LOW-COST

SPECIAL TRAINING

FOR SUCCESS IN MODERN BUSINESS AND INDUSTRY

Air Conditioning and Plumbing Courses

Air Conditioning
Heating
Refrigeration
Steam Fitting
Plumbing

Chemistry Courses

Chemical Engineering
Chemistry, Analytical
Chemistry, Industrial
Chemistry, Mfg. Iron and Steel
Petroleum Refining
Plastics
Pulp and Paper Making

Civil Engineering, Architectural and Mining Courses

Architectural Drafting
Architecture
Bridge and Building Foreman
Building Estimating
Civil Engineering
Coal Mining
Contracting and Building
Highway Engineering
Lumber Dealer
Reading Structural Blueprints
Sanitary Engineering
Structural Drafting
Structural Engineering
Surveying and Mapping

Communications Courses

Electronics
Practical Telephony
Radio, General

Radio Operating
Radio Servicing
Telegraph Engineering

Electrical Courses

Electrical Drafting
Electrical Engineering
Electric Light and Power
Lighting Technician
Practical Electrician

Internal Combustion Engines Courses

Auto Technician
Aviation, Commercial Pilot, Private Pilot
Diesel-Electric
Diesel Engines
Gas Engines

Mechanical Courses

Aeronautical Engineer's, Jr.
Aircraft Drafting
Flight Engineer
Forging
Heat Treatment of Metals
Industrial Engineering
Industrial Metallurgy
Machine Shop
Mechanical Drafting
Mechanical Engineering
Mold-Loft Work
Patternmaking—Wood, Metal
Reading Shop Blueprints
Sheet-Metal Drafting
Sheet-Metal Worker
Ship Drafting
Ship Fitting
Tool Designing
Toolmaking

Welding Engineering
Welding—Gas-Elec.

Railroad Courses

Air Brake
Car Inspector
Diesel Locomotive
Locomotive Engineer
Locomotive Fireman
Locomotive Machinist
RR Section Foreman

Steam Engineering Courses

Boilermaking
Combustion Engineering
Engine Running
Marine Engineering
Steam Electric
Steam Engineering

Textile Courses

Cotton Manufacturing
Rayon Weaving
Textile Designing
Woolen Manufacturing

Business and Academic Courses

Accounting
Advertising
Bookkeeping
Business Administration
Business Correspondence
Certified Public Accounting
Commercial
Commercial Art
Cost Accounting
Federal Tax
First Year College
Foremanship
Good English
High School
Higher Mathematics
Motor Traffic
Postal Civil Service
Retailing
Retail Store Management
Salesmanship
Secretarial Sign Lettering
Spanish
Stenography
Traffic Management
French

If you can read and write,
and are willing to study,

WE CAN TEACH YOU!

• Special service and attention are always given to the student who may need extra help in order to understand.

REASONABLE TERMS
MAY BE ARRANGED



The successful man DOES today what the failure INTENDS to do tomorrow. Mail this coupon NOW!

INTERNATIONAL CORRESPONDENCE SCHOOLS
BOX 5634-K SCRANTON 9, PENNA.

Please send complete information on following subject:

(Write above Technical, Business or General Educational Subject in which you are interested.)

Name _____ Age _____

Home Address _____

City _____ State _____

Present Position _____ Working Hours _____ A.M. _____ P.M.

Employed by _____

Special tuition rates to members of the Armed Forces.
Enrollment under G.I. Bill and P.L. 16 approved for World War II Veterans.

P A T E N T S

A Patent is a Valuable Right. On the basis of a provision in the Constitution of the United States, Congress has established a system under which inventors may secure the exclusive right to prevent the unauthorized use, manufacture and sale of their inventions for periods of seventeen years. The inventor secures this protection for his invention by obtaining a United States Patent.

*T*his firm is registered to practice before the U. S. Patent Office and is available to assist inventors in the preparation and prosecution of their cases. Detailed information and the steps to be taken in obtaining patent protection will be furnished upon request.

Form below for mailing convenience

VICTOR J. EVANS & Co. *Merlin M. Evans*
REGISTERED PATENT ATTORNEY

330-H MERLIN BUILDING, WASHINGTON 6, D. C.

Please send me without obligation a copy of your booklet "Patent Protection For Inventors" together with your convenient "Evidence of Invention" form.

Name.....

Address.....

City and State.....

PATENTS TRADEMARKS COPYRIGHTS

These Men are Learning

ELECTRICITY

in the Great SHOPS of COYNE

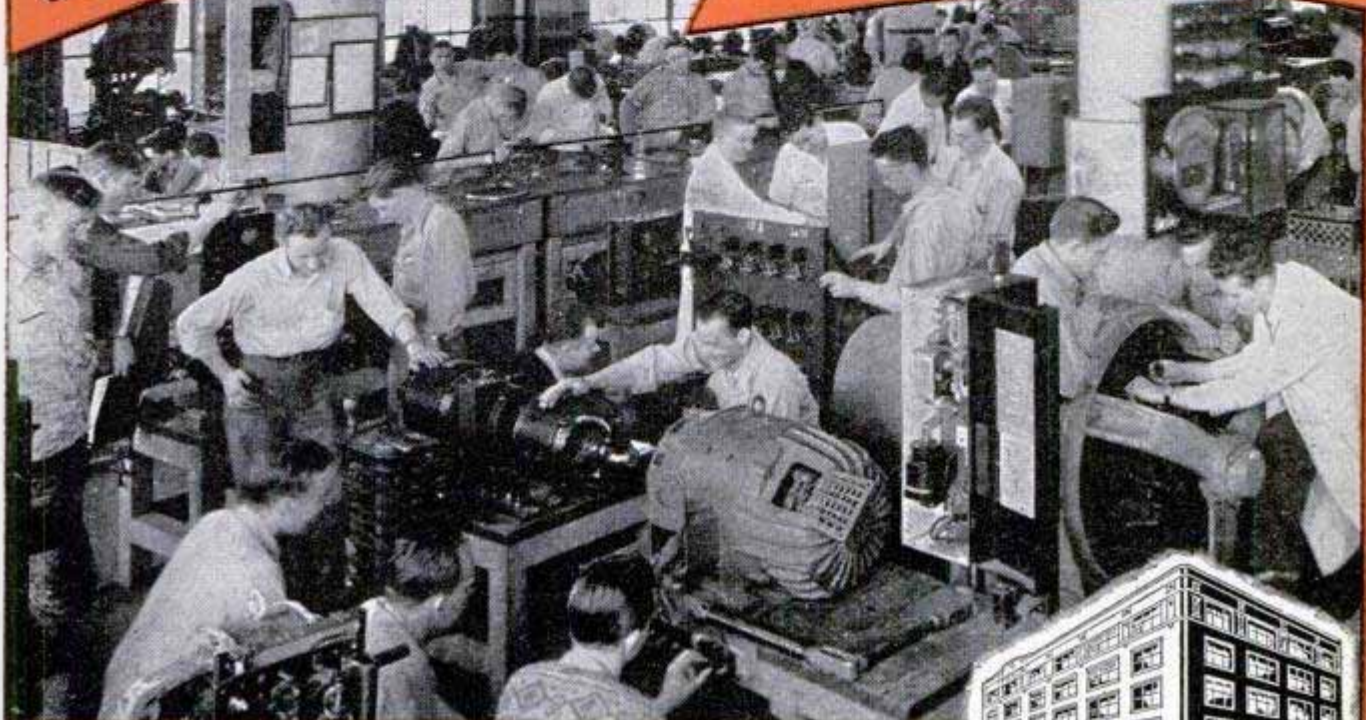

Why Spend Years Preparing for a Good Job? Train Quickly at COYNE—Be Making Real Money While Others are Still Puttering Along!

Learn on Real Equipment

Do as these fellows are doing! Get ready for Good Pay—a Big Future in ELECTRICITY—by training in the Great Shops of COYNE. Here you work on real motors, armatures, switchboards; do actual wiring and trouble shooting; get "all-around" training for dozens of well-paid job opportunities. Mail coupon today!

Not a "Home-Study" Course
We do not teach by mail. All training plus necessary theory is given in our Great Shops. Expert instructors guide you. No advanced education or previous experience needed.

EARN WHILE LEARNING
If you need part-time work to help out with living expenses while at Coyne, we'll help you get it. Don't be held back by lack of money.

GI Approved—Finance Plan for Non-Vets
COYNE is authorized to train men under the G. I. Bill. Non-veterans may enroll now, pay most of tuition after graduation. Whatever your problem, COYNE can help you! Coupon brings details.

Electrical Refrigeration Included
Added training now included in great new field of Electric Refrigeration—also Industrial Electronics. Both mean added opportunities for you.

B. W. COOKE, President
COYNE ELECTRICAL AND RADIO SCHOOL
500 S. Paulina St., Dept. C8-72
CHICAGO 12, ILLINOIS



ESTABLISHED 1899
Oldest, Largest, Best Equipped School of Its Kind in U. S.

Get This Free Book!

See what COYNE offers in quick, pay-raising training. Send coupon for Big FREE BOOK, filled with pictures of our great shops and all the facts to help you. No obligation. No salesman will call. Rush coupon now!



B. W. COOKE, Pres.
COYNE ELECTRICAL AND RADIO SCHOOL, 500 S. Paulina St., Dept. C8-72, Chicago 12, Illinois.

Send me your big FREE BOOK on ELECTRICITY. This does not obligate me in any way and no salesman will call on me.

PREPARE AT COYNE FOR REAL FUTURE in Jobs Like These



- Switchboards
 - House Wiring
 - Power Wiring
 - Maintenance
 - Electric Mfg.
 - Refrigeration
 - Signal Work
 - Motor Testing
 - Armature Work
 - Industrial Electronics
 - Power Plants
 - Substations
 - Your Own Shop
- FREE Lifetime Job Service to COYNE Graduates.

MAIL NOW!

NAME.....
ADDRESS.....
CITY.....STATE.....

USE THESE BOOKS to get ahead in YOUR field



1. INDUSTRIAL ELECTRICITY AND WIRING

by James A. Moyer and John F. Wostrel—A guide to fundamentals of electricity and standard methods of wiring for every industrial application. Includes groundwork in electrical theory; action and application of apparatus, principles of lighting, power circuits, etc. Third edition, 541 pp., 5½ x 8, 238 illus. and diagrams, \$3.50

2. HOUSEHOLD ELECTRICAL REFRIGERATION

by John F. Wostrel and John G. Praetz—This book explains the fundamentals of household refrigeration, including operation, construction, adjustment, servicing and control devices. A practical guide for refrigeration service men, salesmen and all electricians. 406 pp., 6 x 9, 157 illus., 2nd edition, \$4.50

3. SUCCESSFUL SOLDERING

by Louie S. Taylor—Shows both amateur and professional craftsman how to solder all types of material. It explains the various types of soldering—coppers, solders, and fluxes—and explains the purpose and correct use of each. Covers problems encountered with black iron, zinc, tin, stainless steel, copper, aluminum, etc. 76 pp., 4¾ x 7½, 26 illus., \$2.00

4. INTRODUCTORY SHOPWORK

by Mack M. Jones and Aaron Axelrod—Carefully explains every step of shopwork, from correct way of handling tools, to efficient methods of doing jobs. Contains tips on the best materials to use and the care of hand and essential tools. Easy-to-follow illustrations show how to carry out jobs from beginning to completion. 299 pp., 6 x 9, 366 illus., \$3.00

5. SHEET METAL PATTERN DRAFTING

by Frank L. O'Rourke—This book demonstrates and simplifies sheet metal drafting. Step by step, it solves problems related to parallel line, radial line, and triangulation methods of laying out patterns and includes comprehensive instructions for the development of sky-light patterns. 199 pp., 6 x 9, fully illus., \$2.20

6. CARPENTRY FOR THE BUILDING TRADES

by E. A. Lair—Gives complete details on how to handle every phase of carpentry work, from framing, roofing and siding to blueprint reading and safety measures. Includes the planning, selection of materials, and the application of modern methods of carpentry that meet with FHA requirements. 188 pp., 147 illus., \$2.50

7. BRICK STRUCTURES — HOW TO BUILD THEM

by Ralph P. Stoddard—In non-technical language this book tells how to construct successfully brick buildings with loadbearing walls, both solid and cavity. It gives details on the selection of brick, preparation of mortar, elimination of leaky walls, efflorescence, cracking and settlement, etc. 169 pp., 5½ x 8, illus., 11th edition, \$2.20

8. WELDING AND ITS APPLICATION

by Boniface E. Rossi—Covers the various welding and cutting processes, their related phenomena, techniques, and general application in industry. All material represents the best current practices and methods in actual use. 343 pp., 6 x 9, \$3.50

9. RADIANT HEATING

by Richard W. Shoemaker—Provides home builder, architect, and engineer with explanations of methods of design, construction and installation of radiant heating equipment and shows how it can be applied to radiant cooling. Gives a detailed account of the many practical applications of radiant heating. 305 pp., 6 x 9, 242 illus., \$4.00

10. AIR CONDITIONING AND ELEMENTS OF REFRIGERATION

by Samuel P. Brown—This book shows how to calculate heating and cooling loads, and how to heat, cool, ventilate and otherwise condition any building. Selection of equipment, automatic controls, and the design of air ducts and liquid piping systems are thoroughly covered. 655 pp., 6 x 9, 240 illus., \$6.00

11. ELEMENTS OF RADIO SERVICING

by William Marcus and Alex Levy—Explains the elementary principles and practices of radio servicing. Covers the modern superheterodyne A-M receiver, phonograph-combination service problems, and automobile radio servicing—including about 90% of modern radio service and repair problems. 475 pp., 6 x 9, illus., \$4.50

Do you know you can have any or all of these books 10 days free, and pay for those you want in easy monthly installments? Check coupon below for details.



12. MATHEMATICS FOR ELECTRICIANS AND RADIOMEN

by Nelson M. Cooke—A simple explanation of the mathematics used in electrical and radio work. It includes elementary algebra through quadratic equations, logarithms, trigonometry, plane vectors and elementary vector algebra as applied to alternating current circuits. 604 pp., 6 x 9, \$4.50

13. REPAIR SHOP DIAGRAMS AND CONNECTING TABLES FOR INDUCTION MOTORS

by Daniel H. Braymer and A. C. Roe—Shows how to lay out coils for induction motor windings . . . how to connect the ends of the groups of these coils in proper sequence of phase and pole groups for different types of windings. Motors of from 2-24 poles, 2- and 3-phase are covered. Second Edition, 387 pp., 182 illus., \$3.50

14. ELECTRICAL DRAFTING

by D. Walter Van Gieson—Here are tested drafting methods as applied to circuits and wiring. Presented as a series of illustrated discussions, they start with the systematic circuit diagram and cover development of the detailed wiring plan for several typical cases, and correlating conduit and equipment location plans. 140 pp., 5¼ x 8¼, 80 illus., \$2.00

15. SHOP THEORY

Prepared by the Shop Theory Department of the Henry Ford Trade School.—Explains the basic essentials of shopwork clearly and simply. Gives a clear understanding of basic tools, machines and instruments and explains how and when to use them. Revised edition, 267 pp., 8½ x 11, 822 illus., 2nd edition, \$2.60

16. BLUE PRINT READING AND SKETCHING

by H. R. Thayer—Provides thorough training in the making of sketches and the reading of drawings of various kinds. Serves as a review in mathematics, shop terms and the language used in production. Makes for accurate and precise thinking in terms of industrial drawings. Second edition, 135 pp., 6 x 9, illus., \$2.50

See these books — 10 DAYS FREE

McGraw-Hill Book Co., Inc.,
330 W. 42nd St., New York City 18

Send me the books encircled below for 10 days' examination on approval. In ten days I will remit for the books I keep, plus a few cents postage, and return unwanted books postpaid.

1 2 3 4 5 6 7 8
9 10 11 12 13 14 15 16

Check Here if you want to pay for books in 6 monthly installments. First installment is 1/6 of total purchase price of books retained. Balance payable in 5 monthly installments.

Name _____

Address _____

City and State _____

Company _____

Position _____

PM-8-48

WHICH OF THESE *Opportunities* INTERESTS *You* MOST?

Accounting
Air Conditioning
Architecture & Building
Automotive Engineering
Aviation—Practical
Aviation Drafting & Design
Better Foremanship
Bookkeeping
Business Management

Contracting
Diesel Engineering
Drafting & Design
Electrical Engineering
Electricity—Practical
Electronics, Industrial
High School Courses
Machine Shop Operations
Mechanical Engineering

Plastics Engineering
Plumbing—Practical
Private Secretary
Radio Operating & Servicing
Railway Training
Refrigeration
Sheet Metal Pattern Drafting
Shop Management
Tool Making

THINK! LOOK FORWARD!

Business is making big, new plans

Men and Women are preparing for the future

WHAT ARE YOU DOING ABOUT YOUR TOMORROWS?

● Today, choose the job you want—and prepare for it. Or if you are already engaged in the work you like best, start training now for quicker promotion. Acquire the knowledge that will help you to get ahead faster, make more money and have greater security.

Invest part of your spare time in more rapid progress. Start training now, in spare time in your own home. Be ready to grasp your opportunity and step out ahead of those who lack the ability you have attained.

American School, founded in 1897 as an educational institution *not for profit*, can help you to reach your goal just as it has helped others during the past fifty-one years. Give serious thought to the list above. Pick one or more subjects that interest you. Then check the coupon at right, add your name and address and mail it at once. The school will send you details on its training plan and outline of study prepared by specialists. There is no charge, no obligation, so send the coupon immediately.

PRACTICAL, EFFECTIVE HOME - STUDY TRAINING SINCE 1897

Take This First Easy Step

CHECK, CLIP AND MAIL COUPON NOW

AMERICAN SCHOOL, Dept. GC45, Drexel at 58th, Chicago 37, Ill.
Without obligation, Please send FREE and postpaid, bulletin and details of the Subject checked.

- | | | |
|--|---|--|
| <input type="checkbox"/> PLASTICS ENGR'G | <input type="checkbox"/> Accounting | <input type="checkbox"/> Drafting and Design for Men and Women |
| <input type="checkbox"/> Refrigeration | <input type="checkbox"/> Electrical Engr. | <input type="checkbox"/> Radio |
| <input type="checkbox"/> Architecture and Building | <input type="checkbox"/> Electricity-Pract. | <input type="checkbox"/> High School |
| <input type="checkbox"/> Contracting | <input type="checkbox"/> Electronics, Industr. | <input type="checkbox"/> Air Conditioning |
| <input type="checkbox"/> Practical Plumbing | <input type="checkbox"/> Bookkeeping | <input type="checkbox"/> Mechanical Eng. |
| <input type="checkbox"/> Automotive Engineering | <input type="checkbox"/> Private Secretary | <input type="checkbox"/> Shop Management |
| <input type="checkbox"/> Aviation Drafting | <input type="checkbox"/> Diesel Engineering | <input type="checkbox"/> Tool Making |
| <input type="checkbox"/> Aviation | <input type="checkbox"/> Sheet Metal Pattern Drafting | <input type="checkbox"/> Better Foremanship |
| <input type="checkbox"/> Business Mgmtment | | <input type="checkbox"/> Machine Shop Operations |
| <input type="checkbox"/> Railway Training | | |

Name Occupation

Address Age

City State

AMERICAN SCHOOL

Dept. GC45, Drexel at 58th Street, Chicago 37



Satisfied with my JOB and PAY? **NOT ME!!**

"Some day I'll really get a break and go right on to the top."

That's wishful thinking.

You know that the "breaks" go to the man or woman who is prepared to take advantage of them—to the person who can fill the better job and is worth more money. He makes the "breaks" instead of waiting for them.

You can influence your own future by preparing now for the step forward—so that openings come because you are equipped for them—not as the result of luck.

Why not take the road that thousands of ambitious men and women have taken to help them to better jobs and more money.

Prepare now. Send the coupon below—check the business field of your choice and we'll send you without obligation our FREE 48-page book describing the opportunities and complete information on that field.

Send the coupon Now. It may be the turning point in your life to that better job and more money.

LASALLE Extension University A Correspondence Institution

417 S. Dearborn St., Dept. 864-R Chicago 5, Ill.

I want to make my own "breaks" by preparing for a better job. Send me your free 48-page booklet on the subject I have checked below.

- | | |
|--|--|
| <input type="checkbox"/> Foremanship | <input type="checkbox"/> Salesmanship |
| <input type="checkbox"/> Accounting | <input type="checkbox"/> Law: LL.B. degree |
| <input type="checkbox"/> Bookkeeping | <input type="checkbox"/> Business English |
| <input type="checkbox"/> C.P.A. Coaching | <input type="checkbox"/> Effective Speaking |
| <input type="checkbox"/> Industrial Management | <input type="checkbox"/> Stenotypy (Machine Shorthand) |
| <input type="checkbox"/> Traffic Management | <input type="checkbox"/> Business Management |

Name.....Age.....

Position.....

Address.....

City.....Zone.....State.....

Be a Writer

of Short Stories, Mysteries, Articles Free Lesson Shows How You Learn at Home

The demand for writers is creating great new opportunities for people with an urge to write. It's not as hard to succeed as you may imagine. Most famous authors come from ordinary walks of life. At home, you too may learn fiction writing, the best basis for all fields—short stories, novels, features, articles, radio scripts. Palmer Institute's Home Study Training (Established 1917) is endorsed by Rupert Hughes, Ruth Comfort Mitchell, Gertrude Atherton, Katharine Newlin Burt and other famous authors and by scores of successful graduates. Complete instruction material and professional coaching to develop your own style. FREE book and sample lesson show how you may enjoy an ideal part time or full time career. Write today (no salesman will call). Veterans: advise us if you are eligible for G.I. Training.

PALMER INSTITUTE OF AUTHORSHIP • Desk T-88
1680 N. Sycamore • Hollywood 28, Calif.

You can become a good Business Writer, and you can learn Shaded Writing also at home in spare time by my Simplified Method, without going away to school. Write for my FREE BOOK, "How to become an Expert Penman," which shows what others have learned. Send 10c for Special Penpoint and your name with a flourished bird written on a card. Write TODAY.

T. M. TEVIS, BOX 25K, CHILLICOTHE, MO.

ARTISTS MAKE MONEY

Do you like to draw? Send name, address, age and occupation for FREE ART TEST, to find out your ability.

ART INSTRUCTION, Inc.
8138 ART INSTRUCTION BLDG., MINNEAPOLIS 15, MINN.

V-8 DUALS & SINGLES

MUFFLERS
STEELS and ALUMINUMS
with a motorboat tone

SINGLES, Chev., V-8, Plymouth, Steels \$5.50, Aluminum \$7.00. Chry., Olds., Buicks, etc., Steels \$7.50, Aluminum \$9.00. V-8 and MERCURY DUALS, Steel \$17.50, Aluminum \$21.00. Split Manifold Sets, Steels \$35.00, Aluminum \$45.00. Aluminums are guaranteed for life of your car.

DEALERS WANTED

SANDEE MUFFLER CO.
BOX 296 LA TIJ., LOS ANGELES 43, CALIF
2624 W. SLAUSON AVE., LOS ANGELES, CALIF.

LEARN AND EARN AT HOME
Learn SCREEN PROCESS, the modern machineless method of printing. Uncrowded, profitable field where trained men are always in demand. 2 BIG KITS OF SUPPLIES we send start many of our students making money even before finishing home study course. Write today for FREE BOOK giving full details. APPROVED FOR VETERANS.
CALIFORNIA SCHOOL OF SCREEN PROCESS
3740 Overland Avenue, Dept. M-88 Los Angeles 34

BAKING

- a Sound Trade or Business

Baking is one of America's high industries in wages. Not seasonal, but year 'round good field for trained and experienced men. Thorough basic spare time home study course lays solid foundation. If you have the aptitude for this type of work, send coupon below for FREE Booklet, "Opportunities in Commercial Baking."

NATIONAL BAKING SCHOOL
1315 S. Michigan Ave., Dept. 135-C, Chicago 5, Ill.
Send free booklet "Opportunities in the Baking Industry" and full particulars.

Name.....
Address.....
City.....State.....

BIG NEWS from DeForest's Training, Inc.

6-tube "SUPER" RECEIVER

Jewel Bearing MULTI-METER

NOW you can get and **KEEP** all of this equipment to help you master...

RADIO - TELEVISION ELECTRONICS at Home!

You **LEARN-BY-DOING** from building:

- (1) A modern 6-tube Superhet Receiver with **MAGIC TUNING EYE**, plus phono switch, tone control, and other features.
- (2) A high grade, commercial-type **MULTI-METER** with jewel bearing movements.
- (3) Over 200 instructive experiments from many shipments of Radio-Electronic parts, including tools.

You mount your parts on individual bases with spring clip terminals, enabling you to build new circuits and to experiment in a fraction of time normally required.

PLUS... the use of Learn-By-Seeing **MOVIES**. Only D.T.I. provides this remarkable training advantage in your own home to help you learn **FASTER... EASIER!**

PLUS... D.T.I.'s effective **EMPLOYMENT SERVICE** to aid you in getting started in Radio-Electronics-Television.

Mail the coupon today for **FREE FACTS** on how DeForest's Training, Inc., sends you everything you need to prepare and get started in America's great opportunity fields.

IF YOU PREFER, you can get your training in modern, well-equipped Chicago laboratories. Write for details.

DeFOREST'S TRAINING, INC.

Chicago, Illinois

Associated with the DeVry Corporation,
Builders of Electronic and Movie Equipment

Good pay... fascinating work... a bright future are but a few advantages ahead of trained men in the opportunity fields of **RADIO-TELEVISION-ELECTRONICS**. Write for late facts about Television, F.M., Radio, Broadcasting, 2-Way Mobile Radio, Train Radio, and other fast-moving branches. See how D.T.I. helps you get started.

Use of 16 mm HOME MOVIES

ABOVE: In addition to the Radio-Electronic equipment you keep, you get the use of a 16 mm Motion Picture and many reels of movie film to speed your progress.

Many shipments of Radio-Electronic parts, permitting over **200** fascinating experiments

MAIL THIS OPPORTUNITY COUPON NOW!

DeForest's Training, Inc.
2533 N. Ashland Ave., Dept. PM-ES
Chicago 14, Illinois

Send me complete details showing how I may make my start in Radio-Electronics-Television. No obligation.

Name _____ Age _____

Address _____ Apt. _____

City _____ Zone _____ State _____

If under 16, check here for special information. If a discharged veteran of World War II, check here.



AUTO BOOKS ON APPROVAL



SEND NO MONEY. Just mail the coupon for a complete set of 4 Big, Thick Auto Books. 20th Edition. Over 2700 Pages! Whether you are a mechanic or helper, expert or apprentice, auto owner or driver, take immediate advantage of this FREE EXAMINATION OFFER.

MAKE GOOD MONEY NOW HOLD A PERMANENT JOB

America wants its automobiles kept in good repair. Men with "know how" are in demand, at big pay. These books will help you get and hold an important job, or give you a chance to go into business for yourself now or later. Any man who half tries to improve himself can learn auto servicing and repairing by this quick reference method. Use the **JIFFY INDEX** to find easily understood answer to any auto problem. These wonder books prepared by eleven of America's great automobile engineers. Many hundreds of valuable illustrations. Send the coupon TODAY.

A year's consulting privileges with our engineers now given with these books without extra charge.
Vocational Publishers Since 1898

CAN YOU FIX IT?

These wonder books tell step by step HOW to make difficult repairs and adjustments, how to keep a car at maximum efficiency, including latest improvements in car design and operation. Engine troubles and how to correct them well covered.

4 BIG, THICK VOLUMES Over 2700 pages, 2000 illustrations, wiring diagrams, etc., including Diesel engines. Beautiful modernistic, washable cloth binding.

AMERICAN TECHNICAL SOCIETY, Dept. AC19

Drexel Ave. at 58th St., Chicago 37, Ill.

I would like to examine your 4-Volume Set of Auto Books. I will pay the delivery charges only, but if I choose I may return them express collect. If after 10 days' use I prefer to keep them, I will send you \$2 and pay the balance at the rate of only \$3 a month until \$24.80 has been paid. Include consulting service as offered above.

Name _____

Address _____

City _____ State _____

Please attach letter stating age, occupation, employer's name and address and name and address of at least one business man as reference. Men in service, also please give home address.

AUDELS Carpenters and Builders Guides 4 vols. \$6



Inside Trade Information for Carpenters, Builders, Joiners, Building Mechanics and all Woodworkers. These Guides give you the short-cut instructions that you want—including new methods, ideas, solutions, plans, systems and money saving suggestions. An easy progressive course for the apprentice and student. A practical daily helper and Quick Reference for the master worker. Carpenters everywhere are using these Guides as a Helping Hand to Easier Work, Better Work and Better Pay. To get this assistance for yourself, simply fill in and mail the FREE COUPON below.

Inside Trade Information On:

How to use the steel square—How to file and set saws—How to build furniture—How to use a mitre box—How to use the chalk line—How to use rules and scales—How to make joints—Carpenters arithmetic—Solving mensuration problems—Estimating strength of timbers—How to set girders and sills—How to frame houses and roofs—How to estimate costs—How to build houses, barns, garages, bungalows, etc.—How to read and draw plans—Drawing up specifications—How to excavate—How to use settings 12, 13 and 17 on the steel square—How to build hoists and scaffolds—skylights—How to build stairs—How to put on interior trim—How to hang doors—How to lath—lay floors—How to paint



AUDEL, Publishers, 49 W. 23rd St., New York 10, N. Y.

Mail Audels Carpenters and Builders Guides, 4 vols., on 7 days free trial. If OK I will remit \$1 in 7 days and \$1 monthly until \$6 is paid. Otherwise I will return them. No obligation unless I am satisfied.

Name _____

Address _____

Occupation _____

Employed by _____ PM

Have an OFFICE of YOUR OWN!

LEARN NEW PROFITABLE PROFESSION
At Home in 60 Days, Men & Women, 18 to 70!

Be Your Own Boss and the Boss of Others. Be Respected. Meet Interesting People.

Earnings of men and women in this profession run as high as \$5,000-\$15,000 yearly. Others make good money in spare time. Little money needed to start. A business where your earnings begin sooner. Easy to learn. No selling or goods to buy. No experience necessary. A depression-proof business. A course of action to guide you step by step as you earn. All 53 lessons sent at once to use as operating manuals. Easy terms. Diploma. Money-back agreement. Write for **FREE BULLETIN**.



FRANKLIN CREDIT SCHOOL
Dept. 75-H ROANOKE 7, VIRGINIA

BY MAIL in Easy Lessons

How to Make Money with Simple Cartoons



A book everyone who likes to draw should have. It is free; no obligation. Simply address

FREE BOOK

CARTOONISTS' EXCHANGE
Dept. 98-D Pleasant Hill, Ohio



Bar Bells

Buy Direct From Factory

Write for free booklet and price list

\$8.95 up

INDEPENDENT IRON WORKS
2416 East 23rd Street, Dept. B
Los Angeles 11, Calif.

"YOU ARE UNDER ARREST!"



Help Bring Crooks to Justice Through Scientific **CRIME DETECTION!**

We have taught thousands this exciting, profitable, pleasant profession. Let us teach you in your own home. Learn Finger Printing, Firearms Identification, Police Photography, Secret Service Methods thoroughly, quickly, at small cost. Over 800 of all American Bureaus of Identification employ I. A. S. students or graduates. We can prepare you for this fascinating work, during spare time. Write today, stating age, for "Blue Book of Crime."

INSTITUTE OF APPLIED SCIENCE, 1920 Sunnyside Ave., Dept. 135C, Chicago 40, Ill.

INVENTING

—FOR PROFIT! If you have an inventive turn of mind, write for free 28-page booklet explaining how the Institute of American Inventors is helping inventors pre-test the profit possibilities of proposed devices to fill today's unprecedented demand for useful new inventions.

INSTITUTE of AMERICAN INVENTORS

Dept. 4, 1926 Eye St., NW, Washington 6, D. C.

Photography



for

PLEASURE or PROFIT

Learn at home. Spare time. Practical basic training. Long-established school. Many have earned while learning. Send coupon below for free booklet, "Opportunities in Modern Photography" and full particulars.

AMERICAN SCHOOL OF PHOTOGRAPHY
1315 Michigan Avenue Dept. 135C Chicago 5, Illinois

Send booklet, "Opportunities in Modern Photography," full particulars and requirements. No salesman will call.

Name _____ Age _____

Address _____

City _____ Zone _____ State _____

AMERICA'S
FOREMOST SCHOOL OF
PRACTICAL TRAINING
IS READY TO
PREPARE YOU
NOW FOR A
GOOD JOB IN—

REFRIGERATION AIR CONDITIONING

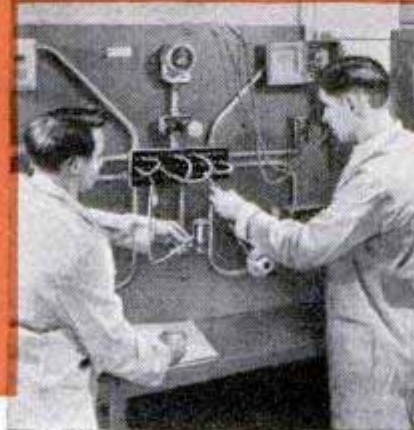

TRAIN BOTH AT HOME



AND IN IT'S BIG SHOPS



What's YOUR ambition? Better pay? An interesting job? Your own business? They're all waiting for you **right now** in Refrigeration and Air Conditioning! The tremendous growth of this great industry is almost unbelievable . . . and a growing industry needs trained men. If you're mechanically inclined and like to work with tools . . . Refrigeration and Air Conditioning offers you a bright future. In a few short months Industrial Training Institute . . . America's foremost school of practical training—will prepare you to step into a good paying job with plenty of opportunity to advance.

Home and Shop Training

Under the famous ITI 2-Way Plan you get all the fundamentals of Refrigeration and Air Conditioning at home . . . during spare hours. Keep your present job and income while training. Upon completion of your ITI Home Study you come to Chicago, with transportation paid, for a **FULL FOUR WEEKS** of practical training in our great shops. You actually work with the same kind of equipment you'll meet on the job.

WARM AIR HEATING INCLUDED

ITI Training is best for you because it's really complete . . . including the huge field of **Warm Air Heating to boost your income**. You learn both the "how" and the "why" of servicing, repairing, installing and rebuilding both home and commercial equipment. The ITI graduate is qualified to handle any practical job in the industry.

AN OLD ESTABLISHED SCHOOL

Established in 1916, ITI has given training to over 400,000 men. Thousands of its graduates hold key jobs at top income. This great school, occupying five large buildings with over \$500,000.00 invested in training equipment and facilities, offers you the training you need for a flying start to success.

ITI TRAINING 100% PRACTICAL

You need no special schooling or experience. ITI training is easy to grasp, simple, 100% practical. No dull mathematics or complicated theory. ITI lesson Work Sheets are written in simple English. **After graduation, ITI's Job Placement Help Department will help you find the job you want.**

GET THE FACTS NOW — Mail Coupon!

Find out what's ahead for you in Refrigeration and Air Conditioning. See how simple it is to study at home and prepare yourself for a fine job with a splendid future. It's all in our fascinating, illustrated **FREE** book, "Your Future in Refrigeration and Air Conditioning." Just fill out and mail the coupon for your **FREE** copy. Take this first step today.

VETERANS:

ITI Residence Training is fully approved under the G. I. Bill.

ITI also **TRAINS AMBITIOUS MEN** for **GOOD JOBS** in . . .

- Electricity and Industrial Electronics
- Machine Drafting & Design
- Precision Instruments

MAIL COUPON TODAY FOR

FREE BOOK!

Mr. C. H. Smith, President,
INDUSTRIAL TRAINING INSTITUTE
2150 Lawrence Ave.,
Dept. H-1, Chicago 25, Ill.

Please send me **FREE** the ITI book, "Your Future in Refrigeration and Air Conditioning" and information about the opportunities for trained men in this fast growing field. I understand I'm under no obligation.



NAME _____ AGE _____

ADDRESS _____

CITY _____ ZONE _____ STATE _____

ARE YOU A VETERAN? _____



INDUSTRIAL TRAINING INSTITUTE
Formerly the L. L. Cooke School of Electricity & Refrigeration & Air Conditioning Institute
Dept. H-1, 2150 LAWRENCE AVE., CHICAGO 25, ILL.

Do you want

- ..to go to College?
- ..or to enter a Profession?

(Such as Accounting, Architecture, Nursing, Dentistry, Teaching, Social Work, Osteopathy, Beauty Culture, Optometry, Embalming, Chiropody, Law, Medicine, etc.)

- ..or get an Office Position?

To get anywhere, you practically MUST finish High School FIRST. You can complete our simplified High School Course in SPARE time at home, as FAST as your time and abilities permit. Equivalent to resident school work—prepares you for college, pre-professional examinations, business, industry. Standard texts furnished. Diploma. Credit for H. S. subjects already completed. Single subjects if desired. Low tuition, easy terms. American School, Chicago, est. 1897—endorsed by educators. Finish your high school education NOW, Write TODAY!

High School Course at Home

Many Finish in 2 Years

American School, Dept. HC45, Drexel Ave. at 58th St., Chicago 37, Ill.

Gentlemen: Send me FREE information covering special training in subjects checked below. No obligation on my part.

- | | |
|--|--|
| <input type="checkbox"/> High School Course | <input type="checkbox"/> Diesel Engineering |
| <input type="checkbox"/> Architecture and Building | <input type="checkbox"/> Drafting and Design for Men & Women |
| <input type="checkbox"/> Automotive Engineering | <input type="checkbox"/> Plastics |
| <input type="checkbox"/> Business Management | <input type="checkbox"/> Private Secretary |
| <input type="checkbox"/> Electrical Engineering | <input type="checkbox"/> Mechanical Engineering |
| <input type="checkbox"/> Elec. and Gas Refrigeration | <input type="checkbox"/> Aviation |
| <input type="checkbox"/> Air Conditioning | <input type="checkbox"/> Salesmanship |
| <input type="checkbox"/> Railway Training | <input type="checkbox"/> Radio |
| <input type="checkbox"/> Electronics, Industrial | |

Name.....

Address.....

Learn this Profitable Profession



IN 90 DAYS AT HOME

Money-Making Career Open to Men and Women, 18 to 50

Hundreds of men and women between 18 and 50 make \$10 to \$20 in a single day giving scientific Swedish Massage and Hydro-Therapy treatments. There is big demand from doctors, hospitals, sanatoriums and clubs. Graduates earn large full time incomes from these or in private practice in their own offices. Others make good money from home treatments given in spare time. Learn this interesting, money-making profession in your own home, through our home study course. Same instructors as in our nationally known resident school. You can win independence and prepare for future security by qualifying for your Diploma. Course can be completed in 3 to 4 months. Many earn while they learn. Begin your training at once.



Anatomy Charts & Booklet FREE

Enroll now and we will include, at no extra cost, many needed supplies. Fit yourself to help meet growing demand for Scientific Swedish Massage. Send the coupon at once for complete details. Anatomy Charts and 32-Page Illustrated Booklet, FREE, postpaid.

THE COLLEGE OF SWEDISH MASSAGE
Dept. 864-K, 100 East Ohio St., Chicago 11, Illinois

Please send me FREE and postpaid, Anatomy Charts, 32-page Booklet and complete details on Home Training.

Name.....

Address.....

City..... State.....

Be A MASTER PLUMBER

Earn \$15 To \$50 A Day

DON'T ENVY THE PLUMBER — BE ONE

Every skilled workman will tell you that Plumbers have the best of it. WINTER and SUMMER the Plumber is busy at top wages. No skilled Plumber is ever out of a job—compare his opportunities with any trade, plus the opportunities of having your own shop. We teach you Plumbing with TOOLS (not books) under Licensed Master PLUMBERS in one of the finest equipped schools in America. We make you a Plumber, every branch is taught thoroughly—Lead Work—Blueprint for plan reading—all other tricks.

LEARN IN 30 WEEKS WITHOUT PREVIOUS EXPERIENCE

If you like to work with tools you owe it to yourself to investigate. No need to ever work as an apprentice. Get free bulletin. Write now! G.I. APPROVED. Our 24th year.

UNIVERSAL PLUMBING SCHOOL
815 HOLMES STREET KANSAS CITY, MO.



FOR BUSINESS AND SOCIAL SUCCESS!

Easy to improve your handwriting at home quickly with my new instruction books just off the press. Master all the secrets of better penmanship. Simple and easy, fully illustrated, highly endorsed. Begin today. Write for: New Free Book, "How to Become a Good Penman" or check books wanted, \$1.00 each. Business Writing Artistic Writing Card Writing Engraving Alphabets Bird and Design Flourishing Complete Set \$4.50 Enclose 10c for your name beautifully written and special penpoint for shaded writing.

S. A. Ziller, President, TAMBLYN SCHOOL OF PENMANSHIP
441 Ridge Bldg. In Business Over 52 Years Kansas City, Mo., U.S.A.

I'LL SHOW YOU HOW TO MAKE MONEY IN WATCH REPAIR

Own your own watch repair business—have a profitable career. No age or physical limits. Estimated 20,000 watchmakers needed to repair 1 1/4 million clocks per month which cannot be handled by repairmen now. Learn in cool, mile-high Denver. Nationally-accredited school. Approved for veterans. Learn by doing—send postcard for free booklet describing course. No obligation.

FREE BOOKLET
American Academy Inc. School of Horology
1450 Lawrence St. Denver 2, Colo.



BE A REAL ESTATE BROKER PAYS BIG!

EASY TO LEARN — Start and run your own business quickly. Many graduates report making up to \$1000 a month. Course of study covers Sales, Property Management, Appraising, Loans, Mortgages and hundreds of related subjects. Course in home study or classroom instruction in leading cities. Big new illustrated catalog from this nationally known school. G. I. Approved. Send a Post Card Today.

WEAVER SCHOOL OF REAL ESTATE (Estab. 1936)
15 E. Pershing Road Dept. PM-1 Kansas City, Mo.

CORRESPONDENCE COURSES IN RADIO and ELECTRICAL ENGINEERING

ELECTRICAL ENGINEERING. Get good grasp of wide electrical field. Modern. Very understandable. Theory made easy. RADIO ENGINEERING. Extra fine course in radio, public address, photo-electric work. Trains you to be super-service man, real vacuum tube technician. Tuition ONLY \$25, either course. Deferred payment plan. Servicemen needed badly. FREE Write for free copies of school catalogs, student magazines, etc. LINCOLN ENGINEERING SCHOOL, Box 931-P116, Lincoln, Nebr.

DO YOU LOVE HORSES?

ARE YOU INTERESTED IN HORSE TRAINING AND MANAGEMENT?
SUBSCRIBE FOR The "EXPERT HORSEMAN" 2 YEARS \$1.00



FREE BOOK—You will also receive a booklet that tells how you can learn to break colts, gait show horses, train rodeo, stock and race horses, break bad habits, handle any horse and train circus trick horses.

SEND \$1.00 TODAY
ANIMAL LOVERS ASSOCIATION
Box No. KA111, TARZANA, CALIFORNIA

Say You Saw It in Popular Mechanics

NEW! LOW COST! RESPIRATOR

Wear when sanding, grinding, paint spraying, sweeping, dusting, furnace cleaning, etc. Handy as a pair of glasses. Just keep mouth closed and breathe through nose as all you do to operate. Protects against nuisance dusts, lint, coal, cement, grain dust, hay fever pollen. Has 9 sq. in. filter. For EYE protection against paint spray, dusts, gases, fumes, smoke, order our Fog-Proof Rubber GOGGLES..... \$2.00 p.p.

JERRY BRYANT, Dept. PM
519 N. Michigan Ave. Chicago 11, Ill.



Order Today \$1.00 POST PAID



ELECTRICAL ENGINEERING



RADIO AND ELECTRONICS

Choose
Your
Career

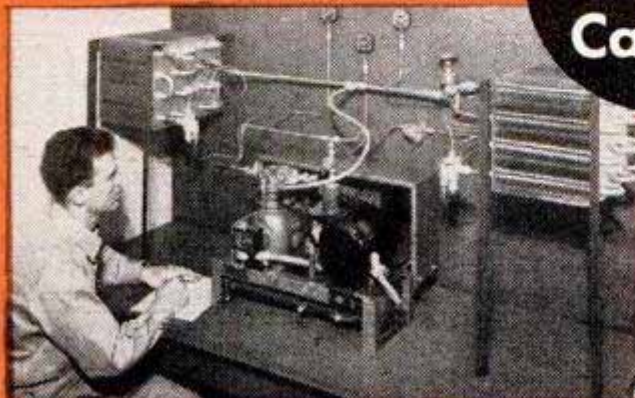

REFRIGERATION & AIR CONDITIONING



GAS AND ARC WELDING

PRACTICAL TECHNICAL TRAINING PREPARES YOU TO SPECIALIZE in 6 Months to 3 Years

CONCENTRIC CURRICULUM



Our time-tested CONCENTRIC SYSTEM enables you to build your career step by step. Each 6-month course is complete in itself. Stay as long as circumstances permit — until you reach your desired occupational objective.

COURSES

SERVICE . . . 6 Months to 12 Months

Practical Electricity
Practical Welding
Refrigeration Service
Heating Service

TECHNICIAN . . . 1 to 2 Years

Electro Technician
Radio Technician
Electronics Technician
Refrigeration, Heating, and
Air Conditioning Technician

PROFESSIONAL . . . 3 Years

Electrical Engineering
Bachelor of Science Degree—
Major in Machinery or
Electronics

Training men for specific and substantial careers in industry has been the primary purpose of the Milwaukee School of Engineering since its founding 44 years ago. More than 35,000 former students in industries the world over attest the school's career-building value. Exceptional facilities in laboratories, comprehensive technical courses, plus a faculty of 72 specialists account for this outstanding record. At present there are 1,538 students enrolled from 48 states and 13 overseas countries. Terms start in **September**, January, April and July. **SEND COUPON TODAY!**

MILWAUKEE
SCHOOL OF ENGINEERING
A Technical Institute Founded 1903

MILWAUKEE,

WISCONSIN

Milwaukee School of Engineering,
Dept. PM-848, N. Broadway and E. State, Milwaukee, Wis.

Without obligation, send me free booklet "Career Building" and more details on course in _____

Name _____ Age _____

Address _____

City _____ State _____

3 opportunities to LEARN MORE and EARN MORE!

1 TYPEWRITER REPAIRING

9 month course teaches repair of all standard machines. Wide demand for trained men. Excellent paying private business.

ALL COURSES APPROVED FOR G. I. TRAINING

2 PLASTICS ENGINEERING

16 month course. Fascinating Plastics field offers great future to creative young men. Thorough training essential.

3 ELECTRO-PLATING

9 month course in plating of all materials. Primary or advanced instruction. Classroom and laboratory study. Job opportunities exceptionally good.

RESIDENT COURSES ONLY

WRITE FOR FULL DETAILS TODAY!

COMMERCIAL INSTITUTE | Pittsburgh School of *Plastics* | **ELECTROPLATING**
Institute of America
2020 W. Liberty Ave. • Pittsburgh 26, Penna.

PRACTICAL AUTO INFORMATION

Keeps Cars Rolling by Making Repairs and Adjustments Easy!

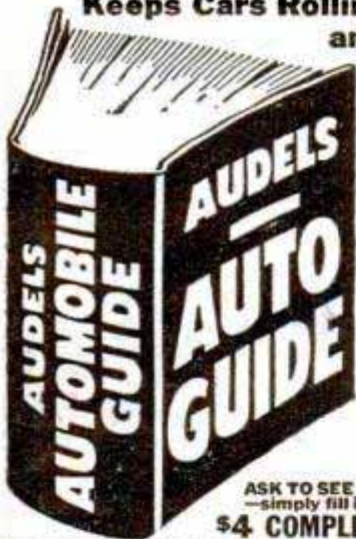

AUDELS AUTO GUIDE
For Every Mechanic, Driver, Owner and Repair Shop.

Sent on 7 Days Approval Shows How to Tune Up—Keep Brakes Safe—Batteries Powerful—Tire Mileage Up—Save Gas—Lubricate Correctly.

ANSWERS YOUR QUESTIONS
Contains all you need to know about 1—Construction, 2—Operation, 3—Service, 4—Repair of Modern Motor Cars, Trucks, Buses & Diesel Engines in every detail.

NEW FLUID DRIVE TREATED
Easy to understand—1540 Pages, 1540 Illustrations. Gives definite directions on How to handle service jobs.

ASK TO SEE IT—Get this information for yourself—simply fill in and mail coupon today.

\$4 COMPLETE • PAY ONLY \$1 A MO.

AUDEL, Publishers, 49 West 23rd St., New York
Mail AUDELS AUTOMOBILE GUIDE (\$4) for free examination. If O. K., I will send you \$1 in 7 days; then remit \$1 monthly until \$4 is paid. Otherwise, I will return book promptly.

Name _____
Address _____
Occupation _____
Reference _____ PM

ELECTRICIANS' SCHOOL

HOUSE AND COMMERCIAL WIRING • MOTOR REPAIR AND REWINDING • ELECTRIC REFRIGERATION

Approved for Veterans Training

PENNSYLVANIA INSTITUTE SCHOOL OF ELECTRICITY

42nd and SPRUCE STS.

PHILADELPHIA 4, PENNA.

LEARN WATCH REPAIRING



AT HOME. By our modern and original system of instruction you can learn every part of the **WATCH REPAIRING TRADE AT HOME.** Prepare yourself for a well-paying position or start in business after completing our course of instruction. Good watch repairers are in demand and generally earn very good salaries. For particulars apply to the **Wisconsin School of Watch Repairing** 759 North Milwaukee St., Milwaukee 2, Wis.

ENGINEERING DEGREE IN 27 MONTHS

INDIANA TECHNICAL COLLEGE

Aeronautical, Chemical, Civil, Electrical, Mechanical, and Radio Engineering (inc. television). Drafting, 1-yr. Gov't approved for G.I.'s. Low rate. Earn board. Large industrial center. Students from 48 states, 18 countries. Demand for graduates. Enter September, December, March, June. Catalog.

588 E. Washington Blvd., Ft. Wayne 2, Ind.

THERE'S MONEY IN CARTOONS!

RAYE BURNS will teach you HOW to CREATE ORIGINAL CARTOONS at home that you may SELL! Course contains 26 lessons and over 600 illustrations. All for Only...

\$2.85

Send name and address for free details.

RAYE BURNS SCHOOL, Dept. M, Box 3583, CLEVELAND, OHIO

Sensational New Electric ① WELDER ② CUTTER!



Uses 110-115 AC or DC • INSTRUCTIONS INCLUDED
WELD - BRAZE - CUT - MELT - SOLDER - HEAT TREAT

The WELDRITE combination—tested and proven by countless commercial and amateur users, is now offered direct to you at the amazingly low price of only \$12.00. No Gas—No Gauges—No Spark Lighter needed. Always ready for immediate use—Just plug WELDRITE into 110-115 AC or DC outlet. Uses standard welding and brazing materials available at all welding supply stores. WELDRITE furnished complete with Converter Unit, #1 Single Holder with attached Alligator clip, for welding metal up to 3/16" thickness, using up to 3/32" rod, and #2 Double Holder with Copper Coated Dual Carbon Electrodes for Cutting, Brazing, Heat Treating, Soldering, etc. Starting welding materials and instructions included.

Ideal for home workshop. Invaluable for body

and fender shops, garages, repair and machine shops, manufacturers, etc.

SEND NO MONEY! 5 DAY TRIAL OFFER
Order your WELDRITE Electric WELDER-CUTTER C.O.D. today. Pay postman \$12 plus postage charges (wt. 4 lbs.) or send \$12 and we pay postage. Either way, if not satisfied, return WELDRITE in 5 days, and money will be refunded. WELDER HOOD—Approved lens found in hoods costing to \$10—only \$3.95. California orders please add 2 1/2% sales tax.

CALIFORNIA TECHNICAL PRODUCTS CO.

448 So. Hill St., Los Angeles 13, Calif. Dept. A-B

BOTH only \$12
LOWEST PRICE IN HISTORY!



GET INTO DRAFTING

The Draftsman Plays a most Important Part in INDUSTRY

DRAWING OUTFIT INCLUDED with Drafting courses

All the tools you need including folding drawing table. With them you can put your ideas on paper quickly and with accuracy. With training you are all set to master Drafting in months, — not years — at home.

Learn in Spare Time—At Home!

(or at the College in Chicago)

A few hours of pleasant home study every week — that's all. With Chicago Tech's help, you train yourself step by step. This tested method — developed over 44 years of C.T.C. progress — prepares men for good positions in industry.



**CHICAGO
TECHNICAL COLLEGE**
K-211 Tech Building, 2000 South Michigan Ave.
Chicago 16, Illinois

Practically everything that's built or manufactured these days is constructed from blue print drawings prepared by the draftsman. He is the KEY man in industry. No new machines can be built, no bridges erected, no buildings constructed until the draftsman has completed his work.

Drafting is clean, interesting, professional-type work. The draftsman is paid well to start. And he has real opportunities for advancement to high-pay jobs in Engineering. The tremendous production programs ahead in industry will require more draftsmen than ever before.

Send today for free information. See what this training has done for others, what it can do for you. Simply MAIL COUPON TODAY in an envelope or use a penny postcard.

MAIL COUPON NOW

Chicago Technical College
K-211 Tech Bldg., 2000 So. Michigan Ave.
Chicago 16, Illinois

Mail me FREE Drafting Lesson with information about big opportunities in DRAFTING and how I can train at home.

- Architectural Drafting Electrical Drafting
 Machine Drafting Structural Drafting
 Builders' Course

Name _____ Age _____

Address _____

City _____ Zone _____ State _____

NEW WRITERS NEEDED

New writers needed to re-write ideas in newspapers, magazines and books. Splendid opportunity to "break into" fascinating writing field. May bring you up to \$5.00 per hour spare time. Experience unnecessary. Write today for FREE details. NO OBLIGATION. Postcard will do.

**FREE
DETAILS**

COMFORT WRITER'S SERVICE

Dept. 11, 200 South 7th St. St. Louis, Mo.

SHOE REPAIR OFFERS BIG INCOME LEARN IN 12 WEEKS TIME

You can own your own shop or earn big income as skilled shoe repairman. Growing demand everywhere at top wages for men who know how. We teach you quickly by actually working on shoes and modern machines. Costs nothing under G.I. Bill of Rights. School open to all from 18 to 60 years of age. FREE BIG 16 PAGE BOOK explains everything. Send for your copy today.

MODERN SHOE REBUILDING SCHOOL

Established 1927

2937 Belmont Ave., Chicago, Ill. Rush Postcard Today.
4577 Hollywood Blvd., Los Angeles 27, Calif.

ACCOUNTING

STUDY AT HOME for C.P.A. and BIG PAY Accounting opportunities with 44 year old school. No previous training needed. Texts furnished. EASY PAYMENTS. Send for FREE BOOK. G. I. Approved.

MacCORMAC EXTENSION SCHOOL

Dept. M 1170 E. 63rd St. Chicago 37, Ill.



LAW FREE BOOK



Write today for FREE 48-page book, "THE LAW-TRAINED MAN," which shows how to learn law easily in spare time at home through the Blackstone course prepared by 60 well-known law authorities. We furnish all material including 18-volume Modern American Law library. Many successful attorneys among our graduates. LL.B. degree. Moderate cost; easy terms; Money-Back Agreement.

BLACKSTONE COLLEGE OF LAW

225 N. Michigan Ave., Dept. 50-C, Chicago 1, Ill.

A Correspondence Institution Founded in 1890

LEARN

AVIATION

AN ESSENTIAL INDUSTRY IN PEACE OR WAR

MAXIMUM TRAINING IN MINIMUM TIME

for 19 years Cal-Aero Technical Institute has specialized in....

✓ AERONAUTICAL ENGINEERING

2 year course — kept abreast of new research and scientific development.

✓ MASTER AVIATION MECHANICS

1 year course — C. A. A. approved for Airplane and Engine License.

Modern "live" training equipment, including helicopters, jets, rockets, wind tunnel... Classes start monthly — Room and board available on our airport... Cal-Aero Tech Training is carefully designed for just one thing — TO MAKE MORE MONEY FOR YOU. More than 7000 successful graduates in addition to 26,000 pilots and 7500 mechanics trained for Army & Navy Air Forces, prove that our career training is unsurpassed. APPROVED FOR VETERANS



**CAL-AERO
TECHNICAL INSTITUTE**

GRAND CENTRAL AIR TERMINAL
GLENDALE 1, CALIFORNIA
LOS ANGELES COUNTY

MAIL THIS COUPON TODAY!

Please send full information on Aviation Training FREE—without obligation.

Name _____ Birth Date _____

Street _____ Zone _____

City _____ State _____

CHECK ONE VETERAN NON-VETERAN P.M.-8

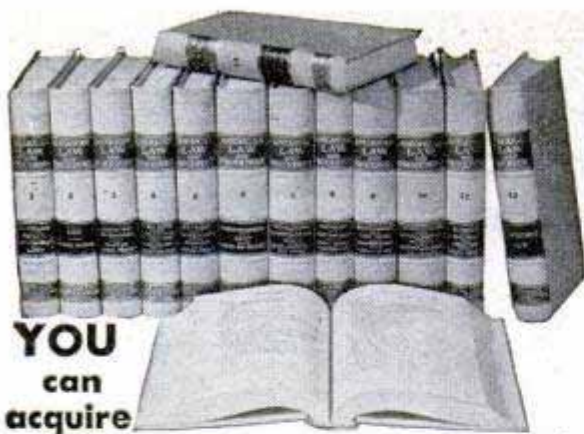

**YOU
can
acquire**

LAW NIGHTS AT HOME! L.L.B. DEGREE

LaSalle's famous Law Library—used as reference in many Law libraries and Law offices—has enabled thousands to master Law surprisingly fast, in spare hours at home, for business and professional advancement.

These 14 remarkable volumes, compiled by leading professors and lawyers, cover the whole basic field of Law in condensed, orderly, simplified manner.

You advance rapidly with this great library, plus special lectures furnished. We guide you step-by-step with personalized Problem Method of instruction . . . you *learn by doing*—handling legal problems—not by memorizing rules.

Send for two FREE 48-page booklets, "Law Training for Leadership," and "Evidence," answering questions about Law and its value to you, and telling how LaSalle Law graduates are winning rapid advancement in business and public life. Mail coupon below. No obligation.

LA SALLE EXTENSION UNIVERSITY

A Correspondence Institution

417 S. Dearborn St. Dept. 864-L Chicago 5, ILL.

Send me your two FREE booklets described above, without obligation.

Name.....Age.....

Street.....

City, Zone & State.....

BE A SUPERVISOR



**Franklin Technical Institute
Helps Young People Get Ahead**

● The door to well-paid supervisory jobs in industry is wide open—to the man or

woman with specialized technical training. 50,000 graduates of this Boston school have gone out to good jobs in engineering and technical fields.

Practical courses in industrial electricity and electronics, industrial chemistry, mechanical and machine design, structural and architectural design, automotive service and management, electric wiring and maintenance. Also preparatory course. Day and evening classes. Approved for veterans. 40th year.

FRANKLIN TECHNICAL INSTITUTE

43 Berkeley St. Boston, Mass.

Please send free information on all courses.

Name.....Age.....

Address.....

City.....State.....

PRINT YOUR OWN POST CARDS

**COMPLETE
OUTFIT**

only

\$7.50

Amazing results in sales, inquiries and contacts . . . saves time and money . . . very easy to use **GEM STENCIL DUPLICATOR** is ideal for Advertising, Announcements, Notices, Labels, Forms, Price Lists—hundreds of uses for every type of business and organization. Comes complete with all supplies, instructions and 60-page Book of Ideas.

FREE TRIAL OFFER: Try it before you buy it! Write and a GEM OUTFIT will be sent you postpaid. After 10 days, send only \$7.50 or return the GEM, no questions asked. The GEM must sell itself; you be the judge.

**BOND EQUIPMENT CO. • Dept. 135
513 Olive St. • St. Louis 1, Mo.**

SEND NO MONEY • FREE TRIAL OFFER



BE AN ARTIST

Send for interesting picture book—"**BUILDING A FUTURE.**" Explains the unique position of the professional artist in American life. Gives examples of huge professional income. Tells definitely how YOU can acquire **PROFESSIONAL skill—AND PROFESSIONAL INCOME**—within one year—in spare time at home. No obligation. Penny is free. Write name, address and age on penny postcard and mail TODAY to:

**GRANT SCHOOL OF ART
Dept. 108-C, 53 W. Jackson Blvd., Chicago 4, Ill.**

EXPERT PHOTOGRAPHY MADE EASY

LEARN PHOTOGRAPHY NOW

—for both a sound and secure future and immediate opportunities. Ever-increasing demand for trained men and women. Excellent earnings. Resident or home study. 38th year. Write for full details.

**NEW YORK INSTITUTE OF PHOTOGRAPHY
Dept. 49, 10 West 33 Street New York 1, New York**

Master Watchmaking

The life-long profitable trade of thousands as taught by the Sweazey System.

"FAMED THE WORLD OVER"

CHICAGO SCHOOL OF WATCHMAKING

Founded in 1908 by Thomas B. Sweazey
1608 N. Milwaukee Ave., Dept. 188 Chicago 47, Ill.

BE A NOTARY PUBLIC

Largest notary supply house equips you for \$16.97, guarantees your appointment by governor. Honor, prestige. You certify legal papers, collect fees. Easy. At home, office, anywhere. You use official seal made with your name. Notaries needed everywhere. Be one.

Write **STATIONERS EXCHANGE, Helotes 10, Texas**

RUPTURED?

Get Relief This Proven Way

Why try to worry along with trusses that gouge your flesh—press heavily on hips and spine—enlarge opening—fail to hold rupture? You need the Cluthe. No leg-straps or cutting belts. Automatic adjustable pad holds at real opening—follows every body movement with instant increased support in case of strain. Cannot slip whether at work or play. Light. Waterproof. Can be worn in bath. Send for amazing FREE book, "Advice To Ruptured," and details of liberal truthful 60-day trial offer. Also endorsements from grateful users in your neighborhood. Write:

CLUTHE SONS, Dept. 31, Bloomfield, New Jersey

THESE 5 TRADES ASSURE YOU HIGH PAY • Future Security

- **PLUMBING** Every phase of plumbing: Pipe-Cutting and Threading, Lead-Wiping, Rough-in Projects on Installations, Completed Installations of entire plumbing systems, Blueprint reading, Estimating.
- **DRAFTING** College-level courses in General Machine and Architectural Drafting, with fundamentals in Drafting Mathematics—all under graduate engineers.
- **SHOE REPAIRING** From simplest repairs on boots and shoes to the finest details of reconditioning and rebuilding, under expert craftsmen.
- **ELECTRICAL** Technical and shop training include Basic Electricity, Residential Wiring, Industrial Wiring, General Testing and Trouble Shooting, and Appliance Repair.
- **AUTOMOTIVE & TRACTOR** Applied training on latest model automobiles and tractors, including engine overhaul, transmission and differentials, carburetion, generator and ignition systems, engine tune up, Hydramatic and Vacumatic Transmissions, and general service.

Choose One of these 5 Essential Trades

Our complete courses of thorough training prepare you to go right into the field as a Qualified Tradesman at High Pay in only 34 weeks (39 in Shoe Repair). All courses under especially trained instructors with practical experience. 6 Hour Classes 5 Days a Week. Our Employment Department helps you.

VETERANS "Approved for veterans' training by the State Department of Education under Public Law 246."
"Approved for veterans' training by the Veterans' Administration under Law 16."

Send Coupon for Free Information Now

"There's Always a Demand for the Man who KNOWS!"

CHOOSE ONE OF THESE 5 LEADING TRADES

Get Out of that Rut... Be a Skilled Tradesman! Have a Lifetime Career... Own Your Own Business and Be Secure in Your Old Age.

NOW while Enrollment is still open, send for FREE information.

THE 5 DIVISIONS OF

NATIONAL TRADE SCHOOL

2610 Grand Ave., Kansas City 8, Mo.

- Plumbing
- Drafting
- Shoe Repairing
- Electrical
- Automotive & Tractor

NAME _____

ADDRESS _____

CITY _____

STATE _____

VETERAN _____

OCCUPATION _____

WHY DON'T YOU WRITE?

Writing short stories, articles on business, sports, homemaking, gardening, shop crafts, local and club activities, etc., will enable you to earn extra money. In your own home, on your own time, the New York Copy Desk Method teaches you how to write—the way newspaper men learn, by writing. Our unique "Writing Aptitude Test" tells whether you possess the fundamental qualities essential to successful writing. You'll enjoy this test. Write for it, without cost or obligation.

Veterans: This course approved for Veterans' Training.

NEWSPAPER INSTITUTE OF AMERICA
SUITE 5598-M, ONE PARK AVENUE, NEW YORK 16, N. Y.

THOUSANDS OF SUFFERERS USE

BREATH EASY

FOR

ASTHMA

CARRY IT WITH YOU
USE IT ANYWHERE

*Sold on Money-Back
Guarantee*

Write To Dept. PM

BREATH EASY DISTRIBUTORS, INC
65 CEDAR STREET
SEATTLE 1 WASHINGTON

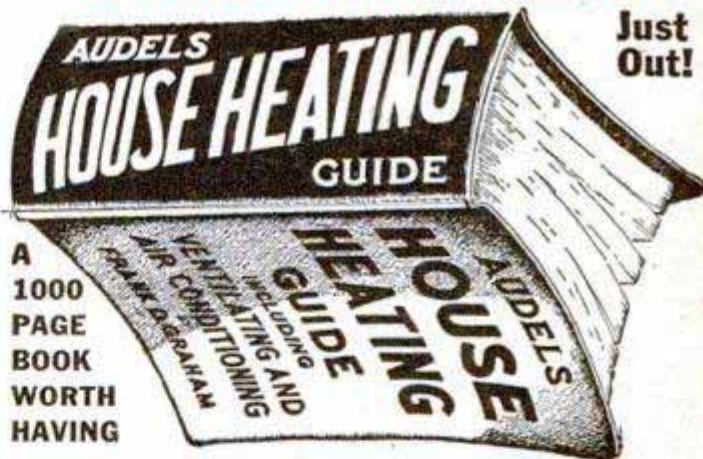

Just Out!

For Heating, Ventilating and Air Conditioning Engineers, Plumbers, Maintenance Men, Contractors, Building Superintendents and Mechanics seeking practical, authentic information on Heating, Ventilating, Air Conditioning. 1000 Pages—910 Illustrations—57 Chapters explaining the working principles of all Modern House Heating, Ventilation and Air Conditioning systems. Fully illustrated and indexed. This up to date book of reference gives answers to 1001 questions on Heating, Ventilating, Air Conditioning & Radiant Heating.

\$4 COMPLETE • PAY ONLY \$1 A MONTH

To get this assistance for yourself, fill in and

MAIL ORDER

AUDEL, Publishers, 49 W. 23rd St., New York 10, N. Y.
MAIL AUDEL'S HOUSE HEATING GUIDE for free examination. If O. K. I will send you \$1 in 7 days; then remit \$1 monthly until price of \$4 is paid. —Otherwise, I will return it.

Name _____

Address _____

Occupation _____

Employed by _____ PM

BE A WINNER AT ANYTHING YOU TACKLE WITH **PROGRESSIVE POWER** Now **ALL 5 FAMOUS JOWETT COURSES** in 1 Volume for only **25c**

DARLING, THAT BULLY WON'T PICK ON YOU AGAIN!

JOE YOUR NEW ENERGY AND APPEARANCE SURE DO A GOOD JOB! YOU EARNED YOUR PROMOTION!



George F. Jowett
Whom experts call "Champion of Champions" World's wrestling and weight lifting champ at 17 and 19. World's Strongest Arms. 4 times World's Perfect Body—plus other records.

Let's Go, Pal! I'll prove I can make YOU an **"ALL-AROUND" HE-MAN** FAST—OR NO COST! says George F. Jowett World's Greatest Body Builder

Enjoy My "Progressive Power" Strength Secrets! Give Me 10 Easy Minutes a Day—Without Strain! I'll teach you the "Progressive Power Method" through which I rebuilt myself from a physical wreck the doctors condemned to die at 15, to the holder of more strength records than any other living athlete or teacher! "Progressive Power" has proven its ability to build the strongest, handsomest men in the world. And I stand ready to show you on a money back basis—that no matter how flabby or puny you are I can do the same for you right in your own home. Let me prove I can add inches to your arms, broaden your shoulders, give you a man-sized chest, powerful legs and a Rock-like back—in fact, power pack your whole body so quickly it will amaze you! Yes, I'll jam you with power and confidence to master any situation—to win popularity—and to get ahead on the job! Through my proven secrets I bring to life new power in you inside and out, until YOU are fully satisfied you are the man you want to be.

PROVE IT TO YOURSELF IN ONE NIGHT
Send only 25c for my 5 easy-to-follow, picture-packed courses now in 1 complete volume "How to Become a Muscular He-Man." Try it for one night! Experience the thrilling strength that surges through your muscles.

I am making a drive for thousands of new friends fast—REGARD-
LESS OF COST!
SO GET NOW MY 5 Muscle Building Courses (Valued at \$5 each)
All in 1 Great Complete Volume Packed With How-To-Do-It Pictures!
Now, this "get-acquainted," extremely low price of only 25c is your chance to build a body you'll be proud of! Follow Jowett's easy method of muscle building NOW!

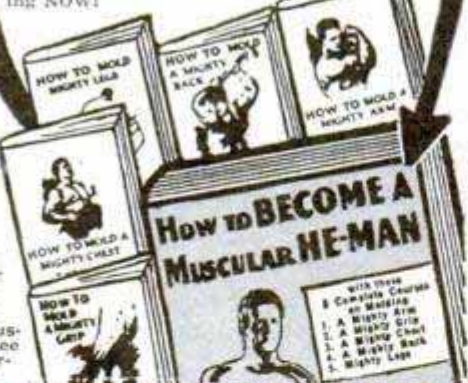

10 DAY TRIAL!
Think of it—all five of these famous courses now in one picture-packed muscle-building volume for only 25c. If you don't actually FEEL results within ONE WEEK, send it back and your money will be promptly refunded! Photo Book Of Famous Strong Men!

FREE!
Photos that inspire you to might and muscle. Free with order.

FREE GIFT COUPON!

Jowett Institute of Physical Culture Dept. PM-88
230 Fifth Avenue, New York 1, N. Y.

Dear George:—Please send by return mail, prepaid, **FREE** Jowett's Photo Book of Strong Men, along with all 5 Muscle Building Courses. 1. Molding a Mighty Chest. 2. Molding a Mighty Arm. 3. Molding a Mighty Grip. 4. Molding a Mighty Back. 5. Molding a Mighty Leg—Now all in One Volume "How to Become a Muscular He-Man." Enclosed find 25c, NO C.O.D.'S.

NAME _____ AGE _____
(Please Print Plainly, Include Zone Number)
ADDRESS _____

BRAKE SERVICE TRAINING

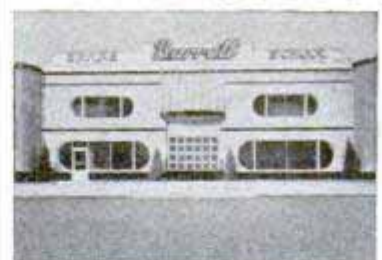

Learn Scientific Brake Service at home in your spare time.

Internationally known manufacturer now offers world's only specialized

extension course in precision brake service. Start training immediately. Write for complete details. No obligation.

BARRETT BRAKE SCHOOL
Division of Barrett Equipment Co.

2017 Cass Ave.

St. Louis 6, Mo.

make **MONEY CASTING** AT HOME

Free FACTS SENT

Make your own rubber molds quickly, cheaply with X.L. RUBBER. Cast thousands of perfect figurines, book ends, plaques, ornaments, ash trays, etc. **GREAT PROFITS!**

Write for NEW Catalog.
X.L. Rubber, Pts. \$2.00; Qts. \$3.50; Gallons \$8.95; Models and enough rubber for 3 molds \$1.00—Foreign \$1.50.

PLASTIC ARTS STUDIO Route 2 • Dept. 2 • Muncie Ind.

FREE - INSTRUCTIONS - FREE

no investment required, become a

PURCHASING AGENT

Start earning a good income immediately, steady work year 'round.

Write

PURCHASING, DEPT. C

2719 LAWRENCE AVE.

CHICAGO 25, ILL.

LEARN MEAT CUTTING

through actual practice. Profitable Meat Cutting and Successful Meat Merchandising taught easily, quickly. **LEARN BY DOING** at Toledo in just six short weeks under actual market conditions. For beginners or men with experience. All subjects taught thoroughly and completely. Diploma. Job help. Get store of own. People must eat. School in operation nearly 25 years. Approved for GI training. Send today for FREE literature. No obligation.

NATIONAL SCHOOL OF MEAT CUTTING, Dept. 50-D, Toledo 4, Ohio

FREE BOOK RAISE HAMSTERS



The new wonder animals from Syria. Often called Toy Bears. Delightful pets. Everyone wants them. Laboratories need thousands. Clean, odorless. Raise anywhere. A profitable and interesting hobby or business. We furnish breeding stock with manual of instructions.

Write today for free illustrated literature.
GULF HAMSTERY, 1536 BASIL, MOBILE, ALA.

TRI-STATE COLLEGE

B. S. Degree in 27 months in Civil, Electrical, Mechanical, Chemical, Aeronautical, Radio Engineering; Bus. Admin., Acc't and Sec. Science. Graduates successful. 65th year. Enter Sept., Jan., March, June. Catalog. 488 College Ave., Angola, Ind.

SUCCEED IN THE POULTRY BUSINESS!

Poultry is providing many trained men and women with a good, comfortable living, either part or full time. For 27 years our Home Study Course has been helping thousands obtain training and "know how" that means extra income from the start. Don't delay—Write today for prospectus describing courses, methods, service, opportunities.

NATIONAL POULTRY INSTITUTE
DEPT. 50 ADAMS CENTER, N. Y.

MAIL THIS

Opportunity COUPON TODAY!

SEND
FOR THIS
30 PAGE
FREE
BOOK

RADIO TRAINING ASSOC. OF AMERICA, DEPT. PMH
5620 Hollywood Boulevard., Hollywood 28, Calif.

Send free illustrated book showing how I can make good in Radio and Television, through training direct from Hollywood.

Name _____ Age _____

Address _____

City _____

Zone _____ State _____

LEARN HOW YOU CAN MAKE GOOD IN

RADIO

TELEVISION-ELECTRONICS

through practical HOME-STUDY plus

10 BIG KITS of RADIO PARTS R. T. A. GIVES YOU!

YOU WILL DO SCORES
OF PRACTICAL JOBS
AND EXPERIMENTS

MASTER HOLLYWOOD TECHNICIANS Guide You

Direct from Hollywood, the very heart of America's Broadcasting, Television, Radio and Sound industries, RTA brings you practical "Time-Tested" Home Training. Because RTA is so favorably located in Hollywood, it is in an excellent position to bring you ACTUAL METHODS developed by the Radio-Television industry, leading to real money-making opportunities!

400 MILLION RADIO and TELEVISION SETS

will be built in the next 10 years. 72 million dollars is being spent RIGHT NOW for radio repairs ALONE! When you are thoroughly trained you can imagine what opportunities await you in Your Own Radio Sales & Service Business, Television, FM, Manufacturing, etc.

EARN EXTRA MONEY while learning AT HOME

Under RTA's easy, practical home-training plan, you study in SPARE TIME ONLY and RTA's Hollywood Experts show you how to earn WELCOME EXTRA CASH, even while learning! In fact, like many RTA students—you may actually get MORE SPARE TIME WORK than you can handle.

25 Years of Home Training Experience
Select your school carefully. Select a school like RTA, with more than a quarter century of practical experience in the home-training field...a school that is right "on-the-spot" in Hollywood, where newest technical improvements are introduced!

RADIO TRAINING ASSOCIATION OF AMERICA 5620 HOLLYWOOD BLVD.
HOLLYWOOD 28, CALIF.

WAR SURPLUS OPTICAL BARGAINS

ASSEMBLE YOUR OWN BINOCULARS!

Save More Than 1/2 Regular Cost



GOVERNMENT'S 7X50 BINOCULARS

Complete Optics!
Complete Metal Parts!

We supply full instructions

METAL PARTS—Set includes all Metal Parts—completely finished—for assembly of 7 X 50 Binoculars. No machining required. Bodies have been factory hinged and covered. A sturdy Binocular Carrying Case is optional with each set of Metal Parts.

Stock # 842-H \$39.40

Postpaid, plus \$4.80 for Case—Total \$44.20

OPTICS—Set includes all Lenses and Prisms you need for assembling 7 X 50 Binoculars. These are in excellent condition—perfect or near-perfect—and have new low reflection coating.

Stock # 5102-H \$25.00 Postpaid

NOTICE! If you buy both Binocular Optics and Binocular Metal Parts, add 20% Federal Excise Tax to above prices.

ARMY'S 6x30 BINOCULARS

COMPLETE OPTICS & METAL PARTS—Model M-13A1, 6 X 30 Binoculars. (Waterproof Model). Everything you need—ready for assembly. When finished will look like a regular factory job costing \$102. to \$120. The Optics are new, in perfect or near-perfect condition. Have new low reflection coating. Metal Parts are new and perfect, all completely finished. No machining required. Bodies factory hinged and covered. Complete assembly instructions included.

Stock # 830-H \$40.00 Postpaid plus \$8.00 tax—Total—\$48.00

TERRIFIC BARGAIN - BUBBLE SEXTANTS

These Army Air Forces Bubble Sextants cost Govt. about \$125 each. Bargain at our price of \$12.50. Wooden carrying case included. Wartime used but COMPLETELY REPAIRED AND COLLIMATED. Return within 10 days for full refund if dissatisfied. Directions for use accompany shipment.

Stock # 924-H \$12.50 Postpaid

Same SEXTANT as above, but BRAND NEW and with Automatic Averaging Device and Illuminated Averaging Disc for nighttime use. Govt. cost \$217. Perfect working order guaranteed.

Stock # 933-H \$22.50 Postpaid

6 POWER GALILEAN TELESCOPE—(Commercial Surplus) 28mm dia. Achromatic Objective Lens. Sturdily constructed of Aluminum. 7" long, extends to 9". Complete with carrying case.

Stock # 941-H \$3.00 Postpaid

We have literally millions of war surplus lenses and prisms for sale at bargain prices ranging 10c and up. Write for Catalog "H" — Sent Free!

Order by Stock No.

Satisfaction Guaranteed

EDMUND SALVAGE COMPANY

P. O. AUDUBON, NEW JERSEY



Learn to Repair ELECTRIC APPLIANCES

WRITE TODAY for FREE BOOK

Prepare now for a permanent future, independence and security with a business of your own. Our practical, easy-to-learn home course teaches you, during your spare time, how to repair washing machines, vacuum cleaners, electric ranges, lamps, motors, irons, etc., and do house wiring. Also how to get started on little capital. Write today for FREE BOOKLET. No obligation.

PACIFIC TRAINING SCHOOL

7217 S. Broadway, Dept. P-88, Los Angeles 3

STUDY AT HOME

With An Educational Institution

Men with specialized training win higher positions, insure larger earnings, and are bigger successes in business and public life. Opportunities NOW greater than ever before. Send for our Catalog.

ARTS and SCIENCES

Courses in Philosophy; Education; Letters; Public Health; Medical Jurisprudence; Psychology; Sociology; Physics; Chemistry; Plastics; Geology; Political Science; Theology; Business and Commerce; Accounting; Mathematics; Statistics; Agriculture.

ENGINEERING

Courses in Electrical, Civil, Mechanical, Drafting, Architectural, Steam, Aeronautical, Radio, Structural, Mining, Industrial, Petroleum, Marine, Chemical, Diesel, Automobile, Refrigeration, and Air Conditioning Engineering.

LAW

Complete Professional Law Course includes 18 Hornbook Series college grade textbooks. Courses also in Commercial Law, Patent Law and Medical Jurisprudence.

McKinley-Roosevelt Incorporated, 4610-K, Sheridan Rd., Chicago 40, Ill.

MEN and WOMEN



Buy and sell world-wide without capital. Travel abroad if desired. Men or women! Your own business—profits unlimited. Export manager salaries to \$10,000 a year. Practical, low cost home study course teaches you quickly in spare time. No previous special experience or schooling needed. World Trade Certificate awarded. Write today for FREE DETAILS. State if veteran. Airmail reaches us overnight. THE MELLINGER CO., Exporters-Importers, 1422-AQ Westwood, Los Angeles 24, Calif.



BAR BELLS

Buy Direct From Factory
Save 20% to 30% \$8⁹⁵
up

Write for Free Booklet
and Price List

INDEPENDENT IRON WORKS
2440 EAST 23RD STREET, DEPT. 15
LOS ANGELES, CALIFORNIA

Speed and Power Handbook

Very latest methods! Construct your own super-chargers, water injectors, compression heads, fuel saving devices—easily, practically without cost. Get racing speed, acceleration, dynamic power increases from any automobile! Build stock conversions! Fast roadsters. Hot-rods. Get ingenious formulas! Speed secrets! Also "Economy Information," Tuning techniques! Ignition! Carburetion! Mileage tricks. Illustrations! Including "Restyling Ideas"—Streamlining. Model revising! Customizing! Sport changes. Photographs! Parts lists! Drawings! ORDER TODAY. \$1.98 POSTPAID.



5941-84 Hereford

Los Angeles 22, Calif.

Learn LANDSCAPE GARDENING

A thorough, interesting, home study course for those who wish to become LANDSCAPERS, GARDENERS, DESIGNERS, etc., for profit or pleasure. Write today for FREE BOOK to

APPROVED FOR VETERANS

NATIONAL LANDSCAPE INSTITUTE
Dent. P-8, 310 So. Robertson, Los Angeles 36

RUPTURED?

HERE'S COMFORTABLE, SAFE RELIEF!



Made of molded rubber, soft and pliable, this form-fitting truss is bringing new comfort, with safe protection, to thousands. Based on nature's way, WEB Truss gives strong support without painful pressure. Has no springs or leather, is completely washable. Under money-back guarantee of satisfaction, you run no risk. Write today for FREE illustrated literature.

WEB TRUSS CO. Dept. M-8 Hagerstown, Md.



You receive all parts, including tubes, for building this fine, modern Superheterodyne Receiver. This and other valuable standard equipment becomes your property.

Learn RADIO

TELEVISION, ELECTRONICS

by

SHOP METHOD HOME TRAINING

Let NATIONAL SCHOOLS, of Los Angeles, a practical Technical Resident Trade School for almost 50 years, train you for today's unlimited opportunities in Radio

these two **FREE** books will tell you how

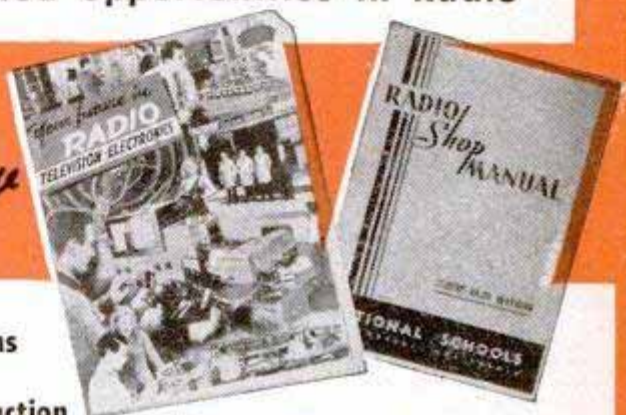

GOOD JOBS AWAIT THE TRAINED RADIO TECHNICIAN

You are needed in the great, modern Radio, Television and Electronics industry! Trained Radio technicians are in constant and growing demand at excellent pay—in Broadcasting, Communications, Television, Radar, Research Laboratories, Home Radio Service, etc. National Schools Master Shop Method Home Study Course, with newly added lessons and equipment, can train you in your spare time, *right in your own home*, for these exciting opportunities. Our method has been proved by the remarkable success of National Schools-trained men all over the world.

You Learn by Building Equipment with Standard Radio Parts We Send You

Your National Schools Course includes not only basic theory, but *practical* training as well — *you learn by doing*. We send you complete standard equipment of professional quality for building various experimental and test units. You advance step by step until you are able to build the modern superheterodyne receiver shown above, which is yours to keep and enjoy. You perform more than 100 experiments—build many types of circuits, signal generator, low power radio transmitter, audio oscillator, and other units. The Free Books shown above tell you more about it—send for them today!



NOW! NEW PROFESSIONAL MULTITESTER INCLUDED

This versatile testing instrument is portable and complete with test leads and batteries. Simple to operate, accurate and dependable. You will be able to quickly locate trouble and adjust the most delicate circuits. You can use the Multitester at home or on service calls. It is designed to measure AC and DC volts, current, resistance and decibels. You will be proud to own and use this valuable professional instrument.



Lessons and Instruction

Material Are Up-to-Date, Practical, Interesting

National Schools Master Shop Method Home Training gives you basic and advanced instruction in all phases of Radio, Television and Electronics. Each lesson is made easy to understand by numerous illustrations and diagrams. All instruction material has been developed and tested in our own shops and laboratories, under the supervision of our own engineers and instructors. A free sample lesson is yours upon request — use the coupon below.

Here's Just a Few of the Interesting Facts you Learn with the

FREE MANUAL

1. Routine for diagnosing Radio Troubles.
2. Preliminary Inspection of Receivers.
3. How to Test and Measure Voltages.
4. How to Test Speaker in Audio Stages.
5. How to Trace the Circuit and Prepare Skeleton Diagram.
6. Complete Reference Table for Quickly Locating Receiver Troubles.

Both Resident and Home Study Courses Offered

APPROVED FOR VETERANS
CHECK COUPON

NATIONAL SCHOOLS

LOS ANGELES 37, CALIFORNIA EST. 1905



MAIL OPPORTUNITY COUPON FOR QUICK ACTION

National Schools, Dept. PM-8
4000 South Figueroa Street
Los Angeles 37, California

(Mail in envelope or paste on penny postcard.)

Mail me **FREE** the books mentioned in your ad including a sample lesson of your course. I understand no salesman will call on me.

NAME _____ AGE _____

ADDRESS _____

CITY _____ ZONE _____ STATE _____

Learn A Trade NOW! PRACTICAL SHOP TRAINING!

In Our Chicago Shops

- | | |
|---|--|
| <input type="checkbox"/> AUTO MECHANICS | <input type="checkbox"/> WELDING—ARC and GAS |
| <input type="checkbox"/> DIESEL MECHANICS | <input type="checkbox"/> MACHINIST |
| <input type="checkbox"/> REFRIGERATION | <input type="checkbox"/> PIANO TUNING |
| Above Approved For G. I.'s and Civilians | |
| <input type="checkbox"/> BODY-FENDER | |

One of America's Leading Practical Schools
7 Floors of Fully Equipped Shops
Over 48,000 Successful Graduates
Expert Individual Instruction
Learn by Doing—Low Living Expense
Established 1902—Day and Evening Classes

Also the following Home Study Courses

- | | | |
|----------------------------------|--|---------------------------------|
| <input type="checkbox"/> PLASTIC | <input type="checkbox"/> REFRIGERATION | <input type="checkbox"/> DIESEL |
|----------------------------------|--|---------------------------------|

—CALL IN PERSON OR MAIL THIS AD TO— GREER SHOP TRAINING

(Dept. PM-288) 460 South State St., Chicago 5, Ill.

Please send without obligation free information regarding trade checked above. (Specify whether you are a Veteran or Civilian)

Name _____ Age _____

Address _____

City _____ State _____

MAKE \$ MORE MONEY

Applying or Selling

CORKSTONE

A General Purpose Magnesium Oxychloride Flooring

THE MODERN PLASTIC FLOORING

EASY TO APPLY
Here's your opportunity to get into business for yourself applying or selling Corkstone, the economical, top-grade plastic flooring. Plenty of profit Act without delay!



Dealers & Agents Wanted

WRITE FOR DETAILS

LASTING PRODUCTS COMPANY

Franklinton Road Plant,

Baltimore 23, Md.

New
Advertising
Machine



Prints & Illustrates 1¢ Post Cards

FREE Learn how thousands of business men, in every line, are boosting sales in spite of conditions—with 1¢ messages—printed and illustrated in a few minutes on gov't post cards—with amazing new patented **CARDMASTER**. Your "today's" ideas, read by your prospects next morning. Not a toy, but a sturdy advertising machine, built to last for years. Low price, sold direct. Guaranteed for five years. Send name today. **SEND NAME** We'll send **FREE** illustrated book of money-making **IDEAS** for your business and complete, unique advertising plans. **RUSH YOUR NAME TODAY.**
CARDMASTER COMPANY
4546 RAVENSWOOD, Dept. 138, CHICAGO 40, ILL.

For Quick
Advancement

Learn

WOOD PRODUCTION ENGINEERING



VETERANS
training is **FREE**
under G. I. BILL.

For quick advancement learn Furniture Drafting and Engineering. You can master these subjects in a short time, either through Home Study or by coming to Grand Rapids. Write for Free information Today. State interest, whether correspondence course . . . or residence course . . . Also state if veteran.

KLOK INST. LOUIS ST. N.W.
GRAND RAPIDS, MICH.

AVIATION TRAINING

AERONAUTICAL ENGINEERING AIRCRAFT and ENGINE MECHANICS (A & E)

Train on famous Northrop Field—New classes starting soon.
Write for illustrated catalog.

Northrop Aeronautical Institute

1527 E. BROADWAY Division of Northrop Aircraft, Inc. LOS ANGELES COUNTY
HAWTHORNE CALIFORNIA

APPROVED FOR VETERANS

GET FREE SAMPLES OF CHRISTMAS



Show gorgeous **EMBOSSED** Name-Imprinted Christmas Cards low as 50 for \$1. Sensational selling values! You keep **BIG PROFIT!** Extra Dollars with smart, new Assortments including lovely 21-Card "Feature" \$1 Christmas Box. Other profit-bringers—Religious, Everyday, Gift Wraps, 50 for \$1 Stationery. Get samples on approval—including **FREE** imprint Samples.

CARDS
To Sell At
50 for
\$1 WITH NAME

Friendship Studios, Inc., 162 Adams St., Elmira, N. Y.

Now CHEAP OIL BURNER

FOR HEATING AND COOKING STOVES—FURNACES
HEAT YOUR HOME, COOK YOUR MEALS
WITH CHEAP FURNACE OIL

NO MORE SHOVELING COAL OR ASHES. Sensational Fuelizer Starter Vaporizing System turns Cheap No. 1 Furnace Oil, also Range, Heater, Tractor Distillate, Kerosene and like oils into oil heat—one of the quickest, hottest fires known. **LIFETIME GUARANTEE. \$1.00 Bonus Offer for Testing.** We will let you try it in your own stove or furnace for one month. Get yours for introducing. Big profits **QUICK.** Be first. Send in your name today for details and cash in on the tremendous demand for this Amazing Invention.

NORTHWEST MFG. CO., 608-K, Mitchell, S. Dak.





Learn BUILDING

AT HOME • All Blue Print Building Plans, Specifications, Lessons Furnished

Earn more money as a building tradesman. Prepare for advancement and increased pay as a building foreman, superintendent, inspector, estimator, material buyer or salesman. Train to be a building contractor, have your own money-making business in this busy, prosperous building field.

More than 19 million new homes needed in U. S., say experts. New building now at rate of one million homes a year, plus 200,000 commercial buildings, plus expanding farm building construction.

Mail coupon today. FREE book tells how you learn Building Construction — How to Read Blue Prints, and Estimate Building Costs — at home in your spare time. Learn modern construction methods and materials, how to lay out work and direct all building operations. This is the training needed for rapid advancement to higher-paid jobs, or your own successful building business.

FIND OUT ABOUT TRAINING AND OPPORTUNITIES FOR YOU IN BUILDING

Established in 1904, Chicago Technical College offers you thorough, practical training in Building, by home-study. Mail coupon for free information. See what this Course has done for others, what it can do for you. Read what Chicago Tech graduates say about their work, earnings, success. Learn the rewards awaiting you as a trained builder — and how quickly, easily you can get started. Simply MAIL COUPON TODAY in an envelope or paste on a penny postcard.



CHICAGO TECHNICAL COLLEGE
K-152, Tech Building, 2000 South Michigan Ave.
Chicago 16, Illinois

MAIL COUPON NOW

CHICAGO TECHNICAL COLLEGE
K-152, Tech Bldg., 2000 So. Michigan Ave.
Chicago 16, Illinois

Mail me FREE building Lesson with information about big opportunities in BUILDING and how I can train at home.

Name _____ Age _____

Address _____

City _____ Zone _____ State _____



WOULDN'T TAKE \$1000 FOR COURSE

"The lessons are so simple that anyone can understand them. I have learned to play by note in a little more than a month. I wouldn't take a thousand dollars for my course."
*S. E. A., Kansas City, Mo.



PLAYS ON RADIO

"I can't keep from telling you that I have a good position playing from KTHS, Hot Springs, Ark., every morning."
*J. S., Okla.



PLAYS AT DANCES

"The Piano course I'm taking is the 3rd course with your school. Over 20 years ago I took Saxophone and Clarinet. Since then I've played a lot of dance jobs."
*E. A., Lake View, Iowa

THOUSANDS NOW PLAY who never thought they could!

You, too, can play any instrument by this EASY A-B-C METHOD

YOU think it's difficult to learn music? That's what thousands of others have thought! Just like you, they longed to play some instrument. But they denied themselves the pleasure—because they thought it took months and years of tedious study to learn.

And then they made an amazing discovery! They learned about a wonderful way to learn music at home—without a private teacher—without tedious study—and in a surprisingly short time. They wrote to the U. S. School of Music about this remarkable short cut method. A free print and picture sample actually showed them how easy it was to learn.

The result? Over 850,000 people have studied music at home this simple, A-B-C way. They have found the key to good times, popularity and profit.

And that's what you can do right now. Simply mail the coupon below. Get the proof that you, too, can learn to play your favorite instrument—quickly, easily, in spare time at home. Just read the fascinating illustrated booklet—examine the print and picture sample.

If interested, tear out the coupon now, before you turn the page. Instruments supplied when needed, cash or credit. U. S. School of Music, 78 Brunswick Bldg., New York 10, N. Y. 50th year.

*Actual names on request. Pictures by professional models.

SEND FOR FREE PRINT AND PICTURE SAMPLE

U. S. School of Music, 78 Brunswick Bldg., New York 10, N. Y.

I am interested in music study, particularly in the instrument indicated below. Please send me your free booklet, "How to Learn Music at Home," and your Print and Picture Sample. (Do you have instrument?)

Piano	Piano Accordion	Reed Organ	Clarinet
Guitar	Saxophone	Tenor Banjo	Trombone
Violin	Trumpet, Cornet	Ukulele	Other Instruments

Name _____ (PLEASE PRINT)

Street _____

City _____ State _____

Check here if under 16 years of age.

SAVE 2c—Stick coupon on penny postcard

GOOD JOB BIG PAY



1,054 Want Ads in Newspapers in One State in One Month Alone Shows Amazing Big Demand for

TRAINED AUTO BODY, FENDER and PAINT MEN

Here's A BIG OPPORTUNITY to earn more money in a steady, good pay job. This specialized trade taught you thoroughly and quickly the practical, modern way by the SWEENEY SYSTEM of Practical Experience. 87,675 auto and tractor mechanics taught since 1908 in my schools, nationally known. All the latest, modern equipment, expert teachers, tools furnished. YOU LEARN BY DOING—PRACTICALLY. Your future success depends on proper training—and getting into a business that is NOT overcrowded. Get the FREE PROOF, the full particulars about this most amazing opportunity for a quick, BIG PAY JOB. Mail coupon below NOW.

APPROVED for VETERANS TRAINING Under P.L. 346 and P.L. 16

SWEENEY AUTO SCHOOL, Inc.
Dept. 20, 2901 East 14th St., Kansas City 1, Mo.

FREE
LITERATURE
POSTPAID

E. J. Sweeney, President
Sweeney Auto School, Inc.
Dept. 20, 2901 East 14th St.
Kansas City 1, Mo.

Name _____

Address or RFD _____

City _____

Veteran

Non-Veteran

U.S. GOVERNMENT JOBS

START AS HIGH AS \$3,021 YEAR

Men—Women
Prepare NOW for Next Examinations.

FRANKLIN INSTITUTE
(Not Gov't Controlled)
Dept. E85, Rochester 4, N. Y.
Sirs: Rush without charge (1) 40-page Civil Service book with list of U. S. Government Jobs. (2) Tell me how to qualify for one.

Vets Get Preference. Mail Coupon today sure.

Name _____

Address _____

Vet? _____

AIR RIFLES

BENJAMIN
PIONEERS - LEADERS

AIR PISTOLS

SEND FOR FREE FOLDER OF LATEST MODELS TODAY If you want a REAL GUN for PRACTICAL USE inside or outdoors get a SAFE - CLEAN - ECONOMICAL - BENJAMIN with Adjustable Power and Amazing Accuracy. For BEST RESULTS use BENJAMIN H-C PELLETS. WRITE AT ONCE. BENJAMIN AIR RIFLE CO., 812 MARION ST., ST. LOUIS 4, MO.

THE GREATEST THING

IN PLASTICS!

PLASTICAST



PLASTICAST is a liquid plastic; can be poured into ANY kind of mold or container. Hardens in a few minutes into a transparent solid, clear-as-glass, tough-as-steel plastic! No tools or machinery required. As easy to use as pouring water out of a glass! Ideal for imbedding flowers, butterflies, photos, souvenirs, and for making beautifully brilliant jewelry, gems, displays, fishing lures, magnifiers, lenses, knick-knacks and novelties. Easily cast into sheets, rods or blocks, ANY shape, ANY color. EVERYTHING FURNISHED, including molds for making PENDANT HEARTS, ENCHANTED GARDENS, MAGNIFYING GLASSES, etc., sufficient materials for making about \$100.00 worth of attractive novelties! The ONLY outfit on the market containing molds! C.O.D. orders accepted with \$1.00 deposit.

COMPLETE MASTER OUTFIT \$3.50
Postpaid U.S.A. and Canada only

FREE

A very attractive and useful novelty made of one of our products given absolutely free with every one of our catalogs! Catalog lists many new materials for making MOLDS and CASTINGS with Liquid Plastics, Liquid Ivory, Liquid Marble, Wax, Latex, Metal, Castwood, Plaster, etc.; also many molds listed. Price of catalog only 10c coin or stamps.

PLASTICAST CO. (Dept. C)

5961 Madison St.
Chicago 44, Illinois

We have no retail store—
order by mail only.

P. O. Box 987
Palo Alto, Calif.

ELECTRICAL TRAINING

Intensive 32 weeks' residence course in fundamentals of industrial electrical engineering, including radio, electronics. Prepares for technician, engineering aides. Approved for veteran training. 54th year. Enter November 22, April 4. Catalog.

BLISS ELECTRICAL SCHOOL
7638 TAKOMA AVENUE
WASHINGTON 12, D. C.



LEARN MEAT CUTTING At Home—In Spare Time

Get into the vital meat industry. Concise, practical Home Training based on 25 years proven instruction methods used at National's famous resident school. Prepares you for bigger pay as Meat Cuts, Supervisor, market manager or more money in your own store. Go as rapidly as your spare time permits. Diploma. Start NOW to turn your spare hours into money. Send for FREE bulletin today. No obligation.

National School of Meat Cutting, Inc., Div. U-96, Toledo 4, Ohio



LEARN MOVIE PROJECTION THEATRE MANAGEMENT

The Motion Picture Theatre Business offers big opportunities for trained men. Get into a fascinating field with a promising future. Train at home in spare time. Free Catalog. Established 20 years.

THEATRE SCHOOL, 370 Washington St., Elmira, New York

SAY YOU SAW IT IN POPULAR MECHANICS

DRAW for MONEY... Be an ARTIST!

Trained Artists are Capable of Earning \$60-\$75 OR MORE A WEEK!

You can learn to draw at home in your spare time the well-known WSA way. COMMERCIAL ART, DESIGNING, CARTOONING—all in ONE complete course. No previous art experience necessary—we teach you step-by-step. Prepare now for a fascinating hobby or profitable career. For 34 years WSA graduates have been making good—WHY NOT YOU?



VETERANS!
WSA is approved for training under the G. I. Bill

Write today for FREE BOOK, "Art for Pleasure & Profit." It fully describes our correspondence course, instruction service, and commercial opportunities for you. TWO ART OUTFITS and other features included with training.

WASHINGTON SCHOOL OF ART, Studio 128M
1115—15th St., N.W., Washington 5, D. C.

Please send me full information and your Free Book, "Art for Pleasure and Profit."

Name _____ AGE _____

Street _____

City _____ Zone _____ State _____

I am entitled to training under the G. I. Bill.

POPULAR MECHANICS

Now YOU Can Lick Any AUTO REPAIR JOB!

IN LESS TIME—WITH LESS WORK



**FREE
7-DAY OFFER**



MoToR's New Auto REPAIR MANUAL shows you how to service and repair ANY part of ANY car!

drawings show you exactly WHAT to do and HOW to do it! Used by the U. S. Army, trade and technical schools everywhere, thousands of auto servicemen.

Now YOU—without cost—can see for yourself what a wonderbook MoToR's Auto Repair Manual really is. TRY it—FREE for 7 days! Learn first-hand how it can pay for itself the first few times you use it.

SEND NO MONEY 7-Day Free Examination

Just mail coupon below—without money! When the postman brings your book, pay him nothing. First make it show you what it's got! Unless you agree this is the greatest time-saver and work-saver you've ever seen—return book in 7 days and pay nothing. Mail coupon today! Address: MoToR Book Department, Desk 1J, 572 Madison Ave., New York 22, New York.

Clear, Pictured Facts on Every Job on Every Car Built Since 1935!

Nearly 200,000 service and repair facts on all these makes:

American	Ford	Nash
Bantam	Frazer	Oldsmobile
Auburn	Graham	Packard
Austin	Hudson	Pierce
Buick	Hupmobile	Arrow
Cadillac	Kaiser	Plymouth
Chevrolet	Lafayette	Pontiac
Chrysler	La Salle	Reo
Cord	Lincoln	Studebaker
Crosley	Lincoln	Terraplane
De Soto	Zephyr	Willys
Dodge	Mercury	

Over 700 big pages; including 70 pages of carburetor text, charts, illustrations, covering all models. Over 200 charts, tables: Tune-up Chart; Valve Measurements; Compression Pressure; Torque Wrench Reading; Starting Motor; Engine Clearances; Generator; Body Service; Dash Gauges; Brake Specifications; Front End Measurements, etc.; Engines; Electric, Fuel, Cooling, Lubricating Systems; Transmissions; Universals; Front Ends; Wheels; Rear Ends, etc.

No Other Manual Like It!

This BIG book—764 pages, 8½x11 inches, bound in sturdy fabric—brings you nearly 200,000 service, repair, adjustment, replacement, tune-up facts on every car built from 1935 to 1948! More than 1700 cut-away photos, diagrams,

Same FREE 7-Day Offer Applies on

MoToR's TRUCK REPAIR MANUAL

For mechanics, truck specialists, service stations, fleet owners. Covers EVERY job on EVERY truck made since 1936! 1400 pictures, 952 pages, 300,000 facts. Used by Armed Forces. Warranted to contain every essential fact you need to know. Sturdy binding, size 8½x11. Covers all types Gasoline En-

gines: Diesels and Hesselmanns. Fuel Systems, Governors, Lubrication Systems, Ignition Systems, Starters, Generators, Clutches, Transmissions, Axles, Torque Dividers, Transfer Cases, Brakes, Steering, etc., etc.

ALSO SERVICES buses, farm and industrial tractors, contractor and road building equipment, stationary power machinery, etc. (on all parts described in Manual). Offered on same FREE 7-Day examination as Auto Repair Manual. Check box in coupon at right.



MoToR Published by MoToR, The Leading Automotive Business Magazine. MoToR's manuals assure high standards of repair work.

MAIL COUPON NOW FOR 7-DAY FREE TRIAL

MoToR Book Dept., Desk 1J, 572 Madison Ave., New York 22, N. Y. Rush to me at once: (check box opposite book you want)

MoToR's AUTO REPAIR MANUAL. If O.K. I will remit \$1 in 7 days, (plus 35c delivery charge), then \$2 monthly for 2 months, and a final payment of 95c one month later. Otherwise I will return book postpaid in 7 days. (Foreign price, remit \$8 cash with order.)

MoToR's TRUCK REPAIR MANUAL. (Described at left.) If O.K. I will remit \$2 in 7 days, and \$2 monthly for 3 months, plus 35c delivery charge with final payment. Otherwise I will return book postpaid in 7 days. (Foreign price, remit \$10 cash with order.)

Print Name _____ Age _____

Print Address _____

City _____ Zone No. _____ (if any)

State _____ Occupation _____

Check box and SAVE 35c delivery charge by enclosing WITH COUPON entire payment of \$5.95 for Auto Repair Manual (or \$8.00 for Truck Repair Manual). Same 7-day return privilege applies.

Learn RADIO -TELEVISION



in the GREAT SHOPS OF COYNE

Get ready for a better job, bigger pay NOW in Radio. Cash in with "All-around" knowledge of Radio—Television. Train on actual equipment. You learn easily at COYNE because it's real shop training. Thousands of graduates in Industry.

Not a "Home-Study" Course!

You get actual shop work on full-size equipment plus necessary theory. Whether you had previous experience or not makes no difference at Coyne.

Easy To Start Own Shop

Right along with our course, we include special training on how to operate your own Radio Shop.

GI Approved—Finance Plan for Non-Vets EARN WHILE LEARNING

If you need part-time work to help out with living expenses while at Coyne we'll help you get it. Don't be held back by lack of money. Free employment service to graduates.

SEND FOR FREE BOOK

Get the facts! BIG FREE BOOK tells about your future in Radio and Television and how you can prepare at Coyne. Dozens of pictures. No obligation—no salesman will call.

Established 1899

MAIL COUPON TODAY!

B.W. COOKE, President
COYNE Electrical and Radio School
500 S. Paulina St., Dept. C8-3H, Chicago 12, Ill.

Please send me your Big Free Radio and Television Book and all the facts.

NAME.....

STREET.....

CITY..... STATE.....



COYNE

Gives You All-Around Training

- RADIO MFG.
- TELEVISION
- FREQUENCY MODULATION (FM)
- RADIO SERVICE (Your own shop)
- SOUND SYSTEMS

- ★ WRIST WATCH
- ★ STOP WATCH
- ★ TELEMETER
- ★ TACHOMETER

Phenomenal Value! 17 JEWEL • 2 PUSH BUTTON CHRONOGRAPH



ONLY \$29⁷⁵ PLUS 10% TAX

INCABLOC SHOCK RESISTANT FEATURE
• Sweep Second Hand
• Radium Dial • Anti-Magnetic • Unbreakable Crystal. (formerly \$71.50)

IDEAL FOR
• Physicians • Engineers
• Radio Men • Sportsmen
• Photographers • Aviators

OUR GUARANTEE

MONEY BACK IN 10 DAYS

If not satisfied for any reason

ADLEW JEWELERS
Dept. PM-7

117 W. 42nd St., N. Y. C. 18

Mail Orders Promptly Filled • Shipped C.O.D. or send check or money order.

Address mail-orders to:
ADLEW JEWELERS, 152 West 42nd St. N.Y.C. 18 (Dept. PM-7)

Also available in 18-k Gold Case. \$64.50 (plus 10% tax), formerly \$125.

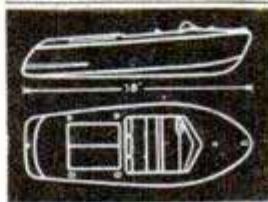

BOAT PATTERNS • BLUEPRINTS

70 Modern plywood designs by leading naval architects. Large scale, fully detailed blueprints, full size paper patterns available. Kayaks to cruisers, 10'-power-sail, 16 to 30 ft.). Send 25c (coin) for Design Catalog, or \$1.00 for Catalog plus booklet, "How to Build Plywood Boats."

MARINE MART, Buffalo 7-B, New York

PRACTICAL MATHEMATICS LIBRARY

Easy self-instruction in 25 branches by college experts. Helps you qualify for better job. 4 volumes, 1300 pages, 600 illustrations. Sent for free trial. Only \$2.00 down, \$2.00 a month; total \$9.50 plus postage. (Cash price \$9.50, postage free.) 140-page Location book free with order. National Educational Alliance, Inc., Dept. 568, 37 West 47th St., New York 19, N. Y.

START A CAREER IN PHOTOGRAPHY

• Photography can be your key to a pleasant, profitable career. Learn the professional way with expert Yawn training. Individual instruction by masters of the camera. Excellent equipment. Thorough 17-week courses in all branches of modern photography—Basic, Commercial, Portrait, Color. Coeducational. G.I. approved. Folder.

Howard W. Yawn, Director
Dept. A, 511-19 N. Broad St., Philadelphia 23, Pa.
YAWN SCHOOL OF PHOTOGRAPHY INC.

MAKE MONEY MAKING DOUGHNUTS

Make new greaseless doughnuts at home on electric machine. Sell for cash to grocers, cafes, drug stores, etc. No exp. nec. Good profits. Small investment. Send for free recipes and plans.

MART RAY CO. • 3605 S. 15 Ave. • Minneapolis 7, Minn.



Dependable, easy to give, scientifically prepared and low in cost, NEMA Worm Capsules effectively remove large round worms and hookworms in dogs and cats.

FREE! Send for illustrated, helpful worm booklet.
PARKE, DAVIS & CO., DETROIT 32, MICH.

DRUG STORES SELL PARKE-DAVIS PRODUCTS

LEARN **DIESEL** THE QUICK, EASY WAY



THE FAMOUS HEMPHILL WAY!

Wherever Diesels are used, the name "HEMPHILL" is famous. It stands for TRAINED MEN—men who *know* Diesel. Many trained Diesel graduates of Hemphill Schools are successfully engaged in work where their Diesel training is "paying off." Perhaps they are assembling Caterpillar Tractors, or servicing Cummins-powered trucks, or installing and maintaining General Motors' Diesels. Perhaps they are working with these and other makes of Diesel engines in trains, ships, drilling rigs, sawmills or construction equipment—but no matter what the Diesel job, Hemphill trained men

have the "know how" to handle it.

Prepare YOURSELF for the great industrial swing to Diesel power which is now here. Get complete details of Hemphill Diesel training now!

STUDY AT HOME—Learn Diesel AT HOME in your spare time, without interfering with your present activities. Prepare for a bigger future this quick, easy way. Mail the coupon below for complete details and free literature. Or attend 34 weeks resident classes at schools listed below.

APPROVED FOR VETERANS

AUTOMOTIVE TUNE-UP SPECIALIST TRAINING at Memphis and Los Angeles. Check coupon.

NEW YORK 31-28 Queens Blvd. Long Island 1, N. Y.
LOS ANGELES 1601 S. Western Ave. Los Angeles 6, Calif.
MEMPHIS 311 S. Main St. Memphis 3, Tenn.

34 weeks practical training. If you would prefer to train at one of these three schools, indicate by check on coupon.

MAIL COUPON NOW!

HEMPHILL DIESEL AND AUTOMOTIVE SCHOOLS

Administrative Office: 1601 South Western Ave., Dept. PM-88
 Los Angeles 6, California

Gentlemen: Please send me FREE BOOKLET and information on your Diesel Courses. I am interested in Home Study Resident School at New York Memphis Los Angeles (Check school desired.) Auto Tune-up L.A. Memphis

Name _____ Age _____
 Street _____ Zone _____
 City _____ State _____
 Veteran Non-Veteran

GET INTO BUSINESS for YOURSELF

meet the demand for...

Metalized BABY SHOES

...in your own home in spare time



WE HELP YOU • STEP BY STEP!

- HOW TO START
- HOW TO BRING THE BUSINESS
- HOW TO METALIZE THE WARNER WAY
- HOW TO PYRAMID PROFITS

This is a lifetime opportunity! No matter what you're doing now, you can get set for the future while beating today's high cost of living. Our plan offers everything you need to know... a completely charted path to personal independence — with your home as your "factory."

This tested and proved plan is working right now. Backed by an old company, it's sent to you on a No-Risk Trial, Money-Back Guarantee! The exclusive Warner Method applies an actual coat of pure metal, in genuine Gold, Silver or Bronze finish, "Eternalizing" Baby Shoes and other keepsakes forever. The de-

mand for these Metalized Keepsakes is big... and getting bigger every day. (More than a million dollars' worth last year.) In every way, it's a proved proposition. Proud parents everywhere buy on sight!

A NEVER ENDING MARKET

No matter where you live, small town or big city, there is a never ending, ready-to-buy market for "Eternalizing" Baby Shoes — more than 3,500,000 babies this year. This tested plan reaches out and brings in the business. Spare or Full Time, you can make money!

BE YOUR OWN BOSS

Get the facts on this new opportunity. Mail the coupon below... TODAY. We'll send you fully descriptive literature, on our No-Risk Trial and Positive Guarantee: "Money Back If You Say So."

Isn't This What You Are Looking For!

1. Steady Income
2. Permanent Future
3. Wide-open Market
4. No House to House
5. Plan Works for You
6. Backed by 25 Year Old Company
7. No-Risk Trial
8. Money-Back Guarantee

SEND THIS COUPON NOW, FOR SURE!

WARNER ELECTRIC COMPANY, Dept. 38
 1512 Jarvis Ave., Chicago 26, Illinois

Please send, without obligation, complete details about your No-Risk Trial, Money Back Plan for "Eternalizing Baby Shoes for Plus Profits."

NAME _____
 ADDRESS _____
 CITY _____ ZONE _____ STATE _____

WARNER ELECTRIC COMPANY, Dept. 38
 1512 JARVIS AVE. CHICAGO 26, ILLINOIS

Paint Your Car for **\$3.95** ONLY

2 FULL COATS ONE QUART DOES ENTIRE JOB

WITH **WYPE** TRADE MARK REG.

NO SPRAYING · NO MASKING · NO BRUSHING

AMAZING NEW BRUSHLESS
AUTO ENAMEL
 You **JUST WIPE ON**
 with a **POWDER PUFF**
 instead of Brushing or Spraying



Get Beautiful Mirror Like Finish
 That Looks Like Spray Job!

Dries Dust Free One Hour · No Streaks or Lapmarks

At last! Practically anyone can now paint his car with WYPE! No previous car-painting experience necessary. You get a beautiful high-gloss job that gives you an expensive finish such as is sprayed on by Professional Auto Painters—at a fraction of regular cost! With WYPE you need **NO BRUSH, NO SPRAY, NO MASKING!** Just **WIPE ON** with Powder Puff—which we furnish at no extra charge. You get a brilliant, glossy finish that is truly "factory-like." No streaks. No lap-marks. Guaranteed for **TWO** years not to crack, peel, chip or fade, if simple directions are followed. Takes about an hour to apply. Dries dust-free in an hour. WYPE comes in nine most popular shades including those on newest model cars. Goes over any other color, lacquer or enamel.

MOST POPULAR COLORS

- Black Brewster (dark) Green
- Maroon Jewel (light) Green
- Red Washington (dark) Blue
- Gray Monticello (light) Blue
- Sun Beige (light) Tan

\$3.95
 Per Quart

SEE YOUR DEALER or ORDER DIRECT
 SEND NO MONEY · Get WYPE Today!

If your dealer can't supply you, just send us a postcard. We'll ship C.O.D. Just pay mailman for Wype, plus postal charges. Or send remittance with order and WE pay postage

You're **SURE**
 You Are **SAFE**
 when You Paint
 with **WYPE**
 HERE'S WHY!

TESTED BY
 U. S. Testing Co., Inc.

Leading Scientific
 Testing Laboratory

Report No. 87496
 Jan. 5, 1948

and found to conform
 to the claims and
 guarantee of the Wype
 Corporation.

No higher or more rigid standards are set by any Testing Laboratory. United States Testing Company conducts scientific tests for the world's foremost organizations and is accepted as a leading authority on such tests.

For Your Protection
 Before you buy any automobile paint, ask for proof that it has passed tests by a nationally known testing laboratory. Remember the value of your car! You can **TRUST** Wype.

2-YEAR GUARANTEE

We Guarantee WYPE against cracking, peeling, fading or chipping for two years after application, if applied according to directions furnished. Your money cheerfully refunded if WYPE does not live up to this Guarantee.

COPYRIGHT 1948, WYPE CORP



**APPLY in ONE HOUR —
 DRIES to GLISTENING
 PROFESSIONAL FINISH**

WYPE is a new Miracle Enamel for Autos. It is NOT a wax or polish but a hard high lustre ENAMEL finish! With WYPE, ANYONE can do a beautiful job! Order a quart to paint your car or to get started in this **BIG-MONEY** Business!

**NO STREAKS OR LAPMARKS
 LOOKS LIKE SPRAY JOB**

**WANTED
 WYPE
 DEALERS**

**WYPE 2 Cars Daily
 at \$25 Each—Gross
 Up to \$260 Weekly**

Start making **BIG MONEY** now! Sell WYPE in cans or go into business painting cars yourself (or hire others). Send for **FREE** details of powerful money-making plan. Why wait? Start now by ordering one quart or more of WYPE today!

**OVER 200,000
 CARS PAINTED
 WITH WYPE**

and thousands more being painted every week. The final test of customer satisfaction—thousands of our new customers are being sent to us by old customers!

Some of the FAMOUS DEPARTMENT STORES that Sell WYPE

**VISIT or PHONE
 THE STORE IN
 YOUR CITY...**

If you live in one of the cities shown here, it will be more convenient to buy from your favorite department store. Ask your dealer! Leading merchants everywhere sell WYPE.

- Akron: M. O'Neill Co.
- Baltimore: May Co.
- Boston: Jordan Marsh Co.
- Buffalo, N. Y.: J. N. Adam & Co.
- Chicago: Goldblatt's 15 Dept. Stores (Goldblatt's, also, at Joliet, Ill.; Hammond, Gary & South Bend, Ind.)
- Cincinnati: Fair Store Co.
- Cleveland: May Co.
- Dallas: Sanger Bros., Inc.
- Denver: May Co.
- Detroit: People's Outfitting Co.
- Ft. Worth: W. C. Stripling Co.
- Grand Rapids, Mich.: Herpolzheimer Co.

- Hackensack, N. J.: Packard-Bamberger Co.
- Houston: Foley's
- Indianapolis: Wm. H. Block Co.
- Kansas City, Mo.: Jones Store Co.
- Los Angeles: May Co.
- Louisville: Kaufman-Straus Co.
- Memphis: B. Lowenstein & Bros.
- Milwaukee: Ed. Schuster & Co., Inc.
- Minneapolis: Donaldson's
- Montgomery: Montgomery Fair Store
- New Orleans: Maison Blanche Co.
- Newark, N. J.: Bamberger's
- New York: Gimbel's

- Philadelphia: Lit Brothers
- Pittsburgh: Kaufmann's
- Providence, R. I.: The Shepard Co.
- Richmond, Va.: Miller & Rhoads, Inc.
- Rochester, N. Y.: Sibley, Lindsay & Curr
- St. Louis: Famous-Barr Co.
- St. Paul, Minn.: The Golden Rule
- San Antonio: Joske's of Texas
- San Diego: Whitney's
- Syracuse, N. Y.: Dey Bros. & Co.
- Toledo: Lion Dry Goods Co.
- Warren, Ohio: Griswold's
- Washington, D. C.: Lansburgh & Bro.
- Youngstown, O.: Strauss-Hirschberg Co.

WYPE CORP. Dept. 16-H 2214 DOLMAN ST. ST. LOUIS 4, MO.

**WORLD'S
BEST
WANT AD
MEDIUM**

CLASSIFIED Advertisements



Advertisements in this section 75 cents per word, each insertion, minimum 10 words, payable in advance
To be inserted under proper classification, copy must be in our office the 22nd of the
second month preceding date of issue

F. W. Johnson, Manager, Classified Advertising
Popular Mechanics Magazine, 200 East Ontario Street, Chicago 11, Illinois

YOU'LL PROFIT

By reading and answering the classified
ads in this section. Hundreds of oppor-
tunities for you to make and save money

AUTOMOBILES, MIDGET CARS

"CUSTOM Styling" Manual—Easily make car look Hollywoodized, custom, ultra-beautiful by quick inexpensive methods! 100 photographs, instructions on customizing, restyling, streamlining—new and old cars. Also speed, model, sport, conversions; accessories; mufflers; engine "soup up" specifications! Most complete book \$2. Almqvist Engineering, Milford 27, Pennsylvania.

P-38 DROP Tanks, new steel, six foot size \$9.95. Free picture. Anzio Boat Co., 89H, Merced 8, Calif.

"SPEED And Mileage" Manual—Easily obtain greater speed, mileage, racing performance from any automobile! "Original" most complete book shows soup up methods; speed tuning; mileage secrets; racing tricks! Photographs! Instructions on building inexpensive speed equipment! Economizers! Custom accessories! Mufflers! "Water injectors!" Superchargers! "Hot-Rods!" Speedsters! Fast conversions! Engines! All about "Economy Tuning," compression, manifolds, ignition, balancing, fuels! Latest "Hollywood customizing," streamlining information; fascinating pictorial section; catalogues; parts lists! Everything \$1.98. Almqvist Engineering, Milford 27, Pennsylvania.

STUDEBAKER. Floyd Clymer's new book (no connection with Studebaker Corporation) gives impartial, uncensored report 3000-mile economy, speed, record tests. Part by part equipment analysis, 3000 Studebaker owner opinion tabulations, 200 owner letters. Good, bad comments, no punches pulled. \$1.50 postpaid. Clymer's book on Kaiser-Frazer same price, Clymer, Dept. A-8S, 1268 So. Alvarado, Los Angeles 6, Calif.

CUSTOM California doll-up accessories. Solid hood sides, grille panels, lowering blocks, fender skirts, mufflers, speed equipment, chrome supplies. Picture catalogue with scores of items, 25c. Eastern Auto Supply, 3319E South Grand, Los Angeles 7, Calif.

"POWERIZER" Water injector—Increases speed, acceleration, mileage to 30%. Easily assemble yourself for few cents! Sensational performance! Prevents wear, knock, oil pumping! Manual includes installation drawings; "Hop Up" tips. Literature. \$1. Almqvist Engineering, Milford 27, Pennsylvania.

FAMOUS Car catalog reprints. Duesenberg, Italian Maserati racing and new sport car, Mercedes-Benz, new rear-engined Isotta-Fraschini V-8, Rolls-Royce "Silver Wraith," Miller race cars, Cord, Rayfield Cyclecar, V-8 Chevrolet, Stanley steamer, Doble steamer. Specify catalog desired. \$1.00 each postpaid. Clymer, Dept. A-8X, 1268 So. Alvarado, Los Angeles 6, Calif.

DUALTONE Crystalline packed California mufflers for all automobiles. Large chrome tailpipe extensions, chromed carburetors, fuel pumps, long shackles, dual manifolds, hi-compression heads, flywheels, camshafts, fender skirts, Plexiglas tops. Send 20c illustrated catalogue, deduct from first order. Dualtone Mufflers, 2636C India St., San Diego 1, California.

HOT Rod Racing Book. 90 photographs, illustrations famous record holders used California Dry Lakes. Contains hotrod tips, closeup action shots, specifications, 8 beautiful drawings suitable framing. \$1.50 postpaid. Clymer, Dept. A-8V, 1268 So. Alvarado, Los Angeles 6, Calif.

CHEVROLET Speed manual now available to discriminating Chevrolet owners who desire real "hotrod" performance from their 1937 to 1948 Chevrolets. Filled with photographs, complete information, proven methods showing you how to make your road car into a genuine 110 m.p.h. job, or how to build 134.52 m.p.h. Chevrolet hotrod. Every page worth the purchase price of only \$2.00 postpaid. California Bill, Box L-1, Eaglerock, Los Angeles 41, Calif.

CUSTOM Supplies, speed equipment for all cars! Finest in power; racing; beautifying accessories. Lowest prices! Catalogue, photographs, recommendations; 20c refundable. Almqvist Engineering, Milford, Pennsylvania.

"SUPERCHARGER" Needle—Increases power, mileage, pep! Starting! 10% more mileage guaranteed! Free trial! Quickly replaces idling jet. Specify car. (8's take 2) \$1.98. Almqvist Engineering, Milford, Pennsylvania.

JET Propelled midget. Assemble yours. Rush name, Maupin, Tipp City 10, Ohio.

1948 SUPERIGNITIONER Pep, starting, mileage \$5.50. EG Mfg., Elmsford, N. Y.

CALIFORNIA Speed equipment, hotrod, dual, single, mufflers, doll-up accessories, cams, head, dual manifolds. Catalog 25c coin. Von Esser's, 2840 No. Kedzie, Chicago 18, Illinois.

BUILD Automatic clutch, midget autos, racers, scooters, tractors. 183 plans. Free handbook. Nichols Equipment Co., Dept. 1011, Purvis, Miss.

MODEL A Ford instruction book. Complete details care, maintenance, 35 charts, drawings. A must for "A" owners. \$1.00 postpaid. Clymer, Dept. A-8W, 1268 So. Alvarado, Los Angeles 6, Calif.

FROM Speedway to roadway! Track-proved hi-speed heads and manifolds now available for your passenger car! No special tools needed! Increase horsepower 25%! Astounding getaway! Free illustrated catalog. Speedsport, 6215AA Diversey, Chicago 39.

FENDER Skirts—Factory direct; streamlined to your fender contours; 16 ga. anodized aluminum with self latching brackets. No holes to drill. Teardrop skirts Chevrolet, Ford, Buick, Oldsmobile, 35-41. Streamlined box skirt Ford 41-48. Specify year, model. Price f.o.b. \$17.95. Send check, money order. Freight collect. E. and E. Mfg. Co., 5322D Banks Street, San Diego 10, California.

"VAPO-STEAMATIC" Water injection. Easily constructed (for less than \$1.00). Finest automatic "moist-humidity" system. Engineering triumph—gets up to 33 miles per gallon! Reduces wear, sludge. Tremendously increases horsepower. Acceleration! Eliminates ping, carbon, overheating! Smoother engine. Copyrighted, fully illustrated "Installation-Handbook," including additional "injection-conversions" covering tractors, airplanes, motorcycles. \$1.00. Newhouse Industries, 5941-B1 Hereford, Los Angeles 22.

MAKE Your Model "A" do 100 m.p.h. Lightning acceleration, breath-taking top speed. Complete details, photographs. \$1 postpaid. Four Barrel, Box L-1, Eaglerock, Los Angeles 41, Calif.

INSTALL V-8 engine in your Model A for extreme acceleration, more top speed, smoother performance. Complete details, photographs. \$1 postpaid; A-V-8, Box L-1, Eaglerock, Los Angeles 41, Calif.

"SPEED And Power" handbook—Very latest methods! Construct your own superchargers, water injectors, compression heads, fuel saving devices—easily, practically without cost. Get racing speed, acceleration, dynamic power increases from any automobile! Build stock conversions! Fast roadsters! Hotrods. Ingenious formulas! Speed secrets! Fuels. Lubricants. Get "Economy Information"—tuning techniques! Ignition! Carburetion! Mileage tricks. Catalogues! Literature! Illustrations! Including "Restyling Ideas"—streamlining. Model revising! Customizing! Sport changes. Photographs! Parts lists! Drawings! \$1.98 complete. Newhouse Industries, 5941-B2 Hereford, Los Angeles 22.

EASILY Built professional midget racer, motorscooter, midget roadster, or midget motorcycle from cast off parts. Plans, specifications for all four contained in illustrated handbook, 25 cents. Directory of bargain priced used parts and motors included free! Midwest, 3839 Drummond, Toledo, Ohio.

WE Sell direct to customers over 200 speed equipment parts manufactured by us. Ford A-B-V8-6-4- (Ferguson), Studebaker Champion, Chevrolets and Willys. Cylinder heads, dual intake manifolds, lynite flywheels, oversize valves, compound springs, camshafts and other supplies. Complete engines ready for race for cars, boats and midgets. \$1.00 to cover illustrated literature and price sheet. R & R Mfg. Co., Robert M. Roof, Box 546, Anderson, Indiana.

AUTOMOBILE Racing, Sixth Edition, 100 illustrations. Working drawings with building instructions for Ford-60 midget, California roadster, Offenhauser racer. Details on racer parts. Sample entrance blank. World's record 158.5 m.p.h. rear engine four-wheel drive car. Interesting information for fans, drivers, mechanics. \$2.00 postpaid; \$2.25 c.o.d. Ray Kuns, Department 63, Cincinnati 27, Ohio.

BUILD Speedy midget track racer from castoff parts! Plans, specifications, construction information, \$1.00. Motor Supply, Box CS-1682, Toledo, Ohio.

AUTOMOBILE Racing book, fifth edition, well illustrated. Instructions on building bodies, frames, engines. Ford A and B conversions. Plans. AAA rules, specifications. Roadster racing. Indianapolis cars. \$1.00 postpaid, \$1.30 C.O.D. Ray Kuns, Dept. 47, Madisonville, Cincinnati 27, Ohio.

GREASE Car yourself. Fast, easy, clean centralized system reduces repairs. Useful information, free. H. B. Rodd, Box 305, Trona, California.

BOOKS—All Kinds—Homecraft, Radio, Plastics, Boat Building, Photography, Model Building. Catalog free. Popular Mechanics Press, 200 E. Ontario St., Chicago 11, Ill.

HOT-ROD Manual, fast Fords, photos, instructions, \$1.50. Airmailed \$1.75. Racing parts list 25c. Hollywood Hot-Rod. Los Feliz, Box 9626P, Hollywood 27, California.

MAKE Your Ford fast! Complete details, photographs. How to construct 120 m.p.h. Hotrod. \$1 postpaid. California Bill, Box L-1 Eaglerock, Los Angeles 41, Calif.

SEE Our ad under motorscooters for midget car bargains. Midget Motors Directory. Athens, Ohio.

AUTO SUPPLIES AND EQUIPMENT

GENUINE Ford parts mailed c.o.d. anywhere by America's original mail-order parts specialist. Speedy, reliable service. Baker Corp., Brookline 46, Mass. Authorized Ford dealer for a quarter century.

GOVERNMENT Surplus. Low voltage circuit tester in steel box. Cost \$302.00. Our price \$27.50. Will test batteries, starters, generators, voltage regulators, grounds, short circuits. Wilt Electrical Company, 7829 S. Racine Ave., Chicago 20, Ill.

THE ABC of water injection. Complete information free. Advanced Automotive Products, 563-17 Lake Road, Webster, N. Y.

INSTALL "Glarecheck." Make your headlights shine straight, horizontal. Simple. Pair, 50 cents, prepaid. J. Lang, 92 Rockdale Street, Mattapan 26, Massachusetts.

GAIN 2 Miles per gallon, with Air-Flow Needles. Free trial in your car. Remit only \$1.50 per needle, (8 cyl. cars take 2). Advanced Automotive Products, 563-9 Lake Road, Webster, N. Y.

CAR Trouble? Million new, used parts. Describe needs. Automotive, 2928A North Western, Chicago 18.

SAVE 1/2 On a new radiator! Recore your own. (Torch required). Instructions furnished. Cores for any radiator. Radiator Service and Supply, McBain, Mich.

JEEP Manuals. Station Wagon body. Diesel conversions. Trailer coach. Each \$1.00. All three \$2.00. Craftsmann Books, Box 1153, Milwaukee 1, Wis.

REPAIR Dents and holes in auto bodies with Duro Plastic Metallic Auto Body Solder. Applied with putty knife. Pints \$1.50, quarts \$2.50 prepaid. Leonard Sales Company, Box 6412, Cleveland, Ohio.

LOOSE Insert main bearings to fit into Ford A or B blocks. \$13.00 for upper set. Send bottom caps for complete set of three mains, \$16.75 complete set. Standard or undersize ready to install. Wellens Auto Supply Co., 417 N. P. Ave., Fargo, North Dakota.

SAVE Gasoline. Free trial. Airflow valve. Inexpensive. Neherco, La Verne, California.

WELDING For low-cost repairs on bodies, blocks, fenders. Adds to your profits. Easy with Hobart Welders. Free catalog. Write Hobart Welders, Box M-882, Troy, Ohio.

CONVERTIBLE Tops — Completely sewn. Easily installed. Reasonable prices. Free literature. Rio Top Company, 1370 Roanoke, Newport News 12, Virginia.

SAVE Gas! Instant starting. Power! "Lektron" spark intensifier. Guaranteed. Easily installed. \$1.25 plus c.o.d. State make car. Free information. Electronic Industries, Cleveland 11, Ohio.

POLISHER And sander combination #49 \$32.00. Spark plugs, new. Blue Crown, guaranteed ea. 35c. (State year and make with order.) S. Miller, 164 W. 33rd St., Bayonne, N. J.

AUTO Parts. Buy direct. Get dealers' prices. Represent us in your territory. Write requirements. Specify car make. Mechanics Auto Parts, Factory Warehouse, 3807-PM N. Ashland, Chicago 13.

BEAUTIFUL Rich-looking seat covers. Mono. 6545 Santa Monica Blvd., Hollywood 38, California.

NEW And used automobile and truck parts. Lowest prices. Complete stock. Prompt reply. Babbitt Auto Parts, 2833 W. Chicago Ave., Chicago 22.

AUTO Parts for all cars, transmissions, motors, differentials, fenders, carburetors. Security Auto Parts, 1923-PM Grace, Chicago 13.

GRILLES For all cars. Meyers Auto Parts, 820 Dryades, New Orleans, La.

PLATING Outfits for auto parts. Connect to a battery. No tanks used. Free particulars and proofs. Gunmetal Co., Ave. J. Decatur, Ill.

MOTORISTS Save gasoline by Vacuumating overrich mixtures. Fits all cars. For free particulars write Vacuumatic, Dept. 1376, Wauwatosa, Wis.

AUTO TRAILERS

TORKSPRING Axle assures low center gravity, swayless action. Install on new or old trailer. S. H. Edwards, Inc., Richmond, California.

MODERN Trailer book tells all. Designing, building, traveling. Circular illustrating 8 designs 20c. Craftsmann Books, Box 1153, Milwaukee 1, Wisconsin.

ACTUAL Photographs and detailed plans for 12' camp and travel trailer \$1.00. Many new features. Ed. Christensen, Box 687, Thief River Falls, Minn.

BUILD Your own trailer! Save money! Have every feature you want! Plans for house, sport, camp and utility trailers. Catalog describing 9 models 10c. 15c in Canada and overseas. Jim Dandy, Box 125-A, Wausau, Wisconsin

TRAILER Plans, parts, accessories; complete line. Prompt delivery. Catalog 25c (coin). Catalog plus booklet, "Trailer Building," 50c (coin). Marine Mart, Buffalo 7-B, New York.

MOTORCYCLES, BICYCLES, MOTORSCOOTERS AND SUPPLIES

BICYCLE Supplies wholesale, retail. List 10c. Universal, 4713 Virginia, St. Louis, Missouri.

JET Propelled bicycle. Assemble yours. Rush name. Maupin, Tipp City 11, Ohio.

WAR Surplus aircooled engine bargains, list 10c. Donz, Mt. Ephraim, N. J.

NEW Bicycles specially priced, \$29.95. Accessories, chains. Bulletin 10c. Lipst's, 3447 Lawrence, Chicago.

MOTORBIKE \$50; Briggs motor \$32; Motorscooter \$45; 3 1/2 h.p. outboard motor \$40; Maytag motor \$15; Indian motorcycle \$60; model airplane engines \$3 and up. Wheels and tires, and many other bargains. Send 25c, mail order only. Behnke's, Dept. B, 5721 Leland, Chicago 30, Ill.

MOTOR Scooters, bicycle engines. 120 miles gallon. Dime for catalog. Clymer, Desk A-85, 1268 So. Alvarado, Los Angeles 6, Calif.

MOTO-SCOOT \$35, Midget racer \$15, Indian motorcycle \$30, Cushman motorscooter with extra tire \$20, motors \$3 and up, homemade motorscooter \$10. Send 25c for new catalog listing these and many other sensational bargains in used motors, wheels, tires, motorscooters, midget cars, motorbikes, etc. Associated, Box 1764-CS, Toledo, Ohio.

NEW 1948 Indian and Harley parts and accessory handbook, 25c. Motor parts, chains, batteries, tires, chrome accessories. Motor rebuilding. Bootz, 622 East Grand, Des Moines, Iowa.

MIDGET Car with three-speed transmission \$35, Cushman motorscooter \$15, Shaw bicycle motor \$15, Harley-Davidson motorcycle \$15, motorbike outfit \$15. Rush 25 cents for special new catalog listing amazing bargains in motorscooters, used motors, tires, parts, midget cars, etc. Gall, 538 Erie, Toledo, Ohio.

MOTORCYCLE News, monthly. Yearly subscription \$1.00. Latest worldwide information. Motorcycle News, 5424-A Sawyer, Chicago 25.

TIRES And industrial wheels, suitable for scooters, wheelbarrows, farm equipment, etc. All sizes. Bicycles and accessories. Largest assortment in America. Send dime for list. Cycle Transport Company, 1241 So. Michigan Ave., Chicago 5, Illinois.

BICYCLES, Tricycles, parts, accessories, Send 10c for bulletin. Propp's, 2202 Fondulac, Milwaukee, Wis.

MOTORCYCLISTS Chromium accessories. New and reconditioned motors. Complete stock Indian parts. Expert motor rebuilding. Indian Motorcycle Sales, Kansas City 1, Missouri.

MOTORCYCLE Cams ground for speed and power. Write Harold Schaller, Box 31, Turlock, Calif.

HARLEY-DAVIDSON Supplies, parts, accessories, oil service, tires all sizes, repaired 45" motors. Send \$2.25 for Army Motorcycle Manual, 10c for bulletin. Knuth's (Harley-Davidson Dealers), 2491 Fondulac, Milwaukee, Wis.

MOTORSCOOTER \$7.50, Midget racer \$10, motorbike \$5 less motors; Harley single \$40, midget car \$55 complete. Motors \$4 up. Plenty brand new engines and surplus motorscooters. Over 5000 small tires \$1 up. Mailorder only. Send 25c for Big War-Bargain catalogue listing the above and hundreds of other bargains in motorscooters, motorcycles, midget racers, outboards, engines, etc. (35c by First Class Mail). Midget Motors Directory, Athens, Ohio.

HARLEY-DAVIDSON Parts, accessories, batteries, and tires. 24 hour service. Authorized factory dealer, Philadelphia Harley-Davidson Company, 857 North Broad Street, Philadelphia 23, Penna.

AVIATION

FAMOUS "Zweng" books include Mechanic's Rating With Examinations, \$3.00; Flight Engineer \$4.00. Surplus Sextants \$12.50. (Free folder). Pan American Navigation Service, 12031-C Ventura Blvd., North Hollywood, Calif.

PROPELLERS—2-3 Blade. Sleds, air-drive boats. Catalog. Standard Aircraft, Ft. Worth, Texas.

JET Propelled bicycle. Assemble yours. Rush name. Maupin, Tipp City 12, Ohio.

LIGHTPLANE Blueprints. Circular designs, motors, 20c. Craftsmann Books, Box 1153, Milwaukee 1, Wisconsin.

PROPELLERS, Plans for ice sleds, snow sleds, air boats. Catalog 10c. Banks-Maxwell, Ft. Worth.

VETERANS: Flight training under the G. I. Bill. Tuition paid. Private, commercial, flight instruction, instrument and multi-engine ratings. Opportunities to work for living expenses or tuition, if not a veteran. Write Gottschalk School of Aeronautics, Adrian, Mich.

ELECTRICAL SUPPLIES

LAMPS—Build own originals, parts wholesale any amounts. Catalogue 10c. Brown Lamp Co., Box 501, Wellston, St. Louis 12, Mo.

LAMP Parts. Orders filled in 24 hours from largest variety of parts in country. Send 10c for illustrated catalog showing hard-to-get items and regular parts. Gyro Lamp, 5416P Clark, Chicago 40.

LELAND Electric generators, 2.5 kva, 120 volt, 60 cycle, single phase with radio filter. Turns at 1800 r.p.m., producing 2500 watts, \$125.00 freight prepaid. Hopper & Company, 3124 East 14th Street, Oakland, California.

FLUORESCENT Maintenance. Complete service manual for repairman. Mailed prepaid \$1.00. Clyde D. Derrick, 2822 West Valley Blvd., Alhambra, Calif.

ELECTRIC Pencil: Engraves all metals, \$1.00. Beyer Mfg. Co., 229-H Dixon, Uniontown, Penna.

WATTHOUR Meters. Reconditioned G.E., West., 115 v., \$2.95. T. Price, 310 14th, Raymond, Wash.

LAMP Parts wholesale. Large variety available for building, repairing, or remodeling. Order in any quantity. New 1948 catalog, 10c. Gearon Company, 27 South Desplaines, Chicago.

ELECTRICAL Repair men, send for literature on motor winding tester and A. C. motor winder. Motor Industries, Quincy, Illinois.

FLUORESCENT Fixture tester—Pocket size. Checks starter, tube, ballast and wiring. Locates exact trouble without dismantling fixture. Mailed prepaid \$5.00. Clyde D. Derrick, 2822 West Valley Blvd., Alhambra, Calif.

ELECTRIC Fans? Assemble your own. 16" correctly balanced aluminum fan blade, 1/2" bore, \$2.25. 18" all welded guard, \$2.50. Use any ordinary motor. No c.o.d. Ted Riseaman, 207 North Fifth, Springfield, Illinois.

WELDING, SOLDERING, PLATING

TRANSFORMER Welders 110v. Welds 1/2" steel, \$20. Morris Welding Service, 1850A State, Schenectady 4, N. Y.

"BUILD-UR-OWN" Portable arc welder. Save \$350. Easy with Hobart generator plus auto engine. Free instruction book. Write Hobart Welders, Box M-883, Troy, Ohio.

ELECTROPLATING Simplified, all metals, latest formulas and instructions, \$1.00. Alan Hawkins Co., 770 Sycamore, Buffalo, N. Y.

OWN Mirror shop. Resilver mirrors, Glass sign making, Electroplating. Supply prices. John Sprinkle, V55, Marion, Indiana.

"POWER-WELDER." New combination a.c. welder; a.c. power plant. Portable, makes you independent of power lines. Gives you welding, plus power for tools, lights, motor, anywhere. Free catalog. Write Hobart Welders, Box M-884, Troy, Ohio.

RECTIFIERS: Ramyr Selenium platers, 10, 30, 50, 100 amp. sizes. Immediate shipment. Complete line of bronze baby shoe mounts. Write for list. Hollywood Bronze Supply, 1770 N. Vermont, Hollywood 27, Calif.

WELDERS For all requirements. Free catalog. Write Hobart Weld, Box M-885, Troy, Ohio.

WELDERS!—New portable Champion special transformer welder; 110/120 volts, a.c. 8 heat stages. Welds, brazes, solders, cuts all metals. Complete with electrode holder, helmet, rods, carbons, fluxes, cables. Also special flame weld torch. Easy to use. Full directions. Splendid for shop, farm and home repairs. Guaranteed. Only \$27.50. Money back guarantee. Also resistor model, now \$14.95. Magic Welder Co., 239 MP Canal St., New York, N. Y.

WELDING—A profitable trade. Learn quickly at best equipped school in U. S. Demand for trained men. Write Hobart Welding School for free catalog. G.I. approved. Box M-886, Troy, Ohio.

MACHINERY, TOOLS, SUPPLIES

MACHINE TOOLS released for private industry—10" bench lathe \$190. 16" loose change lathe \$160. 18"-180, 14" Quick Change \$440, some \$350. Hand miller \$180. Back geared miller \$260. 22" shaper \$380. 3 ft. planer \$220. 6 ft. \$510. Lincoln welder \$180. Air compressor \$50. D.C. and a.c. motors. Spray guns \$10. Money back guarantee. Conversion Parts Co., 278 Adams St., Boston 22, Mass., U.S.A.

BALL BEARINGS: Fafnir 85K, 1 1/2" o.d., 1/2" i.d., 1/4" thick, bargain. Metalcraft Toy, Paul Brown Bldg., St. Louis.

INSTRUCTIONS For perfect tapping, simple, saves time and taps. 25c. Chas. Carvo, 6080 Dequindre, Rochester, Mich.

BLOWTORCH Welding. Instructions. No attachments. Write: Cameron's, Camrose, Alta., Can.

WAR SURPLUS in small tools for machine shop. Send 15c for bulletin. Travers Tool Co., Dept. P, 5 Court Square, Long Island City 1, N. Y.

BUY DIRECT from factory sale. New, Timber City Radial Wood Saws (not war surplus). Today's best saw buy! All steel welded frame, 12 inch diameter saw, 2 h.p. motor, calibrated scale, blade adjustable to any angle, meets all safety codes, complete weight 300 pounds. In stock; immediate delivery. Special sale, limited time only. Save \$120. Retail price \$395, now \$275 f.o.b. factory. Hundreds now in use. Maquoketa Co., Maquoketa, Iowa.

NEW 2-IN-1 unit polisher and sander, fits any electric drill. \$3.00. Cook Co., 40 Walnut St., Newark 2, N. J.

CERAMIC, Glass hand drill. 1/8, 1/4, 3/8, \$1.00 postpaid each. Make vases into lamps, etc. Lavern Tools, Box 7, Caldwell, New Jersey.

LOOK NO FARTHER. New war surplus socket wrench sets at 1/2 price postpaid. Write for details, Royalty Company, Box 4396, Dallas 8, Texas.

\$2.85 POSTPAID. Big box, over 2000 mixed steel cadmium plated machine screws, nuts, washers, etc. Meltz Aircraft, New Brunswick, N. J.

NEW ECLIPSE band saw outlasts five ordinary saws at same price. Hard edge with tooth rake. No resharpening. Set fixed by machine. Ideal for home workshop. Any width, length, point. Circular free. Dept. AM, Alwood Co., 2035 Charleston, Chicago 47, Ill.

BACK GEARED metal and wood cutting 12" band saw, 6" jointer, ball bearing, 47" long. Ball bearing spindle shaper, 15x 20" table, 8" bench saw, tilting table, ball bearing. Lowest priced line of high grade tools on market. Free catalog. Backus Machine Co., Boyd, Wisconsin.

CHUCKS. (Genuine Westcott) Independent, Universal, threaded 1 1/2"-8 for South Bend, Atlas, Logan, Clausing, Craftsman lathes. Also other chucks to 16". Top value. Free literature. Westcott Chuck Co., 3600 Walnut, Oneida, N. Y.

HOME LATHE OWNERS—Build your own attachments. Send for picture, sample of work and list of blueprints. Cut gears, ratchets, etc. Make neat screws easy way. The Home Shop, 415 Raymond Ave., Glendale 1, Calif.

POWER TOOLS. Build your own with Lewis Castings. Save up to 80%! Complete castings, materials and blueprints supplied for 23 woodworking and metalworking tools. Free catalog. Write today. Lewis Machine Tool Co., 3217 Union Pacific Avenue, Dept. M, Los Angeles 23, Calif.

CONCRETE Block machines \$39.50 up. Catalog free. Concrete Machine Company, 5466 Gravois, St. Louis 16, Missouri.

DRILL GRINDER—Grinds drills to factory accuracy. Calipers with direct reading scales. Circle cutters. New Tool grinder. Lowest prices. Free literature. Factory, 811-B East 31st, Kansas City 3, Mo.

DRILL GRINDER for twist drills, \$2.95. See ad on page 241.

ENGINES, MOTORS, DYNAMOS

BARGAINS in war surplus hydraulic transmissions, switches, motors, geared speed reducers, etc. Delta Sales, P.O. Box 968, Shreveport, Louisiana.

GAS DRIVE arc welders. "Build-Your-Own." Portable. Get profitable jobs anywhere. Save \$350 with Hobart generator plus auto engine. Free instruction book. Write Hobart Welders, Box M-887, Troy, Ohio.

WINDING DATA, listing 225 motors, single and three phase. \$1.00. Motor Data Co., Box 7631, Kansas City 3, Mo.

MOTORS: 1/2 H.P. D.C. converted to A.C. All new. High speed 110 volt, 25 or 60 cycle, ball bearing motors. Actual value about \$75.00. Now \$15.00 each or 3 for \$40.00. With forward and reverse switch \$19.50, 3 for \$50.00. Countless uses for home mechanics. Can be used in any position. Order today! Immediate delivery! No c.o.d. orders. "Amazing Bachman's," 27 Herman Street, Rochester 5, New York.

BOATS, OUTBOARD MOTORS

TWENTY Plywood boat plans \$1.00. 6 to 20 feet sail, power. Catalog 10c. The Rudder, 15 Murray St., New York 7, N. Y.

MARINE SUPPLY catalog. Thousands of deliverable items, priced and beautifully illustrated. Send \$1. Arthur Gershel, 51 Chambers St., New York 7.

MARINE ENGINES, new, used. Conversion supplies, boat fittings. Catalog. Lind Supply, 188D No. Hudson, Coldwater, Michigan.

BOAT PLANS by professional naval architects. All sizes and types. Free circular. Westlawn Associates, Montville 5, N. J.

P-38 BELLY Tank speed boat. Complete plans, instructions \$1.00. Twintank Boat Co., 1032 62nd Street, Oakland, Calif.

SUPER-BOAT \$20. Easy to make your own with readymade streamlined laminated one-piece super-hull developed by Navy. Light, sturdy, leakproof. Anyone can convert into dinghy, outboard, scooter, cartopper, other craft. 9'x4'. Warwood, 480 Lexington Avenue, New York 17.

MARINE CONVERSIONS and reverse gears for all Ford and Jeep engines. Catalog 25c. Dept. P, Arthur Gershel, 51 Chambers St., New York 7.

BOAT STEER wheels, windshield brackets \$8.95. Modern hardware kits, bargains galore, folder. Marine, Box 681, Mendota, Minnesota.

MARINE FITTINGS, accessories. Thousands of items (pictured, priced). Prompt delivery. Catalog \$1.00. Marine Mart, Buffalo 7-B, New York.

OUTBOARD MOTORS—Good values, used motors. Also used parts for most makes and models. Crandall-Hicks Co., 911 Commonwealth, Boston, Mass.

BOAT DESIGNERS are highly paid professionals. Complete course by mail. Catalog. Westlawn, Montville, N. J.

MARINE CONVERSIONS for Ford and Jeep engines. Catalog 10c. Lehman Manufacturing Company, Department D, Newark 2, New Jersey.

NEW, USED, rebuilt marine motors. Marine conversions, fittings. Free catalog. Stokes Marine Supply, Dept. 24, Coldwater, Michigan.

BUILD YOUR OWN 25 ft. cruiser, Sea Craft. Adaptable as a sport fisher, express cruiser or utility boat. Sleeps four. Has fresh water tank, sink, galley. Set of 7 complete blueprints and descriptive booklet. The boat you have always wanted to build. \$10.00. Popular Mechanics Press, 200 East Ontario Street, Chicago 11, Illinois.

P-38 BELLY Tanks, new, steel, 10 ft. 2 in. 165 gallon \$9.95. Anzio Boat Co., Box 89M, Merced, Calif.

BOAT PLANS, kits. See display ads, pages 40 and 241. Marine Mart, Buffalo 7-B, New York.

ATHLETIC EQUIPMENT, BODY BUILDING COURSES

DEADLY JUDO—Fiercest fighting technique. Trick knockouts. (200 photographs, plus illustrations.) Expert instructions, three volumes. Complete \$2.25. Variety House, Box 46-B, Wall Station, New York 5.

BARBELLS, Exercise equipment. Courses. Free booklet. Good Barbell Co., Reading, Penna.

SPORTING GOODS, GUNS, FISHING TACKLE, ARCHERY, TRAPPING

FELT Letters anyone can sew on athletic uniforms. Adhesive backed. Sample. Modern Embroidery & Felt Lettering Co., 815 1/2 N. 8th, St. Louis 1, Mo.

SEND 10c For list 100 used guns. Frayseth's, Willmar, Minnesota.

NORTHWOODS Tested air mattresses or swimming rafts from your Navy life belts cheaply and easily. Directions for either, 50c; both 75c (no stamps). Buy our ready made auxiliaries for your belts: Mattress binders, \$1.50 pair; raft covers, \$5. Northwoods Bureau, Box 1005, St. Paul 5, Minn.

NINE GUNS in one—With a Poly-Choke on your favorite shotgun. More than 15,000 installed by us. Satisfaction guaranteed. New ventilated model \$18.75; standard Poly-Choke \$14.75, installed, 3-day service. Write for new fall catalog. Andy Anderson's Sporting Goods Co., 120 W. Grand, Okla. City 2, Okla.

SHOOTERS: Handload your own ammunition. For full information send 60c for a copy of the B & M book "Handloading Ammunition." Circular free. Belding & Mull, Box 428B, Philipsburg, Penna.

GET Three good lures, all different, and a brand new official 3/8 oz. practice casting plug by postage-paid return mail in exchange for three old lures you no longer want, plus \$1.00. Lures you specify sent whenever possible. Satisfaction guaranteed; tell your friends. Trade today as hundreds have. Westbrook Company, 227 N. Water Street, Milwaukee 2, Wisconsin.

AMMUNITION, 75 Sizes in stock. Dime for list. Central Sports, Delphos 5, Ohio.

SHOTGUNS, Rifles, handarms, ammunition, rods, reels. List 10c. Rudolph's, Atchison, Kansas.

5000 BARGAINS, Firearms, binoculars, war relics. Catalog 40c. Smith Firearms, Rummel, New Jersey.

BOWS—Arrows, write headquarters for archery equipment. Quality products. Popular prices, catalog 10c. Large illustrated handbook instructions, aiming and shooting, 50c. Archery, 617-B So. State, Chicago 5.

SHOTGUNS, Rifles, revolvers, over 500 modern, obsolete. Also cartridges, list 10c coin. Ed Howe, 52 Main, Coopers Mills, Maine.

FIELD GLASSES, TELESCOPES, MICROSCOPES, MAGNIFIERS

POWERFUL Astronomical telescopes easily made. Perfect lenses and instructions. Free price list or send 10c for complete set of instructions. Special 50 power lens kit \$1.00 postpaid. Suffolk Science Service, Manorville, N. Y.

BUILD Extraordinary reflecting telescope. Principle of 200" Mount Palomar. Complete optical parts including fully polished and aluminized mirror, eyepiece lenses and flap. 3" (40 power) \$6.00; 4" (60 power) \$10.00; 5" (80 power) \$15.00. Simple instructions. Sharp, clear definition guaranteed. Also spotting and bird use. Thousands satisfied makers. Do not confuse with inferior items offered at any price. Bulletin 10c. Ross, Section C, 68 West Broadway, New York, N. Y.

GIANT Astronomical telescope, 100X, (10,000 area magnification) clear vision and full power guaranteed. Over 4 feet long, complete with 6 ft. tripod. Ready to use. \$15.00 f.o.b. Manorville. 25% deposit on c.o.d. orders. No export orders accepted. Suffolk Science Service, Manorville, N. Y.

ASTRONOMICAL Telescope lens kit. Consists 3" diameter 75" F.L. objective, 50X-100X eyepieces \$3.00. Including 75X terrestrial eyepiece \$5.00. Microscope lens kit 50X to 800X power \$2.00. Postcard brings plans. List outstanding optical values. Pfeiffer Optical Co., PM-8, Sunbury, Penna.

GIANT Land and sea telescope, 35 X 40, over 3 ft. long, complete with tripod, portable, only \$10.00 f.o.b. Manorville, N. Y. Objects one mile distant appear as though only 150 feet away and 1,000 times larger in area. 25% deposit on c.o.d. orders. No export orders accepted. Suffolk Science Service, Manorville, N. Y.

TERRESTRIAL Eyepiece for astronomical telescopes \$3.00 postpaid. Suffolk Science Service, Manorville, N. Y.

BINOCULARS, Telescopes, watches, guns. Buy, sell, trade. Schweer's, Donnellson, Iowa.

REFRACTING Telescopes, accessories; highest quality workmanship. Catalog 10c. Janan Instrument Company, 76 Interhaven Avenue, Plainfield, N. J.

POWERFUL Land and sea telescope easily made. Four perfect lenses and complete instructions \$3.00 postpaid. Suffolk Science Service, Manorville, N. Y.

ASTRONOMICAL Telescopes, binoculars, microscopes; bought, sold, repaired. Books. Lists 10c. Rasmussen-Reece, Amsterdam, N. Y.

TELESCOPES, Binoculars, microscopes, big bargain catalog free. Brownscope Company, 24 West 45th Street, New York.

GOVERNMENT Surplus. Terrific bargains, telescopes, binoculars, lenses, prisms, send stamp for catalogue. H. Jaegers, 123-26 Rockaway Boulevard, South Ozone Park 20, New York.

DOGS, PETS, BIRDS, RABBITS

BEAUTIFUL Puppies to grown dogs. Toy Fox, Wirehaired Fox, Toy Black and Tan, Scotties, Pekinges, Chihuahuas, hunting dogs, Dachshund, Kerry Blue Terriers, Cocker and Springer Spaniels, Police, Dobermans, others. Bargains—all reg. Ann's Kennels, Pau Pau, Ill.

MINK Raising amazingly profitable. Free folder gives inside "secrets" on feed; care. Lawrence Molgard, Brigham City 12, Utah.

BEAUTIFUL Pure white pedigreed police puppies. Ansonia Kennels, Mose, North Dakota.

ZOOLOGICAL And pet animals for sale. Illustrated catalogue, literature, 25c. Trails End Zoo-5, St. Stephen, S. C.

RAISE Guinea pigs. Make money at home. Big demand. Booklet free. Taylor, Box 426A, Hapeville, Georgia.

\$50.00 WEEKLY Raising Angoras for us. Free literature. Associated Angora Breeders, Stanton, Calif.

\$3,000 YEARLY Raising Angoras. Circular free. Vaughn's Rabbitry, Dept. B, Otley, Iowa.

RAISE "White Satin" rabbits, meat and fur. "Golden Hamsters" pets and laboratories. Free information. Pem's Rabbitry and Hamstery, 3010 10th Ave. No., St. Petersburg 6, Fla.

MONEYMAKING Opportunity raising giant Chinchilla rabbits. Waters Rabbitry Farm, W-3, Glennville, Georgia.

ANGORAS, Giant Chinchillas, white giants. World's most profitable rabbits. Finest pedigree, heavy-producing, prize-winners. Literature free. Grinsteeds, Edwardsville, Illinois.

MINK Raising information free. Complete. Lake Superior Mink Farm, Superior E E I, Wisconsin.

WRITE For descriptive circular "Angora Wool Growing." House of Angora, Springfield, Illinois.

\$250.00 MONTHLY. Raising Angora rabbits. Multiply fast. Wool brings \$9.00 pound. Plenty cash markets. Particulars free. White's Rabbitry, Dept. P, Newark, Ohio.

RAISE Chinchilla rabbits. Year-round money-makers from furs, meat, breeders. Experience unnecessary. Write today. Willow Farm, Sellersville 15, Penna.

RAISING Rabbits, cavies, hamsters, chinchillas is profitable. Big demand. Magazine 10c. Instruction book and magazine 25c. Book and magazine (monthly) one year, \$1. Address, Small Stock Farmer, Fairlawn 2, New Jersey.

CONTINUOUS—Profitable market for your production. Raise New Zealand and Chinchilla rabbits for us. Order our "7 Helps To Success" \$3.00 with credit coupon, or send 25c for catalog "Successful Rabbit Raising." Drake's Outdoor Enterprises, Park Ridge 8, N. J.

INCREASE Your income by raising domestic rabbits. Small space needed. Ready market for delicious meat, fur and wool. Largest magazine in the industry tells you how. \$1.50 per year. Sample 15 cents. No stamps. Small Stock Magazine, Lamoni 20, Iowa.

\$3000 YEARLY Raising Angora rabbits. We buy your output. Contract particulars free. Kise's Enterprises, St. Paul 8, Minn.

RAISE Rabbits, market provided. Breeding stock furnished on production pay plan. Literature 25c. with hutch plans \$1. Hansen's Rabbit Institute, 1347 Miller Avenue, Salt Lake City 6, Utah.

SEE Golden Hamsters ad page 34. Shows picture of hamster.

FARMS, FARM LANDS, REAL ESTATE

UNITED'S Fall catalog—Just off press, bargains galore! Farms, ranches, groves, businesses, homes. Exciting, free catalog of up-to-the-minute values. Great Lakes, Midwest, famous Ozarks, to California. America's lowest prices! Write for free copy today! United Farm Agency, 1408-PM Consumers Bldg., Chicago 4, Ill.

\$5.00 MONTHLY Buys 40 acres, near town. Price \$200.00. Free list. Box 425-P, Carthage, Mo.

LOI'S \$300—Convenient payments. California's finest garden section. On Morro Bay's scenic shores. Wonderful fishing, hunting, boating, bathing. Fertile soil, softest water, temperate climate, congenial community. Free literature. Richard Otto, Department M, San Luis Obispo, California.

CHEAP Homes, farms, stock ranches, peach orchards. Valley farms, wonderful free range, mild, pleasant winters, cool summers in beautiful, healthy Ozarks. Free literature, land lists. Write G. W. Starr, Ozone, Arkansas.

STROUT'S Farm catalog—Free! Many equipped. Reduced prices! Over 2800 bargains. Coast to coast. Write today. Strout Realty, 255-P 4th Ave., New York 10, N.Y. 20 W. 9th St., Kansas City 6, Mo. 453 S. Spring, Los Angeles 13, Calif.

GOVERNMENT Lands \$2.00 acre up. Information all states twenty-five cents. National Tax Service, 834-A Majestic Bldg., Detroit.

GOOD Farms—Ranches. Washington, Minnesota, Montana, Idaho, Oregon, North Dakota. Dependable crops, favorable climate. Write for literature, lists describing typical farm opportunities. Specify which state. J. W. Haw, 119 Northern Pacific Ry., St. Paul 1, Minn.

OZARK Lands for all purposes. Actual river frontages, 5 acres \$90.00 and upwards. Free list and literature. Hubbard, 424-I Minnesota Ave., Kansas City 4, Kansas.

POULTRY, FARM SUPPLIES

EARN \$4 To \$12 hourly. Chick and turkey sexing, culling and caponizing—G.I. approved. Pilch's School, Box P.M., Thompsonville, Connecticut.

RAISE Fryers new easy way. One-man home plant earns \$500 monthly. Booklet free. Poultry Guild, 1046-A So. Olive, Los Angeles 15, California.

KNOW How to raise poultry for profit. Read Northeastern Poultryman. Every issue packed with helpful hints and practical suggestions. Latest articles on breeding, feeding and management. Subscribe now. 1 year 65c. 2 years one dollar, foreign subscriptions \$1.00 a year. Northeastern Poultryman, Dept. P.M., 376 Boylston St., Boston 16, Mass.

PROFITABLE OCCUPATIONS

VENETIAN Blinds! Easy, profitable, full or spare time business. Small capital. Construction blueprints, instructions, supply sources \$1.00! Hunter, 2172 Green, Cleveland 21, Ohio.

LEATHERCRAFT Supplies. Catalog 10c. Art Craft Supply Company, 1205 Throckmorton, Fort Worth, Texas.

DO Heating and air conditioning from home. We supply everything wholesale and tell you about installing. "Superior," Lincoln 4, Nebr.

LOOK Here! Wanted—Men to start in business on our capital. Sell some 200 farm-home products. Thousands our dealers now make quick sales, big profits. For particulars write Rawleigh's, Dept. H-192-PPM, Freeport, Ill.

LOCKSMITHING Secrets—Key fitting, lock opening, repairing, prices to charge, supply sources. Illustrated book only \$1.00. Wechsler Supply, 7 W. 36, New York City.

BIG Orders await you as novelty manufacturer. National organization offers opportunity to manufacture fast selling copyright designs. Everything furnished, big profits, orders waiting. Plastex Products, 711 Laguna, San Francisco 2.

PROFITABLE Business making and building with easy-laying interlocking building blocks. Rex Products Co., Dept. 10, Piqua, Ohio.

GET "Our tip sheet" before investing further. Rush 10c. Cox Enterprises, C-601 South Vermont, Los Angeles 5.

FOREIGN Employment! Brief directory, companies with foreign projects or branches \$1 or c.o.d. Foreign Service Institute, Box 3934, Miami 24, Fla.

YOU Can make real money raising Golden Hamsters, the new amazing tiny animal. Food costs less than 10c month per animal. Breeds in 16 days! Easily raised in basement, attic, garage, barn, or shed. Write for convincing details. Hudson Hamstery, R.F.D. #1, Newfoundland, N. J.

MAKE Soaps, cleaners, detergents. Easy instructions, 100 formulas, \$1.00. Brown, 9111-F Hoyne, Chicago 20.

HOW To make money by mail, 48 years uninterrupted proof. Particulars free. Howard Snyder, Canton, Mississippi.

OWN Mirror shop. Resilver mirrors. Glass sign making. Electroplating. Supply prices. John Sprinkle, V50, Marion, Ind.

START Lamp business in your home, basement, garage. Profitable, fascinating, easy to learn. Illustrated course teaches you. General instructions and wholesale catalog \$1.00. Gearon Company, 27 South Desplaines, Chicago.

INTERESTED In Latin American and foreign employment? \$1 brings copyrighted Foreign Service Directory listing firms with interests in construction, oil, mining, aviation, manufacturing by personnel expert. Hot list of companies hiring. Global Reports, P.O. Box 883, Hollywood 28, Calif.

WOULD You pay 3%—first \$350 made? Color-illustrated book "505 Odd, Successful Enterprises" free! Some offer occasional "day off." Work home. Expect something odd! Pacific, Oceanside, Calif.

\$40.00 WEEKLY Made growing mushrooms, fresh, dried. Dominion patent 331583. Free spawn. North American, 169P Yonge, Toronto, Canada.

"ALASKA" The last frontier offers unlimited opportunities. \$1 brings official government map and copyrighted report with listing of firms: Fishing, construction, mining, aviation, homestead lands, prospecting business. Alaska Opportunist, P.O. Box 883, Hollywood 28, Calif.

BE The Popular Mechanics representative in your neighborhood and earn big profits in your spare time. Write Popular Mechanics Magazine, Room 408M, 200 E. Ontario St., Chicago, Ill.

BOOKS, PERIODICALS, PICTURES, POSTCARDS

WE Can supply you with almost any book. Magazine subscriptions. House of Kilroy (Booksellers), Box 772, Detroit 31, Mich.

BOOKHUNTERS! All subjects. Send wants! Jaher Book Service, 620-P East 178 Street, New York 57.

FIGURE Drawing without model, \$1.00. Also free catalogue, interesting books. A. Fuller Company, 201 Dewey Street, Newark 8, New Jersey.

SELF-EXPLAINING Bible: Illustrated circular free. Box 446-P, Minneapolis, Minn.

BOOK Lovers! Send six fictions, good condition, with \$1. We return six different fictions. Robert Miller, 20 Kelly Pl., Springfield 4, Mass.

NATIONAL Geographic Magazine, 1888-1948, any issue. Periodical Service, Dept. PM, Swarthmore, Penna.

BOOKFINDERS! (Scarce, out-of-print, unusual books.) Quickly supplied. Send wants. Clifton Company, Box 1377pm, Beverly Hills, Calif.

BIG Sparetime profits taking magazine subscriptions. Complete supplies, confidential catalog free. Cassell Publishers Service, Westfield, New Jersey.

GAMES, ENTERTAINMENT

FUN For all ages—New, colorful wax picture building set. Complete \$1, money back guarantee. Queen Bee Manufacturing Co., 186 Joralemon St., Brooklyn, N. Y.

MAGIC TRICKS, PUZZLES, JOKER NOVELTIES

FOUR Good card tricks with catalog, 25c. Stivers, 40 Salem, Medford, Mass.

MAGIC Tricks. Includes famous hand-cuff trick, 25c. Culver, 2204 South Third, Terre Haute, Ind.

5c BRINGS Catalogue magic-jokers' tricks! Postways, Box 5325-R, Philadelphia 42.

WORLD'S Largest professional magic shop, keeps you in touch with latest tricks. To receive mailings, send 50c for new catalog. Holden's, M220 West 42nd St., New York.

PRACTICAL Magic course by correspondence. Write Box 1815, Pensacola, Florida.

MAGIC Catalog; book of tricks. Both 10c. Wade, 1423 Palou, San Francisco 24, Calif.

SNEEZING, Itching, powders. Eighteen other tricks free with joker's catalog 25c. 2404-N Fifteenth, Philadelphia.

OPONENTS Foiled, great western belt trick 10c. Schiff, 2319 Newton, Milwaukee 11.

MAGIC Monthly. Year 25c. Sample and 1948 magic catalogue free. Magic Shop, Minneapolis 2, Minn.

DOLLAR Magic set free with Mammoth catalog 25c. "Mysto," 4462-PM Germantown, Philadelphia.

VANISHING Half dollar trick and catalog 25c. Sterling Magic Co., Royal Oak, Mich.

PROFESSIONAL Catalog, 128 pages, 25c. Williams, 900 Plymouth, Ellwood City, Penna.

TRICKY Magic matchbox. It turns around, it stands, it opens. Confuses, amuses everyone, easy to do. Free to you if you send 25c for big illustrated catalog of 425 magic tricks. Magician, 2463-C, Kensington Ave., Philadelphia 25, Penna.

LARGE Catalogue of the best magic for professionals and amateurs. Send 25c. Mazda Magic Co., 1135 Westgate Ave., Oak Park, Ill.

"VENTRILLO" Professional voice throwing instrument and "unusual" catalog 25c. POB-971, Philadelphia.

MAGICIANS' Headquarters. 400-page professional catalogue, pocket, parlor, stage tricks. World's finest magic. Send \$1.00 for catalogue (refunded first \$5.00 order). Kanter's, M-1311 Walnut, Philadelphia 7, Penna.

LEARN Magic, ventriloquism, mind-reading. Write for particulars. Quackenbus, Big Flats, N. Y.

BIG Magic magazine, trick and price lists—25c. Lloyd M. Jones, 4064 39th Avenue, Oakland 2, California.

VENTRILLOQUISM Taught, 3c stamp bringing particulars. Smith, 801 Bigelow, Peoria 5, Ill.

MAGIC Tricks, puzzles, books, cards, punch boards. Catalog 10c. Specialty, Box 671, St. Louis 1, Mo.

500 TRICKS. Send only 10c for Douglas' famous 112-page catalog 500 tricks. New magic for amateur, professional. America's fastest service for 25 years. Douglas Magicland, Dept. 1, Dallas, Texas.

BE A magician. Large professional magic catalog of latest tricks, 35c. Ireland, C-109 North Dearborn, Chicago 2.

COINS, TOKENS, CURRENCY

OLD Money wanted. Do you know that coin collectors pay up to \$100.00 for certain U. S. cents? And high premiums for all rare coins? We buy all kinds. Send 4c for large coin folder. May mean much profit to you. Numismatic Co., Dept. 20, Fort Worth, Texas.

MEXICAN Coins—1 Peso, 50c, 20c silver; 10c, 5c nickel; 20c, 5c, 2c, 1c bronze. Nine pieces. Fine to unc., \$1.65 postpaid. The Border Coin Co., Station A, Box 3535, El Paso, Texas.

SEND 5c For price list on old coins. Leslie Steward Jr., 369 So. Chase Ave., Columbus, Ohio.

BAGDAD Strange rare coins. Nine different including silvers, \$2.00. Edward Basry, Bagdad 31, Iraq.

4-IN-1 Special \$1.00 bargain offer: (1) United States 1893 Columbian world's fair half dollar; (2) album for holding coins; (3) large 56 page coin catalog; (4) genuine wooden nickel. Yes! All four items for only \$1.00. Order today. Money back if not pleased. Ben's Coin Company, 72 W. Washington, Chicago 2, Illinois.

COIN Bargain list for stamp. Toivo Johnson, East Holden, Maine.

GET Profit and pleasure in collecting old coins. Send 10c for 56 page illustrated coin catalog. You'll be delighted with it. Send for it now. B. Max Mehl, 370 Mehl Bldg., Fort Worth, Texas. Largest rare coin establishment in U. S. Established 48 years.

FREE! Foreign coin, banknote and coin collectors illustrated catalog to approval service applicants. Send 3c postage. Tatham Coinco, Springfield-125, Mass.

COMMEMORATIVE 1/2. Oregon, Texas, Kentucky, Cleveland, Long Island, \$2.00 ea. Illustrated catalogue 25c. Norman Shultz, Salt Lake 9, Utah.

COINS Wanted, will pay up to \$2000 for certain coins. send 25c for catalogue. Burton's, 111 So. Third, Columbus, Ohio.

STAMP COLLECTING

POSITIVELY Greatest free offer—Latest Scott's International \$6.00 stamp album—covering entire world, contains 36,000 illustrated descriptive spaces; Scott's 1948 standard \$7.00 catalogues "Philately's Encyclopedia"—absolutely free to applicants for foreign approvals becoming customers. Plymouth Specialty Company, Dept. A9, Bell, California.

FREE! Liberia triangle airmail set, with approvals. Martin, Box 1128, Miami Beach, Florida.

30 SCANDINAVIA 10c To approval applicants only. Bjorn Nielsen, Monmouth 1, Maine.

VICTORY Packet free—Includes stamps from Tanganyika, British Cayman Islands, animal, scarce babyhead, Coronation, early Victorian, airmail, map stamps. Including big illustrated catalogue. Send 5c for postage. Gray Stamp Company, Dept. PM, Toronto, Canada.

FREE—Famous Americans set, plus Flag Set, plus the National Parks Set, plus the Presidential Set to the \$5. A total of 90 stamps absolutely free to customers for our unsurpassed U. S. or foreign selections. Send 3c postage for 15 of the above mentioned stamps and full particulars. Triboro Stamp Company, 145 Nassau St., Dept. 108, New York.

FREE! Mint British Colonies from Solomon Islands, Caymans, Grenada, Dominica, Turks Caicos. Absolutely free to new approval applicants. Viking, 130-Z Clinton St., Brooklyn, N. Y.

GIFT Six Roosevelt San Marino to approval applicants. Deane Stamps, Box 87, Miami 35, Florida.

MAIL Two dollar bills immediately for King's visit air cover; block of set. Ron Dobson, Maddison St., Hastings, New Zealand.

FREE! Colorful pictorial set cataloguing \$2.30. Approvals included. "PG," 195 Park, Lewiston, Maine.

RUSSIA, Spain, China, Persia. Ten beautiful mint stamps, 10c. Approvals. Standard, Box 43, West Farms, New York 60, New York.

50 DIFFERENT China stamps and our price list, one silver dime. Stamp Sales, Box 1649P, Oakland 4, Calif.

STAMP Collecting—World's greatest hobby! "Stamp Collecting For Pleasure and Profit" \$1.00 postpaid. Details free. Bruce, Box 341-A, Palo Alto, Calif.

"ZEKE Sez" send for my colorful approvals and receive a scarce set free. Zeke's Stamp Shoppe, Howard 6, R. 1.

FREE—Beautiful, multi-colored, unused Flag Stamps! Catalog \$1.60. Sent by return mail, no waiting, absolutely free with approvals. George Wentz, San Marcus, Texas.

COSTA-RICA Miniature sheet dime to approval applicants plus free surprise packet. Yellowstone Stamp, Box 266, Bozeman, Montana.

FIJI Included! Stamps from 40 countries 10c. No approvals. Elsea, Bowling Green, Ohio.

1/2c UP U. S. or foreign approvals by countries. Hurt & Fosse, Blue Ridge, Va.

MAGIC Bag penny approvals. Resch Stamps, 3739 North Wilton, Chicago.

75 UNSORTED Newfoundland 25c. Real value. Mayfair, Regal Rd., Toronto 10, Canada.

MONICA'S Monthly, from British Guiana. Sample, 20c. Year, \$1.00. Walter Flesher, 45-PM Second, Garwood, N. J.

307 ALL Different 10c. You will find scores of new varieties here for your collection! Big and little stamps, bisected stamp, commemoratives, triangles, high values! Bicolored beauties! Strange countries! Every stamp is different. Every stamp one you will delight in owning. Think of the fun you will have! All for only 10c to approval applicants. Write today and receive special Ionian Island stamp extra. Garcelon Stamp Company, Box 400, Calais, Maine.

FREE! Complete Balkan aviation set with approvals. Beaman, Leeds, Alabama.

FREE! Tiny Chinese "midget" war set. Approvals, Seminole, Leeds, Alabama.

BRAZIL Diamond shaped set, 10c with approvals. Vargo Stamps, 6044 South Fairfield, Chicago 29, Illinois.

INFORMATIVE. Free, monthly illustrated price list. Frances Reese, Box P30, Martinsville, Indiana.

205 STAMPS Cataloguing to 75c each. Only \$1.00. Eldon Decker, Bear Island, Ontario, Canada.

SPAIN'S "Goya Nude" set complete 35c. Approvals. Royal Stamp Company, Tamaqua, Penna.

SPECIAL! Bicolor Vatican set 3c! Catalogs 90c. Rostamps, 1921 Schiller, Little Rock, Ark.

REDUCED! Worldwide different—200-25c; 500-50c; 1000-\$1.25; 2000-\$3.25; 5000-\$15.00. Beacon Sales, Maynard 2, Mass.

FIVE Large mint pictorials free to approval applicants. Postage paid both ways. Rush postcard to Phipps, 10993-M Wellworth, Los Angeles 24, Calif.

UNITED States bargain. It sounds unbelievable, but it's true! 50 different United States stamps ranging in age as far back as over 60 years and in face value as high as one dollar. Only postage, commemorative, and air mails included. Nothing else. Extra 2 Jap occupation of Philippines, all for only 10c to approval applicants. Please state whether approvals shall consist of U. S. or foreign stamps or both. Globus Stamp Company, 268 Fourth Avenue, New York 10, N. Y., Dept. 211.

FREE 25c Worth of stamps to U. S. approval applicants. Village Stamp Co., 90-39P 214th St., Queens Village 8, N. Y.

EXCHANGE Stamps: Full cat. 3c stamp for details, booklet, Whaling City Stamp Exchange, 108 Pierce St., New Bedford, Mass.

GERMANY-BADEN, Complete set of 13 colorful pictorials, 10c only to approval applicants. Fields, 1939 E. 85th, Cleveland 6, Ohio.

UNEQUALLED Bargain. Stamps from over 25 countries including Fiji, Swaziland, Pitcairn, Tonga, Trinidad, etc., everything 10c to approval applicants. Bennett's, Box 252, Terminal 'A,' Toronto, Canada.

200 WORLD Wide 27c. Pacific Metro, Box 5704, Los Angeles, Calif.

U. S. Bargain price list free. Stone, Box 52-P, Dorchester 24, Mass.

SENSATIONAL! Set Capejuby, Brunei, Perak, Hounduras, Paraguay, Nigeria, and over 100 different others. Everything 10c with approvals. D. O'Keefe, 7517 Merrill Ave., Chicago, Ill.

500 MIXED Worldwide and 1000 mixed U. S., including 1902 to present issues, old coils, imperfs, etc. Only \$1.00. Profitable for sorting. Best mixture we've ever offered! Halay, 132 West 63rd, New York 23.

FIVE Different mint airmails 5c. Approvals accompany. Bob Stovall, 235 Cortland, Detroit 3, Michigan.

200 BRITISH Empire stamps; only 3c! Kenmore Stamps, Arlington 74c, Mass.

FIVE Beautiful Spanish airmails, catalogue 45c, only 10c with approvals. Standard, Box 43, West Farms, New York 60, N. Y.

CHOICE Of 35c worth of stamps from our first U. S. selection free to applicants enclosing 3c postage. Large selection to choose from. Act now! S. C. Engel & Co., 38 Park Row, New York.

FREE, Irish commemorative collection, including rebellion issue with approvals. Raymax, 123-Z William St., New York City 7.

REMOVE Stamps from paper with "Stoff," 25c. L. White, Box 922, Pittsfield 3, Mass.

"CONFEDERATE States." Twelve different unused 10c, approval applicants only. "Stamps," Box 87, Albany 1, New York.

ETHIOPIA, Vatican, Free French and Roosevelt triangle, free to approval applicants. Rare Stamp Co., Box 121, Miami 38, Florida.

GERMANY #B200-81, CBI-3, 95 mint stamps. \$5.00 approvals. Masser, 322 E. 9 St., Brooklyn 18, N. Y.

HISTORICAL Collection! Cavalry Charge! "Bulgaria" Flaming Sword! "Ireland" Big She-Wolf! "Italy" Fort! Legionnaires! Field Marshall! "Pitcairn Mutiny Island" Commemoratives and pictorials! 3c approvals. Star Stamp Co., Jamestown, New York.

FREE U. S. price list, postage 3c. Mark Hanna, 335 5th Ave., Pittsburgh 22, Penna.

IRAQ Approvals, \$1.00 to \$5.00 deposit. Fifty-one rare covers from here \$5.00. Seventeen \$2.00. (U.S.A. money). Edward Basry, Bagdad 31, Iraq.

FREE! U. S. monthly lists. Cole, 43-A Rinewalt, Buffalo 21, N. Y. Precancels also available!

WHAT Have you to offer? Collection? "Shoebox" accumulations? Anything in stamps? We urgently need them. Spot cash paid. Cosmopolitan Stamp Co., 1457 Broadway, New York City.

FREE, Triangle, Roosevelt, Vatican, Ethiopia, Hitler heads. Request approvals. Florida Stamp Company, Box 807, Miami 5, Fla.

SPANISH Air set free to approval applicants. Flamingo Stamp Company, Box 4038, Pinewood Station, Miami 38, Florida.

FREE Monthly illustrated bulletin showing recent issues. Penny approvals on request. Reed Company, Box 980, Chicago 90, Illinois.

WORLD—500 Diff. 50c, 1000 \$1.25, 75 Canada 25c, approvals, lists. Victoria Stamp Co., London 4, Canada.

PENNY Approvals that satisfy. Neil Gronberg, Box 5441-P, Philadelphia 43, Penna.

10 DIFFERENT Iraq 5c to approval applicants. Jeffery Stamp Co., 9726 Chappel, Chicago 17, Illinois.

WORLDWIDE Packet 50 stamps 5c with approvals. Carlin's Approval Service, Box 307, Fresno, Calif.

FLAG Stamp free with U. S. approvals. Wenigman, 929 Oakdale, Chicago.

25 ALL Different stamps 10c. Tunis, Wakeman Ave., Newark 4, New Jersey.

200 DIFFERENT Stamps—Cataloging up to 15c each, only 3c to approval applicants! Littleton Stampco, Littleton 42, N. H.

ZOWIE-E! A barrel of fun for only a dime. 500 United States stamps—absolutely unpicked and unsorted—just as received from church missions. Many varieties, including large commemoratives, airmails, high denominations up to \$5.00! Stampdom's biggest package of fun—and you might find something really valuable! Price only 10c to serious approval service applicants. Money back if not delighted. Illustrated bargain lists with each order. Mystic Stamp Company, Dept. 80, Camden, New York.

WOW! \$10.00 Worth of fun. Only 10c! What a treasure hunt! Big package 500 foreign stamps from foreign missions, other sources. Includes stamps from Africa, South America, Free French, Somali, Palestine, etc. Includes airmails, commemoratives and stamps worth up to 50c. This offer sent for 10c to approval applicants only. Jamestown Stamp Co., Dept. 22, Jamestown, N. Y.

200 DIFFERENT. Including Roosevelt triangle, 5c to approval applicants. H. Avalon Stamp Co., Springfield, Mass.

WORLD'S Largest stamp (7½x14 inches). A real curiosity! Retail for 50c, only 3c to approval applicants. Tatham Stamp Co., Springfield 30, Mass.

DANDY United States approvals. Write immediately. Sullivan, Endicott Building, St. Paul, Minnesota.

50 DIFFERENT United States 10c. No approvals. Seidenberg, Cassopolis, Mich.

FREE! 100 Worldwide different stamps to approval buyers. Big U.S. and illustrated bargain lists sent with approvals. Bookman, Maplewood, N. J.

BRITISH, Spanish and French Colonies. Vatican, Hitler heads, and airmail packet. Free with approvals. Pan-American Stampco, Box 145, New York 33, N. Y.

STAMP Collections wanted. Complete collections, duplicate lots, surplus stock, mint and used. Prefer trade for printing or other items, buy outright if priced right. What have you, what's wanted? Vanroy Shirk, Lebanon, Penna.

U. S. Price list. Send postage. State Stamp Service, 1225 Park Building, Pittsburgh 22, Penna.

DEALERS—Wholesale list. Postage 3c. Frank, 5031 Queensberry, Baltimore 15, Md.

FIRST Day covers on approval. Knobel, 1918 S.W. 12th Street, Miami 35, Florida.

U. S. Price list. Send postage. Stanley Gibbons, 38-P Park Row, New York.

UNITED States approvals complete coverage, fine quality, attractive prices. Seminole Stamps, Box 1138-P, Coral Gables, Florida.

FREE Beautiful airmails. Commemoratives, pictorials, eight countries. Approvals enclosed. Green and Company, Norwood 12, Ohio.

WHOOPIE! Wow! 25c worth of stamps free to buyers. Write M & N Co., 742A Sheffield Ave., Brooklyn, N. Y.

ANTIQUES, RELICS, INDIAN GOODS, CURIOS

180 PAGES Antique and modern pistol, sword, etc. values, 50c. Robert Abels, A860 Lexington Ave., New York 21.

PRECIOUS STONES, MINERALS

ZIRCONS, Sapphires, rubies, others. Best quality; lowest prices. Free catalogue. Imhusex, Box 232, White Plains, N. Y.

'GENUINE' Deep red Arizona rubies (garnets). Send quarter for packet. Mineral Specimens Company, Box 2651, Phoenix, Arizona.

ZIRCONS: 3 Dazzlers totaling 3 carats \$6.00. Don Huse, Armonk, N. Y.

PETRIFIED Wood. 12 cubic inches \$2.00. Flossie Lee, Mountain View 1, Okla.

GEMSTONES, Rough, polished. Crystallized specimens. Every variety, lowest prices. List free. Plummer's 5068 Brighton, San Diego 7, California.

METAL Detectors. The very latest circuit. Free literature. Hedden Metal Detectors, 3329 Liberty Avenue, Pittsburgh 1, Penna.

BEAUTIFUL Arizona agates, polished samples and listings \$2.00. Unpolished samples \$1.00. Arizona Agate Mines, Cave Creek, Arizona.

HOBBIES AND COLLECTIONS

NICKEL Or gilt carscrows, \$2.00 gross, postpaid in U. S. Sequins, beads, etc. Free list. Betty Kay, Box 274-PM, Ridgewood, N. J.

SHELL Collection of tropical treasures, labeled and boxed, \$1.00. Giant conch shell, \$1.00. Indian coconut head, \$1.00. Southern Importers, Box 1285-A, Miami 35, Florida.

HYDROPONIC Plant food (soilless), 6 ounces, \$1.00, p.p., U. S. Makes 48 gallons. Household Hydroponics Co., Inc., Hartington, Nebr.

25 ALASKAN View-cards, 25c. Mabel Witzel, 62816 Lafayette St., Ionia, Michigan.

LEARN To mount butterflies, moths, for pleasure, profit. Illustrated instructions, price list of supplies 20c. Entomology Supply Company, Medina, N. Y.

WANTED Old cigarette cards. Write Charles Bray, East Bangor, Penna.

BUTTERFLIES Real, assorted, tropical, unmounted, unnamed 20 for \$2.00. American Butterfly Co., 3457 Park Heights Ave., Baltimore 15, Maryland.

PLASTICS Pay off! Comprehensive booklet by retired government authority and university instructor. Complete with illustrations, actual plastic samples, plastics identification chart. \$2.00 postpaid. Romark Plastics, 28P W. 31, New York 1.

UNUSED Match book covers, 100 all different \$1.00. Free catalog. Charles Edelman, 1311C East 84, Cleveland 3, Ohio.

INVENTING Can be an interesting and profitable hobby. Write for complete particulars. Institute of American Inventors, Dept. 40-E, 1926-Eye St. N. W., Washington 6, D. C.

50 DIFFERENT Army embroidered patches \$1. Other bargains. Insignia Mart, 703A Broadway, New York 3, N. Y.

CAMERAS, PHOTO SUPPLIES

KODABROMIDE Enlarging paper—4¼ x 825 feet rolls. Enough for almost 2,000 4 x 5 enlargements. Single weight. Actual test prove its worth. Fully guaranteed. Reduces printing costs to a fraction of a cent apiece. Value over \$35.00. Our price \$2.25 postpaid in U.S.A. Delta Photo Supply, 690-M Third Ave., New York 17, N. Y.

BASS Says! At the sign of the old "Horse Trader," 38th year. Thousands of satisfied customers everywhere! Finest brands including Kodak, Bell & Howell, Argus, Zeiss, Leitz, etc. Satisfaction always guaranteed, or your money back! Bass buys 'em, sells 'em, trades 'em. Write or wire. Bass Camera Company, Dept. AG, 179 W. Madison St., Chicago 2.

KODAK Azo paper, 7½"x7½". TROPICALLY packed in gross boxes, single weight glossy, contrast #4, only. Priced for quick clearance at 98c per gross, 4 gross for \$3.50 postpaid. Delta Photo Supply, 690-M Third Ave., New York 17, N. Y.

PHOTOCOPY Anything—Papers, books, No darkroom. \$6.95 complete. Fotoflek, 4801 Yarmouth, Cincinnati 29, Ohio.

PRECISION Pan-head. All-way tilt. Universally adapted for all cameras. With instant on-off attachment permits easy setting on of camera. Value over \$5.00, our price \$1.69 postpaid. Delta Photo Supply, 690-M Third Ave., New York 17, N. Y.

PRESS-VIEW Camera. interchangeable lens board with extreme swing. 360° revolving back, \$49.50! Free literature. Dave Grinnell, 1446½ Toberman St., Los Angeles 15, Calif.

YOUR Prized negatives make beautiful photo enlargements easily, economically with the new Precise Photo Enlarger, only \$22.20 complete, nothing else to buy. Send postcard for details. Tam Products, CM-8, 3814 Wrightwood, Chicago 47.

2X2 SLIDE Projectors, \$10.95. Self-illuminating slide and film viewer, \$4.95. Limited quantity. Bernard Photography Service, 5526 N. Broadway, Chicago 40, Ill.

35MM Owners. Develop, reverse your own film. Make slides in one hour. Sample free. Lake Camera Exchange, Drawer 842-A, Gary, Indiana.

16MM x 400' Projection reels. All metal, used but guaranteed to be perfect. From government surplus, specially priced at 20 cents each, 6 for \$1.00 postpaid. Delta Photo Supply, 690-M Third Ave., New York 17, N. Y.

AMATEUR Photographers—Buy it or sell it through the Camera Directory. No charge for listing items for sale. 25c per copy. The Camera Directory, Box 204, Olney, Ill.

PHOTOGRAPHY For pleasure or profit. Learn at home. Practical basic training. Long established school. Write for booklet. American School of Photography, 1315 Michigan, Dept. 3432, Chicago 5.

FREE! 116-Page illustrated photographic catalog, send 3c stamp. Bloom's Camera Center, 1657 Main, P.M., Springfield, Mass.

MAKE Your own photocopies with the Cop-Ez Printer, only \$15.00. Cop-Ez Equipment Co., 4864 Woodward, Detroit 1, Mich.

ENLARGER? Build your own cheap. We show you how. Complete plans \$1.00. Somerset Specialties, 10514 Somerset, Detroit 24, Mich.

K-21 AAF Aerial Combat Cameras, manufactured by Graflex; motor driven, with flexible shaft; 24 volt operation; including step-down transformer to 110 voltage; may be manually operated. Complete except for lens and filters. New, original government packaging; positively the lowest price in the country, for a limited time only, \$39.50. An amazing value from Amazing Bachman's, Dept. PM, 27 Herman Street, Rochester 5, N. Y.

GERMAN Camera repairs by German factory trained mechanics. Imported replacements parts, new curtains. Republic Camera & Projector Co., Dept. D, 33 Union Square West, New York 3, N. Y.

PICTURES Never before possible! 35 mm. Tri-X film, Weston speed 200 daylight, 160 Tungsten. Guaranteed. 36 exposure cartridges, 4 for \$2.50. Per dozen \$7.50 postpaid. Delta Photo Supply, 690-M Third Ave., New York 17, N. Y.

PHOTO FINISHING

COLOR Prints and enlargements in 30 minutes in your home at fraction of former costs. Guaranteed amazing new process, no darkroom, no enlarger. Sensation at Rockefeller Hall of Science. Only five simple steps. Prints equal or better than transparency. Randall Color Kit contains everything necessary to make over 100 enlarged color prints. Only \$9.95, postpaid. Order from National Photo Sales, Dept. D, 1313 Atlantic Ave., Atlantic City, N. J.

SAME Day service quality finishing JUMBO contact. Lowest prices. Free mailers and price list. Roy Photo Service, Dept. M, G.P.O. Box 644, New York 1, N. Y.

ROLL Developed, 8 prints and two enlargements 25c. Trial offer. Young Photo Service, 405-C, Albany 2, N. Y.

8 BEAUTIFUL Double size pictures and roll developed 30c. 8 hour service. Free mailers. Pacific Photo Service, Box 666, San Francisco, Calif.

2X2 KODACHROME Slides made from any size photograph, sketch, or picture. Reasonable rates. Prompt service. Bernard Photography Service, 5526 N. Broadway, Chicago 40, Ill.

OIL Coloring photographs can be a fascinating hobby or profitable sideline for those with artistic talent. Learn at home. Easy simplified method. Send for free booklet. National Photo Coloring School, 1315 Michigan, Dept. 343C, Chicago 5, Ill.

FREE Snapshots! Free album! Mail this ad and two negatives for free snapshots, complete in album. When you see these free samples you'll want more. Only one free offer to a customer. Artisto, Department 131, Drawer 220, Regina, Sask.

35MM. Roll fine grain developed, every picture enlarged to a 3 1/4 x 4 1/2 glossy print: 36 exposure roll \$1.00, 20 exposures 65c. Credit given for non printing negatives. Reloads with fresh, fine grain panchromatic film: 36 exposures 45c, 20 exposures 30c. Black-and-white projection transparencies: 90c for 36 exposures (unmounted). Satisfaction guaranteed or complete refund. Additional savings to coupon purchasers. Write for free mailing container and complete information. Dept. P.M., Rochester Laboratory, Inc., Box 199, Rochester 1, N. Y.

2 BEAUTIFUL Hi-Gloss prints each good negative and enlarging coupon with each 8 exposure roll developed 28c. Free mailers. Owlphoto Co., Weatherford, Oklahoma.

ENLARGEMENTS! 5x7, 15c; 8x10, 25c, glossy or dull. Gorgeously oil colored, 50c extra. Negatives made from your favorite photos, 50c. Rolls developed, printed, 25c. L. R., Box 1476-c, Milwaukee 1, Wisconsin.

SENSATIONAL Introductory offer! Send snapshot or negative, this ad and 10c. We'll send you a beautiful 7x5" enlargement! Or, Kodak roll developed and printed (with free coupon) only 25c; or 8 giant prints from roll, 30c. Reprints from negatives, any quantity, regular size, 3c; Giant size 4c. Candid rolls—36 exp. 35mm. developed, vapo-rated, enlarged to 3x4, \$1.00, 18 exp. 50c. Free mailers. Free premium offers sent on request. American Studios, Dept. 364, La Crosse, Wisconsin.

24-HOUR Film service, 8 exposures 25c. Quality prints mailed within 24 hours after film received. York Photo Finishing Service, Box 1469, York, Penna.

OVERSIZE Prints; overnight service; 35c. Films developed and 8 prints near postcard, only 35c. Electronic process, non-fade, glossy pictures. Write for free mailers. Peachtree Photo Finishers, Dept. PM, P.O. Box 4324, Atlanta, Georgia.

YOU'LL Be delighted. Eight Never-fade prints now only 25c. Two prints each only 35c. Free mailers and price list showing other services. Write today. Hammond Sales Co., Hannibal, Mo.

NEW Process developing and printing. 8 exposure rolls 35c. Mayfair Photo Service, Box 261K, Toledo, Ohio.

ENLARGEMENTS In album form developed and printed in one continuous story-telling arrangement. Any 8 exposure roll reproduced this novel, loose-leaf way for only 30c. Reprints 4c each. Extra prompt service! Clip this ad for free mailers. Larga-Pic, Box 22, Brookline, Mass.

"BETTER Photo finishing." Jumbo prints 40c a roll. Reprints 3c. Best by test. 35mm. positives \$1.50 strip, 36 ex. Sealstone Photo, Box 468, Seal-Beach, Calif.

EVERY Picture an enlargement! New electronic developments give you bigger and better enlargements at the same low prices. Any 8 exposure roll developed and printed enlarge size, only 30c; reprints 4c each. Fast, accurate service guaranteed. Send for free mailers today! Enlarge Photo Service, Box 791-D, Boston 2, Mass.

PHOTOGRAPHY For pleasure or profit. Learn at home. Practical basic training. Long established school. Write for booklet. American School of Photography, 1315 Michigan, Dept. 3451, Chicago 5.

8 PRINTS All enlarged to nearly postcard size from your roll or negatives 25c; 16-50c. (Trial offer). Willard Studios, Box 3535A, Cleveland, Ohio.

16 DECKLEDGE Prints from any standard 8 exposure roll 25c. Quick service. Professional work. Skrudland, Lake Geneva, Wis.

FREE Price list on quality developing, printing, enlarging. Write for it today. Bryan's Photo Shop, Dept. M, Panama City, Florida.

BE The Popular Mechanics representative in your neighborhood and earn big profits in your spare time. Write Popular Mechanics Magazine, Room 408, 200 E. Ontario Street, Chicago 11.

MOTION PICTURES AND SOUND EQUIPMENT

BASS Says! 38 years of leadership means satisfaction to you! Finest equipment, 8 and 16 mm., sound cameras, sound projectors. Bass buys 'em, sells 'em, trades 'em. Satisfaction always guaranteed, or your money back! Bass Camera Company, Dept. A, 179 W. Madison St., Chicago 2.

GUARANTEED Super X reversible panchromatic 16mm. surplus film! 6-100 foot rolls ready for camera \$8.10! Bulk, 600 feet, \$5.00! Processing available. Filmcraft, 47th and Holly, Kansas City 2, Missouri.

BARGAIN—16MM. sound film, miscellaneous subjects, "as is," one cent per foot. Silent films three quarters cent per foot. Used 16mm. sound projectors from \$112.50, 16mm. sound films, features from \$47.50, shorts from \$3.50. 35mm. sound projectors from \$125.00. Low prices on screens, reels, cans, amplifiers, speakers, microphones, splicers, developing equipment, lenses and cameras. Trades accepted. Write for big bargain lists. Mogull's, 68 West 48th Street, New York 19.

SOUND Features shipped, rental \$3.95, 1,600' shorts, \$2. Free catalog. National Cinema Service, 71 Dey Street, New York City.

THRILLING 8-16mm. movies. Catalog free. Fine Arts Productions, Box 2084, San Antonio 6, Tex.

GOOD Used 16mm. sound projectors. List. Robert Salmon, 3558 So. 11th East, Salt Lake City, Utah.

COMPLETE Stocks always of Castle, Official, Pictorial films, 8mm., 16 mm., sound. Musicals, soundies, free catalogs. We exchange your films and equipment, or buy them for cash. Frank Lane, 5 Little Bldg., Boston, Mass.

A BIG Buy! Victor Model 40-B 16mm. sound projector, thoroughly reconditioned \$214.50. Many other buys in sound, silent films, projectors, cameras, accessories. Trades accepted. Send for lists. Mogull's, 68 W. 48 St., New York 19.

SOUND. Silent 35mm. features, and shorts. Also 16mm. sound films. Simpson, 155 High, Dayton, Ohio.

PROCESS Own movie film. Free literature. Duro Products, 1519 N. Eggert, Buffalo 21, N. Y.

KODAK Super-X movie film at give away prices! Govt. surplus but good as gold! Tested and fully guaranteed. 16mm. 100' \$2.95; 50' magazine \$2.50; 8mm. 25' Double 8 \$1.65. Processing included. Stock up for summer shootin'! Fotoshop, Room 193, 18 E. 42 St., New York City 17.

ELECTRIC Movie cameras, 16mm., Army GSAP, original condition, value \$200, complete with f/3.5, new \$32.50, used \$19.50. Accessories available for home conversion. Free literature. Completely converted Lektro, 16mm. ready-to-operate \$59.50 guaranteed. Magazine film for same, \$2.50, includes processing. Fotoshop, Room 146, 18 E. 42nd St., New York City 17.

MOVIE Film at tremendous savings! Kodak Super X, govt. stock, tested, guaranteed! 16mm. 100 ft., \$2.95; 50 ft. magazine, \$2.50; Double 8mm. 25 ft. \$1.65. Super XX, 50c add'l. each roll. Free processing. Fast service. Photo Surplus Sales, Box J-12, 12 Duane St., New York City.

FREE. Movie catalog; sample films, 10c. Goodwill Company, Jackson, Tennessee.

UNUSUAL 8-16MM. film subjects. Color slides. Films exchanged. Big catalog with sample film 25c; refunded first order. National Film Supply, Broadway Sta. (E), Toledo 9, Ohio.

TITLE Making, free instruction booklet. Westwood Company, 635 Victoria St., San Francisco 12, California.

BRAND New sound prints, 35mm., "Bob Hope Reports." Full reel. Postpaid \$3.00. Rogers, Box 26, East Atlanta, Georgia.

MOVIES—8-16MM. "variety subjects, rare, cold, or indifferent;" silent and sound. Free lists. AeroTraders, Adams, Mass.

BRAND New 16mm. sound projectors \$129.50. Send 10c for 1948 photographic catalogue. Sterling's, 679 Northampton, Easton, Pennsylvania.

8-16 MM. Movie film developed, ready for projecting—24 hour service. 100 ft. 16mm. \$1.25; 50 ft. 16mm. 85c; 25 ft. 8/8mm. 60c. Radiant Cine Laboratories, Box 720B, Chicago 90.

8-16 MM. Movie film in bulk for home processing. Big free catalog—bargains in film, processing equipment, supplies. Superior, 105B S. Wells, Chicago 6.

LEARN Professional motion picture technique at home. Approved for veteran training under G.I. Bill. Free catalog. Motion Picture Institute, Birmingham 4, Mich.

LEARN Movie projection, management. Free catalog. Theatre Institute, Elmira, N. Y.

BARGAINS In 16mm. sound projectors, films, reels, splicers. Harris, 303 West 42nd Street, New York 18.

I BUY, exchange, swap movies. What have you? What do you want? Lowest exchange rates in world. Catalogue \$1.00. Refundable. Harvey Iris, Box 539, Brockton, Mass.

GUARANTEED Fresh anti-halo outdoor movie film! Weston 12! Daylight loading! Processing free! Three spools double 8 mm. \$3.45! Six single 8 mm. for Univex, \$4.60! Postpaid! Catalog. Eso-S, 47th Holly, Kansas City 2, Missouri.

FREE Movie list. Superior Film Service, Box 713, Troy, N. Y.

8-16MM. Silent-sound films. Complete rental library. All latest subjects. Free catalogue, (sample film 10c). Garden Film, 317 West 50th, New York 19.

BEAUTIFUL Kodachrome slide and lists 25c. Slide Supply Service, 3111 West Tuscarawas, Canton, Ohio.

MUSIC AND MUSICAL INSTRUMENTS

SONGWRITERS! Outstanding, ethical composing offer. Ray Hibbeler, C5, 2157 N. Avers, Chicago.

SONGWRITERS Attention! The amazing demand for phonograph records, accelerated by countless juke-boxes, warrants your immediate investigation. We are offering new writers the rare opportunity of having celebrated "hit" composer furnish music on reduced percentage basis for any likely poems received this month. The Petrillo ban does not affect us. Recola Records, Hollywood 28, Calif.

MUSICAL Movements \$2.00. Free photo. Pevar's, Dept. PM, 4218 Viola St., Philadelphia 4, Penna.

SONGWRITERS: Professional piano arrangement and copyright for your song, \$15. Send Mss. to Music Service, 917 Brown St., Ann Arbor, Mich.

LEARN Piano playing quickly. New speed method. Very simple. Public schools approve. Literature free. Speed Method, 435 Abiso, San Antonio 5, Texas.

1948 ACCORDIONS—Wholesale—Free catalog. American Accordion Center, 5329 Belmont, Chicago.

GUARANTEED Satisfactory piano score arranged, \$6.00. Lee, 344 Primrose, Syracuse 5, N. Y.

SONG Titles and poems wanted for immediate consideration. Examination without charge. Send best material today. Special Service, 2115 Kenilworth Ave., Berwyn, Ill.

SONGWRITERS: Honest outstanding music writing offer. Len-Tex Studios, Leonard 2, Texas.

AMPLIFY Your accordion with our new mike \$22.50. Sounds like organ. Installed in minute. Use any amplifier. Amplifier and mike \$72.50. Write Del Principe, 307 So. Wabash Ave., Chicago.

BE Independent, tune pianos, music unnecessary. Practical Piano Tuning shows you how. \$2.00 postpaid. Chord-Slide Co., P3122 Lawrence Drive, Corpus Christi, Texas.

SONGWRITERS—Protect your songs. Get the facts first. Free booklet, attractive offer. Song Service, 331-C West 46th, New York.

POEMS Wanted for musical setting! Send poem for immediate consideration. Hamann Service, 614 Manhattan Building, Milwaukee, Wisconsin.

POEMS Wanted to be set to music. Free examination. Send poems. McNeil, Master of Music, 510-PM S. Alexandria, Los Angeles, California.

SONGWRITERS: Send poems for free examination and outstanding offer. United Music Service, 150, Salem, Indiana.

WRITE Songs. Big money and reputation. Write for information. J. Gordon Pub. Co., 201 N. Hoyne Ave., Chicago.

ACCORDIONS—Guitars, trumpets and all musical instruments, new and used. Direct from national distributors, cash and terms. Save money. Del Principe, 307 So. Wabash Ave., Chicago.

RADIOS, SUPPLIES, INSTRUCTION

BUILD "Loudest" crystal radio. Instructions, loud crystal, catalog, 25c. Amorose, Route Four, Richmond, Virginia.

"ALL About Headphones." Latest complete repair handbook, including "Radio-builder"—25c. Laboratories, Eye-c, San Carlos, California.

RADIO-ELECTRONIC Devices interest you? Write: Grand Federal, Box 57, Argentine Branch, Kansas City 3, Kansas.

FREE Catalog, radios, phonographs, records. Bargain prices. Mail post card today. Jmad Co., 122 Clinton St., Buffalo 3, N. Y.

MAKE Simple, tubeless, batteryless, distance-getting crystal radios. Crystal and illustrated instructions 25c postpaid. Allen, 427-F, Clinton, Missouri.

FIX Any radio. Amazing new instrument locates radio troubles double quick. Simple instructions show you how. Thousands in use. Write today for 24-page booklet, "The Inside Story." Felier Engineering Co., 945 George St., Dept. PM, Chicago 5, Illinois.

BUSINESS OPPORTUNITIES

ENJOY Two incomes! Start spare-time mailorder business. Experience unnecessary. Literature free. Arden, 2618-PM Elendale Place, Los Angeles 7, Calif.

OPERATE Profitable mail order business. Splendid opportunity. For details write Wayne Information Bureau, 8742 St. Paul Ave., Detroit 14, Mich.

START Home manufacturing business making Cleaning Compounds, Soaps, Insecticides, Cosmetics, Polishes, Food Flavors. No machinery. Literature free. Kemix, Park Ridge 8, Ill.

INCREASE Income by mail with inexpensive letters. New, tested, proved methods, plans. Details free. Distinctive, Box 499, Bethlehem, Penna.

TRADE Magazines help you get ahead. Latest copies every trade, business or interest for only few cents each. Write today for free price list. Commercial Engraving Publishing Co., 34C North Ritter, Indianapolis 19, Indiana.

SENSATIONAL. Make \$25-\$30 day easily. Make and sell amazing new mechanic's waterless hand cleaner. Sells fast to garages, gas stations, farmers. Removes paint, grease. No machinery needed. Formula for making this revolutionary product, only \$2.00. Raymond Allen, 84 Edmund Place, Detroit 1, Michigan.

START A home business in spare time. Make extra money. Experience unnecessary. Literature free. K. Clarkson, 34 Coxwell, Toronto, Canada.

NEW Method of casting metal toys and novelties opens opportunity for full or spare time business and profits. Latest 1948 scale model autos, original ashtrays, savings banks, water pistols, etc., easily cast with bronze moulds. Enormous wholesale and chain store Xmas demand keeps manufacturers busy. No experience or special place necessary. Write for details and illustrations of patterns needed. Metal Cast Products Co., Dept. A, 1696 Boston Road, New York 60, N. Y.

EXTRA Money. Start a business for yourself using our flat fibre weaving material to make baskets, hampers and re-weave chair bottoms. Instructions furnished. Frank Veale Mfg. Co., Inc., P.O. Box 5, Columbus, Ind.

METALIZE Baby shoes, make rubber stamps, silver mirrors, make plaster novelties. Catalogue of "20 ideas" free. Universal, Box 1076-A, Peoria, Ill.

MAKE Durable plastic of waste! Attractive floors, walls, roofs, mantels. Bays Laboratory, 327 S.E. 46, Oklahoma City 9.

NEW Industrial hand cleaner. Free manufacturing-distributing plans. Unusual money-making proposition. "Acro-Sol-Ex," 623 West 14th Ave., Denver, Colorado.

BIG Money full or spare time right in your own home. New miracle finishes, professional plush and suede finishes sprayed on signs, radios, figurines, lamps, toys and other items. New Flok-Kraft methods; material costs few pennies; you get dollars. Free sample, details of powerful money-making plan. Coast, 1507 West Manchester, Los Angeles 44.

NATURAL Molding Latex. Extra thick. Free sample. W. Wooley, 115-A Donald, Peoria, Ill.

START Home business making statuettes, plaques, artificial marble flooring, liquid marble, rubber molds, metalizing baby shoes. Amazing profits. Folder free. Creative, 236-L, Winnetka, Illinois.

MAKE \$5.00 Per hour full or spare time right at home preserving baby shoes in real bronze, gold, silver and pearl. Full details free. Kiktavi Co., 2111A W. Manchester, Los Angeles 44, Calif.

LIQUID Marble—Make in any color. Soundproof plastic flooring. Flexible molds. Cast novelties, plaques, statuary. Big money, your own business. Catalog free. Write, Bing Products, 88-A&A Broad Street, Boston 10, Mass.

METALIZE Baby shoes and other non-metallic articles. Fascinating work. Big profits. Shuplate, Box 1388, Lawton, Okla.

PERFUME—Make it yourself. Profitable, sparetime, home business for men and women. Free information tells how. Write "International," 6347 Parnell-X-12, Chicago 21, Illinois.

BE Independent—Operate America's lowest price penny vending machine. Big profits. Immediate shipments. Write for bulletin and prices. Pelding Mfg. Co., Desk (848), Jackson, Mich.

A FACTORY In your home garage! Mfg. and sales rights, mechanics' waterless hand cleaner, \$500-\$800 monthly. No special equipment necessary. Western Aircraft Mfg., Dept. D, Los Angeles 6, Calif.

NEW, Easy, profitable business sweeping country. Be first in your community. Full, exciting particulars 25c. Hunter, 2173 Green, Cleveland 21, Ohio.

BRONZING Baby shoes is big business; start your own business for \$3.95, everything furnished. Metaloids, Box 2095, Wichita, Kansas.

SELECTED Business plans; office, mail order. New edition. Particulars free. Flasco Sales, 2505D 150 St., Flushing, Long Island, N. Y.

SELL By mail "merchandise." Excellent opportunity. Details, McKinzie, 6320 Southern, Detroit 10, Mich.

START Your own business on our capital. Always your own boss. Hundreds average \$6,000 to \$25,000 annual sales year after year. We supply stocks, equipment on credit. 200 home necessities. Selling experience unnecessary to start. Wonderful opportunity to own pleasant, profitable business backed by world-wide industry. Write Rawleigh's, Dept. H-U-PPM, Freeport, Ill.

"FIX Cracked batteries!" Easy! Big profit! Cement \$1.00 can! Details free! Stevens, Grand Junction, Colorado.

"COLLECT And Grow Rich" is a free booklet that's yours for the asking. Learn of this opportunity for an office business of your own, where you can make a profit on the work of others. T. J. Surface, Pres., Dept. 216-H, Roanoke 7, Virginia.

300,000 ARTICLES Wholesale. Directory 25c. Feather Specialties, Chippewa Falls, Wis.

"WATERLESS Hand Cleaner." Make, sell. No machinery. Build profitable business. Complete formula \$1.00. Ideal Service, Park Ridge 2, Illinois.

NEW Proven business, cleared originator \$400, third month. Details sent free. Germaine, 1450 19th, Columbus 11, Ohio.

SELL Earthworms for soil fertility and for profit. We ship under your name. Great moneymaker. Write, Earthworm Farms Co., 6220 Ridgeview Avenue, Baltimore 6, Maryland.

ONYX And plastic mountings for bronzed baby shoes. 15 styles, hardening solution; complete metalizing service. Wholesale, Box 2095, Wichita, Kans.

FAST Sales. Cuts food cost. Nets \$9 a case. Sell 6 daily. Exclusive terr. Jeid, Ltd., Burbank, Calif.

WAR Surplus without bidding. New products. Closeouts. Sacrifice offers. Advance information each week. Subscribe to Surplus Reporter. Business men, rush name for free sample copies. Write: Surplus Reporter, 223 West Main, Tipp City 2, Ohio.

DEPENDABLE Mail business, splendid opportunity. Vassar, 312 Harden St., S.E., Atlanta, Ga.

INCOME From local information. No selling. Neher Company, La Verne, Calif.

CASH For your idea, 280 manufacturers need inventions, patented or unpatented. List free. Invention Bureau, 208M Clinton, Oak Park, Illinois.

NEW Mail order manual tells how, what, where to sell. Details free. Everett, 542 Barclay, Naperville, Illinois.

EARNING Less than \$200 weekly? It's your fault. Distribute approved Simplified Bookkeeping and Tax Systems to small stores. Includes preparation income and estimated tax returns. Large profits. Leads. State background. NAS, Dept. M-1, 5225 Hollywood Blvd., Los Angeles 27, Calif.

HOSIERY, Handkerchiefs, shirts! Quick shipments. Wholesalers, write for prices. Spartan Hosiery Company, Spartanburg, South Carolina.

HANDY Men—Make quick, easy profits repairing leaking water faucets with Economy Renewable Seat Tools. Build valuable sales and service business in your spare time. Territories open, literature free. See our display ad this issue. Economy, 3122 N. California, Chicago 18.

ANNOUNCING Home study course in commercial baking. Practical basic training. Good field for those with aptitude. Nearly depression proof. Send for free booklet, "Opportunities in the Baking Industry." National Baking School, 1315 Michigan Ave., Dept. 343C, Chicago 5, Ill.

PROFITS Selling office supplies by mail. Repeat business. Particulars free. Glenn Snyder, 5-B Spring, Beachwood, New Jersey.

HOW To silver mirrors, \$25.00 for complete instructions. Trowbridge Mirror Works, 573 Washington Ave., Urbana, Ohio.

GOLDEN Opportunity "How to Establish and Operate a Successful Mail Order Business." Free information. Palmer Publications, 4219-A Southwest Marigold, Portland 1, Oregon.

A GOOD Paying business at your own home. Make and sell concrete benches, flower pots, sun dials, bird baths, etc. Madison Equip. Co., Madison, Tenn.

BUILD A profitable real estate business spare time. Write for free particulars. Frank M. Roseman, 55 Clifford St., Boston 19, Mass.

BIG Earnings easily showing the amazing complete Heather Line of cards. Boxed assortments, personals, wrappings, stationery. Special offers. Act now! Request samples. Heather Greetings, Dept. F-48, Springfield, Mass.

BELTS! Make 'em and make money. No tools! Sample 50c. Artinc Leather, 411 Joseph Ave., Rochester 5, N. Y.

PROFITABLE Industry raising earthworms for gardens and fishing. Send dime for details. Box 186, Franklin Park, Ill.

SELL By mail! Ideas galore! Join mail selling opportunities club! Details free! C. Wehner, Box 142-A, Roxbury 19, Mass.

METALLIZE Baby shoes. Excellent profits. New system assures success. Free details. Treasures Forever, 89 Henry Ave., Lynn, Mass.

RUBBER Molds, figurines, plaques, bookends, ashtrays, novelties. List free. Oman, 642-M Broadway, St. Paul 1, Minn.

SAWDUST. Turn it into cash. Six methods. Instructions 25c. Charles Co., 12-BJ, Norwood, Ohio.

CASH-IN On building boom, making and selling interlocking building blocks. Low investment. Rex Products Co., Dept. 11, Piqua, Ohio.

START Your own business. Formulas, duplicated products. Marchild Service, P.O. Box 166, Plymouth, Mass.

ALL Kinds American, Swiss watches, new and used; retail \$3.65-\$345.00; profit 33 1/2% up; show our catalogue, get orders. Brookings, B-AH1975, Little Rock, Ark.

41 WAYS Of raising capital. For any business. Or invention. Write: Director White, 3439 Michigan, Chicago 16.

LIQUID Marble—Colorful, glossy! Molded, brushed, sprayed! Cast novelties, statuary, colored tiles. Flexible molds. Composition floors. Particulars free. Marbleizing Service, Edwardsville, Illinois.

AMAZING Offer! Become successful weekly newspaper publisher! "Know-how" will open all doors to this interesting, lucrative business. Send only \$1 for 50 big pages of priceless information. Buyers say literally worth weight in gold to ambitious reporter, editor, advertising manager, publisher, writer, etc. Yours for only \$1, postpaid. Guaranteed. HURRY! Success Publications, 66 E. Forest, Detroit 1, Michigan.

BUY A new Excel pop corn machine and be your own boss. The only low priced big popper on the market. We set you up in business for only \$121.50. This buys the Excel and all supplies. Act now, write for description. Indiana Pop Corn Co., Muncie, Ind.

SELL Mechanics, printers, factories, stores, sensational gel hand cleaner. Pint sample 50c. Schultz Labs., Boone, Iowa.

50 BUSINESSES You can start with \$10 and make \$10 per week! Complete; detailed! Copy, \$1.00. Literature free. Carey, 25-P, Waverly Place, Melrose 76, Mass.

YOUR Own mail order business at home. New, illustrated course. Free booklet. Registrar, 7219 South Broadway, Los Angeles 3.

MOVIES! Be your own boss. Start your own movie business in your spare time. Big profits with small investment. Write The Movie Man, Ed Hanus, Antigo, Wis.

OPERATORS, Distributors, salesmen. Operate route or sell new AM-FM console hotel coin radio. Field wide open. Tremendous profits. Write immediately B & R Sales, P.O. Box 5684, Dallas, Tex.

AGENT Or exclusive distributor for cigarette lighter mfg. MacGregor, Tahoe Valley 16, Calif.

SEND \$1.00 For information of business with unlimited possibilities. J. Benicewicz, 1212-150th St., East Chicago, Ind.

FREE Particulars on 100 easily made cleaners and soaps. Brown, 9111-E Hoyne, Chicago 20.

OPERATE Mail order business. Splendid opportunity. Write A.C.R., Box 728, Dover, Del.

MOLD-MAKERS. Air-cure concentrated latex. Lowest prices. Major Chemical Co., 131 Inman St., Cambridge 39, Mass.

MONEY By mail. Learn to operate your own mail order business. Big profits. \$1.00. R. S. Kennedy, 419 Dime Bldg., Detroit 26, Michigan.

BE A used car dealer, guaranteed plan \$1.00. Edw. Smith, 17A Rockland, Yonkers, N. Y.

1000% PROFIT Selling snake orchids. Devour live insects. Enterprises-A, Toronto 12, Canada.

WHOLESALE Sources 100,000 items; 60 formulas; 50 mail order success secrets; 64 page, illustrated "secret" catalogue 25c (refundable). Wilborn, 316-P Judson Rives Bldg., Los Angeles 13.

MAKE Money sharpening saws at home on electric machine. No experience necessary. Hardware dealers act as your agents to secure work. Send for free book "Independence After 40" shows complete plan for starting in spare time. Foley Mfg. Co., 47 Foley Bldg., Minneapolis 18, Minn.

"OPPORTUNITIES"—52 Page mail trade magazine, 24 wholesale sources, 3c. Wayne Burger, Baltic, Ohio.

MAKE Money by mail. Work at home. Amazing new plan tells how. Produced at great cost. Real, genuine moneymaker. Information free. Velker, 1836 Champlain Street, Toledo 11, Ohio.

RESILVER Mirrors at home. Formula 25c. Ideal Service, Park Ridge 6, Illinois.

TWO Dollars starts perfume manufacturing business. Big profits. Particulars free. Bob Celaya, Brownsville, Texas.

BE Independent, your own profitable business, home or shop, services for everyone. Complete instructions \$2.00. Packard, 2013 Chenevert, Houston, Tex.

YOU Make them. We sell them! New liquid plastic makes many items. Terrific demand! Earn minimum of \$50.00 per week at home. No experience or machinery required. We supply raw materials and instruction. Write Travaco Laboratories, P.O. Box 1883, Boston 5, Mass.

RUBBER! White liquid rubber! America's finest flexible moulding rubber! New! Extra heavy viscosity! Quick drying! Ideal for home, classroom, or industry. Only \$7.95 per gallon, \$2.95 per quart, and \$1.00 per half-pint sample. Parcel post prepaid! Plastercraft Supply Company, 3051 St. Clair Avenue, Cleveland 14, Ohio.

SPIN Angora wool. Ideal home business. Descriptive circular free. House of Angora, Springfield, Illinois.

VENDING Machines earn big money! An investment as low as \$10.50 will start you in this fascinating, profitable business that can lead you to the road of success and independence. Routes can be established and operated in either full or spare time with no experience needed. Write for full details and our free catalog illustrating our nut, candy, gum and stamp vendors; also slot machines, amusement games, etc. Parkway Machine Corporation, 623 W. North Avenue, Dept. 7, Baltimore 17, Maryland.

NO Selling, operate vendors, amazing profits, details free. Silver-King, 622 Diversey, Chicago 14, Ill.

LIKE Profits? Operate profitable mail order business. Splendid opportunities. For details write: Eugene Cottle, 249 Elm Avenue, North Sacramento, California.

PIANO Tuners are in demand making big money. Learn piano tuning at home. Write Evansville School of Piano Tuning, Dept. B, 714 S.E. Second Street, Evansville, Ind.

SPECIAL Rubber for making molds. Literature and sample free. Universal, Box 1076-A, Peoria, Ill.

POPCORN Machines, peanut roasters, caramelpcorn equipment, griddles, gasoline, bottled gas appliances. Northside Sales, Indianola, Iowa.

HOW And where to obtain capital. Small and large loans. Free particulars. Star Service, Wapakoneta, Ohio.

OWN Mirror shop. Resilver mirrors. Glass sign making. Electroplating. Supply prices. John Sprinkle, V60, Marion, Indiana.

BRONZED Baby shoe mountings and supplies. All metal bronze bookends, picture frames, ash trays, etc. Onyx ash trays, desk sets, plaques. Hardening solution, 30-amp. plating rectifiers with powerstat control, \$85.00. Geared motors for agitation \$20.00. Lead lined tanks. Write for list, Hollywood Bronze Supply, 1770 N. Vermont, Hollywood 27, Calif.

SELL Greeting cards, pictures, signs, novelties, books! Large profits! Catalog free! Elfco, 434 North Wells Street, Chicago 10.

MAKE Money making new greaseload doughnuts at home on electric machine. Wholesale to grocers, drug stores, cafes, hamburger shops. Send for free recipes and plans. M. Ray Company, 3605 South 15 Ave., Minneapolis 7, Minnesota.

MAKE Beautiful vari-colored, highly glazed concrete pottery. Amazing profits. Small capital starts. Write for samples and photographs. Ozark Enterprises, Lock Box 273, St. Charles, Mo.

MONEY For you in your own business. Many surprising opportunities. Free information. Empire, Box 1340-C, St. Louis, Mo.

RUBACREAM! Natural rubber latex! Makes molds quicker! Thicker! Free sample convinces! Castcraft Studios, 509-P Fifth Avenue, New York 17.

DO It with sea shells. Profitable easy home work. Free lesson. A. Werts, Sharp Park, California.

MAKE Liquid marble, artificial marble flooring, flexible molds, statuary, art goods, novelties. Literature free. Kemico, Park Ridge 50, Ill.

EARN \$200 Weekly installing new amazing "Styron" plastic wall tile in homes, offices. Easily applied. Tile your own kitchen, bathroom, too. Instructions, everything furnished. Literature free. U. S. Tile Co., 30 W. Washington St., Chicago 2, Ill.

GET Hundreds money making deals, business ideas, plans and manufacturing. Amazing folio free. Austin Mail Service, 5538 Lexington, Chicago, Illinois.

MAKE Money by mail, every month. Spare time business. Small capital required. Tuff, 429 Robison Ct., Pittsburgh 19, Penna.

QUICK Money. "Repairing car batteries." At home! Easy too! Batteryman, Grand Junction, Colorado.

WANTED Unused U. S. postage stamps, small discount. Advance Stamp Company, 24 East 23rd Street, New York.

MAKE And sell candy professionally, inexpensive to start, information free. Box 670, Kissimmee, Florida.

POPCORN Machines. Potato chip outfits. Long Eakins Company, 4860 Hi Street, Springfield 99, Ohio.

OPERATE Profitable mail order business. Splendid opportunity. For details write V. M. McKinley, 78 Ave. "A," Battle Creek, Mich.

READ "Advance"—The voice of mail order. Offers money-making opportunities, sources of supply, personal guidance, etc. Issued monthly. Sample copy 25c. Yearly subscription \$2.00. American Mail Trade Association, 313 East 21st Street, Suite 450, New York 10, N. Y.

\$46 FROM Square foot plywood. Jigsaw necessary. Write, Woodarts, X-38, Bridgewater, Mass.

OPERATE Profitable mail order business. Write Walter Service, 4159-A East 112th, Cleveland 5, Ohio.

RECAST Old batteries into new. Latest achievements. Battery Laboratories, Minneapolis.

RE-NEW Leather and leatherette—Make cloth into imitation leather with plastic discovery called Leather-New. Opportunity to make real profits taking care of sales resulting from national advertising. Write for free sample of Leather-New covered material and complete deal. 4723A Troost, Kansas City, Missouri.

LEARN Piano tuning, repairing, at home. Tremendous field! Piano parts, tools furnished. Established 1935. Empire School of Piano Tuning, 606-B East University Ave., Champaign, Ill.

COLORGLAZED Concrete pottery made without molds. Patented method. Cemetery products, novelties, tiles. Basement leak-sealing. Money-making projects. Booklet, details free. Men only. National Potteries Company, Grand Rapids, Minnesota.

START Mailorder bookshop—Everything furnished. 25c brings booklet, samples, exciting ideas. General Publications, Ossining, N. Y.

LIQUID Rubber for making flexible molds. Cast novelties. Sample bottle 25c. Free literature. Chaney, 1130 E. 16th St., Jacksonville 6, Fla.

SPECIALTY Manufacturing, the big money business that can be operated anywhere, start on a very small capital; we supply dependable formulas and complete instructions; get interesting free booklet, "Money-making Opportunities in Specialty Manufacturing." Howard Robinson, Ph.G., 1300-A South Ohio Street, Sedalia, Mo.

COPUBLISH Leading m.o. paper. Latest copy Mail Sale Advertiser and proposition, commemorative stamp. Vanroy Shirk, Lebanon, Penna.

\$25 WEEKLY Working two hours daily. No canvassing. No manufacturing. Lycke, Box 2471, Cleveland 12, Ohio.

137 WAYS To make money, in home or office, business of your own. Full particulars free. Elite Co., 220 Grand St., New York 13.

BRUSH Plating outfits connect to a battery. No tanks necessary. Good paying business at home plating autoparts, bathroom fixtures, bicycles, reflectors, silvering mirrors. No shop or experience required. Outfits furnished. Free booklet. Gunmetal Co., Ave. H, Decatur, Ill.

WOULD You pay 3%—first \$350 made? Color-illustrated book "505 Odd, Successful Enterprises" free! Some offer occasional "day off." Work home. Expect something odd! Pacific, Oceanside, Calif.

MAILING Postcards selling repeat merchandise is profitable. Everything supplied. Details free. Gordan Publishers, Box 23, Pawtucket, R. I.

CO-PUBLISH And advertise in The Central Mail Advertiser. Sample copy for stamp. Low rates. Large circulation. Bagby Printing Co., Georgetown, Ohio.

MAIL Order opportunities. Full or spare time. Hundreds of chances. No charge. Postal brings copy. Blackstone Press, Somerville, New Jersey.

MONEYMAKING OPPORTUNITIES

WANT Pleasant outdoor work in a business of your own? Good profits selling over 200 widely advertised Rawleigh home/farm necessities. Pays better than most occupations. Hundreds in business 5 to 20 years or more! Products-equipment on credit. No experience needed to start, we teach you how. Write today for full particulars. Rawleigh's, Dept. H-145-PPM, Freeport, Ill.

LEARN Air conditioning. Trained men needed. Enormous profits. Write Don Nelson, Warner Robins 2, Georgia.

MAKE Money, paint wall plaques. We furnish plaques small cost. Big demand. Marbleite, Ames Station Box 53, Omaha, Nebraska.

YOU Can co-publish impressive 64-page magazine at little cost. Get four profits; free advertising, 5,000 word details. 25c. Kimball, 31 Norway, Berlin 7, N. H.

BUILD Plastic homes. Lovable, lasting, low cost. Bays Laboratory, 327 S.E. 46, Oklahoma City 9.

START Your own business! Big money manufacturing novelties, plaques, statuary. Free catalog. Write Bing Products, 88-A8B Broad Street, Boston 10, Mass.

HELP Wanted to operate our successful mail business. Free details. Reynolds, Box 103Y, McAllisterville, Penna.

BUILD With concrete blocks: Walls, garages, houses. Professional Instructions \$1.00. "Blockmasons," 1256 Amanda, San Bernardino, Calif.

PAST Sales. Cuts food cost. Nets \$9 a case. Sell 6 daily. Exclusive terr. Jeld. Ltd., Burbank, Calif.

CASH In on brand new idea—Personalized remembrance notes. Samples free. Lincolncraft, Dept. PM, Whitestone, N.Y.

SELL Score books to 20,000,000 bowlers. 40% commission. Samples 30c. Sim's, Marysville, Washington.

EARN Up to \$520 month part or full time keeping books for small firms. Simplified system. Write Tax-Saver System, Dept. D, Ft. Worth, Texas.

MAKE Money raising bees. Wonderful spare time hobby explained in 96 page booklet "How to Succeed With Bees." Illustrated. Only \$1.00. Popular Mechanics Press, 200 East Ontario Street, Chicago 11, Illinois.

LATEST Money-making opportunities. Variety of choice. Details free. Edward Stevens, 716 West Fourth, Michigan City, Indiana.

EARN Money evenings, copying and duplicating comic cartoons for advertisers. Adservice 1, Argyle, Wisconsin.

HOW To make money at home spare time. P.O. Box 8357, Chicago.

UNPAINTED Plaster ornaments. Beautiful designs easily decorated with water colors or oil paints. Profit or hobby. Illustrated list free. Midwest Novelty Mfrs., 108-A Cedar Street, Anaconda, Montana.

ANALYZE Handwriting for profit! Complete outfit \$1.00. Graphologists, POB-971, Philadelphia.

CASH For you—Yes, you keep dollars. We fill orders free. You risk nothing. Write, Edwin Velker, 1836 Champlain Street, Toledo 11, Ohio.

TESTED Money making plans. Free details. James Carter, Rocky Mount, Virginia.

100 MONEYMAKING Ideas! 64 pages—\$1.00. Zampino, 2337 Bath Avenue, Brooklyn 14, N. Y.

SEA Shells. Interested in making shell jewelry, lamps, novelties. We have all supplies at wholesale. Write for price list. Sea Shells, 269 W. Flagler Street, Miami, Fla.

THOUSANDS Articles wholesale. "Supply Source Directory" 10c. Ideal Service, Park Ridge 40, Illinois.

PRIZE Contest bulletin gives various contests now operating, and valuable hints. 3¢ stamp. National Contest Bulletin, Box 2685P, Miami, Florida.

WIN Contest money. Send 25c complete instructions for writing winning answers. Winacontest, 22P Westlake Ave., Auburn, N. Y.

WIN Contest money. General Contest Magazine gives hundreds of tips. Lists current contests and rules. Sample 25c. General Contests, 1609½ East 5th, Duluth, Minn.

WOULD You pay 3%—first \$350 made? Color-illustrated book "505 Odd Successful Enterprises" free! Proven! Work at home, office. Expect something odd! Pacific, Oceanside, Calif.

PUBLISH Your own magazine. Handsome 52 page format, well edited, illustrated. Cost low as \$1.00 month. Brings you prestige, profits. 25c brings sample. details. National, Ord. Nebr.

FORMULAS, PLANS, ETC.

21 MONEYMAKING Candy apple, popcorn formulas. Send \$1.00 m.o. We can supply equipment for starting very profitable popcorn, candy floss business at little cost. Concession Supply, Dept. A, Sta. "B," Toledo, Ohio.

PHOTOGRAPHS anywhere, three formulas \$1.00. "Photo," 2437 Hollywood Ave., Toledo, Ohio.

10,000 FORMULAS And trade secrets. Free literature. Stillman, 555 Kingston Ave., Brooklyn 3, N.Y.

TESTED Formulas. Interesting descriptive booklet free. Pont, Box 635-PM, Terre Haute, Indiana.

OPPORTUNITIES! Catalog describing 200 helpful formula, money-making books. Airmailed throughout world for stamps. Adams Brown Company, Boston 67, Mass.

MAKE—Sell cleaners, soaps, polishes, flavors, cosmetics. Literature free. Kemico, Park Ridge 16, Illinois.

REAL Manufacturing formulas. Lists free. Cummings, Chemist, Gordon Ave., Syracuse 4, N. Y.

PLASTICS

YOUR Own business in plastics. Details free. Harco, Edgewood, Maryland.

PLEXIGLAS. Masked sheets; first quality; per square foot 1/16, 68c; .100, 80c; 1/8, 87c; 3/16, \$1.07, 1/4, \$1.26. For sheet sizes write Hub Stamping, 355 Congress, Boston, Mass.

REAL Flowers embedded in clear plastics, pins \$1.50, earrings set \$1.00. Astoria Products, 631-3rd Ave., New York City.

PLASTIC Injection machine, Plexiglas, jewelry findings, dyes, cements, tools, drills. New catalog. G. Baker Company, River Edge, New Jersey.

AGENTS Make big money selling plastic tablecloths, U. S. patented plastic aprons, magic combinations of purse and shopping bag. Also other items. Sells on sight. Samples free. Schneider Products Co., 83 Atlantic Ave., Revere, Mass.

LUCITE. Plexiglas. Masked sheets. All sizes, cost square foot (12"x12") 1/16" 90c; 1/8" \$1.16; 3/16" \$1.43; 1/4" \$1.68; 5/16" \$2.09. Include 10% postage. Almac Plastics Inc., 230 Fifth Avenue, New York 1, N. Y.

BOOK—Illustrated, fabricating, forming lucite. Simplified methods, projects. \$1.00 p.p. Ideas-B, 11379 Ventura, North Hollywood, Calif.

SUMMER Special. Prime quality masked Lucite. 3/16", 16" square \$2.45 postpaid. Free catalogue. Craft-Plastics, Somerville 1, New Jersey.

PLASTIC Materials. Cements, dyes, findings, internal carving drills. Send 10c for catalog and floral carving instructions. Locket with internally carved rose and bud 50c less findings. Art Plastics of Calif., 8125 East 14th Street, Oakland 3, Calif.

BARGAINS In plastics. Lucite, Plexiglas, Catalin. Many colors and sizes. Details free. George Plastics, 6938A George St., Chicago 34, Ill.

RENEW Leather and leatherette—Make cloth into imitation leather with plastic discovery called Leather-New. Opportunity to make real profits taking care of sales resulting from national advertising. Write for free sample of Leather-New covered material and complete deal. 4723B Troost, Kansas City, Missouri.

PLASTIC—Sheets, rods, tubes, etc. Free list. Plastic Supply Co., 2618 St. Louis Ave., St. Louis 6, Mo.

CHEMISTRY

CHEMICALS And apparatus for industrial, analytical, and private laboratories. Catalog 10c. Dept. M-26. Biological Supply Co., 1176 Mt. Hope Ave., Rochester 7, N. Y.

LEARN Chemistry at home, from the house of Winn. Home of supplies for student chemists. New idea chemical and apparatus outfits for home experimenting. Photographic scales, semi-professional microscopes and accessories. Send 15c for retail catalogue. Established 1931. John H. Winn, 124A West 23 Street, New York 11, N. Y.

NEW Laboratory supply catalog of chemicals and apparatus. Contains many thousands of items with illustrations. Send 25c. Standard Science Supply Company, 1232 N. Paulina St., Chicago 22, Illinois.

FREE Catalog: Chemistry, mineralogy, physics, biology. Tracey Laboratories, Evanston, Illinois.

HANDBOOK For chemical experimenters, illustrated, hundreds of experiments, 50c. Experiment booklet 15c. Supply catalog 5c. Reading Scientific Company, Reading, Penna.

HELP WANTED

A WORD To the wise! Ramode's imprinted cards are a most amazing offer. 50 and 25 for \$1.00, 25 for \$1.50, 25 for \$1.95. 25 beautifully boxed assortments for Christmas and everyday. Samples on approval. Ramode Greetings, 7A Hovey Ave., Cambridge 38, Mass.

BOYS Wanted. Over \$50 week! Sell name plates for front doors. Write National, 214-CC Summer, Boston, Mass.

FREE—"Amazing New Book"—"Profits From Classified Advertising." Tells how and what to advertise. Be sure to read this book before you invest one cent in advertising. Remember—it's free! Write for your copy now. F. W. Johnson, Classified Advertising Manager, 200 East Ontario Street, Chicago 11, Illinois.

AGENTS WANTED

BIG, Easy profits to 100% selling new, novel Christmas card, gift wrapping, panorama, Christmas carol assortments. Bonus. Special offers. Request free samples 50 for \$1.00. Personal, silver imprint line, name imprinted and floral stationery and feature Christmas samples on approval. New England Art Publishers, North Abington 190, Mass.

NEW Extra money plan. Make up to 100% profit; without experience; showing Christmas, Everyday Card assortments, wrappings, stationery, coasters. Unusual, attractive. Bonus. Special offers. Send for free samples 30 different name imprinted Christmas cards, 50 for \$1.00. 25 for \$1.00 and \$2.00, stationery, coasters. Christmas, Everyday assortments on approval. Thomas Terry Studios, 90 Union Ave., Westfield, Mass.

EXCLUSIVE Cutlery line. Complete table and kitchen sets. Also open stock. Butcher, paring knives, etc. Free literature. Broadway Cutlery Co., Broadway, Freehold, N. J.

SELL Dental-Stero the amazing new toothbrush holder and sterilizer with nylon toothbrush. Complete package sells for only 75c. Your cost per dozen, \$4.00; net profit on 1 dozen, \$5.00. Every home can use two to five or more. Big profits! Send \$1 today for 2 sample outfits or write for more details. Dental-Stero Company, 3906 Secor Road, Toledo 6, Ohio.

BIG Money selling cast iron and aluminum cooking utensils direct to consumer, exclusive designs. Free illustrations. Jones Machine & Foundry Co., Chattanooga 2, Tenn.

MEXICAN Feather pictures. Unusual novelty. \$1.00 (stamps) brings \$2.00 worth samples, details. Refunded if unsatisfied. Aztec Art-P, Apartado 762, Mexico City.

AGENTS Sweet smelling perfume novelties sell on sight. Gorgeous samples. Free particulars. Mission, 2328R West Pico, Los Angeles 6, Calif.

PAST Selling line beautiful Christmas and all-occasion assortments, gift wrappings, personalized stationery, matches, playing cards, coasters, napkins, guest towels. Profits to 100%. Free samples 50 for \$1.00 personal Christmas cards. Special offer. Write Senrab Co., 212 West Washington St., Syracuse, N. Y.

VARIETY-HARDWARE Salesmen—Distributors: Exclusive territory open. New cast aluminum house numbers. Huge profits. Average sale nets \$5.00. Sample display \$1.00 (returnable). Alproco Inc., 7765 14th South, Seattle, Wash.

CHRISTMAS Cards. Earn \$3.00 an hour. Take orders galore from friends. America's fastest selling 21 Christmas folder assortment. Smart, distinctive! Costs 50c. Sells \$1. A complete line. Samples on approval. No investment. Sunshine Art, Dept. PM-8, 115 Fulton St., New York 8, N. Y.

BIG Profits selling personalized rust-proof metalgram initials for autos, motorcycles, luggage, etc. Thousands waiting to buy. Unlimited opportunities. Generous samples, 3 styles (your initials) and complete details only 50c (coin). Metalgrams, 1945A-74th St., Brooklyn 4, N. Y.

CALL On friends with sensational Christmas cards in handy assortments. Sell for \$1.00. Profit up to 50c. Also popular-priced personal Christmas cards, everyday assortments, stationery, imported napkins. Samples on approval. Wallace Brown, Dept. H-4, New York 10, N. Y.

LOOK Here! Wanted—Men to start in business on our capital. Sell some 200 farm-home products. Thousands our dealers now make quick sales, big profits. For particulars write Rawleigh's, Dept. H-192A-PPM, Freeport, Ill.

BIG Money. Sell friends, others, exclusive Christmas card assortments unobtainable elsewhere. Profits to 100%. Bonus. Request free samples exclusive 50 and 25 for \$1.00 name imprinted Christmas cards with Christmas and everyday assortments on approval. Regal Greetings, Dept. PM-3, Hazel Park, Mich.

100% PROFIT. No investment—Handle quality Fotostamps. Amazing glossy photographs, gummed stamp form. Business year round. Free samples, particulars. American Foto Stamp Co., 103 East 125th St., Dept. PM 8, New York 35.

REAL Live Mexican jumping beans. 18-25c, 125-\$1.00, 500-\$3.00, 1000-\$5.00. J. J. Frank, 525 Palm, Rockford 1, Ill.

40% PROFIT. Power mowers, \$99.50. Free, sales kit. Farm Products, M-2008, Excelsior Springs, Mo.

AT Last! Something new and sensational in Christmas cards. Gorgeous satin, velour designs never before offered. Amazing value! Gets orders fast. Name-imprinted Christmas cards, 50 for \$1 up. Big profits. 30 other assortments 60c to \$1. Imprinted stationery. Samples on approval. Puro Co., 2801 Locust, Dept. 840-K, St. Louis, Mo.

\$1 STARTS You in business. Sell lined ties, 100% wool interlining. Costs you only \$7 per dozen, you make \$5.00 dozen. Send \$1.00 for special introductory offer two ties. Catalog complete line free. Philip's Neckwear, 20 West 22nd St., Dept. K-26, New York 10.

SELL Ultra-blue stock signs to stores. 1000 slogans, comedy, general, religious. "7x11" cost 6c, sells 35c. Make money. 15 samples ultra-blue signs "7x11" \$1.00 postpaid. Lowy, 8 West Broadway, Dept. 399, New York City 70.

QUICK Cash. Sell friends wonder value name imprinted Christmas cards 50 for \$1.00 up to 25 for \$2.50. 43 sensational money makers. Up to 100% profit. Bonus. Special offers. Write for 9 free self-selling sample portfolios name imprinted Christmas cards and stationery. Rainbow Greeting Card Co., 38 East 1st St., Dept. 17-A, New York.

SELL Gold embossed monogram stationery. Sample free. Dunbars, Sanford, Florida.

EARN \$100 A week and more selling nationally advertised aluminumware, silverware, pressure cookers, canners and gift items. No investment required. Simply take orders, collect commissions, we do the rest. Complete sales kit free. Write Ury Co., Dept. 120, 222 4th Ave., New York 3.

AMAZING Offer—\$40 is yours for selling only 50 boxes, each containing 25 new, entirely different deluxe Christmas cards with or without name imprinted. Also 50 for \$1.00. Free samples. Other boxes on approval. Write today. It costs nothing to try. Cheerful Card Co., 383, White Plains, N. Y.

EASY Money. Sell 50 all embossed Christmas cards for \$1.00 with name imprinted. Sensational new 21 card Christmas assortment sent on approval and free samples of all name imprinted Christmas cards. Lorain Art Studios, Dept. M30, Vermilion, Ohio.

\$5.00 CASH Advance commission every sale. 38-piece "Lady Ann" silverplate table service. Guaranteed quality, value bring sales galore. Sells for only \$14.95, including tarnish-resistant chest. Bonus premiums. Write for free outfit. Dexter Silver Co., 303 Fifth Ave., Dept. PM-8, New York.

SILVER Plating liquid (NuSilver). Anyone can apply with cloth. Gives genuine gleaming silver finish. Renews silver-plated ware, articles, pieces. Silver-plates brass, copper. Distributors, salesmen, agents wanted. NuProcess Products, Aurora, Illinois.

CHRISTMAS Cards 50 for \$1.00! Other series of 25 from \$1-\$2.50. Also box assortments. Free sample albums. Commission. Bonus. Richar Greetings, 16 E. 18th, New York 3.

EARN Big money year 'round. Be a one-person-department-store. Take orders for shirts, ties, hosiery, lingerie, household linens, etc. For information, Corporate Merchandisers, Dept. PM 5, 110 West 34 Street, New York City 1.

A DRESS Yours with every 3 you order for yourself and family. Amazing new bonus plan. Everything free. Harford Frocks, Dept. R-9128, Cincinnati, Ohio.

SHINE Shoes without "polish." New invention. Lightning seller. Shoes gleam like mirror. Samples sent on trial. Kristee 125, Akron, Ohio.

BIG Bargains for big profits. Over 100 sensational wholesale values. Men's used suits \$2, pants 35c, topcoats \$1.25, overcoats \$2, shoes 20c. Experience unnecessary. Free catalog. Superior, 1250-A Jefferson, Chicago 7.

GREETING Card money-makers. Birthday. Everyday. Christmas. Catalog free. Greenport Art Company, Dept. 888P, Brooklyn 15, New York.

AMAZING New "Car-Wash"—Whirlwind seller to garages, auto owners, etc. Sell in bulk. Put it up under your own label. Profits simply astounding. Sample free. Imperial Dye & Products Co., Inc., Charlotte 1, N. C.

CHRISTMAS Cards. Earn \$5.00 with every ten 21 card \$1.00 boxes you sell. Also new plastic cards, personalized cards and stationery, note paper and wrappings. Send for samples today. Howard P. Ellis, Dept. PM-9, Pitman, N. J.

FAST Sales. Cuts food cost. Nets \$9 a case. Sell 6 daily. Exclusive terr. Jeld, Ltd., Burbank, Calif.

DUPONT Water repellent—Anyone can use, no limit to earnings. Sells \$1.00 per pint, sample \$1.00. Large profits. Cook Co., 40 Walnut St., Newark 2, N. J.

CALL On hardware dealers, garages, etc. with new 2-in-1 polishing and sanding unit. \$3.00 seller, sample \$2.00. Cook Co., 40 Walnut St., Newark 2, N. J.

POSITIVELY New. On market only short time. Hundreds of virgin territories open. Retails \$1.50. Write for details. Sample \$1.00. Farrell Company, 1377 Galbraith, Cincinnati 31, Ohio.

"SOLVEX" Cleans dirty hands quickly. Exclusive territory. Solvex, Monticello, Iowa.

UNLIMITED Commissions taking orders. Colorful pocket perfume atomizers. Prospects everywhere. Dynamic Sales, Box 2414P, Cleveland 12, Ohio.

MAKE Sensational profits! New, sell-on-sight plastic line: tablecloths, aprons, many other splendid fast-selling items, novelties. Postal brings free details, special deals. Hurry! Royalty, Box K-748, Passaic, N. J.

AGENTS—Unbelievable, until you have tried this self selling foot bath powder. 98% people need it, 50% profits. Excellent repeater. Rush name for free sample. Saari, 1916 Sheffield, Chicago 14.

MEN And women wanted. Full or part time. Women's link name bracelets. Sells on sight. Make up any name in a minute. No tools or skill required. Send \$1.00 for sample. Write for free literature. Etched Metal Plastics Co., 37 Nells Road, Milford, Conn.

TIRE Accessories. Guaranteed 10,000 mile. Tiger Grip Tire patch. Salesman-distributors. Protected territory. Economy Rubber Prod. Co., Riverdale Station, Box 552-E, Dayton 5, Ohio.

BUY Thousands of nationally advertised products direct from manufacturers. Write for "Buy Direct and Save." Consumers Ass'n., 287-A Lebanon Ave., Mt. Lebanon, Penna.

EVERY Housewife a prospect for automatic Speedi-Waxer. Send for details two big profit sales plans. Darby Corporation, Dept. 8M, 241 Centre St., New York 13, N. Y.

BIG Profits taking orders for new fast selling item. Every pipe smoker needs one. Sell direct or wholesale to cigar and gift stores. Write today for free details. B. F. Schernbeck, 5713 22½ Ave. So., Minneapolis, Minnesota.

MAKE More money in spare time handling magazine orders. Fall best selling season. Our helps build big repeat business. Wholesale catalog free. Write McGregor Magazine Agency, Dept. 12, Mount Morris, Illinois.

SELL Luxury perfumes for profits and repeats. Generous samples \$1.00 deductible first order. Edward Lawson, 10-21 Joiner Street, St. Augustine, Florida.

ACT. Sell new Xmas photo greeting folders. Big profits, we deliver, free kit. Spooner, 115 Chauncy, Boston, Mass.

REMNANTS—Amazing values. Housewives buy on sight. Good profit. Write B & M Textiles, 78 N. Main St., Paterson 2, New Jersey.

FREE Sample! Big profit opportunity with amazing Glow-in-the-Dark house numbers, switch plates, pictures, decals, religious articles. Represent large manufacturer. Madison Mills, 303 Fourth Avenue, New York 10, N. Y.

MAKE More money direct from factory. Fibre brooms, floor dusters, patented wet mops. Aluminum mop wringers. Big profits. Write Burtz Fibre Broom Co., Columbia, Penna., Dept. A.

PLASTIC Christmas cards. Exclusive new plastic, sachet, panoramic and carols Christmas assortments. Five leading 21 card \$1.00 feature assortments. Six portfolios of personal cards. All this plus America's fastest imprint service. Free samples. Elmcraft Card Co., 5930 South Western, Chicago 36, Illinois.

AGENT-Distributors. Flo-Glo plastic linoleum finishes. Acme, Box 404, Mount Vernon, N. Y.

AGENTS. Make big profits selling guaranteed Reflex spark plugs, sideline, exclusive territory. Reflex Spark Plug Co., 10902 Madison Ave., Cleveland 2, Ohio.

AMAZING Profits. \$25.00 for selling 50 \$1.00 deluxe Xmas boxes. Embossed 50 and 25 for \$1.00, name imprinted. Free samples. Ed-Brite, Dept. 12, 435 North Terrace Avenue, Mt. Vernon, New York.

\$25 YOURS For selling only fifty \$1.00 boxes, new exclusive different Christmas and all-occasion cards; also extra cash bonuses. Send for Champion Cheerio 21-card box on approval. Free samples 6 new personal groups and stationery. Write today. Dept. 27, Pen-Brush, 154 Nassau St., New York 7.

SALESMEN: \$20 To \$30 a day easy. Sensational new raised letter metal nameplate, beautifully framed in mahogany. Amazing seller to homes, stores, offices, etc. No deliveries. Get our tested plan. Write Raised Letter Metal Co., Dept. 2288 Fox Bldg., Philadelphia 3, Penna.

MAGIC Cleaner—Laundry soap deal. Hotter than a firecracker. Big profits. Sample free. Bestco, 4642 No. Central, Chicago.

SELL The famous \$3 "Fire-Killer" extinguisher with bracket, wholesale or direct; exclusive territory. "Fire-Killer," Syracuse 1, N. Y.

AGENTS: Stamping names on pocket-key protectors. Sample check with your name, address, 25c. Stamping outfits. Emblem checks, check-fobs, name plates. Hart Mfg. Co., 303 Degraw St., Brooklyn, N. Y.

MAKE More money selling personal initialed individualized belts, buckles, cap badges, tie holders, name plates. 2,000 emblems to choose. Big profits, whole or part time. Write today; special outfit offer. Hookfast Specialties, Box 1425, Dept. 6, Providence, Rhode Island.

GUARANTEED Product in protected territory, if you are now selling or intend to sell house-to-house. For full 1 qt. sample amazing High Shine Windsor No Rubbing Wax, send only 25c covering handling and postage. (Sells for \$1.25.) Windsor Wax Co., Inc., Dept. P.M.-2, Hoboken, N. J.

AGENTS Make big profits selling sensational new diapers which require no folding. Every new mother a prospect. Rush name for free sample. Fred Dexter and Staff, 234 West 17th, Houston 8, Texas.

FREE Water and our concentrates, makes flavors, lotions, shampoos, 72 products, labels, bottles furnished. Qualco, E-20030 Russell, Detroit.

INFORMATION—Wholesale supply sources. Moneymaking plans. Increase your income! Write Reynard Service, Smithfield 3, Ohio.

GOLD Lacquered window sign letters. Large sizes penny each. New foils. Absolutely beautiful. Free samples. Atlas, 544 W. 79th, Chicago 20.

EXCELLENT Sideline for printing and advertising salesmen. Decalcomania name plates in small quantities. Great demand. Also, make money with our line of automobile initials and sign letters. Free samples. "Ralco" XL-Roxbury, Boston 19, Mass.

AGENTS—300% Profit selling genuine gold window letters; stores and offices. Free samples. Metallic Letter Co., 438-B North Clark, Chicago.

HIGH-GRADE SALESMEN

FAST Sales. Cuts food cost. Nets \$9 a case. Sell 6 daily. Exclusive terr. Jeld, Ltd., Burbank, Calif.

TERRIFIC Seller. You can sell thousands of Roll-N-Write, the amazing new writing board. Every home, office, student, store, factory, etc. is a multiple prospect. Be first—act now! Robertson & Co., 228P N. LaSalle St., Chicago.

TWISTEE Animal balloons. Make new shapes yourself. Twelve balloons in package. Sells 50c, costs 25c. Hottest selling balloon item. Many others. Ellswood Distributors, La Junta, Colorado.

ALL Kinds American, Swiss watches, new and used; retail \$3.65-\$345.00; profit 33½% up; show our catalogue, get orders. Brookings, B-1975AH, Little Rock, Ark.

ALWAYS needed invention. Proved success. Sales booming. Cover this and nearby territory. Home, stores, factories prospects. Low price, long profit, exclusive. No deposit. Write or wire 318 R. C. Building, Red Comet, Inc., Littleton, Colorado.

NEW Opportunity—Earn big profits. Mailing and shipping cartons are used in every business. We will help you make easy sales, steady commissions on quickly repeating orders. Corrugated Paper Products, Inc., 619A Brooklyn Ave., Brooklyn 3, N. Y.

MAKE Big fast money selling sensational new auto accessory. Exclusive territory to distributors. Electro-Aid Company, Hopkins, Minn.

SELL Anchor pet stakes. One best on market. Big profits. Sample 85 cents. Kauffeld Mfg. Co., 249 Stanton Ave., Akron 1, Ohio.

BRAND New! Revolutionary products! Salesmen make \$10,000 yearly selling one complete lighting line. "Neo-Glo" fluorescent changeable message sign replacing neon. "All-Lite" table lamp using upright fluorescent tube, spectacular "Circline" fixtures using circular tube. Verticals, dual-rays, pin-up lamps, a complete line of fluorescent and incandescent fixtures covering every commercial, industrial, residential need. A triple sales plan insures your success whether you choose selling dealers, direct, straight commission or distributorship on our capital. Get set now with our growing progressive organization. To get you started, we will send a beautifully illustrated catalog showing over 200 profitable, sales-tested styles and models. Order blanks, sales helps, everything needed to start at once included. It costs you nothing. Rush name quickly, today, and start making real money. Rose Company, 539JJ South Franklin, Chicago, Illinois.

PHOTO-SALESMEN-AGENTS. Sell beautiful hand-colored plastic enlargements. Collect deposit, we deliver. Profitable sideline. Send card, for free sample kit. Novel Photo Co., 3343 North Ave., Chicago, Ill.

VALUABLE Franchise available (County, State), handling modern wallpaper treatment; wholesale, retail. Free details. Transglo, Little Neck, N. Y.

SALESMEN. Earn \$100.00 weekly, selling only six pair shoes daily. Commission and bonus. Wide variety for men, women, children. No investment. Experience unnecessary. Tanners Shoes, 300, Boston, Mass.

ADVERTISING Book matches—Cash in on political campaigns; sell union label matches. Cuts for all businesses, political parties. Free powerhouse selling kit, low prices, protection guaranteed on repeat orders. Cash commissions. Superior Match Co., Dept. M88, 7530 Greenwood, Chicago.

YOU Can earn 49%! Salesman wanted to sell nationally advertised desk model portable adding machine. Priced \$12.95, fully guaranteed. Not a toy. Easy to operate and in demand everywhere. You can make 49%! For complete details and full size color illustration, write today to: Lightning Adding Machine Co., Inc., Dept. ZD4, 543 So. Spring Street, Los Angeles 13, Calif.

SELL Delicious candies, nuts, gum. Immediate delivery. Write Casterline, 2031-PK Sunnyside, Chicago 25, Illinois.

SILVER Plating liquid (NuSilver). Anyone can apply with cloth. Gives genuine gleaming silver finish. Renews silver-plated ware, articles, pieces. Silver-plates brass, copper. Distributors, salesmen, agents wanted. NuProcess Products, Aurora, Illinois.

START Your own business on our capital. Always your own boss. Hundreds average \$6,000 to \$25,000 annual sales year after year. We supply stocks, equipment on credit. 200 home necessities. Selling experience unnecessary to start. Wonderful opportunity to own pleasant, profitable business backed by world-wide industry. Write Rawleigh's, Dept. H-UI-PPM, Freeport, Ill.

PORTRAIT Salesmen. Beautiful oil-colored enlargements in 24 karat gold plated frames, big commissions. Write, Ryan Portrait Company, Box 281, Kansas City, Mo.

I'LL Put a "shoe store business" in your pocket! Nation's leader trains you to make big money! Fit men, women. Free sample outfit; write today! Consolidated Shoe System, Dept. S-137, Chippewa Falls, Wis.

PHONOGRAPH Record salesmen wanted. Nation-wide distribution. Salaries to proper parties. Details free. Music-Mart, 510 15th St., Oakland 12, Calif.

BIG Money quickly and easily taking orders for complete line personalized in-itialled buckles, belts, cap badges, 2,000 emblems. Fast repeats. Write today, Hook-Fast Company, Box 480-PM, Roanoke, Virginia.

BIG Profits daily taking every family's magazines subscriptions. Give unlimited choice of valuable books free. Publishers, 323-5 Hammond, Cincinnati 2, Ohio.

JOBS Open in selling! Send name, address for free copy Opportunity Magazine, listing hundreds of companies who need men now, full or spare time. Experience not essential. Opportunity, 28 E. Jackson, Dept. 17, Chicago 4, Ill.

BIG Money taking orders. Shirts, ties, socks, pants, jackets, sweaters, shoes, uniforms, etc. Sales equipment free. Experience unnecessary. Nimrod, 4922-AN Lincoln, Chicago.

SELL Calendars—Every business a prospect. Also wholesale to printers; calendars, sheet pictures. Fleming Calendar Co., 6540 Cottage Grove, Chicago 37.

EDUCATIONAL AND INSTRUCTION

BE A Notary Public. Largest notary supply house equips you for \$16.97, guarantees your appointment by governor. Honor, prestige. You certify legal papers, collect fees. Easy. At home, office, anywhere. You use official seal made with your name. Notaries needed everywhere. Be one. Write Stationers Exchange, Helotes 15, Texas.

SPEED And skill in radio code to qualify for amateur or commercial radiotelegraph license. Learn at home with the famous Candler System used to train radiotelegraph experts and champions. Good pay or fascinating and profitable hobby. Free book, Candler, Dept. 5-J, Box 928, Denver, Colorado.

"HOW To Break and Train Horses"—A book every farmer and horseman should have. It is free, no obligation. Simply address, Beery School of Horsemanship, Dept. 1108, Pleasant Hill, Ohio.

MAKE Up to \$30-\$40 week as a trained practical nurse! Learn quickly at home. Booklet free. Chicago School of Nursing, Dept. M-8, Chicago.

NOW You can have an office. Learn credit-collection business by new home study course. Many earn up to \$5000-\$15,000 annually. Free bulletin. Franklin Credit School, Dept. 202-H, Roanoke 7, Va.

U. S. Gov't. jobs! Big starting pay. Security. Men, women. Qualify now for next examinations. 40-page book; sample lessons; details free. Write Franklin Institute, Dept. E 24, Rochester, N. Y.

FOR An extremely profitable lifetime business operate a collection agency; credit bureau. Easily learned. Free folder. Cole & Associates, Syracuse 2, N. Y.

GET Good jobs by learning free hand technical sketching. Learn with or without instruments. No talent needed. Free lesson. Acme, 1413 Butler, Easton 4, Pennsylvania.

STUDY For work in forests, parks and game refuges. Details sent free. Write Delmar Institute, Mill, Denver, Colo.

LEARN Auctioneering by mail. Sample lesson free. Nelson Auction School, Renville, Minnesota.

AMAZING Low cost home study method. Trains you, charts your capabilities, registers your chances for success. Choose from 100 business and industrial courses. Free bulletin. DeVoto Schools, 35 Vicente, San Francisco 16, Calif.

DEVELOP Photographic mind by Supermemory. Write, Thor Books, CM-8, Box 1210, Chicago.

GET Civil Service job! Have security, big pay! My book tells how! Only \$1.00 postpaid. (Details free). Edwards, Publisher, 3915-B, 12th, Des Moines, Iowa.

3800 LATEST Used correspondence courses. Cat. 50c. EG, Elmsford, N. Y.

LEARN Typewriter repairing under G.I. bill. Adding machine and calculator courses available. For information write Dept. PM8, Capitol School of Typewriter Mechanics, 1328 New York Avenue, N.W., Washington, D. C.

UP To \$8 hourly as self-trained bottled gas plumber. Details free. Ensco, Box 730, Pasadena 16, California.

LEARN Dental technician trade. Ten simple lessons \$5.00. Grant Laboratory, S. Los Angeles 14, Calif.

MEDICAL Laboratory technicians in great demand. We train you in your own home, in your spare time. Also home study course in general chemistry. Free catalogue. Imperial Technical Institute, Box 973-J, Austin, Texas.

USED Correspondence courses and educational books, bought, sold, rented. Catalog free. Educational Exchange, Summer-ville, Ga.

INVESTIGATOR Training. Phillips Secret Service, 1917B North Kenneth, Chicago 39, Illinois.

BOOKKEEPERS! Increase your earnings! Operate your own simplified "dollar-a-week" bookkeeping and tax service. Full or spare time. Details free. No obligation. Ellis, Box 200, Cedar Grove, North Carolina.

USED Correspondence courses and books bought, sold, rented and exchanged. Catalog free. Lee Mountain, Pisgah, Alabama.

LINGUAPHONE Makes languages easy. At home learn to speak Spanish, Portuguese, Italian, French, German, Russian, by quick, easy Linguaphone Conversational Method. Save time, work, money. Linguaphone correspondence courses are available to veterans under G.I. bill of rights. Send for free book. State if G.I. Linguaphone Institute, 83 RCA Bldg., New York, 20, N. Y.

LEARN Photo-engraving at home or in oldest, largest school in America. Work for newspaper or establish own profitable business. New Tasope' Photo-Engraving equipment available soon. Write for information. Veterans ask about G.I. training. The Aurora School of Photo-Engraving, Tasope' Bldg., Aurora, Mo.

SECRET Investigation. Experience unnecessary. Investigators particulars free. George Wagner, M 125 West 86th, New York.

BUSINESS SERVICE

COMPLETE Container service for mail order trade. Request folder. Corrugated Paper Products, Inc., 619J Brooklyn Ave., Brooklyn 3, N. Y.

HOW To get a job by mail. 64 pages. 10 model letters \$1 postpaid. Mrs. Charlotte Mitteer, 216½ Liberty Ave., Endicott, N. Y.

SPECIAL SERVICES

25 YEARS Experience in farm and industrial machinery inventing and improving. Service reasonable. John Langley, Pilot Mt., North Carolina.

CALIFORNIA'S Vacationland beach. Letters mailed 25c. Three scenic cards 25c. Shopping service. Free list Redwood novelties. Collins, 1951 Branciforte, Route 1, Santa Cruz, California.

BAGDAD Reforwarding service. Airmail details 25c. Edward Basry, Bagdad 31, Iraq.

INFORMATION

DIRECTORY: Foreign projects. \$1.00. Foreign Service, Box 3934, Miami 24, Fla.

CARTOONING, COMMERCIAL ART, SHOWCARD WRITING, SIGN PAINTING

"HOW To Make Money With Simple Cartoons"—a book everyone who likes to draw should have. It is free; no obligation. Simply address Cartoonists' Exchange, Dept. 98-C, Pleasant Hill, Ohio.

ARTISTS, Cartoonists. Send six cartoons caricatures or drawings, and \$1.00. Receive drawings by six different artists. Groshek, Rt. 6, Box 405A, Duluth, Minn.

SIGNS Made easily. Instructions and ten sets modern alphabets, numerals, patterns. Sizes up to eight inches. All for \$1.00. Co-operative Business, 7 West Madison, Chicago 2.

SIGN Painting taught at home by an old master. Ben Kerns, Box 812, Greenville, S. C.

9 ALPHABET 3 Numeral pattern sets and catalog. \$1.00. Sign Letter Distributors, P.O. Box 101, Mineola, N. Y.

CHALK Talks. Laugh producing program. \$1.00. Catalog 10c. Balda The Cartoonist, Oshkosh, Wisconsin.

PLAYS, STORIES, MANUSCRIPTS

SCREEN Writers! A known Hollywood writer offers you a complete and original motion picture shooting script, available for first time anywhere, for only \$5.00. If ordered now we include a glossary of motion picture script terms. Hollyvine House, 5336 Corteen Place, N. Hollywood, Calif. Inquiries answered. Scripts criticized \$5.00.

I WANT New writers to cash hundreds of checks for \$1 to \$100, offered each month. The easiest way to write for pay. No previous experience necessary. Send for free details. No obligation. Saunders M. Cummings, 467-M Independence Bldg., Colorado Springs, Colo.

ADVERTISING AGENCIES, LETTER WRITERS, FOR ADVERTISERS

MAILING Lists for all sections. Home-owners, ministers, church societies, veterans, new mothers, purchasing agents, trained nurses, treasurers, canvassers, business executives, teen-agers, corporations, donors, civil service lists, inventors, hobbyists. Dunhill List Company, 565 Fifth Avenue, New York City. Branches in Chicago, Washington.

MAILING Lists—Wealthy prospects. \$1.00 per hundred. BMA Co., Jacksonville 5, Florida.

EARN Money in your spare time. Progressive Mail Trade tells you how. Large 64 page magazine for a dime. Progressive Mail Trade, 822 Center Ave., Sheboygan, Wisconsin.

ADVERTISE In England! Over 1000 magazines, trade papers, technical journals, etc. Send \$1.00 for complete list and information. Ricardo, Sampson, N. Y.

ADVERTISE: 24 Words, 40 newspapers \$3.50. Lists free. Advertising Bureau, 229-C Dixon, Uniontown, Penna.

ADVERTISERS! Reach nearly 18,000,000 readers. 25 Sunday national key newspapers, 18 words, \$47.75. "Terrific pullers." 20 popular newspapers, \$9.75. "Free booklet." Special—One inch display 2-821,198 circulation, \$42.00. Newark's Advertising Agency, (Established 1893) 217-7th Ave., New York 11.

ADS Placed in out of town newspapers and magazines. Low rates. Catalogue free. Ideas that pay. Baker Advertising Agency, Successors Ankrum Agency, 189 W. Madison, Chicago 2.

MAILING Lists, certified, productive, inexpensive, \$5.00 1000. Homeworkers, agents, buyers, etc. Write Dixie Service, King, N. C.

24 WORDS In 64 weeklies \$4.96. H. J. Darnell, 730 Hays, Jackson, Tenn.

TYPEWRITERS, DUPLICATORS, OFFICE DEVICES

STANDARD Typewriters \$17.50 up; duplicators \$12.50; adding machines \$12.50; ship anywhere. Cash Typewriter Service, 118 Spruce, Wichita, Kansas.

DUPLICATORS \$9.95 up. (New.) Immediate delivery. "Free circular." Rucker, 2836-PM Slevin, Louisville 12, Ky.

"PRINTOMATIC" Selffeeding post card stencil printing duplicators \$9.50 up. Office size duplicators, Speedprints, Hilcos, Excellographs \$33.41 up. Literature free. Pittsburgh Typewriter Supply, 336-WK Fourth Avenue, Pittsburgh 22, Penna.

RECONDITIONED Typewriters, mimeograph, multigraph printing devices, appliances, supplies. Catalog. Dixigraph Service, King, N. Carolina.

RUBBER STAMPS AND OFFICE SUPPLIES

3 LINES 45c; Cushioned, indexed 50c. Pads 35c. Stampright, Wauwatosa, Wis.

DE LUXE Cushioned, indexed, knob handle; three lines \$1.00, two 75c. Quick service. Catalog 10c. Warner Stationery, Box D-43, Havre de Grace, Maryland.

QUALITY Stencils, inks, priced right, Riddle, 360 S. Hill, Los Angeles 13.

LINE 20c; 2-35c; 3-50c. Stamp Works, Auburn, Nebraska.

RUBBER Stamps. Illustrated literature free. Lee-Vall Press, Dept. 7-A, Box 1242, Indianapolis 6, Indiana.

PRINTING, MULTIGRAPHING, MIMEOGRAPHING, GUMMED LABELS

25 LETTERHEADS, 20 Envelopes printed. 35c. Glennard Corn, Hendersonville, North Carolina.

MIMEOGRAPHING That looks like printing. Write for samples and prices. Piety Hill Press, Birmingham, Mich.

400 5½ x 8½ LETTERHEADS \$1.25. Mango, 555-A South 20th, Newark 3, N. J.

100 8½ x 11 MIMEOGRAPHED 75c. Free price list. Hugh Gregg, 1424M Workman Mill, Whittier, Calif.

STATIONERY—Personalized with picture of you, your house, anything! GA, 138 N. Locust, Appleton, Wis.

EXCELLENT Printing and folding. Reasonable rates. Quick service. Write, Beery S. Powell, Pleasant Hill, Ohio.

100 LETTERHEADS And 100 envelopes \$1.25. Satisfaction guaranteed. Lawrence Norman, Sterling, Va.

FREE Samples. Quality printing. Backus, 209 S. Laurel, Richmond, Va.

PRINTED 6¼. "Hammermill bond envelopes;" 5,000, \$19.50 f.o.b. Keith's Press, Elizabethtown, New York.

MIMEOGRAPHING Specialists—Any copy. Reasonable. Mailers Service, Box 606-H, Chicago 90, Ill.

PRINTING You'll like. Reasonable prices. Samples. D'Yarmett Printing, Newark, Ohio.

MIMEOGRAPHING—Any copy. Save money. Samples free. Radio Shop, Box 748, Freeport, New York.

1000 EMBOSSD Business cards, \$2.98. Ortiz, 700 West 180 Street, New York.

500 LETTERHEADS And envelopes \$7.00 prepaid. Prompt service. Sumar Press, Creative Printing, 81 W. Van Buren, Chicago 6, Ill.

100—8½x11 HAMMERMILL Letterheads, 100 envelopes, 5 lines, \$2.00. R. Cook, 730 West Gift, Peoria 5, Illinois.

LETTERHEADS. Envelopes, circulars. Small, large quantities. H.M.G. Company, Mecca, Indiana.

QUALITY Printing: Business, personal stationery. State requirements. Samples. Mero Products, 100 Morrison, Punxsutawney, Penna.

WRITE For samples, prices attractive letterheads, cards, circulars. Journal Printing Co., Newark, Arkansas.

100 8½x11 HAMMERMILL Letterheads and envelopes \$1.98. Herbert Hudson, 261 Woonasquatucket, Centredale, R. I.

500 ¾x2¼ FOUR Line gummed stickers 35c; red border 50c. Moritz Printery, Saginaw, Mich.

1000 BUSINESS Cards, \$2.50, prepaid. Samples free. Reliable Print Shop, 905 E. Jefferson, Louisville 6, Ky.

SEND 10c Now, for our 48 page 1948 price list—refunded first order. McCall Press, 1326 South 27th, Omaha, Nebraska.

QUALITY Printing—Reasonable prices. Fast service on catalogs, folders, publications. Write for prices. Bagby Printing Co., Georgetown, Ohio.

MIMEOGRAPHING—Letters, pricelists, formulas, instructions. Lowest prices. Lem's Letter Shop, 5710 Stanton, Detroit 8.

PRINTING OUTFITS AND SUPPLIES

REBUILT Presses, bought, sold. List 3c. Exchange, 212 Curtis, Meriden, Conn.

GOLD Imprinter \$3.25. Samples 10c. Garza, 8 Walden, Cambridge 40, Mass.

HAND Presses, job presses, typewriters, etc. E. G. Bartlett, Atlanta, Missouri.

PRINTERS—Twelve inch brass line gauge, one pair printers steel tweezers. Beauties. Both for \$1.25. Introductory offer; money back if not satisfied. Other supplies. Write Appt Gauge Co., Rossford, Ohio. Dealers, salesman, wanted.

PRINTERS Supply catalog 10c. Brighton's, 4234-M South Mozart, Chicago 32, Illinois.

MAKE Your own printing cuts. Newly invented Plexiplat Process. Plexiservice, Argyle 1, Wisconsin.

PRINTING Presses, type, supplies. Lists 3c. Turnbaugh Service, Loysville, Penna.

PRINTING Presses, type, supplies. Send dime for complete illustrated printer's supply book, details and press samples. Kelsey, Inc., A-11, Meriden, Connecticut.

INEXPENSIVE Home-made printing press. Details free. Novelty Shop, Downs-ville, Louisiana.

PATENT ATTORNEYS

INVENTORS—Patent laws encourage the development of inventions. Our firm is registered to practice before the U. S. Patent Office. Write for further particulars as to patent protection and procedure and "Invention Record" form at once. No obligation. McMorrow, Berman & Davidson, Registered Patent Attorneys, 134-H Victor Building, Washington 1, D. C.

PATENT Protection—This well-known organization will supply inventors, promptly upon request and without obligation, a booklet containing detailed information concerning steps to take to protect their inventions by a U. S. Patent. Victor J. Evans & Co., Merlin M. Evans, Registered Patent Attorney, 331-H Merlin Building, Washington 6, D. C.

REGISTERED Patent attorney offers services. H. Sanders, 6430 Evans, Chicago 37.

INVENTORS: Learn how to protect your invention. Unless the inventor is familiar with patent matters, he should engage a competent registered patent attorney or agent to represent him. We are registered to practise before the U. S. Patent Office and prepared to serve you in handling your patent matters. "Patent Guide for the Inventor" containing detailed information concerning patent protection and procedure with "Record of Invention" form will be forwarded to you upon request—without obligation. Clarence A. O'Brien & Harvey Jacobson, Registered Patent Attorneys, 81B-G District National Building, Washington, D. C.

PATENTS—Trade marks. Irving L. McCathran, 315 McLachlen Bldg., Washington 1, D. C. Registered Patent Attorney.

C. A. SNOW & Co.—M-427, Snow Building, Washington 1, D. C. Registered Patent Attorneys. Write for information.

INVENTORS. For "Record of Invention" form, contact Carl Miller, Registered Patent Attorney, Woolworth Building, New York.

INVENTORS: Without obligation, write for information explaining the steps you should take to secure a patent. John N. Randolph, Registered Patent Attorney, 203 Columbian Bldg., Washington 1, D. C.

INVENTORS: When you are satisfied that you have invented something of value write me, without obligation, for information as to what steps you should take to secure patents or trademarks. Write Patrick D. Beavers (Formerly Randolph & Beavers) Registered Patent Atty., 935 Columbian Bldg., Washington 1, D. C.

PATENT Practice before U. S. Patent Office. Validity and infringement investigations and opinions. Booklet and form "Evidence of Conception" forwarded upon request. Lancaster, Allwine & Rommel, Registered Patent Attorneys, Suite 411, 815-15th Street, N.W., Washington 5, D. C.

"INVENTOR'S Guide" free on request. Frank Ledermann, Registered Patent Attorney, 154 Nassau St., New York 7, N. Y.

PATENTS. "Proof of Invention" folder mailed without obligation. E. E. Vrooman, Registered Patent Attorney, 871 Woodward Building, Washington 5, D. C.

INVENTORS: Write for free brochure "Evidence of Invention." Labiner, World Building, New York 7.

FOR INVENTORS

INVENTORS—A patent is a valuable right. Send for booklet, "Patent Protection for Inventors," outlining the preliminary steps to take to obtain patent protection. Victor J. Evans & Co., 332-H Merlin Building, Washington 6, D. C.

INVENTORS—Patent laws encourage the development of inventions. Our firm is registered to practice before the U. S. Patent Office. Write for further particulars as to patent protection and procedure and "Invention Record" form at once. No obligation. McMorrow, Berman & Davidson, Registered Patent Attorneys, 134-H Victor Building, Washington 1, D. C.

FINANCIAL Aid for invention development. TNB, Box 1434, Amarillo, Texas.

WHERE And how to sell your idea or invention. Get free publicity, and market your product nationally. \$1.00. John Beaudry, 4337-30th Ave., S., Minneapolis 6, Minn.

DRAWINGS, Models and experimental devices, of your ideas. Confidential. Shadyside Engineering Laboratory, Sunbury, Ohio.

YOU Need us for quick profit. Complete assistance. Send sketch, details now. Inventors and Manufacturers Creative Service, 326 W. 3rd St., Los Angeles 13, Calif.

INVENTORS! Have you good patentable ideas? Write Patent Agent Metzler, 11 West 42nd, New York.

IF You have an idea for a new product; take advantage of our expert advice. Free booklet "P" tells you how we can convert your ideas into commercial products, fully protected, and introduce them to reliable manufacturers. Elo Development Co., 29-28 41st Ave., Long Island City 1, N. Y.

"INVENTOR'S Guide" free on request. Frank Ledermann, Registered Patent Attorney, 154 Nassau St., New York 7, N. Y.

INVENTORS: Learn how to protect your invention. Unless the inventor is familiar with patent matters, he should engage a competent registered patent attorney or agent to represent him. We are registered to practise before the U.S. Patent Office and prepared to serve you in handling your patent matters. "Patent Guide for the Inventor" containing detailed information concerning patent protection and procedure with "Record of Invention" form will be forwarded to you upon request—without obligation. Clarence A. O'Brien & Harvey Jacobson, Registered Patent Attorneys, 81A-G District National Building, Washington, D. C.

INVENTORS: If you have an invention for sale, patented or unpatented, write Institute of American Inventors, Dept. 40A, 1926 Eye St. N.W., Washington 6, D. C.

INVENTORS: Without obligation, write for information explaining the steps you should take to secure a patent on your invention. John N. Randolph, Registered Patent Attorney, 202 Columbian Bldg., Washington 1, D. C.

I SELL Patents. Established in 1900. Charles A. Scott, 773PM Garson Ave., Rochester, N. Y.

INVENTORS: The usual first step is to have a search of the U. S. Patents conducted, so I can report on patentability. Write, without obligation, Patrick D. Beavers (Formerly Randolph & Beavers), Registered Patent Atty., 936 Columbian Bldg., Washington 1, D. C.

CASH For your idea. 280 manufacturers need inventions, patented or unpatented. List free. Invention Bureau, 208M Clinton, Oak Park, Illinois.

PATENT Searches: reliable, efficient, air-mail service; \$6.00. Write for free invention protection form. Patent Research Service, 703P Albee Bldg., Washington 5, D. C.

INVENTIONS WANTED

INVENTORS—What have you, patented, patent pending for manufacturers? Submit details, or request free booklet and information. Direct Contacts, 11106-A2 Longwood, Chicago 43.

INVENTORS—Manufacturers. Sell or buy worthwhile patents thru us. Universal Guaranty Company, Lakewood, New York.

HIGHEST Royalties—Cash. Official U. S. I. R. C. certified service. Request free booklet "M." Universal Marketing Co., 126 Lexington Avenue, New York 16, N. Y.

CASH Markets want your ideas. Write, Hendrickson, Argyle 1, Wisconsin.

CASH For your idea. 280 manufacturers need inventions, patented or unpatented. List free. Invention Bureau, 208M Clinton, Oak Park, Illinois.

INVENTIONS Wanted. Patented or pending only. Inventors' Exchange-B, Hartford 1, Conn.

INVENTORS: Hundreds of manufacturers have requested our assistance in locating marketable new products. Complete information, free. Institute of American Inventors, Dept. 40-D, 1926-Eye St. N.W., Washington 6, D. C.

SMALL Inventions wanted by manufacturers. I'll help you sell your invention. Write for circular. Stanley Hull, 7829 Euclid, Cleveland, Ohio.

PATENTS FOR SALE

PENDING—Unique double-deck cookie sheet simple in construction, economical to manufacture. Good item for premiums. Josephine Martin, Corning, Ohio.

INVENTORS: Test the commercial value of your patented or unpatented inventions, quickly and inexpensively. Write for free information. Institute of American Inventors, Dept. 40-B, 1926-Eye St. N.W., Washington 6, D. C.

MANUFACTURING

WOLVERINE Stool for barbers \$26.75. F.O.B. Monroe, Michigan. Send for literature. Discounts. P.O. Box 202, Monroe, Michigan. Wolverine Mfg. Company.

MACHINE Work, experimental models, engineering assistance. John N. Fenner, Route 4, Asheville, N. C.

MODELS. Tools, dies, experimental work; large and small lot manufacturing. Van-Ess Specialties Company, 212 W. 14th Street, Covington, Ky.

PRECISION Dies, molds, experimental. Special machines. Booklet. Arizona Tool & Die, 31 Rillito, Tucson.

PERMANENT Moulds for plastics, aluminum castings. Send drawings. Unanited Mould & Machine Company, Bunker Hill, Ill.

SMALL Lot production wanted. Aluminum castings; stampings; screw machine; plastics. J and M Company, Burlington, Kentucky.

MODELS—Small lot manufacturing. Metals, plastics, etc. Milburn, Burlington, Kentucky.

MODELS, MODEL SUPPLIES

MAKE Your own model gas engine. Four cycle, 1 1/4" stroke. Ideal for model planes, boats and racers. Castings available. 3 prints 75c. Popular Mechanics Press, 200 East Ontario Street, Chicago 11, Illinois.

STEAM Engines, boilers, castings. Catalog 25c. Anton Bohaboy, 2297 Price, Rahway, New Jersey.

MINIATURE Steam locomotives, 1/4", 3/8", 3/4" scales. Castings, parts, rail, steam fittings! Thorough drawings with instructions. Catalog 25c. Little Engines, Wilmington, Calif.

PLANT Layout, architectural, home and factory. Let us bid on your requirements. P.O. Box 202, Monroe, Michigan.

BRASS Gears and model supplies for the inventors. Send 10c for catalog. Pierce Model Works, Tinley Park, Ill.

SHIP And yacht model fittings; blueprints. Send 25c for illustrated catalog No. 21—listing hundreds of items. A. J. Fisher, 1002-1 Etowah Ave., Royal Oak, Mich.

RADIO Control planes. Complete. Less than \$100.00. 10c please. Hobby Center, 12240 Gratiot, Detroit.

LANDLOCKED Sailors! Here's a beautiful, richly illustrated, fully descriptive catalogue of famous model ships—whalers, slovers, corvettes, etc., authentic in every detail. Send for it today. Only 25c. Halesite Yacht Service, Inc., Halesite, Huntington, N. Y.

FUN Building models—Airplanes, trains, ships. Everything furnished. Giant catalog 10c. Ben's Hobby Shop, 72 West Washington, Chicago 2, Illinois.

SHIP Models and yacht supplies complete. Large 64 page catalogue 30c. Bill Wild's, 510 East 11 St., New York City 9.

HOME CRAFTSMEN

LEATHERCRAFT Catalogue and textbook. America's finest. The leatherworker's bible. Mail postcard for details. Artcraft Leather, Dept. PM-8, 271 Twelfth St., Oakland 7, California.

LEATHERCRAFT Kits. Stamp for catalog. Roy's Leathercraft, 2439 Devon, Chicago 45.

LEATHERCRAFTERS! Free catalog! Leathers, tools, supplies. Rosenblum Leather, 518 N. 8th, Sheboygan, Wis.

THREE-DIMENSIONAL Velvety decorations for lamps, greetings, etc. Material for 50 designs, instructions, stencils. \$2. Sparks, 1145 Queen Anne, Los Angeles 6.

LEARN To make seashell jewelry, pins, earrings, hair ornaments, novelties. Design and instruction book free with \$2.00 and \$5.00 kits. Also artificial flower supplies. Herbert Diamond Co., Box 4619, Miami 31, Florida.

ELECTRICIANS. Mechanical pencil with Ohm's law, wire and motor sizes and amperage. Fine for handy men, \$1.50. H. E. Zarek Co., 317 W. Palm St., Compton, Calif.

LAWN Chairs, garden figures, furniture, novelties, toys, etc. 68 popular plans with full size patterns, \$1.00. Mastercraft 8M, 7041 Olcott, Chicago 31, Ill.

HAVE Profitable home business. Make lovely chenille flowers, novelties. Details free. Velva Artcrafts, 324-M East 14th, New York 3, N. Y.

125 TOY Plans. Send 10c for illustrated catalog. Continental Homecrafters, 907 Birch, Eau Claire 3, Wisconsin.

SWISS Music units \$3.50. Two tunes \$4.50. Kits \$4.75 up. Irving Meyers, 126 Lexington Ave., New York 16, N. Y.

LEATHER. Retail, mail orders, catalog, tools, lacing, supplies. National Handicraft Co., 30 Frankfort St., New York City 7.

SHELLCRAFT! Make beautiful seashell jewelry. Income or hobby! Large illustrated catalog! Supplies, instructions, 10c postage. (Buy direct from manufacturer.) Pace's, Box 279M, Bradenton, Florida.

FIND It in the dark! Light pulls, lamp finials, house numerals; make these and other useful objects of phosphorescent plastic at 1/4 usual cost. You get instructions, plastic, plus suggested uses. \$1.25 postpaid. Romark Plastics, 28 West 31, New York 1.

LEATHERCRAFT—Silversmith. Tools, dies, engravers. Made to order. Belt toppers, billfolds, key cases. Louis Jones, 1405 Throckmorton, Ft. Worth, Texas.

PLASTIC Jewelry supplies. Free catalog. J & M Novelties, Box 464P, Griffith, Indiana.

MAKE Your own jewelry! Findings in metal and plastics; earwires, pinbacks, cameos, stones, beads, clasps, sprays, combs, hairbars, plastic and metal chains. Hobby Art Corp., Dept. 7, P.O. B. 276, New York 18, N. Y.

SCRAP Leather, large sizes, assorted colors, 5 lb. \$3.95. Enterprise, Sheboygan, Wisconsin.

KNOCKDOWN Cedar chests. Lumber and veneers. Free price list. Giles & Kendall Company, Huntsville, Ala.

LEATHERCRAFT! Complete stocks of leathers, tools, supplies. Immediate shipment. Free catalog. Kit Kraft, 3203 W. Washington Blvd., Los Angeles 16, California.

CERAMIC Jewelry supplies, bar pins, ear screws, for ceramic and woodworkers; also glass and seashell assemblers. Free catalog. Philadelphia Badge Co., Dept. B-1, 1007 Filbert St., Philadelphia, Penna.

COPPER And brass materials. Complete line for craftsmen and workshops. Catalog A free. Groundmaster Company, Boulder, Colorado.

LEATHERCRAFTERS: Belt kits, projects, leather, supplies. Free catalog. Art Leather, 411 Joseph Ave., Rochester 5, N.Y.

SHELLS, Plastics, findings. Lowest prices. Free catalog. Frances Jones, Box 251, Sarasota, Fla.

MAKE IT YOURSELF

BUILD Concrete blockmaker. Motor or hand. Easy. Inexpensive. Free details. Clyde Lee, Dept. A, Mountain View, Okla.

THOSE Who work nights, trouble sleeping days. For \$1.00 I will send you description my invention to keep out light and at same time give ventilation. Money back if not satisfied. Can be easily made. Roscoe Truworthy, 2A White Rock, Gorham, Maine.

BEAT High cost with this "pattern plan." Build charming two bedroom home yourself. Save one-half. Proven construction. Eligible for loan. Simple, economical methods are detailed for you on full size patterns. No chance for error. Send 25c for sketch, floor plan, descriptive literature. Pattern Plan, 372 E. Orme, Phoenix, Arizona.

BUILD Your own soap-box derby racer. Perfect for any lad. Exact duplicate of the 1946 championship car. Plan only 25c. Popular Mechanics Press, 200 East Ontario Street, Chicago 11, Illinois.

BUILD Concrete block machines, portable saw mills, shop, home, farm machines. 183 plans. Catalog-handbook free. Nichols Equipment Co., Dept. 1310, Purvis, Miss.

MAKE Your own handy lightweight concrete blocks quickly with new blockmaker. Circular stamp. Manual 25c. Peerless, New Lenox, Illinois.

BUILT-IN Kitchen cabinets. \$1.00 brings detailed plans and specifications showing construction methods. Will fit any kitchen. Thombert Co., Box 447D, Newton, Iowa.

"CONCRETE Block homes." 32 page booklet; drawings, instructions on how to build. \$1.00. H. C. Lightfoot, Civil Engineer, Richboro 1, Penna.

WATCHES, OLD GOLD, JEWELRY

RHINESTONES, Moonstones, pearls. Illustrative literature 10c. Herber, 1360-A Hicks, New York 67.

ELGIN, Waltham, Benrus pocket and wrist watches. Wholesale. Box 1874, Chicago 90, Illinois.

ZIRCONS, Loose. Pure white. Special 3 zircons approximate total weights 3-kts. \$6.00. We can supply zircons in all sizes and mountings of all types. Send order or write for details today. B. Lowe, Holland Bldg., St. Louis, Mo. PM.

HIGHEST Cash for old, broken jewelry. Mail gold teeth, watches, rings, silverware, diamonds, spectacles. Satisfaction guaranteed. Free information. Rose Smelting Co., 39-A East Madison, Chicago.

MINIATURE Grandfather electric clocks, Self-starting with swinging pendulum, 13" high, 6" wide, 3" deep; mahogany or ivory finish. Beautifies any home. An ideal gift. Fully guaranteed. \$15.54 f.o.b. Chicago. Dealers wanted. Campet Company, 2066 Canalport Ave., Chicago 8, Ill.

GEMS, Precious and semi-precious, all genuine, from world wide sources. Deal direct, no overhead, save money. Catalog 10c. Hill Co., Route 7, Salem, Oregon.

TOBACCO, SMOKERS' SUPPLIES

BOWL Type pipe filter. Send 25c for 10. State size. Tufford, 919 Grand, Laramie, Wyoming.

MAKE Smoking pipes, briar blocks and stems. Send for circular. Michelson & Sternberg, 23 West 47th Street, New York 19.

PIPE Smokers dream. Pipe that never clogs. Assures sweet, dry, mellow smoke. Genuine imported briar; gives real smoking enjoyment. Unconditionally guaranteed. Particulars free. Bunnell Pipes, 1661-A Elm Street, Stratford, Conn.

RAZORS, BLADES, SHARPENING

ELECTRIC Shavers repaired—One day service. Trade-in allowance. Shoppers Shaver Service, 426 State Street, Madison, Wisconsin.

SURVEYING INSTRUMENTS

GUARANTEED Factory rebuilt transits and levels, sale, or rent, with purchase option. We will repair, trade or buy old instruments. Write for list M-48. Warren-Knight Co. (Manufacturers of Surveying Instruments), 136 North 12th St., Philadelphia 7, Penna.

FOR SALE — MISCELLANEOUS

HULL Automobile compass, value \$4.95, brand new, \$2.50. Prisms for 6x30 or 8x30 binoculars, brand new, \$1.50 each. Offset prisms to be attached to 7x50 B & L binoculars, gives double the field of the ordinary 7x50 binocular. Cost \$98.00, special \$26.00. Green sunshades for binoculars, size 6x30 and 7x50, snap on type, value \$7.50, special \$1.25 per pair. Forward money order. No c.o.d. shipments. Send 25c for catalog of new and used guns, ammunition, binoculars and powder flasks. Public Sport Shops, 11 S. 16th Street, Philadelphia, Penna.

SENSATIONAL \$3.50 Value. Fountain pen, ballpen, mechanical pencil all together \$1. Name imprinted too. Metro Stationery, 60 South Street, Boston 11, Mass.

20,000 GAS Mask face pieces. Army surplus. Write for prices. Elkins, Killen, Texas.

ARMY Gas masks, \$2.00 per dozen plus postage, mailed c.o.d. Amity Products Company, Waltham 54, Mass.

WAR Surplus, aircraft items, shop equipment, machinery and a million other items. Free catalog. Atlas Equipment, 229 Southwest Blvd., Kansas City 8, Mo.

WANTED—MISCELLANEOUS

NEW, Used articles for second-hand store and gift-gadget shop. Whistle Stop, Hazleton, Penna.

METEORITES Wanted, iron or stone. Highest prices. Stuart Perry, Adrian, Mich.

ANYTHING Of value. Robert, 207 North Fifth Street, Springfield, Illinois.

QUICKSILVER (Mercury) urgently needed! Immediate payment. Wholesale Terminal, Norwood, Massachusetts.

LITTLE Library of Useful Information, 113 different books. Catalog free. Popular Mechanics Press, 200 E. Ontario St., Chicago 11, Ill.

PERSONAL

HOLLYWOOD Remail service. Box 1782, Hollywood 36, California. Letters remailed, 25c.

FALSE Teeth wearers. Serious complications possible from loose plates. Literature free. Reine Laboratory, 908 Market, San Francisco, California.

MEXICAN Law. General Practice Attorney, 1203 Arizona Street, El Paso, Texas.

SWAPPERS! Traders! Trade anything. Information: "Swappers" Gazette-PM, Louisville 12, Kentucky.

WE Receive, reforward letters; \$3.00 monthly or 25c each. Hawkins, 1300 Taylor-S, Washington 11, D. C.

BALDNESS—Can it be prevented? 1,500-word booklet absolutely free. Write. Vanguard Research Reports, 3009-F Military Road, N.W., Washington 15, D. C.

PHOTO-STAMPS. Your picture, any object reproduced on genuine, gummed photostamp. 50 stamps \$1.50. Send photo. Returned unharmed. E. Velker, 1836 Champlain Street, Toledo 11, Ohio.

TIE-X-CHANGE. Send six ties and \$1.00. Receive six, 1834 Madison, Eugene, Oregon.

HOW You can find out! Information discreetly developed, any matter, person, problem, anywhere. Personal-business assignments, representations undertaken. Nation-wide. Officially licensed, bonded service established 1922. Reasonable. Confidential. William Herman, 170 Broadway, New York.

HAIR Falling? Dandruff? Write Trichologist, 137 Lewis St., Phillipsburg, N. J.

RUPTURED? Positive comfort, no understraps, no steel, no elastic. Write Smith Manufacturing Company, Preston, Ontario.

MISCELLANEOUS

ABACUS. Now improved and easier to use. An interesting way to learn arithmetic. A fast way to add, subtract, multiply, divide and extract square roots. Specially illustrated instructions show how. New model, \$3.50. Send for free lesson and details. Loy's Chinese Calculator, Dept. 84M, 1317 Rhode Island Ave., N.E., Washington 18, D. C. Agents wanted.

FREE—Assortment photographs of typical Mexico. Aztec Indians, pyramids, scenery. Send 15 cents postage stamps, mailing cost. "Ahora," Apartado 2807M, Mexico City.

BEAUTIFUL Alligator handbags, shoes, \$8.00 upwards. Catalogue. Cuban Articles, 155 Mazon, Havana, Cuba.

LUMINOUS Pigments (powders). Glowell Co., 475-N Fifth Ave., New York 17, N. Y.

PANNING Gold—Free instruction booklet. Catalogue mining books; supplies. Old Prospector, B146, Dutch Flat, Calif.

HELPFUL Radio books. Up-to-date list free. Popular Mechanics Press, (C-43), 200 E. Ontario, Chicago.

SWAP Neck ties! Mail us one to five ties. You'll receive same number hand-somely cleaned different ties we got same way. Then you pay postman \$1.00. Shangrila Novelty Co., 3604 Broadway, New York 31, N. Y.

HOUSES Of earth. Easy to build. Insulated against heat-cold. Ratproof; termiteproof. Approved by government departments. Send today for "Houses Of Earth." Complete instructions, 18 illustrations. A. B. Lee, Box 171P, Washington, D. C.

WHY Forget? Let the "Minute-Timer" bell remind you. Serves million purposes. No burnt foods for housewives. Accurate money saving timing for men. Ideal gift. Send check or money order, \$3.75 postpaid. Amerident, 69-40 Yellowstone Blvd., Forest Hills, Long Island, New York.

BUTTERFLY Brooch pin 2" diameter. Real natural tropical butterflies skillfully mounted under glass. Makes excellent gift, curio, \$1.00 postpaid. American Butterfly Co., 3457 Park Heights Ave., Baltimore 15, Maryland.

SWAP Neckties. Send 8 and \$1.00; receive 8 dry cleaned. Tichenor's Products, 526 So. Western, Dayton 7, Ohio.

"INTERESTING Mails." 25c will keep your mail box full for three months. Bentz, Jr., Chatawa 40, Mississippi.

PERSONALIZED Pencils—Individual or firm name. Dozen 60c, gross \$4.80. Cash delivered. Pencil Market, 611 15th St., Knoxville 16, Tenn.

SCHICK "Super" electric shavers \$13.75. Remington "Foursome" \$14.75. Shavemaster \$17.75. New. Latest models. Prepaid. Order yours today. Sell to others. Stanley Wentling, Palmyra 1, Penna.

SPECIFICATION And prints of permanent magnet motor, \$10.00; plus right to make model. Illustrating literature ten cents. George J. Altman, 150 Broadway, New York 7.

CESSPOOL Trouble cured by the new Septic Bend Co., Rockland, Mass.

"HOW To Win Prize Contests." Amazing booklet \$1.00. Box 28EM, Jackson Heights, New York.

TATTOOING Machines, outfits. Free catalogue. Jensen, 120 West 83rd Street, Los Angeles 3.

MEDICAL Laboratory technicians in great demand. We train you in your own home, in your spare time. Also home study course in general Chemistry. Free catalogue. Imperial Technical Institute, Box 973-J, Austin, Texas.

LUCITE Bar, name pin, safety clasp. Price \$2.00. Made to order. Nightingale Pin Co., P. O. Box 1772, West Palm Beach, Florida.

"RECEIVE Mail." Moneymaking offers, opportunities, catalogs. Name listed 10c. Ideal Service, 100 Park Ridge, Ill.

TREASURE Finders! Goldak's new 11 pound lightweight, gold, silver and mineral locator, money-back guaranteed superior any other device. Free information. The Goldak Co., 1542 West Glenoaks Blvd., Glendale 1, Calif.

BOOKFINDERS! (Scarce, out-of-print, unusual books) Quickly supplied. Send wants. Clifton Company, Box 1377 pmm, Beverly Hills, Calif.

M-SCOPE Metal, mineral locators sensational new electronic lightweight models, immediate shipment. Fisher Research Laboratory, Inc., manufactures some of the finest metal locators for the U. S. Army. Built for Arctic, Tropic use. Unsurpassed efficiency, low prices. Time-payment plan available. Send for free 16-page illustrated booklet. Fisher Research Laboratory, Inc., Palo Alto, Calif.

TATTOOING Outfits, supplies. Illustrated list free. Zels, 728 Lesley, Rockford, Illinois.

70 BIBLE Lessons, 25c. Bulletin, Box 87, Cathedral Station, New York 25.

NOW Ready: New, amazing Classified Advertising Record Book—prepared especially for classified advertisers. Here is a book that tells you instantly whether or not your advertising in any publication is paying you real results. You can tell immediately how many inquiries each publication produced—how much cash received from every ad. Spaces are provided for the name and address of the publication, date of issue, space used, rate, cost of ad, key number, etc. You have a complete record of each publication right before your eyes. Plenty of space to keep accurate record of 28 separate publications. You can have a copy by sending only 10c to cover postage and handling. Send for your copy now. W. F. Johnson, Classified Adv. Mgr., Popular Mechanics Magazine, 200 E. Ontario Street, Chicago 11, Illinois.

SHORTHAND in 6 Weeks at Home

Famous Speedwriting system. No signs; no symbols; no machines; uses ABC's. Easy to learn; easy to write and transcribe. Fast preparation for a job. Surprisingly low cost, 100,000 taught by mail. Used in leading offices and Civil Service. Write for free booklet.

SPEEDWRITING, Dept. 1508-8, 55 W. 42 St., New York 18

New 1948 PLASTICS SUPPLIES CATALOG

Just off press. Full details on Plexiglas, Lucite, rods, sheets, tubes, Acetates, cements, dyes, buffs, molding sets, tools, carving kits, accessories. Everything in plastics. Gives prices, sizes, colors, etc. Price 10c, stamps or coin, with ad for catalog.

PLASTICS MFG. & SUPPLY CORP.
DEPT. M-8 • 4707 EUCLID AVE. • CLEVELAND 3, OHIO

NOW! Build Your Future On

DIESEL Opportunities



LOOK around you. See the way tractors, trucks, buses, railroads, ships, power plants and equipment of many kinds are "going Diesel." Every day new opportunities are opening—in industrial and farming communities—for trained men who can install, maintain, operate and repair Diesel engines. Plan now to build your future in this growing field.

Diesel Knowledge is Earning Power

You don't have to give up your present job. Now, you can begin learning DIESEL in spare time at home. UEI practical training teaches you, step by step, how Diesel engines operate, how fuel systems work, repairs, accessories and auxiliary equipment; a world of Diesel "know how." Includes actual practice on Diesel equipment in our shop under expert guidance. UEI training methods are successful. For 29 years they have helped mechanically inclined men better themselves.

NOW IT'S UP TO YOU!

Coupon below brings you all the facts without cost or obligation. Get going today! MAIL COUPON NOW.

UTILITIES ENGINEERING INSTITUTE Diesel Division
2521 Sheffield Ave., Dept. 188-D, Chicago 14, Ill.



Send Coupon for FREE FACTS

UTILITIES ENGINEERING INSTITUTE, Diesel Division
2521 Sheffield Ave., Dept. 188-D, Chicago 14, Ill.

Please send me Free Facts about Diesel opportunities and training.

NAME _____ Age _____

ADDRESS _____

CITY _____ Zone or County _____ STATE _____

Check here for special information if you are under 17.

ELECTRICIANS

Get this Great Book

Book of 150 Shop Prints, Wiring Diagrams, Full Size 8 1/2 x 11"



FREE

For Merely Examining
Coyne's NEW Pay Raising

8 Volume Set APPLIED ELECTRICITY

Here's a brand new set of electrical books to give you the "know how" on all branches of electricity from appliance repairing to D.C. and A.C. subjects, 11,500 facts, latest methods explained in easy to follow instructions. To prove how valuable and Practical this set can be to you, I'll give you a FREE copy of my book "150 Shop Prints and How to Read Them" just for looking over this set. Written by the Coyne Staff and backed by 47 years' experience, this set has helped many ambitious electrical workers to bigger pay and added opportunity.

OFFER LIMITED • ACT NOW! If you act promptly, I'll send you the 8 volume set Applied Practical Electricity for 7 days FREE examination... together with the 150 Shop Print Book. Look the set over 7 days. If you like it send either \$22.75 cash or \$3.00 after 7 days and \$3.00 per month until \$24 is paid. If you don't want the set, return it and YOU OWE NOTHING. In either event you keep the 150 Shop Print book absolutely FREE.

Coupon below is just a request to see the books free and to get my gift book for doing it. ACT—Send coupon Today!
Technical Book Div. COYNE ELECTRICAL SCHOOL
500 S. Paulina St., Dept. C8-R6, Chicago 12, Ill.

FREE BOOK Coupon

SEND NO MONEY



B. W. Cooke, Director COYNE ELECTRICAL & RADIO SCHOOL
500 S. Paulina St., Dept. C8-R6, Chicago 12, Ill.

O. K. send me, postpaid, Coyne's new 8 volume, "Applied Practical Electricity" for 7 Days FREE TRIAL per your offer. Also send, absolutely FREE, the book of 150 Shop Prints as a gift.

Name _____ Age _____

Address _____

Town _____ Zone _____ State _____

START A BUSINESS AT HOME...

Like John Lehman, Who Says:

"The complete Fyr-Fyter extinguisher line gives me a steady income and real independence."



Yes, capable men like John Lehman will find an outstanding opportunity with Fyr-Fyter. You can be your own boss... operate in your own town and vicinity... build a permanent, steady income. No capital needed. We carry accounts, make deliveries, pay profits weekly. Thousands of prospects due to the vast need for fire protection.

Write for FREE BOOK

Get details on Fyr-Fyter's famous sales kit... facts on the complete, Underwriters' approved Fyr-Fyter line... how you earn while you learn. Write today! No obligation.

Fine Business for men past 40



FYR-FYTER CO. Dept. 90-44, Dayton, Ohio

Get Ready for Big Opportunities!

Engineable

TOOLS AND EQUIPMENT SENT WHEN YOU START

Get a better job with more pay and pleasant working conditions. Get into Drafting—where all products start. I will train you at home—give you experience—on the same kind of jobs you will do with the best paying firms. I furnish instruments and all equipment when you start. Write today for vital facts and FREE book. Give age.

ENGINEER DOBE • Div. 1C • Libertyville, Ill.

I Will Train You at Home

Until You Get a

GOOD PAY JOB in

DRAFTING

PULVEX FLEA POWDER

TWO KINDS

WITH 5% DDT
... for dogs. Kills fleas and lice quick. Keeps fleas off 5-7 days. Many home uses.

OR WITH ROTENONE
... for cats, dogs. Quickly kills fleas, lice. Kills fleas when put on a single spot. Pre-war formula.

EITHER KIND: 25c & 50c



Guaranteed by Good Housekeeping



Thrilling Work COLORING PHOTOS

Fascinating vocation learned at home by those with aptitude. Thrilling pastime. National method brings out life-like colors. Free booklet.

NATIONAL PHOTO COLORING SCHOOL
1315 S. Michigan, Dept. 135C, Chicago 5

HAVE YOU AN APTITUDE FOR WRITING?

Storycrafters Guild determines your writing potentialities with a FREE APTITUDE TEST, then teaches you fundamentals of ALL creative writing. You study current material editors have bought and published. You learn how to write Stories, Articles, Radio, Motion-Picture, Novels, "Fillers"; specialty writing of all kinds under personal direction of Frederick Palmer. EARN WHILE YOU LEARN through Storycrafters Guild Manuscript Sales Service. Send for FREE APTITUDE TEST today!

STORYCRAFTERS GUILD, Dept. 111
5617 Hollywood Blvd., Hollywood 28, Calif.
Send FREE APTITUDE TEST and details of Home-Study Course in Creative Writing.
Mr. Mrs. Miss _____
Address _____
City _____ State _____

DO ANY JOB EASIER MAKE MORE MONEY

Used by Army, Navy, Other Government
Depts., 200 Schools and Industrial Firms.

Mail Coupon

FREE TRIAL in Your Home.
Send No Money!
We Ship C.O.D. in U. S.
and Will Refund Money
if Not Satisfied.



Get Ready for BIGGER OPPORTUNITIES and BEST PAYING JOBS

Do it now! Get the better pay that goes to men with specialized knowledge. Get into one of these big opportunity fields. Big money and many other advantages await you if you prepare now. Here is the help you need—EASY—QUICK—AT LOW COST. Thousands of men have already used these famous books. Beginners and experienced men alike have doubled and tripled their earnings with this help. You too, can now get the special knowledge you need for top pay, better jobs, or a business of your own. This is your **GOLDEN OPPORTUNITY**.

AIR CONDITIONING

Big air conditioning boom interrupted by war now bigger than ever and alive with new opportunities! Get this non-technical book by international authority and be ready for your share of millions to be spent. Covers whole field. 450 pages. Illustrated. \$4.00.

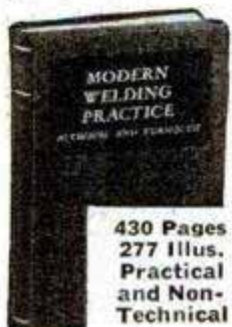

MODERN WELDING PRACTICE

Newest book on all types of welding and heat treatment of metals. Written by recognized specialists in training men for production and non-technical jobs. Practical and Non-Technical.

430 Pages
277 illus.
Practical and Non-Technical

Covers everything you need to know. Prepare for best pay jobs now. Price \$4.00.

SHEET METAL LAYOUT

Makes sheet metal layout work so simple that anyone can learn. Get this new instructor and get into the easiest, cleanest and best paying part of all sheet metal work. 143 jobs worked out in drawings and carefully explained. Gives standard for all sheet metal fittings. \$3.50.



AUTO BODY and FENDER REPAIR

Opens the Door to One of the Big Opportunity Fields of the Day

THE LOW COST, EASY WAY TO A GOOD PROFITABLE BUSINESS OF YOUR OWN

Owners will spend big money to keep their good older cars looking like the new ones coming out. This is a practical money-making guide, ideal for shop owners and every man who wants a share of the millions to be spent in keeping old cars looking new. Tells how to get a good job or start business of your own with small capital. Covers everything including tools, methods and materials. Only book of its kind. 325 pages, 232 illustrations. \$3.50.

HOUSE WIRING LATEST EDITION

Get this sixth edition of this standard and practical electrical wiring book. It gives complete practical instruction on every phase of house wiring in one handy volume. Goes further than most books on subject. Hand-book style. Gives National Electric Code. 400 pages, 669 illustrations. Electrical work will reach a new high with millions of new homes to be built. Get started now. \$3.00.

DYKE'S FAMOUS CARBURETOR BOOK

This famous book has been the standard guide in the best paying auto work for a generation. It has helped thousands of men make money. New edition covers engine tune-up, compression, ignition, carburetion, fuel pump valves, etc. Use this book to specialize in this big field. 244 pages, 549 illustrations. \$3.50.

Modern Gas and Electric REFRIGERATION

New Printing—Almost 1000 Pages,
408 Pictures, 17 Diagrams in Colors

The Book of the Hour

Thousands of Refrigerators need repairs! Owners will pay big for competent service. Get this non-technical guide to all types of refrigerators and get your share of this new profit. Get a job or start your own service business. This book will help you make money anywhere. Price \$5.00.

Make Big Money
Keeping Old Cars
Looking New. Get
This Book Today!



BIG 20th
EDITION
Leading
Auto
Book
for Over
36 Years

World's Greatest AUTO BOOK

New Material on Transmissions,
Trucks, Tractors, Diesels, Air-
craft and Auto Engines

Now with millions of cars needing repairs and thousands of men needed to do the work, you need the famous DYKE Auto Book more than ever before. This big 20th Edition covers all principles, construction, repair, adjustments, testing, troubles and remedies of all cars. Over a half million copies of 20 editions of Dyke's have been sold. Gives specifications of old and new cars. World's biggest book value. \$7.00. This big book, a complete auto library in one volume, has 1483 pages—4600 illustrations and diagrams—weighs 6 lbs.—equal to 4 ordinary books.

BAILEY'S HANDBOOK For Engineers and Firemen

World famous handbook of universal questions and answers for Stationary, Marine and DIESEL engineers and firemen. Prepares for any license examination. This is the one book that men should have if they want to reach the top in installation, maintenance and operation of Diesel and steam plants. Pocket size, \$2.00.

Goodheart-Willcox Co., Inc.
1321 S. Michigan Ave., Dept. 1-C, Chicago 5, Ill.

SEND NO MONEY! Mail Coupon

GOODHEART-WILCOX CO.,
1321 S. Michigan Ave., Dept. 1-C, Chicago 5, Ill.

Send books checked, C.O.D. I will pay postman, plus few cents charges. If not satisfactory I will return books in 5 days and you will refund money paid. (Outside U.S. or possessions remit with order.)

- | | |
|--|--|
| <input type="checkbox"/> Gas & Electric Refrigeration \$5.00 | <input type="checkbox"/> Air Conditioning \$4.00 |
| <input type="checkbox"/> Dyke's Auto Book \$7.00 | <input type="checkbox"/> Engineers Handbook . . . \$2.00 |
| <input type="checkbox"/> Dyke's Carburetor Book \$3.50 | <input type="checkbox"/> Body and Fender Repair \$3.50 |
| <input type="checkbox"/> Modern Welding \$4.00 | <input type="checkbox"/> Shop Math. (2 Vols.) . . . \$3.00 |
| <input type="checkbox"/> Airplane Welding \$3.50 | <input type="checkbox"/> House Wiring \$3.00 |
| <input type="checkbox"/> Sheet Metal Layout . . . \$3.50 | <input type="checkbox"/> A.C. Power Wiring . . . \$4.00 |
| | <input type="checkbox"/> D.C. Power Wiring . . . \$4.00 |

If remittance accompanies order we will pay all postage charges under same return privilege.

Name _____

Address _____

City _____ State _____

AUDELS REFRIGERATION and AIR CONDITIONING GUIDE

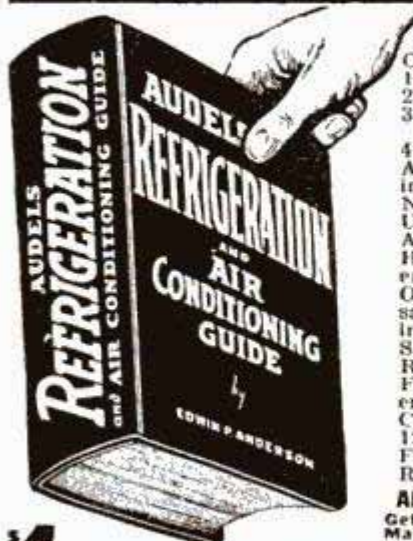

4 Books in One! Covering:

- 1—Household Refrigeration
- 2—Special Refrigeration Units
- 3—Commercial & Industrial Refrigeration
- 4—Air Conditioning Systems

A gold mine of essential important facts for ENGINEERS, SERVICEMEN & USERS. A Good Book is a Good Friend! Here you have at your fingers' ends a Complete Library in ONE VOLUME, the necessary data you have been looking for on: MODERN UNITS, SYSTEMS & MACHINES, REFRIGERANTS, including Freon, Lockers, Water Coolers, Quick Freezing & Air Conditioning Systems. 1280 Pages, 46 chapters all Fully Illustrated & Indexed for Ready Reference.

ANSWERS YOUR QUESTIONS

Get This Information for Yourself. Mail Coupon Today. No Obligation Unless Satisfied. ASK TO SEE IT.

4 COMPLETE • PAY ONLY \$1. A MONTH

AUDEL, Publishers, 49 W. 23rd St., New York 10, N.Y. MAIL AUDELS NEW REFRIGERATION GUIDE for free examination. If O. K. I will send you \$1 in 7 days; then remit \$1 monthly until price of \$4 is paid. Otherwise I will return it.

Name _____
 Address _____
 Occupation _____
 Employed by _____ PM

SAY YOU SAW IT IN POPULAR MECHANICS

INVENTORS

When you are satisfied that you have invented a matter of value—write me, without obligation, for full information as to what steps you should take to secure a Patent or Trademark.

The usual first step is to have a search of the prior U. S. Patents conducted, so that I can report to you on the question of Patentability.

PATRICK D. BEAVERS

(Formerly RANDOLPH & BEAVERS)

Registered Patent Attorney

934 Columbian Building Washington 1, D. C.

PATRICK D. BEAVERS, Registered Patent Atty.

934 Columbian Bldg., Washington 1, D. C.

Please send me full information on how to secure Patent Protection.

Name _____
 Street _____
 City _____ State _____

How To Make Liquid Marble

And BIG PROFITS In Your Own Business

Amazing Liquid Synthetic Marble can be made at home without machinery. Needs no heat or pressure. Can be poured into molds for casting expensive novelties. Liquid Synthetic Marble can be made in any color. It is even more beautiful than genuine marble because of its highly glazed finish. Costs far less. **FLEXIBLE MOLDS:** Make your own Flexible Molds. Cast novelties, statuary, desk sets, book-ends, etc. out of Liquid Marble, plaster and many other molding compositions. A large sized mold costs but a few cents. Hundreds of casts can be taken from a single mold. **UNLIMITED MARKET:** You will find steady year-round demand in your own community. No selling problem. We supply names of buyers for your finished products. Let **BING PRODUCTS** show you how to start with a small investment and build a permanent, independent, profitable business! Write now for **FREE CATALOG!**

BING PRODUCTS: Dept. PM-8A 88 BROAD STREET BOSTON 10, MASS.

LOCKSMITHING & Key Making

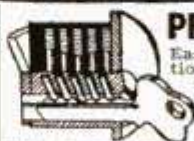

PRACTICAL UP-TO-DATE COURSE

Easy-to-learn modern information for self-instruction. How to work on locks, de-code, make master-keys, repair, install, service, etc. For every handyman, home owner, carpenter, mechanic, service station operator, fix-it shop, hardware dealer, gunsmith, 59 plain illustrated lessons. **FULL PRICE ONLY \$3.95. SEND NO MONEY.** Just pay postman plus C.O.D. postage. Or send \$3.95 with order, we'll ship postpaid. Satisfaction guaranteed or refund. **NELSON-HALL CO., 1139 S. Wabash Ave., Dept. H-02, Chicago 5, Ill.**

USE SIMPLE HOME-MADE EQUIPMENT

Make HOLLYWOOD STYLE cement pottery and birdbaths. Beautiful chemically colored garden things. Amazing designs. Dime brings pictures, color sample, details.

HOLLYWOOD CEMENTCRAFT
 8527-A WONDERLAND AVE.
 HOLLYWOOD 46, CALIF.



MOTOR BARGAIN

1/30 HP 24 volt DC motor 2450 R.P.M. .95 amps 1/4" shaft size overall 3" x 4". Weight 3 lbs.

\$2.45



USE AS 6 VOLT GENERATOR—Generate your own power. Can be operated on your bicycle wheel. Furnishes sufficient power for two 8 volt bulbs. Resistor furnished free with each motor enables you to maintain constant voltage. Special Price \$2.45, or 4 for \$7.50. Lots of 24 for \$36.00. Prices are F.O.B. Chicago. Immediate delivery. Send check or money order today. Sold on money back guarantee.

C & M EQUIPMENT CO. 1831 S. State St., Dept. D-8 Chicago 16, Ill.

PATENTS AND TRADE MARKS

C. A. SNOW & CO.

REGISTERED PATENT ATTORNEYS

WRITE FOR INFORMATION TO

428 SNOW BUILDING, WASHINGTON 1, D. C.

PATENTS

"Proof of Invention" Folder mailed without obligation.

E. E. VROOMAN, Registered Patent Atty.

871 Woodward Building, Washington 5, D. C.

INVENTORS

IF YOU WISH TO PROTECT YOUR INVENTION, You should take steps to protect it by a U. S. Patent. Write me for "Record of Invention" form.

CARL MILLER

REGISTERED PATENT ATTORNEY

Woolworth Bldg., 35th Floor, Dept. 88A, New York City Please send me "Record of Invention" form.

NAME _____

ADDRESS _____

Famous BAILEY TECHNICAL SCHOOLS

OFFER THE FOLLOWING COURSES:

**PRACTICAL DIESEL ENGINEERING
REFRIGERATION-AIR CONDITIONING
COMMERCIAL ELECTRICITY
RADIO-TELEVISION MECHANICS**

Your future success depends largely on the reputation of the school you attend. Don't take chances! Train at America's foremost school of mechanical specialization. Bailey is recognized and approved by industry. Bailey graduates get the top pay jobs! G.I. Approved. Send for FREE Catalog.

BAILEY TECHNICAL SCHOOLS
1655 So. Grand Blvd., St. Louis, Mo.



WHY WEAR DIAMONDS

When dazzling Zircons from the mines of the far-away mystic East are so effective and inexpensive! Thrilling beauty, stand acid, true backs, flashing brilliance! Exquisite gold mountings. See before you buy. Write for FREE catalog.

National Zircon Company
Dept. 21-N
Wheeling, W. Va.

Catalog FREE!

HOW TO CUT RAFTERS

New vest pocket book gives lengths, side cuts, plumb cuts, deductions. For all rafters for any building from one inch to forty feet wide. Gives numbers to cut on square. Also degrees for some cuts for Radial Saws. All standard pitches from 1/2 to 3/4. Just open book to pitch page and there are your lengths, side cuts, etc. Anyone who knows what a jack rafter is can frame a roof if he has this great book. Price one dollar, (\$1.25 in Canada). Builders' Topics, Dept. 5, Lock Box 828, Seattle, Washington. CARPENTERS, PLUMBERS, PLASTERERS, ELECTRICIANS, ETC. subscribe for Builders' Topics, the monthly magazine for HE-MAN CONSTRUCTION WORKERS. Only \$1.00 per year. (In Canada—\$1.25). Sample copies 25c.

APTITUDE TESTS

discover the kind of work or studies best for your success! You get a personal report—a guide for life—more happiness—more prosperity. For men, women, boys and girls. Write for complete facts.

VOCATIONAL COUNSELING INSTITUTE
956 Maccabees Bldg., Detroit 2, Michigan

Raise Broilers in 7-8 Weeks



BROWER BATTERY BROODERS

Raise broilers and pullets with this three deck automatic electric heated 40-a-month broiler plant. Made of steel and aluminum . . . Price, \$40.95. Other batteries from \$15.95 up. All capacities . . . Write for free battery brooder and poultry supply catalog.

Brower Mfg. Co., Box 161, Quincy, Ill.

World's Largest Line of Poultry Supplies

Get on "UNCLE SAM'S" Payroll

START AS HIGH AS \$3,021 YEAR

MEN—WOMEN
Thousands appointments being made. 40-page Book FREE
Mail Coupon Today.
SURE.

FRANKLIN INSTITUTE (Not Gov't Controlled)
Dept. ER6, Rochester 4, N. Y.
Sirs: Rush without charge, (1) 40-page book with list of U. S. Government Jobs; (2) Tell me how to qualify for one.

Name _____
Address _____
City _____ State _____ Zip _____

VETERANS Learn WATCHMAKING

A Lifetime Career

No Age, nor Physical Limitations

YOUR OPPORTUNITY
To Lift Yourself from a Futureless Job



Approved G. I. Training

LEARN WATCHMAKING

and earn from the start, higher than average pay . . . easy hours . . . ideal working conditions . . . be prepared to establish your own business.

WATCH REPAIRING — JEWELRY — ENGRAVING
Always in Demand

Requests for our Graduates from Everywhere. Permanent positions (no layoffs) \$75.00—\$100 per week for trained men. Write today for latest FREE Catalog.

KANSAS CITY SCHOOL OF WATCHMAKING

America's Most Progressive Horological School

617-621 Wyandotte St. Kansas City 6, Mo.

Learn Neon Tube Bending and neon sign fabrication

The Demand for Our Well-trained Men Continues to Exceed the Supply

A HIGH PERCENTAGE OF OUR GRADUATES HAVE BEEN EARNING

\$100⁰⁰ PER WK. OR MORE FOR MANY WEEKS

Not one single student satisfactorily completing one of our neon courses, failed to qualify or hold, a good pay job in the industry, because — our

G.I. APPROVED — 15 MONTH RESIDENT COURSES

are designed for those who seriously desire to become COMPETENT MECHANICS and who are willing to devote enough time to proper training to assure satisfactory development.

When Writing for Information, Please State if You are Veteran or Non-Veteran.

GENERAL INDUSTRIAL TRAINING INSTITUTE

125 N. Seventh Street

Stuebenville, Ohio

FREE
7-DAY TRIAL

How to Build a Better Home

Should You Build or Buy? Stop DREAMING!

HERE is how, step-by-step. Everything you need. Hundreds of complete diagrams, all facts! One diagram can save you hundreds of dollars. How to build from plans to paint.

Get Started NOW

Here at Your Fingertips, the Secrets that Produce Fine Small Homes—Completely Revealed by engineer. How to get started; deciding upon Home Ownership; how to select professional service; how to finance; contract documents; how to obtain good construction; masonry construction; footings for foundation walls, chimneys, piers; how to build basement; waterproofing; how to build fireplaces; grades of lumber; house framing methods and details; finish carpentry and millwork; insulation; sheet metal work, roofing, stucco, lath, plaster; how to paint and finish; tile work, electrical work, plumbing, heating; where to get stock plans; taxes, insurance, interest, maintenance, assessments; how to choose a bank, real estate dealer, contractor; locating lot, tax searches, comparative costs of different designs; prefabs, bungalows; list of usual mistakes; 300 other subjects!

List of 104 Free Publications for the Home Builder Hundreds of Illustrations

Nothing like it before! One simple fact may repay you a HUNDRED times its small cost. A book you will refer to for YEARS to come! Beautifully bound, illustrated, large pages. Great building authorities say: "Best book on subject" "excellent piece of work" "worth 10 times the price." THOUSANDS DELIGHTED PURCHASERS! We are so sure this is the book you have been waiting for that we make you this amazing offer:

SEND NO MONEY! JUST FILL OUT AND MAIL THE COUPON BELOW—NOW

The Westport Publishing Company, Dept. M-8
Westport, Conn.
Please send me, for one week's FREE EXAMINATION, a copy of "How to Build a Better Home." After 7 days I will either return this book and owe you nothing, or I will keep it and send you \$3.98 (plus shipping charges).

Name _____ Age _____
(please print)

Address _____
City and Zone _____ State _____

Save postage. Check here if you enclose full payment of \$3.98 (check or money order) WITH coupon. WE will then pay shipping charges. If not thrilled with book, return it and we will refund your money by AIR MAIL! Foreign Shipment \$4.50, cash only.

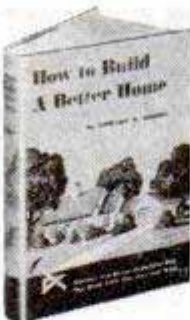

LEARN NEON

BIG PAY—JOBS TO COAST

MEN—You have the chance of your life for really big money — \$100, \$150 a week and UP — by getting into Neon, fastest-growing, most interesting branch of advertising. Come to Acme and let us make you a real Neon Technician. Interesting, 12½ week job-practice, LEARN-BY-DOING Course. We teach you and train you in Glass Blowing, Letter Bending, Color Gassing, Bombarding, other important branches. No text books. No home study. Demand for Acme Graduates far greater than we can supply. Day and Night Classes. Enrollments accepted daily.

FREE FOLDER. Send today for FREE Fact folder, "Your Big Opportunity." Gives you complete facts about jobs open, our training facilities, your chances for SUCCESS. Write today.

VET. APPROVED
Acme Training approved under G.I. Bill of Rights. Acme is also approved as registered school by Board of Education, State of Illinois. Our Instructors are all top grade experts. Our Facilities are best obtainable. We furnish all supplies, equipment.

ACME NEON INSTITUTE Dept. J-3, 330 South Paulina St. Chicago 12, Ill. WORLD'S FOREMOST NEON SCHOOL



NEW BARGAIN CATALOG

It's FREE. Now ready for mailing. Thousands of Govt. and Civilian Surplus items. For the home, industry and farm. Machinery, Motors, Hdw., Elec. Supplies, etc. Write to

MIDWEST SURPLUS SALES CO.
2531 Indiana Kansas City 1, Mo.

WAR SURPLUS AND OTHER BARGAINS

RETRACTING ACTUATOR UNIT



Mf'd. to actuate Flying Fort bomb bay doors. 40 to 1 Gear Ratio. Shaft RPM: 95. 24 Volts D.C. Reversible Motor. Lifts 1200 Lbs. with 2" pulley. 4 ¼" diameter mounting flange. In great demand for powering farm hoists, heavy garage doors, turntables, directional

antenna systems, motion advertising display units, hauling fish nets and for scores of other uses requiring power at low speed. Pays for itself over and over in saving hard manual labor. Illustration shows offset type. Also available in straight line type with 110 Shaft RPM. Original Gov't acquisition cost \$300. All new \$27.50 each. Shipping Wgt. 20 lbs.

25% DEPOSIT REQUIRED ON C.O.D. ORDERS

SHIP'S BELL: U. S. Navy Surplus. Solid Brass with smooth polished finish. 5" Diameter. Great for Patios, Doorways, in Dens, Ranches, etc. Matching solid brass wall bracket included. Weight 3 ½ lbs. All New. \$5.95 Each.



MICROMETER
Chrome plated, precision engineered and carefully tooled to give long life ...
all new. 0-1" capacity, \$2.25.
1-2" capacity, \$3.50 Each.



SEND CHECK, MONEY ORDER or CASH

TRANSFORMER: Jefferson Electric step up or step down transformer. Input, primary 110-117 Volts A.C. Output, from 5 Volts to 650 Volts. Suitable for use with war surplus gadgets, heater relays, radio test filaments, electric trains, house chimes, etc. Weight 10 lbs. New. \$7.95 Each.



ALL PRICES F.O.B. CULVER CITY, CALIF.

WILLARD WET PLATE BATTERY

This extra long life rechargeable battery is ideal for portable radios, mobile units, bell circuits, alarm systems, rural telephones, Strobe bulbs, etc. 2 V 20 Amps. Only 5" high. Visible ball float hydrometer built in Lucite case. Shipped dry. Any battery service will supply standard battery electrolyte. Used singly or in multiples. Shipping Wgt. 3 ½ lbs. All new. \$2.75 each



AIRBORNE SALES CO., INC. DEPT. PM 8-B CULVER CITY, CALIF.

LEARN WATCH REPAIRING AT HOME WITH OUR NEW SELF-TRAINING KIT



Get started NOW in this uncrowded field! EASY to learn! BIG MONEY! SECURE FUTURE! Earn while you learn! Even as a sideline you can make good money! —Our new PRACTICAL SELF-TRAINING KIT is all you need to start. Contains set of PROFESSIONAL TOOLS: (Loupe, 3-4 power; complete set of 6 special screw drivers—finest tempered steel blades; Tweezer AA; Plastic Material tray) and COMPLETE BOOK on Modern Watch Repairing. Fully illustrated, easy to understand, shows every step in repair, adjustment and use of tools. Now only \$5.95 Post Paid (if C.O.D., plus charges.) Money Back Guarantee. If ordered separately: book \$3.25; set of tools, \$3.25. MODERN TECHNICAL BOOK & TOOL CO. Dept. MMC, 55 W. 42nd Street, New York 18, N. Y.

JUST OUT! New All-Inclusive Tool, Material Catalog
Revised and Enlarged for Watch-Clockmakers, Jewelers, Toolmakers, Handicrafters. Over 600 ILLUSTRATIONS and IDENTIFICATION CHART. NEW REDUCED PRICES. All books in these fields: write for literature. SEND 15c for catalog — FREE with order.

IF RUPTURED TRY THIS OUT

Modern Protection Provides Great Comfort and Holding Security Without Torturous Truss Wearing

An "eye-opening" revelation in sensible and comfortable reducible rupture protection may be yours for the asking, without cost or obligation. Simply send name and address to William S. Rice, Inc., Dept. 32-C, Adams, N. Y., and full details of the new and different Rice Method will be sent you Free. Without hard flesh-gouging pads or tormenting pressure, here's a Support that has brought joy and comfort to thousands — by releasing them from Trusses with springs and straps, that bind and cut. Designed to securely hold a rupture up and in where it belongs and yet give freedom of body and genuine comfort. For full information — write today!

MAKE YOUR OWN REPAIRS

Save Money on PLUMBING

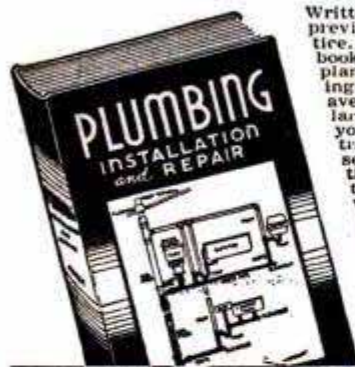

Written primarily for those having no previous experience in plumbing practice. Here, in one handy, easy-to-use book, is everything you need to know to plan, install and repair simple plumbing systems such as those found in the average home. Save hundreds of dollars on repairs or modernization of your home's plumbing. Add that extra bathroom, and do the work yourself at tremendous saving. Covers the entire plumbing system, fixtures, traps, drains, drain and waste pipes, valves and faucets, pipe and fittings, tubing, septic tanks, irrigation, etc. 254 pages. 162 illustrations. Rush order now. Only \$2.00 postpaid. Sent C.O.D. if you wish.

FREDERICK J. DRAKE & CO.
DEPT. 1-C
600 W. VanBuren St., Chicago 7

An ASSURED FUTURE for You

Learn Profitable WATCH REPAIRING

BIG MONEY WHILE LEARNING
Study at Home — or at Our Accredited School
Complete Home Correspondence Course or G. I. Approved Residence School Plan. Also, Post-Graduate Plan at school for correspondence students.

Write Today for COMPLETE DETAILS to
American Institute of Specialized Watch Repair
Dept. No. 100 270-76 East Building Grand Rapids, Michigan

SHINE WITHOUT 'POLISH'



New Invention! • Sells Like Wild
Replaces messy pastes, liquids. Simply glide over shoes—and PRESTO! — you have a lustrous, long-lasting shine. No mess. No fuss. No soiled hands. Clean. Handy. **WORKS LIKE MAGIC!**
For Men's, Women's and Children's Shoes. Low priced. Lightning seller!

SAMPLES FOR AGENTS Sample offer sent immediately to all who send name at once. A penny postal will do. **SEND NO MONEY—just your name.**
KRISTEE CO., 686 Bar Street, AKRON, OHIO

LEARN ACCOUNTING SALESMANSHIP SECRETARIAL WORK

Assure Your Future Now!

Hill's, one of America's outstanding Business Schools, offers you the opportunity to enter one of the three fields acknowledged to hold substantial earnings and a secure future. Our FREE book, "Through Hill's to Success," tells how and where the best positions are found and how you can qualify for them by study at home or in our resident school. We have thousands of successful graduates and maintain nationwide employment service.

FREE WRITE TODAY

USE THIS HANDY COUPON

HILL'S EXTENSION SCHOOL AND BUSINESS UNIVERSITY Dept. PM-8
619 W. Main St., Oklahoma City 2, Okla.
Please send me your Free book, "Through Hill's to Success."

NAME _____
ADDRESS _____
CITY _____ STATE _____
 Check here if eligible under G. I. Bill

Learn DIESEL

AUTOMOTIVE AND ALLIED MECHANICS

at Home in Spare Time

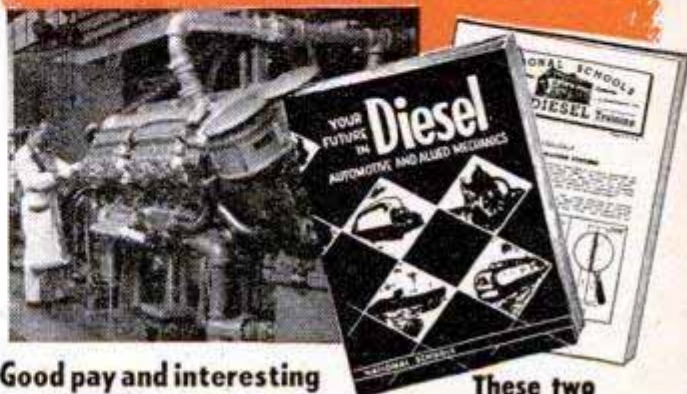

Good pay and interesting job opportunities in the Diesel industry!

These two **FREE BOOKS** will tell you how

These two FREE BOOKS will tell you how Diesel engines are used in locomotives, tractors, farm machinery, stationary and portable power plants, oil pipeline pumping stations, Diesel trucks, and buses, power shovels, excavating machinery and many other applications. Trained Diesel and automotive mechanics are in steady and growing demand to install, maintain and repair Diesel, semi-Diesel, and gasoline engines in these and other fields. Or you can operate your own service shop or commercial garage!

YOU CAN QUALIFY FOR THESE OPPORTUNITIES WITH NATIONAL SCHOOLS' MASTER SHOP METHOD HOME TRAINING!

You learn not only basic Diesel engine principles, construction and repair, but the more specialized fields of Diesel fuel injection, automotive carburetion, ignition and motor tune-up. Your instruction material is interesting, well illustrated, easy to understand... and complete! You receive Practical Assignments covering actual engine repair, installations, operation and maintenance service on all types of Diesel and automotive equipment. Send the coupon today for a Free Sample Lesson and big illustrated book "Your Future in Diesel."

HOME STUDY AND RESIDENT TRAINING OFFERED

NATIONAL SCHOOLS
LOS ANGELES 37, CALIFORNIA
EST. 1905

APPROVED FOR VETERANS

Check Coupon Below

MAIL OPPORTUNITY COUPON FOR QUICK ACTION

National Schools, Dept. PMD-8 (Mail in envelope or paste on penny postcard)
4000 South Figueroa Street
Los Angeles 37, California

Mail me FREE the book, **YOUR FUTURE IN DIESEL**, together with the Sample Lesson. I understand I may keep and use the information with no obligation.

Name _____ Age _____
Address _____
City _____ Zone _____ State _____
 Check here if Veteran of World War II

MAIL THIS COUPON

113 Booklets filled with Money and Time-Saving Helps

Little Library of Useful INFORMATION

Here at amazingly low cost is the practical help and information you have always wanted. Articles in previous issues of Popular Mechanics have been classified according to subject and are now available in these handy reprint booklets. Check Titles wanted, clip ad and mail today.

* Recent titles.

WORKSHOP EQUIPMENT

Power-Driven Saws—74: Complete details on scrollsaw, two circular saws, sliding cut-off saw, bandsaw.
Drill Presses, Plane, Grinders—79.
Sanders—80: Complete constructional details on 8 useful machines.
Wood & Metal-Turning Lathes—81: Two wood lathes, small metal-turning lathe.
Filing Machine, Hacksaw, Cutoff Wheel, Shaper—82.
Metal Lathe Tools You Can Make—101.
Workbenches & Tool Cabinets—47.
Spray Painting—94: Constructing spray guns, compressor, using spray gun.
From Pattern to Casting—91: How to make your own patterns and small castings.
***Handy Farm Implements—114:** Grain elevator, dump truck, spreader and cover.
***Tractor Attachments—116:** Buckrake, stacker, scoop, auger and spray attachment.
***How to Build a Concrete Block Machine—110.**

SHARPENING—USING TOOLS

Correct Measurement—106: How to use micrometers, gauges, calipers, etc.
Tool and Saw Sharpening—92.
Using & Sharpening Drills & Wood Bits—90.
Successful Wood Turning—32: All the information you need to master this art.
***How to Use Your Drill Press—125:** Includes instructions on preparing the work, methods of clamping, drill speeds and feeds, sharpening twist drills, testing and grinding chucks.
How to Read Blueprints—71: Tells you how to understand signs, symbols, and lines.
Metal Turning Lathe Kinks—99: Simple homemade tools, time and labor-saving shortcuts you can use.
Operating a Metal Turning Lathe—100.
Heat Treating & Case Hardening—102.
Working with Glass—103: Cutting, drilling, etching, blowing.
***Using Basic Tools—120:** How to use hammer, files, screwdriver, and cold chisel.

ELECTRICAL BOOKLETS

Rewinding & Servicing Electric Motors—75: Repairing and rewinding a.c. and d.c. motors. Locating trouble. Converting auto generators into 110 v. a.c. motors.
House Wiring—89: All the information you need to do a complete wiring job or install extra outlets.
Electromagnets & Solenoids—44: Designing and building.
Transformer Construction—41: Easy-to-understand instructions for all transformers.
The Boy Electrician—43: Easy-to-build motors, experiments.
***Build Your Own Relays—123:** Complete instructions, graphs and wiring diagrams for a.c., d.c., and thermal relays.
Soldering & Brazing—17.
Arc & Spot Welders—5: Building and operating 110 v. a. c. arc and spot welders.
Electroplating with Copper, Nickel, Chromium, Lead, Zinc, Cadmium—86.
Plating Leather & Other Non-Metallic Objects—Plating with Gold, Silver, Alloys—87.
***How to Fix Electrical Appliances—111:** Repairing clocks, washing machines, vacuum cleaners, electric irons, cords, small motors, etc.

HOME IMPROVEMENT BOOKLETS

Simple Home Improvements—104: Modernizing; making storm sash, ironing boards, etc.
Building Extra Rooms in Attic—23.

Attractive Basement Playrooms—24.
Lower Your Fuel Cost—31: Practical kinks that will save you hundreds of dollars.
Hanging Wallpaper—38: Tricks of hanging wallpaper, removing old paper, etc.
Curing Leaky Basements—45:
Fitting Home Game Room—55: Construct own game & tennis tables, shuffleboard court, action game, portable playrooms.
Ridding the Home of Insect Pests—107: Exterminating and protecting against moths, flies, termites, mosquitos, etc.
Built-in Fixtures—78: Step and space-saving kitchen units, built-in beds, corner cabinets, vanities, linen chest.
Constructing Indoor & Outdoor Fireplaces—88: Stone fireplaces, portable mantels, garden fireplaces.
***Painting Your House Inside and Out—117.**

GARDENING BOOKLETS

Back-Yard Gardening—39: Selecting, planning and getting the best results.
Lawn & Garden Novelties—72: Jig-sawed ornaments, parkway numbers, sundials, flower boxes.
Trellises, Pergolas, Fences—76.
Lawn & Garden Furniture—77: Modern bent-tube furniture, arbor and seat combinations, swings, lawn chairs.
***Lawn and Garden Equipment—124:** Complete details for building rotary lawn cutter, hedge trimmer, and lawn edger. Also articles on sharpening and motorizing your lawn mower.
Playground Equipment—73: Two playhouses, ferris wheel, roller coaster, treadmill, play store, slide, two merry-go-rounds.
Colored Concrete Garden Furniture—6: Garden benches, pottery, flower boxes, bird baths and sundial pedestals in colored concrete. How to build small concrete mixer.
Bird Houses—7: Easy to build homes for all kinds of birds.
Farm & Garden Tractors—8: Two tractors you can build from old automobile parts.

CRAFT WORK—HOBBY BOOKLETS

Working with Plastics—61: Using brilliantly colored plastics in craftwork.
Magazine Racks—49: Ten attractive racks.
Clock Cases—50: Large Hall, Colonial wall and mantel, ship's wheel, miniature grandfather, desk, Spanish style banjo.
Serving Trays for Every Occasion—53: Fourteen different designs.
Children's Room Furniture—51: Twelve attractive pieces.
Book Ends—52: Ten designs offer good selection.
Small Tables—54.
Smoking Stands—56: Seven designs given.
Jigsawed Novelties—57: Sewing kits, string holders, place-card holders, plywood kitchenware, plant and flower holders, coin banks.
Desks—58: Colonial writing desk, two modern-type desks, student's study desk of plywood, combined chest and writing desk.
Book Cases—59: Eight designs.
Doll House & Doll Furniture—60.
25 Shelves You Can Make—64.
Novelties Turned on Lathe—62.
Inlay Pictures—Veneering—63.
Whittling and Wood & Soap Carving—65.
Action Toys—66: 21 easy-to-make toys.
High Flying Kites—67.
Windmills & Weathervanes—68.
Lamps in Wood, Metal, Plastic—69: Selection of 14 designs.

5 for \$1.00
 12 for \$2.00
 25¢ Each

Metal Craft—28: Brass tapping and making of novelties both decorative and useful.
Small Looms—37: Building hand looms for weaving rugs, etc.; leather novelties.
Plain & Novelty Wood Finishing—40.
Gem Cutting—42: How to cut and polish semi-precious stones.
Rustic Furniture—18: How to build chairs, benches, tables, gates, summer house, etc.
***Projects in Plastics—112.** *Bows and Crossbows—115. *Marionettes—113: Designing and operating puppets, how to build stage and backdrops.
***Furniture Upholstery and Repair—122:** Details on upholstering, modernizing beds, and instructions for repairing wooden furniture.

BOAT BUILDING BOOKLETS

Build a boat at home—you can do it

14 Ft. Outboard Runabout—2: Here is a low-cost, fast 14-foot V-bottom boat. Suitable for motors of 4 to 24 hp.
Rowboats, Bicycle Boat, Small Dinghy—83.
Small Sail Boats—84: 12-ft. sailing dinghy, 6-ft. "training ship" for young sailors, how to sail a boat.
Two Outboard Runabouts—85: 14-Ft. family outboard weighs about 400 lbs. and 12-ft. plywood outboard weighs about 110 lbs. Both are V-bottom type.
Build Your Own Canoe, Kayak, Surfboard—30: Complete details on 16-ft. Canadian-type canoe, 17-ft. kayak, and 12-ft. hollow surfboard.
Fast Class-E Ice Yacht—22: Build your own Class-E ice yacht.

AUTOMOBILE BOOKLETS

Automobile Kinks and Shortcuts—10: Money-saving hints on upkeep, operation.
Building Trailers—27: Small Streamlined house trailer; several utility trailers.
Motor-Driven Midget Car & Scooter—34: Both use gas engine of washing machine type.
Curing Auto Electrical Troubles—95.
***House Trailer—121:** Complete instructions and diagrams for building modern 17 ft. trailer.

PHOTOGRAPHY BOOKLETS

Photo Enlargers—1: Condenser lens type; simple vertical; horizontal.
Photo Printers & Drier—25: Describes three practical printers, timer and negative drier.
Photo Darkroom Equipment—96: Cabinets, light-tight box, timer, agitator, washer.
Picture Projector, Trick & Table Top Photography—97: Projectors that enlarge magazine illustrations and shop drawings. Tips for table topers, photomontages, tricks.
Photo Kinks—98: 63 time and money-saving ideas you can use.
***Photo Lighting—119.** *Home Movie Equipment—118: Converting projector to sound, making titler, film cleaner, projector stand.

MISCELLANEOUS BOOKLETS

Cleaning Preparations—11: Easy-to-make cleaners for walls, glass, etc. Removing fabric stains.
Re-Silvering Mirrors—70: Formulas for silvering and coloring.
Knots and Ropework—105.
Chemical Experiments—93: Easy-to-perform experiments. Inexpensive lab.
Taxidermy—9: How to prepare skins and obtain life-like poses.
Log Cabins & Tourists Cottages—14: Year-round log cabins; inexpensive tourists' cabin.
Magic for Everybody—29: Simple tricks to puzzle your friends.
Trapping Small Animals—33: How to lure fur bearers, prepare bait and traps, dress skins.
Tricks of Training Your Dog—35.
Small Furnaces—36: Gas or electric.
Telescopes—20: Design and construction.
Poultry Houses—108: Structures, brooders and incubators.
Guns and Decoys—109: Cleaning, shooting guns; making decoys.

POPULAR MECHANICS PRESS,

200 E. Ontario St., Chicago 11, Ill.

I enclose _____ (U. S. bills may be mailed if carefully wrapped) for "Little Library" booklets numbers:

Name _____
 Address _____ Zone _____
 City _____ State _____

DO ELECTRICAL WORK ON REAL EQUIPMENT IN M. T. I. SHOPS

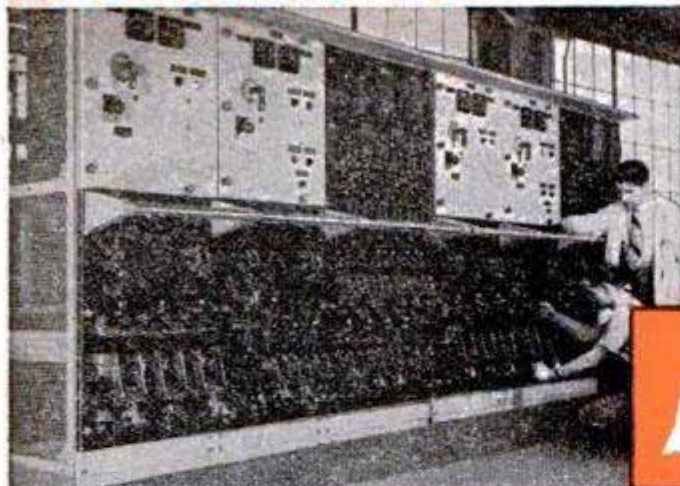

POWER DISTRIBUTION PANEL AT M. T. I.

Why Spend Years
"Picking-Up" a
Trade? . . . This
"Live" Industry
Needs Trained
Men NOW!
Learn



MOTOR WINDING

ELECTRICITY

There is no other place . . . no other way to get the same all-around electrical training you get at M.T.I. NOT A HOME STUDY COURSE! . . . You get actual "hands-on-equipment" experience in our great modern resident shops in Detroit. No previous experience necessary. Learn HOUSE-WIRING, A.C. D.C. MOTORS and CONTROLS, MOTOR REBUILDING AND ARMATURE WINDING, CONSTRUCTION and MAINTENANCE WORK, etc. New classes every few weeks. Living arrangements made.

EARN WHILE YOU LEARN
Our part-time job assistance helps you meet living expenses while attending M.T.I.

NO COST TO VETERANS
Get \$75.00 to \$120.00 monthly subsistence. Easy Pay Plan for Non-Vets. Mail coupon today.

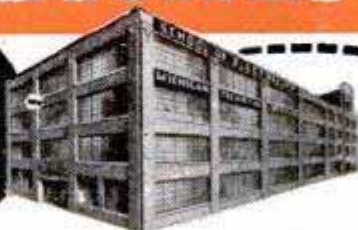

MAIL TODAY

MICHIGAN TECHNICAL INSTITUTE, Dept. PM-8
2281 W. Fort St., Detroit 16, Michigan

RUSH your FREE CATALOG and complete information. (No obligation and no salesman will call.)

Veteran Non-Veteran

NAME _____
ADDRESS _____
CITY _____ ZONE _____ STATE _____

MICHIGAN TECHNICAL INSTITUTE

2281 West Fort Street Dept. PM-8 Detroit 16, Michigan



Drafting PAYS BIG

Learn in Spare Time — At Home or at Allied School in Chicago

KEY POSITIONS OPEN IN INDUSTRY

- Mechanical Drafting
- Tool and Die Making
- Tool Design and Engineering
- Machinist Trade
- Product Design and Illustration

Train Now!

In Nationally Known, Fully Approved School and Endorsed by Industry . . .

Approved for Civilians and Veterans . . .

Write For Catalog — A 1c Postcard will do

ALLIED SCHOOL OF MECHANICAL TRADES

1338-1340-1342 So. Michigan Ave.

428 Allied Bldg.

CHICAGO 5, ILL.

GLOWS in the DARK

FREE Sample!

Be the first to sell luminous house numbers, light switch plates, wall protectors, pull cords. Also luminous pictures, statues, decals, and a host of religious, nursery and other objects that glow in the dark. Get into this new and growing industry. Enormous demand . . . no competition . . . sensational demonstration . . . big profits. Represent a large manufacturer, established over 34 years. Write today for liberal money-making offer and free sample to show how they glow in the dark.

MADISON MILLS, 303 Fourth Ave. Dept. H-4, NEW YORK 10, N. Y.



OPPORTUNITIES AHEAD

For Men Who are Trained in AUTO BODY & FENDER WORK

Men 18 to 60. Want a future with good pay, perhaps a business of your own later? If you are mechanically inclined, start now to learn to become an auto body mechanic and fender repair man. This fast growing field has great possibilities for trained men with experience. U.E.I. spare time, home-study training combined with actual shop practice gives you sound, basic knowledge of latest, best methods so you may get the experience which may bring you big pay. Capable instructors supervise your studies and actual practice. Course includes acetylene welding, spray painting, use of hand and power tools, etc.

THOROUGH, RELIABLE TRAINING

U. E. I. has trained men for new opportunity fields since 1927 and many students are now making good. Auto body and fender repairing is one of the best profit-makers in any garage or service station. Little capital required. . . . placement service, or we will show you how to start your own shop. Get the facts FREE, without obligation. Write today.

Training approved under G. I. Bill

UTILITIES ENGINEERING INSTITUTE

AUTO-CRAFTS DIVISION

2523 Sheffield Ave., Dept. 188-X, Chicago 14, Ill.

Gentlemen:—YES! I want to get into profitable Auto Body and Fender Repair Work. Please send me FREE FACTS at once.

Name _____ Age _____

Address _____

City _____ Zone or County _____ State _____

Check here for Special Information if under 17.

SAY YOU SAW IT IN POPULAR MECHANICS

Here's BIG MONEY FOR YOU

I WILL SEND YOU THIS AMAZING ELECTRONIC KIT!



S. T. CHRISTENSEN

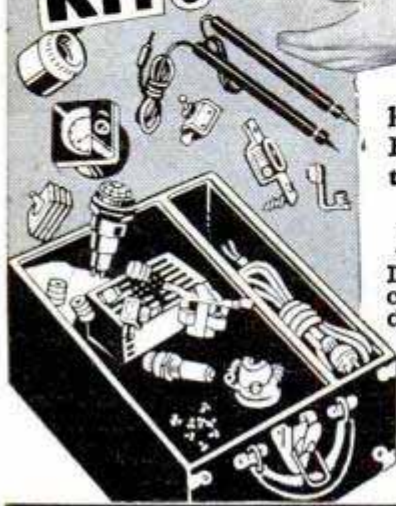

Checks-Tests

Electrical Household Appliances, Factory Equipment. A sure fire trouble detector!

LEARN APPLIANCE REPAIRING

Do as other trained mechanically inclined men do... charge on basis of \$5.00 to \$6.00 an hour! Repair electrical appliances, equipment. Get full facts today how I've trained thousands in their own homes. Write

Mr. S. T. Christensen, PRESIDENT
CHRISTY SUPPLY CO., Dept. D-6003
 2835 N. Central Ave., Chicago 34, Ill.

"SEA CRAFT" BLUEPRINTS READY NOW!

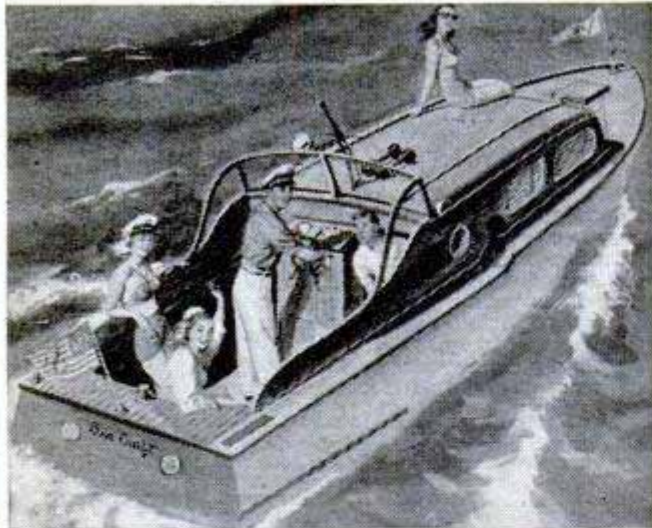

Build this luxurious cabin cruiser yourself and save money. What a beauty it is! A 25-foot boat readily adaptable as a sport fisher, express cruiser, or utility boat. Cruises effortlessly at 15 knots with a marine engine or converted auto motor. Its spacious cabin sleeps four and has a galley complete with fresh-water tank, sink, and cook stove. Has open cockpit large enough for fishing, lounging, etc.

During war the Coast Guard used "Sea Craft" for ship-to-shore travel. Order today your complete set of seven large-size blueprints scaled 1 inch to the foot. These, plus a 40-page two-color illustrated booklet giving step-by-step instructions, only \$10.00.

POPULAR MECHANICS PRESS
 200 EAST ONTARIO ST. CHICAGO 11, ILL.

INVENTORS

HIGHEST ROYALTIES and CASH FOR YOUR INVENTIONS
 INVENTION MARKETING SERVICE "UNPARALLELED" BY ANY OTHER AGENCY IN THE WORLD
 Write for FREE booklet without obligation
UNIVERSAL MARKETING CO.
 126 Lexington Ave. (Suite M) New York 16, N. Y.

CHOOSE A HOTEL CAREER
 Complete, practical training for fascinating and well paid positions-with-a-future. Men-Women-All Ages! Free, successful placement service. Resident classes. Fall Term - August 23rd. Approved for Veteran training. Address: Dept. 5.
FLORENCE UTT HOTEL SCHOOL
 In The Historic Coates House Hotel
 1007 BROADWAY, MEZZANINE FLOOR KANSAS CITY 6, MO.

Become a Doctor of PSYCHOLOGY

Win the degree of Ps.D. Teach the secret of contentment, happiness. Solve mental worries. Experience the revelation of truth. Chartered college. Individual help. Write for FREE book, COLLEGE OF UNIVERSAL TRUTH, 5153-B North Clark St., Chicago.

MAKE UP TO \$5.00 AN HOUR IN YOUR OWN BIG-PROFIT BUSINESS!

National Organization teaches, helps, supplies everything - for establishing Rug, Upholstery, etc. Cleaning Business. Do work in customers' homes, buildings-new, easy way. Only a few dollars needed to start. Big, year-around demand everywhere. Write for FREE details! AMERICLEAN CO., INC.; 211 North 7th St.; Dept. G-20; St. Louis 1, Mo.

YOU TOO CAN BE A BUSINESS MAN

and make large weekly profits. Write at once for our "Get into a Profitable Business of Your Own" plan.
CHEMICAL RESEARCH CORP.
 212 WEST 42 STREET NEW YORK 18, N. Y.

GET GOVERNMENT JOB!

P. O. Clerk, City Carrier, Rural Carrier, Postmaster - many others. Splendid salaries. Veterans get preference. Our inexpensive Exams. prepare you for Exams. Write.
OZMENT INSTRUCTION SERVICE, 80, St. Louis, Mo.

FIBRE ARMS AND LEGS!

Light, correctly fitted, strong and comfortable. Natural appearance. Braces for all deformities. Scientific design. Fair Terms.
BUCHSTEIN-MEDCALF
 223 S. 6th St., Minneapolis, Minn.

WATCHMAKING

Millions of watches and clocks need repairing. Start your training now for a better paying job or own profitable business. Qualified watchmakers in demand. Outstanding training by experts. Write for free catalog. Approved for veterans.
SCIENTIFIC SCHOOL OF WATCHMAKING, Dept. PM-8
 3923 San Fernando Road Glendale 4, Calif.

HELPFUL BOOKS

Send post card asking for FREE catalog
 Popular Mechanics Press, 200 E. Ontario, Dept. 601, Chicago 11.

SAY YOU SAW IT IN POPULAR MECHANICS



BUILD a BOAT

- Row Boat—12 Foot
- Dinghy—8 Foot
- Dinghy—14 Foot Sailing
- Training Ship—6 Foot
- Sea Sled—9 Foot
- Outboard—12 Foot
- Cruiser—18 Foot
- Bicycle Boat—Kayak
- Raw Boat—Sectional
- Dinghy—Sailing
- Canoe—16 Foot
- Sailing—12 Foot
- Outboard—12 Foot
- Outboard—Runabout
- Pontoon Ice Yacht

FOR PLEASURE OR PROFIT DESCRIBES 17 LOW COST BOATS
 Get this outstanding book and build a boat at home for your own use or to sell at a profit. You can do it. Just the boat you've always wanted—power, sail or row boat—17 different kinds and sizes.
 Order BUILD A BOAT on postal card and pay only \$1.50 plus postage on delivery. Return in 5 days if not pleased and get money back. Or send \$1.50 with order and we'll pay postage. (Outside U. S. \$1.70 with order.) Order today.

POPULAR MECHANICS PRESS
 Dept. 598, 200 E. Ontario, Chicago 11

**LOW
FACTORY
PRICES!**

... on the Sensationally **NEW 1949** **MIDWEST RADIOS**

NEW
SERIES 16
SUPER DE LUXE
AM-FM
CHASSIS

30 DAYS TRIAL

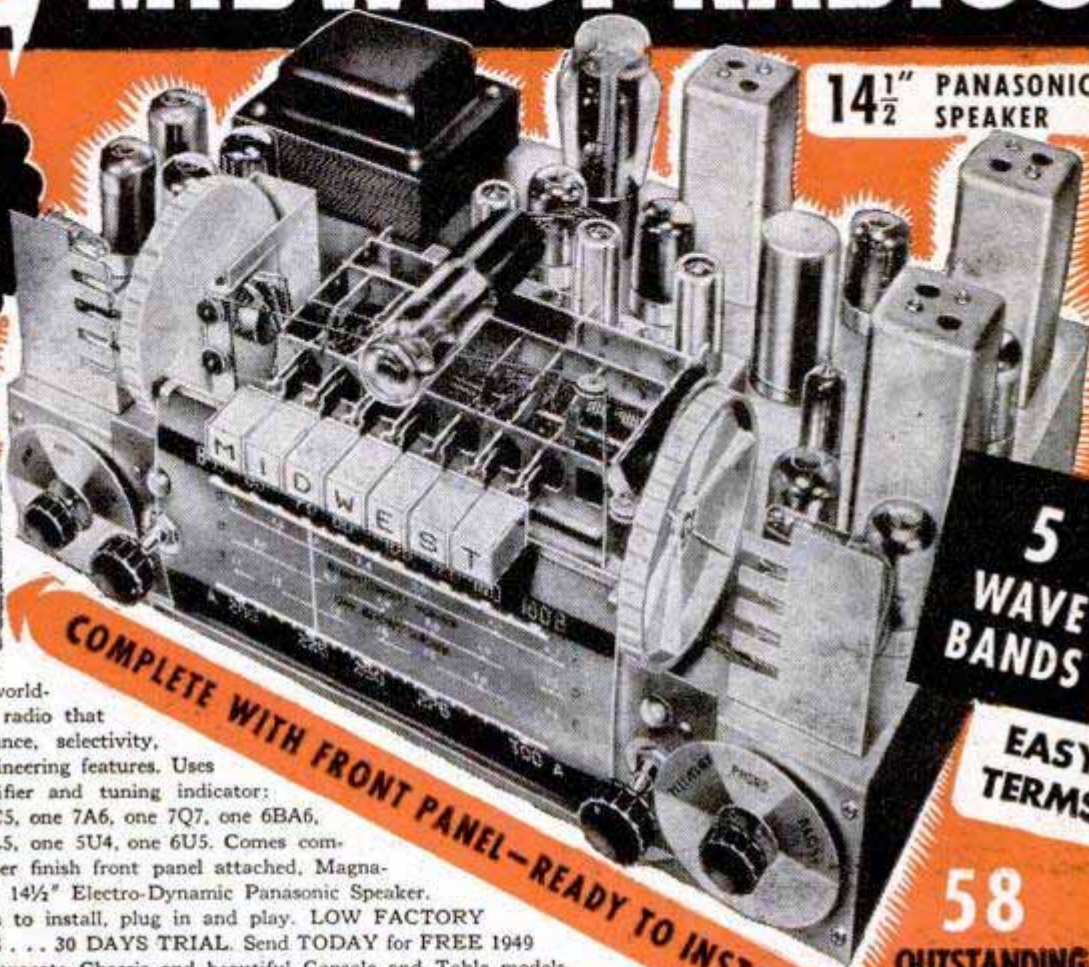

**14 1/2" PANASONIC
SPEAKER**

**5
WAVE
BANDS**

**EASY
TERMS**

**58
OUTSTANDING
FEATURES**

COMPLETE WITH FRONT PANEL—READY TO INSTALL!

Here is the last word in radio engineering . . . a powerful, world-ranging, magnificently-toned radio that is unsurpassed for performance, selectivity, sensitivity, and advanced engineering features. Uses these latest-type tubes, rectifier and tuning indicator: three 7A7, three 7A4, two 7C5, one 7A6, one 7Q7, one 6BA6, one 6BE6, one 6C4, one 6AL5, one 5U4, one 6U5. Comes complete with satin stripe copper finish front panel attached, Magna-Tenna Loop Aerial and giant 14 1/2" Electro-Dynamic Panasonic Speaker. Requires only a few minutes to install, plug in and play. **LOW FACTORY PRICES . . . EASY TERMS . . . 30 DAYS TRIAL.** Send TODAY for FREE 1949 Midwest Radio Catalog of separate Chassis and beautiful Console and Table models.

A Complete Line of FINE RADIOS and RADIO-PHONOGRAPHS . . . Available in SEPARATE CHASSIS Like the POWERFUL SERIES 16 AM-FM Model above or in COMPLETE CONSOLES like this...



Beautiful SYMPHONY GRAND AM-FM Radio-Phonograph with TELEVISION Audio Switch-Over and NEW Intermix AUTOMATIC RECORD CHANGER

A Magnificent musical instrument and a masterpiece of cabinet design—the finest Midwest Radio in 29 years of manufacture. Offers world-ranging radio reception and newest automatic Intermix Record Changing Phonograph. Uses Series 16 Super DeLuxe AM-FM Chassis, Giant 14 1/2" Panasonic Speaker; Tri-Magnadyne Coil System; Built-In Loop Antenna. Other luxurious console and table model cabinets available with Series 16, 12, and 8 chassis—on Easy Terms and 30 Days Free Trial.

Including the
Exclusive Midwest
FLASH-O-MATIC
Volume and Band Indication
TELEVISION
Audio Switch-Over
FIDEL-A-STAT
Color-Ray Tone Selection
TRI-MAGNADYNE
Coil System
...Plus **NO-DRIFT FM**
and many other features

BUY DIRECT FROM FACTORY and SAVE!

MIDWEST RADIO & TELEVISION CORP.

Dept. 251 909 Broadway, CINCINNATI 2, OHIO

Rush for Free Catalog!

**FILL IN COUPON AND MAIL TODAY OR JUST
SEND NAME AND ADDRESS ON 1c POSTCARD**

MIDWEST RADIO & TELEVISION CORP.
Dept. 251, 909 Broadway, Cincinnati 2, Ohio
Please send me your new FREE 1949 Catalog.

NAME

ADDRESS

CITY.....ZONE.....STATE.....

Paint Your Car!

AND 1001
OTHER ITEMS

AMAZING
NEW

"Super" CARONIZE

FACTORY-FINISH TYPE AUTO ENAMEL

One Quart Covers! One Hour to Apply! One Hour to Dry!

Just Wipe it on!

Handy
Applicator



Makes Your Old Car
Gleam Like New!

INCLUDED AT NO EXTRA COST

Now you can quickly and easily make your old car look almost NEW! Just give it a speedy coat of new "SUPER" CARONIZE. With "SUPER" CARONIZE all back-breaking labor is eliminated... NO BRUSHING, SPRAYING, MASKING, BUFFING OR SCRAPING is necessary. Simply clean car and WIPE ON this sensational new fast-drying paint. In just a short time, your car will GLEAM with a mirror-bright finish that LASTS FOR YEARS. "SUPER" CARONIZE won't peel, crack, chip in spite of rain, snow or sun.

THE RESULT OF MONTHS OF LABORATORY RESEARCH!

"Super" Caronize smoothly covers your car because it contains genuine THERMOREZ, the very same type synthetic resin as is used in finishing newest cars. If you are getting a new car, a brilliant "Super" Caronize finish may increase your trade-in value \$100 and more.

Guaranteed
3 FULL YEARS

The only wipe-on enamel in America that gives you a 3-year WRITTEN guarantee against chipping, cracking or peeling when applied according to directions.

16 CHOICE OF BEAUTIFUL NEW COLORS

Black • Maroon • "Fiery" (Bright)
Red • Cloud Grey • "Washington"
(Dark) Blue • Brewster (Dark) Green
Monticello (Light) Blue • Jewel
(Light) Green • Orange • "Lettuce"
(Very Light) Green • Light Yellow • Tan
Ivory • Chrome • Clear • White

"Super" Caronize White is absolutely non-yellowing

SEND NO MONEY

RUSH ORDER TODAY!

Use coupon below. Send us your color choice today! Pay postman only \$2.95 plus postage. Or send cash and we pay postage.

Fill Out and Mail This Coupon Today! Send No Money!

Please send me qts. of
"Super" Caronize at \$2.95 per qt.

COLORS:

NAME
(Please Print)

ADDRESS

CITY STATE

Send Postpaid,
remittance enclosed

Send C. O. D.
plus postal charges

ONLY
\$ 2.95
Enough
to Paint
Almost
Any Auto

AMAZING FOR AUTOS and 1001 OTHER PAINT USES

AT HOME

Caronize colors are wonderful for all refrigerators, gas stoves, furniture. All porcelain, metal and wood surfaces. "Super" Caronize Clear gives a durable coating to floors, linoleum and all household woodwork.

OUTDOORS

Perfect for all lawn furniture, swings, bird-baths and other items of this type. Also recommended for boats, canoes, etc.

ON THE FARM

Durable for tractors and all other kinds of farm implements, dairy and utensil uses.

STORES AND OFFICES

Excellent for desks, table tops, files and 1001 other uses in stores, shops, taverns, beauty parlors, offices, etc.



CARONIZE, INC.

DEPT. PM8 1801 Singleton Ave.
St. Louis 3, Mo.

THE ONLY WIPE-ON ENAMEL IN AMERICA
GUARANTEED FOR 3 FULL YEARS!

STOP WATCH

Genuine Elgin 15 Jewel movement. Ideal for split second timing. Full sweep split second hand graduated in 1/10th seconds. Stem wind, start, stop and reset. Used but guaranteed perfect. A splendid value.



Shp. wgt. 1 lb. No. 200—Each..... **\$9.95**

MESS KITS

Regulation two-piece Army Mess Kits with folding handle. Used, but perfect. Weight 2 lbs. No. A116—Ea. **69c**



CANTEENS

Reg. U. S. issue canteens. Plastic screw top chained to body. Slightly used but perfect. Wgt. 1 lb. 117—Metal 118—Plastic—Ea. **69c**



CANTEEN CUPS

All metal. Folding handle. Wgt. 1 lb. No. A120—Each..... **25c**

CANTEEN COVERS

Heavy canvas. Button fastener. New No. 530—Each..... **69c** Used No. 119—Each..... **35c**

WIRE CUTTER

Heavy duty type with compound leverage. Cuts up to 1/4 inch wire. Extended upper jaw acts as feeder to cutting edges. Insulated handles. Ideal for farm fence work and shop use. Shp. wgt. 2 lbs. Stock No. **\$1.95**



Heavy Duty Rubber Gloves
BRAND NEW

Extra heavy—extra long. Brand new, high quality gum rubber for softness and ease in use. Designed for heavy duty industrial service—protection in handling chemicals, acids, etc. A real bargain at this low price. Stock No. 295—Per Pair, Only..... **79c**

AVIATOR'S OXYGEN OUTFITS

Ball out type. Consists of all metal tank, release valve, gauge and breather hose, all enclosed in khaki colored cloth bag. These tanks are loaded with oxygen at 1800 pressure. Ideal for use as reserve oxygen supply for all types of emergency use. Shipping weight 4 pounds. All brand new. Stock No. 391—Each... **\$4.95**

OXYGEN TANK
Loaded with aviator's breathing type oxygen at 1800 pounds pressure. Tank measures 13 1/2 x 5 1/2 inches with rounded ends. Tank is of solid metal fitted with brass release valve at top. Brand new! Loaded—ready for all types of emergency use. Shp. wgt. 13 pounds. Ship exp. only! Stock No. 390—Each, only..... **\$3.50**



HIGH PRESSURE 400 LB. TEST SHATTERPROOF TANKS

TYPE D2
A high pressure shatterproof tank of 500 cubic inch capacity—for 50 pound pressure or 6.9 cubic feet. All metal—measures 6 1/2 x 24 inches. Threaded plug end vents. Shp. wgt. 6 lbs. No. 388—Each... **\$2.45**

TYPE F1
A high pressure shatterproof tank of 1000 cubic inch capacity—for 50 pound pressure or 13.8 cubic feet. All metal—measures 9 1/2 x 17 inches. Threaded plug end vents. Shp. wgt. 11 1/2 lbs. No. 389—Each... **\$3.75**

WAR SURPLUS AND HUNDREDS OF OTHER BARGAINS

POPULAR RECORD ASSORTMENT



Fifty records of modern dance, race, blues and hillbilly selections. No two alike. Famous name bands and artists included. Used in juke boxes, but guar. perfect. Shipped exp. collect only—no exchanges or refunds. Wgt. 28 lbs. No. A303—50 records..... **\$9.64**

No. A300—25 Records, All Dance. Wgt. 14 lbs..... **\$4.88**

No. A301—25 Records, Hillbilly, Race and Blues. Wgt. 14 lbs. Set... **\$4.88**

No. 302—25 Records, All Hillbilly numbers. Wgt. 14 lbs. Set... **\$4.88**

FLEX. NECK FLASH LIGHT

Ideal trouble shooter's flashlight. Flexible neck lets you direct light around corners and inaccessible spots. Brand new! Plastic case with BX type neck. Uses 2 standard flashlight batteries. (Less batteries) Shp. wgt. 2 lbs.



Has spare bulb in handle. No. 205 Each **\$1.39**

WATERPROOFING COMPOUND

Govt. surplus! A liquid formula for waterproofing tents, tarpaulins, canvas clothing, etc. Equally efficient on old or new materials. Gallon covers 100 to 120 square feet. Stays flexible. Will not peel or chip. Shp. wgt. 10 lbs. Stock No. 423. Per Gallon..... **\$1.49**



ARMY AIR CORPS TYPE SUN GLASSES
Ideal for driving, sun glare, sports and work. 24 carat gold plate frames with Pyralin sweat bar—adjustable nose bands. Large aviation type lenses. Case included. Shp. wgt. 1 lb. No. 238—Per Pair..... **\$2.95**

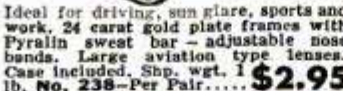

7 LB. EXPERIMENTER PARTS ASSORT. KIT



A "gold mine" for the radio serviceman. Hundreds of valuable radio parts, new radar and electronic parts and subassemblies, coils, resistors, trimming condensers—worth many times this low price. A130R—7 lbs... **\$1.79**

PUP TENTS

Regulation Army Pup Tents of durable, brown canvas. Used, but in good condition. Fine for campers, outdoorsmen, Boy Scouts, etc. Wgt. 8 lbs. A100—Tent only... **\$3.95**
A110—Tent, new..... **\$7.95**
A101—Ropes, wooden poles and stakes for above. Per set..... **\$1.00**



VEEDER ROOT COUNTING MACHINE

Five wheel type—counts to 99,999 and repeat. Nickel finish case. Has 1/8 inch round shank. Use it for any counting job. Brand new. Shp. wgt. 1 lb. No. 241. Each..... **98c**



ARMY TENTS

16x16 Ft. A value you can't beat. Big 16x16 ft. pyramid tent with 4 foot drop wall. Used but in excellent condition. Poles not included. Fine for camping out, carnivals, etc. Worth twice this money. Shp. wgt. 100 lbs. Stock No. 521—Each only... **\$35.00**



STIRRUP PUMP

Works with any pall or bucket. Shoots a high pressure stream up to 30 feet. Use it for spraying gardens and trees, for whitewashing, fire fighting, drainage, etc. Complete with 10 foot flexible hose. All brand new. Regular \$3.80 value. No. 244— **\$1.49**



2-Pc. Rain Suits

New 2 piece rain suits. Of durable wear resisting water and wind repellent OD fabric. Bib style pants, slipper fly. Jacket has parka attached. Guaranteed 100% weatherproof. Small, medium and large sizes. Shp. wgt. 3 lbs. No. R549 **\$4.95**



BAYONET BLADE

Fine forged steel. Ground but not polished. May be made into throwing or hunting knife or spear. Blade 6 1/2 x 1/2 inches, 11 3/4 inches overall. Will take and hold a fine edge. Shp. wgt. 1 lb. No. 664-R—Each..... **49c**

STRANDED AVIATION CABLE

Flexible 133 strand wire cable. 5/32 inch diam. 3300 lb. break test. Length up to 450 feet. Use as tow rope, guy wire, clothes line, etc. Weight per 100 feet, 4 lbs. Specify length wanted when ordering (minimum, 100 ft.). Stock No. 421. Per Foot..... **4c**



Officers Watch Compass
Brand new gov't. surplus. Army-Navy model. Single jewel mounted needle. Silver colored dial. A splendid value. Shp. wgt. 1 lb. A174—Each... **98c**

McCLELLAN SADDLE

Brand new! Top grade cowhide, 12 inch seat. Hair girth. Has straps for blanket roll and knapsack. Gun boot and saddle loops. A real buy for any horseman. Worth much more. Shipping weight 15 lbs. Stock No. A145. Each..... **\$16.95**

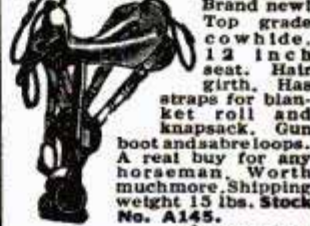

NYLON PONCHO

Fine waterproof nylon in olive drab finish. Gives real protection from storm and rain. Ideal for farmers and outdoor workers. Shipping weight 2 lbs. No. R160. Each only... **\$3.95**



AMMUNITION BOX

Used for 50mm ammunition. Heavy, all metal design with latching top and folding handle. Provides safe, fireproof storage for valuables, etc. Measures 12x6x7 1/2 inches. Used but in new condition. Shp. Wgt. 8 lbs. No. 338—Each **79c**



RUBBER SUIT

Fits over your regular clothes and shoes. Can be cut apart for waist high waders, hip high or knee high boots, also arm length rubber gloves. Heavy gum rubber over fabric. Fine for those who work in the water, commercial fishermen, sewer diggers, etc. All brand new! Wgt. 14 lbs. No. 183 —Each..... **\$4.95**



ORDER DIRECT FROM THIS AD

Values galore! Hundreds of hard-to-find items for home, shop and outdoors. Make remittances by money-order, bank draft or personal check. Send 25% deposit on C.O.D. orders. No C.O.D.'s on orders for less than \$5.00. Include sufficient postage on parcel-post orders—any overage will be promptly refunded. All quotations F.O.B. Chicago. Used items and materials are guaranteed serviceable and as described. Your money back if not more than satisfied.

SEND 10c TO COVER POSTAGE AND MAILING ON BIG CATALOG—READY IN ABOUT 30 DAYS WRITE FOR YOUR COPY TODAY

STARK'S Dept. PMB
509 S. State St.
CHICAGO 5, ILL.

LIFE PRESERVER BELTS

Right from the invasion beaches. Consists of two air chambers. May be inflated automatically with 'sparklet' cartridges or manually by attached hose. Adjustable in waist size. These belts are guaranteed brand new and air tight. You'll use them at the beach when swimming, for making life rafts—or in your boat as a life preserver. No. 1261—Each **\$1.00**



SPARKLET CARTRIDGES
May be used with above belts. In boxes of 10. Stock No. 254. Per Box..... **50c**

A blowout at 70 miles an hour but

“even a child could have held the PLYMOUTH on the road”!

On a trip with his wife and two boys in a Plymouth equipped with Safety-Rim Wheels, A. L. Rives of Dallas, Texas, had a blowout while traveling at 70 miles an hour. “Believe it or not, I had no trouble whatsoever in controlling the car even at that speed,” he writes. “I am convinced that even a child could have held the Plymouth on the road without any difficulty.”

Isn't that the kind of protection you want? Then study the pictures below. Two of them show what can happen when a tire fails on a car with ordinary wheels. The others show how Plymouth avoids these dangers by providing Safety-Rim Wheels as protection. Only Plymouth has this great feature in the lowest-priced field.

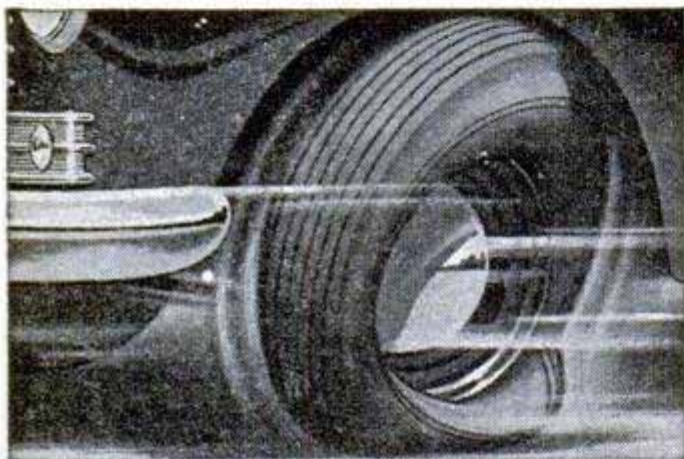

Blowout with Ordinary Rim Wheels. Here's what can happen as a tire blows out on a car with ordinary rim wheels. Such wheels depend on air pressure alone to hold the tire in place. When the air lets go, the tire pulls away from the rim . . . is likely to twist crosswise (as shown) or to jump the wheel entirely. Why take a chance on this?

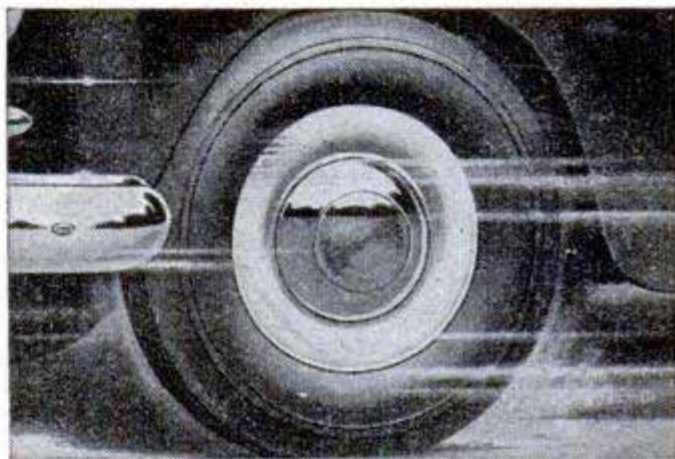

Blowout with Plymouth Safety-Rim Wheels. This is how a blowout looks when you're riding on Plymouth Safety-Rim Wheels. The air lets go, but patented retaining humps are there to hold the tire straight and tight on the rim. Thus centrifugal force is able to give the effect of a certain amount of air pressure. As the car slows down, the tire goes down, and so does the danger.

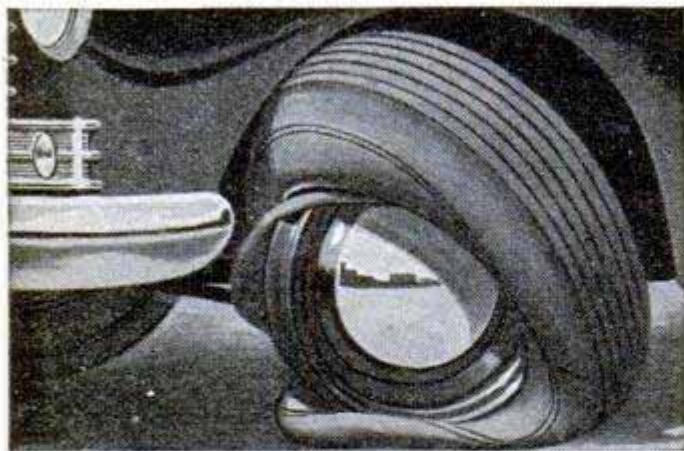

Deflated Tire on Ordinary Rim Wheel. This picture clearly shows why the car with ordinary rim wheels swerved, jerked on the steering wheel, compelled its driver to fight it to a stop after the blowout. The tire has come away from the rim and is twisted. A sudden puncture or any other loss of air pressure could have had the same dangerous effect.

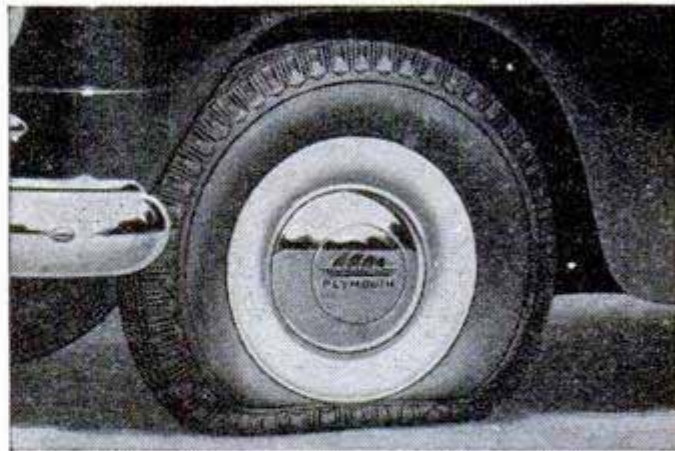

Deflated Tire on Plymouth Safety-Rim Wheel. See how firmly the tire stays on the Safety-Rim Wheel. Thanks to its patented retaining humps, Plymouth's stop was straight, easy and safe. Why do without this proved protection when every new Plymouth has Safety-Rim Wheels and many other safety advantages? Isn't it common sense to insist on Plymouth?

PLYMOUTH Division of CHRYSLER CORPORATION, Detroit 31, Michigan

POPULAR AUGUST 1948 MECHANICS

WRITTEN SO YOU CAN UNDERSTAND IT
VOL. 90 NO. 2

Producing 150 gallons of synthetic gasoline daily, this Standard Oil pilot plant is developing new processes for converting natural gas to gasoline

Do We Need Synthetic Oil Now?

By Dr. Gustav Egloff

Director of Research, Universal Oil Products Co.

OIL, THAT MAGIC LIQUID that does everything from lubricating tiny watches to firing massive boilers, is in the nation's headlines almost every day. Forecasts of imminent exhaustion of our oil fields frighten every user from the motorist to the railroad president.

What is the story on our oil supply as it is described today by experts in the field? Are we facing an oil shortage? Should we build gigantic plants for converting our

Doctor Egloff is vice-president of the American Chemical Society, president of the Chicago Technical Societies Council and is also a member of the Industrial Committee of the Atomic Energy Commission.

abundant coal and oil-shale deposits into synthetic oil?

These questions are not just academic. They are important to the entire economy of this oil-dependent nation.

Experts in the oil industry are accustomed to cries of shortage. Ever since the first gusher began to slacken its flow, predictions of an oil drought have been in the news. These oilmen are the people who are most directly concerned about our oil because it means dollars and cents to them—billions of dollars, in fact. Their huge investment (20 billion dollars) in wells, refineries, pipe lines, tankers and other

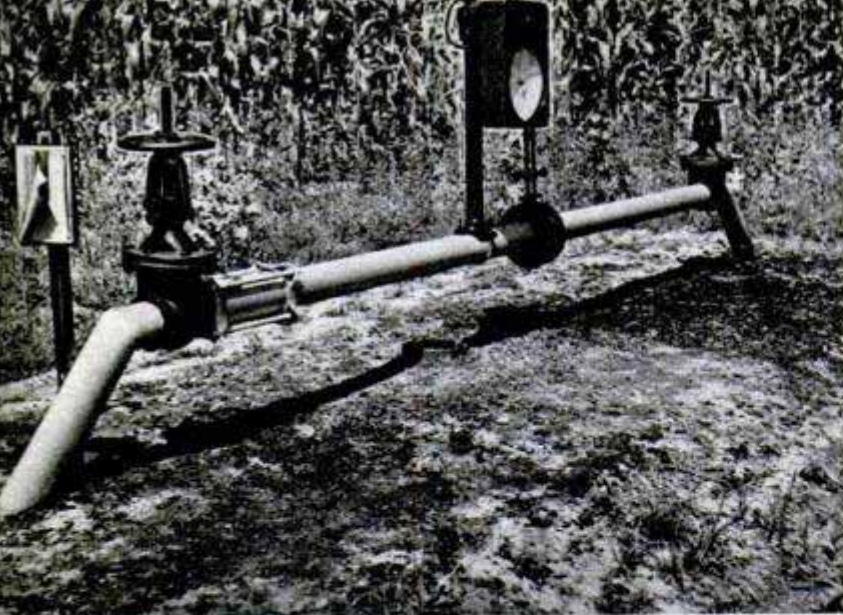

Standard Oil of N. J. photo

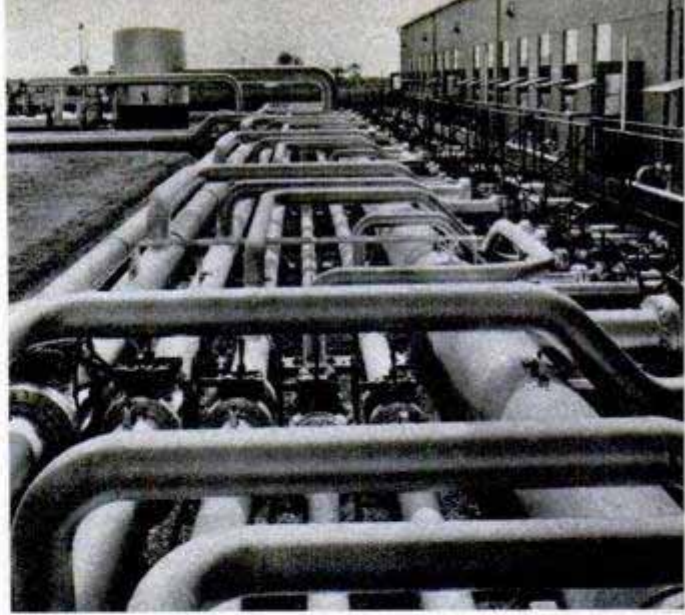

Oil & Gas Journal photo

Left, meter loop measures amount of dry gas pumped back into ground for repressuring wells to increase the yield. Right, this maze of piping is used at a natural-gasoline plant to return recompressed gas to the wells

equipment depends upon the flow of oil from the ground. If that flow stops, their investment becomes almost worthless. Strangely enough, they're not worried!

Oilmen admit that eventually we'll run out of oil. But, they say, eventually is a long way off. They are also agreed that we will probably turn to synthetic oil on a giant scale some day, but, they claim, we shouldn't jump overboard right now. There is still a lot to be learned about the complicated processes involved in economically converting coal to oil. For this reason, they believe we should continue

our research in the field. Small pilot plants should be built and operated. In these test plants the kinks can be ironed out of the complex processes so that, when we do need them, we can build and operate commercial plants efficiently. But that doesn't mean we should expect to convert to oil made from coal or shale tomorrow.

What are our present oil reserves? Definite statements about the actual number of barrels of oil in the earth are impossible to make. Just as you can't state how many trees there are in a forest until you have seen the forest, you can't guess how many

Graph shows that U. S. oil discoveries have greatly exceeded production except during depressions and war

BARRELS YEARLY

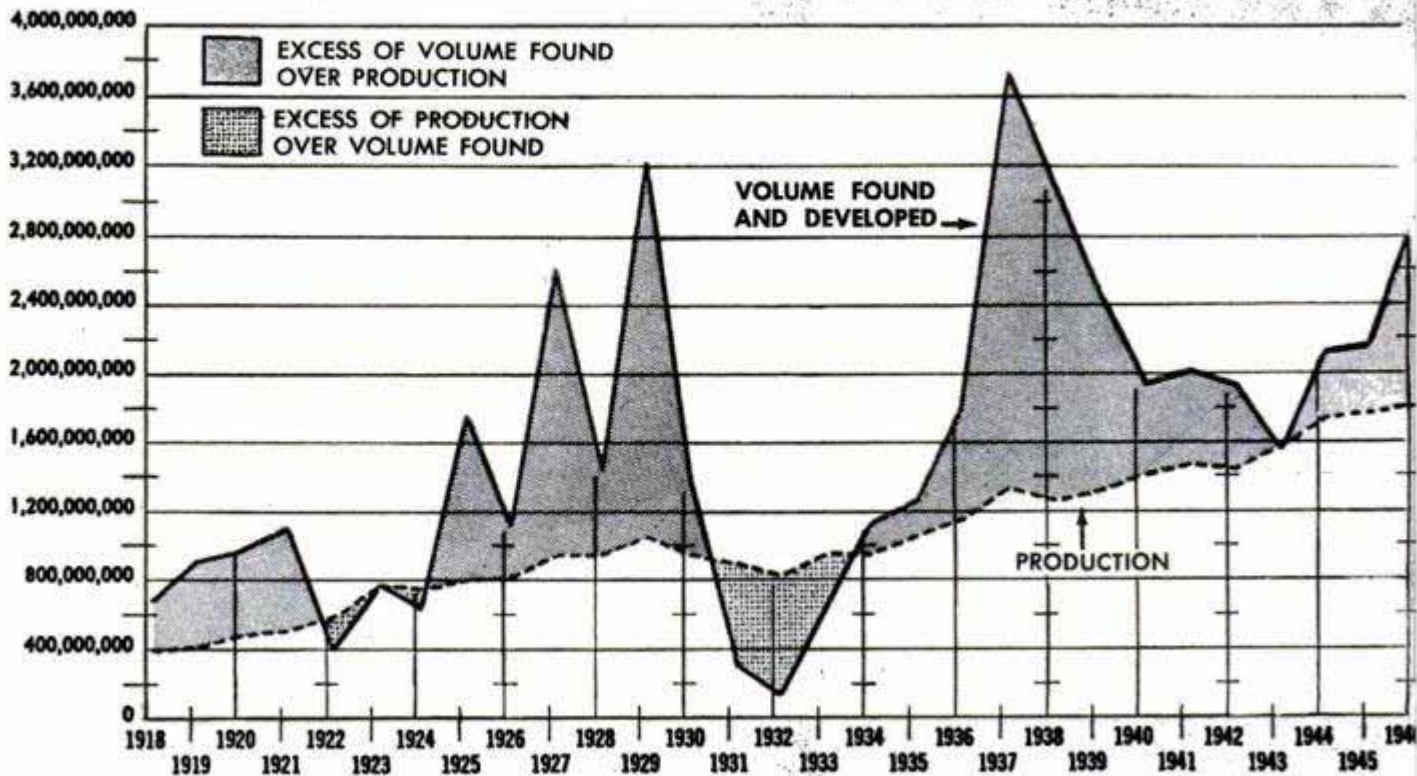

barrels of oil there are under the earth's surface until you've drilled.

However, there are facts to prove that we are not facing an immediate oil shortage. Only in years of serious depression, such as 1931-34, has there been more oil consumed in this country than there were new discoveries. Even when oil exploration was reduced because of steel shortages during the war, annual discoveries of new reserves were much greater than actual consumption in every year but one. In 1947, when oil consumption reached a new peak, we discovered 1.8 billion barrels of petroleum oils more than we actually used. At the end of that year our proved reserves were about 26 billion barrels or over twice as large as they were in 1928 and four times as large as in 1918.

Of course, there were spot oil shortages in various sections of the country last year, but these were not due to a lack of reserves. They were the result of unusually cold weather and inadequate transportation facilities. Even if we had a full-grown synthetic-oil industry we would still have had the transportation bottleneck and the resultant shortages.

To make the oil-reserves picture even more encouraging, there are billions of



Electrode, being guided by driller, is lowered into the shaft to determine oil potential of the new well

Nine miles out in the Gulf of Mexico, drillers sink this well to tap the oil under the tideland waters

Oil & Gas Journal photo

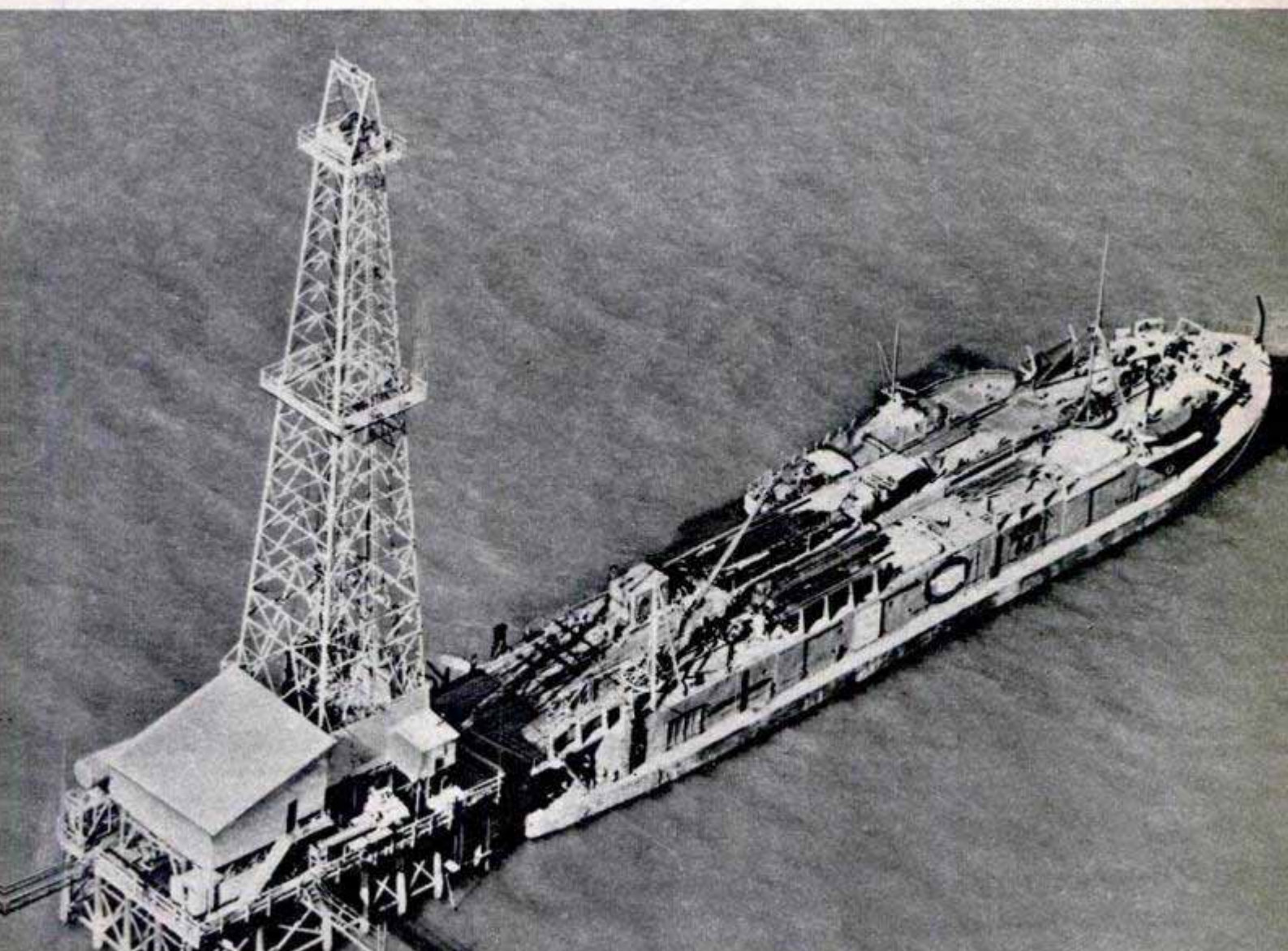

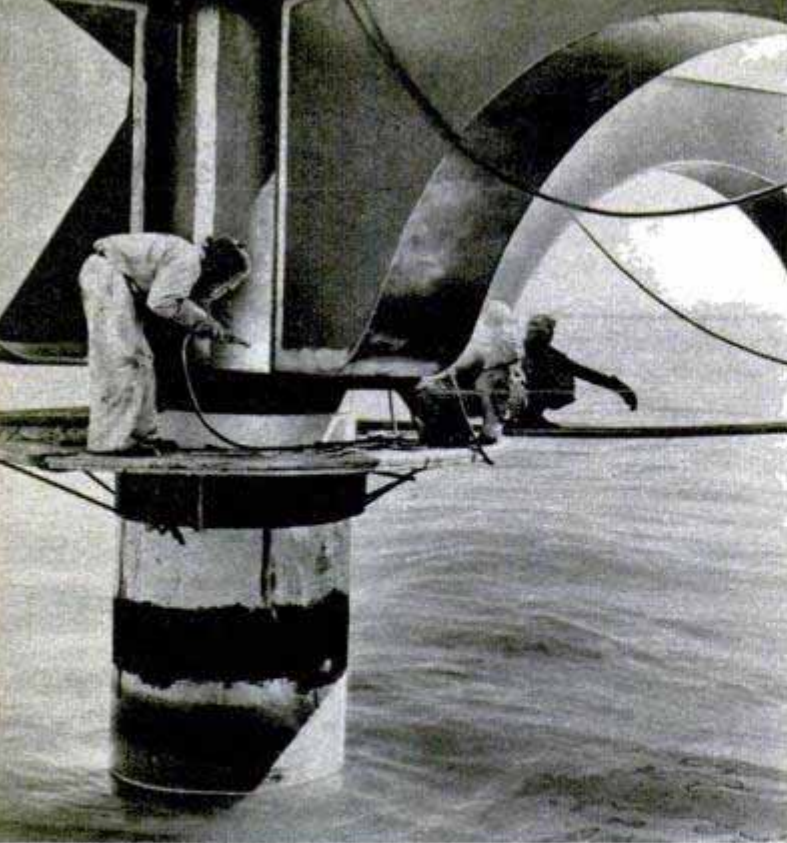

Standard Oil of N. J. photo

Another underwater drilling project is in Venezuela at Lake Maracaibo where vast oil field is under 100 feet of water. Workers weld foundation for derrick

barrels of oil in the ground that can be extracted by methods other than pumping. Oilmen call such processes secondary-recovery methods. One of the biggest challenges to the oil industry is not that of finding more gushers, but the development of methods which will remove a higher percentage of oil from the ground. With the present estimate of 80 percent left underground in parts of Pennsylvania where the oil is of top quality, this challenge is a tempting one. Oil, real petro-

leum, not synthetic, can be extracted from the great quantities of oil sand still available in the areas of "exhausted" wells when necessary. Normally, an oil well is abandoned when the pumps can no longer remove oil from the ground at a rate that will show a profit. These wells "run out" not because the oil is exhausted, but because the water or gas pressure at the base of the well has dropped so low as to be incapable of driving the oil from the sand. Oil companies are using compressed air, water, gas and chemical solutions to increase the yield, but even with these methods there is still a large percentage of oil left in the ground.

There are other methods of secondary oil recovery such as the horizontal drilling technique used by Leo Ranney in the Franklin, Pa., fields. With this process it is possible to drill horizontally into the oil sands for 3000 feet or more. Thus, instead of the vertical drilling alone, there is at the bottom of a conventional shaft a series of horizontal drilled holes radiating outward like spokes on a wheel to tap oil reserves sealed in by natural barriers.

In Australia, the Ranney process is now being used at the bottom of a shaft 1200 feet deep. Radiating outward from the base of this shaft, horizontal holes, each 4000 feet long, are drilled into oil-bearing glauconite sandstone. Perforated pipe, which lines the first 100 feet of these holes,

Synthesis process for converting coal to liquid fuel is complex even as simplified for a schematic diagram
Diagram courtesy Bureau of Mines

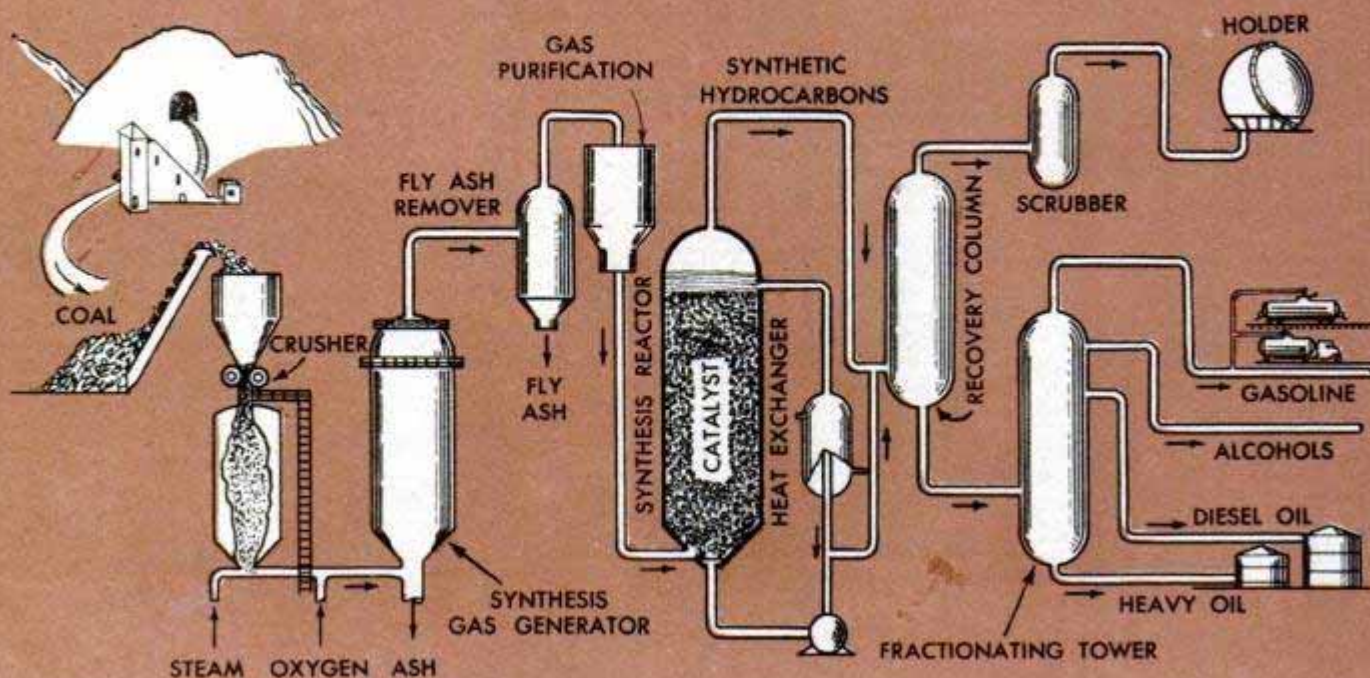

directs the oil that drains from the sand into the pit. From there it is pumped to the surface.

Several nations are today mining oil in a manner very similar to that used in mining coal. Much oil is held firmly by billions of sand particles deep underground. By sinking conventional mine shafts, it is possible to mine and haul these sands to the surface for treatment in baths of hot water and caustic soda. This solution washes the oil from the sand. The released petroleum floats to the top of the tank and is drained off for piping to the refinery. The clear white sand, now devoid of its oil, passes out from the bottom of the tank. It is possible that this

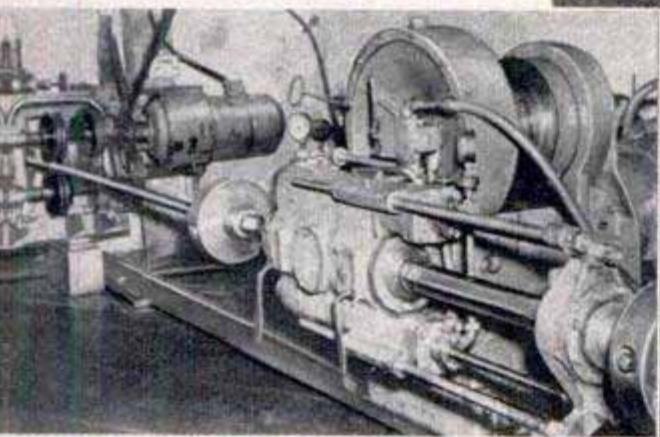

Called the Ranneywell, the horizontal oil well at right removes from the ground oil that is left by ordinary vertical wells. Work chamber at base of shaft holds a horizontal drilling machine (see photo above) that makes two horizontal drillings at once. Below, oil flows in pipes to a pump in work chamber and is forced up to surface. Shaft has an elevator to take men to and from chamber

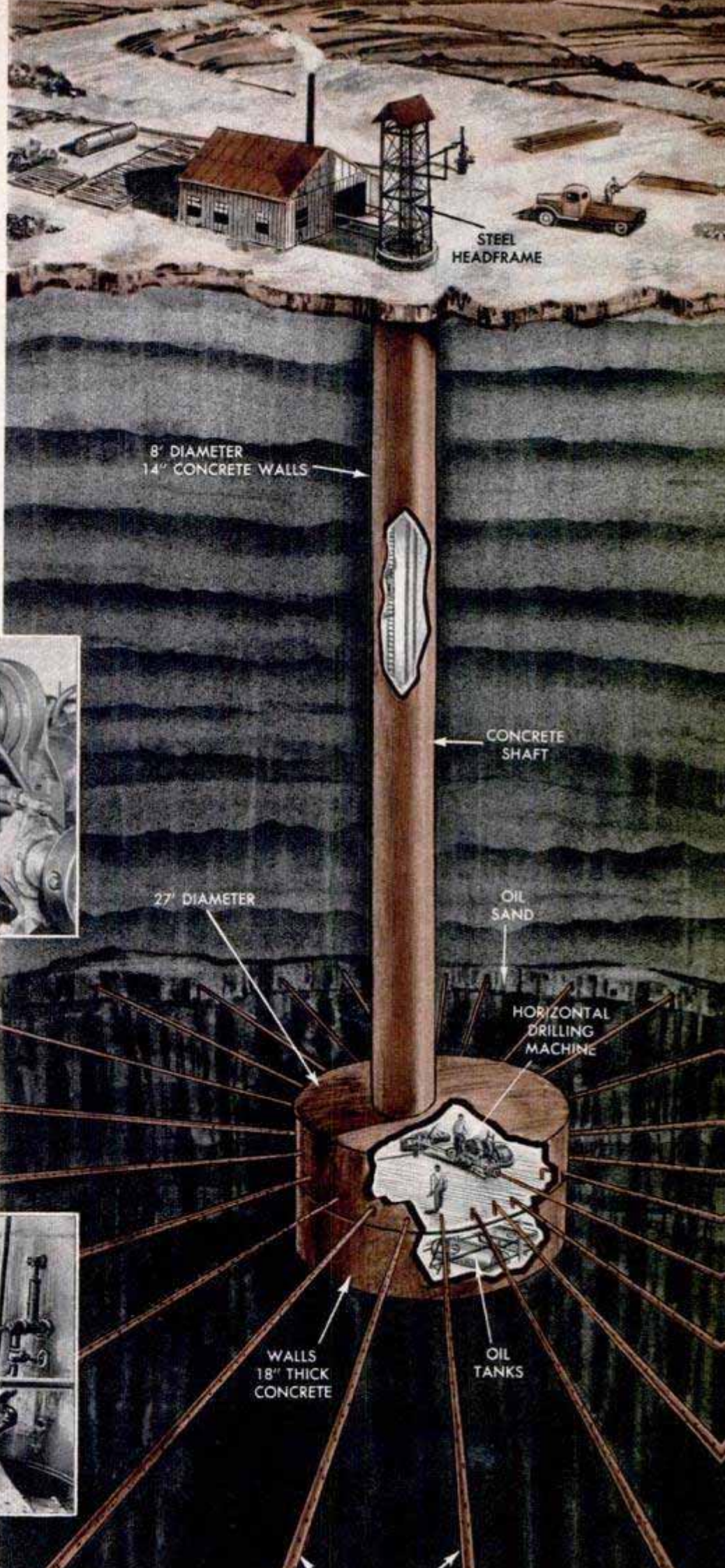
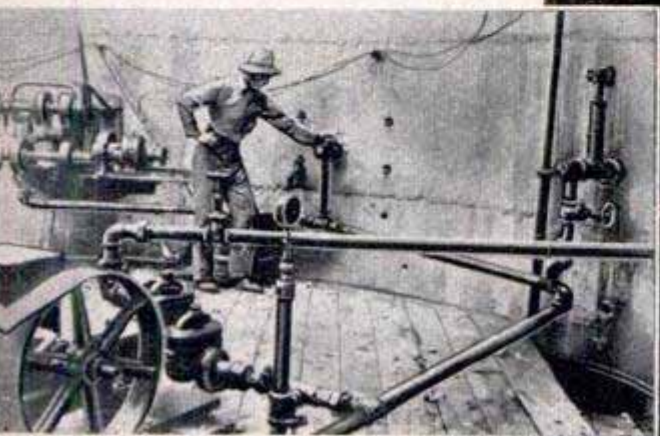

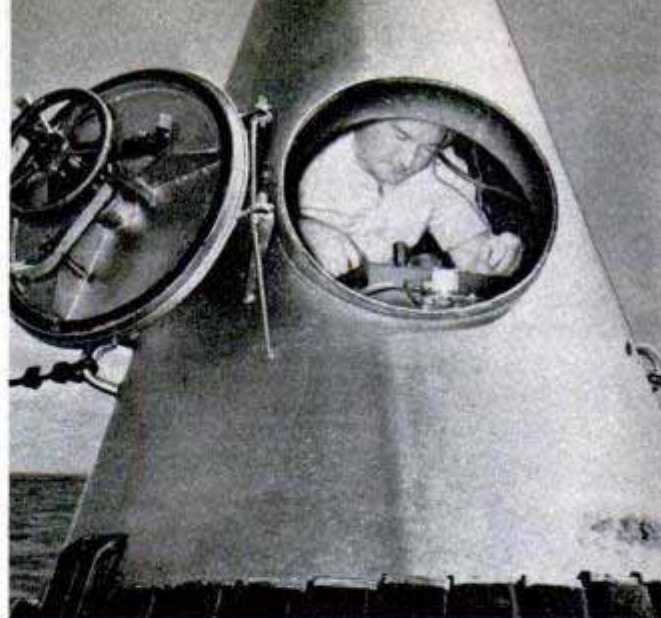
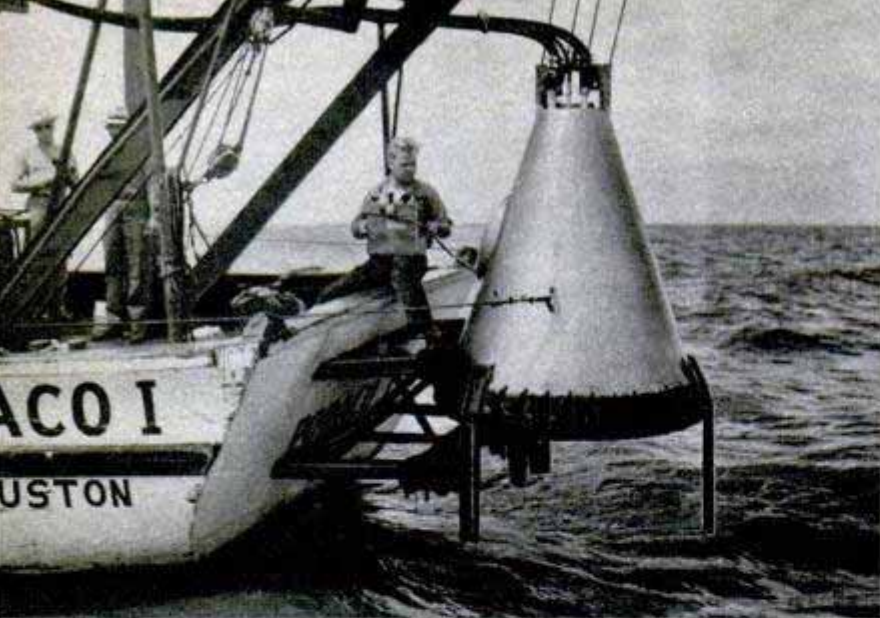

Robert H. Ray Co. photos

Left, diving chamber is lowered to ocean floor where observer inside chamber (right) operates oil detector

sand may have by-product value and if so its sale would cut the cost of the oil.

Oil obtained from this process is not a low-grade variety. Its quality depends upon the field since it is the same grade oil as was recovered initially by drilling. Because of this, the method could be used best in fields where higher-quality oil is found, such as those in Pennsylvania.

At the Wietzer fields near Hanover, Germany, this mining process has been in use for years.

Removing these oil-laden sands is especially important because usually more oil is left in the ground than is removed by drilling and pumping. In some areas the percentage of oil remaining in the sand is as high as 90 percent. Heavy viscous oils cling most firmly to sand particles and it is this type of petroleum deposit that can be best recovered by the mining method.

Another method of secondary oil recovery is that of draining the "exhausted" oil sands, a system being used at Pechelbronn, France. There, oil sands are drained by a series of pits and galleries very similar to those in a coal mine.

At Pechelbronn there are seven shafts currently in use and an eighth is being dug. Some of these shafts go as deep as 1200 feet into the earth. Latest reports show that the process was recovering 620 barrels of oil a day. This figure seems minute compared with our gigantic production, but the important factor is that this is oil that otherwise would have been left in the ground. If the process were used in this country, there would, no doubt, be a greater yield because our fields have much thicker layers of oil sand than those in the Pechelbronn area.

To drain the oil, a vertical shaft is sunk, and from this, horizontal shafts are dug just above the oil-sand seam. Pits are sunk in these galleries at regular intervals and extending down into the oil sand. Then by gravity flow the oil runs into the pits and pumps force it through pipes to the surface. Oil flow can be accelerated by forcing compressed air into the sand.

According to the Bureau of Mines report on the process, "after years of oil-well development and pumping have made

(Continued to page 244)

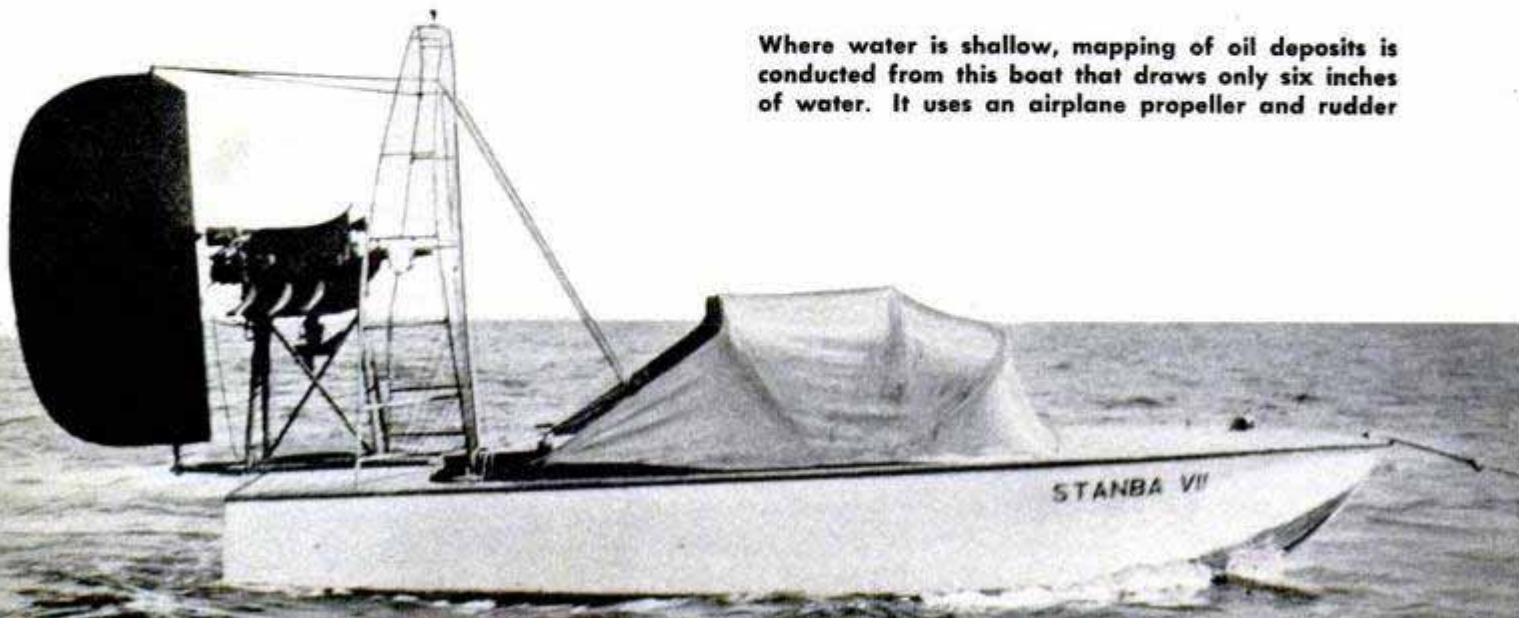

Where water is shallow, mapping of oil deposits is conducted from this boat that draws only six inches of water. It uses an airplane propeller and rudder



Double-End Collets

Lathe collets that are slotted at both ends hold two sizes of stock and provide equal gripping power and expansion throughout their length. The collets fit a chuck that has no projections to snag tools or fingers. The chuck is supplied with three double-end collets and will accommodate stock from $\frac{1}{2}$ to 2 inches in diameter. Two sizes are available—for 1-inch and $1\frac{1}{2}$ -inch arbor holes.



LEADER DISPENSER for anglers holds 100 yards of leader gut. Inside the aluminum dispenser are three reels, each with a different kind of leader. The ends project and are held by a rubber pad. Leader can be cut in a sharp notch on rim of dispenser



Pack Gives Hot or Cold Treatments

You have your choice of heat or cold with a combination ice pack and hot-water bottle that is small enough to be carried in the coat pocket. A liquid, sealed in a flexible Vinylite-plastic bag, congeals to a semisolid state and becomes extremely cold when placed in a refrigerator. For heat treatments, the bag is placed in boiling water for a few minutes and it absorbs heat which it holds for a long period. It folds into a case only 4 by 8 inches in size.



FLASH-BULB DYE gives clear bulbs a blue coating for use with daylight color film. Cost per bulb is a fraction of a cent. One bottle of the dye will coat 400 midget bulbs. Although blue in color, the dye is crystal clear. A dipping beaker is provided

FLEDGLINGS ON PARADE

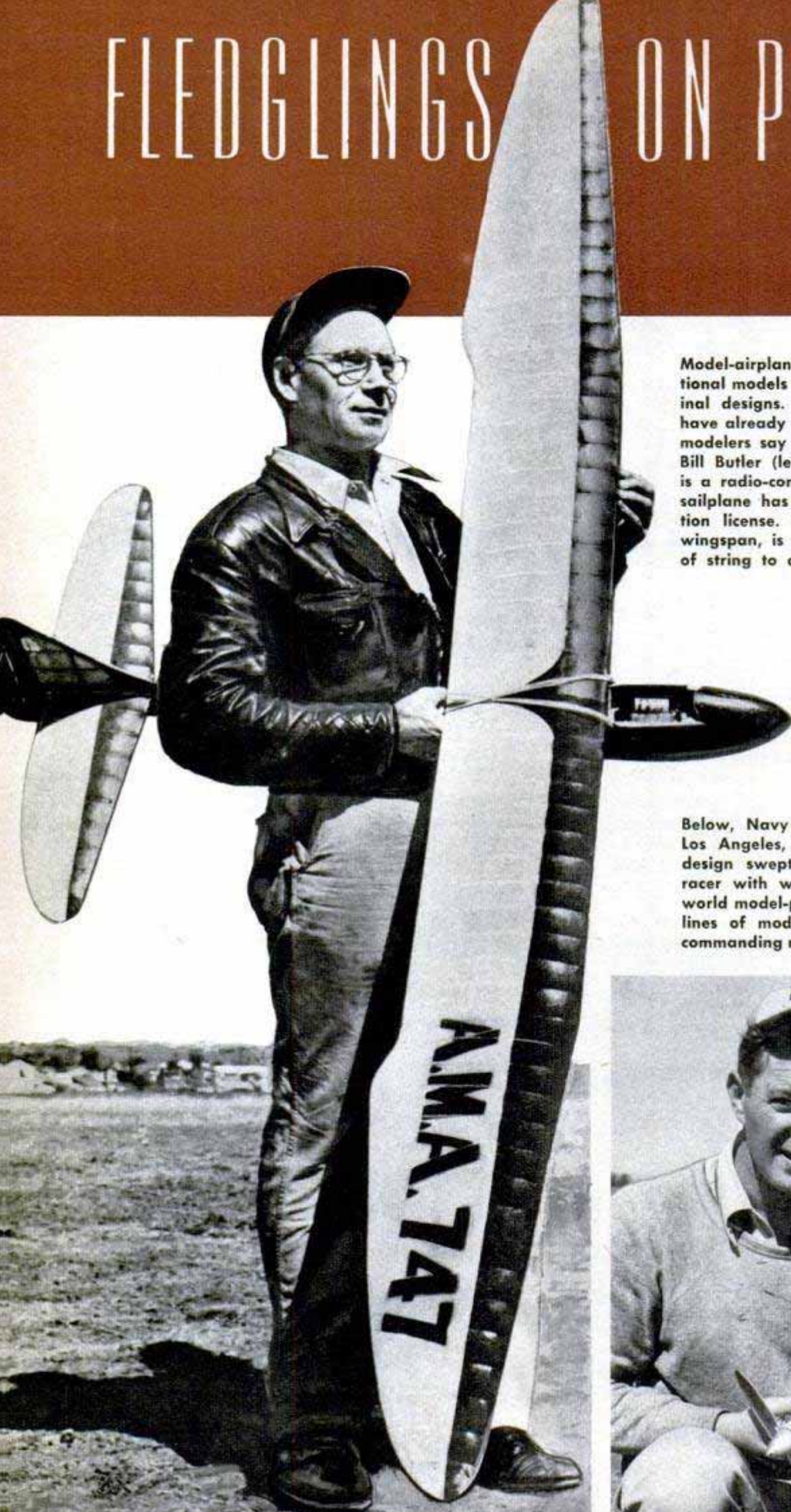

Model-airplane racers scoff at conventional models and are turning out original designs. Tiny plywood airplanes have already exceeded 150 m.p.h. and modelers say 200 m.p.h. is their goal. Bill Butler (left) of Inglewood, Calif., is a radio-control bug. His two-pound sailplane has FCC amateur radio station license. The glider has 100-inch wingspan, is towed aloft on 100 feet of string to catch thermal air current

Below, Navy officer, Lt. Ed Baker of Los Angeles, poses with his original design sweptback wing "supersonic" racer with which he hopes to break world model-plane speed record. Clean lines of models like this set a pace commanding respect of aviation experts





Mad Missile is what Joe Havlik, of San Diego, calls this "supersonic" Class-D racer. The engine is mounted in right wing; plane has a V-tail and no rudder



Novel one-wing half-tail "side winder" built by Glenn F. Crist of Modesta, Calif., has been officially clocked at speed of better than 150 m.p.h.

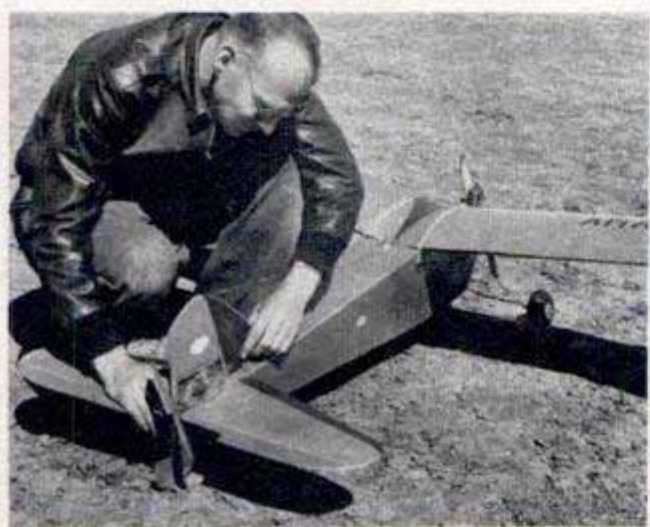

Tiny radio-control unit in this plane weighs only 1.1 ounces and provides two engine speeds in addition to controlling the rudder, elevator and the engine cutoff. It is called the Rudevator and is being inspected by Richard Schumaker, San Diego, Calif.



Ray Benskin (right) of Pomona, Calif., weighs in an original Class-C racer. He has held the world junior speed record. Below, Steve Stevens of Los Angeles holds to conventional design with his Stinson mono-plane scale model which he carries atop his auto

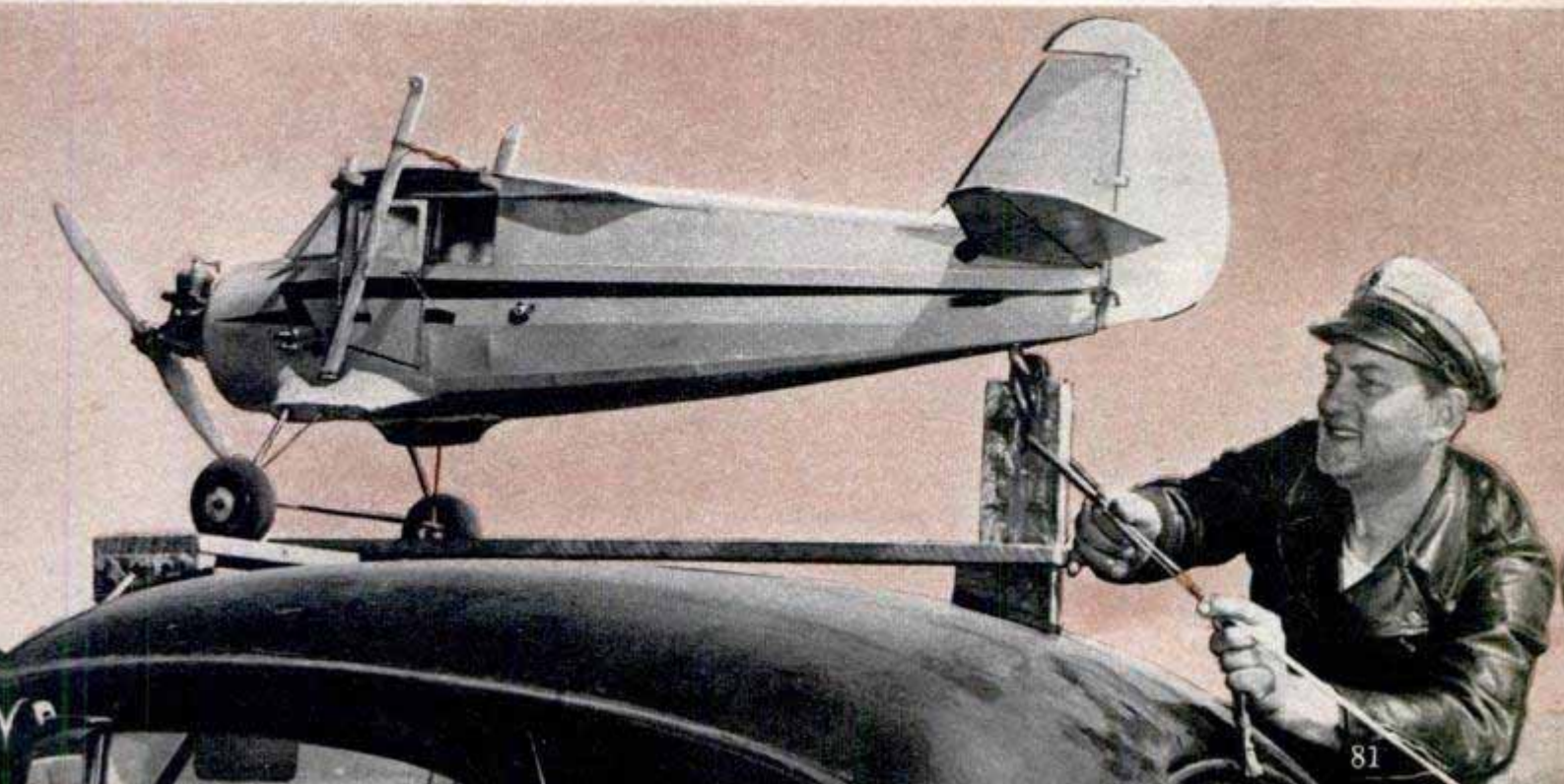

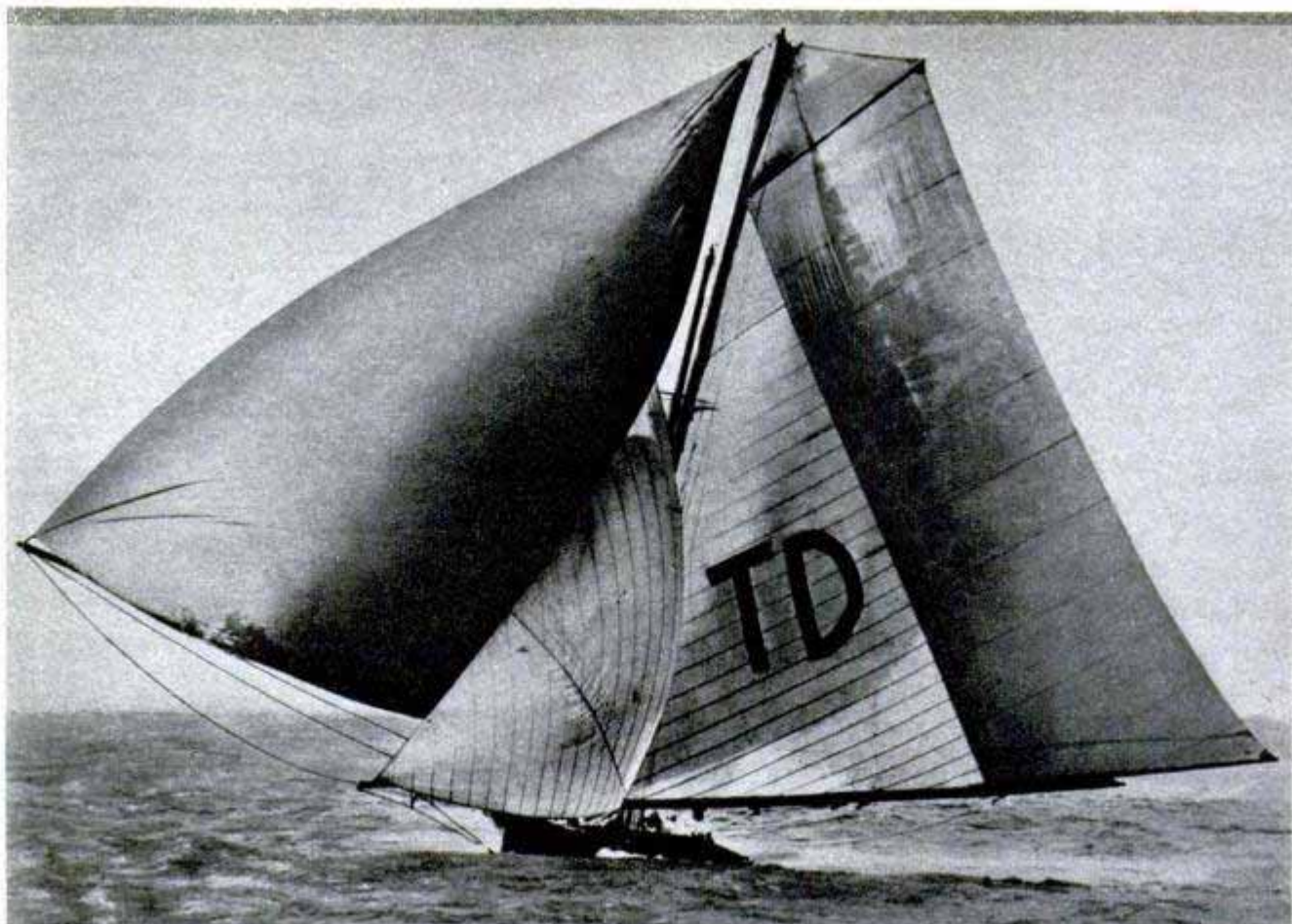

Sails Crowded on Mast Almost Hide Boat During Race

Spectators at the recent world's 18-foot yachting championship saw little of Top Dog, the Australian craft that captured second place. More than 2000 square feet

of sail which were crowded on the mast almost covered up the craft. By contrast, the yacht which finished third was rigged with about 1000 square feet of canvas.



Rotary Hoe Thins Plants When Pushed Along Row

Thinning long rows of plants, a tedious job when done by hand, is a simple operation with a gardening implement that looks like a small cultivator. The offset blades of a rotary hoe, which is geared to the wheels, make 150 gaps each minute. The hoe blades dig under the soil and cut off the plants at regular intervals. These intervals can be adjusted by means of three interchangeable gears. Made in England, the machine is said to thin plants five times faster than an experienced worker.

You may wish to obtain additional information about the new products described each month in *Popular Mechanics*. If you want to know the name and address of manufacturer or distributor, just write to Bureau of Information, *Popular Mechanics Magazine*, 200 East Ontario Street, Chicago 11, Ill.

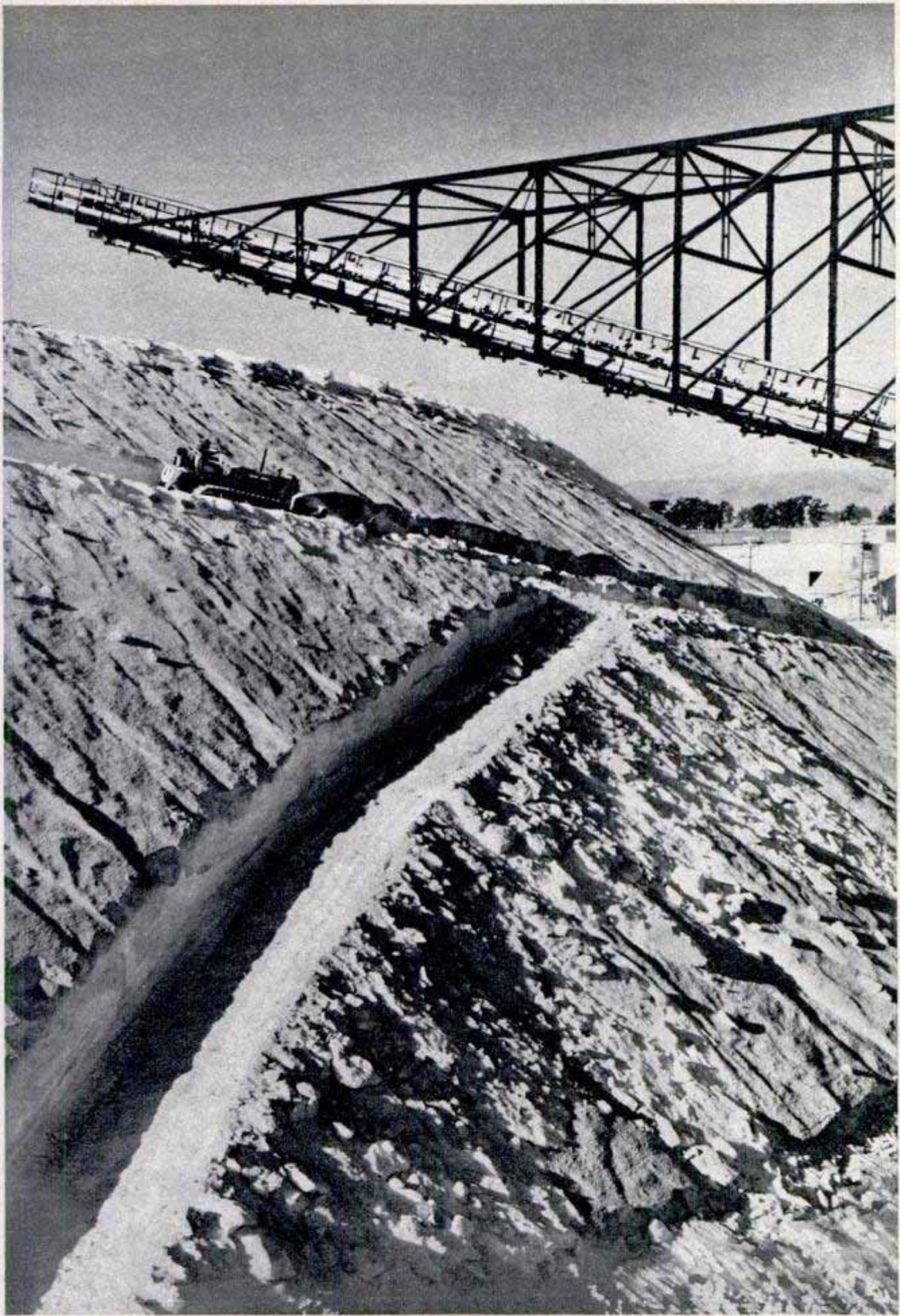

MOUNTAIN OF SALT, 700 feet high, stands near Newark, Calif., a product of solar evaporation. Salt mound, the property of the Leslie Salt Company, is growing in size as conveyor belts on the long framework carry more salt from washers to the pile. Tractors equipped with bulldozers build service roads along the side of the mountain. Salt from the huge mound is processed for commercial, agricultural and domestic uses

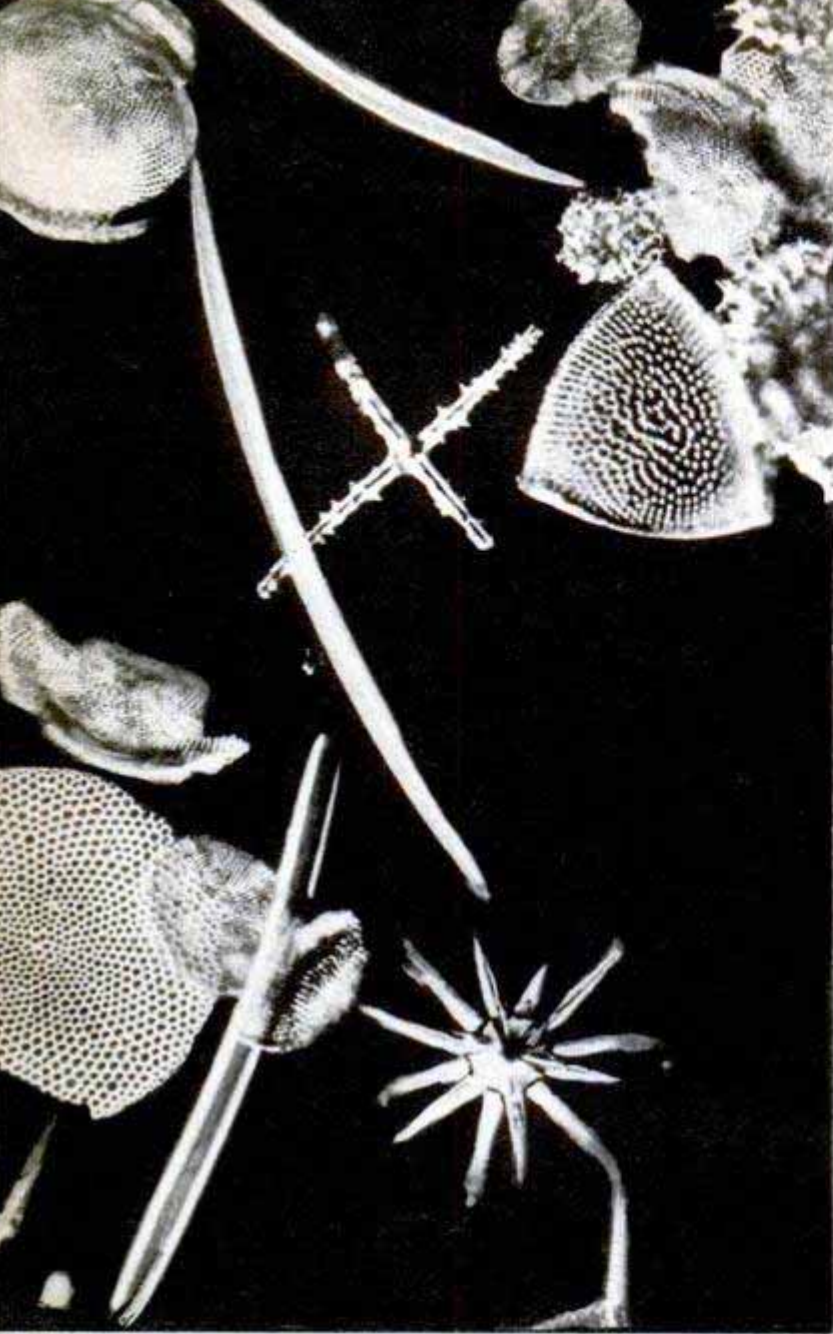

Science Takes a Micro-Eye View

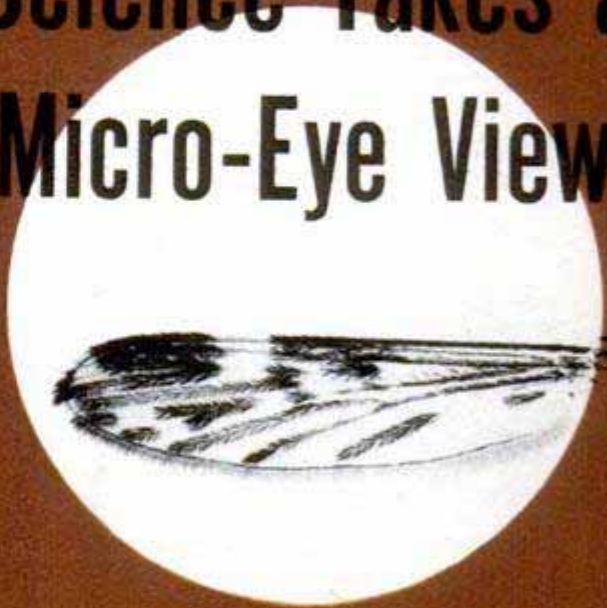

On this page are five photos showing the tiny world Hollis explores and records with the aid of his camera with the microscope attachment. Above is the wing of a mosquito. Note the network that supports the tiny wing. Left, the shells of microscopic sea animals, called diatoms, make an interesting but unplanned pattern in the photo. Center left, these balls look like gooseberries; actually they are the pollen of a hollyhock blossom. Lower left, eggs of a cutworm moth are recorded by the microscope-camera. Below, a fishing net? One of Hollis' stunt photos shows silk stocking under magnification

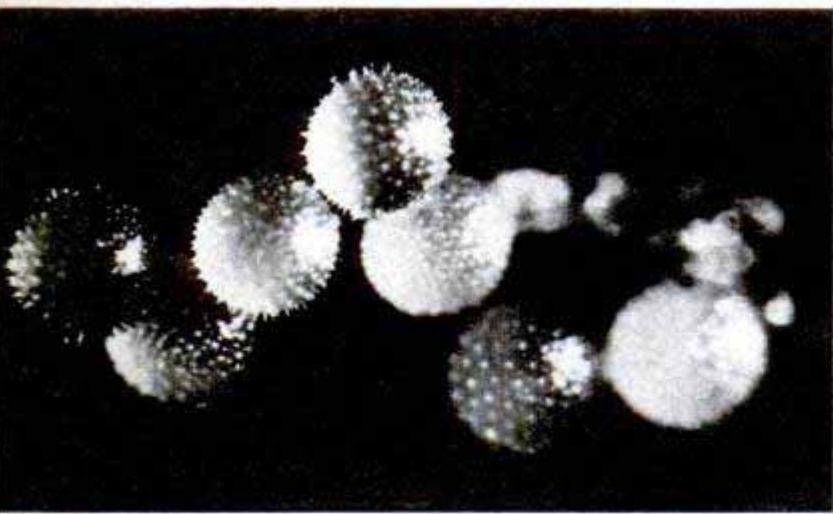

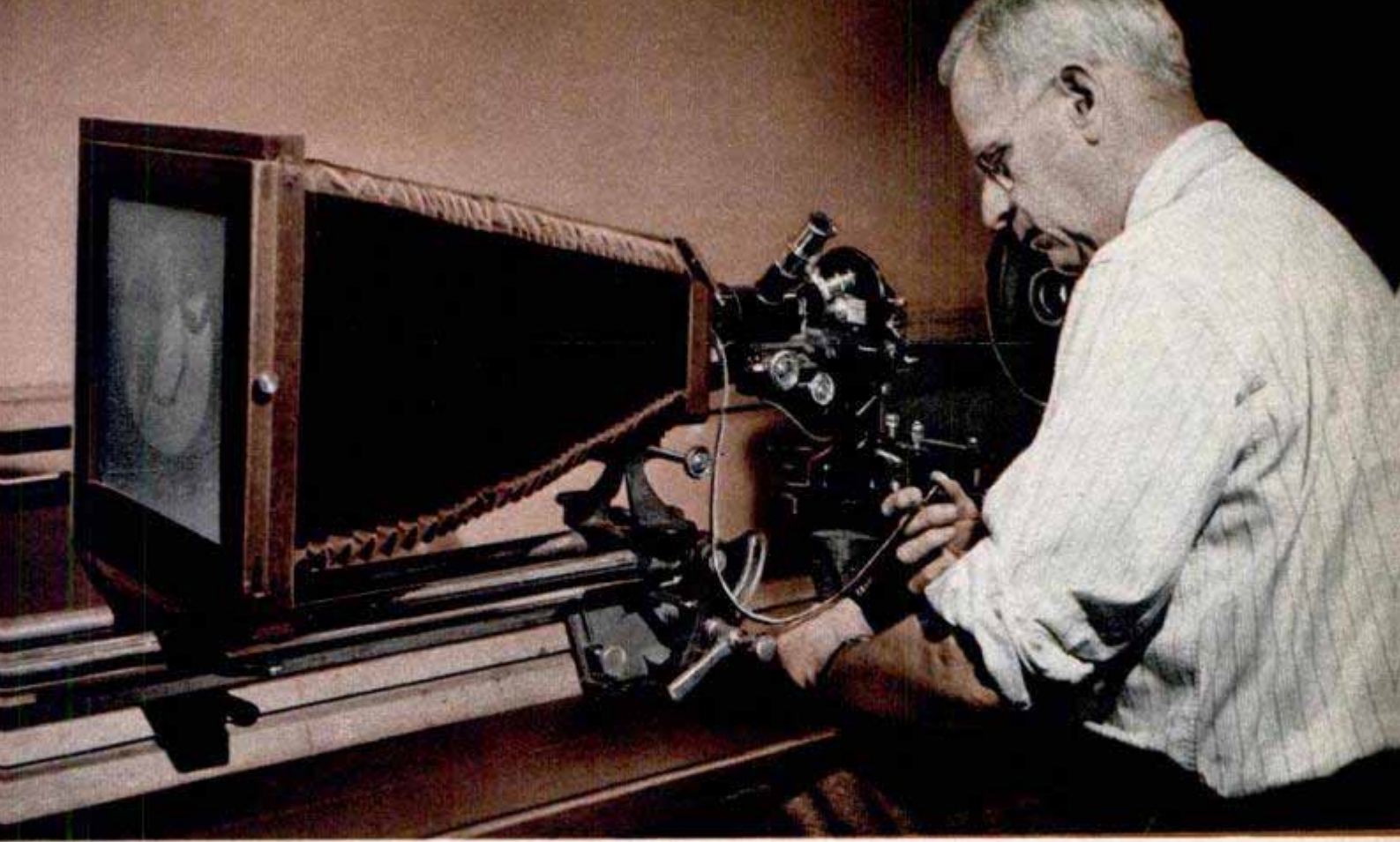

With a slide in microscope just forward of lens, Hollis prepares to snap photo. Ground glass shows the field

SCIENCE continually searches for better ways to record its discoveries. One technique is to photograph a world too small for the human eye to see. V. P. Hollis of the University of Minnesota pries into that world with a microscope and a camera to make photo-

By Clifford B. Hicks

graphs that are works of art as well as tools of the scientists. Hollis is director of the university's photographic laboratory. Scientists and professors consider his photographs invaluable aids in teaching students the facts about life in a suboptical world.

This photo, showing cross section of louse feeding on a leaf, won Hollis a high award in science photography

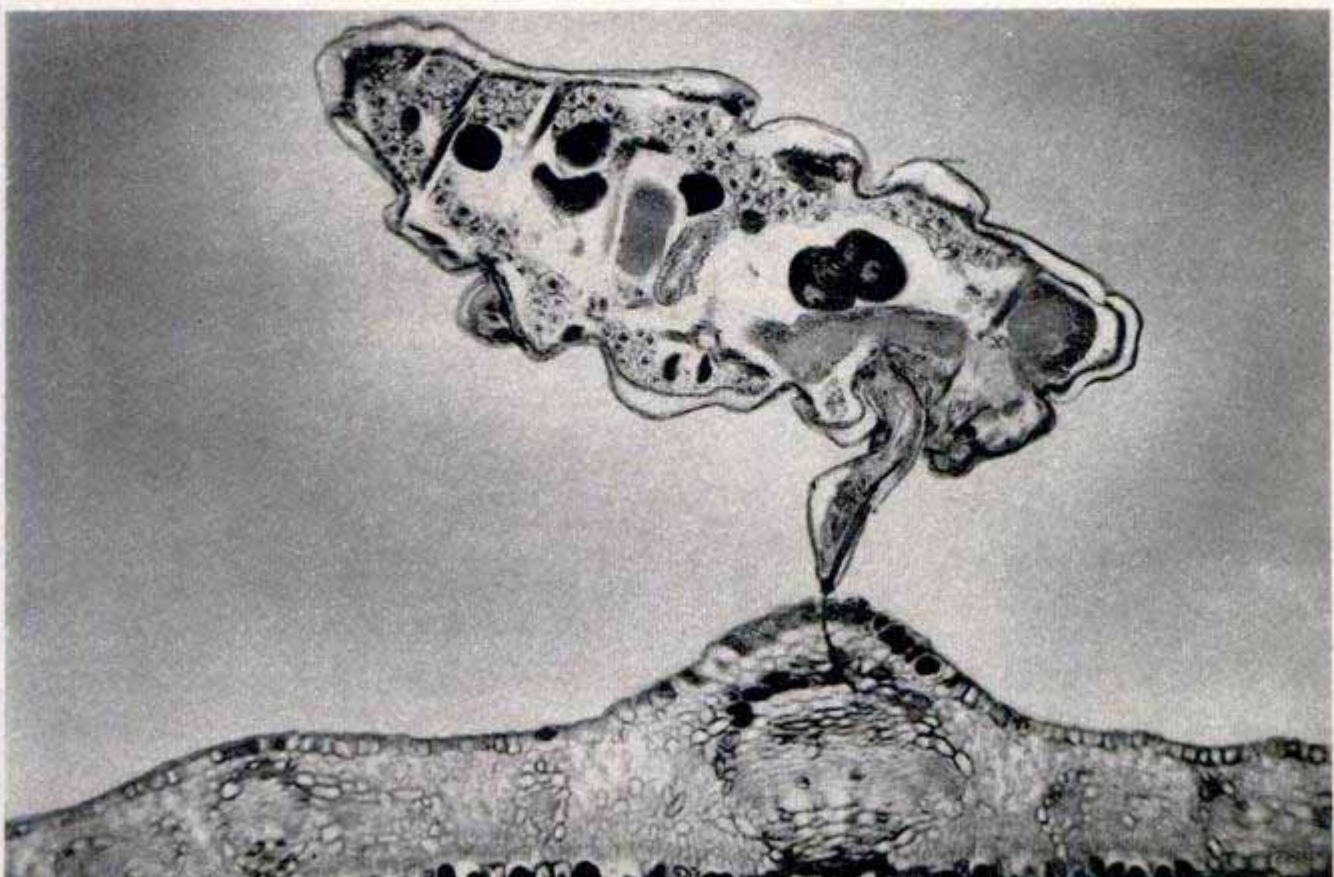

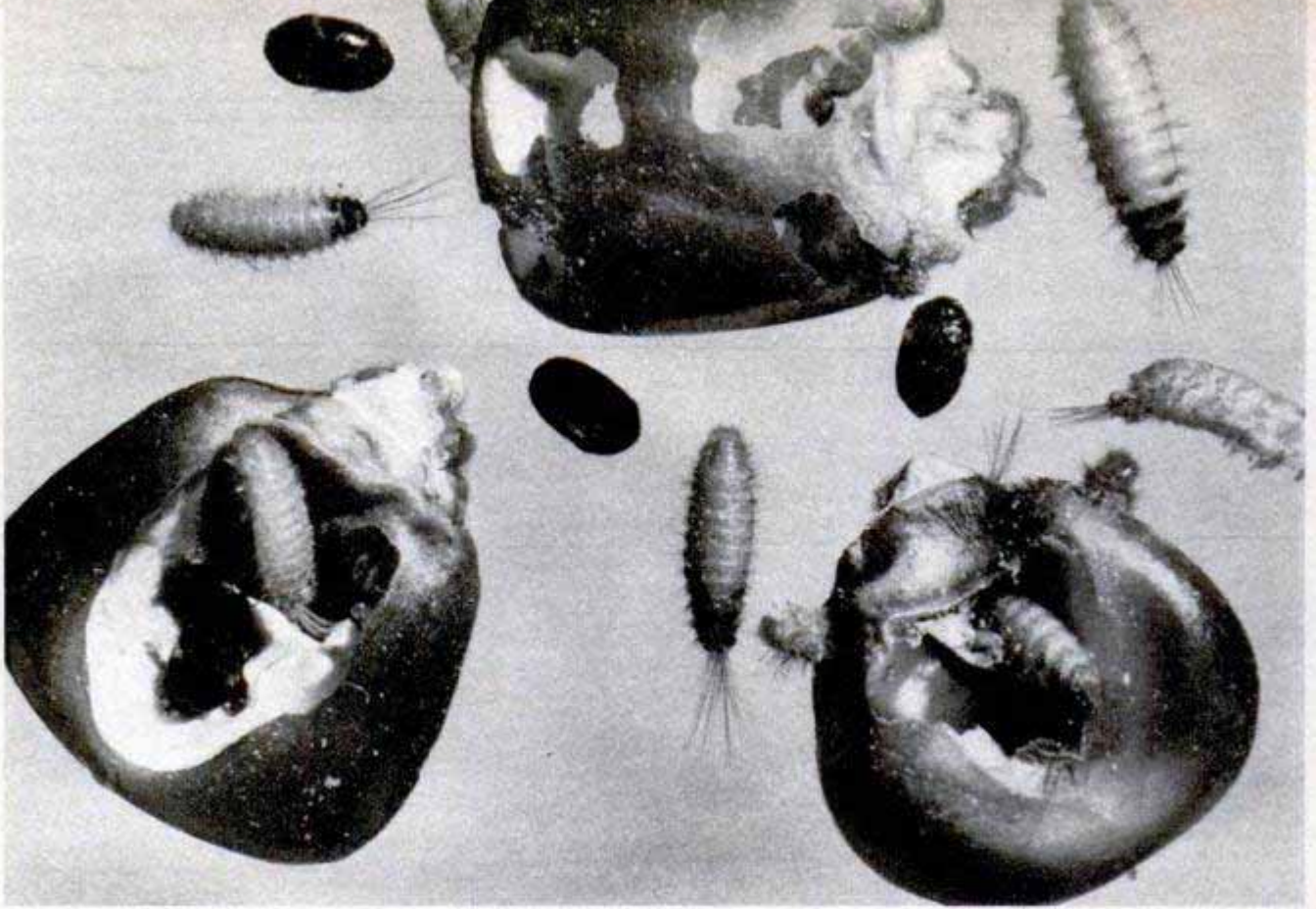

Corn, weevils and larvae were mounted on a slide and photographed with direct instead of transmitted light



Left, an untouched horsehair from the bow of a violin. Right, the same hair after resin has been applied

Left, female flea was mounted on glass slide and light from arc lamp focused through it to make exposure. Right, child's tooth was ground to extremely thin cross section for this photograph. Note the nerve channel

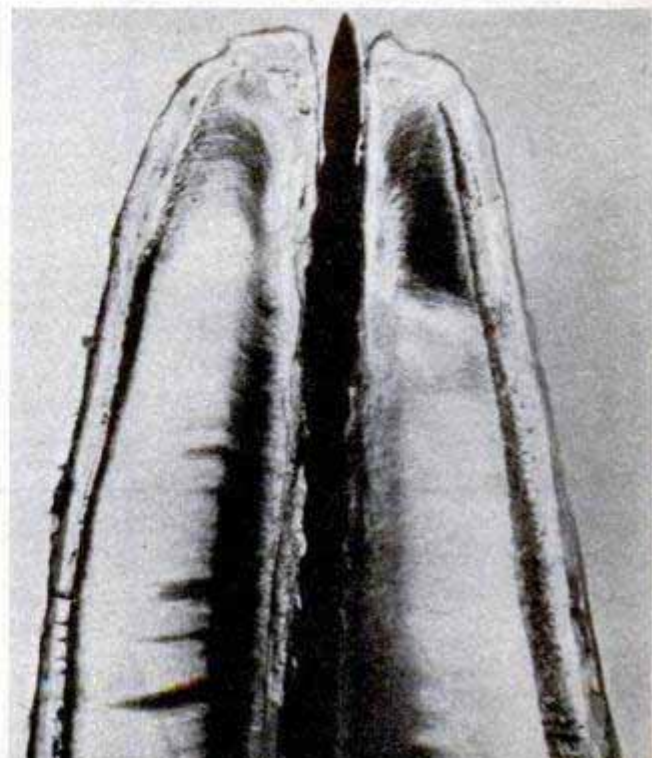
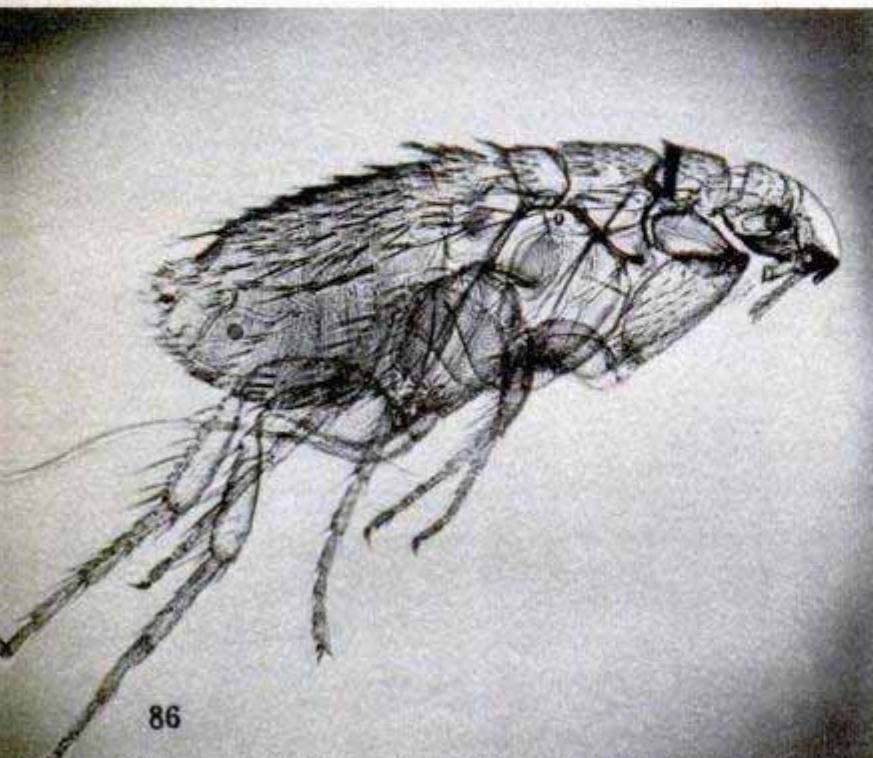

Students in the university's science classes can learn the behavior of minute organisms through lectures, textbooks and drawings; they can catch a glimpse of this tiny world through a microscope; but they can have no accurate record for long-term study without an actual photograph that shows the specimen in detail.

In addition, scientists engaged in research have difficulty in comparing several specimens through microscopes. Photographs of the specimens are an ideal answer to this problem.

Hollis provides those photographs through a process called photomicrography. This method is not merely the technique of taking extreme close-ups with a lens that will catch the subject in detail. Hollis has an expensive microscope connected directly to his camera. He substitutes a sheet of film for his own eye in looking through the microscope, and snaps a permanent record of the specimen mounted on the slide. He has developed his technique over a period of 17 years.

The technical name for Hollis' equipment is the Leitz UMA Photomicrographic Apparatus. The camera is mounted on tubular runners for horizontal movement. Attached to the lens is the microscope with a side telescope for locating the field. The light source, usually an arc lamp, is mounted at the opposite end of the optical bench, and the light passes through a heat-absorbing filter and stage controls before it strikes the specimen. The entire apparatus is floated on springs.

When scientists and professors at the university request Hollis to snap a permanent record of their work, he must first

Right, when specimen is mounted in water, Hollis swings camera into a vertical position so the slide will be level. Below, photos such as this one showing infected pine needles have become tools of science

have the specimen in condition to photograph. This is an art in itself. Scientists usually do this part of the job, slicing tiny cross sections of the organisms and mounting them on glass slides. In some cases, living specimens are mounted in water.

The photographer slips the slide into the microscope, turns on the arc lamp and then squints through the microscope's telescope to locate the tiny portion he wishes to photograph. When he has found his field he turns to the ground glass on his camera, where this field is enlarged many times. Then with a fine-focus adjustment he sharpens the image until it stands out boldly on the glass, and snaps the picture.

In cases where the subject must be mounted in water, the camera and microscope can be swung into a vertical position so the hollowed-out slide stands level.

One of Hollis' unusual photos is his cross section of a plant louse feeding on a leaf. This photo won him a second award in the First International Photography in Science Salon sponsored by the Smithsonian Institution. It is an extremely thin section of the louse, sliced while the insect was feeding on the leaf. In order to make the slide, the leaf and louse were immersed in

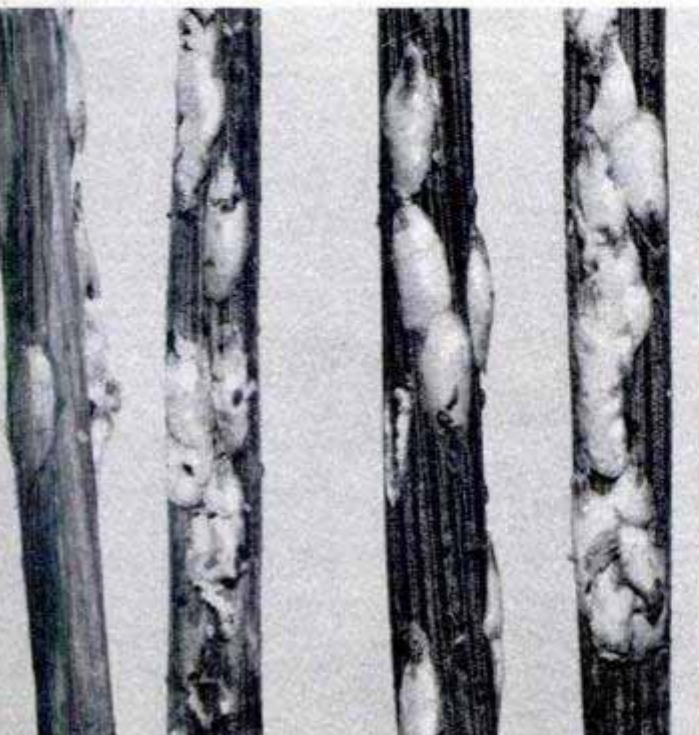

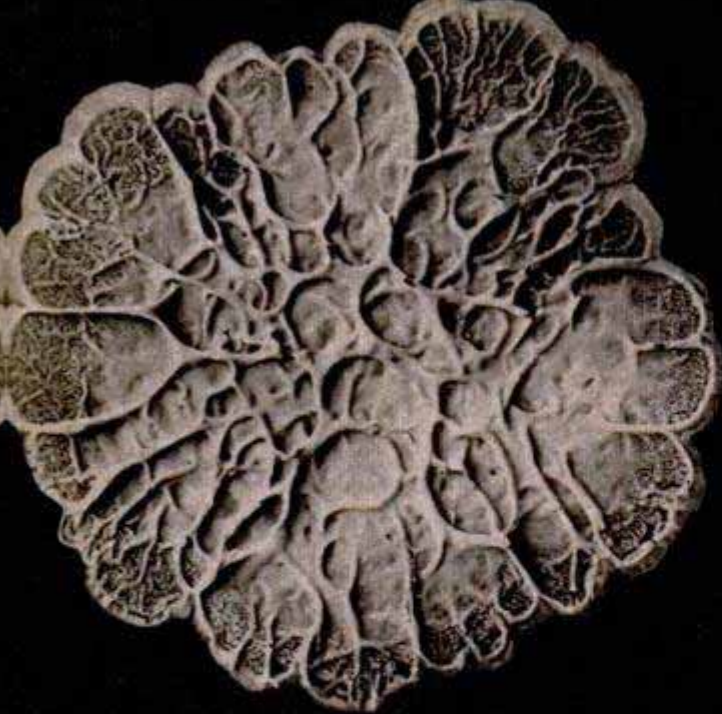

a fixative which "froze" them in their relative positions and killed the insect. The section then was cut about eight microns (in the neighborhood of $3/10,000$ inch) thick, with the louse's beak still penetrating the leaf. This specimen was stained and mounted on a slide for the photo.

Hollis generally uses transmitted light which goes directly through the specimen to expose the film. However, on some photos, such as a beautiful design made by hollyhock pollen, he uses incident light, which falls on the subject without passing through it.

The photographer is justly proud of his photograph of a wheat kernel plainly showing the thiamin it contains. A cross section of the kernel was mounted on a glass slide and a sharp beam of ultraviolet light cast on it. Light in this band excited the fluorescence of the thiamin, so that it stands out plainly in the finished photo.

Hollis uses exposures that vary from $1/100$ second to 5 minutes, although most of his photos are made at $1/10$ or $1/25$ second. He can magnify a specimen up to 4200 diameters, but he seldom goes above 1500. Greater magnification increases size but not resolution so is of little value.

Starting with a crude setup he rigged by himself without special equipment, Hollis has developed a technique that has made his photomicrographs tools for research workers and valuable aids for students.

Panel from top to bottom shows: culture of a disease growth on cereal grasses; that troublesome mite, the chigger; exotic flower? No, just a magnified view of common clover blossom. Below, even a cook wouldn't recognize this, although it's a microscopic photo of cake batter including eggs, sugar and baking powder

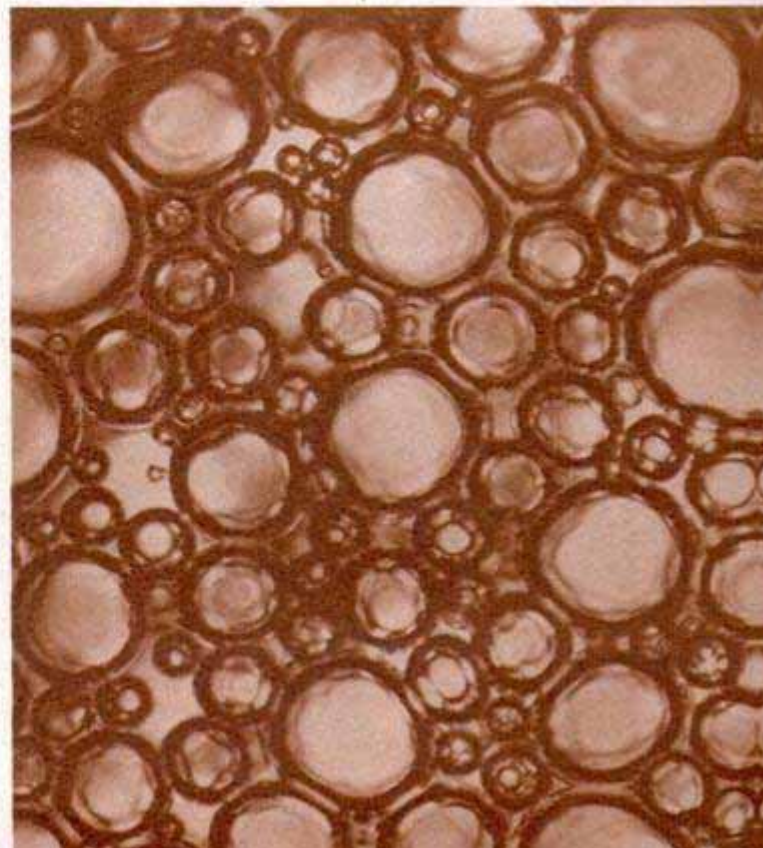
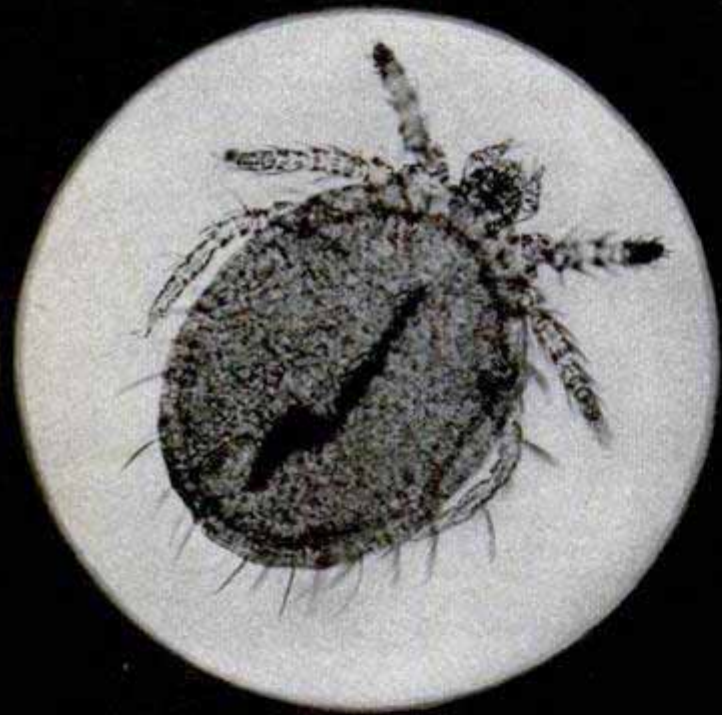

Water Skis

Anyone can walk on water with six-foot shoes made of light plywood. Watertight compartments in the shoes keep the wearer afloat. Fins on the bottom bite into the water to give the "water walker" stability. Beginners use water-ski poles to keep their balance, but experienced users can move without assistance. The water shoes are similar to those developed in Venice, Italy, as reported in *Popular Mechanics*, April 1948.

Nonstop Electric Clock

Even though the power fails, a new electric clock continues to record the time without losing a second. Attached to the clock is a spring-driven unit that takes over instantly if the electric supply is cut off. Most spring-driven non-electric clocks will not start themselves if the balance wheel happens to stop on dead center. This characteristic weakness of spring-driven timepieces has been overcome in the auxiliary unit of the combination clock by magnets which keep the wheel under peak tension while the electric unit is operating. If the electricity is cut off even for an instant, the balance wheel is released and the



main spindle continues to move. The clock will operate on spring power for at least 24 hours. It is designed for recording instruments and time switches where the stoppage of the clock would result in serious complications. An automatic signal gives ample warning when winding is necessary.



International Telephone and Telegraph Corp. photo

Two-Color Radar

Two-color radar that enables operators to distinguish between their own and enemy planes has been developed for the U. S. Air Force. It is undergoing initial tests in a 300-foot, aluminum sheathed tower at Nutley, N. J. Natural echoes and those created by a "responder" in the aircraft register on the same screen as contrastingly colored blobs of light. They are optically combined and superimposed at a spot corresponding to the plane's position. It has previously been necessary to use separate antennas and screens for the two kinds of echoes. As an aid to detection and tracking, the radar's scanning rate has been speeded, with the antenna rotating completely every second instead of every 6 to 10 seconds.

☞ Carpets made of nylon are long-wearing, mothproof and can be cleaned easily with soap and water.

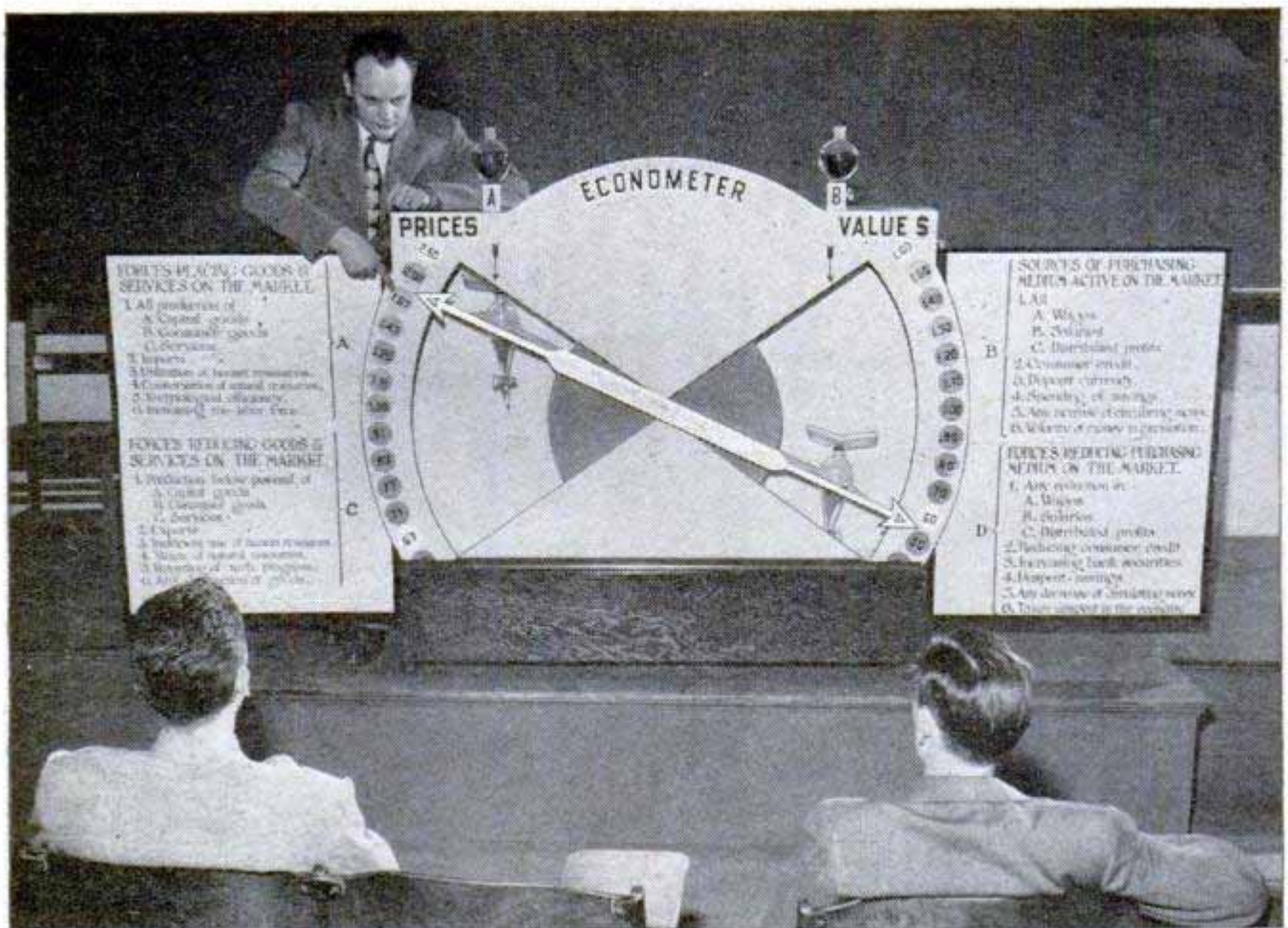

Cost-of-Living Meter

What happens to prices and the value of the dollar under varying conditions is shown with an "econometer" built at the New York University College of Engineering. It consists of a two-pointed arrow several feet long and balanced on a knife edge. Above the arms of the arrow are two flasks containing red and blue liquid on which petcocks may be opened to permit the liquid to fall into beakers suspended from the arms of the arrow. Petcocks at the bottom are used to draw off the liquid. On the left side a scale representing prices is marked in units from \$.67 to \$2.50. These prices are affected by the production rate, imports, exports and other factors. On the right side a scale is marked off from \$.50 to

\$1.60 representing purchasing power measured by the real value of a dollar. The figure \$1.00 on the price side indicates the general price level of goods in 1940; 100 cents on the right scale represents the 1940 value of the dollar. As production increases (represented by red liquid dropping into the beaker) the left arrow goes down lowering prices and raising the value of the dollar on the opposite scale. As purchasing power (blue liquid) is added on the other side the value of the dollar goes down and prices go up. The econometer is constructed so that one cubic meter of liquid represents one billion dollars and today's situation of a 55-cent dollar and about \$1.90 prices is achieved by simply putting in and letting out appropriate quantities of the liquid.

Plastic "Magnets" Are Cheaper and Lighter Than Metal Type

"Magnets" made of plastic instead of metal have been developed and show all the characteristics of permanent metal magnets. The pieces of plastic are not really magnets because their atomic structure must be changed before they will exhibit magnetic properties, so they have been named electrets. They are made by liquefying plastics of either the thermosetting or thermoplastic types and then exposing them to a strong electric field. The bonding forces that hold the atoms to-

gether are realigned in the process, and when the plastic hardens it has a positive and negative pole. The electrets are less expensive to make than cobalt-steel magnets. Being lightweight and extremely sensitive, they may be used in loudspeakers, microphones, vacuum tubes and electrical instruments.

Every second of the day an average of about 16,000,000 tons of rain and snow fall on the surface of the earth.

Television on Wings

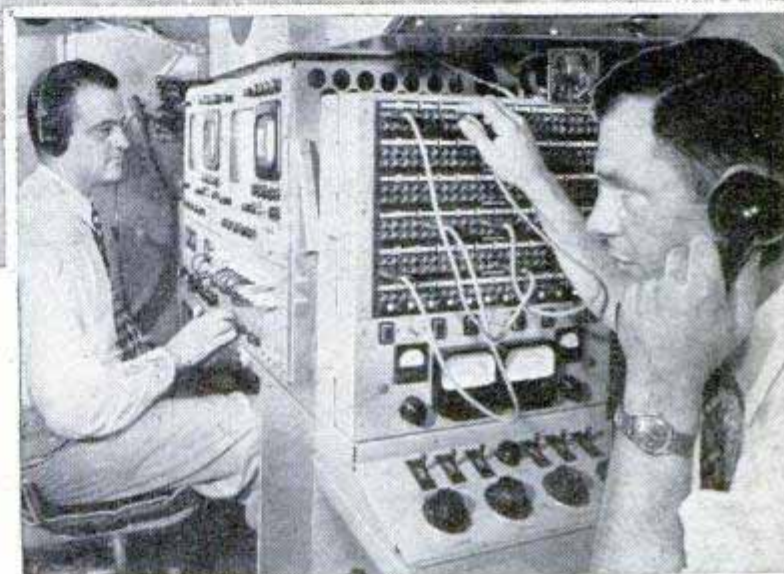

Flying television stations may bring the thrills of video programs into the homes of millions who live beyond the range of metropolitan stations. In a recent test, a modified B-29 equipped with a complete receiving and transmitting station flew above Pittsburgh at 25,000 feet rebroadcasting signals from a Baltimore station over an area about 525 miles in diameter. With the relay, the Baltimore program was picked up in Zanesville, Ohio. Normally, television has a range of about 50 miles. Network plans call for the use of Martin 2-0-2s equipped for all-weather flying

The Stratovision relay plane (top) uses a tail antenna to receive the signal and a long nose antenna for rebroadcasting. Above, control panel inside plane for monitoring signals. Below, proposed network would use 14 planes as shown on map

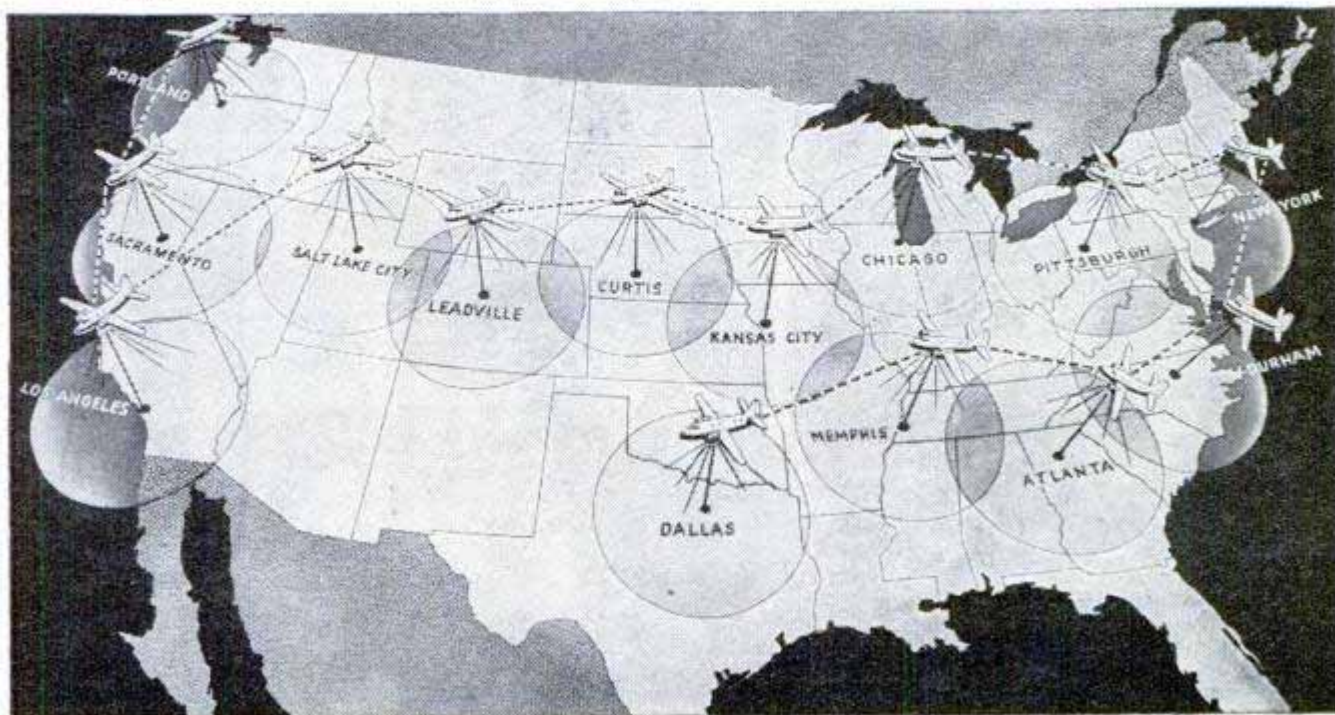

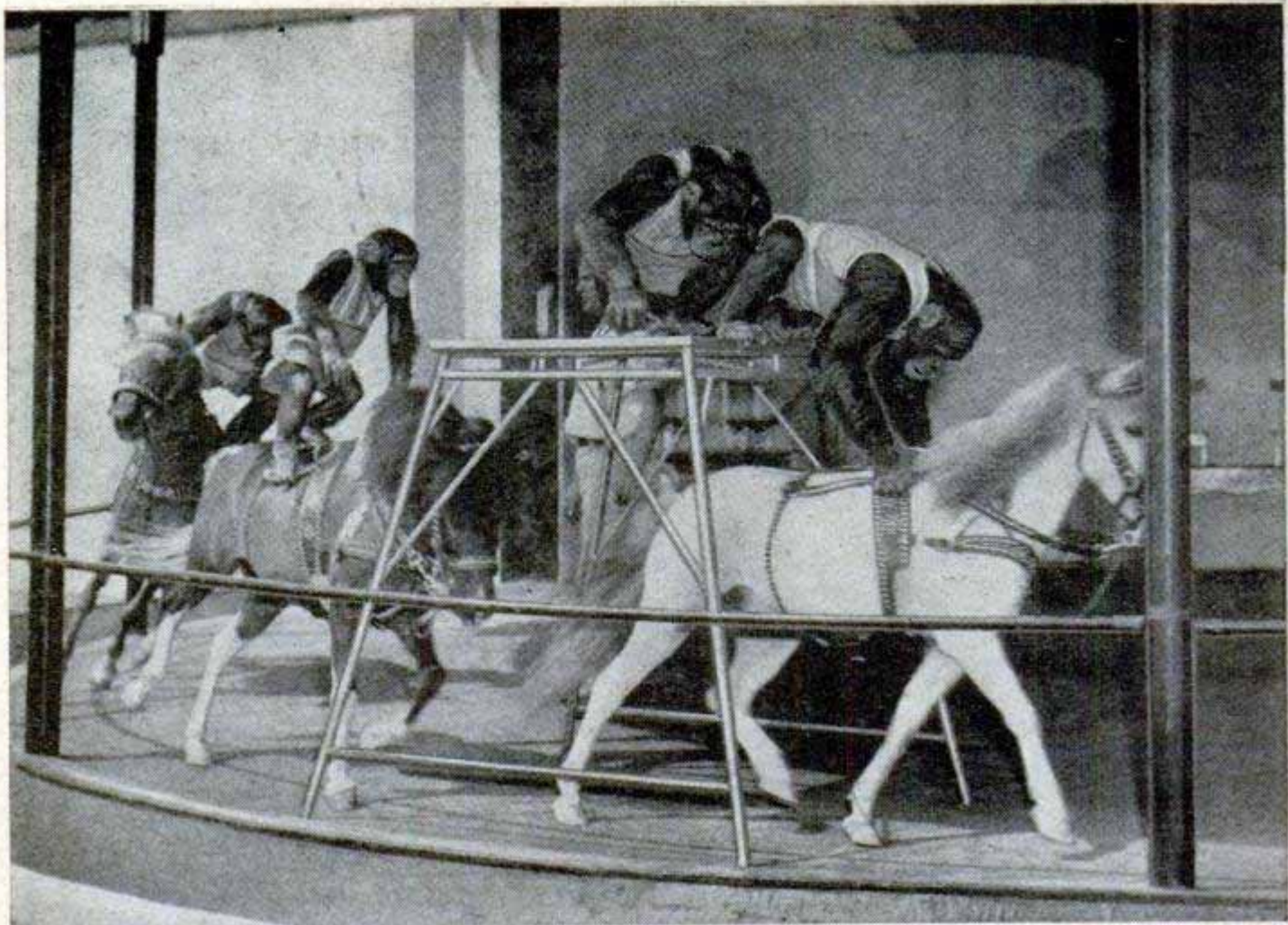

Stellar performers at the St. Louis Zoo are the chimpanzees shown here in a fast pony-riding-jumping act

BRING ZOO

By Wayne Whittaker

Elephant bowlers use regulation ball and pins. Note scorekeeper

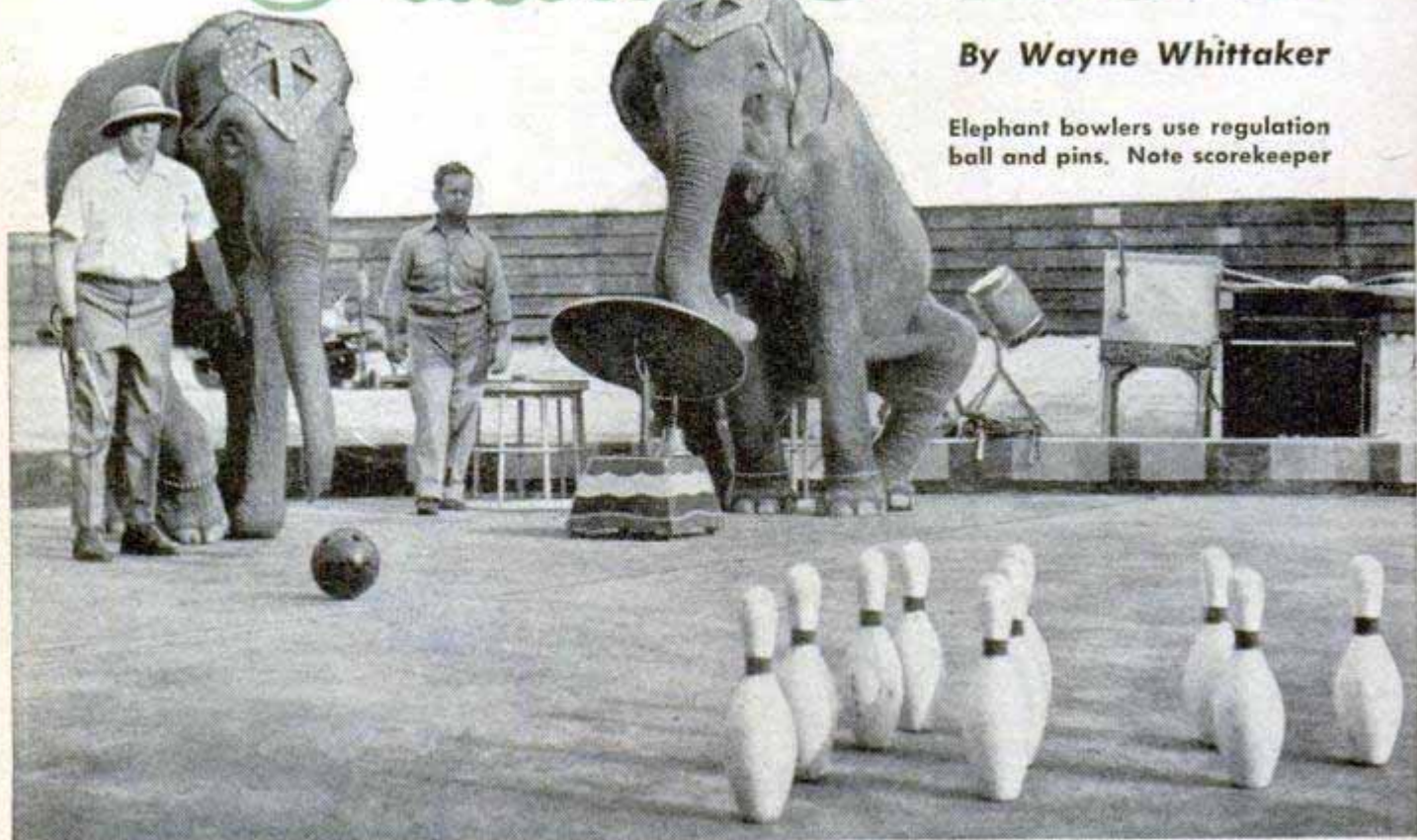

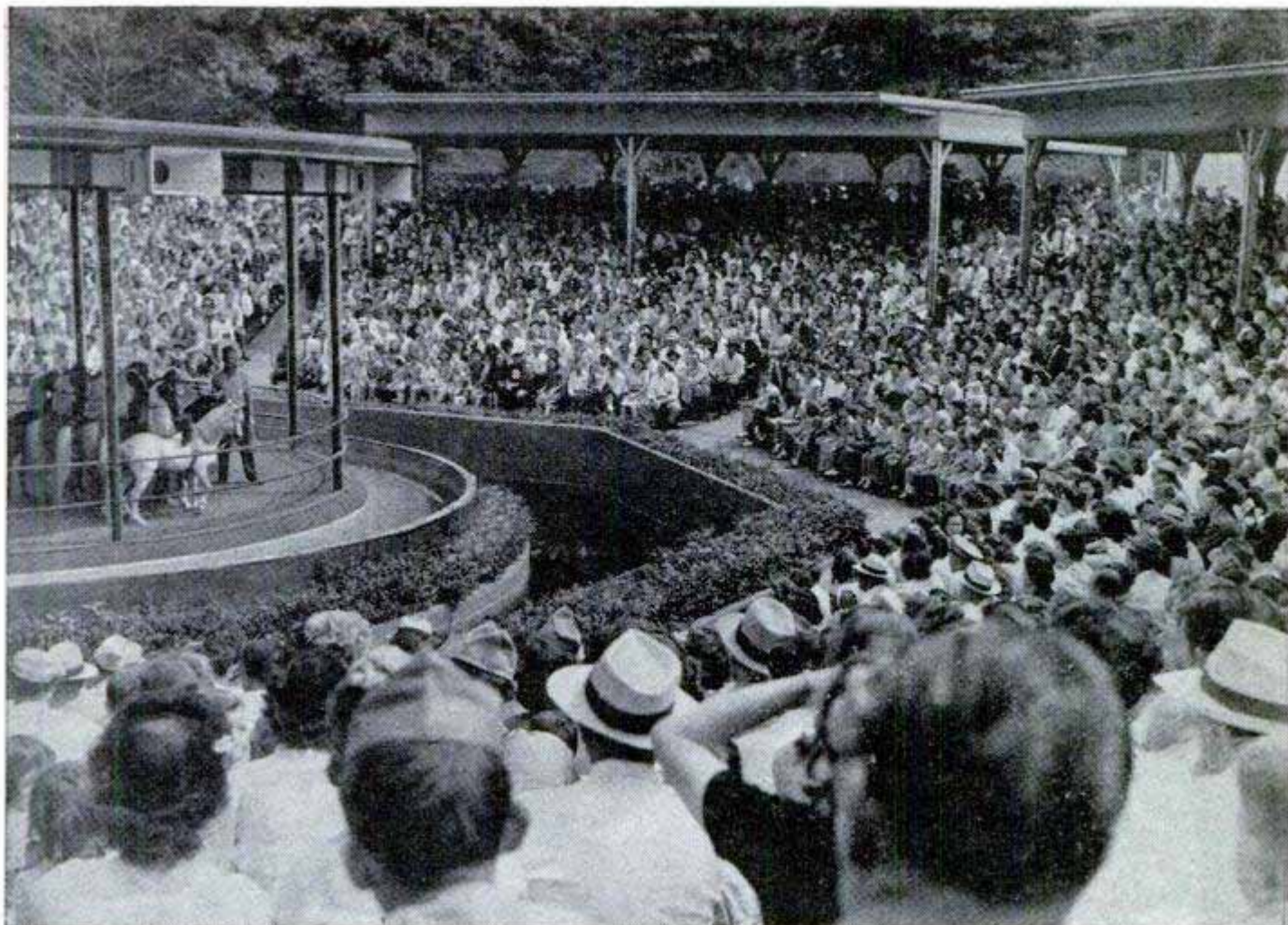

Crowds jam grandstands of monkey theater with its open-air stage. The moat before stage is filled with water. Tunnel connects backstage to monkey house



ONE SUNDAY afternoon just 22 years ago visitors at the St. Louis Zoo witnessed a history-making event. None of them guessed it. In fact, some laughed. Even George P. Vierheller, the zoo director, would not have prophesied that here was the beginning of something that would bring the zoo world-wide renown.

All the visitors saw that Sunday in 1926 was an orangutan that rode a bike and drank water out of a bottle. The crowd of 40 or 50 was amused.

"It's a good little stunt," a friend told Mr. Vierheller, "but I doubt if it will put Ringling Brothers' circus out of business."

This summer nearly a million persons are beating a path to the three-ring circus at the St. Louis Zoo. One Hollywood movie director argued for an hour on the long-distance telephone in a futile attempt to get

one of the acts for a big production scene. But the show, like the zoo itself, belongs to the taxpayers of St. Louis. The zoo circus is not for sale and not a penny is charged for admission. That is only one of the amazing things about the animal acts which experts have acclaimed as three of the best in the world.

One of the acts consists of 13 lions, two tigers and two European brown bears. They perform in a huge iron cage before a permanent amphitheater seating a couple of thousand guests. The monkey act is made up of 10 chimpanzees, seven Shetland ponies and one Sicilian donkey. This show is presented on an attractive moated stage in an outdoor theater seating about 3000. The third act is composed of five Asiatic elephants. Each show lasts about half an hour and is presented twice on week days and three times on Sundays, when frequently a crowd of 30,000 attends.

Let's go to the show. Trumpets blare from loudspeakers as Jules Jacot, veteran lion trainer, steps forth. He addresses the crowd:

"Ladies and gentlemen, here at the wild-animal show we present a grand spectacle entitled 'The Crowning of the King.' You'll

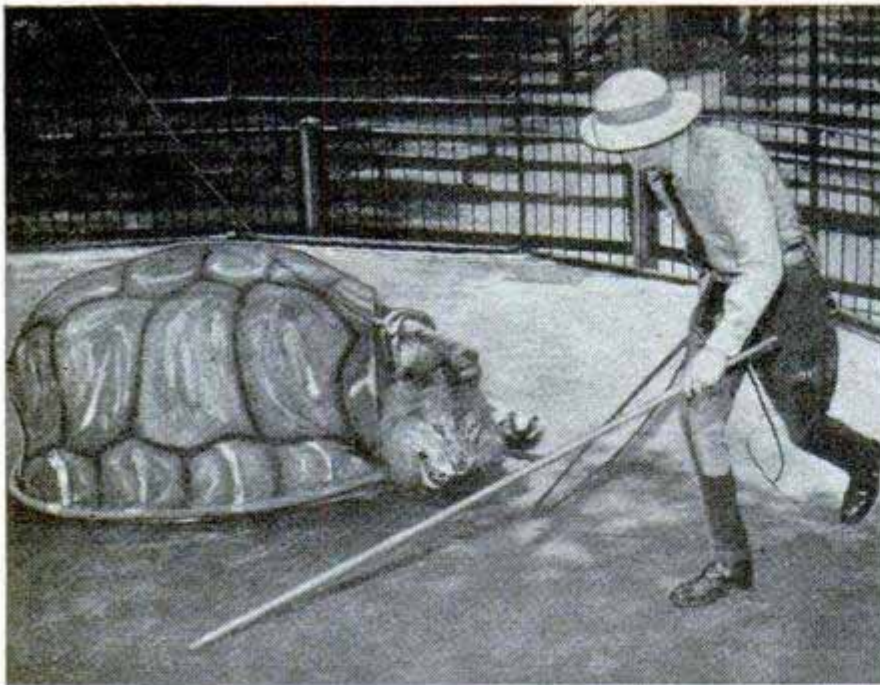

Lion wearing turtle shell snaps at trainer Jules Jacot; shell (right) is made of tubing, wire mesh, papier-mache

see kings, queens and princes of the animal kingdom in this all-star cast. You'll even see Jumbo, the largest and most amazing snapping turtle in the world. We will try to show you not how tame wild animals are, but how intelligent under proper guidance."

Then Jacot, who has worked with circuses all over Europe and the U. S., pulls the trap-door rope and the first lions rush into the cage, followed by two tigers and

two brown bears. The bears put on a nursery scene, drinking out of bottles and riding a rocking horse. The tigers roll over at Jacot's commands. Two lions perform the difficult stunt of walking on their hind legs; a lioness stands on her forepaws; others jump through paper hoops, through Jacot's arms, and one lioness leaps on his back from her perch.

After the show gets under way Jacot begins the novelty acts. Two lions stand on pedestals facing each other. In their teeth they hold a chain of wooden wieners on which their trainer sits and swings nonchalantly.

Leo I, a four-year-old male, plays the part of the king and also the turtle. During his coronation he wears a jeweled crown with attached spectacles and a robe of simulated ermine. As he stands on his pedestal the loudspeakers play "Old King Cole" and the crowd cheers. In the turtle act, Leo crouches under a giant shell with only his head and tail sticking out and lurches around the ring roaring and snapping at Jacot.

After the show Jacot explains some of his tricks.

"Stunts that look easiest are sometimes the hardest," he says, "and some that are

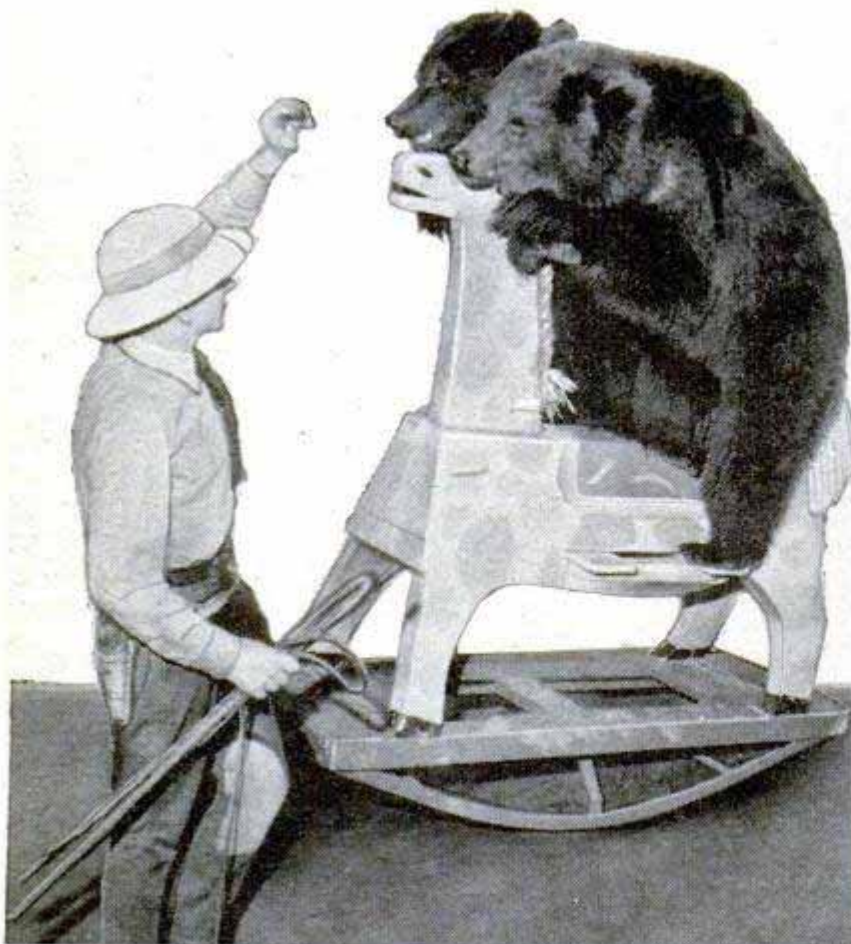

Performing without muzzles or leash bears ride twin rocking horse in a nursery scene of Jacot's animal show

simple bring down the house. Take the bears. Did you notice I work them without muzzles or leashes? I've had my bears, Toska and Senorita, since they were cubs but I don't trust them. They are far more dangerous to work with than lions. When they growl or charge they are not fooling. Tigers are treacherous, too. The lions are great actors and most of their growling and charging is part of the show."

Although Jacot carries a revolver loaded with blank cartridges he never fires it during a show.

"The shots mean nothing to the animals when they hear them all the time," he says. "I will never fire a blank unless there is real danger."

All 17 in Jacot's show are performers. In many shows, he points out, only a few lions perform and the rest are just "stool warmers." After the show closes in October he works the animals daily throughout the winter. His voice cues are given in Spanish for the practical reason that there will probably be no shouts in this language from the crowd to confuse the animals.

"I start training lions when they are two years old," he says. "Before that age they want to

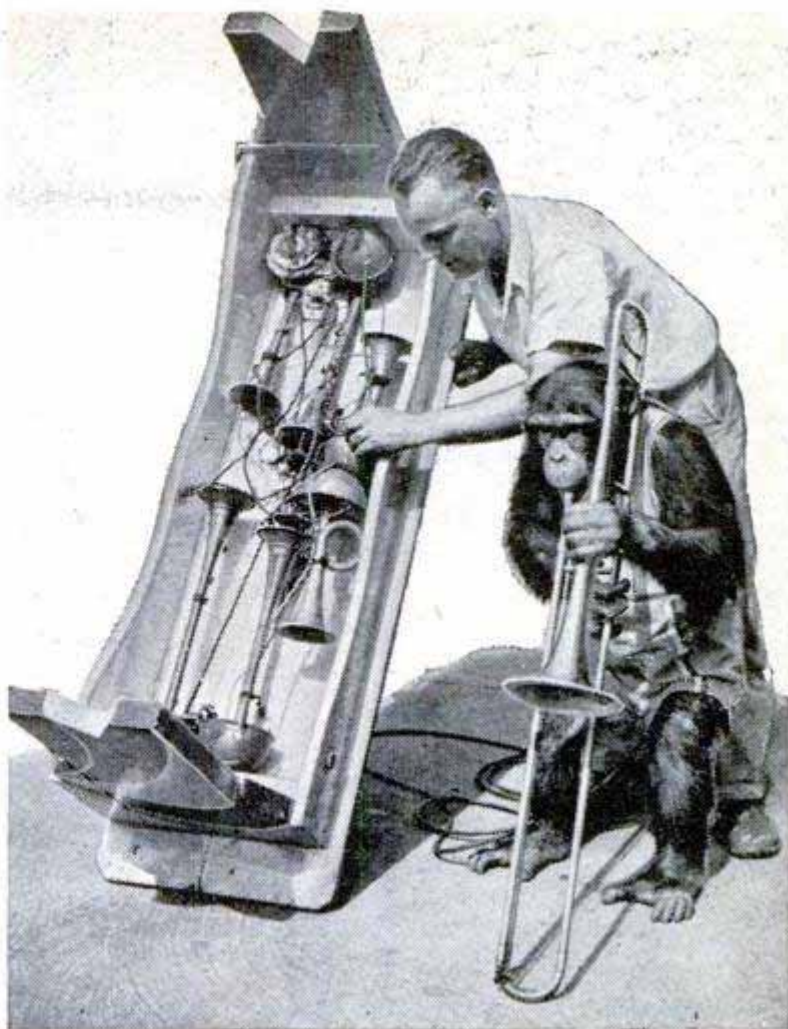

When famous chimp Cookie plays the trombone, sound comes out of three sets of automobile horns concealed under bench. They are electrically connected to slide. Below left, Tommy clowns while he plays the piano with jungle orchestra. Right, steel spectacles help hold the king's crown in place. He wears an ermine robe



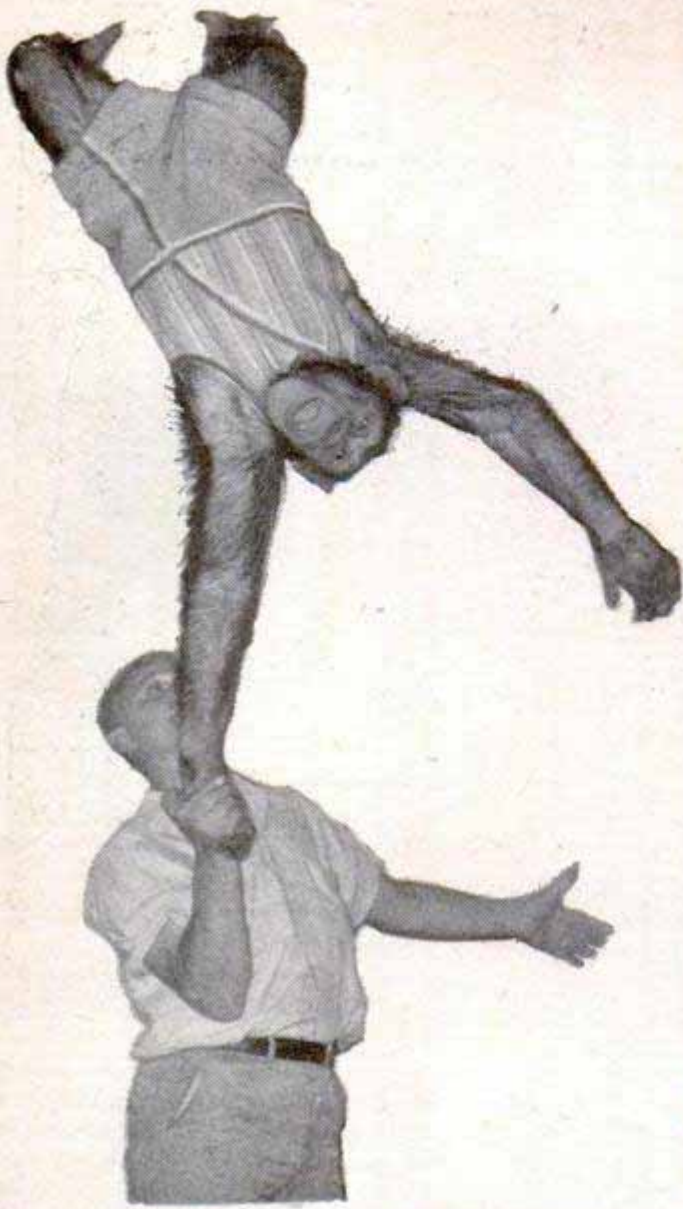

Above, George P. Vierheller, director of St. Louis Zoo, coaches Cookie before bicycle act. Left, Ben Fridrich supports chimpanzee in a one-hand stand. Below, elephant orchestra; washboard is at far left

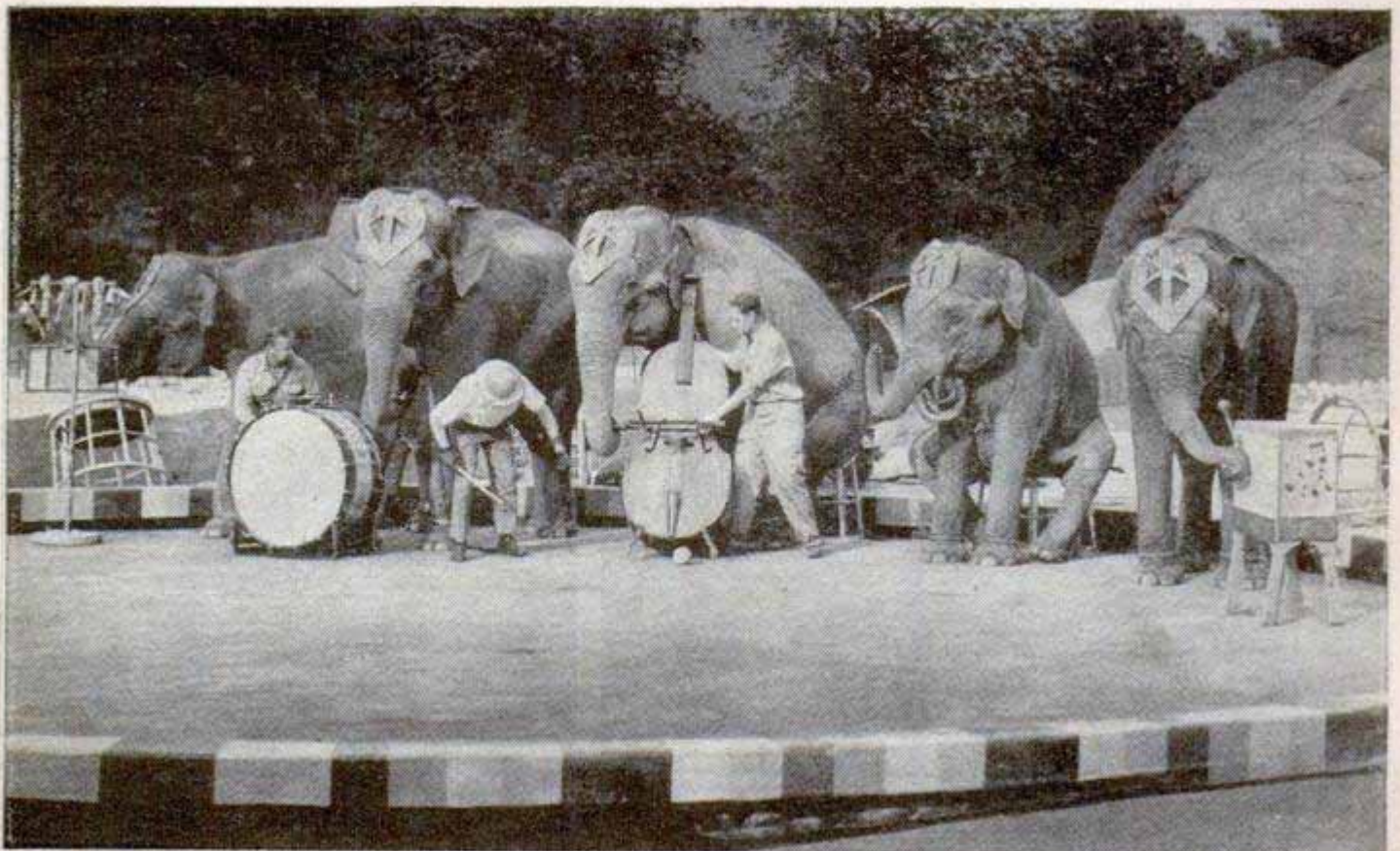

play all the time. I like to pick smart, mean lions instead of training tame ones to act wild. A well-trained mean lion is more dependable, because it's the nature of the beast to perform better when he is a little peeved.

"First I get acquainted with a young lion by moving him from cage to cage. Then I get him used to the arena. When the lion stops prowling back and forth I get in the cage with him. At first I stay close to the door and use a chair. If a lion keeps watching you and moves according to your moves you are safe. When a lion quits moving and begins to stalk, he is concentrating on you and no one can change his mind. Some late lion trainers have tried."

Jacot says lions have a touchy spot and when he finds it, he controls them by pointing his training rod in that direction. Some have it on the end of their tails, some on an ear, ribs, or on top of the tail where it joins the body. Pets lose these "touch" points and that is why he never makes a pet of any performer. It may take years to teach a lion to do a trick (such as the wiener-chain swing or turtle act) but the lion must get the idea during the first week of training. For instance, Leo refused to crawl head first into the turtle shell. Jacot finally discovered that he wanted to back into it. Since then the act has gone smoothly.

(Continued to page 260)

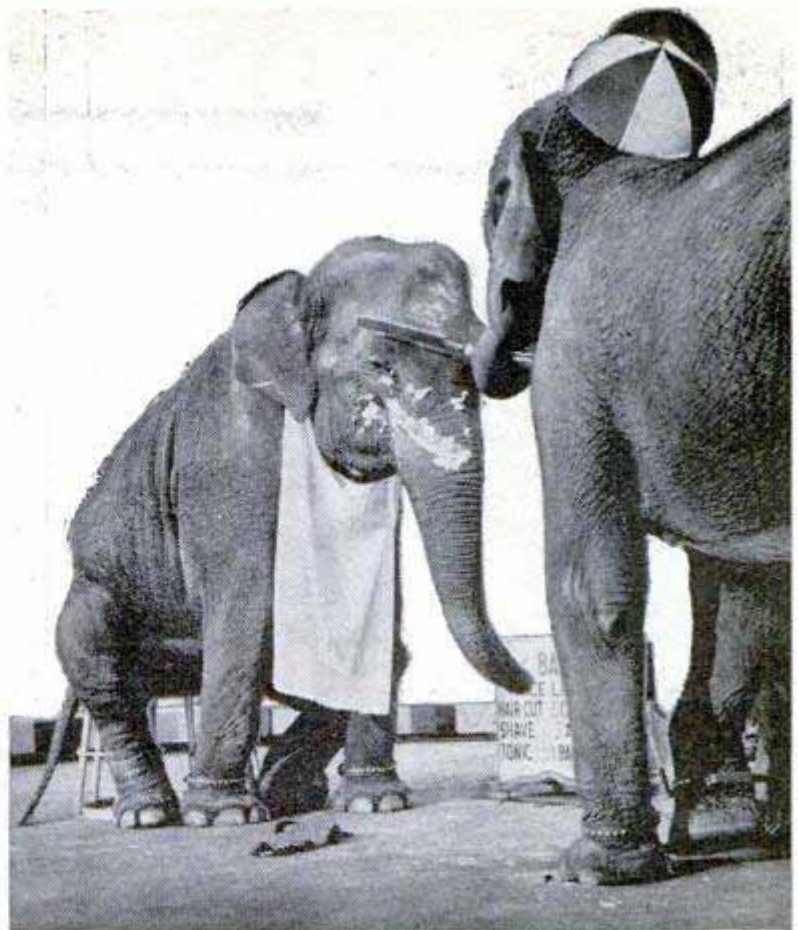

In barber-shop scene lathering of "customer" is followed by shave with wooden razor. Bib is big sheet

Trainer Jules Jacot "relaxes" on a swing of wieners (wood) held in the mouths of two of his leading actors



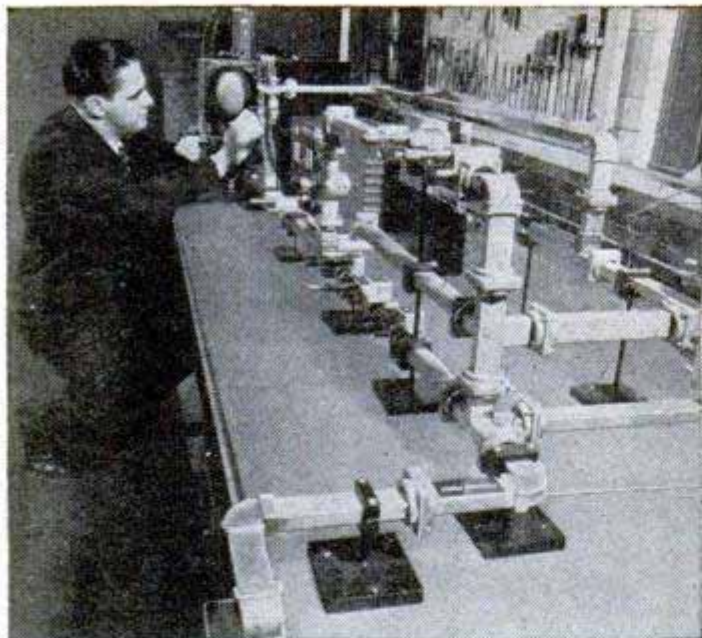

Dry "Raindrops" Aid in Experiments To Eliminate Radar's Blind Spot

Man-made "raindrops" that never fall and aren't wet are being used in experiments designed to cure the blind spot in radar sets. This blind spot occurs in sets using ultra-short waves less than $\frac{1}{2}$ inch long. When these waves strike a raindrop they sometimes bounce back to the receiver and obscure the target image on the

Above, engineer examines one of the splashless "raindrops" used in testing radar. Left, metal ducts carry the reflected waves to instruments

scope. By suspending artificial plastic raindrops in mid-air by four strings, Westinghouse scientists make their own "rainstorms" to test the reflecting capacities of various radar sets. The reflected waves bounce into a hornlike receiver and are piped through a maze of metal ducts to sensitive measuring instruments.

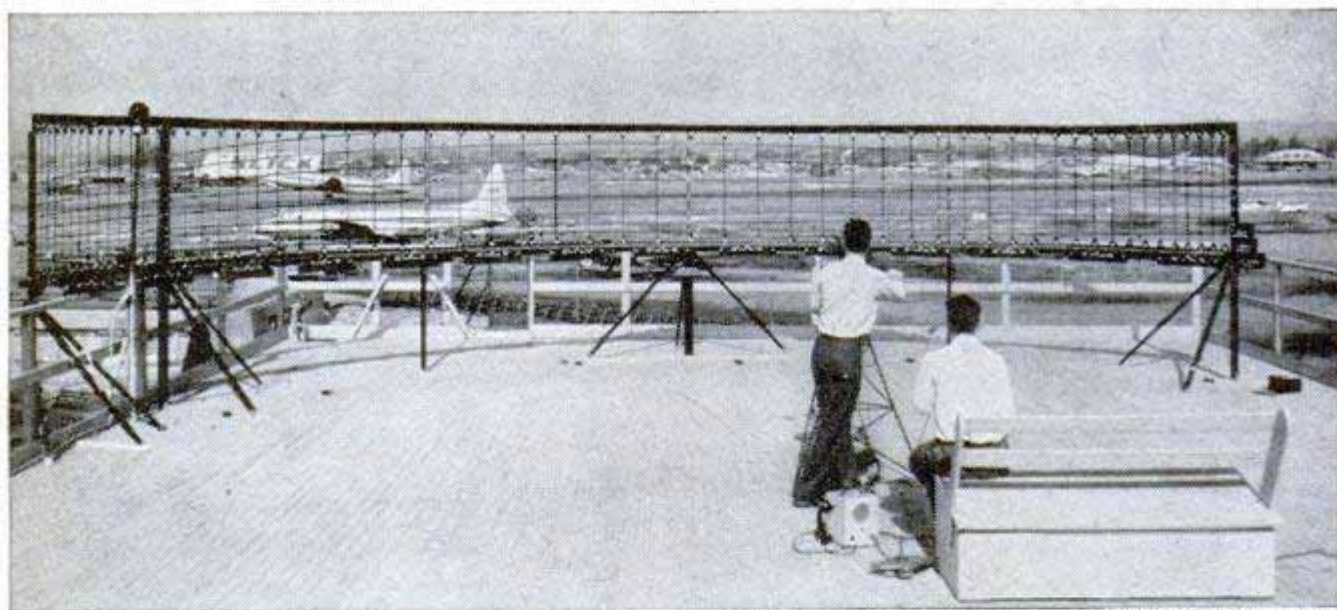

Lockheed Aircraft photo

Camera "Times" Take-Off and Landing Tests

Take-off and landing performance of all Lockheed experimental planes is photographed with a special wire grid and a motion-picture camera. The grid, nine feet high and 64 feet long, has vertical wires marking off 100-foot sections of the runway and horizontal wires indicating altitude at 25 and 50-foot intervals. Twenty feet behind it is the camera, with a telescopic lens trained on the plane 2000 feet away. A

movable tape marked in tenths of a second is pulled past the camera, in the same direction as the plane, by an electrically timed motor. The film shows the exact time and distance required for take-off and landing and where the plane would clear a 50-foot obstacle, one of the government's licensing requirements. Effects of changes in propellers, engines and flap positions can also be observed accurately.

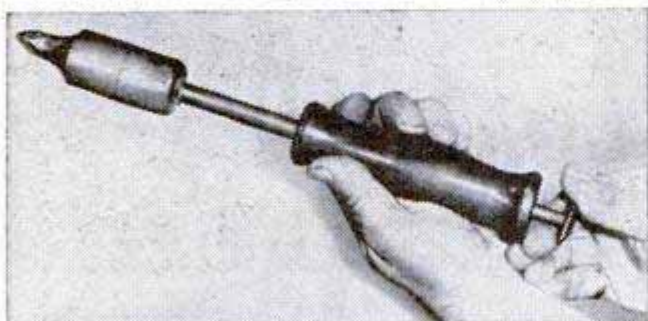

Nonelectric Soldering Iron Heated by Chemical Action

Using no electricity or flame, a quick-heating soldering iron reaches working temperature in five seconds after a chemical cartridge in the tip is punctured. Intense heat is maintained for eight minutes. The small cartridge fits in the recessed tip and is punctured by a spring rod that runs through the handle. At peak heat it has a wattage rating equivalent to a 200-watt iron, according to the manufacturer. For jobs requiring more than eight minutes, additional cartridges are used. The iron, plus one cartridge, weighs 20 ounces.



Dentist "Hitches" a Ride On Movable Stool

Seated on a padded stool that rolls smoothly around the patient's chair, a dentist can now ride with his work. The foot-control switch for the drill moves with the seat as the dentist rolls it around the chair. The seated position, being lower, also gives the dentist better visibility inside the patient's mouth.

Atomic-Ray Counter Has Supersensitive Photo-Eye

Radiation is detected 30 times more efficiently with a "scintillation counter" now being tested at the University of Chicago.

It distinguishes between electrons passing through it at intervals of less than one ten-millionth of a second. Patterned after a wartime German invention, the counter is simply a box containing an extremely sensitive photoelectric tube, surrounded by Dry Ice to deaden outside interference, and a small amount of fluorescent matter. Nuclear particles admitted to the box produce bursts of light in the fluorescent matter, usually naphthalene. The light is picked up by the tube and converted into a momentary current of electricity which can be amplified and measured accurately.

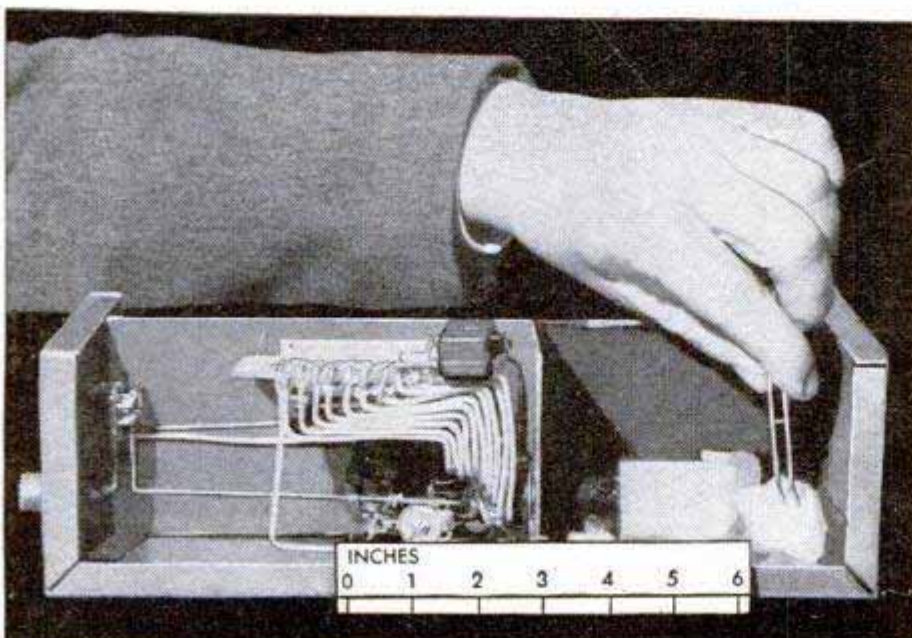

As quaint narrow-gauge railroads and roaring rivers give way to Diesel trucks in hauling logs out of our thinning forests, there's a boom in road building deep in virgin timber

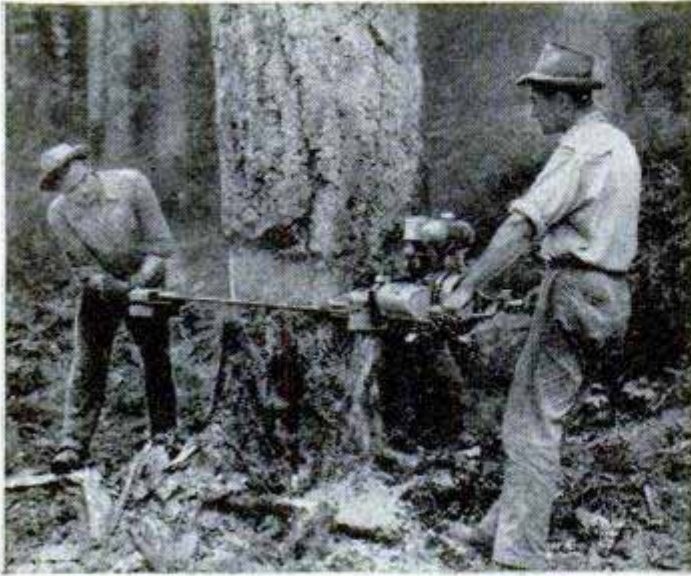

With portable, gasoline-driven chain saws, woodsmen can slice through 24-inch tree in a few minutes. Behind trail blazers come bulldozers, roughing out new forest roads by uprooting trees and brush, shoving rocks aside

U. S. Department of Agriculture photos



New Roads to Timberland

By Lyle F. Watts
Chief, U. S. Forest Service



PAUL BUNYAN was quite a fellow, but he'd be flabbergasted if he and Babe, the Blue Ox, were called upon to deliver to our sawmills and lumber yards as much timber as American lumbermen cut in a day. Right now wood consumption is at a high level; it is one of the critical items in our home-building program and has an ever-growing list of other uses.

That's why the U. S. Forest Service, custodian of one sixth of the nation's commercial timberland, has given high priority to construction of 2100 miles of access roads into virgin timber territory.

In the old days of lumbering, logs were hauled out of the woods by puffing logging railroad engines, or floated down roaring rivers. Modern methods, however, demand gravel or asphalt-surfaced roads for the huge log-carrying Diesel trucks. Access roads are a key to lumber production.

The new program of access-road construction in national forests began during World War II, when 148 mineral-access roads and 85 timber-access roads were built. Today, under an \$18,000,000 program, the Forest Service is supervising construction of additional access roads to help meet postwar lumber needs. Mileage of access roads now being built in 31 states ranges from one mile in Illinois to 190 miles in

At the head of a new access road, a trailer—modern counterpart of the old logging railroad—takes on its load of timber. Below, a midget trail truck of the U. S. Forest Service carries a party of rangers on a narrow trail not yet ready for the big trucks

U. S. Forest Service photos



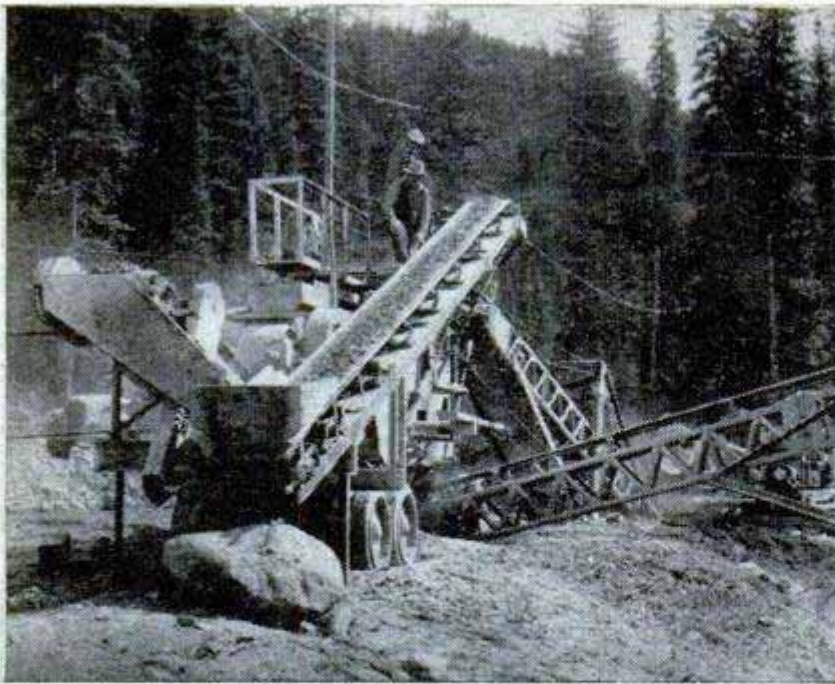

Portable stone-crushing plant provides material for all-weather road

Maps indicate stands of virgin timber that have never heard the ring of a woodsman's ax. The road-building program is finally correlated in the U. S. Forest Service headquarters in Washington, D. C. Roads are carefully plotted to link up with other roads in the area, not run blindly into the woods and stop.

After the planning stage comes construction. Survey crews mark out the new road locations. They are followed by construction crews with bulldozers, jackhammers, dynamite and large power saws to clear away brush, rocks, stumps and trees. Finally, power graders smooth out the roads before crushed rock or asphalt is applied.

On the fringes of some forest areas opened up by access roads, portable saw-mills may be set up. In other areas where

California, 240 miles in Idaho and 257 miles in Montana. These new roads are expected to carry more than a billion board-feet of logs every year.

Planning begins with on-the-ground surveys of resources and topography.

Ranger leads a mule train packing fire-fighting equipment into a timber fire area in a Montana national forest



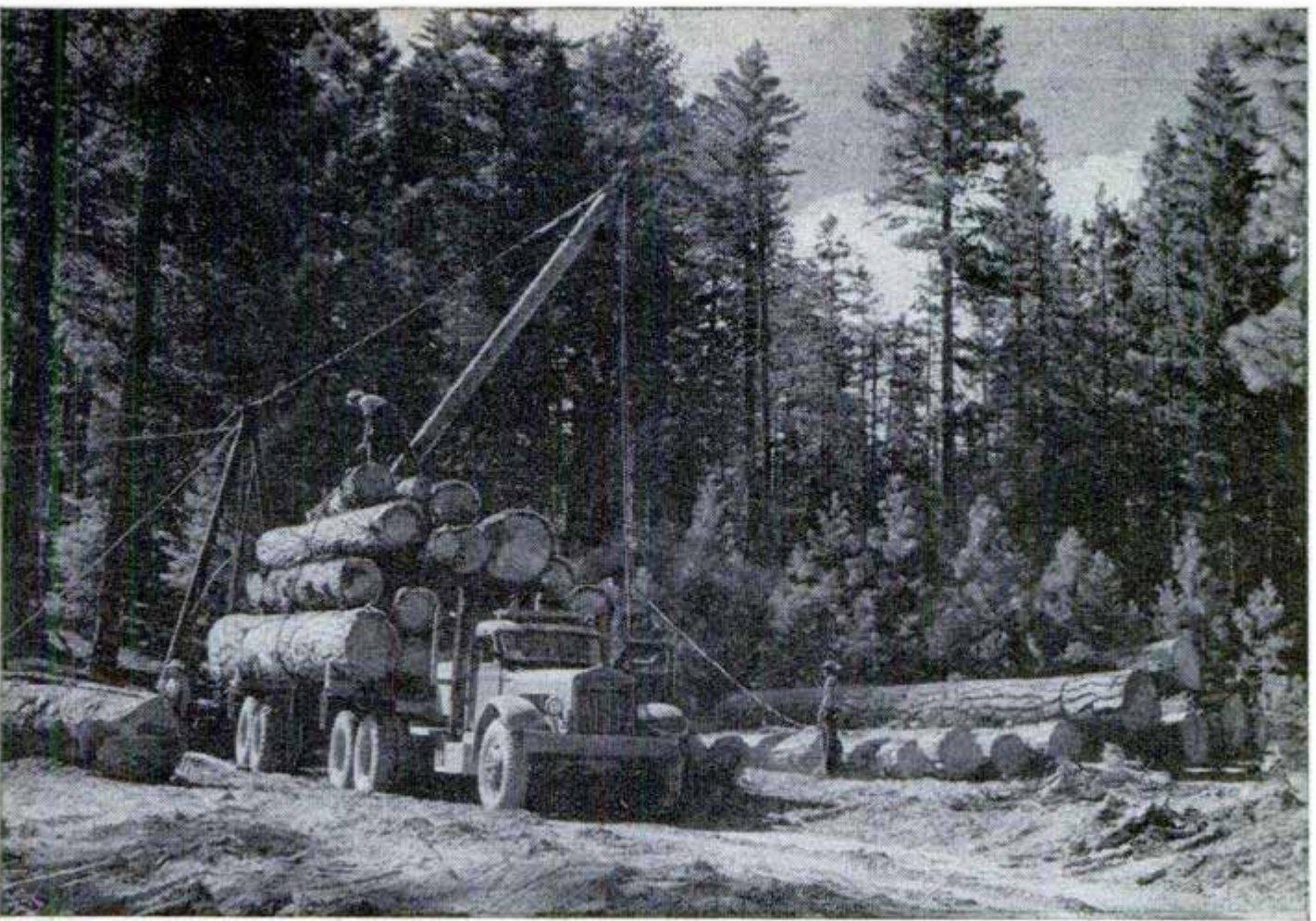

Mobile derricks—called "jammers" in the lumberjack's language—load freshly cut logs aboard the trucks

giant Douglas firs and Ponderosa pines grow 8 and 10 feet thick, logs are felled with gasoline-powered chain saws and trucked to larger sawmills. Normally, loads weighing 18 tons are hauled, but sometimes three monster logs weighing 70,000 pounds make a load for a big truck-trailer unit.

America's national forests include 73,000,000 acres capable of growing commercial timber crops. This publicly owned forest land has one third of the national saw-timber stand. In recent years these lands have supplied about 10 percent of the nation's yearly timber cut. With careful management, the national forests can help cushion the shock of private timber exhaustion. The first requisite for this increased cutting is the new roads, which will provide a means of reaching inaccessible virgin timber in national forests.

The long period needed to grow trees discourages many private lumbermen.

Midget truck crawls to head of new trail to service the trail tractor

Public forests, administered under long-term programs, can assume a substantial part of the country's future production of high-quality material.

"Why," it is sometimes asked, "is the U. S. Forest Service building roads into national forests? Won't that mean cutting down trees at a time when a serious timber shortage threatens?"

It is true that in 1909 the Bureau of
(Continued to page 256)



Iron-Rich Powder in Flame Enables Torch to Cut Stainless Steel



Left, hand-operated powder torch cuts stainless steel in foundry. The hilt on torch protects worker against intense heat. Right, machine cutting torch with the powder dispenser (foreground) connected to it by hoses

Stainless steel, which has defied ordinary oxyacetylene torches, now is being cut by introducing an iron-rich powder into the flame. In the new process an additional head is attached to the standard torch. A nearby hopper is connected with the head by an extra hose. When the hopper is vibrated electrically and the powder forced into the flame by a jet of air, the additional

heat created by the powder, plus the fluxing and oxidizing action, keep the stainless steel in a molten state long enough to be blown out. Generally, a clean-up treatment such as chipping or grinding is necessary if the steel is to be welded. The same process is used for cleaning the sides of stainless-steel billets and for cutting steel alloys and some of the nonferrous metals.

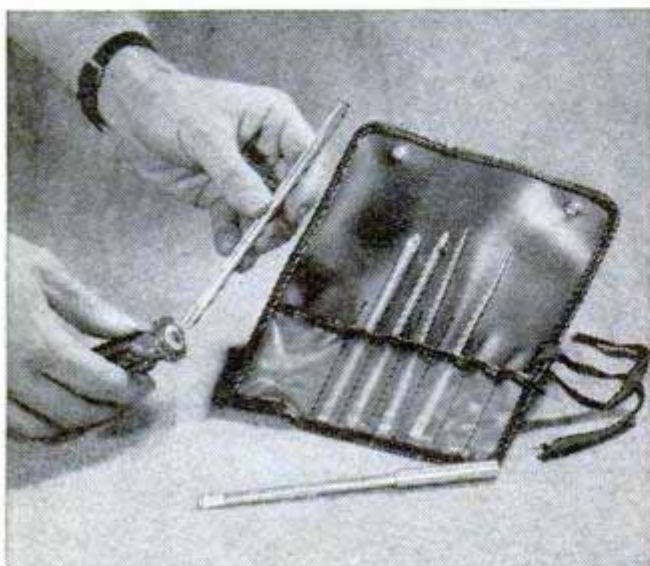

Screwdriver Kit Has Six Tools

Containing the right screwdriver for almost any job, a pocket-size kit eliminates looking through the toolbox for the blade you want. The interchangeable handle is shockproof and fluted for a firm grip. Five different blades, three of them standard screwdrivers and two for use on Phillips screws, lock in the handle by strong spring action. A six-inch extension is also available for reaching hard-to-get-at places. The kit includes a seven-section leatherette tool roll fitted with tie strings.

☛Fastest bird known is the swift, some species of which fly at an estimated 200 miles an hour.

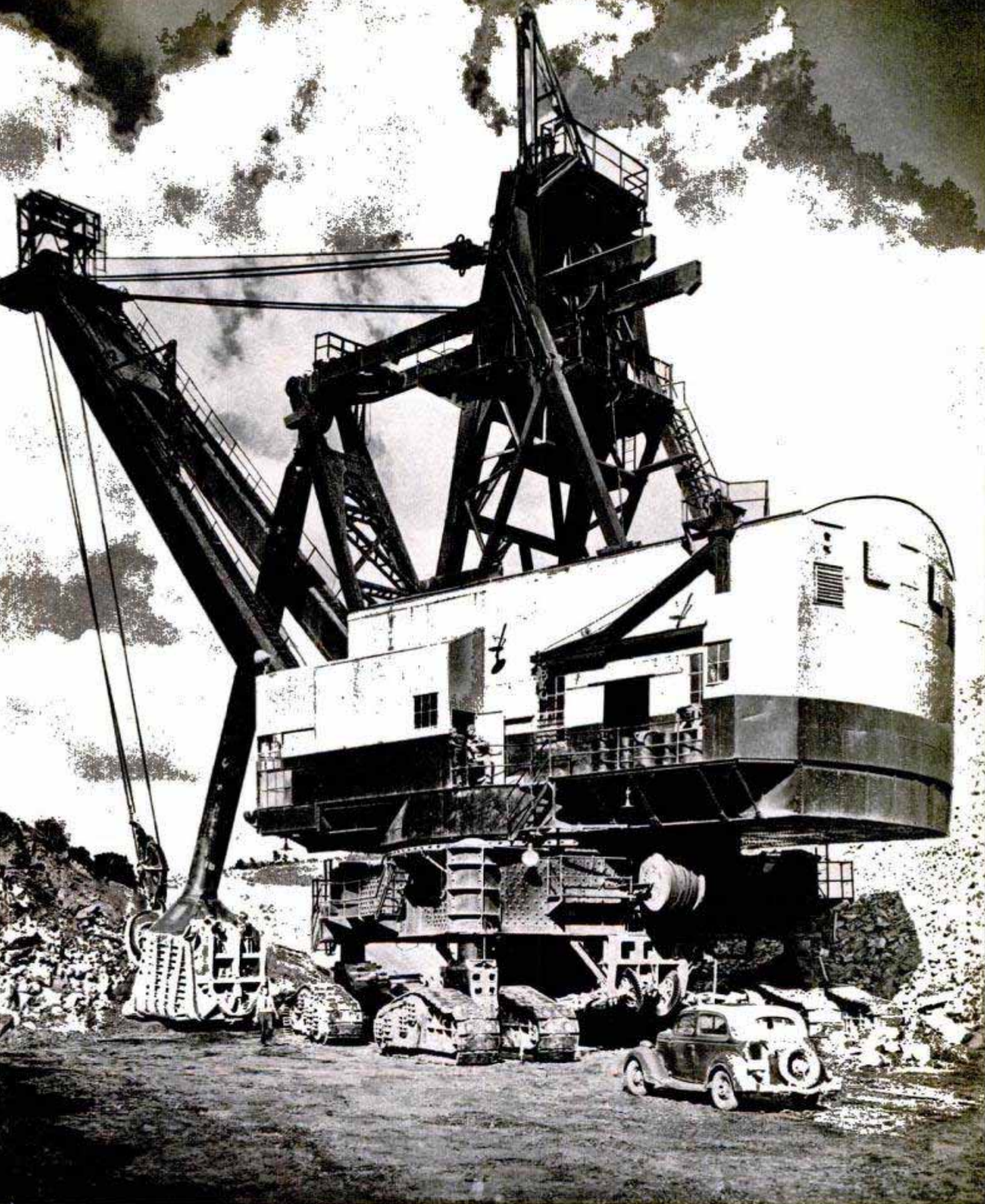

BIG BITE Enough earth to fill a room 9 by 10 by 12 feet in size can be scooped up in one bite by a giant power shovel and dipper designed for strip coal mining. The shovel can swing 40 cubic yards of earth two thirds of a city block and deposit it at a height equal to the top of a seven-story building. The boom of the shovel is 120 feet long and the total weight of the machine is 1675 tons. Operated by electricity, the shovel consumes as much power as a community of 3000 persons would use. It moves on four pairs of crawler-type tracks.

Hints of high-speed submarines firing guided missiles are heard as the Navy starts reshaping its undersea fleet

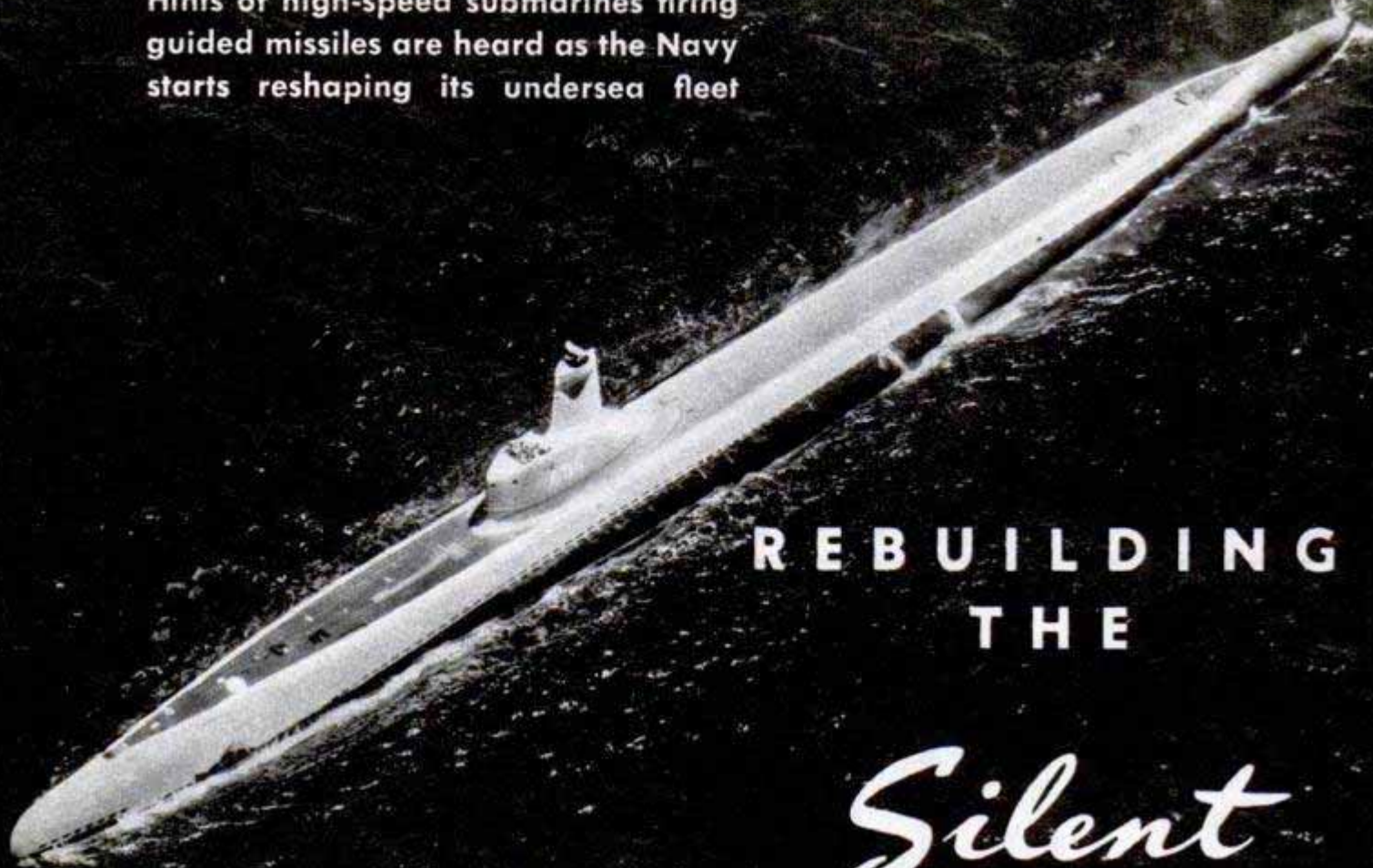

REBUILDING THE

Silent Service

Streamlined like an airplane, the rebuilt sub above may break a few underwater speed records. Cutaway of sonar unit shows the pickup tubes for detecting location and direction of travel of ships or submarines



THE SUBMARINE is making its bid as the major arm of the Navy in warfare of the future.

From the California coast come reports of a new experimental undersea ship firing guided missiles, and of other high-speed submarines playing hide-and-seek with new destroyers in mock battle.

In peace as in war the submarines are the silent service, and their evolution goes on behind closed doors of Navy research offices. But at home and abroad navies are studying the enemy developments of World War II—German “breathing” U-boats that could cruise at length on Diesel engines while submerged, huge Jap subs that launched aircraft from their decks—these advances are being weighed along with our own secret improvements.

The United States kept its cake and ate it too in the last war, so far as submarine warfare was concerned. Our submarines sank hundreds of enemy ships with few losses to themselves, while the American and Allied Navies were destroying a total of 911 enemy subs. We won on both sides of the ledger, and the United States Navy is doing all it possibly can to make that

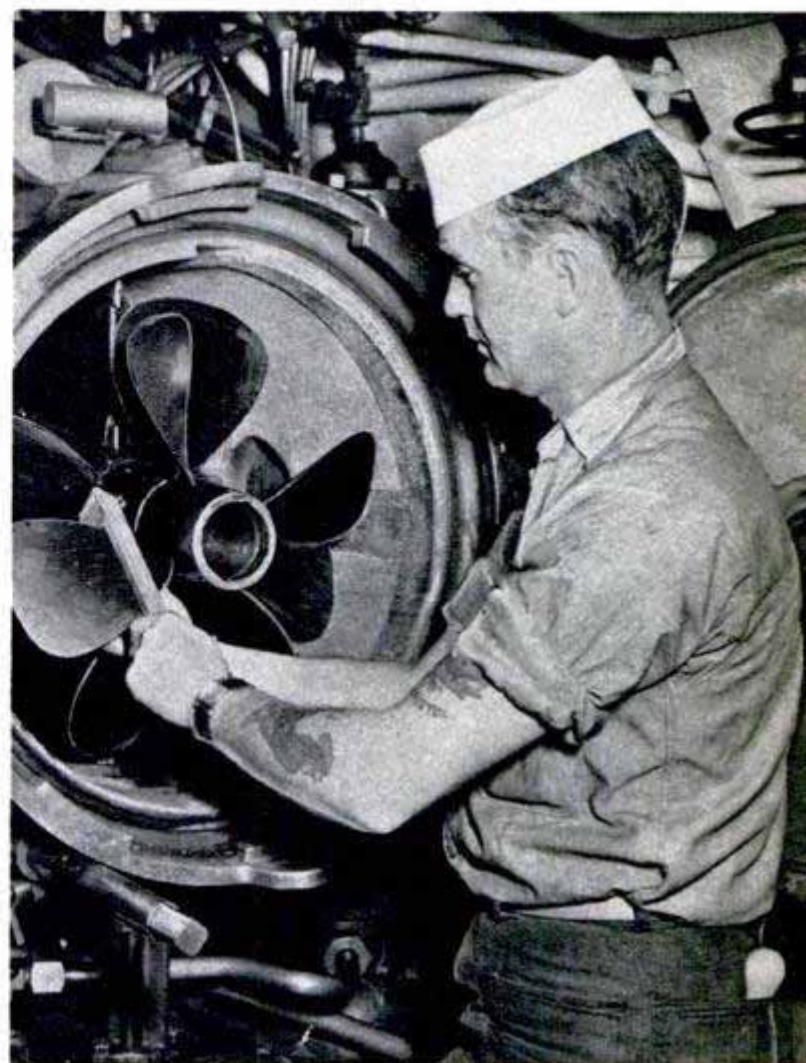
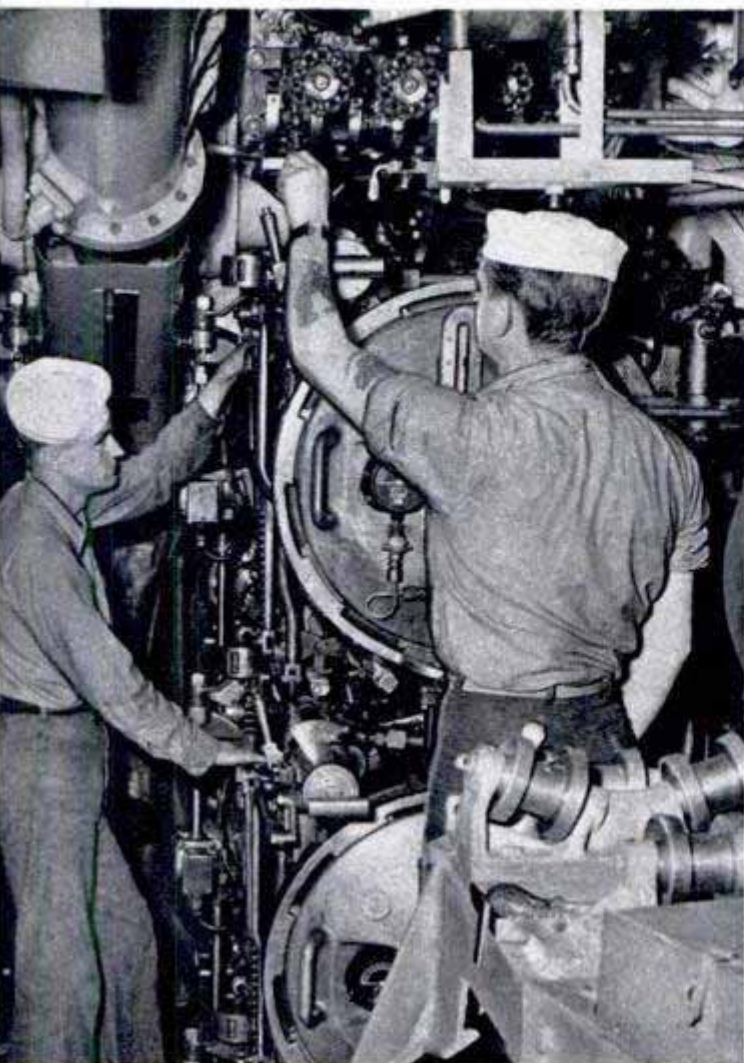

Left, firing one of sub's ten torpedo tubes. Right, removing safety stop attached to the torpedo propeller

pleasant military situation a tradition.

One of the lessons learned during the war was that undersea boats are vastly more versatile than had been supposed. Instead of confining themselves to harrying enemy war vessels and merchant ships, our submarines also served as scouts, as transports, as mine layers in enemy waters, as lifeguards for rescuing downed aircraft crews, for reconnaissance photography and, to a limited extent, for actual shore bombardment.

Since then the importance of the submarine as a major weapon has continued to increase. In a sense, various types of small and medium-sized war vessels will be able to travel under the surface as well as on top of it.

The present American fleet submarines are in excess of 300 feet long, are powered with four big Diesels, and have a surface speed of about 20 knots. At 15 knots they can cruise for 15,000 miles without refueling, more than sufficient for the standard 60-day war patrol. Their maximum underwater speed is about 10 knots which can be maintained for an hour before the batteries are drained.

Armed with one or two 5-inch deck guns

plus anti-aircraft defense, the submarine's principal weapon has been its torpedoes. There are six torpedo tubes in the nose, four in the stern. Modern electric torpedoes leave no wake, can be set so as to turn to a desired course after leaving their tubes, and can be fitted with homing devices that steer them toward their targets.

The submarines use radar equipment on the surface and employ echo ranging and other sonar listening apparatus in both the sonic and supersonic frequencies while either afloat or submerged. These spotting and tracking devices are so accurate that submarines have been able to sink their targets by radar or sonar alone without having had a visual look at the target.

Highly efficient as they proved to be, our World War II submarines already are out of date. The Germans, for instance, made new and astonishing gains in submarine engineering and concepts of operations just as the war ended and this information is now the common property of all the great powers. At the same time our own countermeasures against submarines advanced to such a point that submarines of World War II characteristics are now extremely vulnerable.



Bowplane (left) is carefully checked before start of the cruise. Right, closing exhaust valves of engines

Today, the Navy's submarine experts are engaged in a hurry-up research program of testing ex-enemy developments as well as numerous ideas of our own. New submarines for which construction has been authorized will be designed to take advantage of the best of the new ideas. Existing submarines probably will be rebuilt along the same lines.

At the same time, other groups of naval experts have been given the job of working out improved antisubmarine measures so that new types of submarines can be combatted. Two hunter-killer destroyers identified by the symbol DDK are being

used as test ships. Another countermeasure is the use of sono-buoys that were developed during the war. These are automatic detector buoys that can be moored offshore or set adrift at sea. The buoys are equipped with sonar listening apparatus and a radio transmitter. Whenever the submerged sonar equipment picks up the sounds of a submarine in its vicinity these sounds automatically are broadcast from the buoy's radio, alerting radio stations either on shipboard or ashore. The position of a drifting buoy then can be fixed by using a radio compass loop.

Virtually all of the current research,

Deck guns used against small craft are being removed in new streamline program

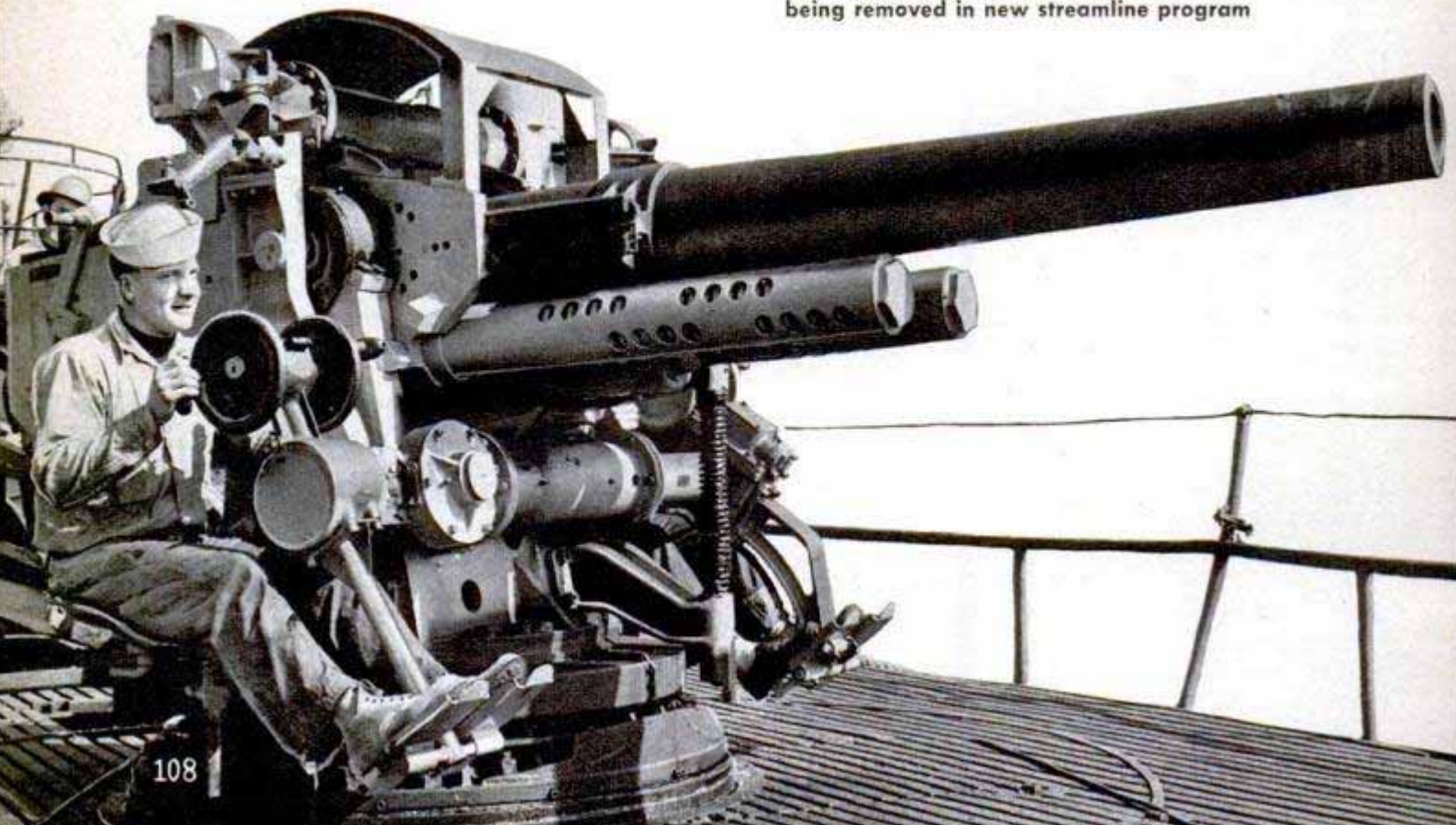

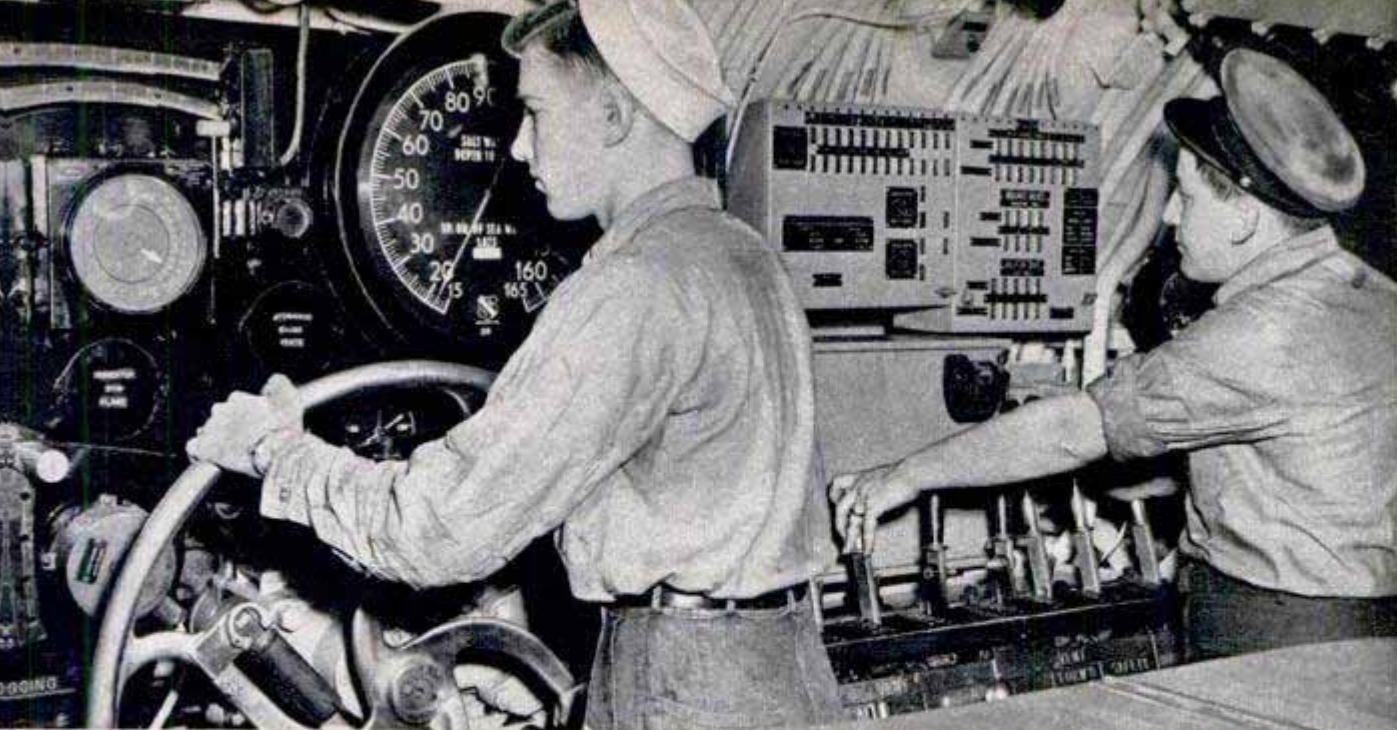

At main diving station seaman at left mans bowplane wheel and officer operates valves to flood sub tanks

both in improving submarines and improving the countermeasures, is in the secret category. About all that the silent service will talk about is the wartime developments of the Germans and Japanese. Some of these are quite important.

The best known is the Schnorkel breathing tube, invented by the Dutch and adopted by the Germans, that allows a submarine to use its Diesels underwater. The tube is a 15-inch pipe that can be raised to the surface and opened while the submarine is at a shallow depth. The pipe draws in air for the crew and the engines and also serves as an outlet for the engine exhaust. Submerged speeds of 16 knots or better are possible with the apparatus. Submarines equipped with it have remained submerged from 40 to 70 days and have cruised for thousands of miles without resurfacing.

The top of the tube is too small for detection by radar equipment and yet it is possible to mount on it a radar scanner or a radar of the IFF type to augment the periscopes.

Parallel with working out improvements on the Schnorkel is another program intended to increase a submarine's underwater speed by improving its streamlining. The submarines Pomodon, Odax, Amberjack and Corporal, rebuilt for these tests, are now making sea cruises in which their speeds, fuel-oil consumption and other characteristics are being compared with

(Continued to page 242)

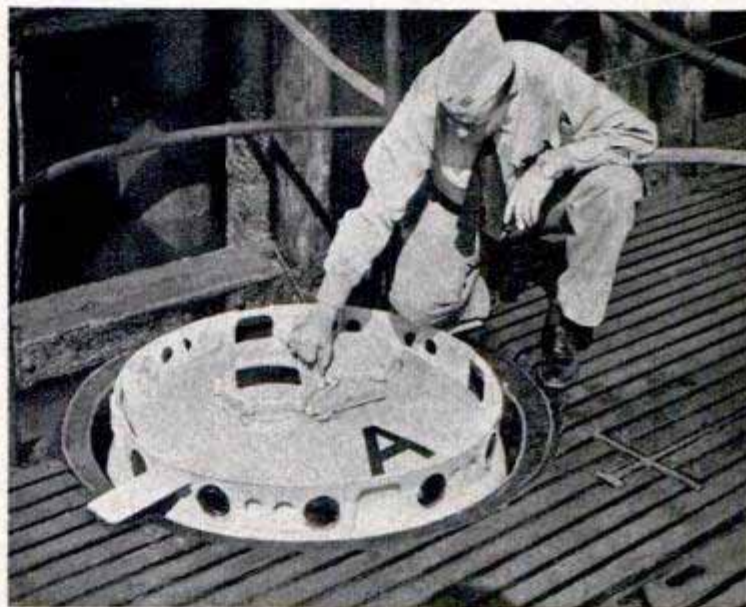

Rescue buoy (A) rises to surface if sub is sunk. It contains telephone connected to the submarine in trouble. Buoy has colored reflectors. Below, sono-buoy guarding harbor uses underwater sonar to pick up the sound of approaching sub



PREVIEW OF U-BOAT WAR?

THE LAUNCHING PLATFORM OPENS AT ONCE WHEN MISSILE REACHES THE SURFACE. THE MISSILE LAUNCHES ITSELF INTO THE AIR IN THE SAME SPLIT SECOND AND THE PLATFORM IS LEFT AFLOAT BUT SINKS LATER.

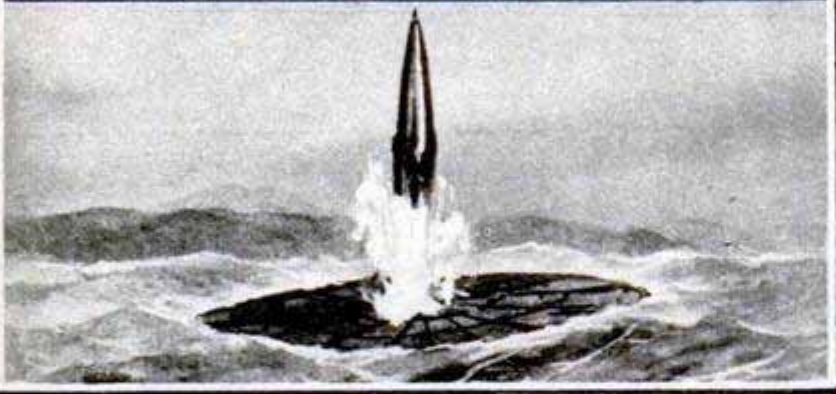

THE MISSILE, PROPELLED BY RAM-JET, COURSES TO ITS TARGET



A SUGGESTED TYPE OF MISSILE

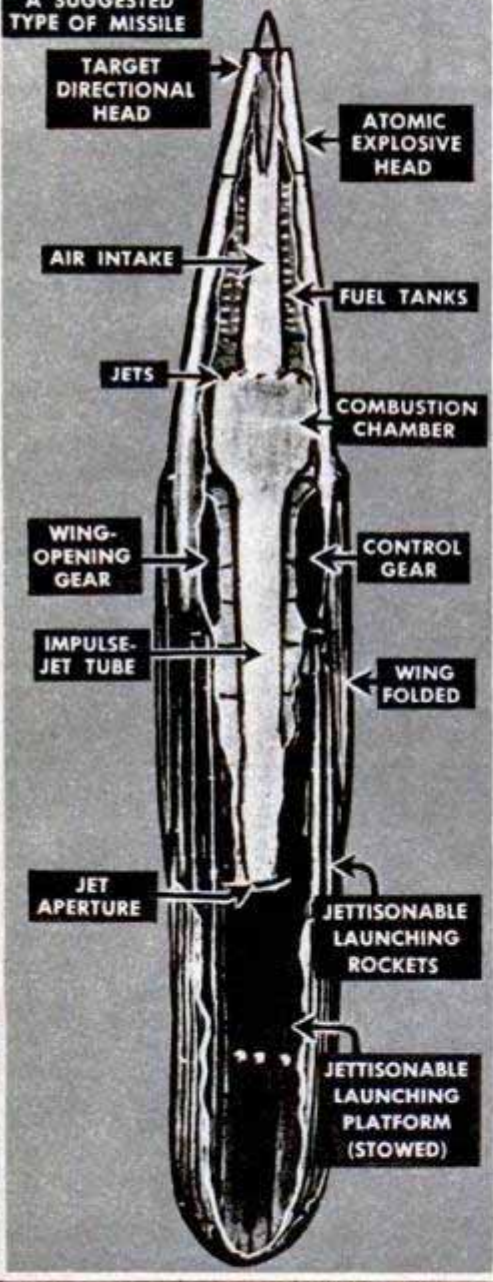

MISSILE JUST LAUNCHED AND RUSHING TO THE SURFACE.

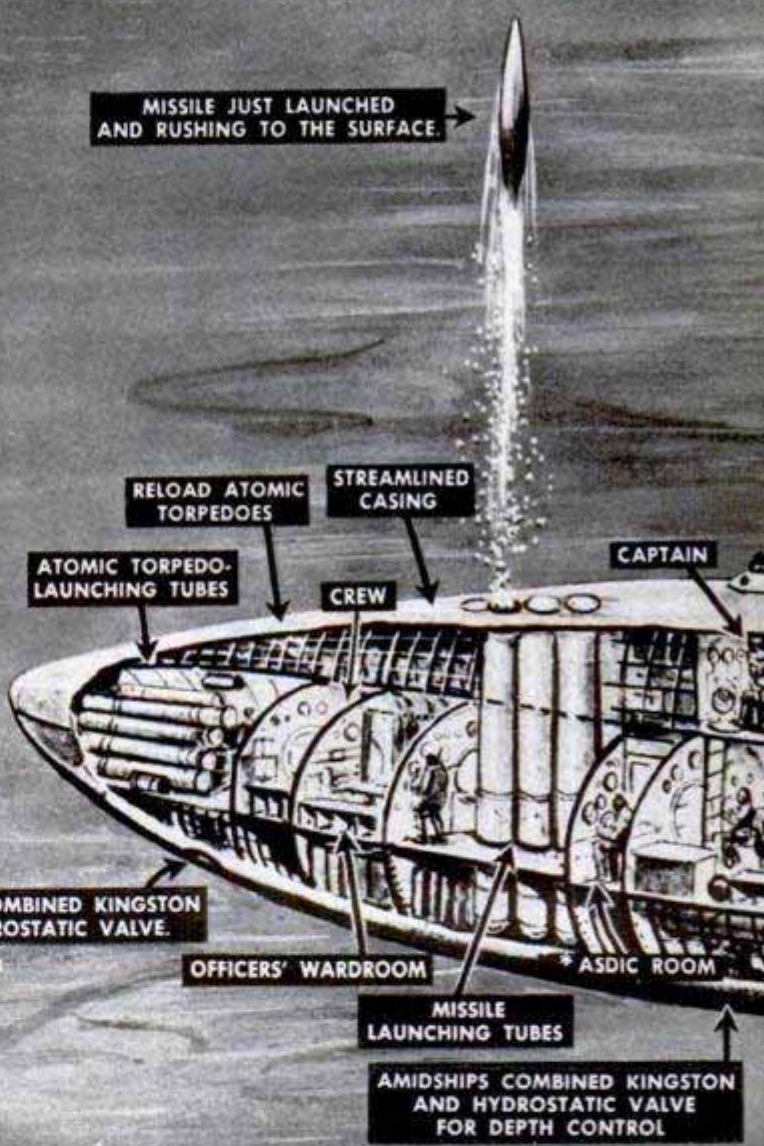

From England come these proposals for waging war from the deep. Submarines powered by jet engines would be equipped with tubes to launch missiles containing atomic war heads. The missile would be expelled from the tube to the surface of the water, where it instantly would release a launching platform from a compartment in the tail. The missile would rise automatically from the platform, which would be left afloat but eventually

ATOMIC MISSILES FOR SUBS

THE ROCKET-PROPELLED MISSILE CLIMBING TO OPERATIONAL HEIGHT

LAUNCHING ROCKETS JETTISONED WHEN SUFFICIENT SPEED IS ATTAINED TO OPERATE THE RAM-JET.

THE SIMPLICITY OF THE RAM-JET (OR ATHODYD) PLUS ITS BUILDUP OF POWER AS ITS SPEED INCREASES, MAKES IT AN EXCELLENT PRIMEMOVER.

RADAR FLOAT

SURFACE

THE MISSILES MAY BE OF TWO TYPES.

NO. 1. ROCKET TYPE CLIMBS TO GREAT HEIGHT, DESCRIBING AN ARC IN ITS FLIGHT TO ITS TARGET.

NO. 2. WINGED MISSILE CLIMBS TO 15,000 FT., AND PROCEEDS ON A MORE OR LESS LEVEL COURSE TO ITS DESTINATION

FOR PROTECTION, THE SUBMARINE WOULD RELY ON ITS SPEED; THE GREAT DEPTH AT WHICH IT OPERATES; AND ITS ABILITY TO REMAIN SUBMERGED FOR LONG PERIODS.

SURFACE

SUBMARINE CRUISING AT A DEPTH WHERE UNDER-WATER DISTURBANCE AND GRAVITATIONAL CHANGE POSSIBLY REDUCES THE EFFECTIVENESS OF ENEMY ASDICS*

FOR ATTACK THE SUBMARINE WOULD HAVE ITS ATOMIC TORPEDOES

(1) ATOMIC AND (2) STANDARD TYPE TORPEDOES COMPARED.

NO. 1

NO. 2

* UNDER-WATER SOUND DETECTION DEVICES

CONTROL CHAMBER

MISSILE RELOADS

ENGINE-ROOM

AFT ATOMIC-TORPEDO LAUNCHING TUBES

CREW

AFT COMBINED KINGSTON AND HYDROSTATIC VALVE

PROPULSION AND MANEUVERING JETS

would sink. When the missile is well on its course toward the target, the launching rockets would be jettisoned and wings would unfold from the side. A ram-jet engine then would propel it to the target. Subs also would be equipped with atomic torpedoes, which could be smaller in size than conventional torpedoes. Subs could cruise at high speeds and at depths where effectiveness of the enemy's sound detection would be reduced



Push-a-Button Subway Map Finds Shortest Routes

Londoners traveling the subway can press a button to find the shortest route to any station on the line. When the destination button is pushed a map lights up to show the proper route with transfer stations. Secret of the map is the neon lamps which won't glow until a certain voltage is reached. In a case where it's possible to reach a given point by two different paths, the shorter path has fewer neon lamps. Thus the voltage builds up until the shorter route glows. The route-finder, built by the Sperry Gyroscope Co., Ltd., also may be used to show passengers on ocean liners the routes between decks.

Aerial "Road Signs" Mark Path Across U.S.

Aerial "road signs" are up along the 3000-mile-long Skyway Number One for private flyers, stretching from Los Angeles to Washington, D. C. A thousand painted markers on rooftops, roads and prominent landmarks name the cities en route, with their exact latitude and longitude separated by an arrow indicating true north, and a symbol showing direction and distance to the nearest good airport. About 4000 more are needed to mark every community in a 40-mile-wide band along the route. Eastward from Abilene, Tex., the skyway takes paths north and south to Washington.

Civil Aeronautics Administration photos

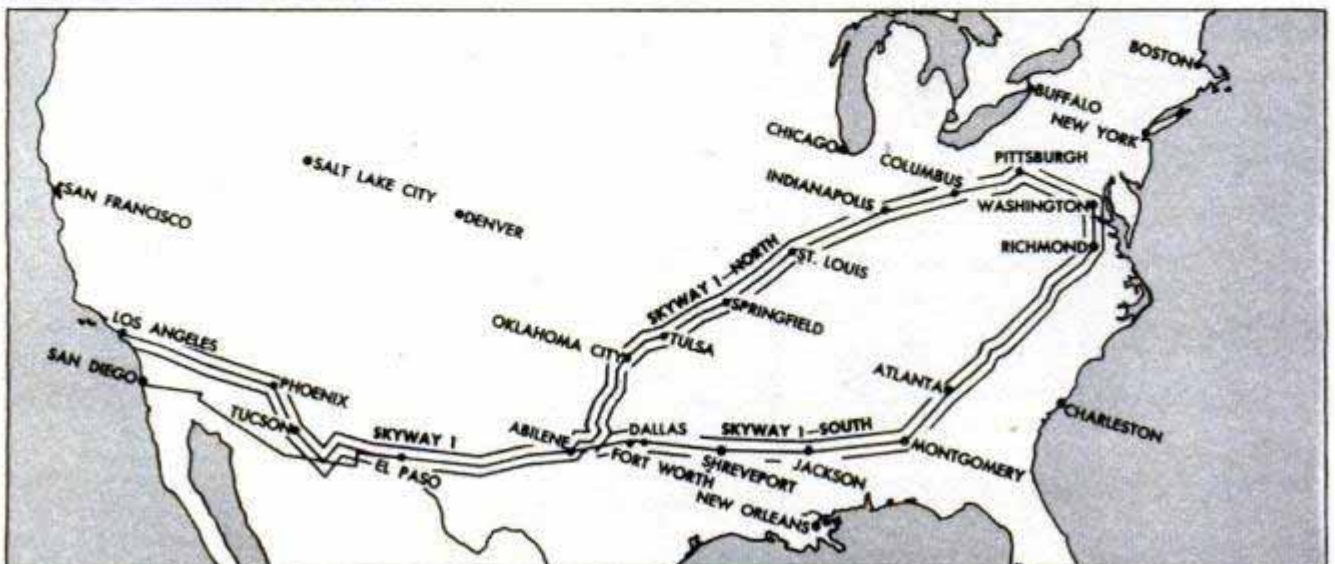

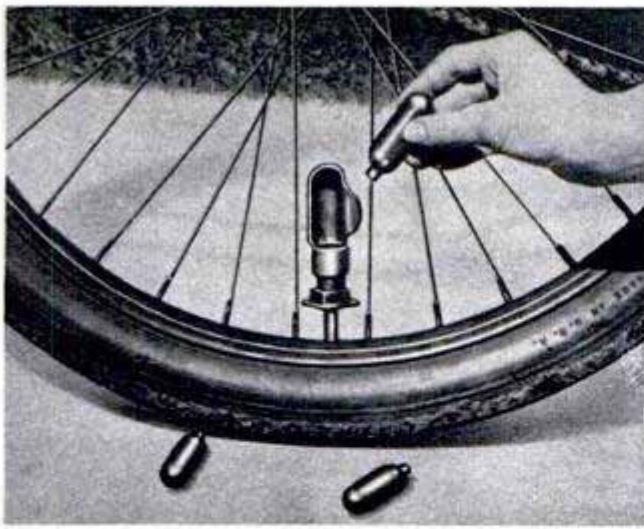

Tire "Pump" Uses Gas Cartridges

Flat bicycle tires are inflated in seconds without a pump by means of a kit that uses compressed-gas cartridges. For light-weight tires one cartridge is enough. Two cartridges inflate a completely flat balloon tire. To use the kit, you screw an adapter on the valve stem. A cartridge is placed in the holder and screwed down on the adapter, puncturing the cartridge and sending compressed gas into the tire. The kit can be carried in a tool bag or pocket.

Bicycle-Wheel Truing Stand

Adjustable for both axle width and wheel diameter, a bicycle-wheel truing stand accommodates any wheel from 6 to 30 inches in diameter. Two truing arms, mounted on an adjustable bar, detect any out-of-true portions of the wheel as it is turned. The stand is cast-aluminum.

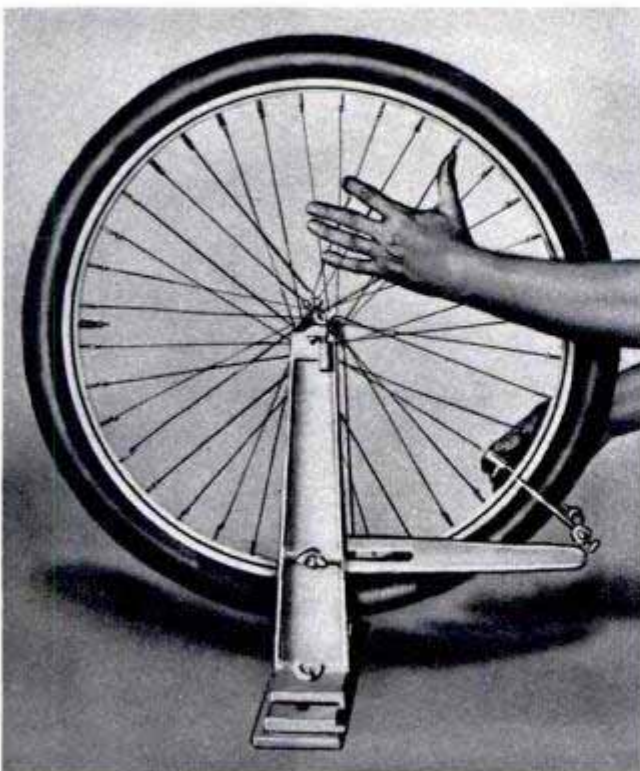

Wickets Form Movable Fence

Individual wickets installed side by side in the ground form a wire fence to protect lawns and flower beds. The wickets may be used as temporary fencing and moved about, or may be wired together to form a permanent fence. Each wicket is embedded in the ground by pushing or hammering on a shoulder that is offset in the wire. Made of steel, the wickets are 12 inches wide and 20½ inches high.

Soap-Filled Wicks Carried in Pocket

You'll always have soap handy if you carry a packet of wicks each containing enough soap for a thorough washing of the hands. The soap is covered by a fine cloth mesh. To wash your hands, you merely place one of the wicks in your palm, run some water over it and lather. The wicks are packaged in a narrow envelope for convenience in carrying.

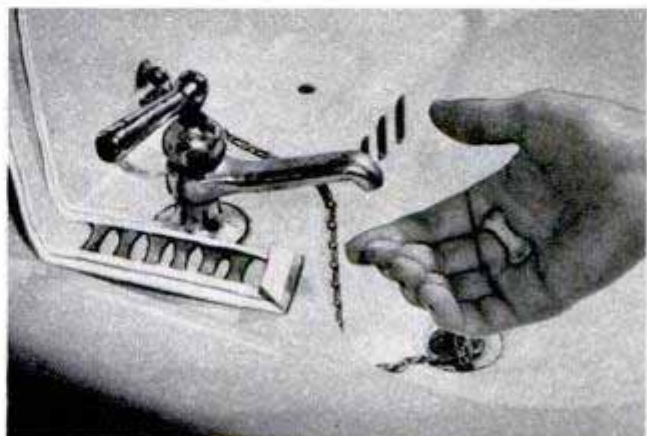

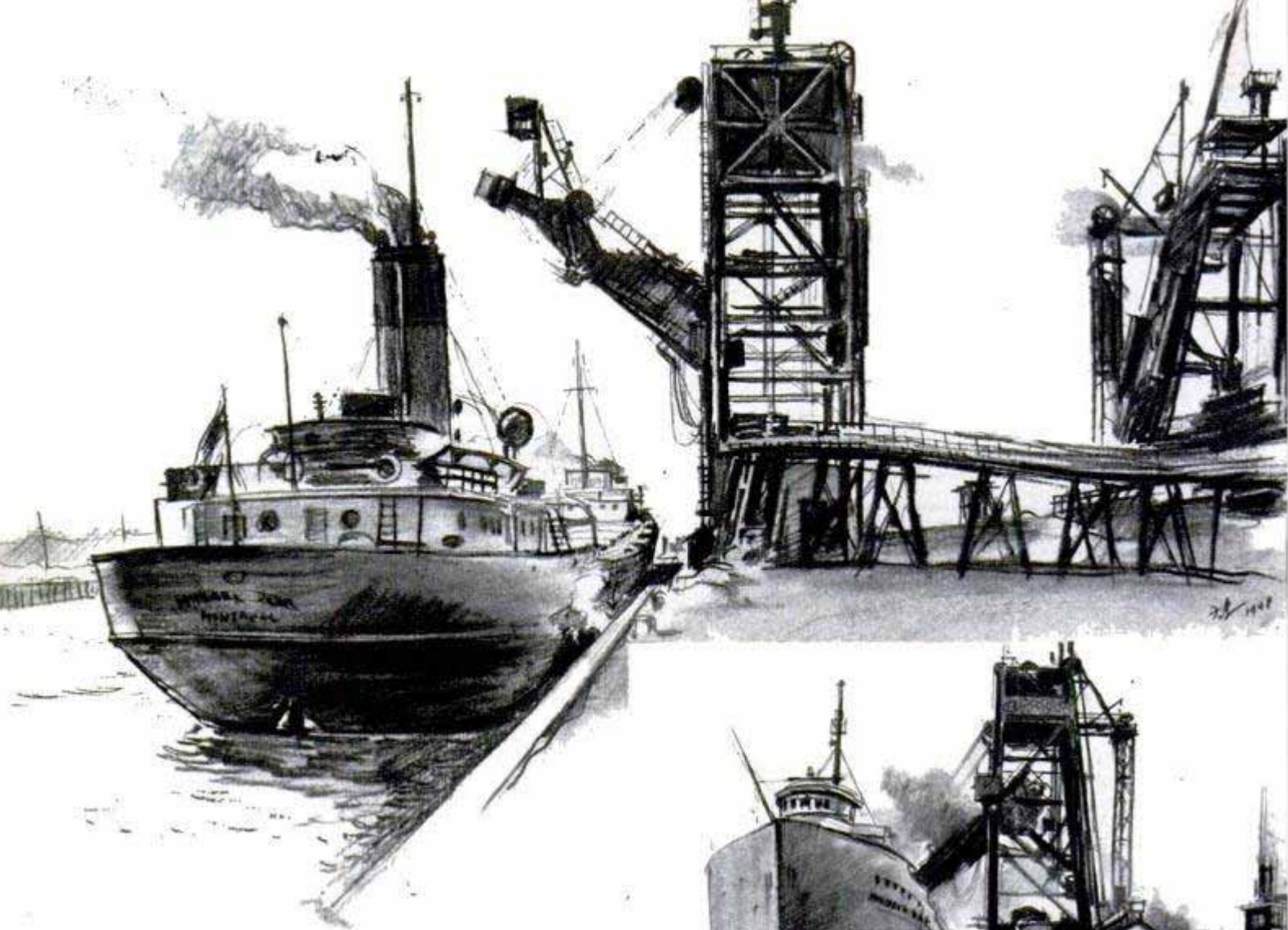

These sketches of the coal-handling facilities at the Toledo dock were drawn by Frank Beatty, Art Director of Popular Mechanics. Above, view from the end of the pier showing a coal dumper with its chute raised as a boat moves in for a load of coal. Right, another dumper viewed from the opposite side as a coal car is pushed up on the cradle. Below, looking toward the kickback trestle. Car retarder tower is in the foreground

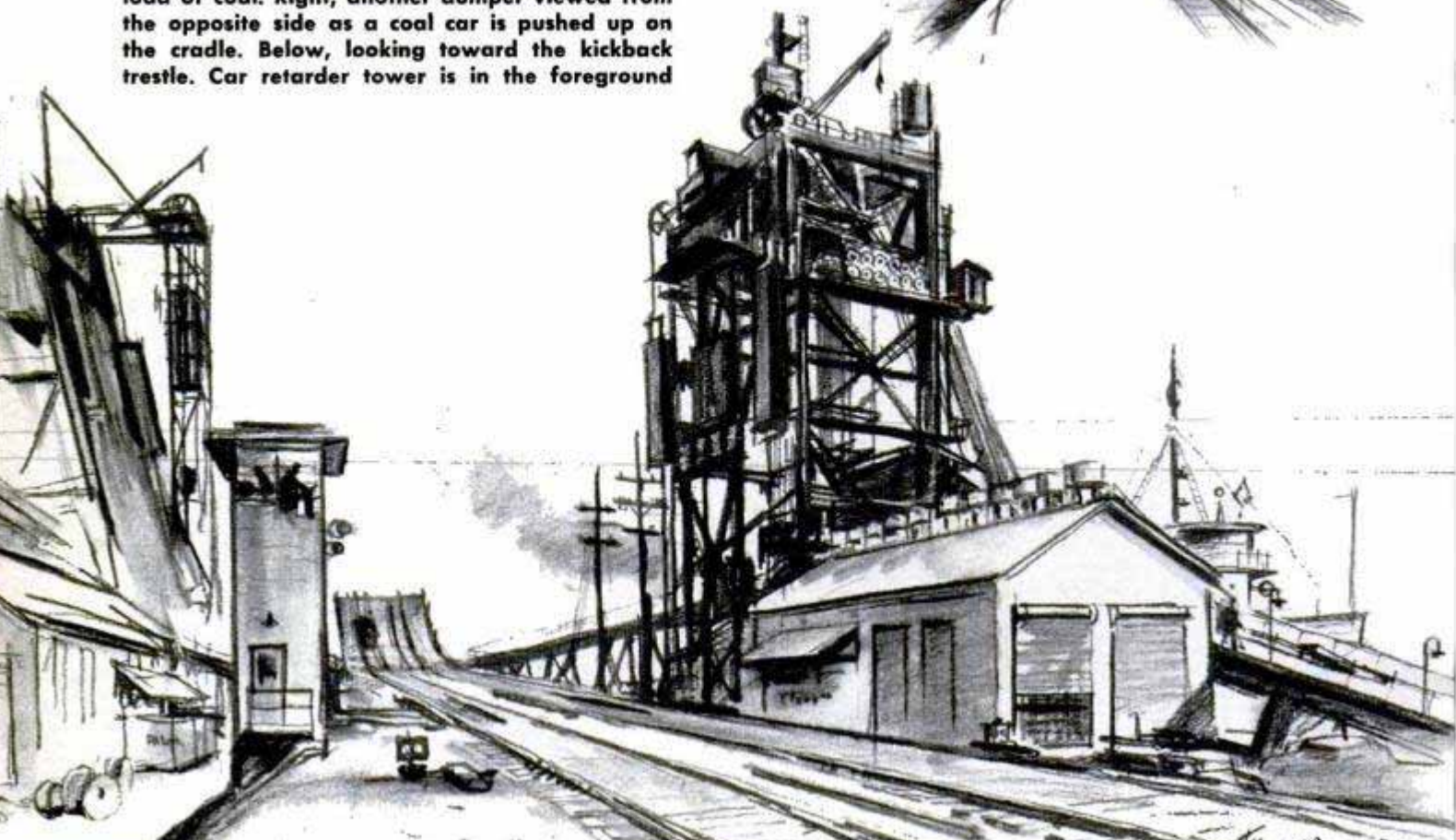

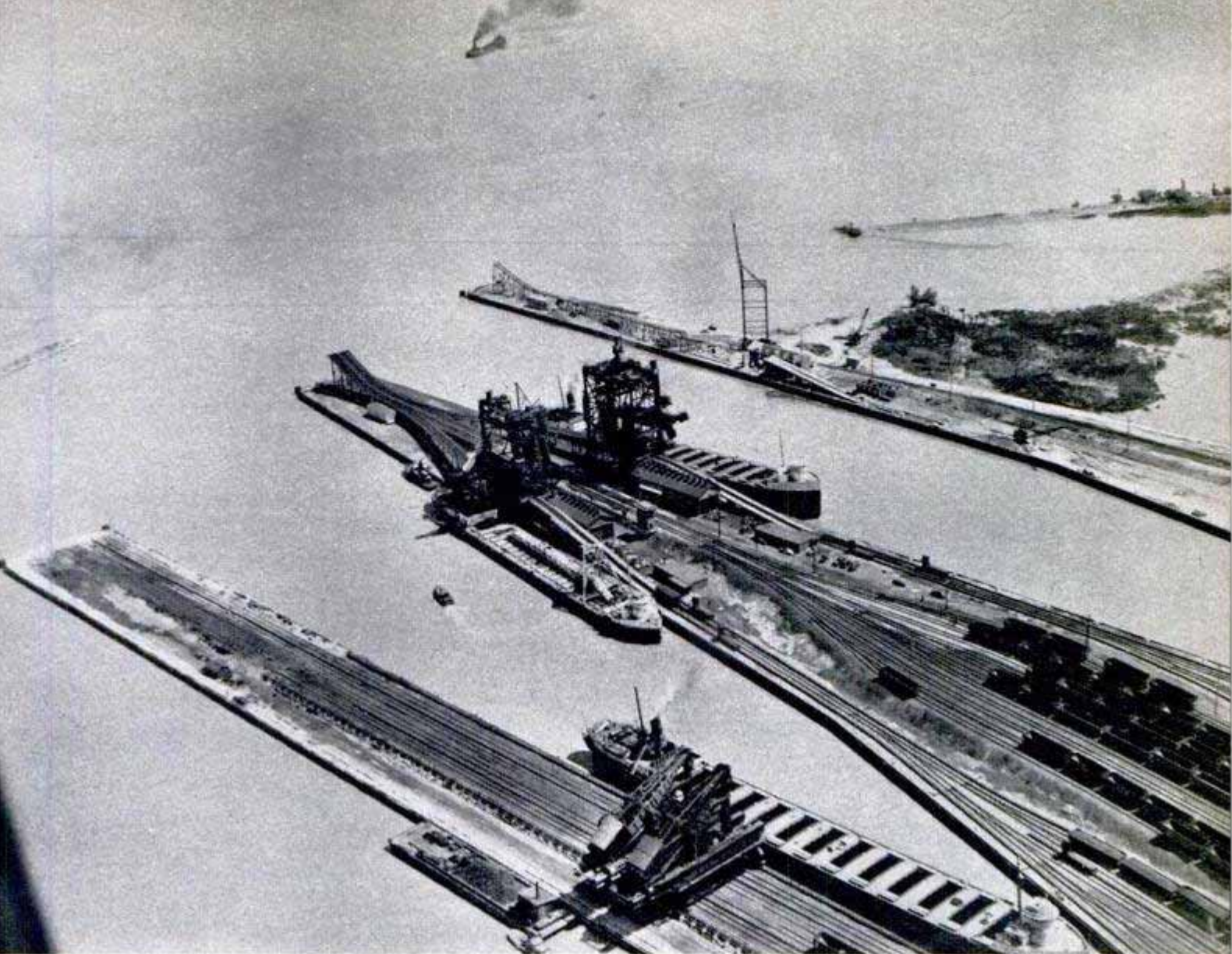

Air view shows ore unloaders in foreground, two coal dumpers in center. Third is going up beyond them

IRON STEVEDORES OF THE COAL DOCKS

By Arthur R. Railton

WITH ELECTRICAL MUSCLES that juggle a 100-ton carload of coal as though it were a basket of feathers, the iron stevedores along the Toledo lake front make the task of filling the cavernous holds of a coal boat look as effortless as throwing a light switch.

These untiring stevedores work at a new coal and ore-handling dock built for the New York Central and Baltimore and Ohio Railroads on the shore of Lake Erie. The dock, which began operation this spring, has a capacity of 20 million tons of coal and 4½ million tons of iron ore a year—and whether you think of those figures as shovelfuls or boatloads, they represent a heap of work!

The mechanical loaders are the middlemen between rail and water transportation. They transfer the bulky cargo so fast and so cheaply that the Great Lakes have become one of the world's busiest waterways. Long trains of cars loaded with coal from the Central States pour into Toledo night and day. To keep up with this steady stream, the dumpers, working 24 hours a day, dump cars at a rate of one a minute.



An empty coal car rolls back down the kickback trestle on its way to the yard. Huletts are at far right

Rolling back to yard, car is slowed down by retarders that grip wheels when operator moves these controls

Juggling coal cars is only part of the work done by the mechanical stevedores. Many of the boats coming in for coal bring iron ore from the Minnesota ranges. Another section of the dock unloads these floating giants at a rate of 30 tons a minute. Each of the twin buckets of the Hulett ore unloaders digs into the heavy cargo and transfers it to railroad cars in 15-ton bites.

In a few hours the ship holds are emptied and the ore, now loaded in railroad cars, is on its way to the steel mills of the Middle West. Riding high in the water, the empty boats move over to the coal dock where, in a few more hours, coal from the mines of the Central States fills the holds. With hatches battened down, the boats steam away carrying their cargo to various Great Lakes ports.

To make this smooth-running cycle continuous everything is timed as precisely as an aerial trapeze act. Coal trains roll into the yard on a strict schedule. From there, the cars are moved up to the coal dumpers which pick them up in an elevator and flip them upside down, dumping



the load into the boat. Now empty, the cars roll back to the yard where they are made into trains for the return trip to the mines. Some empties are pushed over to the ore dock where they are loaded with ore by the Hulettts and hauled away to the steel mills.

It takes a lot of trackage to handle thousands of coal cars a day and there's plenty of it at the Toledo dock. It covers 212 acres and stretches back from the water more than four miles. Covering this tremendous acreage are 56 miles of tracks, enough to hold 5400 coal cars.

Dispatchers in the dumper control room signal yard crews when coal cars are needed. A small electric locomotive pushes the cars in groups of eight or ten up to the bottom of the dumper ramp. From here a tough little locomotive known as a barney takes over.

Cable operated, the barney runs on an unusual narrow-gauge system between the standard-gauge tracks. From its pit below and behind the coal car, the barney rises to the track, like an unstreamlined porpoise breaking water, and rolls forward until it is just behind the car. It automatically slows down, eases against

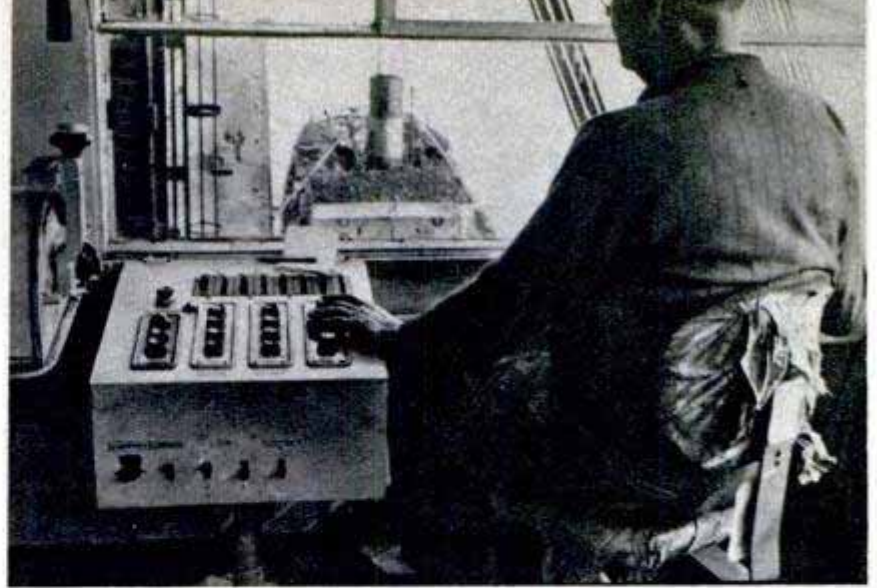

High above the ship, this operator controls the coal dumper

the coupler and pushes the load of coal up to the dumper cradle. As the barney, pushing its load of coal, arrives at the top of the ramp, its wheels are forced inward on their axles by the narrowing track. By the time the coal car is on the cradle the barney is riding an inner pair of tracks that leads back to the pit. Reversing its course, it rolls to its pit below the next car and the process starts again.

The coal car, loaded with as much as 70 tons of coal, is hoisted by the cradle until it is high above the ship tied up at the

Coal car is held firmly by clamps as it is tipped over, spilling its load of coal down the chute into ship

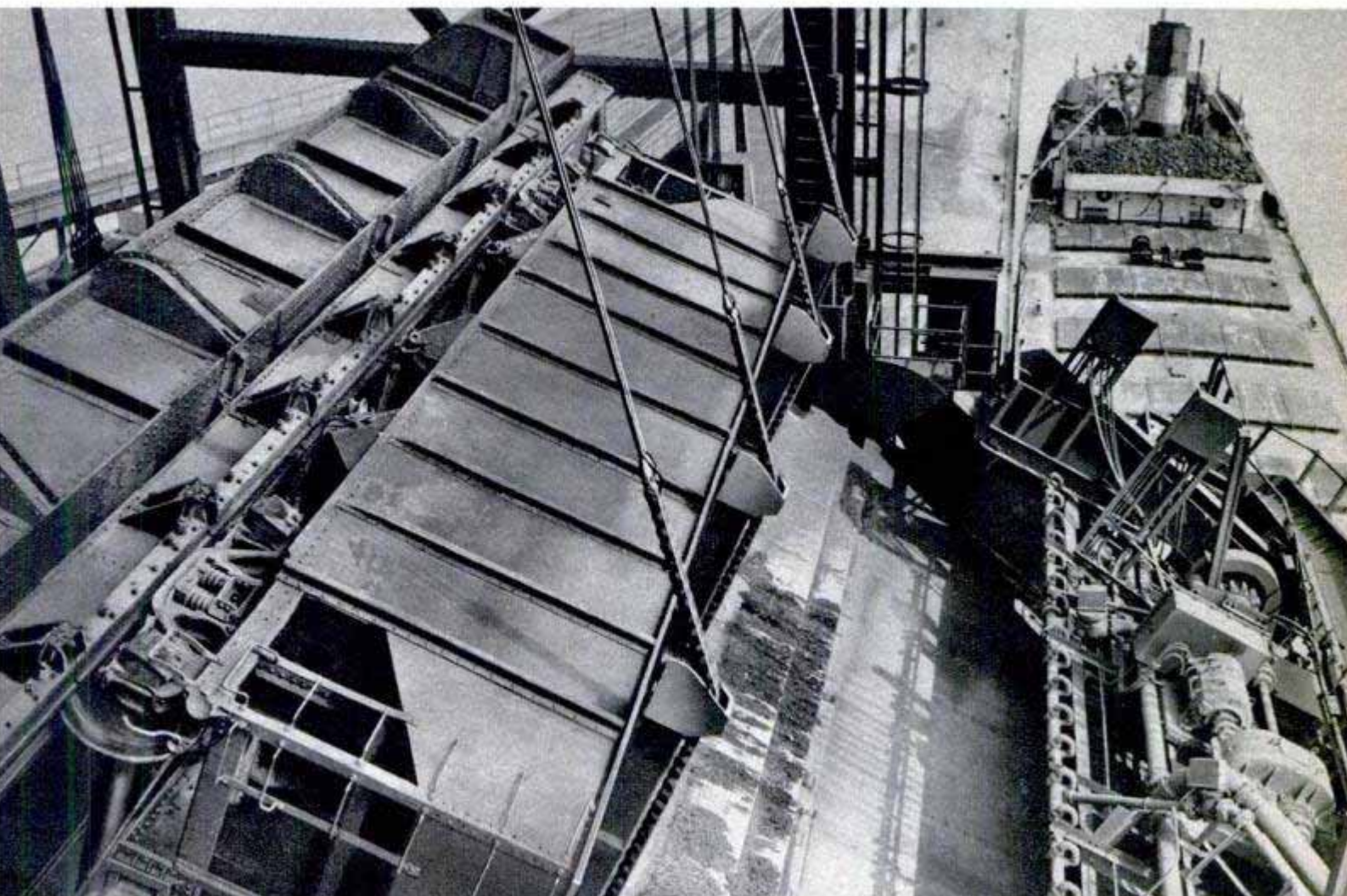



Carload of coal is pushed up the ramp to the dumper by pilotless barney locomotive. Below, the cable-operated barney comes up from its pit between rails to start car up the ramp

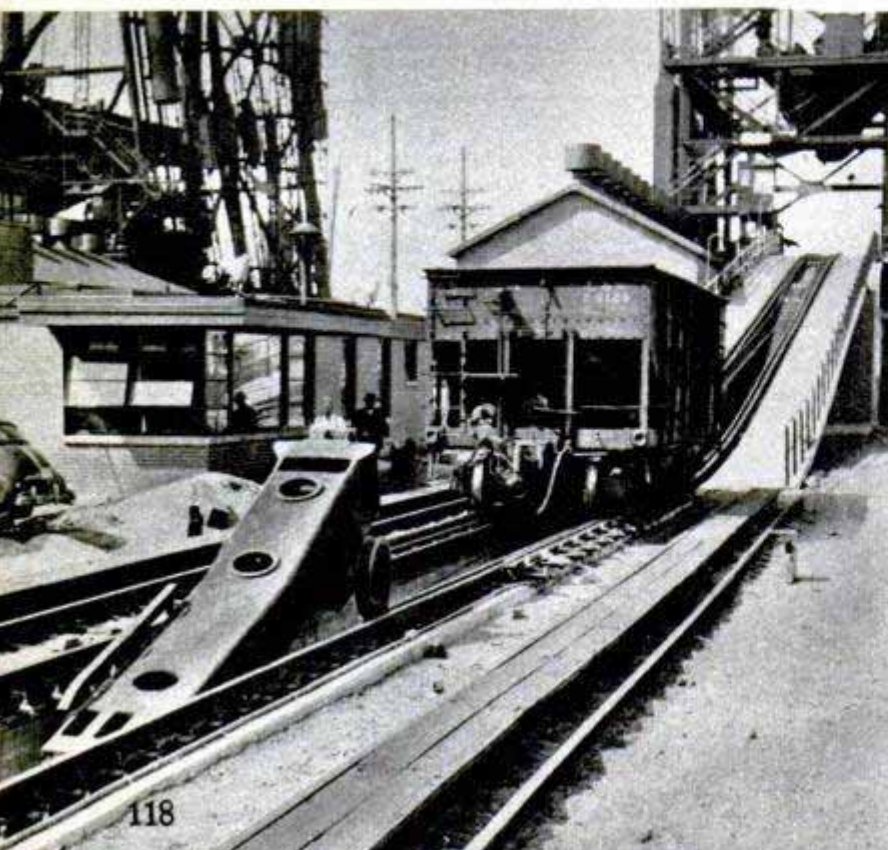

dock. Automatic clamps grab the sides of the car and it is flipped upside down, dumping the coal into a broad pan that looks like a flattened funnel.

After the dumping, the car is righted and lowered to track level. Another car, pushed up the ramp by the barney, hits the empty car knocking it off of the cradle and down a descending ramp on the opposite side of the dumper. This car then rolls up a kickback trestle from which it glides back and is automatically switched into the empty-car yard.

There are two dumpers in operation at the dock now and a third is being built. Each of these machines handles a carload a minute. That means three cars of coal can be dumped every minute, 24 hours a day.

As the empty car rolls back from the kickback trestle to the empty yard it passes a retarder system in the tracks. These retarders squeeze the wheels of the car, slowing it down. From a control tower, an operator regulates the amount of pressure exerted against the wheels to slow down the car so it won't jump the track when it hits the other empties. At the same time he must not slow it down so much that it will stop before it reaches the end of the yard. Every type of coal car—and there are many—has its own rolling characteristics and the retarder operator has to know them all.

A switchman, also in the control tower, opens and closes remote-controlled switches to sort the empty coal cars by railroads. By switching all cars bearing the name of one railroad on the same track, he speeds the job of making up trains for the trip back to the mines. He also inspects each car visually as it passes his station and when he spots a "cripple" he switches it to a sidetrack.

Adjacent to the coal dock, the ore-unloading pier juts out into the lake. On this pier, two Hulett unloaders transfer ore from the boat to railroad cars that roll under their bridgelike chassis.

These Hulett's consist of two jointed arms that dip their tremendous fists into the ship's hold, picking up 30 tons of ore a minute. At the end of each arm is a clamshell bucket controlled by an op-

erator who rides in a cab directly above the scoop. Like a three-dimensional-elevator operator, he guides the giant arm back and forth, up and down, and from side to side.

These twin scoops pick up the ore from the hold, carry it back over the tracks and dump it into a hopper. It is weighed and then dropped into cars on the tracks below.

As the ore in the hold gets so low that the scoop can't pick up full bites, bulldozers are lowered into the boat. These powerful tractors shove the heavy ore into piles big enough for the scoops to get their teeth into. When the holds have been completely emptied, the boat is moved over to the coal dock to take on its load of coal.

A streamlined office building at the dock is the nerve center of the operation. Orders are transmitted by an intercommunication system to the machine operators and to the train yards. Ship-to-shore radio enables ship captains to get their docking instructions while approaching the port.

With the addition of these new facilities, Toledo, already the busiest bituminous-coal port in the world, is expected to forge

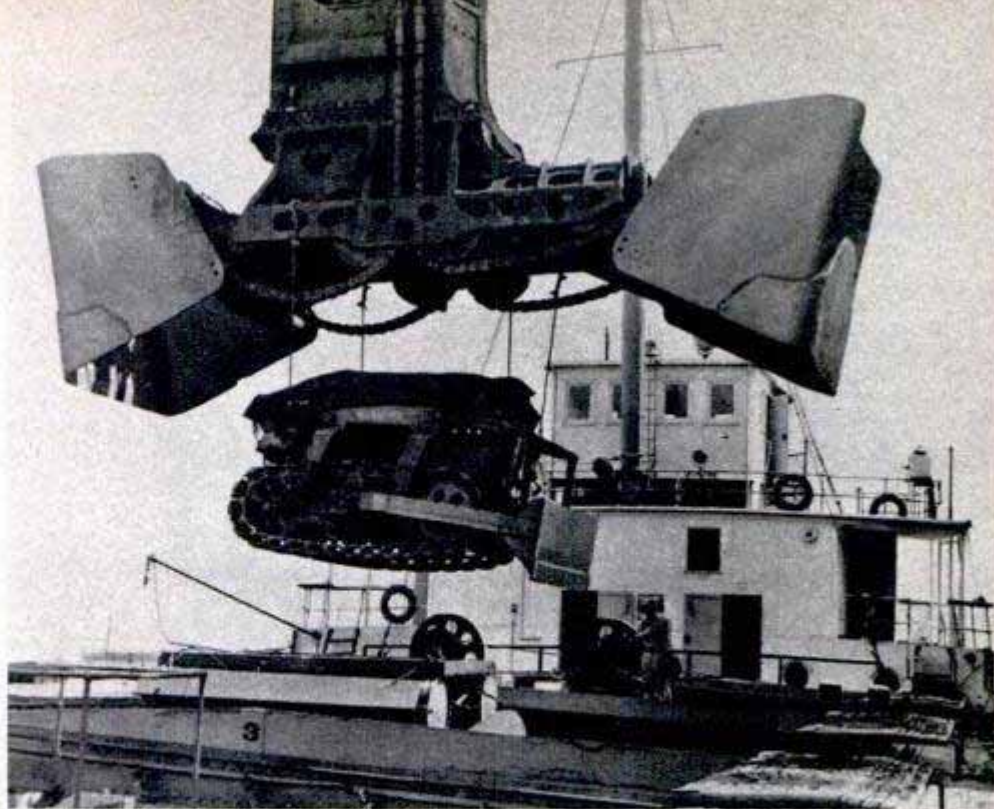

Scoop of the ore unloader lowers bulldozer into hold to scrape up ore

farther into the lead. During 1947, the Toledo area handled 23 million tons of coal and in 1948 the total should greatly exceed this figure.

But whether or not the 1948 total surpasses last year's mark, the new dock will dump a lot of coal and unload a lot of ore. It's a far cry from the old days, not too many years ago, when hundreds of coal shovelers swarmed aboard the lake boats to transfer cargo. Now the work is done by electricity and the machine operators just sit back and push buttons.

Unloading ore at a rate of 30 tons a minute, these two Hulett's can empty this huge lake boat in a few hours



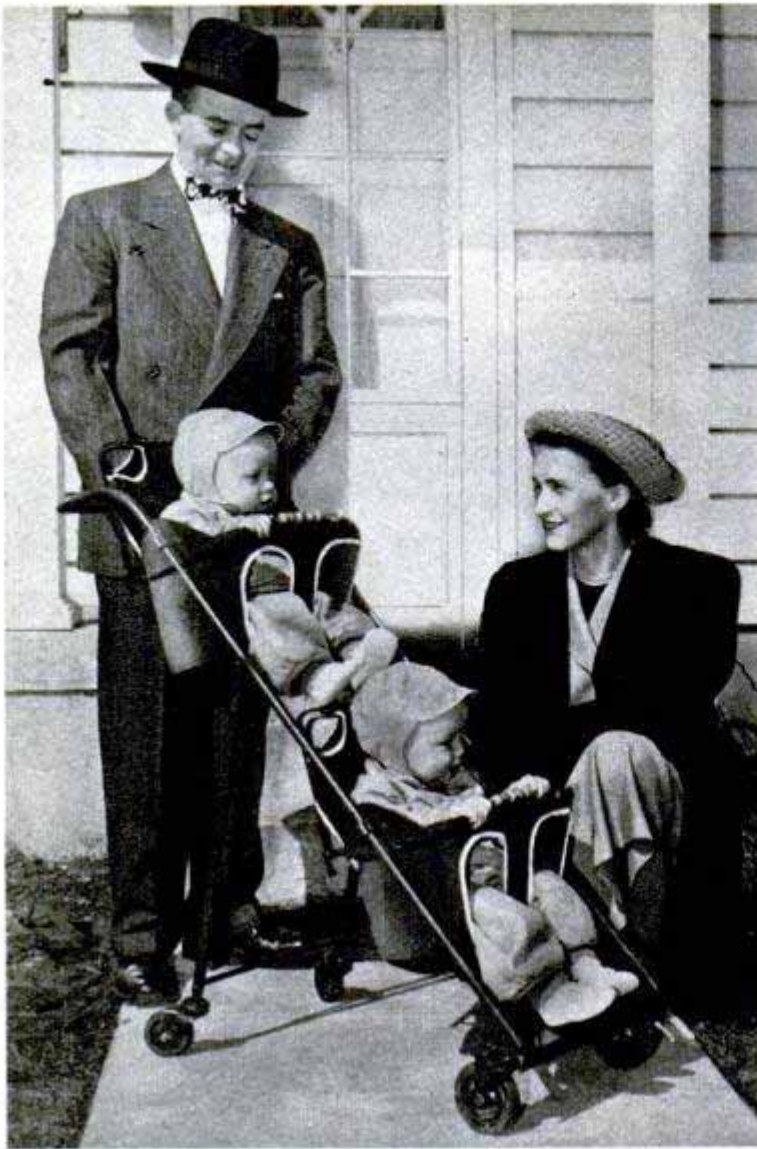

Double-Decker Stroller

Realizing that travel abroad with twin year-old sons wouldn't be easy, Harris W. Jones of Springfield, Ill., built a double-decked stroller especially for the trip. Its rear wheels fold and the cart can be pushed like a wheelbarrow. Before sailing for Europe, Jones applied for a patent on the unique stroller.

Good-by to Toothache?

Mass control of tooth decay could be possible within six years through a chemical dentifrice that would prevent the formation of corroding acids in the mouth, according to Dr. Leonard Fosdick of Northwestern University. Decay is caused by sugars and fermentable carbohydrates which are converted into acids. Research indicates that through use of certain enzyme inhibitors it may be possible to prepare a dentifrice that actually will prevent decay. If such a dentifrice were used in conjunction with the proper diet and oral hygiene, dentists could achieve mass control of tooth decay in a short time, according to Fosdick, who is one of the leaders in tooth-decay research.

Electrical "Yardstick"

With an electrical "yardstick" scientists can measure the high voltages required in many laboratory experiments. Two spheres of the measuring device are held apart by an adjustable frame that permits the gap to be increased or decreased. Normally the air space would prevent electricity from passing in an arc from one sphere to the other. But when the voltage becomes too great the air barrier is broken down and the charge leaps across the gap. The distance between the spheres thus can be used as an accurate measure of the voltage. The instrument is used by Westinghouse scientists in developing improved electrical insulating materials.

☐ Man-made earthquakes in the form of explosions can be detected 200 miles away with small, portable seismographs developed by Carnegie Institution of Washington scientists.

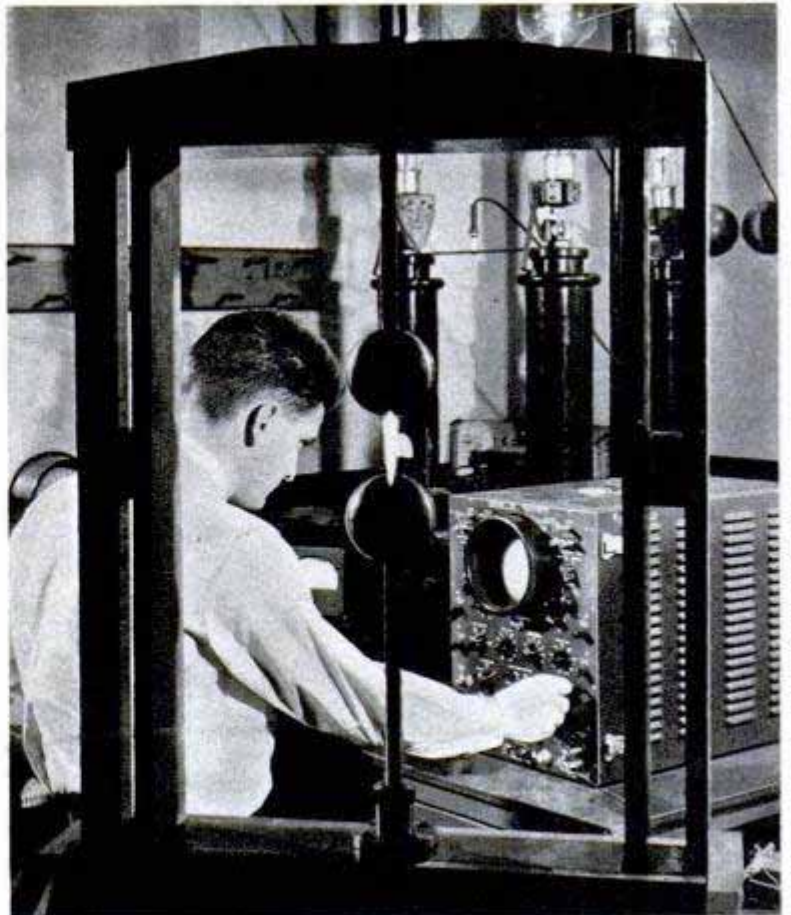

Give it time and the muddy Colorado will fill Lake Mead with sediment, seriously reducing the usefulness of Hoover Dam. Navy and geological engineers are scratching their heads over the problem

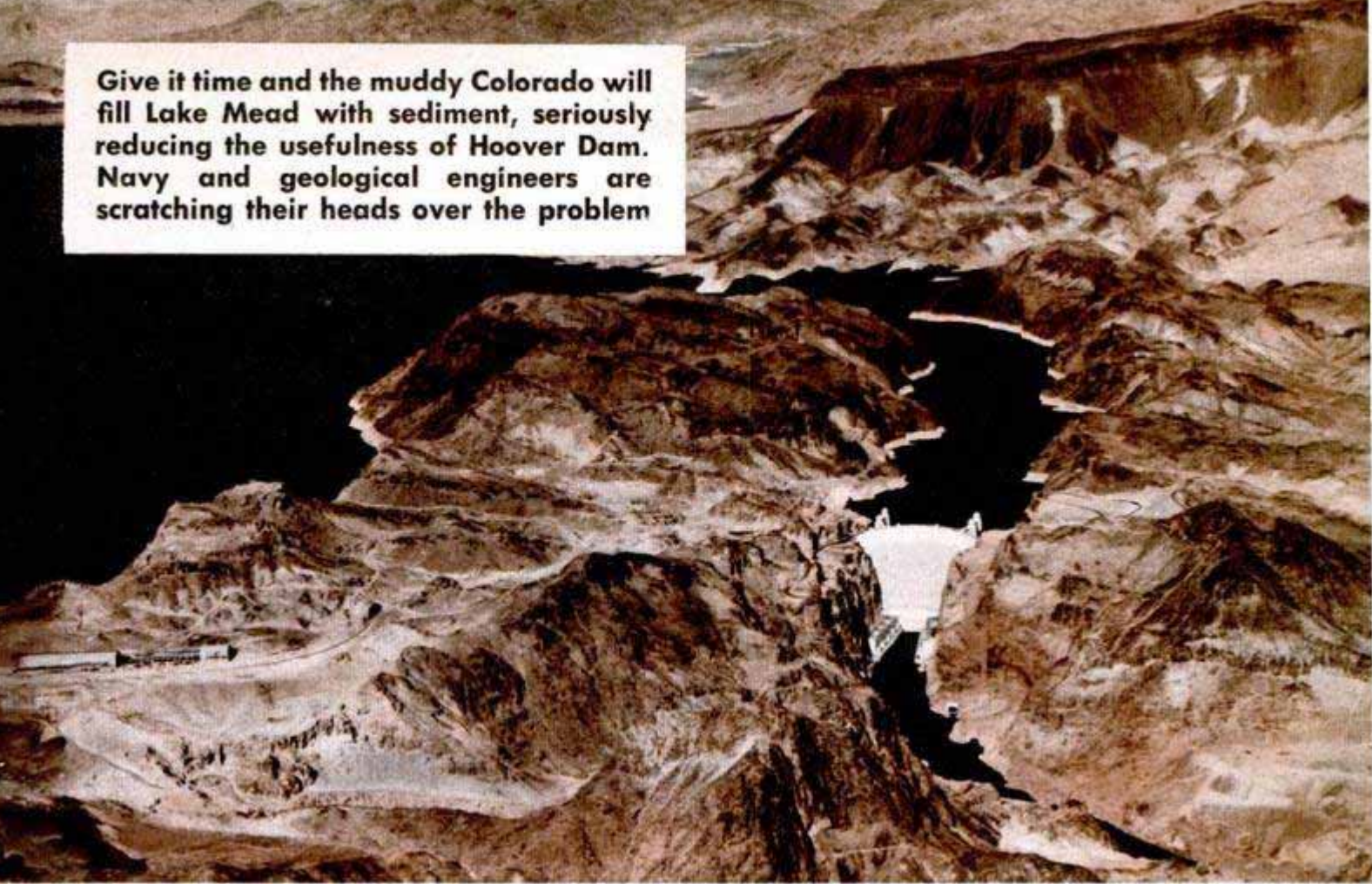

HOOVER DAM CALLS THE DOCTOR

MORE THAN 400,000 tons of silt, clay and sand are being deposited in Lake Mead behind Hoover Dam every day. In the last 13 years the muddy Colorado has dropped two billion tons of sediment in the lake, reducing the capacity of the reservoir by possibly five percent. Unless some remedy is applied, the reservoir eventually will lose most of its storage value.

Lake Mead is a fresh-water reservoir and yet it contains several million tons of salts in solution. So vast is the lake that this quantity of mineral gives the water only nominal hardness. An oddity is the fact that the water that is discharged downstream is saltier than the water flowing into the reservoir.

The weight of the water in the huge lake imposes great strains on the earth's crust and some portions of the Lake Mead area have settled several inches. Light earthquakes due to adjustments of the earth occur frequently.

Nearly one million acre-feet of water evaporate from the surface of the lake every year. The loss amounts to more than a billion tons of precious water that could provide power for a fair-sized city as well as irrigating from 100,000 to 300,000 acres of land if the evaporation could be halted.

By Thomas E. Stimson, Jr.

Sampling bottle is lifted to surface of reservoir from a depth of several hundred feet to test salinity of the water

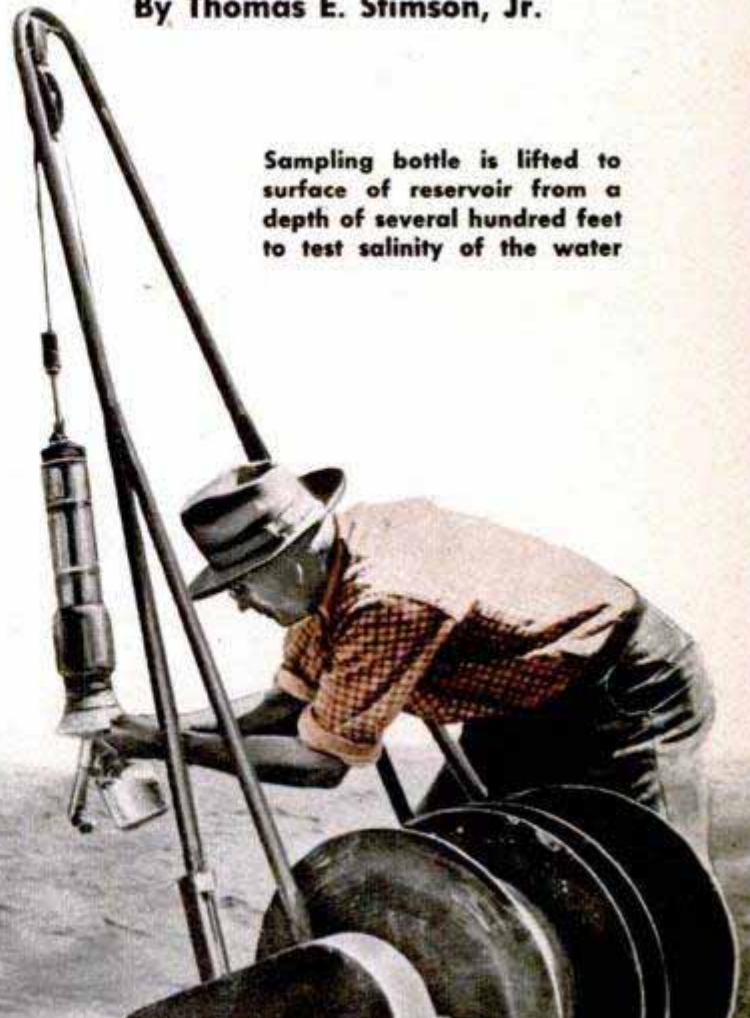



U. S. Navy photo

Navy divers on barge assist in sedimentation study on Lake Mead. Right, charts explain earth shocks near dam

These are some of the high lights from studies that are being conducted by the Office of River Control for the lower Colorado and by associated agencies. The river-control office operates that portion of the river which extends from Lees Ferry, 355 miles upstream from Hoover Dam, to the international border below Yuma, a distance of almost 700 miles.

Hoover Dam and the other structures on the river are used to create electrical energy that is distributed as far away as southern California, to provide drinking water that travels by aqueduct to Los Angeles and its neighboring cities, and to take wa-

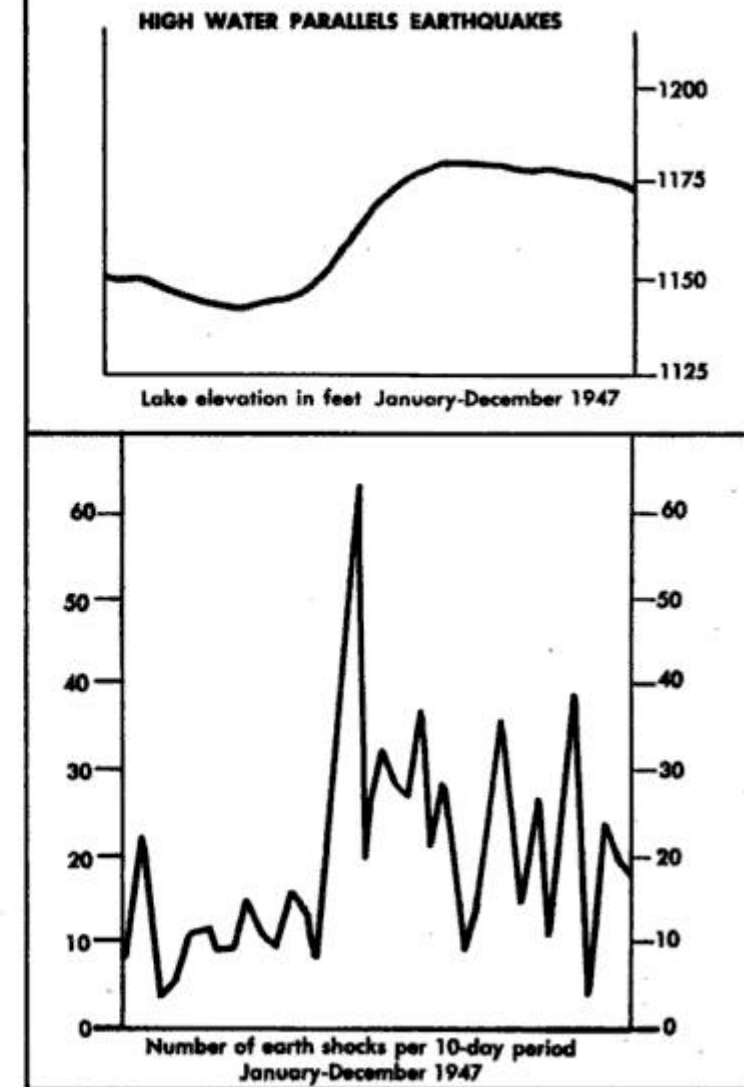

ter from the river for irrigating vast tracts in Arizona and California.

Operating the river is a complex task and one of the big problems now confronting C. P. Vetter, chief of the Office of River Control, is the silting of Lake Mead.

The water that flows into the head of the reservoir looks like brown soup; the water that is discharged through the dam is crystal clear. Vetter knows the approximate tonnage of the sediment that has accumulated, but it's hard to say what volume the sediment occupies.

To find out, the Geological Survey and the Navy are cooperating with the Bureau

Simplified sketch (not drawn to scale) shows how tons of silt are being deposited on the bottom of Lake Mead

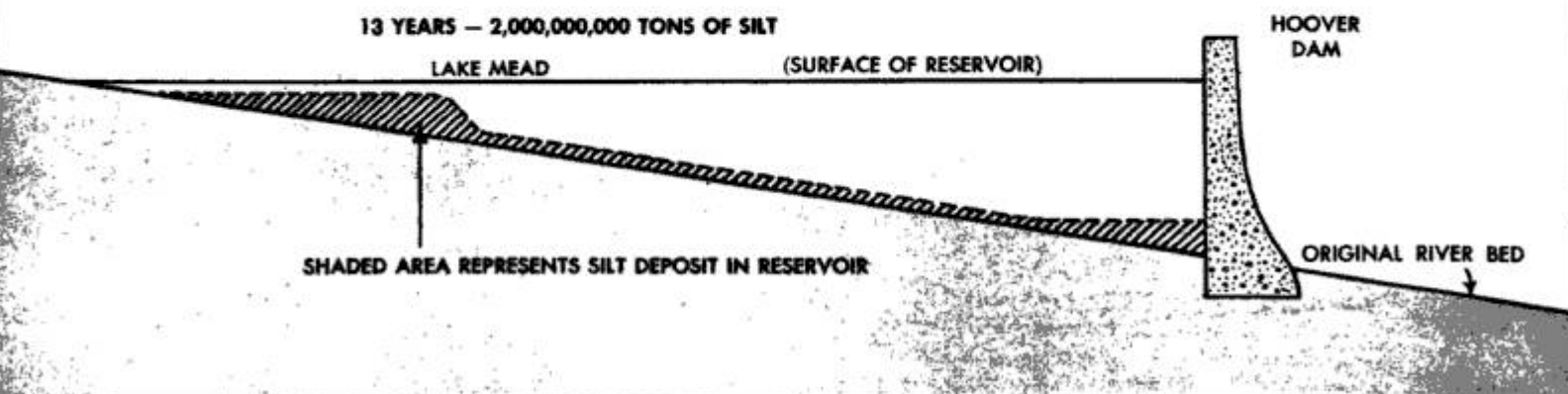

of Reclamation and are measuring the actual depths of the water in the reservoir. These findings will be compared with the original profiles.

The Navy's survey party is using an improved type of fathometer as well as other echo devices for making precise soundings from the surface of the lake. Underwater photographs may also be made to check on the underwater contours. The Navy may employ underwater television apparatus to study the bottom as a way of finding locations from which the most revealing photographs can be made.

In addition to six small craft that were shipped across country to the site, the Navy has launched a 107-foot self-propelled steel pontoon barge on the lake. This is used as a platform for taking corings of the sediment deposits. Analysis will be made of the core samples to determine the degree of compaction, important in measuring the volume of the sediment. The survey will require a full year of field work and is to include the establishment of check points so that periodic measurements can be made in the future.

The sediment problem is not new. It was recognized at the time the dam was built but it was a problem that didn't need to be solved immediately. Now, at the narrow head of the reservoir, the silt is about 250 feet deep. In some portions of the main reservoir the original river bed is buried under as much as 100 feet of sediment.

Scouring out this material or by-passing the incoming sediment via diversion channels are two suggestions that have been considered and discarded because of the tremendous cost. The best solution seems to be to build another dam upstream to remove the sediment load from the water before it enters Lake Mead.

This would simply transfer the sediment problem from Lake Mead to the upper reservoir but the full plan goes further than that. Complete development of the Colorado is to involve the building of some 30 additional dams on the river and its tributaries. The river would be converted into a chain of lakes, each of which would act as a settling basin for sediment in addition to generating power, assisting in flood control, or providing irrigation water. Ultimately the fight against sediment will have to be carried even farther upstream and will consist of erosion-control measures in the areas that are contributing most of the sediment.

Colorado River water is hard and some engineers once thought that Lake Mead would slowly turn into a body of salty water too highly mineralized to drink. They reasoned that evaporation would concentrate the minerals year after year.

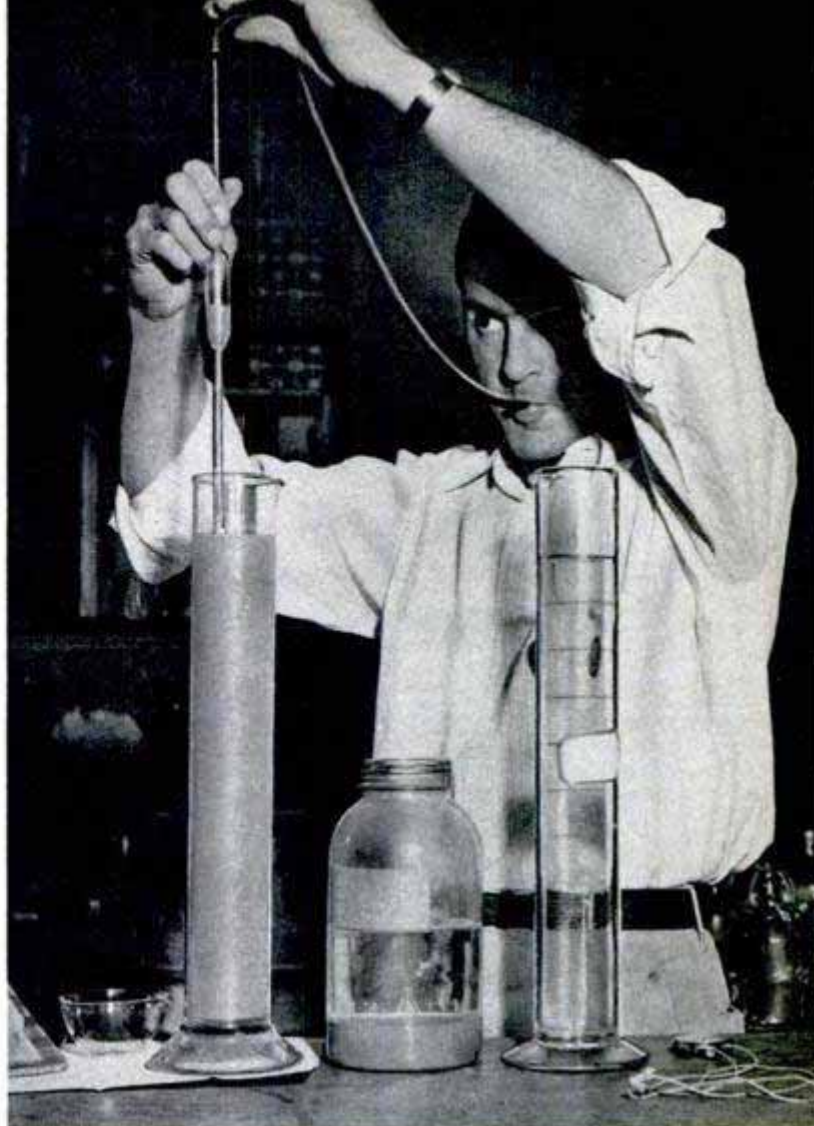

Beaker at left being sampled contains incoming river water full of sediment. Clear water at right is sample of water as it leaves reservoir. Below, coring tube with lead weights is dropped to measure silt deposit





Some day silt may clog intake towers behind dam which supply turbines

That fear has vanished now although evaporation plus the leaching of salts from the bed of the reservoir actually have increased the water's hardness. The average salinity of the incoming river is 575 parts per million and the average salinity of the lake itself is 650 parts per million. The discharge is even higher in mineralization and averages 680 parts per million, because the water that is discharged through the hydroelectric turbines is drawn from a depth at which the minerals are concentrated. The fact is that the salinity of the discharge waters seems to have passed its peak and to be gradually decreasing. Minerals consist mostly of calcium sulphate and calcium bicarbonate with some sodium, potassium and fluoride.

Hard as it is, the water is softer and better for agriculture than the water that irrigators used to draw from the river before Hoover Dam was built. This is because the salinity of the free river used to vary with

the season. The purest water came downstream in the great spring floods when water wasn't needed for irrigation. Salinity was highest in the summer just at the time when water was being diverted to irrigation ditches.

Today the reservoir mixes up a whole year's supply of water before it goes downstream and the average salinity remains pretty constant the year around. The Office of River Control estimates that nearly 10 million tons of salts have been kept out of irrigation ditches in the last 13 years because of the action of the reservoir.

Loss of water by evaporation from the 125,000-acre lake is tremendous. The estimate of a loss of one million acre-feet per year is computed from measurements of evaporation from floating pans of water and from pans that are placed on shore.

Water conservationists regard evaporation as pure waste even though this lost water isn't in demand today. Sometime in the future the demand for water from the river may exceed the supply and when that time

comes the water that just disappears into the air will be needed. One suggestion that may have to be tested is to coat the reservoir surface with some nonvolatile liquid such as a light oil. The thin film would prevent or reduce evaporation and would not affect the purity of the water or its value for generating electricity. Presumably the film would kill the fish life in the reservoir, at present a great tourist attraction, but eventually the need for additional water may overbalance the recreational value of the reservoir.

A moderate earthquake that rattles doors and windows is an alarming event to most people. Residents in the neighborhood of Lake Mead became accustomed to them in 1939 when 34 moderate quakes in one month indicated how the earth was adjusting itself under the weight of the newly filled reservoir.

Seismic activity in the vicinity hasn't again approached that high point but

earthquakes are still occurring and probably will continue as long as the reservoir is used. A week may go by without a shock being felt, then for a time there may be one or more shocks a day. Dozens of others too weak to be noticed are recorded by seismic instruments.

This continuing activity seems to be caused by the seasonal changes in the reservoir's level. Lake Mead has a total capacity of 31 million acre-feet and the water reaches its highest elevation in late July or early August. At that time the water load may be as high as 42 billion tons, depending on the degree to which the reservoir has filled.

By late March the normal discharge of water through the turbines draws down the level of the lake by 65 feet, reducing the impounded water to about 28 billion tons. The earth moves around under this varying load.

The Coast and Geodetic Survey maintains three seismograph stations in the vicinity of the reservoir and other seismographs are installed inside the dam itself. The purpose of the installations is to check the security of the dam and to obtain background information that will be useful in planning other dams. Seismic studies at Lake Mead have confirmed the early conclusions that there are no major faults in the vicinity and that the dam is safe.

Water temperatures in a reservoir might seem unimportant but they are of more than academic interest. At Lake Mead, for instance, they help in eliminating the floating debris and other river trash that might

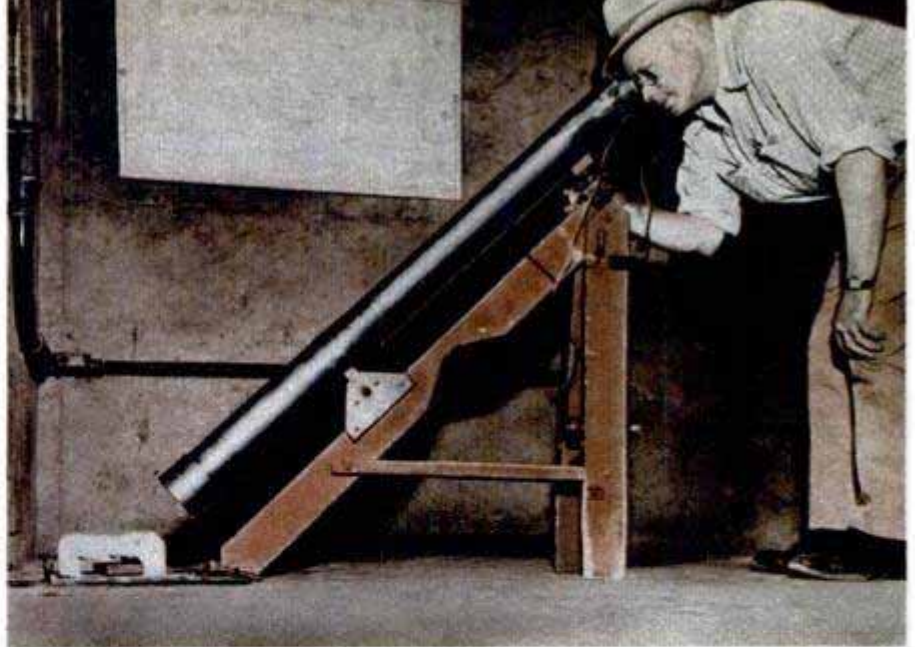

Tilt meter inside Hoover Dam measures slight seasonal movements of tremendous mass of concrete caused by changes in temperature

collect around the intake towers and become a problem. Logs, branches and other material that come down the river into Lake Mead collect in big rafts and remain at the upper end of the reservoir. This is because the inflowing water is cold. It flows into the lake as an undercurrent. A return flow occurs at the surface and keeps surface materials at the head of the lake.

The reservoir is a fisherman's paradise. Once that portion of the Colorado was too muddy and seasonally too warm for trout. It was always too swift for bass. Today rainbow trout are thriving in the cold, clear water below the dam and bass are multiplying in the quiet waters. A fisherman simply decides what kind of fish he wants and picks his spot accordingly. He's too content to worry about the two-billion-ton menace growing beneath this paradise.

Sounding boat used in silt survey carries sensitive fathometer and when reading is made sailors (right) take bearings on two shore markers to determine their exact location on lake. The Navy is cooperating in survey





Rotary Mower Cuts Tall Grass

Grass of any height is cut by a rotary power mower that has a single flexible blade. The blade revolves beneath the motor to cut even tall or tangled grass. The mower's frame is made of polished aluminum and the main wheels are equipped with pneumatic tires. Powered by a direct-drive vertical motor, the mower can be adjusted to three cutting heights. It is available in three models with 16, 18 and 20-inch cutting blades.



Lightweight Motorcycle

Weighing only 170 pounds, the newest entrant in the light motorcycle field is the Harley-Davidson 125, powered by a one-cylinder, two-cycle engine. It has a foot-operated three-speed gearshift and a handle-bar controlled clutch. The reinforced tubular-steel frame has a wheelbase of approximately 50 inches. For more convenient reading, the speedometer is mounted in the headlight housing. The engine is lubricated by oil mixed into the gasoline.



Garden Tool Makes Straight Rows

Straight garden rows are assured without stakes and string when a new tool is used to dig the furrows. A rod across the tool is set for the proper distance between rows. The tip of the rod then can be guided along the preceding row in digging the new furrow; or the tool can be reversed and the rod will scrape the earth to mark off the next row. After the furrow is dug and all of the seeds have been planted the tool is turned over and a corrugated roller covers the seeds with dirt. Two additional tines can be attached to the tool to convert it to a cultivator.

Tool's extension bar is guided along previous row to keep the row straight. Inset, tool is reversed and rolled over the planted row to cover the seeds

Our WHERE-TO-FIND-IT INDEX, which lists names and addresses of the manufacturers or distributors of products described in this issue, is available to readers without charge. For your copy, just write to Bureau of Information, Popular Mechanics, 200 East Ontario Street, Chicago 11



Safety Photo Trimmer Protects Fingers

Instead of the usual lever-type cutting blade that may drop on the operator's fingers, a new paper cutter has two blades only an inch apart and is operated by pressing down on the base. The operator never touches the blade, but merely places the paper under a transparent guide rule, presses down on the platen and the edge is trimmed. The cutter can be operated horizontally on a table or vertically when fastened to the wall. The platen and guide rule are calibrated to assure accurate trimming. With its 11¼-inch cutting blade, the trimmer will handle all popular print sizes.

Overlay Checks Shorthand

Students can easily check their shorthand characters with the aid of a transparent sheet printed with shorthand marks. The sheet, made of Celanese Lumarith plastic, is placed over the student's characters, offering an accurate comparison of the student's letters with perfectly formed letters. The characters appear in opaque red on the sheet. Any finger smudges can be wiped off the plastic with a damp cloth.



Twin Dials Measure Your Bite For Dental Work

Looking like a pair of earphones worn upside down, a new gauge for dentists measures the precise bite of patients being fitted with artificial teeth. Called a condylometer, the device has two dials that measure the movements of the condyles, those bony lumps just in front of the ears that move as the jaw is opened and closed. These measurements enable the dentist to construct better-fitting dentures.

Tool Welds Tread on Metal Floors

Iron or steel surfaces are given a nonskid tread by a vibrating hand tool that attaches to either a.c. or d.c. welding machines. The vibrating electrode holder causes intermittent arcing which melts the electrode and fuses the molten droplets to the floor. Five linear feet can be applied in a minute and no welding skill is required.

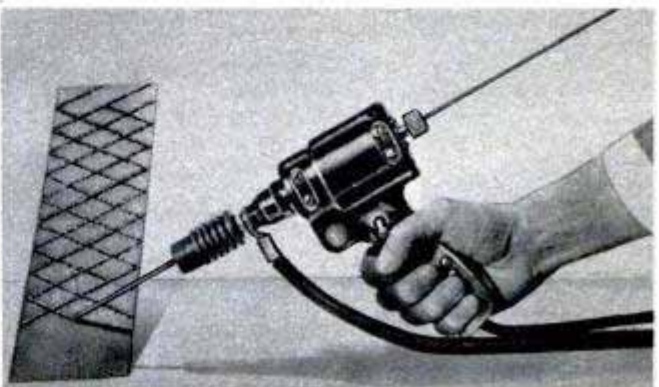

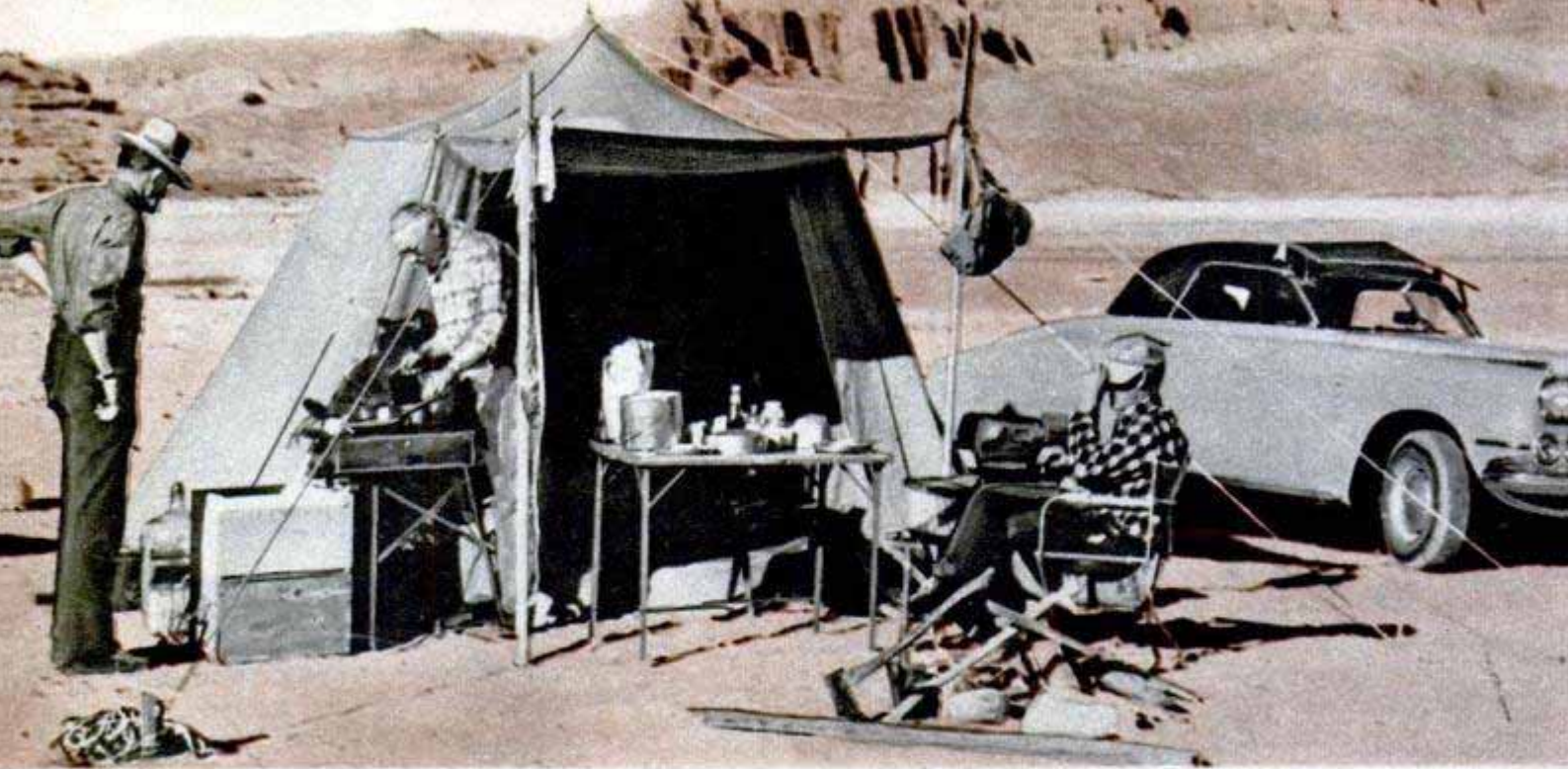

Fine for all-around camping, the umbrella tent is especially comfortable for the desert camp. There is sleeping space for several persons and it closes tightly for protection against wind and sand. The canopy provides shade during heat of day



Above, if you like to travel light, a sleeping bag with flap will keep you warm and dry even in the rain. On canoe trips, the paddles do extra duty as flap poles. Below, home is where you spread your bedroll when it has sheets and a real pillow





Inflating an air mattress is work, but it's worth it

CAMP in COMFORT

TWO ESSENTIALS for a successful camping trip are a rainproof tent and a warm, comfortable bed. Wise campers long ago learned the fallacy of imitating the hardy backwoodsman and "going light" with a meager tarpaulin for shelter, a thin blanket roll for a bed and a rock for a pillow. The summer camper goes for pleasure and health and, if he is wise, plans his outfit carefully for maximum comfort. The trick is to get real comfort without too much weight and bulk.

Adequate shelter being the major consideration, the most important item is the tent. It must be thoroughly rainproof for one driving shower can soak the bedding, ruin the food supply and wreck that long-planned trip right at the start. If you are not sure your tent will shed a hard rain, erect it in the back yard and turn a hose stream on it. If one drop of water goes through, you'd better not plan to use that tent if you want to stay dry.

Of the many types of tents on the market, we can here consider three, each of which has certain advantages depending on your mode of transportation, whether it be by foot, auto, pack horse or canoe.

The umbrella tent: This all-purpose tent—granting that moderate weight and bulk are permissible—is almost universal for the automobile camper. It comes in sizes from about 7 by 10 feet, adequate for two persons, to a four-man size, which is 11½ to 12 feet square. The smaller size, in good, durable, 10-ounce twill, will weigh only about 25 pounds with center pole, while

Bugproof, the mountain tent has a canvas floor. Circular door fastens snugly. "Pipe" above it lets in air

By Claude M. Kreider

Photos by Ray Chapin

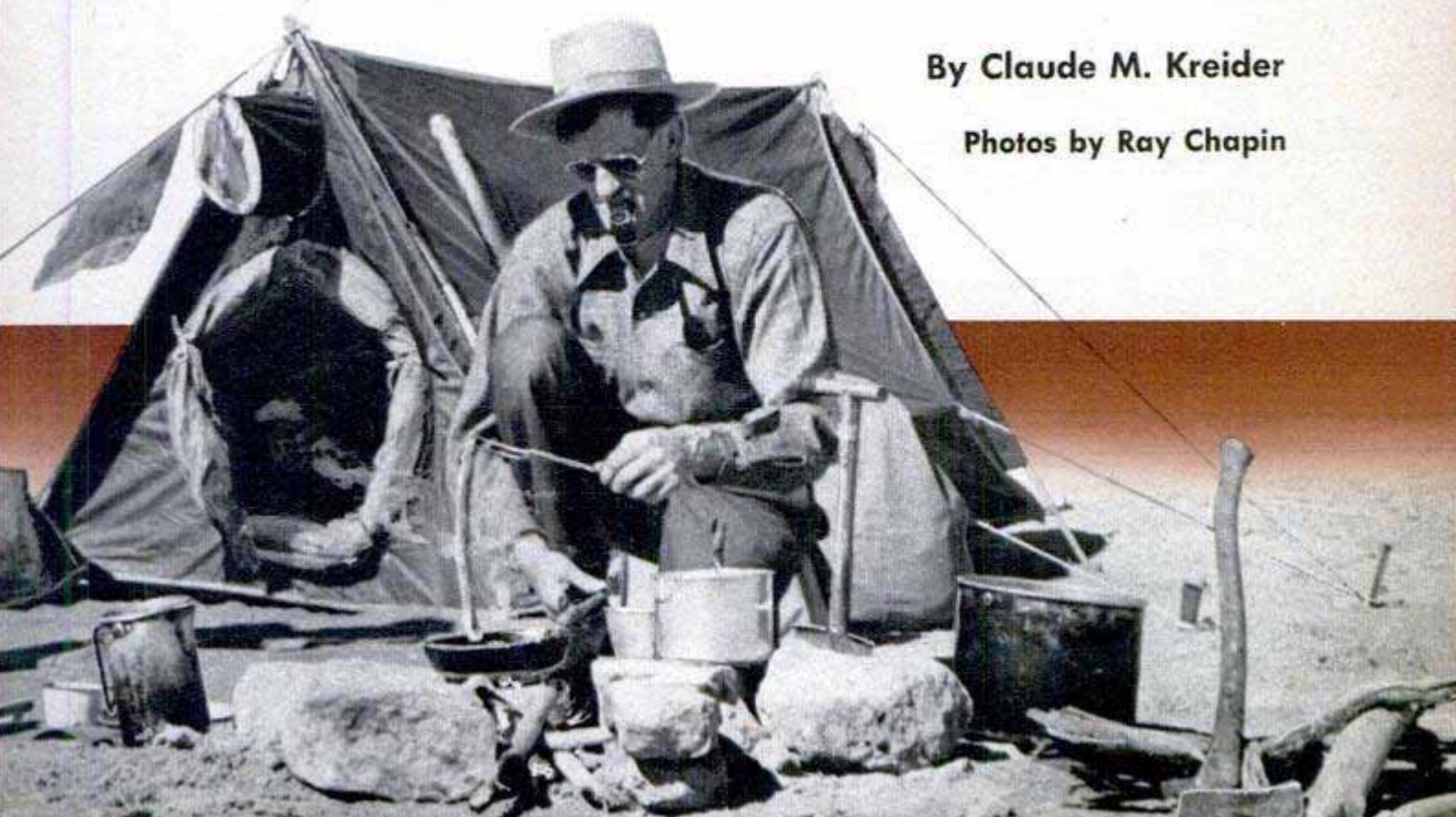

the larger tent may weigh 35 pounds. Made of lighter and more expensive fabrics, either tent will weigh much less, but it will be less durable. The saving in weight and bulk is not important when transportation is by automobile. Of course, all such tents have sewed-in floors.

For the mountain pack trip, where every pound of weight must be considered and the whole outfit goes on a mule's back, the smaller umbrella tent is a practical shelter that takes up no more space than a small sleeping bag. The jointed center pole is as easily carried as a fishing rod and the necessary shovel. With this tent you're sure of a dry camp when that first heavy thunderstorm pelts down. Likewise, the 11-foot tent easily pays its way on the trip when the party numbers three or four persons.

All good umbrella tents have a mosquito curtain of netting or stronger bobbinet sewed in at the top of the door flap, either to tie down along the sides or fitted with the tighter zipper fastening. This is essential, not only in mosquito country, but also to repel flies when you eat inside the tent. On warm nights with the tent flap back and net curtain tight, you sleep soundly, unbothered by flying and crawling insects. In cool weather, the flap is tied down and sufficient air is admitted

through the one or more net-covered windows of the umbrella tent.

This tent has the additional advantage of ample headroom at any point since the sides are nearly vertical. One type has a jointed center pole, with a four-arm stretcher sliding on it, each arm of which is inserted at a top corner of the tent. Many campers prefer this center pole, due to its comparatively light weight and the four stretchers are handy for hanging clothes. Another tent has four metal corner poles with sliding stretchers extending from each pole to the peak of the roof. This type provides an all-clear space inside, but is heavier and requires more time to erect.

At least eight steel pegs, not less than 10 inches long, are needed for the umbrella tent. Additional protection against strong winds is provided by guying the tent peak and its four upper corners to additional pegs. Iron half-hooks welded to the projecting ends of the stretchers, make this job a quick and easy one, anchoring the tent for anything but a gale. Another advantage of this tent is the wide door flap, which may be erected as a sunshade under which to sit or dine in hot weather.

The pyramid or miner's tent: Here is perhaps the most comfortable tent for its

(Continued to page 250)

The lightweight pyramid tent sleeps three comfortably and its steep sides shed water in the heaviest rain



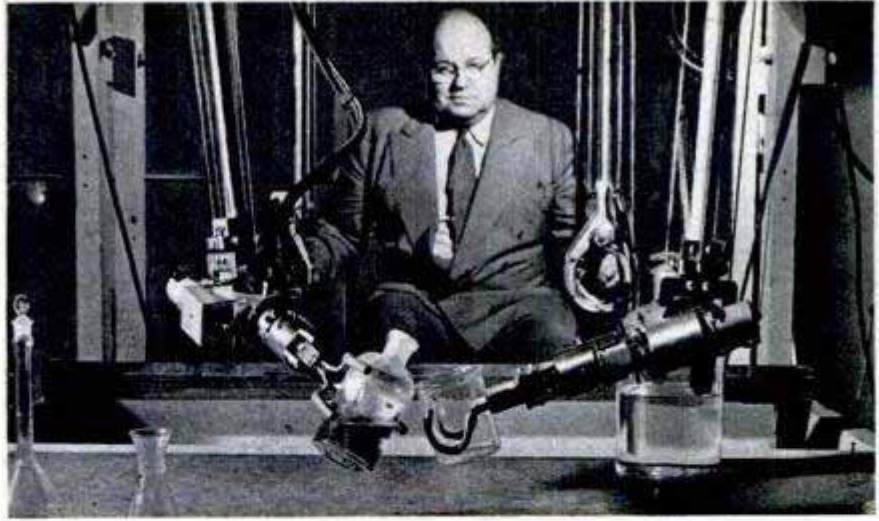
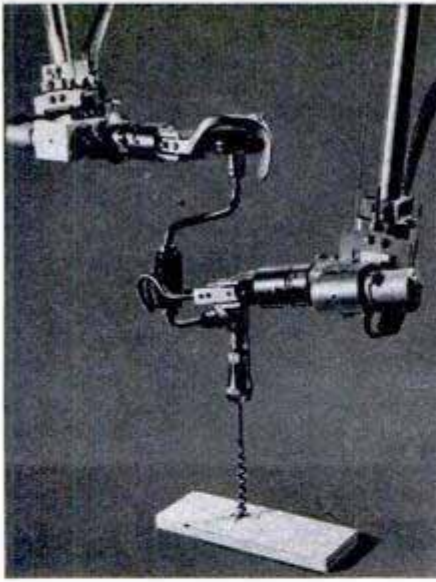

Mechanical Hands

Designed for use by remote control in radioactive areas, a pair of mechanical hands can do everything human hands can and more. The hands extend over a protective wall into the radiation area while the operator controls them from a safe place. Most movements are mechanical, being controlled by linkages with the handles, but wrist action is electrical. This permits the wrist to twist around completely any number of times, a feat which is particularly useful when unscrewing a nut. Interchangeable hands are used for different operations. Some are highly specialized such as one

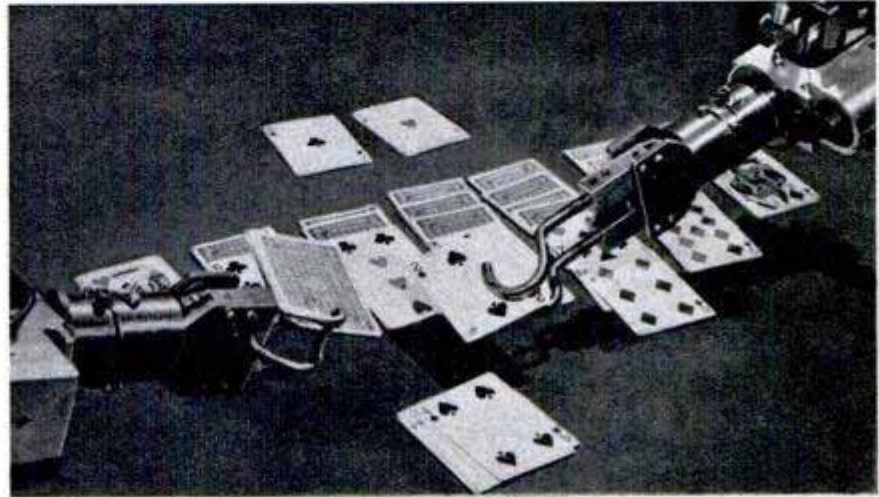

By remote control, mechanical hands do anything the operator (see upper photo) wants: pour chemicals, bore holes, or even play solitaire

hand that consists of a pair of snips instead of hooks. Control of the hands is so sensitive that a gentle squeeze can be applied to break the shell of a hard-boiled egg without damaging its contents.



Trench Digger

Foundations and shallow trenches are dug by a bucket-line machine that can be towed behind a small tractor or jeep. The machine digs a trench from one to 30 inches deep and 12 to 18 inches wide. The endless bucket line brings the dirt to the top of the machine where it is dumped onto a conveyor and moves off to the right of the trench. Powered through the take-off of the tractor or jeep, the digger has a 180-to-1 gear-reduction attachment which slows the vehicle to a "walk" of 160 feet per hour.

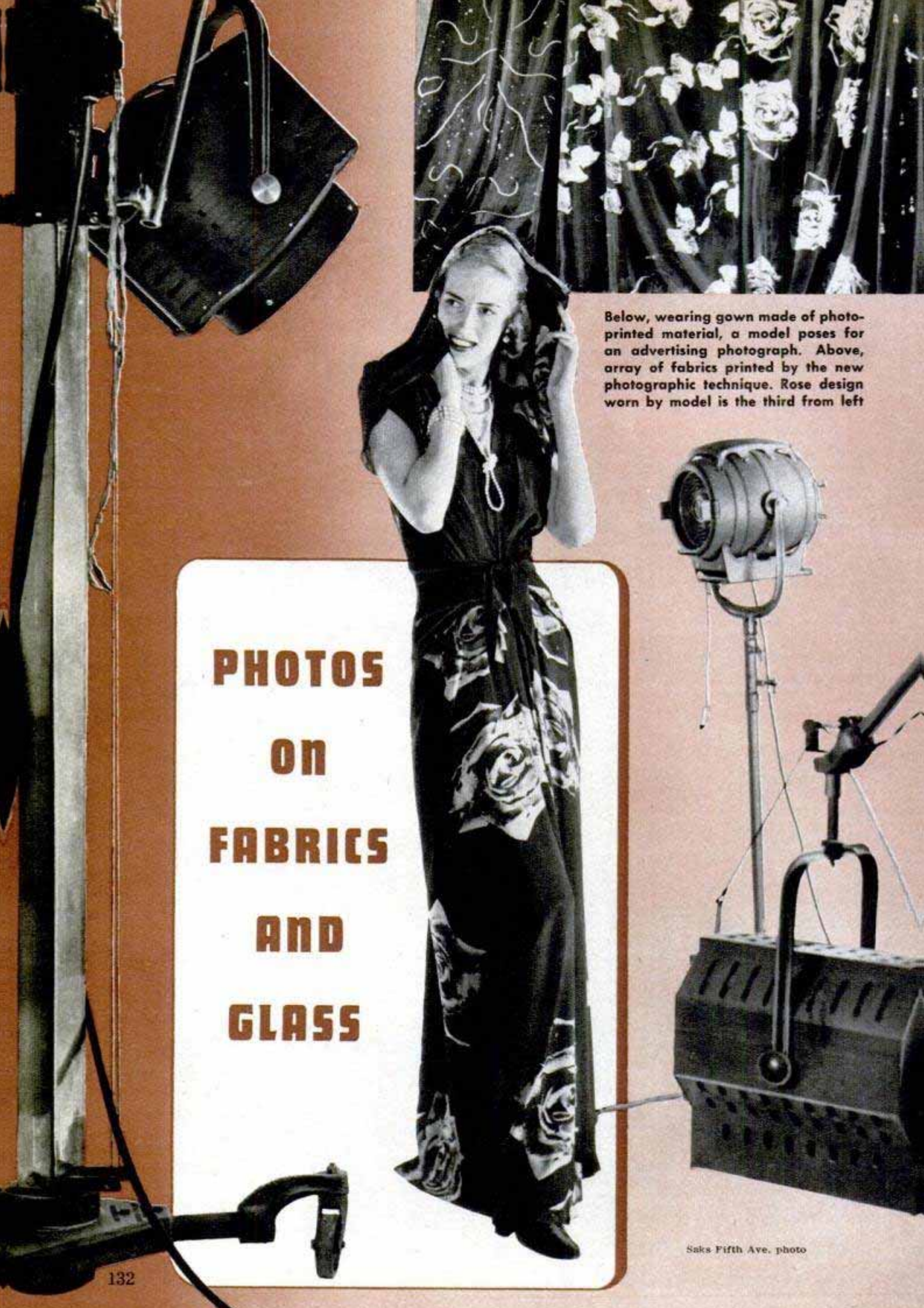

Below, wearing gown made of photo-printed material, a model poses for an advertising photograph. Above, array of fabrics printed by the new photographic technique. Rose design worn by model is the third from left

**PHOTOS
ON
FABRICS
AND
GLASS**

Saks Fifth Ave. photo



By Bill Reiche

PHOTOGRAPHY has come a long way since the days of the tintype, but it still has its eye on the future. Not satisfied with pictures that you merely look at, it is now making some you can wear and use.

The cameraman is invading the fields of fabrics and ceramics. You will soon be wearing photo-printed neckties and eating from photo-decorated dishes.

Fundamental techniques in the art are unchanged, but it is finding new vehicles of expression. It is beginning to free itself from the limitations of film and paper—useful as these are—and is aiming for bigger targets.

The printing of photographs on fabrics will probably be the biggest development

Chemist at light table cuts master printing film in laboratory. At rear, another chemist mixes dye for emulsion as girl proves that fabrics can be ironed

industrially and by far the most obvious insofar as the public is concerned. You will soon be seeing Sinatra's portrait on bobbysoxers' shirts, photographs of fire engines on frocks, and the photogenic Grand Canyon on sofa pillows.

While photographic fabrics will undoubtedly strike the eye most frequently, the scientific-minded will be more interested in a process for printing photographs, not on, but in glass. Pottery, metal and plywood are other substances which are or will soon be used as carriers for the modern photographer's art.

The development of photosensitive glass at the Corning Glass Works goes back to 1937, when Dr. Robert Dalton discovered

Technicians put master printing film on rollers. Goggles shield their eyes from rays of mercury-vapor lamps





Left, examining negative and photosensitive glass before inserting them in contact printing frame at right

that certain ruby glass could be permanently changed in color by ultraviolet irradiation and heat treatment. Before the war, a clear glass was made in which ruby-colored designs could be "printed."

The war interrupted the photosensitive-glass project, although photographic glass almost turned up as legal tender. The Treasury Department was interested in making coins of this material to save critical metals, but the vast quantity required in a hurry exceeded production facilities and the idea was dropped.

Prime ingredient in the photosensitizing process is the introduction into the glass of metallic particles so small that they cannot be seen under a high-powered micro-

scope. Different metals produce different colors in the finished print.

The glass is exposed to ultraviolet light through the film or glass negative—the light preferably being of high intensity and essentially parallel, but it can come from a number of sources. Sunlight, sunlamp, mercury arc or carbon arc may be used for the exposure.

The picture is produced by the precipitation of the metallic particles in the glass. These particles are so fine that the image is virtually without grain. The exposure is made with a contact printing frame and no special precautions need be taken with the glass except to shield it from potent sources of ultraviolet until it is used.

The development of the latent image is completed when the exposed glass is heated to 1000 degrees Fahrenheit in an electric furnace.

Various glasses, depending on their metal content, produce one or more color shades in the finished picture. One glass will give a blue, purple, ruby or orange image, another yellow or brown, and a third only a bright red. The color a particular glass produces is the result of the exposure time. Thus, after a period of exposure which would produce an all-purple image, part of the negative can be masked with black tape and the remainder, after continued exposure, will be ruby.

The picture is three-dimensional, in some cases the image penetrating the glass as much as two inches. Exposure time and duration of heat treatment, either separately or in combination, establish the depth of the image. The finished picture is indestructible, unless the glass is shattered; unalterable, unless again subjected

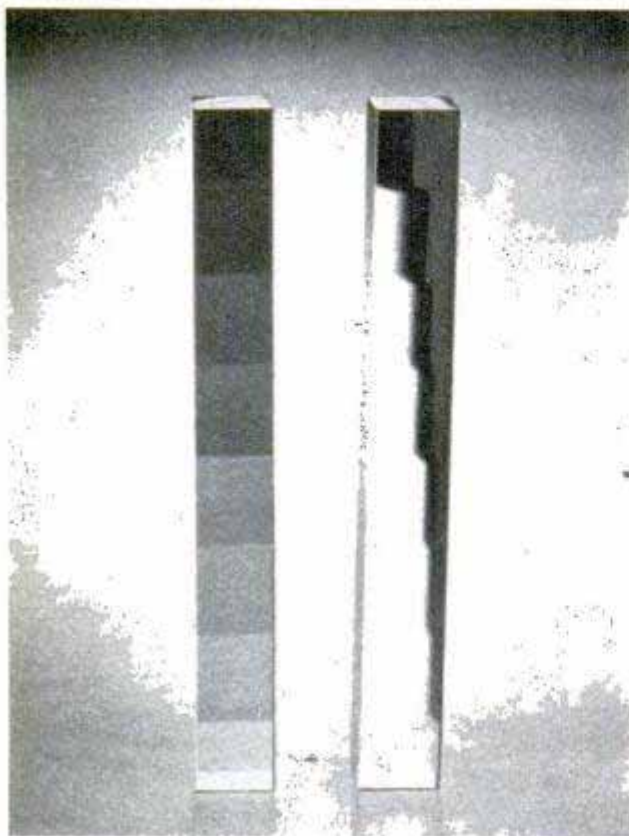

Color and depth of glass picture vary with exposure time. Seven different exposures are shown on strips



Above, exposing a photo glass to ultraviolet light. Right, the exposed glass is then heated in an oven

to 1000 degrees temperature, and ageless as far as any apparent or predictable deterioration is concerned.

The three-dimensional effect of the image is heightened by the fact that dark areas in the image penetrate deeper into the glass than the high-lighted portions.

Photosensitive glass can be worked like ordinary glass; it can be drawn, rolled, blown or pressed in the conventional manner. If extra strength is desired it may be tempered.

The potential uses for this material are almost unlimited, but some which suggest themselves are portraits, land and sea scapes, tableware, costume jewelry such as portraits in pins or rings, photomurals, decorative tile, church windows, advertising displays, scratch and heat-resistant instrument dials, and slides for projection.

Special lighting of the glass picture increases its general effectiveness, particularly when opalescent glass is combined with the clear variety. The opal glass, such as used in lighting fixtures, contains microscopic transparent crystals which scatter light in every direction. It can serve to some extent as a shading medium or, by directing the light on the opal glass, a self-illuminated effect is achieved.

A score of glass and research firms in many parts of the country have been licensed by Corning to use its photosensitive glass. Considerable testing is being done to discover the most economical use for the material. Incidentally, its cost is not much greater than that of ordinary glass of equivalent quality.

Photographic decoration of fabrics has been described as a step "snapping textile printing out of a hundred-year lethargy." Men in the field insist that a revolution in

(Continued to page 230)

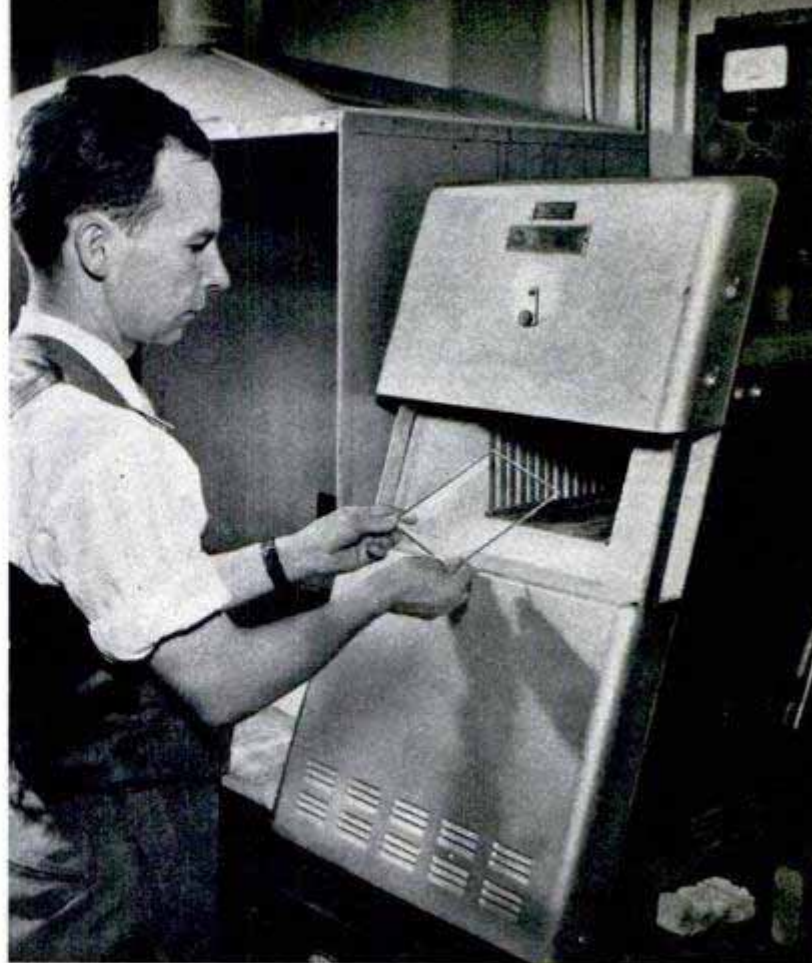

Below, after baking, the completed photo is removed





Luxury Bus Has Snack Bar

Snacks are served en route aboard new express buses operating from Chicago, New York and St. Louis. Each of the luxury buses, placed in service by the American-Burlington Buslines, has a snack bar with a stewardess in attendance where sandwiches and cold drinks are available. Other improvements include complete lavatory facilities, reclining seats, and a two-way radio telephone and complete air conditioning. The seats have individual reading lights. The buses, built on a 41-passenger chassis, seat 32 with the extra space devoted to the lavatory, snack bar and more leg room between seats. All seats on the new buses are reserved.

Electric Cart Keeps Meals Hot

During loading delays, meals for airline passengers are kept hot in dining service carts that can be hooked to portable motor generators. The mobile cart is of steel-frame construction, with aluminum skin, measuring three feet wide, five feet high and eight feet long. Inside, the hot food boxes and liquid containers have electric heating elements that are plugged in when placed in their respective compartments. The cart is wired for 24-volt d.c., the same as that in DC-6 buffets.



United Air Lines photo

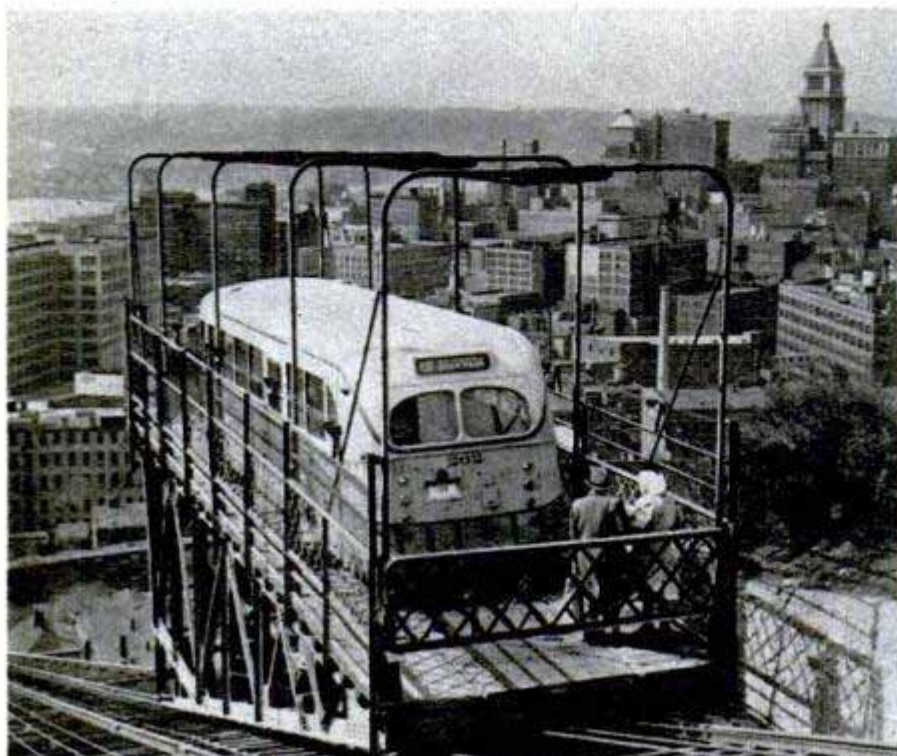

Buses Ride Trolley In Cincinnati

Buses, as well as their passengers, are getting rides now on a route in Cincinnati. They are loaded on platforms controlled by cables for trips up and down a 980-foot incline. A second set of tracks and cables makes it possible for buses to pass on the slope.

☐ About 20,000 tons of steel are used every year to make license plates for motor vehicles in the United States.

Retractable Skis for Planes Permit Landings on Snow or Concrete

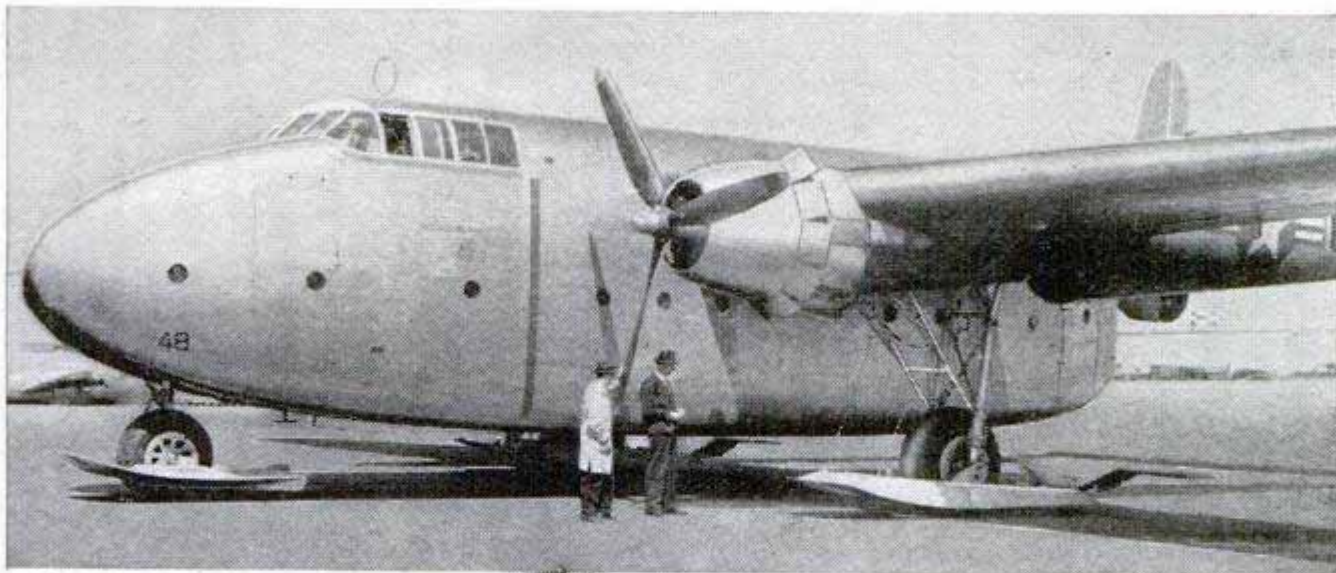

U. S. Air Force photos

Right, installation features first use of ski on nose wheel. Main skis have a wing

Landings on either snow or solid runways can be made with a retractable ski-wheel combination developed for U. S. Air Force C-82 cargo planes. The skis, which are raised or lowered electrically in flight in relation to the plane's wheels, are 16 feet long and four feet wide. The center portion is cut out to permit the wheel to protrude through the ski. A small wing at the tail end of the main skis holds them in place during flight, when the gear is about three fourths retracted.



Shield on Ventilator Wing Keeps Rain Out of Auto

Water can't drip inside the car when the ventilator wing is open during a rainstorm if a metal shield is attached to the bottom of the pivoting window. The device is held in place by a simple snap-on clamp. A rubber seal fits tightly against the glass to prevent leaks. The water that drips down the ventilator collects on the shield and the flow of air drives the water outside the door.

Sources of supply for the new products described in this issue are listed in the WHERE-TO-FIND-IT INDEX. For your copy of the index just write to Bureau of Information, Popular Mechanics Magazine, 200 E. Ontario St., Chicago 11. The Bureau will be glad to answer any other questions you may have on material published in *Popular Mechanics*

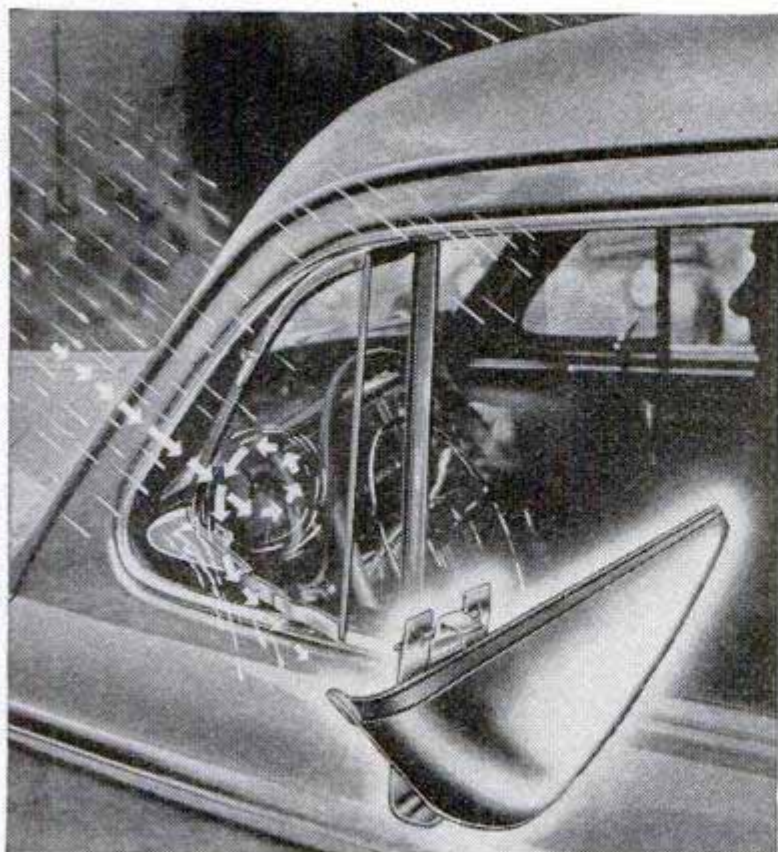



fishing for Shark

By T. T. Mosby

← After gaffing one of the undersea killers, a sharkier hauls him over the side

↓ Several tons of shark, rich in Vitamin A, are stacked aboard this vessel. Most vicious of the lot is the leopard shark

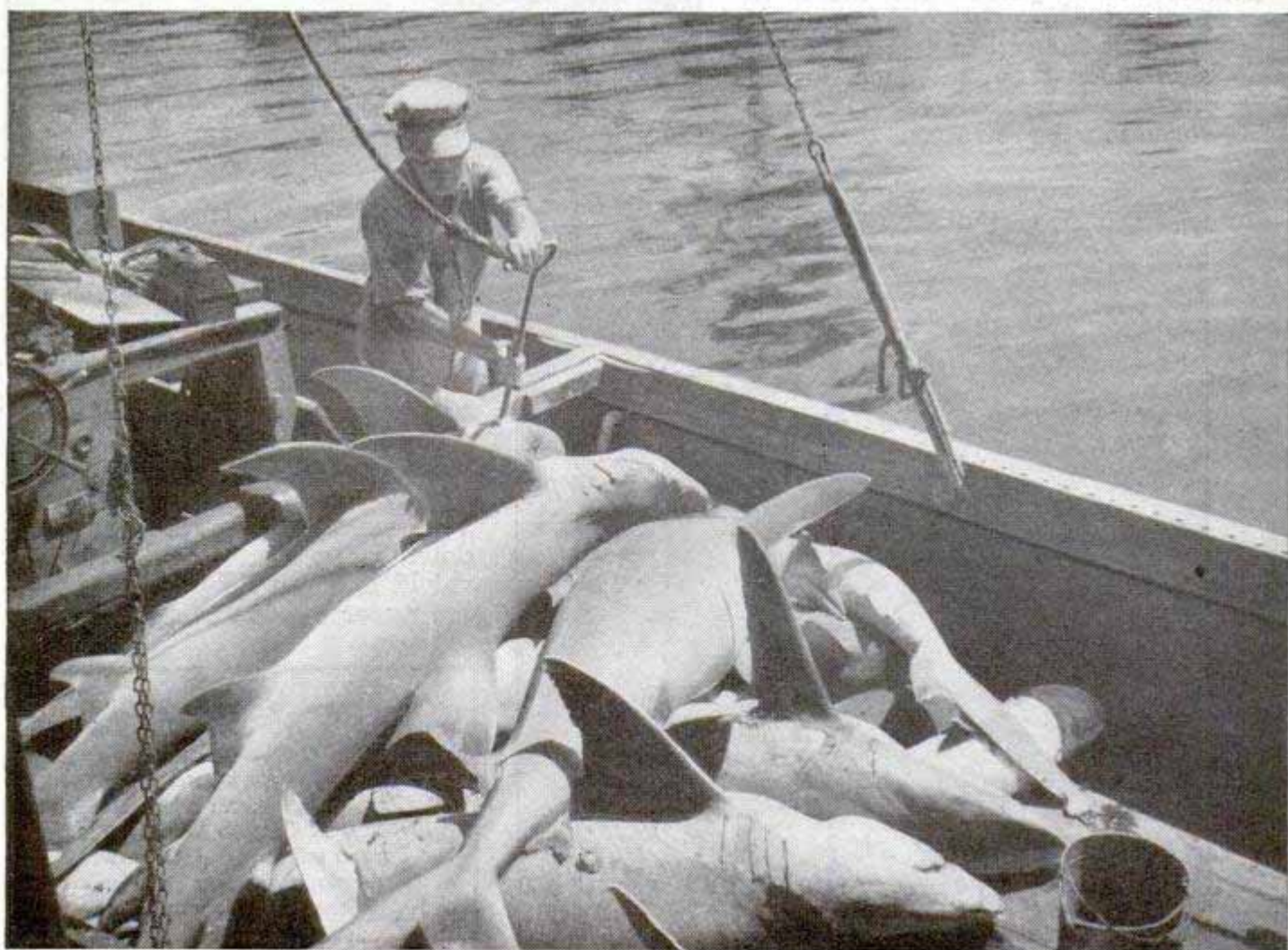

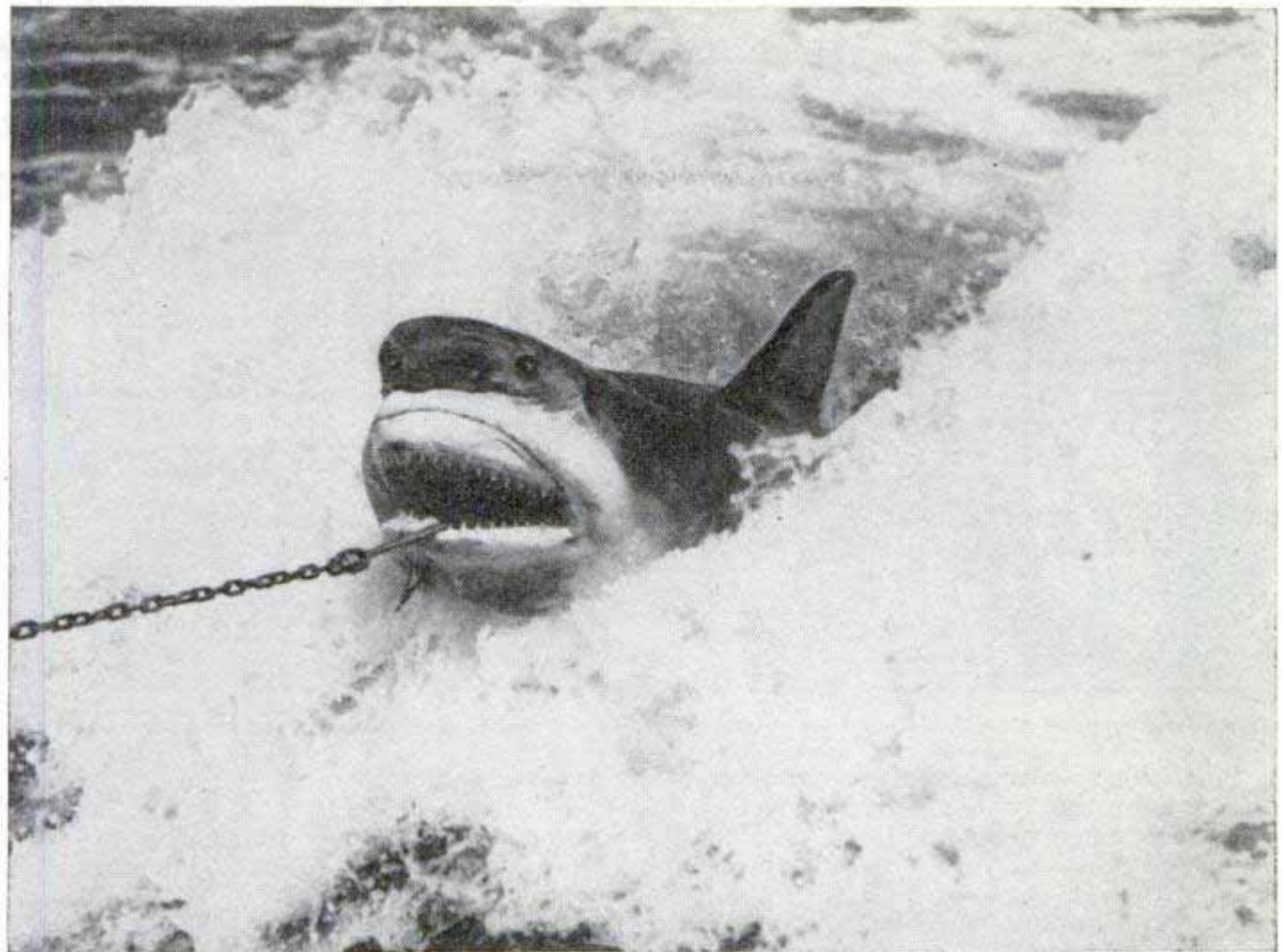

TO SHARKERS the Caribbean is a vast, rich, fishing ground. Wartime research disclosed that the shark is a valuable source of Vitamin A, so more and more fishermen are hunting this vicious undersea killer whose liver and by-products find a market all over the Western Hemisphere.

Today, every part of a shark is valuable: the liver contains Vitamin A; the fins are delicacies in Chinese restaurants; the hide can be sold to leather manufacturers; the meat is eaten all over the world; the carcass is ground into meal for poultry and livestock; even the teeth can be sold—as souvenirs. Recently, the shark's backbone has been found to contain great amounts of calcium, thus adding the dog-food market to the list of outlets.

In the past, sharks have been caught with nets. The bulk of the industry was on the Pacific Coast, where the largest catches still are made, but the Caribbean area promises to reap more valuable catches since the advent of a new shark-fishing rig which utilizes steel cable.

Note the wide mouth on this ugly fellow, pulled alongside by chain. Below, diagrams show two methods of setting chain rig. Some sharkers now use heavy cable instead of chains

Courtesy Commercial Guide to Shark Fishing

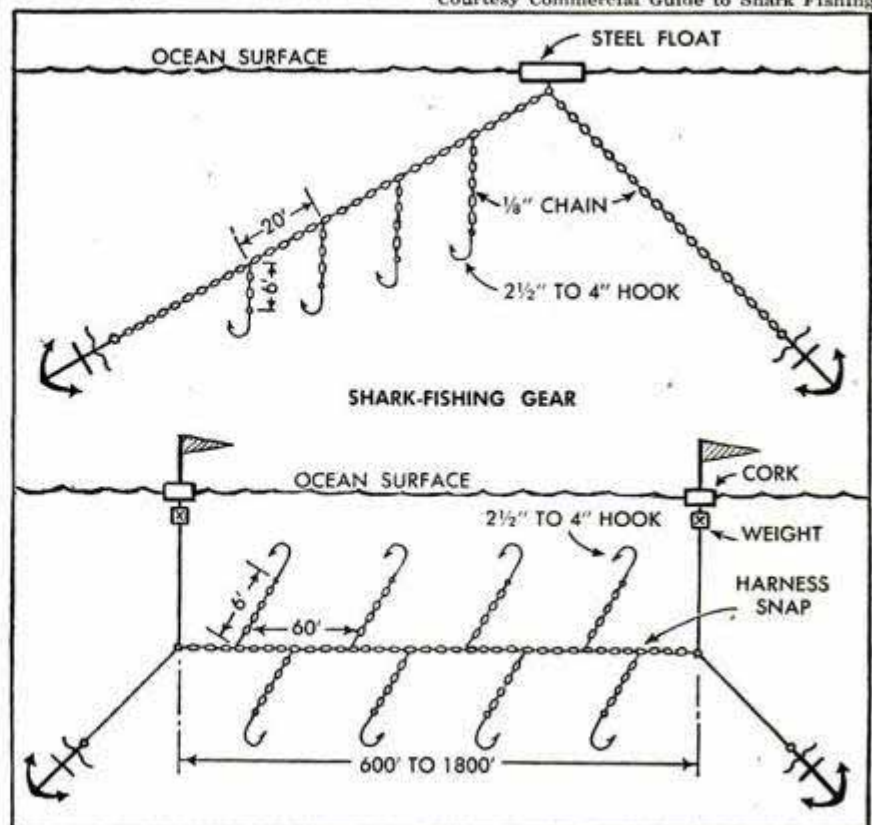

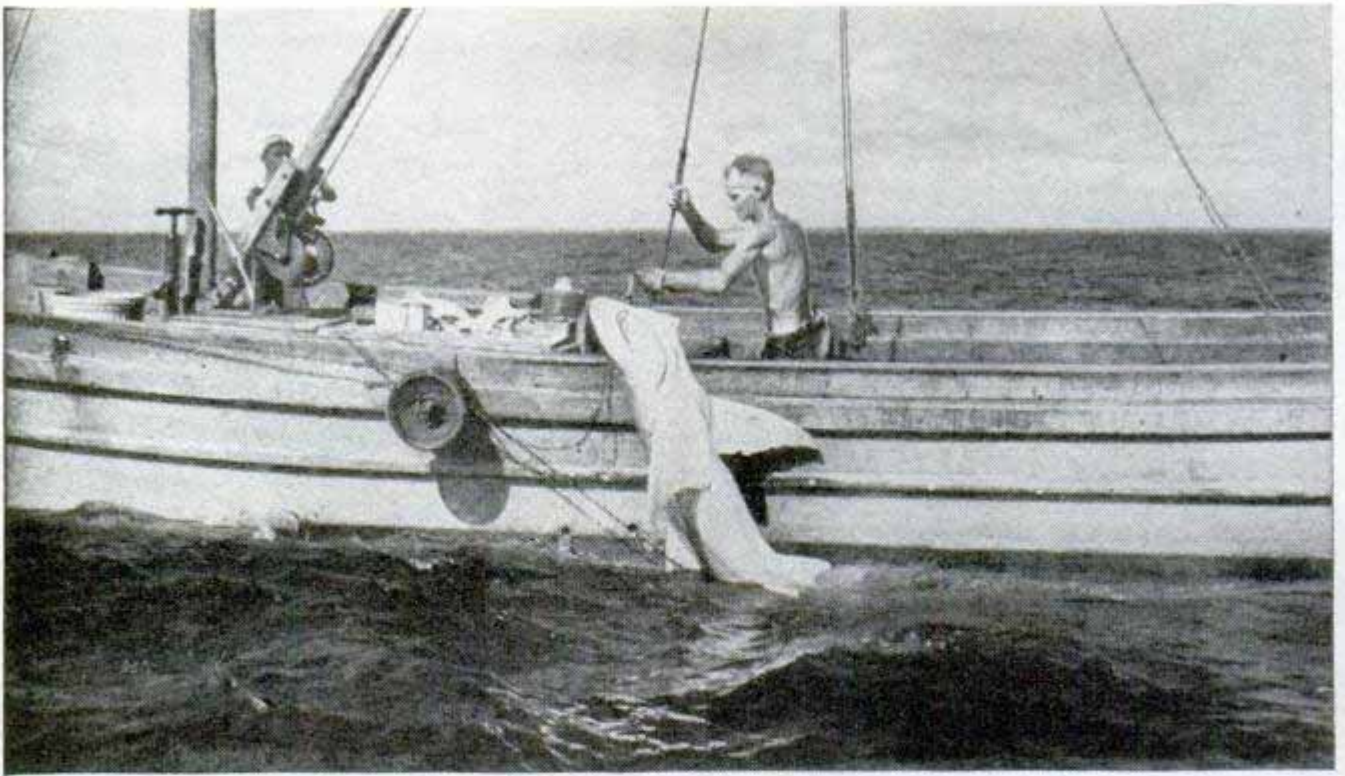

Winch hauls aboard a medium-sized killer. If still alive, he will be quieted by swatting his tender nose

Since deep-water sharks are more valuable than the shallow-water varieties, shark fishermen early saw the need for a rig which would put the giant 5-inch hooks in depths over 100 fathoms. Heavy chain lines were bulky and dangerous under certain conditions. Then a Key West shark-er developed a method which has been rewarding him with unusually large catches. This method, which consists of laying a mile of stranded steel cable strung at 30-foot intervals with 12-foot chain leaders, is also used by Thompson Enterprises, Inc., whose vessel, The Heron, is now equipped

with gear capable of bringing in the huge 14 and 15-foot monsters.

Sharkers begin their operations by filling lockers in the vessel's hold with bonita, yellowjack and barracuda for bait.

Because there are more than 40 different species of sharks in the Caribbean area, the skipper of a shark boat must use all his knowledge of fishing, plus hydrographic charts, to pick a likely spot for his hooks. Sharks vary in value according to type, habitat, season and sex.

As soon as the boat reaches an offshore

(Continued to page 220)



← Cutter in a processing plant slices the meat into steaks which will become prize delicacies on restaurant menus

↓ Many of the organs are ground into a meal, high in protein, which is packaged as feed for poultry and livestock

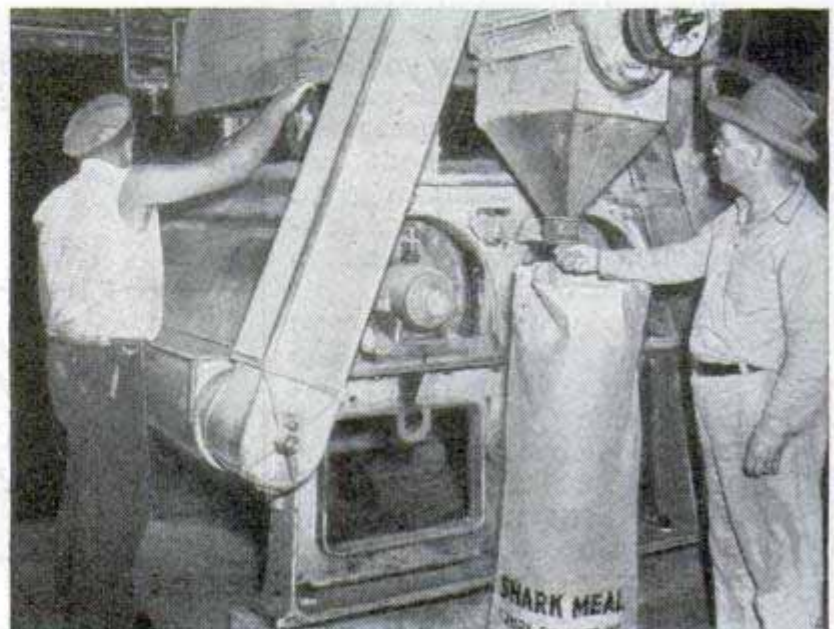

Navy Repair Shop Has Glass Walls

Everything from 16-inch battleship gun mounts to delicate optical instruments can be rebuilt in a new six-story naval repair shop whose walls are built of glass to provide even interior illumination. Heat and glare resistant, the glass covers 80 percent of the exterior walls and roof of the building, located at the San Francisco Naval Shipyard, Hunters' Point, Calif. One large work bay has a ceiling 67 feet high and is equipped with 40 and 60-ton traveling cranes for moving heavy ordnance pieces. An outside crane with a capacity of 15 tons will hoist submarine periscopes from railroad cars to the top floor where they may be set up inside a glass-enclosed tower for testing and

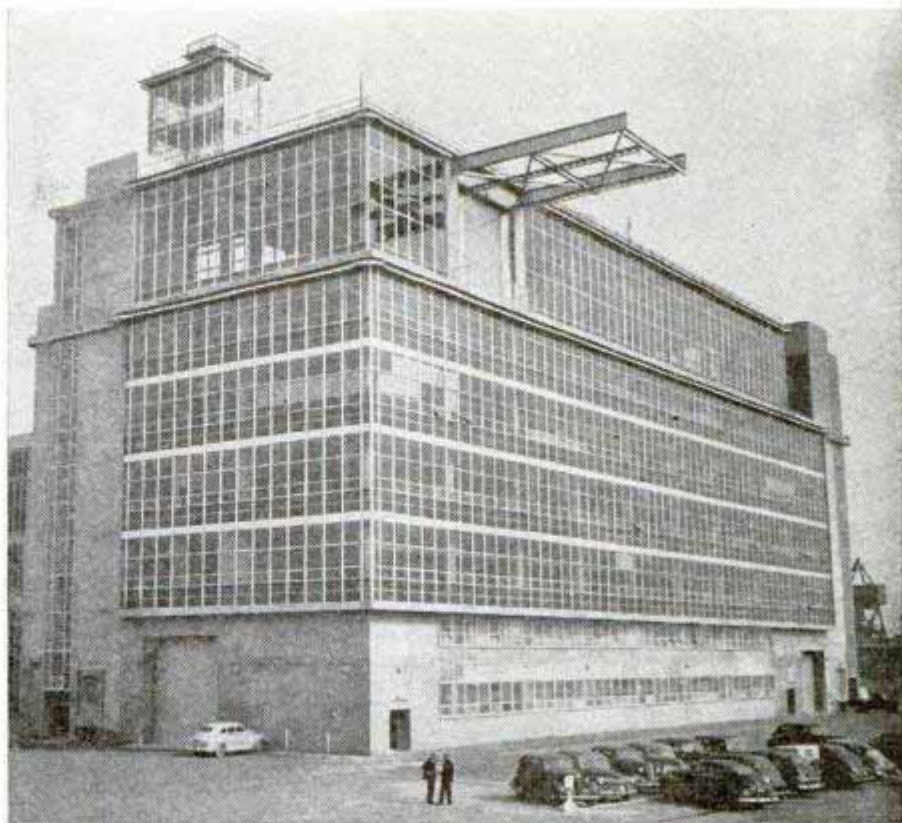

calibration. The building rests on wood and concrete piles driven some 45 feet into the ground and spaced 5 feet apart.

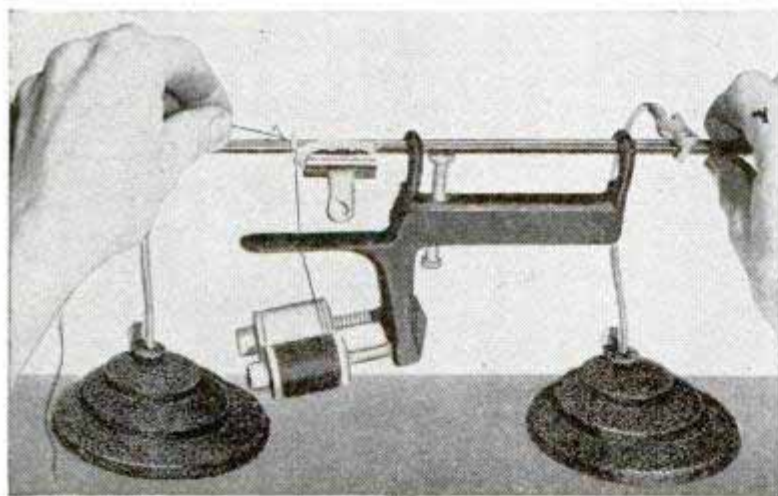

Fishing-Rod Wrapper

Wrapping a fishing rod is done in half the usual time with a semi-automatic machine that lays down any thread evenly, tightly and without bunching. It also ties the thread under automatically. The rod, supported by two uprights, is rotated by hand during the wrapping operation. If desired, two threads can be wrapped simultaneously. The machine can be used also for wrapping golf clubs and for fletching arrows.

Stray-Parts Auto Goes 130 M.P.H.

With 12 speeds forward and two in reverse, a high-powered car built by Walter Johnson, a mechanic of Akron, Ohio, zooms along the highway at 65 miles an hour in low gear. Johnson calls the car the "Mongrel 8" because it's made up of so many stray parts. In a test on the sands of Daytona Beach, Fla., Johnson cruised along at 130 miles an hour and believes the homemade auto is capable of 40 miles faster. The sleek body and fenders



are electric-welded. Johnson figures he has invested only \$200 in his creation, and has turned down an offer of \$5000 for the car.



GLASS WALLS are made of two-pane units joined rigidly by an interlocking device. The panes, five times stronger than ordinary glass, fit in an aluminum frame and are used for inside or outside walls

STEAM CONVERTER consists of a tank and steam chamber. It changes "dry" electric iron to steamer

WHAT'S NEW *For Your Home*

Sources of supply for these products may be obtained from Bureau of Information, Popular Mechanics Magazine

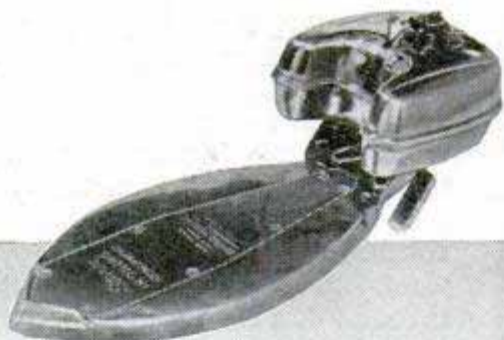

TEETHING RAIL lets the baby chew away on the crib rail without danger. The three-sided guard is formed of a smooth plastic that resists biting. It is easily slipped over the crib or playpen railing





NONCLOGGING SHAKER assures free-pouring salt in damp weather. A chemical vial in shaker absorbs all moisture. When saturated, chemical turns pink and can be dried in oven

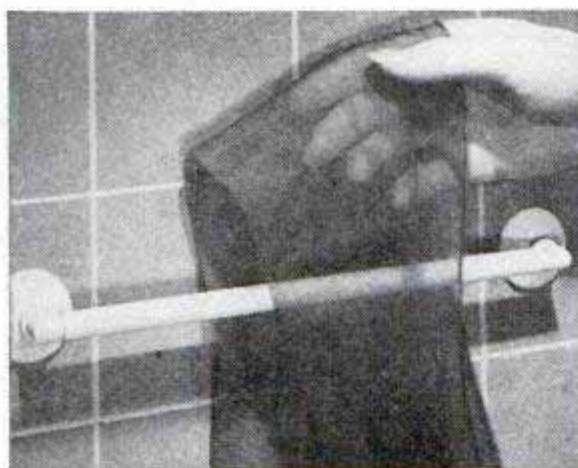

STOCKING RACK, made of snag-free Tenite plastic, is fastened to wall by suction cups

CORD REEL winds up excess wire between lamp and wall plug. It's molded of Bakelite plastic

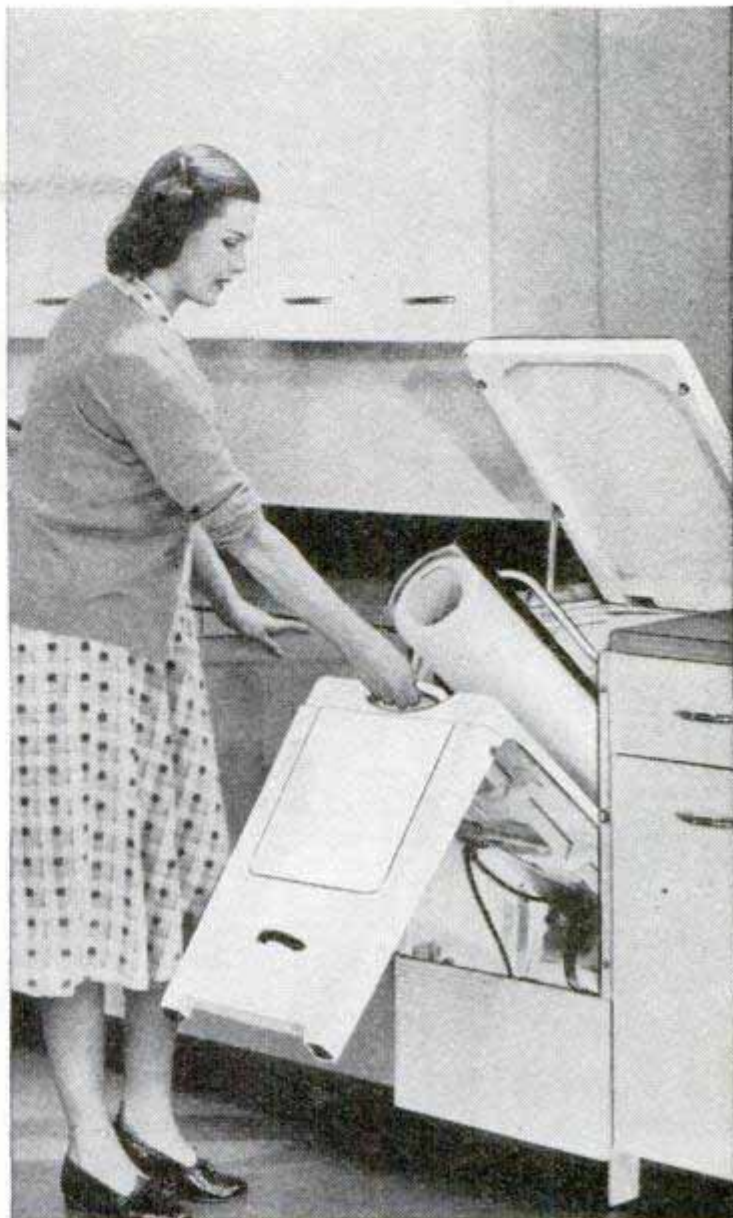
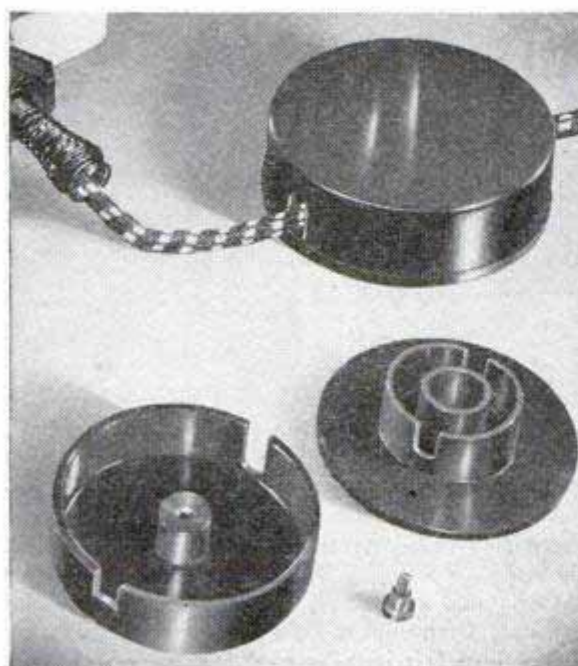

FOLDING IRONER slides out of sight in counter cabinet when not in use. It is counterbalanced for easy opening

THERMOSTATIC REGISTER for warm-air systems closes when room reaches the temperature set on the control dial



TREE CUTTERS

TREES are lopped off in sections and gently lowered to the ground by a hydraulic cutter which prevents damage to near-by buildings. The machine is used in Columbus, Ohio, to remove trees killed by the deadly disease called phloem necrosis. The operator wraps a steel cable on a boom around the upper part of the tree. The saw cuts through the upper branches, which are lowered by the boom. Lower sections of the tree are removed in the same way. An automobile engine operates the hydraulic pump which powers the cutter. A mechanical cutter in operation in North Carolina cuts through trees up to 40 inches in diameter, saws them into log lengths and loads them on a truck. The cutter is credited with producing 40,000 board feet of logs per day.

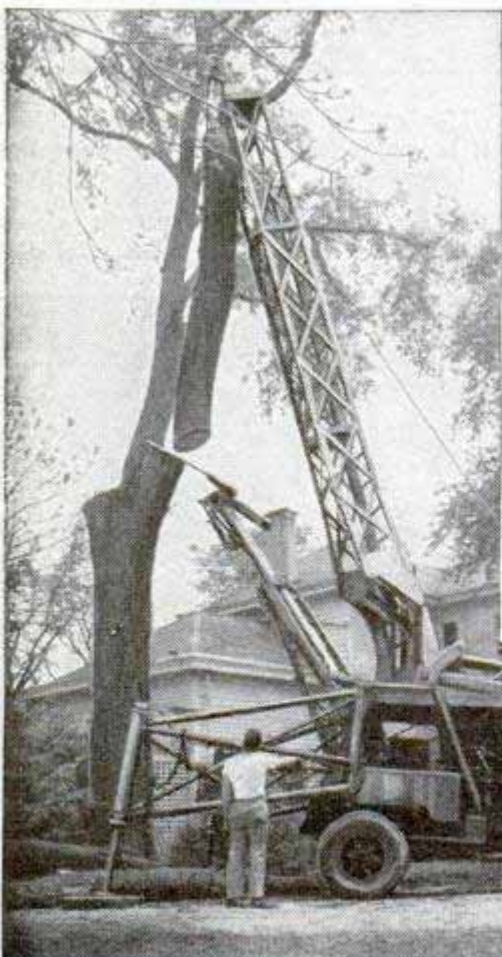

Top, operator climbs a ladder on the boom to wrap a cable around the top part of the tree. Left, saw is raised into position and cuts through one of the main branches, which is supported by the cable and boom. This section then is lowered gently to the ground to avoid damage to near-by buildings. Above, another cutter, used in forests, cuts a tree close to the ground. Then with the aid of the boom the trunk is cut into log lengths and loaded on a truck

Motorcycle for Invalids Has One-Hand Control

Designed for invalids, a British three-wheeled motorcycle has an ingenious control mechanism that permits driving with only one hand. Throttle, brake, clutch, gearshift and steering handle are combined in a compact control head. A gasoline engine is mounted in front of the right rear wheel and is completely enclosed except for the air-cooled cylinder head. The vehicle goes 80 miles on a gallon of gas and cruises at 30 miles an hour.

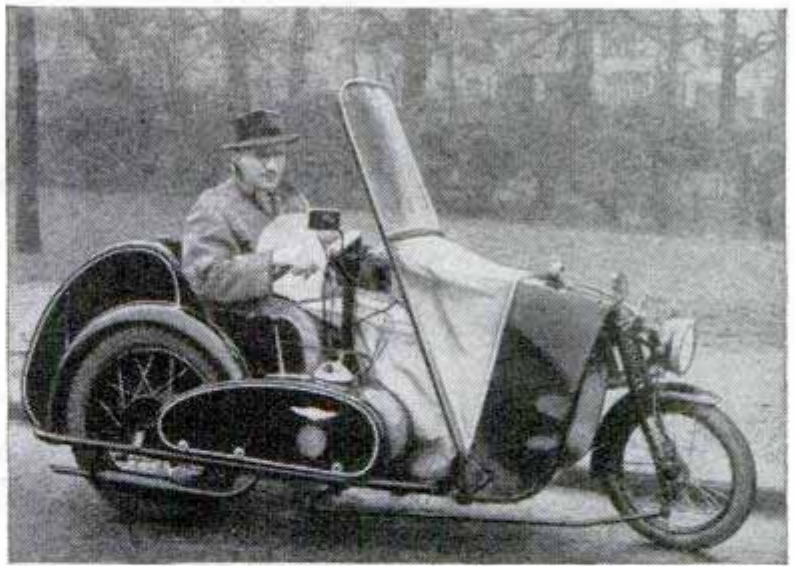

Mechanical Icedman Loads Fishing Boat in 15 Minutes

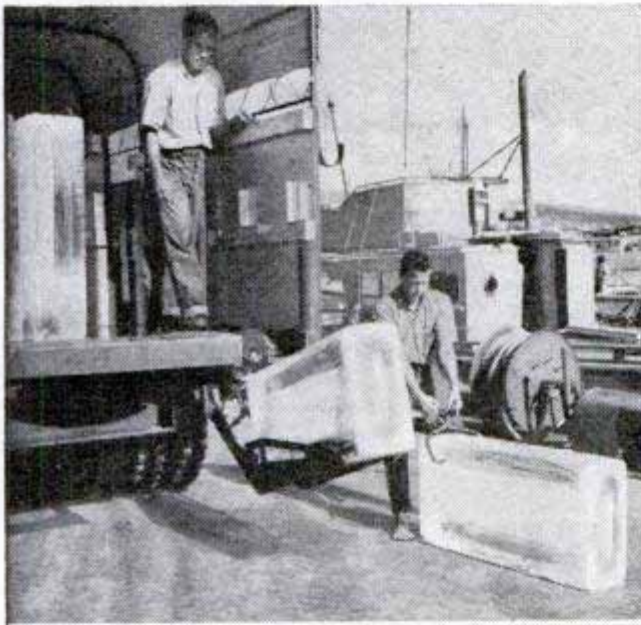

Icing a fishing boat, usually a three-hour operation, is done in 15 minutes by a combination truck and ice crusher used in Honolulu. The truck delivers 12,600 pounds of ice either in block form or as crushed ice piped into the hold. Blocks of ice weighing 300 pounds are lowered from the truck body to the ground by a hydraulic hopper. When crushed ice is needed, blocks are slid on a conveyor in the truck floor and automatically fed into the crusher. The crusher's revolving steel fingers grind 1300 pounds of ice per minute.

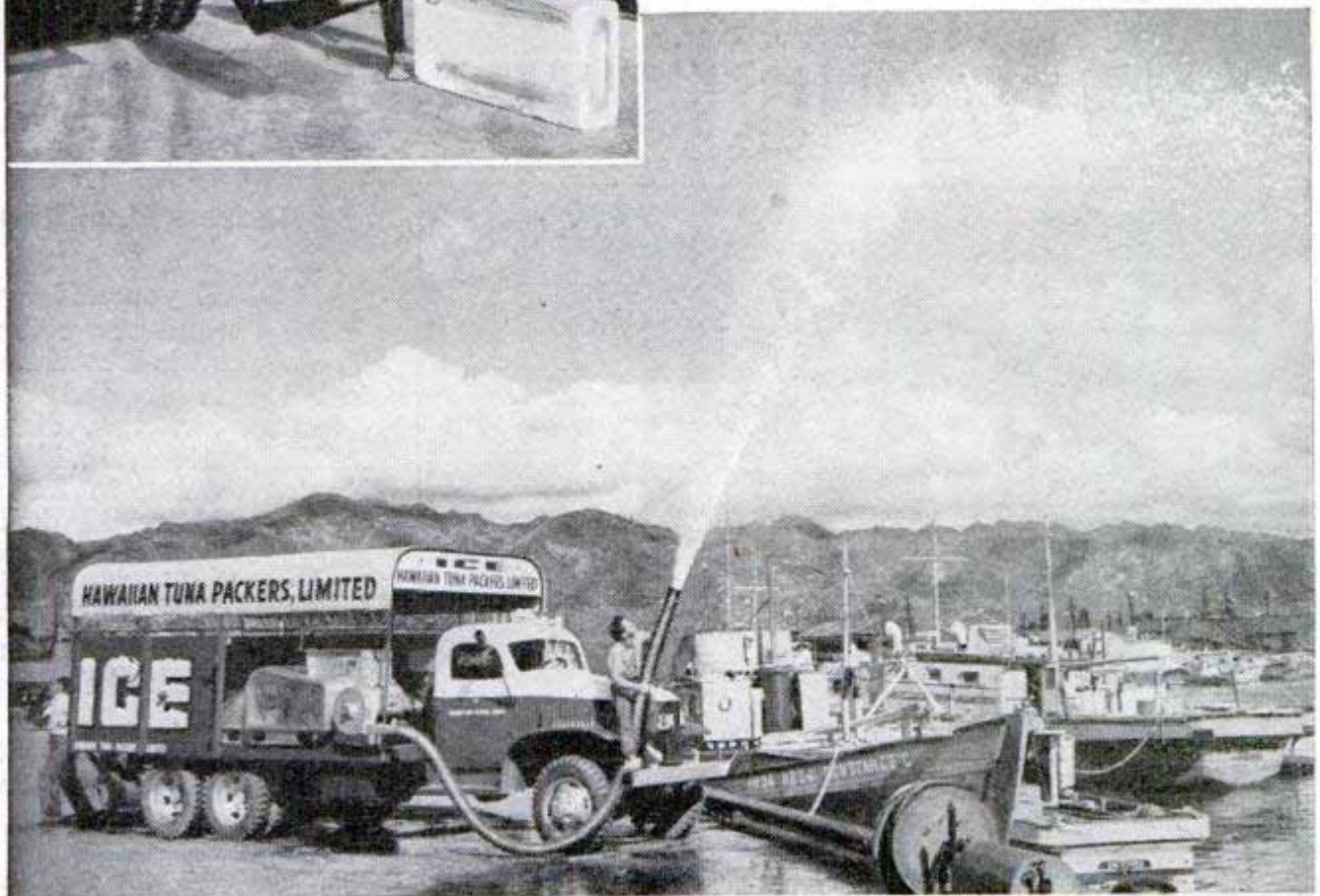

Crushed ice, 1300 pounds of it a minute, is forced through the pipe with enough pressure to send it into the air like a stream of water. Top, 300-pound blocks are unloaded from the truck by this hydraulic hopper

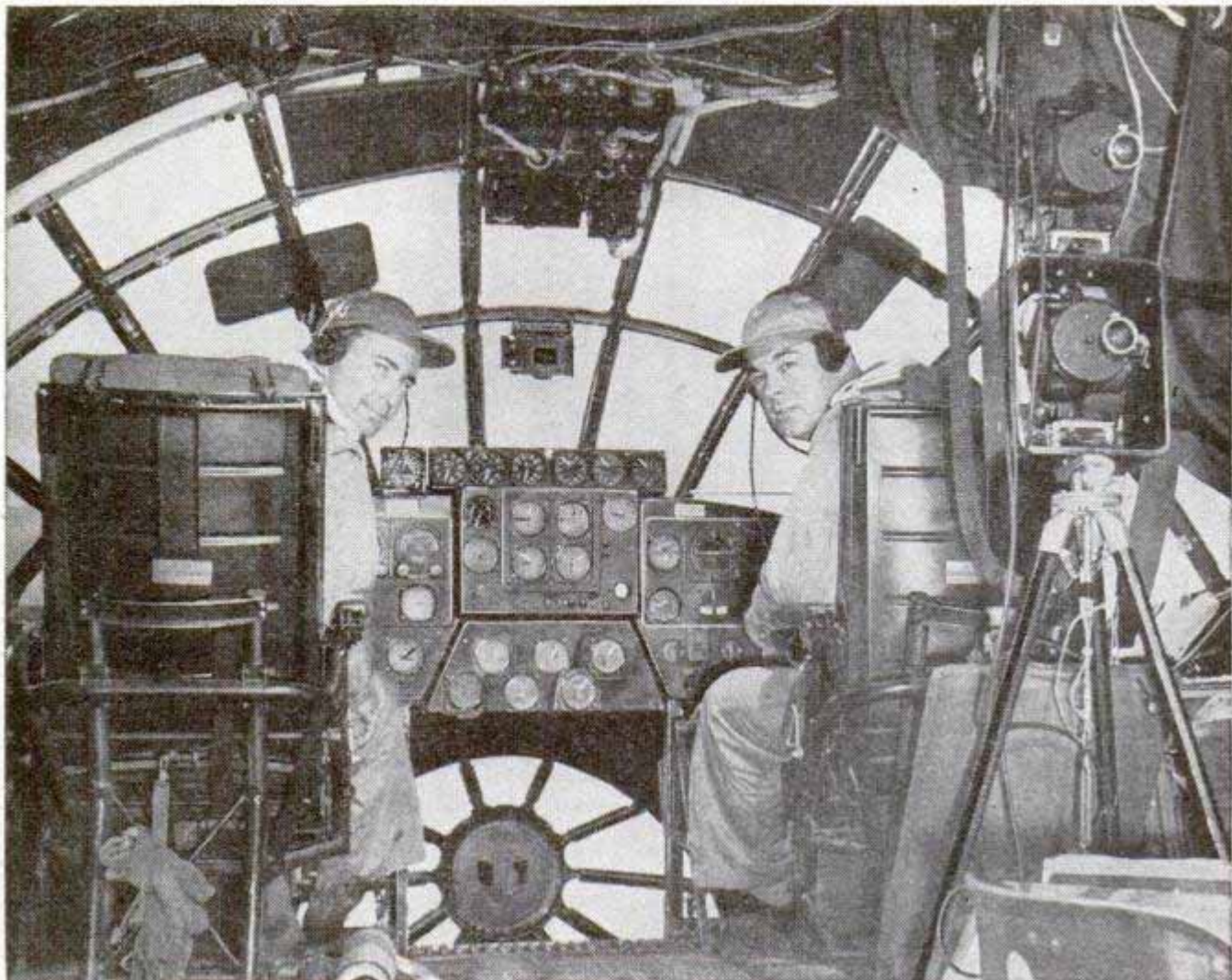

Consolidated-Vultee Aircraft photo

One of the biggest steps toward cockpit simplification is the instrument panel of the B-36, world's largest bomber

CONFUSION IN THE COCKPIT

Northrop Aircraft photo



By Andrew Hamilton

IMAGINE yourself flying a brand-new plane. The cockpit is a mechanical jungle of gadgets—knobs, switches, dials, levers, buttons, handles. You're coming in for a landing. Where the devil are the flap controls? The brakes? The cutoff switch? You grab the book of instructions. But you can't make heads or tails of it....

A nightmare? Actually—no. But if it happened to you—yes.

With automatic aid, tiny stick in copilot's right hand flies a 104-ton Flying Wing. His left hand is on overhead throttles

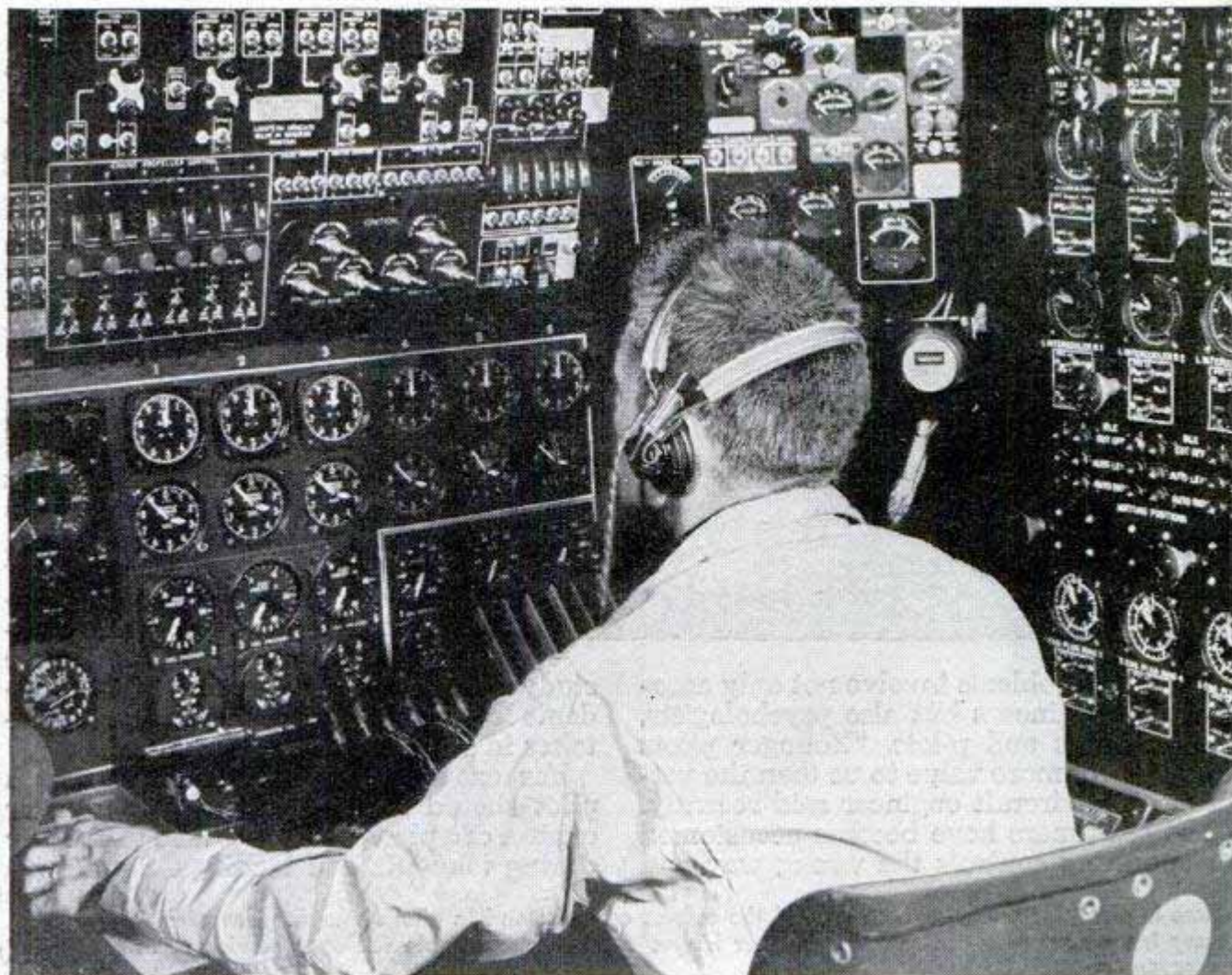

Do you wonder if this man sees dials in his dreams? A B-36 engineer, he has to maintain a constant vigil over power output equal to that of five locomotives

"It's happened to me," says Commander Norval R. Richardson of the research and development group of the Navy's Bureau of Aeronautics. "And I'm supposed to know cockpits!"

Situations such as this have spurred the Navy, the Air Force, the Civil Aeronautics Board and America's major airplane manufacturers to research on the twin problems of (1) making cockpit controls simpler and more efficient, and (2) increasing pilot comfort. Some day airplane cockpits may be as standardized as the dashboard of your automobile.

Cockpit research began during World War II when it was painfully evident that Army and Navy planes had too many controls, guns, radio sets, radars and other equipment jammed into too little space. Some 3000 to 4000 persons worked on Navy cockpits alone and they developed more than 100 mockups and remockups.

Today the work is continuing. Jet planes present a majority of the old cockpit problems—and many new ones. Some of the former instruments have been removed, some additional added. The net result is still confusing.

Lindbergh made his famous solo ocean crossing with just these instruments: (1) compass, (2) oil-pressure gauge, (3) altimeter, (4) magneto switch, (5) tachometer indicating propeller r.p.m., (6) bank-and-turn indicator, (7) air speed, (8) clock, (9) inclinometer, (10) gas pump, (11) control stick, and (12) throttle

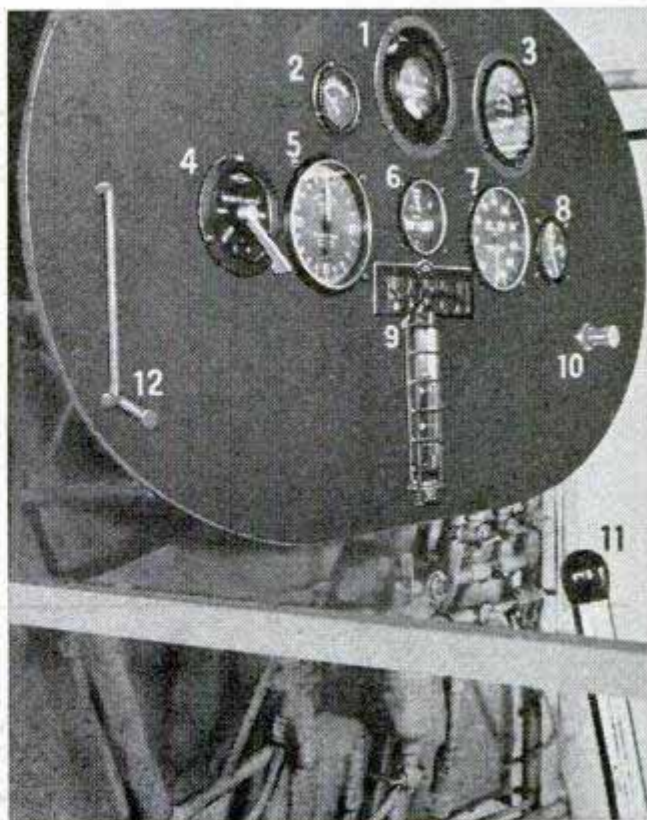

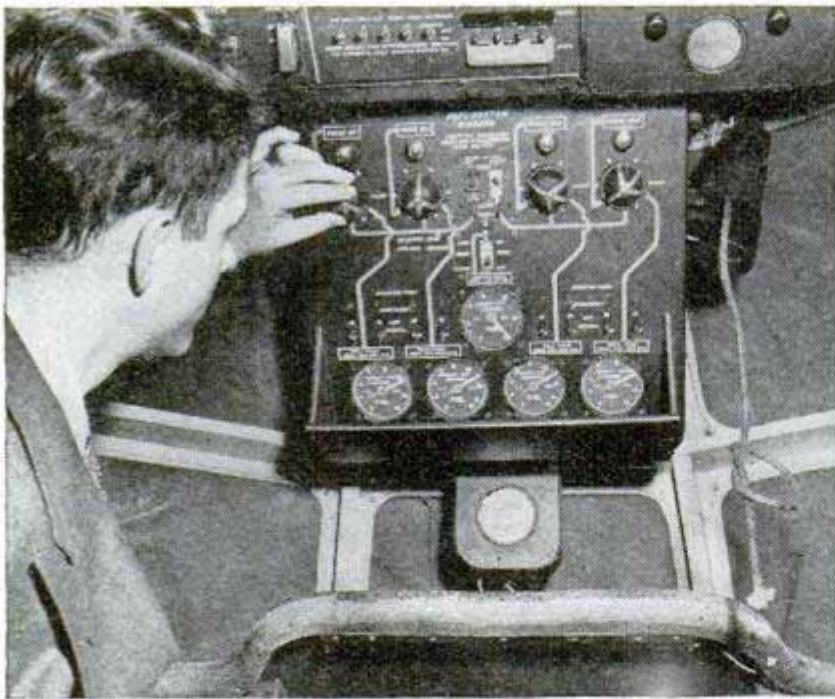

One of the newest cockpit additions, this panel keeps flyers informed on fuel flow during transfer operations

don't like to change. A youngster can tell in a minute if a control doesn't 'feel' right."

The basic principles of cockpit design were developed by the trial-and-error method. Engineers would stumble on a basic principle without knowing it. Then they'd backslide on later cockpits before they were aware that a new principle had been discovered. What was most disconcerting was that flyers had been using badly-designed cockpits for years, which probably explains many crashes and combat losses. One Air Force

Cockpit problems involve not only aeronautical engineers but also psychologists, physiologists and pilots. "Younger pilots are often of more value to us than the veterans," an aircraft engineer said recently. "The old-timers have become accustomed to operating controls the wrong way and

study revealed that 50 percent of the accidents laid to "pilot error" were due to mistakes in selecting the right control.

For example, engineers learned that a pilot should not be required to transfer control of a plane from one hand to another during take-offs and landings. Same with

There is plenty of working room around the central control stand in pilot's compartment of a Stratocruiser. Every instrument panel in the plane either hinges out or is removable for easy servicing "in the open"

Boeing Aircraft photo

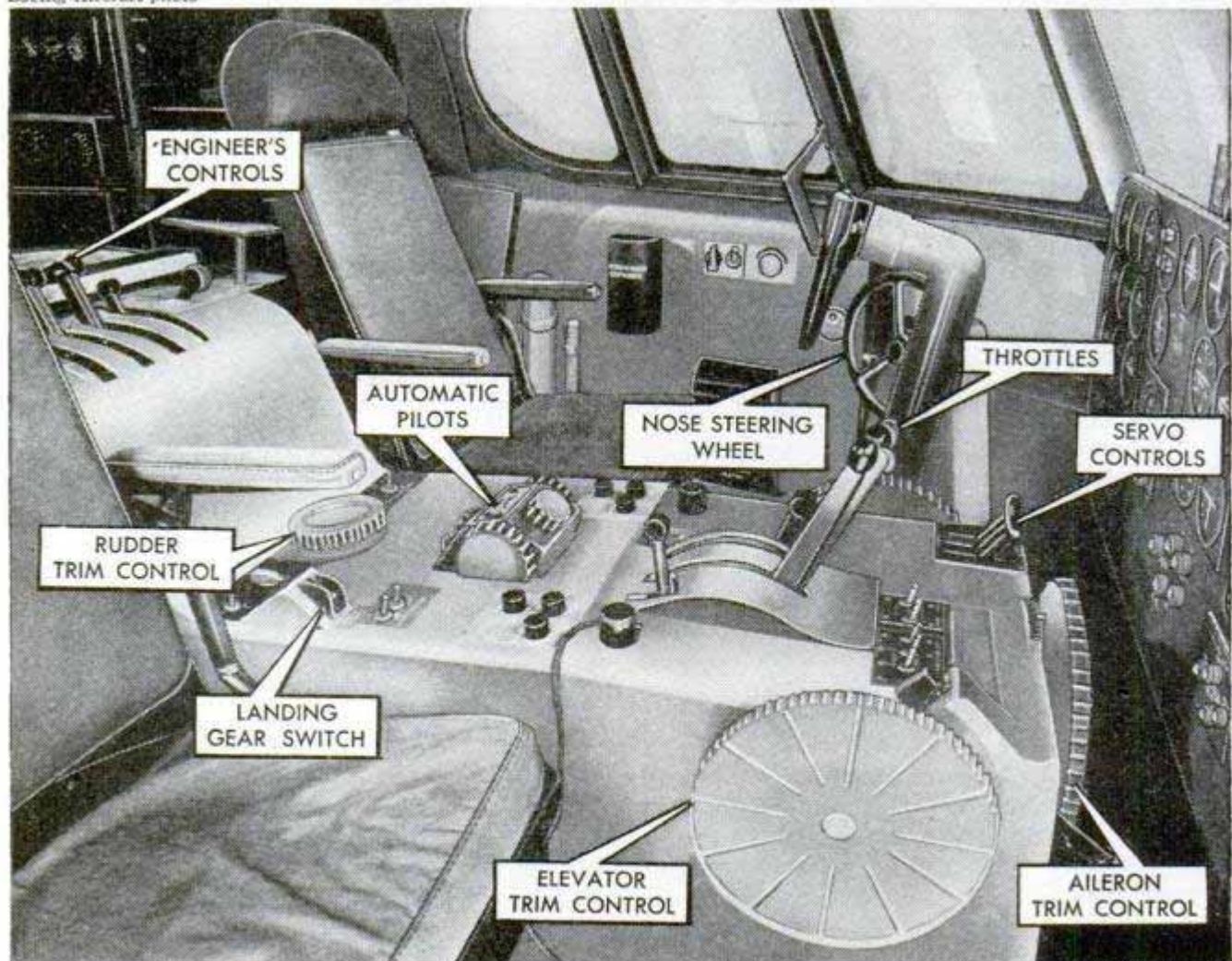

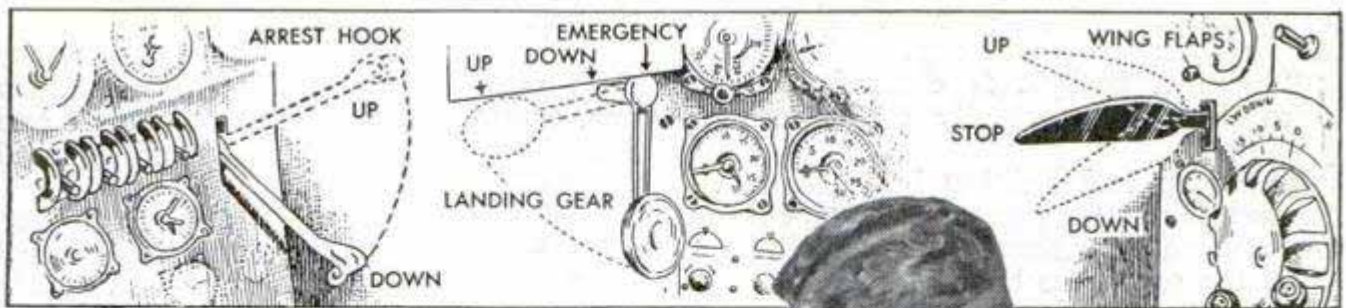

To learn which instrument-handle shapes are easiest to recognize, designers give blindfold tests to Air Force pilots. One of their principal objectives is to make levers look like the part they actuate and, as much as possible, to have them move in the same way. Sketches show how Douglas Aircraft applied the idea in designing a new carrier-based dive bomber

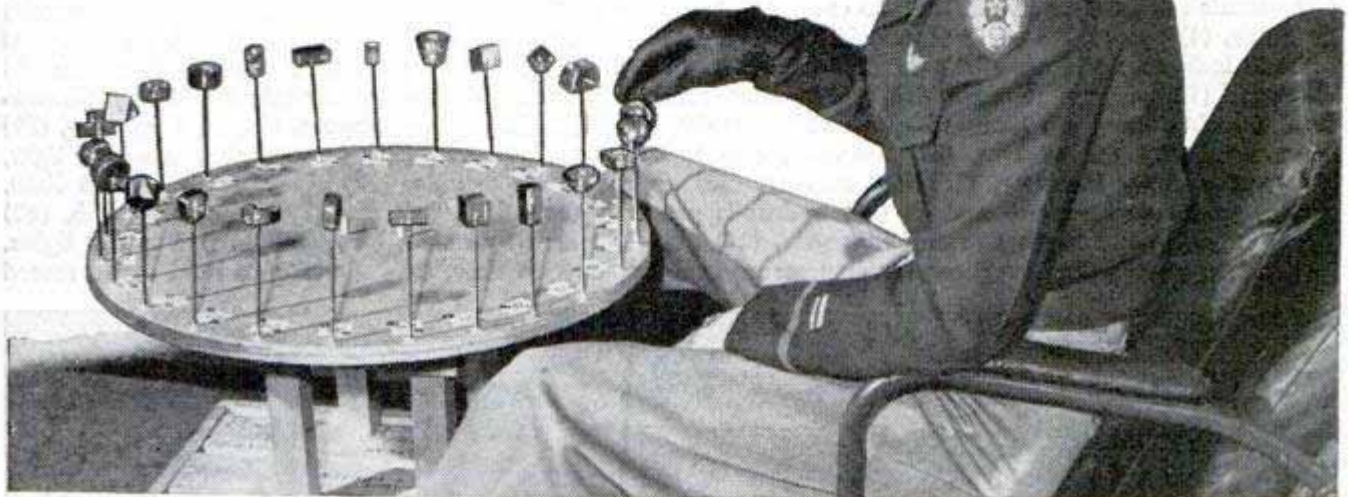

transfer of vision. In many planes a pilot had to wrench his eyes away from the runway and look into the cockpit to find the control he wanted. A few years ago a Navy flyer washed out a dive bomber at Roosevelt Field when he took his eyes off his landing, mistook a golf fairway for the strip and ended up in a bunker.

For many years there was no rhyme or reason for the way many important controls operated. For example, the prop control was mounted on the aft end of the power-control quadrant and moved up and down, rather than forward and backward. The mixture control was another offender. Some planes actually had the "idle" cut-off position at the forward end—just beyond the "full rich" position. In other words, if you pushed all controls forward for a take-off you would cut your fuel.

Some of the most important advances in cockpit controls have been developed by engineers at the El Segundo (Calif.) Division of Douglas Aircraft, and incorporated in the Navy's newest dive and attack bomber, the AD Series Skyraider.

Three principles were followed: (1) the control should, as much as possible, look like the part of the airplane to which it is connected, (2) the control should move in the same direction as the part, and (3)

the control should be placed as nearly as possible in a corresponding position in the cockpit to the place of the part it controls on the plane.

For example, the lever that lowers the arresting hook looks like an arresting hook. Flap controls resemble and work like landing flaps. The landing wheel lever is equipped with a small plastic tire and shock-absorber strut.

With devices like these, recognition is almost instinctive. Or, as Li'l Abner puts it—"as any fool kin plainly see." It goes further. A pilot doesn't even have to look. He can feel the control and know that it is the right one.

Older and slower aircraft gave a pilot time to perform his relatively few tasks. With the increase in instruments, and speed, it was necessary to ration a pilot's time. Power-actuated devices were substituted for manual controls; a flick of a switch held the instrument through its cycle of operation with no additional effort on the part of the pilot.

Records show that many pilots would have survived crashes if their heads had not been banged against gun sights, instrument boards and other hard objects. Engineers are still attempting to remove or recess knobs, cotter keys and levers.

Attention is being given to body clearances for head, knees and elbows.

"When a cockpit is cleaned up and streamlined, it's actually easier to fly," pilots say.

Lettering and lighting have been improved. During the war, fluorescent lighting around instruments eliminated glare. Now the engineers have gone a step farther. Indirect red lighting has increased pilots' night vision. A flyer can look from his instruments into the night sky with practically no adjustment of the pupils.

Interesting developments are being made with plug-in instruments. The base is sim-

ilar to that of a radio tube. If an altimeter should get out of whack in mid-air, the pilot merely pulls it out and plugs in a new one. Plug-in instruments are smaller and are said to produce a saving of 25 to 50 percent in panel space.

A new instrument, the Mach meter, came into being as planes moved toward the speed of sound. One of its first known uses was on the Lockheed P-38. With two hands that are operated by impact and static pressure, it is preset to warn the pilot when his plane nears its particular maximum safe speed. Beyond that, shock waves may break the craft into pieces.

One man, traveling about 10 miles a minute, has to keep himself constantly aware of the information all these instruments relay. They are, in jet P-80 cockpit, (1) standby compass, (2) altimeter, (3) fluid-injection pressure indicator, (4) turn-and-bank indicator, (5) landing-gear warning lights, (6) air-speed indicator, (7) universal altitude indicator, (8) rate-of-climb indicator, (9) gun sight, (10) windshield-defroster valve, (11) windshield defroster, (12) gyrosyn compass, (13) tail-pipe-temperature indicator, (14) rear-view mirror, (15) gyro-instrument warning light, (16) turn-and-bank-instrument warning light, (17) radio compass, (18) fuel pressure, (19) tachometer, (20) oil pressure, (21) ammeter, (22) fire-warning indicator, (23) fuel-quantity warning light, (24) fuel-quantity indicator, (25) fuel counter, (26) parking-brake handle, (27) elevator-tab neutral light, (28) radio-compass remote control, (29) hydraulic pressure, (30) clock, (31) gun-sight selector switch, (32) bomb-dropping switch, (33) control-stick grip, (34) gun-sight reticle dimmer, (35) fuel-pump warning lights, (36) accelerometer, (37) oxygen-cylinder pressure and (38) oxygen flow. This plane once held speed record

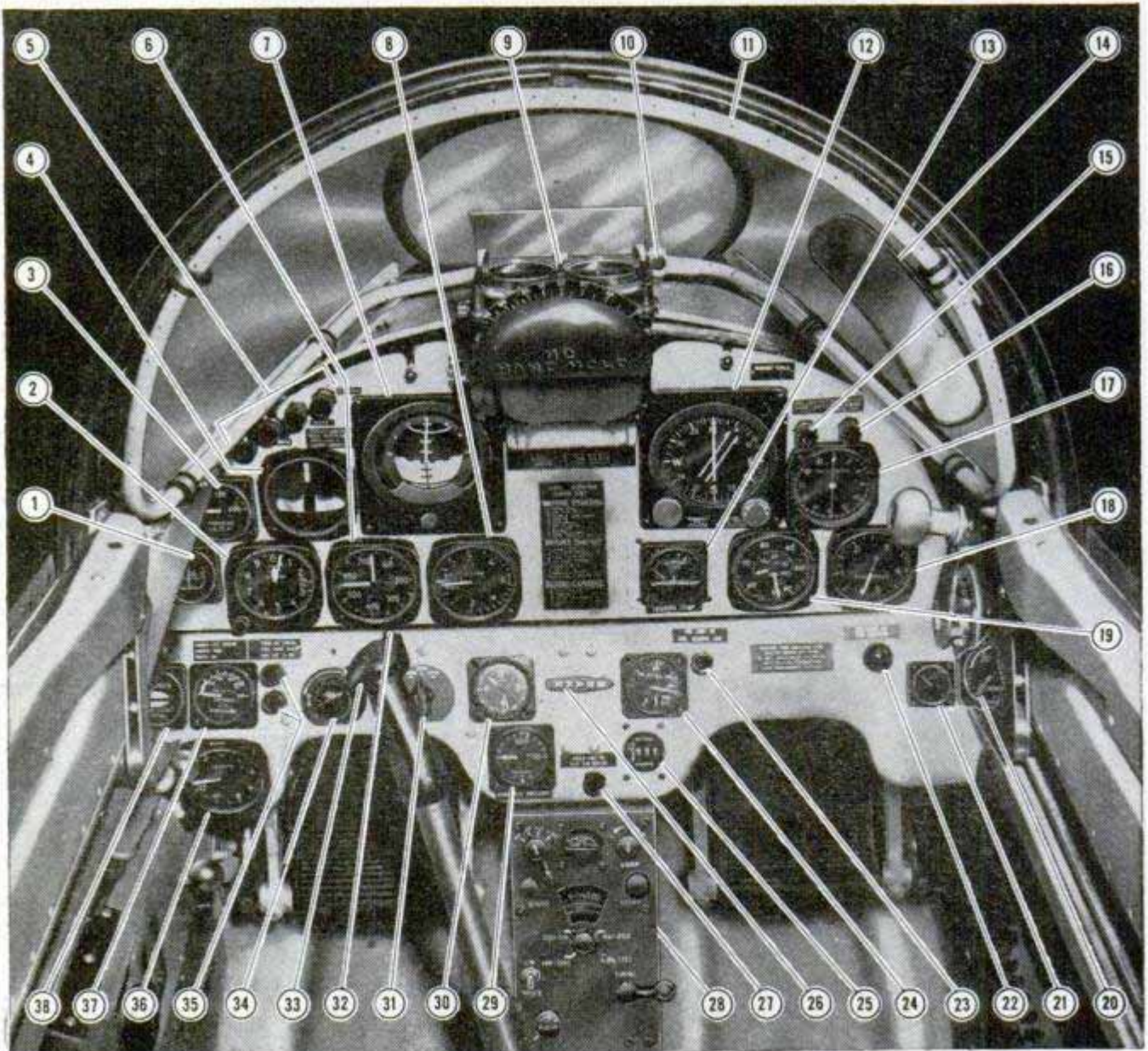

The safe maximum varies with altitude and is gauged by the ratio of true air speed to the speed of sound. For example, the Mach number reached by Maj. Marion Carl of the Marines when he set a world's speed mark of 650 miles an hour was .831, or .169 short of the speed of sound at the altitude at which he flew. Since indicated air speed decreases with altitude and the Mach number increases, the instrument is vital for safety in 600-mile-an-hour planes.

Streamlining today's high-speed planes involved juggling the position of a plane's windshield. The ideal windshield, aerodynamically, would be that parallel with the air stream. On the other hand, the ideal position from the point of view of the pilot—who wants to see where he's going and what's coming—would be perpendicular. So a compromise of about 35 degrees has been necessary.

Cockpit-design studies have been made on the distance between a pilot's eye and the windshield. It has been found that an increase in this distance rapidly reduces the field of vision and aggravates interference of dirt, fog and other matter on the glass.

Another improvement being incorporated in Army and Navy experimental aircraft is a single control for adjusting both rudder pedals simultaneously. The potential hazard of unequal adjustment through individual controls has long been recognized. British, German and Japanese planes during the war used a single adjustment device, American planes did not. Now they're getting them.

Even the color scheme of cockpit interiors is receiving serious study from aircraft engineers in the interest of safety. Factors that enter into this phase of design are night vision, minimum windshield glare from reflection, adequate cockpit illumination, maintenance conditions and—in line with the trend toward more consideration for the man who has to sit in that cockpit—the psychological effect on the pilot.

For the flyer who says, "I don't care about the color scheme, just give me a comfortable seat," there is also

(Continued to page 224)

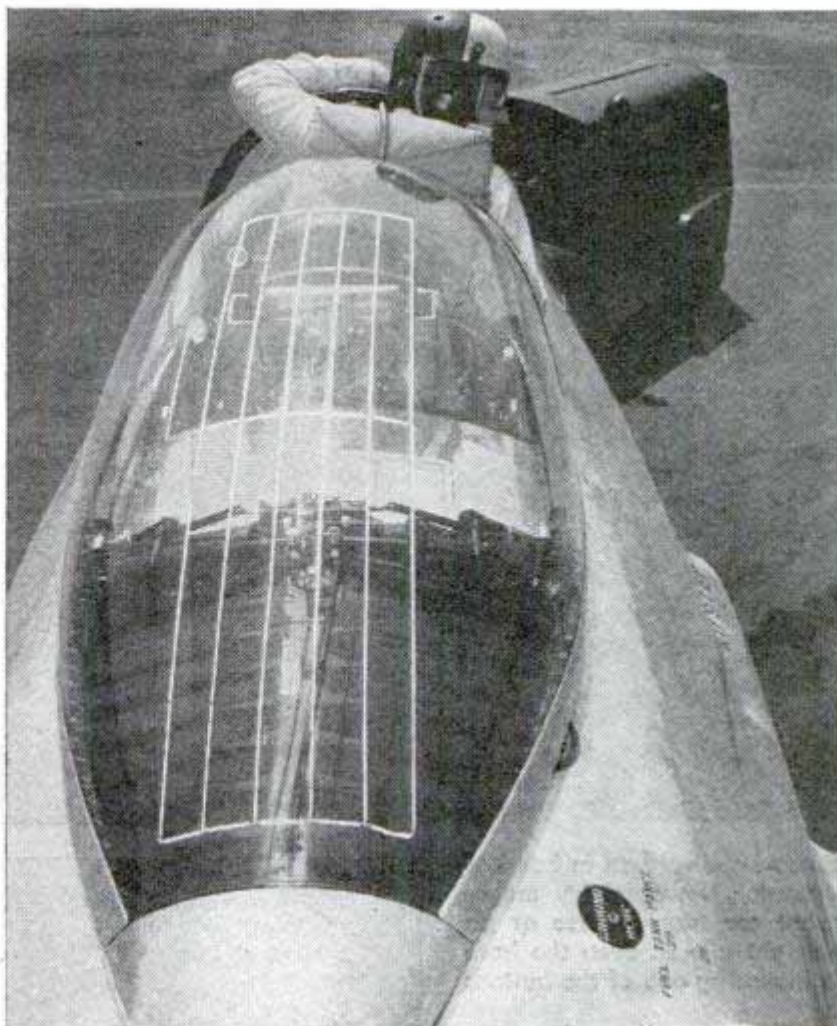

Lockheed Aircraft photos

To cut down drag, radio-antenna wires were built right into the bubble canopy of a speedy P-80

A late-comer, Mach meter (center) tells jet pilot when he nears the preset maximum safe speed



Radio-Control Box Dictates Every Move of Miniature Robot Auto

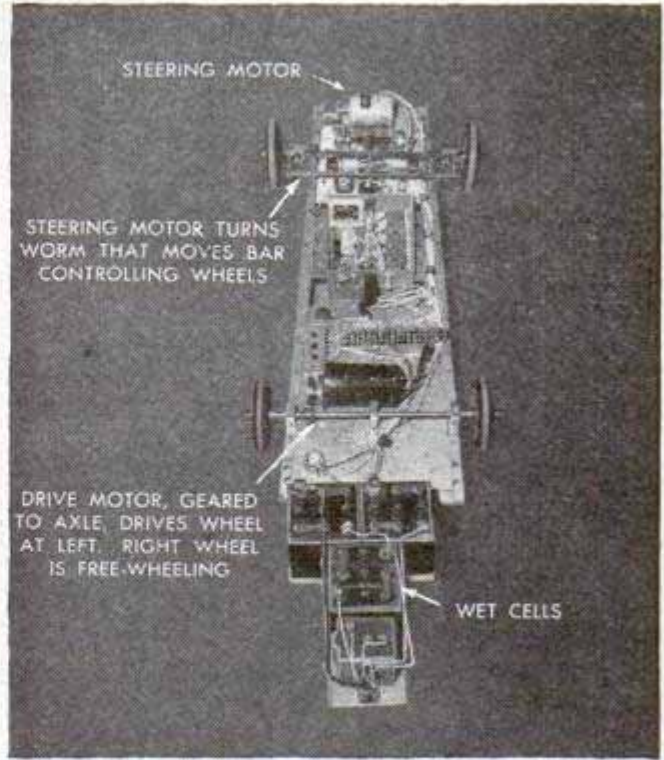
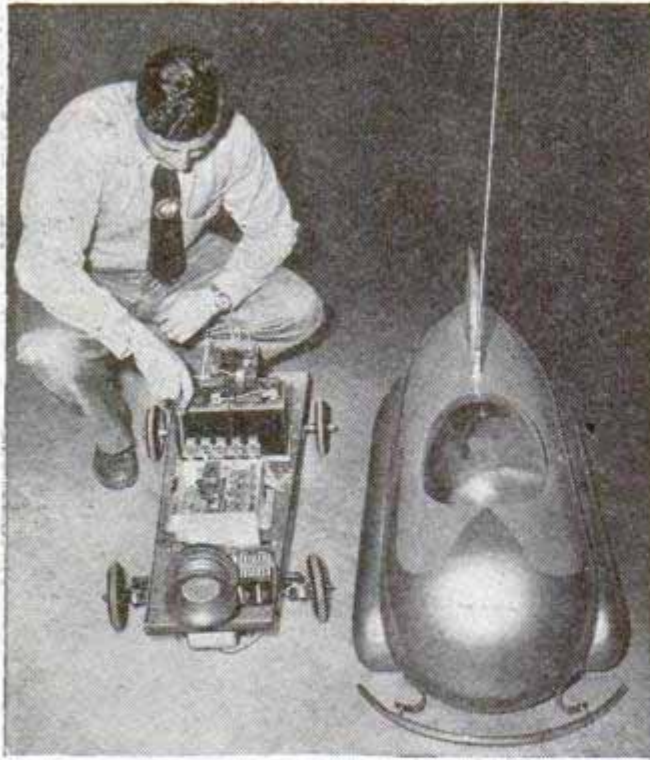

Remote-control box in hand of operator, lower right, makes robot car turn, reverse or go straight ahead. Even the horn is blown by one of the buttons

"Electron," a futuristic miniature robot automobile, sounds its horn and maneuvers like an ordinary car in response to radio directions flashed to it by its operator. The car was built by Dick Glotch, radio mechanic at Mare Island Navy Base, Calif., to demonstrate the principles of radio control. Aside from a specially built body of aluminum and Plexiglas, all the parts used are available from war-surplus materials or other general sources. The car is guided straight ahead, made to turn left or right, back up or stop, or sound its horn by means of a remote-control box attached to a small radio transmitter. Each position of the control-box switch causes the transmitter to radiate at a different frequency. The car's radio receiver has selective amplifiers each tuned to match one of the frequencies radiated by the transmitter and each is connected by relays to the electric motor that performs the desired maneuver. Wet cells supply power to the motors and horn and also serve as the radio receiver's

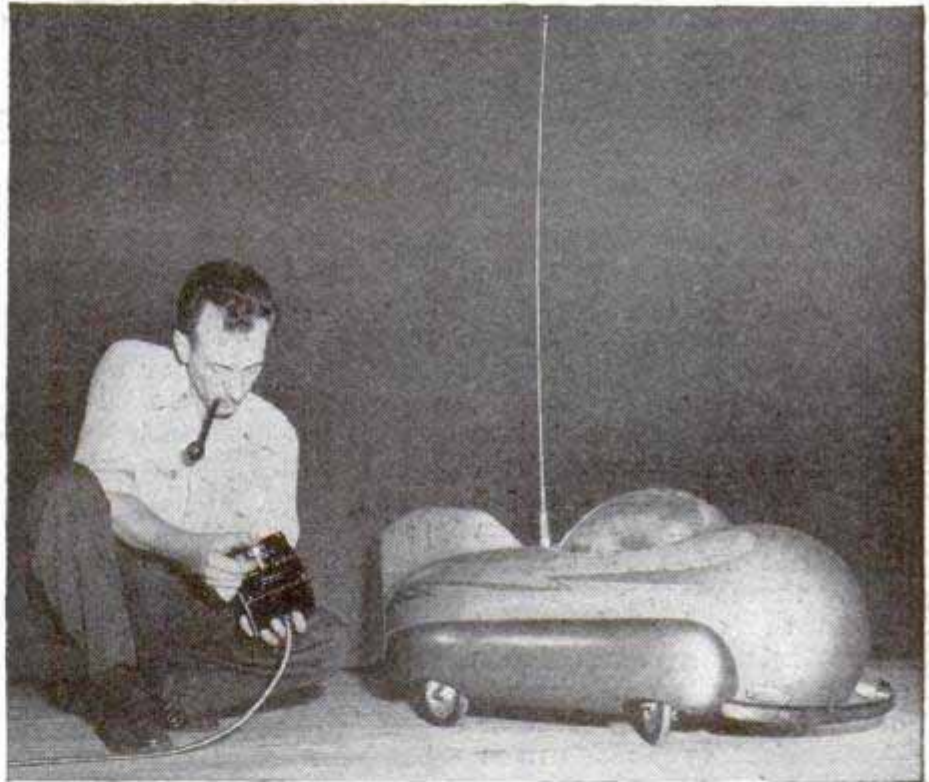

A-battery. It uses a one-wheel drive to avoid differential problems. The front wheels are turned in either direction by starting or reversing the motor that drives a worm gear connected to the wheels. Glotch has maneuvered his car from a distance of several hundred feet and estimates that the range of the radio control is more than a mile. He is working now on a fluid-drive model equipped with headlights that will turn on when the car is in motion and a taillight that will operate when the car is backing.

Revolving Plow "Hugs" Plantings

Vineyard and orchard farmers can do the work that formerly required three separate tools with a new rotary power cultivator. The tractor-pulled cultivator makes it possible for one man to plow close to trees and vines without damaging them. Ordinarily, vineyards and orchards were plowed, then cultivated with a French plow and finished with a circle harrow. The new cultivator performs all three operations at once. It consists of a revolving blade holding six small plows. A circular guard bar keeps the blade away from vines or trees. The blade is revolved by the power take-off from the tractor. It leaves a smooth mulch about three inches deep.

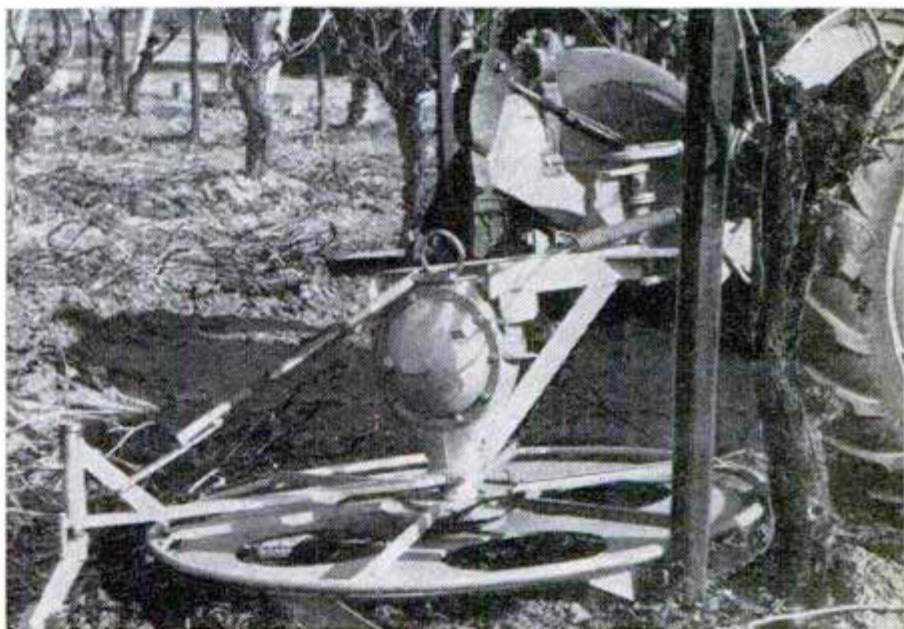
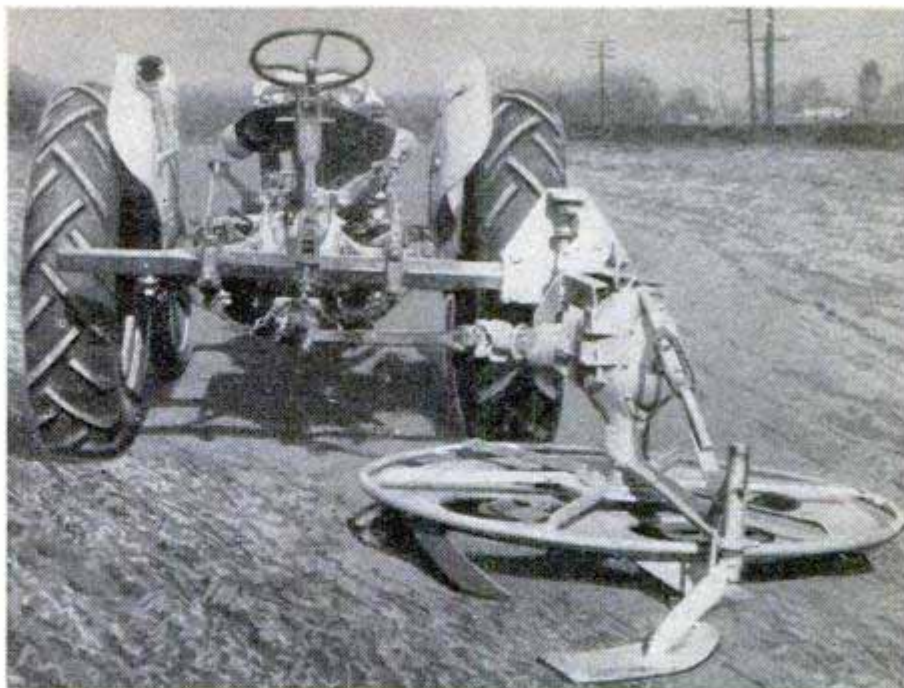

Synthetic Resin Aids Paper Makers

Short-fibered wood, such as poplar, beech, maple and birch, may soon provide a new source of paper, the National Bureau of Standards has announced. A synthetic resin, developed by the bureau, greatly strengthens paper made from these woods. Without this resin, such paper breaks down under the beating process used to develop good

bonding. The new synthetic, melamine-formaldehyde, may increase the use of short-fibered wood, which grows abundantly in the Northeast, by 75 percent.

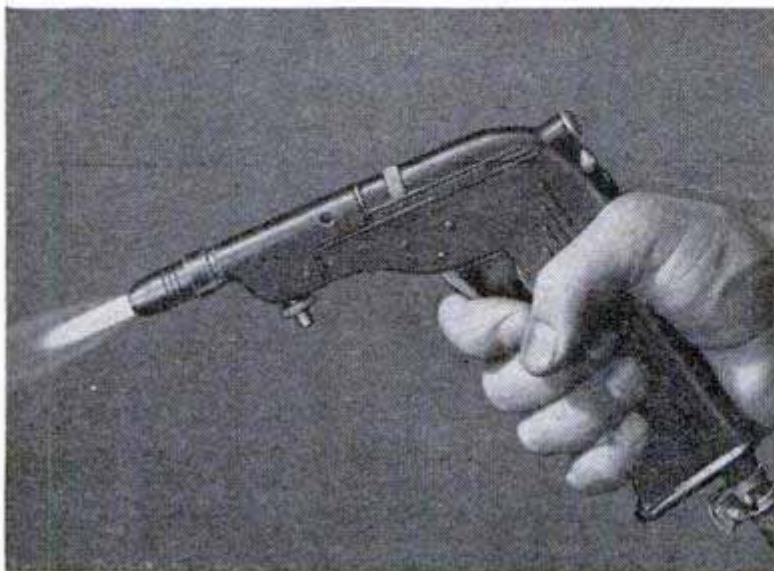

Automatic Acetylene Torch

Because it has an automatic lighting and extinguishing mechanism that is trigger-operated, a pistol-grip acetylene torch saves time and prevents wasting of gas. Designed for use with acetylene gas, the automatic torch weighs only 12 ounces. Its pistol grip makes it easy to operate in places difficult to reach. Interchangeable combustion tubes, nozzles and extension tips are available.

☐ Chocolate-scented ink was used in a Memphis, Tenn., newspaper to print a cake advertisement.

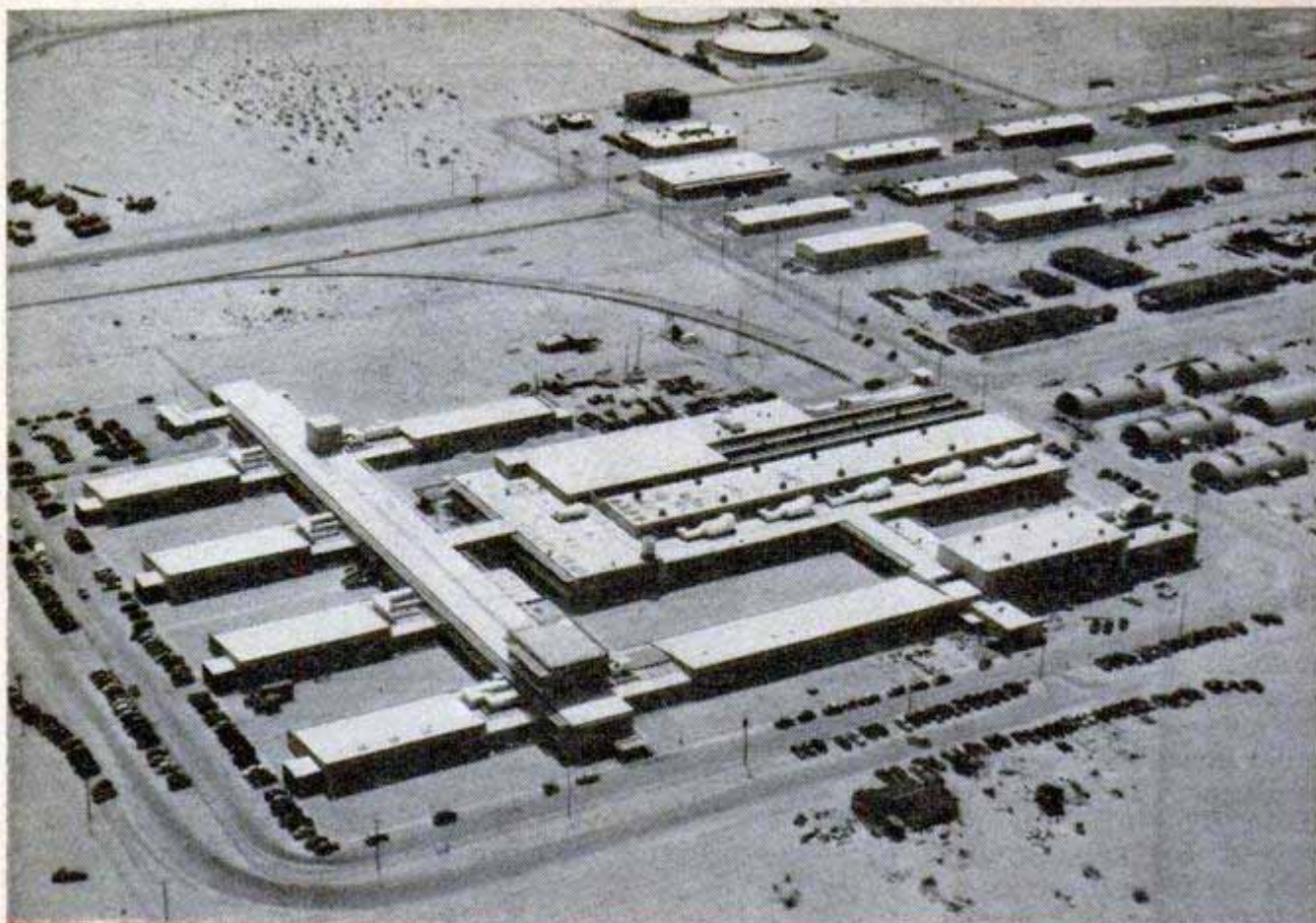

The huge new Michelson Laboratory, heart of the Naval Ordnance Test Station in the Mojave Desert

The Navy's Incredible Eye

Most amazing of a houseful of miracles at the missile laboratory on a California desert is a camera that blinks its eye for a hundred-millionth of a second



OUT OF the barren vastness of California's Mojave Desert has come a photographic miracle—a camera that takes a picture in a hundred-millionth of a second! Invented by Dr. A. M. Zarem of the Naval Ordnance Test Station, the camera is 25,000 times faster than any movie camera commercially available.

But this super-speed camera is only one of many miracles being produced at the Michelson Laboratory, newest addition to the station. Roughly equal in size to the state of Rhode Island, the inland naval base was created in 1943 as a rocket-testing range. It has grown until now it is one of the world's most complex research centers.

Completely self-contained, the scientific community is also one of the world's most modern cities. The heat and dry-

Internal partitions of the laboratory are movable to add flexibility to its 7½ acres of floor space

ness were given a knockout punch by twentieth-century engineering. Every building, including homes for 12,000 residents, is air conditioned.

At present, the community has 2000 permanent buildings, ranging from the sprawling Michelson Laboratory to the streamlined corner grocery. Residents include families of 3800 civilian employees and 1000 naval personnel. Civilians and service personnel combine talents in research on rocket weapons, guided missiles and aviation ordnance. The super-speed camera will be used to record rapidly moving phenomena in these fields.

Principal facility at the station is the Michelson Laboratory. Built at a cost of \$8,000,000, the laboratory has 7½ acres of floor space, all air conditioned. All air entering the building is filtered twice. Windows are sealed. Every entrance is a double-door type providing an air lock between the inside air and the desert atmosphere. Completely insulated, the building is a comfortable oasis in the desert.

On the next two pages are details of the super-speed cameras, the Navy's new research tools.



Fuse technician is protected by this nylon suit



Above, a naval ordnance man probes the internal mechanism of a captured German missile at the Michelson Laboratory. Below, among the various testing facilities is a 1500-foot rocket-launching device. Men place small rocket motor behind "Tiny Tim" rocket before launching it on rails

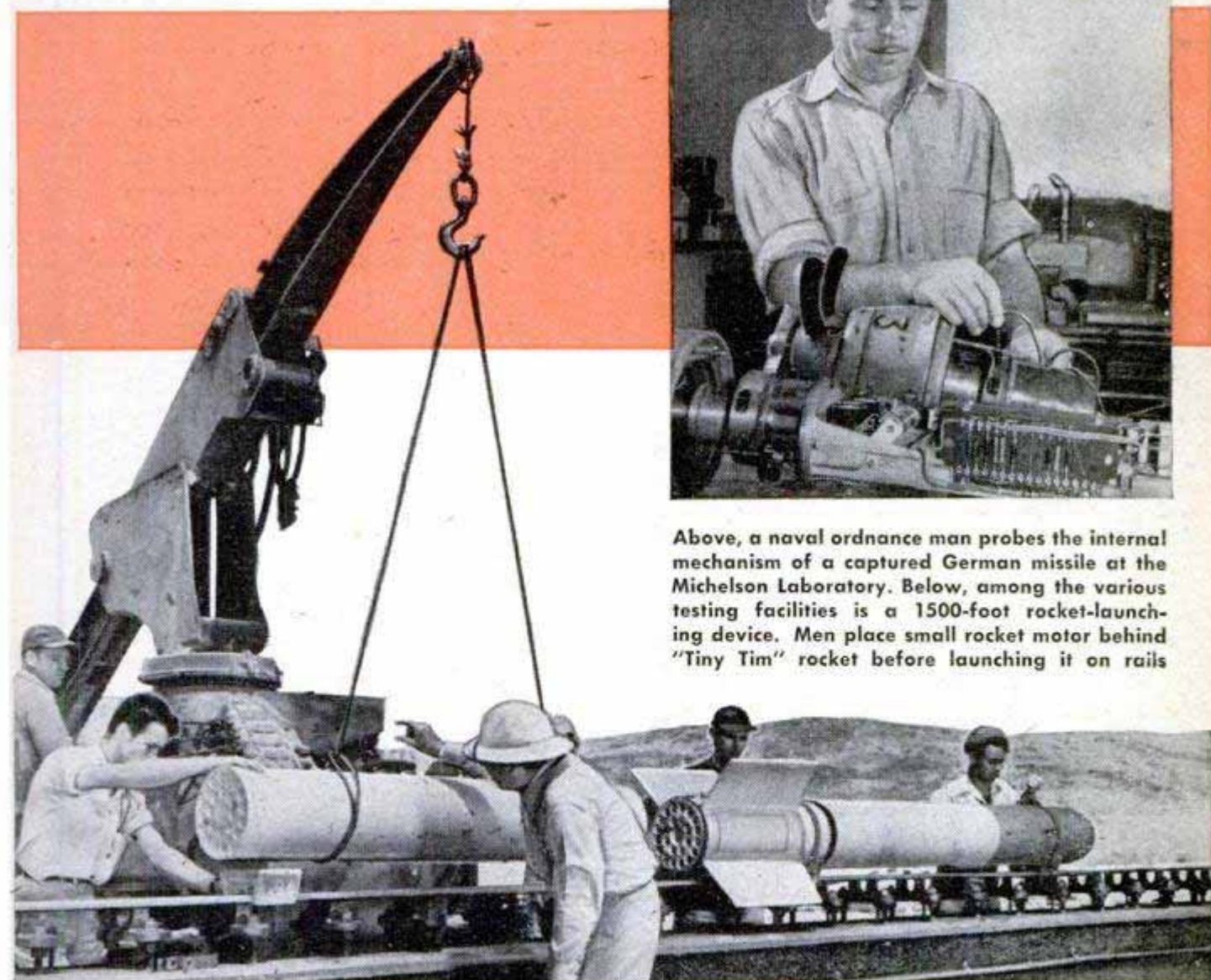

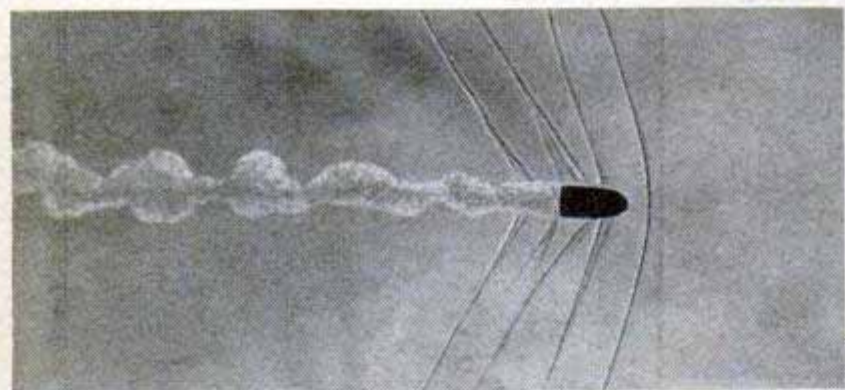
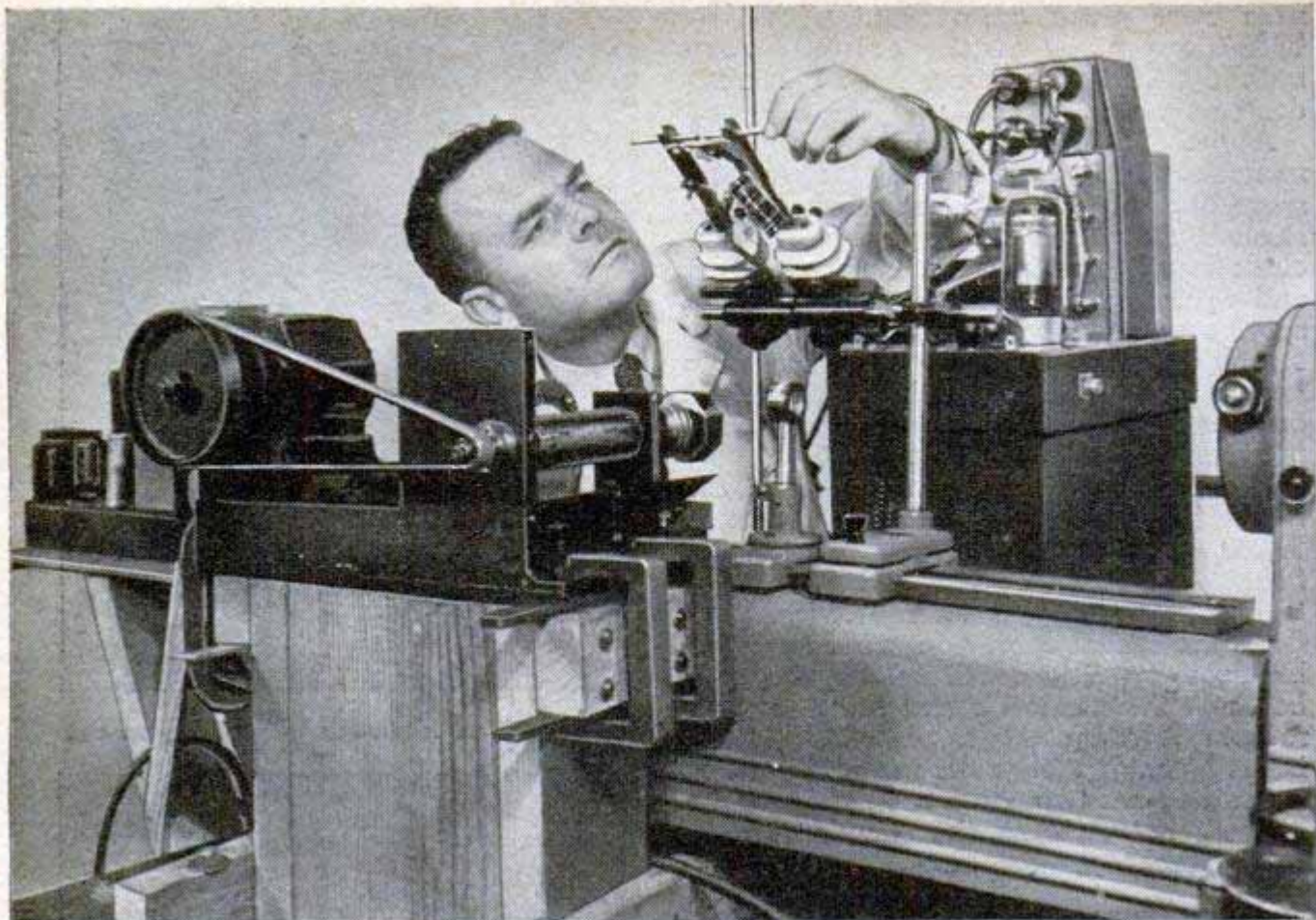

Above, another high-speed photographic device, the spark shadowgraph, took this picture of a high-power .22 rifle bullet traveling faster than the speed of sound. Black lines are shock waves. Note air turbulence behind the bullet

Right, these two pictures, also made by spark shadowgraph, show how a bullet crashes through a thin plywood sheet. Notice the unusual location of the shock waves. The wave that preceded the bullet in the free-flight view (above) has bounced off the wood and moved to the rear. It has a small rupture in the center that was caused by the bullet as it passed through it on its way into the wood. A new wave has formed ahead of the nose as it breaks through the other side. In the lower picture, the advance shock wave once again is clearly defined as the bullet emerges and resumes its flight in air

Above, called a "time microscope," a spectrograph records photographically the spectrum of an electric spark to show, within a millionth of a second, the stages of the discharge. Scientist adjusts spark gap. The octagonal mirror below electrodes revolves rapidly throwing image on spectrograph (right) where the continuous series is filmed

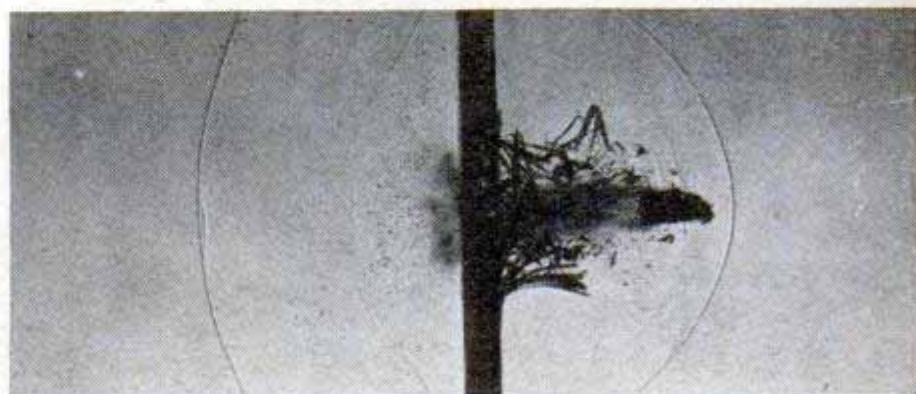
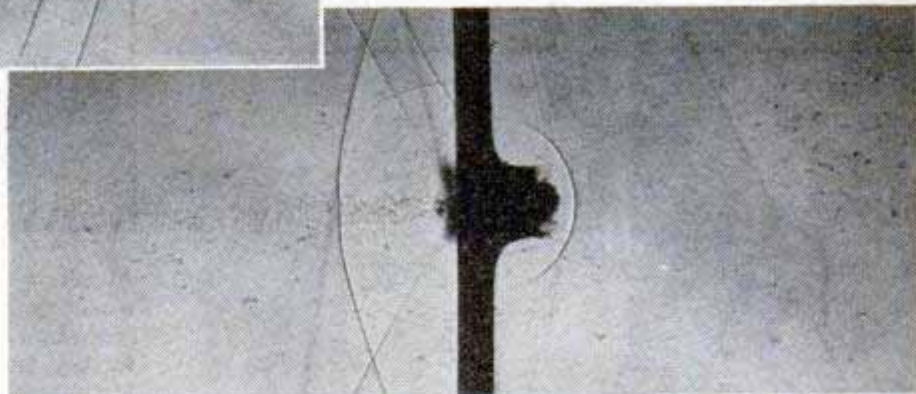

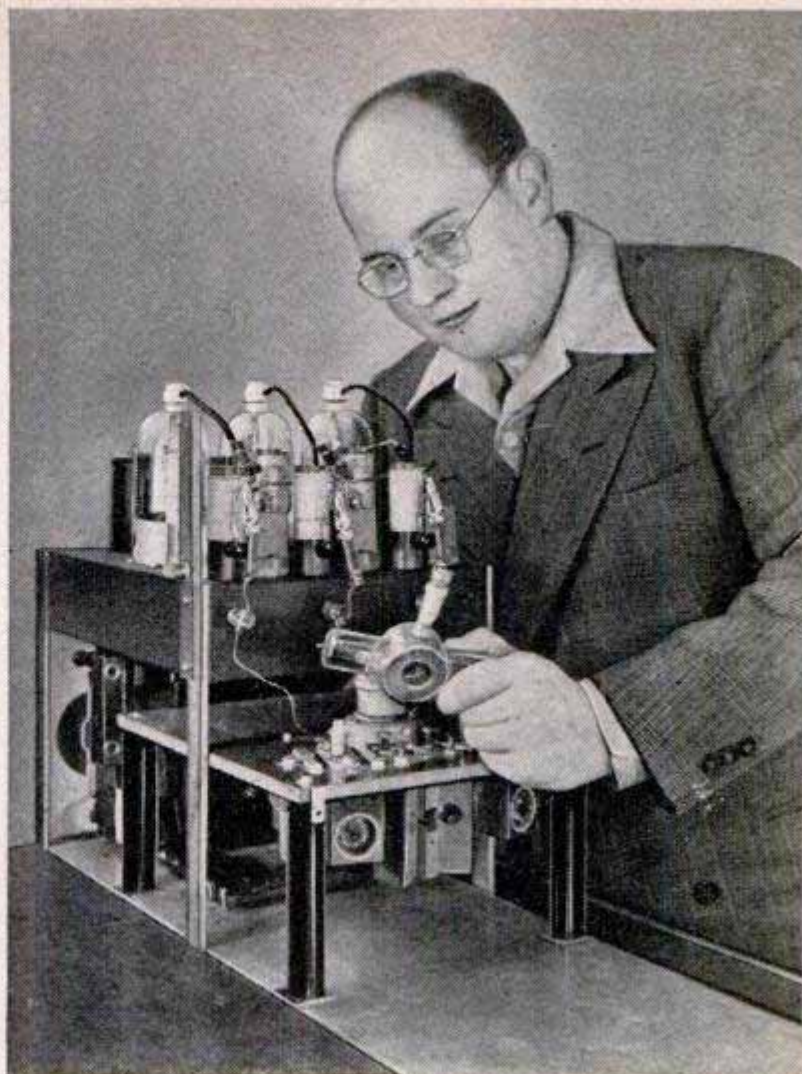
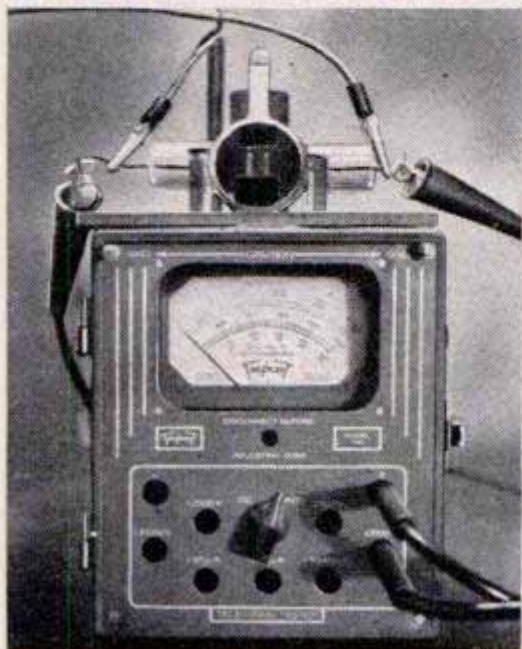
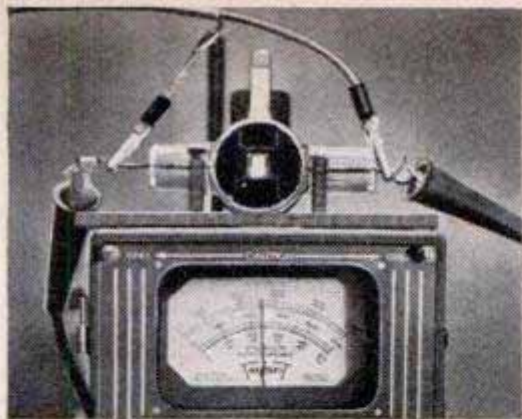

Above, the Zarem camera that snaps a picture in a hundred-millionth of a second is demonstrated by its inventor, Dr. A. M. Zarem. He is holding the Kerr-cell, which acts as an electric shutter. Action of the cell is shown at left. In lower picture, the cell, on top of voltage meter, is closed. When 5000 volts are introduced in upper view the cell opens permitting light to show through in dark circle. Below left, when stationary streamlined object is hit by air under high pressure, a curved shock wave is formed. Right, the RC-4, another fast camera, has 76 lenses arranged in arc. Spinning 8-sided mirror throws image into lenses

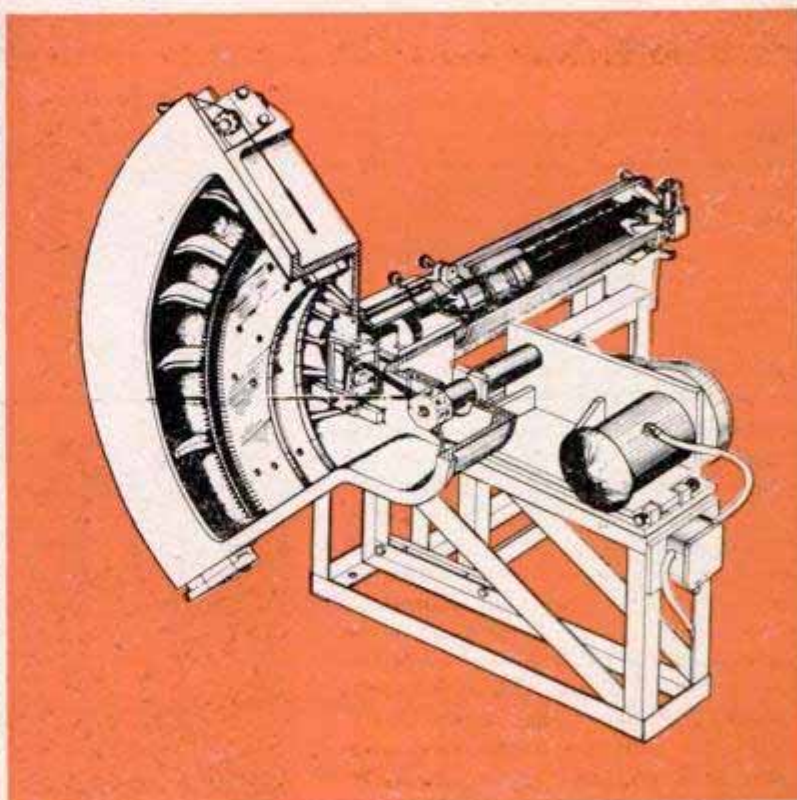
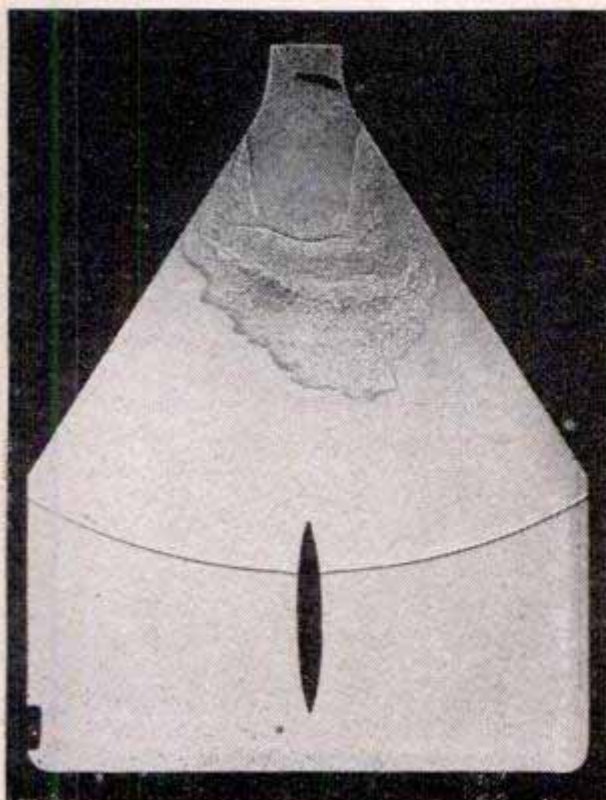

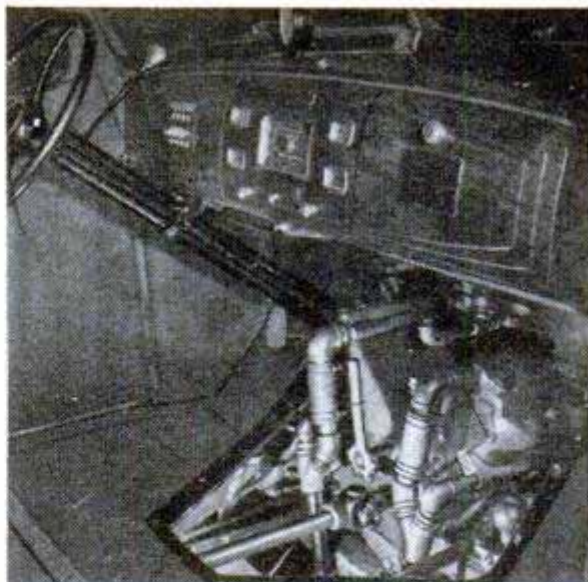
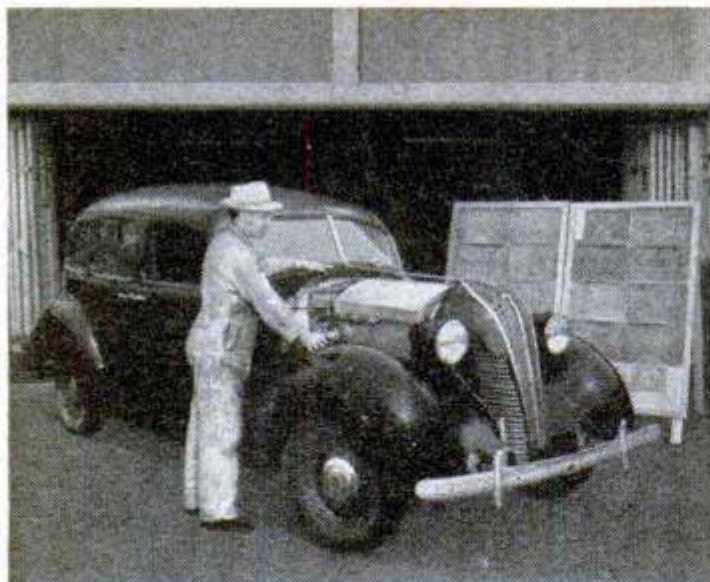

Steam Engine Burning Fuel Oil Installed in Standard Car

Steam power, used in the early automotive days, has been installed in a modern car by James H. Lawler of Huntington Park, Calif. He built the steam engine on a conventional chassis and burns stove oil as fuel. The motor has four cylinders, $3\frac{3}{16}$ -inch bore, with full power at low speed. Lawler says the same type of steam engine can be used to power boats and stationary installations. He plans to supply the unit complete or in parts so mechanics can build their own steam-powered cars.

Top, the steam generator fits beneath the hood of a standard car. Top right, engine is located beneath the dashboard. Right, with the grille off, the simple burner, steam generator and controls can be seen. Steam engine also can be installed on boats

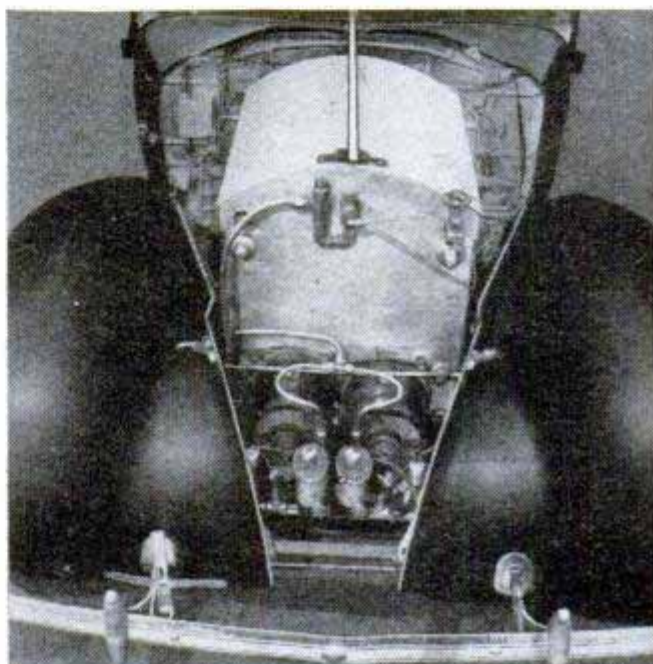

Versatile Jimmy Gets Fire Fighters Through Locked Doors



Designed for opening locked doors quickly, a combination tool officially adopted by the New York Fire Department may replace the fire ax as the fireman's traditional favorite. Even heavy metal doors can be jimmed open from the hinged side with this tool. The claws and prong permit attack from almost every angle.

Releasing tons of pig iron and steel scrap for construction uses, magnetite ore is being used as ship ballast after being mixed with cement and cast into blocks.

Bolt-On Wall Panels Cut Costs

Construction costs of multistory buildings may be greatly reduced by a wall panel that bolts to the framework without the use of scaffolding. The panels are about four feet square and either three or four inches thick. Weighing only $\frac{1}{20}$ as much as a masonry wall, the panels are made of insulating material covered with stainless steel on the exterior and lacquered steel on the interior. Individual panels are connected by a weatherproof, fireproof joint on all four sides and are bolted together and to the girders at each floor. Insulating quality of the four-inch panel equals that of a 12-inch masonry wall. Lightweight, the wall reduces strain on the foundation and its narrowness increases usable floor space. It can be produced for about half the cost of brick or masonry walls and maintenance costs are low due to metal facings.



Fireproof plaster seals joint. Note BX channel in baseboard →

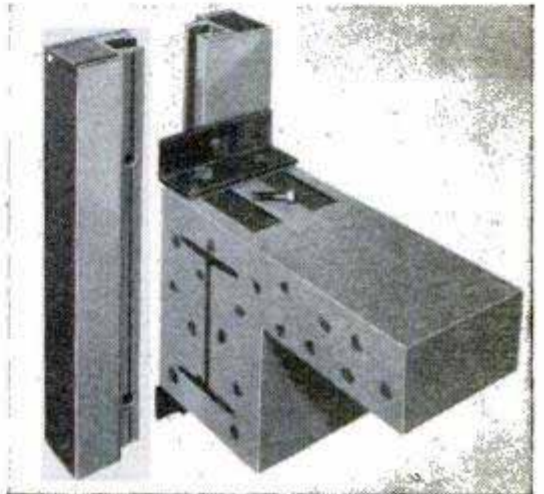
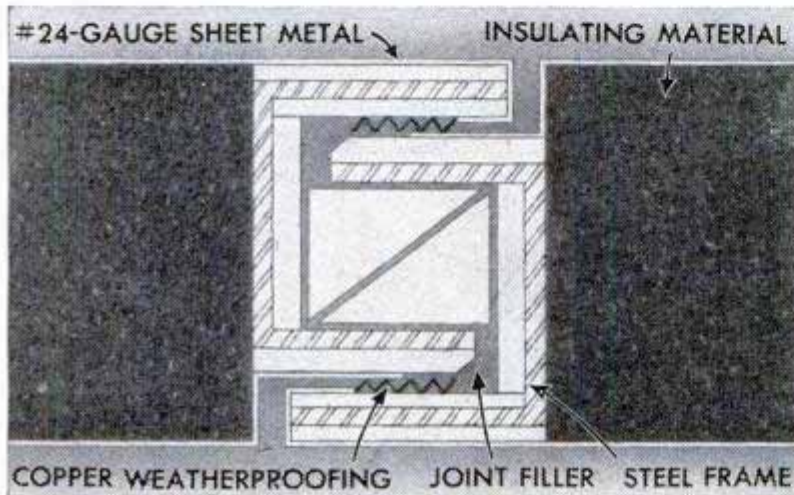

Left, cross-section of joint. White areas are the plaster joint filler. Above, the method of bolting panels together and to floor by use of angle iron. Below, scaffolding is not used during construction

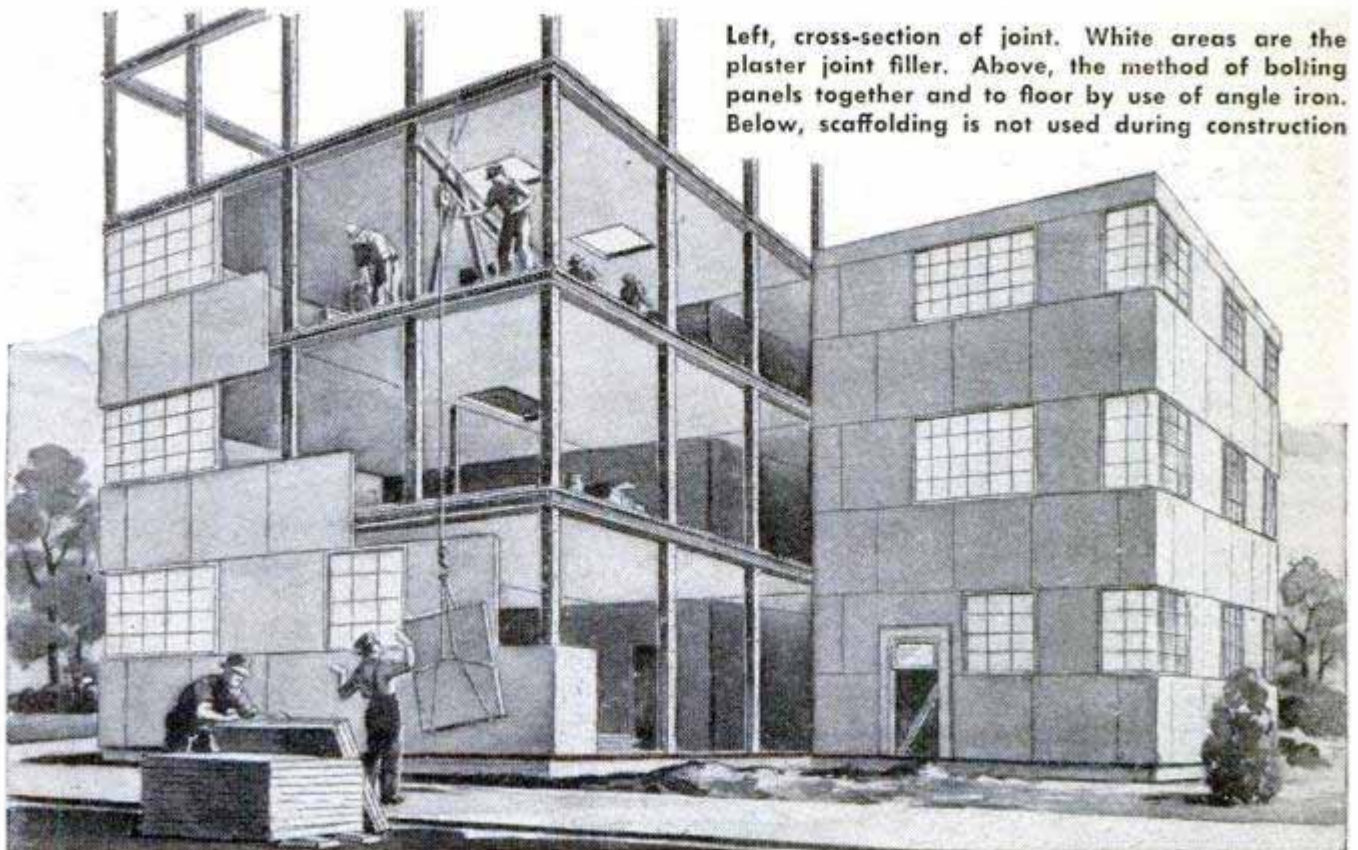

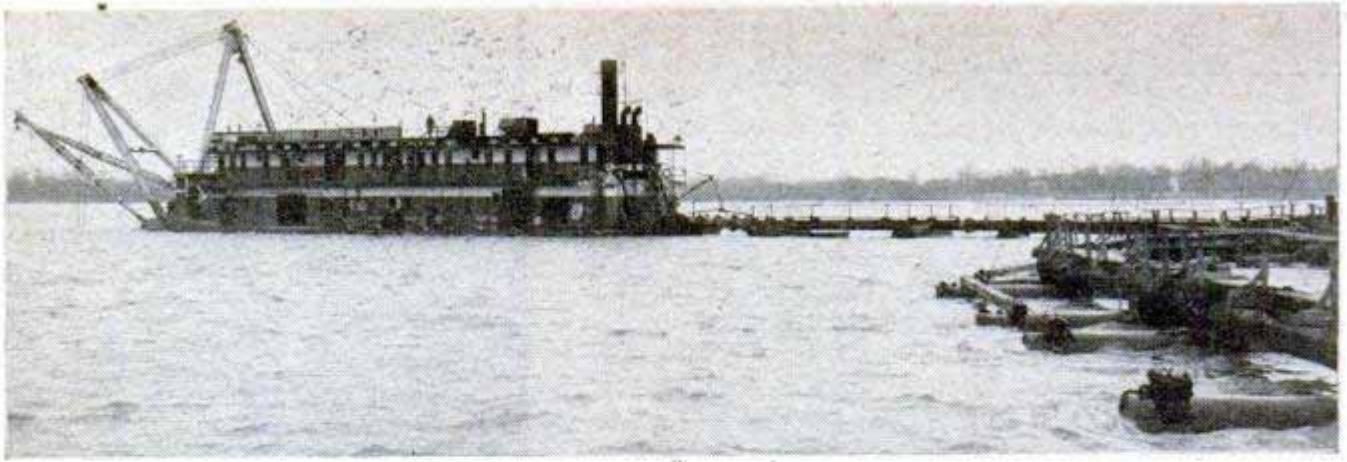

Reversing normal erosion, this dredge sucks silt from river bed to form shoulders for highway. Pipe that carries silt floats in foreground. Below, pipe snakes across fields carrying its load of silt-laden water



Above, about 850 cubic yards of silt an hour gush from end of pipe. Below, locations of dredge, pipe, shoulders and drainage ditch are shown on the map

SILT RETURNS TO THE LAND

Motorists driving on the approach to a new bridge over the Mississippi River at Memphis will soon be riding along 1,480,000 cubic yards of silt sucked up from the bottom of Old Man River. Silt, which is topsoil washed into the river by the erosive action of rains and streams, is usually considered utter waste. By dredging the silt from the river and using it, engineers are recovering some of this huge loss. Because earth slides have damaged previous roadbeds over the lowland between the levee and the river, highway engineers are using the silt to form wide protecting shoulders along the approach. The screw-type blade of a powerful river dredge sucks an average of 850 cubic yards of silt an hour from the river bed and forces it through more than a mile of 25-inch pipe to the project. Water that carries the suspended silt along the pipe drains back to the river in a long ditch after the silt has settled to the bottom. The roadway is 35 feet higher than the surrounding land.

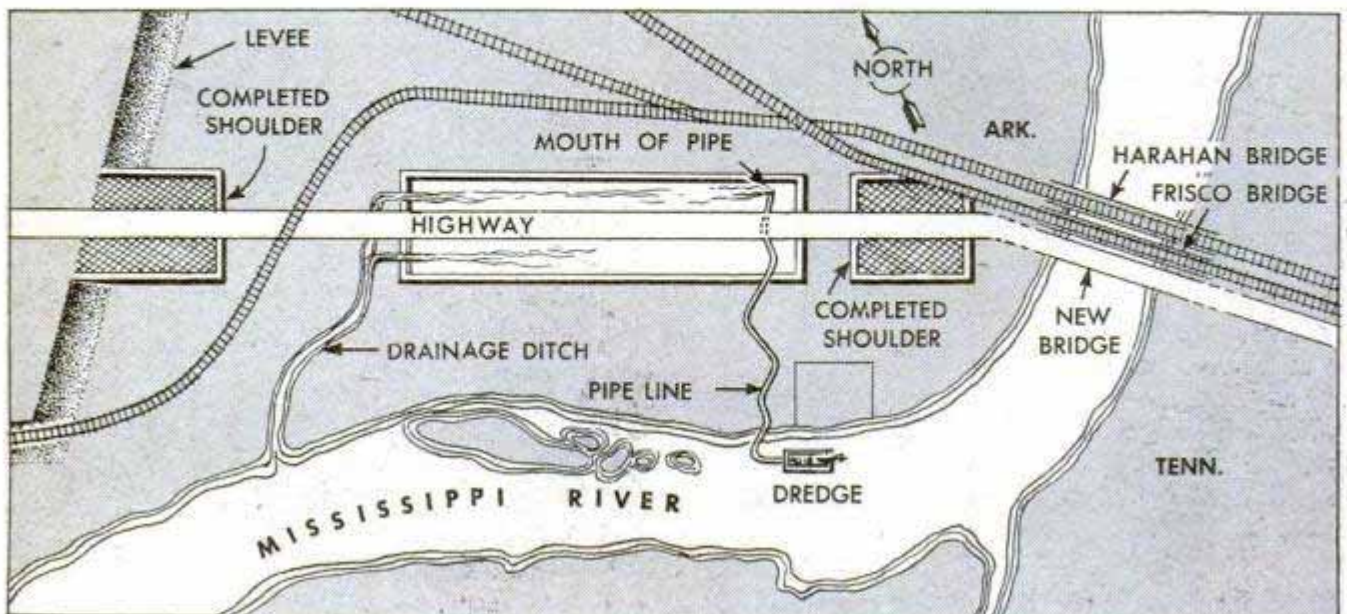

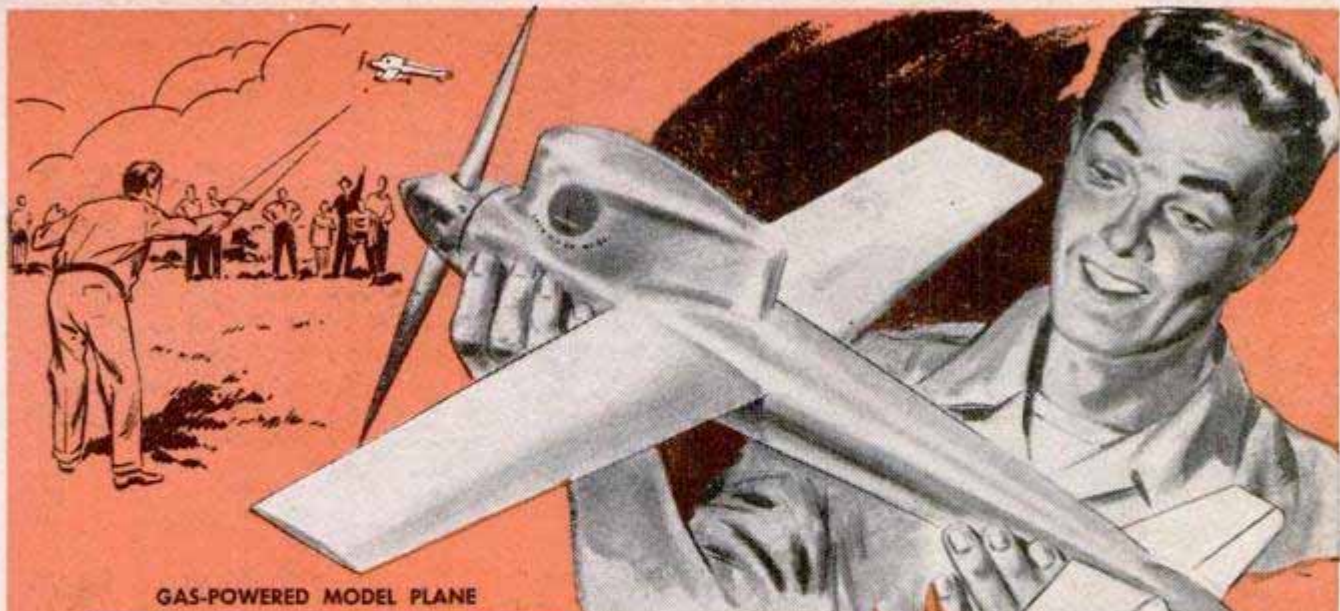

GAS-POWERED MODEL PLANE

The CRAFTSMAN

★ Nearly every model-plane "pilot" in the country knows about the record hung up last year by the "Gold Rush of '47"—an official 134.91 miles per hour! Beginning on page 170 the designer of this record-holding plane gives step-by-step instructions for building a duplicate of it.

★ Photographers—both picture snappers and professionals—have spent a lot of time dreaming about those action shots they could have gotten with a high-speed flash unit. On page 191 a practical photographer-electrician tells how to assemble a battery-operated speed light and how to use it with ordinary cameras having synchronized shutters.

★ The feature woodworking project is an unusual coffee table. The top is shaped from a solid slice of wood cut diagonally from a log of native cherry. See page 162 for plans and detailed instructions.

★ Shop feature for the month, page 197, describes the construction of one of the simplest portable belt sanders we've seen. It's made from small pieces of hardwood and uses regular sanding belts. A flexible shaft drives it at standard motor speed.

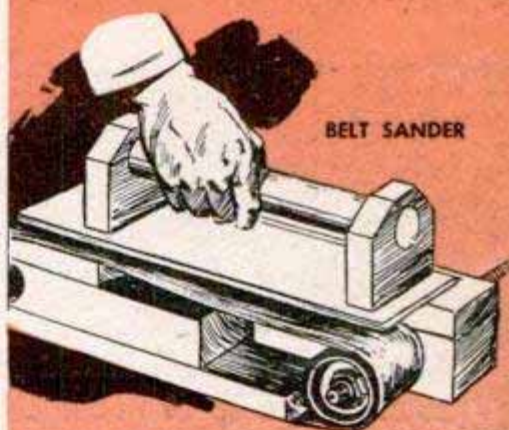

BELT SANDER



COFFEE TABLE



BATTERY FLASH UNIT

COFFEE TABLE

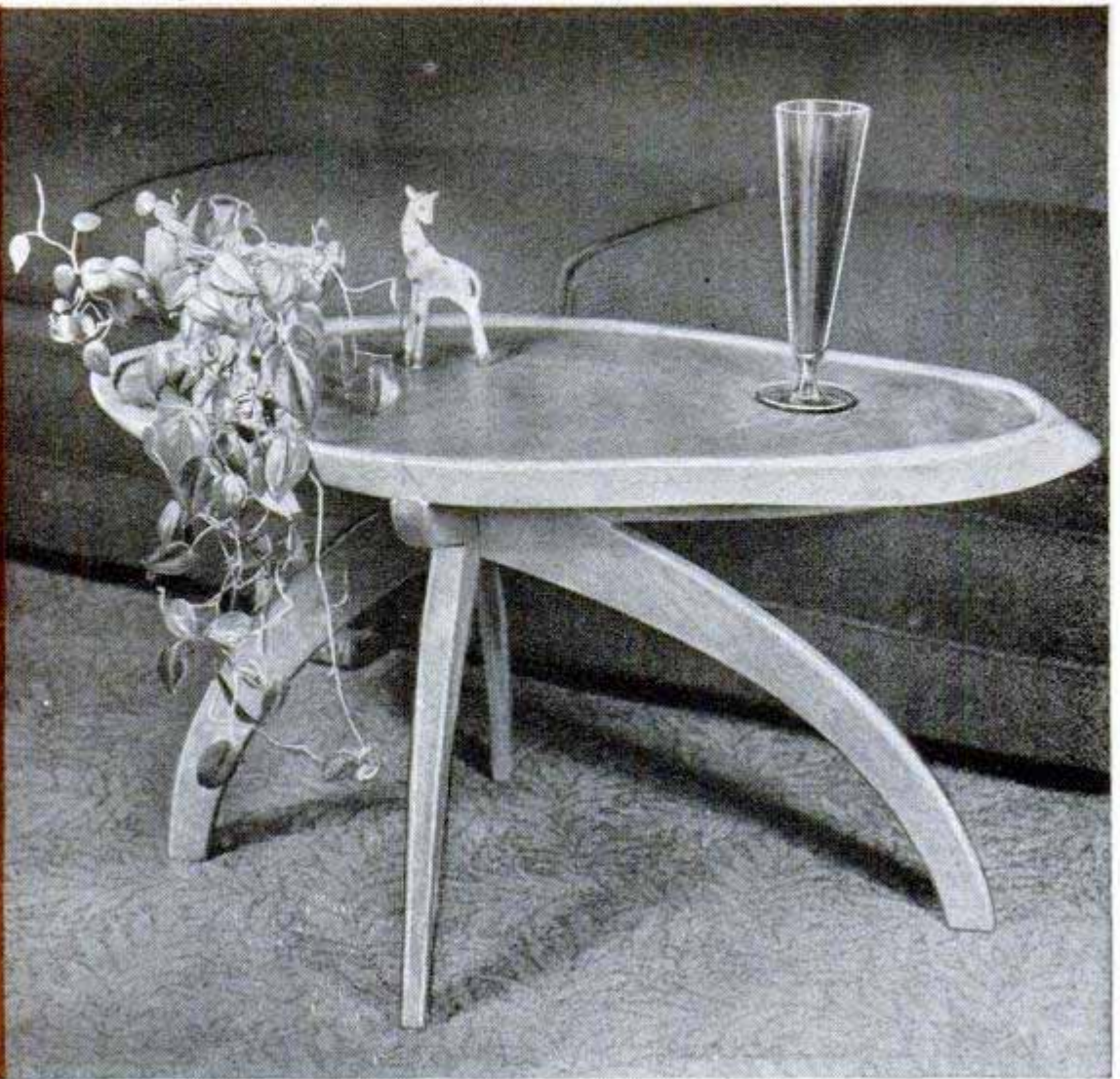

Diagonal slice from hardwood log produces beautiful grain effect to give this graceful coffee table a distinctive and exclusive touch. Legs are half-lapped and interlock

By W. J. LaFleur

IF IT'S the unusual you crave in occasional furniture, this coffee table should really intrigue you. Its novel construction calls for a top sliced diagonally from a log. Cut in this manner, the top assumes the natural contour of the log and the grain is enhanced by the annual-growth rings which take on a beautiful pattern.

The original table top was cut from an 18-in. cherry log, 4 ft. long. The log should be fairly round, thoroughly seasoned and the bark should be removed. To mark the log for cutting, make a wooden frame from stock $1\frac{3}{8}$ in. wide, measuring 18 by $29\frac{1}{8}$ in., inside measurement. The frame is placed over the log as in Fig. 3 and is tacked temporarily in place. Then a pencil is run around both sides of the frame to mark the log and the space between the lines is chalked. Fig. 1 shows how the log can be supported at an angle with a ladder and braced for sawing. Work carefully with a crosscut saw and try to make both cuts parallel. The saw will produce a rough surface which must be planed flat on the side selected for the underside of the top. Then $\frac{3}{16}$ -in. grooves are run on



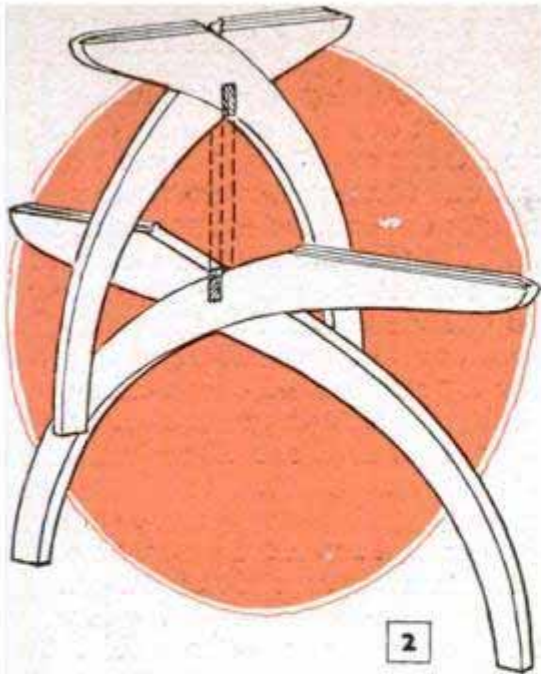

2



3

the underside for the leg tenons, locating them according to Fig. 4. Each groove can be cut on a bench saw by cutting a wooden strip to slide in one of the saw-table grooves and tacking it to the underside of the work parallel with the line of cut. A $\frac{3}{4}$ -in. rim is marked around the top surface and the area inside the rim is routed $\frac{1}{4}$ in. deep. This can be done with a router bit in a drill press, or with a portable router. After sanding smooth, a sealer should be applied to both sides of the top to seal the end grain and to retard checking. Fig. 6 details the leg patterns. Although the point of half lap is indicated by dotted lines, it is best to determine this by placing one corresponding leg on top of the other, as in Fig. 5, and marking directly. The assembled pairs of legs are notched to fit together as in Fig. 2 and then the top is glued to the leg tenons.

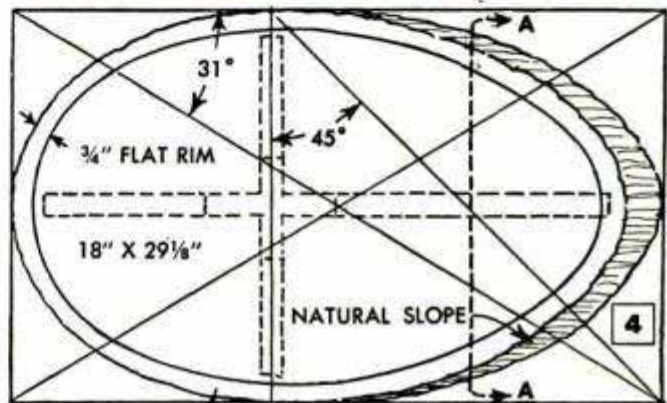

4

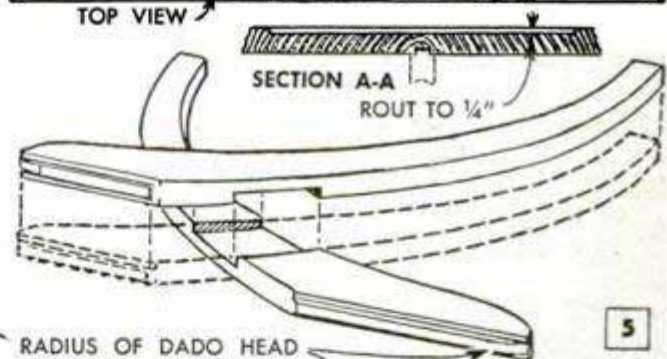

5

RADIUS OF DADO HEAD

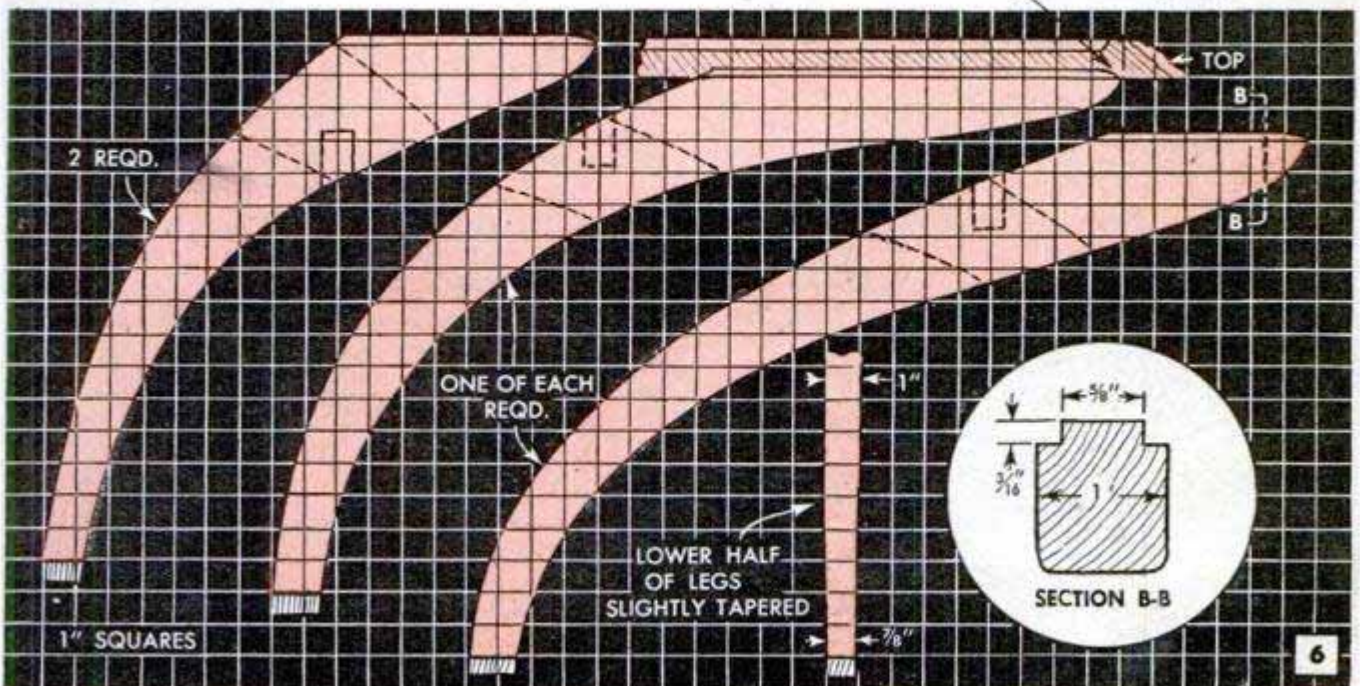

6

Matched Cabinet Doors Hung as One Simplifies Fitting and Hinging

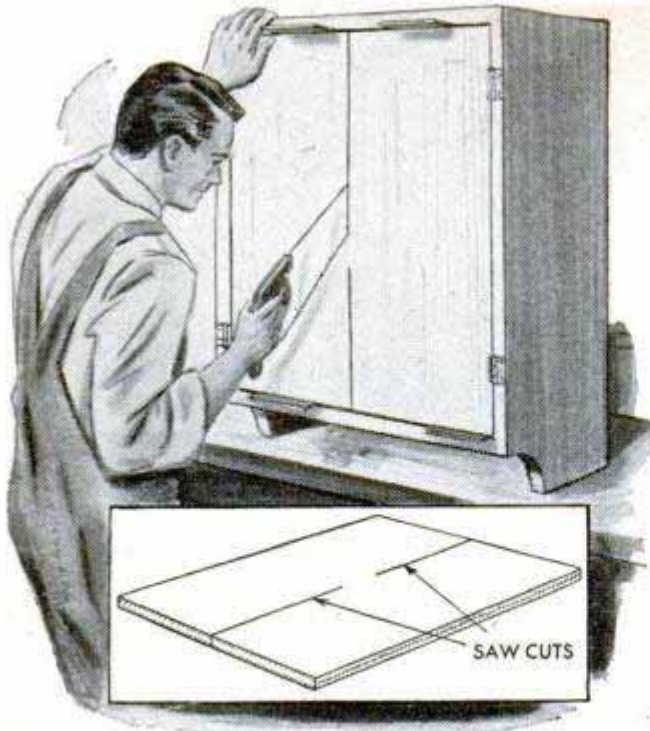

When fitting overlapping or flush-type matched cabinet doors, I save a lot of time by hanging them as a single door. To do this, I first cut the plywood to fit the entire opening, allowing for clearance at top and bottom. If the doors are to overlap the opening, I rabbet the inside edges and round the outside edges. Next, I partially form individual doors by sawing part way in from the top and bottom edges, as shown in the detail, stopping the cuts about 3 in. apart. If fixed shelves are already in the cabinet, the uncut portion of the panel should come at a point between the shelves so that they do not interfere with completing the cut later. Unless a narrow-gauge blade is used, a fine-tooth handsaw is preferred to a power saw to obtain a close-fitting joint between the doors. Next, I fasten the offset part of all four hinges to the rear side of the panel and complete hinging it to the cabinet after shimming it snugly in the opening with cardboard. Finally, I saw through the uncut part to make two separate doors and sand the edges.

Herbert Fey, New Braunfels, Tex.

Chugging Catches Walleyes

Walleyes lie in wait for minnows near the bottom of the water and chugging with this combination of natural and artificial bait usually results in a good catch. To assemble a chugging lure, first take a heavy sinker—one large enough to carry the line to the bottom—and scrape it bright. After tying the sinker to the end of the line, attach two small strips of cloth at the upper end of the sinker, one white and the other red. Then fasten a single or treble hook to the lower ring of the sinker. The hook is baited with a minnow, frog, worms or pork rind. To chug, allow the boat to drift while raising and lowering the bait slowly so that it touches the bottom about every two feet. Sometimes varying the movements, slow to fast, gives good results.—R. A. Jenkins, St. Louis, Mo.

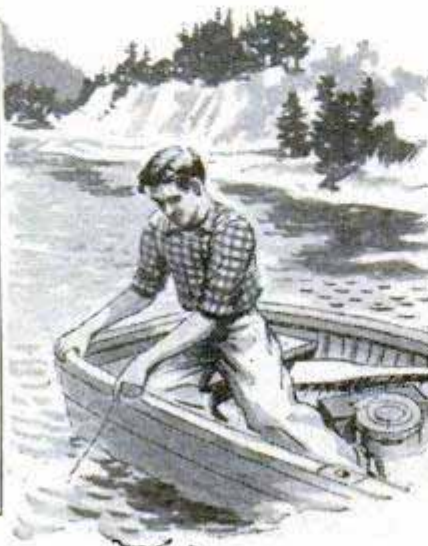

Mending Kit for Fishing Trips

For on-the-spot repairs when fishing, carry a bicycle-tube patching kit in your pocket or tackle box. This can be used to mend leaks or snags in your hip boots, waders or any other rubber footwear.

Improved Lawn Sprinkler

This convenient attachment will enable your garden hose to do double duty as a fountain-type lawn sprinkler. It is made from a $\frac{3}{4}$ -in. street elbow and a $\frac{1}{4}$ -in. metal rod, which serves as a spike. A brass rod and a galvanized elbow are best as they will not rust. After pointing and threading the rod, drill and tap the elbow as indicated. Then turn the rod into the elbow tightly to insure a leakproof fit. Screw the elbow on the garden hose and attach the nozzle as shown. To use, adjust the nozzle for a fine spray and force the spike into the ground.

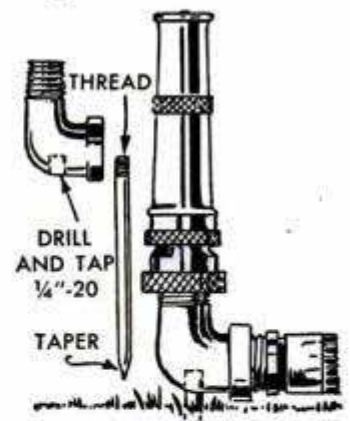

☞ To keep important papers together in your desk, use a spring clothespin as a paper clip.

BRING 'EM

BACK ALIVE

By Hi Sibley



Designed to hook over the transom of a rowboat, this convenient live box rides partially submerged to assure the fish you catch a constant supply of fresh water. Being located at the rear of the boat, the box will not impose any appreciable drag when rowing. Construction details show how it is assembled. Redwood is the most durable wood to use, although pine will do. The rounded side of the box is covered with hardware cloth and trimmed with molding. Flat-iron brackets, which hook over the transom at the top, fit in sockets at the bottom and are anchored with retaining pins. Note that the cover is made large enough to overlap the opening on all three sides.

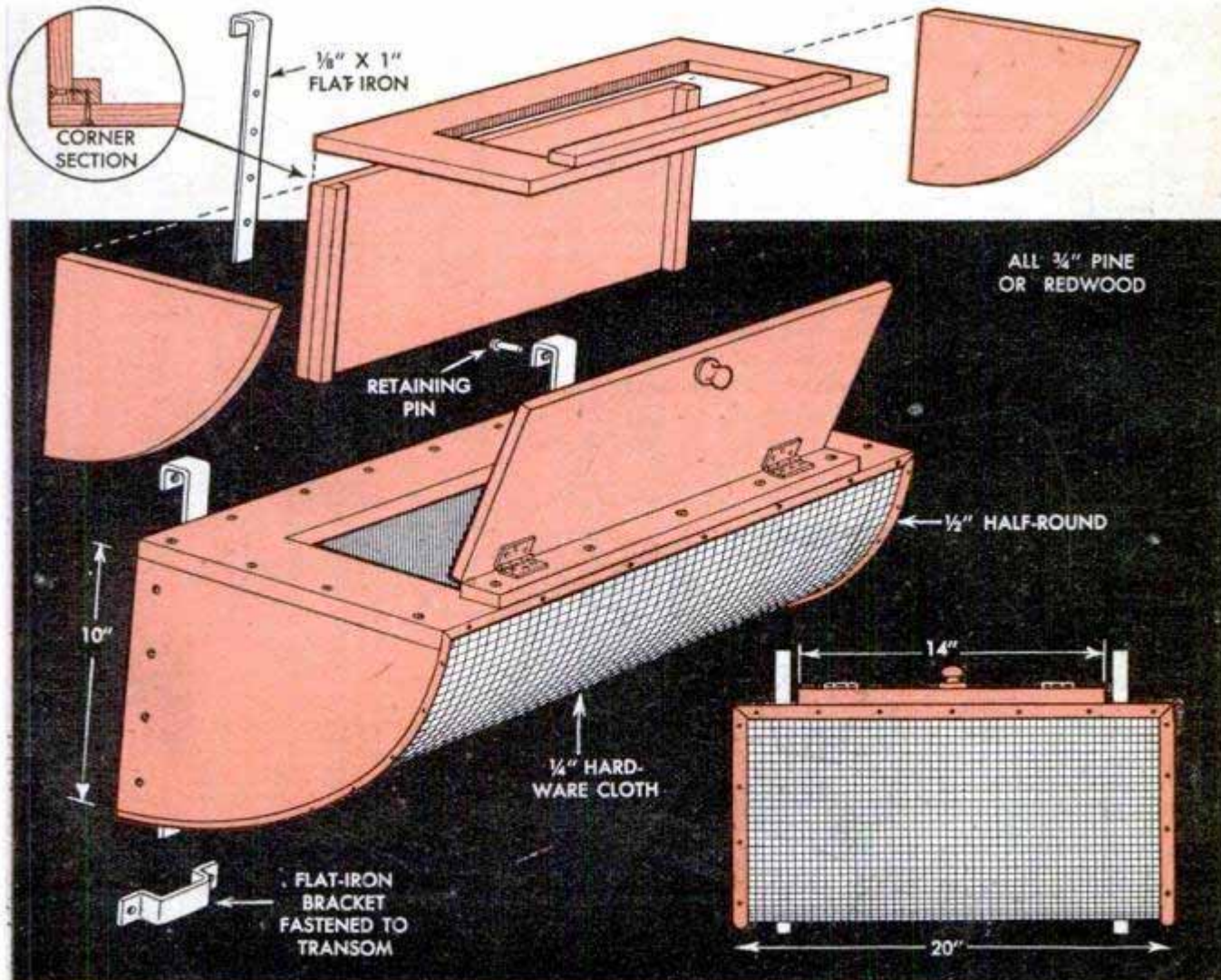
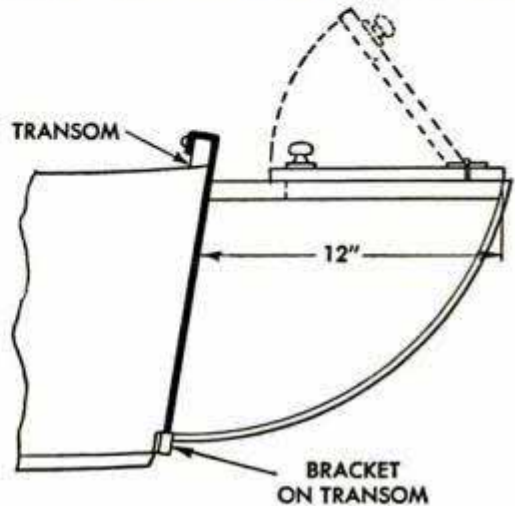

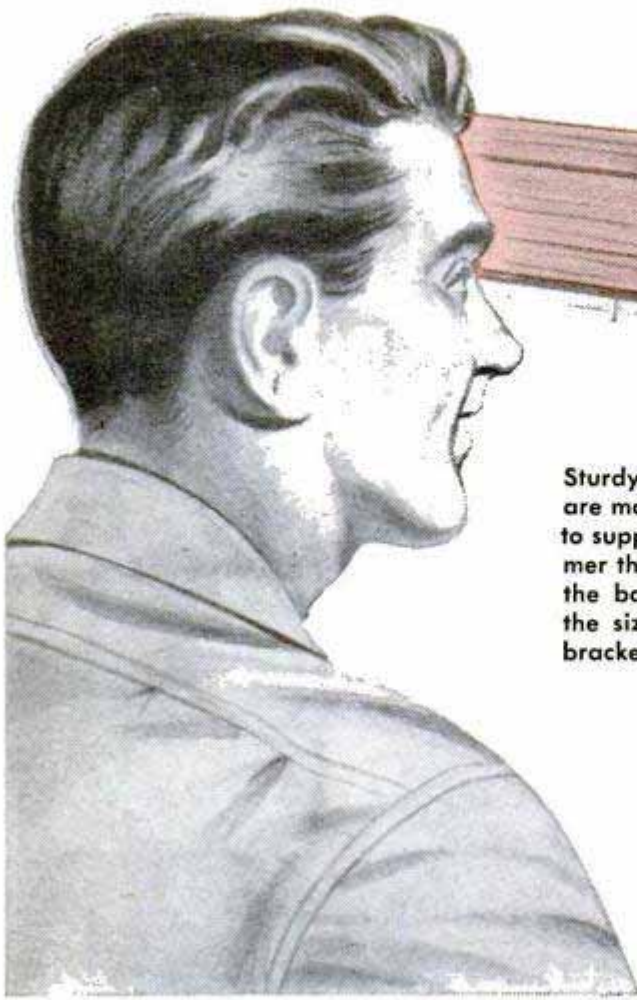

Sturdy hangers to hold a heavy picture are made from discarded brackets used to support a window-shade roller. Hammer them flat and screw one or more to the back of the frame, depending on the size of the picture, then bend the bracket outward to slip over the nail

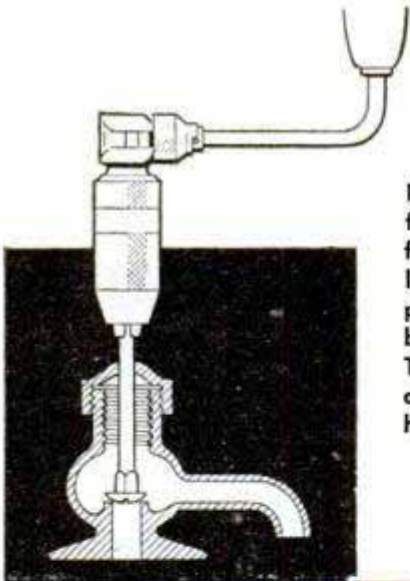
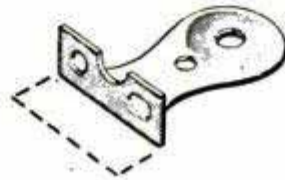

Above, if a faucet continues to leak after installing a new bib washer, you can save the cost of a valve-seat reamer by using a carriage bolt in an auger brace. Saw a slot in the bolt head so that in rotating the bolt it will ream smooth any irregularity in the valve seat. Do not apply much pressure—just enough to remove the burr. Use the largest size bolt that the faucet will admit

Right, to prevent a door key from being pushed out of a lock from the outside, remove inside lock plate, insert key through plate and place a slotted cardboard disk over the key shank. The disk will not interfere with operation of the lock and yet holds the key securely in lock

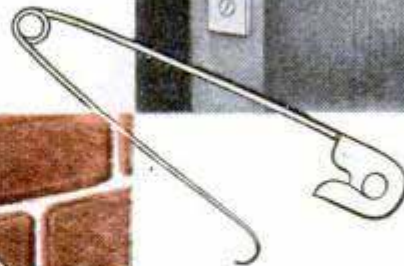
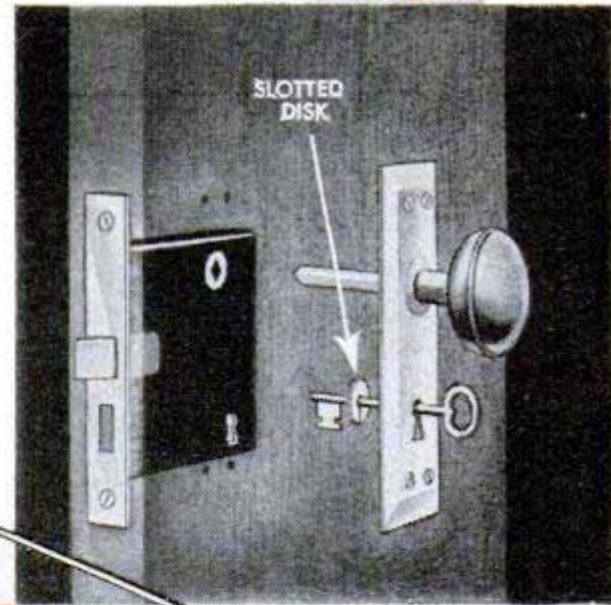

Above, knots in shoe laces difficult to untie with the fingers can be loosened readily with hook point of a safety pin

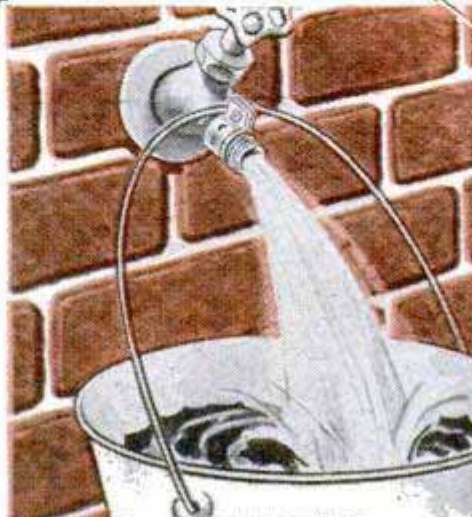

Left, a pail won't slip off a sill faucet when filling it if a hose clamp is fastened to the faucet and used as a hook for the bail. This is especially handy when carrying water as one pail can be filled while the other is emptied

HOME PROBLEMS

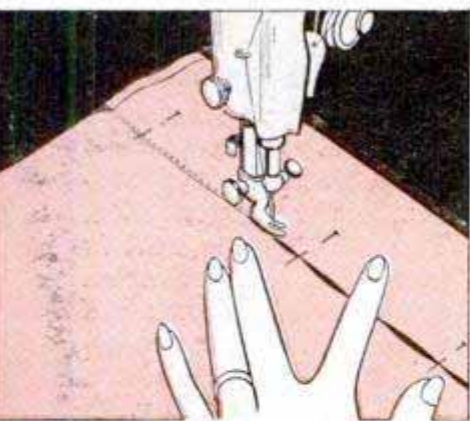

Left, if you use pins instead of thread to save time when basting, place the pins crosswise rather than lengthwise. Then you can stitch right over them with the machine and remove them later. If the needle does strike a pin, it will glance off and not be damaged or broken



Above, the next time you leave a note for the milkman, try this stunt to keep it from falling in the bottle or blowing away. Let one corner of the note project from the bottle and anchor it with a discarded milk-bottle cap



Right, when ironing large and long pieces, such as tablecloths, and they tend to dry out rapidly, pin a turkish towel to ironing-board pad to form an envelope. Place item in towel and pull it out as you iron. Towel will keep it nicely dampened

Lint on a suit or dress can be removed quickly by stroking garment with a "delinter" made by wrapping adhesive tape, sticky side out, on toothbrush holder

When knitting with several different colors of yarn, empty match books make excellent nonslip bobbins for holding the yarn. The flap of the book prevents yarn from unwinding

Save the scraps left over when upholstering a chair and keep them handy for patching holes and tears. Place them in an envelope and tack it to the underside of the chair

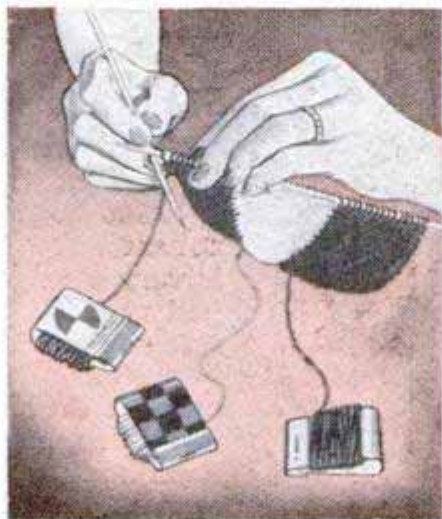

Novel Igloo Incinerator of Troweled Concrete Combines Both Utility and Attractiveness

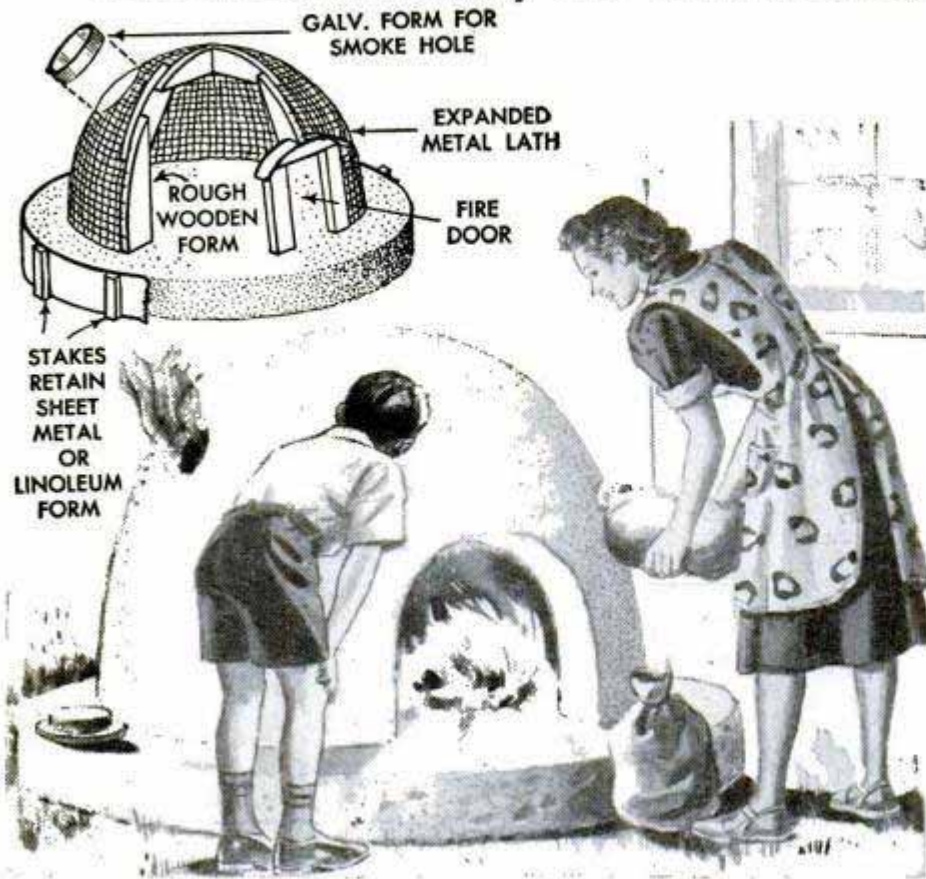

Wish you could burn rubbish in the back yard without having an old oil drum or other eyesore cluttering up the place? Then, here's just the thing for you—an attractive concrete incinerator that will do the job and always present a neat appearance. The base of the unit is poured in a sheet-metal or linoleum form. A wooden form for the igloo is made as shown, and this is covered with expanded metal lath, except over the fire-door and smoke-hole openings. Galvanized iron is used for the smoke-hole form and also to support the concrete over the fire-door frame. Then, cement is troweled over the lath to a 4-in. thickness. The wooden forms may be burned away later.

Pull Cord Attached to Toggle Switch Permits Operation by Small Children

If a young voice exclaiming, "Daddy, please turn on the light for me," frequently interrupts your browsing through the evening paper, you'll like this idea of W. Wild of St. Louis, Mo. He attached a pull cord to the toggle wall switch so the chil-

dren could turn on the lights by themselves. To do this, the top screw of the switch plate is replaced with a wooden pulley, as shown in the detail. Note the sheet-metal guard that keeps the cord from jumping off the pulley. Next, a small screw eye is turned into the side of the toggle switch. One piece of colored cord is looped over the pulley and tied to the upper part of the screw eye. Then, a shorter length of cord is tied to the lower part of the screw eye, and tassels are fastened to the dangling ends of the cord. This arrangement does not interfere with the normal operation of the switch, and the children soon learn to pull the cord to turn the lights on or off.

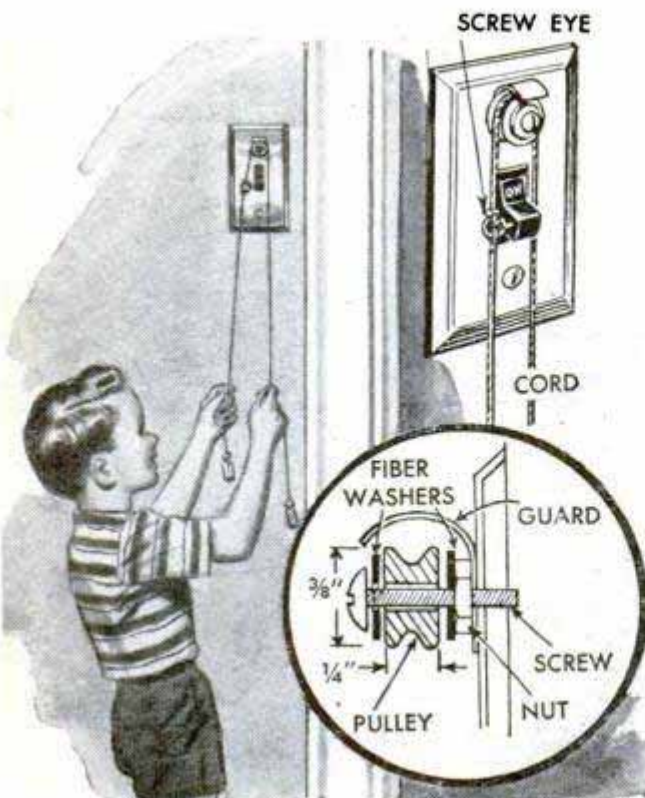

Substitute for Bucktail Flies

For those who prefer to tie their own trout flies and bass bugs, woodchuck (ground-hog) tail hair will serve as an excellent substitute for bucktail hair. This is very similar to bucktail hair and works just as well. To tan woodchuck tails, first remove the tail bone and tack the tail, flesh side out, in a cool, dry place. Then rub salt into the flesh side of the tail. When the tail is dry, pack it in a glass jar along with naphtha flakes or cedar shavings to protect against possible damage by moths.

Attached and removed with a few turns of two wing nuts, this mounting bracket permits a light-weight outboard motor to be operated at maximum efficiency on almost any canoe. As the motor is held well out to one side of the canoe, full benefit of steering, tilting and reversing features is attained. The unit is constructed entirely of $\frac{3}{4}$ -in. oak. The crosspiece is 2 in. wide and long enough to project about 1 in. over one side of the canoe and 10 in. over the other. The motor mount is a 6 by 10-in. piece of wood, screwed to the crosspiece at an angle and braced by two triangular flat-iron brackets bolted in place. The crosspiece is slotted to take two hooks which are tightened with wing nuts so that the bracket is held securely to the gun-

Canoe "Sidemount" for Light Outboard Motor Permits Full Tilting and Steering Control

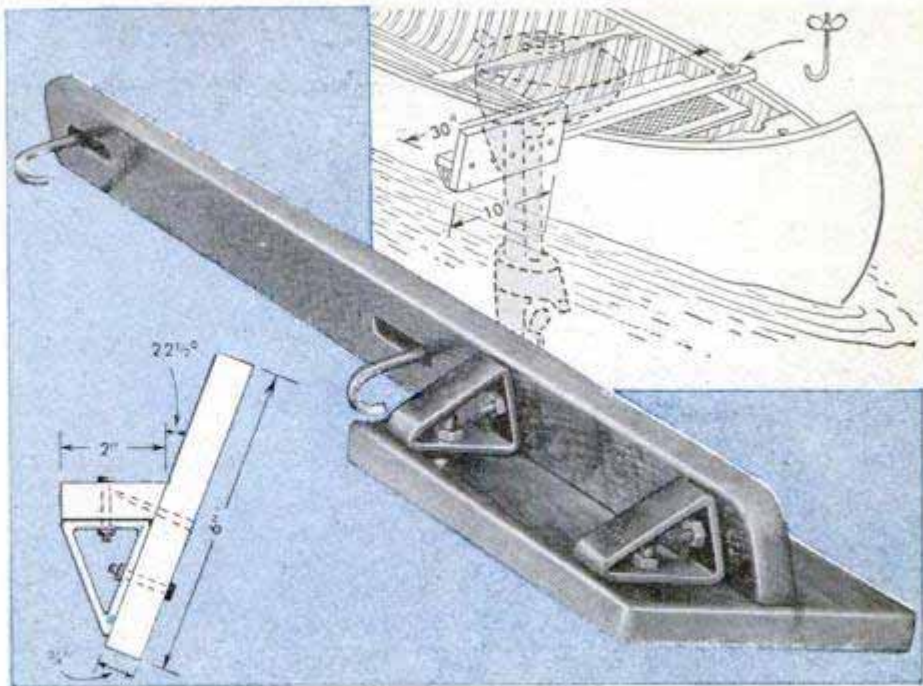

wales. The hooks can be made by cutting the heads from long bolts and bending the unthreaded portion to shape. A coat of marine varnish will preserve the wood.

wales. The hooks can be made by cutting the heads from long bolts and bending the unthreaded portion to shape. A coat of marine varnish will preserve the wood.

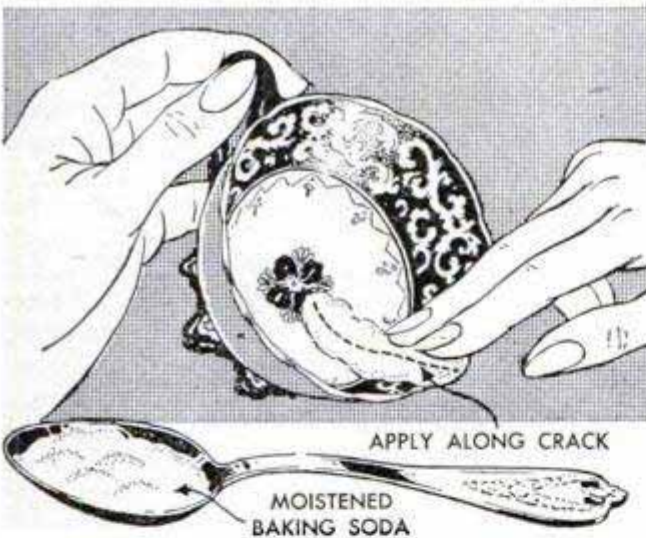

Baking Soda Removes Stains On Rare China

Those who take pride in their collection of rare china will welcome this handy tip for removing tea and coffee stains from hairline cracks. First, apply ordinary baking soda, slightly moistened, to the area that is stained. Let stand for about one hour and wipe off. If one application does not remove the stain completely, repeat the treatment.

☐ While beating ingredients in a bowl with one hand and adding material with the other, the bowl can be prevented from slipping by placing it on a folded towel.

Improved Woodworkers' Clamp Assembled From Scrap Parts

An inexpensive bar clamp can be improvised from two lengths of iron rod, two pieces of flat iron, two nuts, two washers and a couple of cotter pins. Thread one end of each of the rods to take a nut and drill a series of holes along

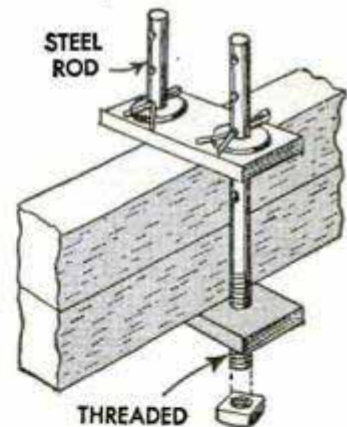

each rod to permit inserting cotter pins. Then drill two holes in each of the flat-iron pieces to fit over the rods. In use, the top piece of flat iron is held in place by washers and cotter pins, and the lower piece is tightened with the nuts. The length of the rods, the number and spacing of the holes determine the over-all width of work the clamp will handle. Make the thread length equal to the distance between the cotter-pin holes.

Al Ferguson, Hollywood, Calif.

☐ When painting a house in regions of intense summer heat, use a light color of paint. This will tend to make the house cooler, as light colors absorb less heat.

Build "GOLD RUSH OF '47" the A.M.A. Open Class B record holder

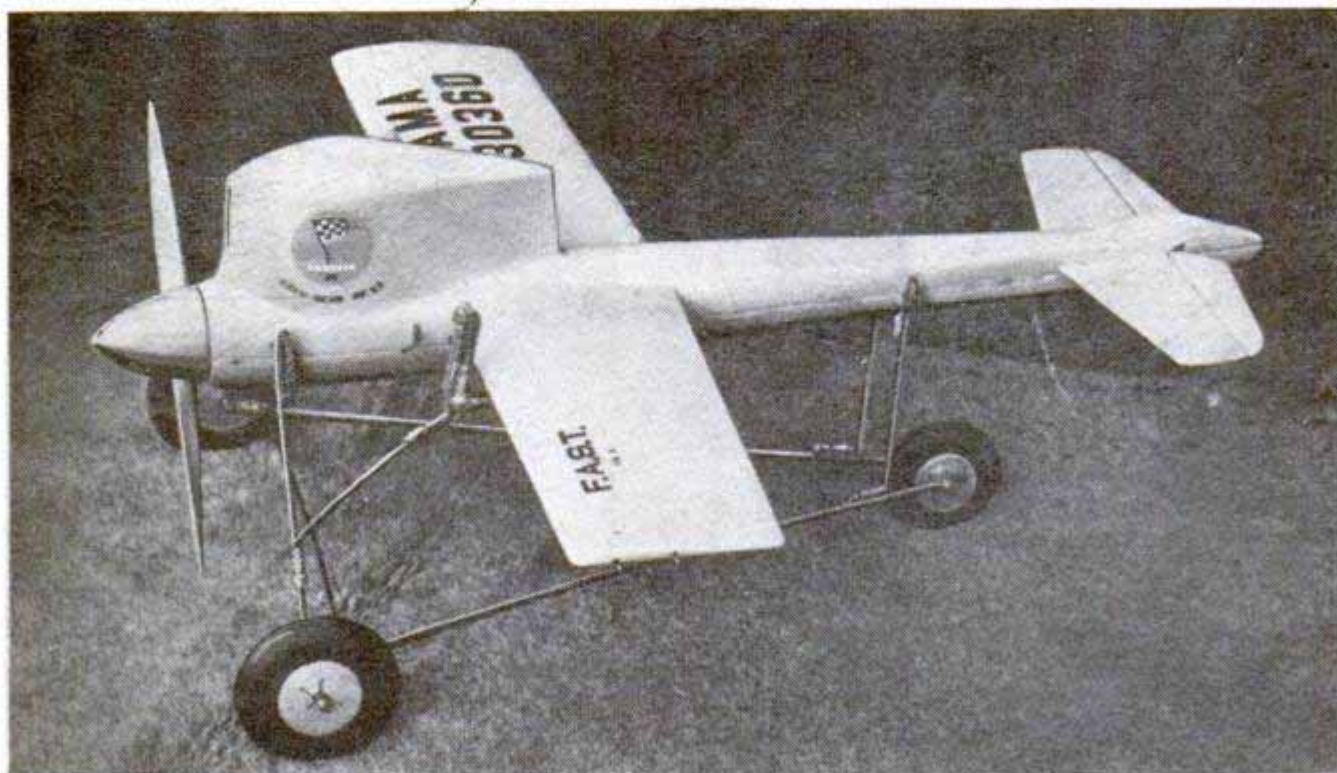

IN RESPONSE to many requests, *Popular Mechanics* presents the plans on how to build the famed model speed plane "Gold Rush of '47"—the A.M.A. Open Class B record holder which blazed across the contest fields of last year at a speed of 134.91 m.p.h. Its construction is so very simple that its record is all the more impressive.

Fuselage: Begin by selecting two pieces of clear white pine to be used as the top and bottom halves. Cut to the rough dimensions with allowance at each end for waste and face off one side of each piece. Then glue the faced sides together with a sheet of thin paper between so they can be easily separated later. Carefully locate center points on the joint. Mount in the lathe, rough-turn, and mark off stations at sections A-A to G-G inclusive, Fig. 2. Then, using a cutoff tool and calipers, cut the fuselage down to size at each station. Remove the waste to depth between the stations, and finish with fine sandpaper. Finally, face off the nose of the fuselage square. Remove from the lathe and cut off the waste at the ends by hand. From a point roughly halfway between sections D-D and E-E, plane a flat on each side of the fuselage to section G-G. Then separate the piece into the original halves by running a knife blade along the joint, and sand the joining faces to remove the glue and paper.

By Keith Storey

Pencil a center line on the flat face of each half of the fuselage and carefully check the dimensions with the plans. See Fig. 2, sections A-A to G-G inclusive. Pick the straightest-grained piece for the bottom half of the fuselage as it will bear the load. Now, draw in all lines indicating wall thickness and location of engine bearers. Back of the engine well, hollow the bottom half to a uniform wall thickness of $\frac{1}{8}$ in. The engine section gets a different process. The original ship was powered by a McCoy 49 engine and dimensions are given for this particular power plant. As the width at the base of the engine mounting lugs is $1\frac{1}{2}$ in., measure $\frac{3}{4}$ in. on each side of the center line and draw lines parallel with the center line from the rear of the engine well to the nose of the ship. The area between these lines is recessed to a depth of $\frac{1}{16}$ in. at the rear and slowly tapered up in depth to conform to the shape of the fuselage at the nose. Wall thickness from a point directly under the engine to the forward end of the fuselage should be at least $\frac{1}{4}$ in. Hollow the top half to a uniform $\frac{1}{8}$ -in. wall thickness and finish the two halves smoothly on the inside with sandpaper so that the bulkheads will fit snugly.

Next, make the magnesium crutch, Fig. 2, by first scribing the layout lines on the magnesium sheet. Saw out the openings

in the center but do not finish-file the outside until the crutch has been mounted in the fuselage. Cut away the bottom half of the fuselage to receive the crutch in a smooth, snug fit. Then drill and tap mounting holes as shown in Fig. 2. After mounting the crutch, file the outside edges flush with the wood. Next, attach the $\frac{1}{16}$ -in. magnesium landing skid to the underside of the bottom half as in Fig. 2, running the tie bolts through both the crutch and skid in a trial fit. Then, remove the crutch and skid from the shell and fit the wooden bulkheads.

The $\frac{1}{4}$ -in.-wide magnesium brace at the nose can be formed from a straight strip of magnesi-

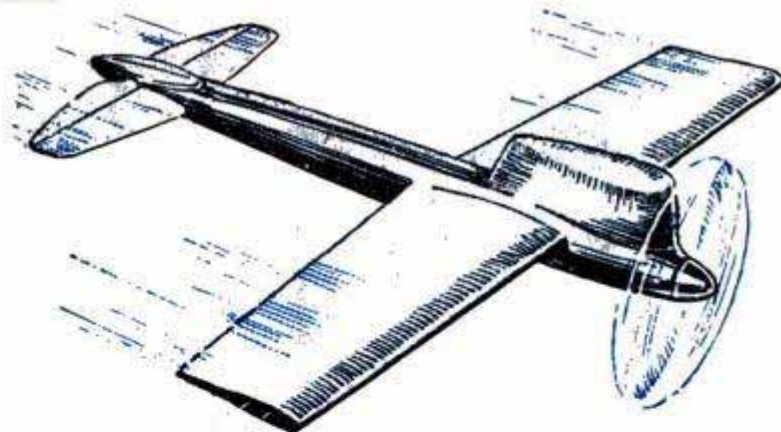

um or, cut a ring from a piece of tubing and split it in half. Drill and tap the brace for a screw which comes up through the forward end of the skid. This brace is mounted on the crutch by means of two 2-56 machine screws. Nut plates, section B-B, Fig. 2, are cut from $\frac{1}{8}$ -in. duralumin and are drilled and tapped to fit the engine mounting bolts. Use 3-48 machine screws for attaching the plates to bottom of the crutch.

Wing: The wing, Figs. 2 and 3, is made in one piece. Location of the ribs, Fig. 3, and the half spar are indicated on the bottom sheet of $\frac{1}{16}$ -in. balsa wood by drawing the outline directly on the wood. Then cement the ribs in place. Now, install the maple half spar shown in Fig. 4. This forms a rigid support on which the control plate, Figs. 4 and 6, is mounted. Drill a No. 10 hole in the half spar and wing bottom to aid the installation of the control plate later, and cut curved slots for the control-plate tabs.

RECORD LOG "GOLD RUSH OF '47"*

No. of Flights	Place	Date	Position	MPH	
4	Anaheim, Calif.	April 1947	2nd	118.21	NS
2	Colton, Calif.	May 1947	1st	124.14	NS
2	L.A.A.M.	May 1947	1st	124.18	†
2	Bellflower, Calif.	May 1947	1st	124.78	†
3	A'moda, Calif.	July 1947	1st	120.65	NS
2	Western Open	June 1947	2nd	119.70	S
1	Long Beach, Ca'if.	July 1947	1st	124.78	S
2	International (Plymouth) Detroit		2nd	119.25	S
1	1947 Nationals		1st	125.25	
1	Joliet, Illinois		1st	128.50	NS
3	East-West (St. Louis)		1st	128.88	†
1	Anaheim, Calif.		1st	129.56	NS
1	Long Beach, Record Trials		Record	134.91	†

† A.M.A. Sanctioned meet — new record.

* The 1948 A.M.A. rules now place this airplane and motor in class C, for motors of .30 to .50-cubic-inch displacement. S = Sanctioned. NS = Not Sanctioned.

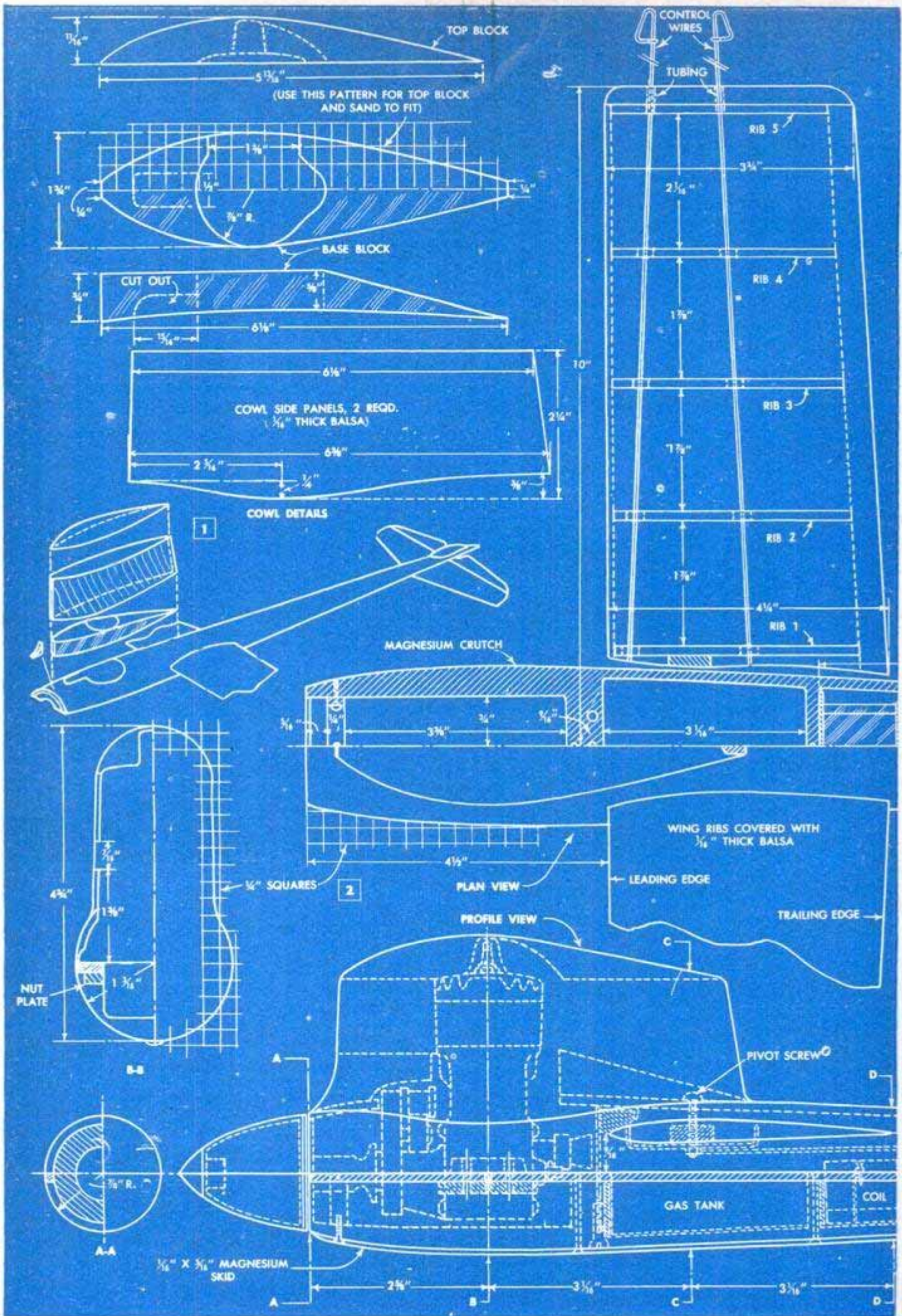

3

WING RIBS
(FULL SIZE)

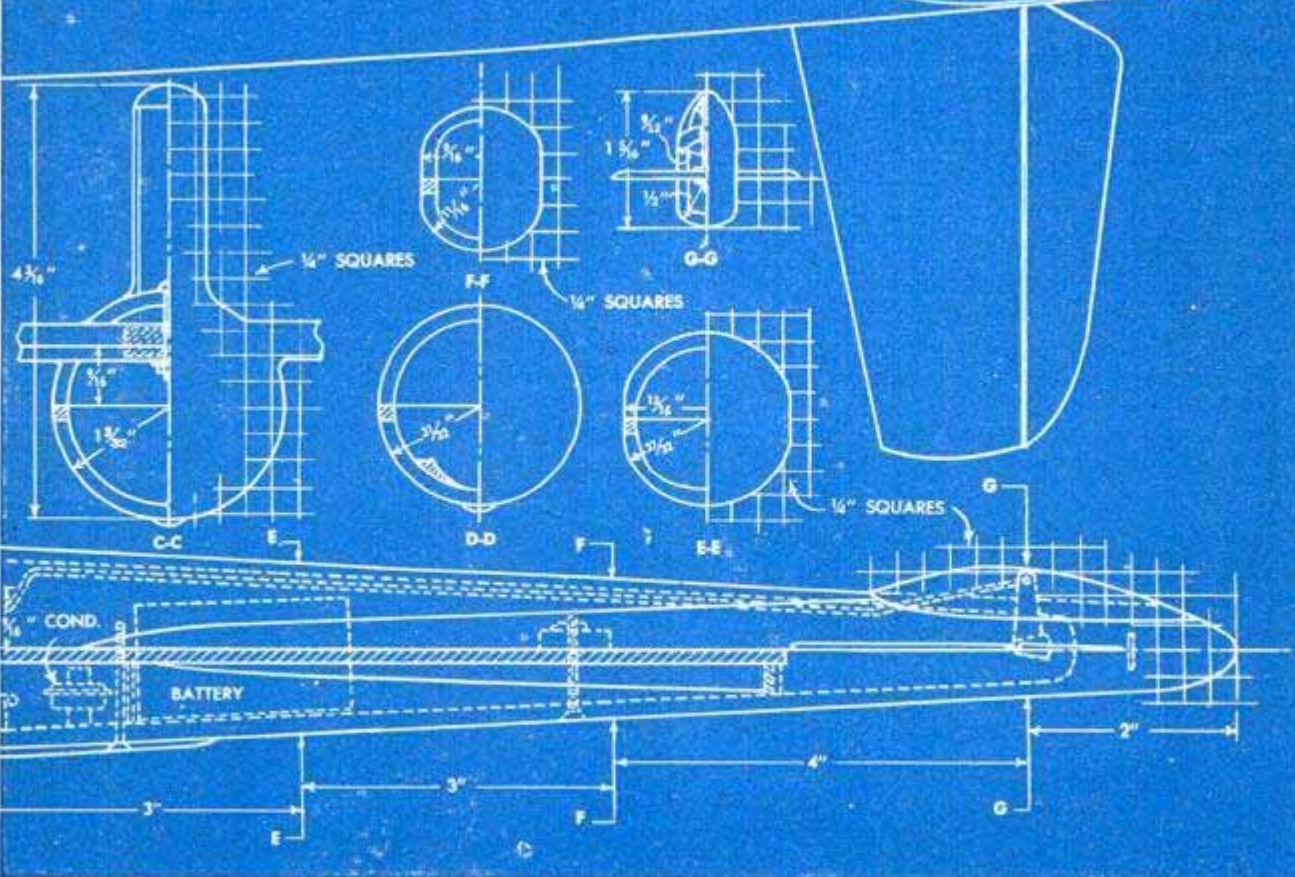
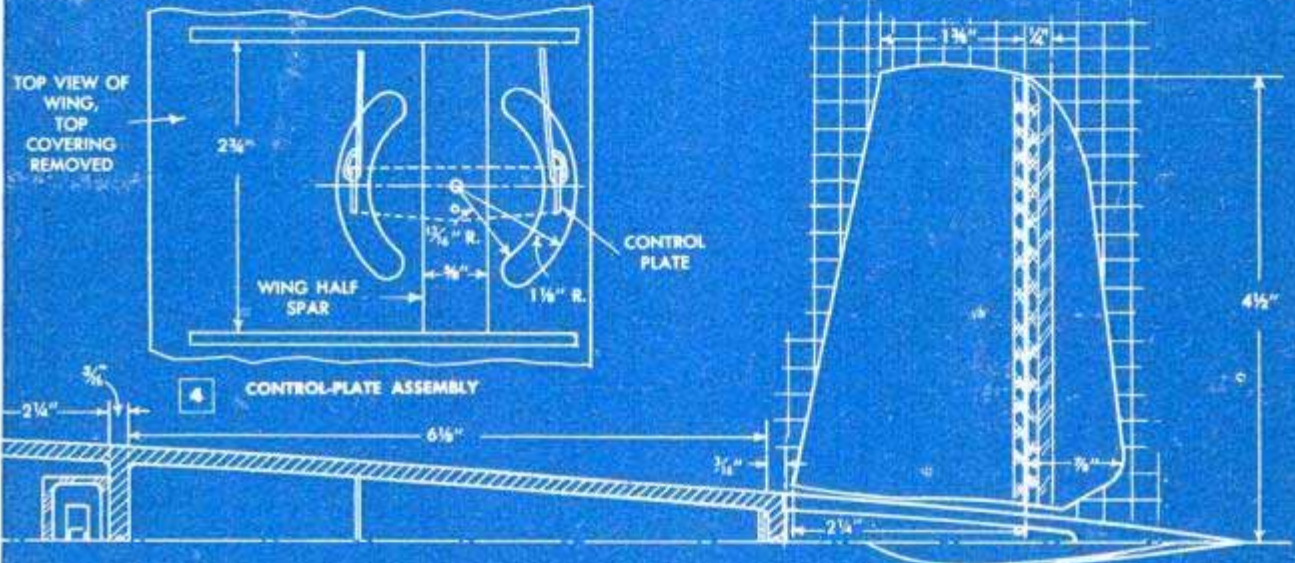
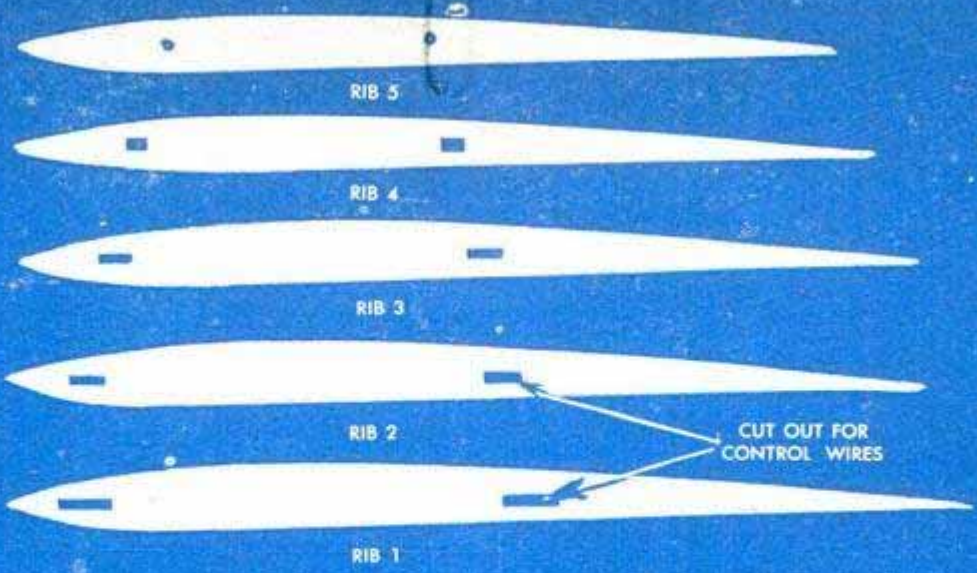

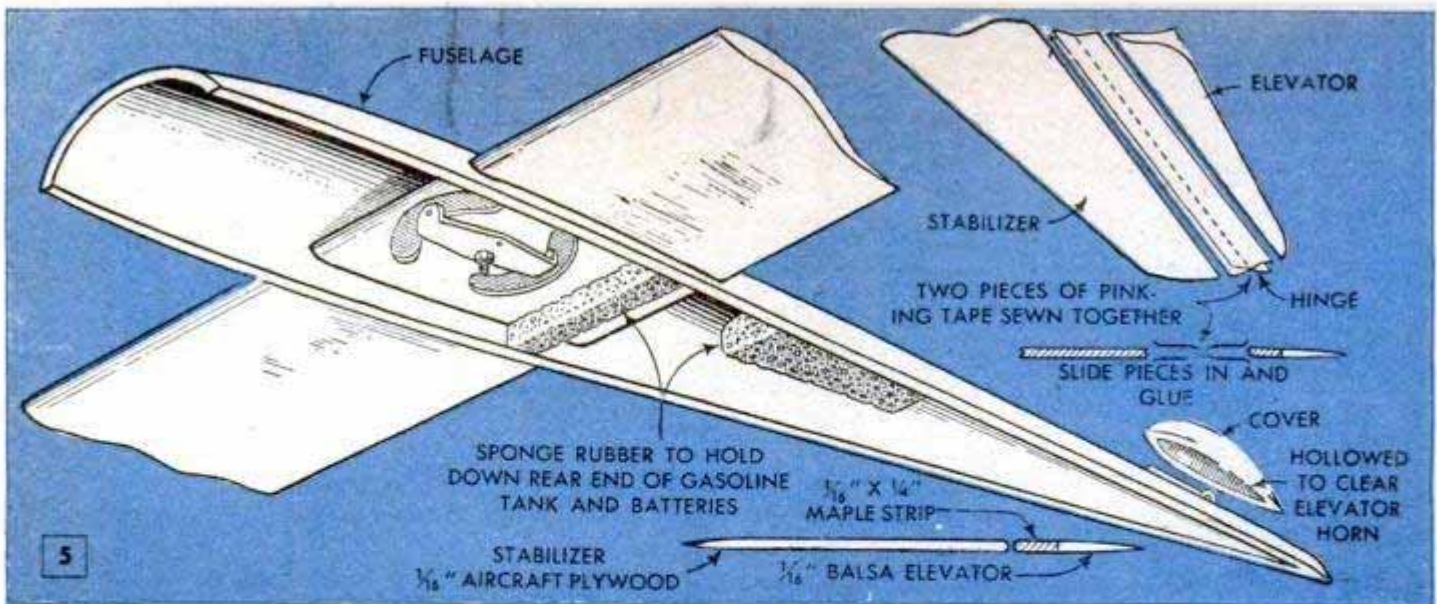

Then glue the top skin over the ribs. Wing tips are made from scrap balsa and merely close the opening at the outer ends of the wing. Two $\frac{1}{2}$ -in. pieces of $\frac{1}{16}$ -in. o.d. aluminum tubing are installed for control-wire guides. See the plan view, Fig. 2. Control wires can be installed in either the right or left wing.

Cover the wing with silk to give an extremely smooth contour, and coat the wing surface with a sealer. To install the wing, measure $\frac{9}{16}$ in. up from the fuselage center line to the leading and trailing edges of the wing center section, Fig. 2, making sure that the 0-deg. incidence is accurate. The leading edge of the wing should be $4\frac{1}{2}$ in. from the nose. Draw the approximate rib profile on each side and cut out with a sharp knife or coping saw. Try the wing and trim the opening to fit. After the wing is correctly located and cemented in place, continue the hole in the bottom of the wing and half spar through the top of the fuselage. Then, make the control plate, Fig. 6, and install on the bottom surface of the wing as in Figs. 4 and 5, inserting the bolt through the top of the fuselage and locking it in place with a staple made from $\frac{1}{32}$ -in. wire. The prongs of the staple are

forced into the top of the fuselage on each side of the bolt head, and the straight section enters the slot in the head to prevent the bolt from turning. Finally, make the block and fitting to hold the bicycle-spoke tie-down which anchors the leading edge of the wing. In the profile view, Fig. 2, these parts are shown in section just forward of the fuel tank and leading edge of the center section of the wing.

Tail section: The stabilizer is made of $\frac{1}{16}$ -in. mahogany or aircraft plywood and the elevator is balsa, edged with a maple strip, Fig. 5. The elevator hinge is made from two pieces of aircraft linen, $\frac{1}{2}$ in. wide and 9 in. long, sewn together down the center of the cloth. Glue the hinge in place before making and installing the control horn and cover, Figs. 5 and 6. At this time, install the piano-wire control cable between the control plate and elevator horn, bending the wire to fit.

Engine cowling: A carefully made cowl, Figs. 1, 2 and 7, gives efficient engine cooling which results in a smoother-running engine. First, mount the base block on the fuselage and then cement the sides in place, holding them in position with pins. Make sure the top block is correctly re-

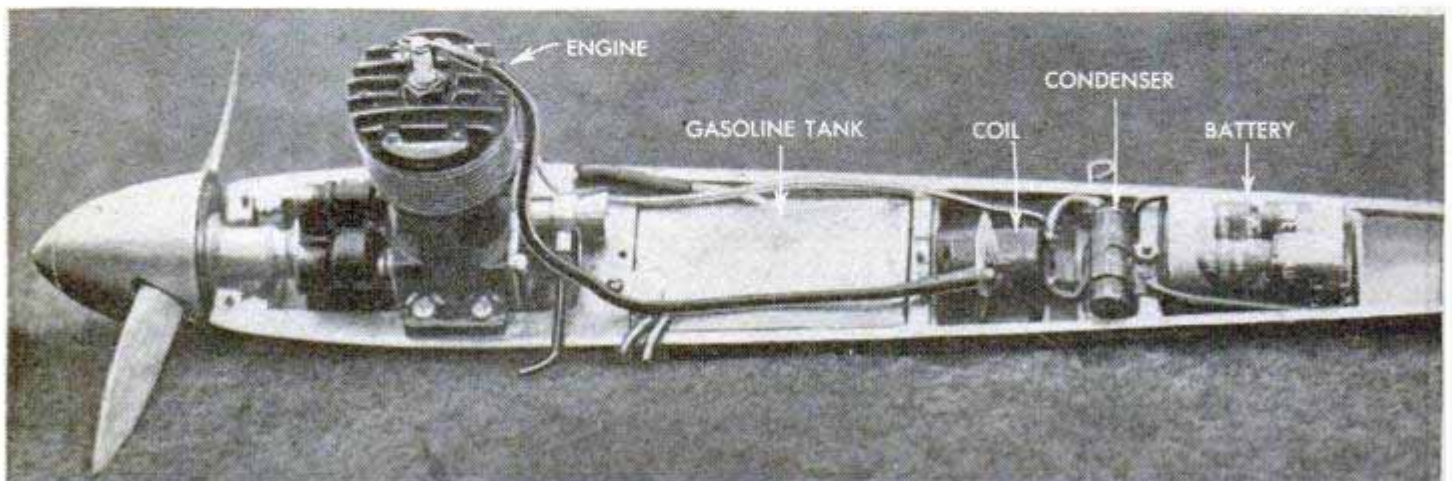

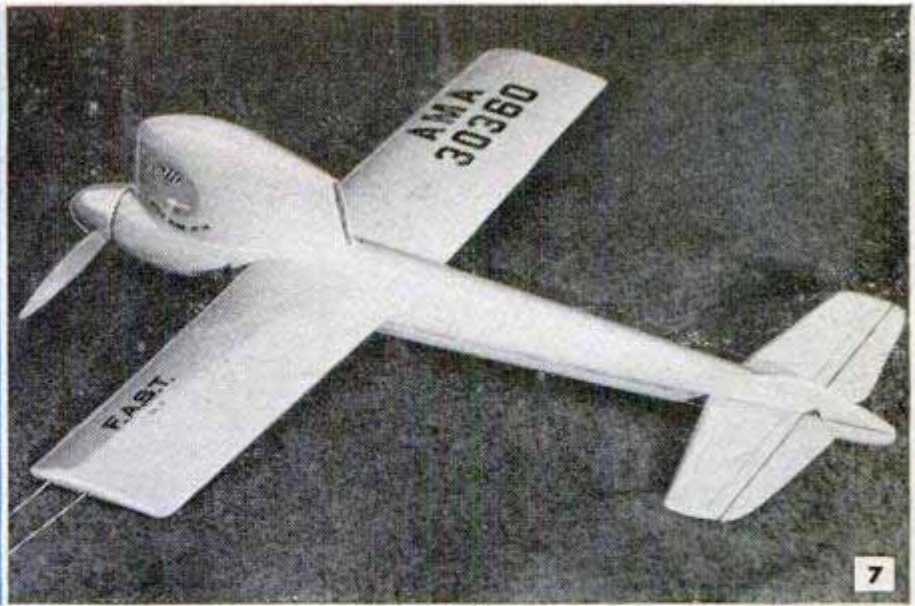
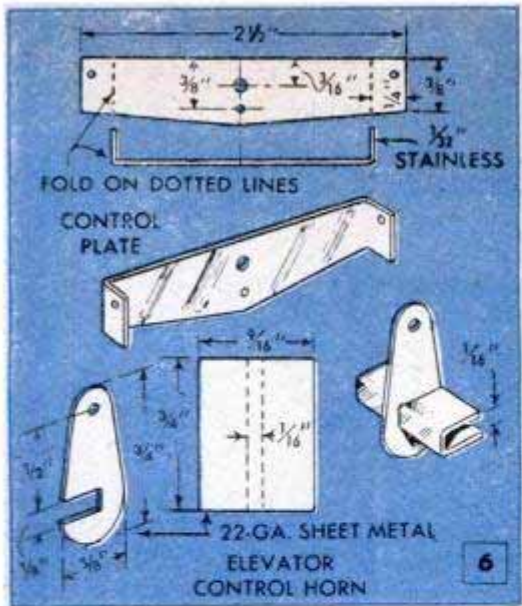

cessed for the cylinder-head fins and spark plug or glow plug, and also that it is grooved for the high-tension wire or glow-plug lead. Place the engine in the bottom shell and mount the top half of the fuselage to determine height of the top block. Allow the block to rest on the head and cement it in place on the side panels. Where the cowl meets the fuselage, fill in to a smooth contour with wood putty. Sand all over and cover the cowl with silk. Next, make the fuel tank, Figs. 8 and 9, and test for leaks. Then install the engine and all accessories in the lower half of the fuselage as in Fig. 10. The take-off dolly, Fig. 8, is easily made, the important thing being to adjust the wheels so that it rolls straight when pushed.

Finish: All surfaces should be filled and sprayed with synthetic enamel.

Flying: Use a 3-1 methanol and castor-oil mixture. If using spark ignition, setting on the point gap should be .003 in. maximum. Start with a 9-in.-dia. 10-in.-pitch prop, true the pitch to approximately 10 1/2 in. and make an accurate airfoil shape for the blades. With the plane at rest, the engine should turn 14,500 r.p.m. minimum.

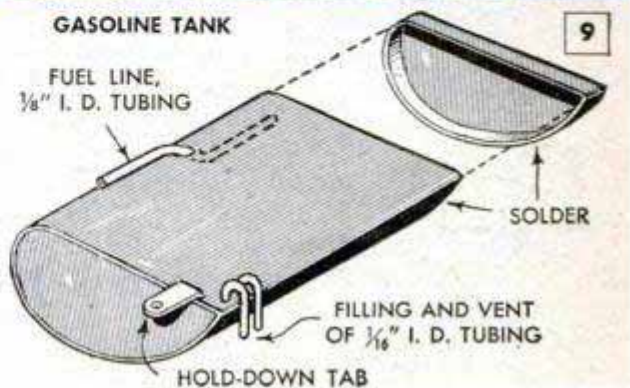
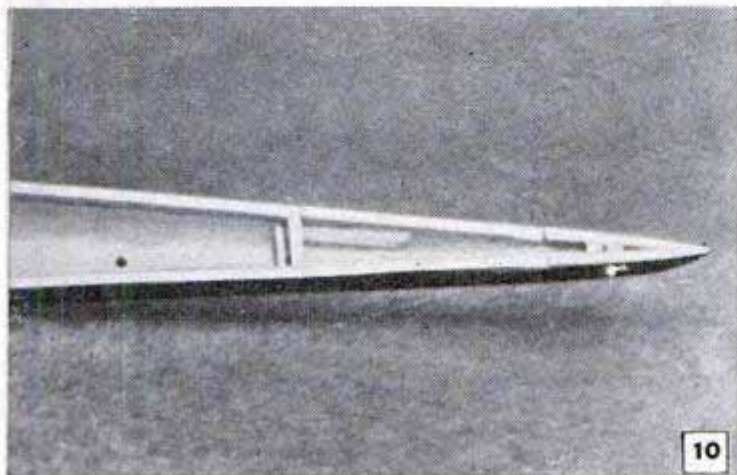
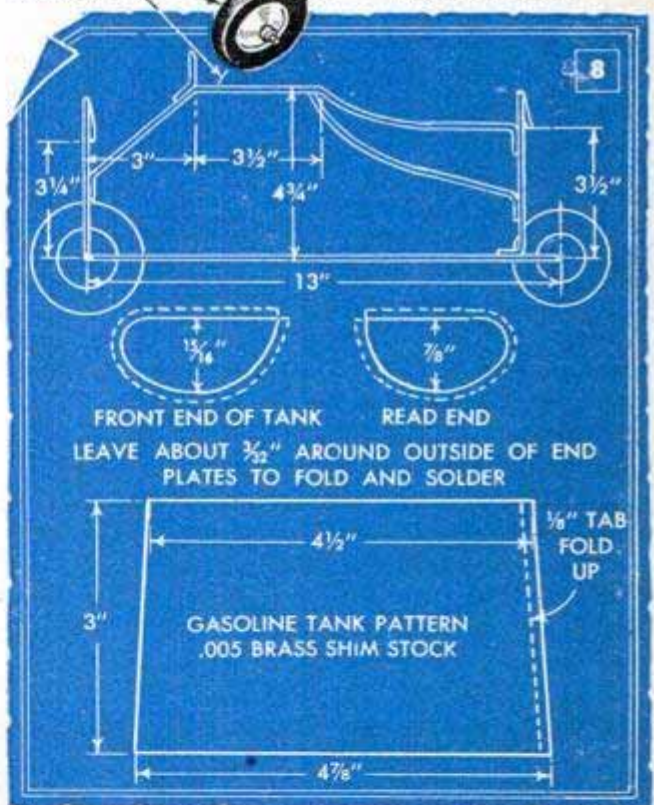
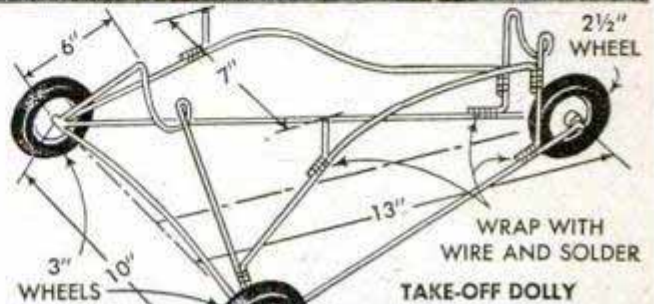

Anchor Held in Raised Position On Outside of Boat

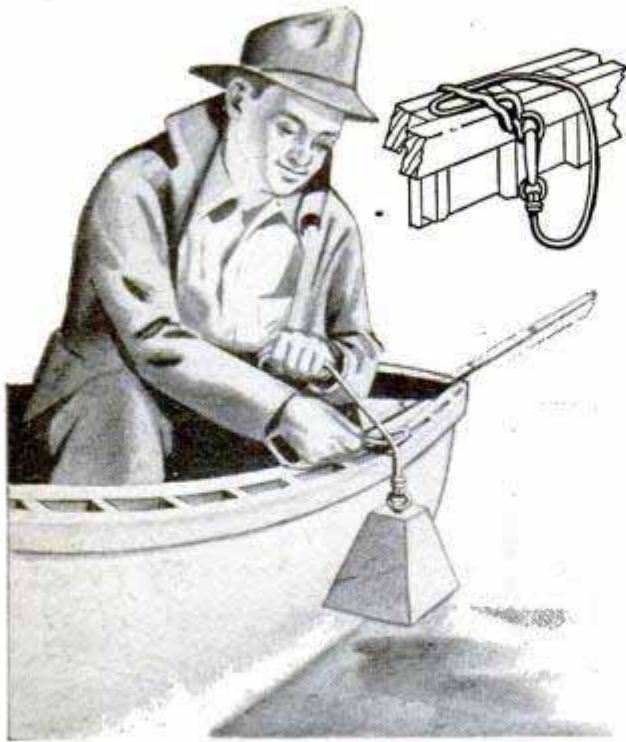

Wet, muddy anchors may be kept on the outside of a small boat by belaying them in the manner shown. Insert an eyebolt through the gunwale of the boat and attach the anchor rope with a snap hook. To hold the anchor in the raised position, loop the rope under the eye of the bolt, bring it up to the top of the gunwale and then under the portion of rope holding the anchor. The weight of the anchor will keep the rope from slipping. Drop the anchor by pulling on the dangling loop of rope.

Lee W. Panney, Ionia, Mich.

Filing Home-Workshop Publications



Colored cellulose tape attached to the backs of home-workshop magazines provides an excellent means of keeping them in order on the bookshelf. After arranging the issues in order as to month and year, fasten a strip of colored tape diagonally across their backs and then cut the tape between each magazine. When you wish to return a magazine to its proper position on the shelf, merely insert it between the other publications so that the diagonal line appears unbroken. By using different colors of tape and reversing the direction of the diagonals, it's easy to have

a systematic and orderly reference library. Use of transparent tape will permit wording to show through.

Henry Zave, Chicago.

Ruler Markings Renewed With Rubber-Stamp Pad

If the graduated markings on a wooden ruler have become worn with use and are difficult to read, try drawing them back and forth across a rubber-stamp pad. After doing this, wipe the ruler lightly with a cloth. The ink will remain only in the calibrations making them clearly visible. Repeat the operation if needed.



Discardable Glue Brushes Cut From Scrubbing Brush

Here is a way one home craftsman produces small glue brushes in quantity, and at a cost so slight that he can discard them after each gluing job. He bought a fine-bristled scrubbing brush having a rectangular wooden back, and marked the back of the brush as shown by the dotted lines, centering one of the tufts in each square. Then he drilled a $\frac{1}{4}$ -in.-dia. hole, $\frac{1}{4}$ in. deep, directly over each tuft, and after sawing the squares apart along the lines, glued a 2-in. length of $\frac{1}{4}$ -in. dowel in each of the holes to serve as a handle.

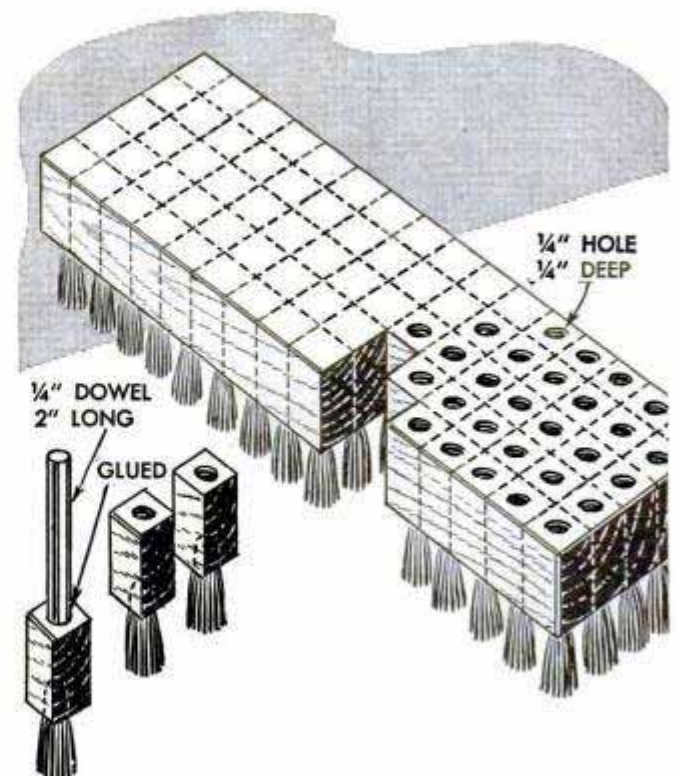

Hitching Posts for Bikes



By
Roberta L. Fairall

THESE colorful bike racks are designed to take care of bicycle-parking problems anywhere. Two are portable, while the third unit is designed for permanent installation. Pine, in the natural finish, combined with harmonizing colored decorations gives the pieces an attractive individuality in design. The unit detailed in Fig. 1, provides four stalls, or racks, placed at right angles about a center post. The upper end of the post is rounded and a curved cross-piece attached to each side represents

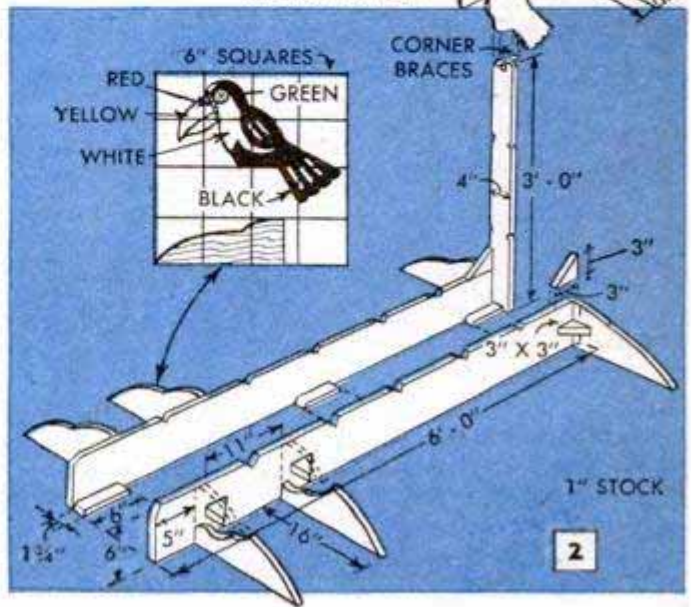
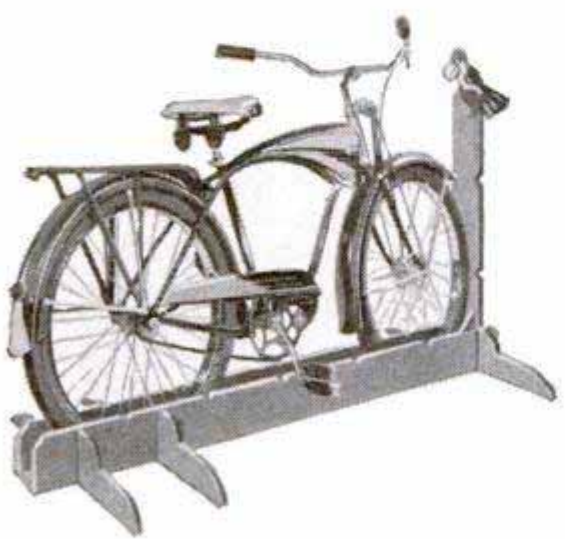
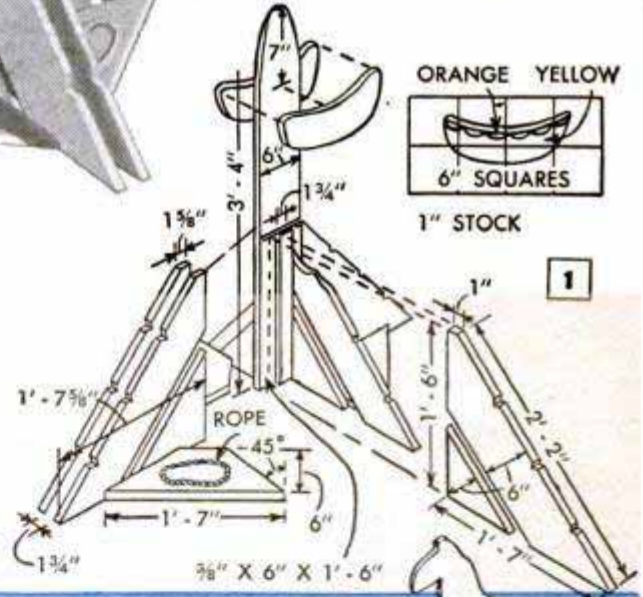

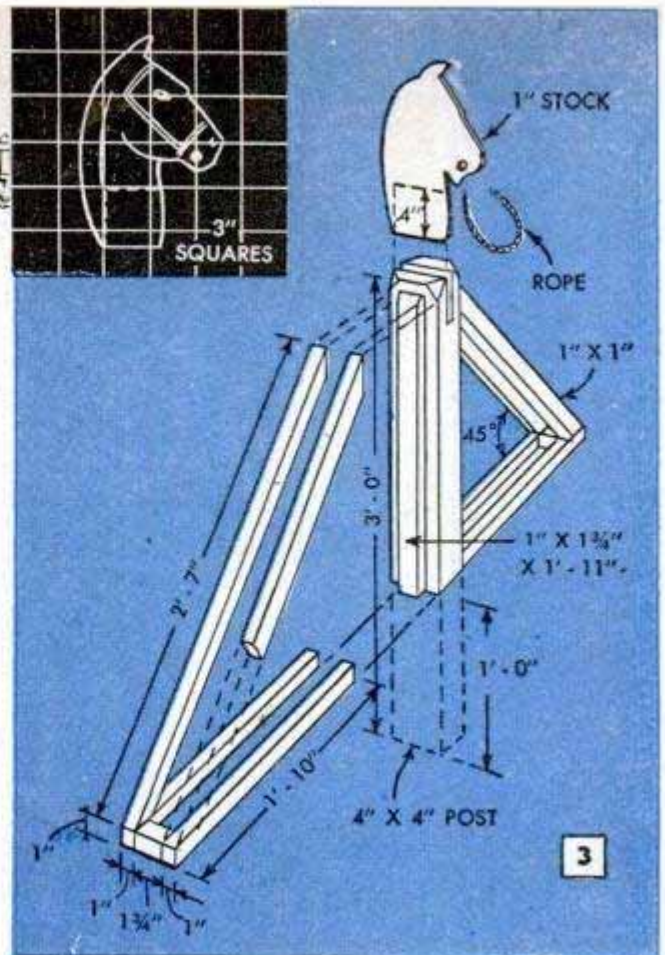

the wide brim of a sombrero, which is a feature of the design as are the V-notches regularly spaced along the top edges of sloping members. The rope decoration on the mitered spacers, Fig. 1, can be omitted without detracting from the appearance.

Another portable rack designed especially for the individual bike is pictured and detailed in Fig. 2. Its construction is similar to the first rack and the finish is the same except for variations in the enamel colors on the jigsawed bird that mounts guard at the head of the rack. Top edges of the long horizontal members, and also the head board, are V-notched at regular

intervals in the same manner as are the sloping members of the four-place rack in Fig. 1. Bandsawed feet are attached to the horizontal members to hold the rack firmly in the upright position.

The permanent rack, Fig. 3, can be made to accommodate either one, two, three or four bikes as required. Set the center post in concrete and slot the top end for a horse's head which is sawed to profile from the cross-hatched detail in Fig. 3. Then add as many racks as desired, following the assembly plan in Fig. 3. Paint the head brown, bridle white, and the balance of the rack a contrasting color.

Adjustable Truss for Garage Ceiling Joist Prevents Buckling Walls

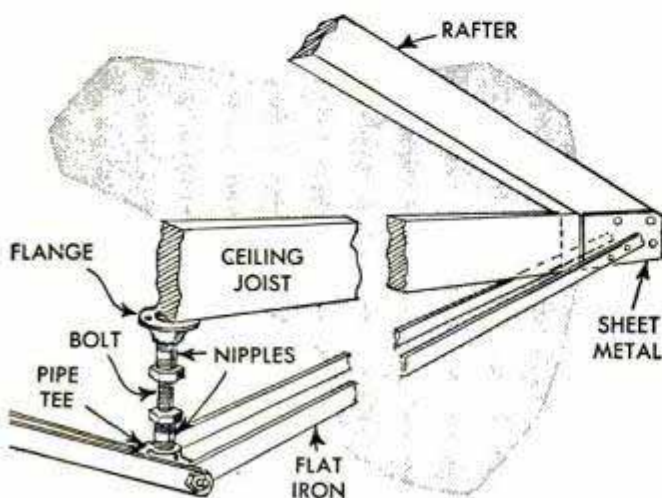

The walls of a hip or gable-roofed garage or small barn can be kept from buckling by installing one or more ceiling joists and fastening this flat-iron truss under each joist. Also, with these trusses in place the space between the joists and rafters may be used for storage without danger of sagging the joists and bulging the side walls inward. The truss consists of four lengths of flat iron, two of which are bolted to the joist and rafter at each plate. These points are reinforced with pieces of sheet metal. At the center of the rafter, the flat-iron strips are bolted to a tension adjustment which is assembled from pipe fittings and a bolt with double nuts, as shown.

Reversing Fan Position Accelerates Cooling

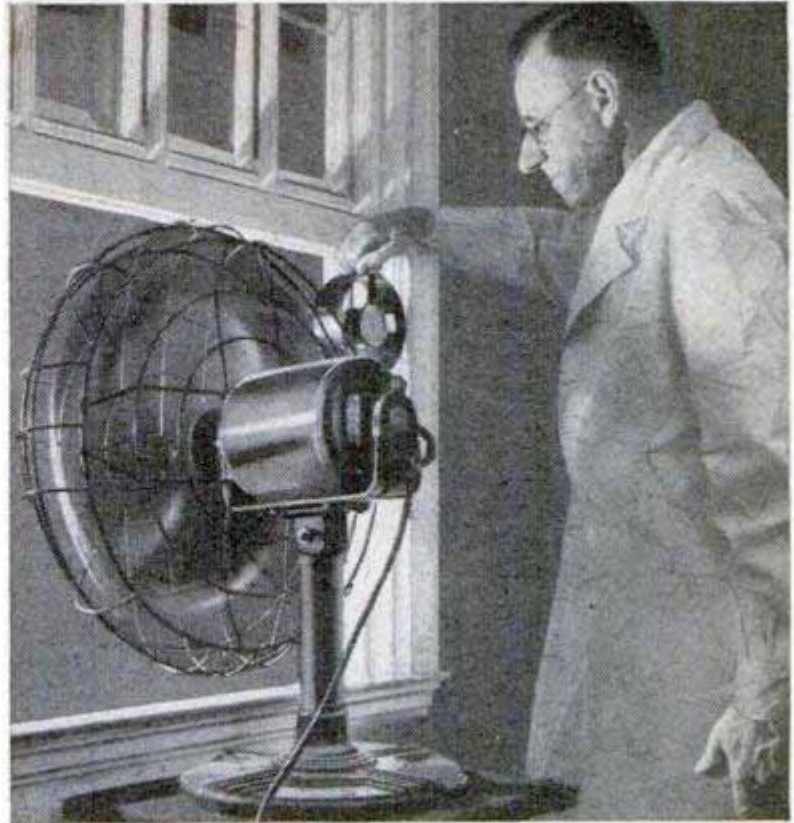
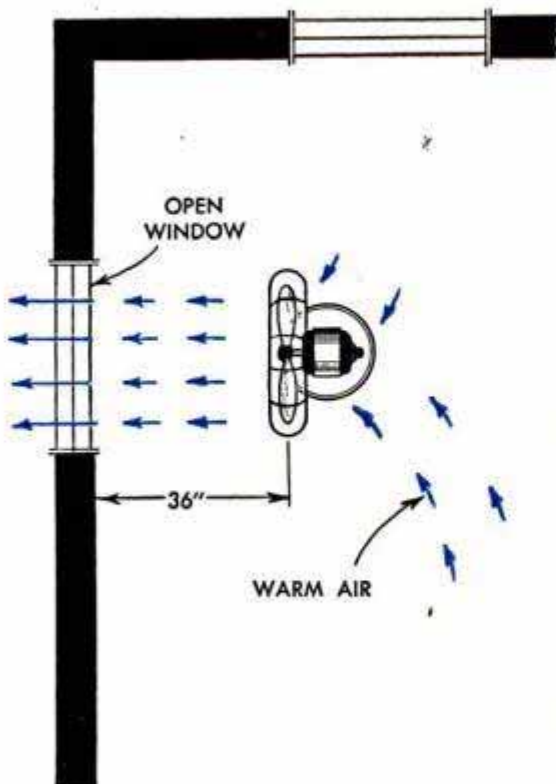

Experiments conducted by Westinghouse Electric Corp. have shown that the cooling power of an electric fan can be increased as much as 75 percent on a sweltering night. This is done by setting the fan in front of an open window to blow air out the window. In one typical test, a nonoscillating, 16-in. portable fan, placed to blow air into a room, reduced room temperature only eight degrees, from 84 to 76, in two hours' time. But when the same fan was turned around, the temperature in the room was lowered from 86 to 72 degrees in the same period of time, a drop of 14 degrees. The distance the fan is placed back from the window should be about 1½ times the width of the opening. Thus, if the open-

ing is 2 ft. wide, the fan should be placed 3 ft. from the window.

This increase in efficiency is explained as being the result of an air stream set up by the fan. As the air stream rushes to the window, it draws with it additional air from the room. This causes greater amounts of cool air to enter through other open windows to replace the warm air exhausted from the room. As warm air will concentrate in the path leading to the fan, it is not advisable to place the fan in the room you are trying to cool. The windows through which the warm air will be expelled and the cool air drawn in should be carefully selected to take advantage of natural air movement through the room.

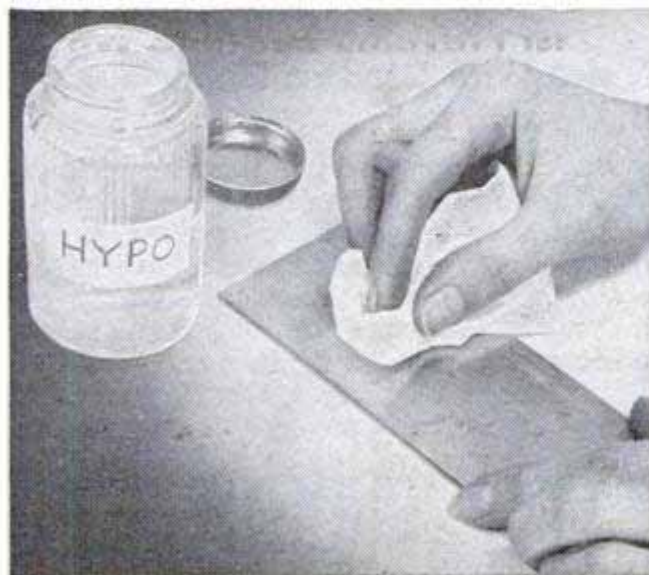

Bringing Out Scribe Lines on Metal With Discarded Hypo Solution

When working with copper, brass or bronze and it is difficult to see the scribed layout, try polishing the metal and swabbing it with photographic hypo solution. The hypo will deposit a thin white film on the metal when dry, bringing out the scribed lines clearly when the hypo is wiped from the surface.

☐ The tendency of furnace pipes to rust in a damp basement during summer months can be avoided to some extent by burning papers in the firebox ten or twelve times throughout the season. This replaces the moist air in the pipes with dry air.

Rolled Paper Soaked in Paraffin Kindles Outdoor Fire in Light Rain



Did you ever find yourself badly in need of a fire when miles away from the nearest shelter, and discover that although the matches were dry, there was no dry wood available? At times, such a situation could have serious consequences, and for this reason, it's an excellent idea to carry several fire rolls on every hunting or fishing trip. These fire rolls are easy to make and their cost is negligible. Just fold a few sheets of newspaper four times and roll them up tightly. Fasten the rolled paper with pieces of light wire spaced an inch or two apart along its length. After cutting the paper into 3-in. rolls, soak it in paraffin melted in a double boiler. Then, remove the rolls from the paraffin and allow them to harden. Place a couple of these rolls in your hunting-coat pocket or tackle box, and when you need a fire in a hurry, pile small twigs and larger branches over one of the rolls and light it. The resulting hot flame, which burns for 5 minutes or more, will ignite the twigs easily. The twigs will dry and ignite the branches, giving you a good fire even in a moderate rain. If the twigs are very wet, use two fire rolls.

Improvised Wallpaper Seam Roller

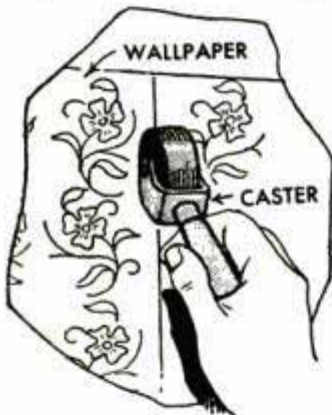

When wallpapering a room and a seam roller is not available, an ordinary castor makes an excellent tool for this purpose. The castor is easier to manipulate if fitted with a handle taken from an old file or other tool.

Removal of Roller-Chain Pins Simplified by Repair Block

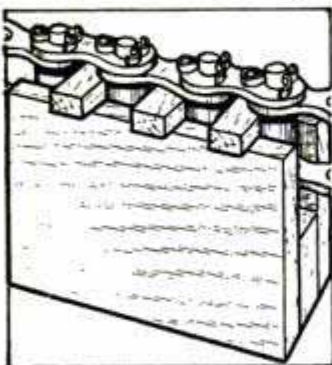

The pins of bicycle and motorcycle roller chains are removed easily without straining the links or rollers if the chain is mounted in a repair block made of hardwood scraps. The block consists of two

side pieces fastened to a center piece, allowing enough room below the chain for the pins to be driven out. Small wooden spacer blocks are slipped between the rollers to hold the chain in position. All of the blocks must be the same thickness in order to keep the rollers and links parallel.

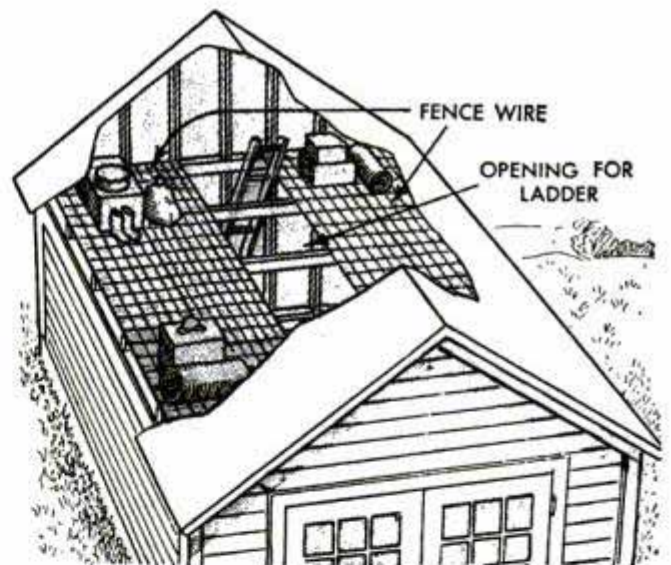

Fence Wire Used as Floor In Garage Attic

Besides being cheaper than wood flooring, I found that wire fencing made an excellent floor for the attic over my garage as it not only prevented dust and dirt from collecting, but also afforded a view from below of the items stored. I left the center unfloored for access by ladder.

George W. Horres, Charleston, S. C.

☐ Place a baked potato in a breadbox to keep the bread from drying out. Also, wash and air the box once a week to keep the bread from having a musty taste.



Parents will feel at ease when baby is safely playing in the yard or on the beach in this screened playpen, which can be folded flat for carrying

PORTABLE "SCREENED PORCH" FOR BABY

This screened playpen consists of only three units which fold into a compact bundle, Fig. 1. The side and end walls are hinged to form two separable units, which are joined at diagonal corners with flat sheet-metal hooks that lock over round-headed screws as in Fig. 2. Frames for the

walls are constructed with mortise-and-tenon corner joints and covered with 14-mesh wire screen. The gable ends, made from pine, are hinged on the outside and wooden turn buttons on the inside hold them erect when the pen is set up. A notched ridgepole supports the awning.

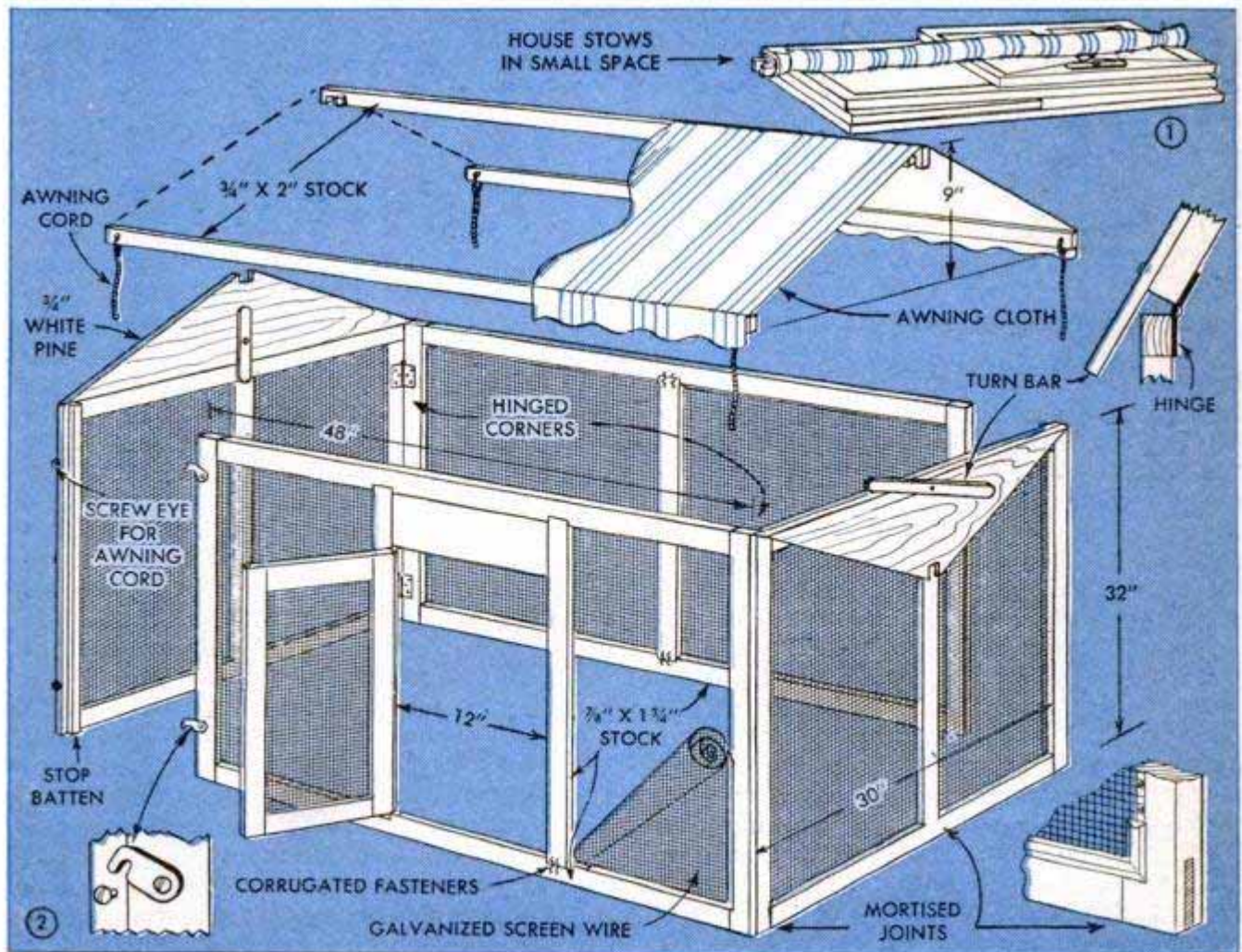



PARTY MAGIC

By Bill Turner

WE AREN'T going to show you how to pull a rabbit from a hat as Johnny Jones, professional magician, is doing above, but some of the following tricks are just as mystifying and can be executed expertly with very little practice and concentration. No special apparatus or stage props are needed, as all the stunts are performed with common articles that are always handy. Some of the tricks are real posers and, if skillfully done, will prove just as baffling to your audience as some involved stunts which require special magic equipment.

As a good example, try this stunt, a favorite of Joe Berg, inventor of tricks. It's done with three empty glass tumblers which are placed in a row on a table. Then, asking the spectators to watch carefully, take a glass in each hand and quickly give them both an end-over-end half-turn, Fig. 1. This movement is repeated twice, always turning two glasses at once. Finally, all the glasses are mouth up. Now turn the center

glass mouth down and challenge a spectator to try it. But try as he will, the spectator cannot bring the three glasses mouth up by turning two at a time. Here's where you take over, rearranging the tumblers and successfully repeating the performance in a few quick moves. After reading the simple secret below, practice a few minutes and try this trick at the next party. You'll have everybody in the place turning tumblers and scratching his head, wondering how it's done. The idea is to start with the end glasses mouth down and the center one mouth up, but when the spectator is invited to try, the two end glasses are placed mouth up and the center one mouth down. The trick derives its mystery from something besides a mere secret. Its success depends to a large extent on a slick presentation, Fig. 2, and also on skill in deception. This is achieved by planning the talk and action to focus attention on the routine, which keeps the audience watching for an extra turn or some other secret

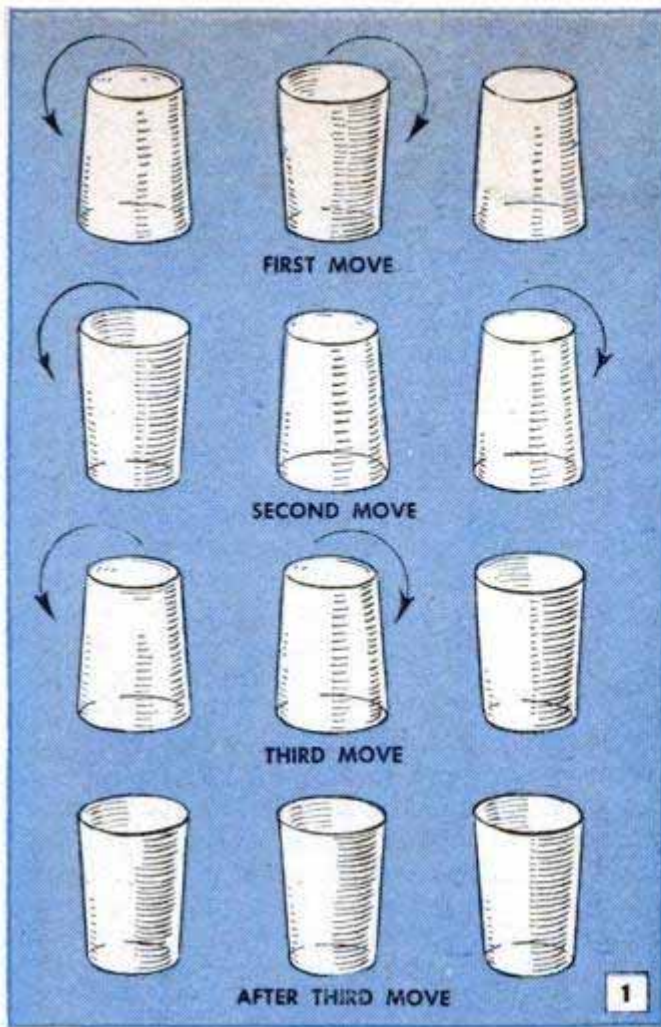

manipulation that will reveal the trick.

By this time, the guests will be asking for more. So borrow a man's handkerchief and proceed to push a small object right through the cloth without leaving a hole in it. First, place the handkerchief over your left hand, doubled loosely into a fist, and poke a pocket into the center of the handkerchief with the right forefinger. At the same time, the right middle finger is secretly extended. Then the left fingers are opened slightly so that the right middle finger can enter the left fist, carrying a fold of cloth with it to form an opening that is unknown to the spectators. Fig. 3 shows this with the fingers slightly opened and Fig. 4 shows how it appears with the fingers closed. Now pick up a pencil, cigarette, or other small object, and place it in the secret opening, holding it in place with the left fingers. To the audience, it appears that the object has been placed in the pocket. Then say a few words of magic, release the grip of the left fingers, and the object drops through the opening in the handkerchief to the floor. But to the attentive spectators, it appears to pass through the solid center of the hankerchief.

Another trick that calls for quick sleight of hand is shown in Figs. 5 and 6. The sequence of this thimble trick begins with the thimble on the forefinger of the right

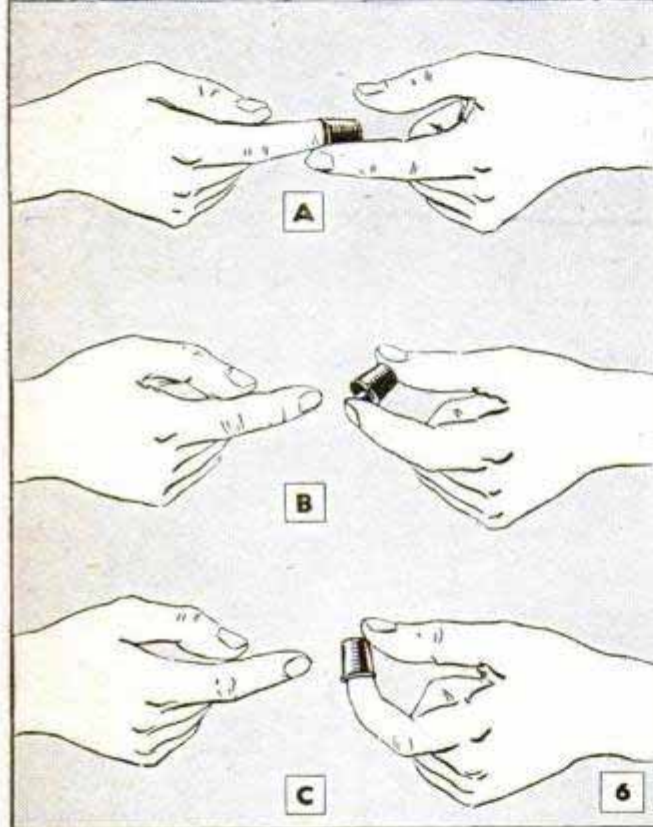

hand. Point this finger to the left and touch the thimble to the end of the left forefinger. Draw the hands apart, rather quickly. Then repeat the action and this time the thimble appears to jump, quite magically, to the left finger tip, Fig. 6, B and C. The deception depends upon easy, swift manipulation of the thimble plus control of the attention of the audience—a technique professional magicians call “misdirection.” The last three fingers of each hand are folded loosely into the palms, while the thumbs are held parallel with the first fingers and are kept out of sight of the audience. As the fingers touch, the tip of the left thumb is near the thimble. The first time the fingers are pulled apart nothing happens except that you follow the thimble on the right finger with your eyes. This serves to misdirect the attention of the

spectators and is an important part of the deception. Now, moving a little slower than before, touch the fingers again, as in Fig. 6, A. Slide the inside of the left forefinger tip against the thimble and secretly seize the thimble between the left thumb and left finger tip, pulling it off the right finger. Bending the left forefinger slightly, push forward on the thimble with the left thumb, and it will flip onto the left finger quite easily. But be sure to follow the right finger with the eyes just as before, Fig. 5. Thus the spectators' attention is directed to the finger and they never see the flipping motion which transfers the thimble. This one will require practice.

Here are three more party tricks which have not been illustrated because they are so very easy to follow. For the first one, obtain a number of spools of colored thread and select six or eight of these of sharply contrasting colors. With these you can perform a puzzling feat of divination. While your back is turned, have a spectator select one of the spools. Next, have him place this spool in your hands, which are held behind your back, and put the other spools in his pocket. Then, apparently by sense of touch alone, you name the color of the spool you hold. Here's the way the trick is worked. When the spectator has put the spool in your hands, turn to face the audience. Quickly and unobtrusively break off a short length of thread from the spool, wad it up, and insert it under the nail of the middle finger of your right hand. In the meantime, distract the attention of the audience by talking about the strange powers of divination. Even ask the spectator to help by concentrating on the color he selected. While talking, bring the right hand out from behind your back and point a finger at the spectators in a natural gesture. This provides an opportunity to glimpse the color of the thread under the fingernail. Do this very subtly, bringing the hand in line with the eyes so it does not attract the attention of those who are watching every move.

Most tricks should never be repeated, but here's one to perform at the dinner table that becomes more baffling with repetition. If there is a dish of olives, select four of them with the right hand, palming one and dropping three on the table in front of you. Hold the concealed olive in the crook of the second and third fingers, keeping the hand in a natural, relaxed position with its back toward the audience. Then pick up one of the three olives from the table, taking it between the right thumb and forefinger. Place it in the palm of the left hand and close the left fingers over it. Do this quickly but openly so that everyone sees just what is done. Then pick

up another olive and put this second olive into the left palm in the same way as the first. At the same time, secretly drop the palmed olive into the left hand and immediately close the fingers. Then pick up the third olive, saying that you will put it into your pocket. Go through the motions of putting it in the right-hand coat pocket, but palm the olive instead. Then, as the final gesture, open the left hand and drop the three olives on the table, saying that the one placed in the pocket has mysteriously joined the others. As the fourth olive remains palmed in the right hand, you are ready to repeat the trick. Most audiences will give up trying to guess and ask how it's done.

Finally, here's a number puzzler which is rare in that it does not appear to depend upon trick figuring as such stunts usually do. To the audience, there seems to be no possible explanation for the feat of prophecy which the magician accomplishes. Write a number, as explained later, on a piece of paper. Then fold the paper and hand it to a spectator for safekeeping. No one but you knows what is written. Now look over the audience and purposely ask a stranger to write certain figures in a column. These are the number of years he has been married, the year of his birth, his age, and the year he was married. The spectator is asked to add the column of figures and read the total. It will be found that this total and the figure written on the paper are exactly the same. It works this way. The total of the stranger's age in years, birth year, number of years married, and the year he was married is certain to equal twice the figure of the current year. In other words, if the year is 1948, the figure 3896 would be the prophecy.

Handle for Heavy Bundles

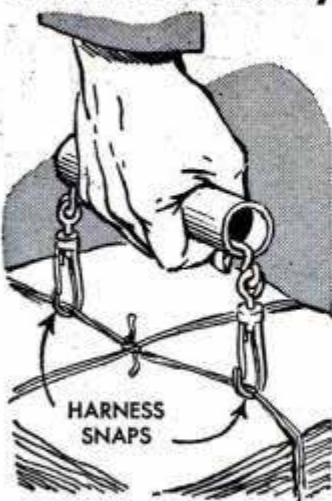

of the wire are bent hook-shaped. Then, an ordinary harness snap is fastened to each hook. To carry a bundle, just clip the harness snaps to the binding.

Length of Dog's Tether Adjusted With Tent-Rope Tightener



In order to protect his plants and shrubs, one man frequently finds it necessary to vary the length of his dog's tether when the animal is staked in different parts of the yard. To adjust the tether, he uses a tent-rope tightener made from a short length of dowel by drilling a hole through it near each end.

Fuller Ball Covers Grease Fitting

The grease fittings on a car or piece of machinery are protected from damage and kept free of dirt if they are covered with ordinary fuller balls. This type of washer fits snugly over the tip of the fitting and is easily removed for greasing. One end of the ball should be plugged to prevent dirt from entering.

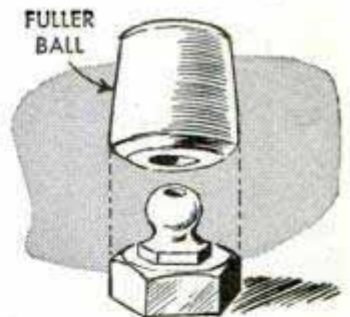

Screwdriver From Key Blank

A useful pocket screwdriver can be made by grinding or filing a screwdriver edge on a steel key blank. If the screwdriver is carried on a ring or in a holder with the rest of the keys, it will always be handy when needed.

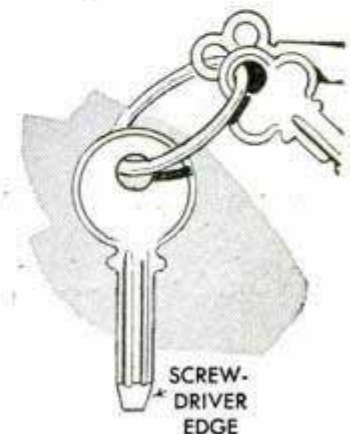

LUBRICATING YOUR AUTO

Good lubrication of the auto engine means more than just adding a quart of new oil occasionally. Like all other common servicing operations, it calls for scheduled attention to important details

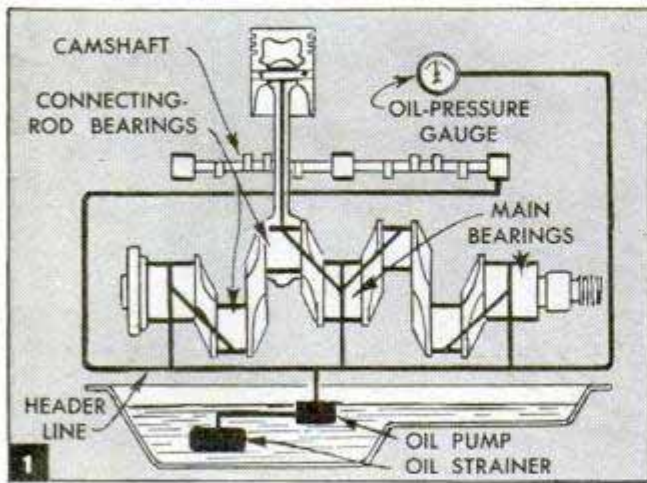

In a full-pressure oil system, oil is pumped directly to the crankshaft and connecting-rod bearings; also to the camshaft and piston rings. In engines with overhead valves, oil is pumped to rocker-arm shaft

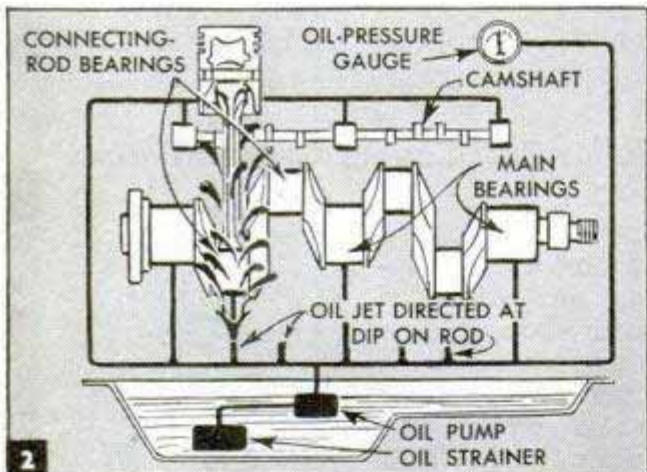

Diagrams courtesy Clawson & Bals, Inc.

In a modified splash system, oil is pumped to the main bearings and the camshaft bearings. Connecting-rod bearings are lubricated by a splash from oil dips located on the lower ends of the connecting rods

ALTHOUGH good engine lubrication represents only a small percentage of the average yearly cost of operating a car, there is more to it than merely adding a quart of oil now and then. Oil in the crankcase gradually becomes contaminated with certain acids and mildly abrasive particles. Just how rapidly the oil becomes contaminated to a point where it is injurious to the engine and should be replaced, depends much on the driver—length of trips, choking, etc.—and on atmospheric conditions. In some cases it may be possible to drive as much as two or three thousand miles without changing oil, while in other cases it may be advisable to change at 500 miles or less.

For example, in a car that is driven only a mile or two at a time in winter, such as on shopping trips, moisture condenses inside the crankcase each time the motor cools, some of it reaching the oil. Combustion gases passing the pistons mix with the moisture and form a mild sulphuric acid, which pits the bearings, pistons and cylinder walls.

An oil filter does not remove moisture, acid or gasoline. It will remove most solid contaminating and abrasive agents, such as dust, metal and rust particles from the engine, gummy residues from leaded fuels, etc. However, even with an oil filter and a carburetor air cleaner, the oil should be changed at regular intervals, length of the intervals being determined by the operating habits of the driver, distances the car is driven regularly, season of the year and condition of the roads on which the car is operated most of the time.

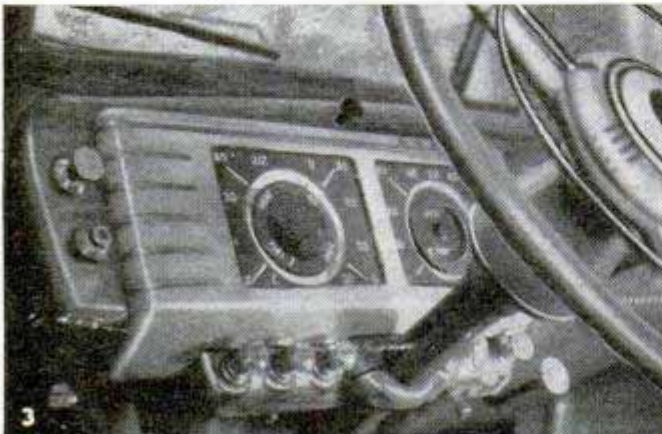

When driving, glance at the dash gauges to see that oil-pressure and temperature readings are normal

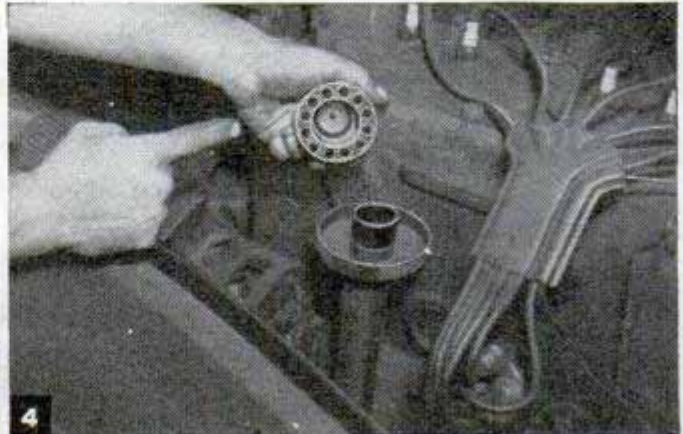

Wash breather cap in gasoline at regular intervals. Then coat the element with a heavy motor oil

ENGINE

By Phil Ruskin

Check the oil level frequently and refill. When checking the oil level after a long drive, wait for the oil to drain back into the oil pan to get the true reading. If the oil appears discolored or if there are indications of water, drain, flush and refill with new lubricant

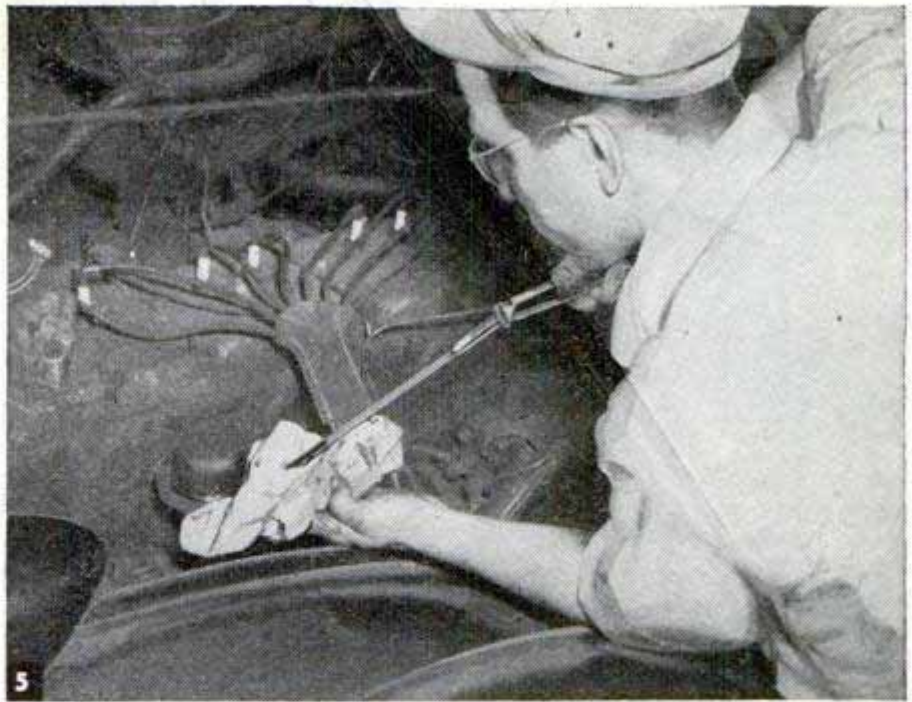

One method often suggested for determining oil-change periods is to test the oil for contamination, especially acid content, at regular intervals over a period of time, and from this data work out an oil-changing schedule for both winter and summer.

A lubricating oil has to perform several separate jobs in protecting the engine from excessive wear. It must lubricate moving parts and reduce friction to a minimum, Figs. 1 and 2. The oil also acts as a coolant in carrying off heat from the cylinders and the bearings. In addition, it seals engine compression by providing an oil film between the pistons and the cylinder walls. Some oils also act as cleansing agents by removing dirt and carbon from the working parts of the motor.

Always use a high-quality motor oil of the correct viscosity for the particular engine, selecting it according to the type of operation and season of the year. Oils are now available for various kinds of operating conditions. Usually these are designated as regular, premium and heavy-duty

grades. The regular-type motor oil is satisfactory for average use in a passenger car. However, regular grades do not ordinarily contain oxidation inhibitors (additives) which aid in preventing sudden breakdown of the oil under exceptionally severe operating conditions. For constant hot-running conditions, such as mountain travel and long runs in summer heat, where motor oil tends to break down rapidly, a premium-type oil should be used. This contains a chemical (additive) which resists breakdown of the oil by oxidation, thus preventing undue sludge formation and bearing corrosion. Heavy-duty motor oils contain not only additives, but also detergent agents which cleanse the engine parts of solid deposits and tend to keep sludge dissolved in the oil. Generally, this special grade is required only for trucks and other heavy-duty engines, but it can be used in passenger-car engines subjected to severe operating conditions. When using these special oils for the first time, the crankcase should be drained after 300

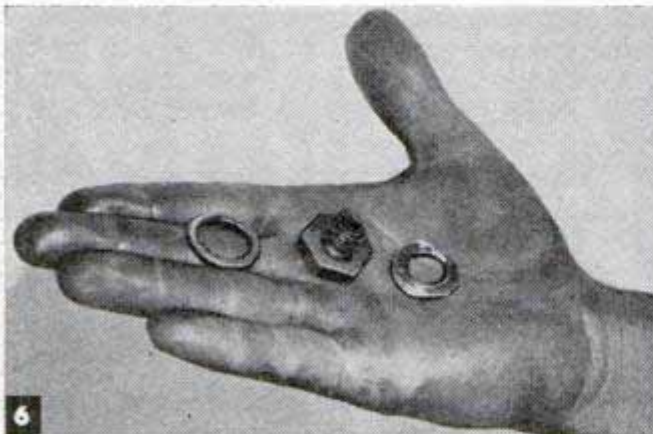

A leaky drain plug may cause complete loss of oil from the crankcase, resulting in a damaged engine



Use a light oil for the generator, starter and other units having oil cups, but do not overlubricate

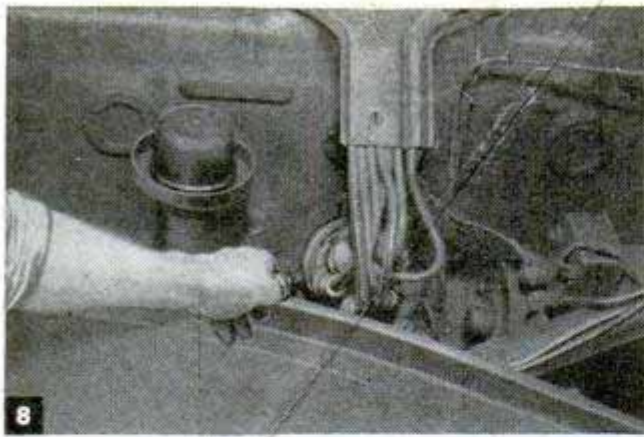

Lubricate distributor shaft with high-temperature grease. Take care not to get dirt in the grease fitting

to 500 miles, as the first filling will rapidly collect crankcase waste and sludge. It is not advisable to mix different kinds of premium lubricating oils.

For best results, engine operating temperatures should never be lower than 140 deg. or more than 180 deg. F., and preferably should be between 160 and 180 deg. F. The proper operating temperature is important as it affects the efficiency of the lubricating system. Clean the cooling system regularly of rust and other loose deposits by a thorough back flushing. A loose fan belt may cause overheating and overloading of the cooling system. If the engine runs too cool in cold weather, cover a portion of the radiator. When starting a cold engine, remember that most engine wear takes place during the warming-up period, especially if the engine is raced idle or put under load immediately after starting. When temperatures are below 70 deg., it is good driving practice to allow the engine to warm up before driving the car. After stopping, oil drains rapidly from the working parts when the engine is warm and because of this the bearing surfaces will be relatively dry when the engine is started again. These bearing and sliding surfaces run dry until oil from the pump reaches them. The small quantity of oil left on the bearing surfaces will not stand up under heavy loads or high speeds. Be sure that the automatic choke is working properly as a rich fuel mixture causes dilution of the crankcase oil.

Poor crankcase ventilation, especially in a cold-running engine, will cause extra condensation of water in the crankcase. Short runs in cold weather aggravate this condition. Check and clean the crankcase ventilator openings, Fig. 4, at regular intervals. Wash the filler cap in gasoline and then reoil. An efficient oil filter is helpful in maintaining a clean oil supply, provided the filter element is replaced regularly. However, a filter does not eliminate the need for a regular oil drain; it simply per-

mits the extension of time between drainings. Always renew the filter element when changing to a premium grade of oil. An oil that looks clean may contain too much acid and fine abrasives for safe lubrication. Only a complete draining, flushing and oil renewal will provide adequate protection.

As the cost of a complete oil change is small compared to the yearly bill for gasoline, repairs, storage, etc., it pays to drain and flush the engine oiling system at least twice a year—spring and fall. Without an efficient filter, draining should be done more often. Because some oil remains trapped in the oiling system when draining, flush the crankcase at each draining. Use a flushing oil, which has the properties of a light lubricant, to eliminate any danger of the bearings running dry during the flushing process. Always drain the oil when hot and be sure the drain plug is replaced tightly. See that the plug gasket, Fig. 6, is in good condition. Check the oil level, Fig. 5, after the engine has run awhile. Remember that the filter takes about a quart. When checking the oil level, allow time for the oil to drain back to the crankcase to get an accurate reading. In both new and reconditioned engines, a light-grade lubricating oil should be added to the gasoline for upper-cylinder lubrication. Too heavy an oil may foul the plugs and cause extra deposits of carbon and gum around the valves, pistons, etc.

Generator and starting-motor bearings, Fig. 7, if provided with oil cups, require a few drops of light motor oil at regular intervals. Clean the cups before oiling to prevent dirt getting into the bearings. Do not overlubricate. Use a high-temperature grease in the distributor-shaft grease cup, Fig. 8, and put a few drops of oil on the felt pad under the rotor. A light smear of grease on the rotating cam face will save wear in the breaker assembly. Water-pump lubrication varies, and some have bearings that do not require lubrication. Use a medium oil in the water-pump oil cups and a special water-pump grease in the grease cups. This grease will resist heat and the dissolving action of water. As with all moving parts, do not overlubricate the water pump.

The fans on some engines require separate lubrication. Use a small amount of chassis lubricant for fans having pressure-type fittings, and a motor oil for those having sump-type lubrication.

☞ If your car won't start due to the ignition system being wet, try sprinkling carbon tetrachloride over the distributor, coil and spark plugs. This usually will permit the motor to be started immediately.

Suspended from the ceiling of a studio living room or informal dining room, this unusual fixture conveys a feeling of pioneer days to your cabin or ranch-type home. It's especially appropriate if western-style architecture and furnishings prevail in the room. The yoke can be bandsawed from a 2 or 3-in.-thick piece of wood, preferably oak, to the size indicated in the squared pattern. The bows may be bent by steaming them and clamping in shape, and they are fastened to the yoke by means of wedges, as shown. Hickory, if available, is excellent wood for the bows. The fixture is held to the ceiling with two lengths of chain which are attached to eyes in the yoke. Although these parts on the original were taken from an old lighting fixture, threaded brass tubing and eyes can be purchased for this purpose. The yoke is drilled to take the tubing and the eyes for the chain and light are turned on each end of this. Then, a lantern-type light, which is attached to the lower eye, is wired through the tubing and along the chain to

Oxen-Yoke Ceiling Fixture for Dining Room Imparts Pioneer Atmosphere to Ranch Home

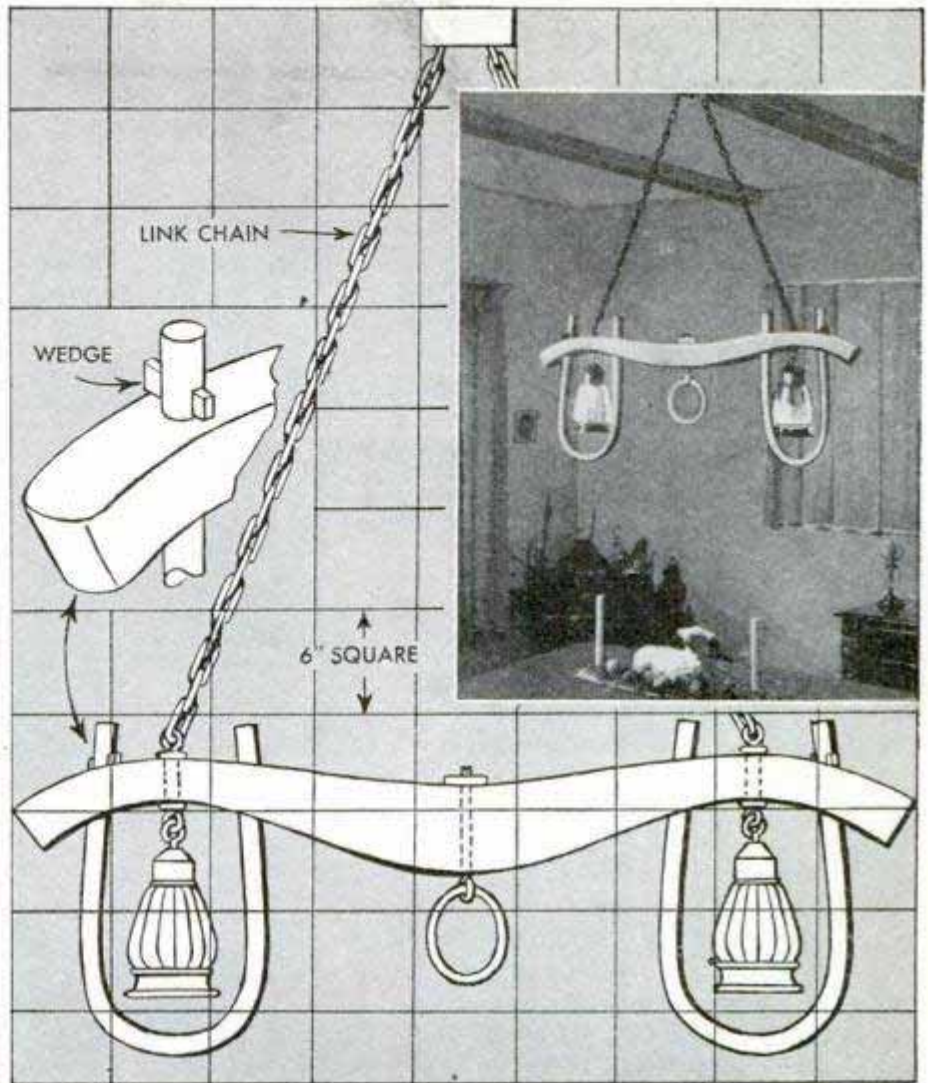

the ceiling outlet. Finally, a large iron ring is bolted through the center of the yoke.
Wm. H. Freeman, Baldwin, N. Y.



Handy Rack Holds Baby's Blankets On End Panel of Crib

If fear of smothering the baby prevents you from hanging blankets, towels, etc. over the side of the crib, you can still keep these items handy by hanging them on this little rack which is screwed to the end panel of the crib. The brackets may be cut from scrap wood and a length of dowel will serve as a bar. After the rack is painted to match the crib, it is attached to the end panel with roundheaded screws.

Patching Small Holes in Walls

The small hole that remains in a wall after a gas or water pipe has been removed is easily patched if a cork is used to back up the plaster. The cork is trimmed to size and pressed in the hole flush with the lath. The edge of the plaster should be undercut.

Shelf Brackets Are Mass-Produced in Plastic With This Simple Four-Piece Wooden Mold

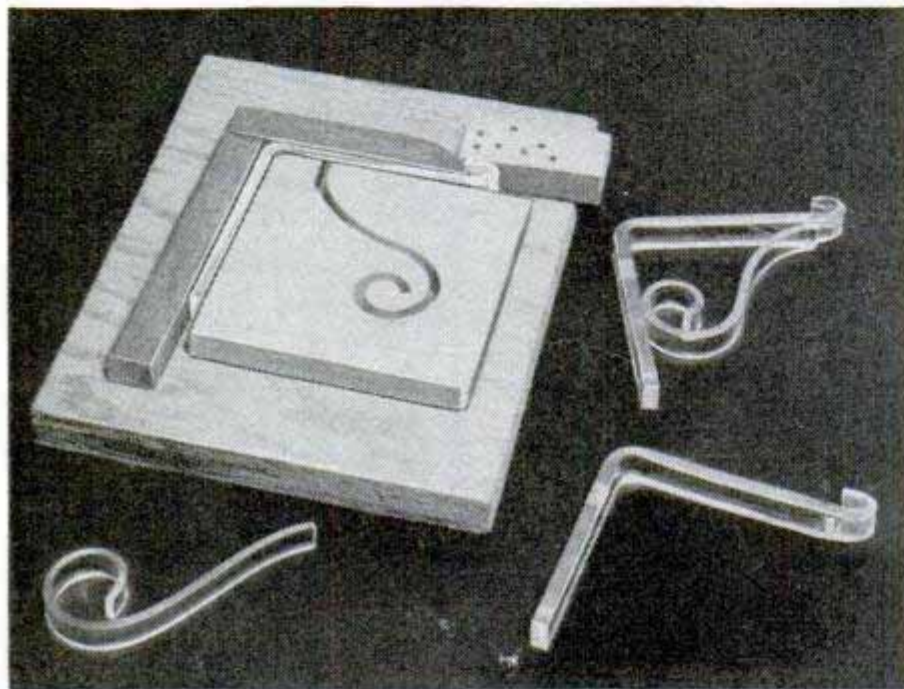
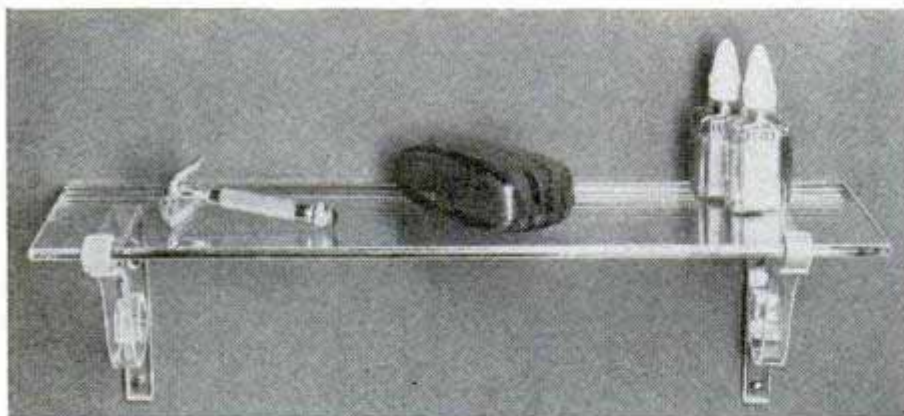

Crystal-clear or brilliantly colored plastic provides distinctive brackets for glass shelves. If Lucite, Plexiglas or other heat-forming plastic is used, it's easy to bend brackets of a variety of interesting designs in a simple wooden mold. The mold is made by nailing two strips of wood to a plywood base to form a right angle, as shown. Then, a square piece of plywood is jigsawed for the scroll and the edges of this same piece are used to form the angle part of the bracket against the wooden strips. The hook to retain the shelf at the end of the angle piece is bent over a dowel and held in place with a small wooden block. For the brackets pictured, $\frac{1}{4}$ by $\frac{1}{2}$ -in. plastic was used for the angle piece, and $\frac{1}{8}$ by $\frac{1}{2}$ -in. material for the scroll. The parts of each bracket are cemented together or held with ornamental drivescrews, and the vertical leg is drilled to take wood screws for attaching the unit to a wall.

Extension Lamp for Workbench Supported by Coat Hanger

Suspended by a bracket bent from a coat hanger, an ordinary drop-cord lamp will provide ample light at any point on your workbench top. A cork, which has been drilled slightly smaller than the drop cord and grooved around the side, is slipped over the cord. Then, a wire coat hanger is bent around the cork, as shown, and is hung from a nail or hook driven into the wall above the bench. Several nails or hooks placed at intervals along the wall permit the light to be moved as needed. The light is adjusted to the desired height by pulling the cord through the cork.

Minimizing Stains on Dresser Tops

The finish on the tops of dressers, night stands, etc. is protected if a sheet of wax paper is placed under the scarf. Spilled cosmetics, medicines and other liquids will not soak through the paper.

Mrs. John Braun, Brooklyn, N. Y.

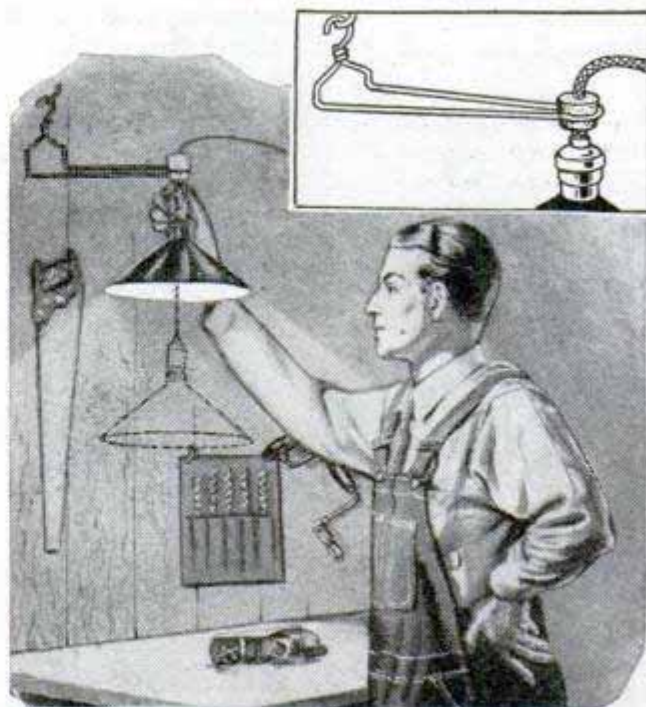

Stored linen is less likely to turn yellow if it is wrapped in black, opaque paper and kept in a cool place.

Make Your Own

HIGH-SPEED FLASH UNIT

Fast action shots of children at play, animals or birds, groups and individual portraits — even close-ups — are a cinch with this outfit

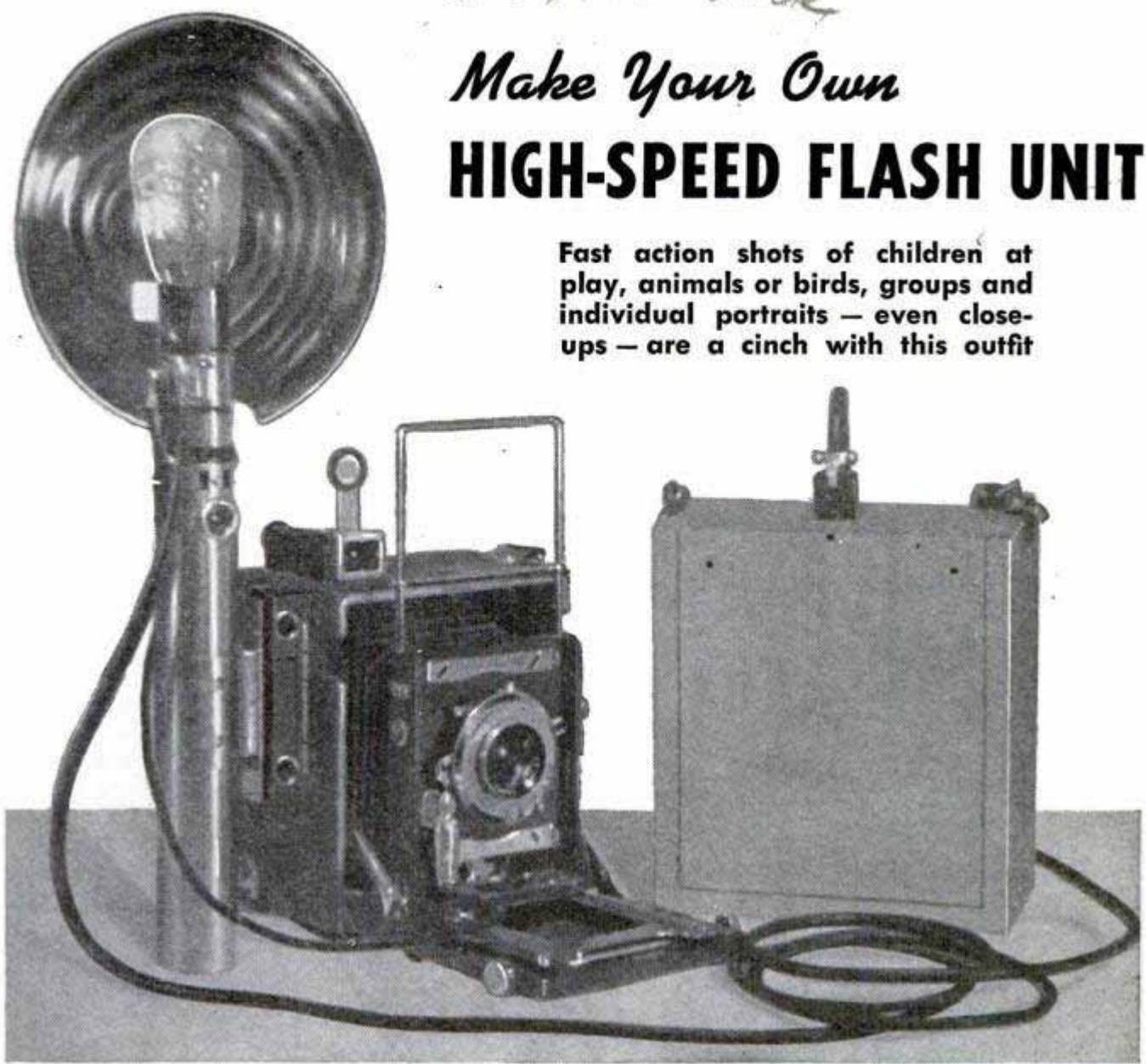

BE CAREFUL

Although the electrical circuit in this unit is not dangerous if handled correctly, you must keep in mind that the power output is 2000 volts, which, if passed through your body under certain conditions, might prove fatal. When testing the unit, stand on a dry, nonconductive surface. Before touching any parts of the circuit inside the case, switch off the power supply and "short" the terminals of the condenser to discharge it, using a screwdriver having an insulated handle. In operation, unless picture exposures are made within a few seconds of each other, always remember to turn off the switch and then flash the bulb, after taking each picture, to discharge the energy remaining in the condenser. Keep wiring and cables in good order

By Cecil Koyama

THOUSANDS of photo flashes of brilliant sunlight quality and positive uniformity at a fraction of a cent per flash—that's what you get in this battery-operated, high-speed flash unit. The speed shot, Fig. 1, of a light bulb being shattered by a rifle bullet is a good example of what can be done in high-speed flash photography. Synchronization of the speed light to the

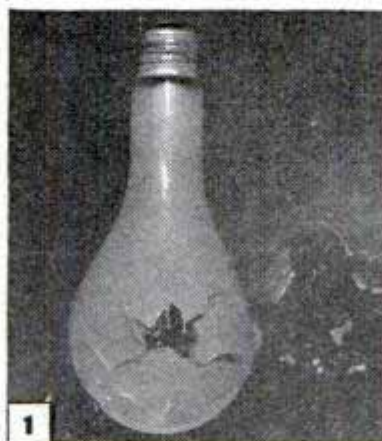

High-speed shot of a lamp bulb being shattered by rifle bullet

shutter of the camera is simple because the total duration of the flash is only $\frac{1}{15,000}$ second. This makes a high-speed camera unnecessary; excellent photographs can be taken with any low-priced camera equipped with a solenoid or used with the open-shut method of exposure. Being battery-operated, the unit can be used anywhere. Completely assembled it weighs less than 10 lbs., and is adaptable to your present flash gun (with

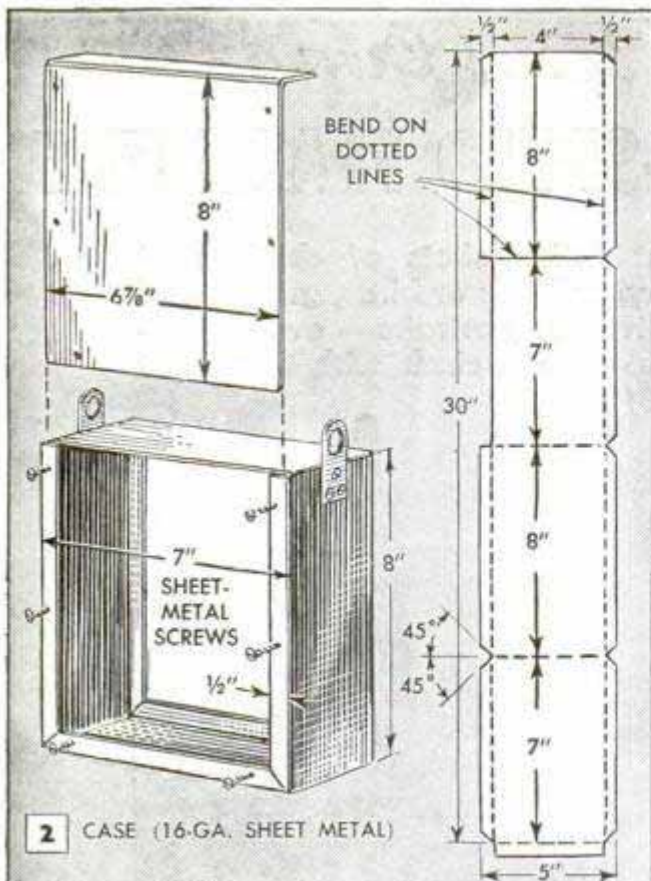

2 CASE (16-GA. SHEET METAL)

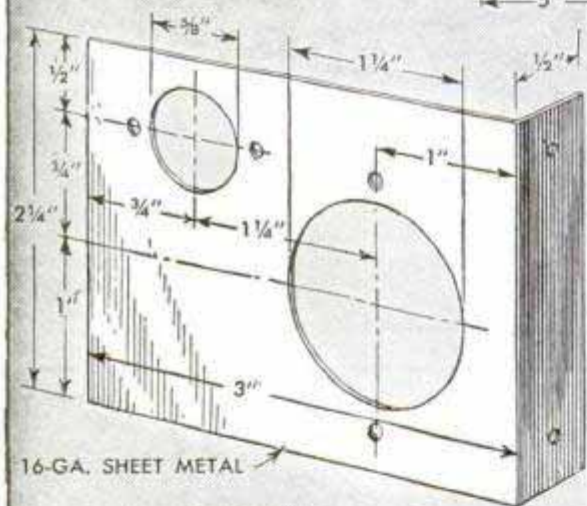

3 BRACKET FOR RECTIFIER TUBE AND VIBRATOR SOCKETS

Next, the filament winding is removed from the coil. It is necessary to work carefully to avoid damage

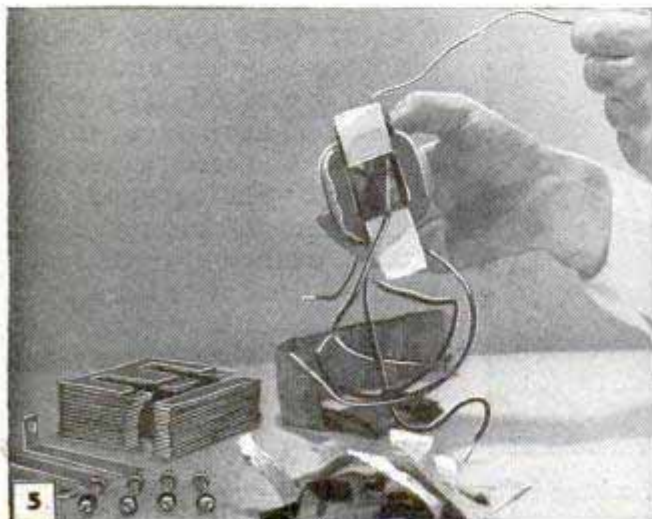

5

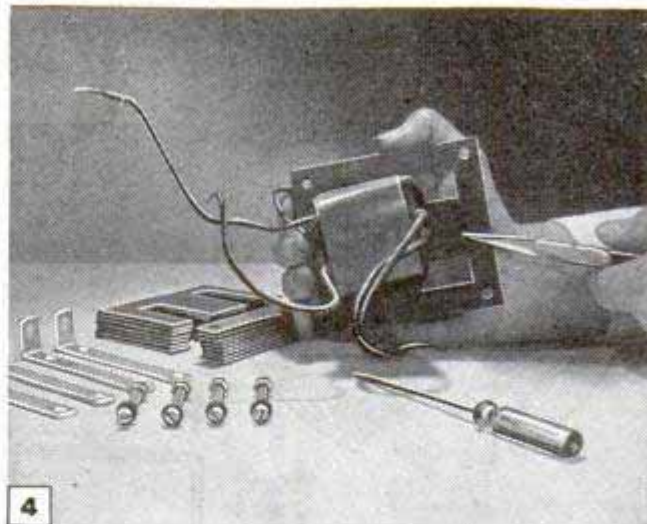

4

To prepare the transformer for rewinding first remove the bolts and brackets and also the iron core

batteries) without disturbing synchronization or hindering normal operation in any way. A high-voltage switch or relay is used in its circuit, making it impossible to come in contact with the 2000 volts in normal operation. All electrical units are housed in a metal case which assures further safety to the operator because it makes a perfect electrical shield. The condenser charges quickly enough to allow a maximum of a flash every four seconds, which is faster than a series of shots normally can be taken under average conditions.

Fully charged batteries will give about 100 flashes of the single high-speed glow lamp. In operation, a high-voltage condenser stores energy. When ready to utilize this stored energy, the capacitor (condenser) is discharged through the flash bulb, giving off an intense blue-white light. The relay acts as a magnetic switch while the rheostat and the output transformer are used solely in the synchronization of any between-the-lens shutter.

Rewinding the transformer: A standard a.c. transformer is rewound for this unit.

Loosen the primary winding by carefully working a screwdriver between primary and secondary windings

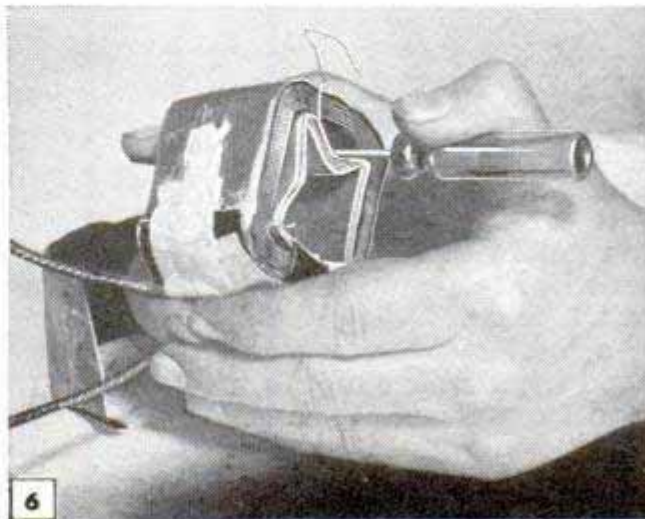

6

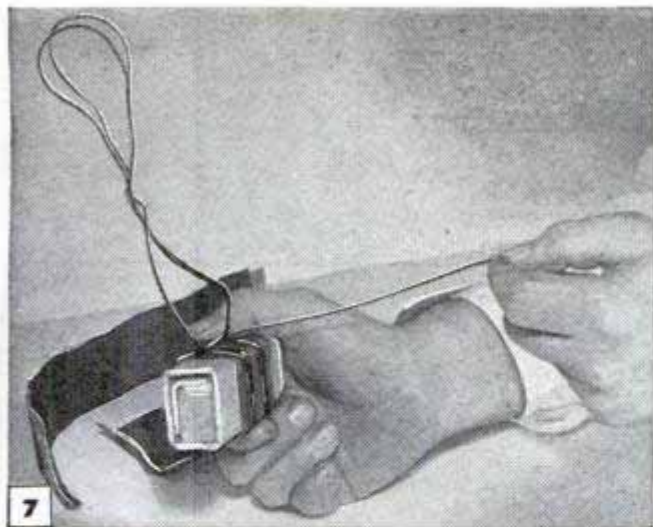

7
 Rewinding new primary coil. Note the looped tap. Wooden form is inserted in cardboard form of coil

It has a 2½-volt filament winding which is unnecessary when using a cold-cathode rectifier tube. (The CK 1013 tube is used to minimize current consumption from the battery.) Remove bolts and mounting brackets, then remove the iron core from the transformer, Fig. 4. Take off the outer insulating material and carefully lift aside the high-voltage leads. Unwind the filament winding from the coil, Fig. 5, being careful not to damage the high-voltage secondary winding. After this is done, the high-voltage leads are replaced in their original position and taped down. The next step, Fig. 6, shows how to remove the primary winding of the transformer by carefully inserting a very small screwdriver all the way through between primary and secondary windings. Press the primary inward, and repeat this on all four sides of the coil until the primary is free and may be removed. The primary is mounted on a square cardboard form, which may be removed in the same manner. After the form has been removed, it is carefully bent back into shape and a wooden block is

Completed coil with the new primary winding in place ready for assembly into the core and brackets

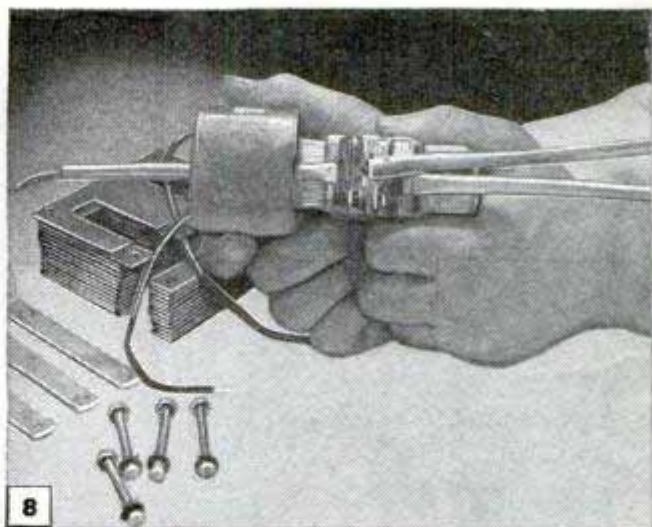
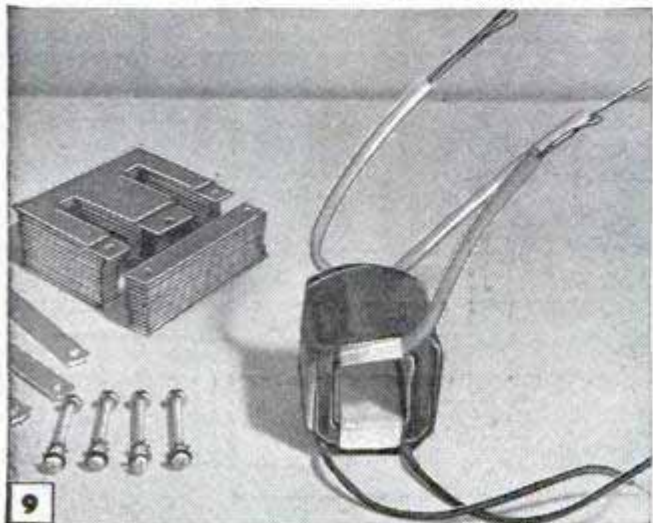

8
 New primary is inserted in the original secondary winding. Leads are insulated and all parts taped

then cut so that it will fit tightly into the paper form. This is done to prevent the form from losing its shape while the primary is rewound. Before rewinding, wind one layer of cellulose tape around the coil form. The primary is wound with two strands of No. 20 enameled copper wire wound parallel with each other in order to have the equivalent of a larger size wire but to minimize the thickness of the primary winding. When starting to wind, leave about 6 in. of wire projecting to serve as primary leads. Wind four turns, leave a large loop and twist this as in Fig. 7 for a center tap, then wind four more turns. Bend the center lead down, laying it parallel with the other two leads. Slip lengths of varnished cambric tubing over each of the three leads of the primary. Another layer of tape is then applied over the coil. Insert the primary, with its leads coming out the sides, back into the secondary winding, Fig. 8. Finally, remove the wooden form and wrap all original insulating material around the transformer coil. Now, replace the transformer core, Fig. 9, and

The new transformer assembled with the original core and brackets ready to be installed in the unit

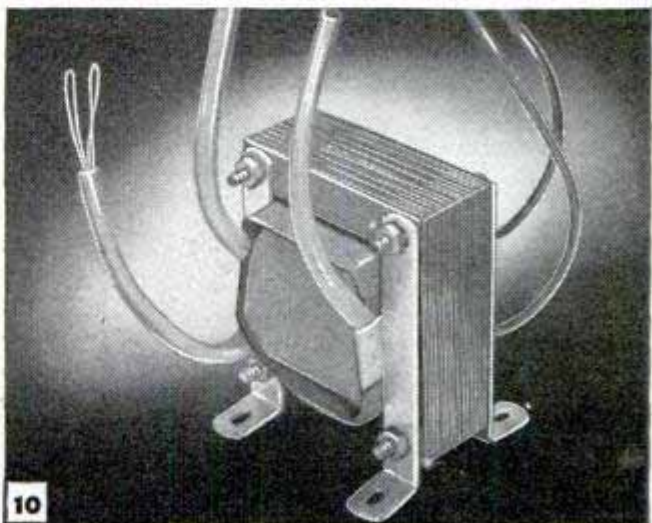

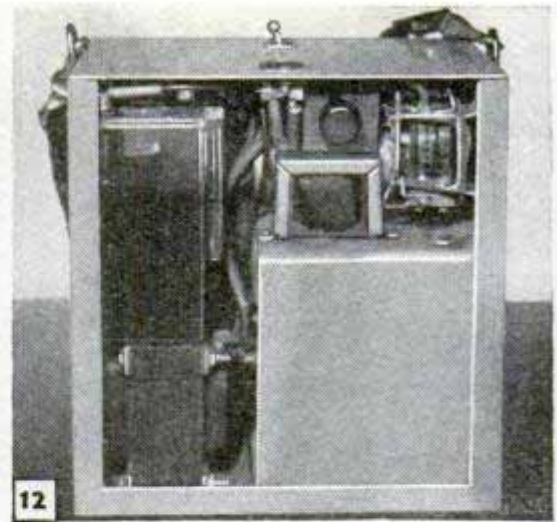
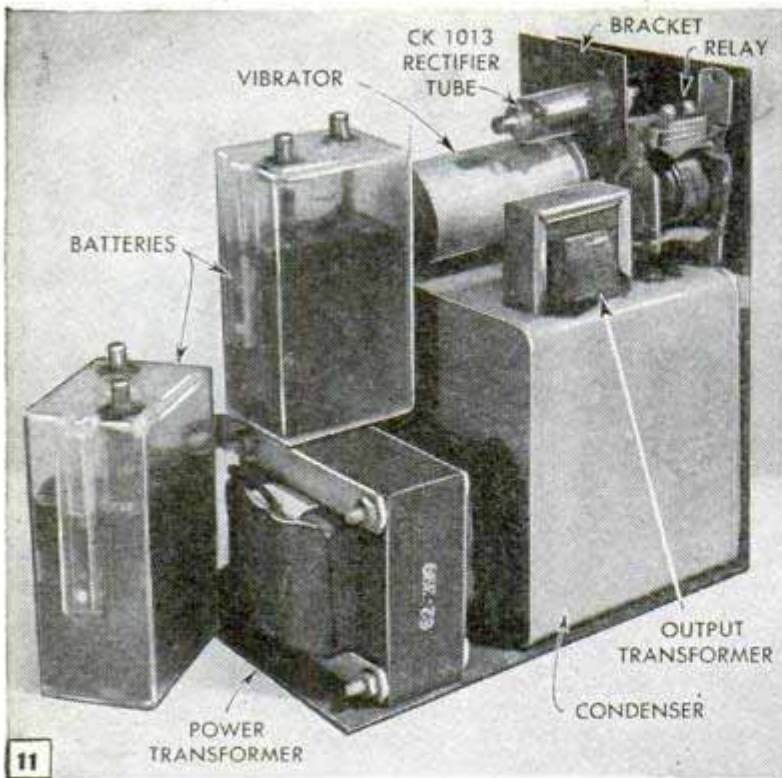

At the left, the electrical parts are shown partly assembled on the chassis, and above, completely assembled in the box. Note the placement of the special batteries

The table below Fig. 11 lists electrical parts required. Key letters correspond to those shown on the wiring diagram, Fig. 13

- A—WILLARD RECHARGEABLE PHOTOFLASH BATTERY (Type ER-6-2B, supplies 2 volts for 6 amp.-hours. 2 reqd.)
 - B—HKG T PHOTOFLASH CAPACITOR (Type 1A00, 15 mfd., 2000 volt d.c.)
 - C—HOWARD B. JONES, 4-CONTACT, POLARIZED PLUG AND SOCKET (Plug, Type P-304-CCT. Socket, Type S-304-AB)
 - D—POTTER AND BRUMFIELD MEDIUM-DUTY POWER RELAY (Model No. MR1D, Type S.P.S.T., Normally open, 8 amps.)
 - E—6-OHM RHEOSTAT
 - F—D.P.S.T. TOGGLE SWITCH
 - G—HIGH-VOLTAGE, PHOTOFLASH TRANSFORMER (Allied Radio Corp., Type 62-399)
 - H—MALLORY VIBRATOR (Type T 4000, 2 volt)
 - J—RAYTHEON RECTIFIER TUBE (Type CK 1013/5517)
 - K—KNIGHT UNIVERSAL RADIO OUTPUT TRANSFORMER (Type 62-021, 8 watts, primary impedances 4000 to 14,000 ohms)
- NOT SHOWN
- JOHNSON MINIATURE-SERIES TUBE SOCKET (7-pin steatite socket for rectifier tube (J))
 - SUB-PANEL, WAFER-TYPE SOCKET (7 prongs for vibrator (H))
 - AMGLO ELECTRONIC PHOTOFLASH LAMP (Type 51Q4X, 20-30 mfd., Max. volts 2000, 40-60 watt-sec.)

reassemble with bolts and brackets as in Fig. 10.

Assembly: Before assembling, have at hand all parts listed in Fig. 11. Note that in the box below Fig. 11, letters A, B, C, and so on, serve as key letters to locate the parts in the wiring diagram, Fig. 13. Actual layout of parts in the case is not important. It is only necessary to arrange them to occupy a minimum of space so as to leave ample room for the wiring. Build the case, Fig. 2, first, as it serves as a chassis on which all parts are mounted. Capacitors vary somewhat in size so make sure the case is large enough. To facilitate mounting of parts, the sides of the case are attached with metal screws so that they can be screwed in place after the electrical units are assembled inside. Since the capacitor is oil-impregnated, and no holes may be drilled in the housing or container, spot solder it into position. Fasten the high-voltage transformer to the case with mounting brackets, using 6-32 bolts and

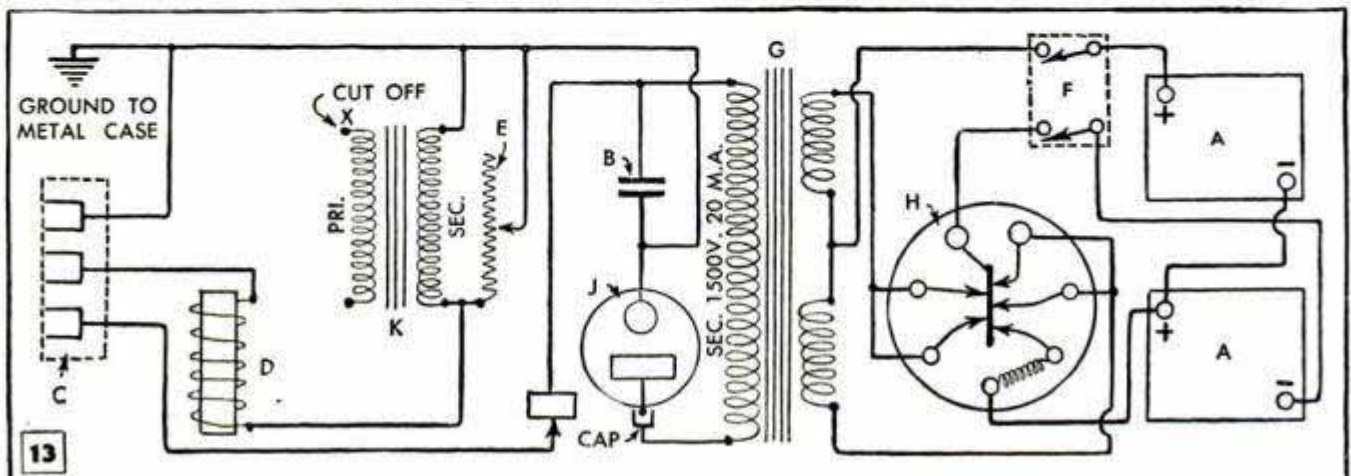

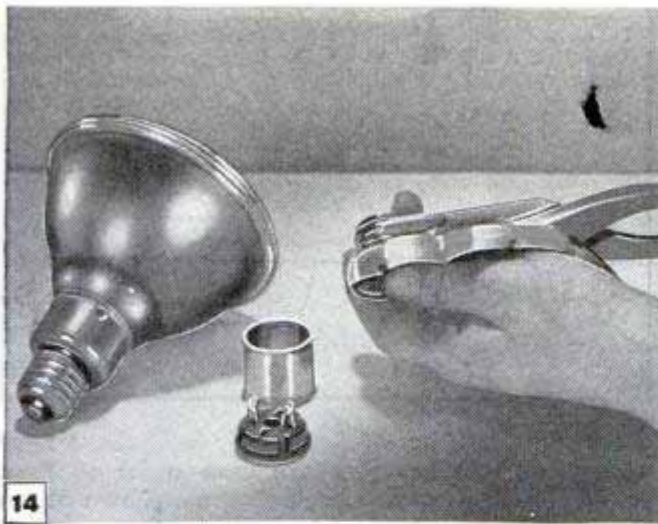

14 The upper flange of the heat-bulb socket is cut off so that a length of brass tubing will fit over it

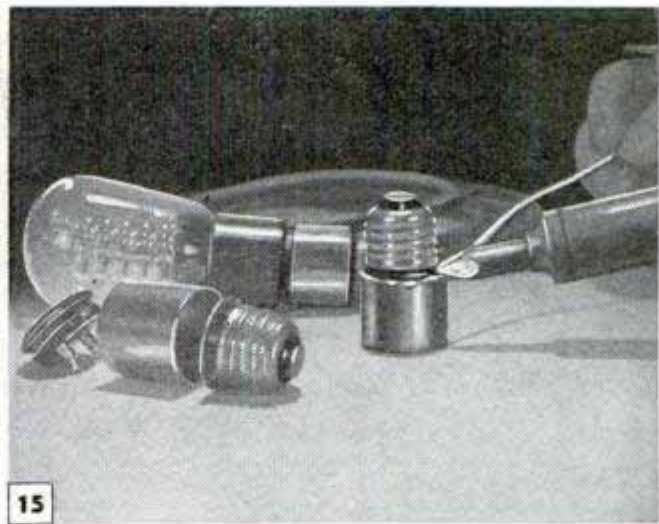

15 The length of brass tubing is then soldered to the heat-bulb socket. Also see the detail below, Fig. 16

nuts. Make the L-shaped bracket of 16-ga. sheet metal as detailed in Fig. 3. Cut two holes, one to mount a miniature-series 7-pin tube socket which holds the CK 1013 rectifier tube, and the second, a larger hole, for the 7-prong wafer socket for the vibrator. After the socket has been mounted on the bracket, bolt the bracket to the case as in Fig. 12. Before mounting the relay, solder 6-in. leads on all the terminals. Mount the relay as in Fig. 12, using 6-32 bolts and nuts. The primary leads of the output transformer are cut short for they are unnecessary to the circuit. Then solder the transformer to the capacitor. Fasten the 6-ohm rheostat, the Howard B. Jones plug and the switch to the top of the case.

Wiring: The wiring is simple if the circuit diagram in Fig. 13 is carefully followed. All wiring in the power-supply unit should be done with a good grade of high-voltage radio test-prod-lead wire. The leads are further insulated by covering the wire with varnished cambric tubing to prevent any possibilities of leakage which would reduce the maximum output voltage. When connecting the secondary of the output transformer, use terminals No. 1 and its highest number to get maximum inductance of the winding. In order to transform d.c. current, it is necessary to use an interrupter. This vibrator, or interrupter, is the synchronous-type 7-prong, 2-volt vibrator commonly used in portable radios with rechargeable batteries. The contacts of the vibrators should be paralleled to give maximum current efficiency. It is wired as shown in the diagram, Fig. 13.

Socket assembly: The glow-lamp socket assembly is made up as in Figs. 14, 15 and 16. First, get a piece of chrome-plated tubing, $1\frac{3}{16}$ in. in diameter and 1 in. long, and also a screw base from a heat lamp with an oversize flange, Fig. 14. Break the glass in the base by wrapping the base with cloth

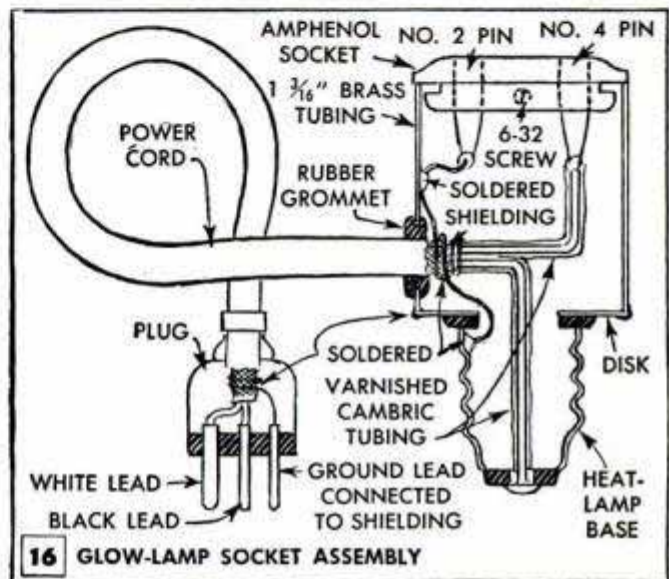

and striking lightly with a hammer. Remove the glass with pliers. Trim off the upright flange, leaving a disk or shoulder $1\frac{3}{16}$ in. in diameter, Fig. 16, so that the screw base will fit snugly inside the tubing. The socket is then soldered into one end of the tubing, Fig. 15. Drill a $\frac{3}{8}$ -in. hole near the bottom of the tubing for the power cord to the glow lamp and synchronizer, Fig. 16. Insert a rubber grommet in the hole and feed the cable through this hole. Solder the outer shielding of the cable to the inside of the tubing. A short length of wire is then soldered, one end to the outer edge of the screw base and the other end to the tubing, to make the ground connection. The black lead of the cable is carefully skinned, covered with the cambric tubing, and then soldered to the center contact of the screw base, Fig. 16. Remove the No. 1 and No. 3 terminals of the 4-prong tube socket. The white lead of the cable is covered with insulation and soldered to the No. 4 pin of the socket. Then push varnished cambric tubing over the No. 4 pin, leaving no exposed socket connection. Solder a short length of wire to the No. 2 pin.

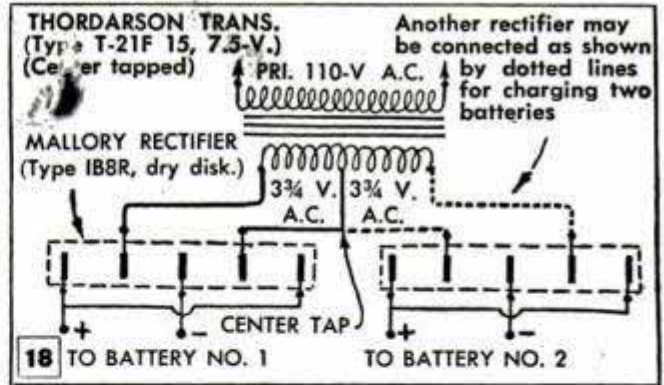
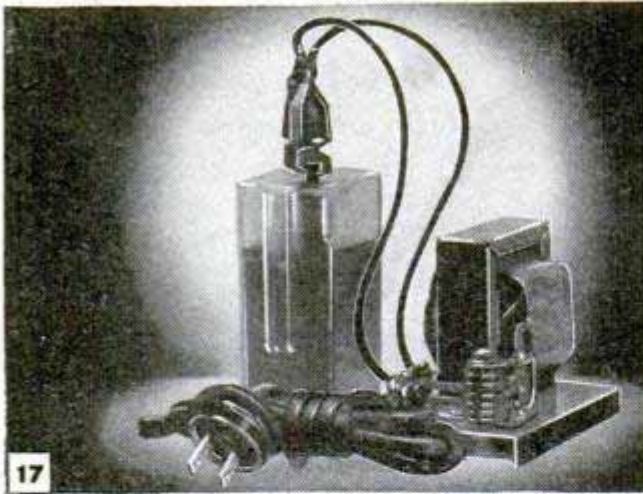

Above and left, an efficient, easily built charger for the speed-light batteries can save a lot of time. Wire according to the circuit diagram shown above

The other end is soldered to the tubing to make an electrical ground, Fig. 16. Fit the socket into the end of the brass tubing. Drill and tap two 6-32 threads, one opposite the No. 1 and the other opposite the No. 3 terminals. Fasten the 4-prong socket to the brass tubing by inserting short screws in the tapped holes. Make sure the screws are short so that they do not project through the prong holes of the 4-prong socket. Solder a male plug to one end of the power cord, Fig. 16. Do all the assembling and wiring before connecting the batteries into the circuit, which should be the last operation before testing. Many electricians keep one hand in a trouser pocket and use only one hand when testing or otherwise working inside the box after connecting the batteries. This helps avoid a possible shock by accidentally getting both hands in a position that would provide a path from one hand to the other for the high-voltage current.

Adjustment and operation: The unit is easily synchronized with the camera shutter without changing the adjustment of the solenoid tripper. The output transformer is used in conjunction with the rheostat in order to increase or decrease the time of the flash. By varying the rheostat, one may synchronize the speed light with the shutter by holding the light unit and reflector as closely as possible to the open back of the camera. A piece of thin paper is placed over the front element of the wide-open lens, with the shutter set at its fastest speed. Now press the button of the gun. You will probably see a "Y" or other odd-shaped light figure on the paper. Turn the rheostat to the left and try another flash. Repeat until you see a clear round spot of light the full diameter of the lens. If the rheostat is turned completely to the left and you still do not see the round spot of light, increase the distance of the contacts on the relay and repeat the test. (Caution: When working on the relay, be careful. Make sure the capacitor has been

shorted several times, before attempting any adjustment.) When the round spot is showing through the lens, the flash is perfectly synchronized with the shutter. Permanently set the control in this position. Make your own tests to determine the correct exposures, as various reflectors differ in their light-concentration and light-reflection qualities.

Battery charger: An efficient charger for the speed-light batteries is pictured and detailed in Figs. 17 and 18. Use a Thordarson (T-21F15, 7.5-volt) center-tapped transformer for the power source, and a small copper-oxide (dry-disk type) rectifier, Mallory (type IB8R, full-wave). Any make of transformer with a 110-volt primary, and with a 7.5-volt secondary center tapped (current rating, 2 amps.) may be used. The center tap on the secondary winding is very important because the oxide rectifier is only connected across one half the secondary winding. Another oxide rectifier may be connected, if desired, to the other half of the filament winding to charge two batteries at once instead of only one at a time, Fig. 18.

Clothespin Handles on Reflectors Prevent Burned Fingers

After burning my fingers in adjusting hot photo-flood reflectors, I clamped a couple of wooden clothespins to the rim of the reflector as shown. These provided cool handles which I could grasp to tilt the



Besides serving as handles, the clothespins also can be used to hold a diffusing cloth over the reflector.

R. F. Donovan, Jersey City, N. J.

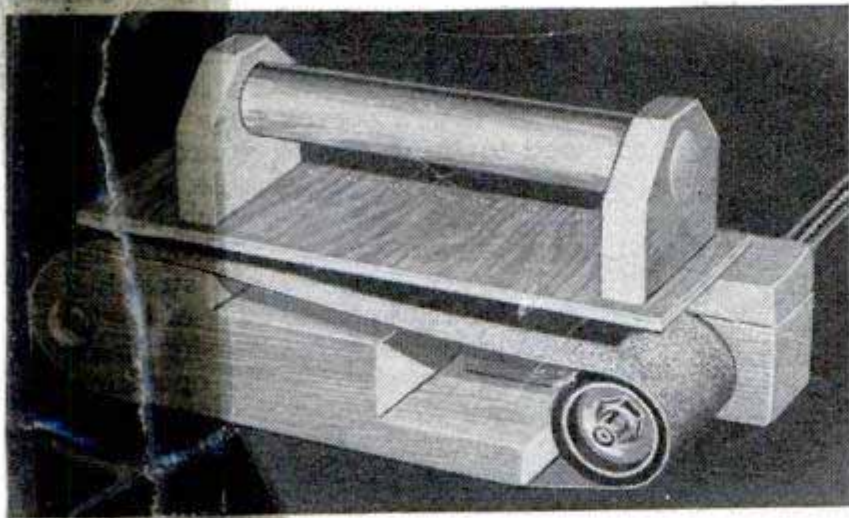

BELT SANDER

By A. B. Carper

I NEEDED a belt sander, but couldn't justify the expense of a self-contained unit, so I made one, which is electrically driven through a flexible shaft. It works efficiently and, being made entirely from scraps of hardwood, costs only the price of a 3-in. sanding belt and a few bolts.

The pull-apart drawing, Fig. 1, shows the assembly of the sander and dimensions all the parts. The dimensions given accommodate a standard 3 by 29½-in. sanding belt, but the sander can be made proportionately larger to take longer belts. A standard rubber-faced sanding drum on the flexible shaft provides the drive drum. A similar one of any width can be made

by placing a number of solid-rubber disks between two metal washers or on a threaded shaft and clamping them together with a nut. Then, the drum is trued while rotating by holding coarse sandpaper or a grinding wheel against the rubber. The block used for the frame is clamped to the handle of the flexible shaft by means of a slotted hole, which is bored exactly at right angles to the inner face of the frame. Two

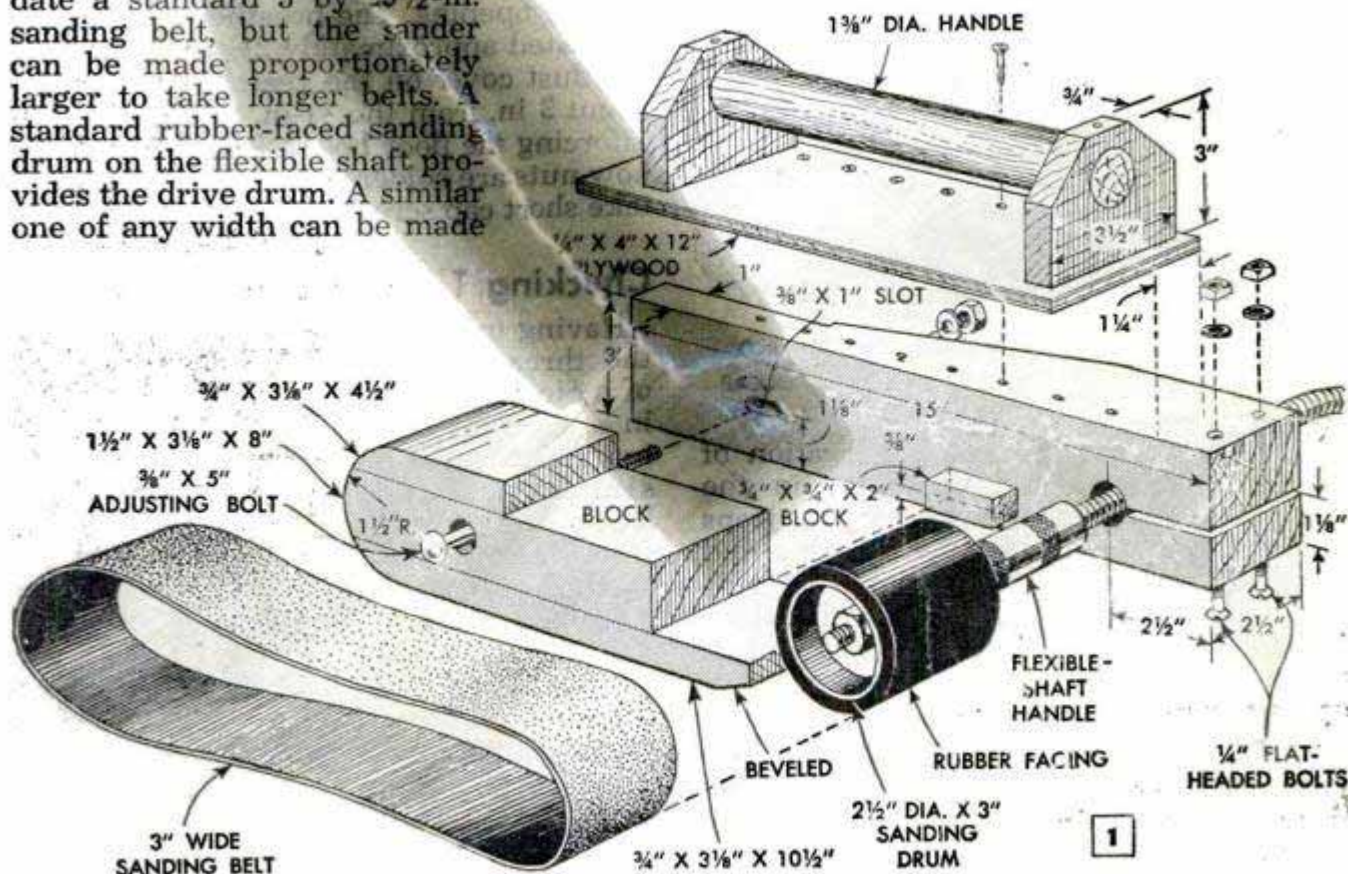

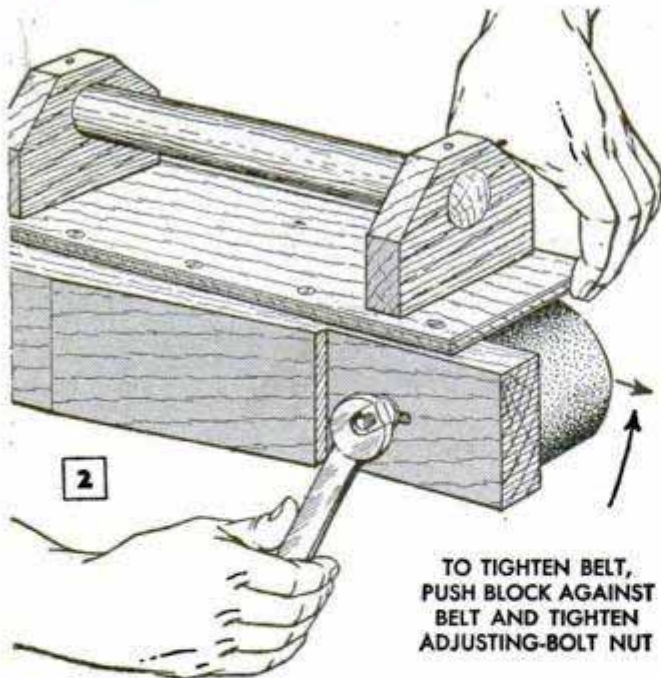

TO TIGHTEN BELT, PUSH BLOCK AGAINST BELT AND TIGHTEN ADJUSTING-BOLT NUT

flat-headed stove bolts take up on the slotted hole and clamp the shaft rigidly. The opposite end of the frame is slotted to take an adjusting bolt on which the tension assembly pivots. The latter consists of three separate blocks, although it can be a single block. It is movable back and forth in the slot to permit proper belt tension. When mounted, the belt surface of the tension assembly is $\frac{3}{8}$ in. below the frame. The as-

sembly is held at a horizontal level by a small stop block screwed to the frame. This block permits the assembly to pivot when the sander is lifted but keeps the bottom or shoe of the assembly level with the face of the sanding drum. A plywood guard keeps the hand from coming in contact with the belt. This overhangs the frame to cover the belt and is attached with screws. Two blocks, bored to take a length of curtain pole which serves as a handle, are screwed to the plywood guard before attaching the latter to the frame. A nail driven through the handle at each end pins it in the holes in the blocks. Proper tension is maintained as the belt stretches by loosening the nut on the back of the frame, Fig. 2, and pushing the tension assembly forward in the slot. Avoid operating the sander with the belt too tight. Excessive friction produced by the belt passing over the wooden tension assembly will only tend to wear the belt prematurely. Waxing the bottom and the rounded end of the assembly will help to reduce friction.

The flexible shaft should rotate counterclockwise at about 1750 r.p.m. A $\frac{1}{4}$ -hp. motor will furnish ample power. In using the sander, apply very little pressure and keep it moving. If a stand is made to hold the sander in an upside-down position, it can be used as a bench sander.

Floor-Board Opening on Jeep Gives Easy Access to Breather Cap

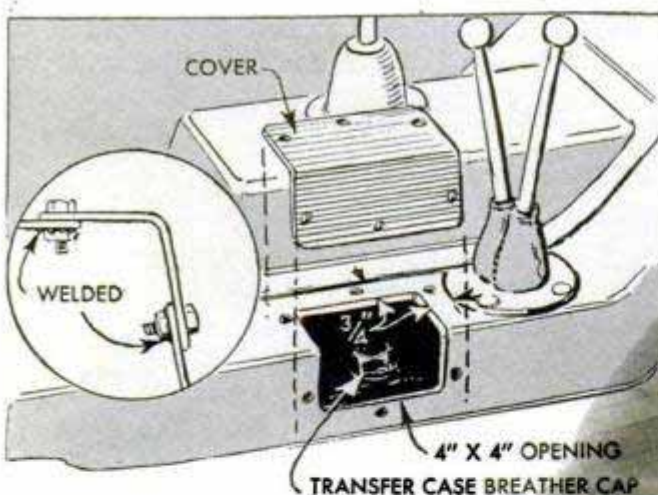

Because of the inaccessible location of the breather cap and ventilator in the transmission, owners of war-surplus jeeps are apt to neglect cleaning the caps and plugged ventilator holes regularly. This results in leaking oil seals and rusted transfer cases. To get at the cap requires reaching up under the floor boards in a space above the transfer case barely large enough for the hand and removing a cotter key from the reverse side of the breather cap. However, a simple solution to the problem was discovered during the war.

An opening is cut in the metal floor board directly over the breather cap so that it can be reached by removing a plate covering the opening. The breather cap usually is located approximately $2\frac{1}{2}$ in. back from the dust cover on the gearshift levers and about 3 in. from the $\frac{1}{4}$ -in. raised plate reinforcing the floor board. The detail shows how nuts are soldered to the floor board to take short cap screws which hold the plate.

Chucking Threaded Work

Having to chuck the threaded end of a piece of work in a lathe for facing, I discovered a simple way to keep the thread from being damaged. I wrapped a piece of wire around the thread so that the chuck jaws would bear against the wire.

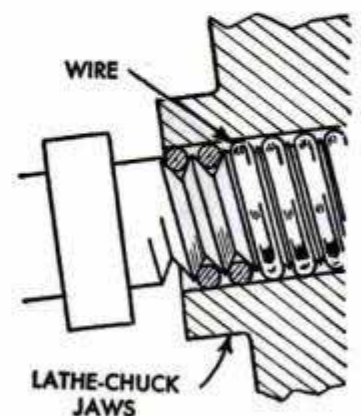

The wire should be heavy enough to keep the jaws from injuring the top of the thread.—Shiro Fujihira, Seattle, Wash.

Fluorescent Ceiling Fixture Converted to Hanging Workshop Light

Wanting a good fluorescent light for his workshop, but hesitating to buy one because of the expense, D. J. Bachner of Jackson Heights, N. Y. converted an ordinary twin-tube ceiling fixture into an excellent workbench and drawing-board light. In addition, the light can be raised to the ceiling to furnish illumination for the entire shop. He first made a sheet-metal reflector to fit over the fixture. This is bent in a U-shape and a hole is cut in it to provide for the lamp cord. Then the reflector is drilled for four small bolts centered and spaced along its length, and the underside of the sheet metal is painted white to afford a good reflecting surface. The overhanging sides of the reflector are bent to come just below the bottom of the fluorescent tubes in order to direct the light downward. When the reflector is finished, the mounting flange is removed from the fixture which is drilled to coincide with the holes in the reflector. Next, a suspension bracket for each end of the fixture is bent from heavy-gauge sheet metal, as shown in the lower photo, and fitted with an eyebolt at the top. Holes are drilled through the legs of the brackets and the end plates of the fixture, and the brackets are bolted to the end plates. After the brackets are in place, the reflector is bolted to the fixture. The fixture is attached to the ceiling by means of screen hooks and lengths of lightweight chain, a method that permits the light to be adjusted to almost any height. As his fixture was of the plug-in type, Mr. Bachner fastened a surface-mounted receptacle to the ceiling near the light. However, if a direct-wired fixture is used, it may be connected to a junction box in the ceiling. A wall switch will be found most convenient.

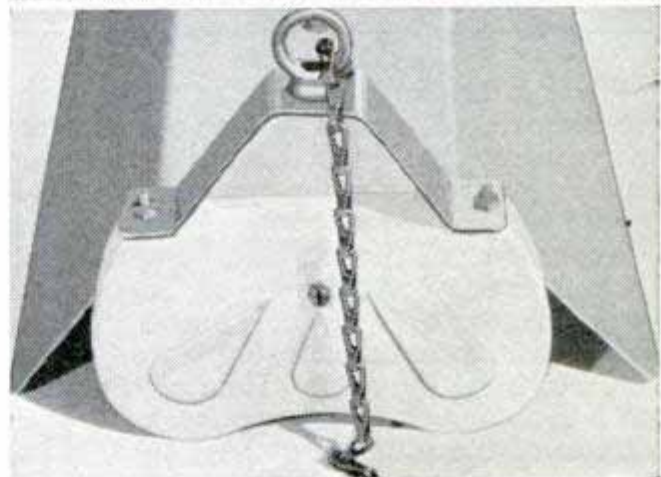
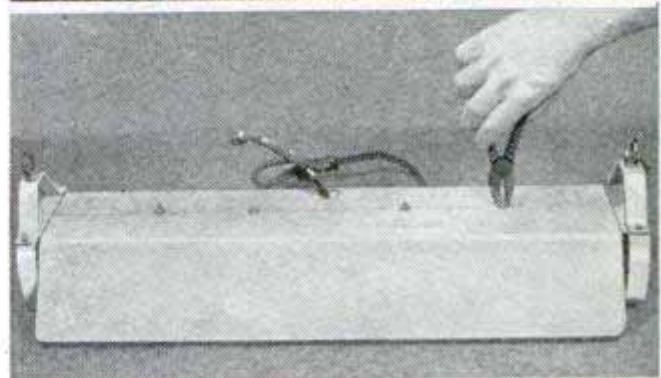
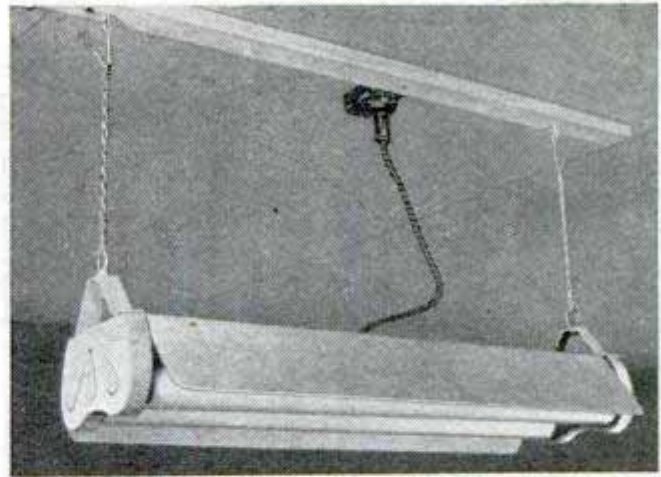

Bleeder Valve for Pneumatic Tools Improved From Gas Shutoff Cock

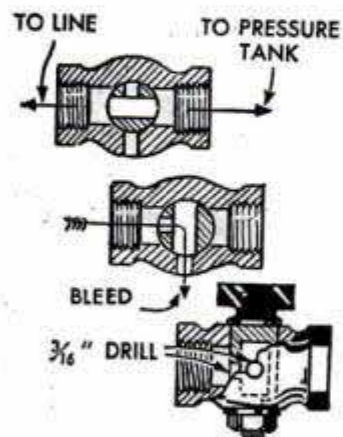

of the threaded openings and make a hole in the side of the cylinder at right angles to the original hole. Then, drill another hole through one side of the valve casting

When a two-way air valve is needed to bleed equipment before disconnecting it from an air-pressure tank, one can be made in a jiffy by altering a gas shutoff cock as shown. With the cock in the closed position, insert a drill through one

to coincide with the original hole in the cylinder. Use a drill with a diameter approximately one half the width of the valve opening. This will retain ample surface on either side of the holes and prevent air leakage. Thus, a $\frac{3}{16}$ -in. drill would be used for a valve with a $\frac{3}{8}$ -in. opening. An extension handle fastened to the top of the valve facilitates operation.

H. W. Billard, Hempstead, N. Y.

Repairing Rust Holes in Car Bodies

Small rust holes in car bodies can be repaired by plugging them with steel wool, applying flux and soldering. They then can be filed, sanded and painted with metal primer. After the primer has dried, a finish coat of the desired color is applied.

Altered Pressure-Type Oilcan Meters Insecticide



To permit regulating the amount of corn-worm oil applied to each ear of sweet corn in my garden, I devised a metering applicator from a pump-type oilcan. I soldered a U-shaped metal bracket under the thumb lever of the can and bored a small hole in the top of the bracket. Then, a nut was soldered over the hole and a machine screw was inserted as a stop. By adjusting the height of the screw, I am able to control the amount of oil applied with each stroke of the plunger.

Clinton R. Hull, Costa Mesa, Calif.

Scale on Locking Lever of Tailstock Permits Critical Clamping Pressure

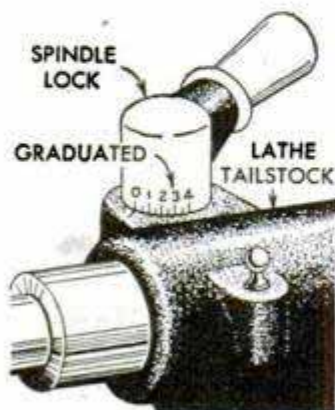

Noticing that varying degrees of spindle tightness affected the centering of work when locking a lathe tailstock spindle, I decided to calibrate the locking lever. This was found especially helpful when releasing the tail center for

lubricating and again engaging it, as I merely had to note the scale reading beforehand and reset the locking lever ac-

ordingly. An index mark is made on the tailstock casting to aid in setting the lever.
Earl R. Goddard, Denver, Colo.

Holder for Carpenter's Chalk Provided by Rubber Ball

A cake of carpenter's chalk will not rub off on everything when kept in a toolbox or carried in an apron pocket if it is placed in a hollow rubber ball. A slit is made in the ball and by pressing the sides of the ball, the slit will open wide for inserting or removing the chalk.—G. E. Hendrickson, Argyle, Wis.

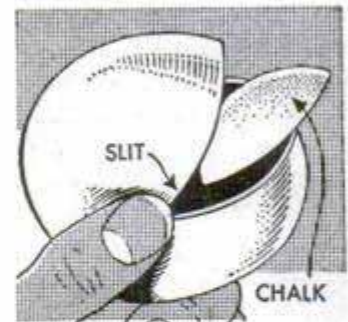

Slapper Aids Driving Animals

Fastened to an old paintbrush handle, a length of inner tube makes an ideal slapper for driving cattle, pigs and other animals. The rubber tube, of course, does not injure the animals.

Paintbrush Strains Cleaning Fluid Used to Wash Small Parts

After using a commercial cleaner or gasoline to wash small parts, much of the residue may be removed from the fluid by straining it through the bristles of a paintbrush. Just place the brush over the funnel spout when the liquid is poured back into the container. Small washers, cotter pins and other parts that may have been overlooked also will be recovered.

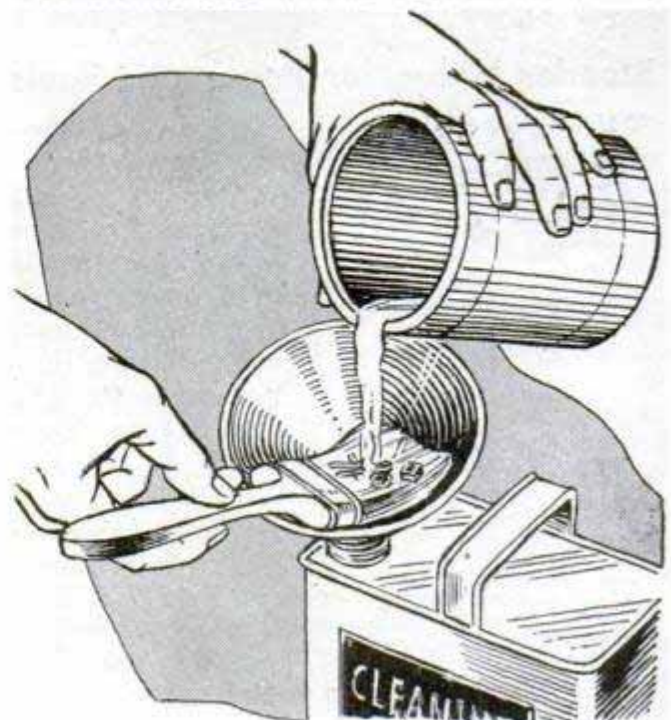

SMALL CLAMPS from HINGES

Hinges need not serve only as hinges. They can be put to work as efficient clamps. Ideal for holding small work in position for soldering and light brazing, they are especially useful where the nature of the work requires a clamp having narrow jaws and a deep throat. Modelmakers will find these clamps just the thing for holding odd-shaped work, as the ends of the jaws can be bent and shaped to fit the exact contour of the parts to be glued or soldered. The four examples show various applications of hinges for clamping small work.

Strap hinges make the best clamps. The drawing below shows a typical clamp and also a few of the many different types of jaws that can be formed. A wing nut, washer and stove bolt provide clamping pressure. The bolt is placed in a hole drilled in the hinge leaf and the head is backed with a nut. A slot formed in the other leaf engages the end of the bolt and permits opening the clamp jaws. The amount the jaws can be opened is determined by the length of the slot. A small coil spring placed over the bolt between the leaves of the hinge will provide a clamp with self-opening jaws. When a clamp is used to hold parts to be brazed, the parts should be clamped to an asbestos pad.

Edward J. Thatcher, Woodstock, N. Y.

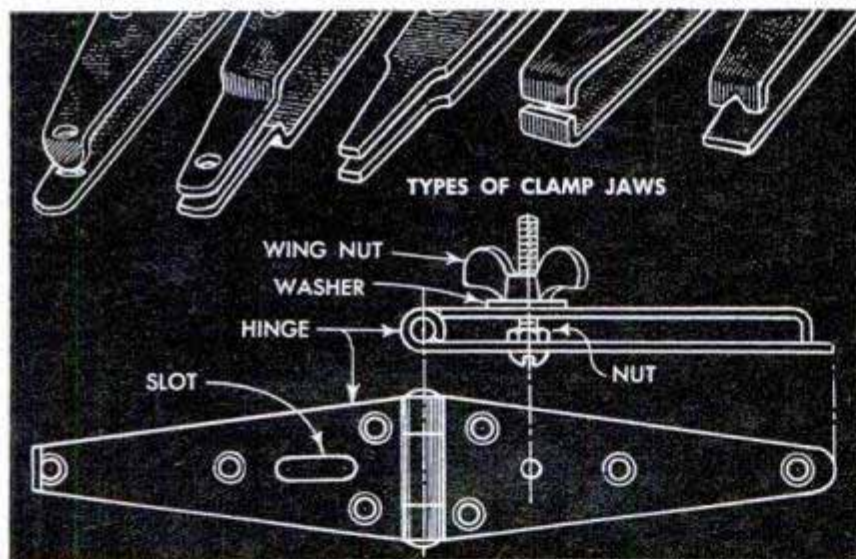
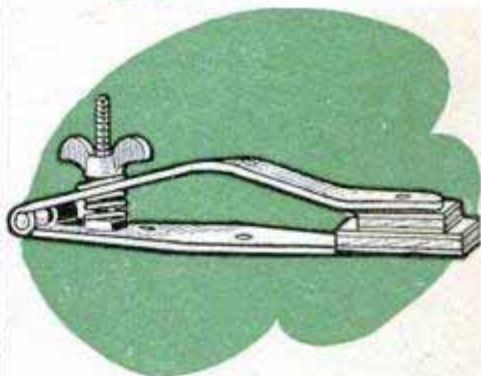
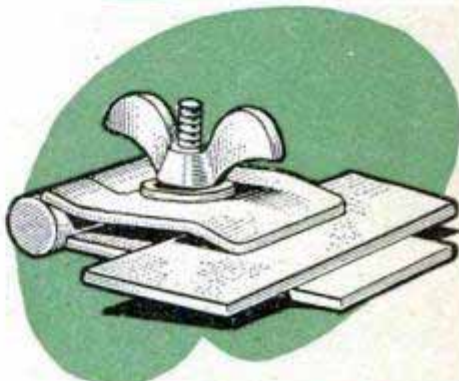
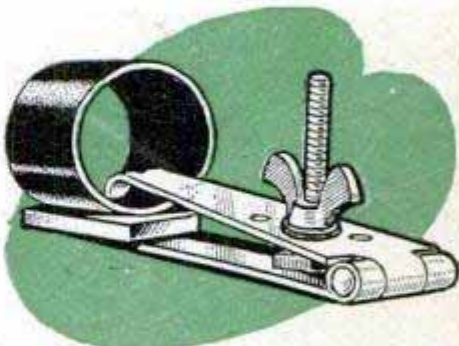
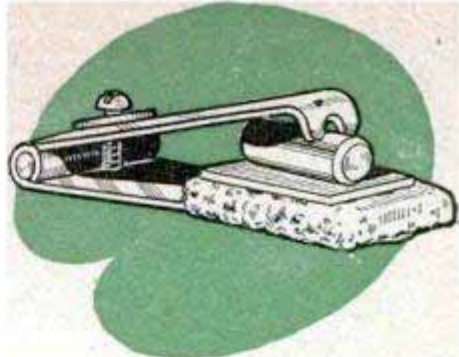

Turpentine Softens Glaze On Sanding Belts

When a sanding belt or disk becomes glazed to the point where it no longer will cut, don't throw it away. You can get further use from it merely by removing the glaze with turpentine. First, soften the glazed areas with the turpentine and then remove the deposits with a wire scratch brush, being careful not to rub too hard so as to wear away the abrasive. An oilcan makes a handy applicator and container for the turpentine. Fast evaporation of turpentine permits the belt to be used almost immediately. Caution: Do not turn on the sander to speed the removal of the glaze, as sparks might ignite the turpentine.

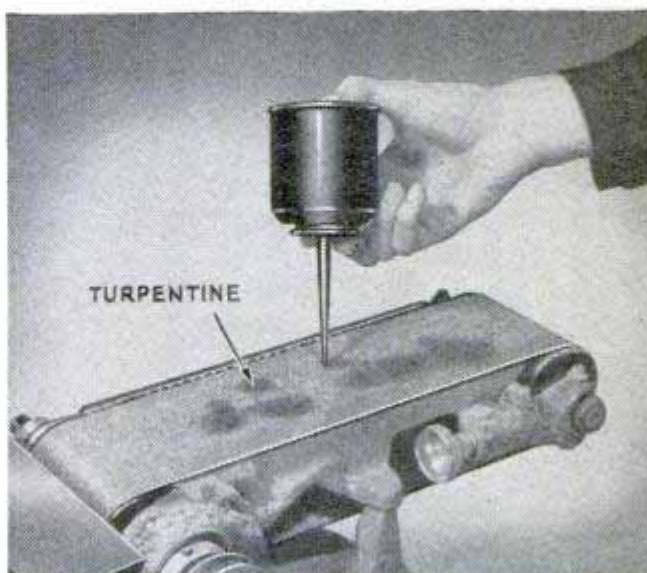



If you can see traces of a white line on the tool edge when held up to a light, the tool is dull and requires sharpening



UTILITY FILE



SCYTHESTONE



KNIFE SHARPENERS

1



COMBINATION BENCH STONE



GOUGE SLIP



ROUND-EDGE SLIP



AUGER BIT STONE



SOFT ARKANSAS POCKET STONE



STICKS

HONE TOOLS

By Sam Brown

UNLESS there are nicks in the cutting edge, it's not necessary to grind a tool each time to sharpen it. Once ground, any tool can be kept razor sharp for many hours of use by frequent, light honing. The right stone to use in honing depends upon the type of tool and its purpose. Grass and bread knives cut best if honed on a coarse stone, while most other tools require honing on a medium or fine stone to prevent the edge from tearing the work and to hold up under cutting pressure.

Artificial abrasives, aluminum oxide and silicon carbide, are gradually replacing natural or mined stones for honing tools. Aluminum oxide is of the same physical structure as natural corundum and is often called "India." In this country, Arkansas is about the only natural oilstone

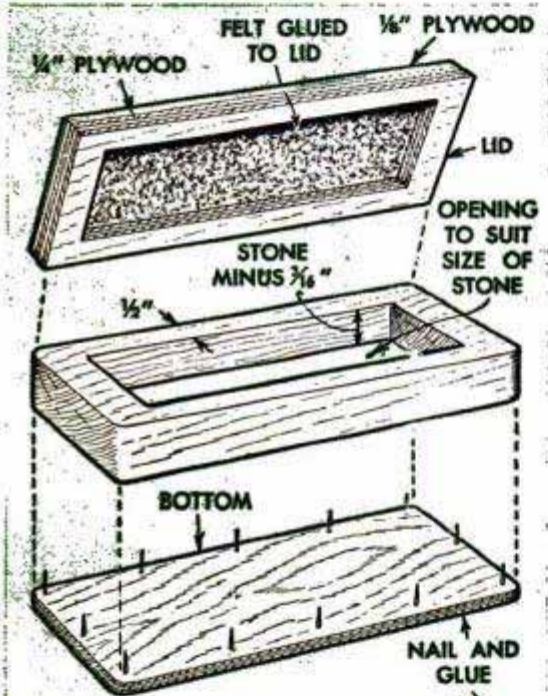

2 STONE BOX

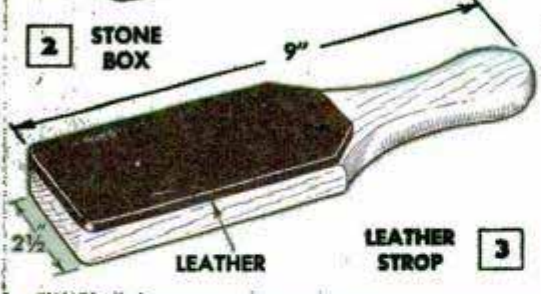

3

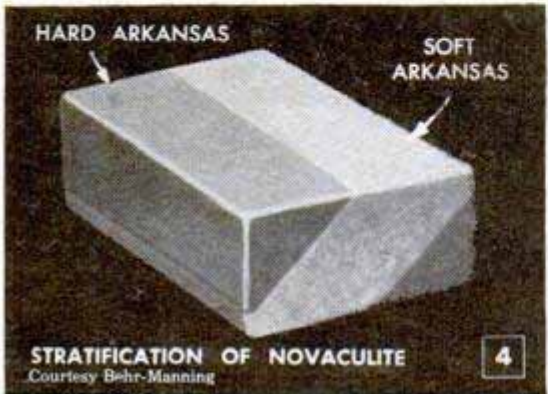

4

5 NATURAL STONES

HARD ARKANSAS—finest grit of all natural stones. Excellent for all delicate cutting edges

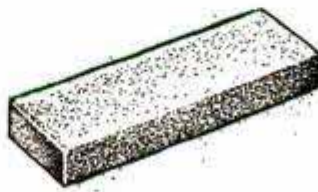

SOFT ARKANSAS—softer and more porous than hard Arkansas but cuts considerably faster

LILY-WHITE WASHITA—a soft but fast-cutting stone with good bite. Best for carpenters

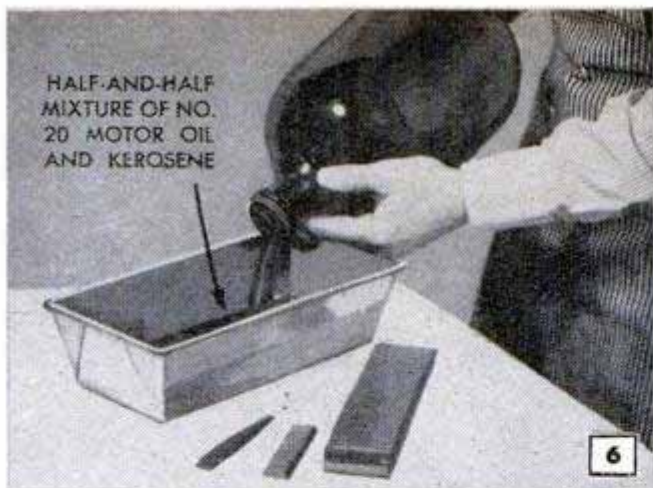

Above, new stone should be soaked in oil before using and then always used with oil to prevent wearing unevenly

Right, if continued use produces hollow in the stone, rub the stone on smooth glass, using silicon carbide and water

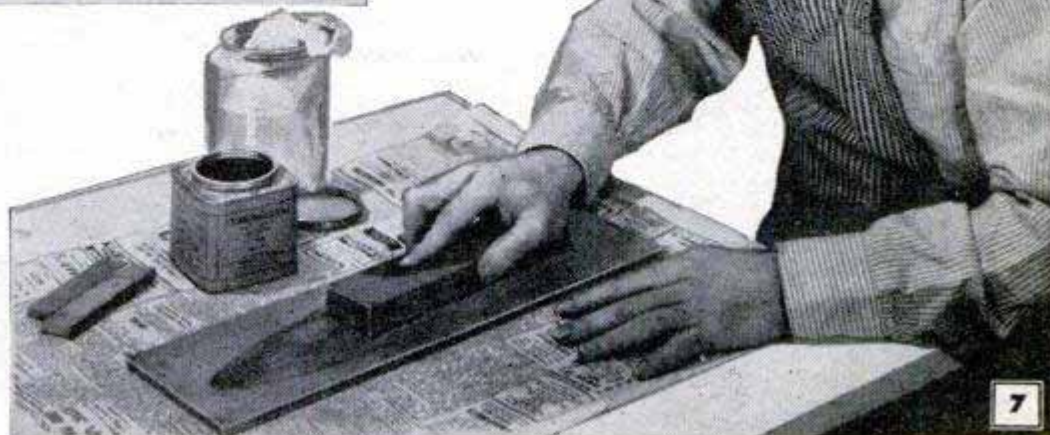

WITH THE RIGHT STONE

of commercial importance. This stone is mineral novaculite, and is largely composed of silica. The stratification of novaculite, Fig. 4, runs from hard Arkansas to soft and then grades off to the still softer and more porous lily-white Washita, Fig. 5. First-grade Washita is the same as lily-white, but is not graded for color.

The bench oilstone: The conventional combination coarse-fine oilstone is widely used in sharpening most straightedge tools in the home shop, although Fig. 1 shows several other shapes which are recommended for honing special tools. The combination oilstone usually consists of either aluminum oxide or silicon carbide. Artificial stones are graded coarse, medium and fine—150, 240 or 320 abrasive grains per inch. Natural stones are not graded by grit

size, but by the variety of stone itself. Hard Arkansas, for example, is of both hard and fine texture, whereas soft Arkansas is soft and coarse. The soft stones cut faster but produce a coarse edge. Certain species of fine sandstone, such as Queer Creek and Hindustan, possess this feature to a marked degree and are used extensively for sharpening scythes and other tools requiring a coarse edge.

The bench oilstone should be kept in a box such as shown in Fig. 2. If the stone has not been preoiled, it should be soaked overnight in a mixture of oil, 1 part, and kerosene, 1 part, Fig. 6. In use, the stone should be worn down uniformly to prevent the formation of a hollow. However, should the stone become hollowed, it should be rubbed flat on a piece of glass, Fig. 7, using



SILICON CARBIDE
Hardest abrasive made. Cuts fast with light pressure, but breaks down under a heavy pressure



ALUMINUM OXIDE
Physically the same as natural corundum, hence often called "India." It is fast-cutting oilstone

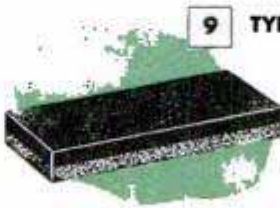

COARSE-FINE
All oilstones can be obtained in a combination of two stones. Coarse-fine is most widely used



MEDIUM
The standard grits in artificial oilstones are: coarse, medium and fine. Combination type is best

Tips on Sharpening a Variety of Tools

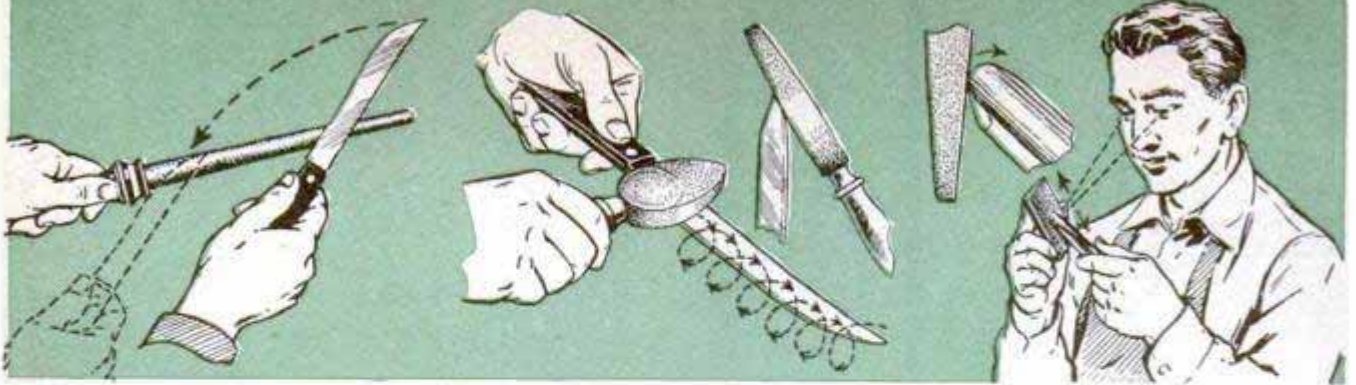

KNIFE (first method)

This type of sharpener is coarse-fine, cuts fast with little pressure and requires no oil. Start the initial stroke as shown, pulling the knife down smartly from heel to tip. Repeat on other side

KNIFE (second method)

Stone is fine-grit silicon carbide, excellent for sharpening stainless steel. Honing is done dry or with water lubricant. Use little circular strokes, as indicated, working stone on one side, then on other

GOUGE

Use flat side of round-edge slip or surface of bench stone. Apply oil, then hold gouge steady and move stone up and down, at same time slowly rotating gouge. Clear view of bevel is had at all times

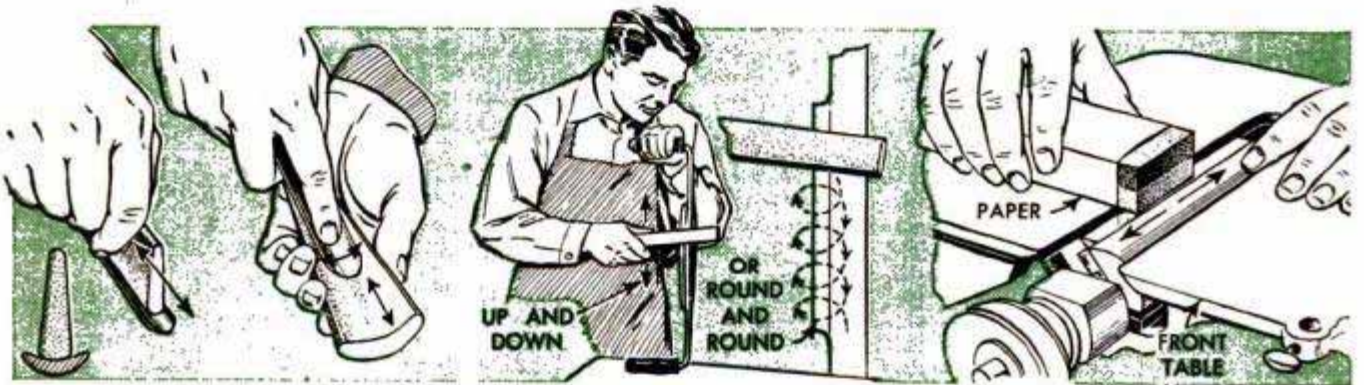

GOUGE (continued)

Wire edge from previous operation is removed by honing with round-edge. Use oil, hold stone flat on tool. Hollow stone is used to hone gouge having outside bevel to help keep proper bevel

DRAWKNIFE

Use a scythestone or a flat stone of coarse grit. Stroke up or down or round and round. Watch bevel by sighting and use stone dry or wet. Same technique is used to sharpen blade of scythe or sickle

JOINTER

Hone jointer knives by wrapping bench stone in paper to prevent marking table. Wedge pulley to hold cutterhead steady. Use oil and hone lightly. Use coarse side of stone first if blades are dull

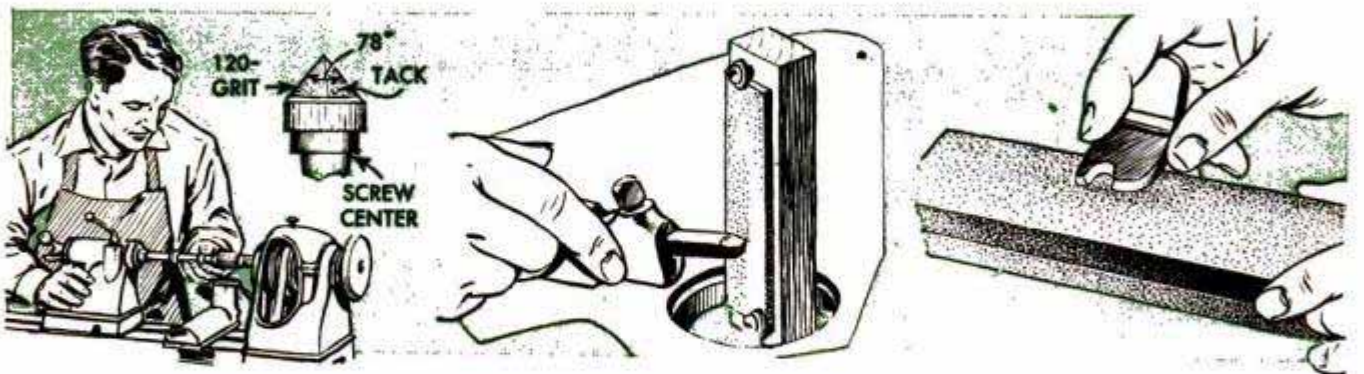

MORTISING CHISEL

If you are unable to obtain a stone of the correct cone shape for sharpening a mortising chisel, turn a wooden cone and cover it with silicon-carbide paper. Apply oil and run lathe at slow speed

LATHE TOOL BITS

Although having blunt edges, lathe bits will stand up much longer if honed to a medium or fine edge. If tool is carbide tipped, use silicon-carbide stone. Mount stone in chuck of jigsaw

SHAPER CUTTERS

Use coarse, then fine side of bench stone. Hone only on flat side of cutter. Give bevel a light paring stroke with sharpening stick to remove wire edge. Molding cutters are honed the same

10 STEPS IN SHARPENING A CHISEL



1. Chisel has been newly ground on 60-grit wheel, so honing starts on coarse side of stone. Apply a few drops of light oil beforehand



2. Hold chisel with heel slightly above stone, as shown in the side view. Stroke chisel back and forth using medium pressure



3. Alternate operations 2 and 3 until edge shows sharp with minimum of burr or wire edge. Repeat same steps on fine side of stone

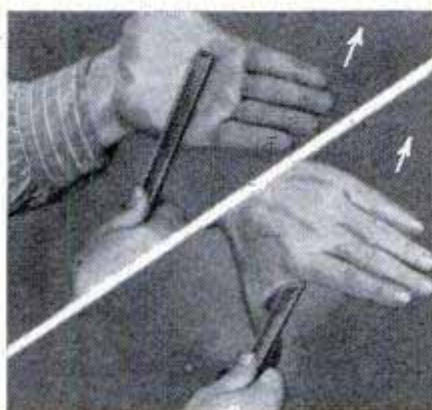

4. To remove final burr or wire edge, hone the chisel on palm of hand, stroking away from edge. This bends and breaks wire edge

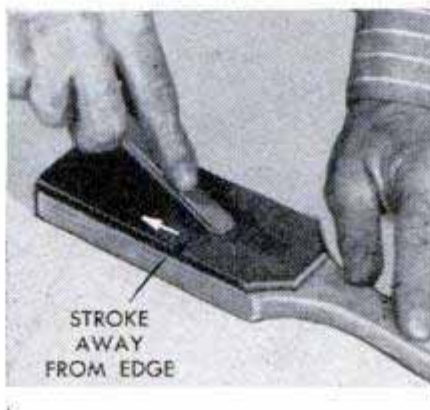

5. Velvety smoothness, provided previous steps have been done properly, is obtained by stropping chisel on smooth piece of leather

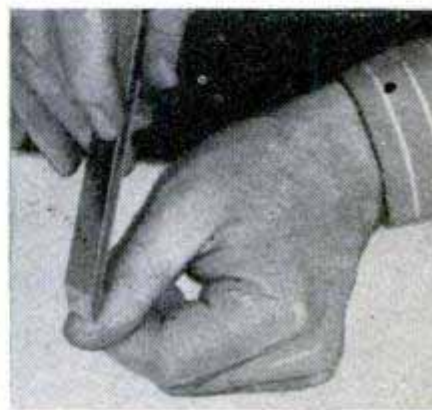

6. Test on your thumbnail — if chisel is sharp, it will bite in; if not, it will slide off. Make this test also at end of step 3

80-grit silicon-carbide grains and water as a lubricant. Silica sand also can be used to dress a hollowed stone.

Using the oilstone: There are no stroking rules in honing other than the obvious one of having the tool in contact with the stone at the proper angle. It is advisable, however, to hone against the edge of the tool whenever possible to hold burring to a minimum. Always use oil but avoid charging the stone with anything heavy or gummy. A kerosene-and-oil mixture is excellent. Being fairly thin, the mixture floats away any metal particles and prevents them from becoming embedded in the stone. It also permits smooth stroking and reduces friction. After a stone has been used, it should be wiped dry with a clean cloth. Never let oil containing metal par-

ticles dry on it, as this will form a glaze.

Kinds of edges: When magnified, any edge will show as a series of sharp "mountain peaks," and the relative size of the peaks classes the edge as coarse, medium or fine. When a chisel is ground on a 60-grit wheel, the edge may be sharp but it is very coarse. Honing on the coarse side of an oilstone gives an ordinary coarse edge, which then can be brought to any degree of fineness by honing on the fine side.

Honing suggestions: The photos in Fig. 10 show the general procedure in honing a chisel and the steps also apply equally as well to plane irons and similar tools. To construct a strop, Fig. 3, glue the leather to a wooden block with the hair side up. Hints on the opposite page cover honing operations for a variety of tools.

Household Lye Distinguishes Aluminum Stock From Similar Metals

When you wish to determine if a piece of metal actually is aluminum or another type of metal with a similar appearance, try this easy test. First make a 40-percent solution of household lye in water, being sure to use a glass container. Then, file or cut a few chips from the stock

in question and drop them into the solution. If the chips produce a vigorous reaction and disappear in a few seconds, the metal is aluminum. When using this solution, be careful not to get it on your hands or clothing. Also, flush the drain thoroughly after disposing of the solution.

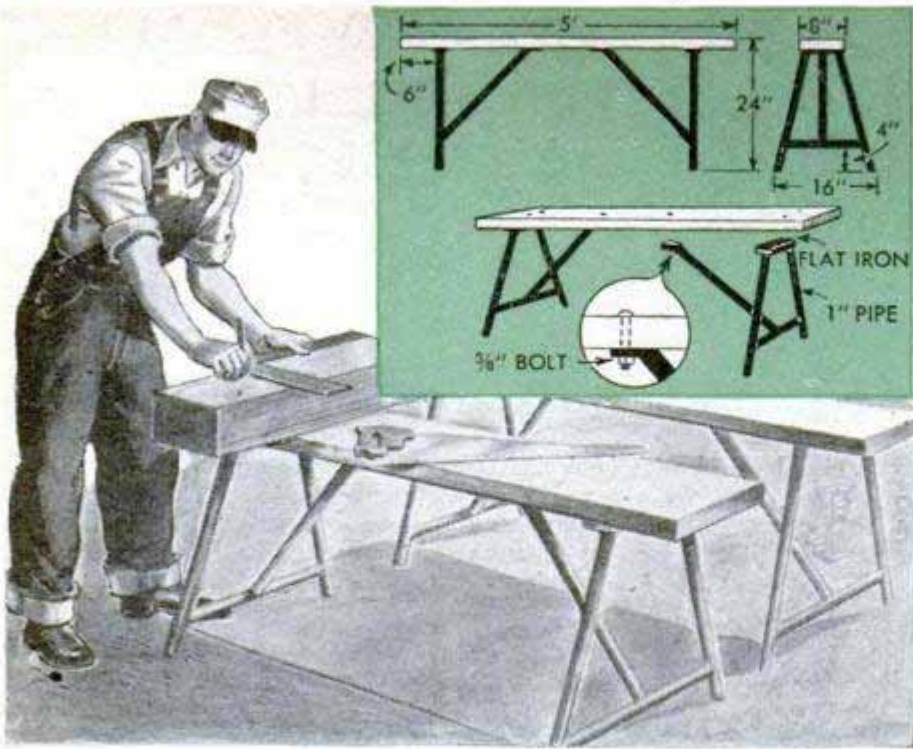

Sawhorse Benches Have Pipe Legs

A pair of sturdy sawhorse benches, made to the dimensions given in the detail, will be invaluable around the shop by providing a rigid working surface even when the heaviest tools are employed. Each set of legs is made by welding together lengths of 1-in. pipe and a piece of flat iron. Bolt holes are drilled through the flattened end of the diagonal brace and also through the flat iron to permit fastening the legs to a plank.

Gravity Coolant Dispenser on Tool Post Rides With the Carriage

For a small lathe not equipped with a coolant system, this handy cutting-oil dispenser makes it easy to keep the tool bit well lubricated at all times. Being mounted on the tool post it rides with the carriage, out of the way, and has a flexible metal

to the bottom of a tin can having a press-type lid. Then a small hole is made in the bottom of the can and a length of tubing, in which the faucet is installed, is soldered over the hole. The flexible metal hose is soldered to the end of the tubing. Note that the drip hole in the faucet must be located at a point where the spring will keep it on the outside of the tube when the faucet is in the "off" position. It is important, too, that the bolt of the faucet be the same size as the inside diameter of the tube.

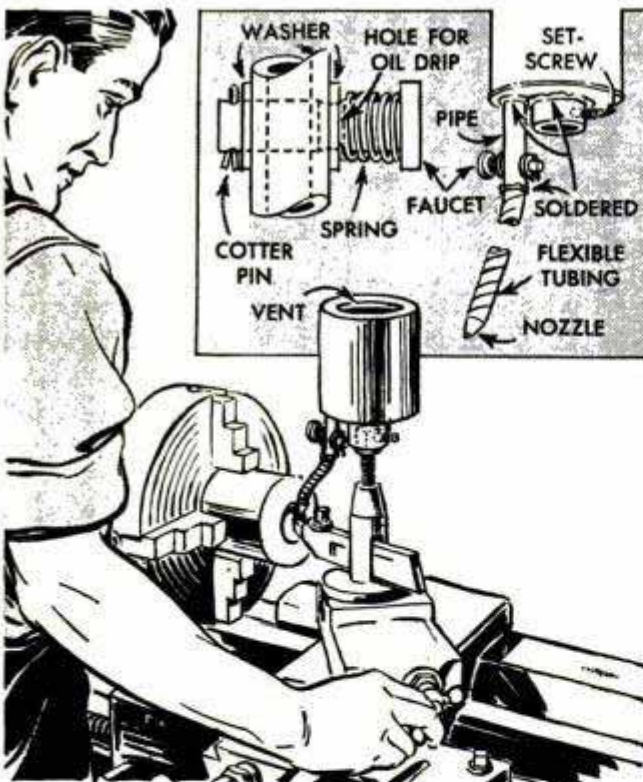

Counterbalanced Hole Cutter Uses Lathe Tool Bit

Designed to compensate for the overhang of the extended tool-bit holder, this hole cutter is balanced to rotate with little or no vibration. The shank and head of the cutter are machined in one piece, the shank and the pilot on the end being off-

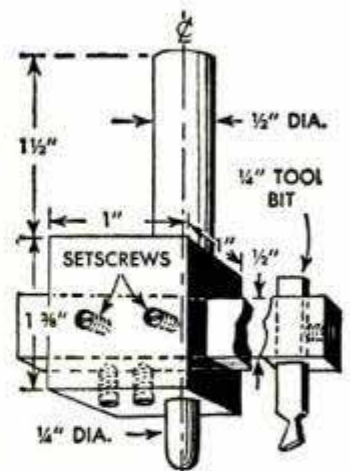

set in the square head. A 1/2-in. hole is drilled through the head and squared with a file to take a 3-in. or longer arm. Another square hole is formed in the end of the arm for a 1/4-in. lathe tool bit. Setscrews are used to lock both the arm and bit in place. Note the shape of the cutting edge.

hose which directs the oil to the very tip of the cutting tool. A simple faucet controls the flow of oil. The details show how the dispenser is made. A section of pipe having an inside diameter which will fit over the square head of the tool-post clamping bolt is tapped for a setscrew and soldered

Jig for Scroll Chamfering and Pattern Routing

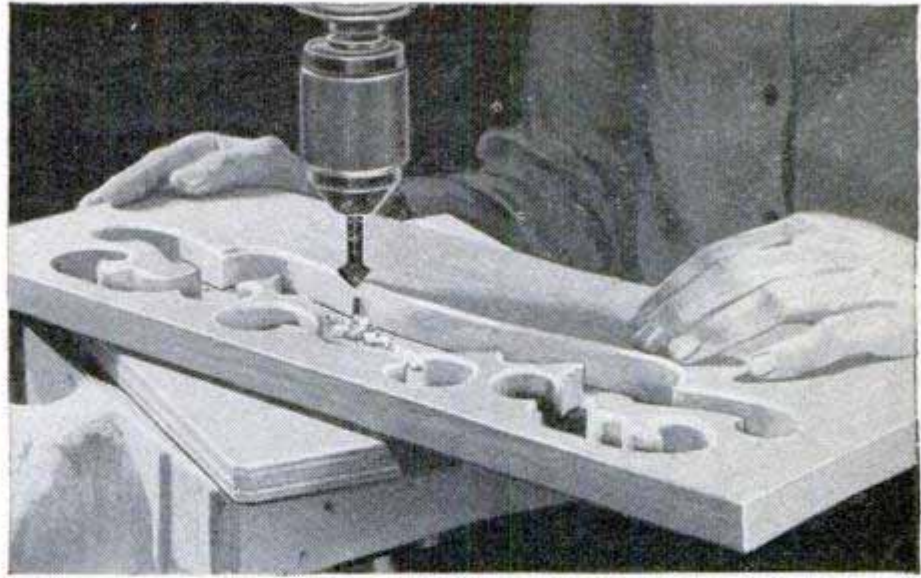

By using this jig as a guide, it's easy to chamfer the edges of a scroll-sawed cutout on a drill press with a rose-head countersink. The jig is made as shown and clamped to the drill-press table. The countersink, with the squared end cut off, is chucked in the drill press and the guide pin in the tapered insert is centered under the countersink. After the countersink is lowered to make the desired bevel, the drill press is locked and the work is guided by holding its edge against the pin. Standard $\frac{5}{16}$ -in. shaper cutters can be used instead of the countersink by mounting on a shaft and offsetting the guide pin to suit the depth of cut. The jig can be adapted for pattern routing by fashioning several wooden inserts and equipping each with a pin of a different size to correspond with the diameters of the routers that will be used. A template

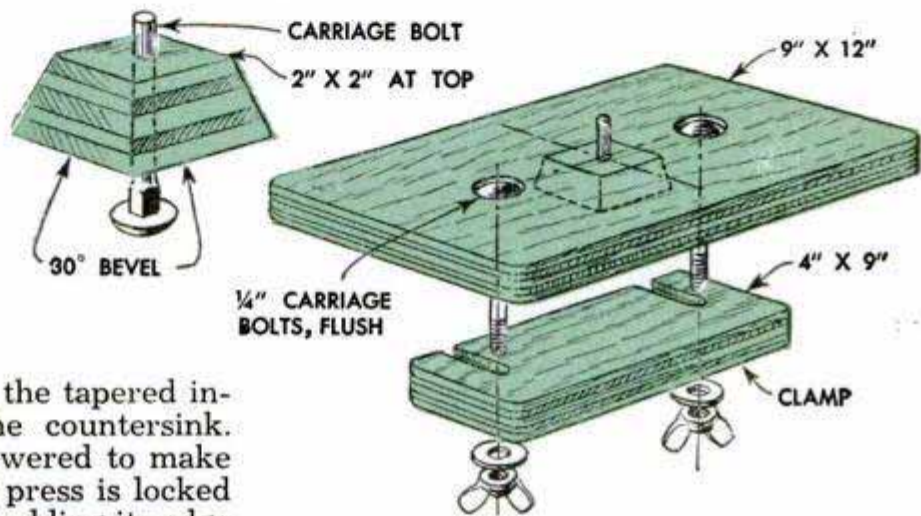

is prepared by sawing or routing a master pattern in a block of wood, and then tacking to the underside of the work. The pin is centered exactly under the router, and the work is guided by placing the master pattern over the pin. In this way, any number of identical pieces can be routed without further adjustment of the jig.

E. M. Love, Palmdale, Calif.

Poultry Watering Fountain Is Improvised From Five-Gallon Oilcan

When small flocks of chickens or turkeys are moved to a temporary range where there are no facilities for supplying water, an automatic watering fountain can be quickly improvised from a 5-gal. fuel-oil can. The can is laid on its side and the spout is inserted to the fullest possible depth in a drinking pan. Water from the can will flow into the drinking pan and maintain a constant level, providing the filler cap of the oilcan is screwed tight to prevent the seepage of air into the can. Depending on the length of the spout, the can may be held off the ground with blocks or propped so it will not roll.

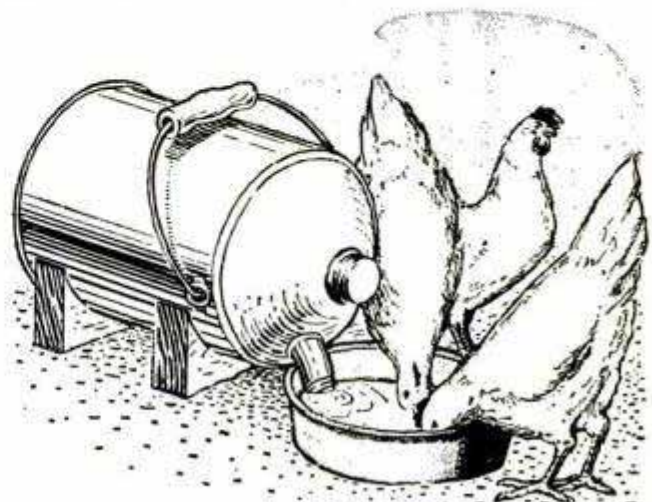

DRILLING

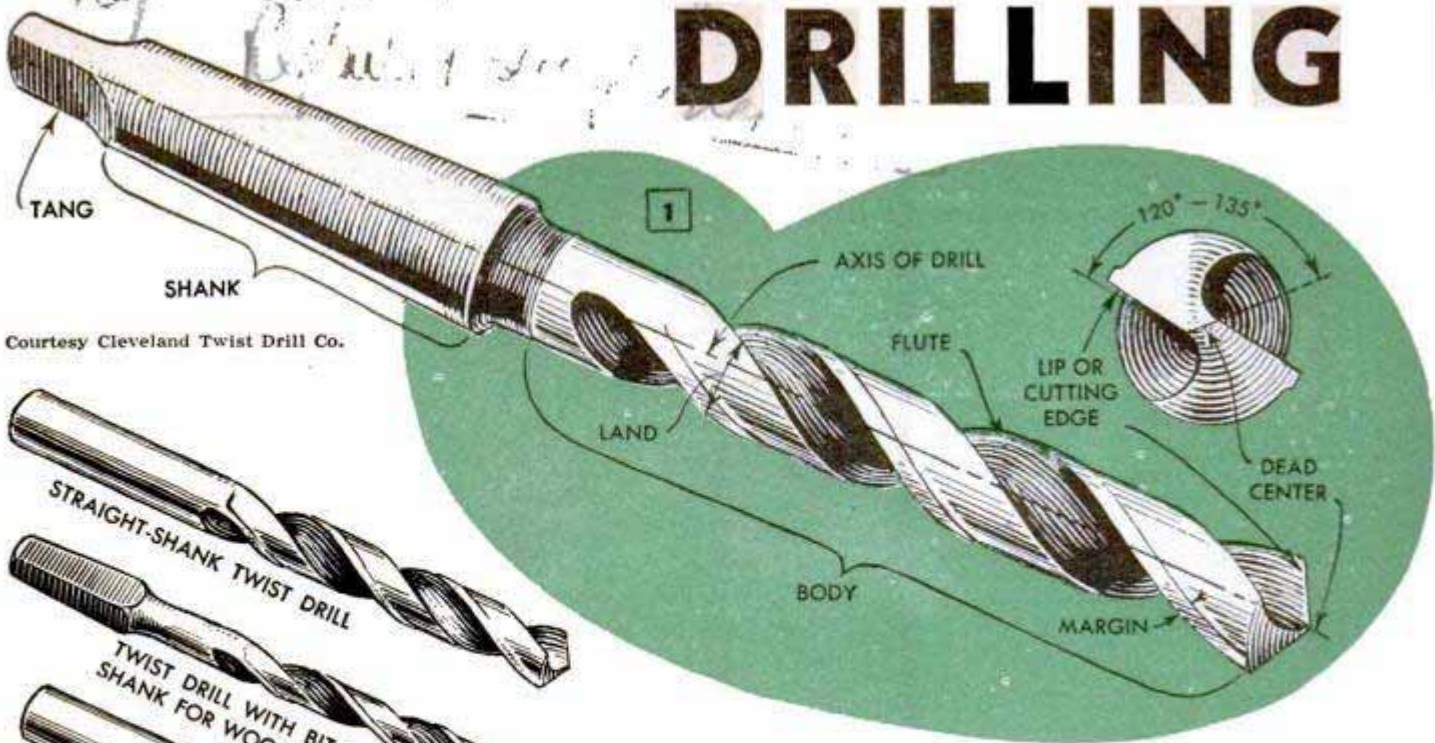

Courtesy Cleveland Twist Drill Co.

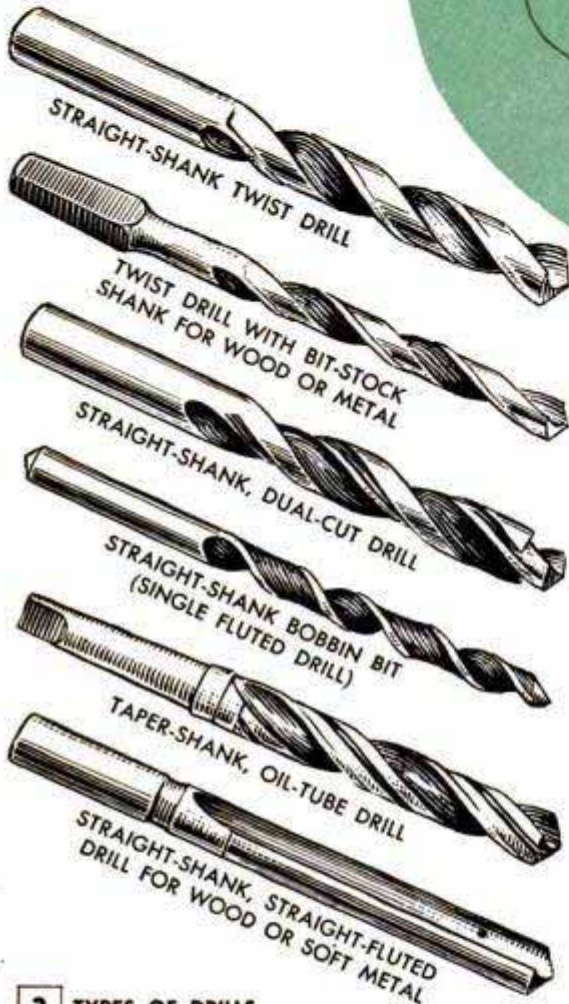





2 TYPES OF DRILLS

By Thomas Trail

ALTHOUGH the actual operation of drilling metal or wood is one of the simplest shop procedures, skill and "know how" are required to keep the drills sharp, to know the correct speed and lubricant to use and the right drill for the job at hand. The principal parts of a drill are shown in Fig. 1. The dead center should be on the exact center of the drill axis and the cutting edges must be equal both in length and in angle. The margin is a narrow, raised rib with a cutting edge being the full diameter of the drill. In operation, the rib accurately sizes the hole and reduces friction. The shank is the end of the drill that is held by a drill-press chuck or a taper socket. The drill shown has a tapered shank with a tang on the end which engages a slot in the small end of the tapered socket to give a positive drive. Drills also are made with a straight

3 CAUSES AND CURES FOR COMMON DRILL TROUBLES

 <p>BREAKING OF CUTTING EDGES AT CORNERS</p> <p>CAUSE</p> <ol style="list-style-type: none"> 1—Too much lip clearance 2—Material has hard spots, sand inclusions or scale 3—Drill running too fast 4—Wrong cutting compound or lubricant 5—Feed too rapid <p>CURE</p> <ol style="list-style-type: none"> 1—Regrind and reduce lip clearance to between 12 and 15 degrees 2—Reduce speed 3—Reduce speed 4—Use proper lubricant or compound 5—Reduce feed 	 <p>OVERSIZED HOLE</p> <p>CAUSE</p> <ol style="list-style-type: none"> 1—Length and angle of lips not equal <p>CURE</p> <ol style="list-style-type: none"> 1—Regrind drill and equalize lip angles and lip lengths 	 <p>BROKEN TANG</p> <p>CAUSE</p> <ol style="list-style-type: none"> 1—Poor fit of tang in socket caused by nicks, burrs, dirt or wear 2—Mutilated tang <p>CURE</p> <ol style="list-style-type: none"> 1—Ream old socket or replace with new one. Cleaning sockets before use lengthens their life 2—Dress or replace 	 <p>CHIP FORM CHANGES</p> <p>CAUSE</p> <ol style="list-style-type: none"> 1—Lubricant not reaching proper location <p>CURE</p> <ol style="list-style-type: none"> 1—Drill chipped, dulled or damaged—Inspect and regrind 2—Remove drill and check lubricant
---	--	---	--

DATA

shank and a bit-stock shank, as in Fig. 2. The diameter of a drill decreases slightly from the cutting point in order to prevent binding in the drilled hole. Sizes are designated in four classifications. Number drills range from No. 80 to No. 1 (.0135 in. to .228 in.); letter drills from A to Z (.234 in. to .413 in.); fractional drills rise from $\frac{1}{64}$ in. upward by 64ths, and metric drills are listed from .5 mm. to 10 mm. by .1 mm., larger than 10 mm. by .5 mm.

Normally, the cutting edges of a new drill gradually wear away with use and require sharpening. A dull drill will not cut properly and may be damaged by excessive heat generated by friction at the cutting point. Drills should be sharpened on a medium-grit grinding wheel. To prevent a drill from overheating and losing its temper while grinding, it should be dipped frequently in water while being sharpened. Cold water should not be used for this purpose, however, as it may cause cracking or distortion of the drill bit.

Most drilling trouble is due to faulty grinding of the cutting-edge clearance and angle. The two cutting edges of a drill must be made equal both in length and angle, and the angle must be such as to produce best results in the material to be drilled, Figs. 3 and 4. For average drilling, an angle of 59 deg. at the cutting edges has been found most satisfactory and new drills are ground to this angle unless made for special purposes. A drill gauge, Fig. 4, is used to check the angle of the cutting edge when grinding.

If either the lengths or angles of the cutting edges are ground unequally, the drill will drift and form an oversize, stepped hole. This will happen even though lip clearance is correct for the angle at which each lip is ground. The clearance, as shown in the center and right-hand details in Fig. 4, allows the drill to penetrate the material being drilled. For average work the clearance angle back of the cutting edges

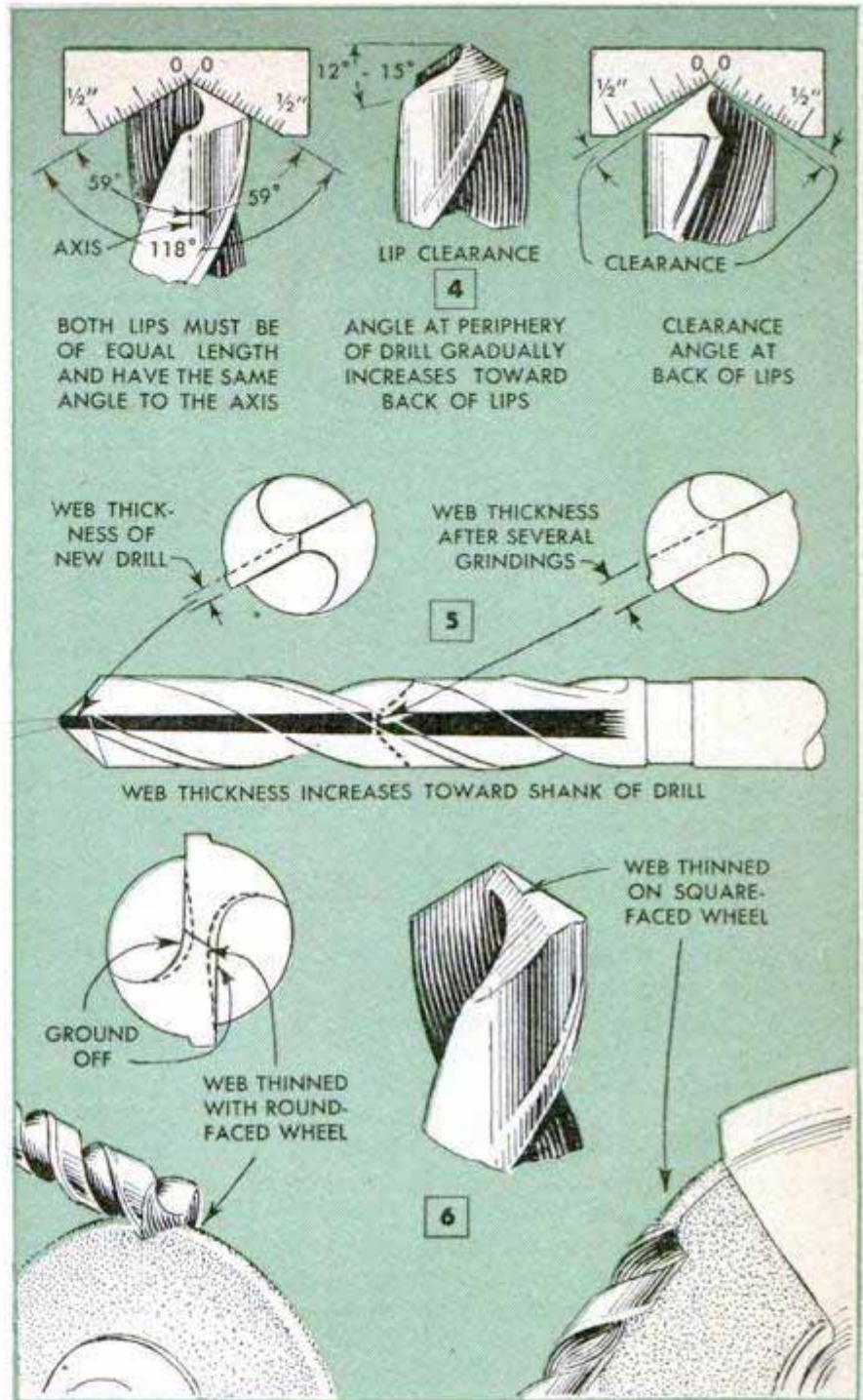

should be between 8 and 12 deg., but it is sometimes increased to 15 deg. where heavy feeds are taken in soft materials. When cutting-edge clearances have been ground uniformly to the proper angle, the angle subtended by the dead-center line and each cutting edge should be at least 120 deg., and not more than 135 deg., as shown in Fig. 1. Excessive clearance will weaken the cutting edges and cause them to break down. Insufficient clearance will prevent the drill from properly penetrating the material and may result in splitting the drill. After grinding, the drill point should be checked carefully to assure accuracy of the cutting-edge lengths and angles, the clearance angles and the location of the dead center.

Although with practice the mechanic can do an accurate job of drill grinding

2073 W. Pitcher St.
Kalamazoo 13-D, Mich

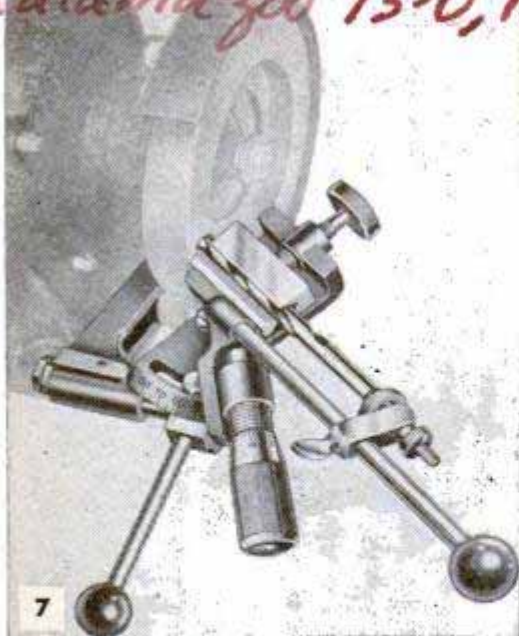

Atlas Press Co. photo

by hand, use of an automatic grinding attachment, Fig. 7, is recommended. This will produce an accurately ground drill point and will save excess grinding.

When drilling hard material it is sometimes desirable to use a heavy feed pressure. To prevent the drill from chipping, a narrow flat is ground on the leading side of each cutting edge. Care must be taken not to give the edge a negative rake, however, as this would cause heating and possible breakage. This type of drill point also is used when drilling soft materials, such as brass, where a normal point may tend to dig in. Note from Fig. 5 that the web increases in thickness from the cutting point to the shank to give the drill greater rigidity. As a result, the web becomes thicker at the point after a number of sharpenings and must be thinned by grinding to maintain ease of penetration of the drill point. Fig. 6 shows two methods of reducing the thickness of the web at the point. The best way is to use a round-faced grinding wheel, the radius of the wheel face being less than that of the flutes. Another method is to grind a bevel on the trailing edge of the heel as in the upper right-hand detail of Fig. 6, using a square-faced wheel. Except for cast iron, which is drilled dry, most metals require use of a lubricant for best results. Lubricant serves a threefold purpose. It dissipates heat rapidly, lubricates the drill at the cutting edges and aids in the formation of uniform chips. This results in smooth, clean work with a minimum of wear on the drill.

The chart, Fig. 8, makes it easy to figure proper drill speeds and feeds in all common drilling operations. It also lists the correct

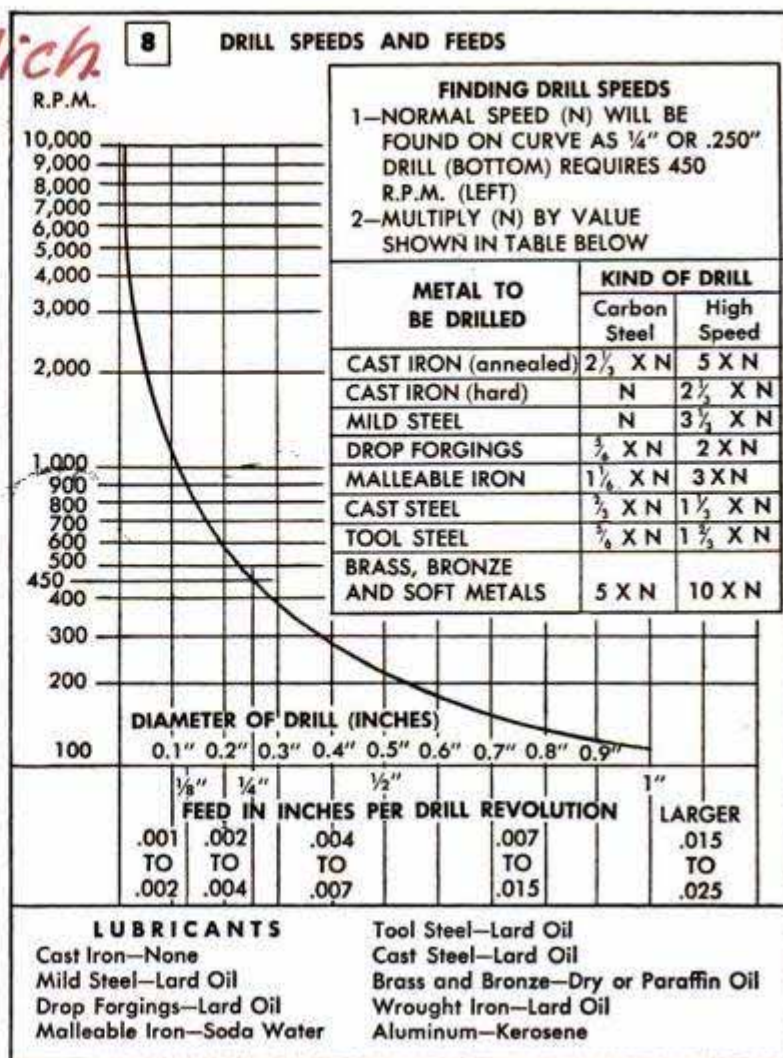

lubricants used on various types of metals.

Work to be drilled should be clamped securely to the drill-press table and the drill should be held firmly by the chuck or taper socket. When using taper-shank drills, see that the shank and the inside of the socket are smooth and free from grit, and that the drill tang is not damaged. Use a block of wood to drive the drill shank tightly in the socket. In removing the drill from the socket, place a piece of wood under the drill point to prevent it from striking the drill-press table or the work, and use a drift of the correct size to drive out the drill. When drills are used at the bench, keep them in a metal stand especially made for the purpose. Drills not in use should never be stored loose in a drawer or chest or together with other tools as they are likely to become nicked or otherwise damaged. Stored drills should be oiled to prevent rusting.

Testing Gear Compound for Grit

Whether or not gear grease contains grit can be determined by placing a small amount of the grease between two clean pieces of glass. These are rubbed together until a thin film of grease remains and then held up to the light. Any foreign particles will be apparent.

MOTOR DIRECTIONAL "SWITCH"

This inexpensive motor directional "switch" differs from the commercial reversing type in that it is used in conjunction with the motor switch. This feature eliminates the possibility of accidentally starting the machine in the wrong rotation. While a directional switch generally is used in operating a shaper or a metal lathe, such a switch also can be adapted for use where a countershaft or a motor is used to drive two machines placed on opposite sides of the drive pulley. This obviates need for crossing the belt.

If the motor is of the split-phase or capacitor type, reversing rotation ordinarily is done by transposing the position of the two starting-coil leads. But when the motor is equipped with this directional switch, the direction of rotation is reversed by just moving a lever. Fig. 1 shows what the switch looks like with the cover removed and Fig. 2 shows the parts and how they go together. To install it on a motor, remove the motor cover plate and disconnect the two starting-coil leads, leaving the motor-switch leads connected. Next, short lengths of wire, connected to the motor terminals, are brought through holes in the cover plate for connection to terminals on the directional switch. The directional switch is connected to the starting-coil leads according to the wiring diagram in Fig. 3 and then mounted on the motor with an angle bracket. Remember that in using this switch, the motor should come to a complete stop before changing the direction of rotation. Positive contact must be maintained to prevent arcing.

Henry Hanscom, Elmhurst, Ill.

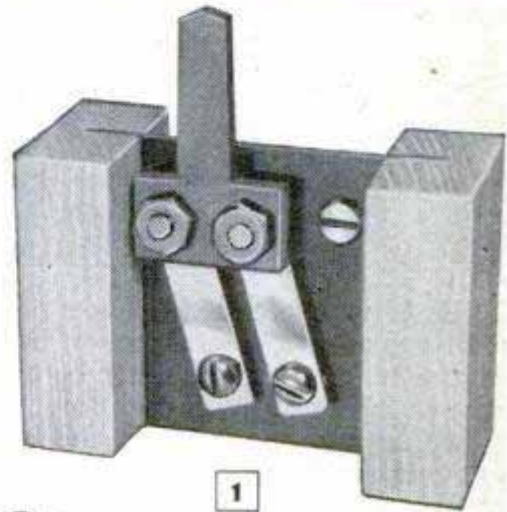
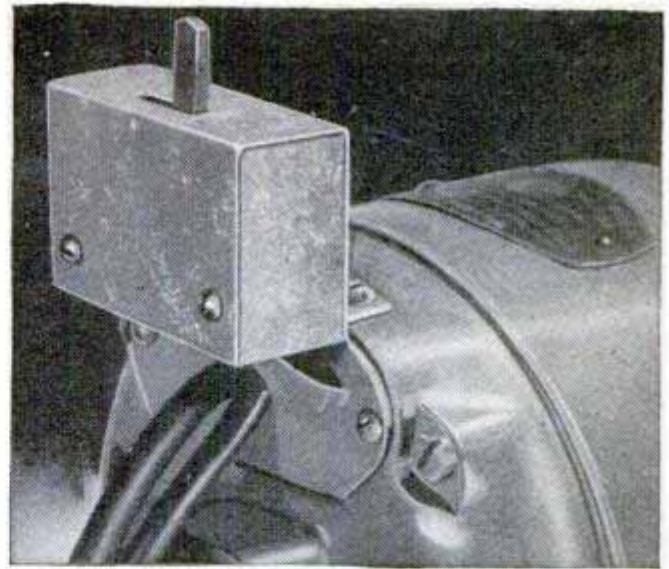

1

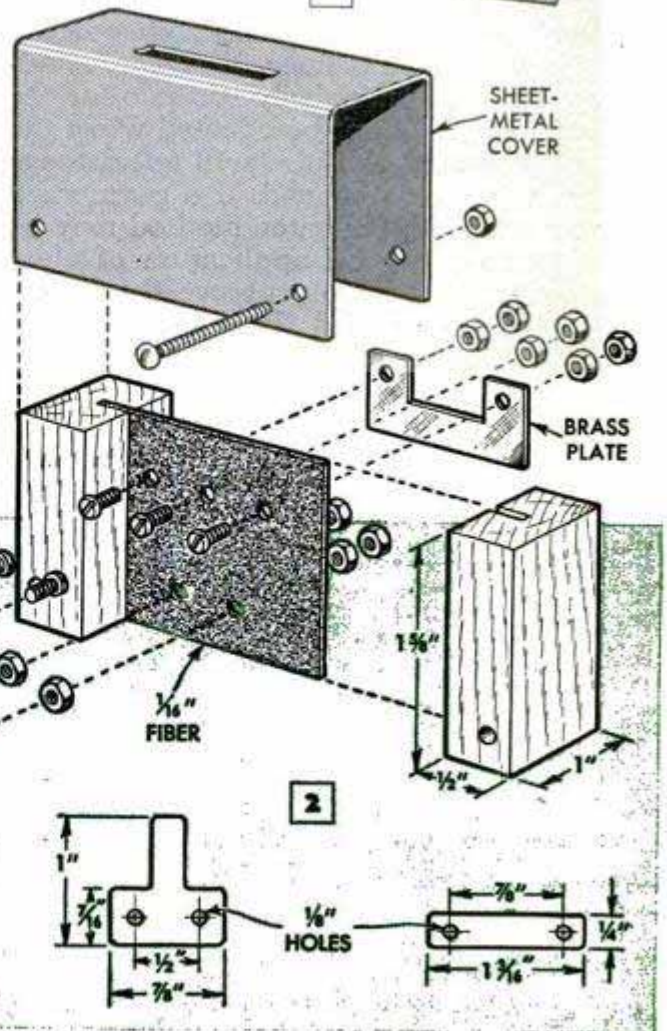

2

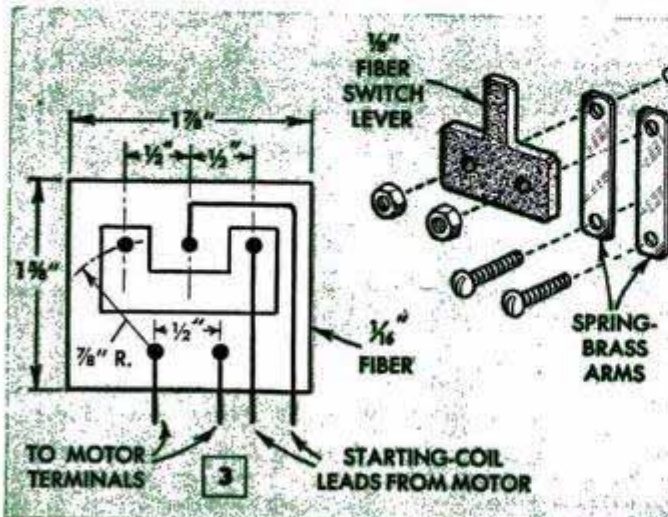

3

Schedule Board Ruled With Tape Permits Easy Arrangement



SCHEDULE BOARD							
MACH.	SUN.	MON.	TUE.	WED.	THUR.	FRI.	SAT.
LATHE		JONES		JONES			
PLANER	SMITH				SMITH		
SHAPER			BROWN				
				BROWN		WOODS	

In plants where ruled schedule boards must be rearranged from time to time, the arrangement of the lines may be changed and the board used again in a few minutes if it is ruled with tape. When the lines are to be rearranged, the tape is stripped off and replaced with new tape in the position desired. This, of course, is much quicker than repainting the lines. Waterproof adhesive tape is particularly suitable for the purpose as it will not be affected when the board is washed and also will not damage the board when removed. If a permanent board is needed, the same method may be used followed by an application of clear lacquer or varnish to preserve the whiteness of the tape and the surface of the board.—Neal Houlahan, Glenshaw, Pa.

Tire-Bead Breaker Helps Remove Inside Car-Door Handles

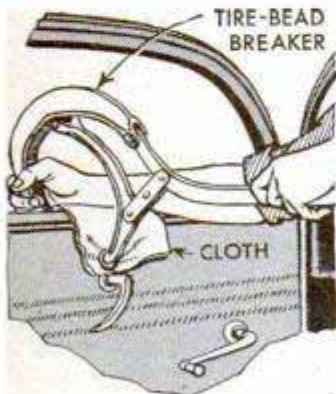

When removing inside door handles from some of the older model cars it is often difficult to keep the collar depressed while knocking out the pin which holds the handle. This was my problem until I thought of using a

tire-bead breaker to apply pressure. I padded the body and upholstery to protect them and placed the tool so it would apply

pressure to the trim pad above the handle. This made it easy to drive the pin out.

Russell L. Card, Tweed, Ont., Can.

Creosote Treatment of Fence Posts

Here's a way to creosote wooden fence posts if pressure treatment, which requires special equipment to apply the preservative, isn't available. All you need are two oil drums, creosote and some used crankcase oil. Prepare a mixture of creosote, 4 parts, and crankcase oil, 1 part. Fill each drum with enough solution to cover the posts to a height of 2½ ft. Prop up one drum and build a fire beneath it; then stand the posts on end in this container and heat for about three hours, keeping the creosote solution just under the boiling point. At the end of this period, remove the posts and plunge them into the unheated mixture in the other drum. Deep penetration of the creosote will result.

Van Allen Bradley, Jr., Chicago.

Determining Machine-Belt Sizes With Flexible Steel Tape

The easiest and most accurate way to determine the length of a belt required for a certain machine is to measure the distance directly, wherever possible. Common practice is to use a string for measuring, but you'll find that a flexible steel tape is much better as it will not stretch and yet will easily bend around the pulleys.

Richard Hanscom, Elmhurst, Ill.

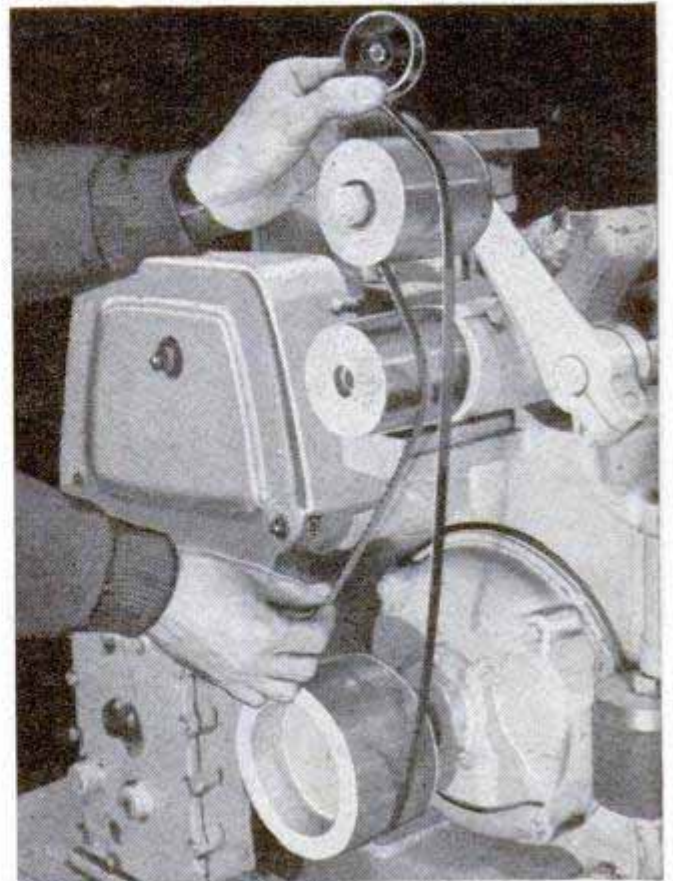



UNIVERSAL FM RECEIVER-TUNER

ALTHOUGH this FM unit is a complete receiver in itself, it is primarily designed to serve as the nucleus of a high-fidelity installation for the reception and reproduction of FM broadcast entertainment. It may be used alone or in conjunction with a public-address system or with any standard broadcast or short-wave receiver. The built-in monitor speaker can be switched on and off as desired. With any external amplifier-loudspeaker system capable of amplifying and audibly reproducing the full output, the high sensitivity and fidelity capabilities of this FM unit are fully realized. Most large standard broadcast receivers have suitable audio-amplifier stages.

Nine tubes, plus a rectifier and tuning indicator, are employed in a superheterodyne circuit with ratio-type FM detector. The frequency range is 87 to 109 megacycles and the dial is calibrated in both megacycles and channels. Volume and tone controls are operative both in the unit and external audio systems. Photo A shows a front view of the cabinet. The weight is 24 pounds. Photo B identifies the various tubes and their location. When using this National FM unit with an external amplifier, the interconnection is made with a low-loss shielded cable that should not exceed 10 ft. in length, and preferably shorter. If a longer connecting cable is necessary, the voltage-divider network, Fig. 1, is used across the output terminals to compensate for the resulting loss of high-frequency tones due to the longer cable. A suitable FM folded-doublet antenna made from Amphenol 300-ohm twin lead is detailed in Fig. 2. As this type of antenna is quite directional, maximum results are obtained when the receiving antenna is parallel with the transmitting antenna.

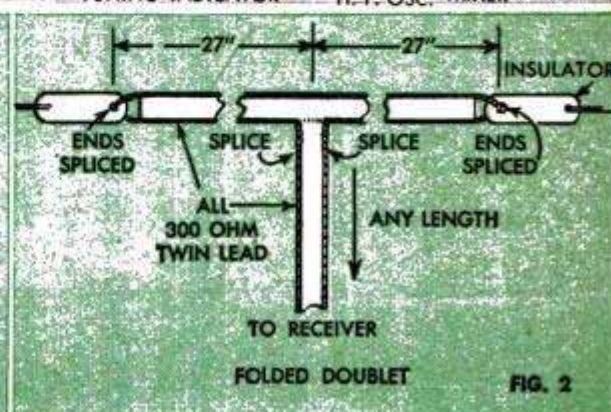
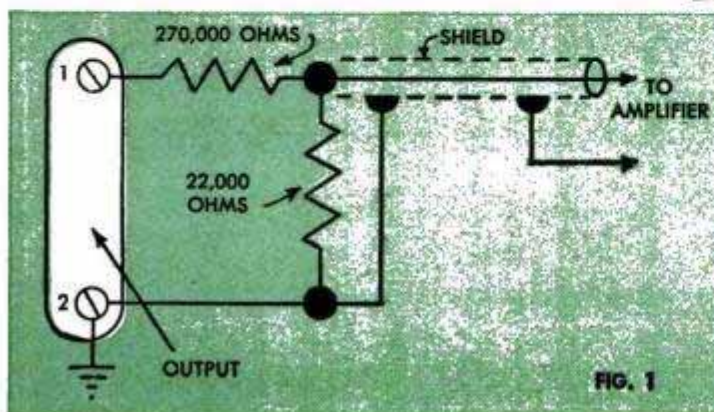
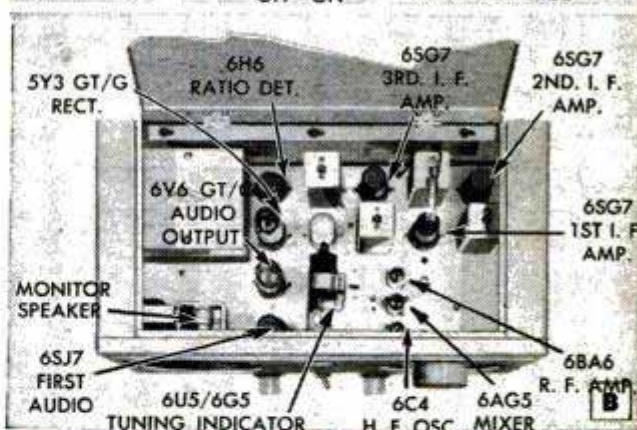
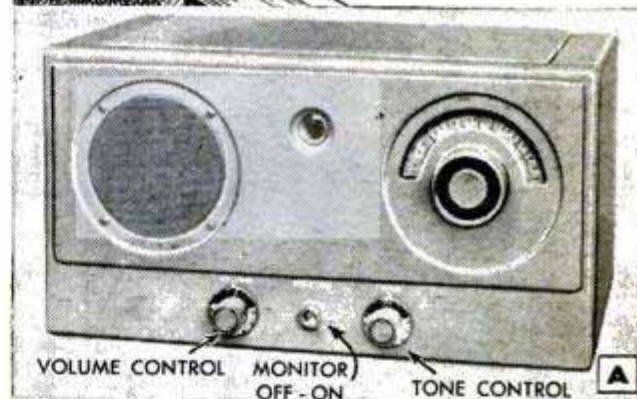
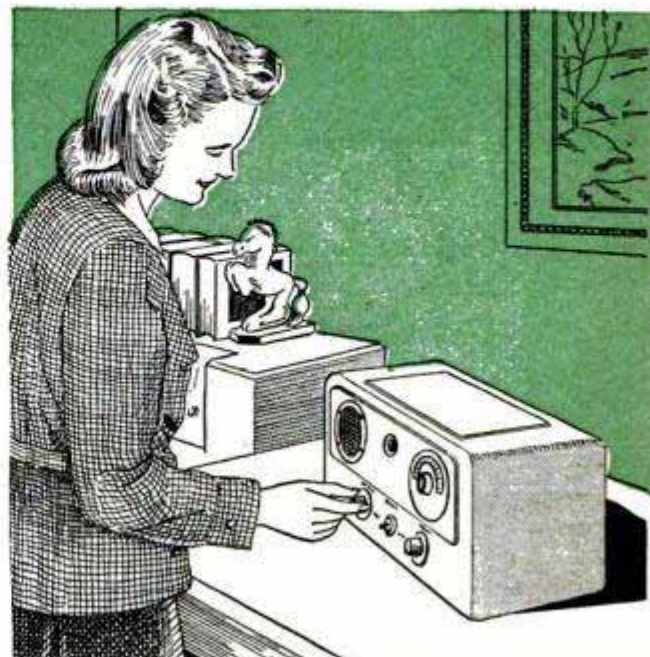

THREE-TUBE POCKET SET

By L. M. Dezettel

THIS three-tube walkie-talkie-type portable receiver is designed for speaker reception of local broadcasting stations and is ideal to take to the ball game or on hikes. The entire broadcast band is covered by a single tuning condenser. Construction is simple in spite of the limited space and the fact that the set employs a 3-tube circuit complete with batteries and speaker.

Construction should begin with the chassis and panel detailed in Figs. 1 and 2. Make a careful study of photos A, B, C, D and E. This panel may be made of either thin plywood or 1/8-in. hard-pressed wood. The speaker should be shock-mounted as detailed in Fig. 5, and covered to protect it during assembly. The chassis and brackets are made of 1/16-in. sheet aluminum. Wiring should begin with the filament circuit, followed with the speaker and the output transformer. A good common-ground connection is carried throughout the set, as indicated in Fig. 4. Miniature electrolytic filter condenser C5 should be carefully mounted so that its outer shell does not touch connections on the tube sockets. The metal shell in the center of each tube socket acts as a shield and may be used for a common-ground tie point.

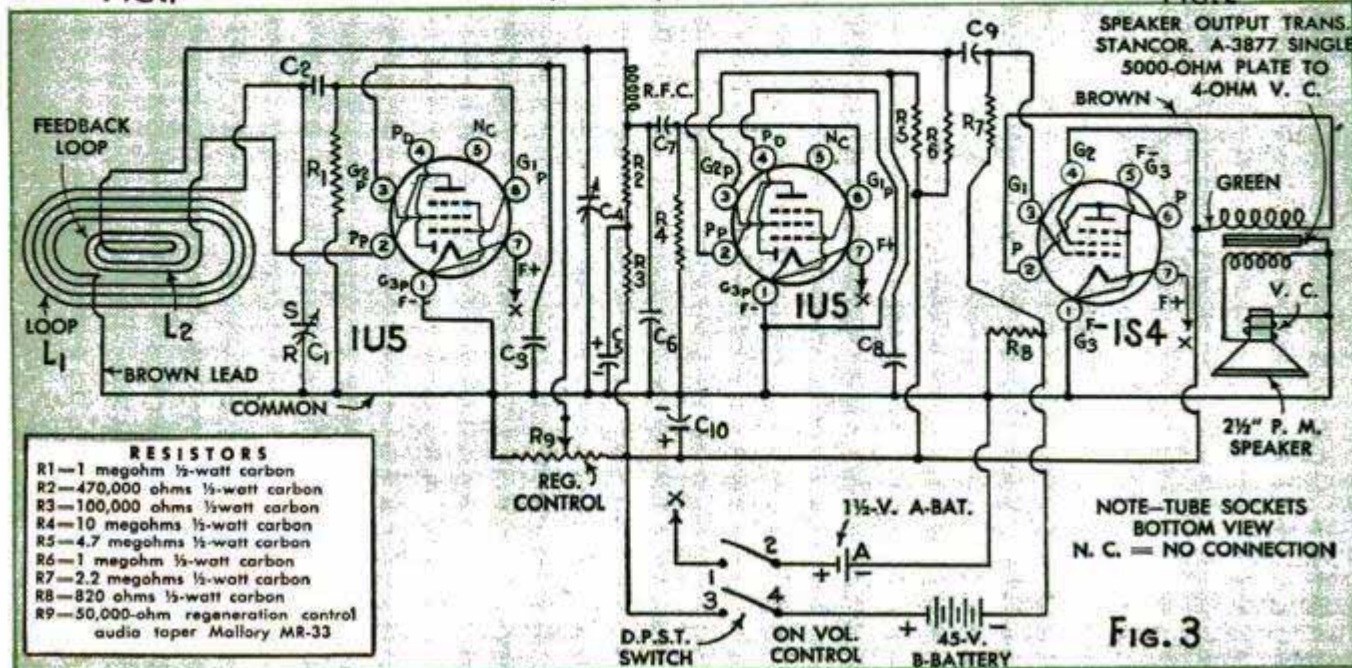
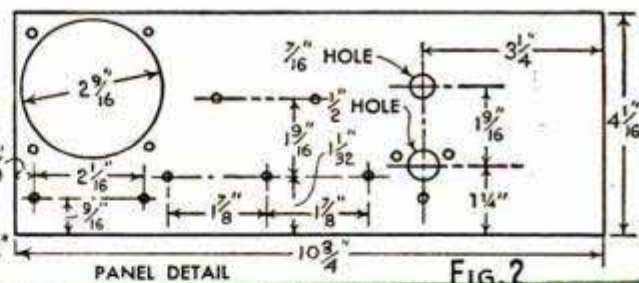
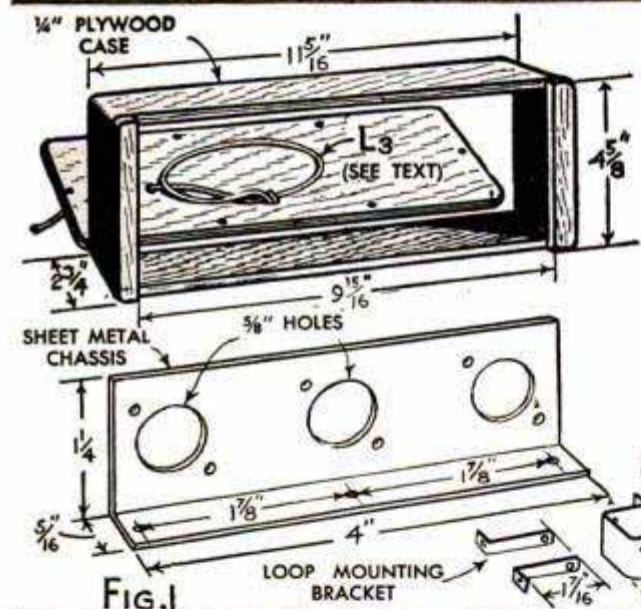
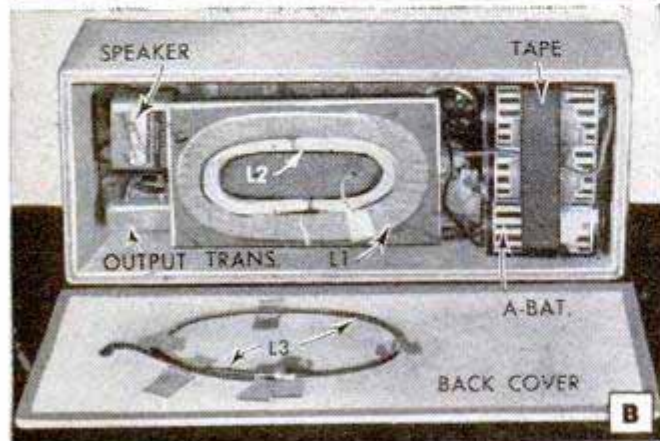
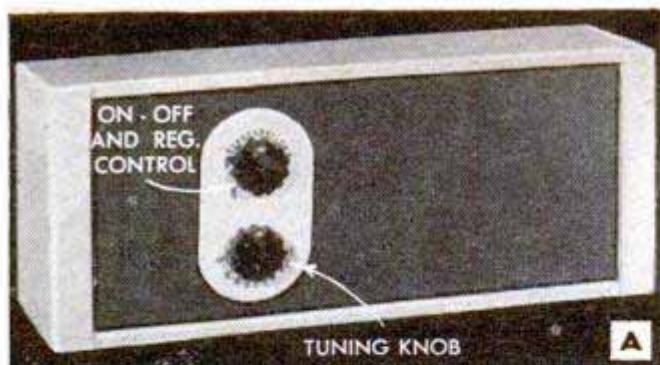

HAS BUILT-IN LOUDSPEAKER

Before installing the loop antenna, check the set to be sure that all wiring up to this point is correct. A hum should be heard in the speaker when the No. 6 pin of the second 1U5 tube is touched with a short piece of wire.

The finished loop L1 is about 2¾ in. wide and 5 in. long. Loop L2 is random-wound with No. 24 d.c.c. wire on a 2½-in.-dia. form. A small can was used for the purpose. The coil is then removed and tied with thread in several places. This coil is next formed until it has the same shape as the inside of coil L1. Duco cement is applied to one side of L2, and the coil is mounted in the center of coil L1. A weight is then placed on top of the loop to insure a flat assembly. The combination loop is finally cemented to the small panel. Before making the circuit connections to L1 and L2, examine the schematic circuit diagram, Fig. 3, to make sure that the coils are connected with the same direction of winding. Now turn the set on, with variable condenser C1 fully opened. The regeneration control is now slowly rotated until a squeal is heard in the speaker. If no squeal is heard, reverse the two wires connected to feedback coil L2. To receive stations, adjust the tuning-condenser C1 and back off

(Continued to page 218)

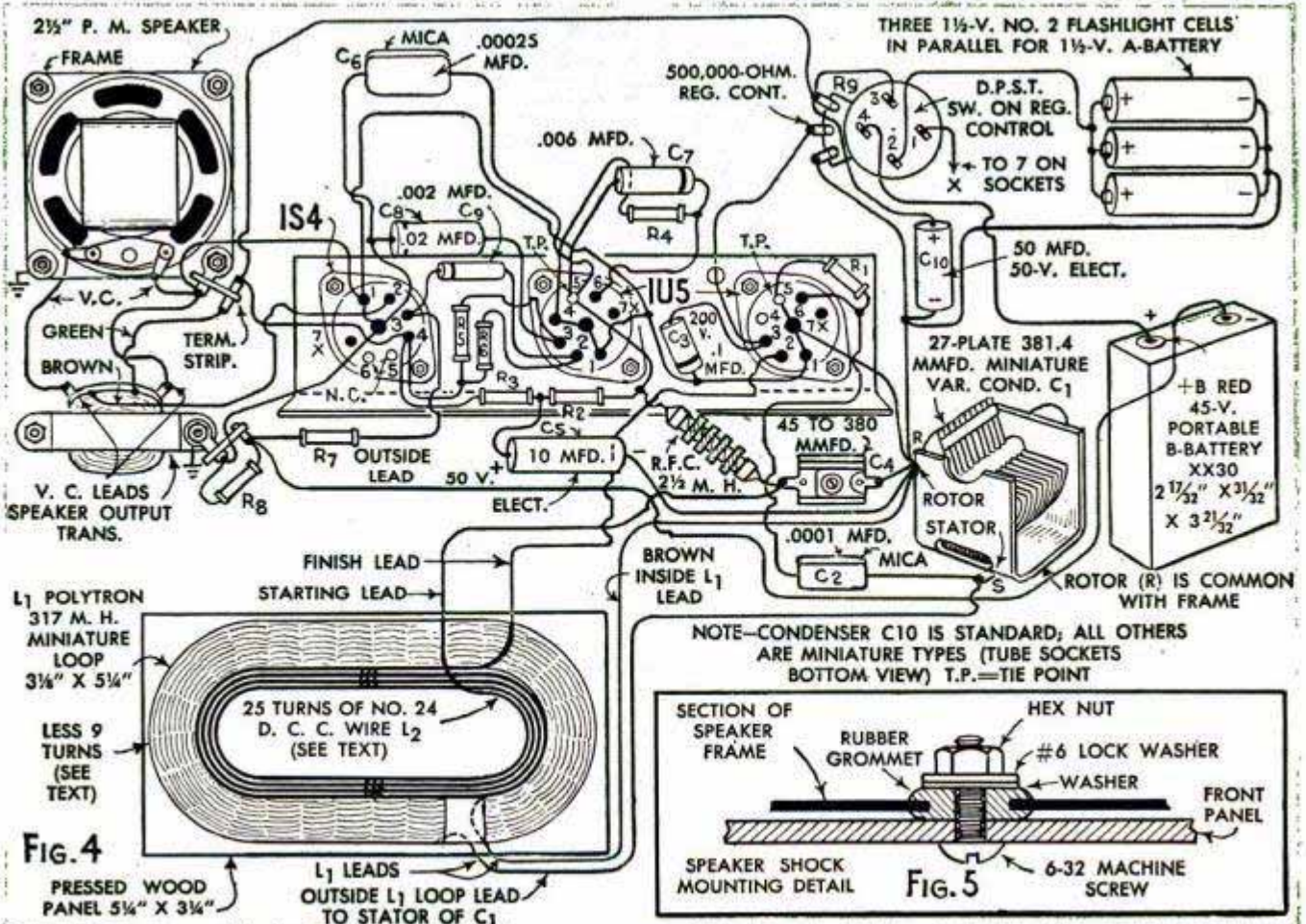
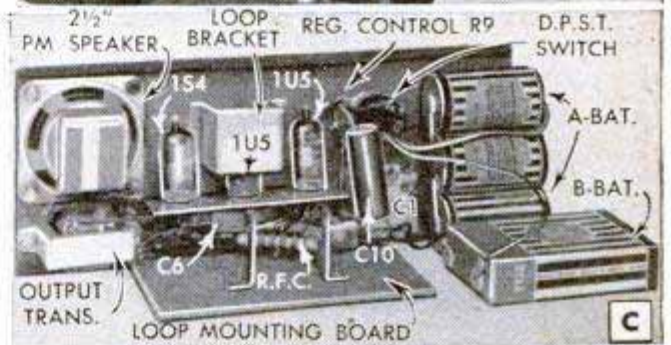

TELEVISION RECEIVER HAS SIMPLIFIED CONTROLS



A

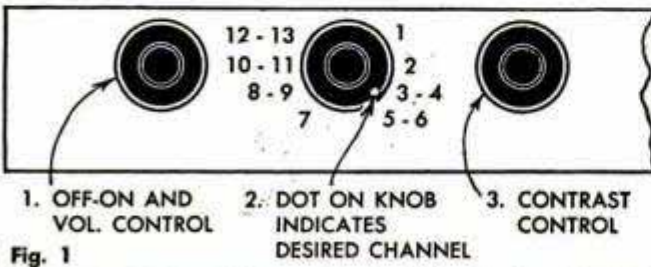
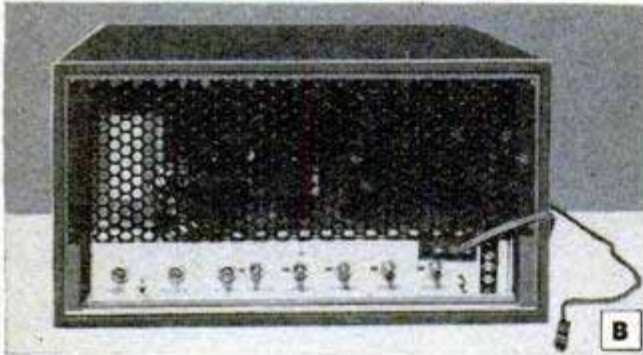

Fig. 1



B

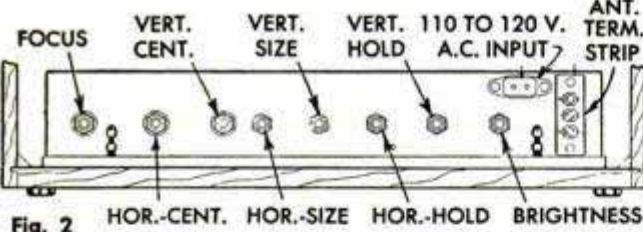

Fig. 2

ONLY three controls on the front panel are necessary for complete operation of this comparatively low-cost table-model television receiver. These controls are clearly shown in photo A and are detailed in Fig. 1. The 8-position tuning knob is adjustable to any 8 of the 13 channels available for television broadcasting in any locality and the set is pretuned for the reception of the 8 stations.

The picture size of this direct-view receiver is 4½ by 6 in., or approximately 26 square inches; the cabinet is 9¼ in. high, 16¾ in. deep and 16¾ in. wide. This compact unit weighs only 26½ pounds and may be easily carried about the house to provide television entertainment in any room desired where antenna leads are available. Owing to its light weight and compact size, special stands or tables are unnecessary.

Designed for use on 115-volt 60-cycle a.c., this Motorola model features a safety interlock which disconnects the power cord from the chassis whenever the protective metal back cover, shown in photo B, is removed from the cabinet. The service adjustment controls in Fig. 2 are adjusted at the factory so that none other than the front-panel operating instructions need be followed in putting the receiver in operation. However, to provide for any misadjustment of the rear-panel controls due to handling, simple instructions are supplied for adjusting these insulated

(Continued to page 218)

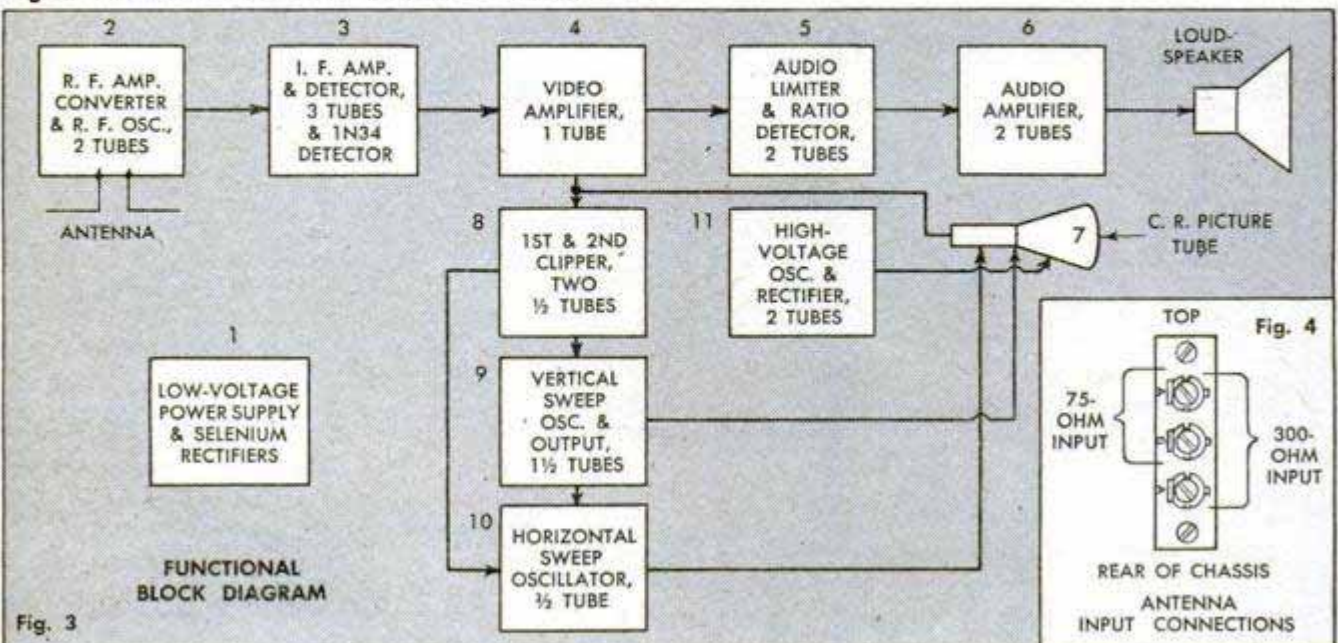



KODAK TURN-TILT TRIPOD HEAD—permits fast aiming with still and movie cameras. Has multiple-disk felt friction clutches for smooth, easy panning.

KODAK EYE-LEVEL TRIPOD (right) sturdily built to last for years . . . designed for fast set-up. Adjusts from 2 to 5 feet in height. A simple twist locks legs at any extension. Weighs only 2 pounds—folded, it measures 22½ inches. Spur points of the legs give firm surface grip—removable rubber tips included for indoor work.

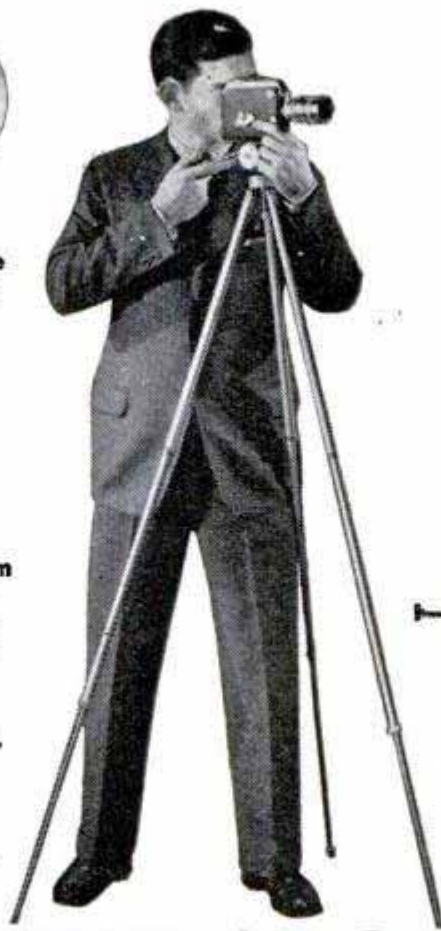

KODAK TABLE TOP TRIPOD—makes table-top photography real fun. Elevates camera to convenient level. 8½-inch rubber-tipped legs are detachable for compact carrying.



KODAK METAL CABLE RELEASES—eliminate danger of jarring camera when tripping shutter. 7-inch and 12-inch sizes to fit practically any camera.

STEADY DOES IT

For "on-the-button" shots it's a KODAK TRIPOD OR OTHER KODAK CAMERA SUPPORT. Try one for easy control of your camera—for all-round better pictures. See them all at your Kodak dealer's.



KODAPOD—substitutes for tripod out-of-doors. Toothed jaws bite into tree, fence, or any other wooden support. The tilt is controlled by thumb screw.

KODAK OPTIPOD (left)—its handy felt-lined clamp grips shelf, table, window ledge. Ball-and-socket head holds camera in any desired position.



KODAK TILT-A-POD—on your tripod it permits tilting either movie or still camera. Quick-locking screw prevents slipping after adjustment.

EASTMAN KODAK CO.
ROCHESTER 4, N. Y.

"Kodak" is a trade-mark

Kodak

Television Receiver

(Continued from page 216)

emergency controls. The efficient audio system employs a 6½-in. permanent-magnet speaker and operates on an intercarrier sound system which eliminates the necessity for vernier tuning. This also does away with the need for automatic frequency control and makes it possible to tune in weak signals for best picture reception and still maintain good audio reception. Additional features include high usable sensitivity, automatic brightness stabilizer and automatic volume control. The chassis is completely shielded against oscillator radiation and all wired connections are pre-tested for resistance to humidity.

The 11-unit block diagram given in Fig. 3 illustrates the operation of the receiver which has 15 tubes, 2 rectifiers, a germanium crystal detector and a 7-in. cathode-ray picture tube. Antenna input connections for either a 300-ohm balanced line or for matching to a 75-ohm shielded lead-in, are made as indicated in the detailed sketch, Fig. 4.

Television Magnifying Lens

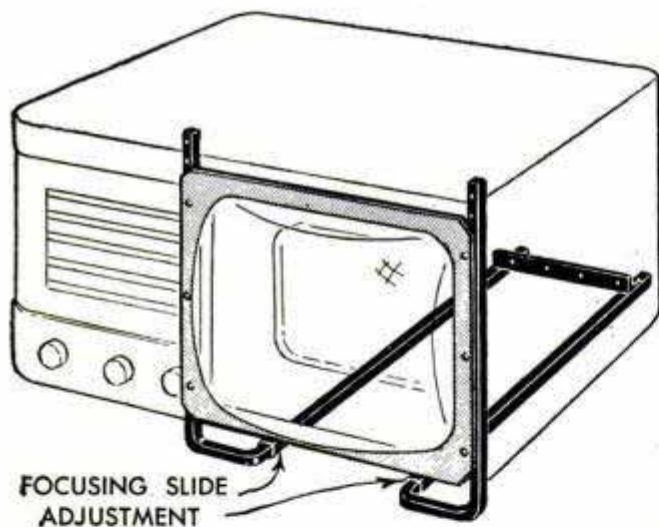

MAGNIFYING-LENS ASSEMBLY

Made of crystal-clear or blue Lucite, this magnifying lens is claimed to enlarge television screens from 2 to 4 times, and also to eliminate glare and eyestrain. Available in sizes for use with television sets having either 7, 10 or 12-in. screens, this Vue-Scope lens is filled with a liquid which has the same index of refraction as its plastic shell. Surfaces are maintained at rigid micrometer standards and micro-polished like the finest optical instruments. The lens assembly is made with a 2-way adjustable bracket as illustrated. This permits raising or lowering and also provides for focusing adjustment.

Three-Tube Pocket Set Has Built-in Loudspeaker

(Continued from page 215)

the regeneration control very slowly until a station comes in clear and loud. Turns should now be removed, one or two at a time, from the outside of the antenna loop L1 until the stations at both ends of the broadcast band can be received. Nine turns were necessary for the original model.

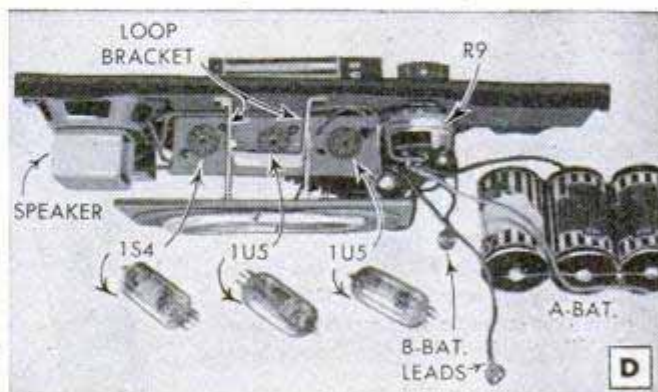

Next, tune C1 to the lowest-frequency station and adjust the regeneration control for maximum volume and clarity. Padder condenser C4 is then adjusted until it is just possible to hear the squeal when the tuning condenser is slightly off the station. The set is now ready for the case. A piece of thin cardboard must be placed between the front panel and the metal brown-flocked grille screen. This screen covers the entire front panel and must be trimmed to give a tight fit when it is in place. The dial is cut from heavy drawing paper and is cemented to the grille screen.

The case was finished in a cream color with matching knobs. L3 is a single-turn

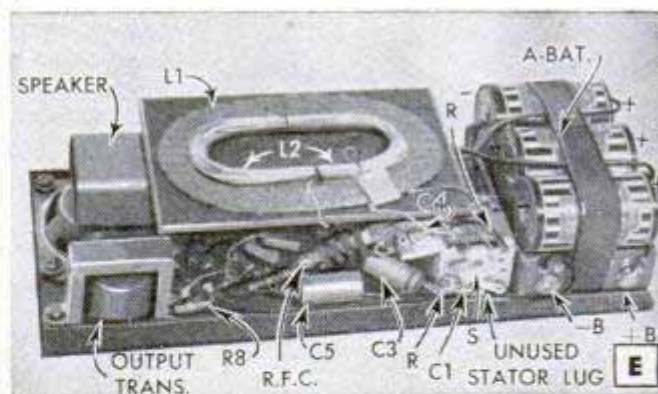

capacity coupling loop for use if an external antenna is desired. It is made with No. 20 insulated hookup wire and is mounted on the inside of the back cover, photo B. If the set is microphonic, wrap a piece of paper around the first 1U5 tube, or use a rubber band. Detailed student material list R-369 is available from Popular Mechanics Radio and Electronics department upon receipt of ordinary letter postage.

Exclusive Du Pont formula makes car polishing fast and easy!



A small section of the surface of an average car magnified 20 times. The left side is shown still covered with Traffic Film. The right side has been cleaned with Du Pont NO. 7 POLISH.

DU PONT NO. 7 POLISH

Contains "stroke saving" methyl cellulose

Now you can polish your car in half the time . . . get a brilliant shine easily and quickly with Du Pont No. 7 POLISH. Made by patented formula, No. 7 POLISH loosens dirt and grime quickly . . . cleans up *fast*, without streaking . . . produces a high, dry gloss. It's the quick, easy way to car beauty!



BETTER THINGS FOR BETTER LIVING
. . . THROUGH CHEMISTRY



Especially FOR NEW CARS!

Here's a wax-polish made especially for new cars—and others whose finish is in first class condition. It

cleans and wax-polishes in one easy operation. Produces a brilliant, lasting lustre. Keeps cars looking new.

DU PONT SPEEDY WAX

See America
the scenic, fun-packed way
on a
HARLEY-DAVIDSON



TAKE a new kind of tour this year! Leave cities, crowds, congested highways, and dull care behind. Go "gypsying" . . . with a Harley-Davidson! See the real America of picturesque back-country roads, breath-taking mountain trails, hidden lakes, out-of-way towns, hard-to-reach historic places, rare beauty spots. Enjoy fun and thrills you've never known before . . . at exciting race meets, endurance runs, hillclimbs. There's no sport like motorcycling, no fun like riding a swift, powerful Harley-Davidson. And it's so easy to own your own! See your dealer today. Mail the coupon now.



HARLEY-DAVIDSON MOTOR CO.,
Dept. P, Milwaukee 1, Wis.

Send free copy of ENTHUSIAST magazine, filled with motorcycle action pictures and stories; also literature on latest models.

Name.....
Address.....
City..... State.....

Fishing for Shark

(Continued from page 140)

spot that is calculated to be a "good hole for sharks" the gargantuan fishing line is let out. The bait is cut into chunks about the size of a man's hand. As the cable pays out a crewman snaps on the baited leaders. These leaders swivel on an ordinary harness snap.

Many methods of laying the line are in use. Some skippers suspend their lines from buoys with anchors at each end. Others prefer to lay the line on the bottom with an anchor on one end and the boat riding on the other. Above an irregular coral bottom, set lines must be suspended high enough to clear the jagged edges of rock which would foul a line.

After about eight hours, the line is drawn up. One man takes position on the bow to signal the winch hand whenever a shark appears. Another man stands by the bollard block to unsnap the leaders. The skipper always operates the engine throttle, backing down whenever necessary to keep the line taut. If a large shark manages to get some slack in the line near the surface, the leader usually parts.

Whenever a shark breaks the surface, the winch is stopped, the leader un-snapped, and the shark towed aft to be gaffed and hoisted aboard by the power boom. This is the ticklish moment in shark fishing. Many times the shark is still alive and thrashes the water into foam. In such cases the crewmen swat the shark's snout—his tenderest spot.

The catch is dumped into a cockpit just forward of the wheelhouse to await butchering, which is done at sea if time permits. Those sharkers who have port facilities for processing the entire shark take their catch to the factory dock for butchering.

Shark livers must be segregated as to type and sex before being sent to the processing plant, for potency varies according to these classifications. This means that when butchering is done at sea the skipper must be able to identify each shark—not an easy matter. Telltale features are shape of head and snout, position of fins and characteristics of teeth. For example, the tiger shark has seven rows of razor-sharp teeth with serrated edges.

Putting hooks on the floor of the Caribbean is asking for trouble. Sharks are not the only monsters that lurk in the 300 and 400-fathom depths. Thompson Enterprises, Inc., reported that one boat recently caught a shark too large to be hoisted aboard. It had to be towed. Boats have brought up giant moray eels and even larger snake eels.

Dependable

CHAMPION

America's Favorite Spark Plug



Most tourists insist on dependable Champion Spark Plugs because they appreciate top performance in their cars. The overwhelming majority of race drivers will use no other spark plug for the same reason. Look under the hood of your car to make sure yours are dependable Champions, too.
Champion Spark Plug Company, Toledo 1, Ohio.

FOLLOW THE EXPERTS

**DEMAND NEW DEPENDABLE
CHAMPIONS FOR YOUR CAR**

Listen to the CHAMPION ROLL CALL . . . Harry Wismer's fast sportscast every Friday night, over the ABC network

NOW

THE JIFFY METAL CABINET WITH RUSTPROOF ALUMINUM DRAWERS

32
DRAWER
UNIT

\$8.95

POSTAGE PAID

64
DRAWER
UNIT

\$15.95

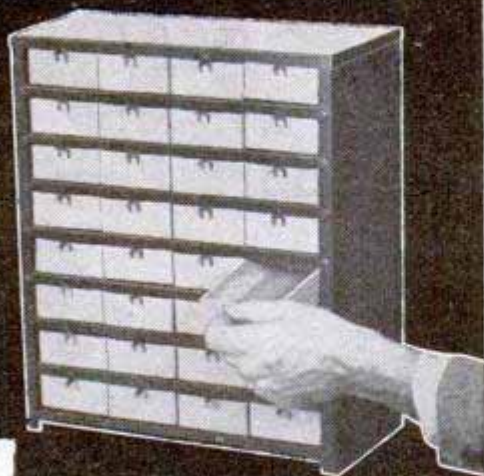

APPROXIMATE
SIZES
DRAWER

1 1/4" Deep
2 3/4" Wide
6" Long

32 DRAWER UNIT

6" Deep
12 3/4" Wide
15 1/4" High

64 DRAWER UNIT

6" Deep
25 1/2" Wide
15 1/4" High

for home or shop,
the handy way to
keep small parts,
washers, nuts, bolts,
nails, screws, etc.

AND
STILL
AVAILABLE

32
DRAWER
UNIT

\$5.95

POSTAGE PAID

64
DRAWER
UNIT

\$9.95

Solid one-piece aluminum drawers for greater strength and long life—and still at low cost. So handy to keep office, shop, work bench, household and hobbyist needs at your fingertips. Spot welded steel cabinet, enamel finish, and metal flange drawer guides.

32-Drawer Unit—\$8.95. 64-Drawer Unit—\$15.95. Postage Paid. Send check or money order. No C. O. D.'s, please. Add 3% sales tax for Ohio orders.

THE JIFFY METAL CABINET WITH LAMINATED FIBREBOARD DRAWERS

Same steel cabinet as above with covered fibreboard drawers. Suitable for most home needs. Thousands in use. 32-Drawer unit—\$5.95. 64-Drawer unit—\$9.95. Postage Paid. Check or money order. No C.O.D.'s. Add 3% sales tax for Ohio orders.

KAYTEE PRODUCTS
DEPT. M • BOX 588 • CANTON, OHIO

PRESSURE QUEEN

Outperforms them all



The only portable spray painting outfit having 4 cylinders in space usually required for one. Paints buildings; refinishes automobiles; inflates tires; lubricates chassis and farm machinery. Does more work in an hour than hand brushing in a day. Uniform pressure without pulsation. Ideal for home, farm, service station, machine shop and contracting painter. Factory tested and guaranteed.

• If your dealer does not sell Pressure Queen, order direct for immediate shipment.

\$99.95

THE CAMPBELL-HAUSFELD CO.

1046 RAILROAD AVE.

HARRISON, OHIO

BUILD YOUR OWN FLOOR JACK

WITH

Build-a-Jack

and save up to 2/3rds

Buy this husky screw assembly and plates from us and use your own two-inch pipe or timber. You'll save up to \$6.00 per installation. Build-A-Jack is coated to resist rust and is easily adjustable. Special collar available for use with timber or pipe up to 3 3/4 inches for extra heavy use . . . 50c extra, prepaid. No C.O.D.'s, please.

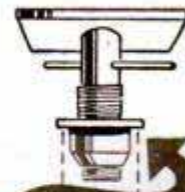

SCREW ASSEMBLY
AND BASE PLATES
\$3.49
PREPAID ANYWHERE
IN U. S. A.



Full refund if not satisfactory

Build-a-Jack MASSILLON, OHIO

Here's Why New AUTO-LITE STA-FUL Battery

*...needs water
only 3 times a year**



ORDINARY BATTERY



BOTH BATTERIES FULL

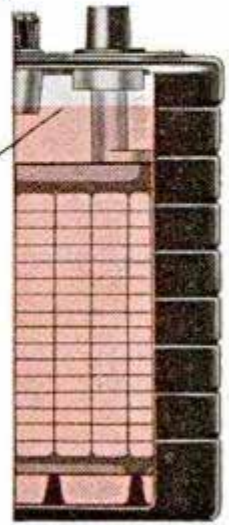

STA-FUL BATTERY

HERE'S WHAT HAPPENS INSIDE AN ORDINARY BATTERY

This battery is now full. Small liquid reserve gives battery plates little protection against damage and loss of power if evaporation lowers liquid level.

HERE'S WHAT HAPPENS INSIDE AUTO-LITE "STA-FUL"

The new "Sta-ful" feature has 3 times the liquid reserve of ordinary batteries. Gives its plates added protection. Helps it last longer too!

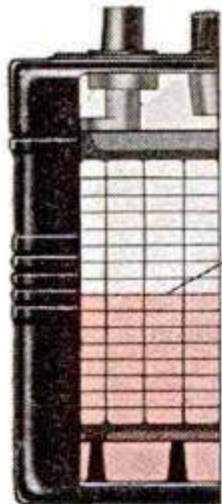

ORDINARY BATTERY



ADVANCED STATE OF EVAPORATION

Equal Liquid Loss From Both Batteries

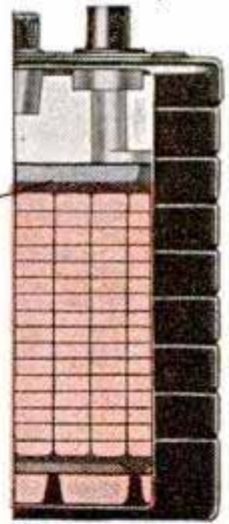

STA-FUL BATTERY

Plates at the left are now exposed and inactive because of the small liquid reserve provided in ORDINARY battery.

The "Sta-ful" Battery plates are still kept fully covered and protected because of the 3 times greater liquid reserve.

**In normal car use*

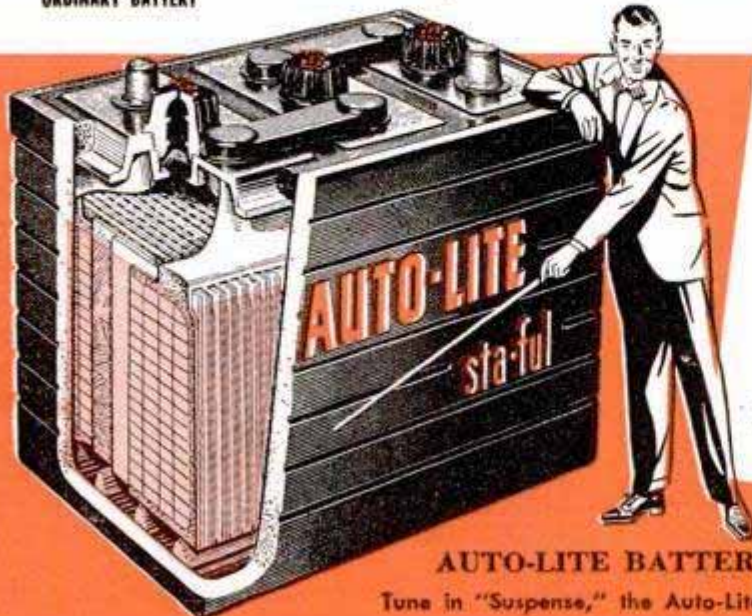

Why the "Sta-ful" Design Is Possible
Fibre-glass mats help to keep the power-producing material from shedding—add to battery life. This makes possible the "Sta-ful" construction with its smaller sediment well which permits room for a liquid reservoir with over 3 times the usual capacity at the top of the battery. Make your next battery an Auto-Lite "Sta-ful."

AUTO-LITE BATTERY CORPORATION, Toledo 1, Ohio
Tune in "Suspense," the Auto-Lite Radio Show—Thursdays, 9:00 P.M.—E.T. on CBS



FOR FAST, ACCURATE WORKMANSHIP

GREENLEE 22 is a name it will pay you well to remember whenever you buy Auger Bits. For it assures you sharp cutting edges, accurate sizing, bright, high finish, and that smooth, easy action so necessary in fine craftsmanship. You can be certain, too, that every GREENLEE 22 Solid-Center Auger Bit is "factory sharp" when it reaches you. For each is "Plastic-Sealed" with a special protective coating to keep it in perfect condition for you. To buy top quality, buy GREENLEE.



SPECIAL OFFER... ONLY 10¢ FOR HANDY WOODWORKING CALCULATOR

Quick solutions to countless woodworking problems. Just set dial: convert linear feet to board feet; compare characteristics and workability of various woods. Also shows bit



sizes; nail specifications; tool sharpening hints; etc. Heavily varnished cardboard, 6" diameter. Send 10c to Greenlee Tool Co., 2108 Columbia Avenue, Rockford, Illinois, U. S. A.

Confusion in the Cockpit

(Continued from page 151)

encouraging work going on. Several aircraft companies, including Boeing and North American, have been improving this part of the plane.

For example, North American's P-82 is equipped with a pulsating seat to reduce pilot fatigue on long flights. The cushion has a multiple-celled rubber bladder, sandwiched between two layers of foam rubber. Air pressure is reduced and increased alternately inside the cells of the bladder—thus giving the pilot relief from compression fatigue or the "double feature feeling."

The breathtaking speeds of jet planes have posed new problems for the cockpit engineers. At low speeds it was a relatively simple matter for a pilot to bail out. At high speeds, the problem becomes complicated. He may be thrown against some part of the plane and be knocked cold, injured or killed.

Ejection seats were developed, first by the Germans, then by the British and the U. S. Army and Navy. Two of the first planes to use the "break away" seat were Lockheed's P-80 and Douglas' Skystreak.

The installation of such seats brings new worries to the cockpit engineers. Adequate clearance must be provided for the pilot and his seat when he is thrown clear. At the same time, the functional cockpit arrangement of controls must be maintained.

The next step, say engineers, will be the ejection of the entire cockpit. Planes soon will be flying at supersonic speeds in the stratosphere. If thrown out at such dizzy speeds, pilots would be torn apart or die from lack of oxygen. If that didn't finish them off, they might freeze to death before they reached earth.

The obvious answer is an ejection cockpit. Then the pilot could voluntarily or—if he had passed out—be automatically thrown free in his pressurized cockpit. When his fall had slowed and he reached a predetermined altitude, his parachute would open and let him down. His pressurized cockpit might serve as a life raft on the ocean or as a protected home in arctic or desert country. It would be equipped with oars, sail, radio, food, water and snowshoes.

Ejection cockpits are still pretty much in the study-and-discussion stage. Engineers hold their heads and say that this new trend means that they'll have to start from scratch and redesign the pilot's compartment all over again.

(Continued to page 230)

SPEED GRAPHIC Photo
by Arnold C. Pearson

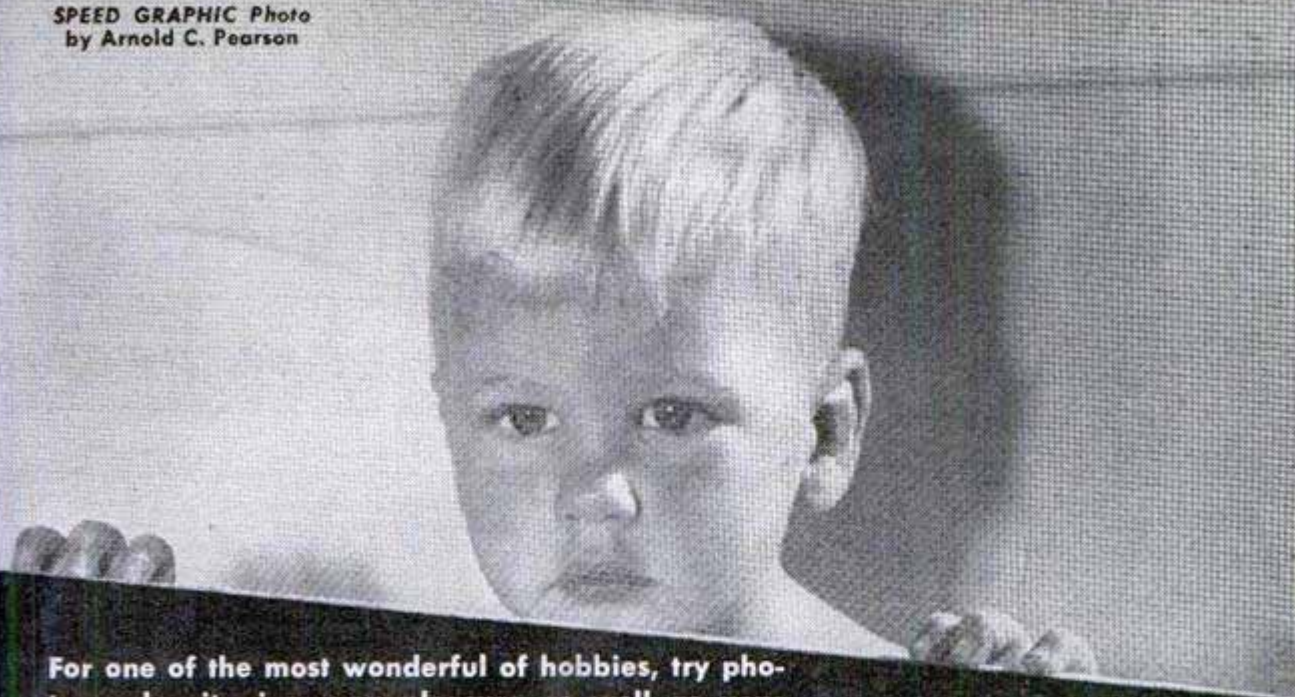

For one of the most wonderful of hobbies, try photography—it gives you pleasure as well as your family and friends. And remember . . . for prize-winning pictures you need one of the

PRIZE-WINNING CAMERAS

See your dealer. Write Graflex, Inc., Room 43, Rochester 8, N. Y., for free data. Western Division, 3045 Wilshire Blvd., Los Angeles

GRAFLEX



Build this Famous C. & N. W. "PIONEER" TRAIN MODEL

All parts ready-shaped for easy assembly. Length 9". Accurate, realistic 1/4" scale model kit of Chicago & North Western's historic "Pioneer" locomotive (1848) to be seen at Railroad Exposition in Chicago this Fall. Ideal to decorate home or office, display on mantel, desk, or in collector's group. Kit complete.....69c

Wide range of other wood model assembly kits (planes, ships, trains) including: DeWitt Clinton Train, first passenger train in New York State, \$1.00; Wm. Galloway locomotive, first freight in U. S., 50c; Rock Island Rocket, famous streamliner (fits HO-gauge layout), \$1.59; HO-gauge locomotive and freight car kits—Mikado locomotive and tender, \$1.00; caboose, 40c; tank car, 40c; refrigerator and box cars, 35c.

AT YOUR TOY OR HOBBY DEALER

Send for free folder showing other models

Strombeck-Becker Mfg. Co.

Dept. PM-8, Moline, Illinois

WOOD MODEL ASSEMBLY KITS

StromBecker

X-acto^{*}

HANDICRAFT KNIVES & TOOLS



Choice of experts in every art and craft field. A blade for every purpose—quickly interchangeable. Singly and in sets, 50¢ to \$50.00. (Slightly higher in Canada.)

Buy where you see this sign—
At hobby, hardware, gift and dept. stores.

X-acto Crescent Products Co., Inc., N. Y.
In Canada, Handicraft Tools, Ltd., Toronto

*Reg. U.S. Pat. Off.

SUPER-SHEAR

... a new principle in a precision file for the industrial or amateur craftsman

SMOOTHING—teeth have narrower spacing and longer angle here.

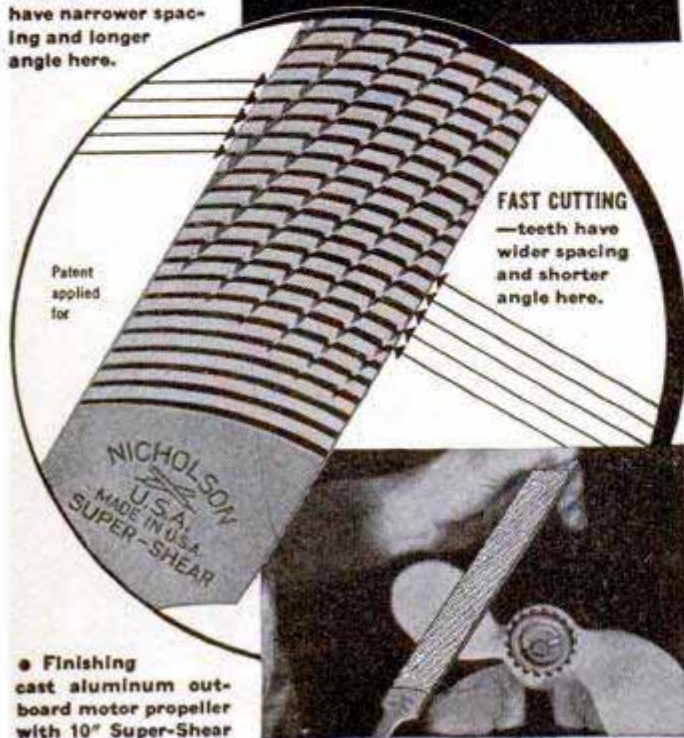

Patent applied for

● Finishing cast aluminum out-board motor propeller with 10" Super-Shear

A development by Nicholson, the Super-Shear is a curved tooth file that *smooths as it roughs*. Practically two files in one! Its extremely sharp teeth are *milled* in an arc that is off-center in relation to the axis of the file. Thus, when used with the usual overlapping right-to-left stroke, the Super-Shear "smooths out its tracks as it goes." Longitudinal serrations help to keep the file clear of chips; to overcome "chatter" and the tendency to run off the work.

Use Nicholson Super-Shear Files on the flat or convex surface of aluminum, brass, babbitt, bronze, copper, magnesium, cast iron, annealed tool steel; on plastics, hard rubber and hardwood.

Unwavering uniformity is assured under the sweeping Nicholson guarantee of *Twelve perfect files in every dozen*. And after it has given you long service, the Super-Shear may be resharpened at low cost. Available through good hardware and industrial distribution houses. For free booklet, "File Philosophy," write to:



NICHOLSON FILE CO.
22 Acorn St., Providence 1, R. I.
(In Canada, Port Hope, Ont.)



NICHOLSON FILES

FOR EVERY PURPOSE

Clinic



for Homemakers

As a service to our readers in solving the hundreds of problems pertaining to a home—inside or out—the editors of *Popular Mechanics* invite you to present your problems to The Clinic Editor for help and advice. Address your questions to The Clinic Editor, *Popular Mechanics Magazine*, 200 East Ontario Street, Chicago 11, Ill.

Gutter Downspouts Open at the Joint

Q—Two of the downspouts on my house are opening at the joints. On one downspout the joint has started to open just above the point where the downspout enters the drain tile. On the other the opening is about a foot below the elbow at the gutter. What causes this and is there any way to repair the parts? They are still in good condition except for the joints.

J.M.—Toronto, Ont., Can.

A—Usually this trouble is caused by a collection of leaves or other trash which only partially clogs the downspout but is sufficient to catch and hold snow and slush. When the temperature falls, this freezes and forces the folded joint open. Ordinarily, downspouts in this condition can be repaired satisfactorily without dismantling by simply wrapping one turn of wire around the pipe at the point where the joint has started to open. Pull the wire tight and twist with pliers. Then wrap another length of wire an inch or so nearer the center of the open joint and again twist tight. By proceeding in this fashion for the length of the open joint, you can force it together as good as new in most cases.

Refinishing Breakfast Set

Q—I have a light-colored maple breakfast set which needs refinishing. The top especially, is badly marred and scratched. I want to refinish the set in the same color as the original. What is the proper procedure? E.R.—San Francisco, Calif.



A—Judging from your description, the original finish of the set was what is known as blonde maple. If, as you say, the set is rather badly marred and scratched, the best procedure is to remove the old finish with a prepared remover. This done, sand thoroughly and then apply a commercial wood bleach, carefully following the directions on the container. After bleaching, any digs or gouges too deep to be removed by sanding should be filled with stick shellac of a color to match the bleached wood. Sand the fills smooth after the shellac has set. Then finish with one coat of white shellac followed by one or two coats of a good furniture varnish. Sand between coats with fine paper and rub down the final coat to a satiny-smooth surface.

(Continued to page 228)

"That brand name means plenty, Mister"

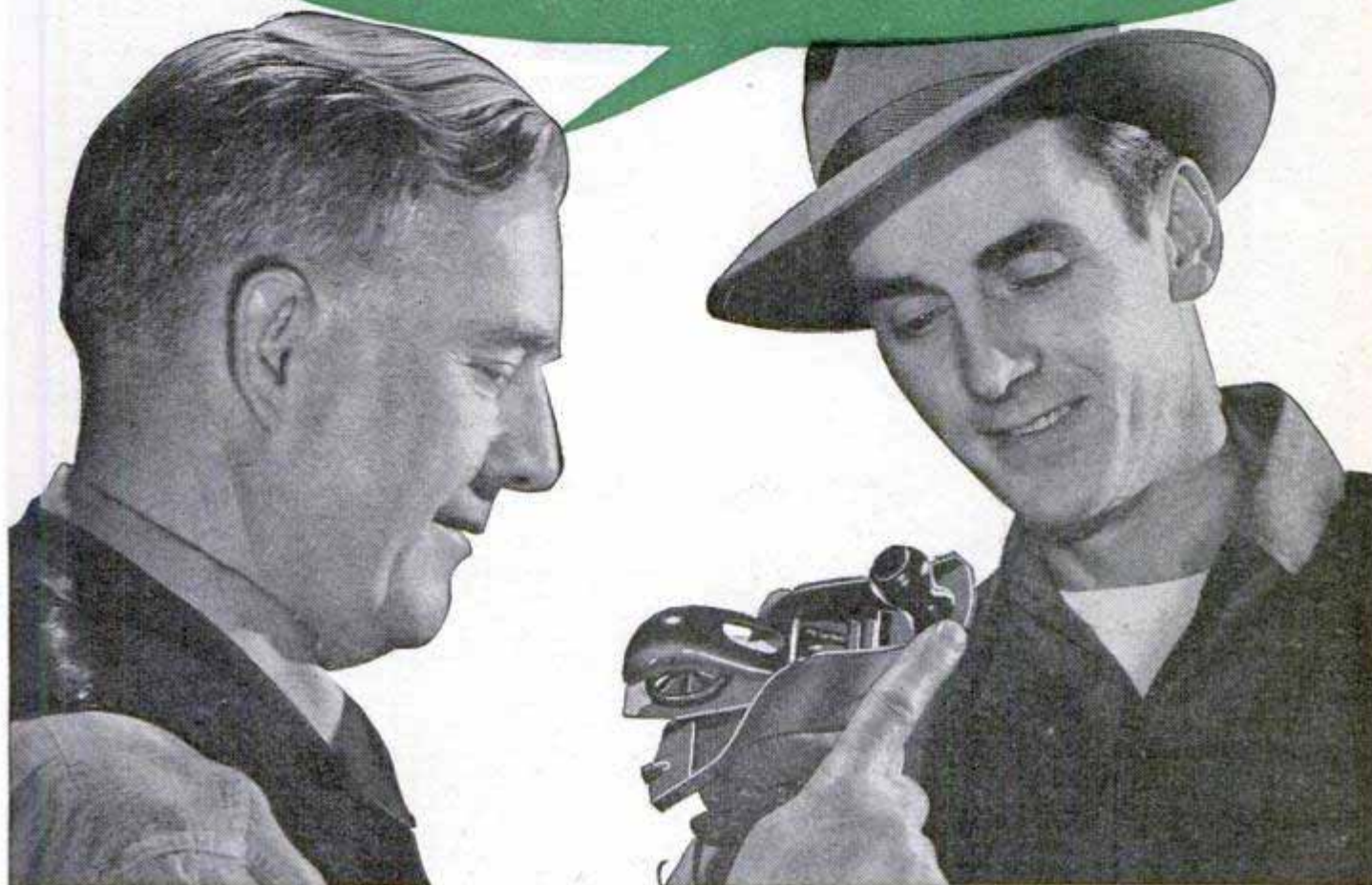

JONES: Sure it does—to you hardware dealers. Tools with advertised names get you higher prices. But how about me? I want the most I can get for my money.

DEALER: Well, sir, let me ask you this. Do you think you get more for your money when you buy unknown tools at bargain counter prices?

JONES: Not necessarily. But I know this much—you can't change a poor tool into a good one just by putting a well-known name on it.

DEALER: Of course not. But don't forget that when a reliable manufacturer puts his advertised brand name on a tool—or

any other piece of hardware—it's got to be good.

JONES: How do you figure that?

DEALER: The manufacturer has a reputation to protect. Thousands of men *believe* in that brand name . . . *depend* on it . . . and he can't afford to let them down. It's the same way with me and my hardware store. I've got to keep *my* reputation for quality merchandise or I couldn't even stay in business.

Your **HARDWARE DEALER** sells **QUALITY tools**
and hardware... Buy from HIM



POPULAR MECHANICS

PERFORMANCE GOES UP IN SMOKE . . .

"IT'S NOT A FIRE, BILL . . ."

IT'S A CAR THAT NEEDS

FEDERAL-MOGUL ENGINE BEARINGS"



WORN CONNECTING ROD BEARINGS CAUSE OIL PUMPING, STEAL POWER

Smoke behind your car means worn connecting rod bearings up front in the engine. They let excess oil reach combustion chambers. It carbon-fouls pistons, rings, valves, spark plugs—means sluggish, costly operation. To restore power, pep and economy, replace with Federal-Mogul Oil-Control Bearings—ask your mechanic!

FEDERAL-MOGUL SERVICE

(DIVISION OF FEDERAL-MOGUL CORPORATION)
COLDWATER, MICHIGAN

Replace in Sets with Genuine

FEDERAL-MOGUL

Oil-Control Bearings
in your car



Removing Oil-Burner Soot From Siding

Q—The siding on my house is stained in spots with a dark, oily stain which I suppose is soot from the oil burner. How can I remove this grime so it will not discolor new paint?
M.M.—Hartford, Conn.

A—Dark, greasy dust from an oil burner that settles on the siding usually can be removed quite easily with an ordinary paint cleaner. If the old paint is chalking uniformly this may not be necessary, as a brisk brushing may remove the loose particles of paint pigment and take the grime along with them. Incidentally, it would be a good idea to have the burner checked, as a correctly adjusted oil burner should not produce the troublesome soot deposit you describe.

Attaching Wooden Strips to Concrete

Q—I'm planning a recreation room in my basement and want to use knotty pine on the wall at one end of the room. My problem is how to fasten the pine boards to the wall, which is concrete. Can you help me?
F.M.—Manchester, N.H.

A—First you will have to attach furring strips to the wall to get a nailing base, and to provide space back of the boards for circulation of air. If the wall is the common height of 6½ or 7 ft. from the basement floor to the bottom of the joists, you will need at least three horizontal strips spaced evenly, the first strip placed about 8 in. above the floor. These strips are attached to the concrete wall with lead or fiber screw anchors. To install the anchors, first drill holes to the required depth with a star drill of the correct size. Tap the anchors in place in the holes with light blows of a hammer so as not to upset the ends. Then simply drive ordinary wood screws through the furring strips into the screw anchors just as you would drive the screws into wood.

Refinishing Wall Registers

Q—The wall registers in my home need cleaning and refinishing. I prefer not to paint them. How can I refinish the registers myself so they will look like new?
M.A.—Des Moines, Iowa.

A—Go over all the metal surfaces lightly with fine steel wool, 00 size or finer, to remove the discoloration and grime. Then clean thoroughly with a soft cloth dipped in lacquer thinner. Have the windows open and avoid inhaling the fumes of the thinner. Finally, finish with one coat of clear lacquer applied with a fine-bristle brush. Do not get lacquer on the painted wall as it will soften oil paint.



Stained Exterior Doors Turn White

Q—Two doors in my home are stained. Recently, both of them have turned white, the color ranging from gray to white on the inside of the door. What is this, and how do I restore the finish?
J.G.—Minneapolis, Minn.

A—Excess moisture commonly causes bleaching of the varnish finish you describe. It is probable that the doors "sweat," that is, high humidity in the house causes moisture from the air to condense on the interior surfaces of the doors. Usually, the only remedy is to remove the old finish entirely, but first try rubbing the doors lightly with camphorated oil. In some cases, this treatment will restore the finish to its original color. To avoid further trouble, reduce the humidity in the house during the winter months.

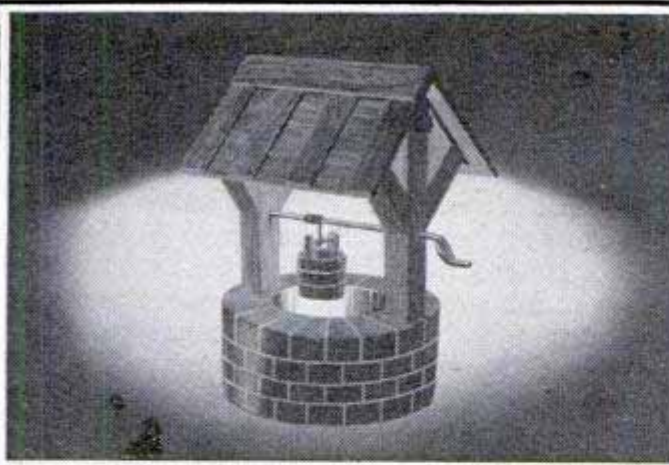

New! Wishing Well Table Lamp

For garden, nursery, kitchen, any room in your home. Changeable colored light (clear, blue, amber or red). Roof and posts of California redwood. Suede-like, velvety-soft textured base in choice of brown, red, blue, black, white, orange or yellow. Completely wired and ready for use, indoors or out. \$5.95 postpaid, direct from manufacturer. 10-day money-back guarantee. U. S. Patent 2297153.

JACK JOHNSON CO., Dept. 288
3365 Army Street San Francisco 10



When Your Radiator Springs a Leak...

Keep Smooth-On No. 1 Iron Cement handy for emergency auto repairs. Use it to stop radiator leaks; seal cracks in water jackets, crank or gear cases; tighten loose door hinges, handles, etc. You can save time and money making these repairs yourself. And they'll STAY TIGHT, for Smooth-On expands a little as it hardens. Buy Smooth-On in 1 3/4-oz., 7-oz. or 1-lb. size at your hardware store. If they haven't Smooth-On, write us.

FREE Repair Handbook

This famous 40-page book shows, as well as the above repairs, many other useful ones you can make around the house. 170 pictures. Send postcard for YOUR free copy today.

SMOOTH-ON MFG. CO., Dept. 37H
570 Communipaw Ave., Jersey City 4, N. J.

Do it with

SMOOTH-ON
THE IRON CEMENT OF 1 000 USES



BUILD LAWN FURNITURE EASILY - ECONOMICALLY! with EASI-BILD* Full-Size Patterns

With these new, full-size patterns, you can build lawn furniture to please the whole family. And the kids will get a kick out of their own child-size chairs. Simply trace the full-size pattern on the wood, saw, and assemble with CASCOPHEN, Casco's new, waterproof glue described below. *Reg. U. S. Pat. Off. by Easi-Bild Pattern Co.

How to choose a glue!

These directions will solve your gluing problems:



For boats, outdoor furniture, sports equipment—joints that must withstand outdoor exposure—Cascophen (Resorcin Resin Glue). *The first completely durable glue available to homecraftsmen!*



For furniture, toys, heavy-duty home repairs—strong, stainfree, moldproof, highly water-resistant Cascamite (Urea Resin Glue). Mixes quickly with cold water!



For models, photo prints, labeling—general home, school, or office gluing, use the new, clean, white, fast-setting Cascorez (Polyvinyl Resin Glue). Liquid ready to use!

Send Coupon for Furniture Patterns to

Casco Pattern Dept. PM-88
P. O. Box 215, Pleasantville, N. Y.

Enclosed is _____¢ for patterns checked below.

- () Lawn Chair, Pattern #32-25¢
- () Miniature Lawn Chair, Pattern #132-25¢
- () Lawn Settee, Pattern #39-35¢
- () Please send free folder illustrating 100 patterns and free gluing chart.

Name _____

Address _____

City _____ Zone _____ State _____

THE BORDEN CO. • CHEMICAL DIVISION
Makers of Casco Glues



KEEPS COLORS FROM FADING!

THE SOONER YOU SIMONIZ YOUR CAR THE BETTER!



Millions of motorists say...
"YOU SHOULD SIMONIZ YOUR CAR!"

MAKES NEW CARS LOOK EVEN BRIGHTER!



for longer lasting beauty and protection!

Simoniz gives your car gorgeous beauty . . . protects the finish . . . keeps colors from fading. And you can do a professional job—in half the time—without a buffer! For a "quickie slick-up" or to clean your car before applying Simoniz—use Liquid Simoniz Kleener (if the finish is unusually dull, restore the luster with Paste Simoniz Kleener). For lasting beauty—follow up with famous Simoniz!

**THE SIMONIZ COMPANY,
CHICAGO 16, ILL.**



MOTORISTS WISE

SIMONIZ

TRADE MARK REG.

MAKES THE FINISH LAST LONGER

Prone-position cockpits—where the pilot lies on his stomach—have been built on an experimental basis over a period of several years, mainly with an eye to high-speed research. To date, engineers have no fixed opinion as to the desirability of such a radical departure. "They solve some problems and create others," says Al Mayo, a Douglas engineer. "We feel that we must know much more about the limitations of the human body under high negative and positive G forces before we know whether prone cockpits are necessary or desirable."

Most of the work on redesigning cockpits has been done on small single-seat military planes. But many of the improvements are being installed on bombers and large transports. Lockheed, Martin, Boeing, Douglas, Consolidated and others are working on problems of greater visibility, increased pilot comfort and decreased noise levels.

The Boeing Stratocruiser, for example, has new-type windows that are electrically heated and made of nonshatterable "bird proof" glass. Consolidated's B-36 bomber is equipped with a simplified, easy-to-read, instrument panel. The latest Martin Mars flying boat groups pilots, flight engineer, navigator and radioman on a compact, efficient flight deck.

Col. Philip B. Klein, chief of the fighter branch of aircraft projects at Wright Field Air Materiel Command, in a pessimistic mood, recently said: "The time is not far distant when we will have to admit God never intended that we should move as fast as the contrivances we put together might carry us."

But until such limitations are reached, cockpit engineers will be plugging away to make flying safer by providing easier and more efficient controls. If clothes make the man, cockpits make the pilot!

Photos on Fabrics and Glass

(Continued from page 135)

the textile-printing industry is at hand. They point out that New York City's largest industry prints 1,500,000,000 yards of fabric a year using methods which are from 100 to 5000 years old.

The leading process for photographic printing of fabrics is Photone, operated by the Ross-Smith Corporation of New York, using a process developed by the General Aniline & Film Corporation. A. M. Ross-Smith states that since the beginning of history there have been only two types of fabric printing: hand blocking, its origins lost in antiquity, which developed mechan-

(Continued to page 232)

SCREW DRIVER TIPS

Choose a screw driver just as carefully as you pick a plane, chisel or other fine tool. And don't try to make one screw driver do for all jobs. The best costs so little, it's a real economy to have a full range of sizes and styles . . . long ones for more powerful driving, short ones for close-quarter work and the correct tip width to fit all sizes of screws. Blades tempered entire length. Stanley makes them all the Stanley way.

Coupon brings you two books . . . one FREE, the other the popular workshop textbook, clothbound, illustrated, just \$1.



NO. 1009 handy for tight places. Blade 1 1/2" long. Unbreakable composition handle.

NO. 2702 for Nos. 5 to 9 Phillips Screws. Blade secured by swaged ears.

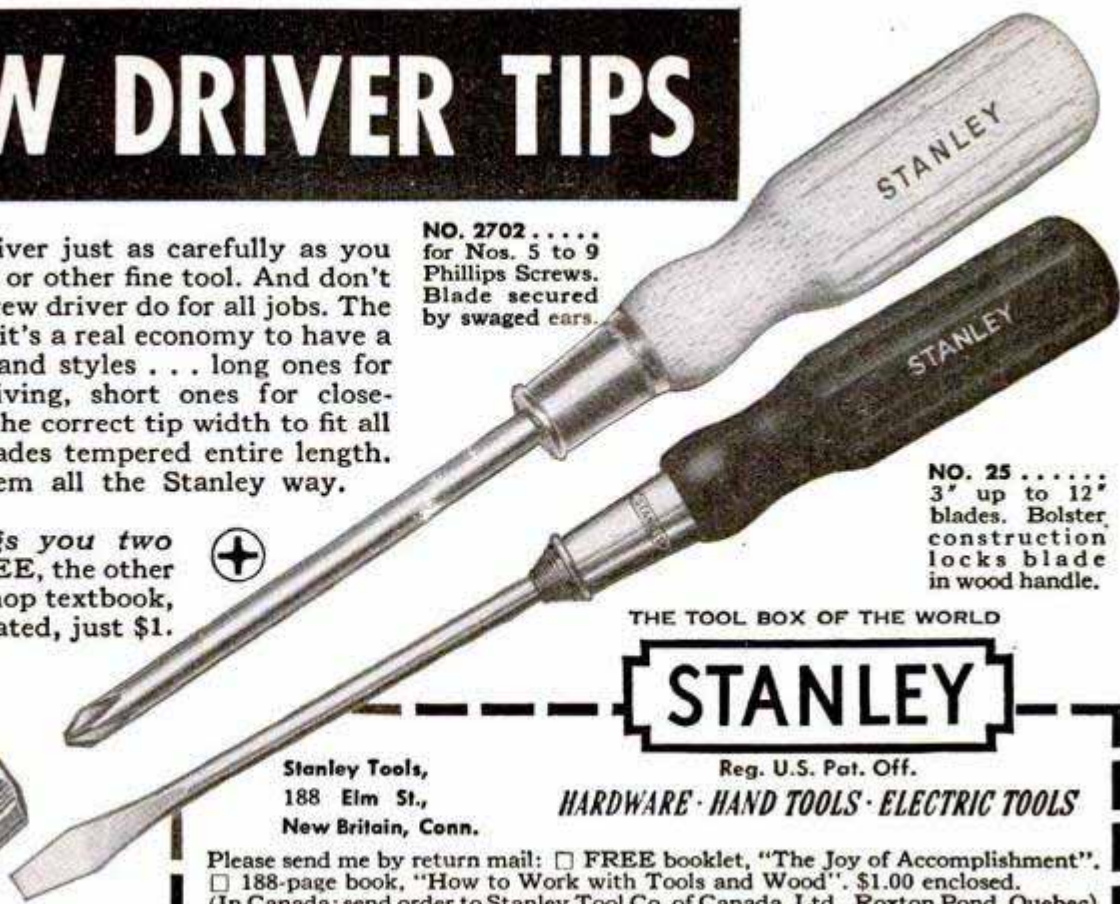

NO. 25 3" up to 12" blades. Bolster construction locks blade in wood handle.

THE TOOL BOX OF THE WORLD

STANLEY

Reg. U.S. Pat. Off.

HARDWARE · HAND TOOLS · ELECTRIC TOOLS

Stanley Tools,
188 Elm St.,
New Britain, Conn.

Please send me by return mail: FREE booklet, "The Joy of Accomplishment".
 188-page book, "How to Work with Tools and Wood". \$1.00 enclosed.
(In Canada: send order to Stanley Tool Co. of Canada, Ltd., Roxton Pond, Quebec)

NAME _____

ADDRESS _____

CITY _____

STATE _____

an extra motor
for only

\$3.95

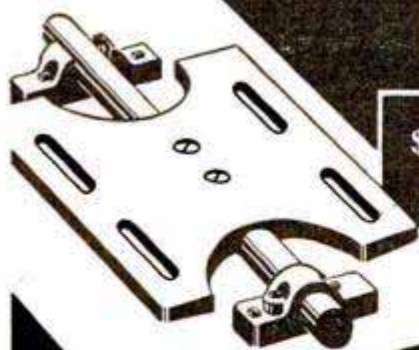

The **QUICK CHANGE** Motor Mount gives you the service of two or more motors! Change from one machine to another in moments! Positions for 5-step pulley. Simple screw clamp permits tilting for belt-tension and tightening. The **QUICK CHANGE** Motor Mount allows one motor to work an entire shop! Complete Motor Mount only \$3.95. Extra mounting blocks only \$1.50 per pair. Send check or money order today. Write for **FREE** illustrated circular.

THE MOTOR MOUNT CO.

P. O. BOX 827

SPRINGFIELD, MASS.



Now Own This
PORTABLE ALL-PURPOSE DIRECT DRIVE
AIR COMPRESSOR

ONLY
\$83.95

F.O.B. Factory
Complete
With
Air Chuck

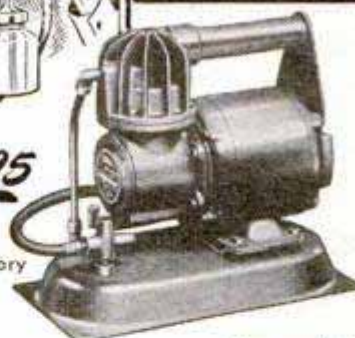

For
PAINTING
SPRAYING
GREASING
INFLATING
CLEANING
DUSTING

Economical Air Power For Garages, Machine Shops, Home Work Shops, Farms, Contractors and wherever air power is needed for operating small air tools. Easily carried. Weighs only 50 lbs. Piston type, single cylinder. 3" bore, 1/2" stroke. Displaces 3 1/2 C. F. M. Maximum working pressure 90 lbs. Sturdy, efficient, trouble-free. Of finest quality and workmanship. Motor is 1/2 h. p., single phase, 60 cycle, 110 volt. (Gasoline models available. Also lower priced belt drives.) Equipped with 15-foot electric cord, plug and switch; 20-foot rubber covered 1/4" air hose with automatic air chuck. Fully guaranteed. See your dealer or write factory sending check, bank draft or money order.

General Products Division
TOKHEIM OIL TANK & PUMP CO.
1628 Wabash Ave., Fort Wayne 1, Indiana





*Millers Falls
No. 220 "Dyno-
Mite" Drill. 1/4"
capacity in steel — drills soft and
hard wood, plastics, masonry, con-
crete with equal ease. Length .9 1/4";
weight 3 1/4 lbs. For home workshop,
farm or light production and main-
tenance work.*

It's new! It's **DYNO-MITE**

If you've always wanted an electric drill, because you've known how useful a good, compact, lightweight drill can be — then "want" no longer! The new Millers Falls "Dyno-Mite" is the drill for you — packed with all the power and speed and stamina you've dreamed of in a tool this size.

"Dyno-Mite" is typical of all the other fine drills, hammers, grinders, screw drivers, sanders, and polishers in the Millers Falls line of portable electric tools. There are 80 years' experience behind every Millers Falls tool you buy at your hardware dealer's. Millers Falls Company, Greenfield, Mass.

It's Millers Falls!

Celebrating 80 Years of Toolmaking



ically into silk-screen printing; and roller printing, which is a hundred years old and has improved only to the extent that its equipment has been made more efficient.

The problem of recording photographs on fabric had been the concern of scientists for 60 years when Ross-Smith walked into the laboratory at General Aniline and asked the head chemist to sensitize his handkerchief and put Lana Turner's picture on it. The chemist used an old method, never before successful. However, the result was so good that the company went to work on the process and perfected it.

The method used in the Photone process is simple. The material to be printed is sensitized and run over rollers which hold the film negatives. The printing is done by contact with a high-wattage mercury-vapor lamp inside the roller. In successive straight-line steps it is developed, fixed and finished.

A number of problems had to be solved before the process could be called a success: Light-sensitive dyes had to be found that would stand up under daily usage; sensitizers and fixatives which would not damage the fabric fibers had to be discovered, and unevenness in development had to be overcome.

Details of the process are being kept secret at present, because many changes have been made in the technique since patents were issued.

The photographic image, as it appears on the fabric, can embrace any or all of 32 tones and may be in red, blue, brown or black. With the development of a color-separation method and the necessary printing equipment, four-color reproduction will be possible—probably within the next two years.

The process can be used on a wide range of fabrics, being effective on rough monk's cloth as well as ultrasoft satin. Even velvets and pile fabrics, such as used in automobiles, previously thought unprintable, produce a good image.

Women's clothes surely will be the first big market, beginning with the luxury lines. But the list of possibilities seems endless. Scarves, neckties, tablecloths, draperies, lingerie, bathing suits, pajamas and sport shirts are a few other uses that come to mind.

Printing pictures on ceramics is a problem under study at the Onondaga (N. Y.) Pottery Company. This involves working with a porous surface—unglazed pottery—but it is believed that the technique resembles the Corning process in that the latent color is brought out by heat.

(Continued to page 242)

The '49 Ford

"THE CAR OF THE YEAR"

Designed to set entirely new standards of comfort, performance, economy and beauty in its field, the '49 Ford represents a complete break with the past. Here is a car that is completely new, inside and out. A car that is the triumphant result of thousands upon thousands of man-hours spent in research, design and testing . . . of millions of dollars invested in new facilities, machines and equipment to do the job. From the clean, low lines of its fresh styling to the smallest detail, inside and out, the '49 Ford is truly "the car of the year."

High on the list of important changes is new riding comfort with new independent front wheel suspension, parallel rear springs and

Hotchkiss drive. Of equal importance to many are the new engines—100-hp. V-8 and 95-hp. Six, which offer greater economy, improved service accessibility and other features which will mean smoother operation and longer engine life.

The complete line of '49 Fords includes two series: the Custom and the Ford. There are five body styles in the Custom Series—Tudor Sedan, Fordor Sedan, Club Coupe, Convertible Club Coupe, and Station Wagon. In the Ford Series are four models—Tudor Sedan, Fordor Sedan, Club Coupe and Business Coupe. A range of ten body colors is also offered, although all colors will not be available on all models.



Advertisement

Body Styling. Regardless of body style or series, at first glance the most impressive feature of the '49 Ford is the complete departure from previous exterior design. The body has been made full width, with rear fenders integral with the rear quarter panels. Front fenders are more massive and have higher crowns, giving an almost unbroken line from side to side across the hood. The clean, smoothly-flowing horizontal lines of the body are evidence of the careful attention paid to this design detail. Wind noise and air resistance are reduced and, of course, usable space within the body is greatly increased by the full width design. In the process of achieving

the rear portion of body and provides exceptionally solid footings for the full-arch roof rails.

Insulation. Bodies are effectively insulated against heat and noise, a variety of methods being used. Roof, floor and deck-lid panels are lined with a special waffleboard-type insulation. Sprayed-on sound-deadening materials are used for door panels, quarter panels and wheel housings. In addition, the dash is insulated by the use of heavy fabric material.

All structural members in the new Ford bodies are carefully cleaned, treated with a rust inhibitor and painted. This treatment is applied even to the inside surfaces of such large box-section members as the center pillars, in which special openings are provided for the purpose.

"Lounge Car" Interiors of the Ford "Forty-Niner" show every bit as much change as the exterior body lines. Most important advancement is the great increase effected in usable space. This has been accomplished, in part, by moving the engine 5 inches forward. Extending the body sides outward to the full width of the car likewise results in substantially increased seat widths, particularly at the hip and shoulder levels. Front seats are 57" wide, an increase of

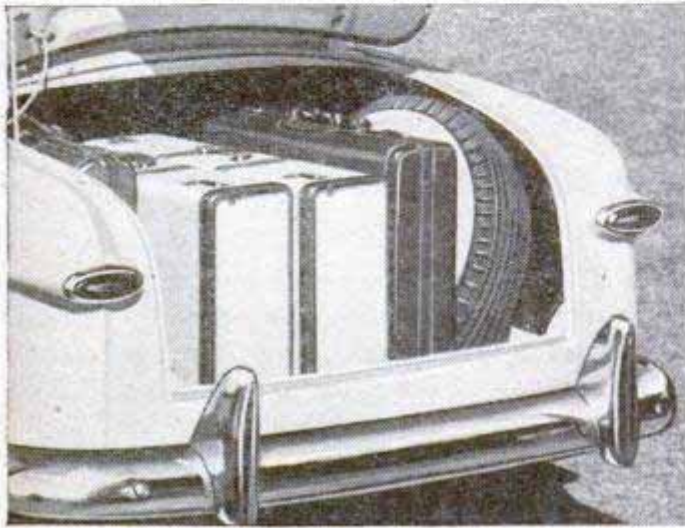

Up to 57% more luggage space.

this smoothness of design a number of the dirt and moisture collecting seams found in conventional designs are eliminated.

Stainless steel moldings extending horizontally backwards along the sides of the body, do double duty as protective rub-rails. Extra-heavy "Fender Guard" bumpers curl around the sides of the fenders for added protection. On all models the trunk capacity has been markedly increased. Usable trunk volume is 28.5 cubic feet in coupes; sedans have 19 cubic feet, an increase of 57%. The trunk lid is externally hinged and provided with an ornamental handle incorporating the license plate lamp, and license plate holder.

Body construction is likewise completely new, affording greater strength and safety with reduced weight. The combined body and frame structure is actually 59% more rigid. It is of the all-steel, all-welded type, incorporating material and design features that reflect over 21 years of research into the problems of combining maximum strength with minimum weight. The body is bolted firmly to the frame at 22 points, with special shims provided for insulation. Front pillar posts have a narrow cross-section to improve visibility. Another interesting innovation is that the rear wheel housings are completely separated from exterior sheet metal and welded to the rear floor pan. This increases stiffness at

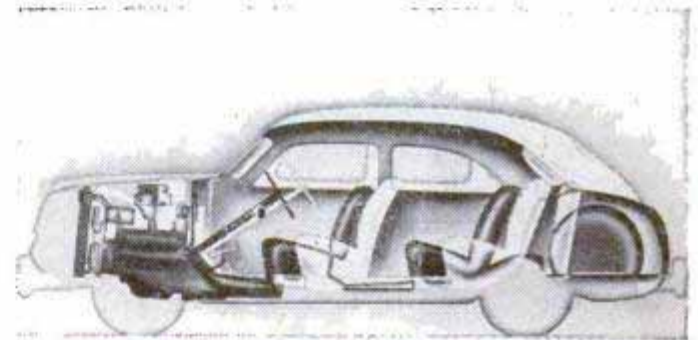

White outline—'48 Ford; gray outline—'49 Ford.

6.5", while rear seats now measure 60", or $7\frac{3}{4}$ " more than before. 56" shoulder room has been provided in the front seat and 55" in the rear seat of sedans, enabling three large people to occupy each seat with complete comfort.

Added riding comfort is obtained by scientifically positioning seats well forward between the wheels, resulting in a smooth, soft "Mid Ship" ride. Also new for Ford this year is the seat construction employed — lightweight tubular frame containing a unique "zig-zag" spring base and short, soft-acting coil springs.

Visibility. Another important achievement in body design has been accomplished by Ford engineers in substantially increasing the window area of the new models, while at the same time lowering the overall height of the body over 3". The greater visibility provided for both driver and passengers alike is an important contribution to greater safety of operation, as well as adding to comfort and pleasure. The total vision area in the popular Tudor model, for example,

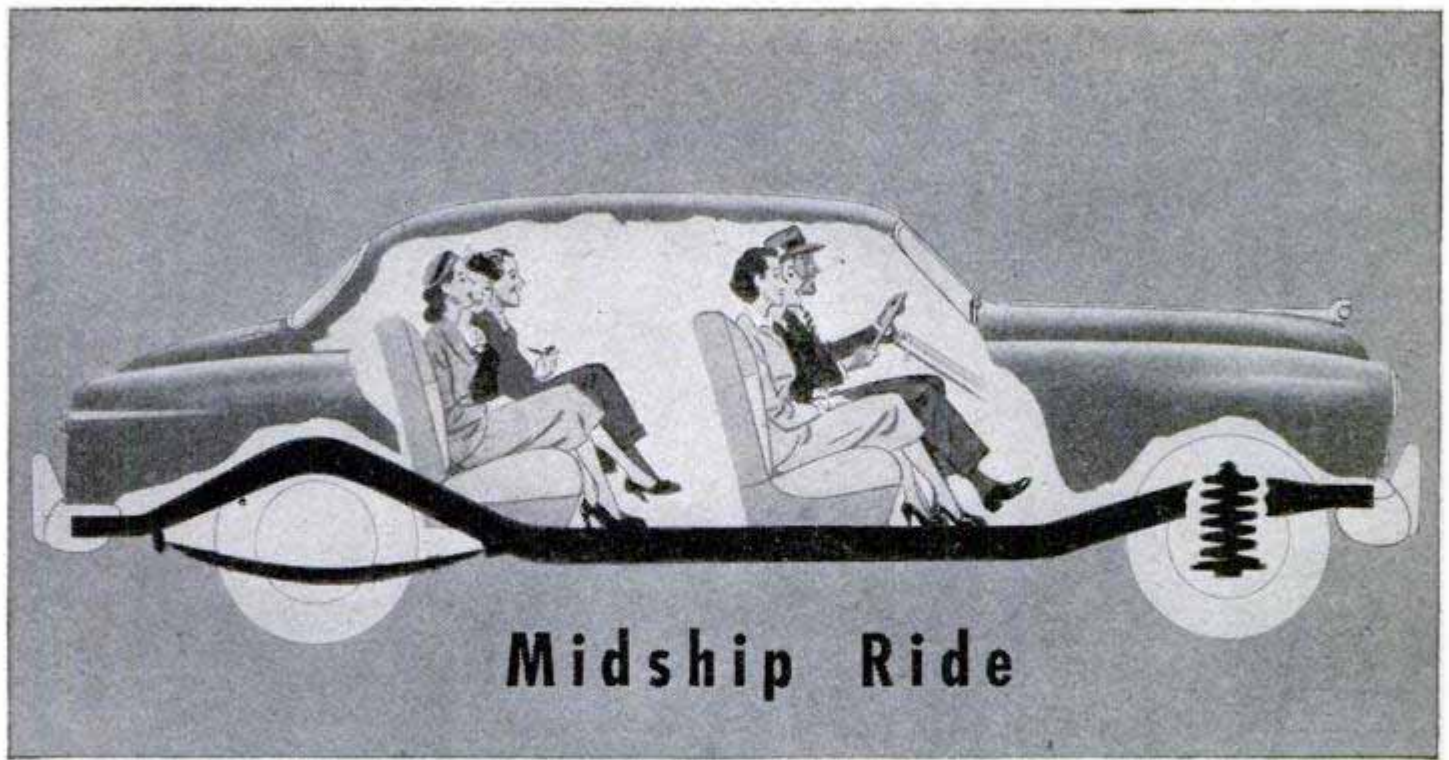

has been increased from 2612 square inches to 2916 square inches. The extra-wide and extra-deep V-type windshield gives over 20% more vision area than before.

Instrument Panel. In keeping with the high quality and luxury feeling of the new Ford interiors, the instrument panel has been completely restyled to combine beauty and utility. Oil pressure gauge, fuel gauge and battery charging and engine temperature indicators have been grouped in a single cluster around the rim of the 100 mph. speedometer directly in front of the driver. The speedometer face also contains the headlight beam indicator light, and provision for turn signal indicators. A completely non-glare lighting system is employed to illuminate the gauges and speedometer. Based on the "black light" system developed during the war for illumination of aircraft control panels, the Ford system uses a light that approximates ultra-violet and is invisible to the human eye. Instrument figures, graduations and pointers are coated with a substance that emits a clear glow when acted upon by the "black light" rays, thus becoming easily readable in the dark with no distracting bright light or reflections.

Custom models have a clock in the center of the instrument panel and locking glove compartment at the far right. Provision is made for the installation of a radio below the clock, with speaker grille located at the top of the panel next to the windshield. Tests show that this high-level speaker placement gives greatly improved acoustical reception for all passengers.

Controls. The popular dash-mounted starter button has been retained. The windshield wiper

control has been placed within easy reach on the instrument panel, along with a three-position light switch, three-position ignition switch and lock, choke control, and on the Custom models, an automatic cigar lighter. An ash tray is also provided in the panel. Operating controls and their placement follow standard practice, a two-spoke steering wheel being used to provide unobstructed vision of the gauges and speedometer cluster. A T-handle pull-type parking brake control is used in place of the pistol-grip type.

Two upholstery choices will be available in the Custom series—blue-gray tweed broadcloth and a gray-green striped mohair. In the Ford series, green striped broadcloth or green and red striped mohair is offered. Both series may be had tailored in tan leather, at extra cost. The convertible model comes in either red leather combined with beige bedford cord, tan leather with beige bedford cord, or green leather with green bedford cord, depending on the exterior body color selected. Station Wagons have genuine leather upholstery on driver's seat and vinyl is used on passenger seats.

Door controls have been extensively modified to give greater ease of operation and safety. Outside door handles operate by pulling outward. Inside door handles pull up to open, thus eliminating the possibility of accidentally opening a door by leaning on the handle. Also, possibility of snagging clothing is minimized by placing open ends of handles towards front of car. Door lock inside controls are push buttons which return to open position whenever the door is opened or closed. It is thus impossible to lock the keys in the car. Ignition key operates

exterior door locks located in both front doors. Either right or left door may be opened with the key, regardless of which one was locked from the outside originally.

Appointments. Ford models are provided with a variety of interior appointments, including arm rests at each side of both front and rear seats in sedans and club coupes, an ash tray in both front and rear compartments, coat hooks, interior light and sun visor. The Custom models are equipped in even greater detail, with extra quality upholstery and floor mats, cigar lighter, robe and assist cords, clock, dual sliding-type sun visors, two ash trays in rear compartment and two interior lights.



Instruments are grouped directly in front of driver, and "black lighted".

A Living Room on Wheels—that's the overall impression created by Ford's new combination of increased visibility, greater usable interior roominess, extra-wide seats and smartly styled materials and fittings. This comparison is further heightened by Ford's new ventilating system, which admits fresh air through screened openings next to the radiator and discharges the air into the car body just above the toe boards. Each inlet is individually controlled by knobs on the steering column bracket. The forward movement of the car produces a ram effect in the air intake, delivering fresh air under pressure. This pressurized ventilation permits vent windows to be opened slightly even in rainy weather to maintain air circulation.

The three-way "Magic Air" heating system (available at extra cost) is designed to operate in conjunction with this new ventilating system. A two-speed blower takes air from the right-hand air intake and passes it through a heating coil. The warmed air then enters the car body through an outlet that extends across the dash above the toe board. A three-way valve permits operation of the system as either (1) a fresh-air heater with forced circulation for cold weather or quick warm-up; (2) a fresh-air heater without blower for milder weather; (3) with intake closed, as a recirculating heater for quick heating in very cold weather or to keep out obnoxious fumes in heavy traffic.

A thermostatically-controlled valve regulates flow of hot water through the heating coil to

maintain nearly constant temperature inside the car regardless of outside temperature. Thermostat is set by a push-pull knob on dash. All the way out permits maximum flow through the coil, and all the way in shuts off flow completely, permitting blower to be used in hot weather for forced circulation of fresh, low-humidity air.

Defroster operates in conjunction with heater. A push-pull knob on dash regulates dampers inside the heating coil box, directing warm air to the windshield. When defroster knob is pulled out to its "full out" position, full discharge from the powerful blower flows through the defroster ducts to remove heavy ice from windshield quickly on the coldest day.

Two New Engines: For the "car of the year" Ford provides a choice of two engines—a new V-8 and a new Six. The following are the basic engine specifications:

	SIX	V-8
Type	L-head.....	L-head, 90° "V"
Displacement, cu. in.	225.9.....	239.4
Bore x Stroke, in.....	3.3 x 4.4....	3-3/16 x 3-3/4
Max. brake hp. @ rpm. .95 @ 3300 .100 @ 3600		
SAE-AMA hp.....	26.1.....	32.5
Compression ratio.....	6.8 to 1.....	6.8 to 1

Both V-8 and Six cylinder engines incorporate many radical changes in design and construction which decrease power losses, increase engine efficiency, provide exceptional accessibility for servicing and assure longer engine life. The major changes incorporated in both engines include: a new "Equa-Flo" cooling system with balanced type thermostat and pressure type radiator cap; greatly improved lubrication system; new combustion chamber contours; redesigned intake manifold; unique vacuum differential spark advance regulation; new single breaker-type distributor mounted for easy accessibility; more effective crankcase ventilation; timing mark on pulley or damper at front of engine and a carefully engineered 3-point rubber mounting system.

The new V-8 engine has an off-center location of oil passage in each crank pin, providing a "sludge pocket" designed to trap foreign matter carried over from main bearings. Individual steel-backed precision-type bearings are locked in the end of each connecting rod replacing the single floating type formerly used for each pair

of rods. V-8 valves are precision set and periodic adjustment is not required. Valves are straight stemmed and guides are one-piece type for better heat transfer and more effective lubrication. Heat and wear resistant valve seat inserts are used at both intake and exhaust valves.

completely new body design with greatly reduced air resistance; (2) the new cooling system which permits higher engine operating temperature with consequent decrease in heat loss to coolant and a decrease in internal friction resulting from higher lubricant temperature; (3) improved

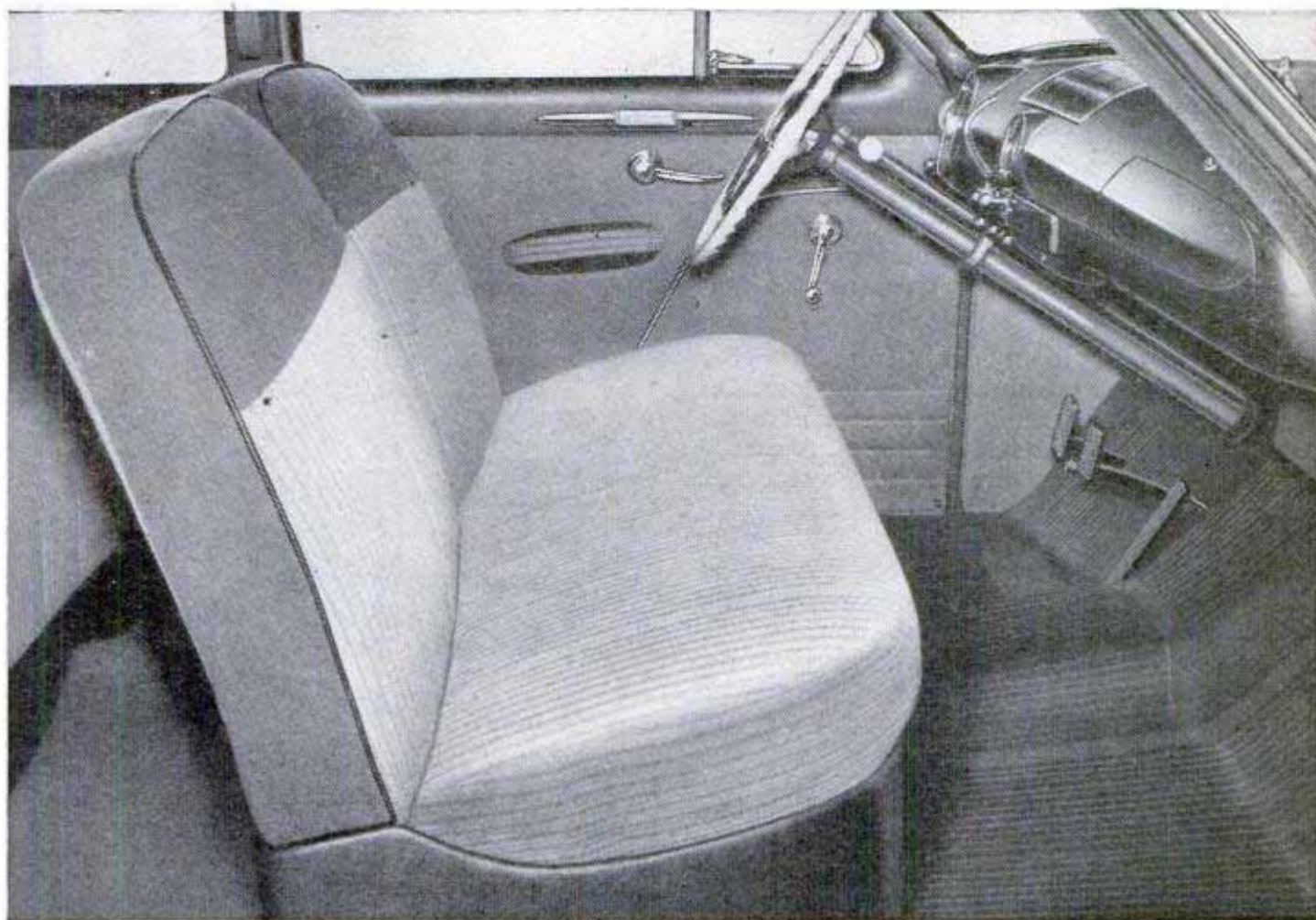

Seats are "sofa wide" and trimly upholstered in modern fabrics.

The Ford 6-cylinder engine block has been increased in height and connecting rods have been made longer with consequent decrease in side-wall thrust. Larger main and connecting rod bearings are provided. Cylinder walls are lubricated by pressure spray from a drilled hole in lower end of each connecting rod. An extra-quiet rotor type oil pump is gear driven from center of camshaft. Another innovation is provision for installing a base-mounted oil filter (at extra cost) connected directly to the engine lubrication system by drilled holes, thus eliminating all external oil lines. Valve mechanism on the Six is completely new with high-lift cams, pressed-in valve guides, and self-locking, adjustable tappets. Either the modern viscous type or the efficient new rubber type vibration damper is bolted to front end of crankshaft.

Savings in gasoline mileage of up to 10% have been achieved. The major factors responsible for this increased economy are: (1) the

manifolding with more even distribution to each cylinder; (4) new combustion chamber contours permitting high (6.8 to 1) compression without detonation even when using non-premium fuels.

Lubricating oil is forced under full pressure to camshaft, crankshaft, main and connecting rod lower bearings through passages in engine block, in both V-8 and Six. On the V-8, timing and distributor drive gears are lubricated by an intermittent pressure spray while cylinder walls, pistons, pins, valve mechanism and oil pump drive gears are lubricated by throw off from the bearings. Cylinder walls, pistons, and pins on the Six receive oil under pressure from a drilled hole in lower end of each connecting rod while timing gears, distributor and oil pump drive gears are lubricated by throw off from bearings.

The new "Equa-Flo" cooling system gives an equal flow of coolant throughout every part of the system. The high-capacity water pumps

(two on V-8, one on Six) force all coolant directly to rear of block, thence up into head and back to radiator. Turbulence is high as a result of the high velocity, improving heat transfer. Uniform temperatures are maintained with no possibility of hot spots. No special provision is required for valve seat cooling. A pressure-type radiator cap is used on the flat tube and fin-type radiator, permitting a maximum pressure of about 4½ pounds in the cooling system with a correspondingly higher, more efficient coolant temperature. Loss of coolant is practically eliminated by use of the pressure type cap. New balanced type thermostats, which are not affected by water pressure, are used on both engines for quick warm-up and a recirculating by-pass at each pump assures uniform temperatures during warm-up period.

Fuel pump on both engines operates at higher pressure, reducing possibility of vapor lock. On the V-8, pump is in center and at rear of block away from the hot exhaust manifolds. A special shield is provided on the Six to protect fuel pump from heat given off by manifold.

The generator is rated at 30 amperes at 7 volts and is air cooled. A three-way regulator maintains constant voltage, limits current output and prevents battery discharge through the generator. Ignition wiring is provided with heavy synthetic sheathing that is highly resistant to moisture, oil and ozone.

Economical Service. The new Ford engines are designed for quick, economical inspection and service. Engine accessories are positioned well above the center plane of the engine where they can be reached easily. The distributor is near the top of engine, and ignition wires are held in place by rubber grommets. A timing mark is provided at front of engine where it can be seen clearly. For quick, easy servicing of bearings, oil pump intake screen, etc., oil

SIX

Ford Six Engine.

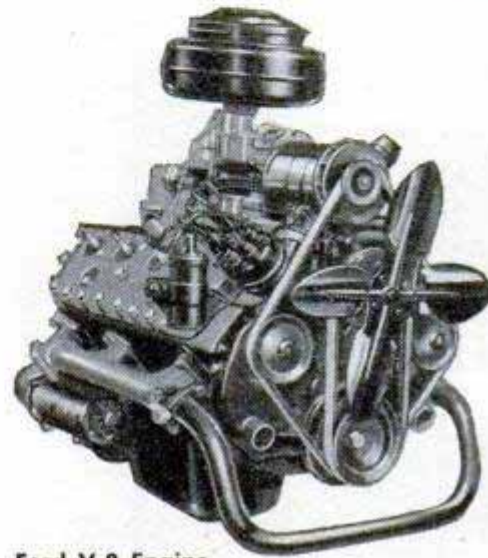
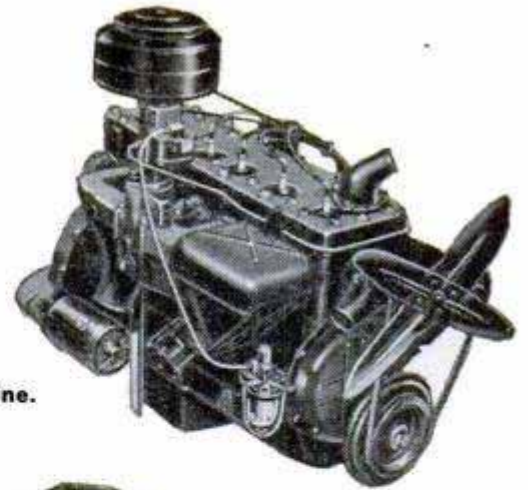

V-8

Ford V-8 Engine.

pan removal has been made as simple as possible on both engines. This careful and thorough attention to engine design, permitting easy maintenance, will be an important '49 Ford feature for both owners and mechanics.

Road lighting is provided by sealed beam headlights which can be readily adjusted both horizontally and vertically. Twin parking lamps are located in the radiator grille and dual combination tail- and stop-lights blend into the rear contour of the car. Provision is made for install-

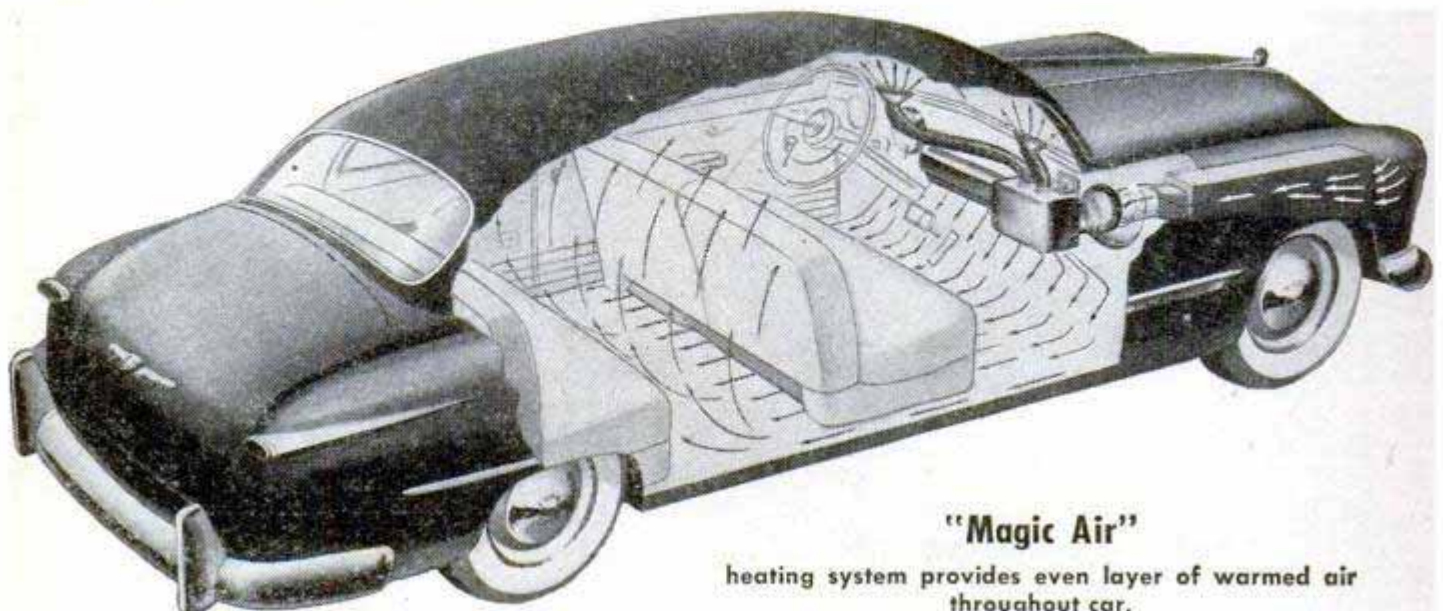

"Magic Air"

heating system provides even layer of warmed air throughout car.

Advertisement

ing directional signal indicators in the parking and taillights. The license plate is illuminated by a light in the trunk lid handle.

New Suspension. Of great interest to automobile enthusiasts is the fact that, with the introduction of the "Forty-Niner," the transverse spring suspension that has long been almost a Ford trade-mark has been done away with. The new Fords for '49 have a completely new suspension system, using "Para-Flex" rear springs and "Hydra-Coil" front springs. Both elements of the system have been carefully engineered to work in complete harmony with each other, for a balanced, cushioned ride.

The "Para-Flex" rear springs are, as the name implies, semi-elliptic leaf springs mounted parallel to the frame. Impregnated inserts between tips of spring leaves, together with concentrated pressure-type rubber bushings at shackles and brackets, make lubrication unnecessary. Rear shock absorbers are hydraulic double-acting aircraft type.

The "Hydra-Coil" front springs have double-acting hydraulic aircraft-type shock absorbers mounted inside them. This method permits the shock absorbers to be readily removed and replaced, without even jacking up the wheels, and the springs protect them from flying stones, etc.

Swinging link independent front wheel suspension is employed to permit either wheel to move up or down without effect on the other. A new, one-piece, rubber-mounted stabilizing bar across the front assists in controlling side sway of the car on curves and turns.

Frame. Serving as the backbone of these new Fords is a completely new double-drop frame, with big box-section side rails 4 inches deep and $3\frac{3}{4}$ inches wide. Two heavy gauge channel sections are welded together at their flanges to form the box-section, which extends from front suspension cross member to center of kick-up at rear axle. Weld is continuous throughout the box-section. Five cross members are used, with an exceptionally large box-section front

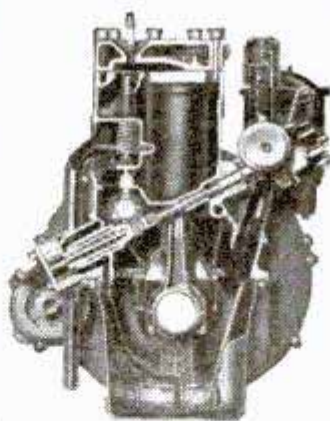

The new Ford Six engine develops 95 h.p.

suspension member. Frames for the Convertible and Station Wagon models are further reinforced to compensate for the inherent loss of body rigidity in the former and the normally heavier loads to be expected in the latter.

Another chassis change for '49 is the adoption of Hotchkiss drive in place of the former torque tube and radius rod system. In this new system all driving and braking forces are transmitted through the rear springs, giving smoother, more comfortable starts and stops, and reducing unsprung weight.

Axle Ratios. A further development is the use of a new semi-floating rear axle, with hypoid ring gear and pinion carried in an extra-strong, light-weight banjo housing. Hypoid design, together with the forward location of the rear seat, practically eliminates drive line tunnel in rear compartment floor. Single row, ball type wheel bearings are permanently lubricated. Rear axle ratio, standard, is 3.73 to 1; with overdrive, 4.10 to 1. An optional ratio of 4.10 to 1 is designed for use in the mountains. The heavier Station Wagon model has a 3.91 to 1 axle ratio as standard and 4.27 to 1 with overdrive.

The transmission of the '49 Ford is of conventional 3-speed type, with shift lever mounted on the steering column. Quiet, long-life helical gears are used in all speeds. Transmission ratios are as follows: 1st, 2.819; 2nd, 1.604; 3rd, direct; reverse, 3.625.

Overdrive. Another innovation is the availability of factory-installed overdrive transmission. The unit consists essentially of a conventional 3-speed transmission plus a planetary gear set, over-running clutch and necessary controls. The planetary gear set provides an automatic 4th speed ratio of 0.70 to 1.

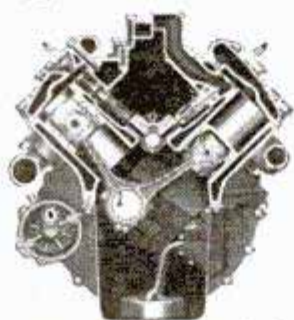

Cross section view of the new 100 h.p. Ford V-8 engine.

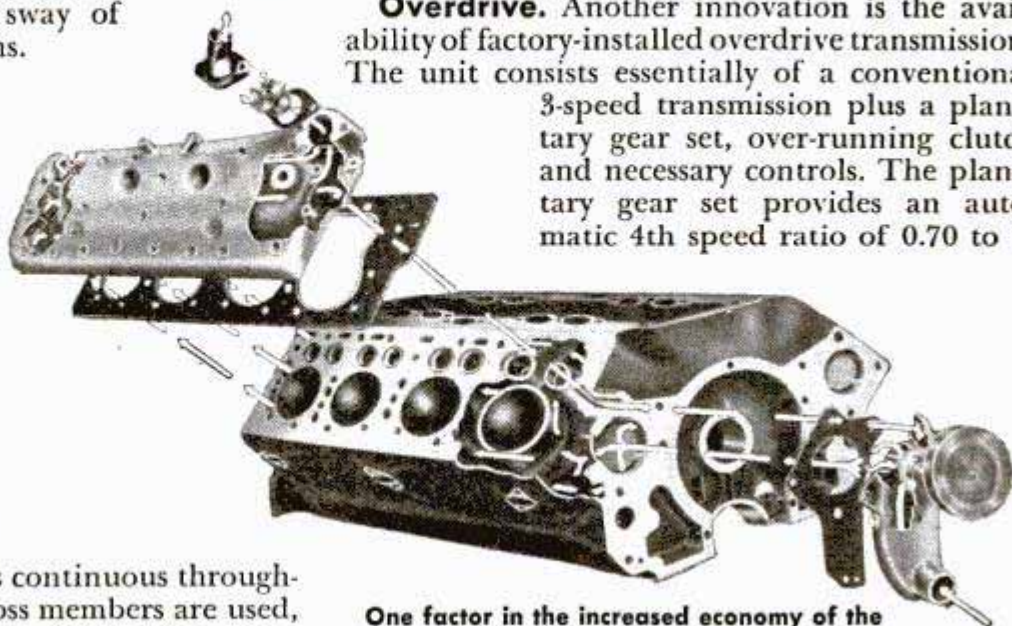

One factor in the increased economy of the '49 Ford is the "Equa-Flow" cooling system.

Shift into overdrive gear is made at any time after car reaches a speed of about 27 mph. by simply releasing accelerator pedal for an instant. Car remains in overdrive until speed drops below about 21 mph. at which speed the drive reverts to regular 3rd gear. Driver may shift from overdrive back to 3rd gear at any time by depressing accelerator past wide open throttle position. This operates a "kick-down" switch that permits transmission to shift back to regular 3rd speed automatically, to provide for faster acceleration in passing other vehicles or for better hill-climbing ability.

The rear axle ratio on cars equipped with the new overdrive is 4.10 to 1, in place of standard 3.73 to 1. With overdrive in operation,



Hydraulic brakes are "King-Size", operate with easy feather-light pedal pressure.

engine speed is 23% lower than in a car with standard axle and no overdrive. The result is smoother, quieter operation, longer engine life and a marked increase in fuel economy. The 4.10 to 1 axle provides exceptional performance for acceleration and hill climbing.

New "King-Size" hydraulic brakes with "Magic Action" touch have been developed for both series. These utilize the energy of the car's momentum to aid in applying the

brakes, thus decreasing the pedal pressure required for a given deceleration rate as much as 35%. Brake area of 177 square inches is an indication of the ample margin of safety provided for a car of this size and weight.

Tires. On all models except the Station Wagon 6.00 x 16 4-ply tires on wheels with 4½-inch rims are standard equipment and the new super balloon 6.70 x 15 4-ply tires on 5-inch rim wheels are available at slight extra cost. Station Wagons are equipped with 7.10 x 16 6-ply super balloon-type tires on 5-inch rim wheels as standard equipment.

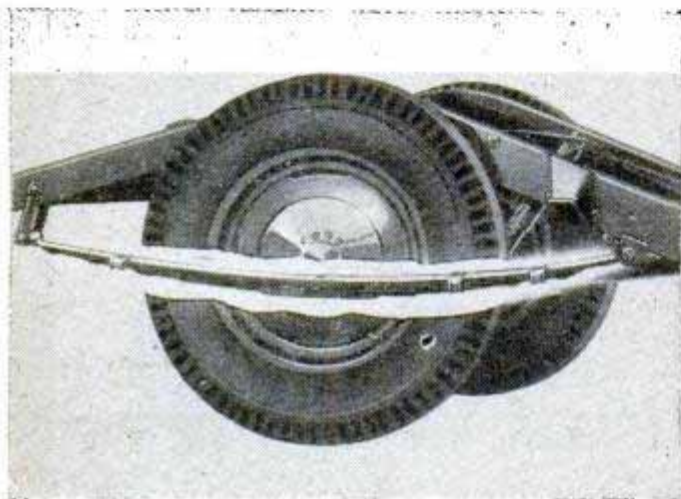

"Para-Flex" Rear Springs are made extra long, extra strong for smoother riding.

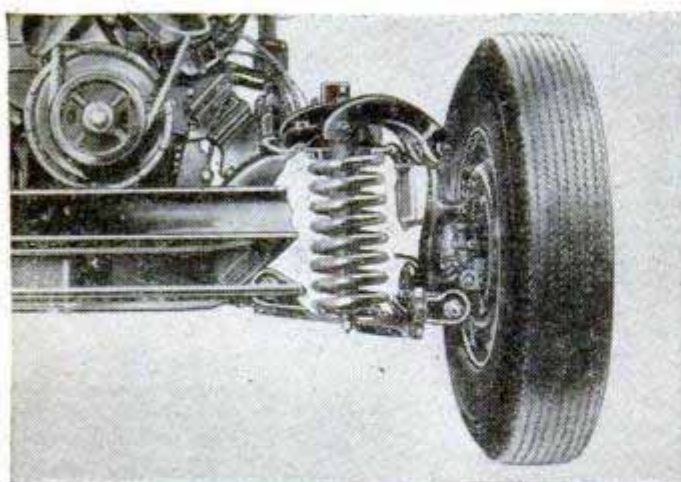

New "Hydra-Coil" Front Springs use soft-acting coils for the spring suspension.

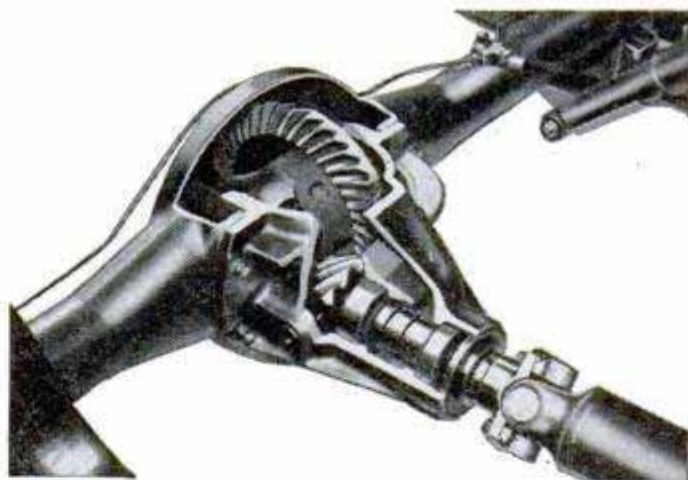

Cut-away view of new Ford axle and differential showing hypoid design.

From road to roof, from bumper to bumper, Ford for '49 makes good the promise of being the one and only *new* car in its field. And to drive one is to *know* that here is "the car of the year" —the '49 Ford.

F O R D M O T O R C O M P A N Y

Advertisement

Put the OLYMPIC SUN VISOR on Your Car Yourself!

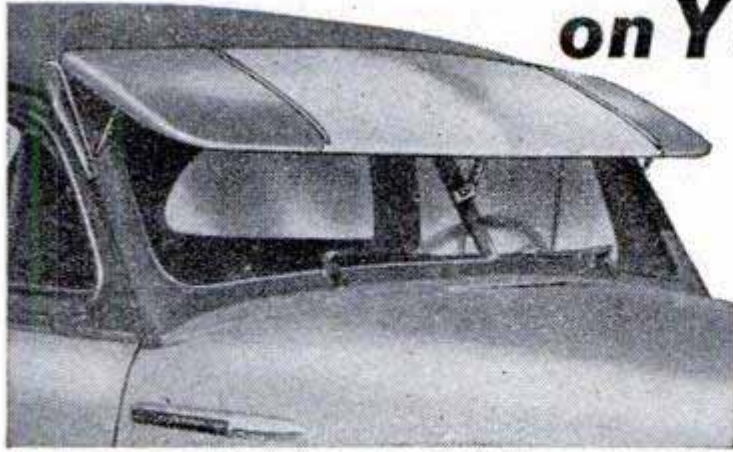

Regular price at Dealers — \$25.00, plus installation charges.

OUR PRICE **\$15.00**
F.O.B. St. Louis

DON'T DELAY. Do something about the heat—now. Fully guaranteed. Send cash—check—or money order. No C.O.D.'s please. State make and year of car.

The newest practical accessory. Keeps burning sun out of your eyes and off your body. Protects from driving rain — sleet or snow. Keeps bugs off windshield. Beautifies the car and adds to year-round driving comfort. Every car needs one. Thousands now in service on the new cars. Gives an old car that "new look."

Made of heavy gauge, full hard, airplane aluminum, die formed — with strong, press curled edges and beautiful, stainless steel brackets and ornamentation. Fits all passenger cars with divided windshields—except Hudson. Attached in half an hour—with simple hand tools.

OLYMPIC PRODUCTS • • St. Louis 6, Mo.

NONE BETTER! SUPER DRILL GRINDER



Sharpens round shank drills from 3/32" to 1-1/16" in diameter, up to 11" long. Grinds old drills like new in 4 different point angles, using hand or power grinding wheels. Money-back guarantee.

Price only \$2.95

At Dealers or Postpaid

CRANDALL MFG. CO. 1512 W. Slauson, Dept. FA-32, Los Angeles 44, Calif.

ASSEMBLE YOUR OWN BOAT

FROM PRE-CUT AND PRE-ASSEMBLED PARTS

Save 50% — Build from our complete, easy-to-assemble Plywood Kits. 16 Models to choose from, all parts pre-cut, frames pre-assembled. Finest designs (8 to 18 ft.)—Exclusive features—Outstanding performance.



8 ft. Dinghy \$34.50
14 ft. Super-Deluxe \$128

\$34.50 up.

SEND 25c (COIN) FOR ILLUSTRATED LITERATURE. MARINE MART, BUFFALO 7-B, NEW YORK



ZIPSCOOT \$49.75

America's Outstanding Scooter Value! This smart looking speedster is easily and quickly assembled from our factory finished kits. Uses standard gasoline motor. Speeds up to 30 miles per hour. 100 miles per gallon of gas. Send 25 cents for assembly information, drawings, and illustrations. Kits available for immediate shipment.
Zipscot Company, Toledo 6, Ohio



MILL IT...ON YOUR LATHE!

PALMGREN

MILLING ATTACHMENT

3 SIZES

No. 250 Illustrated

2 1/2" JAW \$24.75
Only

CONVERT LATHE IN 10 SECONDS



Now you can Mill, Slot, Grind, Groove, Square Shafts, Saw at Angles, Recess and many other important jobs SAVE TIME and MONEY! Why send work out or use costly methods when a PALMGREN MILLING ATTACHMENT will solve your problem.

Precision built, it has accurate graduations for rotary angle adjustments, also graduated vertical feed screw. Fits South Bend, Atlas, Craftsman, Logan, Sheldon and all other lathes. Thousands now in use in small and large machine shops, repair shops, railroads, schools, home work shops, etc. ORDER SIZE NEEDED TODAY!—It will quickly pay for itself.

IMMEDIATE DELIVERY

Nos.	Width Jaws	Depth Jaws	Jaws in. dia.	Weight Pounds	Fits Tool Post	Price F.O.B. Factory
150	1 1/2"	1"	1 5/8"	6 1/2	1" Dia.	\$18.75
250	2 1/2"	1 7/16"	2 1/2"	11	1 1/4" Dia.	24.75
400	4"	1 1/2"	4"	25	1 3/4" Dia.	39.75

Order From Your Dealer or Jobber; Write for Circular No. 351
Mrs. of PALMGREN PRODUCTS Since 1915

CHICAGO TOOL and ENGINEERING CO.

8365 South Chicago Ave. Chicago 17, Ill.

JUST A FEW OPERATIONS YOU CAN DO ON YOUR LATHE!

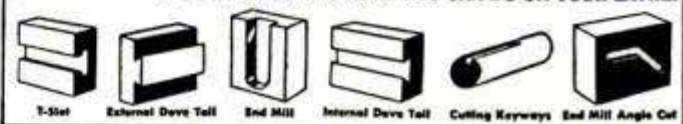

HEAR BETTER or Pay Nothing!

This is all you wear
\$75⁰⁰
Complete



MAIL COUPON
BELOW FOR NEW

Zenith "75"

THE HEARING AID THAT NEEDS NO "FITTING"

Sold Only by Mail
...Money-Back Trial!

Wear the New Zenith "75" at home, at work, anywhere. If it isn't better than you ever dreamed ANY hearing aid could be, return it within 10 days of receipt and Zenith will refund your money in full.

This amazing instrument employs an advanced principle that eliminates the need for "fitting"—enables you to adjust instantly for your best hearing in any surroundings. (Recently confirmed in U. S. Government-sponsored research at Harvard University).

SAVES YOU OVER \$100, TOO! Because the New Zenith "75" comes to you by mail, it saves you embarrassing visits to salesrooms and annoying sales pressure. Also saves you distributor and dealer profits and high-pressure sales commissions that would make this top quality instrument sell for \$195, instead of \$75. So do as tens of thousands have—take the first step toward new happiness and success. Mail the coupon today!

NEW ZENITH RADIONIC HEARING AID

BY THE MAKERS OF ZENITH RADIOS

Look only to your doctor
for advice on your ears and hearing



MAIL THIS COUPON TODAY

Zenith Radio Corp., Hearing Aid Div., Dept. PM88
5801 Dickens Avenue, Chicago 39, Illinois

I enclose check or money order for \$75* for one Zenith "75" Hearing Aid. Unless I am completely satisfied and find the Zenith "75" superior to any other hearing aid, I may return it within ten days of receipt and get my money back in full. *Plus tax of \$1.50 in Illinois or New York City; \$1.88 in California, except Los Angeles, \$2.25.

Please send details of convenient time payment plans.

Please send free descriptive literature.

Name.....

Address.....

City.....State.....

Eastman Kodak has a process by which drawings are transferred photographically to metal, rubber, plywood, certain other woods and many plastics. The whole process takes eight minutes and can be done in normal room lighting.

If you'd like to try printing photographs on various materials, what you'll need is palladium. Such work can be done on any surface porous enough to absorb a thin solution of palladium chloride.

Palladium has 80 degrees of gradation between black and white, as compared to the five of silver, giving it much greater subtlety and flexibility. The palladium does not lie on the paper, as does silver, but soaks in, and with it contact prints can be made in ordinary light using a fluorescent lamp or some other source of ultra-violet light.

What these new developments will do to the fabric and pottery industries is still uncertain. As for you, the consumer, don't be surprised if you find a photograph of yourself decorating your napkin when you sit down at the dinner table some day in the near future.

Rebuilding the Silent Service

(Continued from page 109)

those of unimproved submarines. The streamlining program includes removal of deck guns and other topside appurtenances, reducing the size and smoothing out the contours of the superstructure, and reshaping the bow. Improved breathing tubes are installed on 11 submarines.

Two other wartime undersea vessels have been classified as radar picket submarines for development of radar scouting techniques both for normal ocean climates and under arctic conditions. Undoubtedly part of the research program is to develop ways of raising radar equipment to the surface from a submerged vessel to follow movements of surface ships.

Still another submarine is being used for underwater-transport research. Both the Americans and Japanese put submarines to this use during the war and the idea was so valuable that methods of carrying large cargoes or groups of men underwater are being investigated.

More than usual secrecy surrounds an experimental submarine that is designated by the symbol SSG and is classed as a guided-missile submarine for studies in that field. The Germans had visions of rockets that could be launched from a submerged ship and that would travel up through the water, emerge into the air, and

(Continued to page 244)

A TOOLSHOP IN YOUR HAND

There's Only One Genuine Handee

First tool of its kind—today's finest. Smooth, steady power at your fingertips. Easy to handle. Make ship, plane and train models, bookends, costume jewelry. Grinds, drills, polishes, routs, carves, sands, saws, engraves on metal, wood, plastic, glass, leather, etc. 25,000 r.p.m. AC or DC. Wt. 12 oz. With 7 accessories \$20.50. In case with 40 accessories \$27.50. At stores or sent postpaid. A fine gift for a friend or yourself. CHICAGO WHEEL & MFG. CO., 1101 W. Monroe St., Dept. PM, Chicago 7, Ill. Free 52-page manual.

HANDEE TOOL OF 1001 USES

AUTOMATIC SAW SET

HAND AND BAND SAWS

Set Saw TEETH Automatically—400 per minute without effort. Perfect hammer and anvil action sets teeth uniformly—tensions metal. No tooth breakage. Write today!

Retooth Saws Automatically—with Burr Retooler Cuts new teeth in 50 seconds—any size 4 to 16 points. Old teeth fall off as chips. Easy to operate. A perfect job. Write for literature on Circular Saw Sharpener.

VALUABLE BOOK

Order Burr's Blue Book of Coast to Coast Prices for Saw Shop Services. **25c**

BURR MFG. COMPANY

8933-U Venice Blvd.
Los Angeles 34, Calif.

Say You Saw It in Popular Mechanics

MAKE up to 600 an hour DO RUG WEAVING AT HOME!

Start your own business at home weaving rugs, carpets, etc. The DEEN ALL-WEAVE LOOM turns out 2-3 rugs every hour. No experience needed. Ideal for handicapped people. Small investment gets you started. Write today for FREE booklet.

THE GIBSON COMPANY

.23 Gibson Building Lake Ozark, Missouri



For nifty, thrifty shaves...

STROP YOUR RAZOR AS A BARBER DOES!



use



NEW VALET Auto-Strop RAZOR

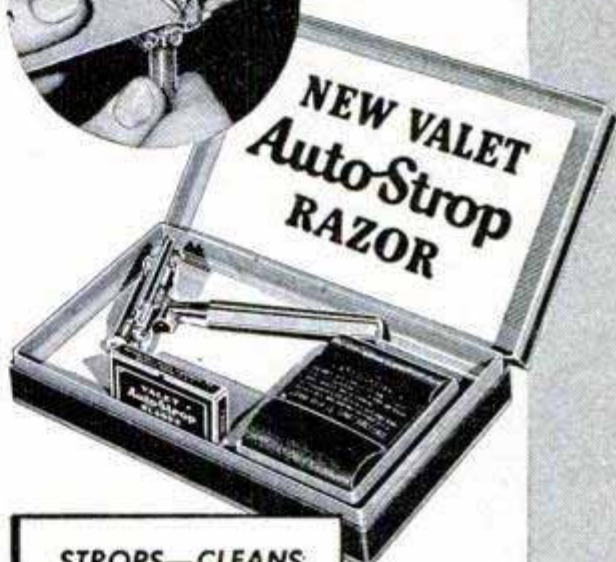

STROPS—CLEANS WITHOUT REMOVING BLADE

RAZOR, STROP AND 5 VALET BLADES

\$1.25

SELF-SHARPENING . . . ONE PIECE

WRITE FOR YOUR **FREE** COPY OF THE NEW **KRW HYDRAULIC PRESS BOOK**

Describes all manner of Production and Shop Work on KRW Hydraulic and Bench Type Arbor Presses. 32 pages illustrating the new KRW Hand-operated, Electric-operated and Air-operated Hydraulic Presses.

Write for your copy today.



K. R. WILSON, DEPT. 17, 215 MAIN ST., BUFFALO 3, N. Y.
Builders of Shop Equipment for Ford Dealers Since 1916

Choose one of these "PROFIT MAKERS" for success in Arc Welding

1 Your own electric power plus arc welding!
AC-AC Generator Only for building your own portable. AC welder—AC power plant.



2 AC-AC Gas Drive—200 amp arc welder and stand-by power unit.

3 Industrial AC—arc welder for heavy duty welding.

4 AC Welder—designed for shops with single phase power supply.

5 Electric Drive—for production and maintenance welding.

6 Generator Only—for "building your own" portable gas engine welder.

7 Welder & Power—A welding generator with 1 to 3 KW aux. D. C. power.

8 Gasoline Engine Drive—arc welder for heavy duty welding in field.

9 Weldmobile—the complete portable welding shop, for any welding job.

10 Gas Drive Welder—with DC Power to handle welding and furnish Electric Power.

11 Gas Drive Arc Welder—with Auxiliary DC Power Generator for welding and power.

12 Hobart Trade School—most modern and efficient available. Non-profit. Covers all welding.

13 free! "Vest Pocket Guide"—contains useful data for weldors. Charts, symbols, etc.

HOBART BROTHERS COMPANY
BOX M-88, Troy, Ohio

HOBART...

HOBART BROS. CO., BOX M-88, TROY, OHIO
"One of the World's largest builders of Arc Welders"

Without obligation send me complete information on the items I've checked by number.

1 2 3 4 5 6 7 8 9 10 11 12 13

NAME _____

ADDRESS _____

CITY _____ STATE _____

continue on to a target. This ideal weapon seems hardly practical as yet but serious efforts are being made to work out techniques for launching medium-sized missiles from decks of surfaced submarines.

Methods for stowing large cargoes of missiles on a sub are suggested by other studies being made in adapting the submarine to aircraft-carrier duties. The Japanese had subs that carried four small aircraft in cylindrical hangars on deck. Launched by catapult, each plane had a 1500-pound bomb load. Range was limited and the plane was not recovered, being crash-landed alongside the submarine so that the pilot could be picked up. Presumably the present flat deck of a submarine can be housed over to provide space for shore-bombardment rockets, guided missiles, or piloted or pilotless aircraft.

New systems of underwater propulsion are an intriguing subject and some people predict that the first installation of an atomic power plant for vehicular use will be in a submarine. Presumably the energy would be used to create steam for operating ordinary turbines. The sub would be capable of operating almost indefinitely underwater at speeds that are attained now only on the surface. Underwater endurance, in fact, would be limited only by the oxygen, food, and health requirements.

At the end of the war the Germans had designed an undersea boat that could do 25 knots, submerged, using as a power plant a special gas turbine that burned kerosene or fuel oil plus hydrogen peroxide. The hydrogen peroxide provided the oxygen needed for combustion. The idea never got into production, for one reason because a tremendous tonnage of hydrogen peroxide would be needed.

Pending the time when atomic power plants are actually built and put to use, the search is still going on for efficient fuels that require no air for combustion.

Do We Need Synthetic Oil Now?

(Continued from page 78)

the project no longer remunerative, petroleum has been recovered by mining and drainage to an additional 40 percent of the original sand content where only 20 percent had been obtained from wells on the surface." In other words, where originally 80 percent of the oil was left in the ground after pumping was discontinued, the mining and draining method recovered twice as much as had been produced by drilling. So, instead of 80 percent being left underground, now there is only 40 percent.

(Continued to page 246)

NOW YOU CAN DRILL YOUR OWN WELLS!

Sturdily Made—Hundreds of satisfied customers. Purchased and used by U. S. Dept. of Agriculture, U. S. Navy and many foreign countries.

Fully Guaranteed
Price Complete
\$385.00

Less Motor
F.O.B. Factory
Price includes drill, bailer and 100' cable. 200 ft. of additional length available at extra cost.



Drill your own wells for that needed water—as many as you need—outside—in the cellar—in the barn. The new improved CONSOL Driller—1948 Model—is equipped with a special replaceable Drill Head. It will drill through many feet of solid rock without re-sharpening. Simple to operate, easy to set up. Do the work yourself at small cost.

We offer 3/4 H.P. Electric Motor or 1 1/2 H.P. Gas Engine to operate the "CONSOL" Well Driller at 38 strokes per minute.

Write for free illustrated booklet.



CONSOLIDATED INDUSTRIES
West Cheshire, Conn.



BUILD YOUR OWN 2500 WATT ELECTRIC LIGHT PLANT

All you need is an electric generator; a small engine to drive generator at proper speed; 2 dual sheaves; 2 V-belts; and a welded angle iron base. No wiring is involved, and you do not need to know anything about electricity to make this assembly.

Start out by buying the 2.5 KVA Leland Alternator shown above. It is a 120 volt, 60 cycle, single phase, A.C. generator, complete with radio filter box, and self regulating voltage. It must turn at 1800 r.p.m. for bright, even lighting. Requires 3 1/4 H.P. to turn generator at full load—so buy an engine of at least 6 H.P. to have plenty of reserve.

We will ship you the GENERATOR ONLY, without pulley or belts, for \$125.00 freight prepaid. If your needs are urgent, we will assemble your set, using above generator and a 6 H.P. Salsbury gasoline engine, manually started, governor controlled, and ship to you \$297.00 freight prepaid. Same unit but with Ensign conversion to run on natural gas \$347.50 freight prepaid.

To eliminate time lapse for personal checks to clear, we suggest remittance by bank draft or cashiers check.

HOPFER & COMPANY
3124 EAST 14TH STREET, OAKLAND, CALIFORNIA

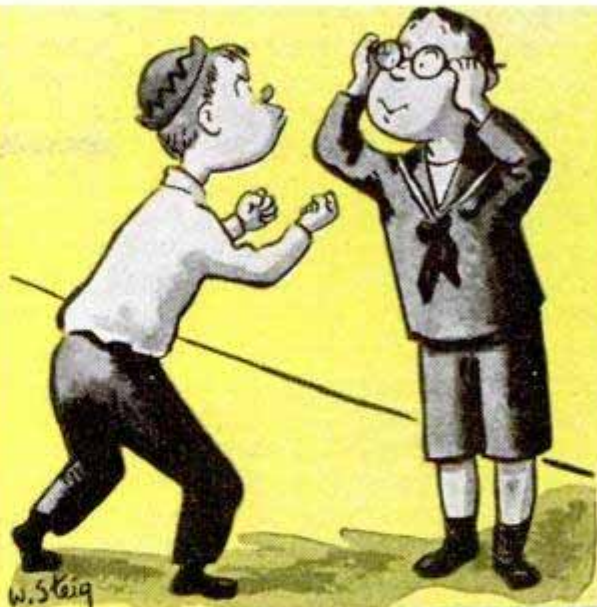

What's Extra Protection Worth to You?

★ Casite gives you extra protection and cuts engine wear because it improves lubrication. No matter what kind of motor oil is being used, Casite gets it around—quickly and into the tight spots. Casite retards formation of sludge and gum . . . keeps your motor clean and free-running . . . guarantees Better Motor Performance or Double-Your-Money-Back.

Get Casite today, from your garage, service station or car dealer. The Casite Corporation, Hastings, Michigan, and the Casite Division, Hastings Ltd., Toronto.

75¢ A PINT
95¢ IN CANADA

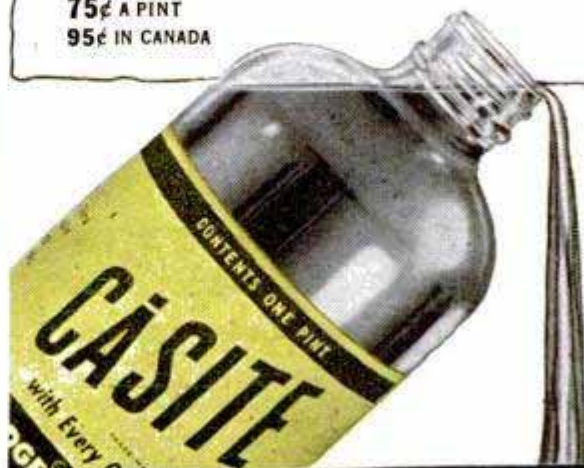

IMPROVES LUBRICATION CUTS ENGINE WEAR

The same process is being used successfully in the Higashiyama fields of Japan. These fields produced 156,710 barrels of crude in the first six years from a series of drainage galleries and crosscuts that divide the sand into rectangular blocks.

In the United States the same technique could be expected to produce better yields per cut especially in areas where the residual content of reservoir sand is much greater than in Japan.

According to recent estimates the capital investment required to set up synthetic-oil plants capable of producing 2 million barrels a day—the target set by governmental advocates of the program—would range anywhere from 20 to over 30 billion dollars. These figures, for plant construction alone, are greater than the total amount invested in our entire petroleum industry. And this industry is now producing, refining and transporting 5½ million barrels of oil daily, or almost three times the hoped-for production from coal and shale.

Not only would the synthetic program require huge amounts of money, it would also require more coal than it is possible to mine today without vast expenditures for equipment and manpower in the mines. Nor does the estimated figure include the

cost of transporting the raw materials and synthetic oil. It doesn't include the cost of housing for the employees required to run the complex plants built in out-of-the-way places. Complete new cities would have to be built around the plant sites.

The government has set aside 60 million dollars for research in the development of commercial synthetic-oil plants, and oil and coal companies are also spending many millions. This is proper procedure. By such investigations we can get the knowledge needed to design, construct and operate commercial plants economically. It is premature to build large plants until we have such knowledge.

One phase of the synthetic-oil program that is commercially practical today is the one using natural gas as the basic material. Two such plants are being built, each of which will produce 7000 barrels of gasoline and Diesel oil a day. In addition, each plant will produce daily about 400,000 pounds of chemicals such as alcohols and fatty acids. The synthetic oil from these plants will be competitive with crude products at today's prices whereas the proposed coal and shale synthetics could not compete on the market if produced by processes we know of at this time.

The synthetic-oil processes as planned

(Continued to page 248)

The Original HOLLYWOOD WOLF WHISTLE

THE CAR HORN WITH THE
VOICE OF AUTHORITY

CAR HORN

\$4⁰⁰



ORDER
TODAY!

Give the
WOLF CALL

DESCRIPTIVE
LITERATURE
ON
REQUEST

Send \$4.00 cash, check or money order. Postage Paid.

Yoder Manufacturing Co.
7403-21J East 103rd Street, Los Angeles 2, Calif.

Gentlemen:
Please send me at once, Postage Paid _____
Original Hollywood Wolf Whistles. I enclose
\$ _____ Cash _____ Check _____ M.O. _____

My nearest Dealer is _____

His Address _____

Name _____ Address _____

City _____ Zone _____ State _____

I may return the Hollywood Wolf Whistle within 5
days and have my money refunded if not completely
satisfied.



You too can become a Hollywood Wolf. Give the wolf call and make other weird noises with the Original Hollywood Wolf Whistle on your car. Precision made. Works off the intake manifold. Easily installed in 15 minutes. Works in automobiles, trucks, motorcycles, motorboats, outboard motors. Money back guarantee.

If your dealer cannot supply you, order today by mail, giving us your dealer's name. No COD's or stamps. No individual foreign orders. Send \$4.00 cash, check or money order. Postage Paid.

DEALERS & JOBBERS

write for information on this fast selling proved item.

YODER MFG. COMPANY

2403-21J East 103rd St., Los Angeles 2, California

SOMETHING NEW!

ELECTRICITY Controlled Economically

THE FAMOUS INFINITE CONTROL

THE ACME OF WAR TIME ENGINEERING



Cost Over
1/4 Million \$
to Develop

First Time
Offered the
Public

This is not a Rheostat, but a highly engineered, scientific wartime development, designed for controlling any desired amount of heat from 1% to 100% of the unit connected.

Controls 4-11 Amp., 240V. Circuits or 4-22 Amp. 115V. circuits, 60 cycle, A.C. Hot Plates, Elec. Irons, Soldering Pots, Ovens, Glue Pots, etc. Also Controls any other electric device where intermittent service is desired, such as signs, conveyors, pumps, fans, motors, stop and go signs, signal systems, Electric ranges, water heaters, etc.

Designed to sell for \$32.50. Mass production makes it possible to offer this ingenious electric device for only Fully guaranteed, easy to install, comes complete ready for use.

\$14.60

Postpaid

Send checks or Money Order now. No COD.

T & H ENGINEERING SERVICE COMPANY

KIRKLAND, ILLINOIS



SAVE TIME, WORK, MONEY!

SHAW "DU-ALL"

and "PEPPY PAL" TRACTORS

These rugged walking or riding tractors are ideal for farm, truck garden, orchard, poultry farm. Operate on a few cents an hour. A child can handle them.

DO DOZENS OF JOBS Both riding and walking tractors quickly and easily plow, cultivate, harrow, disk, bulldoze, spray, haul, grind, saw wood, etc. **LOW FACTORY PRICES** Buy direct or through your dealer. Year's guarantee!

RIDING TRACTORS 4 models from 5 to 12 1/2 H.P., 58 in. wheelbase, 36 to 52 in. wide, 24 in. plant clearance. Hand or electric starter. Walking Tractors 1 1/2 to 3 H.P.

FREE Illustrated folders giving complete details and price lists—write today!

4508 FRONT ST., GALESBURG, KANS.
6686 NORTH 4TH ST., COLUMBUS, O.

**SHAW
MFG. CO.**

SEE IT! TRY IT!

"Lincwelder"
180 AC
Accessories
as shown,
\$19.00



PRICE

\$150

FREIGHT
PREPAID

NEW LOWEST-PRICED WELDER

for World's Easiest Welding

For Repairing, Hardfacing Building Equipment

Easy to weld. Arc striking is now automatic. The instant the electrode touches the work, "Lincwelder's" exclusive "Arc Booster" blasts the end of the electrode with an extra burst of welding current to start the arc. Eliminates electrode sticking and bothersome scratching formerly needed to get the arc started.

Ideal for rural power lines and for use on farms. Draws less than 37 amps. when welding at 180 amps. Approved by power companies and REA. Safe to operate. Open circuit voltage never exceeds 52 volts.

Lowest priced welder. Has many high quality features found only in Lincoln industrial welders . . . yet sells for only \$150 . . . lowest cost of any welder of its capacity.

Full details in Bul. 370. See your local Lincoln Welder or write The Lincoln Electric Company, Dept. 333, Cleveland 1, O.

For Faster Drilling-- Finer Workmanship...



This Husky Drill Tops 'em All!

From the first time you pull its trigger switch and feel its surge of power, this Home-Utility 1/4" Drill will click with you! You'll use it to turn out better work at top speed—drilling holes; driving attachments for sanding, grinding and buffing—in everything from building furniture to repairing appliances. It's a *real tool*, with ample motor, husky housings, full-size gears and bearings. You can count on its top-notch performance because it's well-built by BLACK & DECKER, world's leading maker of quality electric tools for 37 years. And at only \$18.95, it's a buy that's too good to pass up. Order your 1/4" Drill and other Home-Utility Tools from your hardware, electrical or implement dealer.

ELECTRIC HOME-UTILITY TOOLS

Products of THE BLACK & DECKER MFG. CO.
Dept. H8M, Towson 4, Maryland



in ceramics

AC's new *patented* aluminum oxide insulator material is another "first" in the manufacture of spark plug ceramic insulators. As early as World War I, AC developed the *first practical ceramic aircraft spark plug*, for Liberty engines. It was perfected and ready for World War II—and its ceramic aluminum oxide insulator material was used in spark plugs exclusively by American war planes.

Now you can have that same patented aluminum oxide insulator material in AC Spark Plugs especially designed for your car, truck or tractor engine—plugs that can take terrific punishment—plugs whose wider Heat Range adapts them to a wider range of engine temperatures. For easier starting—better idling—steadier firing under heavy load, buy AC's. They give you *utmost reliability*.

= Al_2O_3

AC
SPARK PLUGS

today will produce largely internal-combustion-engine and heating oils. These oils are not true petroleum. Oil from shale is equivalent to a low-grade crude oil. Lubricating oil can be produced from natural-gas synthetic products by the use of expensive secondary processes.

The best way for this country to assure itself of petroleum is to increase exploration for new fields, to develop new ways to increase oil recovery, to develop the vast oil deposits of the continental shelf and to explore the possibilities of new methods of secondary recovery.

In the U. S. tideland oil fields alone, which are those beneath the coastal waters, there are now an estimated 100 billion barrels of crude oil or roughly 50 years' supply at the present rate of consumption. In addition, we have in the United States proved reserves totaling another 13 years' supply. Together these reserves assure us 63 years' supply of oil at the current rate of use. Then, in addition, there are billions of barrels of oil in the proved reserves of South America which are available to us. These reserves do not include the vast oil fields of the Near East.

These proved reserves do not include new quantities of oil still to be discovered in the United States. Every year we find new reserves and there is no reason to assume that we won't find more next year and for years to come. Extensive deep-drilling programs are in progress to test the possibilities of oil production at levels below 15,000 feet underground.

There are other facts that brighten the future of oil. Many power plants and steam engines began burning oil instead of coal when residual fuel oil, left after the refining process, was sold at extremely low prices. The oil industry at that time was selling this oil at a price below its cost from the crude.

Today, the industry can process this residual fuel oil by hydrogenation so that it is converted to more gasoline and higher-valued products by volume than the original amount used. For every 100 gallons of residual oil processed, over 105 gallons of gasoline can be produced. In 1947, for example, the production of residual fuel oil was 448 million barrels. If processed into gasoline, this would have provided more than 460 million barrels or more than 55 percent of our total gasoline production for 1947.

If all this residual oil were refined—and it is not the same oil you burn in your furnace at home, that is a distillate product, not residual oil—we would have a

(Continued to page 250)

Practical
Science + experience = **PERFECTION**
Oil Burning HOME HEATER

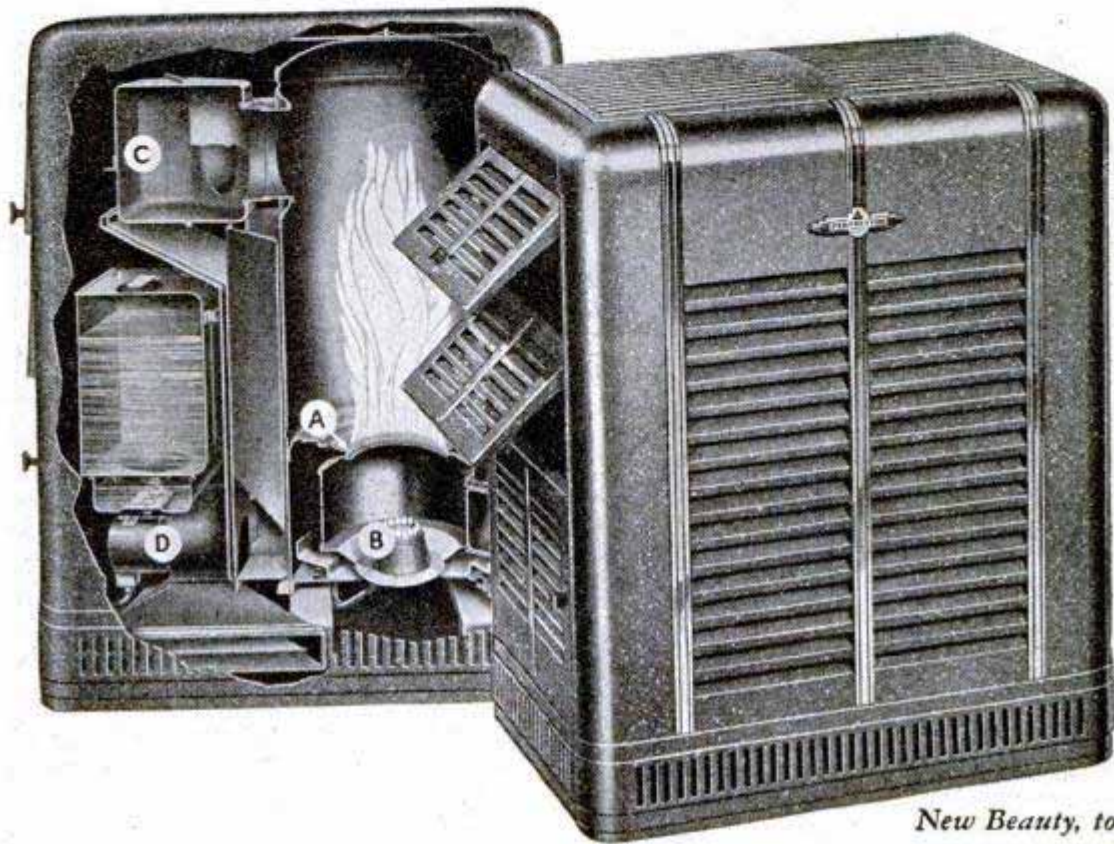

New Beauty, too.

NEW "Multi-Heat" burner (A) balances heat output to actual needs. SAVES FUEL.

NEW midget pilot (B) burns for hours on a cup of oil. SAVES FUEL.

NEW heat extractor (C) between fire-chamber and flue, collects heat that would otherwise go up the chimney.

NEW "Floor-Flo" circulating blower (D) (not just a fan) puts heat where it's needed. SAVES FUEL.

AUTOMATIC CONTROLS, of course. Combined with multiple stages of heat, plus *real pilot*, they assure most comfort with least oil in cold or mild weather. SAVES FUEL.

Designed and proved in Perfection's own Research Center, most complete in the industry. Backed by Perfection's 60 years' experience in making oil-burning equipment for the home.

Write today for Perfection Heating Booklet.

new **PERFECTION** *Oil Heater*

Made by PERFECTION STOVE CO., 7036-A PLATT AVE., CLEVELAND 4, OHIO

Manufacturers of Ranges, Cook Stoves, Heaters, Water Heaters, Winter Air-Conditioning Furnaces

ATLANTA • CLEVELAND • CHICAGO • JERSEY CITY • KANSAS CITY • OAKLAND • ST. PAUL

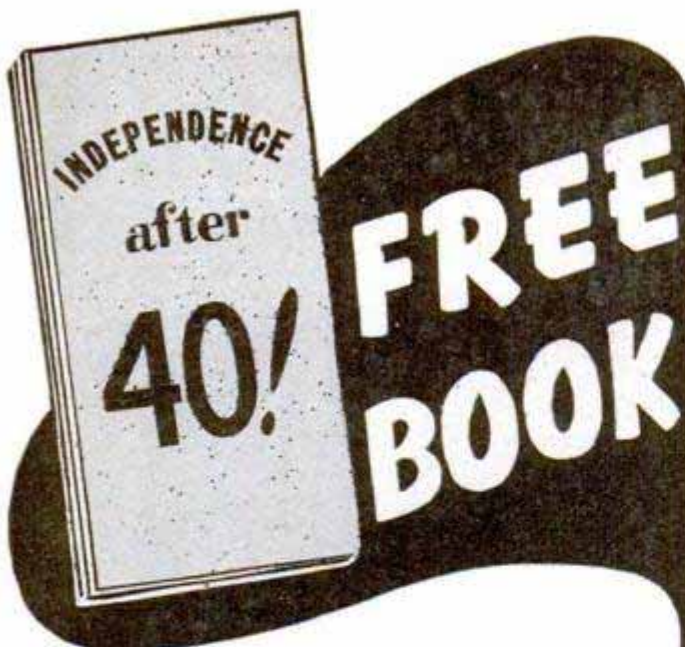

Shows how to win Independence after 40!

Do you dream of independence and freedom from money worries for yourself and your family? The best way to become independent is to have a business of your own. This FREE book "INDEPENDENCE AFTER 40" shows you a proven, practical, profitable way to start in spare time, with a necessary service in every community—sharpening saws with a Foley Automatic Saw Filer.

Start your own Business with SMALL CAPITAL

Here is a steady, repeat CASH business you can start in your basement or garage, with a modest investment and no overhead expense or stock of goods to carry. Machine saw filing pays up to \$2 or \$3 an hour — it is easily possible to make \$20 to \$30 a week or more in spare time. There are thousands of saws in every community to keep sharp. This business is a money-maker in both large and small towns.

"INDEPENDENCE AFTER 40" shows you how to get plenty of saws to file without canvassing, and after you get a start how you can develop into a general repair shop business also sharpening lawn mowers, skates, scissors, making keys, repairing vacuum cleaners, etc. Other men have made themselves independent—you can too! The way to do it is all planned out for you in this practical book—send for your free copy today!



Send Coupon for FREE BOOK

FOLEY MFG. CO., 816-8 Foley Bldg.,
Minneapolis 18, Minn.

Send me free book "INDEPENDENCE AFTER 40!"

Name _____

Address _____

greater supply of gasoline than could be sold on the present market.

Fuel oil should not be used for firing large power plants. The logical fuel for such use is coal and as residual oil prices increase because of its higher value as gasoline, such users may have to change back to coal. When this happens, enough oil will be available for processing so that we will have more than enough motor fuel. The supply of this residual oil is tremendous since about 25 percent of the crude oil run becomes residual oil.

Converting coal into synthetic oil results in a loss of 60 percent of its original heating capacity with present methods of synthesis. These processes require heat to produce the end products leaving only 40 percent of the total BTUs of the original coal in the synthetic oil.

Research in the coal-burning field will develop more efficient use of the tremendous power of coal. Burning powdered coal in gas turbines is an example of such progress. To convert coal into oil and then have only 40 percent of its value left is not the economical way to use our resources.

What about the use of atomic energy as a means of providing heat for power plants instead of burning oil? This is a definite development of the future and it promises to provide, in 25 years or so, enough energy to alleviate some of our fuel problems.

This, then, is what the experts in the oil industry say about the synthetic-oil program. We should continue our research in the field, but it is too soon to consider investing billions of dollars in something that is still not adequately investigated. We should make sure we have the right answers to economical production before we go ahead with plans for commercial plants. We have time for careful study—there's enough oil in the ground for at least another 100 years.

Camp in Comfort

(Continued from page 130)

small weight and bulk. One that has a sewed-in floor, 8 feet square, will sleep three men comfortably and provide space for their duffle. The tall, peaked roof provides headroom and sheds heavy rains very well. In the usual waterproof material, this tent will weigh, with a three-joint center pole and four corner poles, only about 20 pounds. Made with heavy, unbleached muslin, thoroughly waterproofed, a lighter model weighs only 15 pounds. Ideal for the "go light" automobile camper, the pyramid tent is also one of the

(Continued to page 252)

Snap-on

Bench Grinders

With the famous **Blue-Point** Trade Mark

... have the construction features that guarantee smoother, more powerful operation

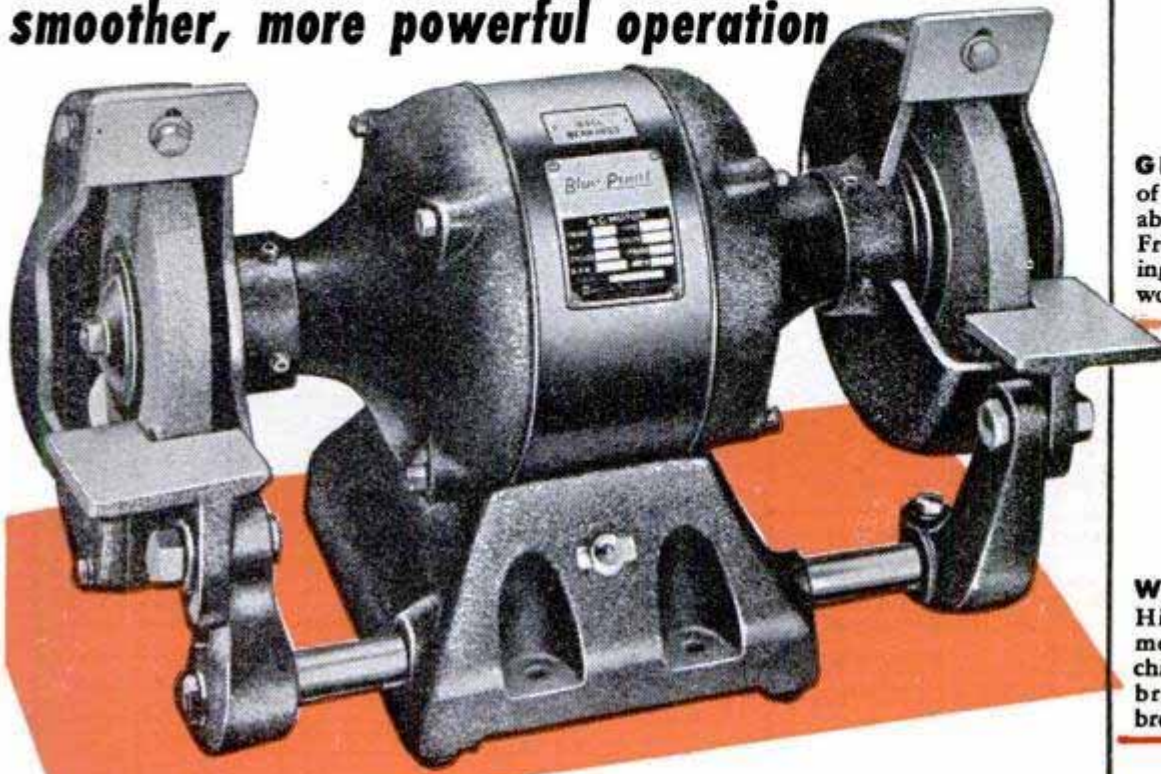

GRINDING WHEELS
of natural aluminous oxide abrasive . . . fully vitrified. From 60 grit for fine grinding to 24 grit for heavy work.



WIRE WHEEL BRUSHES
High quality wire and metal, bound to prevent chips flying loose. Crimped bristles cannot bend or break.



WHEEL DRESSER
Quickly trues, cleans grinding wheels. Protective hood over cutters. Includes extra set of easily inserted cutter wheels.



EYE SHIELDS
Thick safety glass for clear vision, protection. Sturdy aluminum frame. Easily attached to grinder.

LARGE WHEEL GUARDS: Allow use of special shape grinding wheels or wire brushes. Guards fitted with chip breakers.

BELL TYPE CONSTRUCTION: Provides full clearance so that long straight pieces may be ground across the face of the machine.

STURDY TOOL RESTS: Adjustable for any type of work with ample take-up for wheel wear.

CAPACITOR START MOTOR: Uses low starting current . . . actually less than 15 amps. is consumed.

VOLTAGE: Standard models of the 1/3 H.P. and 1/2 H.P. grinder require 110 Volts, 50/60 cycle AC current. Standard 1 H.P. grinder takes 220 Volts, 50 or 60 cycle AC current.

COMPLETELY ENCLOSED MOTOR: Super powered, precision balanced motors enclosed to prevent dirt, grit, etc. from entering.

BALL BEARING CONSTRUCTION: Oversize grease sealed ball bearings used throughout, assure smooth, motor operation.

LARGE RUGGED BASE: Rubber feet provides solid mounting free from vibration. Recessed bolt openings for permanent mounting.

INDUCTION RUN MOTOR: Develops less heat in the windings — more desirable for continuous operation.

SNAP-ON TOOLS CORPORATION

8062-H 28th AVENUE • KENOSHA, WISCONSIN

International Division: Kenosha, Wis., U. S. A.

SNAP-ON TOOLS CORPORATION

8062-H 28th Ave., Kenosha, Wisconsin

Please send me more details about Bench Grinder and accessories.

Name.....

Position.....

Company.....

Address.....

City..... (.....) State.....



GROBAN'S SURPLUS BARGAINS!

WESTINGHOUSE AIR COMPRESSOR

**BRAND NEW
War Surplus Bargain**

2-Cylinder Piston Type

Ideal for:

- Paint Spraying
- Industrial Uses
- Tire Inflating
- Spraying Insecticide
- Operating Air Tools

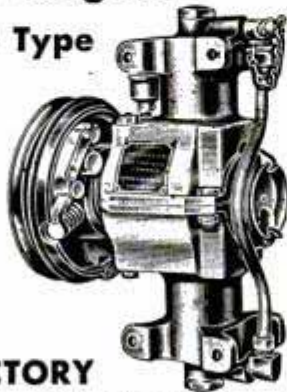

For the:

HOME... FARM... FACTORY

Designed for automotive truck or tractor mounting. Can be run off fan belt or power takeoff. Comes with automatic clutch. Can be installed for use on: farm trucks, jeeps, tractors, tire or garage service trucks, contractor or road building machinery, pneumatic devices, etc. Has 2 inch bore - 1 1/2 inch stroke.

Can be operated with 1/2 H.P. or more electric motor or equivalent portable gas engine.

Light weight, compact and versatile unit... delivers "oil free air" ... simple in operation; requires minimum of maintenance; operates under all climatic conditions; suggested operating pressure 75 P.S.I.; equally efficient operation in either direction of rotation; approx. displacement 3.27 CFM at 600 RPM, 6.54 CFM displacement at 1200 RPM; Overall dimensions: width 9", height 11 3/4", depth 6 5/8"; approx. wt. 23 lbs.

**A REAL BUY...
worth many times
this price**

\$26.95

Send check or money order today.
SATISFACTION GUARANTEED.

F.O.B.
CHICAGO

REGO REGULATORS OXYGEN - MODEL 1601

INLET 967

BRAND NEW

UNDERWRITERS APPROVED

**For the Workshop - Home -
Factory - Farm**



Designed for precision, gas pressures; meet the heavy demands of cutting and welding in shops, ship and scrap yards, mills, etc. REGO REGULATORS deliver an ample supply of gases at constant, even pressures.

Manufactured by Bastian-Blessing Company. This highly dependable accurate instrument is modern in design—diaphragms are 2 3/4" in diameter; two brass gauges are each 2 1/2" in diameter; 0-400 P.S.I. and 0-3000 P.S.I. Ship, wt. 7 lbs.

\$12.95

ORIGINALLY WORTH MANY TIMES MORE

F.O.B.
CHICAGO

1/2 H.P. - A.C.

ELECTRIC MOTOR

(Capacitor Type) BRAND NEW

For the Farm, Home, Factory, Workshop

Here Are a Few of Many Uses:

- | | |
|--------------|---------------------|
| Pumps | Air Compressors |
| Stokers | Refrigeration Units |
| Oil Burners | Conveyors |
| Unit Heaters | Blowers—Fans |
| | Machine Tools |



3/4" Keyed Shaft; 115-230 Volt; 60 cycle; 1725 R.P.M. Single phase - alternating current; capacitor start - induction Run—Resilient Mount and Motor Protector—Reversible Rotation—High Starting Torque—Magnetic Starting Switch. Cooler Operation—Dynamic Balance—Compact Design. A Great Value at.....

\$29.50

F.O.B. Chicago

GROBAN SUPPLY CO.

DEPT. PM8. 1507 S. MICHIGAN AVE., CHICAGO 5, ILLINOIS

best for the mountain pack-animal trip. For the boat or canoe camper, the center pole may be dispensed with and the peak of the tent roped to the limb of a tree. The four small corner poles, likewise, are not essential and only a small amount of space at head height will be lost due to the tent not being stretched tightly.

Two men can erect this tent in about three minutes by first pegging out the corners, then stretching the peak, either by the pole or by a rope fastened to a limb. The four corner poles may then be used or not, as desired. With its sewed-in floor and a mosquito curtain to roll down over the wedge-shaped door, this little tent is adaptable for hot or cold nights. It will withstand a wind of gale force when guyed from the center pole to four additional pegs set well out from the tent corners.

The Army mountain tent: Lightest of all, this tent is perfect for the canoe or back-pack trip, where bulk cannot be great and every pound must pay its way. Made of extremely light and strong waterproof fabric, it is warm and snug for cold nights and equally comfortable when the nights are warm. A circular door fastens snugly and air is provided through tunnel-shaped windows at front and back. A strong bobbinet curtain is insectproof and may be tied back when not in use.

Weighing only a few pounds and with a bulk of not much more than two rolled blankets, this little tent will sleep two men in snug fashion or has space for one sleeper and all his duffle. Available in many war-surplus stores at a fraction of its original cost, the tent comes complete with jointed poles, rope and steel pegs. The poles are erected shear-fashion, front and rear, to eliminate the center-pole problem. The back-packer in a woods country may not bother carrying poles and pegs and instead cut his own in the forest. A strong, sewed-in floor completes this little shelter which is one of the most comfortable and weatherproof small tents that has ever been designed.

The sleeping bag: The one-time popular folding cot, with its bulky bedroll, has been largely replaced by the modern sleeping bag equipped with an air mattress. This is the ideal combination for outdoor sleeping. The air mattress, a perfect insulator against cold and dampness, is inflated in a few minutes with a small pump or by blowing into it. Its weight and bulk are little more than that of a spare blanket.

Most sleeping bags have a pocket for the air mattress. Thus it becomes an integral

(Continued to page 254)

GROBAN'S SURPLUS BARGAINS!

BRAND NEW

AIR OR OIL HYDRAULICS

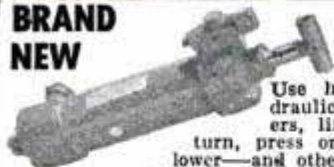

Use hydraulics on arbor presses, hydraulic presses, hay lifts, manure loaders, lift trucks — push or pull, tilt or turn, press or squeeze, open or close, lift or lower—and other hydraulic and industrial applications. Use with either air or oil . . . of finest precision workmanship.

1. Use these cylinders on farm trucks, bulldozers, hay lifts, manure loaders, etc. Double action, 1 1/2" bore, 27" stroke. (Will lift 1760 lbs. in 2 seconds with Vickers Pump). A \$55.00 value. **\$12.95** postpaid
2. Double action, 2 3/4" bore, 8" stroke. (Will lift 4400 lbs. in one second with Vickers Pump). Will withstand 1500 P.S.I. against wall. A \$65.00 value, available now at. **\$14.50** postpaid
3. Double action, 3" bore, 12" stroke. All steel hydraulic cylinder, will lift up to 12,000 lbs. (7000 lbs. in 3 seconds with Vickers Pump). A \$78.00 value. Wt. 12 lbs. **\$19.50** postpaid



Brand New HYDRAULIC CONTROL VALVES

Outlets are standard 1/8" pipe thread and inlet takes standard 1/4" copper tubing fitting.

1. Four-way control valve for use with double action hydraulic cylinder, may be used with 1500 p.s.i. hydraulic system to open and close hydraulic cylinders. Brand new. Shp. **\$7.95** postpaid
2. Four-way control valve for use with two hydraulic double action cylinders. Each cylinder may be operated independently of the other or in conjunction with the other. Oil may be locked in any of the cylinders to hold the piston at any required position. Brand New. Shp. Wt. 6 lbs. A \$60.00 Value. **\$10.95** postpaid
3. Same as valve item 2, except that unit is designed for three double action cylinders. Brand New. Shp. Wt. 8 lbs. A \$72.00 value. **\$12.95** postpaid
4. A two cylinder double action valve with a unique arrangement, allowing the operator to raise both cylinders simultaneously, to lower them simultaneously or to raise one and lower the other at any predetermined rate and speed. Brand New. Shp. Wt. 8 lbs. A \$75.00 value. **\$14.95** postpaid



VICKERS MF6 HYDRAULIC PUMP OR MOTOR

Compact, powerful, rated 1,000 P.S.I., .507 cu. in. per revolution, 8 gal. per min. at 3750 r.p.m. Change rotation by reversing flow. Delivers up to 6 H.P. BRAND NEW. Wt. 4 1/2 lbs., \$60.00 value for **\$14.95** Postpaid

VACUUM-AIR HYDRAULIC GENERAL PURPOSE PUMP

Original Cost

\$45.00

Now Only

\$9.95

Prepaid in

U.S.A.

Use them for

SPRAYING MACHINES

MILKING MACHINES

COMPRESSORS

VACUUM PUMPS

HYDRAULIC SYSTEMS

MANURE LOADERS

PRESSES, etc.

BRAND NEW!



Worth Many Times This Low Sale Price

• Originally cost \$45.00. May be used as air or fluid pump—for pressure or vacuum. Standard 3/4 inch pipe thread with interchangeable ports. Will pump 7 1/2 gal. SAE 30 oil per minute at 300 RPM. Builds air pressure of 30 lbs. per sq. in. at 1000 RPM. Vacuum will draw 26 inches of mercury at 1750 RPM. Develops up to 120 lbs. per sq. inch of hydraulic pressure, which in conjunction with a 3 inch hydraulic cylinder will lift 840 lbs. minimum. Runs forward or reverse. Self aligning shaft. Die cast aluminum housing 6x4x4 inches. Has stainless alloy steel vanes and impeller. Made by Bendix-Avis, Corp. Spline terminal for direct drive—readily replaced with a pulley. Recommend a 1/4 H.P. or stronger electric motor. Rated capacity 1500 RPM with high overload factor. Special price for quantity users. Complete illustrated engineering report and instruction booklet FREE with every pump. Send check or money order today! Postpaid in U.S.A. **\$9.95**

BRAND NEW ALL-PURPOSE WATER PUMP

Ready for use on any pumping need

Use it for: **DRAINING BASEMENTS**

HOME WATER SYSTEMS

FIRE PROTECTION

PRESSURE BOOSTER

IRRIGATION

DRAINING PONDS, TANKS, etc.

SPRINKLING SYSTEMS

STOCK WATERING

INDUSTRIAL PUMPING

Complete with pulley and mounting brackets, ready for use.

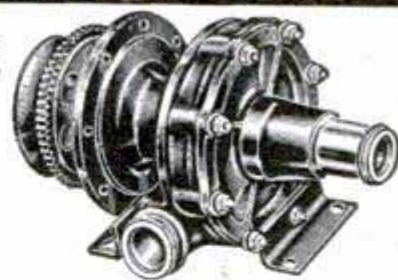

Belt Driven — Centrifugal Pump

An extraordinary value for all types of intermittent or continuous pumping in the home . . . farm . . . factory. Built to exact specifications of Packard Motor Car Co. for use in Rolls-Royce Merlin Aircraft Engines. May be run with electric motor, gas engine or power take-off on tractor. Delivers up to 25 gallons a minute with 1/4 H.P. motor; 80 gal. a min. with one H.P. motor. Will deliver up to 44 ft. head or 25 ft. suction. Use 1" outlet hose; 1" or 1 1/2" inlet hose (recommended).

COMPLETE ENGINEERING REPORTS AND OPERATING INSTRUCTIONS FREE WITH PUMP

Has cast aluminum housing, accurately machined 5" bronze impeller; 3 1/2" V belt pulley and mounting brackets. Shaft rotates on ball bearing; has grease gun fitting.

Original cost approx. \$88.00. Shipping weight 10 lbs. A REAL BUY. Satisfaction guaranteed. Mail orders filled promptly.

\$21.50
F.O.B. Chicago

VICKERS HEAVY DUTY HYDRAULIC PUMP

BRAND NEW



For tractors, bull-dozers, construction machinery, lift trucks, industrial applications, etc. Delivers 18 gal. per minute at 1000 P.S.I. at 1200 R.P.M. using 10 H.P. Has 1 1/2" intake; 1 1/4" outlet; threaded and keyed 3/4" shaft for direct or pulley drive. Wt. 40 lbs. Dimensions: 5 3/4" diameter, 7 1/2" high. Original value \$148.00. NOW **\$39.50**

F.O.B. Chicago

37 PIECE MANGANESE BRONZE LETTER STAMPING KIT

BRAND NEW

5/16" letters, 2 1/2" length, can be used hot or cold—ideal for stamping or burning lettering on leather, wood, plastic and soft metals such as aluminum, lead, copper, brass, etc. Complete alphabet, numbers and punctuation. Available in veneer fitted case. Excellent for marking, identifying and stamping. Worth many times this unsurpassed price of **\$6.95**

Prepaid in U.S.



CLUTCH with UNIVERSAL JOINT

BRAND NEW



Formerly used on Amphibious Jeeps. Has 5 inch ball bearing pulley. Used on garden tractors, midget cars, lawn mowers, etc.

Can be used for power take-off with winch and hoist. ONLY **\$4.95**

Worth a lot more!

F.O.B. Chicago

GROBAN SUPPLY CO. DEPT. PM 8, 1507 S. MICHIGAN AVE., CHICAGO 5, ILL.

RIDE WHILE YOU WORK

with Sickle Bar
or Lawn Mower

Garden-All

LAWN and GARDEN TRACTOR



SICKLE BAR
32 or 36" cut

LAWN MOWER
26 or 30" cut

Write
for Folder

DUMP TRAILER
holds
1000
lbs.



Ride while you cut your grass! It's easier! You can do it with either the Garden-All 2½ h. p. or 3 h. p. tractor. Simply remove the body from the Garden-All Dump Trailer, install the Sulky Seat, and you're ready. To use the trailer just put the body back on. Attachment is quick and simple. You will find many uses for the trailer. It has a 22 x 42 x 12-inch bed with sliding end-gate and exclusive dumping feature; 8-gauge all-steel welded, reinforced construction; 4-ply, 4:00 x 8 tires mounted on roller bearings; foot controlled brakes. Garden-All supplies a tool for every lawn and gardening need for every season. See them all before buying any power equipment.

GARDEN-ALL TRACTOR, INC.

Dept. P, 100 W. UNION STREET, LIBERTY, INDIANA

balance



• Your hardware store has a fine display of Billings wrenches from which to choose the right wrench for your jobs.

BILLINGS

WRENCHES

Buy them at Your Hardware Store

The Billings & Spencer Company, Hartford 1, Conn.

part of the bag with only the corner containing the valve being exposed for inflation and deflation. The best models are zippered down one side and across the foot so they can be opened wide for arranging bedding which may be used for extra warmth. The warmest and lightest type of sleeping bag is padded with down, closely quilted, inside a sateen or cotton cover. It weighs only a few pounds, but is amply warm for the coldest weather and is ideal for the back-packing outdoorsman.

The somewhat heavier and less expensive bags are padded with either kapok or wool, well quilted, and blankets are added when more warmth is necessary. The ordinary-size bag, about 30 inches wide, will take a wool blanket nicely when it is folded the long way. One or two such blankets, plus an inside washable cotton blanket, will insure warm, comfortable sleeping in temperatures well below freezing.

Many campers dislike the close confinement of a small sleeping bag, and for them there is an extra-wide bag, measuring from 36 to 40 inches across. In this, the extra blankets are used full width, the edges tucked in on each side. For real sleeping comfort the wise camper uses a pair of narrow sheets inside the bag and a pillow slip on a feather pillow. Then, tucked in his sleeping bag on an air mattress, inflated just enough so he will sink into it without touching the ground, he enjoys the restful slumber which contributes so much in pleasure and health to outdoor living.

All good sleeping bags have waterproof covers and a long flap, which folds down over the opening. This protects the bedding from dust in transportation and may be stretched out as a shelter for the head, when the bag is used in the open. The canoe traveler and the back-packer, who dispense with a tent entirely, may thus sleep comfortably even in bad weather.

When you plan that camping trip, remember these two essentials: A waterproof shelter and a soft, warm bed. The success of your trip—and often your health—depends on these two items.

Carburetor Ice Detector for Planes

Pilots of private planes can tell exactly when ice begins to form in the carburetor with an ice detector hooked to the engine. A neon light on the instrument panel flashes to warn the pilot to turn on his pre-heater and thus avoid the danger of the engine choking and a crash landing. The instrument is installed in the fuel induction system where the dangerous types of ice form. It is powered by electricity from one of the spark-plug leads.

IT'S EASY



... and your work will have that professional touch when you use

SHOPMASTER TOOLS

Millions of Americans relax the year round with power tools.

Power tools can be a profitable pastime, a relaxing hobby, or better yet a spare time business.

Repairs around the home, the farm, or the cabin—toys for the children, or a boat for dad's fishing trip, all will have that

little extra craft touch only you can put into them.

Mom will be especially happy over that fitted closet, the garden furniture, and the many other conveniences your skill will create.

Shopmaster Tools are attractive, sturdy and precise in operation. Shopmaster Tools' simplicity of operation can make you a skilled craftsman. Easy to master, they'll soon have you designing and making things you'll be proud to display. Built for professional work, they are priced within the reach of every user. Write for free catalog, illustrated in full color, to:

SHOPMASTER, INC.

1214 Third St. South, Minneapolis 4, Minn.



8" TABLE SAW



12" DRILL PRESS



12" BAND SAW



6" JOINTER-PLANER

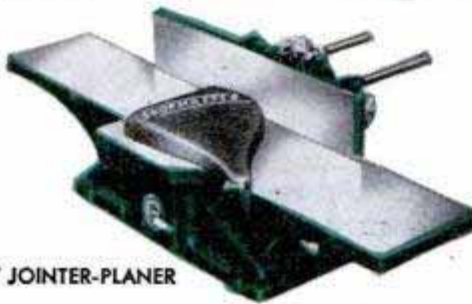

15" JIG SAW



LATHE



SABER SAW



Siegler

PATENTED

Triple Duty Kitchen OIL HEATER



HEATS, COOKS,
FURNISHES
HOT WATER

PAYS FOR
ITSELF
3 WAYS

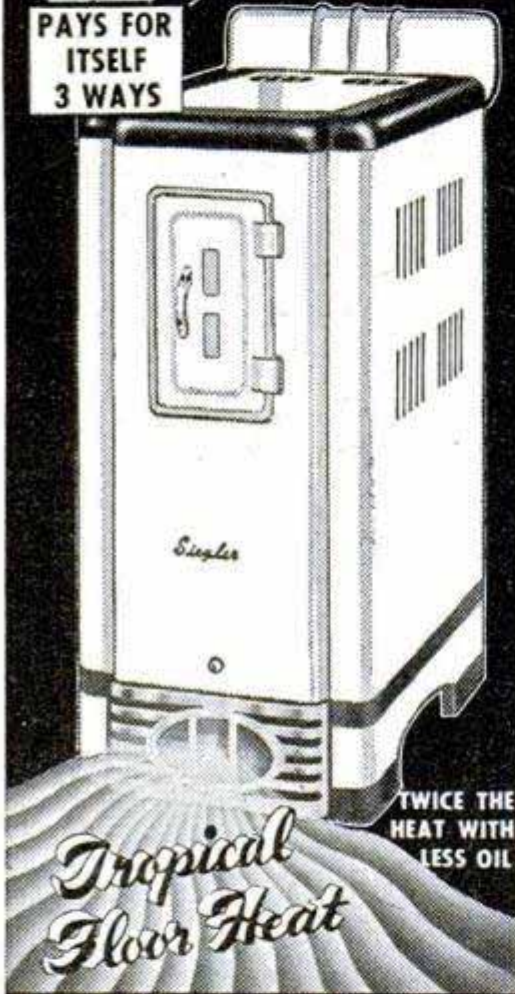

TWICE THE
HEAT WITH
LESS OIL

TRADE NOW AND SEE HOW SIEGLER
SAVES AS IT PAYS FOR ITSELF

See Your Furniture, Hardware or Appliance Dealer

MAIL THIS COUPON TODAY TO
SIEGLER'S Dept. PM8
BOX 111, CENTRALIA, ILL.

For FREE information and the name of your
Siegler dealer

NAME _____

ADDRESS _____

CITY _____ STATE _____

AMAZING LOW COST **BRONZE FOUNDRY** CAST ALUMINUM, SILVER, ETC. — ALL NON FERROUS METALS

Make money in the foundry business casting
Engines, Machinery, Art Objects, Statues, In-
ventions and all other foundry work. Castings
up to 6# made quickly with new invention
called Foundryette. Operates on 110 V AC
and Domestic Gas. Write for complete FREE
information.

KANS. CITY SPECIALTIES

Box 6022, Dept. P-7

Kans. City, Mo.

Sand Casting
Forging-Heat
Treating-Case
Hardening

New Roads to Timberland

(Continued from page 103)

Corporations estimated the total stand of saw timber in the United States at 2,826,000,000,000 board-feet. During 1945-46 the Forest Service estimated that only 1,601,000,000,000 board-feet remained. This would indicate that in 36 years this nation's wood pile has been reduced by 44 percent. The important thing, however, is that depletion has been largely from private lands. National-forest timber has held its own or even increased a little. Where private timberlands are giving out, many communities and industries become more and more dependent upon national-forest timber. The Forest Service, therefore, has the double task of providing as much timber as can be safely cut now, and managing the timber resources wisely so more timber will keep growing for future generations.

Unlike such resources as coal, iron and oil, timber if properly managed can replenish itself and produce a continuing harvest. Uncle Sam, the nation's largest timber farmer, has found it necessary to build roads not only to harvest trees but to (1) fight forest fires, (2) replant burned-over areas and thin out young growth, (3) combat insect pests and disease, (4) improve grazing facilities, and (5) provide recreational areas.

The new timber-access roads will be part of a planned national-forest road network of 138,167 miles, of which 53,438 are now of satisfactory standard, 46,976 miles of unsatisfactory standard, and 37,753 miles merely in the blueprint stage.

In addition to roads, the Forest Service is building or maintaining 165,145 miles of trails. Last year the Forest Service fought nearly 10,000 fires within national-forest boundaries, which burned over 175,000 acres and did \$1,000,000 damage. And even though the new techniques of aerial fire fighting hold much promise, roads and trails are still indispensable in fighting fires. In some areas, it is necessary for fire fighters to travel 10 to 35 miles on foot over mountainous terrain to reach fires.

New roads also are often a boon to reforestation crews. Up to the beginning of World War II, some 1,150,000 acres of deforested land in national forests had been replanted. But some 2,200,000 acres still must be planted to bring the land back to productivity and another 1,000,000 acres are so understocked that fill-in planting is needed. Today, the Forest Service is bringing its system of nurseries back into

(Continued to page 258)

IT'S NEW! HERE'S YOUR RIFLE, SON



It's a he-man shootin' .22 with more new features than you ever saw in a popular priced rifle. You'll go for the new "Red Devil" sight; the "Redi-Feed" drop-in loading platform, streamlined bolt, self-cocking and side thumb-safety features.



"Pioneer" 765

"REDI-FEED"
Drop-in
Loading platform



PRICE
\$13.50

This rifle is newly designed and streamlined throughout for fast, safe, accurate shooting. It's full size, for the fullest measure of shooting pleasure. No other rifle at this price has all the new features of "Pioneer" 765.

Write for folder
or see your
Dealer

HARRINGTON & RICHARDSON ARMS CO.

331 PARK AVENUE, WORCESTER 2, MASS.

TENTS

Small and large, new and used, Army surplus. Also canvas covers, hammocks, canvas cots, clothing, paints. Lowest prices. Free circular.

MORSAN SALES

10-15G 50th AVE., LONG ISLAND CITY 1, N. Y.

In General-Purpose 4-Ohm Intermittent Tests
THE "EVEREADY" NO. 950 FLASHLIGHT BATTERY
OUTLASTS ALL OTHER BRANDS!

THE BULL BUFFER



POLISHING CARS



SANDING WOODWORK



POLISHING FURNITURE



You polish and sand faster, easier—do beautiful, professional work—with this amazing new attachment for your hand drill. And the Bull Buffer more than pays for itself the very first time you make your car, floors, woodwork, furniture gleam like new.

The Bull Buffer fits any chuck on an electric drill (or flexible shaft.) It's easy to use—the only buffer you can turn in a complete circle while you hold your hand drill stationary. Reaches all curved and flat surfaces. It's packed with power, built with lifetime materials and guaranteed.

The sooner you order, the sooner you'll have this tool of a hundred uses in your hands. It's a real bargain—only \$9.95, complete with five-inch rubber disc, sheep-skin bonnet, and 2 sanding discs. (Extra bonnet, \$1.25; extra medium and coarse sanding discs, 10c each.) If your dealer doesn't stock, send cash, check, or money order for \$9.95, postage prepaid. C. O. D. plus postage.

\$9.95

Dealers, Write for Information

BERTRAM D. ENGINEERING CO. • 3034 Main St. • Kansas City, Mo.

NOW CROSLLEY HAS THE NEW LOOK

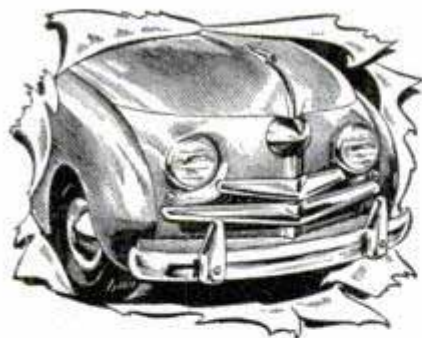

See the stand-out styling of the Crosley Station Wagon. All steel. Seats 4, or 2 with $\frac{1}{4}$ -ton load. Priced \$600 to \$700 lower than any other station wagon, costs about $\frac{1}{2}$ as much to operate. Also available as a panel delivery truck without rear side windows.

And all five Crosleys have the new look, massive radiator louvers and a gleaming spinner adapted from aircraft propellers. Every model features the startling 4-Cylinder Cobra (COpper-BRAzed) engine.

STATION WAGON:
Goes everywhere smartly.



CONVERTIBLE:
If you love sun and air.

SEDAN:
Over 20,000 now on the road.



PICK-UP:
Cuts service and delivery costs.



a **FINE** car

For beautiful full-color catalog, write: Crosley Motors, Inc., 2532-HP Spring Grove Ave., Cin'ti 14, Ohio

How to REVIVE Summer Blasted Lawns **FREE**

READ *Lawn Care*

Each issue is "chock full" of tips on how to keep lawns sparkling green and gives practical methods of controlling crab grass, brown patch, ants, chinch bugs, grubs and other summer lawn enemies. For your lawn's sake, send today for a free 2-year subscription, no obligation of course.

OM Scott & SONS COMPANY
230 Fourth St., Marysville, Ohio
Also Ridgely, N. J., and Palo Alto, Calif.

production and has as a goal completion of planting on these lands in 15 years.

Modern forestry does not depend entirely upon the natural growth, but upon scientific speed-up methods. Cleanings in young stands can favor desired species. Thinnings can provide the best spacing and increase the growth rate of individual trees 50 to 100 percent. Pruning of pole-sized timber can result in growth of knot-free wood at a younger age than would naturally occur. At a cost of \$12 to \$15 per acre, pruning in young conifers may increase the value of timber by \$100 or more per acre.

Science also has developed methods of combating some destructive forest insects and diseases—the white-pine blister rust and the pine bark beetle, for example. Access roads will help this front-line combat, as it will aid the Forest Service in management of national forests where in a year more than 1,300,000 cattle and horses and nearly 4,000,000 sheep and goats graze. Present ranges must be maintained in good condition and other ranges that have deteriorated from droughts and over-grazing built up.

Finally, as host to some 18,000,000 Americans who annually visit national forests, the Forest Service hopes that new roads may expand recreational opportunities.

Yet there will always be roadless areas in the national forests. More than 70 areas, totaling some 13,000,000 acres have been designated as wilderness areas, to be maintained permanently in their primitive status. In these wild areas, accessible only by trail or water, those who wish really to "rough it" or see nature free of artificial influences, will never be bothered by the sound of motor cars.

Forest Service engineers have developed several items of equipment especially adapted to road and trail building and other work. Among the newest is a "trail beetle," a tiny crawler tractor weighing only 1900 pounds. Another is a "trail mule," a three-wheeled, motor-driven, freight-carrying cart to negotiate steep mountain trails. In contrast is the new giant "tomcat" logging tractor, combining tractor and logging arch in one compact unit for snaking out and yarding big logs.

To sum up: the 2100 miles of access roads now under construction not only will provide timber for postwar construction, but will be a part of the transportation network by which the Forest Service can protect and manage the timber resources of the future. How Paul Bunyan would rejoice to be there with Babe, the Blue Ox, helping build those new roads!

Running HOT WATER

-in a Jiffy! from any COLD WATER FAUCET!



NOW ONLY
\$3.98



For every kitchen need For quick shaving A No. 1 beauty aid

Seems too good to be true until you see hot water running continuously from any cold water sink faucets! With the revolutionary new KEM INSTANT HOT WATER HEATER you get as much hot water as you want—from lukewarm to real hot right when you want it! All without waiting, fussing with fires. No boiler or tank needed. Easily and quickly attached, takes only a few seconds to attach or remove. Fits any standard faucet. Ideal for basement, garage, cottage, tourist camp, office, factory—and when home hot water supply fails. Heater skillfully made, and with ordinary care gives many years of satisfactory service.

SOLD ON MONEY BACK GUARANTEE! Don't be inconvenienced another day by lack of hot water. **ORDER NOW! SEND NO MONEY!** Just pay postman \$3.98 plus postage when your heater comes, or send \$3.98 and we will pay postage.

KEM COMPANY, 18 E. 41st St., Dept. 195, New York 17, N. Y.

- Check THESE ADVANTAGES
- ✓ NO MOVING PARTS to wear away or get out of order
 - ✓ Runs on AC or DC current
 - ✓ Constructed of handsomely finished aluminum
 - ✓ Measures 2 3/4" x 3 3/4", requiring small storage space when not in use
 - ✓ Fits any standard cold water faucet
 - ✓ Carries 6-foot extension cord
 - ✓ Takes only few seconds to attach or remove
 - ✓ Exceedingly low cost operation—costs only a few cents a day to use
 - ✓ Fully guaranteed against defects in material or workmanship

for COMFORT, ECONOMY and LONG WEAR

Riegel WORK GLOVES



Ask for the Riegel Brand wherever work gloves are sold. Full descriptive literature sent free if requested on business letterhead.

Riegel Textile Corp.
342 Madison Ave.
New York 17, N. Y.

"THIS TRADE MARK IS YOUR GUARANTEE OF VALUE"

\$4.95 REAL ENGINE VALUE

A miniature gas engine that really operates.



Thousands of Buzz "B" gasoline engines have been sold at twice the price. Now is your chance to buy a real 1/6 H.P. gas engine for only \$4.95. Turns up over 8,000 r.p.m. For Boats, planes, midget cars, etc. Guaranteed and ready to run. Includes Champion spark plug and tank. Send only \$1.00, engine shipped collect for balance, same day.

SEND 10c FOR NEW MAMMOTH ILLUSTRATED CATALOG OF THOUSANDS OF HOBBY ITEMS.

America's Hobby Center, Inc., Dept. B-88, 156 West 22 St., N. Y. 11



We'll Start You Complete in this PRODUCTS BUSINESS And Help You Put It Over

The great building industry is your profitable market for masonry products. Low investment . . . high returns . . . wide-open opportunity to establish a lifetime business.

The biggest building years in the nation's history are just beginning. New construction, involving billions of dollars, means huge demands for block, drain tile, and other masonry products which YOU can manufacture locally, from local materials, with local labor for local consumption. Remember, MASONRY products are in mesh with today's building preference!

Use our modern machines and equipment to insure the finest quality products at pared-to-the-bone manufacturing costs. Sold direct from factory to you. Backed by 40 years of pioneering and manufacturing. Write for new catalog. Describes complete line of equipment with prices plainly marked. Tells how we help you in manufacturing and merchandising. Write TODAY.



CONCRETE EQUIPMENT COMPANY

512 Ottawa Avenue
Holland, Mich.

SAY YOU SAW IT IN POPULAR MECHANICS

New Easy Way TO MAKE

BIG MONEY! AT HOME
Costs You Only 5¢-You Get \$5.00 FULL OR SPARE TIME



Write Now

Now is the time to cash in on this big-paying easy-to-operate year 'round business, and you need no experience! Metallize Baby Shoes in real GOLD, SILVER, BRONZE, and PEARL. Everything furnished so YOU can start earning money in just one week—up to \$1,000 per month full time or \$50 to \$75 per week spare time—at \$5 per hour. They will last FOREVER, and there are 5 million eager customers every year, waiting to buy. **DETAILS FREE**—Send no money—a post card with your name will bring all the facts. Don't pass up this opportunity to start your own business on a shoestring—so ACT NOW. Write at once to

KIKTAVI COMPANY, Dept. P-2, 2111 West Manchester, Los Angeles 44, California

- Big Income
- Huge Demand
- Sales Plans
- Future Security
- Your Own Boss
- Money Back Guarantee
- Most Successful Name in Metallizing



FREE!

Course includes FREE—two actual metallized Baby Shoes guaranteed to be the most attractive on the market—or a pair of your own Baby Shoes metallized if you prefer



Amazing MOTO-SANDER AND POLISHER

Saves Time — Saves Effort! Dremel has developed a combination electric sander and polisher for home or shop . . . so easy to handle that a child can use it. New, inexpensive "Moto-Sander" delivers about 7,200 strokes a minute. (Short, rapid stroke frees dust from sandpaper . . . makes paper last longer.) Moto-Sander does a magically smooth job of sanding . . . gets into places other sanders can't reach. Rubber cushioned sanding pad measures 2 1/4" x 5 1/2". Cam-type-clamp paper holder permits changing sandpaper in seconds. Moto-Sander has only two moving parts . . . never needs oiling or adjustment . . . weighs only 2 1/2 lbs. Uses 110-120 volt, 60 cycle A.C. electric current (only). Gives no radio interference. Comes with 8 ft. (Underwriters' Approved) rubber cord plus 6 sheets assorted grade Garnet paper, plus 1/8" thick felt pad and sheepskin for wax polishing.

FINE FINISH — FAST!

Use Moto-Sander to get satin smooth finish on woodwork, stairways, doors, furniture; ideal for sanding boats, gun stocks or scale models. Just guide it. Uses #2/0 Garnet paper or finer. For speedy, effortless polishing of waxed furniture, automobiles and other surfaces, use felt pad or sheepskin (furnished) in place of sanding paper. Moto-Sander is the lightest, most practical electric sander on the market—the only one of its kind.

MONEY-BACK GUARANTEE: If your dealer does not yet have Moto-Sander, send only \$14.85 . . . we'll pay postage. Or send \$2 now, and pay postman balance plus postage. Money back if not delighted after 5 days' trial.

DREMEL MANUFACTURING CO.
Dept. 118-H • Racine, Wis.



Any job locked in a "Yankee" Vise, is correctly positioned for every operation . . . hand or machine. Lifts on and off swivel base at bench. Machined accurately . . . top, bottom, sides and front end . . . V-grooved block for rounds. Four sizes, with and without swivel base . . . 1 1/2", 2", 2 3/4" and 4" jaw widths. At your dealer's.

Write for "Yankee" Tool Book

YANKEE TOOLS NOW A PART OF **STANLEY**
THE TOOL BOX OF THE WORLD

Three-Ring Zoo

(Continued from page 97)

The turtle shell (made of airplane tubing, wire mesh and molded green papier-mache) is only one of scores of circus properties concocted by the zoo staff. The chimpanzee show requires specially built tricycles, bicycles and unicycles including an old-fashioned high wheeler and a bicycle-built-for-two.

Other chimpanzee properties include stilts of various sizes, harness and saddles for the ponies, bizarre instruments for the jungle orchestra, acrobatic equipment and 42 costumes. These costumes, made by Mrs. Henry Pennypacker, wife of the assistant director, have zippers in hard-to-reach places. The trainers, Ben Fridrich and Mike Kostial, keep a watchful eye on stage to prevent the chimps from unzipping each other and turning the Chimpanzee Circus Review into a strip-tease act.

"Chimps are like people," says Fridrich. "Some have talent and brains and some don't. Take Cookie; he is nine years old and we've had him in the show since he was three. I think he understands everything we say to him." He turned toward Cookie, sitting on his chair on stage. "Hey, Cookie! Make a face." Cookie complied by rolling his lower lip away down and screwing up his nose. "When Cookie was three he could turn a key in a lock and thread a needle. He does back somersaults on the ponies, rides bikes and plays in the orchestra."

The chimpanzee actors range from small four-year-old Nero, who steals many a scene, to Rastus, nine, oldest and toughest, who retires this year. When male chimps reach maturity (about the age of 10) they sometimes become savage and unmanageable and the trainers take no chances. Swanty, one of the brightest, has to wear a muzzle because of his mischievous nature. He not only nips his fellow actors with his sharp teeth but sometimes breaks up an act which he thinks is getting too big a hand. Occasionally, when seven or eight of the group are riding the ponies he will leap at them and knock them all off.

Among the hits of the chimpanzee review are the pony-riding stunts. One of the most difficult is the "table catch," performed by seven ponies, one donkey and nine chimpanzees—one more chimpanzee than there are mounts. As they ride up to a table at the front of the ring each monkey, in turn, leaps on the table top. As he does so the chimp already standing on the table leaps on the first chimp's horse as it comes out from under the table. Then the

(Continued to page 262)



World's Most Complete Hand Tool

Gives One Hand a **TON GRIP**



New
WISE-GRIP
WRENCH

This *new* super-powered tool adjusts to ratchet action or LOCKS to the work—both hands free! Important new features: 1—Involute Jaw Curve gives tremendous holding power, all shapes. 2—Thin Nose, stronger than ever, gets into close quarters. 3—Super Wire Cutter cuts wire, small bolts. 4—Knurled Jaw Tips hold to the very tip. 5—Easier to open from locked position. Positively—the world's most Complete, most Powerful, most Useful hand tool! Fine alloy steel. Nickel plated. WITH cutter—7", \$2.25; 10", \$2.50. WITHOUT cutter—7", \$1.85; 10" \$2.25. If not at your dealers, order direct. Postage paid if price accompanies order. Made only by PETERSEN MFG. CO., Dept. M-8, DeWitt, Nebr.



Make Your Shop More Useful

WITH **Atlas**

PRECISION TOOLS

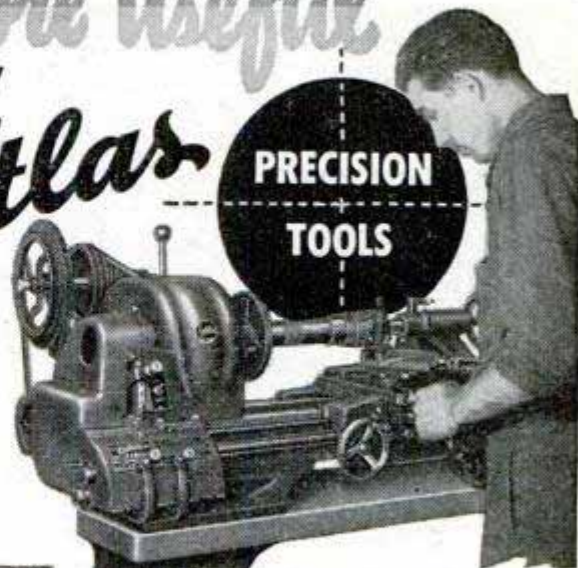

6" - 10" LATHES



DRILL PRESSES



MILLING MACHINES



SHAPERS

The hope of many a man — for a fully equipped shop where he can quickly perform *every* type of precision machining — can be realized now at reasonable cost with Atlas tools.

Metalworking may be your hobby — a practical one for keeping home equipment in repair and building useful things for your home. Perhaps you plan an income producing commercial shop, want to develop a new product, or start an industrial plant.

Whatever use you have in mind for Atlas tools, you'll value their accuracy, efficiency, rugged strength, service and economy. Send the coupon today for complete information.

Send For New **FREE Catalog**

ATLAS PRESS CO.

843 N. PITCHER ST. KALAMAZOO, MICH.



ATLAS PRESS CO., 843 N. Pitcher St., Kalamazoo, Mich.

Please send latest information on Atlas tools.

10" lathe; 6" lathe; drill press; miller; shaper; woodworking tools.

NAME _____

ADDRESS _____

CITY, STATE _____

SMART NEW



POWERBIKE

gets you there safely and economically

The motor is in the rear, mounted low to aid balance and handling. No grease to rub off on your legs, no hot fumes blowing in your face. 100 miles per gallon, 30 MPH.

1½ HP fan cooled engine, kick starter, automatic clutch, fits any man's or woman's balloon-tire bike. See your dealer or write direct. TERRITORIES AVAILABLE.



SAGINAW PRODUCTS CORP. • SAGINAW, MICHIGAN

Tune Up Your Engine In 20 Minutes!

With VACUUMATIC INJECTOR

While engine is running, a measured amount of Tune-Up Solvent is automatically injected into one cylinder at a time while other cylinders are firing. Simple to use! Directions with every kit.

Guaranteed To Make Your Car Run Better . . . Smoother — Or Your Money Back!



- More Power, Pep
- Removes Carbon, Sludge
- Frees Sticky Rings
- Reduces Knocks

**SPECIAL
OFFER**

\$9.56

SOME TERRITORIES OPEN FOR SPECIALTY SALESMEN

RADIATOR SPECIALTY COMPANY
1700 Dowd Road, Charlotte, N. C.

Enclosed find \$9.56 (money order or check). Send me, prepaid, one Vacuumatic Injector (complete with all attachments and instructions), and 6 bottles Nu-Power Tune-Up Solvent.

Name _____

Address _____

City _____ State _____

IT FLIES

Enjoy this Great Outdoor Sport

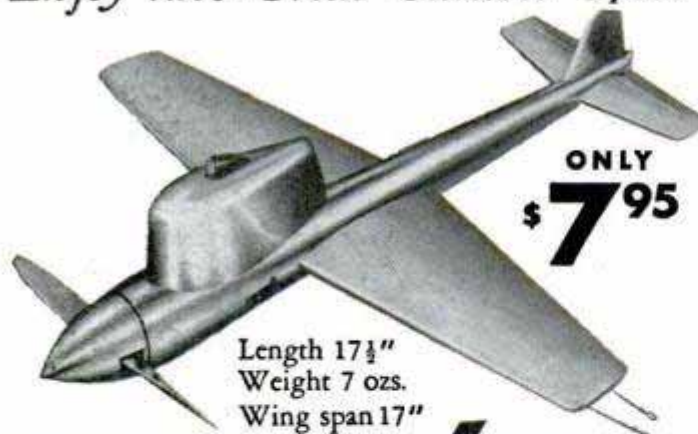

ONLY
\$7⁹⁵

Length 17½"
Weight 7 ozs.
Wing span 17"

DURO-MATIC

Invader

FABRICATED ALL-METAL PLANE KIT

Just 8 pre-built parts . . . no bending, no cutting, no forming. Goes together with a screwdriver. Install any engine (ask your hobby dealer), solder up your gas tank, fill with fuel and let it fly. Complete instructions with each kit. See it at your local hobby store or write to **Duro-Matic Products Co., Dept. M, 1039 North La Brea, Los Angeles 38, Calif.**

first chimp goes over the table to catch the horse of the rider just behind him. The action is so fast there seems to be a continuous stream of chimps pouring over the table and a moving circle of ponies underneath. Another popular riding act is a Wild West solo by Cookie mounted on rearing White Lightning.

The bicycle acts include a Gay Nineties revue. The most difficult act is unicycle riding performed by Cookie and Tommy. Unicycle training starts by the trainer holding both cycle and chimpanzee as he moves them around the stage. Then a rope is used with the chimp gripping the rope and holding on while the trainer pulls him around. This rope is gradually lengthened until the trainer can stand in the center of the stage as the chimpanzee rides around. Finally, he performs without the rope. Only four chimps have mastered this show-stopping stunt.

The chimpanzee orchestra consists of a piano, snare drum, bass drum, trombone, tom-tom and xylophone. Cookie, the trombone player, is the star. He puts his mouth in place and works the slide up and down producing a weird assortment of honks synchronized with his actions. The slide is electrically connected with three sets of automobile horns concealed under a bench. Tommy obviously enjoys his piano act and makes faces as he thumps the keys. Most of the chimpanzee stars have understudies. Eight new actors are being trained to replace the aging stars.

Changing of actors does not worry Floyd Smith, the elephant trainer. His stars, Clara Belle, 15 years old; Marian, 14; Vi, 13; Lady, 7; and Honey, 6, need no understudies. Clara Belle, leader of the herd, has been performing for 11 years.

"The hardest trick to teach an elephant is to lie down on its side," says Smith. "The reason is because this king of beasts (king in my opinion) fears nothing when on his feet. When an elephant lies down it's at the mercy of other animals because it takes him so long to get up. At first I have to use a block and tackle to throw them—doesn't hurt—while I give the command 'down' and pull down on them with the bull hook. They soon get the idea because elephants are smart."

His elephants are so smart, Smith reports, that they craftily test out every new helper he hires. As the new man walks by, Clara Belle casually slaps him with one of her big ears. If she is allowed to get by with it, the next time the man passes near she "accidentally" whacks him with her trunk, looking very innocent. If this passes

(Continued to page 264)

SEND FOR FREE CATALOGUE
AND MANUAL

QUALITY

Aluminum Guard Easily Removed
For Dadoing



NEW IMPROVED TABLE MODEL TILT-ARBOR SAW

OIL IMPREGNATED BRONZE BEARINGS OR DOUBLE
SHIELDED BALL BEARINGS, BOTH WITH THE PATENT-
ED BALL BEARING TRANS-AXIAL MOTOR DRIVE

MODEL #2021X AS SHOWN WITH COMPLETE MITRE
GAUGE. Precision etched scales show angles on mitre
gauge and saw cradle. STEEL BAR RIP FENCE. ALUMI-
NUM SAW INSERT AND GUARD. STEEL SPLITTER,
BALL BEARING TRANS-AXIAL DRIVE $\frac{3}{4}$ " GROUND
ARBOR. "COMPO" OIL IMPREGNATED BRONZE BEAR-
INGS WITH OIL CHAMBER AND CUP, (OR DOUBLE
SHIELDED BALL BEARINGS, \$5 EXTRA). TABLE 18"
x 16". BUILT IN SWITCH. Depth of Cut $2\frac{3}{4}$ ". Shipping
Wt. 110 lbs. Requires $\frac{3}{4}$ or $\frac{1}{2}$ H.P. Motor.

(BALL BEARING FLOOR MODEL WITH 18" x 32" TABLE
INCLUDING EXTENSION \$79.50)

TABLE
18" x 16"

SAW BLADE TILTS TO 50°
TABLE STAYS LEVEL

BRONZE BEARINGS
\$44.95

F.O.B.
ROYERSFORD, PA.
(Less Blade & Motor)

AMERICAN MACHINE & TOOL CO., Inc.
DEPT. 111
ROYERSFORD, PA.

**SOUTH
BEND**

LATHE CENTERS and DRILL PADS

Description	No. 2 Taper	No. 3 Taper
L—SCREW CENTER	\$3.00	\$3.25
G—DRILL PAD	2.50	2.75
H—CROTCH CENTER	2.50	3.25
J—HOLLOW CENTER, 60°	2.00	2.75
I—60° CENTER	2.25	3.00
P—CARBIDE TIPPED CENTER	4.50	8.00
Q—HALF CENTER	2.25	3.00
N—CUP CENTER	2.00	2.75
M—SPUR CENTER	3.00	3.25



SOUTH BEND LATHE WORKS 455A E. Madison St.
South Bend 22, Ind.

FIND UNDERGROUND MINERALS and METALS with M-SCOPE

New sensational lightweight
models, unsurpassed efficiency
Low prices. Time-payment
plan. Write for free 16 page
booklet.

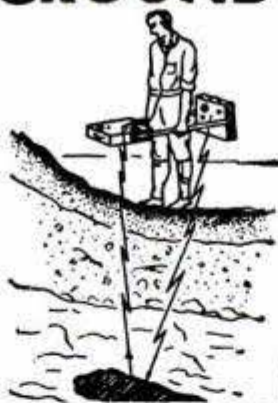

FISHER RESEARCH LABORATORY, INC.
PALO ALTO CALIFORNIA

MASTER CRAFTSMEN use these finest fillers!



- SAVES TIME
- SMOOTH TEXTURE
- EASIER TO WORK
- SHRINKS ONLY 1%
- STAYS IN

FOR a perfect surfacing job on
wood, metal or plastic—use the
expert's choice—Duratite. Easy to
use—faster—shrinkage is so slight,
it fills completely in just one applica-
tion—stays in! 7 wood colors. Ask
your dealer or send for large tube.

SEND FOR
LARGE
TUBE

WEBB PRODUCTS COMPANY

228 S. G St., San Bernardino, Calif
Enclosed find 25c, send large tube Duratite Wood Dough.

Name _____
Address _____
City _____ State _____



DURATITE
WOOD DOUGH and SURFACING PUTTY

FAMOUS CLINTON GASOLINE ENGINES . . .

• NEW. Complete, ready-to-run, compact, dependable 4-cycle single cylinder aircooled gasoline engines, by world's largest producer, specializing in 1½ to 3 H.P. engines. Over 300,000 in world-wide use.

1½-2 H.P. MODEL 700A	\$59.50	Rope starter, direct drive models 1200 to 3600 r.p.m. for power tools, lawn mowers, air compressors, wood saws, etc.
2½-3 H.P. MODEL 1100A	\$74.75	
1½-2 H.P. MODEL 701AS	\$72.50	Kick starter attached, direct drive for scooters, midget autos and machinery.
2½-3 H.P. MODEL 1101AS	\$87.75	
1½-2 H.P. MODEL 700ABR6	\$75.00	Gear reduction 6 to 1, built-in, for machinery, garden tractors, conveyors, etc., requiring shaft speeds from 200 to 600 r.p.m.
2½-3 H.P. MODEL 1100ABR6	\$90.25	

ORDER DIRECT—AND SAVE!

These are all Factory-Fresh Engines—Not War Surplus—With standard 90-day guarantee. Order with confidence. Send Check or Money Order. Immediate Insured Deliveries. Michigan purchasers only—include 3% sales tax. Free literature.

CLINTON ENGINE CO. • 16351 East Jefferson • DETROIT 30, MICH.



MODEL 700 ABR 6

Woodworkers!!
Make your circular saw the most versatile tool you own!

CUT GROOVES LIKE THIS

\$4.95
 SET

POSTPAID
 INCLUDING TAX



WARREN DADO SAWING WASHERS WILL FIT THE ARBOR OF ANY POWER CIRCLE SAW AND CAN BE USED WITH ANY DIAMETER SAW BLADE. . . CUTS GROOVES CLEANER, EASIER AND FASTER THAN AND DADO CUTTER ON THE MARKET. . . MICROMATIC ADJUSTMENT PERMITS A CUTTING ANGLE CHANGE IN 15 SECONDS. . . SAW BLADE HELD RIGID. . . WILL NOT CHATTER. . . WARREN DADO SAWING WASHERS CAN BE LEFT ON THE ARBOR OR QUICKLY REMOVED FOR CUT OFF SAWING.

ORDER YOUR SET OF FOUR WASHERS TODAY, TRY THEM FOR TEN DAYS, IF NOT SATISFIED, YOUR MONEY WILL BE REFUNDED IN FULL. DEALER INQUIRIES INVITED



DADO SAWING WASHERS
Warren

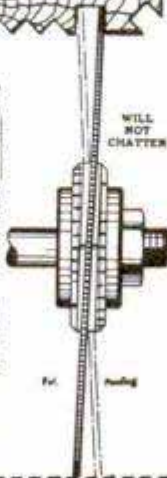

Arbor 1/2 3/4
 Sizes 3/8 1
 Free Circular
 Check
 Money Order

Gentlemen:— Please send _____ sets of sawing washers
 Name _____ PHONE NO. _____
 Address _____
 City _____ State _____

ALL SETS SHIPPED POSTPAID

WARREN DADO SAWING WASHERS CO.
 P. O. BOX 98 NORTH END STATION
 DETROIT, MICHIGAN

NEW!

Atlas POWER KING

ATLAS PRESS CO.
 KALAMAZOO, MICH.
 U. S. A.

12" BAND SAW

Cuts WOOD, PLASTICS, COMPOSITIONS

Add new work range in your shop with this new Power King band saw. It's smooth, accurate, powerful, solid . . . weighs 135 pounds! 14" x 14" precision ground table. Cuts to center of 24" circle. Saw wheels turn on 4 ball bearings. Blade is guided by 4 Oilite bearings—supported in back by 2 ball bearings. Here's a quality tool you'll be proud to have in your shop—built for years of service. Send for new free literature.

ATLAS PRESS CO. • Kalamazoo 13D, Mich.
 809 North Pitcher Street

without reprimand the next time she may knock the man down and tramp him to death. Elephant trainers and handlers must impress their charges at all times with who is boss. Once this lesson is learned the elephant is docile unless frightened.

Smith tried to teach Marian to lie on her side without using the block and tackle. He kept her in a kneeling position for some time urging her to lie down. She refused. When he allowed her to get up she acted as if she had gone mad. Her eyes were wild and her ears stood out straight. A berserk elephant is something no trainer likes to think about. Smith believes Marian's feet went to sleep that day and the strange sensation made her frantic. She calmed down in about the time it would take circulation to return to her feet.

The elephant stunts include a shaving scene in a barber shop with a huge wooden razor and a pail of soapsuds for props, a Spanish dance, a baseball game with one elephant pitching a ball while another swings a bat with her trunk. A bowling game is performed with a regulation two-finger ball. Marian, who rolls out the ball with a flourish of her trunk, always gets at least two pins. During this act Vi serves as pin boy and Clara Belle sits back on a stool and keeps score on a huge board.

Smith watches his animals for special talents. This resulted in a new act this year called "The Crooner." He had noticed that Marian "chirped" at him every time he came near her stall. He encouraged her to make odd bawling noises, bellows and chirps. Now, in a nightclub scene, Marian wears a big bow tie and "croons" while another elephant "plays" a piano—all to appropriate music from the loudspeakers. Another solo is a hula dance performed by Clara Belle in grass skirts.

Featured in the elephant orchestra are a bass viol, hand organ, bass drum, washboard and tuba. The latter has a duck call inserted in the mouthpiece and is actually blown by the elephant. In the hilarious finale an imitation skunk is pulled out of the tuba, the viol lays an egg and the organ collapses. Marian, the drummer, was taught to press the bass-drum pedal by working with an old bedspring.

In a solo act, Vi counts by beating on a gong. The audience calls out numbers up to 10 and with no apparent cue from Smith she hits the gong the right number of times. How this act is performed remains one of Smith's secrets.

No one chides Director Vierheller these days about trying to compete with Ringling Brothers. There's a good reason. Ringlings haven't visited St. Louis for several years.



FOR MOPPING

FOR WAXING

FOR CLEANING RUGS

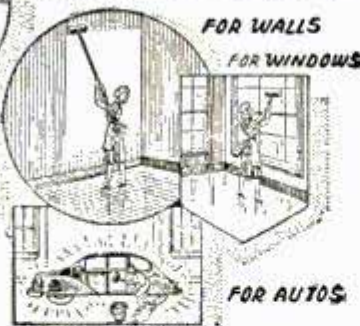

FOR WALLS

FOR WINDOWS



FOR AUTOS

Hands Never Touch the Water—Can be put in Boiling Water. Housewives Like It.

48" Long Handle

Sales QUICK, EASY Every Locality

SALES ARE EVERYWHERE . . . Sells quick to Taverns, Clubs, Hotels, Hospitals, Stores, Restaurants, Large and Small Buildings and the Homes . . . Scores can be sold on a single street . . . Note the Drain Bracket in the illustration . . . This squeezes out the water so thoroughly that HANDS NEVER TOUCH THE WATER . . . Makes no difference what you ever sold, you will like this proposition . . . Your name on a Post Card will bring you FREE PARTICULARS.

CELL-U-MOP CO., Dept. P-8 FREEPORT, Ill.

Quick Easy Way to BIG PROFITS

Read What Others Are DOING!

"Enclosed you will find 56 orders representing 9½ hours' work on Monday and Tuesday."
"Enclosed are twelve orders secured after supper this p.m."

Housewives are Enthusiastic

Everyone that sees this outstanding Cell-U-Mop immediately wants one . . . That's the reason why our distributors are so successful . . . You also have the advantage of our other QUICK SELLING PRODUCTS that step up your Volume Sales and Profits.

• We Teach You How •

Gets down under and around for MOPPING, DUSTING or WASHING

DOES THE WORK OF 6 TOOLS IN 1

Get Choice Territory NOW!

Holds 20 times its weight in water.



PROSPECT WITH A TX-5 WITH A GEIGER COUNTER



LOCATES RADIOACTIVE MINERALS

The TX-5 is light weight, battery operated; Locates deposits of radioactives. Simply switch "on"—clicks in headphones indicate presence of radioactives. Extra sensitive, yet ruggedly built.

Each unit comes complete with headphones, probe, batteries and manual. For prospecting and mining operations. Write for details and price. Dept. 8

OMAHA SCIENTIFIC SUPPLY CORP.,
3623 LAKE, OMAHA 4, NEBR.

Geiger Counters for
-OIL PROSPECTING
-MINERAL LOCATION
-HOSPITAL WORK
-INDUSTRIAL USE

BUILD THIS CONCRETE BLOCK MACHINE

Sell blocks or build your home, garage, barn at 1/3 cost by making and laying your own blocks.

This simple machine which you can build yourself at a cost of about \$15 (excluding motor) will make a block in 30 seconds using only one form. 2 to 4 forms can be used on each vibrator.

Power driven concrete mixer plans also. Write for further information. No obligation.

U-BUILD-IT SERVICE

Dept. 3-A, 206 West Wilder Ave., Tampa 3, Fla.

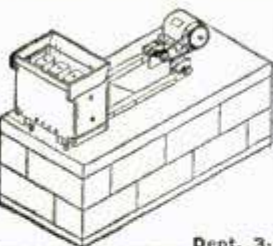

FASTEST PLANER in the WORLD at this Low Price... \$195.00

BELSAW Multi-Duty Planer

Speed up production! Increase your profits! BELSAW power self-feeds at 24 feet per minute . . . The lowest-priced surfacer that will handle 12 x 6 in. stock. Planes green or dry sawed lumber into smooth, worked forms. Three high-speed steel knives make 42 cuts per inch. Multi-duty BELSAW takes inexpensive attachments for all planing mill operations—Jointing, Rabbeting, Grooving, Matching. BELSAW is the only 12 in. planer providing attachments for jointing and grinding its own knives. Start planning NOW for BIGGER VALUE and BETTER PERFORMANCE, with BELSAW. Write for FREE specifications, illustrations and low prices.



• LARGER CAPACITY • FASTER OUTPUT • KNIFE SHARPENING ATTACHMENT

BELSAW MACHINERY CO R-1019 Field Bldg., 315 Westport Rd., Kansas City, Mo.

AIR COMPRESSOR PISTON TYPE

Piston type, size 2 x 1¼, head in valves, bronze bearings, splash lubrication, Belt drive, Intake muffler and cleaner. Capacity 2.8 c.f.m. at 100 lbs. continuous pressure or 150 lbs. Intermittent, with ½ HP motor. Can be used with ¼ HP or ⅓ HP at lower speed. Weight 14 lbs. Operating instructions furnished.

Immediate delivery. \$18.50 Price only

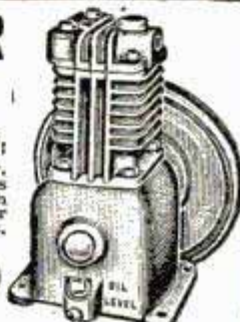

¼" REDUCING VALVE & GAUGE

Oil resistant, pressure 0-to-200 lb. Reduced pressure 0-to-75 lb.; 3 outlets ¼". Wt. 2 lbs. \$5.75



Only \$8.95
AUTOMATIC PRESSURE SWITCH WITH UNLOADER
125-150 lb. pressure. Uses ¼ to 5 H.P. unit
Only \$8.95

DASH POT Check Valves
Prevent leakage after compressor stops. ¼" Check Valve . . . \$2.60



AIR GAUGE

Standard air gauge. 2½" diameter. 0-200 lb. pres. \$1.75 sure . . .



HEAVY DUTY ELECTRIC MOTORS

Ball Bearing 110/220 volts—1 phase—60 cycle—1750 R.P.M.—Continuous duty, 300% full load starting Torque, outlet box, operates clockwise or counter-clockwise, carries one year guarantee against mechanical defects. Also in 3450 R.P.M. at same price.

½ HP Wt. 36 lbs. . . 33.50
¾ HP Wt. 50 lbs. . . 42.00
1 HP Wt. 80 lbs. . . 54.00
1½ HP Wt. 80 lbs. . . 56.00
3450 R.P.M. only.

POP TYPE VALVES

Has a close range of closing after pop-off pressure is reached. ¼" pipe thread. \$1.50 Only . . .



PRICES ARE F.O.B. CHICAGO. Immediate delivery. SOLD ON MONEY BACK GUARANTEE. Send check or money order.

C & M EQUIPMENT COMPANY

1831 S. State St., Dept. D-8 Chicago 16, Ill.

SAY YOU SAW IT IN POPULAR MECHANICS

NOW! CUT WOOD
OR
METAL
ON SAME MACHINE

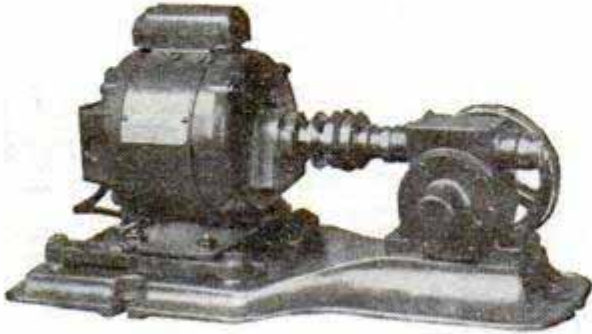

With the New "SPEED MARVEL" Band Saw GEARED SPEED REDUCER you can convert your present Band Saw from wood to metal cutting and still use your present motor.

\$32.75, Less Motor, F.O.B., Norristown, Pa.

Write for free folder No. 10

HUTCHINSON MFG. CO.
NORRISTOWN PENNSYLVANIA

FREE ALLIED'S GREAT
RADIO CATALOG!

172 Value-Packed Pages
SEND FOR IT TODAY

Everything in Radio
At Lowest Prices!

Get ALLIED'S latest Catalog—biggest and most complete in Radio! Tremendous values in new Television receivers, home radios, latest Amateur receivers and Ham station equipment, Sound Systems. Everything for the Builder and Experimenter—thousands of parts, tubes, test instruments, tools, books, diagrams and builders' Kits—the world's largest stocks—all at money-saving low prices! Get your copy today.



The Only COMPLETE
Radio Catalog

FREE
Catalog!
Send
for it

ALLIED RADIO

ALLIED RADIO CORP., 833 W. Jackson Blvd., Dept. 5-H-8
Chicago 7, Ill.

Rush FREE 172-Page ALLIED Catalog.

Name.....

Address.....

City..... State.....

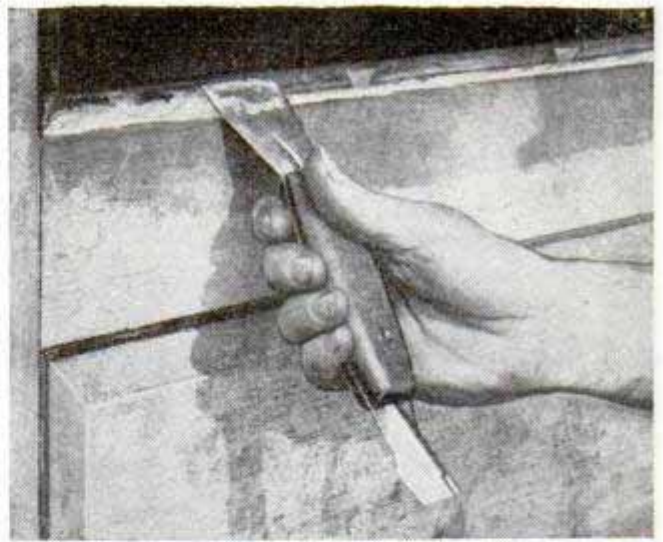

Double-End Putty Tool

You don't have to be an expert glazier to do a neat puttying job when you use a double-end putty applicator. One end of the tool is shaped like a conventional putty knife and is used for applying the putty. The other end is bent to form an angle that spreads the putty along the sash smoothly, pressing it firmly in place. Excess putty is forced out a center slot in the shaper end.

Insecticide Safe for Animals

Because it is entirely harmless to warm-blooded animals, a new insecticide, called Pyrenone, may save up to 300,000,000 bushels of grain annually in this country. Lethal to a wide range of insect life, the insecticide can be used to spray the interiors of grain bins without injury to animals or people who might eat the grain. It can also be used for spraying meat and dairy cattle with no injury to the animals or contamination of meat or dairy products. Pyrenone includes a wide group of concentrates obtained by combining either piperonyl butoxide or piperonyl cyclonene, both synthetic organic chemicals, with pyrethrum which is obtained from a cultivated tropical flower.

☞ Largest living flying bird is the trumpeter swan, weighing around 35 pounds, while the ostrich, weighing 150 to 300 pounds, is the largest flightless bird existing.

EARN BIG MONEY
AND BE YOUR OWN BOSS
Sharpening Lawn Mowers

THE UNIVERSAL GRINDER
PUTS YOU INTO BUSINESS
WITH SMALL INVESTMENT

Earn as much as \$400.00 a month in your basement or garage. Mr. Felber of Ind., writes, "MY UNIVERSAL GRINDER is faster and more accurate than any other grinder. Its efficiency enabled me to sharpen 450 mowers in 4 1/2 months. More than paid for itself the first month. Every customer satisfied." Mr. Hardy of Mississippi writes, "Received my Universal Grinder the first part of May and by August 18 had sharpened over 1000 mowers." Mr. Bacon of California writes, "The lawn mower business, with my Universal Grinder, has been a gold mine these last two years."



Only on the UNIVERSAL GRINDER can the inside face, the edge of the stationary blade, and the reel blades, be ground to proper clearance ALL IN ONE SET-UP WITHOUT REMOVING ANY BLADE FROM THE MOWER
 Free Folder

Rogers Mfg. Co., Dept. M-88, Lindsey, Ohio

ASSEMBLE *King Midget*

45 MILES AN HOUR **90 MILES A GALLON**

New, low cost transportation. Practical. Safe. A pleasure to drive. Home assembly keeps cost low. Just bolt together our factory built units. Immediate delivery. Send 25c for detailed circular with large picture, 4-view drawings, price of all parts. Or send for actual Assembly Book with 42 photographs, blueprints, drawings, sketches AND above literature—all for \$1 (refunded first order).

MIDGET MOTORS MFG. CO., Athens, Ohio
PRINCE ALBERT
 THE NATIONAL JOY SMOKE

Now! You Can Install
DUAL WHEELS!

IN LESS THAN TEN MINUTES

on your Trailer, Pick-up Truck, Farm Wagon or Jeep and on any other vehicle equipped with passenger type wheels.



Complete set for 2 wheels.....only **\$28.50**
 DU-ALL Adapters eliminate expense of changing to truck-type wheels and hubs. Use your spares for duals! Complete—nothing more to buy—no machining or alterations needed.

6 Models to Fit 90% of All Light Vehicles

- DA 201—FORD All Pass. & 1/2 Ton 1928 to 1947 (Except 1936-1939)..... **\$28.50**
- DA 202—FORD All Pass. & 1/2 Ton 1936 to 1939 & 3/4 Ton 1938-1941... **\$32.50**
- DA 203—JEEP All Military & Civil... **\$28.50**
- DA 204—CHEVROLET All Pass. & 1/2 Ton 1928 to 1947..... **\$28.50**
- DA 205—PLYMOUTH—DODGE All Pass. & 1/2 Ton 1933 to 1947..... **\$28.50**
- DA 206—INTERNATIONAL 1/2 Ton 1935-1947..... **\$28.50**



JEEP STANDARD WHEEL TREAD ADAPTERS. Extends width of tread to standard 58" width. Complete set for 4 wheels. No. TA 4 10..... **\$36.00**

GI MILITARY TRUCK PARTS

Axles, Trunion Bars, Pillow Blocks, Transfer Cases, Gears, Wheels, and every part for every G. I. type vehicle from jeep to 20 ton prime mover. 6x6 Stude., GMC, Dodge; 4x4 Chev., Dodge, Ford, Auto Car, Half track, Scout car, etc.

TRAILER AXLE ASSEMBLY

20,000 lb. capacity—4 1/2" round axle; 54" between brakes; 72" between wheel flanges.

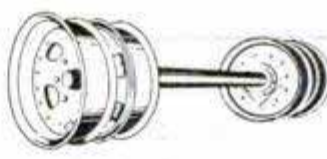

GI-503 NEW COMPLETE ASSEMBLY including latest type double cylinder Hydraulic Brakes, 6 hole Budd hubs, bearings, etc. For single or dual wheels. A War Surplus special. Complete **\$158**

GI-504 BUDD WHEELS to fit 20x7—for 8.25x20 tires. **\$6.75**
 Our Price Each.....

16" DROP CENTER WHEELS For Model T Fords... and all old models with off-standard hubs. Heavy duty, double disc wheels to replace all obsolete wood wheels of odd sizes—for trailers or passenger vehicles.
 Two Types, Only **\$6.45 each**

WF41N—For Model T Fords. With all holes drilled, ready to bolt on.
 WP400N—Universal Fit with Center Hole in Blank Disc for drilling to size.

SEND FOR FREE 64-PAGE CATALOG

The **NORTHWESTERN**
Auto Parts Co.
 834 North 7th Street • Minneapolis 11, Minnesota

WITH MOLLY YOU CAN FASTEN ANYTHING
 and do it quickly, neatly and safely. MOLLY will hold fixtures securely to floors, ceilings or any hollow wall construction... Simple to install, all you need is a screw driver. Sold by leading hardware stores everywhere.

Write for Free Descriptive Folder

PLACE FIXTURE WHERE SCREWS WON'T HOLD — USE MOLLYS

MOLLY
 SCREW ANCHORS

MOLLY CORP.
 522 COURT STREET
 READING, PA.

**All These Jobs With One Tool
SANDS • POLISHES**



- DRILLS
- GRINDS
- BUFFS
- Mixes Paint
- Wire Brushes
- Steel Wools

SANDER-POLISHER

\$36⁵⁰

(F. O. B. Muskegon)
(Accessories listed above—\$28.90)
Sander-Polisher with accessories
\$65.40

Get the Duo at your nearest hardware, paint, appliance store . . . or order direct with coupon below.

Sanding and polishing—easy and fast with the Duo Portable Electric! Use it on wood, metal, plastics. Accessories quickly change it to a drill, grinder, buffer, mixer, brush or steel wooler—the most versatile tool you ever saw. Ideal for work on autos, furniture, boats, building, farms—for all types of refinishing and repair. Lightweight, powerful, rugged. Listed by Underwriters' Laboratories, Inc. AC or DC.

CLARKE SANDING MACHINE CO. — Muskegon, Mich.

Please ship Duo Portable Electric Machines Complete with all accessories \$65.40 Sander-Polisher (only) \$36.50
Ship C.O.D. plus shipping charges Postpaid. Money order enclosed Send information on individual accessories.

Name _____

Address _____

City _____ Zone _____ State _____

**Now for EVERY WORK SHOP!
NEW Invention Electroplates by BRUSH**



Easy to Plate CHROMIUM GOLD, SILVER, NICKEL, COPPER . . . For Pleasure and Profit!

If you have a workshop—at home or in business—you need this new Warner Electroplater. At the stroke of an electrified brush, you can electroplate models and projects—you can replate worn articles, faucets, tools, fixtures, silverware, etc. with a durable, sparkling coat of metal . . . Gold, Silver, Chromium, Nickel, Copper or Cadmium. Method is easy, simple, quick. Everything furnished—equipment complete, ready for use. *By doing a bit of work for others, your machine can pay for itself within a week.* So make your shop complete by getting a Warner Electroplater right away. Send today for **FREE SAMPLE** and illustrated literature. **ACT AT ONCE! Mail Coupon.**
WARNER ELECTRIC CO., DEPT. T-8
1512 Jarvis Avenue, Chicago 26, Ill.

FREE Details & Sample!

WARNER ELECTRIC CO., 1512 Jarvis Avenue, Chicago 26, Dept. T-8

Gentlemen: Send Free Sample and Details to:

Name _____

Address _____

City _____ State _____



TREMENDOUS PROFITS

HERE is the opportunity of a lifetime . . . **QUICK STEADY PROFITS** . . . Get in this fast growing profitable business . . . Full or Part Time . . . Profits Pile Up Quick . . . Place **SKYLINE** Coin Operated Radios in Restaurants, Taverns, Laundrettes, Cocktail Lounges, etc. Then watch profits pile up . . . Plays 15 minutes for 10c . . . Builds up profits day and night . . . The profits are tremendous . . . Join the money-makers . . . Be first in your territory . . . Complete information **FREE** . . . Write or Wire . . . But do it **NOW!** . . . **TODAY!** . . .

SKYLINE COIN RADIO, Dept. P-8

1212 WEST 64th ST.

CHICAGO 36

CADET DUAL VACUUM HORNS

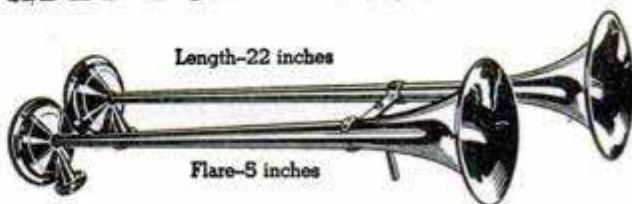

At the Low Price We Can All Afford

Here is your chance to get air horn results—looks, blast and beautiful organ tone—at a fraction of the cost of air horns. Spun brass with gleaming chrome finish or lasting lacquer. Positive operation. Complete unit consists of one pair of beautiful vacuum horns with the mounting brackets, valve, control handle, hose, fittings and installation instructions. Can be mounted on front fender or on top of or under the hood. A must for safety and smart appearance for any car. Chrome finish \$29.50—Lacquer finish \$23.75. Send check or money order and we will pay the postage—*or order C.O.D.*

The Protecturod Company Dept. 601
4033 Windsor Road . . . Youngstown 7, Ohio

AIR COMPRESSOR



General Electric: 1/2 hp 27 volts AC-DC. 2 stage piston type 1000 lbs. per sq. inch rated pressure 17 AMP series wound motor equipped with fan for cooling. Can be adapted to 110 AC with 27 volt transformer or 4-1000 watt heating elements. Thousands now in use for spraying, inflating tires, laboratory use, etc. May be used with low-pressure paint spray gun. 25 lbs. Shipping weight, **\$17.95**
F.O.B. Kansas City, Mo.

TRANSFORMERS: 27 volt. New FOB, Kansas \$14.95
City, Mo., Only

Write for latest circular of surplus bargains

NATIONAL SURPLUS SALES CO. 723 E. 18th Street
Kansas City, Missouri

DRESS UP YOUR CAR WITH Ace FENDER PANTS

Install these "heavy steel" prime finished fender skirts yourself—and pocket a "substantial savings."—Your car will have that "new look!" Hooks on in a jiffy to any 1935 to 1949 model of the cars listed at the right. Enclose money order—save freight—or order C.O.D., freight collect. Specify car make, year and model.
DEALERS WANTED

ACE AUTO PRODUCTS
Dept. PM-8, P.O. Box 9502, Station 5
Los Angeles, Calif.



Order by Mail **\$16.95**

- | | | |
|---------|------------|--------|
| FORD | OLDSMOBILE | BUICK |
| MERCURY | CHRYSLER | DODGE |
| DE SOTO | PLYMOUTH | FRAZER |
| PONTIAC | CHEVROLET | KAISER |

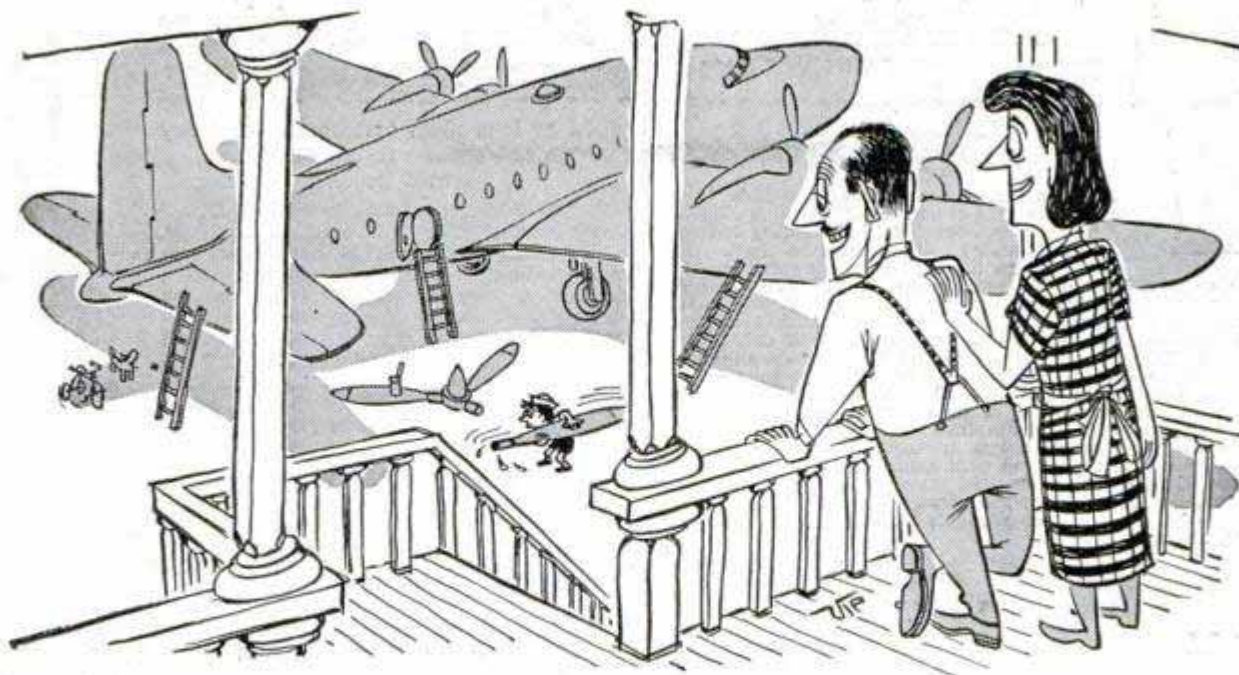

"And to think how we laughed when Junior asked for a can of Weldwood Glue to build a model plane"

When you want a wood-to-wood bond that will really hold... remember Weldwood Glue. It's quick to mix... easy to use... tremendously strong... stain-free... rot-proof... and permanent. At hardware stores, lumber yards, chain stores, in 15¢, 35¢, 65¢, 95¢ and larger sizes.



WELDWOOD
PLASTIC RESIN GLUE

United States Plywood Corporation, New York 18, N. Y.

ALLISON END PLATES

ADAPTER PLATES—To convert Allison engines to direct drive. **\$95.00** Each
 ALLISON EXHAUST STACKS—P-38 model. **\$95.00** Per Set
 All new—heavy duty—stainless steel.....

Shipped to Continental U.S.A. prepaid.

GROSSO AND GROSSO

5509 Klump Street North Hollywood, Calif.

Manufacture for the Building Industry



Get in the Dunbrik-Dunstone business today and ride the tide of the biggest building cycle in history. It's the outstanding manufacturing opportunity in the building field, with broad market potentials and high income possibilities.

A Wide-Open Opportunity

Dunbrik (and Dunstone) is masonry at a new peak point of colorful beauty and modern design. Easy to make in local plants, using local material and local labor. Low costs means you can give more quality for less money—even undersell lumber. We supply all necessary equipment; back you with liberal cooperation. Write today for full information.

W. E. DUNN MFG. CO.
600 W. 24th STREET
HOLLAND, MICH.



DUNBRIK DUNSTONE

HEATHKIT 3-TUBE ALL-WAVE RADIO

110-volt A.C. operation



\$8.75

An ideal way to learn radio. This kit is complete ready to assemble, with tubes and all other parts. Operates from AC..... Simple, clear detailed instructions make this a good radio training course. Covers regular broadcasts and short wave bands. Plug-in coils. Regenerative circuit. Operates loud speaker. Add postage for 3 lbs.

Headphones per set.....**\$1.00**
 2 1/2" permanent magnet loudspeaker.....**\$1.05**

INTERPHONE 2-WAY CALL SYSTEM KIT

Ideal call and communication system for homes, offices, factories, stores, etc. Makes excellent electronic baby watcher, easy to assemble with every part supplied including simple instructions. Distance up to 1/5 mile. Operates from 110-V A.C. 3 tubes, one master and one remote speaker. Shipping Wt. 5 lbs.



\$14.50

HOME WORKSHOP GRINDER



\$3.95

Easily assembled 110V AC or DC ball bearing fully enclosed motor from Army surplus dynamotor. Purchaser to make simple changes and shaft extensions, detailed instructions and all parts supplied. Motor approximately 1/30 H.P., 5,000 R.P.M. Ideal for tool-post grinder, flexible shaft tool, model drill press, saw. Shipping wt. 6 lbs.

HEATH CO. DEPT. M
BENTON HARBOR, MICH.

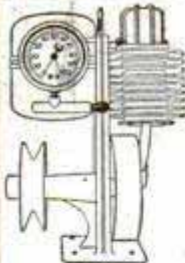

COMPRESSED AIR INSTANTLY, Anywhere!!

Portable Air Compressor and storage tank. Ruggedly built of best materials using lifetime lubricated ball-bearing on connecting rod and oil impregnated main bearing on shaft. Unusual design forever eliminates valve trouble.

The most common fault in air compressors. **PATENTED** unique air intake system increases efficiency tremendously over other compressors so that air output is much greater than that from larger compressors powered by heavier motors. Will deliver approximately 3500 cu. inches of air per minute at maintained pressure of 30 lbs., or will inflate a 90 lb. truck tire in less than one minute. Comes complete with 100 lb. gauge, although fingertip adjustment allows setting of output pressure at any value, which will automatically be maintained. Works from any 1/4 H.P. motor. Useful for spraying paints or lacquers, disinfectants, insecticides, annealing or brazing with natural gas, inflating tires, etc. Price \$14.50 postage prepaid anywhere in the U. S. Efficient, completely adjustable syphon type spray gun complete with 12 ft. of 100 lb. tested hose available for only \$7.75 with pint container, also prepaid.

25% Deposit with C.O.D. orders

BUFFALO RADIO SUPPLY (Dept. 8M)

219-221 Genesee Street

TERRIFIC VALUE—PORTABLE ELECTRIC DRILL

(Sold at less than established factory price so we cannot mention brand name)

Only \$19.95 equipped with 1/4" Jacobs Geared Chuck and Key. Not an intermittent duty drill, but a full size rugged tool. Most convenient type switch, natural grip handle, and balance like a six shooter. Precision cut gears—turbine type cooling blower—extra long brushes. No stalling under heaviest pressure because of powerful 110 Volt AC-DC motor and multiple ball bearing thrust. Other bearings self-aligning lifetime-lubricated Oilite type. Made for toughest year-in and year-out service in plant or on construction jobs.

Amazing perpetual factory guarantee assures you of a lifetime of trouble-free use. Full refund (you pay transportation) if not pleased with drill after trial.



GERSTNER Tool Chests

Genuine Gerstner chests have never been equalled for durable construction and finer finishes. Free catalog for toolmakers.

GERSTNER TOOL CHESTS

448 Columbia St. Dayton 7, Ohio

Built for **WEAR-COMFORT**
Military style **COMBAT BOOTS** \$6.55
FIELD SHOES \$4.99



SIZES 6 TO 12



6 TO 12

Navy style—rugged and comfortable—reversed uppers. Full oak leather innersole with hard wearing composition outer sole. Sizes 6 to 12, D to EE. Add 22c postage please.

For work, outdoor sports, etc. About 9" high—sturdy reversed uppers, full oak leather innersole with extra composition outer sole. Size 6 to 12, D to EE. Add 27c postage please.

MAIL ORDERS

Please send remittance with order. Include postage. Guaranteed satisfaction or your money back. **ORDER TODAY!**

Officer type **OXFORDS** \$6.88



• BROWN
• BLACK

Exceptional values—black or brown. Best quality uppers; solid oak leather soles. Worth considerable more than our low price. Size 6 to 12, D & E. Add 20c postage please.

SIoux FALLS SURPLUS STORE
SIoux FALLS, S.D.

SEND FOR **FREE** War Surplus CIRCULAR



STAR UNIVERSAL NO-LEAK TESTER

AT THE BENCH | AT THE JOB



TEST LAMP SHOWS CONTINUITY
Test CONTINUITY ON THE SPOT, anywhere, in factory or home. No batteries. Just plug into any 110 volt receptacle. Locate open circuits, dangerous grounds in motors, fixtures, etc. Vest pocket size—wt. 2 1/2 oz. Also unexcelled for line testing, 110 to 600 volts.

A NECESSITY for Electricians, Maintenance Men, Home Owners

No-leak neon lamp in one test prod shows definitely what is wrong... and where. At \$2.50 most dealers, or direct from us postpaid

FREE Illustrated Folder on Request.
Address Dept. M

STAR FUSE CO., 233 Canal St., New York 13, N. Y.



FIRST IN FUN FOR FAMILIES ASSEMBLE THIS CLOCK FOR ONLY \$3.95

IT'S EASY — IT'S FUN — IT'S INSTRUCTIVE

(A small screwdriver is the only tool required.)

Complete, Ready to Assemble—Accurate—Lasts for Years

Exquisite Design—Ebony Black Plastic Case

See what makes a clock "tick." See how smart you are mechanically by timing yourself as you assemble this beautiful, weight driven pendulum clock which you can't buy in finished form in stores for twice the price.

You save all assembly costs and you can sell to friends and neighbors to make extra cash.

WILCOX, INC. Dept. P, 971 Goodrich Blvd. Los Angeles 22, Calif.

SOUTH BEND

Universal Tool Block

Replaces tool post and nine standard tool holders. Rigidly supports turning, boring, threading, and cut-off tool bits. Rotatable. Has self-aligning knurling head. Precision adjustment for tool height. No re-adjustment required when replacing tools. Adaptable to some other lathes. Write for dimension sheet.

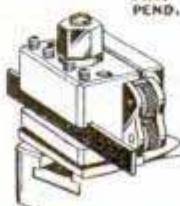

PAT. PEND.

Lathe Size	9"	10"	13"	14 1/2"	16"	16 1/4"
Price	\$11.25	11.75	13.75	15.75	16.25	

SOUTH BEND LATHE WORKS 455A E. Madison St. South Bend 22, Ind.



MOTO-TOOL ★ THE "POCKET-SIZE" MACHINE SHOP



A TESTED TOOL THAT PACKS YEARS OF PLEASURE

If you get a kick out of making things, you'll have fun with a Moto-Tool. It grinds, drills, routs, carves, polishes . . . does work better, faster . . . on practically any material. Moto-Tool is backed by 10 years of successful industrial service . . . also used by every branch of the Armed Forces. Compare Moto-Tool with other grinders and see for yourself why it's better.

10 Reasons Why Moto-Tool's a Better Buy
 Oil-less, sealed bearings • Patented automatic chuck lock pin • Oversize armature shaft; hardened, ground, polished • 110 Volt, AC-DC motor • Sliding snap-type switch • Handy hanger hook; cord protector • Shock-proof bakelite housing • Dust-filtered air-cooling system • Dynamically balanced for vibrationless operation • Weighs only 13 oz.

MONEY-BACK GUARANTEE:

Buy Dremel Moto-Tools from your dealer. If he cannot supply you, order direct from the factory on 10 day trial, money-back guarantee. Shipped postpaid for payment in full (send check or money order); or send only \$2. We will ship C.O.D. You pay postman balance plus postage. Catalog of Moto-Tools and Accessories FREE.

DREMEL MFG. CO.

Dept. 118-H • Racine, Wisconsin



APPROX.
27,000 R.P.M.

New DREMEL DRILL PRESS ONLY \$9.95

(Less Moto-Tool)

Here's a portable, precision drill press at an amazingly low price. Just the thing for creating costume jewelry, model making, wood carving, routing, etc. Utilizes Model No. 2 Moto-Tool, which can be raised or lowered, swung in any direction, or quickly removed for off-hand use. Drill Press stands 12" high. Base is 6 3/4" x 4". Weighs approximately 3 1/2 pounds.



PRE-WAR PRICES STILL PREVAIL

Moto-Tool Kit No. 2, with 23 accessories (high speed steel cutters, grinding wheels, polishing accessories) and heavy-duty professional Model 2 Moto-Tool in natural-finish, hardwood case. \$23.50 (Items purchased separately would cost about \$30.00; you save \$6.50.)
 Moto-Tool No. 2, with one emery point \$16.50
 Moto-Tool Kit No. 1, with 34 accessories and Model 1 Moto-Tool in wood case. \$17.50
 Model 1 Moto-Tool, with one emery wheel point \$9.85

WHEELS + WHEELS

- 5-in. disc wheel, 5/8-in. tire, 5/16-3/8 sleeve \$.30
 - 6-in. disc wheel, 5/8-in. tire, 5/16-3/8 sleeve \$.35
 - 7-in. disc wheel, molded tire, 3/8-in. sleeve \$.45
 - 8-in. disc wheel, 1 1/8 tire, 1/2-in. sleeve \$.70
 - 7-in. disc wheel, 1-in. tire, 1/2-in. B.B. \$.80
 - 8-in. disc wheel, 1 1/8 tire, 1/2-in. B.B. \$1.00
 - 10-in. disc wheel, semi-pneumatic 1 3/4 tire, 1/2-in. B.B. . . . \$1.50
- Above wheels painted red.

10-in. alum. wheel, semi-pneumatic 2 3/4 tire, 5/8-in. B.B. . . \$4.50
 Hub caps for 5", 6", 7" wheels \$.03 extra.

UNITED WHEEL MFG. CO., 2756 W. 115th St., Chicago, Ill.



SOLVE DIRECTIONS as You Drive with a Hull Automobile Compass

Easy, safe and sure way to keep headed right, always, is to drive by accurate, rugged Hull Automobile Compass. Beaconlite illuminated, \$5.95; Streamline standard, \$3.95; Marine Compass, \$2.75. At your dealer's. Write for circular.

HULL MFG. CO., P. O. Box 246-D8, Warren, Ohio



\$1.50

Postpaid

Lock Stitch Sewing Awl

SPECIAL OFFER



This famous, patented, lock-switch sewing awl complete with 3 different style needles, reel of black waxed thread, skein of brown waxed thread and direction folder for only \$1.50 postpaid. Many uses — sewing, repairing leather goods, canvas, belting, old or new harness, saddles, gun cases, golf bags. Satisfaction guaranteed or money back. Send cash, check, or money order, no stamps, please. Yates Mfg. Co., 611-H Main St., Lake Geneva, Wis.

IN ORIGINAL CRATES — BRAND NEW

TYPE P2 DC GENERATORS

BRAND NEW — ORIGINAL COST ABOUT \$300

NOW WHILE THEY LAST, EACH . . . \$10 F.O.B. Our Buffalo or Syracuse Plants



28.5 VOLTS—200 AMPS. DIRECT CURRENT

Manufactured by Bendix Aviation Corporation
 SPEED RANGE 5000 TO 10,000 RPM

Experimenters, inventors, laboratory workers! Here's your opportunity to pick up a magnificent piece of equipment at about 3% of the original government cost. Net weight 38 pounds. Mail check or money order. Prompt shipment guaranteed.

HURWITZ BROS. INC.

P. O. Box 76, Syracuse, N. Y. P. O. Box 213, Buffalo, N. Y.



GIVE YOUR CAR THE "WOLF CALL"

of Deep Tone DUAL MUFFLERS

The rich, low, mellow sound of "straight thru" ADVANCE mufflers is something all your friends will admire.

Also greater power, speed, and economy result from the reduced back pressure of this scientific design. Rugged steel tube throughout (no aluminum); blowout-proof.

SIMPLE TO INSTALL. No welding, cutting, or holes to drill. Complete with rubber mounted clamps (no rattle) and all necessary fittings.

ADVANCE MUFFLERS, 6800 S. Vermont Ave., Dept. P.M-88, Los Angeles 44, Calif.
 Send Check, Money Order, or we will mail C.O.D.
 You pay postage upon receipt.

Dual Muffler Set (Ford, Mercury only) \$20.00 Single Muffler (other makes) \$5.50
 Single Muffler (Ford, Chev., Plym.) 4.86 2 1/2" Chrome tail pipe tips 1.75

Car make _____ Year _____ Model _____

Name _____

Address _____ City _____ State _____

ADVANCE MUFFLERS
 6800 S. Vermont Ave., Los Angeles 44, Cal.

FREE RADIO CATALOG

Lafayette Radio

100 SIXTH AVE. • NEW YORK 13

MAIL COUPON TODAY!

LAFAYETTE RADIO, DEPT. LH-8
100 Sixth Ave., New York 13, N. Y.

Please send me your free catalog.

Name.....

Address.....

City..... Zone..... State.....

It's Wise To Go
WHIZZER
America's Finest Bike Motor

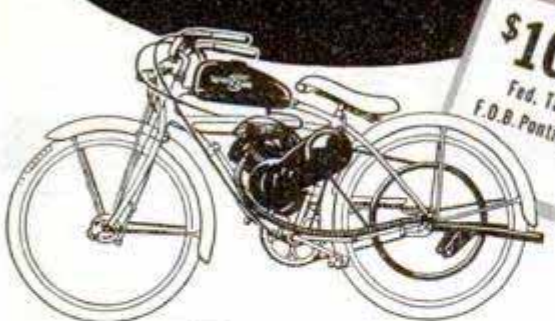

\$10997
Fed. Tax Incl.
F.O.B. Pontiac, Mich.

Better than Ever—new '48 Model with new Twist-Grip controls . . . new steel cable core notched V-belt drive . . . new auto-type carburetor . . . new hot-spark ignition. 4-cycle engine design gives 2½ rugged h.p.; 125 miles per gallon; 35 m.p.h. You can ride 5 miles for a penny!

RIDE ONE AND YOU'LL BUY ONE!

See your Whizzer Dealer . . . or write Whizzer Motor Co., Pontiac, Mich. For 10 years — world's largest bike motor builder.

SAVE ON SURPLUS BARGAINS

PERFECT ALL WOOL OLIVE DRAB

SLEEPING BAG

Handy for fishing trips, hunting, camping, boating, just roughing it or use as auto robe and many other purposes. Warmth of 2 blankets; zipper slide fastener; tiestrap on bottom; approx. Gov't cost \$12.90. Our Price each. . . . \$2.39
Outside Cover for Sleeping Bag—Water repellent. . . . \$2.39

DOWN FILLED SLEEPING BAG with zipper, perfect, like new, orig. value \$1095
\$23.00, our price \$2.40
Outside water repellent cover. \$2.40

ALL RUBBER SUIT Perfect for fisherman, sportsmen, trappers, and all who work in and on the water. For trapping, dam and caisson work. You can make boots, hip high water waders, rubber gloves, rain capes, etc. Fits right over your clothes and shoes. Cost gov't approx. \$25. \$495
Our price \$4.95

NEW GOGGLES Set comes complete. Kit with 1 extra interchangeable shatterproof, flexible, cellulose acetate lens. Green and white colors. A rubber flexible goggle frame. Back adjustment head strap. Cost Gov't approx. \$4.50. Ea. 98c
—Air Corps Type. \$2.95

SUN GLASSES Nothing Finer. \$2.95

PUP TENTS Perfect—2 man size for scouting, Camping, etc. Without Pole. \$2.95

GIANT JACK KNIFE—For hunter, fisherman, camper, work shop, etc. Original aviator's emergency knife used by U. S. Marines. 5 inch parkerized, finished cutting blade and 5 inch "saw type" fish scaling blade. Hard rubber and steel handle, opens to 11 inches overall. Has blade safety lock. Comes in canvas carrier with loop for belt or chain hook. Cost Gov't \$9.50. Our price, only, ea. \$3.95

JUNGLE HAMMOCKS—made of high grade Poplin for US Army, perfect for the home, yard, outings, etc. Complete with ropes and canopy. Special only. \$4.45

Rubber DUST MASKS, complete with goggles, 2 filters and head elastic straps. Original value \$4.00. Perfect protection against all kinds of dust and fumes. (With canvas carrier case, 50c extra.) \$1.95
Send check or M.O. Add 10% for handling and mailing.

AMERICAN SUPPLY CO. Dept. PM
329 W. 5th St.
Kansas City, Mo.

CROSMAN Silent RIFLE
Most Amazing Gun Ever Invented for Target and Small Game Shooting



The ideal rifle for year 'round shooting indoors or out. Shoots low-cost SUPER PELLETS without noise, odor or recoil. Requires no cleaning.
At your dealer or write direct.

Adjustable power—rifled barrel for accuracy. .177 and .22 caliber models.
Write for information.

CROSMAN ARMS CO., INC.
3 HENRIETTA ST., ROCHESTER 7, N. Y.

ADJUSTO SAFETY MIRROR
with "REMOTE CONTROL"



A rugged, heavily chromed safety mirror: designed especially for trucks. Mounts through door or body on either side, and is controlled from within cab. Retracts for extra clearance. Keeps perfect rear-vision at your fingertips! Fits any vehicle!

16" mirror rod. \$7.50 PP.
22" mirror rod. \$7.65 PP.
28" mirror rod. \$7.95 PP.

See your dealer, or order direct; Cash or C.O.D., Immediate delivery.

HUSTAD DISTRIBUTING COMPANY
540 So. 52 St. Dept. MB Omaha 6, Nebr.

FOR BIG MEN ONLY!

QUALITY SHOES IN SIZES 10 TO 16



We specialize in large sizes only—sizes 10 to 16; widths: AA to EEE. Wing Tips, Loafers, Moccasins, Dress Oxfords, High Dress Shoes, Work Shoes, Sox. Styling specially designed for large sizes. Satisfaction guaranteed. FREE Catalog.

KING-SIZE, Inc.
622 Brockton, Mass.

Write for FREE Catalog

BALL BEARING STEEL WHEELS

Complete With Wheels, Tires & Bearings Made To Outwear Other Type Wheels

SIZE	TIRE	BEARINGS	LOAD	ONE	TWO	FOUR
12"x2 1/2"	Semi-Pneumatic	Ball 1/2" or 5/8"	150 lbs.	\$ 5.50	\$10.00	\$18.00
12"x2 1/2"	Semi-Pneumatic	Ball 1/2" or 5/8"	225 lbs.	\$ 6.00	\$11.00	\$20.00
12"x3"	Semi-Pneumatic	Ball 1/2" or 5/8"	340 lbs.	\$ 7.00	\$13.50	\$26.00
10"x1 3/4"	Semi-Pneumatic	Ball 1/2" or 5/8"	125 lbs.	\$ 3.00	\$ 5.50	\$10.00
10"x2 1/2"	Semi-Pneumatic	Ball 5/8"	250 lbs.	\$ 5.50	\$10.00	\$18.00
8"x1 7/8"	Solid	Ball 3/4"	640 lbs.	\$ 8.00	\$15.00	\$29.00
6"x2"	Solid	Ball 1/2"	340 lbs.	\$ 4.00	\$ 7.50	\$14.00
4.00"x8"	Pneumatic 16" O.D.	T.R. 1"	700 lbs.	\$13.50	\$26.00	\$50.00
5.00"x8"	Pneumatic 16" O.D.	T.R. 1"	700 lbs.	\$15.50	\$30.00	\$59.00

The above Pneumatic Wheels are Complete With Wheels, Bearings, Tires and Tubes . . . 4 Ply Tires for One Inch Straight Axles.

ORDER NOW Add 10% for Prepaid Shipment in U.S.A. 25% DEPOSIT ON C.O.D. ORDERS

FOR CIRCULARS SEND 10c: On Power Racers, Steering Wheel Assemblies, Auto Type Axles, Parts, Sulkies, Etc.

OSBORN WHEEL COMPANY, 115 So. Main St., Dept. P-8, Doylestown, Penn. Ride Around in Your Own Car



The New 1949 Model "D" RACER



90" Long
40" Wide

6.6 H.P. ENGINE

10 inch CLUTCH

ALL CHAIN DRIVE

Complete as Shown ONLY \$299.50 (Plus \$7.50 crating) As Shown F.O.B. Doylestown

Less Engine, Jack Shaft and Clutch ONLY \$159.50 F.O.B. (Plus \$7.50 crating) Pulls Up Hills With Ease. Runs as low as 2 miles per hour or UP TO 35 MILES PER HOUR. Safe and Easy to Operate for Work or Play. ANY AGE. Equipped with 4.00 x 8 High Speed Wheels and Many Other Features.



BUILD YOUR OWN FAN

One-piece cast aluminum propellers for cooling and ventilating.

Size	Polished	Unpolished	Bore
Inches 2 Blade 3 Blade 3 Blade			Inches
15	\$3.00	\$4.00	\$2.50 \$3.00 1/2, 5/8, 3/4
18	3.75	4.50	3.00 3.50 1/2, 5/8, 3/4
20	4.00	5.00	3.25 4.00 1/2, 5/8, 3/4
24	4.50	5.50	4.00 4.50 1/2, 5/8, 3/4

Let us give you our prices on your aluminum castings.

Write for pamphlet on larger fan blades, wire guards, fan bases, shutters, pillow blocks, exhaust fan frames, etc., shipped prepaid if money accompanies order. Dealers write for discount.

KLOPPENBORG ALUMINUM FDY., Dept. PM88, Davenport, Iowa

WOODWORKERS . . . Get this

CONSTANTINE MASTER MANUAL
Get the Most Fun From Your Hobby
Indispensable to woodworkers. Newest, biggest edition, more pages, more color, helpful how-to-do-it articles, pre-war and new items, more bargains. Send 25c today and we will include **FREE! FULL YRS. SUBSCRIPTION** to Chips and Chats, published bi-monthly. Keeps you up-to-date on everything in woodworking, offers big money-saving bargains. Send now.



ALBERT CONSTANTINE & SON, Inc.
791-D 135th Street, New York 54, N. Y.

BAND SAW BLADES

FOR FACTORY AND HOMEOWNERS
5'6" to 6'5" x 1/4 \$1.42.. x 1/2 \$1.52
6'6" to 7'5" x 1/4 \$1.54.. x 1/2 \$1.65
7'6" to 8'5" x 1/4 \$1.66.. x 1/2 \$1.79
8'6" to 9'5" x 1/4 \$1.78.. x 1/2 \$1.92

POSTAGE PREPAID ON THE ABOVE

Rubber Band Tires — Write For Prices

LASSEN SAW & SUPPLY

2125 Leland Ave. Dept. P-8 Chicago 25, Ill.

Only \$16.95 DUAL PURPOSE SPRAY GUN

Complete
USES ONLY 25 LBS. AIR PRESSURE
FLOCKS AND SANDBLASTS



AT HOME: You can refinish Lamps, Radios, Book Ends, Statues and hundreds of things with lovely colorful flocking. ETCH GLASS: Many designs and initials can be sandblasted on shower doors, ash trays, glassware. AUTO INTERIORS: Transform ugly dirty auto interiors to "new car beauty" with a BLASTO DUAL PURPOSE SPRAY GUN. Makes reflectorized signs too. Merely spray flock similar to Velvet. Flush. Suede and Mohair inside your car. ANTIQUE WOOD REMOVE PAINT. MAKE EXTRA MONEY by doing any or all the above for profit. BLASTO is highest quality and carries a 5 day money-back guarantee. Operates on small air compressor. Send \$16.95 cash, check or money order for postpaid delivery. Write for free information. Full line of Flocking Supplies.

BLASTO SPRAY GUN MFG. Dept. PM-8, 7007 Haas Avenue Los Angeles 44, California

DO YOUR OWN
Calking
WITH Nu-CALK
SPEED LOAD
AND THIS NEW **SPEED LOADER**

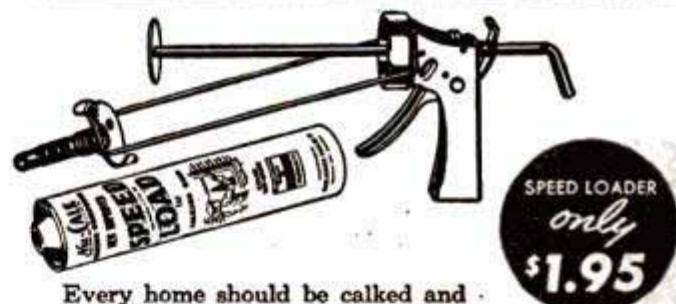

SPEED LOADER
only
\$1.95

Every home should be calked and here's the combination that enables you to do the job yourself. Just snap a Nu-Calk SPEED LOAD into the SPEED LOADER Calking Gun and you're ready to calk. You have an easy, fast, economical way to apply the world's finest calking compound.

Macklanburg-Duncan Co., Oklahoma City 1, Okla.
NO MAIL ORDERS
SOLD ONLY THROUGH LEADING
HARDWARE STORES, LUMBER YARDS
AND BUILDING SUPPLY DEALERS

Write today for booklet on the new FLEX-O-SHAFT Tool Kit, illustrating this improved all-purpose power machine with the hand-piece that works as easily as a pencil. Motor with switch, foot-operated rheostat, and 66 accessories, all at a special low price. FLEX-O-SHAFT SALES CO., Dept. C, Prairieview, Illinois.



Powell SETS THE PACE

DEALER INQUIRIES INVITED

- 7 H.P. Motorcycle-type Engine
- Faster pick-up than a car
- Automatic clutch
- Smooth, simplified control
- Solid steel frame
- Highway cruising speed of 45 miles per hour
- Chrome-plated fenders, handlebars, and sport muffler — looks like a custom job
- Costs no more than ordinary scooters

Write for FREE FOLDER and address of nearest dealer

Powell MANUFACTURING COMPANY DEPT. PM-8 COMPTON, CALIF.

MENDS
BROKEN CHINA, TOYS, ETC.
It's transparent,
waterproof,
flexible and
durable.

DU PONT
REG. U.S. PAT. OFF.

DUCO CEMENT
REG. U. S. PAT. OFF.

SAVE MONEY!

PUMPS

Brand New
in original crates

2" 4" 6"

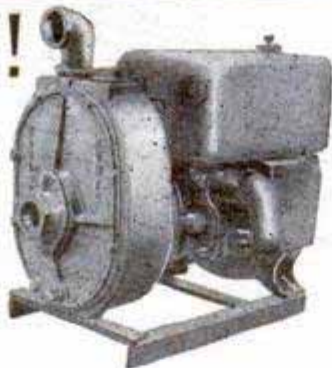

Marlow and Carver
gas engine driven

capacity 55 to 525 gal. per min.

LOWEST PRICES
we have ever offered

FREE 10 gal. all steel
gas tank, with ea. order

Write for circular specify size and output

Benjamin's for Motors

2122 Mill Ave., Brooklyn, N. Y.

STOPS LEAKS PERMANENTLY

Cut your fixture replacement, water and fuel bills with Economy Renewable Seats. Make economical, permanent repairs quickly and easily with the Junior Kit (illus.). Repair bathroom, kitchen and laundry fixtures. Everything you need included in steel box. This is a natural for the "Fixit" shops—get extra income from making permanent repairs on your customers' faucets.

Senior Master Kit also available—repairs faucets and valves up to 1" pipe. At Better Jobbers and Hardware Stores . . . or Write Direct

See our ad under
**BUSINESS
OPPORTUNITIES**

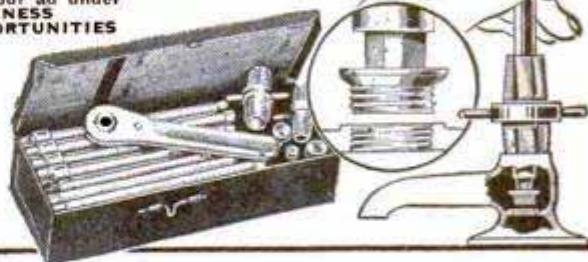

ECONOMY VALVE SEAT CO.

3122 N. California Ave. Chicago 18, Ill.

**GIVES YOU 2
DRILLS IN 1**

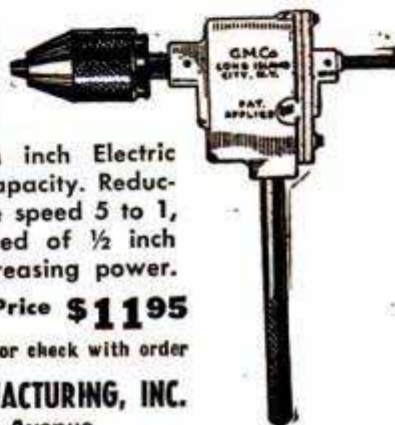

Converts any ¼ inch Electric Drill to ½ inch capacity. Reduction gears reduce speed 5 to 1, the average speed of ½ inch Drill thereby increasing power.

Jobbers write Price \$1195
for proposition

M.O. or check with order

G. M. CO. MANUFACTURING, INC.

1308 43rd Avenue
Long Island City 1, New York

WRITE NOW FOR FREE CATALOG NO. M-320



FOSTER MFG. CO., 1 KINSEY AVE., BUFFALO 17, N. Y.

RENOVATE YOUR JACKET



Leather or Sheeplined Leather Jackets completely reprocessed and renovated to look like new. Complete service includes cleaning, refinishing, waterproofing, replacement of broken zippers, and repairs to rips, tears, etc. only \$3.85 plus postage.

Berlew Mfg. Co., Inc.

2-8 N. Merrick Avenue
Merrick, N. Y.



**CARBURETOR TOO RICH
MAKES MOTORIST TOO POOR**



Car owners who are wasting money and not getting proper gas mileage due to over-rich mixtures will be pleased to learn how to save gasoline by VACU-MATING over-rich mixtures. VACU-MATIC fits all cars, trucks and tractors. It is automatic and operates on the supercharge principle. Easily installed in a few minutes.

SALESMEN WANTED! Big Profits!

Send name, address on penny postcard for free particulars and how to get yours for introducing.

VACU-MATIC CO., 7617-1378 W. State St., WAUWATOSA, WIS.

New IMPROVED Electric MOTO-SAW

ONLY \$5.85
(with 3 Saw Blades) Postpaid



**SAFE AS A HAND SAW
JUST GUIDE IT!**

More like magic than any tool you ever saw. Imagine an electric scroll saw only slightly heavier than a hand coping saw . . . a tool that takes no effort to run, no pressure to feed. Works at any angle — on big assembly jobs or on the tiniest piece you can hold in your fingers. Runs 7200 strokes a minute . . . so fast the blade seems to stand still. Sturdily built . . . only two moving parts . . . never needs oiling. Easily cuts intricate designs — so smooth it eliminates sanding. Novice or craftsman, a thrill awaits you when you get a Moto-Saw in your hand.

THOUSANDS OF SATISFIED USERS
U. S. Patent 2233862
Other Patents Pend.
Dremel Mfg. Co.
Dept. S118-H
Racine, Wisconsin

No Limit to Length of Stock it Will Cut. Saws to Center of 19" Widths.

It's fast . . . cuts on an average of 1 ft. per minute up to 3/4" medium hard wood. Operates on 110-120 V. 50 or 60 cycle alternating current. If your dealer does not yet have Moto-Saw, send \$5.85 . . . we'll pay postage. Or send \$1, pay postman balance plus postage. MONEY BACK if not delighted after 5 days' trial.

New - ALL LUCITE ELECTRIC RAZOR HOLDER

Holds Any Electric Razor

At last . . . a safe, permanent wall-type holder for your electric razor—whatever the model or make. Holds any of them! Has concealed stationary reel on back for orderly winding of cord when not in use.

Truly a handsome utility . . . with beautiful ebony-black Lucite base and contrasting crystal-clear holders, or both, base and holders, in sparkling-clear All Lucite. Both artistically designed to grace any bathroom. Anyone can attach in a "jiffy."

Clip this ad now. State if black or crystal base is desired. Order today, only \$2.95.

Remittance enclosed. Send postpaid.
 Send C.O.D. I will pay postage.

DORENE CO., Dept. PM-8
Box 795 Chicago 90, Ill.



ONLY \$2.95 ea.

A GREAT SURPLUS BARGAIN! AIR REGULATOR and GAUGE

The buy of a lifetime in a standard make air pressure regulator. Used on liquid carbonic tanks and air pressure tanks of all kinds to regulate the pressure. Fitted with standard 1/2 inch pipe thread. Dial calibrated 0 to 200 lbs. Reduced pressure 0 to 150 lbs. Made by U. S. Gauge, Air Reduction Co., Walter Kiddie—all famous makers. Used by artists for air brush work, sign painters, retouchers, welders, etc., soda fountains and taverns.

A \$15.00 VALUE \$5.95
(Wt. 4 lbs.)

Price F. O. B. Chicago. Immediate delivery. Sold on money back guarantee. Send check or money order today.

C & M EQUIPMENT CO.
1831 S. State St., Dept. D-8, Chicago 16, Ill.



Fully Guaranteed
All Brand New and in Perfect Condition

BUILD YOUR OWN POWER LAWN MOWER

WHY BREAK YOUR BACK MOWING FIELD OR LAWN?

FREE Write for Building Instructions
The Rite-Way Mower Attachment

SAVE MONEY SAVE TIME
Now anyone can save time and effort mowing field or lawn by building their own whirl type power mower. Build according to your own ideas and needs at small cost. Cut close to fences, walks, buildings, etc. Build in short time with parts and instructions we furnish. Save hours of time and back breaking labor. Write today for FREE information.

IT'S FUN TO BUILD

T & H MFG. Co., Dept. MP-16
811 E. 31, Kan. City 3, Mo.



Our Finest Precision REBUILT MOTOR BLOCK ASSEMBLIES

Carries the Same 90 DAY GUARANTEE As a New Motor Assy.

Sold Outright or Exchange

Rebuilt by skilled mechanics. Assembly has Reborn Block with New Pistons, Pins, Rings, Reground Crankshaft, all New Bearings. Guaranteed 90 Days. **Allowance on Old Motor** We ship at outright price. Send your motor prepaid, must be suitable for rebuilding. Send in notarized bill of sale showing title number if any. We refund difference when we receive your motor.

	Outright	Exch.
BUICK		
34-47 8 cyl. \$199.00	\$160.00	
CHEVROLET		
29-47 6 cyl. 117.50	87.50	
CHRYSLER		
34-47 6 cyl. 162.50	130.00	
35-47 8 cyl. 199.00	160.00	
DE SOTO		
34-47 6 cyl. 162.50	130.00	
DODGE—3 1/4" bore		
35-47 6 cyl. 144.00	109.00	
3 3/8" bore		
34-47 6 cyl. 162.50	130.00	
FORD		
28-31 4 cyl. 119.00	87.00	
HUDSON-TERRA.		
35-47 6 cyl. 175.00	135.00	
MERCURY		
37-47 6 cyl. 175.00	135.00	
35-47 8 cyl. 199.00	160.00	
Oldsmobile		
37-47 6 cyl. 175.00	135.00	
35-47 8 cyl. 199.00	160.00	
PLYMOUTH		
35-47 6 cyl. 139.00	109.00	
PONTIAC		
37-47 6 cyl. 175.00	135.00	
35-47 8 cyl. 199.00	160.00	
Studebaker		
35-47 6 cyl. 175.00	135.00	
35-47 8 cyl. 199.00	160.00	

60 HP. JEEP Engines

Reconditioned, Tested and Guaranteed in perfect running order and ready to run. Every part is checked to be perfect and carries a 90 Day Guarantee same as a new engine.

COMPLETE with . . . Generator, Starter, Distributor, Coil, Fan and Fan Belt, Water Pump, Fuel Pump, Intake and Exhaust Manifolds, Carburetor, Oil Filter, Spark Plugs, Flywheel, Clutch and Pressure Plate, Wiring.

Outright, **\$179.50**
PG58R-003, Ea.



JEEP FRONT FLOOR MATS

Rubber with Felt Back. For all Jeeps. Ea. **\$3.95**

New JXD Hercules 6-cyl. Engine

Removed from new vehicles. Engine is guaranteed same as new. Complete with 6 volt ignition, Carburetor, Wiring, etc. 6 cyl. 4" bore, 4 1/4" stroke. 320 cu. in. displacement. 84 H.P. at 2800 RPM. Each motor guaranteed 5 hr. test run. Complete with Built-in Mechanical Governor. **READY TO RUN.**

PMG-58N-JXD
Each **\$450.00**

Crating Charge \$5.00



65 KW. 225 Volt D.C. GAS ELECTRIC GENERATING UNIT

RECONDITIONED!

Equipped with 6 cyl. RXLCT Hercules Gas Engine—4 1/4" bore, 5 1/4" stroke. Complete with Carburetor and Electrical equipment. 225 Volt—65 KW General Electric Generator in attached and develops 290 amp. D.C. current at 1800 R.P.M. Complete as shown.

PMG60R-191—
Each **\$695.00**

SEND 25% CASH WITH ORDER, BALANCE C.O.D.



J.C. WHITNEY & Co.

1917 Archer Ave. Chicago 16, Ill.

SAW YOU SAW IT IN POPULAR MECHANICS

NOW! INSULATE

Your Distributor, Spark Plugs, Coil or Magneto



PAT.

Motors Start Easier Under All Conditions

- ELIMINATE hard starting due to moisture, dust and dirt on coil, distributor and spark plugs.
- GAIN quick starting in cold weather.
- NO SHORTING out of ignition under compression load.
- BETTER MOTOR PERFORMANCE guaranteed!
- HELPS STOP FOULING of plugs.
- USE ON CARS, TRUCKS, TRACTORS, BOATS, and any gas motor.

JOBBER - DEALERS
Write for Discounts

SEALTIGHT CORP., Cedar Rapids, Iowa

SEALTIGHT INSULATORS

40c ea.
25c Dealer and West

SEAL

Moisture, Oil and Dirt from Your

- SPARK PLUGS
- DISTRIBUTOR
- COIL or MAGNETO

SAVE!

Users say 5 gallons gas gives mileage of 6 due to perfect firing.

INSTALL YOUR SET TODAY!

Buy from Your Dealer, Service Station, Garage, or Send your Order to Us.

12-32 VOLT UTILITY PUMP

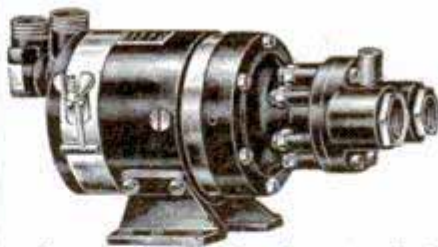

An ideal general utility pump for home, shop, farm or a 1001 other uses. Operates on 12 to 32 volts AC or DC. Pump has a water capacity of 10 gals. per minute at a 50-lb. head and will also pump gasoline, oil or any liquid. Its oil capacity is 3 1/2 gals. per minute at 1000 pounds per square inch. The pump buy of the year. Brand new and perfect condition. Motors by Bendix and are also brand new. Your price. **\$10.00**

SURPLUS ASSETS CORP.
DEPT. P, 2315 W. OGDEN AVE., CHICAGO 8, ILL.

STOP THIS LEAK

SOMETHING NEW!

- 1-Adjustable Collar
- 2-New Rubber Ball
- 3-Improved Guide Rod
- 4-Press-On Solid Brass Seat

Just The 3 Things To Stop These Leaks



ORDER YOUR SUPPLY TODAY

INSTALL IT YOURSELF

Any man, woman or child can install this NEW UNIT in less than 3 MINUTES. No tools or skill needed. 3 KITS \$1.60 EACH . . . 6 KITS \$1.50 EACH . . . 12 KITS ONLY \$1.25 EACH.

SEND NO MONEY -

Merely pay postman on delivery plus postage. Or send cash and we pay postage.

COMPLETE KIT ONLY **\$1.79**

Postpaid in U.S.A.

Gee Co., Dept. L-8, 2600 West 79th St., CHICAGO 29

TROUBLE LAMP



- All high-quality rubber.
- Made for heavy duty.
- 25 feet Underwriters' approved rubber cord.
- Sturdy rust-resisting cadmium plated metal reflector guard will take bulb up to 100 watts.
- Use with A.C. or D.C. current.
- Note switch and extra connection socket.
- Fully guaranteed.
- Complete for only

\$3.00
postpaid U. S. A.

SURPLUS SELLERS CORP.

DEPT. B
624 Madison Avenue, New York 22, N. Y.

INVENTORS

Whether an invention is patentable can be substantially determined by a search of the U. S. Patent records. Without obligation, write for information explaining the steps you should take to secure a patent.

JOHN N. RANDOLPH

Registered Patent Attorney

201 Columbian Building, Washington 1, D. C.

NU-WAY HEAVY DUTY CUTTING UNIT

with Timken Roller Bearings

PRICE

\$16.50

WHY PAY MORE



Build your own rotary type lawn or weed cutter.

Take the hard work out of weed cutting. Build yourself an up-to-date weed and lawn mower with the Nu-Way heavy duty unit.

Write for Free Circular—We Supply Cutting Unit Complete

TRACTOR-LITE MFG. CO., Spirit Lake, Iowa



Original WAR SURPLUS!

JUNGLE HAMMOCKS

EASILY WORTH \$25!

ONLY

\$4.99
COMPLETE

BRAND New!

Get Set For A Summer of Fun!

A complete bed with upper and lower canopy. A perfect way to relax in the cool shade, zipped in safe from pestering insects. A 43" zipper slide opening and hanging ropes.

ORDER YOURS TODAY! Send check or Money Order for \$5.49 (\$4.99 plus 50c for mailing and handling charges) with name and address. Sorry No C.O.D.'s accepted. Ill. Res. add 2% ret. occ. tax. Satisfaction Guaranteed or your money refunded.

The **DRAKE COMPANY**, Dept. PM-30
1380 MILWAUKEE AVENUE CHICAGO, ILLINOIS

EXTRA POWER for V8 Fords and Mercurys
SHARP TRIPLET INTAKE MANIFOLD
SPEED.. ACCELERATION.. ECONOMY!
Dual or triplet manifold, made of cast aluminum.
Write for free catalogue or see your speedshop.
INDEPENDENT IRON WORKS
6225 Wilmington Ave. Dept. A
Los Angeles . . . California

PAY RAISING—EXTRA MONEY

BOOKS

Use these books to prepare for a better job—bigger pay—to start a profitable spare time or full time business of your own, improve your home, start a hobby. Popular Mechanics specializes in books on many subjects. Send for our FREE catalog.

- Outdoor Sports Manual**
Hunters, Fishermen, Trappers, Campers, Archers, Boatmen, here is your book!...\$2.00
- Shop Notes Library**
3 Vols.—1948, 47, 44. (No Dup. Mat.)...\$2.00
- Painting, Furniture Finishing and Repairing**...\$1.50
- Rewinding and Servicing Electric Motors (No. 75)**... 25c
- Elementary School Subjects for Home Study**
Covers high points of grammar, spelling, arithmetic, history, science, geography, etc. 635 pages...\$1.89
- High School Self Taught**
Covers 25 subjects with study guide and self-testing quizzes. Completely revised and enlarged edition, 1280 pages, 300 illustrations...\$3.95
- Garden Book**
Build own trellises, lawn furniture, fireplaces, ornaments, etc...\$1.00
- Diving, Cutting and Welding in Underwater Salvage Operations**
Only book of its kind...\$2.00
- Picture Framing**
Modern methods for making and painting picture frames. Fully illustrated...\$2.75
- Frog Industry**
Breeding, feeding, dressing and marketing...\$2.00
- New Fields for the Writer**
Television, radio, film, drama...\$1.00
- 20 Careers of Tomorrow**
Covers plastics, metallurgy, textiles, radio, electronics, television, transportation, chemistry, etc...\$2.50
- Breaking Into Advertising**...\$1.00
- Into the Freezer and Out**
A complete handbook on the home freezing of foods...\$2.50
- Concrete Handbook**
New book on using concrete around home, garden, farm...\$1.50
- Zero Storage in Your Home**
How to prepare, store and freeze food properly...\$2.50
- This Way Up**
The successful philosophy of practical business men...\$2.00
- Welding, Brazing and Soldering**
How to build own equipment and how to use it effectively...\$1.25
- Modern Refrigeration**
Electric, Gas, Be service expert...\$5.00
- Dyke's Auto Ency. (includes Diesels, airplane engines)**
New 20th Ed. World's greatest book for mechanics...\$7.00
- Household Mechanics**
The "fix-it" book to end all "fix-it" books. Covers electric appliances, painting, carpentry, etc...\$2.75
- Oil Burner Handbook**...\$2.50
- Build Your Own Boat**
Describes 17 popular boats—rowboats, sailboats, plywood outboard, etc. 192 pages...\$1.50
- House Wiring (No. 89)**... 25c
- Turn Scrap Into Money**
Convert old auto generators into motors, welders, etc...\$1.00
- Popular Mechanics Farm Manual**
Packed with practical ideas and usable information that can easily be worth hundreds of dollars to every farm family and to homeowners everywhere. Send for free descriptive folder giving complete contents!...\$3.00
- Woodworking for Every-body**...\$2.75

- Sheet Metal Work**...\$3.00
- Tool and Saw Sharpening (No. 92)**... 25c
- Forging Practice**...\$1.50
- Action Toys (No. 66)**
Plans for 21 easy-to-make toys... 25c
- Foundry Work**...\$2.25
- Pattern Making**
Wood, metal...\$2.25
- Forty Power Tools**
Build own saw, drill, lathe, sander, etc., from scraps—save money...\$1.25
- Carpentry**...\$2.50
- The Young Craftsman**
Over 450 things boys can make...\$1.50
- Five Acres and Independence**
How to make money on small farm...\$2.50
- Your Home and How to Build It Yourself**
Step by step construction of the famous POPULAR MECHANICS house. Wonderfully illustrated...\$3.00
- Artistic Penmanship Self Taught**
New self study course with 48 lessons of interesting and varied exercises...\$2.95
- Knots, Ties and Splices**
For everyone who uses rope...\$1.25
- What to Make for Children**
Junior tough on toys? Build him playthings that will last...\$2.00
- LeJay Manual of Homemade Electric Equipment**
How to construct 100 items that are scarce and valuable...\$1.50
- How to Estimate for the Building Trades: Material and labor costs for masonry, plumbing, electricity, carpentry, heating, hardware, painting, etc.** 628 pp...\$5.50
- Pay Dirt**
How to make soil fertile by obeying Nature's laws...\$3.00
- Rabbits for Food and Fur**...\$2.50
- Tool Making**...\$4.00
- Tool Design**...\$4.50
- Plumbing Installation & Repair**...\$2.00
- Repp's Calculator**
Figuring made easy... 75c
- Slide Rule Simplified**...\$2.75
- Drake's Refrigeration Service Manual**...\$2.00
- Primer for Home Builders**
All the information you need to know in building a house...\$2.50
- Oxy-Acetylene Welding and Cutting**
Up-to-date handbook on gas welding and cutting...\$2.75
- Things You Can Make of Wood**...\$2.50
- A.B.C. of Poultry Raising**...\$2.50
- Ice Cream for Small Plants**
Some technical formulas for ice cream, ices and frozen desserts on a commercial scale...\$2.50
- Furniture Joinery**...\$2.50
- Essentials of Upholstery**...\$3.25
- Radio Physics Course**
A thorough training in radio fundamentals...\$5.00
- Modern Home Medical Adviser**
How to recognize diseases, practice proper hygiene, and know what to do in medical emergencies. 900 pages, 136 illustrations...\$2.49

??? WHY WASTE TIME HUNTING ???

We have for immediate delivery genuine parts for all makes and models, 4x2—4x4—6x4 and 6x6. All models from 1/4 ton to 20 tons. All makes: Autocar, Biederman, Brockway, Chevrolet, Diamond T, Dodge, Federal, Ford, GMC, International, Mack, Oshkosh, Reo, Studebaker, White, Willys and Jeeps. We have parts lists available on most models. Write stating model of G. I. Truck.

PARTS



Special Discounts to Fleet Owners on Above Parts

TRAILER AXLE



Heavy duty trailer axle suitable for many types of trailer construction. Also excellent for building of heavy farm trailers and wagons. It is a 15,000 lb. capacity square type straight trailer axle complete with Timken roller bearings, hubs, and 6 hole 750 x 20 Budd Wheels. Without brakes. Axle is 2 1/2 inches square and 70 inches between wheel mounting flanges. Std. width. AN EXCELLENT BUY.

With Single Wheels...\$49.50 With Dual Wheels...\$59.50

Austin Pintle Hooks

For All Trucks and Trailers, 25,000 lbs. capacity, shipping wght. 30 lbs. List price \$47.50. Single ea. only \$8.95. Lots of 12, each only.....



All prices quoted are FOB, Kansas City. 25% deposit required on COD orders.

AMERICAN AUTO PARTS CO., Inc.
1830 Locust Kansas City, Mo.

NEW BAND SAW BRAZER



SAVES TIME AND MONEY...

better than welding—easy to use—operates on 60 cycle lighting circuit. Complete kit includes resistance brazer, silver solder, flux, and instructions.

Introductory price **\$18.50**

THE ERWOOD COMPANY
214 WOODSTOCK STREET
CRYSTAL LAKE, ILLINOIS

IT STAYS STUCK! WITH... MULTI-PURPOSE AMBROID



If you want permanent results from an adhesive, you can't equal multi-purpose Ambroid liquid cement—for home workshop, household or factory. A quality leader for 37 years, ready-to-use Ambroid is waterproof, transparent, quick-drying, extra strong. Flexible, heat- and corrosion-resistant. For assembling, repairing or mending jobs, keep Ambroid handy. At your dealer's, or send 25¢ for big 2-oz. tube post-paid. Money back guarantee.

Also 50¢ 4-oz. tube. Pts., qts., gals., for industrial use.

AMBROID

303 Franklin St., Boston 10, Mass.

MAIL THIS COUPON TODAY

Check the books you want, write your name and address below, and mail this advertisement with money order or check. Outside U. S. A. Include 15% additional for shipping charges.

Books selected will be mailed promptly on our "money back if you're not entirely satisfied" guarantee.

Name _____

Address _____

City _____ State _____

Mail to **POPULAR MECHANICS PRESS**
Dept. 651—200 East Ontario St., Chicago 11, Ill.

New FAST WAY to Give Your Car a WAX-POLISH

WONT FINGER-MARK
RAIN PROOF
GLASS-HARD LASTS 6 MONTHS
NO SMEARS OR STREAKS

PROTECTS THE FINISH
BETTER THAN PASTE-WAXES
SUN-PROOF
DO YOUR CAR IN 1 HOUR
MUD-PROOF

NOT A PASTE! NOT A LIQUID! AN AMAZING POWDER!

Simply rub powder on and wipe off. Clean and wax-polish your car in an hour. Does both jobs at one time. Finish sparkles like new again. One polish job lasts up to six months.

C.O.D. orders plus postage
DISTRIBUTOR INQUIRIES INVITED

Hurry! Offer Limited!
\$1 POSTPAID FOR BIG \$1.50 CAN
RUSH ORDER & SAVE 30¢

TIMEX PRODUCTS CO., 5064 Arsenal St., St. Louis, Mo.

Ball-Bearing SPEED WHEELS

Juvenile wheels, solid tire—No Bearings

7" wheels	60c
6" wheels	50c
4" wheels	30c

Semi-pneumatic tired wheels

12 x 1.75"	\$3.25
10 x 1.75"	\$2.75
10 x 1.25"	\$2.00
8 x 2"	\$2.00

Industrial wheels for heavy loads
Semi-Pneumatic

400 x 8, 2 ply tire and tube	\$12.50
12 x 3.00", bolt hub, ea.	\$9.75
10 x 2.75" Hollow Core	\$6.75
10 x 2.75" Single Tube	\$7.25
8 x 2.50"	\$4.90
8 x 2.00" bolted wheels, ea.	\$4.75
6 x 2" lug base	\$3.30
6 x 2"	\$2.80

DEALERS WANTED
MANUFACTURERS
INQUIRIES INVITED

Free blueprints with all wheel orders.
Send check with order. Shipments f.o.b. Akron.

JIM BROWN TOY COMPANY

1097 Home Ave. Akron 10, Ohio

Drill Masonry up to 10 Times Faster

with the super-hard Kennadrill

Kennametal (carbide) tipped drill bits are hard and diamond like. They stay sharp up to 100 times longer than steel. Drill smooth, sharp edged holes in masonry and non-metals. Use the same bit on your jobs that gives electricians, contractors, pest control operators, hobbyists, these results: "100 holes in cement, 2 hours." "50 holes in glazed tile, 33 minutes." "1 inch holes in limestone, 3 1/2 seconds." Sizes 1/4" to 1 1/2". Use in drill press, hand brace, or rotary drill. Write for bulletin MK on the KENNADRILL now.

Available in Hardware Stores Everywhere

KENNAMETAL Inc., LATROBE, PA.

NEW ALL PURPOSE WORK GLOVE

Rhinosol makes 'em tough

OUTWEARS LEATHER NO ODOR
RESISTS ACID, OIL, SOLVENTS

BRAND NEW—Toughest, softest, best work glove you ever saw. He is at last is a work glove that really wears. Outlasts many leather gloves, because treated with Rhinosol, new super-chemical, they outwear higher priced gloves made of leather. Soft, pliable, yet extra strong. Long fingers, knit wrists. RHINOSOL RESISTS HEAT, OIL, ACIDS, SOLVENTS. Makes the ideal work glove for all uses around shop, farm or home.

SEND NO MONEY; TRY 5 DAYS!

To get gloves prepaid, tear out this ad and send with low introductory price of \$1.00. Or just send name and address and pay postman \$1.00 plus C.O.D. Use five days and if not satisfied, return for money back. Only one pair to customer at this special low introductory price. Order today.

\$1.00 POST PAID NO RISK GUARANTEE

FRANCIS SUPPLY COMPANY
DEPT. H-3 1836 EAST FULTON STREET COLUMBUS, OHIO

SAVE YOUR KNUCKLES with the NEW K-VISE

SAFETY LOCK WRENCH
POWERFUL 1-TON GRIP—SEMI PISTOL GRIP HANDLE

Has powerful, 1-ton tested, non-slip grip—yet releases at the flick of your little finger. High grade alloy steel. Heat treated jaws. 10" long. Holds work up to 1 1/4". Use as pliers, pipe wrench, portable hand vise, toggle press, etc. If dealer can't supply, order direct, \$2.25 postpaid. Satisfaction or money back.

KASH INDUSTRIES, INC., Elkhart, Indiana

for AMAZING acceleration

DIXIE-WESTERN DUAL INTAKE MANIFOLDS for V-8 FORDS AND MERCURYS

\$1500 Gas Line and Throttle Kit \$2.50 extra

Chrome Plated Velocity Stocks — \$1.60 ea
By Test: Increased Acceleration by 26%
Increased Power and Speed by 11%

All DIXIE-WESTERN manifolds are brightly polished cast aluminum.

DIXIE-WESTERN MANIFOLD CO.
Box 364 Los Angeles 43, California

BUILD YOUR OWN FAST FREEZER

PLANS \$1

It's easy to build this household appliance with LeJay Plans. Made from new or used parts. Save up to 75%. No expert knowledge needed. Plans show 5 sizes and are easy to follow. All details clearly explained. Enjoy making one of these freezers. Mail \$1 for set of plans and catalog. **LEJAY MFG. CO., 447 LeJay Bldg., Minneapolis 8, Minnesota**

5 sizes 8 to 40 cu.ft.

BUILD YOUR OWN TILTING TABLE SAW!

SAVE \$50 OR MORE

- 21x27 in. table tilts full 45°
- 8 in. blade cuts from 0 to 2 1/2 in.
- Ball bearing arbor, precision machined, ready to run
- Sturdy cast aluminum rip fence guide and miter gauge completely machined ready to install

Sturdy wood, steel and aluminum construction
No machining—build easily with hand tools
GIL-BILT Step-by-Step Plans—simplified perspective drawings, full size patterns, 15 actual photographs. \$1.00
GIL-BILT Special Metal Parts kit includes Plans, ball bearing arbor, cast aluminum tilt arms, rip fence guide, miter gauge, and all other metal parts (less blade). \$15.95
Same kit with 8" combination blade. \$19.90

GILLIOM POWER TOOLS P. O. Box 1-R, Lambert Field St. Louis 21, Missouri

BUILD and ENJOY YOUR OWN BOAT!



ASSEMBLED IN 8 HOURS

WITH A Plywood Boat Kit

LIGHTWEIGHT, 12-FOOT LONG

READY CUT — needs no forms nor special tools to assemble. Kit includes all hardware, paint, etc. (less oars).

ONLY \$54.00

(Freight paid)

Send for Free Folder

TAFT MARINE WOODCRAFT

Dept. M, 636 39th Ave. N.E.

Minneapolis 18, Minn.

BE YOUR OWN BOSS DO WELDING for PROFIT

Just Assemble these NECESSARY PARTS NO SPECIAL TOOLS NEEDED!

PROFITS IN WELDING! Increase your earnings this easy way. Do welding in your home or shop. Repair farm equipment, home appliances, tanks, tools. Everyone has something that needs welding. Get started today! IDEAL HEAVY-DUTY WELDER for all-purpose arc welding. Safe, rugged, compact and EFFICIENT. WILL OPERATE FOR ONLY A FEW CENTS PER DAY.

Plugs into either 110 or 220 AC line. Can be used consistently on 30 amp. fuse. ALL PARTS DESIGNED TO GIVE LIFETIME SERVICE. ORDER WITH CONFIDENCE!

Try your ATOMIC WELDER for 30 days. If not satisfied, return as is. Your money will be refunded with no questions asked. What could be fairer than that?

WRITE FOR FULLY ILLUSTRATED BOOKLET P-20
ATOMIC WELDER COMPANY
1038 So. 19th St. Omaha, Nebraska



60 LBS. READY MADE PARTS
Only \$24.95



11 PIECE MIDGET TOOL SET

9/32 Sq. Drive. Consists of Ratchet, with flex. handle, Sliding Bar, Extension Bar, 6 Sockets 3/16" thru 7/16", Mfg. Snap-On and Plomb. and Steel Tool Box. A \$4.75 value.



Our Price **\$2.00** Postpaid in U.S.
14 PIECE TOOL SET 3/4 Sq. Dr. and steel Tool Box (a \$19.00 value) for only \$9.90 FOB Fort Worth. Dealers write for quantity prices.

LAMB SALES CO. Dept. PM, 2225 Western Fort Worth 7, Texas

REGIONAL DISTRIBUTORS WANTED

ALL TERRITORIES NOW OPEN

Are you both mechanically inclined and sales-minded? Earn big money making sales and installations of our new product, for which there is a very definite need. Essential to all places serving bottled beverages.

A small investment brings substantial returns. Our sales engineers will help you get started in a highly profitable business. For further details write:

JOHN GREEN, Manager
Sales Engineering Department
276 Fifth Avenue, Suite 1105 New York 1, New York

DIE-LESS DUPLICATING

Many small parts can be formed without dies, to duplicated accuracy of .001" with DI-ACRO Precision Machines. — Benders, Brakes, Shears. Save die expense and time delay. Ideal for experimental and research work, making samples, models, etc., as well as regular production runs. Write for descriptive literature.

O'Neil-Irwin Mfg. Company
341 8th Ave. Lake City, Minnesota



SHEAR



BENDER



BRAKE

REAL SURPLUS VALUES AIR COMPRESSORS

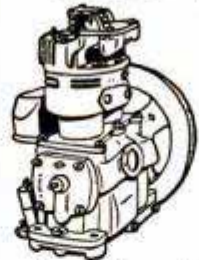

BENDIX-WESTINGHOUSE 4 CU. FT.

Model 2-U-S-4-V-A

Govt. Surplus, 2 cylinder Bus and Truck Type. Ball bearing crank shaft. Pressure feed oil system. Positively one of the finest and most accurately built air compressors on the market.

Original Cost Over \$140.00

In good operating condition with 30 day written guarantee

\$34.50

Accessories available for compressors, air regulators, safety valves, air gauges, control governor, misc. fittings, hose, paint guns.

BRIGGS-STRATTON ENGINES

1 1/2 HP. MODEL N

In good operating condition with 30 day written guarantee

\$44.50

Engines will develop almost 2 Hp. at 3600 RPM. Hurry don't wait, buy now while limited supply lasts. Suitable for lawn mowers, garden tractors, motor bicycles and scooters, midget cars, etc. Will power many kinds of machinery.



EMERGENCY SUPPLY TANK



Fill at any gas station. 150 lbs. airs 5 flat tires. Inflates rubber boats. Use for touch-up spray jobs, tire service truck, air horns, dust out motors, machinery, etc. Shatterproof 12"x24" stainless steel tank with carry handle, check valve, two feet hose and tire filling chuck. Only \$7.95

Tank only 12"x24", tapped each end 1/4 pipe thread. 500 lb. pressure. Build your own. Ideal for paint spray, air receivers, net floats, buoys, etc. Each \$4.75
Small size tank, 6"x24". Only \$2.98

PRICES FOB, K. C. WRITE FOR NEW CATALOG.

MIDWEST SURPLUS SALES CO. 2531PN Indiana Kansas City 1, Mo.

EASY TO BUILD

U-MAK-IT BOAT KITS for Home Assembly. Complete with illustrated instructions. No Experience Necessary. SEND 25c Postage (Coin) Today for 3 Money Saving Illus. Catalogs Showing all '48 Models & Construction Details.

KAYAKS INBOARDS OUTBOARDS ROWBOATS RUNABOUTS DINGHIES V23 CRUISER

KAYAK BOAT CO. 703P-WHITTIER ST., N. Y. 59, N. Y.



ELECTRICITY Anywhere



for HOMES FARMS SHOPS BOATS RADIO USE

Onan gasoline-engine-driven Electric Plants supply reliable, economical electric service for any use. Portable, stationary or standby models. Water or air-cooled, compact and rugged.

A.C.: 350 to 35,000 watts in all standard voltages and frequencies. D.C.: 600 to 10,000 watts. 115 and 230 volts. BATTERY CHARGERS: 500 to 3,500 watts; 6, 12, 24, 32 volts.

Write for folder

D. W. ONAN & SONS INC. 2544 Royalston Ave., Minneapolis 5, Minn.



SAY YOU SAW IT IN POPULAR MECHANICS

Sensational Value! **PAINT SPRAYER**
WITH ELECTRIC MOTOR

DOES ALL ORDINARY PAINT SPRAY JOBS

Positively unheard of 'til now—an electric powered sprayer outfit at such a low price. Not a toy! Not a makeshift. It's a real, practical all-purpose sprayer outfit complete with compressor, 110 volt A.C. or D.C. electric motor, suction type, continuous flow spray gun, paint container, 10 ft. air hose, 6 ft. electric cord and plug. Use it for home shop, auto and 'round the house jobs, and do a good job—quick. Rush order today. Only \$19.95 complete. Send check or M.O. If C.O.D. send a five dollar bill for deposit.



Uses
**Lacquers,
Varnishes,
Paints,
Etc.**

Complete
Only
\$19.95

Weights Only 8 lbs.
Portable. Use it Anywhere.

HOME SHOP PRODUCTS CO.
DEPT. 1-C, 4821 SHERIDAN ROAD CHICAGO 40

**GENERAL UTILITY PUMP
YOU CAN HOOK UP YOURSELF**



Here is a pump that you can hook up yourself to any power source—motor, gas engine, waterwheel, etc. Four different pulleys provided for change of

speed and power. Pumps any liquid; with water capacity of 10 gals./min. at 50 lb. head and oil capacity of 3½ gals./min. at 1000 psi. Pumps are brand new, and satisfaction guaranteed. **\$15.95**
Your price, FOB Chicago, only.....

SURPLUS ASSETS CORP.

DEPT. P, 2315 W. OGDEN AVE., CHICAGO 8, ILL.

ONLY 3c A SLIDE!
50 Slides \$1.50
Only



**WAR PLANES
* TANKS *
* SHIPS**

Originally used by the Armed Forces in Identification training. The "armed might" of the World in 2 x 2 inch mounts ready for your viewer or slide projector.

16 SETS — All Different!

Over 800 different slides, packed 50 to the set — no two sets alike. Start a library of these informative films at a fraction of original cost. Specify classification wanted—PLANES, TANKS, SHIPS, MIXED—

detailed views showing battle equipment of many Nations.

50 Slides \$1.50 each SET

BATTLE Action SLIDES World War II

COMPLETE SETS

1. Pearl Harbor
 2. Saipan
 3. Tarawa
 4. Hollandia
 5. Guam
 6. Iwo Jima
 7. Okinawa
 8. Normandy Invasion
 9. Invas. Beach-head
 10. Patton Breaks
 11. Invas. So. France
 12. 7th Drives North
- Order by Set Number

WORLD WAR II Battle Action—exciting, coherent, educational. From gov't files as filmed by U.S. combat photographers —on 2 x 2 inch slides and Film Strips. Specify SLIDE or STRIP set.

SLIDES 20 Scenes of each Battle **\$1.00**
STRIPS 20 Scenes of each Battle **75c**

WRITE FOR DETAILED LIST OF PHOTO BARGAINS

PHOTO SURPLUS SALES

Dept. 23-K, 12 Duane St. New York City

*A Thousand and One
Ideas You Can
Use on the Farm!*



POPULAR MECHANICS

FARM MANUAL

Use it to Step up Farm Efficiency — Increase Production — Improve Farm Appearance — Save Time, Labor, Money!

A Must for Every Farm Family! Saves Money for City Homeowners Too!

Here is the experience of hundreds of successful farm operators brought together in one handy, easy-to-read, easy-to-use, working handbook by the editors of Popular Mechanics. It is brimful of short cuts, labor-saving ideas, ingenious apparatus and methods that will simplify the day's work and lighten some of the more tedious chores, make money and save money for you.

HELPS IN THE FIELD — IN THE BARN — IN THE HOME

Every department of the farm is covered in the Farm Manual. Every member of the family will find in it something that he or she can use to tremendous advantage in farm operation, maintenance and improvement, from the building and care of equipment to painting the farm home and fast freezing fruits and vegetables. It covers farm buildings, the farmhouse and other homes and is of interest equally to the woman looking for home improvement, beauty and convenience and the man striving for easier and more profitable operation.

ORDER TODAY — FOR YOURSELF — FOR A GIFT

Use the coupon below. Mail it today. Book will be sent at once, postpaid if you include payment with your order. If you don't think the Farm Manual is worth even more than you paid for it after five days' use, send it back by mail and your money will be refunded. This may be the best investment you ever made. Rush coupon today.



284

FACT-PACKED PAGES

Hundreds of Illustrations

Popular Mechanics Farm Manual is packed with practical ideas and usable information that can easily be worth hundreds of dollars to farm families and homeowners everywhere.

Farm Machinery and Implements
How to make and get the most out of farm implements.

Farm Workshop Equipment and Repairs
Ideas that can save hundreds of dollars.

Poultry and Livestock
How to build equipment, gadgets, etc. Care of farm animals and poultry.

Vegetable Storage—Processing
Winter storage, home freezing tips, make your own freezer.

Farm Home Improvement
Fencing, repairing electrical appliances, plumbing, electrical wiring, saving coal, painting, curing leaky basements, hanging wall paper, making garden tools, garages, working with concrete, painting, etc.

Farm Hints and Kinks
Forty pages of illustrated, practical ideas, short cuts, etc., that will save time, labor and money.

MAIL COUPON • Money Back if Not Satisfied

POPULAR MECHANICS PRESS, Dept. 665
200 East Ontario St., Chicago 11, Ill.

Send _____ copies of the Farm Manual at once.
 Remittance (\$3.00 each) enclosed. Send postpaid. Add 15% if outside U.S.A.
 Send C.O.D. (\$3.00 each) plus delivery charges. U.S.A. only.
 If sent as a gift to another, send name and address on separate sheet.

Name _____
Address _____
City _____ Zone or Route _____ State _____

WAR SURPLUS

NAVY KNIFE

Brand new. Tempered steel 5 1/4 inch "Parkerized" blades. Laminated leather grip handle. Complete with sheath.

(Shipped postpaid)



98c



ARMY GOGGLES

Brand new Polaroid goggles in original packing. Each a complete set with two interchangeable shatterproof lenses — one clear, one green. Heavy sponge rubber ventilated frame. Adjustable elastic headband. A MUST for motorcyclists, skiers, and outdoor men. Positive protection against wind, sun, and dust particles.

(Shipped postpaid)

98c



ARMY PUP TENT

Army surplus. Full size. Used — guaranteed perfect condition. Complete with poles and pins.

3.95

MAE WEST Life Preserver

Brand new Army surplus. Positive water safety. Complete with carbon dioxide cylinders.

plus 15c for mailing.



1.98

JUNGLE HAMMOCK

Brand new. Mosquito proof, rain proof, mildew proof nylon. Use as hammock or tent.

Full length zipper opening.



4.98

plus 40c for mailing.

SLEEPING BAG

100% Wool, mummy type. 30 zipper. Reversible — guaranteed like new. Complete with water repellent cover.

plus 25c for mailing.



3.95

C.O.D.'s Shipped Charges Collect. Money Back Guarantee

NATIONAL JOBBING CO.

1703 No. 24th St., Dept. N-2, Omaha, Neb.

Genuine Air Corps Type SUNGLASSES

Brand new 24 Karat gold plated frame. 4 base optically ground lens. Pearloid brow rest. Complete with case.

2.25

(shipped postpaid)



SIGNAL FLASH LAMP

Made for the Signal Corps to transmit messages in Morse code day or night in red or white flashes of light. Operates on 5 dry cell batteries. By operating trigger, of trigger box assembly, can signal from shoulder. 15 ft. cord with hand key attached, made for remote control signaling, by mounting Signal Lamp on 42" tripod. Daytime flashes can be observed 1000 to 2000 yards; night flashes from 2 1/2 to 5 miles. The Signal Lamp, 15' cord, hand key, gunstock, tripod, goggles, bulbs, technical manual are packed in 12 oz. duck bag. Shipping weight 8 1/2 lbs. Lamp can be used as flashlight for spotting planes, animals and many other objects approx. 300 yards. Just the thing for hunting, camping, fishing, scouting.

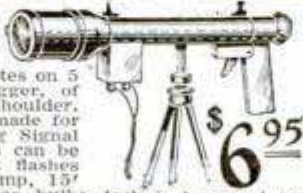

\$6.95

FRENCH TYPE PHONE

TS-13C HAND SET



With butterfly switch on handle. When the switch is pressed, the microphone is connected into the circuit and an additional set of contacts are closed, to operate a change over relay. Has a 6 ft. length of cord, with a PL 55 plug for earphone and PL 68 for microphone and switch. Impedance of earphone approx. 2500 Ohm; impedance of microphone approx. 250 Ohm (carbon); connected with batteries it can be used for inter-communication system. They are brand new and the original cost is many times what we are offering them to you . . . While they last.

\$3.95

MICHAEL STAHL, Inc., 39 Vesey St., Dept. PM8, New York 7, N.Y.

3-50 YD. ROLLS

ABRASIVE CLOTH NOW
1 1/2" - 100 and 400 Grit **\$5.95**
2" - 100, 120, and 150 Grit

FOR Chicago

Bargain!! Three 50 Yd. aluminum oxide rolls of finest abrasive cloth from refrs. like Minn. Mining, Carborundum, Sandpaper Inc. A \$27.00 list value for only \$5.95. Specify widths and grit sizes. Send check or M.O. Or send on \$2.00 deposit and let bal. come C.O.D.

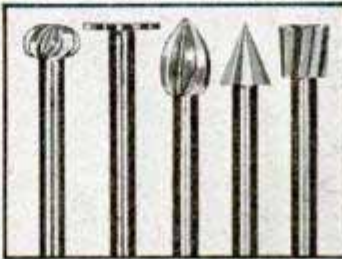

18 ROTARY CUTTERS

Ass't Sizes on 1/8" or 3/32" Shank

Will fit all electric hand grinders. Ideal for cutting wood, metal or plastic.

\$13.50 Value

ONLY **\$5.85** post paid

\$2.00 Deposit on C.O.D. Orders

SCHUPACK SUPPLY & MFG. CO.

7331 Cottage Grove Ave., Dept. PM-8

Chicago 19, Ill.

SUCTION SPONGE



QUICK EASY!

AUTO WASHER

Glide across surface and presto! New "Suction" Auto Washer shampoos cars like magic. Dust, dirt, grease, grime disappear in jiffy. Automobiles gleam like a mirror.

SAMPLES FOR AGENTS

Sample offer sent immediately to all who send name at once. A penny postal will do. Send No Money — JUST YOUR NAME.

KRISTEE CO., 687 Bar St., Akron, O.

BUILD ARC WELDER PLANS 35c

We Show You How to build this new powerful welder without rewinding. For light or heavy work. Uses coils taken from old auto generators. Works on 110 or 220 volts A. C. Has 20 different heats. Send 35c for complete PLANS and valuable Catalog. Write today. LEJAY MFG. CO., 3347 LeJay Bldg., Minneapolis 8, Minn.



FASTEST . . . SAFEST PLANER!

FITS ANY DRILL PRESS

\$4.00 NOW AT POSTPAID

ORDER TODAY EASY TO USE NO CHIPS TO BIND

PAT. PEND.

MONEY BACK . . . IF NOT SATISFIED

Solid cast-brass planer head is machined and accurately balanced. Simple to operate. Ideal for hobbyists, professional woodworking and pattern shops.

ROUTS PLANES RABBETS



DEALERS WANTED

LIGHTNING TOOL CO. SOUTHWICK, MASS.

DEPT. 3

STOP

Discomfort
Dust
Drafts
Dampness

Decay
Wood Rot
Rust



of Your Buildings with

Handicalk

Seal all cracks before you paint. Do it yourself the HANDICALK way. It's easy—it's fun—it's inexpensive. Just snap nozzle cartridge in gun and calk. No mess, nothing to clean. Gun only \$1.98 at Hardware, Paint or Building Supply Dealers. HANDICALK, 2449 Woodhill Road, Cleveland 6, Ohio.



CALKING IS FUN WITH A HANDICALK GUN

JUST OUT! HARD-TO-FIND BRAND NEW PORTABLE

RADIO ANTENNAS

GOV'T. SURPLUS AS USED ON ARMY TANKS. Telescopic—Rust Proof—have tremendous pick-up. Eliminate dangerous wiring.

FOR HOMES, BOATS, AUTOS

Exceptionally rugged sections. Handy for camping also useful for transmitting, F.M. and Television Sets. Each securely packed. Easy to install anywhere.

NOISE FREE RECEPTION
\$13.50—9 FT. SOLID BRASS Now \$3.95

(9 Sections) with clamps, Nut, Lug wire (Postpaid)

\$12.50—9 FT. ALUMINUM Now \$3.95

(8 Sections) with clamps, Nut, Lug, wire (Postpaid)

\$12.00—7 FT. SOLID BRASS Now \$3.45

(9 Sections) with Lo-Loss Lead and Mounting Bracket (Postpaid)

QUANTITY LIMITED ORDER TODAY—Mail check or money order—State Antenna desired. All prices postpaid or sent C.O.D. plus postage. SPECIAL 10% DISCOUNT ON ORDERS FOR 3 OR MORE. Money Back in 10 Days if not satisfied.

RADIO HOSPITAL

442 East 86th St., Dept. A19
New York 28, N. Y.

Do a Better Job WITH ONE OF THESE EMPIRE LEVELS

Smallest, most handy and accurate Level made. "Cigar-shaped"—no sharp corners to tear pocket. Aluminum stock. Only 3 oz. wgt. 9" long. Has Level, Plumb, 45° Vials.

EMPIRE TORPEDO LEVEL



No. 26

\$2.00



ALUMINUM LEVEL — No. 151

Cast and Machined, a Beautiful Tool, with Patented, Removable Level and Vial.

With 2 Plumb, 2 Levels, 2 — 45° Vials. 18".....\$6.00
24".....\$6.50 28".....\$7.00

Order EMPIRE LEVELS from your local dealer. Write direct for literature.

EMPIRE LEVEL MFG. CO.

BOX 97, DEPT. P-253 MILWAUKEE 13, WISCONSIN

EASY WAY TO REMOVE PAINT

Wonder-Paste Remover quickly softens up the toughest paint, varnish, enamel, etc. Apply with brush; allow time for penetration — then remove with a putty knife. At paint and hardware stores.

WILSON-IMPERIAL CO., 119 Chestnut Street, Newark 5, N.J.

PNEUMATIC AIR TOOLS

SAVE \$64.00 AND UP

Ideal fender and bumping hammers, and for riveting brake lining, concrete breaking and many other uses. Like new. At these unheard of low prices it pays to order a good supply.



Chicago Pneumatic RIVETER & CHIPPING HAMMER

CP9X offset handle, with air control. Takes up to 3/4" rivet, weight 8 lbs. List Price \$79.00. Special Price.....

\$10.95

Model CP3X—takes 5/32" rivet, wt. 5 lbs. \$7.95



RIVETER & CHIPPING HAMMER

Chicago pneumatic CP4 with air control, push button throttle, takes up to 3/16 rivet. Weight 6 lbs. List Price \$73.00 Special Price.....

\$8.95

Prices are F.O.B. Chicago. Immediate delivery. SOLD ON MONEY BACK GUARANTEE. Send check or money order today. DEALERS — WRITE . . .

C & M EQUIPMENT COMPANY 1831 S. State St., Dept. D-8 Chicago 16, Ill.

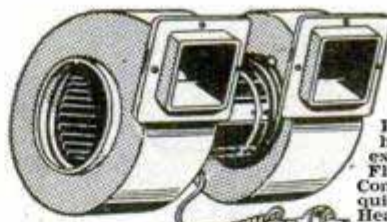

HEAVY CAST ALUMINUM DOUBLE EXHAUST BLOWERS
Only \$15.85

Install it yourself with any household tools. Double intake and exhaust from 2 balanced wheels. Flanges for attachment to ducts. Cont. duty motor is extraordinarily quiet. 110 V., A.C. 50-60 cycles. Heavy duty cord attached.

heavy cast alum. construction as DOUBLE—\$10. Add 50c handling; 81 west of Miss. Send check, M.O. Money Back Guarantee. Free lit. UNIVERSAL YONKERS CORP. (M-8), 137 Alexander St., Yonkers 2, N. Y.

COMPLETE FLEXIBLE SHAFT MACHINE only

WITH PENCIL-SIZE HANDPIECE for "FINGER-TIP" CONTROL. Performs countless tasks quickly, easily! Use FOREDOMS on wood, metal, glass, plastics, etc. Provides easy accessibility, unobstructed view. Grinds, polishes, drills, mills, engraves, sharpens, slots, sands, carves, etc., etc. Complete \$19.95. No. 50 Accessory Set \$1.50 additional. Order today. FREE CATALOG.

\$19.95

FOREDOM ELECTRIC CO., Dept. F-119, 27 Park Pl., N. Y. 7

WOOD WORKERS

LUMBER—PLYWOOD AVAILABLE

Harold Hunt wants to send new No. 15 catalog. Over 148 pages of woodworking ideas. UNEQUALED BARGAINS in imported and American woods, supplies, hard-to-find hardware. Send only 15c to cover postage and handling.

CRAFTSMAN WOOD SERVICE CO. 2729 S. Mary St., Dept. A-96, Chicago 8, Ill.

only \$15

EARN MONEY in your spare time

FAST TURNOVER SELLERS — 100% PROFIT!

AIR CONDITIONED 4"x17" TELEVISION DECAL SIGNS

Durable! Washable! Colorful! Easy to apply!

Every tavern, restaurant, bowling alley is a prospect!

Send \$1.00 for samples and prices

DEL-D-CAL, 1217 W. Webster Ave., Chicago 14, Ill.

DUAL CROSS and ROTARY FEED

PALMGREN ROTARY, INDEX, MILLING TABLE No. 83

Has 8" table, 360° movement and 4" cross feed travel. Adjusting wheels and dials graduated in degrees and thousands. Slotted for bolting to table. No. 83 Priced \$49.50. No. 82 without rotary feed \$39.75.

Write for Circular No. 10 CHICAGO TOOL AND ENGINEERING CO. 8365 South Chicago Ave., Chicago 17, Ill.



LAWN ORNAMENT-NOVELTY PATTERNS

28 Lawn Ornament Patterns, 25c. Other patterns: 15-20" high; Dutch Girl, Dutch Boy, Pirate, Bull Terrier, Mexican Girl, Mexican Boy, Dwarf, Penguin, Flower Girl, 10c each. 25 Novelty Patterns, 30c. All 62 Full Size Patterns, \$1.00 Postpaid. Strother Pattern Service, Dept. A0-8, Box 383, Belinaton, W. Va.

LELAND ELECTRIC GENERATOR

2.5 KVA, 120 volt, 60 cycle, 1 phase, AC. Any comparable new generator will cost you twice our price.

Remit by Bank Draft HOPFER & COMPANY 3124-A E. 14th St., Oakland, Cal.

\$125 Freight Prepaid In U.S.A.

INVENTORS
LEARN WHY YOUR INVENTION SHOULD BE STYLED AND ENGINEERED BEFORE YOU APPLY FOR A PATENT. SEND FOR FREE ILLUSTRATED BOOK, "INDUSTRIAL DESIGN AND THE INVENTOR."
ETTEL INDUSTRIAL DESIGN
ROOM 40 - 112 SOUTH 106TH ST. - SEATTLE 29, WASH.

Stroller Poncho "Rainproofs" Baby



Rain won't bother baby during the afternoon stroll if mother is ready with a transparent stroller poncho. The poncho, made of waterproof Vinylite plastic, fits over the baby and stroller and zips neatly up the back. A detachable hood of the same material ties under the chin and is easily removed when the rain clouds vanish.

Bobber With Aluminum "Wings" Sets Hook in Fish

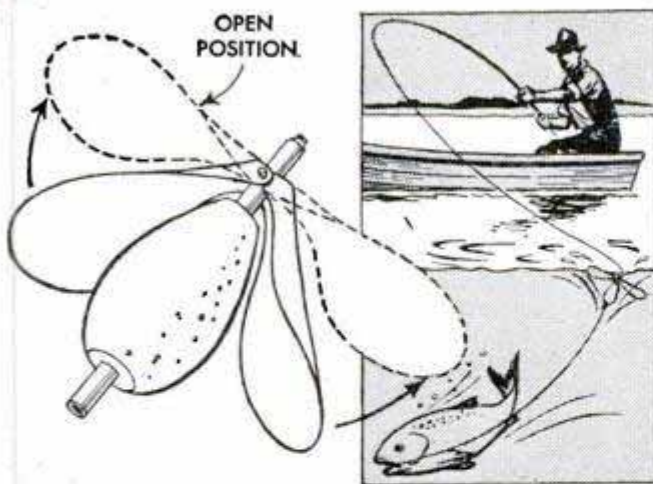

Two aluminum wings hinged at the top of a cork float automatically "set" the fish-hook in a fish's mouth. When a fish strikes the hook and drags down on the bobber, the wings swing out at right angles to place a sudden resistance on the line, embedding the barb of the hook in the fish. The wings also aid in keeping the line taut.

AUGUST 1948

NOW, YOU TOO CAN WELD!

IT'S EASY—WITH THE

HIGH IN
PERFORMANCE
—LOW IN
COST!



Miller
"Hobby
Arc"
HOME
WELDER
110 VOLTS

Designed and built by the men who make the Miller industrial welders. Compact, light in weight, low in cost yet able to do a man sized welding job with electrodes up to 1/8". Operates on AC current on a 30 ampere fuse. Shipped complete with electrodes, electrode holder, helmet and cables.

TRY IT IN YOUR WORKSHOP

Miller ELECTRIC MANUFACTURING CO.
APPLETON, WISCONSIN

PRIVATE TELEPHONE

Your own private phone; no fuss or bother. Just push buzzer to call. No Tubes—No Hum—No Squeals—No Electric Connections. Can be used for long distances. Consists of 2 French type handsets, as shown, activated by a 10 cent penlight battery which fits into body of handset, 100 ft. of double connecting wire, everything set, all ready to work. Instruction sheet enclosed. Complete price only

\$12.95
Per
Set



TALLEN CO., Inc.
562 ATLANTIC AVENUE
BROOKLYN 17, N. Y.
Tel. TRIangle 5-8241

CURIOUS?

ABOUT A
SHIP-IN-A-BOTTLE

Here is the secret plus all of the material less bottle. See your dealer first. Catalog 10c.

BRAUN-CRAFT, 1232 Etowah, Dept. PM8, Royal Oak, Mich.



Postpaid
in U.S.A. 75c



How One Tube of Tip-Top Solder Stopped the Leak in a 5,680 Gallon Gasoline Tank!

"About a year ago with one tube of Tip-Top Liquid Solder, I stopped a small leak in a 5,680 gallon galvanized storage gasoline tank. You can guess what this would have cost to fix with a welding torch."

Mr. R. H. E., Minnesota

TIP-TOP Liquid Solder saves you big money on repair bills. Forms a perfect joint in metals, wood, leather, paper, glass, china — most any material. Water and gasoline proof — exceptional adhesive properties.

Always keep a tube handy on work bench, in kitchen, in car. Get TIP-TOP at your hardware dealer today or write TIP-TOP PRODUCTS, OMAHA. Always insist on TIP-TOP—the original and superior Liquid Solder.



Sensational!

GENERAL ELECTRIC MOTORS

For Kitchen, Office, Darkroom, Furnace or Attic Ventilation

Here is everything you want in an all purpose ventilating fan, GENERAL ELECTRIC 1/25 H.P. totally enclosed motor. Guaranteed Perfect, quiet operation. Bearings lubricated for life. 1550 R.P.M., 115 Volts A.C. 30-60 cycle. Horseshoe mounting bracket, 2 wire rubber lead cord, 6-blade fan—size 7 1/2" Dia. Overall height 9 1/2". This smashing value complete as shown—NOW— at **\$8.95** only No. 1400

Immediate Delivery

6 Volt HEATER MOTORS
Don't wait for winter—get ready now! Ideal 6 volt heavy duty heater motors for automobiles, buses, or trucks. Adaptable for defrosting fans, heaters, etc. Motor screws extended for mounting purposes. 1/2" shaft. Motor size 3 1/2" L x 2 1/2" Dia. Don't delay—Order today. No. J110

\$2.75 POSTAGE PREPAID IN U.S.A.

James Individeo

1390 W. Fulton St., Chicago 7, Ill. Write For Bargain Catalog

NEW SCIENTIFIC DRILL GAUGE

New 3 Way Drill Gauge measures point angle, clearance, and chisel points of twist drills INSTANTLY. Shows why some drills cut where others do not. A must for FAST ACCURATE DRILLING.

FREE Chart showing proper drill angles for a wide variety of materials.

\$2.50 Postpaid

ORDER YOURS TODAY! ONLY

SWANSON PRODUCTS INC.
2927 N. Pulaski Rd. CHICAGO 41

METALS

sold in small quantities for the home workshop. Steel, Brass, Copper, Aluminum, etc. In Bars, Shapes, Tubes and Sheets. Write for free price list.

CASHMETALS CO., 2720 California Ave., Pittsburgh 12, Pa.

DUAL TAIL PIPE EXTENSION

Fits all cars — chrome plated
DEEP TONE

produced by 2 1/2 inch outlets **\$2.95**
Postage free on prepaid orders
DEALER INQUIRIES INVITED

LYONS PRODUCTS COMPANY
PAT. PEND. 2426 South LaBrea, Dept. PM-8, Los Angeles 16, Calif.

NOW YOU CAN OWN A GENUINE CALIFORNIA

Ideal STAINLESS STEEL WATCH BAND

FOR **\$1.00** FULL PRICE

Flexible • Secure
Sanitary • Comfortable
Closely Adjustable

Used by ENGINEERS
MACHINISTS • FARMERS
SPORTSMEN • FLYERS
Order Yours Today!

Fits any wrist up to 8-in. Ends of band at watch 5/8" wide. If your dealer cannot supply you, send \$1 cash or money order. Band sent at once postpaid.

MARQUARDT MFG. CO. 1825 N. MAIN STREET
LOS ANGELES 31, CALIF.

OWN a Business

Clean and Mothproof rugs and upholstery "in the home." Patented equipment. No shop needed. Duraclean dealer's gross profits up to \$20 a day on EACH serviceman. These Nationally Advertised services create repeat customers. Easy to learn. Quickly established. Easy terms. Send today for FREE Booklet — Full details.

DURACLEAN CO., 16-8 Ct., Deerfield, Ill.



Make Concrete Blocks and Bricks

New superior method makes square, true, easy-to-lay units which will pass any building code. Small investment, high production, big profits. One \$30.00 machine will make four 5"x8"x12" blocks per minute—1000 per day. Pays for itself in a few days. Sell blocks or save 2/3 building cost by making and laying your own.

POST CARD BRINGS FREE FOLDER

Economy Manufacturing Company
Dept. P Stone Mountain, Georgia

CUBIC-INCHER RADIO SET \$2.39

SIGNAL-POWERED
NO ELECTRICITY

Entire set less than one cubic inch in size, rests in bowl of teaspoon! Radar IN34 detector, world's best for crystal sets. Works anywhere—never wears out—costs nothing to operate. Safe and foolproof. Reception is guaranteed. With connecting leads and complete directions, \$2.39 postpaid without phone. \$3.19 postpaid with phone. Foreign orders 10% extra, prepaid only.

CARING PRODUCTS Dept. M-3, Box 1308
Chicago 90, Ill.

MAKE OWN POWER TOOLS

Complete details on sturdy tools you can make at small cost . . . Drill Press, Wood Lathe, Jigsaw, Belt Sander, Circular Saw. Five plans \$1.00 postpaid. **CRAFT-PLANS**, Dept. P-122, 7241 Madison, Kansas City 5, Mo.

V-8 DUALS & SINGLES

MUFFLERS

STEELS and ALUMINUMS with a motorboat tone

SINGLES, Chev., V-8, Plymouth, Steels \$5.50, Aluminum \$7.00. Chry., Olds., Buicks, etc., Steels \$7.50, Aluminum \$9.00. V-8 and MERCURY DUALS, Steel \$17.50, Aluminum \$21.00. Split Manifold Sets, Steels \$35.00, Aluminum \$45.00. Aluminums are guaranteed for life of your car.

DEALERS WANTED

SANDEE MUFFLER CO.
BOX 296 LA TIJ., LOS ANGELES 43, CALIF
2624 W. SLAUSON AVE., LOS ANGELES, CALIF.

BRUSH PLATING OUTFITS

for re-plating articles in the home and shop. No tanks necessary. Free particulars.

GUNMETAL CO., AVE. M, DECATUR, ILLINOIS

BUILD AN ELECTRIC LAWN MOWER

Make this Battery-Driven, Rotary-Blade mower from an old auto generator and inexpensive parts. Cuts forward, backward, grass or weeds, any height. Plans complete, easily followed.

LEJAY MFG. CO., 847 LeJay Bldg., Minneapolis 8, Minn.

PLANS ONLY \$35
WRITE TODAY

BUY A STONE

MARK LOVED ONES GRAVES
Special prices. Freight paid. Erected. Write for our BIG FREE Book.

U. S. MARBLE & GRANITE CO., ONECO, 19, FLORIDA

Concrete-Block Lifting Tool

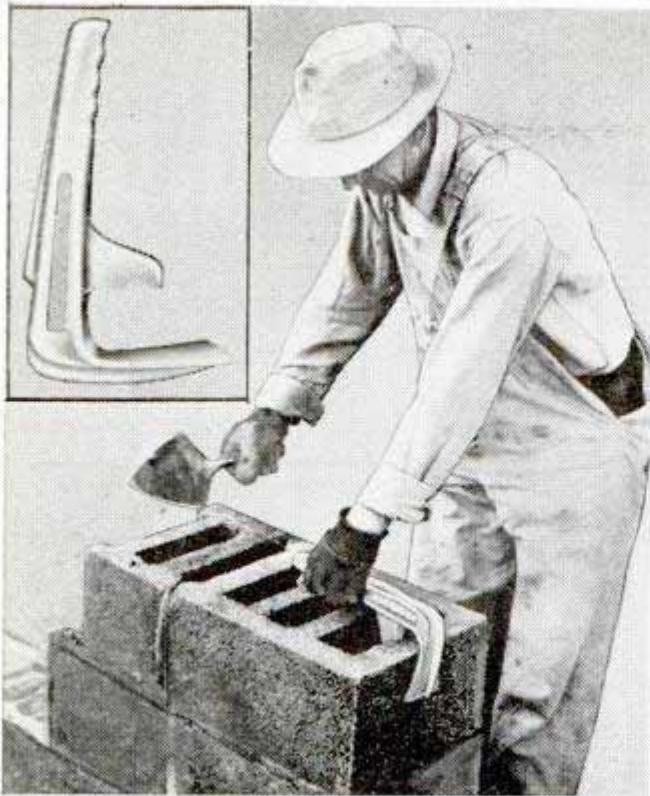

Concrete blocks are picked up and carried in one hand with a lifting tool that grips the side of the block when the sturdy handle is lifted. Made of cast aluminum, the tool has no moving parts to break and can be used with any standard web block. Because the tool requires only one hand and can be used to true up the block in the wall, the mason doesn't have to stop to put down or pick up his trowel. By using two tools, he can carry two blocks at a time without strain.

Glass 'Lung' Gives Oxygen to Blood

Victims of pneumonia, tuberculosis and other lung-damaging diseases may be aided by an artificial lung that has been successfully used in the laboratory on animals and is ready for trial on humans. When lung tissues are injured by diseases, the lungs fail to absorb oxygen and eliminate carbon dioxide. The artificial lung takes over these functions outside the body. The blood is drawn from the patient, oxygenated, rid of carbon dioxide and restored to the body. Carbon dioxide is absorbed by a container of calcium hydroxide. The lung, a glass chamber, was developed by four brothers, Dr. John R. Guarino, a physician, and Louis, Frank and Vincent Guarino, who are engineers.

Eighty farm animals weighing 11,000 pounds were flown overseas to Milan, Italy, in a transport plane equipped with prefabricated stalls.

AUGUST 1948



**TWO DAYS'
FUN
SAVES
\$200!**

You've seen the CUB Sports Trailer on local lots for more than \$500. You've envied CUB owners who could afford the luxury of an all-metal trailer. Now you can have a CUB of your own—for \$279.50.

Here, for the first time, is a full-size trailer in construction kit form—at less than the cost of materials alone. Best of all, assembly is so simple that you can build the CUB with a crescent wrench and screw-driver—in less than two days.

Actually, the CUB is all but ready to roll when it leaves our factory. Aluminum panels are precision cut and guaranteed to fit, holes are all drilled, and every practical sub-assembly is completed by factory craftsmen. You simply tighten a few bolts—and hit the road with a streamlined sportster that pays for itself on one vacation.

The CUB is 12' 7" long, 6' wide, 5' high, sleeps two, adds only 75 pounds tongue-weight to your car, and includes galley, wheels, fenders—all essential parts except tires and tubes.

F.O.B. Los Angeles, price for full kit—\$279.50
(C.O.D. shipment will be made if at least \$50 deposit accompanies order)

Write for illustrated booklet . . . FREE

National Trailer Stores

Dept. 54, Box 2353, Terminal Annex,
Los Angeles 54, California

**DO TONGUE AND GROOVE—FLUTING—
NOTCHING AND INLAY—**

**Aladdin's Tool
AND YOUR
DRILL PRESS**



Patent
Pending

DeLuxe Model

\$11⁹⁵

Makes any cut wood shaping tools costing up to \$300 can make. Comes complete with adaptor, six blades, balance blade and bottom bearing in sturdy wood box.

THE DESIGN COMPANY

2603 Warwick, Dept. T23 Kansas City 6, Mo.

**The Right Press
will save you money**

The right size press, chosen from the complete Dake line, will handle those hard jobs for you — pressing, straightening, separating, or bending. Up to 75 tons capacity. Manual, hydraulic, electric-hydraulic, or air-hydraulic operated. Send for free bulletin.

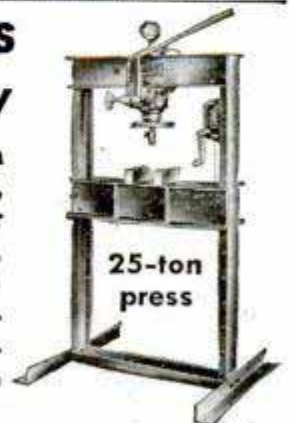

DAKE ENGINE COMPANY

624 Seventh Street, Grand Haven, Michigan

285

MORE POWER

With a 4 Cycle Air-Cooled
CLINTON



Two Power Ranges
1½ to 2 H.P. 2½ to 3 H.P.

The sturdy, easy starting CLINTON Engine gives more power... dependable power... power when needed. Use its power for tractors, generators, small boats, bicycles, mowers, and innumerable other uses. At all times CLINTON Engines (sold worldwide—service everywhere) give peak performance under all conditions.

It's Powered Best When Clinton Powered

Write Box 102PM **CLINTON MACHINE CO.**
CLINTON, MICHIGAN



Pat. applied for

Start a NEW BUSINESS
Or Add to Your Present
Repair Business
**Sharpen Dull Pipe Wrenches
Pipe Taps & Dies
"Gum" Circular Saws**

Write for information.

J. C. MOORE INDUSTRIES P. O. Drawer 276
FREDONIA, PA.



MAKES DRIVING EASIER

Automatic accelerator control! Pedal stays put in any position. No more cramped leg from constant pressure on accelerator. Disengages immediately when brake is applied. May also be engaged and disengaged at will, by touch of foot. Drive for miles with both feet free. Save gas by steady driving. Safe. Economical. Easy to install. Mailed complete, postpaid, for \$2.98, with full instructions. Folder on request.

AUTOMATIC ACCELERATOR CONTROL, Inc.
MONROE, MICHIGAN

AMAZING NEW SAFE JIG SAW READY!

At last—a revolutionary, new electric jig saw small children may use, yet powerful enough to be the basic tool in Dad's workshop! Make "Standing Photo Silhouettes" of favorite snap shots... fancy what-nots, toys, for fun and profit! Just plug in—and Saw! No motor to buy—no oiling. Thousands sold. Use in living-room, apartments, etc. Patented. Nothing else like it. Mail postal NOW for illustrated, Free Circular, low price! (Dealers write!)

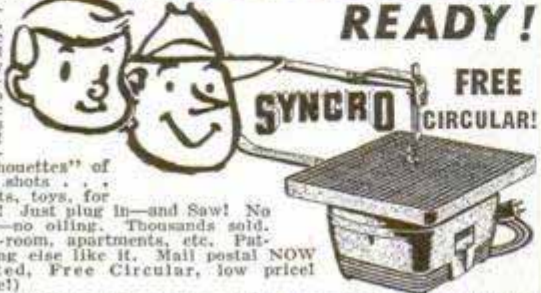

SYNCRON SAW CORP., DEPT. A-88, ROCHESTER, MICH.

Engineers All Metal Army Type Hand-Sighting

LEVELS

\$2.00

PRECISION QUALITY



Send \$1.50 for 3rd Edition of Gun Digest with our complete catalog of new and used guns, etc. Our separate catalog 25c.

PUBLIC SPORT SHOPS

11 S. 16th St., Phila. 2, Pa.

No COD's

AIR AND LIQUID TANKS



at New Low Prices **\$3.69** f.o.b. K. C., Mo.
Non-rusting stainless steel; 10 gallons liquid capacity; 12" diameter, 24" length. Holds up to 400 pounds safe air pressure. Ideal for water supply in home trailers, bottled gas, air horns and brakes, floating rafts, buoys, compressed air. No operating cost; fill free at any filling station. Price list of accessories (air hose, gauge, fittings) on request.

MIDWEST BUY-ANYTHING CO.

1520 Locust

Kansas City, Mo.

GAINE

BURNS MORE OXYGEN — LESS GASOLINE

AIR-FLOW NEEDLES

For Cars, Trucks, Tractors

"HAIR-LINE" ADJUSTMENT

Perfect Fuel-Air Mix

STATE MAKE - MODEL OF CAR - KIND OF CARBURETOR.

8 CYLINDER TAKES 2 DUAL CARBURETORS TAKES 4

SEND CHECK, M. O. CAMERON CO. 539 East Adams Street PHOENIX, ARIZONA

ORDER NOW! \$1.50 EACH—POSTPAID

FASTER PICK-UP

SMOOTHER MOTOR

EASIER STARTING

PERFECT IDLING

MORE MILES PER GALLON

INSTRUCTIONS ENCLOSED

1000 FT. BLOWER WITH 1/6 H.P. MOTOR

\$45.00 FOB Chicago

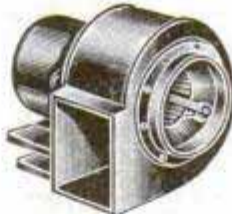

1000 cubic feet free air per minute for cooling, heating, drying, blowing, ventilating, air conditioning, dust collecting, etc. 14 inches high, 14 inches wide, 12 inches deep, 6 inch wheel, blower complete with cont. duty 1/6 H.P., 110 Volt, 60 cycle, A.C. motor. List price \$65.00. While they last \$45.00. Send deposit, Bal. C.O.D.

Dealers Write for Bargain Listings
C. MARSHALL SALES
3546 W. FULLERTON, CHICAGO, ILLINOIS

ELECTRIC TRIGGER

HEAVY SPRING TENSION. FIRES ON 12 TO 110VDC—25 TO 110VAC

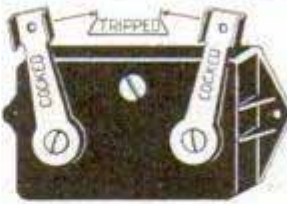

Wiring diagram furnished. Include postage for 3 lbs. Free List.

\$1.49 EA.

SATISFACTION GUARANTEED OR YOUR MONEY BACK
DICK ROSE—ERECO, 2912 Hewitt Ave., Everett 21, Wash.

OWN THIS FINE 8 PC. COMB. BOX AND OPEN END WRENCH SET



In transparent leatherette roll. Made of hi-grade alloy steel and heat treated. 8 sizes 15/64 to 7/16. At your local dealer.

PRICES Retail \$3.00 per set Dealer \$24.00 per doz. sets SALESMEN WANTED

Send \$2.00 only for sample set postpaid.

STEPHENS TOOL WORKS
Box 306, La Tijera Sta., L. A. 43, Calif.

WORLD'S LOWEST PRICED ADDING MACHINE



Vest Pocket Size **FREE TRIAL**
\$2.95
IDEAL FOR BUSINESS OR PERSONAL USE — GUARANTEED ACCURATE. Not a toy. Operates with only a finger flick. Adds, subtracts, multiplies, divides. only Counts up to one billion. Pays for itself over and over. Ideal Gift — for Business, Income Tax and School use. MONEY BACK GUARANTEE. Send name and address. Pay postman only \$2.95 plus postage. (Send full cash if outside U. S.) Beautiful rich-looking Leatherette Case included at no extra cost. Money back in 10 days if not delighted. AGENTS WANTED.

CALCULATOR MACHINE CO., (Mfrs.)
Dept. 205, P. O. Box 248 Glenview, Illinois

NEW 30" SHEET METAL BRAKE

Forms angles, channels, vees, flanges, locks, zees. Handles 26 gage sheet steel, heavier gages of aluminum, copper, plastic, etc. Portable. Can be held in a bench vise, or bolted down. All steel. Wt. 40 lbs. Shipped exp. collect, \$24.50.
12" BRAKE. Fits in vise to form difficult and compound bends, up to 20" gage steel 12" wide, \$12.50.
18" CURVE FORMER. Handles 16 gage steel 2" to 30" dia., \$9.50 PP.
VISE IRON BENDER. Forms rings, hooks, eyelets, etc. in 1/2" round or square; 1/4" up to 2" wide in bar iron. Price \$10.00 PP. with attachment to bend 1/2" pipe, \$12.50.
SHEAR. Cuts 16 gage steel any length and width, \$18.50.
SHEET METAL PLIERS. 21 1/2" wide, \$2.00; 5", \$3.50. 20 page instruction booklet, 50c.



Immediate delivery. Order direct, cash or C.O.D., or send for folder.
VISE BRAKE MFG. CO.
1116 So. 27th St. Dept. P8 Omaha 5, Nebr.

MICROSCOPES & SCIENTIFIC INSTRUMENTS
SUPPLIES-ACCESSORIES
BEL SPENCER NEW & USED LEITZ ZEISS
BOUGHT-SOLD-EXCHANGED-REPAIRED
Send for FREE LIST
NATIONAL SCIENTIFIC INSTRUMENT CO. 119 CHAMBERS ST. NY 7
MEDICAL INDUSTRIAL AMATEUR

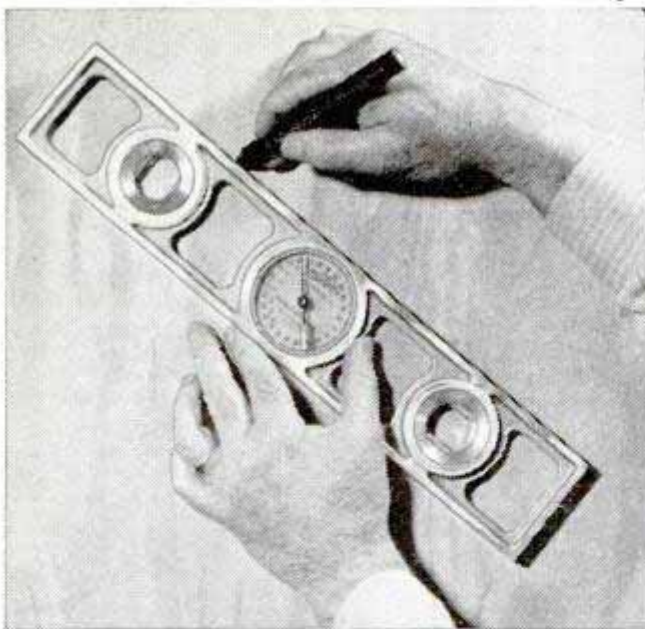

Level Has Built-In Angle Indicator

Eliminating complicated figuring, a combination level and angle indicator gives the craftsman the exact degree of slope or pitch by means of a 360-degree dial and weighted needle. To cut a board at the proper angle to fit a sloping wall, ceiling or cornice, the carpenter merely places the level against the slope and reads the angle on the dial. He then transfers this angle to the board and marks it. Made of aluminum, the tool also has four level vials, two horizontal and two vertical.

Same Fuse Can Be Used Six Times

Six fuses are built into a single unit, giving the same plug six lives before it must be renewed. Whenever a fuse blows, a red neon signal glows through a window in the unit so the household-er can tell at a glance which fuse in the fuse box is burned out. He then turns a small handle on the plug to the right until it clicks, placing a new fuse in operation. The plug eliminates the danger of fumbling in the dark, as the handle can be located from the neon signal. The six-in-one fuses are available in 10, 15, 20, 25 and 30-amp. sizes.



Although there are an estimated 20 million dogs in the United States, fewer than 100 of them are pure-bred English mastiffs, once one of the most popular breeds in this country and England.

AUGUST 1948

Guides you to hobby happiness

Woodworking handbook and catalog of **Homecraft® Power Tools**

Send for your copy today!

10¢
Postpaid



Shows how you can have a complete home shop without spending a lot of money! Gives you useful information: Plan for woodworking bench. Handy hints on using a band saw. Reference charts on screws, bolts, board measure. Dimensions for power-tool stands. Method of enlarging plans and drawings. Names of helpful books. Get your copy of Catalog HC-1!

Ask us for your Homecraft dealer's name.

DELTA MFG. DIV., 681 H. E. Vienna Ave., Milwaukee 8, Wis.

THIS IS THE BUSINESS YOU DREAM ABOUT

QUICK STEADY PROFITS

CORADIO

The Coin Operated Radio

IT'S the new, fast-growing, depression-proof business. Coin operated radios are

placed in hotels, tourist courts, clubs, hospitals, etc. on a commission basis—play 1 or 2 hours for 25c and produce immediate profits.

The best coin operated radio is CORADIO

ACT NOW

Start your own lifetime business, full or part time.

Limited capital required. Send for further information.

WRITE TODAY Dept. P. M.

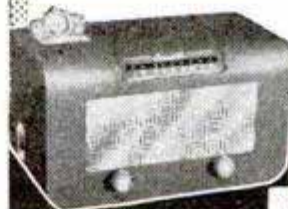

CORADIO

COIN OPERATED RADIO

212 Broadway New York 7, N. Y.
Beekman 3-0038-9

HIGH PRESSURE HYDRAULIC PUMP FOR HOME, SHOP AND FARM USE



Genuine Vickers constant displacement high pressure pump. Use it for any type of liquid pumping job. Will pump 400 gal. per hour at 3750 R.P.M. Precision piston type design provides 1000 lbs. per square inch pressure. Self priming. Standard thread 3/4 inch intake and discharge ports. With 5/8 inch splined shaft — just add pulley and power and you're ready to go.

HAS HUNDREDS OF USES

These pumps are brand new. Original acquisition cost approx. \$100.00. Can also be used as hydraulic motor; for rams, opening doors, hydraulic lifts, etc.—also for any liquid transporting job. War surplus, but brand new. Shp. wgt. 7 lbs. Send check or money order. Satisfaction guaranteed. Postpaid in U.S.A. Each only

\$9.95

SOUTHWEST AERO SUPPLY, Dept. PM8
Drawer 488 South Houston, Texas.

EVINRUDE Catalog Free



Describes complete line of 1948 Evinrude Outboard Motors—sensational new "Sportwin" model — 2 models with revolutionary "Weedless Drive" — 3 thrilling four-cylinder models. Gives helpful information on boats, speeds, etc. Profusely illustrated. Write

EVINRUDE MOTORS
5689 N. 27th St., Milwaukee 9, Wis.

Make your Oil Heater an AUTOMATIC Heating Plant...

Stop turning your heater up and down. Just set a thermostat dial—and your heater delivers steady, uniform heat day and night, if you use an A-P THERMOSTATIC HEAT REGULATOR SET. Save up to 10% on oil, get greater comfort, avoid overheating. Easy to install on any oil heater using A-P Manual Control. Ask your dealer. (Mention heater name and control model number.) . . . ONLY \$22.97. (Thermostat, Conversion Top, Transformer, Accessories).



For FREE Booklet—"3 Times More Comfort" write

AUTOMATIC PRODUCTS CO.

2522 N. 32nd Street, Milwaukee 10, Wisconsin



"The gun that looks and feels like a Luger"

HY-SCORE

World's Most Powerful AIR PISTOL

ACCURATE! FAST! HARD-HITTING . . . Expensively made piston-type pistol for use by experts. No pumping. 30½ oz. 10¼" long. Cal .177 or .22. \$19.85 for set including Hy-Score Pellets and darts*. Extra ammunition per box of 500 rounds. \$1.49 for cal .177, \$1.88 for cal .22.

Use HY-SCORE Pellets for best air pistol shooting.

*When available.

If your dealer cannot supply, write for free booklet, Dept. PM-8 HY-SCORE ARMS CORP., BROOKLYN 1, N. Y.

BENCH GRINDER OR BUFFER



Life Time Sealed Ball Bearings. Base Constructed to Rest Firmly Without Bolting. Stone Guards May Be Removed For Use As Polishing Head. Tool Rests May Be Raised or Lowered—Used On Face or Side of Stone. 6" x 1" x ½" Grinding Stones—Can Be Used Until Worn to 2". Conveniently Located Toggle Switch.

13" Between Grinding Wheels for Permanent Mounting if Desired. Bearings and Stones are Standard—May Be Purchased at Your Hardware or Automotive Stores. Can Be Purchased Complete with ½ H. P. Motor and Grinding Wheels. \$45.45.

Or Less Motor and Grinding Wheels. \$18.95. NOT A TOY—Suitable for Use in Hobby Shops or in Any Place Where a Heavy Grinder or Buffer is Required. Send for free Booklet Number 22-A. Immediate Delivery.

MODERN MANUFACTURING CO.

160 N. FAIR OAKS AVE.

PASADENA 7, CALIF.

MAKE THESE LEATHER and LEATHERETTE ITEMS LIKE NEW

With New Plastic LEATHER-NEW

Covers leather, leatherette and cloth and gives new finish and color—wears like leatherette. Easily applied with brush—quickly renews with liquid artificial leather. Write for FREE sample.

Own Your Own LEATHER-NEW Contracting Business—Big Profits Renew equipment for Bars, Restaurants, Hotels, etc. Profits possible up to \$125.00 on a single job . . . write for details.

FREE Sample of coated material—Write for it—No Obligation

LEATHER-NEW, 4723A Troost, Kans. City, Mo.

Leather Covered Furniture

Grille and Cafe Equipment

Any Leather or Leatherette Item

AIR DRILLS

Pistol Type pneumatic hand drills. With Jacobs Chuck and 10 ft. hose. Used. In perfect condition

\$12.50



A TO Z STEEL LETTER PUNCH SETS

1/16" (Booker) . . . \$1.95 1/4" \$4.95
1/16" (Matthews) . . . \$2.50 3/8" \$5.95

Prices FOB, Kansas City. Send 25c for handling and mailing.

ATLAS EQUIPMENT & SALVAGE CO.

229 SW. BLVD.

KANSAS CITY, MO.

Say You Saw It in POPULAR MECHANICS

make your own Gems 29.50 F.O.B.

All necessary lapidary equipment is furnished, including a super-charged diamond blade for sawing, and all wheels for grinding, shaping and polishing; also complete instructions. The complete equipment as shown, less motor and belt, for only \$29.50, f.o.b., Burlington, Wisconsin. Write today for information and literature.

B&I MANUFACTURING CO.

Dept. S Burlington, Wis.



Make your STOP LIGHT SHOUT!



AMAZING STOP LIGHT FLASHER!

Makes Your Stop Light Flash 115 Times Per Min. A SENSATION! Automatic. Instant acting when foot brake applied. Non-rusting. Dust, Oil, Vapor and Waterproof. Used by police and fire depts. Attach in 5 min. to any model car or truck. Approved by leading safety engineers.

FREE WITH ORDER. "HOW TO SAVE MONEY ON CAR 'Motoring Hints' BOOKLET." ACT NOW! If dealer can't supply send \$3.00 cash or M.O. We pay postage.

"STOP-IT" makes stop light flash 115 times per min.

MACCHI & CO., Dept. MA
927 Larkin St., San Francisco, Calif.
DEALERS AND AGENTS WANTED



LOW PRICED STEAM CLEANER

Jenz Super Chief

Portable—No moving parts—Cleans anything—Motors—Chassis—Machinery—Floors—Buildings—Remove wallpaper—Dairy & Creamery—Oil Rigs etc. Oil fired—Economical—fully tested and warranted. 75# Steam in less than 10 min. Model 70, Complete as illustrated \$276.50

F.O.B. factory. HI-PURE LABORATORIES EVANSVILLE, IND.



VALVE CAP WITH BUILT-IN TIRE GAUGE

Be safe! Check your tires at a glance! Installs in a second just like regular valve cap. Has super sensitive beryllium copper diaphragm—no other moving parts. Nothing to wear out. Weighs only 1 1/5 oz. Prolong tire life and guard your safety. Satisfaction guaranteed! Set of 4, \$1, postpaid, plus postage if sent c.o.d. Order through your dealer or direct from

CAP-GAUGE CO. 1506 WABASSO WAY GLENDALE 8, CALIF.

NEW! 25c each postpaid

Print Your Own

Cards, stationery, circulars, tags, labels, photo and movie titles, advertising, etc. Save money. Print for Others, Good Profit! Easy rules sent. Raised Printing like Engraving, too. Send dime for press samples, supply book, all details and advice on your needs. No obligation. KELSEY INC., B-37, Meriden, Conn.

MAKE YOUR OWN POWER TOOLS at Low Cost

from old Auto Parts, etc.

A New Edition Featuring TOOLS of WOOD

Now you can have a good lathe, drill press, circular and band saw and other power tools in your home workshop, at a cost of only a few dollars each. Make them yourself from old auto parts, discarded sewing machines and other odds and ends that cost little or nothing. Get this new book—"Forty Power Tools You Can Make." Costs only \$1.25 postpaid. This book gives every detail in plain language you can understand and follow. Hundreds of pictures and plans show every step to follow in making the power tools you want. Actual photographs of finished machines included. Send \$1.25 today. Money back if not satisfied.

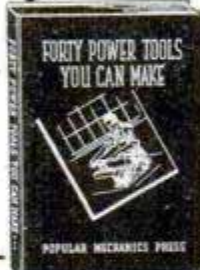

MAKE EVERY POWER TOOL NEEDED IN YOUR HOME WORKSHOP

- Some of the power tools you can make are:
- | | |
|--------------------|------------------------------|
| 2 Band Saws | 2 Drill Presses |
| 2 Sanding Machines | 1 Scroll Saw |
| 2 Circular Saws | 2 Wood Turning Lathes |
| 1 Metal Lathe | 3 Grinders |
| 1 Power Hack Saw | 1 Shaper or Moulding Machine |
| 1 Jig Shears | 1 Vibrating Pencil |
| 1 Cut-Off Wheel | and others |
- Information too, about pulleys, belts, motors and drive methods. Just published. No other book like it. Order today.

POPULAR MECHANICS PRESS

Dept. 621 • 200 E. Ontario Street, Chicago 11

WINDMILL--RAINBOW--FLASHER

SPINNING AUTO LIGHT
PATENTED

Spins with the wind. The most beautiful light in the world. Red, White and Blue. Everybody wants one. Easily put on auto, Bicycle, Airplane or Boat. Pay Mailman \$2 plus postage or send \$2 and we pay postage. Be First. Agents Wanted.

SPIN LIGHT CO.
373 1/2 BELMONT AVE. HALEDON, N. J.

OTTAWA Buzz Master

A faster brush cutter and wood sawing machine. Propels itself while cutting saplings and brush. 7 H-P motor. Many outstanding and exclusive features. Available attachments: sickle bar, rotary tiller, sprayer, air compressor, snow plow and pulley for belt work. Thousands in use. Send for FREE booklet.

OTTAWA MFG. CO., 1-827 Brush Ave., Ottawa, Kansas

New Designs in FRANZITE GRIPS

Modernize Your Gun! Improve Your Score! Most durable grips made. Positively unbreakable! For Colt, Smith & Wesson, Hi-Standard, Ortgies, Luger & Mausers in a wide choice of beautiful designs in ivory, pearl, walnut, onyx, etc. Low prices. FREE CATALOG. Dealers Wanted.

SPORTS, INC. (Mfrs.) 5501 Broadway, Dept. P-8, Chicago 40, Ill.

ARMATURES

Rebuilt and guaranteed like new, factory methods only used in our plant. Money back guarantee. Send us your old armature. Ford, Chevrolet, Plymouth, and all popular makes of cars 1937 and down.....\$3.35 ea. 1938 to 1948.....\$4.45

OTHER ARMATURES AT CORRESPONDINGLY LOW PRICES

DELTA ARMATURE CO.
1400 W. 8 Mile Rd. Ferndale, Mich.

A Perfect Tool Holder for Home Workshop Lathes

Holds 3/16", 1/4", and 5/16" tool bits, round or square. Holds all bits in four or more positions. This one holder will take place of R.H. Offset—L.H. Offset—Straight and Boring Bar holders. Shank size 7/8" x 3/8". Other sizes available.

EDWARD BLAKE COMPANY
634 Commonwealth Ave., Newton Centre 59, Mass.

Get that NEW-CAR FEEL again!

SEALED POWER PISTON RINGS

The only ring with the Full-Flow Spring!

SEALED POWER CORP., DEPT. G-8, MUSKEGON, MICH.

WOOD SHAPER \$29.50

9" x 16" surface ground cast iron table. Cast iron base and guard. Ball bearing 1/2" spindle. 3/4" x 1/4" mitre groove. NOT A TOY. Wt. 40 lbs. F.O.B. Memphis. Write for descriptive folder. (PAT. PENDING)

V. J. Gegumis & Sons, 2564 Everett, Memphis, Tenn.

MAGNETS

OF ALL TYPES—10c UP
AMAZINGLY POWERFUL!!

5 oz. Alnico Magnet, lifts 10 lbs. \$1.00. Our Leader, 15 oz. Magnet, lifts 40 lbs. \$1.95. New alloy—will not weaken! Useful for lifting valuables from tanks, lakes, or rivers easily! 7 small magnets \$1.00 with list of many shop and home uses. Satisfaction guaranteed.

R. EYRICH, 2566 N. 49TH ST., MILWAUKEE 10, WIS.

Would You Believe It?

POWER TOOLS

Only \$7.00 Each?

5 big capacity power tools in one machine: lathe, drill press, circular saw, grinder and sander. Equal to equipment costing five times as much—uses 3/4 to 1/2 H.P. motor. Factory-to-you only \$34.95 complete. Send \$17.50 (balance COD) on 10-day FREE trial, money-back guarantee, or write for FREE catalog.

EMRICK, INC., 1738 Clinton, Kalamazoo, Mich. FREE TRIAL

PAINTERS' STRIPING TOOL

Now! Set of 7 STRIPE SIZES at a BARGAIN PRICE

Now you can paint 7 stripe widths on furniture, bikes, model planes, bulletins, wall board... make plain walls look like tile! Easier than using a pencil! Straight, curved, circular, even parallel stripes made expertly in any color! Regular price Type "M" Tool with tip for 1/16" stripe \$1.00. Tool with 1/64", 1/32", 3/64", 5/64", 3/32", 1/8"—\$1.50... all tips 75c ea. Tool with complete set of 7 tips \$5.00. (COD's postage collect.) **WENDELL MFG. CO., 4234-B Lincoln Ave., Chicago 18, Ill.**

A TOOL... NOT A BRUSH

Dealers Write Today!

WITH 7 TIPS \$5 POST PAID

NO MORE BACK BREAKING MOWER PUSHING

Build a POWER LAWN MOWER yourself from your old HAND MOWER

We supply complete ATTACHMENT that needs no welding. Easy to install in less than an hour, fits any make or size of mower for Electric Motor or Gasoline Engine.

ENGINE:
OUR 1 1/2-2 H.P. 4 Cycle Air Cooled with High and low Adjustable Jets Dependable Starting. Light weight, 30 lbs.

Both the ATTACHMENT and the ENGINE are ABSOLUTELY GUARANTEED, you are getting the very best that money can buy at a price you can afford.

Orders filled in seven days. Send for FREE FOLDERS.

ROYAL-OAK LAWN MOWER SHOP
Box 48 Royal-Oak, Mich.

FENDER SKIRTS \$17.20 PER PAIR

For Ford Chev., Merc., Plym., DeSoto, Chry., Dodge Kaiser-Frazer and Buick. Beautify your car—bring out the flowing lines inherently designed there. Sparkling beauty you'll like. Constructed of heavy gauge body steel, finished in prime, perfect fit.

SANDEE MUFFLER CO
Box 296, La Tijera Sta. Los Angeles 43, Calif.

Gentlemen: Please send me one set of Sandee Fender Skirts to fit my..... (year and make of car)

Check for \$17.20 enclosed
 Ship C.O.D.

GENERAL PURPOSE ELECTRIC PUMP FOR HOME, SHOP OR FARM

The ideal pump for your use in the home, on the farm or in the shop. Easy to hook up and for 110-120V AC only. Precision built with lifetime bearings, dynamic balance. Brand new motor and pump.

Capacity: Water—10 gals. per minute at 50-lb. head; Oil—3 1/2 gals. per minute at 1000 lbs. per sq. inch. Will pump gasoline or any liquid. Clean and efficient. A real bargain at only..... **\$39.50**

SURPLUS ASSETS CORP.
DEPT. P. 2315 W. OGDEN AVE., CHICAGO 8, ILL.

QUICK BIG PROFITS ON New Magic Cleaner

Let Us Help YOU Establish Your
Own Business — Big Steady Profits

"7-X" Magic cleaner is new—a miracle all-purpose cleaner for removing paint, grease, grime from hands, leaving them soft, white, smooth with no chap or dryness! "7-X" cleans perfectly upholstery, carpets, linoleum, woodwork, etc., removes gum, tar, grease. Ideal for cleaning and polishing automobiles, chrome, brass, and other surfaces! **BIG PROFITS** for Distributors selling "7-X" to hotels, garages, printing and manufacturing plants, painters and thousands of other buyers. Wonderful territories wide-open. **BUILD YOUR OWN BIG BUSINESS, Be Your Own Boss. No capital needed!**

Send for **BIG TEST** Sample Only

Get full details of our big money making offer. Test in your spare time the great money-making OPPORTUNITY "7-X" offers you—discover how easy it is to make **BIG DAY AFTER DAY PROFITS!** Send only **10c** to cover packing and postage of sample—start taking orders immediately.

SUNNY CAL CO., KANSAS CITY 15, KANSAS

Plastic Coasters
and Tiles

EMBED REAL FLOWERS in NEW Magic PLASTIC

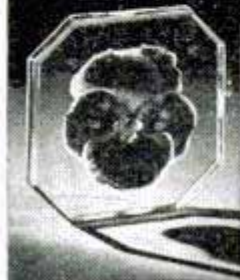

Makes fine gifts, novelties, things to sell.

Embed real flowers, butterflies, medals, photos. Make book-ends, jewelry, figurines, and hundreds of other useful and decorative objects that are distinctive and different. Castolite is crystal clear, may be dyed for brilliant color effects. Can be sawed, carved, turned, drilled. Pours cold, sets at low temperature. No training, no tools required. **20-PROJECT CASTOLITE KIT \$3.50** postpaid. Contains everything needed to get started at once. Send M.O., check, or order C.O.D. For Castolite manual alone, 25c.

MANUAL
25c

THE CASTOLITE COMPANY

DEPT. J-1, BOX 391

WOODSTOCK, ILLINOIS

"TERRIFIC" BARGAIN



Original Cost \$150.00 — Our Price \$7.50

BRAND NEW 3X ARMY TELESCOPE, ALL COATED LENSES. An ideal gift for viewing objects, landscapes, seashores, etc. The high resolving power of the six coated lenses, five of them achromats will bring out great details. For the experimenter it can be dismantled and used for hundreds of projects. Length 22½ inches. 36° Field. **Postpaid \$7.50.**

500,000 Lenses and Prisms. Send 3c stamp for "Bargain" List

A. JAEGER'S 123-26P ROCKAWAY BLVD. SO. OZONE PARK 20, N. Y.

ARMY SURPLUS A-C PLANTS

Nation's greatest bargains in 110-volt, 60-cycle, 2500-watt power plants. Briggs Engine. Ideal for farmers, contractors for full time or emergency power. (Cost Govt. \$535.) New plants \$266.80 prepaid. Fully reconditioned plants \$229.80 prepaid. 2500-watt practically new A-C generators \$129.80 prepaid. Brand new famous Salsbury gas engines 6½ H.P. \$82.90 (cost \$162.60). Satisfaction guaranteed. Free catalog. **LECO ENGINEERING CO., Box 908-PM8, Lincoln, Nebr.**

OUT OF PAWN! Genuine DIAMONDS

Direct to You—Save up to 50% and more on fine quality, Genuine Diamonds, reset in beautiful modern mountings, styled for Ladies and Men—Sold with an Iron-Clad Money-Back Guarantee. Over 100,000 satisfied customers. Order now from this ad. Write us for **FREE ILLUSTRATED CATALOG** of other Unredeemed Diamond Pledges from \$5.00 to \$5000. Send today. Reference: Any Bank or any Mercantile Agency.

1/5 CARAT
\$125-Value

\$49
Tax incl.

1/2 CARAT
\$200 Value

\$95
Tax incl.

BERMAN'S COLLATERAL LOAN BANK

Dept P-12, 636-38 W. Balto. St.

Baltimore 1, Md.



BEST BUFFING BONNETS

Hand Made of Finest Lambskin
For Buffing and Polishing
5" — \$1.20 Special \$1 Ppd.
6" — \$1.40 7" — \$1.65 8" — \$1.85
Bargain — Any 3 Sizes \$4 Ppd. U.S.A.
For Sales Tax in California ADD 2 1/2%

BEST BUFFER CO.

259 W. Harriet St.
Altadena, Calif.

100 POWER TELESCOPE



Designed for serious astronomical study. 2 3/8" objective, hand corrected to astronomical quality. Body tube 31" long finished in black aluminite and chromium plate. Special mounting will fit any standard camera tripod. Price \$65.00. Tripod extra. Free literature. Catalog 10c.

JANAN INSTRUMENT CO.

76 INTERHAVEN AVENUE, PLAINFIELD, N. J.

MARCOT KEY MACHINES

MARCOT No. 8 KEY MACHINE, mounted on Cabinet \$ 95.00
Auto Code Book and
Auto Depth Keys 12.50
100 Dz. Popular Cylinder Key Blanks 60.00
Set — Key File, Follow-Through
Rods, Lock Picks, Bit Key Gauge, Thimble, Pins, Springs... 10.50
"Locksmith Trade Books": 6.75
How to Open Locks without Keys or Picks; Secret of Locksmithing; How to Make Keys by the Impression Method; Master Key Systems. **TOTAL COST \$184.75**
The \$60.00 cost of the Key Blanks would return approximately \$350.00. This would more than pay for your entire KEY MACHINE OUTFIT. **IMMEDIATE DELIVERY**—Motors available with Key Machine Orders.
A. J. MARCOTTE CO. DEPT. PM, CHICAGO 51, ILL.

CANVAS COVERS

Waterproof tarpaulins, war surplus (Used), perfect condition. Originally made for tents. Approx. 5'x8'. Two buttoned together make approx. 80 sq. ft. Complete with buttons attached. Suitable for use as canvas dams, hay covers, truck covers, machinery and equipment covers, etc. Packed in bales of 30, priced 30 covers, \$1.50 ea.; 15 covers, \$2.00 ea. Less than 15, \$2.50 ea. All FOB, Kansas City.

AMERICAN SUPPLY CO.

329 W. 5th

Dept. PM

Kansas City, Mo.



PRACTICAL BOOKS ON HOME PLANNING BUILDING · REPAIRS

MAIL
ORDER
TODAY

Plan Now—Build When You Can
Books Sent C.O.D. Anywhere in U.S.A.

Select from this list of helpful books. In U. S. books sent postpaid if remittance accompanies order. Outside U. S. include 15% extra for shipping charges.

- How to Plan a House. \$5.00
- Your Home and How to Build It Yourself. \$3.00
- Painting, Decorating. \$1.75
- Carpentry \$2.50
- Painting, Furniture Finishing and Repairing
Includes floor renewal \$1.50
- How to Remodel a House Complete, practical. \$5.00
- Building Insulation .. \$4.50
- Concrete Handbook
Do work for yourself, others \$1.50
- Blueprint Reading for Building Trades \$1.50
- Practical Bricklaying. \$2.00
- Primer for Home Builders \$2.50

FAMOUS PLAN BOOKS

Books contain floor plans, photos, descriptions of homes.
AMERICA'S BEST LOW COST HOMES. 125 designs \$1.00
DE LUXE SMALL HOMES. 210 designs. \$1.00
OUR FUTURE HOME. Wide selection of residences, summer homes, garage apartments. \$1.00
MODERN HOME & GARDENING. 42 popular designs. Improvements, garden short-cuts, etc. 50c

Set of
Four
Books
\$3.50

Stair
Building
\$2.50



POPULAR MECHANICS PRESS

DEPT. 646 • 200 E. ONTARIO STREET, CHICAGO 11

New SWISS WATCH

This brand new 17 Jewel Swiss Watch has every desirable feature: chrome case with stainless steel back; sweep-second hand and radium dial; it is waterproof, shockproof and anti-magnetic. Delivered complete with stainless steel expansion band for only \$23.75 Federal Tax included. This watch has a full one year guarantee—order yours now. Five dollar deposit required on C.O.D.'s.



Money refunded if not completely satisfied.

REGISTERED JEWELERS

172 1/2 Canal Street New York 13, N. Y.



DRAINS CELLARS, WASH TRAYS CIRCULATES OIL

Pumps 1800 GPH 300 gal. 30' high, use 1/8 to 1/2 HP **\$6.50** motor. Will not clog.

Postpaid if cash with order. (Add 50c for west of the Mississippi.)

Thousands in use since 1936

LABAWCO PUMPS, BELLE MEAD 7, N. J.



TALK-SING thru your own radio with RADIO MICROPHONE



Be the life of the party. Put on your own broadcasts at home. Talk-Sing make announcements from any room. Wonderful voice practice. Microphone easily attached to any radio. Follow enclosed instructions. SEND NO MONEY—pay postman \$1.98 plus postage. Send Money Order or check and save postage.

EMPIRE RADIO & TELEVISION CO. (Dept. M4) 1521 Bedford Ave. Brooklyn 16, N. Y.

ONE-MAN SAWMILL LESS THAN \$200.00

Easy To Turn Trees Into Money

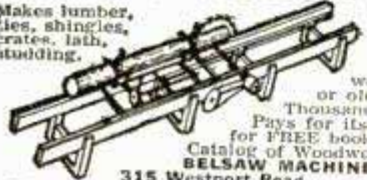

Makes lumber, ties, shingles, crates, lath, studding.

Belsaw Models in 10 to 24 foot sawing lengths. MECHANICAL FEED, accurate set works and positive dogs. Use tractor or old auto engine for low cost power. Thousands used for commercial sawing. Pays for itself quickly. Send post card today for FREE booklet, "How To Make Lumber" and Catalog of Woodworking Equipment.

BELSAW MACHINERY CO., 811-G Field Bldg. 315 Westport Road Kansas City 2, Mo.



FIX SEWING MACHINES

BIG MONEY. Spare or full time. Open your own neighborhood shop. Thousands need repairs. Send for complete Service Manual—only \$1.98 postpaid. Money back guarantee. SEWING MACHINE SERVICE CO., Hamilton 25-DD, Ohio

BUILD "EXTRA" SPARE TIME PROFITS!

Genuine Poly ball bearing arbor C4 (shown) with 1/2 x 12 1/2 spindle only \$7.95 postpaid. Order today! Free literature available on request.



POLY PRODUCTS • 2032-C E. Walnut • Pasadena 8, Calif.

LIQUID MARBLE

COMPOSITION FLOORS FLEXIBLE MOLDS MOLD Novelties, Statuary, Art Goods in Flexible Plastic Molds; Se-

material makes \$1 seller. Make Marbleized floors. Tile Walls. Colorful, glossy, amazing! Easily learned; start in garage or basement. Particulars free. MARBLEIZING SERVICE, Dept. 10-F, Edwardsville, Ill.

Say You Saw It in POPULAR MECHANICS

RACING CAR EQUIPMENT FOR ALL CARS

Engines, Racing Heads, Manifolds, Carburetors, Mufflers, etc. Speed Instructions and literature \$1.00—refunded first order. LEE MOTORCRAFT CO. 1412 Great Northern Bldg. Chicago, Ill.



RAISE Money Making CHINCHILLAS

Several females and a male start a large herd which will furnish you an income for years. Just a few feet of space are required. No experience needed. We furnish all instructions. Write world's largest breeder today for free details. WILLOW BROOK FARM, R-36, Sellersville, Pa.

SIGNS EASILY AND EXPERTLY PAINTED WITH LETTER PATTERNS AND SHOWCARDS

MANY SIZES & STYLES WRITE FOR FOLDER! JOHN F. RAHN 1380-31 N. Central Ave. CHICAGO 51, ILL.

SHATTERLESS "ALL PURPOSE" STEEL BOTTLE

HAS HUNDREDS OF USES *FOR LIQUIDS, GASES, STORAGE, AIR PRESSURE, ETC.



Formerly used by AAF for oxygen storage. You can use it now as an air pressure tank for inflating tires, operating horns, air motors, etc. May also be used as a buoy or float or for water supply storage on boats, trailers and trucks. Ideal as shipping container for gases, chemicals, etc. Bottle is non-shatterable with working pressure up to 500 lbs. psi. and weighs only 6 lbs. when empty. Internal volume 300 cu. in. (approx. 9 qts.). Has 3/8 in. pipe thread at each end. Approx. size 2 1/2 x 6 in. They won't last long at this low price. Guaranteed brand new. Order now!

REGULAR STEEL, EA. **\$2.95** Stainless Ea. \$3.95

WAR SURPLUS COMPLETE HYDRAULIC PRESSURE ASSEMBLY \$49.50

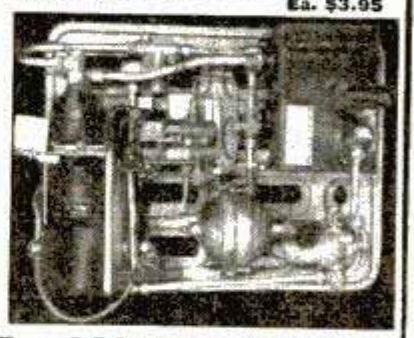

A COMPLETE UNIT - READY TO HOOK UP

Complete to the last detail—and at a price that you couldn't begin to buy half of the parts for. It is completely equipped ready to go—just add the oil and put it to work. Unit is mounted on an alloy rack and contains the following high quality components: hydraulic reservoir 5 x 10 x 8 inches; large Purolator filter; hydraulic pressure accumulator; pressure relief valves; Bendix hydraulic pressure control unit; solenoids; genuine Pesco valves; Pesco hydraulic gear type pump of 1000 lbs. per sq. in. pressure at 1750 R.P.M. (motor turns at 4000 R.P.M.); full 2 1/2 horse power Pesco elec. motor; AC or DC 24 volts, 4000 R.P.M. (will run on 110 AC by use of transformer); all connectors, tubing, fittings, wiring, etc. are included. Unit measures 24 x 18 x 6 inches overall. Just add the hydraulic oil and you can put the system to work on any type of hydraulic power action. Has hundreds of uses. For cash with order will include full gallon high grade hydraulic oil and send shipping charges collect. Will ship C.O.D. against \$10.00 deposit less oil. Shipping wgt. approx. 60 lbs. Guaranteed perfect. Price complete, **\$49.50** only. Except where noted, you pay transit charges. Mail orders promptly filled. Send check or money order. Satisfaction guaranteed.

AERO PARTS SUPPLY, Dept. PM8 MUNICIPAL AIRPORT HOUSTON 17, TEXAS

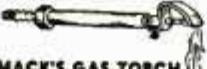

MACK'S GAS TORCH AND SOLDERING IRON 4,000 B.T.U. attaches to any gas hose; furnished with 2 jets for natural and bottled gas; equipped with adjustment set screw. \$2.00 Postpaid



Mack's GAS BURNER Jet Power, Self-Acting (Pat. pending), 24,000 B.T.U. for natural and bottled gas, industrial and home use. Guaranteed. \$2.00 Postpaid

Mack's Automatic Water Heater

Approx. 20 gal. capacity and larger for home and industry. Easily installed. Amazingly low-priced. Guaranteed. \$32.50 Del.



McDaniel MANUFACTURING CO., INC. 10214 FOWHATTAN ST. • DALLAS 7, TEX.

HERE'S A CHANCE For YOU to Test

Selrodo



INHALANT METHOD FOR RELIEF FROM BRONCHIAL ASTHMA and HAY FEVER FREE! WITHOUT OBLIGATION, COMPARE 10 DAYS FREE TRIAL IN YOUR OWN HOME

If at the end of 10 days you are not completely satisfied, return the full SELRODO set to us. If you obtain the wonderful relief experienced by thousands of others, send \$7.50 for specially priced trial set.

(CAUTION: Use Only As Directed)

C-L-I-P THIS ADVERTISEMENT and send it with your name and address to: STANSBURY CHEMICAL CO. Dept. 482A 1929 Aurora Avenue, Seattle 9, Washington



Why Pay More?

TUBE GIVEN WITH EVERY TIRE
 Send this AD with Order
 Slightly Used
 High Original Treads
 ★ **BUY IN CONFIDENCE** ★
 Safe! Dependable! Standard Brands
GUARANTEED to give A-1 Service
Positively Not Re-caps!

600-16 .. \$5.72	700-15 .. \$5.92
650-15 .. 5.12	700-16 .. 6.22
650-16 .. 5.80	750-16 .. 7.22
900-16 \$8.52	900-20 \$15.52
650-20 9.52	1000-20 15.52
700-20 12.52	1100-20 15.52
750-20HD 12.52	32x6(8) 11.82
825-20 15.52	32x6(10) 13.82
750-20 MILITARY 8 PLY \$13.52	

1/2 million tires shipped to satisfied customers.
 Trial will convince you. Orders Rushed. SEND
 MONEY ORDER. If your size is not listed — WRITE

STANDARD
 834 N. Broad St. Phila. 30. Pa.

15 H.P. "V" TYPE ENGINES

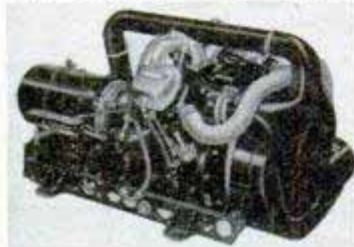

TWIN CYLINDER
 Here is power galore for midget racing cars, speed boats, etc., or build your own garden tractor, mower, welding outfit, mill, saw, home lighting plant. Use it for any type of power job. Engines measure 32" long, 22" wide, 18" high. Mounts flat with mounting brackets 14" apart each way.

FOR SHOP, FARM AND HOME POWER
 Precision built—orig. acquisition cost many times our asking price. Famous Lawrence and Andover make. Designed for 3600 max. RPM with 31.91 cu. in. displacement. Full 2 3/4" bore, 2-11/16" stroke. Dual carburetion with shielded ignition and fuel system. Removable governor included. Each motor is fitted with 28.5 volt generator (removable) ideal for welding outfits.

A RARE BARGAIN AT THIS LOW PRICE
 These are built to run like a Rolls-Royce. Some are slightly used—some like brand new. Sold "as is" but no junk. Guaranteed as described or your money back. Your cost, each, only \$119.00—two or more, \$110.00 each while they last. Send check or money order. You've seen our ads since 1941.

FEDERAL IDENTIFICATION CO.
 1910 CLASSEN BLVD., Dept. PMS OKLAHOMA CITY, OKLA.



BETCO PORTABLE PAINT UNIT

A sturdy spraying outfit. Equipped with pressure regulator, moisture trap, 25 ft. 1/4 in. hose. 100% external mix, one quart paint gun. Sprays fast drying lacquers, synthetic enamels, etc. Operates on 25 to 50 lbs. pressure. 1/3 h.p. motor, 2.39 cu. ft. displ., 150 lb. pressure. Complete \$110.00. Less gun, hose and air reg. \$96.00 FOB Okla. City. Money Back Guarantee. Send check or money order.

BROADWAY ELECTRIC TOOL CO.
 619 N. Broadway Oklahoma City 2, Okla.

22 Big Money-Makers in a Single Line!
Amazing New Fluorescent Lights with Circular Tubes

THE HOMELITER



FREE Sales Outfit

Don't send a penny. Sample Outfit is FREE. Rush name on penny post card for money-making facts about sensational new "CIRCLINE" Fluorescents. Latest scientific development gives you 22 new type circular tube fixtures for kitchens, dinettes, halls, and play rooms. Also Floor and Table lamp for living rooms and pin-ups for shaving and vanity tables. Sells on sight to homes, restaurants, stores, offices. No other fluorescents like CIRCLINE. Salesmen who order samples quickly reorder in large quantities. All fixtures complete with tubes. No waiting. Also immediate delivery on all standard type Fluorescent Fixtures. This is too good to miss. Big, quick profits waiting. Rush name on postcard today for FREE Sales Outfit.

MAXILUME COMPANY • 125 W. HUBBARD • DEPT. 88 • CHICAGO 10, ILLINOIS

NOW! FILE YOUR OWN SAWS



Do expert saw filing at home. Precision filing easy without experience. Two simple adjustments. Keeps any hand saw extra sharp and true-cutting. Complete with file. Money back guarantee. Cash with order, prepaid. (COD postage extra.) Order today.

THE SPEED CORP., Dept. PM1
 2025 N. E. Sandy, Portland 12, Oregon

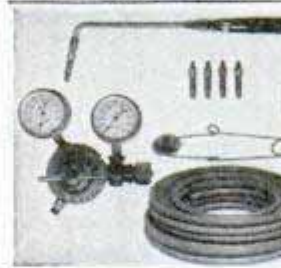

NEW WELDING OUTFIT
 Complete like picture
\$54.50

Electric Welding Outfits from \$39.00 up. Distributor inquiries invited.
EAGLE WELDING EQUIPMENT CO.
 Dept. 40, 5085 Broadway Chicago 40, Ill.

BLOCK WOOD PLANE
AMAZING VALUE!



This new plane has a sturdily constructed body of nickel-plated copper and steel. The hardened and tempered bit has a finely ground cutting edge. This is an indispensable tool for your workshop.
 Order now . . . only . . . **\$1.00** post-paid

BARRO PRODUCTS
 Empire State Bldg. New York, N. Y.

FULLSIZE, CUT-TO-SHAPE BOAT PATTERNS

and specifications. Designed by Naval Architect. Cruisers, runabouts, sloops, outboards, sailing canoe, etc. Low prices. Send 10c (coin) for illustrated catalog. **SPECIAL:** Send \$1.00 for "HOW TO BUILD BOATS" book, postpaid. PolyWog Houseboat Plans, \$10. Cleveland Boat Blueprint Co. Dept. 666, Cleveland 13, Ohio

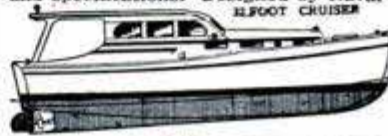

FREE for Trailer Builders

Safety-Engineered

• TORQ-LESS AXLES • BULL DOG HITCHES AND PARKING JACK LITERATURE

HAMMER BLOW TOOL CO.

Dept. 125 • WAUSAU, WIS.

FREE . . . WRITE TODAY!



MAKE BIG MONEY!

Be a floor surfacing contractor and sand both new and old floors. Sanders are easy to operate and better still, you're your own boss. Write for latest "tell-all" booklet entitled "Opportunities in Floor Surfacing", enclosing 25 cents in coin or stamps to cover handling.



AMERICAN

FLOOR SURFACING MACHINE CO.
 535 So. St. Clair Street • Toledo 3, Ohio



NEW MAXILUME PIN-UP MIRROR LIGHT



7X50 PRISM BINOCULARS

BRAND NEW
With Leather Case

\$48

With Coated Optics

\$58

Plus 20% Tax

Actual
Photograph
HL. 7"
Wt. 36 oz.

Ultra-precise optics, made to military specifications, sealed against moisture and dust in light-weight aluminum bodies. Money-back guarantee. Immediate delivery. We pay the Shipping Cost.

BROWNSCOPE CO.

Dept. 8M 24 West 45th St. New York 19, N. Y.

Sharpen Lawnmowers

MAKE
\$5.00 PER HOUR

You need no experience to operate the Ideal Lawnmower Sharpener. It is simple to adjust, simple to operate. Sharpens blades easily, speedily, accurately. Ideal sturdy, strong construction is the result of 45 years of engineering design. WRITE TODAY FOR FREE BOOK.



The **FATE-ROOT-HEATH CO.**

DEPT. D-3, PLYMOUTH, OHIO

14,000 sanding strokes per min. with **SAND-O-FLEX**



—Compare this speed with hand sanding!

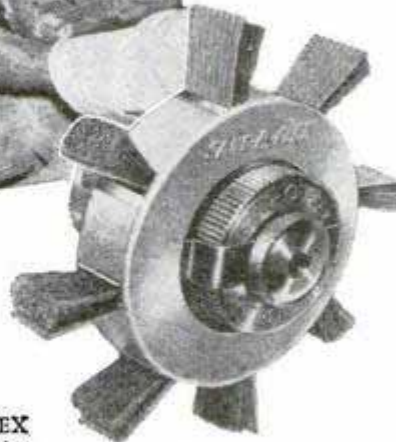

Quickly cleans and finishes intricate curves, contours on metals, wood, etc.

EACH SAND-O-FLEX

sanding wheel contains 8 abrasive strips backed up by 8 separate brushes. When rotated at usual motor speed, you get 14,000 sanding strokes per minute!

Not only does SAND-O-FLEX finish faster—it gets in and around complicated forms. Brushes mold to the work shape and rapidly sand, de-burr, finish. Produces beautiful satin finishes on metal. Abrasive strips unroll when worn. Replacement cartridges in many grits available at low cost.

Use SAND-O-FLEX on your present tools—motor shaft, electric drill, flexible shaft, drill press, lathe, etc. SAND-O-FLEX has unlimited uses in home, farm and industrial workshops—3 sizes. See your dealer or write for free literature.

MERIT PRODUCTS, INC., 4373 Melrose Ave., Los Angeles 27, California

SAY YOU SAW IT IN POPULAR MECHANICS

The New Improved
All-Purpose

DYNAMIC Super Charged ARC WELDER

Industrial Transformer Type

ONLY

\$2850
COMPLETE

Do Your Own Welding

Just a few repair jobs will pay for this machine. A practical and profitable machine tool for any workshop... Make money doing repair work for others.

Write Today for Particulars

GET DETAILS on our 10 day Trial Offer.

Member Chicago Association of Commerce.

IT WELDS • IT BRAZES • IT SOLDERS

IDEAL FOR AUTO—HOME APPLIANCE AND FARM REPAIRS. This portable, industrial transformer type welder easily carried right to the job can be operated from any convenient properly wired 110 Volt 60 Cycle Line. Can also be supplied for 220 volt 60 cycle operation and other voltages and cycles at slight additional cost.

EASY-TO-OPERATE. If inexperienced you can easily learn to do a variety of high grade welding jobs by following the practical, simplified welding and operating instructions furnished. Once you see the **DYNAMIC WELDER** in operation you won't want to be without it. Its simplicity will amaze you. In a year the **DYNAMIC** only costs you about 7c a day. COMES COMPLETE READY TO OPERATE WITH HELMET, RODS, CABLES, HOLDER, OPERATING AND WELDING INSTRUCTIONS, ETC.

SAVES YOU VALUABLE TIME AND MONEY!

DESIGNED TO DO HIGH GRADE WELDING inexpensively—Maintenance Men, Farmers, Mechanics, Machine Shops, Foundries, Auto, General Repair and Job Welding Shops, all using the **DYNAMIC** find it so indispensable and useful that they can't afford to be without it. **WORKS ON IRON, STEEL, BRASS, BRONZE AND OTHER METALS.** Has 8 metallic and carbon arc heat stages. **DOES WORK YOU WOULD THINK ONLY POSSIBLE WITH A LARGER, MORE EXPENSIVE MACHINE.**

DYNAMIC WELDER CO., 15 EAST 23rd ST., M, CHICAGO 16, ILLINOIS

SPECIAL GIFT OFFER! ELECTRIC ARC TORCH ATTACHMENT WORTH \$6.80

THIS TWIN CARBON TORCH illustrated below for use with the **DYNAMIC** is unsurpassed for brazing, soldering, pre-heating and cutting on iron, steel, brass, bronze and other metals. With it you can greatly increase the profitable uses of your welder. Comes complete with instructions, carbons & cables. Does work of an Oxy-Acetylene Torch.

MAIL COUPON FOR FREE DETAILS

10-DAY TRIAL OFFER

DYNAMIC WELDER CO.

15 EAST 23rd STREET, M, CHICAGO 16, ILL.

Send me FREE details of your ELECTRIC Arc Torch Gift Offer and Dynamic Welder 10-Day Trial Offer.

NAME _____

ADDRESS _____

CITY _____ Zone _____ STATE _____

Yours at No Extra Cost!

For a limited time only we are giving away a Twin Carbon Electric Arc Torch worth \$6.80 with every **DYNAMIC WELDER**. This valuable premium is yours at the single low price of welder alone if you act now.

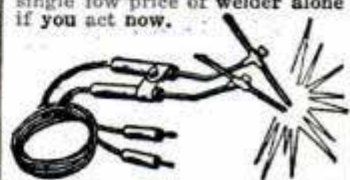

T.V. RADIO SYSTEMS ELECTRONICS

NEW 1948

Complete RADIO CATALOG FREE



Absolutely FREE . . . this gigantic, all inclusive radio and electronics Catalog with sets, parts, systems, newest developments. It's practically a power-packed reference library of vital needs and information. Every one of the illustrated 160 pages is crammed with amazing bargains much too good to miss! No matter WHAT your interest in Radio or Radio-Electronics, you MUST have this FREE Catalog. Write at ONCE . . . NOW!

FREE ENGINEERING SERVICE

Bring us your problem or question about Radio, TV, or Radio-Electronics. Write to Concord. No charge for this service.

28 YEARS TO DEVELOP 160 BARGAIN PACKED PAGES 32,210 RADIO AND TV ITEMS

CONCORD RADIO CORPORATION
Dept. 49-K 901 W. Jackson Blvd., Chicago 7, Ill.

• 2 BIG UTILITY ITEMS •



WORK BENCH

An outstanding value. In a few minutes you have a real work bench. 71 inches Long, 35 inches High and 20 inches Wide. **ONLY \$8.50** fob Chicago (weight 71 lbs.)

at Big Savings

Pre-cut and **READY TO ASSEMBLE**. Made of kiln dried pine. For the Home Mechanic or Craftsman.

Every housewife appreciates this jar storage space. Holds 90 quarts or 130 pints. Ideal for Basement or Closet. 24" Wide, 48" High and 12" deep. **ONLY \$5.65** fob Chicago (weight 34 lbs.)

JAR STORAGE



GEE LUMBER CO.

Dept. K-8, 2600 West 79th St. CHICAGO 29

AGENTS 300% Profit SIGN LETTERS

For Store Fronts and Office Windows. Anyone can put them on. Free Samples. Liberal Offer to General Agents. **METALLIC LETTER CO., 430 N. Clark, Chicago 10**

Sensational SHAPER CUTTER For Endless Molding Contour Designs



Employs exclusive double notched sets of full 1" and 1/2" split blades. Blades automatically held in position by notched design and in absolute alignment. No set screws to loosen; blades cannot fly out. Provides endless varieties of standard and special contours. Specify type of spindle on drill press or shaper. Available in six standard adapter sizes. Ten-day money back guarantee. Complete literature on request.

\$9.00 Complete with 3 sets of Hi-speed Tool Steel Cutters

TOOLS FOR USE ON ALL DRILL PRESSES

- ROTARY WOOD PLANERS
- ALL-METAL SHAPER FENCES
- SPINDLE ADAPTERS
- ROTARY SURFACE SANDERS
- DRUM SANDERS
- AUXILIARY DRILL PRESS TABLES

BARRON TOOL COMPANY, INC., 569 Architects Bldg., Detroit 1, Mich.

FREE Power Tool CATALOG

BARRON PRECISION WORK SHOP TOOLS



WORLD'S SMALLEST RADIO

USE ANYWHERE

\$2.89

- No Tubes
- No Batteries
- No Electricity

Sensationally tiny! But with this remarkable **CRYSTAL RECEIVER**, you can get reception . . . indoors or outdoors! Just connect one clip to ground and another to a bit of aerial wire. Or, for DOUBLE fun, attach two **RADA-PHONES** for a walkie-talkie, hear up to 100 feet. Trim unbreakable hard rubber receiver, 2 attachment clips, 5 feet insulated rubber wire. **SEND NO MONEY.** Just pay postman \$2.89 each, plus postage or order C.O.D.

BERNARD FINE CO., INC. 59 EAST 8th ST. N. Y. 3, N. Y., DEPT. PM14

LAW STUDY AT HOME for Personal Success and **LARGER EARNINGS.** 39 years expert instruction—over 114,000 students enrolled. LL.B. Degree awarded. All text material furnished. Easy payment plan. Send for **FREE BOOK—"Law and Executive Guidance."**

AMERICAN EXTENSION SCHOOL OF LAW
Dept. 92-PM 646 N. Michigan Ave. Chicago 11, Ill.

60 POWER TELESCOPE \$2.95

VARIABLE EYEPIECE 20X-40X-60X

NEW! Three telescopes in one, 3 different magnifications. 20 power for ultra-bright images with 40 and 60 power for extra long range. Guaranteed to bring distant objects, people, sports events, ships, moon, stars, etc., 60 times as close.



Most powerful for anywhere near the money. 5 sections. Closes to 1 ft. long. Contains 4 ground and polished lenses. Also used as a powerful compound microscope. Directions included. Mass production enables us to offer this high-powered instrument at the amazing price of only \$2.95. We pay the postage. Get yours immediately.

BROWNSCOPE CO. Dept. 8M 24 West 45 St. New York 19, N. Y.

NEW! Sell 21 **CHRISTMAS** only **PHOTO-FOLDERS \$2.25**
Customer's own personal photo. Big Profits!

Quick, easy money. Sell New Photo-Folders. Genuine personal photo in colorful artist-designed Christmas Greeting Folders. Big appeal, exclusive, amazing value. New Box Line: Water Colors by 20 eminent artists; Etchings; New Deep Color Embossed and Foil Box; Imprinting; Gift Wraps; Stationery. Big Money. Samples on approval. Write today.

Herbert Spooner Greetings, 115 Chauncy, Dept. 7, Boston, Mass.



PAINT \$1.69 GAL.

Surplus bargain! Genuine Armstrong lusterless OD enamel for both inside and outside use—for farm buildings, porches, homes, industrial equipment, etc. For metal or wood. Add pigment if desired to change color. The bargain of a lifetime while quantity lasts. F.O.B. Oklahoma City. Send check or money order. Will ship C.O.D. against 25% deposit. 1 Gal. \$1.69—5 Gal. \$1.50 Gal.—55 Gal. Steel Drum \$1.12 Gal.

FEDERAL IDENTIFICATION CO., Dept. PM8 1910 Classen Blvd., Oklahoma City, Okla.

SHINE and SAVE

SHOE SHINES are easy with **HOME VALET**



\$2.50 postpaid

Hammered finish cast aluminum. Fits all shoes. Dismountable when not in use. If C.O.D., send \$1.00; pay postman balance \$1.50 plus postage. Money back guarantee.

PREFERRED MERCHANDISE CO.

Box 923, Dept. D, Grand Central Station, New York 17, N. Y.

Attention! Buyers!

Here's your directory of 10,000 items about plans, blueprints, tools, machinery, sports, and business opportunities. The latest on schools, courses, hobbies, patents, photography, autos and boats. Cross-indexed to use in a jiffy. Four and a half million readers must be right. You will be too with this **HANDY GUIDE to POPULAR MECHANICS** advertisers. Send for it today, only 25¢!

POPULAR MECHANICS PRESS, 200 E. Ontario St., Chicago 11, Ill.

UP TO
SAVE 85%

in WAR SURPLUS...SENSATIONAL VALUES
at "GADGETEER'S HEAVEN"
IN MANY ITEMS WE HAVE
THE WORLD'S LARGEST SUPPLY

NEW HYDRAULIC CYLINDERS, VALVES, PUMPS, FITTINGS, HOSE & TANKS



51 sizes & types.
World's Largest Supply
1001 Labor Saving Adaptations for pulling, pushing, lifting operations. Finest precision workmanship and materials. Liquid and air operation, developing terrific power.
20,000 Available WRITE FOR CATALOGUE
PRICED TO SELL AT 15% GOV'T. COST.

PUMPS

HYDRAULIC, VACUUM, AIR
For every purpose at 15% of Value.

P-1 Hydraulic Pesco Type

Positive displacement gear type.
Capacity: 1 gal. per min. at 1500 P. M. at 1500 P. S. I.
Operating speed: 3750 R. P. M.
Intermittent maximum 4500 R. P. M.
Rotation: either direction with slight adjustment.
\$9.49

P-4 VICKERS

Positive displacement angle piston type.
HYDRAULIC
Capacity: 6 gal. per min. at 3000 R. P. M. at 1500 P. S. I.
Operating Speed: 3750 R. P. M.
Intermittent maximum 4500 R. P. M.
Rotation to right only.
\$14.49

PV-1

May be used as air or fuel pump for pressure or vacuum.
Will pump 7 1/2 gals. oil at 300 R. P. M. Builds air pressure 20 lbs. per sq. in. at 1000 R.P.M.
Vacuum draws 28 in. of mercury at 1750 R. P. M.
Valve Type
\$9.49

ROMEY FUEL

800 GPH at 30 PSI, can also be used as hydraulic for 4 GPM at 400 PSI or for Vacuum drawing 15 in. mercury at 1500 RPM.
\$6.29 ea.

NEW PRESSURE TANKS

Stainless steel - Shatter proof. Rustless. 10,000 available in 3 different sizes, 1001 uses.
G-1 12 1/2" x 24 inches - 2100 Cu. in. capacity
23 cu. ft. **\$4.75**
D-2 8 1/2" x 24 in. - 500 Cu. in. capacity
7 cu. ft. **\$2.49**
F-4 -10" x 18" 1000 Cu. in. Capacity
\$3.95
F-2 6 x 6 in. - 1000 Cu. in. capacity
14 cu. ft. **\$3.95**
A-4 5 1/2" x 8" 104 cu. in. Capacity
\$1.35
A-4 5 1/2" x 13" 288 cu. in. Capacity
\$1.95
Perfect portable air tank to carry air to cut or trailer. Ideal for painting, cooking, spraying, ocean buoy, underwater fishing or diving.
#OR-1 Oxygen Resistant with 500 lb. gauge will fit all tanks.
\$1.39

DC GENERATOR

140 AMP
Direct Current Generator, especially suited for adaptation to homemade welding unit.
A fast moving item at **\$15.95**

P-1 GENERATOR

200 AMP **\$22.50** ea.

R-1 GENERATOR

300 AMPS. **\$29.50** ea.

BEARING MIX

Needle, ball and roller bearings in excellent assortment. Sizes from 1/2" to 2".
#170 Introducing this treasure chest assortment of 15 Bearings at **\$2.95**

SPRING MIX

Torsion, compression and tension springs. Assorted sizes. #206
2 lbs. 89c
A treasure chest for emergencies!

WINCH HOIST

new equipped with mounting frame, handle, cable, etc. complete. Thousands of Satisfied Users! Hundreds have written, telling us it's the most wonderful tool in the world!
Capacity 2500 lbs. 20:1 ratio
Bronze Worm Gear
Ideal for Garages, Truck loading, Machine Shops, Boat Builders, etc.
\$15.99

Here's a Real "Lite Special"

Farm, Auto, New U. S. Navy Portable Pistol Grip, Sealed Beam, 12v. Search Spot, or Emergency, Light - featherweight Gov. Cost our price **\$15.00**
3 Extra filters - Red, Green & Amber. **93c Set**
\$2.95

NEW FLEXIBLE GOOSENECK LAMP

110 V. A. C. 13 ft. wire with socket, switch and plug. In mounting bracket suitable for home or workshop. Wire alone worth our price of **99c** each.

#516 BATTERIES

NEW! FULL STRENGTH FOR PORTABLE RADIOS, SIGNAL LAMPS, BOATS, ELECTRIC TRAINS, ETC.
#516 9 Volt 8 1/2" x 6 x 4 in. **79c**
3 run 27 Volt motor **69c**
#517 6 7/8" x 1 1/2" Volt Battery **69c**

VALUABLE GEARS BARGAINS!

#112 8 to 1 ratio, spindle drive. #110 **\$2.98**
6 to 1 with screw shaft. #111 **\$4.98**
85 to 1 (can be used for radio, antenna, etc.) #112 **\$3.95**
#G-11 10:1 gear ratio **\$3.95**
2 to 1 ratio 90° right angle **\$4.95**
10 tooth bevel steel boxed gear **\$4.95**
Flexible Gear Shafts With End Drives
115-30" **69c** ea.
115a-60" **99c** ea.
Radio tuning shafts that can be used as flex gear drives #115a 12 ft. 1/2" nut -15 tooth internal spline **\$1.95** ea.
#115b 25 ft. 1/2" nut 12 tooth with internal spline **\$4.25**
#115a

FILES

NEW INCHLONAL & KEARNEY & FOOT CO.
12" Amer. Std. 2nd cut dbl. cut eq. edges lapra. sides and tang New **49c** ea.
16" Amer. Std. Mill type, beveled angle, cut. eq. edges, tang, sds. and tang new **69c** ea.
12" Usp'd Vian File 33c ea. 16" **29c** ea.

HOBBYISTS! An Unequaled Value!

GADGET MIX
Rivets, spacers, Clamps, bolts, nuts, Radio parts, gears, etc.
A gold mine #104 5 lbs. **\$1.19**

PIANO HINGE

Overall Width Length Price
1 1/4" (5/8 side) 72" alum. **\$1.00** ea.
2" (1" side) 72" alum. **\$1.19** ea.
1 1/2" (3/4 side) 53" cad. steel **.75** ea.
3 1/2" (1 3/4 side) 33" steel **\$1.00** ea.

FIRE EXTINGUISHER

Little Lux Co2 Type. Built to Gov't spec. 3 1/2 lb. wirebound shatterproof heavy case 20" x 4". Trigger controlled with horn fully recharged. 418 Type.
#601 **\$30.00** value #601A **\$11.75**
2 LB. CO2 TYPE **\$22.50** value #402 **\$8.75**
10 lb. Chgd. CO2 with hose **\$60.00** value #60 **\$27.50**
13 lb. Chgd. CO2 with horn. #605a New 15 lb. CO2 Break-down type with horn. \$70. value **\$33.95** ea.
#505b New 11 lb. CO2 squeeze type with horn. \$80. value **\$42.50** ea.
Indispensable for small or large plants, trucks, auto, home, factory.

JEEP CANS

Used but good condition, non-leak, 5 gal. gas or oil, self-locking screw cap type 18" x 6 1/2" x 13" Wide **\$1.19** ea.
In lots of 5 **\$1.09** ea.
25 or more **\$1.05** ea.
Self locking, flexible screw spouts with brass filter at end. 1" I. D. x 16" lg. **39c**

New Electric Motors

#500 new 1/2 H.P. 27 Volt D. C. 24 Volt A. C. This motor can be readily adapted to 110 A. C. by the simple method of rearranging armature brush leads. We furnish free diagram of instructions with each order. A Sensational Value @ **\$5.95**
Converted to 110 A. C. Equipped with plug and 3/4" Heavy Duty Cord **\$8.49** ea.
#501 1/16 H. P. 24 Volt D. C. Motor, Series Wound. New. #501 **\$3.95** ea.
#502 - 2 H.P. 24 V D.C.M. used, **\$8.95**
COMPRESSOR, 1000 lb. pr., 2 stg. with 1/2 H. P. 27 V. D. C. motor. Tank and Fitting **\$17.95**

4 INCH PAINTERS DUSTER BRUSH

Only **59c** ea.
PEXTO PLIERS
Side cutting beveled head. A \$3.50 Value Only **\$1.79**

PLASTIC Mallet

clear, with 2" dia. 1/4" head, 12" handle, for soft metal or plastic work where fire non-marking or tapping is desired. A \$2.50 Value for Only. **79c** ea.

METAL SNIPS

Compound action. Hard steel blades. Expansion spring. Locking device. Right Hand and Left Hand **\$2.59**

PLASTIC PARALLEL STRAIGHT EDGE

with knobs and rubber pads for non slippage on each surface. A must for navigators, mechanics, draftsmen, engineers... You've never seen 'em at **97c** ea.

PNEUMATIC AND AIR TOOLS

10,000 in various popular makes, sizes, types. Cleco, Aro, Ingersoll Rand, Chicago, Pneumatic, Buckeye, etc.

RIVET
#180 Gun
#181 Pistol
Chicago Pneumatic, Cleco, Ingersoll Rand Makes, E3, E2, JX, 2X, OY **\$55** Value **\$8.95** Value **\$15.95**
GUNS & Goose-neck Type
101 One Chipping Bitting, Hammering Breakers cement and auto body work.
PNEUMATIC SQUEEZER
#186 ALLIGATOR SQUEEZER **\$15.95**

AIR DRILLS OR MOTOR SPECIAL

with 1/4" JCB Chuck Straight ARO PISTOL **\$15.00**
\$12.95

PNEUMATIC ANGLE DRILL

With Terry Adapter ea. **\$12.50**

CHI. PNU. IMPACT WRENCH

Model 337rs 3 3/8" sq. dr. frwd. & revrs. 5 spd. cntrl. Send for Catalogue and List of Other Sizes, Types of Pneumatic Tools. **\$17.50**

HIGH PRESSURE OXYGEN BOTTLE

New. Will hold up to 3,000 lbs. PSI, with Co2 used as tire inflator or fire extinguisher, with oxygen for sick room or deep-water diving, etc. Completely equipped with brass valve, 36" hose, dial gauge, & canvas bag **\$2.29** ea.

ABRASIVE & GRINDING WHEEL MIX

50 pcs. including honing stone, pen-cil rolls, wheels, abrasive sheets, etc. A Real Value for Only **99c**

HINGE MIX

12 pairs of strap butt Hinges, sizes 1" x 1" to 1 3/4" x 4" in length, to 8" strap. A \$3.00 Value for Only **\$1.09**

AIRCRAFT CABLE

Alloyed steel, rust resistant, 3/16" dia. 18 ft. long, with turnbuckle ends. On reels in any length **99c** ea.
1/16" 3c ft. 5/32 5c ft.
3/32 4c ft. 3/16 6c ft.
1/8 4 1/2c ft. 9/32 8c ft.

RUBBER GOODS

NEOPRENE SHEET RUBBER
Thick-ness Weight Price per sq. yd.
#325 .020" 1/64 36" .75
#326 .037" 1/32 36" 1.00
#327 .064" 1/16 36" 1.75
#329 .125" 1/8 46" \$4.75
Item #329 is laminated rubber sheet with cloth center. Flexible but very low loss heat.

PALLEY SUPPLY CO. THE LARGEST FIRM OF ITS TYPE IN THE WORLD DEPT. P. M. 88 — 6321 SAN FERNANDO RD. GLENDALE 1, CALIFORNIA

SOUTH BEND 9" LATHE

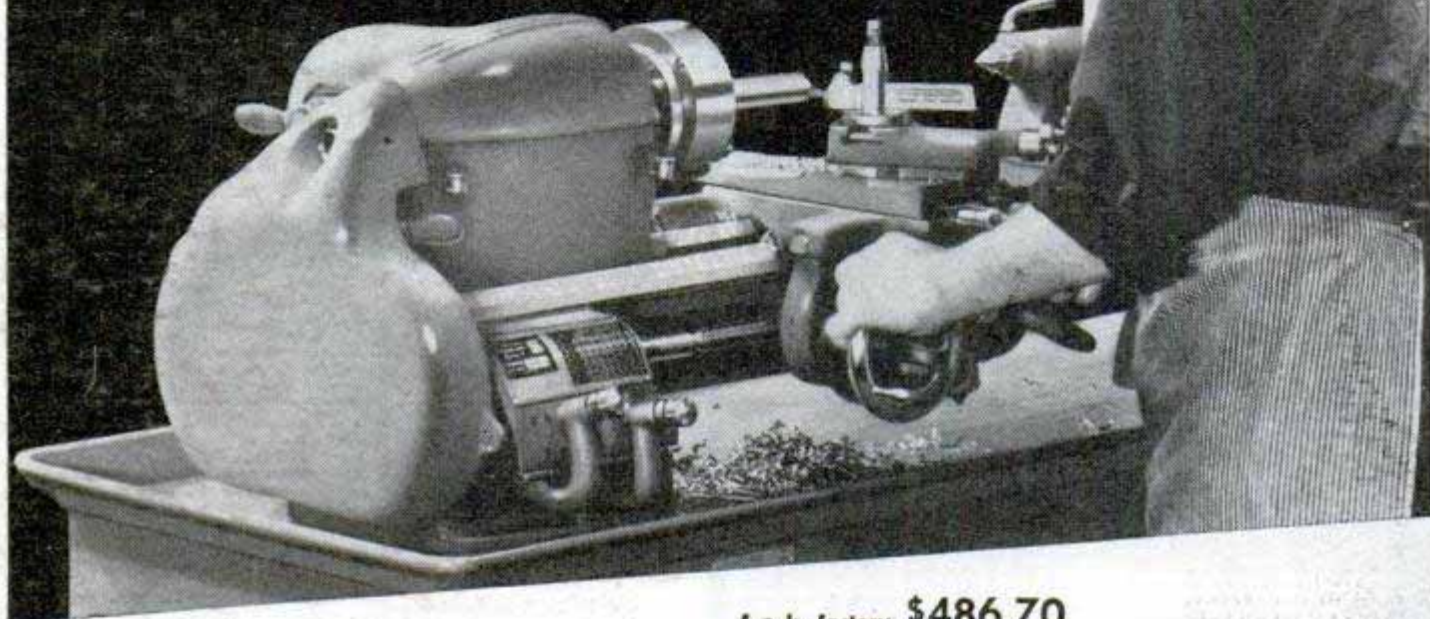

f. o. b. factory **\$486.70**

9" x 3-1/2' MODEL A UNDERNEATH MOTOR DRIVEN LATHE
with 1/2 h.p., 60 cy., 115 v. motor and switch. Other 9" lathe prices start at \$145.

The accuracy and versatility of this 9" Underneath Motor Driven Lathe makes precision machining possible in any type of shop. A direct belt drive to the carefully balanced spindle assembly provides quiet, vibration-free speeds up to 1270 r.p.m. The quick change gear equipment makes available any of 48 different screw threads or feeds. And the 3/4" spindle bore facilitates the machining of bar or tube stock. A complete line of practical attachments greatly simplifies tooling for a wide variety of operations. Mail coupon for complete information about this lathe, Catalog No. 344-ZN, or see our local distributor.



SOUTH BEND LATHE WORKS

Building Better Tools Since 1906 • 455 E. MADISON ST., SOUTH BEND 22, IND.

SOUTH BEND LATHE WORKS, 455 East Madison Street, South Bend 22, Indiana
Please send 9" Lathe Catalog Drill Press Catalog Time Payment information.

NAME _____

STREET _____

CITY _____ STATE _____



NEW 14" DRILL PRESS

A superior machine unsurpassed for accuracy, ease of operation, and dependable performance. Prices — f.o.b. factory, complete with 1/3 h.p. motor.

Bench Model \$129.30
Floor Model \$144.30

Printed by Popular Mechanics Company, Chicago, Ill., U. S. A.

Pen, \$17.50—Pencil, \$6.00
Stratowriter, \$12.50
Complete set, \$36.00,
plus fed. tax.

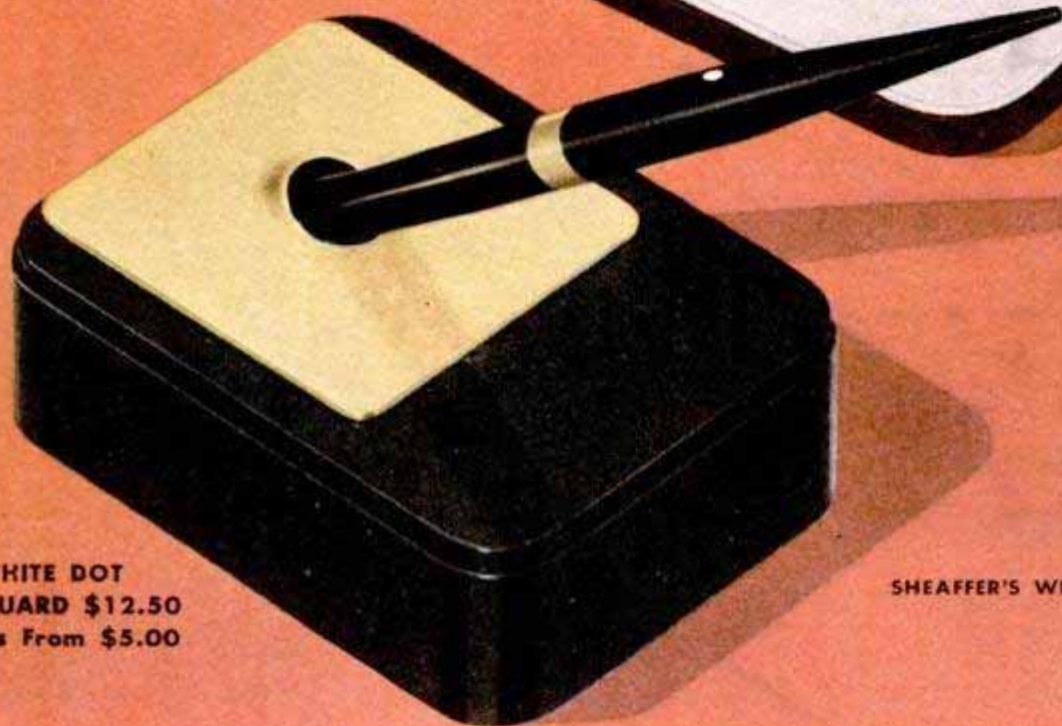

WHITE DOT
GUARD \$12.50
Pens From \$5.00

SHEAFFER'S WHITE DOT • MARK OF DISTINCTION



For going through school ...and going through life

For many years Sheaffer's writing instruments have been silent partners in the careers of America's most successful men and women. There are many today who are still using with pride the Sheaffer's pens which went with them to college twenty or thirty years ago! . . . Today a White Dot identifies Sheaffer's finest products—the best writing instruments which Sheaffer, or

anyone else, ever built! It will pay you to look for *and find* this Mark of Distinction. You'll discover that it stands for upright quality and downright value! W. A. Sheaffer Pen Company, Fort Madison, Iowa—Malton, Ontario, Canada.

See your Sheaffer dealer. He has Sheaffer pens from \$3.50 up; pencils from \$1.50 up; desk sets from \$10.00 up.

SHEAFFER'S

Copyright 1948, W. A. Sheaffer Pen Co.

NEW Amazing HOME UTILITY GUN!

GET ONE TODAY!

**ASTONISHING
MAGIC SUDS**

A priceless new time and work-saver needed and wanted in every home. Precision made of finest materials. Nothing to wear out. Has innumerable uses.

GLAZEWASH YOUR CAR

In 10 minutes for only 3¢

Here's effortless cleaning which produces a beautiful, streakless finish. Dries with a luster. No chamois needed. Gun handle holds enough GLAZEWASH to clean one complete car.



Attach
to Any
Garden
Hose



**SUPERB
GARDEN
SPRAYER**

Sprays liquid insecticides, fertilizers, weed-killers. No pumping necessary, no tank to carry, water pressure does all the work. Merely fill with desired solution . . . attach garden hose, pull trigger.



**OPENS
CLOGGED
PLUMBING**

When drain stops up, place rubber adapter in opening, place gun nozzle in adapter, pull trigger, and *Presto!!!* drain is opened and *really cleaned*. Pays for self in plumbing bills saved.



**CLEANS
GREASY
FLOORS**

Magically whisks grease and dirt from garage floors, driveways, porches, patios, etc. Washes outside walls, fences, screens, garden furniture! Many other uses in home and industry.

PAT.
PENDING

Only - \$9.75

Complete Including

- 1 SPRAY-FOAMATIC, Jr. Home Utility Gun
- 1 Package Glazewash (Cleans 12 to 16 cars)
- 1 Package Utility Solvent (Makes 12 gals. all-purpose cleaning solution)
- 1 Garden Spray Adapter
- 1 Plumbing Drain Adapter

5 YEAR GUARANTEE

MOTO-SWAY CORP., OF AMERICA
Dept. M, 205 Pasadena Ave., South Pasadena, Cal.

Send one SPRAY-FOAMATIC, Jr. Gun with Accessories, postpaid, for which find Check \$9.75; send C.O.D. (I Pay Postage).

Name _____

Address _____

Please Print Plainly. Include Zone No.

SPRAY-FOAMATIC JR.
TRADE-MARK REG.

Manufactured by MOTO-SWAY CORP., So. Pasadena, Calif.

One of America's Oldest Manufacturers of Quality Automotive Products

Extra pkgs. Glazewash only 45c ea. Cleaning Solvent 25c ea.
If your dealer can't supply you, order direct. . . .