

JULY 1948

25 CENTS

ANC



POPULAR MECHANICS

MAGAZINE

WRITTEN SO YOU CAN UNDERSTAND IT

REG. D. TRADE MARK, GREAT BRITAIN, NO. 40426

REG. U.S. PAT. OFF.

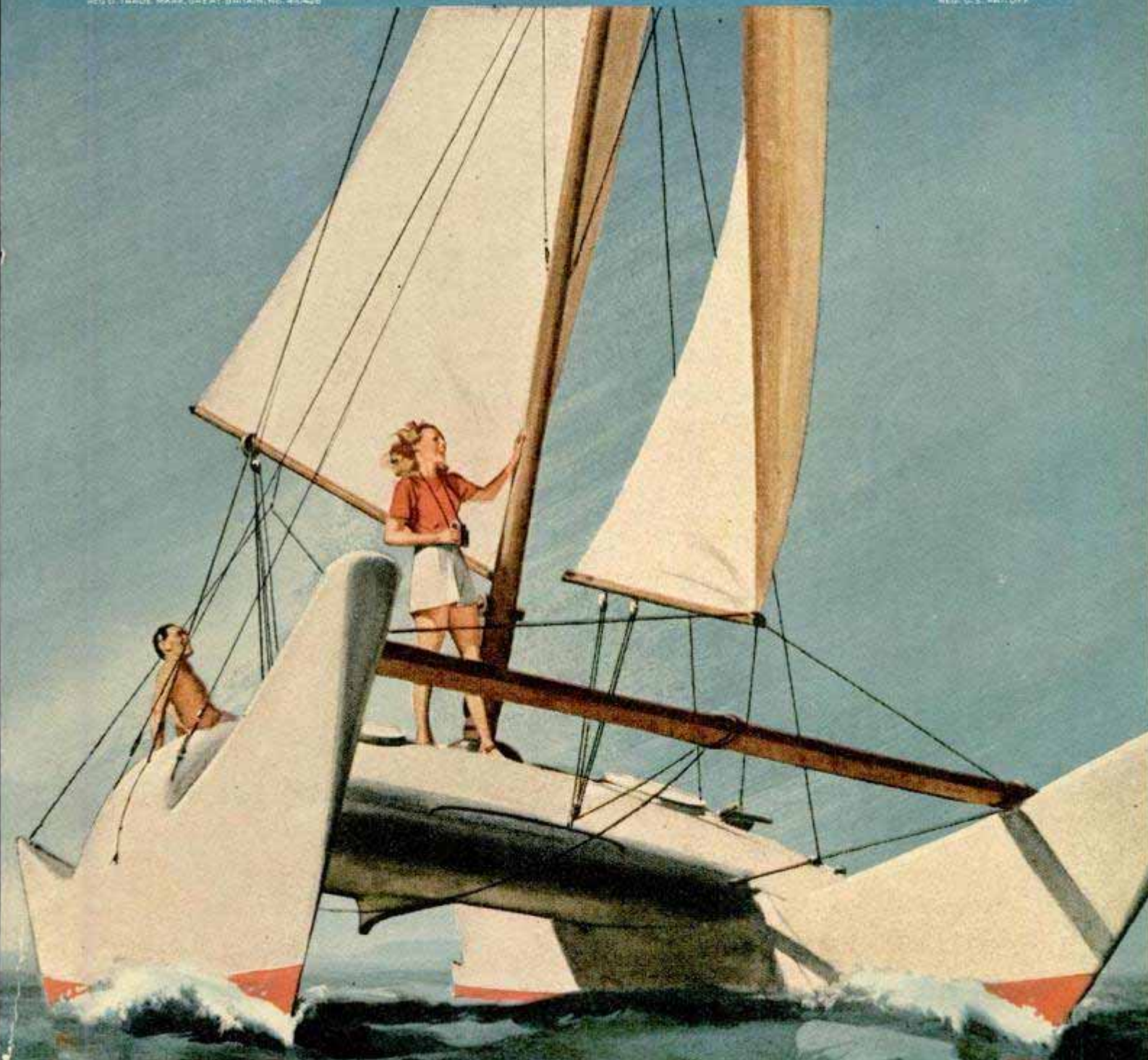

SAILING THE WINGED "SEABIRD"

*Used on
more new cars
-sold by more
dealers!*



replace with a
DELCO
BATTERY

DELCO-REMY WHEREVER WHEELS TURN OR PROPELLERS SPIN

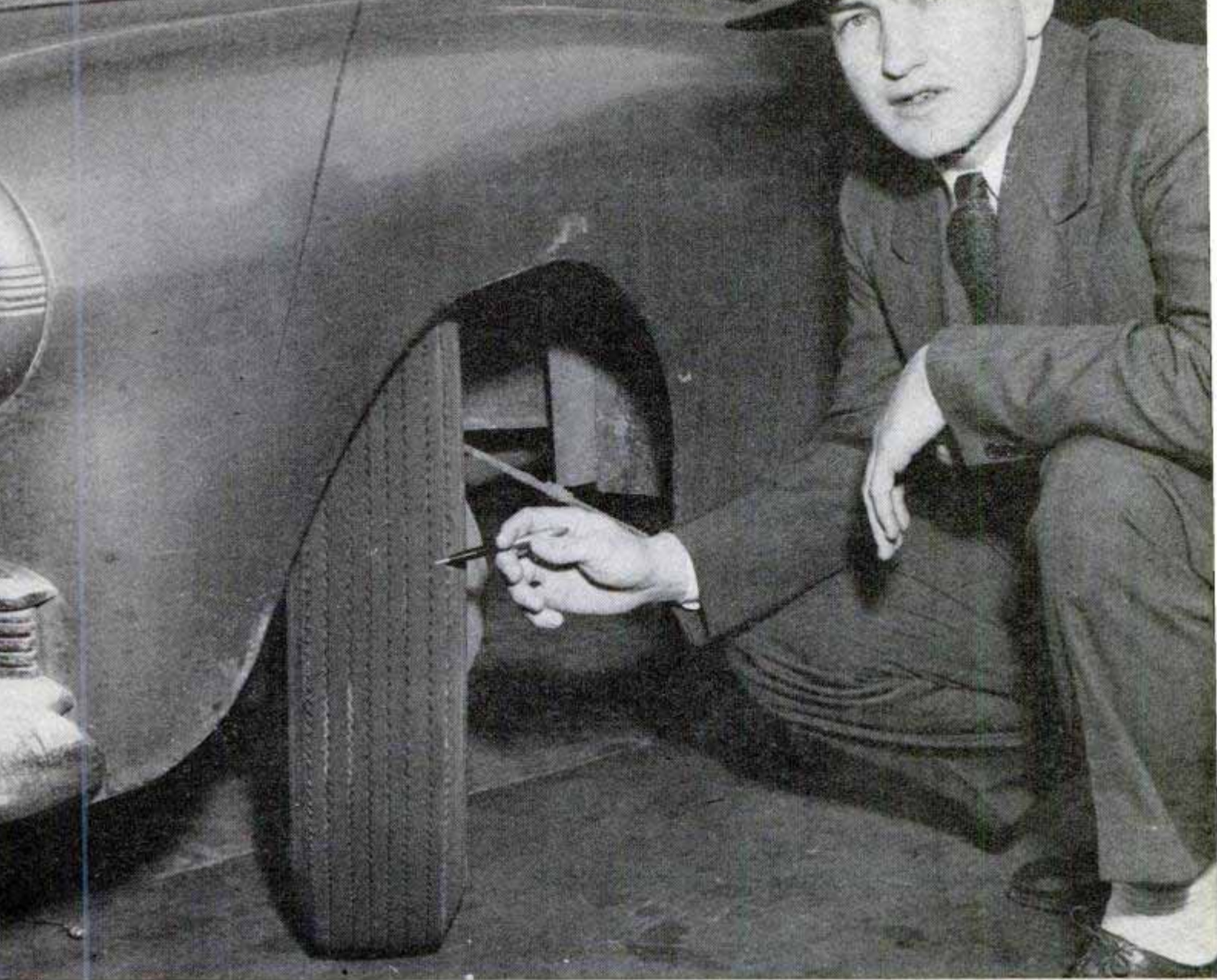

Typical example: user's experience with B. F. Goodrich tires

MR. FELIX R. HELMS of the Military Service Company lives in Birmingham, Alabama. But like the man from Missouri, when it comes to tire advertising he likes to be shown.

Recently he wrote us: "It is a pleasure to inform you that B. F. Goodrich tires are just as good as they are advertised to be . . . My sales job involves driving in all types of weather and on any type of road mentionable.

"The original equipment tires on my 1947 . . . 2-door Sedan have given me twenty-six thousand (26,000) miles of uninterrupted service. I can reasonably

expect another 20,000 miles.

"I am extremely pleased with B. F. Goodrich tires and hope to always be able to use such a fine product."

The picture above, taken at the time Mr. Helms wrote this letter, clearly shows why he expects 20,000 *more* miles of trouble-free driving on his B. F. Goodrich tires. The tires still look like new because B. F. Goodrich tires are built to last, inside and out.

The tire body is made tougher, longer lasting with more—and stronger—cords. The tread wears slower and more evenly because it's broader, and hugs the surface

of the road, putting every inch of rubber to work. Under the tread, a special breaker strip cushions shocks.

You can easily prove to yourself, like Mr. Helms did, that B. F. Goodrich Silvertowns outwear other tires, including prewar tires. With the big trade-in allowances given by B. F. Goodrich dealers, the cost of a new set of B. F. Goodrich tires is surprisingly low. *The B. F. Goodrich Company, Akron, Ohio.*

B.F. Goodrich



These "sound jurors" record their preferences as they listen over test circuits.

Trial by "Sound Jury"



The engineer in the foreground talks over the test circuits which the other engineer sets up on a "circuit simulator."

AFTER Bell Laboratories engineers have designed a new talking circuit, they measure its characteristics by oscilloscopes and meters.

But a talker and a listener are part of every telephone call, and to satisfy them is the primary Bell System aim.

So, before the circuit is put into operation, a "sound jury" listens in. An actual performance test is set up with the trained ears of the jurors to supplement the meters.

As syllables, words, and sentences come in over the telephones, pencils are busy over score sheets, recording the judgment of the listeners on behalf of you and millions of other telephone users.

Targets of the transmission engineer are: your easy understanding of the talker, the naturalness of his voice, and your all-around satisfaction. To score high is one of the feats of Bell System engineering.

BELL TELEPHONE LABORATORIES

• EXPLORING AND INVENTING, DEVISING AND PERFECTING FOR CONTINUED IMPROVEMENTS AND ECONOMIES IN TELEPHONE SERVICE



Popular Mechanics Magazine

Registered in U. S. Patent Office and Canada

H. H. WINDSOR, Founder

H. H. WINDSOR, Jr., Editor and Publisher

GOING FISHING? You'll find an expert's opinion on "Baits for Bass" on page 94, with some tips on casting from a champion.

NEXT MONTH might be a good time to set out for a vacation camping trip. The money you save by living outdoors on one trip will almost pay for a camping outfit. But don't carry just a thin blanket roll and try to use a rock for a pillow. An August feature tells how to "Camp in Comfort."

GUSTAV EGLOFF, noted oil researcher, faces the annual bugaboo of oil shortage with a frank and enlightening article, "Do We Need Synthetic Oil Now?" in the August issue. Other outstanding features tell why the submarine is increasing in importance, why the Hoover Dam needs a "doctor," and why there's "Confusion in the Cockpit" of airplanes.

IN THE Craftsman section next month you will find complete how-to-build details on Keith Storey's model plane, Gold Rush of '47, which set an official speed record of 134.91 m.p.h.

TEN THOUSAND flashes—10,000 photos without changing a bulb. You can do just that with a battery-operated, high-speed flash unit described in the August issue.

EVERYONE can't be the "life of the party," of course, but a bag of impromptu magic tricks described next month will help. The tricks are simple, but mystifying, and need no special props.

IN THE August Shop Notes section you will learn some of the secrets of skilled craftsmanship when an old-time machinist tells how to hone cutting tools.

RADIO experimenters will find a 3-tube pocket set with built-in loudspeaker in the Radio and Electronics section next month.

Volume 90	JULY 1948	Number 1
Managing Editor.....	Roderick M. Grant	
Assistant Managing Editor.....	Wayne Whittaker	
Shop Notes and Crafts Editor.....	James R. Ward	
Radio and Electronics Editor.....	Frank L. Brittin	
Aviation Editor.....	Aubrey O. Cookman, Jr.	
Associate Editor.....	Clifford B. Hicks	
Eastern Editor.....	Bill Reiche	
Western Editor.....	Thomas E. Stimson, Jr.	
Art Director.....	Frank Beatty	

Assistant Editors

Donald R. Brooks Arthur R. Railton

Assistant Editors, Shop Notes and Crafts

W. Clyde Lamme Wayne C. Leckey Frank N. Stephany A. E. Youngquist

In This Issue

Debut for the '49 Ford	73
Sailing the Winged "Seabird"	84
X-Rays 500 Times Brighter	90
Baits for Bass	94
Pay Dirt in Chula Vista	106
One Car—Two Gas Tanks	116
Cops on the Campus	121
Shakedown Laboratory for Navy Ordnance	128
The Story of Rope	137
Prospecting for Better Metals	146
Optical Glass Cookers	153

For the Craftsman

Designs for Swimming	170
Getting Home on a Sick Engine	185
Yachting on a Budget	194
Taper Turning and Boring Practice	202
"Sea Craft"—Cabin Cruiser	
Part V	208
Radio and Electronics	213
Clinic for Homemakers	226

Table of Contents continued on page 8

Published monthly by POPULAR MECHANICS COMPANY, 200 East Ontario Street, Chicago 11, Ill. H. H. Windsor, Jr., president; Paul H. Dunakin, vice president and general manager; D. F. Windsor, vice president and secretary-treasurer; William Harrison Fetridge, vice president and assistant to the publisher; Clover L. Perkins, advertising manager; Alan M. Deyoe, circulation manager. Single copy in the United States and Canada, 25 cents; subscription rates in United States and possessions, Canada, Philippines and countries of the Pan-American Postal Union, 1 year, \$2.50; 2 years, \$4.50; 3 years, \$6.00. To all other countries add \$1.00 a year over United States prices for overseas postage. If you plan to move, notify us at least 30 days in advance so you will not miss an issue. Give both old and new addresses. Entered as Second Class Matter, September 15, 1903, at the Post Office at Chicago, Illinois, under Act of March 3, 1879. Entered as Second Class Matter at Post Office Dept., Canada, Copyright 1948 by Popular Mechanics Company, Copyright under International Copyright Union, Copyright in France. All rights reserved under Pan-American Copyright Union. Printed in the United States of America.

ANCO® RAIN-MASTER®

"Dead-Locker"®

WINDSHIELD WIPER ARMS and BLADES

BLADE SNAPS ON...
STAYS PUT

FINGER-
TIP
RELEASE

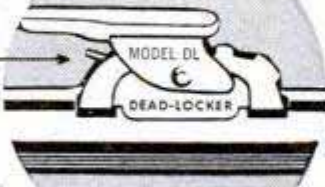

CAN'T FALL OFF
CAN'T BLOW OFF

(A war-born invention—by ANCO—first)
for military aircraft—now for your car.)

DON'T SHOOT YOUR GAS-PUMP MAN!

He's doing the best he can. Sure, he knows how dangerous it is for you to drive your car . . . in stormy weather . . . with your dull old windshield wipers that SMEAR and SMEAR. He'll gladly put on for you quickly a pair of keen new ANCO RAIN-MASTER Wiper Blades and Arms. He has them—Newest Models! But he forgets to remind you? Too busy? You can't shoot him for that!



After all, it's YOUR car to protect. So YOU remind HIM. Get RAIN-MASTERS . . . patented features . . . original equipment for years on De Luxe models of quality cars . . . and on high-grade trucks . . . used also on our fighting Ships and Tanks and Trucks and Bombers too . . . because ANCO RAIN-MASTERS clean quicker, clean cleaner . . . last longer.

May save you a costly smashup!

Ask for RAIN-MASTER Windshield Wiper Arms and Blades next time you buy gas.

Quality Protected Under Fair Trade Laws
ANCO Patented Products - Patents Make Jobs

THE ANDERSON COMPANY

GARY, INDIANA

Our Thirty-first Year in This Business

FREE

value packed

RADIO CATALOG

write for it today!

Lafayette Radio

DEPT. LG-8, 100 SIXTH AVE., NEW YORK 13



**GET MORE FUN for
LESS MONEY with
a CROSMAN!**



ADJUSTABLE POWER without powder means you can shoot your Crosman indoors with safety and accuracy, without recoil, noise or odor. It means keen sport outdoors, too . . . target shooting, small game. Ammunition (Super-Pells) less than 1/3 cent a shot.

Crosman Silent RIFLE



. . . is available in single-shot or magazine types, .177 or .22 cal. A man's size, fine quality gun, with perfect balance, rifled barrel, rear peep and blade front sights. At sporting goods or hardware dealers, or write direct.

Crosman "Bullseye"



is a new .177 cal. single-shot target pistol with all Crosman "power without powder" advantages. Endorsed by experts . . . inexpensive to own and shoot—everyone can enjoy it. At your dealer's . . . or write direct.

CROSMAN ARMS CO., INC.

3 HENRIETTA ST. • ROCHESTER 7, N. Y.

Here's Why New AUTO-LITE STA-FUL Battery

*...needs water
only 3 times a year**



ORDINARY BATTERY

HERE'S WHAT HAPPENS INSIDE AN ORDINARY BATTERY

This battery is now full. Small liquid reserve gives battery plates little protection against damage and loss of power if evaporation lowers liquid level.

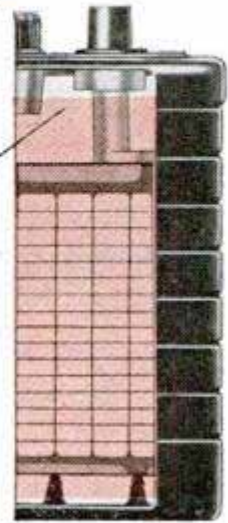

STA-FUL BATTERY

HERE'S WHAT HAPPENS INSIDE AUTO-LITE "STA-FUL"

The new "Sta-ful" feature has $3\frac{1}{2}$ times the liquid reserve of ordinary batteries. Gives its plates added protection. Helps it last longer too!

BOTH BATTERIES FULL



ORDINARY BATTERY

ADVANCED STATE OF EVAPORATION

Equal Liquid Loss From Both Batteries

Plates at the left are now exposed and inactive because of the small liquid reserve provided in ORDINARY battery.

The "Sta-ful" Battery plates are still kept fully covered and protected because of the $3\frac{1}{2}$ times greater liquid reserve.

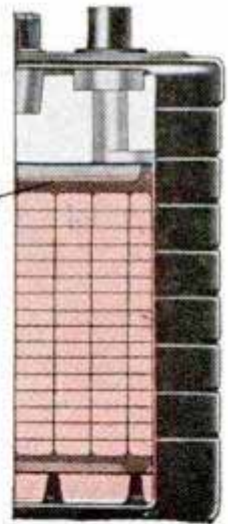

STA-FUL BATTERY

*In normal car use

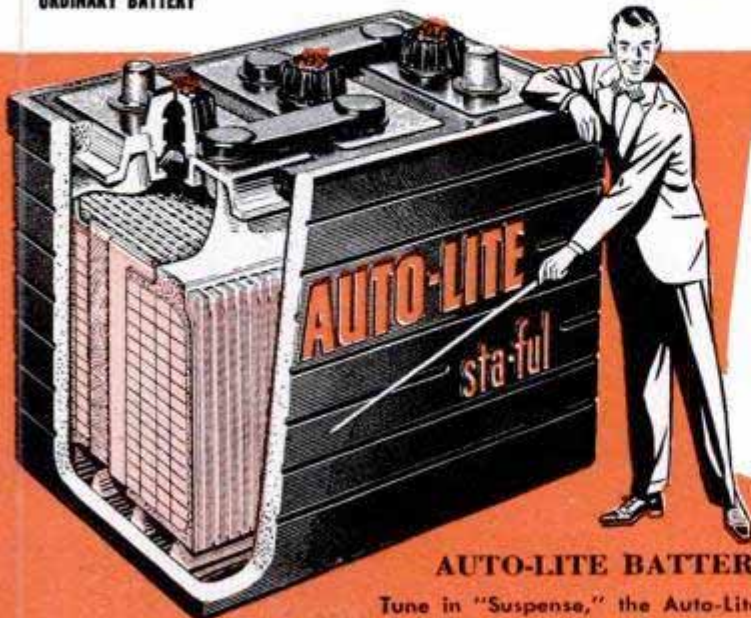

Why the "Sta-ful" Design Is Possible
Fibre-glass mats help to keep the power-producing material from shedding—add to battery life. This makes possible the "Sta-ful" construction with its smaller sediment well which permits room for a liquid reservoir with over 3 times the usual capacity at the top of the battery. Make your next battery an Auto-Lite "Sta-ful."

AUTO-LITE BATTERY CORPORATION, Toledo 1, Ohio

Tune in "Suspense," the Auto-Lite Radio Show—Thursdays, 9:00 P.M.—E.T. on CBS



091C-7PE-19EQ

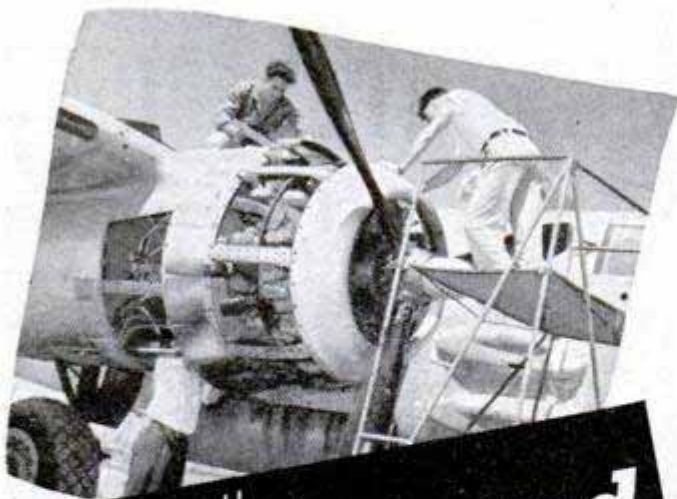

well
Be prepared
for what's ahead!

... Get **NORTHROP**
Aircraft & Engine Mechanics Training

NOW is the time to start getting prepared for the future. The trained man has all the advantages. The certificated Aircraft and Engine Mechanic is a key man in all branches of Aviation. Get your A & E training — be ready for important duties, top pay, leadership, and a lifelong career with security and success.

Come to Northrop and get the many advantages of A & E Mechanic training in the midst of important, large-scale aviation activities — training with direct aviation "know-how" — training based on Northrop's long experience as a major employer of thousands of engineers, technicians, and mechanics. You get actual experience on all types of aircraft — from single-seaters and helicopters to multi-engine military planes.

Train on NORTHROP FIELD in a technical institute that is part of a famous aircraft company. Northrop graduates are in demand. Send coupon for complete information on 50-weeks A & E course — approved by Civil Aeronautics Administration. Classes start every four weeks.



APPROVED FOR VETERANS

NORTHROP Aeronautical Institute

Division of Northrop Aircraft, Inc.

James L. McKinley, Managing Director

1527 E. Broadway, Hawthorne, Los Angeles County, Calif.

Please send me the Institute catalog and complete information, including starting dates of classes. I am interested in

- Aircraft and Engine Mechanics (A & E)
 Aeronautical Engineering

Name _____

Address _____

Age _____

City _____

Zone _____ State _____

Check one: Veteran In Service Civilian

PRESSURE QUEEN

Outperforms them all



The only portable spray painting outfit having 4 cylinders in space usually required for one. Paints buildings; refinishes automobiles; inflates tires; lubricates chassis and farm machinery. Does more work in an hour than hand brushing in a day. Uniform pressure without pulsation. Ideal for home, farm, service station, machine shop and contracting painter. Factory tested and guaranteed.

● If your dealer does not sell Pressure Queen, order direct for immediate shipment.

\$99⁹⁵

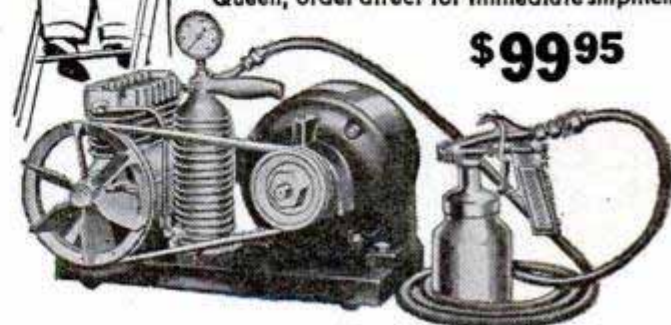

THE CAMPBELL-HAUSFELD CO.

1046 RAILROAD AVE.

HARRISON, OHIO

**V-8 VALVE JOBS
MADE EASY!**

with *Johnson*

**ADJUSTABLE
TAPPETS**



Provide accurate adjustment and quiet performance for Ford and Mercury V-8 engines.

Save money! Make tappet installations yourself.

No expensive shop tools needed.

Complete instructions with each set of tappets.

Adjustments easily made to proper clearance and maintained for many thousands of miles.

SEE YOUR JOBBER OR WRITE DIRECT TODAY

Johnson PRODUCTS INC.
MUSKEGON, MICHIGAN

"Tappets Are Our Business"

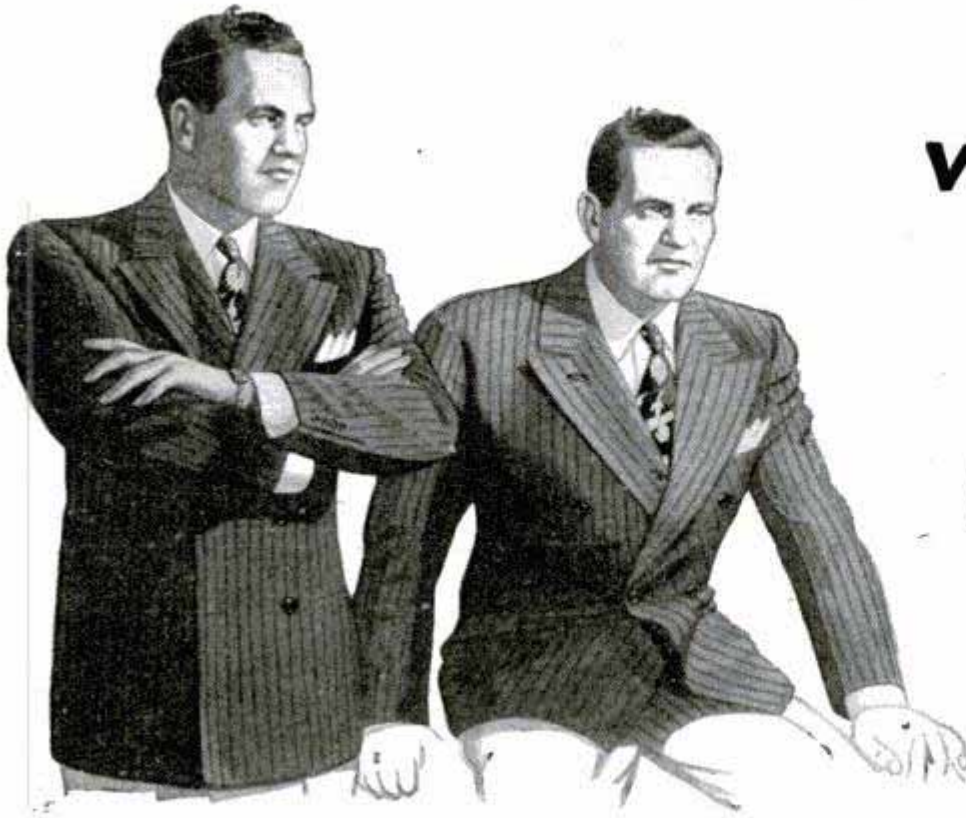

IF YOU were Boss would YOU promote "YOU"?

Be honest now—

suppose that a better job had opened up in your company—carrying with it promotion and more money—could you qualify?

If you were boss, would you select "YOU" for that better job?

Consider before you answer.

First of all, could you *fill* the job? Has your experience fitted you for the step forward—have you been preparing for promotion apart from experience gained on the job?

Or have you just been filling a niche, doing daily tasks well but making no real and intelligent effort to learn and qualify for the job ahead so that if an opening should occur you would be ready to fill it?

The man who gets real promotion makes his own breaks—the man who slaves in the ordinary job at low pay just wishes and dreams of promotion and more money. Which are you?

Business is always willing to pay the man who knows—and pay him well. The man who is ready and willing to take responsibilities—and capable of directing the efforts of other men is a

valuable asset to any business organization. He never wants for a good job and above average earnings. He gets ahead.

We have helped thousands of men achieve promotion and more money—success sometimes beyond their dreams—a success that was started by a coupon similar to the one below.

Get out of that rut—don't be satisfied with a mediocre job at small pay—be a success in business—this coupon may be your first step.

So send it today—right now—tomorrow never comes for the man who consistently puts things off.

La Salle Extension University *A Correspondence Institution*

Dept. 764-R

417 S. Dearborn, Chicago 5

If you can help me get the ability and knowledge for real promotion, I want to know it. Please send me your free 48 page booklet telling how I can succeed in the field I have checked below. I understand you will send this without obligation to me.

- | | |
|--|--|
| <input type="checkbox"/> Accounting | <input type="checkbox"/> Salesmanship |
| <input type="checkbox"/> C. P. A. Coaching | <input type="checkbox"/> Law: LL. B. Degree |
| <input type="checkbox"/> Bookkeeping | <input type="checkbox"/> Foremanship |
| <input type="checkbox"/> Business Management | <input type="checkbox"/> Industrial Management |
| <input type="checkbox"/> Effective Speaking | <input type="checkbox"/> Traffic Management |
| <input type="checkbox"/> Stenotypy (Machine Shorthand) | <input type="checkbox"/> Business English |

Name.....Age.....

Position

Address.....Zone, if any.....

City and State

the GOING is better with PYROIL

The secret to long motor life is lubrication—and the secret of lubrication is the constant maintenance of an oil film between moving metal surfaces. The difficult lubrication spot in your car is the surface between piston and cylinders. Park your car and the surface drains dry—start it and metal rubs metal to produce wear. PYROIL gives oil the property of clinging to metal surfaces. Ask your gas station attendant to add PYROIL—and add miles to your car.

GIVEN! An attractive Pyroil metal savings bank—takes coins up to 50c pieces—is yours for the asking—sent postage paid.

PYROIL FOR AIRCRAFT ENGINES

Use Aircraft Pyroil B for lubricating oil, Aircraft Pyroil A for gasoline.

Manufactured and Guaranteed by Pyroil Company, 81 Pyroil Bldg., La Crosse, Wisconsin.

Canadian Distributors: Central Purchasing Agencies, Ltd., Toronto, Ontario



PYROIL COMPANY
81 Pyroil Bldg., La Crosse, Wisconsin

I want my car to last and run properly. Please tell me more about Pyroil and how it can accomplish this for me.

Name _____

Address _____

City or Town _____ State _____



TABLE OF CONTENTS (Continued)

AUTOMOTIVE

Speedy racing car assembled from kit.....	79
Wipe-on paint for cars applied with mitten.....	79
Dashboard table slides out of way.....	119
Oil solution washes cars.....	157
Auto towing bar.....	159

AVIATION

Push-button dock.....	80
Helicopter jets get "whirl test".....	82
Metal rotors help helicopter ngnt ice.....	83
USAF pack plane to have detachable fuselage.....	100
Pocket-size exposure suit.....	135
Four-jet bomber tops 500 m.p.h. in low-level tests.....	135
Plane builders do it with mirrors.....	142
"Land ship" trains pilots.....	151
Carrier crash crane lifts 24,000 pounds.....	152
Radar "eyes" of airliner see storms 150 miles away.....	157
Model-T of the airways.....	160

CAMPING AND TRAILERS

Retractable wheels form boat trailer.....	79
Small camp stove fits in pocket.....	93
Chicagoan wins P.M. camp trailer.....	100
Air from spare tire "blows up" canvas bunkroom atop car.....	115
Synthetic may inoculate picnickers against poison ivy.....	120

FISH AND FISHING

Dresser for fishline clamps on fly rod.....	82
Spring rod lengthens casts.....	93
Oyster hoister.....	120

HOUSE AND HOME

What's new for your home.....	102
Furnace burns oil or gas.....	104
Rod prevents tank rust.....	119
Penthouse is city version of country estate.....	136
Miniature louvers ventuate eaves.....	150

INDUSTRY

Small utility press operated by city water, compressed air or oil.....	82
Mortar sculptured into stone.....	104
Synthetic rubber is improved when produced at zero.....	105
Stone carvers' art repairs bomb scars.....	114
Fire-stop coating applied like paint.....	126
Portable mast is "pushed" into air to test antenna sites.....	127
Strip of steel six miles long rolls out of massive mill every five minutes.....	134
Research scientists bottle sub-zero cold—458 degrees below!.....	134
Drum power hoist lifts four at once.....	151
Pouring a building from the top down.....	158

LAWN AND GARDEN

Sprinkler turns itself off with time valve.....	78
Mushroom trays yield private crop in the basement.....	83
Hood for lawn mower returns grass to blades.....	89
Runners on mower guide blades.....	101
Suction from lawn trimmer pulls grass into blade.....	104

MODELS AND NOVELTIES

Chimney model shows draft.....	101
Typewritten flag.....	145
"Coal" tractor run by steam.....	151
Traffic cop dummy aids school children crossing street.....	152

PHOTOGRAPHY

X-ray movies made by photographing fluorescent screen.....	136
Speeding electron has its picture taken.....	136
Radio controls camera lights.....	159

RECREATION

Foot-triggered skeet trap shoots "propeller" targets.....	89
"Workshop" bus trains hobbyists.....	119
Flip-flop marker for football.....	135
Disk anchored to golf ball indicates length of practice shots.....	144
Golf practice on swivel tee.....	157
Swiss golf watch keeps hole-by-hole and total score.....	160

TOOLS

Portable spot welder weighs only 23 pounds.....	89
Table supports portable saw.....	101
Hobbyist's foundry is small enough for your workshop.....	136
Bender for warped lumber.....	144

TRANSPORTATION

Luxury bus has washroom.....	115
Farmer's ski-car built from wrecks.....	126
Collapsible baby stroller folds for carrying.....	145

MISCELLANEOUS

Piston on tobacco pouch fills pipe without waste.....	78
Trap catches rats with water.....	78
Rack holds book at desired page.....	93
Seismograph forecasts hurricanes by spotting tiny earth tremors.....	105
Pocket-size plastic binoculars.....	105
Painter's power hoist eliminates ladders.....	127
Fire door closes automatically.....	144

(Continued to page 10)

“Many of our key men owe their success to I.C.S. training”



**C. W. JENSEN, General Superintendent
Struthers Wells Corp.
Warren, Pa.**

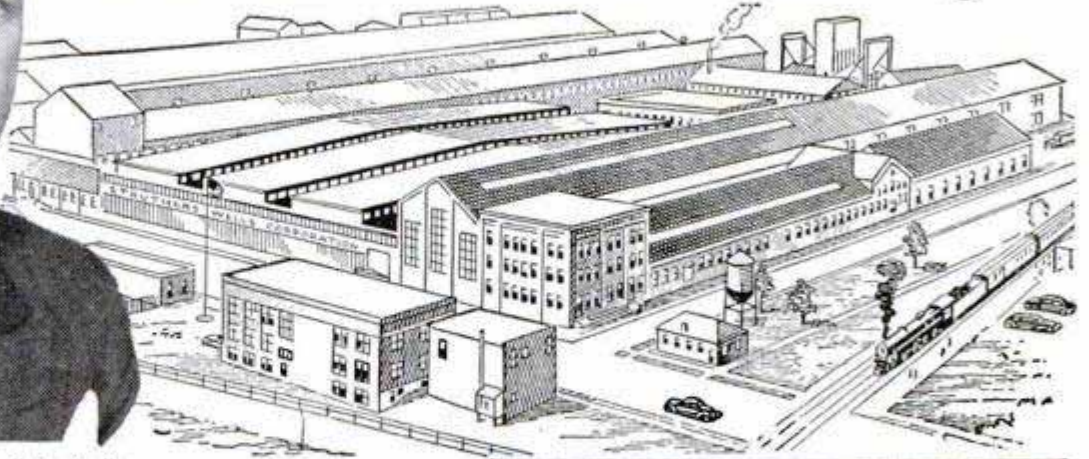

The Struthers Wells Corporation makes custom-built industrial equipment—specializes in precision and accuracy. The skill and training of the Struthers Wells engineers, designers, craftsmen are reflected in the quality of the work they turn out. It's significant that a high percentage of these men received their training through International Correspondence Schools. Their records of success prove the worth of this sound, practical training.

The same opportunity is open to you. If you have ambition, foresight, normal intelligence—I. C. S. can help you get ahead. The first step is to mail the coupon below. Do it now!

“ We have five engineering departments and the heads of four of them are I.C.S. men.

“ I.C.S. has trained 33 per cent of our engineers and draftsmen.

“ 85 per cent of our shop supervisors have studied I. C. S. courses.

“ 12 per cent of all employees in this plant are I.C.S. students or graduates.”

INTERNATIONAL CORRESPONDENCE SCHOOLS



BOX 5631-K, SCRANTON 9, PENNA.

Without cost or obligation, please send me full particulars about the course BEFORE which I have marked X:

- | | | | |
|---|---|--|---|
| <p>Air Conditioning and Plumbing Courses</p> <p><input type="checkbox"/> Air Conditioning <input type="checkbox"/> Heating
<input type="checkbox"/> Refrigeration <input type="checkbox"/> Plumbing
<input type="checkbox"/> Steam Fitting</p> <p>Chemistry Courses</p> <p><input type="checkbox"/> Chemical Engineering
<input type="checkbox"/> Chemistry, Analytical
<input type="checkbox"/> Chemistry, Industrial
<input type="checkbox"/> Chemistry, Mfg. Iron & Steel
<input type="checkbox"/> Petroleum Refining <input type="checkbox"/> Plastics
<input type="checkbox"/> Pulp and Paper Making</p> <p>Civil Engineering, Architectural and Mining Courses</p> <p><input type="checkbox"/> Architecture
<input type="checkbox"/> Architectural Drafting
<input type="checkbox"/> Bridge and Building Foreman
<input type="checkbox"/> Building Estimating
<input type="checkbox"/> Civil Engineering
<input type="checkbox"/> Coal Mining
<input type="checkbox"/> Contracting and Building
<input type="checkbox"/> Highway Engineering
<input type="checkbox"/> Lumber Dealer
<input type="checkbox"/> Reading Structural Blueprints
<input type="checkbox"/> Sanitary Engineering
<input type="checkbox"/> Structural Drafting</p> | <p><input type="checkbox"/> Structural Engineering
<input type="checkbox"/> Surveying and Mapping</p> <p>Communications Courses</p> <p><input type="checkbox"/> Electronics
<input type="checkbox"/> Practical Telephony
<input type="checkbox"/> Radio, General
<input type="checkbox"/> Radio Operating
<input type="checkbox"/> Radio Servicing
<input type="checkbox"/> Telegraph Engineering</p> <p>Electrical Courses</p> <p><input type="checkbox"/> Electrical Drafting
<input type="checkbox"/> Electrical Engineering
<input type="checkbox"/> Electric Light and Power
<input type="checkbox"/> Lighting Technician
<input type="checkbox"/> Practical Electrician</p> <p>Internal Combustion Engines Courses</p> <p><input type="checkbox"/> Auto Technician <input type="checkbox"/> Aviation
<input type="checkbox"/> Diesel-Electric
<input type="checkbox"/> Diesel Engines <input type="checkbox"/> Gas Engines</p> <p>Mechanical Courses</p> <p><input type="checkbox"/> Aeronautical Engineer's, Jr.
<input type="checkbox"/> Aircraft Drafting
<input type="checkbox"/> Flight Engineer
<input type="checkbox"/> Forging <input type="checkbox"/> Foundry Work
<input type="checkbox"/> Heat Treatment of Metals</p> | <p><input type="checkbox"/> Industrial Engineering
<input type="checkbox"/> Industrial Metallurgy
<input type="checkbox"/> Machine Shop
<input type="checkbox"/> Mechanical Drafting
<input type="checkbox"/> Mechanical Engineering
<input type="checkbox"/> Mold-Loft Work
<input type="checkbox"/> Patternmaking—Wood, Metal
<input type="checkbox"/> Reading Shop Blueprints
<input type="checkbox"/> Sheet-Metal Drafting
<input type="checkbox"/> Sheet-Metal Worker
<input type="checkbox"/> Ship Drafting <input type="checkbox"/> Ship Fitting
<input type="checkbox"/> Tool Designing
<input type="checkbox"/> Toolmaking
<input type="checkbox"/> Welding—Gas and Electric</p> <p>Railroad Courses</p> <p><input type="checkbox"/> Air Brake <input type="checkbox"/> Car Inspector
<input type="checkbox"/> Diesel Locomotive
<input type="checkbox"/> Locomotive Engineer
<input type="checkbox"/> Locomotive Fireman
<input type="checkbox"/> Railroad Section Foreman</p> <p>Steam Engineering Courses</p> <p><input type="checkbox"/> Boilermaking
<input type="checkbox"/> Combustion Engineering
<input type="checkbox"/> Engine Running
<input type="checkbox"/> Marine Engineering
<input type="checkbox"/> Steam Electric <input type="checkbox"/> Steam Engines</p> | <p>Textile Courses</p> <p><input type="checkbox"/> Cotton Manufacturing
<input type="checkbox"/> Rayon Weaving
<input type="checkbox"/> Textile Designing
<input type="checkbox"/> Woolen Manufacturing</p> <p>Business and Academic Courses</p> <p><input type="checkbox"/> Accounting <input type="checkbox"/> Advertising
<input type="checkbox"/> Arithmetic <input type="checkbox"/> Bookkeeping
<input type="checkbox"/> Business Administration
<input type="checkbox"/> Business Correspondence
<input type="checkbox"/> Certified Public Accounting
<input type="checkbox"/> Commercial
<input type="checkbox"/> Commercial Art
<input type="checkbox"/> Cost Accounting
<input type="checkbox"/> Federal Tax
<input type="checkbox"/> First Year College
<input type="checkbox"/> Foremanship <input type="checkbox"/> French
<input type="checkbox"/> Good English <input type="checkbox"/> High School
<input type="checkbox"/> Higher Mathematics
<input type="checkbox"/> Motor Traffic <input type="checkbox"/> Postal Service
<input type="checkbox"/> Salesmanship <input type="checkbox"/> Secretarial
<input type="checkbox"/> Sign Lettering
<input type="checkbox"/> Spanish <input type="checkbox"/> Stenography
<input type="checkbox"/> Traffic Management</p> |
|---|---|--|---|

Name _____ Home Address _____
 City _____ State _____
 Age _____ Present Position _____ Working Hours _____ A.M. to _____ P.M.

Special tuition rates to members of the Armed Forces. Special discount to World War II Veterans.
 Canadian residents send coupon to International Correspondence Schools Canadian, Ltd., Montreal, Canada.

ISN'T IT A HONEY!

...with the "super-imposed-image" Range Viewer



UNIVERSAL'S BUCCANEER

—double frame 35mm. candid with "super-imposed-image" Range Viewer formerly only on expensive imports... yet only...65.00

IT sure IS a honey . . . this Universal Buccaneer: The slick, double quick Range Viewer finds your range and composes your picture in a single look.

It goes into split-second action . . . takes "out of this world" color shots, indoors or out; brilliant black and white on dull days or bright. Its shutter release automatically locks against double exposures. No more wasted film or picture disappointments.

It's only the Buccaneer that combines all these features: coated f3.5 lens for all-purpose use; built-in flash synchronizer . . . versatile shutter speeds: 1/10th to 1/300th, time and bulb; built-in extinction type exposure meter with calculator. See Universal's Buccaneer—the camera that experts endorse.

UNIVERSAL CAMERA CORPORATION
New York, Chicago, Hollywood



UNIVERSAL'S METEOR
The economy candid with 15 "professional" features! Coated lens, synchronized flash unit, variable aperture . . . 15.00



UNIVERSAL'S MERCURY II
"The greatest candid for color." 35 mm. single frame. Extreme depth of focus, coated f2.7 lens, speedsto 1/1000thsec. . . . 82.90

For Pictures that *Click*...click a **UNIVERSAL**

(Continued from page 8)

Portable grandstand.....	144
Project begun on sick bed pays big dividends.....	145
Army signal corps uses rockets to lay field telephone wires.....	150
Self-winding reel on droplight ends slack-cord nuisance.....	157

Craftsman and Shop Notes Index

FARM

Repairing pipe fence posts rusted off at base.....	165
Eliminating trailer-hitch rattle.....	201
Scrap pipe makes sturdy handles for shed and barn doors.....	201
Tank cart speeds mixing liquid used in tractor tires.....	207

FISH AND FISHING

Plumb bob anchors pie-tin buoy used as fishing-hole marker.....	176
Nontangling fishhook holder.....	189
Handling fishhooks safely.....	198

HOUSE AND HOME

Concrete gutter at rock-ledge base keeps cellar of hillside home dry.....	164
Solving home problems.....	166
Flat-glass panes reduce cost of semicircular sash.....	180
Infant's crib converted into swinging cradle.....	184

LAWN AND GARDEN

Pyramid-type strawberry bed.....	176
Slat houses aid in starting seedlings.....	182
Wire mesh prevents damage to growing gladioli.....	184

OUTDOOR RECREATION

Improvised outdoor ovens give uniform heat.....	165
Step on beach-umbrella shaft aids embedding it in sand.....	165
Getting the most from canned heat.....	176
Colored lengths of string on spool used for measuring range lengths.....	198

PHOTOGRAPHY

Panoram photography.....	190
Battery-operated tester picks out duds among your flash bulbs.....	191
Spring-type clamp of photoflood reflector doubles as "tripod" for folding camera.....	192
Avoid using your expensive tubular-type tripod in sand and dirt.....	192
Cooling developer by evaporation.....	192
Preventing water from splashing.....	192
Cable release operated by darkroom timer.....	193
Sizing solution permits spotting glossy-surface prints.....	193
Detached flash gun hung from camera handle.....	193

RADIO AND ELECTRONICS

Radios in your hair.....	213
Beginner's one-tube A.C.-D.C. loudspeaker set.....	214
Radio and electronics today.....	216

TOOLS

Improved method for striping accurate border line on circular work.....	164
Abrasive bands renewed quickly by spool-type locking device.....	168
Channel iron provides C-clamps for modelmakers.....	168
Cutting openings in sheet metal.....	189
Tape adds nonslip surface to drill-press table.....	198
Screwheads filled with solder discourage hinge removal.....	198
Magnet holds jigsaw blades.....	198
Drill-press sanding sleeve does coarse or fine work.....	201
Milling setup doubles output.....	201
Try square cut from block of wood aligns rubber stamp when printing data on tracing.....	207
Special wrench speeds tightening of conduit locknuts.....	207

TOYS AND NOVELTIES

They serve you right.....	162
Gocart has coil springs.....	181
Wall plaque enlivens child's room.....	189

WOODWORKING

Garden furniture.....	169
Outdoor desk.....	177
Pivoted "miter box" for bench use permits sawing intermediate angles.....	189
Woodworker's tool chest.....	199

MISCELLANEOUS

Linoleum-block cuts mounted with friction tape.....	164
Easy way to pour half of contents from open-top container.....	168
Cleaning oilstove tank.....	168
Screw inserted in rim lock prevents use of passkey.....	176
Build your model plane to win.....	178
Snap restores halyard pulley to flagpole top.....	180
Pull-chain shock absorber for ceiling fixture.....	184
Ruler fastened in notebook with rubber bands.....	184
Ball-point pen serves as stylus when tracing stencil.....	189
Lacquer preserves chrome parts.....	198
Dyed door mat simulates grass for lawn-mower display in store window.....	207

IMPORTANT NOTICE—It is the intention of this magazine to provide its readers with information regarding the latest developments in the mechanical arts. We take no responsibility as to whether the disclosures contained in our articles are covered by patents and advise readers to investigate this subject before making, using, or selling any of the products, machines, or processes described in order to avoid possible liability for patent infringements.

AUDELS REFRIGERATION & AIR CONDITIONING GUIDE.....\$4

New from Cover to Cover—1280 Pages, Fully Illus. Covering basic principles, servicing, operation & repair of household, commercial & industrial refrigeration & air conditioning. A gold mine of essential important facts for engineers, servicemen, users.

AUDELS CARPENTERS & BUILDERS GUIDES—4 Vols.\$6

A practical illustrated trade assistant on modern construction for carpenters, joiners, builders, mechanics and all woodworkers. 4 vols., 1600 pages, 3700 illustrations, flexible covers. Pocket size. Each volume sold separately \$1.50 a vol.

AUDELS AUTOMOBILE GUIDE.....\$4

A practical quick ready reference book for auto mechanics, service men, operators & owners. Explains theory, construction & servicing of modern motor cars, trucks, buses & auto type Diesel engines. 1700 pages, fully illustrated, 55 chapters. Indexed. A standard book for mechanics. New fluid drive covered.

AUDELS DIESEL ENGINE MANUAL..\$2

A practical, concise treatise with questions and answers on the theory, operation and maintenance of modern diesel engines including General Motors 2 cycle Diesel. 384 pages, fully illus., flexible binding, pocket size. All details plainly brought out, this book is of extreme value to engineers, operators & students.

AUDELS WIRING DIAGRAMS.....\$1

210 Pages. Illustrated. Gives practical facts on wiring of electrical apparatus. It shows clearly how to wire apparatus for practically all fields of electricity. Each diagram is complete & self-explanatory. Highly Endorsed Pocket Companion.

AUDELS PLUMBERS & STEAMFITTERS GUIDES—4 Vols.\$6

A Practical Trade Assistant & Ready Reference. Explains in plain language & by clear illustrations, diagrams, charts, graphs, pictures principles of modern plumbing practice including Marine Pipe Fitting and Air Conditioning. 4 Vols.—1670 Pages—3642 Diagrams. Pocket size. Each Vol. Sold Separately \$1.50 a Vol.

AUDELS SHEETMETAL WORKERS HANDY BOOK.....\$1

Practical inside information. Fundamentals of Sheet Metal Work. 388 pages. Illustrated. 11 sections. Clearly written. Essential & important facts, figures, pointers in everyday language. Ref. Index.

AUDELS SHEETMETAL PATTERN LAYOUTS.....\$4

Developed by Experts for Sheet Metal Workers, Layout Men & Mechanics. A Practical Encyclopedia in 10 Sections, size 7 x 10 x 2—1125 Pages—350 Layouts—1600 Illustrations. 1001 Key Facts. Fully indexed for ready reference in answering your layout problems. Covers all phases of sheet metal work including Pattern Cutting, Pattern Development & Shop Procedure.

AUDELS ANSWERS ON BLUE PRINT READING.....\$2

For Mechanics & Builders. Covers all types of blue print reading including ship & airplane. 416 pages, fully illustrated.

AUDELS NEW MACHINIST & TOOLMAKERS HANDY BOOK.....\$4

Covers modern machine shop practice in all its branches. 5 practical books in 1. New from cover to cover. Tells how to set up & operate lathes, screw and milling machines, shapers, drill presses and all other machine tools. 1600 pages, fully illustrated, 5 x 8 1/2 x 2. Indexed. 5 sections. 1—Modern Machine Shop Practice. 2—Blue Print Reading & How to Draw. 3—Calculations & Mathematics for Machinists. 4—Shop Physics. 5—How to Use the Slide Rule. 60 chapters. Easy to read and understand. A shop companion that answers your questions.

AUDELS MATHEMATICS & CALCULATIONS FOR MECHANICS \$2

Mathematics for home study or reference. 700 pages, 550 illus. Practical mathematics from beginning. How to figure correctly. Easy, correct methods covering complete review. Illus. & Indexed.

AUDELS HANDY BOOK OF PRACTICAL ELECTRICITY.....\$4

For maintenance engineers, electricians & all electrical workers. 1440 Pages, 2600 Illus. Covers important electrical information in handy form—including Marine Wiring, Radio Principles, Welding. Indexed. A Key to a practical understanding of electricity.

AUDELS RADIOMANS GUIDE.....\$4

A key to the practical understanding of radio including Frequency Modulation, Television, etc., Aircraft & Marine Radio. For radio engineers, servicemen, amateurs, 914 Pages, 633 Illustrations & Diagrams. Photos. Review Questions & Answers, Reference Index. Authentic, clear, concise.

AUDELS ELECTRONIC DEVICES.....\$2

Tells What You Know About Electric Eye. Easily Understood. Covers photo-electric cells & their applications. Amplifiers, illumination, frequencies, voltage, photocell, tubes, Ohm's Law, wiring diagrams, etc.

AUDELS WELDERS GUIDE.....\$1

A concise, practical text on operation & maintenance of all welding machines for all mechanics. Over 400 pages, illustrated. Covers all methods of electric and acetylene welding including airplane work.

AUDELS, Publishers, 49 W. 23 St., N. Y. 10

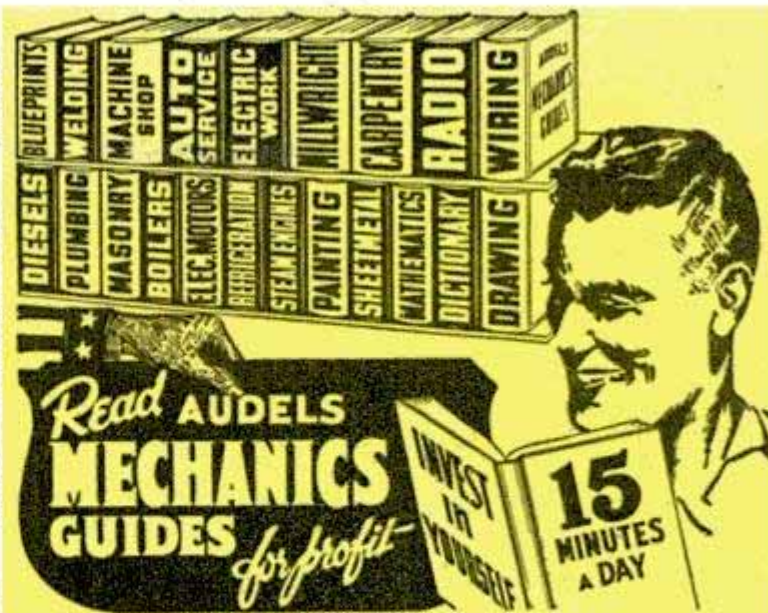

AN AUDEL GUIDE IS A GOOD FRIEND!

Step Up Your Own Skill with the Practical Facts and Figures of Your Trade. Save time and money with right methods, short cuts, labor saving ideas. CHECK NOW! You can look over any Audel Guide in your home. Start the Easy Payments if satisfied.

CUT HERE MAIL ORDER

AUDELS, Publishers, 49 W. 23 St., New York 10, N. Y.

Please mail me for 7 days' free examination the books marked (X) below. I agree to mail \$1 in 7 days on each book or set ordered, and to further mail \$1 a month on each book or set ordered until I have paid purchase price.

If I am not satisfied with Guides I will return them.

- Audels HOUSE HEATING GUIDE \$ 4
 - Audels ELECTRIC MOTOR GUIDE 4
 - Audels OIL BURNER GUIDE 1
 - Audels REFRIGERATION & Air Conditioning Guide 4
 - Audels POWER PLANT ENGINEERS GUIDE 4
 - Audels PUMPS, HYDRAULICS & AIR COMPRESSORS 4
 - Audels WELDERS GUIDE 1
 - Audels BLUE PRINT READING 2
 - Audels SHEET METAL WORKERS Handy Book 1
 - Audels SHEET METAL PATTERN LAYOUTS 4
 - Audels AIRCRAFT WORKER 1
 - Audels MATHEMATICS and CALCULATIONS 2
 - Audels MACHINISTS & TOOLMAKERS Handy Book 4
 - Audels MECHANICAL Dictionary 4
 - Audels AUTOMOBILE GUIDE 4
 - Audels DIESEL ENGINE MANUAL 2
 - Audels MARINE ENGINEERS Handy Book 4
 - Audels MECHANICAL DRAWING GUIDE 1
 - Rogers MECHANICAL DRAWING and DESIGN 2
 - Audels MILLWRIGHTS and Mechanics Guide 4
 - Audels CARPENTERS and Builders Guides (4 vols.) 6
 - Audels PLUMBERS and Steamfitters Guides (4 vols.) 6
 - Audels MASONS and Builders Guides (4 vols.) 6
 - Master PAINTER and DECORATOR 2
 - Audels GARDENERS & GROWERS GUIDES (4 vols.) 6
 - Audels ENGINEERS & FIREMANS EXAMINATIONS 1
 - Audels ENGINEERS and Mechanics Guides (8 vols.) 12
 - Audels Answers on Practical ENGINEERING 1
 - Audels ELECTRICIANS EXAMINATIONS 1
 - Audels WIRING DIAGRAMS 1
 - Audels Handy Book of PRACTICAL ELECTRICITY 4
 - Audels ELECTRICAL POWER CALCULATIONS 2
 - Audels ELECTRONIC DEVICES 2
 - Audels ELECTRIC Dictionary 2
 - Audels RADIOMANS GUIDE 4
 - Audels NEW ELECTRIC LIBRARY at \$1.50 a Volume 4
- Vols. I, II, III, IV, V, VI, VII, VIII, IX, X, XI, XII

Name _____
 Address _____
 Occupation _____
 Employed by _____

PM

Knowledge
That Has
Endured
With the
Pyramids



A SECRET METHOD FOR THE MASTERY OF LIFE

WHENCE came the knowledge that built the Pyramids? Where did the first builders in the Nile Valley acquire their astounding wisdom that started man on his upward climb? Did their knowledge come from a race now submerged beneath the sea? From what concealed source came the wisdom that produced such characters as Amenhotep IV, Leonardo da Vinci, Isaac Newton, and a host of others?

Today it is known that they discovered and used certain *Secret Methods* for the development of their inner power of mind. They truly learned to master life. This secret art of living has been preserved and handed down throughout the ages and today is extended to those who dare use its profound principles to meet and solve the problems of life in these complex times.

This Sealed Book—FREE

The Rosicrucians (not a religious organization) have prepared an unusual book, which will be sent free to sincere inquirers, in which the method of receiving these principles and natural laws is explained. Write *today* for your copy of this sealed book. Possibly it will be the first step whereby you can accomplish many of your secret ambitions and the building of personal achievements . . . Address your inquiry to: Scribe F. D. H.

The Rosicrucians
(A M O R C)
San Jose, California

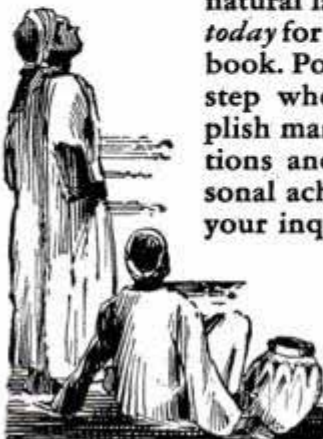

STUDY AT HOME

With An Educational Institution

Men with specialized training win higher positions, insure larger earnings, and are bigger successes in business and public life. Opportunities NOW greater than ever before. Send for our Catalog.

ARTS and SCIENCES

Courses in Philosophy; Education; Letters; Public Health; Medical Jurisprudence; Psychology; Sociology; Physics; Chemistry; Plastics; Geology; Political Science; Theology; Business and Commerce; Accounting; Mathematics; Statistics; Agriculture.

ENGINEERING

Courses in Electrical, Civil, Mechanical, Drafting, Architectural, Steam, Aeronautical, Radio, Structural, Mining, Industrial, Petroleum, Marine, Chemical, Diesel, Automobile, Refrigeration, and Air Conditioning Engineering.

LAW

Complete Professional Law Course includes 18 Hornbook Series college grade textbooks. Courses also in Commercial Law, Patent Law and Medical Jurisprudence.

McKinley-Roosevelt Incorporated, 4610-K, Sheridan Rd., Chicago 40, Ill.

WATCHMAKING

JEWELRY ENGRAVING AND REPAIR

Enter this high-paying, time-honored profession, or prepare for a business of your own. Watchmakers in great demand. More jobs than qualified workers. Study under expert instructors in a long-established, nationally recognized school. Receive recognized diploma and certificate. Placement service. Approved under G. I. Bill. Write for FREE booklet.



The Baronian School, Inc.

2116 WALNUT ST. (DEPT. C) PHILA. 3, PA.

WORK FOR THE



GOVERNMENT START

AS HIGH AS \$3,021 YEAR

Veterans Get Special Preference

MEN — WOMEN

Postoffice Clerks, Carriers
Storekeeper-Gaugers
Stenographers-Typists
Patrol Inspectors
Many Other Jobs

PREPARE
IMMEDIATELY
Common Education
Often Sufficient

Mail
Coupon
TODAY

Franklin Institute
Dept. D85
ROCHESTER 4, N. Y.

Gentlemen: Rush to me, FREE of charge, list of U. S. Government big pay jobs. Send FREE 40-page book describing salaries, vacations, hours, work. Tell me how to qualify for one of these jobs.

Name _____

Address _____ Vet? _____



YOU BUILD THIS Radio Circuit early in Course with Soldering Equipment and Radio Parts I send; practice mounting, connecting, soldering Radio parts.



YOU PRACTICE Radio Servicing with this Tester built from parts I send. Also use it to help earn EXTRA MONEY fixing neighbors' Radios.

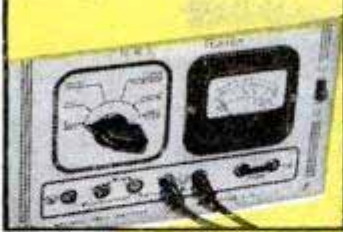

YOU PRACTICE "FM" Servicing on this Frequency Modulation (FM) Signal Generator, built with parts I supply; learn by repairing circuit defects.

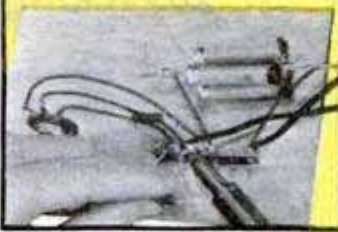

YOU BUILD THIS Vacuum Tube Power Pack, make changes which give you experience, learn how to locate and correct power pack troubles.

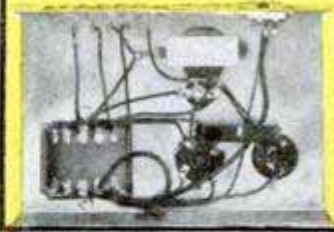

YOU BUILD THIS A. M. Signal Generator which provides amplitude-modulated signals for many tests and experiments, gives you practical experience.

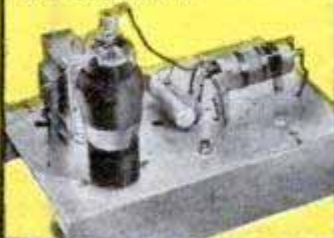

YOU PRACTICE signal tracing on this complete Superheterodyne Circuit you build with parts I send you, use it to conduct many tests and experiments.



You Get PRACTICAL EXPERIENCE With This Superheterodyne Receiver

YOU BUILD THIS complete, powerful Radio Receiver that brings in local and distant stations. N. R. I. gives you ALL the Radio parts . . . speaker, tubes, chassis, transformer, sockets, loop antenna, etc.

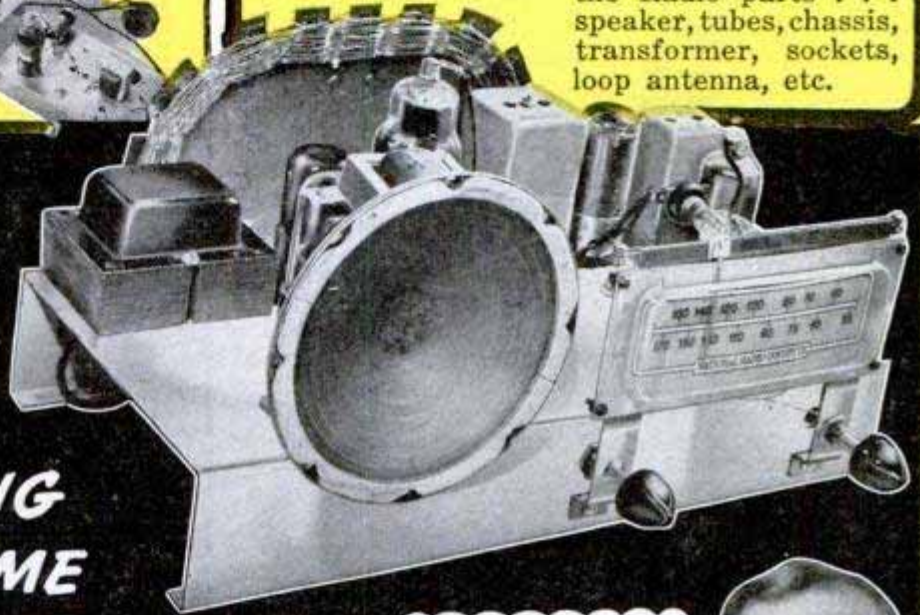

LEARN RADIO

BY PRACTICING IN SPARE TIME

WITH BIG KITS OF PARTS I SEND YOU

Do you want a good-pay job in the fast-growing Radio Industry—or your own Radio Shop? Mail the Coupon for a Sample Lesson and my 64-page book, "How to Be a Success in RADIO—Television, Electronics," both FREE. See how I will train you at home—how you get practical Radio experience building, testing Radio circuits with BIG KITS OF PARTS I send!

Many Beginners Soon Make Extra Money in Spare Time While Learning

The day you enroll I start sending EXTRA MONEY manuals that show how to make EXTRA money fixing neighbors' Radios in spare time while still learning! Now's the time to get

into Radio Repair. Trained Radio Technicians also find profitable opportunities in Police, Aviation, Marine Radio, Broadcasting, Radio Manufacturing, Public Address work. Think of even GREATER opportunities as demand for Television, FM and Electronic devices grows.

Find Out What NRI Can Do For You
Mail Coupon for Sample Lesson and my FREE 64-page book. Read the details about the Course, letters from men I trained; see how quickly, easily you can get started. No obligation! MAIL COUPON NOW.
J. E. SMITH, President
Dept. 8GP, National Radio Institute, Pioneer Home Study Radio School, Washington 9, D. C.

I WILL TRAIN YOU AT HOME

MY COURSE INCLUDES FREQUENCY MODULATION, TELEVISION, ELECTRONICS



GETTING ACQUAINTED WITH RECEIVER SERVICING

I TRAINED THESE MEN

Has Own Radio Service
"I have my own Radio and Television sales and servicing business. I get enough repair jobs to keep me going right along."—ALEXANDER KISH, 34 Pershing Avenue, Carteret, N. J.

Good Spare Time Business
"I have been getting receivers to repair right along, and with NRI methods I don't have to spend much time on them."—S. N. STRICKLAND, 191 Dale Homes, Portsmouth, Va.

GET BOTH 64 PAGE BOOK SAMPLE LESSON FREE

MR. J. E. SMITH, President, Dept. 8GP NATIONAL RADIO INSTITUTE, Washington 9, D. C. Mail me FREE Sample Lesson and 64-page book about how to win success in Radio and Television—Electronics. (No salesman will call. Please write plainly.)

Name..... Age.....
Address.....
City.....Zone.....State.....
 Check if Veteran



VETERANS

You get this training in your own home under G. I. Bill. Mail Coupon.

APPROVED FOR TRAINING UNDER GI BILL

3 opportunities to LEARN MORE and EARN MORE!

1 TYPEWRITER REPAIRING

9 month course teaches repair of all standard machines. Wide demand for trained men. Excellent paying private business.

ALL COURSES APPROVED FOR G. I. TRAINING

2 PLASTICS ENGINEERING

16 month course. Fascinating Plastics field offers great future to creative young men. Thorough training essential.

3 ELECTRO-PLATING

9 month course in plating of all materials. Primary or advanced instruction. Classroom and laboratory study. Job opportunities exceptionally good.

WRITE FOR FULL DETAILS TODAY! RESIDENT COURSES ONLY

COMMERCIAL INSTITUTE Pittsburgh School of *Plastics* **ELECTROPLATING**
Institute of America
2020 W. Liberty Ave. • Pittsburgh 26, Penna.

TRAIN for HIGH EARNINGS IN

Auto Body and Fender Work



REFRIGERATION and AIR CONDITIONING or DIESEL

Men are needed in these mechanical trades. The pay is good. There are opportunities to grow with the industries and perhaps have own business. Find out now about U. E. I. training that prepares mechanically inclined men for these opportunities.

U. E. I. "Balanced Training" includes preparatory study at home followed by actual practice in our modern shops under experienced instructors. All courses meet high standards gained from 21 years of technical training. Available to veterans and civilians. High School diploma not needed. For complete information mail coupon today!

UTILITIES ENGINEERING INSTITUTE
DEPT. 178 CHICAGO 14, ILLINOIS



SEND FOR FREE FACTS

Utilities Engineering Institute, Dept. 178
2525 SHEFFIELD AVE., CHICAGO 14, ILL.

Please send me free facts about U. E. I. training and opportunities in the field checked below:

- Diesel Refrigeration Welding
 Auto Body & Fender Repair Air Conditioning

NAME _____ Age _____

ADDRESS _____

CITY _____ Zone or County _____ STATE _____

Check here for special information if you are under 16.

MAKE UP TO \$5.00 AN HOUR In Your Own YEAR ROUND Business!

ONLY A FEW DOLLARS PUTS YOU IN BUSINESS!

Many Clearing High as \$20 to \$30 a Day NET Cleaning Rugs, Carpets, Upholstery, Auto Upholstery - By Amazing, New, Quick, Easy Method. No Machine or Equipment to Buy!

Here's the opportunity you've been looking for to step into a pleasant, dignified, big-pay business of your own that offers a steady, year 'round income. Start on "a shoe-string," full or spare time, right from your home. Equal opportunities for men, women, young or old, in small towns or big cities. No experience needed. Easy to learn. We send you complete instructions and quick-cleaning supplies so you can start making money the first day! Quick method cleans upholstery, rugs and carpets like new without taking off floor! Also cleans wall-paper and walls. Big Money using our Moth-Proofing Method, too. Tremendous demand in homes, apartments, hotels, stores, office and public buildings. Steady repeat business. Territories going fast. Write today for FREE information about quick, easy way to get started. No obligation. Rush letter or post-card to: **AMERICLEAN CO., Inc.**

Dept. G-19, 211 North 7 St.; St. Louis 1, Mo.

WRITE FOR FREE DETAILS NOW!

Be an INVESTIGATOR

JAMES S. BOLAN, FORMER POLICE COMMISSIONER OF NEW YORK CITY offers MEN & WOMEN an attractive opportunity to prepare for a future in *Investigation & Criminology* by comprehensive Home Study Course. Free placement service assists graduates to obtain jobs. APPROVED UNDER G. I. BILL OF RIGHTS.

Write for Free Booklet PM.

THE BOLAN ACADEMY, INC.
EMPIRE STATE BLDG., NEW YORK 1, N. Y.

Sensational New Electric 1 WELDER 2 CUTTER!

BOTH only \$12 LOWEST PRICE IN HISTORY!



WELDER UNIT



CUTTER UNIT

Uses 110-115 AC or DC • INSTRUCTIONS INCLUDED WELD - BRAZE - CUT - MELT - SOLDER - HEAT TREAT

The WELDRITE combination—tested and proven by countless commercial and amateur users, is now offered direct to you at the amazingly low price of only \$12.00. No Gas—No Gauges—No Spark Lighter needed. Always ready for immediate use—Just plug WELDRITE into 110-115 AC or DC outlet. Uses standard welding and brazing materials available at all welding supply stores. WELDRITE furnished complete with Converter Unit, #1 Single Holder with attached Alligator clip, for welding metal up to 3/16" thickness, using up to 3/32" rod, and #2 Double Holder with Copper Coated Dual Carbon Electrodes for Cutting, Brazing, Heat Treating, Soldering, etc. Starting welding materials and instructions included. Ideal for home workshop. Invaluable for body

and fender shops, garages, repair and machine shops, manufacturers, etc.

SEND NO MONEY! 5 DAY TRIAL OFFER

Order your WELDRITE Electric WELDER-CUTTER C. O. D. today. Pay postman \$12 plus postage charges (wt. 4 lbs.) or send \$12 and we pay postage. Either way, if not satisfied, return WELDRITE in 5 days, and money will be refunded. WELDER HOOD—Approved lens found in hoods costing to \$10—only \$3.95. California orders please add 2 1/2% sales tax.

CALIFORNIA TECHNICAL PRODUCTS CO.
448 So. Hill St., Los Angeles 13, Calif. Dept. A-7



INVENTORS



Learn how to protect your invention. The U. S. Patent Laws provide that any new and useful art, machine, article of manufacture, or composition of matter, or any new and useful improvement thereof, may be patented if the act of invention is involved. Therefore, every inventor with a valuable invention should take advantage of the Patent Laws and proceed for patent protection in order to safeguard his rights.

A patent gives the inventor the exclusive right to prevent others from making, using, or selling the invention claimed in the patent for a period of seventeen years.

The Patent Laws were enacted for the benefit of the inventor to give him protection for the features of his invention which are patentable. These features must be properly and concisely set forth and claimed in a formal application for patent, in order to comply with the requirements of the U. S. Patent Office. For that reason, the Patent Office advises the inventor, unless he is familiar with such matters, to engage a competent registered patent attorney or agent to represent him. We maintain a staff of registered patent attorneys ready to serve you in the handling of your patent matters.

A specially prepared booklet entitled "Patent Guide for the Inventor", containing detailed information with respect to patent protection and procedure, together with a "Record of Invention" form will be promptly forwarded to you without obligation upon request.

**Registered
Patent
Attorneys**

CLARENCE A. O'BRIEN & HARVEY B. JACOBSON
Registered Patent Attorneys
81-G District National Bldg., Washington 5, D. C.

Please send me copy of "Patent Guide for the Inventor" and also "Record of Invention" form. This request does not obligate me.

Name _____

Address _____

City _____ State _____

(Please write or print plainly.)

**CLARENCE A. O'BRIEN
& HARVEY B. JACOBSON**

81-G District National Building + Washington 5, D. C.



GET THESE 2 BIG BOOKS
FREE.

IF YOU
WANT TO LEARN

RADIO!

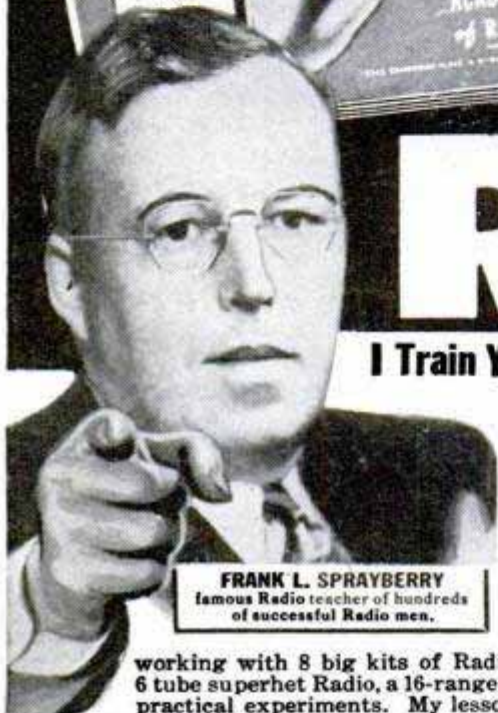

FRANK L. SPRAYBERRY
famous Radio teacher of hundreds
of successful Radio men.

I Train You RIGHT by Sending You 8 BIG KITS of Radio Equipment including A POWERFUL 6 TUBE SUPERHET RECEIVER and 16 RANGE TEST METER!

Find out NOW how Sprayberry Training prepares you for a Radio Service Business of your own — or a good pay Radio job. Just mail the coupon for a FREE Sample Lesson and my big FREE book, "How To Make Money In Radio, Electronics, Television." I train you at home during spare hours by putting you to work building, testing, repairing,

no previous *Business* experience in Radio. My famous *Business Builders* help you earn EXTRA CASH getting and doing neighborhood Radio Service jobs while learning. You couldn't pick a better time to get into Radio. Good Radio Service and Repair Shops are needed everywhere as millions of new sets are in use. Trained men are wanted for opportunities in Police, Aviation and Marine Radio, F.M., Standard Broadcasting and Television. Mail coupon today for my FREE Books.

working with 8 big kits of Radio parts I supply. You build a powerful 6 tube superhet Radio, a 16-range test meter, perform over 175 interesting, practical experiments. My lessons are easy and interesting . . . you need

LEARN HOW TO BUILD-TEST-REPAIR RADIOS By Working with YOUR HANDS!



I give you a fine, moving coil type Meter—with parts for a complete analyzer and Circuit Continuity Tester. "Trouble-shoot" with professional accuracy.

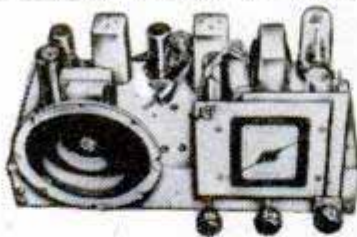

You really learn Radio the PRACTICAL way . . . when you build this big, powerful 6-tube Superhet Radio from parts I send you.

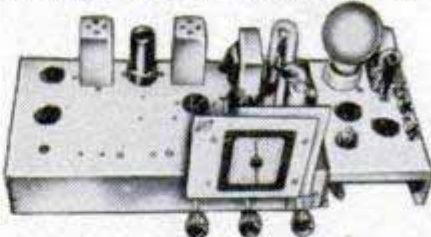

You don't have to buy expensive ready-made equipment. You get valuable experience building this Signal Generator and Multi-purpose Tester.

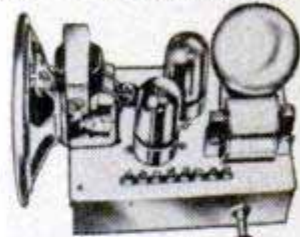

You construct this rectifier, filter, resistor and condenser tester, and really get on the Practical end of Radio.

LOW COST RADIO TRAINING STUDY AT HOME IN SPARE HOURS

RUSH COUPON Today!

SPRAYBERRY ACADEMY OF RADIO
F. L. SPRAYBERRY, President
Room 1078, Sprayberry Bldg., Pueblo, Colorado
Please rush my FREE copies of "How To Make Money In Radio, Electronics and Television" and "How To Read Radio Diagrams and Symbols." No salesman will call.

Name _____ Age _____

Address _____

City and Zone _____ State _____

CHECK HERE IF A VETERAN

(Mail in an Envelope or Paste on Penny Postcard)

Easy monthly payments, if desired. Everything you need is furnished — nothing else to buy. The equipment I send you is yours "for keeps"—to use in your business or job. I have trained hundreds of successful Radio men — and I can help you, too. Get the facts about Sprayberry Training—it's your first step to success, security and a bigger income. Fill out and mail coupon today. I'll rush my 2 Free books to you by return mail.

VETERANS: Approved for G. I. Training under Public Laws 16 and 346.

SPRAYBERRY ACADEMY of RADIO

F. L. SPRAYBERRY, President

Room 1078, Sprayberry Bldg., Pueblo, Colorado



Trained Radio men can step into their own profitable Radio Service Shop—or



New developments constantly open new big pay job opportunities in Radio.

INVENTORS

Patent laws encourage the development of inventions.

We recommend that an inventor employ a registered Patent Attorney or agent, if the inventor is not familiar with patent matters. This is because the value of a patent depends largely upon the skillful preparation of the specification and claims in the patent application.

The firm of McMorrow, Berman and Davidson is registered to practice before the United States Patent Office. Additionally it engages patent attorneys able to readily understand inventors' disclosures, to advise concerning patentability, and to prepare appropriate specifications and claims.

If an inventor believes he has an invention, a search of the most pertinent prior U. S. patents should be made and a report obtained relative to its patentability. Where such report indicates that the invention appears patentable, in order to secure protection, diligence should be exercised in making application for a patent.

Send for a copy of Patent Booklet entitled "How To Protect Your Invention." This booklet contains information on patent protection and procedure. You will also receive an "Invention Record" blank. This will be promptly forwarded to you upon request—no obligation.

McMORROW, BERMAN & DAVIDSON

Registered Patent Attorneys

PATENTS • TRADE MARKS • COPYRIGHTS

135-L VICTOR BUILDING, WASHINGTON 1, D. C.

McMORROW, BERMAN & DAVIDSON

Registered Patent Attorneys

135-L Victor Building, Washington 1, D. C.

Send me your Patent Booklet, "How To Protect Your Invention", and also "Invention Record" form at once. I understand this request does not obligate me.

Name.....

Address.....

City.....

(WRITE OR PRINT NAME CLEARLY)

Lend Me 15 Minutes A Day



*..and I'll prove
I can make you
a NEW MAN*

I'M trading in old bodies for new! I'm taking men who know that the condition of their arms, shoulders, chests and legs—their strength, "wind," and endurance—is not 100%. And I'm making NEW MEN of them!

If you can simply raise your arm and flex it, I can add SOLID MUSCLE to your biceps—yes, on each arm—in double-quick time! I can broaden your shoulders, strengthen your back, develop your whole muscular system INSIDE and OUTSIDE!

What Only 15 Minutes a Day Can Do

I can add inches to your chest, give you a vise-like grip, make those legs of yours lithe and powerful. I can shoot new strength into your old backbone, exercise those inner organs, help you cram your body so full of pep, vigor and red-blooded vitality that you won't feel there's even "standing room" left for weakness and that lazy feeling! Before I get through with you I'll have your whole frame "measured" to a nice, new, beautiful suit of muscle!

I Was a 97-lb. Weakling

All the world knows I was ONCE skinny, scrawny 97-pound weakling. And NOW it knows that I won the title, "The World's Most Perfectly Developed Man." Against all comers! How did I do it? How do I work miracles in the bodies of other men in only 15 minutes a day? The answer is "Dynamic Tension," the amazing method I discovered and which changed me from a 97-pound weakling into the champion you see here!

FREE THIS FAMOUS BOOK "EVERLASTING HEALTH AND STRENGTH"

Almost two million men have sent for and read my book, "Everlasting Health and Strength." It tells you exactly what "Dynamic Tension" can do. And it's packed with pictures that SHOW you what it does. Results it has produced for other men. RESULTS I want to prove it can get for YOU! Learn how you can actually become a NEW MAN, right in the privacy of your own home and in only 15 minutes a day! Mail this coupon NOW!

CHARLES ATLAS, Dept. 8G, 115 East 23rd St., New York 10, N. Y.



Charles Atlas

Actual photo of the man who holds the title, "The World's Most Perfectly Developed Man."

CHARLES ATLAS, Dept. 8G, 115 East 23rd St., New York 10, N. Y.

I want the proof that your system of "Dynamic Tension" will help make a New Man of me—give me a healthy, husky body and big muscular development. Send me your free book, "Everlasting Health and Strength."

Name _____ Age _____
(Please Print or Write Plainly)

Address _____

City _____ State _____

Famous BAILEY DIESEL SCHOOLS Now Accepting CIVILIAN STUDENTS!

Bailey has a national reputation for "finest training methods." Bailey teaches you fundamentals, plus the practical application of theory in plenty of actual shop work. Bailey is approved by industry. Bailey graduates get the jobs!

Civilian men and boys over 17 who are ambitious to get ahead will act now. Send for FREE catalog. No salesman will call.

BAILEY TECHNICAL SCHOOLS
1655 So. Grand Blvd., St. Louis, Mo.



LEARN MEAT CUTTING At Home — In Spare Time

Get into the vital meat industry. Concise, practical Home Training based on 25 years proven instruction methods used at National's famous resident school. Prepares you for bigger pay as Meat Cutter, Supervisor, market manager or more money in your own store. Go as rapidly as your spare time permits. Diploma. Start NOW to turn your spare hours into money. Send for FREE bulletin today. No obligation.

National School of Meat Cutting, Inc., Div. U-95, Toledo 4, Ohio

LEARN MONEY- MAKING CARTOONING

IN SPARE TIME — by Easy Picture Chart Method

Same Simplified Method that has helped train creators of "Terry & Pirates," "Freckles," "Out Our Way," "Winnie Winkle," "Regular Fellers," "Strange As It Seems," "The Neighbors," and many others. Earn while learning. Send 10c for Picture Chart (to test your ability), and full details. (State age.)

THE LONDON SCHOOL, 4807 Clevel. Transit Bldg., Cleveland, O.



Learn To MOUNT BIRDS

Tan SKINS, Make Up FURS

Be a Taxidermist. Double your hunting fun. We teach you at Home. Mount Birds, Animals, Pets, Heads and Fish. Save your hunting trophies; decorate home and den. MAKE MONEY. Mount and Krome-tan for others. Big sparetime profits. INVESTIGATE TODAY.

FREE BOOK with 100 game pictures, 48 pages. Hunters, get yours! It's Now Free.

Send postal card TODAY — This Minute! State your AGE.

NORTHWESTERN SCHOOL OF TAXIDERM; Dept. 2567, Omaha, Nebr.



COMMERCIAL ART

APPLIED ART ACADEMY 248 Carroll Street, Akron 4, Ohio.
18 Month Diploma Courses. 12 Modern Fully equipped studios. Located in the Rubber Center of the World. Approved by the Ohio State Department of Education for Veteran and Civilian Training. New Classes beginning every month. Inquire Immediately. Telephone HE-7661.

Photography



for

PLEASURE or PROFIT

Learn at home. Spare time. Practical basic training. Long-established school. Many have earned while learning. Send coupon below for free booklet, "Opportunities in Modern Photography" and full particulars.

AMERICAN SCHOOL OF PHOTOGRAPHY
1315 Michigan Avenue Dept. 135B Chicago 5, Illinois
Send booklet, "Opportunities in Modern Photography," full particulars and requirements. No salesman will call.
Name _____ Age _____
Address _____
City _____ Zone _____ State _____

OPPORTUNITY has a long arm

IT ISN'T even necessary to go half-way to meet Opportunity. It seeks out the man who has prepared himself for advancement.

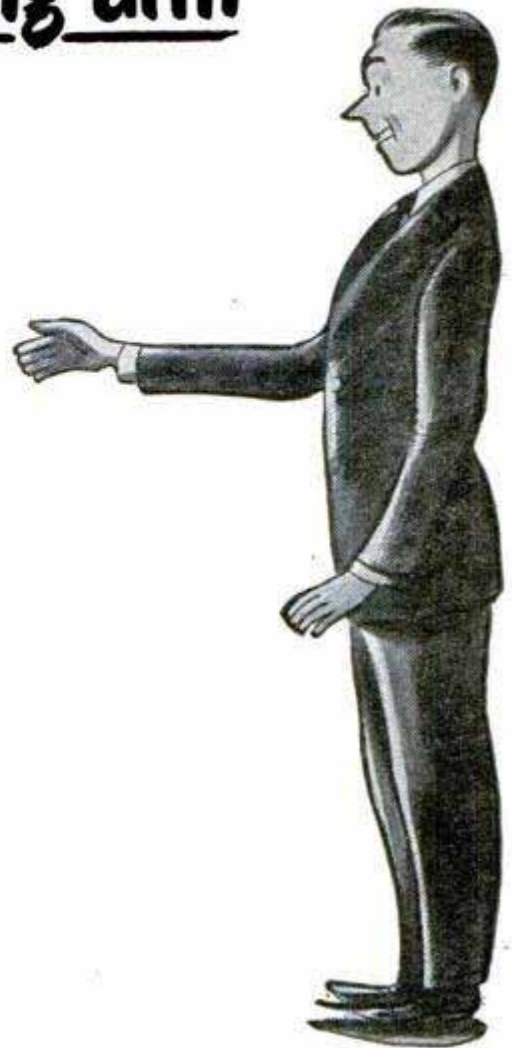
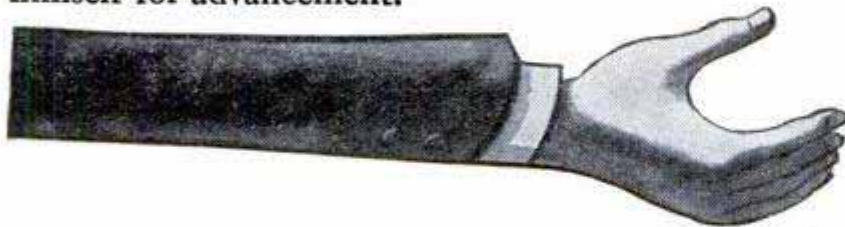

I.C.S. training is one of the effective forms of preparation. When you have mastered an I.C.S. Course, you're ready and able to take on larger responsibilities in your chosen field.

In a single period of four months, I.C.S. has received as many as 1,920 student letters reporting advancement in salary and position. Graduates include the presidents, board chairmen, chief technicians of some of the largest industrial, transportation, publishing and other enterprises in the nation.

You can get ready for Opportunity as they did. Mark and mail the coupon today and be prepared for tomorrow's rewarding openings.

INTERNATIONAL CORRESPONDENCE SCHOOLS



BOX 5632-K, SCRANTON 9, PENNA.

Without cost or obligation, please send me full particulars about the course BEFORE which I have marked X:

- | | | | |
|---|---|---|---|
| <p>Air Conditioning and Plumbing Courses</p> <p><input type="checkbox"/> Air Conditioning <input type="checkbox"/> Plumbing</p> <p><input type="checkbox"/> Heating <input type="checkbox"/> Steam Fitting</p> <p><input type="checkbox"/> Refrigeration <input type="checkbox"/> Refrigeration</p> <p>Chemistry Courses</p> <p><input type="checkbox"/> Chemical Engineering</p> <p><input type="checkbox"/> Chemistry, Analytical</p> <p><input type="checkbox"/> Chemistry, Industrial</p> <p><input type="checkbox"/> Chemistry, Mfg. Iron & Steel</p> <p><input type="checkbox"/> Petroleum Refining <input type="checkbox"/> Plastics</p> <p><input type="checkbox"/> Pulp and Paper Making</p> <p>Civil Engineering, Architectural and Mining Courses</p> <p><input type="checkbox"/> Architecture</p> <p><input type="checkbox"/> Architectural Drafting</p> <p><input type="checkbox"/> Bridge and Building Foreman</p> <p><input type="checkbox"/> Building Estimating</p> <p><input type="checkbox"/> Civil Engineering</p> <p><input type="checkbox"/> Coal Mining</p> <p><input type="checkbox"/> Contracting and Building</p> <p><input type="checkbox"/> Highway Engineering</p> <p><input type="checkbox"/> Lumber Dealer</p> <p><input type="checkbox"/> Reading Structural Blueprints</p> <p><input type="checkbox"/> Sanitary Engineering</p> <p><input type="checkbox"/> Structural Drafting</p> | <p><input type="checkbox"/> Structural Engineering</p> <p><input type="checkbox"/> Surveying and Mapping</p> <p>Communications Courses</p> <p><input type="checkbox"/> Electronics</p> <p><input type="checkbox"/> Practical Telephony</p> <p><input type="checkbox"/> Radio, General</p> <p><input type="checkbox"/> Radio Operating</p> <p><input type="checkbox"/> Radio Servicing</p> <p><input type="checkbox"/> Telegraph Engineering</p> <p>Electrical Courses</p> <p><input type="checkbox"/> Electrical Drafting</p> <p><input type="checkbox"/> Electrical Engineering</p> <p><input type="checkbox"/> Electric Light and Power</p> <p><input type="checkbox"/> Lighting Technician</p> <p><input type="checkbox"/> Practical Electrician</p> <p>Internal Combustion Engines Courses</p> <p><input type="checkbox"/> Auto Technician <input type="checkbox"/> Aviation</p> <p><input type="checkbox"/> Diesel-Electric</p> <p><input type="checkbox"/> Diesel Engines <input type="checkbox"/> Gas Engines</p> <p>Mechanical Courses</p> <p><input type="checkbox"/> Aeronautical Engineer's, Jr.</p> <p><input type="checkbox"/> Aircraft Drafting</p> <p><input type="checkbox"/> Flight Engineer</p> <p><input type="checkbox"/> Forging <input type="checkbox"/> Foundry Work</p> <p><input type="checkbox"/> Heat Treatment of Metals</p> | <p><input type="checkbox"/> Industrial Engineering</p> <p><input type="checkbox"/> Industrial Metallurgy</p> <p><input type="checkbox"/> Machine Shop</p> <p><input type="checkbox"/> Mechanical Drafting</p> <p><input type="checkbox"/> Mechanical Engineering</p> <p><input type="checkbox"/> Mold-Loft Work</p> <p><input type="checkbox"/> Patternmaking—Wood, Metal</p> <p><input type="checkbox"/> Reading Shop Blueprints</p> <p><input type="checkbox"/> Sheet-Metal Drafting</p> <p><input type="checkbox"/> Sheet-Metal Worker</p> <p><input type="checkbox"/> Ship Drafting <input type="checkbox"/> Ship Fitting</p> <p><input type="checkbox"/> Tool Designing</p> <p><input type="checkbox"/> Toolmaking</p> <p><input type="checkbox"/> Welding—Gas and Electric</p> <p>Railroad Courses</p> <p><input type="checkbox"/> Air Brake <input type="checkbox"/> Car Inspector</p> <p><input type="checkbox"/> Diesel Locomotive</p> <p><input type="checkbox"/> Locomotive Engineer</p> <p><input type="checkbox"/> Locomotive Fireman</p> <p><input type="checkbox"/> Railroad Section Foreman</p> <p>Steam Engineering Courses</p> <p><input type="checkbox"/> Boilermaking</p> <p><input type="checkbox"/> Combustion Engineering</p> <p><input type="checkbox"/> Engine Running</p> <p><input type="checkbox"/> Marine Engineering</p> <p><input type="checkbox"/> Steam Electric <input type="checkbox"/> Steam Engines</p> | <p>Textile Courses</p> <p><input type="checkbox"/> Cotton Manufacturing</p> <p><input type="checkbox"/> Rayon Weaving</p> <p><input type="checkbox"/> Textile Designing</p> <p><input type="checkbox"/> Woolen Manufacturing</p> <p>Business and Academic Courses</p> <p><input type="checkbox"/> Accounting <input type="checkbox"/> Advertising</p> <p><input type="checkbox"/> Arithmetic <input type="checkbox"/> Bookkeeping</p> <p><input type="checkbox"/> Business Administration</p> <p><input type="checkbox"/> Business Correspondence</p> <p><input type="checkbox"/> Certified Public Accounting</p> <p><input type="checkbox"/> Commercial</p> <p><input type="checkbox"/> Commercial Art</p> <p><input type="checkbox"/> Cost Accounting</p> <p><input type="checkbox"/> Federal Tax</p> <p><input type="checkbox"/> First Year College</p> <p><input type="checkbox"/> Foremanship <input type="checkbox"/> French</p> <p><input type="checkbox"/> Good English <input type="checkbox"/> High School</p> <p><input type="checkbox"/> Higher Mathematics</p> <p><input type="checkbox"/> Motor Traffic <input type="checkbox"/> Postal Service</p> <p><input type="checkbox"/> Salesmanship <input type="checkbox"/> Secretarial</p> <p><input type="checkbox"/> Sign Lettering</p> <p><input type="checkbox"/> Spanish <input type="checkbox"/> Stenography</p> <p><input type="checkbox"/> Traffic Management</p> |
|---|---|---|---|

Name _____ Home Address _____

City _____ State _____

Age _____ Present Position _____ Working Hours _____ A.M. to _____ P.M.

Special tuition rates to members of the Armed Forces. Special discount to World War II Veterans.
Canadian residents send coupon to International Correspondence Schools Canadian, Ltd., Montreal, Canada.

A D V I C E F O R T H E I N V E N T O R

Unless an inventor is thoroughly familiar with such matters, he is advised to employ a competent registered patent attorney or agent as the value of patents depends largely upon the skillful preparation of the specification and claims.

For his guidance, the following are the usual preliminary steps which the inventor takes toward patent protection.

The "Evidence of Invention" form mentioned below is offered as a convenience to the inventor in making his disclosure of invention.

The inventor should date and sign his disclosure and have it witnessed by two or more persons who are capable of understanding his invention. The disclosure should then be mailed to the registered patent attorney or agent whom he

selects to assist him. The disclosure should be accompanied by a letter authorizing the patent attorney or agent to conduct a preliminary search among previously granted U. S. patents for similar types of invention. The patent attorney or agent then prepares a report of the probable patentability of the invention and recommends the further course the inventor should take, provided the report indicates possible patentability.

This firm is registered to practice before the U. S. Patent Office and is available to assist inventors in the preparation and prosecution of their cases. The coupon below is suggested as a convenience to the inventor in starting action on his invention.

VICTOR J. EVANS & Co. *Merlin M. Evans*
REGISTERED PATENT ATTORNEY

330-G MERLIN BUILDING, WASHINGTON 6, D. C.

Please send me without obligation a copy of your booklet "Patent Protection For Inventors" together with your convenient "Evidence of Invention" form.

Name.....

Address.....

City and State.....

PATENTS TRADEMARKS COPYRIGHTS

Choose one of these **2 GREAT FIELDS**

- Get Ready **QUICK** at **COYNE!**

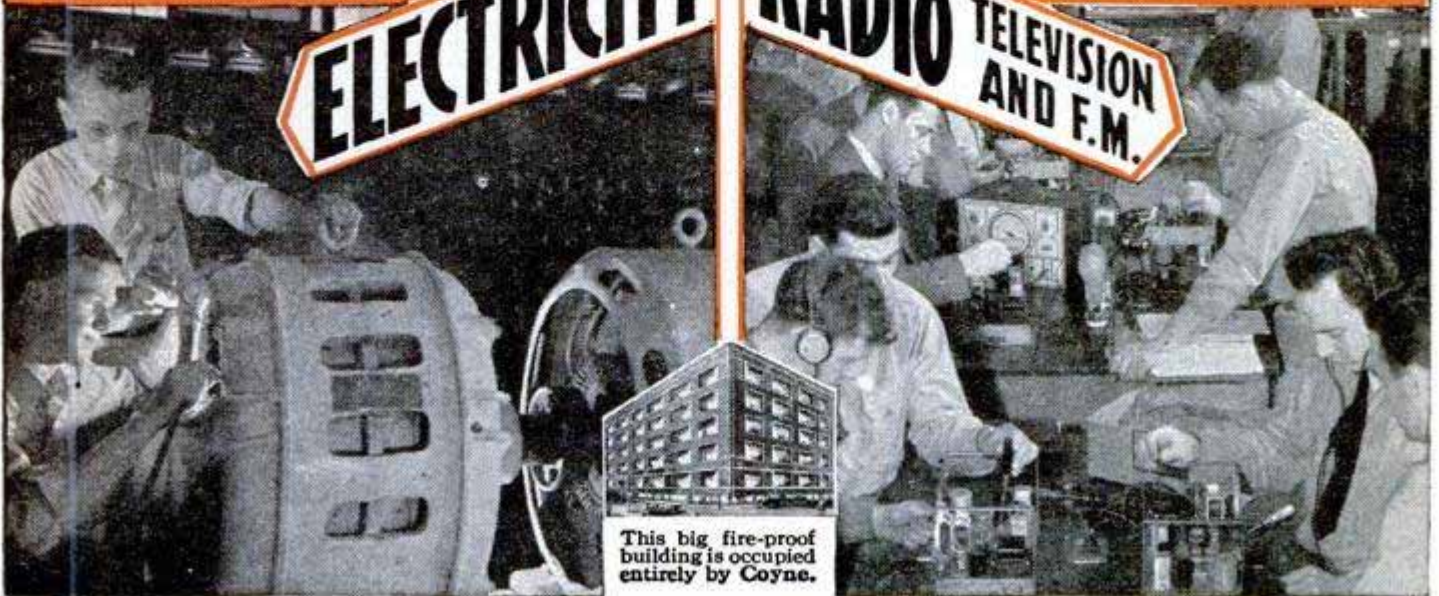
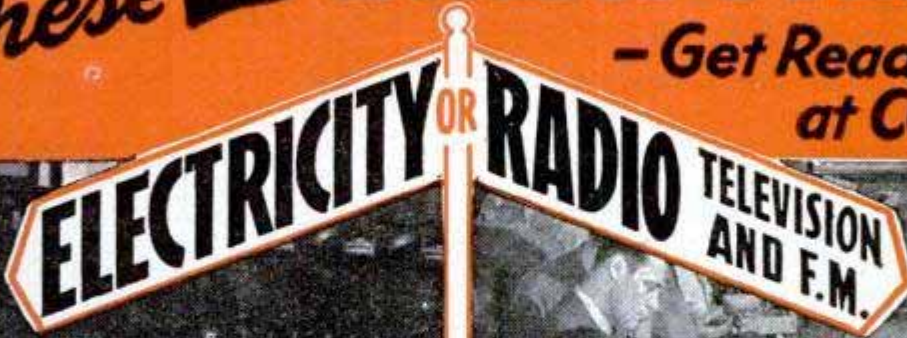

This big fire-proof building is occupied entirely by Coyne.

Prepare for Success Quickly... in the

GREAT SHOPS OF COYNE

Conditions today are different. Many "one-operation" jobs that pay well will not last. Plan for steady pay and advancement by training NOW. Come to the great shops of COYNE in Chicago, for "all-around" training in **Electricity or Radio-Television**—the 2 great opportunity fields.

NOT "HOME-STUDY" COURSES

Our famous "Learn-by-Doing" method gives you practical experience on a massive outlay of equipment. Not by correspondence, but actual shop work plus necessary theory. You are trained right here in the great Coyne shops that has been training men and young men for over 49 years.

ELECTRICITY RADIO TELEVISION and F.M.

INCLUDING INDUSTRIAL ELECTRONICS

Big future in Power Plant Work, Motors, Armature Winding, Home and Factory Wiring, Appliances, Refrigeration, Maintenance, Illumination, etc. Electricians are in demand everywhere—lifetime job service to Coyne graduates. Send for **BIG FREE BOOK**.

A great field now, even greater growth ahead. Here at COYNE you're trained for Construction, Testing, Trouble-Shooting on Radio, Public Address, Sound Picture Units. Training includes FM, Photo-cells, Television, etc. Our training is quick, easy, practical. Many Coyne trained men own well-paying radio businesses of their own.



ELECTRIC REFRIGERATION

Added training in Electrical Refrigeration now included with either our Electrical or Radio Course.

NON-VETERANS who are short of cash can finance most of their tuition and pay in easy monthly payments after graduation. Many earn while learning.

VETERANS

COYNE is authorized to train those who qualify for training under G. I. Bill of Rights. Coupon brings Special G. I. Bulletin.

LARGEST, OLDEST, BEST EQUIPPED SCHOOL OF ITS KIND IN THE U.S.



Pick Field You Like

—Mail Coupon for **Big FREE Book**

Whether you prefer Electricity, or Radio, train on actual equipment, at Coyne. We have a big, fully illustrated book on each course, and we'll send you the one you want, without obligation. Mail coupon — **TODAY**.

B. W. COOKE, President
COYNE ELECTRICAL AND RADIO SCHOOL
500 S. Paulina St., Dept. B8-72H, Chicago 12, Ill.

Send me your **BIG FREE BOOK** — for the course checked below. This does not obligate me and no salesman will call.

ELECTRICITY RADIO — TELEVISION

NAME.....

ADDRESS.....

CITY..... STATE.....

COYNE Founded 1899 **ELECTRICAL AND RADIO SCHOOL** B. W. COOKE, President

500 So. Paulina Street, Dept. B8-72H, CHICAGO 12, ILL.

PRACTICAL AUTO INFORMATION

Keeps Cars Rolling by Making Repairs and Adjustments Easy!

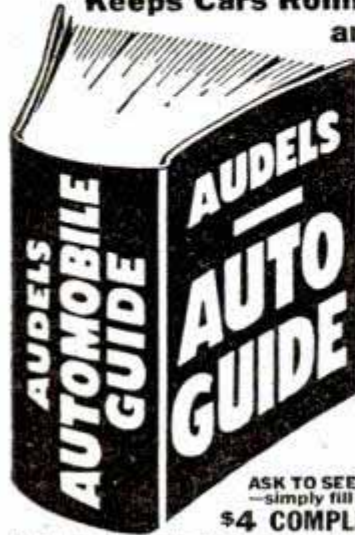

AUDELS AUTO GUIDE
For Every Mechanic, Driver, Owner and Repair Shop.

Sent on 7 Days Approval Shows How to Tune Up—Keep Brakes Safe—Batteries Powerful—Tire Mileage Up—Save Gas—Lubricate Correctly.

ANSWERS YOUR QUESTIONS
Contains all you need to know about 1—Construction, 2—Operation, 3—Service, 4—Repair of Modern Motor Cars, Trucks, Buses & Diesel Engines in every detail.

NEW FLUID DRIVE TREATED
Easy to understand—1540 Pages, 1540 Illustrations. Gives definite directions on How to handle service jobs.

ASK TO SEE IT—Get this information for yourself—simply fill in and mail coupon today.

\$4 COMPLETE • PAY ONLY \$1 A MO.

AUDEL, Publishers, 49 West 23rd St., New York
Mail AUDELS AUTOMOBILE GUIDE (\$4) for free examination. If O. K., I will send you \$1 in 7 days; then remit \$1 monthly until \$4 is paid. Otherwise, I will return book promptly.

Name _____
Address _____
Occupation _____
Reference _____ PM

AVIATION Career

MAXIMUM TRAINING IN MINIMUM TIME

CAL-AERO TECH TRAINING will add dollars to your pay check all the rest of your life. Specializing in AERONAUTICAL ENGINEERING and MASTER AVIATION MECHANICS since 1929, Cal-Aero Tech training is carefully designed for just one thing—TO MAKE MORE MONEY FOR YOU. An alumni of over 6000 successful graduates proves our career training is unsurpassed.

VETERANS —Write us about Aviation Training, as provided under "G.I. Bill of Rights."



KAL-AERO TECHNICAL INSTITUTE
MAJOR C. C. MOSELEY PRES. SINCE 1929
FORMERLY CURTISS-WRIGHT TECHNICAL INSTITUTE

GRAND CENTRAL AIR TERMINAL
GLENDALE 1, CALIFORNIA
LOS ANGELES COUNTY

MAIL THIS COUPON TODAY!

Cal-Aero Technical Institute, Grand Central Airport, Glendale 1, California
Please send full information on Aviation Training FREE—without obligation. Dept. PM-7

Name _____ Birth Date _____
Street _____
City _____ State _____

PROTECT LIVES and PROPERTY with these

LOW COST FIRE EXTINGUISHERS

A little foresight now may save LIVES and PROPERTY later. Equip your home, your garage, your office, your boat with **AutoFYRstop**, the modern fire extinguisher and alarm that is setting new records . . . Write for FREE literature today.



KILLS FIRE BY ITSELF



We have openings for high grade salesmen in choice territories. If interested in outstanding money-making opportunity, write for plan TODAY!

AUTOFYRSTOP CO., Dept. PM-748
2035 Washington Ave., Philadelphia 46, Pa.

"YOU ARE UNDER ARREST!"



Help Bring Crooks to Justice Through Scientific CRIME DETECTION!

We have taught thousands this exciting, profitable, pleasant profession. Let us teach you in your own home. Learn Fingerprinting, Firearms Identification, Police Photography, Secret Service Methods thoroughly, quickly, at small cost. Over 800 of all American Bureaus of Identification employ I. A. S. students or graduates. We can prepare you for this fascinating work, during spare time. Write today, stating age, for "Blue Book of Crime."

INSTITUTE OF APPLIED SCIENCE, 1920 Sunnyside Ave., Dept. 1358, Chicago 40, Ill.

EXPERT PHOTOGRAPHY MADE EASY

LEARN PHOTOGRAPHY NOW

—for both a sound and secure future and immediate opportunities. Ever-increasing demand for trained men and women. Excellent earnings. Resident or home study. 38th year. Write for full details.

NEW YORK INSTITUTE OF PHOTOGRAPHY
Dept. 49, 10 West 33 Street New York 1, New York

RELEASE the Full Power of YOUR MIND

Send for free booklet telling how you can achieve success and reach your personal goals. Find out how to remove frustrations and inferior feelings. Learn how to make your subconscious mind work for, not against, you. Write today. No obligation.

Broadwell Studio Schools, Dept. 18-G Covina, California
Established 22 Years



MAKE MAGIC your HOBBY

BE A MAGICIAN FOR FUN OR PROFIT!

Rush 25c for a sample copy of "MAGIC IS FUN," magazine that teaches how to do tricks with coins, cards, ropes, etc. FREE, with order, large catalog of magical apparatus. D. Robbins & Co., Dept. M-163, 152 W. 42 St., N. Y. 18, N. Y.

Say You Saw It in Popular Mechanics



Bar Bells

Buy Direct From Factory

Write for free booklet and price list

\$8.95
up

INDEPENDENT IRON WORKS
2416 East 23rd Street, Dept. B
Los Angeles 11, Calif.

WHICH OF THESE *Opportunities* INTERESTS *You* MOST?

● Today, choose the job you want—and prepare for it. Or if you are already engaged in the work you like best, start training now for quicker promotion. Acquire the knowledge that will help you to get ahead faster, make more money and have greater security.

American School, founded in 1897 as an educational institution *not for profit*, can help you to reach your goal just as it has helped others during the past fifty-one years. Check the coupon at right, add your name and address and mail it at once. The school will send you details on its training plan and outline of study prepared by specialists. There is no charge, no obligation, so send the coupon immediately.

CHECK, CLIP AND MAIL COUPON NOW

AMERICAN SCHOOL, Dept. GB45, Drexel at 58th, Chicago 37, Ill.
Without obligation, Please send FREE and postpaid, bulletin and details of the Subjects checked:

- | | | |
|--|---|--|
| <input type="checkbox"/> PLASTICS ENG'R | <input type="checkbox"/> Accounting | <input type="checkbox"/> Drafting and Design for Men and Women |
| <input type="checkbox"/> Refrigeration | <input type="checkbox"/> Electrical Engr. | <input type="checkbox"/> Radio |
| <input type="checkbox"/> Architecture and Building | <input type="checkbox"/> Electricity-Pract. | <input type="checkbox"/> High School |
| <input type="checkbox"/> Contracting | <input type="checkbox"/> Electronics, Industrial | <input type="checkbox"/> Air Conditioning |
| <input type="checkbox"/> Practical Plumbing | <input type="checkbox"/> Bookkeeping | <input type="checkbox"/> Mechanical Eng. |
| <input type="checkbox"/> Automotive Engr. | <input type="checkbox"/> Private Secretary | <input type="checkbox"/> Shop Management |
| <input type="checkbox"/> Aviation Drafting | <input type="checkbox"/> Diesel Engineering | <input type="checkbox"/> Tool Making |
| <input type="checkbox"/> Aviation | <input type="checkbox"/> Sheet Metal Pattern Drafting | <input type="checkbox"/> Better Foremanship |
| <input type="checkbox"/> Business Management | <input type="checkbox"/> Railway Training | <input type="checkbox"/> Machine Shop Operations |

Name _____ Occupation _____
Address _____ Age _____
City _____ State _____

AMERICAN SCHOOL

Dept. GB45, Drexel at 58th Street, Chicago 37

SHORTHAND in 6 Weeks at Home

Famous Speedwriting system. No signs; no symbols; no machines; uses ABC's. Easy to learn; easy to write and transaction. Fast preparation for a job. Surprisingly low cost. 100,000 taught by mail. Used in leading offices and Civil Service. Write for free booklet.
SPEEDWRITING, Dept. 1507-8, 55 W. 42 St., New York 18

YOU CAN BE AN ELECTROPLATER



Be your own boss or work for big pay. Make money while you learn at home in spare time. Interesting, uncrowded field. Plate with chrome, nickel, silver, gold, etc. Money making trade secrets furnished. Send postcard for FREE idea booklet today!
HYDE SCHOOL OF ELECTROPLATING
432 F Street, Room 520, San Diego 1, California



NEW BALL BEARING LIVE CENTER

Designed for maximum strength and rigidity, the Ball Bearing Live Center is recommended for high speeds, heavy roughing cuts, etc. 60 degree point runs in substantial precision ball bearing which is easily replaceable.



Center with No. 2 taper shank . . . \$11.50
With No. 3 shank . . . 13.50

SOUTH BEND LATHE WORKS 455A E. Madison St. South Bend 22, Ind.

DRAW for MONEY... Be an ARTIST!

Trained Artists are Capable of Earning \$60, \$75 and MORE a WEEK!

YOU CAN learn to draw at home in your spare time the well-known WSA way. COMMERCIAL ART, DESIGNING, CARTOONING all in ONE complete course. No previous Art experience necessary—we teach you step-by-step. Prepare for a fascinating hobby or profitable career. For 34 years WSA graduates have been making good—WHY NOT YOU?



VETERANS! WSA Approved for Training Under G. I. Bill. Write for FREE BOOK, "Art for Pleasure and Profit," fully describes course, method of instruction and commercial opportunities for you. TWO ART OUTFITS included with training.

MAIL COUPON TODAY FOR DETAILS.

Washington School of Art, Studio 127M
1115—15th St., N.W., Washington 5, D. C.
Please send me full information and your Free Book, "Art for Pleasure and Profit."

Name _____ AGE _____

Street _____

City _____ Zone _____ State _____

I am entitled to training under "G.I." Bill



AUDELS Carpenters and Builders Guides 4 vols. \$6

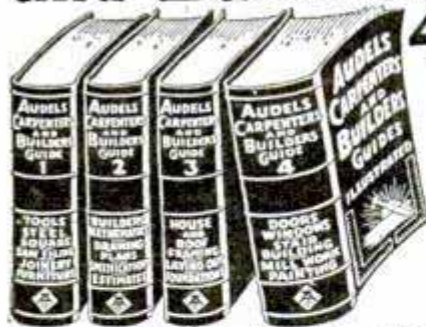

Inside Trade Information for Carpenters, Builders, Joiners, Building Mechanics and all Woodworkers. These Guides give you the short-cut instructions that you want—including new methods, ideas, solutions, plans, systems and money saving suggestions. An easy progressive course for the apprentice and student. A practical daily helper and Quick Reference for the master worker. Carpenters everywhere are using these Guides as a Helping Hand to Easier Work, Better Work and Better Pay. To get this assistance for yourself, simply fill in and mail the **FREE COUPON** below.

Inside Trade Information On:

How to use the steel square—How to file and set saws—How to build furniture—How to use a mitre box—How to use the chalk line—How to use rules and scales—How to make joints—Carpenters arithmetic—Solving mensuration problems—Estimating strength of timbers—How to set girders and sills—How to frame houses and roofs—How to estimate costs—How to build houses, barns, garages, bungalows, etc.—How to read and draw plans—Drawing up specifications—How to excavate—How to use settings 12, 13 and 17 on the steel square—How to build hoists and scaffolds—skylights—How to build stairs—How to put on interior trim—How to hang doors—How to lath-lay floors—How to paint



AUDEL, Publishers, 49 W. 23rd St., New York 10, N. Y.

Mail Audels Carpenters and Builders Guides, 4 vols., on 7 days free trial. If OK I will remit \$1 in 7 days and \$1 monthly until \$6 is paid. Otherwise I will return them. No obligation unless I am satisfied.

Name _____
 Address _____
 Occupation _____
 Employed by _____ PM



AUTO BOOKS ON APPROVAL



SEND NO MONEY. Just mail the coupon for a complete set of 4 Big, Thick Auto Books. 20th Edition. Over 2700 Pages! Whether you are a mechanic or helper, expert or apprentice, auto owner or driver, take immediate advantage of this **FREE EXAMINATION OFFER.**

MAKE GOOD MONEY NOW HOLD A PERMANENT JOB

America wants its automobiles kept in good repair. Men with "know how" are in demand, at big pay. These books will help you get and hold an important job, or give you a chance to go into business for yourself now or later. Any man who half tries to improve himself can learn auto servicing and repairing by this quick reference method. Use the **JIFFY INDEX** to find easily understood answer to any auto problem. These wonder books prepared by eleven of America's great automobile engineers. Many hundreds of valuable illustrations. Send the coupon **TODAY.**

A year's consulting privileges with our engineers now given with these books without extra charge.

Vocational Publishers Since 1898

AMERICAN TECHNICAL SOCIETY, Dept. AB19
 Drexel Ave. at 58th St., Chicago 37, Ill.

I would like to examine your 4-Volume Set of Auto Books. I will pay the delivery charges only, but if I choose I may return them express collect. If after 10 days' use I prefer to keep them, I will send you \$2 and pay the balance at the rate of only \$3 a month until \$24.80 has been paid. Include consulting service as offered above.

Name _____
 Address _____
 City _____ State _____
 Please attach letter stating age, occupation, employer's name and address and name and address of at least one business man as reference. Men in service, also please give home address.



Why Pay More?

SEND THIS AD WITH ORDER

EVERY TIRE GUARANTEED
98% NON SKID, ORIGINAL TREAD
TRIPLE INSPECTED DEMONSTRATORS

Positively Not Re-caps!

600-16\$6.42	700-15\$8.42
650-15 7.12	700-16 8.82
650-16 7.42	750-16 9.42
900-16\$ 9.52	900-20	...\$17.52
650-20 9.52	1000-20	... 17.52
700-20 12.52	1100-20	... 17.52
750-20 (8)	.. 12.52	32x6 (8)	... 12.52
750-20 (10)	.. 14.52	32x6 (10)	.. 14.52
825-20 16.52	34x7 (10)	.. 14.52

7.50-20 MILITARY 8 PLY \$17.52

1/2 million tires shipped to satisfied customers. Trial will convince you. Mail Orders Rushed on Receipt of Check or Money Order.

STANDARD

834 N. Broad St., Phila. 30, Pa.

NEW WRITERS NEEDED

New writers needed to re-write ideas in newspapers, magazines and books. Splendid opportunity to "break into" fascinating writing field. May bring you up to \$5.00 per hour spare time. Experience unnecessary. Write today for **FREE** details. **NO OBLIGATION.** Postcard will do.

FREE DETAILS

COMFORT WRITER'S SERVICE

Dept. 11, 200 South 7th St. St. Louis, Mo.

ENGINEERING DEGREE IN 27 MONTHS

INDIANA TECHNICAL COLLEGE

Aeronautical, Chemical, Civil, Electrical, Mechanical, and Radio Engineering (inc. television). Drafting, 1-yr. Gov't approved for G.I.'s. Low rate. Earn board. Large industrial center. Students from 48 states, 18 countries. Demand for graduates. Enter September, December, March, June. Catalog.

578 E. Washington Blvd., Ft. Wayne 2, Ind.

ARTISTS MAKE MONEY

Do you like to draw? Send name, address, age and occupation for **FREE ART TEST**, to find out your ability.

ART INSTRUCTION, Inc.

7138 ART INSTRUCTION BLDG., MINNEAPOLIS 15, MINN.

ACCOUNTING

STUDY AT HOME for C.P.A. and **BIG PAY** Accounting opportunities with 44 year old school. No previous training needed. Texts furnished. **EASY PAYMENTS.** Send for **FREE BOOK.** G. I. Approved.

MacCORMAC EXTENSION SCHOOL

Dept. M 1170 E. 63rd St. Chicago 37, Ill.



RAISE Money Making CHINCHILLAS



Several females and a male start a large herd which will furnish you an income for years. Just a few feet of space are required. No experience needed. We furnish all instructions. Write world's largest breeder today for free details.

WILLOW BROOK FARM, R15A, Sellersville, Pa.

Save Money-Make Money with LARSON Leathercraft

For gifts or for sale—make easy-to-assemble leather items. Complete stock leathers, tools, accessories. Send ten cents for new catalog of 101 money-making ideas.

J. C. LARSON CO. 824 S. Tripp Ave. Chicago 24, Illinois

DE FOREST'S TRAINING, INC.

CHICAGO
ILLINOIS

AFFILIATED WITH DE VRY MOTION PICTURE COMPANY, CHICAGO



Step Out in Front in RADIO-ELECTRONICS ...LET US SHOW YOU HOW!

TELEVISION

TELEVISION . . . offers exciting opportunities in a growing number of areas for men with the proper training and background. D.T.I. is helping many of its graduates get started in this fascinating field. Write for full details now.

No previous radio or electrical experience is necessary.

YOU CAN BUILD 7 DIFFERENT RADIO RECEIVERS

You "Learn-By-Doing" at home from 8 big Kits of radio parts and assemblies (similar to the equipment shown here). You build 7 different radio receiving circuits and dozens of other fascinating projects.

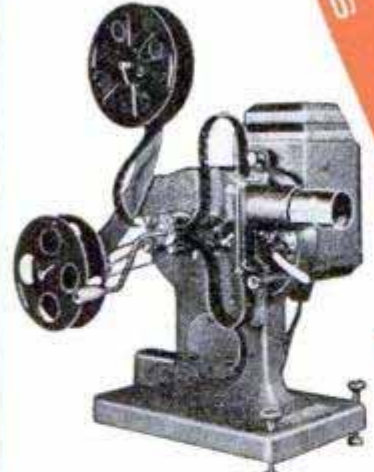

You use "learn-by-seeing" movies. We supply you with a 16mm Motion Picture projector and 12 reels of information-packed film.

DeForest's Training, Inc. includes instruction in motion picture sound equipment, F.M. Radio and Television. In addition to our Home Study courses, RESIDENTIAL TRAINING is available in our new, modern Chicago laboratories. Ask us for information regarding same.



DeForest's Training, Inc.
2533 N. Ashland Ave., Dept. PM-E7
Chicago 14, Illinois

Send me complete details showing how I may make my start in Radio-Electronics-Television. No obligation.

Name _____ Age _____
Address _____ Apt. _____
City _____ Zone _____ State _____

If under 16, check here for special information. If a discharged veteran of World War II, check here.

EMPLOYMENT SERVICE

Our effective Employment Service goes to work immediately upon the completion of your course to help you get started.

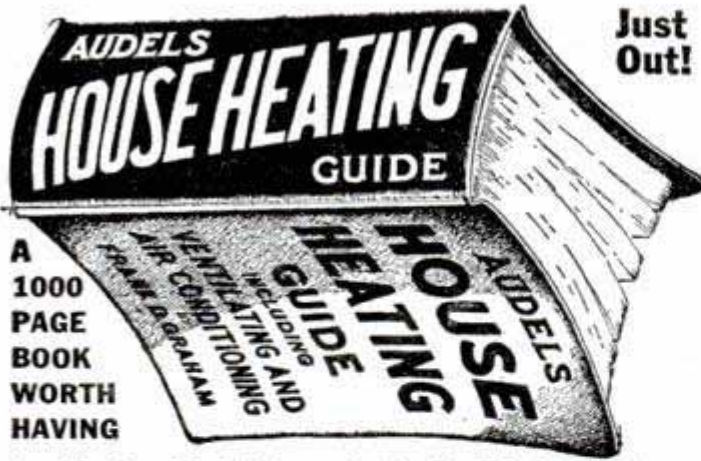

Just Out!

A 1000 PAGE BOOK WORTH HAVING

For Heating, Ventilating and Air Conditioning Engineers, Plumbers, Maintenance Men, Contractors, Building Superintendents and Mechanics seeking practical, authentic information on Heating, Ventilating, Air Conditioning, 1000 Pages—910 Illustrations—57 Chapters explaining the working principles of all Modern House Heating, Ventilation and Air Conditioning systems. Fully illustrated and indexed. This up to date book of reference gives answers to 1001 questions on Heating, Ventilating, Air Conditioning & Radiant Heating.

\$4 COMPLETE • PAY ONLY \$1 A MONTH

To get this assistance for yourself, fill in and

MAIL ORDER

AUDEL, Publishers, 49 W. 23rd St., New York 10, N. Y. MAIL AUDELS HOUSE HEATING GUIDE for free examination. If O. K. I will send you \$1 in 7 days; then remit \$1 monthly until price of \$4 is paid. —Otherwise, I will return it.

Name _____
 Address _____
 Occupation _____
 Employed by _____ PM

Now for EVERY WORK SHOP!
NEW Invention Electroplates by BRUSH



Easy to Plate CHROMIUM GOLD, SILVER, NICKEL, COPPER . . . For Pleasure and Profit!

If you have a workshop—at home or in business—you need this new Warner Electroplater. At the stroke of an electrified brush, you can electroplate models and projects—you can replate worn articles, faucets, tools, fixtures, silverware, etc. with a durable, sparkling coat of metal . . . Gold, Silver, Chromium, Nickel, Copper or Cadmium. Method is easy, simple, quick. Everything furnished—equipment complete, ready for use. *By doing a bit of work for others, your machine can pay for itself within a week.* So make your shop complete by getting a Warner Electroplater right away. Send today for FREE SAMPLE and illustrated literature. ACT AT ONCE! Mail Coupon. WARNER ELECTRIC CO., DEPT. T-7 1512 Jarvis Avenue, Chicago 26, Ill.

FREE Details & Sample!

WARNER ELECTRIC CO., 1512 Jarvis Avenue, Chicago 26, Dept. T-7

Gentlemen! Send Free Sample and Details to:

Name _____
 Address _____
 City _____ State _____

AMERICAN JIU JITSU TRICKS ★ COMMANDO FIGHTING ★

Learn American Jiu Jitsu. Be a winner in clean or dirty fighting where it means do or die. Fear no man, club, knife or gun. A complete course by the world's most famous Jiu Jitsu instructor. He has personally taught many in the U. S. Army, Navy, Marine, National Guard, Coast Guard, R.O.T.C., Customs, Immigration Border Patrol, peace officers, civilians, men and women throughout the United States and Canada.



36 SECRET KNOCK OUT BLOWS and DEATH BLOWS 25c ABOVE the WAIST WITHOUT the USE OF FISTS

Just a jab with tip of fingers or strike with edge of hand and numerous nerve pressure points. 62 photographic illustrations.
 Book No. 2. A course on a series of Come Along Holds that will enable you to subdue and hold any man with ease. With 45 illustrations. 50c
 Book No. 3. A course of shaking down the Gunman, shows how you can approach and search and disarm armed persons so that they can't disarm you, regardless of how much they know of any jiu jitsu methods. 51 illustrations. 50c
 Book No. 4. All the latest in disarming persons with guns, knives or clubs; defense against any kind of foul attack. Also how to do dirty fighting, where it means your life. 108 pages, 151 illustrations. \$1.00 You can have the complete set for only \$2.00 postpaid, or sent C. O. D. plus postage in U.S.A. only. Send the four books on those latest methods of hand-to-hand fighting to a fighting man today.

THE ALLIED ARMED FORCES EMPLOYED MY METHODS
 S. J. JORGENSEN, 1111-87 Virginia St., Seattle, Wash.

RESORT OPERATION AND MANAGEMENT



INCLUDING AUTO COURT and TRAILER PARKS
 A book that deals with Resort Management, solving many of its difficult problems. Directs the way to profitable operation. "Must" guide for beginners and the resort owners "bible." Send \$2.00 postpaid.

WOODBEEK PUBLISHING CO.
 WINCHESTER BLDG. GRAND RAPIDS, MICH.

TRI-STATE COLLEGE

B. S. Degree in 27 months in Civil, Electrical, Mechanical, Chemical, Aeronautical, Radio Engineering; Bus. Admin., Acc't and Sec. Science. Graduates successful 65th year. Enter Sept., Jan., March, June. Catalog. 478 College Ave., Angola, Ind.

Learn BAKING At Home

Baking is one of America's high industries in wages. Nearly depression-proof. Thorough basic home course lays sound foundation. If you have aptitude, write for FREE BOOKLET, "Opportunities in Commercial Baking." National Baking School, 1315 Mich. Ave., Dept. 135B, Chicago 5



LEARN MEAT CUTTING

through actual practice. Profitable Meat Cutting and Successful Meat Merchandising taught easily, quickly. LEARN BY DOING at Toledo in just six short weeks under actual market conditions. For beginners or men with experience. All subjects taught thoroughly and completely. Diploma. Job help. Get store of own. People must eat. School in operation nearly 25 years. Approved for GI training. Send today for FREE literature. No obligation. NATIONAL SCHOOL OF MEAT CUTTING, Dept. 50-C, Toledo 4, Ohio

THOUSANDS OF SUFFERERS USE

BREATHEASY

FOR

ASTHMA

CARRY IT WITH YOU
 USE IT ANYWHERE

Sold on Money-Back Guarantee

Write To Dept. PM
 BREATHEASY DISTRIBUTORS, INC
 65 CEDAR STREET
 SEATTLE 1 WASHINGTON



1 FIRST! You get vital basic knowledge at home—during spare hours. Train as fast or as leisurely as you like.



2 THEN! You come to ITI's giant shops in Chicago—for a **Full Four Weeks** of practical instruction and actual work on newest, most modern equipment.



REFRIGERATION—Trained men needed to handle service and repair jobs.



AIR CONDITIONING—Plenty of opportunity in this great industry for trained men.

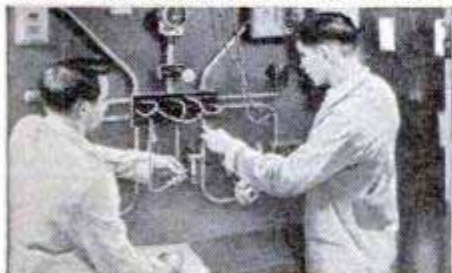

HEATING—ITI trains you in this big pay field to handle essential service work.

Prepare **NOW**—Start Training in Spare Time for a **BETTER JOB** in

REFRIGERATION AIR CONDITIONING

Good Practical Training Pays Rich Rewards in **BIGGER PAY** and Steady Advancement

AMERICA'S FOREMOST SCHOOL of PRACTICAL TRAINING
preparing ambitious men for greater opportunities since 1916

••• Now is the time to lay your plans for a better job at better pay! Get the facts about your future in the amazingly **FAST GROWING** field of Refrigeration, Air Conditioning and Heating! Men who know how to install, repair, rebuild and maintain this equipment are going ahead **FAST!** But many more fine jobs are open **NOW** in this rapidly expanding industry in both the home and commercial equipment fields. Experts say the opportunities are almost unlimited... **BUT ONLY THE PROPERLY TRAINED MEN CAN QUALIFY!**

Train at Home and in ITI's Huge Shops

Investigate the Industrial Training Institute's 2-Way Course in Refrigeration, Air Conditioning **AND** Heating. In a few months this training gives you solid, practical, down-to-earth knowledge and experience you need. You don't have to leave home or give up your present job. Then you come to the huge ITI shops in Chicago for **FOUR FULL WEEKS** of action-packed practical experience!

Interesting, Practical Course

You don't need any special schooling or experience to master the ITI course. Just a desire to learn and advance. Useless theory and dull mathematics have been reduced to a minimum. ITI lesson Work Sheets are easy to read, interesting and 100% practical. The ITI trained man is ready to handle any practical job in the industry. **And ITI helps you find your job!**

TRAINING MEN FOR INDUSTRY SINCE 1916!

ITI Training is backed by more than 30 years of success and experience. We have given training to over 400,000 men since 1916. Today thousands of ITI graduates hold down top paying jobs. ITI occupies five large buildings, with over \$500,000.00 invested in shops and training facilities. Instruction staff of more than 150 men. ITI is recognized as the world's foremost school of practical training!

Mail Coupon for FREE Facts!

Find out about ITI Training. See for yourself how easy and simple it is to start at home, in your spare time, and prepare yourself for a fine job with a real future. It's all in ITI's fascinating, illustrated **FREE** book, "Your Future in Refrigeration & Air Conditioning." Just fill out and mail the coupon below **NOW!** Take this first step toward success **TODAY!**

VETERANS:

ITI Residence Training is fully approved under the G. I. Bill.

ITI also trains ambitious men for good pay jobs in . . .

- Electricity & Industrial Electronics
- Machine Drafting & Design
- Precision Instruments

MAIL COUPON TODAY FOR

FREE BOOK!

Mr. C. H. Smith, President,
INDUSTRIAL TRAINING INSTITUTE
2150 Lawrence Ave.,
Dept. G-1, Chicago 25, Ill.

Please send me **FREE** the ITI book, "Your Future in Refrigeration and Air Conditioning" and information about the opportunities for trained men in this fast growing field. I understand I'm under no obligation.

NAME _____ AGE _____

ADDRESS _____

CITY _____ ZONE _____ STATE _____

ARE YOU A VETERAN? _____



INDUSTRIAL TRAINING INSTITUTE
Formerly the L. L. Cooke School of Electricity & Refrigeration & Air Conditioning Institute
Dept. G-1, 2150 LAWRENCE AVE., CHICAGO 25, ILL.

FOR YOU!

UNUSUAL OPPORTUNITY TO BE AN ACCOUNTANT



More and more opportunities. NOW in Accountancy "The Profession That Pays"—and pays unusually well to the man or woman who knows.

Executive Accountants and C.P.A.'s earn \$3,000 to \$10,000 per year. New conditions steadily increase demand. Preliminary knowledge of bookkeeping unnecessary. You can train thoroughly at home in spare time for C.P.A. examinations or executive accounting positions. Personal training under supervision of staff of C.P.A.'s, including members of American Institute of Accountants. Our free book on Accountancy fully explains how we train you from the ground up, or start with what you already know—according to your individual needs. Low cost; easy terms.

Get all the facts NOW. Our Book, "Accountancy, the Profession That Pays" is FREE. Write for it now.

LASALLE EXTENSION UNIVERSITY
A Correspondence Institution
417 S. Dearborn St., Dept. 764-H, Chicago 5, Ill.



MADE \$14 PER DAY While Still Learning

"By the time I finished half your course, I was making \$14.00 per day. I have made enough on the side to more than pay for the course—"

T.E.H.—West Virginia

LEARN ELECTRIC APPLIANCE

We Teach How to Repair
Washing Machines
Vacuum Cleaners
Electric Ranges
Lamps
Motors
Irons, etc.
Refrigeration and House Wiring
At Home In Your SPARE TIME!

REPAIR & SERVICE

For a man handy with tools, and happiest when working with his hands, OPPORTUNITY is Wide Open Today in this great and growing field. Everyone is a customer for the man trained to service electric appliances.

OPEN YOUR OWN SHOP

Our practical HOME COURSE teaches you this business from A to Z—preparing you to take a well paid job or open your own shop. You can actually start in your basement or garage with the tools I send you . . . before finishing.

I INCLUDE A **BIG KIT** of special appliance tools at **NO EXTRA COST**

MAIL THIS COUPON for FREE BOOK

PACIFIC TRAINING SCHOOL
7217 So. Broadway, Dept. P-87, Los Angeles 3, Calif.

Dear Sirs: Please send me, without obligation, your free booklet and complete details.

Name _____
Address _____ Zone _____
City _____ State _____

Have an OFFICE of YOUR OWN!

LEARN NEW PROFITABLE PROFESSION
At Home in 60 Days, Men & Women, 18 to 70!

Be Your Own Boss and the Boss of Others. Be Respected. Meet Interesting People.

Earnings of men and women in this profession run as high as \$5,000-\$15,000 yearly. Others make good money in spare time. Little money needed to start. A business where your earnings begin sooner. Easy to learn. No selling or goods to buy. No experience necessary. A depression-proof business. A course of action to guide you step by step as you earn. All 53 lessons sent at once to use as operating manuals. Easy terms. Diploma. Money-back agreement. Write for **FREE BULLETIN**.



FRANKLIN CREDIT SCHOOL
Dept. 75-G ROANOKE 7, VIRGINIA

BY MAIL in Easy Lessons

V-8 DUALS & SINGLES



DEALERS WANTED

MUFFLERS STEELS and ALUMINUMS with a motorboat tone

SINGLES, Chev., V-8, Plymouth, Steels \$5.50, Aluminum \$7.00. Chry., Olds., Buicks, etc., Steels \$7.50, Aluminum \$9.00. V-8 and MERCURY DUALS, Steel \$17.50, Aluminum \$21.00. Split Manifold Sets, Steels \$35.00, Aluminum \$45.00. Aluminum are guaranteed for life of your car.

SANDEE MUFFLER CO.
BOX 296 LA TIJ., LOS ANGELES 43, CALIF
2624 W. SLAUSON AVE., LOS ANGELES, CALIF.

The American Institute of Specialized Watch Repair
276-276 East Building GRAND RAPIDS 6, MICHIGAN

A Fully Accredited School

You can learn this highly fascinating and profitable trade through this Institute, either at home by correspondence . . . or at the excellent school.

Earn While You Learn

Write for Free Circular



Learn WATCH REPAIRING

DO YOU LOVE HORSES?

ARE YOU INTERESTED IN HORSE TRAINING AND MANAGEMENT?

SUBSCRIBE FOR The "EXPERT HORSEMAN"

2 YEARS \$1.00

FREE BOOK—You will also receive a booklet that tells how you can learn to break colts, gait show horses, train rodeo, stock, and race horses, break bad habits, handle any horse and train circus trick horses.

SEND \$1.00 TODAY



ANIMAL LOVERS ASSOCIATION
Box No. KA111, TARZANA, CALIFORNIA

LAW FREE BOOK



Write today for **FREE 48-page book, "THE LAW TRAINED MAN,"** which shows how to learn law easily in spare time at home through the Blackstone course prepared by 60 well-known law authorities. We furnish all material including 18-volume Modern American Law library. Many successful attorneys among our graduates. LL.B. degree. Moderate cost; easy terms; Money-Back Agreement.

BLACKSTONE COLLEGE OF LAW
225 N. Michigan Ave., Dept. 50-B, Chicago 1, Ill.
A Correspondence Institution Founded in 1890

Say You Saw It in Popular Mechanics

MONEY for MEN ALL FREE

THE PLASTEX Industry needs manufacturers on small scale and for big production of Lamp and Clock Stands, Art Goods and Novelties in Plaston and Marble imitation. Experience unnecessary. 1/2c material makes regular 10c store sellers. Rubber moulds furnished for speed production. Small investment brings good returns. Big chain store orders now being placed. Ambitious men have chance for real prosperity. Our Free booklet will interest and benefit you.

PLASTEX INDUSTRIES, Dept. A
3400 Third Ave. New York 56, N. Y.



Now Any AUTO REPAIR JOB Can Be a "Push-Over" for You!

**IN LESS TIME —
WITH LESS WORK —
AND MORE PROFITS!**

MoToR's new AUTO REPAIR MANUAL shows you how to service and repair ANY part of ANY car! Now you can lick even the toughest jobs when you have this amazing Manual to make your work easier!

Every job on every car built since 1935 is explained as simply as A-B-C. Clear, illustrated instructions lead you step by step. NOW you can tackle ANY job from carburetor to rear end—and do it quick, easy, right, the FIRST time! Just look up make, model, and the job in the quick index of MoToR's AUTO REPAIR MANUAL—and go to it!

ONLY Manual of Its Kind

No wonder this manual is used by the U. S. Army, Navy, trade and technical schools everywhere, and thousands of successful auto servicemen!

To make this great book possible, the engineer-editors of MoToR Magazine condensed all the meat from over 150 official factory manuals for you. They dug out all the information you need; made sure every word is crystal-clear; and put "the whole works" into this one great, handy book!

MoToR's AUTO REPAIR MANUAL is a big book: over 700 large pages, 8½ x 11 inches, bound in sturdy covers. Nearly 200,000



Same FREE 7-Day Offer Applies on MoToR's Truck Repair Manual

For mechanics, truck specialists, service stations, fleet owners. Covers EVERY job on EVERY truck made since 1936! 1400 pictures, 952 pages, 300,000 facts. Used by Armed Forces. Warranted to contain every essential fact you need to know. Strong binding, size 8½x11.

Covers all types Gasoline Engines; Diesels and Hesselmans. Fuel Systems, Governors, Lubrication Systems, Ignition Systems, Starters, Generators, Clutches, Transmissions, Axles, Torque Dividers, Transfer Cases,

Brakes, Steering, etc., etc. Also services buses, farm and industrial tractors, contractor and road building equipment, stationary power machinery, etc. (on all parts described in Manual.)

Offered on same FREE 7-Day examination as Auto Repair Manual. Check box in coupon at right.



Published by MoToR, The Leading Automotive Business Magazine. MoToR's manuals assure high standards of repair work.

service, repair, adjustment, replacement, tune-up facts on every car built from 1935 to 1948!

Over 1700 Pictures!

More than 1700 cutaway photos, diagrams, drawings, charts, SHOW you what the clear text TELLS you! No wonder thousands of men call this amazing book their Auto Repair "Bible"! No wonder it will save YOU countless hours of work—and help you make MORE MONEY from auto repairs!

See for yourself—without cost!—what a work-saver, time-saver, and "life-saver" MoToR's AUTO REPAIR MANUAL will be for you! TRY it FREE—for 7 days. Learn first-hand how it can pay for itself the first few times you use it!



Just mail coupon below—without money! When the postman brings your book, examine it thoroughly. Make it show you what it's got! Unless you agree this is the greatest time-saver and work-saver you've ever seen—return book in 7 days and pay nothing. Mail coupon today! Address: MoToR Book Department, Desk 1H, 572 Madison Ave., New York 22, New York.



Clear, Pictured Facts on Every Job on Every Car Built Since 1935!

Nearly 200,000 service and repair facts on all these makes:

American	Crosley	Lafayette	Pierce
Bantam	De Soto	La Salle	Arrow
Auburn	Dodge	Lincoln	Plymouth
Austin	Ford	Lincoln	Pontiac
Buick	Frazer	Zephyr	Reo
Cadillac	Graham	Mercury	Studebaker
Chevrolet	Hudson	Nash	Terraplane
Chrysler	Hupmobile	Oldsmobile	Willys
Cord	Kaiser	Packard	

Over 700 big pages; including 70 pages of carburetor text, charts, illustrations covering all models. Over 200 charts, tables; Tune-up Chart; Valve Measurements; Torque Wrench Reading; Starting Motor; Engine Clearances; Generator; Body Service; Dash Gauges; Brake Specifications; Front End Measurements, etc.; Engines; Electric, Fuel, Cooling, Lubricating Systems; Transmissions; Universals; Front Ends; Wheels; Rear Ends, etc.

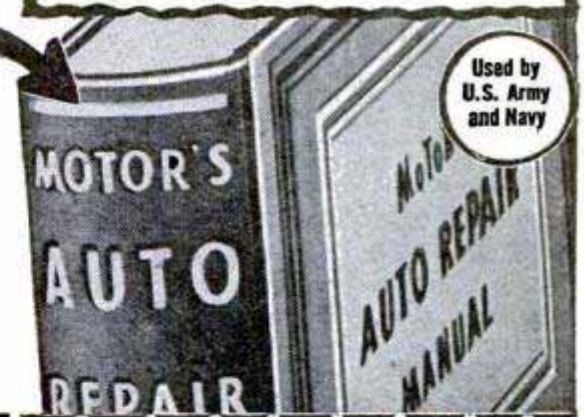

Used by
U.S. Army
and Navy

MoToR Book Dept., Desk 1H, 572 Madison Ave., N. Y. 22
Rush to me at once: (Check box opposite book you want)

- MoToR's AUTO REPAIR MANUAL. If O.K. I will remit \$1 in 7 days, plus 35c delivery charges; \$2 monthly for 2 months and a final payment of 95c a month later. Otherwise I will return book postpaid in 7 days. (Foreign price, remit \$8 cash with order.)
- MoToR's TRUCK REPAIR MANUAL. (Described at left.) If O.K. I will remit \$2 in 7 days, and \$2 monthly for 3 months, plus 35c delivery charge with final payment. Otherwise I will return book postpaid in 7 days. (Foreign price, remit \$10 cash with order.)

Print Name _____ Age _____

Print Address _____

City _____ Zone No. _____
(if any)

State _____ Occupation _____

Check box and SAVE 35c delivery charge by enclosing WITH COUPON entire payment of \$5.95 for Auto Repair Manual (or \$8.00 for Truck Repair Manual). Same 7-day return-refund privilege applies.

Less than **50¢** A week buys as much as **\$1746** of Old Line Legal Reserve **LIFE INSURANCE**

YOU ACTUALLY PAY only *\$2.00 a month at all ages for the amounts shown below.

*THIS IS HALF THE PERMANENT RATE WHICH TAKES EFFECT THE 6TH YEAR.

AT AGE	FOR MONTHLY PREMIUM OF	YOU GET A POLICY FOR
20	\$2.00	\$1746.
25	2.00	1582.
30	2.00	1408.
35	2.00	1250.
40	2.00	1086.

Proportionate amounts at all other ages, 15-55. Mail coupon now for full facts and amounts at your age.

Here is a unique plan that lets you budget your Life Insurance like rent. The rate is the same no matter what your age! The amounts vary but, even at 40 you can get \$1086 of this Solid, Old Line, Legal Reserve Life Insurance protection! And not only that—but your policy will be

FULLY PAID-UP IN 30 YEARS

with no more premiums to pay, yet your

insurance continues in force the rest of your life.

POSTAL LIFE operating under the rigid New York State Insurance laws has sold Life Insurance by mail and over the counter for 43 years and has satisfied policyholders everywhere. Over \$14,000,000 in assets! More than \$60,000,000 paid out in benefits!

Postal Policies are participating! Mail Coupon today!

Get the FACTS by mail!

Postal Life Insurance Company
511 Fifth Avenue, Dept. D—812
New York 17, N. Y.

Mail me complete information about your new "\$2.00-per-month", 30-payment Modified 5 Whole Life Policy at my age.

NAME
OCCUPATION
DATE OF BIRTH
ADDRESS

Include Postal Zone, if any.

SAY YOU SAW IT IN POPULAR MECHANICS

Free.. TO YOU WHO WANT SUCCESS IN AVIATION
BEAUTIFUL 28-PAGE BOOKLET -- WRITE DEPT. 69A



Embry Riddle
International
SCHOOL OF AVIATION
MIAMI 30, FLORIDA

Be A MASTER PLUMBER
Earn \$15 To \$50 A Day

DON'T ENVY THE PLUMBER — BE ONE

Every skilled workman will tell you that Plumbers have the best of it. WINTER and SUMMER the Plumber is busy at top wages. No skilled Plumber is ever out of a job—compare his opportunities with any trade, plus the opportunities of having your own shop.

We teach you Plumbing with TOOLS (not books) under Licensed Master PLUMBERS in one of the finest equipped schools in America. We make you a Plumber, every branch is taught thoroughly—Lead Work—Blueprint for plan reading—all other tricks.

LEARN IN 30 WEEKS WITHOUT PREVIOUS EXPERIENCE

If you like to work with tools you owe it to yourself to investigate. No need to ever work as an apprentice. Get free bulletin. Write now! G.I. APPROVED. Our 24th year.

UNIVERSAL PLUMBING SCHOOL

815 HOLMES STREET

KANSAS CITY, MO.



Learn to Write

You can become a good Business Writer, and you can learn Shaded Writing also at home during spare time by my Simplified Method, without



cost of going away to school. Easy Lessons. Diploma. Write for my FREE BOOK, "How to Become an Expert Penman," which shows what others have learned. Send 10c for Special Penpoint and your name with a flourished bird written on a card. Write TODAY.

T. M. TEVIS, BOX 25K, CHILLICOTHE, MO.

LEARN WATCH REPAIRING



AT HOME. By our modern and original system of instruction you can learn every part of the **WATCH REPAIRING TRADE AT HOME.** Prepare yourself for a well-paying position or start in business after completing our course of instruction. Good watch repairers are in demand and generally earn very good salaries. For particulars apply to the Wisconsin School of Watch Repairing 759 North Milwaukee St., Milwaukee 2, Wis.



BAR BELLS

Buy Direct From Factory **\$8⁹⁵**
Save 20% to 30% **up**

Write for Free Booklet and Price List

INDEPENDENT IRON WORKS
2440 EAST 23RD STREET, DEPT. B
LOS ANGELES, CALIFORNIA

NEW! LOW COST! RESPIRATOR

Wear when sanding, grinding, paint spraying, sweeping, dusting, furnace cleaning, etc. Handy as a pair of glasses. Just keep mouth closed and breathe through nose is all you do to operate. Protects against nuisance dusts, lint, coal, cement, grain dust, hay fever pollen. Has 9 sq. in. filter. For EYE protection against paint spray, dusts, gases, fumes, smoke, order our Fog-Proof Rubber GOGGLES \$2.00 p.p.



Order Today **\$1⁰⁰** POST PAID

JERRY BRYANT, Dept. PM
919 N. Michigan Ave. Chicago 11, Ill.

POPULAR MECHANICS



Learn BUILDING

AT HOME • All Blue Print Building Plans, Specifications, Lessons Furnished

FIND OUT ABOUT TRAINING AND OPPORTUNITIES FOR YOU IN BUILDING

Established in 1904, Chicago Technical College offers you thorough, practical training in Building, by home-study. Mail coupon for free information. See what this Course has done for others, what it can do for you. Read what Chicago Tech graduates say about their work, earnings, success. Learn the rewards awaiting you as a trained builder — and how quickly, easily you can get started. Simply MAIL COUPON TODAY in an envelope or paste on a penny postcard.



CHICAGO TECHNICAL COLLEGE
H-152, Tech Building, 2000 South Michigan Ave.
Chicago 16, Illinois

MAIL COUPON NOW

CHICAGO TECHNICAL COLLEGE
H-152, Tech Bldg., 2000 So. Michigan Ave.
Chicago 16, Illinois

Mail me FREE building Lesson with information about big opportunities in BUILDING and how I can train at home.

Name _____ Age _____

Address _____

City _____ Zone _____ State _____



REFRIGERATION



ELECTRONICS



WELDING

SPECIALIZE In 6 Months to 3 Years COURSES

SERVICE

6 to 12 Months

- Electricity
- Welding
- Refrigeration
- Heating

TECHNICIAN

1 to 2 Years

- Electricity
- Radio
- Electronics
- Refrigeration, Heat-Cond.
- ing. and Air tioning

PROFESSIONAL

3 Years

- Electrical Engineering
- Bachelor of Science Degree
- Major in Machinery or Electronics

PRACTICAL TECHNICAL TRAINING

Train for a substantial career in industry . . . or a business of your own. Our time-tested Concentric System enables you to build your career step by step. Each 6-month course is complete in itself, yet prepares you for advanced courses. Stay as long as circumstances permit, until you reach the top step in your technical training. More than 1,538 students now enrolled from 48 states and 13 overseas countries. Faculty of 72 specialists. World-wide alumni counselor committee. Terms start January, April, July and September. SEND COUPON TODAY!

MILWAUKEE SCHOOL OF ENGINEERING

"A Technical Institute — Founded 1903"

Milwaukee School of Engineering
Dept. PM-748, N. Broadway and E. State, Milwaukee, Wis.
Without obligation send me free booklet "Career Building" and more details on course

In _____

Name _____ Age _____

Address _____

City _____ State _____

Learn this Profitable Profession



IN 90 DAYS AT HOME

Money-Making Career Open to Men and Women, 18 to 50

Hundreds of men and women between 18 and 50 make \$10 to \$20 in a single day giving scientific Swedish Massage and Hydro-Therapy treatments. There is big demand from doctors, hospitals, sanatoriums and clubs. Graduates earn large full time incomes from these or in private practice in their own offices. Others make good money from home treatments given in spare time. Learn this interesting, money-making profession in your own home, through our home study course. Same instructors as in our nationally known resident school. You can win independence and prepare for future security by qualifying for your Diploma. Course can be completed in 3 to 4 months. Many earn while they learn. Begin your training at once.



Anatomy Charts & Booklet FREE

Enroll now and we will include, at no extra cost, many needed supplies. Fit yourself to help meet growing demand for Scientific Swedish Massage. Send the coupon at once for complete details. Anatomy Charts and 32-Page Illustrated Booklet, FREE, postpaid.

THE COLLEGE OF SWEDISH MASSAGE

Dept. 864-H, 100 East Ohio St., Chicago 11, Illinois

Please send me FREE and postpaid, Anatomy Charts, 32-page Booklet and complete details on Home Training.

Name _____

Address _____

City _____ State _____

JUST OUT! NEW FROM COVER TO COVER

AUDELS REFRIGERATION and AIR CONDITIONING GUIDE



4 Books in One! Covering:

- 1—Household Refrigeration
 - 2—Special Refrigeration Units
 - 3—Commercial & Industrial Refrigeration
 - 4—Air Conditioning Systems
- A gold mine of essential important facts for ENGINEERS, SERVICEMEN & USERS.

A Good Book is a Good Friend! Here you have at your fingers' ends a Complete Library in ONE VOLUME, the necessary data you have been looking for on: MODERN UNITS, SYSTEMS & MACHINES, REFRIGERANTS, including Freon, Lockers, Water Coolers, Quick Freezing & Air Conditioning Systems. 1280 Pages, 46 chapters all Fully Illustrated & indexed for Ready Reference.

ANSWERS YOUR QUESTIONS

Get This Information for Yourself. Mail Coupon Today. No Obligation Unless Satisfied. ASK TO SEE IT.

4 COMPLETE • PAY ONLY \$1. A MONTH ←

AUDELS, Publishers, 49 W. 23rd St., New York 10, N.Y.

MAIL AUDELS NEW REFRIGERATION GUIDE for free examination. If O. K. I will send you \$1 in 7 days; then remit \$1 monthly until price of \$4 is paid. Otherwise I will return it.

Name _____

Address _____

Occupation _____

Employed by _____ PM

Learn to MOUNT BIRDS



Tan SKINS, make up FURS

Be a Taxidermist. Double your hunting fun. We teach you at Home. Mount Birds, Animals, Fish, Heads, common specimens. Fun and profits. Decorate home and den **MAKE MONEY**. Mount game, tan for others. Big profits in spare time. **WRITE TODAY.**

100 game pictures in FREE BOOK Hunters, get your copy. It's **Now Free.** Send post card. State your AGE.

FREE BOOK

NORTHWESTERN SCHOOL OF TAXIDERMY
Dept. 2507
Omaha, Nebraska

LEARN TO WRITE a Good Hand!

FOR BUSINESS AND SOCIAL SUCCESS!

Easy to improve your handwriting at home quickly with my new instruction books just off the press. Master all the secrets of better penmanship. Simple and easy, fully illustrated, highly endorsed. Begin today. Write for: New Free Book, "How to Become a Good Penman," or check books wanted, \$1.00 each. Business Writing Artistic Writing Card Writing Engraving Alphabets Bird and Design Flourishing Complete Set \$4.50 Enclose 10¢ for your name beautifully written and special pinpoint for shaded writing.

S. A. Ziller, President, **TAMBLYN SCHOOL OF PENMANSHIP**
441 Ridge Bldg. In Business Over 52 Years Kansas City, Mo., U.S.A.

WHY DON'T YOU WRITE?

Writing short stories, articles on business, homemaking, sports, shop crafts, local and club activities, etc., will enable you to earn extra money. In your own home, on your own time, the New York Copy Desk Method teaches you how to write the way newspaper men learn, by writing. Our unique "Writing Aptitude Test" tells whether you possess the fundamental qualities essential to successful writing. You'll enjoy this test. Write for it, without cost or obligation.

Veterans: This course approved for Veterans' Training.

NEWSPAPER INSTITUTE OF AMERICA
SUITE 5598-L, ONE PARK AVENUE, NEW YORK 16, N. Y.

INVENTING

—FOR PROFIT! If you have an inventive turn of mind, write for free 28-page booklet explaining how the Institute of American Inventors is helping inventors pre-test the profit possibilities of proposed devices to fill today's unprecedented demand for useful new inventions.

INSTITUTE OF AMERICAN INVENTORS

Dept. 4, 1926 Eye St., NW, Washington 6, D. C.

STAMMER ?

This new 128-page book, "Stammering, Its Cause and Correction," describes the Bogue Unit Method for scientific correction of stammering and stuttering—successful for 47 years. Benj. N. Bogue, Dept. 4824, Circle Tower, Indianapolis 4, Ind.



FREE BOOK



RAISE HAMSTERS

The new wonder animals from Syria. Often called Toy Bears. Delightful pets. Everyone wants them. Laboratories need thousands. Clean, odorless. Raise anywhere. A profitable and interesting hobby or business. We furnish breeding stock with manual of instructions.

Write today for free illustrated literature.

GULF HAMSTERY, 1536 BASIL, MOBILE, ALA.

RUPTURED?

Get Relief This Proven Way

Why try to worry along with trusses that gouge your flesh—press heavily on hips and spine—enlarge opening—fail to hold rupture? You need the Cluthe. No leg-straps or cutting belts. Automatic adjustable pad holds at real opening—follows every body movement with instant increased support in case of strain. Cannot slip whether at work or play. Light. Waterproof. Can be worn in bath. Send for amazing FREE book, "Advice To Ruptured," and details of liberal truthful 60-day trial offer. Also endorsements from grateful users in your neighborhood. Write: **CLUTHE SONS, Dept. 31, Bloomfield, New Jersey**

THESE 5 TRADES ASSURE YOU HIGH PAY • Future Security

- **PLUMBING** Every phase of plumbing: Pipe-Cutting and Threading, Lead-Wiping, Rough-in Projects on Installations, Completed Installations of entire plumbing systems, Blueprint reading, Estimating.
- **DRAFTING** College-level courses in General Machine and Architectural Drafting, with fundamentals in Drafting Mathematics—all under graduate engineers.
- **SHOE REPAIRING** From simplest repairs on boots and shoes to the finest details of reconditioning and rebuilding, under expert craftsmen.
- **ELECTRICAL** Technical and shop training include Basic Electricity, Residential Wiring, Industrial Wiring, General Testing and Trouble Shooting, and Appliance Repair.
- **AUTOMOTIVE & TRACTOR** Applied training on latest model automobiles and tractors, including engine overhaul, transmission and differentials, carburetion, generator and ignition systems, engine tune up, Hydramatic and Vacumatic Transmissions, and general service.

"There's Always a Demand for the Man who KNOWS!"

CHOOSE ONE OF THESE 5 LEADING TRADES

Get Out of that Rut... Be a Skilled Tradesman! Have a Lifetime Career... Own Your Own Business and Be Secure in Your Old Age.

NOW while Enrollment is still open, send for FREE information.

THE 5 DIVISIONS OF

NATIONAL TRADE SCHOOL

2610 Grand Ave., Kansas City 8, Mo.

- Plumbing Drafting
 Shoe Repairing Electrical
 Automotive & Tractor

NAME _____

ADDRESS _____

CITY _____

STATE _____

VETERAN _____

OCCUPATION _____

Choose One of these 5 Essential Trades

Our complete courses of thorough training prepare you to go right into the field as a Qualified Tradesman at High Pay in only 34 weeks (39 in Shoe Repair). All courses under especially trained instructors with practical experience. 6 Hour Classes 5 Days a Week. Our Employment Department helps you.

VETERANS "Approved for veterans' training by the State Department of Education under Public Law 346."
"Approved for veterans' training by the Veterans' Administration under Law 16."

Send Coupon for Free Information Now

IMAGINE THEIR JOY WHEN THEY FOUND THEY COULD PLAY

this easy-as-ABC way!



LEARNED QUICKLY AT HOME

"I didn't dream I could actually learn to play without a teacher. Now, when I play for people they hardly believe that I learned to play so well in so short a time."
*H.C.S., Calif.



PLAYS AT DANCES

"Your lessons have been most satisfactory. I can play all of the popular songs. I have earned money playing at dances."
*E.N.J., New York.



PLAYS ON RADIO

"I can't keep from telling you that I have a good position playing from K T H S, Hot Springs, Ark., every morning."
*J. S., Okla.

What Instrument Would You Like to Play?

JUST name your instrument and we'll show you how you can learn to play it—quickly, easily, in spare time at home. Never mind if you don't know one note of music from another—don't worry about "special talent." And forget all you've ever heard about music being hard to learn.

The truth of the matter is that *thousands now play who never thought they could!* Yes, men and women everywhere have discovered this amazingly easy way to learn music at home.

Now they are enjoying the thrilling satisfaction of playing the piano, violin, guitar, saxophone or other favorite instruments. Some of them are playing in orchestras and over the radio; others are teaching music, making money in spare or full time. And thousands are having the time of their lives playing for their own enjoyment and the entertainment of their friends.

No tedious study and practice, no tiresome exercises. You learn to play by

Easy as A-B-C



playing—start right in with the melody of a simple tune! It takes only a few minutes a day; the cost is trifling. Does it sound too good to be true? Mail the coupon and get the FREE PROOF!

SEND FOR FREE PROOF

Fascinating illustrated booklet answers all your questions; free Print and Picture Sample shows how method works. If interested, just mail coupon. U. S. School of Music, 77 Brunswick Bldg., New York 10, N. Y. 50th Successful Year.

**Actual pupils' names on request. Pictures by professional models.*

FREE! Print and Picture Sample

U. S. School of Music, 77 Brunswick Bldg., New York 10, N. Y. Please send me Free Booklet and Print and Picture Sample. I would like to play instrument checked below.

- | | | |
|--|--|--|
| <input type="checkbox"/> Piano | <input type="checkbox"/> Saxophone | <input type="checkbox"/> Modern Elementary |
| <input type="checkbox"/> Guitar | <input type="checkbox"/> Trumpet, Cornet | <input type="checkbox"/> Harmony |
| <input type="checkbox"/> Hawaiian Guitar | <input type="checkbox"/> Reed Organ | <input type="checkbox"/> Mandolin |
| <input type="checkbox"/> Violin | <input type="checkbox"/> Tenor Banjo | <input type="checkbox"/> Practical Finger |
| <input type="checkbox"/> Piano Accordion | <input type="checkbox"/> Clarinet | <input type="checkbox"/> Control |

Name _____ Have You Instrument? _____

Address _____

City _____ State _____

Save 2c—Stick Coupon on Penny Postcard

BE A WINNER AT ANYTHING YOU TACKLE WITH **PROGRESSIVE POWER** Now **ALL 5 FAMOUS JOWETT COURSES** in 1 Volume for only **25c**

DARLING, THAT BULLY WON'T PICK ON YOU AGAIN.

JOE YOUR NEW ENERGY AND APPEARANCE SURE DO A GOOD JOB! YOU EARNED YOUR PROMOTION.



Let's Go, Pal! I'll prove I can make YOU an **"ALL-AROUND" HE-MAN**

FAST — OR NO COST! says George F. Jowett World's Greatest Body Builder

Enjoy My "Progressive Power" Strength Secrets! Give Me 10 Easy Minutes a Day — Without Strain! I'll teach you the "Progressive Power Method" through which I rebuilt myself from a physical wreck the doctors condemned to die at 15, to the holder of more strength records than any other living athlete or teacher! "Progressive Power" has proven its ability to build the strongest, handsomest men in the world. And I stand ready to show you on a money back basis—that no matter how flabby or puny you are I can do the same for you right in your own home. Let me prove I can add inches to your arms, broaden your shoulders, give you a man-sized chest, powerful legs and a Rock-like back—in fact, power pack your whole body so quickly it will amaze you! Yes, I'll jam you with power and confidence to master any situation—to win popularity—and to get ahead on the job! Through my proven secrets I bring to life new power in you inside and out, until YOU are fully satisfied you are the man you want to be.

PROVE IT TO YOURSELF IN ONE NIGHT

Send only 25c for my 5 easy-to-follow, picture-packed courses now in 1 complete volume "How to Become a Muscular He-Man." Try it for one night! Experience the thrilling strength that surges through your muscles.

George F. Jowett
Whom experts call "Champion of Champions" World's wrestling and weight lifting champ at 17 and 19, World's Strongest Arms, 4 Times World's Perfect Body — plus other records.

10 DAY TRIAL!
Think of it—all five of these famous courses now in one picture-packed muscle building volume for only 25c. If you don't actually FEEL results within ONE WEEK, send it back and your money will be promptly refunded! Photo Book of Famous Strong Men!

I am making a drive for thousands of new friends fast—REGARDLESS OF COST!

SO GET NOW MY 5 Muscle Building COURSES (Valued at \$5 each)

All in 1 Great Complete Volume Packed With How-To-Do-It Pictures!

Now, this "get-acquainted," extremely low price of only 25c is your chance to build a body you'll be proud of! Follow Jowett's easy method of muscle building NOW!

For Only **25c**



FREE!
Photos that inspire you to might and muscle. Free with order.

FREE GIFT COUPON!

Jowett Institute of Physical Culture Dept. PM-87
230 Fifth Avenue, New York 1, N. Y.

Dear George:—Please send by return mail, prepaid, **FREE** Jowett's Photo Book of Strong Men, along with all 5 Muscle Building Courses. 1. Molding a Mighty Chest. 2. Molding a Mighty Arm. 3. Molding a Mighty Grip. 4. Molding a Mighty Back. 5. Molding Mighty Legs—Now all in One Volume "How to Become a Muscular He-Man." Enclosed find 25c. NO C.O.D.'S.

NAME _____ AGE _____
(Please Print Plainly, Include Zone Number)

ADDRESS _____

YOU CAN PLAY IN ALL JAM SESSIONS!



NEW easy-to-use Chord Dictionary TELLS HOW! With the simple scales you already know, you can lead jam sessions with use of this new amazing book. Play from memory easily the handy chords and harmony combinations needed for modern music. Arrange songs like top-notch band leaders. Send for your book NOW! Only \$3.00 postpaid. Hoffmann-Smith Publishing Co., Dept. A, 228 San Diego Trust and Savings Bldg., San Diego 1; California.

GREAT PROFITS
MAKE YOUR OWN RUBBER MOLDS

X.L. RUBBER MOLDS
will realize you great profits quickly!
WRITE FOR NEW FREE CATALOG

YOU can EASILY learn to cast thousands of perfect plaques, book ends, figurines, ash trays, etc. IT'S EASY, FUN, PROFITABLE!
X.L. Rubber, Pts. \$2.00; Qts. \$3.50; Gallons \$8.00; Models and enough rubber for 3 molds \$1.00—Foreign \$1.50.

SEND FOR FREE FACTS

PLASTIC ARTS STUDIO • Route 2 • Dept. 2 • Muncie, Ind.

BE AN ARTIST

Send for interesting picture book — "BUILDING A FUTURE." Explains the unique position of the professional artist in American life. Gives examples of huge professional income. Tells definitely how YOU can acquire PROFESSIONAL skill — AND PROFESSIONAL INCOME — within one year — in spare time at home. No obligation. Book is free. Write name, address and age on penny postcard and mail TODAY to:

GRANT SCHOOL OF ART
Dept. 108-B, 53 W. Jackson Blvd., Chicago 4, Ill.

PRACTICAL MATHEMATICS LIBRARY

Easy self-instruction in 25 branches by college experts. Helps you qualify for better job. 4 volumes, 1300 pages, 600 illustrations. Sent for free trial. Only \$2.00 down, \$2.00 a month; total \$9.80 plus postage. (Cash price \$9.50, postage free.) 160-page Logarithm book free with order. National Educational Alliance, Inc., Dept. 567, 37 West 47th St., New York 19, N. Y.

THERE'S MONEY IN CARTOONS!

RAYE BURNS will teach you HOW TO CREATE ORIGINAL CARTOONS at home that you may SELL! Course contains 26 lessons and over 600 illustrations. All for Only... **\$2.85**

Send name and address for free details.

RAYE BURNS SCHOOL, Dept. M, Box 3583, CLEVELAND, OHIO

LEARN ACCOUNTING SALESMANSHIP SECRETARIAL WORK

Assure Your Future Now!

Hill's, one of America's outstanding Business Schools, offers you the opportunity to enter one of the three fields acknowledged to hold substantial earnings and a secure future. Our FREE book, "Through Hill's to Success," tells how and where the best positions are found and how you can qualify for them by study at home or in our resident school. We have thousands of successful graduates and maintain nationwide employment service.

FREE WRITE TODAY

USE THIS HANDY COUPON

HILL'S EXTENSION SCHOOL AND BUSINESS UNIVERSITY Dept. PM-7
619 W. Main St., Oklahoma City 2, Okla.

Please send me your Free book, "Through Hill's to Success."

NAME _____
ADDRESS _____
CITY _____ STATE _____

Check here if eligible under G. I. Bill

4 Career Ways to Success

CHOOSE THE ONE THAT FITS YOU BEST

APPROVED FOR TRAINING THE YOUNG MEN OF AMERICA — VETERAN AND NON-VETERAN

WATCHREPAIRING — A CAREER FIELD!



WORK — and plenty of it — Millions of watches and clocks need fixing. An interesting and needed service in the top-pay bracket, or start an independent business of your own. ALL TRAINING TOOLS provided. Special list

of tools becomes student's property upon graduation. A training system unsurpassed anywhere. Free information. Send coupon in envelope or paste on penny postcard.

AMERICAN SCHOOL OF WATCHMAKING,
Dept. PM-78-4, 5145 W. San Fernando Rd., Los Angeles 26, Calif.
Gentlemen: Please send me free booklet and information on your training.

Name (PRINT) _____
Street _____ Age _____
City _____ State _____
Veteran _____ Non-Veteran _____

PLASTICS — MAGIC WORD!

Here at Plastics Institute in Los Angeles, men are learning the secrets of this glamorous industry for which the future seems unlimited. Hundreds of new products are being made of plastics requiring trained men to develop and fabricate them. Plastics Institute is the pioneer and leader in the field of plastics instruction. Its faculty and directors are leaders in the industry.



Write for beautiful four-color catalog today. No obligation. Courses available either residential or *study at home*. Mail coupon in envelope or paste on penny postcard.

PLASTICS INDUSTRIES TECHNICAL INSTITUTE,
Dept. PM-78-4, 1601 S. Western Ave., Los Angeles 6, Calif.

Gentlemen: Please send me free booklet "World of Plastics" and information on your training.

Name (PRINT) _____
Street _____ Age _____
City _____ State _____
Veteran _____ Non-Veteran _____
Residence School _____ Home Study _____

BE AN INSTRUMENT TECHNICIAN

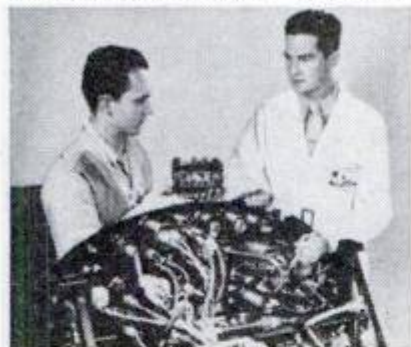

Do you like to take things apart and see what makes them tick? Then be the important man who knows how to install, service and maintain delicate instruments in airplanes and industrial equipment. The instrument field offers many opportunities to trained men.

American School of Aircraft Instruments specializes in this important field, and does a fine job for you in only 34 weeks. Many graduates in industry or have own business. Write today for free booklet. Send coupon in envelope or paste on penny postcard.

AMERICAN SCHOOLS OF AIRCRAFT INSTRUMENTS,
Dept. PM-78-4, 5145 W. San Fernando Rd., Los Angeles 26, Calif.
Gentlemen: Please send me free booklet on your training.

Name (PRINT) _____
Street _____ Age _____
City _____ State _____
Veteran _____ Non-Veteran _____

BE A DIESEL EXPERT the Hemphill Way

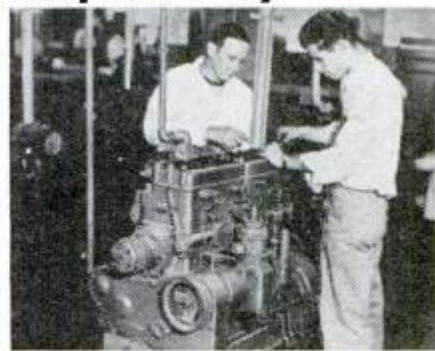

Wherever Diesels are used the name "Hemphill" means TRAINED MEN who know Diesel. Many graduates successfully employed in Diesel industry or have own business. You can get this training *at home* NOW, without interfering with your present activity. Or study in Hemphill shops at New York, Memphis, or Los Angeles. Check preference on coupon below. Prepare yourself for the great swing to Diesel this quick, easy way. Mail coupon for complete information.

HEMPHILL DIESEL & AUTOMOTIVE SCHOOLS,
Dept. PM-78-4, 1601 S. Western Ave., Los Angeles 6, Calif.
Gentlemen: Please send me information on your

Home Study Course _____ Shop training _____ in
New York _____ Memphis _____ Los Angeles _____
Name (PRINT) _____
Street _____ Zone _____
City _____ State _____
Veteran _____ Non-Veteran _____

ALL ARE MEMBERS NATIONAL COUNCIL OF TECHNICAL SCHOOLS

SEND COUPON TODAY

Do you want

- ➔ ..to go to College?
- ➔ ..or to enter a Profession?
- ➔ ..or get an Office Position?

(Such as Accounting, Architecture, Nursing, Dentistry, Teaching, Social Work, Osteopathy, Beauty Culture, Optometry, Embalming, Chiropody, Law, Medicine, etc.)

To get anywhere, you practically **MUST** finish High School **FIRST**. You can complete our simplified High School Course in **SPARE** time at home, as **FAST** as your time and abilities permit. Equivalent to resident school work—prepares you for college, pre-professional examinations, business, industry. Standard texts furnished. Diploma. Credit for H. S. subjects already completed. Single subjects if desired. Low tuition, easy terms. American School, Chicago, est. 1897—endorsed by educators. Finish your high school education **NOW**, Write **TODAY!**

High School Course at Home

Many Finish in 2 Years

American School, Dept. HB45, Drexel Ave. at 58th St., Chicago 37, Ill.

Gentlemen: Send me **FREE** information covering special training in subjects checked below. No obligation on my part.

- | | |
|--|--|
| <input type="checkbox"/> High School Course | <input type="checkbox"/> Diesel Engineering |
| <input type="checkbox"/> Architecture and Building | <input type="checkbox"/> Drafting and Design for Men & Women |
| <input type="checkbox"/> Automotive Engineering | <input type="checkbox"/> Plastics |
| <input type="checkbox"/> Business Management | <input type="checkbox"/> Private Secretary |
| <input type="checkbox"/> Electrical Engineering | <input type="checkbox"/> Mechanical Engineering |
| <input type="checkbox"/> Elec. and Gas Refrigeration | <input type="checkbox"/> Aviation |
| <input type="checkbox"/> Air Conditioning | <input type="checkbox"/> Salesmanship |
| <input type="checkbox"/> Railway Training | <input type="checkbox"/> Radio |
| <input type="checkbox"/> Electronics, Industrial | |

Name.....

Address.....

Learn A Trade NOW! PRACTICAL SHOP TRAINING!

In Our Chicago Shops

- | | |
|---|--|
| <input type="checkbox"/> AUTO MECHANICS | <input type="checkbox"/> WELDING—ARC and GAS |
| <input type="checkbox"/> DIESEL MECHANICS | <input type="checkbox"/> MACHINIST |
| <input type="checkbox"/> REFRIGERATION | <input type="checkbox"/> PIANO TUNING |
| <input type="checkbox"/> BODY-FENDER | |

Above Approved For G. I.'s and Civilians

One of America's Leading Practical Schools
7 Floors of Fully Equipped Shops
Over 48,000 Successful Graduates
Expert Individual Instruction
Learn by Doing—Low Living Expense
Established 1902—Day and Evening Classes

Also the following Home Study Courses

- | | | |
|----------------------------------|--|---------------------------------|
| <input type="checkbox"/> PLASTIC | <input type="checkbox"/> REFRIGERATION | <input type="checkbox"/> DIESEL |
|----------------------------------|--|---------------------------------|

—CALL IN PERSON OR MAIL THIS AD TO— GREER SHOP TRAINING

(Dept. PM-278) 460 South State St., Chicago 5, Ill.

Please send without obligation free information regarding training trade checked above. (Specify whether you are a Veteran or Civilian)

Name..... Age.....

Address.....

City..... State.....

LEARN WATCH MAKING

JEWELRY REPAIR

Engraving

G. I. APPROVED



Prepare **NOW!** Our Master Course covers everything needed for high-salaried positions in Jewelry Field. Latest equipment makes learning a pleasure. High percentage of graduates successfully placed. Housing available. (Schools in Warren, O. and P'gh, Pa.). Catalog **FREE**.

A. W. THACKER ACADEMY FOR JEWELERS
Dept. P • 423 Federal St. • Pittsburgh 12, Penna.

I'LL SHOW YOU HOW TO MAKE MONEY IN WATCH REPAIR

Own your own watch repair business—have a profitable career. No age or physical limits. Estimated 20,000 watchmakers needed to repair 14 million clocks per month which cannot be handled by repairmen now. Learn in cool, mile-high Denver. Nationally-accredited school. Approved for veterans. Learn by *doing*—send postcard for free booklet describing courses. No obligation.



FREE BOOKLET
American Academy Inc. School of Horology
1525 Lawrence St. Denver 2, Colo.

LAW

STUDY AT HOME for Personal Success and **LARGER EARNINGS**. 39 years expert instruction—over 114,000 students enrolled. LL.B. Degree awarded. All text material furnished. Easy payment plan. Send for **FREE BOOK**—"Law and Executive Guidance."

AMERICAN EXTENSION SCHOOL OF LAW
Dept. 91-PM, 646 N. Michigan Ave. Chicago 11, Ill.

BE A REAL ESTATE BROKER PAYS BIG!

EASY TO LEARN—Start and run your own business *quickly*. Many graduates report making up to \$1000 a month. Course of study covers Sales, Property Management, Appraising, Loans, Mortgages and hundreds of related subjects. Course in home study or classroom instruction in leading cities. Big new illustrated catalog from this nationally known school. G. I. Approved. Send a Post Card Today.

WEAVER SCHOOL OF REAL ESTATE (Estab. 1936)
15 E. Pershing Road Dept. PM-1 Kansas City, Mo.



LEARN MOVIE PROJECTION THEATRE MANAGEMENT

The Motion Picture Theatre Business offers big opportunities for trained men. Get into a fascinating field with a promising future. Train at home in spare time. Free Catalog. Established 20 years.

THEATRE SCHOOL, 370 Washington St., Elmira, New York



Thrilling Work COLORING PHOTOS

Fascinating vocation learned at home by those with aptitude. Thrilling pastime. National method brings out life-like colors. Free booklet.

NATIONAL PHOTO COLORING SCHOOL
1315 S. Michigan, Dept. 135B, Chicago 5

SHINE WITHOUT 'POLISH'

New Invention! • Sells Like Wild



Replaces messy pastes, liquids. Simply glide over shoes—and **PRESTO!**—you have a lustrous, long-lasting shine. No mess. No muss. No soiled hands. Clean. Handy. **WORKS LIKE MAGIC!** For Men's, Women's and Children's Shoes. Low priced. Lightning seller!

SAMPLES FOR AGENTS Sample offer sent immediately to all who send name at once. A penny postal will do. **SEND NO MONEY—just your name.** **KRISTEE CO., 685 Bar Street, AKRON, OHIO**



You receive all parts, including tubes, for building this fine, modern Superheterodyne Receiver. This and other valuable standard equipment becomes your property.

Learn RADIO

TELEVISION, ELECTRONICS

by

SHOP METHOD HOME TRAINING

Let NATIONAL SCHOOLS, of Los Angeles, a practical Technical Resident Trade School for almost 50 years, train you for today's unlimited opportunities in Radio

these two **FREE** books will tell you how

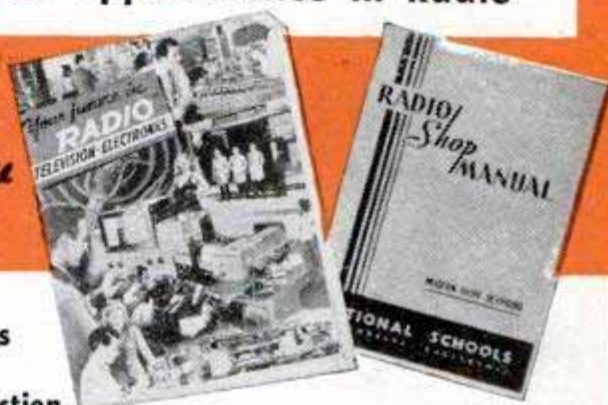

GOOD JOBS AWAIT THE TRAINED RADIO TECHNICIAN

You are needed in the great, modern Radio, Television and Electronics industry! Trained Radio technicians are in constant and growing demand at excellent pay—in Broadcasting, Communications, Television, Radar, Research Laboratories, Home Radio Service, etc. National Schools Master Shop Method Home Study Course, with newly added lessons and equipment, can train you in your spare time, *right in your own home*, for these exciting opportunities. Our method has been proved by the remarkable success of National Schools-trained men all over the world.

You Learn by Building Equipment with Standard Radio Parts We Send You

Your National Schools Course includes not only basic theory, but *practical* training as well—you learn by *doing*. We send you complete standard equipment of professional quality for building various experimental and test units. You advance step by step until you are able to build the modern superheterodyne receiver shown above, which is yours to keep and enjoy. You perform more than 100 experiments—build many types of circuits, signal generator, low power radio transmitter, audio oscillator, and other units. The Free Books shown above tell you more about it—send for them today!

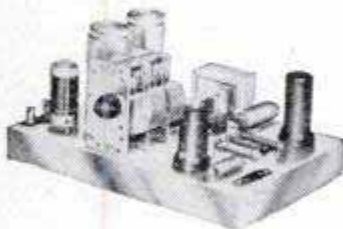

NOW! NEW PROFESSIONAL MULTITESTER INCLUDED

This versatile testing instrument is portable and complete with test leads and batteries. Simple to operate, accurate and dependable. You will be able to quickly locate trouble and adjust the most delicate circuits. You can use the Multitester at home or on service calls. It is designed to measure AC and DC volts, current, resistance and decibels. You will be proud to own and use this valuable professional instrument.



Lessons and Instruction

Material Are Up-to-Date, Practical, Interesting

National Schools Master Shop Method Home Training gives you basic and advanced instruction in all phases of Radio, Television and Electronics. Each lesson is made easy to understand by numerous illustrations and diagrams. All instruction material has been developed and tested in our own shops and laboratories, under the supervision of our own engineers and instructors. A free sample lesson is yours upon request—use the coupon below.

Here's Just a Few of the Interesting Facts you Learn with the

FREE MANUAL

1. Routine for diagnosing Radio Troubles.
2. Preliminary Inspection of Receivers.
3. How to Test and Measure Voltages.
4. How to Test Speaker in Audio Stages.
5. How to Trace the Circuit and Prepare Skeleton Diagram.
6. Complete Reference Table for Quickly Locating Receiver Troubles.

Both Resident and Home Study Courses Offered

APPROVED FOR VETERANS

CHECK COUPON

NATIONAL SCHOOLS

LOS ANGELES 37, CALIFORNIA EST. 1905



MAIL OPPORTUNITY COUPON FOR QUICK ACTION

National Schools, Dept. PM-7
4000 South Figueroa Street
Los Angeles 37, California

(Mail in envelope or paste on penny postcard.)

Mail me **FREE** the books mentioned in your ad including a sample lesson of your course. I understand no salesman will call on me.

NAME _____ AGE _____

ADDRESS _____

ELECTRICIANS

Get this Great Book **FREE**

Book of 150 Shop Prints, Wiring Diagrams, Full Size 8 1/2 x 11"



For Merely Examining Coyne's NEW Pay Raising

8 Volume Set APPLIED ELECTRICITY

Here's a brand new set of electrical books to give you the "know how" on all branches of electricity from appliance repairing to D.C. and A.C. equipment, electrical refrigeration, Industrial Electronics, etc. 3,400 subjects, 11,500 facts, latest methods explained in easy to follow instructions. To prove how valuable and Practical this set can be to you, I'll give you a FREE copy of my book "150 Shop Prints and How to Read Them" just for looking over this set. Written by the Coyne Staff and backed by 47 years' experience, this set has helped many ambitious electrical workers to bigger pay and added opportunity.

OFFER LIMITED • ACT NOW! If you act promptly, I'll send you the 8 volume set Applied Practical Electricity for 7 days FREE examination . . . together with the 150 Shop Print Book. Look the set over 7 days. If you like it send either \$22.75 cash or \$3.00 after 7 days and \$3.00 per month until \$24 is paid. If you don't want the set, return it and YOU OWE NOTHING. In either event you keep the 150 Shop Print Book absolutely FREE.

Coupon below is just a request to see the books free and to get my gift book for doing it. ACT—Send coupon Today!

Technical Book Div. COYNE ELECTRICAL SCHOOL
500 S. Paulina St., Dept. 88-R-6, Chicago 12, Ill.

FREE BOOK
Coupon

SEND NO MONEY



B. W. Cooke, Director COYNE ELECTRICAL & RADIO SCHOOL
500 S. Paulina St., Dept. 88-R-6, Chicago 12, Ill.

O. K. send me, postpaid, Coyne's new 8 volume, "Applied Practical Electricity" for 7 Days FREE TRIAL per your offer. Also send, absolutely FREE, the book of 150 Shop Prints as a gift.

Name _____ Age _____
Address _____
Town _____ Zone _____ State _____

MAKE \$ MORE MONEY

Applying or Selling

CORKSTONE

A General Purpose Magnesium Oxychloride Flooring

THE MODERN PLASTIC FLOORING

EASY TO APPLY
Here's your opportunity to get into business for yourself applying or selling Corkstone, the economical, top-grade plastic flooring. Plenty of profit Act without delay!

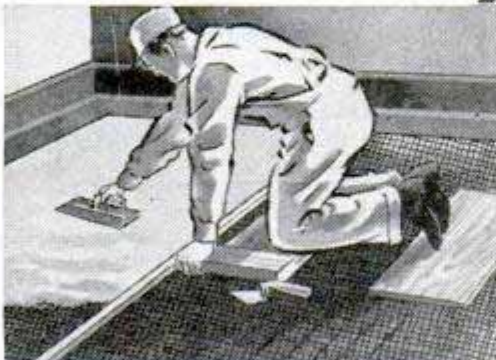

Dealers & Agents Wanted
WRITE FOR DETAILS
LASTING PRODUCTS COMPANY
Franklinton Road Plant, Baltimore 23, Md.

DRAFTING

Plan for a **TOP PAY JOB** · Drafting Outfit Included
SEND FOR FREE LESSON

Here is a modern practical way to learn Drafting right in your own home. You are furnished all the instruments and supplies you need to actually do the assignments, and the entire Drafting Outfit is included at no extra cost. Visual aid instruction helps you learn quickly, easily—you receive projector and slides. Draftsman has Key Job in industry—many executives advanced to present top positions with aid of a knowledge of Drafting. Find out about this up-to-date C.T.I. training program in Drafting. Write today for FREE lesson and full information. No obligation.

COMMERCIAL TRADES INSTITUTE, Dept. J2-7
1400 W. Greenleaf Chicago 26, Ill.

Made to U. S. Army Specifications!

16-JEWEL

ELGIN
\$19⁹⁵



Sturdy 16-Jewel ELGIN men's wrist watches. Water-repellent. Sweep second hand. Stainless Steel back. Unbreakable crystal. **QUALITY! American made.** Fully reconditioned with **ONE YEAR GUARANTEE!** Made for the U. S. Army Air Corps. **They HAD to be good. SEND NO MONEY.** Simply pay postman \$19.95 plus 10% tax and postage on delivery. Cash orders sent postpaid. Limited supply. **UNITED PRODUCTS CO.,** 7941 S. Halsted St., Dept. RES-909, Chicago 20, Ill.



OWN a Business

Clean and Mothproof rugs and upholstery "in the home." Patented equipment. No shop needed. Duraclean dealer's gross profits up to \$20 a day on EACH serviceman. These Nationally Advertised services create repeat customers. Easy to learn. Quickly established. Easy terms. Send today for FREE Booklet — Full details.

DURACLEAN CO., 16-7 Ct., Deerfield, Ill.



TALK-SING thru your own radio with **RADIO MICROPHONE**



Be the life of the party. Put on your own broadcasts at home. Talk-Sing make announcements from any room. Wonderful voice practice. Microphone easily attached to any radio. Follow enclosed instructions. **SEND NO MONEY**—pay postman \$2.25 plus postage. Send Money Order or check and save postage.

EMPIRE RADIO & TELEVISION CO. (Dept. M1) 1521 Bedford Ave. Brooklyn 16, N. Y.

ANIMAL TRAINERS — STUNTMEN — CHILDREN — ACTORS — ACTRESSES — SINGERS — DANCERS

"HOW TO BREAK INTO THE MOVIES"

This book tells inside "dope" . . . pitfalls to avoid . . . way to be discovered . . . how to join the guild, etc. "Anyone planning a career in pictures should read this first." Only \$2.00 postpaid.
TALENT ADVISERS • DEPT P • P. O. BOX 69 • TARZANA, CALIF.

FENDER SKIRTS \$17.20 PER PAIR

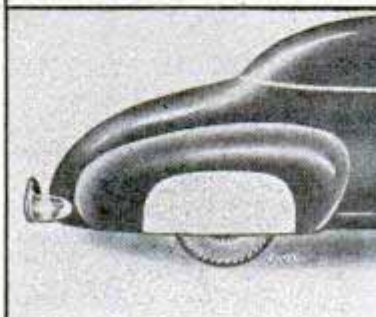

For Ford Chev. Merc. Plym., DeSoto, Chry., Dodge Kaiser-Frazer and Buick. Beautify your car bring out the flowing lines inherently designed there. Sparking beauty you'll like. Constructed of heavy gauge body steel, finished in prime, perfect fit.

SANDEE MUFFLER CO
Box 296, La Tijera Sta.
Los Angeles 43, Calif.
Gentlemen Please send me one set of Sandee Fender Skirts to fit my
..... (year and make of car)
 Check for \$17.20 enclosed
 Ship C.O.D.



GET INTO DRAFTING

The Draftsman Plays a most
Important Part in INDUSTRY

DRAWING OUTFIT INCLUDED with Drafting courses

All the tools you need including folding drawing table. With them you can put your ideas on paper quickly and with accuracy. With training you are all set to master Drafting in months, — not years — at home.

Learn in Spare Time—At Home! (or at the College in Chicago)

A few hours of pleasant home study every week — that's all. With Chicago Tech's help, you train yourself step by step. This tested method — developed over 44 years of C.T.C. progress — prepares men for good positions in industry.



Practically everything that's built or manufactured these days is constructed from blue print drawings prepared by the draftsman. He is the KEY man in industry. No new machines can be built, no bridges erected, no buildings constructed until the draftsman has completed his work.

Drafting is clean, interesting, professional-type work. The draftsman is paid well to start. And he has real opportunities for advancement to high-pay jobs in Engineering. The tremendous production programs ahead in industry will require more draftsmen than ever before.

Send today for free information. See what this training has done for others, what it can do for you. Simply MAIL COUPON TODAY in an envelope or use a penny postcard.

MAIL COUPON NOW

Chicago Technical College
H-211 Tech Bldg., 2000 So. Michigan Ave.
Chicago 16, Illinois

Mail me FREE Drafting Lesson with information about big opportunities in DRAFTING and how I can train at home.

- Architectural Drafting Electrical Drafting
 Machine Drafting Structural Drafting
 Builders' Course

Name _____ Age _____

Address _____

City _____ Zone _____ State _____

**CHICAGO
TECHNICAL COLLEGE**
H-211 Tech Building, 2000 South Michigan Ave.
Chicago 16, Illinois

SHOE REPAIR OFFERS BIG INCOME LEARN IN 12 WEEKS TIME

You can own your own shop or earn big income as skilled shoe repairman. Growing demand everywhere at top wages for men who know how. We teach you quickly by actually working on shoes and modern machines. Costs nothing under G.I. Bill of Rights. School open to all from 18 to 60 years of age. FREE BIG 16 PAGE BOOK explains everything. Send for your copy today.

MODERN SHOE REBUILDING SCHOOL

Established 1927
2937 Belmont Ave., Chicago, Ill. Rush Postcard Today.
4577 Hollywood Blvd., Los Angeles 27, Calif.

INVENTORS

HIGHEST ROYALTIES and CASH

FOR YOUR INVENTIONS
INVENTION MARKETING SERVICE "UNPARALLELED" BY ANY
OTHER AGENCY IN THE WORLD
Write for FREE booklet without obligation

UNIVERSAL MARKETING CO.

126 Lexington Ave. (Suite M) New York 16, N. Y.

CADET DUAL VACUUM HORNS

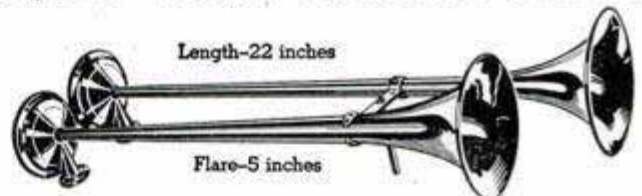

At the Low Price We Can All Afford

Here is your chance to get air horn results—looks, blast and beautiful organ tone—at a fraction of the cost of air horns. Spun brass with gleaming chrome finish or lasting lacquer. Positive operation. Complete unit consists of one pair of beautiful vacuum horns with the mounting brackets, valve, control handle, hose, fittings and installation instructions. Can be mounted on front fender or on top of or under the hood. A must for safety and smart appearance for any car. Chrome finish \$29.50—Lacquer finish \$23.75. Send check or money order and we will pay the postage—*or order C.O.D.*

The Protectured Company Dept. 501
4033 Windsor Road • • • Youngstown 7, Ohio

TRAVEL—for 'UNCLE SAM'

ARE YOU JOB-SATISFIED? GET A U. S. GOVERNMENT JOB Many Positions to Be Filled

Postoffice Clerks—Mail Carriers—Stenographers—Typists.
Statistical Clerks—Storekeeper—Gauger, etc. 40 Page Civil
Service Book—FREE.

MEN — WOMEN Veterans Get Preference

Mail Coupon immediately—today sure.

Although not government controlled, this can be your first step toward a secure Civil Service career.

AS HIGH AS \$3,021
FIRST
YEAR

COUPON

FRANKLIN INST., Dept. D86, Rochester 4, N. Y.

Gentlemen: Rush to me without charge, 40 page book with list of U. S. Government big paid positions. Advise me also regarding salaries, hours, work, vacation, etc. Tell me how to qualify for a position.

Name.....

Address..... Vet?.....

Increasing your hold on your job and giving yourself a chance for advancement

Few men deliberately plan to work persistently on self-improvement. If progress comes naturally, they're happy; if it doesn't, they worry or ignore the situation. Yet it is possible to pay attention to self-improvement with considerable hope of success. A noticeable degree of advancement is practically assured any one who will make an intelligent and persistent effort. Thousands of men have proved this for themselves, with:



The Croft Library of Practical Electricity

The Croft Library is a complete electrical educator. It is founded on practice—on 20 years of shirt-sleeve experience—on work as it is actually done. It is jammed from cover to cover with the kind of hard-headed facts you want. Written so that the beginner can easily understand it, yet so sound, so thorough, that it is the daily guide of 59,000 highly paid electrical workers and engineers. Croft tells you the things you need to know about motors, generators, armatures, commutators, transformers, circuits, switchboards, distribution systems—electrical machinery of every type—wiring for light and power—wiring of finished buildings—underwriters and municipal requirements—illumination in its every phase—the most improved methods of lighting lamps—and lamp effects, etc.—how to do a complete job, from planning it, to completion.

No money down — easy payments

Fill in and mail the coupon attached and we will send you the entire set of seven volumes for ten days' examination on approval. We take all the risk—you assume no obligation. If you decide to keep the books, send \$3.50 in ten days and the balance at the rate of \$4.00 a month. Send the coupon NOW and see the books for yourself.

McGraw-Hill Book Co., 330 W. 42nd St., New York 18, N. Y.
Send me for ten days' examination on approval the Croft Library of Practical Electricity, 7 vols. If satisfactory I will send you \$3.50 in 10 days and \$4.00 monthly until the price of \$19.50 is paid. If not wanted, I will return the books postpaid.

Name _____
Home Address _____
City and State _____
Company _____
Position _____

PM-7-49

VETERANS Learn WATCHMAKING

A Lifetime Career

No Age, nor Physical
Limitations

YOUR OPPORTUNITY
To Lift Yourself from a
Futureless Job



Approved
G. I. Training

LEARN WATCHMAKING

and earn from the start, higher than average pay . . . easy hours . . . ideal working conditions . . . be prepared to establish your own business.

WATCH REPAIRING — JEWELRY — ENGRAVING
Always in Demand

Requests for our Graduates from Everywhere. Permanent positions (no layoffs) \$75.00—\$100 per week for trained men. Write today for latest FREE Catalog.

KANSAS CITY SCHOOL OF WATCHMAKING

America's Most Progressive Horological School

617-621 Wyandotte St. Kansas City 6, Mo.

Plastic Coasters
and Tiles

EMBED REAL FLOWERS in NEW Magic PLASTIC



Makes fine gifts, novelties, things to sell.

Embed real flowers, butterflies, medals, photos. Make book-ends, jewelry, figurines, and hundreds of other useful and decorative objects that are distinctive and different. Castolite is crystal clear, may be dyed for brilliant color effects. Can be sawed, carved, turned, drilled. Pours cold, sets at low temperature. No training, no tools required. **20-PROJECT CASTOLITE KIT \$3.50** postpaid. Contains everything needed to get started at once. Send M.O., check, or order C.O.D. For Castolite manual alone, 25c.

MANUAL
25¢

THE CASTOLITE COMPANY

DEPT. H-1, BOX 391

WOODSTOCK, ILLINOIS

Get into Good Paying AUTO BODY and FENDER WORK



BIG DEMAND in Auto Body and Fender work. Start training now in your spare time at home for good pay work. Practical shop experience included. U. E. I. Training covers metal work, welding, painting, etc. Placement service—or we will show you how to start your own shop.

Behind U. E. I. TRAINING is a large national organization founded 1927. Write today for **FREE FACTS**—No obligation.

Approved
for Training
under G. I. Bill

AUTO-CRAFTS
DIVISION

UTILITIES ENGINEERING INSTITUTE

2523 Sheffield Avenue, Dept. 178-X, Chicago 14, Illinois

Learn about Earning Opportunities in THE BUILDING TRADES

FREE—Important Information Telling How to Get Started. Do you want to be on the inside in the building boom—where big money is made? This is your chance now. HOME TRAINING prepares you for these big opportunities. Course recognized by Building Industry. (Approved for Veterans.) Write today—no obligation.



COMMERCIAL TRADES INSTITUTE, Dept. D2-7
1400 W. Greenleaf Chicago 26, Ill.

LUMBER MEASUREMENT BOOK FOR CARPENTERS, CHECKERS, BUILDERS, ETC.

Teaches lineal, square and board ft. of all size lumber. Flooring, fencing, etc. shown by piece or bundle. Also teaches stock tallies of lumber P.P. \$1.00.

R. C. MORRONE, P. O. BOX 8911, PHILADELPHIA 35, PA.

New Advertising Machine



**PRINTS and
ILLUSTRATES**

1¢ POST CARDS

Send
Coupon

**CARDMASTER CO., 4546 Ravenswood
DEPT. 137, CHICAGO 40, ILL. FREE!**

Send **FREE** Illustrated Book* and complete, unique advertising plans and money making ideas for my business.

* Shows HOW thousands of business men in every line are boosting sales in spite of conditions with 1c messages printed and illustrated in few minutes on gov't post cards—with amazing, new, patented **CARDMASTER**. Your "today's" ideas, read by your prospects next morning. Not a toy, but a sturdy advertising machine built to last years. Sold direct at low price. Guaranteed five years. **SEND NAME TODAY. All FREE!**

NAME _____

ADDRESS _____

CITY _____ ZONE _____ STATE _____

WAR SURPLUS NYLON THREAD



Amazing Strong Thread used to sew Parachutes

NOW AVAILABLE

Hundreds of Uses . . .

This genuine Du Pont Nylon thread is practically unbreakable. What every hobbyist, sportsman, sailor, camper, wants. Used in model making, sail mending, tent repairing, bow and arrow winding, bamboo rod wrapping, kite flying and repairing, and many other uses. Used by Air Force on parachutes because of its amazing strength and dependability. Here is your chance to get a giant spool of 4800 feet—almost a mile of Nylon thread—at the sensational low war surplus close-out price of only \$1.49. Black or white. Order TODAY.

GIANT SPOOL
only
\$1.49
BLACK or WHITE
APPROX 4800 FEET

SEND NO MONEY, TEST AT OUR RISK

Just send your name and address. Specify white or black or two giant spools for only \$2.89. On arrival, deposit only \$1.49 per spool (\$2.89 for two spools) plus C.O.D. postage on our guarantee. If you are not delighted, you can return in 10 days and your money back. Cash with order, we pay postage. Only limited amount available. Order Today.

LEEWARD PRODUCTS

Dept. 49-J, 189 W. Madison St., Chicago 2, Ill.

Learn LANDSCAPE GARDENING

A thorough, interesting, home study course for those who wish to become LANDSCAPERS, GARDENERS, DESIGNERS, etc., for profit or pleasure. Write today for FREE BOOK to

APPROVED NATIONAL LANDSCAPE INSTITUTE
FOR VETERANS Dept. P-7, 310 So. Robertson, Los Angeles 36

Ottawa "YARD-MASTER"



New 2-HP mower with **two speeds and free wheeling**. Does any kind of mowing. 3 to 5 acres per day. Cuts 40 in. swath. Attachments for soil tilling, pumping, spraying and many other labor-saving jobs. Sold only direct to user. Free details. Low price.

OTTAWA MFG. COMPANY
4-827 Lawn Ave. Ottawa, Kansas

HOW TO CUT RAFTERS

New vest pocket book gives lengths, side cuts, plumb cuts, deductions. For all rafters for any building from one inch to forty feet wide. Gives numbers to cut on square. Also degrees for same cuts for Radial Saws. All standard pitches from 1/8 to 5/8. Just open book to pitch page and there are your lengths, side cuts, etc. Anyone who knows what a jack rafter is, can frame a roof if he has this great book. Price one dollar, \$1.25 in Canada. Builders' Topics, Dept. 5, Lock Box 828, Seattle, Washington. CARPENTERS, PLUMBERS, PLASTERERS, ELECTRICIANS, ETC. subscribe for Builders' Topics, the monthly magazine for HE-MAN CONSTRUCTION WORKERS. Only \$1.00 per year. (In Canada—\$1.25). Sample copies 25c.

PULVEX FLEA POWDER

TWO KINDS

WITH 5% DDT

. . . for dogs. Kills fleas and lice quick. Keeps fleas off 5-7 days. Many home uses.

OR WITH ROTENONE

. . . for cats, dogs. Quickly kills fleas, lice. Kills fleas when put on a single spot. Pre-war formula.

EITHER KIND: 25c & 50c



ACE Hollywood Experts
WILL TRAIN YOU AT HOME . . .
NOW YOU CAN MAKE GOOD IN

RADIO

**TELEVISION
ELECTRONICS**

Through Practical
Experiments With



**YOU WORK
ON REAL
EQUIPMENT**

**10
BIG KITS
R.T.A.
Gives you!**

Opportunities Wide Open

400 MILLION new radio and television sets will be built within ten years. 72 MILLION dollars are being spent RIGHT NOW for radio repairs alone! When you are trained by RTA's Hollywood Experts, you too can qualify for big, interesting GOOD-PAYING technicians jobs, or YOUR OWN profitable radio-television repair business.

Extra Cash in Spare Time

RTA's Hollywood Experts show you how to earn welcome EXTRA CASH, while you learn. In fact, like many RTA students, you may actually get MORE spare time work than you can handle.

25 Years of Success

RTA's long years of experience assure you quickest progress. If you are at all mechanically inclined, RTA can teach YOU to MAKE GOOD in Radio-Television.

You Do
Scores of
Practical
Experiments

Illustrated above are only a few of the many job-exercises you do, through RTA's "shop-type" home training method. You build a TRF Receiver, a High-Frequency Converter, a 6-tube AC-DC Superhet Receiver, plus dozens of other interesting jobs.

These jobs give you actual SHOP EXPERIENCE necessary to your success.

**FILL OUT
COUPON
AND MAIL
TODAY!**

**SO GET THE FACTS!
SEND FOR FREE
30-PAGE BOOK
TODAY!**



**RADIO TRAINING ASSOC. OF AMERICA
DEPT. PMG
5620 Hollywood Blvd., Hollywood 28, Calif.**

Send FREE BOOK showing how to make good in Radio-Television through training by Hollywood experts.

NAME _____ AGE _____

ADDRESS _____

CITY _____ ZONE _____ STATE _____

Say You Saw It in Popular Mechanics

WAR SURPLUS OPTICAL BARGAINS

ASSEMBLE YOUR OWN BINOCULARS!

Save More Than 1/2 Regular Cost

GOVERNMENT'S 7X50 BINOCULARS



Complete Optics!
Complete Metal Parts!

We supply full instructions

METAL PARTS—Set includes all Metal Parts—completely finished—for assembly of 7 X 50 Binoculars. No machining required. Bodies have been factory hinged and covered. A sturdy Binocular Carrying Case is optional with each set of Metal Parts.

Stock # 842-H \$39.40

Postpaid, plus \$4.80 for Case—Total \$44.20

OPTICS—Set includes all Lenses and Prisms you need for assembling 7 X 50 Binoculars. These are in excellent condition—perfect or near-perfect—and have new low reflection coating.

Stock # 5102-H \$25.00 Postpaid

NOTICE! If you buy both Binocular Optics and Binocular Metal Parts, add 20% Federal Excise Tax to above prices.

ARMY'S 6x30 BINOCULARS

COMPLETE OPTICS & METAL PARTS—Model M-13A1, 6 X 30 Binoculars. (Waterproof Model). Everything you need—ready for assembly. When finished will look like a regular factory job costing \$102. to \$120. The Optics are new, in perfect or near-perfect condition. Have new low reflection coating. Metal Parts are new and perfect, all completely finished. No machining required. Bodies factory hinged and covered. Complete assembly instructions included.

Stock # 830-H \$40.00 Postpaid
plus \$8.00 tax—Total—\$48.00

TERRIFIC BARGAIN - BUBBLE SEXTANTS

These Army Air Forces Bubble Sextants cost Govt. about \$125 each. Bargain at our price of \$12.50. Wooden carrying case included. Wartime used but COMPLETELY REPAIRED AND COLLIMATED. Return within 10 days for full refund if dissatisfied. Directions for use accompany shipment.

Stock # 924-H \$12.50 Postpaid

Same SEXTANT as above, but BRAND NEW and with Automatic Averaging Device and Illuminated Averaging Disc for nighttime use. Govt. cost \$217. Perfect working order guaranteed.

Stock # 933-H \$22.50 Postpaid

6 POWER GALILEAN TELESCOPE—(Commercial Surplus) 28mm dia. Achromatic Objective Lens. Sturdily constructed of Aluminum. 7" long, extends to 9". Complete with carrying case.

Stock # 941-H \$3.00 Postpaid

We have literally millions of war surplus lenses and prisms for sale at bargain prices ranging 10c and up. Write for Catalog "H" — Sent Free!

Order by Stock No.

Satisfaction Guaranteed

EDMUND SALVAGE COMPANY

P. O. AUDUBON, NEW JERSEY

Original HOLLYWOOD WOLF WHISTLE

CAR HORN



Give the
WOLF CALL



You, too, can become a Hollywood Wolf. Give the wolf call and make other weird noises with the original HOLLYWOOD WOLF WHISTLE on your car. Precision made. Works off the intake manifold. Easily installed in 15 minutes.

Works in trucks, motorcycles, motor boats, outboard motors, too. Guaranteed. If your dealer cannot yet supply you, order direct, giving us your dealer's name. No COD's or stamps. No individual foreign orders. AUTOMOTIVE DEALERS & JOBBERS write for information on this fast selling, proved item.

YODER MFG. COMPANY

2403-216 East 103rd St., Los Angeles 2, California

DESCRIPTIVE
LITERATURE
ON
REQUEST

LEARN WATCH REPAIRING AT HOME WITH OUR NEW SELF-TRAINING KIT



Get started NOW in this uncrowded field! EASY to learn! BIG MONEY! SECURE FUTURE! Earn while you learn! Even as a sideline you can make good money!—Our new PRACTICAL SELF-TRAINING KIT is all you need to start. Contains set of PROFESSIONAL TOOLS: (Loupe, 3-4 power; complete set of 6 special screw drivers—finest tempered steel blades; Tweezer AA; Plastic Material tray) and COMPLETE BOOK on Modern Watch Repairing. Fully illustrated, easy to understand, shows every step in repair, adjustment and use of tools. Now only \$5.95 Post Paid

(If C.O.D., plus charges.) Money Back Guarantee.

If ordered separately: book \$3.25; set of tools, \$3.25.

MODERN TECHNICAL BOOK & TOOL CO.

Dept. MMC, 55 W. 42nd Street, New York 18, N. Y.

JUST OUT! New All-Inclusive Tool, Material Catalog

Revised and Enlarged for Watch-Clockmakers, Jewelers, Toolmakers, Handcrafters. Over 600 ILLUSTRATIONS and IDENTIFICATION CHART. NEW REDUCED PRICES. All books in these fields; write for literature. SEND 15c for catalog — FREE with order.

Get Ready for Big Opportunities!

Engineer Dobe

TOOLS AND EQUIPMENT
SENT WHEN YOU START

Get a better job with more pay and pleasant working conditions. Get into Drafting — where all products start. I will train you at home — give you experience — on the same kind of jobs you will do with the best paying firms. I furnish instruments and all equipment when you start. Write today for vital facts and FREE book. Give age.

ENGINEER DOBE • Div. 1B • Libertyville, Ill.

I Will Train You at Home
Until You Get a

GOOD PAY JOB in
DRAFTING

REFRIGERATION

AIR CONDITIONING—Trained men paid well to service, install, maintain, repair, rebuild household and commercial refrigerators. Opportunity for full time, spare time earnings. Train at home or in our big shops. Approved for Veterans. (Non-Veterans inquire about our Low Payment Plan and Pay After Graduation Plan.) Send for FREE BOOK-LET AND FULL INFORMATION. No obligation.

COMMERCIAL TRADES INSTITUTE, Dept. A2-7

1400 W. Greenleaf

Chicago 26, Illinois

ELECTRICIANS' SCHOOL

HOUSE AND COMMERCIAL WIRING • MOTOR REPAIR
AND REWINDING • ELECTRIC REFRIGERATION

Approved for Veterans Training

PENNSYLVANIA INSTITUTE SCHOOL OF ELECTRICITY

42nd and SPRUCE STS.

PHILADELPHIA 4, PENNA.



CORRESPONDENCE COURSES IN
RADIO and ELECTRICAL ENGINEERING

Tuition
\$25

ELECTRICAL ENGINEERING. Get good grasp of wide electrical field. Modern. Very understandable. Theory made easy. **RADIO ENGINEERING.** Extra fine course in radio, public address, photo-electric work. Trains you to be a superior service man, real vacuum tube technician. Tuition ONLY \$25, either course. Deferred payment plan. Servicemen needed badly. Write for free copies of school catalogs, student magazines, etc.

FREE LINCOLN ENGINEERING SCHOOL, Box 931-P115, Lincoln, Nebr.

FIBRE ARMS AND LEGS!



Light, correctly fitted, strong and comfortable. Natural appearance. Braces for all deformities. Scientific design. Fair Terms.

BUCHSTEIN-MEDCALF

223 S. 6th St., Minneapolis, Minn.

Now CHEAP OIL BURNER FOR HEATING AND COOKING STOVES - FURNACES

HEAT YOUR HOME, COOK YOUR MEALS
WITH CHEAP FURNACE OIL



NO MORE SHOVELING COAL

OR ASHES. Sensational Fuelizer

Starter Vaporizing System turns Cheap

No. 1 Furnace Oil, also Range, Heater,

Tractor Distillate, Kerosene and like

oils into oil heat—one of the quickest,

hottest fires known. LIFETIME GUAR-

ANTEE. \$1.00 Bonus Offer for Testing.

We will let you try it in your own stove or furnace for one month. Get yours for introducing. Big profits QUICK. Be first. Send in your name today for details and cash in on the tremendous demand for this Amazing Invention.

NORTHWEST MFG. CO., 608-J, Mitchell, S. Dak.



DO ANY JOB EASIER MAKE MORE MONEY

Used by Army, Navy, Other Government
Depts., 200 Schools and Industrial Firms.

Mail Coupon

FREE TRIAL in Your Home.
Send No Money!
We Ship C.O.D. in U. S.
and Will Refund Money
if Not Satisfied.



Get Ready for BIGGER OPPORTUNITIES and BEST PAYING JOBS

Do it now! Get the better pay that goes to men with specialized knowledge. Get into one of these big opportunity fields. Big money and many other advantages await you if you prepare now. Here is the help you need—EASY—QUICK—AT LOW COST. Thousands of men have already used these famous books. Beginners and experienced men alike have doubled and tripled their earnings with this help. You too, can now get the special knowledge you need for top pay, better jobs, or a business of your own. This is your **GOLDEN OPPORTUNITY**.

AIR CONDITIONING

Big air conditioning boom interrupted by war now bigger than ever and alive with new opportunities! Get this non-technical book by international authority and be ready for your share of millions to be spent. Covers whole field. 450 pages. Illustrated. \$4.00.

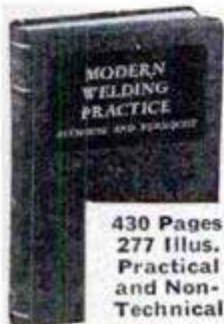

MODERN WELDING PRACTICE

Newest book on all types of welding and heat treatment of metals. Written by recognized specialists in training men for production jobs. Practical and Non-Technical.

430 Pages
277 illus.
Practical and Non-Technical

Covers everything you need to know. Prepare for best pay jobs now. Price \$4.00.

SHEET METAL LAYOUT

Makes sheet metal layout work so simple that anyone can learn. Get this new instructor and get into the easiest, cleanest and best paying part of all sheet metal work. 143 jobs worked out in drawings and carefully explained. Gives standard for all sheet metal fittings. \$3.50.



AUTO BODY and FENDER REPAIR

Opens the Door to One of the Big Opportunity Fields of the Day

THE LOW COST, EASY WAY TO A GOOD PROFITABLE BUSINESS OF YOUR OWN

Owners will spend big money to keep their good older cars looking like the new ones coming out. This is a practical money-making guide. Ideal for shop owners and every man who wants a share of the millions to be spent in keeping old cars looking new. Tells how to get a good job or start business of your own with small capital. Covers everything including tools, methods and materials. Only book of its kind. 325 pages, 232 illustrations. \$3.50.

HOUSE WIRING LATEST EDITION

Get this sixth edition of this standard and practical electrical wiring book. It gives complete practical instruction on every phase of house wiring in one handy volume. Goes further than most books on subject. Handbook style. Gives National Electric Code. 400 pages, 669 illustrations. Electrical work will reach a new high with millions of new homes to be built. Get started now. \$3.00.

DYKE'S FAMOUS CARBURETOR BOOK

This famous book has been the standard guide in the best paying auto work for a generation. It has helped thousands of men make money. New edition covers engine tune-up, compression, ignition, carburetion, fuel pump valves, etc. Use this book to specialize in this big field. 244 pages, 549 illustrations. \$3.50.

Modern Gas and Electric REFRIGERATION

New Printing—Almost 1000 Pages,
408 Pictures, 17 Diagrams in Colors

The Book of the Hour

Thousands of Refrigerators need repairs! Owners will pay big for competent service. Get this non-technical guide to all types of refrigerators and get your share of this new profit. Get a job or start your own service business. This book will help you make money anywhere. Price \$5.00.

Make Big Money
Keeping Old Cars
Looking New. Get
This Book Today!

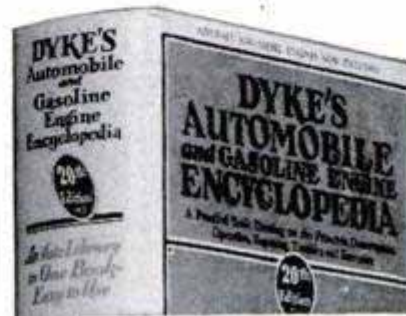

BIG 20th EDITION
Leading Auto Book for Over 36 Years

World's GREATEST AUTO BOOK

New Material on Transmissions, Trucks, Tractors, Diesels, Aircraft and Auto Engines

Now with millions of cars needing repairs and thousands of men needed to do the work, you need the famous DYKE Auto Book more than ever before. This big 20th Edition covers all principles, construction, repair, adjustments, testing, troubles and remedies of all cars. Over a half million copies of 20 editions of Dyke's have been sold. Gives specifications of old and newer cars. World's biggest book value. \$7.00. This big book, a complete auto library in one volume, has 1483 pages—4600 illustrations and diagrams—weighs 6 lbs.—equal to 4 ordinary books.

BAILEY'S HANDBOOK For Engineers and Firemen

World famous handbook of universal questions and answers for Stationary, Marine and DIESEL engineers and firemen. Prepares for any license examination. This is the one book that men should have if they want to reach the top in installation, maintenance and operation of Diesel and steam plants. Pocket size, \$2.00.

Goodheart-Willcox Co., Inc.
1321 S. Michigan Ave., Dept. 1-B, Chicago 5, Ill.

SEND NO MONEY! Mail Coupon

- GOODHEART-WILLCOX CO.,**
1321 S. Michigan Ave., Dept. 1-B, Chicago 5, Ill.
- Send books checked, C.O.D. I will pay postman, plus few cents charges. If not satisfactory I will return books in 5 days and you will refund money paid. (Outside U.S. or possessions remit with order.)
- | | |
|--|--|
| <input type="checkbox"/> Gas & Electric Refrigeration \$5.00 | <input type="checkbox"/> Air Conditioning \$4.00 |
| <input type="checkbox"/> Dyke's Auto Book \$7.00 | <input type="checkbox"/> Engineers Handbook . . . \$2.00 |
| <input type="checkbox"/> Dyke's Carburetor Book . \$3.50 | <input type="checkbox"/> Body and Fender Repair . \$3.50 |
| <input type="checkbox"/> Modern Welding \$4.00 | <input type="checkbox"/> Shop Math. (2 vols.) . . . \$3.00 |
| <input type="checkbox"/> Airplane Welding \$3.50 | <input type="checkbox"/> House Wiring \$3.00 |
| <input type="checkbox"/> Sheet Metal Layout \$3.50 | <input type="checkbox"/> A.C. Power Wiring \$4.00 |
| | <input type="checkbox"/> D.C. Power Wiring \$4.00 |

If remittance accompanies order we will pay all postage charges under same return privilege.

Name _____
Address _____
City _____ State _____

Paint Your Car for ONLY \$3.95

ONE QUART DOES ENTIRE JOB
2 FULL COATS

WITH **WYPE** TRADE MARK REG.

NO SPRAYING · NO MASKING · NO BRUSHING

AMAZING NEW BRUSHLESS AUTO ENAMEL
You **JUST WIPE ON**
with a **POWDER PUFF**
instead of Brushing or Spraying



ANYONE CAN DO BEAUTIFUL JOB

Get Beautiful Mirror Like Finish That Looks Like Spray Job!

Dries Dust Free One Hour · No Streaks or Lapmarks

At last! Practically anyone can now paint his car with WYPE! No previous car-painting experience necessary. You get a beautiful high-gloss job that gives you an expensive finish such as is sprayed on by Professional Auto Painters—at a fraction of regular cost! With WYPE you need **NO BRUSH, NO SPRAY, NO MASKING!** Just **WIPE ON** with Powder Puff—which we furnish at no extra charge. You get a brilliant, glossy finish that is truly "factory-like." No streaks. No lap-marks. Guaranteed for TWO years not to crack, peel, chip or fade, if simple directions are followed. Takes about an hour to apply. Dries dust-free in an hour. WYPE comes in nine most popular shades including those on newest model cars. Goes over any other color, lacquer or enamel.

MOST POPULAR COLORS

- Black Brewster (dark) Green
- Maroon Jewel (light) Green
- Red Washington (dark) Blue
- Gray Monticello (light) Blue
- Sun Beige (light) Tan

\$3.95 Per Quart

You're SURE You Are SAFE when You Paint with WYPE HERE'S WHY!

TESTED BY U. S. Testing Co., Inc.

Leading Scientific Testing Laboratory

Report No. 87496 Jan. 5, 1948

and found to conform to the claims and guarantee of the Wype Corporation.

No higher or more rigid standards are set by any Testing Laboratory. United States Testing Company conducts scientific tests for the world's foremost organizations and is accepted as a leading authority on such tests.

For Your Protection Before you buy any automobile paint, ask for proof that it has passed tests by a nationally known testing laboratory. Remember the value of your car! You can **TRUST** Wype.

2-YEAR GUARANTEE

We Guarantee WYPE against cracking, peeling, fading or chipping for two years after application, if applied according to directions furnished. Your money cheerfully refunded if WYPE does not live up to this Guarantee.

COPYRIGHT 1948, WYPE CORP



APPLY in ONE HOUR — DRIES to GLISTENING PROFESSIONAL FINISH

WYPE is a new Miracle Enamel for Autos. It is NOT a wax or polish but a hard high lustre ENAMEL finish! With WYPE, ANYONE can do a beautiful job! Order a quart to paint your car or to get started in this **BIG-MONEY Business!**

NO STREAKS OR LAPMARKS LOOKS LIKE SPRAY JOB

WANTED WYPE DEALERS

WYPE 2 Cars Daily at \$25 Each—Gross Up to \$260 Weekly

Start making **BIG MONEY** now! Sell WYPE in cans or go into business painting cars yourself (or hire others). Send for **FREE** details of powerful money-making plan. Why wait? Start now by ordering one quart or more of WYPE today!

OVER 200,000 CARS PAINTED WITH WYPE

and thousands more being painted every week. The final test of customer satisfaction — thousands of our new customers are being sent to us by old customers!

SEE YOUR DEALER or ORDER DIRECT SEND NO MONEY · Get WYPE Today!

If your dealer can't supply you, just send us a postcard. We'll ship C.O.D. Just pay mailman for Wype, plus postal charges. Or send remittance with order and WE pay postage

Some of the FAMOUS DEPARTMENT STORES that Sell WYPE

VISIT or PHONE THE STORE IN YOUR CITY...

If you live in one of the cities shown here, it will be more convenient to buy from your favorite department store. Ask your dealer! Leading merchants everywhere sell WYPE.

- Akron: M. O'Neil Co.
- Baltimore: May Co.
- Boston: Jordan Marsh Co.
- Buffalo, N. Y.: J. N. Adam & Co.
- Chicago: Goldblatt's 15 Dept. Stores (Goldblatt's also, at Joliet, Ill.; Hammond, Gary & South Bend, Ind.)
- Cincinnati: Fair Store Co.
- Cleveland: May Co.
- Dallas: Sanger Bros., Inc.
- Denver: May Co.
- Detroit: People's Outfitting Co.
- Fl. Worth: W. C. Stripling Co.
- Grand Rapids, Mich.: Herpolshelmer Co.

- Hackensack, N. J.: Packard-Bamberger Co.
- Houston: Foley's
- Indianapolis: Wm. H. Block Co.
- Kansas City, Mo.: Jones Store Co.
- Los Angeles: May Co.
- Louisville: Kaufman-Straus Co.
- Memphis: B. Lowenstein & Bros.
- Milwaukee: Ed. Schuster & Co., Inc.
- Minneapolis: Donaldson's
- Montgomery: Montgomery Fair Store
- New Orleans: Maison Blanche Co.
- Newark, N. J.: Bamberger's
- New York: Gimbel's

- Philadelphia: Lit Brothers
- Pittsburgh: Kaufmann's
- Providence, R. I.: The Shepard Co.
- Richmond, Va.: Miller & Rhoads, Inc.
- Rochester, N. Y.: Sibley, Lindsay & Curr
- St. Louis: Famous-Barr Co.
- St. Paul, Minn.: The Golden Rule
- San Antonio: Joske's of Texas
- San Diego: Whitney's
- Syracuse, N. Y.: Dey Bros. & Co.
- Toledo: Lion Dry Goods Co.
- Washington, D. C.: Lansburgh & Bro.
- Youngstown, O.: Strouse-Hirshberg Co.

WYPE CORP. Dept. 16-G 2214 DOLMAN ST. ST. LOUIS 4, MO.

**WORLD'S
BEST
WANT AD
MEDIUM**

CLASSIFIED Advertisements



Advertisements in this section 75 cents per word, each insertion, minimum 10 words, payable in advance
To be inserted under proper classification, copy must be in our office the 22nd of the
second month preceding date of issue

F. W. Johnson, Manager, Classified Advertising
Popular Mechanics Magazine, 200 East Ontario Street, Chicago 11, Illinois

1043

CLASSIFIED ADVERTISEMENTS

1043

OPPORTUNITIES FOR YOU

AUTOMOBILES, MIDGET CARS

CHEVROLET Speed manual now available to discriminating Chevrolet owners who desire real "hotrod" performance from their 1937 to 1948 Chevrolets. Filled with photographs, complete information, proven methods showing you how to make your road car into a genuine 110 m.p.h. job, or how to build 130 m.p.h. Chevrolet hotrod. Every page worth the purchase price of only \$2.00 postpaid. California Bill, Box L-1, Eaglerock, Los Angeles 41, Calif.

RACING Cams. Ford, Mercury, Chevrolet. Increased power and speed. Write for particulars. Iskenderian, Dept. P-7, 4807 W. Adams, Los Angeles 16, Calif.

INTERCHANGEABLE Parts book. New book tells every automobile part that interchanges with others. Same parts many times vary 100% in price. This book enables garages, mechanics, dealers, owners to buy under cheapest listing. Tremendous savings for users. \$15.50 postpaid. Clymer, Dept. A-IP, 1268 So. Alvarado, Los Angeles 6, Calif.

SPEED Equipment: Edelbrock, Meyers, Offenhauser, Weiland for Ford V8 and Mercury: high compression heads \$72.00 pair. Specify compression ratio desired. Dual manifolds, new Edelbrock Super, \$44.00; Offenhauser, \$48.00; Weiland, \$44.50. Throttle kits \$5.50. Order by make and model. Chrome carburetor stacks \$2.50 pair. Chrome acorn head nuts, 20c each. Chrome acorn manifold bolts, 25c each. Racing Equipment Co., Dept. M-2, 1916 W. Valley Blvd., Alhambra, Calif.

FAMOUS Car catalog reprints. Duesenberg, Italian Maserati racing and new Sport car, Mercedes-Benz, new rear-engine Isotta-Fraschini V-8, Rolls-Royce "Silver Wraith," Miller Race Cars, Cord, Rayfield Cyclecar, V-8 Chevrolet, Stanley Steamer, Doble Steamer. Specify catalog desired. \$1.00 each postpaid. Clymer, Dept. A-7X, 1268 So. Alvarado, Los Angeles 6, Calif.

FENDER Skirts—Factory direct; streamlined to your fender contours; 16 ga. anodized aluminum with self latching brackets. No holes to drill. Teardrop skirts Chevrolet, Ford, Buick, Oldsmobile, 35-41. Streamlined box skirt Ford 41-48. Specify year, model. Price f.o.b. \$17.95. Send check, money order. Freight collect. E. and E. Mfg. Co., 5322D Banks Street, San Diego 10, California.

AIR Horns—Strombos most powerful of all signals; complete, passenger car kits. Models available for diesel locomotives, trucks, buses, boats. We guarantee quick action from road hogs. Free bulletin. Strombos Company, 4525 Twelfth, Detroit, Michigan.

P38 DROP Tanks. New, steel, six foot size, \$9.95. Free picture. Anzio Boat Co., 89h, Merced 8, California.

DOUGLASS Steelpacked Deeptone dual mufflers for Ford V8 and Mercury '35 through '48 \$20.00 set; singles for all popular cars \$4.95 to \$5.96. Chrome station wagon stacks \$13.00 each. Chrome tailpipe extensions 2½" Deeptone singles \$1.75, duals \$2.95. Chrome carburetor stacks \$1.25. Openings for reliable dealers. Racing Equipment Co., Dept. M-1, 1916 W. Valley Blvd., Alhambra, Calif.

MODEL A Ford instruction book. Complete details care, maintenance, 35 charts, drawings. A must for "A" owners. \$1.00 postpaid. Clymer, Dept. A-7W, 1268 So.

"CUSTOM-SPEED" Catalogue. Latest racing; speed equipment; Hollywood beautifying accessories; full line custom supplies; all cars! Photographs, recommendations, lowest prices! 25c refundable. Almqvist Engineering, Milford 16, Pennsylvania.

BUILD Automatic clutch, midget autos, racers, scooters, tractors. 183 plans. Free handbook. Nichols Equipment Co., Dept. 911, Purvis, Miss.

STUDEBAKER. Floyd Clymer's new book (no connection with Studebaker Corporation) gives impartial, uncensored report 3000-mile economy, speed, record tests. Part by part equipment analysis. 3000 Studebaker owner opinion tabulations. 200 owner letters. Good, bad comments, no punches pulled. \$1.50 postpaid. Clymer's book on Kaiser-Frazer same price. Clymer, Dept. A-7S, 1268 So. Alvarado, Los Angeles 6, Calif.

"POWERIZER" Water injector. Increases speed, acceleration, mileage to 30%. Easily assemble yourself for few cents! Sensational performance! Prevents wear, knock, oil pumping! Manual includes "Installation Drawings," "Hop Up" Tips, literature. \$1. Almqvist Engineering, Milford 16, Pennsylvania.

MIDGET Auto. Build from surplus airplane belly tank. Complete plans instructions \$2.00. Abco, 1032 62nd Street, Oakland, California.

DUALTONE Crystalline packed California mufflers for all automobiles. Large chrome tailpipe extensions. Chromed carburetors, fuel pumps, chrome mouldings, dual manifolds, hi-compression heads, flywheels, camshafts, fender skirts, plexiglass tops. Send 20c illustrated catalogue, deduct from first order. Dualtone Mufflers, 2636C India Street, San Diego 1, California.

HOT Rod racing book. 90 photographs, illustrations famous record holders used California Dry Lakes. Contains hotrod tips, closeup action shots, specifications, 8 beautiful drawings suitable framing. \$1.50 postpaid. Clymer, Dept. A-7V, 1268 So. Alvarado, Los Angeles 6, Calif.

FORD-Mercury owners, attention! Supertone dual exhaust systems. Reduce pressure 50%. Increase gas mileage. Pleasing tone. Springs flat? Our stabilizer spring will restore arch, eliminate side-sway. Free literature. Supertone Mufflers, 2470 E. Slauson, Huntington Park, Calif.

"SPEED & Mileage" manual. Obtain greater speed, mileage, racing performance from any automobile! "Original" book shows easiest soup up methods; speed tuning; mileage secrets; complete data. Instructions on building speed equipment! Economizers, mufflers, "water injectors," manifolds, superchargers, "hot rods," speedsters, fast conversions, engines. All about carburetion, compression, balancing, fuels! "Economy tuning." Latest "Hollywood customizing" information, photographs, catalogues, parts lists \$1.98. Almqvist Engineering, Milford 16, Pennsylvania.

"CUSTOM Styling" manual. Easily make car look Hollywoodized, custom ultra-beautiful by quick inexpensive methods! 100 photographs, instructions on customizing, restyling, streamlining; new and old cars. Also model, sport, conversions; accessories; mufflers; engine "soup up" specifications! Most complete book \$2. Almqvist Engineering, Milford 16,

FORD-Mercury owners 1938-1948. Give your engine that "Hot Rod Look." Install our polished aluminum cylinder head covers over original heads. Price \$9.00 per pair. Beautiful snap-shot free upon request. Tarzian Automotive, 730 Ellis St., San Francisco, Calif.

CALIFORNIA Doll-up accessories. Steel fender skirts, solid hood sides, grille panels, lowering blocks, custom supplies, speed equipment. Buy direct, save. Illustrated catalogue; scores of items, 25c. Eastern Auto Supply, 3319B S. Grand, Los Angeles 7, Calif.

FROM Speedway to roadway! Track-proved hi-speed heads and manifolds now available for your passenger car! No special tools needed! Increase horsepower 25%! Astounding getaway! Free illustrated catalog. Speedsport, 6215 Diversey, Chicago 39.

"VAPO-STEAMATIC" Water injection. Easily constructed (for less than \$1.00). Finest automatic "moist-humidity" system. Engineering triumph—gets up to 33 miles per gallon! Reduces wear, sludge. Tremendously increases horsepower. Acceleration! Eliminates ping, carbon, overheating! Smoother engine. Copyrighted, fully illustrated "Installation-Handbook" including additional "Injection-conversions" covering tractors, airplanes, motorcycles. \$1.00. Newhouse Industries, 5941-B1 Hereford, Los Angeles 22.

CLYMER'S Indianapolis Race History Book. Complete details every race held 1909 to date. 352 large pages, 1100 illustrations. Postpaid \$3.50. Deluxe edition fabricoid binding, gold lettering \$5.00. 1946 and 1947 race books \$1.00 each. Complete driver history book \$1.50. Specify ones wanted. Clymer, Dept. A-7U, 1268 So. Alvarado, Los Angeles 6, Calif.

STUDEBAKER Champion power and racing equipment. Engines 135 to 177 inch. Engineering help and list free. Frank Morgan, Studebaker Dealer, Marysville, California.

FOREIGN Car books. British sports cars, 96 makes described, fine illustrations, specifications \$2.00. Post-war British cars. 34 makes illustrated, specifications, \$2.00. British Motor Industry from 1896 to 1946. 176 photos, drawings. \$1.50 postpaid. Clymer, Dept. A-7Y, 1268 So. Alvarado, Los Angeles 6, Calif.

"SPEED And Power" handbook—Very latest methods! Construct your own superchargers, water injectors, compression heads, fuel saving devices—easily, practically without cost. Get racing speed, acceleration, dynamic power increases from any automobile! Build stock conversions! Fast roadsters! Hotrods. Ingenious formulas! Speed secrets! Fuels. Lubricants. Get "Economy Information"—tuning techniques! Ignition! Carburetion! Mileage tricks. Catalogues! Literature! Illustrations! Including "Restyling Ideas"—streamlining. Model revising! Customizing! Sport changes. Photographs! Parts lists! Drawings! \$1.98 complete. Newhouse Industries, 5941-B2 Hereford, Los Angeles 22.

EASILY Built professional midget racer, motorscooter, midget roadster, or midget motorcycle from cast off parts. Plans, specifications for all four contained in illustrated handbook, 25 cents. Directory of bargain priced used parts and motors included free! Midwest, 3839 Drummond, Toledo, Ohio.

RACING Car builder book. 22 drawings. Racing rules. Contains information on cams, compression, balance, midgets, big cars, roadsters. V-8 speed data. \$2.00 postpaid. Clymer, Dept. A-RB, 1268 So. Alvarado, Los Angeles 6, Calif.

HIGH Compression heads. V-8. More speed, acceleration, power. Offenhauser or Edlebrock \$75.00 complete set. Dual manifolds complete with throttle kit, fuel lines. Edlebrock \$49.00. Offenhauser \$55.00. Give make, model V-8. Catalog 10c. Clymer, Dept. A-73, 1268 So. Alvarado, Los Angeles 6, Calif.

DON'T Buy any car until you read "Buyer's Manual!" Fully copyrighted charts, instructions, etc. expose dealers' secrets. \$1.00 postpaid. Groben, 21 Lansing, Auburn, New York.

RACING Camshafts for all cars; semi, 3/4, full race, and super full race. Harman & Collins or Weber for V8 Ford and Mercury \$30.00; all 6 cylinder cars \$30.00; all other 8 cylinder cars \$40.00. Winfield cams: semi, 3/4, and full race for V8 Ford and Mercury \$36.00, super full race \$40.00. All prices exchange. If no exchange, price of new cam will be added. Specify make, model, type of grind desired. Racing Equipment Co., Dept. M-3, 1916 W. Valley Blvd., Alhambra, Calif.

CLYMERTONE, Twin muffler sets, beautiful sound, complete with necessary welded pipes, E-Z installation. Ford V-8, \$20.00. Chevrolet set with split manifolds, \$37.50. Specify car model. Clymer, Dept. A-74, 1268 So. Alvarado, Los Angeles 6, Calif.

MAKE Your Model "A" do 100 m.p.h. Lightning acceleration, breath-taking top speed. Complete details, photographs. \$1 postpaid. Four Barrel, Box L-1, Eaglerock, Los Angeles 41, Calif.

1948 SUPERIGNITIONER. Atomic starting, pep, mileage \$5.50. EG Mfg., Elmsford, N. Y.

INSTALL V-8 engine in your Model A for extreme acceleration, more top speed, smoother performance. Complete details, photographs. \$1 postpaid. A-V-8, Box L-1, Eaglerock, Los Angeles 41, Calif.

WE Sell direct to customers over 200 speed equipment parts manufactured by us. Ford A-B-V8-6-4-(Ferguson), Studebaker Champion, Chevrolets and Willys. Cylinder heads, dual intake manifolds, lynch flywheels, oversize valves, compound springs, camshafts and other supplies. Complete engines ready for race for cars, boats and midgets. \$1.00 to cover illustrated literature and price sheet. R & R Mfg. Co., Robert M. Roof, Box 546, Anderson, Indiana.

SEE Our ad under motorscooters for midget car bargains. Midget Motors Directory, Athens, Ohio.

AUTOMOBILE Racing, Sixth Edition. 100 illustrations. Working drawings with building instructions for Ford-60 midget, California roadster, Offenhauser racer. Details on racer parts. Sample entrance blank. World's record 158.5 m.p.h. rear engine four-wheel drive car. Interesting information for fans, drivers, mechanics. \$2.00 postpaid; \$2.25 c.o.d. Ray Kuns, Department 63, Cincinnati 27, Ohio.

BUILD Speedy midget track racer from castoff parts! Plans, specifications, construction information, \$1.00. Motor Supply. Box CS-1682, Toledo, Ohio.

AUTOMOBILE Racing book, fifth edition, well illustrated. Instructions on building bodies, frames, engines. Ford A and B conversions. Plans. AAA rules, specifications. Roadster racing. Indianapolis cars. \$1.00 postpaid, \$1.30 C.O.D. Ray Kuns, Dept. 47, Madisonville, Cincinnati 27, Ohio.

GREASE Car yourself. Fast, easy, clean centralized system reduces repairs. Useful information, free. H. B. Rodd, Box 305, Trona, California.

HOT-ROD Manual, fast Fords, photos, instructions, \$1.50. Airmailed \$1.75. Racing parts list 25c. Hollywood Hot-Rod, Los Feliz, Box 9626P, Hollywood 27, California.

MAKE Your Ford fast! Complete details, photographs. How to construct 120 m.p.h. Hotrod. \$1 postpaid. California Bill, Box L-1 Eaglerock, Los Angeles 41, Calif.

AUTO SUPPLIES AND EQUIPMENT

BURN Water in your car. Costs less than gas. More power, cleaner motor. Mail card for data on \$17.50 Octa-Gane Water Injecting Carburetor. Advanced Automotive Products, 563-2 Lake Road, Webster, N. Y.

LOOSE Insert main bearings to fit into Ford A or B blocks. \$13.00 for upper set. Send bottom caps for complete set of three mains, \$16.75 complete set. Standard or undersize ready to install. No outright sales on bottom caps until we can buy more old caps. Wellens Auto Supply Co., 417 N. P. Ave., Fargo, North Dakota.

FOR Safety's sake, get Vis-A-Brake. 207 Findlay, Cincinnati 10, Ohio.

AUTO Parts. Buy direct. Get dealers' prices. Represent us in your territory. Write requirements. Specify car make. Mechanics Auto Parts, Factory Warehouse, 3807-PM N. Ashland, Chicago 13.

REPAIR Dents and holes in auto bodies with Duro Plastic Metallic Auto Body Solder. Applied with putty knife. Half-pint \$1.00 prepaid. Leonard Sales Company, Box 6412, Cleveland, Ohio.

BERMUDA Auto bells—Nickel plated brass, two loud, musical chimes. No wiring, installed under floorboard. Details. 16 Concord St., West Hartford 7, Conn.

GAIN 2 Miles per gallon with Air-flow needles. Free trial in your car. Remit only \$1.50 per needle (8 cyl. cars use 2). Advanced Automotive Products, 563-9 Lake Road, Webster, N. Y.

SAFETY Light control. Automatic hand switches auxiliary lights on should head lights go out. Literature free. Willard Via, 209 North Bell, Dothan, Alabama.

WELDING For low-cost repairs on bodies, blocks, fenders. Adds to your profits. Easy with Hobart Welders. Free catalog. Write Hobart Welders, Box M-782, Troy, Ohio.

AMAZING New invention! Quick-charges; protects; controls; conditions battery and generator while driving! Sensational low price; write quick for Free Demonstrator Offer! Gen-O-Batt, 1136A Dodge, Evanston, Ill.

AUTO Mechanics—Having trouble replacing king pin bushings? We have tool to drive them in exactly correct position. \$2.75 postpaid. Argie Developments, 2008 El Rey Drive, Whittier, Calif.

HYDRAULIC Jack repair kits. Repair your own. Send for prices. Beerman Precision Machine Works, 2000 So. Claiborne, New Orleans 13, La.

NEW Grilles for all cars. 1940 Plymouth shells. Wagner Grille Co., Route 2, Bernville, Penna.

SAVE Gas! Instant starting. Power! "Lektron" spark intensifier. Guaranteed. Easily installed. \$1.25 plus c.o.d. State make car. Electronic Industries, Cleveland 11, Ohio.

PAINT Your car two-tone, yourself. Sufficient enamel four fenders \$1.95. Instructions free. Bass Co., C31 W. 32 St., New York.

CONVERTIBLE Tops—Completely sewn. Easily installed. Reasonable prices. Free literature. Rio Top Company, 1370 Roanoke Ave., Newport News 10, Virginia.

MOTORISTS Save gasoline by Vacuumating overrich mixtures. Fits all cars. For free particulars write Vacuumatic, Dept. 1368, Wauwatosa, Wis.

NIGHT Drivers—Eliminate approaching headlight glare with "Saf-T-Aid" glare filter. Easily attached. \$2.00 postpaid. Brookmyre Distributors, 4924 State Road, Drexel Hill, Penna.

BEAUTIFUL Rich-looking seat covers. Mono. 6545 Santa Monica Blvd., Hollywood 38, California.

MECHANICS: Modern manufacturing methods allows reduction. \$12.50 gasoline saving vacuum supercharger now only \$9.75. McDowell, 2000 NE. Union, Portland, Oregon.

OIL Filter elements—Purolator N-50, N-51, Fram C-31, C-31D, AC C-117, interchange chart and prices mailed upon request. Discounted as much as 85%. Hill Equipment Co., 1301 East 5th St., P.O. Box 643, Reno, Nevada.

BEAUTIFUL Two-tone plastic leatherette seat covers. Pax Products, 55 E. Washington, Chicago, Illinois.

NEW And used automobile and truck parts. Lowest prices. Complete stock. Prompt reply. Babbitt Auto Parts, 2833 W. Chicago Ave., Chicago 22.

AUTO Parts for all cars, transmissions, motors, differentials, fenders, carburetors. Security Auto Parts, 1923-PM Grace, Chicago 13.

GRILLES For all cars. Meyers Auto Parts, 820 Dryades, New Orleans, La.

PLATING Outfits for auto parts. Connect to a battery. No tanks used. Free

AUTO TRAILERS

TRAILER Plans, parts, accessories—complete line. Prompt delivery. Catalog 25c (coin); catalog plus booklet, "Trailer Building," 50c (coin). Marine Mart, Buffalo 7-B, New York.

MODERN Trailer book tells all. Designing, building, traveling. New circular illustrating 8 designs 20c. Craftsman Books, Box 1153, Milwaukee 1, Wisconsin.

ACTUAL Photographs and detailed plans for 12' camp and travel trailer \$1.00. Many new features. Ed. Christensen, Box 687, Thief River Falls, Minn.

BUILD Your own trailer! Save money! Have every feature you want! Plans for house, sport, camp and utility trailers. Catalog describing 9 models 10c. 15c in Canada and overseas. Jim Dandy, Box 125-A, Wausau, Wisconsin.

MOTORCYCLES, BICYCLES, MOTORSCOOTERS AND SUPPLIES

WHIZZER And Cushman ground cams and high compression heads. More speed and power. Also telescoping spring forks for motorbikes. Thomas, Dept. T-13, 1916 W. Valley Blvd., Alhambra, Calif.

TELESCOPING Bicycle spring fork. The new Thomas Spring Fork is the only telescoping fork made for motorbike and bicycle. Absorbs all road shocks, makes riding velvety smooth. \$9.95. Write for free illustrated folder. Jobber and dealer openings. Mercury Specialties Co., 1916 W. Valley Blvd., Alhambra, Calif.

PISTON Rings for all engines, any size or age. Trade discounts. Thomas, Dept. T-23, 1916 W. Valley Blvd., Alhambra, Calif.

MOTO-SCOOT \$35. Midget racer \$15. Indian motorcycle \$30, Cushman motorscooter with extra tire \$20, motors \$3 and up, homemade motorscooter \$10. Send 25c for new catalog listing these and many other sensational bargains in used motors, wheels, tires, motorscooters, midget cars, motorbikes, etc. Associated, Box 1764-CS, Toledo, Ohio.

MOTORSCOOTER \$7.50. Midget racer \$10, motorbike \$5 less motors; Harley single \$40, midget car \$55 complete. Motors \$4 up. Plenty brand new engines and surplus motorscooters. Over 5000 small tires \$1 up. Mailorder only. Send 25c for Big War-Bargain catalogue listing the above and hundreds of other bargains in motorscooters, motorcycles, midget racers, outboards, engines, etc. (35c by First Class Mail). Midget Motors Directory, Athens, Ohio.

HARLEY-DAVIDSON "45" Engines. Govt. surplus, rebuilt with generator and carburetor. Few left, close out \$89.00. Clymer, Dept. A-7Z, 1268 So. Alvarado, Los Angeles 6, Calif.

MIDGET Car with three-speed transmission \$35. Cushman motorscooter \$15. Shaw bicycle motor \$15. Harley-Davidson motorcycle \$15, motorbike outfit \$15. Rush 25 cents for special new catalog listing amazing bargains in motorscooters, used motors, tires, parts, midget cars, etc. Gail, 538 Erie, Toledo, Ohio.

NEW 1948 Indian and Harley parts and accessory handbook. 25c. Motor parts, chains, batteries, tires, chrome accessories. Motor rebuilding. Bootz, 622 East Grand, Des Moines, Iowa.

MOTORCYCLE Pistons and parts, new, used. Harley Indian, Henderson, Super-X. List 10c. Ballak, 811 N. 9th, St. Louis 1, Missouri.

BICYCLE Supplies, wholesale, retail, list 10c. Universal, 4713 Virginia, St. Louis, Missouri.

MOTORBIKE \$50.00; 3 1/4 H.P. outboard motor \$40.00; Briggs motor \$15.00; midget car \$40.00; model airplane motors \$3.50 and up. Motorcycles, bicycles, scooters, race cars, midgets and big race cars. Mail order only. Send 25c in coin for latest bulletin. Behnke's, Dept. B, 5721 Leland, Chicago 30, Ill.

FLAT Rate repair manual for Harley-Davidsons. Gives flat rate charge for every operation. Every dealer, owner, mechanic needs this new book. \$2.00 postpaid. Clymer, Dept. A-FR, 1268 So. Alvarado, Los Angeles 6, Calif.

WHEELS—Aluminum disc: 10"x1 1/4" semi-pneumatic tires, bronze bearings, for 7/16" shaft. \$1.25 each. Metalcraft Toy Company, Paul Brown Bldg., St. Louis.

AIRCOOLED Engines aplenty List 15c. Motorscooter plans 50c. Donz, Mount Ephraim, N. J.

NEW Bicycles specially priced. \$32.50.

MOTOR Scooters, bicycle engines. 120 miles gallon. Dime for catalog. Clymer, Desk A-75, 1268 So. Alvarado, Los Angeles 6, Calif.

MOTORCYCLE News, monthly. Yearly subscription \$1.00. Latest worldwide information. Motorcycle News, 5424-A Sawyer, Chicago 25.

TIRES And industrial wheels, suitable for scooters, wheelbarrows, farm equipment, etc. All sizes. Bicycles and accessories. Largest assortment in America. Send dime for list. Cycle Transport Company, 1241 So. Michigan Ave., Chicago 5, Illinois.

BICYCLES, Tricycles, parts, accessories. Send 10c for bulletin. Propp's, 2202 Fondulac, Milwaukee, Wis.

MOTORCYCLISTS Chromium accessories. New and reconditioned motors. Complete stock Indian parts. Expert motor rebuilding. Indian Motorcycle Sales, Kansas City 1, Missouri.

MOTORCYCLE Cams ground for speed and power. Write Harold Schaller, Box 31, Turlock, Calif.

HARLEY-DAVIDSON Supplies, parts, accessories, oil service, tires all sizes, repaired 45" motors. Send \$2.25 for Army Motorcycle Manual, 10c for bulletin. Knuth's (Harley-Davidson Dealers), 2491 Fondulac, Milwaukee, Wis.

HARLEY-DAVIDSON Parts, accessories, batteries, and tires, 24 hour service. Authorized factory dealer. Philadelphia Harley-Davidson Company, 857 North Broad Street, Philadelphia 23, Penna.

WHEELS! Build wagons, scooters, mowers, trailers, wheelbarrows, grocery carts, baby carts, play pens, baby carriages. 4" to 16" Free list. Truism Mfg. Co., 811 E. 31, Kansas City, Mo.

AVIATION

PROPELLERS—2-3 Blade, snow-ice sleds, boats. Catalog. Standard Aircraft, Box 387, Ft. Worth, Texas.

FAMOUS "Zweng" books include Mechanic's Rating With Examinations, \$3.00; Flight Engineer \$4.00. Surplus Sextants \$12.50. (Free folder). Pan American Navigation Service, 12021-C, North Hollywood, Calif.

LIGHTPLANE. Blueprints. Circular 20c. Craftsman Books, Box 1153, Milwaukee, Wisconsin.

VETERANS: Flight training under the G. I. Bill. Tuition paid. Private, commercial, flight instruction, instrument and multi-engine ratings. Opportunities to work for living expenses or tuition, if not a veteran. Write Gottschalk School of Aeronautics, Adrian, Mich.

PROPELLERS, Plans for ice sleds, snow sleds, air boats. Catalog 10c. Banks-Maxwell, Ft. Worth.

ELECTRICAL SUPPLIES

LAMPS—All parts to build or repair. Illustrated catalog 10c. Gyro Lamps, 5402P Clark, Chicago 40.

FLUORESCENT Noise filters 25c; three 50c, prepaid. Box 214, Lawrence, Mass.

LAMPS—Build own originals, parts wholesale any amounts. Catalogue 10c. Brown Lamp Co., Box 501, Wellston, St. Louis 12, Mo.

WATTHOUR Meters. Reconditioned G.E., West., 115 v. \$2.95. T. Price, 310 14th, Raymond, Wash.

LAMP Parts wholesale. Large variety available for building, repairing, or remodeling. Order in any quantity. New 1948 catalog, 10c. Gearon Company, 27 South Desplaines, Chicago.

ELECTRICAL Repair men, send for literature on motor winding tester and A. C. motor winder. Motor Industries, Quincy, Illinois.

ELECTRIC Fans? Assemble your own. 16" correctly balanced aluminum fan blade, 1/2" bore, \$2.25. 18" all welded guard, \$2.50. Use any ordinary motor. No c.o.d. Ted Riseman, 207 North Fifth, Springfield, Illinois.

ELECTRIC Pencil: Engraves all metals. \$1.00 postpaid. Beyer Mfg., 229-H Dixon, Uniontown, Penna.

BATTERIES

GENUINE Edison storage batteries. Non-acid, odorless. Fifteen year life. Unconditionally guaranteed. 450 ampere hour type. \$242.50. Literature. See-Jay Company, 321 Yonkers Avenue, Yonkers, New York.

WELDING, SOLDERING, PLATING

WELDING—A profitable trade. Learn quickly at best equipped school in W. S. Demand for trained men. Write Hobart Welding School for free catalog. G.I. approved. Box M-786, Troy, Ohio.

ELECTROPLATING Simplified, all metals, latest formulas and instructions, \$1.00. Alan Hawkins Co., 770 Sycamore, Buffalo, N. Y.

OXY-ACETYLENE Welding outfit—New. Complete including: full oxygen and acetylene cylinders, torches, goggles, lighter, regulators, hose, carrying case, and supply of rod. Only \$89.75; supply limited. Check or deposit with order, balance c.o.d. Cylinders can be refilled anywhere. Ideal for hobbyists, garages, repair shops, etc. Burdett Oxy-Weld Equip. Co., Dept. B, 3399 Lakeside Ave., Cleveland 14, Ohio. Leading suppliers since 1923.

WELDERS For all requirements. Free catalog. Write Hobart Weld, Box M-785, Troy, Ohio.

TRANSFORMER Welders 110v. Welds 1/2" steel, \$29. Morris Welding Service, 1850A State, Schenectady 4, N. Y.

OWN Mirror shop. Resilver mirrors. Glass sign making. Electroplating. Supply prices. John Sprinkle, V55, Marion, Indiana.

"POWER-WELDER"—New combination a.c. welder; a.c. power plant. Portable, makes you independent of power lines. Gives you welding, plus power for tools, lights, motors; anywhere. Free catalog. Write Hobart Welders, Box M-784, Troy, Ohio.

RECTIFIERS: Ramyr Selenium platers, 10, 30, 50, 100 amp. sizes. Immediate shipment. Complete line of bronze baby shoe mounts. Write for list. Hollywood Bronze Supply, 1770 N. Vermont, Hollywood 27, Calif.

WELDERS!—New portable Champion special transformer welder; 110/120 volts, a.c. 8 heat stages. Welds, brazes, solders, cuts all metals. Complete with electrode holder, helmet, rods, carbons, fluxes, cables. Also special flame weld torch. Easy to use. Full directions. Splendid for shop, farm and home repairs. Guaranteed. Only \$27.50. Money back guarantee. Also resistor model, now \$14.95. Magic Welder Co., 239 MP Canal St., New York, N. Y.

"BUILD-UR-OWN" Portable arc welder. Save \$350. Easy with Hobart generator plus auto engine. Free instruction book. Write Hobart Welders, Box M-783, Troy, Ohio.

NEW Airplane tires, tubes, wheels, bearings, spindles. For harvesters, implements, lawnmowers. Free pictures. World's largest stock. Airplane Tire Company, Dept. 3, Box 89, Merced 3, California.

MACHINERY, TOOLS, SUPPLIES

FILE Handles, 2# cast aluminum, 6 for \$1.50 postpaid. J&R Mfg. Co., Box 162, So. Omaha, Nebr.

LAWN Mower sharpener, \$3.65. Guaranteed. Goodwin Mfg. Co., Crab Orchard, Ky.

BACK Geared metal and wood cutting 12" band saw, 6" jointer, ball bearing, 47" long. Ball bearing spindle shaper, 15x 20" table, 8" bench saw, tilting table, ball bearing. Lowest priced line of high grade tools on market. Free catalog. Backus Machine Co., Boyd, Wisconsin.

INDEX Heads for sale. Very inexpensive. Sixty two different divisions. Used on lathes, drill press, milling machines, etc. Very accurate and durable. Not a toy. Every shop owner should have one. Write for free folder. Long's Index Head's, Box 537, Torrington, Wyoming.

HYDRAULIC Leather cups for jacks, lifts, presses, pumps. Write for prices. Beerman Precision Machine Works, 2000 So. Claiborne, New Orleans 13, La.

SPECIAL T handle tap wrench 1/2" capacity \$1.89. Spraymaster with motor \$19.95. Craftsman Supplies, Box 895, Rockford, Ill.

CHUCKS, (Genuine Westcott) Independent, Universal, threaded 1 1/2"-8 for South Bend, Atlas, Logan, Clausing, Craftsman lathes. Also other chucks to 16". Top value. Free literature. Westcott Chuck Co., 3600 Walnut, Oneida, N. Y.

DRILL Grinder for twist drills, \$2.95. See ad on page 239.

HOME Lathe owners—Build your own attachments. Send for picture, sample of work and list of blueprints. Cut gears, ratchets, etc. Make neat screws easy. The Home Shop, 415 Raymond Ave., Glen-

BAND Saw—Special \$14.95. Ideal for hobbyists and home workshop. Circular free. Woodcraft Tools Inc., 147 E. Lake, Minneapolis, Minn.

POWER Tools. Build your own with Lewis Castings. Save up to 80%! Complete castings, materials and blueprints supplied for 23 woodworking and metalworking tools. Free catalog. Write today. Lewis Machine Tool Co., 3217 Union Pacific Avenue, Dept. M, Los Angeles 23, Calif.

SHEBEL Saw filer. Files all saws. Circular. A. P. Shebel, 730 B. So. 2nd St., Milwaukee 4, Wis.

CONCRETE Block machines \$39.50 up. Catalog free. Concrete Machine Company, 5466 Gravois, St. Louis 16, Missouri.

DRILL Grinder—Grinds drills to factory accuracy. Calipers with direct reading scales. Circle cutters. New Tool grinder. Lowest prices. Free literature. Factory, 811-B East 31st, Kansas City 3, Mo.

ENGINES, MOTORS, DYNAMOS

HORIZONTAL 1 1/4 h.p. gasoline engines. Many uses. Used, "as is," complete, \$22.50. Circular. Warwick, Denbigh, Va.

GAS Drive arc welders. "Build-Your-Own." Portable. Get profitable jobs anywhere. Save \$350 with Hobart generator plus auto engine. Free instruction book. Write Hobart Welders, Box M-787, Troy, Ohio.

BRAND New 1/4 h.p. 1725 r.p.m., 60 cy., 110 v., cushion base General Electric motors with thermal overload protector. Special introductory price \$16.50. Also in stock at lowest prices, all size motors, fans, blowers. Send for catalog. Motors & Equipment Corp., 178 Lafayette St., New York 13, N. Y.

BARGAINS In war surplus motors, switches, geared speed reducers, instruments, etc. Delta Sales, P.O. Box 968, Shreveport, Louisiana.

MOTORS! 1/4 h.p., 1750 RPM, A.C., \$10.75. 1/6 h.p., \$9.75; 3 K.W., 32 Volt Lighting Plant, \$155.00. Robert Electric, 7232 Madison, Forest Park, Illinois.

IMPLEMENT Dealers, magneto repairmen, send for magneto tester circular. Abbott Electric Co., Quincy, Ill.

MOTORS! 1/2 H.P. D.C. converted to A.C. All new. High speed 110 volt, 25 or 60 cycle, ball bearing motors. Actual value about \$75.00. Now \$15.00 each or 3 for \$40.00. With forward and reverse switch \$19.50, 3 for \$50.00. Countless uses for home mechanics. Can be used in any position. Order today! Immediate delivery! No c.o.d. orders. "Amazing Bachman's," 27 Herman Street, Rochester 5, New York.

WINDING Data, listing 225 motors, single and three phase. \$1.00. Motor Data Co., Box 7631, Kansas City 3, Mo.

BOATS, OUTBOARD MOTORS

SAILS, Canvas, all widths. Wingdope, marine paints, equipment for canoes to cruisers. Alan-Clarke, 96 1/2 Chambers, New York City 7.

BOAT Plans by professional naval architects. All sizes and types. Free circular. Westlawn Associates, Montville 5, N. J.

P-38 BELLY Tank speed boat. Complete plans, instructions \$1.00. Twintank Boat Co., 1032 62nd Street, Oakland, Calif.

MARINE Fittings, accessories. Thousands of items (pictured, priced). Prompt delivery. Catalog \$1.00. Marine Mart, Buffalo 7-B, New York.

SUPER-BOAT \$20. Easy to make your own with readymade streamlined laminated one-piece super-hull developed by Navy. Light, sturdy, leakproof. Anyone can convert into dinghy, outboard, scooter, cartopper, other craft. 9'x4', Warwood, 480 Lexington Avenue, New York 17.

BOAT Plans, kits—See display advertisement page 239. Marine Mart, Buffalo 7-B, New York.

BOAT Steer wheels, windshield brackets \$8.95. Modern hardware kits, bargains galore, folder. Marine, Box 681, Mendota, Minnesota.

OUTBOARD Motors—Good values, used motors. Also used parts for most makes and models. Crandall-Hicks Co., 911 Commonwealth, Boston, Mass.

P-38 BELLY Tanks, new, steel, 10 ft. 2 in. 165 gallon \$9.95. Anzio Boat Co., Box 89H, Merced, Calif.

BUILD Your own boat by the Welch System, ready cut parts. No experience necessary. Save 2/3 cost. Rowboats to cruisers. Illustrated catalog 25c. Midwest Boat Company, Menomonee Falls, Wis.

ASK About Osco Electric Tachometer for all popular makes of outboard motors. Oscometers, 2020B E. Orleans St., Philadelphia 34.

BOAT Designers are highly paid professionals. Complete course by mail. Catalog. Westlawn, Montville, N. J.

MARINE Conversions for Ford and Jeep engines. Catalog 10c. Lehman Manufacturing Company, Department D, Newark 2, New Jersey.

NEW, Used, rebuilt marine motors. Marine conversions, fittings. Free catalog. Stokes Marine Supply, Dept. 24, Coldwater, Michigan.

ATHLETIC EQUIPMENT, BODY BUILDING COURSES

BARBELLS, Dumbbells \$8.65 up. Stamp for folders. Jackson Barbells, Springfield, New Jersey.

BARBELLS, Exercise equipment. Courses. Free booklet. Good Barbell Co., Reading, Penna.

SPORTING GOODS, GUNS, FISHING TACKLE, ARCHERY, TRAPPING

SPEAR Fish and bait, Indian method. Get the big ones. Spear head \$3.50, plans to make 65c. Campet, 1826 N. Springfield Ave., Chicago, Ill.

FISHERMEN'S Special. Braided nylon line, 23 test. \$2.00 hundred yard spool prepaid. Donaldson's, 7416 S. Vermont, Los Angeles 44, Calif. Established 1936.

BASEBALL, Softball. Uniforms, equipment. Catalog ready. Craigco, 670 East 42, Brooklyn 3, N. Y.

GET Three good lures, all different, and a brand new official 1/2 oz. practice casting plug by postage-paid return mail in exchange for three old lures you no longer want, plus \$1.00. Lures you specify sent whenever possible. Satisfaction guaranteed; tell your friends. Trade today as hundreds have. Westbrook Company, 227 N. Water Street, Milwaukee 2, Wisconsin.

GUNS! Catalog listing 2,000 modern and antique guns. Also war relics, edged weapons, ammunition. 600 illustrations. 50c coin. Martin Retting, W. Hurley 12, N. Y.

AMMUNITION—45/70 Blank cartridges, loaded with black powder, center fire, standard length, mfg. 1943 Western cartridge, 1 1/2c each, minimum order 500. Hill Equipment Co., 1301 East 5th St., P.O. Box 643, Reno, Nevada.

REPROCESSED Golf balls—Guaranteed satisfactory. \$3.95 dozen c.o.d. Indianapolis Golf Co., 4903 Brookville, Indianapolis.

AMMUNITION, 75 Sizes in stock. Dime for list. Central Sports, Delphos 5, Ohio.

PISTOLS: Walthers, 32/7.65mm. calibre, double-action hammer, automatic, perfect, \$50.00. J. P. Shuer 32/7.65mm. calibre, double-action hammerless, automatic, perfect, \$50.00. Mausers, 32/7.65mm. calibre, excellent, \$40.00. Smith-Wesson .38 specials, military-police, 5 inch barrels, excellent, \$55.00. Complete firearms-ammunition lists postpaid 25c. Frank Parish, Vicksburg, Mississippi.

SHOTGUNS, Rifles, handarms, ammunition, rods, reels. List 10c. Rudolph's, Atchison, Kansas.

FIREARMS—Ammunition; complete list 25c. Satisfaction. Frank Parish, Vicksburg, Miss.

5000 BARGAINS, Firearms, binoculars, war relics. Catalog 40c. Smith Firearms, Pennemede, New Jersey.

FISHERMEN! Make real savings on your tackle needs. Get our catalog. Snap swivels 3 for 10c. Jointed cane poles \$1.95; floating minnow buckets \$2.49. Hundreds of other bargains just like these. Send for free catalog today. Write Dept. PM, Andy Anderson's Sporting Goods Co., 124 W. Grand, Oklahoma City 2, Okla.

BOWS—Arrows, write headquarters for archery equipment. Quality products. Popular prices, catalog 10c. Large illustrated handbook instructions, aiming and shooting, 50c. Archery, 617-B So. State, Chicago 5.

SHOTGUNS, Rifles, revolvers, over 500 modern, obsolete. Also cartridges, list 10c coin. Ed Howe, 52 Main, Coopers Mills, Maine.

FIELD GLASSES, TELESCOPES, MICROSCOPES, MAGNIFIERS

BINOCULARS, Telescopes, watches, guns. Buy, sell, trade. Schweer's, Donnellson, Iowa.

TELESCOPES, Rangefinders, aiming circles, optics. Lowest prices. List free. Donn Surplus, Dept. M, Box 27, Norwalk, Ohio.

MICROSCOPE, 75 Power, achromatic objective, standard optical threads, \$19.95. Free folder, Rowe Co., Dept. 2, Box 1, Brighton Station, Rochester 10, N. Y.

TERRESTRIAL Eyepiece for astronomical telescopes, \$3.00 postpaid. Suffolk Science Service, Manorville, New York.

7x50 **COATED** Optics sets \$13.00, telescopes, supplies, surplus. 10c for list. R. Beach, 703 S. Claudina, Anaheim, Calif.

ASTRONOMICAL—Terrestrial telescope lens kit. 50X, 100X, 200X, 400X powers \$3.00. Microscope lens kit. 50X, 100X, 200X, 400X, 800X \$2.00. Postcard brings plans. Optical list outstanding values. Pfeegor Optical Co., PM-7, Sunbury, Penna.

POWERFUL Astronomical telescopes easily made. Perfect lenses and instructions. 100 power \$3.00, 100 and 200 power \$4.00, 100, 200 and 400 power \$6.00. Clear vision and full power guaranteed. Instructions alone 10c. Suffolk Science Service, Manorville, N. Y.

ASTRONOMICAL Telescopes, binoculars, microscopes; bought, sold, repaired. Books, Lists 10c. Rasmussen-Reece, Amsterdam, N. Y.

TELESCOPES, Binoculars, microscopes, big bargain catalog free. Brownscope Company, 24 West 45th Street, New York.

GOVERNMENT Surplus. Terrific bargains, telescopes, binoculars, lenses, prisms, send stamp for catalogue. H. Jaegers, 123-26 Rockaway Boulevard, South Ozone Park 20, New York.

DOGS, PETS, BIRDS, RABBITS

\$3000 RAISING Pedigreed and registered angoras. Vaughn's Rabbitry, Otley, Iowa.

MINK Raising information free. Complete. Lake Superior Mink Farm, Superior E E I, Wisconsin.

REPTILE Catalogue 10c. Hobby catalogue 10c. Reptile Bulletin 5c. Pair golden hamsters \$2.75. Chameleon 25c. Quivira Specialties, Topeka, Kansas.

RAISE "Golden Hamsters" breeders, pets, laboratories. Free literature. Pem's Hamstery, 3010 10th Ave. No., St. Petersburg 6, Fla.

\$50.00 WEEKLY Raising Angoras for us. Free literature. Associated Angora Breeders, Stanton, Calif.

WRITE For descriptive circular "Angora Wool Growing." House of Angora, Springfield, Illinois.

\$250.00 MONTHLY Raising Angora rabbits. Multiply fast. Wool brings \$9.00 pound. Plenty cash markets. Particulars free. White's Rabbitry, Dept. P, Newark, Ohio.

RAISE Chinchilla rabbits. Year-round money-makers from furs, meat, breeders. Experience unnecessary. Write today. Willow Farm, Sellersville 15, Penna.

RAISING Rabbits, cavies, hamsters, chinchillas is profitable. Big demand. Magazine 10c. Instruction book and magazine 25c. Book and magazine (monthly) one year, \$1. Address, Small Stock Farmer, Fairlawn 2, New Jersey.

RAISE Guinea pigs. Make money at home. Big demand. Booklet free. Taylor, Box 426A, Hapeville, Georgia.

ANGORAS Giant Chinchillas, White Giants—World's most profitable rabbits. Finest pedigree, heavy-producing, prize-winners. Literature free. Grinsteads, Edwardsville, Illinois.

CONTINUOUS—Profitable market for your production. Raise New Zealand and Chinchilla rabbits for us. Order our "7 Steps To Success" \$3.00 with credit coupon, or send 25c for catalog "Successful Rabbit Raising." Drake's Outdoor Enterprises, Park Ridge 8, N. J.

INCREASE Your income by raising domestic rabbits. Small space needed. Ready market for delicious meat, fur and wool. Largest magazine in the industry tells you how. \$1.50 per year. Sample 15 cents. No stamps. Small Stock Magazine, Lamoni 20, Iowa.

\$3000 YEARLY Raising Angora rabbits. We buy your output. Contract particulars free. Kise's Enterprises, St. Paul 8.

\$250.00 MONTHLY Raising angora rabbits. Particulars free. White's Rabbitry, Newark, Ohio.

MONEYMAKING Opportunity raising Giant Chinchilla Rabbits. Waters Rabbit Farm, Glennville, Georgia.

RAISE Rabbits, market provided. Breeding stock furnished on production pay plan. Literature 25c, with hutch plans \$1. Hansen's Rabbit Institute, 15 Miller Avenue, Salt Lake City 6, Utah.

FARMS, FARM LANDS, REAL ESTATE

\$5.00 MONTHLY Buys 40 acres, near town. Price \$200.00. Free list. Box 425-F, Carthage, Mo.

UNITED'S Summer catalog, bargains galore! Farms, ranches, groves, businesses, homes. Exciting, free catalog of up-to-the-minute values. Great Lakes, midwest, famous Ozarks, to California. America's lowest prices! Write for free copy today! United Farm Agency, 1408-PM Consumers Bldg., Chicago 4, Ill.

CHEAP Homes, farms, stock ranches, peach orchards. Valley farms, wonderful free range, mild, pleasant winters, cool summers in beautiful, healthy Ozarks. Free literature, land lists. Write G. W. Starr, Ozone, Arkansas.

LOTS \$300—Convenient payments. California's finest garden section. On Morro Bay's scenic shores. Wonderful fishing, hunting, boating, bathing. Fertile soil, softest water, temperate climate, congenial community. Free literature. Richard Otto, Department M, San Luis Obispo, California.

STROUT'S Farm catalog—Free! Many equipped. Reduced prices! Over 2800 bargains. Coast to coast. Write today. Strout Realty, 255-P 4th Ave., New York 10, N. Y. 20 W. 9th St., Kansas City 6, Mo. 453 S. Spring, Los Angeles 13, Calif.

GOVERNMENT Lands \$2.00 acre up. Information all states twenty-five cents. National Tax Service, 834-A Majestic Bldg., Detroit.

GOOD Farms—Ranches. Washington, Minnesota, Montana, Idaho, Oregon, North Dakota. Dependable crops, favorable climate. Write for literature, lists describing typical farm opportunities. Specify which state. J. W. Haw, 119 Northern Pacific Ry., St. Paul 1, Minn.

OZARK Lands for all purposes. Actual river frontages, 5 acres \$90.00 and upwards. Free list and literature. Hubbard, 424-I Minnesota Ave., Kansas City 4, Kansas.

FARM MACHINERY AND SUPPLIES

FREE—Big 1948 new and used tractor parts catalog. Satisfaction guaranteed. Write Irving's Tractor Lug Company, Fargo, North Dakota.

POULTRY, FARM SUPPLIES

EARN \$4 To \$12 hourly. Chick and turkey sexing, culling and caponizing—G.I. approved. Pilch's School, Box P.M. Thompsonville, Connecticut.

THE "Debeaker" stops cannibalism. Saves feed. Free literature on poultry supplies. Lyon Electric Company, San Diego 12, California.

RAISE Fryers new easy way. One-man home plant earns \$500 monthly. Booklet free. Poultry Guild, 1046-A So. Olive, Los Angeles 15, California.

KNOW How to raise poultry for profit. Read Northeastern Poultryman. Every issue packed with helpful hints and practical suggestions. Latest articles on breeding, feeding and management. Subscribe now. 1 year 65c. 2 years one dollar, foreign subscriptions \$1.00 a year. Northeastern Poultryman, Dept. P.M., 376 Boylston St., Boston 16, Mass.

PROFITABLE OCCUPATIONS

HOW To make money by mail. 48 years uninterrupted proof. Particulars free. Howard Snyder, Canton, Mississippi.

START Your own business on our capital. Always your own boss. Hundreds average \$6,000 to \$25,000 annual sales year after year. We supply stocks, equipment on credit. 200 home necessities. Selling experience unnecessary to start. Wonderful opportunity to own pleasant, profitable business backed by world-wide industry. Write Rawleigh's, Dept. G-U-PPM, Freeport, Ill.

HYDROPONICS Soilless vegetables, cheap chemicals. Free information. U.S.

START Lamp business in your home, basement, garage. Profitable, fascinating, easy to learn. Illustrated course teaches you. General instructions and wholesale catalog \$1.00. Gearon Company, 27 South Desplaines, Chicago.

MAKE Soaps, chemical cleaners, synthetic detergents. Easy instruction booklet. 100 formulas. \$1.00. U. S. or foreign. Brown, 9111-A Hoyne, Chicago 20.

MUSHROOMS Grown. Boxes, barrels, instructions 50c. Spawn \$1.00. Gordons, 553 William, Winnipeg, Manitoba.

LEARN Piano tuning and repairing at home. Course by Dr. William Braid White. Write Karl Bartenbach, 1001-H Wells Street, Lafayette, Indiana.

MAKE—Sell new amazing auto paint you simply wipe on. Complete formula \$1.00. Ideal Service, Park Ridge 8, Ill.

OWN Mirror shop. Resilver mirrors. Glass sign making. Electroplating. Supply prices. John Sprinkle, V50, Marion, Ind.

RINGNECK Pheasants and Chukar partridge. Raise and sell these profitable colorful game birds. Send \$1.00 for new booklet "A Profitable Hobby" containing complete instructions for raising, handling and selling. Will also send prices on eggs, chicks and grown pheasants and partridge for your beginning stock. Blue Lakes Game Farms, Inc., Fairmont, Minnesota.

INTERESTED In Latin American and foreign employment? \$1 brings copyrighted Foreign Service Directory listing firms with interests in construction, oil, mining, aviation, manufacturing by personnel expert. Hot list of companies hiring. Global Reports, P.O. Box 883, Hollywood 28, Calif.

WOULD You pay 3%—first \$350 made? Color-illustrated book "505 Odd, Successful Enterprises" free! Some offer occasional "day off." Work home. Expect something odd! Pacific, Oceanside, Calif.

\$40.00 WEEKLY Made growing mushrooms, fresh, dried. Dominion patent 331583. Free spawn. North American, 169P Yonge, Toronto, Canada.

FOREIGN Employment? Brief directory, companies with foreign projects or branches \$1 or c.o.d. Foreign Service Institute, Box 3934, Miami 24, Fla.

"ALASKA" The last frontier offers unlimited opportunities. \$1 brings official government map and copyrighted report with listing of firms: Fishing, construction, mining, aviation, homestead lands, prospecting business. Alaska Opportunist, P.O. Box 883, Hollywood 28, Calif.

MAKE Flexible molds! Few cents each! Cast plaques, novelties, bookends! Free sample! H. Tooker, Hamilton 9, Ohio.

LOCKSMITHING Secrets—Key fitting, lock opening, repairing, prices to charge, supply sources. Illustrated book only \$1.00. Wechsler Supply, 7 W. 36, New York City.

YOU Can make real money raising Golden Hamsters, the new amazing tiny animal. Food costs less than 10c month per animal. Breeds in 16 days! Easily raised in basement, attic, garage, barn, or shed. Write for convincing details. Hudson Hamstery, R.F.D. #1, Newfoundland, N. J.

PERMANENTLY Stops chimney creosote—down draft. Profitable. Wig, Abington, Mass.

BE The Popular Mechanics representative in your neighborhood and earn big profits in your spare time. Write Popular Mechanics Magazine, Room 408, 200 E. Ontario Street, Chicago 11.

BOOKS, PERIODICALS, PICTURES, POSTCARDS

PLENTY Money. Best seller books. Free catalog. Lighthouse Publishers, 210 Fifth Avenue, New York 10, N. Y.

BACK Dated magazines. All types bought, sold. Hobby crafts, technical, sports. Dayton's, 1217 So. Blvd., Bronx 59, N. Y.

FIGURE Drawing Without a Model, \$1.00. Also free catalogue, interesting books. A. Faller Company, 201 Dewey Street, Newark 8, New Jersey.

LEARN Amazing secrets of guerrilla self defense. Send for free particulars of book. Michael Wrona, 2027 N. Park Ave., Tucson, Arizona.

STARTLING Revelations! Read "Prophetic Years 1947-1953." Free literature. Progress Company, 4033 Chown, Minneapolis 10, Minn.

PLEASURE Profit book list free. Johnson, Box 49, Astoria Station, Long Island City, N. Y.

IMPROVE Your conversation, thinking; new ideas on old and new subjects, including marriage, cities, happiness, poems on each subject 50c. E. Wells, 212 S. Broadway, Los Angeles 12, California.

ALASKAN Photos. See for yourself. Interesting, educational, collector's items. Sample 50c. 6 for \$1.00. Wain, 7-PM, Gen. Del., Anchorage, Alaska.

BOOK Hunters! All subjects. Send wants! Jaher Book Service, 620-P East 178 Street, New York 57.

BOOKS, All subjects, promptly supplied. Alta Book Service, Box 258-H, Waterbury, Conn.

NATIONAL Geographic Magazine, 1888-1945, any issue. Periodical Service, Dept. PM, Swarthmore, Penna.

BOOKFINDERS! (Scarce, out-of-print, unusual books.) Quickly supplied. Send wants. Clifton Company, Box 13779m, Beverly Hills, Calif.

BIG Sparetime profits taking magazine subscriptions. Complete supplies, confidential catalog free. Cassell Publishers Service, Westfield, New Jersey.

BOOK Reading made easier, more pleasant and comfortable using amazing new bookholder. Postcard brings descriptive literature. Book Saver Products, 1318-P North Wolcott, Chicago 22, Ill.

BACK-DATE Magazines. Books. Specific issues; years. Arkell's, Tarzana 1, Calif.

WE Can supply you with almost any book. (Magazine subscriptions.) House of Kilroy (Booksellers), Box 772, Detroit 31, Mich.

GAMES, ENTERTAINMENT

STICKEROO. Play the newest, fastest card game. Easily learned. Fun for all. Directions 25c. Stickeroo, Box 1533, Rochester 3, N. Y.

MAGIC TRICKS, PUZZLES, JOKER NOVELTIES

MAGIC Has vast opportunities. Illustrated catalogue 25c. Hall Magic Co., 345 John R, Detroit 26, Michigan.

MAGIC Envelope 10c. Insert penny, extract dollar. Fool everybody. Wade, 1423 Palou, San Francisco 24, Calif.

AMAZING Bargain! "Seven Mystifying Tricks," catalog and interesting Reno souvenirs 10c. Vancamp, 453 Reno Ave., Reno, Nevada.

3 MAGIC Catalogs and "Magic Is Fun" magazine sent for only 25c. Robbins Co., 152-F West 42nd Street, New York.

COIN And ring trick 25c with pamphlet of magic and joke items. Powell's, P.O. Box 2155(P), Potomac Station, Alexandria, Virginia.

LARGE 160 Page catalog, just published, 35c. We have supplied the best tricks to beginners and professionals for 38 years. Chicago Magic Company, 2300-J No. Mason Avenue, Chicago 39.

EARN Money in any crowd. Call names of strangers, tell unspoken questions. Professional course mindreading, faked spiritualism, etc., \$1 postpaid. Reiss, 3017-C Ocean Parkway, Brooklyn 24, N. Y.

CATALOG And card trick 25c. Stivers, 40 Salem, Medford, Mass.

OPPONENTS Poiled, great western belt trick 10c. Schiff, 2319 Newton, Milwaukee 11.

LEARN How to be a magician. You can easily entertain friends and earn extra money in your spare time. For complete information write Stallard Enterprises, 1888 Richmond Drive, Louisville 5, Kentucky.

MAGIC Monthly. Year 25c. Sample and 1948 magic catalogue free. Magic Shop, Minneapolis 2, Minn.

CARD Oddities. Booklet, 50c. Milner, Box 239, Back Bay Annex 17, Boston, Mass.

VANISHING Half dollar trick and catalog 25c. Sterling Magic Co., Royal Oak, Mich.

PROFESSIONAL Catalog, 128 pages, 25c. Williams, 900 Plymouth, Ellwood City, Penna.

TRICKY Magic matchbox. It turns around, it stands, it opens. Confuses, amuses everyone, easy to do. Free to you if you send 25c for big illustrated catalog of 425 magic tricks. Magician, 2463-C, Kensington Ave., Philadelphia 25, Penna.

LARGE Catalogue of the best magic for professionals and amateurs. Send 25c. Mazda Magic Co., 1135 Westgate Ave., Oak Park, Ill.

MAGICIANS' Headquarters. 400-page professional catalogue, pocket, parlor, stage tricks. World's finest magic. Send \$1.00 for catalogue (refunded first \$5.00 order). Kanter's, M-1311 Walnut, Philadelphia 7, Penna.

FREE Pack trick cards with catalog 25c. 12 Churchlane, Philadelphia.

"VENTRILLO" Professional voice-throwing instrument and illustrated catalog 25c. POB-971, Philadelphia.

LEARN Magic, ventriloquism, mind-reading. Write for particulars. Quackenbus, Big Flats, N. Y.

BIG Magic magazine, trick and price lists—25c. Lloyd M. Jones, 4064 39th Avenue, Oakland 2, California.

VENTRILLOQUISM Taught, 3c. stamp bring particulars. Smith, 801 Bigelow, Peoria 5, Ill.

SNEEZING, Itching powders, eighteen other tricks, free with joker's catalog 25c. 2404-N Fifteenth, Philadelphia.

WORLD'S Largest professional magic shop, keeps you in touch with latest tricks. To receive mailings, send 35c for new catalog. Holden's, M220 West 42nd St., New York.

MAGIC Tricks, puzzles, books, cards, punch boards. Catalog 10c. Specialty, Box 671, St. Louis 1, Mo.

500 TRICKS. Send only 10c for Douglas' famous 112-page catalog 500 tricks. New magic for amateur, professional. America's fastest service for 25 years. Douglas Magician, Dept. 1, Dallas, Texas.

DOLLAR Magic set free with gigantic catalog 25c. Mysto, 4462 Germantown, Philadelphia.

BE A magician. Large professional magic catalog of latest tricks, 35c. Ireland, C-109 North Dearborn, Chicago 2.

BOOKS—All Kinds—Homecraft, Radio, Plastics, Boat Building, Photography, Model Building. Catalog free. Popular Mechanics Press, 200 E. Ontario St., Chicago 11, Ill.

COINS, TOKENS, CURRENCY

OLD Money wanted. Will pay fifty dollars for nickel of 1913 with Liberty head (no buffalo). We pay cash premiums for all rare coins. Send 4c for large coin folder. May mean much profit to you. Numismatic Co., Dept. 20, Fort Worth, Texas.

20 DIFFERENT Indian head cents \$1.00, 4 copper-nickel cents \$1.00, 4-2c pieces \$1.00, 4-3c nickels \$1.00, 4 Whitman coin folders \$1.00, handbook 75c. Our 1948 retail catalogue 15c. Bebee Coin Company, 1180 East 63rd, Chicago 37, Illinois.

100 COINS And bills \$1.00. Oddehon, Box 482, St. Louis, Mo.

20 DIFFERENT Fine coins 50c. Free lists. Selections on approval. Bishop, Box 2201, Kansas City, Mo.

BAGDAD Strange rare coins. Nine different including silvers, \$2.00. Edward Basry, Bagdad 31, Iraq.

4-IN-1 Special \$1.00 bargain offer: (1) United States 1893 Columbian world's fair half dollar; (2) album for holding coins; (3) large 56 page coin catalog; (4) genuine wooden nickel. Yes! All four items for only \$1.00. Order today. Money back if not pleased. Ben's Coin Company, 72 W. Washington, Chicago 2, Illinois.

COIN Bargain list for stamp. Toivo Johnson, East Holden, Maine.

SOUTH Africa, Rhodesia coins. Set \$3.00. McDonald, 30 Rosetta Street, Regents Park, Johannesburg, Africa.

GET Profit and pleasure in collecting old coins. Send 10c for 56 page illustrated coin catalog. You'll be delighted with it. Send for it now. B. Max Mehl, 370 Mehl Bldg., Fort Worth, Texas. Largest rare coin establishment in U. S. Established 48 years.

FREE! Foreign coin, banknote and coin collectors illustrated catalog to approval service applicants. Send 3c postage. Tatham Coinco, Springfield-125, Mass.

COMMEMORATIVE 1/2, Oregon, Texas, Kentucky, Cleveland, Long Island, \$2.00 ea. Illustrated catalogue 25c. Norman Shultz, Salt Lake 9, Utah.

COINS Wanted, will pay up to \$2000 for certain coins, send 25c for catalogue. Burton's, 111 So. Third, Columbus, Ohio.

BE The Popular Mechanics representative in your neighborhood and earn big profits in your spare time. Write Popular Mechanics Magazine, Room 408M, 200 E. Ontario St., Chicago, Ill.

STAMP COLLECTING

CHOICE Of 35c worth of stamps from our first U. S. selection free to applicants enclosing 3c postage. Large selection to choose from. Act now! S. C. Engel & Co., 38 Park Row, New York.

FREE—Famous Americans set, plus Flag Set, plus the National Parks Set, plus the Presidential Set to the \$5. A total of 90 stamps absolutely free to customers for our unsurpassed U. S. or foreign selections. Send 3c postage for 15 of the above mentioned stamps and full particulars. Tribune Stamp Company, 145 Nassau St., Dept. 107, New York.

FREE. Irish commemorative collection, including rebellion issue with approvals. Raymax, 123-Z William St., New York City 7.

GIBRALTAR Packet free—Nice collection Gibraltar, New Zealand Centennial, British Uganda, French Colonials, early British Colonial, West Indies, South American, war stamps plus Philatopic Monthly Magazine. All for 5c postage. Empire Stamp Company, Dept. PM, Toronto 5, Canada.

FREE Packet pricelist, 250 bargains. Charles Chase, R.F.D. 1, North Conway, N. H.

CHINA "Victory." Catalogs \$2.30. Only 5c. Approvals. Country Stamps, Route 76, Tacoma, Washington.

BET You haven't these! South Georgia, South Orkneys, Grahamland, South Shetlands, Shortlived Falkland Dependencies. Everything 3c with approvals. Viking, 130-Z Clinton St., Brooklyn, N.Y.

FREE! Airmails with approvals. Deane Stamps, Box 87, Miami 35, Florida.

REMOVE Stamps from paper with "Stoff," 25c. L. White, Box 923, Pittsfield 3, Mass.

"CONFEDERATE States." Twelve different unused 10c, approval applicants only. "Stamps," Box 87, Albany 1, New York.

SALE! World assortment 10c. Oscar Ritter, 1508 Fifth, Corpus Christi, Texas.

ETHIOPIA, Vatican, Free French and Roosevelt triangle, free to approval applicants. Rare Stamp Co., Box 121, Miami 38, Florida.

INFORMATIVE. Free. Monthly illustrated price list. Frances Reese, Martinsville, Indiana.

LIBERIA—277-279 for 10c. Page, Manners Avenue, Haverhill, Mass.

SENSATIONAL! Set Capejuby, Brunel, Perak, Honduras, Nigeria, Paraguay, and over 100 different others. Everything 10c with approvals. D. O'Keefe, 7517 Merrill Ave., Chicago, Ill.

GERMANY #B200-91, CBI-3, 95 mint stamps, \$5.00 approvals, Masser, 322 E. 9 St., Brooklyn 18, N. Y.

SOUTH America and Cuba packet. Free to approval applicants. Martin, Box 1128, Miami Beach, Florida.

DIME Brings surprise package free to serious stamp collectors wishing approvals. Lincoln Stamp Co., No. Conway, N.H.

EARN Money at home. Operate your own mail order stamp business. Details free. Kelly, T-9544 Whitcomb, Detroit 27, Michigan.

FREE! 100 Diff. with approvals. Kloster, 4126 Winona St., San Diego 5, Calif.

WORLDWIDE. Different 200, 25c; 500, 60c; 1000, \$1.50; 2000, \$4.25. Beacon Sales, Maynard 2, Mass.

FREE! Canadian sets, royal visit, George VI, George V, coronation, jubilee, others, to approval applicants. Ensign, Box 118-M, South Orange, N. J.

EXCHANGE Stamps universe. Particulars free. "Exchangers," Bry 126, Seine, France.

PENNY Approval bargains—Write Department PM, 1267 Tutwiler, Memphis 7, Tennessee.

U. S. Approvals. Used or unused. Panners, Box 52-P, Dorchester 24, Mass.

HISTORICAL Collection! Cavalry Charge! "Bulgaria" Flaming Sword! "Ireland" Big She-Wolf! "Italy" Fort! Legionnaires! Field Marshall! "Pitcairn Mutiny Island" Commemoratives and pictorials! 3c approvals. Star Stamp Co., Jamestown, New York.

UNEXCELLED! Cataloging to \$1.00 each. Includes Ascension, Congo, Samoa, Triangle, etc. Everything 10c with approvals. Stanfield, 624M West 139 Street, New York.

\$50,000 BRITISH Guiana #13 facsimile 3c; approvals. Ajax, Box 6009, Kansas City 4, Missouri.

FREE—25c Worth of stamps to U. S. approval applicants. Village Stamp Co., 90-39P 214 St., Queens Village 8, N. Y.

DIFFERENT. 25 Canada, 25 Denmark, 25 Finland, 25 U. S. 3c with approvals. Alatalo, Maynard 14, Massachusetts.

BERLIN Bears, complete set of eight and 100 different stamps only 10c to approval applicants. Reich Stamp Co., 4647 Kenmore, Chicago 40, Ill., Dept. M11.

FREE—China airmail set, large pictorials with approvals. Fields, 1939 E. 85th, Cleveland 6, Ohio.

FREE U. S. price list, postage 3c. Mark Hanna, 335 5th Ave., Pittsburgh 22, Penna.

MY Exceptionally nice general approvals will please beginner or advanced collector alike. Taaffe, 1766 32nd Ave., San Francisco 22, California.

ARTCRAFT First day cover service. Best, 696-P Greene, Brooklyn 21, New York.

MOZAMBIQUE Triangles, unused. Set 10c with approvals. Vargo Stamps, 6044 South Fairfield, Chicago 29, Illinois.

50 DIFFERENT Japan stamps and our price list, one silver dime. Stamp Sales, Box 1649P, Oakland 4, California.

POSITIVELY Greatest free offer—Latest Scott's International \$6.00 stamp album—covering entire world, contains 36,000 illustrated descriptive spaces; Scott's 1948 Standard \$7.00 catalogues "Philately's Encyclopedia"—absolutely free to applicants for foreign approvals becoming customers. "Approval Service," Box 1700, San Francisco, California.

50 PICTORIALS, Etc., 3c. Approvals, Budwits, Box 108, Meriden, Connecticut.

FIVE Beautiful Spanish airmails, catalogue 45c, only 10c with approvals. Standard, Box 43 West Farms, New York 10, N. Y.

75 UNSORTED Newfoundland 25c. Real value. Mayfair, Regal Road, Toronto 10, Canada.

200 WORLD Wide 27c. Pacific, P.O. Box 5704, Los Angeles, Calif.

FREE! Dollar stamps for you! Send now! Approvals. Keating, 637 Bergen, Jersey City, N. J.

CHINA—Post office set only 3c to approval applicants. Floyd Frederick, 513 1/2 Green Street, Lancaster, Penna.

GERMANY, "Nazi Army Issue"; ships, planes (13) free to approval customers. William Deems, Ravenswood, W. Va.

ROOSEVELT Commemoratives; 18 different 25c! Approvals. Robert Wilks, Beverly, Mass.

12,000,000 COLLECTORS Your market! Become successful stamp dealer. Earn big profits! Proven method. Details free. Largentiere Company, 6462 83rd Place, Forest Hills, New York.

UNPICKED: 5000 U. S. \$2.00; 5000 foreign \$3.00. Kuhn, 3315 80th, Jackson Heights, New York.

WORLD'S Finest approvals. Free set accompanies your request. Yokums, Box 1327E, San Antonio 6, Texas.

FREE! U. S. monthly lists. Cole, 43-A Rinewalt, Buffalo 21, N. Y. Precancels also available!

BOY, Oh boy! 500 France and Colonies—unpicked as received from French missions including stamps from France and her colonies, such as Camerouns, Guadeloupe, Inini, Niger, etc. Only 10c to approval applicants! Methuen Stamp Service, Inc., Dept. 40, Methuen, Mass.

IRAQ Approvals, \$1.00 to \$5.00 deposit. Fifty-one rare covers from here \$5.00. Seventeen \$2.00. (U.S.A. money). Edward Basry, Bagdad 31, Iraq.

WHAT Have you to offer? Collection? "Shoobox" accumulations? Anything in stamps? We urgently need them. Spot cash paid. Cosmopolitan Stamp Co., 1457 Broadway, New York City.

FREE Premium to new approval applicants. Modern Stamp Service, Box 12, Wakefield Station, New York.

FREE. Triangle, Roosevelt, Vatican, Ethiopia, Hitler heads. Request approvals. Florida Stamp Company, Box 807, Miami 5, Fla.

SPANISH Air set free to approval applicants. Flamingo Stamp Company, Box 4038, Pinewood Station, Miami 38, Florida.

FREE Monthly illustrated bulletin showing recent issues. Penny approvals on request. Reed Company, Box 980, Chi-

WORLD—500 Diff. 50c, 1000 \$1.25, 75 Canada 25c, approvals, lists. Victoria Stamp Co., London 4, Canada.

PENNY Approvals that satisfy. Neil Gronberg, Box 5441-P, Philadelphia 43, Penna.

10 DIFFERENT Iraq 5c to approval applicants. Jersey Stamp Co., 9726 Chappel, Chicago 17, Illinois.

WORLDWIDE Packet 50 stamps 5c with approvals. Carlins Approval Service, Box 307, Fresno, Calif.

FLAG Stamp free with U. S. approvals. Wenigman, 929 Oakdale, Chicago.

FREE—\$25.00 Stamp collector outfit—Finest, most complete outfit ever offered: Large Scott album, valuable collection of 1050 different stamps, airmails, odd-shapes, hi-values, "Stamp Finder," watermark, magnifier, perf-gauge, tongs and hinges. Actually over \$25.00 value absolutely free when regular customer. Mail application now for foreign approvals. Bargain Stamp Service, Dept. "D," Santa Ana, California.

25 ALL Different stamps 10c. Tunis, Wakeman Ave., Newark 4, New Jersey.

200 DIFFERENT Stamps—Cataloging up to 15c each, only 3c to approval applicants! Littleton Stampco, Littleton 42, N. H.

ZOWIE-E! A barrel of fun for only a dime. 500 United States stamps—absolutely unpicked and unsorted—just as received from church missions. Many varieties, including large commemoratives, airmails, high denominations up to \$5.00! Stampdom's biggest package of fun—and you might find something really valuable! Price only 10c to serious approval service applicants. Money back if not delighted. Illustrated bargain lists with each order. Mystic Stamp Company, Dept. 80, Camden, New York.

WOW! \$10.00 Worth of fun. Only 10c! What a treasure hunt! Big package 500 foreign stamps from foreign missions, other sources. Includes stamps from Africa, South America, Free French, Somali, Palestine, etc. Includes airmails, commemoratives and stamps worth up to 50c. This offer sent for 10c to approval applicants only. Jamestown Stamp Co., Dept. 22, Jamestown, N. Y.

ILLUSTRATED Stamp Magazine, 26 weeks 25c. Stamp Journal, Kalamazoo, Michigan.

200 DIFFERENT, Including Roosevelt triangle, 5c to approval applicants. H. Avalon Stamp Co., Springfield, Mass.

WORLD'S Largest stamp (7 1/2 x 14 inches). A real curiosity! Retail for 50c, only 3c to approval applicants. Tatham Stamp Co., Springfield 30, Mass.

DANDY United States approvals. Write immediately. Sullivan, Endicott Building, St. Paul, Minnesota.

50 DIFFERENT United States 10c. No approvals. Seidenberg, Cassopolis, Mich.

FREE! 100 Worldwide different stamps to approval buyers. Big U.S. and illustrated bargain lists sent with approvals. Bookman, Maplewood, N. J.

BRITISH, Spanish and French Colonies. Vatican, Hitler heads, and airmail packet, free with approvals. Pan-American Stamp Co., Box 145, New York 33, N. Y.

STAMP Collections wanted. Complete collections, duplicate lots, surplus stock, mint and used. Prefer trade for printing or other items, buy outright if priced right. What have you, what's wanted? Vanroy Shirk, Lebanon, Penna.

U. S. Price list. Send postage. State Stamp Service, 1225 Park Building, Pittsburgh 22, Penna.

DEALERS—Wholesale list. Postage 3c. Frank, 5031 Queensberry, Baltimore 15, Md.

319 ALL Different stamps from Vatican City, Palestine, Cyprus, San Marino, etc., with our sensational new illustrated 32 page Stamp Finder. It identifies all difficult stamps immediately. All for only 10c to approval applicants. A tremendous bargain. Garcelon Stamp Company, Box 800, Calais, Maine.

FIRST Day covers on approval. Knobel, 1918 S.W. 12th Street, Miami 35, Florida.

U. S. Price list. Send postage. Stanley Gibbons, 38-P Park Row, New York.

UNITED States approvals complete coverage, fine quality, attractive prices. Seminole Stamps, Box 1138-P, Coral Gables, Florida.

"GOYA Nude" set complete 35c. Approvals. Royal Stamp Company, Tamaqua, Penna.

ROOSEVELT, Hitlers, etc. 110 different 15c. Buckley, PM-208 Ludlow Bldg., Day-

FREE Beautiful airmails. Commemoratives, pictorials, eight countries. Approvals enclosed. Green and Company, Norwood 12, Ohio.

WOOHIE! Wow! 25c worth of stamps free to buyers. Write M & N Co., 742A Sheffield Ave., Brooklyn, N. Y.

U. S. 50 Different mint commemoratives, \$2.50. Faith, 838 W. 62nd St., Los Angeles 44, Calif.

ANTIQUES, RELICS, INDIAN GOODS, CURIOS

180 PAGES Antique and modern pistol, sword, etc. values, 50c. Robert Abels, A860 Lexington Ave., New York 21.

PRECIOUS STONES, MINERALS

ZIRCONS — Guaranteed! Mounted or unmounted. Lowest prices—highest quality! 10c brings you colorful illustrated catalog. Write today. Dept. V, Orlando Creations, Inc., 112 Prospect Ave., Cleveland 15, Ohio.

ZIRCONS, Siamese mined, master-craftsman cut, ready-to-set. 2 fiery samples \$1.00. Two 2/3 carat engagement size \$2.00. One carat beauty \$2.00. 1 1/2 carat dazzler \$3.35. Others. Imhusex, P.M. Box 232, White Plains, N. Y. Agents wanted.

GEMSTONES, Rough, polished. Crystallized specimens. Every variety, lowest prices. List free. Plummer's 5068 Brighton, San Diego 7, California.

ZIRCONS, Beautiful sparkle, ready-to-set. 2 samples almost 1 carat each. Both for \$3.00. 2 big beauties, 1 1/4 carat size, both \$5.00. Don Huse, Armonk, N. Y.

COLLECT Minerals and gems as a hobby. Free list. Elbert McMacken, Route 2, Box 177, Escondido, Calif.

METAL Detectors. The very latest circuit. Free literature. Hedden Metal Detectors, 3329 Liberty Avenue, Pittsburgh 1, Penna.

BEAUTIFUL Arizona agates, polished samples and listings \$2.00. Unpolished samples \$1.00. Arizona Agate Mines, Cave Creek, Arizona.

HOBBIES AND COLLECTIONS

MERCEDES, Pioneer of an industry. Profusely illustrated history of development of gasoline engine and thrilling early races. Send \$2.00. Alec Ulmann, Riverside, Connecticut.

HEP, The Hobbyists' News-Letter, presents latest information of lesser-known hobbies. Official organ of Hobby Enterprise Program, new and different worldwide hobby club. Sample copy, full details twenty cents. Hep, Box 369, GPO, Brooklyn, N. Y.

FROM The wonderland Hawaii. Sixteen beautiful hotel souvenir luggage stickers for only one dollar. Wieser, Box 3531, Honolulu, Hawaii.

WORLDWIDE Hobby magazine; twelve issues \$1.00; sample 10c. Klings', Blue Island, Illinois.

UNUSED Match book covers, 100 all different \$1.00. Free catalog. Charles Edelman, 1311C East 84, Cleveland 3, Ohio.

INVENTING Can be an interesting and profitable hobby. Write for complete particulars. Institute of American Inventors, Dept. 40-E, 1926-Eye St. N. W., Washington 6, D. C.

50 DIFFERENT Army embroidered patches \$1. Other bargains. Insignia Mart, 703A Broadway, New York 3, N. Y.

CAMERAS, PHOTO SUPPLIES

35MM. Develop, reverse your own film. Slides in one hour. Sample free. Lake Camera Exchange, Drawer 842, Gary, Indiana.

YOU Make breathtaking, long treasured, prize winning photo enlargements easily, economically with the New Precise Photo Enlarger, only \$22.20 complete, postpaid, nothing else to buy. Send postcard for details. Tam Products, CM-7, 3814 Wrightwood, Chicago 47.

TITLE Making amateurs free booklet. Westwood Company, 635 Victoria Street, San Francisco 12, California.

PHOTOGRAPHY For pleasure or profit. Learn at home. Practical basic training. Long established school. Write for booklet. American School of Photography, 1315 Michigan, Dept. 3432, Chicago 5.

INFRA-RED Film makes for unusual pictures! Eastman Kodak, 35mm Infra-red, four 36 exposure reloaded cartridges, \$2.50 postpaid. Short-dated but guaranteed. Delta Photo Supply, 690-M Third

COLOR Slides duplicated 4 for \$1. Photo Lab., Inc., 3825 Georgia Ave., Washington, D. C.

FREE! 116-Page illustrated photographic catalog, send 3c stamp. Bloom's Camera Center, 1657 Main, P.M., Springfield, Mass.

HAVE You a camera? Improve your hobby of photography and learn how to make better pictures. Write today for our latest free book catalog. Enclose 10c if you desire recent copy of American Photography, containing articles and pictures by the world's foremost writers and photographers. 602 Camera House, 353 Newbury St., Boston 15, Mass.

SNAPSHOOTERS: Learn develop your own; all materials, instructions, 5 undeveloped pictures \$1.00. Davis, 538 Palisades, Akron 3, Ohio.

MAKE Your own photocopies with the Cop-Ez Printer, only \$15.00. Cop-Ez Equipment Co., 4864 Woodward, Detroit 1, Mich.

PICTURES Never before possible! 35mm. Tri-X film, Weston speed 200 daylight, 160 Tungsten. Guaranteed, 36 exposure cartridges, 4 for \$2.50. Per dozen, \$7.50 postpaid. Delta Photo Supply, 690-M Third Ave., New York 17, N. Y.

ENLARGER? Build your own cheap. We show you how. Complete plans \$1.00. Somerset Specialties, 10514 Somerset, Detroit 24, Mich.

KODABROMIDE Enlarging paper—4 1/4" x 8 1/2 feet rolls. Enough for almost 2,000 4x5 enlargements. Single weight. Actual tests prove its worth. Fully guaranteed. Reduces printing costs to a fraction of a cent apiece. Value over \$35.00, our price \$2.25 postpaid in U.S.A. Delta Photo Supply, 690-M Third Ave., New York 17, N. Y.

K-21 AAF Aerial Combat Cameras, manufactured by Graflex; motor driven, with flexible shaft; 24 volt operation; including step-down transformer to 110 voltage; may be manually operated. Complete except for lens and filters. New, original government packaging; positively the lowest price in the country, for a limited time only, \$39.50. An amazing value from Amazing Bachman's, Dept. PM, 27 Herman Street, Rochester 5, N. Y.

OIL Coloring photographs can be a fascinating hobby or profitable sideline for those with artistic talent. Learn at home. Easy simplified method. Send for free booklet. National Photo Coloring School, 1315 Michigan, Dept. 3432, Chicago 5, Ill.

BASS Says! At the sign of the old "Horse Trader," 37th year. Thousands of satisfied customers everywhere! Finest brands including Kodak, Bell & Howell, Argus, Zeiss, Leitz, etc. Satisfaction always guaranteed, or your money back! Bass buys 'em, sells 'em, trades 'em. Write or wire. Bass Camera Company, Dept. AG, 179 W. Madison St., Chicago 2.

PHOTO FINISHING

2 BEAUTIFUL Hi-Gloss prints each good negative and enlarging coupon with each 8 exposure roll developed 28c. Free mailers. Owlphoto Co., Weatherford, Oklahoma.

ENLARGEMENTS! 5x7, 15c; 8x10, 25c, glossy or dull. Gorgeously oil colored, 50c extra. Negatives made from your favorite photos, 50c. Rolls developed, printed, 25c. L. R., Box 1476-c, Milwaukee 1, Wisconsin.

SENSATIONAL Introductory offer! Send snapshot or negative, this ad and 10c. We'll send you a beautiful 7x5" enlargement! Or, Kodak roll developed and printed (with free coupon) only 25c; or 8 giant prints from roll, 30c. Reprints from negatives, any quantity, regular size, 3c; Giant size 4c, Candid rolls—36 exp. 35mm. developed, vaporated, enlarged to 3x4, \$1.00, 18 exp. 50c. Free mailers. Free premium offers sent on request. American Studios, Dept. 364, La Crosse, Wisconsin.

SAME Day service. Roll developed, 8 sparkling clear Velox deckle edge prints 25c. 2 sets prints 40c. Reprints 3c. Enlarged reprints 5c. Superior Finishers, Box 5610, Dallas 2, Texas.

DEVELOPING, Printing, 8 exposures 20c. 8x10 enlargements 3 for \$1.00. Speed Photo, Box 822, G.P.O., New York 1, N. Y.

FREE Introductory offer! Send 2 negatives, receive 2 sparkling hi-gloss prints free, with mailers. Roll developed and printed 35 cents. Gorek's Photo Service, 3619A East 131st Street, Cleveland 20, Ohio.

24-HOUR Film service, 8 exposures 25c. Quality prints mailed within 24 hours after film received. York Photo Finish-

SPECIAL, 10 Reprints 25c. 100—\$2.00. Roll 25c. Dick's Photo, Louisville, Ky.

OVERSIZE Prints; overnight service; 35c. Films developed and 8 prints near postcard, only 35c. Electronic process, non-fade, glossy pictures. Write for free mailers. Peachtree Photo Finishers, Dept. PM, P.O. Box 4324, Atlanta, Georgia.

MOEN'S Sensational 50th anniversary supersize prints! Our amazing new \$15.-000 equipment will produce better, sharper supersize prints and faster, no longer need you wait. Send film today and see the difference, be the first to show your friends. 8 exposure rolls all supersize genuine Moentone Varigam prints only 35c; 12 exposure 55c; 16 exposure 65c. Moen Photo Service, 18 Moen Bldg., La-Crosse, Wis.

YOU'LL Be delighted. Eight Never-fade prints now only 25c. Two prints each only 35c. Free mailers and price list showing other services. Write today. Hammond Sales Co., Hannibal, Mo.

PORTRAIT Quality 5x7 enlargements 15c, 2 for 25c. NuTone Fotos, Box 228, Pottstown, Penna.

8 HOUR Service, Box 468, San Francisco. Your 8 exposure roll printed jumbo or regular size 30c; 12 exposures 35c; 16 exposures 50c; 36 exposures \$1.00. Reprints, jumbo or regular 3c. Regular prints deckled. Fine grain developing. Send for free mailers. Quality Photo Service, Box 468, San Francisco 1, Calif.

NEW Process developing and printing. 8 exposure rolls 35c. Mayfair Photo Service, Box 261K, Toledo, Ohio.

ENLARGEMENTS In album form developed and printed in one continuous story-telling arrangement. Any 8 exposure roll reproduced this novel, loose-leaf way for only 30c. Reprints 4c each. Extra prompt service! Clip this ad for free mailers. Larga-Pic, Box 22, Brookline, Mass.

"BETTER Photo finishing." Jumbo prints 40c a roll. Reprints 3c. Best by test, 35mm. positives \$1.50 strip, 36 ex. Sealstone Photo, Box 468, Seal-Beach, Calif.

EVERY Picture an enlargement! New electronic developments give you bigger and better enlargements at the same low prices. Any 8 exposure roll developed and printed enlarge size, only 30c; reprints 4c each. Fast, accurate service guaranteed. Send for free mailers today! Enlarge Photo Service, Box 791-D, Boston 2, Mass.

JUMBO Or photo pack prints, 8 exp. roll 35c. 16 exp. roll 65c. NuTone Fotos, Box 228, Pottstown, Penna.

PHOTOGRAPHY For pleasure or profit. Learn at home. Practical basic training. Long established school. Write for booklet. American School of Photography, 1315 Michigan, Dept. 3451, Chicago 5.

8 PRINTS All enlarged to nearly postcard size from your roll or negatives 25c; 16-50c. (Trial offer). Willard Studios, Box 3535A, Cleveland, Ohio.

16 DECKLEDGE Prints from any standard 8 exposure roll 25c. Quick service. Professional work. Skrudland, Lake Geneva, Wis.

FREE Price list on quality developing, printing, enlarging. Write for it today. Bryan's Photo Shop, Dept. M, Panama City, Florida.

BUTONE Jumbo prints are different. Any 8 exposure roll developed and one Butone Jumbo print each, only 30c; additional Jumbo prints 4c each. Butone bargain: Any 8 exposure roll developed and two regular size prints each 25c; additional regular size prints only 3c each. All work guaranteed. Butone Finishers, Box 1777, Wichita, Kansas.

MOTION PICTURES AND SOUND EQUIPMENT

BRAND New 16mm. sound projectors \$129.50. Send 10c for 1948 photographic catalogue. Sterling's, 679 Northampton, Easton, Pennsylvania.

GOOD Used 16mm. sound projectors. Particulars. Robert Salmon, 3558 So. 11th East, Salt Lake City, Utah.

35MM. SOUND Films. Lists free. R. Jerge, 50 Manhattan, Buffalo, N. Y.

8-16 MM. Movie film developed, ready for projecting—24 hour service. 100 ft. 16mm. \$1.25; 50 ft. 16mm. 85c; 25 ft. 8/8mm. 60c. Radiant Cine Laboratories, Box 720B, Chicago 90.

8-16 MM. Art movies. Free list. Box 103, Malden 48, Mass.

8-16 MM. Movie film in bulk for home processing. Big free catalog—bargains in film, processing equipment, supplies. Superior, 105B S. Wells, Chicago 6.

ROLL Developed, 8 prints and two enlargements 25c. Trial offer. Young Photo Service, 405-C, Albany 2, N. Y.

THRILLING 8 MM. - 16 mm. movies. Catalog free. Fine Arts Productions, Box 2084-X, San Antonio 6, Tex.

EXCLUSIVE Movies, projectors, accessories, free catalog. Home Pix, 1674 Broadway, New York 19.

ENLARGEMENTS And negative from your movie film. Send one dollar and frames. Curiophoto, 1187 Jerome, New York 52.

PROCESS Own movie film. Free literature. Duro Products, 1519 Eggert, Buffalo 21, N. Y.

FILM—Free processing 100 ft. 16mm. Weston 12 \$3.25. Weston 24 \$4.90. Weston 64 \$4.95. 25 ft. double 8mm. Weston 12 \$1.50. Weston 24 \$1.89. Weston 64 \$1.99. Free circulars. Fromader Genera, Davenport 4, Iowa.

LEARN Professional motion picture technique at home. Approved for veteran training under G.I. Bill. Free catalog. Motion Picture Institute, Birmingham 4, Mich.

LEARN Movie projection, management. Free catalog. Theatre Institute, Elmira, N. Y.

BARGAINS In 16mm. sound projectors, films, reels, splicers. Harris, 303 West 42nd Street, New York 18.

ELECTRIC Movie cameras, 16mm., Army GSAP, original condition, value \$200, complete with f/3.5, new \$32.50, used \$19.50. Accessories available for home conversion. Free literature. Completely converted Lektro, 16mm. ready-to-operate \$59.50 guaranteed. Magazine film for same, \$2.50, includes processing. Fotoshop, Room 138, 18 E. 42nd St., New York City 17.

SURPLUS 16mm. Eastman Super X on 50' cores, 50c postpaid! 12 rolls \$5.00! Outdated but tested and guaranteed! 100' camera spools 25c postpaid! Processing, 75c. Filmmcraft, 47th Holly, Kansas City 2, Missouri.

MOVIE Film processing—Finest automatic machine processing, 8mm., 16mm. 48 hour service. Also duplicating, editing, titling, other lab. services. Send for list of prices. Fotoshop, Inc., Room 162, 18 E. 42nd Street, New York City 17.

I BUY, exchange, swap movies. What have you? What do you want? Lowest exchange rates in world. Catalogue \$1.00. Refundable. Harvey Iris, Box 539, Brockton, Mass.

GUARANTEED Fresh anti-halo outdoor movie film! Weston 12! Daylight loading! Processing free! Three spools double 8 mm. \$3.45! Six single 8 mm. for Univex, \$4.60! Postpaid! Catalog. Eso-S, 47th Holly, Kansas City 2, Missouri.

FREE Movie list. Superior Film Service, Box 713, Troy, N. Y.

KODAK Super-X movie film at give away prices! Govt. surplus but good as gold! Tested and fully guaranteed. 16mm. 100' \$2.95; 50' magazine \$2.50; 8mm. 25' Double 8 \$1.65. Processing included. Stock up for summer shootin'! Fotoshop, Room 185, 18 E. 42 St., New York City 17.

8-16MM. Silent-sound films. Complete rental library. All latest subjects. Free catalogue, (sample film 10c). Garden Film, 317 West 50th, New York 19.

BASS Says! 37 years of leadership means satisfaction to you! Finest equipment, 8 and 16 mm., sound cameras, sound projectors. Bass buys 'em, sells 'em, trades 'em. Satisfaction always guaranteed, or your money back! Bass Camera Company, Dept. A, 179 W. Madison St., Chicago 2.

BEAUTIFUL Kodachrome slide and lists 25c. Slide Supply Service, 3111 West Tuscarawas, Canton, Ohio.

MOVIE Film at tremendous savings! Kodak Super X, govt. stock, tested, guaranteed! 16mm. 100 ft., \$2.95; 50 ft. magazine, \$2.50; Double 8mm. 25 ft. \$1.65. Super XX, 50c add'l. each roll. Free processing. Fast service. Photo Surplus Sales, Box J-11, 12 Duane St., New York City.

MUSIC AND MUSICAL INSTRUMENTS

REAL Composer of music will co-operate with lyric writers in song production. Fine publication proposition. National distribution of publication. C. Isabel Mayer, Box 3896, Portland 8, Ore.

MUSICAL Instruments, 5 day trial. Free bargain list. Meyer's, 454-D Michigan, Detroit 26, Michigan.

LEARN Piano playing quickly. New speed method. Very simple. Public schools approve. Literature free. Speed Method, 435 Abiso, San Antonio 5, Texas.

1948 ACCORDIONS — Wholesale — Free catalog. American Accordion Center, 5329 Belmont, Chicago.

SAXOPHONES, Clarinets overhauled carefully, reasonably. Master Repair, 29 Hunter, Glens Falls, N. Y.

GUARANTEED Satisfactory piano score arranged, \$6.00. Lee, 344 Primrose, Syracuse 5, N. Y.

SONG Titles and poems wanted for immediate consideration. Examination without charge. Send best material today. Special Service, 2115 Kenilworth Ave., Berwyn, Ill.

MUSICAL Movements \$2.00. Free photo. Pevar's, Dept. PM, 4218 Viola, Philadelphia 4, Penna.

SONGWRITERS: Honest outstanding music writing offer. Len-Tex Studios, Leonard 2, Texas.

AMPLIFY Your accordion with our new mike \$22.50. Sounds like organ. Installed in minute. Use any amplifier. Amplifier and mike \$72.50. Write Del Principe, 307 So. Wabash Ave., Chicago.

BE Independent, tune pianos, music unnecessary. Practical Piano Tuning shows you how. \$2.00 postpaid. Chord-Slide Co., P3122 Lawrence Drive, Corpus Christi, Texas.

SONGWRITERS! Ethical composing offer. Hibbler, C5, 2157 N. Avers, Chicago.

ACCORDIONS, Streamline, wholesale. Request circular. Metro Accordion, 44 North Albany, Chicago.

MUSIC Arranged, Songs printed. Frank Wildt, Music Publisher, Lancaster, Penna.

SONGWRITERS—Protect your songs. Get the facts first. Free booklet, attractive offer. Song Service, 331-C West 46th, New York.

POEMS Wanted for musical setting! Send poem for immediate consideration. Hamann Service, 614 Manhattan Building, Milwaukee, Wisconsin.

POEMS Wanted to be set to music. Free examination. Send poems. McNeil, Master of Music, 510-PM S. Alexandria, Los Angeles, California.

SONGWRITERS: Send poems for free examination and outstanding offer. United Music Service, 150, Salem, Indiana.

WRITE Songs. Big money and reputation. Write for information. J. Gordon Pub. Co., 201 N. Hoyle Ave., Chicago.

ACCORDIONS—Guitars, trumpets and all musical instruments, new and used. Direct from national distributors, cash and terms. Save money. Del Principe, 307 So. Wabash Ave., Chicago.

SONGWRITERS. Have your songs recorded. Music or lyrics written for uncompleted songs. Information. Dixon, 634 Common, New Orleans, La.

POEMS Wanted for musical setting. Send poems for free examination. Five Star Music Masters, 630 Beacon Bldg., Boston, Mass.

RADIOS, SUPPLIES, INSTRUCTION

RADIOMEN, Servicemen, beginners—Make more money, easily, quickly. \$250 weekly possible. We show you how. Information free. Merit Products, 216-32A 132nd Avenue, Springfield Gardens 13, New York.

24 PAGE Plans "18 Long Distance Crystal Sets," including "Radiobuilder"—25c. Laboratories, Eye-c, San Carlos, California.

CLOSEOUT Specials: crystal radio kit with plastic base, crystal, wire, clips, headphone, instruction book \$1.00. Headphone only 50c. Crystal and instructions 10c. Crafton Industries, Waseca, Minn.

NEW Pocket signal generator. All types of trouble shooting. Only \$4.50. Money back guarantee. Howard Products, Dept. PM-7, 2754 Diversey, Chicago 47, Ill.

MAKE Selective distance getting crystal radios, tube radios. New designs. Instructions, crystal, catalog, 25c. Radio Leader, LaVerne, Calif.

RADIO Parts bargain assortment, \$2.95 prepaid. Box 214, Lawrence, Mass.

FREE Detailed information television kits, easy to build. Save money. Famous Western Electric fixed crystal fine detector crystal sets 89c prepaid. Murray Barron Industries, Box 74, West Englewood, N.J.

FREE Catalog, radios, phonographs, records. Bargain prices. Mail post card today. Jmad Co., 122 Clinton St., Buffalo 3, N. Y.

26 YEARS Experience radio repairing at your fingertips. I've repaired 45,000 radios. Have perfected simple system you can follow step by step. No calculations or formulas. Total price \$2.00 postpaid or c.o.d. Moneyback guarantee. Ross Radio, 14615-M Grandriver, Detroit 27, Michigan.

MAKE Simple, tubeless, batteryless, distance-getting crystal radios. Crystal and illustrated instructions 25c postpaid. Allen, 427-P, Clinton, Missouri.

FIX Any radio. Amazing new instrument locates radio troubles double quick. Simple instructions show you how. Thousands in use. Write today for 24-page booklet, "The Inside Story." Feiler Engineering Co., 945 George St., Dept. PM, Chicago 5, Illinois.

BUILD "Loudest" crystal radio. Instructions, loud crystal, catalog: 25c. Amorose, Route Four, Richmond, Virginia.

BUSINESS OPPORTUNITIES

BE Independent — Operate America's lowest price penny vending machine. Big profits. Immediate shipments. Write for bulletin and prices. Fielding Mfg. Co., Desk (748), Jackson, Mich.

GOOD Business, own boss. Building rent, local advertising only capital needed. Write for details. Ray Woods, 320 Main St., Kerrville, Texas.

SELLS On sight! Beautiful flower designed plastic tablecloths. Retail at \$1.98. Wholesale price, \$12.00 dozen. \$1.50 sample. Van der Plate Products, Glen Rock, New Jersey.

EXTRA Money! Start a business for yourself or work spare time using our flat fiber $\frac{1}{4}$ ", $\frac{1}{2}$ ", $\frac{3}{8}$ " and $\frac{3}{4}$ " width weaving material to make baskets, waste baskets, hampers and reweave chair bottoms and porch chairs. Instructions furnished. Frank Veale Mfg. Co., Inc., P.O. Box 5, Columbus, Indiana.

START Home business making statuettes, plaques, artificial marble flooring, liquid marble, rubber molds, metalizing baby shoes. Amazing profits. Folder free. Creative, 236-L, Winnetka, Illinois.

CHANCE Eliminated! Guaranteed steady income while your own boss. Free details. No obligation. Write Auditax, 4513-J Sunset, Los Angeles 27, Calif.

HELP Wanted to operate our successful mail business. Free details. Reynolds, Box 103Y, McAllisterville, Penna.

RUBBER Molds—Duplicate hundreds of items, own your own business, starting in spare time, we make genuine rubber molds from any models, quality molds that do not shrink, harden or deteriorate. Beginner's kits. Information, sample of workmanship and material free. Pacific Mold and Rubber Co., Dept. P, 706B-So. Pacific Coast Highway, Redondo Beach, California.

START A home business in spare time. Make extra money. Experience not essential. Literature free. Lee & Lee Products Co., 293 S. Diamond St., Mansfield, Ohio.

PERFUME — Make it yourself. Profitable, sparetime, home business for men and women. Free information tells how. Write "International," 6347 Parnell-X-10, Chicago 21, Illinois.

GOLDEN Opportunity to own and operate wholesale distributing and service business. Very thick market. Repeat business. Year-round. Employ others. Protected territory. Small investment for supplies and electrically operated equipment. Write Hinson & Company, Incorporated, Richmond, Indiana.

WANT Pleasant outdoor work in a business of your own? Good profits selling over 200 widely advertised Rawleigh home/farm necessities. Pays better than most occupations. Hundreds in business 5 to 20 years or more! Products-equipment on credit. No experience needed to start—we teach you how. Write today for full particulars. Rawleigh's, Dept. G-145-PPM, Freeport, Ill.

MAKE Money sharpening saws at home on electric machine. No experience necessary. Hardware dealers act as your agents to secure work. Send for free book "Independence After 40" shows complete plan for starting in spare time. Foley Mfg. Co., 47 Foley Bldg., Minneapolis 18, Minn.

SELECT Collection, money making plans. Local and mail order. New edition. Particulars free. Flasco Sales, 2505A 150 St. Flushing, I. I. New York.

AMAZING Profits in home business making plastics and novelties. Literature free. Fenway Mailing Service, 119 Peterborough St., Boston 15, Mass.

TRADE Magazines will help you get ahead. Latest copies on every trade, business or interest for only a few cents each. Write today for free pricelist. Commercial Engraving Publishing Co., 34C North Ritter, Indianapolis 19, Indiana.

"OPPORTUNITIES"—52 Page mail trade magazine, 24 wholesale sources, 3c. Wayne Burger, Baltic, Ohio.

"HARNESING The Earthworm." Author will mail valuable free booklet: Successful Earthworm Breeding. Thomas J. Barrett, Dept. 14-B, Box 488, Roscoe, Calif.

MAKE Money by mail. Work at home. Amazing new plan tells how. Produced at great cost. Real, genuine moneymaker. Information free. Velker, 1836 Champlain Street, Toledo 11, Ohio.

RESILVER Mirrors at home. Formula 25c. Ideal Service, Park Ridge 6, Illinois.

BUILD Successful home business! Free "How" details. Scott, Box 151, Morning-side Station, New York 26.

ARE You interested in getting the "Start" you have always dreamed about? A small business of your choice? It's new—it's yours. Free information. Business Consultants, Inc., Dept. 122, Clinton, Illinois.

GOLDEN Opportunity "How to Establish and Operate A Successful Mail Order Business." Free information. Palmer Publications, 4219-A Southwest Marigold, Portland 1, Oregon.

OPERATE Moneymaking mailorder business. Details, McKinzie, 6320 Southern, Detroit, Mich.

START Electrifying sewing machines. Free details. Pasaak's, M-Pauling Ave., Tappan, N. Y.

WRITE For details to start your own business, full, spare time, operating deluxe vendors in your territory. Large profit, small investment. Venmaco Corporation, 135 Headley Terrace, Union, New Jersey.

UNPAINTED Bookends, plaques, statues, figurines. List. Haverty Products, 1219 8th Ave., Altoona, Penna.

RENEW Guaranteed best liquid rubber for flexible molds. Earn money! Write Renflex, Box 74A, Queens Village, N. Y.

AMAZING New, profit tested, moneymaking business. Your locality or mail. Big income. Free details. Boss, 2265B Warren, Toledo, Ohio.

INCOME From local information. No selling. Neher Company, La Verne, Calif.

LEARN Import-export! Represent manufacturers! Sell-buy abroad, make 1000% profit. Send \$1 for two bulletins, supplying hundreds of overseas addresses seeking connections. Money refunded if unsatisfied. Benko, 246-P Fifth Ave., New York 1.

TWO Dollars starts perfume manufacturing business. Big profits. Particulars free. Bob Celaya, Brownsville, Texas.

NEW Mail order manual tells how, what, where to sell. Details free. Everett, 542A Barclay, Naperville, Illinois.

OWN A mail-order paper products business. Sell envelopes, tags, bags, boxes—wholesale. Tremendous demand. Steady profits. No capital necessary. Omaha Envelope Service, Dept. 248, 4721 California, Omaha 3, Nebraska.

FACT Packed book on mail order work twenty five cents. Satisfaction or money refunded. Write Houston Mail Order House, 5306 Pease Avenue, Houston 3, Texas.

FOR An extremely profitable lifetime business operate a collection agency-credit bureau. Easily learned. Free folder. Cole & Associates, Syracuse 2, N. Y.

ONYX And plastic mountings for bronzed baby shoes—15 styles. Hardening solutions. Complete metallizing service, wholesale only. Box 2095, Wichita, Kansas.

"HOW To Sell by Mail." Valuable book for beginners, 25c. Maule, 1007 13th Street, Niagara Falls, N. Y.

MAKE Rubber stamps. Metalize baby shoes, silver mirrors, make plaster novelties. Catalogue of "20 Ideas" free. Universal, Box 1076-A, Peoria, Ill.

SALESMEN: Earn nice profits selling costume jewelry. 10c brings information and prices. Master Makers, P.O. Box 207, DuBois, Penna.

LEARN Candlesmaking. Big profits. In-

BE Independent, your own profitable business, home or shop, services for everyone. Complete instructions \$2.00. Packard, 2013 Chenevert, Houston, Tex.

YOU Make them. We sell them! New liquid plastic makes many items. Terrific demand! Earn minimum of \$50.00 per week at home. No experience or machinery required. We supply raw materials and instruction. Write Travaco Laboratories, P.O. Box 1883, Boston 5, Mass.

RUBBER Stamps. Sell locally or by mail. Stamp brings details. Carb, 2739-R Magnolia, Chicago 14, Ill.

LIKE Profits? Operate profitable mail order business. Splendid opportunities. For details write: Eugene Cottle, 249 Elm Avenue, North Sacramento, California.

RUBBER! White liquid rubber! America's finest flexible moulding rubber! New! Extra heavy viscosity! Quick drying! Ideal for home, classroom, or industry. Only \$7.95 per gallon, \$2.95 per quart, and \$1.00 per half-pint sample. Parcel post prepaid! Plastercraft Supply Company, 3051 St. Clair Avenue, Cleveland 14, Ohio.

SPIN Angora wool. Ideal home business. Descriptive circular free. House of Angora, Springfield, Illinois.

SILVER Plating, new way. Big profits. Fairchild Company, Mt. Vernon, Ohio.

SAWDUST. Turn it into cash. Six methods. Instructions 25c. Charles Co., 12-BH, Norwood, Ohio.

START Real estate business. America's finest profession spare time. Details free. Educational Book Co., 2907 Berwick Ave., Baltimore 14, Md.

TURN Waste into durable plastic! Make attractive walls, floors, roofs, mantels. Laboratory, 327 S.E. 46, Oklahoma City.

OPERATE Dependable mail order business, splendid opportunity, write Joseph Vassar, 312 Harden St., S.E., Atlanta, Ga.

BOOKKEEPERS—Operate own bookkeeping and tax service. Part or full time. Free course, "How to Operate a Contract Bookkeeping Service," A. J. Hawthorne, Public Accountant, Decatur, Ala.

CREATE Your own products. Our "Flexible Mold Master" teaches amazingly simple method for making flexible molds for plaster novelties. Complete with illustrations, \$1.00. Emco Enterprises, Dept. M2, 6750 Stony Island Ave., Chicago 49, Ill.

"DOLLARS And Sense" pictorial mail trade magazine. Sample copy 10c. Brown, 18 Gracie Station, New York 28.

WATCHES, Wholesale. Rebuilt Elgins, Walthams, Bulovas, etc., new and used railroad, stop, diamond, rhinestone. \$9.50 up. Catalogue free. Brookings, B-E1975, Little Rock, Ark.

MAKE \$3 To \$10 per hour in spare time with Emrick Workshop, doing home repair jobs for others. Five power tools in one unit (lathe, drill press, circular saw, grinder and sander). Uses 1/4 h.p. motor. No toy or gadget—does heavy work—83 operations. Buy at factory price—save 50%—complete, only \$34.95. Write for free literature. Emrick, Inc., 1732 Clinton, Kalamazoo, Mich.

FREE Details on 100 easily made soaps and chemical cleaners. Brown, 9111-C Hoyne, Chicago 20.

MAKE Your own gold, silver, metallic, sign letters for store windows, etc. Samples, literature free. Art Enterprises, Box 852, New Westminster, British Columbia, Canada.

SELL By mail! Learn how! Join Mail Selling Opportunities Club! Details free! Chas. Wehner, Box 142-A, Roxbury 19, Mass.

AMAZING Hold screw drivers! Insert, remove screws inaccessible places! Exclusive distributor; factories, garages, mechanics, stores buy quantities. Millenco, 271 Miller Bldg., Boston, Mass.

VENDING Machines earn big money! An investment as low as \$10.50 will start you in this fascinating, profitable business that can lead you to the road of success and independence. Routes can be established and operated in either full or spare time with no experience needed. Write for full details and our free catalog illustrating our nut, candy, gum and stamp vendors; also slot machines, amusement games, etc. Parkway Machine Corporation, 623 W. North Avenue, Dept. 7, Baltimore 17, Maryland.

START Home manufacturing business making Cleaning Compounds, Soaps, Insecticides, Cosmetics, Polishes. Food Fla-

PIANO Tuners are in demand making big money. Learn piano tuning at home. Write Evansville School of Piano Tuning, Dept. B, 714 S.E. Second Street, Evansville, Ind.

NO Selling, operate vendors, amazing profits, details free. Silver-King, 622 Diversey, Chicago 14, Ill.

SPECIAL Rubber for making molds. Literature and sample free. Universal, Box 1076-A, Peoria, Ill.

"PLIASTONE"—New building material. Resurface old homes, build new ones. Composition floors; colored tile. Particulars free. Marbleized Service, Edwardsville, Illinois.

LIQUID Marble—Colorful, glossy! Molded, brushed, sprayed. Cast novelties, statuary, colored tiles. Flexible molds. Composition floors. Particulars free. Marbleizing Service, Edwardsville, Illinois.

BIG Money in vending machines. Smallest capital start brings immediate profits that build permanent profitable business. Starting instructions free. Becker Vendors, 105-A Dewey, Brillion, Wis.

START Your own business. Formulas, duplicated products. Marchild Service, P.O. Box 166, Plymouth, Mass.

POPCORN Machines, peanut roasters, caramelize equipment, griddles, gasoline; bottled gas appliances. Northside Sales, Indianola, Iowa.

DON'T Chance an income, guarantee it. Free. Roard, 629 Drexel Building, Philadelphia 6, Penna.

HOW And where to obtain capital. Small and large loans. Free particulars. Star Service, Wapakoneta, Ohio.

OWN Mirror shop. Resilver mirrors. Glass sign making. Electroplating. Supply prices. John Sprinkle, V60, Marion, Indiana.

DOLLARS In your own business at home. Literature free. Frank Webster, Box 1972A, Hollywood, Calif.

"OPPORTUNITIES for You in Modern Electroplating." Full or part time. Free illustrated booklet. Write Joseph B. Kushner, Metal Finishing Engineer, Stroudsburg 8A, Pennsylvania.

RUBACREAM! Natural rubber latex! Makes molds quicker! Thicker! Free sample convinces! Castcraft Studios, 509-P Fifth Avenue, New York 17.

MAILORDER Offers increased income! Free details. Cox, 14 Church, Saugus 10, Massachusetts.

LOOKING For a profitable sideline? Metallize baby shoes! Good profits. Small investment. Easy work. Free details. Joseph B. Kushner, Metal Finishing Engineer, Stroudsburg 8, Pennsylvania.

MAKE Beautiful vari-colored, highly glazed concrete pottery. Amazing profits. Small capital starts. Write for samples and photographs. Ozark Enterprises, Lock Box 273, St. Charles, Mo.

MONEY For you in your own business. Many surprising opportunities. Free information. Empire, Box 1340-C, St. Louis, Mo.

MOLD Makers. Genuine natural latex for rubber molds, only two coats needed for thick mold. Reproduce statuary, plaques. Inexpensive. Write Major Chemical Co., 131A Inman Street, Cambridge 39, Mass.

INVENTIONS Protected in 30 days. Patents for sale. Patent News, 12M, Washington, D. C.

\$100 BUYS Ten year license to sell copyrighted mailorder article. Make full profit ten years. Free particulars. Robert J. Drummond, 33 North St., Stoneham 80, Mass.

BRONZED Baby shoe mountings and supplies. All metal bronze bookends, picture frames, ash trays, etc. Onyx ash trays, desk sets, plaques. Hardening solution, 30-amp. plating rectifiers with powerstat control, \$85.00. Geared motors for agitation \$20.00. Lead lined tanks. Write for list. Hollywood Bronze Supply, 1770 N. Vermont, Hollywood 27, Calif.

SELL Greeting cards, pictures, signs, novelties, books! Large profits! Catalog free! Elfcoc, 434 North Wells Street, Chicago 10.

MAKE Money making new greasless doughnuts at home on electric machine. Wholesale to grocers, drug stores, cafes, hamburger shops. Send for free recipes and plans. M. Ray Company, 3605 South 15 Ave., Minneapolis 7, Minnesota.

YOUR Own business in plastics. Details free. Harco, Edgewood, Maryland.

ADVERTISE Your business—5,000 6x9 circulars \$14.00 postpaid. Journal Printing Co., Newark, Ark.

START Business! "with \$1.00." Money-maker! Free sample! Stephens, Grand Junction, Colorado.

A FACTORY in your home garage! Mfg. and sales rights, mechanics' waterless hand cleaner. \$500-\$800 monthly. No special equipment necessary. Western Aircraft Mfg., Dept. D, Los Angeles 6, Calif.

DO It with sea shells. Profitable easy home work. Free lesson. A. Werts, Sharp Park, California.

MAKE Liquid marble, artificial marble flooring, flexible molds, statuary, art goods, novelties. Literature free. Kemico, Park Ridge 50, Ill.

NEW Low prices. Complete line cosmetics, flavorings, specialties. Distributors, jobbers, agents wanted. Victor's Products Company, 917-201 College Avenue, Morgantown, W. Va.

TEN Moneymaking home business opportunities. Details, 25c. Crawford, Box 1161-PM, Bridgeport, Conn.

EARN \$200 Weekly installing new amazing "Styron" plastic wall tile in homes, offices. Easily applied. Tile your own kitchen, bathroom, too. Instructions, everything furnished. Literature free. U. S. Tile Co., 30 W. Washington St., Chicago 2, Ill.

GET Hundreds money making deals, business ideas, plans and manufacturing. Amazing holo free. Austin Mail Service, 5538 Lexington, Chicago, Illinois.

PRIVATE Label service. Complete line cosmetics, flavorings, specialties. You furnish labels, we label, or will ship unlabeled and you label. Can supply complete line labeled our Victor's label. Also big line flavor concentrates and flavor ingredients. Hindman Products, Inc., 917-200 College Avenue, Morgantown, W. Va.

MAKE Money by mail, every month. Spare time business. Small capital required. Tuff, 429 Robison Ct., Pittsburgh 19, Penna.

BABY Shoes preserved. Formulas, instructions \$1.00. Reilly, 5432 Malcolm St., Philadelphia, Penna.

EASY \$500 Month profits. Men or women. Your own distributing business. Not house to house. Nationally distributed, fast selling line cosmetics, flavorings, specialties. Sales or business experience desirable. High school or equal education. Car and extensive traveling required. New, profitable, proven sales plan by telephone. Investment secured by merchandise required, or credit arranged. Victor's Products Company, 917-202 College Avenue, Morgantown, W. Va.

QUICK Money. "Repairing car batteries." At home! Easy too! Batteryman, Grand Junction, Colorado.

WANTED Unused U. S. postage stamps, small discount. Advance Stamp Company, 24 East 23rd Street, New York.

MAKE And sell candy professionally, inexpensive to start, information free. Box 670, Kissimmee, Florida.

AGENT Or exclusive distributor for cigarette lighter mfg. MacGregor, Tahoe Valley 16, Calif.

OWN—Operate ball gum, nut, cigarette vending machines. Amazing profits, no selling. Write for free details. Cameo Vending, Dept. P, 432 West 42nd, New York.

METALLIZE Baby shoes. Excellent profits. New system assures success. Free details. Treasures Forever, 89 Henry Ave., Lynn, Mass.

POPCORN Machines. Potato chip outfits. Long Eakins Company, 4860 Hi Street, Springfield 99, Ohio.

OPERATE Profitable mail order business. Splendid opportunity. For details write V. M. McKinley, 76 Ave. "A," Battle Creek, Mich.

READ "Advance"—The voice of mail order. Offers money-making opportunities, sources of supply, personal guidance, etc. Issued monthly. Sample copy 25c. Yearly subscription \$2.00. American Mail Trade Association, 313 East 21st Street, Suite 450, New York 10, N. Y.

\$46 FROM Square foot plywood. Jigsaw necessary. Write, Woodarts, X-38, Bridgewater, Mass.

OPERATE Profitable mail order business. Write Walter Service, 4159-A East 112th, Cleveland 5, Ohio.

RE-NEW Leather and leatherette—Make cloth into imitation leather with plastic discovery called Leather-New. Opportunity to make real profits taking care of sales resulting from national advertising. Write for free sample of Leather-New covered material and complete deal. 4723A Troost, Kansas City, Missouri.

EXTRA Money? Free details. Trable, 1018 1/2 A Elm Street, Dallas, Texas.

RECAST Old batteries into new. Latest achievements, Battery Laboratories, Minneapolis.

MAKE Money casting new 1948 metal toys and novelties. Latest scale model autos, original ashtrays, savings banks, water pistols, etc. Enormous wholesale and chain store demand keeps manufacturers busy. Spare or full time. No experience or special place necessary. Write for details and illustrations of patterns needed. Metal Cast Products Co., Dept. A, 1696 Boston Road, New York 60, N. Y.

LEARN Piano tuning, repairing, at home. Tremendous field! Piano parts, tools furnished. Established 1935. Empire School of Piano Tuning, 606-B East University Ave., Champaign, Ill.

COLORGLAZED Concrete pottery made without molds. Patented method. Cemetery products, novelties, tiles. Basement leak-sealing. Money-making projects. Booklet, details free. Men only. National Potteries Company, Grand Rapids, Minnesota.

START Mailorder bookshop—Everything furnished. 25c brings booklet, samples, exciting ideas. General Publications, Ossining, N. Y.

LIQUID Rubber for making flexible molds. Cast novelties. Sample bottle 25c. Free literature. Chaney, 1130 E. 16th St., Jacksonville 6, Fla.

OPERATE Profitable home business selling merchandise by mail. Past sellers. Large profits. Powell Service, 5713 Euclid, Cleveland 3, Ohio.

SPECIALTY Manufacturing, the big money business that can be operated anywhere. start on a very small capital; we supply dependable formulas and complete instructions; get interesting free booklet, "Moneymaking Opportunities in Specialty Manufacturing." Howard Robinson, Ph.G., 1300-A South Ohio Street, Sedalia, Mo.

COPUBLISH Leading m.o. paper. Latest copy Mail Sale Advertiser and proposition, commemorative stamp. Vanroy Shirk, Lebanon, Penna.

\$25 WEEKLY Working two hours daily. No canvassing. No manufacturing. Lycke, Box 2471, Cleveland 12, Ohio.

137 WAYS To make money, in home or office, business of your own. Full particulars free. Elite Co., 220 Grand St., New York 13.

BRUSH Plating outfits connect to a battery. No tanks necessary. Good paying business at home plating autoparts, bathroom fixtures, bicycles, reflectors, silvering mirrors. No shop or experience required. Outfits furnished. Free booklet. Gunmetal Co., Ave. H, Decatur, Ill.

WOULD You pay 3%—first \$350 made? Color-illustrated book "505 Odd, Successful Enterprises" free! Some offer occasional "day off." Work home. Expect something odd! Pacific, Oceanside, Calif.

MAILING Postcards selling repeat merchandise is profitable. Everything supplied. Details free. Gordon Publishers, Box 23, Pawtucket, R. I.

CO-PUBLISH And advertise in The Central Mail Advertiser. Sample copy for stamp. Low rates. Large circulation. Bagby Printing Co., Georgetown, Ohio.

MAIL Order opportunities. Full or spare time. Hundreds of chances. No charge. Postal brings copy. Blackstone Press, Somerville, New Jersey.

MONEYMAKING OPPORTUNITIES

EARN Extra money. Easy pleasant work. Write: Reminder, Thurmont, Maryland.

LOOK Here! Wanted—men to start in business on our capital. Sell some 200 farm-home products. Thousands our dealers now make quick sales, big profits. For particulars write Rawleigh's, Dept. G-192-PPM, Freeport, Ill.

MAKE Money having fun—Novel idea and sample 25c. Aircastle, 7050 Van Buren, Hammond, Indiana.

CASH For you—Yes, you keep dollars. We fill orders free. You risk nothing. Write, Edwin Velker, 1836 Champlain Street, Toledo 11, Ohio.

PUT Your wife in business; Sell home decorations. 200% profit, everyone buys, no investment. Camnet Company, 1826 N.

TESTED Money making plans. Free details. James Carter, Rocky Mount, Virginia.

100 MONEYMAKING Ideas! 64 pages—\$1.00. Zampino, 2337 Bath Avenue, Brooklyn 14, N. Y.

BIG Profits raising earthworms. Wetzel's, 4051 West 226, Cleveland 16, Ohio.

EARN Money evenings, copying and duplicating comic cartoons for advertisers. Adservice, Argyle 1, Wisconsin.

EARN Up to \$520 month part or full time keeping books for small firms. Simplified system. Write Tax-Saver System, Dept. V, Ft. Worth, Texas.

MORE Money needed? Postal brings profitable proposition. Ace, Brentwood, Maryland.

MAKING Money mailing circulars. Booklet 25c. Artistic, 217P Longwood, Merchantville, N. J.

SEA Shells. Interested in making shell jewelry, lamps, novelties. We have all supplies at wholesale. Write for price list. Sea Shells, 269 W. Flagler Street, Miami, Fla.

CO-OPERATIVE Publishing pays! Copublish "Progressive" for profits, prestige, independence! Complete instructions, 25c. Kimball, 31-P Norway, Berlin, N. H.

THOUSANDS Articles wholesale. "Supply Source Directory" 10c. Ideal Service, Park Ridge 40, Illinois.

CONCRETE Block molds, 8x16x4 \$6.70, others, literature free. Lehnert, Norwood 2, N. J.

PRIZE Contest bulletin gives various contests now operating, and valuable hints. 3c stamp. National Contest Bulletin, Box 2685P, Miami, Florida.

WIN Contest money. Send 25c complete instructions for writing winning answers. Winacontest, 22P Westlake Ave., Auburn, N.Y.

ANALYZE Handwriting for profit! Complete outfit \$1.00. Graphologists, POB-971, Philadelphia.

EARN Money at home! Thousands do! "Home Worker Magazine" tells how. Sample, 25c. Sizemore, Box 7, 4917 Kostner, Chicago 30, Ill.

WIN Contest money. General Contest Magazine gives hundreds of tips. Lists current contests and rules. Sample 25c. General Contests, 1609 1/2 East 5th, Duluth, Minn.

WOULD You pay 3%—first \$350 made? Color-illustrated book "505 Odd Successful Enterprises" free! Proven! Work at home, office. Expect something odd! Pacific, Oceanside, Calif.

PUBLISH Your own magazine. Handsome 52 page format, well edited, illustrated. Cost low as \$1.00 month. Brings you prestige, profits. 25c brings sample, details. National, Ord. Nebr.

FORMULAS, PLANS, ETC.

OPPORTUNITIES! Catalog describing 200 helpful formula, money-making books. Airmailed throughout world for stamps. Adams Brown Company, Boston 67, Mass.

MONEY Making formulas. Circular free. Arthur Beers, R2, Freehold, N. J.

"EVERYBODY Likes Candy." Learn to make professionally. (Our 38th year.) Ragsdale Candies, D5, East Orange, New Jersey.

FREE Formula catalog. Anything analyzed \$20.00. Western Chemical, Salem, Oregon.

FORMULAS For twenty-five useful products. One dollar. Chemist, Box 274, West De Pere, Wisconsin.

MAKE—Sell cleaners, soaps, polishes, flavors, cosmetics. Literature free. Kemico, Park Ridge 16, Illinois.

21 POPCORN, Candy apple, etc. formulas. All money-makers. \$1.00. We can supply equipment. Concession Supply Co., Dept. "A," Box 133 Sta. "B," Toledo, O.

10,000 FORMULAS And trade secrets. Free literature. Stillman, 555 Kingston Ave., Brooklyn 3, N. Y.

REAL Manufacturing formulas. Lists free. Cummings, Chemist, Gordon Ave., Syracuse 4, N. Y.

PLASTICS

PLEXIGLASS, clear, masked, 3/8" \$2.00 square foot, postpaid. Guaranteed perfect. Crafton Industries, Waseca, Minn.

"PANTOGRAVER." Motor tool attachment, engraves plastic signs. Details. Sample engraving 25c. Desco, 6334 Senul-

LUCITE, Plexiglas. Masked sheets. All sizes, cost square foot (12"x12") 1/16" 90c; 1/8" \$1.16; 3/16" \$1.43; 1/4" \$1.68; 5/16" \$2.09. Include 10% postage. Almac Plastics Inc., 230 Fifth Avenue, New York 1, N. Y.

PLEXIGLAS—Red, black, white, green, yellow, blue, with supplies for two tone jewelry set. \$1.00. Bradlee, P.O. Box 142, Buffalo 5, N. Y.

BOOK—Illustrated, fabricating, forming lucite. Simplified methods, projects. \$1.00 p.p. Ideas-B, 11379 Ventura, North Hollywood, Calif.

INTERNAL Carved wild-life pins \$1.50. Rose costume jewelry sets \$1.75. Crystal Floral Novelty Co., Somerville, New Jersey.

SUMMER Special. Prime quality masked Lucite. 3/16", 16" square \$2.45 postpaid. Free catalogue. Craft-Plastics, Somerville 1, New Jersey.

PLASTIC Materials. Cements, dyes, findings, internal carving drills. Send 10c for catalog and floral carving instructions. Locket with internally carved rose and bud 50c less findings. Art Plastics of Calif., 8125 East 14th Street, Oakland 3, Calif.

BARGAINS in plastics. Lucite, Plexiglas, Catalin. Many colors and sizes. Details free. George Plastics, 6938A George St., Chicago 34, Ill.

RENEW Leather and leatherette—Make cloth into imitation leather with plastic discovery called Leather-New. Opportunity to make real profits taking care of sales resulting from national advertising. Write for free sample of Leather-New covered material and complete deal. 4723B Troost, Kansas City, Missouri.

PLASTIC—Sheets, rods, tubes, etc. Free list. Plastic Supply Co., 2618 St. Louis Ave., St. Louis 6, Mo.

CHEMISTRY

RADIUM (Uranium) Specimens, apparatus. Catalog 10c. Luminous paints: five colors, phosphorescent or fluorescent, \$1.00 each set. Hammer Laboratories, Denver 7, Colorado.

EDISON'S Home laboratory made him famous. Start yours today. Catalogue chemicals and apparatus 15c. Microscopic stain catalogue 20c. Both for 25c. National Scientific Company, 2204 North Ave., Chicago 47, Ill.

CHEMICALS, Ounce quantities, apparatus, catalog 10c. Fleischer's Laboratories, Everett 49, Mass.

NEW Laboratory supply catalog of chemicals and apparatus. Contains many thousands of items with illustrations. Send 25c. Standard Science Supply Company, 1232 N. Paulina St., Chicago 22, Illinois.

CHEMICALS And apparatus for industrial, analytical and private laboratories. Complete supply service for correspondence school students. Send 10c for catalog. Dept. M-43, Biological Supply Co., 1176 Mt. Hope Ave., Rochester 7, New York.

FREE Catalog: Chemistry, mineralogy, physics, biology. Tracey Laboratories, Evanston, Illinois.

HANDBOOK For chemical experimenters, illustrated, hundreds of experiments, 50c. Experiment booklet 15c. Supply catalog 5c. Reading Scientific Company, Reading, Penna.

HELP WANTED

BOYS Wanted. Over \$50 week! Sell name plates for front doors. Write National, 214-CC Summer, Boston, Mass.

AGENTS WANTED

DENTAL-STERO—The new toothbrush holder and sterilizer for money-making salesmen. Used in every home! Big profits. Write Dental-Stero Company, 3906 Secor Road, Toledo 6, Ohio.

EARN Big money year 'round. Be a one-person-department-store. Take orders for shirts, ties, hosiery, lingerie, household linens, etc. For information, Corporate Merchandisers, Dept. PM 4, 110 West 34 Street, New York City 1.

SELL Ultra-blue stock signs to stores. 1000 slogans, comedy, general, religious. "7x11" cost 6c, sells 35c. Make money. 15 samples ultra-blue signs "7x11" \$1.00 postpaid. Lowy, 8 West Broadway, Dept. 391, New York City 70.

MAKE More money in spare time handling magazine orders. Fall best selling season. Our helps build big repeat business. Wholesale catalog free. Write McGregor Magazine Agency, Dept. 12,

VIS-A-BRAKE Sells on sight, fits all cars. 207 Findlay, Cincinnati 10, Ohio.

INFLATABLE 12" Plastic play balls, excellent summer sellers. Send \$1.00 for sample. Wholesale prices. Nythor Company, 259 West 34 St., New York, N. Y.

LECTRIK Silver Kleaner Atomic Metal Electrode Plate (magnetic principle). De-tarnishes silverplated ware (and other metals) quickly. Simply dip, rinse, dry. Agents wanted, Part or full time. NuProcess Products, Aurora, Ill.

MAKE Money easily. Fast-selling line 50 new boxes Christmas, everyday cards, stationery. Unusual Christmas carol, Americana, etching, "flocked" initial stationery, others. Profits to 100%. Bonus. Special money-saving offers. Experience unnecessary. Write today for Christmas Leader assortment on approval and free samples 5 different name imprinted Christmas card lines, personal, floral stationery. Elmira Greeting Card Co., M-9 Elmira, N. Y.

\$1 STARTS You in business. Sell lined ties, 100% wool interlining. Costs you only \$7 per dozen, you make \$5.00 dozen. Send \$1.00 for special introductory offer two ties. Catalog complete line free. Philip's Neckwear, 20 West 22nd St., Dept. K-25, New York 10.

BIG, Easy profits to 100% selling new, novel Christmas card, gift wrapping, panorama, Christmas carol assortments. Bonus. Special offers. Request free samples 50 for \$1.00 personals, silver imprint line, name imprinted and floral stationery and feature Christmas samples on approval. New England Art Publishers, North Abington 171, Mass.

AMAZING Offer—\$40 is yours for selling only 50 boxes, each containing 25 new, entirely different deluxe Christmas cards with or without name imprinted. Also 50 for \$1.00. Free samples. Other boxes on approval. Write today. It costs nothing to try. Cheerful Card Co., 354 White Plains, N. Y.

MAKE Money fast! Sell Christmas cards to friends, neighbors, others. Big variety etchings, religious, 50 for \$1.00. Wrappings, stationery. New \$1.25 line "Little Ones," flower box, plastic frosted, Saints 'n' Sinners. Special offers, bonus. Fund raising opportunity for individuals, clubs, churches, schools. Mail postal today for feature 21 card \$1.00 Christmas assortment on approval. Hedenkamp, 343 Broadway, Dept. Y-42, New York 13.

SELL Luxury perfumes for profits and repeats. Generous samples \$1.00 deductible first order. Edward Lawson, 10-21 Joiner Street, St. Augustine, Florida.

CHRISTMAS Cards. Earn \$3.00 an hour. Take orders galore from friends. America's fastest selling 21 Christmas folder assortment. Smart, distinctive! Costs 50c. Sells \$1. A complete line. Samples on approval. No investment. Sunshine Art, Dept. PM-7, 115 Fulton St., New York 8, N. Y.

START Your own business on our capital. Always your own boss. Hundreds average \$6,000 to \$25,000 annual sales year after year. We supply stocks, equipment on credit. 200 home necessities. Selling experience unnecessary to start. Wonderful opportunity to own pleasant, profitable business backed by world-wide industry. Write Rawleigh's, Dept. G-U1-PPM, Freeport, Ill.

AT Last! Something new and sensational in Christmas cards. Gorgeous satin, velvet designs never before offered. Amazing value! Gets orders fast. Name-imprinted Christmas cards, 50 for \$1.00 up. Big profits. 30 other assortments 60c to \$1.00. Imprinted stationery. Samples on approval. Puro Co., 2801 Locust, Dept. 840-J, St. Louis, Mo.

ACT. Sell new Xmas photo greeting folders. Big profits, we deliver, free kit. Spooner, 115 Chauncy, Boston, Mass.

DE-ODORIZER—Refrigerator and ice-box unit. Sell finest, retails \$2.00 and profit 100 to 300%. Exclusive territory. Write L. A. Muffler, Continental Bldg., Los Angeles.

REMNANTS—Amazing values. Housewives buy on sight. Good profit. Write B & M Textiles, 78 N. Main St., Paterson 2, New Jersey.

SHINE Shoes without "polish." New invention. Lightning seller. Shoes gleam like mirror. Samples sent on trial. Kristee 124, Akron, Ohio.

FREE Sample! Big profit opportunity with amazing Glow-in-the-Dark house numbers, switch plates, pictures, decals, religious articles. Represent large manufacturer Madison Mills, 303 Fourth Ave.,

A DRESS Yours with every 3 you order for yourself and family. Amazing new bonus plan. Everything free. Harford Frocks, Dept. P-9128, Cincinnati, Ohio.

CALL On friends with sensational Christmas cards in handy assortments. Sell for \$1.00. Profit up to 50c. Also popular-priced personal Christmas cards, everyday assortments, stationery, imported napkins. Samples on approval. Wallace Brown, Dept. G-4, New York 10, N. Y.

AGENTS Wanted to sell nationally advertised pocket atomizers. Just four sales daily net \$50.00 weekly. Write Dept. M, Louell Products Co., 423 Fulton Street, Brooklyn 1, N. Y.

AGENTS, Fast sales. Cuts food cost. Nets \$9 a case. Sell 6 daily. Jeld, Ltd., Burbank, Calif.

MAKE More money direct from factory. Fibre brooms, floor dusters, patented wet mops. Aluminum mop wringers. Big profits. Write Burtz Fibre Broom Co., Columbia, Penna., Dept. A.

PLASTIC Christmas cards. Exclusive new plastic, sachet, panoramic and carols Christmas assortments. Five leading 21 card \$1.00 feature assortments. Six portfolios of personal cards. All this plus America's fastest imprint service. Free samples. Elmercraft Card Co., 5930 South Western, Chicago 36, Illinois.

LATEST Discovery. Savol Waterless Hand Cleaner Creme. Removes stains. Pounds 50c postpaid. Valtex Company, Rochester 7, New York.

SENSATIONAL New rubber toilet bowl applicator free with each Skasol sale to filling stations, homes, etc. Good profits, sure repeats. Box 80, Webster Groves 19, Missouri.

100% PROFIT! Selling gasoline-savers. Literature 10c. Thorn, P2842, Paterson, New Jersey.

MAKE Sensational profits! New, sell-on-sight plastic line: Tablecloths, aprons, many other splendid fast-selling items, novelties. Postal brings free details, special deals. Hurry! Royalty, Box K-748, Passaic, N. J.

BE A jobber, sell brushless auto enamels to retailers. Car or bicycle helpful. High earnings on our capital. Sterling Chemicals, Middletown 99, Conn.

AGENT-Distributors. Flo-Glo plastic linoleum finishes. Acme, Box 404, Mount Vernon, N. Y.

CHRISTMAS Cards 50 for \$1.00! Other series of 25 from \$1-\$2.50. Also box assortments. Free sample albums. Commission. Bonus. Richar Greetings, 16 E. 18th, New York 3.

AGENTS. Make big profits selling guaranteed Reflex spark plugs, sideline, exclusive territory. Reflex Spark Plug Co., 10902 Madison Ave., Cleveland 2, Ohio.

SPOOK Hand cleaner sells itself—Pays you 130% profit. Amazes prospects by instantly removing paint, grease, etc. without water. Sold coast to coast and export. Everyone a prospect. No offensive odor. Contains antiseptic. Repeats. Free particulars. Sample 50c. Arrow, 1012 Charlevoix Building, Detroit 26, Michigan.

BIG Money. Sell friends, others, exclusive Christmas card assortments unobtainable elsewhere. Profits to 100%. Bonus. Request free samples exclusive 50 and 25 for \$1.00 name imprinted Christmas cards with Christmas and everyday assortments on approval. Regal Greetings, Dept. PM-2, Hazel Park, Mich.

CANVASSERS Make to \$36 cash daily. New electric device, everyone needs. We deliver, sample kit \$2.00. Sibert Company, Newark 3, N. J.

BUY Thousands of nationally advertised products direct from manufacturers. Write for "Buy Direct and Save." Consumers Assn., 287-A Lebanon Ave., Mt. Lebanon, Penna.

BIG Money selling cooking utensils direct. Cast iron and aluminum, exclusive designs, nationally known. Free photo illustrations. Jones Machine & Foundry Co., Chattanooga 2, Tenn.

CHRISTMAS Cards. Earn \$5.00 with every ten \$1.00 21 card boxes you sell. Also new Plastic cards, personalized cards and stationery. Note paper and wrappings. Send for samples today. Howard P. Ellis, Dept. PM-8, Pitman, N. J.

START Flocking—Spray professional plush finish on everything. Easy, profitable, inexpensive. Free samples, illustrated folder. Coast, 1507 W. Manchester, Los Angeles 44.

HOUSEHOLD Specialty. Profitable fast seller. Flinson, Box 4333-B, Kansas City, Mo.

A NEW Fast-selling kitchen item. Big profits. P.O. Box 3631, Highland Park 3, Mich.

ALIVE—Permanizing salesmen. Dodge Studio, Meriden, Conn., 37 Gravel St.

BALLPOINT Pens. Unexcelled. 200% profit. Circular. Hebron, 6422 Fitchett, Regopark, New York.

\$25 YOURS For selling only fifty \$1.00 boxes, new exclusive different Christmas and all-occasion cards; also extra cash bonuses. Send for Champion Cheerio 21-card box on approval. Free samples 6 new personal groups and stationery. Write today. Dept. 27, Pen-Brush, 154 Nassau St., New York 7.

AMAZING Profits. \$25.00 for selling 50 \$1.00 deluxe Xmas boxes. Embossed 50 and 25 for \$1.00, name imprinted. Free samples. Ed-Brite, Dept. 12, 435 North Terrace Avenue, Mt. Vernon, New York.

SALESMEN: \$20 To \$30 a day easy. Sensational new raised letter metal nameplate, beautifully framed in mahogany. Amazing seller to homes, stores, offices, etc. No deliveries. Get our tested plan. Write Raised Letter Metal Co., Dept. 2288 Fox Bldg., Philadelphia 3, Penna.

FACTORY Representatives. Power units. Drop shipments. Liberal commissions. Farm Products, M-2007, Excelsior Springs, Mo.

FREE Nylons given if Kendex hosiery runs or snags! World's only women's hosiery sold with a written guarantee that amazes everybody. Mere words could not possibly express the almost unbelievable opportunity you now have to make money. Fantastic and "impossible" earnings now become a reality. Can you imagine a guarantee that replaces hosiery regardless if damage is due to use or abuse and regardless whether it is the fault of the hose or the wearer? Here is sales dynamite that will blast your earnings to the sky! Even if you never sold a thing in your life, three magic words: "guaranteed against everything" will open doors for you—will make women listen and will pour money in your pocket. Kendex stockings are not sold in stores, so you have no competition. Complete line includes beautiful sheer nylons; long wearing, durable service nylons; three different lengths; genuine outsize nylons; latest shades; choice of full fashioned with seams or seamless; lowest priced rayons. Also separate complete line of men's hosiery including nylon, list, rayon, cotton, mixtures etc.; plain and fancy; long and short. Thousands of pairs shipped daily. No money or experience needed. Nothing to invest or risk. No samples to buy. Nothing to pay, now or later! Simply write orders. We deliver and collect. Liberal advance cash plus huge cash bonus. Write orders spare or full time; exclusively or as a side line. Become a manager and appoint others to sell for you with steady income on their sales! Complete money-making outfit, including salesbooks in color, samples cut from actual hose, instructions, order blanks etc. furnished free and prepaid. Rush name and address on postcard and start making money next week. Kendex Co., Babylon 157, New York.

BIG Money selling plastic tablecloths—from \$6.00 dozen. Also curtains, aprons. Fast sellers! Free details. Durever, 255C East 95 Street, Brooklyn, N. Y.

AMAZING Foot lotion. Agents, crew managers, distributors. Big profits. Miltor Products, 216 Jackson, Chicago 6, Ill.

MAGIC Cleaner—Laundry soap deal. Hotter than a firecracker. Big profits. Sample free. Bestco, 4642 No. Central, Chicago.

AGENTS For educational institution New York City area; liberal commission; no investment. Box 686, Journal Square Station, Jersey City 6, N. J.

SELL The famous \$3 "Fire-Killer" extinguisher with bracket, wholesale or direct; exclusive territory. "Fire-Killer," Syracuse 1, N. Y.

AGENTS: Stamping names on pocket-key protectors. Sample check with your name, address, 25c. Stamping outfits. Emblem checks, check-fobs, name plates. Hart Mfg. Co., 303 Degraw St., Brooklyn, N. Y.

POCKET Pal: Replaces pocket knives. New, safe, beautiful. Always razor sharp. 50c seller. 231% profit. \$15.00 or more daily. Agents, salesmen, distributors. Sample 10c. Nelson Mfg. Co., 222 W. Kellogg, St. Paul 2, Minn.

SELL Gold embossed monogram stationery. Sample free. Dunbars, Sanford, Florida.

MAKE More money selling personal initialed individualized belts, buckles, cap badges, tie holders, name plates. 2,000 emblems to choose. Big profits, whole or part time. Write today; special outfit offer. Hookfast Specialties, Box 1425, Dept. 6, Providence, Rhode Island.

GUARANTEED Product in protected territory, if you are now selling or intend to sell house-to-house. For full 1 qt. sample amazing High Shine Windsor No Rubbing Wax, send only 25c covering handling and postage. (Sells for \$1.25.) Windsor Wax Co., Inc., Dept. P.M.-2, Hoboken, N. J.

AGENTS Make big profits selling sensational new diapers which require no folding. Every new mother a prospect. Rush name for free sample. Fred Dexter and Staff, 234 West 17th, Houston 8, Texas.

FREE Water and our concentrates, makes flavors, lotions, shampoos, 72 products, labels, bottles furnished. Qualco, E-29030 Russell, Detroit.

INFORMATION—Wholesale supply sources. Moneymaking plans. Increase your income! Write Reynard Service, Smithfield 3, Ohio.

GOLD Laquered window sign letters. Large sizes penny each. New foils. Absolutely beautiful. Free samples. Atlas, 544 W. 79th, Chicago 26.

EXCELLENT Sideline for printing and advertising salesmen. Decalcomania name plates in small quantities. Great demand. Also, make money with our line of automobile initials and sign letters. Free samples. "Ralco" XL-Roxbury, Boston 19, Mass.

AGENTS—300% Profit selling genuine gold window letters; stores and offices. Free samples. Metallic Letter Co., 438-B North Clark, Chicago.

QUICK Money! Earn \$20 daily. Sell name plates, door knockers, etc. Complete line. Catalog available. Hub Stampings, 357 Congress, Boston, Mass.

HIGH-GRADE SALESMEN

YOU Can earn 49%! Salesman wanted to sell nationally advertised desk model portable adding machine. Priced \$12.95, fully guaranteed. Not a toy. Easy to operate and in demand everywhere. You can make 49%! For complete details and full size color illustration, write today to: Lightning Adding Machine Co., Inc., Dept. ZD3, 543 So. Spring Street, Los Angeles 13, Calif.

ADVERTISING Book matches—Cash in on political campaigns; sell union label matches. Cuts for all businesses, political parties. Free powerhouse selling kit, low prices, protection guaranteed on repeat orders. Cash commissions. Superior Match Co., Dept. M78, 7530 Greenwood, Chicago.

SALESMEN—Distributors—Fast selling automotive specialty—big profits. Sell direct or to garages and filling stations. Vis-A-Brake Sales, 207 Findlay, Cincinnati 10, Ohio.

SELL Direct to offices, homes, cottages, apartments, trailers. America's sensational portable electric steam radiator. Johnson's wax and paint products. Write immediately. Demand terrific. Trans-Atlantic Supply Company, National Distributors, Appleton, Wisconsin.

\$100.00 PROFIT Yearly each sale. Ten sales weekly possible, three minimum. Sell needed intangible to businessmen, following advertising leads. Unusual proposition. Auditax, 4513-K Sunset, Los Angeles 27, Calif.

SALESMEN—Distributors. Sell to dealers, real fur and plush stuffed toys with Swiss music box or electric eyes. Liberal commission. Send for illustration sample 18"x12" brown fur monkey \$4.25, and get attractive catalog "P." Money refunded upon receipt of \$100 order. Ace Toy Mfg. Co., 122 West 27 St., New York 1, N. Y.

INCREASE Your sales. Make sure of orders using effective advance cards. Write Economy Sign and Card Company, 504 South Bonniebrae, Los Angeles 5.

WANT Pleasant outdoor work in a business of your own? Good profits selling over 200 widely advertised Rawleigh home/farm necessities. Pays better than most occupations. Hundreds in business 5 to 20 years or more! Products—equipment on credit. No experience needed to start—we teach you how. Write today for full particulars. Rawleigh's, Dept. G-145A-PPM.

SELL Calendars and Christmas cards. Large profits for you. Business necessities, restaurant items, shelf molding, advertising specialties. Free sales portfolio. Experience unnecessary. Willens & Co., 2130-AM Gladys Ave., Chicago 12, Ill.

SELL Delicious candies, nuts, gum. Immediate delivery. Write Casterline, 2031-PJ Sunnyside, Chicago 25, Illinois.

CALENDAR Salesmen, sideline. New farm record book. Carlyle Systems, Red Wing, Minnesota.

SPECIALTY Printed item! Profitable! Experience unnecessary. Berliner, 3581 Milwaukee, Chicago 41.

FANS—Fans—Salesmen making \$50 to \$100 per day selling our electric fans and sump pumps. Have also, all kinds of fan parts; build your own. Write Universal Fan Co., Peru, Ind.

PHONOGRAPH Record salesmen wanted. Nation-wide distribution. Salaries to proper parties. Details free. Music-Mart, 510 15th St., Oakland 12, Calif.

UNBELIEVABLE Earnings, salesmen, crew managers, taking orders for metalized baby shoes. Every mother definite prospect. \$1.00 deposit brings complete selling outfit—including sample shoe and photographs. Make big money quick. Box 2095, Wichita, Kans.

REVOLUTIONARY Product! Thousands prospects everywhere. Men earning up to \$250 week. Placed on free trial; sells itself. Orders financed by factory. Special demonstrator offer. John Wilson, 2433 Indiana Ave., Dept. 309, Chicago 16, Ill.

BALL Point pens, sample three dimes, \$24.00 gross. Refundable. S. Kelly, 2302 Ontario St., Ft. Wayne 6, Ind.

BRAND New! Revolutionary products! Salesmen make \$10,000 yearly selling one complete lighting line. "Neo-Glo" fluorescent changeable message sign replacing neon. "All-Lite" table lamp using upright fluorescent tube, spectacular "Circline" fixtures using circular tube. Verticals, dual-rays, pin-up lamps, a complete line of fluorescent and incandescent fixtures covering every commercial, industrial, residential need. A triple sales plan insures your success whether you choose selling dealers, direct, straight commission or distributorship on our capital. Get set now with our growing progressive organization. To get you started, we will send a beautifully illustrated catalog showing over 200 profitable, sales-tested styles and models. Order blanks, sales helps, everything needed to start at once included. It costs you nothing. Rush name quickly, today, and start making real money. Rose Company, 539AA South Franklin, Chicago, Illinois.

SALESMEN—Put yourself in line for big money and real future. Keep stores supplied with 5c-10c counter goods. Nationally advertised merchandise. Top profits for you and merchants. Liberal deals boost sales. Sideline or full time. World's Products, Dept. 10-E, Spencer, Ind.

BIG Money quickly and easily taking orders for complete line personalized initialed buckles, belts, cap badges, 2,000 emblems. Fast repeats. Write today. Hook-Fast Company, Box 480-PM, Roanoke, Virginia.

BIG Profits daily taking every family's magazines subscriptions. Give unlimited choice of valuable books free. Publishers, 323-5 Hammond, Cincinnati 2, Ohio.

JOBS Open in selling! Send name, address for free copy Opportunity Magazine, listing hundreds of companies who need men now, full or spare time. Experience not essential. Opportunity, 28 E. Jackson, Dept. 17, Chicago 4, Ill.

BIG Money taking orders. Shirts, ties, sox, pants, jackets, sweaters, shoes, uniforms, etc. Sales equipment free. Experience unnecessary. Nimrod, 4922-AN Lincoln, Chicago.

SELL Calendars—Every business a prospect. Also wholesale to printers; calendars, sheet pictures. Fleming Calendar Co., 6540 Cottage Grove, Chicago 37.

EARN Several thousand yearly handling advertising pens. Permanent. Arrow Press, Dept. M, Box 933, Buffalo, N. Y.

EDUCATIONAL AND INSTRUCTION

NOW You can have an office. Learn credit-collection business by new home study course. Many earn up to \$5000-\$15,000 annually. Free bulletin. Franklin Credit School, Dept. 2026, Roanoke 7, Va.

UP To \$8 hourly as self-trained bottled gas plumber. Details free. Enscob, Box

BECOME A Doctor of Psychology or Metaphysics. Teach secret of contentment, happiness. Win degree of Ps.D. or Ms.D. Solve mental worries. Free book. College of Universal Truth, 5153-C North Clark, Chicago.

MAKE Up to \$30-\$40 week as a trained practical nurse! Learn quickly at home. Booklet free. Chicago School of Nursing, Dept. M-7, Chicago.

SPEED And skill in radio code to qualify for amateur or commercial radio telegraph license. Learn at home with the famous Candler System used to train radiotelegraph experts and champions. Good pay or fascinating and profitable hobby. Free book. Candler, Dept. 5-H, Box 928, Denver, Colo.

"HOW To Break and Train Horses"—A book every farmer and horseman should have. It is free, no obligation. Simply address, Beery School of Horsemanship, Dept. 1107, Pleasant Hill, Ohio.

WIN A well-paid job in travel—Step into a new world of glamorous opportunity! Today more Americans are "going places" than ever before in history. As a result—the hotel and institutional field is surging ahead to new prosperity. Successful Lewis graduates are "making good" everywhere in luxurious hotels, fashionable resorts, smart restaurants and clubs. Free book explains how to qualify at home for a well-paid position in this ever-growing business where you are not dropped because you are over 40—shows how you are registered free of extra cost in the Lewis National Placement Service. Course approved for Veterans' Training. Write today. Room NL-395, Lewis Hotel Training School, Washington 7, D. C. (Now in its 32nd year.)

SPECIALIZING in educational mail order courses. Full particulars. Write Milton Camps, P.O. Box 3, Denver 1, Colo.

SHOE Repair school. Teach you quickly! Age 18 to 60. In 12 weeks you can be skilled. Modern Shoe Rebuilding, 4577 Hollywood Blvd., Los Angeles; 2935 Belmont, Chicago.

LEARN Typewriter repairing under G.I. bill. Adding machine and calculator courses available. For information write Dept. PM-7, Capitol School of Typewriter Mechanics, 1328 New York Avenue, N.W., Washington, D.C.

WORK For the U. S. government. Big starting pay. Security. Men-women. Prepare now for next examinations. 40-page book—details free. Write Franklin Institute, Dept. D24, Rochester, N. Y.

LEARN Dental technician trade. Ten simple lessons \$5.00. Grant Laboratory, S. Los Angeles 14, Calif.

HOW To get the job and pay you want. Other men are getting their choice of jobs—pay increases. You can too, by using tested methods described in this new publication. Tells "How to Get the Position You Deserve," "How to Get Your Promotion and More Pay," etc. Send \$1.00 for your copy of "Getting Farther Faster." Modern VO-K Services, 707 Land Bank Bldg., Kansas City, Mo.

STEP-UP Your brains, income, importance. Amaze with super-memory. Facts, figures, faces stick like burrs. Write for free details. Thor Books, CM-7, Box 1210, Chicago.

CARPENTRY Made easy! New self-instruction course in one large handy volume, complete with full page photographs, working drawings, etc. Teaches practical woodworking, painting, decorating, upholstering, power tools, etc. Amazing value, only \$1.98 postpaid; \$2.25 c.o.d. Satisfaction guaranteed! Order "Build It Yourself." Nelson Company, 1139 Wabash, Dept. 2G02, Chicago 5.

INCREASE Your earning power. Learn mathematics for use in business. Large 360-pp. book postpaid. Send \$2.00. Addison-Wesley Press, Cambridge 42, Mass.

3800 LATEST used correspondence courses. Catalog 50c. EG. Elmsford, N. Y.

OIL Painting—Economic, home study course. Write Carlos Art Academy, Correspondence Division, Watertown, N. Y.

AMAZE Others. Add columns instantly. Add faster than adding machine. Free details. P. Math Institute, Box 463, Nashville 2, Tenn.

MEDICAL Laboratory technicians in great demand. We train you in your own home, in your spare time. Also home study course in general chemistry. Free catalogue. Imperial Technical Institute, Box 973-J, Austin, Texas.

USED Correspondence courses and educational books, bought, sold, rented. Catalog free. Lee Mountain, Pisgah, Alabama.

SHADOWING—Interesting, illustrated instructions by veteran investigator. \$2.00. Sheldon Hutchins, Box 4921-P, Los Angeles 1, California.

BOOKKEEPERS! Increase your earnings! Operate your own simplified "dollar-a-week" bookkeeping and tax service. Full or spare time. Details free. No obligation. Ellis, Box 200, Cedar Grove, North Carolina.

GRADUATE Work in all subjects. Degrees available in one year. Resident and extension classes. Golden State University, Hollywood, Calif.

USED Correspondence courses and books bought, sold, rented and exchanged. Catalog free. Lee Mountain, Pisgah, Alabama.

LINGUAPHONE Makes languages easy. At home learn to speak Spanish, Portuguese, Italian, French, German, Russian, by quick, easy Linguaphone Conversational Method. Save time, work, money. Linguaphone correspondence courses are available to veterans under G.I. bill of rights. Send for free book. State if G.I. Linguaphone Institute, 83 RCA Bldg., New York 20, N. Y.

INVESTIGATOR Training. Phillips Secret Service, 1917B North Kenneth, Chicago 39, Illinois.

LEARN Photo-engraving at home or in oldest, largest school in America. Work for newspaper or establish own profitable business. New Taspoe Photo-Engraving equipment available soon. Write for information. Veterans ask about G.I. training. The Aurora School of Photo-Engraving, Taspoe Bldg., Aurora, Mo.

SECRET Investigation. Experience unnecessary. Investigators particulars free. George Wagner, M 125 West 86th, New York.

STUTTER! Stop it. My simple instructions really help. Write. Mr. Joseph J. Gerard, 2067 West 10 St., Brooklyn 23, New York City.

BUSINESS SERVICE

MILWAUKEE Postmark. Letters mailed 25c each. 5 post cards \$1.00. P.O. Box 1931, Milwaukee, Wis.

SURPRISE Your friends—4 lithographed views of Virginia Beach 50c, remailed free. Letters forwarded 25c. P.O. Box 1504, Norfolk, Va.

INFORMATION. Satisfaction or money back. 25c each letter. Letters-cards forwarded, 10 cents each. Washington. Arthur Simmons, General Delivery, Washington, D. C.

MINNEAPOLIS Mailing Service. 4845 Lyndale South, Minneapolis, Minnesota. Other services.

SPECIAL SERVICES

FINANCIAL Organization will consider financing the development and marketing of ideas suitable for direct mail selling. Agency, Box #707, Hutchinson, Kans.

MEXICO City, letters remailed, forwarded 25c. Senorita Esponda, Panuco 200, Mexico D. F.

CALIFORNIA'S Vacationland beach. Letters remailed 25c. Three scenic cards 25c. Shopping service. Free list Redwood novelties. Collins, 1951 Branciforte, Route 1, Santa Cruz, California.

POSTMARK Mail Baltimore or Washington. 25c each letter. Monthly rates. Inquiries invited. Alexander Business Services, 224 Monument St., Baltimore 1, Md.

BAGDAD Re forwarding service. Airmail details 25c. Edward Basry, Bagdad 31, Iraq.

VISIT Nation's birthplace by proxy. Letters remailed 25c. Historical information. The Pilgrim, P.O. Box 166, Plymouth, Mass.

INFORMATION

CALIFORNIA—\$3.00 for information on jobs, housing conditions. Box 6359, Los Angeles.

CARTOONING, COMMERCIAL ART, SHOWCARD WRITING, SIGN PAINTING

"HOW To Make Money With Simple Cartoons"—a book everyone who likes to draw should have. It is free; no obligation. Simply address Cartoonists' Exchange, Dept. 97-C, Pleasant Hill, Ohio.

OPTICAL Illusion! Makes drawing sim-

LEARN Sign painting. Wonderful trade. Big money. New method teaches you how. No experience. Price \$2.00. Free particulars. Haines System, Sabina, Ohio.

LEARN Showcard writing in spare time. Fascinating, profitable. Free information. Sherwood Publishing Company, Irvington 11-N, New Jersey.

SIGNS Made easily. Instructions and ten sets modern alphabets, numerals, patterns. Sizes up to eight inches. All for \$1.00. Co-operative Business, 7 West Madison, Chicago 2.

SIGN Painting taught at home by an old master. Ben Kerns, Box 812, Greenville, S. C.

9 ALPHABET 3 Numeral pattern sets and catalog. \$1.00. Sign Letter Distributors, P.O. Box 101, Mineola, N. Y.

CHALK Talks. Laugh producing program. \$1.00. Catalog 10c. Balda The Cartoonist, Oshkosh, Wisconsin.

PLAYS, STORIES, MANUSCRIPTS

I WANT New writers to cash hundreds of checks for \$1 to \$100, offered each month. The easiest way to write for pay. No previous experience necessary. Send for free details. No obligation. Saunders M. Cummings, 467-M Independence Bldg., Colorado Springs, Colo.

ADVERTISING AGENCIES, LETTER WRITERS, FOR ADVERTISERS

LEARN—"Writing Letters That Sell." Send \$1.00 for this and free self-study assignment book. Addison-Wesley Press, Dept. A, Cambridge 42, Mass.

MAILING Lists guaranteed. 100 typewritten names \$1.00. Gonzales, 304 South Broadway, Los Angeles 13, California.

\$15,000 MINIMUM. Lists of salaries paid executives of national corporations. Name, address, amount, company. Compiled from recent official files. Guaranteed accurate. Not income tax. 100, \$1; 500, \$3. Research Reports Service, Box 1081, Washington 13, D. C.

300 CERTIFIED Opportunity seekers \$1.00. Trable, 1018 1/2 X Elm, Dallas, Texas.

ADVERTISE: 24 Words, 40 newspapers, \$3.50. Lists free. Advertising Bureau, 229-C Dixon, Uniontown, Penna.

BUSINESS Building sales literature written by direct mail specialist. Sales letters as low as \$3.00. Stamp brings complete price-list. Paul Wallace, Box 143, Sheboygan 5, Wis.

ADVERTISERS! Reach nearly 18,000,000 readers. 25 Sunday national key newspapers, 18 words. \$47.75. "Terrific pullers." 20 popular newspapers, \$9.75. "Free booklet." Special—One inch display 2,-821,198 circulation. \$42.00. Newmark's Advertising Agency, (Established 1893) 217-7th Ave., New York 11.

ADS Placed in out of town newspapers and magazines. Low rates. Catalogue free. Ideas that pay. Baker Advertising Agency, Successors Ankrum Agency, 189 W. Madison, Chicago 2.

MAILING Lists, certified, productive, inexpensive, \$5.00 1000. Homeworkers, agents, buyers, etc. Write Dixie Service, King, N. C.

24 WORDS in 64 weeklies \$4.96. H. J. Darnell, 730 Hays, Jackson, Tenn.

TYPEWRITERS, DUPLICATORS, OFFICE DEVICES

STANDARD Typewriters \$17.50 up; duplicators \$12.50; adding machine \$12.50. Ship anywhere. Cash Carry Service, 118 North Spruce, Wichita, Kansas.

DUPLICATORS \$9.95 Up. (New.) Immediate delivery. "Free circular." Rucker, 2836-PM Stevin, Louisville 12, Ky.

"PRINTOMATIC" Selffeeding post card stencil printing duplicators \$9.50 up. Office size duplicators, Speedoprints, Hilcos, Excellographs \$33.41 up. Literature free. Pittsburgh Typewriter Supply, 336-WK Fourth Avenue, Pittsburgh 22, Penna.

RECONDITIONED Typewriters, mimeograph, multigraph printing devices, appliances, supplies. Catalog. Dixiegraph Service, King, N. Carolina.

RUBBER STAMPS AND OFFICE SUPPLIES

DE LUXE Cushioned, indexed, knob handle; three lines \$1.00, two 75c. Quik service. Catalog 10c. Warner Stationery, Box D-43, Havre de Grace, Maryland.

"NEW" Rubber stamp. Prints blue air-mail inside red arrow, one impression. Mailed anywhere \$1.00 or write for free illustrated folder. Multi-Color Stamp Co., Keene 3, Texas.

QUALITY Stencils, inks, priced right, Riddle, 360 S. Hill, Los Angeles 13.

LINE 20c; 2-35c; 3-50c. Stamp Works, Auburn, Nebraska.

RUBBER Stamps. Illustrated literature free. Lee-Vall Press, Dept. 7-A, Box 1242, Indianapolis 6, Indiana.

2 LINES 35c. 3 Lines 50c. Newman, Box 284, Fort Collins, Colo.

PRINTING, MULTIGRAPHING, MIMEOGRAPHING, GUMMED LABELS

500 LETTERHEADS And envelopes \$7.00 prepaid. Prompt service. Sumar Press, Creative Printing, 81 W. Van Buren, Chicago 6, Ill.

1000 NAME-ADDRESS Stickers \$1.00. Your four lines printed. Kay Press, 1560 South Fifth, Milwaukee 4, Wis.

100-8 1/2 x 11 HAMMERMILL Letterheads, 100 envelopes, 5 lines, \$2.00. R. Cook, 730 West Gift, Peoria 5, Illinois.

100 8 1/2 x 11 LETTERHEADS With envelopes \$2.00 postpaid. Benneville, Box 1931, Pittsburgh 30, Penna.

LETTERHEADS. Envelopes, circulars. Small, large quantities. H.M.G. Company, Mecca, Indiana.

WEDDING Invitations, personal-business stationery. Printshop, 176-B Fourth, Leominster, Massachusetts.

PRINTING Of the better kind. Samples. D'Yarmett Printing, Newark, Ohio.

1000 BUSINESS Cards (embossed) \$2.95 postpaid. 1000 #6 3/4 white envelopes \$5.50 postpaid. Zephyr Printing, Box 312pmm, Venice, California.

50 CALLING Cards, 1 line, 25c postpaid. Metro Stationery, 60 South Street, Boston 11, Mass.

DANKS Defies competition. Get our prices. Print anything. Rochester 4, N. Y.

CUTS \$2.00 Up. Free estimates. Schumacher, 1418 Franklin Street, Oakland, California.

QUALITY Printing: Business, personal stationery. State requirements. Samples. Mero Products, 100 Morrison, Punxsutawney, Penna.

QUALITY Printing at low prices! Send for price list today! Nationwide Printing Company, Dept. PM, 2337 Bath Avenue, Brooklyn 14, N. Y.

SELL Printing. Amazing profit. Mango, 555-A South 20th, Newark 3, N. J.

WRITE For samples, prices attractive letterheads, cards, circulars. Journal Printing Co., Newark, Arkansas.

100 8 1/2 x 11 HAMMERMILL Letterheads and envelopes \$1.98. Herbert Hudson, 261 Woonasquatucket, Centredale, R. I.

500 3/4 x 2 1/4 FOUR Line gummed stickers 35c; red border 50c. Moritz Printery, Saginaw, Mich.

1000 BUSINESS Cards, \$2.50, prepaid. Samples free. Reliable Print Shop, 905 E. Jefferson, Louisville 6, Ky.

SEND 10c Now, for our 48 page 1948 price list—refunded first order. McCall Press, 1326 South 27th, Omaha, Nebraska.

QUALITY Printing—Reasonable prices. Fast service on catalogs, folders, publications. Write for prices. Bagby Printing Co., Georgetown, Ohio.

MIMEOGRAPHING—Letters, pricelists, formulas, instructions. Lowest prices. Lem's Letter Shop, 5710 Stanton, Detroit 8.

1000 BUSINESS Cards, raised letter printing, \$3.75. Salespoint, Dept. M, Box 5082, Long Beach 5, Calif.

PRINTING OUTFITS AND SUPPLIES

PRINTERS Supply catalog 10c. Bright-on's, 4234-M South Mozart, Chicago 32, Illinois.

MAKE Your own printing cuts. Newly invented Flexplate Process. Plexiservice, Argyle 1, Wisconsin.

PRINTING Presses, type, supplies. Lists 3c. Turnbaugh Service, Loysville, Penna.

PRINTING Presses, type, supplies. Send dime for complete illustrated printer's supply book, details and press samples. Kelsey, Inc., A-11, Meriden, Connecticut.

INEXPENSIVE Home-made printing press. Details free. Novelty Shop, Downs-ville, Louisiana.

PATENT ATTORNEYS

INVENTORS: Learn how to protect your invention. Unless the inventor is familiar with patent matters, he should engage a competent registered patent attorney or agent to represent him. We are registered to practise before the U.S. Patent Office and prepared to serve you in handling your patent matters. "Patent Guide for the Inventor" containing detailed information concerning patent protection and procedure with "Record of Invention" form will be forwarded to you upon request—without obligation. Clarence A. O'Brien & Harvey Jacobson, Registered Patent Attorneys, 81B-G District National Building, Washington, D. C.

INVENTORS—If you consider your invention to be something of importance, you may take steps to protect it with a U. S. Patent which gives you the right to exclude others from making, using and selling your invention as claimed. "Patent Protection for Inventors" booklet outlining steps to take to secure patent protection will be mailed promptly without obligation. Victor J. Evans & Co., Merlin M. Evans, Registered Patent Attorney, 331-G Merlin Building, Washington 6, D. C.

IF An inventor believes he has an invention, a search of the most pertinent prior U. S. Patents should be made and a report obtained relative to its patentability. Write for further particulars as to patent protection and procedure and "Invention Record" form at once. No obligation. McMorro, Berman & Davidson, Registered Patent Attorneys, 134-G Victor Building, Washington 1, D. C.

PATENTS—Trade marks. Irving L. McCathran, 315 McLachlen Bldg., Washington 1, D. C. Registered Patent Attorney.

C. A. SNOW & Co.—M-427, Snow Building, Washington 1, D. C. Registered Patent Attorneys. Write for information.

INVENTORS. For "Record of Invention" form, contact Carl Miller, Registered Patent Attorney, Woolworth Building, New York.

INVENTORS: Without obligation, write for information explaining the steps you should take to secure a patent. John N. Randolph, Registered Patent Attorney, 203 Columbian Bldg., Washington 1, D. C.

INVENTORS: When you are satisfied that you have invented something of value write me, without obligation, for information as to what steps you should take to secure patents or trademarks. Write Patrick D. Beavers (Formerly Randolph & Beavers) Registered Patent Atty., 936 Columbian Bldg., Washington 1, D. C.

PATENT Practice before U. S. Patent Office. Validity and Infringement investigations and opinions. Booklet and form "Evidence of Conception" forwarded upon request. Lancaster, Allwine & Rommel, Registered Patent Attorneys, Suite 411, 815-15th Street, N.W., Washington 5, D. C.

"INVENTOR'S Guide" free on request. Frank Ledermann, Registered Patent Attorney, 154 Nassau St., New York 7, N. Y.

PATENTS. "Proof of Invention" folder mailed without obligation. E. E. Vrooman, Registered Patent Attorney, 871 Woodward Building, Washington 5, D. C.

INVENTORS: Write for free brochure "Evidence of Invention." Labiner, World Building, New York 7.

FOR INVENTORS

INVENTORS: Learn how to protect your invention. Unless the inventor is familiar with patent matters, he should engage a competent registered patent attorney or agent to represent him. We are registered to practise before the U.S. Patent Office and prepared to serve you in handling your patent matters. "Patent Guide for the Inventor" containing detailed information concerning patent protection and procedure with "Record of Invention" form will be forwarded to you upon request—without obligation. Clarence A. O'Brien & Harvey Jacobson, Registered Patent Attorneys, 81A-G District National Building, Washington, D. C.

IF An inventor believes he has an invention, a search of the most pertinent prior U. S. Patents should be made and a report obtained relative to its patentability. Write for further particulars as to patent protection and procedure and "Invention Record" form at once. No obligation. McMorro, Berman & Davidson,

INVENTORS—Send today for booklet "Patent Protection for Inventors" containing detailed patent information and preliminary steps to take toward patent protection—also "Evidence of Invention" form. Victor J. Evans & Co., 332-G Merlin Building, Washington 6, D. C.

EVERYTHING Under one roof for the inventor. Turn your idea into cash and royalty. Bring it here. We do the rest. Idea sketched, model built, patent applied for by our attorney, invention put on sale. All these services \$250.00 and up. House of Inventions, 631 Third Avenue, New York 17, N. Y.

NEED Help in making detail drawings or calculating invention problems? Use our confidential, friendly and experienced engineering service. Details free. Machine Design Service, 416 Madison Avenue, Rahway, New Jersey.

MANUFACTURERS! Inventors! We are looking for items which can be successfully sold through agents or by mail. Send full details of your products and lowest wholesale prices. Robert Glass, Ellwood City, Penna.

IF You have an idea for a new product; take advantage of our expert advice. Free booklet "P" tells you how we can convert your ideas into commercial products, fully protected, and introduce them to reliable manufacturers. Elo Development Co., 29-28 41st Ave., Long Island City 1, N. Y.

FREE. Two months on trial. Patent News, Washington, D. C. 12.

INVENTORS: Without obligation, write for information explaining the steps you should take to secure a patent on your invention. John N. Randolph, Registered Patent Attorney, 202 Columbian Bldg., Washington 1, D. C.

INVENTORS: The usual first step is to have a search of the U. S. Patents conducted, so I can report on patentability. Write, without obligation, Patrick D. Beavers (Formerly Randolph & Beavers), Registered Patent Atty., 936 Columbian Bldg., Washington 1, D. C.

INVENTORS: If you have an invention for sale, patented or unpatented, write Institute of American Inventors, Dept. 40A, 1926 Eye St. N.W., Washington 6, D. C.

"INVENTOR'S Guide" free on request. Frank Ledermann, Registered Patent Attorney, 154 Nassau St., New York 7, N. Y.

I SELL Patents. Established in 1900. Charles A. Scott, 773PM Garson Ave., Rochester, N. Y.

INVENTORS! Have you good, patentable ideas? Write Patent Agent Metzler, 11 West 42nd, New York.

CASH For your idea. 280 manufacturers need inventions, patented or unpatented. List free. Invention Bureau, 208M Clinton, Oak Park, Illinois.

PATENT Searches; reliable, efficient, air-mail service; \$6.00. Write for free invention protection form. Patent Research Service, 703P Albee Bldg., Washington 5, D. C.

RELIABLE Patent and trade-mark searches made in U. S. Patent Office \$6.00. Invention protection forms with Certificate of Search free. Write Raymond L. Smith, Patent Searcher, 410-M Bond Building, Washington 5, D. C. (Formerly with U. S. Patent Office.)

PLASTICS. Your idea developed for market. Models constructed. Free estimate. Romark Plastics, 28 West 31, New York 1.

INVENTIONS WANTED

MANUFACTURERS Want patented or patent pending inventions! Send details. Universal Guaranty Company, Lakewood, New York.

CASH For your idea. 280 manufacturers need inventions, patented or unpatented. List free. Invention Bureau, 208M Clinton, Oak Park, Illinois.

INVENTIONS Wanted. Patented or pending only. Inventors' Exchange-B, Hartford 1, Conn.

INVENTORS: Hundreds of manufacturers have requested our assistance in locating marketable new products. Complete information, free. Institute of American Inventors, Dept. 40-D, 1926-Eye St. N.W., Washington 6, D. C.

SMALL Inventions wanted by manufacturers. I'll help you sell your invention. Write for circular. Stanley Hull, 7829 Euclid, Cleveland, Ohio.

HIGHEST Royalties—Cash. Free liter-

PATENTED, Unpatented inventions wanted. We have tremendous lists of manufacturers who may pay cash royalties. Descriptive booklet free. National Invention Service, 1404-T Mitchell St., Oakland 1, Calif.

PATENTS FOR SALE

AUTOMATIC Dispensing tooth-brush \$3,000.00, also electric artificial flower lamp. Phillip Seibel, 3510 Grace, St. Louis, Mo.

(PENDING). Accelerator pedal attachment. Rodd, Box 305, Trona, California.

INVENTORS: Test the commercial value of your patented or unpatented inventions, quickly and inexpensively. Write for free information. Institute of American Inventors, Dept. 40-B, 1926-Eye St. N.W., Washington 6, D. C.

MANUFACTURING

OPEN Time. All types of silk screen work, decals, posters, glass, wood, plastics, or what have you. Estimates cheerfully given. Lac-ed Decal, 59 E. Illinois St., Chicago 11, Ill.

PATENT Models, experimental devices constructed. Reasonable. Nelson Manufacturing, Woodburn, Oregon.

PRECISION Dies, gears, parts, inventions, manufacturing. Baum's Metal Specialties, Kansas City, Mo.

SMALL Lot production wanted. Aluminum castings; stampings; screw machine; plastics. J and M Company, Burlington, Kentucky.

MODELS — Small lot manufacturing. Metals, plastics, etc. Milburn, Burlington, Kentucky.

MODELS, MODEL SUPPLIES

ENGINE Steam, miniature working model. Brass and iron. Bore 9/16; stroke 11/16; weight 2 lb. Assembled \$17.50. Steam boiler for model engines. Uses "Sterno." Withstands 300 lb. pressure. Cast bronze, silver soldered. Complete with pressure gauge and fittings. \$22.50. Ross, 68 West Broadway, Section A, New York 7, N. Y.

BUILD Historic ship models, complete kits 39c to \$8.50; send 10c for catalog. Ideal Models, 19 West 18th Street, New York 11, N. Y.

MINIJET Engine kit now \$9.95 pp. U.S.A. Assemble real pulse-jet at home. Send m.o. today. No c.o.d.'s. Minijet Motors Sales Company, Box 406, Pasadena, California.

SHIP And yacht model fittings; blueprints. Send 25c for illustrated catalog No. 21—listing hundreds of items. A. J. Fisher, 1002-1 Etowah Ave., Royal Oak, Mich.

MODEL Railroads exclusively—Complete stock scale; Lionel, American Flyer. Send for catalog, 15c, state gauge. Eric Fuchs, 26 Tremont Street, Boston 8, Mass.

RADIO Control planes. Complete. Less than \$100.00. 10c please. Hobby Center, 12240 Gratiot, Detroit.

RAILWAY Models, complete informative catalog HO and O gauge. 132 pages, 50c. Walthers, 247 Erie, Milwaukee, Wisconsin.

LANDLOCKED Sailors! Here's a beautiful, richly illustrated, fully descriptive catalogue of famous model ships—whalers, slavers, corvettes, etc.—authentic in every detail. Send for it today. Only 25c. Halesite Yacht Service, Inc., Halesite, Huntington, N. Y.

FUN Building models—Airplanes, trains, ships. Everything furnished. Giant catalog 10c. Ben's Hobby Shop, 72 West Washington, Chicago 2, Illinois.

SHIP Models and yacht supplies complete. Large 64 page catalogue 30c. Bill Wild's, 510 East 11 St., New York City 9.

HOME CRAFTSMEN

LEATHERCRAFTERS—Ten best assorted patterns \$1.00. Guided Crafts, 1582 Lurting Avenue, New York 61, N. Y.

"**EVERYBODY** Likes Candy." Learn to make professionally. (Our 38th year.) Ragsdale Candies, D6, East Orange, New Jersey.

SHELLCRAFTERS. Write for catalog. Tropicrafts, P.O. Box 1951-P, Fort Myers, Florida.

SEMI-FINISHED Cowboy buckle sets, rings, etc. in silver. Will cast 10 or 10,000 items in gold, silver or brass from your model or drawing. Free circular. Southwestern, Box 3506, Station A, El Paso

LEATHER. Retail, mail orders, catalog, tools, lacing, supplies. National Handicraft Co., 30 Frankfort St., New York City 7.

LEATHERCRAFT—Silversmith. Tools, dies, engravers. Made to order. Belt toppers, billfolds, key cases. Louis Jones, 1405 Throckmorton, Ft. Worth, Texas.

LEATHER For coin purses, billfolds, novelties. Assorted kinds, sizes. Five lbs. \$3.00. Surplus, Route 4-800, Madison 5, Wis.

SWISS Music movements \$3.50. Musical novelty kits \$4.75. Irving Meyers, 126 Lexington, New York 16, N. Y.

JIGSAW Patterns—Full size new, original designs. Illustrated folder 10c. Joannes Patterns, P.O. Box 141, Omaha 7, Nebr.

SHELLCRAFT! Make beautiful seashell jewelry. Income or hobby! Large illustrated catalog! Supplies, instructions, 10c postage. (Buy direct from manufacturer.) Pace's, Box 279M, Bradenton, Florida.

LAWN Chairs, toys, novelties, garden figures, furniture, etc. 68 popular plans and patterns, \$1.00. Mastercraft 7M, 7041 Olcott, Chicago 31, Ill.

LEATHER Scrap—Bargain assortment—50c pound. Donroy, Box 41, Bethel, Conn.

VELVETY Decorations. Three-dimensional effect. Material for 50 designs, instructions and full-size stencils \$2. V-Sparks, 1145 Queen Anne, Los Angeles 6.

LEARN To make seashell jewelry, pins, earrings, hair ornaments, novelties. Book of instructions and designs free with \$2.00 and \$5.00 kits, postpaid. Herbert Diamond Co., Box 4619, Miami 31, Florida.

SHELLCRAFT—Create attractive jewelry from shells. Instruction book free or send \$1 for 450 Caribbean shells and findings to make \$6 worth. Shell Company, Miami 36, Florida.

HOBBY Tool set: Stainless steel scroll saw (cuts to 11" center); 6 blades; steel drill and bit; steel clamp; wood working base; cement; plywood sheet; 3 big books of patterns for making beautiful, useful wood, metal, plastic objects; complete instructions. Entertainment, relaxation, for all ages. Attractively boxed, prepaid, only \$3.95. Satisfaction guaranteed. Literature free. Hobby Set, Box 5531, Chicago, Ill.

PHENOLITE Tubing 1", rod 1/2". Surplus. 50 cents brings foot samples, quantity prices, TNB, Box 1434, Amarillo, Texas.

BLACK Palm—Beautiful, rare tropical wood. Sample, literature, Dollar bill. Carmen de Pugh, Apartado 896, Colon, Panama.

PLASTIC Jewelry supplies. Free catalog. J & M Novelties, Box 464P, Griffith, Indiana.

PATTERNS: Lawn ornaments, weather-vanes, letters, numerals, silhouettes, plaques, frames, toys, jig and bandsawed plywood novelty furniture. Craft-hobby books, booklets, decals, tools, etc. Further details free. Wo-Met Shop, Ashburn, Ga.

MAKE Your own jewelry! Findings in metal and plastics; earwires, pinbacks, cameos, stones, beads, clasps, sprays, combs, hairbars, plastic and metal chains. Hobby Art Corp., Dept. 7, P.O. B. 276, New York 18, N. Y.

HOBEE-TOOL—New, low cost home workshop multi-purpose unit. Buy complete set or individual tools singly. Central power unit to work with your motor. \$53.20 buys complete unit—7" bench saw with 45° tilt; face plate lathe; 7" disc sander; 20" jig saw; grinder and drill chuck attachments. Prices for individual tools on request. At any local hardware store or write Wadsworth Wampler Co., 1155 Hillside Avenue, Plainfield, N. J.

SCRAP Leather, large sizes, assorted colors, 5 lb. \$3.95. Enterprise, Sheboygan, Wisconsin.

ARTIFICIAL Flower, novelty, making. Wonderful home business pays excellent profits. Literature free. Velva Artcrafts, 324-M East 14, New York 3, N. Y.

KNOCKDOWN Cedar chests, Lumber and veneers. Free price list. Giles & Kendall Company, Huntsville, Ala.

LEATHERCRAFT! Complete stocks of leathers, tools, supplies. Immediate shipment. Free catalog. Kit Kraft, 3203 W. Washington Blvd., Los Angeles 16, California.

CERAMIC Jewelry supplies, bar pins, ear screws, for ceramic and woodworkers; also glass and seashell assemblers. Free catalog. Philadelphia Badge Co. Dept.

COPPER And brass materials. Complete line for craftsmen and workshops. Catalog A free. Groundmaster Company, Boulder, Colorado.

LEATHERCRAFTERS; Belt kits, projects, leather, supplies. Free catalog. Art Leather, 411 Joseph Ave., Rochester 5, N.Y.

SHELLS. Plastics, findings. Lowest prices. Free catalog. Frances Jones, Box 251, Sarasota, Fla.

MAKE IT YOURSELF

OUTDOOR Grilles, fireplaces. Necessary finished castings and parts to make barbecues. Bulletin upon request. Smith Matthews Foundry, 6636 Charlevoix Ave., Detroit 7, Mich.

TRAPUM Alive. Catch garden pests uninjured, rabbits, crows, foxes, etc., plans 50c. Finished trap \$4.50. Campet, 1826 N. Springfield Ave., Chicago, Ill.

MAKE Your own handy lightweight concrete blocks quickly with new block-maker. Circular stamp. Manual 25c. Peerless, New Lenox, Illinois.

BUILD Concrete block machine. Easy, inexpensive, power or hand. Thousands satisfied. Write, Clyde Lee, Dept. A, Mountain View, Okla.

BUILD Concrete block machines, portable saw mills, shop, home, farm machines. 183 plans. Catalog-handbook free. Nichols Equipment Co., Dept. 1210, Purvis, Miss.

BUILT-IN Kitchen cabinets. \$1.00 brings detailed plans and specifications showing construction methods. Will fit any kitchen. Thombert Co., Box 447D, Newton, Iowa.

COOL Your home economically. Literature free. Engineering Development, Box 37M, Sta. C, Lincoln, Nebraska.

SAVE 25% Fuel heating hot water; regardless of make or type. Proven plan \$3.00. Evergreen, Box 37, Brooklyn 22, New York.

PAINTERS, Carpenters, maintenance men! Build simple, adjustable, portable scaffold. Drawings, instructions, \$1.00. J. L. Aure, Oslo, Minn.

AIR Conditioners or attic fans, build your own. Plans free. Mills, 108 North Commerce, Fort Worth 2, Texas.

MAKE Plastic wallets. Everything furnished. Details free. Lakeshore Supply, 534 Surf St., Chicago 14, Ill.

"**CONCRETE** Block homes." 32 page booklet; drawings, instructions on how to build. \$1.00. H. C. Lightfoot, Civil Engineer, Richboro 1, Penna.

WATCHES, OLD GOLD, JEWELRY

ASSEMBLE Rhinestone, pearl jewelry. Instructions 10c. Herber, 1360-A Hicks, New York 67.

WATCHES. Wholesale: Rebuilt Elgins, Walthams, Bulovas, etc., new and used railroad, stop, diamond, rhinestone. \$9.50 up. Catalogue free. Brookins, B-1975E, Little Rock, Ark.

HIGHEST Cash for old, broken jewelry. Mail gold teeth, watches, rings, silverware, diamonds, spectacles. Satisfaction guaranteed. Free information. Rose Smelting Co., 29-A East Madison, Chicago.

WATCHMAKERS, Beginners; watches; movements. Price list! Box 1874, Chicago 90, Ill.

SEND Your discarded jewelry, watches, crowns, bridges, spectacles, silver, etc., for cash offer. Goods returned promptly if offer unsatisfactory. Old State Metal Co., P.O. Box 1054, Houston 1, Texas.

JEWELERS Findings, supplies. Latest catalog, 10c. George Sassen, 154 Nassau Street, New York 7.

STUN Your friends with genuine, sparkling, brilliant-white zircons. Cut, polished, mounted just like diamonds. Amazing diamond-like appearance. Top-quality. Hard for even experts to tell the difference. Beautiful settings 14K gold. Over 100 gorgeous latest-style rings to choose from. Attractive low prices. Send for big free catalog. U. S. Zircon Syndicate, 139 N. Clark, Dept. 15, Chicago 2.

GEMS, Precious and semi-precious, all genuine, from world wide sources. Deal direct, no overhead, save money. Catalog 10c. Hill Co., Route 7, Salem, Oregon.

TOBACCO, SMOKERS' SUPPLIES

SECONDS \$5.00 Pipes 65c. Briar blocks, bits. Carvapipe, 2829-G Dixie, Hamilton, Ohio.

CIGARS. Full size, factory fresh, extra fine quality. Guaranteed. Prices on request. Trial sample \$1.50 postpaid. S. & E. Co., Dept. PM, Red Lion, Penna.

FRESH Cigars from factory. Mild Havana blend \$3.75, box 50. Check, m.o. Primate, 1109 45 St., Brooklyn 19, N. Y.

PIPE Smokers dream. Pipe that never clogs. Assures sweet, dry, mellow smoke. Genuine imported briar; gives real smoking enjoyment. Unconditionally guaranteed. Particulars free. Bunnell Pipes, 1661-A Elm Street, Stratford, Conn.

PIPE Smokers! Handcarved imported briar pipes \$1.00. Pipelitters \$1.00. Regens Automatic Stormlitters \$1.50, postpaid. William West, 246 Fifth Avenue, New York City.

RAZORS, BLADES, SHARPENING

ELECTRIC Shavers at wholesale. Remington "Foursome," \$14.75; Schick "Super," \$13.75; Shavemaster, \$17.75. New, latest models, prepaid. Order yours today and sell to others. Stanley Wentling, Palmgra 1, Penna.

ELECTRIC Shavers repaired—One day service. Trade-in allowance. Shoppers Shaver Service, 426 State Street, Madison, Wisconsin.

FOR THE HOME

FLOORS—Asphalt tile 9"x9" blocks 10c. Beautiful colors easily installed yourself. Samples, literature free. Star, Franklin Ave., Aliquippa, Penna.

ANDIRONS. All steel! For photos, prices, Attleboro Forge, Attleboro, Mass.

MORE Hot water, faster, less cost, automatically with Gas-Mizer. Electronic Controls Company, 2519 Wilson Blvd., Arlington, Virginia.

FARMERS: Homeowners—Professional advice on all phases of plumbing. Send whatever you think is fair fee. Evergreen, Box 37, Brooklyn 22, New York.

FOR SALE — MISCELLANEOUS

WAR Surplus. Army O. D. blankets, all wool, re-issue, sterilized, perfect condition, \$3.85, plus 25c insured mailing, \$1.00 deposit on C.O.D. orders. Money back guarantee. Barney's Surplus Supplies, 242 Canal St., New York City 13, N. Y.

HULL Automobile compass, value \$4.95, brand new, \$2.50. Prisms for 6x 30 or 8x 30 binoculars, brand new, \$1.50 each. Off-set prisms to be attached to 7x 50 B & L binoculars, gives double the field of the ordinary 7x 50 binocular. Cost \$98.00, special \$25.00. Green sunshades for binoculars, six 6x 30 and 7x 50, snap on type, value \$7.50, special \$1.25 per pair. Forward money order. No C.O.D. shipments. Send 25c for catalog of new and used guns, ammunition, binoculars and powder flasks. Public Sport Shops, 11 S. 16th Street, Philadelphia, Penna.

1000 EMBOSSED Business cards \$2.98. Ortiz, 700 West 180 Street, New York.

PAINT. White house paint, for wagon jobbers and auctioneers; 95c gallon in 5-gallon cans; single gallons \$1.00. Minimum 50 gallons, f.o.b. Kansas City. Surplus black enamel 75c gallon. Aluminum paint for every purpose, \$1.50 gallon. Packed 4-gallon in carton. Mail check or money order for immediate shipment. No correspondence. Trading Post, 2104 Burlington, North Kansas City, Mo.

PHONOGRAPH Records. Rare, old, operatic. Lists. Delano, Lindenwold, Ambler, Penna.

OUTBOARD Motor, "Firestone" 3½ horse-power \$99.99. Auto floor-mats, universal for all cars, good rubber, felt back, \$2.49. Firestone Products, 3843 W. 25, Cleveland, Ohio.

BARGAINS in fur surplus. Write for free catalog. Pacific Fur & Wool Co., Box 926-PM, Sacramento, California.

WANTED—MISCELLANEOUS

WANTED. Envelopes with postage stamps, old collections. Write. Alatalo, Maynard 14, Massachusetts.

METEORITES Wanted, iron or stone. Highest prices. Stuart Perry, Adrian, Mich.

ANYTHING Of value. Robert, 207 North Fifth Street, Springfield, Illinois.

QUICKSILVER (Mercury) urgently needed! Immediate payment. Wholesale Terminal, Norwood, Massachusetts.

PERSONAL

FORGET Birthdays, anniversaries? We'll remind you. Send 10 names, \$1. Prompter, P.O. Box 1141, Louisville, Ky.

HOBBYISTS—Positive wholesale contact. 25 firms \$1.00. Desert Art and Toy, Pacoima, Calif.

WORKERS Tired of being bossed? Helpful details free. Nimtz, 4253 Austin, Milwaukee 7, Wis.

HIGHTONE Your friends. Mail them cards from San Francisco. 6 cards \$1. You address, return, we remit free. Letters mailed 25c. Bill Brennan, P.O. Box 1703, San Francisco 1, Calif.

MEXICAN Law. General practice attorney, 1203 Arizona Street, El Paso, Texas.

PHOTO-STAMPS. Your picture, any object reproduced on genuine, gummed photostamp. 50 stamps \$1.50. Send photo. Returned unharmed. E. Velker, 1836 Champlain Street, Toledo 11, Ohio.

WE Receive, reforward letters; \$3.00 monthly or 25c each. "Hawkins," 1300 Taylor—r, Washington 11, D. C.

PERSONALIZED Gifts—Free catalog. Stuart Printing Service, 923 West Market Street, Scranton, Penna.

CREATIVE Psychology can change your world as you would wish to have it. New, different; gets results. Thrilling details free. Beacom, Box 177, New Brighton, Penna.

SUN Glasses. Air Corps type with pearloid sweat bars, made to meet optical standards with no-glare olive green lenses, self adjusting pearloid nose pads, comfortable cable temples, 14k gold plated, complete with carrying case, at only \$2.49. Men's and ladies' sizes. R. C. Horne, 401 E. Chestnut St., Goldsboro, N. C.

PRETEND Visiting Hawaii. Five Hawaiian glamour cards and instructions \$1. Box 997, Honolulu, Hawaii.

BAFFLE Your friends. Visit beautiful Toronto, Canada by proxy. 5 cards (scenes) \$1.00. Letters 25c, forwarded, re-mailed. "Herb," 5 Temple Ave., Toronto, Canada.

YOUR Penmanship corrected, few hours with grooved hand guides. Write, Ozment, 9, St. Louis, Mo.

WORLD'S Smallest Bible; considered world's outstanding novelty. Abundantly illustrated. Truly remarkable. Unusual value. Sample 10c. Dealers, churches, Sunday Schools; 100, \$4.00; 1000, \$32.00. Groot, 159 East 34th, New York 16.

WE Mail, receive, forward letters. Details free. Lefferts, Box 121, Brooklyn 25, N. Y.

TIE-X-CHANGE. Send six ties and \$1.00. Receive six, 1834 Madison, Eugene, Oregon.

HOW You can find out! Information discreetly developed, any matter, person, problem, anywhere. Personal-business assignments, representations undertaken. Nation-wide. Officially licensed, bonded service established 1922. Reasonable. Confidential. William Herman, 170 Broadway, New York.

HAIR Falling? Dandruff? Write Trichologist. 137 Lewis St., Phillipsburg, N. J.

SWAP! Trade! Anything, everything. Free information. "Swappers" Gazette-PM" Louisville 12, Kentucky.

RUPTURED? Positive comfort, no under-taps, no steel, no elastic. Write Smith Manufacturing Company, Preston, Ontario.

MISCELLANEOUS

MEN! Large size shoes, large size socks! We specialize large sizes 10 to 16, widths AA-EEE. Oxfords, hipops, work shoes. Guaranteed extra quality. Free catalog. Kingsize, 554, Brockton, Mass.

"HOW To Win Prize Contests." Amazing booklet \$1.00. Box 28EM, Jackson Heights, New York.

PANNING Gold—Modern methods, two instruction booklets 25c. Old Prospector, B-128, Dutch Flat, Calif.

POLISHED Manzanita wood wall plaques. Plain or hand-painted 50c up. Sample 10c. 3913 Rosemont, Montrose, California.

EUREKA! Flask filled gold ore, \$1.00. Black-Hills Enterprises, Deadwood, South Dakota.

INTERESTING Mails. Will keep your mail box full for three months for 25c. Bentz, Jr., Chatawa 28, Mississippi.

BALLOONS, \$2.50 Gross. Price lists. Johnson, 2611 PM Harriet, Minneapolis.

DON'T Throw your old ties away. Swap them. Send 1 to 8 ties, plus \$1.00 and we'll send the same number of cleaned and pressed ties; good lookers, too. Pease Company, Grover Hill, Ohio.

TIRED Of your old ties? Send me 2 to 6. I shall return an equal number of thoroughly renewed, different, handsome ties. You pay postman \$1.00 for the exchange. Tie-X-Change, P.O.W. Highland Station, Springfield, Mass.

STOP Foot torture with Kindschi Foot Balancers. Thousands have gained instant relief. V. T. of Compton, Calif. writes, "I put a pair in my shoes, all pains and aches were gone at once. Worth many times the price paid." Rush name for your free trial offer. Kindschi Foot Appliances, Dept. A7, 321 W. Jefferson, Dallas 8, Texas.

TATTOOING Machines, outfits. Free catalogue. Jensen, 120 West 83rd Street, Los Angeles 3.

AMAZING Carlie Cream, with Lanolin, whisks paint and lacquer from hands. No harsh solvents, no grit, leaves hands soft, smooth. 8 oz. jar \$1.00 postpaid. Carlie, 6651 Washington, University City 5, Mo.

BABY Bottle warmer. Uses any heat. Sanitary. Wonderful shower gift. \$3.00 postpaid in U.S.A. Free literature. The Hager Studios, 1032 West Compton Blvd., Gardena, California.

IRON Rallings made! For photos, prices, Attleboro Forge, Attleboro, Mass.

DANCE Instruction in the privacy of your own home. Booklet free. Engstrom Dance Studios, Pm4, Box 358, Grand Island, Nebraska.

KITCHEN Cabinets, \$8.50 up. Streamlined solid wood base and wall cabinets. Fifty sizes. Parts completely machined ready for assembly. Free literature, planning service for builders, home owners. Lexington Woodcraft, Mamaroneck, N. Y.

MEDICAL Laboratory technicians in great demand. We train you in your own home, in your spare time. Also home study course in general Chemistry. Free catalogue. Imperial Technical Institute, Box 913-J, Austin, Texas.

TATTOOING Equipment. List free. Northeast Tattoo Supply, 18 Monument Sq., Portland, Maine.

LUCITE Bar, name pin, safety clasp. Price \$2.00. Made to order. Nightingale Pin Co., P. O. Box 1772, West Palm Beach, Florida.

ABACUS. Now improved and easier to use. An interesting way to learn arithmetic. A fast way to add, subtract, multiply, divide, and extract square roots. Specially illustrated instructions show how. New model, \$3.50. Send for free lesson and details. Loy's Chinese Calculator, Dept. 84M, 1317 Rhode Island Ave., N.E., Washington 18, D.C., Agents wanted.

MEXICAN Jumping beans. July crop. Dozen 25c, hundred \$1.00. Also wholesale. Mexican Products Co., 126 No. Main, Tulsa 3, Oklahoma.

"RECEIVE Mail." Moneymaking offers, opportunities, catalogs. Name listed 10c. Ideal Service, 100, Park Ridge, Ill.

TREASURE Finders! Goldak's new 11 pound lightweight, gold, silver and mineral locator, money-back guaranteed superior any other device. Free information. The Goldak Co., 1542 West Glenoaks Blvd., Glendale 1, Calif.

BOOKFINDERS! (Scarce, out-of-print, unusual books) Quickly supplied. Send wants. Clifton Company, Box 1377 pmm, Beverly Hills, Calif.

M-SCOPE Metal, mineral locators sensational new electronic lightweight models, immediate shipment. Fisher Research Laboratory, Inc., manufactures some of the finest metal locators for the U. S. Army. Built for Arctic, Tropic use. Unsurpassed efficiency, low prices. Time-payment plan available. Send for free 16-page illustrated booklet. Fisher Research Laboratory, Inc., Palo Alto, Calif.

TATTOOING Outfits, supplies. Illustrated list free. Zels, 728 Lesley, Rockford, Illinois.

70 BIBLE Lessons, 25c. Bulletin, Box 87, Cathedral Station, New York 25.

WIRE Telephone steel two conductor plastic covered @ 1/2 cent per ft. Harry H. Yard, Sea Girt, New Jersey.

WHY Forget? Let the "Minute-Timer" bell remind you. Serves million purposes. No burnt foods for housewives. Accurate money saving timing for men. Ideal gift. Send check or money order. \$3.75 postpaid. Amerident, POB 262, Forest Hills,

BE A GOVERNMENT LICENSED AIRPLANE AND ENGINE MECHANIC

Train Now at **LINCOLN**

EARN BIG PAY IN AVIATION

Our new enlarged school now offers these courses: **MASTER AVIATION MECHANICS**, CAA Approved 1 Yr. Airplane & Engine Mechanics Course, **REFRESHER AIRPLANE & ENGINE MECHANICS**. Designed for veterans with aviation mechanics experience. Either course is available to veterans under the G. I. Bill of Rights. Write today for complete information.

LINCOLN AVIATION INSTITUTE

UNION AIR TERMINAL DEPT. P-7 LINCOLN, NEBRASKA

AUTO BODY & FENDER REBUILDING

Tired of Working for the Other Fellow?
Be Your Own Boss
A Big Field for Your Future

Body & Fender Rebuilding is one of the best paid branches of the automobile industry. Go into business for yourself or prepare for good job opportunities. Train at home or in our big shops. Approved for Veterans. (Non-Veterans inquire about our Low Payment Plan and Pay After Graduation Plan.) Send for **FREE** Booklet and full information. No obligation.

COMMERCIAL TRADES INSTITUTE, Dept. F 2-7
1400 W. Greenleaf Avenue, Chicago 26, Ill.

SUCCEED IN THE POULTRY BUSINESS!



Poultry is providing many trained men and women with a good, comfortable living, either part or full time. For 27 years our Home Study Course has been helping thousands obtain training and "know how" that means extra income from the start. Don't delay — Write today for prospectus describing courses, methods, service, opportunities.

DEPT. 50 NATIONAL POULTRY INSTITUTE
ADAMS CENTER, N. Y.

INVENTORS

LEARN WHY YOUR INVENTION SHOULD BE STYLED AND ENGINEERED BEFORE YOU APPLY FOR A PATENT. SEND FOR FREE ILLUSTRATED BOOK, "INDUSTRIAL DESIGN AND THE INVENTOR."
ETTEL INDUSTRIAL DESIGN
ROOM 40 - 112 SOUTH 106TH ST. - SEATTLE 88, WASH.

BUILD AN ELECTRIC LAWN MOWER



Make this Battery-Driven, Rotary-Blade mower from an old auto generator and inexpensive parts. Cuts forward, backward, grass or weeds, any height. Plans complete, easily followed.

PLANS ONLY
35¢
WRITE TODAY

LE JAY MFG. CO., 847 LeJay Bldg., Minneapolis 8, Minn.

Raise Broilers in 7-8 Weeks



BROWER BATTERY BROODERS

Raise broilers and pullets with this three deck automatic electric heated 40-a-month broiler plant. Made of steel and aluminum... Price, \$40.95. Other batteries from \$15.95 up. All capacities... Write for free battery brooder and poultry supply catalog.
Brower Mfg. Co., Box 161, Quincy, Ill.

World's Largest Line of Poultry Supplies

NEW SERIES 16 IMPROVED NO-DRIFT FM



in the Sensational 1948
MIDWEST RADIOS

Separate Chassis Like the Powerful Series 16 AM-FM Above, or Beautiful Radio-Phono Consoles Available

The SYMPHONY GRAND RADIO-PHONOGRAPH AM-FM CONSOLE



A truly magnificent instrument that offers new, improved No-Drift FM, 5 Wave Bands, Automatic Intermix Record Changer that handles both 10" and 12" records, 14 1/2" Panasonic Speaker, and exclusive Midwest Tri-Magnadyne Coil System and Color-Ray Tone Selection. Luxurious Cabinets. Other Console and Table Models with Series 16, 12, and 8 Chassis.

EASY TERMS 30 DAYS TRIAL

SEND FOR FREE Catalog BUY DIRECT FROM FACTORY AND SAVE
FILL IN COUPON AND MAIL TODAY OR JUST SEND YOUR NAME AND ADDRESS ON 1c POSTCARD

MIDWEST RADIO CORPORATION
Dept. 25-Y, 909 Broadway, Cincinnati 2, Ohio

Please send me your new FREE 1948 Catalog.

NAME
STREET.....
CITY..... ZONE... STATE

Manufacture for the Building Industry



Get in the Dunbrik-Dunstone business today and ride the tide of the biggest building cycle in history. It's the outstanding manufacturing opportunity in the building field, with broad market potentials and high income possibilities.

A Wide-Open Opportunity

Dunbrik (and Dunstone) is masonry at a new peak point of colorful beauty and modern design. Easy to make in local plants, using local material and local labor. Low costs means you can give more quality for less money — even undersell lumber. We supply all necessary equipment; back you with liberal cooperation. Write today for full information.

W. E. DUNN MFG. CO.
600 W. 24th STREET
HOLLAND, MICH.

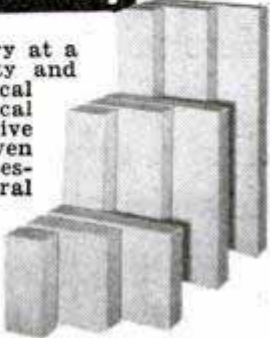

DUNBRIK DUNSTONE

Says Man Has Strange Powers That Work While He Sleeps

A strange man in Los Angeles, known as "The Voice of Two Worlds," reveals the story of a remarkable system that often leads to improvement in power of mind, achievement of brilliant business and professional success and new happiness. Many report improvement in health. Others tell of increased bodily strength, magnetic personality, courage and poise.

The man, a well-known explorer and geographer, tells how he found these strange methods in far-off and mysterious Tibet, often called the land of miracles by the few travelers permitted to visit it. He discloses how he learned rare wisdom and long hidden practises, closely guarded for three thousand years by the sages, which enabled many to perform amazing feats. He maintains that these immense powers are latent in all of us, and that methods for using them are now simplified so that they can be used by almost any person with ordinary intelligence.

He maintains that man, instead

of being limited by a one-man-power-mind, has within him the mind-power of a thousand men or more as well as the energy-power of the universe which can be used in his daily affairs. He states that this sleeping giant of mind-power, when awakened, can make man capable of surprising accomplishments, from the prolonging of youth to success in many fields. Strangely, he says that this power works best while we sleep, when proper methods are used.

The author states the time has come for this long-hidden system to be disclosed to the Western world, and offers to send his amazing 9000-word treatise which reveals many startling results—to readers of this paper, free of cost or obligation. For your free copy, address the Institute of Mental-physics, 213 South Hobart Blvd., Dept. 270-G, Los Angeles 4, Calif. Readers are urged to write promptly, as only a limited number of the free treatises have been printed.

THE GREATEST
THING

IN
PLASTICS!

PLASTICAST



PLASTICAST is a liquid plastic; can be poured into ANY kind of mold or container. Hardens in a few minutes into a transparent solid, clear-as-glass, tough-as-steel plastic! No tools or machinery required. As easy to use as pouring water out of a glass! Ideal for imbedding flowers, butterflies, photos, souvenirs, and for making beautifully brilliant jewelry, gems, displays, fishing lures, magnifiers, lenses, knick-knacks and novelties. Easily cast into sheets, rods or blocks. ANY shape, ANY color. **EVERYTHING FURNISHED**, including molds for making **PENDANT HEARTS, ENCHANTED GARDENS, MAGNIFYING GLASSES**, etc., sufficient materials for making about \$100.00 worth of attractive novelties! The ONLY outfit on the market containing molds! C.O.D. orders accepted with \$1.00 deposit.

COMPLETE MASTER OUTFIT \$3.50

Postpaid U.S.A. and Canada only

FREE

A very attractive and useful novelty made of one of our products given absolutely free with every one of our catalogs! Catalog lists many new materials for making **MOLDS and CASTINGS** with Liquid Plastics, Liquid Ivory, Liquid Marble, Wax, Latex, Metal, Castwood, Plaster, etc.; also many molds listed. Price of catalog only 10c coin or stamps.

PLASTICAST CO. (Dept. C)

5961 Madison St.
Chicago 44, Illinois

We have no retail store—
order by mail only.

P. O. Box 987
Palo Alto, Calif.

EXTRA MONEY

EASY

Show friends and others sensational Christmas card values! Get orders full or spare time. Personal Christmas cards with sender's name 50 for \$1.00 and up. Also \$1.00 Box Assortments—21-card "Feature," Religious, Everyday, Gift Wrappings, Stationery. No experience needed. Get samples sent on approval. Write TODAY.

ARTISTIC CARD CO., INC.
334 Way Street
ELMIRA, N. Y.

**SHOW
Christmas
CARDS
50 for \$1
With Name**

PATENTS

"Proof of Invention"
Folder mailed without
obligation.

E. E. VROOMAN, Registered Patent Atty.
871 Woodward Building, Washington 5, D.C.

**PATENTS
AND TRADE MARKS
C.A. SNOW & CO.
REGISTERED PATENT ATTORNEYS**

WRITE FOR INFORMATION TO
428 SNOW BUILDING, WASHINGTON 1, D. C.

INVENTORS

IF YOU WISH TO PROTECT YOUR INVENTION,
You should take steps to protect it by a U. S. Patent.
Write me for "Record of Invention" form.

**CARL MILLER
REGISTERED PATENT ATTORNEY**

Woolworth Bldg., 35th Floor, Dept. 78A, New York City
Please send me "Record of Invention" form.

NAME _____

ADDRESS _____

Get into **BUSINESS**
for *yourself!*

**METALIZING
BABY SHOES
AT HOME IN
SPARE TIME**



Get facts now about amazing money-making *Warner Success Plan* that shows you every easy step in completely charted path to personal independence—with your home as your headquarters... This proved and tested Plan is working like magic. It's backed by an old, reliable company... And we send it to you on a No-Risk Trial Money Back Guarantee.

QUICK CASH WAITING
Demand for METALIZED Baby Shoes and other keepsakes is growing bigger daily. Our Tested Plan Shows How to Do the Work, How to Bring in the Business, How to Make as much as \$5 an Hour. Spare or full time, big steady profits are waiting for you. Send penny postcard or mail coupon for FREE Facts. Act! Time is precious.

FREE
offer of
**COMPLETE
MONEY
MAKING
PLAN**
•
**SEND NO
MONEY**
Just Mail
COUPON

Ray Brandell, Mgr., Warner Electric Co.,
1512 JARVIS AVE., DEPT. 37, CHICAGO 26, ILL.

Please rush complete details about your No-Risk Trial Money Back Plan for Metalizing Baby Shoes. Everything you send is FREE and costs me nothing—now or ever.

NAME _____

ADDRESS _____

CITY _____ ZONE _____ STATE _____

INVENTORS

When you are satisfied that you have invented a matter of value—write me, without obligation, for full information as to what steps you should take to secure a Patent or Trademark.

The usual first step is to have a search of the prior U. S. Patents conducted, so that I can report to you on the question of Patentability.

PATRICK D. BEAVERS

(Formerly RANDOLPH & BEAVERS)

Registered Patent Attorney

934 Columbian Building Washington 1, D. C.

PATRICK D. BEAVERS, Registered Patent Atty.

934 Columbian Bldg., Washington 1, D. C.

Please send me full information on how to secure Patent Protection.

Name _____

Street _____

City _____

State _____



PROTECT YOUR INVENTION

This Book Tells How: 230 pages, beautifully bound, fully illustrated, answers every question about Patent Law, protection for your patentable ideas, patent licensing, etc., which every Executive, Engineer and Inventor should know. Important Chapters: How to Get a Valid Patent, How to Keep Invention Records, How to Avoid Patent Infringement, Basic Requirements of an Invention to be Patentable, and 16 others.

PATENT LAW for the EXECUTIVE and ENGINEER

2nd Edition . . . fourth printing

Sent on approval for five days to Executives and Engineers who write for it on their business letterhead. Pay \$2.95 plus postage in five days or return the book. . . . This authoritative book on Patent Law, bought by thousands of Executives, Engineers and Inventors and their companies, will pay for itself countless times. You can't afford to be without it. Learn how to protect yourself on all matters concerning Inventions and Patents. FREE: for cash with your order we'll send free a complete set of 12 Invention Record Forms widely used in industry, retail price alone \$1.00, worth many times more in protecting your patentable invention. Multicolored, 8 1/2" x 11" forms include every record necessary for your protection. Check or money order only. Postage prepaid if you send \$2.95 with order.

RESEARCH PRESS, 429 Hunter Ave., Dayton 4, Ohio:
Send me "Patent Law for the Executive and Engineer."
—Check or Money Order enclosed (You pay postage and send FREE complete set of Invention Records).
—Five days approval. I'll remit \$2.95 plus postage or return the book in five days.

Name _____ Title _____
Address _____
City _____ Zone _____ State _____ PM7

YOU CAN MAKE \$50 A DAY!

Be INDEPENDENT in your own business



with our
15
TRADE
SECRETS

START your own business in your spare time with our 15 private manufacturing processes—like THERMO-SOL Fireproofing Material.

In your own home—garage, basement, kitchen, fill the demand for this amazing fire-proofer—it leaves materials soft and flexible—and 14 other wanted products.

We tell you ALL! How to MAKE. Where to BUY simple inexpensive materials. How to Package, Promote, SELL. If you can follow simple directions, here are 15 roads to success. We give you full details on all 15 processes!

The public NEEDS these 15 products. You, yes you, can make them. And you can have OTHERS SELL THEM for you, too.

Lose no time! Write for details!

CHEMICAL RESEARCH CO.

214 West 42nd St. New York 18, N. Y.

HERE'S A CHANCE For YOU to Test

Selrodo



INHALANT METHOD

FOR RELIEF FROM BRONCHIAL ASTHMA and HAY FEVER

FREE! WITHOUT OBLIGATION, COMPARE 10 DAYS FREE TRIAL IN YOUR OWN HOME

If at the end of 10 days you are not completely satisfied, return the full SELRODO set to us. If you obtain the wonderful relief experienced by thousands of others, send \$7.50 for specially priced trial set.

(CAUTION: Use Only As Directed)

C-L-I-P THIS ADVERTISEMENT and send it with your name and address to:

STANSBURY CHEMICAL CO. Dept. 483A
1929 Aurora Avenue, Seattle 9, Washington

CARBURETOR TOO RICH MAKES MOTORIST TOO POOR

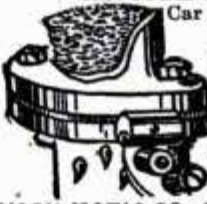

Car owners who are wasting money and not getting proper gas mileage due to over-rich mixtures will be pleased to learn how to save gasoline by VACU-MATING over-rich mixtures. VACU-MATIC fits all cars, trucks and tractors. It is automatic and operates on the supercharge principle. Easily installed in a few minutes.

SALESMEN WANTED! Big Profits! Send name, address on penny postcard for free particulars and how to get yours for introducing.

VACU-MATIC CO., 7617-1371 W. State St., WAUWATOSA, WIS.

Master Watchmaking

The life-long profitable trade of thousands as taught by the Sweazey System.

"FAMED THE WORLD OVER"

CHICAGO SCHOOL OF WATCHMAKING

Founded in 1908 by Thomas B. Sweazey
1608 N. Milwaukee Ave., Dept. 178 Chicago 47, Ill.

LEARN WELDING

Use latest equipment in established recognized school. Lifetime trade at better than average earnings. G. I. Approved. Write for FREE booklet.

Dept. A, KALIX TRADE SCHOOL
439 N. 11th STREET PHILADELPHIA, PENNA.

LIQUID MARBLE

COMPOSITION FLOORS FLEXIBLE MOLDS MOLD Novelties, Statuary, Art Goods in Flexible Plastic Molds; 5c material makes \$1 seller. Make Marbleized floors, Tile Walls. Colorful, glossy, amazing! Easily learned; start in garage or basement. Particulars free. MARBLEIZING SERVICE, Dept. 10-F, Edwardsville, Ill.

LOSING YOUR HAIR?



Have Dandruff? Annoying itchy scalp? Dull, lifeless-looking hair or thin fuzz and want thick, healthy hair? We may solve your problem easily and inexpensively, in the privacy of your own home. We are helping many people and may help you, too. For FREE BOOKLET write today.



THE MODERN SYSTEM, INC.

3220 Hudson Blvd. Dept. X Jersey City, N. J.

- ★ WRIST WATCH
- ★ STOP WATCH
- ★ TELEMETER
- ★ TACHOMETER

Phenomenal Value!
17 JEWEL • 2 PUSH BUTTON
CHRONOGRAPH

ONLY \$29⁷⁵ PLUS 10% TAX



- INCABLOC SHOCK RESISTANT FEATURE**
- Sweep Second Hand
 - Radium Dial • Anti-Magnetic • Unbreakable Crystal. (formerly \$71.50)
- IDEAL FOR**
- Physicians • Engineers
 - Radio Men • Sportsmen
 - Photographers • Aviators

OUR GUARANTEE

MONEY BACK IN 10 DAYS
If not satisfied for any reason

ADLEW JEWELERS Dept. PM 6
117 W. 42nd St., N. Y. C. 18

Mail Orders Promptly Filled • Shipped C.O.D. or send check or money order.
Address mail-orders to:
ADLEW JEWELERS (Dept. PM-6)
152 West 42nd St., N.Y.C. 18

Also available in 18-k Gold Case. \$64.50 (plus 10% tax), formerly \$125.

MAKE EXTRA MONEY!

Make extra money selling Guaranteed Nationally Advertised Window, Pedestal, Table, Floor, Attic and Basement Fans, Full or part time. Quality products. Prompt shipments. Others make up to \$10,000.00 a year, and more. You can, too. Write for details, today.

APPLIANCE DISTRIBUTING CO., Inc.
163 WALTON ST. ATLANTA, GA.

NOW! MAKE YOUR OWN LEATHER BELTS & HANDBAGS

Portfolio of 10 NEW handbag patterns, full size, easy to follow instructions for transferring, tooling, etc. No. 332 set only \$1.30
47 NEW Western and Novelty Belt Designs No. 397 set only 75c
A full stock of quality leather and lucite fittings.
Large catalog included with first order for materials.
OSBORN BROS., Dept. M, 225 W. Jackson Blvd., Chicago 6, Ill.

FREE - INSTRUCTIONS - FREE

no investment required, become a

PURCHASING AGENT

Start earning a good income immediately, steady work year 'round.

Write

PURCHASING, DEPT. C
2719 LAWRENCE AVE. CHICAGO 25, ILL.

22 Big Money-Makers in a Single Line!
Amazing New Fluorescent Lights with Circular Tubes

THE HOMELITER



FREE Sales Outfit

Don't send a penny. Sample Outfit is FREE. Rush name on penny post card for money-making facts about sensational new "CIRCLINE" Fluorescents. Latest scientific development gives you 22 new type circular tube fixtures for kitchens, dinettes, halls, and play rooms. Also Floor and Table lamp for living rooms and pin-ups for shaving and vanity tables. Sells on sight to homes, restaurants, stores, offices. No other fluorescents like CIRCLINE. Salesmen who order samples quickly reorder in large quantities. All fixtures complete with tubes. No waiting. Also immediate delivery on all standard type Fluorescent Fixtures. This is too good to miss. Big, quick profits waiting. Rush name on postcard today for FREE Sales Outfit.



NEW MAXILUME PIN-UP MIRROR LIGHT

MAXILUME COMPANY • 125 W. HUBBARD • DEPT. 87 • CHICAGO 10, ILLINOIS

FREE

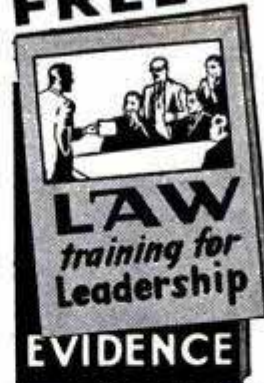

TO the MAN INTERESTED IN LAW

Every question about Law and its value to you is answered in LaSalle's 48-page booklet, "Law Training for Leadership." And the question of how you can master Law is answered in the companion booklet, "Evidence"—in which

scores of our students tell how they have advanced through LaSalle Law Training in spare hours at home. Legal training gives you what the business and professional world prizes highly and rewards liberally—a keen, analytical mind, the ability to judge shrewdly, talk convincingly, and act with confidence. LaSalle's "Problem Method" of personalized instruction by lawyer-instructors gives you practice in handling legal problems... you learn by doing, not by memorizing rules. We guide you step-by-step, furnish all texts, including remarkable 14-volume Law Library prepared by leading law professors and lawyers, and used as reference in many Law libraries and offices. Degree of L.L.B. conferred. Low cost, easy terms. Investigate your opportunities in Law. Mail coupon today for free booklets described—without obligation.

LA SALLE EXTENSION UNIVERSITY
A Correspondence Institution

417 S. Dearborn St. Dept. 764-L Chicago 5, Ill.

Send me "Law Training for Leadership" and "Evidence"—without obligation.

Name..... Age.....

Street.....

City, Zone & State.....

How To Make Liquid Marble

And BIG PROFITS In Your Own Business

Amazing Liquid Synthetic Marble can be made at home without machinery. Needs no heat or pressure. Can be poured into molds for casting expensive novelties. Liquid Synthetic Marble can be made in any color. It is even more beautiful than genuine marble because of its highly glazed finish. Costs far less. **FLEXIBLE MOLDS:** Make your own Flexible Molds. Cast novelties, statuary, desk sets, book-ends, etc. out of Liquid Marble, plaster and many other molding compositions. A large sized mold costs but a few cents. Hundreds of casts can be taken from a single mold. **UNLIMITED MARKET:** You will find steady year-round demand in your own community. No selling problem. We supply names of buyers for your finished products. Let **BING PRODUCTS** show you how to start with a small investment and build a permanent, independent, profitable business! Write now for **FREE CATALOG!**

BING PRODUCTS: Dept. PM-7A 88 BROAD STREET BOSTON 10, MASS.

Thousands of Parts
For Military

TRUCKS

We have for immediate delivery genuine parts for all makes and models, 4x2 - 4x4 - 6x4 and 6x6. All models from 1/4 ton to 20 tons. All makes: Auto-car, Biederman, Brockway, Chevrolet, Diamond T, Dodge, Federal, Ford, GMC, International, Mack, Oshkosh, Reo, Studebaker, White, Willys and Jeeps. We have parts lists available on some models. Write stating model of Truck.

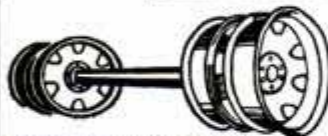

TRAILER AXLE

Heavy duty trailer axle suitable for many types of trailer construction. Also excellent for building of heavy farm trailers and wagons. It is a 15,000 lb. capacity square type straight

trailer axle complete with Timken roller bearings, hubs, and 6 hole 750 x 20 Budd Wheels. Without brakes. Axle is 2 1/2 inches square and 70 inches between wheel mounting flanges. Std. width. AN EXCELLENT BUY.

With Single Wheels...\$49.50 With Dual Wheels...\$59.50

A 30 Day Special Offer on New POWER WINCHES

On all orders received during the month of July for any of the Winches that we have listed in this ad at regular prices, we will allow an additional discount of 15%. To qualify for this discount your order must have a JULY postmark.

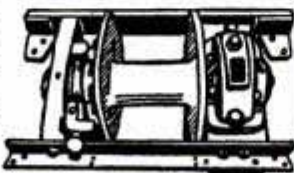

GOVERNMENT SURPLUS WINCHES

Suitable for Front or Rear Mounting

BRADEN WINCH—5,000 lb. cap. For 1/2, 3/4 and 1 ton trucks. **\$95.00**

WINCH, GARWOOD OR HEIL—15,000 lb. capacity. **\$150.00**

GARWOOD WINCH—12,000 lb. capacity. **\$125.00**

GARWOOD WINCH—25,000 lb. capacity. **\$200.00**

WINCH KIT FOR INTERNATIONAL TRACTORS MODELS TD-9 and TD-14—A 25,000 lb. Winch with 3 speed power take-off, shafts, joints and attaching parts for front mounting. Shipping weight 1700 lbs. **\$250.00** Only.

We can furnish cables, power-take-offs, shafts, joints, sprockets and chain at reasonable prices.

All prices quoted are FOB, Kansas City. 25% deposit required on COD orders.

AMERICAN AUTO PARTS CO., Inc.
1830 Locust Kansas City, Mo.

SAY YOU SAW IT IN POPULAR MECHANICS

PNEUMATIC AIR TOOLS

At a Saving of \$64.00 and Up!

Ideal fender and bumping hammers, and for riveting brake lining, concrete breaking and many other uses. Like new. At these unheard of low prices it pays to order a good supply.



RIVETER & CHIPPING HAMMER

Ingersoll-Rand AVC-11 with air control, push button throttle, takes up to 5/32 rivet. Like new. Weight 5 pounds. List Price \$73.00—Special Price **\$7.95**



RIVETER & CHIPPING HAMMER

Chicago pneumatic CP4 with air control, push button throttle, takes up to 3/16 rivet. Weight 6 lbs. List Price \$73.00—Special Price **\$8.95**



Chicago Pneumatic RIVETER & CHIPPING HAMMER

CP9X offset handle, with air control. Takes up to 1/4" rivet, weight 8 lbs. List Price \$79.00. Special Price **\$10.95**



THOR PNEUMATIC ALLIGATOR

Squeezer and Compression Riveter Model PRS-10. Alligator jaws, or PRS-10. "C" Type Yoke. Weight 5 lbs. List Price \$93.00—Special Price **\$12.95**

PRICES ARE F.O.B. CHICAGO. Immediate delivery. SOLD ON MONEY BACK GUARANTEE. Send check or money order today.

C & M EQUIPMENT COMPANY 1831 S. State St. Chicago 16, Ill., Dept. D-7

Out of Pawn!

GENUINE DIAMONDS



Direct to You—Save up to 50% and more on fine quality, Genuine Diamonds, reset in beautiful modern mountings, styled for Ladies and Men—Sold with an Iron-Clad Money-Back Guarantee. Over 100,000 satisfied customers. Order now from this ad. Write us for FREE ILLUSTRATED CATALOG of other Unredeemed Diamond Pledges from \$5.00 to \$5000. Send today. Reference: Any Bank or any Mercantile Agency.

1/5 CARAT \$125 Value

\$49 Taxincl.

1/2 CARAT \$200 Value

\$95 Taxincl.

BERMAN'S COLLATERAL LOAN BANK

Dept. P-11, 636-38 W. Balto. St. Baltimore 1, Md.

LEARN TO EARN! • SKILLED MEN NEEDED NOW!

for BIG PAY JOBS in the METAL TRADES



Resident or Home Study

- Mechanical Drafting
- Tool and Die Making
- Tool Design and Engineering
- Machinist Trade
- Product Design and Illustration

Train Now!

In Nationally Known, Fully Approved School and Endorsed by Industry . . . Est. 1928

APPROVED FOR CIVILIANS FREE EMPLOYMENT and VETERANS . . . —SERVICE . . .

Write For Catalog — A 1c Postcard will do

ALLIED SCHOOL OF MECHANICAL TRADES

1338-1340-1342 So. Michigan Ave. CHICAGO 5, ILL. 427 Allied Bldg.

GET U. S. GOV'T JOB!

Big Salaries! Yearly vacation. Congenial surroundings, dependable job. Our inexpensive Keyed Exams. train you at home for Exam. Write, INSTRUCTION SERVICE, St. Louis 3, Mo.

APTITUDE TESTS

discover the kind of work or studies best for your success! You get a personal report—a guide for life—more happiness—more prosperity. For men, women, boys and girls. Write for complete facts.

VOCATIONAL COUNSELING INSTITUTE
956 Maccabees Bldg., Detroit 2, Michigan

BROKEN JEWELRY WANTED

All kinds. Highest prices paid for jewelry, rings, spectacles, gold teeth, diamonds, broken and usable watches, etc. Cash mailed promptly. Write for FREE shipping container.

LOWE'S, Dept. PM, Holland Bldg., St. Louis 1, Missouri



SAVE on High Quality GABARDINE Dress Trousers for Summer Wear

\$12.00 VALUE

\$6.95 PR.

Huge direct-to-you volume enables us to give exceptional value! Fully guaranteed. Genuine virgin wool and fine-spun rayon. Cool, comfortable. Twill weave resists wrinkles, holds crease, gives amazing wear. Expert fashion tailored for perfect fit. Zipper front. Roomy pockets. Blue, Tan, Sand, Lt. or Dk. Blue, Blue-Gray. WAIST SIZES 28-38 pleated or 28-44 plain.

SEND NO MONEY Send name, waist size, color. Pay postman only \$6.95 plus small postage. Or, send money and save postage.

LINCOLN TAILORS Dept. PM-7 Lincoln, Nebr.

DO ELECTRICAL WORK ON REAL EQUIPMENT IN M. T. I. SHOPS

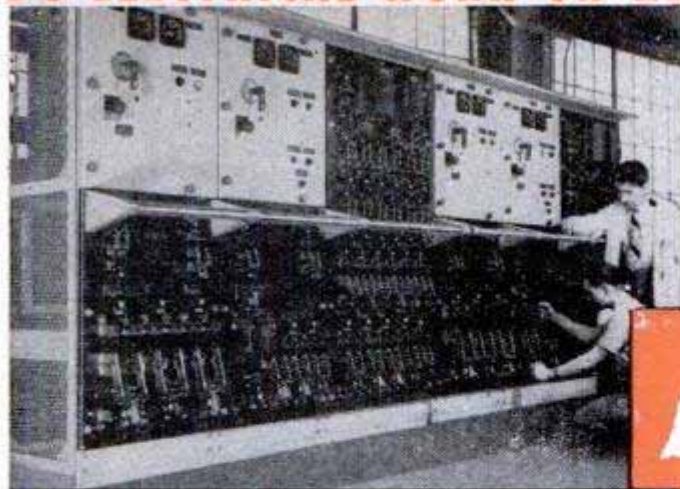

POWER DISTRIBUTION PANEL AT M. T. I.

Why Spend Years
"Picking-Up" a
Trade? . . . This
"Live" Industry
Needs Trained
Men NOW!

Learn

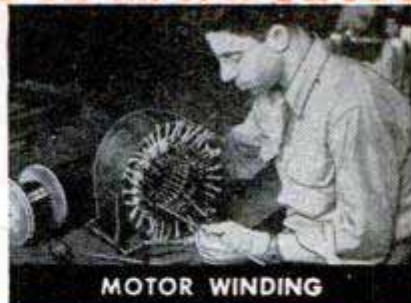

MOTOR WINDING

ELECTRICITY

There is no other place . . . no other way to get the same all-around electrical training you get at M.T.I. NOT A HOME STUDY COURSE! . . . You get actual "hands-on-equipment" experience in our great modern resident shops in Detroit. No previous experience necessary. Learn HOUSE-WIRING, A.C. D.C. MOTORS and CONTROLS, MOTOR REBUILDING AND ARMATURE WINDING, CONSTRUCTION and MAINTENANCE WORK, etc. New classes every few weeks. Living arrangements made.

EARN WHILE YOU LEARN
Our part-time job assistance helps you meet living expenses while attending M.T.I.

NO COST TO VETERANS
Get \$75.00 to \$120.00 monthly subsistence. Easy Pay Plan for Non-Vets. Mail coupon today.

The Nation's
LARGEST, EXCLUSIVE
School
of
Electricity



MAIL
TODAY

MICHIGAN TECHNICAL INSTITUTE, Dept. PM7
2281 W. Fort St., Detroit 16, Michigan

RUSH your FREE CATALOG and complete information. (No obligation and no salesman will call.)

Veteran Non-Veteran

NAME _____

ADDRESS _____

CITY _____ ZONE _____ STATE _____

MICHIGAN TECHNICAL INSTITUTE

2281 West Fort Street Dept. PM7 Detroit 16, Michigan

'How to Make Money with Simple Cartoons'
A book everyone who likes to draw should have. It is free; no obligation. Simply address **FREE BOOK**
CARTOONISTS' EXCHANGE
Dept. 97-D Pleasant Hill, Ohio

LAW STUDY AT HOME for Personal Success and LARGER EARNINGS. 39 years expert instruction—over 114,000 students enrolled. LL.B. Degree awarded. All text material furnished. Easy payment plan. Send for FREE BOOK—"Law and Executive Guidance."

AMERICAN EXTENSION SCHOOL OF LAW
Dept. 91-PM, 646 N. Michigan Ave. Chicago 11, Ill.

GET THIS FAMOUS BOOK NOW!

Make Money in REFRIGERATION

Completely Covers all Service Work

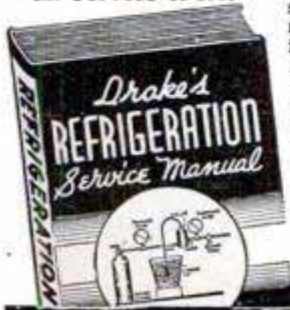

This is the help you need to cash in on the tremendous demand for refrigeration service. It will give you everything you need to know and costs only \$2.00. Nothing else to pay. 317 pages of up-to-the-minute instruction, including 148 illustrations. Covers all types of electric refrigeration, both in the field and in the repair and service shop. Makes all trouble shooting, testing, repairs as simple as ABC. Rush order now. Only \$2.00 postpaid. Sent C.O.D. if you prefer.

FREDERICK J. DRAKE & CO.
DEPT. 1-B
600 W. Van Buren St., Chicago 7

WAR SURPLUS AND OTHER BARGAINS



BLOWER COOLER or HEATER:

For trailers, autos, offices, darkrooms, homes. DUMORE Motor, 1/6 cont. HP, Amperage 7.5, RPM 6400, 24 Volts. May also be used as dryer. Simple installation, radiator type, copper coils. Transformer advertised in this ad will operate this unit from house current. Weight 13 lbs. New, \$15.00

SHIP'S BELL: U. S. Navy Sur-



plus. Solid Brass with smooth polished finish. 5" Diameter. Great for Patios, Doorways, in Dens, Ranches, etc. Matching solid brass wall bracket included. Weight 3 1/4 lbs. All New. \$5.95 Each.

MICROMETER



Chrome plated, precision engineered and carefully tooled to give long life . . .

all new. 0-1" capacity, \$2.25.
1-2" capacity, \$3.50 Each.

TRANSFORMER: Jefferson Electric step up or step down transformer. Input, primary 110-117 Volts A.C. Output, from 5 Volts to 650 Volts. Suitable for use with war surplus gadgets, heater relays, radio test filaments, electric trains, house chimes, etc. Weight 10 lbs. New. \$7.95 Each.



CONDUIT WRENCH: Mfd. by JOAR. Jaws pass over conduit, pipe or tubing, slips down to snugly encircle fittings. Slight pressure tightens or loosens fittings. Will not mar or kink material. Set of 8. All new wrenches, Nos. 4-6-7-8-10-14-22-28, (Reg. cost \$50.00), \$10.00 per set.

Send check, money order or cash. 25% Deposit required on C. O. D. orders. All prices F. O. B. Culver City, Calif.

AIRBORNE SALES CO., INC. DEPT. PM 7-B
CULVER CITY, CALIF.

SAY YOU SAW IT IN POPULAR MECHANICS

Learn ELECTRICAL APPLIANCE REPAIRING

IN YOUR SPARE TIME!



S. T. Christensen
President

HERE'S BIG MONEY and INDEPENDENCE

WRITE ME TODAY!

NO PREVIOUS EXPERIENCE NEEDED!

This fascinating lifetime opportunity can be yours if you are mechanically inclined (can hold and use tools). I have trained thousands in their homes, many now earning \$5.00 to \$6.00 an hour!

CHRISTY APPLIANCE COURSE SENT ON APPROVAL!

A complete practical, easy to understand course, full of pictures and drawings. Shows you how to locate trouble, then how to fix it, and what to charge! Rush name and address by return mail and I will send you our special form telling how you can get our complete course without one penny investment! Pay us later with your EARNINGS WHILE LEARNING!

Mr. S. T. Christensen, President
Christy Supply Co., Dept. D-5903
2835 N. Central Ave., Chicago 34, Ill.



Original WAR SURPLUS!
JUNGLE HAMMOCKS

EASILY WORTH \$25!

ONLY **\$4.99** COMPLETE

BRAND New!

Get Set For A Summer of Fun!

A complete bed with upper and lower canopy. A perfect way to relax in the cool shade, zipped in safe from pestering insects. A 43" zipper slide opening and hanging ropes.

SEND NO MONEY! Send Name and Address and on delivery, pay postman \$4.99 plus C.O.D. charges plus 40c for mailing and handling charges. Satisfaction guaranteed or money refunded.

The DRAKE COMPANY, Dept. PM-29
1380 MILWAUKEE AVENUE CHICAGO, ILLINOIS

LEARN EXPORT



Buy and sell world-wide without capital. Travel abroad if desired. Export men and women in demand. Your own business — profits unlimited. Salaried jobs — up to more than \$10,000 a year. Practical, low cost **WORLD TRADE COURSE** teaches you quickly at home in spare time. No previous special experience or schooling needed. World Trade Certificate awarded. Write today for **FREE DETAILS**. No obligation. Please state age. Air-mail reaches us overnight. **THE MELLINGER CO., Exporters-Importers, 1422-AK Westwood, Los Angeles 24, Calif.**

LOCKSMITHING & Key Making

PRACTICAL UP-TO-DATE COURSE



Easy-to-learn modern information for self-instruction. How to work on locks, de-code, make master-keys, repair, install, service, etc. For every handyman, home owner, carpenter, mechanic, service station operator, fix-it shop, hardware dealer, gunsmith, 53 plain illustrated lessons. Full price only \$3.95. **SEND NO MONEY.** Just pay postman plus C.O.D. postage. Or send \$3.95 with order, we'll ship postpaid. Satisfaction guaranteed or refund.

NELSON-HALL CO., 1139 S. Wabash Ave., Dept. G-02, Chicago 5, Ill.

Speed and Power Handbook



Very latest methods! Construct your own super-chargers, water injectors, compression heads, fuel saving devices—easily, practically without cost. Get racing speed, acceleration, dynamic power increases from any automobile! Build stock conversions! Fast roadsters. Hot-rods. Get ingenious formulas! Speed secrets! Also "Economy Information." Tuning techniques! Ignition! Carburetion! Mileage tricks, illustrations! Including "Restyling Ideas"—Streamlining, Model revising! Customizing! Sport changes. Photographs! Parts lists! **ORDER TODAY. \$1.98 POSTPAID.**

NEWHOUSE AUTOMOTIVE INDUSTRIES
5941-B4 Hereford Los Angeles 22, Calif.



M. S. S. CO. MID-YEAR CATALOG

SURPLUS OF SAVINGS

2531 INDIANA AVE. KANSAS CITY 1, MO.

NEW BARGAIN CATALOG

Now ready for mailing. Thousands of Govt. and Civilian Surplus items. For the home, industry and farm. Machinery, motors, Hdw., Elec. Supplies, etc. Write NOW to

MIDWEST SURPLUS SALES CO.
2531 INDIANA KANSAS CITY 1, MO.



A PENNY POSTCARD MAY CHANGE YOUR FUTURE . . .

Get full information on the coin-operated vending machine industry. Start with a few machines and build to a wonderful future. We'll give you complete advantage of our "know-how."

Send For Free Booklet Today—No Routes Sold!

PIONEER VENDING SERVICE

Address all mail to Dept. PM
461 SACKMAN ST. • BROOKLYN 12, N. Y.

LEARN TO MOUNT BUTTERFLIES



and Moths for Pleasure and Profit. Complete Entomology Kit and Instructions. Ready to start. Only \$1.00. Order today.

ENTOMOLOGY SUPPLY CO.
Dept. 201 Medina, New York

LEARN AND EARN AT HOME

Learn **SCREEN PROCESS**, the modern machineless method of printing. Uncrowded, profitable field where trained men are always in demand. 2 BIG KITS OF SUPPLIES we send many of our students making money even before finishing home study course. Write today for **FREE BOOK** giving full details. **APPROVED FOR VETERANS.**

CALIFORNIA SCHOOL OF SCREEN PROCESS
3740 Overland Avenue, Dept. M-78 Los Angeles 34

BLISS Electrical Training

ELECTRICAL SCHOOL

Intensive 32 weeks' residence course in fundamentals of industrial electrical engineering, including radio and electronics. Extensive laboratory, shop work, drafting. Prepares for electrical technician and engineering aides in communications, power, manufacturing, business machines, sales, service. 54th year. Classes begin July 26, Nov. 22. Catalog. **7636 TAKOMA AVENUE WASHINGTON 12, D. C.**

LEARN NEON

BIG PAY—JOBS TO COAST

MEN— You have the chance of your life for really big money — \$100, \$150 a week and UP — by getting into Neon, fastest-growing, most interesting branch of advertising. Come to Acme and let us make you a real Neon Technician. Interesting, 12½ week job-practice, LEARN-BY-DOING Course. We teach you and train you in Glass Blowing, Letter Bending, Color Gassing, Bombarding, other important branches. No text books, No home study. Demand for Acme Graduates far greater than we can supply. Day and Night Classes. Enrollments accepted daily.

FREE FOLDER. Send today for FREE Fact folder, "Your Big Opportunity." Gives you complete facts about jobs open, our training facilities, your chances for SUCCESS. Write today.

VET. APPROVED

Acme Training approved under G.I. Bill of Rights. Acme is also approved as registered school by Board of Education, State of Illinois. Our Instructors are all top grade experts. Our Facilities are best obtainable. We furnish all supplies, equipment.

ACME NEON INSTITUTE

Dept. H-3, 330 South Paulina St.

Chicago 12, Ill.

WORLD'S FOREMOST NEON SCHOOL

RADIO ENGINEERING.

Broadcasting, Television, FM, Servicing, Electronics, Aviation, Marine & Police Radio taught thoroughly.

Engineering course equivalent to 3 years' college radio work. Approved Veteran Training. Catalog free.

VALPARAISO TECHNICAL INSTITUTE, Dept. D, Valparaiso, Ind.

CHOOSE A HOTEL CAREER

Complete, practical training for fascinating and well paid positions-with-a-future. Men-Women-All Ages! Free, successful placement service. Resident classes or home study. Approved for Veteran training. Address: Dept. 5.

FLORENCE UTT HOTEL SCHOOL

In The Historic Coates House Hotel

1007 BROADWAY, MEZZANINE FLOOR KANSAS CITY 6, MO.

GET THIS FINE SUIT NO MONEY TO PAY!



BIG CASH EARNINGS, TOO!

Big news! This fine tailored suit yours without paying one cent—and big cash earnings, too! It's easy! Just take a few orders. Earn up to \$10 in a day and get your own suit as extra bonus. Dozens of rich new fabrics, superbly tailored in latest styles, at low prices produce orders on sight. Money-back guarantee.

FREE SAMPLES! Write today giving name, address, age, etc. for big complete outfit of actual samples and details of amazing new BONUS SUIT and money-making plan—All Sent Free! No experience. **SEND NO MONEY!** W. Z. GIBSON, Inc. 500 S. Throop, Dept. G-516, Chicago 7, Ill.

Ottawa Self-Propelled Buzz Master

CLEAR LAND FAST! Powerful 7-HP motor with friction clutch for safe operation. Cuts down timber, brush and hedge; turn blade vertically and saw logs to length. Also furnished with post hole diggers. Has clutch pulley for belt work.



OTTAWA MFG. CO., 1-827 Brush Ave., Ottawa, Kansas

GLOWS in the DARK

FREE Sample!

Be the first to sell luminous house numbers, light switch plates, wall protectors, pull cords. Also luminous pictures, statues, decals, and a host of religious, nursery and other objects that glow in the dark. Get into this new and growing industry. Enormous demand... no competition... sensational demonstration... big profits. Represent a large manufacturer, established over 34 years. Write today for liberal money-making offer and free sample to show how they glow in the dark.

MADISON MILLS, 303 Fourth Ave. Dept. G-4, NEW YORK 10, N. Y.

Learn DIESEL

AUTOMOTIVE AND ALLIED MECHANICS

at Home in Spare Time



Good pay and interesting job opportunities in the Diesel industry!

These two **FREE BOOKS** will tell you how

Diesel engines are used in locomotives, tractors, farm machinery, stationary and portable power plants, oil pipeline pumping stations, Diesel trucks and buses, power shovels, excavating machinery and many other applications. Trained Diesel and automotive mechanics are in steady and growing demand to install, maintain and repair Diesel, semi-Diesel, and gasoline engines in these and other fields.

You can qualify with National Schools' approved Master Shop Method of Home Training!

Or you can operate your own service shop or commercial garage! Send the coupon today for a Free Sample Lesson and big illustrated book "Your Future in Diesel."

Home Training Developed in National's Great Shops and Laboratories

With Shop Method Home Training you learn not only basic Diesel engine principles, construction and repair, but the more specialized fields of Diesel fuel injection, automotive carburetion, ignition and motor tune-up. Your instruction material is interesting, well illustrated, easy to understand... and complete!

HOME STUDY AND RESIDENT TRAINING OFFERED

NATIONAL SCHOOLS

LOS ANGELES 37, CALIFORNIA EST. 1905

APPROVED FOR VETERANS

Check Coupon Below

MAIL OPPORTUNITY COUPON FOR QUICK ACTION

National Schools, Dept. PMD-7
4000 South Figueroa Street
Los Angeles 37, California

(Mail in envelope or paste on penny postcard)

Mail me FREE the book, YOUR FUTURE IN DIESEL, together with the Sample Lesson. I understand I may keep and use the information with no obligation.

Name _____ Age _____

Address _____

City _____ Zone _____ State _____

Check here if Veteran of World War II

MAIL THIS COUPON

113 Booklets filled with Money and Time-Saving Helps

Little Library of Useful INFORMATION

5 for \$1.00
12 for \$2.00
25¢ Each

Here at amazingly low cost is the practical help and information you have always wanted. Articles in previous issues of Popular Mechanics have been classified according to subject and are now available in these handy reprint booklets. Check Titles wanted, clip ad and mail today.

* Recent titles.

WORKSHOP EQUIPMENT

Power-Driven Saws—74: Complete details on scrollsaw, two circular saws, sliding cut-off saw, bandsaw.
Drill Presses, Plane, Grinders—79.
Sanders—80: Complete constructional details on 8 useful machines.
Wood & Metal-Turning Lathes—81: Two wood lathes, small metal-turning lathe.
Filing Machine, Hacksaw, Cutoff Wheel, Shaper—82.
Metal Lathe Tools You Can Make—101.
Workbenches & Tool Cabinets—47.
Spray Painting—94: Constructing spray guns, compressor, using spray gun.
From Pattern to Casting—91: How to make your own patterns and small castings.
***Handy Farm Implements—114:** Grain elevator, dump truck, spreader and cover.
***Tractor Attachments—116:** Buckrake, stacker, scoop, auger and spray attachment.
***How to Build a Concrete Block Machine—110.**

SHARPENING—USING TOOLS

Correct Measurement—106: How to use micrometers, gauges, calipers, etc.
Tool and Saw Sharpening—92.
Using & Sharpening Drills & Wood Bits—90.
Successful Wood Turning—32: All the information you need to master this art.
***How to Use Your Drill Press—125:** Includes instructions on preparing the work, methods of clamping, drill speeds and feeds, sharpening twist drills, testing and grinding chucks.
How to Read Blueprints—71: Tells you how to understand signs, symbols, and lines.
Metal Turning Lathe Kinks—99: Simple homemade tools, time and labor-saving shortcuts you can use.
Operating a Metal Turning Lathe—100.
Heat Treating & Case Hardening—102.
Working with Glass—103: Cutting, drilling, etching, blowing.
***Using Basic Tools—120:** How to use hammer, files, screwdriver, and cold chisel.

ELECTRICAL BOOKLETS

Rewinding & Servicing Electric Motors—75: Repairing and rewinding a.c. and d.c. motors. Locating trouble. Converting auto generators into 110 v. a.c. motors.
House Wiring—89: All the information you need to do a complete wiring job or install extra outlets.
Electromagnets & Solenoids—44: Designing and building.
Transformer Construction—41: Easy-to-understand instructions for all transformers.
The Boy Electrician—43: Easy-to-build motors, experiments.
***Build Your Own Relays—123:** Complete instructions, graphs and wiring diagrams for a.c., d.c., and thermal relays.
Soldering & Brazing—17.
Arc & Spot Welders—5: Building and operating 110 v. a. c. arc and spot welders.
Electroplating with Copper, Nickel, Chromium, Lead, Zinc, Cadmium—86.
Plating Leather & Other Non-Metallic Objects—Plating with Gold, Silver, Alloys—87.
***How to Fix Electrical Appliances—111:** Repairing clocks, washing machines, vacuum cleaners, electric irons, cords, small motors, etc.

HOME IMPROVEMENT BOOKLETS

Simple Home Improvements—104: Modernizing; making storm sash, ironing boards, etc.
Building Extra Rooms in Attic—23.

Attractive Basement Playrooms—24.

Lower Your Fuel Costs—31: Practical kinks that will save you hundreds of dollars.
Hanging Wallpaper—38: Tricks of hanging wallpaper, removing old paper, etc.
Curing Leaky Basements—45:
Fitting Home Game Room—55: Construct own game & tennis tables, shuffleboard court, action game, portable playrooms.
Ridding the Home of Insect Pests—107: Exterminating and protecting against moths, flies, termites, mosquitos, etc.
Built-In Fixtures—78: Step and space-saving kitchen units, built-in beds, corner cabinets, vanities, linen chest.
Constructing Indoor & Outdoor Fireplaces—88: Stone fireplaces, portable mantels, garden fireplaces.
***Painting Your House Inside and Out—117.**

GARDENING BOOKLETS

Back-Yard Gardening—39: Selecting, planning and getting the best results.
Lawn & Garden Novelties—72: Jig-sawed ornaments, parkway numbers, sundials, flower boxes.
Trellises, Pergolas, Fences—76.
Lawn & Garden Furniture—77: Modern bent-tube furniture, arbor and seat combinations, swings, lawn chairs.
***Lawn and Garden Equipment—124:** Complete details for building rotary lawn cutter, hedge trimmer, and lawn edger. Also articles on sharpening and motorizing your lawn mower.
Playground Equipment—73: Two playhouses, ferris wheel, roller coaster, treadmill, play store, slide, two merry-go-rounds.
Colored Concrete Garden Furniture—6: Garden benches, pottery, flower boxes, bird baths and sundial pedestals in colored concrete. How to build small concrete mixer.
Bird Houses—7: Easy to build homes for all kinds of birds.
Farm & Garden Tractors—8: Two tractors you can build from old automobile parts.

CRAFT WORK—HOBBY BOOKLETS

Working with Plastics—61: Using brilliantly colored plastics in craftwork.
Magazine Racks—49: Ten attractive racks.
Clock Cases—50: Large hall, Colonial wall and mantel, ship's wheel, miniature grandfather, desk, Spanish style banjo.
Serving Trays for Every Occasion—53: Fourteen different designs.
Children's Room Furniture—51: Twelve attractive pieces.
Book Ends—52: Ten designs offer good selection.
Small Tables—54.
Smoking Stands—56: Seven designs given.
Jigsawed Novelties—57: Sewing kits, string holders, place-card holders, plywood kitchenware, plant and flower holders, coin banks.
Desks—58: Colonial writing desk, two modern-type desks, student's study desk of plywood, combined chest and writing desk.
Book Cases—59: Eight designs.
Doll House & Doll Furniture—60.
25 Shelves You Can Make—64.
Novelties Turned on Lathe—62.
Inlay Pictures—Veneering—63.
Whittling and Wood & Soap Carving—65.
Action Toys—66: 21 easy-to-make toys.
Wing Flying Kites—67.
Windmills & Weather-vanes—68.
Lamps in Wood, Metal, Plastic—69: Selection of 14 designs.

Metal Craft—28: Brass tapping and making of novelties both decorative and useful.
Small Looms—37: Building hand looms for weaving rugs, etc.; leather novelties.
Plain & Novelty Wood Finishing—40.
Gem Cutting—42: How to cut and polish semi-precious stones.
Rustic Furniture—18: How to build chairs, benches, tables, gates, summer house, etc.
***Projects in Plastics—112. *Bows and Crossbows—115. *Marionettes—113:** Designing and operating puppets, how to build stage and backdrops.
***Furniture Upholstery and Repair—122:** Details on upholstering, modernizing beds, and instructions for repairing wooden furniture.

BOAT BUILDING BOOKLETS

Build a boat at home—you can do it

14 Ft. Outboard Runabout—2: Here is a low-cost, fast 14-foot V-bottom boat. Suitable for motors of 4 to 24 hp.
Rowboats, Bicycle Boat, Small Dinghy—83.
Small Sail Boats—84: 12-ft. sailing dinghy, 6-ft. "training ship" for young sailors, how to sail a boat.
Two Outboard Runabouts—85: 14-Ft. family outboard weighs about 400 lbs. and 12-ft. plywood outboard weighs about 110 lbs. Both are V-bottom type.
Build Your Own Canoe, Kayak, Surfboard—30: Complete details on 16-ft. Canadian-type canoe, 17-ft. kayak, and 12-ft. hollow surfboard.
Fast Class-E Ice Yacht—22: Build your own Class-E ice yacht.

AUTOMOBILE BOOKLETS

Automobile Kinks and Shortcuts—10: Money-saving hints on upkeep, operation.
Building Trailers—27: Small Streamlined house trailer; several utility trailers.
Motor-Driven Midget Car & Scooter—34: Both use gas engine of washing machine type.
Curing Auto Electrical Troubles—95.
***House Trailer—121:** Complete instructions and diagrams for building modern 17 ft. trailer.

PHOTOGRAPHY BOOKLETS

Photo Enlargers—1: Condenser lens type; simple vertical; horizontal.
Photo Printers & Drier—25: Describes three practical printers, timer and negative drier.
Photo Darkroom Equipment—96: Cabinets, light-tight box, timer, agitator, washer.
Picture Projector, Trick & Table Top Photography—97: Projectors that enlarge magazine illustrations and shop drawings. Tips for table toppers, photomontages, tricks.
Photo Kinks—98: 63 time and money-saving ideas you can use.
***Photo Lighting—119. *Home Movie Equipment—118:** Converting projector to sound, making titler, film cleaner, projector stand.

MISCELLANEOUS BOOKLETS

Cleaning Preparations—11: Easy-to-make cleaners for walls, glass, etc. Removing fabric stains.
Re-Silvering Mirrors—70: Formulas for silvering and coloring.
Knots and Rope-work—105.
Chemical Experiments—93: Easy-to-perform experiments. Inexpensive lab.
Taxidermy—9: How to prepare skins and obtain life-like poses.
Log Cabins & Tourists Cottages—14: Year-round log cabins; inexpensive tourists' cabin.
Magic for Everybody—29: Simple tricks to puzzle your friends.
Trapping Small Animals—33: How to lure fur bearers, prepare bait and traps, dress skins.
Tricks of Training Your Dog—35.
Small Furnaces—36: Gas or electric.
Telescopes—20: Design and construction.
Poultry Houses—108: Structures, brooders and incubators.
Guns and Decoys—109: Cleaning, shooting guns; making decoys.

POPULAR MECHANICS PRESS,

200 E. Ontario St., Chicago 11, Ill.

I enclose _____ (U. S. bills may be mailed if carefully wrapped) for "Little Library" booklets numbers:

Name _____
 Address _____ Zone _____
 City _____ State _____

AVIATION CABLE



Flexible 133 strand wire cable, 5/32 in. diam., 3300 lb. break test. Lengths up to 450 ft. Use for tow rope, guy wire, clothes line, etc. Wgt. per 100 ft. 4 lbs. Specify length wanted. No. 421—Per Ft. **4c**



Ind. Goggles

Large, shatterproof, clear lenses, plastic frame with side guards. Brand new! Protect your eyes from flying chips, dust, dirt, etc. Wgt. 1 lb. No. 422—Each **98c**

MESS KITS

Regulation two-piece Army Mess Kits with folding handle. Used, but perfect. Weight 2 lbs. No. A116—Ea. **69c**



CANTEENS

Reg. U. S. issue canteens. Plastic screw top chained to body. Slightly used but perfect. Wgt. 1 lb. 117—Metal **69c**



CANTEEN CUPS

All metal. Folding handle. Wgt. 1 lb. No. A120—Each **25c**

CANTEEN COVERS

Heavy canvas. Button fastener. New No. 530—Each **69c**

Stock No. 119—Each **35c**

WIRE CUTTER

Heavy duty, compound leverage. Cuts up to 1/4 inch wire. Upper jaw acts as feeder to cutting edges. Insulated handles. Ideal for farm fence work and shop use. Shp. wgt. 2 lbs. Stock No. 392—Each **\$1.95**



Heavy Duty RUBBER GLOVES BRAND NEW

Extra heavy—extra long. Brand new, high quality gum rubber for softness and ease in use. Designed for heavy duty industrial service—protection in handling chemicals, acids, etc. A real bargain at this low price. Stock No. 295—Per Pair, Only **79c**

AMMUNITION BOX

Used for 50mm ammunition. Heavy, all metal design with latching top and folding handle. Provides safe, fireproof storage for valuables, etc. Measures 12x6x7 1/2 inches. Used but in new condition. Shp. Wgt. 8 lbs. No. 338—Each **79c**



ARMY AIR CORPS TYPE SUN GLASSES

Ideal for driving, sun glare, sports and work. 24 carat gold plate frames with Pyralin sweat bar—adjustable nose bands. Large aviation type lenses. Case included. Shp. wgt. 1 lb. No. 238—Per Pair **\$2.95**

PLASTIC BOX

Clear transparent plastic, 4 1/4 x 7 1/2 x 1 1/2 in., with 17 compartments, hinged lid. Use for fishing tackle, jewelry, small parts, etc. Shp. wgt. 1 lb. No. 260—Each **98c**



Waterproofing Compound Gov't. surplus! A liquid formula for tents, tarpaulins, canvas clothing, etc. Use on old or new materials. Gallon covers 100 to 120 sq. ft. Stays flexible—will not peel or chip. Shp. wgt. 10 lbs. No. 423—Per Gallon **\$1.49**

WAR SURPLUS AND HUNDREDS OF OTHER BARGAINS

POPULAR RECORD ASSORTMENT



Fifty records of modern dance, race, blues and hillbilly selections. No two alike. Famous name bands and artists included. Used in juke boxes, but guar. perfect. Shipped exp. collect only—no exchanges or refunds. Wgt. 28 lbs. No. A303—50 records **\$9.64**

No. A300—25 Records. All Dance. Wgt. 14 lbs. **\$4.88**

No. A301—25 Records. Hillbilly, Race and Blues. Wgt. 14 lbs. Set **\$4.88**

No. 302—25 Records. All Hillbilly numbers. Wgt. 14 lbs. Set **\$4.88**

STIRRUP PUMP

Works with any pail or bucket. Shoots a high pressure stream up to 30 feet. Use it for spraying garden and trees, for whitewashing, fire fighting, drainage, etc. Complete with 10 foot flexible hose. All brand new. Regular \$3.80 value. No. 244—Each **\$1.49**



27 LENSES, ALL NEW, PERFECT.

For experimental work in optics. Consists of 27 precision ground and polished prisms and lens elements in assorted diameters and focal lengths. Big variety, positive, negatives, etc. Actual value over \$100.00. A519—27 PIECES **\$7.95**



15 JEWEL STOP WATCH U. S. AIR CORPS SURPLUS

Genuine Elgin 15 Jewel movement. Ideal for split second timing in racing, sports, time study, etc. Full sweep split second hand graduated in 1/10th seconds. Stem wind, start, stop and reset. Used but guaranteed perfect. Wgt. 1 lb. No. 200—Each **\$9.95**



McCLELLAN SADDLE

Brand new! Top grade cowhide, 12 inch seat. Hair girth. Has straps for blanket roll and knapsack. Gun boot and saddle loops. Shipping weight 15 lbs. Stock No. A145. Each **\$16.95**

BAYONET BLADE

Fine forged steel. Ground but not polished. May be made into throwing or hunting knife or spear. Blade 6 3/4 x 7/8 inches, 11 3/4 inches overall. Will take and hold a fine edge. Shp. wt. 1 lb. No. 664-R—Each **49c**



VEEDER ROOT COUNTING MACHINE

Five wheel type—counts to 99,999 and repeat. Nickel finish case. Has 1/2 inch round shank. Use it for any counting job. Brand new. Shp. wgt. 1 lb. No. 241—Each **98c**



ARMY TENTS



A value you can't beat. Big 16x16 ft. pyramid tent with 4 foot drop wall. Used but in excellent condition. Poles not included. Fine for camping out, carnivals, etc. Wgt. 100 lbs. Stock No. 521—**\$35.00** Each only

Center and corner poles. Express collect. No. 500—Only **\$3.00**

RUBBER OVERBOARD SUIT



Here is a buy! Fits over your regular clothes and shoes. Can be cut apart for waist high waders, hip high or knee high boots, also arm length rubber gloves. Heavy gum rubber over fabric. Fine for commercial fishermen, sewer diggers, etc. Use it as is or cut it up for waders. All brand new! Wgt. 14 lbs. No. 183, Each **\$4.95**

Please include 75c for postage.

HIGH PRESSURE SHATTERPROOF TANKS

TYPE D2 400 LB. TEST A high pressure shatterproof tank of 500 cubic inch capacity—for 50 pound pressure or 6.9 cubic feet. All metal—measures 6 1/2 x 2 1/2 inches. Threaded plug end vents. Shp. wgt. 6 lbs. No. 388—**\$2.45** Each

TYPE F1 400 LB. TEST A high pressure shatterproof tank of 1000 cubic inch capacity—for 50 pound pressure or 13.8 cubic feet. All metal—measures 9 1/2 x 17 inches. Threaded plug end vents. Shp. wgt. 11 1/2 lbs. No. 389—**\$3.75** Each



7 LB. EXPERIMENTER PARTS ASSORT. KIT



A "gold mine" for the radio serviceman. Hundreds of valuable radio parts, new radar and electronic parts and sub-assemblies, coils, resistors, trimming condensers—worth many times this low price. **\$1.79**

A130R—7 lbs.

RAIN SUITS

New 2 piece rain suits. Of durable wear resisting water and wind repellent OD fabric. Bib style pants, zipper fly. Jacket has parka attached. Guaranteed 100% weatherproof. Small, medium and large sizes. Shp. wgt. 3 lbs. No. R549—**\$4.95** Ea.



Officers Watch Compass

Brand new gov't. surplus. Army-Navy model. Single jewel mounted needle. Silver colored dial. A splendid value. Shp. wgt. 1 lb. A174—Each **98c**



OXYGEN TANK

Loaded with aviator's breathing type oxygen at 1800 pounds pressure. Tank measures 13 1/2 x 5 1/2 inches with rounded ends. Tank is of solid metal fitted with brass release valve at top. Brand new! Loaded—ready for all types of emergency use. Shp. wgt. 13 pounds. Shp. exp. only. Stock No. 390—Each, **\$3.50** only



AVIATOR'S OXYGEN

Ball out type. Consists of all metal tank, release valve, gauge and breather hose, all enclosed in khaki colored cloth bag. These tanks are loaded with oxygen at 1800 pressure. Ideal for use as reserve oxygen supply for all types of emergency use. Shipping weight 4 pounds. All brand new. Stock No. 391—Each **\$4.95**



ORDER DIRECT FROM THIS AD

Values galore! Hundreds of hard-to-find items for home, shop and outdoors. Make remittances by money-order, bank draft or personal check. Send 25¢ deposit on C.O.D. orders. No C.O.D.'s on orders for less than \$5.00. Include sufficient postage on parcel-post orders—any overage will be promptly refunded. All quotations F.O.B. Chicago. Used items and materials are guaranteed serviceable and as described. Your money back if not more than satisfied.

SEND 10c TO COVER POSTAGE AND MAILING ON BIG CATALOG—READY IN ABOUT 60 DAYS

STARK'S Dept. PM7
509 So. State St.
CHICAGO 5, ILL.

WILLARD 1 1/2 VOLT STORAGE BATTERY



A rechargeable, wet plate battery good for years of service. Brand new. Battery is shipped dry but fully charged—any battery station will add acid. Use singly or in multiples for radio sets, bell circuits, alarm systems, etc. Measures 5 1/4 x 4 x 3 inches. Ball floats indicate condition of charge. Shp. wgt. 4 lbs. Stock No. 297—**\$2.95** Each Only

WHAT EVERY PERSON OVER 21

SHOULD KNOW about advertising



I AM an ad. And everyone who has a job or wants one should know what I do.

For it's advertising—by selling more goods to more people—that makes jobs, and makes jobs *more secure*.

Whether you want a job or want a better one, remember—jobs all along the line depend on somebody selling something to somebody else. And advertising is the lowest cost way yet devised to sell goods.

That's why advertising is called the spark plug of American business. Advertising makes the wheels go around. For advertising's job is to sell. When more goods are sold, there are more jobs and better jobs for everyone. Selling less goods means failures, pay cuts, layoffs.

So whenever you see or hear advertising don't forget that it's helping you. If it weren't for advertising's low-cost way of selling goods you couldn't have such a secure job or opportunity in the future.

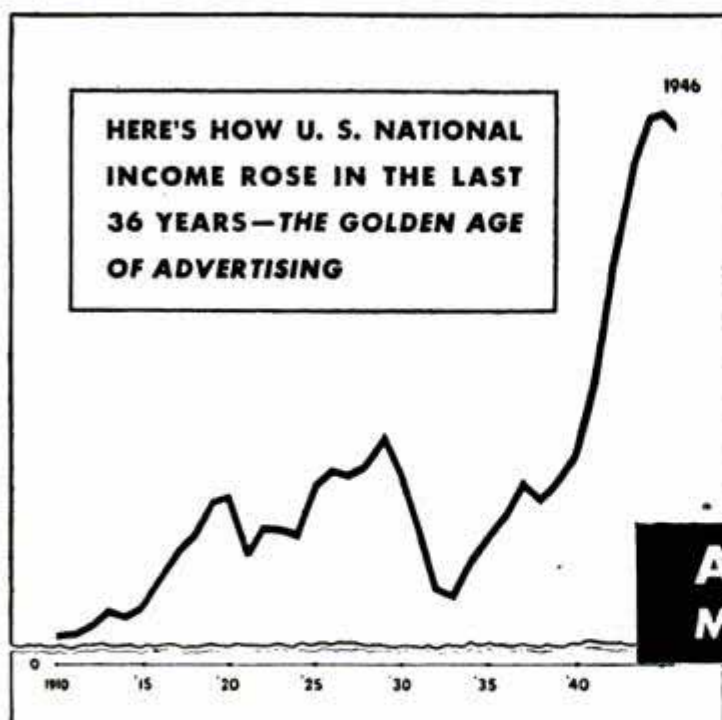

OTHER WAYS ADVERTISING HELPS YOU AND YOUR FAMILY

- 1 Brings you better goods for less money
- 2 Makes shopping more pleasant and easier.
- 3 Gears consumer demand to production, to create prosperity.

Advertising... BY SELLING MORE GOODS TO MORE PEOPLE
Makes your job more secure

This rise in the standard of living for you and yours is unequalled in all history. Advertising helped raise this standard—is needed even more today to sell industry's new developments.

**ADVERTISING FEDERATION
OF AMERICA**

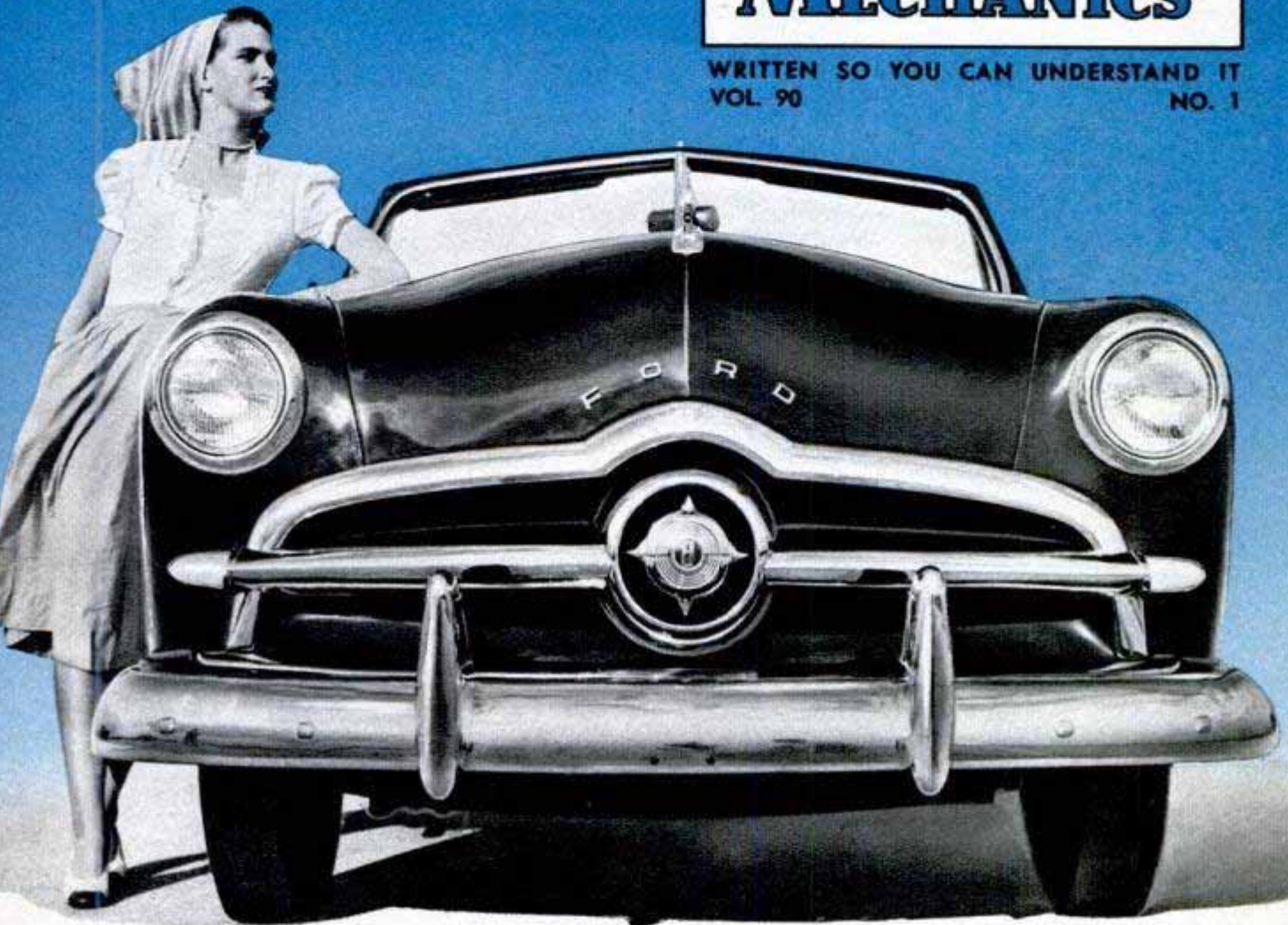

Debut for the '49 FORD

ONE ICY FEBRUARY night a 1949 Ford test car was delayed by road conditions on its return to the Ford Motor Company's proving grounds at Dearborn, Mich. The driver was upset because there was an ironclad rule that all the super-secret test cars had to be back behind the high board fence of the proving grounds by dawn.

Like all test cars, this particular tardy model was devoid of chrome and dress-up trimmings. Despite its beaten-up look the car had the line and design of the new Ford.

"I was really sweating it out that morn-

ing," the driver said, "and making no unnecessary stops along the way. Once I was stopped for 20 minutes by a bottleneck caused by the slippery highway. People kept giving the car a second look. Then several men gathered around it. One of

them said, 'We've been trying to figure out what you got there. Is it a 1949 Studebaker?' I nodded and they were completely satisfied."

The Ford test driver still chuckles over that incident. As a matter of fact, the new Ford no more resembles a 1948 or prewar Ford than do the new Studebakers or Hudsons. It's

By Wayne Whittaker

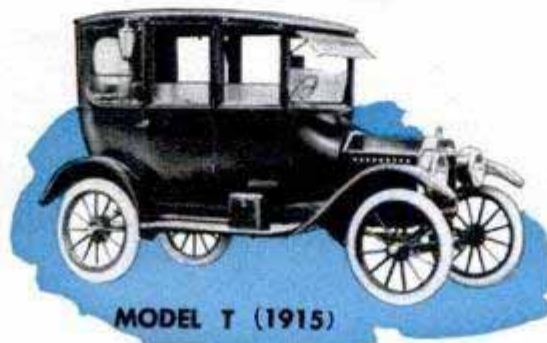

MODEL T (1915)

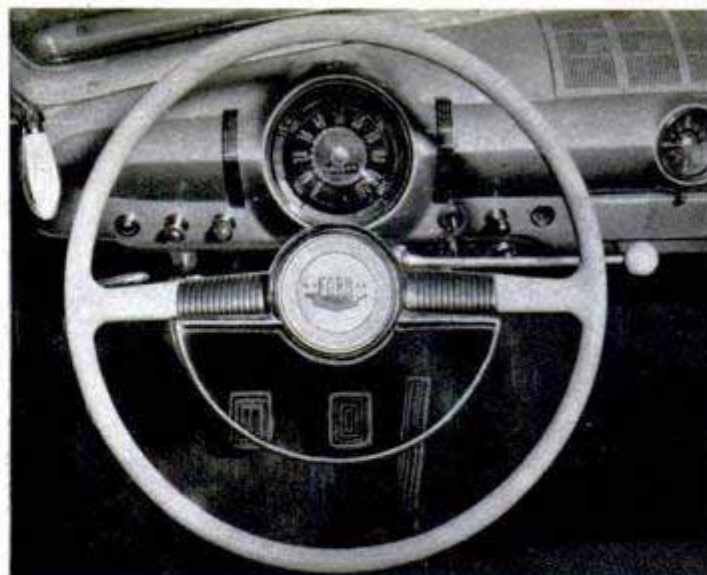
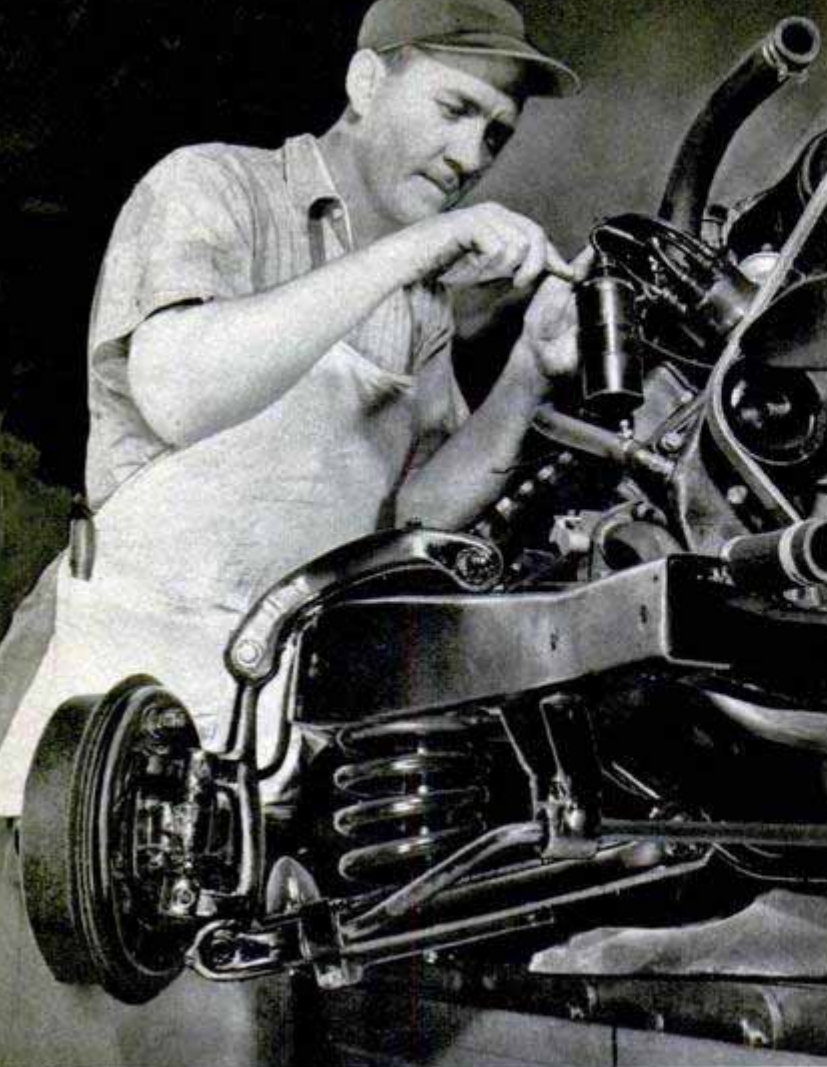

Left, "hydra-coil" springs in front replace the old transverse leaf springs. Above, indicators are all clustered on speedometer rim directly before driver

a strictly new postwar car following closely in the trend pioneered by Studebaker in 1946. If there had been no new Studebaker, Hudson, or — right in the Ford family — Mercury, the '49 Ford would have been a sensationally new postwar car. As it is, it is a sensationally new Ford which is totally unlike in appearance its grandparents of the Ford line.

Gone are the rough-riding old-fashioned transverse-leaf springs; gone are the narrow seats and windows of poor visibility, and — far from least — gone are the con-

Over-all view of the new '49 six-cylinder engine. Oil filter is one feature. Rubber mounts hold engine

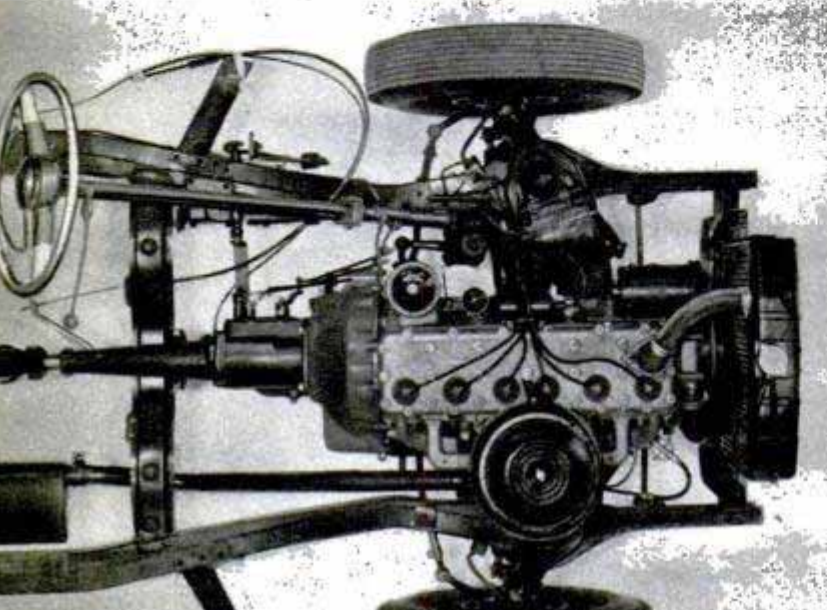

servative black and gray paint jobs associated for years with Ford. The new cars rival the rainbow in attractive color variations. They have straight, modern lines, a massive but short hood, and the body is so wide the rear fenders have been entirely eliminated.

About the only points of similarity between the old and new Fords are the wheelbase (both 114 inches), tire size (600 x 16) and the basic V-8 engine. This engine has been improved in the '49 to such an extent that Ford engineers claim a 10 percent increase in gasoline mileage. The six-cylinder engine is entirely new and either the six or V-8 is available in all models. The horsepower of the improved

COMPARATIVE SPECIFICATIONS

(Ford Four-Door Sedan)

	1948	1949
Wheelbase	114"	114"
Curb Weight	3414	3175
Over-all Length	196.08	196.75
Maximum Width	73.25	71.7
Height—Loaded	66.15	62.75
Horsepower	V-8—100 Six—90	V-8—100 Six—95
Brake	Hydraulic	Hydraulic
Front Spring	Transverse Leaf	Independent Coil
Rear Spring	Transverse Leaf	Longitudinal Leaf
Drive	Torque Tube	Hotchkiss
Differential	$\frac{3}{4}$ Floating Spiral Bevel, 4-Pinion Differential	Semi-Floating Hypoid, 2-Pinion Differential
Tire Size	600 x 16	600 x 16
Front Seat Width (Hip Room)	55.3	61.5
Front Seat Shoulder Width	54.25	57.2
Width of Body at Center Pillar	55.6	61.0
Rear Seat Hip Room	51.5	60.0



Taking its place among the forefront of smart convertibles, the '49 Ford is low and graceful and seats six persons with ease. Luggage space under rear deck is twice as big as in the '48 and totals 28 cubic feet

V-8 is the same as previously (100) and the six has been stepped up from 90 to 95. A 10 percent boost in gasoline mileage is also claimed for the new six. The engineers say gas consumption can be reduced as much as 25 percent by taking advantage of the overdrive which is available as optional equipment.

If you have been a Ford driver in the past, prepare to be completely at a loss when you first get behind the wheel of the new '49. Few of the familiar gadgets are in their old familiar places. On the instrument panel, fuel level, oil pressure, water temperature and charge indicators are grouped around the outside rim of the speedometer. This handy five-in-one cluster is in line with the driver's view of the road. The clock dial has been centered on the panel and placed higher. Night glare has been eliminated on all instruments by "black lighting."

The car's interior is all new and inviting. The front seat is six inches wider than the '48 and the rear eight inches wider. The visibility, both front and rear, is excellent—there are 20 square feet of windows in the '49. You feel closer to the ground, and actually are four inches lower. This lower center of gravity is particularly noticeable as you take the car around a sharp curve on the proving ground at high speed.

British-made Fords from top to bottom are the half-ton light panel truck, a two-door four-passenger Anglia sedan with a 90-inch wheelbase, and the four-door Prefect sedan with 94-inch wheelbase. All are powered by 30-hp. four-cylinder engine. Ford has imported 12,000 of these cars into the U. S. as a test of public taste for light cars

BRITISH FORD

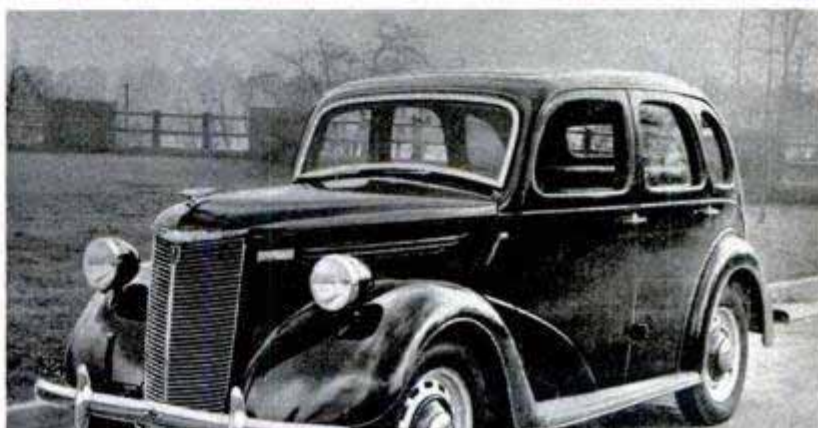
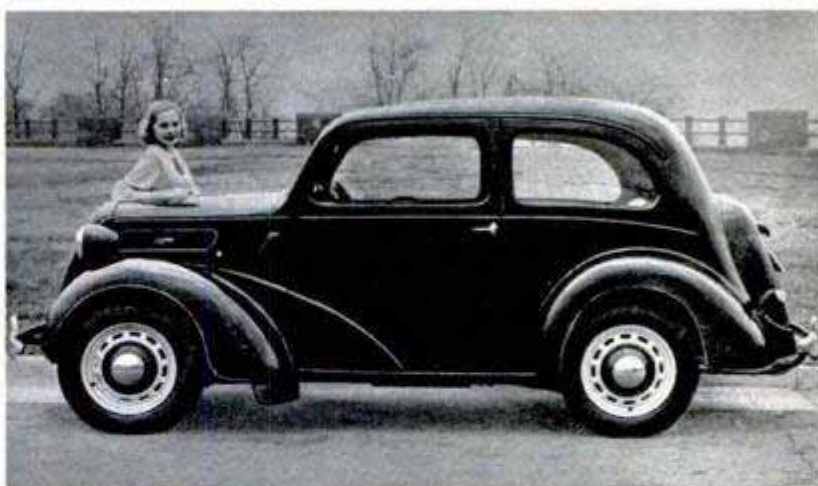
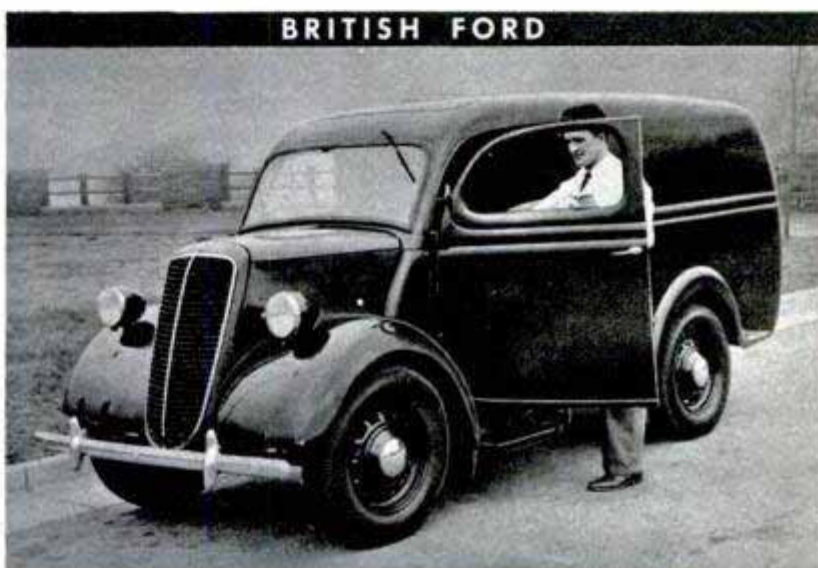

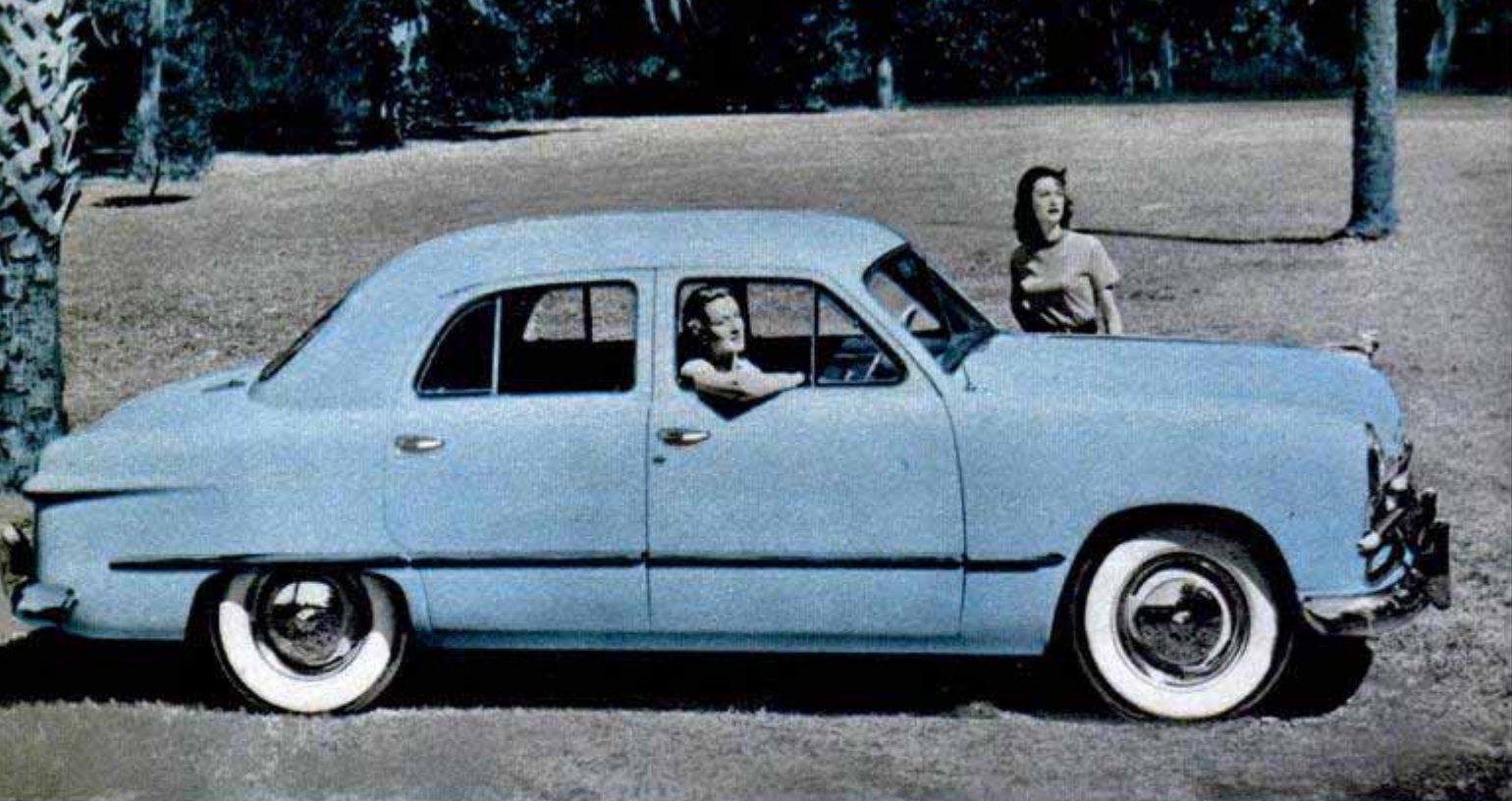

This four-door '49 Ford sedan shows radical change from traditional Ford styling and follows postwar trend

There is also the feeling of sitting further forward as one does in the Studebaker and Hudson. This is because Ford, too, has moved the body forward (five inches) which makes possible cradling of the seats between the axles for a smoother ride.

There is no questioning the smoothness of the new ride. The car rolls over rough Belgian block paving, over sharp bumps and dips, with an easy ride completely alien to any previous Ford. Even over a section of staggered bumps, which are taken by one wheel at a time, the car performs amazingly well. The reason is that Ford engineers, after years of holding onto an antique springing system, have adopted coil springs in the front, longitudinal springs in the rear and airplane-type shock absorbers. Also, the drive-shaft tunnel has

been decreased by adoption of the Hotchkiss drive and the hypoid rear axle. These changes have helped to minimize road noises, and engine vibration has been greatly reduced by rubber mounts.

The new heating system, which has an automatic temperature control, can be used as a fresh-air ventilator, a fresh-air heater or as a recirculating heater. The fresh air is scooped into the car through large intakes just behind the grille.

Better fuel distribution is achieved with a new intake manifold which is attached to the engine horizontal to the ground. This reduces the tendency of raw gasoline to flow toward the rear cylinders and makes engine operation smoother. In the car's new "equa-flow" cooling system water flows in volume to the full length of the block. Temperatures in "hot spots" in the six and eight-cylinder engines have been decreased by as much as 12 degrees. The water pumps in the improved V-8 are larger. Combustion chambers have been redesigned and there is a new crankcase ventilation system.

Although the new four-door sedan is 239 pounds lighter than last year's model, Ford engineers point out that new standards of safety have been set in the rugged construction of the '49 chassis and body. The box-type frame is of all-welded construction in contrast to spot welds used on most frames. Despite



Two-door '49 Ford sedan affords glimpse of wide windshield and enlarged windows

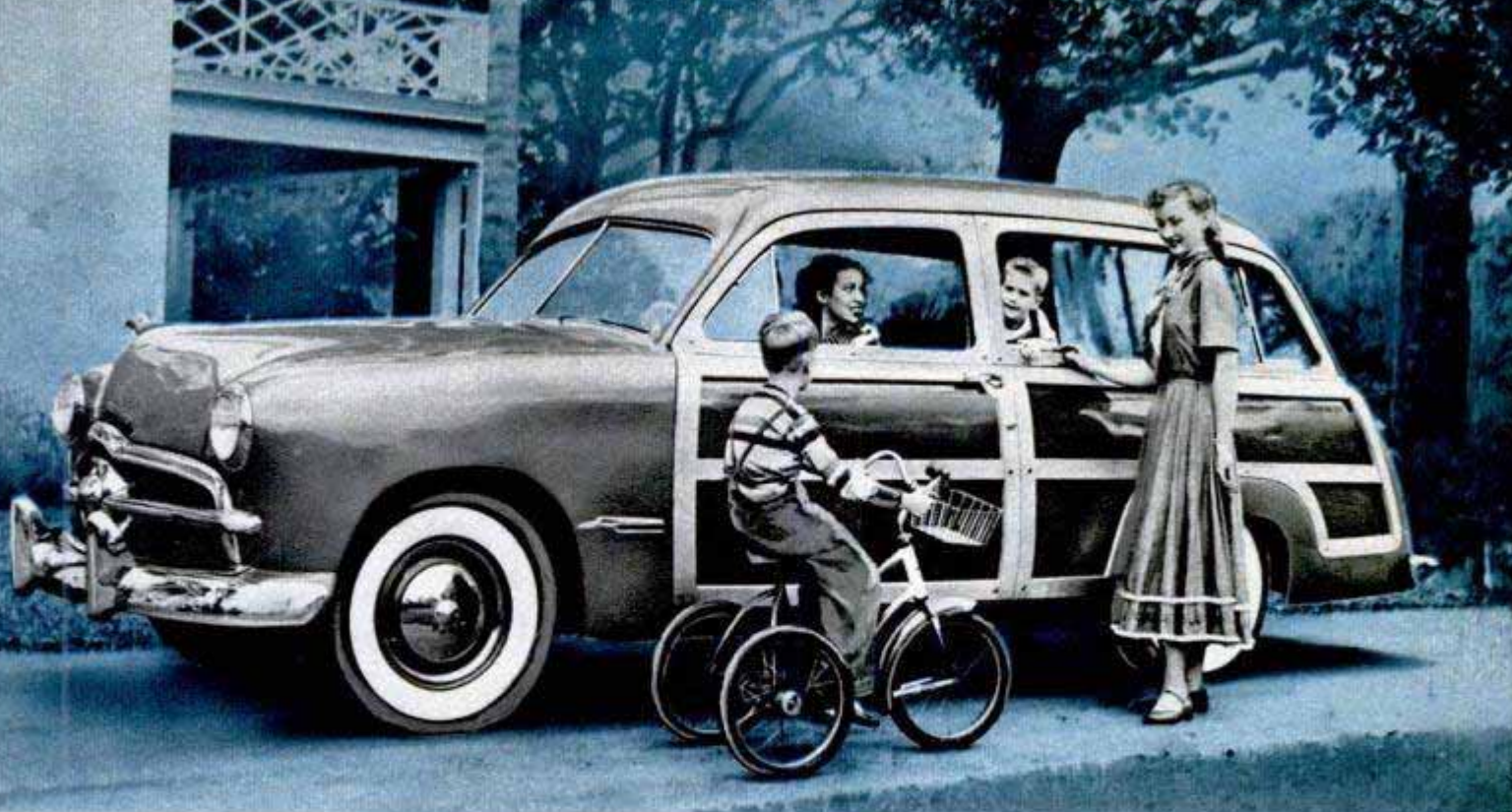

the fact that the frame is lighter, tests have shown that there is 59 percent more rigidity when combined with the body. A minor safety factor is that all doors hinge at the front and the inside handles push up instead of down to open the doors. Both features help prevent accidental opening. The doors have a new lock which eliminates persons being locked out with the keys inside.

The Ford steering is greatly changed and improved. It has a big car "feel" and hugs the road under a high wind. Road shocks have been cut to a minimum. This is partly the result of a newly designed linkage in which the pivot point of the tie rods is on the same center as the wheels.

There are two lines of the '49 cars — Ford and Ford Custom. The body styles in both lines include the club coupe, four-door sedan and two-door sedan. Convertible and station wagon (two-door all-steel body) are obtained only in the custom line and the three-passenger coupe only in the Ford line. The new colors are Bayview Blue Metallic, Birch Gray, Sea Mist Green, Arabian Green, Colony Blue, Gun Metal, Midland Maroon Metallic, and Black. Two others—which would make the '49 Ford's great-great grandpappy Model-T spin in his junkyard grave—are Fez Red and Miami Cream which are available only in the convertible.

The new two-door Ford station wagon has an all-steel body; plywood veneer panels are bolted directly to the stout steel body. It carries eight passengers. The two rear seats are removable

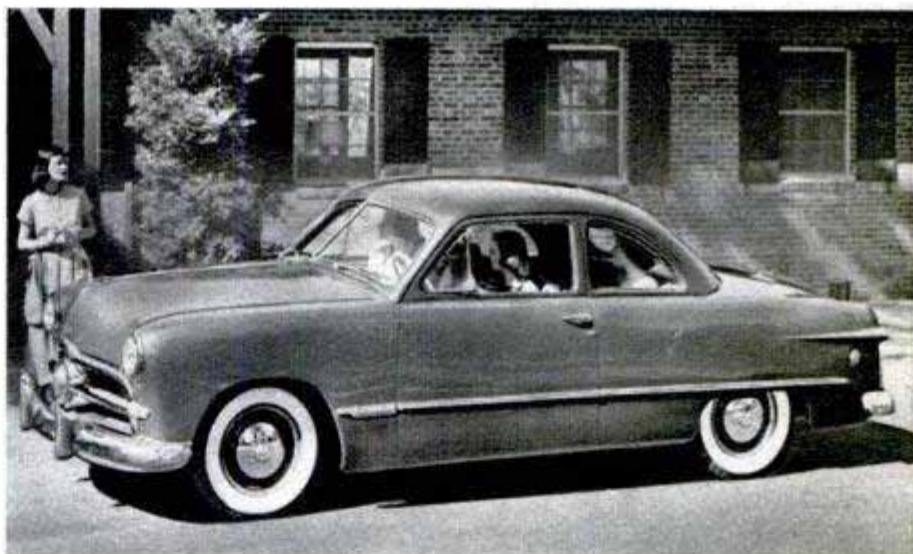

Sedan coupe above is available in either the Ford or Ford Custom lines. Chassis below shows many new features such as improved frame and coil springs in front which replace leaf springs

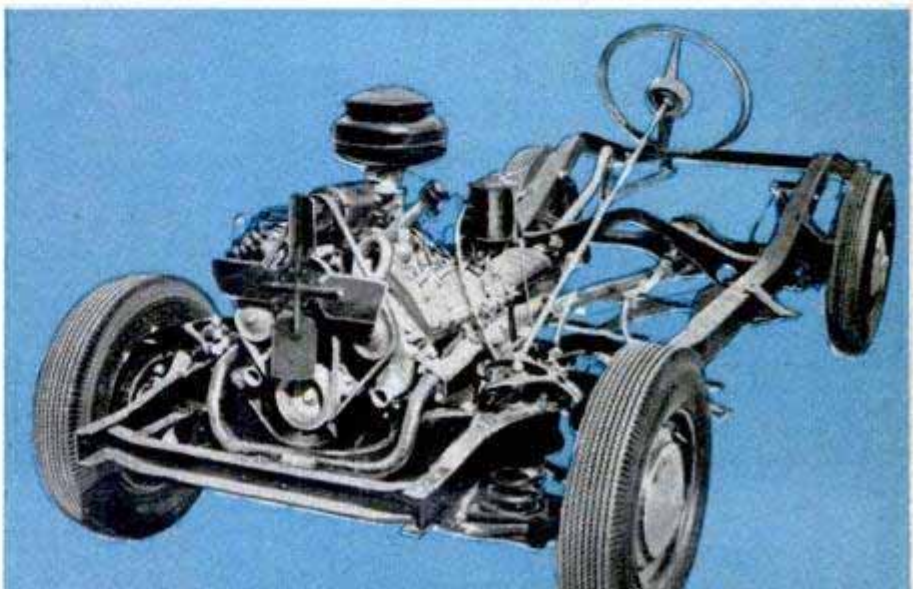

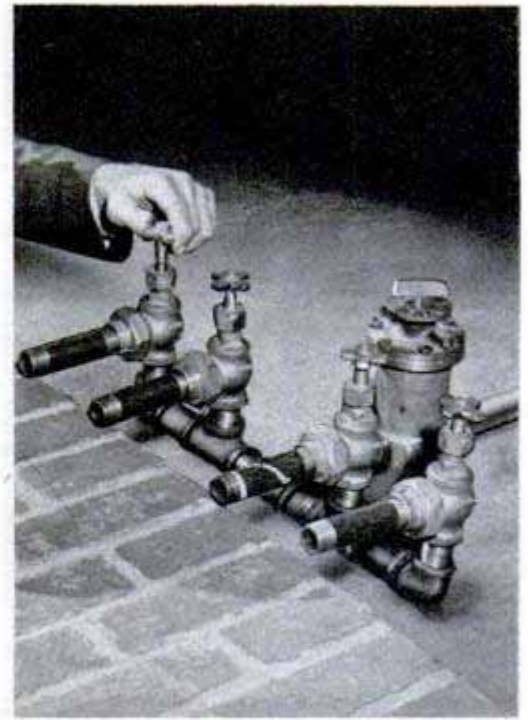

Left, setting the pointer to desired time of flow. Center, cutaway shows piston that is forced down to shut off water. Right, one or more of several faucets can be controlled by timer with this T-shaped arrangement

Sprinkler Turns Itself Off With Time Valve

Lawn and garden sprinkler systems are turned off automatically after a preset period of flow by a time valve that operates by water pressure. A tiny portion of the water passing through the valve flows

through a by-pass into a cylinder and moves a piston that closes the valve. A dial on top of the valve is set for the number of minutes the valve will remain open. Available in 1, 2 and 4-inch sizes, the valves can be set for any period from five minutes to two hours. Pressure variations do not affect its operation.

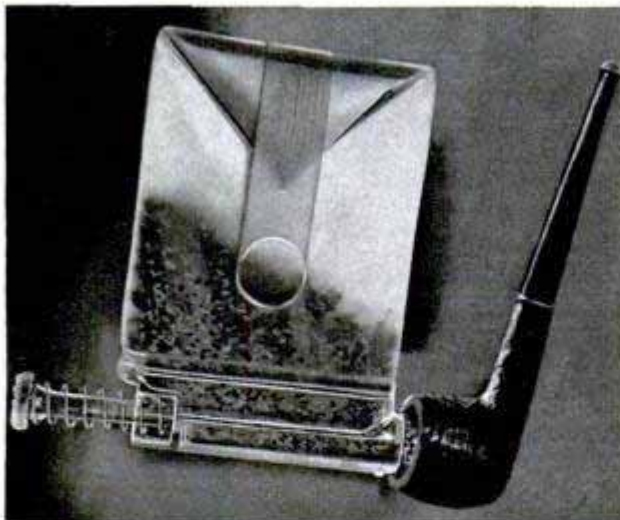

Piston on Tobacco Pouch Fills Pipe Without Waste

Pipes are filled with tobacco without spilling by a pouch that has a piston-operated filler attachment. The pouch doesn't have to be opened except for refilling. When the pouch is inverted, tobacco falls into a plastic cylinder and is forced into the pipe bowl and tamped by the piston. The tobacco stays moist longer because it is not exposed to the air.



Trap Catches Rats With Water

Liquid instead of food is used as the bait in a new rat trap. Tests prove that rats are as eager for water as for food. The rust-proof metal trap is designed for use where food is plentiful but water is difficult to find. In appearance, the trap is similar to conventional traps except that one end is depressed to form a saucer. A perforated trigger covers this section and releases the powerful spring upon contact. Food also can be used as bait.

Retractable Wheels Form Boat Trailer

Like the landing gear of an airplane, the wheels on a boat trailer retract out of the way when the boat is in the water. For traveling over the road, the wheels are locked in the down position. The tow bar swings downward to act as a bow support for storing. In the water, it folds against the keel. For launching, the boat is unhooked from the car and wheeled into the water. When the boat floats, the wheels are raised out of the water to the retracted position.



Wipe-on Paint for Cars Applied With Mitten

Refinishing a car is easy with a smooth-flowing paint and a mitten that acts as a brush. The enamel dries to a hard gloss. It is applied by dipping the mitten in the paint and then wiping it across the car, the fingertip pad serving as a five-inch brush. The thumb pad is used as a smaller brush for painting window frames and other narrow surfaces. One coat of the paint dries in about two hours. The mitten and enough paint for two coats are provided in a kit which also includes a solvent cleaner for removing dirt before painting, sandpaper for smoothing the surface, plastic for filling cracks, and a spatula.

Speedy Racing Car Assembled From Kit

You can build your own racing car that will go up to 100 miles an hour with a kit now being sold in England. The car, called the "Marwyn," has a one-cylinder motor and is sold without the body. The buyer can design and build his own body style to fit the chassis, which is sold in parts ready for home assembly.





United Air Lines photos

With only one side of tail assembly dock lowered into place, workers at three levels "operate" on a 30-foot-high DC-6. Above right, four hydraulic jacks lift the landing gear a few inches off the ground

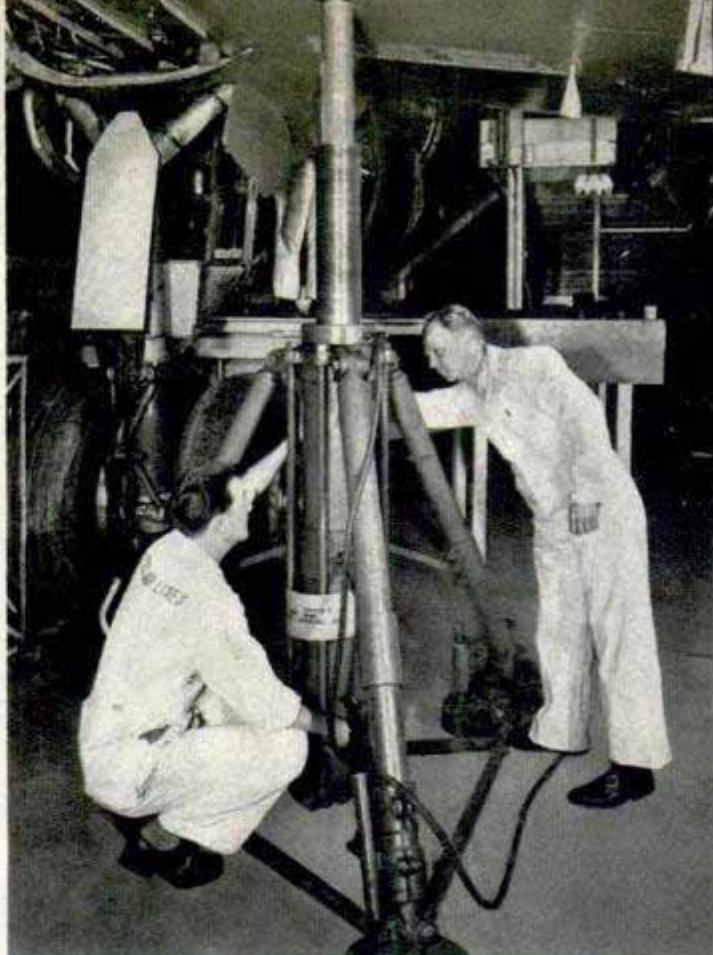

Push-Button Dock

FOUR-ENGINE airliners are practically rebuilt in four days at United Air Lines' new San Francisco maintenance base, featuring a push-button dock that fits around giant DC-6s and 4s like a tight glove. It replaces temporary workstands and ladders that, a company official explained, "made mechanics wait 50 minutes to do every 10 minutes of actual work."

Now, a few moments after a pressed button has flipped open the 25-ton steel hangar door, an army of 50 workers is swarming over the plane at the start of a 700-hour overhaul that every big plane gets about four times yearly. Two sections of a massive tail dock meanwhile swing down from the ceiling, enveloping the rear of the plane from either side, and metal

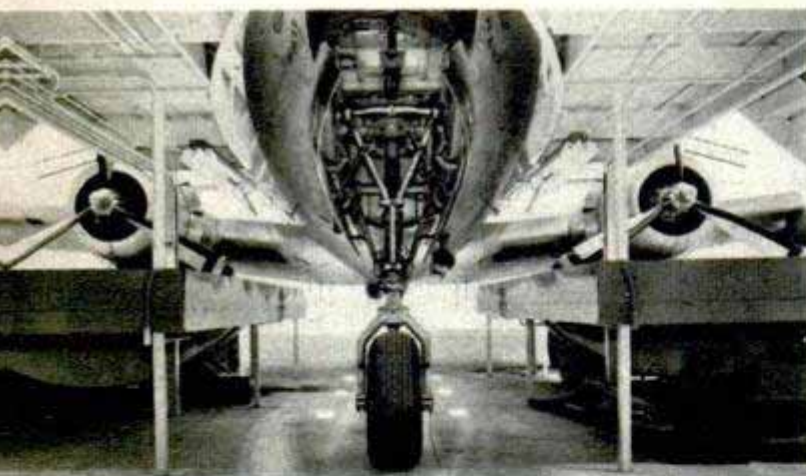

Seen from below, nose of the DC-6 above fits snugly in dock. Below, empty dock, showing steel framework

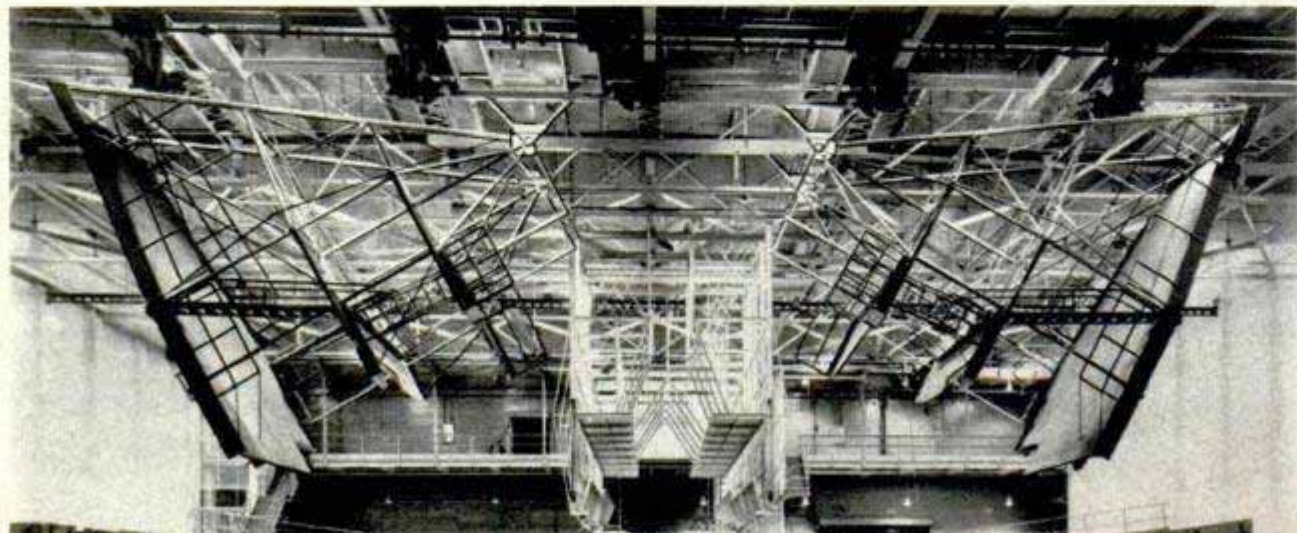



Halves of tail dock, upper right and in left background, drop into position when plane moves forward

catwalks that parallel the cabin on both sides drop into place. Four jacks boost the plane enough to get the landing gear a few inches off the ground.

The four engines nose forward over an inclined ramp, so accessible that their complete removal is accomplished in less than 16 minutes. Permanent floor lights play on working areas beneath the wings and cabin. Removed parts are sped to the base's cleaning and overhaul shops by electric hoists, overhead chain conveyors and elevators. Since about 95 percent of the parts needed can be anticipated from the ship's service record, they are set out in advance near their installation point.

Compressed air spray of finely ground walnut shells, right, cleans and polishes cylinders. Below, there is solid working space for all around the big airliner

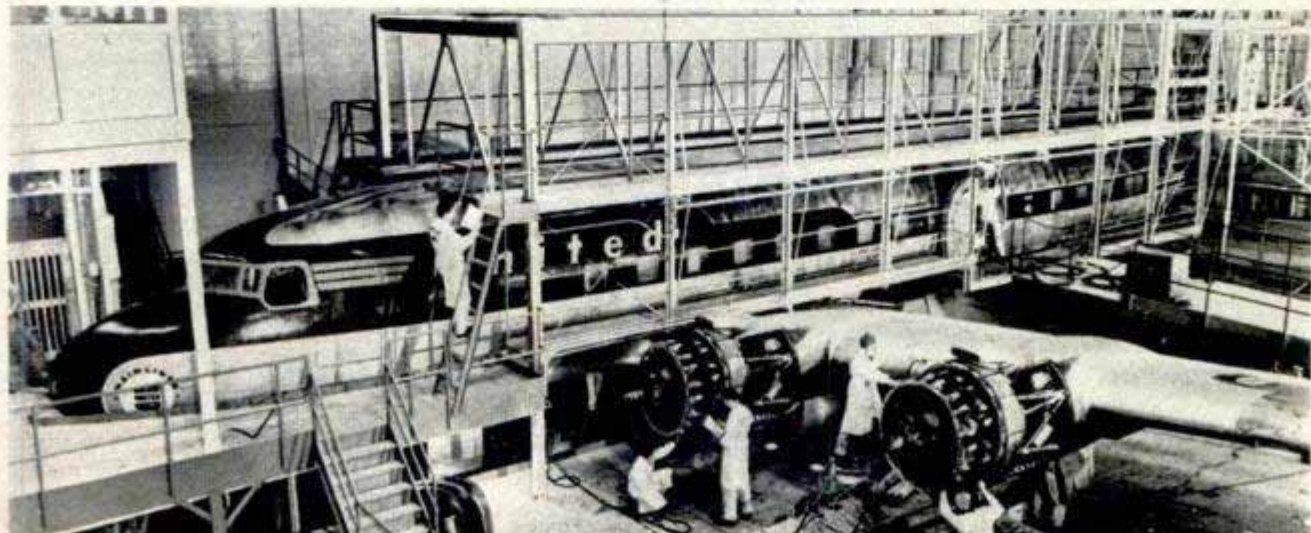
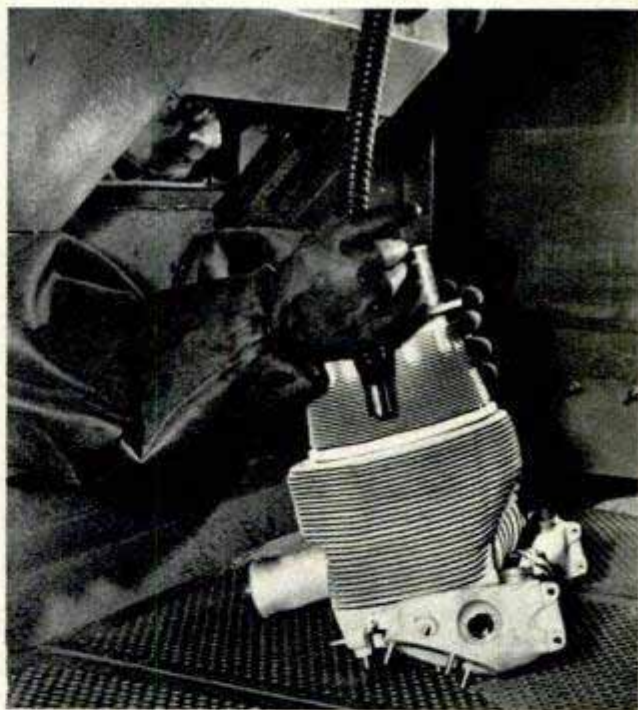

Small Utility Press Operated by City Water, Compressed Air or Oil

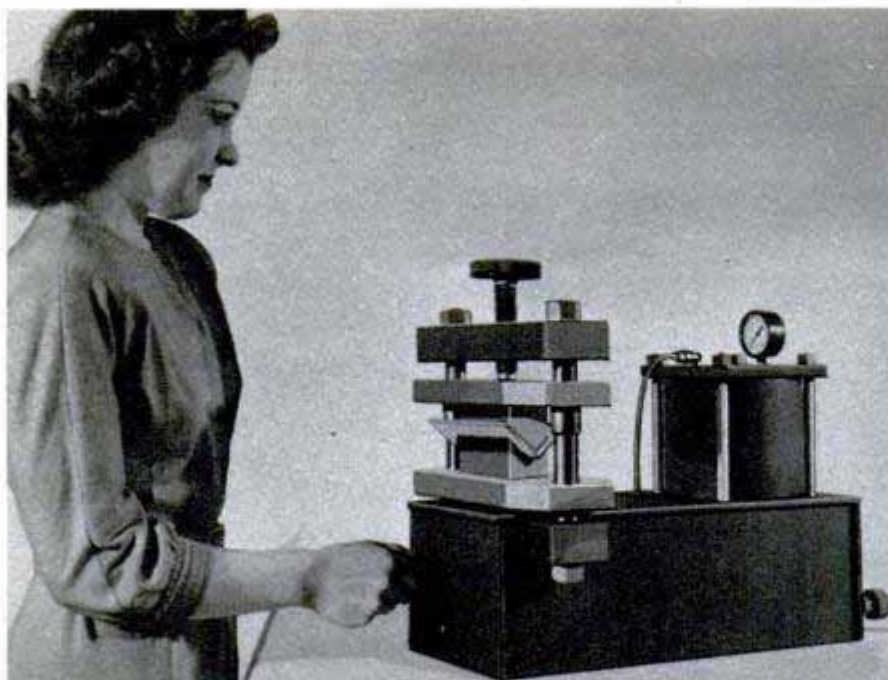

Designed for use with air, oil or water pressure, a small utility press develops a force of 10,000 pounds from a line pressure of 100 pounds per square inch. If no air compressor is available, the press can be connected to a water tap and pressures of from 3500 to 7500 pounds are possible. Its unusual valve permits smooth speed control and enables work to be held at any selected pressure. It can be used for bending cold-rolled steel up to $\frac{1}{8}$ inch in thickness, notching, shearing, punching and embossing metals.

Helicopter Jets Get "Whirl Test"

To duplicate operating conditions, jet engines for helicopters are whirling through tests at the tip of a giant blade at General Electric's experimental flight center. The runs are made in an outdoor bowl-shaped pit, 150 feet in diameter and 13 feet deep. A 1000-horsepower electric motor drives the blade when the drag caused by the engines is being measured. When the burners are operating, the motor functions as a generator in gauging the thrust the jets produce.

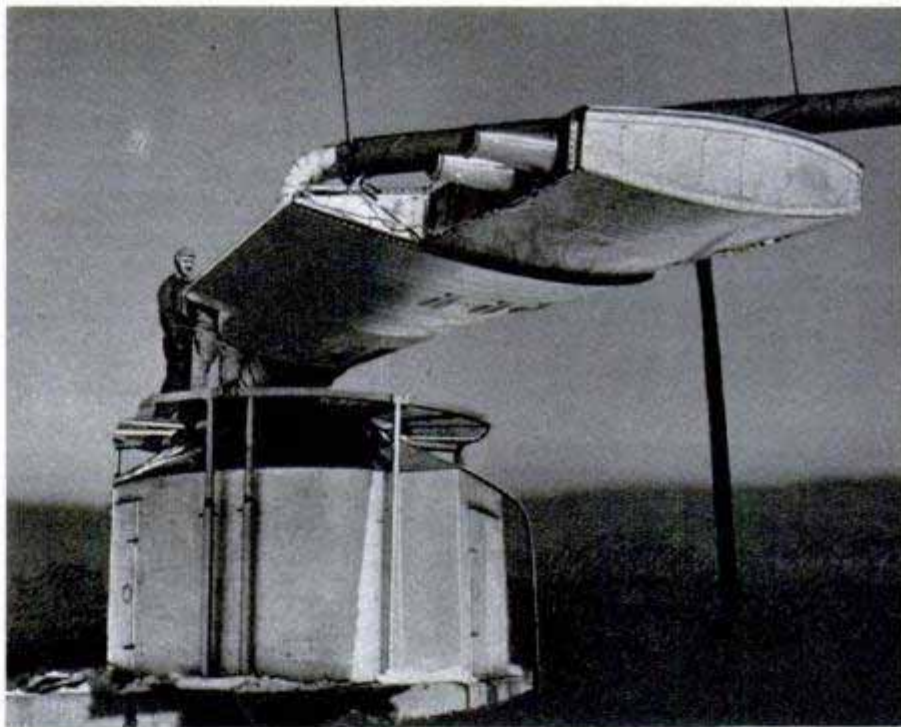

General Electric photo

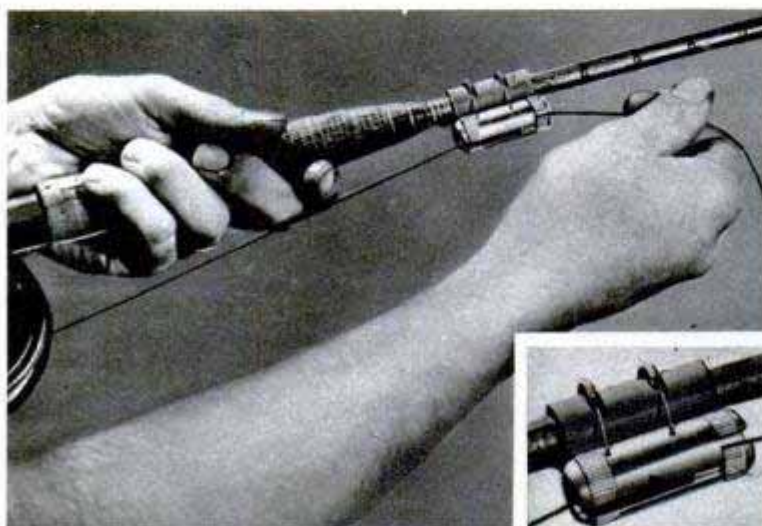

Dresser for Fish Line Clamps on Fly Rod

Fly line can be dressed on the rod without leaving the stream with an aluminum cylinder that clamps to the pole. The cylinder, mounted midway between the handle and first guide, is filled with felt padding and two coil springs. The line is pulled into a slot in the side of the cylinder where it is squeezed between the pads. When the line is pulled off the reel the dressing is applied. The pads come without dressing so fishermen can choose their own.



U. S. Navy photo

Metal Rotors Help Helicopter Fight Ice

All-metal rotor blades and a cabin floor hatch are novel features of a Sikorsky helicopter being tested by the Navy for use on carriers, battleships and cruisers. The blades are more easily adapted to de-icing equipment than the wooden ones now used and are less likely to be damaged. Air-sea rescues and cargo loading are simplified

by the hatch. To protect deck personnel and prevent the blades from striking a rolling deck during landings on heavy seas, the tail rotor is mounted on an arm that extends upward high enough to give full head clearance. Designated the XHJS-1, the craft carries five, has a 110-mile-an-hour top speed and range of 330 miles.

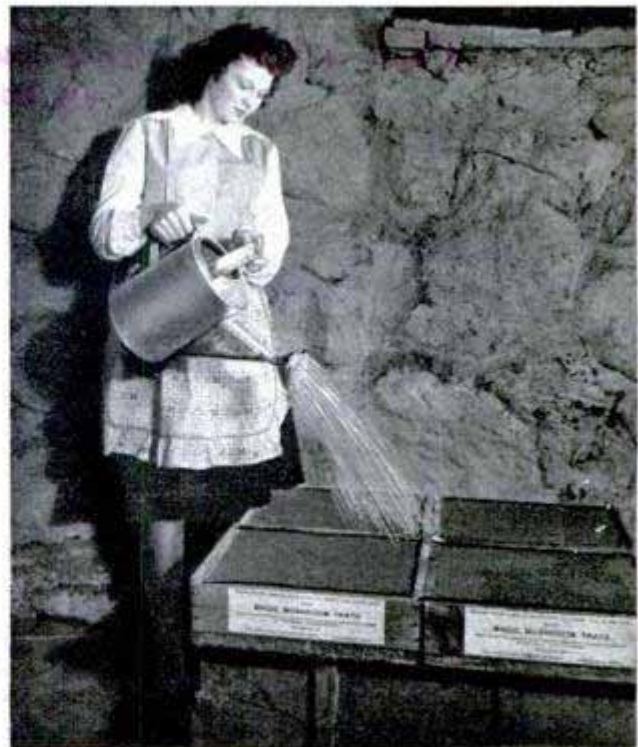
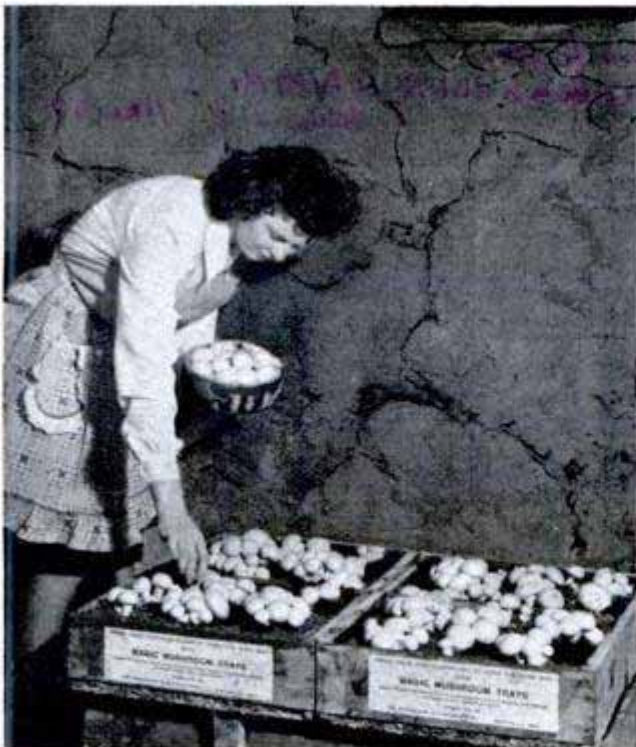

MUSHROOM TRAYS contain a bed of mushrooms in prepared dirt, permitting the housewife to raise a private crop in the basement. Each bed produces its first crop in about three weeks and continues to yield for four or five months before tray is exhausted. Trays must be watered and kept at about 55-degree temperature

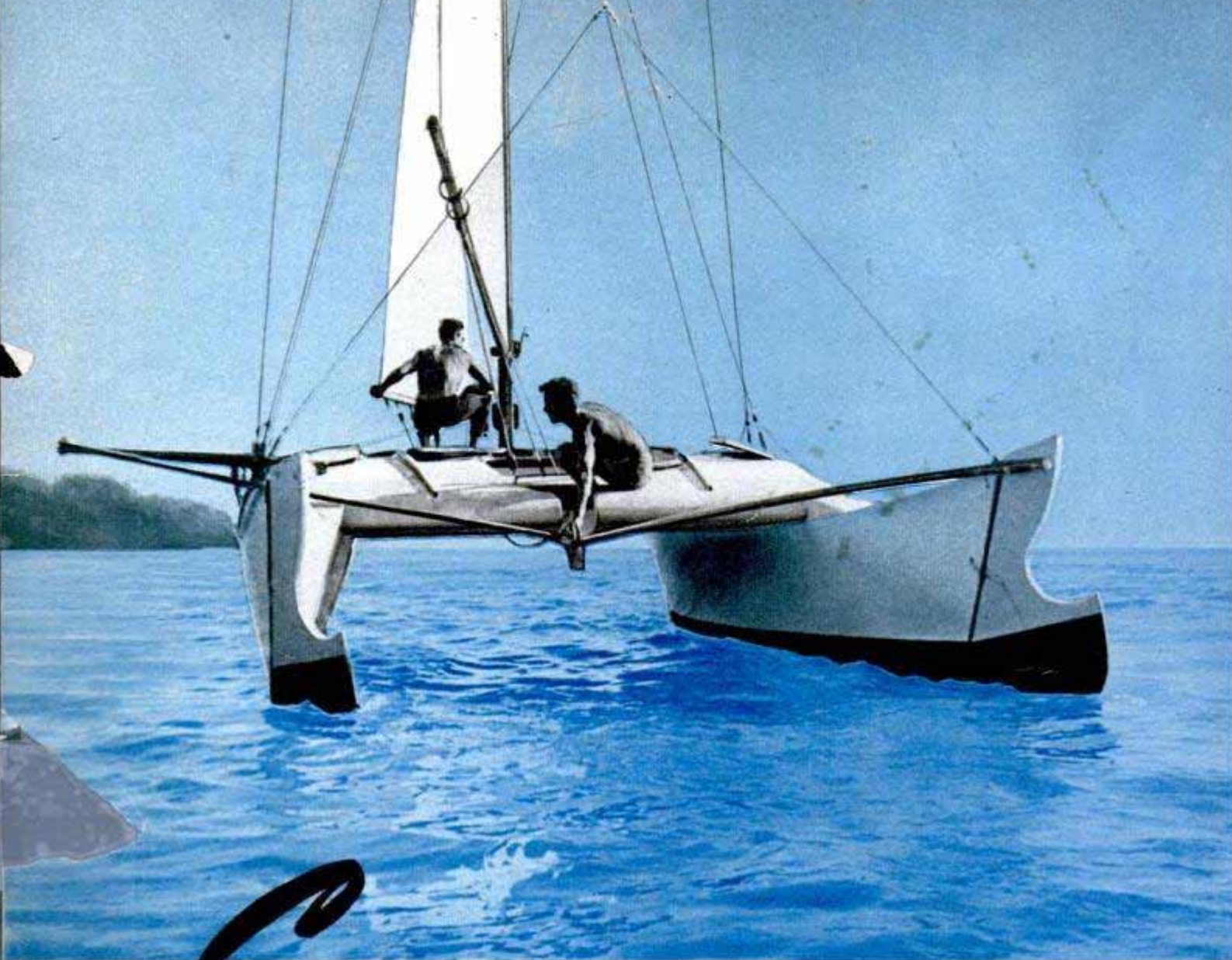

Sailing the Winged "Seabird"

*Photo & Ketch for Calamians from
 W.A. DICKSON & COMPANY, WAIKIKI,
 HONOLULU, HAWAII*

COMBINING the sailing secrets of the ancient Polynesian with modern principles of aeronautics, "Woody" Brown and Alfred Kumalae of Honolulu have built a 40-foot catamaran, believed to be the largest and fastest in the world today.

They provide thrills for the tourists, and dollars for themselves, by skimming passengers over the waters of Waikiki at better than 22 knots.

Woody first made a name for himself as a glider champion in Kansas, where he set a world's distance record. He came to Honolulu shortly before the Japanese attacked Pearl Harbor.

On Christmas Island, as a war worker, he watched natives build a catamaran after an ancient design. Completed, he saw it sail with extraordinary speed.

Here was something that made his glider seem tame. He decided to do research on

By Richard M. Botts Polynesian catamarans, and work into the design of one some of his knowledge of aeronautics. He wanted to build the fastest catamaran the world had ever seen.

He found in Alfred Kumalae, a Hawaiian lad, the partner he needed, and together they worked out the design for their new craft at Waikiki. They followed the ancient Polynesian design exactly, except for the wing innovation. They built it entirely of plywood. It took almost a year to complete and dug into their savings to the not inconsiderable sum of \$4000. They christened it "Manu Kai," which means seabird in Hawaiian.

The craft's remarkable speed is due to several factors.

One is the light weight of the catamaran (just over 2000 pounds) compared with other craft of equal size, giving it a draft of only 15 inches. The small draft and light



One man easily handles the 40-foot catamaran. Lines from both jib and mainsail run into the small cockpit

weight leave little drag or weight for the sails to pull over the water.

The catamaran is able to outdistance other sailing craft because it keeps its stability and sails in an upright position. Conventional sailboats heel over in even a moderate breeze and spill air off the top of the sail. Because the catamaran keeps upright, the wind flows off the back of the sail instead of spilling off, giving it added speed and thrust.

Trials proved the most speed could be obtained in a beam wind or a close reach.

Taper ratios run from about 3 to 1 in ordinary sailboats to as high as 9 to 1 in racing yachts. In contrast, the *Manu Kai's* hulls have a 20 to 1 taper ratio. This makes the craft long, slender, and very fast.

Woody's innovation, the wing, besides holding the two hulls together, is designed to add speed. It is skin stressed and internally braced like an airplane. When the

Brown and Kumalae carefully studied the designs of ancient Polynesian catamarans, like the one below that made better than 20 knots, in planning the speedy *Manu Kai*

Sketch from "Canoes of Oceania" by A. C. Haddon and James Hornell. Vol. II, Special publication, Bernice P. Bishop Museum

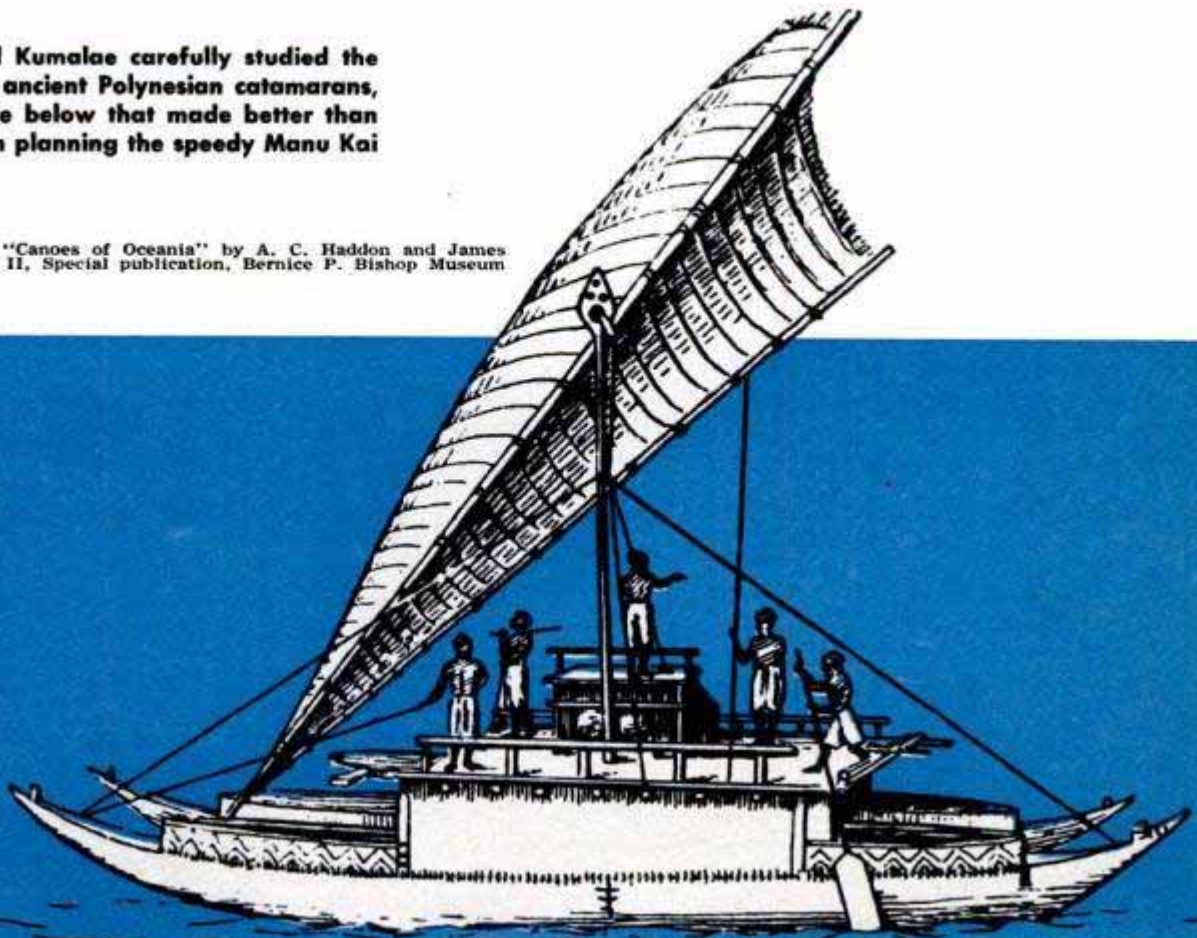

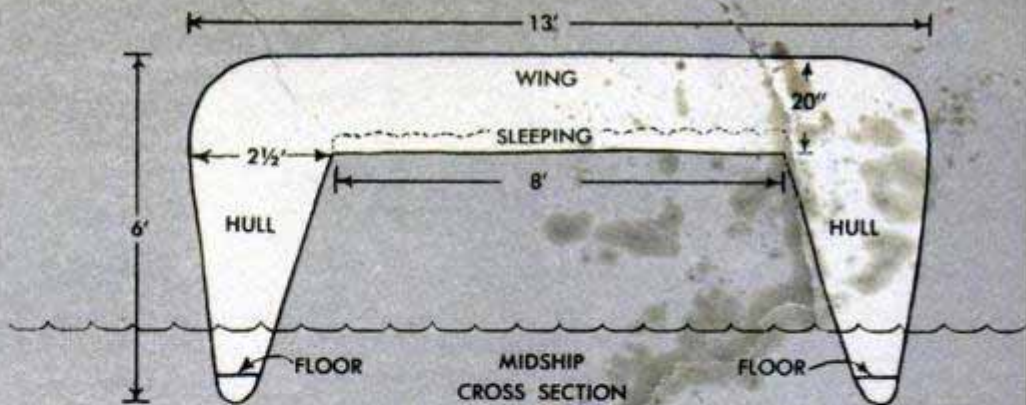
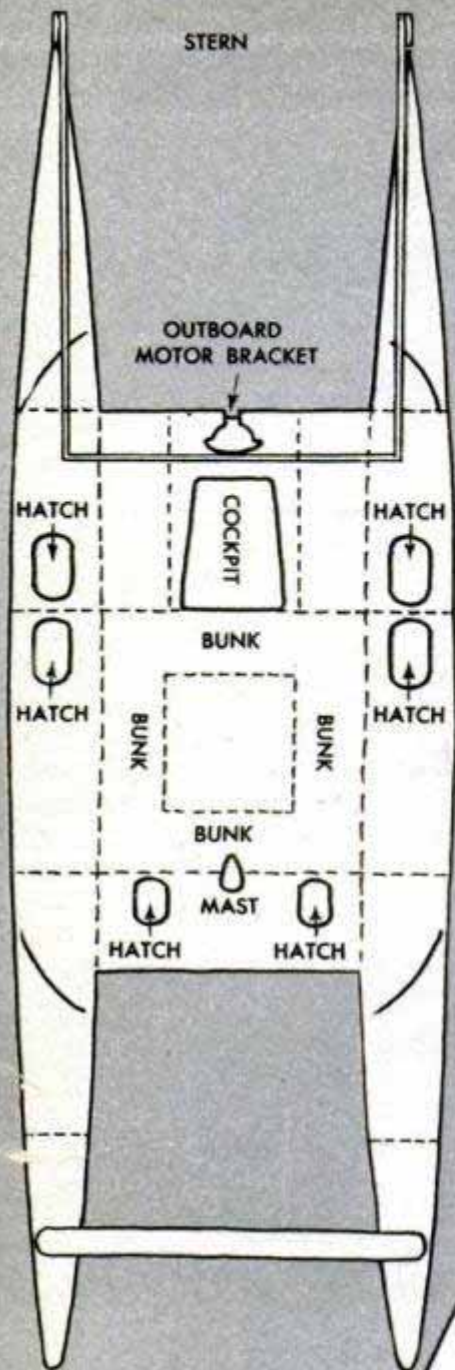

Built in about a year at a cost of \$4000, the *Manu Kai* carries 16 passengers and has a top speed of better than 22 knots. The two hulls are held together by a wing, "Woody" Brown's innovation, which gives the craft lift as it sails into the wind. Very light construction and a draft of only 15 inches leaves little drag for the sails to pull over the water. While the taper ratio of racing yachts only runs to 9-1, the *Manu Kai*'s hulls are 20-1, a design feature that greatly boosts its speed

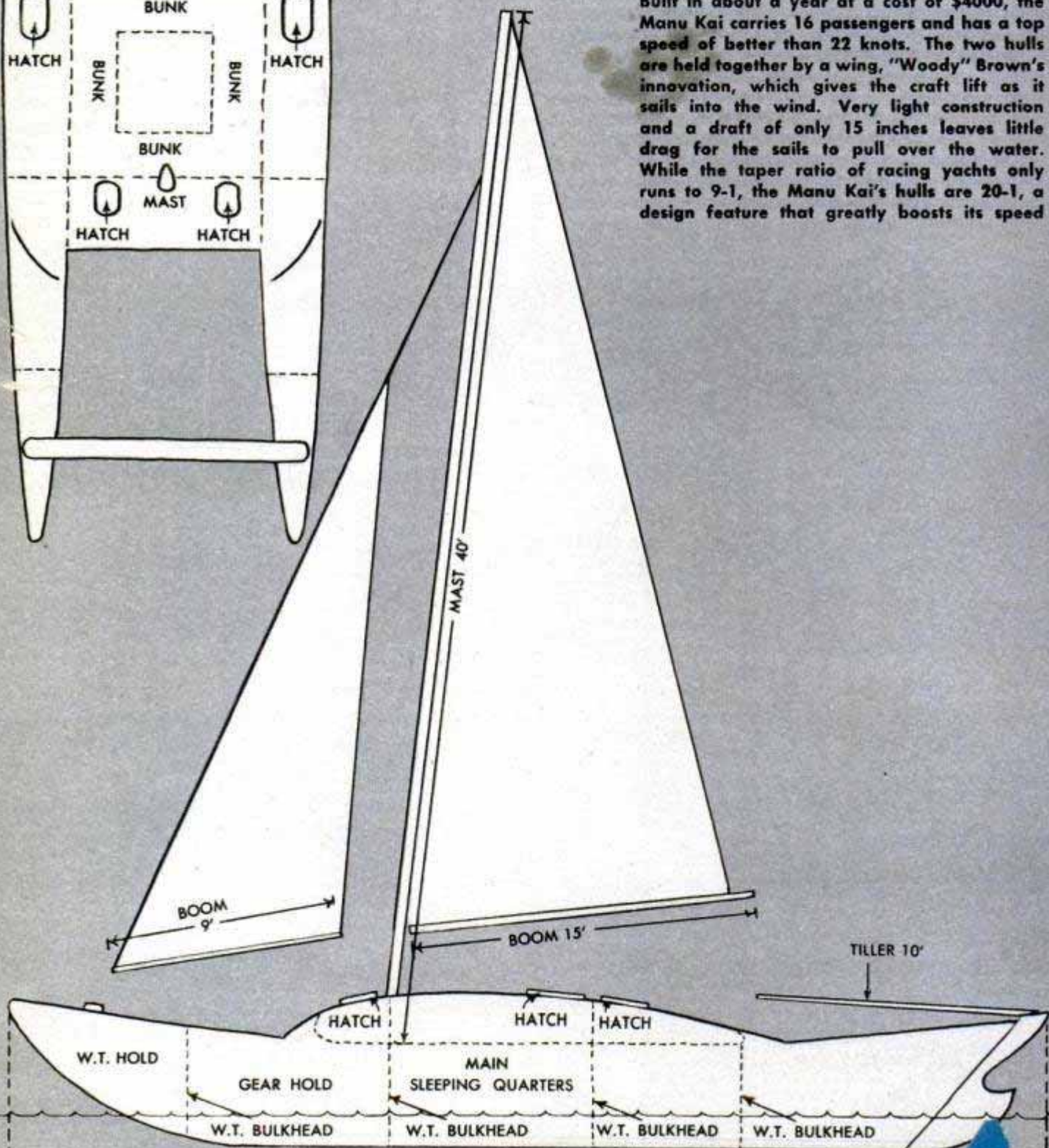

craft sails to windward, the wing, an airfoil, lifts the catamaran, thus reducing the weight in the water and increasing the speed.

What makes the *Manu Kai* so unusual and astounding to the yachting fraternity is the lack of either keel or centerboard that mark other modern catamarans.

Until the "seabird" was built no modern catamaran had been able to prevent leeway without the use of a keel or centerboard. One was built without keel or centerboard, but it made too much leeway and had to be refashioned.

The secret lies in the unsymmetrical hulls, designed in the old Polynesian fashion. The inboard sides are curved, the outboard sides are straight up and down, making a hydrofoil of the hulls. When a hydrofoil is pushed through the water, it lifts, like an airplane wing, and prevents leeway.

Another convenience for singlehanded sailing of the *Manu Kai* is her small amount of sail area and short 15-foot boom for the mainsail and six-foot boom for the jib. It uses only 370 square feet of sail, against some 430 square feet in the latest Herreshoff catamaran developed in 1945. Despite this it is considerably faster than Herreshoff's 15-knot craft, but no official speed runs have been made.

As in all catamarans, a double rudder is needed for greater control. If one hull and rudder were out of the water, the opposite rudder would still provide control.

From each rudder a long tiller runs to the after end of the wing. These tillers are connected by a 10-foot crossbar, making it possible for the helmsman to steer from any position on the after-section of the wing, as the beam of the craft is only 13 feet.

Both the hulls and wing serve as stowage space and living quarters.

The catamaran has five water-tight compartments, each accessible from a hatchway.



Six can be slept comfortably in the craft. Four are put in the wing section, which is entered by the hatches on deck, and there is space for one in each of the after hulls. Below, the *Manu Kai* carries only 370 square feet of sail, which is considerably less than half of that carried by one of the fastest catamarans developed in the early '30s



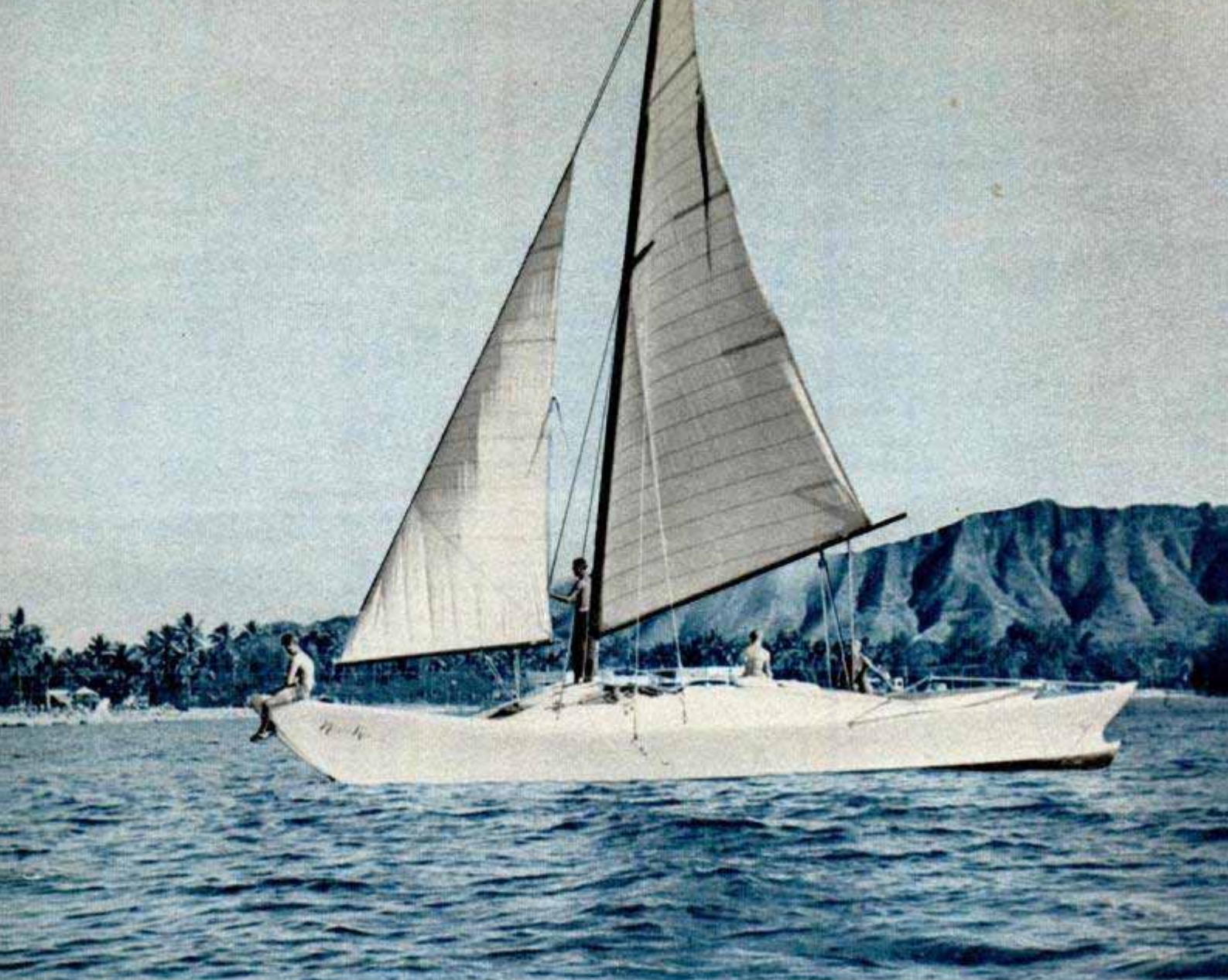

Its comparatively light weight and complete streamlining allow the catamaran to ride high at all times

The two forward sections of each hull are used for storage space for the lines, anchor and fishing gear.

The center part, comprising most of the wing and the two center sections of both hulls, provides the living and sleeping

quarters. This main section will sleep four. Two small built-in chairs, a desk and clothes pegs make up the furnishings.

The after sections of the hulls sleep one each. They, too, have plenty of room for clothing and additional gear.

The catamaran rides the sea very easily, partly cutting through, but mostly riding over the waves. This is due to the light weight and draft and because the twin hulls are very sharp.

A round trip open-sea sail of almost 200 miles in rough weather between the Islands of Oahu and Maui has convinced Woody of the catamaran's seaworthiness under adverse conditions.

Built entirely of plywood, the winglike center section is 8 feet wide and 20 inches thick

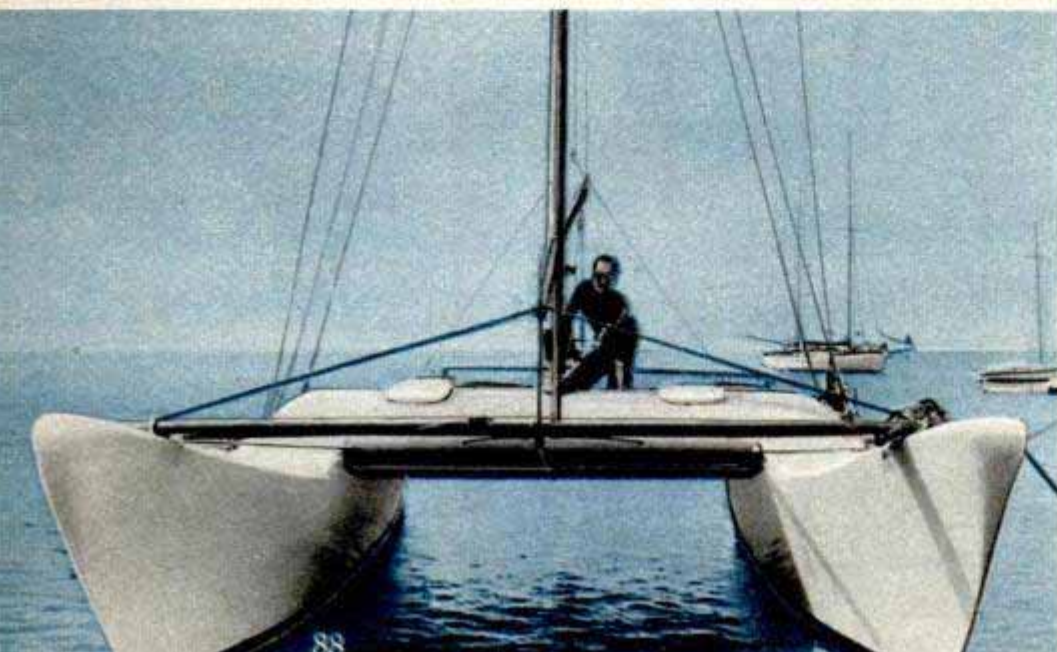

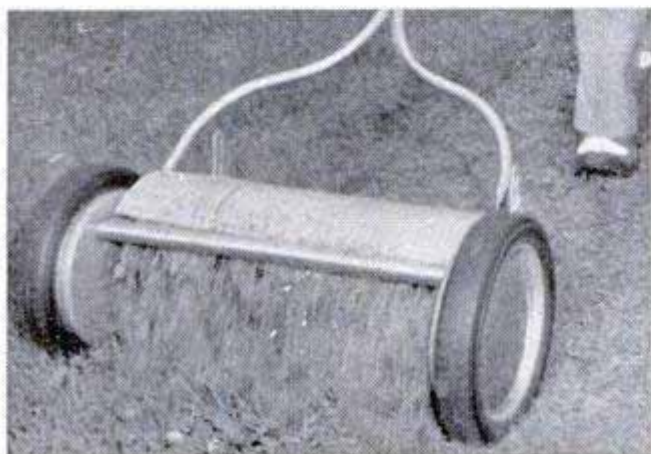
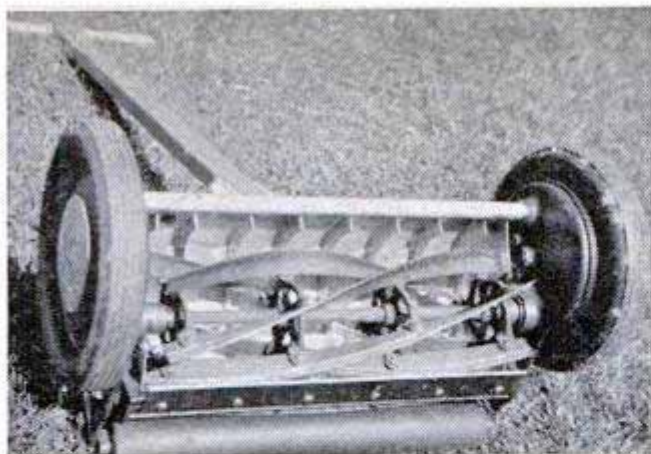

Hood for Lawn Mower Returns Grass to Blades

Freshly cut grass is changed from a nuisance to a valuable fertilizer by the invention of Harold Elliott and Thellar Johnston of St. Paul, Minn. It is a hood with vertical fins that fits over the blades of a lawn mower. When cut grass flies back against the hood, it is carried forward and caught by the mower blades a second time. This is repeated until the grass is chopped into minute bits, then it is deposited on the ground as mulch. Built of aluminum and weighing less than two pounds, the attachment has an extension plate and can be fitted to any size mower.

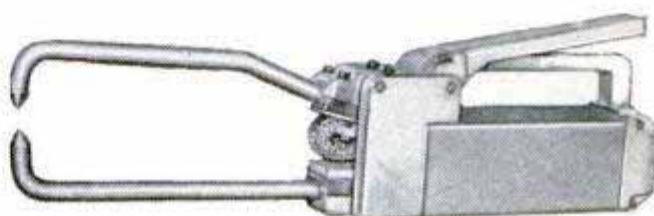
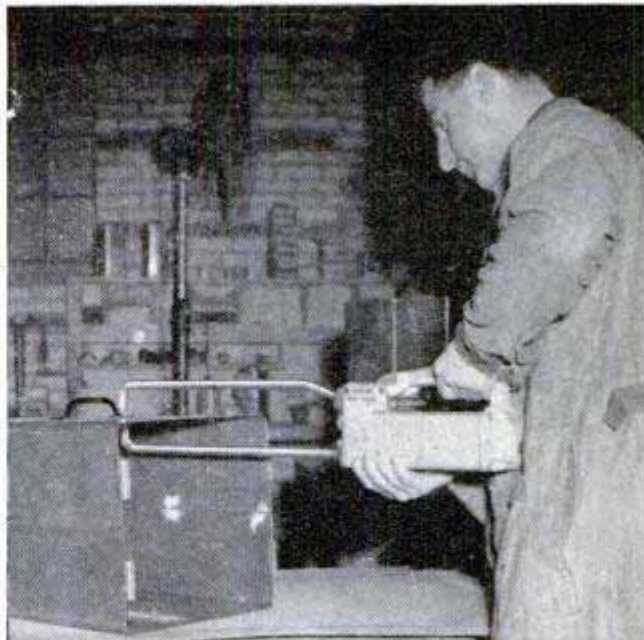

Portable Spot Welder Weighs Only 23 Pounds

Spot-welding jobs that can't be carried into the shop can be reached with a portable welder weighing only 23 pounds. The self-operating unit has a cast aluminum case and is available in models for both 220 and 110-volt current. It welds up to $\frac{1}{8}$ -inch combined thickness of metal. The copper arms come in 6, 12 and 18-inch lengths and the alloy tips are available in an assortment of shapes. The unit is designed for welding window frames, skylights, display signs, wire fences and other installations that are difficult to reach with a conventional spot welder.

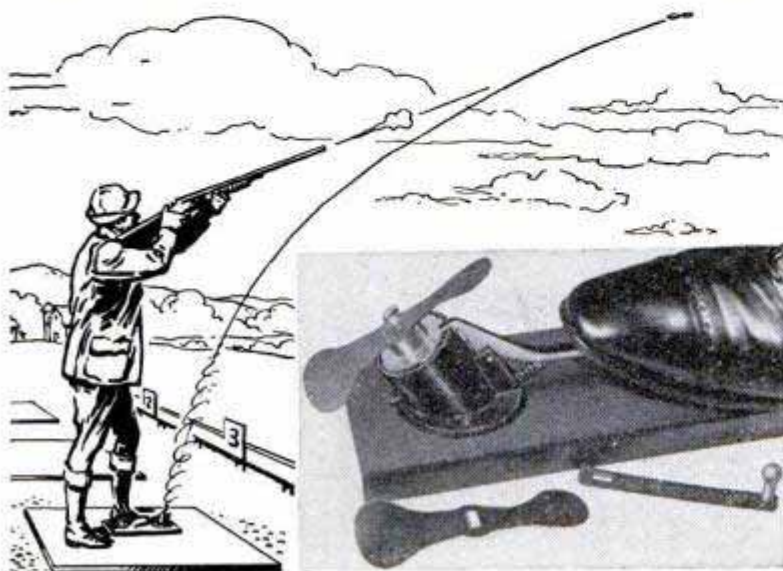

Foot-Triggered Skeet Trap Shoots "Propeller" Targets

Propeller-shaped targets spin up from a small skeet trap which is triggered by foot. The spring-operated trap sends aloft metal targets which can be adjusted to skim over the ground for more than 60 yards or rise almost straight into the air. When a target is hit it takes a sudden change in course. Targets which are not badly hit can be straightened and used many times. The trap's spring is wound by approximately three turns of a crank.

X-RAYS 500 TIMES BRIGHTER

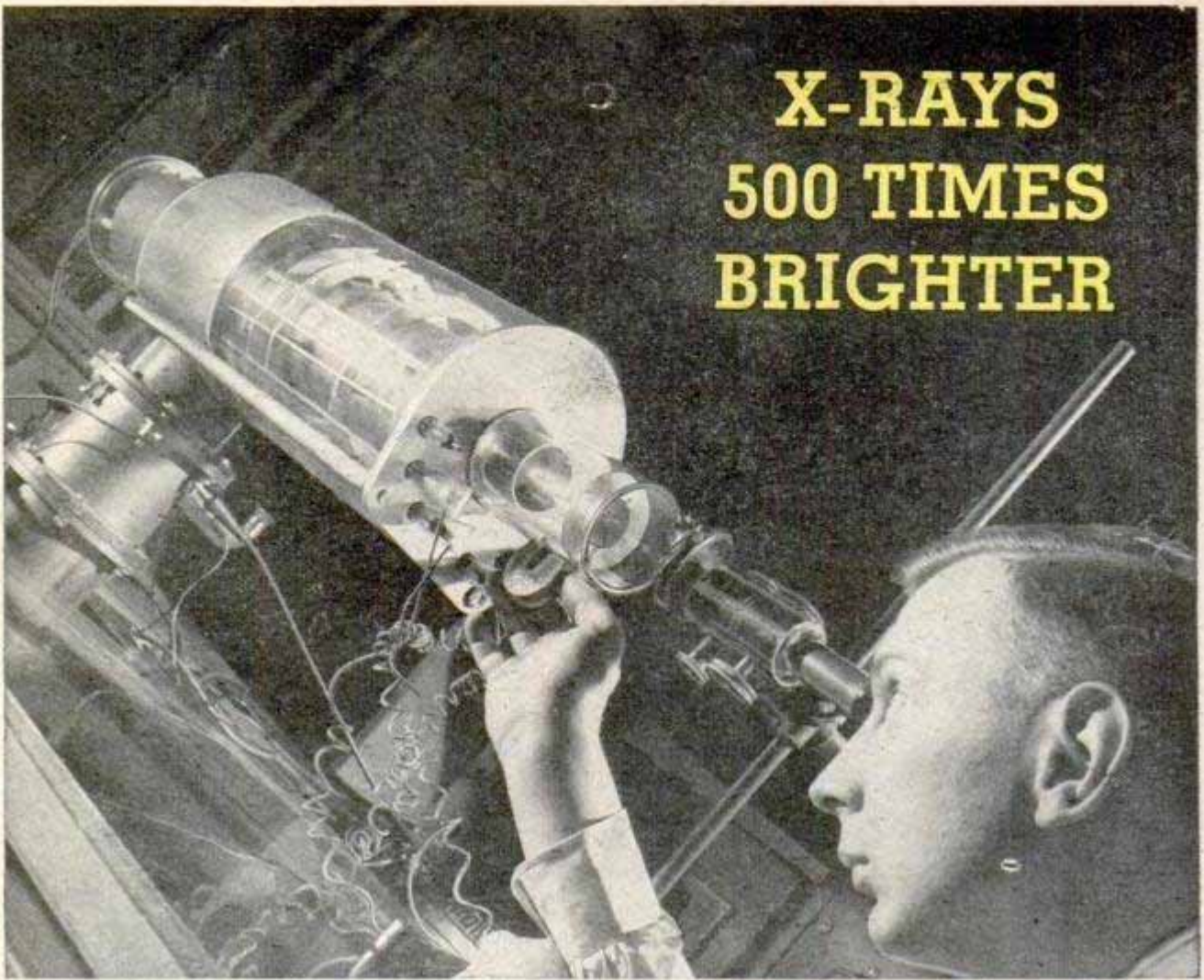

Opening a new field to medical science is the X-ray "telescope" which has helped Dr. John W. Coltman (above) of Westinghouse Research Laboratories discover how the X-ray image seen on screen of fluoroscope can be brightened 500 times. The panel of three pictures below and on opposite page shows from left to right (1) what physician sees on fluorescent screen today, (2) brightness increased five times, (3) 500 times

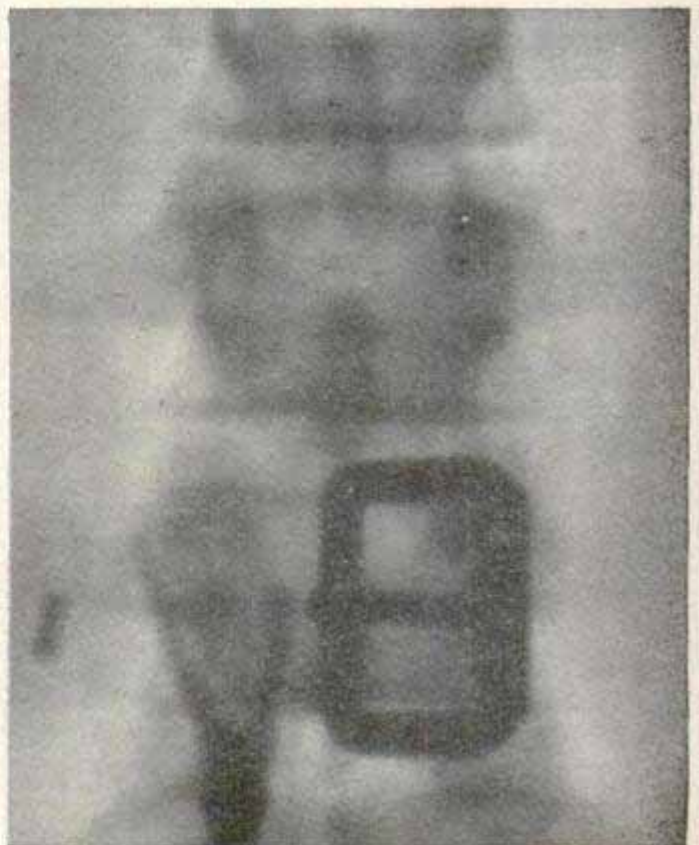
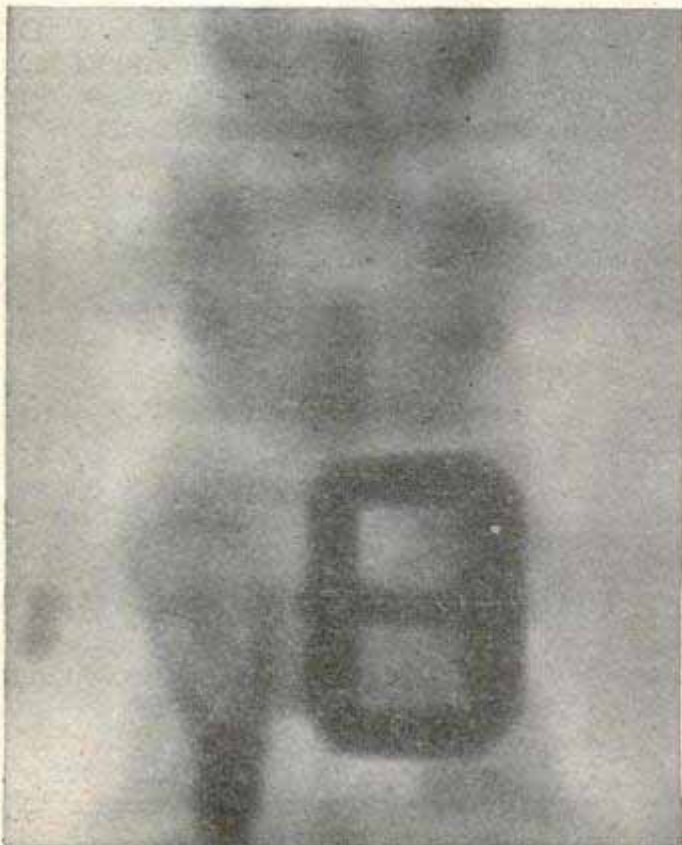

By Bill Reiche

FLUOROSCOPY, the "motion picture" member of the X-ray family and valuable diagnostic tool, is emerging from its own Dark Age.

For almost 50 years, since Roentgen discovered the X-ray, the fluoroscope has been potentially the ideal medium for examining the human body, presenting for the doctor's observation the movements of the organs in a light and shadow picture on a fluorescent screen.

However, only a certain intensity of radiation could be tolerated by the patient without injury and the screen could produce a definitely limited amount of light from a given number of X-ray quanta. The resulting image was so dim that the physician could not distinguish objects less than one eighth inch apart, even after increasing the light-sensitiveness of his eyes for 30 minutes in a pitch-dark room.

It is estimated that the image of the average human abdomen, using the best equipment available today, is 30,000 times dimmer than a sheet of white paper held under a reading lamp.

It seemed obvious that, since the rays couldn't be increased in power, or focused, or speeded up, or otherwise be made to produce greater brilliance on the screen, something had to be done with the rays after they left the patient's body and before they reached the doctor's eyes.

Dr. John W. Coltman, research physicist of Westinghouse Research Laboratories,

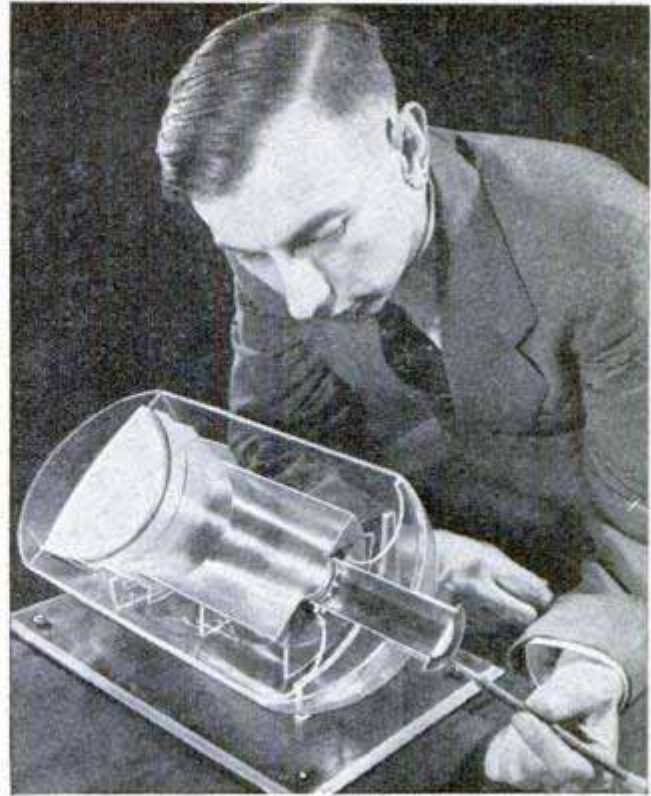

Scientist with model points to fluorescent screen on which image will be 500 times brighter than in the past. At other end of tube is replica of larger fluorescent screen coated inside with metal that ejects electrons when light falls on it. Metal section in center of tube represents lens system that focuses electron beam on small screen. In practice, X-rays leaving patient strike large screen at left and release light rays; these strike photosensitive surface on other side of screen and eject electrons which speed across the tube at 5000 miles a second. Light rays released when they strike the screen at right give image which is magnified optically. Below, drawing of a commercially practical ray outfit

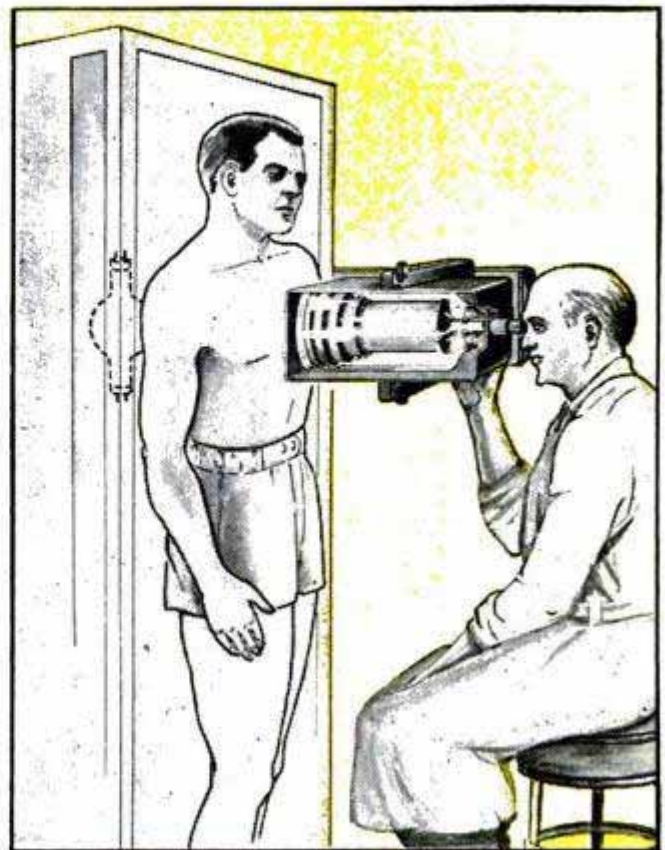
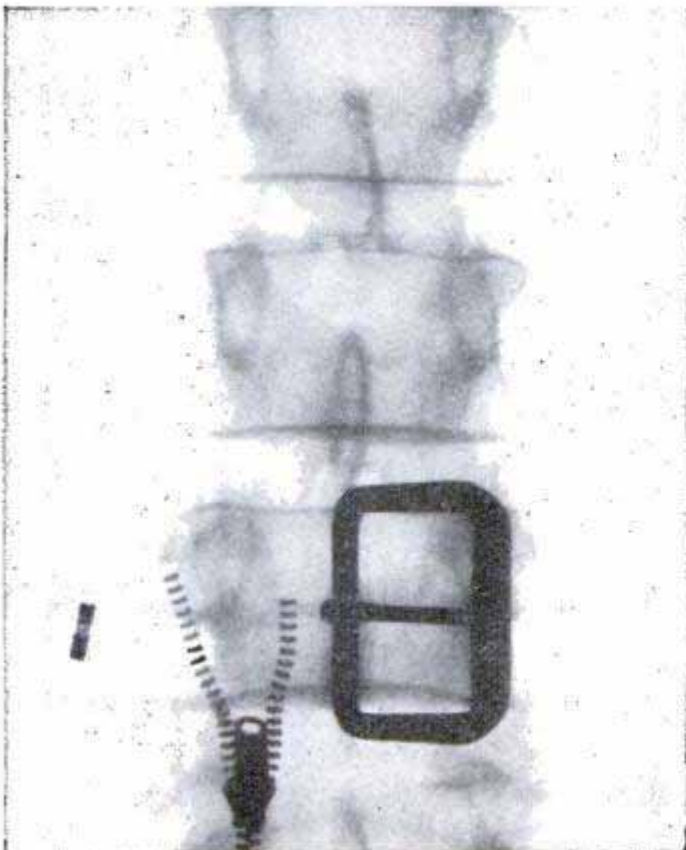

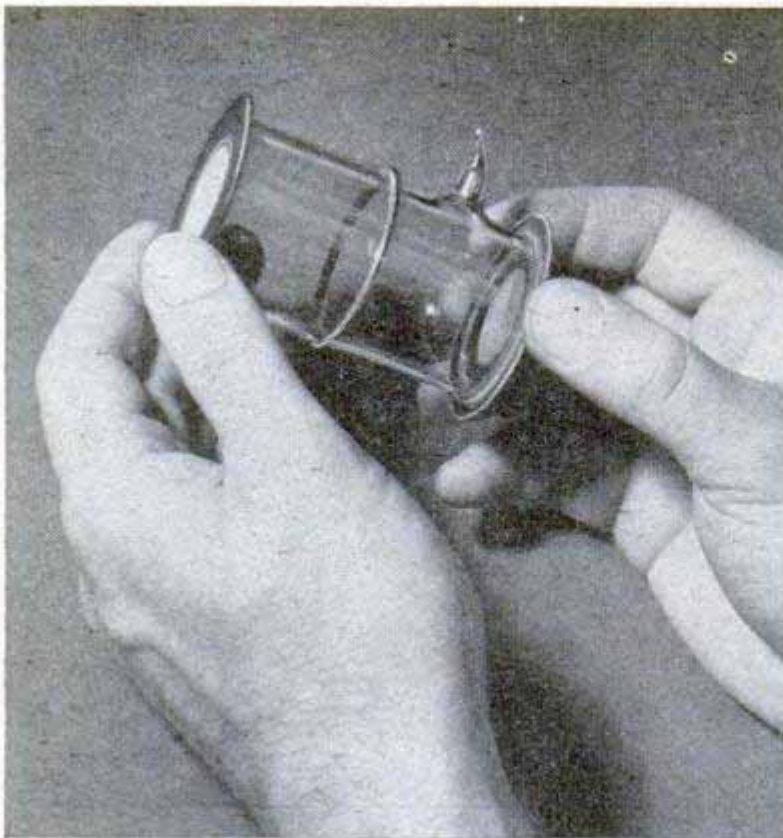

In this tiny tube, X-ray image brightening was first achieved. It's a four-way play: X-rays to light rays to electrons to the light rays again which give intensified image on small screen

after four years study and experimentation, recently announced the perfection of a device which will, in its fully developed form, increase the brightness of the screen 500 times over what we have today.

The ingenious process worked out by Coltman and his associates introduces the use of electrons, which, unlike X-rays, can be accelerated and focused. In a vacuum-tube "straightaway" the electrons are accelerated from 500 to 5000 miles per second as the diameter of the straightaway narrows from six inches to one inch. It was this conversion of X-rays to light to electrons to light that, for the first time, brought fluoroscopy out of the shadows.

The tube, 18 inches long and tapering in successive steps from a diameter of six inches to one inch, is contained in a glass

envelope and is itself evacuated. The larger end is sealed with a fluorescent surface on the outside and backing this up is a photoelectric or photosensitive surface coated with cesium and antimony.

The larger end of the tube is placed against the patient and the X-rays proceed through his body and strike its fluorescent surface, which lights up. The cesium-antimony combination has the useful quality of emitting a stream of electrons when exposed to light and a flow of these particles results from the action of the light on the photoelectric surface.

In this first and widest section of the tube there is an electrical field with a 200-volt potential and in it the electrons are still in low gear and moving at 500 miles per second. A series of electrostatic lenses, which focuses the electron beam much as glass lenses focus light, guides the beam into the next field. This has a 500-volt potential which accelerates the electrons to 800 miles per second;

the third field gets them up to 1300 miles per second with 1300 volts; the fourth field, with 3300 volts, speeds their rate to 2000 miles per second and in the final field, only one inch across and boasting a 20,000-volt potential, the tiny particles hit the finish line at 5000 miles per second.

The finish line is another fluorescent screen, where all the electrons launched by the light from a five-inch screen land on a one-inch screen and at a considerably higher velocity than the original X-rays. This screen has an aluminum backing to prevent light from going through the wrong way. Image brightness is proportional to the speed at which the electrons strike the screen; definition or contrast—to use a photographic term—depends on the number of electrons striking a given area.

The use of accelerated electrons brightens the image 20-fold and since the area of the second fluorescent screen is only $\frac{1}{25}$ that of the first, then 25 times 20 equals 500, the increase in brightness.

A simple lens or two, with either a single or double eyepiece, inverts the image to its normal position—it was reversed by the path of the electrons in the tube—and enlarges it so that it appears about

(Continued to page 240)

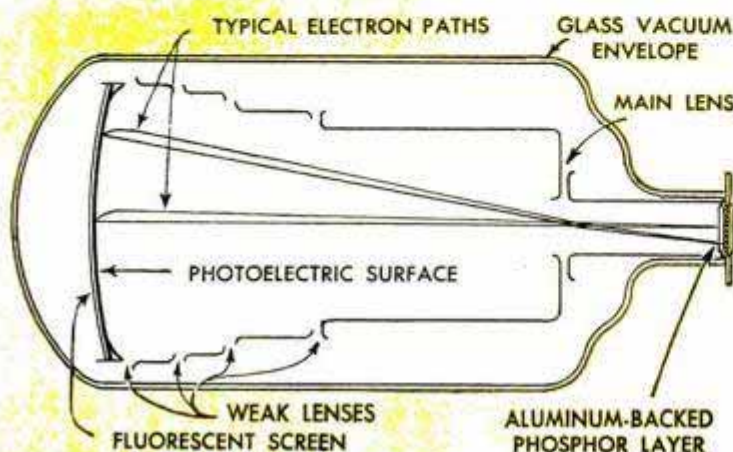
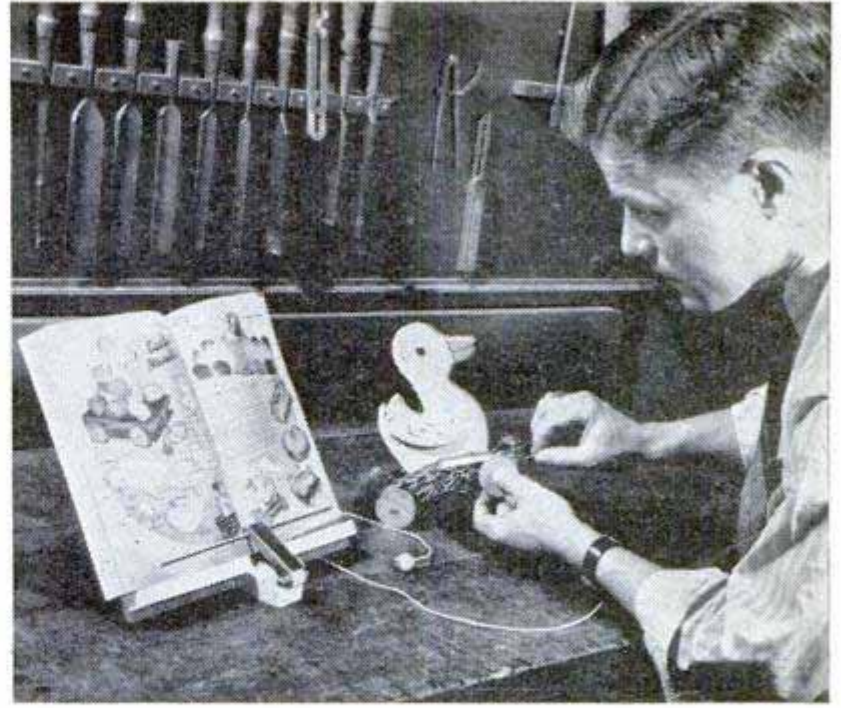
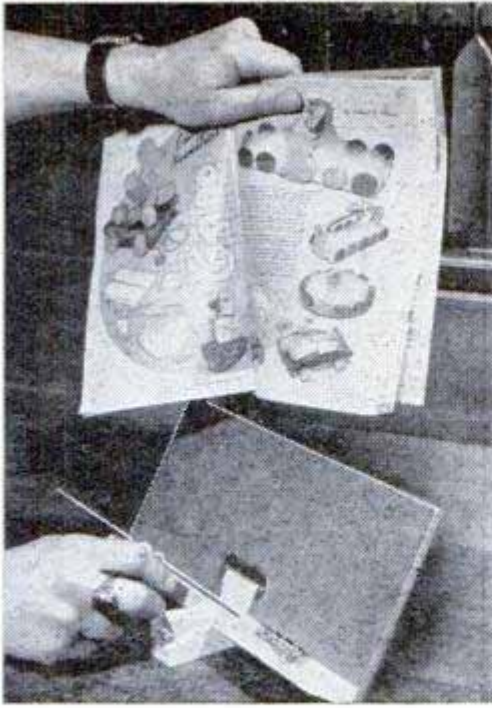

Diagram shows electron paths. Final image is only one inch across before magnifying



Rack Holds Book at Desired Page

Books and magazines are held open at any desired page by a rack which leaves both of the reader's hands free. The holder is designed for use with cookbooks and

workshop instruction books so that the user always has the information directly in front of him. After the book is opened to the proper page and placed on the rack, a metal bar is swung into place which prevents the pages from flipping over.

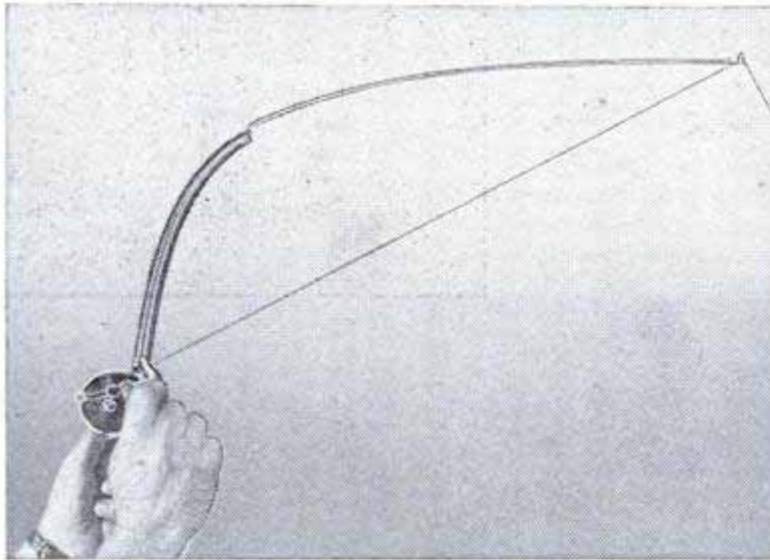

Spring Rod Lengthens Casts

Coiled at the base to form a spring, a steel bait-casting rod has great flexibility which gives a longer cast with less effort. Inside the coil spring are several flat steel springs to prevent lateral action during flexing and thus to increase casting accuracy. Less than a yard long, the rod has only one guide, a feature that assures free line action. Its shortness permits underhand casting along bushy streams and makes for greater safety when two or more fishermen are casting from the same boat.

Small Camp Stove Fits in Pocket

Small enough to fit in your coat pocket, a gasoline camp stove has a windshield, metal grid and generates enough heat for a four-quart pot or a large skillet. No pump is used as the stove is self-pressurizing. Made of rustproof metal, it burns any kind of gasoline and holds enough fuel for 90 minutes' operation.



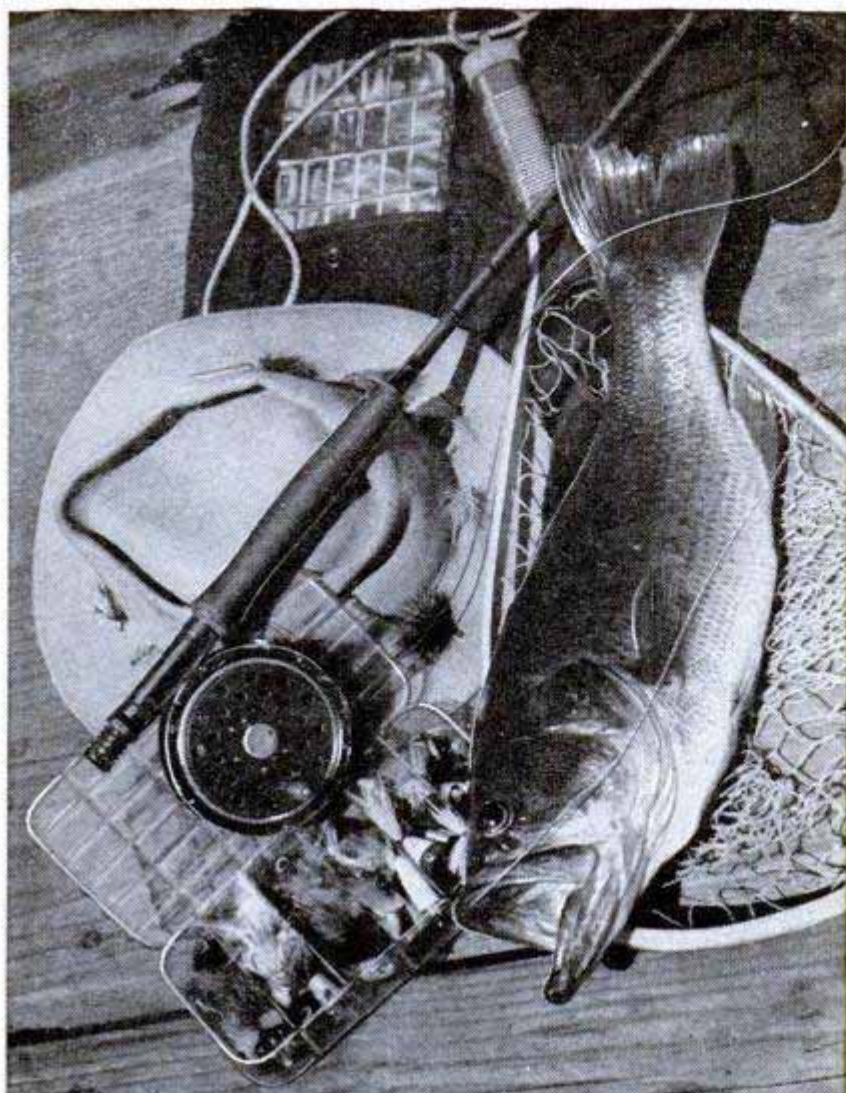

BAITS for BASS

By Claude M. Kreider

Here's the answer to any bass fisherman's dream. Surface poppers for use with the fly rod provide the ultimate sport in bass fishing. Below, among the assortment of casting-rod plugs, both deep-running and subsurface, is one popper, top row fourth from right

Photos by Ray Chapin

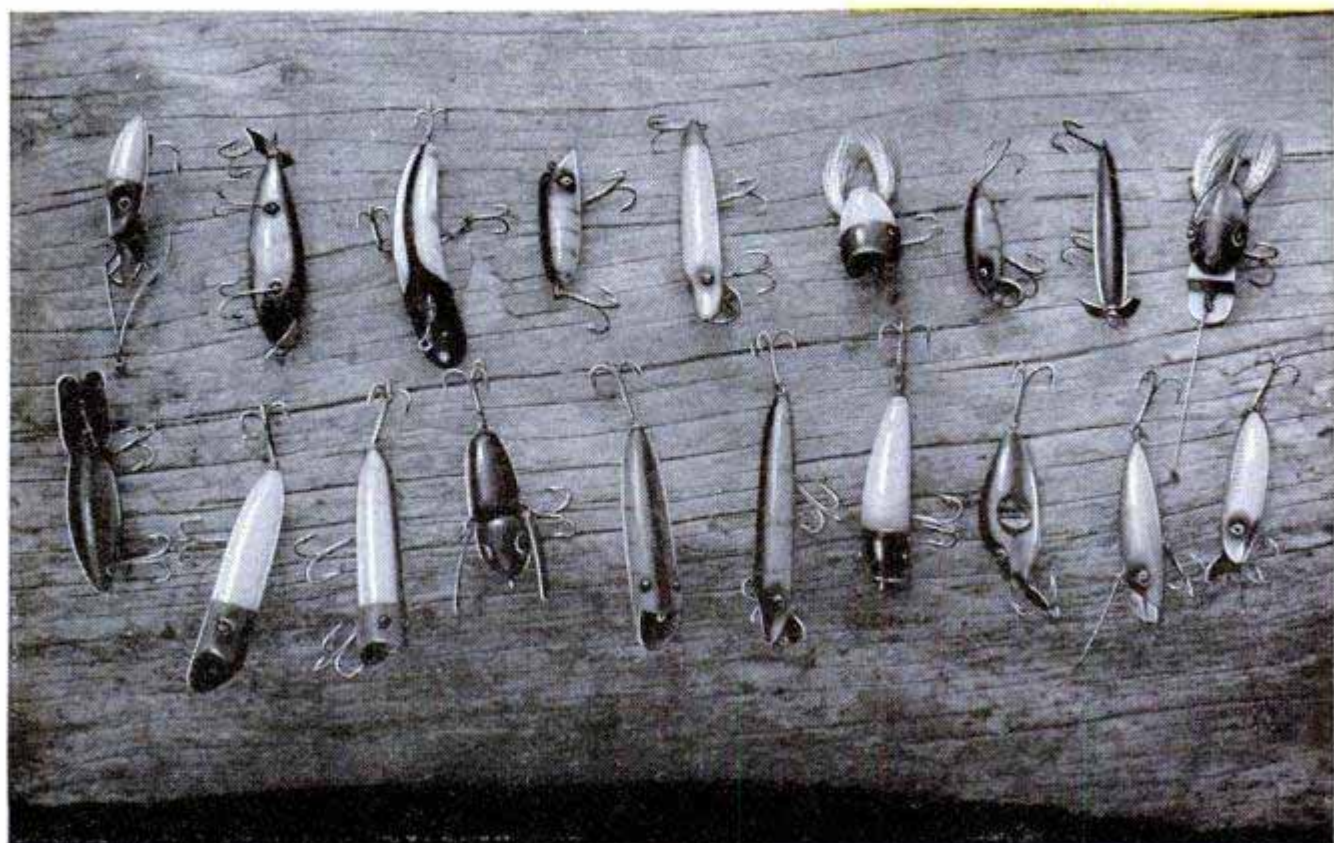



The wisest bass cannot resist a popping plug when expertly cast into pockets and tiny bays along a shore

A SAVAGE and spectacular warrior is the large-mouth bass, most popular game fish we have, and sought by more anglers, young and old, expert and beginner alike, than any other fresh-water game fish. The bass is at home in countless lakes, streams and sloughs in almost every state, and provides nerve-tingling sport almost the year around for he may be fished all through the winter in many states of the South and Southwest.

The seasoned angler will seek this bronze-back battler with a wide variety of tackle and methods, with both live baits and a large assortment of artificial lures, for never can he know what will please these notional and unpredictable game fish. Plugs, spoons, wobbling lures and surface poppers and flies all provide fine sport, and their use is more interesting and exciting than that of bait, so we will deal with this type of fishing, which is becoming increasingly popular.

There is a tremendous thrill for the angler when a great bronze-back seizes his deep-running plug or wobbler, makes a wild run to the surface and comes out in a mighty leap, his great head shaking, in an effort to dislodge the hooks; and still more exciting is when a great fish smashes a surface offering with fury, his wide mouth agape. Each type of lure and the method of fishing it has its place, and each is studied by the successful seeker after old *Microp-terus salmoides*.

There are hundreds of effective bass lures on the market of every size, color, action and weight. These may be divided into two general classes: the deep-running, underwater baits, which include plugs, wobblers and spinners; and the surface lures embracing the various poppers, "paddlers," "splashers," and scores of varieties of large flies. So beautifully colored and finished are many of these baits, and so varied the effective methods of casting and

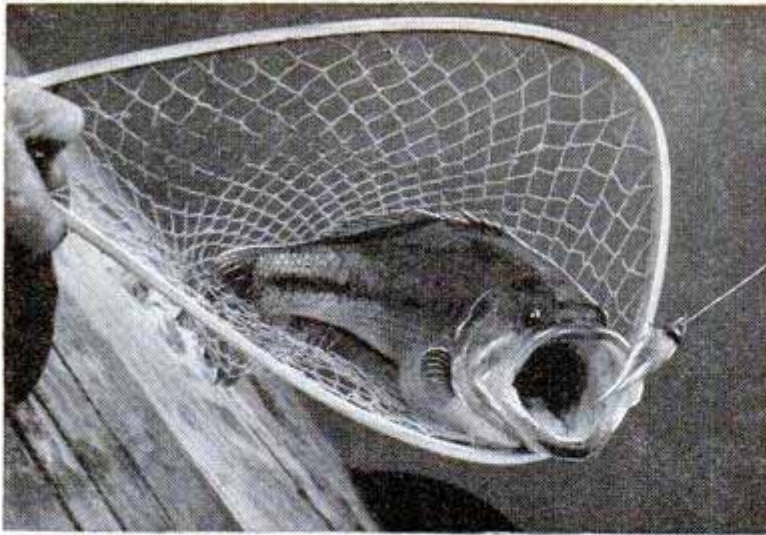

Big mouth? You bet. The mouth of the bass is tough and muscular, and large single hook of this fly-rod lure digs deep

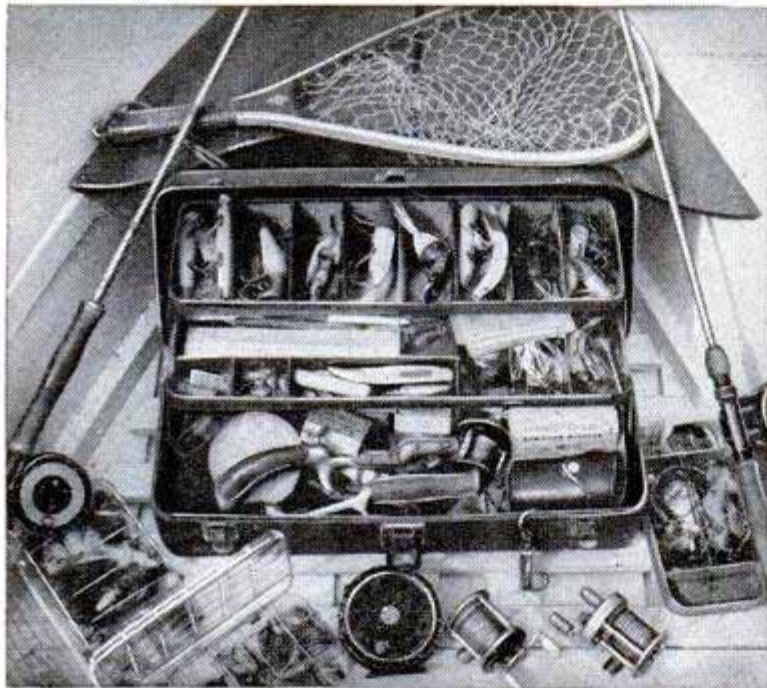

Well-stocked tackle box carries favorite plugs in tray and a box of fly-rod baits in box at right. Also present are a good fly reel and two level-wind casting reels which carry 100 yards of nylon line each. Below, "gang" hooks on lures penetrate well but can be shaken out by the leverage of the plug



"working" them, that just their possession and use contributes much to the angler's pleasure.

Surface lures: In warm weather, and particularly in shallow water, in the evening, bass will often be cruising for surface food, ready to smash anything that splashes or moves. It is then that the poppers provide the most thrilling sport. The larger sizes of these are cast with a light 5½ or 6-foot rod—for the best sport—and a level-wind reel holding about 100 yards of 10 or 12-pound test line of braided silk or nylon. The plug is placed near a lily pad, log or projecting boulder, and is retrieved in slow, short jerks, which produce a disturbance on the surface.

Such baits probably simulate the movement of a frog or drowning mouse, and so provoke a strike. Again, that savage surge of a big bass may be due to pure pugnacity. But always it is satisfying and exciting. Some poppers are designed simply to create a disturbance; others, with spinners attached, hair or feather wings simulate some type of small mammal or large insect. The wise angler will try them all when necessary.

Casting-rod popping lures will weigh from ½ to ⅝ ounce, since it is the weight of the plug which flexes the rod and permits easy, accurate casting. These can be handled nicely up to a distance of about 100 feet. And sometimes a "surface and subsurface" plug is best. It is a floater which can be permitted to lie motionless for a moment—perhaps a big bass is craftily watching it—and retrieved in short jerks or by steady reeling, which will cause the plug to dart and dive, depending on its shape and construction.

Fly-rod surface lures: The finest sport of all is in the use of a pliant fly rod for bass, and a big one will test its strength to the limit. The fly rod, of course, depends on the weight of the line to flex it properly and so permit easy, long casts. It is usually fitted with an oil-dressed line of silk or nylon of size "D" or "C" to fit the fairly powerful rod which this fishing requires. A good rod is one nine feet long, weighing from 6 to 6½ ounces. The reel may be any fairly large-size single-action fly reel.



James Corbell, national fly-casting champion, tests casting rod with offset handle and an effective surface plug with perch-scale finish. Below, he examines a favorite bass bug. Every kind of lure—and there are hundreds—answers special need

These lighter lures for the fly rod will weigh only from $\frac{1}{16}$ to $\frac{1}{8}$ ounce, and in the popper type will be made of cork, balsa wood or of one of these materials with feathers or hair wings attached. Retrieving is done by snapping up the tip of the rod while, at the same time, a bit of line is pulled in through the rod guides.

While all these popping lures attract bass by their surface disturbance, there are many types of bass bugs for use with fly rods which resemble very closely small frogs, minnows and large flying insects. Some are designed to float, while others will sink slowly, but come to the surface with gentle rod manipulation. All such bugs and the poppers have large single hooks, often protected by a slender wire to render them weedless, and may be cast directly on floating weeds, brush or lily pads. This is usually the best method of fishing them, the bug being skipped to the water from its resting place on the theory that a bass, often lying under the vegetation, will at once



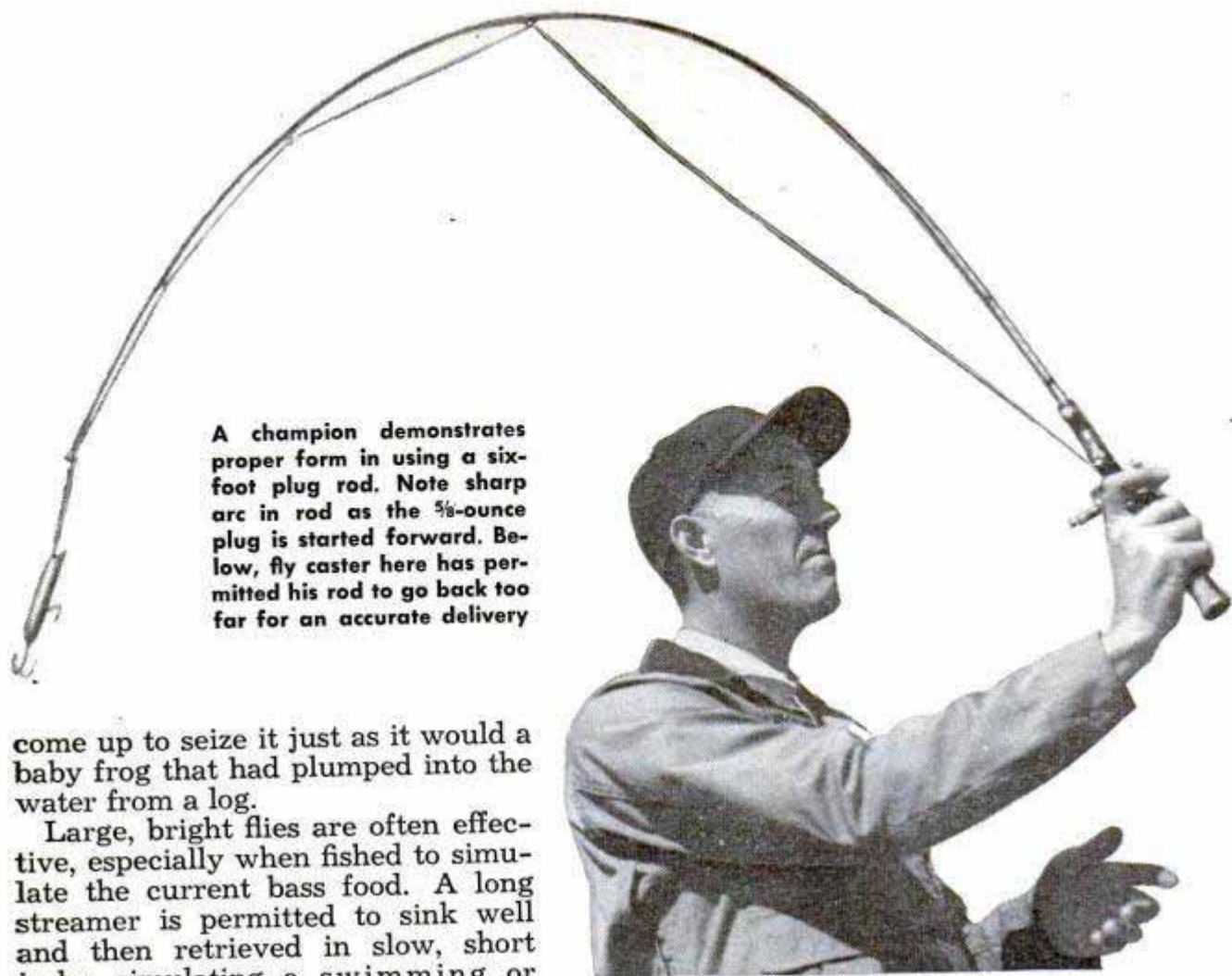

A champion demonstrates proper form in using a six-foot plug rod. Note sharp arc in rod as the $\frac{5}{8}$ -ounce plug is started forward. Below, fly caster here has permitted his rod to go back too far for an accurate delivery

come up to seize it just as it would a baby frog that had plumped into the water from a log.

Large, bright flies are often effective, especially when fished to simulate the current bass food. A long streamer is permitted to sink well and then retrieved in slow, short jerks, simulating a swimming or wounded minnow. Other bushier flies are fished on the surface with a slow movement, then allowed to sink a foot or two and retrieved with varying speed and action, when they probably imitate bottom-hatched nymphs of many insects coming slowly to the surface. And the brighter flies, colored like miniature rainbows, just seem to arouse the ferocious pugnacity of the large-mouth, and he smashes at them with utter abandon.

All these fly-rod lures may be fished either from a boat, from shore or by wading, and offer the utmost in thrilling sport, but knowledge of where the bass lie and the action of the lure is essential. Good casting is important, too, and the proper rhythm and timing with the various lures on the fly rod may be done on one's lawn at home.

Underwater lures: First there are the plugs, of a hundred sizes, shapes and colors. Some of these are designed to go deep, perhaps 20 feet down when reeled in fast, and many have a metal "shovel" on the head, which may be bent to increase the diving action. Others will sink of their own weight and literally crawl along the bottom, the action varying with the angler's style of retrieve. And very often such a plug is most effective when permitted to stop, then is started suddenly.



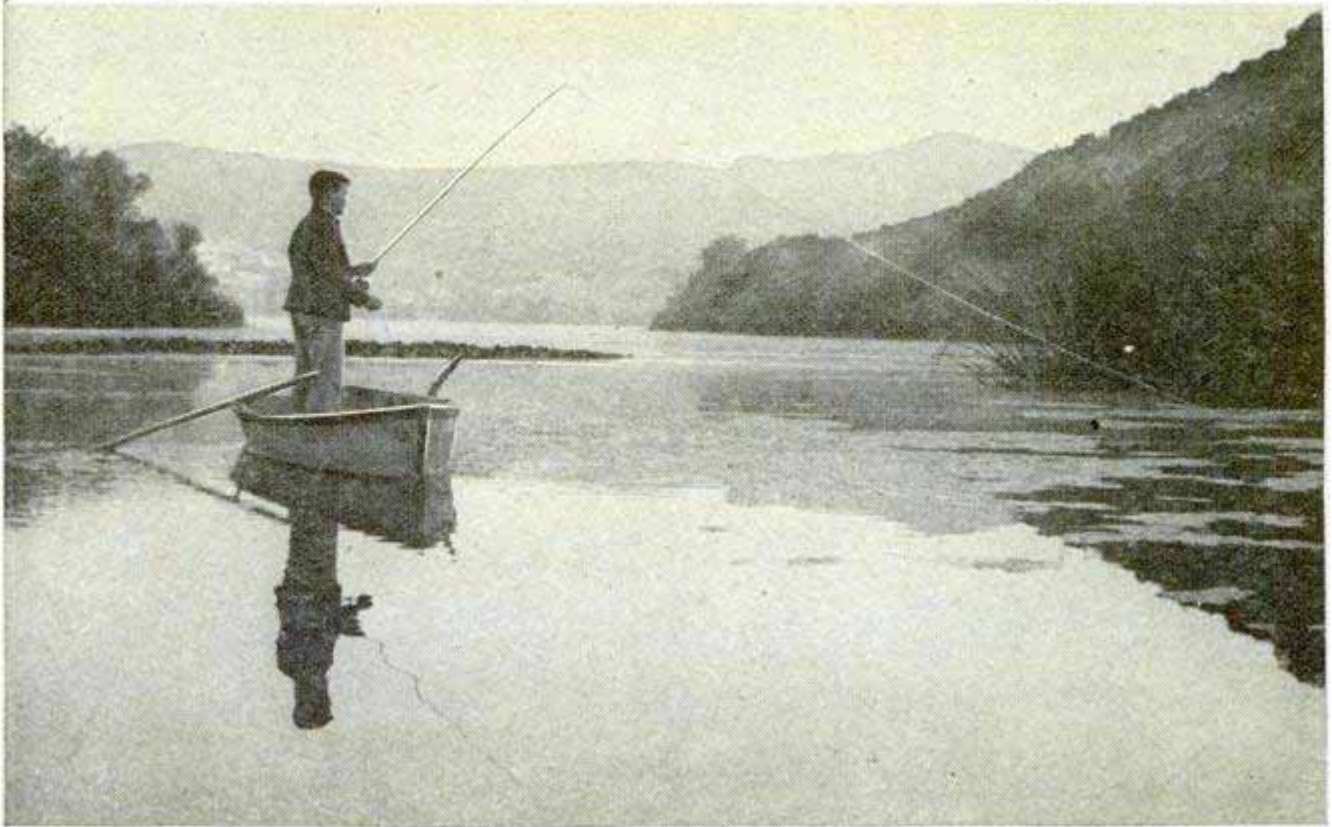

This angler is fishing a fly-rod lure with proper technique—rod tip well up and line slowly stripped in

These deep-searching plugs are best in deep lakes, having boulders, crevices and sunken logs, near which the big bass lie, and experience will help the angler decide when they are best. Next is the plug which goes to medium depth. It usually floats until the retrieve is started, then dives at once with irregular, darting motion, and so simulates a wounded minnow again. It is one of the best of all bass plugs when expertly maneuvered by the fisherman, for the predatory large-mouth cannot resist taking a minnow, especially one that apparently cannot escape.

Most of the plugs are equipped with two or more sets of "gang" hooks, usually fastened both fore and aft. These promise sure hooking of fish, and add considerable attractive action to the lure, but hang up easily on rocks, brush and logs. Also, they are attached to the body with a loose ring, and when a big bass leaps from the water shaking his head savagely, the leverage of the plug outside his mouth will often let him throw the plug—sometimes "right back at the boat."

Wobbling and darting lures: In this class we have the various "wounded minnows," of many types. Some of these are made of wood, curved for erratic action and fitted with many small gangs of hooks. They are

most effective bass-getters when used in color combinations such as red and white; mottled green; and finished with "scale" and "perch" markings.

The many wobbling spoons, with large, single hook are also popular, particularly in the bright chrome finish. These are usually fine weedless attractors, for combing grass and weeds along the stream or lake bottom. Then many of the large spinners, nickel, copper, brass, red, red and white, and all these colors in various combinations, will often provoke a big old "he" bass to surge from his lair.

There are many fine single-hook, weedless lures, which have a slender metal body for quick sinking, over which is slipped a skirt of fiber, plastic or shredded rubber. These skirts come in a variety of solid and variegated colors so the angler who favors this type of bait, a splendid one for easy bulletlike casting, has only to change skirts to please the whim of the waiting large-mouth. This bait sinks readily and can be fished far down directly beneath the boat by retrieving with varying speeds when the fish are unusually deep.

In considering the basic advantages of all these casting lures, for use with the casting rod, the action comes first: the

(Continued to page 244)

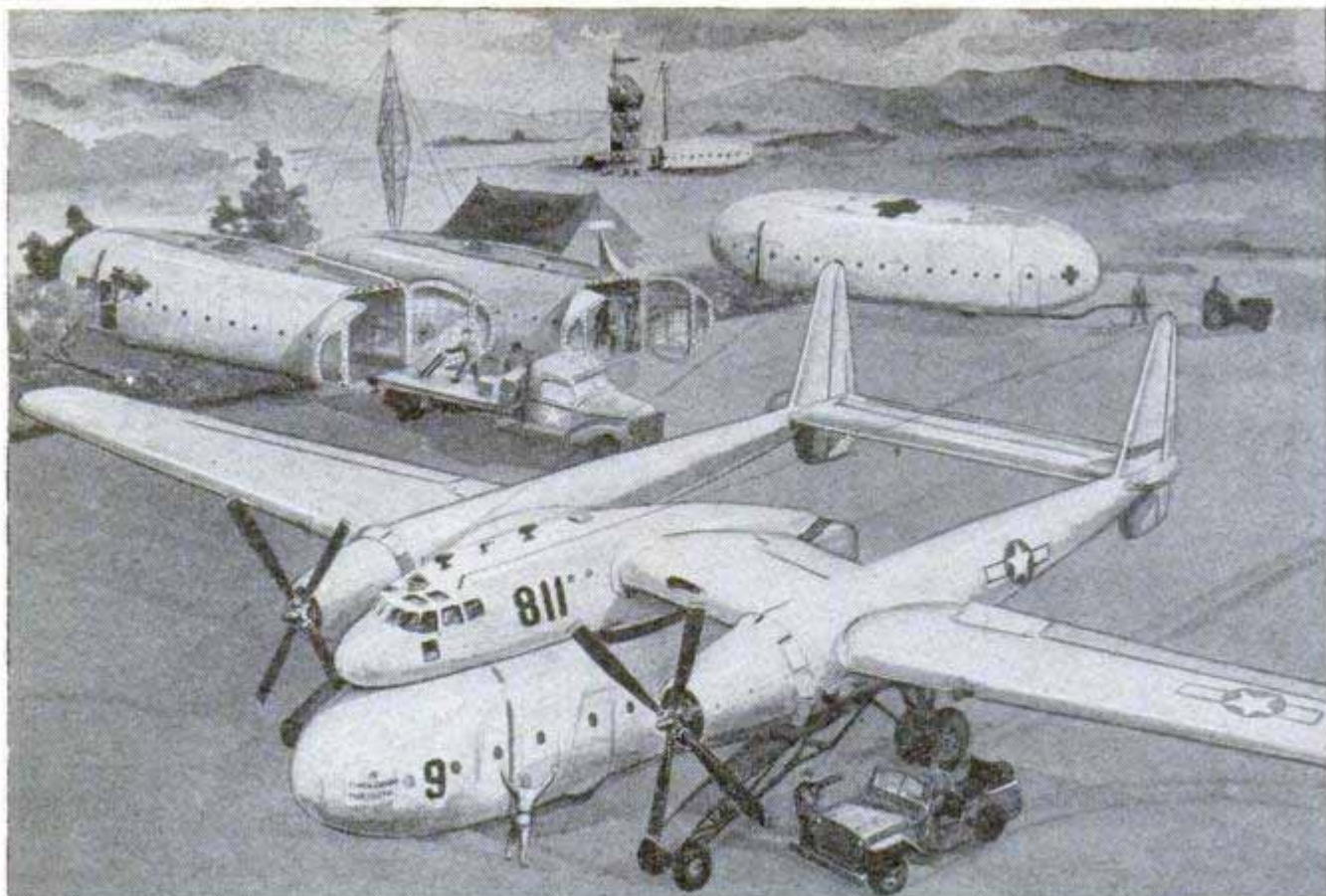

Fairchild Aircraft Drawing

USAF Pack Plane to Have Detachable Fuselage

Borrowing the trailer-truck principle, a pack plane being developed for the U. S. Air Force will have a detachable fuselage that can quickly be "traded" for another for return trips. It will carry nine tons of cargo or, as a medical unit, 36 litter patients. The plane itself will serve as an air tractor, flying with or without its pack or fuselage. Under the latter condition it is

expected to perform like a fighter, with high speed and maximum maneuverability for evasive action. In shuttle service it would permit air delivery of supplies and ammunition and the evacuation of wounded on return flights. According to present plans, it will have two Pratt and Whitney Wasp Major engines, with a take-off rating of 3250 horsepower.

Chicagoan Wins P.M. Camp Trailer

Winner of the camp-type trailer presented by *Popular Mechanics Magazine* at the World Hobby Exposition was Edward C. Helwig of Chicago. Ideal for vacation and camping trips, the compact trailer has a bed for two, closet space and cooking facilities that are reached through a rear door. It was completed at the exposition from plans printed in this magazine.



Our WHERE-TO-FIND-IT INDEX, listing names and addresses of manufacturers and sources of further information for products and articles in this issue, is available free upon request. This index is one of the many services offered to *Popular Mechanics* readers by the Bureau of Information. For your index, just write to the Bureau of Information, *Popular Mechanics Magazine*, 200 East Ontario Street, Chicago 11

BLUEPRINTS SV1102 - SV1105 \$1.50

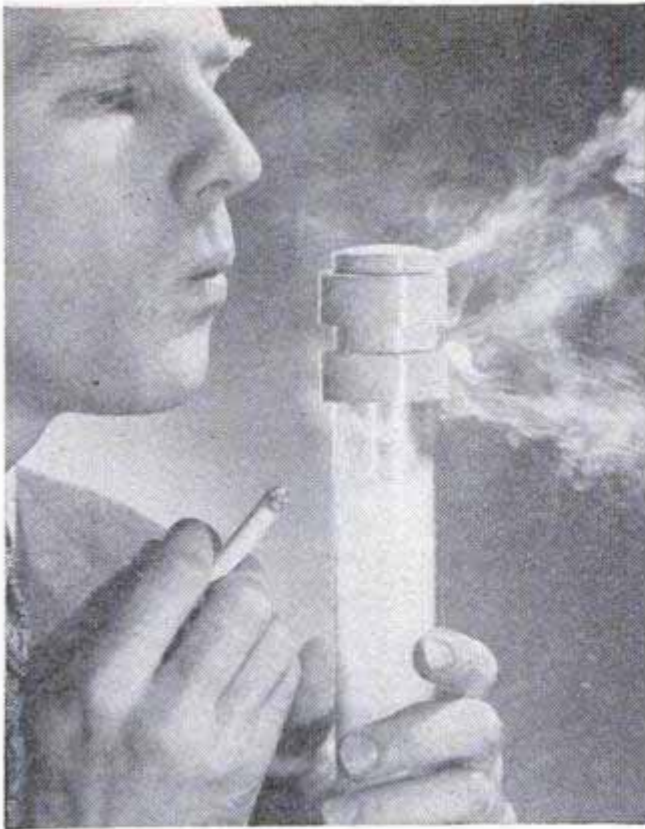

Chimney Model Shows Draft

Efficient chimney draft is illustrated by a unique plastic model that shows just what happens when wind strikes a new chimney crown from any angle. First, the model's transparent tube of Tenite plastic is filled with cigarette smoke. Then the chimney crown is blown on from any direction—up, down or across—and the force of the air creates a siphon effect which draws the smoke out through vents. Since the crown is round, air from any direction produces the same effect. Downdrafts are guided across rather than into the vents to produce suction.



Table Supports Portable Saw

Portable saws of one type can be mounted on a sheet-steel stand to convert them for sanding, wire brushing, tongue-and-groove work, and other shop jobs. The saw is mounted beneath the stand with the blade projecting through the surface. In this position the saw can be used for face sanding, cross cutting and sawing tile. With the saw mounted on its side so that the shaft projects through the table top, the assembly can be used as a drum sander, wire brusher and shaper for tongue-and-groove work. A switch extension simplifies control of the saw.

Runners on Mower Guide Blades

Sled-type runners on a power mower slide along the contours of the ground to guide the blades for an even cut. The mower's wheels always travel on cut grass, eliminating unsightly ridges. Powered by a 1½-horsepower motor, the machine is easily controlled by a lever near the handle which starts or stops both the cutting unit and the tractor. The mower is available in two models. One makes a 21-inch cut with a capacity of three acres per day and the other a 25-inch



cut with a four-acre capacity. With a steel-blade attachment the mower can be used as a snowplow in winter.



DAY-NIGHT THERMOSTAT is installed in five minutes. Mounted on any manual-thermostat bracket, it uses same wiring. Clock cord plugs into a wall outlet

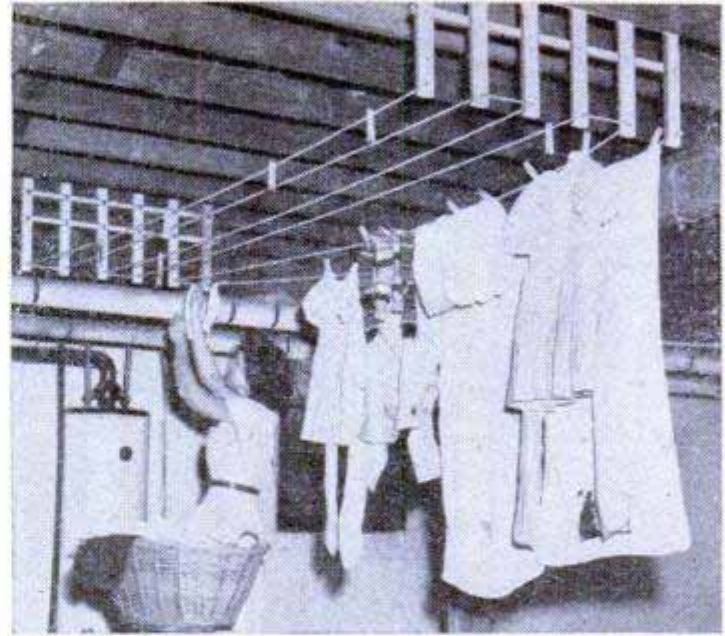

CLOTHESLINE HANGER swings up against ceiling (below) out of the way when not in use. When being used, it's pulled down to convenient height

WHAT'S NEW *For Your Home*

Sources of supply for these products may be obtained from Bureau of Information, Popular Mechanics Magazine

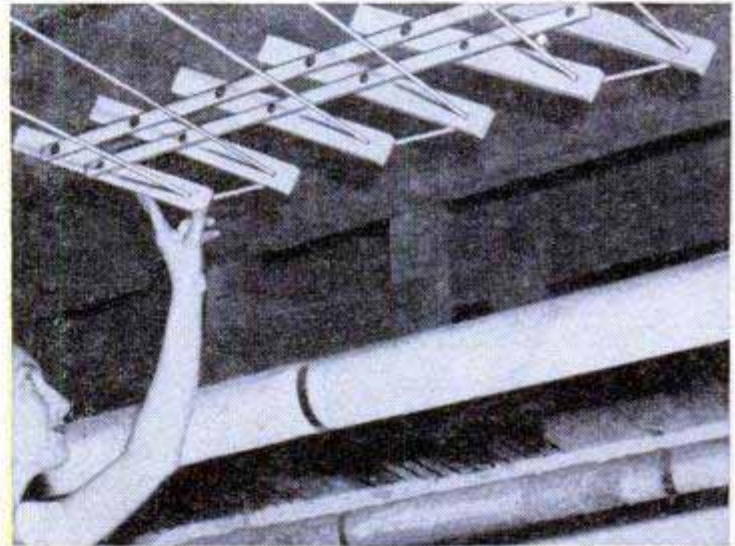

PORTABLE SPRAY will make any child anxious for bathtime. It's made of plastic tubing and has suction cups on the back for attaching it to tub. Used outdoors, it provides a cooling spray in summer

BABY-FOOD WARMER consists of a large cover and three small ones that hold jars suspended in water

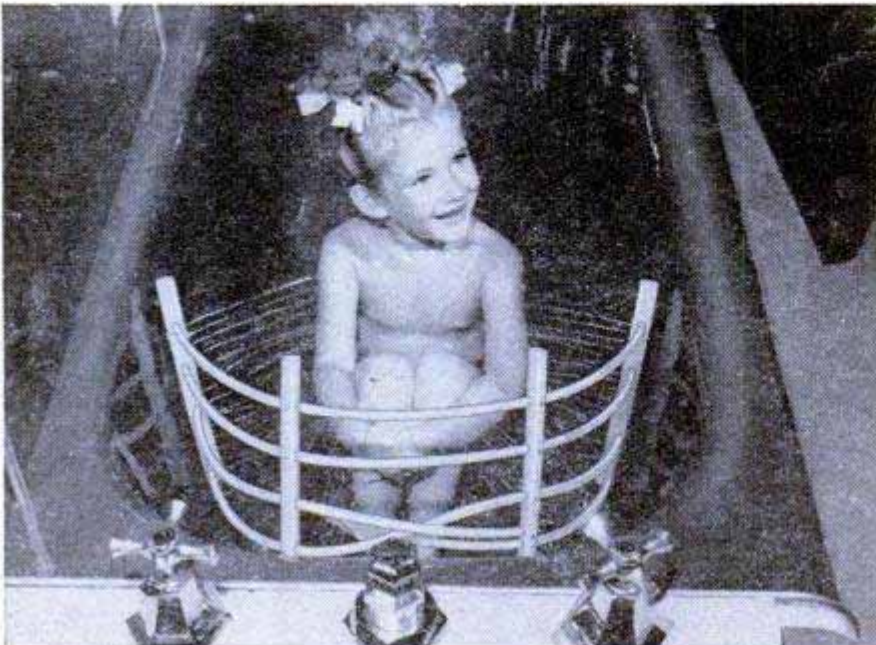



FRUIT JUICER catches juice in its double-duty base that serves as shaker when the cover is used



TILTING CHAIR provides a comfortable leg rest for sitting up and reading or, when tilted back, lets you relax with your feet in the air. The fabric covering is attached to the aluminum frame with springs

CONVERTIBLE HANDLE holds mop, brush or wax applicator. Spring action holds them all securely

NO-NAIL ROD is held up by pressure of rubber ends against walls. Plastic-covered rod telescopes to fit



SHELF HANGERS need only four large nails to hold them up. Boards up to 12 inches wide are laid across them. Lower shelves are then suspended from the hangers already in place

ADJUSTABLE LAMP locks in any position. The handle of Tenite plastic controls lamp movement. When released, it locks in place

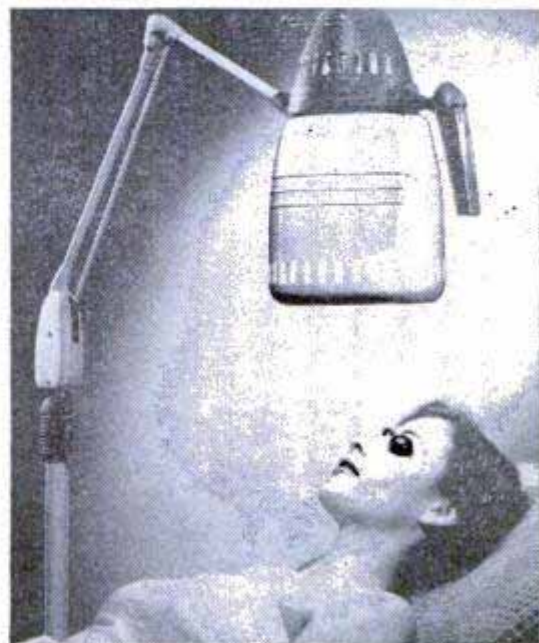
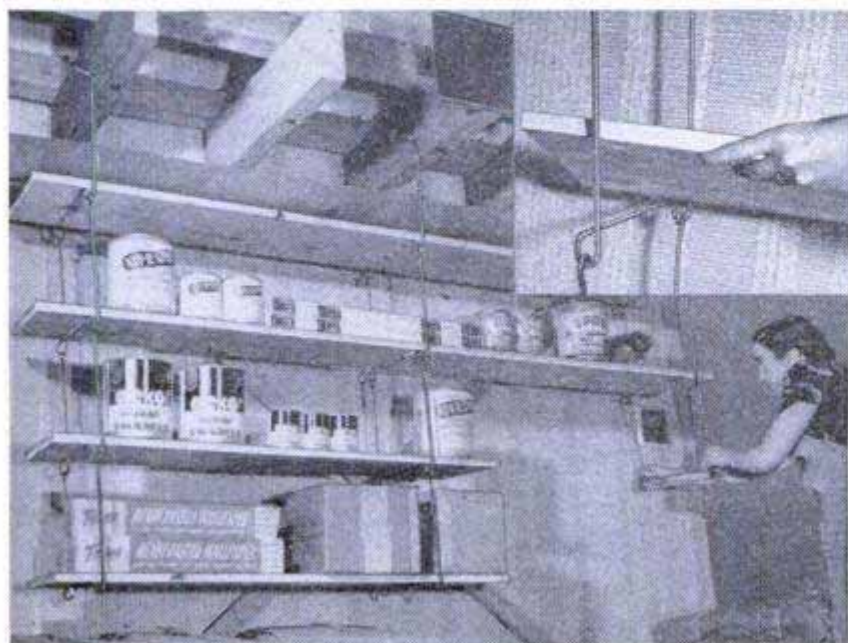



Above, workmen form rough stones from the mixture. Left, air gun sprays stone particles on the surface

Mortar Sculptured Into Stone

Artificial stonework that looks like the real thing can be applied to building exteriors or interiors and can be installed over any type of surface. The plastic stone is a mortar made by mixing natural stone with cement and insulating materials. This mortar is applied to the surface and hand-

sculptured into individual stones. Particles of natural stone in various colors then are sprayed over the surface. In the final step, each "stone block" is tooled around the edges to create a mortar-joint effect. The stone can be installed over shingles, siding, brick, stucco and concrete block.



Suction From Lawn Trimmer Pulls Grass Into Blade

Suction pulls grass into the blade of an electric lawn cutter designed for trimming around trees, flower beds and stones. The blade is constructed like a fan so that it draws the grass away from stones or flowers and into cutting range. The motor has a dustproof cover shaped like a bowl to aid in creating suction. The switch is located on the tubular handle which can be adjusted to the operator's reach. Powered by 110-volt alternating or direct current, the trimmer is available with 50, 100 or 150 feet of cord.

Furnace Burns Oil or Gas

Either oil or gas can be used as fuel for a new furnace burner. The gas component for the burner uses either artificial or natural gas. The regular No. 2 grade of oil serves as fuel whenever the oil burner is used.



Seismograph Forecasts Hurricanes By Spotting Tiny Earth Tremors

Certain weather predictions can be made 25 percent more accurately by measuring earth tremors, it is claimed by Dr. L. Don Leet of Harvard, inventor of a new seismograph. The new device, on which readings are made continuously and above ground, can discover and follow the progress of storms by measuring the microseisms, small earth waves that are standard messengers of hurricanes. They consist of very slight tremors that only the most sensitive seismographs detect. These waves travel more than a mile per second through the ground and may be recorded as far as 1000 miles from the "eye" of a hurricane. The new seismograph is buried in the ground, but earth tremors are recorded on a roll of paper by a machine in the operator's office. With the old type of recorder, seismologists had to go underground to observe the recordings or wait until photographic plates were brought up and developed.

Our WHERE-TO-FIND-IT INDEX, which lists names and addresses of the manufacturers or distributors of products described in this issue, is available to readers without charge. For your copy, just write to Bureau of Information, Popular Mechanics, 200 East Ontario Street, Chicago 11



Pocket-Size Plastic Binoculars

Consisting of only 12 separate parts, six of which are of Bakelite plastic, a pair of binoculars is lightweight and small enough to carry in the shirt pocket. The plastic parts are formed simultaneously in the same mold, making it possible for the manufacturer to produce the item economically.

Synthetic Rubber Is Improved When Produced at Zero

Tropical temperatures may be best for natural rubber trees, but tests have proved that a better synthetic rubber is produced when the temperature is held down to zero. Synthetic rubber made under frigid conditions has a tensile strength and stretching ability equal to natural rubber. In resistance to cracking and abrasion, it is expected to be superior to the natural product. Previously, synthetic rubber was made at a temperature of 125 degrees. Heat speeds the processing and as the temperature was lowered the time required increased until chemicals were found that cut processing time to the original 12 hours.

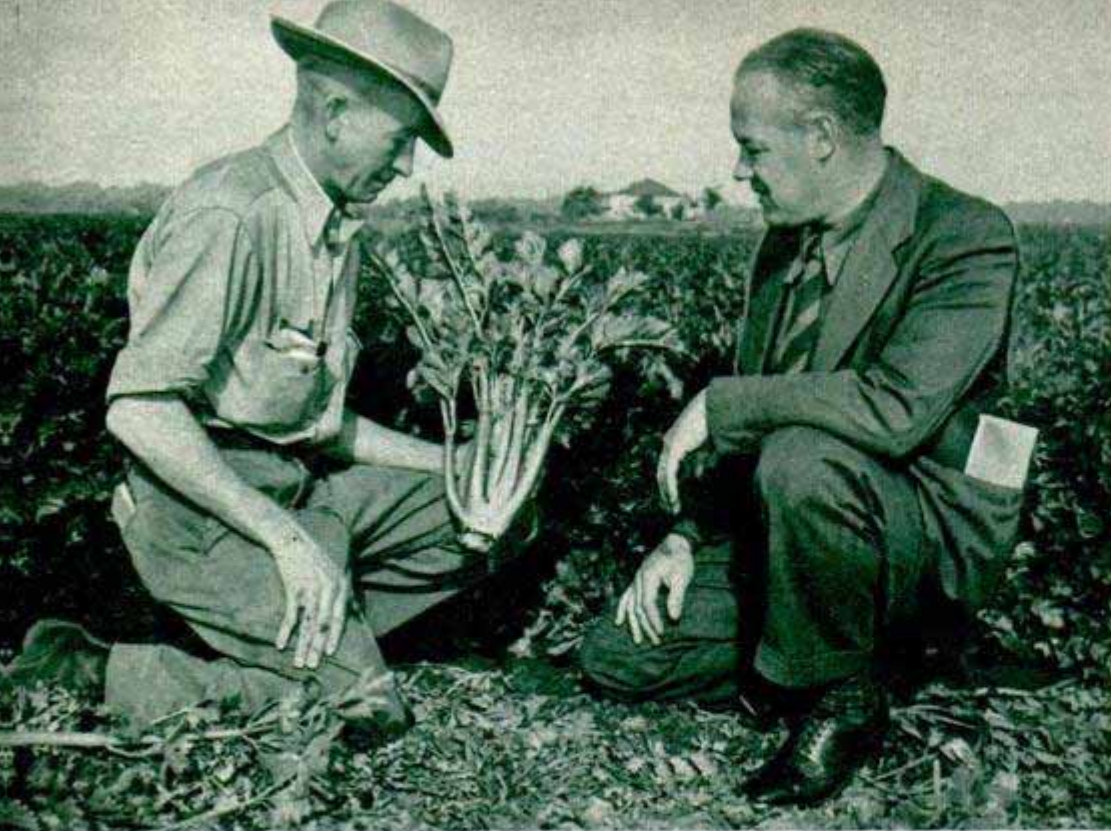

As soon as this celery is harvested, the farmer will plant another crop

By Thomas E. Stimson, Jr.

THE POT OF GOLD at the end of the rainbow is small change to the farmers of the Chula Vista district near San Diego. They reap a pot of gold off every acre, two or three times a year.

"Did all right last year," one of them muses as he figures his income tax. "Grossed \$2300 an acre from celery, another \$2000 from tomatoes. Total, \$4300. Costs were \$1900 an acre and that leaves a profit of \$2400. Now I multiply that by 20 acres . . ."

Fantastic? It sounds

Pay Dirt in Chula Vista

Scientific farming in this Garden of Eden with fertile soil and 12-month season yields profits of \$2000 to \$5000 an acre in cut flowers and vegetables

Crop-dusting with a helicopter means a bigger yield. Here the hoppers are filled for a jump



so to farmers who consider a couple of hundred dollars an acre a good return. But some of the Chula Vista farmers do even better. Last year one man banked \$5000 an acre from cut flowers.

Chula Vista adjoins San Diego Bay, a few miles north of the Mexican border. The town and its environs boast the "world's shortest thermometer" with a winter average of 55 degrees and a summer average of 67 degrees. Some days are much hotter, of course, and the oldest inhabitants can recall a few winter frosts. But growers who keep smudge pots handy in case of a freeze rarely light them except for a routine test.

The year-round growing climate allows cultivation of two or three crops on the same ground in a year. A man who plants early cucumbers, for instance, may replant with string beans as soon as he harvests the cucumbers, and then raise a crop of asters after the beans are picked.

This doesn't mean that Chula Vista has a magic soil or that anyone can stick a few seeds in the ground and automatically become rich. There are plenty of farmers in the district who earn only average incomes. The secret of success is the application of scientific knowledge and good business principles to agriculture. These pay off in Chula Vista just as they can boost farm profits anywhere. High income per acre is based on raising large tonnages of top-quality vegetables that are harvested at times when the same crops are out of season elsewhere.

Chula Vista is only one of numerous examples of high-income regions. Farms in the Encinitas district north of San Diego, in much of Los Angeles County, and in other areas as far north as Lompoc

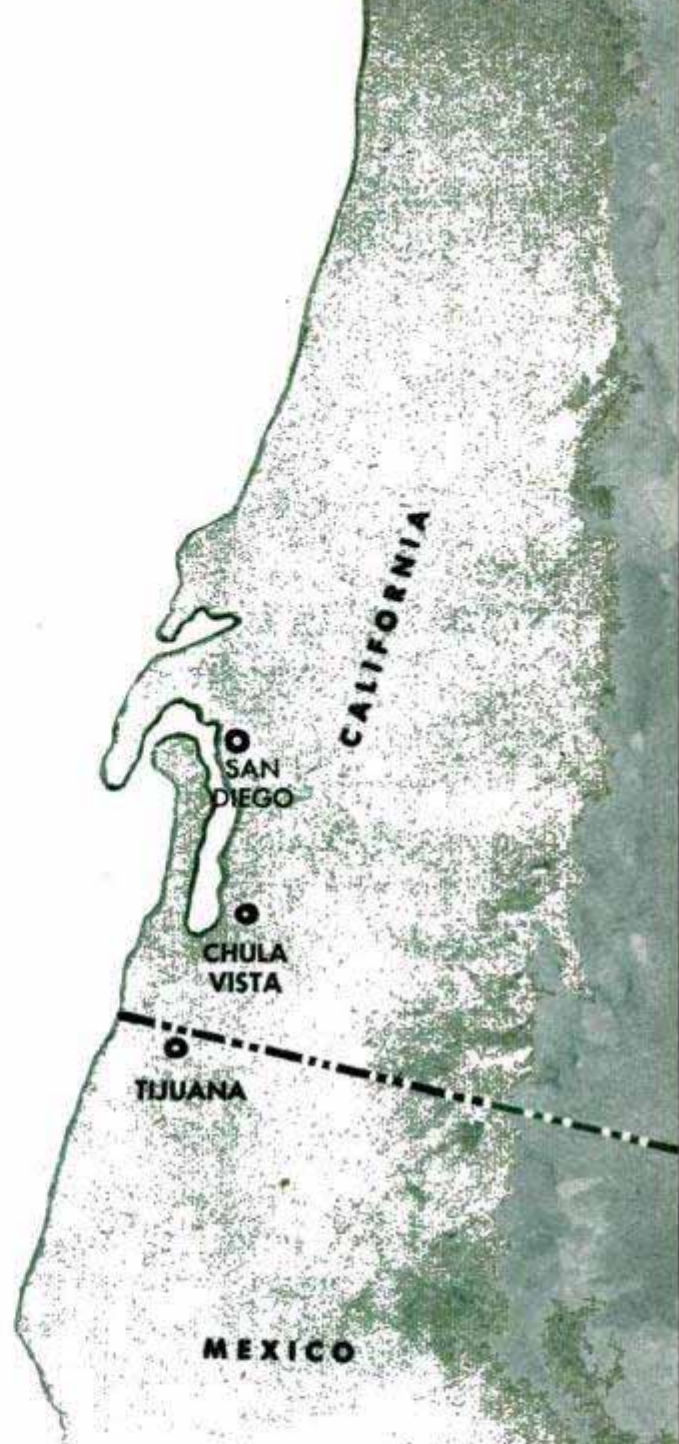

Map at right shows the location of Chula Vista, one of the richest farm areas in the country. Below, a helicopter hovers over a cauliflower field to dust the plants



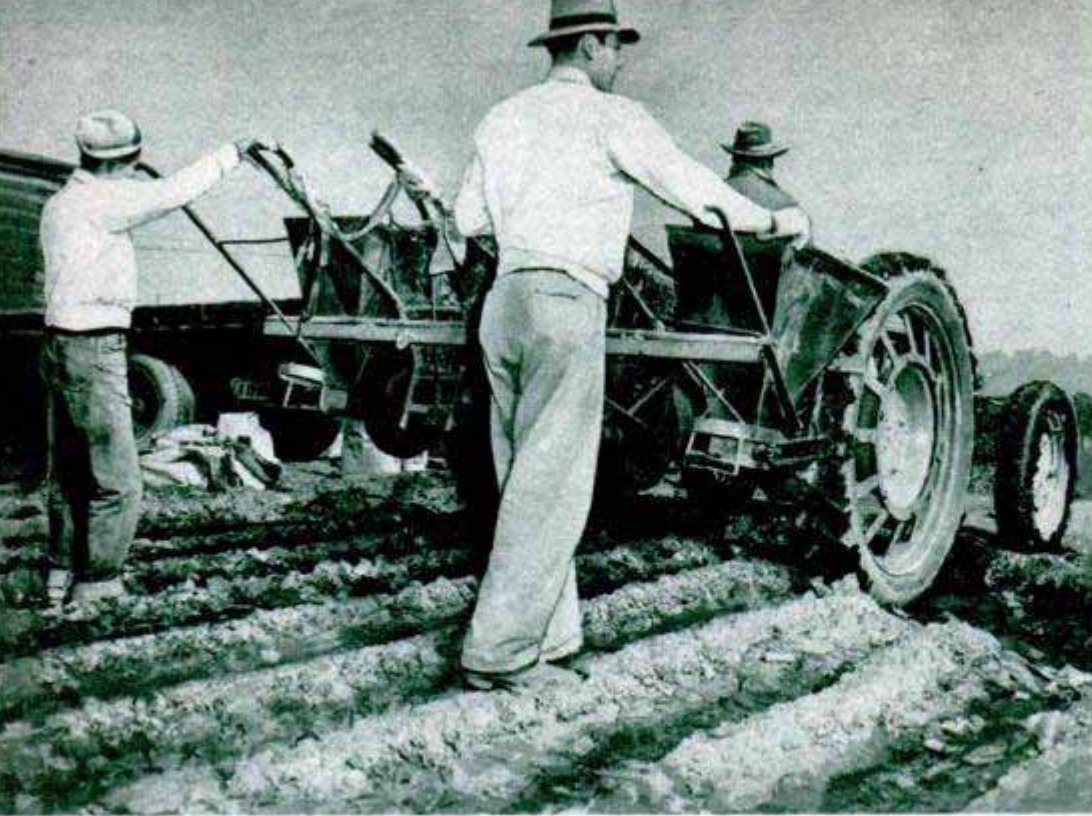

Four small fertilizer machines, normally operated by hand, are attached to a tractor, permitting workers to fertilize four celery rows at once

in California are made to yield big returns. Carroll Lorbear, for instance, who grows winter celery and summer lima beans in West Los Angeles almost under the shadow of the Douglas aircraft factories, has grossed as much as \$40,000 from a seven-acre portion of his farms in an exceptional year.

Market fluctuations can make a farmer rich or poor almost overnight and most Chula Vista growers try to stabilize their income by doing their plantings over a period of weeks or longer. They prefer a long harvest season to the possibility that

they would have to market an entire crop when the market is glutted.

Price fluctuations can have odd results. One farmer who was virtually down to his last dollar two years ago unexpectedly cleared a big income simply because he fell ill with influenza. He had staked all his money on tomatoes and then, when the crop was ripe, the price fell so low that he couldn't afford to pick them. He'd lost his shirt and all his friends advised him to plow the tomatoes under and get another crop into the ground as fast as he could. But he no sooner started to plow when the flu put him in bed.

Meanwhile, a sudden frost killed off the tomatoes in another section of the country. The price shot from two cents to 10 cents a pound. The farmer's tomatoes were still prime and as soon as he got out of bed he started to harvest them. He ended up with a lot of money in the bank.

One businesslike farmer in Chula Vista finds it profitable to fly east for checking up on the markets and arranging his shipping schedules, even though his entire farm is less than 10 acres in size. Others who operate 30 or 40 acres are apt to spend \$800 a year in long-distance telephone calls, an

Two men sweep down eight rows at once with a spray boom, while other workers support the 400-foot hose. During some years water is scarce at Chula Vista



expense that pays off in obtaining the best prices.

Super-intensive cultivation produces fabulous crops. A typical example is the production from the 40-acre Chula Vista farm of Jaekel & Rogers. This farm is organized like any good business concern, with W. F. Rogers in charge of sales, Bob Conforth in charge of production, and Elmer Conforth in charge of equipment.

The farm has its own packing shed and spur track. Refrigerated cars carry much of the production to the Northwest, Midwest and East. Some 15 people are on the regular base payroll and employment sometimes runs as high as 100 during harvest seasons.

From their 40 acres Jaekel & Rogers harvest as much as 80 carloads of celery every winter and some 500 tons of tomatoes, plus 24,000 dozen ears of corn every summer.

To obtain this astonishing production,



Combination planter built of several machines speeds work by laying four rows of fertilizer, shaping seed beds and planting them in one operation

Bob Conforth keeps men and equipment busy in the fields every day of the year. There is practically no slack time. Celery, for instance, requires that the field be plowed, disked from six to 10 times to pulverize the soil, leveled, furrowed, planted,

Power spray rig has nozzles aimed at different angles to shoot insect spray on celery rows from the top and from both sides



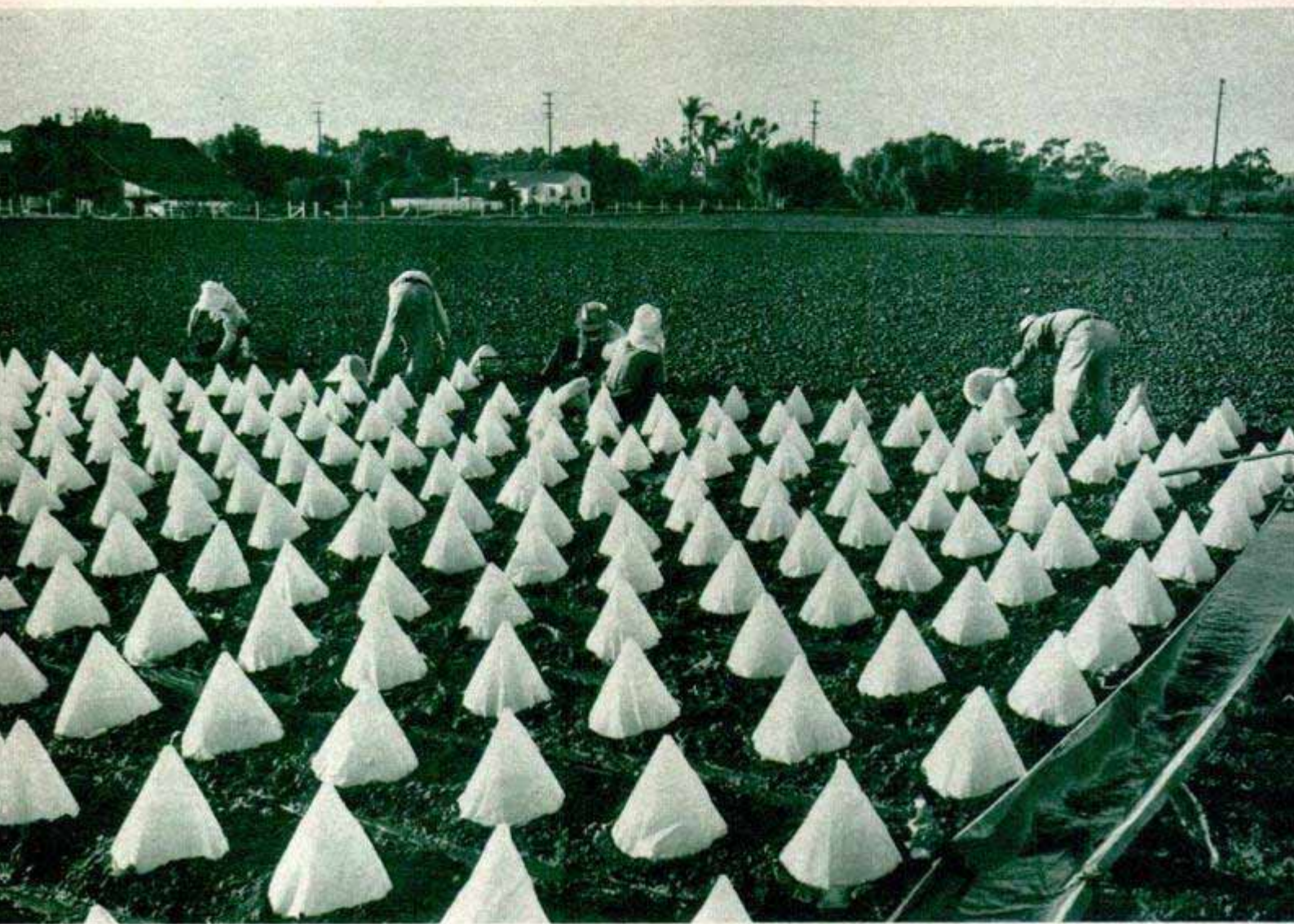

Pepper plants are kept humid and warm during the late winter with paraffin-paper bags shaped like wigwams

fertilized several times, cultivated numerous times, sprayed frequently and irrigated periodically before harvesting.

For one purpose or another men ride equipment through the field or walk the rows a total of 45 times during the season. Each single acre involves 100 miles of equipment movement and 45 miles of walking on foot. Even this is not enough in itself. A quality crop hinges a great deal on the timing of the different operations. The entire farm including all personnel must

operate with the smoothness of clockwork.

Each acre of celery ground is fertilized with 2½ to four tons of commercial fertilizer heavy in phosphoric acid and potash and in addition some 20 tons of barnyard manure are spread over each acre. Dusts and sprays are employed against blight and aphids. Weeds are kept down with chemicals and with hand weeding. The total pre-harvest costs are in the neighborhood of \$800 per acre.

Jaekel & Rogers begins transplanting cel-

Celery on this five-acre field absorbs heat during the day. Late in the afternoon huge canvas covers are spread over the field to help the plants retain the heat. Young celery plants grow faster under this protection

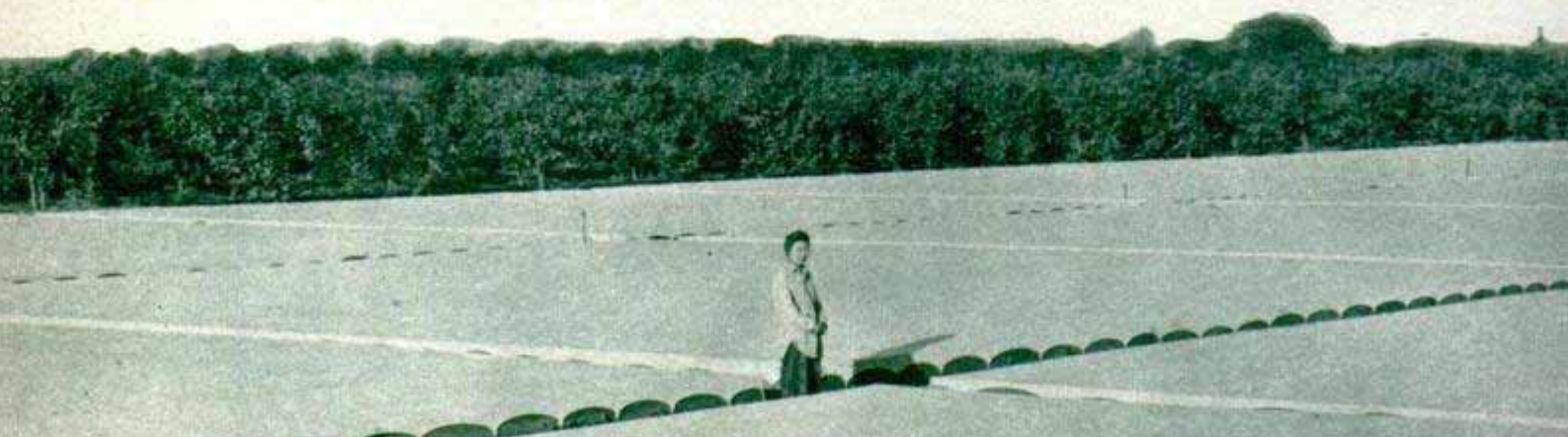

ery into the fields about August 15 and continues to plant until the middle of October. This provides a long harvest season that runs from December 15 to March 15.

To make most efficient use of the sun, rows are laid out in an east-west direction and the seedlings are planted along the southern exposure of ridges. If the slope of the land requires north-south rows for proper irrigation, the seedlings are planted on the east side of the rows to take advantage of the early sun. Consistent with the dimensions of the field and with good irrigation practice the rows are as long as possible. Long rows reduce the number of turn-arounds for equipment at the ends of the field, cutting down the time required to cultivate each acre.

Preparation of the soil for summer crops begins almost on the day the celery is harvested. Sweet corn is planted beginning in late February, pole tomatoes are set out in late March. The corn will be marketed in July, August and September, and the tomatoes will bear from the 10th of July until early winter. A small acreage is planted to miscellaneous crops for use by the farm employees.

The farm's equipment includes two track-type tractors, a spray rig on a wheel tractor, plows and a subsoiler, two disks, six cultivators, power dusters and hand dusters, and fertilizer equipment. Mules are used to pull the cultivators. Jaekel & Rogers tries out new mechanical equipment as

Top, Chula Vista flower grower tunes in ball game on the radio he installed on his tractor. Center, two-foot clearance of bumper permits car to be driven across fields. Right, sheet-metal gates dam irrigation water

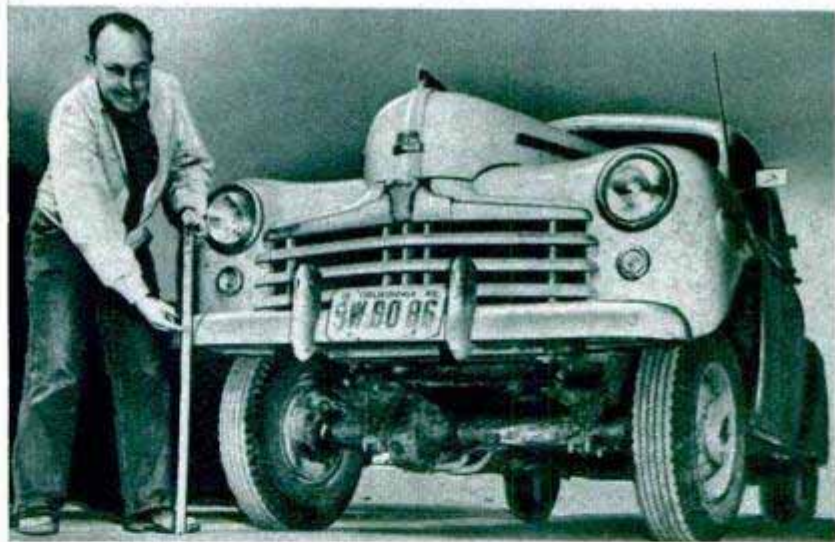



Endless belt conveyors move the celery past workers who trim the stalks, grade them and pack them in crates to be loaded into refrigerator cars. ↓ Flatbed trailer has a hand-operated hydraulic lift so the bed can be raised or lowered when equipment is transferred from one field to another

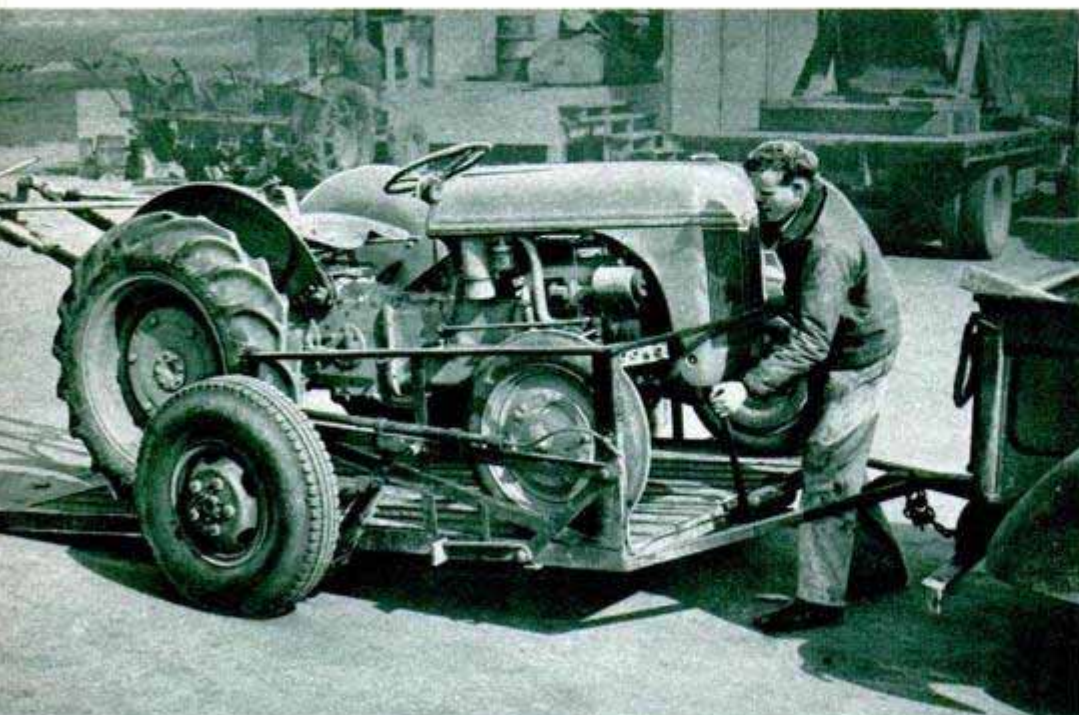

soon as it becomes available and the firm devotes part of one field to test plots in which new seed varieties, new fertilizers and new farming methods are evaluated. The farm makes use of the advisory services offered by state and federal agricultural agencies.

How small an acreage in Chula Vista can support a family? That's hard to say, though an ex-construction foreman by the name of C. D. Cash does very well on 8½ acres. With water, planning and hard work he has turned his small acreage into a gold mine.

Cash raises giant column stock on 3½ acres, summer asters and vegetables on the rest. At the peak of the winter stock season he ships hundreds of dozens of cut flowers by air to eastern florists. He gets top prices. He makes some deliveries in nearby San Diego and he derives part of his income from the flowers that he sells from a wayside stand on the highway alongside his farm.

The logical question is, why doesn't everyone rush to Chula Vista and start right in to make a fortune? There are lots of reasons against it. In the first place, while commodity prices may be high at any given time, no one can tell when they will drop, cutting deep into the farmer's profits.

In the second place, the Chula Vista district includes less than 100 square miles of agricultural land and all of it is in use. There is salt water on one side, the international border on another, the city of San Diego at the north and some barren hills on the East. There's simply no room for expansion in the area. In all, the district produces \$1,500,000 worth of celery

per year, the same amount in lemons and other citrus crops, \$500,000 worth of cucumbers, plus \$1,000,-000 worth of other crops.

The cost of farm land is up in the thousands of dollars per acre and water is always a problem. Some farms get irrigation water from their own wells but underground water can't be found everywhere. Reservoir water may cost as much as \$200 per acre per year and in a dry season like the spring of 1948 it could be severely rationed for irrigation.

Finally, not everyone makes a success of farming. There is a special know-how to scientific agriculture. The big-income farmers of Chula Vista have it, acquired from education, experience and experiment. They know that only by cashing in on the year-round growing season can they keep profits up. And year-round cultivation means year-round work for the farmers of this Garden of Eden.



C. D. Cash has made as much as \$5000 per acre from cut flowers like those he is tying in bundles here. Below left, an A-frame attached to a surplus Army command car comes in handy for lifting heavy equipment. Below, although smudge pots are seldom needed, they must be tested every year

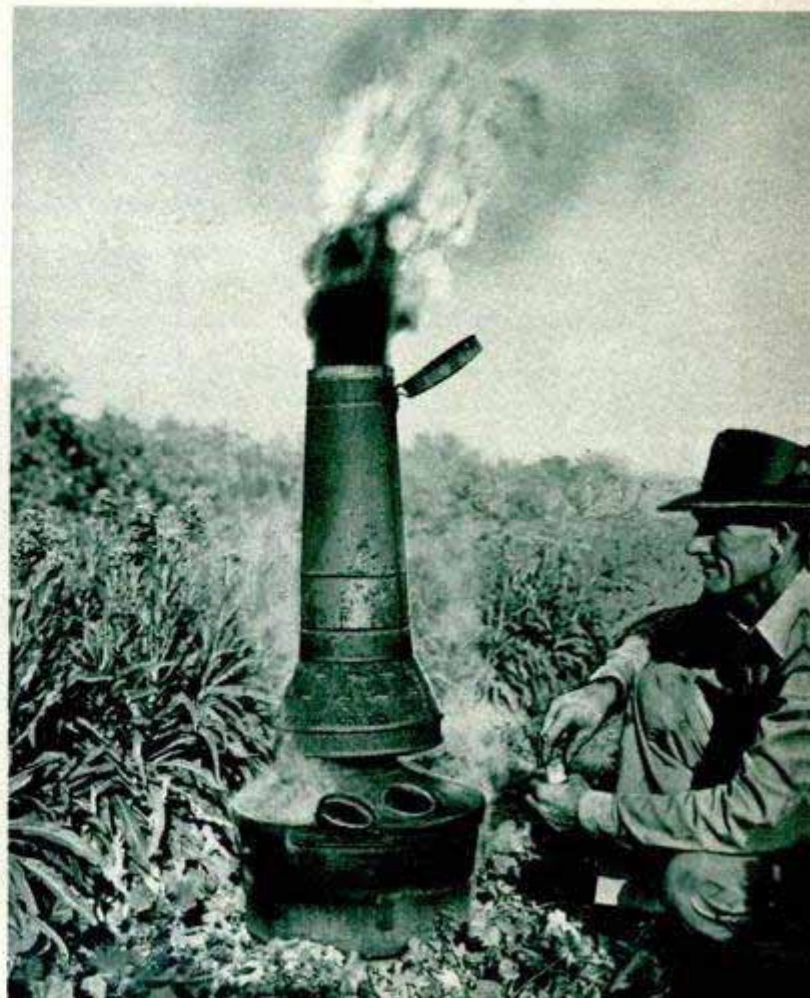
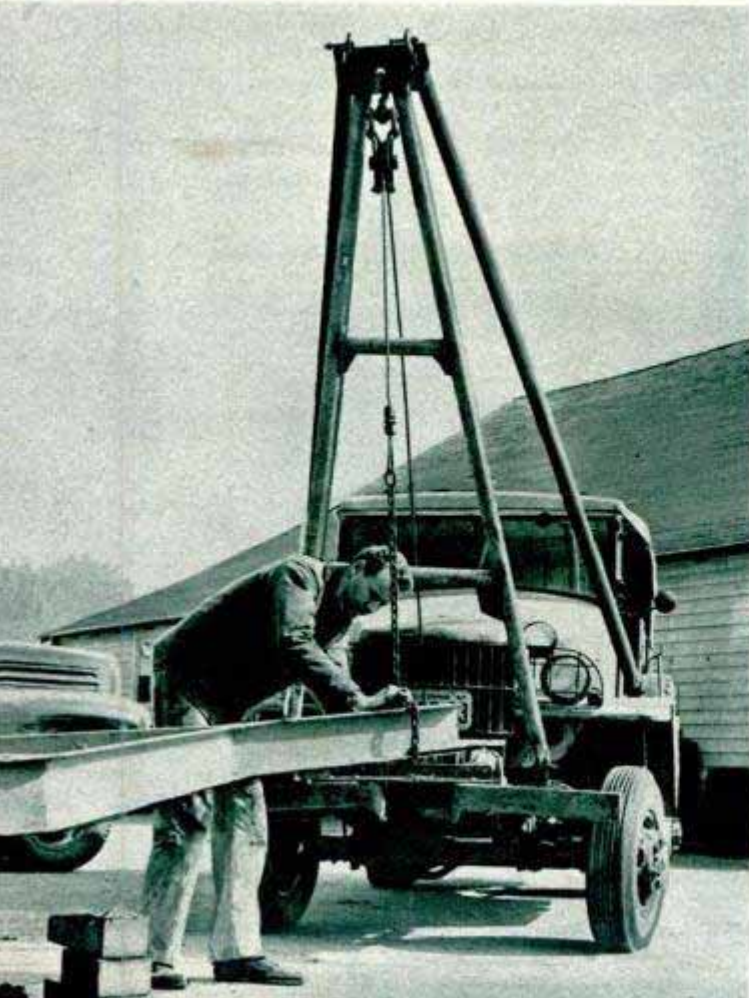



STONE CARVERS' ART REPAIRS BOMB SCARS

Craftsmen using century-old techniques are patiently wiping bomb scars from the masonry of St. Paul's Cathedral in London, damaged by air raids during the war. The cathedral was built during a 35-year period starting in 1675. Today the workmen are using bow drills and other tools that have remained unchanged in the centuries since that time. Damaged arch stones are carefully replaced by stones carved in the same patterns. Only through handwork can some of the old mosaics and carvings be duplicated. A giant screen will be built across the cathedral to permit later work on the interior. A few scars will be left to mark the peril which the cathedral survived.

Copyright Central Press Photos, Ltd.

Staging for the repair of the choir arch and vaulting has been thrown across the cathedral. Upper right, these damaged arch stones will be duplicated by carving new stones by hand

↓ Carver operates a bow drill similar to those used by workmen in 1675 when the cathedral was started. Below right, a new carving is patiently matched to old work by a stone carver



Luxury Bus Has Washroom

Travel luxuries that include a cabinet for cold drinks, a drinking fountain, individual radios and a washroom are found on a new 50-passenger highway bus. The bus is divided into three compartments on two different levels. A 12-seat compartment on the lower level has the refrigerated cabinet, fountain and washroom. On the upper level, reached by two stairways, are the forward compartment seating the driver and six passengers, and the main compartment with 31 seats. Each seat has a pillow-type radio which can be heard only by the individual passenger, who has a choice of two programs. A public-address system permits announcements by the driver. The Greyhound bus is powered by two air-cooled, six-cylinder engines, rated at 150 horsepower each, installed at the rear. Under normal conditions one engine powers the bus while the second operates the acces-

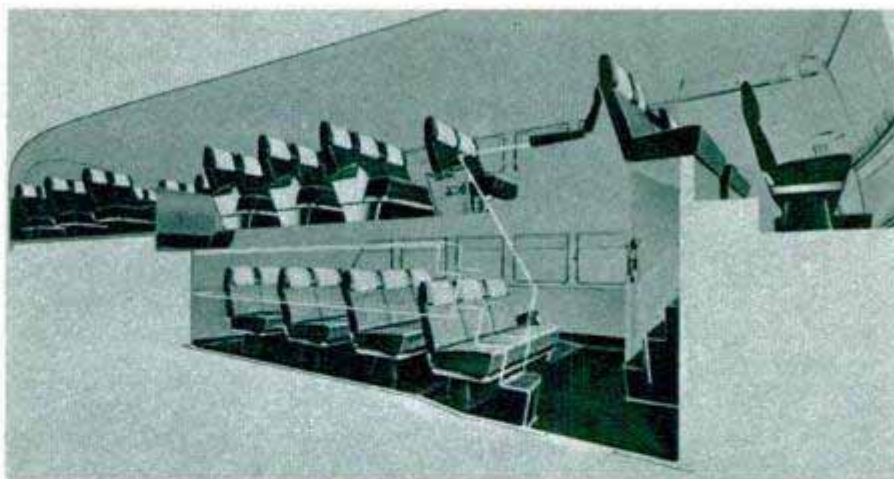

sories. On steep grades the second engine cuts in automatically to maintain power without a shift in gears. Other features include a crashproof gasoline tank made of rubber, and tires with steel wire cords.

Air From Spare Tire "Blows Up" Canvas Bunkroom Atop Car

Tourists can make their bed on top of a car with a canvas sleeping compartment. When collapsed for travel the compartment extends only 11 inches above the top of the car. The dressing compartment is 6½ feet high and is built into the trunk. Flexible hoses inside the canvas are inflated with

air from the spare tire to "blow up" the canvas to three feet high. Inside the compartment are a full-size mattress and springs, a dresser drawer, two folding chairs and a wash basin with water under pressure. The water tank is equipped with an automatic gasoline heater.



Left, 6½-ft. dressing compartment extends into the car trunk. Right, the three-foot-high sleeper is collapsible



Tomorrow's cars may spurt up hills on superfuels, but the high-octane gas will cut deep into the driver's budget. Engineers seek a solution in a dual-fuel system — standard gas for cruising and a jet of high test for quick starts

ONE CAR— TWO GAS TANKS

DUAL-FUEL SYSTEMS which will permit the motorist to cruise on standard-grade gasoline and switch to a high-octane tank for quick acceleration or hill climbing may be the best answer to the demand of the motoring public for better performance and economical travel.

Those who read of the 100-octane gasoline developed for warplanes have wondered when this superfuel would be ready for their automobiles. Today's automobiles do not need it. Already engineers have road-tested an auto equipped with a dual-fuel system and demonstrated that it operated without engine knocks on 40-octane gas during most of its time on the road.

This experiment is part of a cooperative effort by the automotive industry and Soco-Vacuum Oil Co., Inc., to provide more miles of travel per dollar spent on

Signal panel shows driver which fuel is used. With both carburetors in operation, center light glows. The left light represents low octane, right high octane. If the driver switches to only one fuel, one of the other lights glows



gasoline, and optimum performance from fuel in automobiles already in the drawing-board stage.

In the automobile industry, there is a definite trend toward engines with still higher compression ratios which will give benefits in better performance and greater economy. Whether, for this development, fuels with higher octane-number ratings are necessary to provide knock-free performance over the entire operating range is open to question. Dual-fuel systems may provide a common meeting ground.

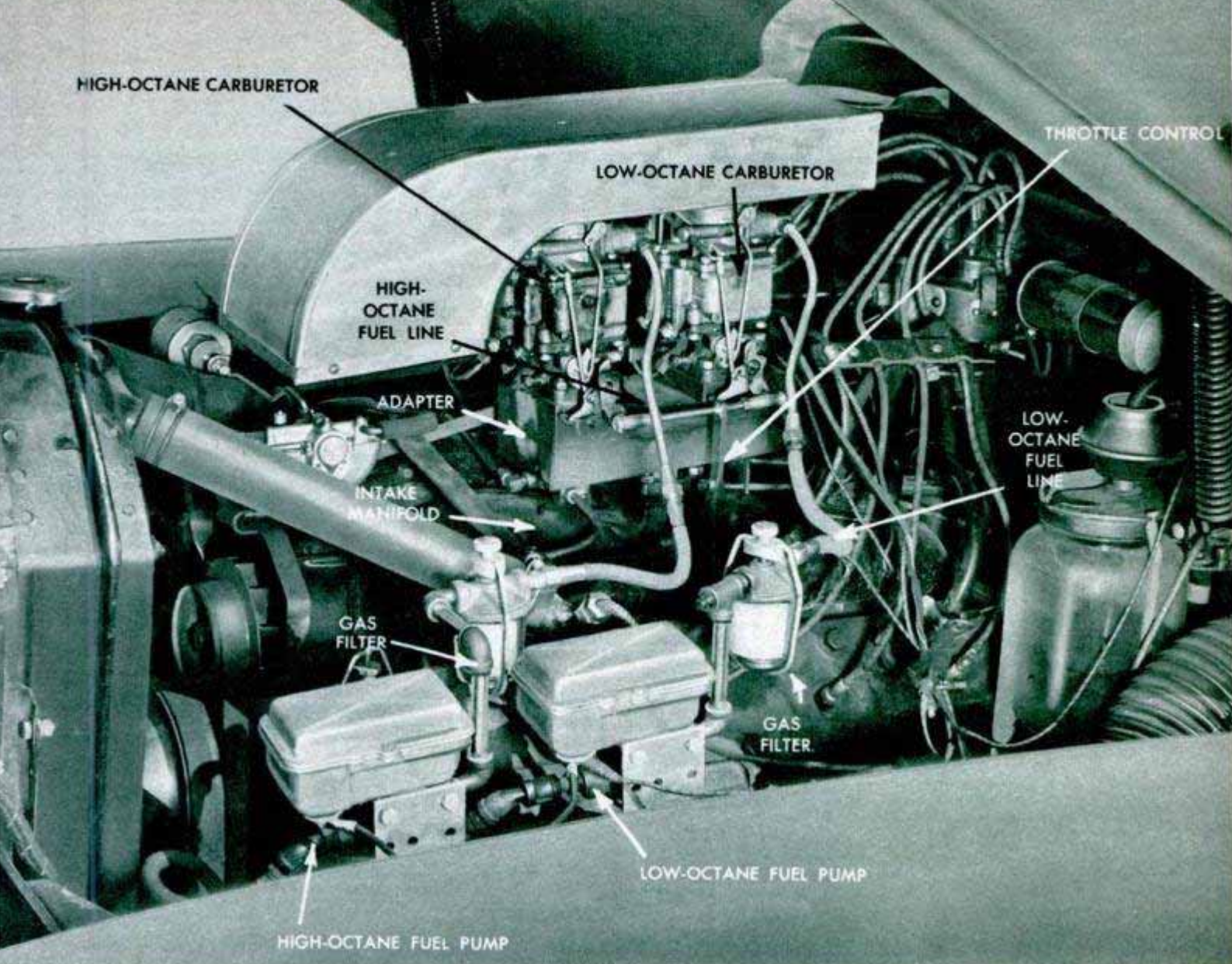

Twin carburetors under the test car's hood automatically switch on and off depending on fuel requirements

Heretofore, in supplying automotive fuels, the octane-number requirements at the most severe operating condition have been used of necessity by the petroleum industry as the criterion of the quality of the fuels. Requirements at other operating conditions consequently have received little attention.

More than \$4,000,000,000 must be spent by the petroleum industry in the next several years to increase production and refining capacity to meet demands; therefore, it is unlikely that octane-number levels of motor gasoline can be increased economically at as fast a rate as in the past.

Already, investments required for producing fuels with today's octane-number ratings are high. Still higher octane-number ratings will result in just as sharply increased investment totals.

During the war years, \$927,000,000 were expended on major projects in the nation's refineries. Of this total amount, \$864,000,000 were required alone for facilities to produce 100-octane-number aviation gasoline, represented principally by construction of catalytic cracking units.

This was a huge expenditure for equipment to manufacture a quality product. And what was its effect on the octane number of motor gasoline? Between 1941 and 1946, premium and regular grades increased barely three octane numbers, in spite of the fact that aviation-fuel production had been diverted largely to automobile gasoline by 1946!

In other words, an increase in anti-knock quality of one octane number cost in the neighborhood of \$300,000,000. And it should be remembered too, that the refinery investment cost per octane number at present is about 50 percent above the average, for various reasons, of the period from 1941 to 1945.

It is with this economic background that the Socony-Vacuum Oil Company, Inc., undertook a test program on the practicability of dual-fuel systems in automobiles, guided by the facts that current fuels are not utilized to their highest degree, and that cost and other factors stand in the way of sharply increased octane-number ratings. The company's goal was to obtain serious consideration of the principle of

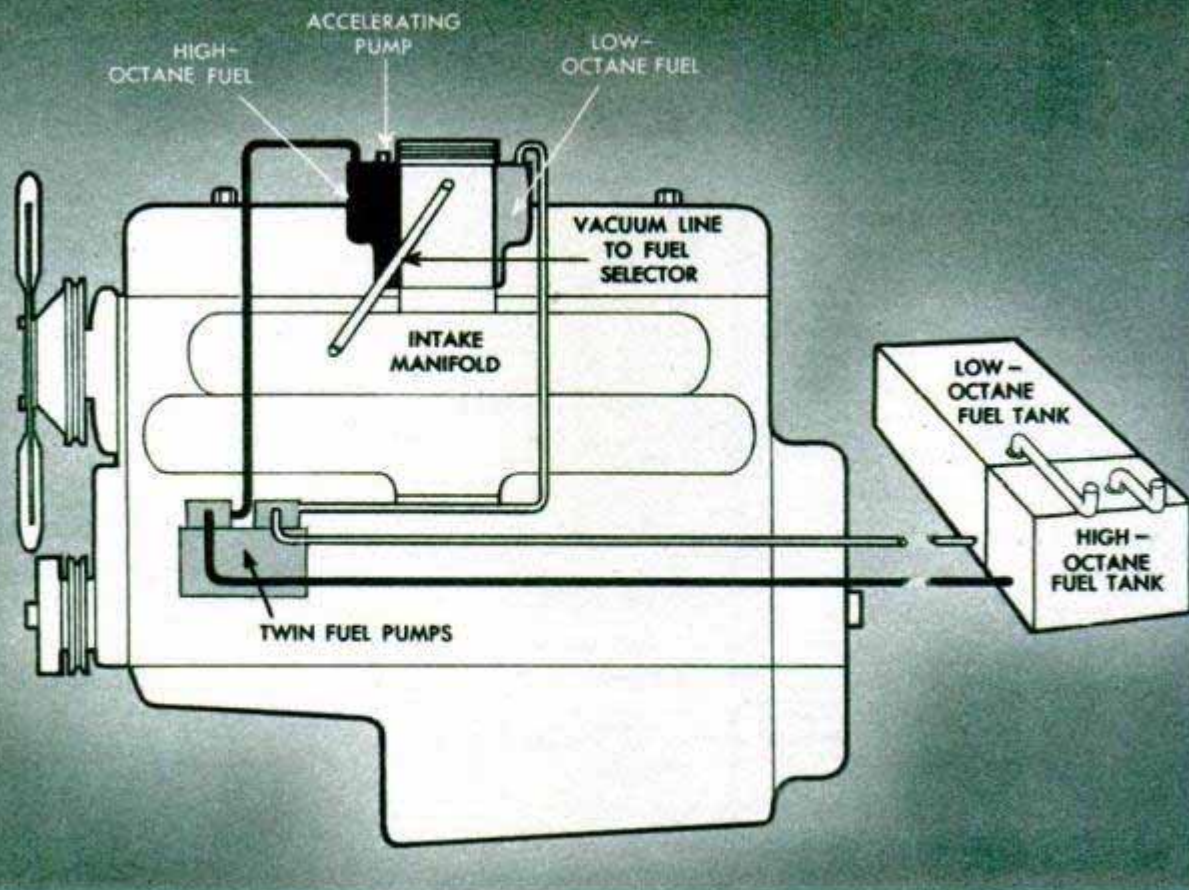

Diagram shows fuel system of the car. Note small size of high-octane tank compared with low-octane tank

dual-fuel carburetion by the automobile and petroleum industries.

To launch the test program, a 1947 eight-cylinder car at the laboratories in Paulsboro, N. J., was equipped with a combination carburetor and control system.

This installation quickly demonstrated that knock-free operation was possible with fuel of a 40-octane-number rating for a majority of the time the car was in operation, although it normally has a full-throttle road requirement of fuel with a 77-octane-number rating.

The test car was operated under driving conditions of all kinds. It proved that the virtues of premium grade, high-octane-number gasoline are utilized to their fullest only for quick starts in traffic, for the bursts of additional speed necessary for passing other cars and for climbing steep hills with heavy loads.

The dual-fuel system also demonstrated that consumption of the high-octane-number fuel should not exceed 20 percent of the car's total consumption. Thus complete freedom from knock without change in car performance, and under all driving conditions, is possible.

What does this mean? It proves that less investment is required for developing high-quality gasolines. The refining industry must be expanded to handle another 1,000,000 barrels per day of crude—production is already at the rate of better than 5,000,000 barrels daily—to meet the anticipated demands for petroleum products in the next few years. This expansion in re-

fining equipment and an increase in distribution facilities will cost the industry about \$1,500,000,000 at today's prices and, in light of current price trends, probably more at the time of installation. Another \$2,750,000,000 will be needed to find, produce and distribute the additional crude oil to fill these demands.

In this expansion program, current high qualities will be maintained. But the very need for expansion, with its total investment of \$4,250,000,000 precludes any additional investments aimed solely at improving the quality of products.

It might be noted, though, that the expansion program for the nation's refineries is certain to result in moderate increases in anti-knock quality, since the modern equipment to be installed incorporates many recent technological developments.

With present refining facilities, crude oil can be made without difficulty to yield 20 percent gasoline with a 97-octane (Research) number and 80 percent gasoline with an 83-octane (Research) rating, supplemented in each case by two milliliters of tetraethyl lead, which could constitute the new premium and regular grades.

It appears possible, therefore, for modern, existing refineries to take complete care of the anti-knock requirements of automobiles of the near future with high compression—provided the dual-fuel systems are utilized.

It is apparent that any improved engine design which leads to fuller utilization of

(Continued to page 234)



"Workshop" Bus Trains Hobbyists

Ten instructors and a complete assortment of craft tools are aboard a bus touring communities in the southeastern United States to promote youth interest in hobbies and in organizing hobby clubs. At every stop, modeling techniques are shown with movies and demonstrations. The tour was arranged by Aero King Modelers, a national hobby organization with headquarters in Chicago.

Dashboard Table Slides Out of Way

Attached under the glove compartment, a sliding table for automobile dashboards provides a convenient work space while traveling. Strong enough to support a typewriter, the table can be used for serving refreshments, holding a make-up kit, or even as a seat for the baby. The table slides in a metal channel that is held in place by three bolts.

Rod Prevents Tank Rust

Hot-water tanks of the household type are prevented from rusting by installation of a small magnesium rod. The rod, technically known as an anode, reverses the batterylike action set up between the water and the metal. It becomes self-sacrificing and disintegrates in place of the tank walls. The rods can be installed in old or new water heaters and last about six years, depending upon the type of water used.

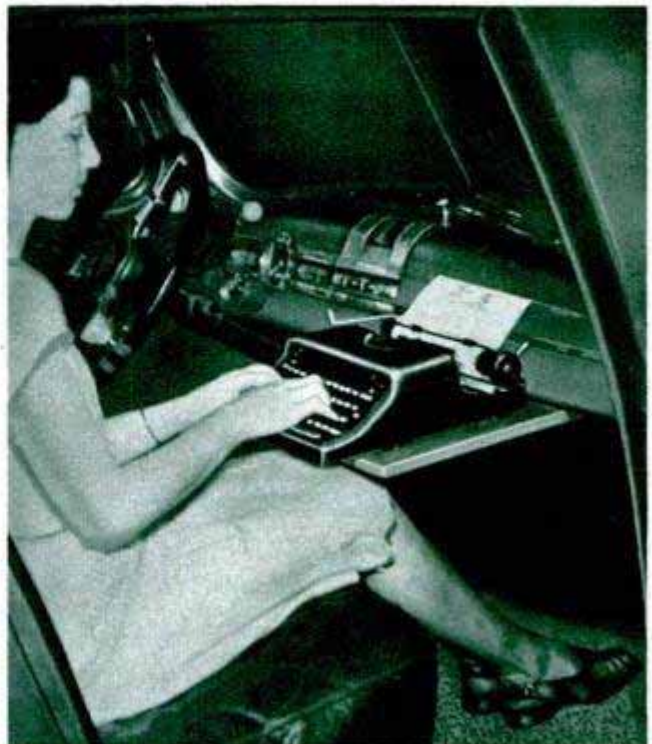



Oyster Hoister

Oysters are raked off the bottom of the sea, carried to the surface on an elevator and dumped in a barge by an oyster harvester. The harvester is attached permanently to the bow of the barge and powered by a small gasoline engine. Its conveyor belt has 19 rows of steel prongs which rake the bottom of the oyster bed, picking up all oysters but riding over objects too heavy to lift. Crawl wheels on the front of the conveyor revolve as the belt moves, digging into the water bottom to pull the craft along. A centrifugal pump shoots a high-pressure spray on the oysters to clean them as they are being carried up by the conveyor. The oyster elevator is suitable for harvesting oysters only a foot from the surface or on reefs eight feet deep. Three men can operate the machine. In a demonstration in Louisiana, A. M. Brown of Mobile, Ala., who invented the machine, painted several oysters and tossed them overboard in all direc-

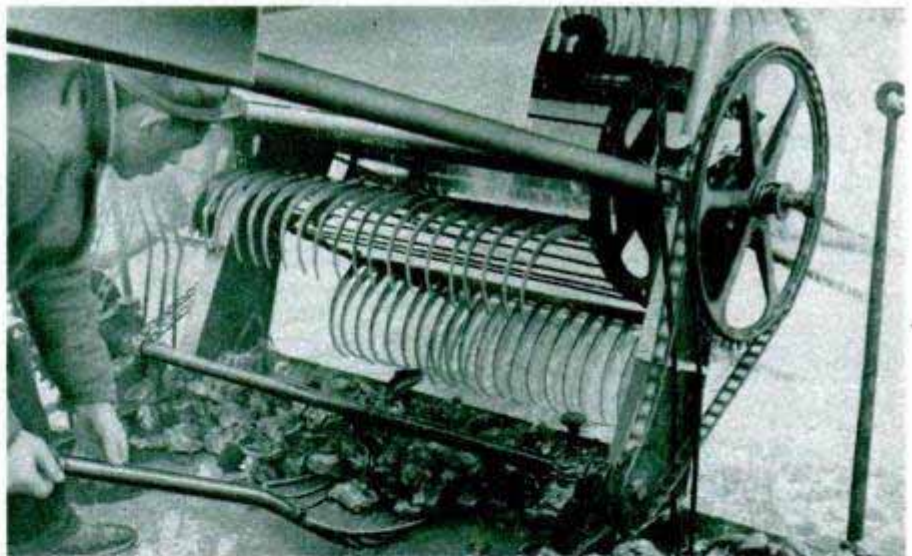

Top, square boxes on the hoister are ballast tanks. Center, a high-pressure spray cleans the oysters. Above, the rakes dump oysters on the deck

tions. The machine picked up every oyster that had been marked. Custom-built models will be built for very deep beds.

Synthetic May Inoculate Picnickers Against Poison Ivy

Science may soon provide picnickers and outdoor workers with a synthetic for inoculation against poison ivy. A synthetic compound has been produced at Columbia University which successfully imitates urushiol, the irritating substance in poison

ivy. First use of the compound may be for inoculation against poison ivy, poison sumac and poison oak. Principal value, however, will be in the study of all natural blister-raising substances including those in Oriental lacquers and related materials.

Officer students at the institute take a basic course in first aid. Note the variety of state uniforms

At the Traffic Institute, veteran officers—finest in the country—are pumped full of facts on how accidents happen and how to help motorists behave

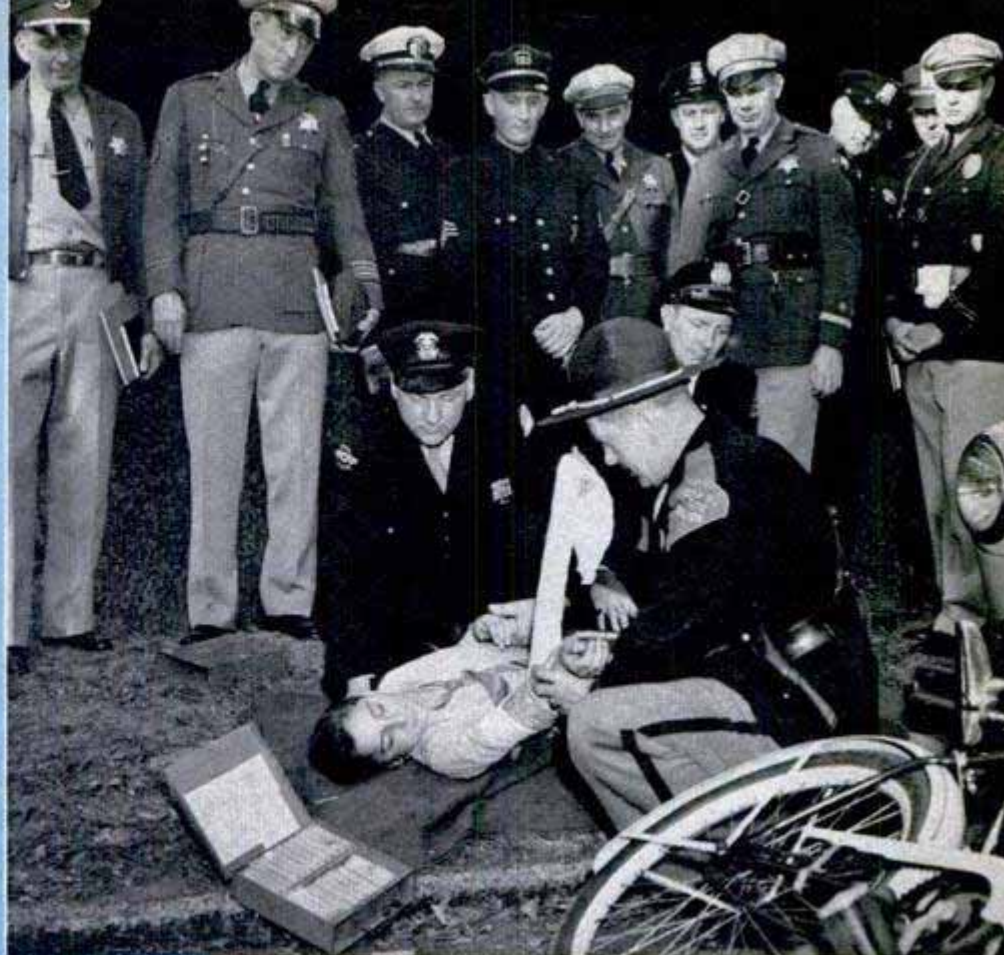

COPS

ON THE CAMPUS

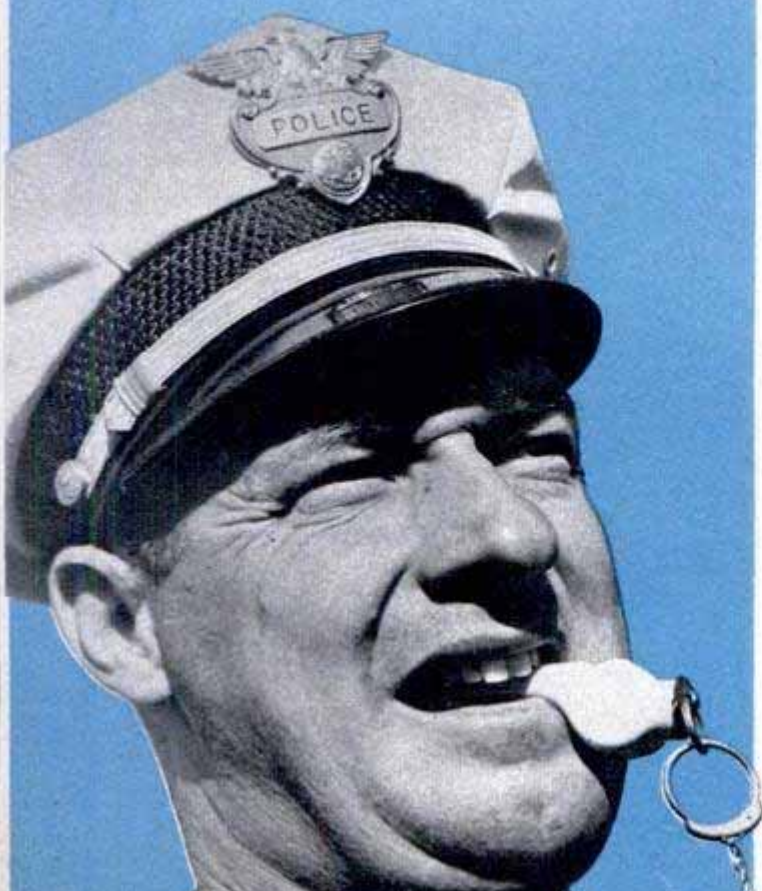

By Clifford B. Hicks

SEVENTEEEN HUNDRED police officers from every section of the country have been learning the finer points of traffic enforcement at Northwestern University's Traffic Institute since 1936. It's not entirely coincidence that the national death rate per 100,000,000 vehicle miles has been cut more than half—since 1936.

Even faculty members don't suggest that the institute is solely responsible for this startling reduction in fatalities. Yet during the past 12 years those 1700 officers, crammed with knowledge of how accidents happen and what to do to prevent them, have taken over key positions on traffic police forces throughout the country. And the institute's sister organization, the Traffic Division of the International Association of Chiefs of Police, has probed traffic enforcement in 60 cities, counties and states and made recommendations that invariably have brought surprising slashes in the accident rate.

Franklin M. Kreml, director of both organizations, believes that if a cop can put his fingertip on the causes of a smash-up and remove them, similar accidents never will occur. The institute is dedicated to producing a superior police officer who can undercut accidents by operating on those causes.

Obviously, one organization can't teach every traffic cop in the country how to apply science to his job. So Kreml and his associates are forming a network of well-

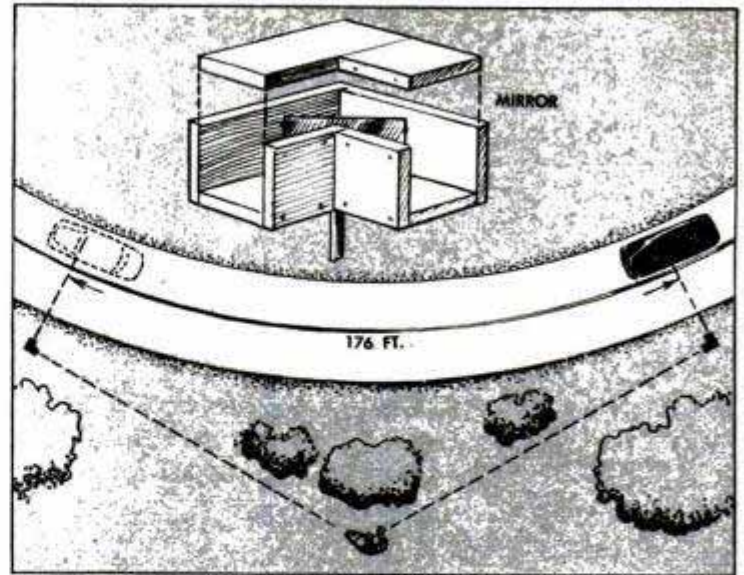

Mirror instrument aimed by officer reflects flash of car, giving accurate check of speed as in diagram



Posed photos show patrolmen how to throw road blocks around an area to block the escape of a criminal, and below, full equipment for patrol car



trained men to blanket the country. Only those officers who are in key positions, or soon will work their way into those positions, are accepted as students, on the theory that the techniques these men are taught will sift down to every officer who waves a white glove or lives in the saddle of a motorcycle. Key men from every section of the country and from Panama, Canada, the Canal Zone, the Philippines, Puerto Rico, Mexico and China have graduated and now are directing model programs of traffic control.

Because the officer students are key men, they also are experienced patrolmen. Many have spent five to 15 years on motorcycles or in patrol cars. They already know how to handle traffic, so the instructors focus training on long-range programs for reducing accidents.

Part of the institute's program is basic research in traffic control. The U. S. Public Roads Administration and other interested organizations provide grants for research projects.

James Stannard Baker, Director of Research, has on the drawing board a mechanical cop that should be able to snare any driver who speeds through a restricted zone. The heart of the instrument will be a radar device for determining the speed of the car. Baker plans to combine this radar with a camera and a stroboscopic light.

The instrument will be pointed down the highway. Each car that passes the mechanical cop will come within the field of its radar beams. These beams bounce back to the instrument at a rate depending on the speed of the car. When a car exceeds the speed limit, the radar will trip the camera shutter and the light. The camera snaps a photo of the rear end of the car, plainly showing the license plate. One edge of the film catches a photo of a speedometer and

a 24-hour watch. After the photo is snapped the camera rolls the film for the next exposure.

At the end of every 24 hours the film is removed from the camera and developed. It contains a photo of every car that speeded, the license plate, and shows the actual speed and time of day of the violation. The speeder then is mailed a ticket and the photo becomes positive evidence in court.

Baker realizes that thoughtless persons who invariably push the edge of the law will raise an objection to the instrument when it is placed in use on the grounds that it spies on drivers. He points out that traffic lights and parking meters raised violent protest when first installed, but today they are accepted by every driver. The mechanical cop can't be bribed by a speeder who tries to buy his way out of trouble. And one patrolman with eight machines can replace about eight officers and the same number of patrol vehicles.

The research department also is working on a project to determine the "halo" effect of a cop. It's known that when a driver sees an officer he invariably slows down or pays scrupulous attention to highway signs. Just how far does this "halo" effect, this radiation of the cop's presence, extend? Half a mile? Three miles? The research department is determining the patrolman's average range of influence by observing what drivers do over a long distance before and after they see an officer.

About 30 officers attend each 4½-month course at the institute. Sixteen are awarded fellowships that pay all their expenses. Most of the others receive scholarships of some kind, and every officer, by previous agreement, draws his regular pay from his home town.

These picked officers attend classes 39 hours each week and crack the books for well over 30 hours outside class—a tough weekly grind.

The instructors pump knowledge into them on such specialized subjects as accident investigation and photography, questioning of suspects and how



Student cops learn to use the "drunk-o-meter," an instrument that puts suspect's breath from balloon through chemical tests



Instructor points out a possible solution to a classroom problem on intersections to officers from four different states. ↓ Officer students study efficient intersections such as this one with its well-marked left turns and its broad pedestrian lanes





to present a court case. They learn to use scientific instruments in traffic enforcement. Students pick up the fundamentals of the "drunk-o-meter," an instrument for determining the alcoholic content of the blood. The suspect is required to blow up a balloon, and the instrument puts his breath through a series of tests to give a positive answer as to the amount of alcohol his system has absorbed.

Officers also learn to use the "Enoscope," an instrument that is as simple as it is effective. The Enoscope actually is a horizontal periscope—a frame containing two openings at right angles and a mirror at a 45-degree angle to pick up the view of one opening and reflect it through the other. An officer places two Enoscopes a known distance apart along a highway and stands between them with a stop watch in his hand. When a car passes one of the instruments he sees it flash in the mirror. By timing the car until he sees an answering

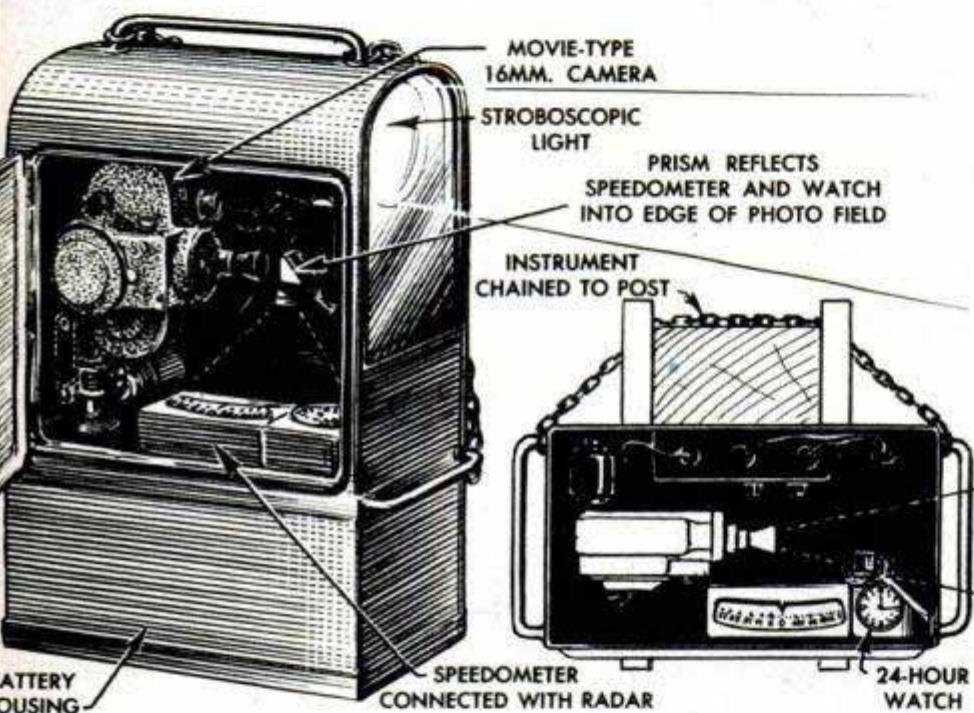

Top, officers learn photography. Left, artist's drawing of proposed "automatic cop." Radar checks each car's speed, trips camera and light when driver exceeds limit. Photo shows the license number



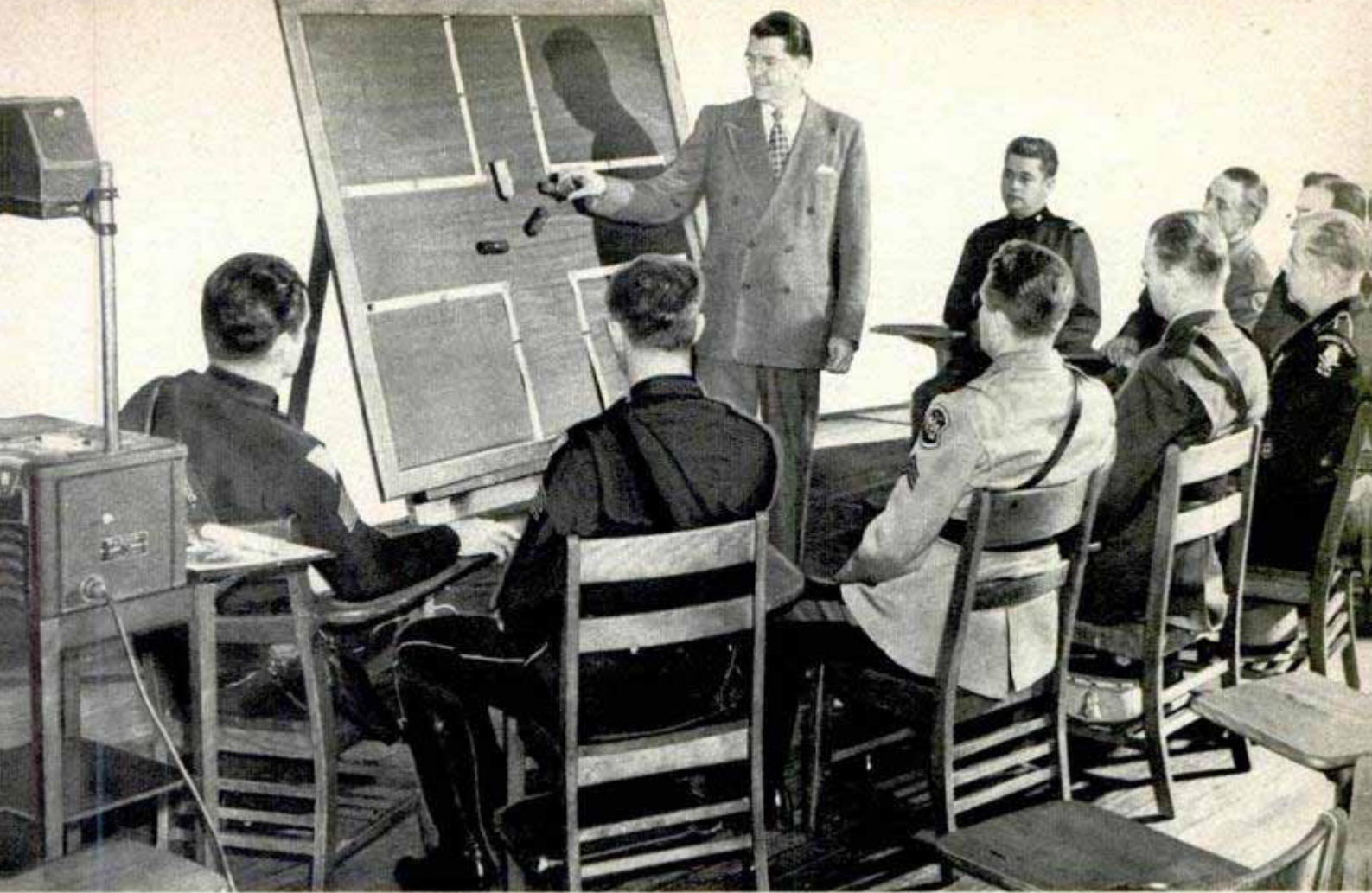

Magnetic blackboard holds car models in position. Right, magnets hold cars to board

flash in the other mirror he can figure its exact speed.

After the student cop digests books, lectures and discussions for three quarters of his term he is assigned to investigate traffic control in a town similar in size to his home town. For one week he probes the ins and outs of traffic police administration in that town, working with everyone from the mayor to the cop at the intersection. When he returns to the campus he is required to write a detailed report on the traffic police program. The report is not just a record of what he saw, but an interpretation of what can be done to increase safety in the

(Continued to page 236)



Officer's time exposure of traffic flow at night shows use of the main thoroughfare

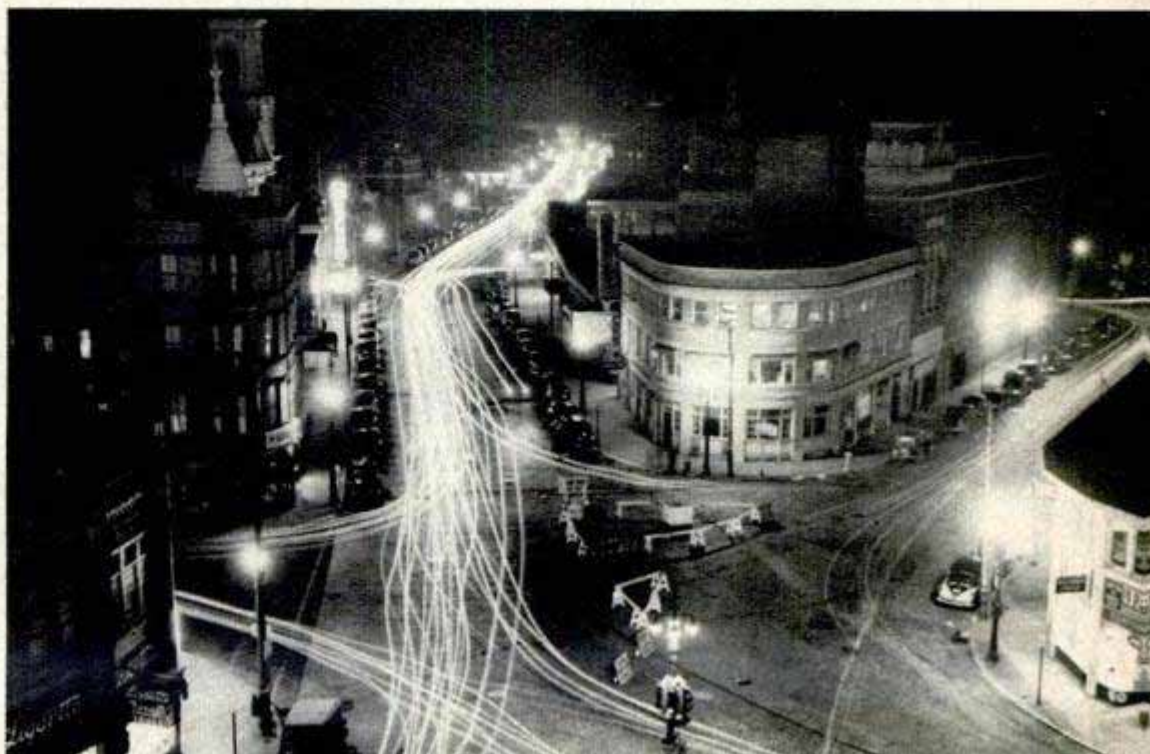



Fire-Stop Coating Applied Like Paint

By fighting fire with fire, a liquid coating that is spread over wood and fabric like paint reduces the danger of fire damage. Heat from the fire changes the thin coating into a heavy insulating blanket, preventing the spread of the flame. The hotter the fire becomes the thicker it makes the protective blanket so that, in effect, the fire helps put itself out. In a recent test, the curtains in two identical rooms, separated by a conventional plywood partition, were exposed to the flame of blowtorches. In the room that had not been treated with the protective coating, the flames spread rapidly and completely gutted it. In the second room, in which the curtain and woodwork had been sprayed with the coating, fire did no damage. The plywood panels of the treated wall were painted on both sides with the retardant and, even though the flame burned through the wall panels behind them, they effectively stopped the flames. Even a blowtorch flame failed to ignite the treated plywood.



Farmer's Ski-Car Built From Wrecks

By combining parts of three wrecked automobiles, a farmer-trapper in northern Saskatchewan made a ski-equipped car for driving over snow-covered roads. The motor and chassis are from a Chevrolet, the rear end is from a Hupmobile and the wheels were taken from a Ford. The skis were made from the steel frame of the Ford and are welded to the front wheels.



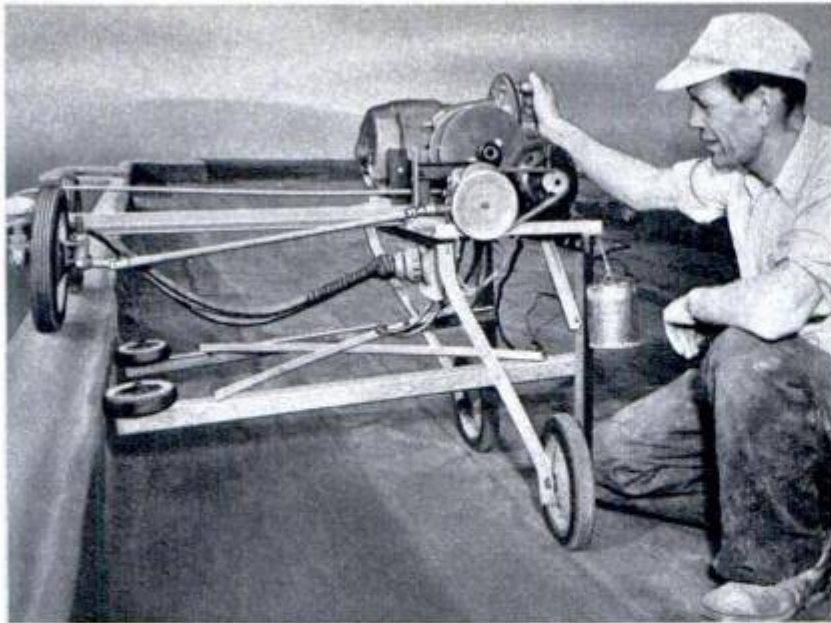

Painter's Power Hoist Eliminates Ladders

Because he doesn't like to climb ladders, Harold C. Raftery of Long Beach, Calif., built himself an electric hoist that enables him to paint buildings comfortably and safely. He can move sideways or up and down by pressing control buttons mounted on the cage. The power unit runs along the edge of the roof and contains two electric motors, one for up and down movement and one for sideways movement. The cage and power-unit chassis are made of aluminum angle strips.

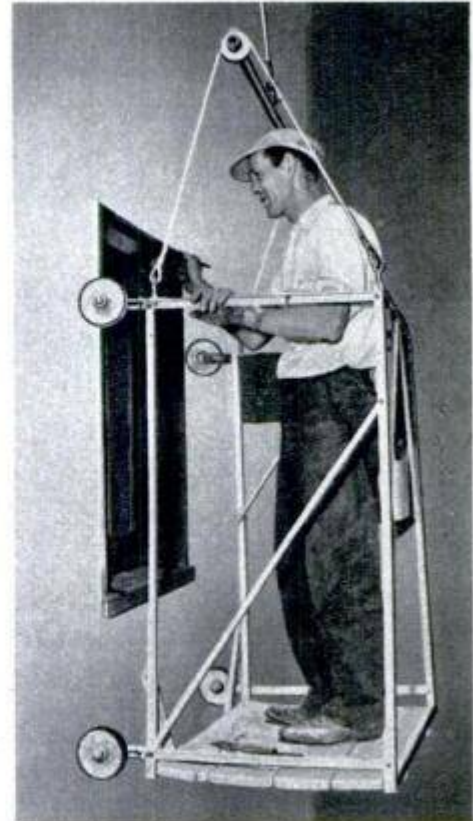

↑ Push buttons mounted on right side of the cage control two electric motors of roof power unit (left) enabling the painter to move vertically or horizontally. Power unit, with its winch and motors, rolls along the roof parapet

Portable Mast Is "Pushed" Into Air to Test Antenna Sites

Like stacking a pile of blocks in reverse, a new method of speedy erection of portable microwave radio towers raises the mast by adding new sections to the bottom. A hoisting yoke at the ground level has a long-handled winch that raises the tower high enough so that another section can be added to the bottom. The hoisting is repeated until the tower is 200 feet high. Guy

cables are added to every sixth section. A microwave receiver with its antenna and dishlike reflector rolls up and down the tower to test reception qualities of the location. When testing is completed, the portable tower is taken down and a permanent mast erected. Developed by Bell Laboratories, the tower will be used in laying out the Chicago-New York relay system.

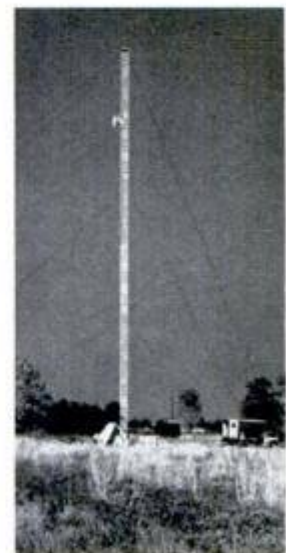
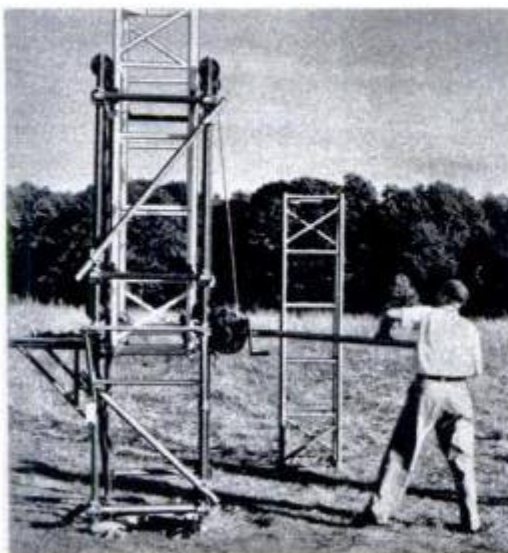

Left, tower being raised by hand winch. Section behind winch bar will be added when lifting is completed. Center, antenna carriage begins its trip to the tower top. Right, the 200-foot tower with antenna in place

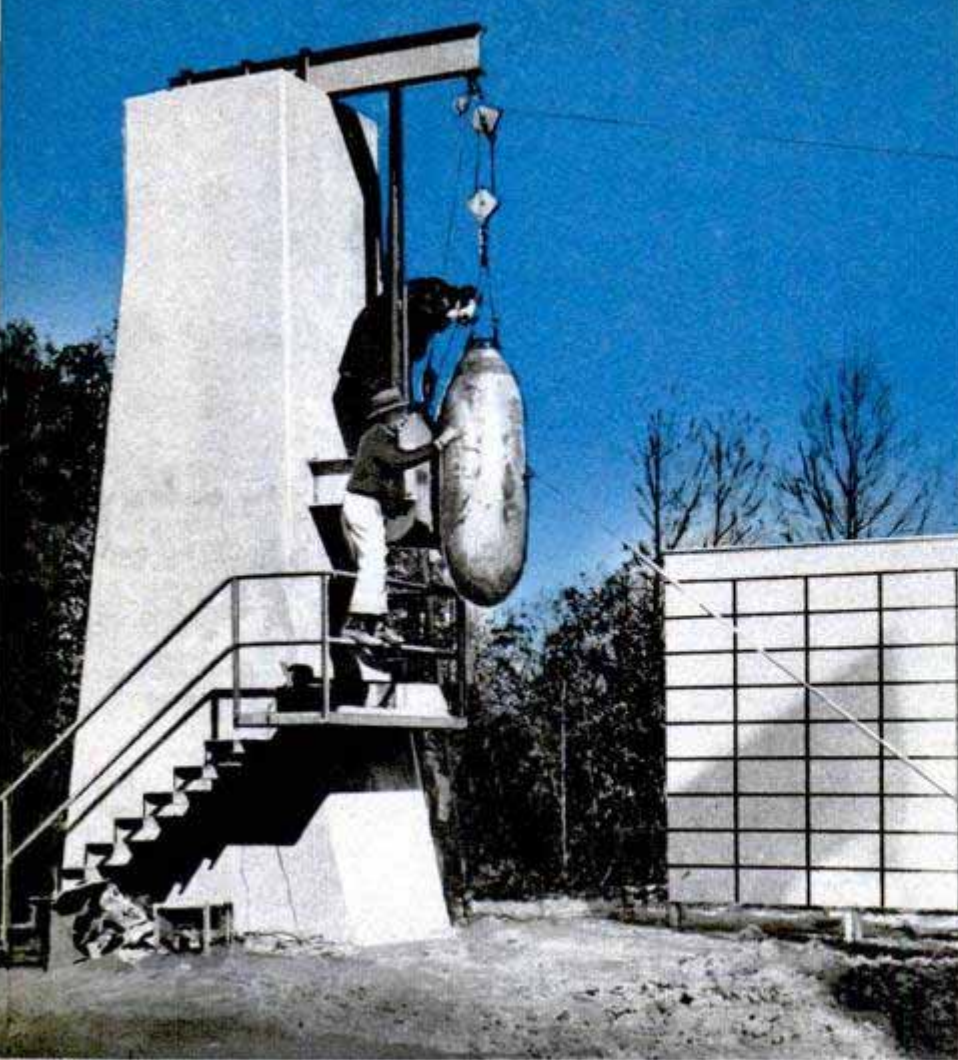

Official U. S. Navy photos

Bomb ejector tester and fast cameras make certain that bomb released from plane in vertical dive won't strike propeller

Specialists in underwater warfare, scientists at the Ordnance Laboratory developed this new submarine mine-laying device



ON HIS birthday, Rear Admiral Frank E. Beatty was given a crosscut saw by officers, bluejackets and civilian scientists of the Naval Ordnance Laboratory in Washington, D. C.

"What's this for?" he asked.

"A professional joke," said a spokesman. "We figured that you'd need something to help cut up those knotty problems we're going to run into at White Oak."

White Oak—938 acres of rolling Maryland countryside 12 miles north of Washington, D. C.—is one of the Navy Bureau of Ordnance's newest research centers. Congress appropriated \$15,000,000 to get it started, with more likely to be voted later. It is almost completed and in a few more months, 1000 Navy and civilian researchers and technicians will be at work on the project.

They'll be using more than \$10,000,000 worth of new scientific equipment on a hundred or more research programs in torpedoes, mines, fuses, rockets, supersonic projectiles, depth charges, ammunition and pyrotechnica. "We investigate anything that makes noise or wiggles—above or below water," one of the laboratory's scientists pointed out.

Admiral Beatty explained the reason for the new laboratory:

"Since most ordnance has little or no industrial use, the Navy finds it necessary to conduct its own research, development and testing. In peacetime, you can't farm out a magnetic mine or a torpedo to an automobile manufacturer or a university."

White Oak is an outstanding example of a military-civilian team at work. The administrative side of the laboratory consists of a small group of naval officers with seagoing experience, under the command of Admiral Beatty. A graduate of Annapolis, with a mechanical engineering degree from M.I.T., he won his blue-and-white Navy Cross as the skipper of the cruiser *Columbia* during the chips-down fighting in the South Pacific. The civilian research and development work is directed by Dr. Ralph Bennett, an expert on mine warfare.

White Oak itself is the result of an acorn that was planted in 1918. The Navy's mine barrage in the

"SHAKEDOWN" LABORATORY

for navy ordnance

North Sea helped to defeat the Kaiser's U-boat threat. Subsequently, it was decided to continue research on mines and a laboratory was set up in the Naval Gun Factory in Washington, D. C. There it remained until the end of World War II. Now it is taking root at White Oak.

As planned, White Oak is a "dream" laboratory — designed after consultation with scores of U. S. scientists. It consists of approximately 50 permanent buildings all fitted with prefabricated, movable partitions so that laboratories and offices of any size may be created. They are fireproof, air-conditioned, provided with fluorescent lighting and connected by pedestrian tunnels. Laboratory areas are supplied with voltages of different values, compressed air, gas, steam, hot and cold water. A model shop is equipped to do all but the heaviest kind of machine work.

First group of buildings to be completed at White Oak (in which scientists are already at work) is the Magnetics Group.

The seven buildings in this group are as free from magnetism as science can make them. They were built in an area isolated from minor disturbing influences such as other buildings and vehicles. Iron and steel have been entirely eliminated. Nails are copper, light switches are porcelain, drains are transite, building beams are wood. Even the sand that went into the bricks was screened to make certain it did not contain minute particles of iron oxide.

"This kind of planning," according to Bennett, "has resulted in what is probably the earth's largest 'nonmagnetic' pole."

The buildings are equipped with coils of



When completed, the Navy's \$15,000,000 research center at White Oak, Md., will stretch out over 938 acres

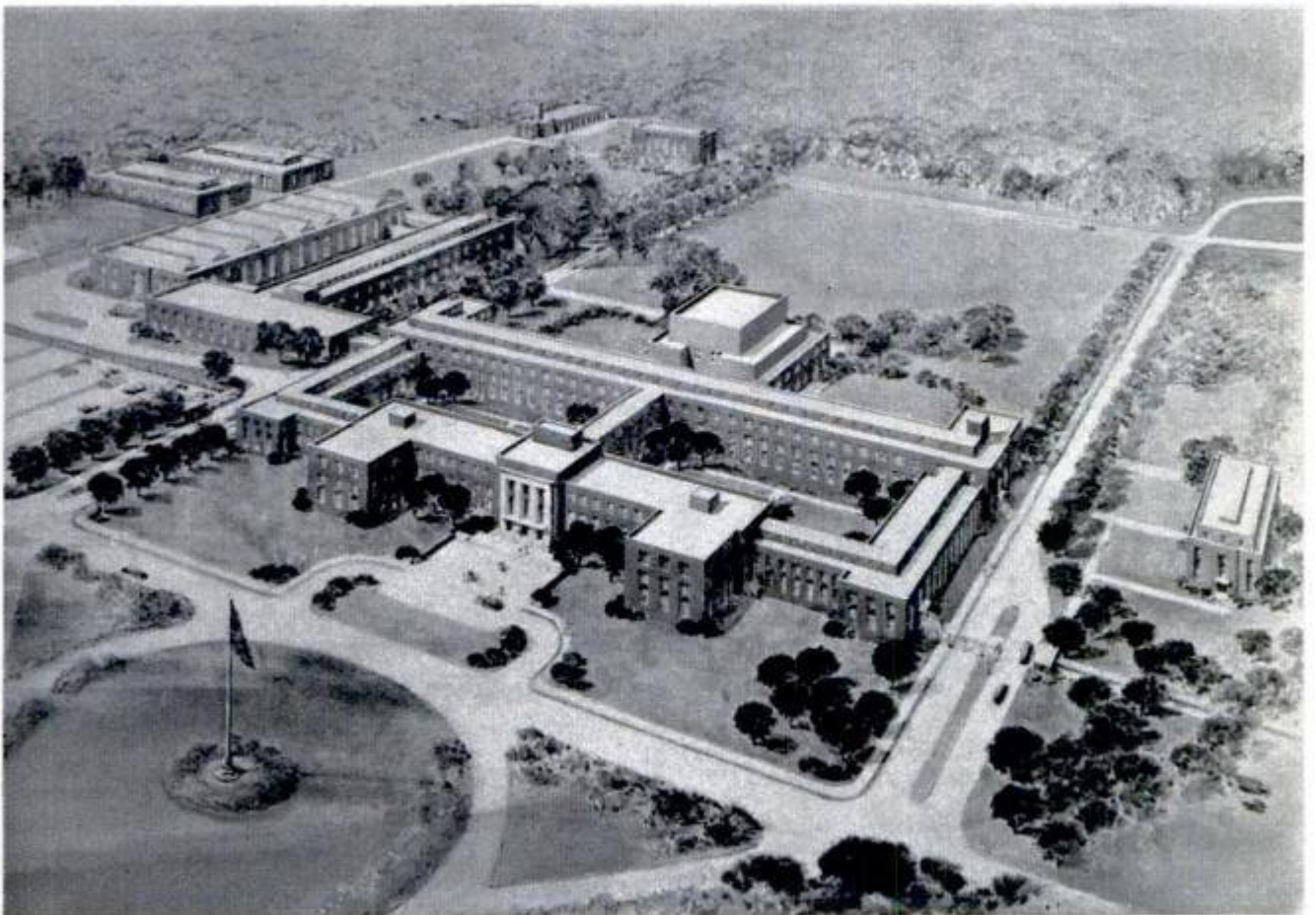

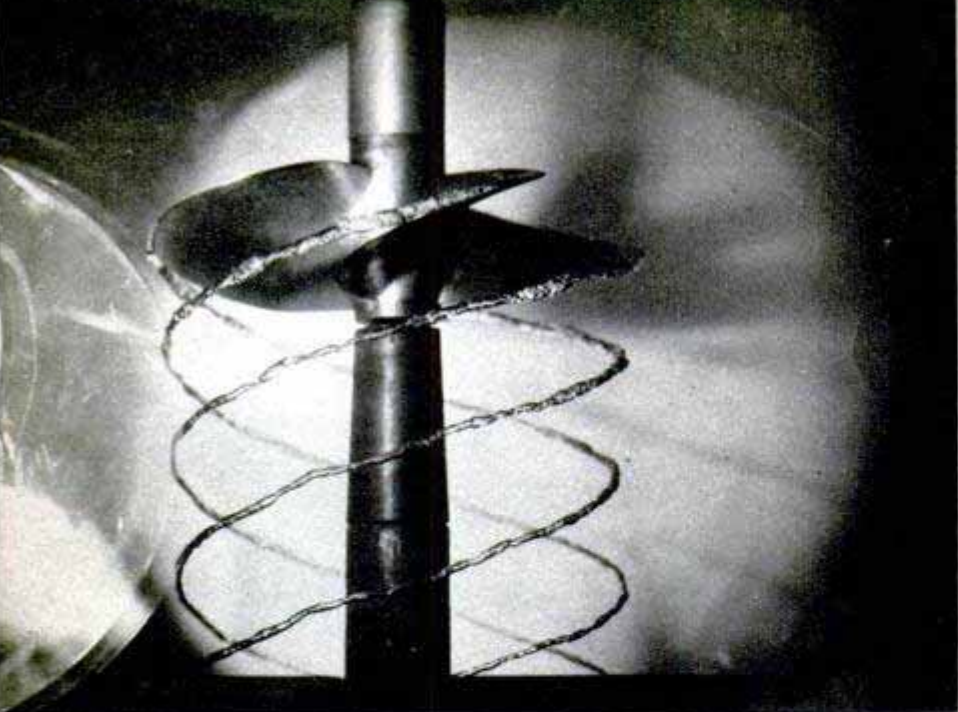

Spiral pattern set up by a propeller in 12-inch, variable water-pressure tunnel. White Oak also has seven varied-size wind tunnels



This 340-gram lithium-sulphate crystal, used in underwater weapons, was grown in 23 days. Below, a wind-tunnel nozzle with mirrors used to photograph air flow around supersonic projectiles

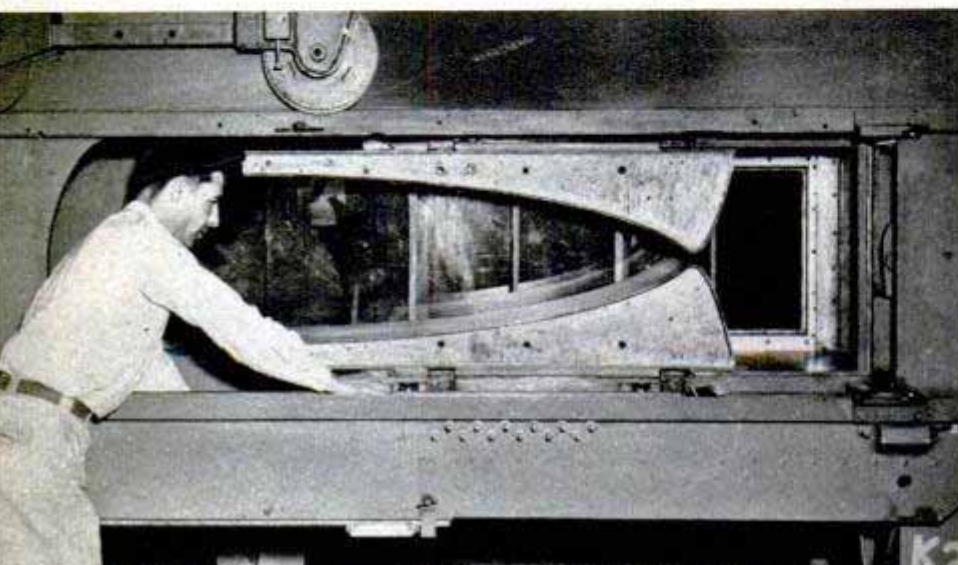

varying size, through which electric current can be sent from a master control panel. The purpose is to duplicate terrestrial magnetic fields under any sort of a ship, at any speed, in any part of the world.

The magnetism research program at White Oak will not only be aimed at developing new and more powerful kinds of mines—but also toward such new equipment as the compensated airborne magnetometer. This is an uncannily sensitive device which has been described as “starting where radar leaves off.” It was originally designed to point a finger at submerged submarines. It can also be used to locate oil and mineral deposits, and the contour of the earth underneath the polar ice cap.

One of the most interesting—and perhaps significant—group of buildings at White Oak is the Wind Tunnel and Ballistics Group.

Three of the seven planned wind tunnels are from the famous Nazi supersonic research center at Peenemunde on the Baltic, where the famous V-2 was developed. After the bombing of Peenemunde, this tunnel was moved to Kochel, Bavaria, where it was captured by the U. S. Army. The equipment was loaded aboard 38 railroad cars and shipped to White Oak. Redesigned and modernized, it will provide the Navy with a wind tunnel whose range of Mach numbers and number of nozzles are greater than any in existence.

The wind tunnel is operated from a huge steel sphere—52 feet in diameter—and two huge pipes that run out from it to two separate wind tunnels which can be worked in alternation. This is how it works: a vacuum is created in the sphere; quick-acting valves are opened and the air rushes in through the pipes. This takes but 40 seconds, after which the air is pumped out of the sphere—the whole cycle taking about 10 minutes.

What gives the air its tremendous speed are two nozzles. The first nozzle constricts

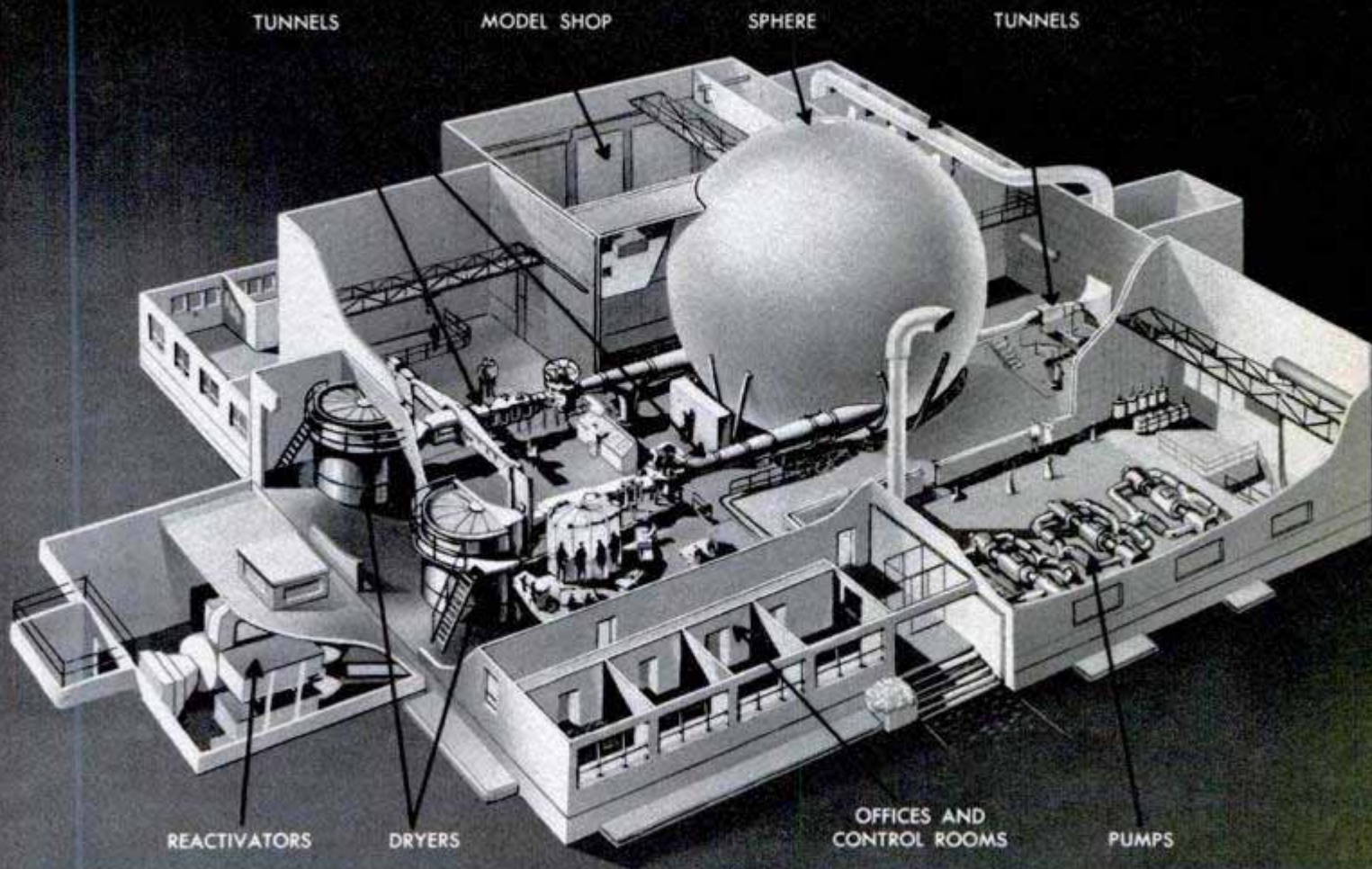

Shipped in pieces from Germany, a wind tunnel at White Oak, already capable of simulating speeds up to 4000 miles an hour, is being further improved so that it will increase to almost 10 times the speed of sound

the air and speeds it up to the speed of sound, roughly 700 miles per hour. The second nozzle expands the air, but instead of slowing down, it speeds up still more—to almost 4000 miles per hour. Further improvements are planned to increase it to almost 10 times the speed of sound.

In these streams of air that flow at dizzying speeds are placed small models of rockets and other missiles (average size—2 inches in diameter). As the air rushes past, they are observed or photographed with elaborate optical apparatus. Two pressurized ranges will check, in free flight, models previously tested in wind tunnels.

In the future, the Acoustics Division plans to build apparatus whereby sound waves can be projected into the air to obtain upper-atmosphere temperatures and pressures. At present, such information is recorded by balloons and V-rockets fired into the stratosphere.

The laboratory will have one of the most complete X-ray experimental stations in the world, featuring a 10,000,000-volt betatron. This huge machine will produce powerful X-rays that will penetrate up to 20 inches of steel, exposing radiographic film in less than a minute.

The betatron is useful not only for detecting flaws in steel and other materials,

but also for looking inside weapons without disassembling them.

One of the more spectacular testing devices at the laboratory is a 75-foot steel drop-tower that can handle bombs and projectiles up to 1000 pounds. Its main purpose is to test live fuses. The fuses are mounted in dud bombs, hoisted by an electric motor to a height of 40 feet, and dropped on sand or armor plate.

The idea of the drop-tower grew out of experiences in World War II. Occasionally bombs were accidentally dropped in the course of handling—endangering ships and crew. Experiments at White Oak are designed to provide the knowledge of how to handle such “runaway” bombs and to test the workability of fuses after a fall.

Another bomb-testing device that has been tried is the bomb ejector tester, which simulates a plane diving at a 90-degree angle. The problem is to make certain that the bomb will clear the plane’s propellers in a vertical dive. Inert bombs are hoisted up a 15-foot tower, fired from an ejector and their path measured by fast cameras.

Equally important as drop tests are the shock and vibration trials. Four pieces of equipment, based on the “air gun” principle, are used in shock testing. A projectile fired from a 16-inch gun or a heavy

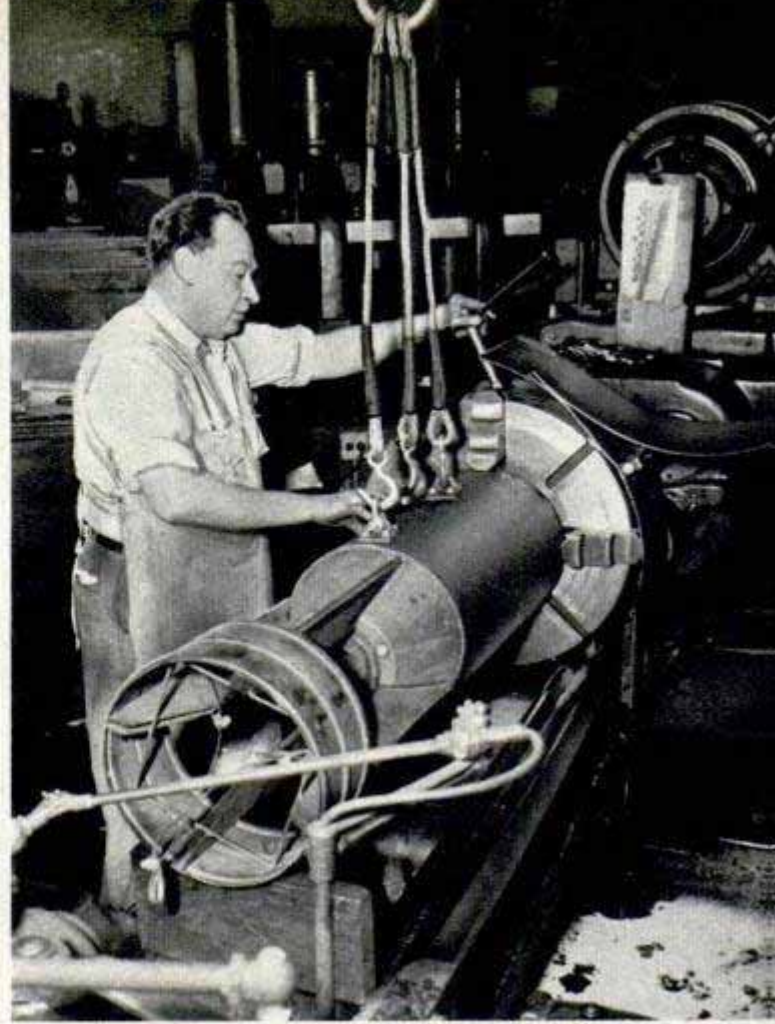

Fuses under test are put in dud bombs and projectiles weighing up to 1000 pounds and dropped on sand or armor plate from 75-foot tower at left. Right, machine shop where pilot models of new weapons are developed

bomb striking the water must be built rugged enough to withstand such a shock without being damaged or exploding upon contact. The equipment at White Oak tests acceleration and deceleration ranging from 4 to 35,000 times that of gravity.

And what about those billions of smaller shocks called vibrations? What happens to ammunition, mines and bombs that are transported by jiggling railroads, trucks, planes or ships? The White Oak facilities include a vibration machine that, as one scientist puts it, "shakes the very devil out of everything that goes into it."

Another question that the Navy is cur-

rently asking is: what happens to live-loaded rounds of ammunition when continuously drenched with salt water? Projectiles to be tested are placed in a spray cabinet and receive a three or four-week drench treatment. Other boxes and cubicles—which look like huge butchers' ice-boxes—are temperature rooms that can be regulated between the span of 200 degrees above to 60 degrees below, Fahrenheit.

To study the peculiarities of sound waves, White Oak scientists are preparing one of the world's largest anechoic or "dead" rooms. This is a room which reflects almost no echo from its walls. Sound

As a contrast in shock-wave patterns formed in wind-tunnel trials, note how closely boundary layer follows surface of pointed projectile at left. Sphere at right, held by stinger, pushes air instead of cutting through

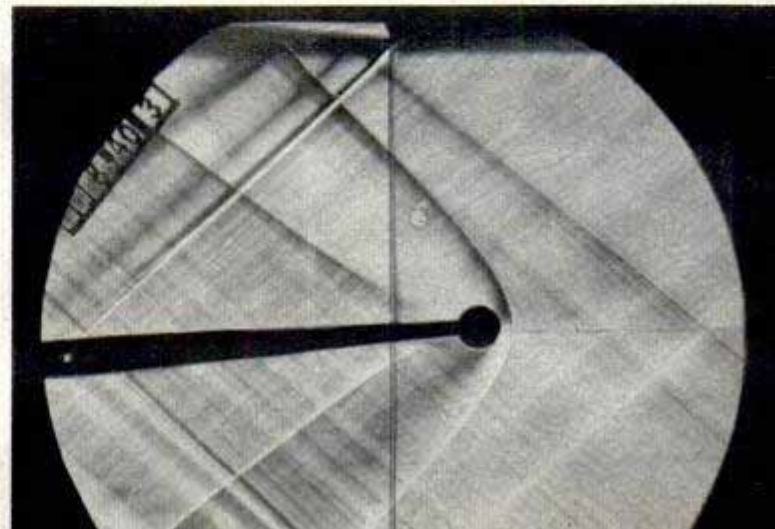
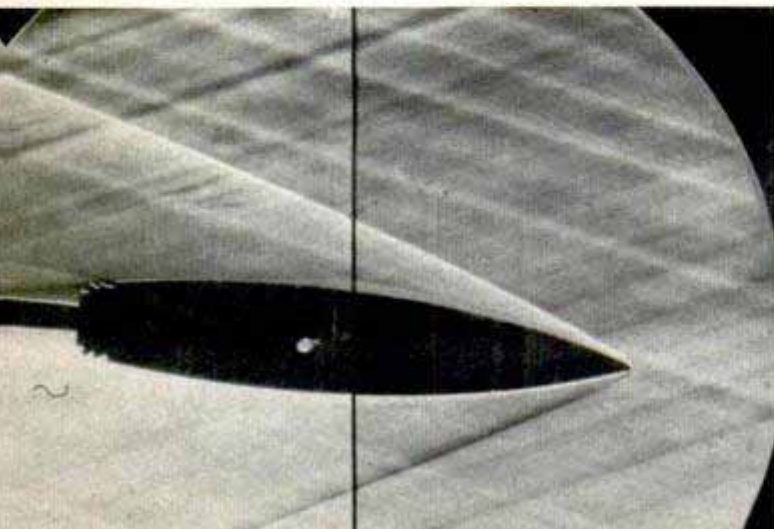

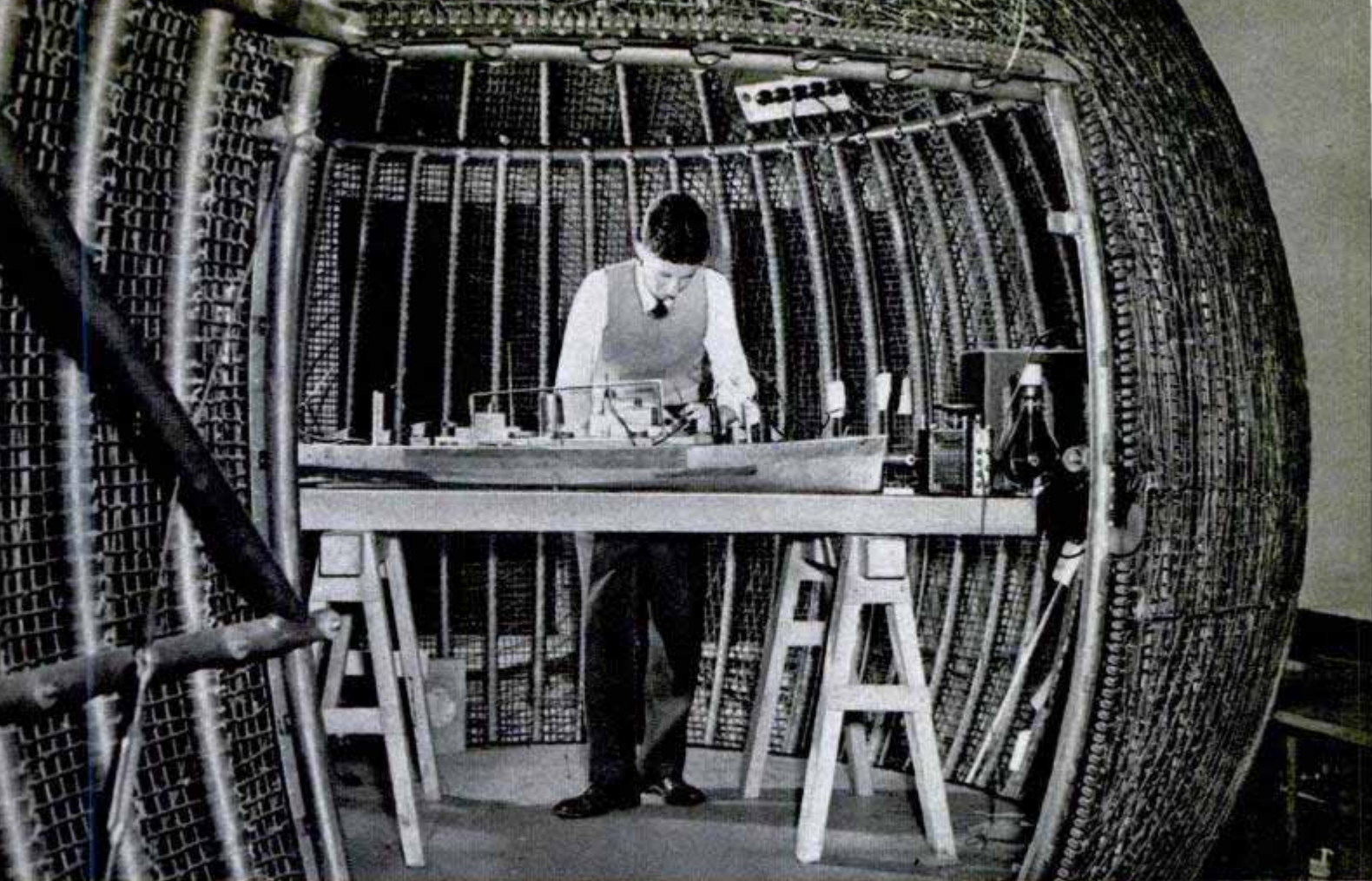

Magnetic field created inside the "bird cage" is used in Navy research to render enemy mines harmless. White Oak scientists boast that they "investigate anything that makes noise or wiggles—above or below water"

waves are trapped by five-foot wedges of fiber glass which line the walls, floor and ceiling—making the room 99.9 echoproof.

The anechoic room will be three stories high, with a control room located on the second floor. Loudspeakers, microphones, sirens and acoustic air fuses will be tested here. The latter is a new type of weapon which holds great possibilities. The Nazis began experiments with it during the war. German fighter planes would fly above an American air formation and drop "air mines" equipped with acoustically sensitive fuses. The mines exploded when they fell within sound range of the American-made motors.

Also to be investigated in the anechoic room are human hearing problems. How loud can the reproduced spoken word become before it is unintelligible? An authoritative answer to this will be useful in designing loudspeakers and earphones.

The laboratory will also manufacture plastic devices in experimental lots and grow its own experimental lithium-sulphate crystals, used in weapons and such intricate devices as sonar, underwater sound detection and transmission systems. Because few crystals are known which possess the necessary piezo-electric qualities, the Navy hopes to discover new ways of producing and using them.

Although White Oak is one of the

"brains" of the Bureau of Ordnance, its eyes, ears and hands operate all over the U. S. Torpedoes are tested at Hiwassee Dam, N. C., and at Morris Dam, Calif. Mines and depth charges are tested at Fort Monroe, Va., and exploded near Solomons, Md. Fuses, pyrotechnica and parachute gear are tried out at the Naval Proving Ground, Dahlgren, Va. Rockets and jet motors are flown at Inyokern, Calif. New types of guns are developed at the Naval Gun Factory, Washington, D. C.

In addition, little groups travel literally to the ends of the earth to test Navy weapons under all conditions. One group may be at the atom-bomb testing grounds in the South Pacific. Another group may be testing the magnetometer in the Antarctic. The third may be investigating seismic waves in an Alaskan volcano.

"In the next war—which we hope will never come—there can be no delaying action," pointed out Admiral Beatty. "We hope to have completed a large backlog of pure and applied research which can be translated immediately into weapons. There won't be any time for research in a world of atomic weapons, proximity fuses and supersonic guided missiles."

Navy and civilian scientists at the Naval Ordnance Laboratory, White Oak, Md., are fighting the "cold war" right now with blueprints instead of bullets.

Strip of Steel Six Miles Long Rolls Out of Mill Every Five Minutes

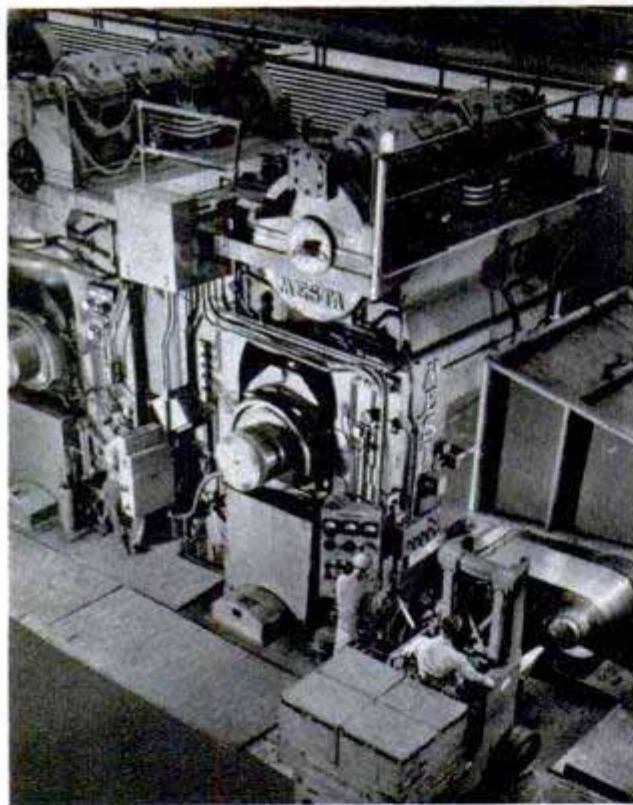
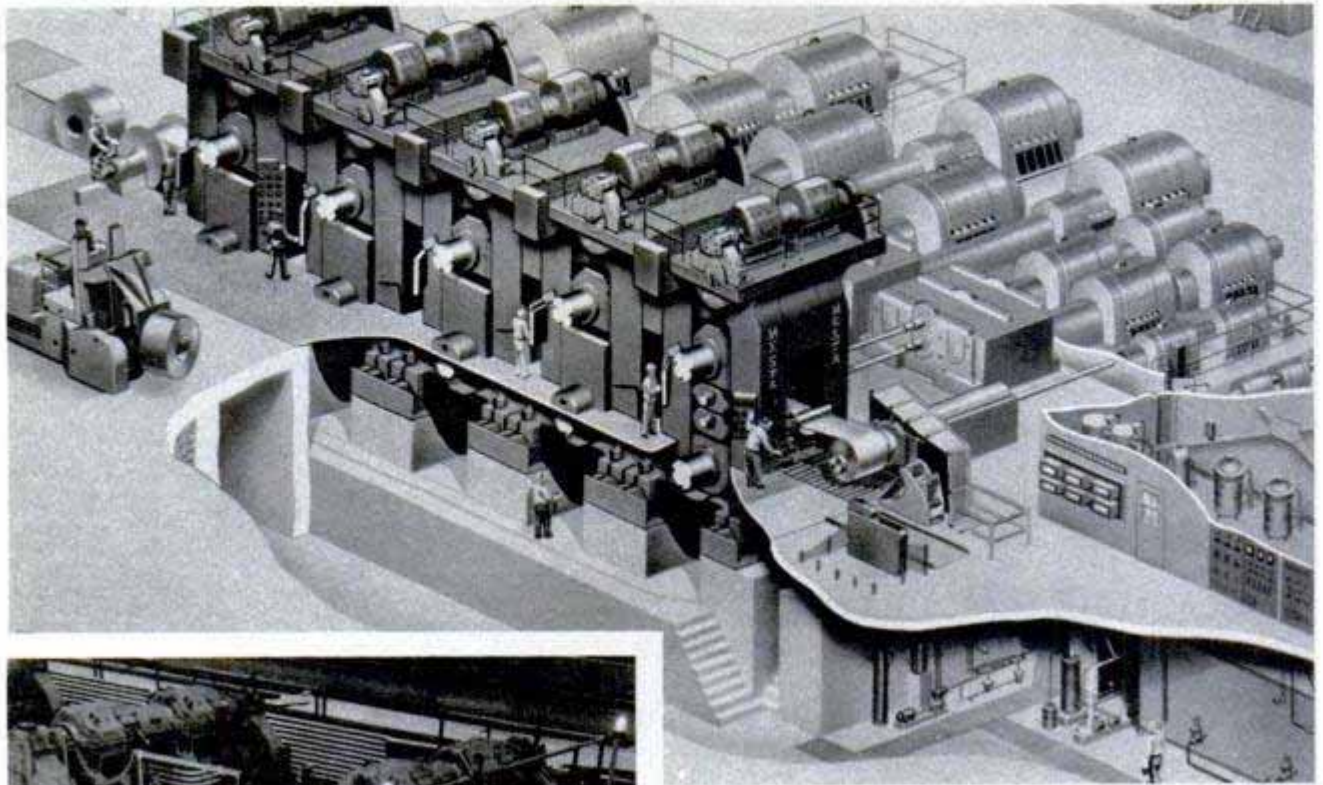

Top, drawing of the five-stand mill shows strip entering at left and rolling out at tin-can thickness at right. Note power equipment in background. Above, each of the stands requires many electrical controls

Every five minutes a massive rolling mill can produce a strip of steel 30 inches wide and more than six miles long. The cold mill, recently completed for Jones & Laughlin Steel Corporation, operates at more than 70 miles an hour to reduce hot-rolled strip to tin-plate gauges. The strip is processed into tin cans and tops for glass containers. Hot-rolled strip about .095 to .109 inch in thickness is threaded into the mill. After passing through five stands in the machine it rolls out the other end, reduced in thickness to about .009 inch and elongated approximately nine times. Six large motors that power the mill have a total capacity of 16,850 horsepower. Because the strip moves at such high speeds it is difficult to measure accurately, so a special gauge X-rays the strip to check thickness. Great quantities of water that flow across the rollers to dissipate the heat produced by the mill are turned to steam, which is cleared from the room by a fog-elimination system.

Research Scientists Bottle Sub-Zero Cold—458 Degrees Below!

Temperatures only one degree above absolute zero—about 458 degrees below zero Fahrenheit—are being “manufactured” by Westinghouse scientists. The purpose of the research is to discover how metals act in this super-cold and to find uses for such frigid temperatures. Absolute zero is approached by changing gaseous helium into a liquid, causing a drop of about 520 degrees Fahrenheit. The gas under high pres-

sure is put to work driving two piston engines, causing it to give up a large amount of energy in the form of heat, thus cooling the gas. The cold gas is used to cool still more gas in a continuous process. Finally a small portion is expanded through a tiny opening, changing it into a liquid. The liquid then is bottled up in a five-foot-deep cylinder. Metals to be studied are lowered into the cylinder.



Flip-Flop Marker for Football

Football downs are recorded for spectators by a marker with numerals which flop into place when a cord is pulled. Made of aluminum alloy, the marker has large numbered plates which are hinged at the top and turn over to expose the next number when the cord is pulled. A model for stadiums has numbers which can be viewed from four sides.



Pocket-Size Exposure Suit

Exposure, one of the biggest trials of airmen downed at sea, is curbed by an inflatable rubber suit small enough to be rolled into a pocket in the collar of a Mae West jacket. It weighs less than three ounces and provides air insulation against cold and damp. The suit is being tested in England and may soon be adopted as standard equipment for Royal Air Force crews.

Four-Jet Bomber "Hits the Deck" in 500 M.P.H. Tests

Low-level speed runs at more than 500 miles an hour have been made by one of the U. S. Air Force's new four-jet bombers, the North American XB-45. The craft

hurtled along just a few feet above the runway at the Muroc, Calif., desert test center. Two jet engines are paired in a single nacelle in each wing.



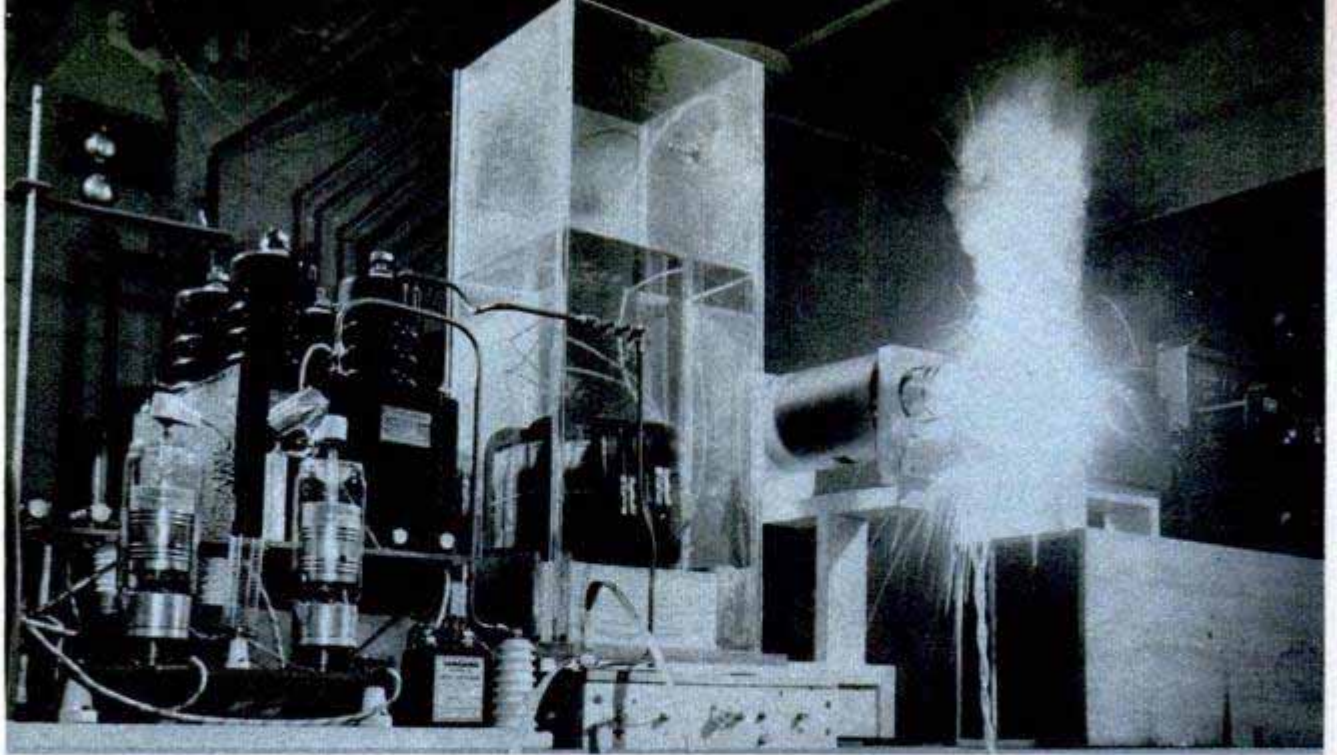

X-RAY MOVIES of burning iron oxide and aluminum are made by photographing a fluorescent screen which picks up X-rays projected through fire. No shutter is used as the rays last only 10 millionths of a second

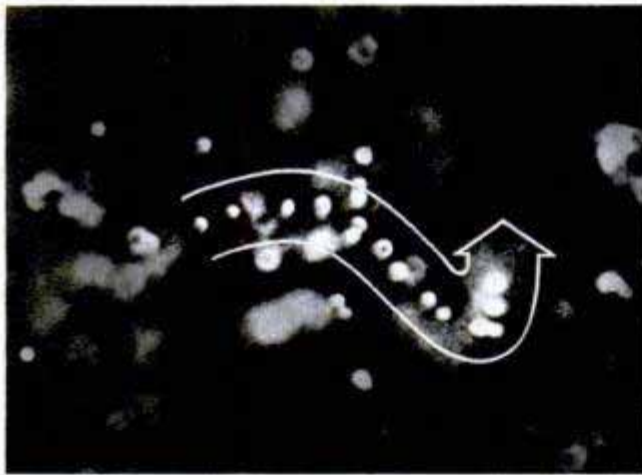

SPEEDING ELECTRON has its picture taken for first time on new Eastman film. The actual length of travel is less than the thickness of sheet of paper

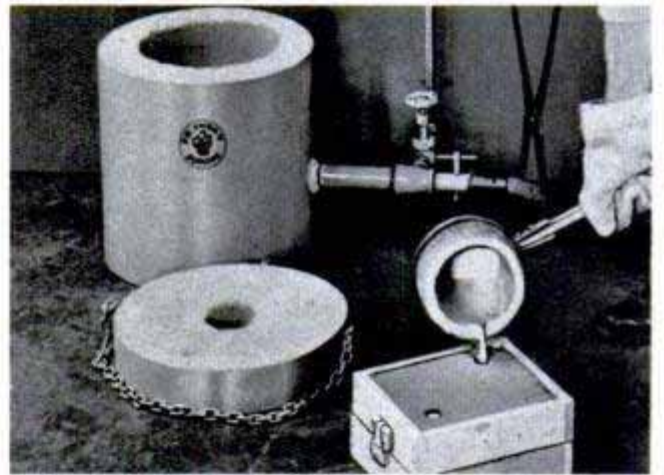

HOBBYIST'S FOUNDRY is small enough for your workshop, yet has everything you need to make sand and plaster-mold nonferrous castings. It burns gas

PENTHOUSE DELUXE has everything a country estate has except a garage. A luxuriant lawn separates the two buildings. Overlooking San Francisco's waterfront, it has a patio, sun deck, swimming pool and gardens



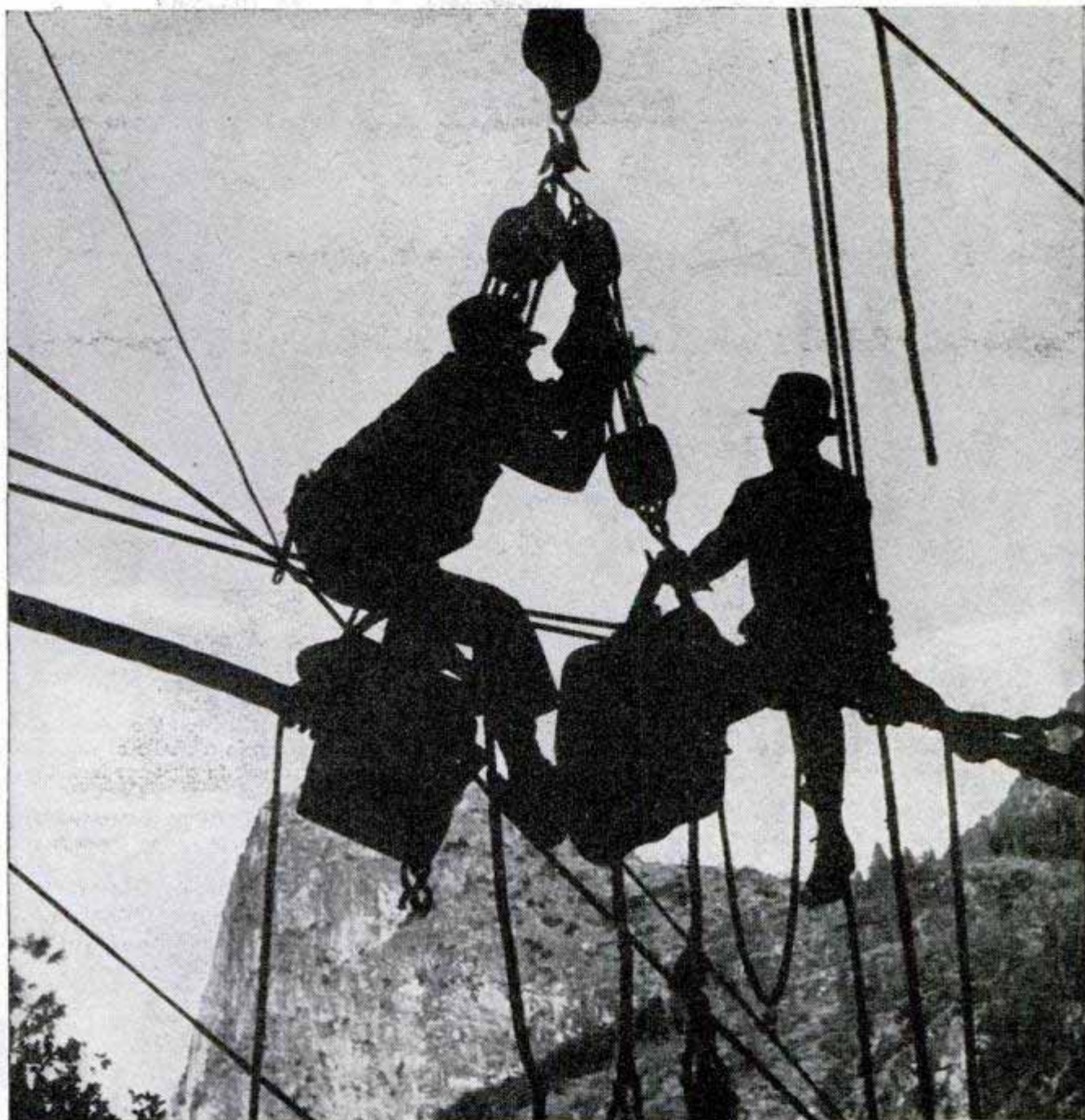

The Story of Rope

THE OLD INDIAN rope By Andrew Hamilton **ing is difficult. Monkeys are trained to climb ropes and strip off the leaves.**

trick has amazed and mystified people for generations. A fakir throws a rope above the stage where it stands without apparent support, as stiff as a rod. The trick is simply this: an unnoticed four-pronged hook at the end catches a taut piano wire in the dim light above the stage.

This vaudeville stunt is not half as amazing as the miracle of rope itself—one of mankind's most useful tools.

In China, tea bushes are sometimes planted on steep hillsides where harvest-

A tremendous hawser, 18 inches in diameter, was once woven for a special harbor job in South America.

Earliest automobile tires were not made of rubber, but of rope.

Thread equal to that in 932 nylon stockings is required to make a single 350-foot tow rope for a military glider.

There are many kinds of cordage other than rope. A cable is simply a super-rope

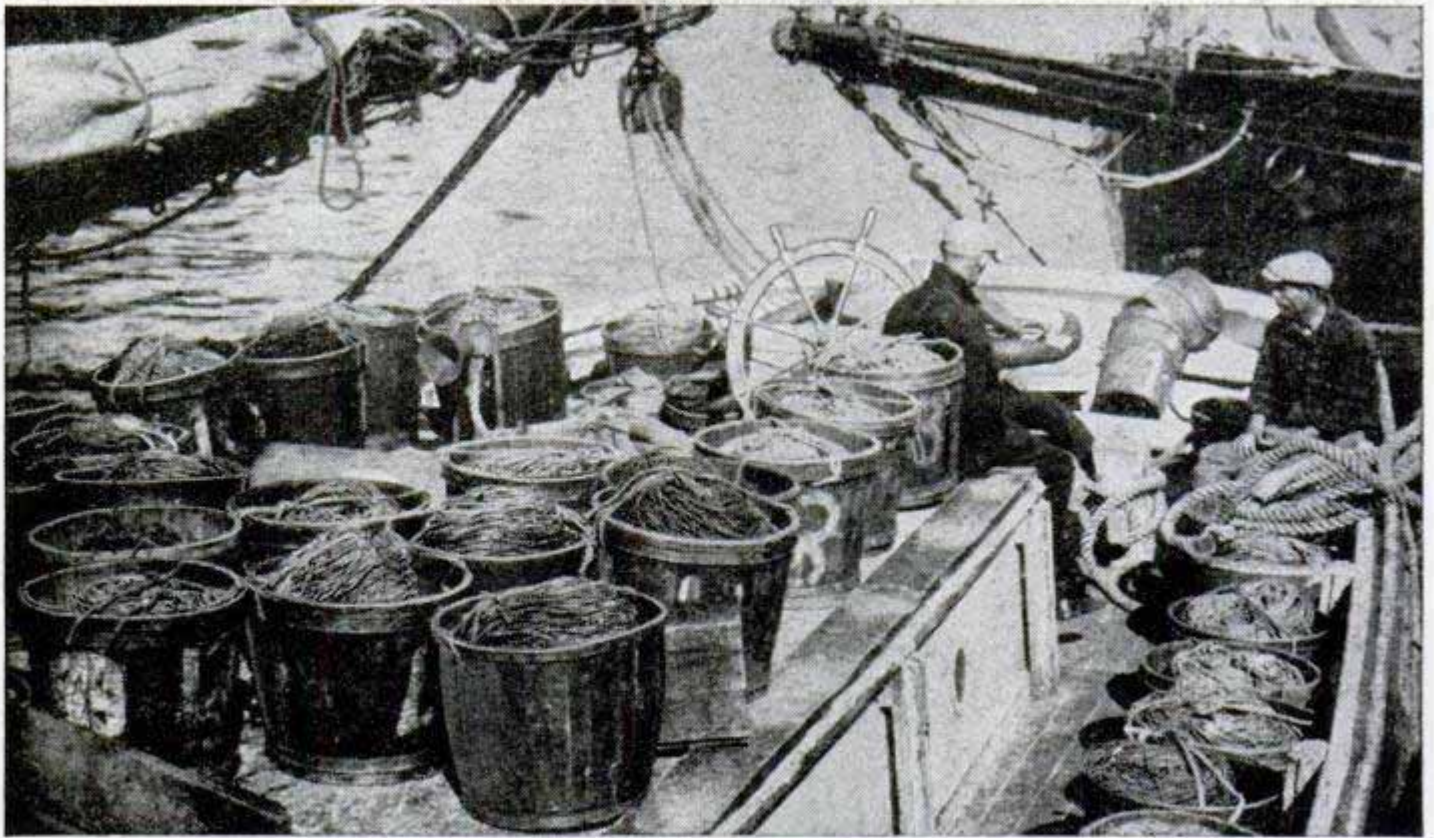

Coils of rope cover the deck of a commercial fishing vessel. There would be few fish on the dinner table if there were no rope or netting. Below left, a circus elephant comes ashore, slung in a cradle of rope. Below right, transmission belts made of many strands of rope turn the huge generators in a power installation

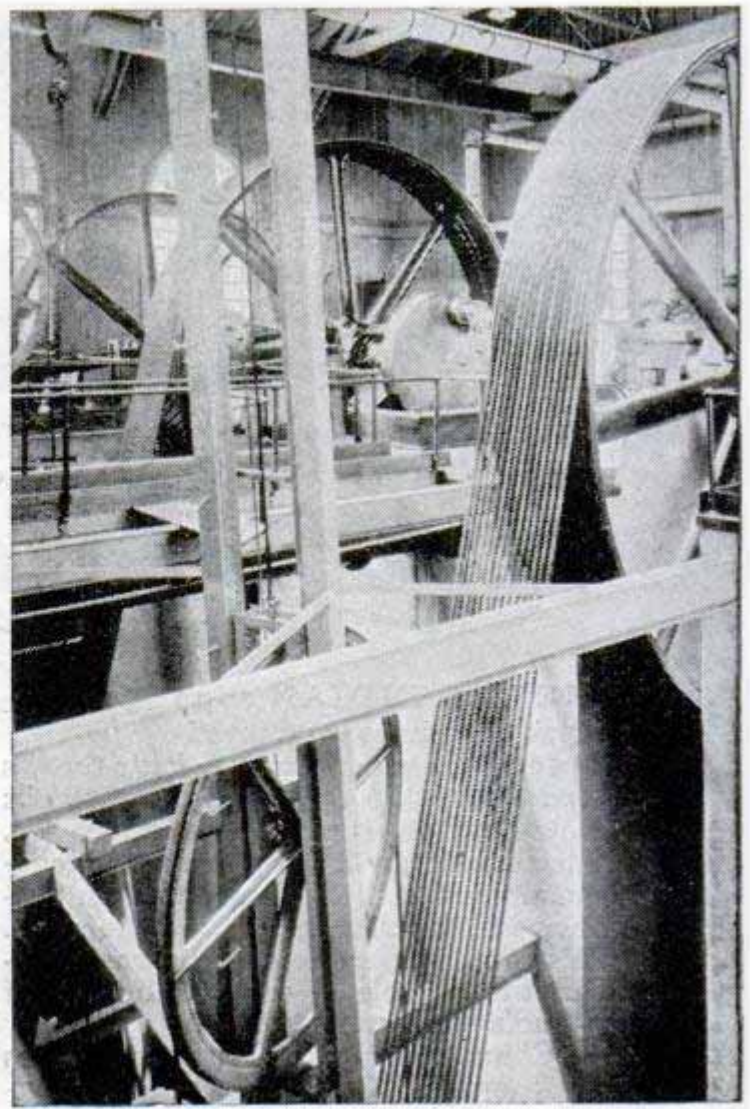
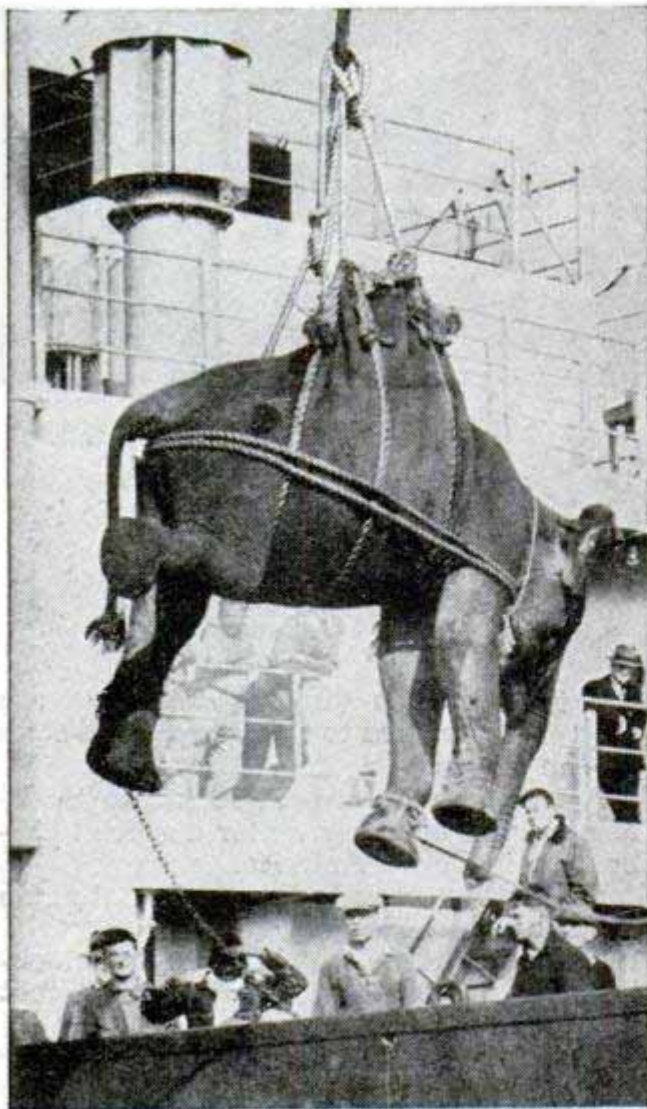



Finest Manila rope is made from abaca fiber, stripped from the inside of a fruitless banana plant grown in the Philippines. The supply of rope became critical during the war when no fiber was shipped from the islands

in which ordinary rope is used as the component strands. Twine is two or more yarns, twisted together.

Rope is one of the oldest devices for lightening back-breaking work. Anthropologists say that our caveman ancestors probably used it even before they invented fire, the ax or the wheel.

Today, cordage-making in the United States is a giant and far-flung industry. Before World War II a score or more hard-fiber cordage and twine manufacturers were producing approximately 350,000,000 pounds a year. Wartime demands stepped this up to 600,000,000 pounds by 1945. Now production has leveled off at about the prewar figures.

World War II proved that rope was indispensable to modern warfare. The Army used rope for tents and trucks, to lash guns in position, to help mountain troops scale peaks; the Navy used rope for cargo nets, boat fenders and refueling lines. A 35,000-ton battleship carries about 50 tons of rope. The Air Force

used rope for parachutes, for glider tows and for securing gear inside planes. The War Production Board found 400 uses for rope that were considered "critical."

Best material for making strong, long-lasting rope is abaca, commonly known as Manila fiber. This is a fiber from a tree, botanically the same as the banana.

Other fibers, not quite as good as Manila, are sisal from the Dutch East Indies, Africa and Haiti, and henequen from Cuba and Mexico. Materials used to make ropes for special purposes are: cotton, jute, flax, strips of leather and, newest of all, nylon.



Loose bales of the silky blond fiber await shipment to United States factories where they will be combed and twisted into rope

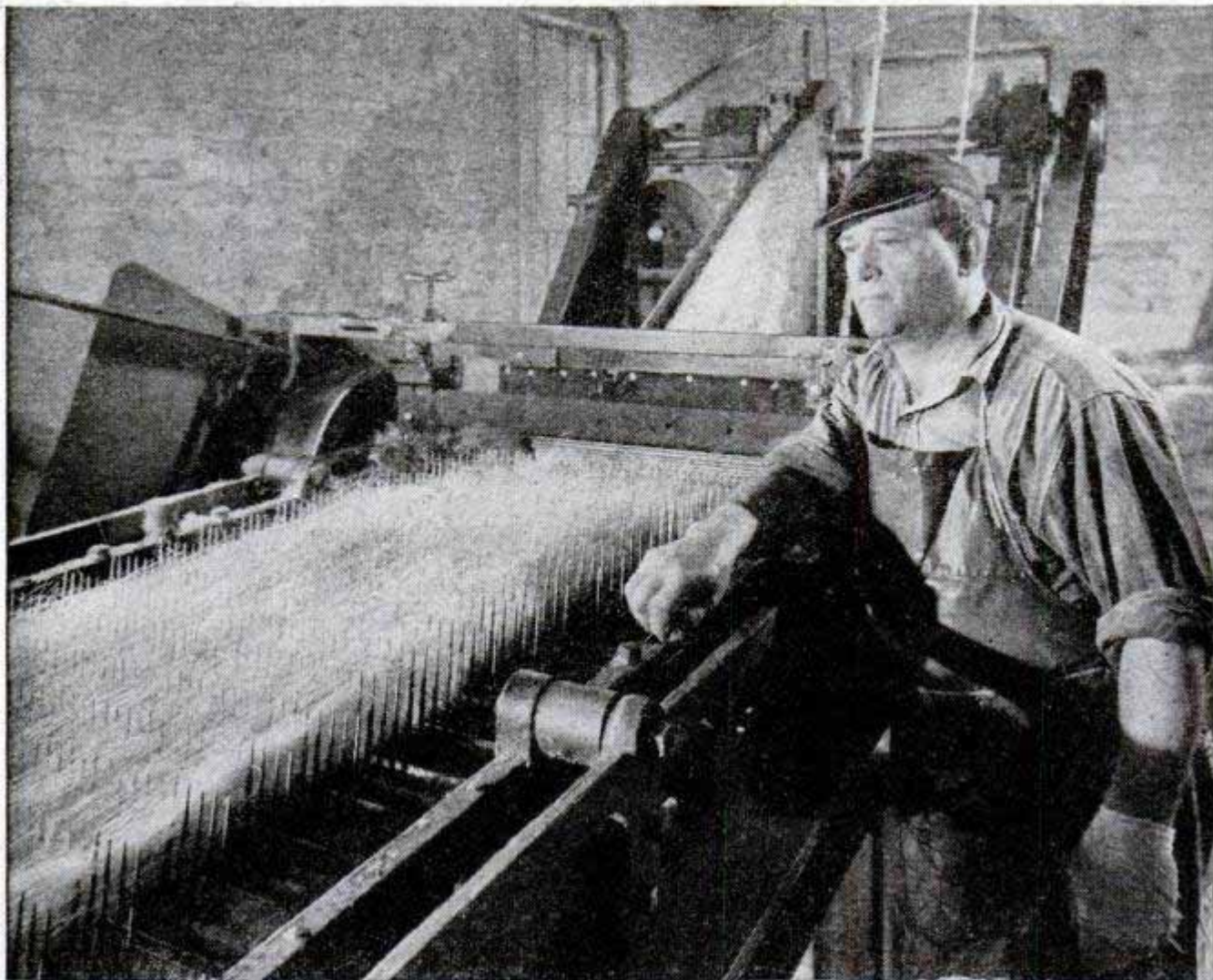

Plymouth Cordage Company photos

In the preparation machine the fiber is combed by hundreds of mechanical teeth before it is blended and mixed. Right, the Gill spinner removes bunches and thin spots in the yarn, then spins it into the uniform strand suitable for use as binder twine

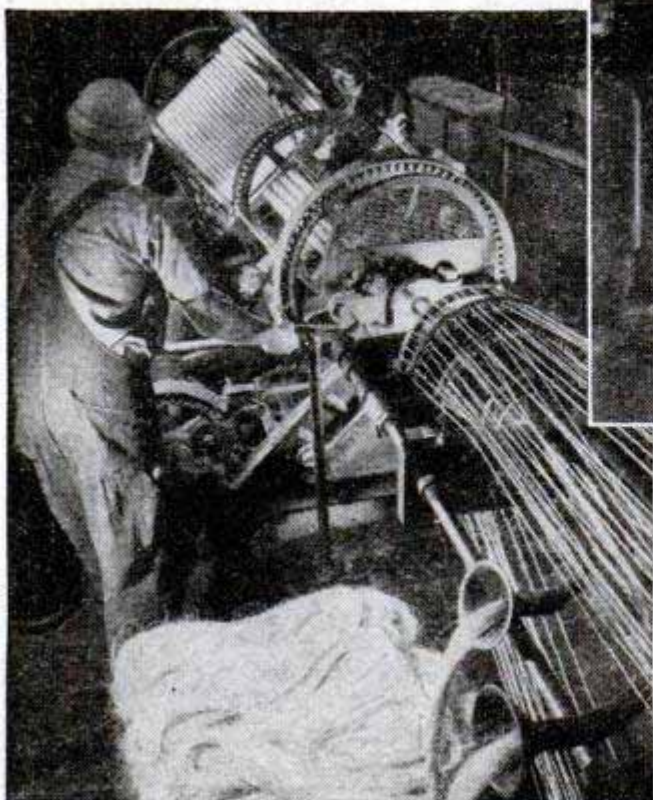
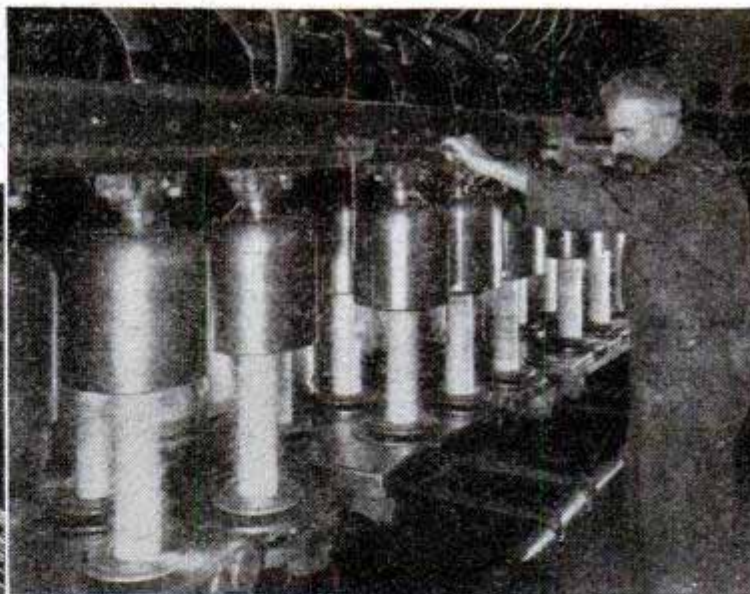

FIBERS

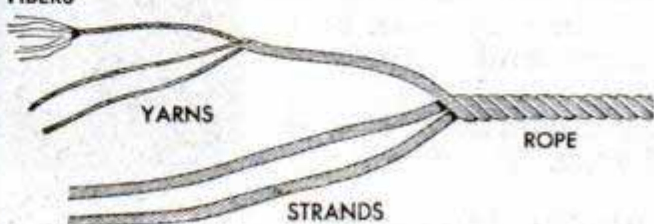

Diagram shows how rope is constructed from fibers. ← Machines twist the yarn into strands, which must have correct degree of twist to make a strong rope

In rope-making there are four steps: preparing the fiber; spinning the yarn; forming the strand; and laying the rope.

When bales of fiber arrive at the mill, they look like huge batches of blond hair. These fibers are scientifically blended and fed into the preparation machine. Thousands of small moving teeth comb, mix, overlap and parallel them into a continuous length of soft, silky "sliver." Oils—animal and vegetable fats and waterproofing compounds—are added at this stage to make the rope water repellent, flexible, easy to handle and less likely to wear out by internal friction.

In the second stage, the sliver is converted into yarn. Machines again comb the fiber, pass it through a funnel-shaped tube, twist it into yarn and wind it around a small capstan. From there it is wound on a large spool. Size and correct turn of the yarn are carefully regulated.

Third step is forming the strand. A scientific formula determines the number of individual yarns that will make up the finished strand.

Fourth and final step is laying the rope. A rope is usually formed of three or four strands. One of the chief problems of rope-making is to overcome the tendency for yarns to untwist. This is done by making the first twist when the fiber is spun into yarn from left to right. The second twist—from right to left—is applied when the yarns form the strand. The third twist, when strands are laid to form rope, is again from left to right. The three twists counteract each other.

About one third of all
(Continued to page 230)

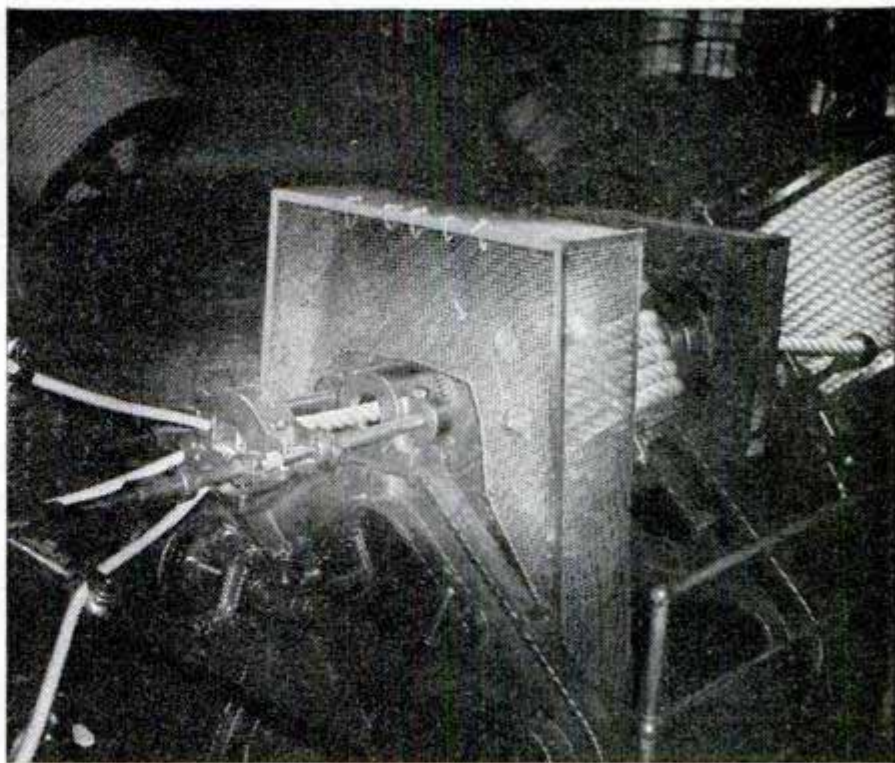

Three strands are turned into a rope with a twist directly opposite to that of the individual strands. This keeps the fibers from straightening. ↓ Largest rope for general use is this heavy Manila measuring 16 inches in circumference. A special hawser 18 inches in diameter once was made

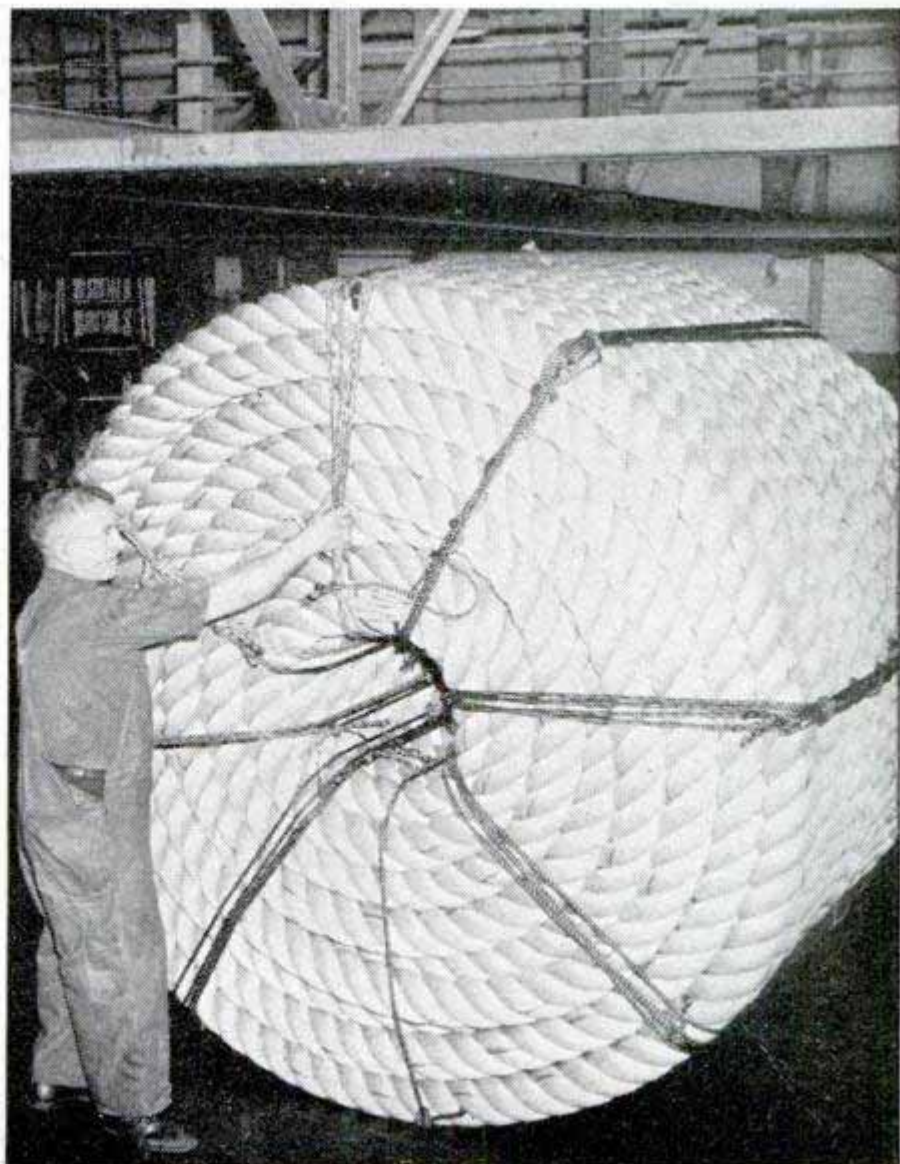



PLANE BUILDERS DO IT WITH MIRRORS

THERE'S more truth than fiction to the old bromide—"It's done with mirrors"—when applied to testing and building airplanes at Boeing's Seattle plant. In some unusual forms, the common household mirror is used to inspect hard-to-reach parts, in aligning electric machine-gun turrets and to check such minute parts as bolt threads for perfection.

Above, with 15-foot lighted "telescope," worker inspects rivets inside a wing. **Below left,** five mirrors "transport" a moving shadow of shock wave, caused by air stream striking obstacle (man's hand). **Right,** two shock waves as they appear on shadowgraph. Device gives visual proof of disruption in air flow

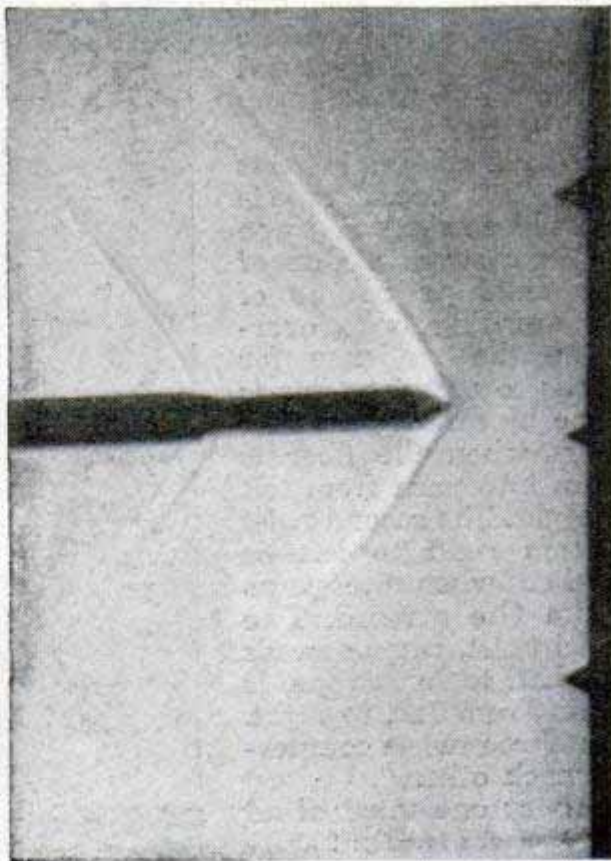
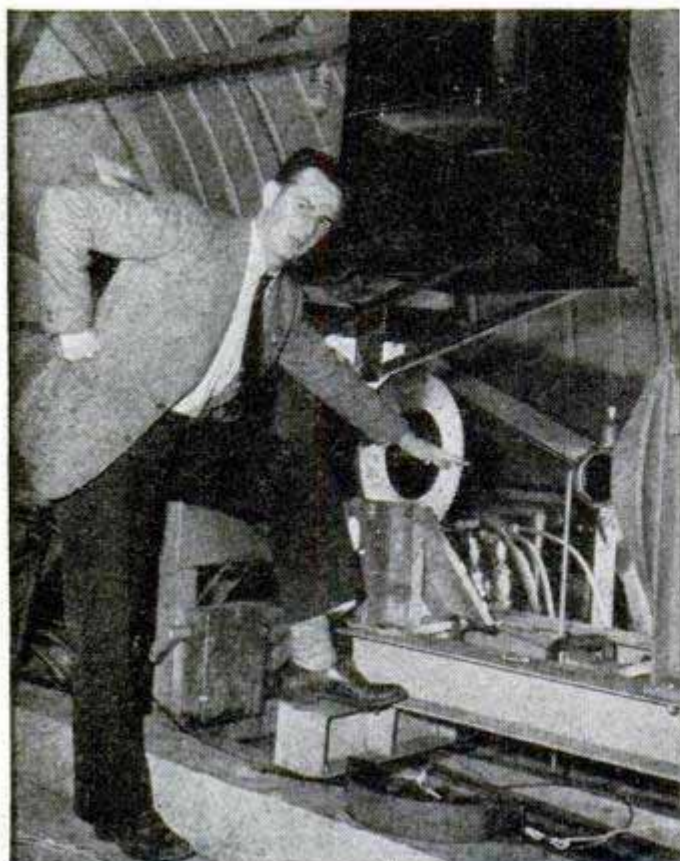

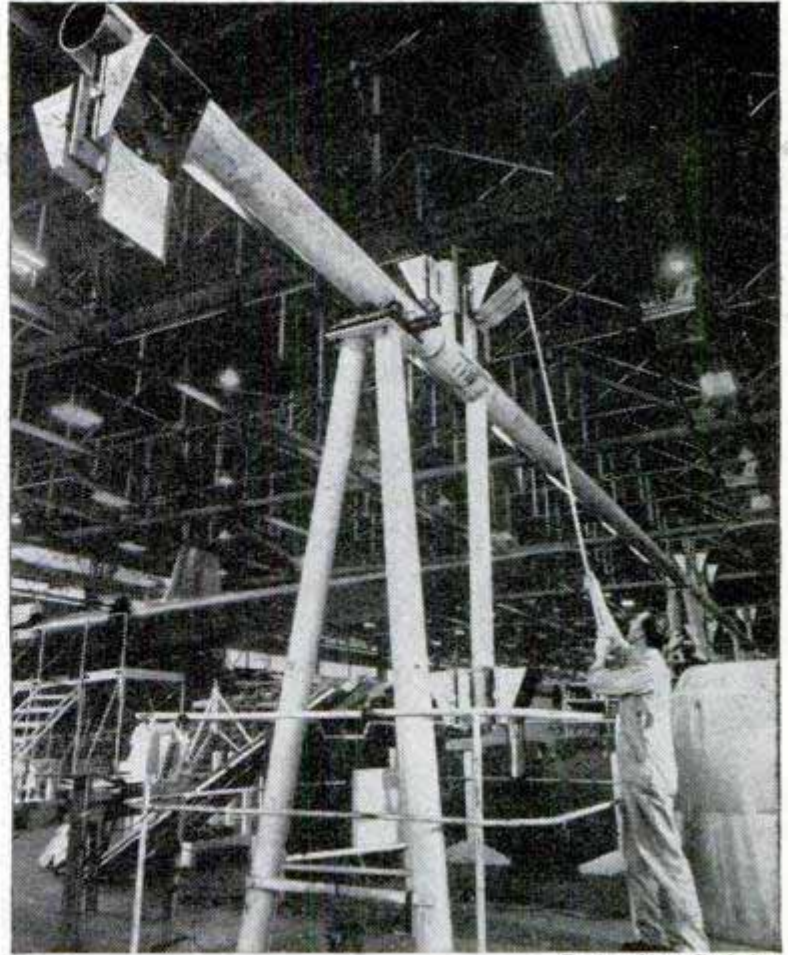

Boeing Aircraft photos

Resembling flapjack turner, mirror in right hand of worker (left) enables him to inspect inaccessible rivets and structures. Towering "mirror range," right, extends almost 98 feet. Each turret and sighting station is lined up perpendicular to one of seven mirrors, so they can be electrically "tied together" to work in harmony

On mirror range, worker inside sighting blister at left adjusts equipment so that it will work in perfect unison with turret. Right, first step in harmonizing is to set all guns perpendicular to mirrors. Inspector raises gun so center of the target on front of scope he is using reflects back exactly on the cross hairs

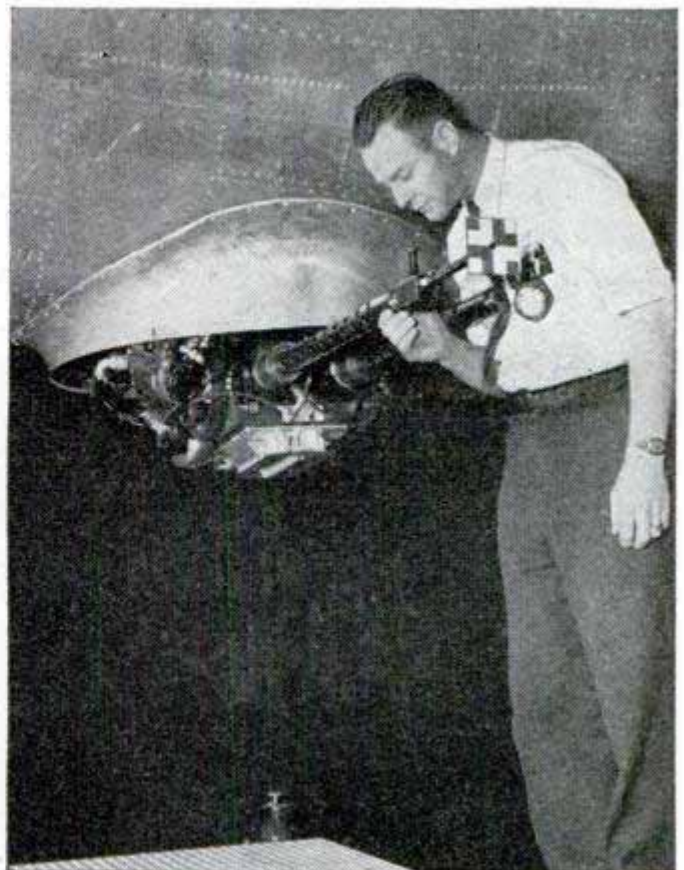

Golf-Trainer Co.
407 S Dearborn Chicago 5 Ill.

Disk Anchored to Golf Ball Indicates Length of Practice Shots

Pierpad. 20-51 *

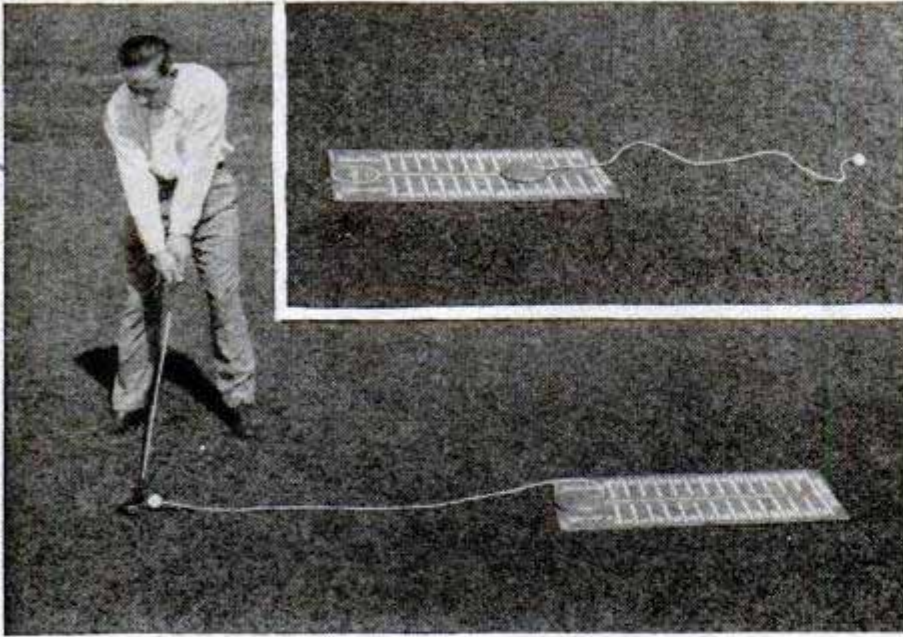

There's an answer now for golf practice swingers who boast "a shot like that would have traveled a mile!" It consists of a regulation golf ball, a cord anchored to the ball and to a steel disk, and a three-foot-long board with markings scaled up to 300 yards. When the ball is driven the disk-anchor checks its flight, but momentum drags the disk forward along the board. The disk's position indicates both the shot's distance and direction. The trainer can be used indoors or outdoors.

Portable Grandstand

When the circus comes to town its grandstand will roll into position under the Big Top and in a few minutes it will be ready to seat the crowd. Mounted on a trailer, the portable grandstand, which folds into a compact package for traveling, will seat 300 persons. During a recent demonstration, the grandstand was tested by adding the weight of an elephant to that of the spectators.

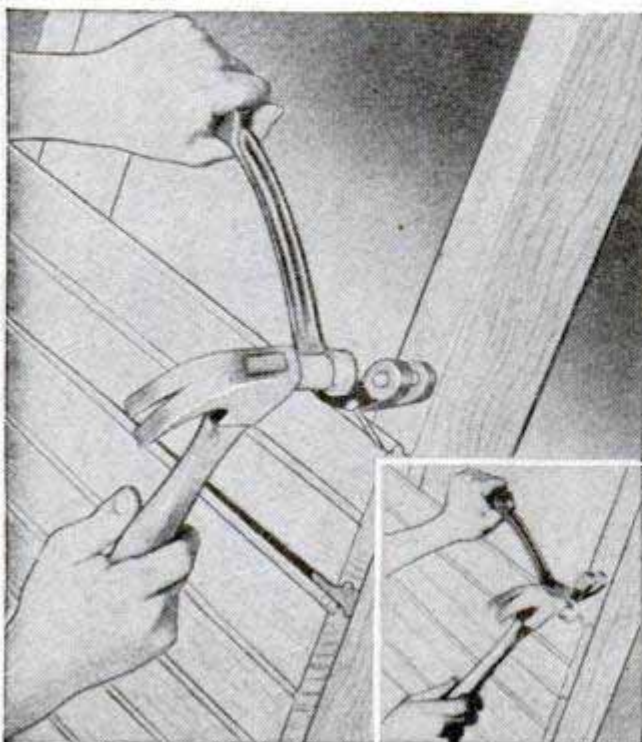
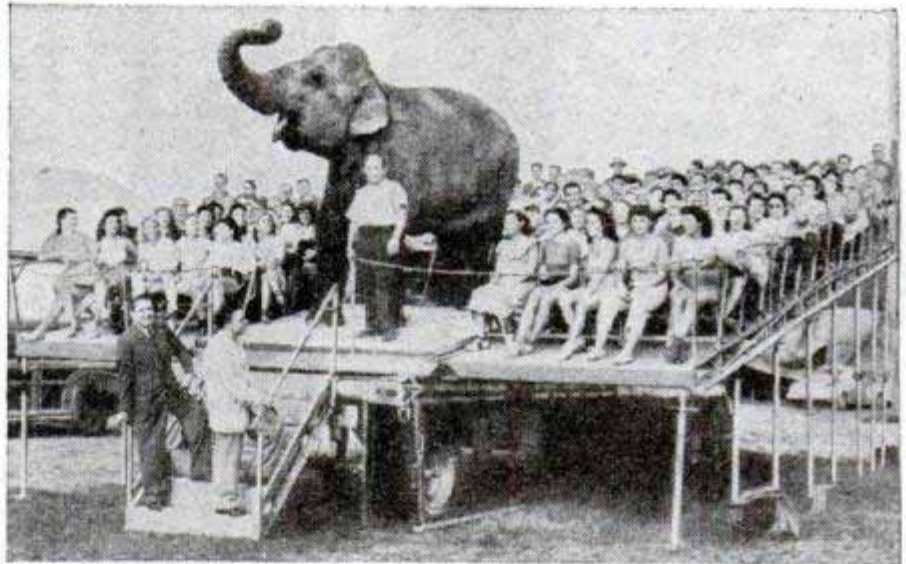

Bender for Warped Lumber

Warped, rough or twisted lumber is forced into place for nailing by an ingenious board bender. The tool's anchor pin is hammered in above the board and its handle then drawn down until the wood is forced into the position desired for nailing. Made of aluminum, the tool adds little weight to a tool chest.

Fire Door Closes Automatically

Fire-resisting doors, often kept open for ventilation purposes, are closed automatically when fire breaks out by a heat-actuated device that attaches to the standard door closer. Resembling an automatic sprinkler head, the device holds the door open until the temperature reaches 135 degrees. Expanding thermal liquid in the device releases the plunger on the door closer and the door shuts automatically.

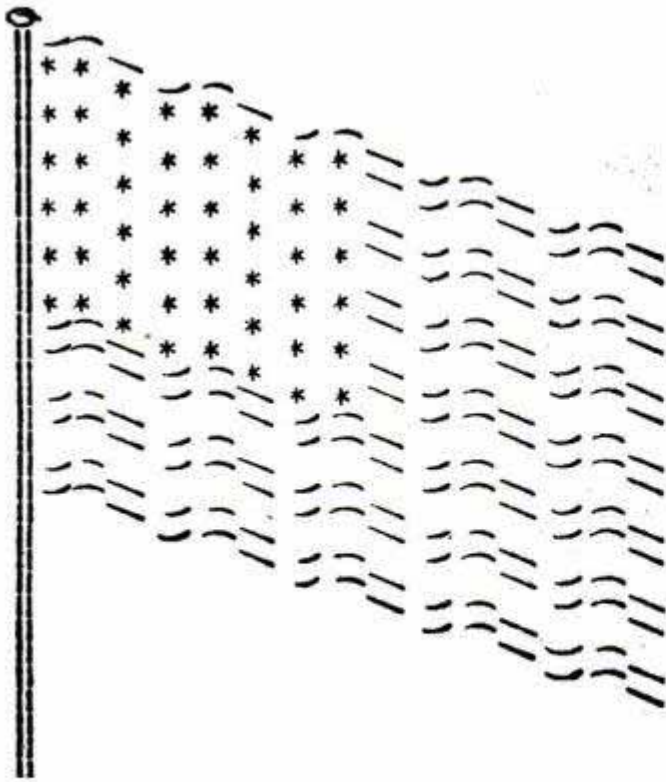

Typewritten Flag

Anyone can draw an accurate picture of the American flag on a typewriter, according to Menno Fast, a relief worker in Poland. Fast read a recent *Popular Mechanics* article on drawing pictures with a typewriter. He submits a drawing of the flag as proof that it can be made on an ordinary typewriter using standard spacing. The flag, with a full 13 stripes and 48 stars, appears to be rippling in the wind.



Collapsible Baby Stroller Folds for Carrying

Small enough when folded so that it can be carried like a suitcase, a stroller that is made in England weighs only 15 pounds. It is opened or closed in a few seconds. In bad weather, the child is protected from rain and wind by a light cover that is attached to the handle.

Project Begun on Sick Bed Pays Big Dividends

What started out as a convalescence hobby after a serious illness turned out to be a valuable investment for Jack Lawton of Moscow, Idaho. While confined to bed he poured over his file of *Popular Mechanics*

and decided to build a garden tractor that was described in one issue. As soon as he became strong enough to do light work for a few hours a day he began building the tractor and by the time he was fully recovered he had completed it. That was 14 years ago and the tractor, made of junk Model-T Ford parts, is still doing plenty of work. He uses it for everything from plowing and harrowing gardens to shoveling snow.

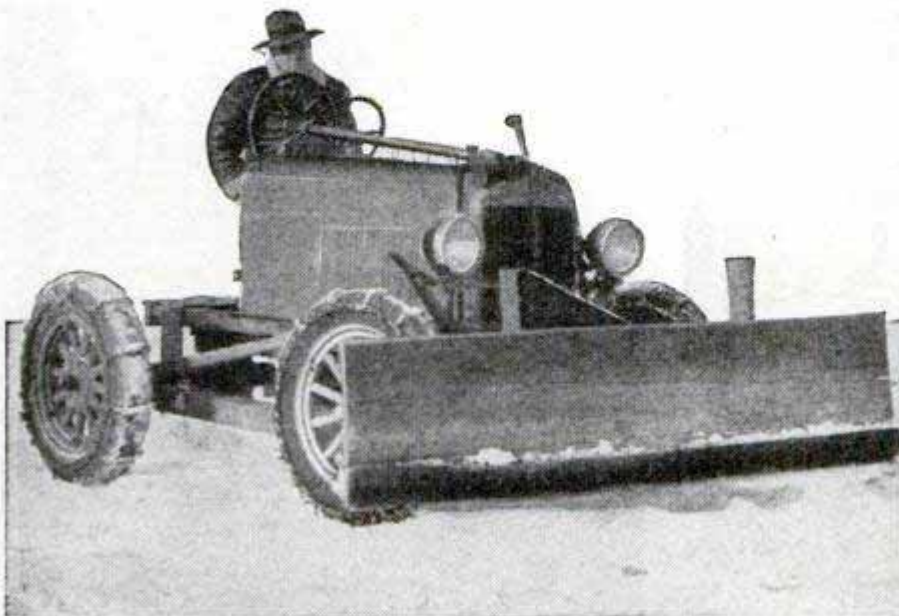

Instead of lead, extra high-voltage cables that will give up to 50 years service are sheathed with Bakelite polyethylene, a material which is waterproof, flexible and chemically inert when in contact with high-voltage insulation.

PROSPECTING for Better Metals

THE SEARCH for new and better metals goes on endlessly at the Westinghouse Research Laboratories where a score of scientists are attacking the problem from every conceivable angle. Like a giant jigsaw puzzle in which the main pattern is apparent but not wholly clear, the concept of the right metal for the right job is gradually taking shape.

Here are just a few of the questions that scientists are seeking to answer. What ingredients mixed together will produce the best metal for high-temperature applications such as the jet engine? What ingredients give a metal strength, hardness, toughness, elasticity? What hidden changes occur in a metal under heat treatment? How does the microscopically thin "skin" that forms on metal surfaces at high temperatures protect it from further corrosion? How is the presence of carbon in steel linked to brittleness?

To dig for the facts, researchers have at their command an ingenious array of equipment especially created for the job. There was the problem of testing the whirling disks used to hold the blades in jet engines. Such disks must be able to stand up under the simultaneous assaults of terrific heat and blurring speed. The

scientists wanted to learn what happens inside a metal subjected to such punishment.

They built a "bombproof" dugout in which they can study jet disks under every temperature and speed up to the point where they literally explode. In this dugout, ringed with heavy sandbags and sunk deep below floor levels, disks made of specially developed alloys are heated up to temperatures above 1400 degrees Fahrenheit, and spun around at dizzying speeds of 1200 miles an hour—35,000 revolutions a minute. That's much more than presently used metals in jet engines can safely stand.

During tests, the disk is covered by a thin steel hood from which air has been evacuated to reduce friction. The hood was constructed purposely of very light steel, so that flying fragments of metals will easily penetrate its thin skin. Use of heavier steel would cause serious damage to the fragments and prevent close scrutiny of the type of fracture or break involved—vital information to the scientist.

As the heated disk spins, research engineers A. C. Hagg, B. Cammetti and Gale Sankey make continuous measurement of its temperature and of the expanding diameter. Even the toughest of metals tend to flow or "creep" under high stress or

Left, taking hot metal from furnace in laboratory steel mill. Right, metal in jet-engine blades must be tough
Westinghouse photos

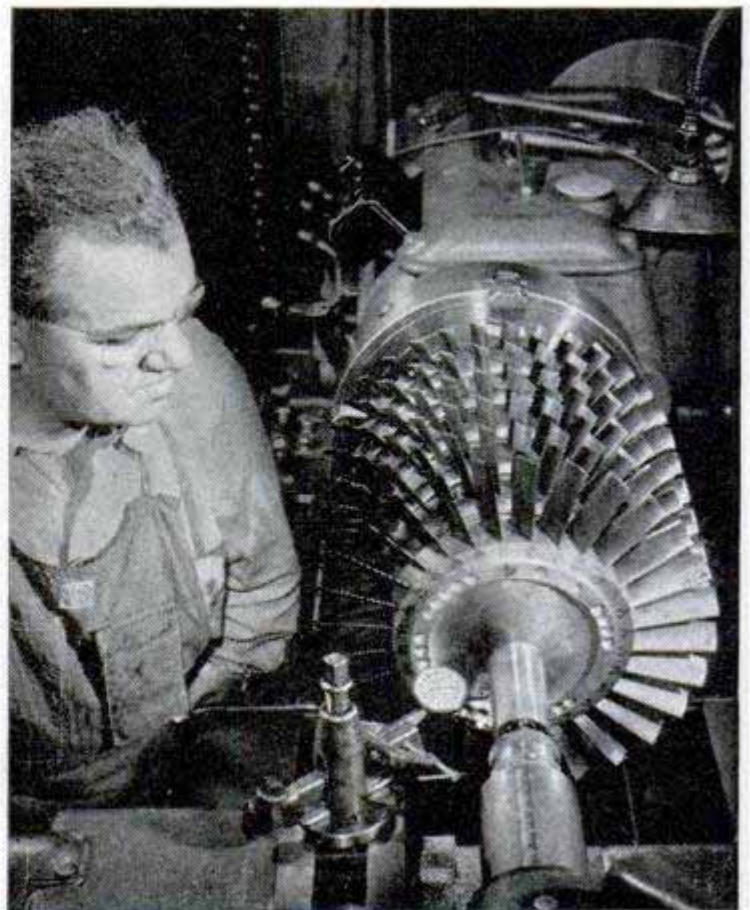

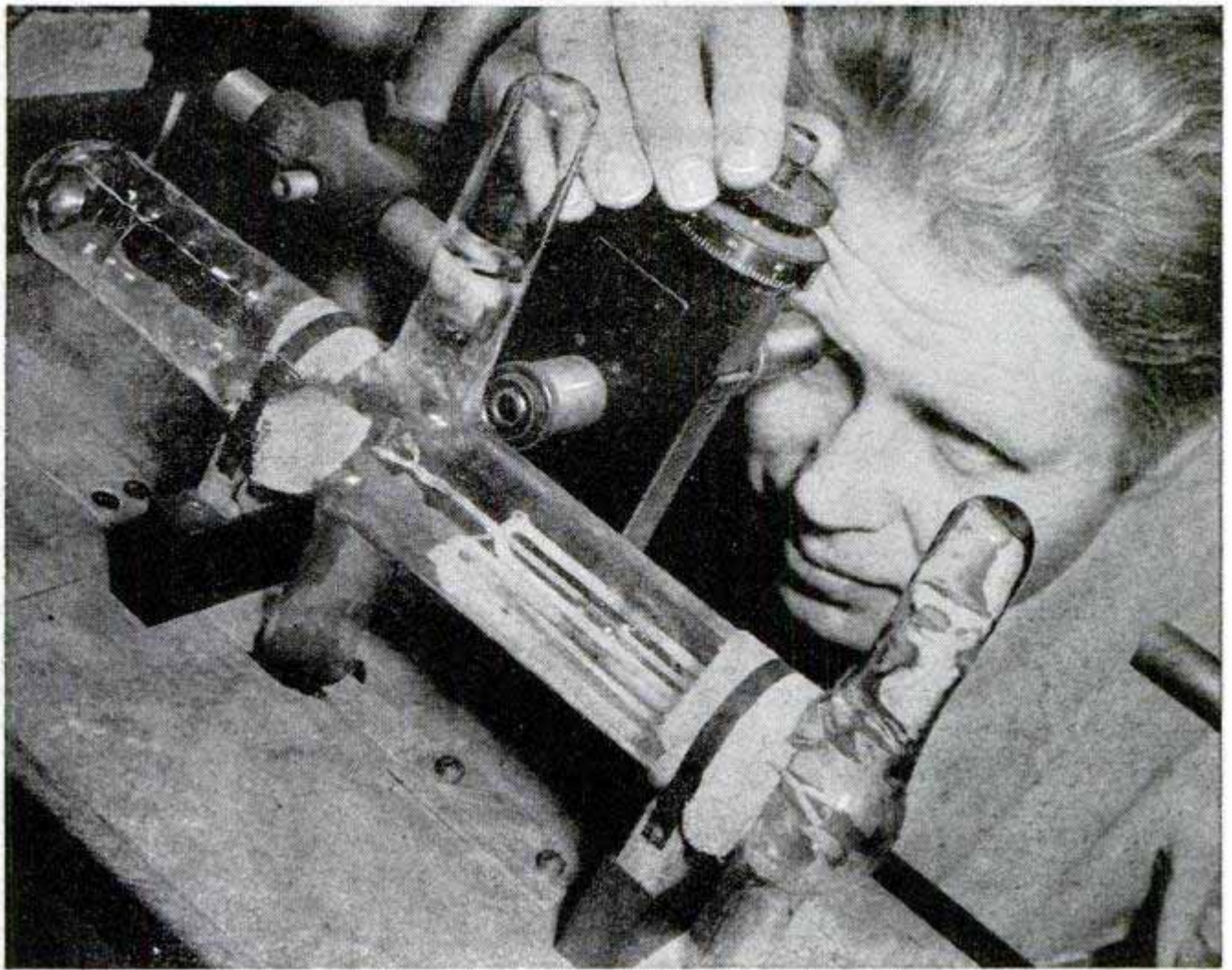

Micro-balance scales weigh single layer of oxygen atoms forming skin on metal. Below, "vest pocket" rolling mill turns out strips thin as tissue paper

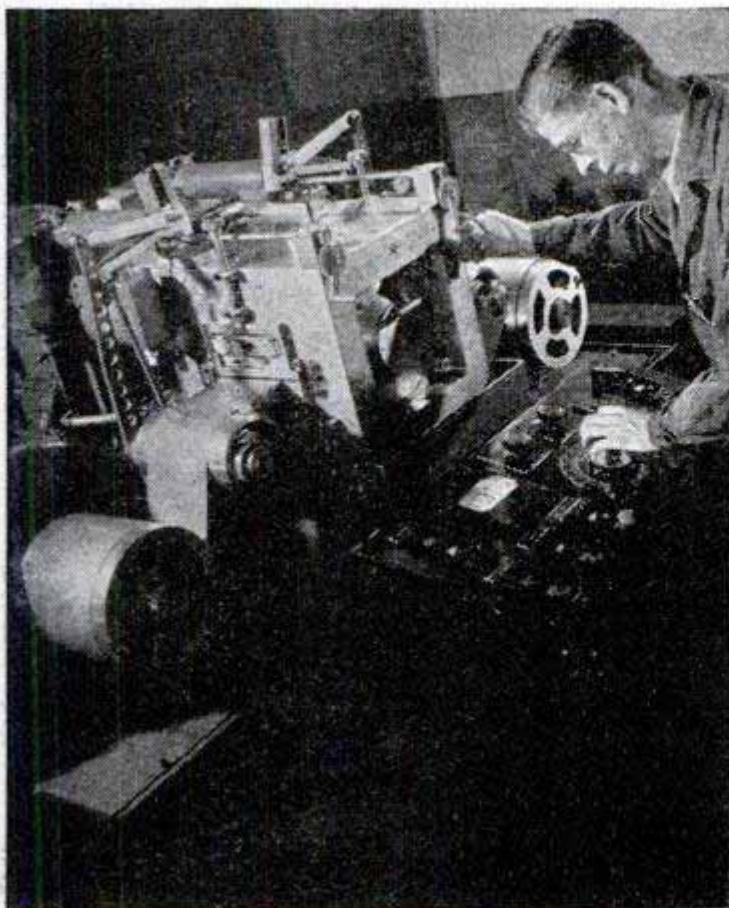

temperature, and with the narrow clearances in the jet engine, knowledge of this rate of flow is vital to the design engineer to prevent future rubbing of surfaces.

Many other things happen to a metal when it gets red-hot. One of the most significant and interesting of these is oxidation—essentially the same process that causes exposed metals to rust. But scientists wonder whether oxidation at high temperature really is a "metal termite."

For as a metal grows hotter, a curious process takes place. A sub-microscopically thin skin—only a few atoms thick—is formed on the metal surface and protects the metal underneath from further deterioration. Is it possible, scientists are asking themselves, to develop an alloy in which this oxide skin would provide permanent protection over a wide range of temperatures? At present, all known oxide protection is vaporized as the temperature continues to go up.

Westinghouse men are attacking this problem from within and without. To study how fast and how thick the skin is formed, they use a balance scale so sensitive it can weigh a single layer of oxygen atoms! That's about one ten-millionth of an ounce. A perfectly clean metal sample is attached to the balance, which consists

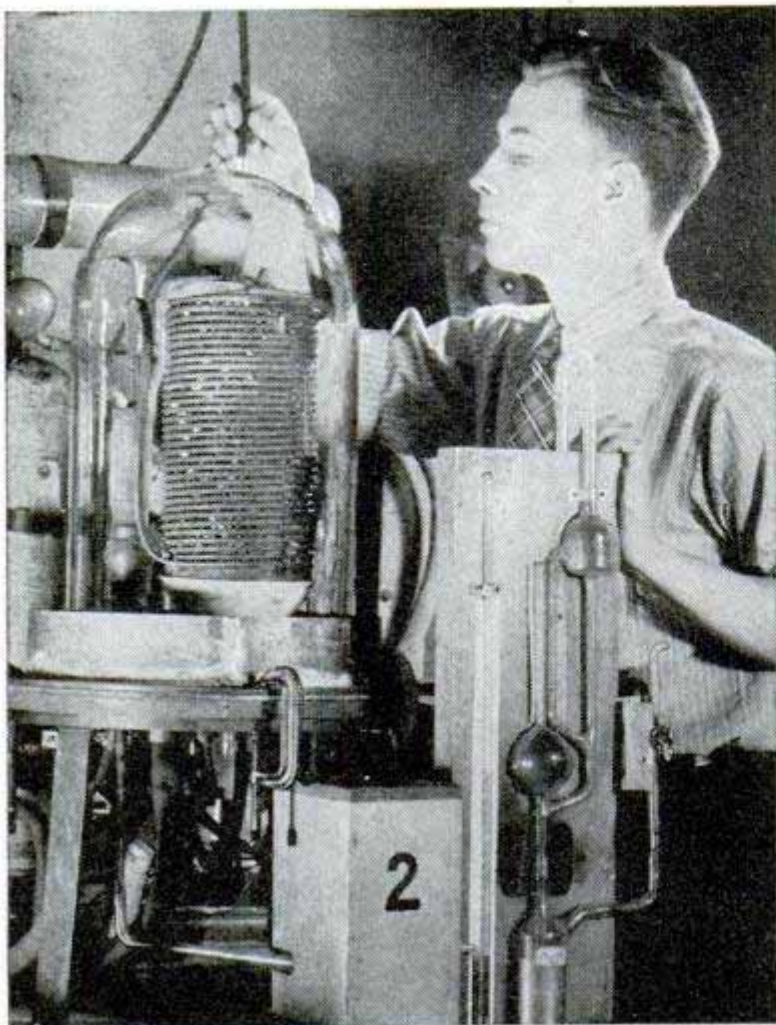

Stream of water cools bell jar of induction furnace which has a heat of 3000 degrees Fahrenheit inside the furnace coils

"Bombproof" dugout is used to test jet-engine disks at high speeds and a heat of 1400 degrees Fahrenheit. Below right, an ingot of new magnetic alloy (Hiperco) is poured by scientist

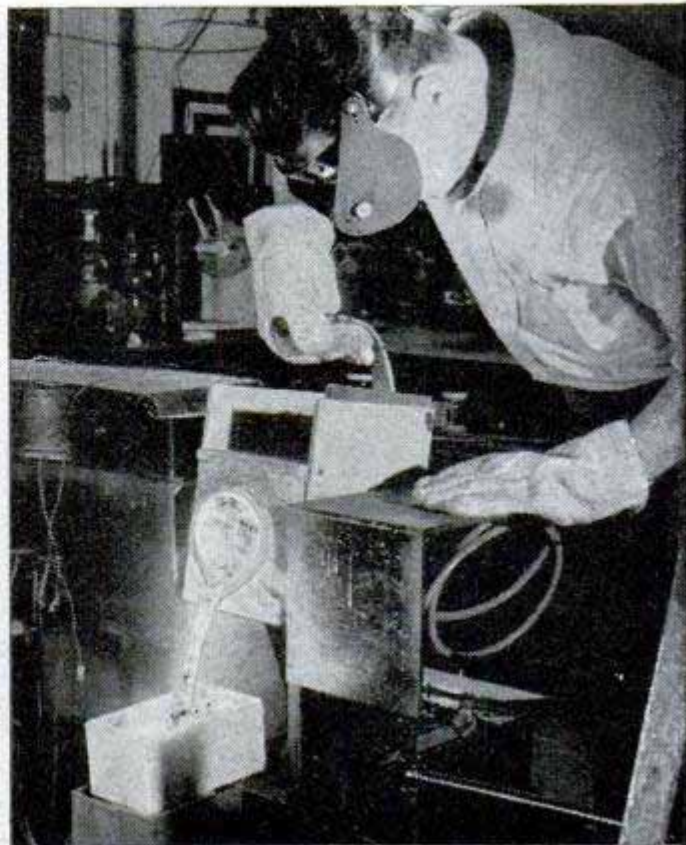

of a hair-thin tungsten wire in a sealed quartz tube. Then oxygen is admitted into the tube and heat applied. As the skin is formed, the balance is tipped in favor of the metal sample and the gradual change in weight of the film is recorded step by step. In this way, the scientist gets a clear picture of when and how oxidation forms.

But this is only a partial view of metal oxide skins. To complete the picture, E. A. Gulbransen and J. W. Hickman, Westinghouse scientists, employ two sets of electronic "eyes"—the electron microscope and the electron diffraction camera.

With the electron microscope—which can magnify his vision 200,000 times—the scientist sees the physical make-up of the film. He sees how atoms and molecules combine to form crystals and how these crystals grow as the temperature increases and the skin thickens. It tells him the size of the particles, how they are linked together and how they shift position under various temperatures.

What of the chemical nature of this skin? How do the oxygen atoms and molecules link up with the metal and what oxides do they form? These answers come from the electron diffraction camera which takes up where the electron microscope leaves off.



Left, electronic portrait of skin formed on nickel at 900 F. was made by the electron microscope at right

In this unique camera, the metal sample to be studied is bombarded with a powerful electron beam. The beam ricochets off various "faces" and "ridges" on the metal oxide skin and strikes a strip of photographic film. The result is a portrait consisting of a series of concentric half-circles. By measuring the distance between these half-circles, the scientist is able to determine the distance between the atoms in

the oxide skin being studied. This tells him the chemical nature of the film and how the oxidation takes place. It enables him to "fingerprint" chemically the great variety of oxide films that form on metals.

Research men recently made the camera an even more effective tool by adding a tiny furnace, so that the portraits can be made continuously at temperatures up to

(Continued to page 218)

"Torture" machine in Westinghouse lab shows how fast copper creeps when the metal is heated and pulled

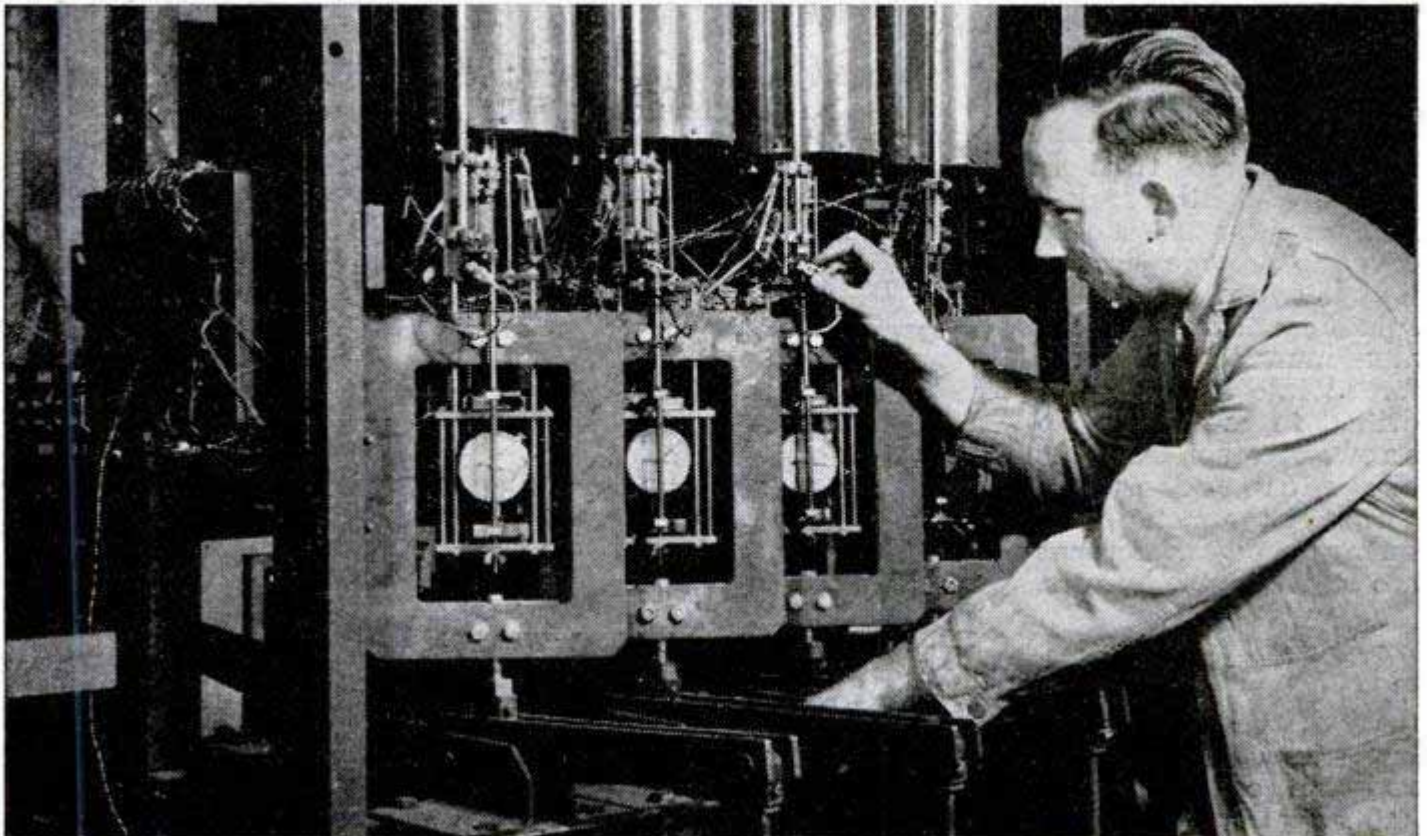

Army Signal Corps Uses Rockets to Lay Field Telephone Wires

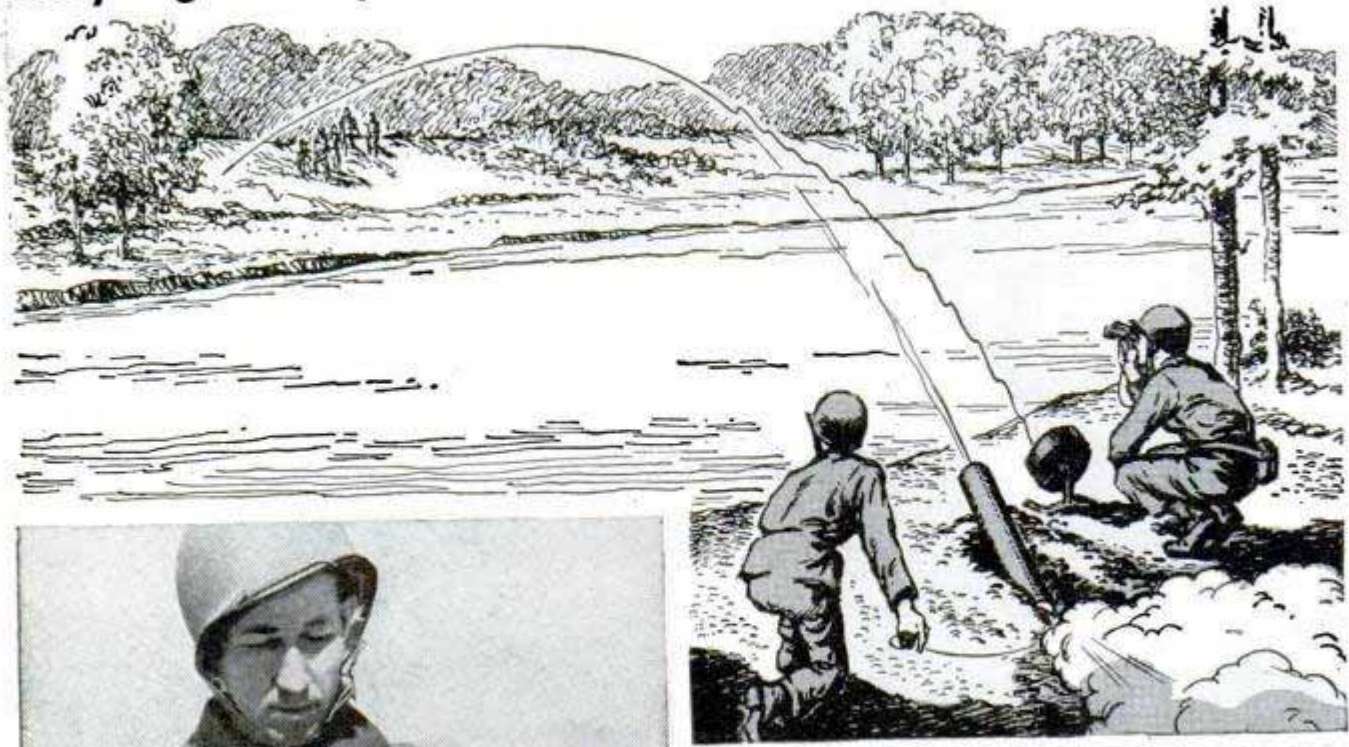

Army Signal Corps photo

Fired from original container, rocket pays out wire from dispenser. One mile of wire weighs 48 pounds

Employing a rocket that can be fired from its original container, the Army Signal Corps has developed a lightweight portable unit for laying telephone wire over rough country. The rocket is fired from a wedge-shaped hole dug in the ground. One man, equipped with a wire dispenser, small field telephone and a rocket, can establish wire communications for relatively short distances over rivers, cliffs and ravines.

Miniature Louvers Ventilate Eaves

Midget louvers, 2½ inches in diameter, provide air circulation in building space that is normally tightly sealed. Designed for use under eaves to provide circulation between ceiling insulation and rafters, the aluminum louvers are forced into a small hole drilled in the wood. No screws or other fasteners are required as the spring of the metal holds them in place. Screens are built into the louvers.

☐ Weighing 120 tons, a blue whale can speed through the water at 20 knots for short distances and can cruise at 14.5 knots for long periods.

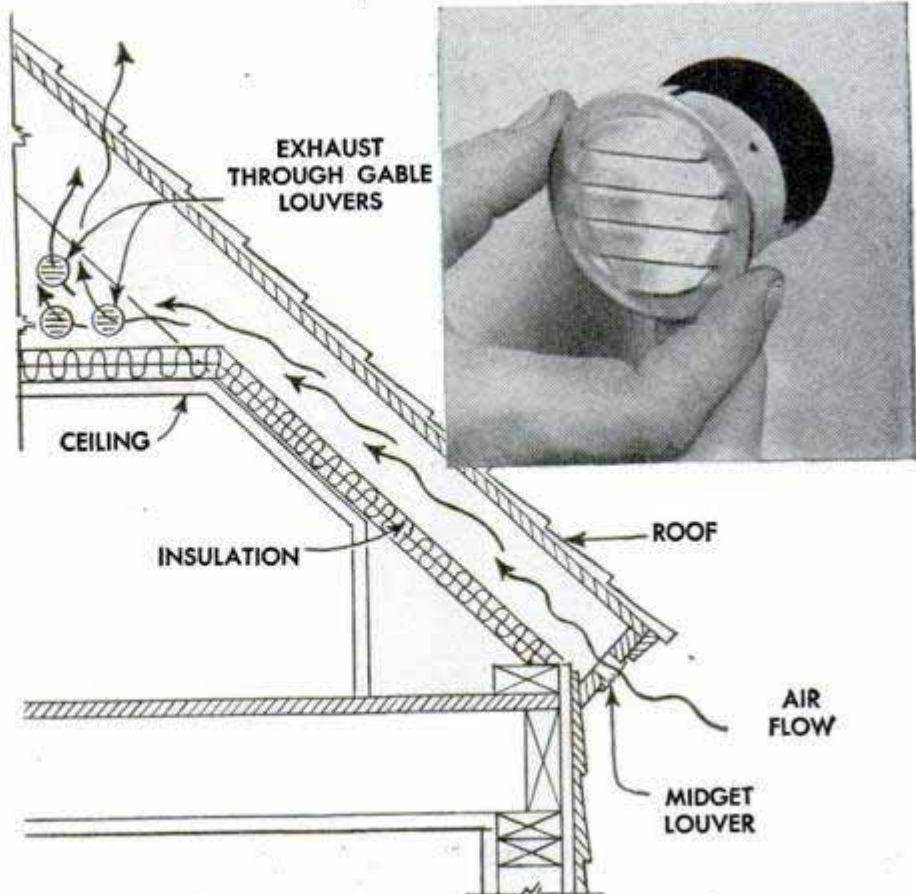

"Coal" Tractor Run by Steam

Live steam powers a scale model of an early type farm tractor, a coal or wood-burning vehicle used many years ago. The model, built by Warren A. Taylor of Kansas City, Mo., is 41 inches long and weighs 200 pounds. It required three years of sparetime work and an outlay of \$204.39 for materials. Built to a scale of two inches to the foot, the model is driven by steam generated from charcoal or by a supply of compressed air.

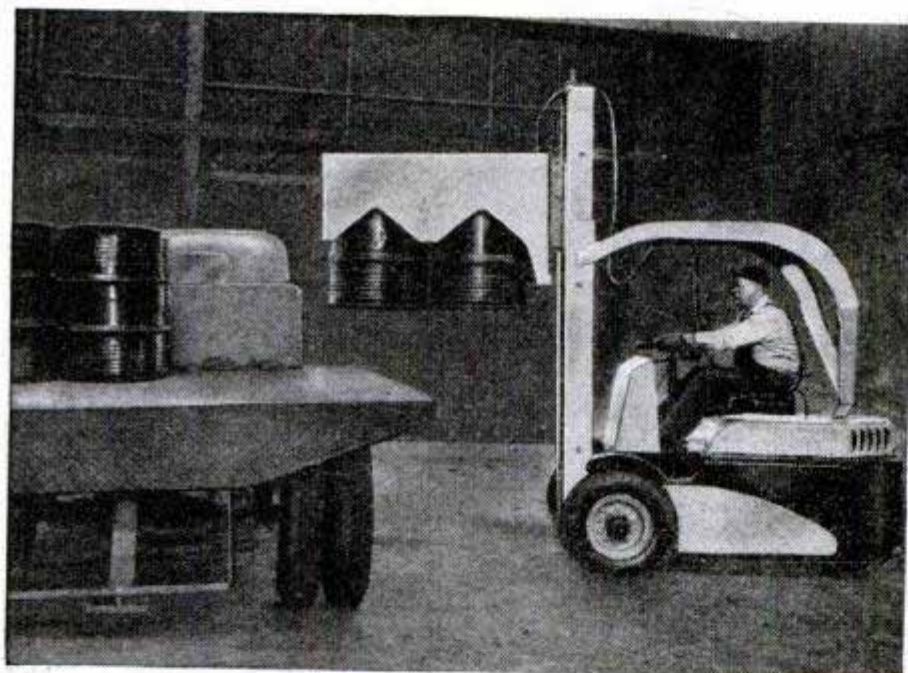
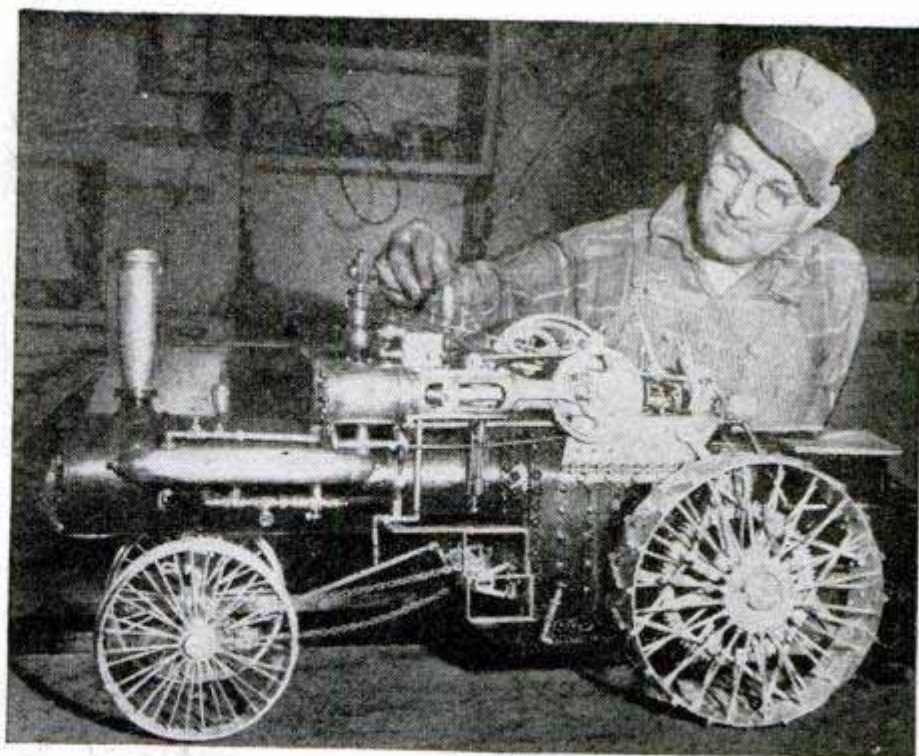

Drum Power Hoist Lifts Four at Once

By installing a multiple drum carrier on a fork-type power truck, one man can move up to four drums at a time. The carrier does not interfere with the driver's vision. It grips the drums firmly by hydraulic pressure and releases them quickly when desired. Not all drums need be the same size; it can handle drums that vary two inches in diameter. The carrier can be removed from the truck in 10 minutes.

"Land Ship" Trains Pilots

Far different from the streamlined planes they are learning to fly, a "land ship" is used to instruct British trainees in compass navigation. The boxlike vehicle is swung around in varying directions by the instructor and fliers learn to adjust their compass bearings accordingly. It is part of the training at the Air Service Training School in England.

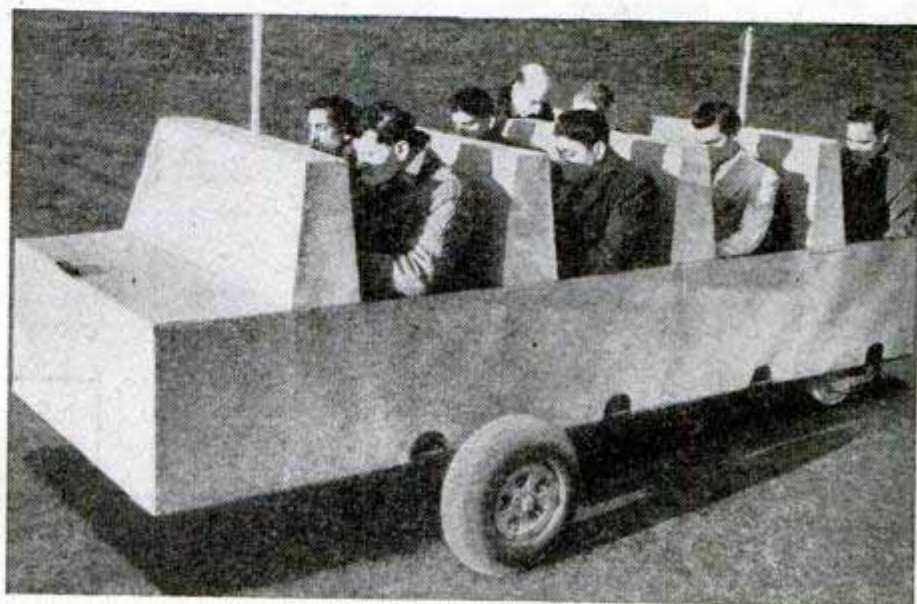

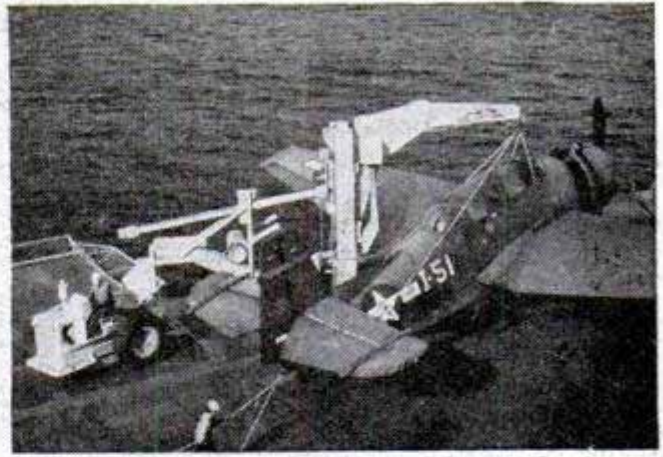
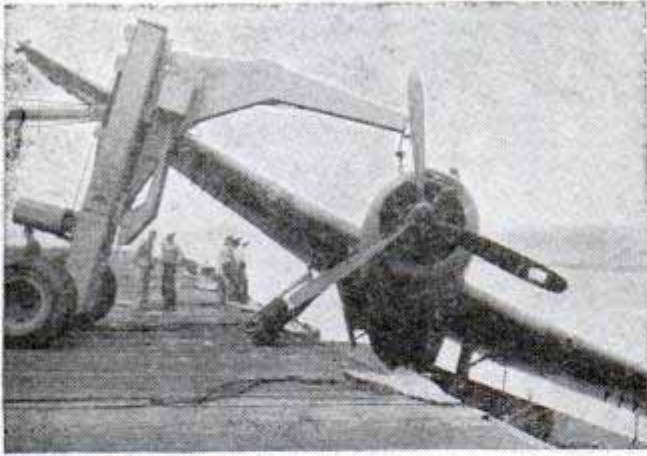

U. S. Navy photos

Carrier Crash Crane Lifts 24,000 Pounds

Flyers can be rescued faster and larger planes salvaged with the Navy's new mobile carrier crash crane, now aboard the USS Franklin D. Roosevelt. It lifts 24,000 pounds, almost double the amount of previous models, and is the first to be operated entirely by electricity. Two lift forks can speedily right an overturned plane if immediate rescue of trapped occupants is necessary. Instead of operating only on the flight deck of the carrier, it can reach out 65 feet over the side of the ship or from the hangar deck to lift up to 13,000 pounds. Though larger than previous types, the

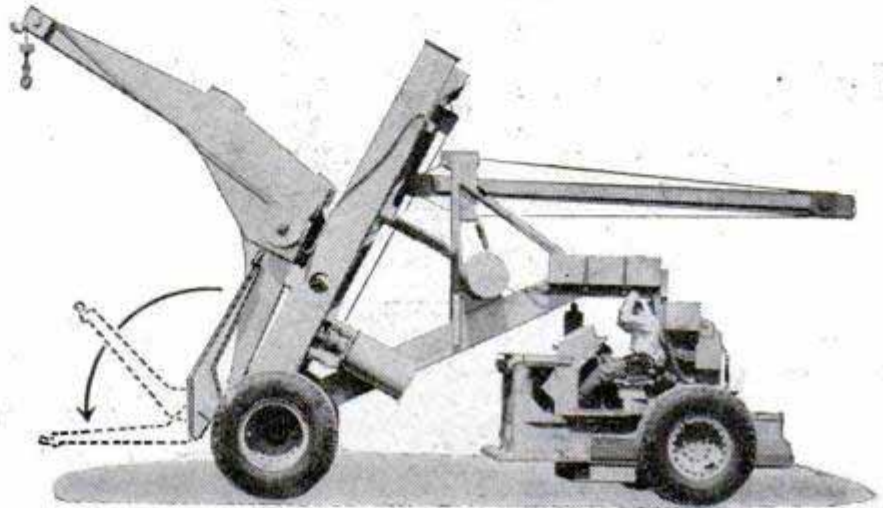

Mobile crash crane has a pair of forks which are extended from the base to speedily right planes that have overturned and trapped the occupants

crane requires less space when folded. It has a speed of 10 miles an hour. The improved capacity permits lifting of the Navy's largest carrier plane, the F7F Tigercat.

Traffic Cop Dummy Aids School Children Crossing Street



Some policemen in Hawthorne, Calif., can be called dummies safely because that's what they are. With too few policemen to regulate traffic at grade-school crossings, Chief Jack Baumgardner decided to increase his force with life-size wooden dummies. The cutouts, mounted on two-wheeled platforms, hold large stop signs to stop traffic when school children are crossing. A 15-foot pole is attached to the figure and the children push it into the street without leaving the curb. They then cross in safety.

Information, including the names and addresses of manufacturers or distributors, concerning products described in this issue may be obtained by writing Bureau of Information, Popular Mechanics, 200 E. Ontario St., Chicago 11

After 24 hours in the furnace, the pot, with its load of cooked glass cooled to about 1100 degrees Centigrade, is removed with this wheeled lifter. Panel on right shows glass blanks after removal from the molds

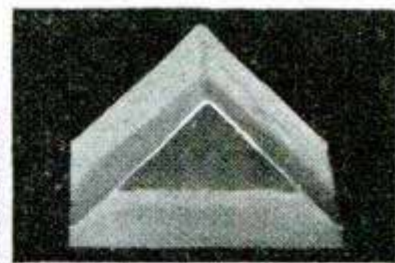
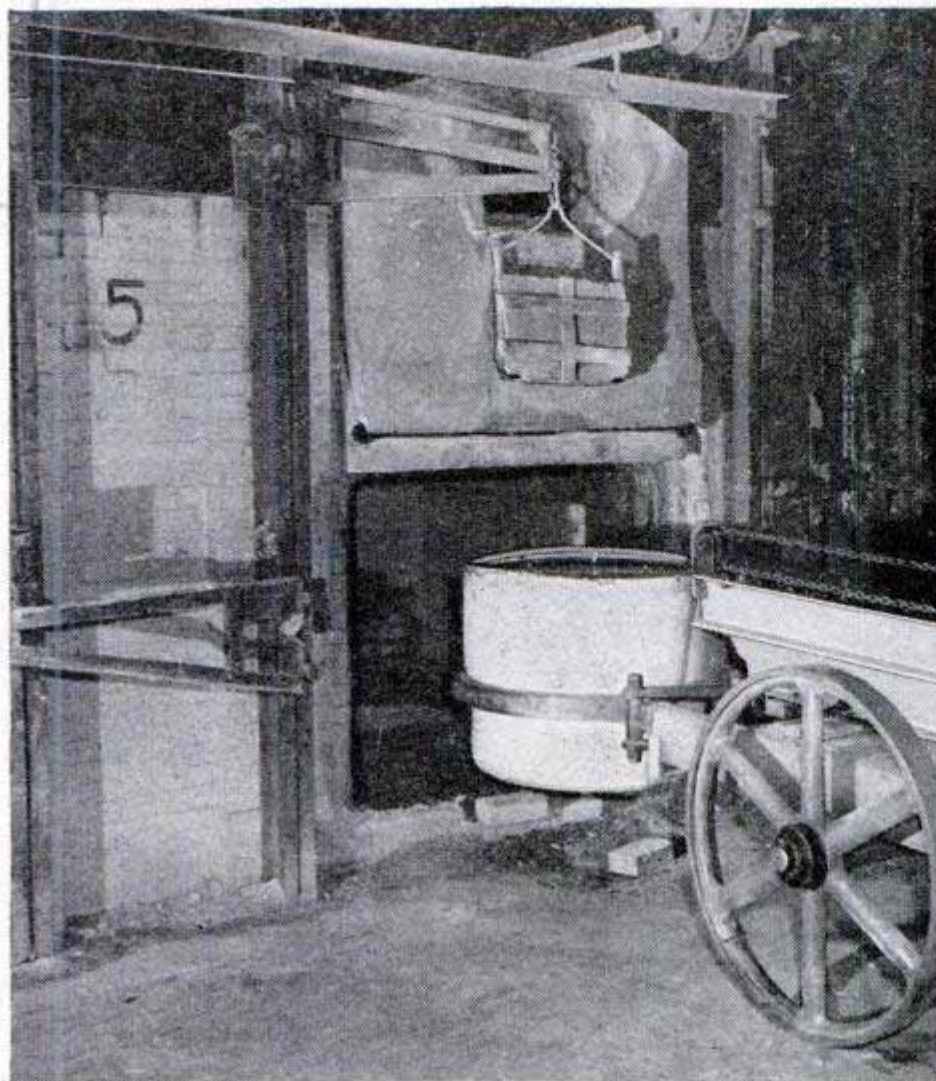

Optical Glass Cookers



These "chefs" in glass are cooking up lenses that will make your binoculars better

By John L. Kent

"HOW COME?" many an American asked himself early in World War II when asked to lend his binoculars to the Navy. The appeal was reminiscent of the British collection of shot-guns and other firearms in the dark days of 1940 when a Hitler invasion was feared.

The Navy explained why we didn't have enough of these supposedly common optical devices. Civilian requirements for precision optical instruments such as binoculars, telescopes and microscopes in peacetime are negligible compared with the demands made on the industry during war.

Before the war we imported European optical glass. Bausch & Lomb, chief domestic supplier, increased production ten times in 1940 as war drew near. During the war, this company produced over five million pounds, but more was needed. The military asked for help from the Bureau of Standards where research had been conducted since 1912. Three miles



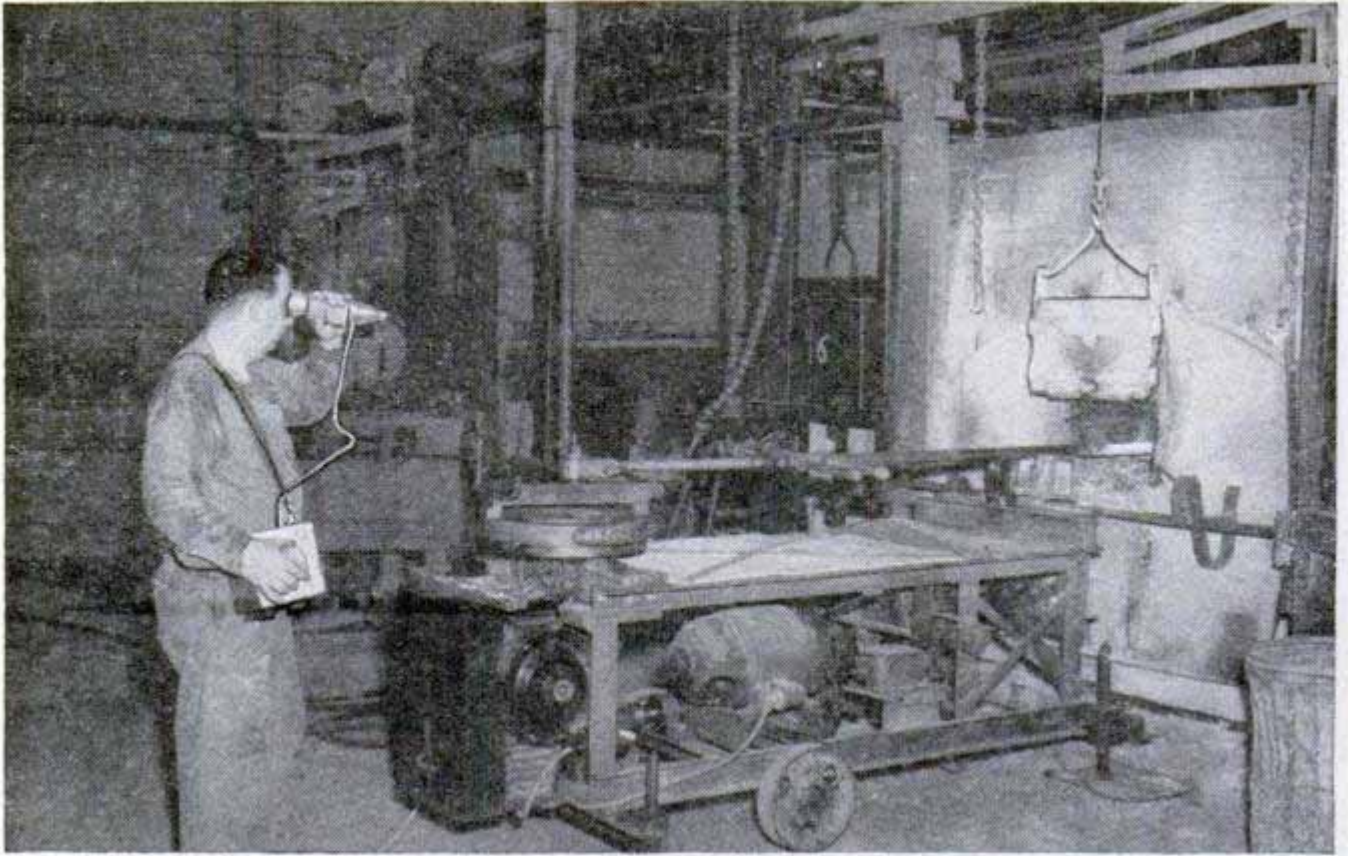

Technician inspects molten glass within the furnace with his optical pyrometer as he gets ready to remove the stirring rod

Ground and polished close to perfection, each element is tested by interferometer to assure uniform refraction throughout

from the White House, the bureau's laboratory was converted into a large-scale factory, producing more than a million pounds of high-quality optical glass for the armed services.

Optical glass should not be confused with the glass used in spectacles and reading glasses. Optical instruments must see things that are far beyond the human eye's capacity and must convert them into images which the eye can see. Tiny imperfections which do not affect vision with ordinary eyeglasses cannot be tolerated in instruments.

Perfect optical glass is practically impossible to make, but glass makers strive to get perfection by careful manufacture and the use of only pure materials.

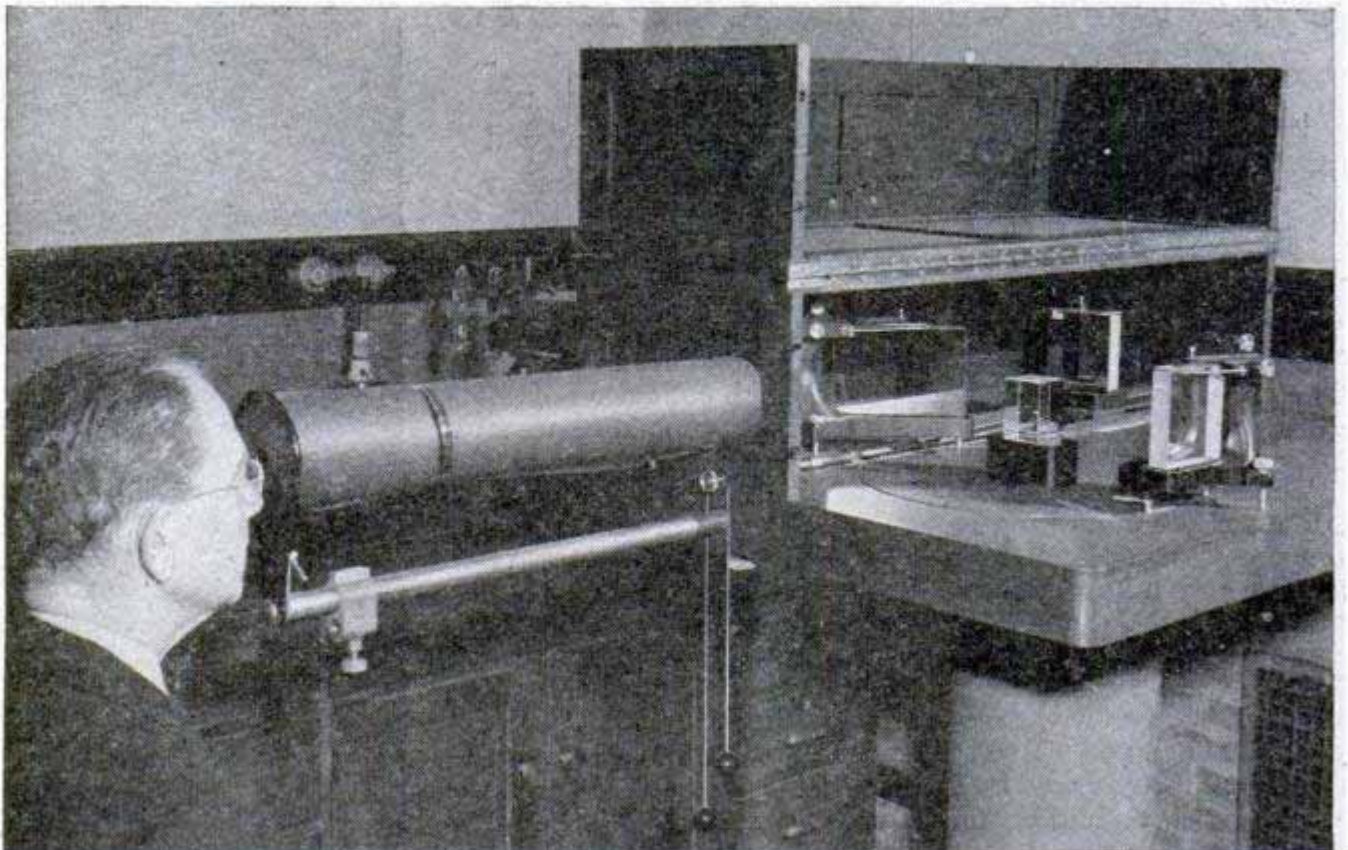

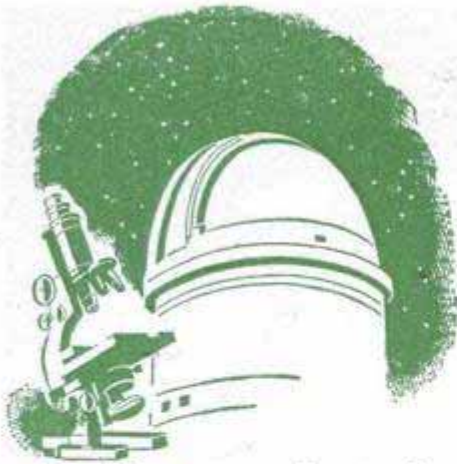

Work begins early in the morning as the charging of the melting pot may take as long as 10 hours. An empty preheated pot is wheeled into the furnace and fired to the right melting temperature.

As the technicians take turns watching the temperature indicator, the raw materials are assembled close to the furnace. A typical batch weighs 1400 pounds and includes sand, boric acid, borax, soda ash, saltpeter, zinc oxide, arsenic oxide and potash. It will produce about 1200 pounds of glass, enough to yield about 250 pounds of optical blanks.

When the temperature indicator reaches the critical point, the hanging door covering the furnace opening is swung up and charging begins. First part of the charge is cullet or waste glass from previous melts. This protects the bottom of the pot and hastens melting of the batch. Then the other materials are added slowly. The pot holds about 7 cubic feet and it normally takes from 5 to 10 hours to fill it.

The batch foams while melting. After the foaming subsides, a mechanically-driven, water-cooled metal rod, mounted on a carriage, is inserted through the opening in the furnace gate. At the end of the rod is a special ceramic stirrer or "thimble" made of the same material as the pot. Stirring eliminates bubbles. If not eliminated, these bubbles of gas trapped in the molten glass form "seeds" when the glass cools.



Removed from the molds, the optical-glass blanks are packed in big metal boxes and placed in furnaces for a critical annealing process

In its first cooling period, the glass cracks into irregular pieces that look like chunks of ice. Later it is remelted and cast into molds



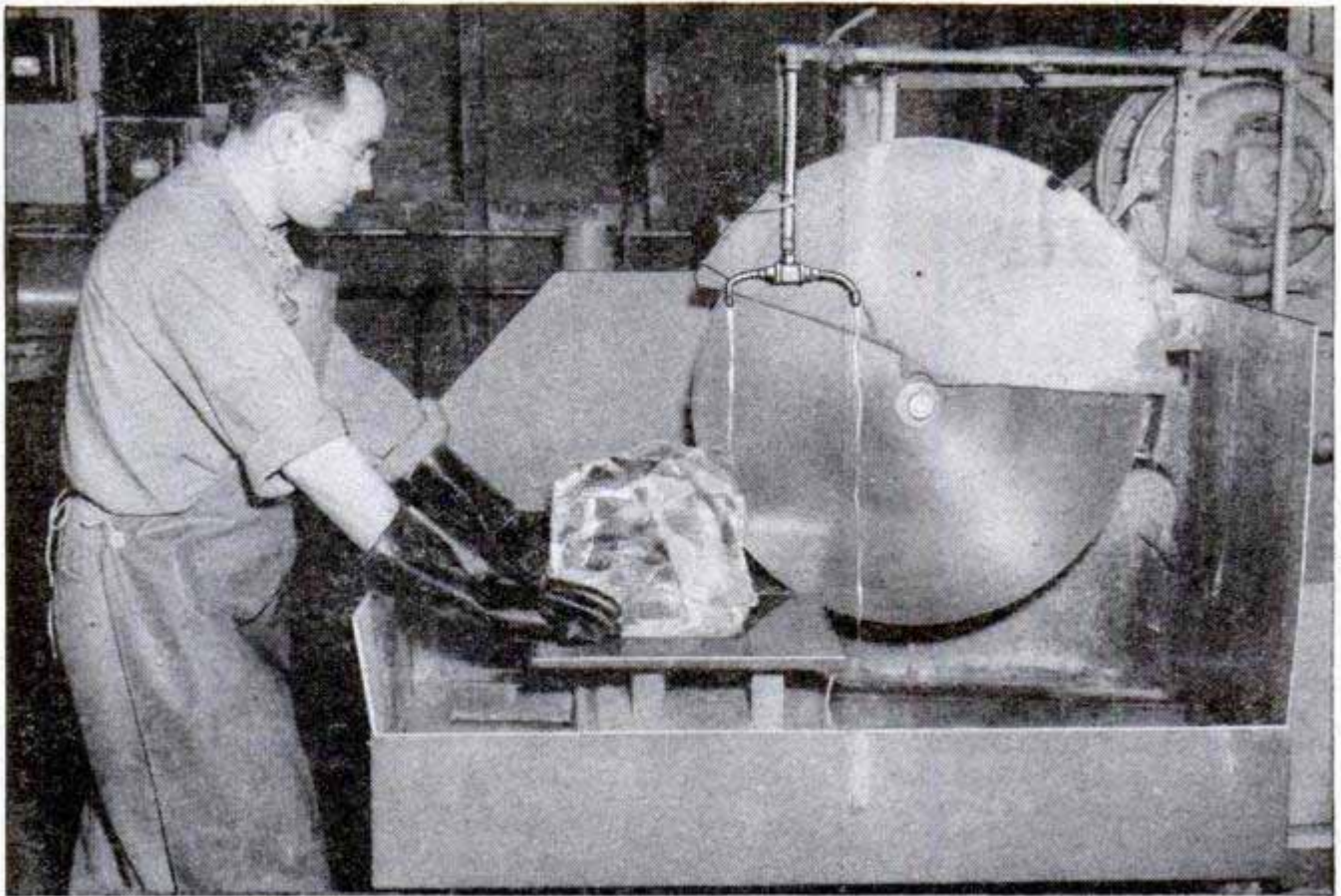

Before remelting, the large chunks of glass are cut with a diamond saw into sizes small enough for molding

Seeds and striae are the most common defects of optical glass. Striae are fine streaks within the glass which have a slightly different composition and therefore a different refractive index.

When the molten glass is reasonably free of bubbles, the heat is decreased and the pot gradually cooled in the furnace. Another shift of technicians takes over and stirring continues through the night and into the next day. The stirring is done more and more slowly until the cooling glass thickens to the point where it would be

ruined by further agitation. The temperature at which stirring is stopped is between 950 and 1100 degrees Centigrade, depending on the type of glass being made.

The pot is then removed from the furnace, covered with an insulated jacket and cooled slowly for about 3 days. In cooling, the glass breaks into large chunks which can be handled easily after the pot is broken. The large pieces are then broken or sawed to more convenient sizes for the molding operation.

(Continued to page 224)

Left, on the end of the punty, the soft glass is rolled until it is cut with scissors (right) to fit mold

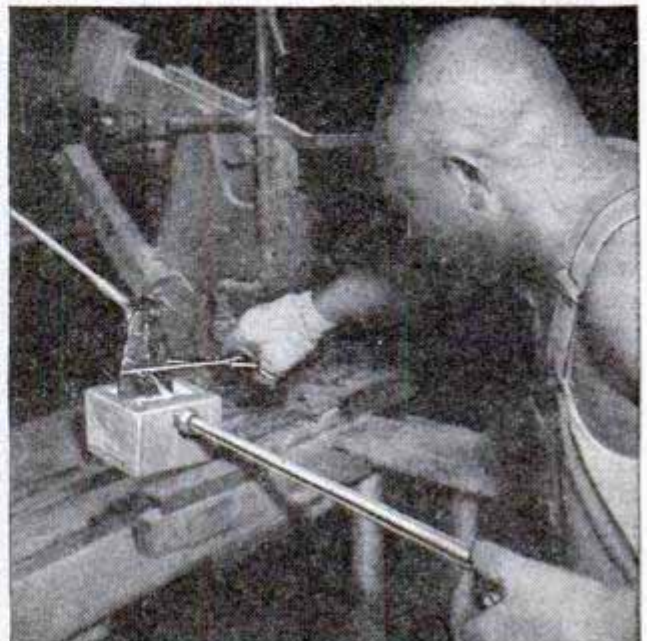
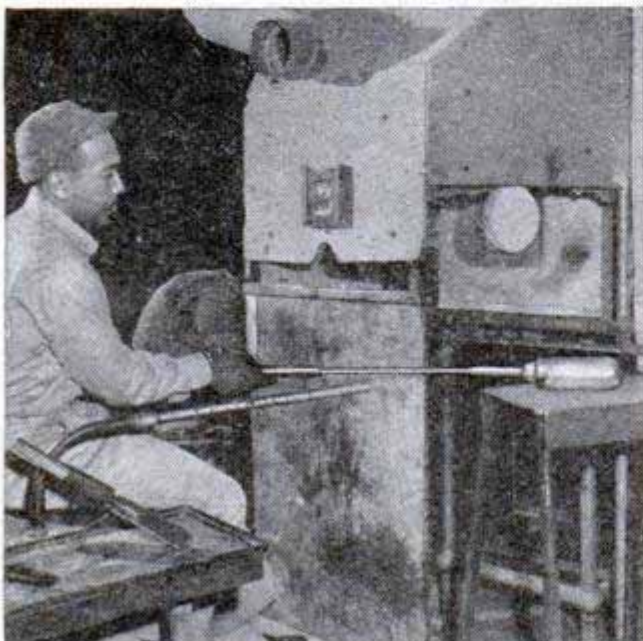

Radar "Eyes" of Airliner See Storms 150 Miles Away

"Eyes" that see 150 miles through darkness, fog and other obscuring weather are being installed in the front of airliners. The airborne visual radar presents on a screen in front of the pilot a picture of mountains, tall buildings and nearby aircraft to help prevent collisions.

Oil Solution Washes Cars

By the addition of a newly developed organic detergent, Diesel oil and kerosene are given soap-like properties and can be used effectively to remove mud and grease from trucks, buses and automobiles. One part detergent is mixed with 100 parts of the oil. The solution is sprayed over the painted surfaces and allowed to penetrate the grime, which is then rinsed away by water from a hose.



← Golf Practice on Swivel Tee

After properly hit golf shots a ball swivels freely on a portable driving range that can be used either indoors or outdoors. If topped, the regulation-size rubber ball swivels erratically around the cast-iron base to which it is anchored. The unit has three steel spikes that can be pushed into the ground for outdoor use.

Self-Winding Reel on Droplight Ends Slack-Cord Nuisance

With 20 feet of cord on a self-winding reel, a combination drop-light and trouble light can be used at various heights without dangerous slack cord. The rubber handle contains the off-on switch. For reeling and unreeling, the bracket swivels almost 180 degrees and rocks 90 degrees.



Scientists have measured the speed of lightning traveling 133,220,000 miles an hour and the pace of a snail crawling .000-363005 miles an hour.



POURING a BUILDING from the

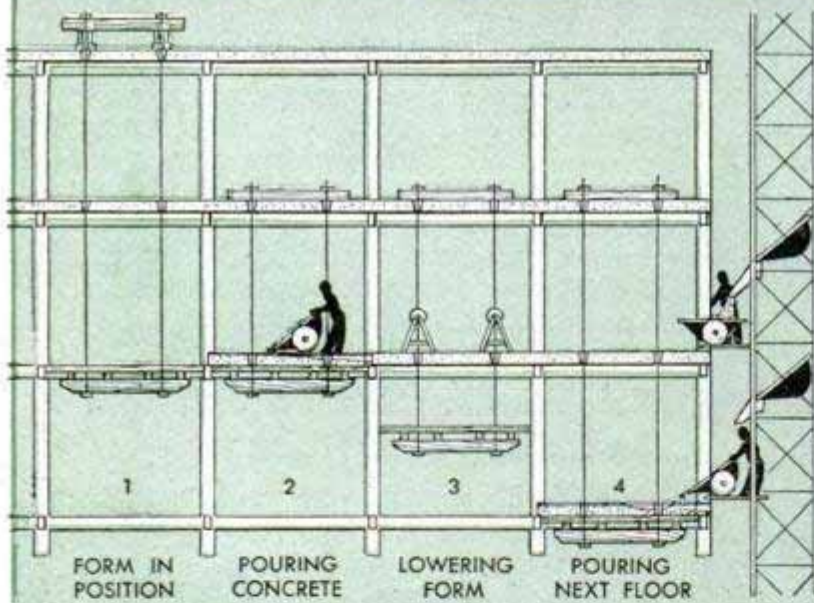
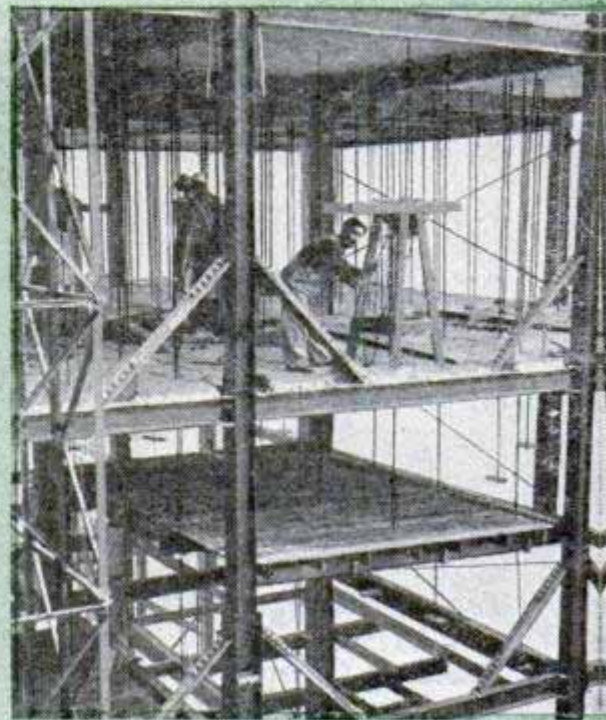
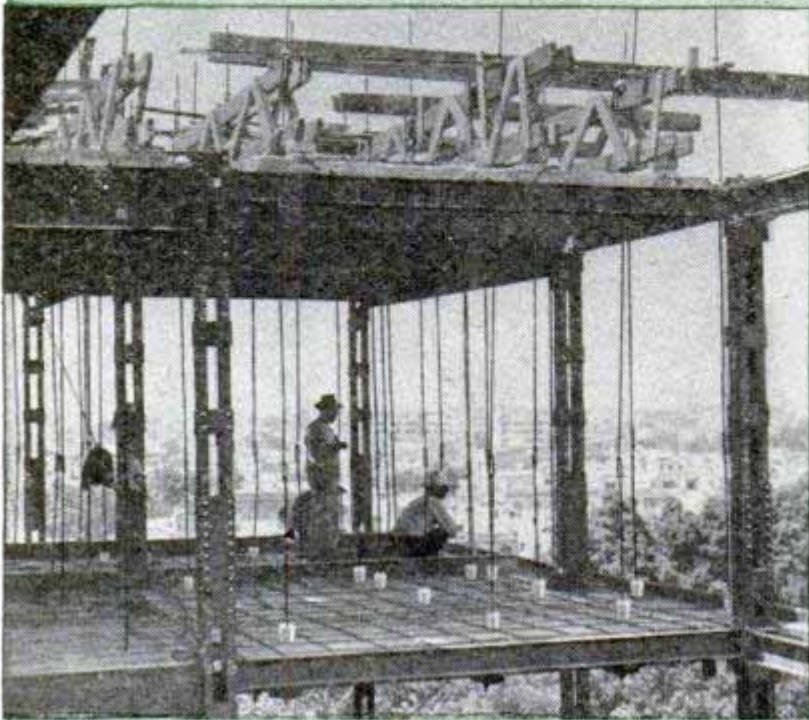

Top left, with roof poured and set, "elevator" form is suspended from the roof support on steel rods. After the concrete hardens, form will be moved one floor lower. Above, chain hoists are used to lower the form. Left, diagram shows the successive steps as the floors are poured from the top down. Roof supports the form only while top floor is poured. Bottom left, steel rods set between two planks and reinforced by a crosspiece support the form, which is removed as soon as the concrete partially hardens. Below, chain hoists move the form from floor to floor. Rods move through holes in the new concrete

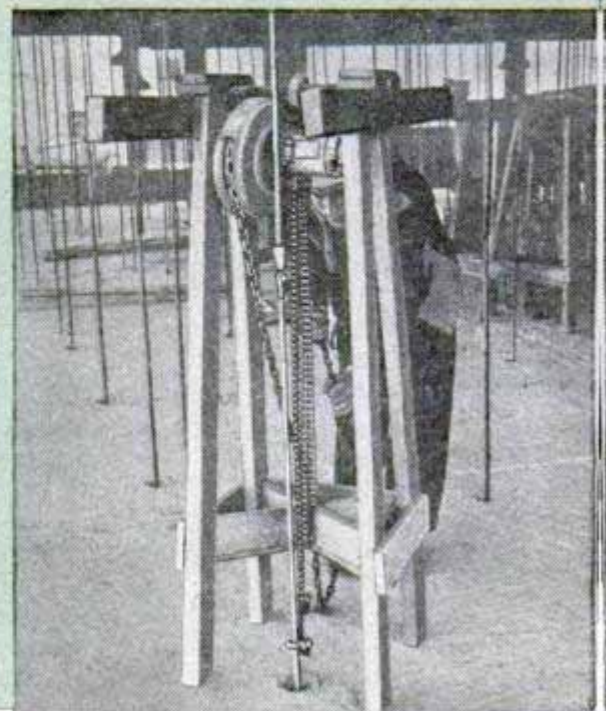

TOP DOWN

POURING concrete floors in reverse order is the method used successfully in Mexico and now under trial in the United States. Instead of pouring the bottom floor and working up, workers pour the roof first and then work downward. The method was invented by Manuel Gonzales Flores, a civil engineer of Mexico City. Principal feature of the system is a concrete form which descends like an elevator as each floor is poured. The steel framework of the building is erected in the usual manner. Then the concrete form is suspended from the roof framework on steel rods, adjusted until it fills the top floor, and filled with concrete. When the concrete has partially hardened, all the suspension rods are loosened except two, which are used to lower the form to the next floor, where it again is anchored in place and the process repeated. As the interior rods must pass through the concrete when the form is lowered, wooden cones are inserted to provide openings. The system enables the builder to use the same forms many times with subsequent savings in material, time and labor. After the top floor has been poured, it provides a "roof" over the building, protecting workmen during bad weather. By using the system, a building can be completed in one third the time required by conventional methods, according to the inventor.

View from below shows bottom of the form. System permits using same form as many as 30 times

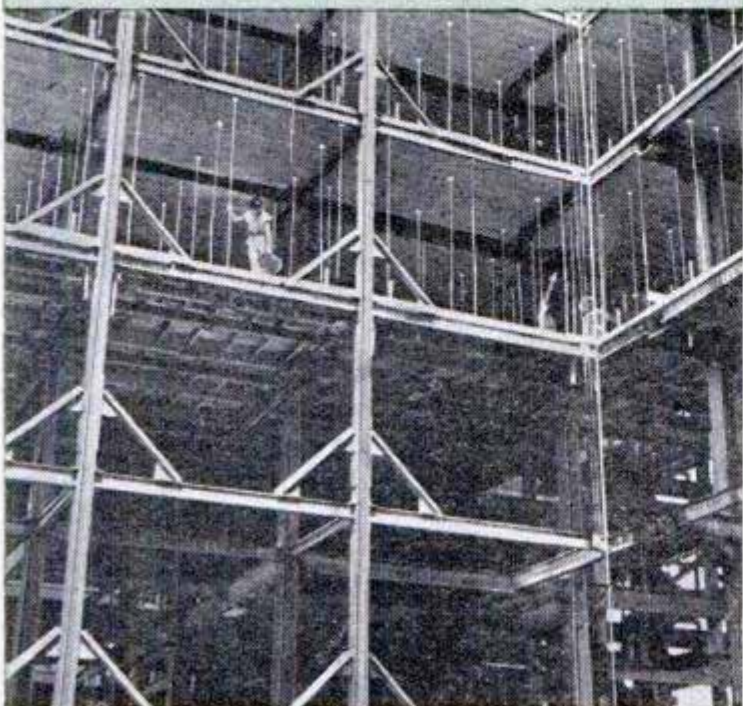

Radio Controls Camera Lights

Photographic lights some distance from the camera can be set off by radio through a system invented by Kenneth Goodman, an electronics engineer of Columbus, Ohio. Attached to the camera is a miniature transmitter which sends out a signal at the proper instant. The signal is picked up by a receiver at the base of the light and flashes the bulb. The light then transmits the signal to similar lights.



Auto Towing Bar

Only 60 seconds are needed to install a tubular-steel rod as a rigid towing hook-up for passenger cars and light trucks. It is held in place on the bumpers by two steel clamps, each tightened by a single wing nut. Weighing 8 pounds, the 39-inch-long tow bar can pull 4000-pound vehicles up a grade of 25 percent.

¶ If all cropland in the United States were divided among the inhabitants, each person would have about three acres, a decrease from the average of four acres at the end of World War I.



Model-T of the Airways

Fifty miles on a gallon of gasoline is one accomplishment of a new plane described by its designer as the "Model-T of the air." The builder, Al Mooney of Wichita, Kans., used four steel belts to gear a 26-horsepower midget auto-type engine down from 3900 to 1950 revolutions a minute. Fuselage construction from nose to the rear of the cockpit is metal and from there back it is wood. The entire tail can be moved forward or back seven degrees, making elevator trim tabs unnecessary. Mooney's plane has a 27-foot wingspan, is 18 feet long and weighs only 450 pounds empty. It cruises 90 miles an hour and has a normal gasoline capacity of eight gallons.

Right, demonstrating slightly more than seven-degree arc of movement, eliminating the need for trim tabs, ruler shows normal position of tail on Mooney plane



Swiss Golf Watch Keeps Hole-By-Hole and Total Score



"Minute" hand on scoring watch indicates hole being played. Pressure on crown registers each stroke and "hour" hand reveals total in units of 10. A "second" hand shows single strokes

Golfers can keep a hole-by-hole and total score on a unique Swiss watch. In place of the usual 12 hour numbers, there are 18 openings to indicate holes in a round of golf. A blue "minute" hand is turned forward to each hole being played and the crown pressed down every time a stroke is taken. The

strokes (up to 10) are registered on a small disk opposite the number of each hole and this number stays there after the minute hand is moved ahead. A red "hour" hand keeps the running total in units of 10 and a red "second" hand records single strokes. For example, if the minute hand is at 14, the hour hand at six, and the second hand at eight, a player knows he has completed 14 holes in 68 strokes. The watch can be cleared for a new round by revolving the blue minute hand once or twice around the dial, which brings the 18 small disks and the two red hands back to zeros.

☐ For people who are hard-of-hearing a new alarm clock flashes a light off and on instead of ringing a bell.

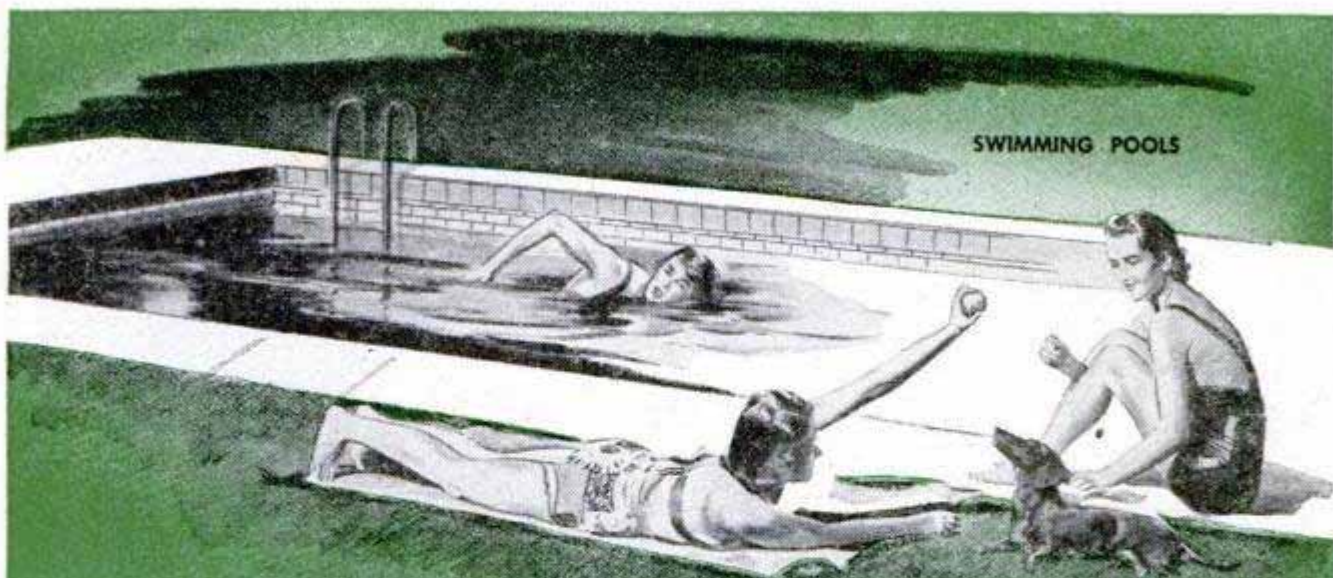

SWIMMING POOLS

The CRAFTSMAN

★ A practical angle in swimming-pool construction is the money you can save by building the pool yourself. That's added to the fun the whole family will get from it year after year. Beginning on page 170 we outline the construction of pools from the simplest wading type to the most elaborate, with its sloping bottom and walls that require double forming.

★ Craftsmen with the habit of keeping hand tools in order will welcome the bench tool cabinet described on page 199.

★ Organizing a yacht club from scratch is easy if you get a few old hands together who are experienced on small boats. They'll teach the beginners the mechanics of sailing in short order and at very little cost to members. See page 194.

★ Our regular shop feature for the month, page 202, covers taper turning, how to set up the work, how to figure tapers, etc

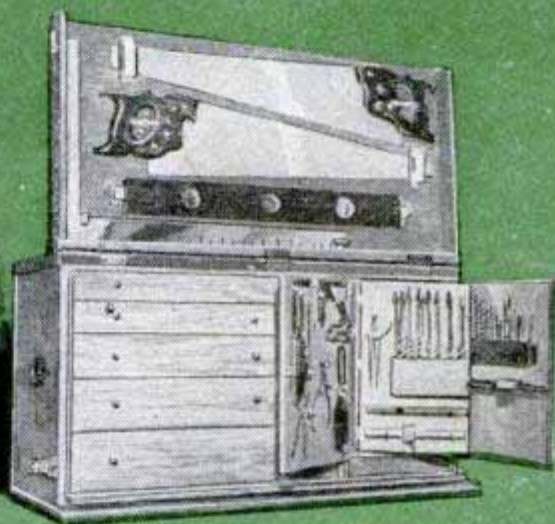

TOOL CABINET

MECHANICS OF SAILING

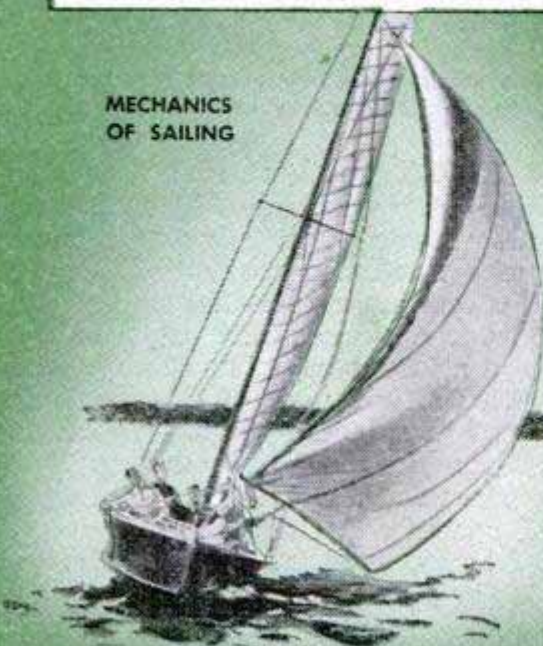

TAPER TURNING

THEY SERVE

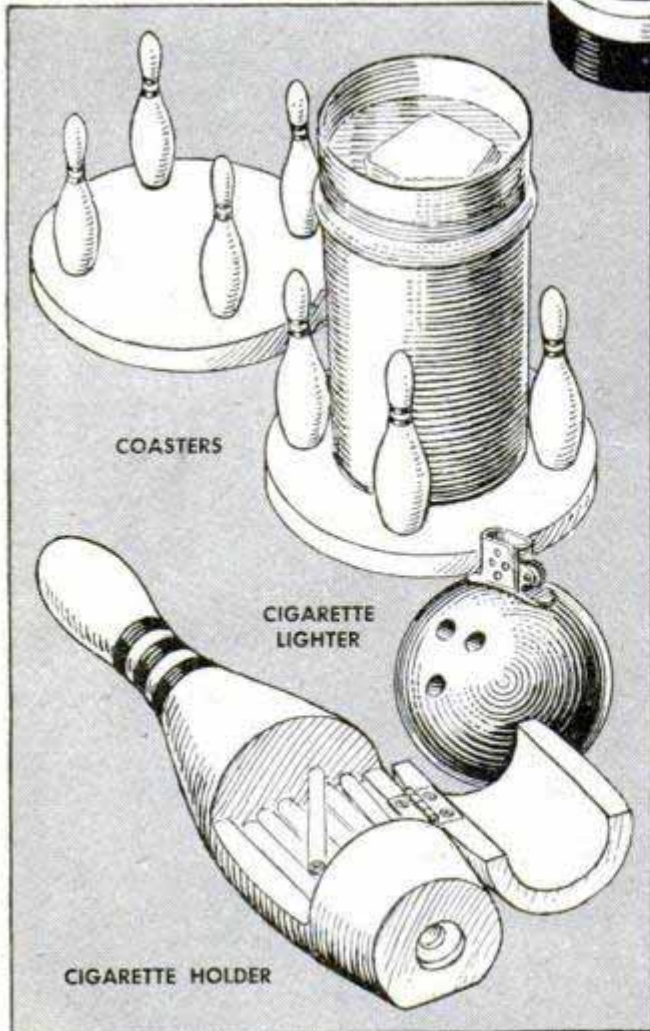
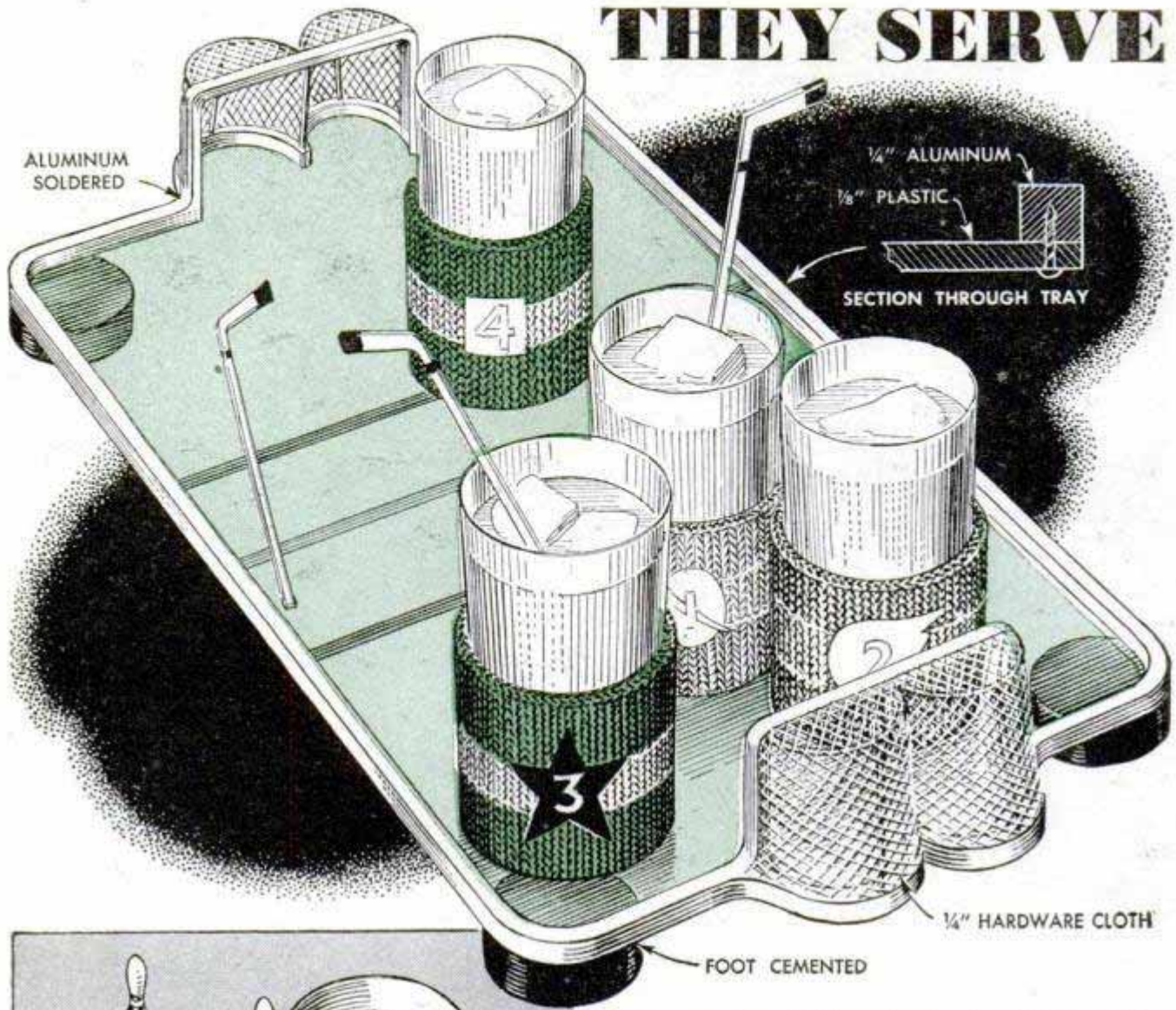

Above, a piece of clear plastic, about 12 by 18 in., represents ice for the hockey tray. An edging of $\frac{1}{4}$ -in. square aluminum is bent to conform with the shape of the plastic and attached from below with drive nails. The framework supporting the goal nets is soldered separately, then covered with hardware cloth, using aluminum solder to fasten it. Puck feet are cemented to each corner, and hockey clubs and knitted jackets add to the realism. Left, the bowling set consists of a cigarette lighter fitted in the top of a miniature bowling ball, coasters and a turned tenpin hollowed to hold several cigarettes

NO DOUBT, you have seen these clever serving trays before. They have appeared nationally in advertisements of Kentucky Tavern, a product of Glenmore Distilleries, in many leading magazines. In response to hundreds of requests for plans on these unusual trays, *Popular Mechanics*, with the approval of Glenmore Distilleries, has selected several which lend themselves most readily for duplicating. Some serve as table accessories, others for actual serving. All are sure to intrigue your friends, especially those who have hobbies or participate in a sport exemplified by the tray. The little workbench tray will make a hit with woodworking hobbyists, the bowling set with keglers.

YOU RIGHT

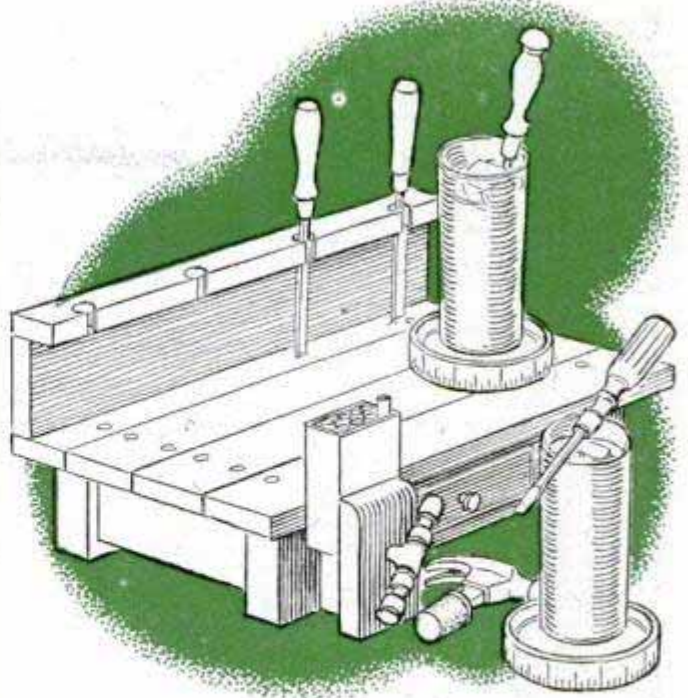
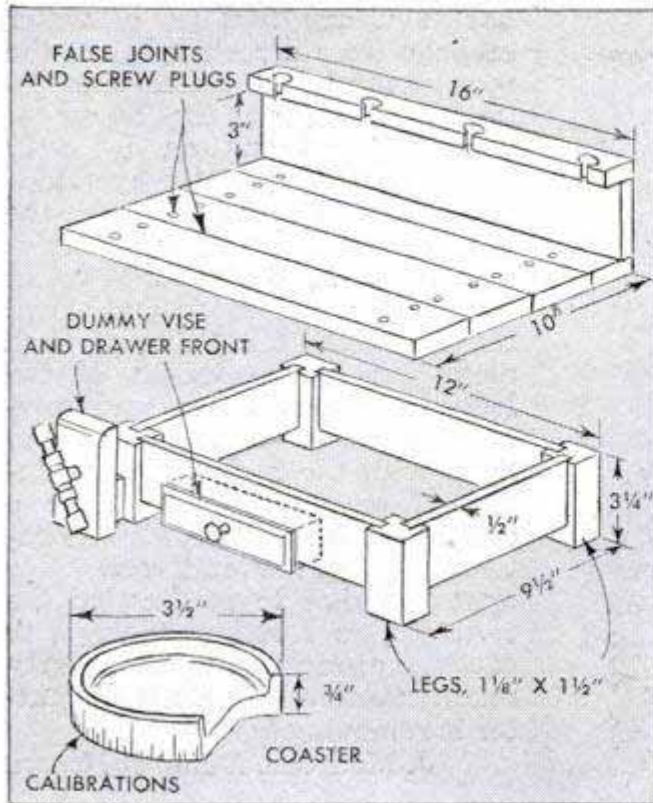

Whatever your hobby, the latest fad is to exemplify it in the form of a serving tray, as shown in these four examples. The workbench tray is designed for the woodworking hobbyist and employs related tools to serve as stirring rods, coasters and bottle stopper. A plastic cigarette case is cemented in the vise

If tennis or ping pong is your favorite sport, the hobby tray at the right is the one for you. The court is a piece of 1/4-in. plywood, painted green, and framed with picture molding. Stepped handles represent bleachers and are attached to each end of the tray with flat-headed screws. A miniature replica of a court marker, which serves to hold cigarettes, is fastened in place with a screw driven up from the bottom. The net is a piece of screen wire or 1/4-in. hardware cloth painted white and stretched between two posts made of straightened L-hooks turned into the base. The court marking is done in white with a striping tool, or with a small brush by first masking off the surface with tape. The handles and edging also are painted white, after which felt is glued to the bottom

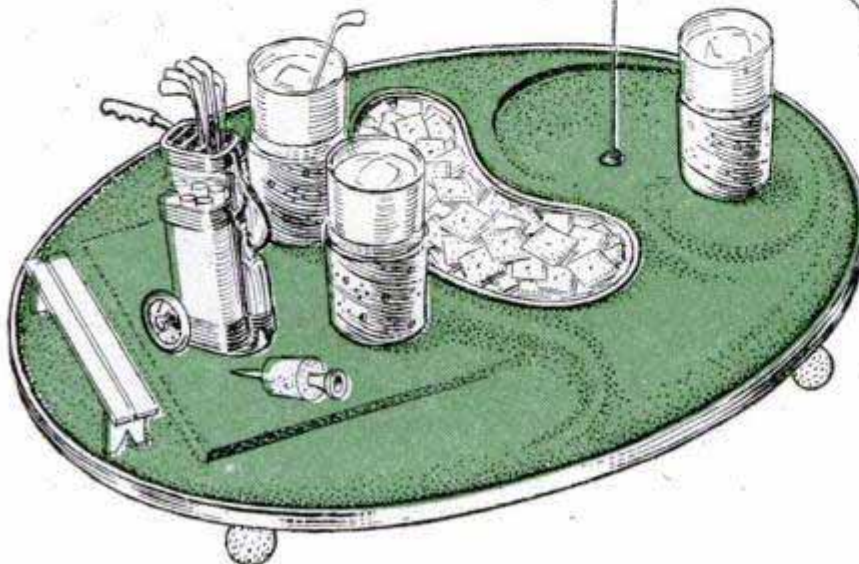
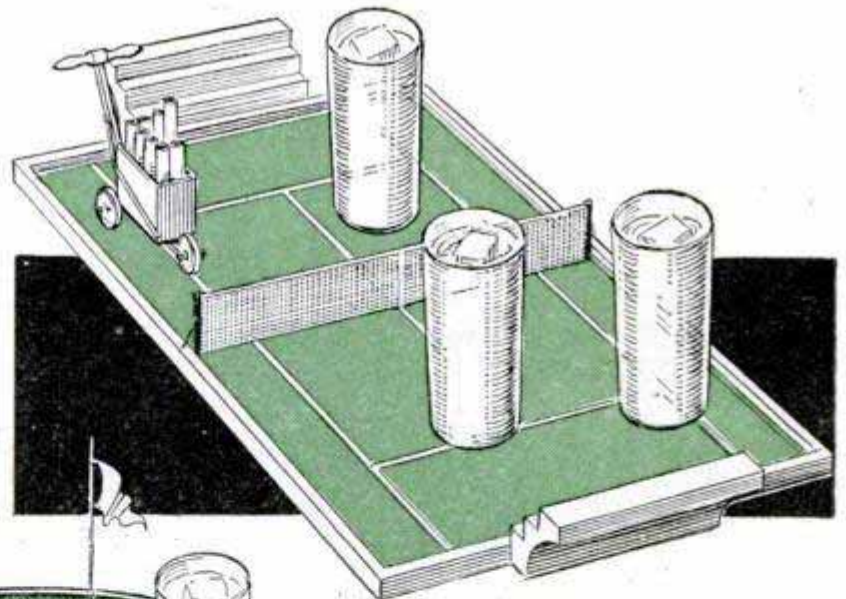

Golf fans will go for the tray at the left. The "course" is built up of three pieces of 1/4-in. plywood. Two are cut oval shaped and openings are cut in one of these to accommodate a shallow tidbit tray and to form a slight depression representing the green. The third piece of plywood, which is square and has the edges beveled, is added to provide a raised tee. Then green felt is glued over the entire surface and formed into the depressions. Metal banding covers the edge, a miniature bag holds golf-club stirring rods and cigarettes. Wooden golf balls serve as feet, and leather wristband jackets add to the effect

Concrete Gutter at Rock-Ledge Base Keeps Cellar of Hillside Home Dry

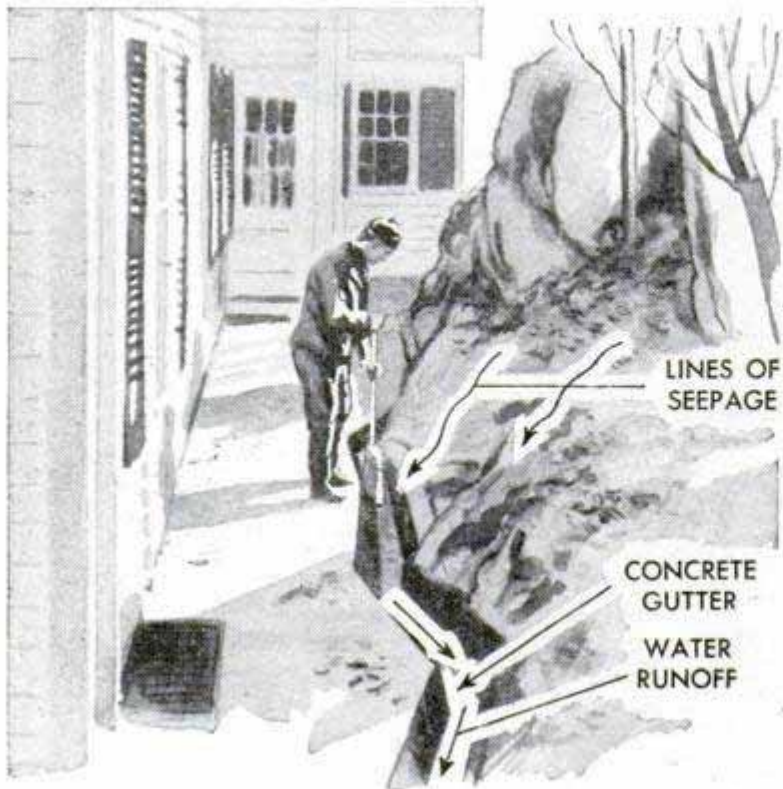

My home is in a beautiful hillside location, but I had the perplexing problem of keeping my basement dry because of water seepage from a rock ledge at the rear of the house. After attempting to waterproof the basement walls without success, I finally corrected the difficulty by building a concrete gutter along the base of the ledge. The gutter is sloped so it drains the water away from the house and down the side of the hill. I dug a trench along the entire length of the ledge back of the house, and troweled concrete on the sides and flush with the rock, using a section of eaves trough to form a channel at the bottom. Cracks between the gutter and rock ledge appeared due to settling of the concrete, so I sealed these with calking compound. The only maintenance required for the gutter is removing leaves.

J. Modroch, Danbury, Conn.

Improved Method for Striping Accurate Border Line on Circular Work

Instead of using the edge of the work itself as a guide when striping a border line around a disk, a better job results if the work is rotated and the striping tool is held stationary against a fixed point. This method produces a perfect circle by preventing any irregularity in the edge of the work from being duplicated in the striped line. The work rotates on a nail point located at one end of a scrap board. Another nail is driven in the board a distance from the pivot point slightly greater than the radius

of the disk. The guide arm on the tool is set for depth and is held against the nail while the work is rotated.

Richard Hanscom, Elmhurst, Ill.

Linoleum-Block Cuts Mounted With Friction Tape

When electricians' friction tape is used to mount a linoleum-block cut, the cut can be detached simply by peeling it from the wooden base. This method enables just one mounting block to be used for several different cuts, if they are of approximately the same size. As the friction tape is sticky on both

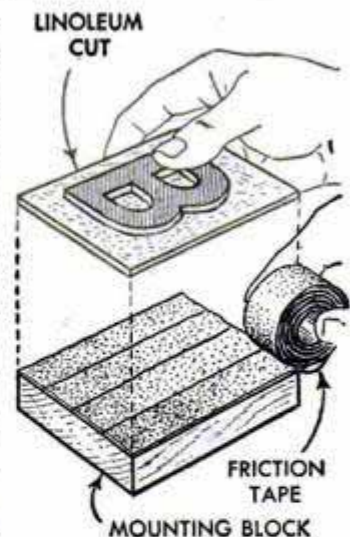

sides, the strips are attached to the mounting block by pressing them in place, as shown in the drawing. Then the linoleum cut is pressed down on the tape. Cover the entire surface of the block by placing the strips of tape edge to edge. If the tape is not sticky enough, fasten it with airplane cement or small carpet tacks.

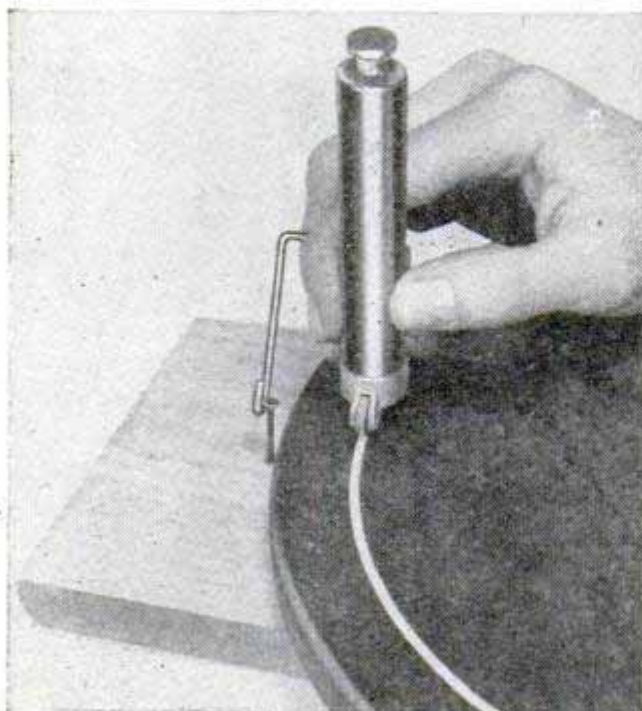

Improvised Outdoor Ovens Give Uniform Heat

By cutting a section from the top of a 5-gal. can and hinging the piece with wire to serve as a door, an excellent camping or picnic oven can be improvised inexpensively. In use, the can is placed over a fire and supported by stones, which confine the heat to the oven, maintaining ample heat for roasting or baking. In addition, smoke and dust will not contaminate the food. A permanent oven is made by building up rock around the can to form a flue, as shown, and covering the unit with sand or clay to provide insulation. Light baking may be done by spreading a ½-in. layer of sand over the bottom of the can. A small oven for baking fish or toasting marshmallows on a fork is made quickly by building a fire over a round tin can, which has been laid on its side. The open top of the can is left exposed to permit inserting the food.

C. L. Meehan, Lakeview, Ont., Can.

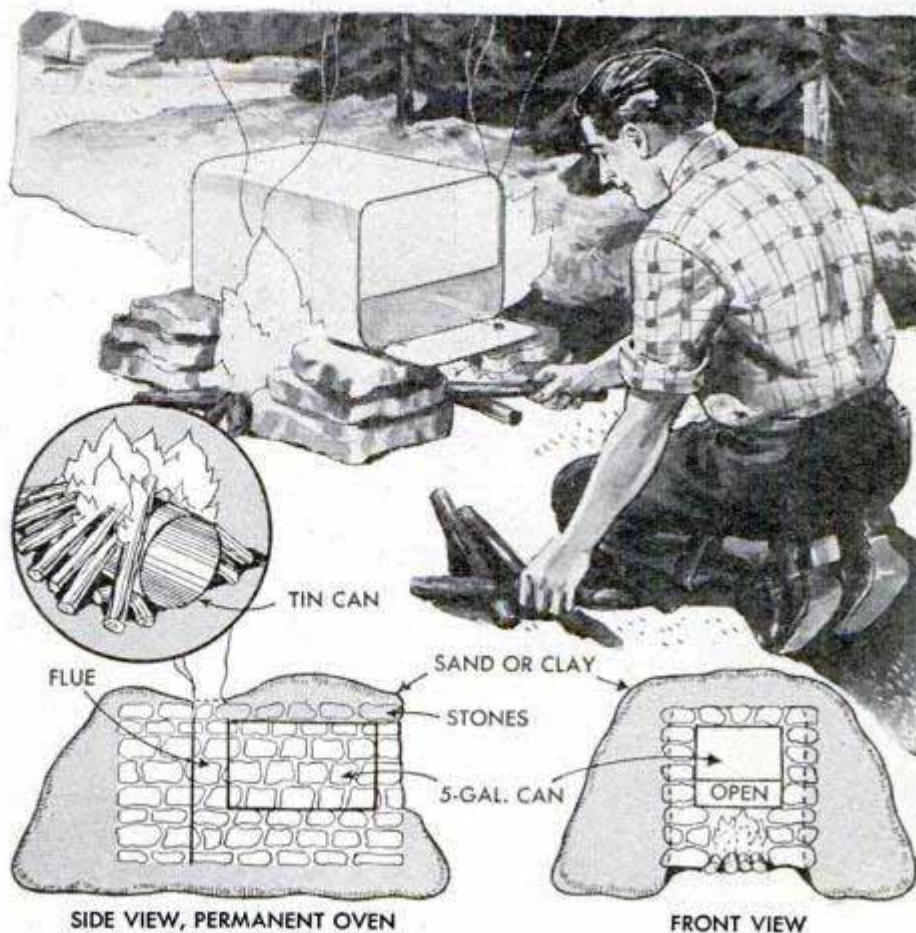

Repairing Pipe Fence Posts Rusted off at Base

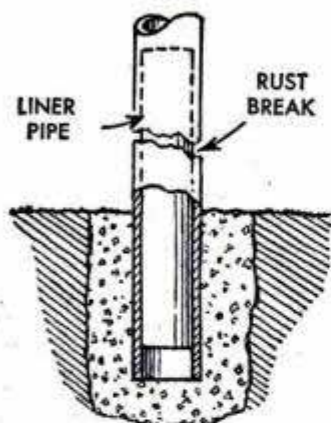

If a pipe fence post has rusted off at its base, it can be repaired to last for years. To make the repair, select a length of galvanized pipe which will fit inside the post snugly. For example, a 1½-in. pipe will fit nicely inside a 2-in. pipe.

The length of pipe required should be twice the length of the embedded post. The pipe is inserted inside the lower half of the rusted post, and then the upper portion of the post is placed over the projecting length of pipe. Coat the break with thick white-lead paint to make the joint watertight. When dry, paint the post with a rubber-base paint.

Evans E. Plummer, Hollywood, Calif.

Step on Beach-Umbrella Shaft Aids Embedding It in Sand

The point of a beach-umbrella shaft may be embedded in the sand easily, if a small step is screwed to the shaft near the point. Just hold the shaft erect and push down on the step with the foot. Groove the step to fit around the side of the shaft.

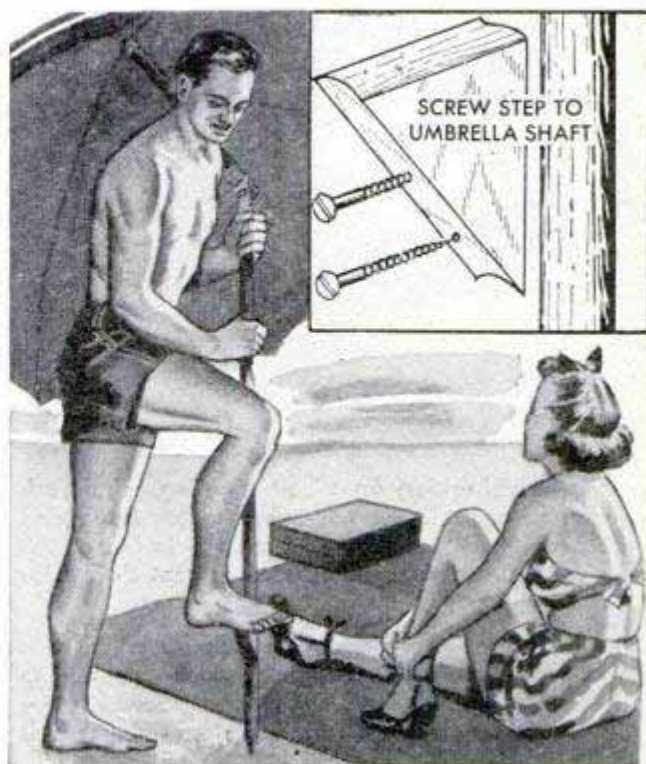

SOLVING



A tablespoonful of uncooked rice and a cupful of warm water poured in a vacuum bottle will get it sparkling clean. Shake the bottle vigorously. The rice-and-water mixture is especially effective in cleaning a vacuum bottle which is used for coffee



To prevent embroidery floss from tangling, wind each remnant of a skein on an empty match book and write brand and color number on the inside of the cover for future reference. Thread is kept clean also

When you want to use a clothes wringer on a small tub and the thumbscrews will not permit clamping to tub, cut two notches in the edge of a board, wedge it over the rim of the tub and clamp the wringer to it

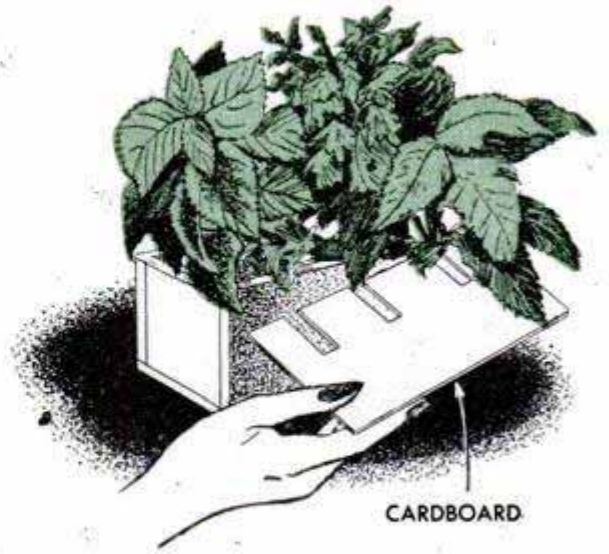

If you are to be away from home a few days, slip a cardboard collar over potted plants to help retain the moisture



It takes less time to cut out a dress pattern if you use glass tumblers instead of pins to hold the pattern in place on the material, particularly if it is a large pattern requiring many pins

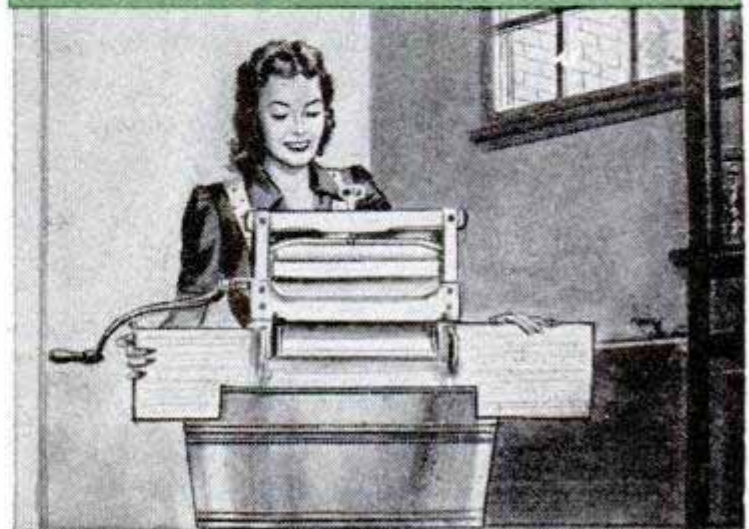

HOME PROBLEMS

By boring a series of holes in the top of a wooden ironing board, steam escapes through the vents and moisture doesn't collect in the pad. Clothes dry faster and you will use less current. Use a $\frac{1}{4}$ -in. bit and space the holes about $1\frac{1}{2}$ in. apart. The vents in the top will also reduce heat radiation and make ironing cooler on hot days

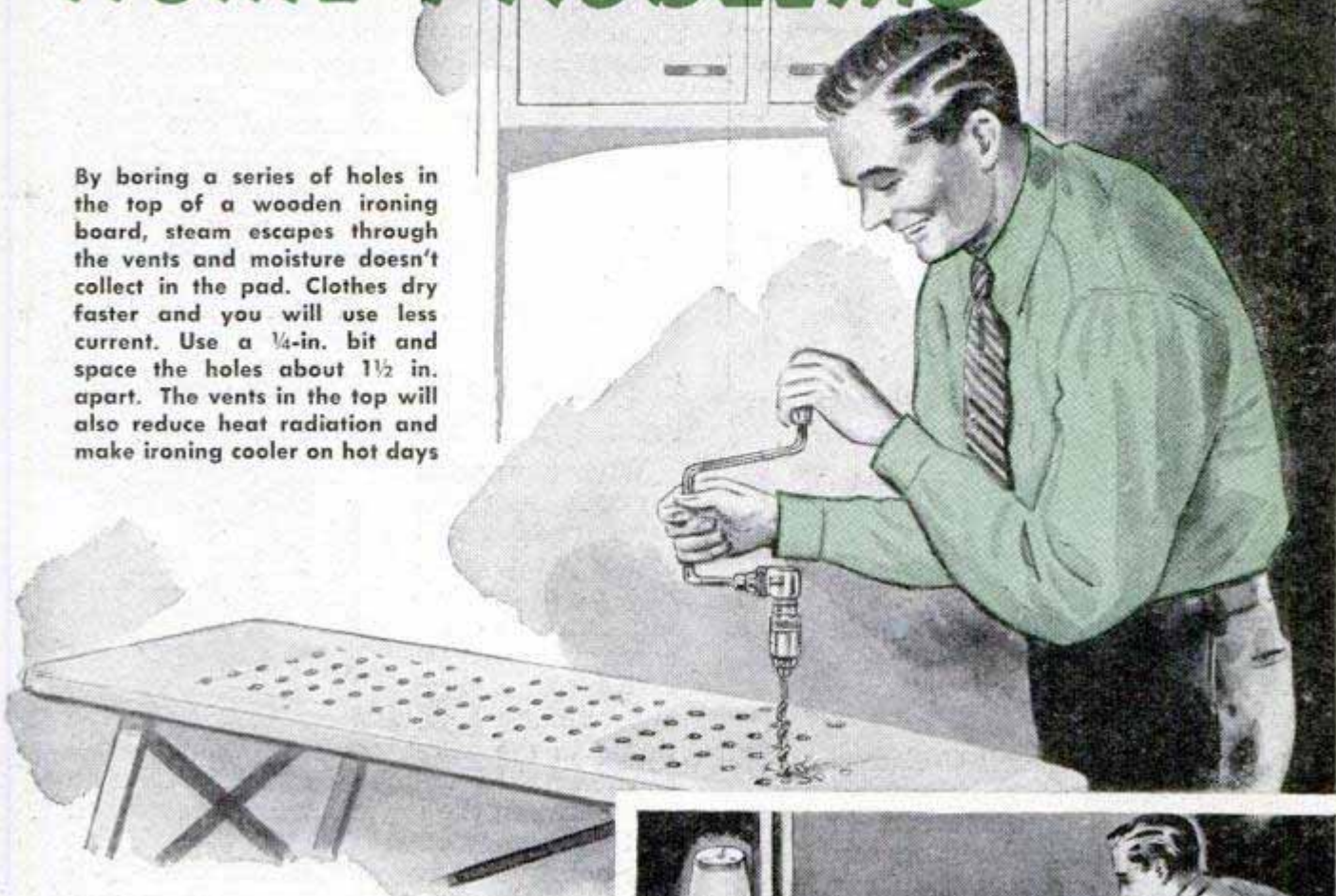

Unsightly wires trailing from boudoir lamps, clock, radio, etc., are avoided if two electrical utility boxes in which the fixtures can be plugged, are attached to the back of a vanity. Boxes are wired and plugged in wall outlet. Protect the wall behind the vanity by padding the boxes

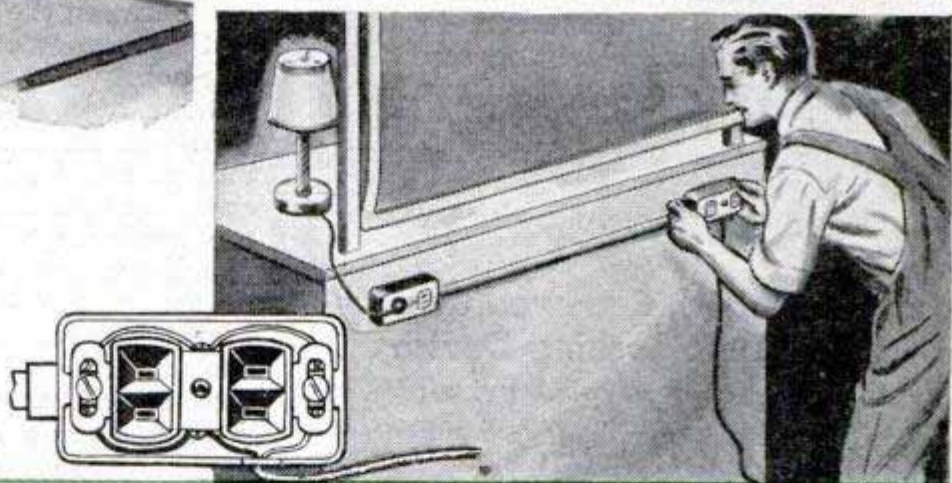

You won't need to worry about getting metal polish on the woodwork when polishing brass door plates if a cardboard mask is cut to fit snugly over the plate and held in position

An excellent inside catch for matching cupboard doors is improvised from an old sash lock. One half of the lock is screwed to the door, the other half to the rail on the inside. Surface of door and rail must be flush

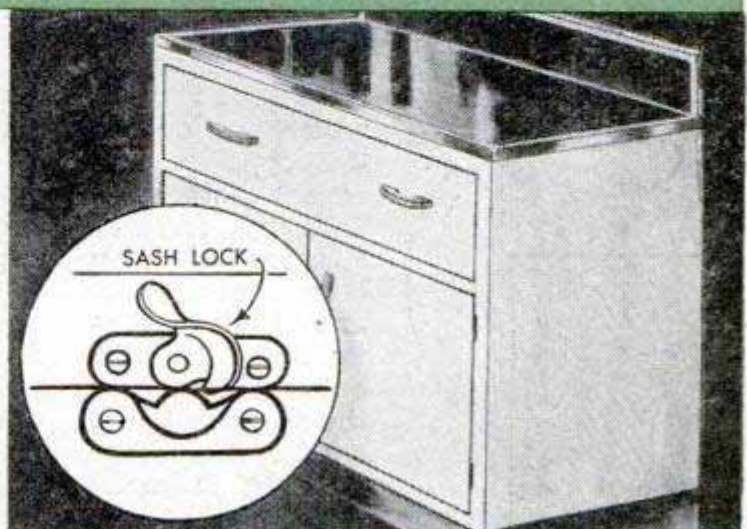

Channel Iron Provides C-Clamps For Modelmakers

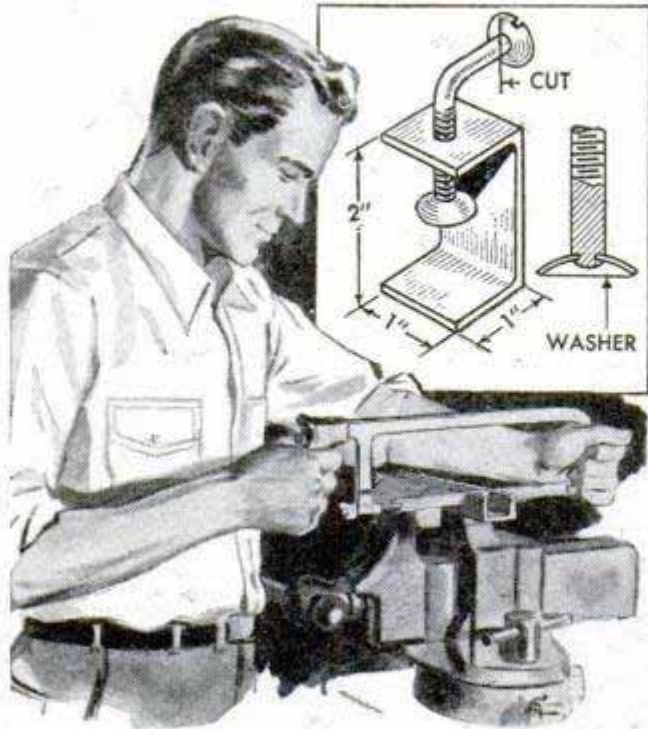

Any number of small C-clamps can be mass-produced quickly simply by sawing off sections of a length of channel iron and fitting them with a clamping screw. The clamping screw can be a 1/4-in. carriage or stove bolt, the head being cut off and the bolt bent L-shape. The threaded end is filed to form a tenon to take a cup washer, which is peened loosely to the bolt.

Abrasive Bands Renewed Quickly By Spool-Type Locking Device

Using the camera-spool principle, one man found an effective way to tighten abrasive bands on a wooden sanding wheel. The bands are easy to attach and remove. First, he drilled a hole through the wheel near the rim and cut a slot between the hole and rim. Then he turned a wooden spool which is inserted in the hole as shown. The spool is centered in the hole by a shoulder turned in the flange and by

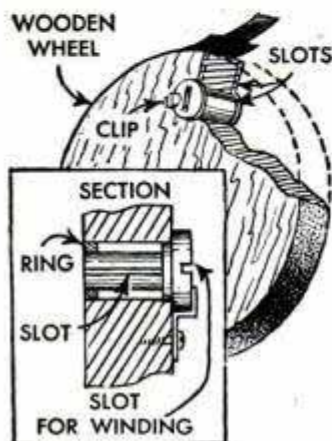

a separate wooden insert ring which is glued in the opposite end of the hole flush with the face of the wheel. The barrel of the spool is slotted lengthwise to take tabs cut on the ends of the abrasive band, and a slot for winding is made across the end of

the spool. To apply the abrasive band, tabs on the ends of the strip are inserted through the slot in the spool. Then the spool is placed in the hole, and at the same time the ends of the band are passed through the slot in the wheel. The spool is turned to tighten the band. When tightened, a metal clip, screwed to the side of the wheel, keeps the spool from unwinding. If necessary, the wheel may be counterbalanced by driving screws near the rim opposite the spool.

Herbert E. Pott, Victoria, B.C., Can.

Easy Way to Pour Half of Contents From Open-Top Container

When you wish to pour half the contents of a full can of paint, gasoline or other liquid into another container, here's a way to get a close

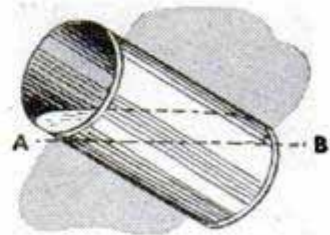

approximation of this amount. Pour the liquid in the usual manner until the level of the liquid remaining in the can forms a line between the lower edge of the rim, A, and the upper edge of the bottom, B. At this point you have poured about one half of the contents from the can. This rule will hold true for both round and square cans, but, of course, it can be done only with open-top containers. If you want to divide the contents of a partially empty can equally, make a mark or place your finger on the outside of the can at the level of the liquid when the can is vertical. Then, use this mark in the same way as you would the lower edge of the rim when pouring from a full can.

Opie Read, Jr., Chicago.

Cleaning Oilstove Tank

Mere removal of the filler cap when cleaning sediment from the tank of an oilstove usually is not sufficient to empty the tank completely. A better way of doing this, which assures that all foreign matter will be drained out, is to remove the generator-stem assembly from the side of the tank and drain the contents through this hole instead of through the filler-cap opening.—Lester M. Diehl, Pittsfield, Mass.

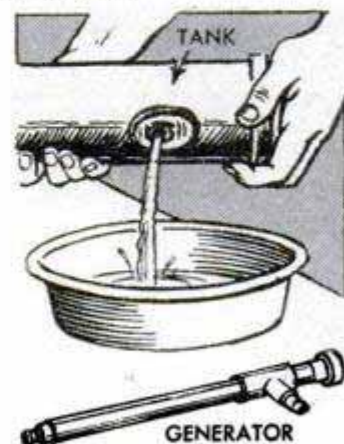

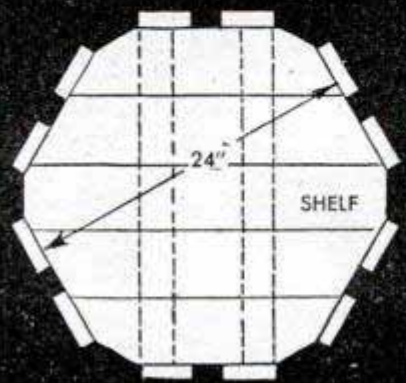
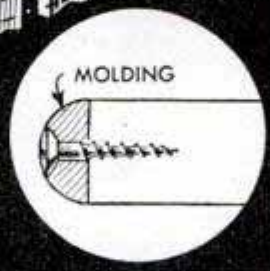
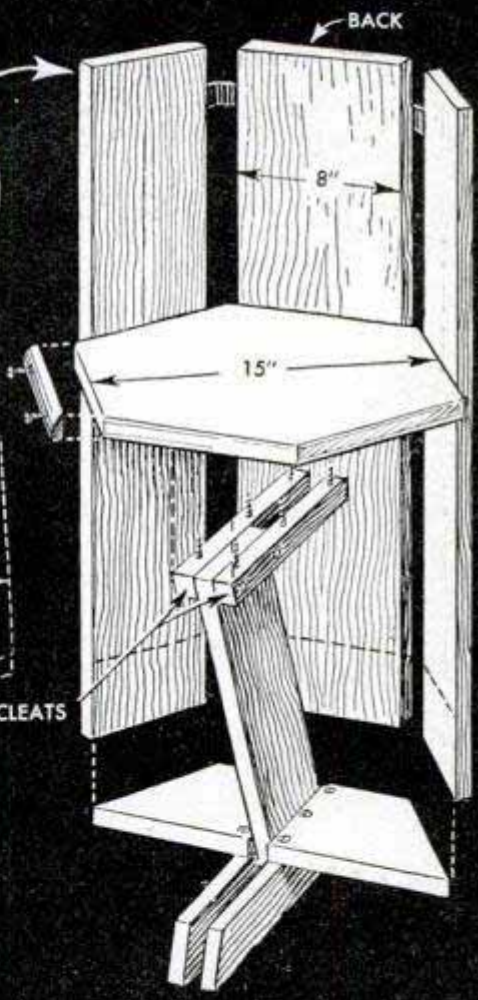
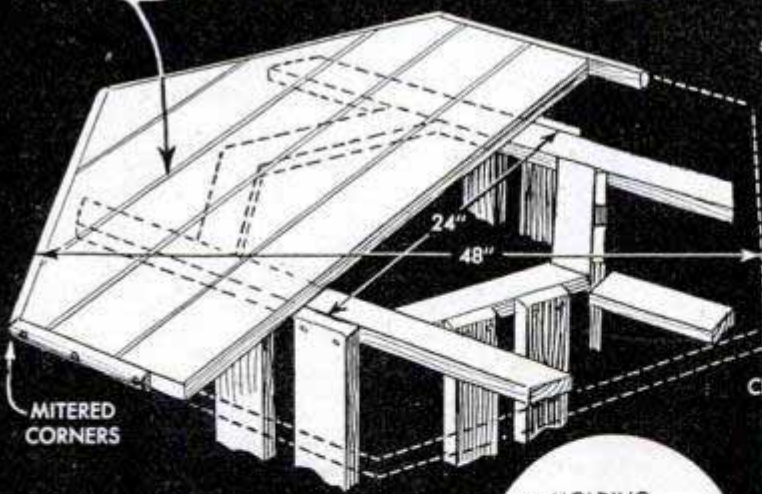
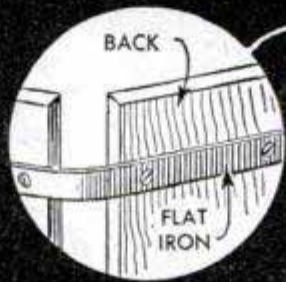
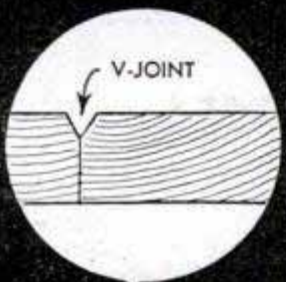
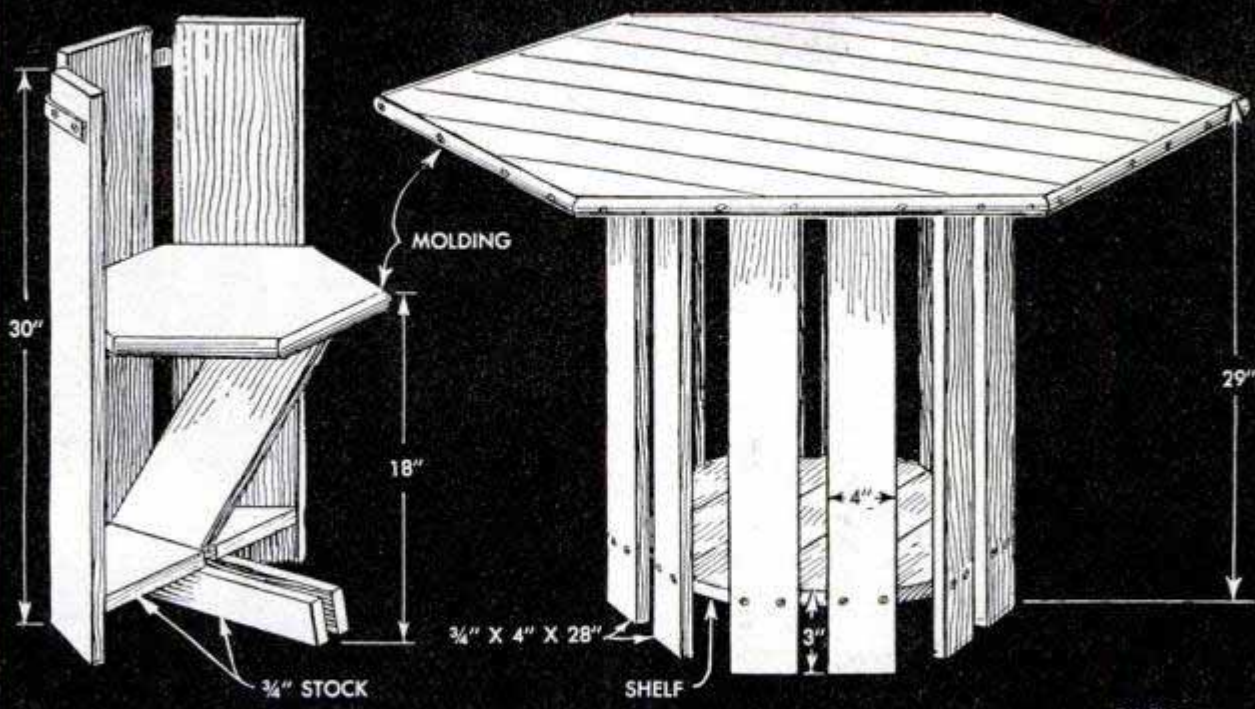

GARDEN FURNITURE

Pool of Harry J. Keeling, Los Angeles, Calif.

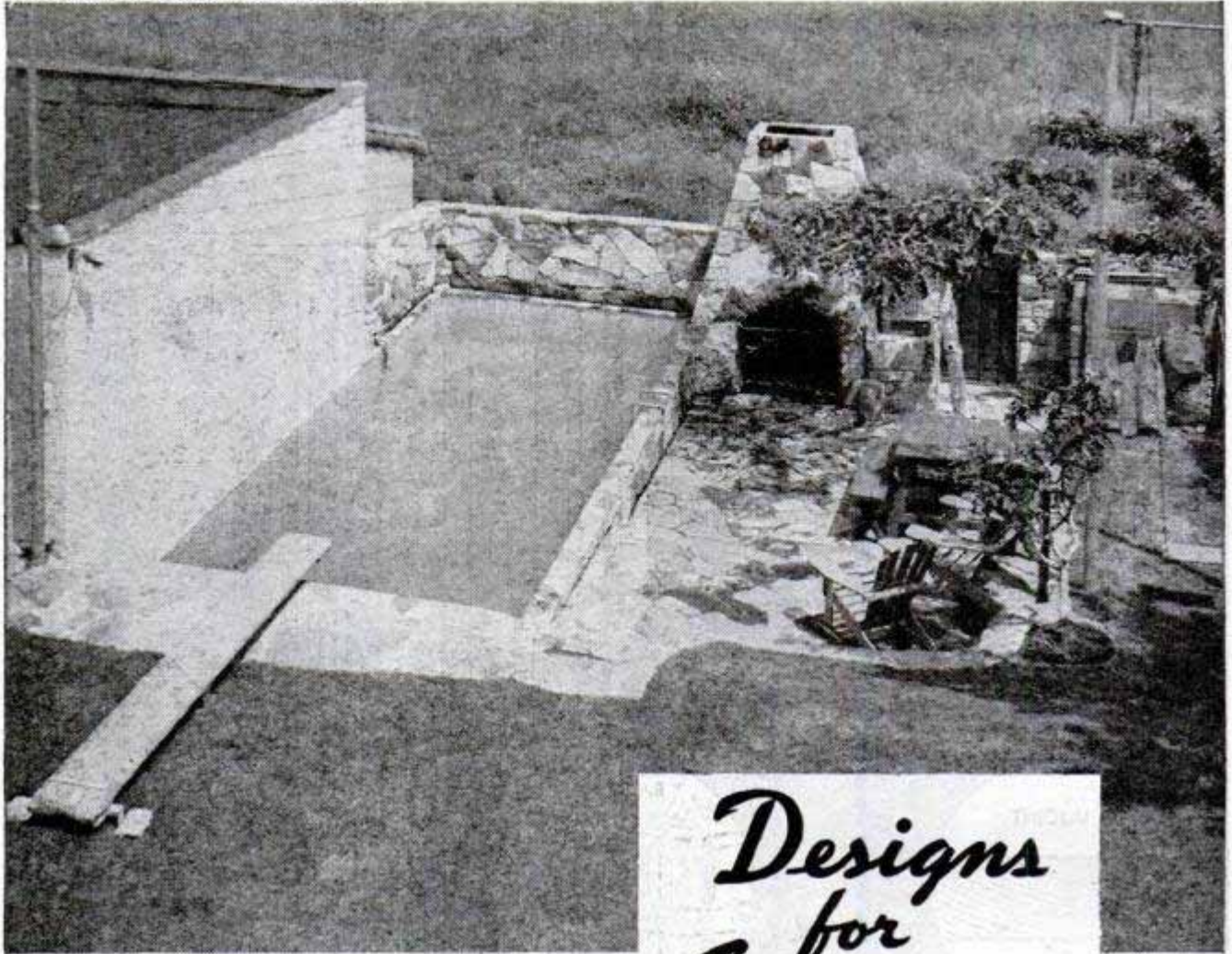

*Designs
for
Swimming*



Pool of Irving Snyder, Palm Springs, Calif.

By Hi Sibley

WHETHER it's large and elaborate or small and unpretentious, there's nothing like the privacy and convenience of a swimming pool right in your own back yard. And when you can do most of the work yourself or with the help of friends and neighbors, the cost can be kept well within the limitations of the average pocketbook. The suggestions and pointers presented here cover construction ranging from simple wading pools to a large family-size swimming pool.

When building a wading pool for youngsters, locate it on high ground if possible to simplify draining and also to save excavating, Fig. 1. A simple circular-shaped wading pool is shown in Fig. 2. A novel feature of this pool is a sprinkler head which is attached to a length of coupipe and screwed into a coupling on the drainpipe. The children will enjoy frolicking in the spray from the sprinkler while the pool is being filled. When the sprinkler head is not used, it is removed and the drain stopped with a pipe plug, Fig. 2. The sprinkler feature is practical only if the drainpipe outlet is easily accessible for attaching a hose. Galvanized sheet metal or heavy linoleum makes ideal forms for a circular pool. Fig. 7 shows how stakes and cross braces are used to support metal forms. As a safety precaution, do not make the depth of the pool at the center more than 12 in.

Fig. 6 details a pool of unusual construction which is suitable for youngsters learning to swim. However, it is not desirable in regions where winter temperatures drop below freezing as the 2-in. walls will not withstand movement of the ground due to frost. The excavation for this pool is furred with strips nailed to stakes driven into the earth walls. Then metal lath is stapled to the furring strips and poultry wire is used in the bottom for reinforcement. Walls are plastered with cement and the

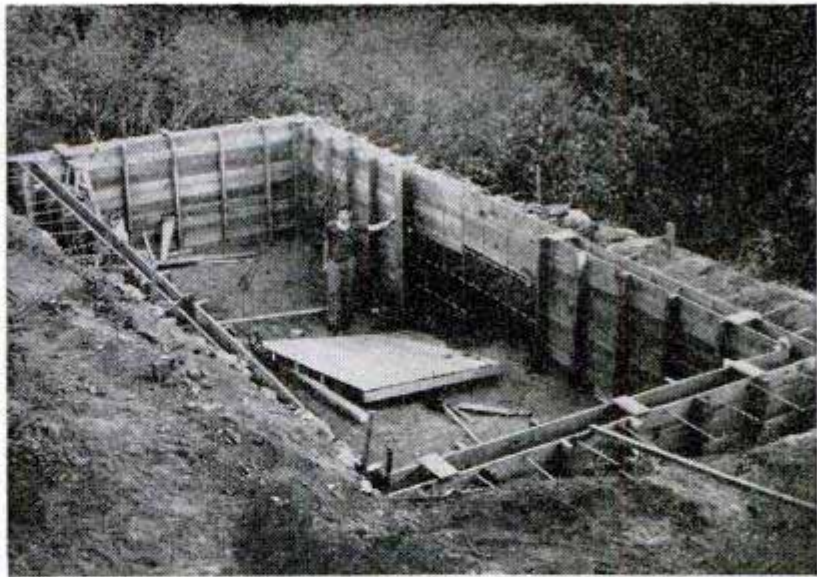

Here is an example of how a pool built on sloping ground reduces the job of excavating. Double-formed, pool is ready to be poured



This view shows the pool poured, the forms removed and drain installed. Walls take less concrete when bottom of pool is sloped



Pool of William D. Soper, La Mesa, Calif.

Finished pool in use. Drainage is no problem of pool similarly situated. Here, drain in side carries water off for irrigation purposes. Note metal ladder which is embedded in concrete at time of pouring

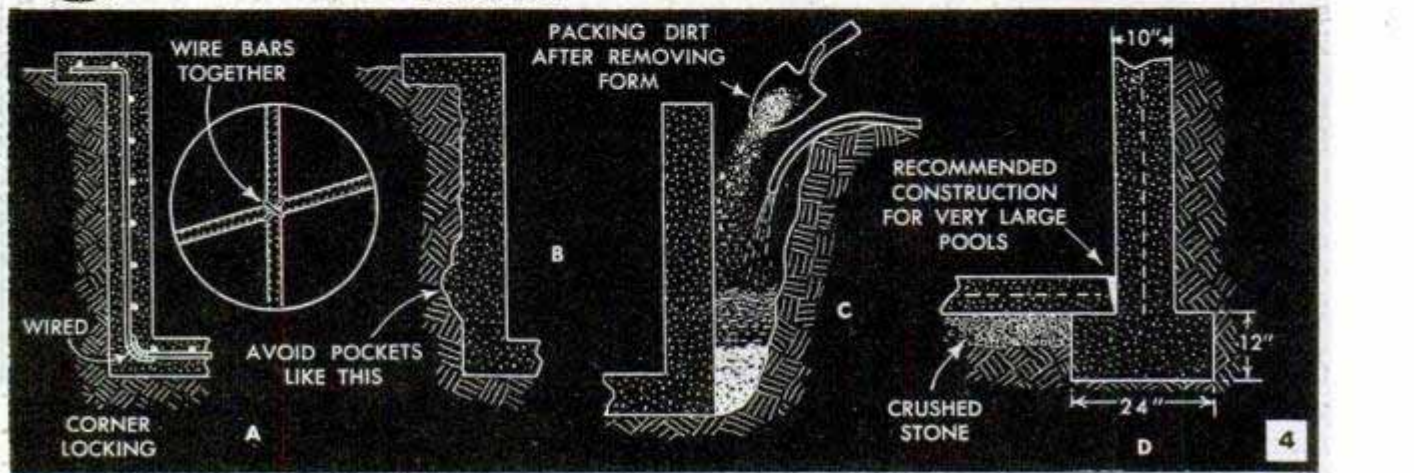
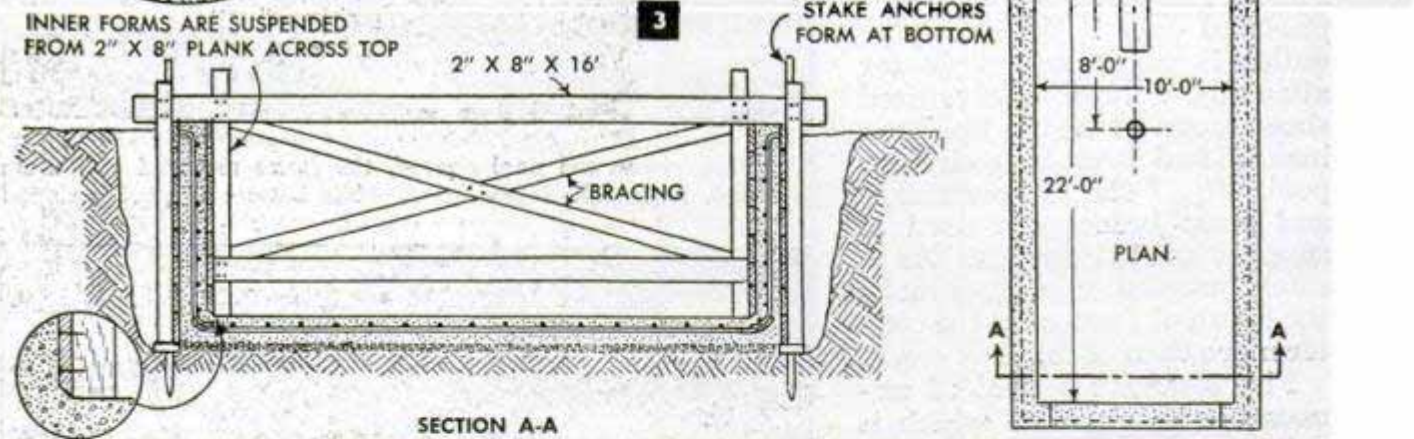
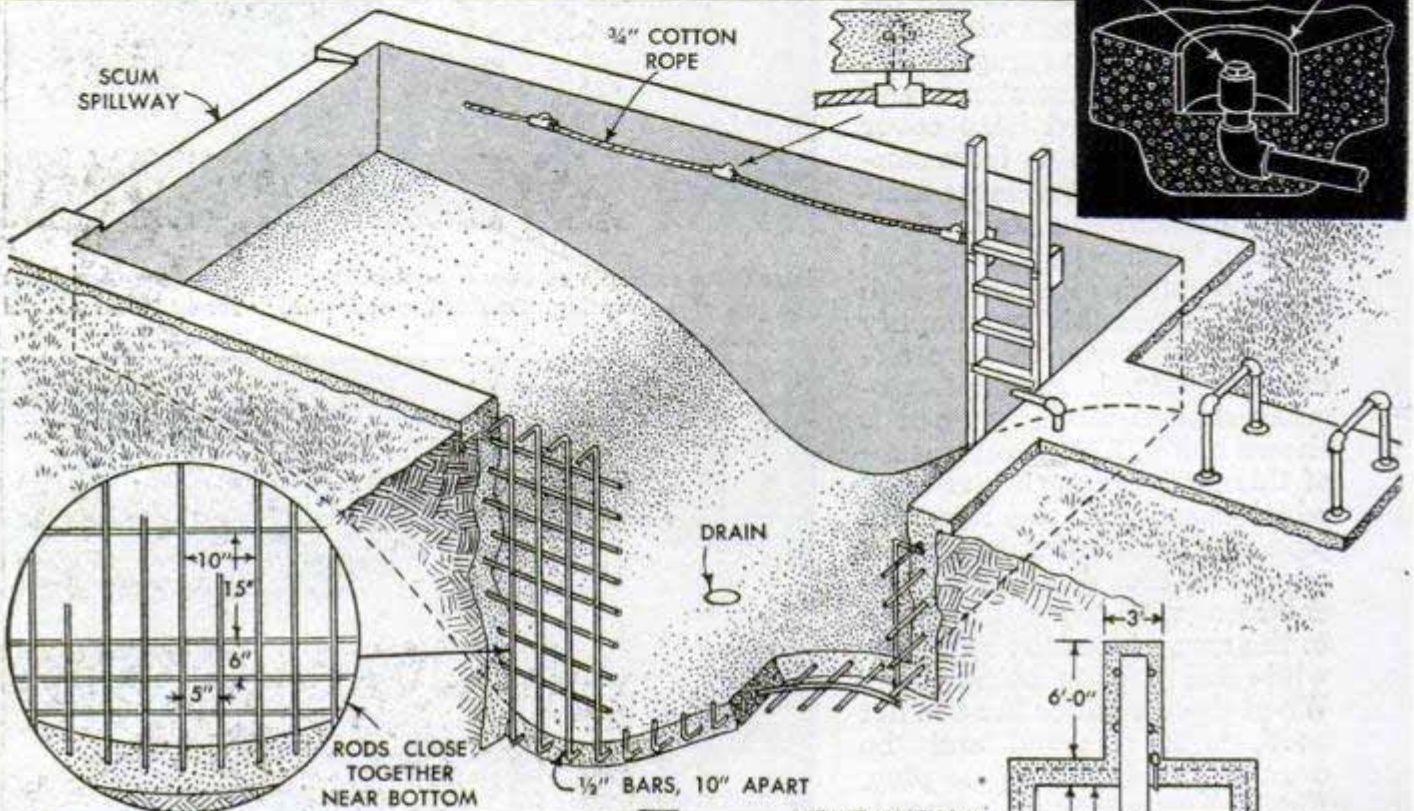
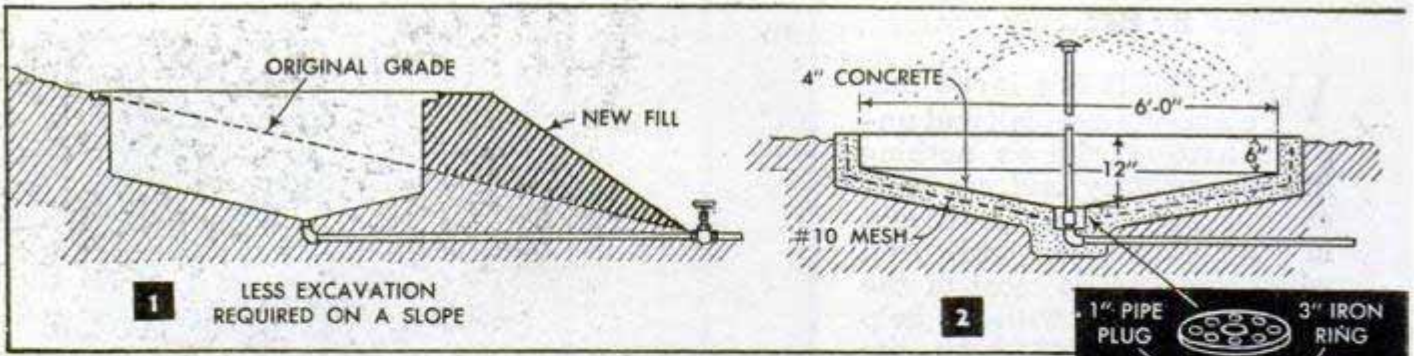

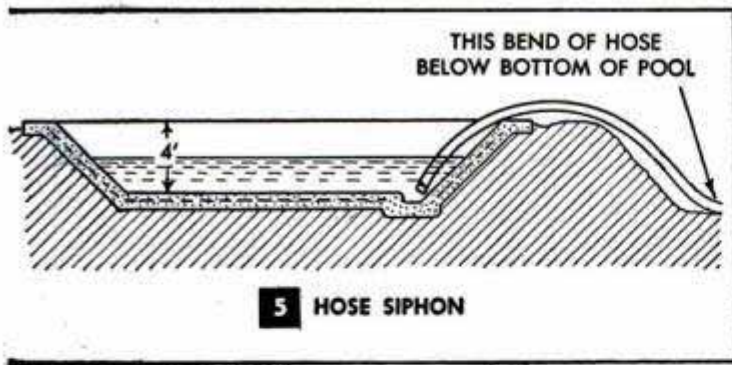

bottom is covered with a 3-in. layer of concrete poured over a 4-in. bed of gravel and strengthened with the wire. Finally, a reinforced curbing or parapet is laid around the edge.

An inexpensive pool without plumbing is shown in Fig. 5. Measuring 12 by 20 ft., it is designed for high ground to eliminate drainage piping and has sloping walls to do away with the need for forms. Bottom and sides of the excavation are tamped well and then 2 in. of concrete is poured over the bottom. This is reinforced with 6-in. spot-welded wire mesh, on top of which an additional 2-in. layer of concrete is poured. When the bottom is firm but still soft, the walls are plastered with cement to form an integral mass which is troweled into a parapet all around the top. The bottom is troweled to slope toward a sump from which the water is siphoned with a hose to drain the pool.

Figs. 3 and 11 detail an adult-size pool, 10 by 22 ft. Note that it is complete with water filter, centrifugal pump, suction-cleaning facilities, diving board and ladder. The deep portion just off the diving board slopes upward at each end to cut material cost. However, don't skimp on the wall thickness and the reinforcement. A minimum wall thickness of 6 in. is recommended for mild climates. Pools built in regions of severe cold should be 10 in. thick to avoid cracking. Section A-A of

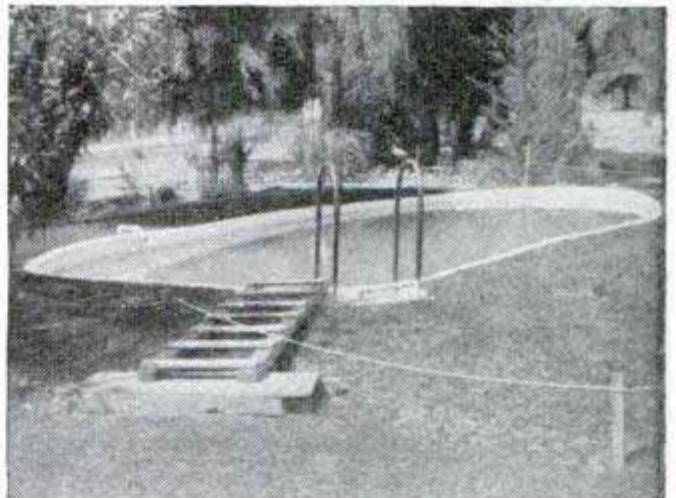

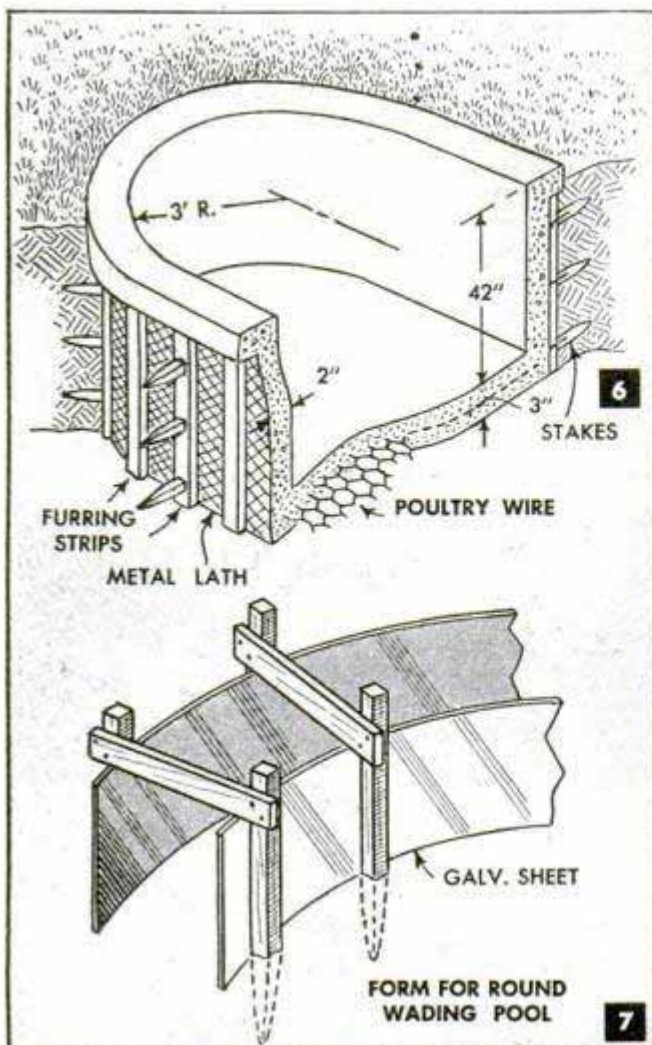
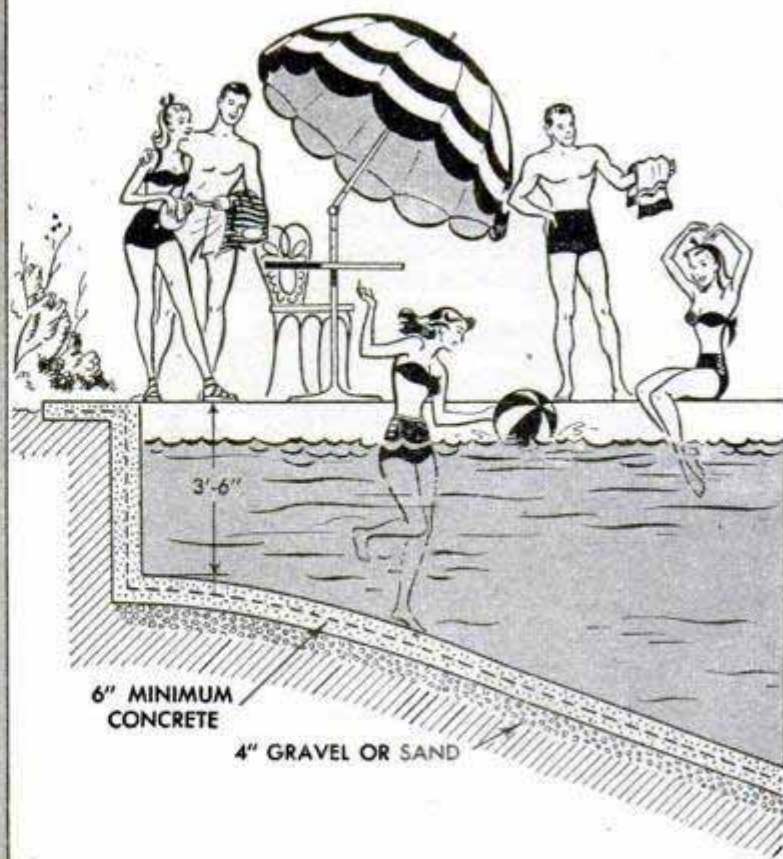
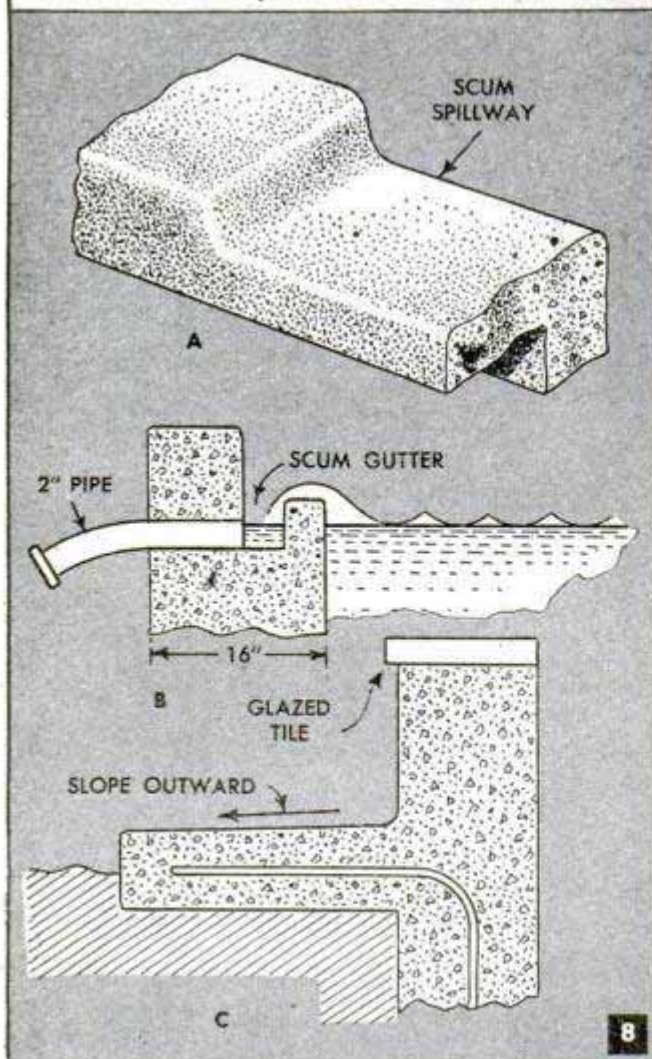

Fig. 3 shows how the pool is double-formed—with inside and outside forms, and how it is reinforced. Note that the inner forms are suspended from crossbeams and that stakes are used to prevent the outer forms from giving way at the bottom. Rods reinforcing the walls and bottom are wired together at the lower corner as shown in Fig. 4, detail A. The walls of large pools generally are poured on footings and a separate slab poured for the bottom, much like the foundation of a house. Then a mastic is run in the joint to make it watertight as shown in Fig. 4, detail D.

Figs. 9 and 10 give suggestions for making ladders of pipe or wood, and also plans for a springboard. The metal ladder should be of galvanized or stainless steel and embedded in the concrete at the time it is poured. Spruce is the best material for the springboard. Bevel the edges and cover the end with a nonslip padding of rope matting.

Three types of parapets are shown in Fig. 8. Parapets A and B incorporate a spillway in the top of the wall for floating off leaves and litter by raising the water level. In the case of B, drainpipes are spaced about 8 ft. apart all around the pool. Detail C shows construction of a parapet which extends above ground to provide a low seat around the pool and keeps debris from blowing into the water.

The concrete for small wading pools can be mixed in a wheelbarrow, but for large pools it is best to rent a small power mixer.



A recommended proportionate mix consists of portland cement, 1 part; sand, $2\frac{1}{2}$ parts; and gravel, $3\frac{1}{4}$ parts. If the pool is to be plastered, the proportions should be as follows: portland cement, 1 part; and sand, 3 parts. Six gallons of water per sack of cement is about right. It is always best to pour a job complete at one time, but if this cannot be done, the joint should be roughened to assure a good bond and brushed with a soupy mixture of cement and water just before the pouring is resumed. Be sure that the concrete is well spaded in the forms with a long pole, to prevent air pockets and porous places in the finished wall. Also, avoid cave-in areas in the dirt walls, Fig. 4, detail B, which take considerably more concrete. Forms should not be removed for two or three days, after which the concrete should be cured gradually by wetting it frequently for several days. Dirt fill around the outside of the walls is packed solidly by wetting with a hose as it is shoveled in place, Fig. 4, detail C.

The nozzle from an old vacuum cleaner attached to a long pole will be found handy for cleaning the walls and bottom of a pool. Fasten it to a length of large hose and connect it to the suction-pump inlet, Fig. 11. Finish the walls and bottom of the pool with a couple coats of rubber-base paint. When cracks develop which cause serious leakage, they can be filled with asbestos roofing cement and then painted.

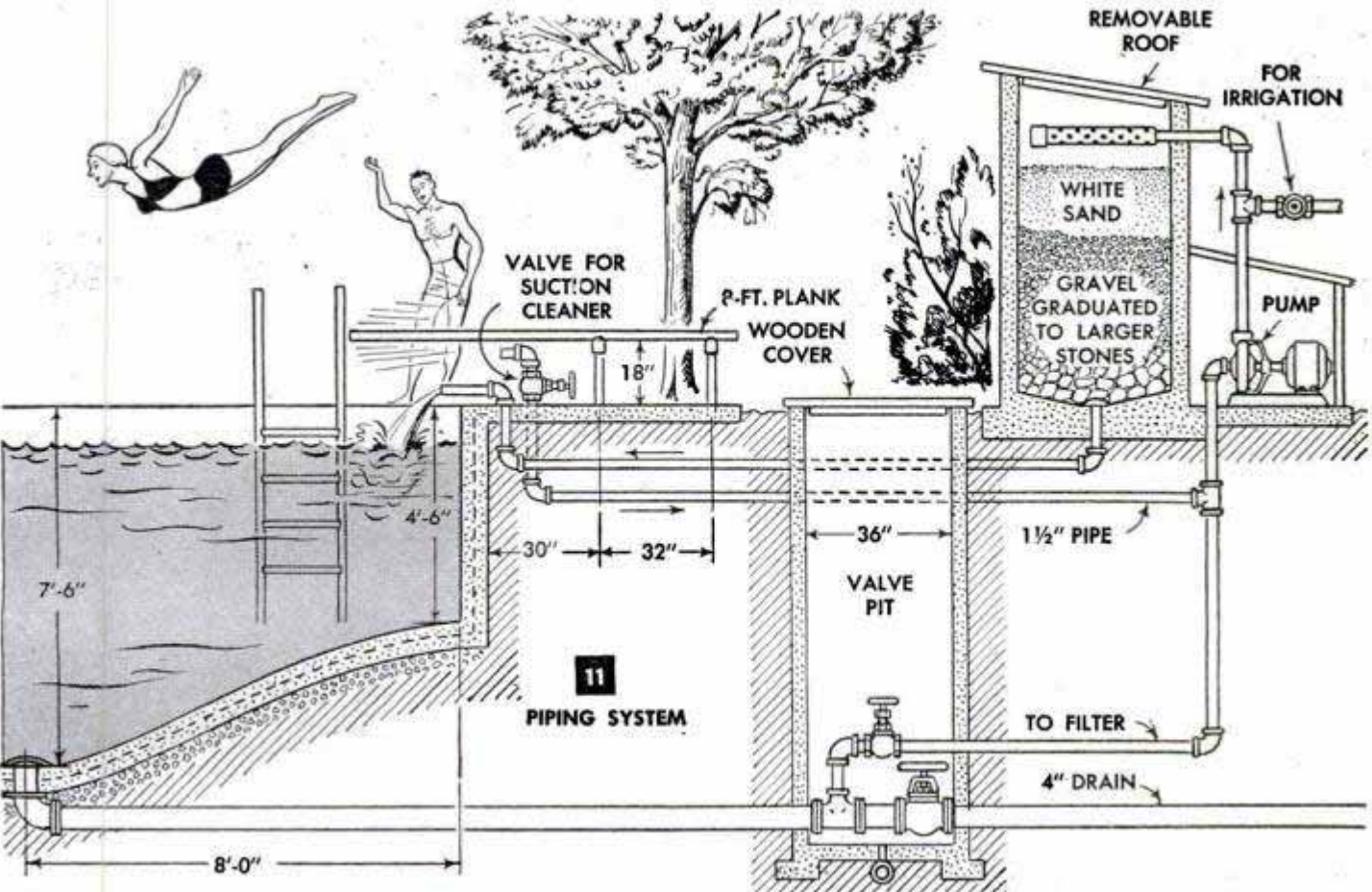
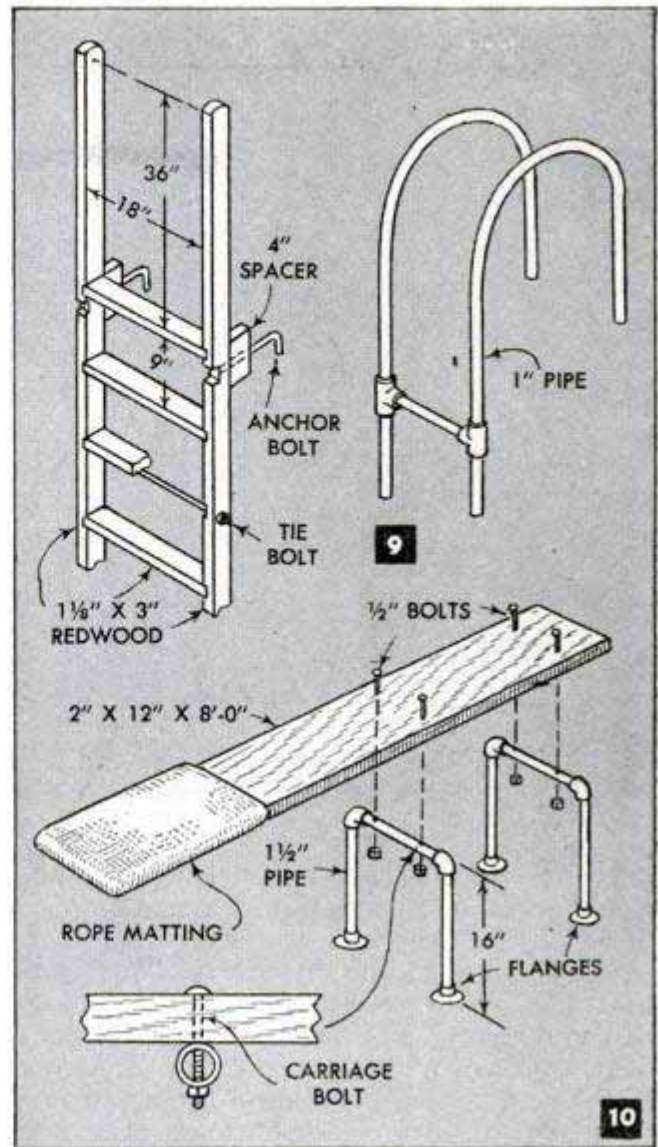

Pyramid-Type Strawberry Bed

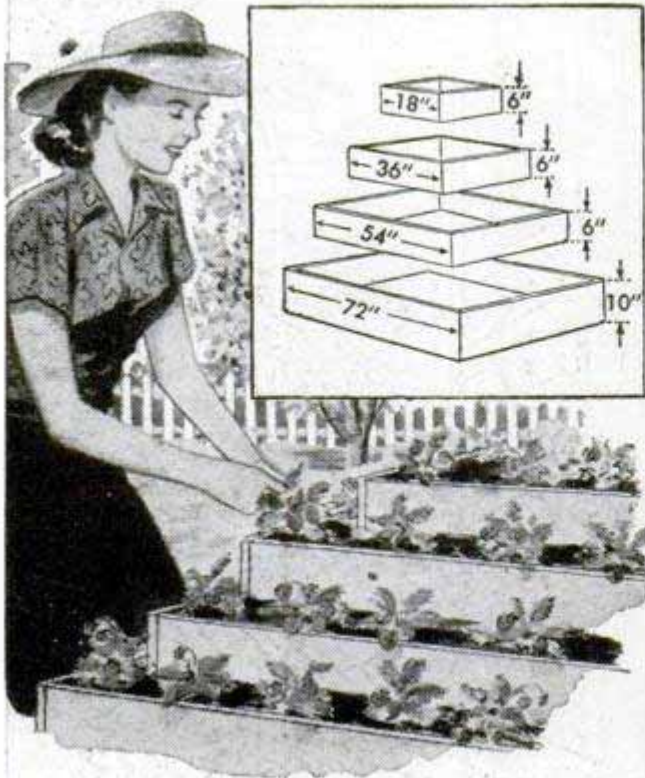

This pyramid-type strawberry bed holds a large number of plants in a small space while bringing each plant within easy reach for individual attention. The original bed, built to the dimensions given in the drawing, holds 64 plants in a space 6 ft. square without crowding. Because of the design of the pyramid the strawberry plants are not likely to spread, and weeding, watering and gathering the fruit is simplified. The bed consists of four square frames of diminishing size, filled with soil to about 2 in. above the top to allow for settling, and stacked pyramid fashion. A cheesecloth cover placed over the bed, will prevent birds from eating the fruit.—Carl C. Buebke, Portland, Ore.

Screw Inserted in Rim Lock Prevents Use of Passkey

If you have a mortise or rim-type lock on your door, you can alter it so that a passkey will not open it by simply turning a small machine screw through the bottom of the lock, as shown. Place the screw at one side of the keyhole so that it will not interfere with inserting the key.

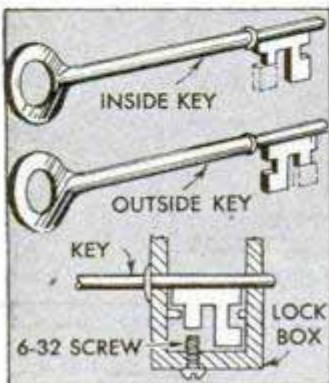

Also, determine the location of the screw by noting the direction the key is turned to unlock the lock.

Then make two keys for your own use, one to operate the lock from the inside and the other from the outside, and grind off the portion of each key indicated by the dotted lines.

Nathan Bogoch, Winnipeg, Man., Can.

Getting the Most From Canned Heat

When using canned heat to cook outdoors after a long day of hunting or fishing, it's very annoying if the flame burns low because the fuel is almost exhausted. However, you can produce a high flame and enjoy a warm meal merely by



punching several holes around the side of the can with a nail. Punch the holes near the fuel level to obtain effective draft.

Plumb Bob Anchors Pie-Tin Buoy Used as Fishing-Hole Marker

On large lakes or rivers where it's often difficult to return to the exact location of a good fishing hole, a brightly colored marker buoy will permit you to find the spot in a jiffy. A float can be made by soldering two pie tins together and soldering a screw eye to the bottom of one of them. A plumb bob attached by means of a line serves as a weight to anchor the marker in place. When you find a spot you wish to mark, drop the weight and pay out the line until the weight is on the bottom. Then tie the buoy to the line. If it is painted orange, it will be easy to see in daylight and can be picked up at night in the beam of a flashlight.

Wm. P. Houser, Organ, N. Mex.

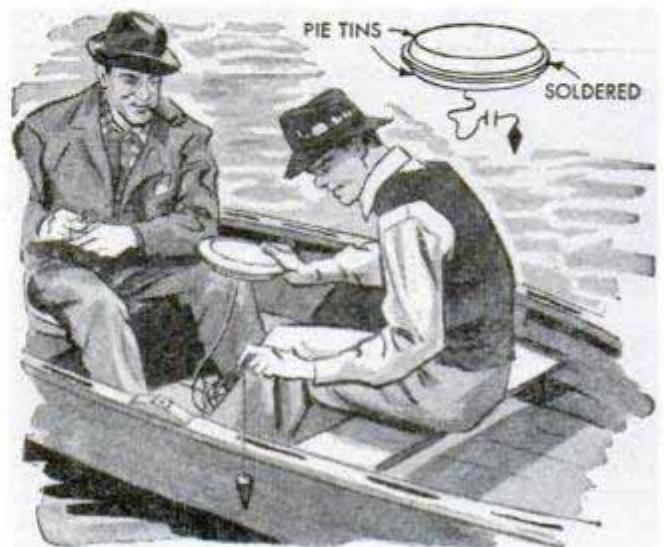

OUTDOOR DESK

By B. P. Horsley

IDEAL for the naturalist, archaeologist or anyone who must do documentary work in the field, this folding desk-and-stool combination provides substantial writing surface along with comparative comfort. The desk folds into a compact case for traveling. In addition to containing all the essential writing equipment, it also carries the three-drawer stool. Shelves, together with the stool drawers, afford ample space for storing paper, records and reference books. Two small drawers at the center partition hold pencils, pens, etc. A bottle of ink is inserted in a hole cut in the lower drawer and is held by means of a thumbscrew. A lamp, which can be connected to a portable power supply, is attached as shown. In this location, the lamp will furnish sufficient illumination and still not interfere with packing of the stool. The desk legs fold for carrying and are held folded by spring sash stops.

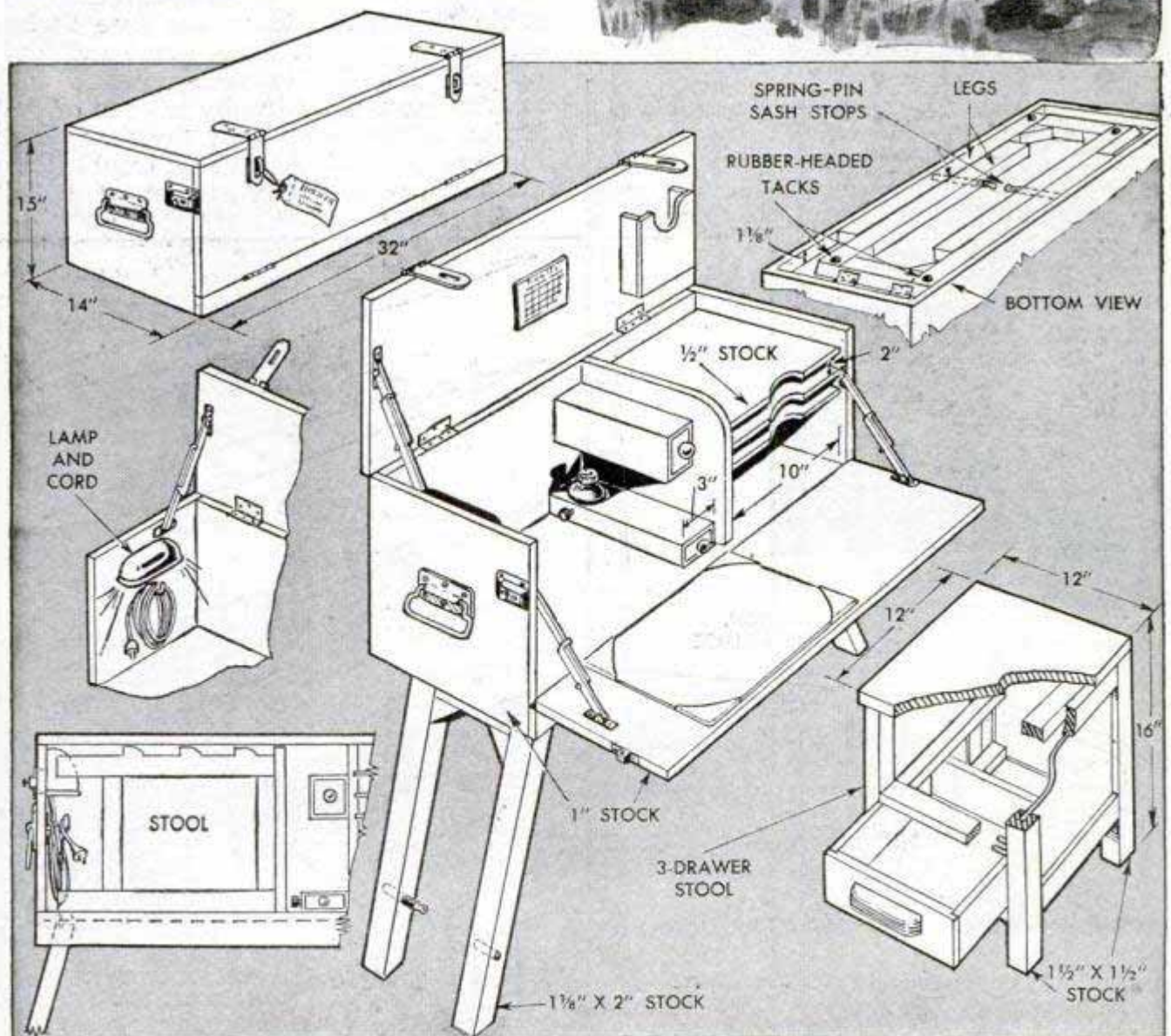

Build your MODEL PLANE

There are 141 trophies and \$7875 awaiting builders of the best entries in Plymouth's 2nd International Model Plane Contest at Detroit, Aug. 18-23. Cut yourself a slice!

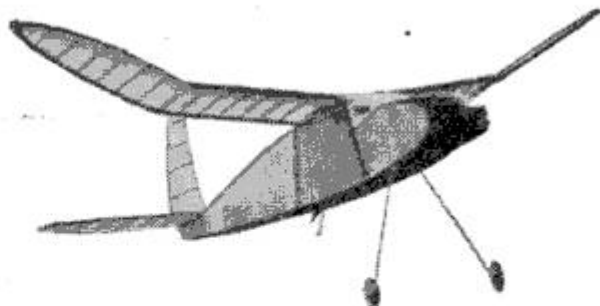

RUBBER-BAND POWERED



THOUSANDS of model-plane "engineers" are busy preparing their contenders for one of the big air shows of the model world—the 2nd International Model Plane Contest scheduled at Detroit, August 18-23.

Elimination meets are being held in cities and states with 500 finalists being picked for the big air meet, sponsored by Plymouth Motor Corporation. Every contestant must build and fly his own plane.

There are 45 events for indoor and outdoor rubber-band models (both stick and cabin classes), outdoor gas free flight, control-line speed, scale, stunt and jet-propelled. In addition, there will be a permanent high-point trophy in each of the junior, senior and open divisions, and three perpetual international trophies for the stunt, scale model and jet-propelled

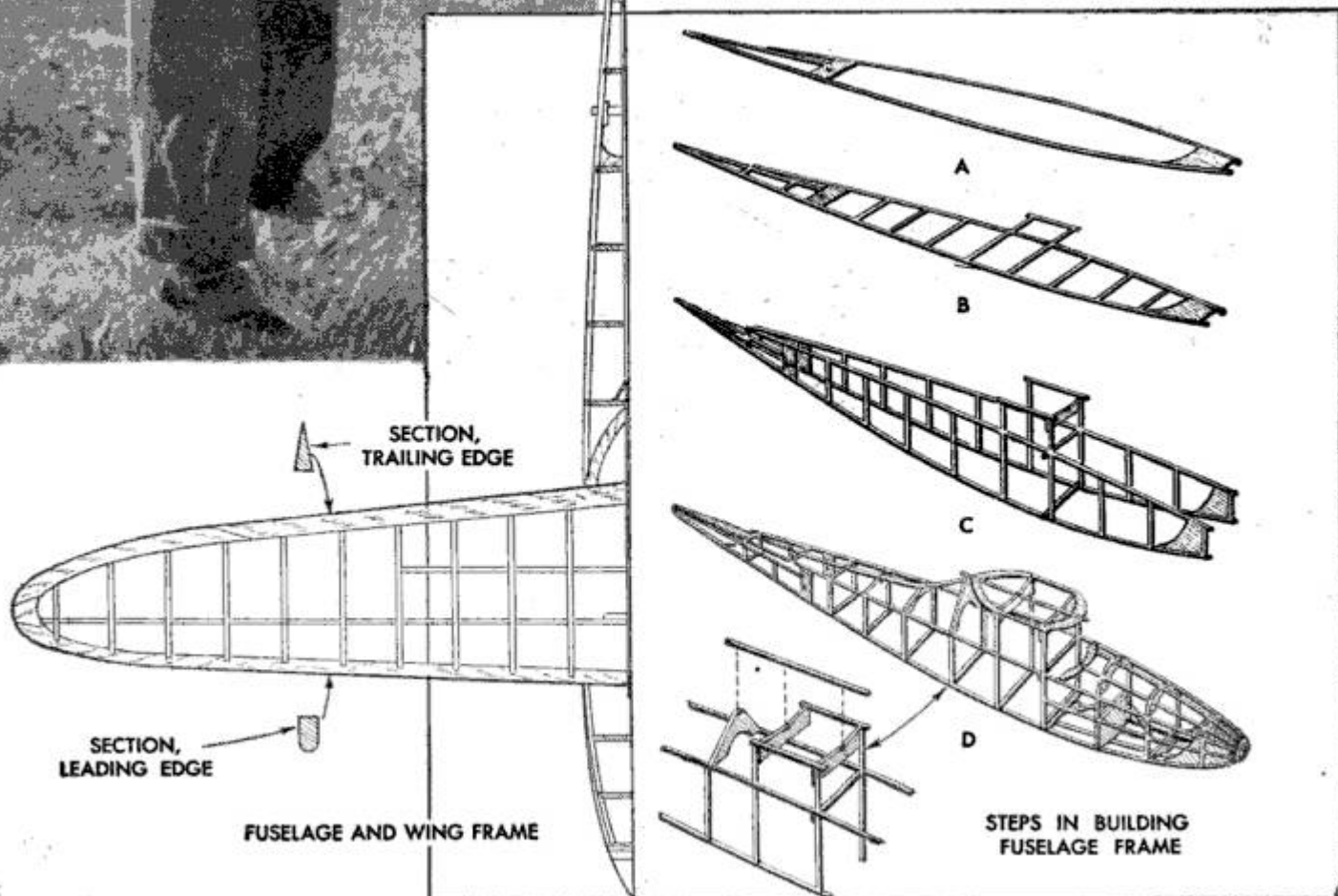

to WIN



GAS-POWERED

events. The meet is invitational and you must first qualify. Rules and entry blanks are available from Plymouth dealers.

Here are some things to watch: In indoor events, wing area of both stick and cabin models must be limited to a maximum of a 150 sq. in. Maximum cross-sectional area of stick models must conform to the formula $L^2/150$ as a maximum (L —the over-all length, excluding propeller), while the maximum cross-sectional area of cabin models must be $L^2/100$ as a minimum.

Cross-section formulas are the same for outdoor rubber, but wing area may vary from 100 to 300 sq. in. Minimum weight is 4 oz. per 100 sq. in. of wing area. In gas free flight, the minimum weight is 100 oz. per cu. in. of piston displacement, and no model can weigh more than 7 pounds. In control-line events, no model can weigh more than 4 pounds. No metal props are permitted.

The details below are only representative of the acceptable methods of construction of the fuselage, or cabin types, in both rubber and gas models. Special care must be taken with built-up sections such as those in details A, B, C and D below at the left.

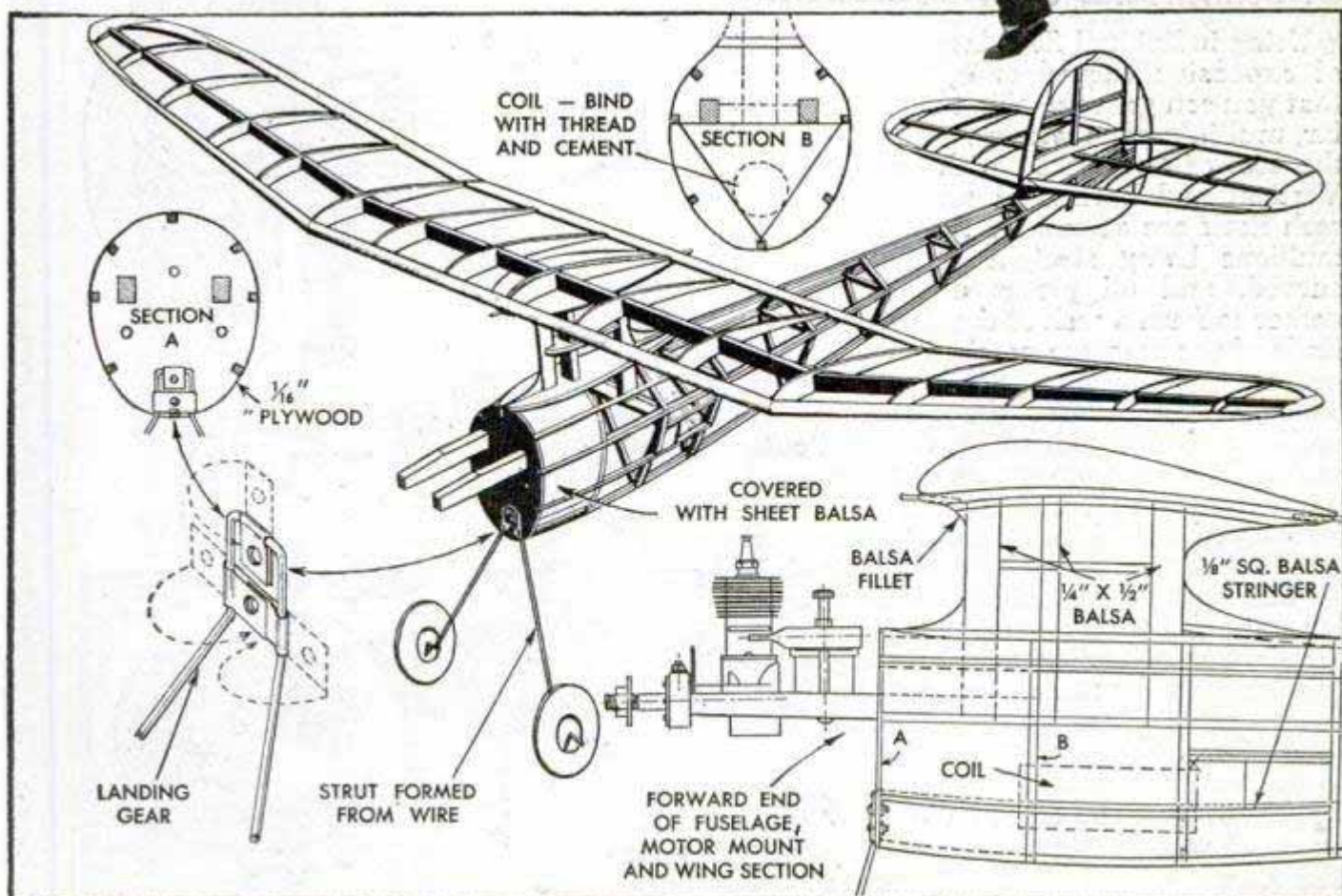

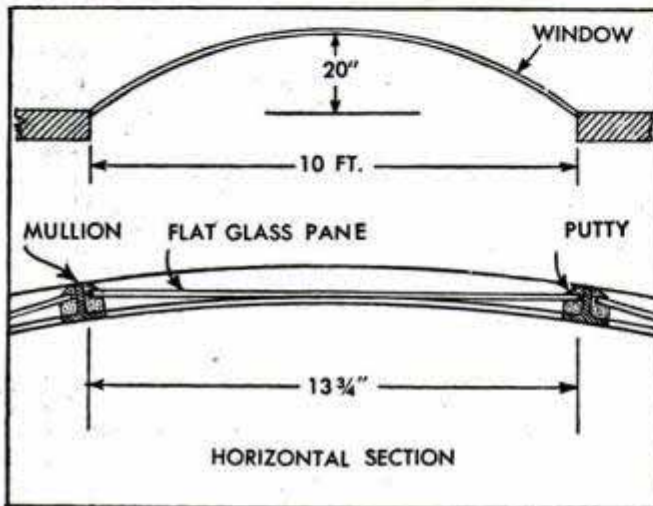
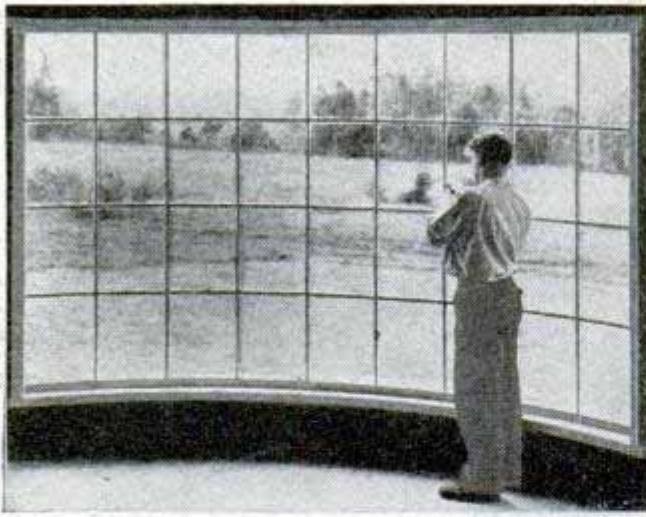

Flat-Glass Panes Reduce Cost Of Semicircular Sash

Using individual flat-glass panes instead of expensive curved ones, here's a way that you can gain the effect of a semicircular, multiple-pane window at a fraction of the cost of one glazed with curved glass. Vertical and horizontal members of the sash itself are assembled from T-iron, the mullions being straight and the bars curved, and all pieces are welded together to form a sash of the desired radius. Ends of the bars are notched to butt flush against the mullions. The width of the panes, which governs the spacing of the mullions, is determined by the particular radius. The example shows that the maximum glass size for a 10-ft. sash which projects 20 in., is 13 $\frac{3}{4}$ in. This is the maximum width that the T-iron will accommodate. To determine the spacing of the mullions, lay out a full-size drawing on paper as in the horizontal-section detail. Swing a line representing the radius and swing another representing the width of the T-iron to be used. Then hold a straightedge at a tangent to the second line and note the maximum length that can be drawn within the two lines, allowance being made for glazing. The panes are set in the T-iron rabbets.

Snap Restores Halyard Pulley To Flagpole Top

To solve the problem of replacing a fallen halyard pulley at the top of a tall flagpole, one man devised this snap clamp which remains a permanent attachment on the pole. It is made in two parts cut from heavy-gauge sheet metal in the shape of a letter S. The two parts are pivoted together with a cap screw to form a figure eight and one end is provided with a coil spring. Then, the other end is fitted with a trigger made from heavy wire and a V-shaped piece of sheet metal. One end of the wire engages a notch filed in one leg as shown. In use, a light touch disengages the trigger, causing the spring to snap the jaws shut. The device is raised with a pole built up of sections, the first one having a hole in the end to receive the pivot screw snugly. Wire loops, formed around the flagpole and attached to each section as it is added, help guide the pole. The pulley and halyard are tied to the device with string or a rubber band so that a slight tug will free them. After the clamp reaches the top of the flagpole, the trigger is bumped against the ball spike to snap the clamp in place. Then the sectional pole is pulled away from the cap screw.

Jack Bronte, Grass Valley, Calif.

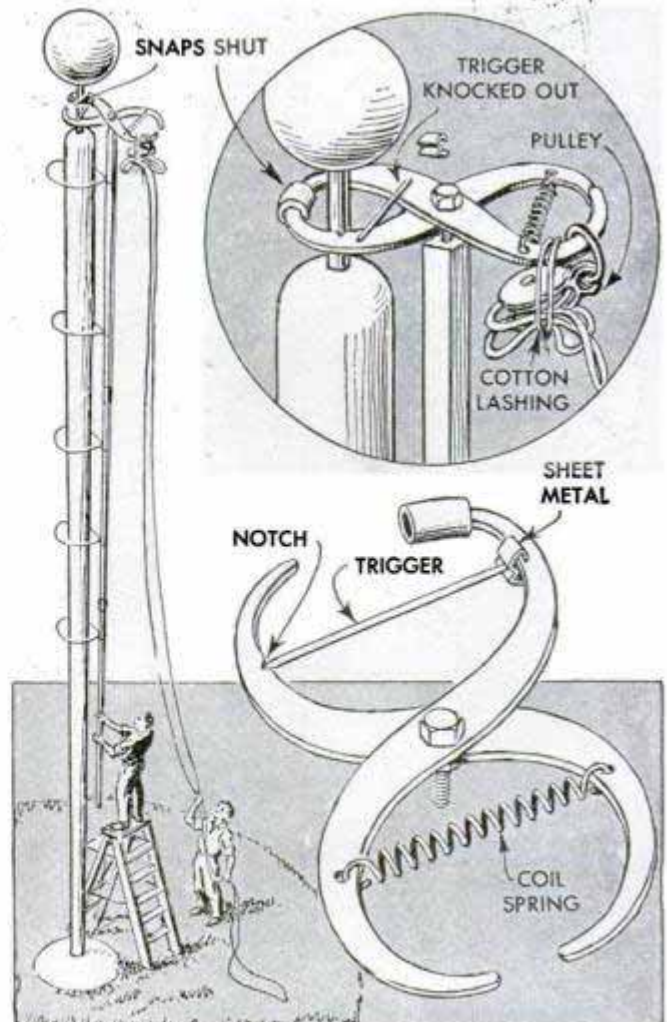

GOCART

has coil springs

Baby is in for a smooth ride in this sporty streamlined gocart for it has "knee action" which takes the bumps like a new automobile. Tractor valve springs provide the knee action and these are set in can covers bolted to the axle with the same bolts which fasten the radius rod. A screw and a hexagon nut anchor each spring at the top and a leather snubber holds the springs in place, slightly compressed. Waterproof plywood and solid stock are used in the body, with sheet metal being used to cover the rounded ends. The teardrop fenders are shaped from 2 by 8-in. plank, covered with plywood.—J. C. Montgomery, Bowness, Alta., Can.

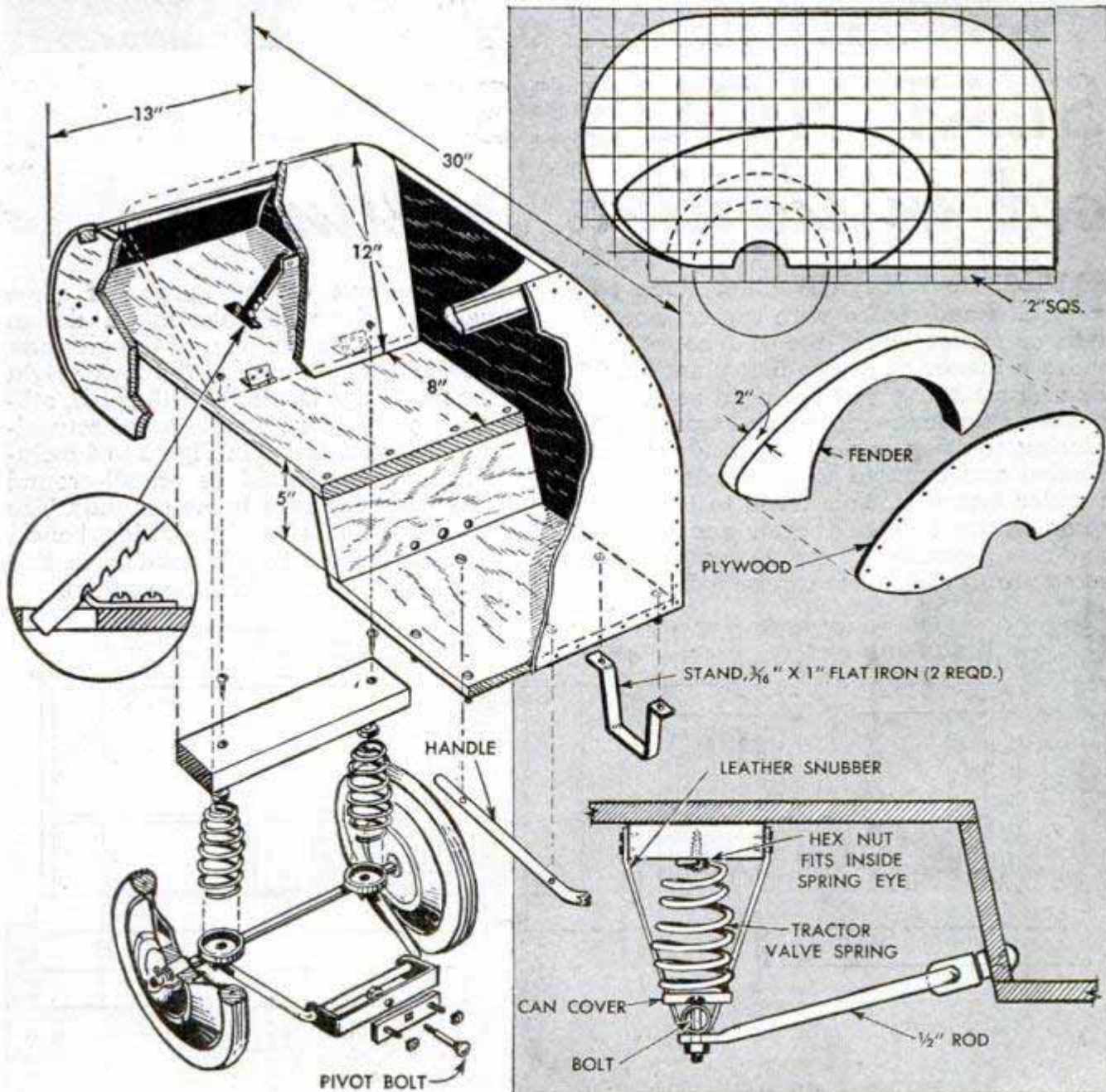

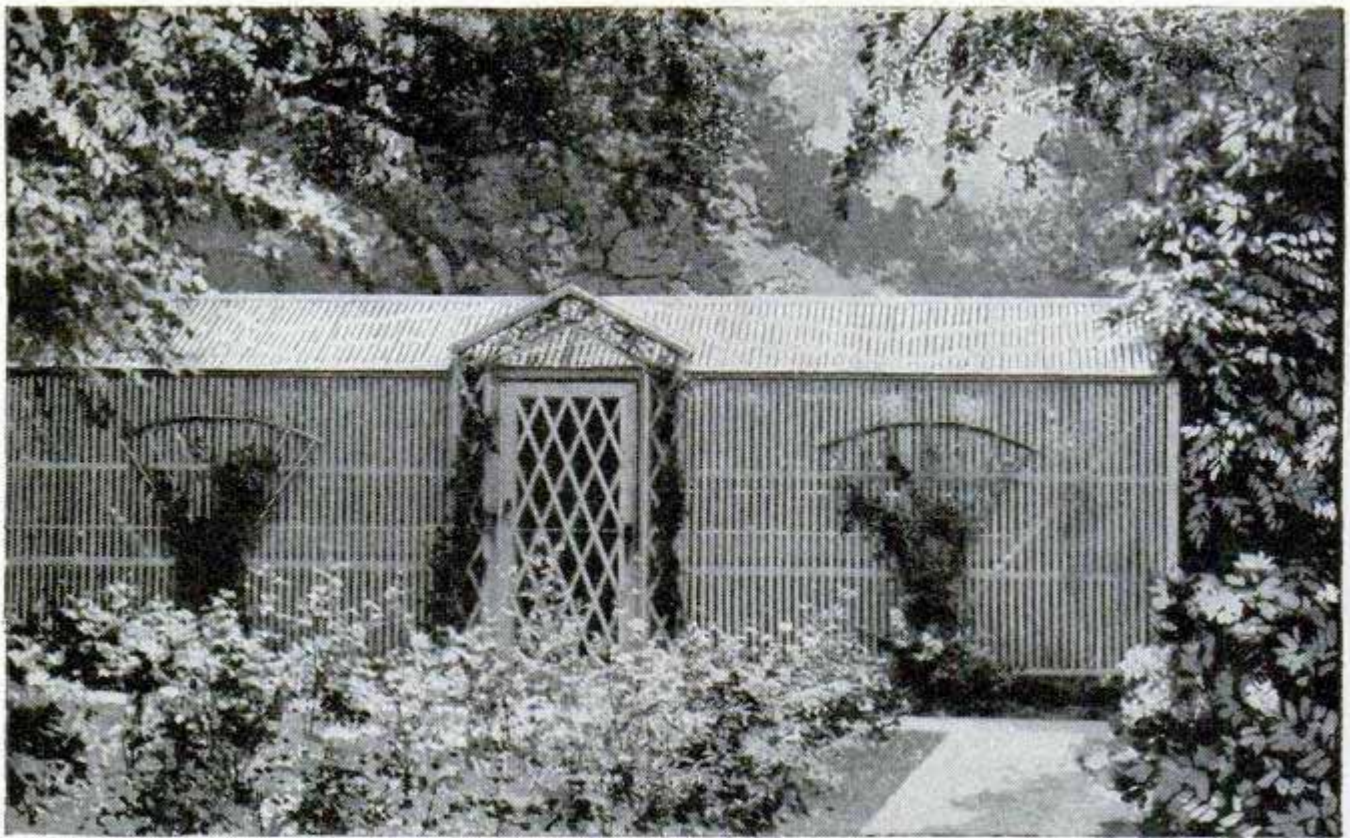

SLAT HOUSES

aid in starting seedlings

BUILT from rough framing stock and sided and roofed with spaced wooden lath or lattice stock, the slat house provides a means of controlling plant shade. Spaced slats give just the right amount of shade to tender seedlings and transplants. During the day each plant is alternately shaded and exposed to direct sunlight at regular intervals. This tends to lower the temperature both of the air and seedbed and also prevents too rapid evaporation of moisture. A slat house can be made an at-

tractive feature of the garden if some thought is given to selecting a design which fits in with the plan of the grounds. While the type pictured at the lower right on the next page is wholly utilitarian, others shown are more ornate architecturally. The design detailed in Figs. 1 to 4 inclusive has been selected as an all-around type suitable for most home grounds. The plan, Fig. 4, includes the potting bench, Fig. 2, and the framing is detailed in Fig. 3. Frame and slats should be stained.

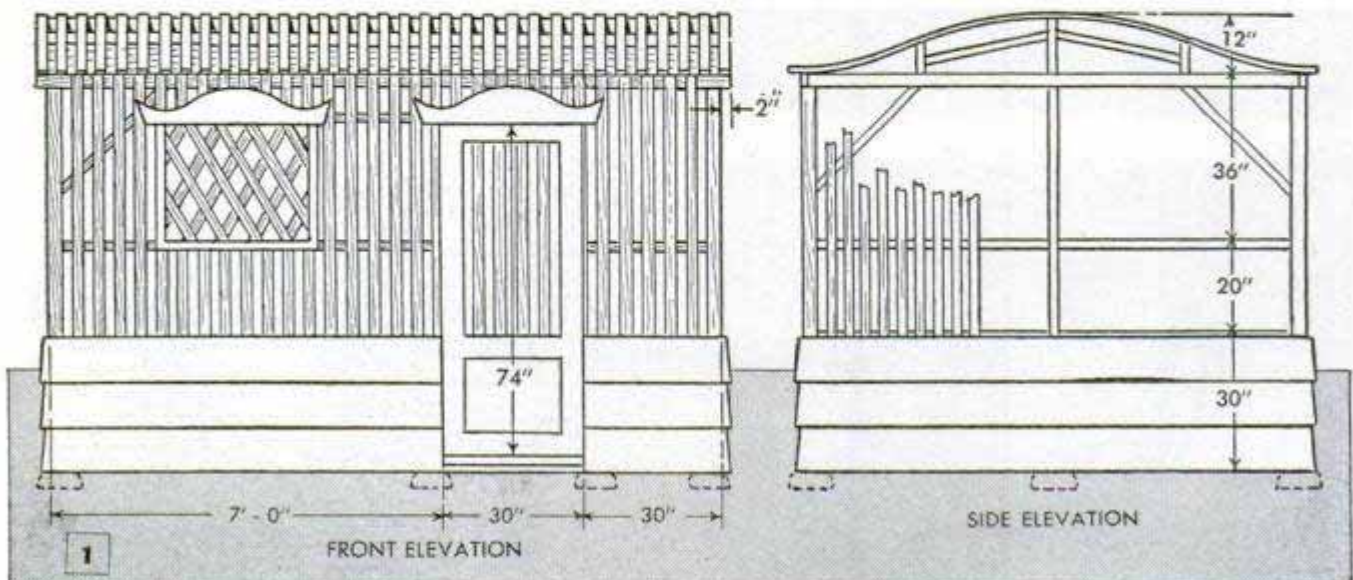

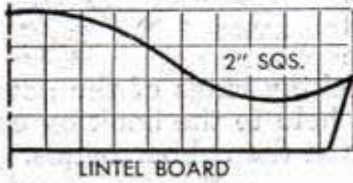
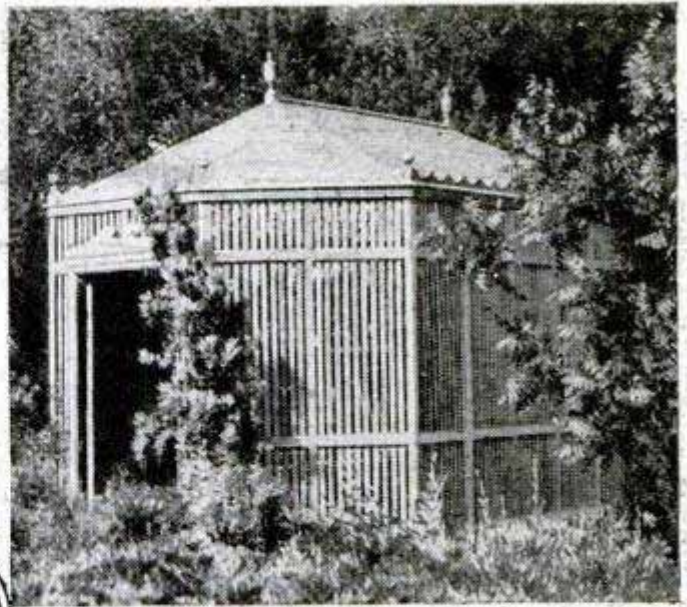
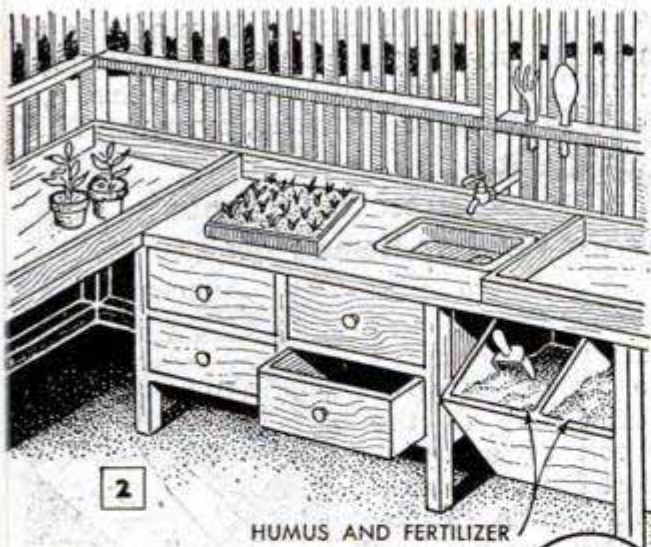

3/8" X 2" BATTENS
SPACED 2"

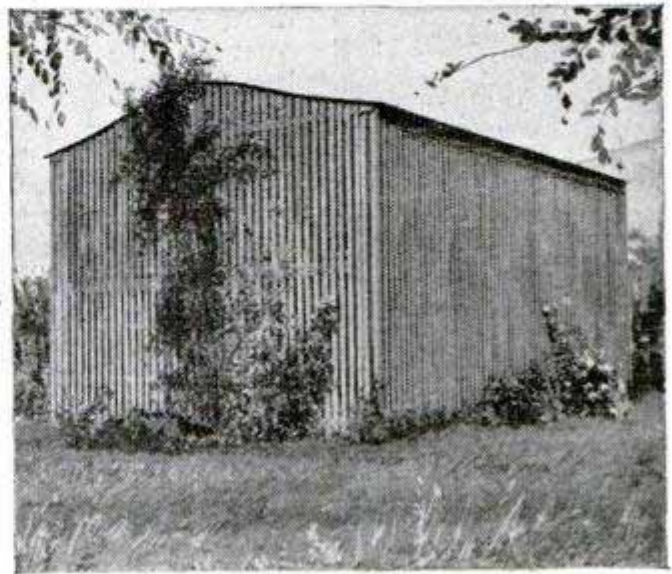
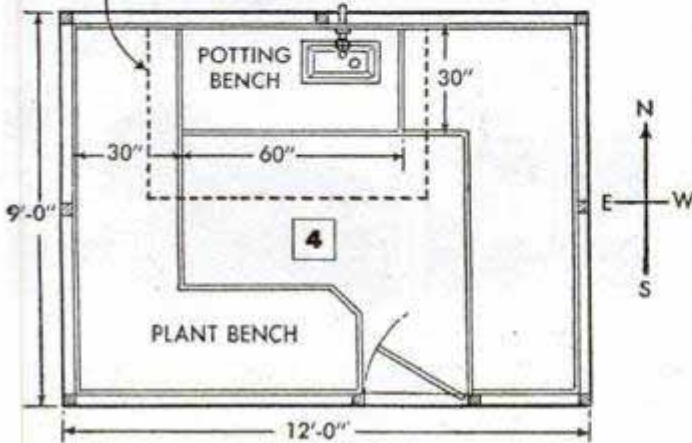
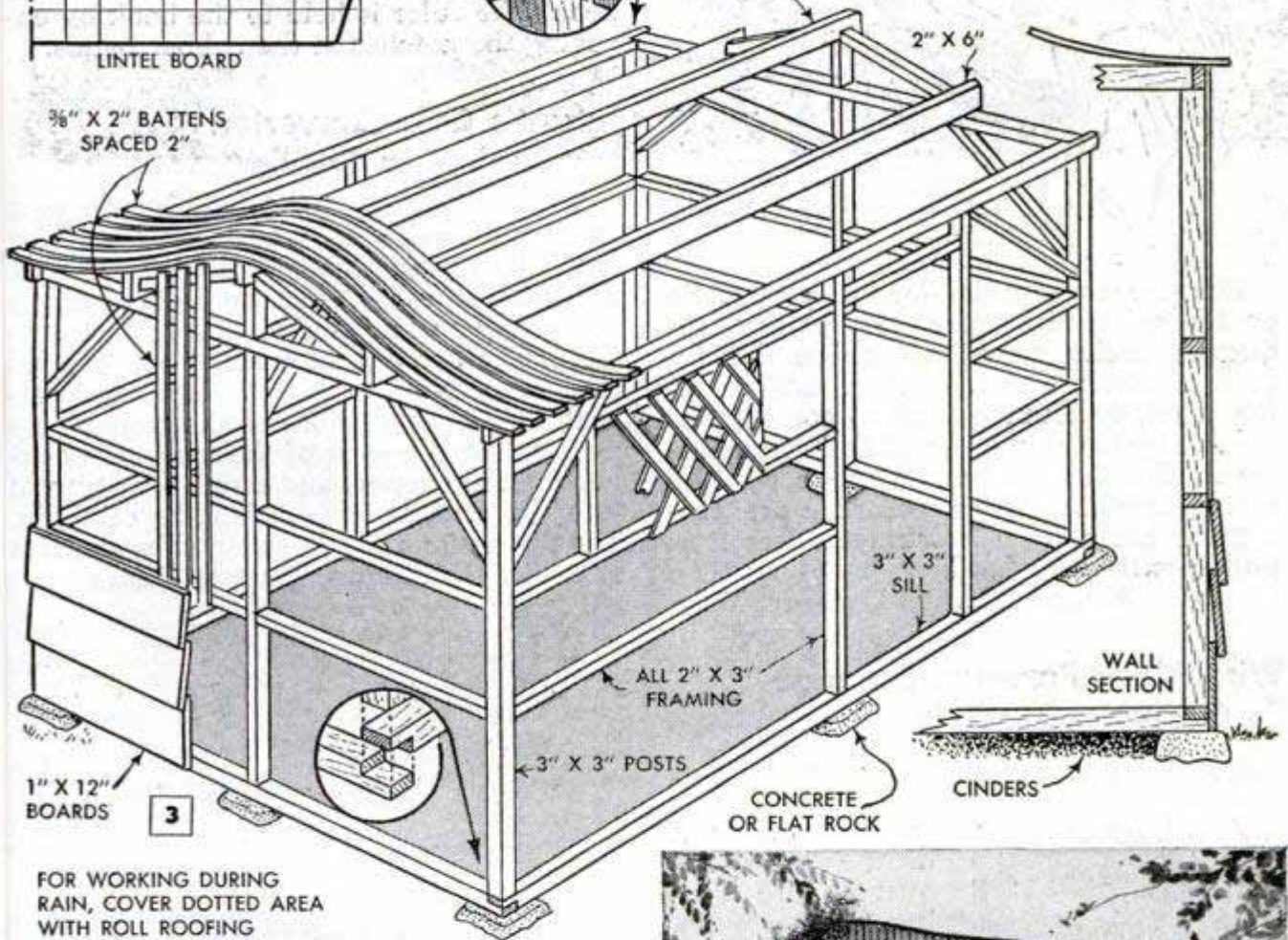

Pull-Chain Shock Absorber For Ceiling Fixture

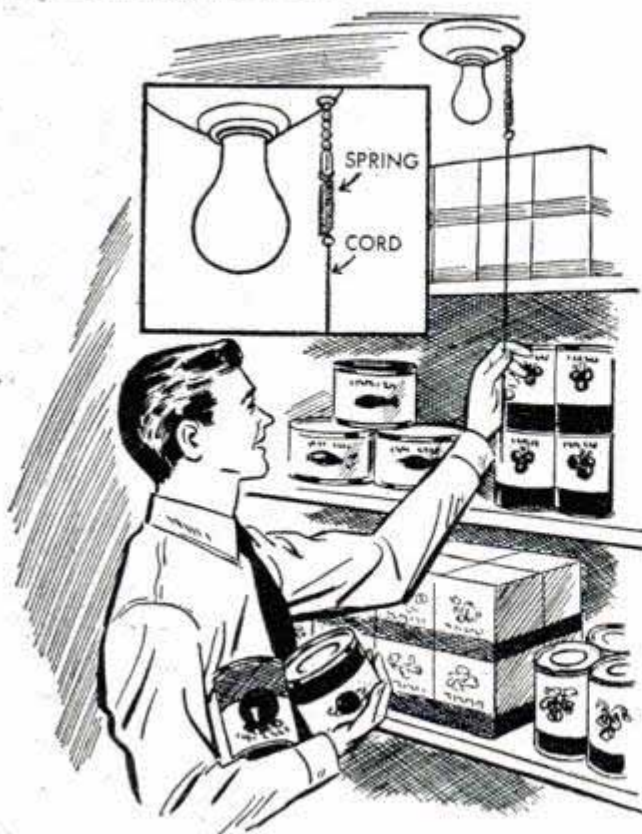

Because it was pulled too hard; the chain on the ceiling fixture in our pantry frequently broke, sometimes inside the fixture necessitating a bothersome repair job. I finally found a way to correct this trouble by fastening a small coil spring between the pull chain and the cord. The spring acts as a shock absorber preventing the chain from breaking unless it is pulled extremely hard.

Willard Allphin, Danvers, Mass.

Wire Mesh Prevents Damage To Growing Gladioli

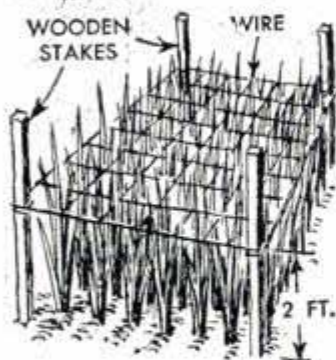

Tender stalks of "glads" growing in small beds out in the open frequently are broken by the wind. To prevent this, drive wooden stakes at the four corners of the bed and stretch welded wire fencing

(4-in. mesh) over the bed when the plants are 6 to 8 in. high. Train the stalks through the wire mesh as the plants grow and raise the wire at intervals as growth progresses. With average-sized plants, height of the wire should not exceed 2 ft. at the end of the growing period. As the metal gets very hot on sunny days, some foliage should be

above the wire to keep it from getting too hot and injuring the plant. The fencing is held to the posts with soft-iron wire.

Lorraine Palmeto, Syracuse, N. Y.

Ruler Fastened in Notebook With Rubber Bands

Here is a convenient way for students to carry a ruler. Simply attach it to the back of a loose-leaf notebook. The ends of the ruler are notched and a rubber band is placed on the top and bottom locking rings of the notebook. The ruler is held to the book by engaging the notches in the rubber bands.

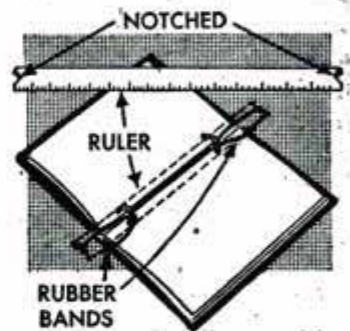

Infant's Crib Converted Into Swinging Cradle

Since I converted the baby's crib to a swinging cradle, he amuses himself for hours by kicking his legs to rock the crib. If he is restless during the night, rocking the crib gently usually will lull him to sleep. The two end supports are assembled from 2 by 2-in. stock and made rigid laterally by a 1 by 6-in. board. Eyebolts inserted near the ends of the top crossmember in each support and screw eyes turned into the crib, hold four lengths of chain.

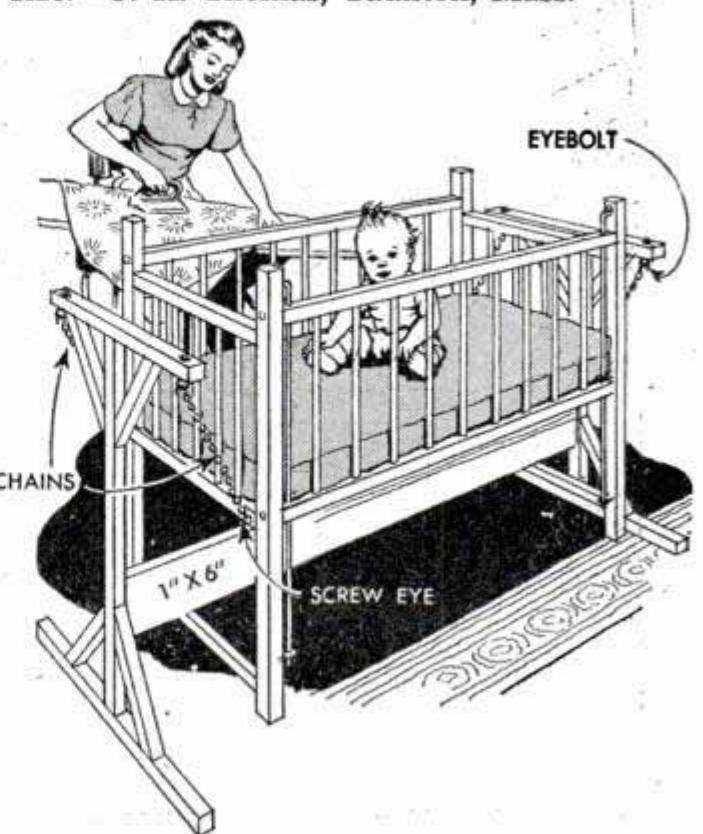

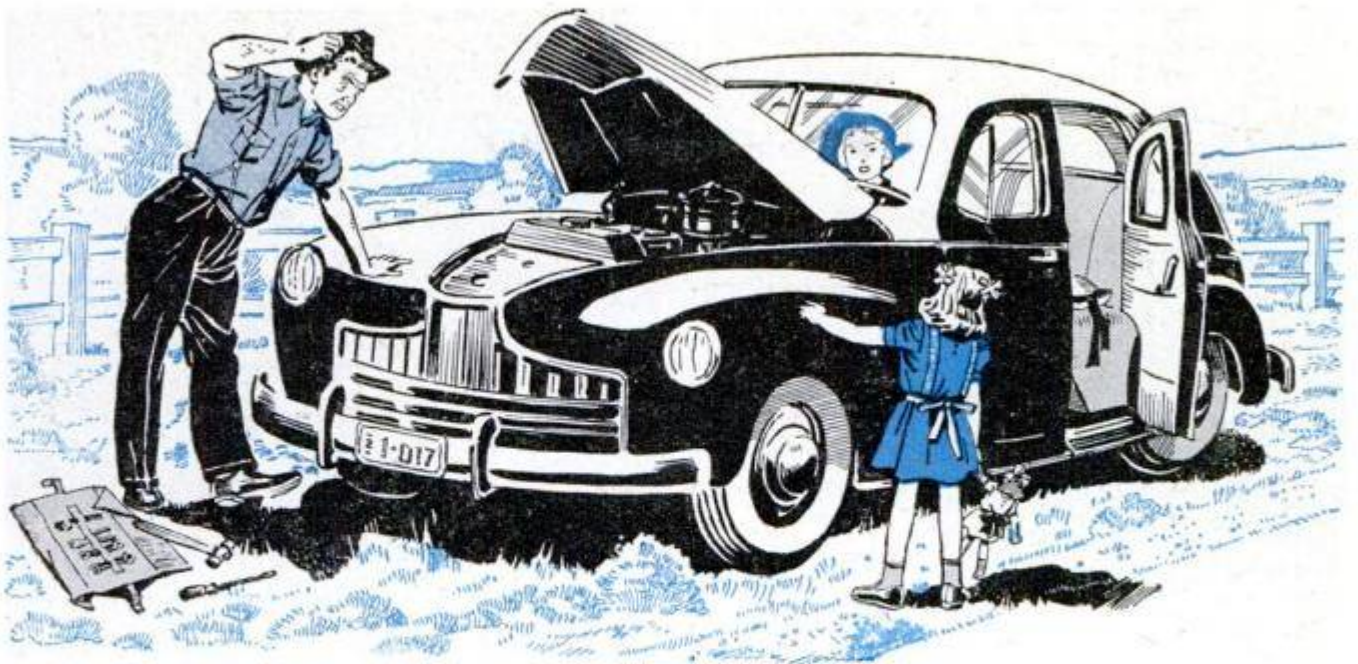

Getting Home on a Sick Engine

If your car suddenly goes dead on the road, simple checks may enable you to locate and repair the trouble, at least temporarily so that you can get to a garage

IF YOU have ever had your car engine conk out on the road and experienced a helpless feeling as the car coasted to a stop miles from a garage, this article will be helpful. No doubt, your first thoughts were of an expensive service call, or even a stiff tow bill.

In many cases you can locate the trouble right on the spot and either correct it, or at least make a temporary repair that will permit the car to be driven home or to the nearest garage where permanent repairs can be made, thus saving the delay and expense of a service call or tow charge, especially on holidays when repair shops are closed.

Naturally, insurance against engine trouble on the road is to inspect the engine at regular intervals, make necessary adjustments and keep worn parts replaced. Also, it is a good idea always to carry a small emergency kit consisting of a few simple tools, such as wrenches, spare insulated wire, friction tape, a quart bottle and a 3-ft. length of small hose for siphoning gas from the tank.

But if you do get stuck on the road, just remember that a car engine needs four things to make it operate; fuel in the carburetor, spark at the spark plugs to ignite the fuel, and oil and water to prevent wear

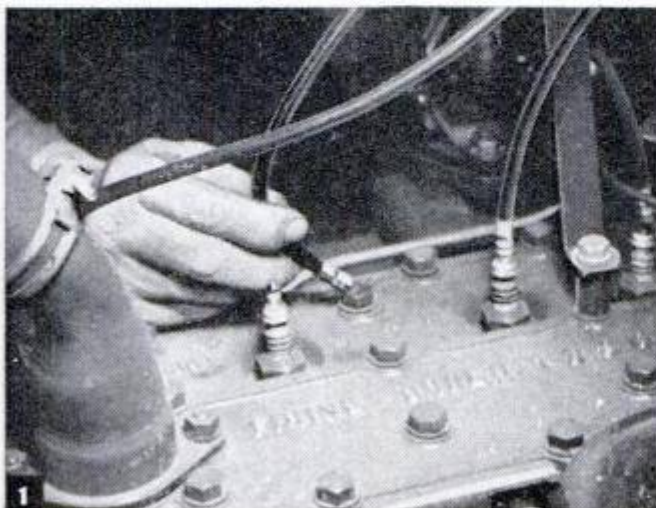

1 Holding spark-plug cable $\frac{1}{8}$ in. from cylinder head should produce a hot spark as engine is turned over

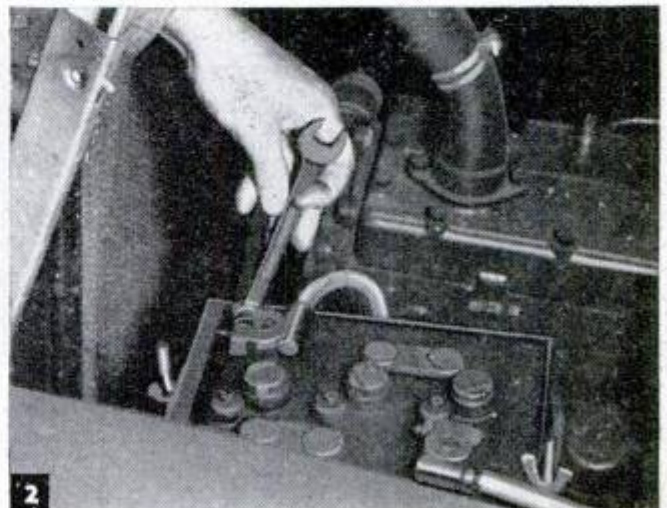

2 Clean and tighten cable connections at battery periodically. See that the ground connection is tight

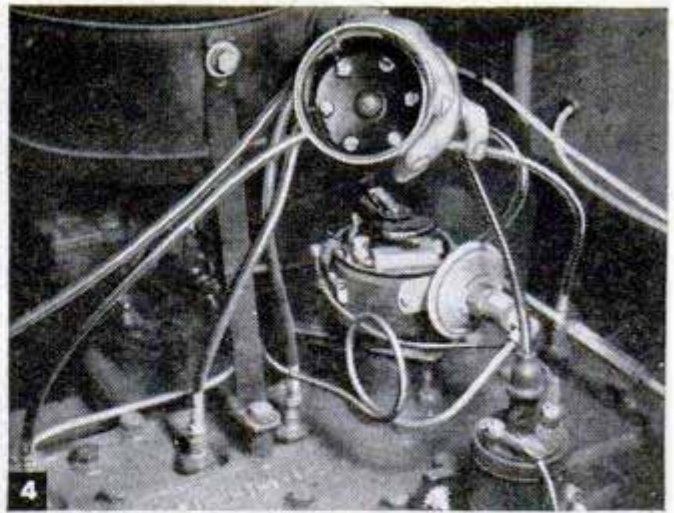
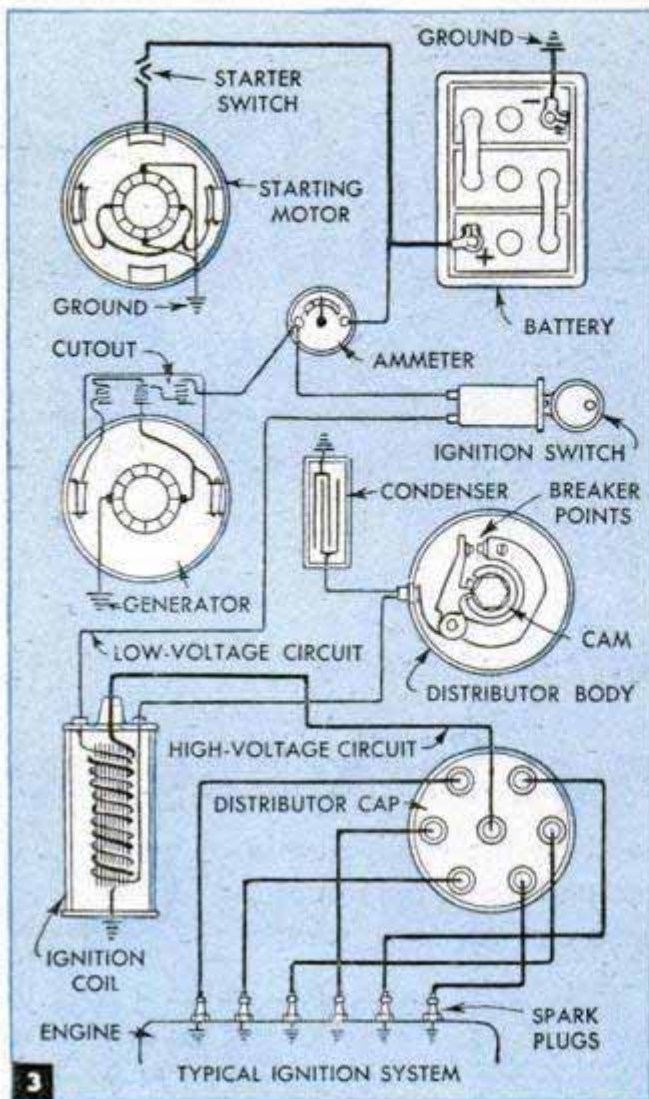

When you remove distributor cap, inspect for cracks

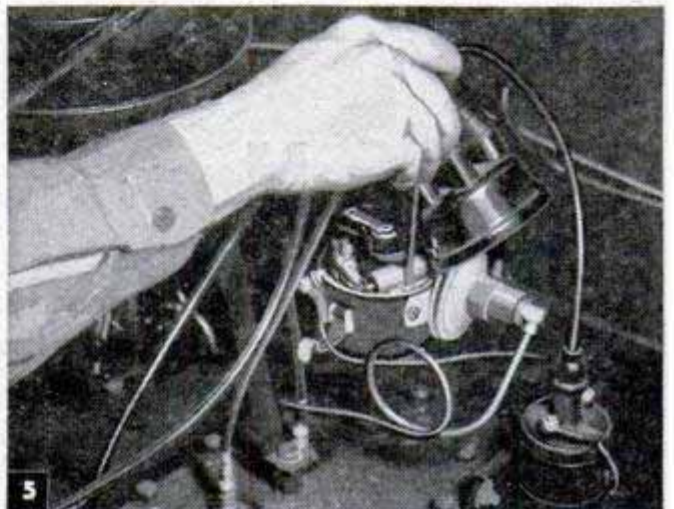

Check all wiring in the distributor whenever it is opened and make sure the condenser ground is tight

and overheating. A glance at the temperature gauge will take care of the latter two. If the reading is normal, your water is okay, and the chances are the oil is too, because lack of oil would cause the engine to heat. This leaves the fuel and ignition systems, but a process of elimination may enable you to locate the trouble quickly. Just how the engine "died" may give you the key to which system is at fault. If the engine gave no signs of starting as the car coasted, the ignition system may be suspected. Sputtering, grabbing and kicking in and out is likely to indicate that the fuel system is at fault. In any case, check the fuel supply in the tank first.

If you suspect the ignition system, start the process of elimination by trying the starter. If it works, the battery and cables are all right, but don't overlook the possibility of loose connections at each end of the battery cables, or a broken cable. Sometimes they loosen and vibration will break the circuit enough to stop the engine, which may operate when the car is standing. Tighten the cables, Fig. 2. If one is broken, twist a few strands of heavy wire together, even fencing wire, for a repair.

If this does not locate the trouble, and

still assuming that the starter works, go back to the ignition. Remove the distributor cap and inspect it for cracks, Fig. 4. Then turn on the ignition switch and crank the motor until the distributor breaker points close. Now, with the switch on, spread the points quickly with your fingers. This should produce a spark. If it does, the ignition is okay to the distributor. Next, remove one of the spark-plug wires and hold it about $\frac{1}{8}$ in. from a cylinder-head bolt, Fig. 1, and crank the motor over a few times. You should see a spark jump from the end of the wire to the bolt. If it does, the entire ignition system is okay.

The next move is to check the fuel system. Disconnect the fuel line at the carburetor or at the discharge side of the fuel pump and crank the motor several times. Gas should flow from the pump. If these few preliminary checks, which are fairly easy to do, have not disclosed the trouble, they should enable you to determine which system is at fault. It is now a matter of tracing the trouble to its source.

Suppose you found that the fuel system caused the trouble and gas did not flow

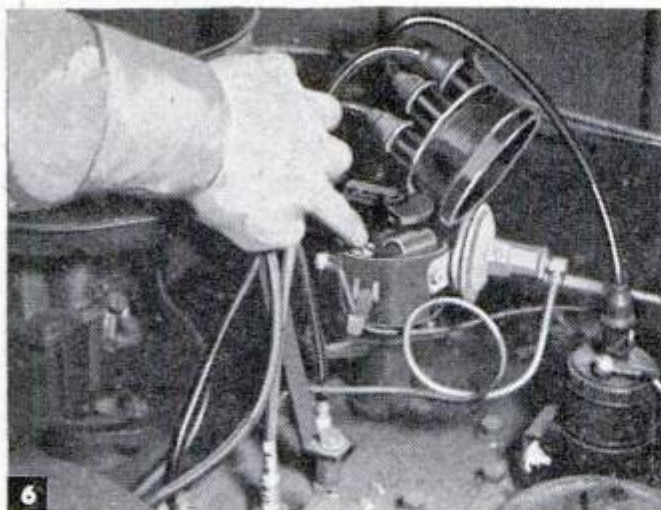

6 Breaks and abrasions in wiring, or loose connections inside distributor, may short-circuit the ignition coil

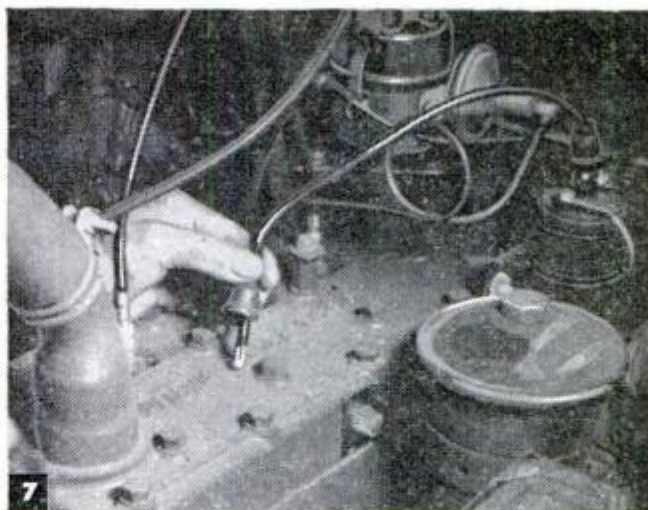

7 Hold coil-to-distributor lead $\frac{1}{4}$ in. from the cylinder block. If the coil is okay there will be a hot spark

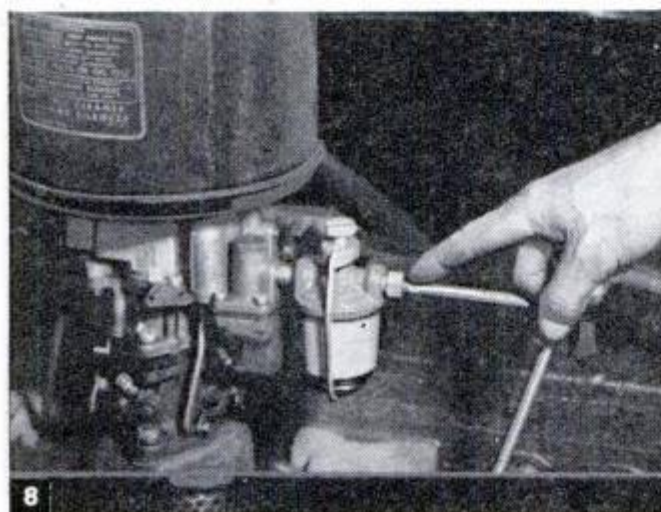

8 The fuel filter should be cleaned periodically. Wash out sediment and be sure screen is clean and open

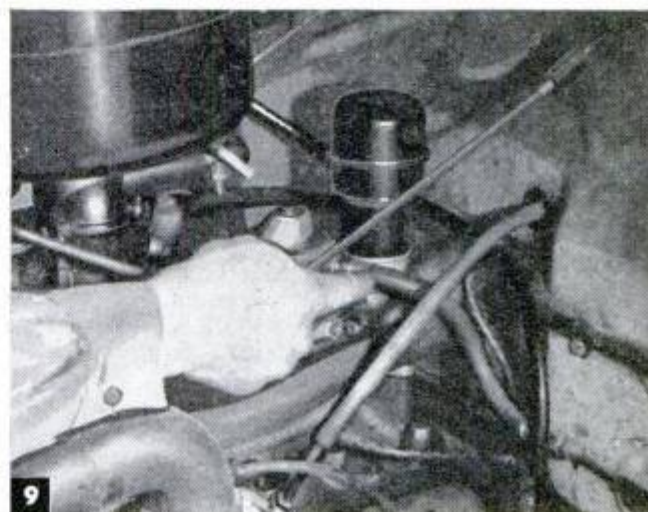

9 Examine flexible line on the suction side of the fuel pump closely. Breaks here often cause air leaks

from the line when it was disconnected. The trouble is most likely to be in the fuel pump or the flexible connection between the main fuel line and the pump. However, check the filter screen in the line. The screen may be located as in Fig. 8, or it may be at the pump or carburetor. Usually a clogged screen does not stop the motor dead without long warning several days ahead. Again connect the fuel line to the carburetor, remove the air cleaner from the carburetor and pour a tiny stream of gas into the air intake while cranking the motor with the switch on. A pop bottle is best for pouring the gas. If there isn't a small hose for siphoning the gas from the car tank, there is a drain plug in the bottom of the tank that can be taken out to get gas. Be careful, though, in doing this or you will be sprayed with gas. Race the motor for several seconds. Sometimes this procedure will start a defective fuel pump to working. If it does, don't stop the motor because the pump may refuse to work again. If the motor refuses to start, check the flexible connection between the pump and main gas line, Fig 9. It may be cracked

either externally or internally, allowing the pump to suck air into the line. Wrap it tightly with tape and again try the above procedure. If this fails, disconnect the fuel line at the pump, remove the fuel-tank cap and blow into the tank, pressing your cheeks tightly over the filler hole to prevent air from escaping. By this means, you can build up enough pressure to force gas from the line at the pump if the line is not clogged. If it is clogged, try to blow it out with a tire pump. If all of these remedies fail to correct fuel-system trouble, a mechanic is about your only hope.

If, however, the difficulty was found to be in the ignition system, it's a matter of eliminating the most likely causes of the trouble progressively. Fig. 3 shows the circuit of a typical ignition system. Suppose, for example, you had a spark at the distributor breaker points, but none at the plugs. The trouble is probably a damaged rotor. The spring contact may be broken or worn so that it does not touch the center contact in the cap. Sometimes a temporary repair can be made by binding a piece of tin or other thin metal to the rotor to carry

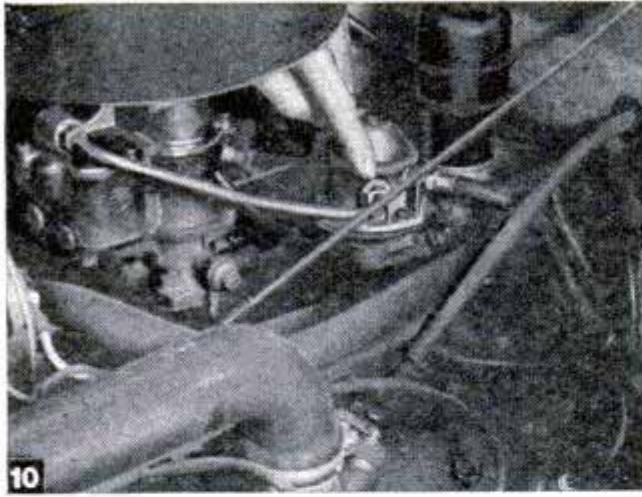

To check operation of the fuel pump disconnect the line on discharge side and turn the engine over

current from the center contact through the rotor. Don't overlook the possibility of a loose ground on the condenser, Fig. 5, which should be tightened.

The final check for this part of the ignition system is to remove the high-tension wire from the center contact of the distributor cap and make sure that it is clean and is seating correctly in the cap well, and also that it is not broken. Hold the free end about $\frac{1}{4}$ in. from the cylinder head as in Fig. 1, and crank the motor over several times. You should get a fat spark from the wire to the head. If not, the coil may be at fault.

To make sure about the coil, remove the "hot" primary wire from it and rub the end against an unpainted metal part of the car. There should be some indication of sparking. If there is sparking, and the connections in the distributor are tight and in good condition, Fig. 6, the trouble is likely a dead coil, which will have to be replaced. If you did not get sparking at the end of the primary wire, the trouble is between the coil and the battery. Trace the circuit, tightening all connections as you progress. Likely you will find a loose connection or a broken wire, but don't overlook the possibility of trouble in the ignition switch. Be sure the ignition switch is on when making the tests on the ignition.

In making periodic checks to avoid engine failure, consider the following:

(Approx. intervals: M—monthly, T—twice a year, Y—yearly)

IGNITION SYSTEM

Spark Plugs

1. Clean, inside and outside T
2. Look for cracks in the porcelain T
3. Adjust points to recommended setting..... T

Distributor

1. Clean inside and outside T
2. Clean terminal sockets in cap and metal contacts on wire ends T
3. Inspect for cracks in cap and body T

4. Adjust breaker-point gap. Replace points if necessary T
5. Replace frayed or swollen wiring T
6. Test condenser and tighten connections..... Y
7. Oil drive shaft and wick under rotor. Wipe trace of petrolatum on cam face M
8. Check breaker spring tension and condition of fiber bumper on breaker arm T
9. Inspect rotor contacts for burning or wear. Also, inspect metal inserts which distribute current to spark-plug wires T
10. Have timing and various timing controls checked Y

Coil

1. Clean and tighten connections T
2. Test for condition Y

Battery

1. Clean surface. Grease terminals M
2. Clean and inspect ground strap and starter lead T
3. Check gravity and water level M

Instrument Panel and Wiring

1. See that all gauges work properly M
2. Check wiring under dash for loose connections and frayed or broken insulation T

FUEL SYSTEM

Tank

1. Clean vent M
2. Drain and clean Y

Pump and Filter

1. Drain filter and renew gasket M
2. Check pump delivery T

Carburetor

1. Have cleaned and adjusted Y
2. Check choke action T
3. Check manifold heater T
4. Lubricate controls M

Fuel Lines

1. Check for kinks and air leaks and tighten all connections T
2. Especially check any flexible connections on suction side of pump T

Air Cleaner

1. Clean element M
2. Drain and refill oil type T

COOLING SYSTEM

Radiator

1. Flush complete cooling system and protect with antifreeze and antirust T
2. Repair leaks and clean outer surface of core and grille T
3. Check thermostat T
4. Replace hose connections, including heater leads T

Water Pump and Fan

1. Grease both (if required) M
2. Check for leaks T
3. Check fan-belt condition and tension..... T

MISCELLANEOUS

Crankcase

1. Drain, flush and refill T
2. Use seasonal grade of oil T
3. Replace oil-filter element (if any) T

Cutting Openings in Sheet Metal

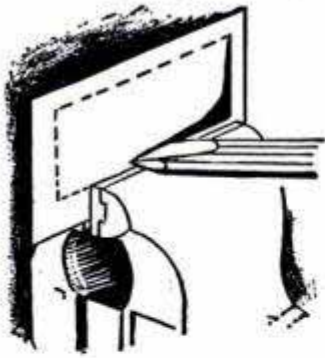

When you want to cut a square or rectangular opening in sheet metal, mount the work in a vise and cut it with a cold chisel. This method will simplify the job and result in a straight-edged opening with

square corners. First, scribe the section to be removed and then clamp the work in the vise, aligning the jaws flush with one of the scribed lines. Rest the chisel at a slight angle on the vise jaw and give it a sharp blow with a hammer. The shearing action produced in this manner will cut through the metal easily, even if it is of fairly heavy gauge. The chisel should have a long tapering point.—Jo Ro Jung, New Orleans, La.

Wall Plaque Enlivens Child's Room

Made from wood scraps and finished in gay colors, this duck wall plaque will add a novel touch to a child's room. Suitable animal cutout designs can be obtained



from children's coloring books, or decals may be used. These are applied to the wood, then outline-sawed and finished with clear lacquer or shellac. Finish the parts separately and assemble with glue and brads, the brads being driven from the rear side. A roundheaded brass screw and a washer make an excellent eye for the duck, or regular glass-bead eyes can be used.—I. M. Fenn, Chicago.

Ball-Point Pen Serves as Stylus When Tracing Stencil

An inexpensive ball-point fountain pen makes a good substitute for a stylus when writing, ruling or drawing on a duplicator stencil. The pen makes a clear impression

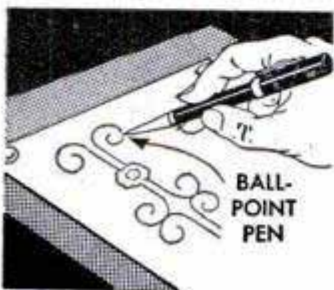

that gives an excellent reproduction and, unlike the sharp point of the stylus, the ball point practically eliminates the danger of tearing the stencil.

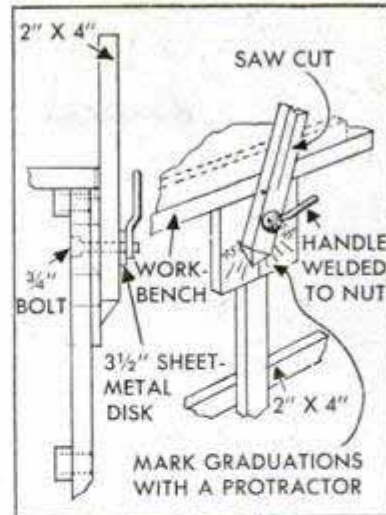

Pivoted "Miter Box" for Bench Use Permits Sawing Intermediate Angles

Permitting a greater number of angles to be sawed than a common wooden miter box, this unusual one features a pivoted saw guide for making either right or left-hand cuts. It can be adjusted to any angle between 45 and 90 degs. Mounted permanently to the front edge of a workbench, it is designed so that the saw guide can be swung down out of the way when not in use. A vertical 2 by 4-in. support, having a 12-in. square block nailed to the face at one end, is spiked to the bench at the top to bring the block flush and nailed to the bench crossrail at the bottom. Then, calibrations, 90 to 45 degs., are marked on the block as shown, the 90-deg. mark and the hole for the pivot bolt being aligned exactly at right angles to the bench surface. The saw slot in the guide also must be centered exactly, and the lower end of the guide is pointed to serve as an indicator. The clamping handle is formed by welding a short length of rod to the bolt nut and is backed by a sheet-metal disk. The head of the pivot bolt should be embedded in the block so that it will not rotate. In using the "miter box," a cleat should be nailed temporarily to the bench top to provide a fence, its position determined by the thickness of the work, against which the latter is held when being sawed.

Nontangling Fishhook Holder

Often fishermen have trouble keeping snelled hooks from tangling and kinking in the tackle kit. Here's one way to keep them straight. Cut a piece of discarded garden hose about 8 in. long and make several slits in one end. Then fit the hooks over the other end and slip the snells into the slits, pulling them tight.



By *Frank P. Fritz* **PANORAM**

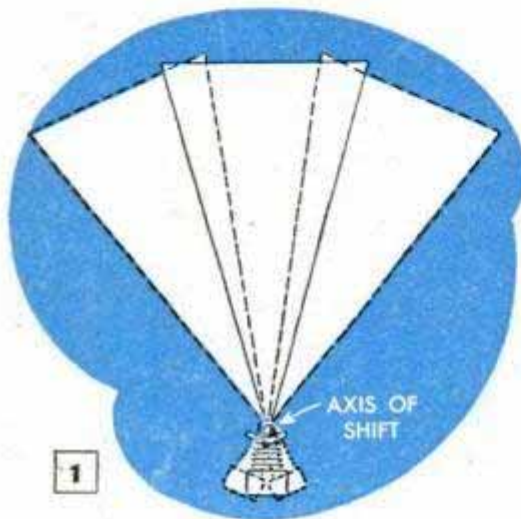

PANORAMS are fun to make. All you have to do is take a series of four or five shots of a landscape or sky line covering an arc of 90 to 120 degrees, and crop the prints to line up. Then you'll have a panoramic picture similar to the one at the top of the page. While each print will not align perfectly, a continuous photo can be produced by careful matching and trimming.

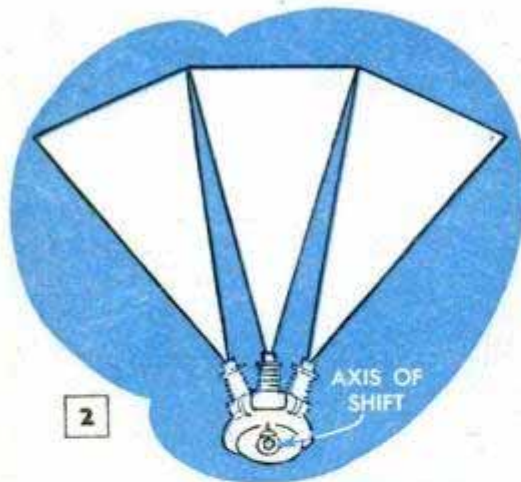

The important point in making a panorama is to have the rear nodal point of the camera lens directly over the axis of shift or rotation. As long as the lens is rotated on an axis perpendicular to the optical axis, the images of distant subjects will change their relative position very little with each shot, as illustrated in Fig. 1. But, if the camera is held by hand, the axis of shift or rotation is at your body, Fig. 2, and not the lens, and the series of prints will not match properly. The approximate location of the front and rear nodal points of a lens is shown in Fig. 4, and to bring the rear nodal point on a center line with the tripod axis, it is necessary to use a wooden top on the pan or tripod head as in Fig. 5.

Best results are obtained by using a camera which has a ground glass and a spirit level to correct distortion and keep it to a minimum. If you use a camera without a ground glass, use a spirit level and view each picture so that the outer edge of the





PHOTOGRAPHY

previously exposed area slightly overlaps the succeeding shot. Avoid shooting a panoram on a bright sunny day. Negative densities will vary as you swing away from the sun, making it difficult to match the tone of each photo when printing, so it is better to shoot on an overcast but bright day.

In making the prints, keep the enlarger at the same setting for all enlargements. Develop all the prints at the same time to allow you to watch and control the uniformity of tone values during development. When the prints are dried, trim adjoining edges and skive the rear side of the abutting edges with sandpaper to prevent a ridge at the joint. Match prominent parts of the image first. It will be necessary to shift the prints slightly and retrim to get them to align as closely as possible. Hold the prints in position with tabs of masking tape and when all the prints are matched, Fig. 3, use a straightedge to mark and crop the top and bottom edges of the finished print. Finally, mount them on cardboard with rubber cement.

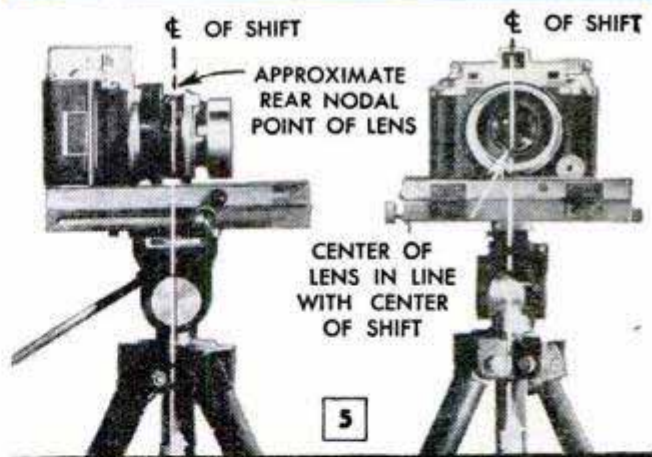
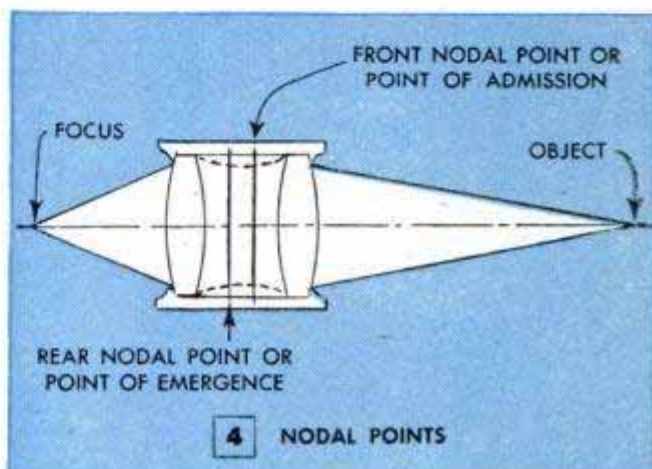

Battery-Operated Tester Picks Out Duds Among Your Flash Bulbs

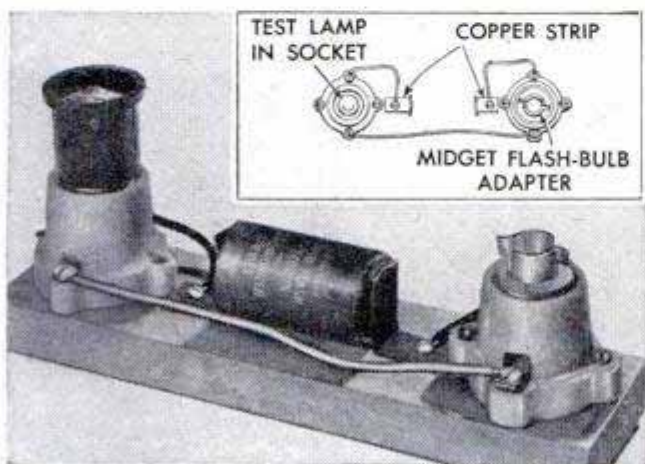

To prevent missing spectacular shots due to flash-bulb failure, one photographer made sure his flash-bulb bag contained no duds by testing them beforehand in this little tester. The tester is designed to handle all sizes of flash bulbs and glows to indicate a good bulb. It consists of two porcelain sign sockets, a flashlight battery, a test lamp and two strips of copper, assembled and wired as shown. By flattening the threads in one of the sockets, the bulbs can be tested quickly without screwing them in. A midget flash-bulb adapter permits testing bayonet-base bulbs.

Use of Photoflood Reflector Spring-Type "Tripod" for Folding Camera

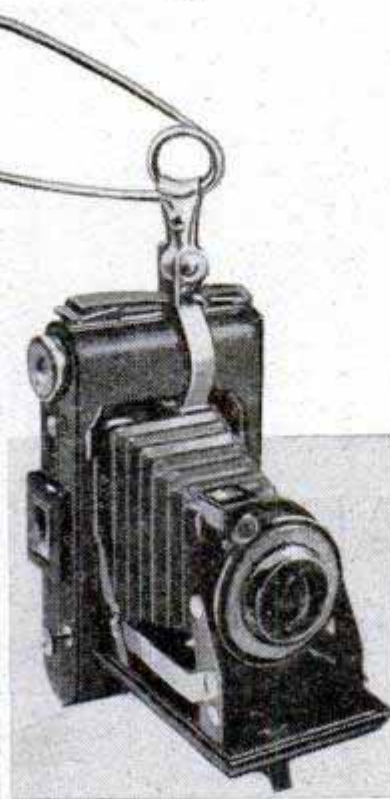
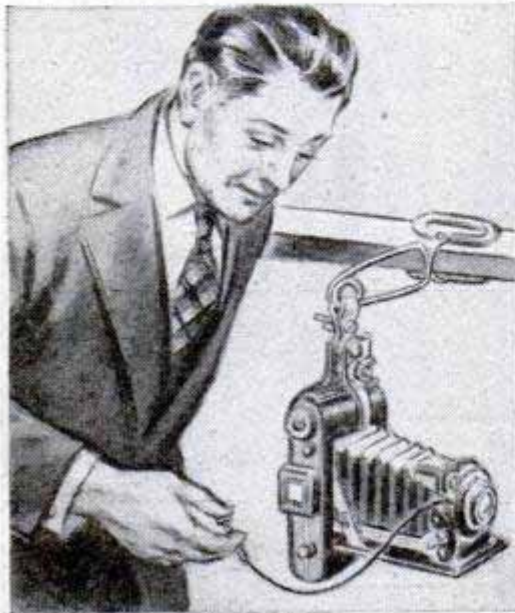

It's not always necessary to carry a tripod when taking pictures either indoors or outdoors with your folding camera. The spring-type clamp from a photoflood reflector, which may be fastened to almost any convenient object, will serve as a handy "tripod." This clamp will hold a light folding camera easily merely by tightening the socket clamp over the top of the camera. One arm of this clamp first should be flattened to provide a better grip on the back of the camera, and it may be padded with felt or cloth to prevent scratching the camera case. The swivel joint allows the camera to be held in practically any convenient position.

Avoid Using Your Expensive Tubular-Type Tripod in Sand and Dirt

When there is danger of getting grit from sand or mud into the telescoping legs of a tubular-type tripod, mount the pan-type head on a wooden tripod. To mount the pan head, drill a small hole in the top of the tripod to engage the short stop pin in the base of the head, and attach the latter in the regular way.



Cooling Developer by Evaporation

During hot weather, if ice or cold water are not available, a tank of developer can be kept cool if wrapped in a cloth saturated with fast-evaporating fluid. Rubbing alcohol, which is economical and easy to obtain, can be used. Hold the cloth in place around the tank with rubber bands.

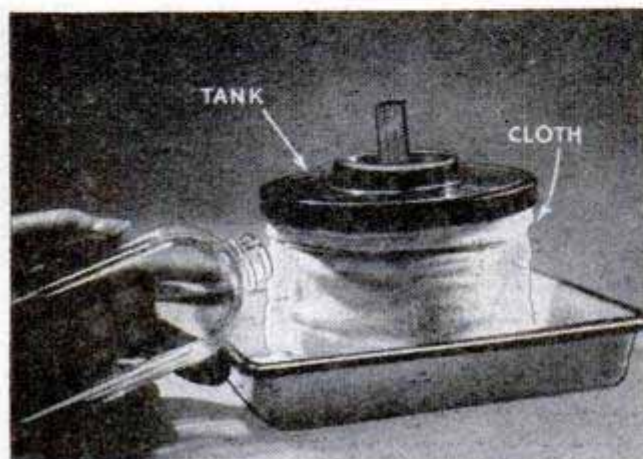

Preventing Water From Splashing

Water can be prevented from splashing when washing photo-prints under a sink faucet if a strip of clean cloth is suspended from the faucet so the water runs down it. The cloth, which is held with a rubber band, should reach the tray bottom.



Detached Flash Gun Hung From Camera Handle

When taking pictures with a flash gun, many photographers who use a Speed-Graphic camera prefer to remove the gun from its bracket and hold it high above the bellows, as this method produces improved lighting effects affording better modeling and composition. However, the bothersome job of detaching the flash-gun cable from the camera or taking time to slide the gun on its bracket after each shot can be eliminated in the following manner. Merely unsnap the upper end of the leather handle and hang the flash gun from the square ring. The bulb may be changed and the gun left in this position ready for the next shot. The handle, of course, is snapped back easily in the carrying position when finished.



Sizing Solution Permits Spotting Glossy-Surface Prints

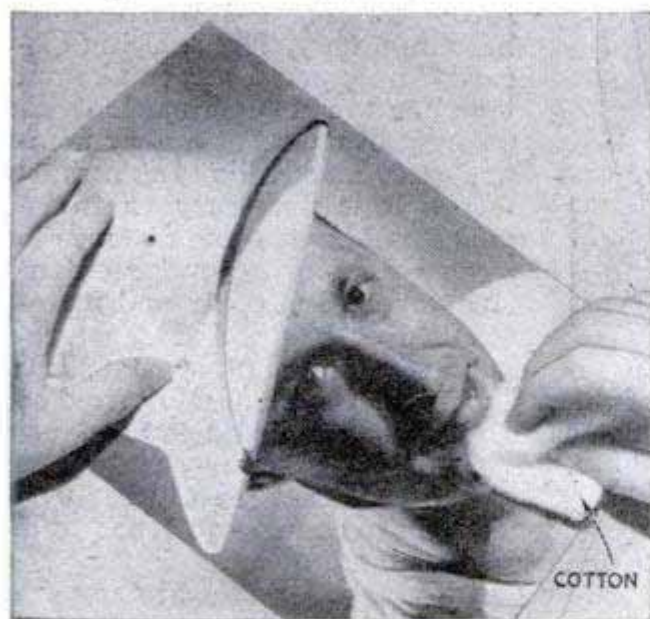

Glossy-type prints may be spotted or retouched as easily as prints having a matte or semi-matte finish if they are first sized with this simple solution. It is prepared by dissolving in water any of the wetting agents sold commercially as water-spot preventatives for negatives. Mix the solution to the proportions of powder, 1 gm.,

and water, 100 c.c. Apply the solution generously to the surface of the glossy print. Then remove the excess with a swab of dry cotton and spot the print in the usual way with pencil or water color and a brush. If you wish, a stock solution of the sizing can be prepared to manufacturer's directions and mixed as follows: stock solution, 1 part, and water, 8 parts.

R. F. Donovan, Jersey City, N. J.

Cable Release Operated By Darkroom Timer

If your camera is not equipped with a built-in timer for taking self-portraits, you can use a darkroom timer of the wind-up type to trip the shutter remotely at a preset time. Just tape the end of the cable release to the face of the timer in a position where the side of the pointer will contact and depress the plunger when it reaches the preset interval. Masking or adhesive tape will do to fasten the cable to the timer.



YACHTING



ONE GOOD WAY to budget individual costs to a minimum and still enjoy all the thrills of sailing is to form a yacht club. Any group of friends with a common interest in sailing can pool talents, equipment and cash, and thereby gain all the advantages of group action on the purchase of additional gear, boats, tools, shore property for a clubhouse site and other incidental items. A clubhouse, grounds and a pier come high on the list of requirements. With careful planning, a clubhouse and a suitable pier can be built by the club members, thus confining the cash outlay to that required for good materials. Every clubhouse should have private rooms for changing from ship to shore clothes, a locker for each member so that he has space for storage of sails, clothing and other small gear, and a fairly complete set of tools for the common use of all members for repair and maintenance. No clubhouse really "belongs" until it is fitted out with a flagpole rigged complete with yardarm so that the national ensign and club pennants can be flown in correct order on all occasions. Landscaping, telephone, an oar rack and other minor details of the layout usually are decided by a vote of the club members. A slanting dock constructed at the water's edge is handy as small sailing boats can be hauled up on it

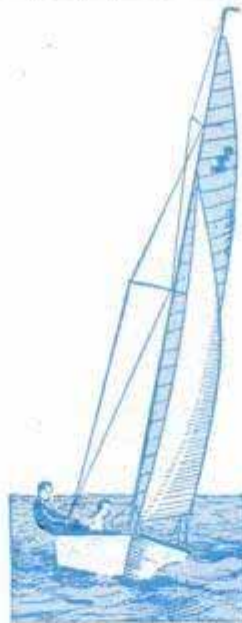

between runs or for minor repairs. A small pier adds to the completeness of the layout, provides for loading and discharge of passengers and serves as a temporary mooring for the boats when readying sail, Fig. 1. In some cases, the more rough-and-ready sailors will prefer the beaching dolly, Fig. 3. Using discarded auto parts, this can be put together to suit average individual requirements at a very nominal cost. Such a dolly is a must where it is necessary to transport small boats some distance to a yard for storage or for extensive repair. In repair and maintenance of boats, and construction of additional equipment, special skills of the members should be administered so that each individual contributes an equal share. With careful planning, clubs can build their own boats at greatly reduced costs by arranging a change-work schedule which includes all members.

Sailing dinghies, or "dinks" as they are often called, are the smallest and simplest of the common sailboats. Having only one sail, they are easy to handle because there is no complicated rigging, unless of course, you add a spinnaker like the more daring sailors in Fig. 2. And if members are holding costs to a minimum, then the club will own mostly little boats of the Snipe class with perhaps an occasional Lightning or

ON A BUDGET

Comet, which are larger, or in other words, a lot more boat. But the pleasure of sailing your own boat is not determined by the size of the craft or the amount of money you, as an individual member of your club, spend on the sport. With skillful handling, the tiny little boats of the Snipe class are flashy performers and once you get the feel of sails in a fair wind you'll understand why seasoned yachtsmen regard this particular sport so highly.

If you are a beginner, you'll need to take lengthy counsel with an experienced member of the club before venturing to hoist sail alone, Fig. 5. Take an instructor with you, not only on the first trip, but on several succeeding trips. You must acquire absolute confidence in the boat and in your own ability to handle it. Many beginners have difficulty overcoming the fear of getting away from shore, especially if there is a fairly strong offshore breeze. But a competent sailor will show you how to run out before the wind, then turn, come into the wind and tack back across it to the harbor, Fig. 9. You will be much impressed with the ease with which he handles the latter

By Bob Hurst

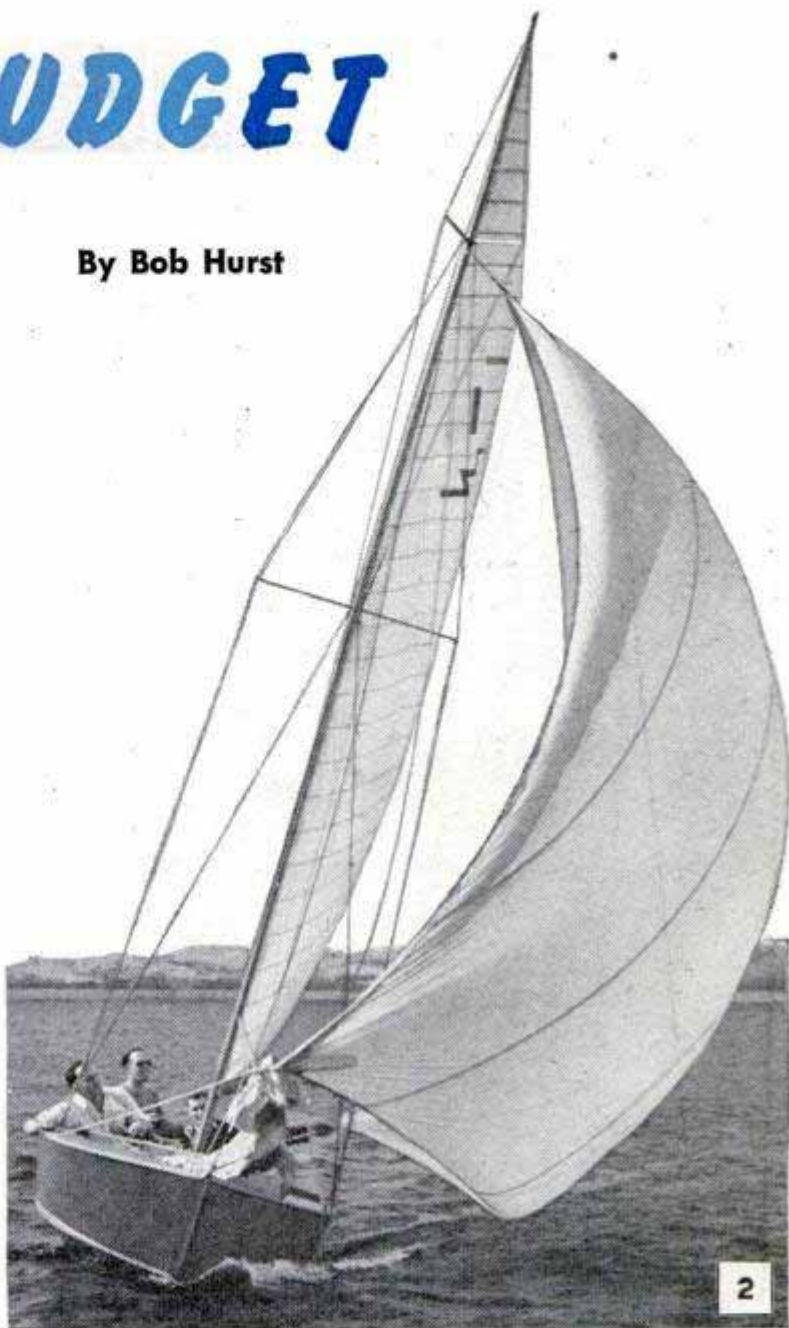

Below left, a beaching dolly is just the thing for launching small boats without the aid of a dock crane or where they are transported some distance for repairs. Right, approved manner of holding tiller and sheet



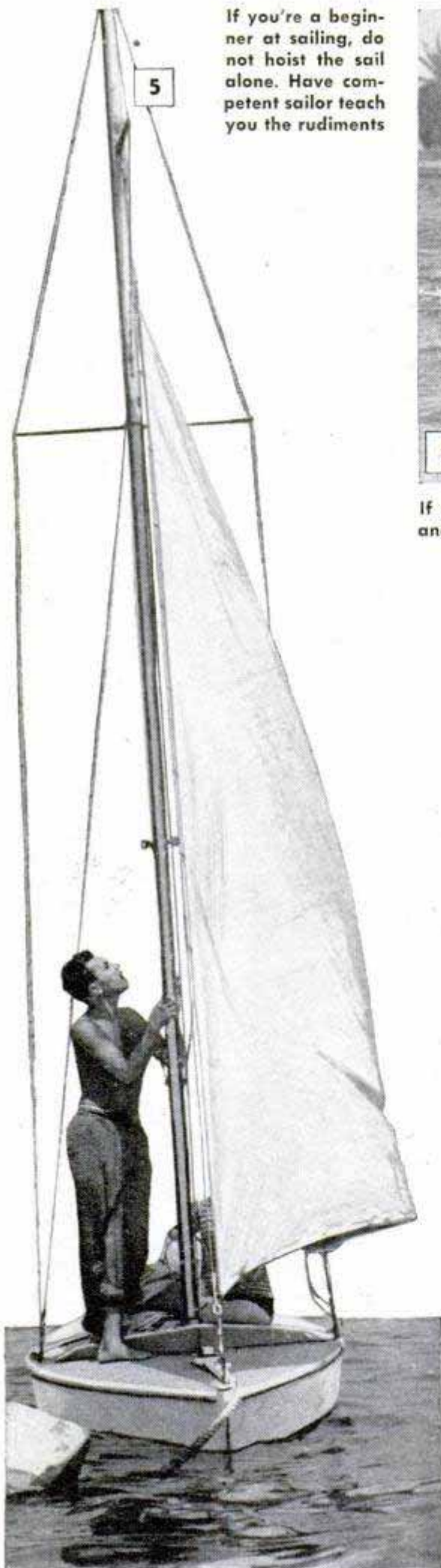

If you're a beginner at sailing, do not hoist the sail alone. Have competent sailor teach you the rudiments



If you drive your boat hard, always keep on the weather side and hold the sheet ready for instant trimming of the sail

maneuvers; how, after running on the port tack for an interval (reach), he eases off on the sheets to luff sail and simultaneously puts the rudder hard down to tack ship. The boom will swing to the opposite side to allow the sail to catch the wind from the new quarter, and before you know it your little boat is away on the starboard tack. It's a neat trick just to watch, if it's done by an old hand, but the real thrill comes when you do it yourself for the first time. Once you see demonstrated how quickly and smoothly the craft responds to the rudder and the set of the sail, you get the idea that with fair and steady winds you can go anywhere there is water under your keel, and you can come back just as easily to home harbor.

Your sailor friend also will show you how to turn into the wind and coast your little boat smoothly up to the dock. To do this expertly, you have to judge distance and wind strength to a nicety, because a light boat loses way quickly on being turned into the wind. It's a good idea to practice the maneuver often in both light and strong winds. Fig. 4 shows an approved manner of holding the sheet and tiller when sailing a small boat. It's easy and comfortable and you're in a position to slack off instantly on the sheet if the boat heels (tips) too sharply to an unexpected gust. And this brings up one of the first principles in sailing a small boat. Always hold the sheet in your hand. Never snub it, or fasten to a cleat, for even when the weather is fair and the wind light, some unlooked-for emergency may make it necessary to trim sail quickly to release wind pressure. Keep the sheet free. It's a rule in small boats. When sailing, except perhaps when everything is going smoothly as in Fig. 8, it's regular practice to sit on the weather side of the boat, that is, the side from which the wind is coming, Fig. 6, and change from starboard side to port side



Above left, quick work with tiller and sheet usually will avoid heeling and capsizing, but if you do go over, the boat will not sink unless the hull is badly damaged. Right, all a yachtsman asks for is smooth sailing

and back again when you're beating to windward on repeated tacks. If the wind turns suddenly gusty or if a squall races down on you and the boat begins to heel alarmingly, ease off on the sheet and the tiller simultaneously. Or, if it looks like an emergency, merely let go of everything. The sail will swing out and the boat will come up into the wind and right herself. If you are quick, you usually can avoid capsizing, even when hit by a severe gust or wind squall. The student sailor need not unduly fear capsizing, for small sailboats do not sink readily when upset, Fig. 7. Unless the hull is damaged by collision or other accident, it will support your weight until a rescue party comes alongside and picks you up.

When working back to windward, that is, tacking, many beginners tend to sail too close to the wind on the port and starboard tacks. This probably is due partly to the amateur's desire to reach home port, but mostly to the natural tendency of small sailing craft to come up into the wind when running the reach between tacks. To get the full drive of the sail and to steady the boat, it's generally considered good practice to hold her off, even where you must shorten the reach between port and starboard tacks. In this, good sailors rely on their judgment and gauge the procedure by the performance of the boat under varying conditions. Many sailing practices apply only loosely to the handling of the very small boats, particularly after one gains experience and comes to know his own boat well.

After you have mastered ordinary sailing techniques under the tutelage of your instructor and have gained confidence in yourself, your boat and your ability to take her out in any reasonably good sailing weather, you're eligible in most unofficial small clubs to wear the snappy blue-and-gold yachting cap and club emblem.

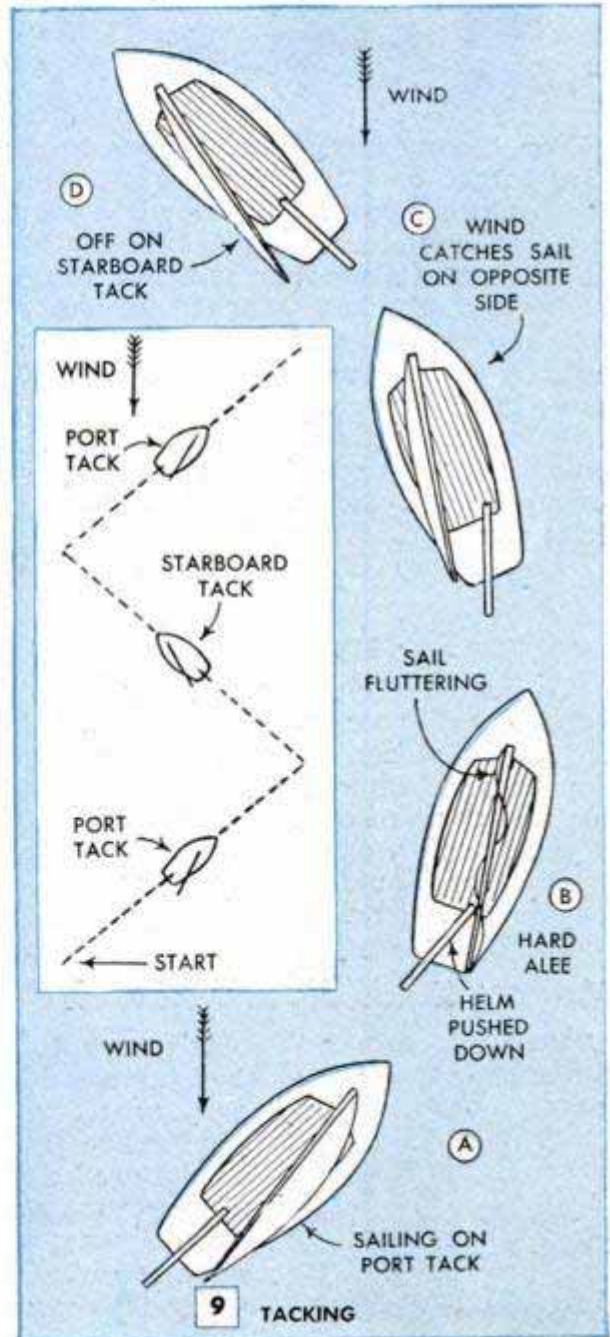

Colored Lengths of String on Spool Used for Measuring Range Lengths

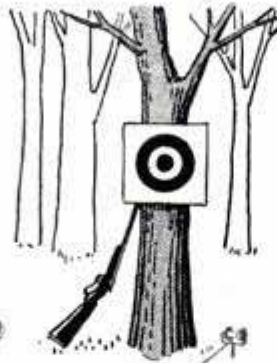
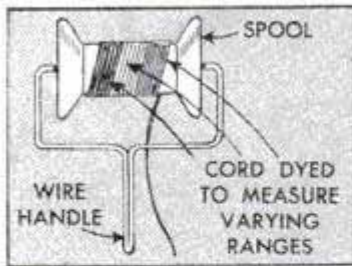

For the marksman who likes to practice target shooting away from marked ranges, this measuring device will come in handy for determining target distances. It consists of a spool on which is wound a string that has been marked for the various ranges, and a wire handle. To mark the string, dye the first fifty yards red, the next twenty-five blue and leave the last twenty-five yards white, etc., varying the color scheme and distances to suit your own purposes. Clothing dyes or waterproof inks are used to color the string.

Harry Wandrus, Milwaukee, Wis.

Lacquer Preserves Chrome Parts

To keep the chrome on your car at its original brilliance without constant polishing, coat it with a mixture of clear lacquer, 1 part, and thinner, 3 parts. The lacquer may be sprayed on the large surfaces and applied with a clean brush to the smaller parts. This should be done on a warm, dry day so the finish will not appear milky.

Magnet Holds Jigsaw Blades

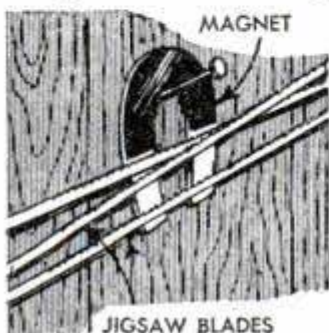

It's easy to select just the blade you want when your extra jigsaw blades are held by a horseshoe magnet. Hang the magnet on a nail near the workbench or jigsaw.

Storing the blades in this manner will be found more convenient than when they are kept in a drawer. A magnet is provided for each size of blades.

Screwheads Filled With Solder Discourage Hinge Removal

Petty theft from a toolbox, which has a cover that is surface hinged, is discouraged if the heads of the exposed hinge screws are soldered over to fill the slots. This has been found effective in foiling attempts to remove the screws, due to the likelihood of the thief being discovered because of the extra time and work involved in removing the solder.

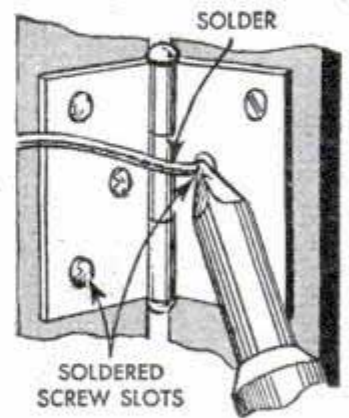

Tape Adds Nonslip Surface To Drill-Press Table

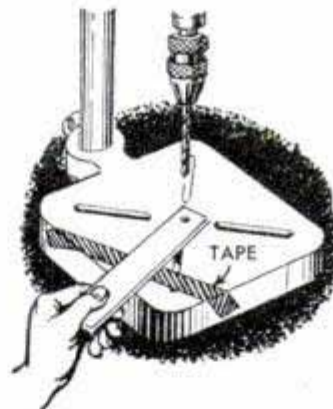

When drilling strips of sheet metal on a drill press, the possibility that the work will rotate and injure the hands is reduced considerably if electrician's friction tape is applied to one corner of the table and the work rested on it.

As this tape is sticky on both sides, it will adhere to the table top and provide a nonslip surface for the work.

Handling Fishhooks Safely

Even if fishhooks are kept in books or holders, the barbs on the hooks are apt to injure a finger when they are handled. To avoid this, place a drop of nonwaterproof glue on the point of the hook and around the barb. Then the hook can be handled safely and, when placed in the water, the protective covering will dissolve.

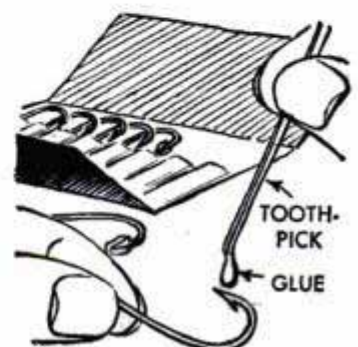

SHOP NOTES

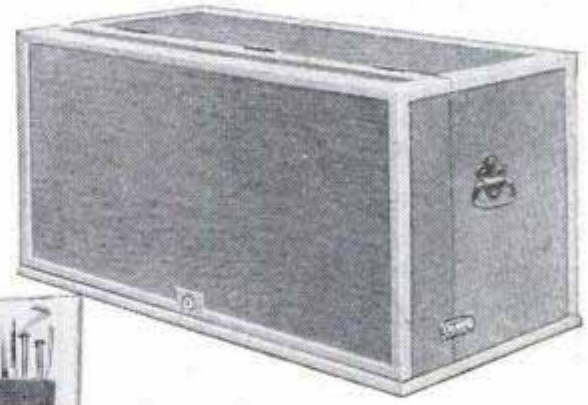
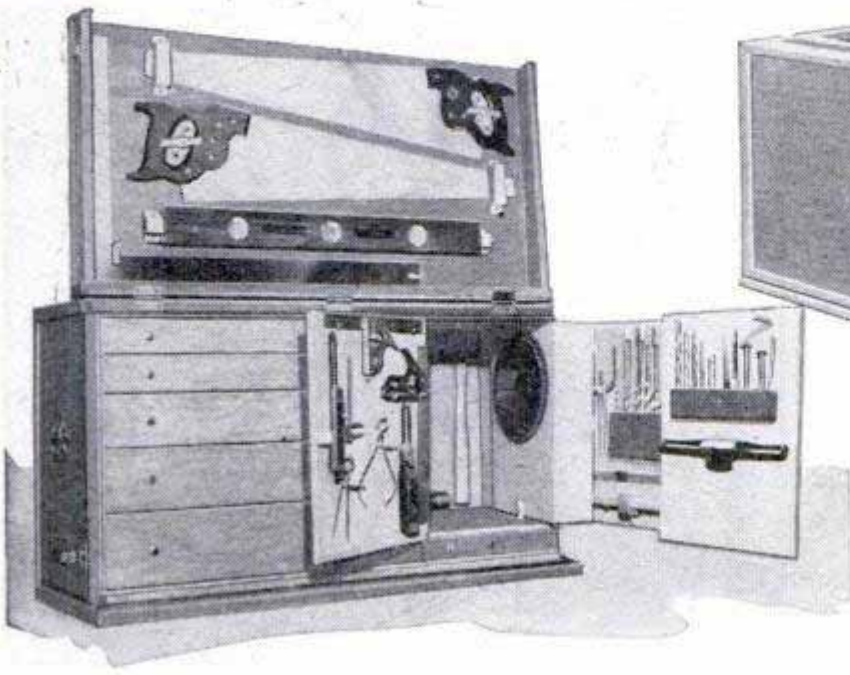

Woodworker's TOOL CHEST

By Edward R. Lucas

THERE'S a place for each tool and you'll know just where to find it if your woodworking tools are kept in a chest like the one built by Vernon Cutler of Bremerton, Wash. In addition to its convenience and efficiency, this chest conserves workshop space and, if constructed with close-fitting joints and lid, it appreciably retards tool rust. The chest has a spacious drawer for storing planes and other large tools, nine smaller drawers, a tool panel that folds compactly into its compartment, and plenty of room on the inside of the lid for hanging saws, a level and a square. Even the space between the large drawer and chest bottom can be utilized

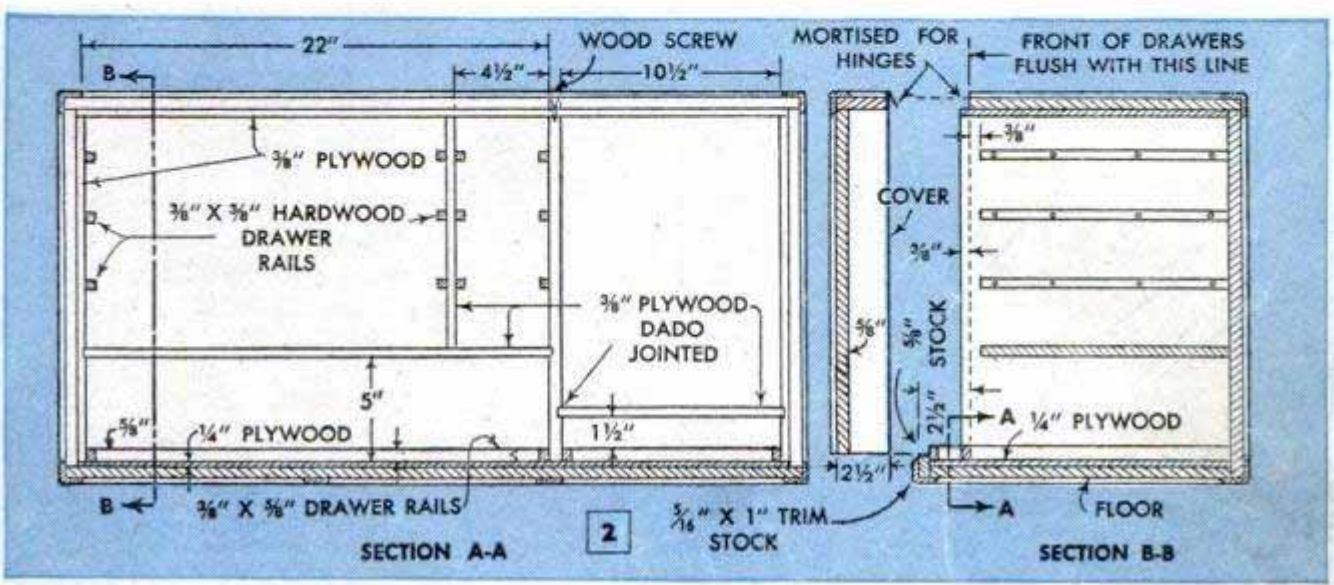
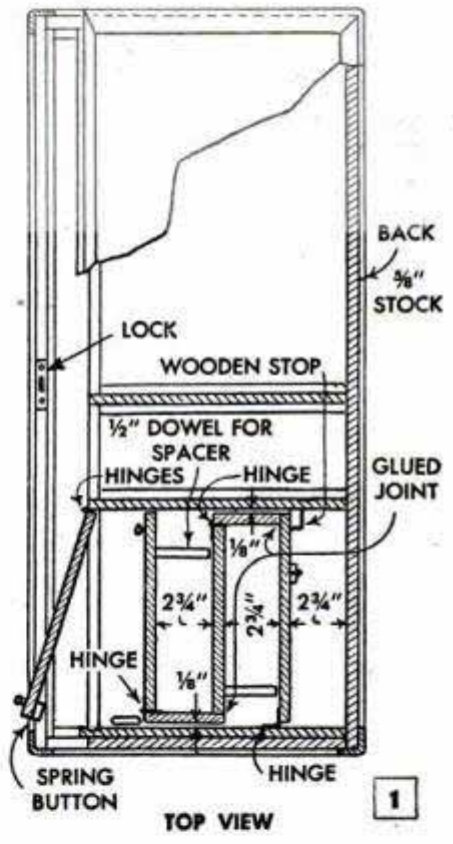

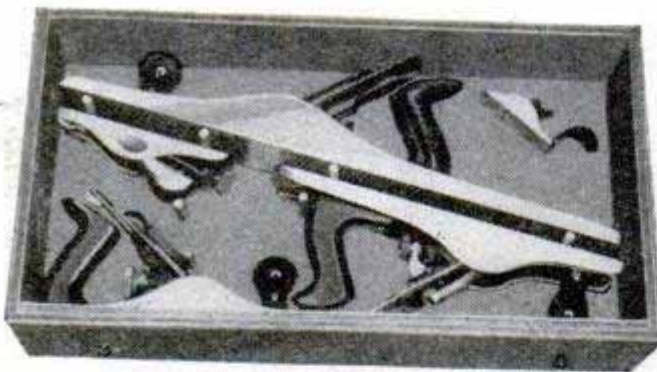
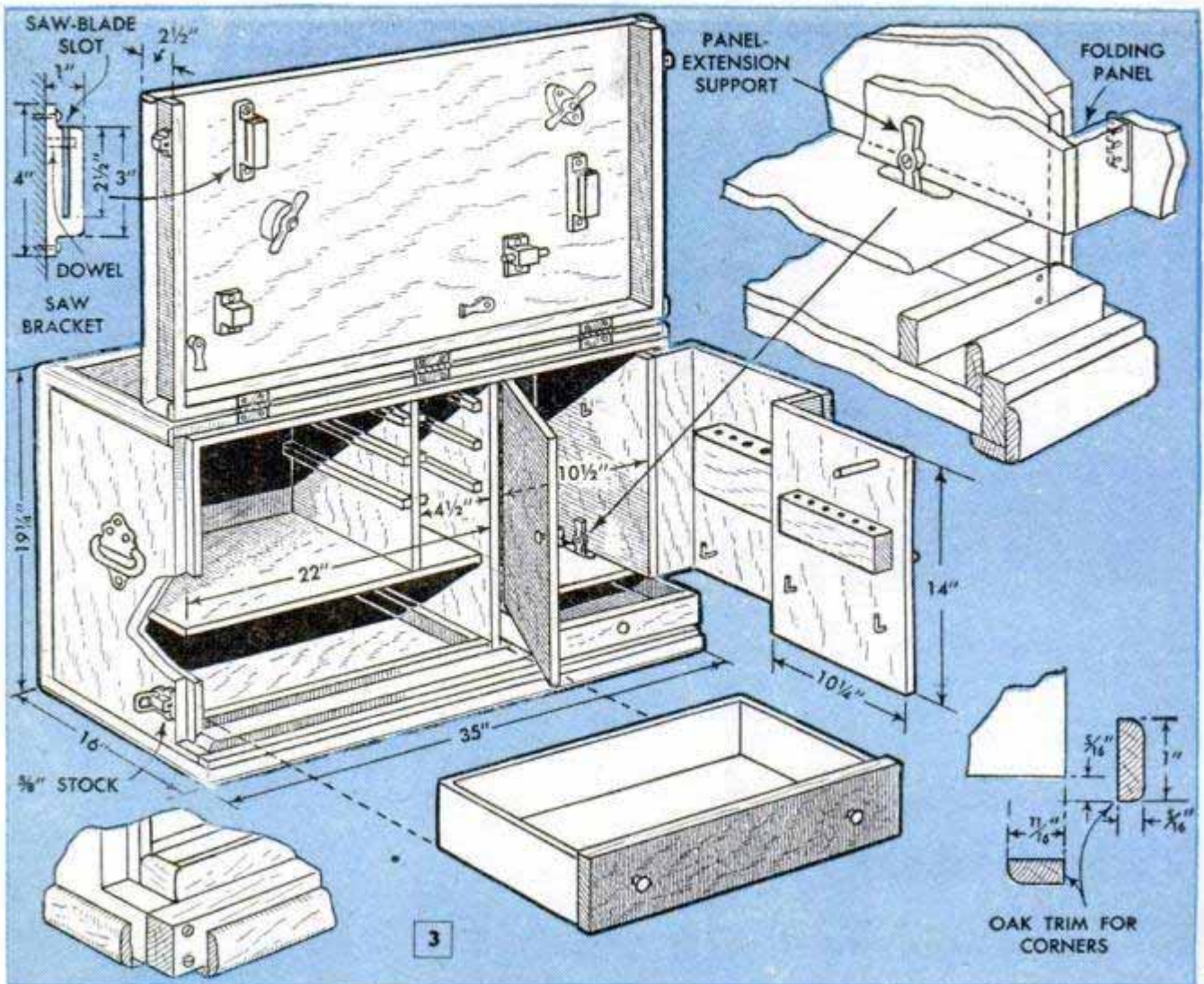

Above, roomy bottom drawer provides ample storage space for planes or other large tools. Below, drawer inserts permit the number of compartments to be increased without the installation of extra drawers

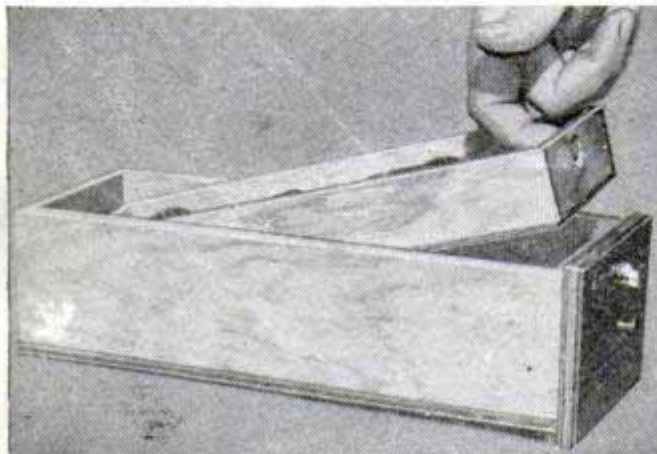

for storing blueprints, magazine plans and pamphlets.

The outer shell of the chest is of cedar with all corners and edges protected by oak trim. The top and sides are lined with 3/8-in. plywood panels and the bottom with 1/4-in. plywood. These liners extend 3/8 in. beyond the front edges of the top and sides to form a rabbet for the lid, Fig. 1 and Fig. 2, section B-B. Two 5/16 by 1-in. oak cleats are fastened across the bottom of the chest to give additional support. The vertical partitions and hardwood drawer runners are inserted as in Fig. 1 and Fig. 2, section A-A. All drawer fronts and the door for the tool-panel compartment should fit flush with the chest sides.

The tool panels are hinged and fitted as in Fig. 1, leaving at least 1/8-in. clearance between each wall of the compartment and the panels when they are folded. Note the wooden stop and the dowel spacers for the panels. The extension support, upper right-hand detail, Fig. 3, holds the tool panels in the open position. The lid is constructed in the same way as the rest of the chest, and is mortise-hinged to the chest top. Fig. 3 shows fixtures for mounting tools on inside of lid.

Milling Setup Doubles Output

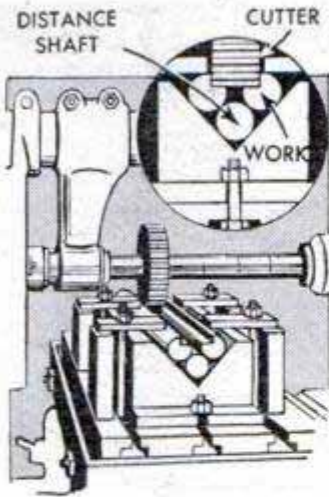

Two identical cuts can be milled in the time it takes to make one cut, if the work is clamped as shown and a straight-faced cutter is used instead of an angular one. Here, the idea is used to mill shallow V-grooves in shafting. Two pieces of work are placed in a V-block and

supported by a third piece labeled "distance shaft." As the distance shaft determines the spacing of the work and the depth of cut, the size of the shaft and cutter must be such to permit milling an identical groove in each shaft. Mounting two pieces of work in this manner also permits the work to be clamped along each side and thereby provides free passage for the cutter along the entire length.

H. Moore, Leeds, England.

Scrap Pipe Makes Sturdy Handles For Shed and Barn Doors

Excellent, inexpensive handles for the doors of barns and other out buildings can be made from lengths of pipe by sawing and bending them as shown. The finished handle has a round, comfortable grip and its size, of course, is determined by the pipe used. Holes are drilled in the flattened ends to permit fastening the handles to the door with screws.

John Krill, North Lima, Ohio.

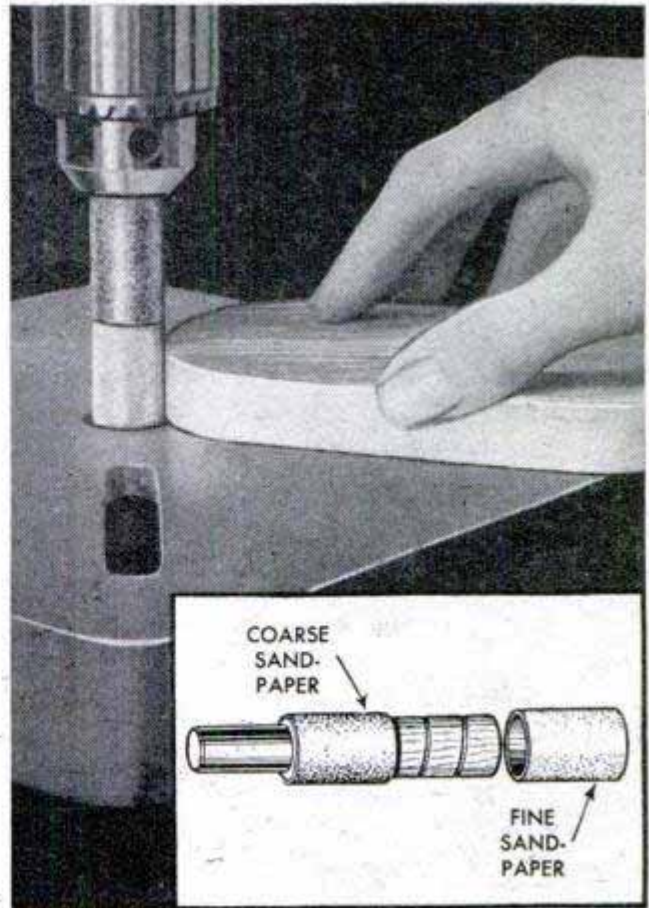
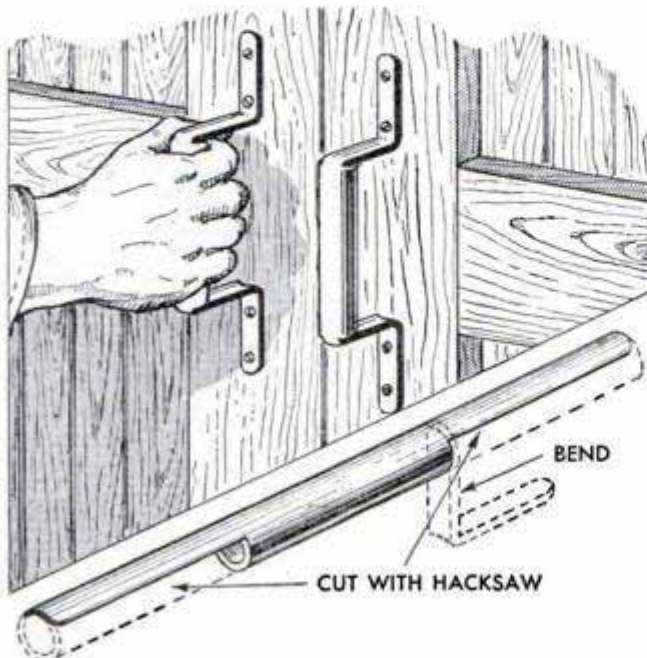

Drill-Press Sanding Sleeve Does Coarse or Fine Work

Both coarse and fine sanding may be done on the same drill-press sanding drum without changing sleeves, if sleeves of two different grit sizes are cut in half and a piece of each is slipped on the drum. Raising or lowering the spindle and locking it in place brings either grit into working position. If the sanding drum is too large to pass through the hole in the drill-press table, a piece of wood the same thickness as the height of the lower sleeve section will serve as a platform to elevate the work.

Eliminating Trailer-Hitch Rattle

Rattling of the pin-type hitch between a tractor and wagon is eliminated by placing rubber washers on the clevis pin so that one is on each side of the drawbar. Suitable washers can be fashioned by making a hole through the center of two rubber shoe heels.

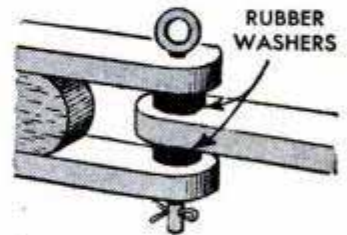

Ⓜ Torn coat linings, due to hanging the coat on a nail in the shop or barn, can be prevented by driving the nails lengthwise through a cork. Long, small-diameter corks are most suitable for this purpose.

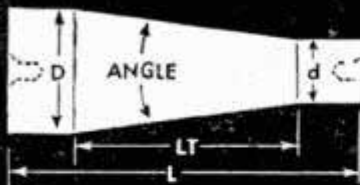

TAPER TURNING

TO FIND SETOVER

- T.P.F. GIVEN:**
FIND NEAREST T.P.F. IN COL. 1. READ SETOVER FACTOR ON SAME LINE, COL. 4. MULTIPLY FACTOR BY TOTAL LENGTH OF WORK (L).
- TOTAL ANGLE GIVEN:**
FIND NEAREST ANGLE IN COL. 2. READ SETOVER FACTOR ON SAME LINE, COL. 4. MULTIPLY FACTOR BY L.
- DIAMETERS AND LENGTH GIVEN:**
APPLY THIS FORMULA TO FIND TAPER PER INCH:

$$\text{T.P.I.} = \frac{D-d}{L}$$
 THEN, FIND NEAREST T.P.I. IN COL. 3. READ SETOVER FACTOR IN COL. 4. MULTIPLY FACTOR BY L.
- PROPORTIONAL TAPER:**
A TAPER SPECIFIED, FOR EXAMPLE, 1 IN 24, MEANS T.P.I. OF 1/24". LOCATE THIS FIGURE IN LEFT SIDE OF COL. 3, THEN READ SETOVER FACTOR AND MULTIPLY BY LENGTH.

TAPER ATTACHMENT

IF T.P.F. OR TOTAL ANGLE IS GIVEN, SET DIRECT ON TAPER-ATTACHMENT SCALE. IF LENGTHS AND DIAMETERS ONLY ARE GIVEN, CALCULATE T.P.I. AS PER UNIT NO. 3 ABOVE. THEN, LOCATE T.P.I. IN TABLE AND ON SAME LINE READ EITHER T.P.F. OR TOTAL ANGLE FOR TAPER-ATTACHMENT SETTING.

COMPOUND SWIVEL

- T.P.F. GIVEN:**
FIND NEAREST T.P.F. IN COL. 1. READ EQUIVALENT COMPOUND SWIVEL IN COL. 5.
- TOTAL ANGLE GIVEN:**
TABLE NOT NEEDED. SET COMPOUND PARALLEL WITH LATHE BED; THEN, SWIVEL THROUGH 1/2 OF THE TOTAL ANGLE SPECIFIED.
- DIAMETERS AND LENGTH GIVEN:**
CALCULATE T.P.I. AS PER UNIT NO. 3 ABOVE. THEN, FIND NEAREST T.P.I. IN COL. 3. ON SAME LINE, READ EQUIVALENT COMPOUND SWIVEL IN COL. 5.

1		2	3		4	5	6
TAPER PER FT.		TOTAL ANGLE	TAPER PER INCH		SETOVER FACTOR	COMPOUND SWIVEL	SPECIFIC USE
Fraction	Decimal		Approx. Fraction	Decimal			
	.006	0° 02'	—	.0005	.0003	0° 01'	Mandrels
1/8	.125	0° 36'	1/100	.010	.0052	0° 18'	
3/16	.187	0° 54'	1/62	.016	.0078	0° 27'	
	.210	1° 00'	1/59	.017	.0087	0° 30'	
1/4	.250	1° 12'	1/48	.021	.0104	0° 36'	Taper Pins
5/16	.312	1° 30'	1/38	.026	.0130	0° 45'	
3/8	.375	1° 47'	1/32	.031	.0156	0° 53'	
	.419	2° 00'	1/29	.035	.0174	1° 00'	
7/16	.437	2° 05'	1/28	.036	.0182	1° 02'	
1/2	.500	2° 23'	1/24	.042	.0208	1° 11'	All Brown and Sharpe Except No. 10
	.516	2° 28'	1/23	.043	.0215	1° 14'	Brown and Sharpe No. 10
9/16	.562	2° 42'	1/21	.047	.0234	1° 21'	
	.597	2° 52'	1/20	.050	.0249	1° 26'	Jacobs No. 0
	.600	2° 52'	1/20	.050	.0250	1° 26'	Morse Nos. 1, 2, 3 Jarno (All)
5/8	.625	3° 00'	1/19	.052	.0260	1° 30'	Morse Nos. 0, 4, 6, 7 Jacobs Nos. 4, 5, 6
	.630	3° 00'	1/19	.053	.0263	1° 30'	Morse No. 5
	.637	3° 02'	1/19	.053	.0265	1° 31'	Jacobs No. 3
11/16	.687	3° 18'	1/17	.057	.0286	1° 39'	
3/4	.750	3° 25'	1/16	.062	.0312	1° 47'	Pipe Threads
	.838	4° 00'	1/14	.070	.0349	2° 00'	
7/8	.875	4° 12'	1/14	.073	.0365	2° 06'	
	.923	4° 24'	1/13	.077	.0384	2° 12'	Jacobs No. 1
	.978	4° 40'	1/12	.082	.0407	2° 20'	Jacobs No. 2
1	1.000	4° 45'	1/12	.083	.0417	2° 23'	
	1.047	5° 00'	1/11	.087	.0436	2° 30'	
1-1/4	1.250	5° 58'	1/9	.105	.0521	2° 59'	
	1.257	6° 00'	1/9	.105	.0523	3° 00'	
	1.465	7° 00'	1/8	.122	.0610	3° 30'	
1-1/2	1.500	7° 08'	1/8	.125	.0625	3° 34'	
	1.676	8° 00'	1/7	.140	.0698	4° 00'	
1-3/4	1.750	8° 20'	1/7	.146	.0729	4° 10'	
	1.885	9° 00'	1/6	.157	.0785	4° 30'	
2	2.000	9° 32'	1/6	.167	.0833	4° 46'	
	2.094	10° 00'	1/6	.174	.0872	5° 00'	
	2.310	11° 00'	1/5	.192	.0958	5° 30'	
2-1/2	2.500	11° 54'	1/5	.208	.1042	5° 57'	
	2.513	12° 00'	1/5	.209	.1045	6° 00'	
	2.717	13° 00'	1/4	.226	.1132	6° 30'	
	2.931	14° 00'	1/4	.244	.1219	7° 00'	
3	3.000	14° 16'	1/4	.250	.1250	7° 08'	
3-1/2	3.500	16° 36'	1/3	.292	.1458	8° 18'	Milling Machine

and BORING PRACTICE

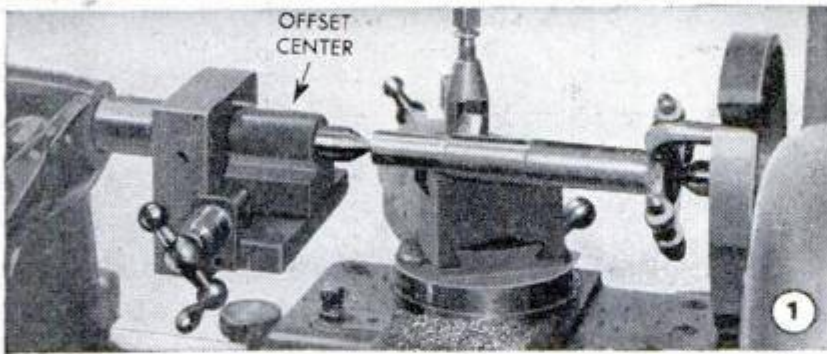

By Sam Brown

ALTHOUGH taper turning is a common shop operation, it requires a careful setup to produce work accurately to required dimensions. In most shops it commonly is done by one of three methods: (1) Setting-over the tailstock; (2) by use of a taper attachment and (3) by swiveling the compound. Most craftwork and small machine-shop work is done with the set-over method. The mechanics of this operation are fairly well understood by most workers, and the main difficulty is not in the work itself but in calculating the required amount of setover. This is simplified by the table on the opposite page, which lists a considerable range of standard tapers. If the job happens to call for a taper not listed, use the next size under the specified taper.

Setover method: Nearly all lathes are equipped with setover tailstocks, the amount of setover varying with the size and type of machine. Although it serves the purpose where only an occasional taper is turned, in production work this system has two faults: First, it requires movement of the tailstock and the consequent tedious adjustment of getting it back to the proper position for straight turning; second, it tends to score the tail center. One good remedy for the first fault is to use an offset center, which is adjustable for setover. A simple type is shown in Fig. 2. Another style with a micrometer sleeve is pictured in Fig. 1. This model has a ball center, Fig. 5, which eliminates the problem of scored centers. Why the work scores the common 60-deg. center can be seen from Fig. 4. This is exaggerated, of course, as the scoring is not bad when cutting medium tapers. However, there is the possibility of an inaccuracy developing while the work is in progress, due to deep scoring of the center

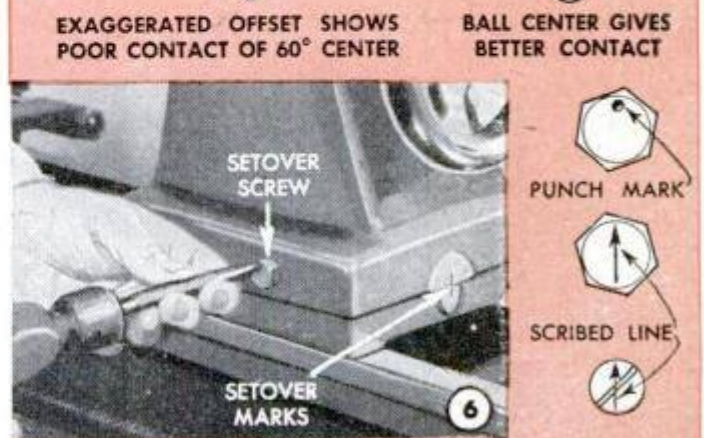
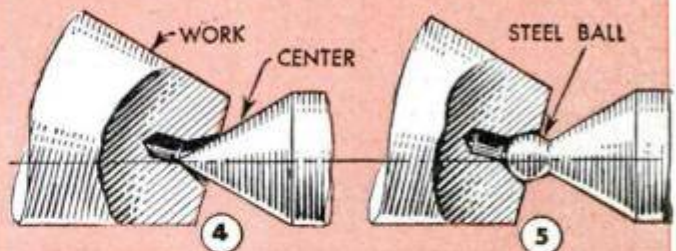
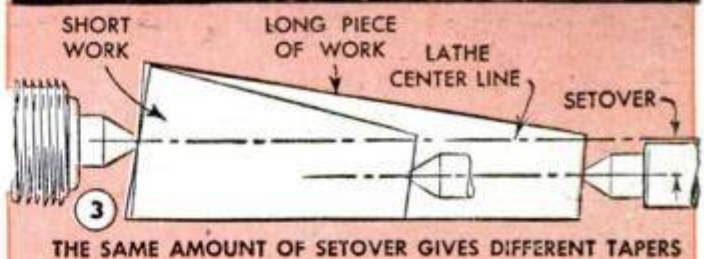
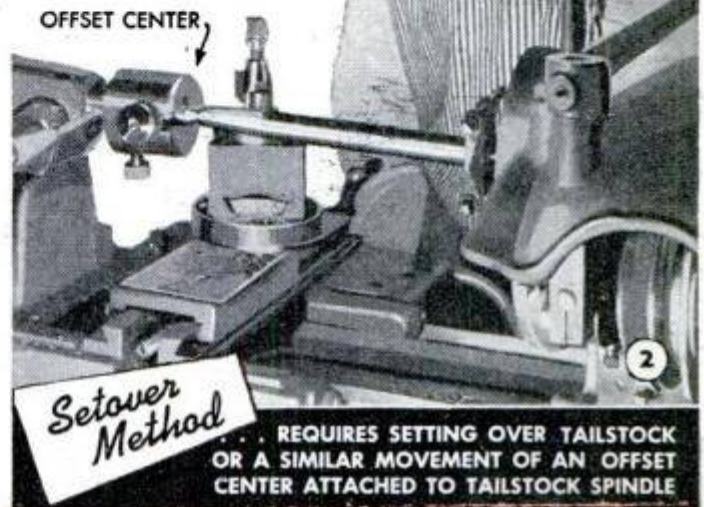

PUNCH MARK OR SCRIBED LINE ON SETOVER SCREWS ASSURES ACCURATE RESETTING OF TAILSTOCK

5 - Ways to Measure Setover

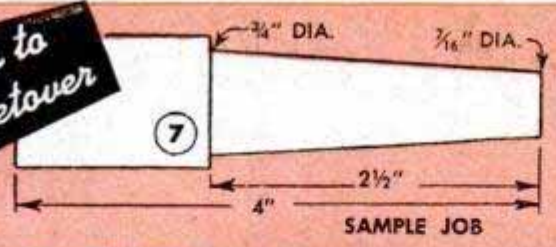

SETOVER CALCULATION
 $T.P.I. = \frac{D-d}{LT} = \frac{.750-.437}{2.5} = .125$
 T. P. I. OF .125 = .0625 SETOVER FACTOR
 (THIS FROM TAPER-TURNING TABLE)
 THEN: .0625 X 4 = .25" SETOVER

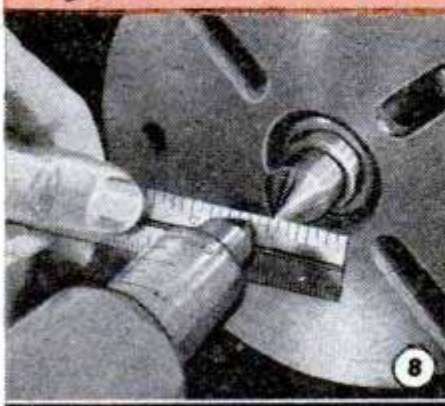

1 BY MEASURING AT CENTERS

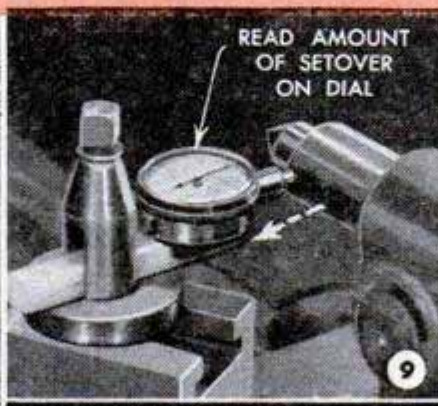

2 DIRECT DIAL READING

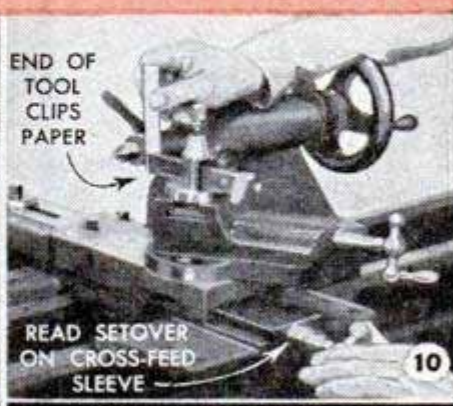

3 READING MICROMETER SLEEVE

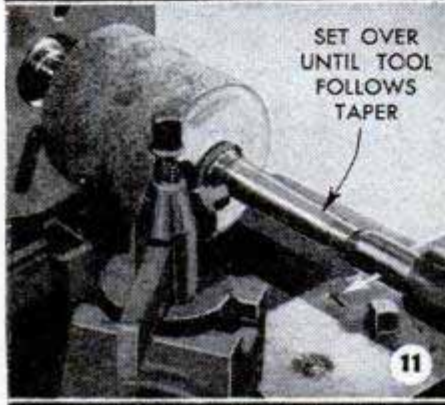

4 SET TO DUPLICATE TAPER

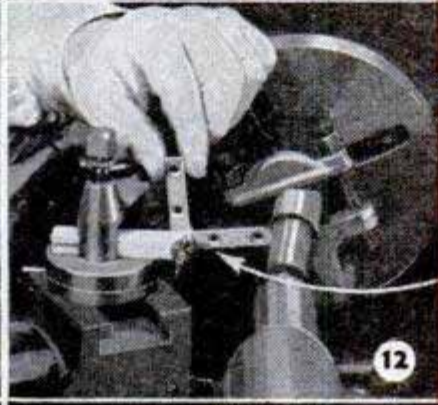

5 SET TO GUIDE CUTS

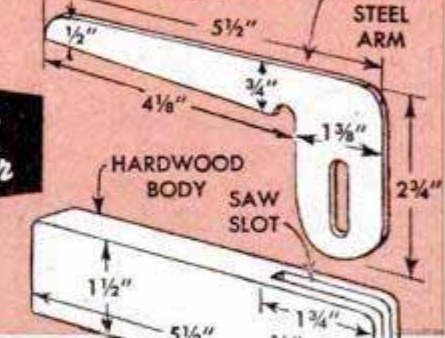
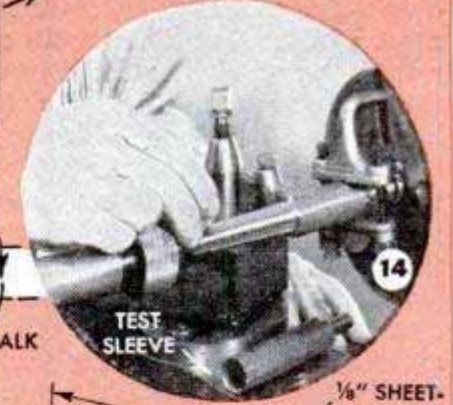
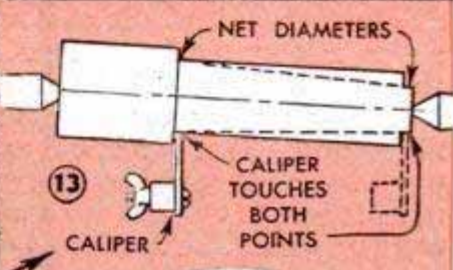

16 TAPER GAUGE



or, in some cases, the work. Another simple way to eliminate this trouble is to use a ball-bearing center instead of the plain type. When the tailstock itself is set over, resetting is made easier if the setover screws are indexed. By punch-marking the adjusting screws as in Fig. 6, you can easily readjust the centers to the parallel position after turning a taper.

The main point in setover taper turning is that the over-all length of the work always determines the setover. The taper can be part or full length, at either end or at the center, but the amount of setover depends on over-all length. Fig. 3 shows how the same amount of setover produces different tapers on different lengths of work. If the work is mounted on a mandrel, the setover is calculated from the length of the mandrel, not the length of the work. For external cutting, the setover usually is made toward the operator; internal cuts are made with the setover away from the operator. The tool bit must be exactly on center, as inaccurate work will result if the cutting point is above or below center.

Five ways to measure setover: Figs 8 to 12 inclusive show five ways to measure the



SETTING TAPER ATTACHMENT FOR 1" PER FOOT TAPER

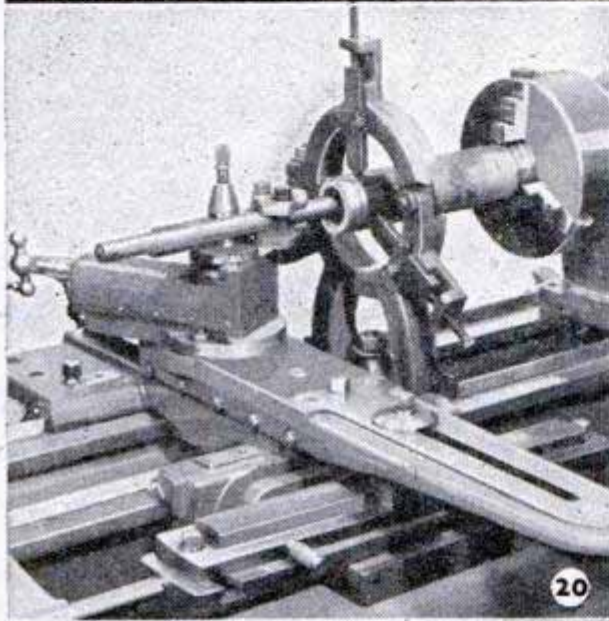

BORING WITH TAPER ATTACHMENT

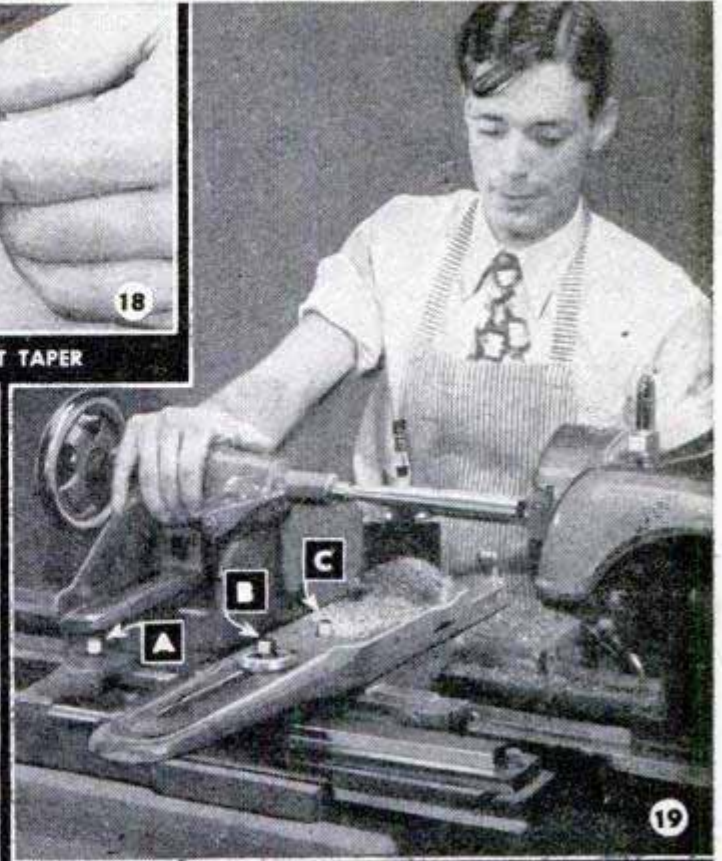

Taper Attachment

FURNISHES BEST WAY OF DOING TAPER TURNING, EITHER INTERNAL OR EXTERNAL. THE DEVICE IS A PERMANENT PART OF THE LATHE

tailstock setover. These are numbered 1 to 5 inclusive. A sample job, Fig. 7, is used to illustrate. However, when work is specified in this way, it is practical to make the setover without calculation, using the method shown in Figs. 12 and 13. In this method, the body of the taper is turned to the net diameter at the big end, and a shoulder cut is run in at the small end to the small-end diameter to give a second measuring point. Now, if the tailstock is offset so that the two measuring points are equidistant from the parallel line of carriage travel, the longitudinal carriage movement consequently will cause the tool to cut the taper as specified. This can be seen in Fig. 13. Method No. 4, Fig. 11, is another system of direct setting without calculating the setover. This requires a duplicate taper which is mounted between centers. Then the tailstock is set over until the tool point follows the taper. Now, if the workpiece is made the same length as the sample, the taper cut will duplicate the sample. Methods 1, 2 and 3 are measuring methods from a calculated setover. No. 2 is the most exact and simplest; No. 1 is fast but rough; No. 3 is the method most commonly used. In this last method, the calculated amount of setover is read on the cross-feed micrometer sleeve. In order

to take out backlash in the screw, the reading should be made as follows: Run the flat end of the tool holder lightly against a strip of paper held over the tailstock spindle, as shown in Fig. 10. Now, back up the feed until the paper can be pulled free. Take the micrometer reading from the sleeve and back off the calculated amount of setover. Then, with the tool remaining in this position, the tailstock is set over until it clips the paper with the same "feel" as before. In any case, do not overrun the setover—set it light and take a sample cut preparatory to checking.

Checking the taper: If a test sleeve is available, the work is tested by chalking the turned portion, Fig. 14, and then rotating the work inside the sleeve. Fig. 15 shows the small end of the work oversize; more setover is needed. This is the correct way to proceed—gradually coming down to size with a series of cuts. Testing should begin as soon as you have about 1 in. of tapered surface. Figs. 16 and 17 picture one of many types of taper gauges. These are often handy, but must be accurately made to be useful.

Taper attachment: The best taper attachments are specially-made fixtures permanently attached to the lathe, just like the gear box or carriage. A typical unit is

Tapering With Compound

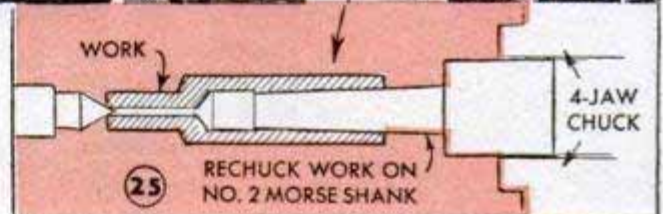
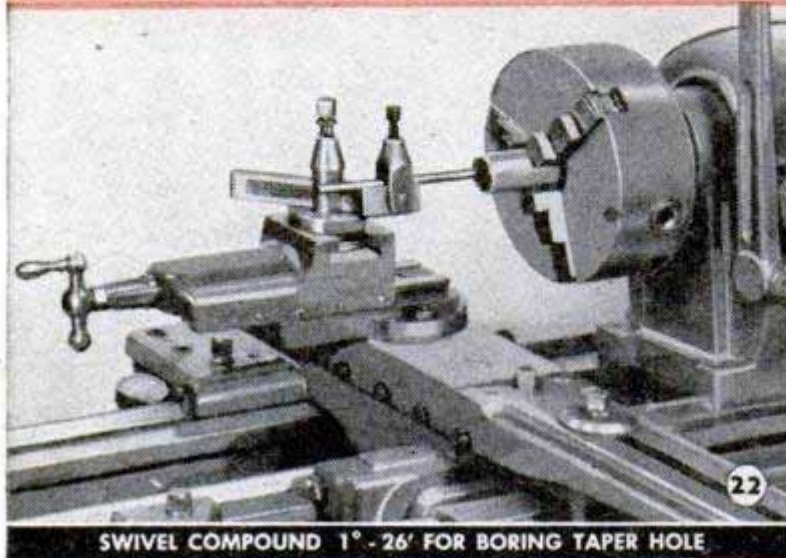
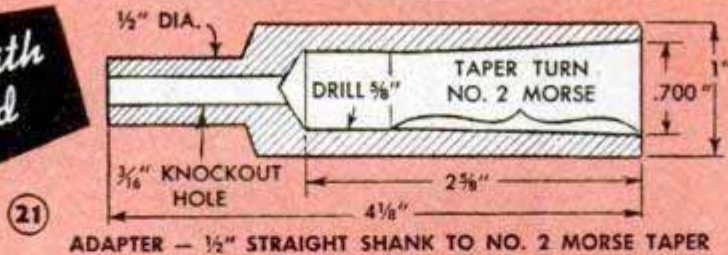

shown in Fig. 19. Screw C is the normal cross slide lead-screw nut, and when the lathe is used for straight turning, this screw is tightened while screws A and B are loosened to allow the parts to move freely. For taper turning, bracket screw A is tightened to hold the taper-turning unit in a fixed position. Lead-screw nut C is loosened, releasing the cross-feed. Screw B is tightened, and this ties the free cross slide with the slide bar of the taper attachment. The taper-per-foot is set by swinging the pivoted taper bar until the index mark on the end of the bar reaches the correct reading on the fixed scale, Fig. 18. A taper attachment has many advantages: It is not necessary to set the tailstock over or to measure the amount of setover; the same taper can be cut on work of any length; work can be mounted in the chuck, and internal cuts, Fig. 20, are just as easily made as external cuts.

Tapering with compound: Lacking a taper attachment, internal taper cuts are usually made with the compound-slide hand-feed. A sample job is shown in Fig. 21. The feed of the average compound slide is 2 to 2½ in., so instead of boring the full length of the taper, a short distance at the bottom is bored straight with a suitable tool. The remaining distance is then within the travel of the compound, and also is sufficient for accurate fitting and practical use. Since this sample job is a No. 2 Morse taper, the compound swivel is 1 degree and 26 minutes, which is just a little under 1½ degrees. Set the compound parallel with

the lathe bed, and then swivel it the 1½ degrees required. It is a good idea to check the parallel position first, since the compound scale cannot always be relied on for this purpose. Fig. 22 shows the cut being made, using a ¼-in. boring bar.

Reaming a taper: Accurate boring with the boring tool alone can be done, but if you do much of this work it is better to finish with a taper reamer. Using the reamer, the hole need only be rough-bored, and then finished with a light reamer cut, Fig. 23. In this operation, the work should be flooded with oil, should run at lowest lathe speed and the feed must be slow and even to prevent jamming or "freezing." When doing this type of reaming, especially where considerable stock is to be removed, it may be necessary to withdraw the reamer at short intervals to clear it of chips. If the flutes fill with chips this may cause the reamer to freeze with possible scoring of the work. The outside of the sample job is finished by mounting on a No. 2 Morse chucking fixture or any kind of shank having a No. 2 Morse taper. The operation is shown in Figs. 24 and 25. If desired, the procedure can be reversed, turning the outside first and then centering in a 4-jaw chuck for the taper cut.

Dyed Door Mat Simulates Grass for Lawn-Mower Window Display

Looking for a novel way to display lawn mowers, one hardware dealer dyed a door mat bright green, to simulate close-cropped grass, and set the mower on it in his show window. This arrangement, which is economical in cost, attracted considerable attention. The same idea could be used for other lawn and garden equipment.

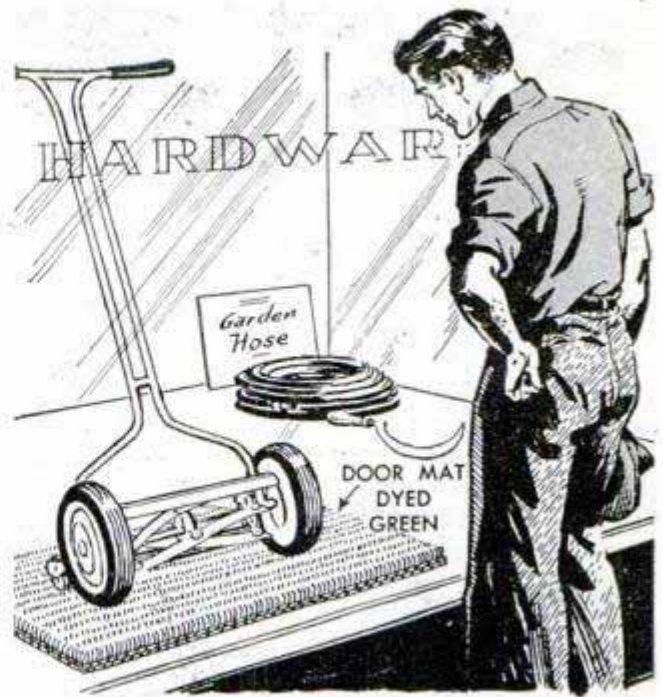

Special Wrench Speeds Tightening Of Conduit Locknuts

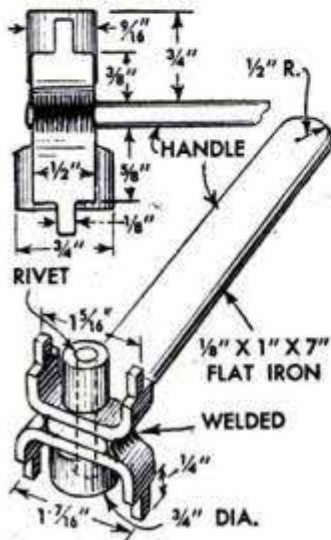

Not satisfied with the hammer-and-screwdriver method of tightening the thin locknuts on conduit connectors, Joseph Marino of Chicago devised this special wrench which does the trick in a jiffy. The wrench has two guides which fit both thin-wall and rigid-type conduit connectors. It is

used by inserting the proper guide in the conduit connector after the locknut is started with the fingers. Two prongs on the wrench engage the lugs on the nut and permit drawing it up tightly against the outlet box. Both heads of the wrench are the same design but of different size. They are riveted and then tack welded to a suitable flat-iron handle. If the guides are grooved lengthwise, the wrench can be used to loosen nuts where wires are in place.

Try Square Aligns Rubber Stamp When Printing Data on Tracing

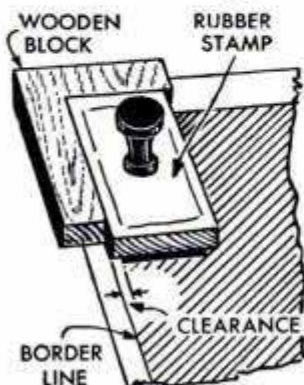

For draftsmen who use a rubber stamp to print the necessary information on a blue-print tracing, a try square cut from a wooden block will simplify aligning the stamp with the border of the tracing. As the lettering usually

does not extend to the lower edge of the stamp, this must be taken into consideration when locating the try square.

W. B. Eagan, Louisville, Ky.

Tank Cart Speeds Mixing Liquid Used in Tractor Tires

To facilitate the job of filling tractor tires with liquid when extra weight is desired or when adding an antifreeze solution to the tires, one service station rigged up this handy mixing cart. It is nothing more than two 55-gal. oil drums anchored to a caster-fitted platform, and is used to mix thoroughly calcium chloride and water by pumping the solution from one tank to the other several times. This speeds

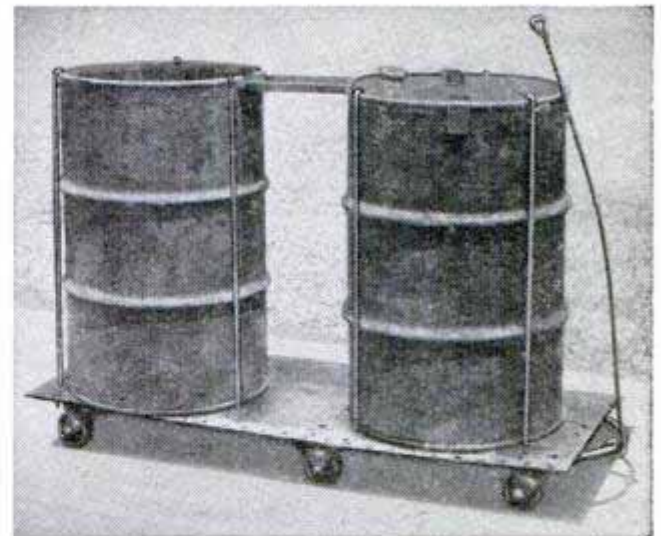

mixing, after which the solution is pumped into the tires. The amount of chemical used is varied according to the manufacturer. Avoid using a solution consisting of common table salt and water for an anti-freeze, as the salt will separate from the water and permit the water to freeze and damage the tire.

W. N. Skourup, Jr., Columbia, Mo.

"SEA CRAFT" - a 25-ft.

IN THIS, the final installment of the "Sea Craft" series, the boat is completed ready for launching and the thrill of her maiden voyage.

Continuing with the cabin interior, install the framing and plywood covering of the port and starboard bunks and forward cabinets. The top of the port-side cabinet is cut out to take a 12 by 12-in. galley sink, which drains through the hull, as in Fig. 43 of Part 4. Fresh water is piped to a faucet fitted through the bulkhead, Fig. 30 of Part 3. The bunk mattresses are supported on a removable frame woven of burlap webbing, as in Fig. 33 of Part 3. They are kept in place by a 1½-in. projection of the plywood bunk sides, which extend down over the inboard sides of the floor stringers. The hull ribs above the bunk frames are covered with ½-in. mahogany, Figs. 41 and 42 of Part 4. Center of the cabin floor is made in two removable sections, each supported by cleats fastened to the plywood bunk sides and floor timbers which are bolted to the frames on top of the tie bars (see station 3, Fig. 43 of Part 4). Note that the floor slopes to obtain maxi-

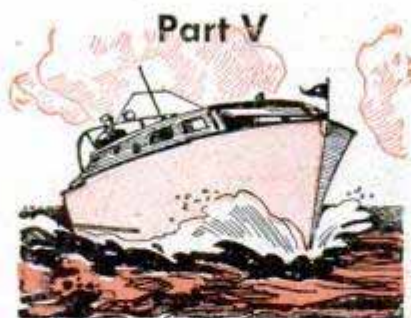

By Edward Colby

mum headroom at station 6. The cabin floor on both sides of the engine compartment is fastened permanently to the top edges of the floor stringers and floor timbers, Figs. 35 and 38 of Part 3.

Before covering the cockpit-bulkhead framing, install the water closet, which must be purchased from a marine supply house. Plywood is

used for the walls and doors of the toilet room, engine compartment and chart cabinet. Note in Fig. 35 of Part 3, that the sides and top of the engine compartment are removable. They also must be lined with asbestos. The sides are held in place at the top by hooks and at the bottom with quarter round nailed to the floor. One side and top are shown removed in the photo, Fig. 36 of Part 3. An alcohol cooking stove is bolted in a sheet-metal cabinet mounted on the bulkhead frame. The cabinet must be removable for access to the rear of the control box as detailed in Figs. 49 and 43 of Part 4. This box houses the compass, electrical switches, engine controls and steering gear. An inspection door in the front of the box, Fig. 37 of Part 3, is held in

Location of engine controls in the cockpit permits unobstructed view for close maneuvering

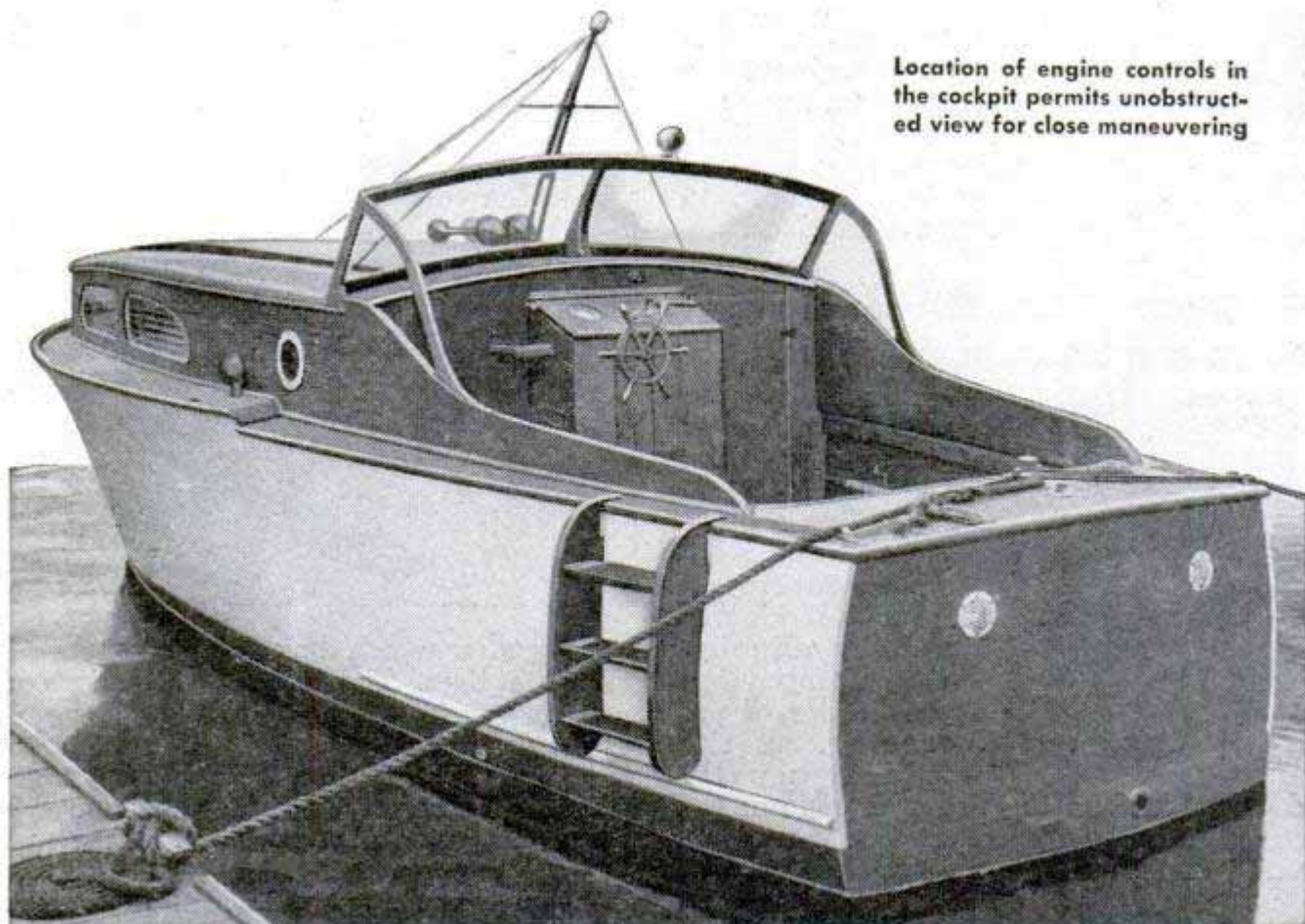

Cabin Cruiser

*Ed. E. Wildie
4-W Ranch.
17308 Kungsholm
San Francisco, Cal.*

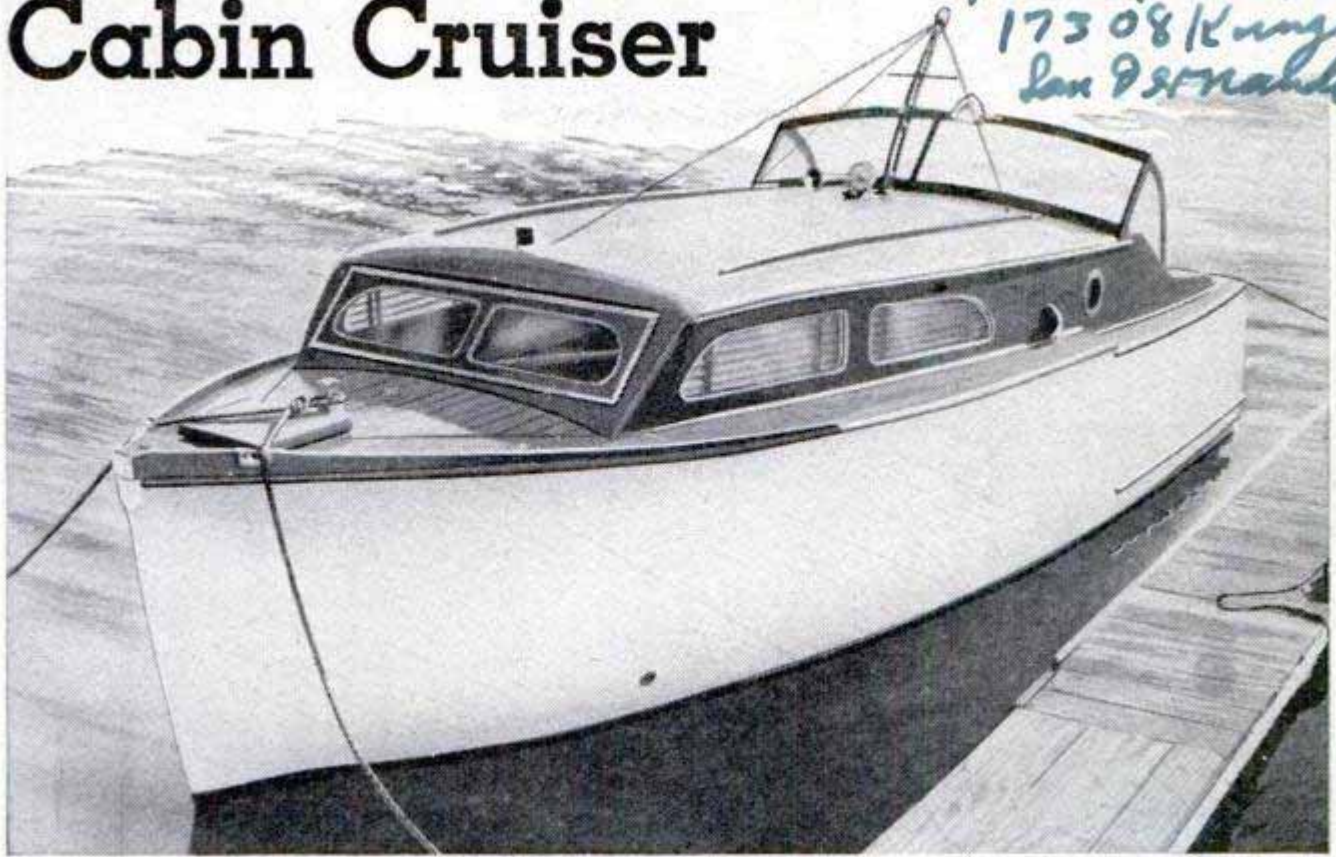

"Sea Craft's" lines show to best advantage when viewed off the bow. Cabin roof can be used for sun bathing

place with brass door buttons and plates.

The steering system, Figs. 30 and 38 of Part 3, consists of an automobile steering knuckle of the worm-gear type bolted in the control box so that a steering wheel can be fastened to the worm shaft. The stub shaft of the worm gear is welded to a vertical shaft extending below the cockpit floor. Lever arms attached to the lower end of the shaft and rudder post are connected with a steering rod of $\frac{1}{2}$ -in. pipe, which has a clevis welded to each end. A hand-operated bilge pump is fastened to the port side of the control box with the outlet connected to a $\frac{1}{2}$ -in. galvanized pipe running under the cockpit floor to a hole in the transom. The pump intake is connected to a hose extending down to the bilge.

The cabin stairway, Figs. 41 and 43 of Part 4, is covered with a trap door which projects under the cabin door when closed, preventing entrance to the cabin when the cabin door is locked.

Two 6-volt storage batteries, placed in a box under the cockpit floor are connected to a S.P.D.T. switch located in the control box. The wiring hookup should be arranged so the batteries may be used individually or disconnected when the boat is not in use.

The stern deck is made of the same material as the forward deck. It is crowned 2 in. and the forward edge curved to conform with the radius of the cockpit seat, as in Fig. 47 and also Figs. 40 and 41 of Part 4. The seat top is made from three pieces of

plywood and is removable for access to storage space beneath. This provides an ideal place to store life preservers, which must be carried for each person on board. The side decks or shelves, extending from the sheer drop to the transom, should be installed at the same time as the stern deck. They are of $\frac{3}{4}$ -in. mahogany cut to fit snugly against the cabin sides and trimmed flush with the hull planking. The shelves, forward of the sheer drop, are of $\frac{3}{4}$ -in. plywood covered with canvas to provide a nonslip surface. They must be notched to clear the ventilating ducts. A block of wood is inserted between the fore and aft shelves where the sheer line drops, and $\frac{3}{4}$ -in. quarter round is fastened along the joint of the shelf and cabin side.

Before the cabin top is put on, cut grooves in the center strip for the insulated electrical wires, as in Figs. 46 and 47. These wires, which are connected to switches on the control-box panel, are brought through holes in the cabin top to the combination light, mast light and a horn which is required for a boat of this size. The wires leading to the cabin dome lights and toilet-room wall light, which have individual switches, are connected directly to an ammeter on the panel.

The two outer supports for the cockpit windshield, shown in pattern squares in Fig. 41 of Part 4, are installed next. Each side is made from two pieces doweled and glued together at the top and screwed to

45 CABIN WINDSHIELD
(TRIM TO SIZE
AFTER ASSEMBLING)

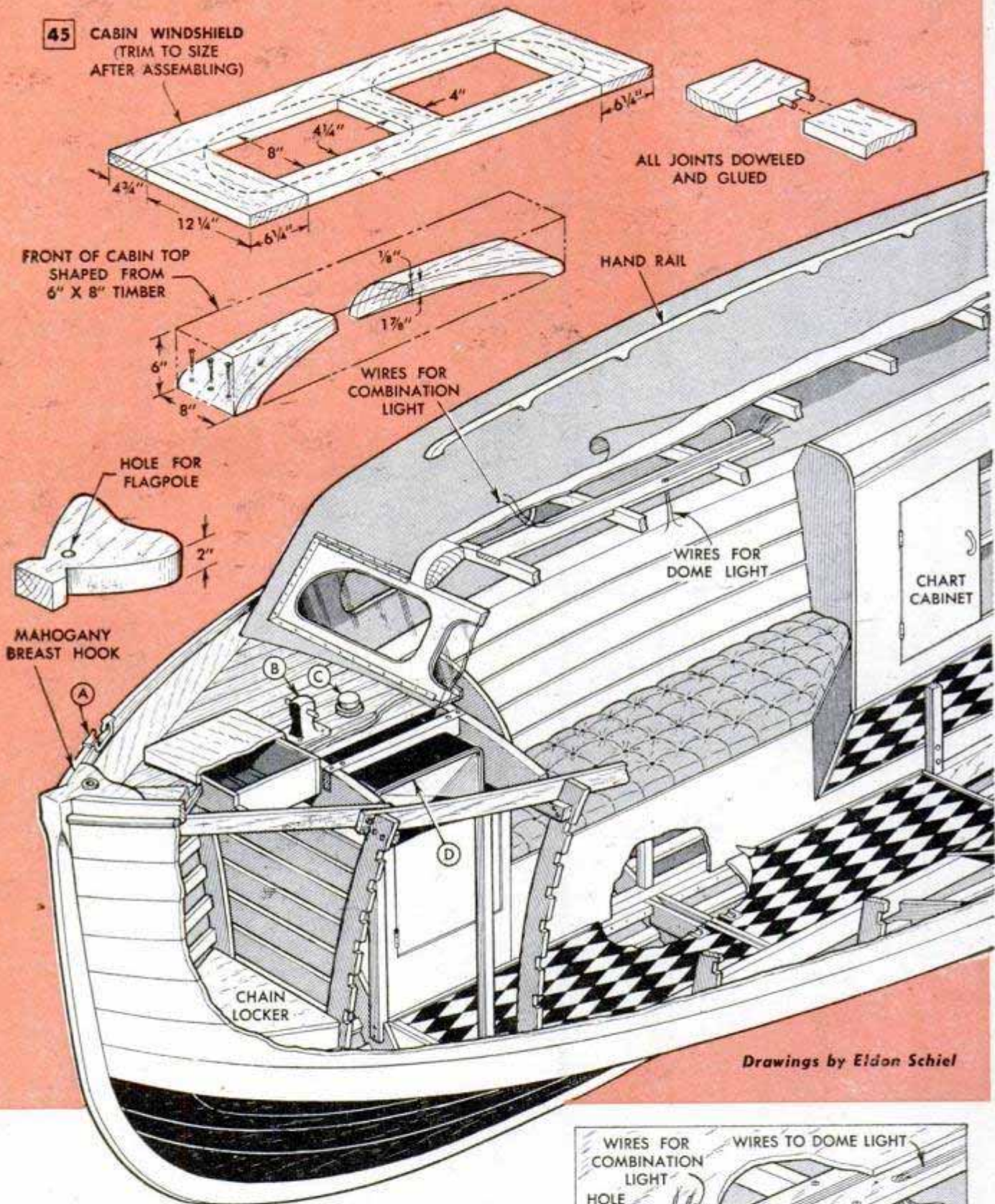

Drawings by Eidon Schiel

"SEA CRAFT" BLUEPRINTS AVAILABLE
SINCE IT IS DIFFICULT TO REPRODUCE BLUEPRINTS
TO A WORKING SCALE WITHIN THE LIMITS OF A
PRINTED PAGE, A COMPLETE SET OF SEVEN LARGE-
SIZE BLUEPRINTS SCALED 1 IN. TO THE FT. MAY BE
PURCHASED FROM POPULAR MECHANICS BOOK
DEPARTMENT, 200 E. ONTARIO ST., CHICAGO 11

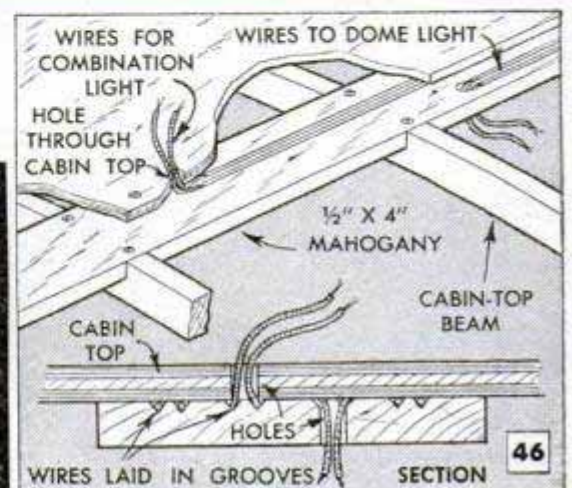

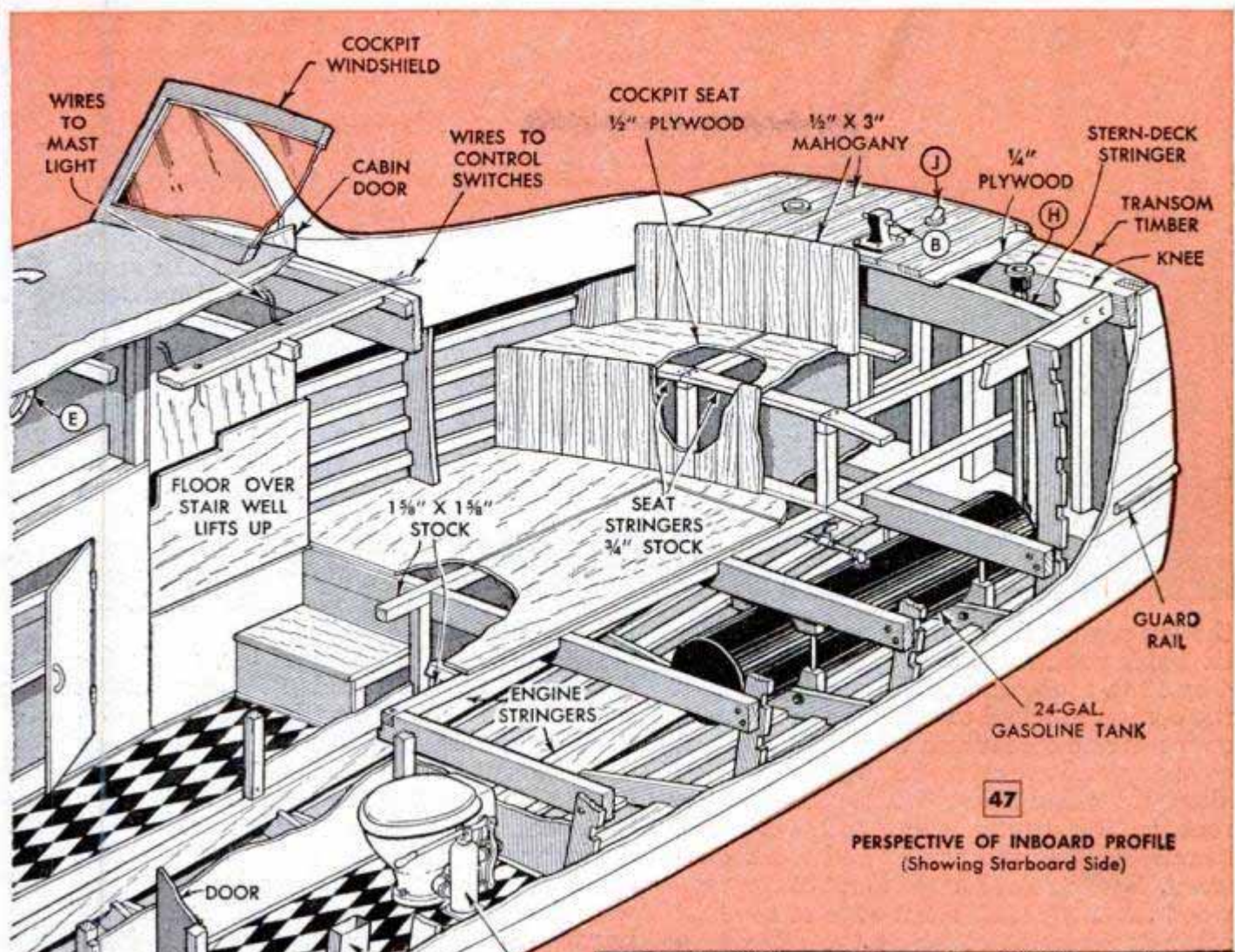

47

PERSPECTIVE OF INBOARD PROFILE
(Showing Starboard Side)

- A—SKENE BULWARK BOW CHOCK
- B—MOORING BITT
- C—PIPE DECK PLATE
(For Filling Fresh-Water Tank)
- D—15-GAL. FRESH-WATER TANK
- E—PORT LIGHT
- F—SHEET-METAL VENTILATING DUCT
- G—MARINE-TYPE PUMP CLOSET
- H—PIPE DECK PLATE
(For Filling Gasoline Tank)
- J—FLAGPOLE SOCKET

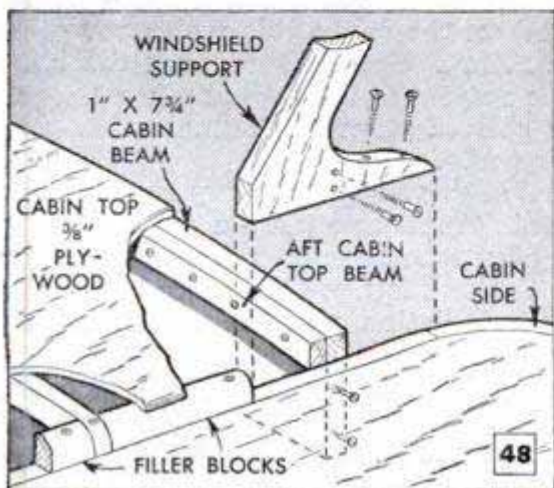

48

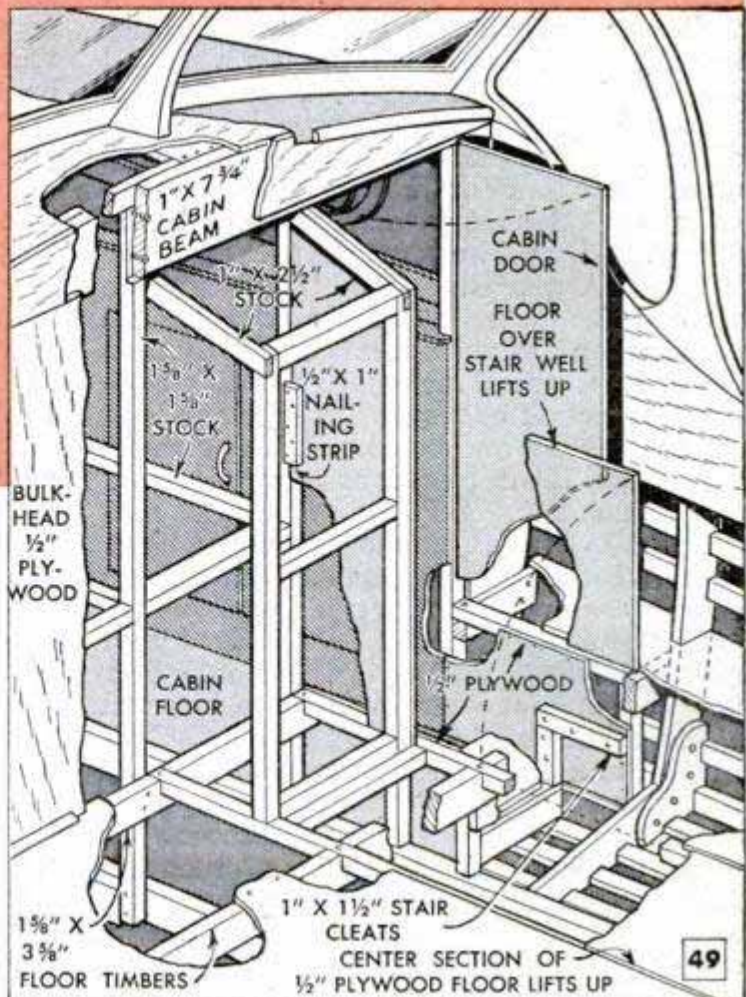

49

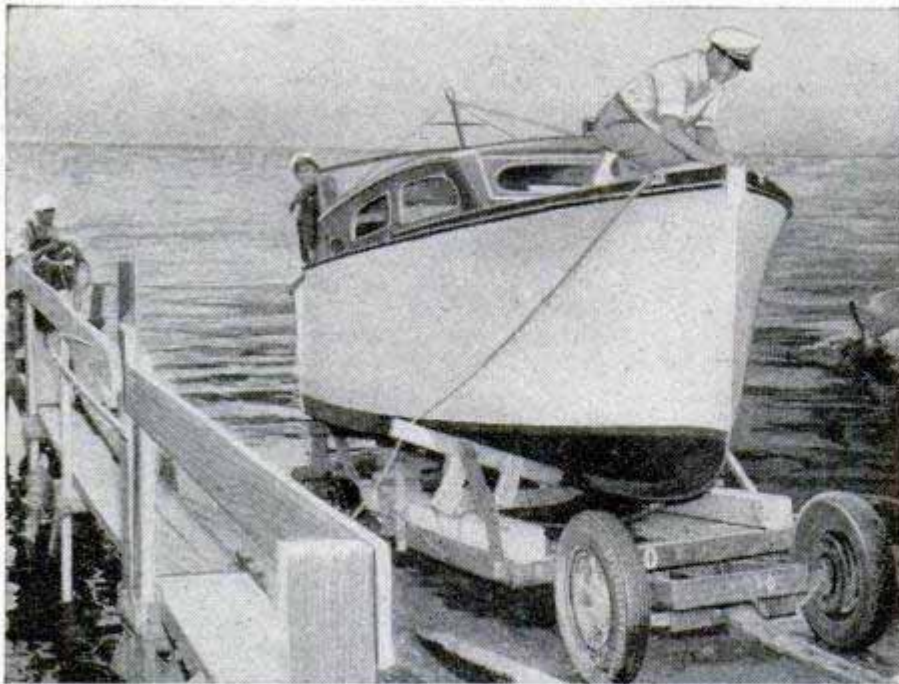

Thrill of launching the boat will help compensate for the many hours spent building it

station 4 on both sides along the sheer, Figs. 40 and 41 of Part 4, are screwed to the deck planking as in the upper detail of Fig. 42. The seam between the hull and deck planking at the sheer is covered with 1½-in. half-round molding. This also is used for the guard rail at the aft end of the hull, Fig. 41. The hatch cover for the chain locker should be a snug fit. It is planked with ½ by 3-in. mahogany over ¼-in. plywood, which is rabbeted into the

the top edge of the cabin sides, Fig. 48. For the cabin roof, two pieces of ¾-in. plywood 4 by 12 ft. are needed. These are joined at the center, notched to clear the windshield supports and come flush with the bulkhead covering, and are trimmed slightly oversize along the cabin sides. When screwing the roof to the center strip and cabin-top beams, start at the center and work outward. Saw off the forward end of the plywood flush with the front edge of the first cabin-top beam and plane the sides to a well-rounded corner to blend into the filler blocks. The front of the cabin top is shaped from a timber, as in Fig. 45. The entire top is coated with canvas cement and one piece of canvas stretched tightly and tacked along the sides just below the seam between the filler blocks and cabin sides. The forward edge of the canvas is tacked under the front edge of the shaped timber and the aft edge is tacked to the bulkhead. The canvas then is given several coats of thinned paint. Half-round mahogany molding covers the tacked edges of the canvas along the cabin sides and bulkhead. The cockpit windshield is completed, as in sections F-F and E-E of Fig. 41, Part 4. The mast, also detailed in Fig. 41, supports a white light. Section D-D of Fig. 41 gives the dimensions of handrails fitted to the cabin top.

The cabin windshield, Fig. 45, fits into a rabbet cut in three pieces of 1½-in. stock, two of which are screwed to the forward edges of the cabin sides, section C-C of Fig. 41, and one placed horizontally across the forward deck. Widths of these pieces are not given as they will vary somewhat with each boat. Note in Fig. 47 that the rabbet on the athwartship piece is cut at an angle to fit a 36-deg. bevel on the lower edge of the windshield. Toe rails extending from the breast hook at the bow to

top edges of the cover frame.

Before painting the exterior, mark the L.W.L. on the hull and fill the planking seams above this line with a fresh or salt-water seam sealer. Give the hull three or four coats of flat-white marine paint above the L.W.L., sanding the hull by hand after each coat. Then apply a mixture of flat and glossy white paint and follow with a coat of glossy white. The decks, cabin sides and windshield frames are sanded, and a mahogany-colored wood filler or a stain is applied, after which three coats of marine varnish are applied, sanding the first two coats. The seams between the deck planks are filled with a white seam sealer before varnishing.

All exterior hardware is installed next. The fore and aft mooring bits must be bolted securely in position to withstand considerable strain. Plate glass for the windshields and cabin windows is held in place with lead beading, as in Figs. 31 and 41. Mahogany on the interior of "Sea Craft's" cabin was stained and varnished and the plywood painted white, as in Fig. 44 of Part 4. The boat must be provided with a fire extinguisher which should be mounted on the cabin side wall above the chart cabinet. Before launching the boat give the bottom of the hull another coat of copper bottom paint and launch while the paint is wet.

A boat of this size must carry registration numbers. Application for a certificate of award of number can be made by the boat owner to the District Coast Guard Officer having jurisdiction over the area in which the owner resides.

In addition to a set of seven working-size blueprints, full-size paper patterns for the hull frames and keel are also available.

The end



Radios in Your Hair

RADIO receivers, tinier than a penny matchbox have been developed by Paramount sound men in Hollywood. These replace the megaphones that directors used in the days of silent pictures to shout instructions to their stars. The resulting confusion on crowded sets was nerve racking to both the director and members of the cast. When sound was added, the megaphone had to go. It was then replaced by intricate signaling systems and many necessary interruptions and expensive retakes. Now this tiny inductive-type receiver, that uses no batteries or tubes, is concealed on the actor's person. It is claimed that it can pick up signals as far as 300 feet away from the transmitter which is placed near the movie studio stage.

In photo A, Director Mitchell Leisen shows the studio hairdresser how to work the antenna into Andrea King's hairdo. The antenna wire is not long and is easily hidden in the hair; a flesh-colored plastic tube carries messages to the ear. The receiver, which is smaller than any hearing aid, has to be set on frequency before it is used. Its tiny size is clearly illustrated in the engineer's hand shown in photo B. Worn suspended from a neck ribbon it is easily concealed. John Beal carries his in his coat pocket, and the antenna is wound around his waist. The earplug lead comes up his neck behind his ear and tape holds it in place. Although flesh-colored plastic is used for the tubing, make-up is applied to hide both the tubing and tape.

Either music or words of direction may be broadcast to the actors, but the sounds are inaudible to those not equipped with the tiny receivers. There are no trailing wires and the members of the cast are free to move about anywhere within the range of the transmitter, which is out of camera range. Engineer Robert Carr, in the studio sound department, operates the 150-watt transmitter located just off stage as shown in photo C. He monitors the signal and works in close cooperation with the stage director.

It is quite possible that this specialized 2-way communication system will find other useful applications; a similar system might be useful for the legitimate stage, especially for magicians.



BEGINNER'S ONE-TUBE

By S. A. Johnson



ONLY A HANDFUL of parts are required to build this very simple loudspeaker set. Although reduced to practically absolute fundamentals, it will give satisfactory loudspeaker volume on any strong local broadcasting station which can be received well on a good crystal receiver. As a matter of fact, this set is designed around a Sylvania 1N34 diode crystal detector, one of the types which were developed for radar during the war. This detector is connected directly to the grid of a 117N7-GT power pentode tube. This dual-purpose tube is a combination half-wave rectifier and beam-power amplifier that operates directly from the ordinary 115-volt a.c. or d.c. power line; no ballast tube or line-cord resistor is required. With this tube, the signal from the crystal detector is amplified sufficiently to operate a permanent-magnet speaker.

There is no tuning coil to wind and the usual variable tuning condenser is not required. Tuning is provided for with an inexpensive adjustable commercial tuning unit available from all radio parts houses for about 60 cents. This I.C.A. 3-in-1 radio tuner consists of a simple solenoid single-layer-wound coil with an adjustable slider for tuning. The terminal clips at each end of the tuner are common with the mounting brackets. For ease of construction the receiver is assembled on a $\frac{3}{16}$ by 9 by $11\frac{1}{2}$ -in. hard-pressed-wood base, supported by

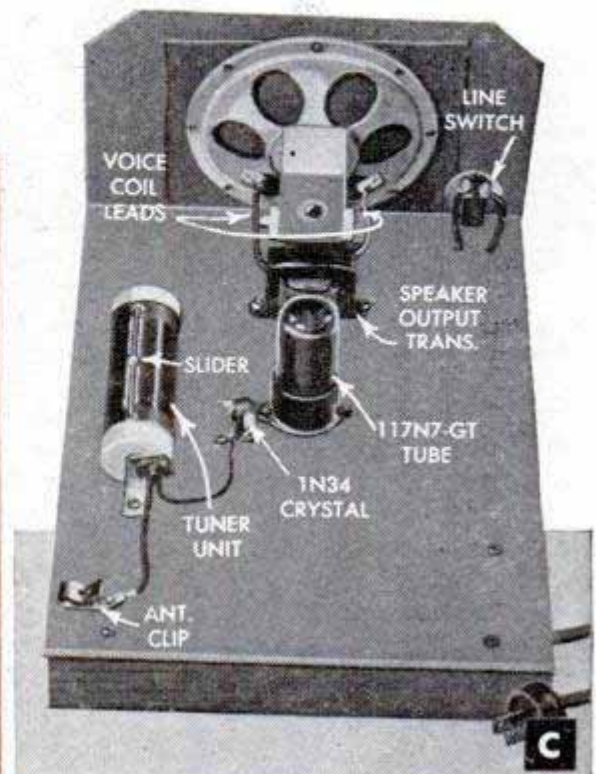
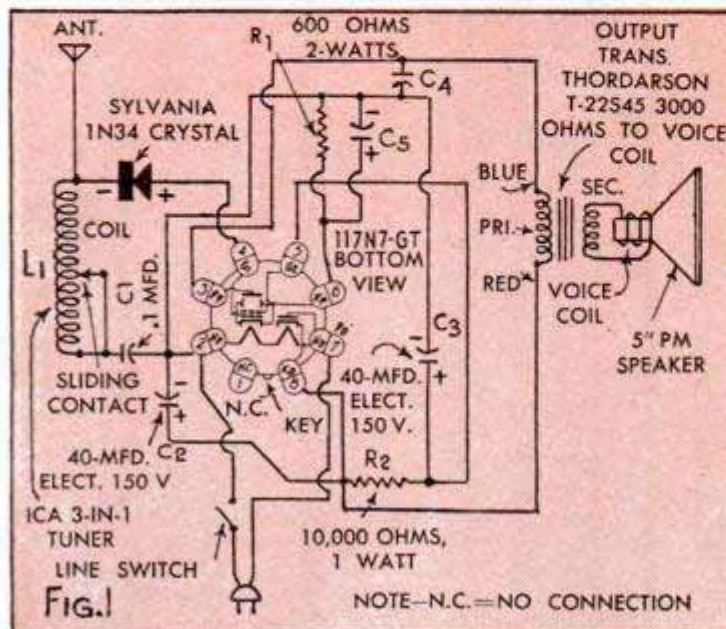
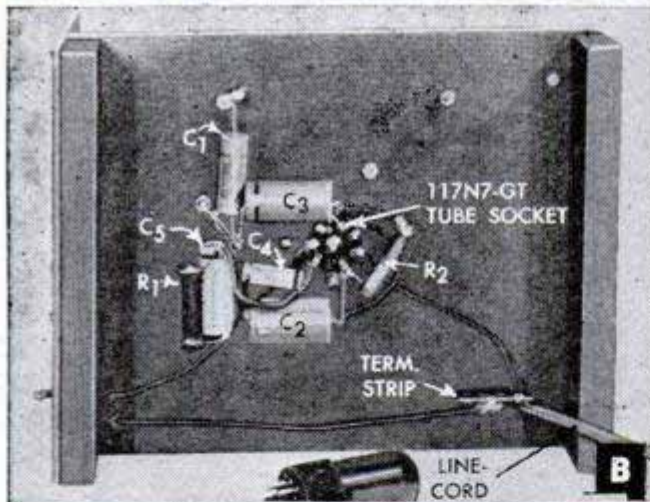
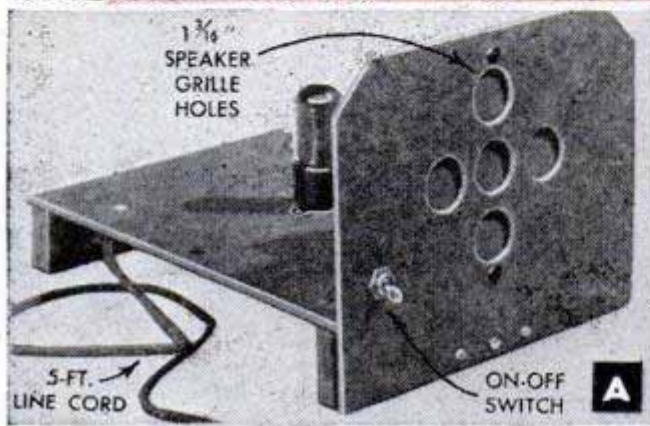

A.C.-D.C. LOUDSPEAKER SET

$\frac{3}{4}$ by $1\frac{3}{4}$ by 9-in. wooden cleats at each end. One cleat serves for mounting the front panel, which consists of a $\frac{3}{16}$ by $7\frac{1}{4}$ by 9-in. piece of hard-pressed wood. Three wood screws are used to fasten the panel to the wood cleat in the final assembly. This panel also acts as an efficient baffle for the 5-in. PM loudspeaker; the on-off line switch is also mounted on this front panel. The speaker grille merely consists of 5 holes, $1\frac{3}{16}$ in. in diameter, arranged as shown in photo A, and backed with a piece of grille cloth.

Except for the speaker-matching transformer, tuning coil and the crystal detector, all of the other parts such as the various resistors and fixed condensers are underneath the base, as shown in photo B and pictorial wiring diagram Fig. 2. The schematic circuit diagram appears in Fig. 1. To mount the tube socket in the center of the base, it is necessary to cut a hole $1\frac{1}{8}$ in. in diameter. Place the socket so that the center key is in the position shown in Fig. 2; short 6-32 machine screws hold the mounting plate at each end. In this position, as viewed from the bottom, the socket terminals are numbered clockwise from 1 to 8.

When soldering the crystal detector on the 2-lug terminal strip mounted on the top of the base, be sure that the positive end goes to terminal 4 on the tube socket as indicated in Fig. 1. Apply the soldering iron only to the wire leads, and take care that the crystal itself is not overheated. Do not attempt to use a metal base for this set; the hard-pressed wood provides good insulation, and is easy to cut and drill. Make all connections just as shown in Fig. 2; use rosin-core wire solder and be sure that all soldered

(Continued to page 220)

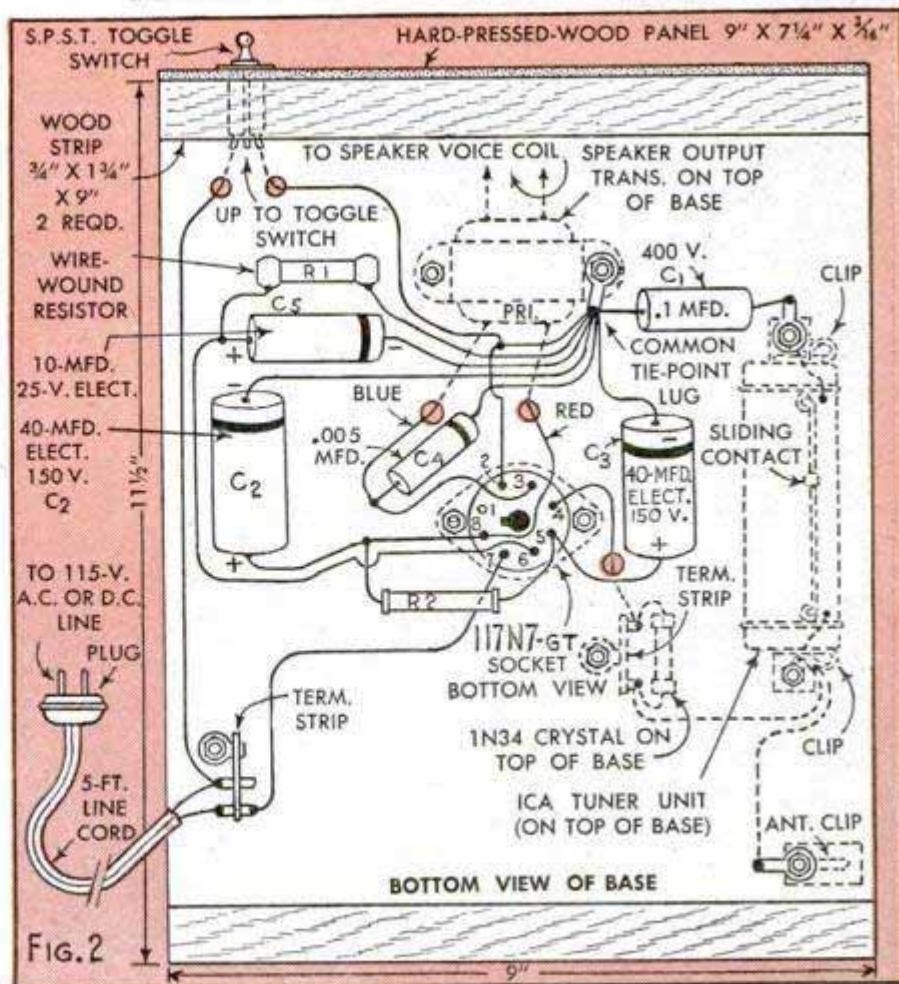
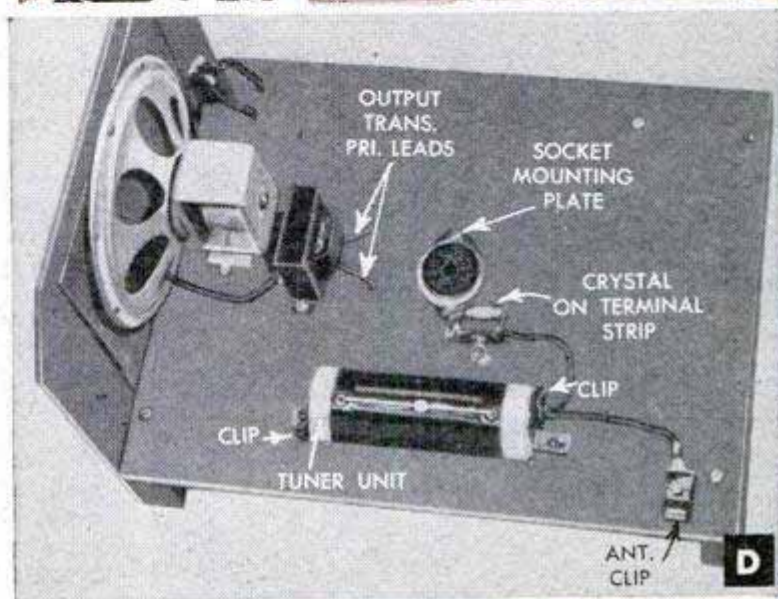

RADIO AND ELECTRONICS TODAY



1

1—Safety radio for children is housed completely in a one-piece plastic cabinet. Although the back is enclosed, ample provision is made for required cooling. A concealed handle makes it conveniently portable



2

2—Easily installed on the package deck behind the rear seat in an auto sedan or coach, this remote speaker does not require a recessed hole to be cut in the shelf. It is held in position with two small screws



3

3—Combining a 4-band radio, phonograph and television receiver in one compact unit, this new console employs a swinging mounting for the television picture tube so that the image may be viewed from the most desirable angle without moving room furniture

4—Handy auxiliary weatherproofed car speaker is provided with a heavy rubber-covered hanger which fits over the car door sill when the glass is rolled down

5—As handy to use as a desk fountain-pen set, this improved crystal microphone features a detachable base for hand operation. It is especially recommended for P.A. systems, home recorders and amateur phone use

6—Hearing-aid B-battery charger operates from 110-volt house line. It is claimed to extend the useful life of the battery. The user rotates two batteries, one in use and the other is placed on charge each day

7—Five-tube built-in radio fits into a steel flush wall receptacle 6½ in. high, 9¾ in. long and 3¾ in. deep. It is intended primarily for installation in rooms where space is at a premium, such as modern breakfast nooks, kitchens and children's playrooms

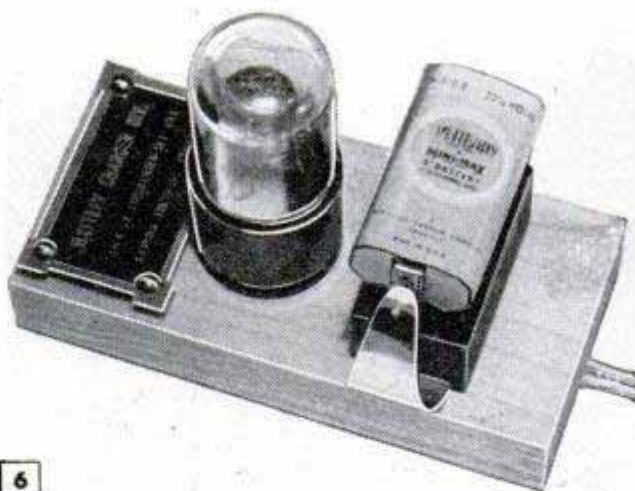

6

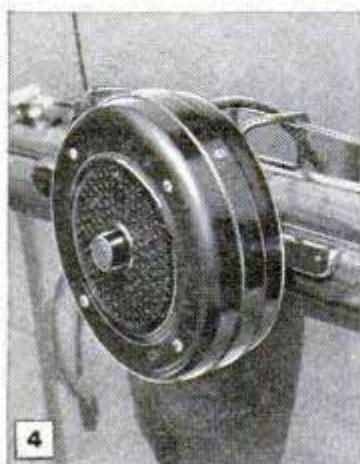

4



5



7



KODAK FILTERS
snap up cloud effects



KODAK POLA-SCREEN
cuts reflected light



KODAK PORTRA LENSES
for magnified close-ups



KODAK LENS HOOD
for side-lighted shots

Give your Pictures
PUNCH
with Kodak Filters
and Combination
Lens
Attachments

Easy to use . . . inexpensive

Why not get in on the fun of making better pictures than the next fellow? It's as simple as one, two, three.

1. Snap the right Kodak attachment on your camera lens
2. Check lens for correct adjustment
3. Trip the shutter for the "best shot in the book"

Ask your Kodak dealer to show you the wide choice of Kodak Filters and Combination Lens Attachments. He also has pocket-size Kodaguides that give correct camera settings for filter and film combinations.

EASTMAN KODAK CO.
Rochester 4, N. Y.

"Kodak" is a trade-mark

Kodak

Speed Sweep

+ Arbitrin



Speed Sweep, the brush with the steel back, is designed to sweep cleaner, faster, easier, and to outlast ordinary brushes 3 to 1. Arbitrin sweeping fluid, sprayed on the floor before sweeping, disinfects, deodorizes, and removes stains in the process of sweeping. These, plus many more advantages (16 in all) have proved to be the perfect answer to effective, low cost floor sanitation in over 60,000 factories, offices, schools, and stores. Mail coupon for complete facts. Milwaukee Dustless Brush Co., 530 N. 22nd St., Milwaukee 3, Wis.

Milwaukee Dustless Brush Co.
530 North 22nd St. • Milwaukee 3, Wis.

We are interested in complete information about Speed Sweep brushes and Arbitrin sweeping fluid.

Name

Address

City Zone State

Prospecting for Better Metals

(Continued from page 149)

2000 degrees Fahrenheit — an increase of several hundred degrees over previously attainable temperatures. A series of 20 tungsten-wire "hairpins," through which electric current passes to produce tremendous heat, is the heart of the furnace.

Still another piece of the giant jigsaw puzzle is being fitted in place with the aid of radioactive, "tagged" atoms, like those being used to track down and treat diseases of the human body. Here the problem is to find out how and why carbon, phosphorus and other elements affect the properties and behavior of metals.

James K. Stanley is tackling this problem by administering tiny "doses" of the tagged atoms and then tracing their path through the metal by means of sensitive recorders and counters. Only a pinch of the radioactive material is required to follow it through as much as a ton of molten steel. The electrons and rays thrown off by the "exploding" atoms are ticked off by the famed Geiger counter, while the position of the tagged atom can be determined by periodic exposure to a photographic plate which fogs up when bombarded with atomic particles.

The case of the "wandering" carbon atoms is another major project.

"Under the effect of heat, carbon atoms are always meandering about in the internal structure of metals," says Stanley. "Even at room temperature, the carbon atoms in the steel beams of a building, for example, are constantly taking up new positions, resulting in what metallurgists call 'aging' of steel, and bringing about a slight strengthening of the metal. The position of such atoms also determines the hardness and wearability of the metal, as well as brittleness. If we can follow the path of the atoms as they move through the metal and take up definite positions, we may eventually arrive at methods of spotting the carbon in the most advantageous places."

For this purpose, the scientists use radioactive carbon 14, which has a half life of 5000 years and hence can be stockpiled.

In another laboratory, scientists are "looking inside" metals in quite a different way. A plastic model of some piece of industrial equipment—a crane hook, for example—is loaded with heavy weights, and heated to somewhere around the boiling point of water. Then with the weights still attached, the model is cooled gradually down to room temperature. Next the scientist examines the plastic hook under

(Continued to page 224)



*Radiator rusted-
Vacation busted*

Clean out rust with

DU PONT Cooling System CLEANSER

Before your engine is ruined by overheating, clean out rust and scum in the radiator. Just pour in a can of DU PONT COOLING SYSTEM CLEANSER, run the engine 30 minutes or more, then drain. No reverse flushing is necessary. It dissolves rust—cleans thoroughly, quickly, and safely.



Then keep out rust with

DU PONT Acid and Rust INHIBITOR

After cleaning out the radiator, you can keep it free from rust all season by pouring in a can of DU PONT ACID AND RUST INHIBITOR. This neutralizes the acid and prevents damaging rust from forming.



Avoid radiator leaks with

DU PONT Cooling System SEALER

You can stop leaks quickly and securely—and make the cooling system LEAK-PROOF—by pouring in DU PONT COOLING SYSTEM SEALER. It will not clog the radiator or harm hose or metal parts.



DU PONT

BETTER THINGS FOR BETTER LIVING
...THROUGH CHEMISTRY

REG. U.S. PAT. OFF.

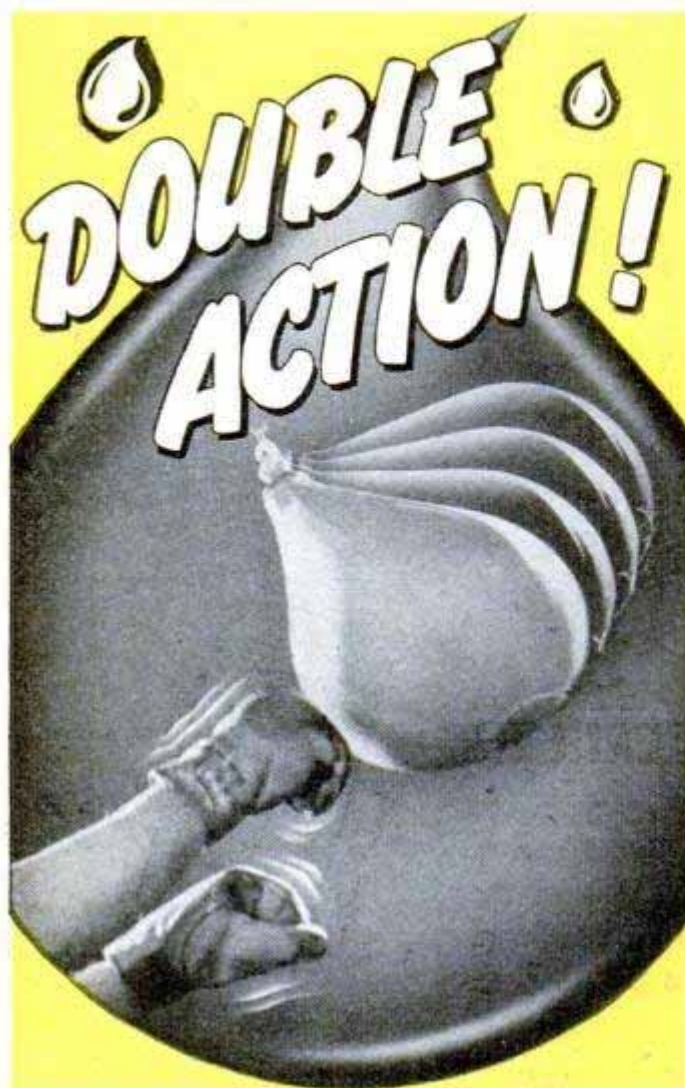

PENNZOIL

MOTOR OIL

FLOWS FAST-STAYS TOUGH!

Your car's engine needs *instant* protection during warm-up, *lasting* safety for all kinds of driving...

Pennzoil gives you both!



Copyright, 1948, The Pennzoil Co.

At this sign of better dealers, coast to coast

*Registered Trade Mark Member Penn. Grade Crude Oil Ass'n., Permit No. 2

**Tough-film PENNZOIL* gives all engines
an extra margin of safety**

Beginner's One-Tube A.C.-D.C. Loudspeaker Set

(Continued from page 215)

connections are neat and well made. No. 20 flexible insulated hookup wire is used for the circuit connections. It is necessary that the negative ends of the electrolytic filter condensers C2 and C3 be connected to common floating ground on the tie-point lug, as shown in Fig. 2. Mount the speaker-output transformer so that the primary leads face the tube socket, and drill two small holes for the leads that pass down through the base. The secondary leads connect directly to the voice-coil terminals on the speaker. A universal output transformer may be substituted, if desired.

Like any extremely simple receiver, this one has its limitations. Therefore, for maximum results a good antenna is absolutely necessary. If there is only one station in your locality, make this antenna as long and as high as you possibly can. If there are a number of stations in the area, you will have to compromise, since a long antenna will make the stations overlap on the tuning range. If the stations cannot be separated by adjusting the position of the slider on the tuning coil, shorten your antenna gradually until you can tune out the undesired station. No external ground is required on this set, and none should be used. Do not expect loud volume on distant stations as this receiver will only amplify the signals that can be picked up by the crystal detector, and these are usually limited to strong local broadcasting stations. With a good antenna, the results are highly satisfactory. The chassis base is intentionally large and provides room for experimenting with other circuits in which practically all of the same parts can be used. Detailed student material list R-368 is available from Popular Mechanics Radio and Electronics department upon receipt of ordinary letter postage.



**Model Builders
Attention!**

	V	V-2	V-3
Hex	1/2"	3/8"	5/16"
Thread	3/8"-24	1/4"-32	1/4"-32
Thread Length	7/32	7/32	5/32
Weight, Grams	8	3 1/2	2 1/2

Actual Size V-Plug

Champion Spark Plugs for model gas engines give the same dependable performance as regular Champions. Champion Ceramic insulation—Sillment sealed. Alloy needlepoint electrodes for easy starting. One piece construction.

CHAMPION

SPARK PLUG COMPANY • TOLEDO 1, OHIO

Dependable
CHAMPION

America's Favorite Spark Plug

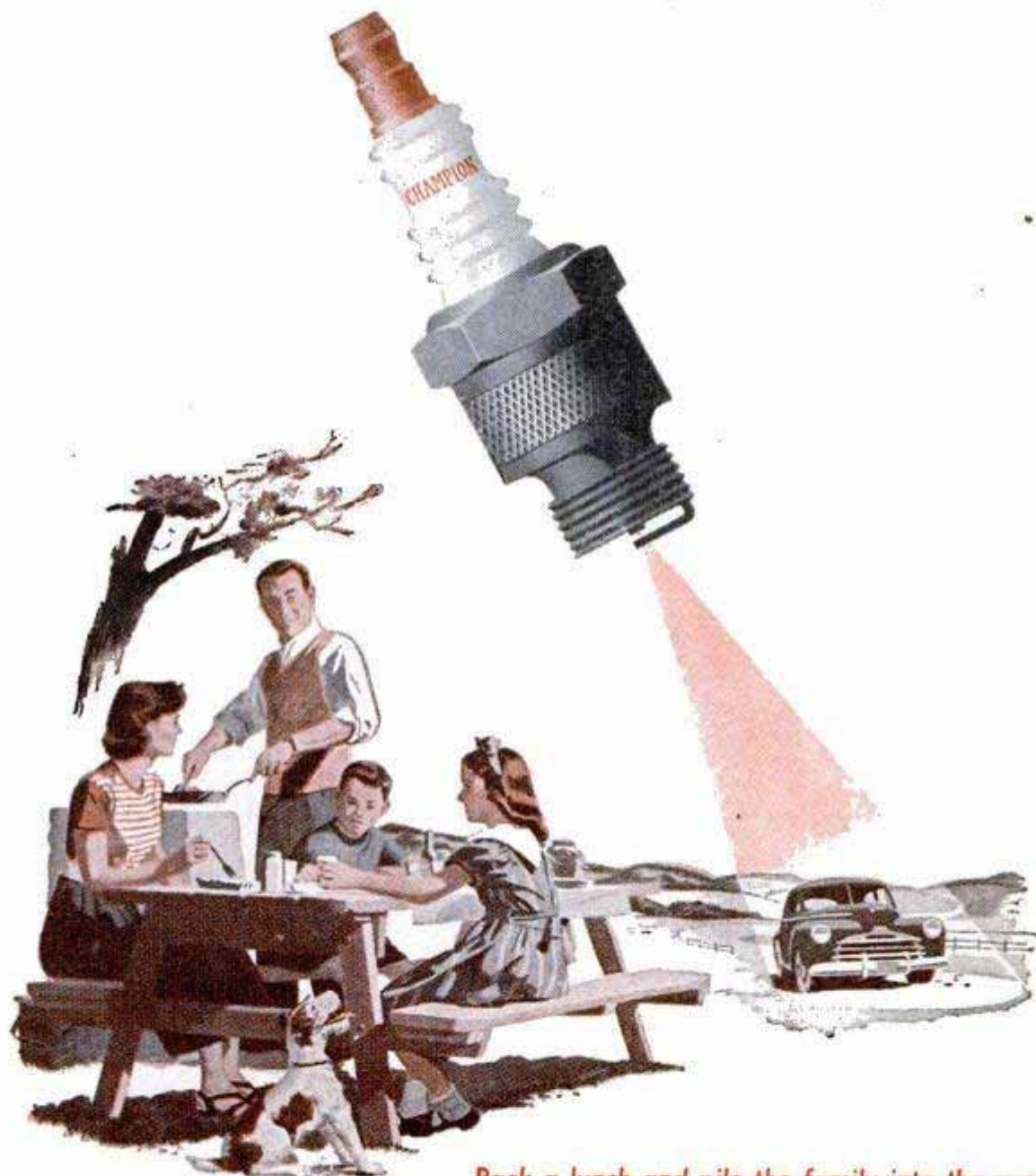

Pack a lunch and pile the family into the car, and all out-of-doors is yours to enjoy through the mere turn of an ignition key.

The key to good ignition and a carefree day is the most dependable spark plug you can buy. Be sure you have dependable Champion Spark Plugs in your engine.

They are the overwhelming choice of such experts as the racing champions of land and water, and are preferred and used by most motorists.

Champion Spark Plug Company, Toledo 1, Ohio.

FOLLOW THE EXPERTS DEMAND NEW DEPENDABLE CHAMPIONS FOR YOUR CAR

Listen to the CHAMPION ROLL CALL... Harry Wismer's fast sportscast every Friday night, over the ABC network



Orphan? What do you mean, Dad?

This chisel. There's no brand name on it.

What of it? Just feel that edge.

That's not much to go by when you're buying a chisel, son. Even a piece of cheese can have a sharp edge, you know.

You mean this chisel's no good?

I mean you can't be *sure* it's good. No brand name, no reputation to back it up. It's one of those bargain counter orphans—and they generally let you down.

Well, it didn't cost much, anyway.

Better get your money back—if you can. And then go over to the hardware store and buy a *good* chisel—one with an advertised brand name you can trust. The hardware man will always steer you right.



POPULAR MECHANICS

IF YOUR DRILL ACTS LIKE
THIS... IT'S TIME TO USE
THE GRINDER. . . AND

IF YOUR CAR FEELS LIKE THIS...
IT'S TIME FOR MARFAK
CHASSIS LUBRICATION



THAT CUSHIONY FEELING LASTS LONGER WITH MARFAK!

You want lubrication that does its stuff—not for just a couple of hundred miles—but for 1,000 miles and more. That calls for tougher, longer-lasting *Marfak* Chassis Lubrication. It really sticks to bearings and wear points. You can *feel* it in the cushiony way your car rides and the easy way it handles. Applied by chart, never by chance. Ask your nearby Texaco Dealer, the best friend your car ever had, for *Marfak* Lubrication.



THE TEXAS COMPANY
TEXACO DEALERS IN ALL 48 STATES

Tune In: TEXACO STAR THEATER every Wednesday night featuring Gordon MacRae and Evelyn Knight. See newspaper for time and station.



**Fun Spots are
Quickly Reached with a
HARLEY-DAVIDSON!**

Every highway and byway leads to holiday land, every road reveals new pleasures . . . in the world's greatest sport, motorcycling! Go picnicking, vacationing, adventuring, where and when you please! Take in exciting race meets, gypsy tours, hillclimbs, endurance runs! Enjoy the new sense of freedom, the thrilling fun that's always yours whenever you swing into the big, comfortable saddle of a smooth-riding, fleet-footed Harley-Davidson. Owning a world's champion Harley-Davidson is easier than you think. See your dealer today. Mail coupon now.

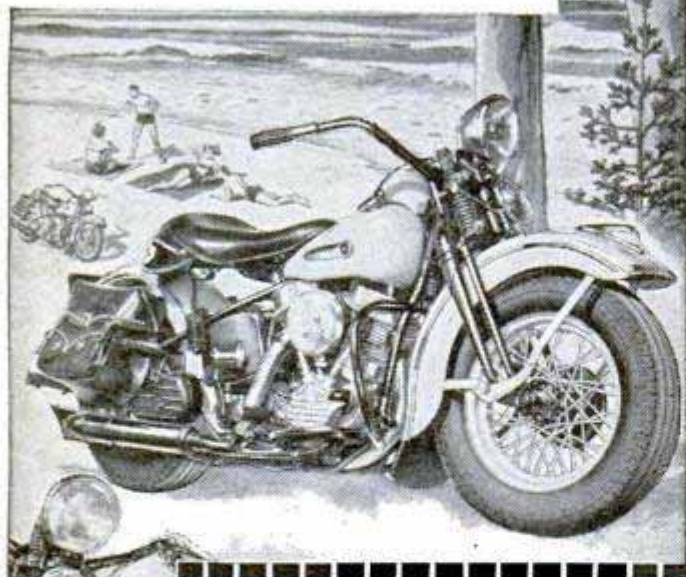

HARLEY-DAVIDSON MOTOR COMPANY
Dept. P, Milwaukee 1, Wisconsin

Send free copy of ENTHUSIAST magazine filled with motorcycle action pictures and stories; also literature on late models.

Name.....

Address.....

City.....Zone.....State.....

special polarized light. What he sees is a series of brightly colored lines—red, yellow, green in a definite progression—literally “frozen” into the plastic material.

This is called the photoelastic method for studying how metals react to various loads. To the scientist's skilled eye, every line in the brightly colored pattern tells a story: how great the stresses are, where the greatest concentration of stresses occurs, and in what direction they are.

In the quest for new metals there are many other prospectors: researchers who make elaborate, painstaking analyses of the “creep” or plastic flow in metals, those who are probing the grain size and structure of metals to find out what secrets can be yielded here, and those who try countless combinations in the hope of developing new alloys for particular applications.

Although they work independently—each intent on his own area of conquest—their efforts are solidified on one broad frontal attack with a common objective: the creation of new alloys and metals to further man's progress.

Optical Glass Cookers

(Continued from page 156)

Expert glass molders manipulate the glass at this stage. The rough pieces are first heated gradually in a preheating furnace to a temperature just below the softening point. Each piece is then picked up on the end of a steel pontil rod or punty as it is commonly called. The molder thrusts the hot glass fragment into a molding furnace and spins it until it is just fluid enough to start dropping off. He then quickly withdraws the punty from the furnace and, holding the soft glass over a heated steel mold, cuts off the right size piece with a pair of shears.

The hot syrupy glass drops into the mold and is pressed into shape. The molds are left to cool. When cool enough to be handled, the blanks are taken from the molds and inspected by immersion in a liquid having the same index of refraction as the glass.

The method gives an X-ray picture of the glass. In the liquid the glass surfaces of the blank disappear and any imperfection beneath the surface of the glass shows up clearly when illuminated.

As the glass had solidified in the molds, internal strains were created which seriously affect its physical and optical properties. One of the most critical processes in the manufacture of optical glass, annealing, is used to remove these strains. The blanks

(Continued to page 230)

Ingenious New Technical Methods

To Help You
Simplify Shop Work

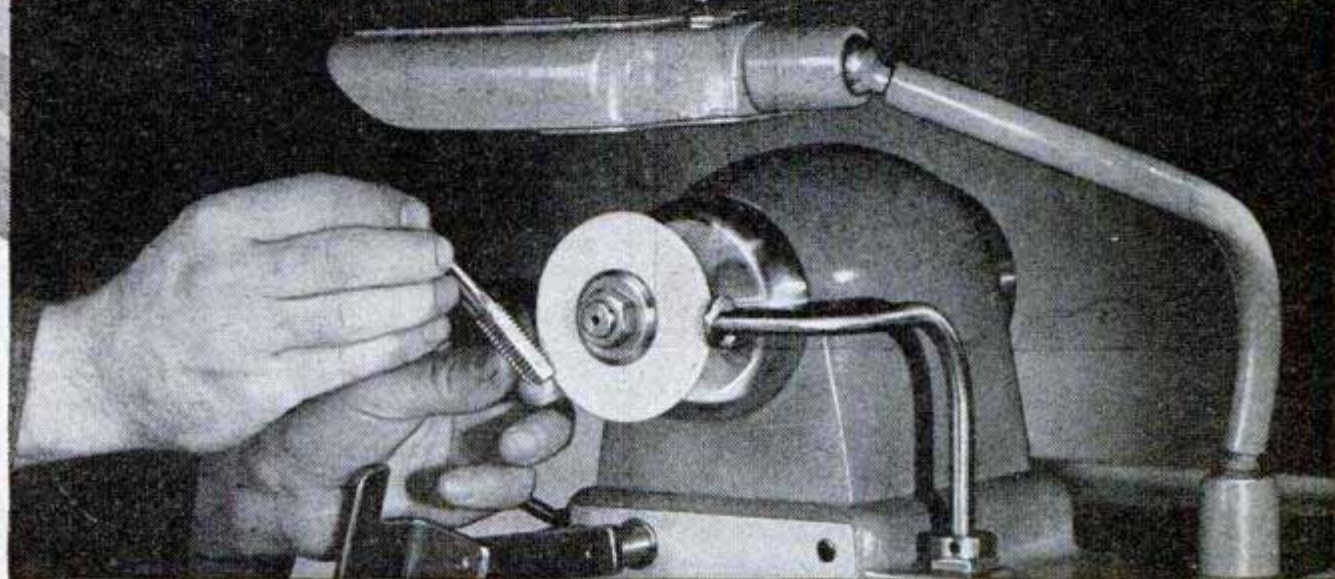

Versatile New Grinder Saves Time —Improves Grinding Efficiency

A new grinder, the Corlett-Turner G-3, permits changing of grinding wheels in a matter of seconds and assures a true running wheel at all times. Each wheel is individually mounted on a ground, tapered arbor.

Easy wheel changing is accomplished by a slight wrist motion on the end bells of the grinder head. A twist to the left releases the wheel arbor; the reverse action instantly secures it in place. It's all done in a matter of seconds. No costly time is lost in repeated wheel dressing.

In addition to its primary function, the G-3 grinder has innumerable uses for burring, buffing, polishing, and production applications requiring a high speed spindle. Powered by a 1/3 horsepower motor, a three-step pulley arrangement provides speeds of 5600, 8000 and 12,000 r.p.m.

Efficiency in precision work is also increased when tension is relieved by the act of chewing. And chewing Wrigley's Spearmint is a pleasant, easy way to help relieve workers' nervous tension. For these reasons Wrigley's Spearmint Chewing Gum is being made available more and more by plant owners everywhere.

Complete details may be obtained from
Corlett-Turner Co., 1001 S. Kostner Avenue
Chicago 24, Illinois

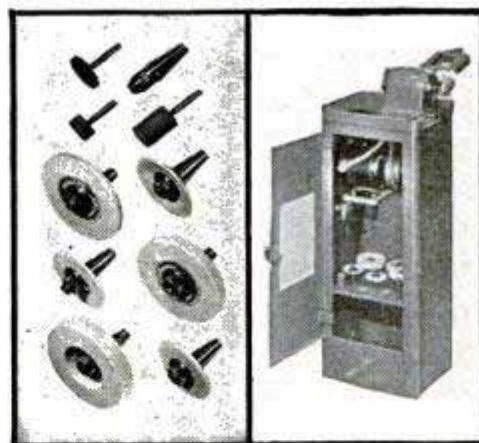

Grinding
Wheels

Corlett-Turner
Grinder



AC-69

THE FAITHFUL
HEART
OF YOUR FUEL
SYSTEM



**OVER
30,000,000 IN USE
TODAY**

Pulsing steadily, nearly 100,000 times an hour, your AC Fuel Pump is the strong, reliable heart of your fuel system. It has given you long, faithful service because of its inbuilt quality and scientific design.

You can prolong that faithful service indefinitely, if you insist upon a new AC when you replace your present pump.

There is no satisfactory substitute for quality.

AC Fuel
Pumps

AC SPARK PLUG DIVISION • GENERAL MOTORS CORPORATION

Clinic



for Homemakers

As a service to our readers in solving the hundreds of problems pertaining to a home—inside or out—the editors of *Popular Mechanics* invite you to present your problems to The Clinic Editor for help and advice. Address your questions to The Clinic Editor, *Popular Mechanics Magazine*, 200 East Ontario Street, Chicago 11, Ill.

Puttying Window Sash

Q—I reputted most of the window sash in my home a year ago. The putty was allowed to dry two weeks before the sash were painted. Now the putty seems to be loose and on some of the windows, sections of it have fallen out. What is the cause of this and what is the remedy, if any?

H.M.—Lincoln, Neb.

A—It is essential that the wood be thoroughly dry before new putty is applied, and it also is necessary to paint the exposed wood in the rabbet with a light priming coat before the putty is applied. The procedure steps are: Remove all cracked and loose putty and clean the fine material out of the rabbet with a wire brush. Then apply a priming coat of paint in the rabbet, using the same color primer as will be used for the finishing coats. Apply putty after the paint is dry. After the putty has hardened, paint the sash in the regular way.

Water Creeps Under Front Door

Q—During driving rainstorms water comes under my front door, which is directly exposed, there being no hood or porch. Due to the location of the door, I cannot install a hood without some alteration of the exterior. Is there any other remedy for this trouble?

G.F.—Birmingham, Ala.

A—There are several remedies, of course, but usually the simplest is to rehang the door, although in some instances it is easier to install a new threshold. In either case the idea is to relocate the door or the threshold so that the outer edge of the door bottom overhangs the top edge of the threshold bevel about $\frac{1}{4}$ to $\frac{3}{8}$ in. In rehang the door, simply move the hinges, stops and striker plate out $\frac{1}{4}$ to $\frac{3}{8}$ in. This usually can be done without damaging the frame in any way. The alternative is fitting a new threshold so that the outer bottom edge of the door overhangs it as described. When the door or threshold are installed in this way, water drips from the lower outside edge of the door directly onto the sloping bevel of the threshold and is carried away.

Repairing Cracks in Stonework

Q—How can I fill narrow cracks in the stonework across the front of my house? The stone is a reddish-brown color.

W. S.—Oklahoma City, Okla.

A—If cracks follow the mortar joints the wall should be pointed up in the usual way, but to fill small cracks in the stone, mix equal parts of red lead and litharge, and add glycerine to make a thick paste. Then apply to the cracks with a stiff-bristled brush or with a putty knife.

(Continued to page 228)



Quick Patching Floor Cement

Fill in cracks, ruts, shallow holes and spreading seams in concrete floors with Smooth-On No. 7B Quick Floor Patch Cement. Made especially for patching concrete. Hardens quickly and stays in place, for it expands slightly as it sets. Buy Smooth-On No. 7B by name and number in 1-, 5-, 20- or 100-lb. size. If your hardware store hasn't it, write us.

FREE Leaflet and Handbook

Leaflet shows how to apply Smooth-On No. 7B. 40-page Smooth-On Handbook describes other Smooth-On Cements and shows many time-saving, money-saving household and auto repairs. Cracks sealed, leaks stopped, loose parts tightened. 170 illustrations. Write for both — free — today.



SMOOTH-ON MFG. CO., Dept. 37G
570 Communipaw Ave., Jersey City 4, N. J.

Do it with
SMOOTH-ON
NO. 7B IRON CEMENT

SEE IT! RIDE IT! BUY IT!

The New '48 Whizzer **Bike Motor**

New Twist-Grip controls . . . Carter carburetor
. . . new steel cable core notched V-belt drive . . .
new ignition . . . chrome trim, 2½ h.p. 4-cycle
engine . . . 125 miles per gal., 35 m.p.h.

It's Wise To Go
WHIZZER
Ride 5 Miles for a Penny!

Still Only **\$97.55**
PLUS TAX
F. O. B. Pontiac, Mich.

See Your Whizzer Dealer Today . . . or write Whizzer Motor Co., Pontiac, Mich. For 10 years—world's largest bike motor builder.

DON'T YOU BELIEVE IT! THAT PISTON RINGS ARE ROUND

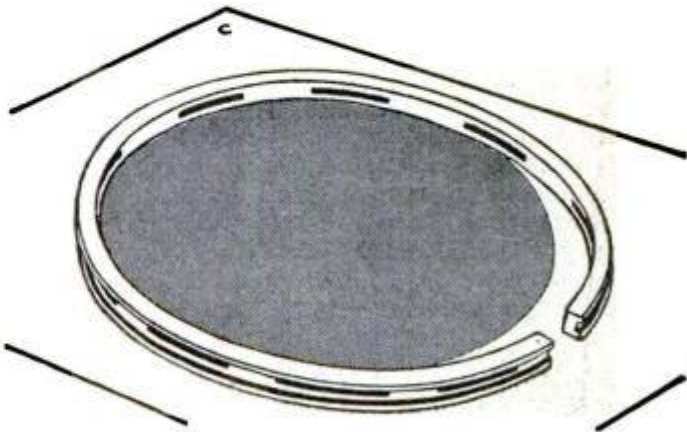

● Many people are under the impression that piston rings are made round. Burd "Graf-Flox" Piston Rings are purposely made *out-of-round* to insure uniform tension and perfect roundness when the rings are compressed around the pistons within the engine cylinders. Each type of ring has its own special metal formula to impart the right degree of hardness, flexibility, tension and long life for its specific use. The exclusive "Graf-Flox" process insures faster seating . . . without danger of rings scoring, seizing, or sticking in piston grooves. Burd "Graf-Flox" Piston Rings *stop* fuel and oil losses . . . *restore* pep and power. The coupon will bring you more information in two FREE booklets.



BURD PISTON RING CO.
ROCKFORD, ILLINOIS

BURD
AUTOMOTIVE
PRODUCTS

"Engineered for results"

MAIL THIS COUPON FOR THESE FREE BOOKLETS

BURD PISTON RING CO., DEPT. 118-G
Rockford, Illinois

I'd like copies of your "Servicemen's Handy Handbook" which tells how to keep my car in good working order, and the booklet "No Job For a Dub."

Name

Address

City..... State.....



**HERE'S ONE
for your boat!**

The right one! From the complete six-model Evinrude line, it's easy to choose the motor that gives you exactly what you'd like in power and performance. Three thrilling four-cylinder motors . . . smoothest on the water! A brilliant new "Sportwin" with dozens of exciting new features! Two models with the revolutionary FISHERMAN DRIVE — weedless, shoal-riding, snag-proof . . . a boon to fishermen! See your Evinrude dealer — look for his name under "Outboard Motors" in the yellow pages of your phone book. Catalog FREE — write EVINRUDE MOTORS, 5807 N. 27th St., Milwaukee 9, Wis.

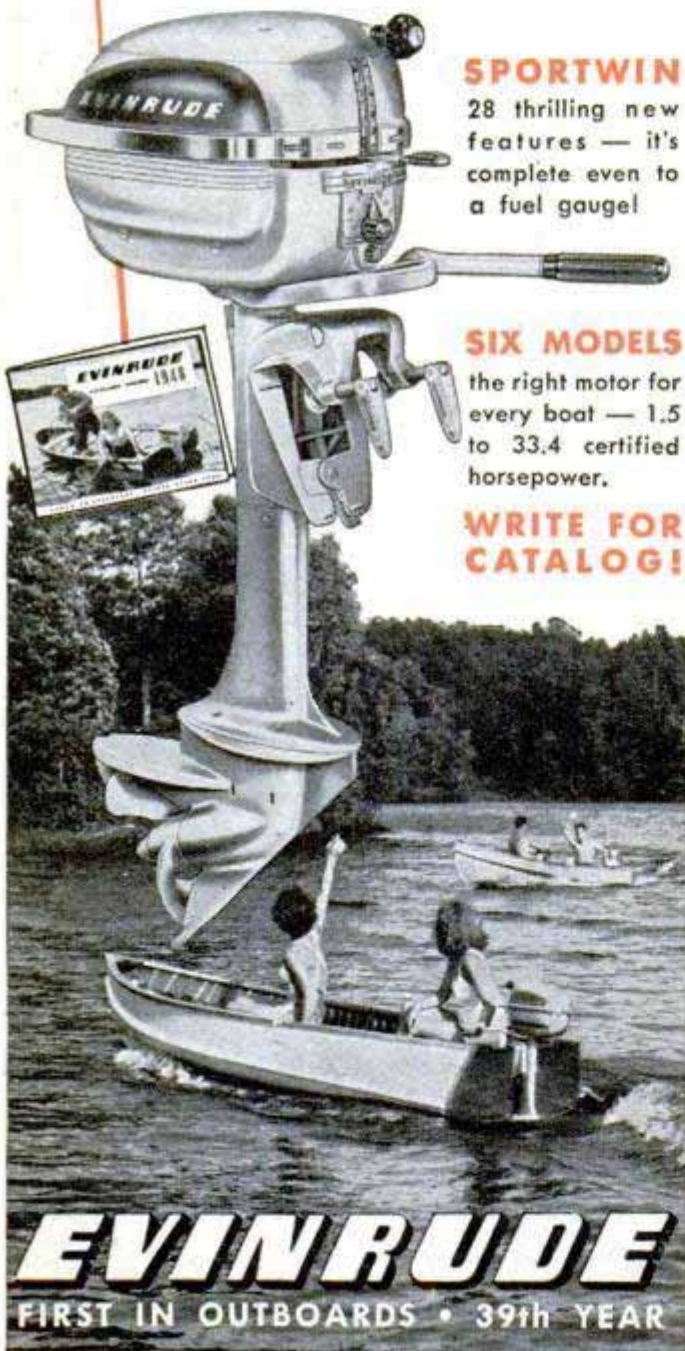

SPORTWIN

28 thrilling new features — it's complete even to a fuel gauge!

SIX MODELS

the right motor for every boat — 1.5 to 33.4 certified horsepower.

WRITE FOR CATALOG!

Installing Cleanout in Chimney

Q—My chimney has no cleanout door at the bottom. Soot has filled the flue up to the furnace-pipe opening, and it seems impossible to get it out by any means I know of. The chimney is lined with tile. How can I break an opening through this tile to install a cleanout door, and is there any substitute for a cleanout door? I have found it impossible to obtain one thus far.

E. R.—Lynn, Mass.

A—In many cases the tile lining does not extend to the bottom of a single-flue chimney, especially where the tile is square or rectangular in section. It is easy, therefore, to break an opening in the brick with a bricklayer's chisel or an ordinary cold chisel. Make the opening large enough so that the cleanout door can be set in mortar. Where the tile lining extends to the bottom, break through the bricks and chip the opening to the proper size. Then score the tile deeply with a cold chisel, and it will be possible to break through it without shattering. A discarded check damper of cast-iron construction makes a good cleanout door.

Removing Ink Stains From Fabric

Q—Recently I spilled writing ink on an article of clothing. Can you tell me what will remove the ink stains without damaging the fabric?

J. G. R.—Monterrey, N. L., Mexico

A—To remove ordinary ink stains from fabric, first soak the material in lukewarm water. Next squeeze or wring very lightly and spread over a clean, dry cloth. Apply a few drops of concentrated liquid ammonia, specific gravity 0.891, to the ink stain. Then saturate a tuft of absorbent cotton with dilute phosphoric acid and apply repeatedly to the ink spot. Press firmly but do not rub. Finally, rinse the fabric in clean, warm water and dry in the sun.

Reseeding Old Lawn

Q—My lawn is patchy and infested with weeds, and on several spots moss appears to be crowding out what little grass there is. The soil is very hard — seems to be mostly clay — and grass seed does not germinate and take root except in a few scattered places. I do not want to go to the expense of reworking, tilling and reseeding the entire lawn. Is there any other method by which I can improve it, get rid of the weeds, etc?

J. V.—Terre Haute, Ind.

A—Unless you rebuild the sod completely, you cannot expect to attain a perfect lawn, but there is much you can do to improve what you have. First, allow the grass to grow to a height of 3 or 4 in., and clip any tall-growing weeds with a small scythe or weed hook. Then apply a complete lawn fertilizer which is combined with a weed killer. This should be applied with a wheeled spreader so that you get uniform distribution. Several applications may be necessary during one season to kill the weeds and stimulate growth of the grass. As the weeds are killed out, there will be bare spots. Loosen the soil lightly in these spots with a spading fork and then spread rich black soil over the whole lawn, raking it to a uniform depth of about 1½ to 2 in. so the blades of grass will be exposed to the sunlight. Next, apply grass seed and fertilizer, mixed half and half, with the spreader. Finally, when the top ½ in. of soil is dry, roll the entire lawn. Do not rake it, as this tends to bunch the grass seed. By repeating this process of applying seed and fertilizer over a period of several seasons, your lawn will be greatly improved.

Removing Dark Stains From Red Linoleum

Q—The cabinet tops in my kitchen are red linoleum and lately several dark-colored stains in the form of rings have appeared on the top of one cabinet. How can I remove these stains?

Mrs. J. M.—Boise, Idaho.

A—Go over the stains lightly with fine steel wool, working carefully so that the wool does not bunch and scratch the surface. Then wash with mild soap and water and wipe dry. Saturate a cloth with furniture polish and rub, first with the saturated cloth, then wipe with a dry, clean cloth. Finally, apply several coats of paste wax, polishing each coat to a high gloss.

Floralite

Your Garden **FOR ONLY \$5.00**



DON'T LET NIGHT-TIME BLACKOUT THE BEAUTY OF YOUR GARDEN

Can you picture the magic of an electric-lighted garden? Roses, azaleas, iris, shrubs, take on new glory when back-lighted, or high-lighted with FLORALITE. Flower gardens that ordinarily lose loveliness after dark now become the center of attraction. Just place FLORALITE near your favorite garden spot, plug in cord, and your garden fairly glows with nighttime splendor! Amber light of FLORALITE does not attract insects. Height 24", plus 8" push-in-ground base. Approved all-weather electric cord. On sale at electric, hardware, department stores, and florists everywhere!

Write for **FREE** folder today!

STEBER MFG. CO.
Dept. 85, Maywood, Illinois

PROFITS AND SPEED

THE MODERN LAWN MOWER SHARPENER

PRICE
\$241⁵⁰
LESS
MOTOR

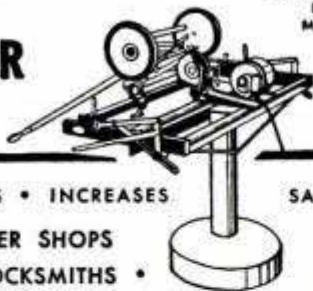

INCREASES PROFITS • INCREASES SALES!
FOR LAWN MOWER SHOPS
FIXIT SHOPS • LOCKSMITHS •
HARDWARE STORES • GOLF COURSES • SCHOOLS
PARKS • PLAYGROUNDS • INSTITUTIONS •
CEMETERIES • AND ALERT INDIVIDUALS!

Sharpens All Reel Type Mowers • Hand, Power or
Gang • 10 to 20 Minutes • No Dismantling
No Extra Attachments Needed

All reel type mowers, from 5-inch edgers to 36-inch power mowers, are quickly sharpened to extreme ends of both left and right twist reel blades. Handle, wheels, roller and motor remain in place when sharpening is in process. Bed knife is sharpened in same brackets that hold mower in grinding position. No extra attachments required. One lever puts mower or bed knife in grinding position. 100% steel construction. Grinding head rides on five ball bearing races. Small, compact, easy to operate. Sharpens wood chisels, joiner knives and planer blades without extra attachments.

ORDER NOW
Immediate Delivery

Skate Sharpener Attachment Available
Send For Free Bulletin No. 10B

MODERN MFG. CO. 160 N. FAIR OAKS AVE
PASADENA, CALIFORNIA

NOW

THE JIFFY METAL CABINET WITH RUSTPROOF ALUMINUM DRAWERS



32 DRAWER UNIT \$8.95
POSTAGE PAID

64 DRAWER UNIT \$15.95

APPROXIMATE SIZES DRAWER
1 1/4" Deep
2 3/4" Wide
6" Long

32 DRAWER UNIT
6" Deep
12 3/4" Wide
15 1/4" High

64 DRAWER UNIT
6" Deep
25 1/2" Wide
15 1/4" High

for home or shop,
the handy way to
keep small parts,
washers, nuts, bolts,
nails, screws, etc.

AND STILL AVAILABLE

32 DRAWER UNIT \$5.95
POSTAGE PAID

64 DRAWER UNIT \$9.95

Solid one-piece aluminum drawers for greater strength and long life—and still at low cost. So handy to keep office, shop, work bench, household and hobbyist needs at your fingertips. Spot welded steel cabinet, enamel finish, and metal flange drawer guides.

32-Drawer Unit—\$8.95. 64-Drawer Unit—\$15.95. Postage Paid. Send check or money order. No C. O. D.'s, please. Add 3% sales tax for Ohio orders.

THE JIFFY METAL CABINET WITH LAMINATED FIBREBOARD DRAWERS

Same steel cabinet as above with covered fibreboard drawers. Suitable for most home needs. Thousands in use. 32-Drawer unit—\$5.95. 64-Drawer unit—\$9.95. Postage Paid. Check or money order. No C.O.D.'s. Add 3% sales tax for Ohio orders.

KAYTEE PRODUCTS
DEPT. M • BOX 588 • CANTON, OHIO

SAY YOU SAW IT IN POPULAR MECHANICS

Riegel WORK GLOVES

tops in...



comfort...
economy...
long wear

Enjoy the genuine comfort and protection of Riegel Work Gloves. They cost no more . . . and you'll find them tops in working ease and rugged resistance to wear. Made from raw cotton to finished glove, in America's largest work glove plant.

STYLES TO FIT EVERY NEED

canvas, jersey, leather . . . knit wrist, band top, gauntlet . . . double-palm, reversible, quilted . . . for factory, farm and home. Ask for the Riegel brand wherever work gloves are sold.

Riegel Textile Corporation
342 Madison Ave., New York 17, N. Y.

**Riegel
WORK
GLOVES**



FREE

Full descriptive literature if requested on business letter-head.

"THIS TRADE MARK IS YOUR GUARANTEE OF VALUE"

are packed in metal cases and heated at carefully controlled temperatures in electric furnaces. They are then slowly cooled so that neither strains nor refractive inequalities develop.

Removed from the furnace, the blanks are again inspected in the immersion tank. After grinding and polishing, the optical element is ready for installation in binoculars, microscopes or other instrument. The grinding and polishing is done on ordinary abrasive wheels and buffing machines.

A peak production of 236,000 pounds was reached in 1943 by the Bureau of Standards. By the summer of 1944, there was a drop in production as requirements of the armed services were beginning to be met by commercial plants. Today, the Bureau is producing special types of glass and advancing optical-glass research.

Thus the little-publicized glass factory only a few miles from the White House was and still is a vital part of our glass industry. Because of its continuing research, your new binoculars and microscope "see" more than the old ones did.

The Story of Rope

(Continued from page 141)

the rope manufactured in the United States is used for general marine purposes. Another third goes to industry and agriculture. The remaining third is used for making wire-rope centers, for commercial fishing, oil-well drilling and miscellaneous purposes.

In addition to rope, agriculture, industry and commerce consume huge amounts of wrapping and baler twine. An official of the U. S. Department of Agriculture says:

"If no harvesting machines were made for a year, farmers would be inconvenienced . . . but they'd get along. However, if the supply of twine for a single harvest were suddenly cut off, it would mean not only a national but an international calamity. It would be impossible to get enough help to gather the crops."

The Plymouth Cordage Company, one of America's oldest and largest rope-makers, recommends 15 rules for the proper care of rope.

Remove from coils properly. When taking the usual right-laid rope from the coil, make sure it unwinds in a direction opposite to clockwise. Lay coil flat on the floor with the inside end at the bottom. Pull end of rope through the center of coil.

Store properly. A dry, unheated building, or a room with free air circulation is the best place to store rope.

(Continued to page 232)

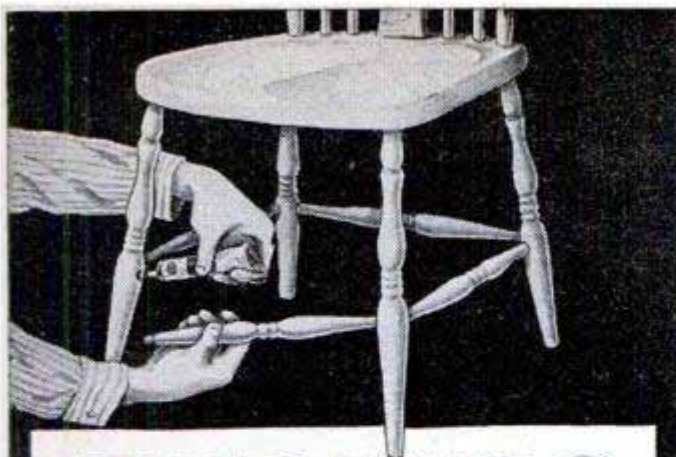

REPAIRS

FURNITURE, LUGGAGE, ETC.

It's transparent, water-proof, flexible and durable.



DUCO CEMENT

REG. U. S. PAT. OFF.

Everything you want for outdoor pleasure when you ride a . . .



Royal Enfield

FAMOUS ENGLISH LIGHTWEIGHT MOTORCYCLE RUNS 100 MILES ON A GALLON OF GAS

Up and go—with the rugged new Royal Enfield popular Model R.E. Style, safety, flexibility, 125 c.c. 2-stroke, single cylinder engine, 3-speed gears; 45 m.p.h. Write today for folder "P", for complete details. Also 350 c.c. and 500 c.c. models are immediately available.

Dealer inquiries given prompt attention.

WHITEHALL DISTRIBUTORS, Inc.
1385 Commerce Avenue, New York 61, N. Y.



STROP YOUR RAZOR AS A BARBER DOES!

For extra shaving comfort plus economy

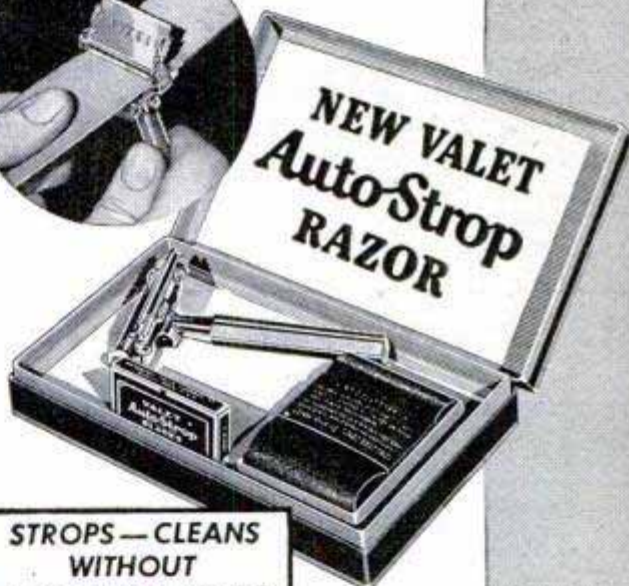

STROPS—CLEANS WITHOUT REMOVING BLADE

RAZOR, STROP AND 5 VALET BLADES

\$1.25

SELF-SHARPENING . . . ONE PIECE

SOUTH BEND

QUALITY LATHE DOGS

Heavy malleable iron. Tail shaped to fit face plate slot. Standard Dog has square head screw. Safety Dog has headless screw. Prices for either style.



Capacity	Price*	Capacity	Price**
1/2"	\$0.80	3/8"	\$0.70
3/4"	.95	1/2"	.75
1"	1.05	5/8"	.90
1 1/4"	1.20	1"	1.00
1 1/2"	1.40	1 1/4"	1.10
1 3/4"	1.55	1 1/2"	1.35
2"	1.70		
2 1/2"	1.95		
3"	2.20		
3 1/2"	3.00		
4"	4.00		

*13-inch or larger lathes.
**9-inch and 10-inch lathes.

SOUTH BEND LATHE WORKS 455A E. Madison St. South Bend 22, Ind.

Dry after wetting. A wet rope never should be stored—make sure it is thoroughly dry before putting away.

Keep it clean. If your rope gets dirty, wash with clean water and dry thoroughly before storing.

Protect from chemicals. Keep rope away from storage batteries, paint, linseed oil, manure and fertilizer.

Avoid kinks. If usage involves continual twisting in one direction, throw more turns into or out of the rope to avoid damage to rope structure.

Don't overload. With first-quality rope, it is safe to load up to one fifth the guaranteed minimum breaking strength.

Slack off guys. When ropes are used as guy lines, and other supports exposed to weather, they should be slacked off to prevent overstrain due to shortening from wetting.

Avoid sharp angles or bends. A sharp bend reduces tensile strength by putting extra strain on the outer fibers.

Sheave right. You put unnecessary strain and friction load on a rope with sheaves that are too small.

Reverse ends. When using rope as tackle, reverse the ends periodically. If a rope is damaged, cut and splice.

Don't lubricate. A well-made rope is already lubricated by the manufacturer and

no additional lubrication is necessary.

Avoid unnecessary wear and abrasion. Surface wear may come from allowing one rope to chafe another.

Splice correctly. Splices are better and stronger than knots, which reduce the strength of the rope up to 50 percent.

Avoid sudden jerks or strains. A common piece of twine may be difficult to break with a steady pull—yet it can be broken easily with a sharp snap. The same is true of ropes.

Shears With Double Grips Can't Be Picked Up Wrong



Because of the double hand grips, each forming a figure eight, reversible shears can't be picked up the wrong way. They can be used with the pointed blade up or down. The double grips on the handles give greater leverage and prevent cramped fingers.

MAKE LIFE-LIKE PHOTOS OF YOUR FAVORITE HOBBY

WITH THE
Pacemaker

SPEED

GRAPHIC!

Do you have a detailed model train layout that you've never thought of photographing? Or one that you *have* photographed, but not to your satisfaction?

Start to take "breathing" pictures of your pride and joy with a new Pacemaker SPEED (or Crown) GRAPHIC! Whatever your hobby, you can get more fun out of it by taking sharp, clear shots suitable for hanging . . . or for record purposes.

It will pay you to see your Graflex dealer today! Meanwhile, write for literature, Graflex, Inc., Room 42, Rochester 8, N. Y.

GRAPHIC cameras and accessory photo-products are manufactured only by Graflex, Inc., Rochester 8, N. Y.

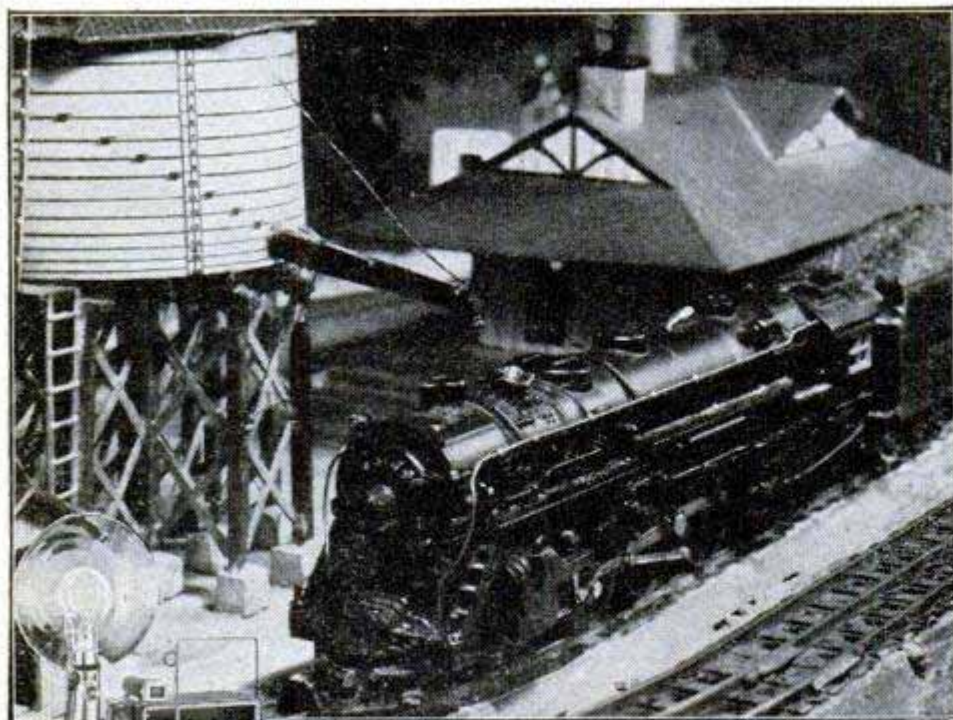

GET PRIZE-WINNING PICTURES WITH

GRAFLEX

Western Division Office, 3045 Wilshire Blvd., Los Angeles, Cal.



SAVE YOUR PRECIOUS EYESIGHT!



Soften that GLARE...
wear these genuine

U. S. ARMY AIR FORCE TYPE

SUN GLASSES



SPECIAL OFFER
WHILE
THEY LAST!

Regular \$15.00 Value

SUPER-SENSATIONALLY PRICED

at only **\$2.49**

including convenient leather case
Men's and Women's sizes!

Imagine! These attractive, optically-correct sun glasses at such a bargain price! U.S. Gov't. approved for meeting all specifications for absorption of ultra-violet and infra-red rays.

DON'T BE A SUMMER AND WINTER SQUINTER!

Effectively protect your eyes from harsh glare of summer sun and winter snow. Wear these smartly-made, official Army type sun glasses for carefree, glare-free pleasure . . . the year 'round!

- Ground and polished 4 base lenses.
- Made to highest optical standards.
- Gold plated adjustable frames.
- Absolute satisfaction guaranteed or money cheerfully refunded.
- Pearloid sweatband and pads.

LIFETIME GUARANTEE!

If at any time during the life of these sun glasses you return them to us for repairs, we will be glad to fix them for a nominal service charge of 50c.

AMERICAN HANDCRAFTERS INC.
Successors To S & B SURPLUS SALES COMPANY

HURRY! FILL OUT AND MAIL THIS ORDER COUPON NOW!

AMERICAN HANDCRAFTERS INC.
2905 W. Madison Street, Chicago 12, Ill.
Dept. PM7

Please send me _____ men's _____ women's SUN GLASSES.

- Send C.O.D.
- Enclosed find check or money order for \$2.49 pr. postpaid.

Name _____

Address _____

City & State _____

(Illinois residents add 2% ret. occ. tax)

Get **BOOK** and **PLANS** for only \$14
and **BUILD THIS HOUSE YOURSELF**

Save

**THOUSANDS
OF DOLLARS
WITH THESE
REMARKABLE
PLANS!**



**POPULAR
MECHANICS**
**Build-It-Yourself
House**

Actual Photograph of House Built
by 23 Year Old Veteran

PROPOSED SECOND-FLOOR PLAN

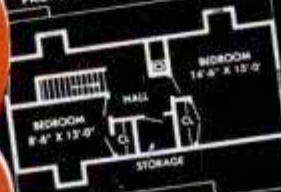

FIRST-FLOOR PLAN



Your HOME
and how to build it YOURSELF

If you can use common tools you can build this house yourself, in any of its five exterior designs, following the Popular Mechanics Build-It-Yourself Book and plans and save thousands of dollars. Even if you have the work done by a contractor or an ordinary carpenter, this amazing book and plans will give you a tremendous saving.

**SPACE FOR LIVING AND
FAMILY GROWTH**

This beautiful, modern home, with breezeway and garage, as pictured above, was built from these same plans and instructions by Jacques Brownson, a 23-year-old veteran in Aurora, Illinois. It is 1½ stories with basement, recreation room, living room, kitchen, dining nook, two bedrooms, bath, plenty of closets and space for 2 additional bedrooms on the second floor. An inspection of floor plans, shown in reduced size, indicates an unusually large amount of good, usable living space that can easily be increased to meet the needs of a growing family. The house itself is 35'-9" x 28'-11"; breezeway 20'-10" x 8'; garage 20'-10" x 12'.

**DESIGNED BY POPULAR MECHANICS
AND FAMOUS ARCHITECTS**

The big, basic idea behind the design of the Build-It-Yourself House is ease of construction (so a man could do the job himself with very little assistance) and the most living space and the most useful space, at the least

cost, considering attractiveness and suitability for any neighborhood and most income groups. It is a home anyone can enjoy and be proud to own.

**Read the Book—Study the
Plans—Start Building
When You Can**

"Your Home and How to Build It Yourself," contains 100 pages, size 8½ x 11 inches. Three-fifths of the book consists of photographs and drawings. Several sections are printed in extra colors and a full-color insert shows just how your own house will look in actual colors. Every detail of the house and its construction is discussed in minute details that will guide you in every step. Plans consist of ten working-size blueprints, giving floor plans, elevations, notes on construction, framing, lumber list, millwork list, specifications, plumbing and wiring diagrams. Every measurement is marked, every detail made as clear as A.B.C.

**FOR EXTRA SAVING ORDER BOOK
AND PLANS TOGETHER**

With the Build-It-Yourself Book as a guide and the remarkably complete plans to follow, any handy man who can use simple tools can build this remarkable house and enjoy every minute of the work while saving thousands of dollars.

Plans

Set of ten full-size working blueprints — easy to read and easy to follow. Every construction detail included. See reduced combination price below.

Book

**Your Home — How to
Build It Yourself**

Plastic bound. 8½ x 11 inches. 100 pages—60 in colors. Complete instructions for building "Build-It-Yourself House." Valuable also to every home builder no matter what house is built. Can easily save you hundreds of dollars—much time, trouble and worry, too.

Order Today

Your Home and How to Build It Yourself \$ 3.00
Complete set of plans 12.50
Book and Plans ordered together 14.00
Duplicate sets of plans 5.00

ORDER BUILD-IT-YOURSELF HOUSE BOOK AND PLANS TODAY!

NOW... *Sheppard* DIESEL POWER for Small Engine Users!

Sheppard

DIESEL POWER UNITS

3.5 to 100 H.P. Pushbutton starting on all models, in any weather, using non-explosive Diesel fuel oil. Easy maintenance, long operating life, low operating costs. All accessories are standard equipment, *no extras to buy*; delivered complete, ready to operate.

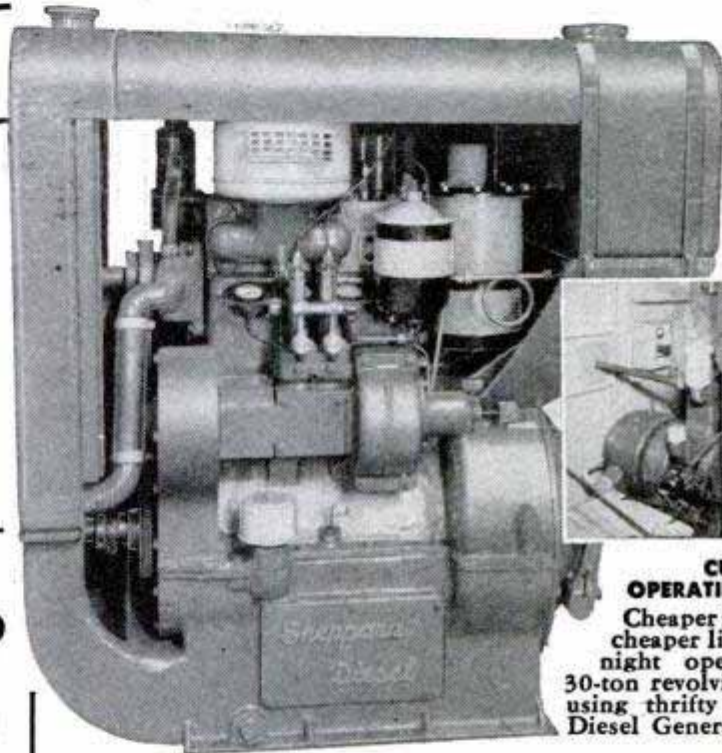

CUTS NIGHT OPERATING COSTS
Cheaper fuel means cheaper lighting for night operation of 30-ton revolving cranes using thrifty Sheppard Diesel Generating Sets.



SMALLEST AIR-COOLED DIESEL AVAILABLE AMAZING 5.4 H. P. SHEPPARD DIESEL

At last—dependable Diesel power for original equipment manufacturers, plant operators, farmers, contractors, lumber mills, other small engine users! Available as 5.4 H.P. power unit or 2,000 watt generator. Does any job your present engine will do . . . with less maintenance . . . at lower operating cost. Standard Sheppard features: pushbutton starting; only one moving part in injector.

SHEPPARD PUTS SAFETY FIRST. Sheppard Diesel power has *no electrical ignition system; no dangerous fumes.* That's one important reason why Yale and Towne Mfg. Co. engineers designed this high octane aviation gas pump assembly with a Model 7 Sheppard Diesel Power Unit.

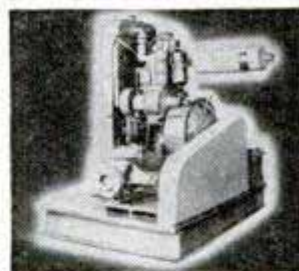

Mail this **FREE BOOKLET COUPON** *Today*

DEALERS:

Complete your line of engines and equipment with Sheppard—the *small engine* that opens a great new market for Diesels! A few dealer territories are still open. Send coupon for Sheppard Diesel franchise plan.



GET FACTS on how Sheppard Diesels can do your small power jobs at amazing savings in fuel costs, upkeep, and do the jobs better due to long life, dependable operation! Mail coupon now for free illustrated data sheets, facts, specifications, figures. No obligation!

R. H. SHEPPARD CO., INC.

307 Philadelphia St., Hanover, Pa.

Send me further information on Sheppard Diesels. I am interested in (check):

- Dealer Equipment Air-cooled Engines
 Franchise Manufacturers Marine Engines
 Power Units Generating Sets Marine Engines

Name.....

Address.....

City & Zone.....County.....State.....

DIESEL'S THE POWER *Sheppard's* **THE DIESEL**

STOP Battery Failure!



No one likes to buy a new battery. No one likes the starting delays that come with battery failure. Eighty per-cent of battery failure is traced to lack of water.

The Superior Automatic Battery Filler keeps the water in your battery at the proper level, AUTOMATICALLY, while you drive. You can see the water level at a glance. This automobile necessity protects your battery against dangers of fast evaporation in Summer—keeps starting power at peak in Winter.

This new invention pays for itself on the first battery. It makes your battery last 2 to 3 times as long. Can be changed from car to car. Easy to install, requires no drilling or cutting. See your dealer or send \$4.75 for inexpensive battery protection. It's a real automotive necessity. For sale at many Ford, Mercury, Chrysler, Dodge, DeSoto and Plymouth dealers. Dealer and Jobber inquiries invited.

DON'T WAIT — SEND TODAY

Superior Seal & Stamp, 1401 Vermont Avenue, Detroit 16, Michigan

Please send me _____ Superior Battery Filler(s) as advertised. I have enclosed \$4.75 for each filler. Rush prepaid.

Name _____

Address _____

City _____ State _____

Make of car _____ Year _____

Fits all cars with battery under hood except Hudson previous to 1948.

One Car — Two Gas Tanks

(Continued from page 118)

the anti-knock qualities of gasoline than at present, is certain to result also in improved economy. The improvement, therefore, does not depend solely upon increases in the octane numbers of the gasolines.

Too, the policies already existing in automotive design and in the marketing of motor fuel can provide the 20 percent premium gasoline sufficiently high in anti-knock quality to meet the requirements of proposed high-efficiency auto engines.

Development of dual-fuel systems for automobiles underscores the fact that although significant increases in the octane number of motor fuels may be several years off, it should not impede the progress that the automotive industry can make in designing and producing engines and cars with improved performance and economy.

Currently, the Socony-Vacuum Oil Company, Inc., is cooperating with a major manufacturer of carburetors to develop a commercially practical unit for new automobiles which would utilize premium-grade gasoline only under the conditions when this special fuel is needed. Other carburetor manufacturers are interested in the subject also. Hence the day of important announcements in this respect might not be far off.

The eventual commercial product, it is hoped, will reconcile the differences in octane-number requirements observed in the Paulsboro tests at various throttle openings (manifold vacuums). In order to study this relationship, several cars were operated on various octane-number fuels in city traffic, level open road and over mountainous terrain to determine the percentage of time during which knock-free operation was obtained.

In the test car alone, fuel of 70-octane number gave knock-free performance for 95 percent of the driving time. This demonstrates the waste of anti-knock quality because normally in similar cars an 80-octane-number fuel is used 100 percent of the time solely to satisfy the peak requirement.

In contrast to passenger vehicles, trucks and busses operate a greater proportion of the time under more nearly full-throttle conditions. Consequently they utilize octane ratings of their fuel more efficiently; but in general, commercial vehicles do not have as high maximum anti-knock quality requirements.

The potential importance of dual-fuel systems in automobiles also shows that distribution and marketing of a third grade

(Continued to page 236)

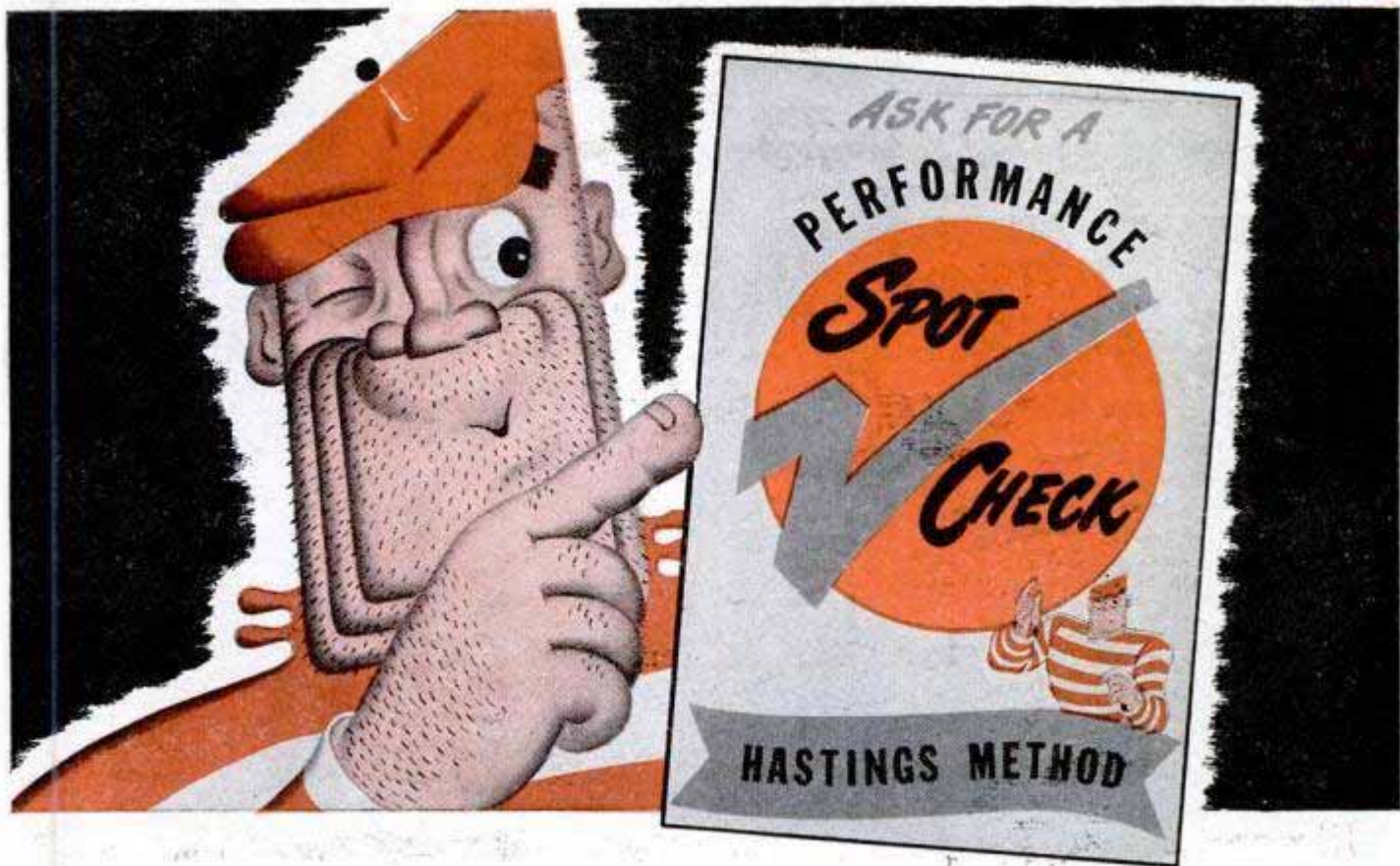

HERE'S A "CAR-SAVING" SERVICE THAT'S YOURS FOR THE ASKING

Wouldn't you like to have an expert check up on your car? A skilled mechanic's "once-over" now can save you real money later on.

Thousands of Hastings dealers are offering this service right now. They're set up to give your car a Performance Spot Check—a quick and accurate

analysis that will help you get the most out of your car and avoid major repairs.

Ask your Hastings dealer to give your car a Spot Check tomorrow. He'll give you an expert diagnosis and an honest recommendation. And there's no obligation.

HASTINGS MANUFACTURING COMPANY • HASTINGS, MICHIGAN
HASTINGS LTD., TORONTO

TOUGH BUT OH SO GENTLE



HASTINGS

STEEL-VENT PISTON RINGS

TOUGH on Oil Pumping
GENTLE on Cylinder Walls

New Type Hearing Aid

Needs No "Fitting"



New Radionic *Zenith "75"*
This is all you wear. \$75 complete.

SAVES YOU OVER \$100

Coupon below brings it to you—no salesman, no visits to salesrooms. Hear better or pay nothing!

MONEY-BACK TRIAL!

Wear the Zenith "75" at home, at work, anywhere. If it isn't better than you ever dreamed ANY hearing aid could be, return it within 10 days of receipt and Zenith will refund your money in full.

Because it needs no "fitting," it comes to you by mail—no salesman to high pressure you, no embarrassing visits to salesrooms. If its price had to include "fitting," middlemen's profits and high sales commissions, the Zenith "75" would have to sell for \$195 instead of \$75. So do as tens of thousands have already done. Order your Zenith "75"—mail the coupon today.

BY THE MAKERS OF THE WORLD-FAMOUS ZENITH RADIOS



Look only to your doctor for advice on your ears and hearing



MAIL THIS COUPON TODAY

Zenith Radio Corporation
Hearing Aid Division, Dept. PM78
5801 Dickens Avenue, Chicago 39, Illinois

I enclose check or money order for \$75* for one Zenith "75" Hearing Aid. Unless I am completely satisfied and find the Zenith "75" superior to any other hearing aid, I may return it within ten days of receipt and get my money back in full.

*Plus tax of \$1.50 in Illinois or New York City; \$1.88 in California, except Los Angeles, \$2.25.

Please send me free descriptive literature.

Name.....

Address.....

City..... State.....

of gasoline—a "super-premium" gasoline—is not feasible. Not only is the required capital investment excessive, but the materials required for the installation of additional pumps, lines and tankage at the refineries, bulk terminals and service stations would have to be drawn from the same limited stocks now being used for the expansion of crude-oil production and refining facilities.

Whether the industry will be in a position to continue an upward trend in anti-knock quality indefinitely is a serious question and will continue to be so for years. Such improvements cannot be obtained simply by turning valves and readjusting operating conditions on equipment currently in use. All of it is now being operated at maximum capacity to meet quantity demands. Refining facilities must be built to meet these increasing quantity requirements before emphasis can be placed upon construction for quality.

Certainly improvements in performance and economy in automobile engines through increases in compression ratios is highly desirable—up to the point where such engines will require fuels with higher octane ratings. This obstacle diminishes in importance if cars can utilize currently available octane ratings to their fullest. Dual-fuel systems to accomplish this are appropriate and appear justified so far on the basis of Socony-Vacuum's development efforts.

Cops on the Campus

(Continued from page 125)

town through wise traffic enforcement.

Some of the knowledge crammed into the officer's head may save home-town taxpayers some money when he returns to his job. For example, selective enforcement is emphasized throughout the course. Instructors explain this technique by pointing out that accidents occur according to definite patterns. Cars may frequently smash up on a particular corner between 5:00 and 6:00 p.m. Another area may be a hazard between 7:00 and 8:00 a.m. These areas need special attention from the traffic police at particular times, but they are as safe as other areas the rest of the day. By making a master pattern of such accidents for an entire town, city or county, and enforcing the danger areas "selectively," the head of the traffic police may, in some cases, reduce his force without any cut in its efficiency.

Modern training aids help the student cops solve traffic problems. One classroom

(Continued to page 238)

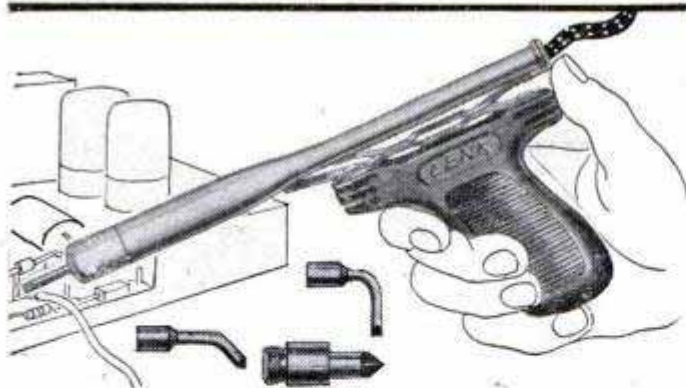

All Soldering is a Cinch with the
LENK Gun-Grip*
SOLDERING IRON

The perfect Soldering Iron for hobbyist, novice and mechanic. Has always cool, unbreakable plastic Gun-Grip. 4 interchangeable tips for varied angle approach—light and heavy duty. Spring construction cushions pressure for delicate work. Built-in stand rests iron safely. Brilliantly chrome plated. Completely U. L. approved. Buy one at your dealer's today.

FREE! Write for booklet
 "TIPS ON SOLDERING"

THE LENK MANUFACTURING CO.
 30-38 Cummington Street, Boston, Mass.

BUY DIRECT...

SAVE 1/3!



Sold at \$19.95
 in the stores...

TERRIFIC demand for more and MORE and MORE of these super deluxe Sussex wagons at this sensational \$12.95 direct-from-factory price, enables us to continue this smashing offer.

Top quality from its shiny-chrome-plated handle to its patented hubless, steel disc wheels, the Sussex super-wagon has a solid oak frame, steel bottom, semi-pneumatic tires, supports 1/4 ton, and has a brand new auto-type steering gear that makes a 90° turn without tipping!

Prompt delivery. Send \$12.95, money order, or check, or send \$5.00, pay balance on delivery.

ONLY
\$12.95
 F. D. B.
 Milw.
DIRECT TO YOU

STAR features:

- ★ Big 16"x 36" body
- ★ 10"x 1 3/4" Firestone demountable tires
- ★ Chrysler Oilite bronze bearings
- ★ New auto-type steering gear
- ★ Metal parts cadmium and nickel plated
- ★ Chrome-plated handle of channeled steel

MARKWARDT MANUFACTURING COMPANY
 3354 N. BUFFUM STREET MILWAUKEE, WISCONSIN

New Easy Way
 TO MAKE
BIG MONEY!
 AT HOME

FULL
 OR SPARE
 TIME



Permanently
METALLIZED
BABY SHOES

Costs You Only 5¢-You Get \$6.00

Now is the time to cash in on this big-paying, easy-to-operate year 'round business, and you need no experience! With actual illustrations and step by step instructions, YOU can start earning money in only one week—up to \$1000 per month full time, or

LARGEST NUMBER OF SUCCESSFUL BUSINESSMEN

Our course has the largest number of successful businessmen in this field today! They are all men and women who acted and are making money. This course is guaranteed—your money will be fully refunded if you are not more than satisfied. There is nothing to lose, so act at once.

- Money Back Guarantee
- Most Successful Name in Metallizing
- Big Income
- Huge Demand
- Sales Plans
- Future Security
- Your Own Boss

\$50 to \$75 per week spare time... at \$5.00 per hour. Working only a few hours you can make more money than most people make working an entire week.

IMMEDIATE RESULTS

This tested and proven method shows you complete details, so that you may start at once, metallizing Baby Shoes, with real GOLD, SILVER or BRONZE. They will last forever, retaining every priceless detail of the natural shoes; something for which there are 5 million new customers waiting to buy every year.

BEGIN AT HOME

Don't pass up this real opportunity to start your own business on a shoestring right at home. **ACT NOW!** We will send you all the details absolutely free.



FREE!

Two actual metallized Baby Shoes guaranteed to be the most attractive on the market—or a pair of your own Baby Shoes metallized if you prefer.

SEND NO MONEY
 USE THIS COUPON

KIKTAVI
 Company Dept. P-1
 2111 W. Manchester
 Los Angeles 44, California

Rush me FREE full particulars at once.

Name _____
 Address _____
 City _____ State _____

Handy Electric Drill

Saves Time 3 Ways



HOME-UTILITY
1/4" Electric Drill
\$18.95

1 FOR PORTABLE DRILLING—

Drills bolt holes, lead holes in metal, wood, plastics. Saves you time, turns out better work in homes, on farms, in workshops.



HOME-UTILITY
1/4" Horizontal Stand
\$3.35

2 FOR GRINDING, SANDING, buffing, polishing—Helps you sharpen cutlery and tools, remove rust, sand hobby shop items, etc. Frees both hands for applying work.

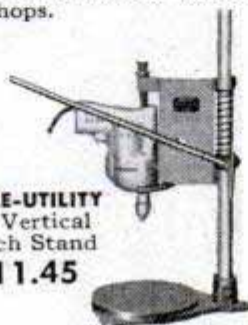

HOME-UTILITY
1/4" Vertical Bench Stand
\$11.45

3 FOR DRILL PRESS WORK—Quickly converts the Drill into a convenient drill press with a smooth feed for bench work. Drill is slipped into both Stands, or removed, in a few seconds.

Versatile Home-Utility Drills and Stands—including the 1/2" Drill (only \$35.95)—are quality-built by BLACK & DECKER, famous maker of electric tools for 37 years! Order Home-Utility Tools from your hardware, electrical or implement dealer.

ELECTRIC HOME-UTILITY TOOLS

Products of THE BLACK & DECKER MFG. CO.,
Dept. H7M, Towson 4, Maryland



IT STAYS STUCK!
WITH... MULTI-PURPOSE AMBROID

If you want permanent results from an adhesive, you can't equal multi-purpose Ambroid liquid cement—for home workshop, household or factory. A quality leader for 37 years, ready-to-use Ambroid is waterproof, transparent, quick-drying, extra strong. Flexible, heat- and corrosion-resistant. For assembling, repairing or mending jobs, keep Ambroid handy. At your dealer's, or send 25¢ for big 2-oz. tube post-paid. Money back guarantee.

Also 50¢ 4-oz. tube. Pts., qts., gals., for industrial use.

AMBROID

303 Franklin St., Boston 10, Mass.

has a magnetic blackboard which attracts and holds small models of cars, so that the instructor quickly can set up a visual problem in enforcement. The officers get an overview of everything that's new in enforcement through demonstrations of wire recorders for taking statements of witnesses, speed tests in relation to stopping distances, walkie-talkies for emergency use, and the latest developments in engineering equipment.

The 4½-month course is not the only service of the institute and the IACP. They also offer a basic course in enforcement lasting only three weeks, sponsor regional courses in other parts of the country, courses for judges and prosecutors of traffic courts and a course for supervisors of large fleets of vehicles. In addition, the institute publishes information on enforcement, maintains a library of films dealing with traffic and backs up its graduates with an extension service. Extension men go into the officer's home town and help him apply what he has learned at the institute.

Hundreds of photos are submitted to the institute each year during the contest for police photographs. These pictures are snapped by officers on active duty. In last year's contest one photo showed a lipstick print on a car compared to the lipstick prints of a hit-and-run victim, resulting in a prison term for the driver.

Facilities aren't available for training the number of officers who are eager to attend the course. One young man was so enthusiastic about the institute after a visit that he immediately applied for enrollment. Unfortunately, he was not an officer and had never been on any police force, so his application was rejected. A few days later he telephoned from his home town—population a few hundred—that he had persuaded the village fathers to appoint him Chief of Detectives. Kreml accepted him as a student on the theory that anyone with that much ingenuity could serve well in unsnarling some of the present traffic problems.

Cleaner for Concrete Surfaces

Oil and grease stains on concrete driveways or floors are removed in a few minutes by a liquid cleaner at a cost of less than two cents per square foot. The resulting surface is etched and ready for painting if desired. The cleaner is poured on the surface and brushed in. After a few minutes, it is rinsed off with water. The cleaner can also be used on magnesite, terrazzo flooring and masonry surfaces. It is safe to use and does not injure the hands.

ELECTRICITY *Anywhere*

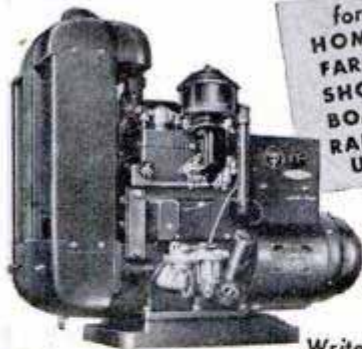

for
HOMES
FARMS
SHOPS
BOATS
RADIO
USE

● Onan gasoline-engine-driven Electric Plants supply reliable, economical electric service for any use. Portable, stationary or stand-by models. Water or air-cooled, compact and rugged.

A.C.: 350 to 35,000 watts in all standard voltages and frequencies. D.C.: 600 to 10,000 watts. 115 and 230 volts. BATTERY CHARGERS: 500 to 3,500 watts; 6, 12, 24, 32 volts.

Write for folder

D. W. ONAN & SONS INC.
2543 Royalston Ave., Minneapolis 5, Minn.



BUILD YOUR OWN BOAT

PACKAGED BOATS FOR HOME ASSEMBLY

Save 50%—build from our complete, easy-to-assemble plywood kits. All parts pre-cut, frames pre-assembled. Finest designs (8 to 18 ft.) available. \$34.50 up. Send 25c (coin) for literature.

BOAT BLUEPRINTS & PATTERNS

50 finest plywood designs—large scale blueprints—full size patterns available—kayaks to cruisers—send 25c (coin) for design catalog or \$1.00 for catalog plus booklet, "How to Build Plywood Boats."



MARINE MART—BUFFALO 7-B, N. Y.

BUILD YOUR OWN FAN



One-piece cast aluminum propellers for cooling and ventilating.

Size Inches	Polished 2 Blade	Polished 3 Blade	Unpolished 2 Blade	Unpolished 3 Blade	Bore Inches
15	\$3.00	\$4.00	\$2.50	\$3.00	1/2, 5/8, 3/4
18	3.75	4.50	3.00	3.50	1/2, 5/8, 3/4
20	4.00	5.00	3.25	4.00	1/2, 5/8, 3/4
24	4.50	5.50	4.00	4.50	1/2, 5/8, 3/4

Let us give you our prices on your aluminum castings.

Write for pamphlet on larger fan blades, wire guards, fan bases, shutters, pillow blocks, exhaust fan frames, etc., shipped prepaid if money accompanies order. Dealers write for discount.

KLOPPENBORG ALUMINUM FDY., Dept. PM78, Davenport, Iowa

NONE BETTER! SUPER DRILL GRINDER



Sharpens round shank drills from 3/32" to 1-1/16" in diameter, up to 11" long. Grinds old drills like new in 4 different point angles, using hand or power grinding wheels. Money-back guarantee.

Price only \$2.95

At Dealers or Postpaid

CRANDALL MFG. CO. 1512 W. Slauson, Dept. FA-31, Los Angeles 44, Calif.

MAGNETS OF ALL TYPES—10c UP

AMAZINGLY POWERFUL!!

5 oz. Alnico Magnet, lifts 10 lbs., \$1.00. Our Leader, 15 oz. Magnet, lifts 40 lbs. \$1.95. New alloy—will not weaken! Useful for lifting valuables from tanks, lakes, or rivers easily! 7 small magnets \$1.00 with list of many shop and home uses. Satisfaction guaranteed. R. EYRICH, 2566 N. 49TH ST., MILWAUKEE 10, WIS.

Guides you to hobby happiness

Woodworking handbook and catalog of **Homecraft®** Power Tools

Shows how you can have a complete home shop without spending a lot of money! Gives you useful information: Plan for woodworking bench. Handy hints on using a band saw. Reference charts on screws, bolts, board measure. Dimensions for power-tool stands. Method of enlarging plans and drawings. Names of helpful books. Get your copy of Catalog HC-1!

Ask us for your Homecraft dealer's name.

DELTA MFG. DIV., 681 G E. Vienna Ave., Milwaukee 1, Wis.

Send for your copy today!



10¢ Postpaid

Earn Big Money! ...Arc Welding



NEW HOBART A.C. Arc Welder and Power unit

You can even "Build Your Own" gas drive portable welder and SAVE \$300⁰⁰ to \$500⁰⁰

Small Investment Starts You

in the profitable arc welding business. All you need is a low cost reconditioned auto engine, chassis and Hobart generator to "build your own" portable unit. Easy to build and saves you \$300 to \$500 over cost of factory built job. Send for FREE instruction book today and get started immediately on the "Big Pay" welding jobs!



Gas Drive Portable

Simplified in Operation

and it's no trouble at all to learn to weld with the Hobart "Simplified" Arc Welder. Practice makes you perfect.



Hobart AC Arc Welders

are ideal for low cost shop operation and you'll want one later on for general shop use. Leaves your portable unit for "Big Pay" outside jobs.

Electric Drive Portable

Hobart School of Welding

can teach you arc welding in a short time at low cost. Individual instructions by expert instructors. Qualified under G.I. Bill of Rights. Check coupon.



20-200 A.C. Welder

Hobart Bros. Co., Box M-78, Troy, O.

"World's largest builder of Arc Welders"



• Yes, send me **free** instruction book on "How to Build Your Own Gas Drive Welder," and information and catalogs on the items I've checked.

- Gas Engine Drive A.C. Welder
 Electric Drive Welder Welding School

HOBART BROTHERS COMPANY, BOX M-78, TROY, OHIO

Name _____

Address _____

Please Mention Popular Mechanics When Answering Ads

NEW! SPEED MARVEL BAND SAW GEARED SPEED REDUCER

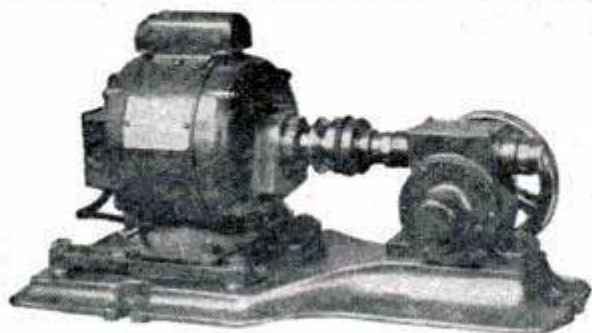

Cut wood or metal on same machine. Convert your present Band Saw from wood to metal cutting by use of this REDUCER and still use your present motor. \$32.75, less Motor, F.O.B., Norristown, Pa.

Write for free descriptive literature

HUTCHINSON MFG. CO.

NORRISTOWN PENNSYLVANIA



*"Factory"
at your
Fingertips*

Saw blade tilts
table stays flat

New POWER KING 8" SAW

• All your "construction" work — shelves, cabinets, furniture — can be built in a fraction of the time with this accurate Power King saw in your shop. Big 18" x 20" table, has 10 $\frac{3}{8}$ " ahead of blade. Saw cuts 2 $\frac{3}{8}$ " deep. Precision ball bearings assure long service. Rip fence locks at both ends, releases instantly for positioning or removal. It's America's outstanding table saw value. See it at your Power King dealers today, or send postcard for free literature.

NOW ONLY
\$58⁷⁵

F.O.B. Warsaw
less motor



POWER KING TOOL CORP.

743 Cleveland Street
WARSAW, INDIANA

Division of ATLAS PRESS COMPANY

X-Rays 500 Times Brighter

(Continued from page 92)

five inches in diameter, or the size of the original screen.

Two laboratory tools brought this device over the hump from theory to practice. The first is a small pilot tube, three inches long by two inches in diameter, which proved that the fluorescent image could be intensified by the use of electrons as already described. It achieved a five-fold increase in brightness. A second tube, which more closely resembles the still unbuilt production model, proved that a 500-fold increase could be attained by electron acceleration and compression.

The advantages of this brighter image are manifold. It will largely eliminate the need for the doctor to remain in darkness for long periods or to wear red glasses in normal light in order to increase the light-sensitiveness of his eyes. A minute or two in darkness will enable him to see far greater detail and in a much shorter period than ever before.

Since examination and diagnosis will be possible in a much shorter time than heretofore, it will be possible for more persons to have fluoroscopic examination. Details, which are nothing more than shadows contrasted against the brightness of the background, will be visible to an extent hitherto undreamed of.

Shortening of the examination period is also important to both doctor and patient for another reason: X-rays in too heavy or too lengthy doses can be harmful to the human body. A patient who must have thorough fluoroscopic examinations at frequent intervals may be running a risk and the physician who exposes himself to X-radiations for many hours a week may suffer unpleasant consequences.

This is a situation which is not emphasized by persons engaged in working with X-ray or manufacturing such equipment, but occasional hints in the direction of caution are encountered. The producer of a new fluoroscopic screen claims 40 percent greater brilliance, but he does not suggest that the doctor use this increased brightness to enable him to see more. No, the screen manufacturer suggests that power can be reduced with no deterioration of the image.

It is believed that, where extraordinary circumstances demand it, the fluoroscopic image can be transmitted by television from city to city, permitting eye-witness consultation by two or more specialists in widely separated points.

(Continued to page 242)

"DANGDEST THING YOU EVER SAW!"

Flex-O-Pic

An Amazing Convenience around
**AUTOS
RADIO SHOPS
AIRPLANES
BOATS
ALL HOME WORKSHOPS**

WORKS
AROUND CORNERS!

A Specialty Tool for HARD-TO-REACH PARTS AND PLACES

Specially invented for tricky service jobs. Expanding and retracting fingers in flexible housing reach in anywhere and grab ahold of anything. Works around corners, S-turns, etc. 100 different uses around the home or shop. Mother will like it too. Try it on a 5-day money-back guarantee. Send name and address for C.O.D. delivery, or send \$1.00 now, and we ship prepaid. Descriptive circular free.

NOW ONLY \$1.00

DEALERS:

This is a terrific item! Write for complete details.

EMCO ENTERPRISES, Inc.

6750 Stony Island Dept. H1 Chicago 49, Ill.

TRAILER BUILDERS!

BUILD or BUY... SPECIFY

• Torq-Less Axles • Bull Dog Hitches and

Parking Jacks, Safety-Engineered by

HAMMER BLOW TOOL COMPANY

Dept. 124 Wausau, Wisconsin

Send for **FREE** Catalog

NO MORE BACK BREAKING MOWER PUSHING

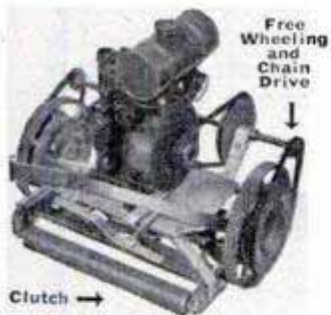

Build a POWER LAWN MOWER yourself from your old HAND MOWER

We supply complete ATTACHMENT that needs no welding. Easy to install in less than an hour, fits any make or size of mower for Electric Motor or Gasoline Engine.

ENGINE:

OUR 1½-2 H.P. 4 Cycle Air Cooled with High and low Adjustable Jets Dependable Starting. Light weight, 30 lbs.

Both the ATTACHMENT and the ENGINE are **ABSOLUTELY GUARANTEED**, you are getting the very best that money can buy at a price you can afford.

Orders filled in seven days. Send for **FREE FOLDERS**.

PRECISION BUILT To Last A Lifetime

ROYAL-OAK LAWN MOWER SHOP

Box 48

Royal-Oak, Mich.



Save 1/2!

"DIRECT TO YOU"

Belt Driven, Attic and Basement

STONEWALL EXHAUST FANS

G.E. or Westinghouse Motors

SPECIAL FEATURES • Sealed-in Lubrication • Roller Bearings • Rubber Mounted • Automatic Belt Adjustment • Aluminum Hub and Pulley • Fully Guaranteed.

Size	C.F.M.	H.P.	List	Less 50%
30"	8,000	¼	\$125.10	\$62.55
36"	9,600	¼	141.52	70.76
42"	13,100	½	156.76	78.38

(20 other models—Window, Pedestal, Table, Floor and Exhaust — at special prices)

STONEWALL FANS are designed for years of trouble-free service and are carefully tested before shipment. Send check or Money Order, or 25% with order, balance C.O.D. Money refunded if fan returned in ten days.

Order one or more today

STONEWALL SALES CO.

Station E, Box 64 • Atlanta, Georgia

GIVE YOUR CAR THE "WOLF CALL"

of Deep Tone DUAL MUFFLERS

The rich, low, mellow sound of "straight thru" ADVANCE mufflers is something all your friends will admire.

Also greater power, speed, and economy result from the reduced back pressure of this scientific design. Rugged steel tube throughout (no aluminum); blowout-proof.

SIMPLE TO INSTALL. No welding, cutting, or holes to drill. Complete with rubber mounted clamps (no rattle) and all necessary fittings.

ADVANCE MUFFLERS, 6800 S. Vermont Ave., Dept. PM-78, Los Angeles 44, Calif.

Send Check, Money Order, or we will mail C.O.D.

You pay postage upon receipt.

Dual Muffler Set (Ford, Mercury only) \$20.00 Single Muffler (other makes) \$5.50
Single Muffler (Ford, Chev., Plym.) 4.86 2½" Chrome tail pipe tips 1.75

Car make _____ Year _____ Model _____

Name _____

Address _____ City _____ State _____



ADVANCE MUFFLERS

6800 S. Vermont Ave., Los Angeles 44, Cal.

Window
Glazing
Easy!



ALL FOR
\$1.00

PUTTY PAL kit gives you everything you need to set glass easily, quickly, expertly! No experience necessary. Cut broken window costs by replacing them yourself. Easily! Quickly! Expertly! No experience needed — any man, woman or boy sets glass perfectly. Putty Pal's sturdy plastic handle and steel swivel point forms the putty around the corners smoothly and evenly without stopping. The putty stays. No crumbling or breaking loose. **Send no money!** But save time and money by writing "Putty Pal" together with your name and address on a postcard and mailing to Dept. E, Devoe & Reynolds Company, Inc., 787 First Avenue, New York 17, N. Y. Your Putty Pal will be sent you for only \$1.00 plus postage. Or send \$1.00 cash, check or money order and we pay postage! Act now!

DEVOE & RAYNOLDS CO., INC.



Working with a powerful Dumore is faster, easier — twice the fun!

—extra power, capacity, and flexibility for jobs in plastics, wood, and metal

A Dumore Duplex gives you: a full 1/14 HP motor for heavy jobs; extra-capacity chuck for 1/4", 1/8", 3/32" tool sizes; attachments to convert for bench, lathe, and flexible-shaft duty. See it at your dealers, or write for details today! The Dumore Co., Dept. E-51, Racine, Wis.



Tear out this coupon and mail today!

The Dumore Co., Dept. G-51, Racine, Wis.
check
 Please send me complete information on the Duplex Grinder.
 Send me Deluxe Duplex Kit (27 accessories), \$27.50 enclosed.
 Send me Standard Duplex Kit (9 accessories), \$19.75 enclosed. — Shipping charges C.O.D.
 Name.....
 Address.....
 City..... (.....) State.....
 H-14A

The device could also be applied directly to the television transmission and reception techniques, but not where you might first suspect. While it would be possible to use the kinescope screen in place of the larger screen in Coltman's tube and obtain a smaller and much more brilliant image, this would be undesirable in some cases and more easily achieved by other methods in other cases.

Brilliant images can now be obtained on kinescope or receiver tubes by reducing the size of the tube head, but it is possible that the image intensifier might prove useful on the transmission end. Where scenes of low brightness were to be telecast, the light rays of the scene itself could be brought directly to the photoelectric surface, which would accelerate the electrons and permit the orthicon or other television camera to pick up a greatly brightened image for transmission.

What Coltman has done is to make up for certain inherent deficiencies in the human eye, which has been the weak member of the team in the use of fluoroscopy up to now. The most carefully "light conditioned" eye sees a dim image on the screen because of its low sensitivity to light. The same amount of light striking a negative in radiography for even a short period of time produces a vastly superior image owing to the cumulative effect of the exposure.

The contrast sensitivity of the eye—its ability to distinguish between closely spaced objects—cannot be increased, but by raising the level of brightness of the background the contrast of the shadows is increased and they can be much more readily distinguished.

Chief problems which were encountered by Coltman were in selecting fluorescent and photoelectric coating materials which would work together as a team. In most cases the latter "attacks" the phosphors in the former, resulting in an unstable and quite useless combination. The finding of a harmonious combination was the major factor in perfecting this development—which has the laboratory name of "image intensifier."

Fortunately, the intensifier will in no way make obsolete current fluoroscopic equipment, which can use it simply by substituting the new tube assembly in place of the screen now used.

No production date has been set by Westinghouse, but a good guess places early 1950 as the date when it may be in the hands of the medical profession.

☐ More than 100 kinds of birds have become extinct in the last 200 years.



**Complete
AIRPLANE GALLEY**
plug-in • all-electric
NEVER-USED • SURPLUS
Cost Gov't \$48.00

\$13.95

POSTPAID
anywhere in U. S.
24-32 volts d-c

115-volt a-c model
\$17.95 postpaid

Ideal for camps, trailers, boats, or to take on auto trips for cooking wherever there is electric power available.

Includes 30-ounce hot cup for boiling and heating liquids • aluminum grill with 5 $\frac{3}{4}$ " x 7 $\frac{1}{2}$ " removable top and drip pan • two 3-quart, covered, enamel-ware hot-pots keep contents at 140°F • three-piece, clear plastic condiment set • sturdy steel case, 30 x 15 x 9 $\frac{1}{2}$ ", with gleaming white inside finish and convenient carrying handles • heavy canvas cover with snap-fasteners.

The hot-cup alone — just like those you see at lunch bars — is worth more than our low price for the whole outfit.

ORDER NOW — MONEY-BACK GUARANTEE

CANTON SALES CO Canton Mass

BRAND NEW GOVERNMENT SURPLUS EQUIPMENT

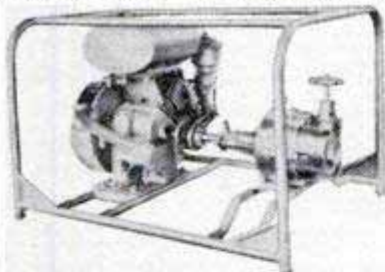

PORTABLE PUMPING UNITS, gasoline engine driven rotary pump, good lift and pressure, 1 $\frac{1}{2}$ in. suction, 1 $\frac{1}{4}$ in. discharge, adjustable flow control. Direct connected to Johnson 4 cycle gasoline engine, foot starter, develops about 1 $\frac{3}{4}$ h.p. mounted in steel frame base, capacity to 3000 gals. per hr., can be used for pumping water, gasoline, kerosene, distillate and most oils.
Price complete boxed F.O.B. . . \$96.00
As above, less engine F.O.B. . . \$35.00
Suction hose, wire wound 16 ft. length with connection . . . \$ 6.50
Discharge hose, wire wound 20 ft. length with connection . . \$ 6.50



ELECTRIC HEAVY DUTY PORTABLE DRILL

Electric 3/4 in. drill 110 volt A.C. - D.C. 3/4 in. Jacobs key chuck takes 3/16 in. to 3/4 in. (incl.) standard round shank drills. Easily handles 3/4 in. drill in metal, 1 $\frac{3}{4}$ in. in wood. 2 speed switch in handle 275-375 r.p.m. chuck speed. Heat treated machined steel gearing enclosed precision ball bearing equipped. Oleomatic safety clutch. 50 ft. extra heavy oil and weather proof Electric cord with grounding wire. Electric motor, switch, gearing and housing made by nationally known precision manufacturer in U. S. Each drill carefully tested and packed in original individual shipping carton with cord, chuck wrench and instructions.

PRICE COMPLETE F.O.B. **\$56.50**

A limited quantity of each item available. Send check or money order. Money refunded if condition not as represented new and unused. All prices quoted are only a fraction of the original purchase price.

PRONTO MOWERS, Oldsmar, Florida

enjoy a pouchful
of fresh tobacco

Rogers
Air-tite®

the finest in
tobacco pouches

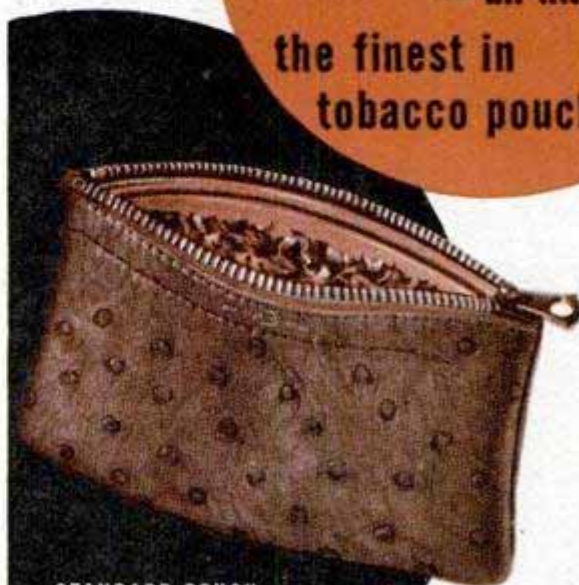

STANDARD POUCH

Holds generous supply
of tobacco. Choice of
leathers. \$1.50 to \$15



COMBINATION POUCH

Holds pipe as well as tobacco.
Choice of leathers . . . \$2.50 to \$20
ROGERS RARITY PIPE \$5

The Rogers Air-tite® with its patented inner pouch of moulded, seamless rubber, protects freshness and flavor. Exquisitely made of fine leathers in a variety of models, by Rogers craftsmen. The largest-selling tobacco pouch made. At better shops everywhere.

• **Rogers imports, inc.**

419 Fourth Avenue, New York 16, N. Y.
manufacturers and importers of the finest smokers' accessories
EXCLUSIVE U. S. DISTRIBUTOR, PETERSON'S PIPES, DUBLIN, LONDON
Rogers Air-tite Pouches in Canada—G. T. Lanning Ltd., Toronto

*TRADE MARK REGISTERED U. S. PAT. NO. 1,801,192. CAN. PAT. NO. 374,167

BRAND NEW!

Sensational

Screw Drivers

- with new hand-fitted handles made of superior plastic—make all others out-of-date!

Revolutionary shape of handle is better for hands . . . better for work. Amazing plastic material is excellent insulator, non-inflammable, non-explosive and tough.

These quality features and many more will make these new screwdrivers your first choice. You'll find them easy to use in your work because this advanced design was created from many suggestions made by tool users. They are available in a complete range of sizes, so buy the ones you need from your Plomb Tool Co. dealer near you.

4861

Streamlined

PLOMB TOOL CO.

2255 S. SANTA FE AVENUE, LOS ANGELES 54



Baits for Bass

(Continued from page 99)

wobbling, crawling, erratic, diving or darting motion, which at first attracts the pugnacious bass. Each plug has its special characteristics of motion, but the angler's skill in retrieving, in pausing and changing speed is of equal necessity. Next in importance comes the hooks. The gangs will hook a fish easier, but are more easily thrown out during that high, head-shaking leap for which the bass is famous.

Many plugs so fitted will be lost on hidden obstructions. Also, this type does not usually cast as easily as the more slender, single-hook lure. The large single hook, with its long, keen point bites deep and is not easily dislodged. It is usually protected by a weedless device, which saves much tackle and also the angler's temper. This type lure, being heavy and slender, casts very easily and accurately.

Color of plugs: No two anglers will agree here, for one day the bass will take a red-and-white affair, and disregard it the next for something entirely different—perhaps jet black. And it is certain that color is less important than the plug's action. But experience has shown that certain color combinations have been most productive for a great many anglers. Thus, we might place red and white first; next, perhaps a yellow or yellow and brown "perch-scale." It looks like a large minnow. Then, sometimes black and white works well, as does a combination of red and yellow.

And, regardless of how we try to concentrate upon a few "tried and proven" bass lures, there is always a chance that the bass will want something different. Each season scores of new and attractive lures come on the market—and we must try them. That is why the confirmed bass fisherman buys the largest tackle box he can find, and stocks it full of such a variety of beautiful, shiny new gadgets. And that is one reason he is a bass enthusiast.

But finally, with all his lures, the angler must be expert in their use. Casting practice for distance and accuracy, at home on the lawn or in a park pool, is essential. The slender little rod will send out that plug easily, granting a good level-wind reel, and the delicate, all-important thumbing of its spinning spool.

At the current rate of mining, the Lake Superior ore deposits, which have yielded 2,300,000,000 tons of ore since 1850, are expected to last only 20 more years. Last year, the area produced 82 percent of all ore mined in the United States.

SAVE HALF ON 50" CIRCLE ESS FLEXIBLE SHAFT



Identical shaft which has sold and is selling everywhere for \$10.95. You SAVE almost HALF. Ideal for sanding, cleaning, polishing, buffing, drilling, grinding and scores of other jobs.

NOTE THESE FEATURES

Fits any 1/2 inch motor shaft. Head-piece has 1/2 inch by 20 thread arbor; will accommodate any internal threaded tool or adapter with same size thread or hole. 5/16 inch inner core, built of transverse wound, high-carbon steel wire; extremely strong and flexible. Steel end fitting insures durability. Outer flexible casing of high carbon steel wire wound in combination with a dead-soft filler wire. Double ball bearings in head piece and motor coupling. Ball bearing motor coupling assembly. 50 inch length. Simple, complete instructions. Only \$5.95.



13 PIECE HIGH SPEED DRILL SET SENSATIONAL VALUE



Made of finest high speed steel. Complete set includes 13 straight shank drills (1/16" - 5/64" - 3/32" - 7/64" - 1/8" - 9/64" - 5/32" - 11/64" - 3/16" - 13/64" - 7/32" - 15/64" - 1/4"), plus sturdy Huot steel case with flat indexed panels, which stand up for easy selection when box is open. Sells regularly everywhere for \$5.95.

ONLY
\$3.95
POST PAID

SAVE \$\$\$ ON THIS HANDY-HEAD GRINDING AND POLISHING HEAD

Every part highest quality. 1/4" JACOBS HAND-TITE CHUCK; TORRINGTON NEEDLE BEARINGS, 1/2" x 3/4" insure fast, smooth running; SPINDLE-hardened, bearing surfaces ground, 1/2" x 24 thread with 4 flanged nuts, holds up to 1" x 6" wheel; 2 1/2" V-Pulley, cut from solid piece of steel; FRAME - one piece, cast aluminum alloy. Can be driven from rear, above or below. Base 4" x 4"; height to center of spindle 6". Sells regularly for \$7.50.



ONLY
\$3.95
POST PAID

Good in U. S. only. Send check or money order. No C.O.D. SATISFACTION GUARANTEED

SURPLUS VALUE CENTER 4636 St. Clair St. CLEVELAND 3, O.

SOUTH BEND

NEW ADJUSTABLE COLLET BUSHING CHUCK -

provides an accurate method for mounting centerless armature shafts and similar parts in a lathe. Use in either head or tail spindle. The brass collets are adjustable for running or driving fits. Chucks supplied with 3 collets; 9/16", 5/8", and .637" capacity. Extra round collets, 1/4" to 1" by 16ths, \$1.00 each.
Chuck with No. 2 shank \$8.95
Chuck with No. 3 shank \$9.45



SOUTH BEND LATHE WORKS 455A E. Madison St. South Bend 22, Ind.



ONE CAMERA THAT CLICKS

WITH EVERYONE!

Beacon III

Synchronized for Flash Photography

Just aim, click! You can't miss getting perfect shots with the new Beacon II.

Takes color and black and white with

detail needed for sharp enlargements

up to 8x10. Two

optical lenses, coated

four sides. Flash unit takes any size bulb.

Push-button "hot bulb" ejector. Flash tester. Handsome, compact camera.

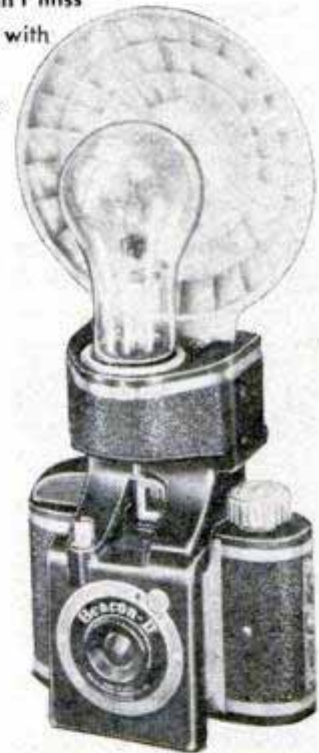

Beacon II
Camera

\$9.95 tax incl.

Beacon II
Flash Unit

\$4.95 tax incl.

AVAILABLE AT ALL CAMERA STORES
SEE SPECIALLY DESIGNED ACCESSORIES
WHITEHOUSE PRODUCTS, INC.
360 FURMAN STREET
BROOKLYN 2, N. Y.

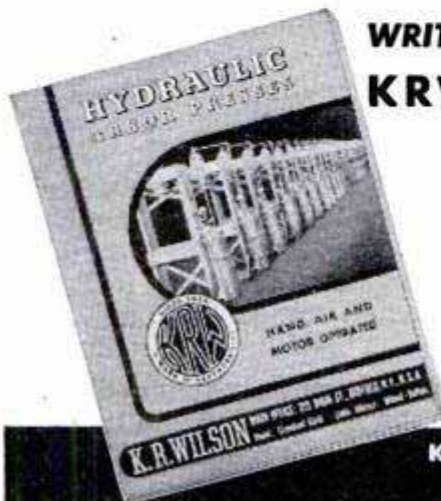

WRITE FOR YOUR FREE COPY OF THE NEW KRW HYDRAULIC PRESS BOOK

Describes all manner of Production and Shop Work on KRW Hydraulic and Bench Type Arbor Presses. 32 pages illustrating the new KRW Hand-operated, Electric-operated and Air-operated Hydraulic Presses.
Write for your copy today.



K. R. WILSON, DEPT. 17, 215 MAIN ST., BUFFALO 3, N. Y.
Builders of Shop Equipment for Ford Dealers Since 1916

GROBAN'S SURPLUS BARGAINS!

WESTINGHOUSE AIR COMPRESSOR

**BRAND NEW
War Surplus Bargain**

2-Cylinder Piston Type

Ideal for:

- Paint Spraying
- Industrial Uses
- Tire Inflating
- Spraying Insecticide
- Operating Air Tools

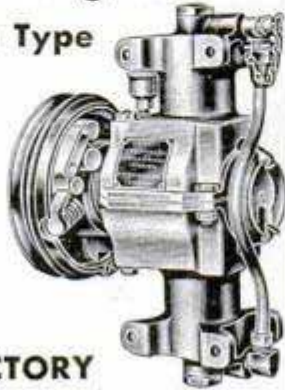

For the:

HOME... FARM... FACTORY

Designed for automotive truck or tractor mounting. Can be run off fan belt or power takeoff. Comes with automatic clutch. Can be installed for use on: farm trucks, jeeps, tractors, tire or garage service trucks, contractor or road building machinery, pneumatic devices, etc. Has 2 inch bore — 1½ inch stroke.

Can be operated with ½ H.P. or more electric motor or equivalent portable gas engine.

Light weight, compact and versatile unit... delivers "oil free air" simple in operation; requires minimum of maintenance; operates under all climatic conditions; suggested operating pressure 75 P.S.I.; equally efficient operation in either direction of rotation; approx. displacement 3.27 CFM at 600 RPM, 6.54 CFM displacement at 1200 RPM; Overall dimensions: width 9", height 11 7/8", depth 6 5/8"; approx. wt. 23 lbs.

**A REAL BUY...
worth many times
this price**

\$26.95

Send check or money order today.
SATISFACTION GUARANTEED.

F.O.B.
CHICAGO

REGO REGULATORS OXYGEN — MODEL 1601

INLET 967

BRAND NEW

UNDERWRITERS APPROVED

**For the Workshop — Home —
Factory — Farm**



Designed for precision, gas pressures; meet the heavy demands of cutting and welding in shops, ship and scrap yards, mills, etc. REGO REGULATORS deliver an ample supply of gases at constant, even pressures.

Manufactured by Bastian-Blessing Company. This highly dependable accurate instrument is modern in design—diaphragms are 2 5/8" in diameter; two brass gauges are each 2 1/2" in diameter; 0-400 P.S.I. and 0-3000 P.S.I. Ship. wt. 7 lbs.

ORIGINALLY WORTH MANY TIMES MORE

\$12.95

F.O.B.
CHICAGO

½ H.P. — A.C.

ELECTRIC MOTOR

(Capacitor Type) BRAND NEW

For the Farm, Home, Factory, Workshop

Here Are a Few of Many Uses:

- | | |
|--------------|---------------------|
| Pumps | Air Compressors |
| Stokers | Refrigeration Units |
| Oil Burners | Conveyors |
| Unit Heaters | Blowers—Fans |
| | Machine Tools |

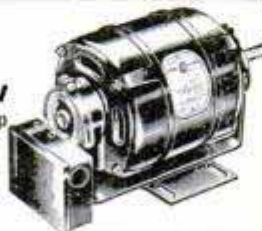

5/8" Keyed Shaft; 115-230 Volt; 60 cycle; 1725 R.P.M. Single phase—alternating current; capacitor start—Induction Run—Resilient Mount and Motor Protector—Reversible Rotation—High Starting Torque—Magnetic Starting Switch. Cooler Operation—**\$34.95**
Dynamic Balance—Compact Design.....
F.O.B. Chicago

GROBAN SUPPLY CO.

DEPT. PM 7, 1507 S. MICHIGAN AVE., CHICAGO 5, ILLINOIS

Spiral Tripod Fits in Pocket

Small enough to be carried in the pocket when collapsed, a spiral tripod extends to more than five feet and will support any camera. The legs are formed of spiral coils of stainless-steel strips. When the spiral

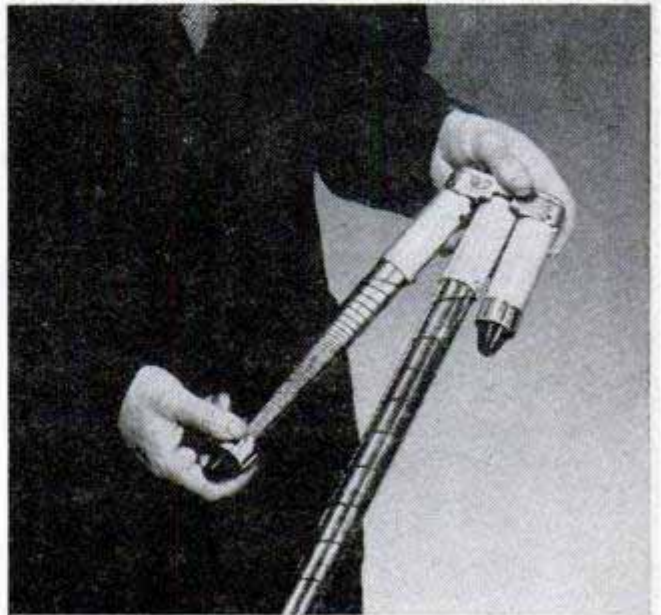

is pulled out to extend the legs, the light-weight tripod will not vibrate if accidentally tapped. The legs are locked open by a few turns of the tips. For table-top photography, it can be set up only 5½ inches high. Steel spear points under the rubber tips can be used to prevent slipping.

Tinsel Downpour

There's no connection between holiday spirit and tons of tinsel dropped from planes on Panama's highest peaks. It is a timesaver for United States Air Force teams mapping the entire republic, much of which is covered by dense jungle. Ground observers have had to laboriously select and work their way to the highest points for geodetic information. Now, air observers use altimeters to determine the greatest elevations, then drop batches of aluminum foil to mark them. The metal's bright reflection is detectable for great distances against the green foliage. The foil is war-surplus material that was used to fool enemy radar warning systems. It comes in 300-foot-long strips ½ inch wide and in narrow two-inch strips. Tinsel dropping has also been proposed as a method of marking paths for ground parties to follow to planes downed in jungle country.

More than three billion dollars worth of eggs and chickens were raised in the United States during 1947, a record-breaking year for the poultry industry.

GROBAN'S SURPLUS BARGAINS!

BRAND NEW

AIR OR OIL HYDRAULICS



Use hydraulics on arbor presses, hydraulic presses, hay lifts, manure loaders, lift trucks — push or pull, tilt or turn, press or squeeze, open or close, lift or lower—and other hydraulic and industrial applications. Use with either air or oil . . . of finest precision workmanship.

1. Use these cylinders on farm trucks, bulldozers, hay lifts, manure loaders, etc. Double action, 1½" bore, 27" stroke. (Will lift 1760 lbs. in 2 seconds with Vickers Pump). A \$55.00 hydraulic cylinder value for only . . . **\$12.95** postpaid Wt. 8 lbs.
2. Double action, 2¾" bore, 8" stroke. (Will lift 4400 lbs. in one second with Vickers Pump). Will withstand 1500 P.S.I. against wall. A \$65.00 value, available now at . . . **\$14.50** postpaid Wt. 7 lbs.
3. Double action, 3" bore, 12" stroke. All steel hydraulic cylinder, will lift up to 12,000 lbs. (7000 lbs. in 3 seconds with Vickers Pump). A \$78.00 value. Wt. 12 lbs. . . . **\$19.50** postpaid



Brand New HYDRAULIC CONTROL VALVES

Outlets are standard ½" pipe thread and inlet takes standard ¼" copper tubing fitting.

Four-way control valve for use with

1. double action hydraulic cylinder, may be used with 1500 p.s.i. hydraulic system to open and close hydraulic cylinders. Brand new. Shp. wt. 4 lbs. A \$38.00 value. . . . **\$7.95** postpaid
2. Four-way control valve for use with two hydraulic double action cylinders. Each cylinder may be operated independently of the other or in conjunction with the other. Oil may be locked in any of the cylinders to hold the piston at any required position. Brand New. Shp. Wt. 6 lbs. A \$60.00 Value. . . . **\$10.95** postpaid
3. Same as valve item 2, except that unit is designed for three double action cylinders. Brand New. Shp. Wt. 8 lbs. A \$72.00 value. . . . **\$12.95** postpaid
4. A two cylinder double action valve with a unique arrangement, allowing the operator to raise both cylinders simultaneously, to lower them simultaneously or to raise one and lower the other at any predetermined rate and speed. Brand New. Shp. Wt. 8 lbs. A \$75.00 value. . . . **\$14.95** postpaid



VICKERS MF6 HYDRAULIC PUMP OR MOTOR

Compact, powerful, rated 1,000 P.S.I. .507 cu. in. per revolution, 8 gal. per min. at 3750 r.p.m. Change rotation by reversing flow. Delivers up to 6 H.P. BRAND NEW, Wt. 4½ lbs., \$60.00 value for . . . **\$14.95** Postpaid

VACUUM-AIR HYDRAULIC GENERAL PURPOSE PUMP

Original Cost

\$45.00

Now Only

\$9.95

Prepaid in

U.S.A.

BRAND NEW!



Worth Many Times This Low Sale Price

• Originally cost \$45.00. May be used as air or fluid pump—for pressure or vacuum. Standard ¾ inch pipe thread with interchangeable ports. Will pump 7½ gal. SAE 30 oil per minute at 300 RPM. Builds air pressure of 30 lbs. per sq. in. at 1000 RPM. Vacuum will draw 26 inches of mercury at 1750 RPM. Develops up to 120 lbs. per sq. inch of hydraulic pressure, which in conjunction with a 3 inch hydraulic cylinder will lift 840 lbs. minimum. Runs forward or reverse. Self aligning shaft. Die cast aluminum housing 6x4x4 inches. Has stainless alloy steel vanes and impeller. Made by Bendix Avia, Corp. Spline terminal for direct drive—readily replaced with a pulley. Recommend a ½ H.P., or stronger electric motor. Rated capacity 1500 RPM with high overload factor. Special price for quantity users. Complete illustrated engineering report and instruction booklet FREE with every pump. Send check or money order today! Postpaid in U.S.A. . . . **\$9.95**

Use them for

SPRAYING MACHINES

MILKING MACHINES

COMPRESSORS

VACUUM PUMPS

HYDRAULIC SYSTEMS

MANURE LOADERS

PRESSES, etc.

BRAND NEW ALL-PURPOSE WATER PUMP

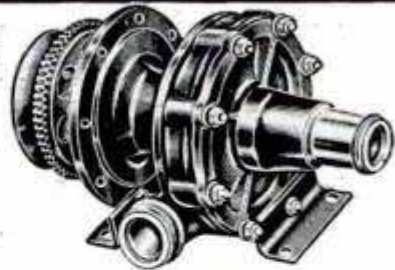

Ready for use on any pumping need

Use it for: DRAINING BASEMENTS

HOME WATER SYSTEMS

FIRE PROTECTION

PRESSURE BOOSTER

IRRIGATION

DRAINING PONDS, TANKS, etc.

SPRINKLING SYSTEMS

STOCK WATERING

INDUSTRIAL PUMPING

Complete with pulley and mounting brackets, ready for use.

Belt Driven — Centrifugal Pump

An extraordinary value for all types of intermittent or continuous pumping in the home . . . farm . . . factory. Built to exact specifications of Packard Motor Car Co. for use in Rolls-Royce Merlin Aircraft Engines. May be run with electric motor, gas engine or power take-off on tractor. Delivers up to 25 gallons a minute with ¼ H.P. motor; 80 gal. a min. with one H.P. motor. Will deliver up to 44 ft. head or 25 ft. suction. Use 1" outlet hose; 1" or 1½" inlet hose (recommended).

COMPLETE ENGINEERING REPORTS AND OPERATING INSTRUCTIONS FREE WITH PUMP

Has cast aluminum housing, accurately machined 5" bronze impeller; 3½" V belt pulley and mounting brackets. Shaft rotates on ball bearing; has grease gun fitting.

Original cost approx. \$88.00. Shipping weight 10 lbs. A REAL BUY. Satisfaction guaranteed. Mail orders filled promptly.

\$21.50

F.O.B. Chicago

Here is YOUR identification stencil set! Ideal for all industries in marking boxes and packages, identifying inventory, numbering doors, etc. GUARANTEED. Saves time, money and effort, easy to use, pays for itself. Metal letters, INTERLOCKING to make words. Comes in handy wooden box with sliding top.

STENCIL

OUTFIT

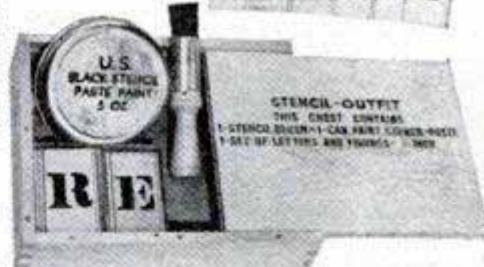

CONTAINS
1 stencil brush;
1 can paint,
stencil paste;

1 complete set of metal letters, figures, punctuation and spacers

COMPLETE KIT with 1" letters . . . **\$2.50** Pre-paid

COMPLETE KIT with 2" letters . . . **\$3.95** Pre-paid



U.S. SURPLUS BARGAIN

Polaroid Goggle Kit

USE THEM FOR ALL OUTDOOR SPORTS, BEACH, MOTORING, BOATING—ANYTHING.

Brand New! In original packing. Each with four interchangeable lenses. Shock Proof Frame. Shatterproof Lenses.

Heavy windproof sponge rubber ventilated frame with snap button lens retainers! Adj. elastic head band. Clear, red, green, amber, flexible, shatterproof lens, all instantly interchangeable, with carrying case. They won't last long at this price—it's smart to buy an extra. **\$1.00** Prepaid in U.S.A.

GROBAN SUPPLY CO. DEPT. PM 7, 1507 S. MICHIGAN AVE., CHICAGO 5, ILL.

EARN BIG MONEY
AND BE YOUR OWN BOSS
Sharpening Lawn Mowers

THE UNIVERSAL GRINDER
PUTS YOU INTO BUSINESS
WITH SMALL INVESTMENT

Earn as much as \$400.00 a month in your basement or garage. Mr. Felber of Ind., writes, "MY UNIVERSAL GRINDER is faster and more accurate than any other grinder. Its efficiency enabled me to sharpen 450 mowers in 4 1/2 months. More than paid for itself the first month. Every customer satisfied." Mr. Hardy of Mississippi writes, "Received my Universal Grinder the first part of May and by August 18 had sharpened over 1000 mowers." Mr. Bacon of California writes, "The lawn mower business, with my Universal Grinder, has been a gold mine these last two years."



Only on the UNIVERSAL GRINDER can the inside face, the edge of the stationary blade, and the reel blades, be ground to proper clearance ALL IN ONE SET-UP WITHOUT REMOVING ANY BLADE FROM THE MOWER
 Free Folder

Rogers Mfg. Co., Dept. M-78, Lindsey, Ohio

SEND TODAY FOR FULL DETAILS

ROGERS MFG. CO., Dept. M-78, Lindsey, Ohio
 Please send me without obligation complete details about how I can earn BIG Money with the Universal Grinder.

Name _____
 Address _____
 City _____ Zone _____ State _____

FREE ALLIED'S GREAT RADIO CATALOG!

172 Value-Packed Pages
SEND FOR IT TODAY

Everything in Radio At Lowest Prices!

Get ALLIED'S latest Catalog—biggest and most complete in Radio! Tremendous values in new Television receivers, home radios, latest Amateur receivers and Ham station equipment, Sound Systems. Everything for the Builder and Experimenter—thousands of parts, tubes, test instruments, tools, books, diagrams and builders' Kits—the world's largest stocks—all at money-saving low prices! Get your copy today.



The Only COMPLETE Radio Catalog

FREE Catalog!
 Send for it

ALLIED RADIO

ALLIED RADIO CORP., 833 W. Jackson Blvd., Dept. 5-G-8
 Chicago 7, Ill.
 Rush FREE 172-Page ALLIED Catalog.

Name.....
 Address.....
 City..... State.....

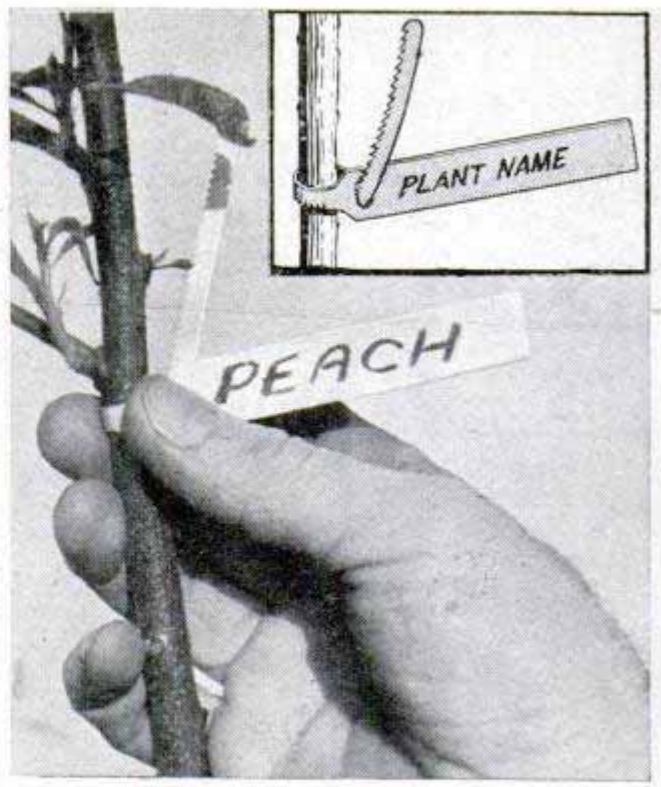

Zinc Tags Mark Garden Rows

Garden rows are marked with metal tags that stand out parallel with the ground for easy reading. The tags are made of zinc so they won't rust or corrode. The writing surface is covered with thousands of tiny holes that retain the marks of a grease pencil. The tags are locked to stakes with a saw-tooth strip that is inserted through a hole in the label.

Big-Game Animal Population Up 25 Percent in Three Years

Good news to the sportsman is the fact that big-game animals in the United States increased their numbers by 25 percent from 1943 to 1946, according to the Fish and Wildlife Service. There were an estimated 8,240,400 big-game animals in 1946 compared with 6,598,422 in 1943. Michigan had the largest big-game population with 880,600 animals, nearly all of them being deer. Wisconsin and Pennsylvania ranked second and third. Kansas is the only state with no big game, the report stated. Of the total big-game animals in the country, 7,375,200 or about 90 percent were deer. Others in numbers exceeding 100,000 were elk, prong-horned antelope, peccary and black bear. Rocky Mountain bighorn sheep showed the largest increase with a gain of 75 percent from 9152 in 1943 to 16,000 in 1946. The moose population went up from 14,803 to 23,300 while buffalo dropped from 6047 to 5000. The Fish and Wildlife Service estimates that 923,600 big-game animals were killed in 1946.

an extra motor
for only

\$3.95

The QUICK CHANGE Motor Mount gives you the service of two or more motors! Change from one machine to another in moments! Positions for 5-step pulley. Simple screw clamp permits tilting for belt-tension and tightening. The QUICK CHANGE Motor Mount allows one motor to work an entire shop! Complete Motor Mount only \$3.95. Extra mounting blocks only \$1.50 per pair. Send check or money order today. Write for FREE illustrated circular.

THE MOTOR MOUNT CO.

P. O. BOX 827

SPRINGFIELD MASS.

BUILD YOUR OWN FLOOR JACK

WITH

Build-a-Jack

and save up to 2/3rds

Buy this husky screw assembly and plates from us and use your own two-inch pipe or timber. You'll save up to \$6.00 per installation. Build-A-Jack is coated to resist rust and is easily adjustable. Special collar available for use with timber or pipe up to 3 3/4 inches for extra heavy use . . . 50c extra, pre-paid. No C.O.D.'s, please.



SCREW ASSEMBLY
AND BASE PLATES
\$3.49
PREPAID ANYWHERE
IN U. S. A.

Patented

Full refund if not satisfactory

Build-a-Jack MASSILLON, OHIO

**NOW HANDLE HUNDREDS
OF NEW PROJECTS!**

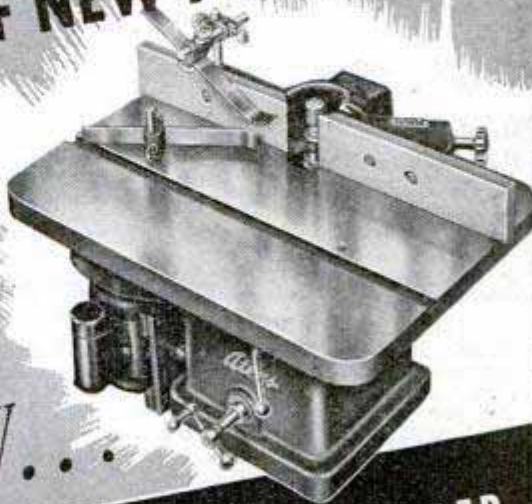

NEW . . .

Atlas WOOD SHAPER

- ★ 21" x 15" PRECISION GROUND TABLE
- ★ STATIONARY SPINDLE (Table raises and lowers)
- ★ PRECISION BALL BEARINGS (Sealed)
- ★ TAKES ALL CUTTERS WITH 1/2" BORE

They say it takes an old, experienced craftsman to appreciate the value of a wood shaper. Perhaps this new Atlas shaper will change that idea — because here is one of the most versatile and helpful tools you can have in your shop. It will handle all your shaping work on chairs, tables, desks, lamps, cabinets, beds, doors, trim, window moulding, storm windows and screens. And every job you tackle will come out as smooth and finished as the work of a master craftsman.

This is one of the new Atlas woodworking tools built to industrial quality standards for the men of America who really know tool values. Use the coupon for complete information.



ATLAS PRESS COMPANY

743 N. PITCHER ST., KALAMAZOO, MICH.

MAIL TODAY FOR NEW FREE CATALOG!

GENTLEMEN:

I'D LIKE TO HAVE COMPLETE INFORMATION ABOUT THE NEW ATLAS WOOD SHAPER.

NAME _____

ADDRESS _____

CITY, STATE _____



... Quick Easy Way to BIG PROFITS

Read What Others Are DOING!

"Enclosed you will find 56 orders representing 9 1/2 hours' work on Monday and Tuesday."
 "Enclosed are twelve orders secured after supper this p.m."

Housewives are Enthusiastic

Everyone that sees this outstanding Cell-U-Mop immediately wants one . . . That's the reason why our distributors are so successful . . . You also have the advantage of our other QUICK SELLING PRODUCTS that step up your Volume Sales and Profits.

Hands Never Touch the Water—Can be put in Boiling Water. Housewives Like It.

48" Long Handle

Sales QUICK, EASY Every Locality

SALES ARE EVERYWHERE . . . Sells quick to Taverns, Clubs, Hotels, Hospitals, Stores, Restaurants, Large and Small Buildings and the Homes . . . Scores can be sold on a single street . . . Note the Drain Bracket in the illustration . . . This squeezes out the water so thoroughly that HANDS NEVER TOUCH THE WATER . . . Makes no difference what you ever sold, you will like this proposition . . . Your name on a Post Card will bring you FREE PARTICULARS.

CELL-U-MOP CO., Dept. P-7 FREEPORT, Ill.

• We Teach You How •

Gets down under and around for MOPPING, DUSTING or WASHING

DOES THE WORK OF 6 TOOLS IN 1

Get Choice Territory NOW!

Holds 20 times its weight in water.



CLOSED

Sensational!
GENERAL ELECTRIC MOTORS
 For Kitchen, Office, Darkroom, Furnace or Attic Ventilation

Here is everything you want in an all purpose ventilating fan. GENERAL ELECTRIC 1/25 H.P. totally enclosed motor. Guaranteed Perfect, quiet operation. Bearings lubricated for life. 1550 R.P.M., 115 Volts A.C. 50-60 cycle. Horseshoe mounting bracket. 2 wire rubber lead cord. 6-blade fan—size 7 1/2" Dia. Overall height 9 1/2". This smashing value complete as shown—NOW— at **\$8.95**

Immediate Delivery

6 Volt HEATER MOTORS
 Don't wait for winter—get ready now! Ideal 6 volt heavy duty heater motors for automobiles, buses, or trucks. Adaptable for defrosting fans, heaters, etc. Motor screws extended for mounting purposes. 1/2" shaft. Motor size 1 1/2" L x 2 1/2" Dia. Don't delay—Order today. No. 1110 **\$2.75** POSTAGE PREPAID IN U.S.A.

SEND CHECK OR MONEY ORDER! NO C.O.D.'s SATISFACTION OR MONEY BACK. Dealers Write

James J. White
 1390 W. Fulton St., Chicago 7, Ill. Write For Bargain Catalog

YOU NEED THIS!

Today, tomorrow, next week—sometime—you wouldn't trade this tool for a hundred dollars. It's different—better than anything you have ever seen in its field—a hydraulic bumper utility jack that picks up loads from 8" below its base to 22" above, raises load a full 17". It's the famous American Hydraulic Bumper Utility Jack with chain and grab hook attachment. It's the bumper jack that's safe. Grab hook can't slip off bumper or bracket. Chain and grab hook pull fence posts, pipe, small trees, roots, forms, rocks. Hundreds of uses—and at all times the greatest tire-changing jack you've ever seen. 3,000 lb. capacity. If your dealer can't supply you today with the American with 30" chain and grab hook, write direct. Change tires safely, easily on any make car. Jack fully guaranteed. Order today. Enclose draft or money order for **\$15.95**. We will ship immediately, post paid. Address: **AMERICAN HYDRAULICS, Inc., Sheboygan, Wis.**

ONE-MAN SAWMILL LESS THAN \$200.00
Easy To Turn Trees Into Money

Makes lumber, ties, shingles, crates, lath, studding.

Belsaw Models
 in 10 to 24 foot sawing lengths. **MECHANICAL FEED**, accurate set works and positive dogs. Use tractor or old auto engine for low cost power. Thousands used for commercial sawing. Pays for itself quickly. Send post card today for FREE booklet, "How To Make Lumber" and Catalog of Woodworking Equipment.

BELSAW MACHINERY CO., 811-F Field Bldg. 315 Westport Road Kansas City 2, Mo.

"I'LL TAKE THE WHITE ONE EVERY TIME!"

WYTEFACE
 TRADE MARK
STEEL MEASURING TAPES

KEUFFEL & ESSER CO.

KAYAKS
AQUA VIR
Easy to Build

U-MAK-IT BOATS
Easy to Build

Cut-To-Fit for Quick Assembly. Everything Complete plus Illustrated Instructions. No Experience Necessary. Simple as A. B. C. SEND 25¢ POSTAGE (COIN) TODAY FOR 3 MONEY SAVING ILLUS. CATALOGS Showing all '48 Models (marine plywood) & construction details.

25¢ COIN FOR ALL THREE

OUTBOARDS ROWBOATS

AQUAMOBILE V-18

V-23 CRUISER

KAYAKS
ROWBOATS
DINGHIES
INBOARDS
OUTBOARDS
RUNABOUTS

KAYAK BOAT CO. 703 P. WHITTIER ST. NEW YORK 59, N. Y.

Compare and BUY!
Order Direct from this Ad.

POLISH - GRINDING HEAD

Act NOW!

Flexible POWER SHAFT

Only 648-

\$6.95

Fits motor with 1/2 in. drive shaft. Overall length 50 inches. Inner core 5/16 in. diam. — wound of transverse layers of high carbon steel wire for greatest strength and flexibility. Outer casing is of flexible steel wire. Headpiece has 1/2 in. x 20 thread arbor, and will accommodate any tool with this size thread or hole. Shpg. wt. 5 1/2 lbs.

SUN VISOR
 • For Greater Safety, more Comfort and Pleasure!

Protects against eyestrain caused by glare on sloping windshield. Helps keep windshield free of snow, ice and sleet by the **air flow sweep** and by direct protection. Easily installed, clamps on — no holes to drill.

THE PERFECT AUTO VISOR

Frame is of all-steel construction covered with weatherproof and durable leatherette cover with zipper closure. Adds class and distinction to any car.

\$12.95 Ea.

New "DRIVE-EZ" ARM REST

• For Greater Safety and Driving Comfort.
 • Fits seat of any car, truck, boat, trailer... home use.

The "Drive-EZ" Arm Rest gives arm chair comfort to the motorist... relieves driving strain and thus promotes greater safety. Especially helpful and comfortable on the longer trips. Filled with sponge foam with velon cover.

\$2.98

Price, each

NOKEE GAS TANK CAP

Latest Theft-Proof Gas Tank Cap on the market. Prevents siphoning of valuable gas and eliminates loss of cap. No keys or combinations... One model for all cars. Installed in a jiffy — no tools required. Beautiful chrome plated.

Our Price... **\$1.98**

Retails **\$2.50**

RADIATOR and HOOD ORNAMENTS

• Beautiful Designs...
 Flashing Chrome Plate

Flying Lady. Popular streamlined creation. Harmonizes with all cars. Length 5".

Closed Wing Heron. Latest, graceful design. Easily installed on any car. Lgth. 8".

Bucking Ram. Life-like design in gleaming chromium plate. Length 4".

Bull Dog. Brand new. Rich looking chrome. Heavy and massive.

\$1.95

Your Choice

Hydraulic BUMPER JACK

Smooth action pump type bumper jack... fast, efficient and easy to operate. All working parts fully enclosed—dirt and dust proof. Lifting capacity 2500 lbs. Full 18 inch lift. A top quality jack at a sensational low price. Compare!

Ship. wt. 8 lbs. Each... **\$4.87**

Sherill AUTO COMPASS

Dependable and serviceable, liquid type, airplane style for use on auto, plane or boat. Foolproof, easy to install. Shpg. wt. 1 1/2 lbs. Each... **\$1.79**

ALL TRADES Hyd. JACK

Handles all loads up to 10,000 lbs. with ease and speed. Made of treated steel for dependable performance. Ship. wt. 17 lbs. Each... **\$7.95**

Pebble DEFLECTORS

Give Beauty and Flash to any car! — These Chrome plated deflectors are practical and durable... give real protection to rear fenders. Easily installed... will not rust.

No. GG-7 For Ford V-8 & 6 cyl. (also Mercury) 1942-48 Made of Steel, chrome plated.

No. GG-70 For Chev. 1942-48 Heavy brass, chrome plated.

Specify for car wanted.

Per Pair... **\$6.95**

CLINTON MOTIVE SALES Co.
 545 W. ROOSEVELT ROAD
 DEPT. M-7 — CHICAGO 7, ILL.

Ball-Bearing SPEED WHEELS

Juvenile wheels, solid tire—No Bearings

7" wheels 60c
 6" wheels 50c
 4" wheels 30c

Semi-pneumatic tired wheels

12 x 1.75" \$3.25
 10 x 1.75" \$2.75
 10 x 1.25" \$2.00
 8 x 2" \$2.00

Industrial wheels for heavy loads

Semi-Pneumatic

400 x 8, 2 ply tire and tube... \$12.50
 12 x 3.00" bolt hub, ea. \$9.75
 10 x 2.75" Hollow Core \$6.75
 10 x 2.75" Single Tube \$7.25
 8 x 2.50" \$4.90
 6 x 2" lug base \$3.30
 6 x 2" \$2.80

DEALERS WANTED
 MANUFACTURERS
 INQUIRIES INVITED

Free blueprints with all wheel orders.
 Send check with order. Shipments f.o.b. Akron.

JIM BROWN TOY COMPANY
 1097 Home Ave. Akron 10, Ohio

ELECTRIC WELDER

AC or DC 110 Volts

Pre-war type—All metal—No chemical—5 year written guarantee. Welds 1/8" thick metal or money back. Repairs tanks, tools, fenders, machine parts, etc. Comes complete with rods, unit directions and eye shield.

On C.O.D. mailing charges extra.

\$6.45 COMPLETE

ESSAY MFG. CO., INC., Dept. P.M., Quincy 69, Mass.

HANDY TOOL BURNER

HANDY TOOL

BEST FOR SOLDERING

What every workshop needs. A gas blast burner for forging, tempering; thaws pipe, removes paint, melts lead; has many other uses. No compressed air, no fumes, no smoke. Use stationary or portable; no adjustments; heats red hot instantly—generates over 2500 F. Use natural, propane or butane gas. SPECIFY GASES. Order direct or thru dealers—\$2.98—check, money order or C.O.D. Postage paid. Money back guarantee if not satisfied with Handy Tool Burner.

HEATS WHITE HOT IN TWO MINUTES

SIMPLE TO OPERATE... ATTACH TO ANY GAS OUTLET

HANDY TOOL CO. 220 EAST 6TH STREET PAWHUSKA, OKLAHOMA

FAMOUS CLINTON GASOLINE ENGINES . . .

• NEW. Complete, ready-to-run, compact, dependable 4-cycle single cylinder aircooled gasoline engines, by world's largest producer, specializing in 1½ to 3 H.P. engines. Over 300,000 in world-wide use.

1½-2 H.P. MODEL 700A \$59.50

2½-3 H.P. MODEL 1100A \$74.75

1½-2 H.P. MODEL 701AS \$72.50

2½-3 H.P. MODEL 1101AS \$87.75

1½-2 H.P. MODEL 700ABR6 \$75.00

2½-3 H.P. MODEL 1100ABR6 \$90.25

Rope starter, direct drive models 1200 to 3600 r.p.m. for power tools, lawn mowers, air compressors, wood saws, etc.

Kick starter attached, direct drive for scooters, midget autos and machinery.

Gear reduction 6 to 1, built-in, for machinery, garden tractors, conveyors, etc., requiring shaft speeds from 200 to 600 r.p.m.



MODEL 700 ABR 6

ORDER DIRECT—AND SAVE!

These are all Factory-Fresh Engines—Not War Surplus—With standard 90-day guarantee. Order with confidence. Send Check or Money Order. Immediate Insured Deliveries. Michigan purchasers only—include 3% sales tax. Free literature.

CLINTON ENGINE CO. • 16351 East Jefferson • DETROIT 30, MICH.

HOME WORKSHOPPERS!



NOW . . . a Metal Punch Kit with Special and Exclusive features at rock bottom price.

Here's a Metal Punch Kit worth far more than it costs. Light, strong, 9" punch with compounded leverage cuts clean holes in metal sheet of all kinds up to #16 gauge sheet steel. 7 quick-changeable die sizes. Saves time, saves bother and effort. A "must" for metal work hobbyists and for many home repair jobs.

A professional model of highest quality made by makers of the famous BERNARD punches and pliers.

ONLY \$8.95 including handsome, rugged metal box holding complete kit with 7 dies and combination screwdriver-wrench.



Die sizes: 1/16, 3/32, 1/8, 5/32, 3/16, 7/32 and 1/4 in.

SEND FOR IT TODAY! Money back if not completely satisfied.

SARGENT & CO. (SCHOLHORN DIV.)
87507 Water Street, New Haven 9, Conn.

Send me your metal kit, punch, seven dies and combination screwdriver wrench. Check or money order for \$8.95 enclosed.

NAME.....
STREET.....
CITY.....STATE.....

Zone

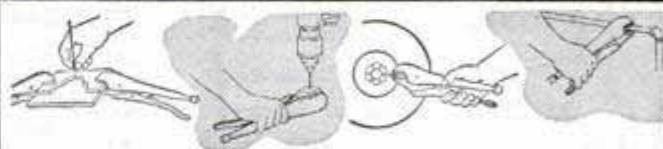

BULL DOG GRIP WITH NORMAL HAND PRESSURE

Householders! Hobbyists! Mechanics! The handiest tool you could have. Automatically locks itself onto work. Quickly and simply applied—just as simply released. Pre-adjustable, forged steel jaws. A tool with 1001 uses—as portable vise, pipe wrench, pliers, clamp, wrench, etc. 10-inch size offered at special price. Send money order or pay the postman \$1.39 (plus postage) when he delivers this Vise Wrench to you.

FORDOAK PRODUCTS 12841 Ford Road Dearborn, Mich.

MORE POWERFUL PORTABLE

BENCH GRINDER-\$13.50 DELIVERED

FULL 1/12 H.P. MOTOR AT 3450 R.P.M. BY DYNAMOMETER TEST

With adjustable tool rests and removable cast wheel guards for buffing. Diamond-trueed 4" x 1/2" coarse and fine wheels . . . dust proof bearings . . . off-on switch . . . 6 ft. rubber cord . . . baked hammertone finish . . . 110-120 volts a.c., 60 cycle . . . guaranteed one year against defective workmanship or materials. Send check or money order, we prepay postage.



ALHAMBRA PRODUCTS, BOX 328, ALHAMBRA, CALIF.

SEND FOR FREE CATALOGUE AND MANUAL

QUALITY

Aluminum Guard Easily Removed For Dadoing

8%

NEW IMPROVED TABLE MODEL TILT-ARBOR SAW

OIL IMPREGNATED BRONZE BEARINGS OR DOUBLE SHIELDED BALL BEARINGS, BOTH WITH THE PATENTED BALL BEARING TRANS-AXIAL MOTOR DRIVE

MODEL #2021X AS SHOWN WITH COMPLETE MITRE GAUGE. Precision etched scales show angles on mitre gauge and saw cradle. STEEL BAR RIP FENCE. ALUMINUM SAW INSERT AND GUARD. STEEL SPLITTER. BALL BEARING TRANS-AXIAL DRIVE 5/8" GROUND ARBOR. "COMPO" OIL IMPREGNATED BRONZE BEARINGS WITH OIL CHAMBER AND CUP, (OR, DOUBLE SHIELDED BALL BEARINGS, \$5 EXTRA). TABLE 18" x 16". BUILT IN SWITCH. Depth of Cut 2 5/8". Shipping Wt. 110 lbs. Requires 1/3 or 1/2 H.P. Motor.

(BALL BEARING FLOOR MODEL WITH 18" x 32" TABLE INCLUDING EXTENSION \$79.50)

TABLE 18" x 16"

SAW BLADE TILTS TO 50° TABLE STAYS LEVEL

BRONZE BEARINGS \$44.95 F.O.B. ROYERSFORD, PA. (less Blade & Motor)

AMERICAN MACHINE & TOOL CO., Inc. DEPT. 111 ROYERSFORD, PA.

STOP

Discomfort
Dust
Drafts
Dampness

Decay
Wood Rot
Rust



of Your Buildings with

Handicalk

Seal all cracks before you paint. Do it yourself the HANDICALK way. It's easy—it's fun—it's inexpensive. Just snap nozzle cartridge in gun and calk. No mess, nothing to clean. Gun only \$1.98 at Hardware, Paint or Building Supply Dealers. HANDICALK, 2449 Woodhill Road, Cleveland 6, Ohio.



**CALKING IS FUN
WITH A HANDICALK GUN**

NAUTICAL SURPLUS BARGAINS IN DIVING EQUIPMENT

Here's Your Chance to SAVE MONEY . . .

MK V Helmets, Face Masks, Pumps, Hose, Belts, Shoes, Etc.

We offer one of the most complete lines in America of New and Used Surplus Shallow and Deep Water equipment. BARGE PROPULSION UNITS, 115 h.p. Diesel and 141 h.p. M-8 Gas. Get complete details and price list.

WRITE FOR FREE CATALOG
M & E MARINE SUPPLY CO.
P.O. Box #601-V, Camden, N. J.



FIX SEWING MACHINES

BIG MONEY. Spare or full time. Open your own neighborhood shop. Thousands need repairs. Send for complete Service Manual—only \$1.98 postpaid. Money back guarantee.

SEWING MACHINE SERVICE CO., Hamilton 25-CC, Ohio

Now A DYNAMIC Industrial Transformer Type Super WELDER

FOR AUTO—HOME APPLIANCE & FARM IMPLEMENT REPAIRS! WORKS ON IRON, STEEL & other metals . . . does work you'd expect from a larger, costlier machine; portable, easily carried; OPERATES FROM ANY properly wired 110 VOLT LINE. Also available for 220 volt operation at slight additional cost; has 8 metallic & carbon arc welding heat stages. EASY TO OPERATE TRANSFORMER TYPE WELDER—If inexperienced you can learn to do professional work by following the SIMPLIFIED WELDING & OPERATING INSTRUCTIONS FURNISHED—comes complete ready to operate with helmet, rods, cable, instructions. SAVE TIME AND MONEY—Do your own welding—Just a few repair jobs will pay for this machine. A practical and profitable machine tool for any workshop. Make money doing repair work for others. Write today for full particulars and 10 DAY FREE TRIAL OFFER.

ONLY \$28.50 COMPLETE

DYNAMIC WELDER CO., 15 E. 23rd St., K, Chicago 16, Ill.



ELECTRONIC KITS For HOBBYISTS and EXPERIMENTERS

HEATHKIT 3-TUBE

ALL-WAVE RADIO

110-volt AC operation



\$8.75

An ideal way to learn radio. This kit is complete ready to assemble, with tubes and all other parts. Operates from AC . . . Simple, clear detailed instructions make this a good radio training course. Covers regular broadcasts and short wave bands. Plug-in coils. Regenerative circuit. Operates loud speaker. Battery model for use where no AC house current is available. Add postage for 3 lbs.

Heathkit Beginners' Radio 110-volt type . . . **\$8.75**
Heathkit Beginners' Radio, battery type (2 tubes, no rectifiers) . . . **\$8.75**
Headphones for either type HS 30 per set . . . **\$1.00**
2 1/2" permanent magnet loudspeaker for either type . . . **\$1.95**
Batteries, complete kit for battery type set . . . **\$3.25**

MIDGET TRANSMITTER KIT

Complete kit to assemble a 1 Watt battery operated amateur 80 meter transmitter, including tube and crystal. Range up to 500 miles. Only accessories needed are sending key and batteries. Complete instructions supplied. Add postage for 2 lbs.

Key—add postage for 2 lbs. . . . **\$1.00**

Batteries—add postage for 4 lbs. . . . **\$3.25**



\$3.95

INTERPHONE 2-WAY CALL SYSTEM KIT



Shipping Wt. 5 lbs.

\$14.50

Ideal call and communication system for homes, offices, factories, stores, etc. Makes excellent electronic baby watcher, easy to assemble with every part supplied including simple instructions. Distance up to 1/5 mile. Operates from 110-V A.C. 3 tubes, one master and one remote speaker.

GENERAL ELECTRIC TRANSMITTER-RECEIVER FOUNDATION

A beautifully constructed tuner containing the best in variable condensers, coils, vernier dials, etc., at least \$30.00 worth of parts, complete with conversion instructions to transmitter and receiver. Add postage for 20 lbs. . . . **\$2.49**



MINIATURE MOTOR

24V. D.C. size 1 1/4" x 1" x 2" Add postage for 1 lb.

\$2.95



G. E. CIRCUIT BREAKER

Protect your electrical equipment, eliminate fuses. 50 AMP 220 Volt rating. Add postage for 4 lbs.

\$2.95

ORDER DIRECT FROM THIS AD

Include postage for weight shown. Print name and address. No orders under \$2.00

HEATH CO. DEPT. M BENTON HARBOR, MICH.

RIG Your Own TRAILER

for DOZENS
of HAULING
USES



Universal

3000 LB. CAPACITY

TRAILER CHASSIS

FOB **\$59.95**
E. Boston, Mass. Plus 7% Federal Tax

Consists of rugged tubular all-steel frame, heavy-duty forged steel spindles, Timken tapered roller bearings, drop center wheels, dust-seal hub covers, extension goose-neck hitch, safety chain and parking stand.

2 Tires with Tubes for Chassis \$31 extra
(4-ply 600x16 standard make tires)

Tires furnished only with order for chassis

TERRIFIC BUY! Immediate Delivery AT NET MANUFACTURER'S PRICES

Universal's trailer chassis is sold and guaranteed direct by manufacturer. Remittance of \$20 must accompany order. Balance, including freight from E. Boston, plus U.S. tax to be paid C.O.D.

Universal Mfg. Co.

EAST BOSTON (28) MASS. DEPT. P7

ORDER NOW! DIRECT FROM MANUFACTURER

UNIVERSAL MFG. CO. 160 Prescott St., E. Boston 28, Mass.

Send _____ Trailer Chassis, @ \$59.95 FOB E. Boston, plus 7% Tax.

Send _____ Trailer Chassis, 2 tires & tubes \$90.95 FOB E. Boston plus tax

Send _____ Fenders, @ \$3.15 pair FOB E. Boston Plus Tax

I enclose \$ _____ Will pay balance, freight and tax on delivery.

Name _____

Address _____

New BRUSH Electroplater

ESPECIALLY BUILT FOR MECHANICS, MODEL MAKERS HOME CRAFTSMEN

Easy to Plate GOLD, SILVER, NICKEL, COPPER, etc... For Pleasure and Profit!

If you have a workshop—at home or in business—you need this new Warner Electroplater. At the stroke of an electrified brush, you can electroplate models and projects—you can replate worn articles, faucets, tools, fixtures, silverware, etc. with a durable, sparkling coat of metal... Gold, Silver, Nickel, Copper, Cadmium, and after a bit of practice, even Chromium! Everything furnished—equipment complete, ready for use. By doing a bit of work for others, your machine can soon pay for itself. So make your shop complete by getting a Warner Electroplater right away. Send today for FREE PLATING SAMPLE and illustrated literature. **ACT AT ONCE.**

WARNER ELECTRIC CO., Inc., Dept. T-10
1512 Jarvis Ave., Chicago 26, Illinois

FREE Details & Sample!

WARNER ELECTRIC CO., Inc., 1512 Jarvis Ave., Chicago 16, Ill., Dept. T-10
Gentlemen: Send Free Sample and Details to:

Name _____

Address _____

City _____

State _____

Stucco Spraying

Today's Outstanding Business Opportunity



Beauty and protection are sprayed on old and new buildings... exterior and interior surfaces... by COLORCRETE. It's a plastic, water-resistant material, spread evenly over surfaces and forced into cracks by air pressure. Fuses to masonry with enduring tenacity. Many textures. Range of 39 smart colors. Fully proven by 20 years of actual use under all conditions.



Big Earnings for Colorcretors

Colorcrete ties in with today's huge building program. Renews old buildings. Makes new construction more attractive and enduring. Large waiting market, because building owners get long lasting beauty and protective values at low price. Yet your selling price can be several times your basic cost. Machine is easy to operate. Moderate investment. Write or wire for complete information.

COLORCRETE INDUSTRIES, INC.
570 Ottawa Avenue Holland, Michigan

COLORCRETE

FIND UNDERGROUND MINERALS and METALS with M-SCOPE

New sensational lightweight models, unsurpassed efficiency
Low prices. Time-payment plan. Write for free 16 page booklet.

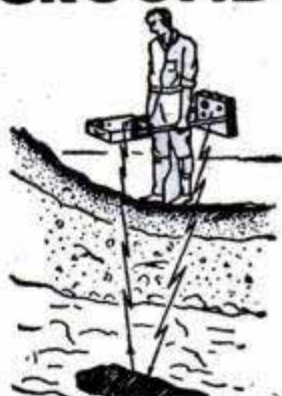

FISHER RESEARCH LABORATORY, INC.
PALO ALTO CALIFORNIA

INVENTORS

Whether an invention is patentable can be substantially determined by a search of the U. S. Patent records. Without obligation, write for information explaining the steps you should take to secure a patent.

JOHN N. RANDOLPH

Registered Patent Attorney

201 Columbian Building, Washington 1, D. C.



The Modern PLASTIC for lasting Home Repairs

PERMANENTLY mends cracks or holes in wood, tile, stone or plaster. Sticks and stays put—Does not chip, shrink or fall out. Easy to use. Economical. Mold it, chisel it, polish or paint it. If unobtainable from your lumber, paint or hardware dealer, the big 4-lb. can will be sent you post-paid (in U.S.) for only \$1. Full money-back guarantee, order now.

DONALD DURHAM CO.
Box 804-S, Des Moines, Ia.

SAVE ON WAR SURPLUS

ARMY GOGGLES

Brand new polaroid goggles. Sponge rubber ventilated frame. adjustable elastic headband. Complete with 2 interchangeable lenses — clear and green.



NAVY GOB HAT

Brand new white duck. Sizes 6 3/4-7 5/8.



2 for \$1

pr. 98¢

SLEEPING BAG

100% wool, mummy type. 30" zipper. Reissue — guaranteed like new. Complete with water repellent cover.

3⁹⁵



ARMY RAINCOAT

Army surplus. Renovated — perfect condition. Sizes small med., large. 1.79



Jungle HAMMOCK

Brand New Mosquito proof, rain-proof, mildew-proof, nylon. Use as hammock or tent. Full length zipper. 5⁹⁵



NEW KHAKI TROUSERS

Brand new. First quality. 8 oz. mercerized cotton twill. Sizes 29 thru 42. 3.75

NAVY KNIFE

Brand New. Tempered steel 3 1/4 inch "Parkerized" blade. Laminated leather grip handle. Complete with sheath. 98¢



NAVY T-SHIRT

Brand New. First quality. Soft fine knit cotton. Sizes small, med., large. 3 for \$2



Air Corps Type SUNGLASSES

New Air Corps Type. 24 Karat gold plated frame. 4 base optically ground lenses. Poloroid brow rest. Complete with case. 2²⁵



ARMY PUP TENT

Army surplus. Full size. Used — guaranteed perfect condition. Complete with poles and pins. 3⁹⁵



SEND NO MONEY

Parachute
Army surplus. Brand new nylon. 30" diameter. 8 nylon shroud lines. 69¢

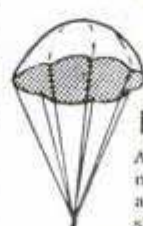

NEW KHAKI SHIRTS

Finest quality. Full cut. 8 oz. mercerized cotton. Sizes 14 thru 17. 2.95

MAE WEST

Brand New Air Corps surplus. Insures positive water safety. Complete with CO2 cylinders. 2.49



NAVY RAIN SUIT

RAIN PARKA
Brand new. Waterproof silpover jacket. Sizes small, med. large, extra large. 2.98



RAIN PANTS
Brand new. Waterproof overall pants. Size large only. 1.98

ORDER FROM THIS AD - MONEY BACK GUARANTEE

NATIONAL JOBBING COMPANY
1703 No. 24th St. Dept. N-1 Omaha Nebr.

MAKE THESE LEATHER and LEATHERETTE ITEMS LIKE NEW

With New Plastic LEATHER-NEW

Covers leather, leathette and cloth and gives new finish and color — wears like leatherette. Easily applied with brush — quickly renews with liquid artificial leather. Write for FREE sample.

Own Your Own LEATHER-NEW Contracting Business — Big Profits
Renew equipment for Bars, Restaurants, Hotels, etc. Profits possible up to \$125.00 on a single job... write for details.

FREE Sample of coated material — Write for it — No Obligation
LEATHER-NEW, 4723A Troost, Kans. City, Mo.

- Leather Covered Furniture
- Grille and Cafe Equipment
- Any Leather or Leatherette Item

ASSEMBLE



King Midget

45 MILES AN HOUR 90 MILES A GALLON

New, low cost transportation. Practical. Safe. A pleasure to drive. Home assembly keeps cost low. Just bolt together our factory built units. Immediate delivery. Send 25c for detailed circular with large picture, 4-view drawings, price of all parts. Or send for actual Assembly Book with 42 photographs, blueprints, drawings, sketches AND above literature — all for \$1 (refunded first order).

MIDGET MOTORS MFG. CO., Athens, Ohio

Woodworkers!!
Make your circular saw the most versatile tool you own!

CUT GROOVES LIKE THIS

\$4⁹⁵ SET
POSTPAID INCLUDING TAX.



WARREN DADO SAWING WASHERS WILL FIT THE ARBOR OF ANY POWER CIRCLE SAW AND CAN BE USED WITH ANY DIAMETER SAW BLADE. CUTS GROOVES CLEANER, EASIER AND FASTER THAN AND DADO CUTTER ON THE MARKET... MICROMATIC ADJUSTMENT PERMITS A CUTTING ANGLE CHANGE IN 15 SECONDS... SAW BLADE HELD RIGID... WILL NOT CHATTER... WARREN DADO SAWING WASHERS CAN BE LEFT ON THE ARBOR OR QUICKLY REMOVED FOR CUT OFF SAWING.

ORDER YOUR SET OF FOUR WASHERS TODAY, TRY THEM FOR TEN DAYS, IF NOT SATISFIED, YOUR MONEY WILL BE REFUNDED IN FULL. DEALER INQUIRIES INVITED

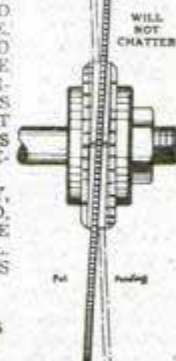

Arbor 1/2 3/4 1
 Sizes 3/8 1
 Name _____
 Address _____
 City _____ State _____
 Free Circular
 Check
 Money Order
 ALL SETS SHIPPED POSTPAID

WARREN DADO SAWING WASHERS CO.
P. O. BOX 98 NORTH END STATION
DETROIT, MICHIGAN

NEW MOWER ATTACHMENT

WITH MANY
NEW FEATURES!

Garden-All
LAWN and GARDEN TRACTOR

Write for
Folder

Another efficient
Garden-All
Attachment!

26 or 30-inch cut.



Also a
SICKLE BAR
32 or 36-inch cut

Here's a new lawn mower attachment that is truly outstanding in engineering, construction and versatility! The 7½-inch diameter, 5-blade, heavy-duty reel is set in perfect alignment with a spring-laden bed knife; full-floating action permits mowing over banks or uneven ground; solid objects pass through without springing the mower; an individual clutch disengages the mower while the tractor stays engaged or vice versa. Or, if you prefer, get the Sickle Bar (with Weed Deflector) which has features all its own. Remember that Garden-All supplies tools for every lawn and gardening need. See them all before buying any power equipment.

GARDEN-ALL TRACTOR, INC.

Dept. P, 100 W. UNION STREET, LIBERTY, INDIANA

NONE BETTER AT ANY PRICE!

PAINT YOUR
CAR WITH

KAR-WIPE NEW AUTO
ENAMEL SENSATION

WIPE IT ON!
NO SPRAYING!
NO BRUSHING!
2 FULL YEARS \$1.95



YOU
CAN DO
A FACTORY
LIKE JOB

One Quart Covers
Average Car With
Two Gleaming Coats.
A Glowing Professional
Finish!

Not a streaky wax or
polish. KAR-WIPE is the
new miracle high lustrous
auto enamel that is so
easy to use. Anyone
can do a professional
looking job quickly.

KAR-WIPE CO., Dept. P7, 828 S. 18th St., St. Louis, Mo.

Almost anyone can
get high-gloss job
that looks like a
Professional finish.
KAR-WIPE
does the trick!
Easy to apply! No
brush! No masking!
Simply WIPE IT ON
with the applicator that
we give you FREE. Get a
factory-like finish that's

GUARANTEED
2 FULL YEARS
GUARANTEED against chipping, crack-
ing, peeling, fading when simple
directions are followed. Dries
dust free quickly. In newest colors,
SEND NO MONEY! Order one or more
quarts today. Just mail postcard.
Pay postman plus C.O.D. upon deli-
very. Send remittance, save postage.

SEND NO MONEY! ORDER Kar-Wipe TODAY!
In Black, Grey, Firey Red,
Brewster Green, Washington
Blue, Maroon ... \$1.95 per qt.

SEE...

What 10¢
brings You..

3 sets of plans for making handsome end
tables, sewing chests, etc., at home. Simplified
so beginners can follow.

PLUS—Full size jar of famous Rogers
"Gorilla Grip" Glue—strongest glue on the
market. Makes wood furniture, toys, etc., last
a lifetime.

Offer good only until Sept. 1, 1948.

Send 10c TODAY to Rogers In-
glass & Glue Co., Gloucester, Mass.

ROGERS

the best LIQUID FISH GLUE

GLOUCESTER, MASS.



The Big New Boone AIR TARGET PISTOL

Not a toy but a genu-
ine Target Air Pistol.
Sturdy single shot
construction with rustless steel barrel
and solid aluminum grip. Shoots
standard BB shot and is amazingly
accurate to 25 feet. 9¾" long over-
all with open v rear sight. Serrated
pistol grip and balanced
trigger pull. Modeled after a
famous firearm. Single action air
cylinder. Positive cocking action.
Price includes 150 BB shot.
Postpaid if prepaid, or send \$1, with \$2.95 plus
postage COD.



\$3.95

PRECISION SPORTS PRODUCTS, Parma 2, Mich.

MARCOT KEY MACHINES

MARCOT No. 8 KEY MACHINE, mounted on Cabinet	\$ 95.00
Auto Code Book and Auto Depth Keys	12.50
100 Dz. Popular Cylinder Key Blanks Set—Key File, Follow-Through Rods, Lock Picks, Bit Key Gauge, Thimble, Pins, Springs..	60.00
"Locksmith Trade Books": How to Open Locks without Keys or Picks: Secret of Lock- smithing; How to Make Keys by the Impression Method; Master Key Systems.	10.50
TOTAL COST	6.75
The \$60.00 cost of the Key Blanks would return approximately \$350.00. This would more than pay for your entire KEY MACHINE OUTFIT. IMMEDIATE DELIVERY—Motors available with Key Machine Orders.	\$184.75

A. J. MARCOTTE CO. DEPT. PM, CHICAGO 51, ILL.
1200 N. KEDZIE AVE.

REYNOLDS CIRCULAR SAW GRINDER



FOR
SAWS
5"-30"

FOR JOINTING
GUMMING • SHARPENING
ALL TYPES OF CIRCULAR SAWS
Write for Circular

REYNOLDS MACHINERY CO.
305 EDDY ST., PROVIDENCE 3, R. I.

BURIED TREASURE, MINERALS AMAZING NEW GOLDAK LOCATORS

SENSATIONAL NEW MODEL!
ONLY 11 pounds weight! One hand
operation! Money-Back Guarantee of
Superiority. Write for full details.

THE GOLDAK CO.
1542 WEST GLENOAKS BLVD.
GLENDALE 1, CALIFORNIA

World's
largest
maker
of fine
locators.



ELECTRIC SHEAR SHARPENER

Over 35,000 Sold—It Must Be Good!



Genuine Carborundum
wheel ideal for shop or
home use. Send remit-
tance with order and ship-
ment will be made at
once, prepaid to your door,
complete with electrical
goods catalogue.

MOTOR
DRIVEN

\$9.75
complete
with vise

WILLIAM MARVY COMPANY
479 West St. Peter Street St. Paul 2, Minn.

Nimrod

PIPELITER



DOWN-DRAFT

CHIMNEY-ACTION

\$3.50
AT YOUR
DEALER

- WINDPROOF
- LIGHTWEIGHT
- LARGE FLAME

Unconditionally Guaranteed

ASHLEY F. WARD, INC., Dept. 35-K, 2968 Jessamine St., Cincinnati, O.

TX-5 GEIGER COUNTER

for Locating
RADIOACTIVE MINERALS

The TX-5 is light weight, battery operated. Locates deposits of radioactives. Simply switch "on"—clicks in headphones indicate presence of radioactives. Extra sensitive, yet ruggedly built.

Each unit comes complete with headphones, probe, batteries and manual. For prospecting and mining operations. Write for details and price.

Address Dept. PM 7



Geiger Counters
for every purpose..

- OIL PROSPECTING
- MINERAL LOCATION
- HOSPITAL WORK
- INDUSTRIAL USE

OMAHA SCIENTIFIC SUPPLY CORP., 3623 LAKE, OMAHA 4, NEBR.

GERSTNER Tool Chests

Measured by longer service, the cost of genuine Gerstner chests is unimportant. Free catalog.

GERSTNER TOOL CHESTS

448 Columbia St. Dayton 7, Ohio

NEW Family SAFETY JIG SAW READY!

At last—a revolutionary, new electric jig saw small children may use, yet powerful enough to be the basic tool in Dad's workshop! Make "Stunning Photo Silhouettes" of favorite snap shots... fancy what-nots, toys, for fun and profit! Handy as a hammer—just plug in! No motor to buy—no oiling. Thousands sold. Use in living-room, apartments, etc. Patented. Nothing else like it. Mail postal NOW for illustrated, free circular, low price! (Dealers write!)



FREE
SYNGRO CIRCULAR!



SYNGRO SAW CORP., DEPT. A-78, ROCHESTER, MICH.

CROSLLEY NOW HAS "New Look"

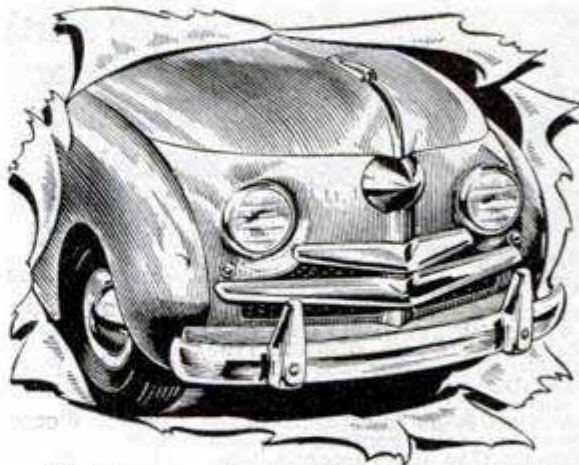

Here's new smartness to make you prouder than ever to drive a Crosley. Now Crosley steps out—steps up—with a newly designed front. It's the "new look"! Massive louvers and a gleaming spinner adapted from aircraft propellers. See the new Crosley today—see why every-one's saying when a Crosley passes, "Crosley cars are better looking than ever."

Available in 6 smart styles—
Station Wagon:
Sedan: Convertible: Panel Delivery: Pick-up: Sports-Utility.



Priced at several hundred dollars under comparable models, operate for about half as much. All are roomy, easy-driving, give 35 to 50 miles per gallon. Powered by the revolutionary 4 cylinder Crosley COBRA engine.

CROSLLEY

a FINE car

For beautiful full color catalog, write: Crosley Motors, Inc., 2532-HO Spring Grove Ave., Cincinnati 14, Ohio

AIR RIFLES BENJAMIN AIR PISTOLS

PIONEERS - LEADERS

SEND FOR FREE FOLDER OF LATEST MODELS TODAY
If you want a REAL GUN for PRACTICAL USE inside or outdoors get a SAFE - CLEAN - ECONOMICAL - BENJAMIN with Adjustable Power and Amazing Accuracy. For BEST RESULTS use BENJAMIN H-C PELLETS. WRITE AT ONCE. BENJAMIN AIR RIFLE CO., 812 MARION ST., ST. LOUIS 4, MO.

SOLDERING IRONS—AMAZING OFFER!

YOU SAVE OVER HALF ON NEW HI-QUALITY ELECTRIC SOLDERING IRONS—WHILE THEY LAST

NOW ONLY
\$2.95

FOR A LIMITED TIME ONLY

We bought out a mfg., lock, stock and inventory. Hence this unusual "clear the decks" offer, with savings up to \$4.95. Now you can get these specially-made, highest quality irons at a price little over our clearance cost. YOU COULDN'T ASK FOR A BETTER CHANCE TO SAVE REAL MONEY ON TOOLS OR REPLACEMENTS. Don't delay. Limited number left.

10-DAY MONEY-BACK GUARANTEE

CRANDALL MFG. CO.
1512A W. Slauson Ave., Los Angeles 44, Calif.

ACT NOW — MAIL YOUR ORDER TODAY!

CRANDALL MFG. CO.
1512-A W. Slauson Ave.
Los Angeles 44, Calif.

All orders filled promptly while stock lasts. Orders will be returned when stock is gone.

Please send, postage paid, _____ Hy-Temp irons. 100 Watt

150 Watt. I enclose \$ _____ Check Cash Money Order.

Name _____

City _____ Zone _____ State _____

PLEASE PRINT



OUTSTANDING IRON
Underwriters Lab. approved... hot tip, threaded... cool handle... quick heat... fully tested... long life... not an orphan.



PHOTOFLASH KIT . . .

Replaces
\$2000 Worth
of Regular
Flash Bulbs

BRILLIANT,
PROFESSIONAL
STUDIO-TYPE
ILLUMINATION

Brand new **STROBOFLASH KIT**, including 2 LAMPS, POWER SUPPLY, REFLECTORS, ACCESSORIES and COMPLETE INSTRUCTIONS for immediate 12-volt DC operation or 110-volt AC conversion. Yours for **ONLY**

\$59.50

POWER SUPPLY in attractive grey finish steel case, including relay control, two 50mfd 2000 volt condensers (110 Watt seconds light output). For immediate 12-volt DC use or simple 110-volt AC conversion. (Power pack alone worth double the price.)

ULTRA-BRILLIANT FLASH TUBES in unbreakable sealed plastic give 12,000,000 peak lumens, over 15,000 flashes.

PLUS aluminum reflectors, transformer, connectors, cabling, instructions and 110-volt AC conversion parts.

Strobo-Lamps with reflectors ea. \$10.95, 2 for \$21.00
Flash condensers 15mfd. 2000V INT. 4.50
25mfd 2000V INT. . . \$7.95; 8mfd 3000V . . . 4 for 11.95
SPECIAL! Just received . . . 16mm film, Weston Speed 50,
25-ft. rolls, 54 rolls per sealed can, '46 date. . . . \$19.95

"TAB" Dept. 7PM, Six Church Street **"THAT'S"**
New York 6, N. Y., U. S. A. **"A BUY"**



PAINTERS' STRIPING TOOL

NOW you can do your own expert striping on furniture, bikes, model planes, bulletins, autos, toys, signs, linoleum, wall board . . . make plain walls look like tile! It's easy to paint straight, curved, circular, even parallel lines with any color. Handiest paint tool in your workshop! Type "M" Master Painters' Striping Tool complete with tip for 1/16" stripe, \$1.00. Extra tips 1/64", 1/32", 3/64", 1/16", 5/64", 3/32", 1/8"—75c each. Tool with complete set of 7 tips \$5.00. (C.O.D. orders 25c extra.)
WENDELL MFG. CO., 4234 -B Lincoln Ave., Chicago 18, Ill.

**A TOOL . . .
NOT A BRUSH**



Dealers
Write
Today!

1/2" ELECTRIC DRILL



Famous Speedway, long life, high-torque, air-cooled motor. Practically stall-proof. Keeps turning under 500-lb. thrust. 1/2" DRILL STAND — ideal for above drill. Holds it rigidly, accurately. Makes

Full 1 Year
Factory
Guarantee
OVER
200,000
IN USE

convenient drill press. \$12.95. Speedway 1/4" drill \$11.80, 1/4" drill stand \$5.25, bench grinder \$14.95, hand grinder \$8.25. Check, money order post paid or C.O.D. plus post.

with
SNAP-ON
CHUCK
\$29.95
Jacob Chuck
\$34.95

IMMEDIATE DELIVERY

TOOL-CRAFT 3516 VICTORY AVENUE
RACINE, WISCONSIN

IMMEDIATE DELIVERY!

Complete
as shown



\$24.95

F. O. B. ROYERSFORD, PA.



BENCH SAW

CUTS THROUGH 2 5/16"

UNCONDITIONALLY GUARANTEED ONE YEAR

Comes complete with Floating motor mount—miter gauge with adjustable stop—aluminum guard—soft aluminum insert—spring steel splitter—heavy gray iron fence—(no motor—no blade). Table 12" x 14". Tilts to 45°—Oilite bearings. Shipping Wt. 48 lbs.

AMERICAN MACHINE & TOOL CO. Inc.

DEPT. 100

ROYERSFORD, PA.

WRITE FOR FREE BOOKLET AND GUARANTEE BOND

NU-WAY HEAVY DUTY CUTTING UNIT

with Timken Roller Bearings

PRICE

\$16.50

WHY PAY MORE

Build your own rotary type lawn or weed cutter.

Take the hard work out of weed cutting. Build yourself an up-to-date weed and lawn mower with the Nu-Way heavy duty unit.



Write for Free Circular—We Supply Cutting Unit Complete,

TRACTOR-LITE MFG. CO., Spirit Lake, Iowa

GARDEN TRACTOR

3, 4, 5 H.P. On market nearly a quarter century. No belts. No chains. Worm driven. 2 clutches. Power turning. All tractors guaranteed. Full line of attachments. Buy direct from factory. Write Dept. 108 for free catalogue.

RED E TRACTOR COMPANY RICHFIELD, WISCONSIN

AIR COMPRESSOR

NEW. Cornelius, 1/3 HP 27 V DC-AC. 3 stage piston type, 1500 lbs. PSI rated pressure. 20 AMP series wound motor. 2 cf of air per minute. Easily converted to 110 V AC with 27 V transformer. Perfect for low pressure paint spray gun, inflating tires, air horn, laboratory use, etc. Shipping weight 25 lbs. Cost Govt. over \$200.00. Our price FOB, K. C., Mo., only **\$17.95**

TRANSFORMER — NEW, 27 V 17 AMP. FOB, \$14.95
K. C., Mo.

Write for Circular
NATIONAL SURPLUS SALES CO. 723 E. 18th St. Kansas City, Mo.



**How a Part Tube
of TIP-TOP SOLDER
Fixed 3 Leaky
Water Pipes!**

"I had three water pipes with bad leaks. Being an expensive amount of work to be done, I decided to try TIP-TOP. I took a part of a tube of TIP-TOP LIQUID SOLDER and fixed those pipes in a few minutes. It's been seven months now and they are still under our high water system."

Mr. W. W. E., North Carolina

TIP-TOP LIQUID SOLDER saves you big money on repair bills. Forms perfect bond on metals, wood, leather, paper, glass . . . most any material. Water and gasoline proof.

Always keep a tube handy in car, kitchen, on work bench. Get TIP-TOP at your hardware dealer or write TIP-TOP PRODUCTS, Omaha, Nebraska, today. Insist on TIP-TOP, the original and superior liquid solder.



U-BUILD-IT TRAILER COMPANY



supplies all parts to size for quick, easy assembly of complete metal trailer body—Roof Caps, Roof Bows, Doors, Complete Chassis, Roof Corners, Roof Ends. Build this modern

streamlined design economically yourself.

Write

for complete working plans showing detailed construction, location of parts for 12 ft., 16 ft., 20 ft., 24 ft. and 28 ft. lengths. Only \$100

U-BUILD-IT Trailer Co., P. O. Box 611, Elkhart, Ind.

MOTORS - PLANES - CARS - BOATS - MODELS

400 Pictures — 2,000 Model Items

A bible for wide-awake modelers. Model gas engines, planes, boats, cars, rubber-powered planes, jet models, accessories, etc., PLUS articles and stories on building and flying. Send only 10¢ stamps or coins. Also free catalog available.

SPECIAL: U-Control or Free Flight Flying Outfit, complete with motor, plane and over 30 needed accessories.

Only \$10 COMPLETE

1/6th h.p. Engines: Thor \$9.95; Ganie \$6.95; Judco \$7.25

AMERICA'S HOBBY CENTER, INC. DEPT. B7B 156 WEST 22 ST., N. Y. 11

Electric Refrigerator Kits

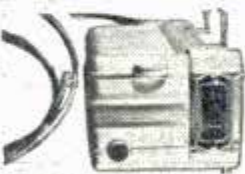

Convert your ice box into an electric refrigerator. Finest quality machines for trailer or home ice refrigerators. Easy for the handy man to install. Price \$149.50. Send 50c for catalog and details.

B-L-M ELECTRIC CO.

812 D St. San Bernardino, Cal.



Ask Your Hardware Store for
**FULLER'S
Unbreakable Amber Handle
SCREW DRIVERS**

America's most popular line of moderately-priced screw drivers! Wide range of sizes. FULLER TOOL CO., Inc., 911 Faile St., New York 59
World's largest maker of Amber-Handle Tools

Our Finest Precision REBUILT MOTOR BLOCK ASSEMBLIES



\$5.00
Crating
Charge

BUICK Outright Exch.
34-47 8 cyl. \$199.00 \$160.00

CHEVROLET Outr. Exch.
29-47 6 cyl. 117.50 87.50

CHRYSLER Outright Exch.
34-47 6 cyl. 162.50 130.00
35-47 8 cyl. 199.00 160.00

DE SOTO Outright Exch.
34-47 6 cyl. 162.50 130.00

DODGE—3 1/4" bore Exch.
35-47 6 cyl. 144.00 109.00

3 3/8" bore Outright Exch.
34-47 6 cyl. 162.50 130.00

FORD Outright Exch.
28-31 4 cyl. 119.00 87.00

Sold Outright or Exchange

Rebuilt by skilled mechanics. Assembly has Reborn Block with New Pistons, Pins, Rings, Reground Crankshaft, all New Bearings. Guaranteed 90 Days.

Allowance on Old Motor

We ship at outright price. Send your motor prepaid, must be suitable for rebuilding. Send in notarized bill of sale showing title number if any. We refund difference when we receive your motor.

FORD Outright Exch.
32-34 V8 .. \$139.00 \$ 99.00
35-47 V8 .. 149.00 99.00

HUDSON-TERRA. Outright Exch.
35-47 6 cyl. 175.00 135.00

MERCURY Outright Exch.
39-47 V8 .. 149.00 99.00

Oldsmobile Outright Exch.
37-47 6 cyl. 175.00 135.00
35-47 8 cyl. 199.00 160.00

PLYMOUTH Outr. Exch.
35-47 6 cyl. 139.00 109.00

PONTIAC Outright Exch.
37-47 6 cyl. 175.00 135.00
35-47 8 cyl. 199.00 160.00

Studebaker Outright Exch.
35-47 6 cyl. 175.00 135.00
35-47 8 cyl. 199.00 160.00

We Can Supply REBUILT ENGINES, TRANSMISSIONS, REAR ENDS, etc., for Cars and Trucks. Also JEEP ENGINES. Write for Prices!



\$5.00
Crating
Charge

60 HP. JEEP Engines

Reconditioned, Tested and Guaranteed in perfect running order and ready to run. Every part is checked to be perfect and carries a 90 Day Guarantee same as a new engine.

COMPLETE with . . . Generator, Starter, Distributor, Coil, Fan and Fan Belt, Water Pump, Fuel Pump, Intake and Exhaust Manifolds, Carburetor, Oil Filter, Spark Plugs, Flywheel, Clutch and Pressure Plate, Wiring.

Outright, **\$198.50**
PG58R-003, Es.

65 KW. 225 Volt D.C. DIESEL ELECTRIC GENERATING UNIT



RADIATOR
for above \$69.50
Unit. . . .

RECONDITIONED

Equipped with 6 cyl. DEARBORNE DIESEL engine, 4 1/4" bore, 5 1/4" stroke, 120 H.P. at 2000 R.P.M. Complete with injector, pump, nozzles and electrical equipment. Generator attached to engine. Complete as shown.

PG60R-193 **\$1095.00**
Each

SEND 25% CASH WITH ORDER, BALANCE C.O.D.

J.C. WHITNEY & Co.
1917 Archer Ave. Chicago 16, Ill.

WINDMILL--RAINBOW--FLASHER SPINNING AUTO LIGHT



Spins with the wind. The most beautiful light in the world. Red, White and Blue. Everybody wants one. Easily put on auto, Bicycle, Airplane or Boat. Pay Mailman \$2 plus postage or send \$2 and we pay postage. Be First.

Agents Wanted.
SPIN LIGHT CO.
373 1/2 BELMONT AVE. HALEDON, N. J.

SAY YOU SAW IT IN POPULAR MECHANICS

Surplus Bargains

12 VOLT GENERATOR 50 AMP.



AS LOW AS **\$7.95**

Less Pulley

OR ONLY **\$9.45**

With Pulley

These generators are excellent for truck or bus use. They also will make a fine power supply for your radio shack or nice light welder. Brand new in original boxes as pictured with pulley, \$9.45 each or with keyed shaft less pulley—\$7.95 each.

(SHIPPED EXPRESS - CHARGES COLLECT)

NOW only \$9.50 NEW Mine Detectors



Mine Detector type AN-PRS-1 Brand new complete (except batteries) in original case. Each unit contains an instruction Manual. Good for detecting objects under the earth's surface. Requires one 6 volt and three 4-5 volt batteries. (Shipped express charges collect)

MICH. RESIDENTS AD 3% TAX

N. SILVERSTINE CO.

6532 EAST MICHOLDS ROAD DETROIT 12, MICHIGAN

Seven Acres of Surplus

Get that NEW-CAR FEEL again! SEALED POWER PISTON RINGS

The only ring with the Full-Flow Spring!

SEALED POWER CORP., DEPT. 6-7, MUSKEGON, MICH.

AMAZING NEW Plastic Plaster BRUSHES ON LIKE PAINT

• One coat plasters and paints any type of wall surface — hides cracks, seams, checks, joints, nailheads, etc. Comes in 12 beautiful colors. Does the job where paint alone is not enough. Washes easily. Get "PLASTIC PLASTER" today — wherever building materials are sold. Or write to . . .



SICCA SOYA PAINT CO., Inc. PEORIA, ILL.



GIVE YOUR EYES
THIS TREAT

GENUINE U. S. ARMY AIR CORPS SUN GLASSES

THEY SOLD IN THE PX STORES FOR \$10.00
GUARANTEED BRAND NEW — WITH CASE

These are GENUINE Air Corps glasses—NOT the Air Force TYPE. Made by a famous name optical company to Gov't. specifications with finely processed metal frame, plastic sweat bar, adjustable nose pads and easy flexing ear loops. Optically ground 4 base green aviation lenses cut out over 90% of harmful sun rays. Glasses are brand new — case included.

PRaised BY GEN. HAP ARNOLD

These are the glasses that Gen. Hap Arnold was so lavish in his praise about. Use them for all outdoor sports, sunbathing, driving, etc. Money back guarantee. Send check or money order. Two pair \$9.00. One pair, postpaid.

\$4.95

CARLETON HOUSE 3312 Lincoln Ave., Dept. PM 7
Chicago 13, Illinois

NEW 30" SHEET METAL BRAKE



Forms angles, channels, vees, flanges, locks, zees. Handles 26 gage sheet steel, heavier gages of aluminum, copper, plastic, etc. Portable. Can be held in a bench vise, or bolted down. All steel construction. Wt. 40 lbs. **\$24.50**

Shipped exp. collect. ONLY

12" BRAKE. Fits in vise to form difficult and compound bends, up to 20 gage steel any length and width, \$12.50 PP.

18" CURVE FORMER. Handles 16 gage steel 2" to 30" dia., \$9.50 PP.

VISE IRON BENDER. Forms rings, hooks, eyelets, etc. in 1/2" round or square; 1/4" up 2" wide in bar iron. Price \$10.00 PP., with attachment to bend 1/2" pipe, \$12.50.

SHEAR. Cuts 16 Gage steel any length and width, \$18.50.

SHEET METAL PLIERS. 2 1/2" wide, \$2.00; 5", \$3.50. 20 page instruction booklet, 50c.

Immediate delivery. Order direct, cash or C.O.D., or send for folder.

VISE BRAKE MFG. CO.

1318 So. 30th Ave.

Dept. P6

Omaha 5, Nebr.

ALL PURPOSE FOLDAWAY

TABLE or BENCH LEGS

Make sturdy folding tables, benches or work horses with these steel channel, riveted folding legs. Black enameled and rubber tipped. 30" high for table tops 5.98 pr.; 24" high for benches or work horses 4.98 pr. Send for free circular.



\$4.98
(LEGS ONLY)

THE DIAMOND MFG. CO.
1100 ALTAMONT AVE. SCHENECTADY 7, NEW YORK

Genuine Snap-on Tools

Available Only Through Snap-on's
Direct-To-User Tool Service

WRITE FOR INFORMATION

SNAP-ON TOOLS CORP. • Kenosha, Wisconsin

COMPLETE FLEXIBLE SHAFT MACHINE only

WITH PENCIL-SIZE HANDPIECE for "FINGER-TIP" CONTROL. Performs countless tasks quickly, easily! Use FOREDOMS on wood, metal, glass, plastics, etc. Provides easy accessibility, unobstructed view. Grinds, polishes, drills, mills, engraves, sharpens, slots, sands, carves, etc., etc. Complete \$19.95. No. 50 Accessory Set \$1.50 additional. Order today. FREE CATALOG.

\$19.95

FOREDOM ELECTRIC CO., Dept. F-118, 27 Park Pl., N. Y. 7

ARMATURES

Rebuilt and guaranteed like new, factory methods only used in our plant. Money back guarantee. Send us your old armature. Ford, Chevrolet, Plymouth, and all popular makes of cars 1937 and down. \$3.35 ea. 1938 to 1948. \$4.45

OTHER ARMATURES AT CORRESPONDINGLY LOW PRICES

DELTA ARMATURE CO.

1400 W. 8 Mile Rd.

Ferndale, Mich.

You Can Afford an Underground
Lawn Sprinkling System with
AQUASpray
SELF-DRAINING SPRINKLER HEADS



EASILY INSTALLED BY ANYONE

All bronze. Exclusive self-draining feature protects against freezing. Adjustable to any shape lawn. Six heads required to spray 500 square feet. **\$149**

Write for Descriptive Literature EACH - PREPAID

AQUA-SPRAY LAWN SPRINKLER CO.

439 E. FORT ST. DETROIT 26, MICHIGAN



Amazing MOTO-SANDER AND POLISHER

Saves Time — Saves Effort! Dremel has developed a combination electric Sander and Polisher for home or shop . . . so easy to handle that a child can use it. New, inexpensive "Moto-Sander" delivers about 7,200 strokes a minute. (Short, rapid stroke frees dust from sandpaper . . . makes paper last longer.) Moto-Sander does a magically smooth job of sanding . . . gets into places other sanders can't reach. Rubber cushioned sanding pad measures 2 1/4" x 5 1/2". Cam-type-clamp paper holder permits changing sandpaper in seconds. Moto-Sander has only two moving parts . . . never needs oiling or adjustment . . . weighs only 2 1/2 lbs. Uses 110-120 volt, 60 cycle A.C. electric current (only). Gives no radio interference. Comes with 8 ft. (Underwriters' Approved) rubber cord plus 3 sheets assorted grade Garnet paper, plus 1/4" thick felt pad and sheepskin for wax polishing.

FINE FINISH — FAST!

Use Moto-Sander to get satin smooth finish on woodwork, stairways, doors, furniture; ideal for sanding boats, gun stocks or scale models. Just guide it. Uses #2/0 Garnet paper or finer. For speedy, effortless polishing of waxed furniture, automobiles and other surfaces, use felt pad or sheepskin (furnished) in place of sanding paper. Moto-Sander is the lightest, most practical electric sander on the market—the only one of its kind.

MONEY-BACK GUARANTEE: If your dealer does not yet have Moto-Sander, send only \$14.85 . . . we'll pay postage. Or send \$2 now, and pay postman balance plus postage. Money back if not delighted after 5 days' trial.

DREMEL MANUFACTURING CO.
Dept. 118-G • Racine, Wis.



V-8 DUALS & SINGLES

MUFFLERS
STEELS and ALUMINUMS
with a motorboat tone

SINGLES, Chev., V-8, Plymouth, Steels \$5.50, Aluminum \$7.00. Chry., Olds., Buicks, etc., Steels \$7.50, Aluminum \$9.00. V-8 and MERCURY DUALS, Steel \$17.50, Aluminum \$21.00. Split Manifold Sets, Steels \$35.00, Aluminum \$45.00. Aluminum are guaranteed for life of your car.

DEALERS WANTED

SANDEE MUFFLER CO.
BOX 296 LA TIJ, LOS ANGELES 43, CALIF
2624 W. SLAUSON AVE., LOS ANGELES, CALIF

GEAR BOX 80-1 RATIO

Jack and Heintz, 4 gears 8 ball brgs. for H.S. Grinder, Trolling Box etc. \$2.95 postpaid. Hyd. Hand Pump, 1000 psi \$5.95 postpaid.

ANCHOR SURPLUS

6987 W. FORT ST. DETROIT 9, MICHIGAN

PISTON TYPE COMPRESSOR

EASY PROFIT IN PAINT SPRAYING

Paints walls, ceilings, screens, furniture and machinery faster, better. All complete as shown less motor. Carry anywhere. Fully guaranteed. Could be used with 1/4 H.P. motor or less. Price \$35.00 less motor F.O.B. Chicago. \$5.00 deposit balance C.O.D. or see your dealer. With motor \$55.00.

IDEAL AUTOMATIC PUMP CO., Dept. P.M. 8
801 W. Washington Blvd. Chicago 7, Ill.

Make your STOP LIGHT SHOUT!

AMAZING STOP LIGHT FLASHER!

Makes Your Stop Light Flash 115 Times Per Min. A SENSATION! Automatic. Instant acting when foot brake applied. Non-rusting. Dust, Oil, Vapor and Waterproof. Used by police and fire depts. Attach in 5 min. to any model car or truck. Approved by leading safety engineers.

FREE WITH ORDER. "HOW TO SAVE MONEY ON CAR Motoring Hints" BOOKLET." ACT NOW! If dealer can't supply send \$3.00 cash or M.O. We pay postage.

MACCHI & CO., Dept. U
927 Larkin St., San Francisco, Calif.
DEALERS AND AGENTS WANTED

Build YOUR OWN LOG CABIN!

\$425 to \$5,000

Shipped In Sections — Ready to Erect

Build your log cabin yourself and save money! Braun Cabins (Patent No. 2320466) come to you prefabricated in sections, lettered and numbered—easy to erect. Beautiful Michigan White Cedar vertical half-logs, machined and splined. Weathertight joints. Interior—knotty cedar. Many designs to choose from, as low as \$425, F.O.B. Detroit — or we can adapt our material to your plan. Prompt shipment. Send 25c for 24-page Catalog, including overnight and guest cabins.

Send 25c for Catalog

BRAUN LUMBER CO.
CEDAR CABIN DIVISION
1571 E. Davison Detroit 3, Mich.

BRAUN CEDAR CABINS

BARGAINS OF A LIFETIME!

PISTON TYPE AIR COMPRESSOR

Piston type, size 2 x 1 3/4, head in valves, bronze bearings, splash lubrication, "V" Belt drive, Intake muffler and cleaner. Capacity 2.8 c.f.m. at 100 lbs. continuous pressure or 150 lbs. Intermittent, with 1/2 HP motor. Can be used with 1/4 HP or 3/4 HP at lower speed. Weight 14 lbs. Operating instructions furnished.

Immediate delivery. **\$18.50**
Price only

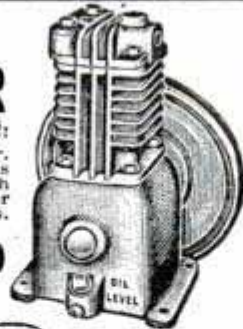

1/4" REDUCING VALVE & GAUGE

Oil resistant, pressure 0-to-200 lb. Reduced pressure 0-to-75 lb. 3 outlets 1/4".
Wt. 2 lbs. **\$5.75**



DASH POT CHECK VALVES

Prevent leakage after compressor stops.
3/4" Check Valve..... **\$2.50**
1/2" Check Valve..... **\$4.25**



AIR GAUGE

Standard air gauge. 2 1/2" diameter. 0 to 165 lbs. 2" diam. 0 to 200 lbs. **\$1.75** pressure. ...



POP TYPE VALVES

Has a close range of closing after pop-off pressure is reached. 1/4" pipe thread. Only..... **\$1.50**



AUTOMATIC PRESSURE SWITCH WITH UNLOADER

125-150 lb. pressure. Uses 1/4 to 5 H.P. unit
Only **\$8.95**

Only **\$8.95**

Flexible Shaft



Only **\$16.50**

6 ft. Stow Flexible Shaft, Heavy Duty, 3/8" Core. Best piano wire. Ball bearing handle and arbor, rubber covered housing; for 1/2" motor shaft; for 1/2" bore wheels. Operates on 1/4 H.P. Motor at 1725 or 3450 R.P.M. \$29.00 Value, only **\$16.50**. Wt. 8 lbs.



\$24.00
Up

HEAVY DUTY ELECTRIC MOTORS

Ball Bearing 110/220 volts—1 phase—60 cycle—1750 RPM—Continuous duty, 300% full load starting Torque, outlet box, operates clockwise or counter-clockwise, carries one year guarantee against mechanical defects.

1/4 HP	Wt. 30 lbs.	...\$24.00
1/2 HP	Wt. 33 lbs.	...\$28.00
3/4 HP	Wt. 36 lbs.	...\$34.50
1 HP	Wt. 50 lbs.	...\$44.00
1 HP	Wt. 80 lbs.	...\$7.00

These motors also furnished in 3450 R.P.M. at same price.

MOTOR BARGAIN \$2.45



USE AS 6 VOLT GENERATOR—Generate your own power. Can be operated on your bicycle wheel. Furnishes sufficient power for two 6 volt bulbs. Resistor furnished free with each motor enables you to maintain constant voltage. Special Price **\$2.45**, or 4 for \$7.50, or 24 for \$36.00.

PRICES ARE F.O.B. CHICAGO. Immediate delivery. SOLD ON MONEY BACK GUARANTEE. Send check or money order today.

C & M EQUIPMENT COMPANY 1831 S. State St., Dept. D-7 Chicago 16, Ill.

AUTO ELECTRIC TESTER



This tester is a necessity for all Auto Mechanics and Car owners. It will test All 6 or 12 volt circuits and devices on an automobile. Comes supplied with screw-type lamp for easy replacement. Send for yours now.....**\$1.50** postpaid.

BRONX INSULATED WIRE CO.
2026 WEBSTER AVENUE BRONX 57, N. Y.

SAY YOU SAW IT IN POPULAR MECHANICS

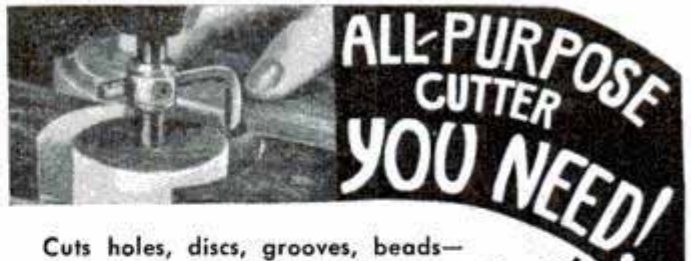

ALL-PURPOSE CUTTER YOU NEED!

Cuts holes, discs, grooves, beads—routs—rabbets in wood, plastic, even soft metal. "Wouldn't take \$100 for it," say users. No drill press or home workshop is complete without it. ONLY

Send check or money order to

SOUTHERN ENGINEERING & METAL PRODUCTS, Inc.

21 N. E. 17th Terrace, Miami, Florida

\$1.00 with 3 Bits Postpaid



Quilted

ASBESTOS MITTS

... they last twice as long
These asbestos mitts for handling hot metal molds and shapes are reversible to fit either hand. Both sides quilted, won't shred or fray on rough, jagged material. Double wear, double life. Wool lined. All seams double stitched. The answer to troublesome problems. Discounts for quantities. One of 4300 production—speeding, time-saving safety gloves, aprons, sleeves, spats, etc.

Write for Free Catalog.

INDUSTRIAL GLOVES CO.

1401 Garfield Blvd. Danville, Ill.
(In Canada: Safety Supply Co., Toronto)



NOW! FILE YOUR OWN SAWS

Do expert saw filing at home. Precision filing easy without experience. Two simple adjustments. Keeps any hand saw extra sharp and true-cutting. Complete with file. Money back guarantee. Cash with order, prepaid. (COD postage extra.) Order today.

\$2.95 EACH

THE SPEED CORP., Dept. PM
2025 N. E. Sandy, Portland 12, Oregon

"YOU ARE UNDER ARREST!"



Help Bring Crooks to Justice Through Scientific CRIME DETECTION!

We have taught thousands this exciting, profitable, pleasant profession. Let us teach you in your own home. Learn Finger Printing, Firearms Identification, Police Photography, Secret Service Methods thoroughly, quickly, at small cost. Over 800 of all American Bureaus of Identification employ I. A. S. students or graduates. We can prepare you for this fascinating work, during spare time. Write today, stating age, for "Blue Book of Crime."

INSTITUTE OF APPLIED SCIENCE, 1920 Sunnyside Ave., Dept. 935B, Chicago 40, Ill.

Write today for booklet on the new FLEX-O-SHAFT Tool Kit, illustrating this improved all-purpose power machine with the hand-piece that works as easily as a pencil. Motor with switch, foot-operated rheostat, and 66 accessories, all at a special low price. FLEX-O-SHAFT SALES CO., Dept. C, Prairieview, Illinois.



REPAIR CRACKED BLOCKS AND HEADS—

External and internal leaks in blocks, cylinders and valve ports quickly and easily with LUSCO PLASTIC SEAL. 90 day Service Guaranteed or your money back. Send money order or check for full pint—more than sufficient for average repair Postpaid **\$3.00**

C. F. LUSK CO., 5924 Bonna Ave., Cleveland 3, Ohio

A TOOLSHOP IN YOUR HAND



There's Only One Genuine Handee

First tool of its kind—today's finest. Smooth, steady power at your fingertips. Easy to handle. Make ship, plane and train models, bookends, costume jewelry. Grinds, drills, polishes, routs, carves, sands, saws, engraves on metal, wood, plastic, glass, leather, etc. 25,000 r.p.m. AC or DC. Wt. 12 oz. With 7 accessories \$20.50. In case with 40 accessories \$27.50. At stores or sent postpaid. A fine gift for a friend or yourself. **CHICAGO WHEEL & MFG. CO., 1101 W. Monroe St., Dept. PM, Chicago 7, Ill. Free 52-page manual.**

HANDEE

**TOOL OF
1001 USES**



WORLD'S LOWEST PRICED ADDING MACHINE

FREE TRIAL \$2.95
Ideal for business or personal use—guaranteed accurate. Not a toy. Operates with only a finger flick. Adds, subtracts, multiplies, divides. Counts up to one billion. Pays for itself over and over. Ideal gift for Business, Income Tax and School use. **MONEY BACK GUARANTEE.** Send name and address. Pay postman only \$2.95 plus postage. (Send full cash if outside U. S.) Beautiful rich-looking Leatherette Case included at no extra cost. Money back in 10 days if not delighted. AGENTS WANTED.

CALCULATOR MACHINE CO., (Mrs.)
Dept. 204, P. O. Box 248 Glenview, Illinois

Engineers All Metal Army Type Hand-Sighting

LEVELS

\$2.00 PRECISION QUALITY



Send \$1.50 for 3rd Edition of Gun Digest with our complete catalog of new and used guns, etc. Our separate catalog 25c.

PUBLIC SPORT SHOPS

11 S. 16th St., Phila. 2, Pa.

No COD's

WOOD WORKERS

LUMBER—PLYWOOD AVAILABLE
Harold Hunt wants to send new No. 15 catalog. Over 148 pages of woodworking ideas. **UNEQUALED BARGAINS** in imported and American woods, supplies, hard-to-find hardware. Send only 15c to cover postage and handling.
CRAFTSMAN WOOD SERVICE CO.,
2729 S. Mary St., Dept. A-95, Chicago 8, Ill.

only
15¢



PLOW



CULTIVATE



**SHAW
MFG. CO.**

SAVE TIME, WORK, MONEY!

SHAW DU-ALL

and "PEPPY PAL" TRACTORS

These rugged walking or riding tractors are ideal for farm, truck garden, orchard, poultry farm. Operate on a few cents an hour. A child can handle them.

DO DOZENS OF JOBS Both riding and walking tractors quickly and easily plow, cultivate, harrow, disk, bulldoze, spray, haul, grind, saw wood, etc. **LOW FACTORY PRICES** Buy direct or through your dealer. Year's guarantee!
RIDING TRACTORS 4 models from 5 to 12½ H.P., 58 in. wheelbase, 36 to 52 in. wide, 24 in. plant clearance. Hand or electric starter. Walking Tractors 1½ to 3 H.P.

FREE Illustrated folders giving complete details and price lists—write today!

4507 FRONT ST., GALESBURG, KANS.
8686 NORTH 4TH ST., COLUMBUS, O.

WALKIE-TALKIES!



Radio Telephone Sends And Receives Several Miles

This is the light weight battery-operated radio that was used so successfully by the Army. One knob tunes both transmitter and receiver. Sends and receives merely by pushing a button. Recommended for amateurs, explorers, police and Government services, etc. Shipped ready to operate, complete with tubes, telephone handset, telescoping antenna, and new batteries. Rebuilt by the Government and guaranteed. Price only \$45.00 each or \$90.00 per pair F. O. B. Chicago.

Extra Batteries (80 hours continuous service) \$4.75 each.

Parts and Accessories for Walkie Talkies

We maintain complete stocks of replacement parts, batteries, antennas, chassis, etc., for Army Walkie Talkies and Handie Talkies. Write for Special Listing No. 20.

**WELLS
SALES, INC.**

320 N. La Salle St., Dept. P-7
Chicago 10, Illinois

C-Thru DRAWING INSTRUMENTS



ONLY
\$5.95
COMPLETE
SET

ALL CRYSTAL CLEAR PLASTIC

Complete! . . . Seven necessary items for the price you'd expect to pay for two or three. Handy clear plastic drawing outfit, beautifully designed, durable . . . set consists of 15" T-Square, 10"×30" Triangle, 8"×45" Triangle, 2 French Curves, Speed-Dotter, 12" Ruler, all in attractive gold colored case. Ask for C-Thru Drawing Instruments at your dealers. Send for FREE catalog showing dozens of quality C-Thru ruling and drawing devices.

FREE CATALOG C-THRU Ruler Co.
MAIL COUPON TO

DEPT. C, 823 WINDSOR STREET, HARTFORD, CONN., U.S.A.

NAME _____

ADDRESS _____

Built for WEAR-COMFORT
Military style
COMBAT BOOTS \$6.55
FIELD SHOES \$4.99



SIZES 6 TO 12

Navy style—rugged and comfortable—reversed uppers. Full oak leather innersole with hard wearing composition outer sole. Sizes 6 to 12, D to EE. Add 22c postage please.

For work, outdoor sports, etc. About 9" high—sturdy reversed uppers. Full oak leather innersole with extra composition outer sole. Size 6 to 12. D to EE. Add 27c postage please.

MAIL ORDERS

Please send remittance with order. Include postage. Guaranteed satisfaction or your money back. **ORDER TODAY!**

Officer type
OXFORDS \$6.88

Exceptional values—black or brown. Best quality uppers, solid oak leather soles. Worth considerable more than our low price. Size 6 to 12, D & E. Add 20c postage please.



SIoux FALLS SURPLUS STORE
SIoux FALLS, S.D. **SEND FOR FREE War Surplus CIRCULAR**

WONT FINGER MARK
RAIN PROOF
GLASS-HARD LASTS 6 MONTHS
NO SMEARS OR STREAKS



PROTECTS THE FINISH
BETTER THAN PASTE WAXES
SUN-PROOF
DO YOUR CAR IN 1 HOUR
MUD-PROOF

New FAST WAY to Give Your Car a WAX-POLISH



RUB ON! LET DRY! WIPE OFF!
TIMEX PRODUCTS CO.,

C.O.D. orders plus postage
 DISTRIBUTOR INQUIRIES INVITED

Hurry! Offer Limited!
\$1 POSTPAID FOR BIG \$1.50 ONLY
 1 CAN RUSH ORDER & SAVE 50c

5506 Virginia Ave., St. Louis, Mo.

Mows and Trims Lawns



In One Simple Easy Operation 8 1/4 Lbs.

Save Time and Labor with a MONTAMOWER

New model. New type metal handle has special device to adjust cutting height. Drive shaft now mounted on free rolling, factory lubricated, sealed ball bearings. No tired backs or aching arms. 8 1/4 lbs. live precision made mechanism that first gathers, then cuts smoothly a clean 16" swath through grass, dandelions, spike grass, lawn weeds. No noise or clatter. As modern and efficient as your electric razor. Cuts right up to walls, fences, trees or posts; leaves no fringes to be trimmed by hand. Cutters self-sharpening. Built to last many years. Many thousands in use. Sold direct from factory for 26 years. Costs little. Write at once for trial on your own lawn "approval offer," guarantee information and literature.

MONTAMOWER DISTRIBUTING CO.

820 Keeler Bldg. GRAND RAPIDS 2, MICHIGAN

4 SPEED MOTORS



ONLY \$7.95
 Californians Please Add 20c For Sales Tax
PLUS \$1.00 FOR PACKING AND SHIPPING

Approximately 11 inches long
1/20th HORSEPOWER 115 VOLT 50/60 CYCLE AC MOTORS with integral gear box having four 1/4 inch drive shafts turning simultaneously at the following speeds:
4000 RPM—For grinders, buffers, flexible shaft tools, small drills, fans or blowers.
320 RPM—For wrapping fishing rods, slow speed tools.
32 RPM—For developing tray rocker for photographic darkroom.
8 RPM—For turning barbecue spits, advertising displays.
A THOUSAND OTHER USES AROUND THE WORKSHOP
 Dealers and Jobbers Write for Quantity Discounts.
 Money Back Guarantee. Pulleys, Mandrels, Belts, Etc. Available.
 Write for List.

TROUP ENGINEERING CO.

2223 GRAND AVE. LONG BEACH 4, CALIF.

for AMAZING acceleration

DIXIE-WESTERN
DUAL INTAKE MANIFOLDS for V-8 FORDS and MERCURYS

\$1500 Gas Line and Throttle Kit \$2.50 extra
 Chrome Plated Velocity Stocks — \$1.50 ea.
 By Test: Increased Acceleration by 26%
 Increased Power and Speed by 11%

DIXIE-WESTERN MANIFOLD CO.
 Box 364 Los Angeles 43, California

ZIPSCOOT \$49.75

America's Outstanding Scooter Value!
 This smart looking speedster is easily and quickly assembled from our factory finished kits. Uses standard gasoline motor. Speeds up to 30 miles per hour. 100 miles per gallon of gas. Send 25 cents for assembly information, drawings, and illustrations. Kits available for immediate shipment.



Zipscot Company, Toledo 6, Ohio

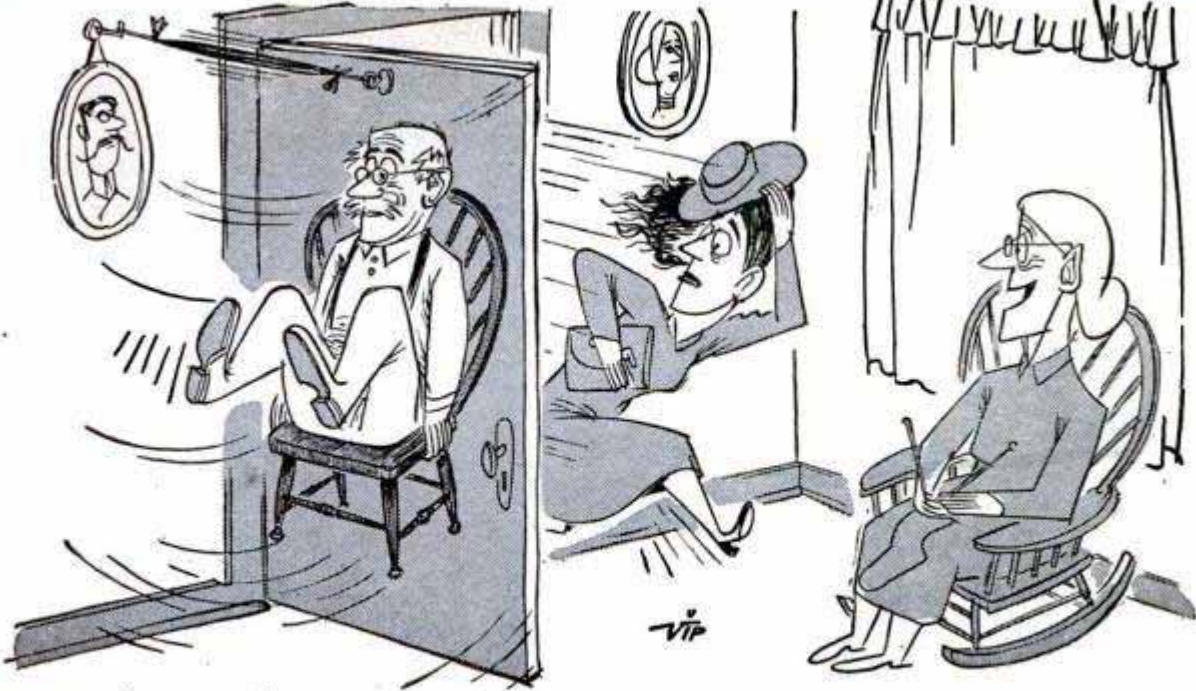

"Company's more fun ...

since Paw glued his chair to the door with Weldwood Glue"

When you want a wood-to-wood bond that will really hold... remember Weldwood Glue. It's quick to mix... easy to use... tremendously strong... stain-free... rot-proof... and permanent. At hardware stores, lumber yards, chain stores, in 15¢, 35¢, 65¢, 95¢ and larger sizes.



WELDWOOD
PLASTIC RESIN GLUE

United States Plywood Corporation, New York 18, N. Y.

Handy With Tools? Open your own AWNING AGENCY

Establish your own agency at home!

Or supplement your other business — part or full time. Our dealers sell and install our complete line of top quality made-to-measure California awnings, patio and terrace covers, recoveries for all types of garden furniture and many other popular good selling items. Every home owner a prospect. PLEASANT EASY WORK—GOOD PROFITS! ACT NOW FOR A DEALER FRANCHISE IN YOUR TERRITORY. Responsible parties only. Cool, colorful, modern awnings keep the sun's heat and glare out of homes at low cost. Orders promptly shipped anywhere. WHY NOT TRY IT ON YOUR OWN HOME? For full information write today. Box 344, Dept. P.

CALIFORNIA TENT & AWNING CO.
SUNNYVALE, CALIF.



MILL IT... ON YOUR LATHE!

PALMGREN

MILLING ATTACHMENT

3 SIZES

No. 250 Illustrated

2 1/2"
JAW
Only

24⁷⁵

CONVERT LATHE
IN 10 SECONDS

Now you can Mill, Slot, Grind, Groove, Square Shafts, Saw at Angles, Recess and many other important jobs. SAVE TIME and MONEY! Why send work out or use costly methods when a PALMGREN MILLING ATTACHMENT will solve your problem.

Precision built, it has accurate graduations for rotary angle adjustments, also graduated vertical feed screw. Fits South Bend, Atlas, Craftsman, Logan, Sheldon and all other lathes. Thousands now in use in small and large machine shops, repair shops, railroads, schools, home work shops, etc. ORDER SIZE NEEDED TODAY!—it will quickly pay for itself.

IMMEDIATE DELIVERY

Nos.	Width Jaws	Depth Jaws	Jaws Open	Weight Pounds	Fits Tool Post	Price F.O.B. Factory
150	1 1/2"	1"	1 5/8"	6 1/2	1" Dia.	\$18.75
250	2 1/2"	1 7/16"	2 1/2"	11	1 1/4" Dia.	24.75
400	4"	1 1/2"	4"	25	2" Dia.	39.75

Order From Your Dealer or Jobber: Write for Circular No. 351
Mfrs. of PALMGREN PRODUCTS
Since 1915
8365 South Chicago Ave.
Chicago 17, Ill.

**CHICAGO TOOL and
ENGINEERING CO.**

JUST A FEW OPERATIONS YOU CAN DO ON YOUR LATHE!

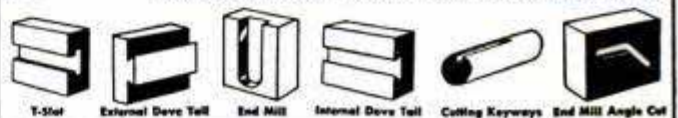

Sharpen Lawnmowers MAKE \$5.00 PER HOUR

You need no experience to operate the Ideal Lawnmower Sharpener. It is simple to adjust, simple to operate. Sharpens blades easily, speedily, accurately. Ideal sturdy, strong construction is the result of 45 years of engineering design. WRITE TODAY FOR FREE BOOK.



The FATE-ROOT-HEATH CO.

DEPT. D-3, PLYMOUTH, OHIO

Free! New CONCORD RADIO Catalog



The ONLY Complete
Up-to-the-minute Catalog of
RADIO PARTS • RADIO SETS
KITS • HAM GEAR • TESTERS

The greatest, latest complete presentation of radio, electronic and television equipment and supplies in Concord history! Packed from cover to cover with thousands of items—100 pages of everything in Radio and Electronics. Special bargain section of hundreds of money-saving values. Scores of

new items from famous makers. Parts, blueprints for famous Popular Mechanic and many other kits. Mail coupon for your FREE copy.

CONCORD RADIO CORP.

CHICAGO 7 ATLANTA 3
901 W. Jackson Blvd. 265 Peachtree Street
Downtown Chicago Branch: 229 W. Madison
LAFAYETTE RADIO CORPORATION

CONCORD RADIO CORP., Dept. 49-J
901 W. Jackson Blvd., Chicago 7, Ill.
Yes, rush FREE COPY of the comprehensive new Concord Radio Catalog.

Name _____
Address _____
City _____ State _____

TOOL BARGAIN

Electric Hand Grinder Assortment for cutting wood, metal or plastic.

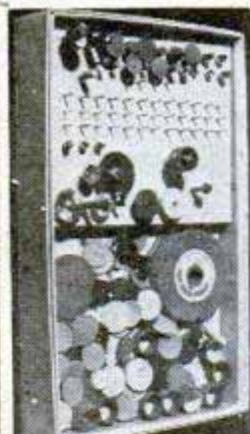

MASTER \$9.75 \$45 Value
KIT Only Postpaid in U.S.A.

- 115 Grinding, Cutting and Polishing WHEELS PLUS 150 assorted tools most useful for Home or Shop.
- 3 Grinding Wheels from 1" to 3" dia.
- 1 Rotary File, High Speed Steel.
- 3 Rotary Cutters 1/8" Shank.
- 6 Rotary Cutters 3/32" Shank.
- 6 Mounted Grind, Wheels 1/8" Shank.
- 6 Mounted Wheels 3/32" & 1/4" Shk.
- 3 Rubber Wheels.
- 4 Speed Drills 3/32" Shank.
- 30 Rotary Cutting Burs 3/32" Shank.
- 2 Mandrels 3/32" Shank.
- 1 Mandrel 1/8" Shank.
- 1 Screw Tyme Mandrel 3/32" Shank.
- 3 Rotary Bristle Brushes 3/32" Shank
- 1 Rotary Wire Wheel Brush.
- 1 Circular Saw
- 1 Mandrel for Circular Saw 1/4" Shank.
- 2 Rubber Cylinders and Mandrel 3/32"
- 10 Cut-off Discs and grinding wheels.
- 1 Rotary Drum Sander 1/8" Shank.
- 15 Bands for Rotary Drum Sander.
- 15 Rotary Felt Wheels 1" dia.

• The right attachment for every job.
ORDER TODAY. Send check or send \$2.00 deposit with C.O.D. order.

3-ROLL ASSORTMENT

1 1/2" — 100 and 400 Grit
2" — 100, 120, 150 Grit
3-50 YD. ROLLS
ABRASIVE CLOTH \$5.95
Now Only

Tremendous bargain in abrasive cloth rolls. Three 50 yd. aluminum oxide rolls of finest abrasive cloth from mfrs. like Minn. Mining, Carborundum, Sandpaper Inc. A \$27.60 list value for only \$5.95. Specify widths and grit sizes. Send check or M.O. Or send on \$2.00 deposit and let bal. come C.O.D.



SCHUPACK SUPPLY & MFG. CO.

7331 Cottage Grove Ave., Dept. PM-7 Chicago 19, Ill.

It's EASY!
ECONOMICAL!

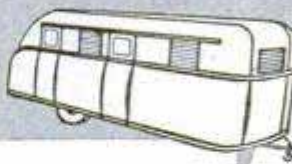

Build Your Own Trailer with NATIONAL'S Simplified Plans

Beat the housing shortage with a full-size house on wheels or add new pleasure to your vacations and week-ends with a sleek sport trailer. Step-by-step instructions and complete bill of materials with every plan. Three different models.

NATIONAL MODEL 27: A 27-ft. luxury liner with 3 rooms, lavatory, sleeping space for six. Plans \$1.00

NATIONAL MODEL 20: A 20-ft. cabin trailer that's good-looking and sturdy, with beds for four. Plans \$1.00

NATIONAL CAMPER: The sport trailer you've wanted for hunting, fishing, vacations. Sleeps two. Plans .50

ORDER ALL THREE—AND GET ONE FREE Complete set \$2.00

Big parts catalog FREE with any order!

NATIONAL TRAILER STORES

Dept. 51 • Box 2353 Terminal Annex • Los Angeles 54, Calif.

ATTIC FAN KITS

MAKE YOUR OWN HOME VENTILATOR

Save from \$100 to \$200. Parts same as used on our nationally advertised fans. 6,500 to 16,000 CFM air movement. Each kit includes dynamically balanced propeller, shaft, two bearings, fan pulley, motor pulley and belt. Motor optional.

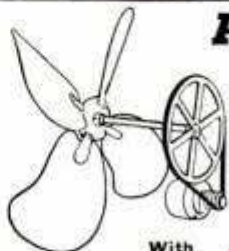

	With Motor	Without Motor
30" Fan Kit	\$27.92	\$11.92
36" Fan Kit	28.92	12.92
42" Fan Kit	34.21	18.21
48" Fan Kit	54.75	21.12

1/3 hp. 110V. 60 cycle G.E. motor for 30", 36" and 42" fans.
1/2 hp. 110V 60 cycle G.E. motor for 48" fans only. All prices FOB, Nashville, Tenn. 25% deposit on C.O.D.'s; pay express charges on delivery.

TENNESSEE VALLEY ASSOCIATES, INC.
117 NINTH AVE., NO. NASHVILLE, TENN.

BUILD YOUR OWN ZEOLITE WATER SOFTENER



You can do it inexpensively with only a wrench and a little spare time. Same Zeolite process as used by other leading water softeners. Send \$1 for easy-to-follow directions and list of materials. (Materials available locally or from us.) Your money back if not satisfied.

LAKE REGION MFG. CO.
4184-A Xenwood Ave. Minneapolis 16, Minn.

BUILD THIS CONCRETE BLOCK MACHINE

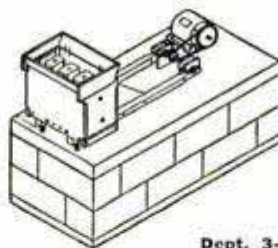

Sell blocks; or build your home, garage, barn at 1/3 cost by making and laying your own blocks.

This simple machine which you can build yourself at a cost of about \$15 (excluding motor) will make a block in 30 seconds using only one form. 2 to 4 forms can be used on each vibrator.

Power driven concrete mixer plans also. Send dime for details and "How to Make and Lay Blocks."

U-BUILD-IT SERVICE

Dept. 3-A, 206 West Wilder Ave., Tampa 3, Fla.

CUBIC-INCHER RADIO SET \$2.39

SIGNAL-POWERED NO ELECTRICITY



Entire set less than one cubic inch in size, rests in bowl of teaspoon! Radar 1N34 detector, world's best for crystal sets. Works anywhere—never wears out—costs nothing to operate. Safe and foolproof. Reception is guaranteed. With connecting leads and complete directions. \$2.39 postpaid without phone. \$3.19 postpaid with phone. Foreign orders 10% extra, prepaid only.

CARING PRODUCTS Dept. M2, Box 1308 Chicago 90, Ill.

Say You Saw It in Popular Mechanics

WOODWORKERS... Get this

CONSTANTINE MASTER MANUAL

Get the Most Fun From Your Hobby Indispensable to woodworkers. Newest, biggest edition, more pages, more color, helpful how-to-do-it articles, pre-war and new items, more bargains. Send 25c today and we will include FREE! FULL YRS. SUBSCRIPTION to Chips and Chats, published bi-monthly. Keeps you up-to-date on everything in woodworking, offers big money-saving bargains. Send now.

ALBERT CONSTANTINE & SON, Inc.
791-C 135th Street, New York 54, N. Y.



**DO TONGUE AND GROOVE—FLUTING—
NOTCHING AND INLAY—**

**Aladdin's Tool
AND YOUR
DRILL PRESS**



Patent Pending

DeLuxe Model

\$11.95 Makes any cut wood shaping tools costing up to \$300 can make. Comes complete with adaptor, six blades, balance blade and bottom bearing in sturdy wood box.

THE DESIGN COMPANY
2603 Warwick, Dept. L22 Kansas City 8, Mo.

**REMOVE PAINT
WITH WONDER-PASTE**



In refinishing furniture, woodwork, etc. all cracked or peeling portions of the old finish should be removed. It's easy with WONDER-PASTE REMOVER. Applied with an ordinary paint brush, this remarkable paste quickly softens up the toughest finish, whether paint, varnish, enamel, lacquer or shellac. Will not run, even on an upright surface. Turns the finish into a soft sludge that comes off easily at every stroke of the scraper. A long-time favorite of painters.

Get Wonder-Paste at your paint or hardware store. Write for Wonder-Paste leaflet, and for advice on your particular removing problem.

Wilson-Imperial Co., 119 Chestnut Street, Newark 5, N. J.

**WHEELS
AT BARGAIN PRICES**

- ...4" wheel & tire, 5/16" sleeve bearing & hub cap \$0.45 ea.
- ...5" wheel 5/8" solid tire 5/16" shaft hole 0.65 ea.
- ...6" wheel 5/8" solid tire 5/16" shaft hole 0.75 ea.
- ...7" wheel 3/4" solid tire 3/4" shaft hole 0.85 ea.
- ...8" wheel 1" solid tire 1/2" sleeve bearing 1.25 ea.
- ...8x2" wheel, semi-pneumatic tire 7/16" ball bearing 2.50 ea.
- ...10x1.75 wheel semi-pneumatic tire 7/16" or 1/2" ball bearing 3.25 ea.
- ...12x1.75 wheel semi-pneumatic tire 1/2" bronze bearing 4.00 ea.
- ...10x2.50 wheel semi-pneumatic 1/2" ball bearing 4.50 ea.
- ...8x2" wheel 5/8" ball bearing, solid tires 3.95 ea.

BUILD YOUR OWN—Wagons—Scooters—Soap Box Racers—Welding Carts—Baby Pens—Etc. To order above wheels write number wheels wanted in space provided, tear out and mail this ad with check or money order and your name and address. If other sizes are wanted write for FREE LIST.

TRULSON MFG. CO., 811 E. 31 St., Dept. PM-15, Kansas City, Mo.

SAY YOU SAW IT IN POPULAR MECHANICS

THE BULL BUFFER

POLISHING CARS

SANDING WOODWORK

POLISHING FURNITURE

BERTRAM C. ENGINEERING CO. • 3034 Main St. • Kansas City, Mo.

NEW GOV'T SURPLUS

**CAMPING AND SPORTING
EQUIPMENT**

**U. S. AIR CORPS NEW!
ONE MAN
LIFE RAFT**

GOV'T COST \$90.00
YOU BUY FOR ONLY **\$19.95**



Here's the Army's most popular item for summer fun. Complete with sail, hand pump, sea anchor, canvas carrying case and all accessories. These rafts can be inflated by mouth, hand pump or CO2 cartridge included. Folds into compact carrying case approx. 1 cu. ft. This item comes to you brand new and complete with all accessories in original gov't packing. Weight approx. 20 lbs.

Can be used as a swimming pool in your back yard for the kids.

**U. S. ARMY 9x9 WALL TENTS
\$50.00 VALUE
YOU BUY FOR ONLY
\$19.95 NEW!**



Now you can go fishing or camping and have complete shelter with a U. S. Army officer's tent. Will accommodate two to four beds. Length 9'2", Width 8'10", height 8'6". Complete with lines, and wire tent slips. Absolutely fireproof, waterproof and mildew resistant. This heavy O. D. Canvas tent will give many years service.

**U. S. AIR CORPS
MAE WEST
LIFE PRESERVERS NEW!**



Enjoy safety and comfort with the Air Corps' most popular and practical life preserver. Adjustable to fit any size. Easily inflated by mouth or cartridge. **\$1.95**

SATISFACTION GUARANTEED OR MONEY REFUNDED
—Send Check or Money Order—
Cash orders rushed F.O.B. Birmingham, C.O.D.'s sent plus charges.

SPORTSMAN'S MAIL ORDER HOUSE
"Exclusively Sportsman's Merchandise"
2124 2nd Ave. N. Birmingham, Alabama.

You polish and sand faster, easier—do beautiful, professional work—with this amazing new attachment for your hand drill. And the Bull Buffer more than pays for itself the very first time you make your car, floors, woodwork, furniture gleam like new.

The Bull Buffer fits any chuck on an electric drill (or flexible shaft). It's easy to use—the only buffer you can turn in a complete circle while you hold your hand drill stationary. Reaches all curved and flat surfaces. It's packed with power, built with lifetime materials and guaranteed.

The sooner you order, the sooner you'll have this tool of a hundred uses in your hands. It's a real bargain—only \$9.95, complete with five-inch rubber disc, sheep-skin bonnet, and 2 sanding discs. (Extra bonnet, \$1.25; extra medium and coarse sanding discs, 10c each; wire brush attachment for removing paint, \$1.75.) If your dealer doesn't stock, send cash, check, or money order for \$9.95, postage prepaid. C. O. D. plus postage **\$9.95**

Dealers, Write for Information

Sensational offer!
ARMY AIR FORCE STYLE
4 Base Curved Ground & Polished Lenses
SUN GLASSES
*Handsome
 Feather
 Made in
 U.S.A.*



AT THIS AMAZING LOW PRICE
\$1.99

MAIL ORDERS

Please send remittance with order—add 7c per pr. postage

Send for our **FREE WAR SURPLUS CIRCULAR**

GREATEST SUN GLASS VALUE IN AMERICA

While 12,000 pr. last we offer these Aviators style sun glasses @ 1.99. Thousands were sold up to \$6. Full size, 24k G. P. rims, pearl sw'tb'd, adj. nose pc. Ophthalmic grd.; with cs.

SIOUX FALLS SURPLUS STORE
 113 N. PHILIPS SIOUX FALLS, S. D.

BUILD and ENJOY YOUR OWN BOAT!



ASSEMBLED IN 8 HOURS

WITH A **Plywood Boat Kit, ONLY \$54.00**
LIGHTWEIGHT, 12-FOOT LONG (Freight paid)

READY CUT — needs no forms nor special tools to assemble. Kit includes all hardware, paint, etc. (less oars).

Send for Free Folder

TAFT MARINE WOODCRAFT

Dept. M, 636 39th Ave. N.E. Minneapolis 18, Minn.

HOW TO SUCCEED WITH BEES
 By E. MATTING & HARRISON



BEE RAISING PAYS BIG PROFITS

Get HOW TO SUCCEED WITH BEES, written by two outstanding experts, which gives more than 190 successful plans to produce big crops of honey. Join the ranks of spare time money-makers and send for this guaranteed 96-page book today. Tells all about queens, equipment, summer, winter and spring management, swarming, increasing colonies, how to produce section honey and extracted honey, etc. 19th edition, fully revised, only \$1.00.

POPULAR MECHANICS PRESS

200 E. Ontario St. Chicago 11, Ill.

POPULAR MECHANICS

Outdoor Sports Manual!

All sportsmen, attention! Here are 156 pages of helpful hints for the Hunter, Fisherman, Trapper, Camper, Archer, and Boatman. How to make your own decoys, recondition your fishing rod, outwit the fur bearers, make an insect and vermin proof tent, shoot a modern crossbow, and service your outboard motor. These and a pack bag full of other articles for outdoor men. Your News Dealer has it in the 60c paper edition and we can supply the beautifully bound \$2.00 library edition.

Popular Mechanics Press
 200 E. ONTARIO ST. CHICAGO 11



PAY RAISING—EXTRA MONEY BOOKS

Use these books to prepare for a better job—bigger pay—to start a profitable spare time or full time business of your own, improve your home, start a hobby. Popular Mechanics specializes in books on many subjects. Send

supplying outstanding self-help books on many subjects. Send for our FREE catalog.

- Outdoor Sports Manual**
 Hunters, Fishermen, Trappers, Campers, Archers, Boatmen. Here is your book! . . . \$2.00
- Shop Notes Library**
 3 Vols.—1948, 47, 44. (No Dup. Mat.) . . . \$2.00
- Painting, Furniture Finishing and Repairing** . . . \$1.50
- Rewinding and Servicing Electric Motors (No. 75)** . . . 25c
- Elementary School Subjects for Home Study**
 Covers high points of grammar, spelling, arithmetic, history, science, geography, etc. 635 pages. . . . \$1.89
- High School Self Taught**
 Covers 25 subjects with study guide and self-testing quizzes. Completely revised and enlarged edition, 1280 pages, 309 illustrations. . . \$3.95
- Garden Book**
 Build own trellises, lawn furniture, fireplaces, ornaments, etc. . . . \$1.00
- Diving, Cutting and Welding in Underwater Salvage Operations**
 Only book of its kind . . \$2.00
- Picture Framing**
 Modern methods for making and painting picture frames. Fully illustrated. . . . \$2.75
- Frog Industry**
 Breeding, feeding, dressing and marketing . . . \$2.00
- New Fields for the Writer**
 Television, radio, film, drama . . . \$1.00
- 20 Careers of Tomorrow**
 Covers plastics, metallurgy, textiles, radio, electronics, television, transportation, chemistry, etc. . . . \$2.50
- Breaking Into Advertising** \$1.00
- Into the Freezer and Out**
 A complete handbook on the home freezing of foods. \$2.50
- Concrete Handbook**
 New book on using concrete around home, garden, farm . . . \$1.50
- The Vegetable Growing Business** . . . \$3.50
- This Way Up**
 The successful philosophy of practical business men \$2.00
- Welding, Brazing and Soldering**
 How to build own equipment and how to use it effectively . . \$1.25
- Modern Refrigeration** . . . \$5.00
- Electric, Gas, Be service expert** . . . \$5.00
- Dyke's Auto Ency. (includes Diesels, airplane engines)**
 New 20th Ed. World's greatest book for mechanics \$7.00
- Household Mechanics**
 The "fix-it" book to end all "fix-it" books. Covers electric appliances, painting, carpentry, etc. . . . \$2.75
- Oil Burner Handbook** . . . \$2.50
- Build Your Own Boat**
 Describes 17 popular boats—rowboats, sailboats, plywood outboard, etc. 192 pages \$1.50
- House Wiring (No. 89)** . . . 25c
- Turn Scrap into Money**
 Convert old auto generators into motors, welders, etc. . . . \$1.00
- Popular Mechanics Farm Manual**
 Packed with practical ideas and usable information that can easily be worth hundreds of dollars to every farm family and to homeowners everywhere. Send for free descriptive folder giving complete contents! . . . \$3.00
- Woodworking for Every-body** . . . \$2.75

- Sheet Metal Work** . . . \$3.00
- Tool and Saw Sharpening (No. 92)** . . . 25c
- Forging Practice** . . . \$1.50
- Action Toys (No. 66)**
 Plans for 21 easy-to-make toys . . . 25c
- Foundry Work** . . . \$2.25
- Pattern Making**
 Wood, metal . . . \$2.25
- Forty Power Tools**
 Build own saw, drill, lathe, sander, etc., from scraps—save money . . . \$1.25
- Carpentry** . . . \$2.50
- The Young Craftsman**
 Over 450 things boys can make . . . \$1.50
- Five Acres and Independence**
 How to make money on small farm . . . \$2.50
- Your Home and How to Build It Yourself**
 Step by step construction of the famous POPULAR MECHANICS house. Wonderfully illustrated . . . \$3.00
- Artistic Penmanship Self Taught**
 New self study course with 48 lessons of interesting and varied exercises . . . \$2.95
- Knots, Ties and Splices**
 For everyone who uses rope . . . \$1.25
- What to Make for Children**
 Junior tough on toys? Build him playthings that will last. . . . \$2.00
- LeJay Manual of Homemade Electric Equipment**
 How to construct 100 items that are scarce and valuable . . . \$1.50
- How to Estimate for the Building Trades: Material and labor costs for masonry, plumbing, electricity, carpentry, heating, hardware, painting, etc. 629 pp.** . . . \$5.50
- A Small Store and Independence**
 Guide to successful retailing . . . \$2.50
- Rabbits for Food and Fur** . . . \$2.50
- Tool Making** . . . \$4.00
- Tool Design** . . . \$4.50
- Plumbing Installation & Repair** . . . \$2.00
- Ropp's Calculator**
 Figuring made easy . . . 75c
- Slide Rule Simplified** . . . \$2.75
- Drake's Refrigeration Service Manual** . . . \$2.00
- Primer for Home Builders**
 All the information you need to know in building a house . . . \$2.50
- How to Remodel A House**
 Nothing is omitted . . . \$5.00
- Toys You Can Make of Wood** . . . \$2.50
- A.S.C. of Poultry Raising** \$2.50
- Ice Cream for Small Plants**
 Some technical formulas for ice cream, ices and frozen desserts on a commercial scale . . . \$2.50
- Furniture Joinery** . . . \$2.50
- Essentials of Upholstery** . . . \$3.25
- Radio Physics Course**
 A thorough training in radio fundamentals . . . \$5.00
- Science Digest Reader**
 Fascinating articles on astronomy, atomic energy, psychology, medicine, etc. \$3.00



MAIL THIS COUPON TODAY

Check the books you want, write your name and address below, and mail this advertisement with money order or check. Outside U. S. A. include 15% additional for shipping charges.

Books selected will be mailed promptly on our "money back if you're not entirely satisfied" guarantee.

Name _____
 Address _____
 City _____ State _____

Mail to POPULAR MECHANICS PRESS
 Dept. 651—200 East Ontario St., Chicago 11, Ill.



HIGH PRESSURE HYDRAULIC PUMP FOR HOME, SHOP AND FARM USE

Genuine Vickers constant displacement high pressure pump. Use it for any type of liquid pumping job. Will pump 400 gal. per hour at 3750 R.P.M. Precision piston type design provides 1000 lbs. per square inch pressure. Self priming. Standard thread 3/4 inch intake and discharge ports. With 5/8 inch splined shaft — just add pulley and power and you're ready to go.

HAS HUNDREDS OF USES

These pumps are brand new. Original acquisition cost approx. \$100.00. Can also be used as hydraulic motor; for rams, opening doors, hydraulic lifts, etc.—also for any liquid transporting job. War surplus, but brand new. Shp. wt. 7 lbs. **\$9.95**

SOUTHWEST AERO SUPPLY, Dept. PM7
Drawer 488 South Houston, Texas.



DUAL TAIL PIPE EXTENSION

Fits all cars — chrome plated

DEEP TONE

produced by 2 1/2 inch outlets **\$2.95**

Postage free on prepaid orders

DEALER INQUIRIES INVITED

LYONS PRODUCTS COMPANY

PAT. PEND. 2319 Ridgeley Drive, Dept. PM-7, Los Angeles 16, Calif.

New 1948 PLASTICS SUPPLIES CATALOG

Just off press. Full details on Plexiglas, Lucite, rods, sheets, tubes, Acetates, cements, dyes, buffs, molding sets, tools, carving kits, accessories. Everything in plastics. Gives prices, sizes, colors, etc. Price 10c, stamps or coin, with ad for catalog.

PLASTICS MFG. & SUPPLY CORP.

DEPT. M-7 • 4707 EUCLID AVE. • CLEVELAND 3, OHIO



SPECIAL! LOW PRICES ON— Natural Rubber Latex FOR BETTER MOLDS

This new molding compound with 70% natural rubber concentration is easier to use, gives cleaner, sharper, more profitable castings. Order now at these low prices: 53 Qt., \$5 1/2-Gal., \$8.50 Gal., \$7.50 per Gal. in 5-Gal. Cans. Send check or m.o. New Molding Manual sent with each order.

FRANCIS RUBBER PRODUCTS CO.

Dept. G-3, 1836 E. Fulton Columbus 9, Ohio

HOW
to Make
ART
OBJECTS
with
RUBBER
MOLDS



New Designs in FRANZITE GRIPS

Modernize Your Gun! Improve Your Score!

Most durable grips made. Positively unbreakable! For Colt, Smith & Wesson, Hi-Standard, Ortgies, Luger & Mausers in a wide choice of beautiful designs in ivory, pearl, walnut, onyx, etc. Low prices. FREE CATALOG. Dealers Wanted.

SPORTS, INC. (Mfrs.) 5501 Broadway, Dept. P-7, Chicago 40, Ill.

MORE POWER FOR YOUR WHIZZER

WEBER'S "CUSTOM DESIGNED" CYLINDER HEAD
FOR WHIZZER BICYCLE MOTORS

- PROVIDES INCREASED POWER • SAVES GASOLINE
- ELIMINATES GASKET TROUBLE • SMOOTH COMBUSTION

WEBER'S Hi-Compression Cylinder Head is designed with an unrestricted gas chamber, and machined for perfect seating thus eliminating all gasket complications.

SEND YOUR ORDER TODAY

WEBER TOOL COMPANY • 4200 WHITESIDE • LOS ANGELES 33, CALIF.



\$5.95

POST PAID
CASH WITH
ORDER

WRITE NOW FOR FREE CATALOG SHEETS



FOSTER MFG. CO., 1 KINSEY AVE., BUFFALO 17, N. Y.

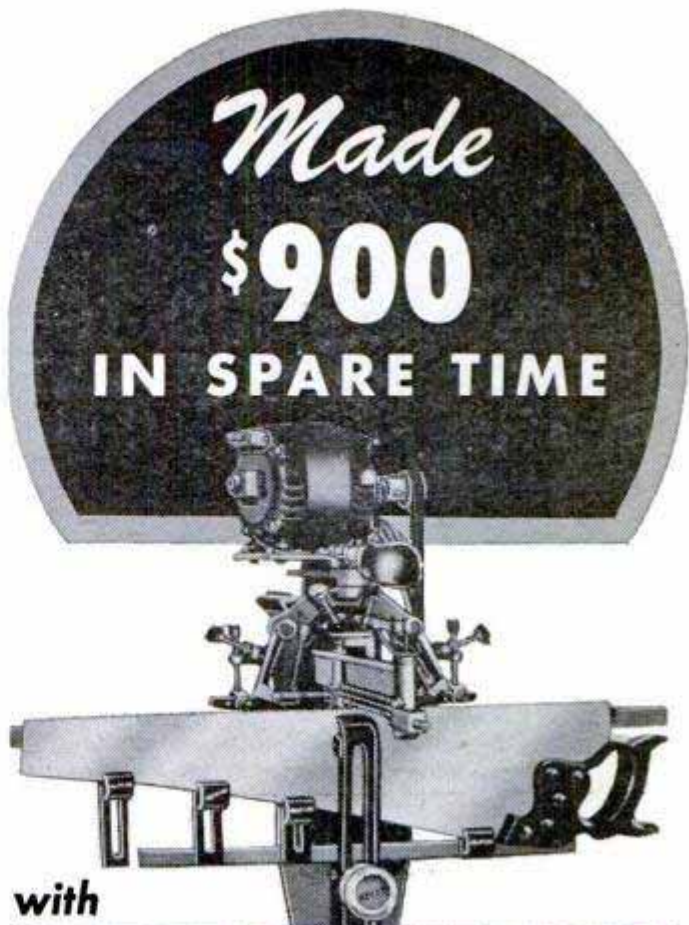

Made
\$900
IN SPARE TIME

with

FOLEY* automatic SAW FILER

*Trade Mark Reg. U. S. Pat. Off.

"I did very well last year with my Foley equipment, about 950 saws and 240 lawn mowers, in my spare time. About \$900 for me." L.H.M., New York. A.G.W. in Mass. says: "I have filed over 5000 saws in 8 years and find the Foley Automatic Saw Filer very satisfactory."

Make up to \$2 or \$3 an hour in Spare Time. With the high prices of food, clothing and everything else, just think what you could do with extra money every week! With a Foley Automatic Saw Filer you can file hand, band and circular saws better than the most expert hand filer. "The first saw I sharpened with my Foley Filer came out 100%"—writes C.E.P. Every saw you sharpen with the machine accuracy of the Foley Saw Filer is an ad that brings you more customers. Cash business, no canvassing. No eyestrain, no experience needed.

FREE BOOK INDEPENDENCE AFTER 40!

Shows just how you can start at home in spare time in your basement or garage. Just think—with a small investment, no overhead, no stock of goods to carry, you can get right into a cash business—and later on develop into a full-time repair shop. Send coupon today for this practical plan.



Send Coupon for FREE BOOK

FOLEY MFG. CO., 716-8 Foley Bldg., Minneapolis 18, Minn.
Send FREE BOOK—"Independence After 40."

Name _____

Address _____

We're GILDING the LILY!

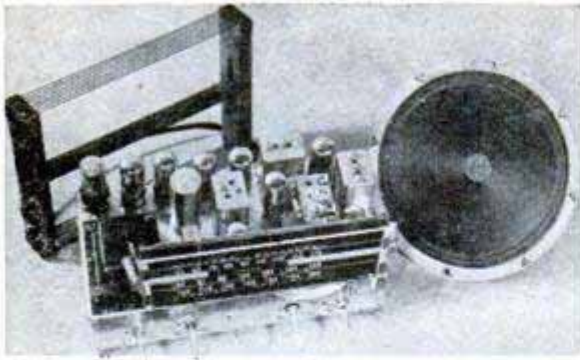

the NEW, IMPROVED Model 7-B-1, engineered to meet YOUR needs!

Carefully engineered, and manufactured of the finest materials, the ESPEY Model 7-B-1 is specifically designed to meet the most exacting requirements for a replacement chassis, and will lend itself to any type of installation. This model is drift-compensated, AM/FM, with 10 tubes plus rectifier. Supplied complete, ready to operate.

Send to DEPT. D-7 TODAY for FREE LITERATURE

ESPEY MANUFACTURING COMPANY, INC.
528 EAST 72ND STREET-NEW YORK 21, N. Y.

"ESTABLISHED — 1928"

DUAL CROSS and ROTARY FEED

PALMGREN ROTARY, INDEX, MILLING TABLE No. 83

Has 8" table, 360° movement and 4" cross feed travel. Adjusting wheels and dials graduated in degrees and thousands. Slotted for bolting to table. No. 83 Priced \$49.50. No. 82 without rotary feed \$39.75. Write for Circular No. 10 CHICAGO TOOL and ENGINEERING CO. 8365 South Chicago Ave., Chicago 17, Ill.



Sensational Value! **PAINT SPRAYER WITH ELECTRIC MOTOR**

DOES ALL ORDINARY PAINT SPRAY JOBS

Positively unheard of 'til now—an electric powered sprayer outfit at such a low price. Not a toy! Not a makeshift. It's a real, practical all-purpose sprayer outfit complete with compressor, 110 volt A.C. or D.C. electric motor, suction type, continuous flow spray gun, paint container, 10 ft. air hose, 6 ft. electric cord and plug. Use it for home shop, auto and 'round the house jobs, and do a good job—quick. Rush order today. Only \$19.95 complete. Send check or M.O. If C.O.D., send a five dollar bill for deposit.

Uses **Lacquers, Varnishes, Paints, Etc.**



Weights Only 8 lbs. Portable. Use it Anywhere.

HOME SHOP PRODUCTS CO.
DEPT. 1-B, 4821 SHERIDAN ROAD CHICAGO 40

★ ★ ★

MAKE YOUR OWN POWER TOOLS at Low Cost from old Auto Parts, etc.



A New Edition Featuring TOOLS of WOOD

Now you can have a good lathe, drill press, circular and band saw and other power tools in your home workshop, at a cost of only a few dollars each. Make them yourself from old auto parts, discarded sewing machines and other odds and ends that cost little or nothing. Get this new book—"Forty Power Tools You Can Make." Costs only \$1.25 postpaid. This book gives every detail in plain language you can understand and follow. Hundreds of pictures and plans show every step to follow in making the power tools you want. Actual photographs of finished machines included. Send \$1.25 today. Money back if not satisfied.

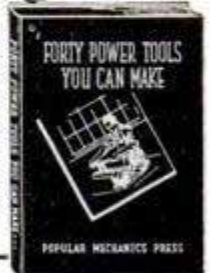

MAKE EVERY POWER TOOL NEEDED IN YOUR HOME WORKSHOP

Some of the power tools you can make are:

2 Band Saws	2 Drill Presses
9 Sanding Machines	1 Scroll Saw
2 Circular Saws	2 Wood Turning Lathes
1 Metal Lathe	3 Grinders
1 Power Hack Saw	1 Shaper or Moulding Machine
1 Jig Shears	1 Vibrating Pencil
1 Cut-Off Wheel	and others

Information too, about pulleys, belts, motors and drive methods. Just published. No other book like it. Order today.

POPULAR MECHANICS PRESS

Dept. 621 • 200 E. Ontario Street, Chicago 11

WHAT TO MAKE SERIES

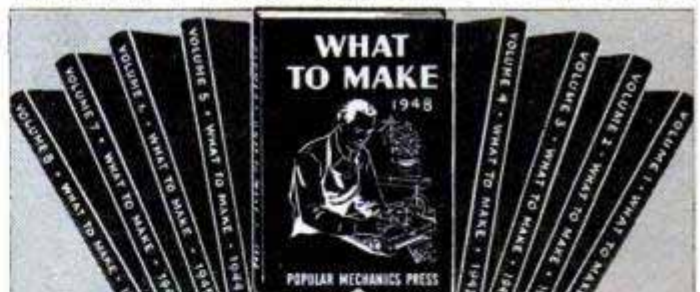

Send for your copy of the new 1948 clothbound edition now! Keep your set up to date. This is the 9th in this famous series of Home Workshop and Hobby Guides. If you do not have the earlier volumes you are missing a wonderful source of inspiration for making fascinating things at home. Every book is different... contains material not in the other volumes.

POPULAR MECHANICS 1948 EDITION

Partial contents: Birdhouses, sideboards, benches, furniture, book ends, chairs, toys, games, photo equipment, Dutch windmill, leathercraft, bookbinding, ship and yacht models, reclining chairs, fruit baskets, bobbed, hamper, garden furniture, log cabins, porch furniture, tables, hostess trays, footstools, desks, lamps, fireplace screens, bookcases, wall cabinets.

PACKED WITH FUN AND PROFIT FOR EVERY HOME CRAFTSMAN

Nine big books 1900 pages, 4000 pictures
\$1.75 a volume \$14.00 for set of nine

POPULAR MECHANICS PRESS, 200 E. Ontario St., Chicago 11, Ill.

Please send What To Make books as checked below. I will pay postman price and few cents postage. It is understood my money will be refunded if I'm not satisfied.

What To Make Vol. 9 \$1.75
What To Make Library (9 vols.) \$14.00
Postage paid if remittance accompanies order.
Outside U.S.A. 15% additional.

Name _____
Street and No. _____
City _____ Zone _____ State _____

Only \$16.95 DUAL PURPOSE SPRAY GUN

Complete



USES ONLY 25 LBS. AIR PRESSURE FLOCKS AND SANDBLASTS

AT HOME: You can refinish Lamps, Radios, Book Ends, Statues and hundreds of things with lovely colorful flocking. ETCH GLASS: Many designs and initials can be sandblasted on shower doors, ash trays, glassware. AUTO INTERIORS: Transform ugly dirty auto interiors to "new car beauty" with a BLASTO DUAL PURPOSE SPRAY GUN. Merely spray flock similar to Velvet, Plush, Suede and Mohair inside your car. ANTIQUE WOOD . . . REMOVE PAINT. MAKE EXTRA MONEY by doing any or all the above for profit. BLASTO is highest quality and carries a 5 day money-back guarantee. Operates on small air compressor. Send \$16.95 cash, check or money order for postpaid delivery. Write for free information. Full line of Flocking Supplies.

BLASTO SPRAY GUN MFG. Dept. PM-7, 7007 Haas Avenue
Los Angeles 44, California

Start a NEW BUSINESS
Or Add to Your Present
Repair Business
Sharpen Dull Pipe Wrenches
Pipe Taps & Dies
"Gum" Circular Saws
Write for information.



Pat. applied for

J. C. MOORE INDUSTRIES P.O. Drawer 276
FREDONIA, PA.

Never Follow a Wrong Steer GO BY HULL COMPASS

AUTOMOBILE COMPASS
(Illuminated)
\$5.95
At your dealer's.



AUTOMOBILE COMPASS
(Standard)
\$3.95
Write for circular.



BOAT COMPASS \$2.75

HULL MFG. CO., P.O. Box 246-D6, Warren, Ohio

FREE! "HOW TO BUY AN OUTBOARD MOTOR"

Write for this 52 page book packed with facts on boats and motors. Tells you how to select the right one for your needs. Sent free. A postcard gets it.

JOHNSON MOTORS

400 Pershing Road, Waukegan, Illinois
Johnson Motors of Canada, Peterboro, Canada



15 OUTDOOR FIREPLACE Plans

new
Constructional details on 15 easy-to-build fireplaces simple fireplace from 60 bricks to deluxe job with multiple cooking units. Build on own grounds at small cost; enjoy sizzling steaks. Send dollar bill or check for plans now. Money-back guarantee.

CRAFTPLANS, Dept. P-121, 7241 Madison, Kansas City 5, Mo.

HARD TO FIND—NEW PORTABLE RADIO ANTENNAS

Solid Brass—Noise Free—Perfect for Transmitting, P.M. and Television Sets \$13.50—9 Ft. Now \$3.95—\$12—7 Ft. (Lo Loss Lead) Now \$3.45 Postpaid—Mail Check or Money Order. Sent C.O.D. plus postage. Money back if not O.K.

RADIO HOSPITAL • 442 A East 86 St. • New York 28, N. Y.

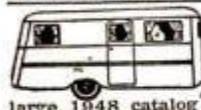

TRAILER BUILDERS' SUPPLIES!

TO BUILD, REPAIR OR MODERNIZE!

And save money. You must have our big Catalog. We are the largest and most complete trailer supply house in the States. Our new large 1948 catalog 10c; blue prints and building instructions, 25c.

NATIONAL TRAILER EQUIPMENT CO., 1007 N. Water St., Milwaukee 2, Wis.

John B. Smith

YOUR SIGNATURE ON A DECAL TRANSFER. EASILY APPLIED TO YOUR PERSONAL POSSESSIONS. CAMERAS, LUGGAGE, BOOKS, WALLET, FISHING RODS. LUNCH BOXES, ETC. PERMANENT BLACK OR GOLD BACKGROUND. AUTHENTICALLY REPRODUCED. SEND \$2.00 WITH YOUR SIGNATURE. JUST THE WAY YOU WANT IT. IN A SPACE ONE-HALF BY TWO AND ONE-HALF INCHES FOR FORTY OF THESE ATTRACTIVE, PERSONALIZED SIGNATURE DECALS. NO C.O.D. ORDERS, PLEASE. ORDER NOW. PROMPT DELIVERY. CALRAY CO., 520 WEST ESTHER STREET, LONG BEACH 13, CALIFORNIA

ARMY SURPLUS A-C PLANTS

Nation's greatest bargains in surplus 110-volt, 60-cycle, 2500-watt power plant. Briggs Engine drive. Ideal for farmers, ranchers, contractors for full time or emergency power. (Cost Govt. \$535.) Low as \$174.50. Fully reconditioned plants \$229.80 prepaid. 2500-watt practically new A-C generators \$129.80 prepaid. Brand new famous Salisbury gas engines 6 1/2 H.P. \$82.90 (cost \$162.50.) Free plan to make units full automatic starting. Free Catalog.

LECO ENGINEERING CO., Box 908-PM7, Lincoln, Nebr.

BEST BUYS FROM AERO PARTS SUPPLY

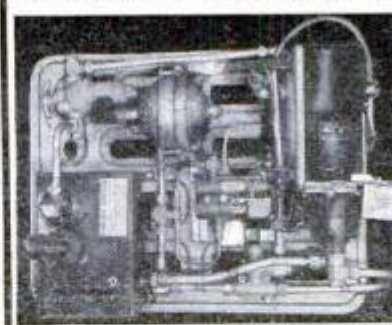

WAR SURPLUS COMPLETE HYDRAULIC PRESSURE ASSEMBLY \$49.50

A COMPLETE UNIT - READY TO HOOK UP

Complete to the last detail—and at a price that you couldn't begin to buy half the parts for. It is completely equipped ready to go—just add the oil and put it to work. Unit is mounted on an alloy rack and contains the following high quality components: hydraulic reservoir 5 x 10 x 9 inches; large Purolator filter; hydraulic pressure accumulator; pressure relief valves; Bendix hydraulic pressure control unit; solenoids; genuine Pesco valves; Pesco hydraulic gear type pump of 1000 lbs. per sq. in. pressure at 1750 R.P.M. (motor turns at 4000 R.P.M.); full 2 1/2 horse power Pesco elec. motor, AC or DC 24 volts, 4000 R.P.M. (will run on 110 AC by use of transformer); 24 all connectors, tubing, fittings, wiring, etc. are included. Unit measures 24 x 18 x 6 inches overall. Just add the hydraulic oil and you can put the system to work on any type of hydraulic power action. Has hundreds of uses. For cash with order will include full gallon high grade hydraulic oil and send shipping charges collect. Will ship C.O.D. against \$10.00 deposit less oil. Shipping wgt. approx. 60 lbs. Guaranteed perfect. Price complete, \$49.50 only.

2—PILOT'S TYPE SUN GLASSES

The better type glass with 22 K gold plated frame and large aviation type optically ground green lenses that cut out 90% of sun's harmful rays. Lifetime guarantee! Case included. Use for flying, boating, driving, sports, etc. (Postpaid to you for \$2.95 10c.) Per pair

3—PILOT'S TYPE WRIST WATCH

An unbeatable value. Full sweep red colored second hand, luminous dial and hands, round chrome plate case. Has mathematical graduations on dial. Wrist band included. Guaranteed to reach you in perfect and brand new condition. Postpaid, only \$7.95

4—CELESTIAL NAVIGATION OUTFIT

Learn navigation! Outfit includes famous Link A12 Sextant with navigation course (in book form), a pair of 18 in. dividers and 18 in. chart rule with complete operating instructions. Orig. \$17.50 cost of Sextant was over \$200.00. All for only \$17.50

5—ASTRO COMPASS - MARK II

Used like a Pelorus to determine bearings, courses, etc. through 360 degrees. Instructions, mounting base and carrying case included. Limited quantity. Only \$9.75

6—PELORUS A-3 MODEL - USED BY AAF

Calibrated 0-360 degrees, with rotatable reflecting glass, double sun filters, precise lens and recticle system. For use with 6, 12 or 24 volt light (specify when ordering). Good condition, \$5.95 less case. Reduced from \$9.75 to only

7—PILOT'S FLYING GOGGLES

Ideal for motorcyclists, hot rods, boatmen, etc. These are genuine AMERICAN OPTICAL units with metal framed ground glass lenses decentered for wide vision and fitted with two-piece soft rubber face mask for wind protection. Adjustable nose piece for fit and comfort. Brand new—regular \$16.00 value. Molded aluminum case included free. Per Pr. only \$4.95

8—SPEED-O-MATIC CAMERA

The wonder camera that snaps, prints and develops your pictures within minutes. Built-in exposure meter, telescopic type view finder, 5 lens openings. No technical knowledge needed for operation. Kit includes camera, all equipment, 12 free film, picture making book and instructions. Brand new! Only \$9.95

9—ELECTRIC DRY SHAVER

Operates on regular house current to give you a cool, smooth, quick shave. Complete with plug and extension wire. Pocket size. With manufacturer's one year guarantee. Not a toy! Sent postpaid for only \$5.95

10—MAGNETIC COMPASS

Late model AIRPATH. Panel mounting for 3/4 inch hole. Unused condition. Postpaid if you send cash. Only \$7.95

11—THROAT MICROPHONE

Straps onto neck. Allows free hands and head movement. Used but in good condition. Ideal for experimental work. Each \$1.00

CORD, SWITCH AND PLUG FOR ABOVE

Rubber covered cord with plug and phone jack. Includes finger control switch with loop for hanging on neck or clothes. Each \$1.25. Both microphone and cord assembly \$2.00 postpaid.



12—50 2x2 INCH SLIDES

A collection of world famous war-plane slides. Designed for training our birdmen in plane identification. Slides show profile and broadside views in silhouette. Set consists of 50 or more slides in 2x2 in. mounts, ready for projection. Brand new! Identification of plane printed on each slide. You'll want to add these interesting slides to your collection. Per Set, postpaid, \$2.95 only

Assortment of 2x2 slides as above but warships (surface) instead of planes. Per Set, postpaid, \$2.95

Except where noted, you pay transit charges. Mail orders promptly filled. Send check or money order. Satisfaction guaranteed.

AERO PARTS SUPPLY, Dept. PM7

MUNICIPAL AIRPORT

HOUSTON 17, TEXAS

Say You Saw It in
POPULAR MECHANICS

SMALL VERTICAL SPEED REDUCER

Just the thing for Home and Shop Bench work, Animated and Revolving Displays, Revolving Antennae, Light Production work. Sturdy, compact, (see dimensions), efficient. Case of aluminum, gears of specially selected nickel bronze; worm of hardened steel. Roller bearings throughout. Torque capacity, 25 to 150 inch lbs. Available in 4 different assemblies (see below) and in any one of these standard ratios:

4-1	25-1	64-1	200-1
8-1	30-1	75-1	300-1
10-1	40-1	80-1	400-1
16-1	50-1	100-1	600-1
20-1	60-1	150-1	800-1
	1600-1		

When ordering be sure to specify assembly and ratio required. Shipping weight in carton 8½ lbs. Prompt delivery. Full Money Back Guarantee.



\$26.75

WEST OF ROCKIES
\$27.50

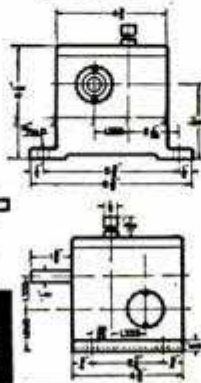
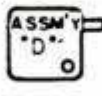
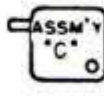

THE OHIO GEAR CO.
1406 EAST 179th ST. • CLEVELAND 10, OHIO

SAVE UP TO \$20

OFF LIST PRICE — ON BRAND NEW

GASOLINE ENGINES

Briggs & Stratton, Clinton, Lauson

1 ½ - 2 ½ - 3 ½ - and 6 H. P.

Write for illustrated circular and details on special **FREE OFFER**

BENJAMIN'S FOR MOTORS

2124 Mill Ave. Brooklyn 10, New York

AMAZING LOW COST BRONZE FOUNDRY

CAST ALUMINUM, SILVER, ETC. — ALL NON FERROUS METALS

Make money in the foundry business casting Engines, Machinery, Art Objects, Statues, Inventions and all other foundry work. Castings up to 6" made quickly with new invention called Foundryette. Operates on 110 V. AC and Domestic Gas. Write for complete FREE information.

KANS. CITY SPECIALTIES
Box 6022, Dept. P-6 Kansas City, Mo.

**Sand Casting
Forging-Heat
Treating-Case
Hardening**

ARC WELDING

FOR PROFIT OR PLEASURE

EASY TO OPERATE—EASY TO ASSEMBLE

OWN THIS GENUINE INDUSTRIAL-TYPE HEAVY DUTY WELDER

Ideal for all-purpose welding. SAFE, RUGGED, COMPACT and EFFICIENT. WILL OPERATE FOR ONLY A FEW CENTS PER DAY.

Plugs into 110 or 220 AC line. Can be used consistently on 30 amp. fuse. ALL PARTS DESIGNED TO GIVE LIFETIME SERVICE. Why pay expensive assembling and shipping costs? **ATOMIC WELDER PARTS** come in a compact box—YOU SAVE THE DIFFERENCE! ORDER WITH CONFIDENCE!

Try your **ATOMIC WELDER** for 30 days. If not satisfied, return as is. Your money will be refunded with no questions asked. **IMMEDIATE DELIVERY—WRITE FOR FULLY ILLUSTRATED BOOKLET P-19**

ATOMIC WELDER CO.

1038 SO. 19th ST. OMAHA, NEBR.

60 LBS. READY MADE PARTS
Only **\$24.95**

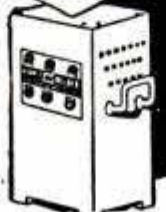

Get This Fascinating New Popular Mechanics Book

WHAT to MAKE for Children



175 Things Dad and Mother can Make for Young Folks at Home!

This is a book by the editors of Popular Mechanics. It will show you how to make, at little or no cost, many of the

things so dear to the hearts of younger children—things that money won't buy, such as play-room and nursery toys and trappings, dolls and dollhouses, gymnasium equipment, things to ride on, toys that "work" and go.

A BOOK FOR THE ENTIRE FAMILY
Mother and Dad and Big Sister and Brother can save many dollars and have worlds of fun too, making all these things for the little tots. Only discarded materials or inexpensive new materials and only simple tools are needed, with **WHAT TO MAKE FOR CHILDREN** as a guide.

SIMPLIFIED INSTRUCTIONS — ANYONE CAN FOLLOW

The book contains 175 different projects with detailed "how-to-do-it" instructions, dimensions and more than 250 sketches, drawings, plans and photographs covering every detail of construction.

Order **WHAT TO MAKE FOR CHILDREN** today. Mail coupon below for immediate delivery. Money back if not satisfied.

**175 PROJECTS
250 ILLUSTRATIONS**

Action Toys—Dolls—Pull Toys—Play Houses—Games

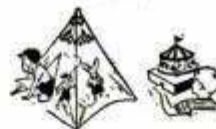

Swings—Furniture—Stools—Playground Equipment—Desks—Sandboxes



Wagons—Coasters—Merry-go-round—Animals—Cribs—Dozens of Others



Popular Mechanics Press, Dept. 660
200 East Ontario St., Chicago 11, Ill.

Send at once _____ copies of **WHAT TO MAKE FOR CHILDREN** at \$2.00 each. Remittance enclosed. I understand I may return the book in 5 days if not satisfactory and you will refund my money.

Name _____
Address _____
City _____ State _____

Biggest Power Tool Bargain in U. S.

95% of those who see this outfit BUY it — wonderfully satisfied. 5 power tools in single unit: lathe, drill press, circular saw, grinder and sander. Uses 1/4 h.p. motor. Does heavy-duty work. Easy to learn every operation. Complete, only \$34.95. Send \$17.50 (balance c.o.d.) on FREE trial, money-back guarantee. Or write for FREE literature today.



See it - Use it!
FREE TRIAL - 10 DAYS

EMRICK, INC., 1737 Clinton, Kalamazoo, Michigan



750' 2-PLY NYLON 25 lb. T
150' 3-PLY NYLON 85 lb. T
250' 3-PLY NYLON 45 lb. T
500' 3-PLY NYLON 35 lb. T
300' SILK LINE 30 lb. T
500' LINEN LINE 32 lb. T

3 Ply Nylon Rope 1/4" dia. 6c Ft. Braided Nylon Line 1/16 dia. 250 lb. T 2c ft. Pachner & Koller Lite Wght. Fly Reel 52. Braided Nylon Line 1/8" dia. 550 lb. T 3c ft. All lines available in longer lengths. Send Check, M.O., or C.O.D.'s. MAC MILLS, Dept. 8-E Pleasant Valley, New York, N. Y.

Army Air Force Type SUN GLASSES



Precision ground and polished 4-base lenses. True green color. Pearloid nose pads and sweatband. Gold-plated frames. Leatherette carrying case!

Send check or money order. Plus 10c postage.

1.95
WORTH \$8.95

JERRY THE SUPPLY SERGEANT

BOX 387, BALTIMORE, MARYLAND

SIMPLEX REAR TOOL BLOCK

No owner of a lathe can afford to be without this new lathe fixture that will do most of the work of a turret tool post. Fits compound of 9' and 10' lathes. You can cut taper with compound and still use cross feed for cut off or form work.

\$3.75 Post Paid

ROBIN MACHINE SHOP BOX 97 ONSTED, MICH.

FURNACES FOR HOME AND SHOP



COAL—LP—GAS—OIL. Fittings, pipes and registers. Water heaters, Ranges and floor furnaces. COOLING, evaporative; water coil or refrigerated. BLOWERS with motors. Of interest to contractors and builders. DEALERS.

FREE BOOKLET

PEERLESS SALES & SUPPLY

4318 Sheridan Lincoln 6, Nebr.

make your own Gems 29.50 F.O.B.

All necessary lapidary equipment is furnished, including a super-charged diamond blade for sawing, and all wheels for grinding, shaping and polishing; also complete instructions. The complete equipment as shown, less motor and belt, for only \$29.50. E.o.b., Burlington, Wisconsin. Write today for information and literature.

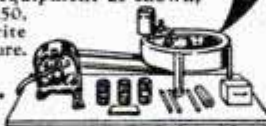

B&I MANUFACTURING CO.
Dept. S Burlington, Wis.

BRUSH PLATING OUTFITS

for re-plating articles in the home and shop. No tanks necessary. Free particulars.

GUNMETAL CO., AVE. M, DECATUR, ILLINOIS

NEW SCIENTIFIC GLARE FILTER

Headlight glare protection for all who drive at night! Reduces eye strain and fatigue. Makes night driving a pleasure. Scientifically designed. Installed in a second. Fully adjustable for all cars and all drivers. "Doctor Kill-Glare" kills blinding headlights. Order Today.

Dr. Kill-Glare, 804 Marion St., Oak Park, Illinois

\$1 POST PAID



Nationally Known SILVER SEAL Rebuilt Engines SHIPPED TO ALL PARTS OF THE WORLD

PRECISION REBUILDING AND EXPERT CRAFTSMANSHIP make the nationally known Silver Seal engine the outstanding rebuilt engine in the automotive industry.

MOST LIBERAL WRITTEN GUARANTEE ever offered on any engine—new or rebuilt.

FULL ALLOWANCE ON OLD MOTOR if not cracked or welded, no charge off for excessive wear, etc.

YOU PAY VERY LITTLE MORE, YOU GET A LOT MORE.

Make	Exchange Price	Trade-In Deposit
FORD Mod. A & B	96.50	28.00
FORD V8 all	108.50	48.00
CHEV. 6 cyl. all	96.50	28.00
PLYM. 6 cyl. all	118.00	20.00
DODGE, CHRYS., DE SOTO	124.50	35.00
All 6 cyl. PONT, OLDS, STUDE, NASH.		
PACKARD, HUDSON	134.50	45.00
All 8 cyl. BUICK, PONT, OLDS, STUDE		
NASH, PACKARD, HUDSON	159.50	40.00

If old engine does not accompany order—add trade-deposit to exchange price. Deposit will be promptly refunded upon receipt of your old engine.

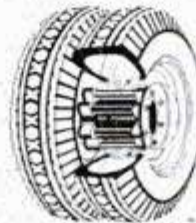

Du-All Converters \$28.50 for Dual Wheels

You can install Dual wheels on your Farm Wagon, Trailer, Pick-up Truck, or Jeep in less than ten minutes. Du-All Adapters eliminate expense of changing to truck-type wheels and hub. Use your spares for duals! Guaranteed to do the job or your money back.

G. I. MILITARY TRUCK PARTS

Axles, Trunnion Bars, Pillow Blocks, Transfer Cases, Gears, Wheels, and every part for every G.I. type vehicle from jeep to 20 ton prime mover. 6x6 Stude, GMC, Dodge; 4x4 Chev, Dodge, Ford. Auto car, Half track, Scout car, etc.

LOOK AT THESE WAR SURPLUS BUYS!

Trailer Axle Assembly

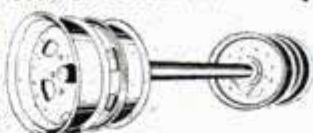

20,000 LB. CAPACITY

GI 503—New Complete Assembly including latest type double cylinder Hydraulic Brakes, 6 hole Budd hubs, bearings, etc. For Single or Dual Wheels, A War Surplus Complete \$158.00
GI 504—20x7—6 hole Budd Wheels to fit. Each \$675

Pintle Hook Assemblies



GI 575—Large Type with Coil Spring for 25 Ton pull. List Price \$47.50. Our Price \$13.50
GI 576—Medium Type with Coil Spring for 15 Ton pull. List Price \$41.00. Our Price \$11.50
GI 577—Light Type as used on Jeep Vehicles. Our Price \$4.75

OIL BATH TYPE AIR CLEANERS



AC or UNITED Air Cleaners. Stock No. GI 619. Fits 90% of all standard cars and trucks. Except Ford V-8. 1 Quart Size—2.5/10" Air Intake. Openings. List Price \$8.50 each. Our Price... \$3.85

DAYTON FIFTH WHEEL



NEW 33" Replace worn fifth wheels with this Standard make. A new one at a price less than overhauling old one. A War Surplus \$68.50 plus buy... \$68.50 each

SEND FOR FREE 64 PAGE CATALOG FOR OTHER GREAT MONEY SAVING BUYS!

The NORTHWESTERN Auto Parts Co.

834 North 7th Street • Minneapolis 11, Minnesota

BUILD & RACE The Thrilling New Bee-Line Jets

Speed Up To 125 M.P.H.

SUPER SONIC STREAK

You'll Get The Thrill Of A Lifetime Building And Racing These Sensational New BEE-LINE JETS. They whiz through the air on a fine steel guide wire at terrific speeds up to 125 M. P. H. Realistic jet power is supplied by CO₂ Fizz Cartridges which are simple and safe to use.



Slick As A Whistle

Fast As Lightning

Both Only \$1.50 P.P.

ORDER YOURS TODAY

FLASH ROCKET



Thrilling As A Trip To The Moon

JIFFY-BUILT KITS

Balsa Wood Bodies Completely Formed, Sanded And Drilled For CO₂ Cartridges. All Other Parts Semi-Finished. Complete Plans and Instructions. One CO₂ Cartridge For Racing Models. 75¢ Each Postpaid

Victor Stanzel & Co., Schulenburg, Texas

Brand New Autolite 6 Volt AUTOMOTIVE STARTERS

Fits Bantam Jeeps and Continental engines. Also fits 4 cylinder Hercules Engines.

Part #MZ4063 Your cost \$10.20 Lots of 6 \$8.95 LIST PRICE \$34.00 EACH or more, ea.

REAR HUBS For 2 1/2 ton G.M.C. or Studebaker Trucks. Each \$5.00

1/2 TRACK CLUTCH DISK with Facing \$5.00 ea.

SPECIAL PRICES ON FUEL PUMPS

Manufactured by Tuthill #00L-X31 or #00LK \$7.50 ea. Please specify model No.

Manufactured by Webster Electric Co. Part #7A351 \$9.00 ea.

Manufactured by Buckley Scott Co. Part #S11-108. One stage unit. \$9.00 ea. Part #S21-102-1. Two stage unit. \$9.00 ea.

TERMS: 25% with order—Balance C.O.D. Rated firms on open account. F.O.B. Chicago. All merchandise is subject to prior sale. OLSWANG BROS. 2415 So. State Street Chicago 16, Illinois

UTICA TOOLS

FOR MORE TOOL MILEAGE



No 91—4", 6", 8", 10", 12" Adjustable Steel Wrench

UTICA DROP FORGE & TOOL CORPORATION
UTICA 4, NEW YORK

15 H.P. "V" TYPE ENGINES

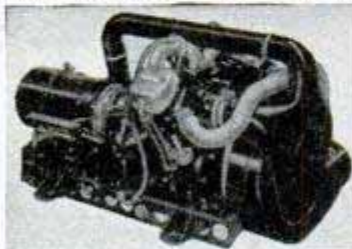

TWIN CYLINDER

Here is power galore for midget racing cars, speed boats, etc., or build your own garden tractor, mower, welding outfit, mill, saw, home lighting plant. Use it for any type of power job. Engines measure 32" long, 22" wide, 18" high. Mounts flat with mounting brackets 14" apart each way.

FOR SHOP,

FARM AND HOME POWER

Precision built—orig. acquisition cost many times our asking price. Famous Andover make—replacement parts available. Designed for 3600 max. RPM with 31.91 cu. in. displacement. Full 2 3/4" bore, 2-11/16" stroke. Dual carburetion with shielded ignition and fuel system. Removable governor included. Each motor is fitted with 28.5 volt generator (removable) ideal for welding outfits.

A RARE BARGAIN AT THIS LOW PRICE

These are built to run like a Rolls-Royce. Some are slightly used—some like brand new. Guaranteed as described or your money back. Your cost, each, only \$119.00—two or more, \$110.00 each while they last. Send check or money order. You've seen our ads since 1941.

FEDERAL IDENTIFICATION CO.

1910 CLASSEN BLVD., Dept. PM7 OKLAHOMA CITY, OKLA.

A Thousand and One Ideas You Can Use on the Farm!



POPULAR MECHANICS

FARM MANUAL

Use it to Step up Farm Efficiency — Increase Production — Improve Farm Appearance — Save Time, Labor, Money!



A Must for Every Farm Family! Saves Money for City Homeowners Too!

Here is the experience of hundreds of successful farm operators brought together in one handy, easy-to-read, easy-to-use, working handbook by the editors of Popular Mechanics. It is brimful of short cuts, labor-saving ideas, ingenious apparatus and methods that will simplify the day's work and lighten some of the more tedious chores, make money and save money for you.

HELPS IN THE FIELD — IN THE BARN — IN THE HOME

Every department of the farm is covered in the Farm Manual. Every member of the family will find in it something that he or she can use to tremendous advantage in farm operation, maintenance and improvement, from the building and care of equipment to painting the farm home and fast freezing fruits and vegetables. It covers farm buildings, the farmhouse and other homes and is of interest equally to the woman looking for home improvement, beauty and convenience and the man striving for easier and more profitable operation.

ORDER TODAY — FOR YOURSELF — FOR A GIFT

Use the coupon below. Mail it today. Book will be sent at once, postpaid if you include payment with your order. If you don't think the Farm Manual is worth even more than you paid for it after five days' use, send it back by mail and your money will be refunded. This may be the best investment you ever made. Rush coupon today.

284 FACT-PACKED PAGES

Hundreds of Illustrations

Popular Mechanics Farm Manual is packed with practical ideas and usable information that can easily be worth hundreds of dollars to farm families and homeowners everywhere.

Farm Machinery and Implements

How to make and get the most out of farm implements.

Farm Workshop Equipment and Repairs

Ideas that can save hundreds of dollars.

Poultry and Livestock

How to build equipment, gadgets. Care of farm animals and poultry.

Vegetable Storage—Processing Winter storage, home freezing tips, make your own freezer.

Farm Home Improvement

Fencing, repairing electrical appliances, plumbing, electrical wiring, saving coal, painting, curing leaky basements, hanging wall paper, making garden tools, garages, working with concrete, painting, etc.

Farm Hints and Kinks

Forty pages of illustrated, practical ideas, short cuts, etc., that will save time, labor and money.

MAIL COUPON • Money Back if Not Satisfied

POPULAR MECHANICS PRESS, Dept. 665
200 East Ontario St., Chicago 11, Ill.

Send _____ copies of the Farm Manual at once.

- Remittance (\$3.00 each) enclosed. Send postpaid. Add 15% if outside U.S.A.
- Send C.O.D. (\$3.00 each) plus delivery charges. U.S.A. only.
- If sent as a gift to another, send name and address on separate sheet.

Name _____

Address _____

City _____ Zone or Route _____ State _____

SAVE MONEY

build your own

SMITH COMPRESSOR

Now, use the world-famous Smith Air Compressor to operate rock drills, paving breakers, spray guns, sandblasting, etc., at low cost! Just order the Smith Compressor Head and Accessories with complete instructions for assembling. All you need is a Ford Motor and shop facilities. Capacity 60 cu. ft.—ample power for most compressor jobs. Pressure up to 100 lbs. per square inch. Head equipped with high speed compressor valves; automatic unloading and idling.

WRITE **GORDON SMITH & CO., Inc.**
TODAY! 410 College Street Bowling Green, Ky.



Compare These Prices

COMES COMPLETELY ASSEMBLED,
READY TO MOUNT ON YOUR TRUCK

COMPLETE CHAIN HOIST
WITH SUPER STRUCTURE
AND TOW BAR — NEW!

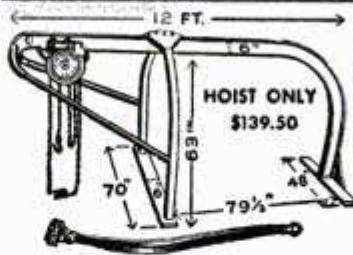

WAR SURPLUS WRECKING SETS

ORIGINAL COST \$380.00

YOUR COST **\$184⁵⁰**

QUANTITY DISC. WRITE FOR SPECIAL PRICES

**BUILD YOUR OWN WRECKER —
EQUIP YOURSELF for HEAVY
LIFTING, LOADING and HAULING**

Completely Assembled . . . Ready to mount on your own truck. Ideal for towing, picking up and lifting all types of heavy equipment. Ready to mount on any truck immediately . . . yet can be quickly removed when truck is needed for other hauling. Here is your chance to build your own wrecker and equip yourself for heavy lifting, loading and hauling.

Complete Chain Hoist with Super Structure and Tow Bar. All assembled—ready to mount on truck for all types of towing, plus heavy duty lifting and loading. Full 1 1/2 ton capacity enables you to handle the biggest jobs with only one man. The Spur geared chain hoist is of Wright or Yale manufacture, trolley type with safety lock. Superstructure is solidly constructed of heavy angular and tubular steel with I-Beam crane. Units were used by U. S. Army on regular 2 1/2 ton 6x6 cargo trucks.

SAVE ON TRUCK PARTS!

- Studebaker and Reo # S-506—OIL PUMP REPAIR KIT \$1.00 each
- Studebaker and Reo 2 1/2 TON FRONT AXLE STEERING KNUCKLE. #669558—Right side \$8.95 each
- #669559—Left side \$8.95 each
- Studebaker and Reo 2 1/2 TON I-BEAM FRONT AXLE. #669557 . . . \$8.50 each
- TRAILER BACKING PLATE ASSEMBLY complete (used on 1 ton, 2 wheel cargo trailers) \$3.50 each. Lots of 10 \$3.00 ea.
- NEW GMC 6X6 COMPLETE RADIATORS . . . \$37.50 each
- Dodge 1/2 ton, 4X4 FRONT AXLE SHAFT (short side) \$17.50 each
- Diamond T—DIESEL INJECTOR PUMP, Type A. P. E. 6A 90 QK 4205—527 \$150.00
- Diamond T—DX 15112 STEERING ASSEMBLY . . \$32.50
- Westinghouse piece part # 220148
- 7 1/4 CU. FT. AIR COMPRESSOR \$97.50
- Westinghouse piece # 220601
- 12 CU. FT. AIR COMPRESSOR \$167.50

SAVE ON JEEP PARTS!

WILLYS No.	FORD No.	DESCRIPTION	PRICE EA.
A2896	GPW16892	Hood catches, ea.25
A7525	9N-11450A	Starter switches, ea.75
637041	GPW6105	STD .010, .020, .030, .040 Pistons and pins, ea.	3.50
WO-A15098	GPW18343B	Distributor kit, ea.60
638636	GPW6513	Lots of 10, ea.50
A1495	GPW8620	Valve springs, ea.15
A1409	GPW10505	Fan belt, ea.95
A1655	GPW12106	40 Amp. voltage regulator auto light VPY 4303A, ea.	22.50
A1223	GPW9510	Distributor cap Auto light IG 1324, ea.	1.50
A1195	GPW7700	Carburetors	
		Outright	13.50
		Exchange	12.50
		Transfer case assembly (Reprocessed)	
		Outright	120.00
		Exchange	95.00
A1326	GPW3365	Propeller drive shaft, front or rear, ea.	15.00
A1327	GPW4602	Hub and drum assembly, ea.	6.50
A1690	GPW1102	Brake shields and Shoe complete, each	6.95
A1496	GPW2011	Hand windshield wiper arm and clip assembly50
A11570	—		

ALL ITEMS SUBJECT TO PRIOR SALE.

All Exchanges Must be Shipped to Us Prepaid
25% Deposit with order . . . Balance C.O.D. F.O.B. Chicago

World's Largest Stock of Jeep Parts!

KING of JEEPS

BERG TRUCK & PARTS CO.

1608 S. WABASH AVE. • CHICAGO

AMERICA'S FIRST JEEP DISTRIBUTOR

OVER 250 SURPLUS BARGAINS

Write for FREE Catalog PM-7 TODAY!

FISLER SALES CO. 721 Walnut
Kansas City 6, Mo.

SCREWY-MIX BARGAINS

HANDY WORKSHOP KITS—ALL NEW FINEST QUALITY

- 1—Assorted machine screws, sheet metal screws and bolts, sizes 2-56 to 3/8-24, various type heads. Three pounds \$1.15. Five pounds \$1.50.
- 2—Mixed Steel Rivets 1/16" to 1/4" diameter, various lengths, round and flat heads—five pound pkg. \$1.00.
- 3—Mixed aluminum rivets—50c lb. Mixed cotter pins 35c lb. Minimum order one item \$1.00—mixed items minimum \$1.50.

ADD 15c POSTAGE PER ORDER

JAY-CEE SALES CO., 4554 Grand River Ave., Detroit 8, Mich.

RE-STRING RACKETS AT HOME

● EARN MONEY ●
WITH THE WONDER VISE



It's pleasant, profitable work. No experience or skill required. Easy to learn. Full line of guaranteed Stringing Tools, Frames, Gut and Silk Strings. Every item high quality.

W. A. BICKEL & CO.

803 South Boulevard, Dept. A-63, Oak Park, Ill.

ELECTRIC CIRCUIT TESTER



24 G.E. Mazda 313 Pilot lights and sockets. 7 test leads and plugs mounted in bakelite box. New original packages, \$3.00 ea. Postpaid

BARDANAL, INC.

1222 W. Washington Blvd., Whittier, California

HELPFUL BOOKS

Send post card asking for FREE catalog

Popular Mechanics Press, 200 E. Ontario, Dept. 601, Chicago 11

Gas Ration

INCREASE MILEAGE GANE AIR-FLOW NEEDLES
Adds 1 to 4 MORE Miles. Smoother, Easier Starting, Slower Idling, Faster Pickup. Ask YOUR Service Station, Garage, Car Dealer to replace your ordinary idling screw with GANE, the NEW Carburetor improvement. \$1.75 each installed. 10-Day Free Trial Money Back Guarantee. Order Direct Mail card for Free Data. Gane 2425 E. 57th St. L.A. 11 Calif.



STAR UNIVERSAL NO-LEAK TESTER

AT THE BENCH AT THE JOB

TEST LAMP SHOWS CONTINUITY

Test CONTINUITY ON THE SPOT, anywhere, in factory or home. No batteries. Just plug into any 110 volt receptacle. Locate open circuits, dangerous grounds in motors, fixtures, etc. Vest pocket size—wt. 2 1/2 oz. Also unexcelled for line testing, 110 to 600 volts.

A NECESSITY for Electricians, Maintenance Men, Home Owners

No-leak neon lamp in one test prod shows definitely what is wrong . . . and where. At \$2.50 most dealers, or direct from us postpaid.

FREE Illustrated Folder on Request.
Address Dept. M

STAR FUSE CO., 233 Canal St., New York 13, N. Y.

AUTOMATIC RETOOTHER

MAKES NEW PROFITS

Cuts new teeth in 50 seconds! Any size 4 to 16 points. Old teeth fall off as chips. Easy to operate. A perfect job.

IMMEDIATE DELIVERY

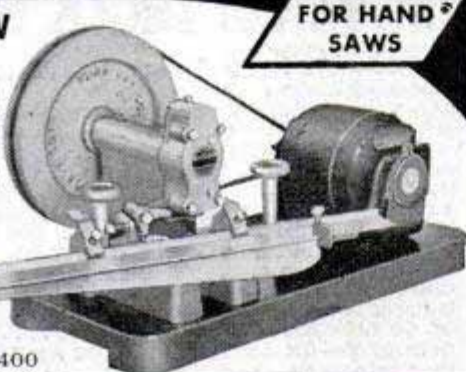

FOR HAND SAWS

Set saw teeth—400 per minute with new Automatic SAW SET. Perfect hammer and anvil action sets teeth uniformly. No tooth breakage.

VALUABLE BOOK

ORDER BURR'S BLUE BOOK OF COAST TO COAST PRICES FOR SAW SHOP SERVICES.

25c

BURR MFG. COMPANY 8933-T Venice Blvd. Los Angeles 34, Calif.

BRAND NEW SURPLUS

REAL FIRE PROTECTION!
War Surplus Bargain—New, Unused
FIRE EXTINGUISHERS



Approved by Underwriters. 1 gal. capacity fully charged, ready to use. Anyone can operate them. Carbon-tetrachloride is non-conductor—will not freeze; stored pressure type shoots 40 foot stream; height 23", diameter 5"; anyone can use them. Ideal for home, office, garage, boats, workshop, summer cabins, etc. Lists for approx. \$65.00. Our price

\$14.95

New Precision Bilt MICROMETERS



Chrome finished nationally known makes. Gives a lifetime of accurate detailed service. Individually boxed.

1" Central	\$3.50
1" Central, Tubular	\$3.75
1" Reed	\$4.00
2" Central	\$4.95
2" Reed	\$5.25
4" Central	\$6.25
5" Reed	\$7.25
6" Central	\$7.75

EMERGENCY TANK

Type F-1, used good condition, stainless steel. A high pressure shatterproof tank of 1000 cubic inch capacity—for 50 pound pressure or 13.8 cubic feet. All metal—measures 9 1/2 x 17 inches. Threaded plug end vents. Shp. weight 11 1/2 lbs. Each

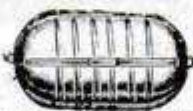

\$3.75

PRICES FOB, KANSAS CITY, MO. NO COD'S.

Write for our New Catalog

ATLAS SALVAGE & EQUIPMENT CO.

229 S. W. BLVD.

KANSAS CITY, MO.

USE SIMPLE HOME-MADE EQUIPMENT

Make HOLLYWOOD STYLE cement pottery and birdbaths. Beautiful chemically colored garden things. Amazing designs. Dime brings pictures, color sample, details.

HOLLYWOOD CEMENTCRAFT
8527-A WONDERLAND AVE.
HOLLYWOOD 46, CALIF.



For Quick Advancement Learn WOOD PRODUCTION ENGINEERING

VETERANS
training is FREE under G. I. BILL.

For quick advancement learn Furniture Drafting and Engineering. You can master these subjects in a short time, either through Home Study or by coming to Grand Rapids. Write for Free information Today. State interest, whether correspondence course . . . or residence course . . . Also state if veteran.

KLOK INST. LOUIS ST. N.W. GRAND RAPIDS, MICH.



DRAINS CELLARS, WASH TRAYS CIRCULATES OIL

Pumps 1800 GPH 300 gal. 30' high, use 1/8 to 1/2 HP **\$6.50** motor. Will not clog.

Postpaid if cash with order. (Add 50c for west of the Mississippi.)

Thousands in use since 1936

LABAWCO PUMPS, BELLE MEAD 7, N. J.



GLUE GLUE GLUE

Amazing wartime development now available. Extra strong liquid glue, requires no heat or mixing. Easily applied, dries quickly with little or no pressure. Glued joint is stronger than wood. Can be used on wood, paper, leather, etc. Large 8 oz. can 75 cents. Full pint \$1.25. Send check or money order. We pay postage.

GILNER MFG. CO., STEGER, ILLINOIS

WAR SURPLUS LUBE PUMP \$3.95 POSTPAID

NEW PRECISION GEAR IMPELLER PUMP

An aviation unit of finest bronze and steel construction. 3 1/2" x 8 1/2" size. Std 1/2" shaft. Mechanics say it is "out of this world!"

- Useful for pumping high vacuum, air pressure, liquids, coolant for lathes, operating hydraulic units, etc.
- Actually two pumps in one housing. Operates in parallel for large capacity or in tandem for high pressure.
- Full instructions and specifications furnished. Sent postpaid \$3.95. Send check, money order or currency, or will ship P.P. C.O.D.

LECO ENGINEERING CO. Box 908-LP1 Lincoln, Nebr.



Original Cost \$24.25

HOW TO BUILD YOUR OWN ELECTRIC WATER HEATER

Efficient, low cost, water heater capable of delivering hot water almost instantaneously. Easy to build, yourself, with this book; which contains 30 pages of drawings, explanations—complete, easy-to-follow directions. Send only money orders for \$3.00 to:

HOME-LAB F-7, 3015 2nd AVENUE, W. HIBBING, MINNESOTA, U. S. A.

CRESCENT TOOLS

Give Wings to Work

ASK YOUR
HARDWARE
DEALER

TENTS

Small and large, new and used, Army surplus. Also canvas covers, hammocks, canvas cots, clothing, paints. Lowest prices. Free circular.

MORSAN SALES

10-15G 50th AVE., LONG ISLAND CITY 1, N. Y.

Rupture Troubles Ended

Advanced method has healed thousands. No leg straps, no elastic, no plasters. No pressure on hips or spine. Flexo-pad. Entirely different. Endorsed by doctors, mechanics, clerks. Very light. **INEXPENSIVE. GUARANTEED.** Write for information and trial.

SMITH MANUFACTURING COMPANY
EST'D 1893; DEPT. PM, PRESTON, ONTARIO

Sale! WAR SURPLUS BARGAINS Sale!



WINDOW AND ATTIC EXHAUST FAN

Fresh air everywhere — stores, homes, barns, restaurants, etc. 22 inch, belt drive. Delivers 4000 CFM, 700 rpm. 110 volt, 60 cycle 1/6 hp motor. Quiet operation. List price \$68.00. **OUR PRICE \$49.95** new



FLAT IRONS

Feather-weight (1 1/2 lb.) — automatic — with cord. Has Chromalox sealed element. List price \$9.95. **OUR PRICE \$3.95** new and guaranteed



AC ARMY LIGHT PLANTS

New 750 watt 110 volt light plant with Briggs-Stratton model BP gas engine. **\$135.00**
 New 2500 watt 110 volt light plant with Briggs-Stratton model Z, 6 hp gas engine. **\$225.00**
 Rebuilt 5000 watt 110 volt light plant with automatic remote control. Powered by Jeep 4 cyl. gas engine. Rebuilt like new and guaranteed. **\$625.00**
 DC LIGHT PLANT, 3000 watt 110 volt DC powered by 6 HP Briggs-Stratton Model Z gas engine. Rebuilt and guaranteed. **\$135.00**

GENERATORS

New 750 watt 110 volt AC generator. Made by Eicor. **\$35.00**
 Only
 3000 watt 110 volt DC generator. Manufactured by Deleo. Rebuilt and guaranteed. **\$50.00**
 Only

BRIGGS-STRATTON GAS ENGINES—SAVE \$25

Rope start, 1750 RPM. All brand new and guaranteed.

2 1/2 H.P. Model AP . . . list price \$102.10. **OUR PRICE \$77.00** only

3 1/2 H.P. Model BP . . . list price \$111.50. **OUR PRICE \$86.00** only



SCALING AND CHIPPING HAMMER WITH CHISEL



Both new and used Chicago Pneumatic hammers size FC, Ingersoll Rand size AV11, used only. Air control and push button throttle. Takes up to 3/16 rivet. Weight 6 lbs. List price new \$73.00. **OUR PRICE \$17.00** Used and guaranteed **\$8.50**

ROTARY PUMP



Heavy duty, designed to pump water, oil, gasoline, etc. Will pump 35 gal. per min. Also used as vacuum pump. Includes lovejoy coupling for 5/8" shaft, 3/4" outlet, 3/4" inlet on bottom. Size of pump, 7 1/2" W x 5" D x 7" H. Compact and sturdy. Four mounting holes in base. Can be used with 1/4, 1/2 or 1/2 HP motors. Ship. Wt. 17 lbs. **Only \$14.95** new

RIFLE CLEANING RODS

War surplus rifle cleaning rods made of 1/4" brass. Comes in four sections and handle. Overall length 35". Never used. **59c**

ORDER AT ONCE! SURPLUS MERCHANDISE IS SUBJECT TO PRIOR SALE
 All prices F.O.B. Milwaukee. 25% deposit required on all C.O.D. orders.
MONEY BACK GUARANTEE ON ALL ITEMS!

C & H ELECTRIC COMPANY

DEPT. PM7
 436 W. JUNEAU AVE. MILWAUKEE 3, WISCONSIN



ELECTRIC RUBBER CABLE

(All New)

CORD SETS—Extension cords, 100 ft. heavy duty. Plug, socket and guard.

Number 16 wire. Worth at least \$10.00. **Our PRICE . . . \$4.85**
 Same as above—50 ft. length. **\$3.85**

HEAVY DUTY ELECTRIC CABLE: 3 wire #10 submarine cable—can be placed underwater, underground or overhead. Also for portable tools. Will carry 40 amps.

50 ft. 100 ft. 250 ft.
\$7.50 \$14.00 \$30.00

RUBBER CABLE: 2 wire #12. Will carry 30 amps. Comes in 25 ft. lengths. 25 ft. for **\$2.50**

RUBBER CABLE: 150 ft. reels. 3 wire #6 with two 60 amp Crouse & Hines male and female connectors. Perfect for welders, hay loaders, saws, electric ranges, etc. List price \$190.00 per **\$45.00** reel. **OUR PRICE**

BACKYARD SWIMMING OR BATHING POOL



Made of heavy glass cloth with rubber impregnation on both sides. Diameter 12 ft. Height 5 ft. Holds 3000 gal. of water. Complete with cover, stays and guide lines. Cost gov't approx. \$350. **\$39.50**
OUR PRICE
 Due to handling, 50% deposit required on this item.

U. S. Surplus Horns and Howlers,



motor driven. (Not a vibrator), Heavy duty with great power and long life. 110 volt A.C. current. Weather proof. For alarm or signal horn on boats, school yards, factories, etc. List price \$47.00. **OUR PRICE \$9.45** new



CHAIN HOIST

2 ton worm gear chain hoist manufactured by Hobbs. 17 ft. of chain **\$49.95** new lift. **ONLY**

RUBBER WHEELS



Hollow core rubber wheels made by Goodrich, 2.75 x 10. Ball Bearing, 3/8" or 5/8" bore, 3 1/2" across hub. **\$3.50** each

RUBBER WHEELS (pneumatic) with tubes, Goodrich or Firestone. 6 x 9 with Timken bearings. High speed, 4 ply tire with overall height of 21". Overall length of axle 42". 2 wheels with tires, tubes and axle. **\$37.50**
 Only



STRONG BOX

Fire resistant steel strong box. Office green enamel finish, lock clasp. Box has inner tray and front flap. Made of 16 ga. steel, 8 1/4" high, 12 1/2" wide and 14" long.

ONLY \$2.95
 New

BAND SAW BLADES

FOR FACTORY AND HOMEOWNERS
 One skip tooth band for most everything. Straight and Contour Cutting all woods, bakelite, brake lining, sand castings, rubber, lead, Zinc, carbon.

RUBBER BAND SAW TIRES
 5'6" to 6'5" x 1/4 \$1.42 . . x 1/2 \$1.52
 6'6" to 7'5" x 1/4 \$1.54 . . x 1/2 \$1.65
 WE PREPAY THE POSTAGE

LASSEN SAW & SUPPLY

2125 Leland Ave. Dept. P-7 Chicago 25, Ill.

HELPFUL BOOKS

Send post card asking for **FREE** catalog

Popular Mechanics Press, 200 E. Ontario, Dept. 601, Chicago 11

HOLD-E-ZEE

AUTOMATIC GRIP SCREWDRIVERS

MORE WORK IN LESS TIME!



UPSON BROS., INC.,
 86 Exchange St.,
 Rochester 4, N. Y.

Hold-E-Zees do the job better, faster. They excel wherever screwdrivers are used. Gripper instantly released by spring action, sliding up out of way when not in use. All materials highest quality.

AT LEADING DEALERS EVERYWHERE

Safe! FOR FAST BATTERY CHARGING START YOUR OWN BUSINESS

Sell nationally advertised, portable, fast battery charger-compressors to service stations, garages, car lots, fleet owners, farmers. Amazing low price, big discounts. Valuable territory still open. Wire or write now to . . .
H&H PRODUCTS MFG. CO., Dept. PM3, 306 Boyd Street, Los Angeles 13, California

MAGNET WIRE HEAVY FORMVAR IN LB. LOTS

A.W.G. size 8 to 19 \$1.00 per lb.
 20 to 24 \$1.25 per lb.
 25 to 29 \$1.65 per lb.
 30 to 34 \$2.25 per lb.
 35 to 39 \$3.50 per lb.

PETERS ELECTRIC CO., P. O. 89, Royal Oak, Mich.

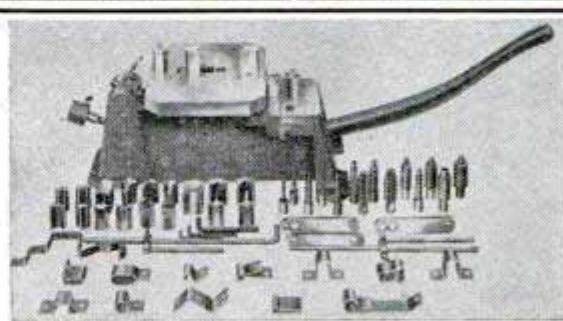

Make It On A "MULTIFORM" BENDER-CUTTER

BENDS — CUTS — PUNCHES
 All Types Metal and Plastics

**J. A. RICHARDS CO., Dept. 5M
 KALAMAZOO 13F, MICH.**

UP TO 80% SAVINGS ON WAR SURPLUS

LIVE RUBBER SHOCK CORD

Made in accordance with rigid army specification. Clean fresh stock. $\frac{3}{8}$ " contains approx. 500 strands of live rubber, $\frac{3}{8}$ " approx. 100 strands, $\frac{1}{4}$ " approx. 40 strands. Sold in 25 ft. lengths or more. At about 20% of original cost.

DIA.	PRICE (per 25')	Ship. Wt.
$\frac{1}{4}$ "	\$1.00	2 lbs.
$\frac{3}{8}$ "	\$1.25	2 lbs.
$\frac{1}{2}$ "	\$1.75	3 lbs.

LT. WT. ALUMINUM PIANO HINGE

Length 72 inches, thickness .040—width $1\frac{1}{4}$ "—

Operating radius 275 degrees. Made of aluminum alloy, sold in 6 feet lengths only—\$1.14 per length.

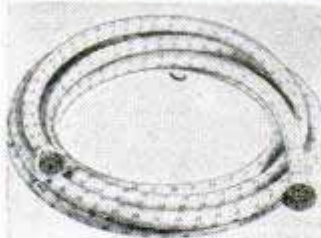

HEAVY DUTY STEEL PIANO HINGE

Length 56" — Thickness $3/32$ " — Width (open) $3-5/16$ " — Operating radius 330 degrees—Made of heavy duty steel—Drilled ready for use. Ideal for drop tables, heavy tool boxes, heavy doors, and many other uses where heavy hinges are required. Sold in 56" lengths only. Ship. Wt. 7 lbs. At a fraction of original \$1.45 cost.

Prices F.O.B. Chicago. Include approx. postage on orders paid for in advance. C.O.D. orders enclose 25% balance sent C.O.D. WRITE FOR FREE ILLUSTRATED CIRCULAR.

U. A. S. Corp. Dept. PM3, 5637 W. 63rd Pl. Chicago, Illinois

TROUBLE LAMP



- All high-quality rubber.
- Made for heavy duty.
- 25 feet Underwriters' approved rubber cord.
- Use with A.C. or D.C. current.
- Note switch and connection socket at base under heavy metal guard.
- Fully guaranteed.
- Complete for \$3.00 postpaid

SURPLUS SELLERS CORP.

DEPT. B
624 Madison Avenue, New York 22, N. Y.

NOW AVAILABLE

6 FOOT FOLDING RULE



Accurate 6-foot folding rule with sure-lock joints. Solid black calibrations on

sturdy, satin-finish aluminum. Clear, distinct readings. $1/16$ -inch divisions with $1/32$ divisions on first inch. Rust-proof rivets at all joints. Folds to 7-inch length. Sent postpaid on receipt of \$1.00. You take no risk. Satisfaction guaranteed. Money cheerfully refunded if rule is returned within 5 days. Order NOW.

\$1.
Postpaid

HESSE & CO. 77 W. WASHINGTON ST. CHICAGO 2, ILL.

FASTEST PLANER in the WORLD at this Low Price... \$195.00

BELSAW Multi-Duty Planer



Speed up production! Increase your profits! BELSAW power self-feeds at 24 feet per minute. . . The lowest-priced surfacer that will handle 12×6 in. stock. Planes green or dry sawed lumber into smooth, worked forms. Three high-speed steel knives make 42 cuts per inch. Multi-duty BELSAW takes inexpensive attachments for all planing mill operations—Jointing, Rabbeting, Grooving, Matching. BELSAW is the **only** 12 in. planer providing **attachments for jointing and grinding its own knives.** Start planning NOW for BIGGER VALUE and BETTER PERFORMANCE, with BELSAW. Write for FREE specifications, illustrations and low prices.

- LARGER CAPACITY • FASTER OUTPUT • KNIFE SHARPENING ATTACHMENT

BELSAW MACHINERY CO B-1018 Field Bldg., 315 Westport Rd., Kansas City, Mo.

BUILD YOUR OWN TILTING TABLE SAW!



- 21x27 in. table tilts full 45°
- 8 in. blade cuts from 0 to 2 1/2 in.
- Ball bearing arbor, precision machined, ready to run
- Self-aligning and indexed rip fence and miter gauge

SAVE \$50 OR MORE

- Sturdy wood, steel, and aluminum construction
- No machining—build easily with hand tools

GIL-BILT Step-by-Step Plans—simplified perspective drawings, full size patterns, 15 actual photographs. \$ 1.00

GIL-BILT Special Metal Parts Kit—includes Plans, ball bearing arbor, all other metal parts (less blade). \$14.95
Same Kit with 8" combination blade. \$18.95

GILLIOM POWER TOOLS P. O. Box 1-P, Lambert Field St. Louis 21, Missouri

CASTING REEL

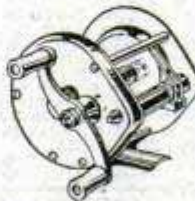

No Fancy Gadgets! Just a Well Built Conventional Level Wind Fishing Reel!

Highly plated brass construction. Smooth click. Adjustable tension. Capacity 100 yds. 25 lb. test line. Money back guaranteed. Send check or money order.

Direct Factory Sales Make This Price Possible
\$3.95
POSTPAID

Mohawk Products Co., 235 SARGENT ST., HARTFORD, CONN.

NEW SAW EASY HANDLING BIG POWER



New American Portable Electric Saw saves time, labor and money in production work. Not a hobby tool. One hand operation. Cuts any angle. 8" blade. Write . . . give occupation.

AMERICAN

FLOOR SURFACING MACHINE COMPANY
535 So. St. Clair St. Toledo 3, Ohio

LOW PRICED STEAM CLEANER

Jenz Super Chief

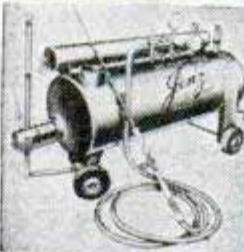

Portable—No moving parts—Cleans anything—Motors—Chassis—Machinery—Floors—Buildings—Remove wallpaper—Dairy & Creamery—Oil Rigs etc. Oil fired—Economical—fully tested and warranted. 75# Steam in less than 10 min. Model 70. Complete as illustrated. \$276.50

F.O.B. factory.
HI-PURE LABORATORIES
EVANSVILLE, IND.

MAKES DRIVING EASIER



Automatic accelerator control! Pedal stays put in any position. No more cramped leg from constant pressure on accelerator. Disengages immediately when brake is applied. May also be engaged and disengaged at will, by touch of foot. Drive for miles with both feet free. Save gas by steady driving. Safe. Economical. Easy to install. Mailed complete, postpaid, for \$2.98, with full instructions. Folder on request.

AUTOMATIC ACCELERATOR CONTROL, Inc.
MONROE, MICHIGAN

NEW PATENTED PLATING PROCESS No Vats, Brushes or Electricity needed!

Just rub **INSTANT NICKEL, SILVER or GOLD** on to Iron, Steel, Brass, Silver, Copper, Bronze, etc., and **INSTANTLY** it takes on a heavy, permanent **PLATING** of **NICKEL, SILVER, or GOLD.** (Pat. Jan. 1948, & Pats. Pend. resp.) Makes old, worn, dingy or shabby table ware, faucets, instruments, furniture, appliances, urns, bicycle or machinery parts, almost anything of metal, look like **NEW.** A **PLATING**, not just a polish. Contains **NO POISONOUS CYANIDES or QUICK SILVER.** Will not crack or peel off. Plate for others at handsome profit. Fascinating hobby. Sensational introd. offer! Complete kit of each of **GOLD, SILVER, or NICKEL, \$2.50, postpaid.** Any two, \$4.75. All three, \$6.75. C.O.D.'s a few cents extra. **INSTANT PLATING, Dept. 6, 1216 Park Row Bldg., New York 7, N. Y.**

SAY YOU SAW IT IN POPULAR MECHANICS

NEWEST OTTAWA LOG SAW

SELF-PROPELLED — MOVES ANYWHERE on OWN POWER

World's fastest Log Saw. Powerful 6 H-P air-cooled motor. Attachments for sawing down trees, buzzing limbs, post hole digging and pulley for belt jobs. Big demand for wood, pulp, posts. Make big money sawing wood this easy way. Low factory-to-user prices. Nothing like it. **FREE details.**
OTTAWA MFG. CO., 7-827 Pine St., Ottawa, Kansas



MOTORIZE ANY HOUSEHOLD SEWING MACHINE

NO WIRING! NO DRILLING!
ANYONE CAN INSTALL IT

Any household sewing machine can be quickly and easily changed into a completely motorized sewing machine without wiring or drilling with the Quick-Sew (Pat. Reg.) Unit includes motor (AC or DC), rubber and steel grooved pulley, foot control, cord set with extension plug and socket, variable speed foot control, and mounting bracket. **EXTRA**—Sewing machine light with extra Quick-Sew.



Send Check or Money Order Today!

SUNSHINE MFG. CO., Dept. PM-7
 614 N. 3rd St., St. Louis, Mo.

GIVES YOU 2 DRILLS IN 1

Converts any 1/4 inch Electric Drill to 1/2 inch capacity. Reduction gears reduce speed 5 to 1, the average speed of 1/2 inch Drill thereby increasing power.

Jobbers write Price \$1195 for proposition
 M.O. or check with order

G. M. CO. MANUFACTURING, INC.
 1308 43rd Avenue
 Long Island City 1, New York

PRACTICAL BOOKS ON HOME PLANNING BUILDING - REPAIRS

Plan Now - Build When You Can
Books Sent C.O.D. Anywhere in U.S.A.

- Select from this list of helpful books. In U. S. books sent postpaid if remittance accompanies order. Outside U. S. include 15% extra for shipping charges.
- How to Plan a House \$5.00
 - Your Home and How to Build It Yourself \$3.00
 - Painting, Decorating \$1.75
 - Carpentry \$2.50
 - Painting, Furniture Finishing and Repairing \$1.50
 - Includes floor renewal
 - How to Remodel a House Complete, practical \$5.00
 - Building Insulation \$4.50
 - Concrete Handbook Do work for yourself, others \$1.50
 - Blueprint Reading for Building Trades \$1.50
 - Practical Bricklaying \$2.00
 - Primer for Home Builders \$2.50

FAMOUS PLAN BOOKS

Books contain floor plans, photos, descriptions of homes.

- AMERICA'S BEST LOW COST HOMES. 125 designs \$1.00
- DE LUXE SMALL HOMES. 210 designs \$1.00
- OUR FUTURE HOME. Wide selection of residences, summer homes, garage apartments \$1.00
- MODERN HOME & GARDENING. 42 popular designs. Improvements, garden short-cuts, etc. \$50c

Set of Four Books \$3.50

Stair Building \$2.50

POPULAR MECHANICS PRESS
 DEPT. 646 • 200 E. ONTARIO STREET, CHICAGO 11

SAVE ON SURPLUS BARGAINS

PERFECT ALL WOOL OLIVE DRAB SLEEPING BAG
 Handy for fishing trips, hunting, camping, boating, just roughing it or use as auto robe and many other purposes. Warmth of 2 blankets; zipper slide fastener; tiestrap on bottom; approx. Gov't cost \$12.90. Our Price each..... **\$3.95**
 Outside Cover for Sleeping Bag—Water repellent..... \$2.39

DOWN FILLED SLEEPING BAG with zipper, perfect, like new, orig. value \$10.95
 \$23.00, our price
 Outside water repellent cover..... \$2.40

ALL RUBBER SUIT Perfect for fishermen, sportsmen, trappers, and all who work in and on the water. For trapping, dam and caison work. You can make boots, hip high water waders, rubber gloves, rain capes, etc. Fits right over your clothes and shoes. Cost gov't approx. \$25. **\$4.95**
 Our price

CANVAS COVERS Waterproof tarpaulins, war surplus (used) perfect condition. Originally made for tents. Approx. 5'x8'. Two buttoned together make approx. 80 sq. ft. Complete with buttons attached. Suitable for use as canvas dams, hay covers, truck covers, machinery and equipment covers, etc. Packed in bales of 30, priced 30 covers \$1.50 ea.; 15 covers, \$2.00 ea. **\$2.50** ea. Less than 15.....

NEW GOGGLES Set comes complete. Kit with 1 extra interchangeable shatterproof, flexible, cellulose acetate lens. Green and white colors. A rubber flexible goggle frame. Back adjustment head strap. Cost Gov't approx. \$4.50. Ea. **98c**

SUN GLASSES—Air Corps Type, Nothing Finer **\$2.95**

PUP TENTS Perfect—2 man size for scouting, Camping, etc. Without Pole..... **\$2.95**

PYRAMIDAL TENTS—16'x16', 8 man tent. Re-conditioned, perfect. Of heavy duck. Complete with tie ropes. Cost Govt. over \$100.00. Our Sale Price **\$26.95**

MARKSMEN PIPES—Smoker's Preference. \$5.00 retailer. **\$3.49**

NEW PARACHUTES (Green Rayon) Approx. 36 sq. ft. Cloth good for making into ties, handkerchiefs, lining, etc. Complete with canister, wght. approx. 10 lbs. **\$2.95**

TENTS—14'x14' of heavy duck, with ropes..... **\$23.95**

SQUAD TENTS, 16'x32'6" with 6'2" door, fire and mildew resistant, heavy duck OD color. Excellent for storage of machinery, equipment, truck covers, etc. Orig. cost \$172.00. **\$48.00**
 Our price

JACK KNIFE—original aviators' emergency knife, used by US Marines. 5 inch parkerized finish blade, hard rubber and steel handle, opens to 11 inch overall length. Has blade safety lock. Comes in canvas carrier with belt loop or chain hook. Real buy for hunters, fisher- **\$3.95**
 men, for work shops, etc. Original value \$7.50—only.....

JUNGLE HAMMOCKS—made of high grade Poplin for US Army, perfect for the home, yard, out- ings, etc. Complete with ropes and canopy. Special **\$4.45**
 only.....

Rubber DUST MASKS, complete with goggles, 2 filters and head elastic straps. Original value \$4.00. Perfect protection against all kinds of dust **\$1.95** and fumes. (With canvas carrier case, 50c extra.)
 Send check or M.O. Add 10% for handling and mailing.

AMERICAN SUPPLY CO.
 Dept. PM
 329 W. 5th St.
 Kansas City, Mo.

NOW! INSULATE

Your Distributor, Spark Plugs, Coil or Magneto

SEALTIGHT INSULATORS
 40c ea.
 45c Denver and West

SEAL
 Moisture, Oil and Dirt from Your

- SPARK PLUGS
- DISTRIBUTOR
- COIL or MAGNETO

SAVE!
 Users say 5 gallons gas gives mileage of 6 due to perfect firing.

INSTALL YOUR SET TODAY!

JOBBERS - DEALERS
 Write for Discounts

SEALTIGHT CORP., Cedar Rapids, Iowa
 Buy from Your Dealer, Service Station, Garage, or Send your Order to Us.

SAVE \$100.00 ON NEW LIGHTING PLANT

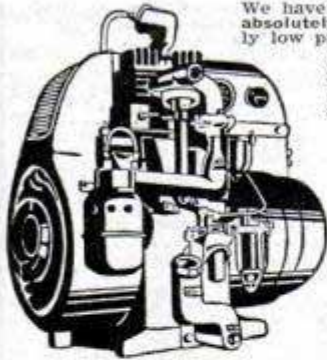

We have just obtained a limited quantity of absolutely new lighting plants at an amazingly low price. You can share in our fortunate purchase by acting quickly. This is your buying opportunity of a lifetime. Remember, this equipment has never been used before. Act at once and save \$100.00.

1000 Watts—110 Volts AC—Manufactured by Onan and Sons. Generator 4 pole, self-excited, self-regulated, direct connection to the engine. Drip-proof, conservatively rated. Engine 1 cylinder, 4 cycle, air cooled, gasoline driven, magneto ignition, radio shielding. Manual Start. Brand New Units. Shipping weight 275 pounds. Factory Price \$295.00

Special \$195.00 Price

PRICE F.O.B. CHICAGO. Immediate delivery. SOLD ON MONEY BACK GUARANTEE. Send check or money order today.

C & M EQUIPMENT COMPANY

1831 S. State St.
Chicago 16, Ill., Dept. D-7

Thompson
BEATS
the World
on BOATS



**Better Built
Lower Prices**

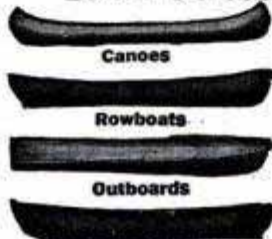

Light Boat for Auto
THOMPSON BROS. BOAT MFG. CO. (181)
113 Elm St.
CORTLAND, N.Y.

Safe Boats With Full Length Spray Rails
Keep passengers perfectly dry—even at high speeds. Catalog also shows two new models of "Take-Along" Boats. Two big factories—save you freight.

CATALOG FREE
Write for your copy. State kind of boat in which you are interested.
THOMPSON BROS. BOAT MFG. CO.
213 Ann St.
PESHIGO, WIS.

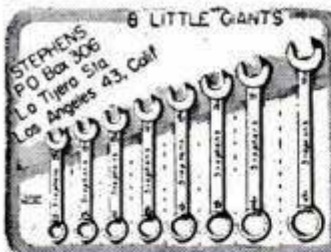

OWN THIS FINE 8 PC. COMB. BOX AND OPEN END WRENCH SET

In transparent leatherette roll. Made of hi-grade alloy steel and heat treated. 9 sizes 13/64 to 7/16. At your local dealer.

PRICES Retail \$3.00 per set
Dealer \$24.00 per doz. sets
SALESMEN WANTED
Send \$2.00 only for sample set postpaid.

STEPHENS TOOL WORKS
Box 306, LaTijeraSta., L.A. 43, Calif.

HEAVY CAST ALUMINUM BLOWER
Now Only \$10.00

SINGLE EXHAUST BLOWER DELIVERS APP. 100 CU. FT. AIR PER MINUTE. Ready to install yourself with any household tools. It's built for that. Housing is solid cast aluminum to last indefinitely. 110 V., A.C., 50-60 cycles. Cont. duty motor.

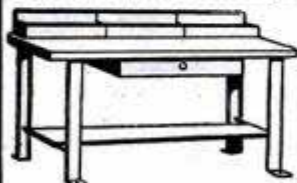

Only \$15.35 F.O.B. YONKERS

ed steel. Top is 2" solid plank stock. Bottom shelf 1" pine. Large, roomy tool rack and bins for nails, nuts, bolts are pine. 32" high, 60" long x 23" wide with lower shelf and big drawer. Wt. approx. 100 lbs. . . . Shipped KD with bolts, nuts, screws for easy assembly.

ALL PRODUCTS CARRY MONEY-BACK GUARANTEE!
Send check, money order. Free Literature.

UNIVERSAL YONKERS CORP. (M-7)

137 Alexander St.

Yonkers 2, N. Y.

Trim Gage for Ships

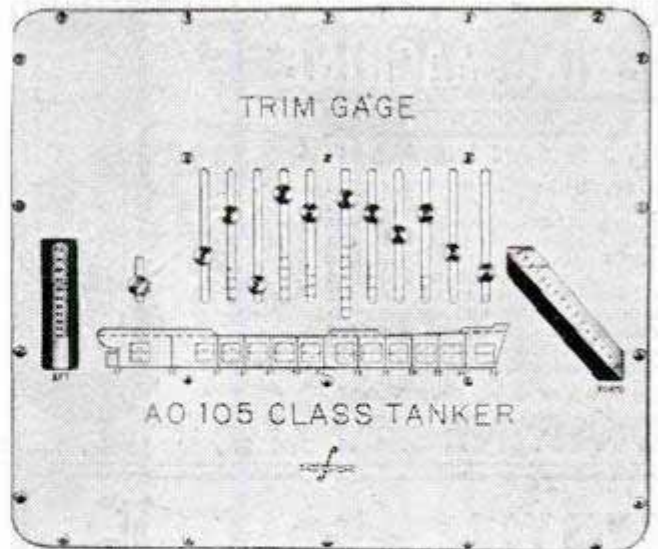

Ship loading plans can be formulated quickly with the aid of a trim gage that automatically shows the fore and aft draft the ship will have under any distribution of weight. The gage is a profile of the vessel with slots representing each compartment. The total weight to be stored in each compartment is set on a scale in each slot. When the weight in all the compartments has been set, scales at the right and left give direct readings of the fore and aft draft of the ship. This information is vital in loading the ship in order to keep it in correct trim. The gage also will calculate the trim for a voyage with several ports of call by determining the effect of discharging cargo at each port.

Pliofilm Keeps Apples Fresh

Apples kept in cases lined with Pliofilm hold their color and ripeness as much as three months longer than those in ordinary storage, tests at Iowa State College indicate. Weight loss is one half to one fourth of normal and soft rot is particularly reduced in Washington and West Virginia Delicious and Iowa Jonathan types. The apples were kept at 36 degrees, with a relative humidity of 86 percent.

Australia Drops Huts by Air To Hunters Slaughtering Deer

Australia is going to drop prefabricated huts by air to aid deer hunters in isolated areas. It is part of a campaign to wipe out thousands of red deer which have become a menace to crops and the national forests. Nearly 18,000 were killed in 12 months by hunters, spurred by large government bounties. The huts are divided into four-foot plywood panels for easy assembly and have a galvanized steel covering.

WANTED - MEN or WOMEN WITH CARS
SELL PAINTS HELP FILL 6-YR. DEMAND!
 Operate an S-I-P Mobile Paint Store, full or part time. Sell guaranteed paints. Exclusive territory, complete line, no investment or experience needed.
 Write TODAY to Dept. S-5



STANDARD INDUSTRIAL PRODUCTS, Inc., Evansville 4, Ind.

RUBBER WATER SIPHON



with 50 inch rubber tubing \$2.50 postpaid anywhere in U.S.A. It will empty and fill your washer, drain fish ponds, boats and flooded basements. Lifts water 14 feet, will draw it 100 feet. Fits any size or shape faucet from 3/8 inch to 1 1/4 inch. Over one million Emp-or-fil rubber siphons now in use. No C.O.D.

EMP-or-FIL MFG. CO.
 1310 CRENSHAW BLVD., LOS ANGELES 6, CALIF.

RENOVATE YOUR JACKET



Leather or Sheeplined Leather Jackets completely reprocessed and renovated to look like new. Complete service includes cleaning, refinishing, waterproofing, replacement of broken zippers, and repairs to rips, tears, etc. only \$3.85 plus postage.



Berlew Mfg. Co., Inc.
 2-8 N. Merrick Avenue
 Merrick, N. Y.

Say You Saw It in
POPULAR MECHANICS

AGENTS 300% Profit SIGN LETTERS

For Store Fronts and Office Windows. Anyone can put them on. Free Samples. Liberal Offer to General Agents.
METALLIC LETTER CO., 430 N. Clark, Chicago 10

Radiator Repairing

Self instruction course teaches this profitable business. Every community needs a radiator man. Start your own shop on less than \$200.
RADIATOR SERVICE AND SUPPLY, McBain, Mich.

OWN A Printing Business

Cards, Tickets, Stationery, etc. Good profit in spare time. PRINT YOUR OWN greeting cards, movie titles, church work, etc. Save money. Easy rules supplied. Raised printing like engraving too. Have home shop. Sold direct from factory only. Send dime for supply book, suggested outfits, all details and advice on your needs. No obligation. **KELSEY, INC. C-37, MERIDEN, CONN.**

RACING CAR EQUIPMENT FOR ALL CARS

Engines, Racing Heads, Manifolds, Carburetors, Mufflers, etc. Speed Instructions and literature \$1.00—refunded first order.
LEE MOTORCRAFT CO.
 1412 Great Northern Bldg. Chicago, Ill.

"LATHE TOOL HOLDER IS AMAZING!" says Howard Ladue of Royal Oak, Mich. "I can grind tool bits! Turn large discs! Hold dial indicator! Dress grinding wheels and do many other things with the Porter Holder on my Atlas 10" lathe. It's a whiz!" Fits all 1" tool posts. See your dealer or order direct. \$2.65 postpaid. Money back guarantee.
HURON FACTORY SERVICE CO.
 505 Lafayette Bldg., Dept. 7 Detroit 26, Mich.

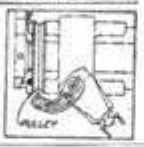

New ONLY \$49.50
F.O.B. Chicago SPERRY S-1 Bomb Sight
 Same As Above But Used. **ONLY \$29.50**

MOMENTARY SWITCH
 Made by Cutler Hammer. Excellent for Photo Flash Gun, Testing Circuits, Microphones, etc. Only **\$1.25** Postpaid

6 BIG SPECIAL BARGAINS at LOW PRICES
 ← COST U. S. GOVERNMENT \$4,500

SPERRY S-1 BOMB SIGHT—Here is an unusual opportunity to get one of these MARVELOUS Precision Mechanical Instruments . . . Marvelous beyond description. Contains hundreds of parts usable in 1001 ways . . . Regular and Bevel Gears, Shafts, Approx. 100 Roller Bearings, Electrical Parts, Precision Lenses and Prisms. Countless Gears, Dials, Knobs, Switches, Polaroid Filter, Calibrated Dials for Air Speed, Drift Indicator and Illuminated Spirit Level, Gyroscope, etc. . . . Excellent for Inventors, Experimenters, Hobbyists. Schools use for Study Demonstration. **Only \$49.50.**

LENSATIC COMPASS (used)
 With Sight Finder and Stop Button. In Case with Folding Cover. Perfect for travel.
Only \$1.59 ea. Postpaid

PISTOL GRIP SWITCH (new)
 Double Contact Switch. Trigger Action for ON and OFF. Complete with 6 ft. Insulated Lead Wires. Any circuit to 115 volts. **\$1.19** ea. Postpaid

GENERAL ELECTRIC AIR COMPRESSOR
 Catalog #T8252882 G1 . . . Rated Pressure 1000 pounds to square inch . . . Dual Cylinders . . . Shipping Weight 9 1/2 lbs.
Only \$9.95 ea. fob. Chicago

ACE SURPLUS SALES CO., INC., 1449 West 69th St., Dept. P-7, Chicago 36, Ill.

Talk AS FAR AS 17 MILES WITH **ARMY FIELD Telephones**



Easy to install for quick, low-cost, dependable 2-way communication, indoors or out. Compact . . . rugged . . . portable. Originally cost government \$39.90 each. Hundreds of uses around home, shop, farm, industry. *Performance equals present-day commercial telephones.*



You will be amazed at simplicity of operation. Just hook up terminals of two or more phones to any two-strand wire and you are ready to talk! Up to six phones can be used on single line without a switchboard. Powered by standard flashlight batteries. No maintenance required. Each phone complete with self-contained hand-operated ringer. *Every phone checked for perfect operation and fully guaranteed.*

NOW AS LOW AS \$7.45 each

- USED—good, serviceable condition \$ 7.45 ea.
- USED—excellent condition 8.95 ea.
- RECONDITIONED—(by U. S. Signal Corps) 10.75 ea.
- NEW—unused but soiled 10.75 ea.
- BRAND NEW PHONES—canvas case 15.00 ea.
- BRAND NEW PHONES—mfg. by Western Electric, Stromberg Carlson and Kellogg, with canvas case 16.75 ea.
- NEW WESTERN ELECTRIC HANDSETS 4.75 ea. Pstpd.

WIRE—UNUSED W-110-B two-strand ARMY FIELD WIRE—500 ft. \$3.50, 1000 ft. \$6.50 (One-mile reels available also).

BRAND NEW SWITCHBOARDS

For systems of six to 24 phones, use

ARMY FIELD TELEPHONE SWITCHBOARDS:

- NEW—BD-71, 6 drops \$32.50 ea.
- NEW—BD-72, 12 drops 65.00 ea.
- NEW—BD-72, with outer cases soiled 45.50 ea.

Write for New FREE Folder — Just Out!

All prices FOB Sacramento. No COD. California residents add 2 1/2% for sales tax.

SEND CHECK OR MONEY ORDER LORIS SALES

P. O. BOX 1896-B SACRAMENTO, CALIFORNIA

BUILD "EXTRA" SPARE TIME PROFITS!

Genuine Poly ball bearing arbor C4 (shown) with 1/2 x 12 1/2 spindle only \$7.95 postpaid. Order today! Free literature available on request.
POLY PRODUCTS • 2032-C E. Walnut • Pasadena 8, Calif.



REAL SURPLUS VALUES AIR COMPRESSORS

Model 2-U-S-4-V-A Bendix-Westinghouse 4 cu. ft.

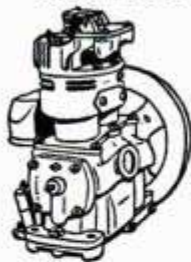

Govt. Surplus, 2 cylinder Bus and Truck Type. Ball bearing crank shaft. Pressure feed oil system. Positively one of the finest and most accurately built air compressors on the market.

Original Cost Over \$140.00

In good operating condition with 30 day written guarantee. **\$3450**
Special Low "as is" price **\$2950**

Accessories available for compressors, air regulators, safety valves, air gauges, control governor, misc. fittings, hose, paint guns. Write for Prices and Catalogue

BRIGGS-STRATTON ENGINES

1 1/2 HP. MODEL N - GOVT. SURPLUS

Special Low
"as is" price
Only

\$34⁵⁰

In good operating condition with 30 day written guarantee. **\$4450**

Engines will develop almost 2 Hp. at 3600 RPM. Hurry don't wait, buy now while limited supply lasts. Suitable for lawn mowers, garden tractors, motor bicycles and scooters, midget cars, etc. Will power many kinds of machinery.



EMERGENCY SUPPLY TANK



Fill at any gas station. 150 lbs. airs 5 flat tires. Inflates rubber boats. Use for touch-up spray jobs, tire service truck, air horns, dust out motors, machinery, etc. Shatterproof 12"x24" stainless steel tank with carry handle, check valve, two feet hose and tire filling chuck. Only **\$795**

Tank only 12"x24", tapped each end 1/4 pipe thread. 500 lb. pressure. Build your own. Ideal for paint spray, air receivers, net floats, buoys, etc. Each **\$475**
Small size tank, 6"x24". **\$298**
Only

PRICES FOB, K. C. WRITE FOR NEW CATALOG.

MIDWEST SURPLUS SALES CO. 2531 Indiana Kansas City 1, Mo.

8 ways to make a FRIENDLIER YARD . . . JUST 10¢

[STANLEY] PLAN SET No. 14

• Lure the birds you like by building them a home . . . 5 types plus a feeding box. Plans also for garden seat and a trellis. Hours of pleasure and a better yard. Send 10c for Plan Set No. 14 and list of others. Stanley Tools, 178 Elm St., New Britain, Conn.

SAY YOU SAW IT IN POPULAR MECHANICS

NEW! DIFFERENT! EASY! **EARN BIG MONEY!** **RIGHT IN YOUR OWN HOME**

WRITE NOW! **a few cents worth of material . . . BRINGS YOU DOLLARS!**

New MIRACLE finish sprayed on signs—store displays—radios—lamps—toys—figurines—Makes old objects saleable, makes new things worth more—Learn in a few days—start earning BIG MONEY—\$500 to \$1000 per month full time—up to \$75 a week spare time—everything furnished

—not a long course of instruction but a NEW METHOD that is EASY to learn—Send NO money—a post card will do—it's too good to miss! Write now for details, FREE sample of FLOK-KRAFT covered material, Illustrated Folder and hundreds of profitable and decorative IDEAS.

COAST INDUSTRIES, 1507-11 W. Manchester, Los Angeles 44, Calif.

New Low Prices on ELECTRIC MOTORS

IMMEDIATE DELIVERY!

Super power, heavy duty. 1-year guarantee by manufacturer on these trouble-free power units. Use for pumps, stokers, refrigeration units, fans, blowers, etc. Capacitor start, resilient mount, single phase, high starting torque, Klixon overload protected. Easily reversible.

60 CYCLE — 115-230V — AC
25% deposit on C.O.D. ORDERS.
Cash orders shipped prepaid.

1/4 H.P. **\$16.95**
1/3 H.P. **\$19.95**



DEALERS WANTED: Write for quantity prices today. **1/2 H.P. \$27⁹⁵**

AMERICAN DIST. CO., Dept. M-7
P.O. Box 1042, Central Station St. Louis, Mo.

2 Motors, 50 Gears for \$2⁹⁵

Instructions for Operating Motors on 110VAC

CONTAINS 2 1/20HP 5000 RPM 27V. SHUNT MOTORS, 25 / 1 & 50 / 1 GEAR REDUCTIONS, MICRO-SWITCH, SELECTOR SWITCH, PILOT LIGHT & CONNECTORS. NET WT. 12 LBS.

FREE ILL. LIST. SATISFACTION GUARANTEED OR YOUR MONEY BACK.

DICK ROSE—ERECO, 2912 HEWITT AVE., EVERETT 21, WASH.

NEW Safty-T-Kit Driving Glasses \$2.00

Essential for safe driving. Fine quality, adjustable driving glasses in Safty-T-Kit (richly styled Auto-pocket that attaches securely to automobile sun visor by a simple clip.) No need to search for sun glasses—Safty-T-Kit driving glasses always instantly accessible, and easy to find—just lower sun visor. Comfort, convenience and relief from eye strain always at hand. Send check or money order for \$2.00—Safty-T-Kit sent to you at once, postage prepaid.

ASHLEY, 6 North 7th Avenue MAYWOOD, ILLINOIS

HEATERS

Gasoline, burning 40,000 B.T.U., built by Stewart Warner for USAAF as cabin and engine heaters. Brand new and in original cases. Small modification makes ideal installation in trucks, buses, trailers, boats, small buildings, etc. No exposed flame. Crated shipping wt. 40 lbs. A bargain at \$28.50 ea. FOB Wash., D. C.

MICHEHL INDUSTRIES
ATLANTIC BLDG. WASHINGTON, D. C.

In General-Purpose 4-Ohm Intermittent Tests
THE "EVEREADY" NO. 950 FLASHLIGHT BATTERY OUTLASTS ALL OTHER BRANDS!

UNITED STATES

MONUMENTS AND MARKERS are good. We erect anywhere. Write for FREE Catalog. U. S. MARBLE & GRANITE CO., Oneco, 18, Florida.

LAWN ORNAMENT - NOVELTY PATTERNS

28 Lawn Ornament Patterns, 25c. Other patterns; 15-20" high; Dutch Girl, Dutch Boy, Pirate, Bull Terrier, Mexican Girl, Mexican Boy, Dwarf, Penguin, Flower Girl, 10c each. 25 Novelty Patterns, 30c. All 62 Full Size Patterns, \$1.00 Postpaid. Strother Pattern Service, Dept. AN-8, Box 383, Belington, W. Va.

Binding Device for Transparencies

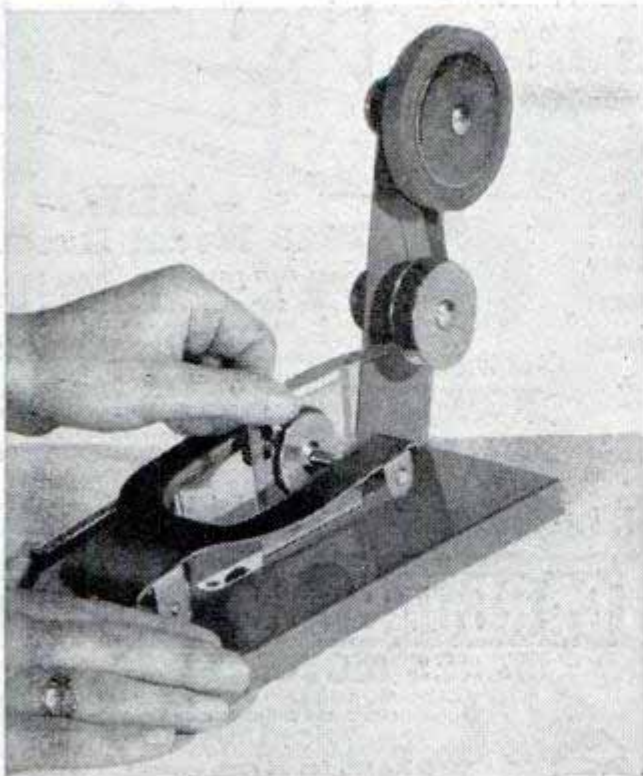

Color-transparency fans can bind their own slides between protective glass covers with a device that holds the covers securely as binding tape is applied to the edges. With the machine, it takes less than a minute to bind a slide. Tape is guided by a pulley, assuring neat and straight binding. The binder handles all standard sizes from 2 by 2 inches to 3¼ by 4¼ inches.

Medicine From Earth Mold?

Dug out of the earth, a new mold similar to streptomycin has given excellent results in laboratory tests in the treatment of typhus fever, Rocky Mountain spotted fever, scrub typhus and parrot fever. The mold, called chloromycetin, was discovered by Dr. Paul R. Burkholder of Yale University in soil from a field near Caracas, Venezuela. The mold has not yet been used in the treatment of patients, although tests with animals show no poisonous effects. The chemical has been administered both by mouth and hypodermic injection. Results in the treatment of parrot fever are significant because the disease is caused by a virus, and virus diseases from the common cold to infantile paralysis have shown little reaction to molds or other chemicals.

Because telephones are scarce in Lima, Peru, and many passengers can't contact the terminal, an airline has its own radio station there to broadcast last minute news of plane arrivals and departures.

It's Kester for Real Soldering Efficiency



Kester Cored Solders—Acid and Rosin Core—are the choice of all home and hobby craft workers for clean, fast, and efficient soldering.

KESTER SOLDER COMPANY
4251 Wrightwood Ave., Chicago 39, Illinois
Factories Also at
Newark, New Jersey • Brantford, Canada

**KESTER
SOLDER**

7 x 50 BINOCULARS

Brand New

\$44

With
COATED
Lenses & Prisms
\$54

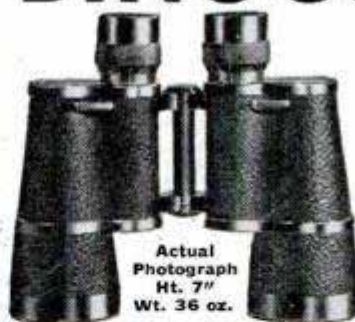

These magnificent 7x50 prism binoculars were obtained through the Supreme Commander of the Allied Powers. They have the brilliant luminosity, precise clarity, and wide, undistorted field of view obtainable only with a good large glass. Because 7x50 glasses give the highest performance obtainable they are now the official choice of the Army, Navy and Marine Corps. This is your opportunity to purchase a brand new 7x50 AT 1/3 OF THE USUAL COST. Lifetime construction. Lightweight aluminum body. Ultra-precise optics, sealed against moisture and dust. Unsurpassed by any other binoculars, regardless of price. Sold with a guarantee of complete satisfaction or money refunded. Supply limited so don't delay.

Price		Price With	
Without Case		Richly Finished Case & Straps	
7x50	7x50	7x50	7x50
Uncoated	Coated	Uncoated	Coated
\$44*	\$54*	\$48*	\$58*

*Plus 20% Federal Tax

IMMEDIATE DELIVERY WE PAY THE SHIPPING COST

BROWSCOPE CO.

Dept. 7M, 24 West 45th St., New York 19, N. Y.

BALL BEARING STEEL WHEELS

Complete With Wheels, Tires & Bearings Made To Outwear Other Type Wheels

SIZE	TIRE	BEARINGS	LOAD	ONE	TWO	FOUR
12"x2 1/2"	Semi-Pneumatic	Ball 1/2" or 5/8"	150 lbs.	\$ 5.50	\$10.00	\$18.00
12"x2 1/2"	Semi-Pneumatic	Ball 1/2" or 5/8"	225 lbs.	\$ 6.00	\$11.00	\$20.00
12"x3"	Semi-Pneumatic	Ball 1/2" or 5/8"	340 lbs.	\$ 7.00	\$13.50	\$26.00
10"x1 3/4"	Semi-Pneumatic	Ball 1/2" or 5/8"	125 lbs.	\$ 3.00	\$ 5.50	\$10.00
10"x2 1/2"	Semi-Pneumatic	Ball 3/4"	250 lbs.	\$ 5.50	\$10.00	\$18.00
8"x1 7/8"	Solid	Ball 3/4"	640 lbs.	\$ 8.00	\$15.00	\$29.00
6"x2"	Solid	Ball 1/2"	340 lbs.	\$ 4.00	\$ 7.50	\$14.00
4.00"x8"	Pneumatic					
	16" O.D.	T.R. 1"	700 lbs.	\$13.50	\$26.00	\$50.00
5.00"x8"	Pneumatic					
	16" O.D.	T.R. 1"	700 lbs.	\$15.50	\$30.00	\$59.00

The above Pneumatic Wheels are Complete With Wheels, Bearings, Tires and Tubes . . . 4 Ply Tires for One Inch Straight Axles. (Also 18", 21" and 23" High Speed Auto Type Wheels.)

FOR CIRCULARS SEND 10c: On Power Racers, Steering Wheel Assemblies, Auto Type Axles, Parts, Sulkies, Etc.

OSBORN WHEEL COMPANY, 115 So. Main St., Dept. P-7, Doylestown, Penn.



- NEW - 1948 Model Racers

MODEL "A" CHASSIS . . . Price \$39.75 with 10" Semi-Pneumatic Wheels.

MODEL "B" CHASSIS . . . Price \$56.00 (shown above) 12" Semi-Pneumatic Wheels.

MODEL "D" CHASSIS . . . Price \$139.50 with 5.00"x8" (16" dia.) Pneumatic Wheels.

Less Engines and Transmissions

Also sold Complete With 1 3/4 to 6.6 H.P. Gasoline Engines

25% DEPOSIT ON C.O.D. ORDERS

ORDER NOW

Add 10% for Prepaid Shipment in U.S.A.

New Improved Electric MOTO-SAW

ONLY \$5.85

(with 3 Saw Blades) Postpaid



SAFE AS A HAND SAW
JUST GUIDE IT!

More like magic than any tool you ever saw. Imagine an electric scroll saw only slightly heavier than a hand coping saw . . . a tool that takes no effort to run, no pressure to feed. Works at any angle — on big assembly jobs or on the tiniest piece you can hold in your fingers. Runs 7200 strokes a minute . . . so fast the blade seems to stand still. Sturdily built . . . only two moving parts . . . never needs oiling. Easily cuts intricate designs — so smooth it eliminates sanding. Novice or craftsman, a thrill awaits you when you get a Moto-Saw in your hand.



THOUSANDS OF SATISFIED USERS

U. S. Patent 2253862
Other Patents Pending

Dremel Mfg. Co.
Dept. 5118-G
Racine, Wisconsin

No Limit to Length of Stock it Will Cut. Saws to Center of 19" Widths.

It's fast . . . cuts on an average of 1 ft. per minute up to 3/4" medium hard wood. Operates on 110-120 V. 50 or 60 cycle alternating current. If your dealer does not yet have Moto-Saw, send \$5.85 . . . we'll pay postage. Or send \$1, pay postman balance plus postage. MONEY BACK if not delighted after 5 days' trial.

CARBURETOR TOO RICH MAKES MOTORIST TOO POOR



Car owners who are wasting money and not getting proper gas mileage due to over-rich mixtures will be pleased to learn how to save gasoline by VACU-MATING over-rich mixtures. VACU-MATIC fits all cars, trucks and tractors. It is automatic and operates on the supercharge principle. Easily installed in a few minutes.

SALESMEN WANTED! Big Profit!

Send name, address on penny postcard for free particulars and how to get yours for introducing.

VACU-MATIC CO., 7617-1372 W. State St., WAUWATOSA, WIS.

FULLSIZE, CUT-TO-SHAPE BOAT PATTERNS

and specifications. Designed by Naval Architect. Cruisers, runabouts, sloops, outboards, sailing canoes, etc. Low prices. Send 10c (coin) for illustrated catalog. SPECIAL: Send \$1.00 for "HOW TO BUILD BOATS" book, postpaid. Poly Woz Houseboat Plans, \$10. Cleveland Boat Blueprint Co., Dept. 666, Cleveland 13, Ohio

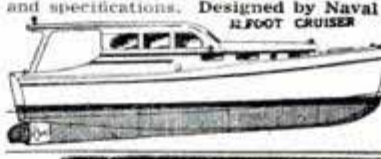

BETTER PERFORMANCE FOR OUTBOARD MOTORS



Enjoy more speed, smoother performance, greater carrying capacity by equipping your motor with the Michigan propeller recommended for your particular motor and type of boat used. Write for outboard catalog containing recommendation chart for all motors, old and new.

INBOARD: Our "AQUA-MASTER" is miles faster; smoother than conventional propellers. Investigate.

MICHIGAN WHEEL COMPANY
DEPT. P, GRAND RAPIDS 3, MICHIGAN

100,000 FISHING WORMS - \$1

WORM MAGIC Brings 'em to The Surface BY THE THOUSANDS

Hundreds, thousands, MILLIONS of fishing worms without even touching a spade to the ground! Just put a little WORM MAGIC in water and sprinkle on the ground where worms are. Then watch 'em come popping to the surface. Nothing else like WORM MAGIC. Saves hours of time and hard labor. ONE BOTTLE LASTS ALL SEASON. Economical as well as sure-fire. Send only \$1.00 on money-back guarantee.

DEALERS: Write for quantity prices and discount to Walter W. Weiss, 127 N. Dearborn St., Dept. 16, Chicago 2, Ill.



SAY YOU SAW IT IN POPULAR MECHANICS

WAR SURPLUS SLEEPING BAGS

WATER REPELLENT — DOWN AND FEATHER

*Brand new government surplus materials make this arctic type mummy sleeping bag the finest of its kind available. Down and feather filled, convenient, easy zipper closure, combined to provide restful sleeping under the most adverse conditions. Properly quilted to prevent bunching. Lowest price in U. S. for first quality, new sleeping bag. Limited quantity available

Send money order today . . . only \$11.95

POSTPAID ANYWHERE IN U.S.A.

U. S. CONSUMER BEDDING CO.

1153 East 47th St., Dept. PM, Chicago 15, Illinois



ONLY \$11.95
POSTPAID U.S.A.

RADIOMEN'S HEADQUARTERS * WORLD WIDE MAIL ORDER SERVICE!

1948 MODEL OUTBOARD MOTOR AT DEALER WHOLESALE PRICE!!

Powerful deluxe twin cylinder outboard motor with automatic starter (no fumbling for a rope), a positive cooling unbreakable water pump, and an improved magneto for sensationally quick starts as well as smooth, efficient operation at slowest trolling speed or with the throttle wide open. Dozens of additional outstanding features are provided, such as corrosion resistant aluminum alloy castings, to protect the engine and give the unit a sleek, streamlined appearance; hardened alloy steel connecting rods with roller bearings, and a rugged, perfectly balanced crankshaft. Delivers a full 7.5 H.P., as rated by the Outboard Boating Club of America. Net weight—52 lb. Gross shipping weight including free steel storage stand—100 lb. For a limited time we are selling this motor, which is produced by the world's second largest maker of outboards to sell for more than \$30.00 above our price—for only **\$139.00**, brand new, FOB Buffalo.

ALUMINUM GEAR BOX 18x8x7 that contains two powerful electric motors and two matched gear trains, 62 gears in all varying in size from 1/2 to 4 inches in diameter. This unit is readily converted to rotate a beam antenna or for any other similar use. **\$3.00**

Terrific Value — Portable Electric Drill

(Sold at less than established factory price so we cannot mention brand name)

Only \$19.95 equipped with 1/4" Jacobs Geared Chuck and Key. Not an intermittent duty drill, but a full size rugged tool. Most convenient type switch, natural grip handle, and balance like a six shooter.

Precision cut gears — turbine type cooling blower — extra long brushes.

No stalling under heaviest pressure because of powerful 110 Volt AC-DC motor and multiple ball thrust bearing.

Other bearings self-aligning lifetime-lubricated Chrysler Oilite type. Made for toughest year-in and year-out service in plant or on construction jobs.

Amazing perpetual factory guarantee assures you of a lifetime of trouble-free use.

25% deposit on C.O.D.'s. Full refund (you pay transportation) if not pleased with drill after trial.

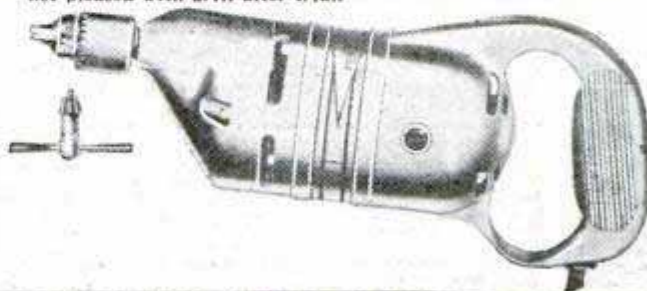

..... SOS EMERGENCY TRANSMITTER SOS

This is the famous Gibson Girl Transmitter that saved so many lives during the war. It is used as a distress call transmitter on boats and airplanes. The Gibson Girl is the easiest transmitter in the world to operate. No instruction or experience necessary. No external power supply required for operation. It is merely necessary to turn the crank on the top of the transmitter and power is generated and the distress signal is automatically sent out on the international distress frequency. Brand New Gibson Girl transmitter complete with tubes **\$9.95**

Antenna Kit for Gibson Girl transmitter. This kit was designed to improve the effectiveness of the Gibson Girl Transmitter by increasing the range several times. The kit includes 300 feet of special antenna wire, two balloons for raising the antenna in calm

weather, two hydrogen generators to inflate the balloons, a special box kite for antenna erection in windy weather, and a searchlight, powered by the crank operated generator in the transmitter. Complete kit **\$9.95**

AUTO RADIO DEALERS! ATTENTION!

Nationally advertised brand of 1948 car radio which will fit practically any car and every pocketbook. Six tube superhet with three gang condenser and 6 1/2" speaker. **\$32.20** for sample, or 2 for **\$29.97** each.

GENERAL ELECTRIC RT-1248 15-TUBE TRANSMITTER-RECEIVER

TERRIFIC POWER — (20 watts) on any two instantly selected, easily pre-adjusted frequencies from 435 to 500 Mc. Transmitter uses 5 tubes including a Western Electric 316 A as final. Receiver uses 10 tubes including 955's, as first detector and oscillator, and 3—7H7's as IF's, with 4 slug-tuned 40 Mc. IF transformers, plus a 7H7, 7E6's and 7F7's. In addition unit contains 8 relays designed to operate any sort of external equipment when actuated by a received signal from a similar set elsewhere. Originally designed for 12 volt operation, power supply is not included, as it is a cinch for any amateur to connect this unit for 110V AC, using any supply capable of 400V DC at 135 MA. The ideal unit for use in mobile

or stationary service in the Citizen's Radio Telephone Band where no license is necessary. Instructions and diagrams supplied for running the RT-1248 transmitter on either code or voice in AM or FM transmission or reception, for use as a mobile public address system, on 80 to 110 Mc. as an FM broadcast receiver, as a Facsimile transmitter or receiver, as an amateur television transmitter or receiver, for remote control relay hookups, for Geiger-Mueller counter applications. It sells for only **\$29.95** or two for **\$53.90**. If desired for marine or mobile use, the dynamotor which will work on either 12 or 24V DC and supply all power for the set is only **\$15.00** additional.

PE-109 32-VOLT DIRECT CURRENT POWER PLANT

This power plant consists of a gasoline engine that is direct coupled to a 2000 watt 32 volt DC generator. This unit is ideal for use in locations that are not serviced by commercial power or to run many of the surplus items that require 32V DC for operation. The price of this power plant is only **\$58.95**. We can also supply a converter that will supply 110V AC from the above unit or from any 16-32V DC source for **\$12.95**.

(Due to the fact that the PE-109 comes to us sealed in heavy steel strapped govt. cases we are unable to determine whether the individual units are new or used or what the condition is if used, and consequently must sell them as is. In general, they represent a terrific bargain.)

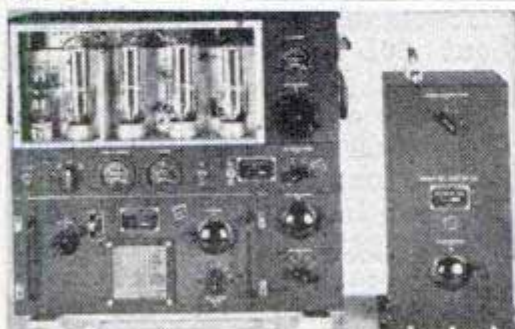
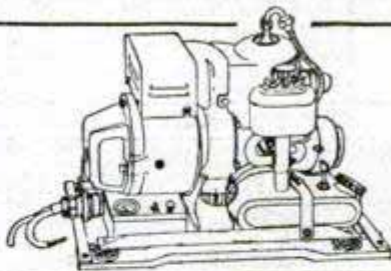

"B"—uses two 211 tubes. POWER SUPPLY: Supplied complete with dynamotor which furnishes 1000V at 350 MA from either 12 or 24 volts DC (specify). Complete instructions are furnished to operate

CABLE ADDRESS
BUFRAD

Minimum order \$3.00 — All prices subject to change — 25% deposit with C.O.D. orders.

GENERAL ELECTRIC

150 WATT TRANSMITTER

COST THE GOVERNMENT \$1800.00

COST TO YOU BRAND NEW \$67.50!!!

This is the famous transmitter used in U.S. Army bombers and ground stations, during the war. Its design and construction have been proved in service, under all kinds of conditions, all over the world. The entire frequency range is covered by means of plug-in tuning units which are included. Each tuning unit has its own oscillator and power amplifier coils and condensers, and antenna tuning circuits—all designed to operate at top efficiency within its particular frequency range. Transmitter and accessories are finished in black crackle, and the milliammeter, voltmeter, and RF ammeter are mounted on the front panel. Here are the specifications: FREQUENCY RANGE: 200 to 500 KC and 1500 to 12,500 KC. (Will operate on 10 and 20 meter band with a slight modification for which diagrams are furnished.) OSCILLATOR: Self-excited, thermo compensated, and hand calibrated. POWER AMPLIFIER: Neutralized class "C" stage, using 211 tube, and equipped with antenna coupling circuit which matches practically any length antenna. MODULATOR: Class set from 110V AC. SIZE: 21 1/2 x 23 x 9 1/4 inches. Total shipping weight 200 lbs., complete with all tubes, dynamotor power supply, seven tuning units, antenna tuning unit and the essential plugs.

BUFFALO RADIO SUPPLY, 219-221 Genesee St., Dept. 7-M, BUFFALO 3, N. Y.

WAR SURPLUS

TERRIFIC BARGAINS

ELECTRIC MOTOR 1/2 H. P., 27 V.D.C., R.P.M. 4000, No. 750, FOR INTERMITTENT OR CONTINUOUS DUTY. 3/8" SHAFT, VARIABLE SPEED MOTOR. Can be adapted to 110V. A.C. or R.E.A. line by rearranging armature brush leads. UNUSED. Instructions \$5.50 Incl. Ea.

RARE GENERATOR BARGAIN. For Home, Farm, Ranch or Shop
 • Navy Type
 • #211220-A
 • 430 Volts D.C. 86
 • Watts
 • Length of Shaft 1 1/2"
 • Made by Russell
 Chance of a lifetime to acquire a magnificent piece of equipment. Ea. **\$7.50**



DYNAMOTORS, NEW. Check list and order now. G.E. 485 KVA, Input 27 V.D.C., Output 115 V.A.C. Ea. **\$4.50**

DYN. NEW, G.E. Type D, Input 28 V., A19, Output 1000 Volts D.C. R.P.M. 5000. Wt. 38 lbs. Ea. **\$4.95**

DYN. NEW, Type S.3416-1, Input 9 V., output 400 V., 7 Amps and .08 Amps. Ea. **\$2.50**

DYN. NEW, Model #23350, Input 27 V.D.C. 1.75 Amps., Output 285 Volts D.C., .075 Amps. Ea. **\$1.50**

DYN. New, Model #DY-22/ARC Input 28 V.D.C., Output 210 V.D.C. Duty Cont. Ea. **\$1.50**



NEW CUNO OIL FILTER, aircraft type keeps oil clean without cartridge replacement. For AUTOS, TRUCKS, and TRACTORS. Install at home in a few minutes. STOP CHANGING MOTOR OIL! Instructions \$4.95 incl. Ea.

SEXTANTS—Surplus Bargain Close-Outs

FAIRCHILD TYPE A-10 army air force bubble sextant averaging type includes light system for night readings, used, but in good condition. Wood case includes accessories and instructions. Ea. only **\$7.50**

GREATEST PUMP VALUE IN YEARS. Save Big Money. USE THEM FOR HOMES, FARMS, RANCH AND SHOPS. Thompson Booster Pump, Motor driven centrifugal pump will empty 50 gal. drum of water in approx. 20 min. Runs on 24V.D.C./A.C. New. Ea. **\$7.50**



LUBE PUMP, Capacity up to 3 gal. per minute. Pressure up to 200 lbs. per sq. in. from 1 to 3900 R.P.M. Instruction inc. Brand NEW. Ea. **\$3.50**

VICKERS PUMP, High Pressure Hydraulic pump. Use it for any type liquid pumping job. 400 gal. per hr. at 3750 R.P.M. rated 1000 P.S.I. NEW, ONLY. **\$7.50**

PESCO Gear Type Utility Hydraulic Pump. At 1750 R.P.M. exerts 1000 P.S.I. Hydraulic pressure and pumps over 2 gal. per minute, new, Ea. **\$7.50**

Send check or money order. No C.O.D.'s. Prices f.o.b. K.C.

GENERAL SALVAGE COMPANY

Dept. 7, 2920 E. 27th St.

Kansas City, Mo.

MAKE up to 600 an hour DO RUG WEAVING AT HOME!

Start your own business at home weaving rugs, carpets, etc. The DEEN ALL-WEAVE LOOM turns out 2-3 rugs every hour. No experience needed. Ideal for handicapped people. Small investment gets you started. Write today for FREE booklet.

THE GIBSON COMPANY
 123 Gibson Building Lake Ozark, Missouri



SEE YOU SAW IT IN POPULAR MECHANICS

Sensational SHAPER CUTTER

For Endless Molding Contour Designs



Employs exclusive double notched sets of full 1" and 1/2" split blades. Blades automatically held in position by notched design and in absolute alignment. No set screws to loosen; blades cannot fly out. Provides endless varieties of standard and special contours. Specify type of spindle on drill press or shaper. Available in six standard adapter sizes. Ten-day money back guarantee. Complete literature on request.

\$9.00 Complete with 3 sets of Hi-speed Tool Steel Cutters

TOOLS FOR USE ON ALL DRILL PRESSES

ROTARY WOOD PLANERS ROTARY SURFACE SANDERS
 ALL-METAL SHAPER FENCES DRUM SANDERS
 SPINDLE ADAPTERS AUXILIARY DRILL PRESS TABLES

BARRON TOOL COMPANY, INC.,
 569 Architects Bldg.: Detroit 1, Mich.

FREE
 Power Tool
 CATALOG

BARRON PRECISION WORK SHOP TOOLS

Telephone Holder Is Curved To Fit Contour of Shoulder



Leaving both hands free, a telephone holder designed to fit the contour of the shoulder balances the instrument perfectly in talking position. The three-point suspension holds the handset so securely that typing is possible during a conversation. The holder snaps on in five seconds and does not have to be removed to place the instrument in its cradle.

Steel Ball Spinning 1800 M.P.H. Tests Paint for High-Speed Planes

Adhesive quality of paint is tested by putting dabs of it on a tiny steel ball that spins 2,400,000 times a minute, or about 1800 miles an hour. The method was developed by the Navy and the University of Cincinnati to test paint for high-speed aircraft, where its thickness has to be limited to about .001 inch because of the weight factor. At high speeds the thin coating tends to come off, causing dangerous disruption of the airflow. The ball is suspended in a vacuum in a centrifuge and subjected to a rotating magnetic field. After a small dab of paint is put on the ball, its speed is increased until centrifugal force is great enough to make the paint fly off. Both the ball's speed and the weight and area of the paint dot are then used to compute the adhesive qualities. The spinning is so swift and friction-free that the ball will continue to rotate for a week after the power is cut off.

SAVE UP TO 85% in WAR SURPLUS... SENSATIONAL VALUES

IN MANY ITEMS WE HAVE THE WORLD'S LARGEST SUPPLY

NEW 1-PIECE COVERALLS

Made in U. S. Gov't. specification of Herringbone Twill in evidence toughest, roughest wear. Full concealed front zipper. 4 large pleated patch pockets with double snap fastened flaps. snap collar, full action knee back. Inside suspenders to keep part can be thrown at shoulders for sun exposure.

Sizes 36 to 48. In original dark or light camouflage color. **\$3.95**

Dyed in guaranteed fast Royal blue color. **\$4.95**

NEW DUST RESPIRATORS

200,000 in 5 different types with adjustable hd. bnds. Bi Valve Type **29c** each

in lots of 50, 25c ea., 100 or more, 19c ea.

FOR PNEUMOCOCCUS—producing dusts, road dusts, mists, & chronic acid mist, produced in crushing, mining, road building, abraded, farming, drought, painting, spraying, etc. Ideal for Farm, Mill, Factory, Garage, Foundry.

COMFO-RESPIRATOR

dual-disc, Style BM-2101, with 10 extra filters. a \$3.50 value. **\$1.59** each

WILSON CO., dual disc, type J-750 with 10 extra filters in appearance like BM-2101 **\$1.29** each

AMERICAN OPTICAL CO. RESPIRATOR

Style R-8100 small & compact especially suited to laboratory & hospital **\$5.9c** ea. work.

MICARTA TUBE

Ideal for insulation or bushing stock. 36" x 1/4" wall x 1" O. D. Original use was for trailing antenna - F 10. Use for towel rack, souvenir displays, shafting spacers, bearings, etc. **\$5.9c** ea. In original carton.

Radio ANTENNA Reel

Just the thing for tuning beam antenna. Powered by 1/2 h. p. 24v G. I. Motor. Removable 4" Reel-limit Switch - Cam Worn gear. Rev. el gear. Solenoid clutch.

Motor engaged to gear reduction only when electrical contact made. Operates in either direction. Ideal for auxiliary power take-off, opening and closing doors, etc. **\$4.29**

A TREMENDOUS VALUE

RADIO HEAD SET

AN-BH-1 with Leather Sponge Rubber Pad A Wonderful Buy **\$1.00**

Excell. Condition Low Impedance

NEW U. S. Officers THERMOS FOOD CONTAINER

Keeps Food Hot or Cold. 3 compartments, containing 2 3-Quart Pyrex Cooking Dishes layered with asbestos and 1 8-Quart Fibre-lined covered compartment. All in light but strong plastic case. Will carry liquids. Vegetables, Meats, etc. Ideal for the Sportsman, Hunter, Outdoor Man. At a fraction of Gov't. Cost. Only 100 Available. wt. 21 lbs. **\$12.95** Each

New Navigators Magnetic Compass

Type D-17 size 7" dia x 4 1/2" deep. Rubber lined - rotating vernier range rings calibrated in 1 degree from 0-360° with 1 parallel and wires for alignment with N.S. line. Bobs. **\$17.95**

MESS TRAY

6 compartments, rustless, stainless steel. Barbecue, outdoor cooking, save dish-washing. Hospital, Restaurant, Home, or roughing. **83c** New ea.

#311A Used but in Fine Serviceable Condition. **59c** ea.

SLEEPING BAG

NEW! 100% wool. Mummy type Heavy duty 20' zipper. Gov't. Cost \$22.50 **\$4.95**

\$1.50 extra for used water repellent cover. Sold only with Sleeping Bag

NEW HUNTING KNIFE

6" chrome vanadium blade handle, leather grip. In leather sheath. **\$5.98** Value For Only **\$1.69**

Like above but black Parkerized Finish. #307A **\$1.39** ea.

BOLO KNIFE

10" x 2" Parkerized Blade 5" Grippd Handle. Weight 1 1/4 lbs. Ideal for Hunting, Clearing Brush, or Trails **99c** ea.

TEAR SHAPED PLEXI DOME

Overall length 21" width at widest point 11." at base 4" 6" deep. **\$1.39** ea.

FISH & FLOWER BOWLS CAB BEEP LIGHTS

24 Pt. PLASTIC KIT.

Plexiglass, Lucite, Dye Colors, Cement, Project Book of Plans and Instructions. For Pir. and Pfr. #701B **\$2.39** ea.

FLYING HELMET

#407 Fleeced-lined winter **\$1.59** ea. Ideal for cycle drivers, racers, sportsmen. Used.

CANYAS HELMET

but in excellent condition. #407 A—Summer weight **69c**

NEW OXYGEN MASK

A-14 Demand type **\$3.50** ea.

Slightly used but perfect **\$1.95** ea.

Used but with mikes **\$2.50** ea.

DRIFTMETER

Used for Drill & Air Speed. Can be dismantled for:

1. Acromatic 25 MM Double Lens.
2. 51 MM 121 Double Lens.
2. Engraved Scales.
3. Sponge Rubber Discs.
5. Nitro. Metal Parts.
6. Slide Viewer Parts.
7. Tracer Parts.

Can be adapted to 25 MM Projectors, Fortell and Enlarging Work, Photograph, etc. by DeLuxe. Artist, etc. Information Bulletin with ea. Ditch Meter. Gov't Cost \$200.00. Yours for Only **\$4.98**

PILLOWS

CURLED CHICKEN FEATHERS. 26" x 17" Blue & White ticking. New, but still Renovated and Sterilized. in accordance with Laws of California **99c** ea.

SUNGLASSES

Here's the real McCoy. Army Air Force 6 Base over Polished and ground clear-lens lens with leather case that can be attached to belt. Gold plated adjustable frame. Pearlloid sweet box **\$3.95**

and pads. A real Palley \$17.50 value for **\$2.39** ea.

ARMY AIR FORCE TYPE SUNGLASSES

4 base, polished and ground lens. 95% Ultra Violet Ray free gold plated frame. Pearlloid lens with leather case. Our price **\$2.39** ea.

U. S. NAVY SUNGLASSES

Plastic Frame **\$1.29** ea.

Optic Ground, Polaroid Type With Carrying Case. 56-1

GOGGLES

New One Pc. Type Shatterproof Sponge Rubber Frame. Flexible Lens. Colored and Polaroid. GO-1 **59c** ea.

GOGGLES

GENUINE Aviators (AN-6530) Windproof & Damp Proof **\$1.69** ea.

Sponge and leather protected frame with ground lens in clear, amber and green. Clear set in replaceable metal frame with hinged nose bar. Go-5 Ideal for Motorcycles, etc. Same appearance as above, but with plastic lens in clear color only. Go-3 **79c** ea.

So You want make lots of Spaghetti. We got just the right size **COLANDER**

Made of Tinned Steel. Army Size. 12 Quart **\$1.95** each

CANTEENS & COVERS

1 Quart Aluminum. Porcelain Lined and Cvd. Plastic Screw Top. Slightly used but Perfect. **59c** ea.

Canvas Cover, Felt Lined with Belt Holder Button Fastened **29c** ea.

Canteen Cups, Aluminum **19c** ea.

BED TRAY-TABLE

adjustable legs, removable tray. stainless steel formed tray. spreads 33" x 12" high in 17" x 23" on bed. Made of light weight metal. **\$4.49**

NEW AIRCRAFT ALUMINUM BUCKET SEAT

Use for boats, jeeps, tractor seats, etc. 17" x 18" seat, 18" x 24" back. Rib enforced. Adjustable height tube mounting. Wide, high back gives excellent support. Easily installed. Shipped in original carton. You'll appreciate the buy at **\$4.95**

CUSHIONS

New int. leather cushions, yellow pig-skin color. Filled with kapok. Will float. Size - 22 1/2" x 17" x 1 1/2" thick. At fraction of Gov't. cost. **\$2.95**

RUBBER GLOVES

Neo-Prene. Protective. Impermeable 1000 Uses. Home Farm, Factory or Laboratory. **69c**

STOP WATCH

Elgin 15 jewel. Pocket style. Shatterproof crystal. Split seconds (1/10th). Waterproof. Stainless steel, spring suspension Case. NEW **\$12.95** = 300

Aviation Emergency Vests

Sturdy, Yet Light Weight. Satin Lined with Tie Straps. 14 Outside Pockets. Plus Knife, Gun, or Tool Leather Holder. 2 large 11" x 8" Pockets Inside. Wonderful for Hunting, Fishing, or Mechanic. Cost the Government \$30. A Seal at **\$2.49** ea. AV-1

Here it is! Everyman's Favorite the **EISENHOWER JACKET**

Sizes 34 to 40. Used, but in Perfect Condition. While They Last **\$3.99** ea.

NEW TARPS - HEAVY CANVAS

Mildew & Flame Resistant. Cheap Outside Storage. They are Really Moving at These Prices.

5' x 7' **\$3.95**

8 1/2' x 10' **\$8.50**

9' x 16' **\$11.95**

Rubberized Nylon NEW Tarps, 7' x 11' **\$6.95**

Rubberized Linen 7' x 11' **\$5.95**

Only 3 lb. light weight yet waterproof. Ideal for outside car storage, etc.

NEW 100% ALL WOOL BLANKET

7 x 7 ft. Extra heavy. Also Double warmth. Fits Wood's Robe sleeping bag. **\$4.65**

'Twas Made for the Air Forces THE BEST **Loose Leaf BINDER**

You ever saw - 3 metal post. Cylindrical locking heavy duty 3/16" fabric-lined hinged cover. End Identification window. Ideal for photo albums, student publications, Reference books, artist sketch books, etc. Will hold 500 sheets. 8 1/2" x 11". A \$3.50 Value for Only **59c**

50 Page Binder Road Fillers for **25c** Extra. **ea.**

HORSEHIDE WORK GLOVES

ALL LEATHER GAUNTLET TYPE REINFORCED PALMS & FINGERS STITCHING. LENGTH 13 1/2" - #31 **\$1.95** ea.

ALL LEATHER WRIST Length 10 1/2"..... **\$1.55** ea.

Barbed wire, welding, all purpose work gloves. A Steel... Gov't. cost many, many times more.

COMPASSES

#151 Marching, lensite, with luminous dial **\$1.59**

#152 Matchbox, both jewel & hard floating dial **39c**

#154 Wrist strap Compass **69c**

PALLEY SUPPLY CO. THE LARGEST FIRM OF ITS TYPE IN THE WORLD DEPT. P. M. 78 — 6321 SAN FERNANDO RD. GLENDALE 1, CALIFORNIA

SOUTH BEND PRECISION LATHES have solved the production of precision parts for many manufacturers. Their accuracy, speed and adaptability to a wide range of operations contribute to efficient machining. Perhaps you are running some small, precision jobs on slow, heavy machines. If so, you should find out about South Bend Precision Lathes. These are the kind of jobs for which they are built. Their use can often effect appreciable savings. And, being reasonable in price, they can be installed without excessive capital investment.

Call our local distributor for complete information. You will find his name listed under "Machine Tools" or "Lathes" in your classified telephone book. Or, write today for catalog.

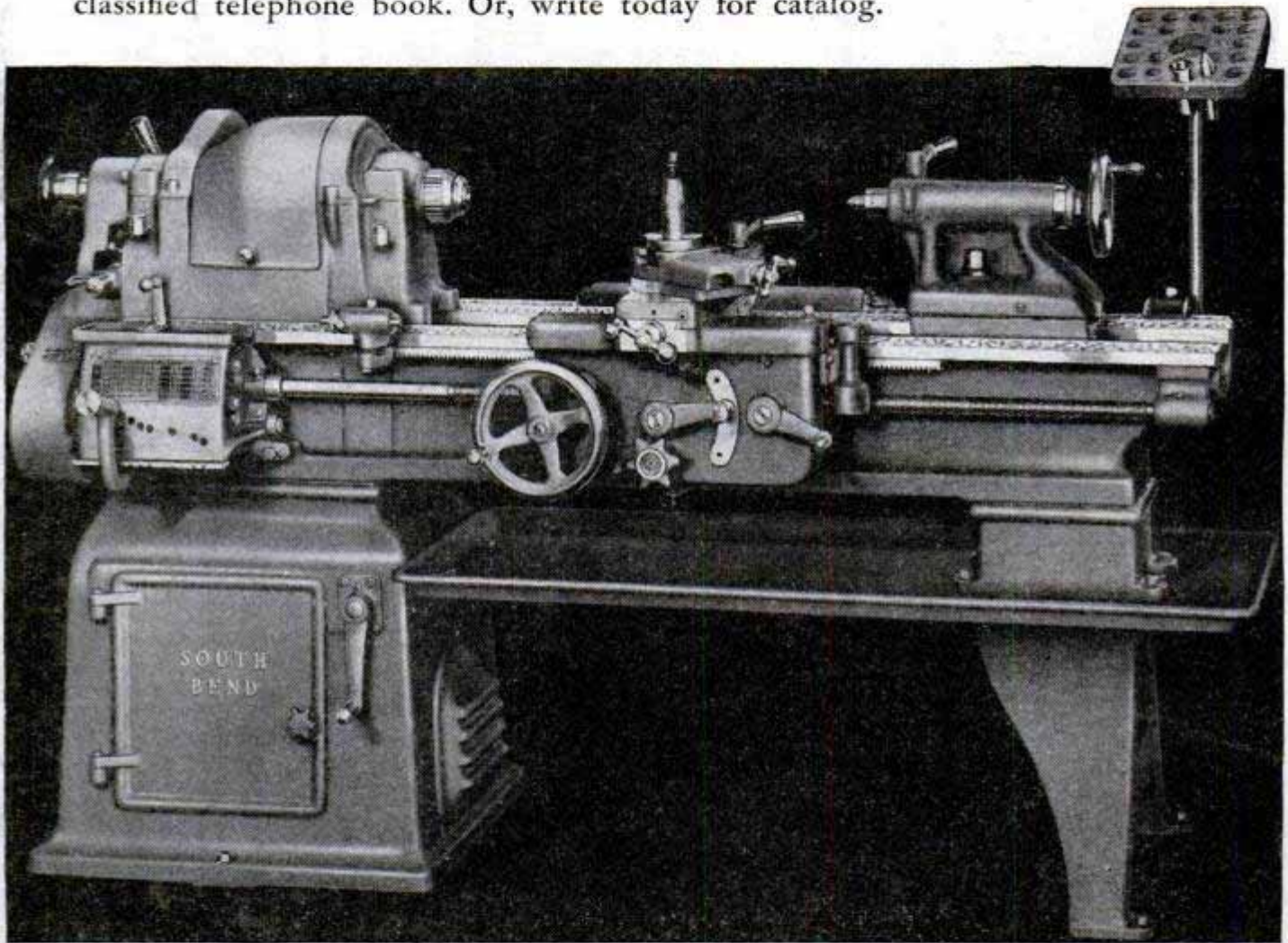

16" X 6' TOOLROOM LATHE with handwheel collet attachment; collet rack; taper attachment; micrometer carriage stop; chip pan; thread dial; 3 phase, 60 cycle, 220 volt motor; and drum switch. Catalog No. 8117-C.

\$2031.50

PRICES OF SOUTH BEND LATHES

LATHE SIZE	16" x 6' LATHE	14½" x 5' LATHE	13" x 5' LATHE	10" x 3' LATHE	9" x 3' BENCH LATHE
QUICK CHANGE GEAR MODEL	\$1640.50	\$1382.50	\$1153.50	\$863.60	\$312.70
TOOLROOM MODEL	2031.50	1735.50	1481.50	1151.60	481.70

Prices include 3 phase, 60 cycle, A. C. motor and drum switch — f. o. b. factory

SOUTH BEND LATHE WORKS

Building Better Tools Since 1906

455 EAST MADISON STREET, SOUTH BEND 22, INDIANA



Printed by Popular Mechanics Company, Chicago, Ill., U. S. A.

Pointers on exterior painting



Before painting, prepare surfaces. Scraping with a wire brush or smoothing with 1½ or 2 grade sandpaper will do if paint has worn evenly. A trisodium phosphate solution will clean old paint stained by mildew, rust or water.

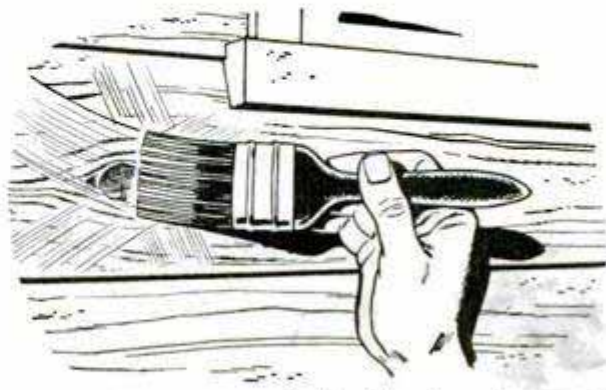

In painting new exterior lumber, brush over all knots and sappy places with turpentine or solvent naphtha. Coat with shellac and let dry. Apply priming coat, fill cracks, then apply finish coat.



Brushes should be cleaned with the proper thinner. For oil base finishes (paint, enamel and varnish), use turpentine, then naphtha or mineral spirits. Alcohol for shellac or alcohol stain, lacquer thinner for lacquers, water for water-thinned paint. After cleaning, dry and suspend by the handle.



And now white lead paint comes all ready to use! Eagle RTU is factory-mixed to perfect painting consistency. You just open, stir and apply. It brushes evenly and easily, making a smooth, gleaming white coat that protects and beautifies longer because it's pure white lead.

EAGLE RTU makes EXTERIOR painting EASY

Yes, it's true. Now you can get famed, durable, beautiful white lead paint that's all ready to use. Eagle RTU is pure carbonate of white lead, in pure linseed oil. It's carefully formulated and mixed for instant, easy use. Eagle RTU has the opacity, covering power and endurance qualities that only pure white lead paint gives—plus the convenience of being ready-mixed. It's made by the Eagle-Picher Company, makers of quality white lead paint since 1843. Eagle RTU comes in two forms: Primer Sealer, Outside White Finish Coat. Quarts, one, two, and five gallon cans.



Since 1843

EAGLE-PICHER

CINCINNATI (1), OHIO

FREE

Hints on House Painting for Home-owners.

THE EAGLE-PICHER CO.
Department PM-78,
Cincinnati (1), Ohio

FREE! Please send me a copy of your booklet, "Helpful Hints on House Painting."

Name

Street Zone

City

County State

IT TAKES EXPERIENCE TO GO

Sailing on the Sand

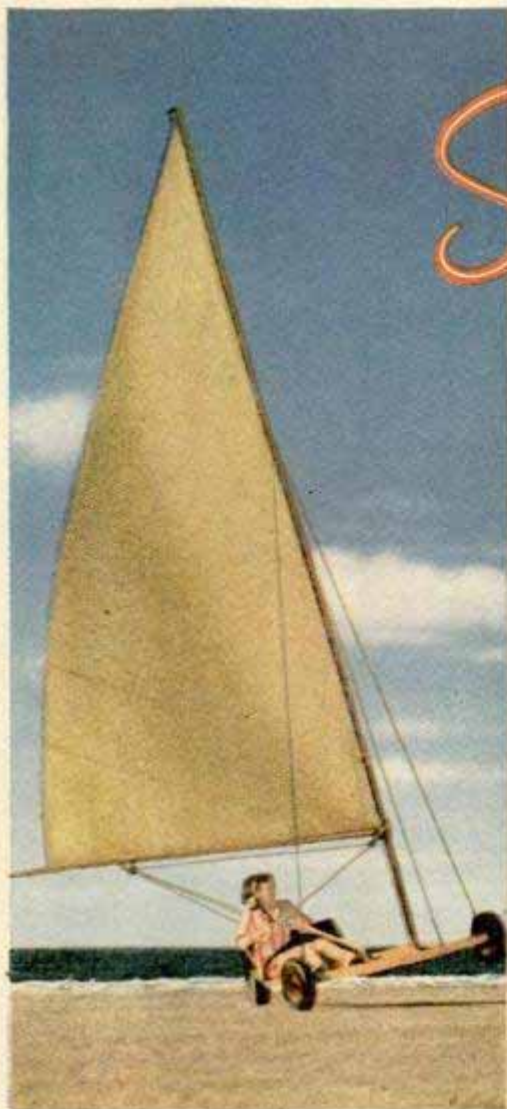

On Florida's Daytona Beach, Skipper Peg Neeley "beels over" in a stiff breeze.

Skipper
PEG NEELEY
agrees: "In sand sailing—and in cigarettes too—
EXPERIENCE IS THE BEST TEACHER!"

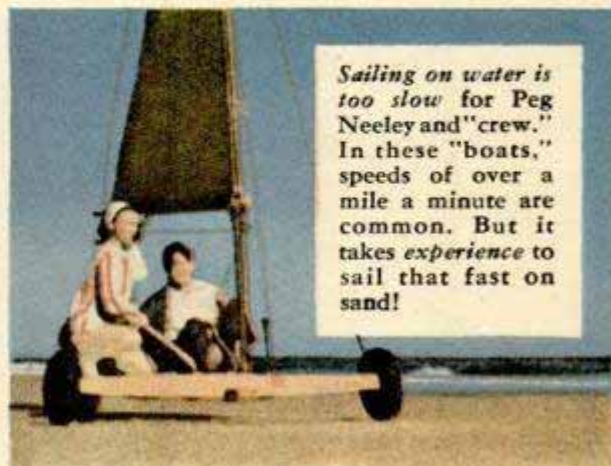

Sailing on water is too slow for Peg Neeley and "crew." In these "boats," speeds of over a mile a minute are common. But it takes experience to sail that fast on sand!



I'VE TRIED MANY BRANDS...
CAMELS SUIT ME BETTER ALL WAYS!

CAMELS ARE THE CHOICE OF EXPERIENCE WITH ME

Let your "T-ZONE" tell you why

More people are smoking CAMELS than ever before!

R. J. Reynolds Tobacco Company, Winston-Salem, N. C.

The "T-Zone"
T for Taste...
T for Throat...
that's your proving ground for any cigarette. See if Camels don't suit your "T-Zone" to a "T"!

CAMEL
TURKISH & DOMESTIC BLEND CIGARETTES
CHOICE QUALITY

THE CHOICE OF EXPERIENCE

MOST everywhere you go—you see more people smoking Camels.

You'll understand the reason why—when you try Camels . . . and compare them . . . in your "T-Zone" . . . that's T for Taste and T for Throat. See how *your* Taste welcomes Camel's rich, delightful flavor. See if *your* Throat doesn't welcome Camel's cool mildness. Let *your* experience in *your* "T-Zone" tell you why more people are smoking Camels than ever before!

According to a Nationwide survey:

MORE DOCTORS SMOKE CAMELS THAN ANY OTHER CIGARETTE

Three leading independent research organizations asked 113,597 doctors what cigarette they smoked. The brand named most was CAMEL!